

中央自動車道長野線
埋蔵文化財発掘調査報告書 6

— 松本市内 その3 —

下 神 遺 跡

図 版 編

1 9 9 0

日本道路公団名古屋建設局
長野県教育委員会
勸長野県埋蔵文化財センター

中央自動車道長野線
埋蔵文化財発掘調査報告書 6

— 松本市内 その3 —

下 神 遺 跡

図 版 編

1 9 9 0

日本道路公団名古屋建設局
長野県教育委員会
勸長野県埋蔵文化財センター

凡 例

1 本書に掲載した実測図の縮尺は、特に断りのある場合を除いて下記のように統一してある。

(1) 遺構実測図

本文挿図 竪穴住居址・掘立柱建物址 1:60 住居址内施設・基址・土坑 1:40

図 版 遺構図 1:120

(2) 遺物実測図等

土器・陶磁器 1:4 (大型品 1:4~1:8) 文字関係資料 1:3 墨書文字 1:2

土器拓影 1:3 金属製品 1:2 石器・石製品 1:6~2:3 銭貨拓影 2:3

(3) 遺物写真

土器・陶磁器 2:5 内耳鍋・常滑系甕 1:4 中世土器・陶磁器破片 1:2

鉄製品 1:2 銅製品・銭貨 1:1 石器・石製品 1:6~2:3

2 遺物実測図の番号は、遺跡ごとに次のように付けてある。

(1) 縄文・弥生土器、石器……1から通し番号 (4) 文字関係資料………1から通し番号

(2) 古代土器………各遺構毎の通し番号 (5) 金属製品………1から通し番号

(3) 中・近世土器・陶磁器……1から通し番号 (6) 古代以降の石製品……1から通し番号

3 実測図中のスクリーン等は以下の事項を表わしている。

(1) 遺構

ア 竪穴住居址

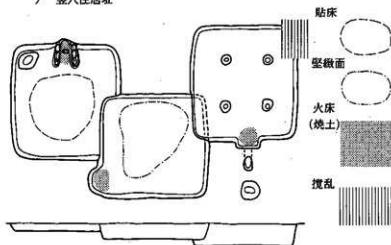

イ 掘立柱建物址

本文中の模式図は、約1:200で以下の事項を表わしている。

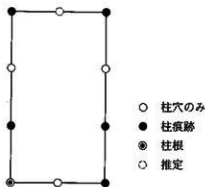

(2) 遺物

ア 古代土器

① 実測図の断面は、黒色土器・赤彩土器を含む土師器—白抜き、須恵器・施釉陶器—黒塗り、輸入陶磁器—スクリーン [スクリーン] によって区別した。黒色処理・赤彩を施したものはその処理された器面の範囲に、漆・炭化物の付着については以下のスクリーンにより表現してある。



② 施釉陶磁器の施釉範囲は一点鎖線で示した。

イ 中・近世土器・陶磁器

① 実測図の断面は、土器—白抜き、陶器—黒塗り、輸入陶磁器—スクリーン [スクリーン] により区別してある。

② 国産陶磁器の釉の種類は以下のスクリーンにより区別してある。但し、灰釉は白抜きにした。



③ 施釉陶磁器の施釉範囲は一点鎖線で示した。

ウ 金属製品

① 金属製品の形状はX線等の観察にもとづいており、錆・付着物によるふくらみは線の太さを落して表現してある。

② 断面図は、平面形状観察にさしさわりのない範囲で平面図に組み入れてある。

③ 鉄製品、銅製品の断面図と、漆・炭化物の付着および木質部を以下のスクリーンで表現してある。



鉄製品



銅製品



漆



炭化物・木質部

エ 石器・石製品

① 打製石斧・磨石等の磨耗範囲は  で示し、砥石の使用面は、断面図に |← →| で示した。

オ 土製品

① 羽口のタール付着・ガラス状発泡範囲を  、被熱により変色した範囲を  で示した。

圖 版 目 次

- | | |
|----------------|----------------------------|
| 圖版 1 周辺遺跡分布圖 | 圖版 44 古代遺構実測圖 |
| 圖版 2 遺跡周辺地形圖 | 圖版 45 古代遺構実測圖 |
| 圖版 3 遺構分布圖 | 圖版 46 古代遺構実測圖 |
| 圖版 4 遺構分布圖 | 圖版 47 古代遺構実測圖 |
| 圖版 5 遺構割り付圖 | 圖版 48 古代遺構実測圖 |
| 圖版 6 古代遺構実測圖 | 圖版 49 古代遺構実測圖 |
| 圖版 7 古代遺構実測圖 | 圖版 50 古代遺構実測圖 |
| 圖版 8 古代遺構実測圖 | 圖版 51 古代遺構実測圖 |
| 圖版 9 古代遺構実測圖 | 圖版 52 古代遺構実測圖 |
| 圖版 10 古代遺構実測圖 | 圖版 53 古代遺構実測圖 |
| 圖版 11 古代遺構実測圖 | 圖版 54 古代遺構実測圖 |
| 圖版 12 古代遺構実測圖 | 圖版 55 古代遺構実測圖 |
| 圖版 13 古代遺構割り付圖 | 圖版 56 古代遺構実測圖 |
| 圖版 14 古代遺構実測圖 | 圖版 57 古代遺構実測圖 |
| 圖版 15 古代遺構実測圖 | 圖版 58 古代遺構実測圖 |
| 圖版 16 古代遺構実測圖 | 圖版 59 古代遺構実測圖 |
| 圖版 17 古代遺構実測圖 | 圖版 60 古代遺構実測圖 |
| 圖版 18 古代遺構実測圖 | 圖版 61 古代遺構実測圖 |
| 圖版 19 古代遺構実測圖 | 圖版 62 古代遺構実測圖 |
| 圖版 20 古代遺構実測圖 | 圖版 63 古代遺構実測圖 |
| 圖版 21 古代遺構実測圖 | 圖版 64 古代遺構実測圖 |
| 圖版 22 古代遺構実測圖 | 圖版 65 古代遺構実測圖 |
| 圖版 23 古代遺構実測圖 | 圖版 66 古代遺構実測圖 |
| 圖版 24 古代遺構実測圖 | 圖版 67 古代遺構実測圖 |
| 圖版 25 古代遺構実測圖 | 圖版 68 古代遺構実測圖 |
| 圖版 26 古代遺構実測圖 | 圖版 69 古代遺構実測圖 |
| 圖版 27 古代遺構実測圖 | 圖版 70 古代遺構実測圖 |
| 圖版 28 古代遺構実測圖 | 圖版 71 古代遺構実測圖 |
| 圖版 29 古代遺構実測圖 | 圖版 72 古代遺構実測圖 |
| 圖版 30 古代遺構実測圖 | 圖版 73 古代遺構実測圖 |
| 圖版 31 古代遺構実測圖 | 圖版 74 古代遺構実測圖 |
| 圖版 32 古代遺構実測圖 | 圖版 75 古代遺構実測圖 |
| 圖版 33 古代遺構実測圖 | 圖版 76 古代遺構実測圖 |
| 圖版 34 古代遺構実測圖 | 圖版 77 古代遺構実測圖 |
| 圖版 35 古代遺構実測圖 | 圖版 78 古代遺構実測圖 |
| 圖版 36 古代遺構実測圖 | 圖版 79 古代遺構実測圖 |
| 圖版 37 古代遺構実測圖 | 圖版 80 古代遺構実測圖 |
| 圖版 38 古代遺構実測圖 | 圖版 81 縄文時代遺物実測圖 |
| 圖版 39 古代遺構実測圖 | 圖版 82 古代土器実測圖 SB1・2・3・4 |
| 圖版 40 古代遺構実測圖 | 圖版 83 古代土器実測圖 SB4・5・6 |
| 圖版 41 古代遺構実測圖 | 圖版 84 古代土器実測圖 SB7・8・9 |
| 圖版 42 古代遺構実測圖 | 圖版 85 古代土器実測圖 SB9・10・11・12 |
| 圖版 43 古代遺構実測圖 | 圖版 86 古代土器実測圖 SB13・14 |

- 图版 87 古代土器实测图 SB15·17·18·19
- 图版 88 古代土器实测图 SB20·21
- 图版 89 古代土器实测图 SB22·23
- 图版 90 古代土器实测图 SB24·25·26
- 图版 91 古代土器实测图 SB26
- 图版 92 古代土器实测图 SB27·29
- 图版 93 古代土器实测图 SB29·31·32·33
- 图版 94 古代土器实测图 SB34·36·37·38·39
- 图版 95 古代土器实测图 SB39·40·42
- 图版 96 古代土器实测图 SB43·44
- 图版 97 古代土器实测图 SB44·45·46·47·48
- 图版 98 古代土器实测图 SB48·49·50·51
- 图版 99 古代土器实测图 SB52·53·54
- 图版100 古代土器实测图 SB55·56·57·58
- 图版101 古代土器实测图 SB59·60·61·62·63
- 图版102 古代土器实测图 SB64·65
- 图版103 古代土器实测图 SB66·67·68·69·70·71
- 图版104 古代土器实测图 SB72·73·74
- 图版105 古代土器实测图 SB76·77
- 图版106 古代土器实测图 SB77·78·82·83
- 图版107 古代土器实测图 SB84
- 图版108 古代土器实测图 SB85·87·88
- 图版109 古代土器实测图 SB89·90
- 图版110 古代土器实测图 SB91·92
- 图版111 古代土器实测图 SB92
- 图版112 古代土器实测图 SB92·93·95
- 图版113 古代土器实测图 SB96
- 图版114 古代土器实测图 SB97(上·下層)
- 图版115 古代土器实测图 SB97(下層)
- 图版116 古代土器实测图 SB97·99
- 图版117 古代土器实测图 SB100·101
- 图版118 古代土器实测图 SB101·102·103
- 图版119 古代土器实测图 SB104·105·106
- 图版120 古代土器实测图 SB107·108·109·110
- 图版121 古代土器实测图 SB110·111
- 图版122 古代土器实测图 SB112·114·115
- 图版123 古代土器实测图 SB115·116
- 图版124 古代土器实测图 SB117·118·119·120
- 图版125 古代土器实测图 SB121·122·123
- 图版126 古代土器实测图 SB124·125·127
- 图版127 古代土器实测图 SB126
- 图版128 古代土器实测图 SB126·128·129
- 图版129 古代土器实测图 SB130·131·132
- 图版130 古代土器实测图 SB133·134·135
- 图版131 古代土器实测图 SB136·138
- 图版132 古代土器实测图 SB139·140·141·142
- 图版133 古代土器实测图 SB143
- 图版134 古代土器实测图 SB143·144·145
- 图版135 古代土器实测图 SB146·147·148·149
- 图版136 古代土器实测图 SB150·151·152·153
- 图版137 古代土器实测图 ST3·6·7·8·9·12·17·30·101·102·105·108·111
- 图版138 古代土器实测图 ST111
- 图版139 古代土器实测图 ST113·123·区画溝 I
- 图版140 古代土器实测图 区画溝 I
- 图版141 古代土器实测图 区画溝 I
- 图版142 古代土器实测图 区画溝 I·Ⅱ·Ⅲ
- 图版143 古代土器实测图 区画溝Ⅲ·SD1·7·18·52·100·104·105
- 图版144 古代土器实测图 SD108
- 图版145 古代土器实测图 SD108
- 图版146 古代土器实测图 SD108
- 图版147 古代土器实测图 SD108
- 图版148 古代土器实测图 SD108
- 图版149 古代土器实测图 SD108
- 图版150 古代土器实测图 SD108
- 图版151 古代土器实测图 SD108
- 图版152 古代土器实测图 SD108·106·109·110
- 图版153 古代土器实测图 SD117·118·12·119
- 图版154 古代土器实测图 SD130·132·135·137
- 图版155 古代土器实测图 SD137·139·147·151·163·173·176·181
- 图版156 古代土器实测图 SD170·171·溝址群Ⅲ
- 图版157 古代土器实测图 SK110·435·170·436·466·491·533·540·530·534·554
- 图版158 古代土器实测图 SK579·551·555·599·565·566
- 图版159 古代土器实测图 SK574·580·609·610·624·628·684
- 图版160 古代土器实测图 SK632·643·652·833·834·835·910·937·975·1008·1069·1276·1338
- 图版161 古代土器实测图 SK1208·1281·1285·1286·1410·1527·SX30
- 图版162 古代土器实测图 SX30
- 图版163 古代土器实测图 SX30
- 图版164 古代土器实测图 SX30
- 图版165 古代土器实测图 SX30·遺構外
- 图版166 文字関係資料 墨書土器
- 图版167 文字関係資料 墨書土器

図版168 文字関係資料 墨書土器
 図版169 文字関係資料 墨書土器
 図版170 文字関係資料 墨書土器
 図版171 文字関係資料 墨書土器
 図版172 文字関係資料 墨書土器
 図版173 文字関係資料 墨書土器
 図版174 文字関係資料 墨書土器
 図版175 文字関係資料 墨書土器
 図版176 文字関係資料 墨書土器
 図版177 文字関係資料 墨書土器
 図版178 文字関係資料 墨書土器
 図版179 文字関係資料 墨書土器
 図版180 文字関係資料 墨書土器
 図版181 文字関係資料 墨書土器

図版182 文字関係資料 墨書土器
 図版183 文字関係資料 墨書土器
 図版184 文字関係資料 墨書土器
 図版185 文字関係資料 墨書土器
 図版186 文字関係資料 墨書土器
 図版187 文字関係資料 墨書土器
 図版188 文字関係資料 刻書土器・硯類
 図版189 金属製品 鉄製品
 図版190 金属製品 鉄製品
 図版191 金属製品 銅製品
 図版192 石製品
 図版193 石製品
 図版194 石製品・土製品

写真図版目次

PL 1 調査遺跡周辺

PL 2 下神遺跡遠景・同近景

PL 3 南部Ⅲ地区航空写真

PL 4 南部Ⅰ地区遺構写真

PL 5 南部Ⅱ地区遺構写真

PL 6 南部Ⅲ地区遺構写真

PL 7 北部Ⅰ・Ⅱ地区遺構写真

PL 8 北部Ⅰ・Ⅱ・Ⅲ地区遺構写真

PL 9 北部Ⅲ地区遺構写真

PL 10 SB7-9

PL 11 SB12-14

PL 12 SB19-20-24

PL 13 SB26-27-29

PL 14 SB38-39

PL 15 SB52-53

PL 16 SB64-65

PL 17 SB68-72

PL 18 SB74-76-77-78・83

PL 19 SB84-85

PL 20 SB88-89

PL 21 SB92

PL 22 SB96-97

PL 23 SB97

PL 24 SB97

PL 25 SB101-108-109

PL 26 SB111

PL 27 SB119-120-121

PL 28 SB126127

PL 29 SB130-138-139-140-142

PL 30 SB143-144-147

PL 31 SB148-152

PL 32 石組カマド SB96・100・101・112・115・136・
145-148

PL 33 函形カマド SB12・82・108・123・130・140・
142-149

PL 34 ST2-3-4

PL 35 ST6-8-9

PL 36 ST7-8-9

PL 37 ST15-16

PL 38 ST21-22-23

PL 39 ST101-102-106

PL 40 ST102-103-105

PL 41 ST108-111

PL 42 ST113-114-115-120

PL 43 区画溝Ⅰ・Ⅱ・Ⅲ

PL 44 SD108

PL 45 SD108

PL 46 SD7-18-106-109

PL 47 SA1-2-101

PL 48 SK460-580-703-705-835

PL 49 SX30-SN1

PL 50 古代土器 SB4

PL 51 古代土器 SB6-14

PL 52 古代土器 SB14-21-72

- | | | | | | |
|--------|------|---------------|--------|---------|------------|
| P L 53 | 古代土器 | SB72-76 | P L 73 | 古代土器 | 区画溝 I |
| P L 54 | 古代土器 | SB76-84 | P L 74 | 古代土器 | 区画溝Ⅱ・Ⅲ |
| P L 55 | 古代土器 | SB84-85 | P L 75 | 古代土器 | SD108 1区 |
| P L 56 | 古代土器 | SB89 | P L 76 | 古代土器 | SD108 3区 |
| P L 57 | 古代土器 | SB92 | P L 77 | 古代土器 | SD108 3区 |
| P L 58 | 古代土器 | SB92 | P L 78 | 古代土器 | SK580 |
| P L 59 | 古代土器 | SB96 | P L 79 | 古代土器 | ST111・SX30 |
| P L 60 | 古代土器 | SB97 | P L 80 | 古代土器 | SX30 |
| P L 61 | 古代土器 | SB97-99 | P L 81 | 古代土器 | 緑釉陶器 |
| P L 62 | 古代土器 | SB99-100 | P L 82 | 墨書土器 | |
| P L 63 | 古代土器 | SB100・101 | P L 83 | 墨書土器 | |
| P L 64 | 古代土器 | SB111 | P L 84 | 墨書土器 | |
| P L 65 | 古代土器 | SB111・121・124 | P L 85 | 墨書土器 | |
| P L 66 | 古代土器 | SB124-126 | P L 86 | 陶硯 | |
| P L 67 | 古代土器 | SB126-130 | P L 87 | 鉄製品 | |
| P L 68 | 古代土器 | SB136 | P L 88 | 鉄製品 | |
| P L 69 | 古代土器 | SB143 | P L 89 | 銅製品・鉄貨 | |
| P L 70 | 古代土器 | SB143 | P L 90 | 石製品 | |
| P L 71 | 古代土器 | SB148-152 | P L 91 | 石製品・土製品 | |
| P L 72 | 古代土器 | 区画溝 I | P L 92 | 漆紙文書 | |

圖 版



図版2 遺跡周辺地形図

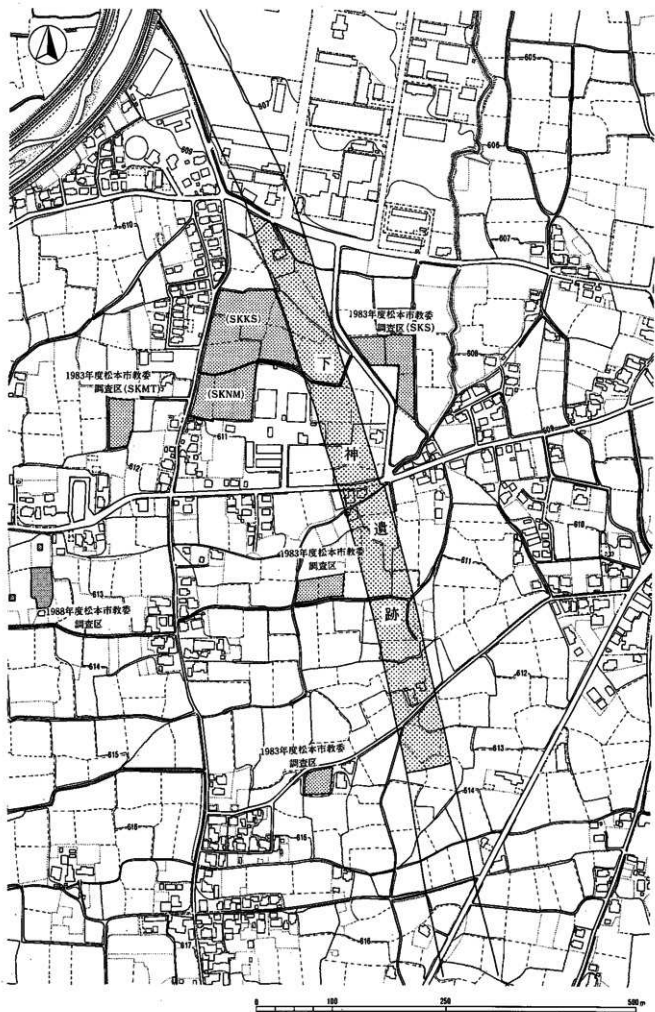



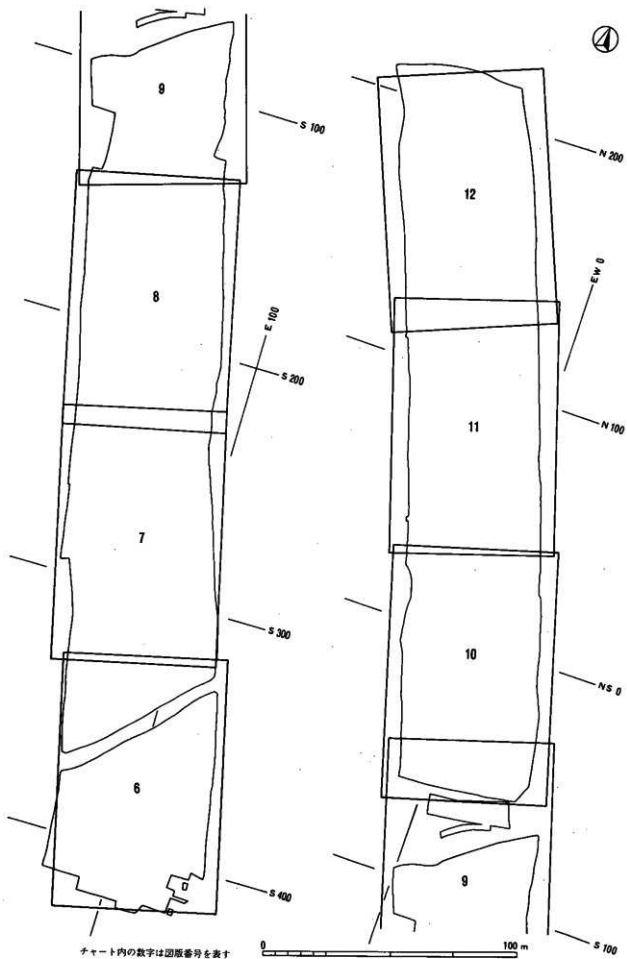

チャート内の数字は図版番号を表す

0 100 m

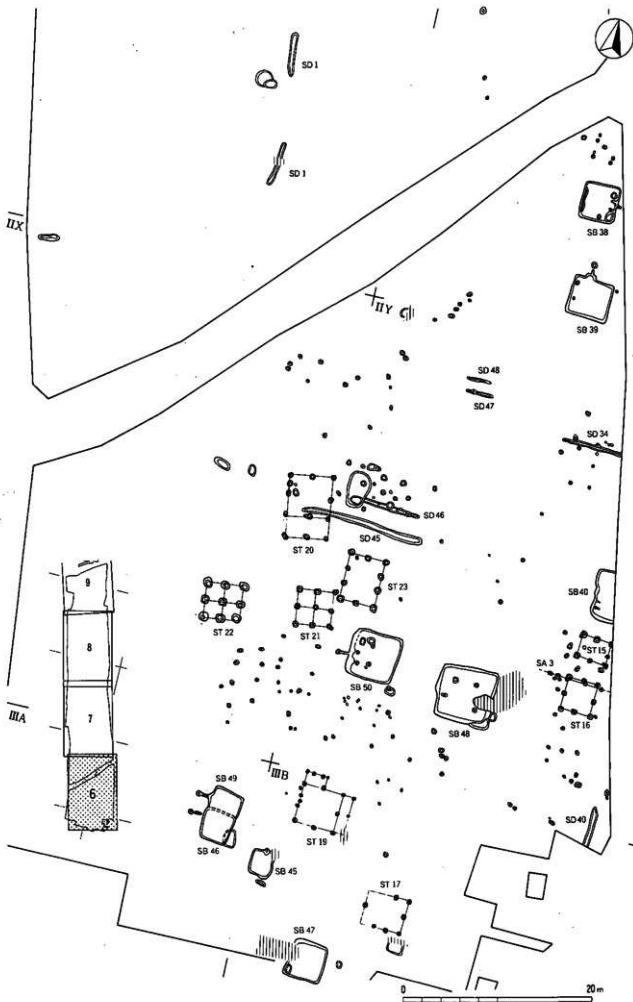

図版7 古代遺構実測図

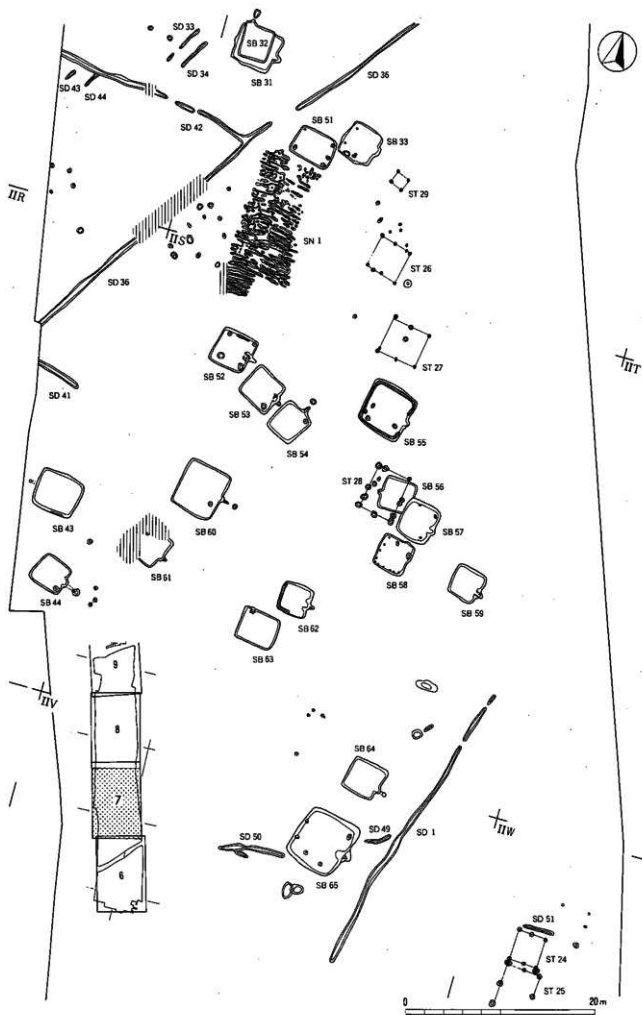

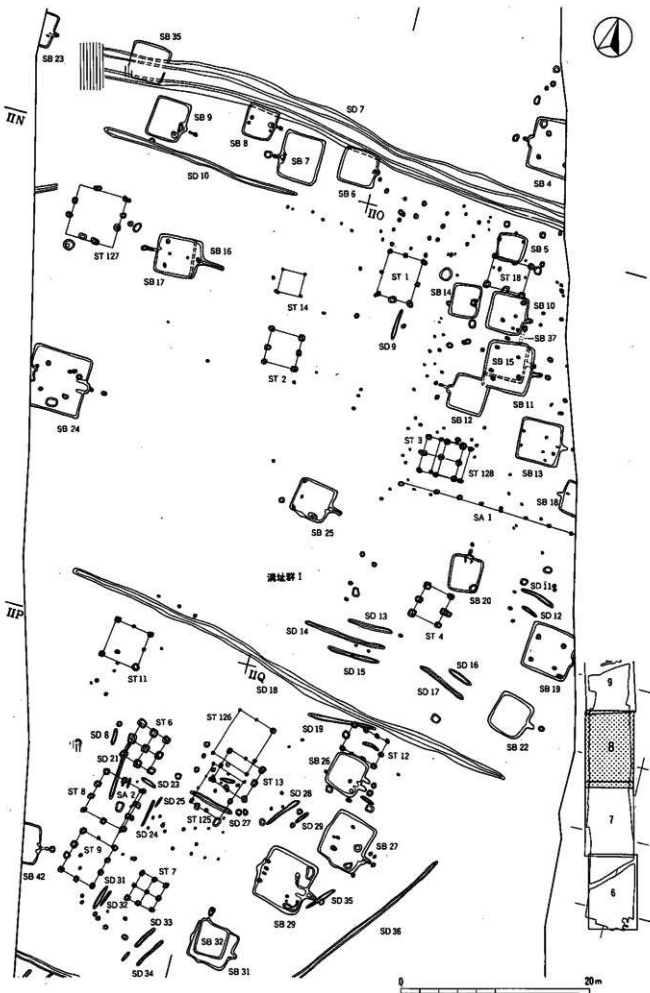

图版 9 古代遺構実測図

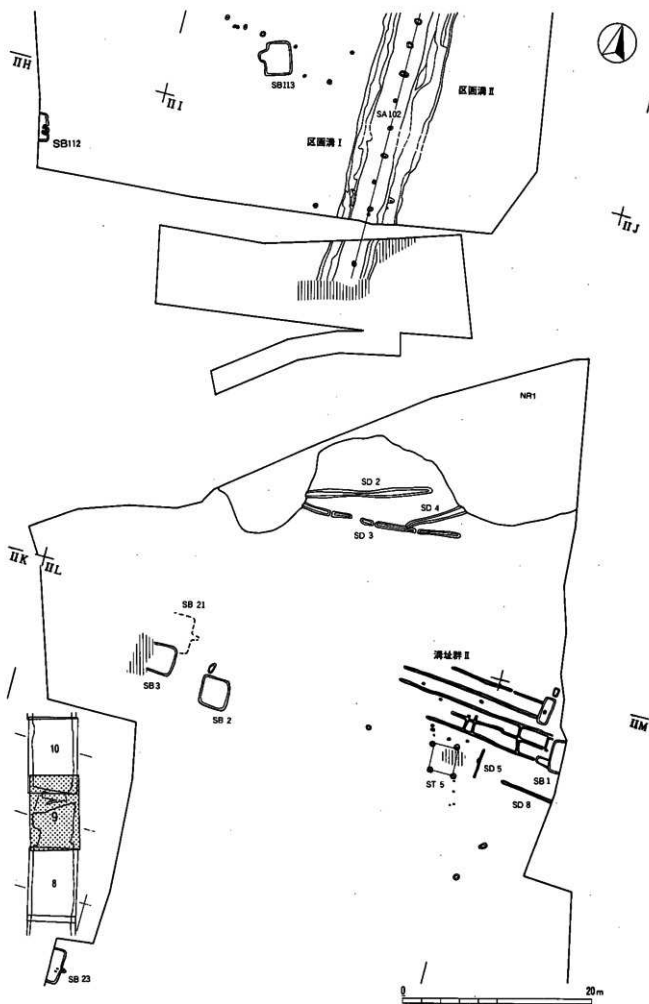

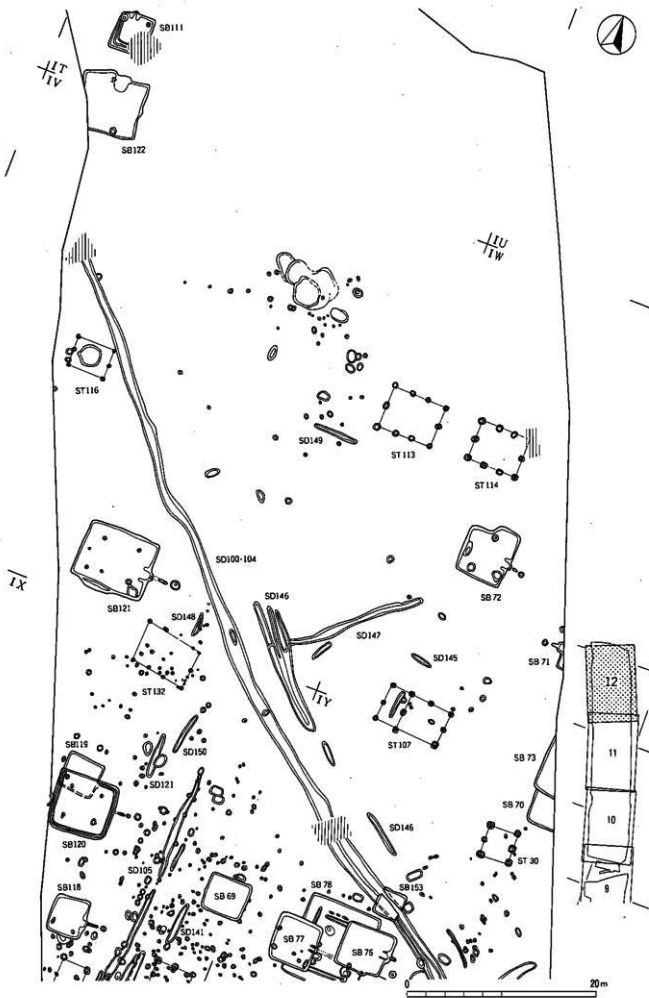

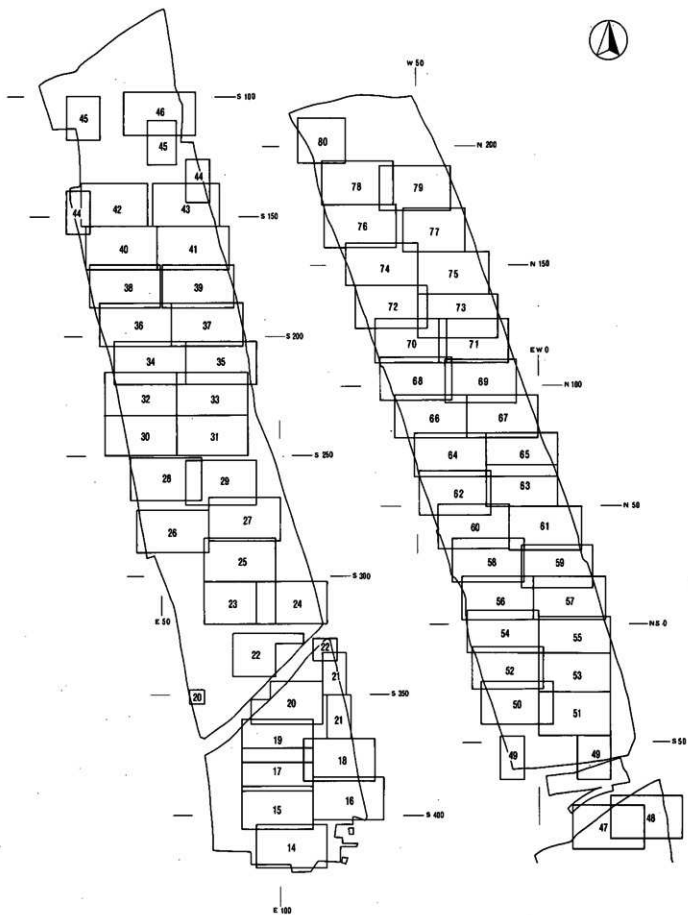

チャート内の数字は図版番号を表す

0 100m

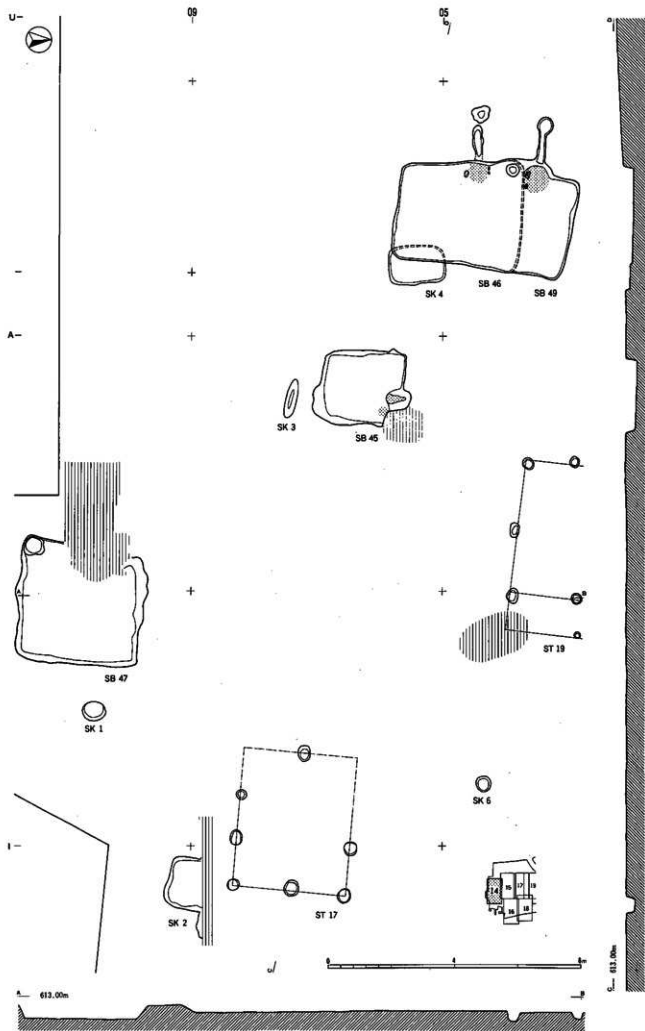

図版15 古代遺構実測図

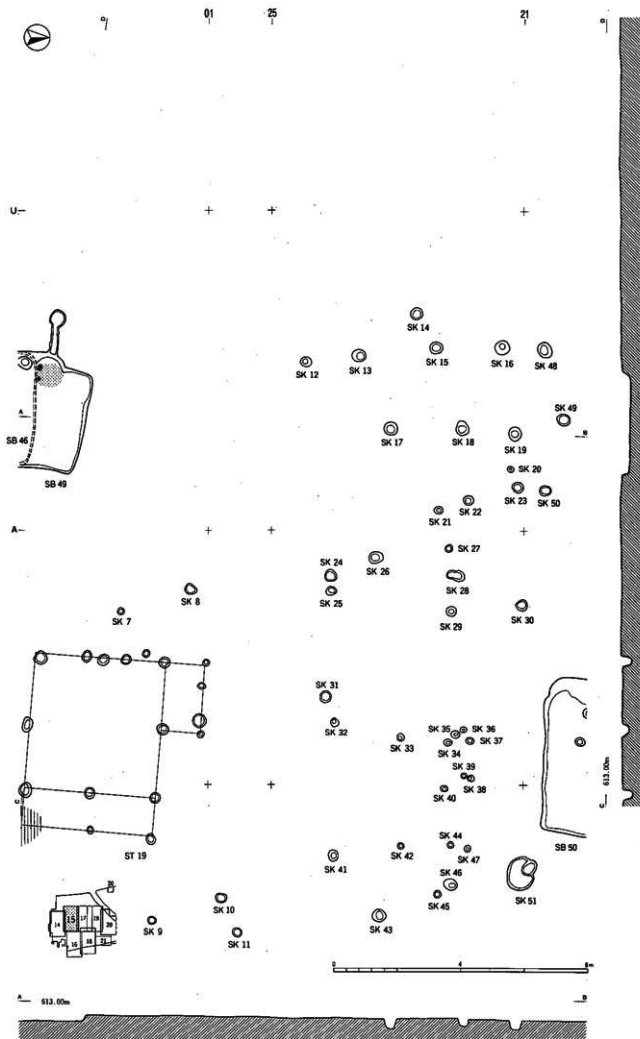

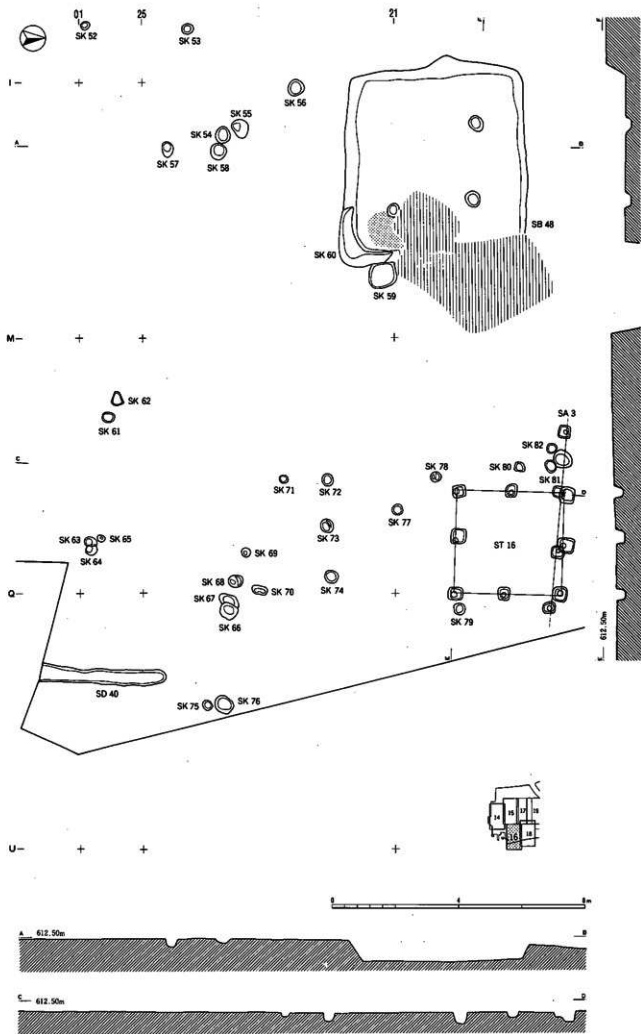



21

17

13

U+

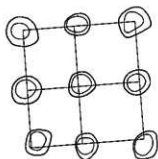

ST 22



SK 48

SK 49

Y+

SK 50

SK 64

A+

SK 30

SK 85

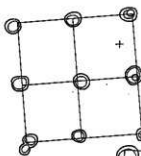

ST 21

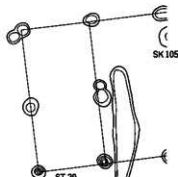

ST 20

SK 105

SK 110

SK 86

E+

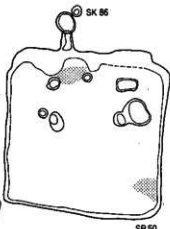

SB 50

SK 51

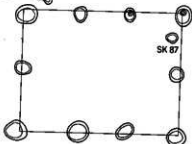

ST 23

SK 87

SK 88

SD 45



SK 99

612.0m

612.00m

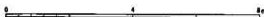

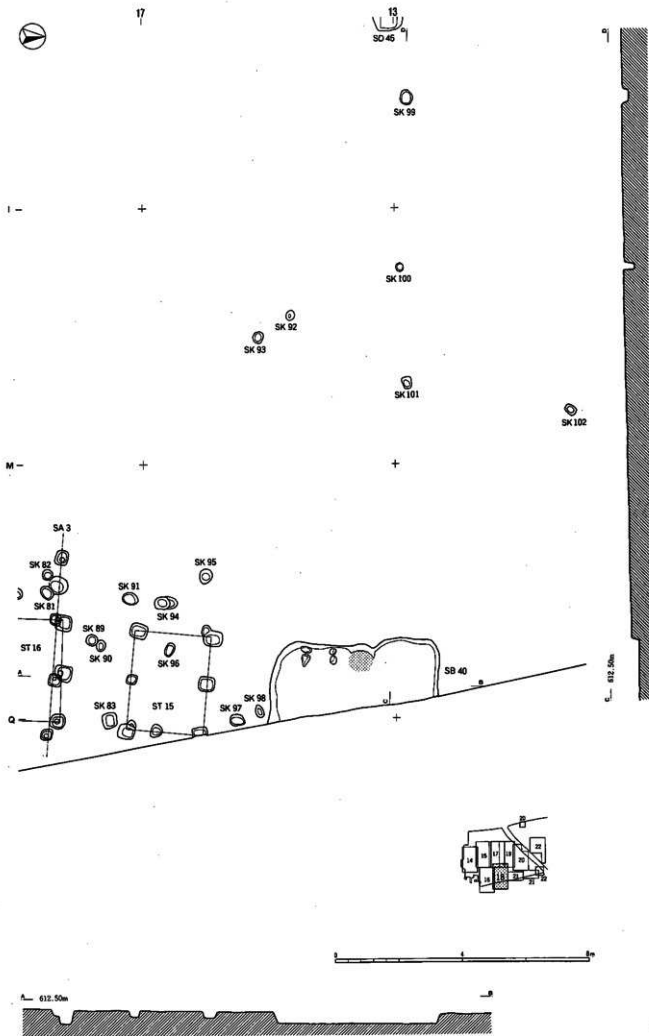

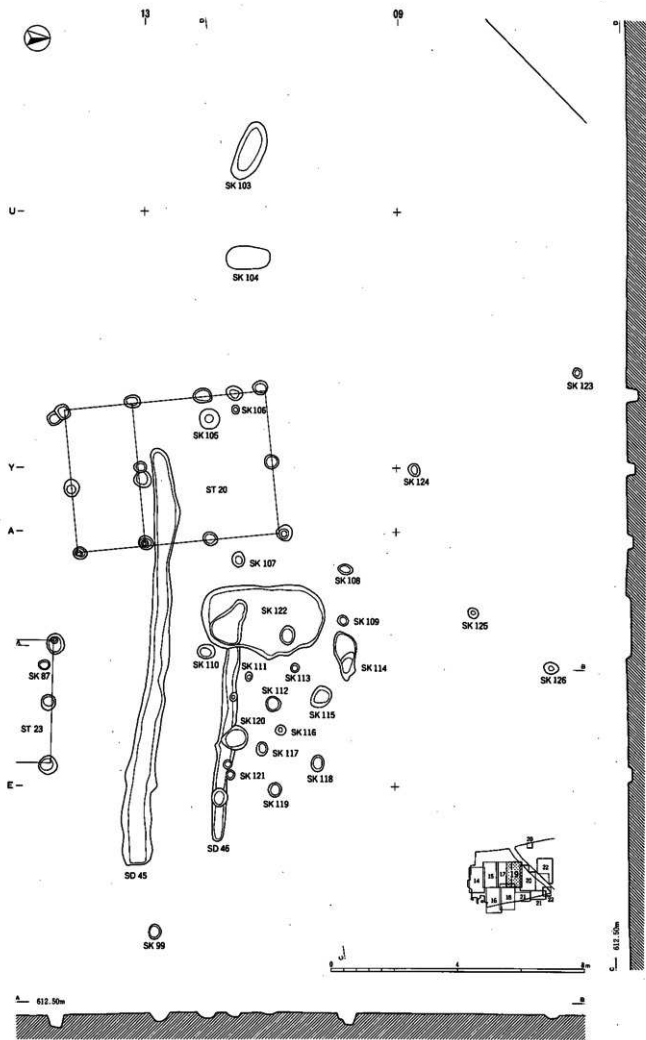

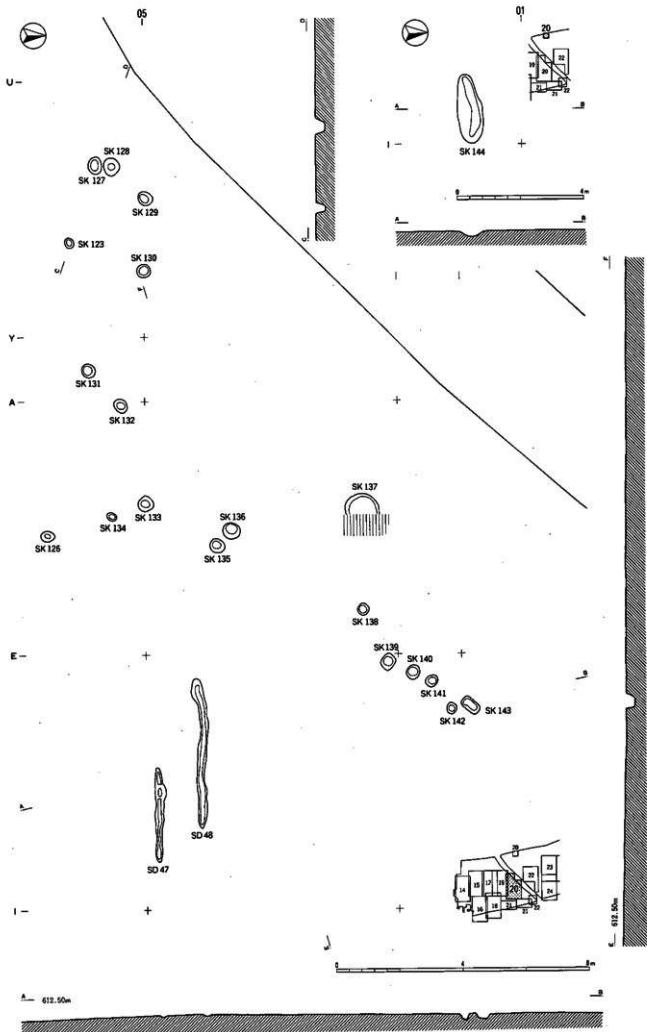

図版21 古代遺構実測図

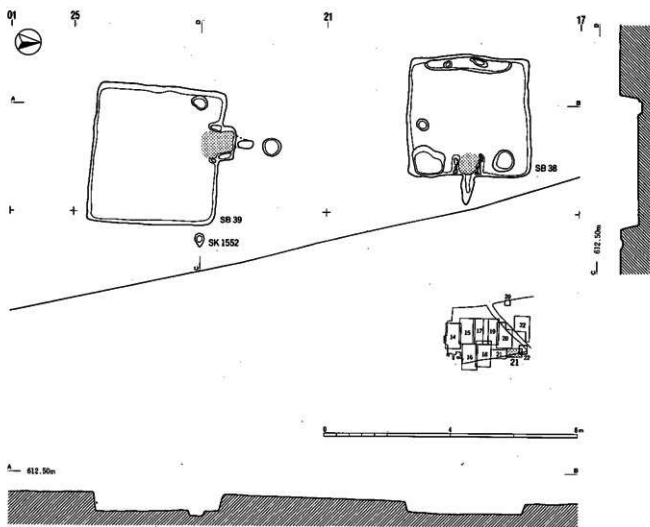
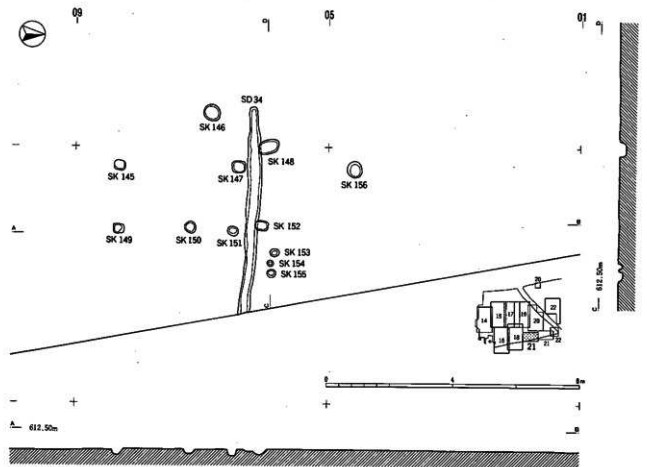

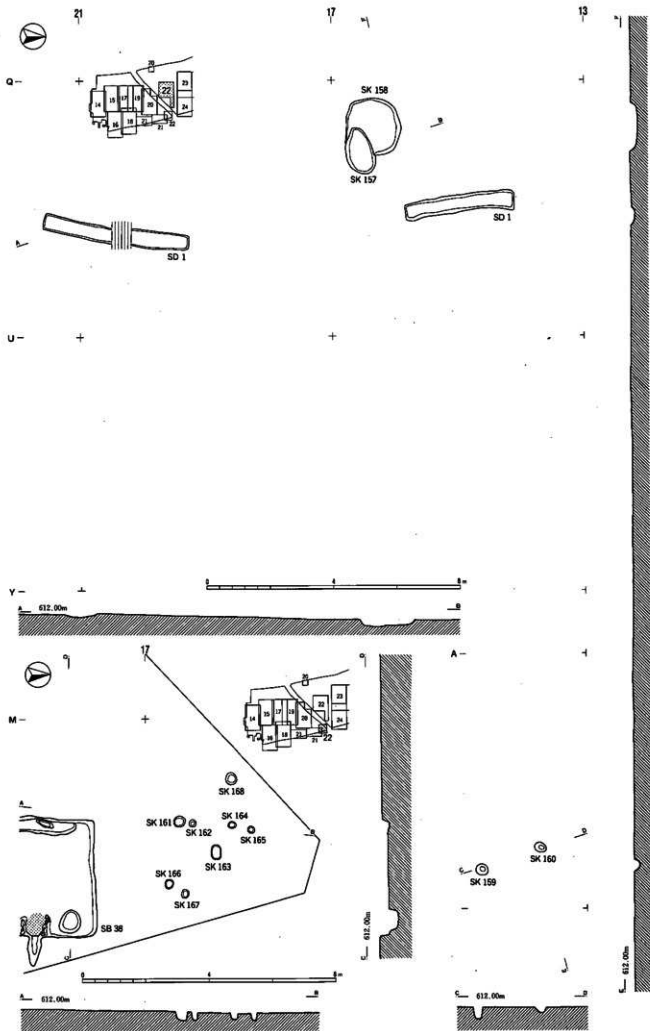

図版23 古代遺構実測図

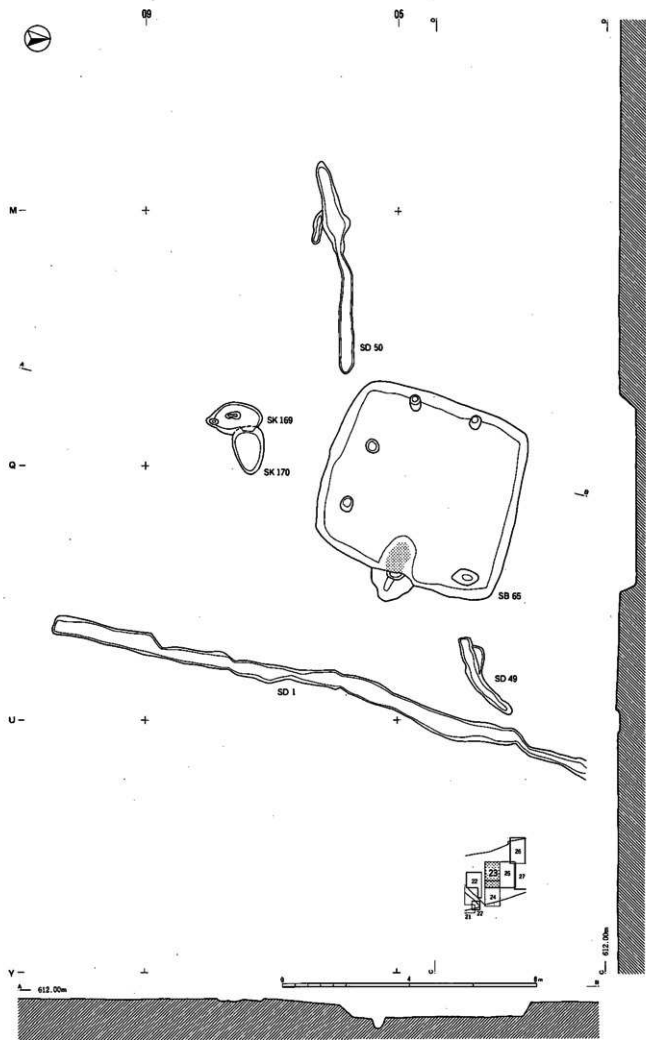



09

05

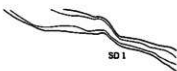

SD 1

V-

+

+

A-

+

+

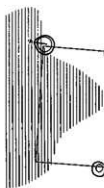

ST 25

ST 24

SD 51

SK 172

SK 171

SK 173

SK 174

0-112.00m



0-612.00m

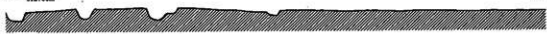

图版25 古代遺構実測図

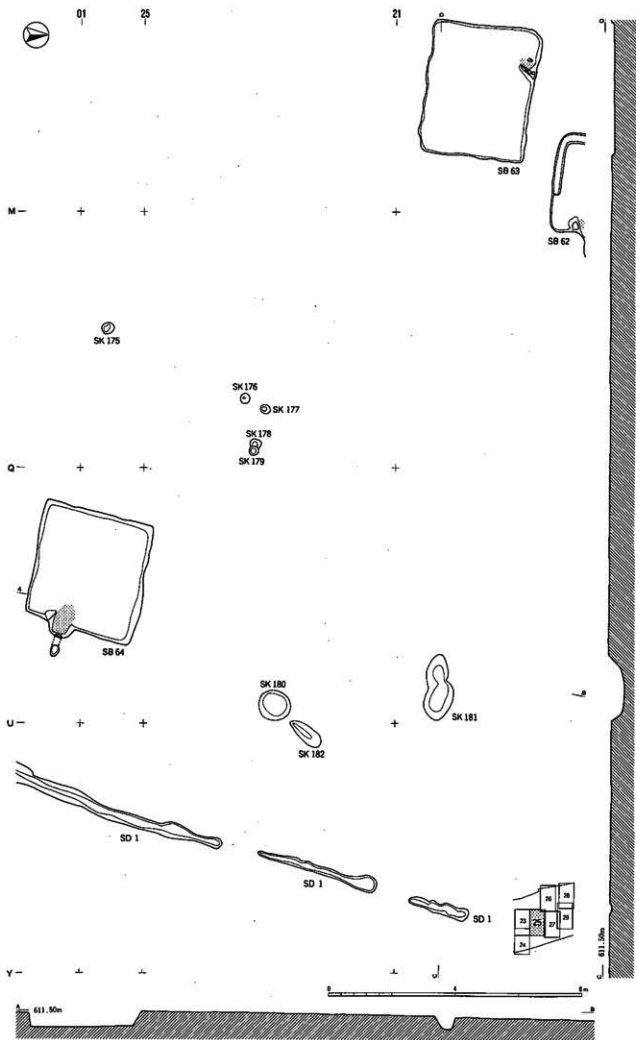



17

18

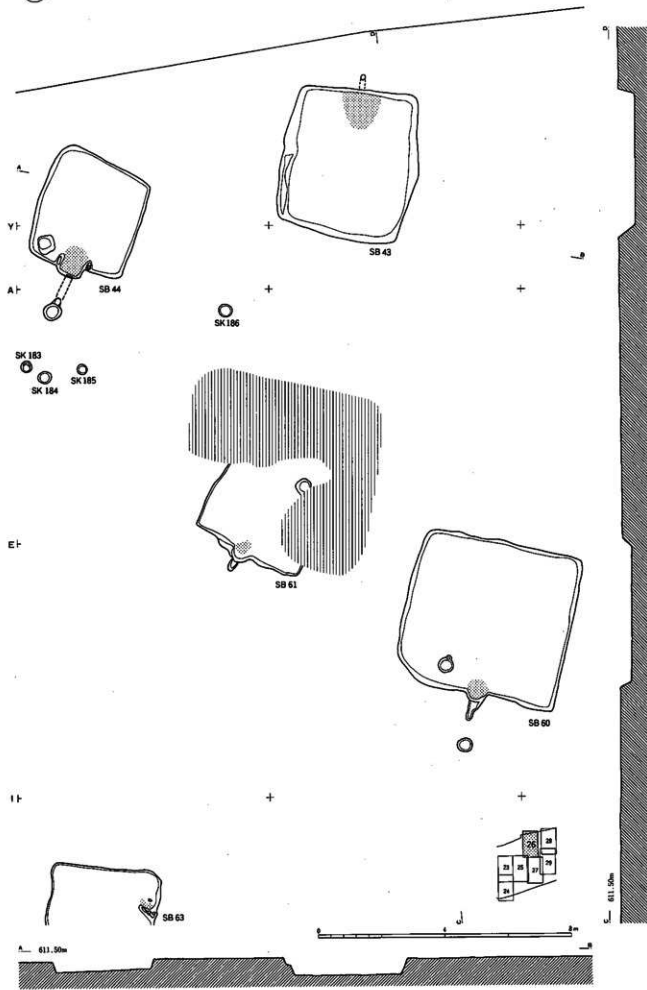

0 11.50m

0 11.50m

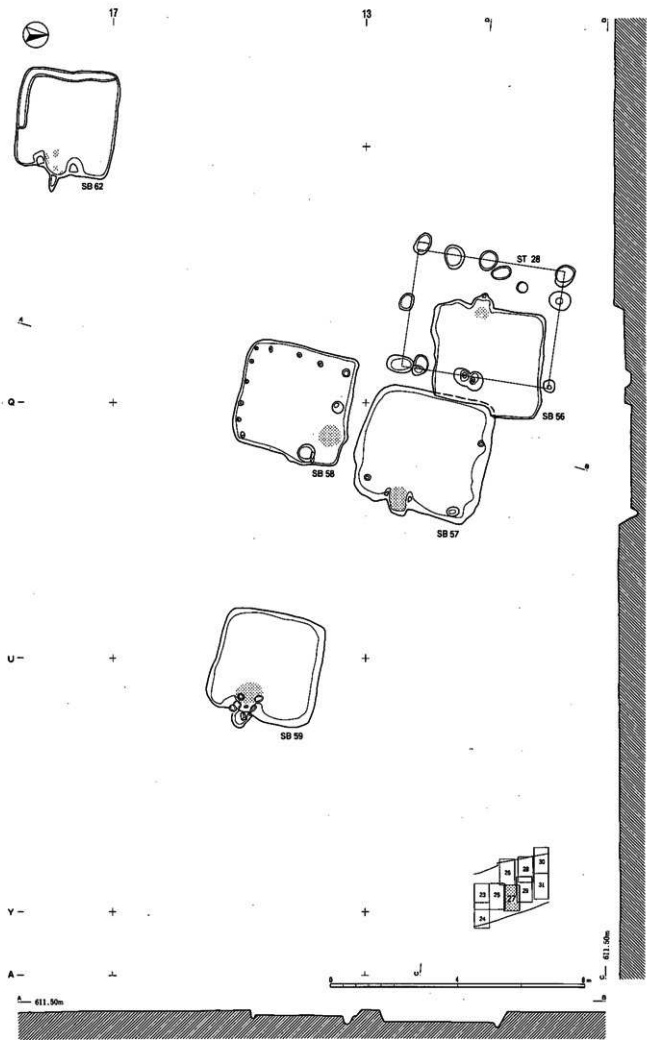

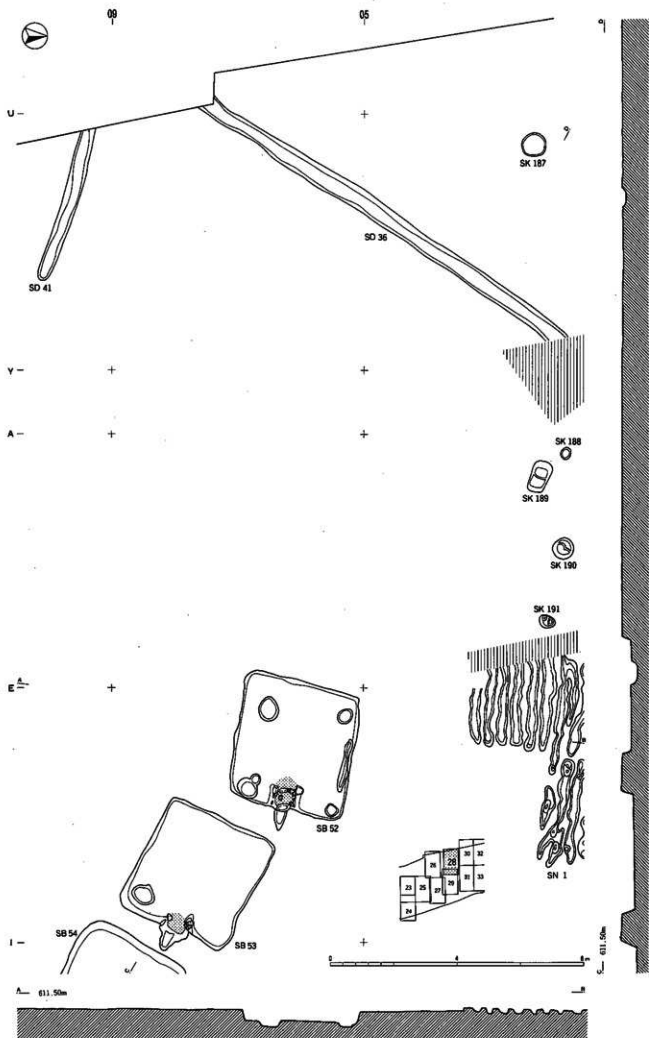

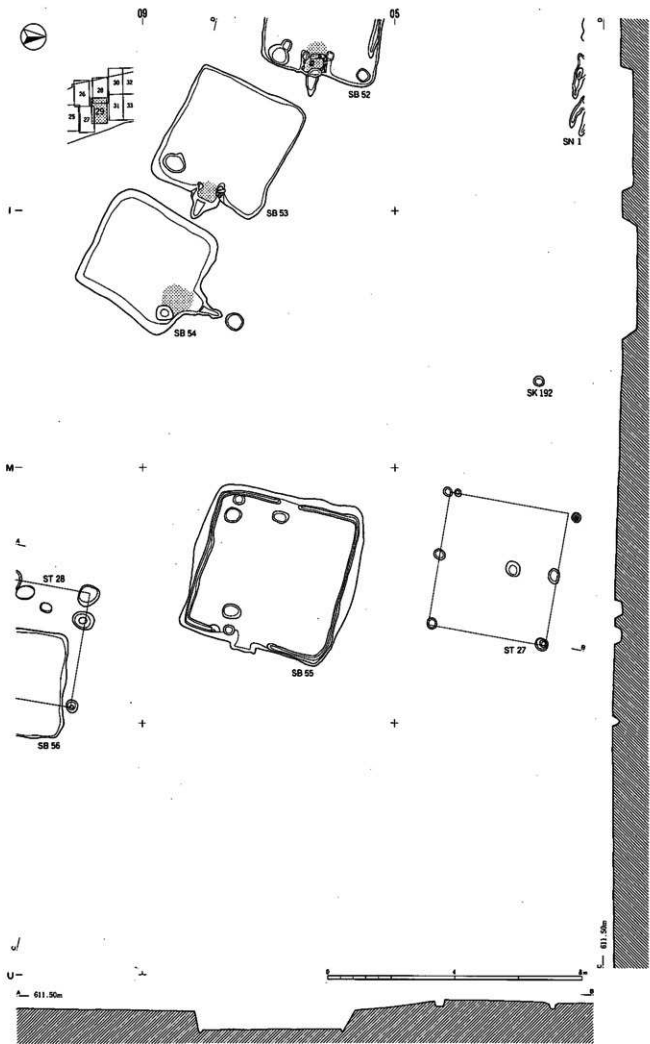

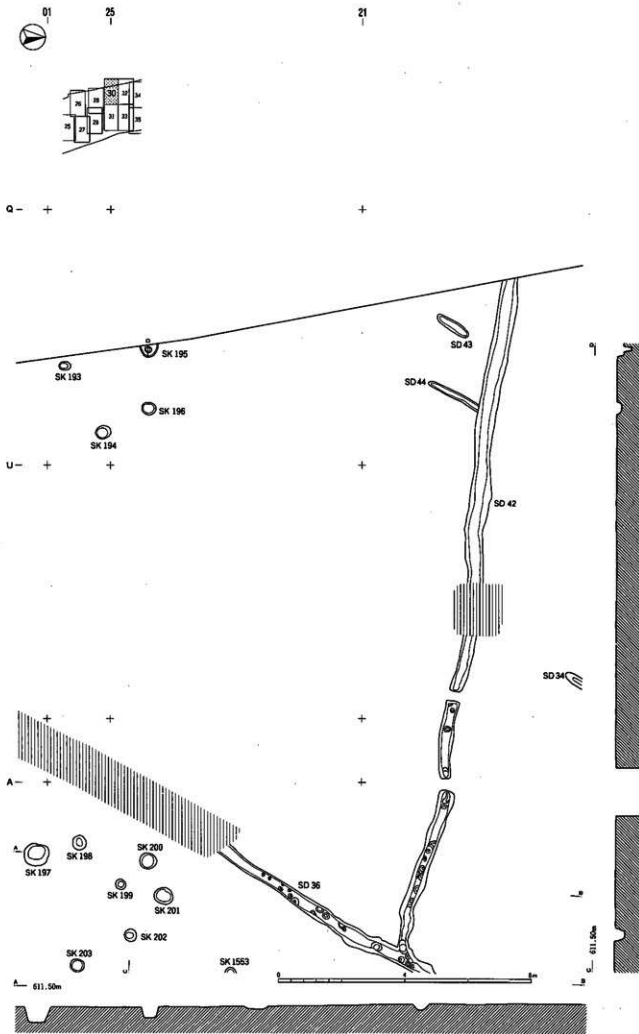

図版31 古代遺構実測図

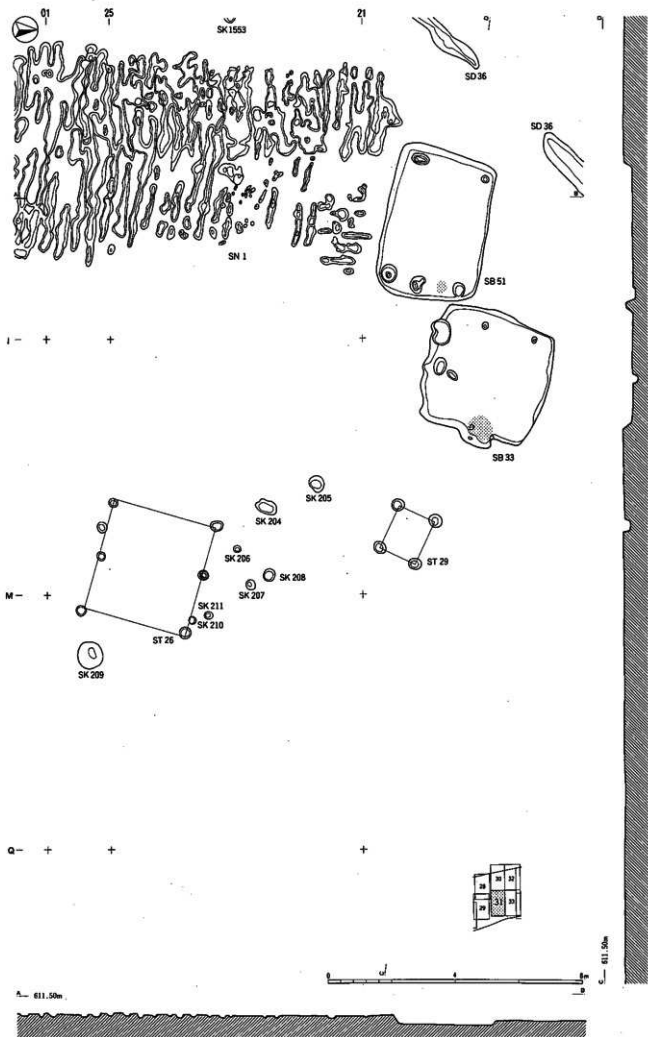

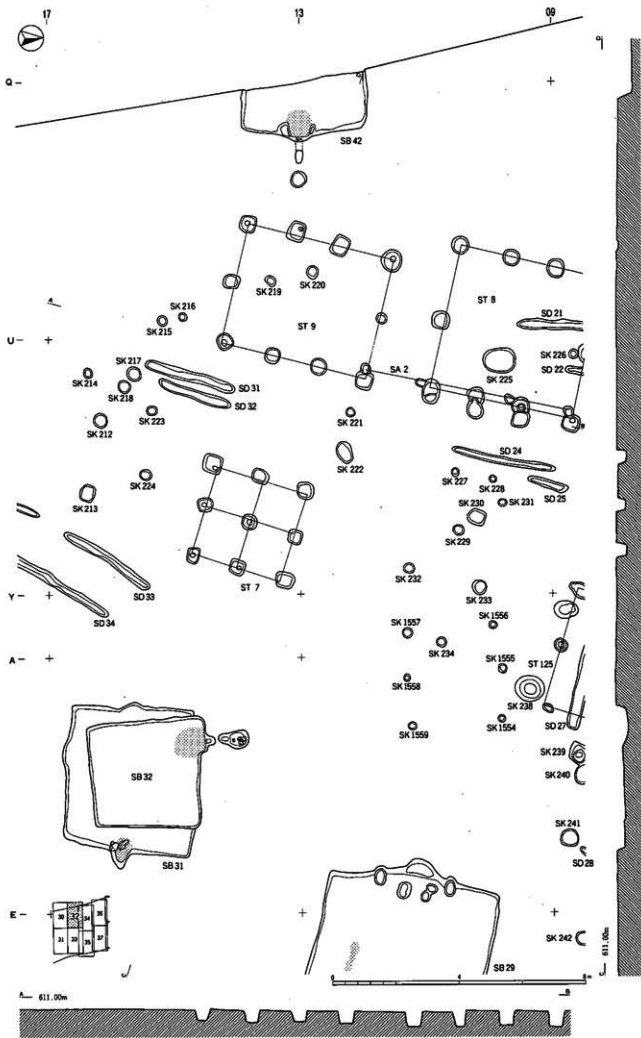

図版33 古代遺構実測図

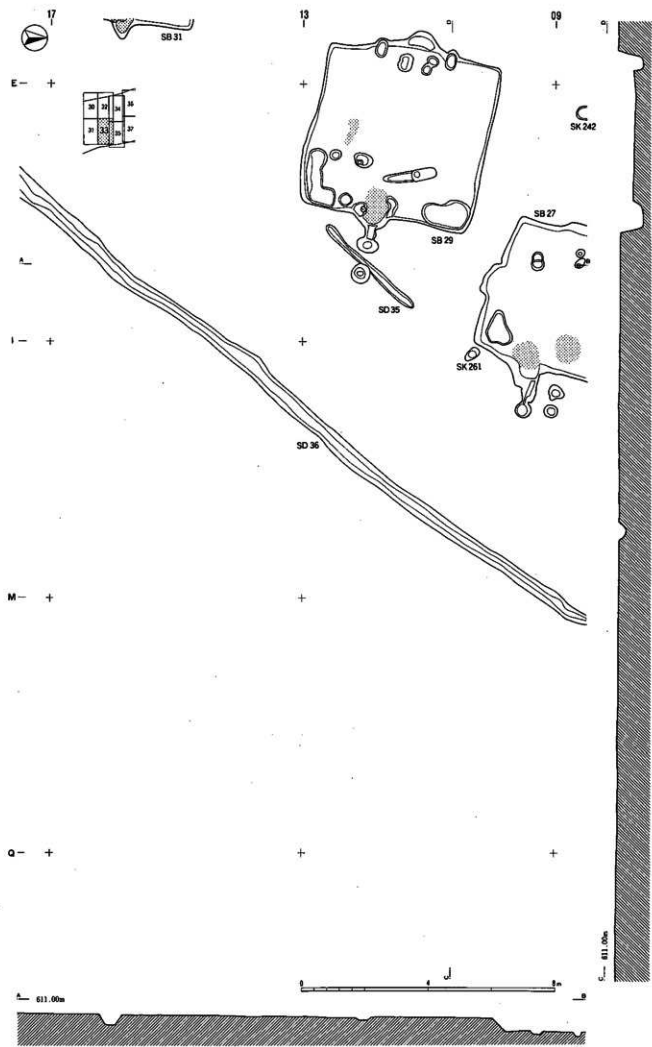

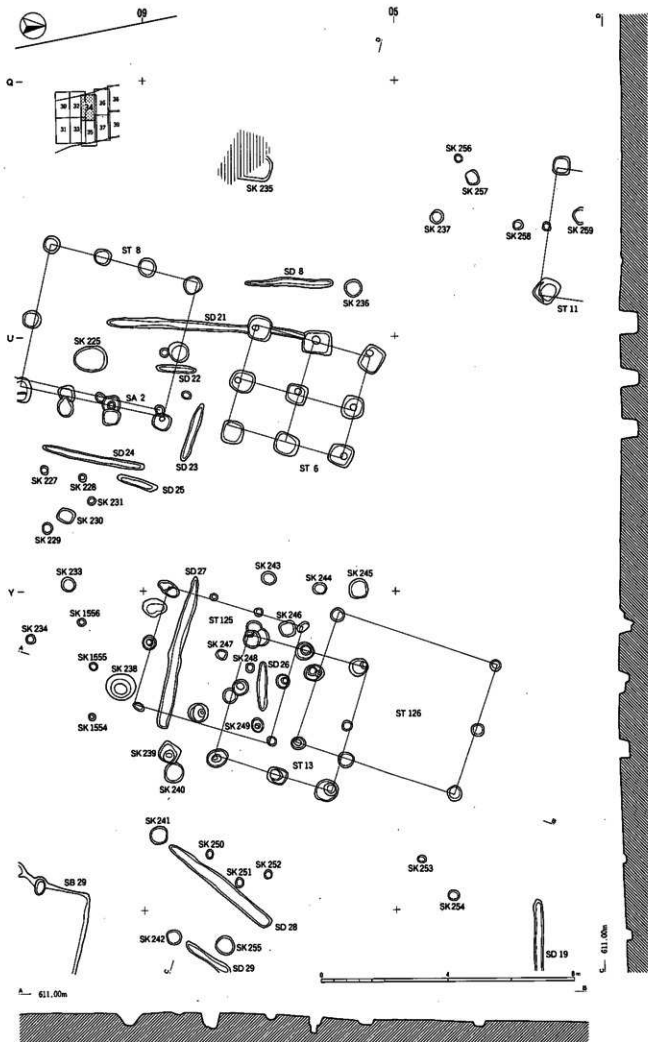

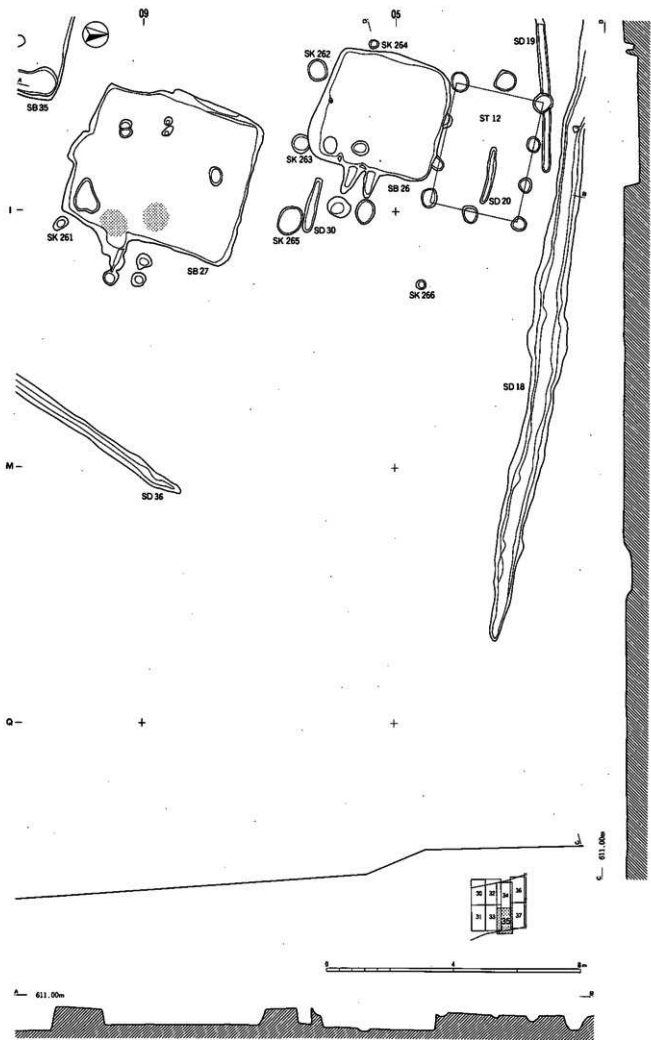

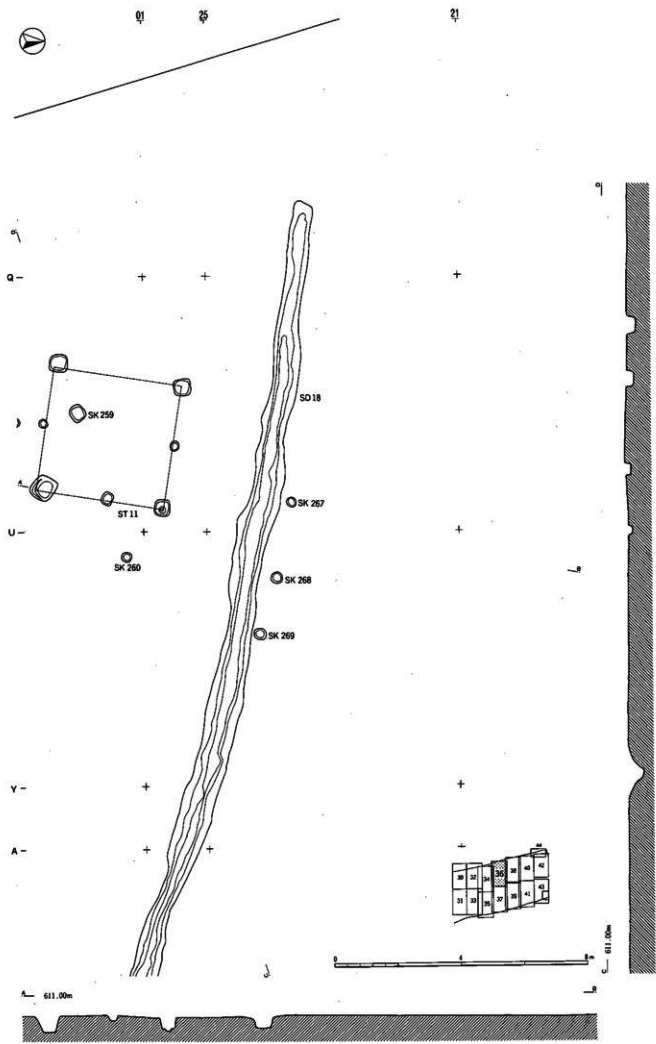

36	37	38	39	40	41	42
31	32	33	36	38	41	42
31	32	33	36	38	41	42

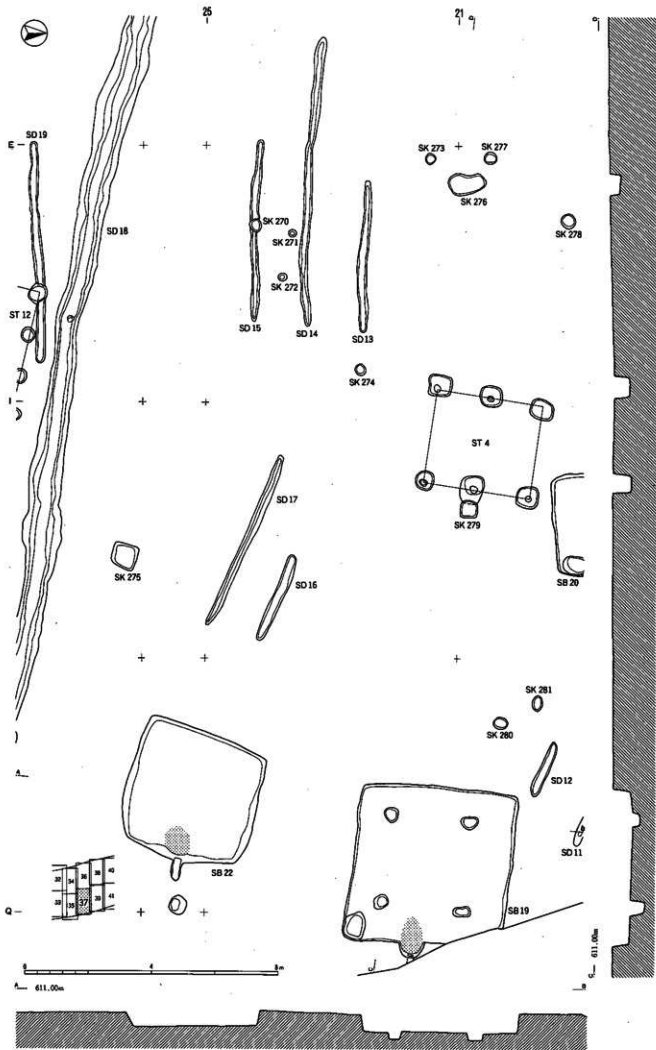

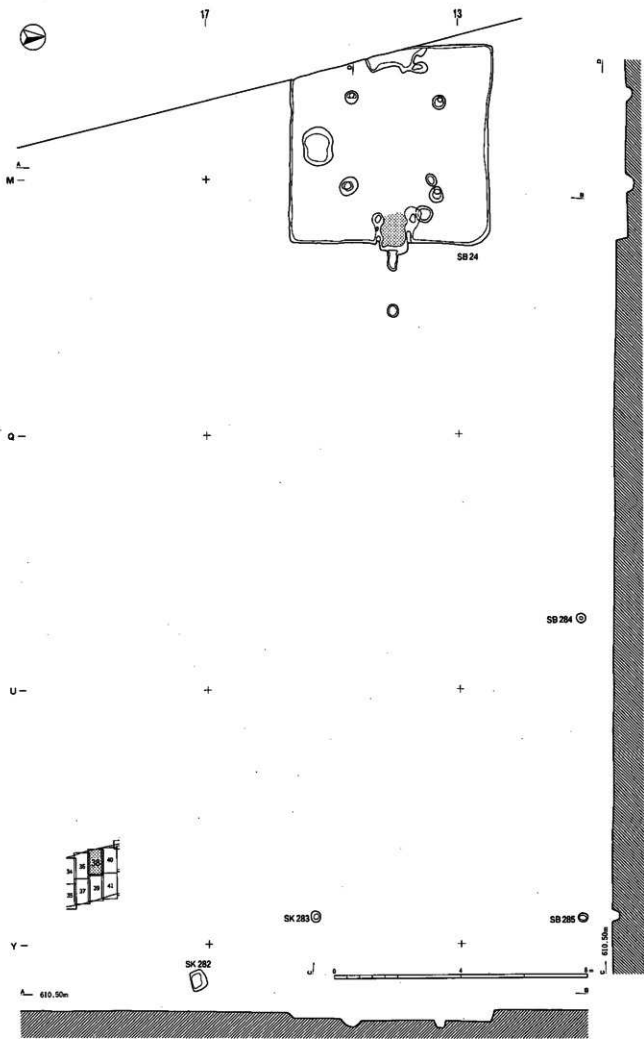

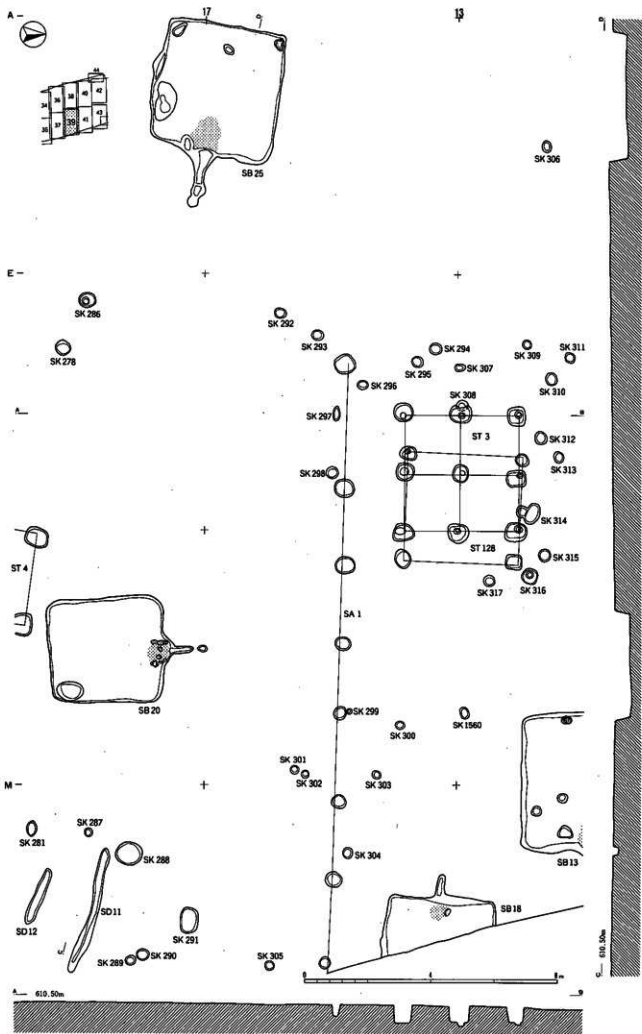

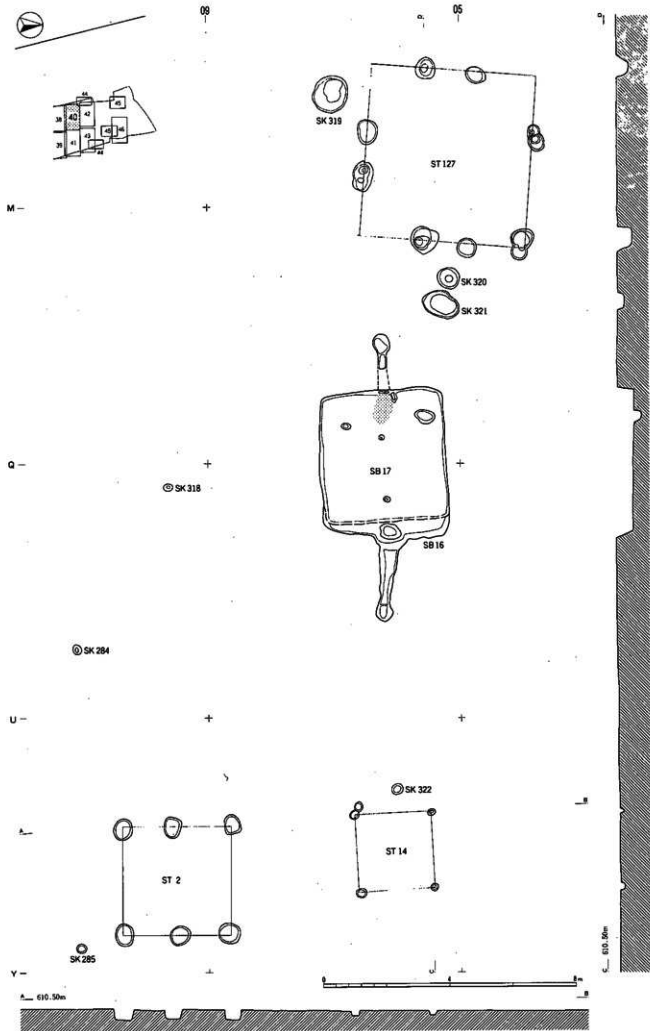

図版41 古代遺構実測図

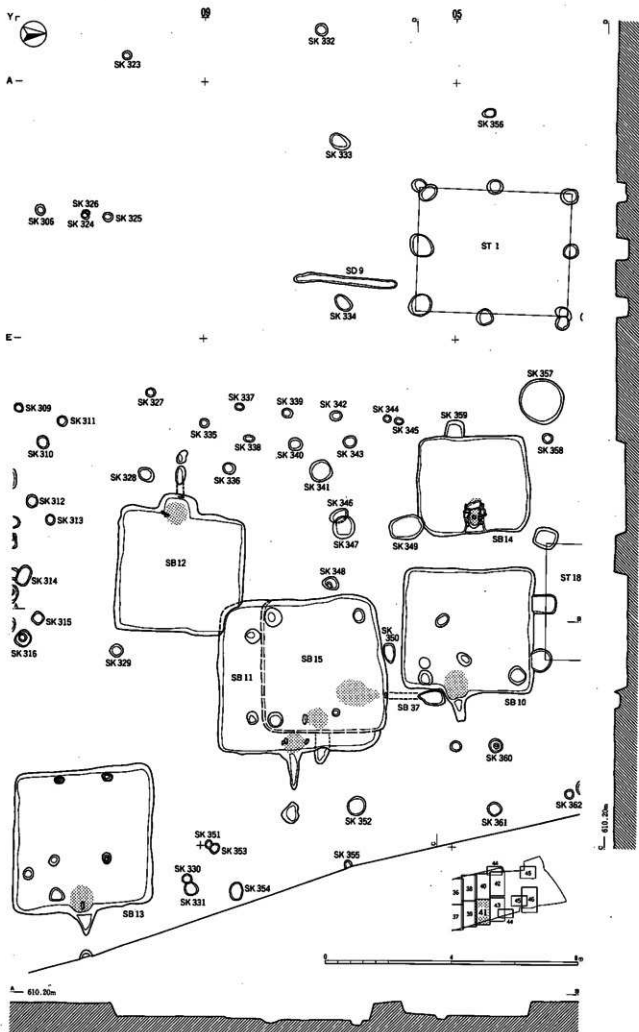

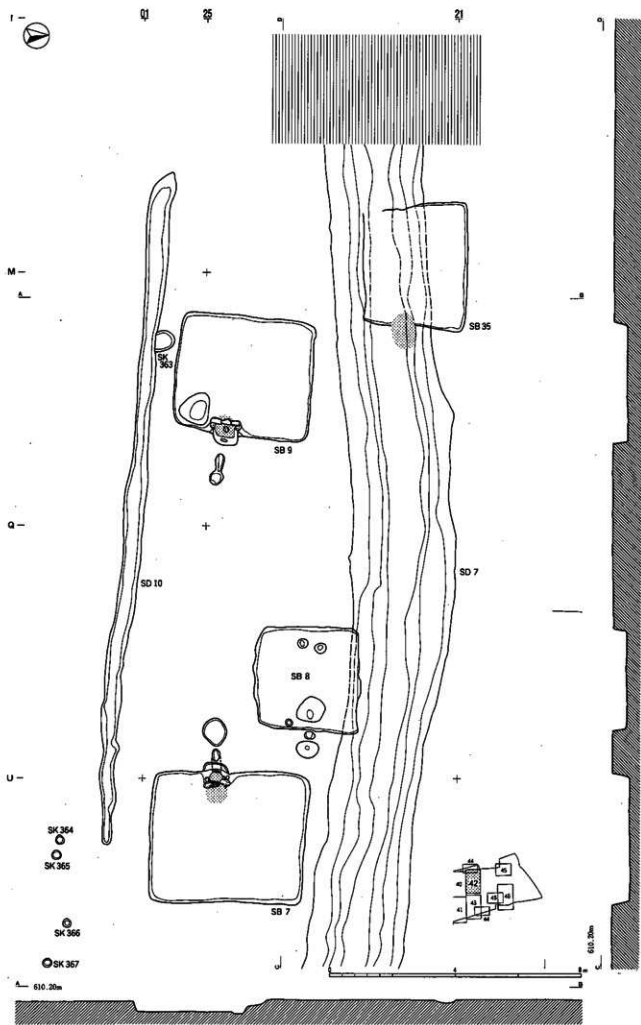

図版43 古代遺構実測図

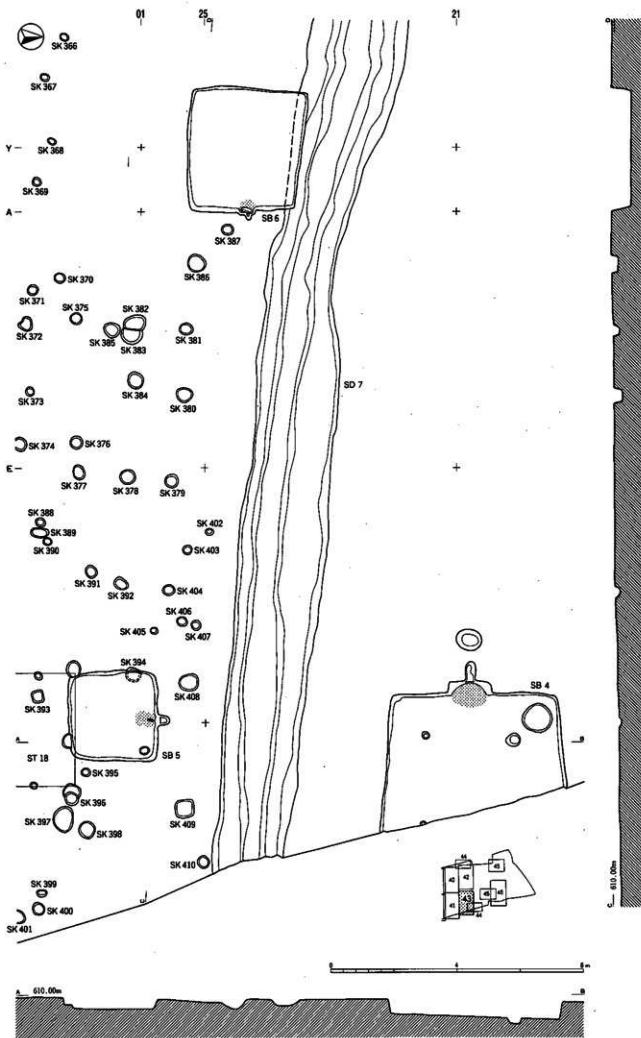

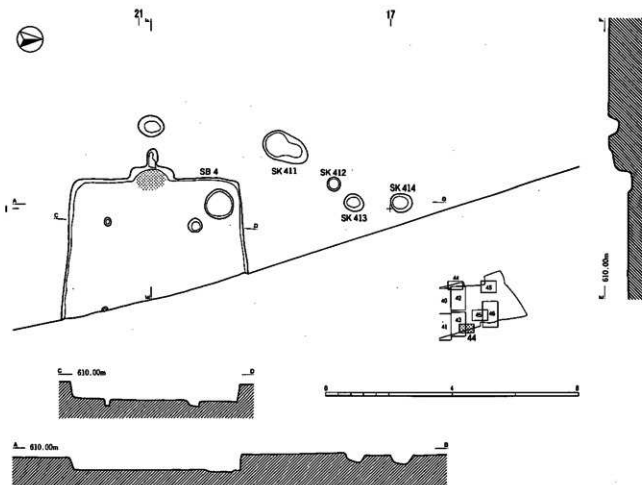
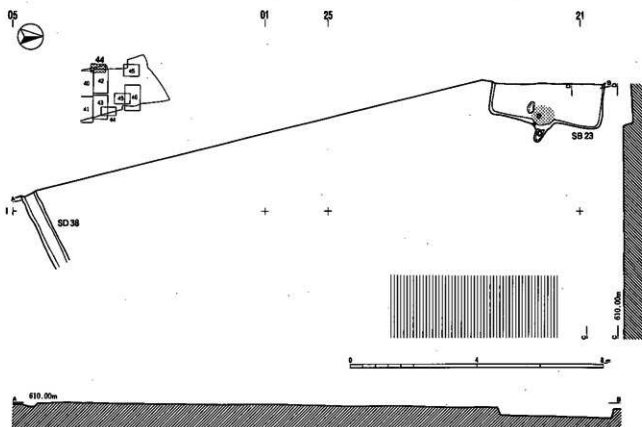

图版45 古代遺構実測図

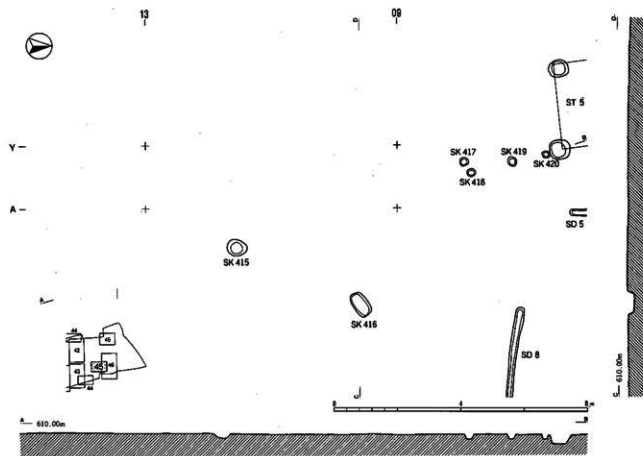
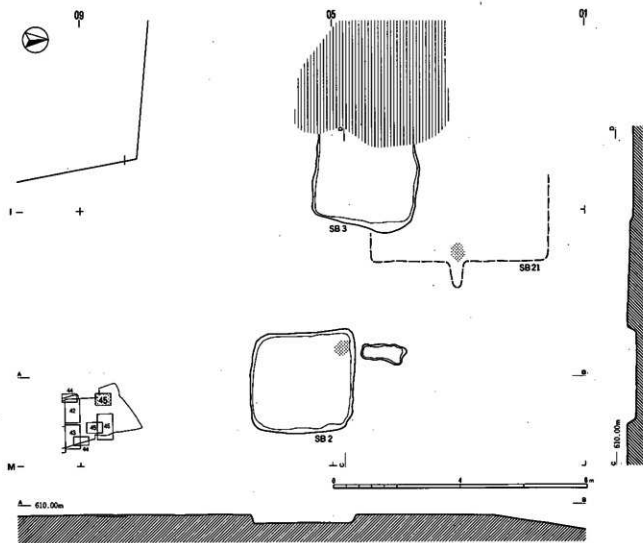

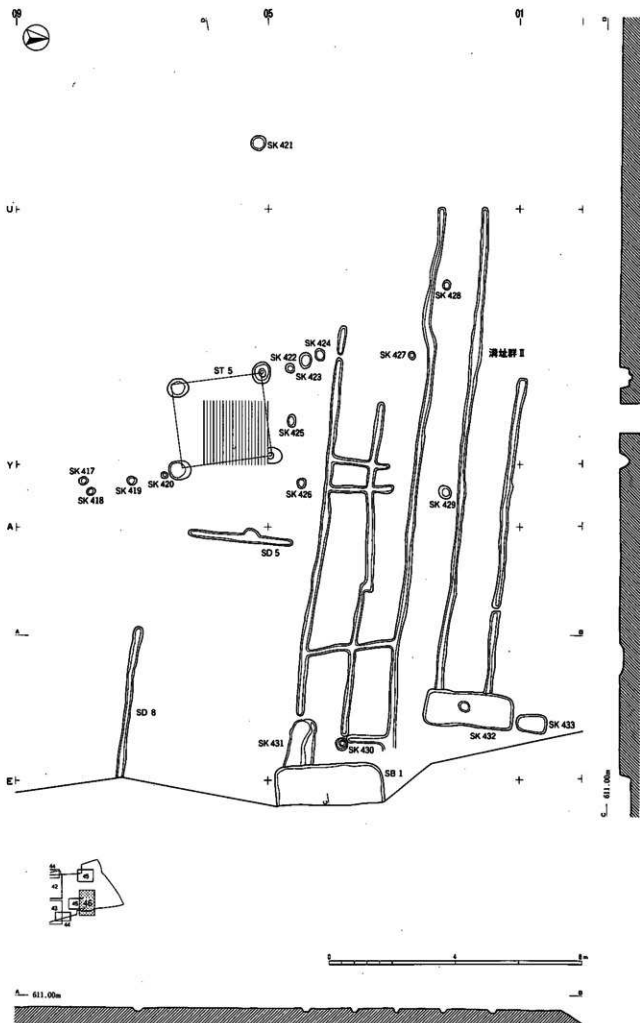

图版47 古代遺構実測図

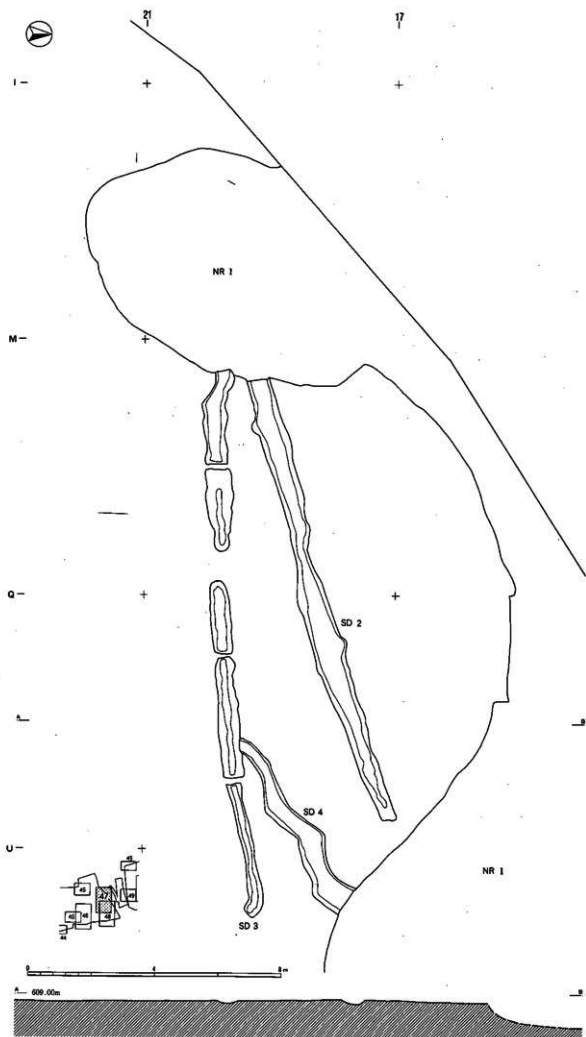

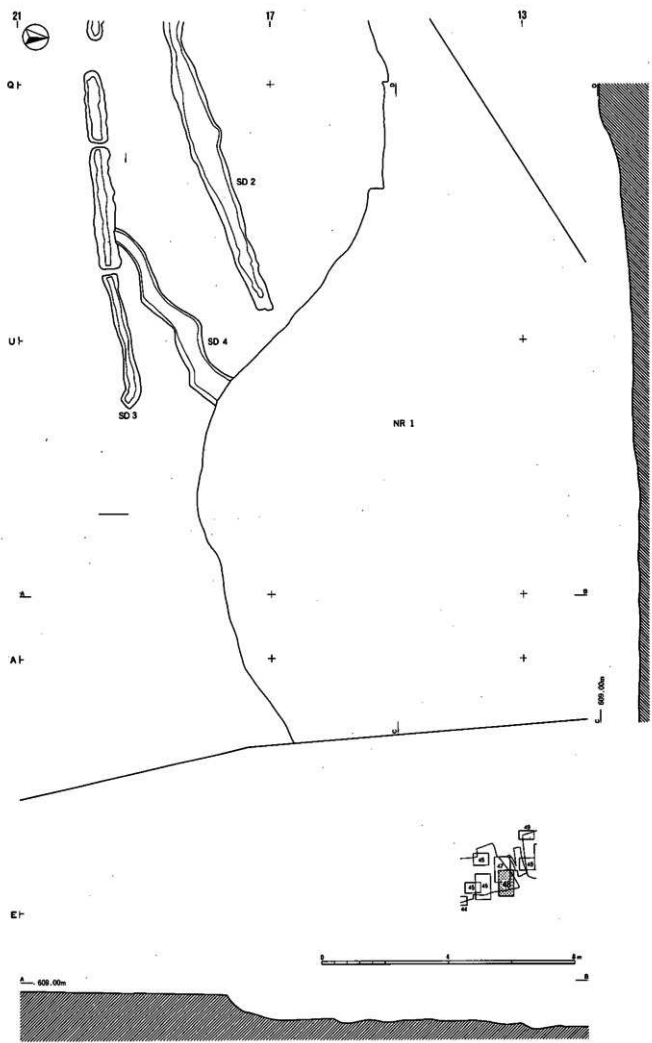

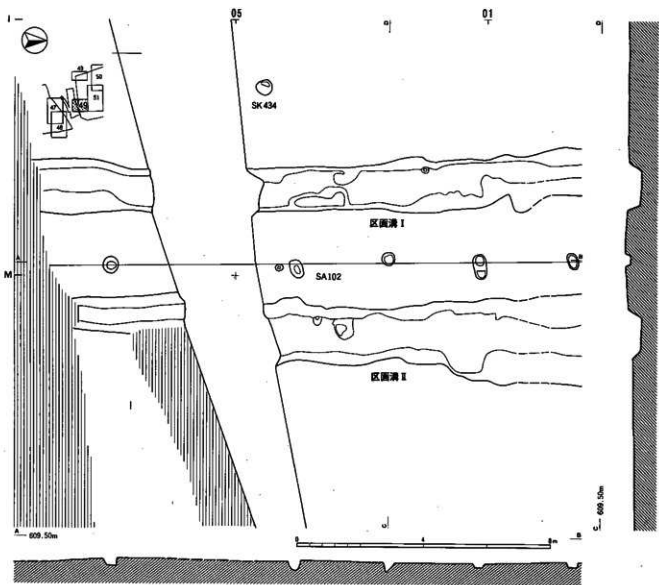
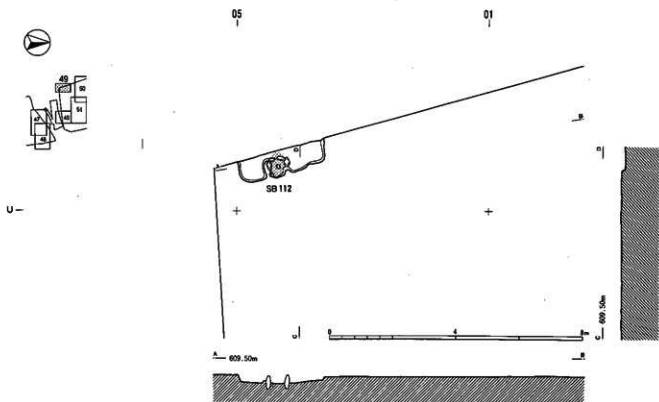

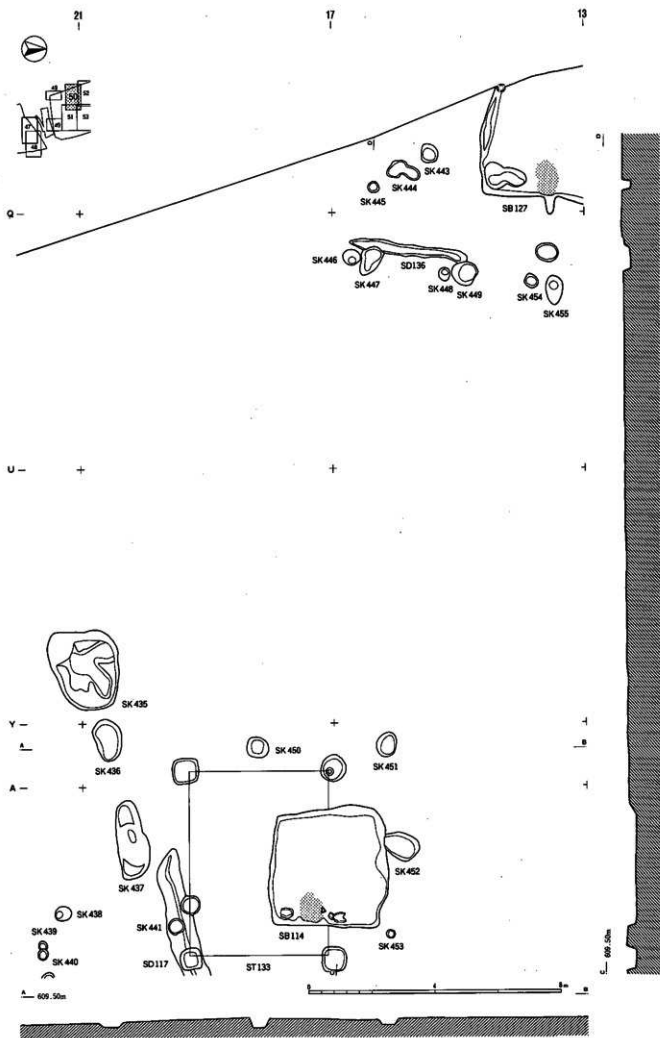

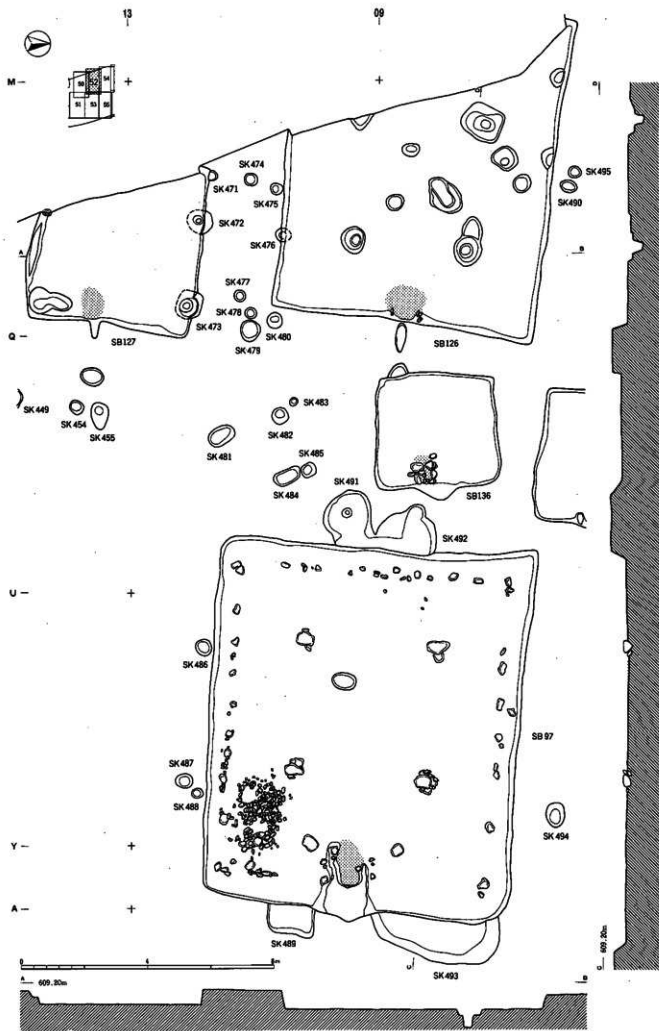

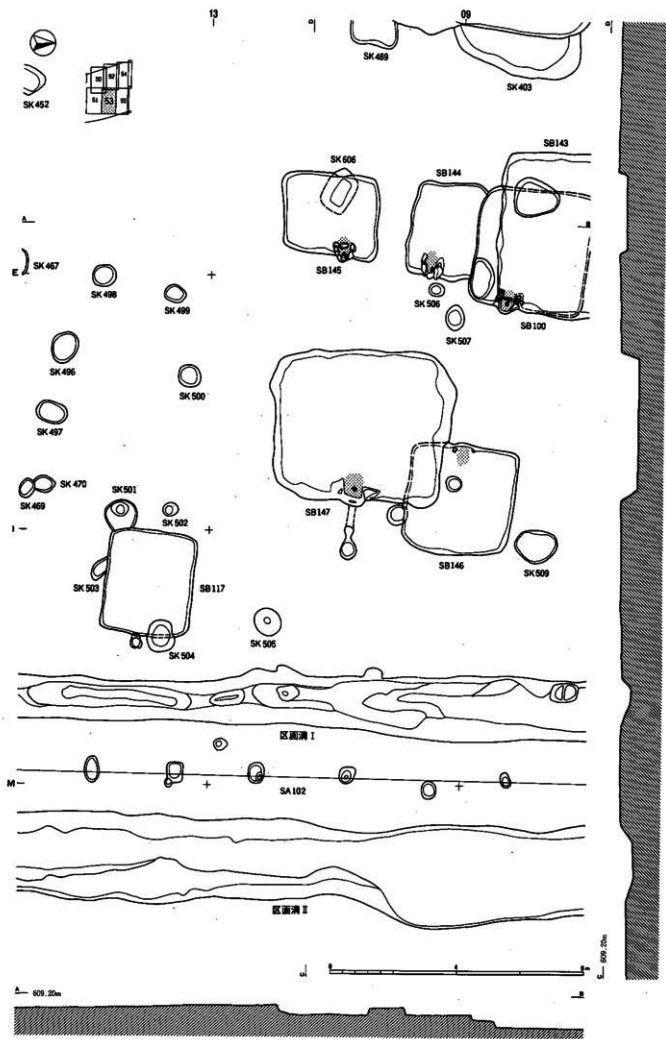

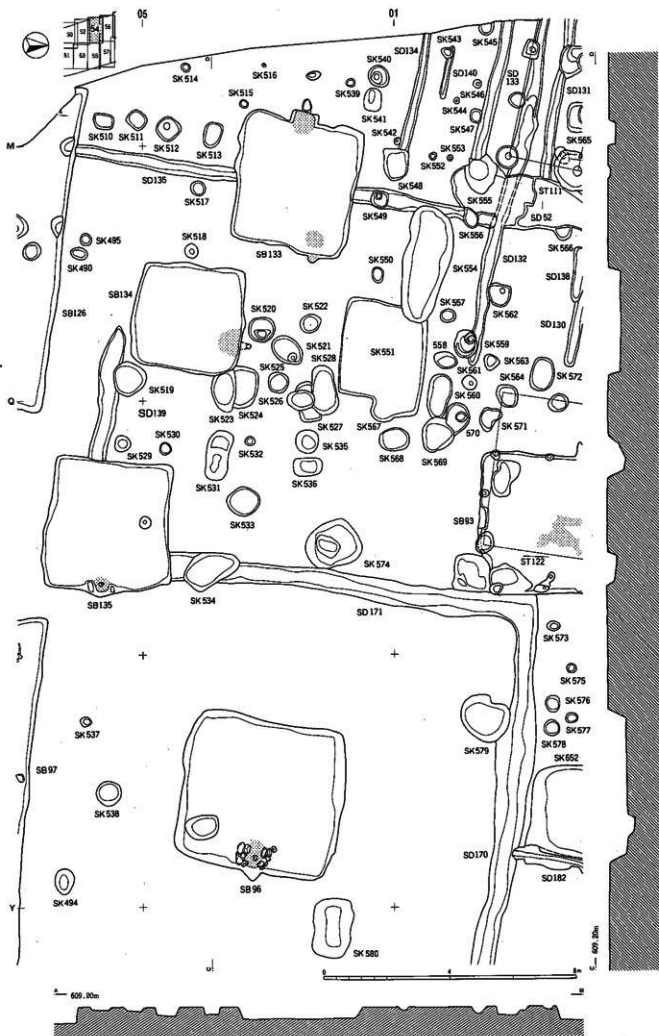

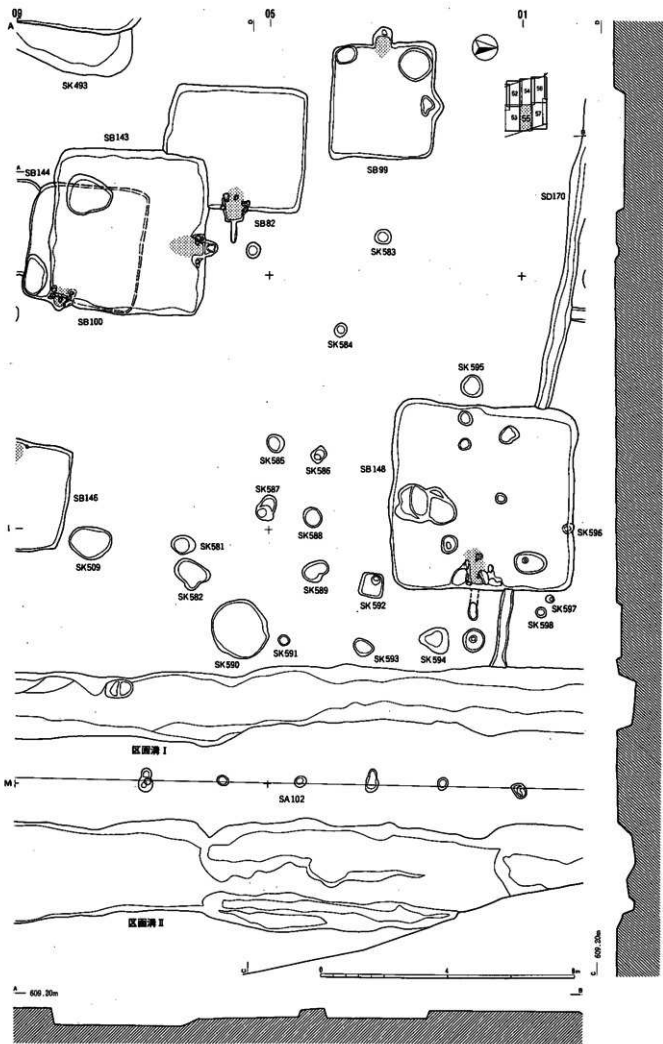

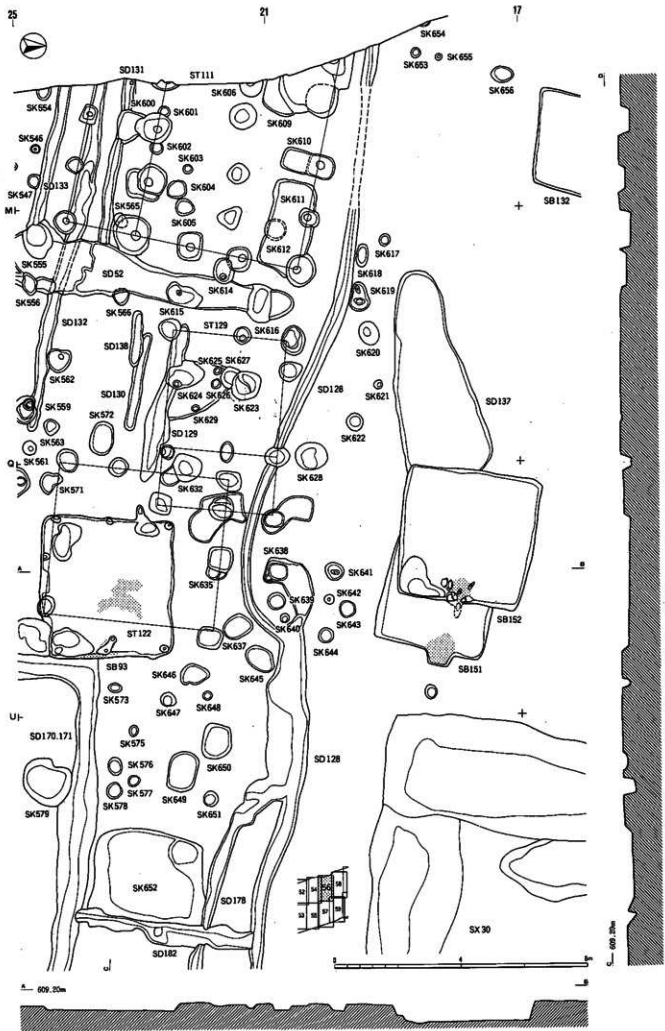

图版57 古代遺構実測図

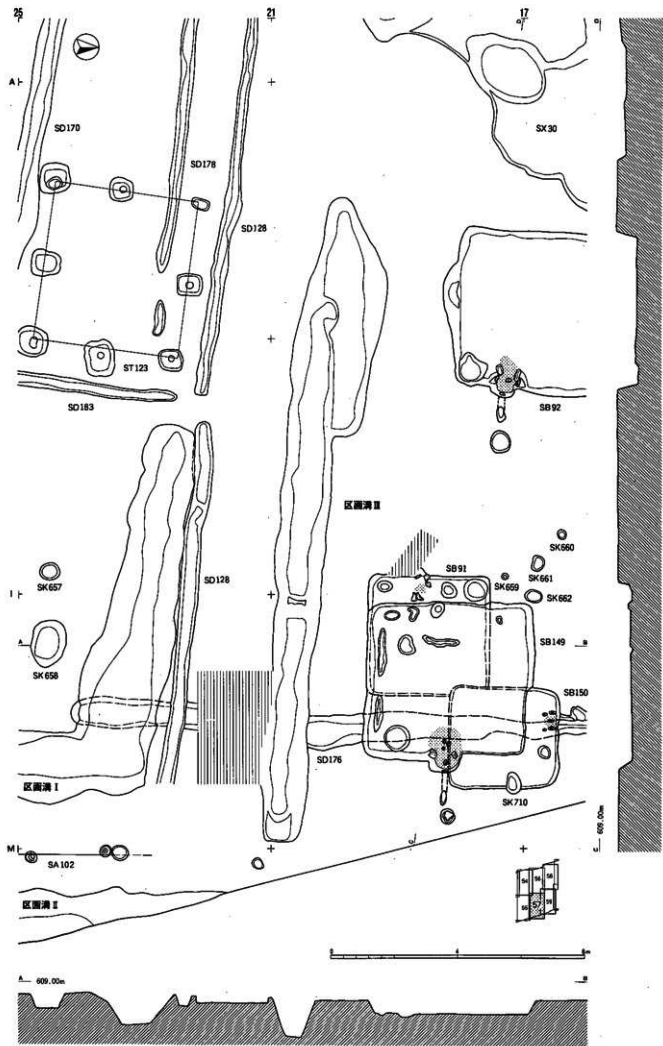

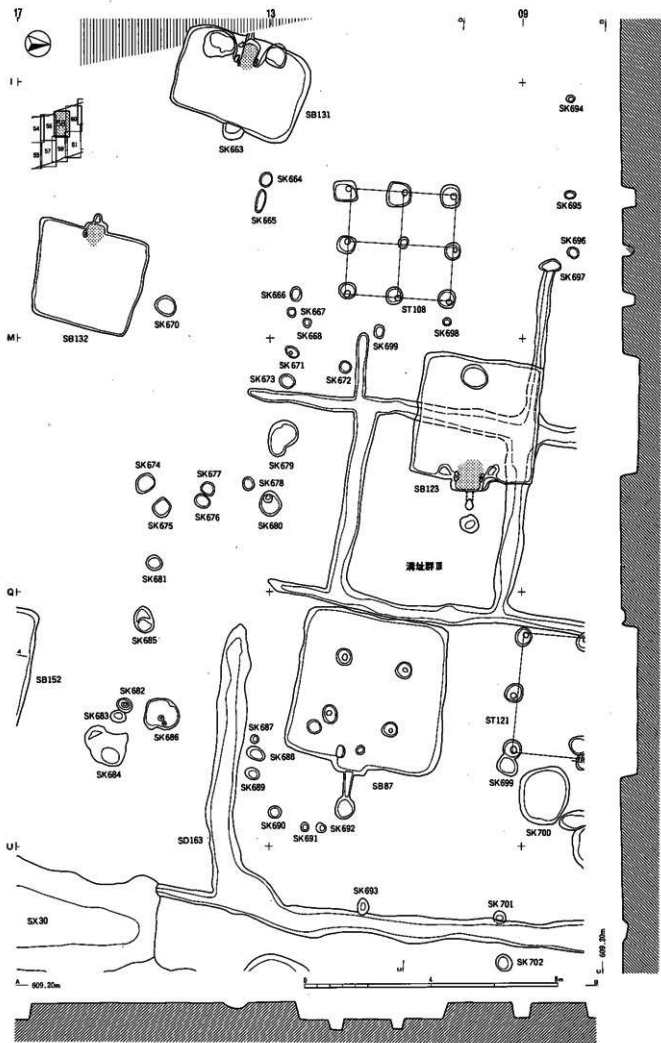

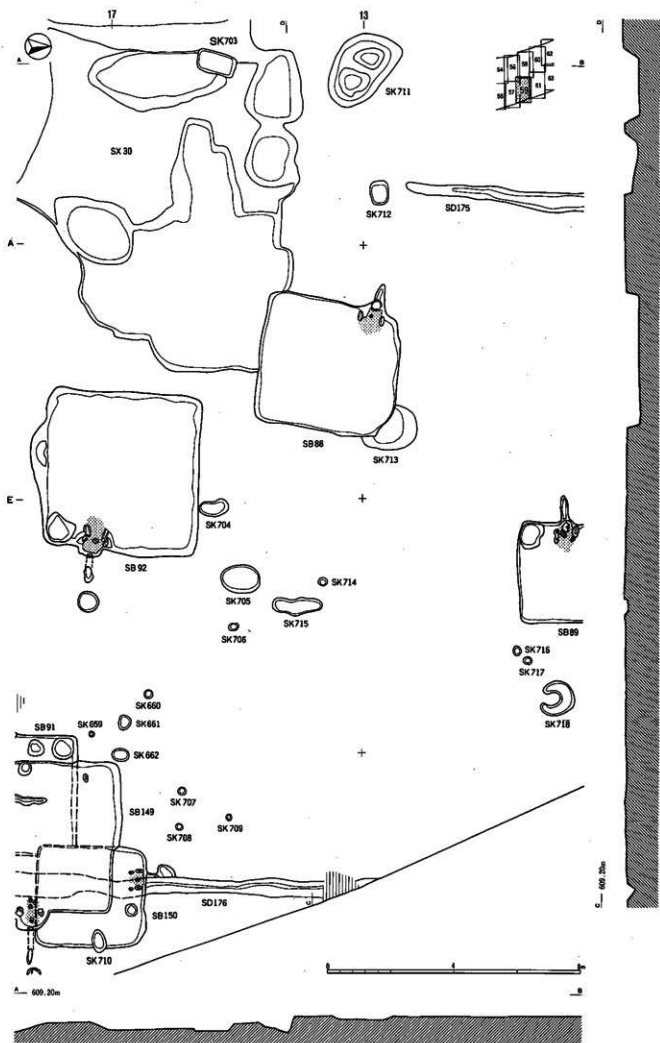

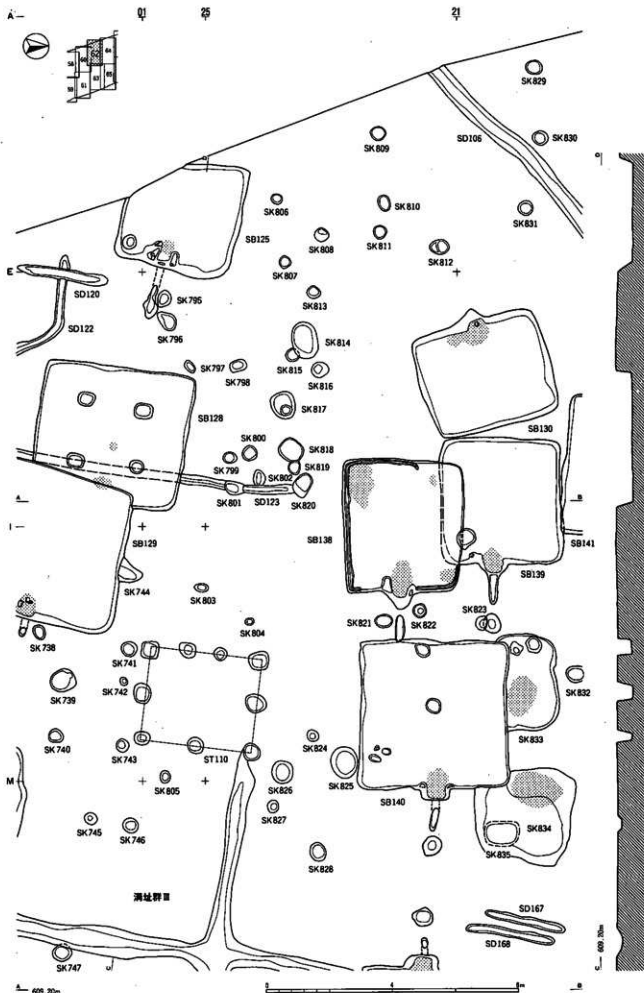

图版63 古代遺構実測区

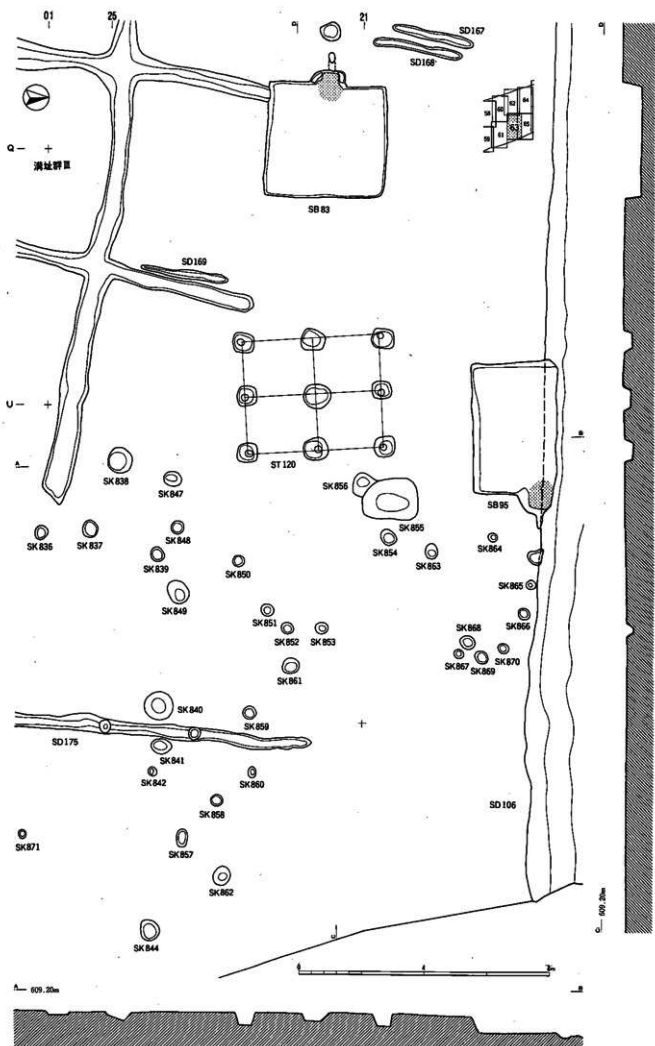

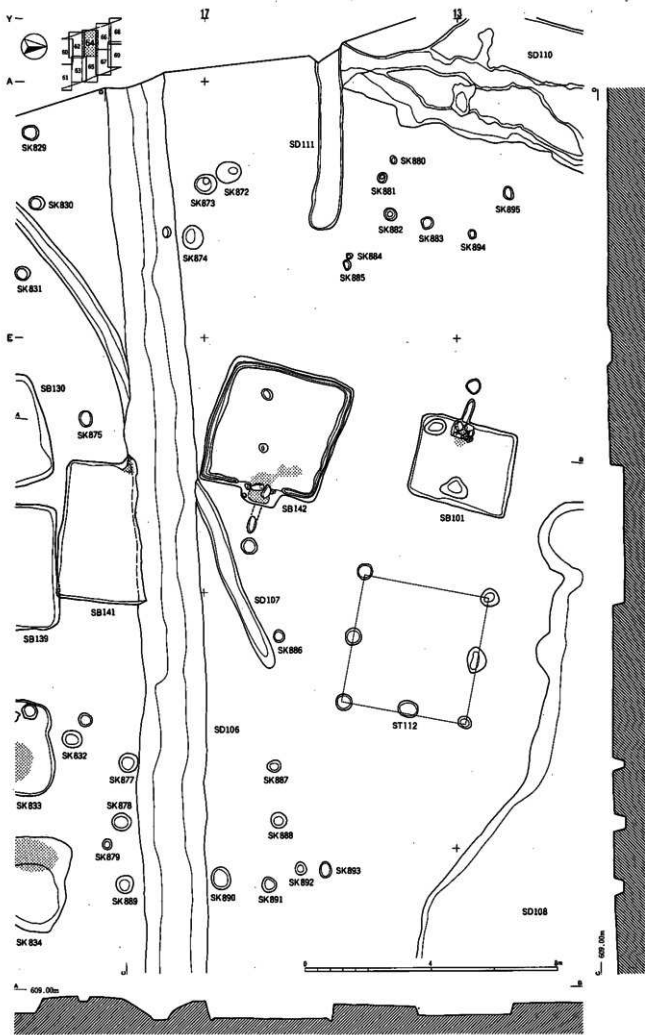

図版65 古代遺構実測図

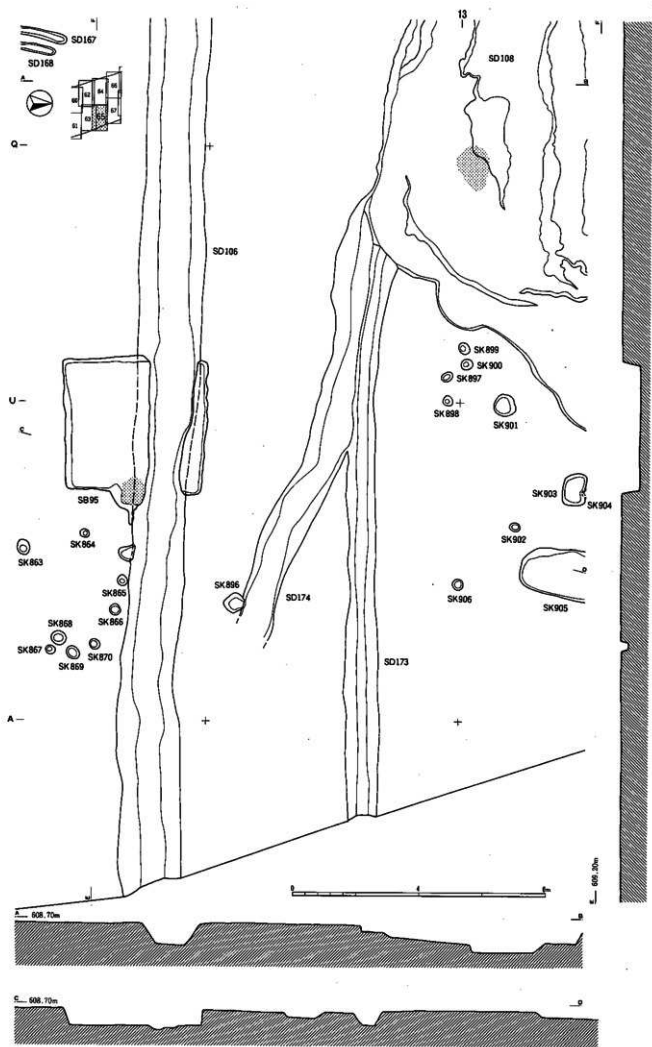

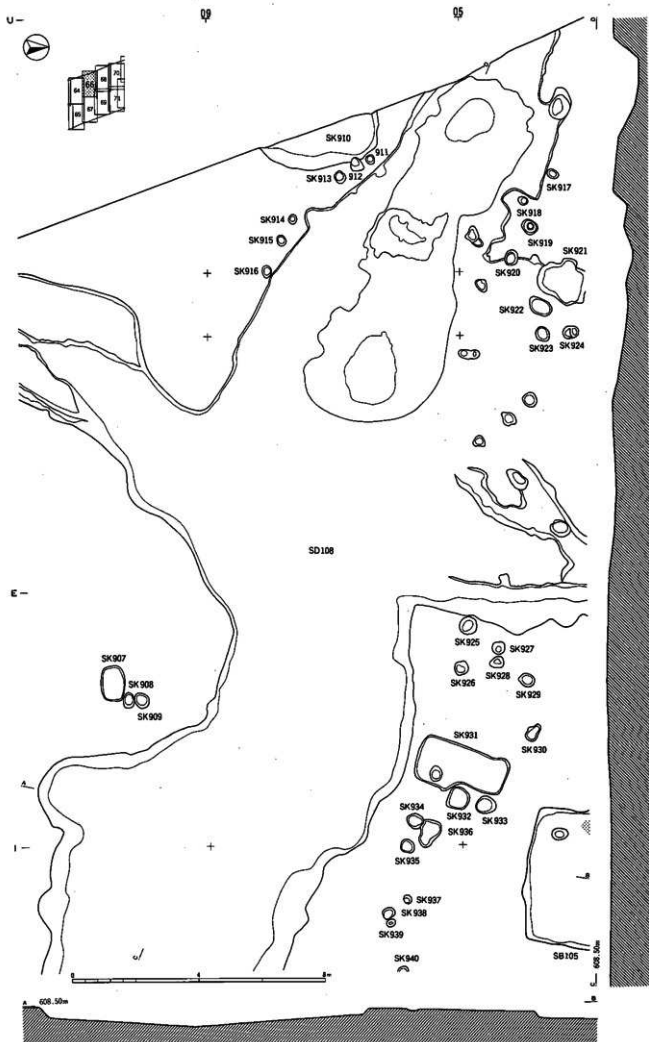

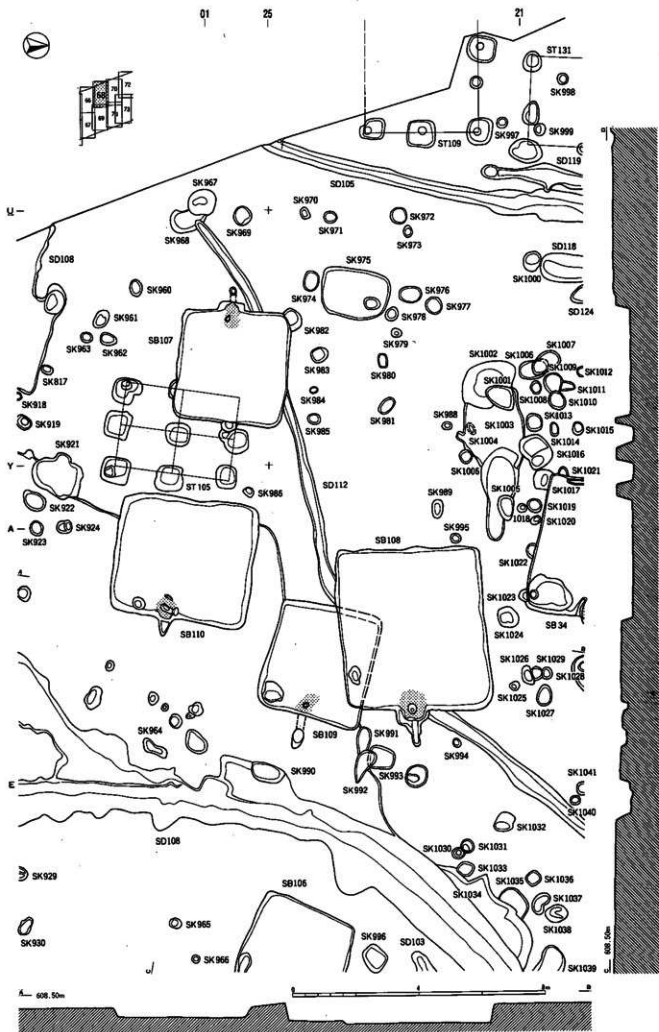

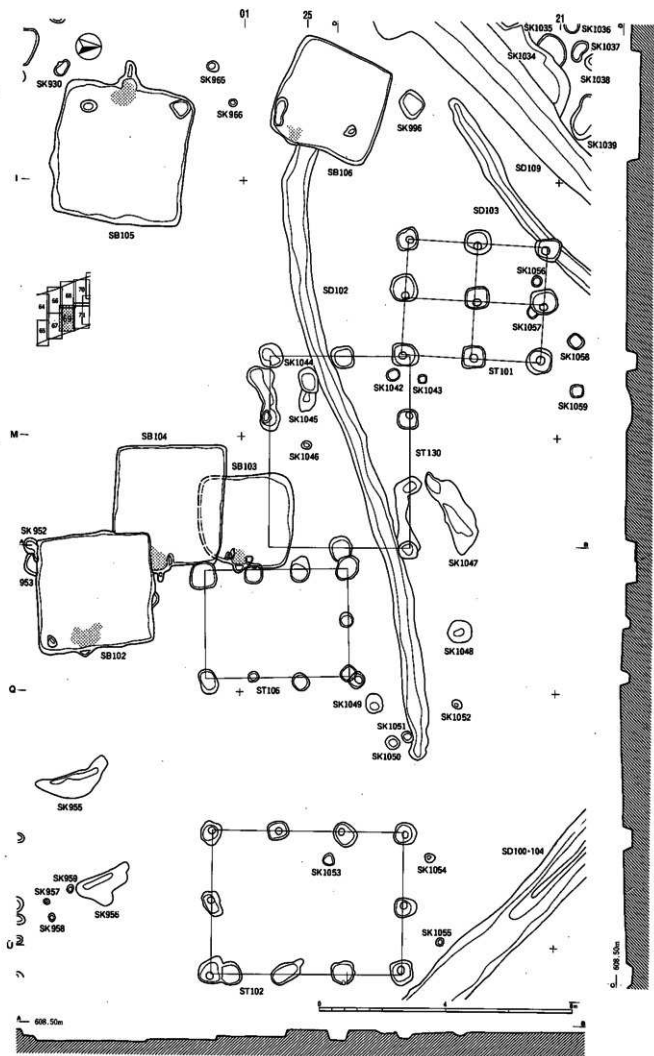

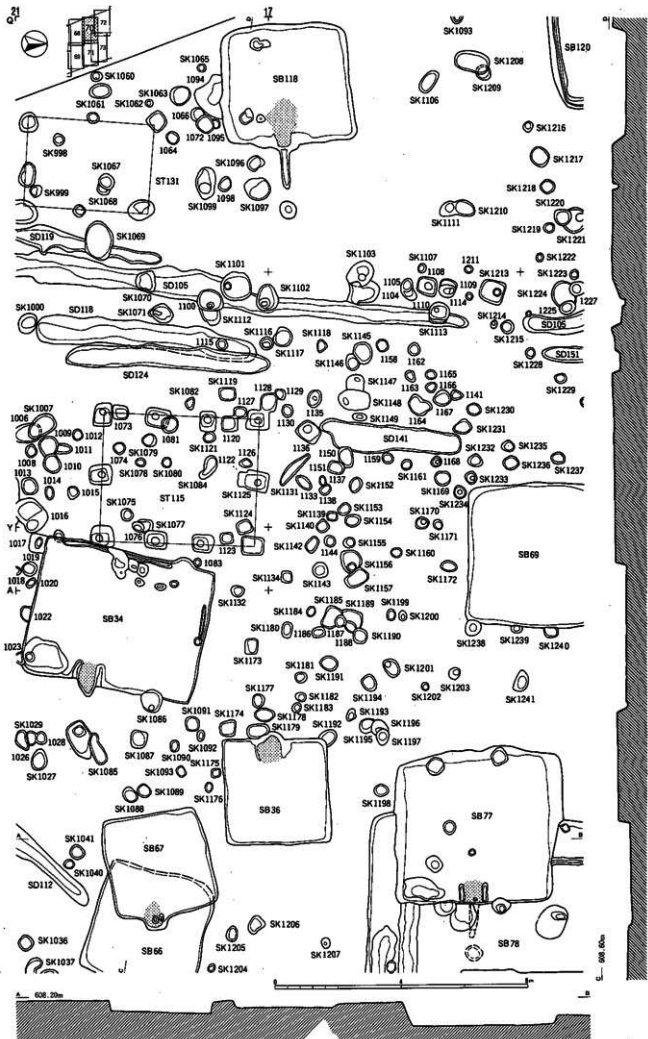

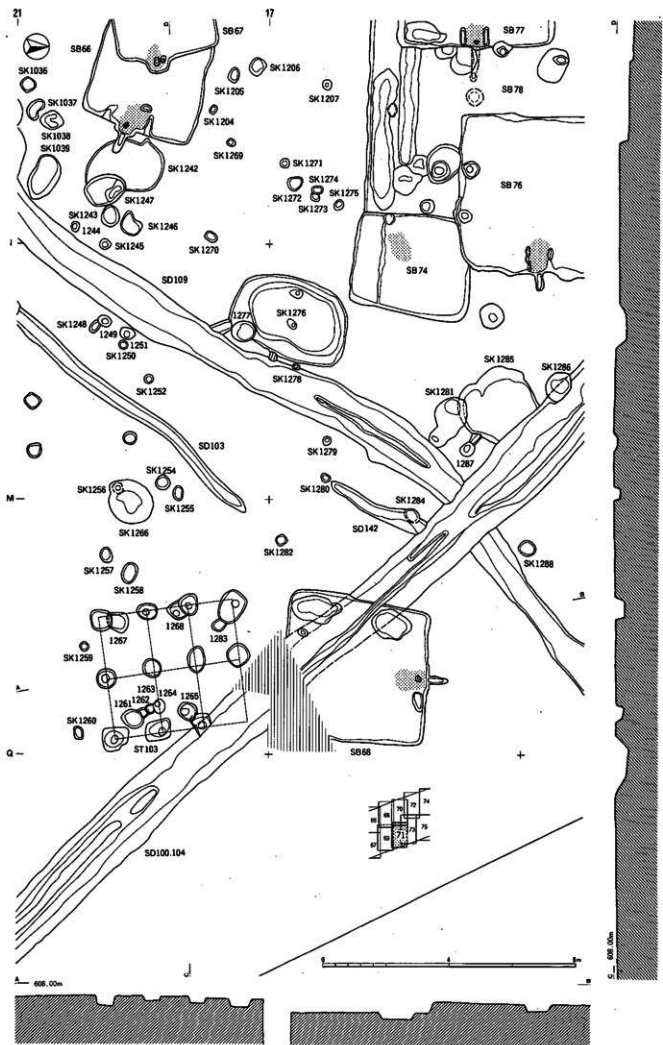

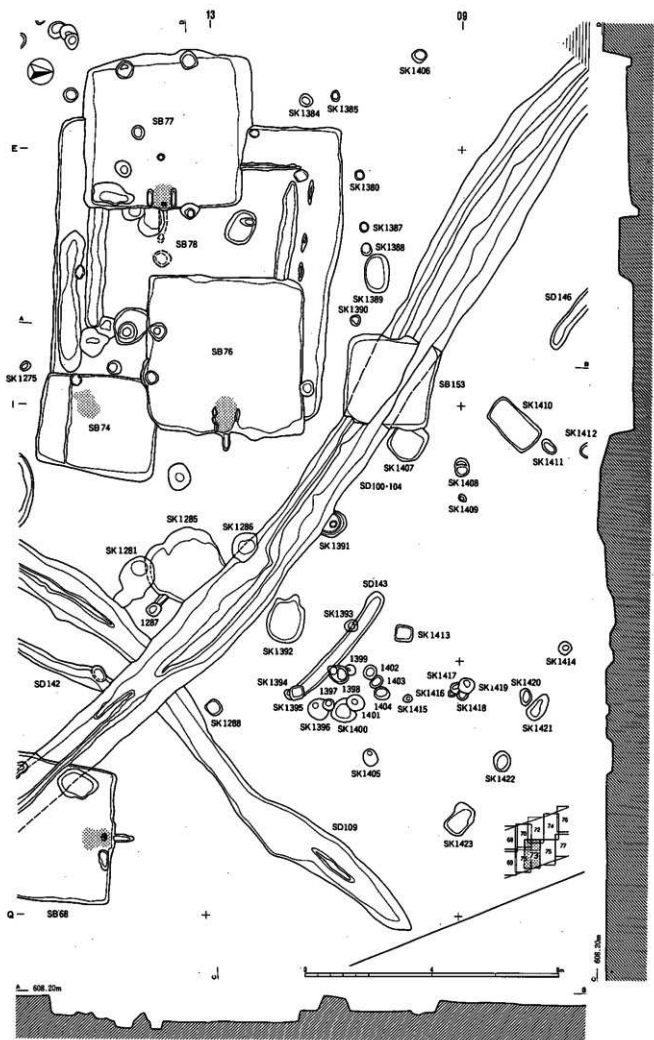

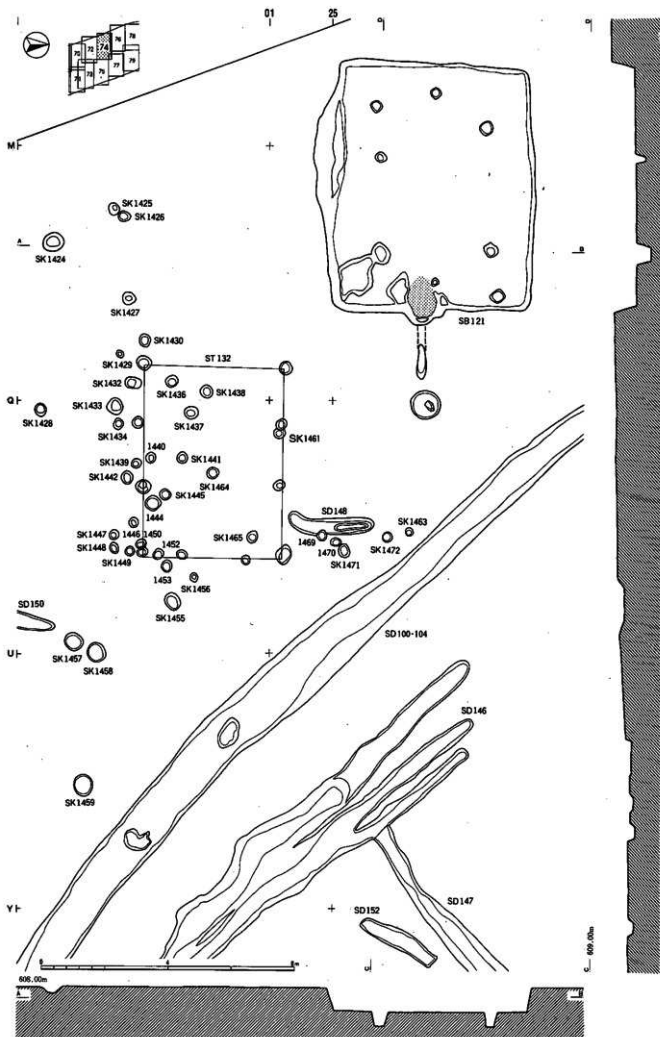

図版75 古代遺構実測図

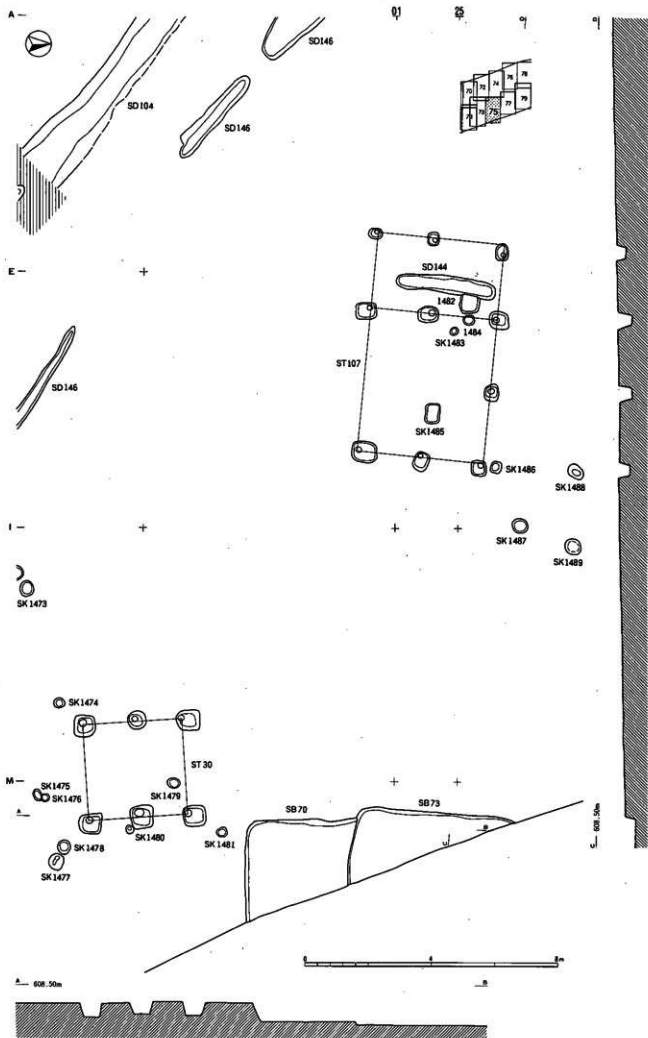

図版77 古代遺構実測図

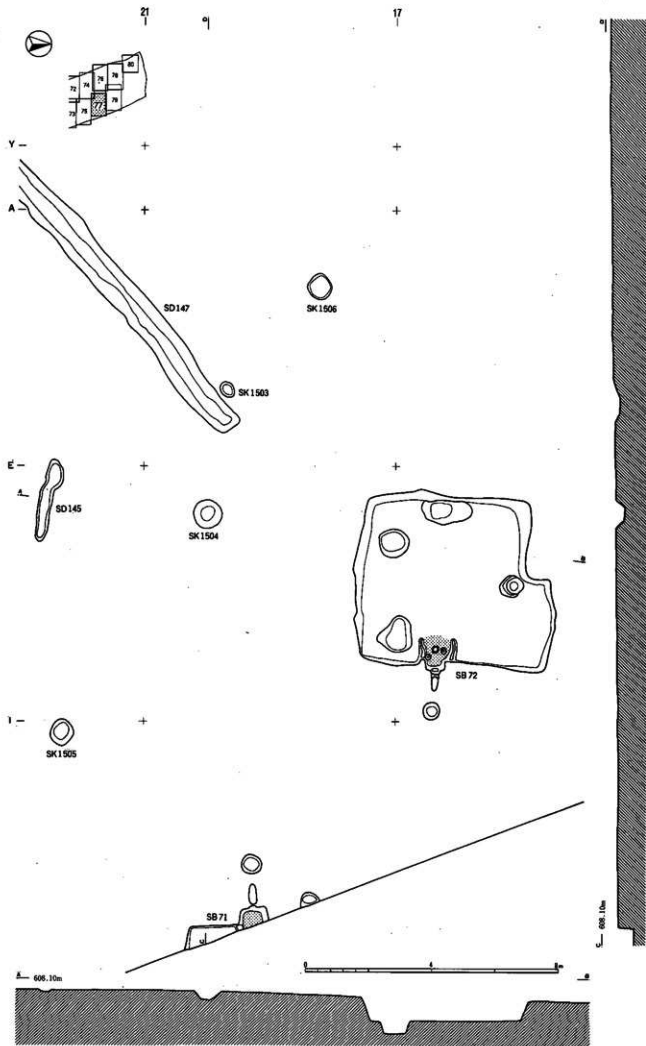

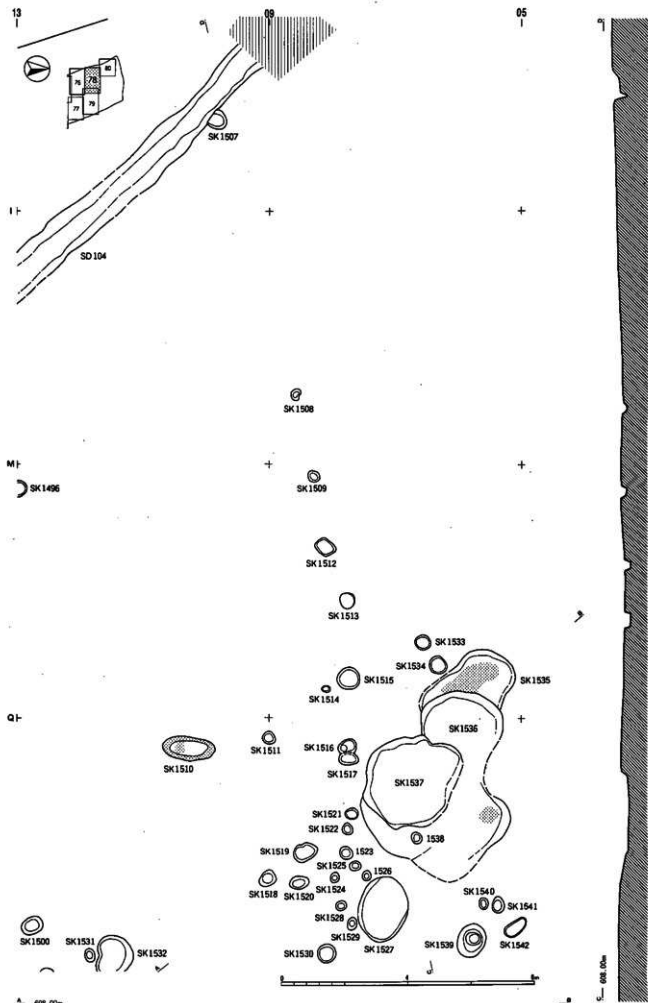

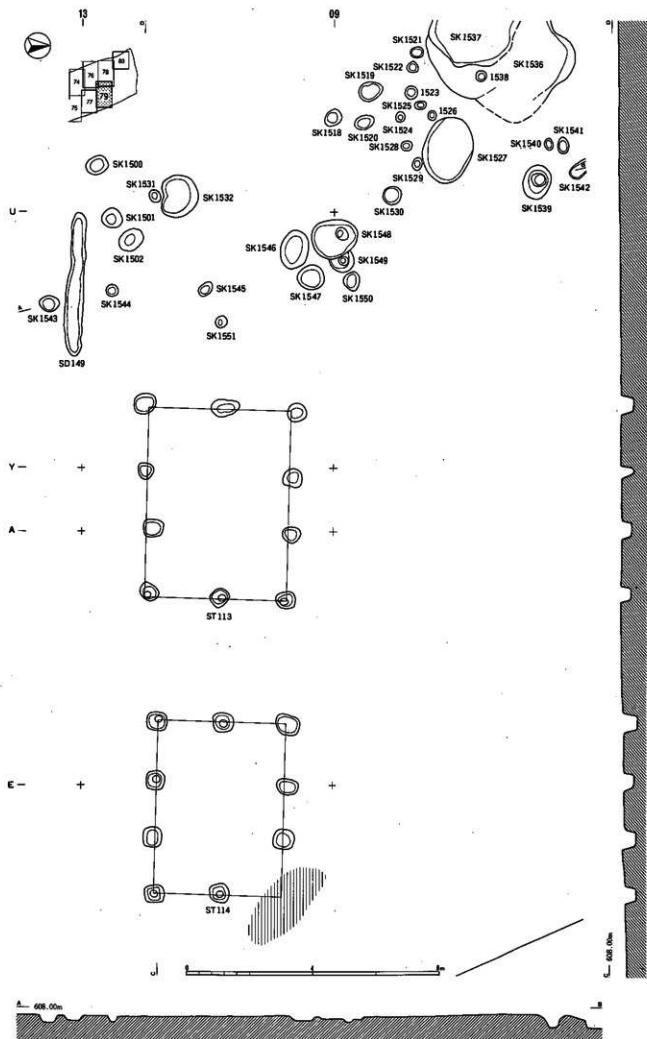

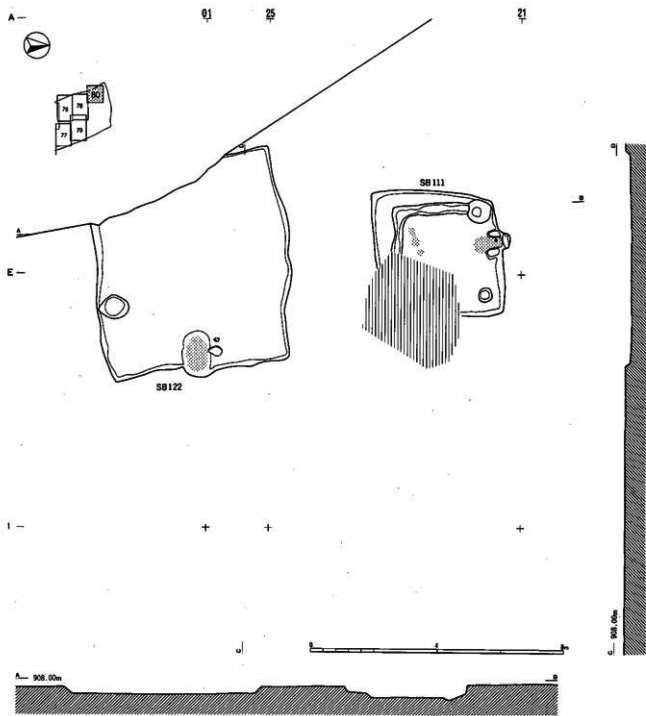

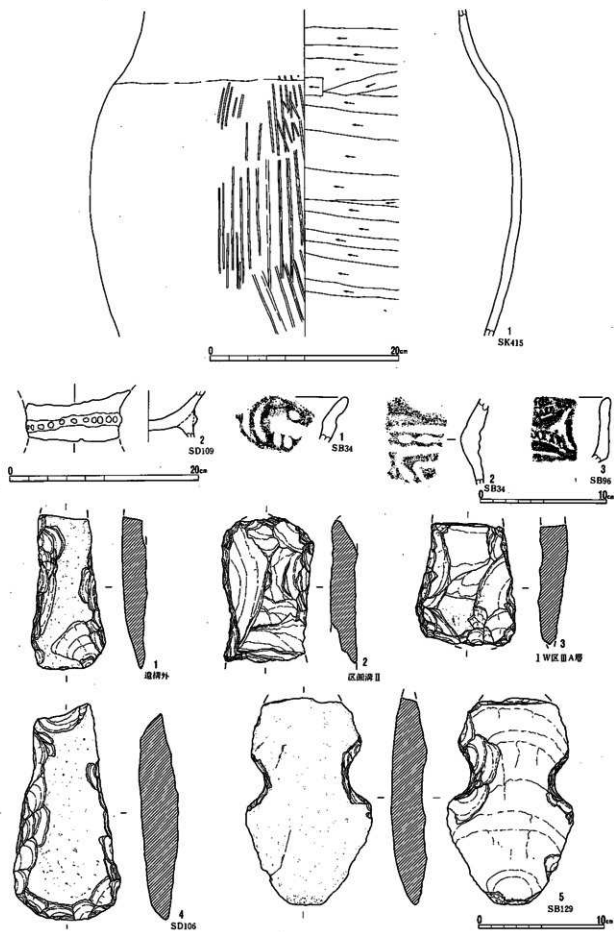

SB 1

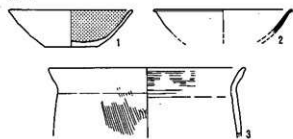

SB 2

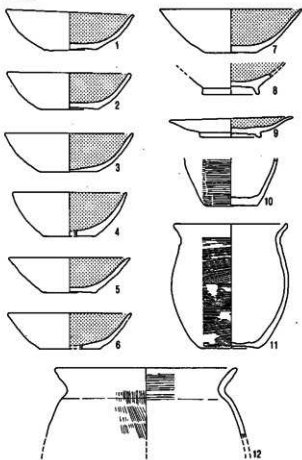

SB 3

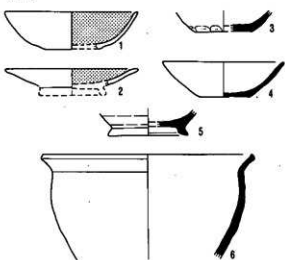

SB 4

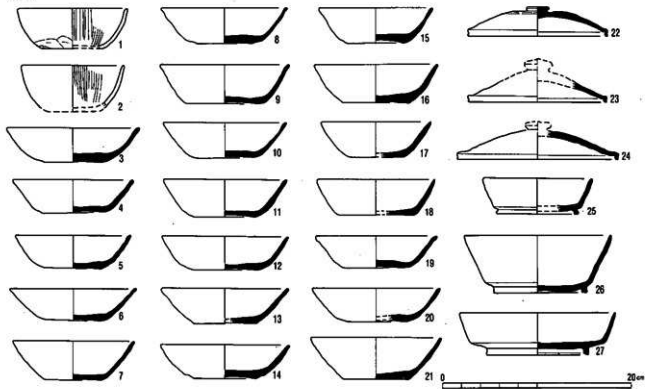

SB 4

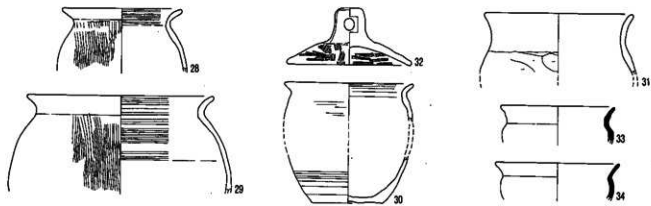

SB 5

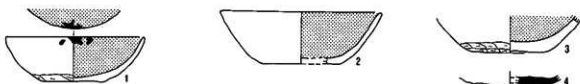

SB 6

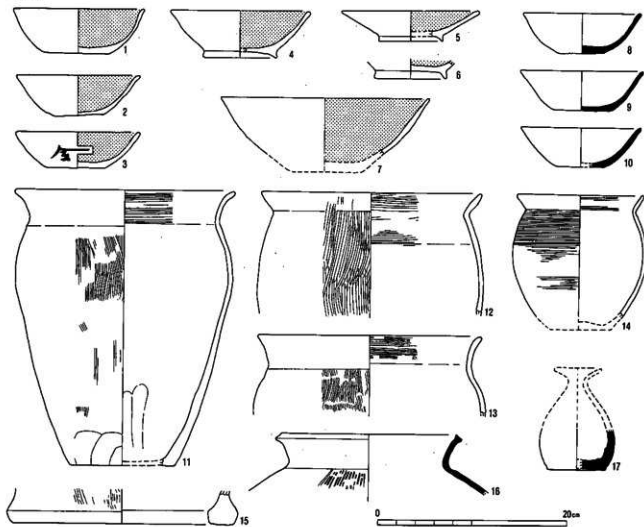

SB 7

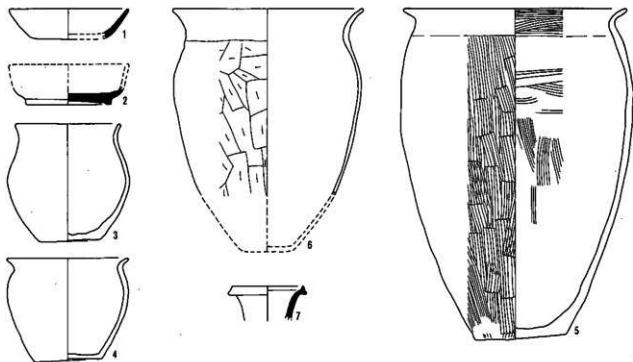

SB 8

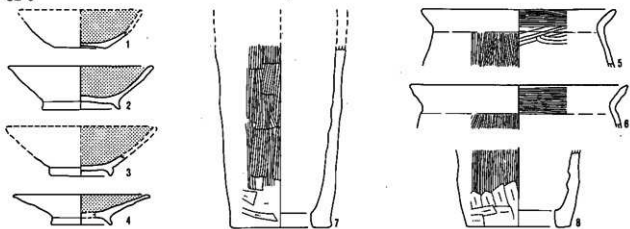

SB 9

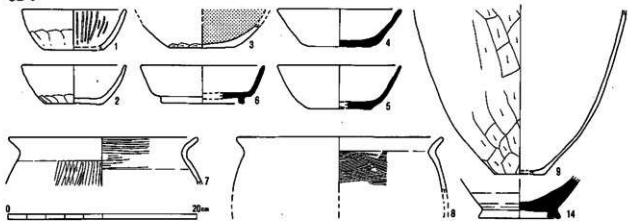

SB 9

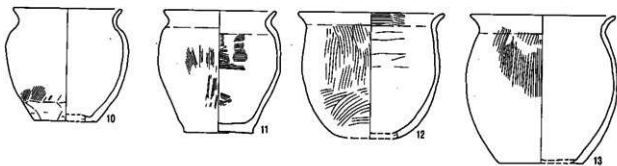

SB 10

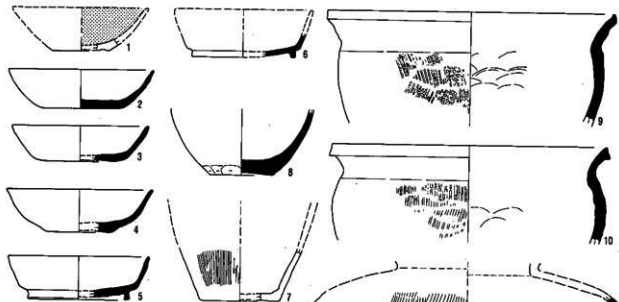

SB 11



SB 12

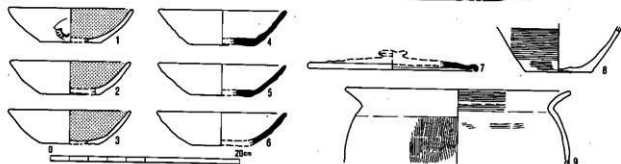

SB 13

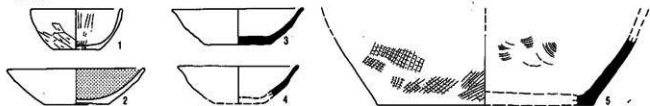

SB 14

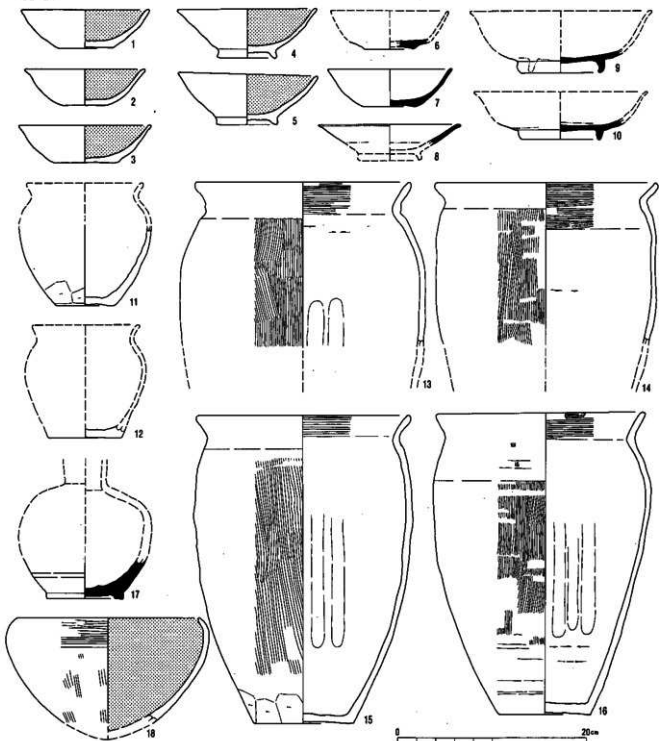

SB13-14

SB 15

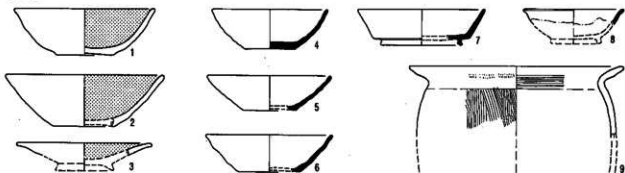

SB 17

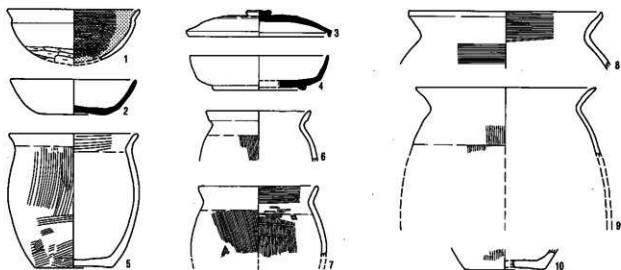

SB 18

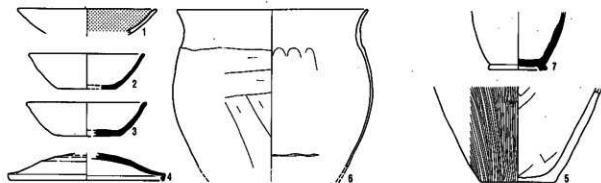

SB 19

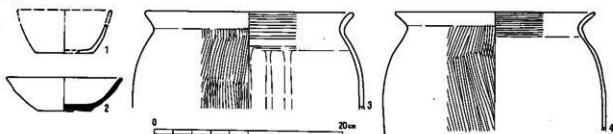

SB 20

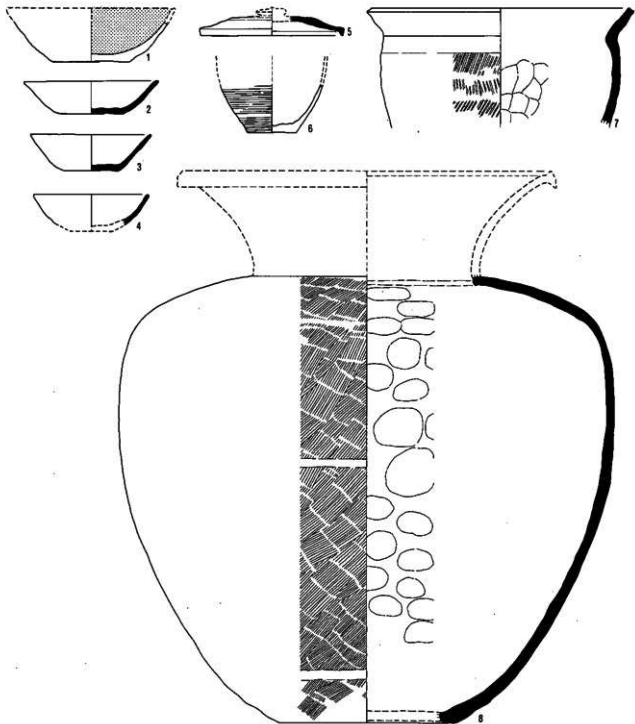

SB 21

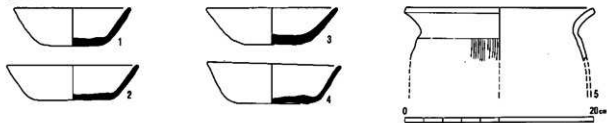

SB20·21

SB 22

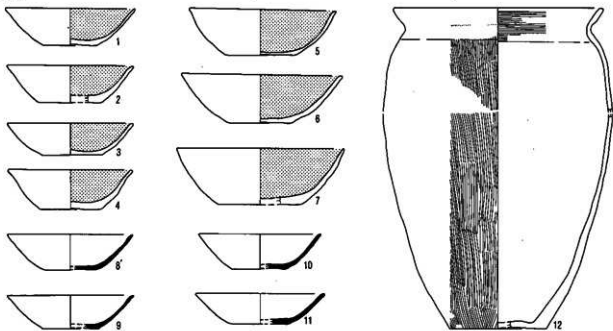

SB 23

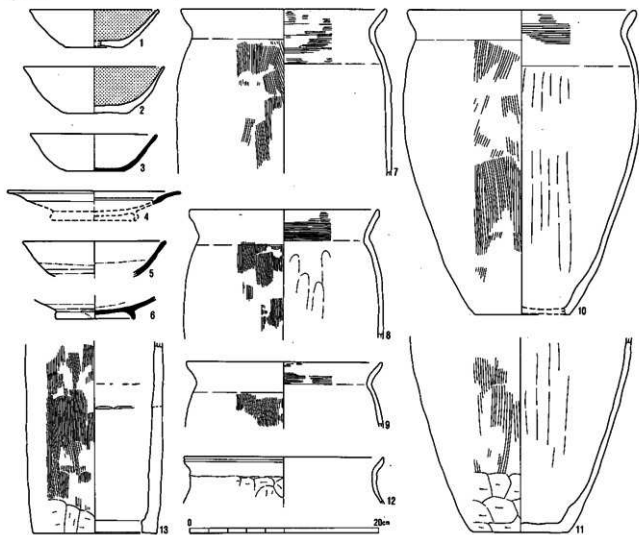

SB22·23

SB 24

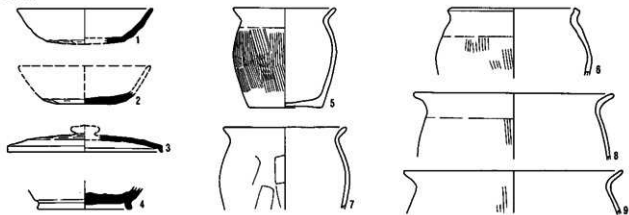

SB 25

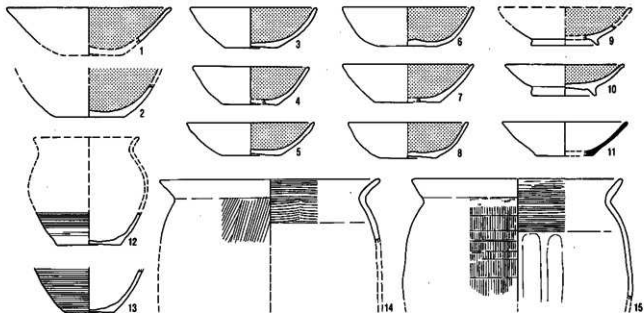

SB 26

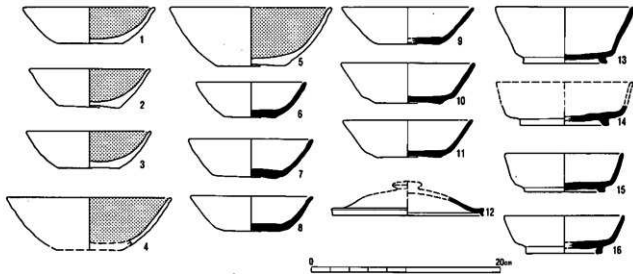

SB 26

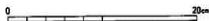
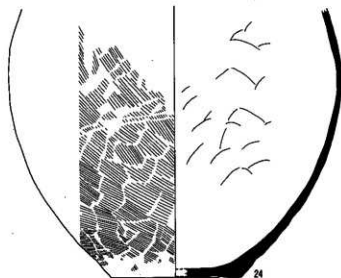
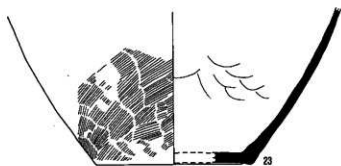
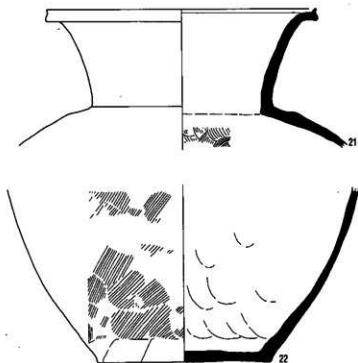
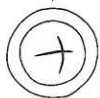
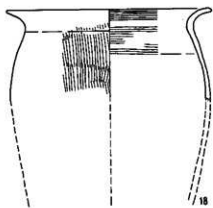
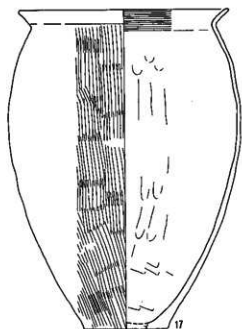

SB26

SB 27

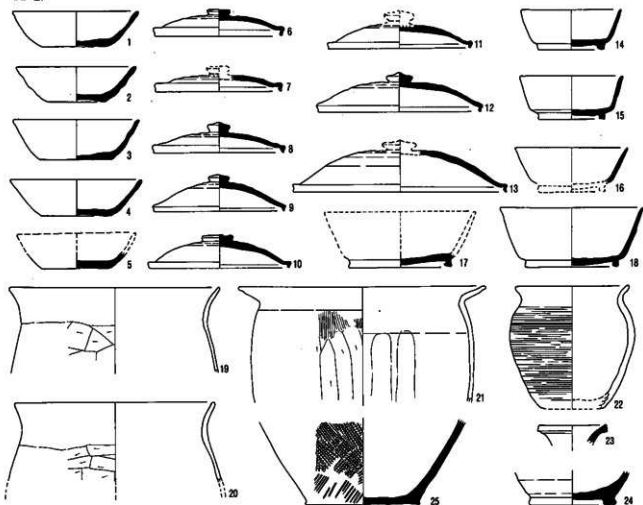

SB 29

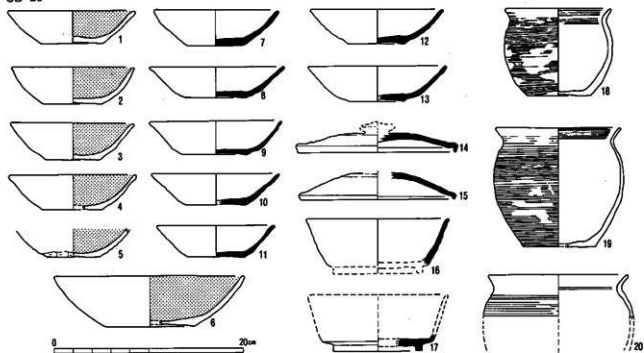

SB27-29

SB 29

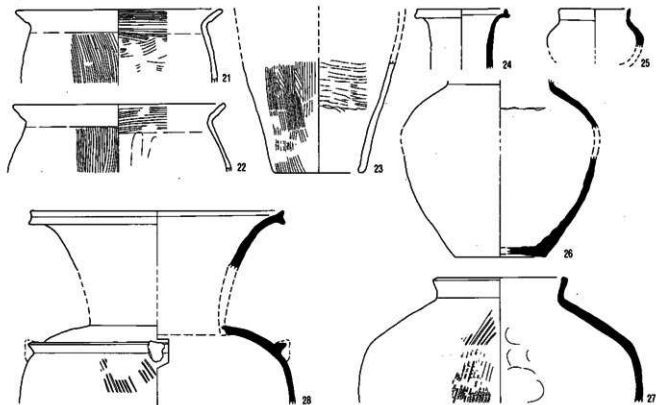

SB 31

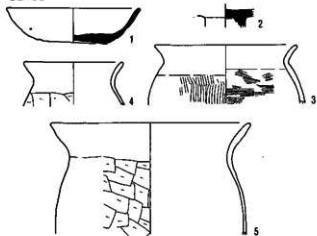

SB 32

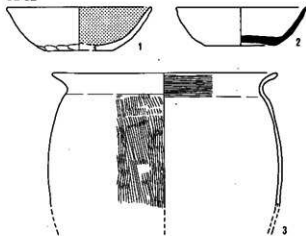

SB 33

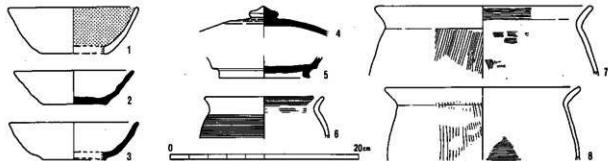

SB29·31·32·33

SB 34

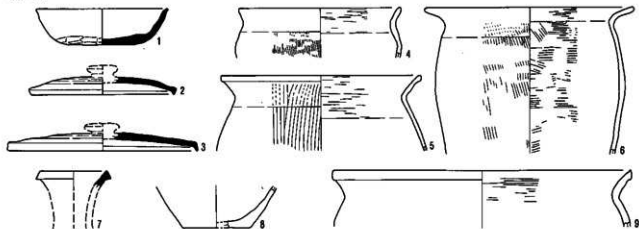

SB 36

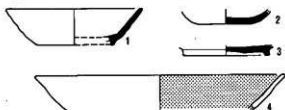

SB 37



SB 38

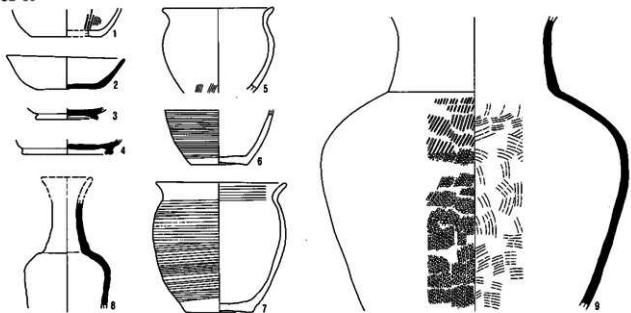

SB 39

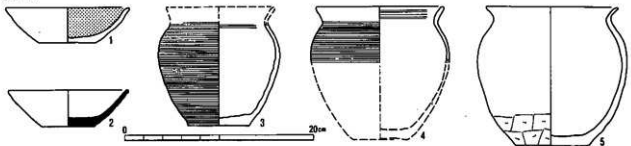

SB 39

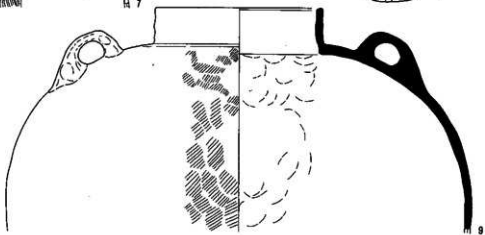
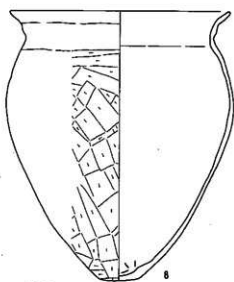
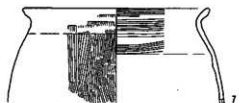
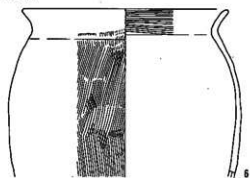

SB 40

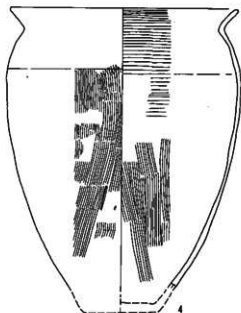
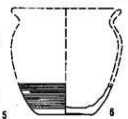
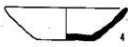
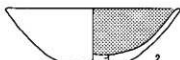
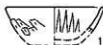

SB 42



SB39·40·42

SB 43

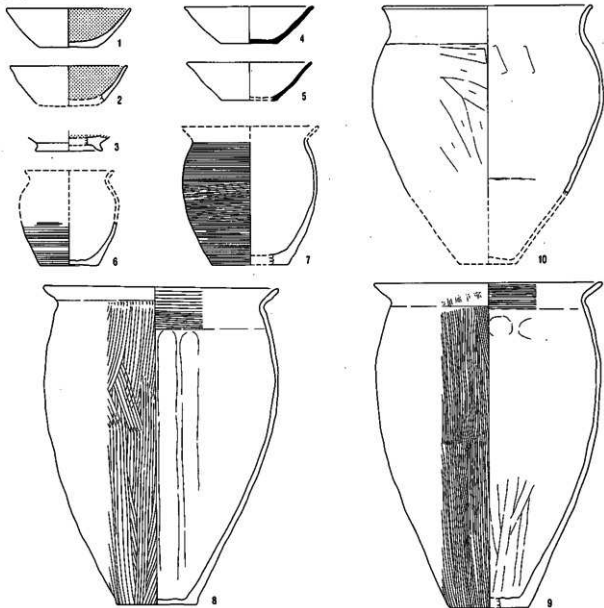

SB 44

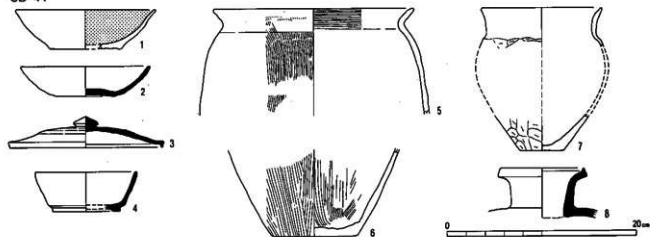

SB43-44

SB 44

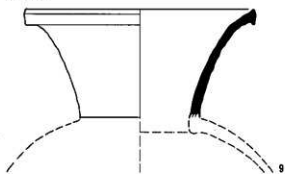

SB 45

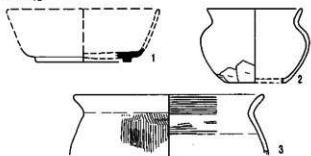

SB 46

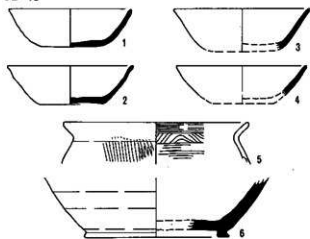

SB 47

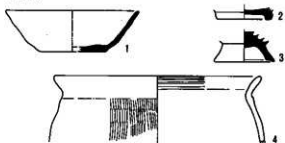

SB 48

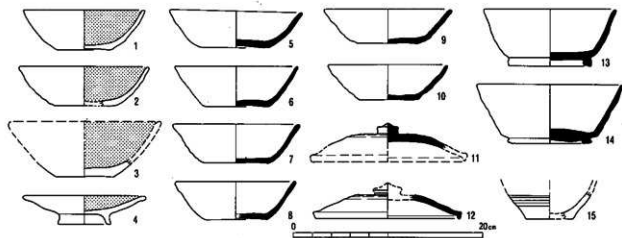

SB44·45·46·47·48

SB 48

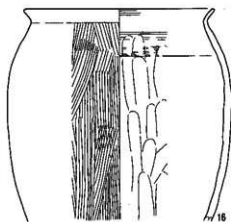
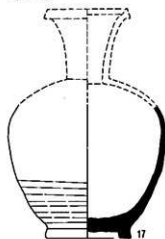

SB 49

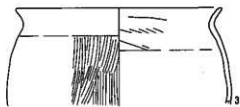

SB 50

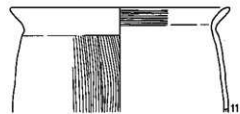
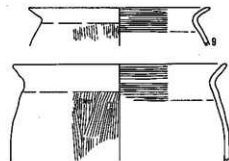
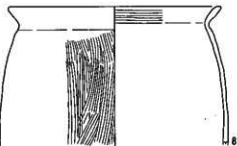
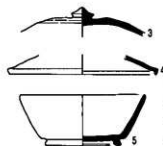

SB 51

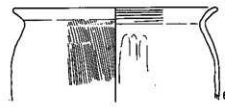
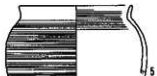

SB 52

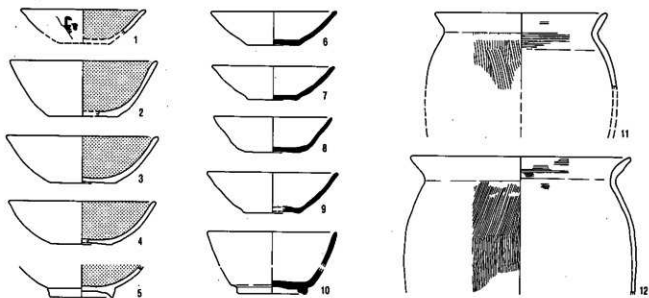

SB 53

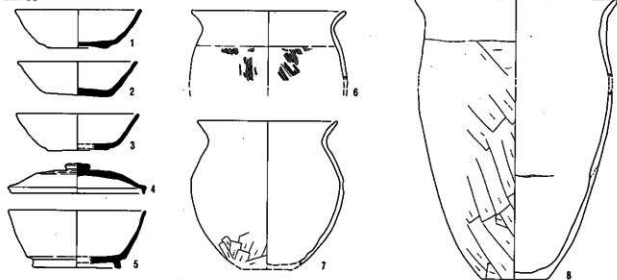

SB 54

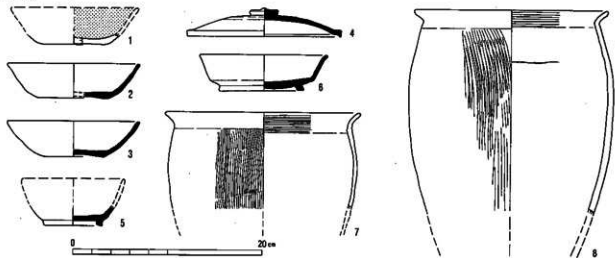

SB 55

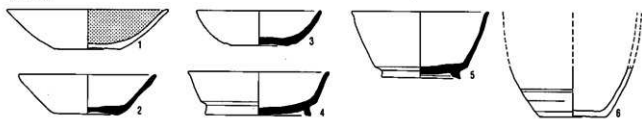

SB 56

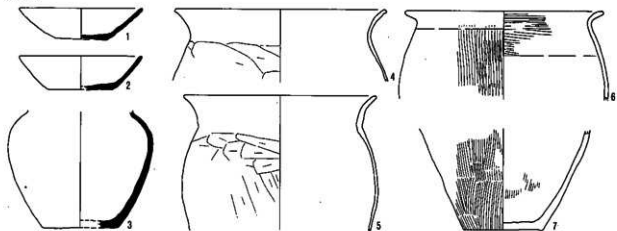

SB 57

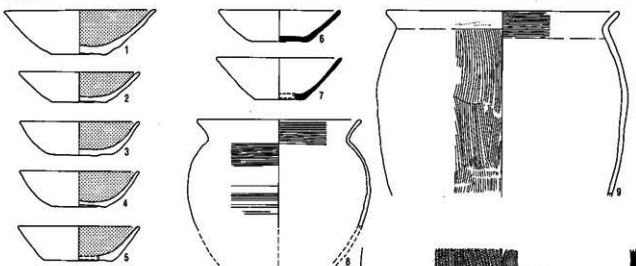

SB 58

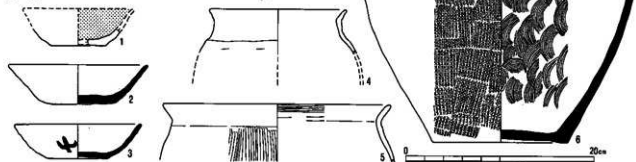

SB 59

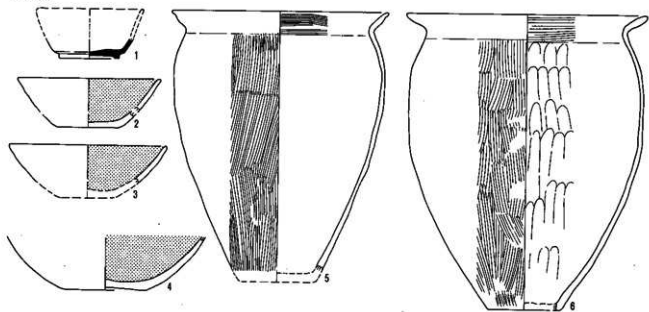

SB 60

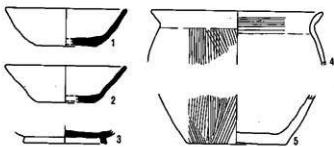

SB 61

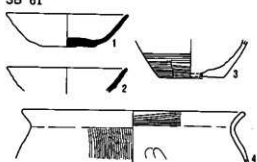

SB 62

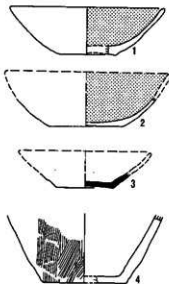

SB 63

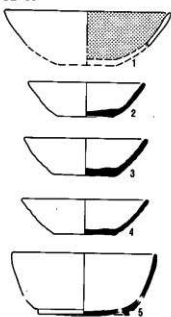

SB 64

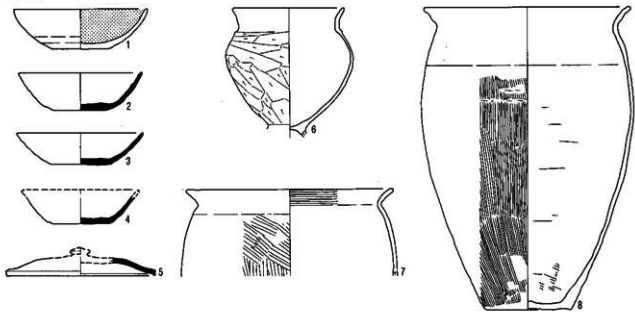

SB 65

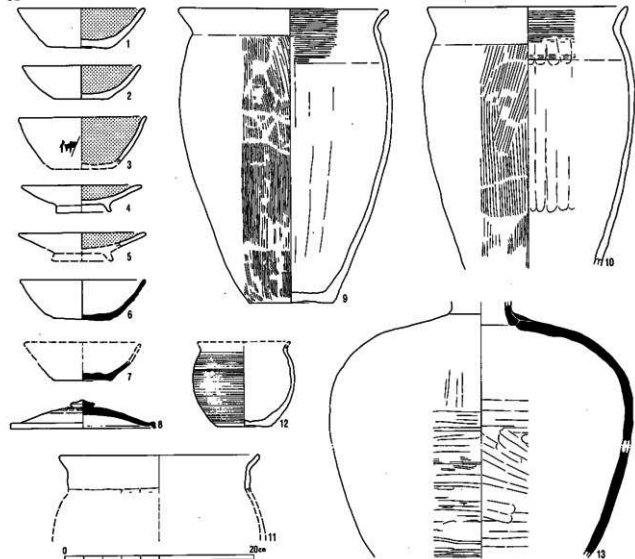

SB64・65

SB 66

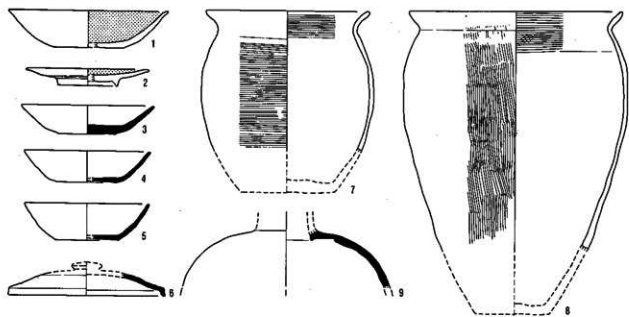

SB 67

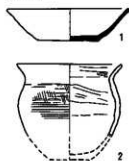

SB 70

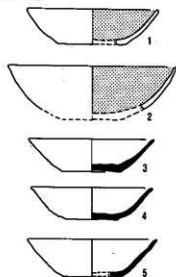

SB 71

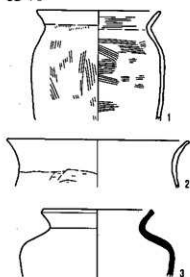

SB 69



SB 68

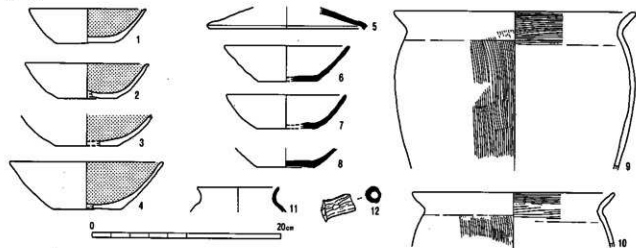

SB 72

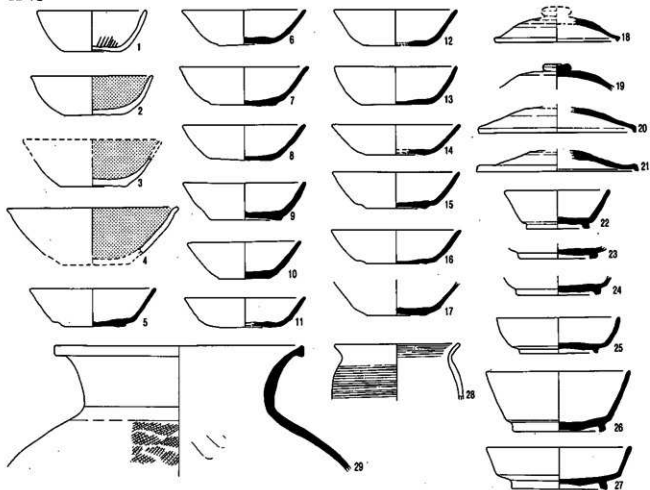

SB 73

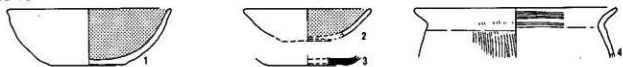

SB 74

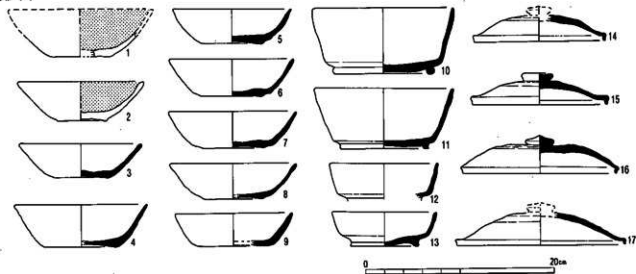

SB 76

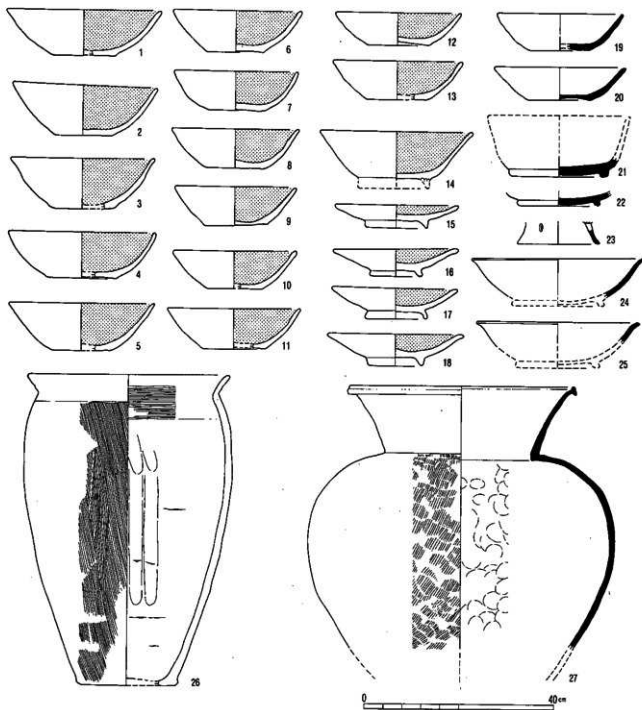

SB 77

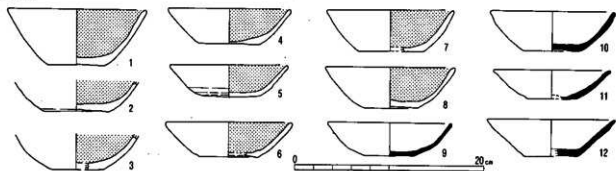

SB76-77

SB 77

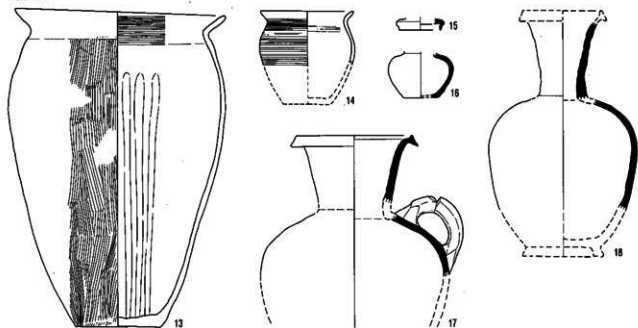

SB 78

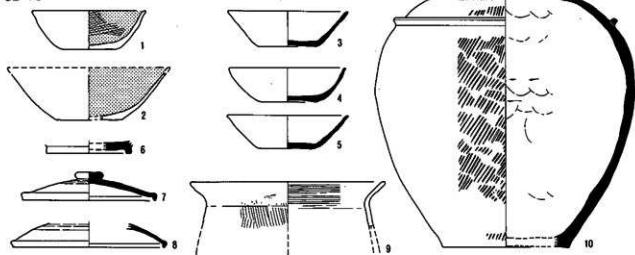

SB 82

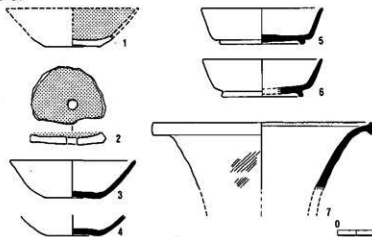

SB 83

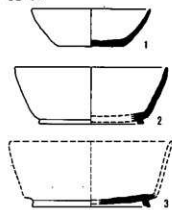

0 20cm

SB77·78·82·83

SB 84

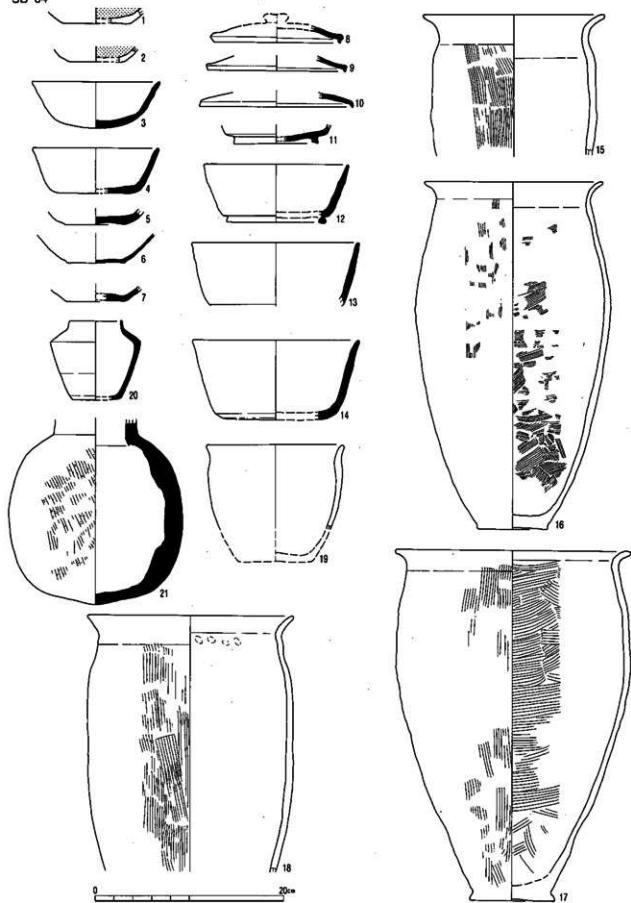

SB84

SB 85

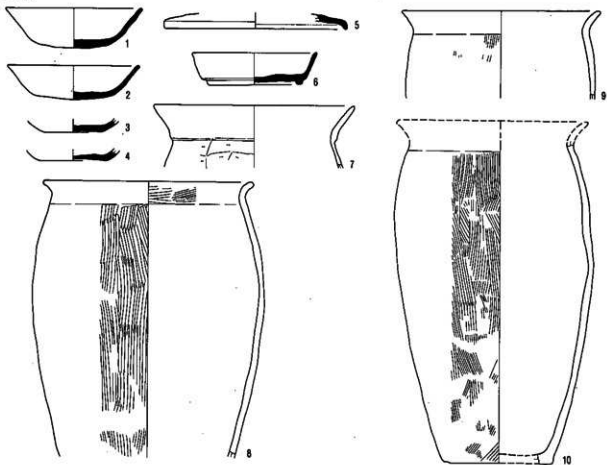

SB 87

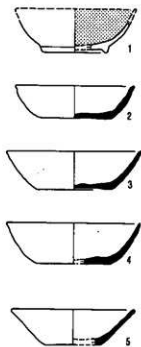

SB 88

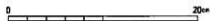
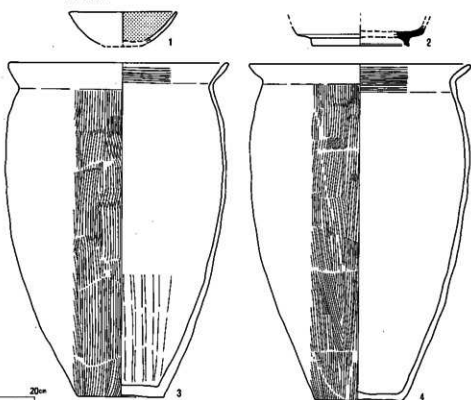

SB85-87-88

SB 89

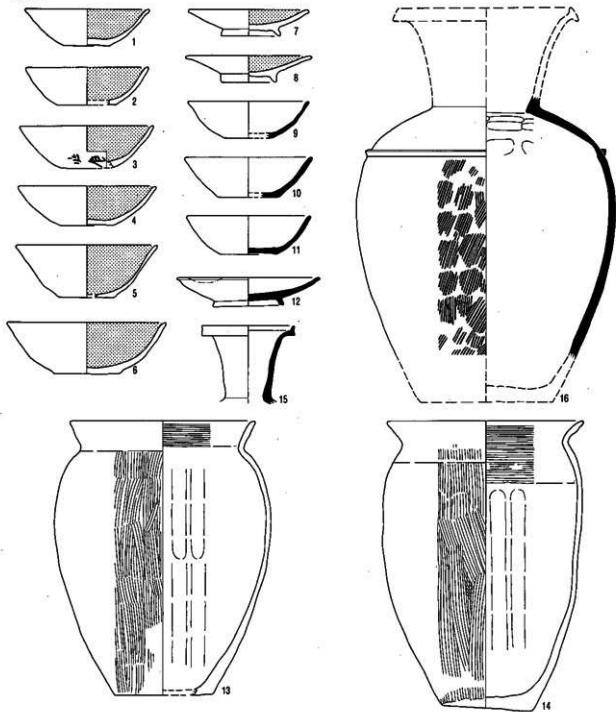

SB 90

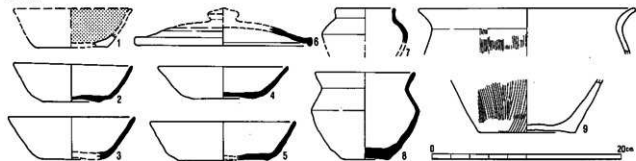

SB 91

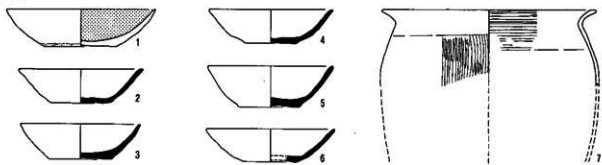

SB 92

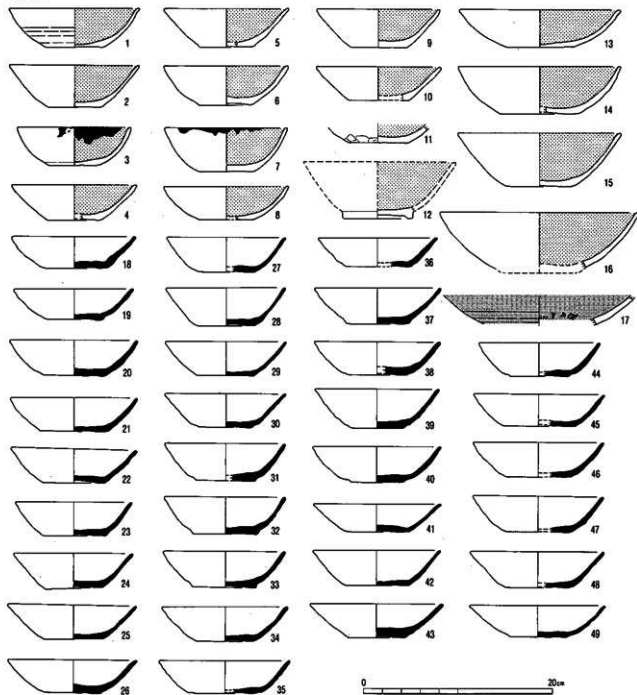

SB 92

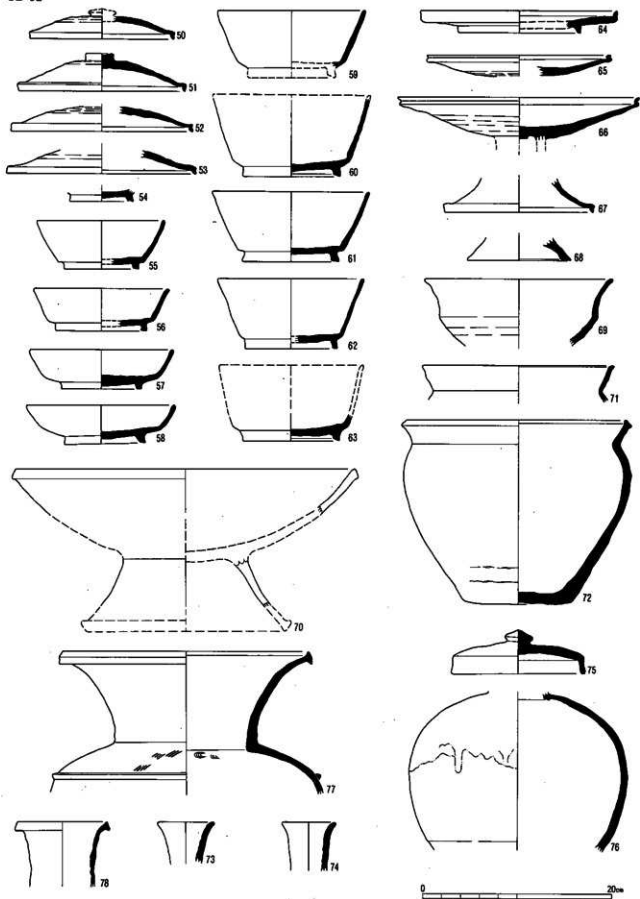

SB92

SB 92

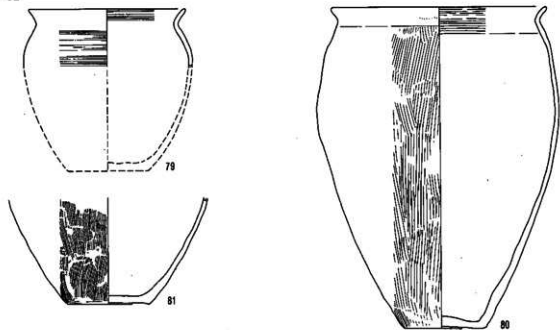

SB 93

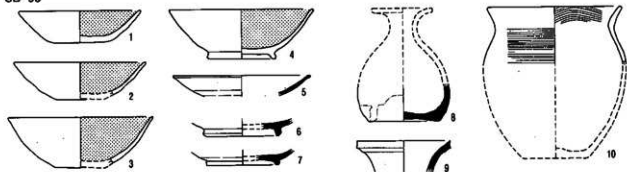

SB 95

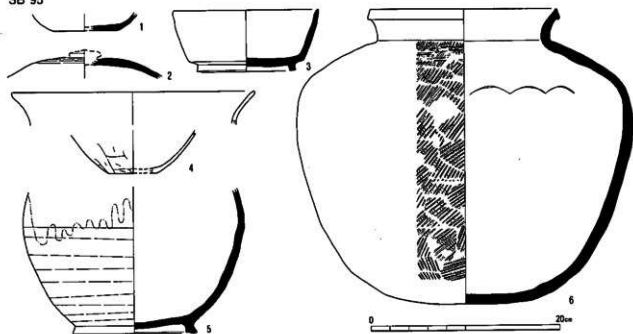

SB 96

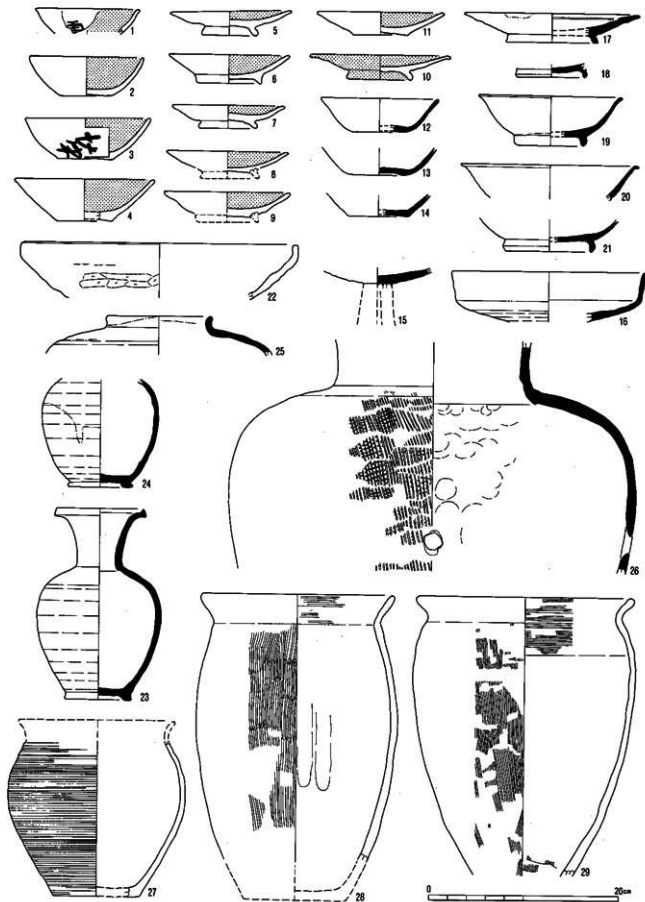

SB96

SB 97 上層

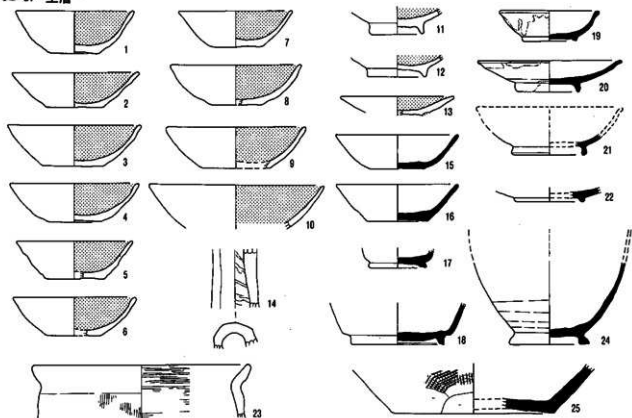

SB 97 下層

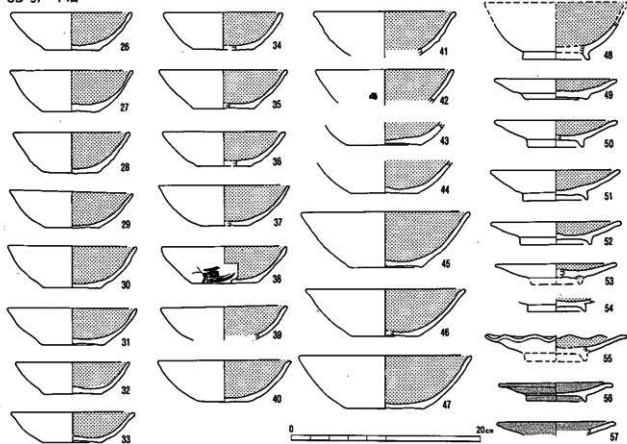

SB 97 下层

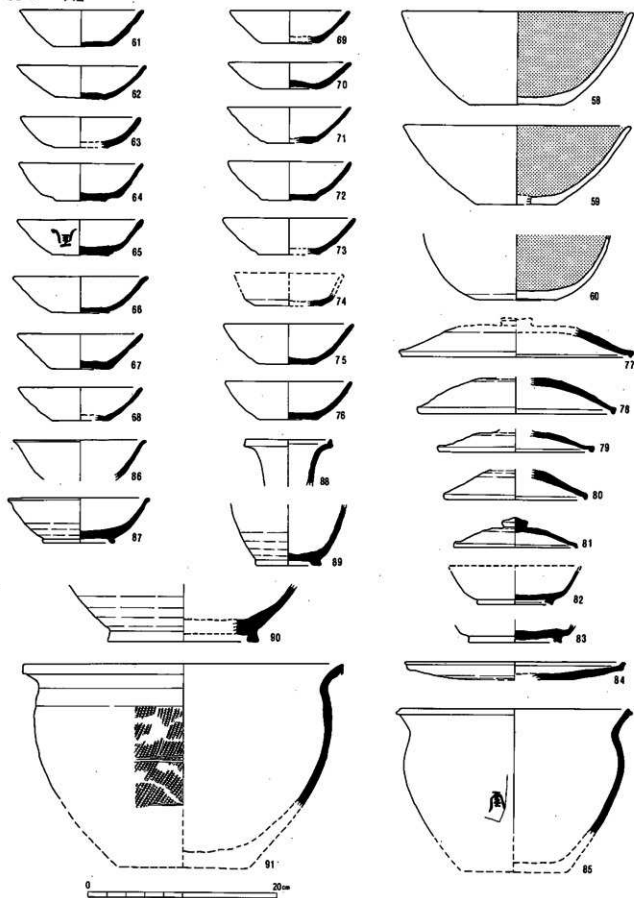

SB 97 下層

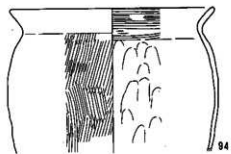
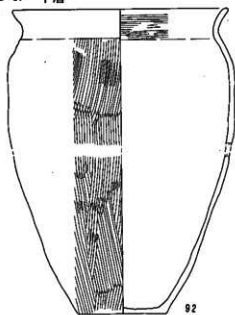

SB 99

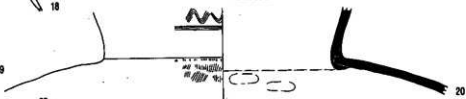
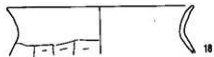
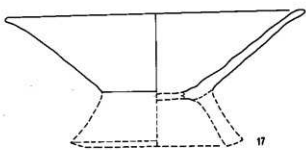
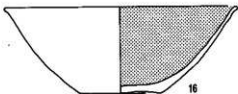
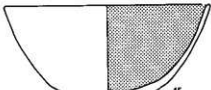
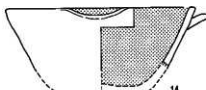
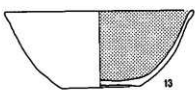
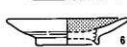
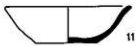
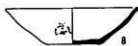
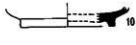
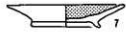
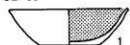

SB97・99

SB 100

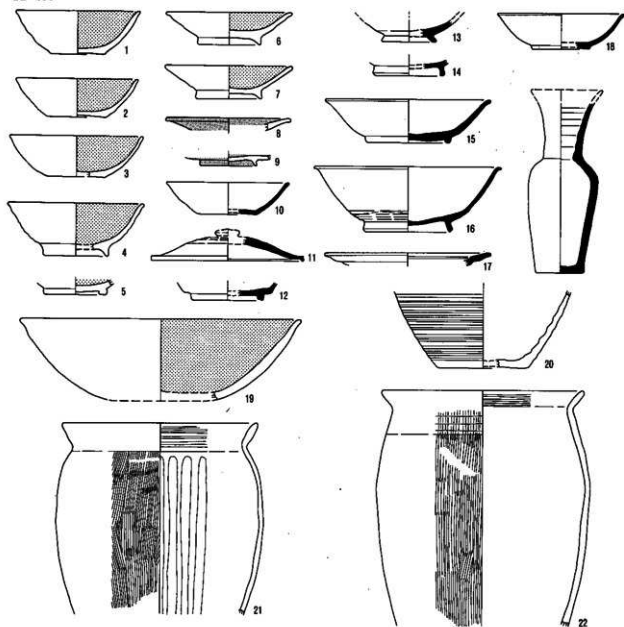

SB 101

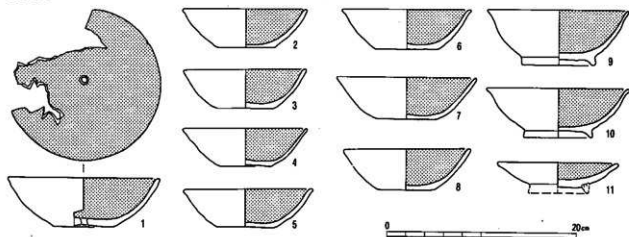

SB100-101

SB 101

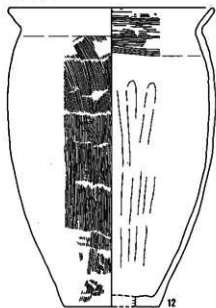

SB103

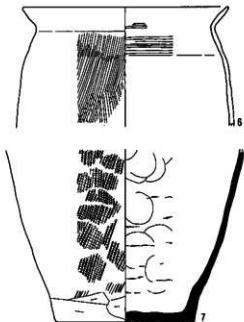
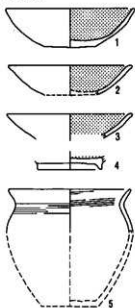

SB 102

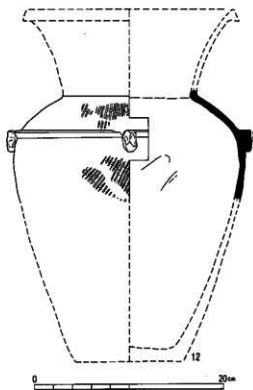
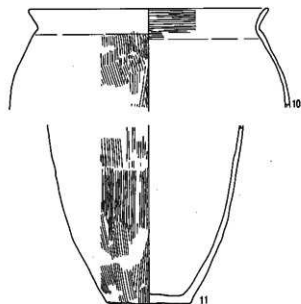
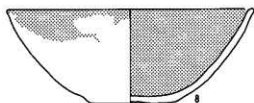
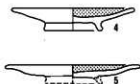
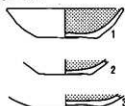

SB 104

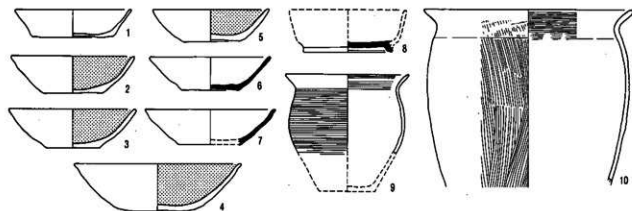

SB 105

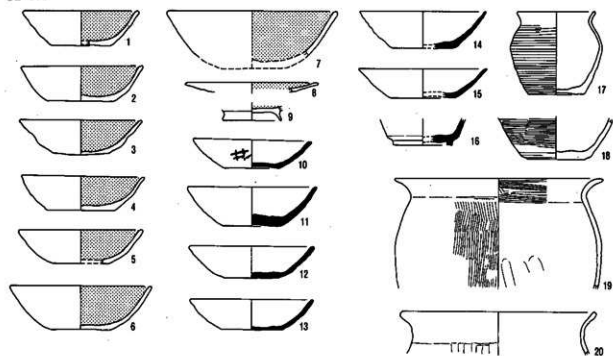

SB 106

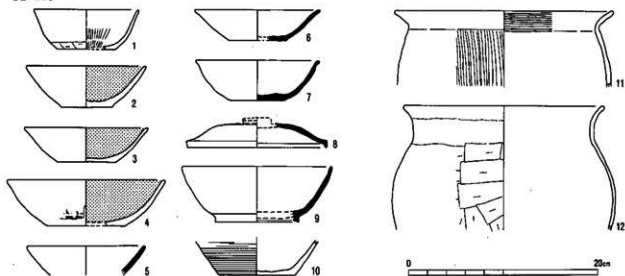

SB 107



SB 108

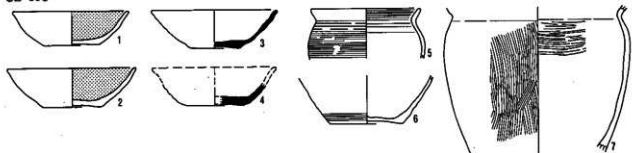

SB 109

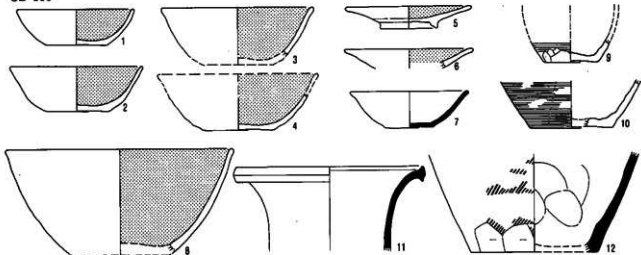

SB 110

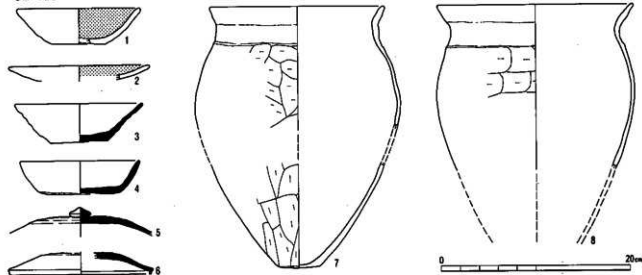

SB107・108・109・110

SB 110

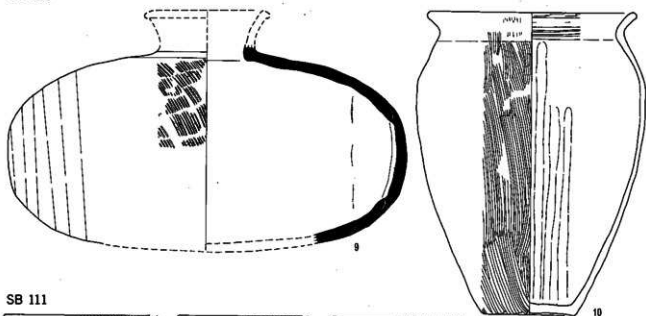

SB 111

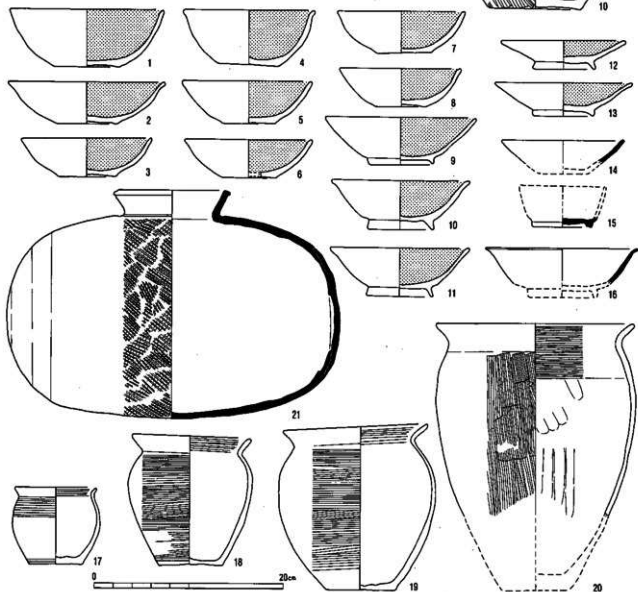

SB110-111

SB 112

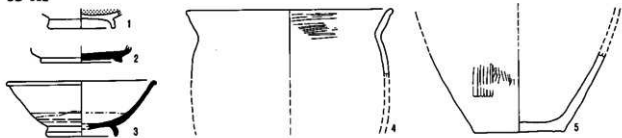

SB 114

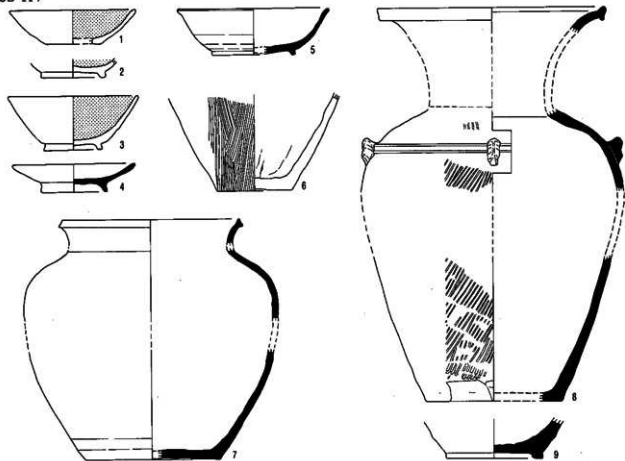

SB 115

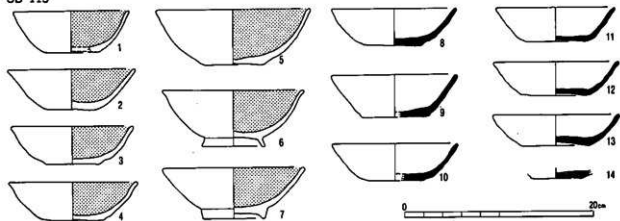

SB112-114-115

SB 115

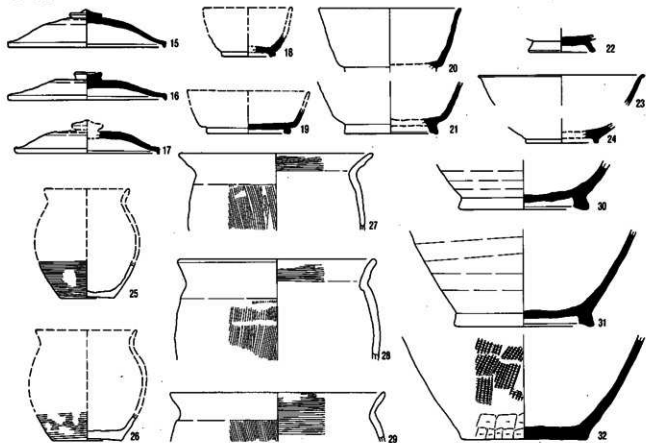

SB 116

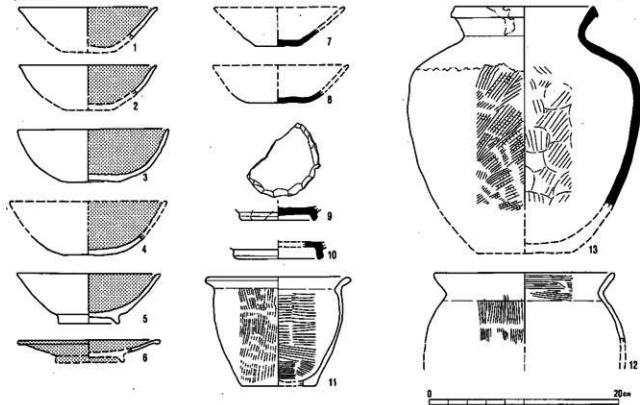

SB 117

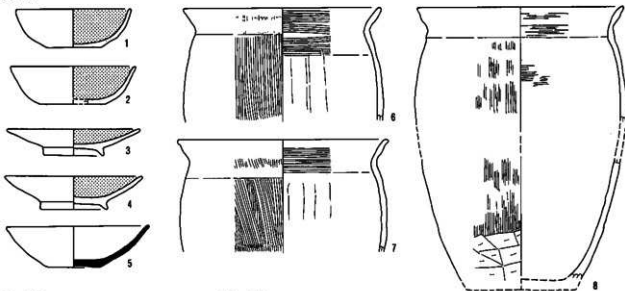

SB 118

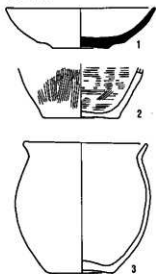

SB 119

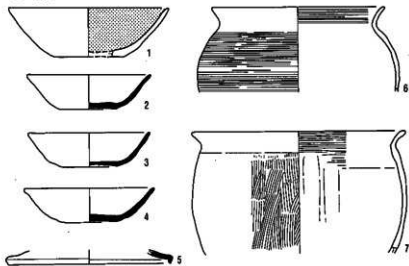

SB 120

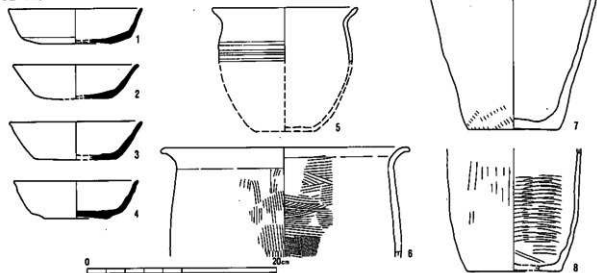

SB117・118・119・120

SB 121

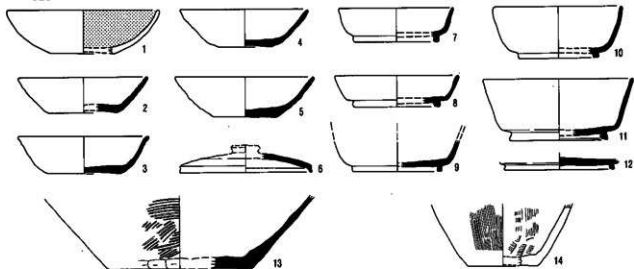

SB 122

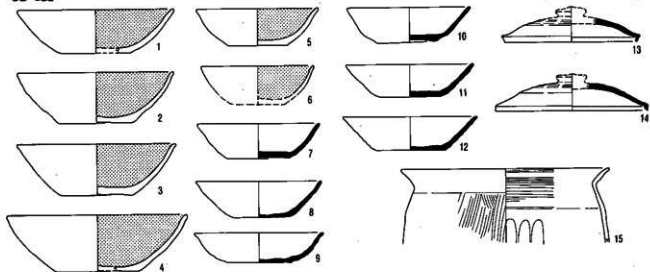

SB 123

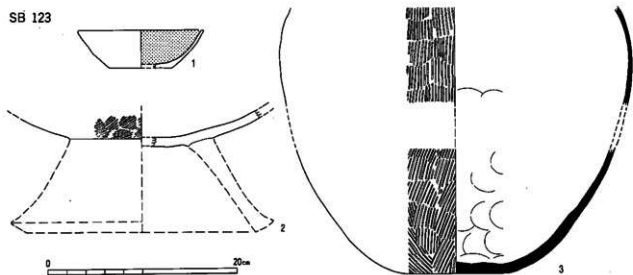

SB 124

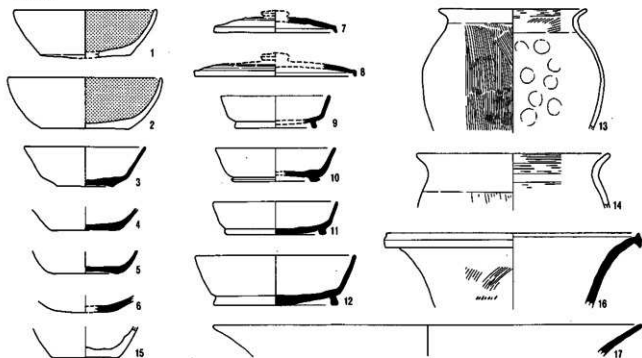

SB 125

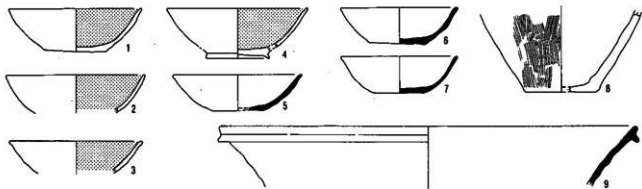

SB 127

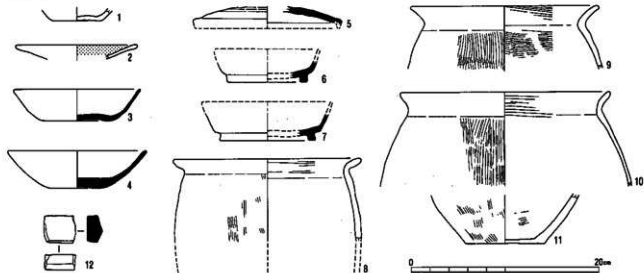

SB 126

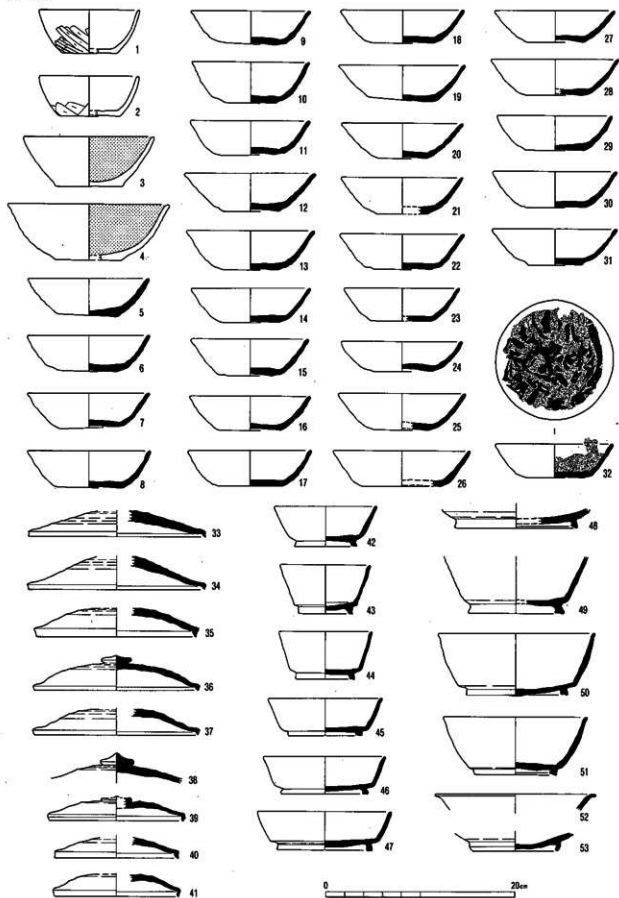

SB126

SB 126

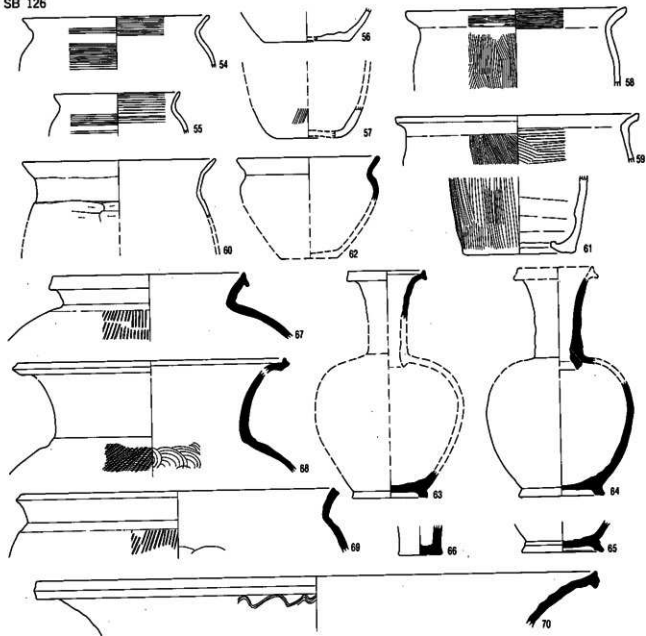

SB 128

SB 129

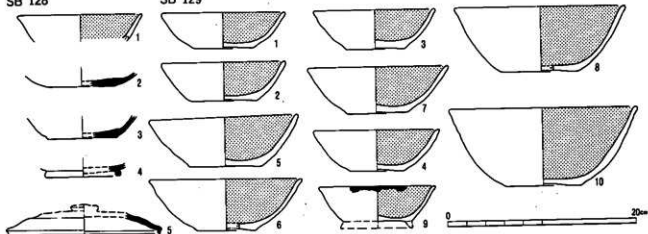

SB 130

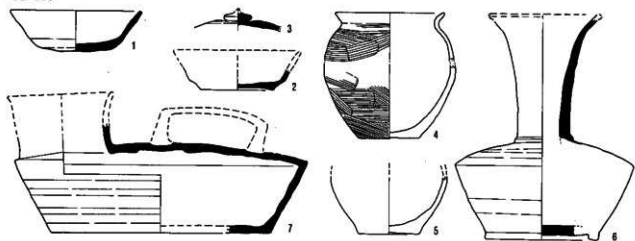

SB 131

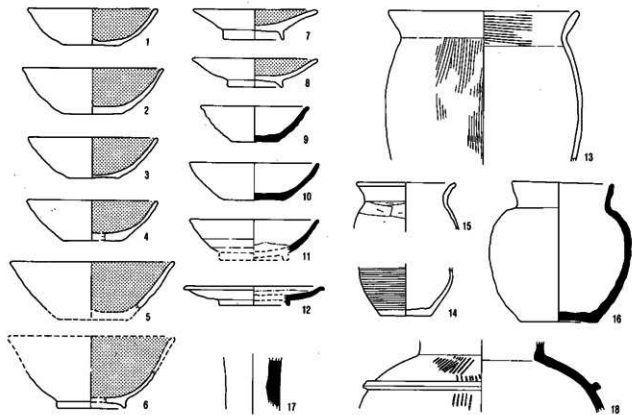

SB 132

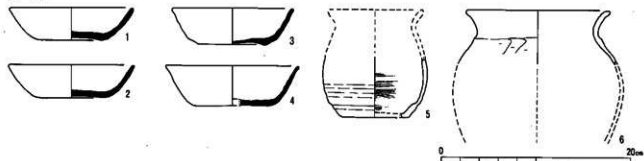

SB 133

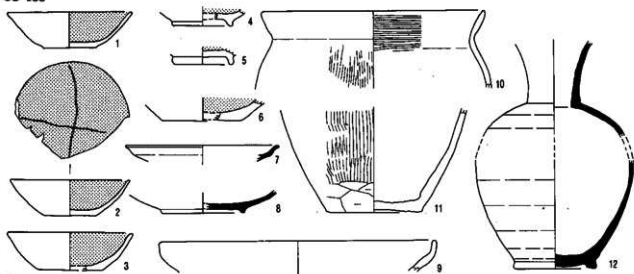

SB 134

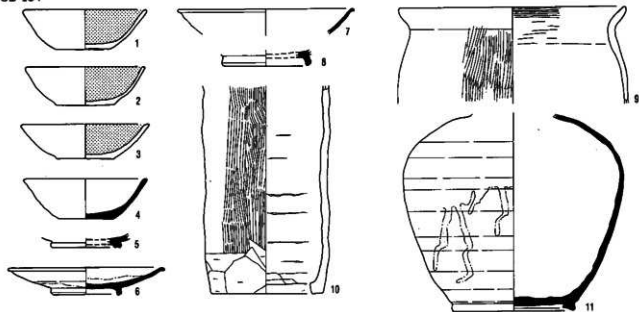

SB 135

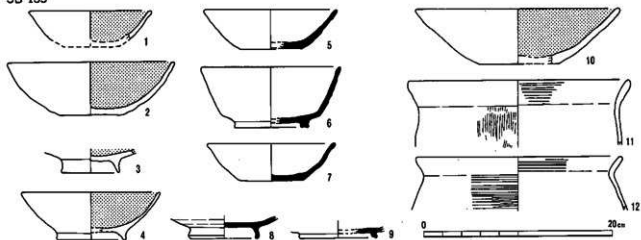

SB 136

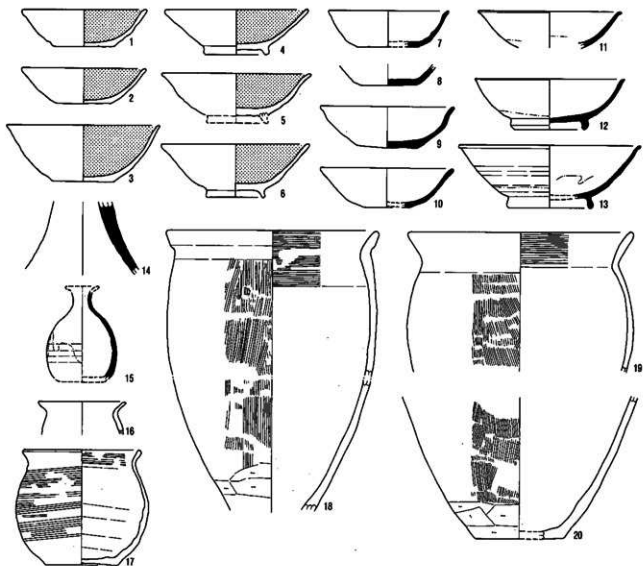

SB 138

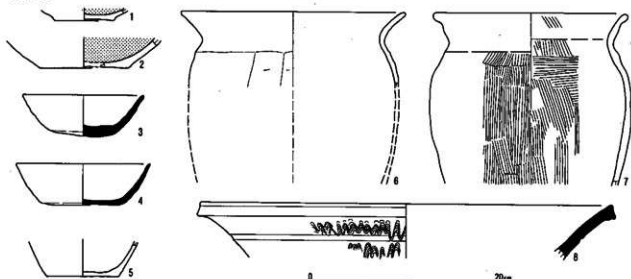

0 20cm

SB136·138

SB 139

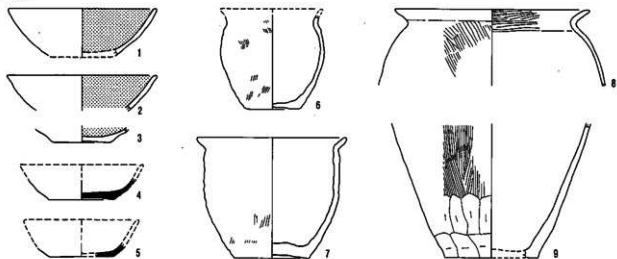

SB 140

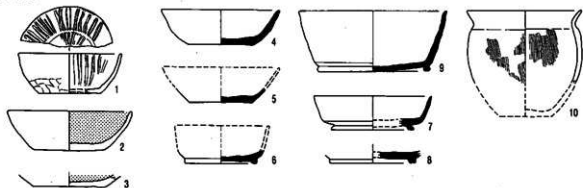

SB 141

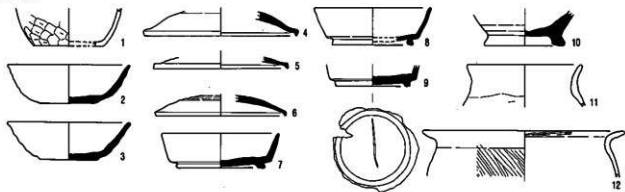

SB 142

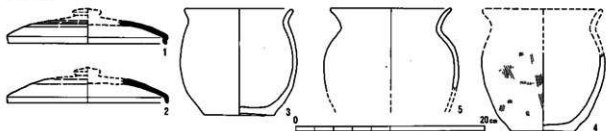

SB 143

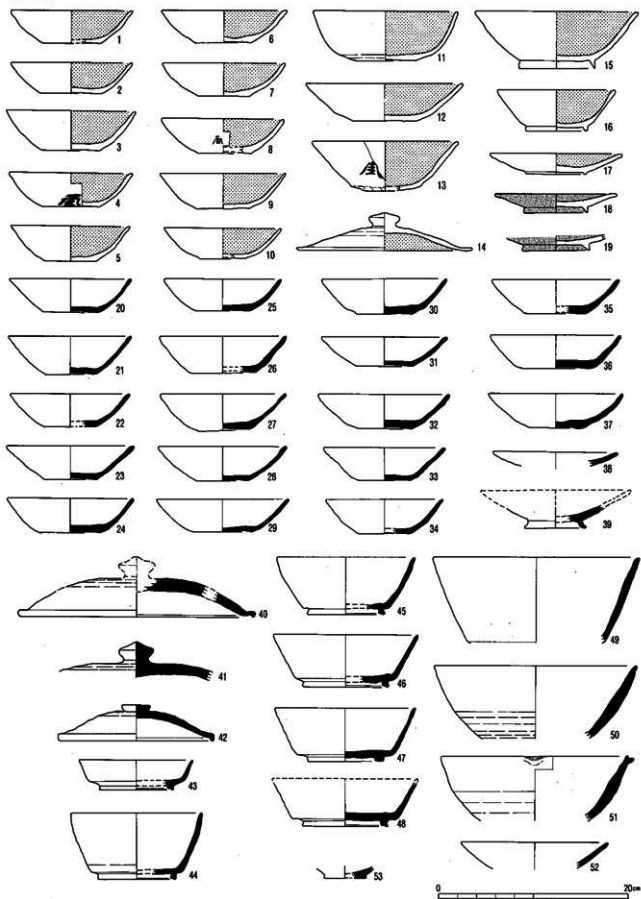

SB143

SB 143

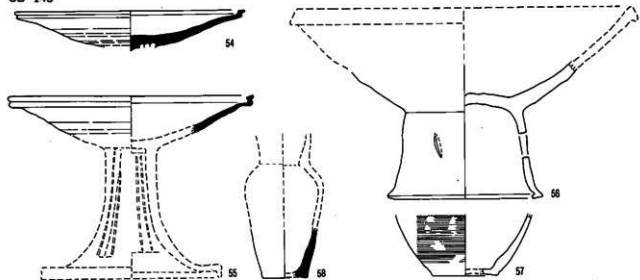

SB 144

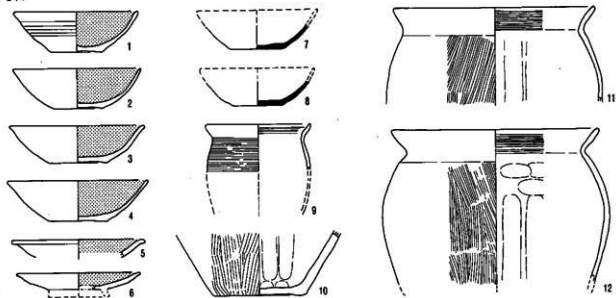

SB 145

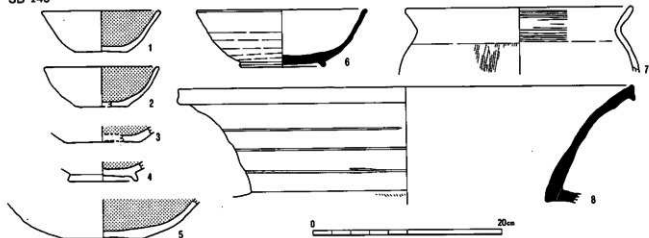

SB 146

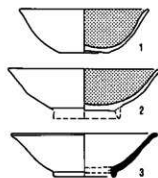

SB 147

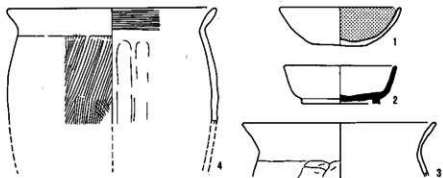

SB 148

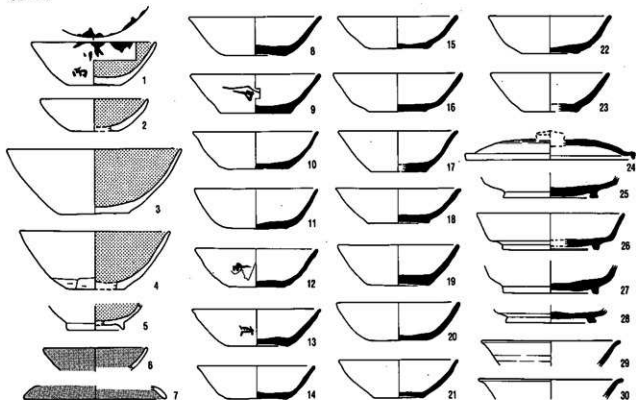

SB 149

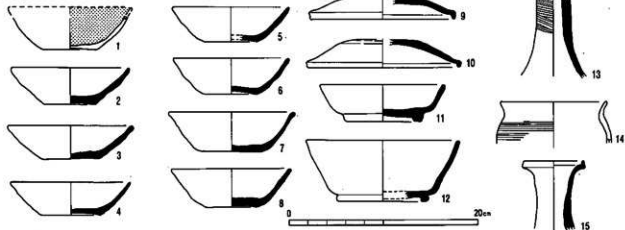

SB 150

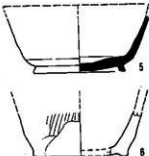
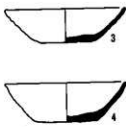
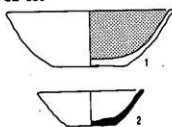

SB 151

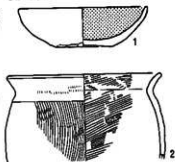

SB 152

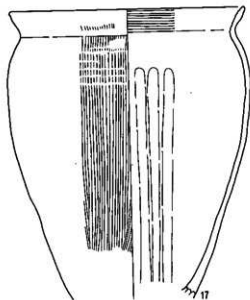
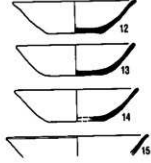
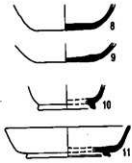
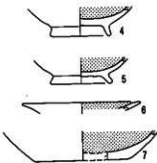
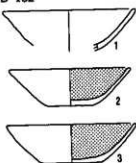

SB 153

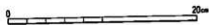
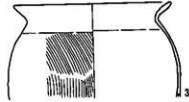
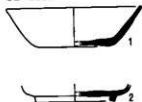

ST 3

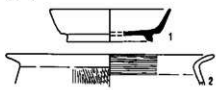

ST 8



ST 6

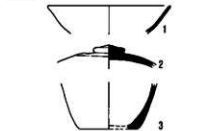

ST 111

ST 7



ST 9



ST 12



ST 17



ST 21



ST 30



ST 101



ST 102



ST 105



ST 108

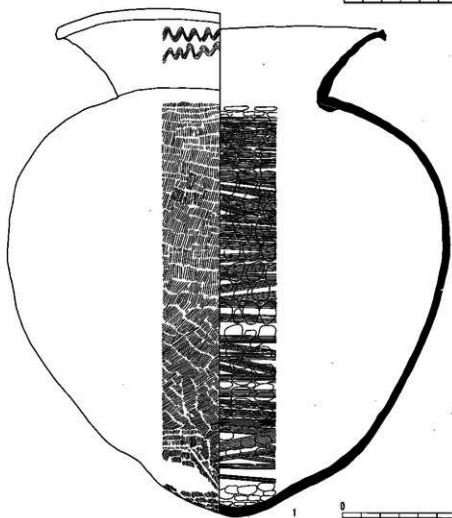
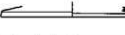

ST 111

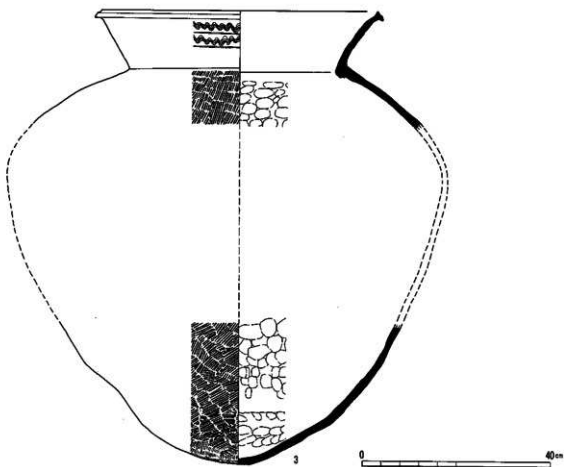
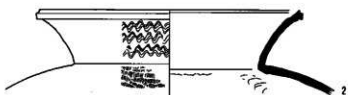
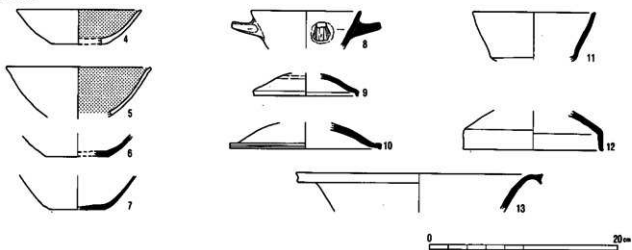

ST111

ST 113

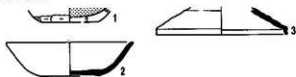

ST 123



区画沟 I (南北沟 1 层)

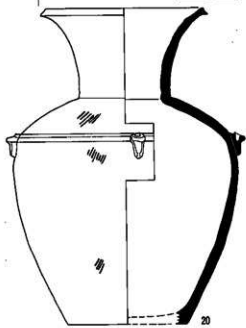
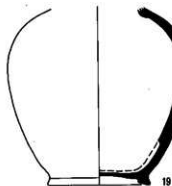
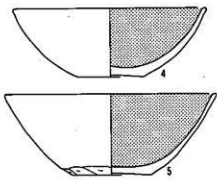
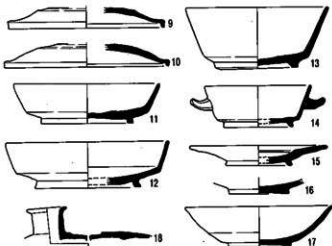
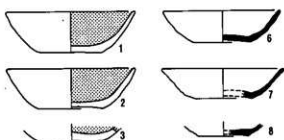

区画沟 I (南北沟 2 层)

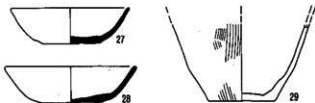
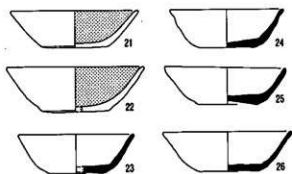

区画溝 I (南北溝 3層)

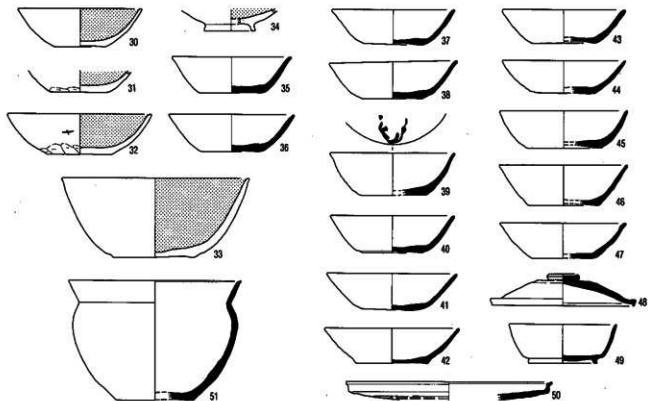

区画溝 I (南北溝 7層)

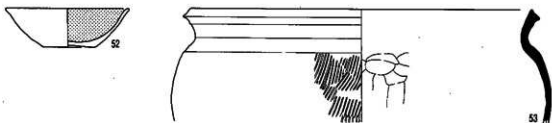

区画溝 I (南北溝その他)

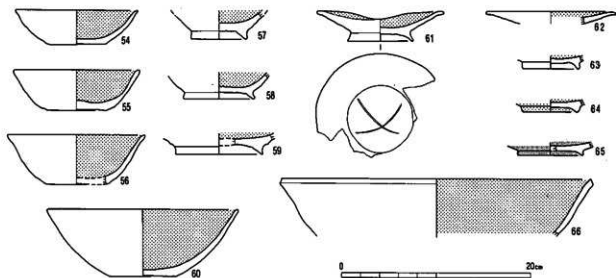

区画溝 I (南北溝 3・7層・その他)



区画溝 I (南北溝その他)

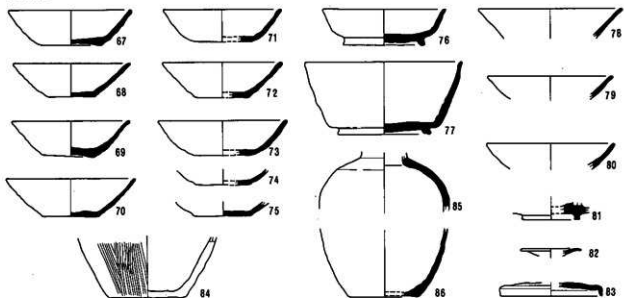

区画溝 I (東西溝1層)

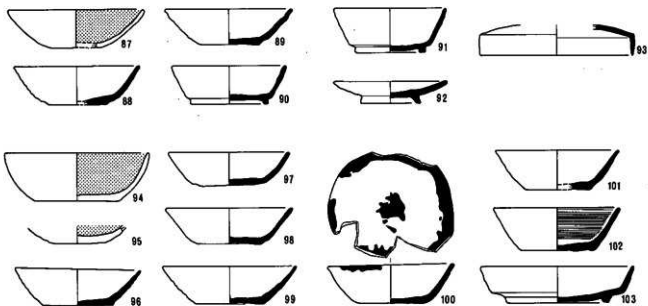

区画溝 I (東西溝3層)

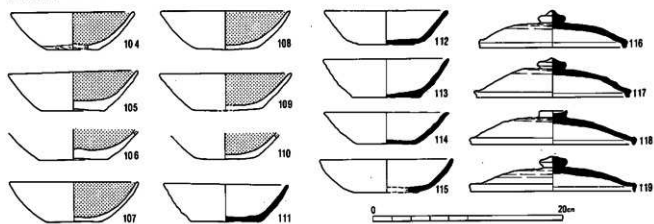

0 20cm

区画溝 I (東西溝 3層)

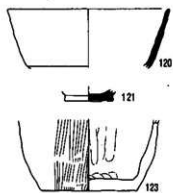

区画溝 I (東西溝 4層)

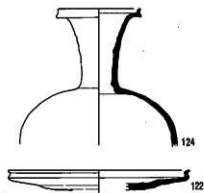
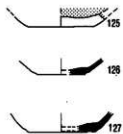

区画溝 II (南北溝)

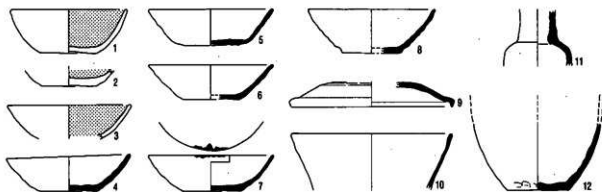

区画溝 III (東西溝 1層)

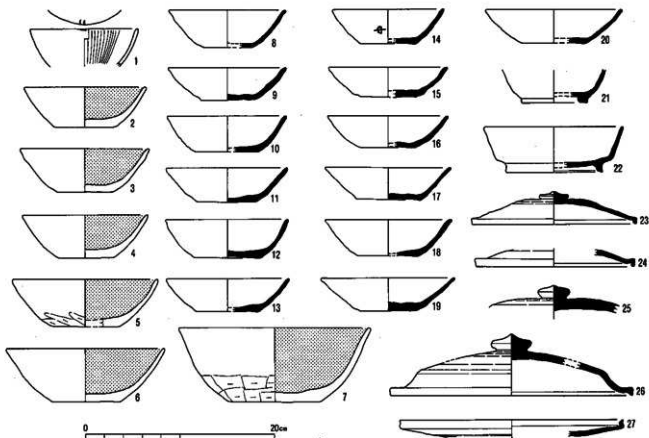

区画溝 I (東西溝 3-4層)・II (南北溝)・III (東西溝 1層)

区画溝Ⅲ (東西溝その他)

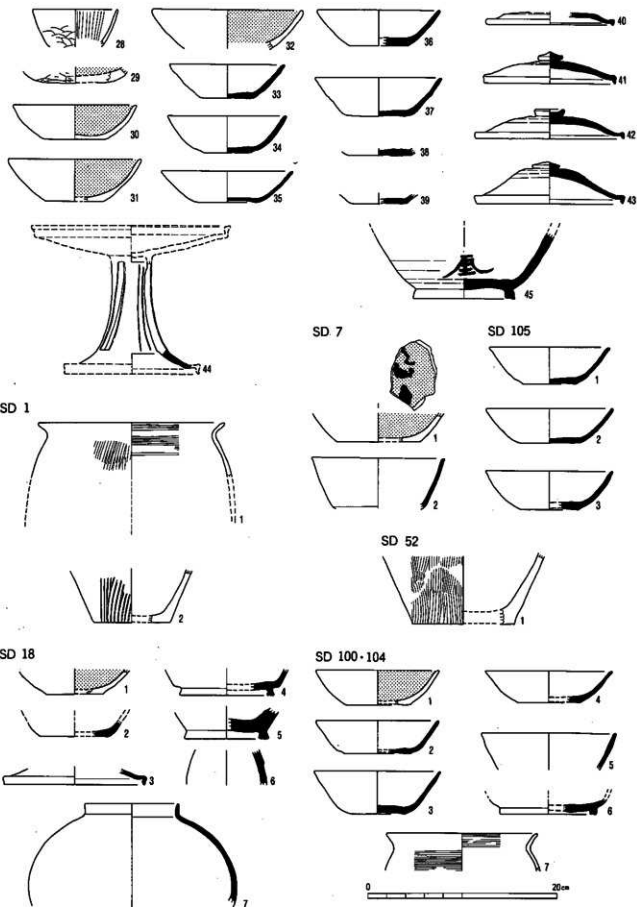

SD 108 (1区2册)

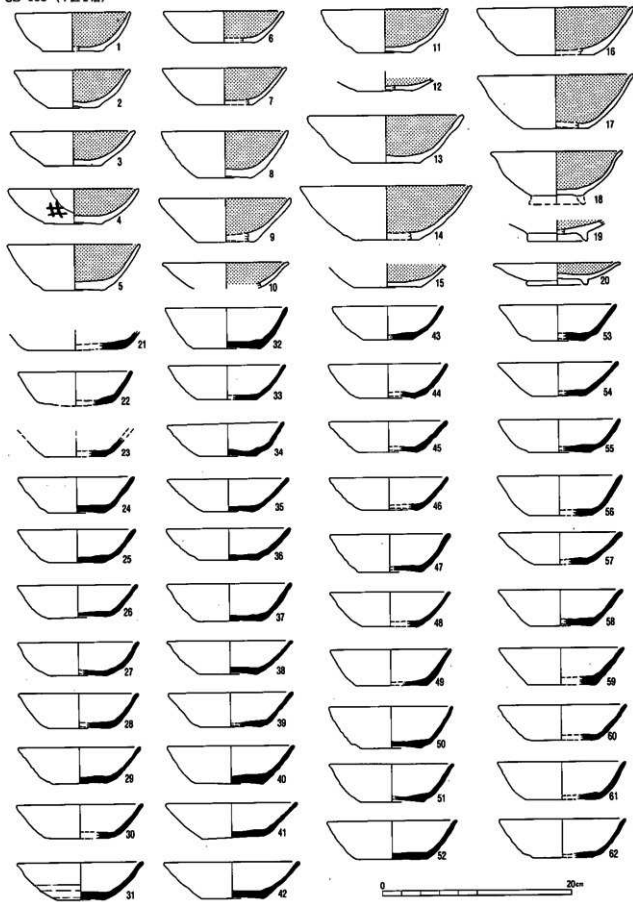

SD108 (1区2册)

SD 108 (1区2層)

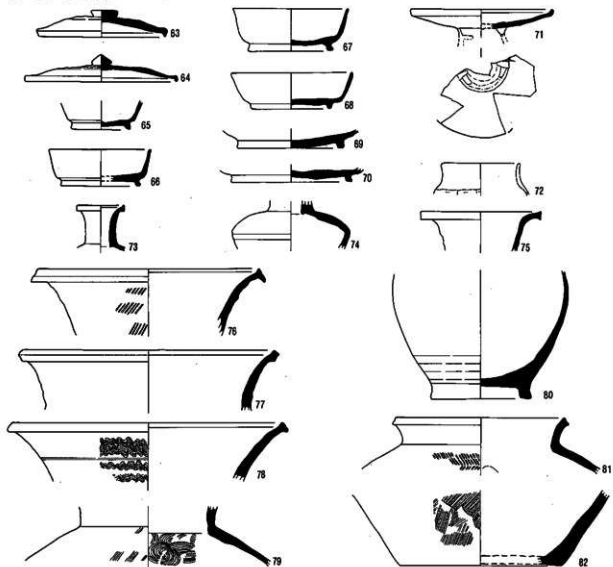

SD 108 (1区3層)

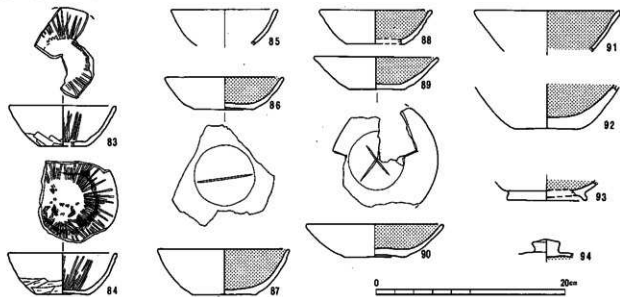

SD108 (1区2-3層)

SD 108 (1区3層)

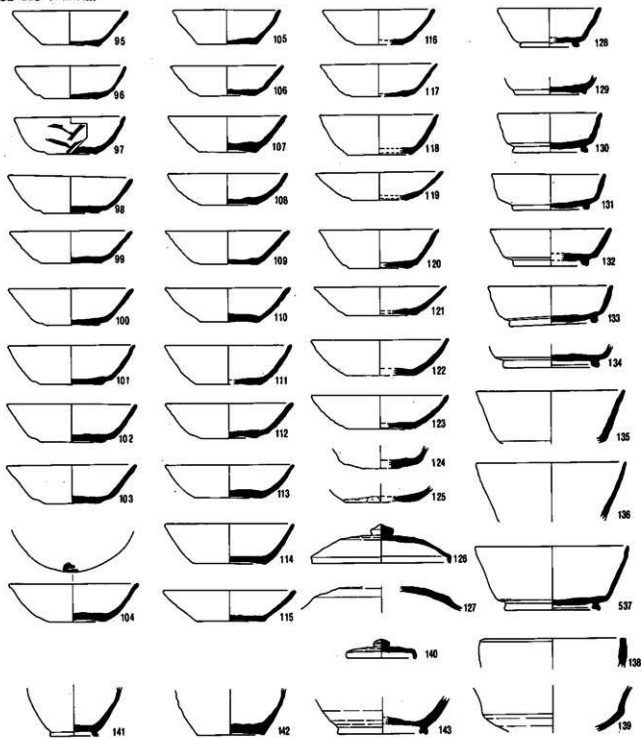

SD 108 (2区1層)

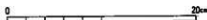
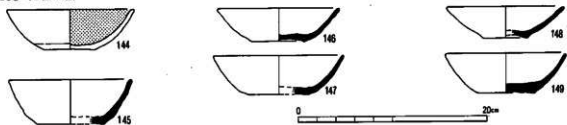

SD108 (1区3層・2区1層)

SD 108 (2区2层)

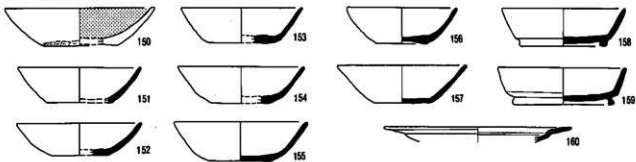

SD 108 (3区2层一括土器)

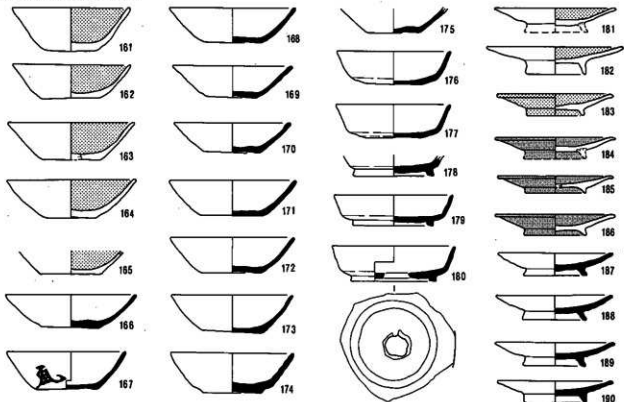

SD 108 (3区2层)

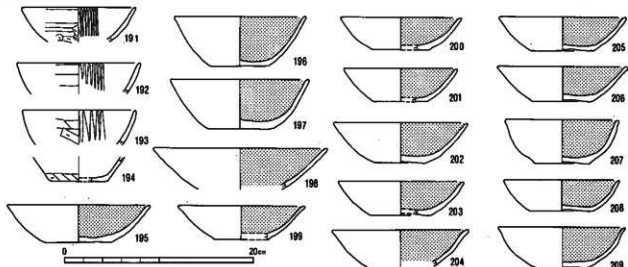

SD 108 (3区2層)

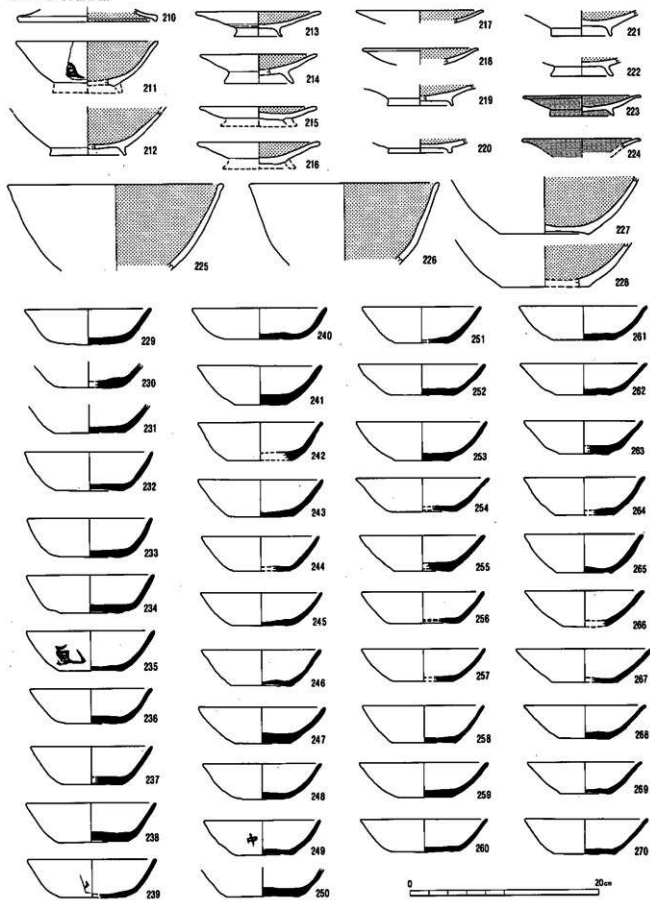

SD108 (3区2層)

SD 108 (3区2层)

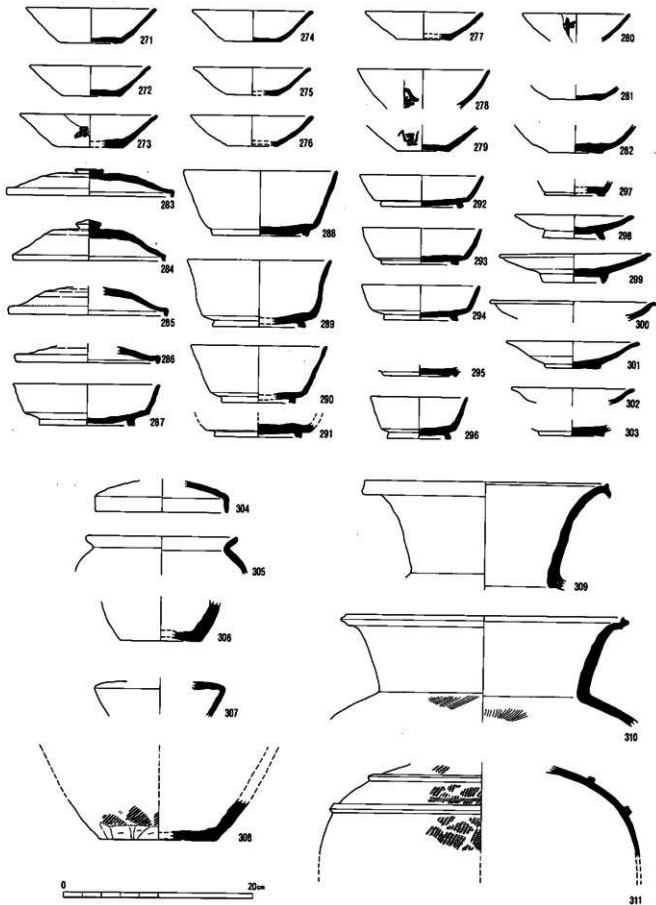

SD108 (3区2层)

SD 108 (3区2層)

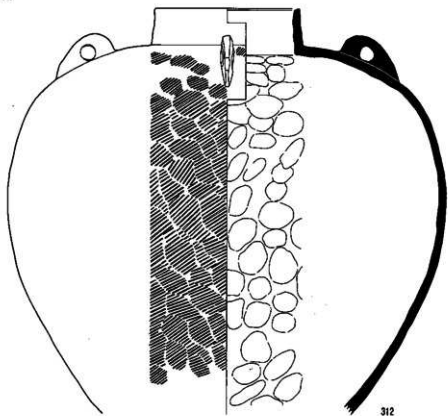

SD 108 (3区枝溝1層)



313



315



314

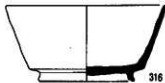

316

SD 108 (4区1層)

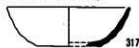

317



319



318



319

SD 108

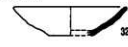

320

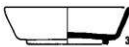

325



330



332



321



326

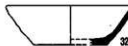

322

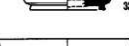

327

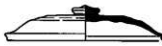

323

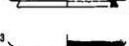

328



331



333



324



329

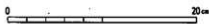

SD108 (3区2層-枝溝1層-4区1層)

SD 108 (4区2層)

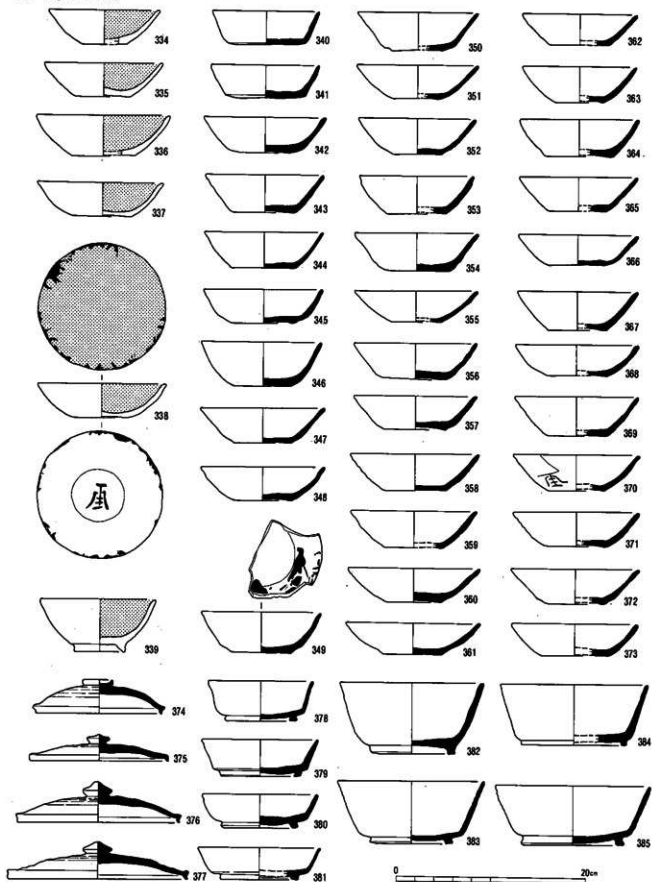

SD108 (4区2層)

SD 108 (4区)

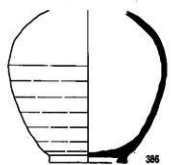

SD 106



SD 110

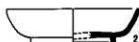

SD 109

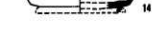
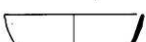
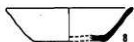
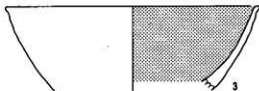
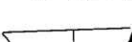
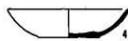
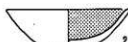

SD 117

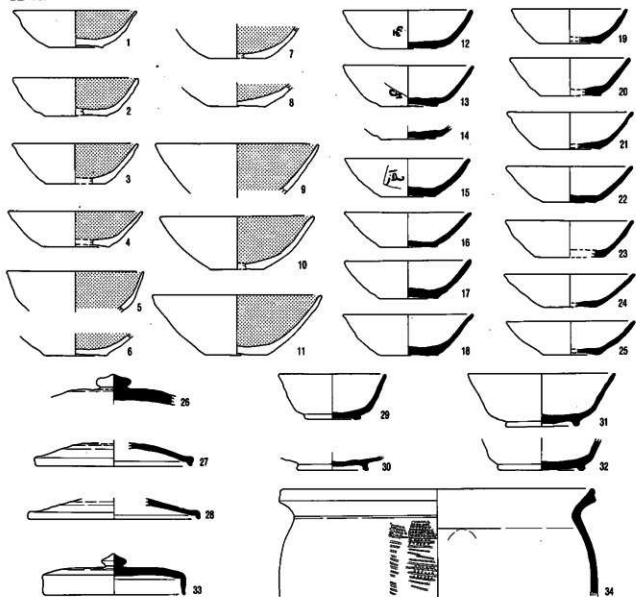

SD 118

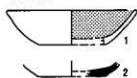

SD 119

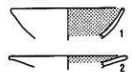

SD 124



SD 128

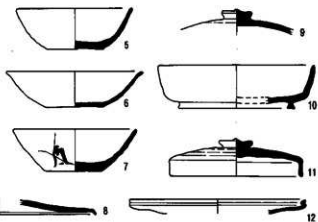
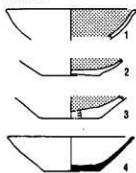

SD 130



SD 135



SD 132



SD 137

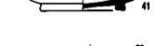
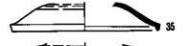
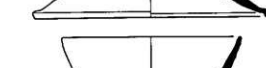
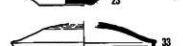
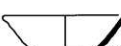
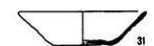
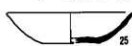
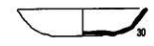
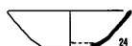
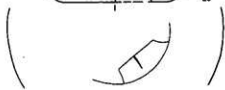
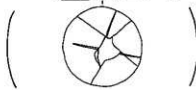
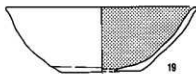
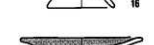
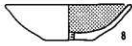
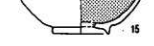
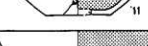
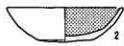
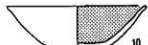
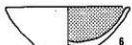
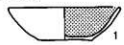

SD130・132・135・137

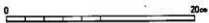

SD 137

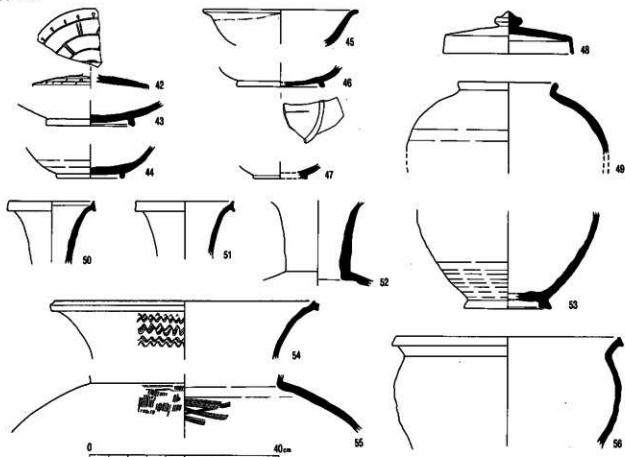

SD 139

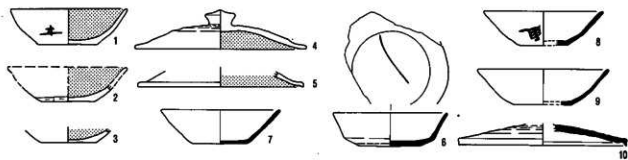

SD 147



SD 163

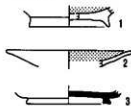

SD 151



SD 176

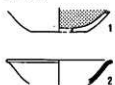

SD 173

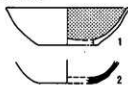

SD 181



SD 170

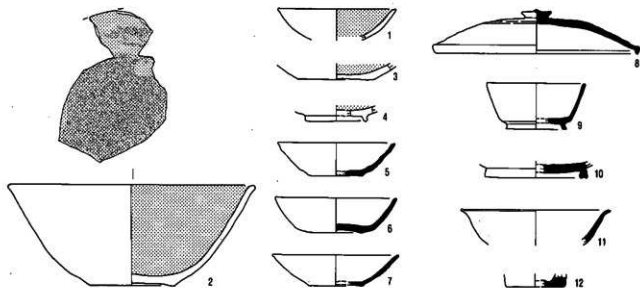

SD 171

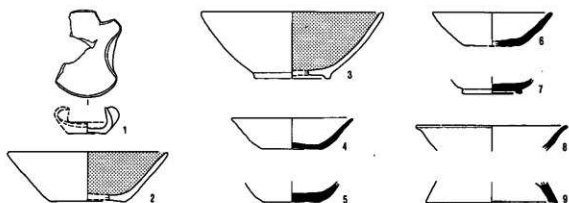

溝址群Ⅲ

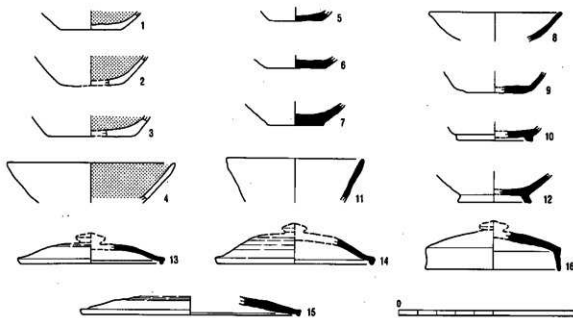

SD170・171・溝址群Ⅲ

SK 110

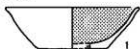

SK 435

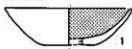

SK 170



SK 398

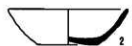

SK 436

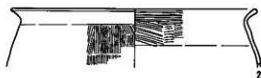

SK 460



SK 533



SK 491



SK 466



SK 540

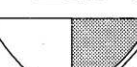
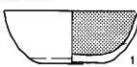

SK 530



SK 534

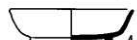

SK 554

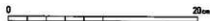
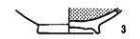
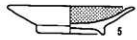
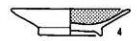
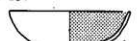

SK 579

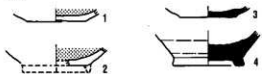

SK 599



SK 551

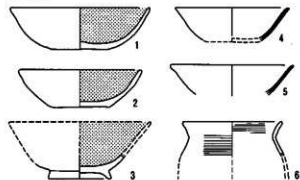

SK 555

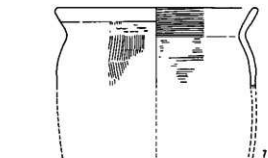
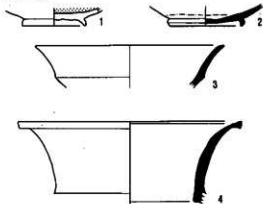

SK 565



SK 566

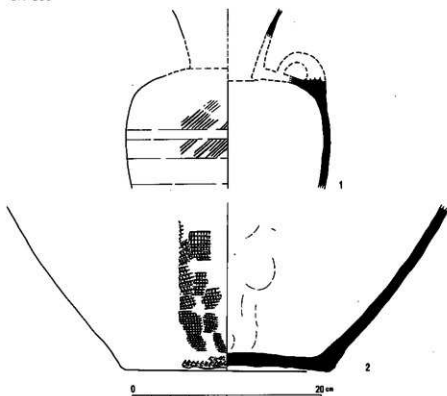

SK551・555・565・566・579・599

SK 574

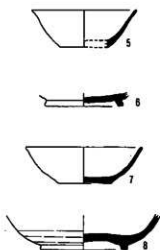
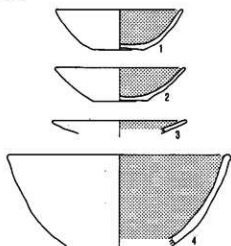

SK 610



SK 624

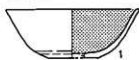

SK 628



SK 580

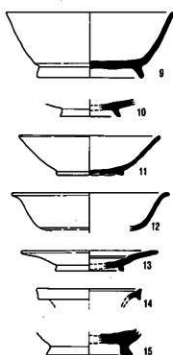
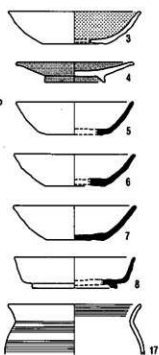
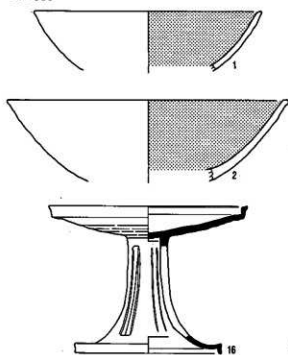

SK 609

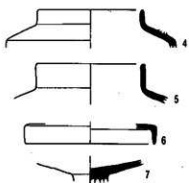
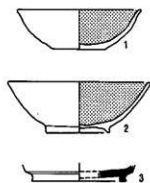

SK 684

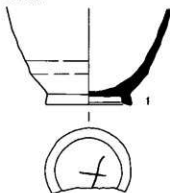

SK 632

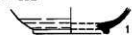

SK 643



SK 833

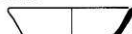

SK 1008

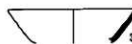

SK 652

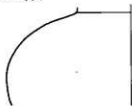

SK 834



SK 910



SK 1276

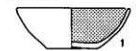

SK 937



SK 975



SK 1338

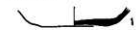

SK 835

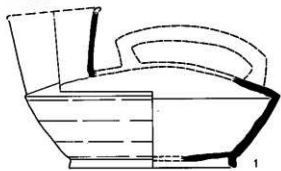

SK 1069

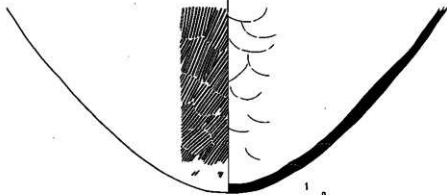

SK 1281

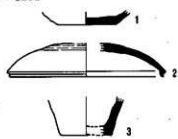

SK 1285

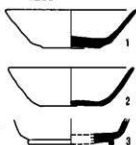

SK 1208

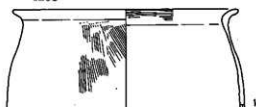

SK 1286



SK 1527

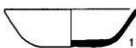

SK 1410



SX 30 (1区)

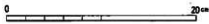
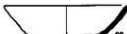
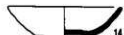
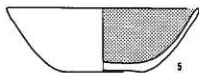

SX 30 (2区)

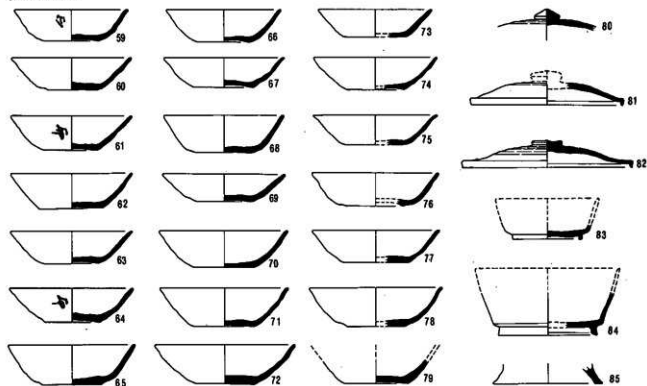

SX 30 (3区)

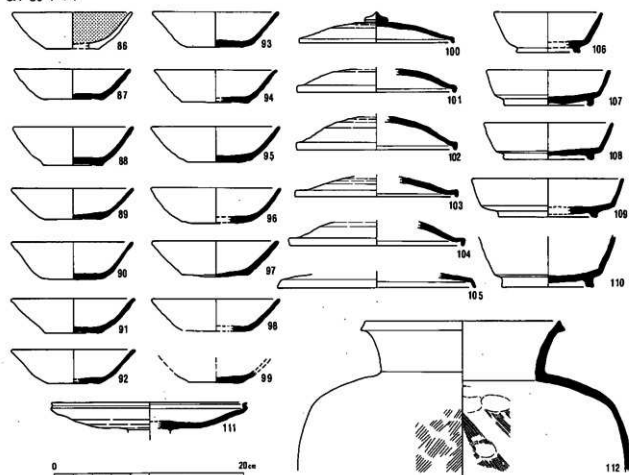

SX30 (2・3区)

SX 30 (3区)

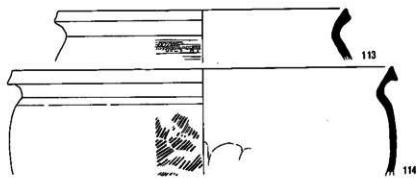
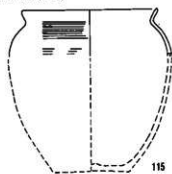

SX 30 (5区)

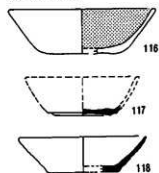

SX 30 (6区)

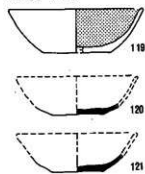

SX 30 (7区)

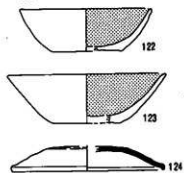

SX 30 (その他)

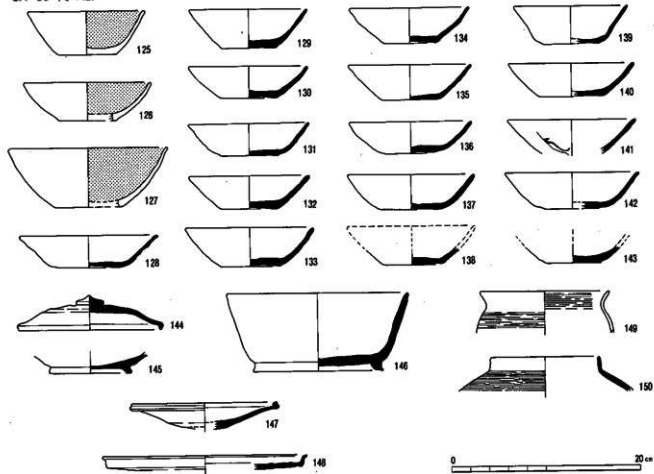

SX30 (3・5・6・7区・その他)

0 20cm

遺構外

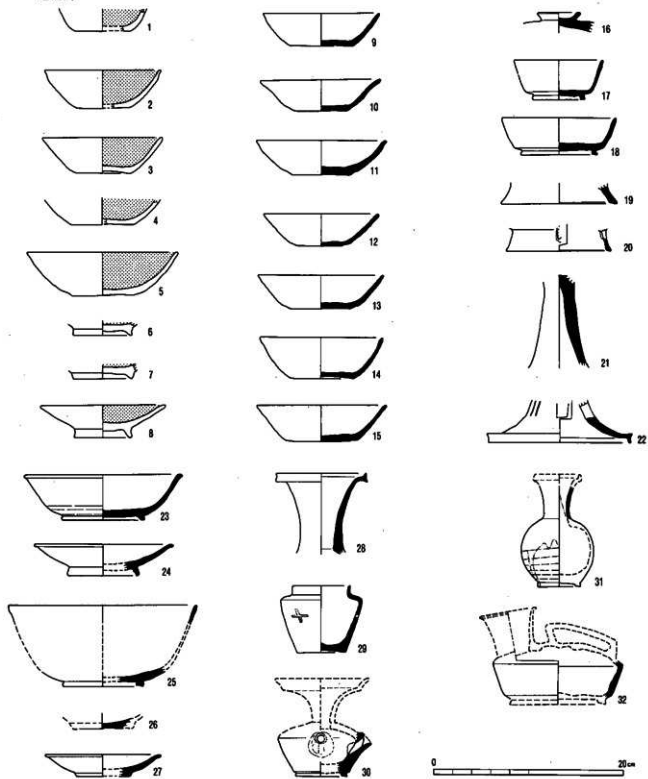

遺構外

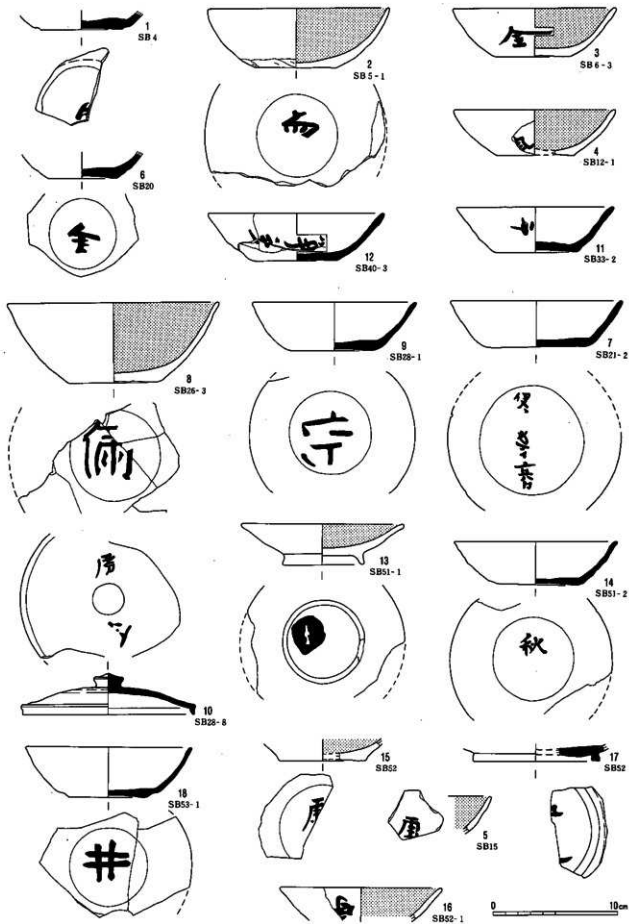

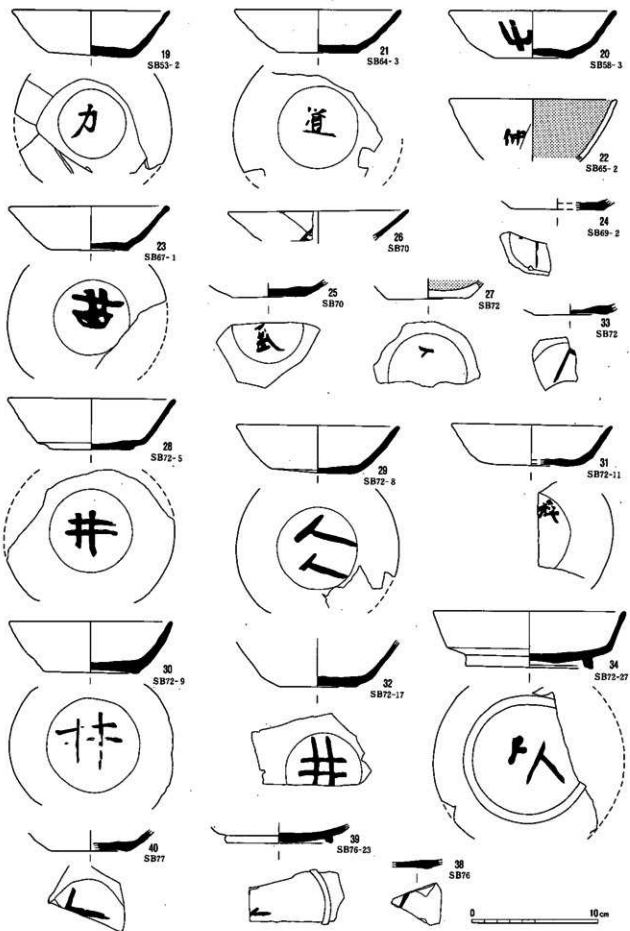

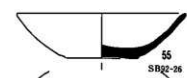
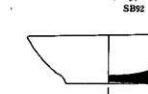
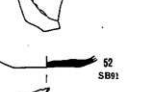
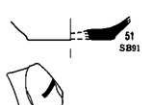
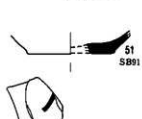
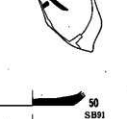
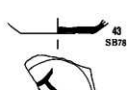
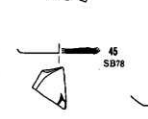
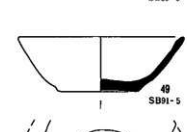
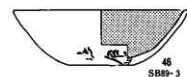
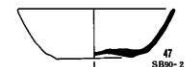
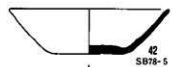
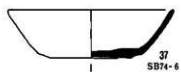
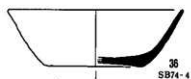

0 10cm

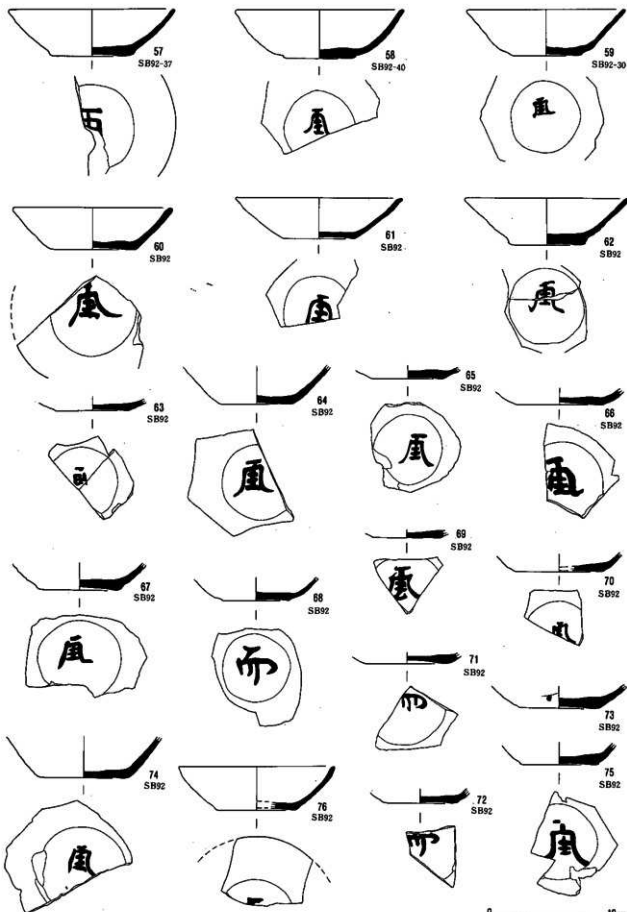

0 10 cm

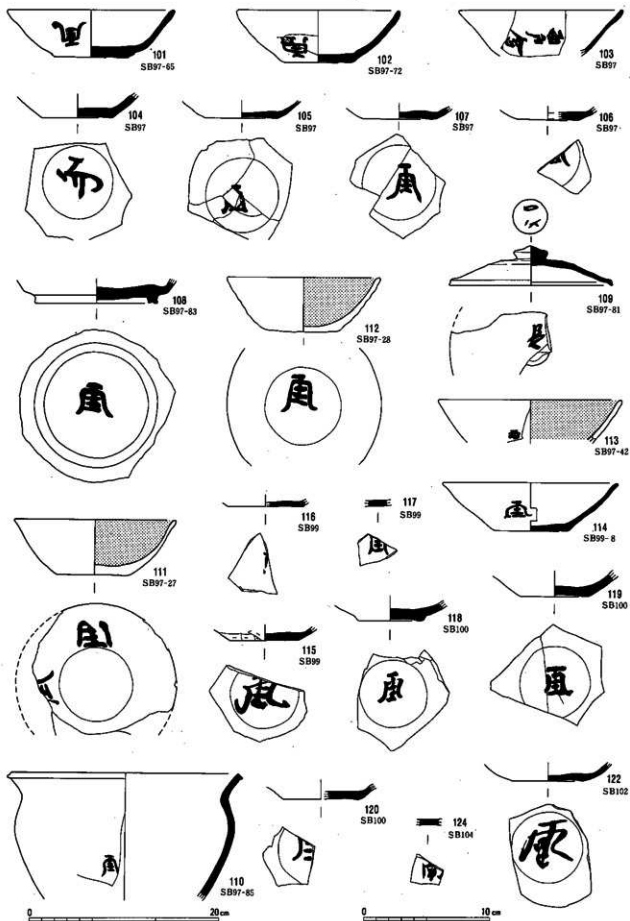

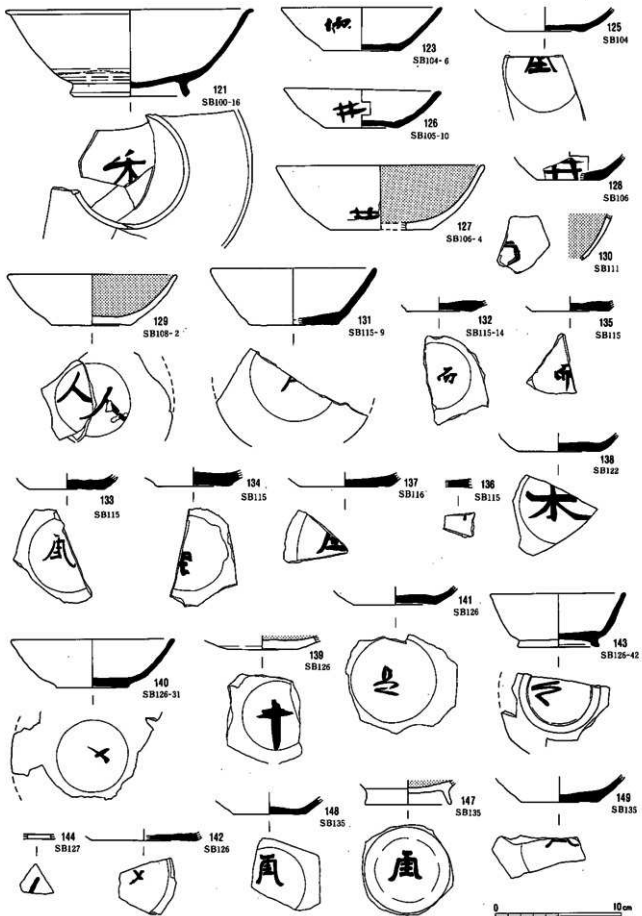

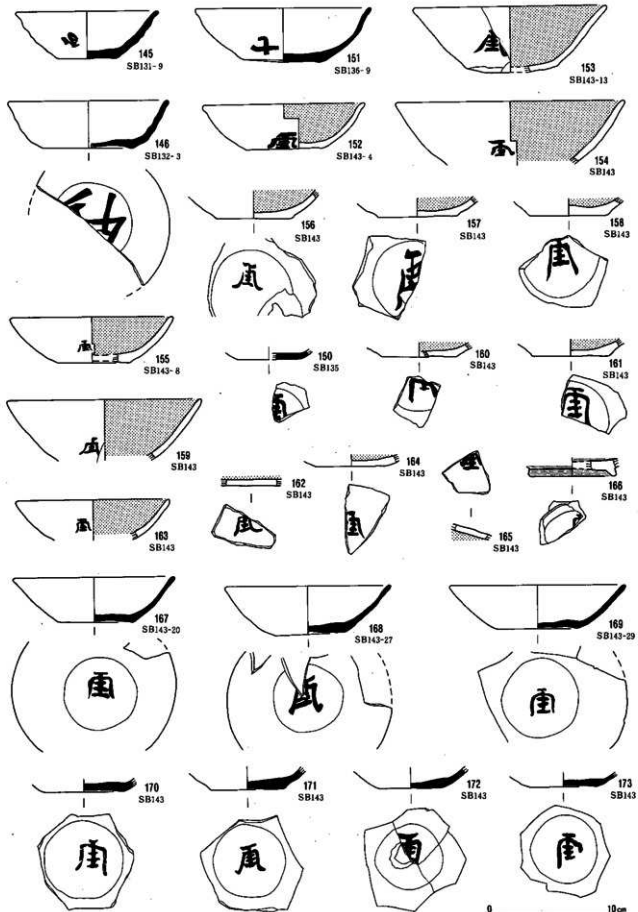

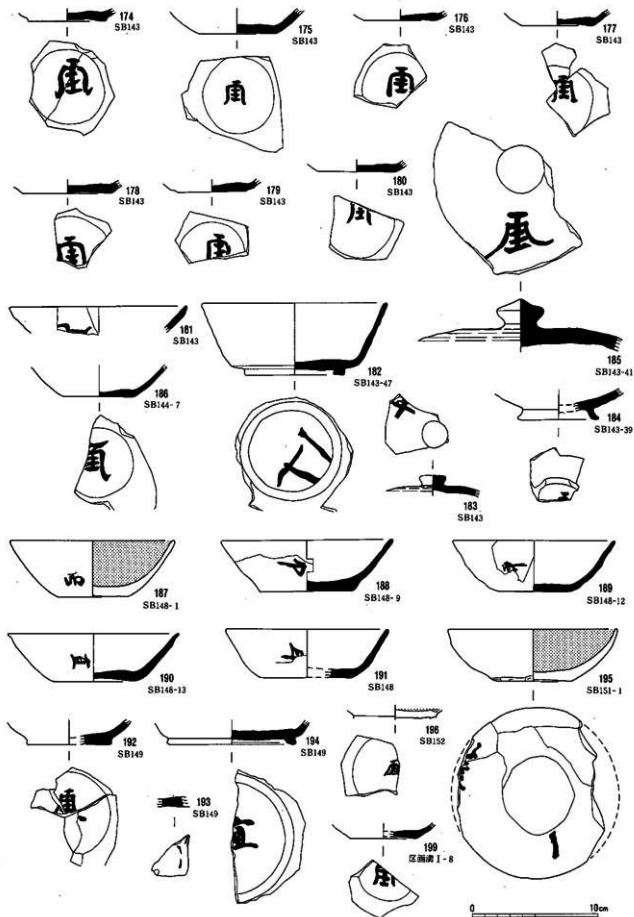

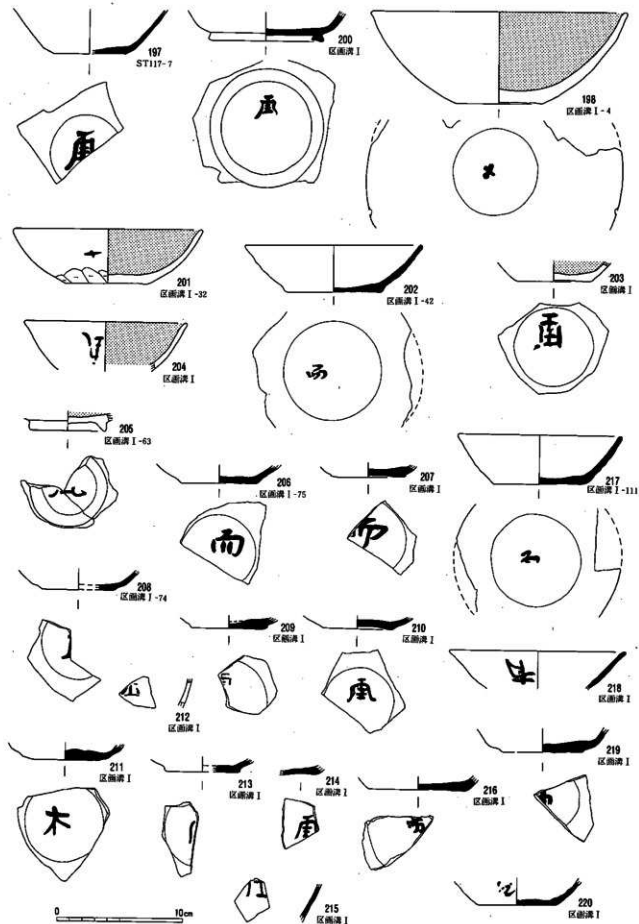

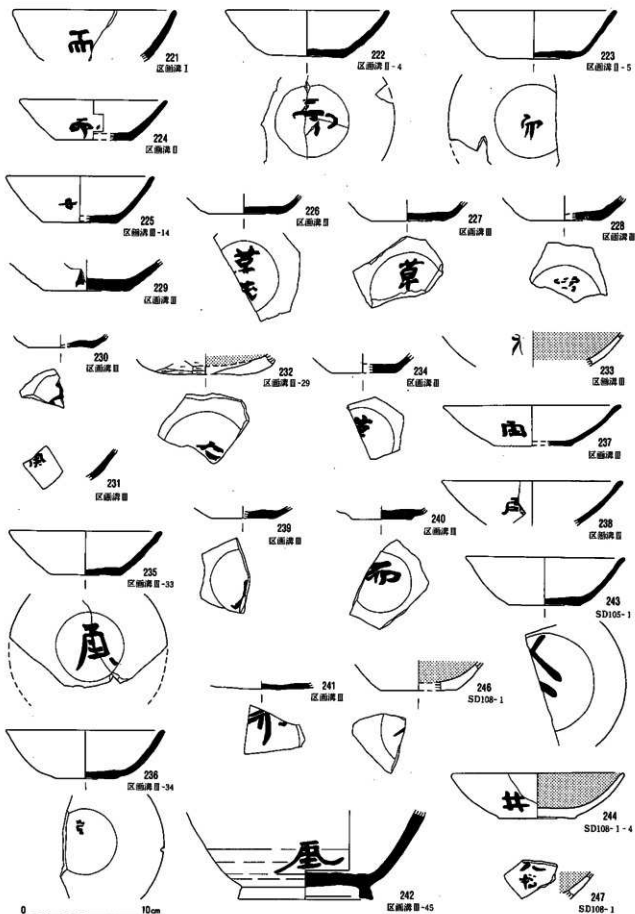

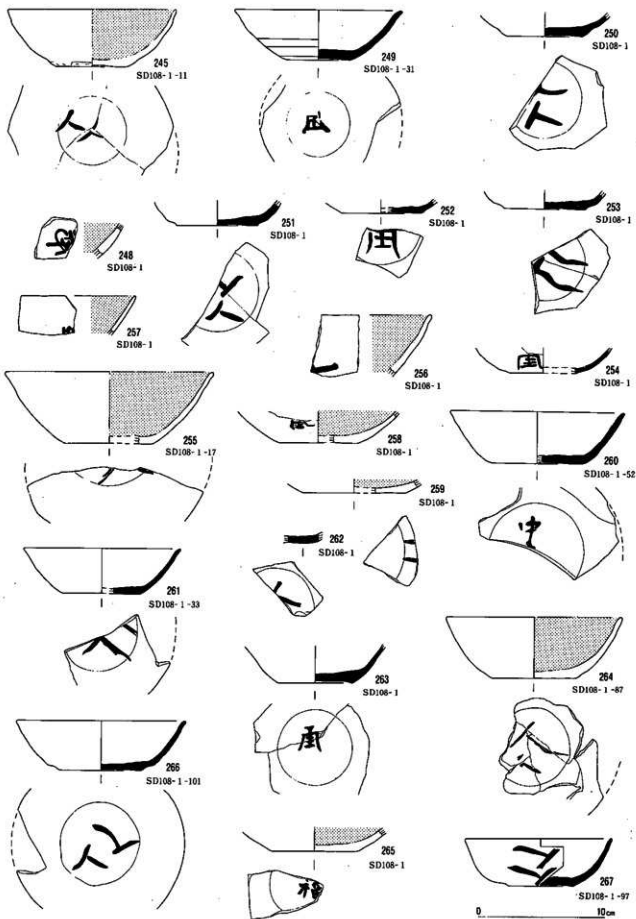

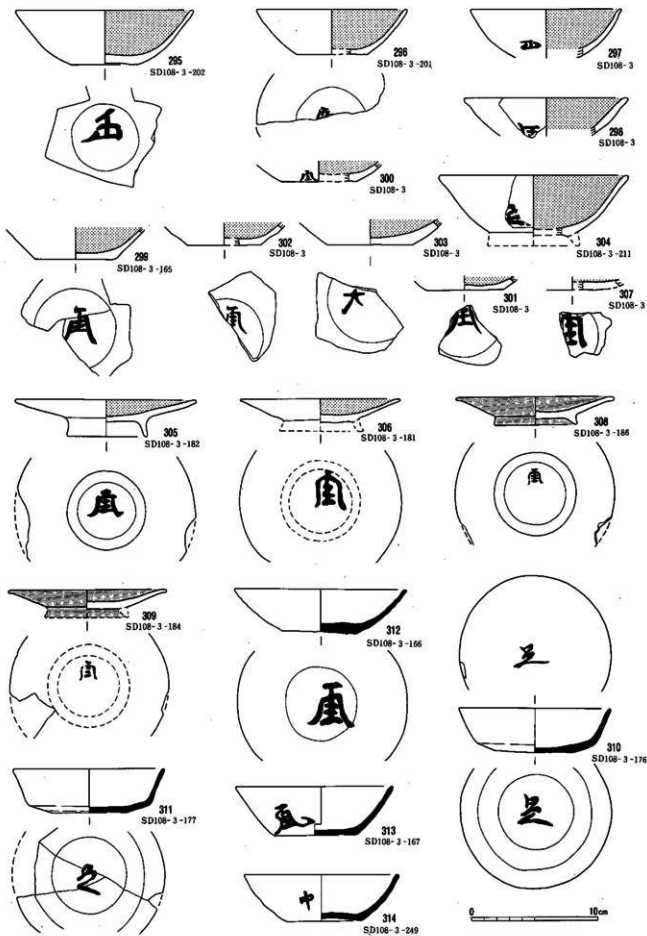

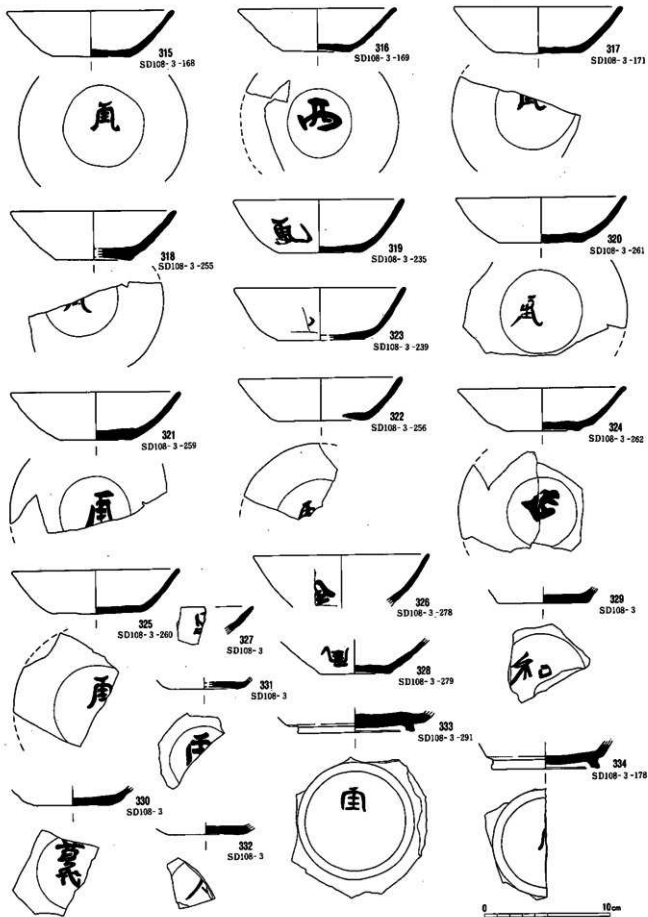

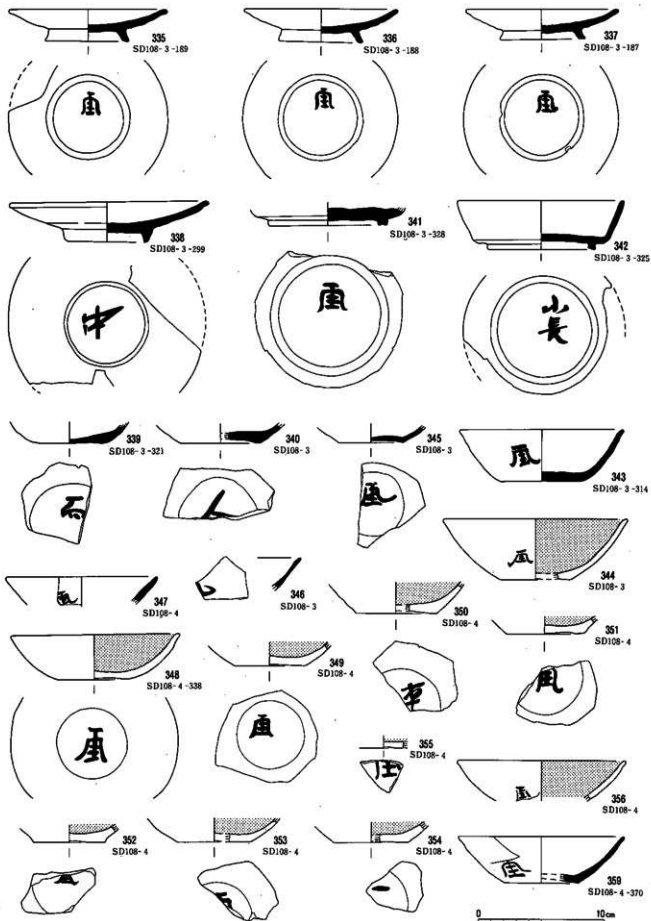

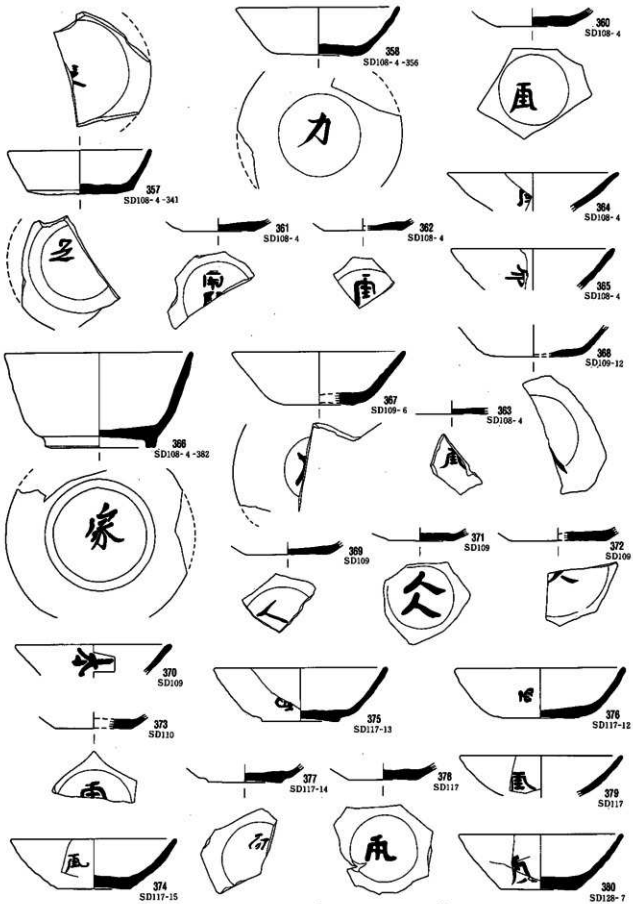

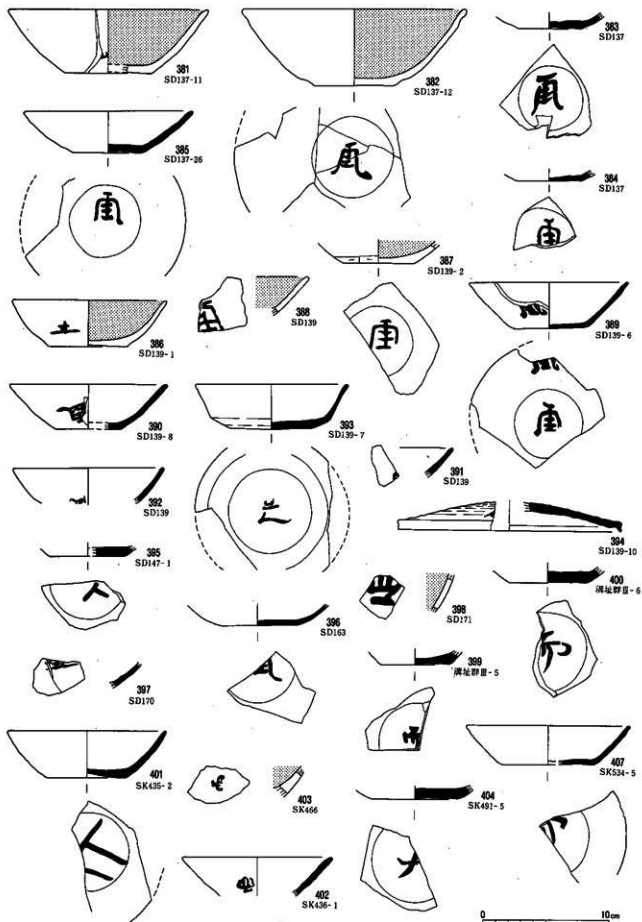

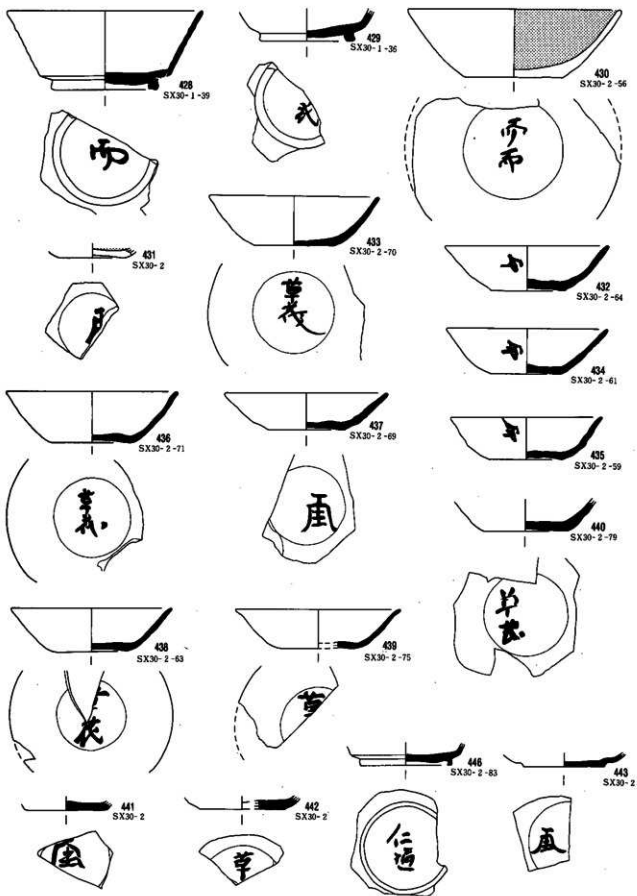

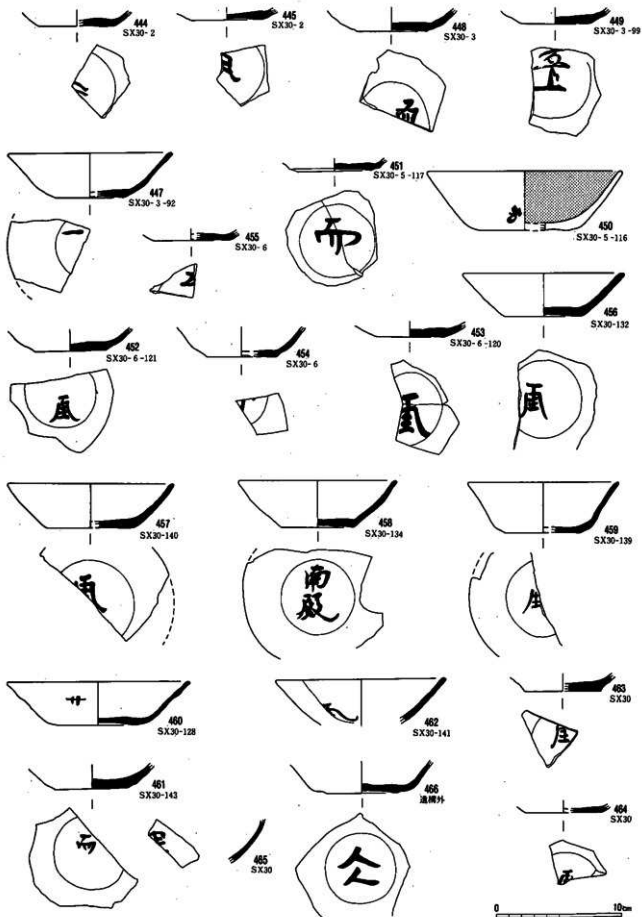



493
SB127



496
遺構外



495
区西溝目

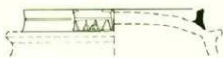

497
溝址群目



494
区西溝1



496
区西溝目

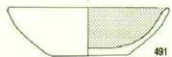

491
SK351-2



499
SR23-6



500
SR92

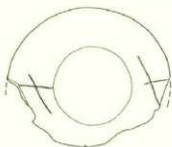

504
SD117-25

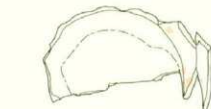

501
SR92-60

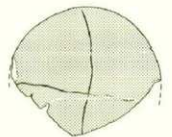

492
SB113-2



502
SB123



503
SB126-11

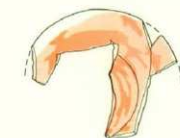

505
SX30-2-58



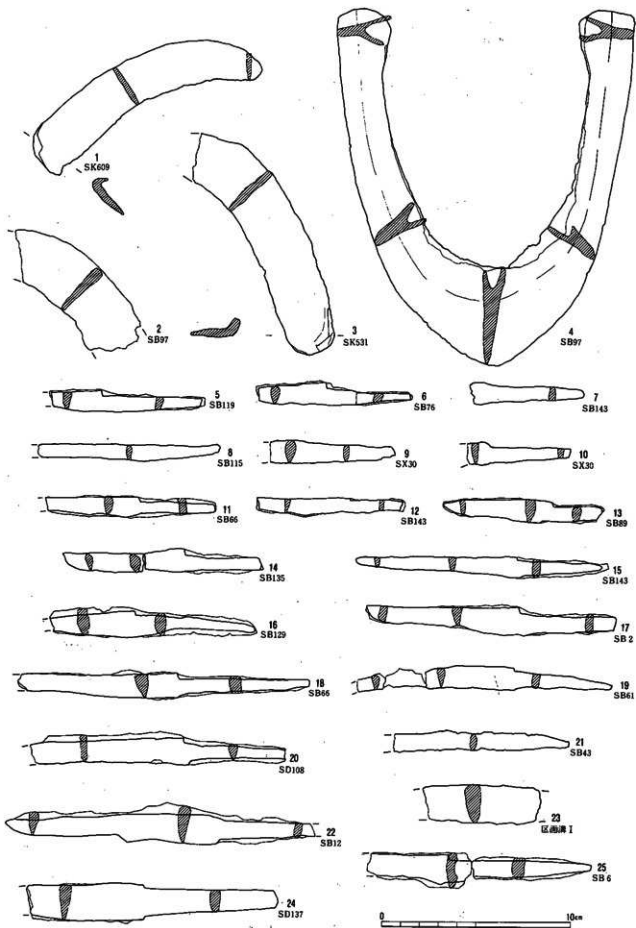

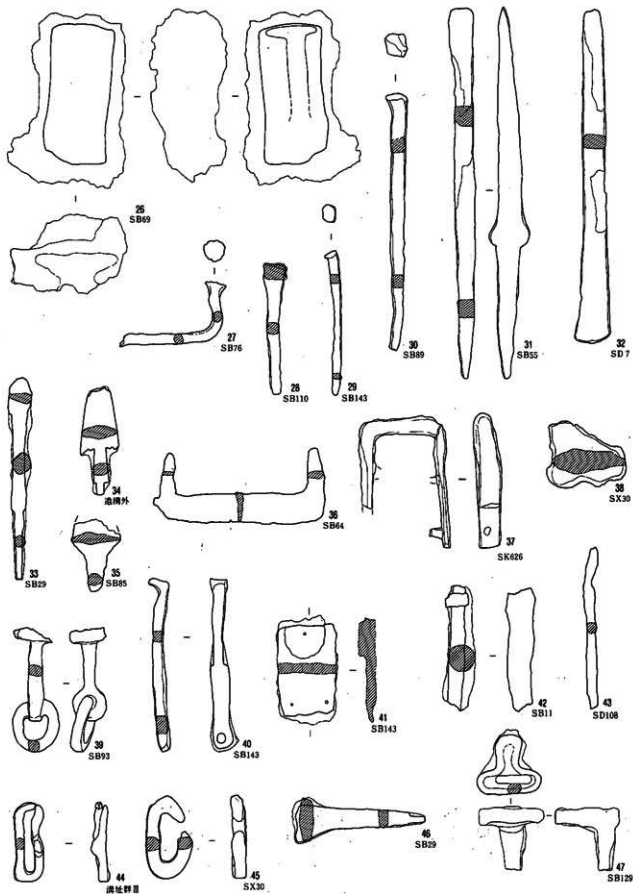

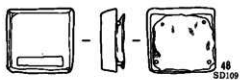

48
SD109

■ 鍍金部分

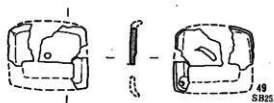

49
SB25

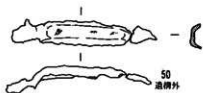

50
透牌外



51
透牌外 (II FV25)

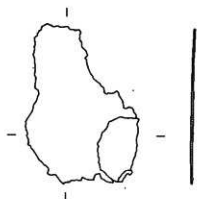

52
区鑄溝 I

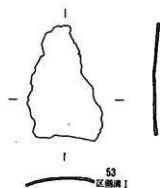

53
区鑄溝 I

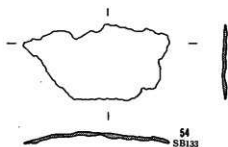

54
SB133

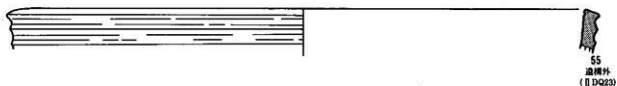

55
透牌外 (II DQ23)



56
SK490



57
SK490



58
SK490



59
SK490



60
SK554



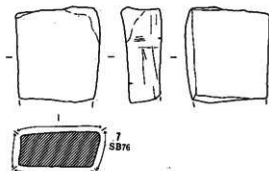
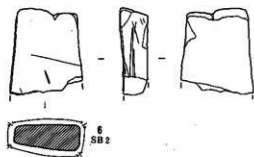
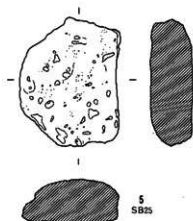
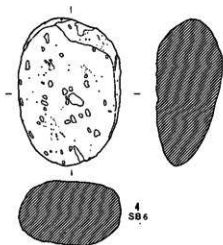
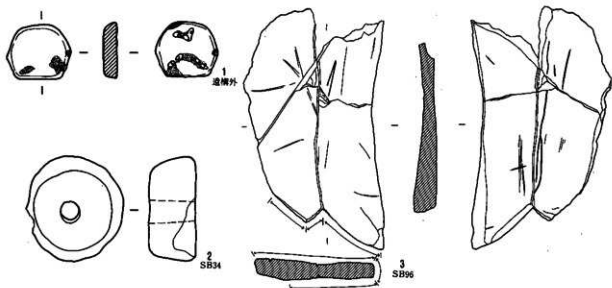

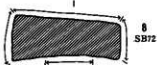
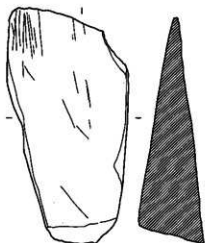

8
SB172

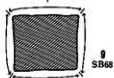
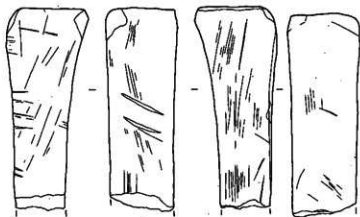

9
SB66



10
SB107

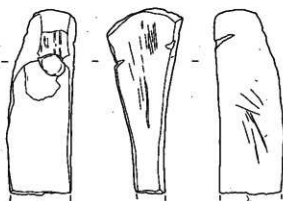

11
SB19

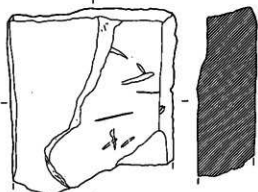

12
SD106

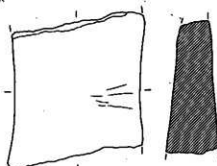

13
SB118

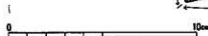

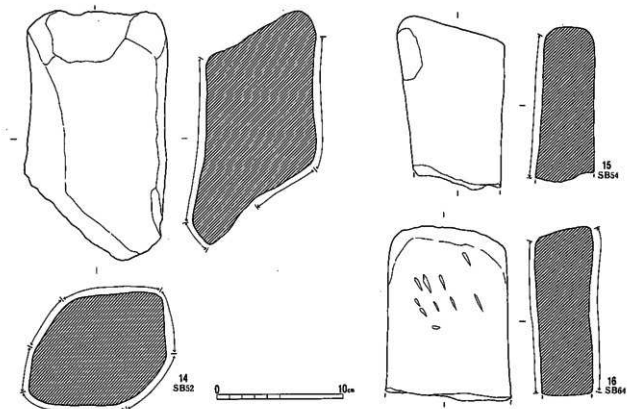

土製品

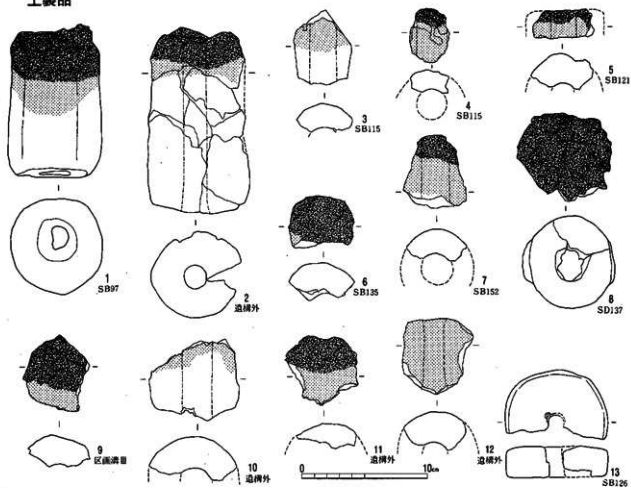

写 真 图 版

(P L)



1. 下神遺跡
2. 神戸遺跡
3. 上二子遺跡
4. 中二子遺跡
5. 南栗遺跡
6. 北栗遺跡
7. 三の宮遺跡
8. 下二子遺跡
9. 大久保工業団地遺跡
10. 南苑井遺跡
11. 川西遺跡
12. 三間沢川左岸遺跡
13. 太子堂遺跡
14. 和田遺跡
15. 和田山の神遺跡
16. 和田町遺跡
17. 梶海濱遺跡
18. 高岡中学校遺跡

PL2



遺跡遠景

遺跡遠景
(北西上空から)



遺跡近景
(北東中から)



南部里地区
航空写真
(北上空から)



南部Ⅰ地区
SB45・46・47・49
(東から)



左 南部Ⅰ地区
SB40・ST15・16(南から)
右 南部Ⅰ地区
SB38・39・40(北から)



南部Ⅰ地区
建物址群(ST20・21・22・23)
(東から)

古代遺構

PL5

南部Ⅱ地区

SB33-51~60
(北から)



南部Ⅱ地区

SB60-61
(西から)



南部Ⅱ地区

SB52-69
(西から)



PL6



古代遺構

南部Ⅲ地区

ST 6・8
SB26-29
(西から)

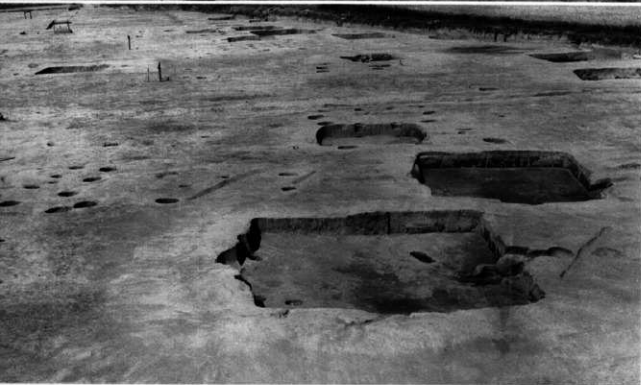

南部Ⅲ地区

SB29・27・26
(南から)



南部Ⅲ地区

SB 9-6
(西から)

古代遺構

PL7

北部Ⅰ地区
(北上空から)



北部Ⅰ・Ⅱ地区
(東上空から)

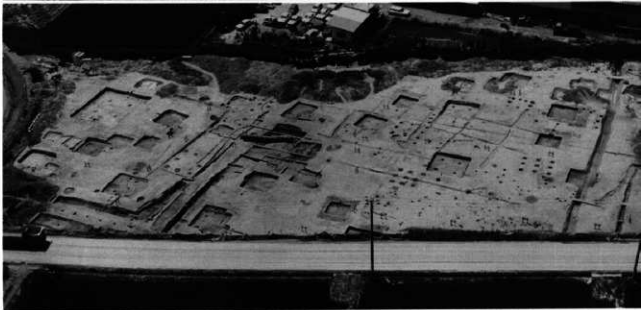

北部Ⅰ地区
(南から)





北部Ⅰ地区
区画Ⅰ・Ⅱ
(南上空から)



北部Ⅱ地区
(西から)



北部Ⅲ地区
(北東上空から)

北部Ⅲ地区

SD108
SB102~106
(西から)



北部Ⅲ地区

SB118~121
(南から)



北部Ⅲ地区

ST115
SB34-69
(南から)



PL10



古代遺構

SB7 完掘
(東から)



SB9 完掘
(西から)



左 SB7カマド
右 SB9カマド

SB12完掘

(東から)



SB14完掘

(西から)



左 SB14カマド
右 同遺物出土状況
(南から)





古代遺構

SB19完掘
(西から)



SB20完掘
(南から)



SB24完掘
(北から)

SB29・27・26完掘

(南から)



SB29完掘

(西から)



左 SB29カマド

遺物出土状況

(西から)



右 SB27煙道先ビット

遺物出土状況

(東から)



PL14

古代遺構



SB38完掘
(西から)

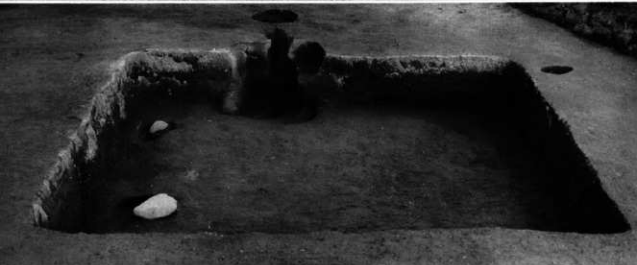

SB39完掘
(南より)



左 SB38カマド
右 SB39カマド



左 SB38ピット
(カマド左)
中 SB38ピット
(カマド右)
右 SB39
小型竈出土状況

古代遺構

PL15

SB52完掘
(西から)



左 SB52カマド
右 同カマド
遺物出土状況



SB53完掘
(西から)



PL16

古代遺構

SB64完掘
(西から)



左 SB64カマド遺物
右 SB65土師器甕B
出土状況



SB65遺物出土状況

SB68完掘
(南から)



SB72完掘
(西から)



SB72完掘
(南から)



左 SB72カマド
右 SB72 礫石出土状況



PL18



古代遺構

SB74・76・77・78完掘
(西から)



左 SB76カマド
右 SB77カマド



SB83完掘
(東から)

SB84完掘
(西から)



左 同遺物出土状況



右 同カマド遺物出土状況



SB85完掘
(西から)



同完掘
(南から)



PL20



古代遺構

SB88完掘

(西から)



左 SB88カマド完掘

右 同遺物出土状況



SB89完掘

(東から)

SB92完掘
(西から)



SB92床面遺物
(西から)



左 同カマド遺物
右 同カマド完掘

