

図版215 古墳時代前期割付図48 (SK以外)

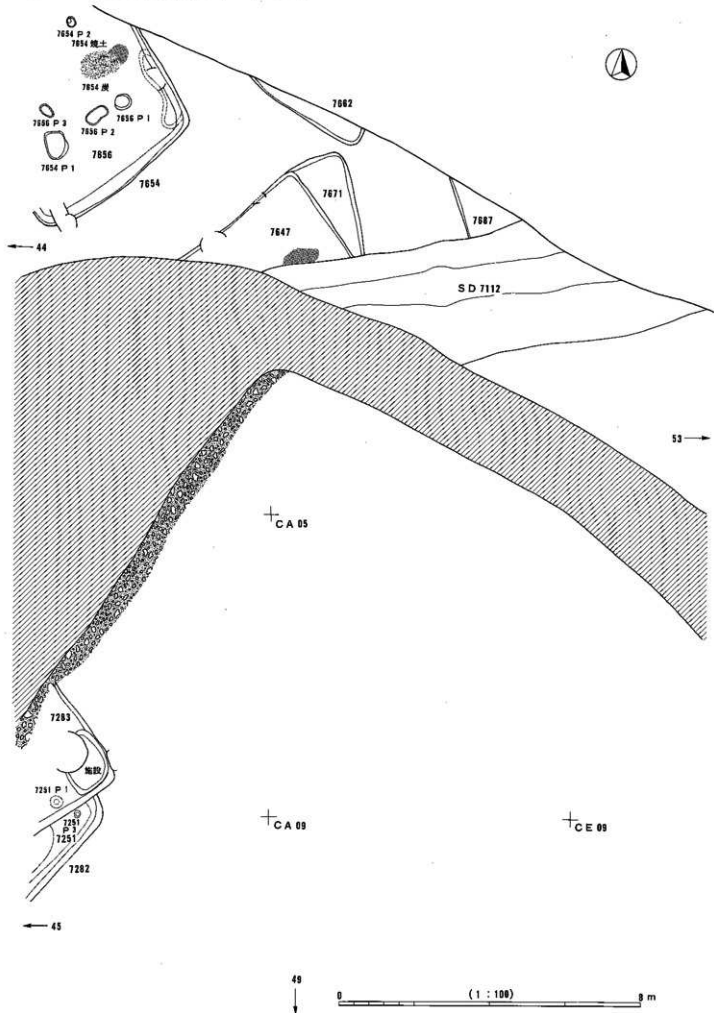

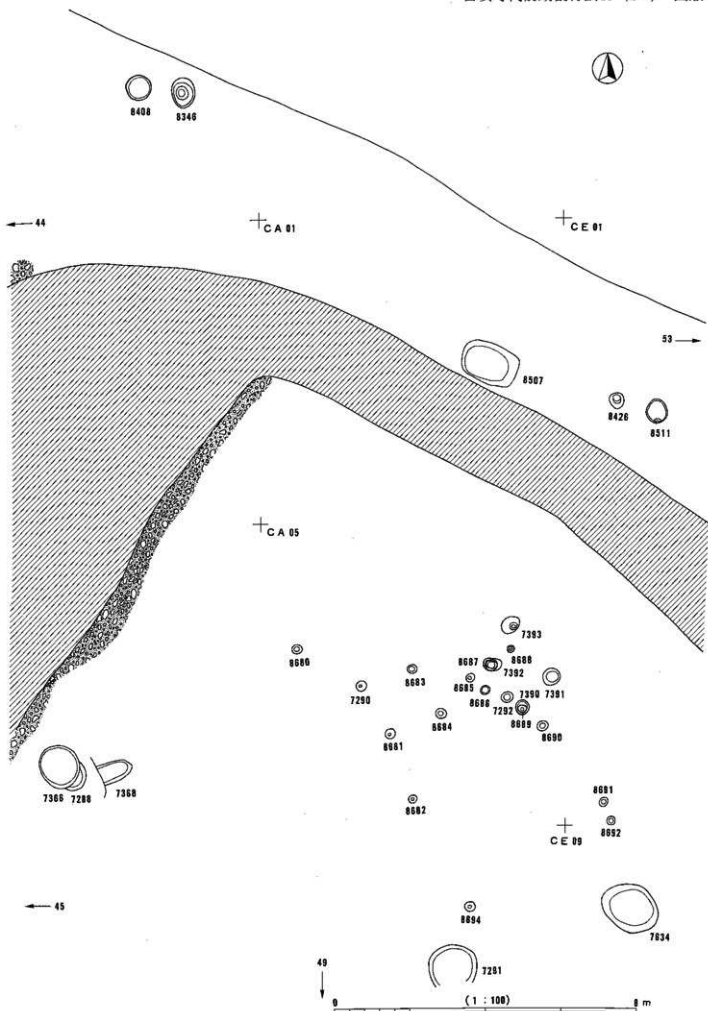

図版217 古墳時代前期割付図49 (SK以外)

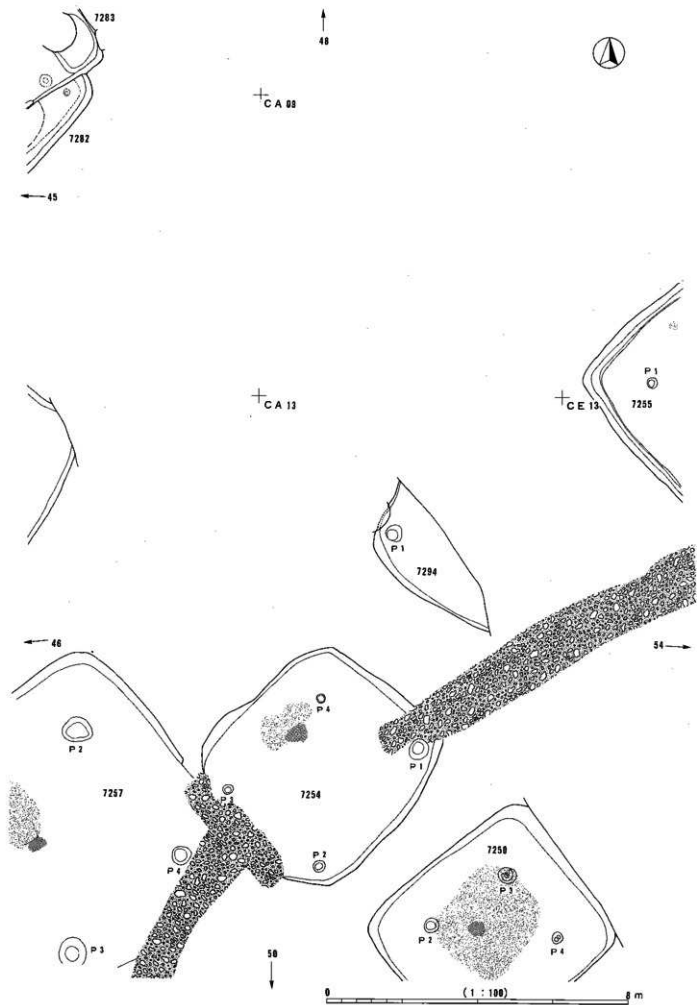

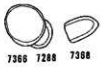

8682



8681  
8682

8684



7364



7291

8700



8683

8685  
8686  
8687  
8688  
8689

+ CA 13

+ CE 13

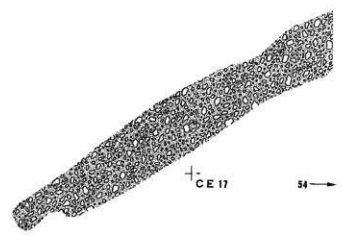

+ CE 17

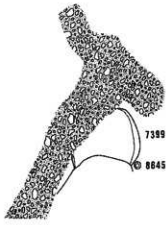

7389

8645



50

0

(1 : 100)

8 m

図版219 古墳時代前期割付図53 (SK以外)

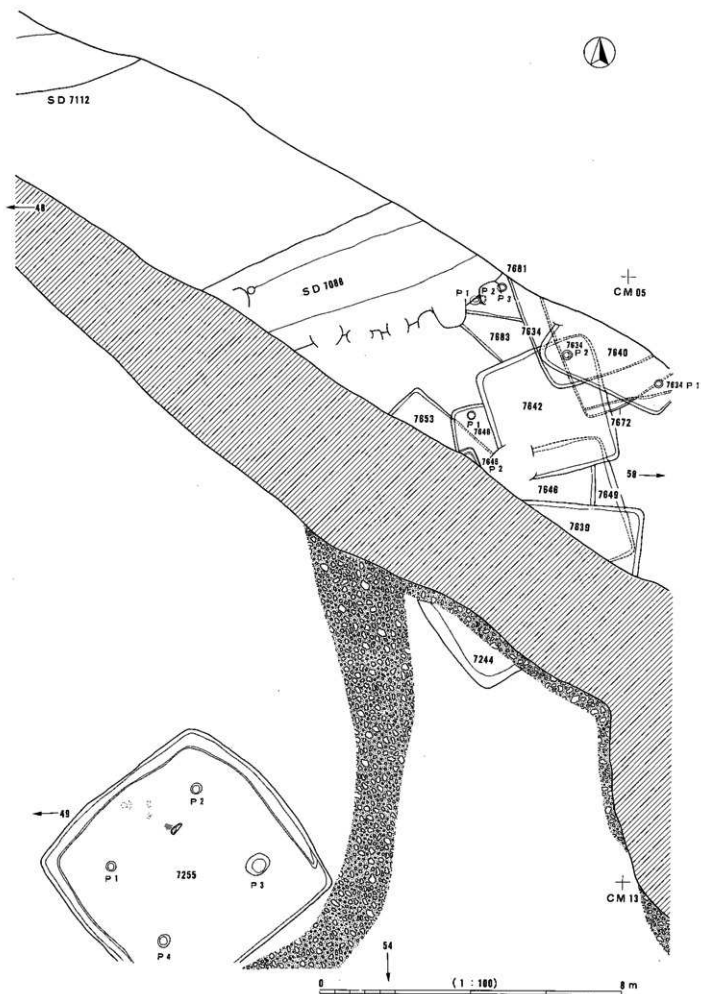

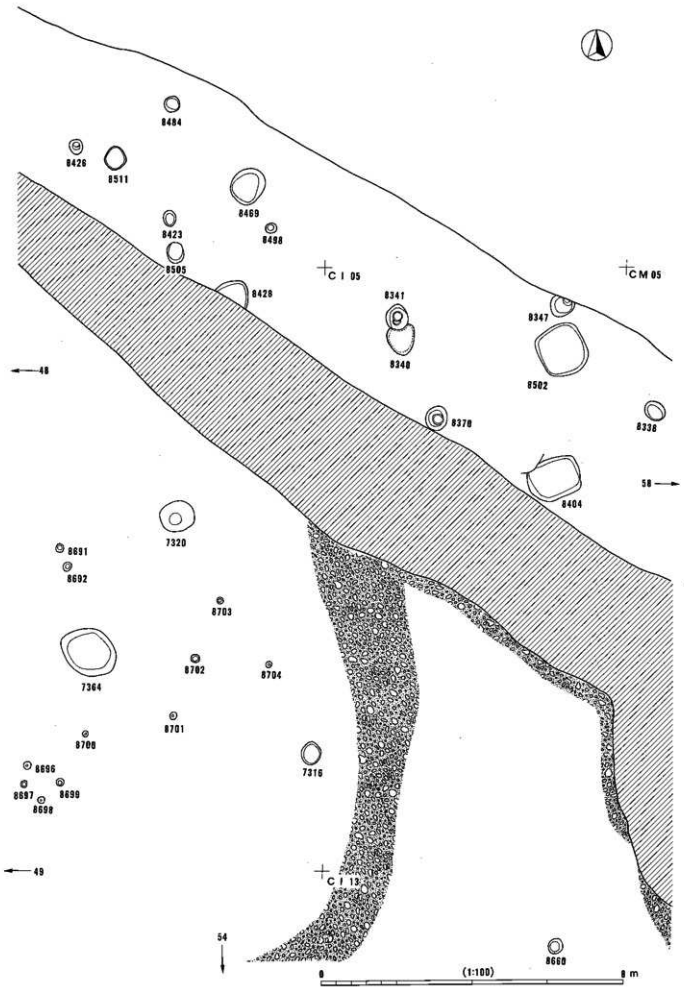

図版221 古墳時代前期割付図58 (SK以外)

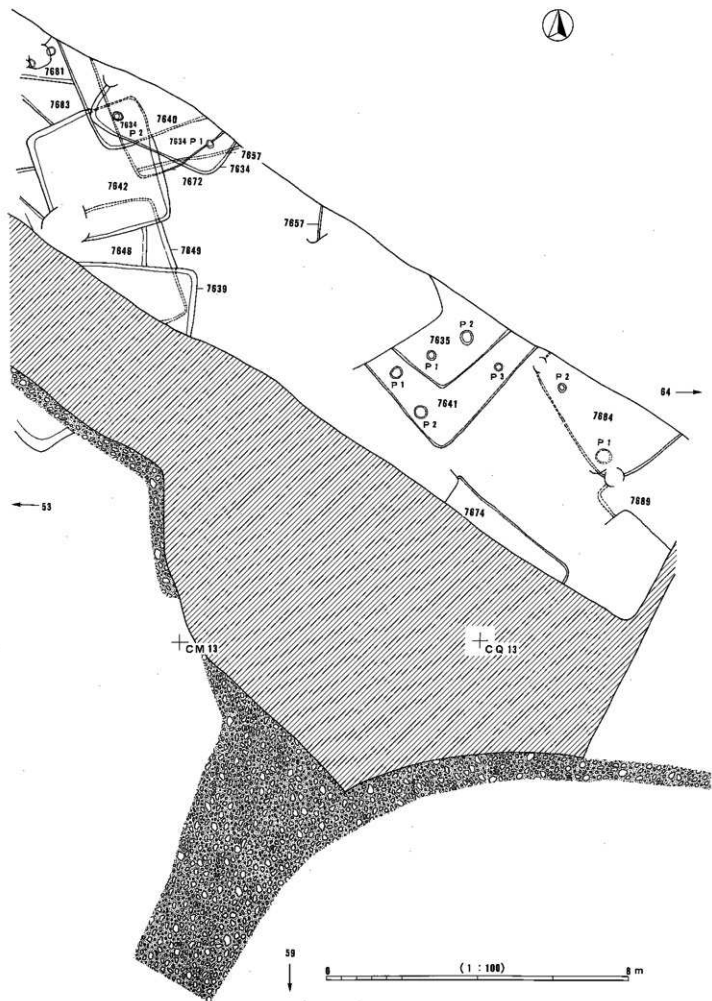



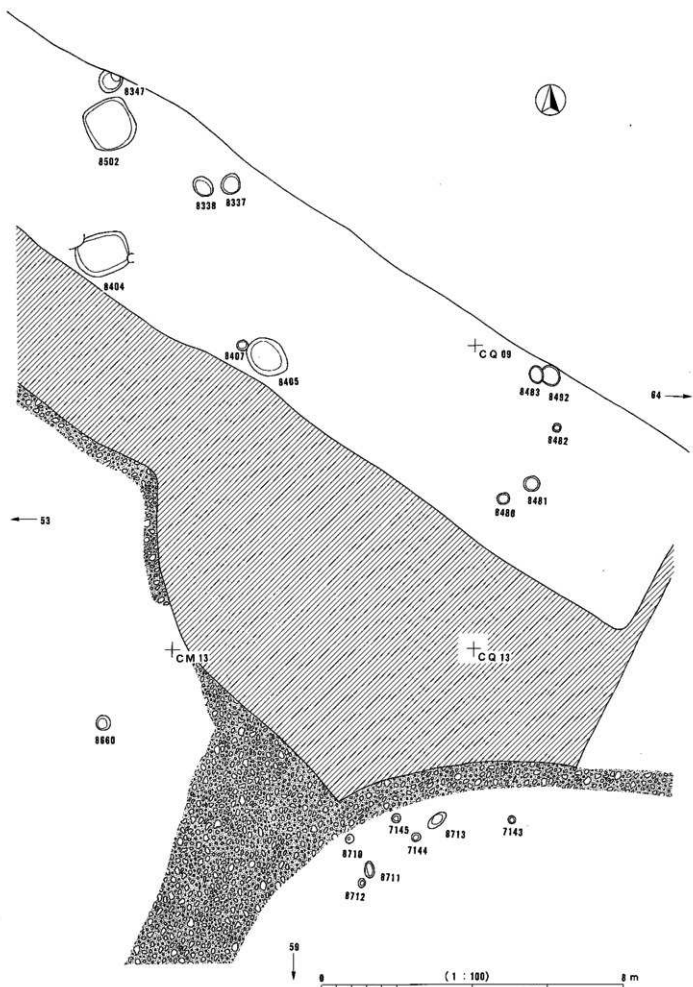

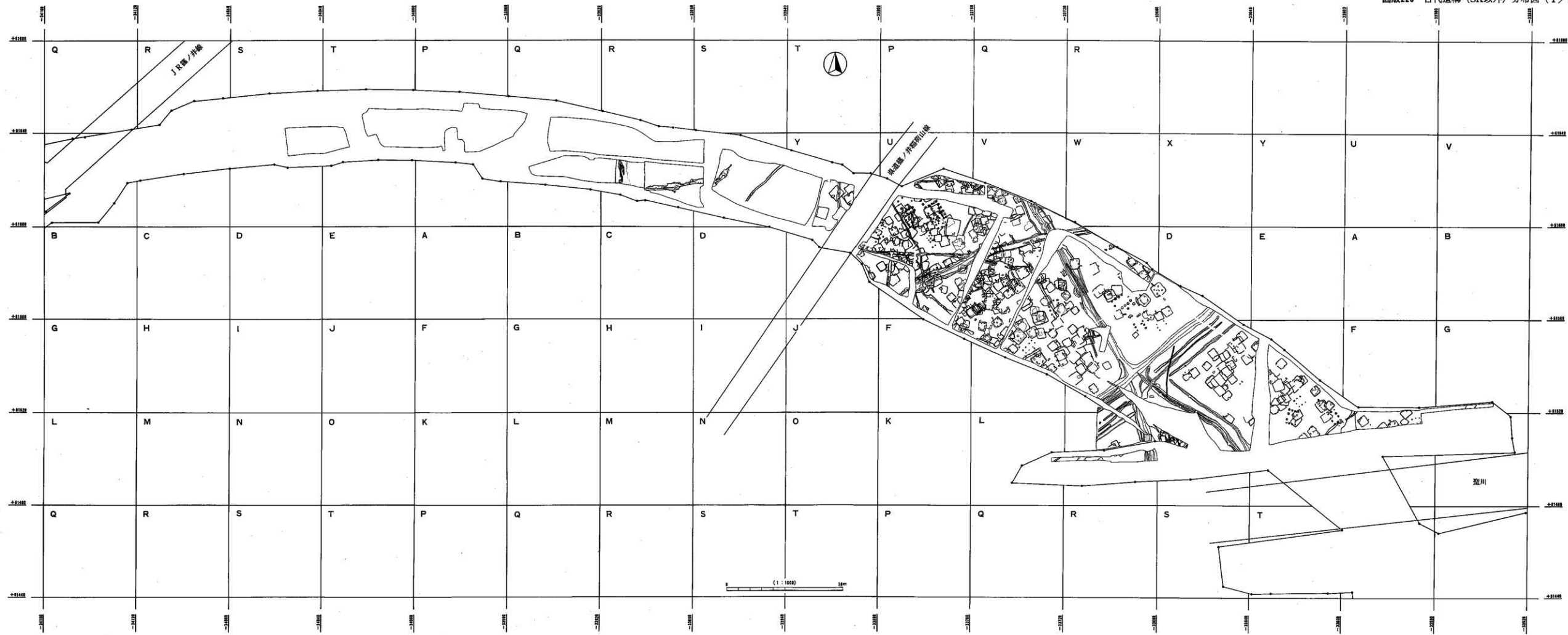

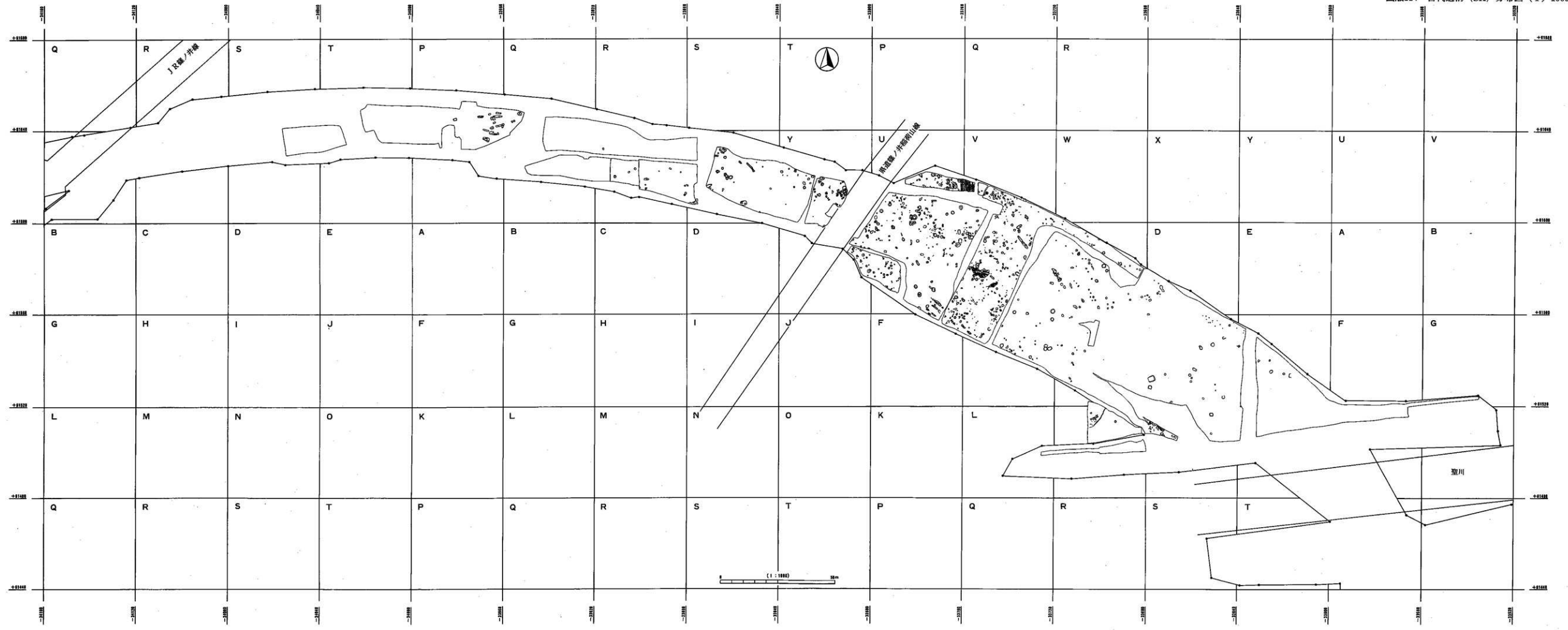



PA 17

5 →

SA 6002

UA 01

UE 01

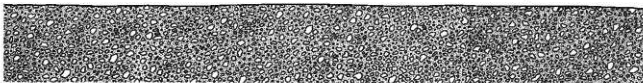

0 ( 1 : 100 ) 8 m

図版226 古代割付図5 (一括)

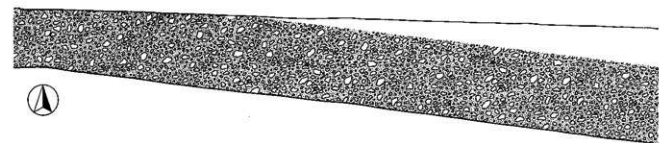

SA 6001



+PE 17

+P I 17



SK 6021

+UE 01

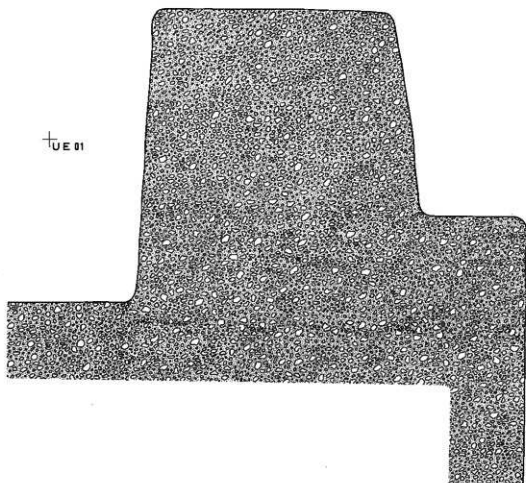

(1 : 100) 8 m

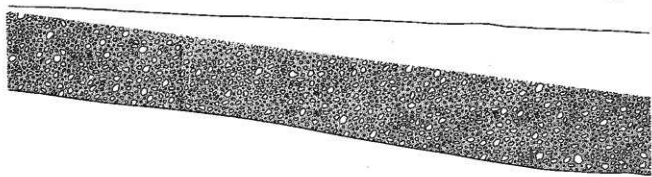

← S



SK 6021

+PM 17



SK 6015



SK 6019



SK 6004

+UM 01

SK 6011



SK 6012

SK 6010

+UQ 01



SK 6024



SK 6009

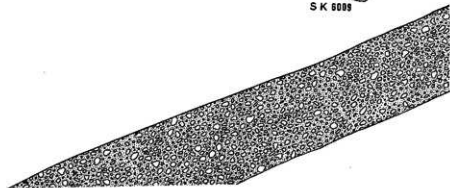
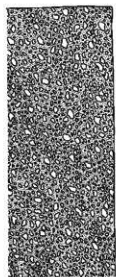

0 (1 : 100) 8 m

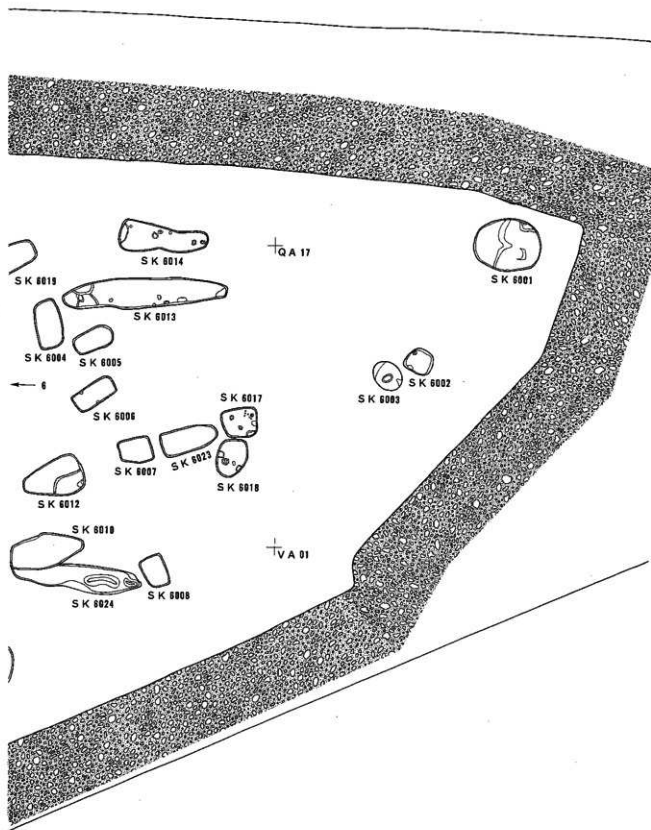

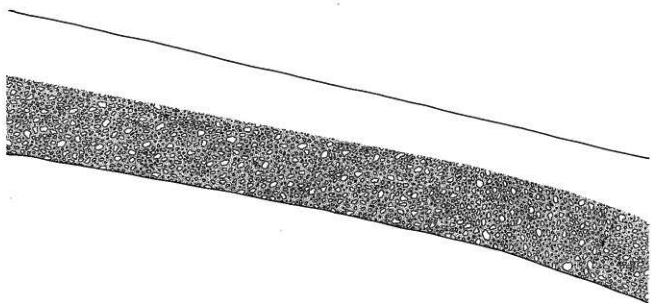

+WA 01

+WE 01

+WA 05

○  
SK 9101

10 →

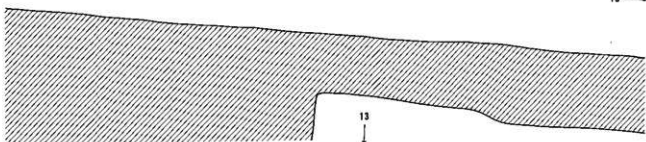

0 (1 : 100) 8 m



↑  
12



+WA 05



SK 0101

+WE 05

18 →

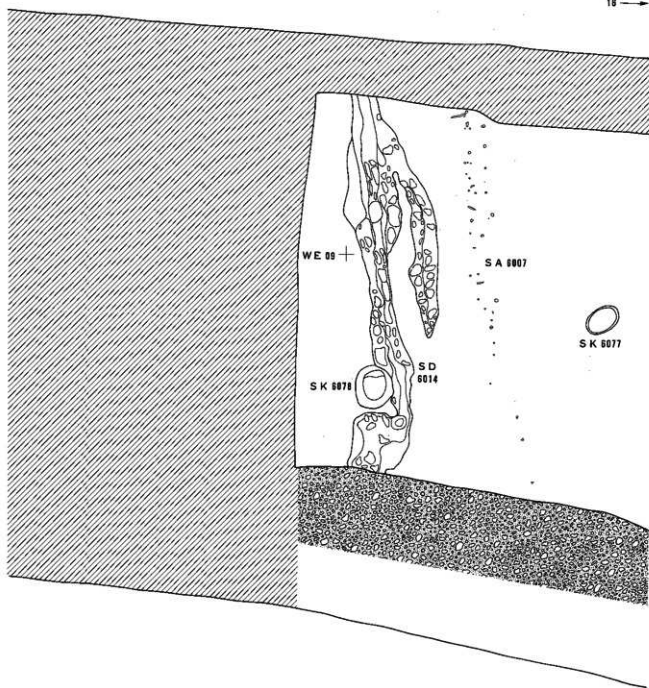

0 (1 : 100) 8 m



WQ 05 17 →

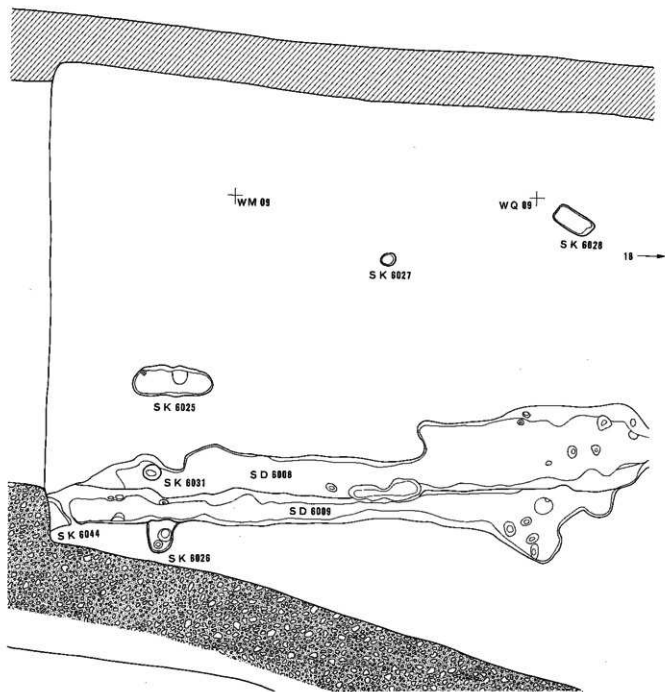

0 (1 : 100) 8 m

图版232 古代割付图16 (一括)

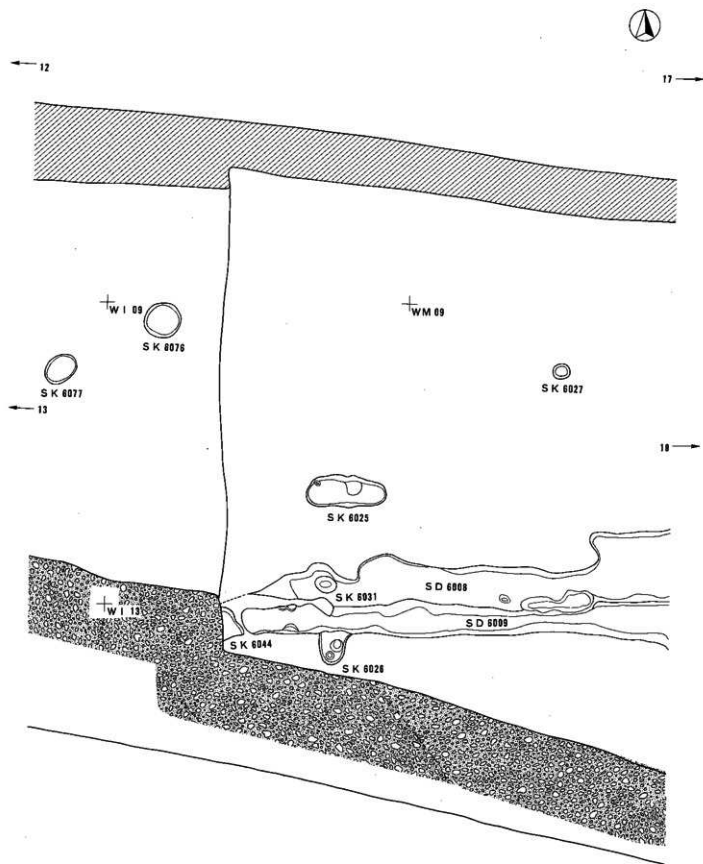

0 (1 : 100) 8 m

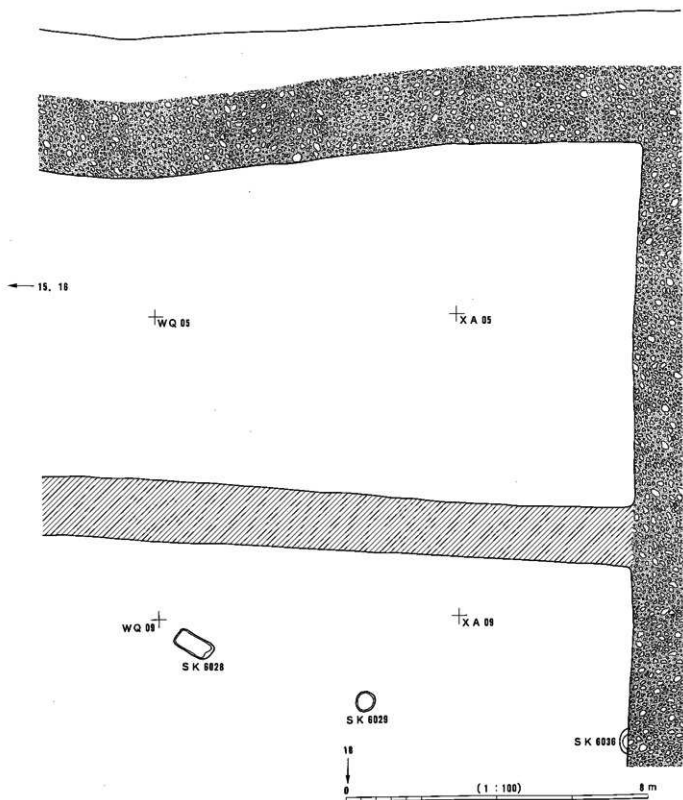

図版234 古代割付図19 (一括)

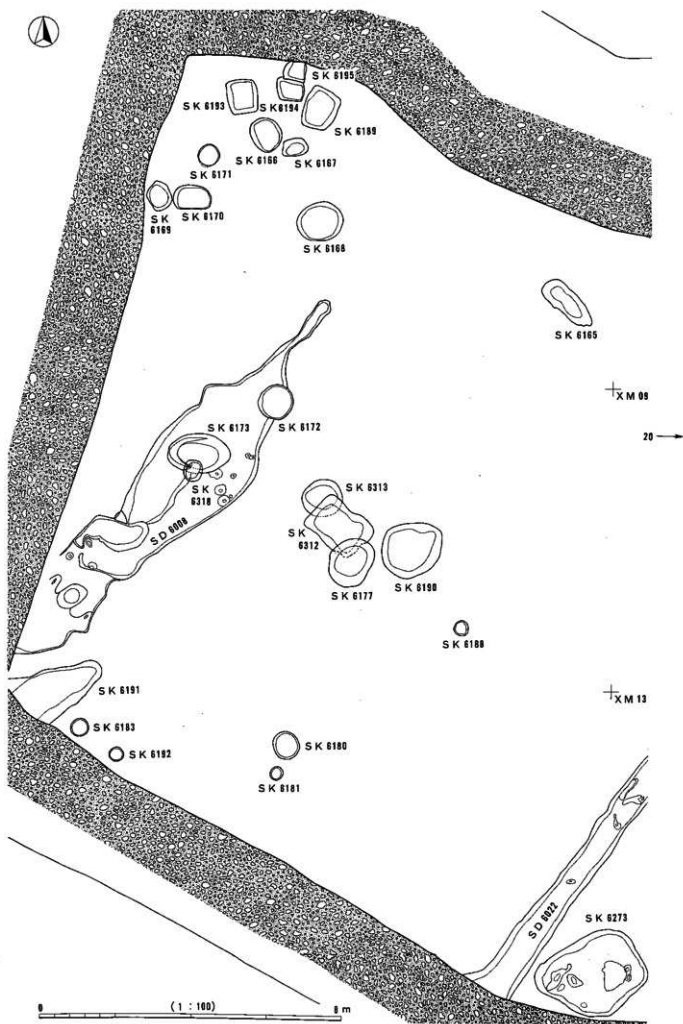

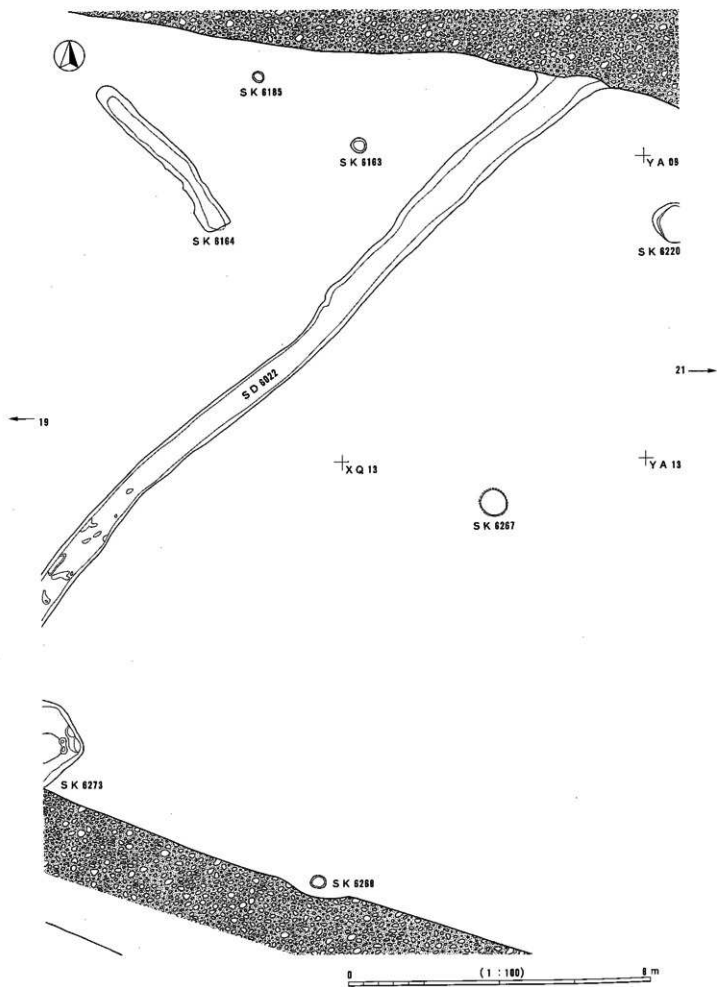

图版236 古代割付图21 (一括)

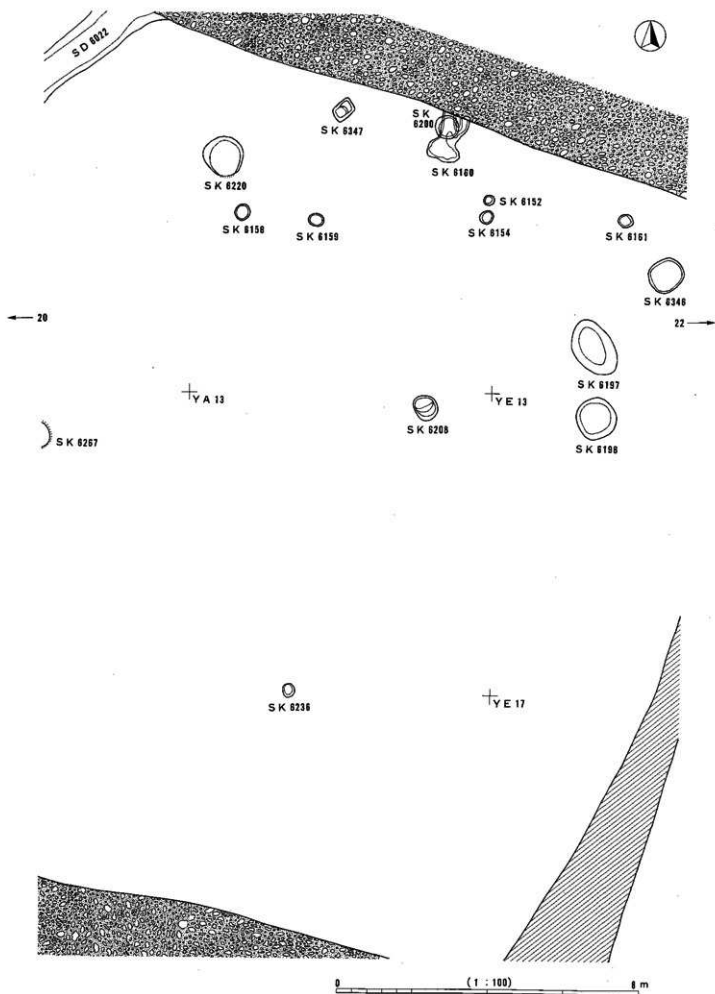



57 →

MA 09

ME 09

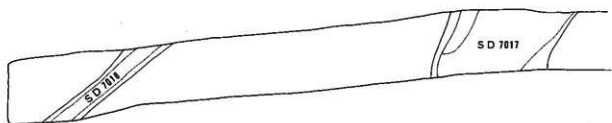

MA 13

0 (1 : 100) 8 m



図版238 古代割付図60 (一括)

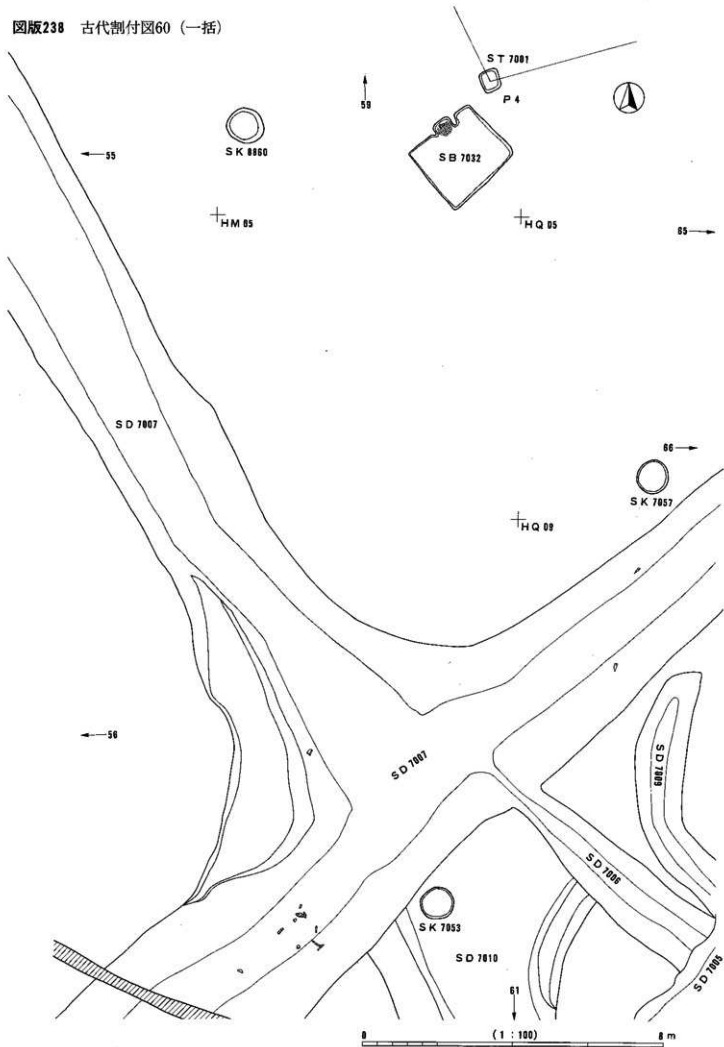

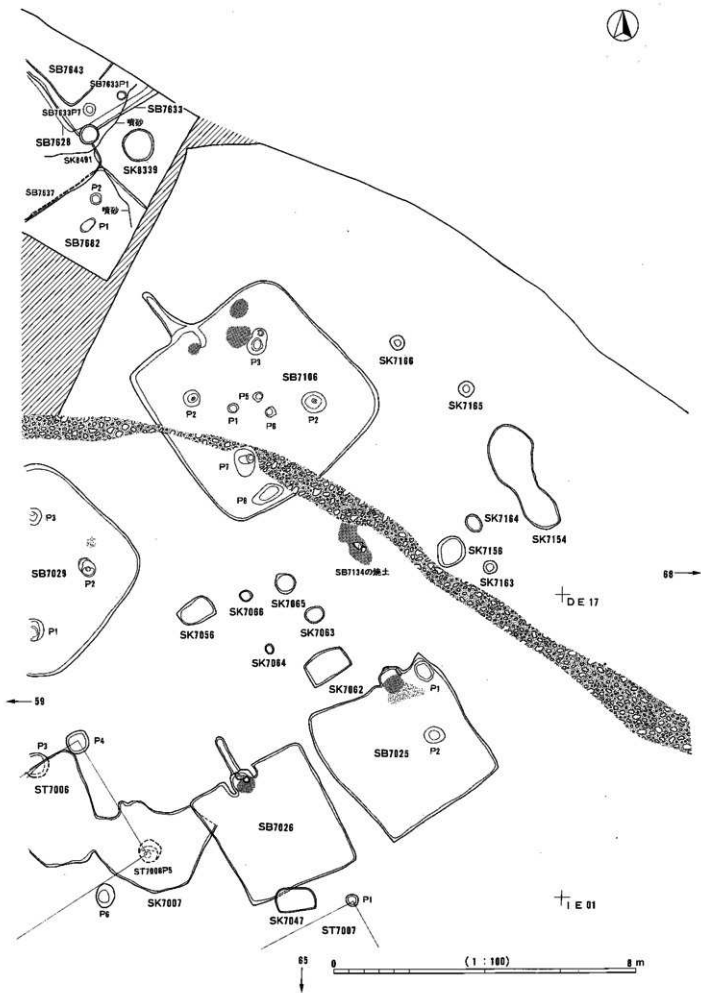

図版240 古代割付図65 (一括)

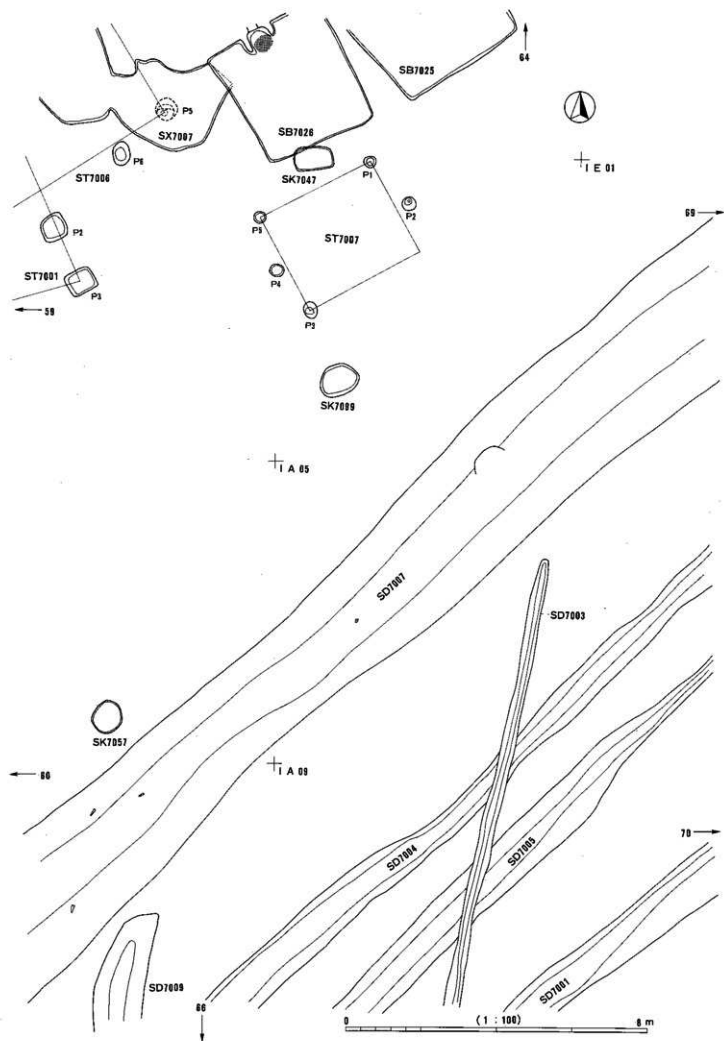

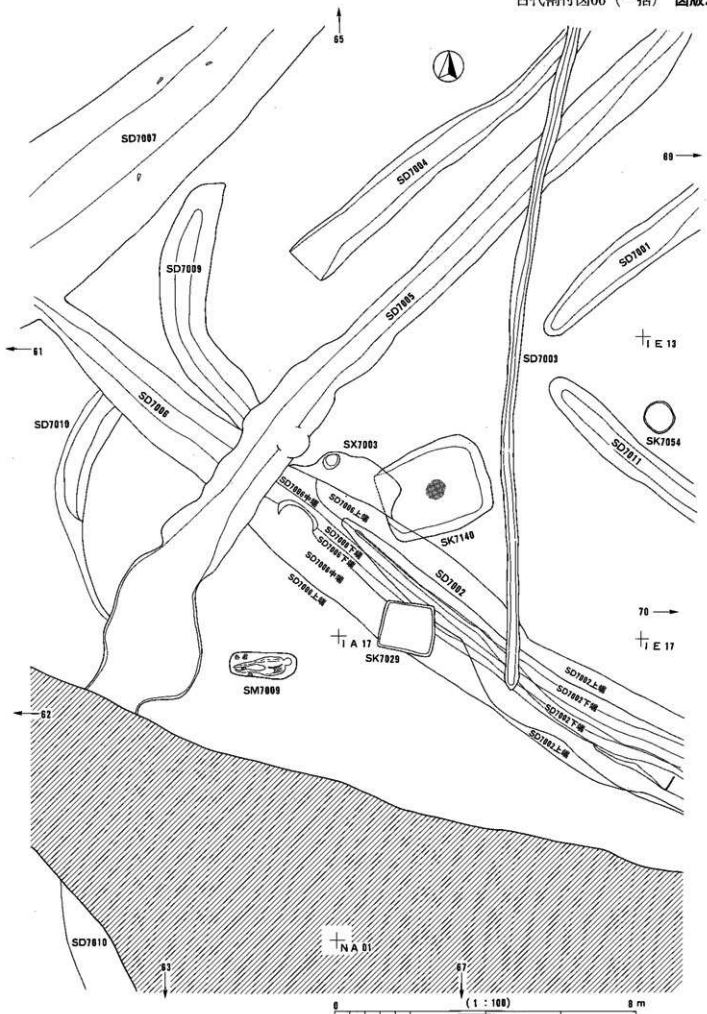

图版242 古代割付图68 (一括)

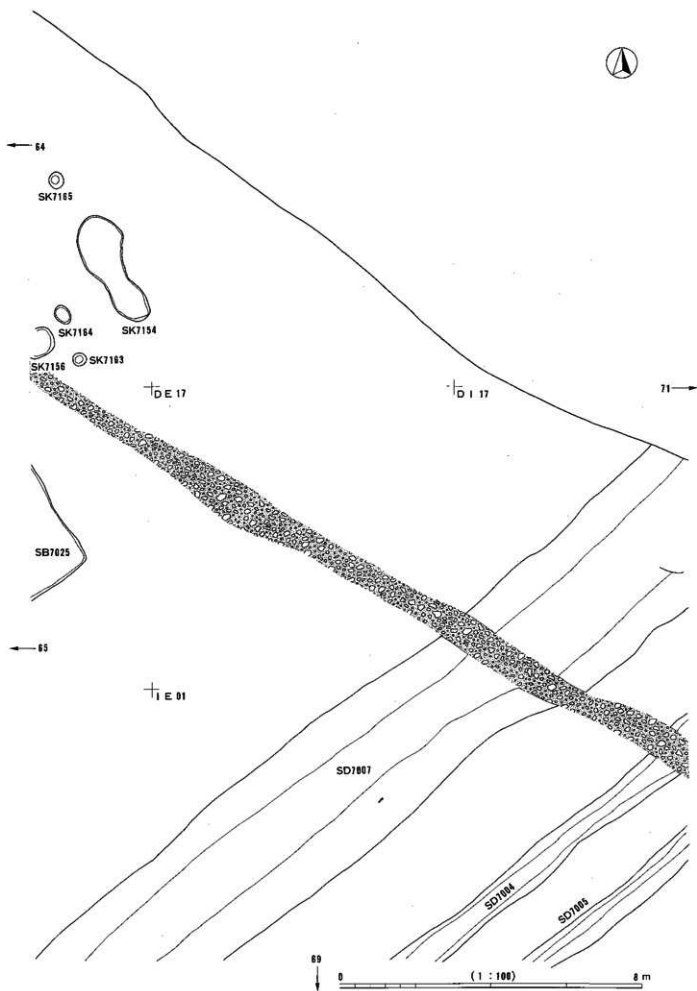

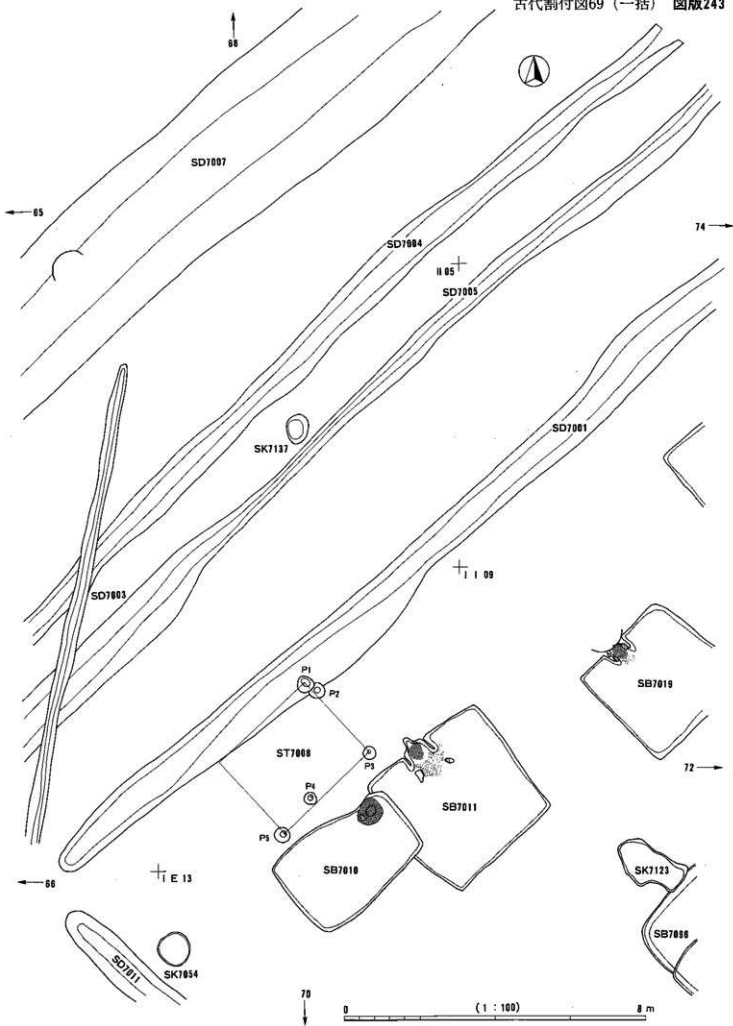

図版244 古代割付図70 (一括)

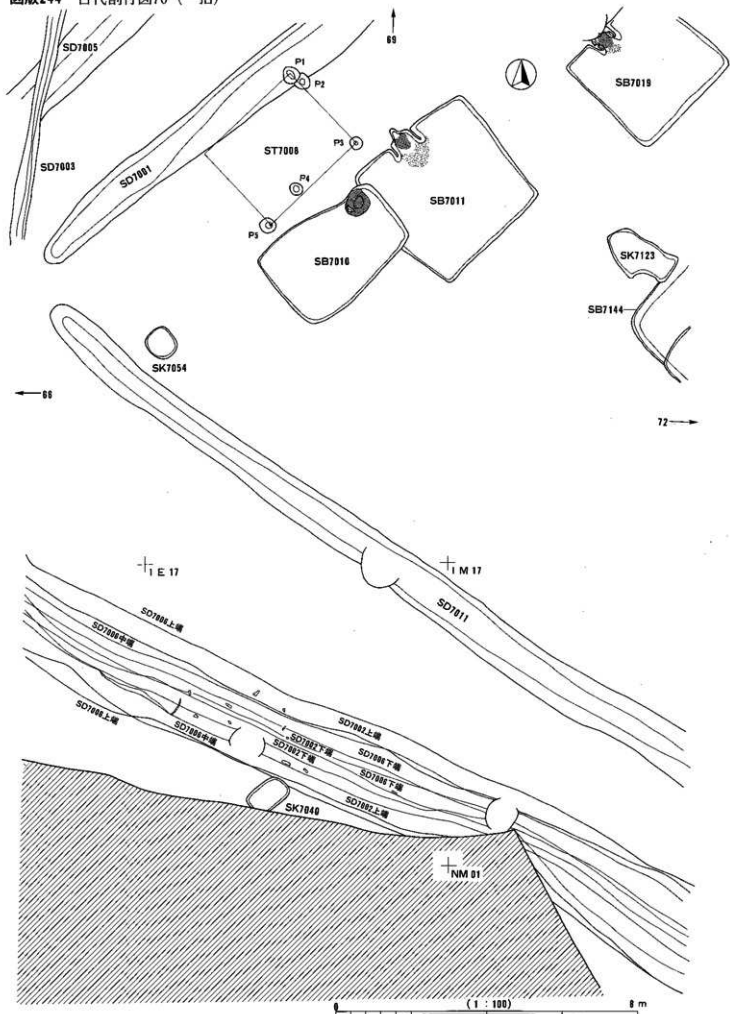





図版246 古代割付図73 (一括)

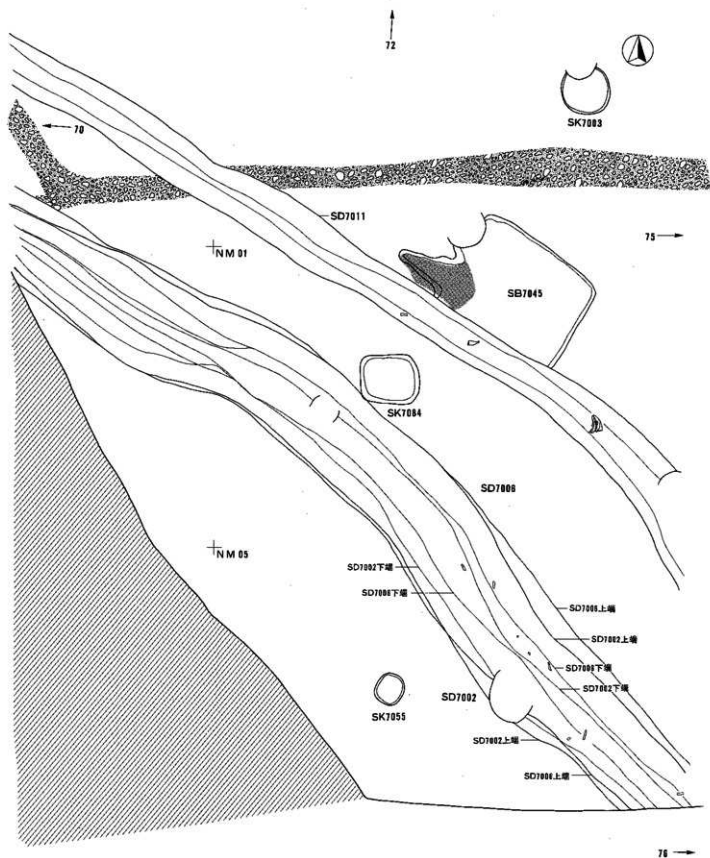

0 (1 : 100) 8 m

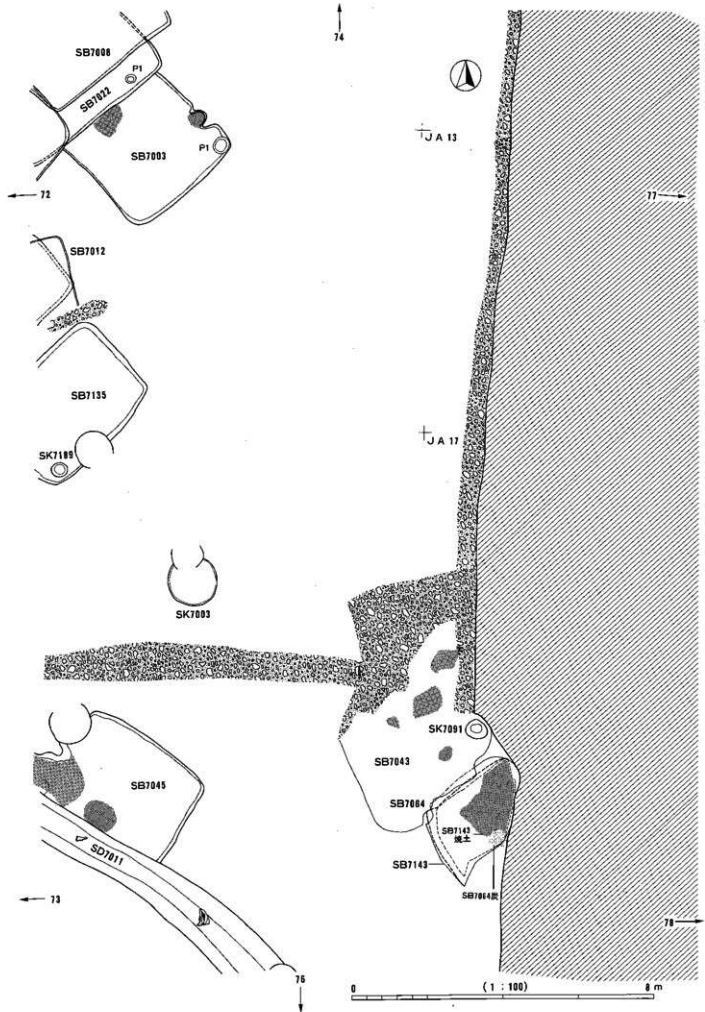

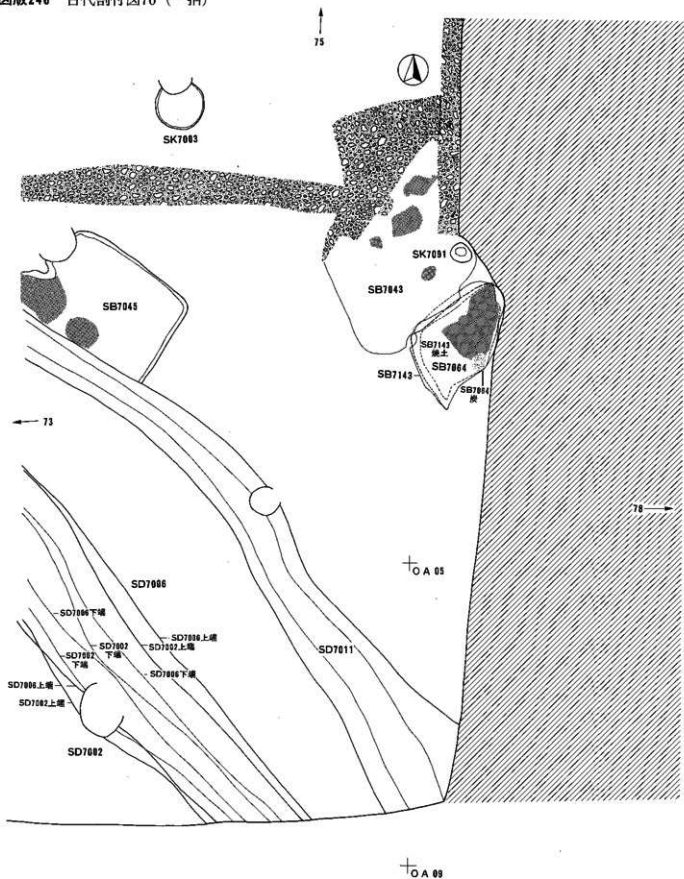

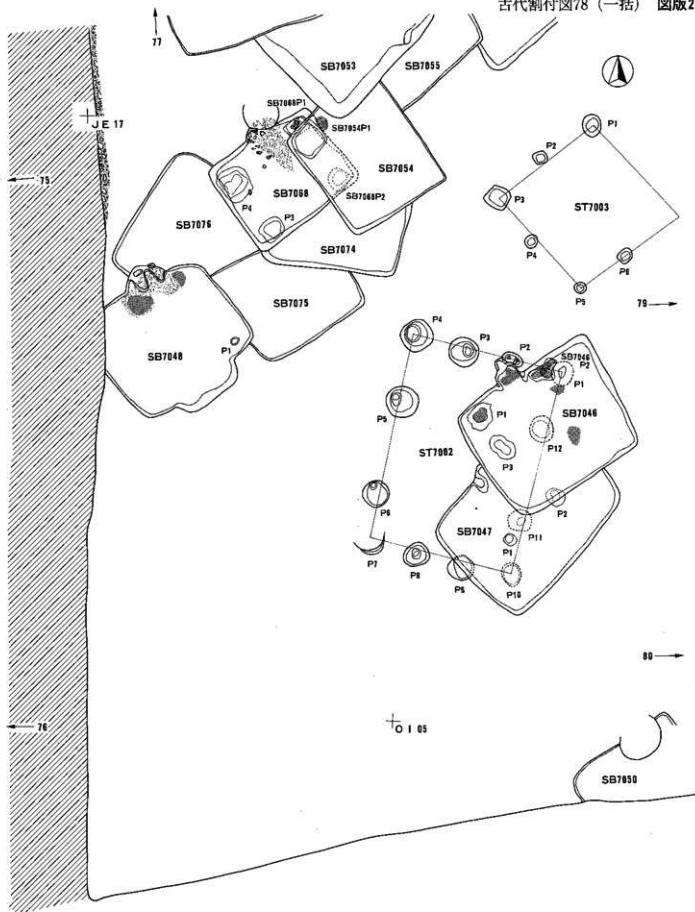

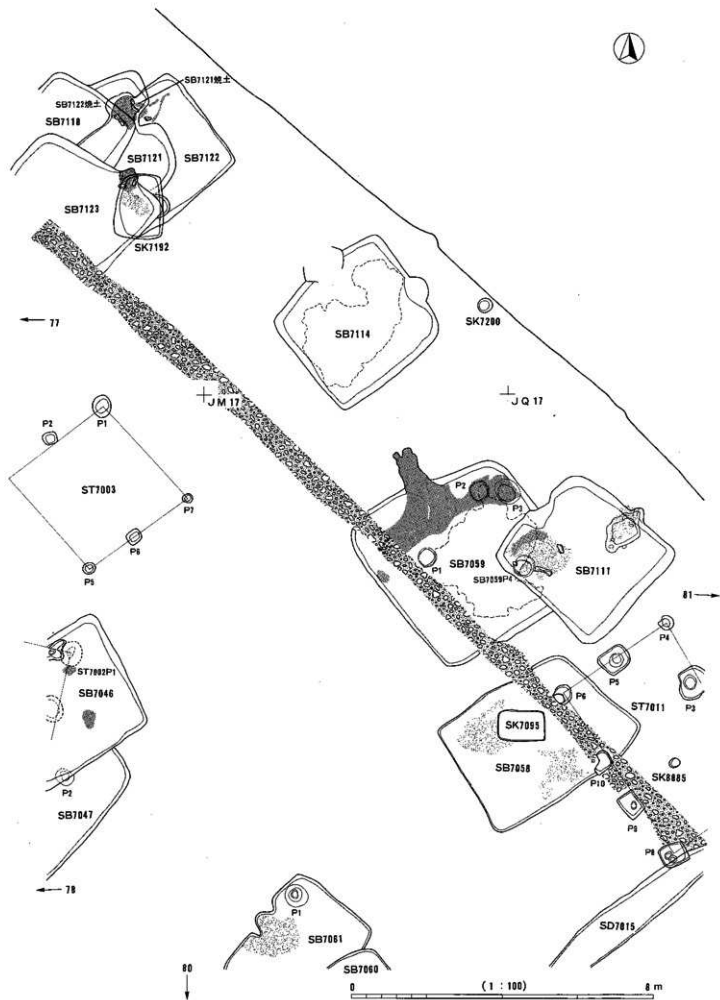

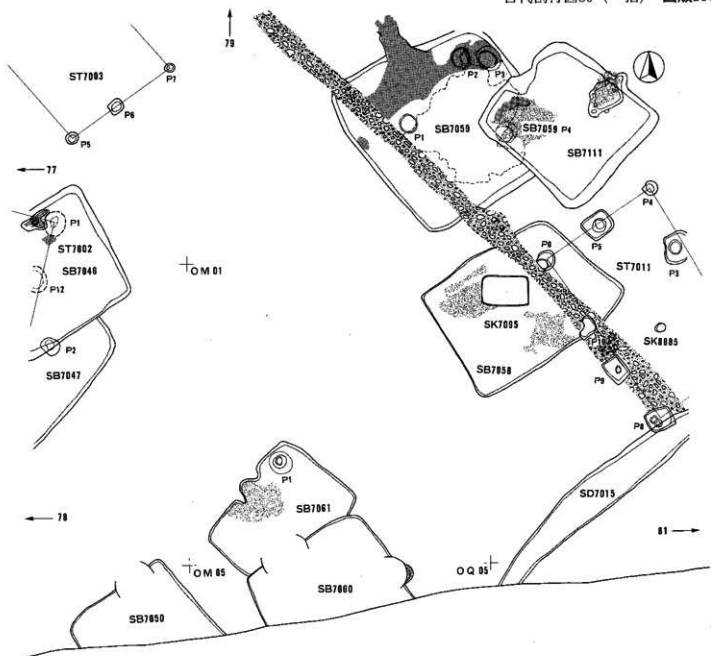

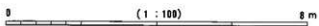
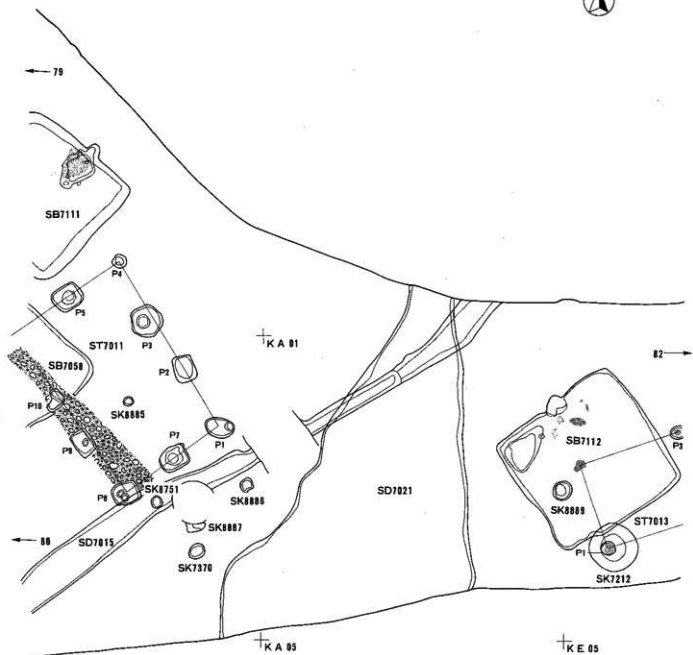

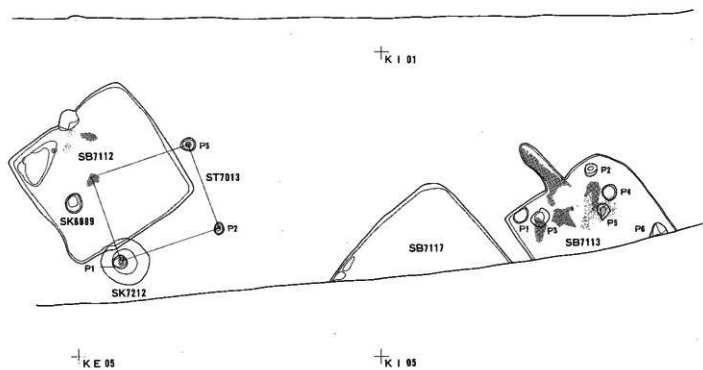



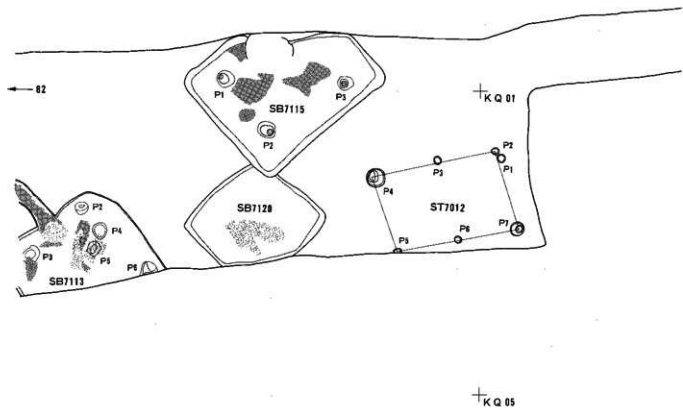

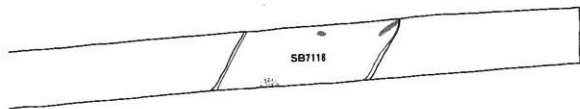

†LE 01

†LI 01

図版256 古代割付図18 (SK以外)

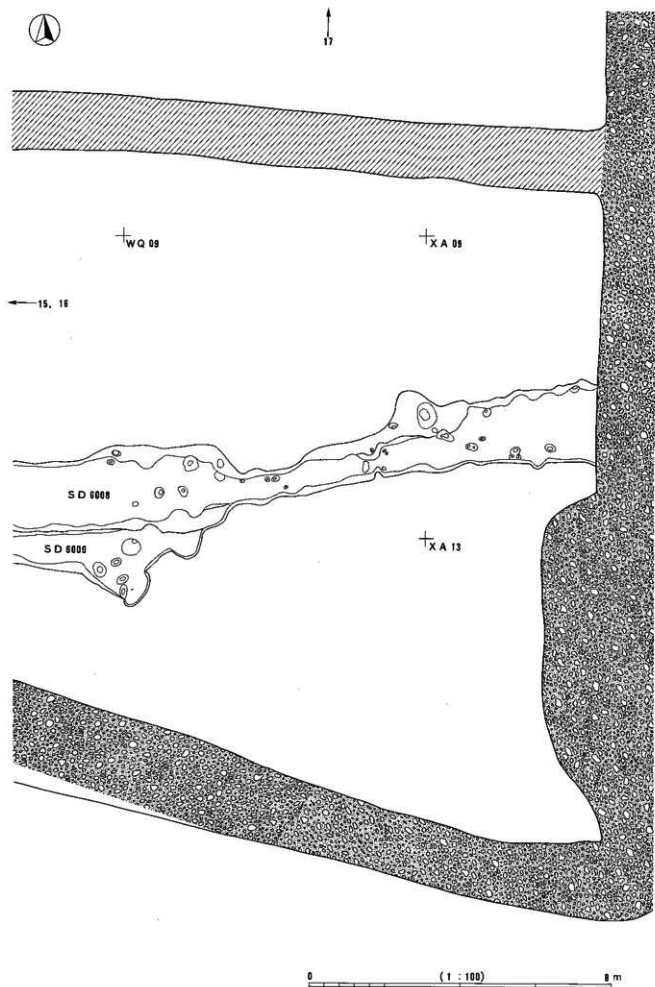

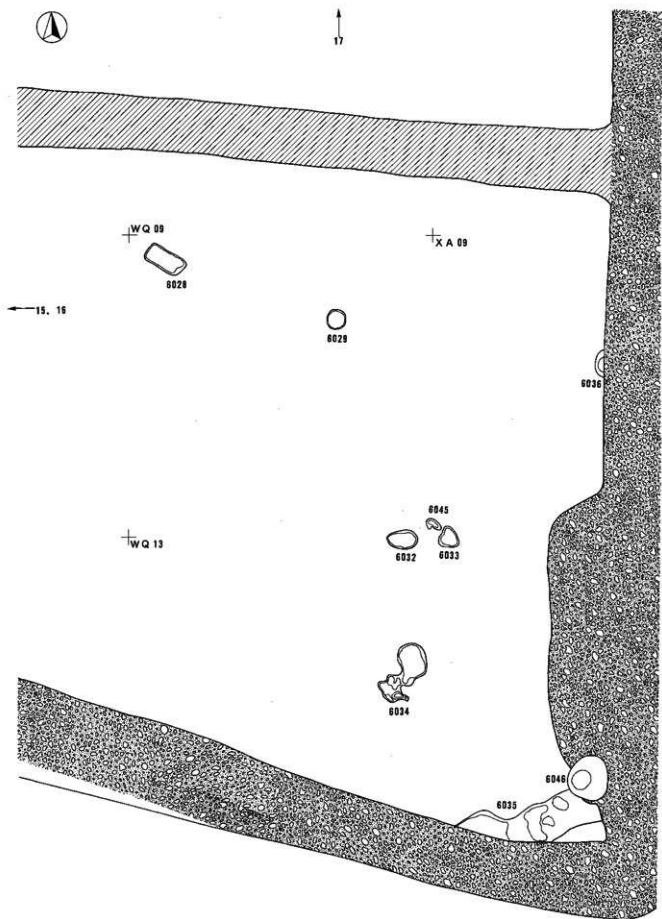

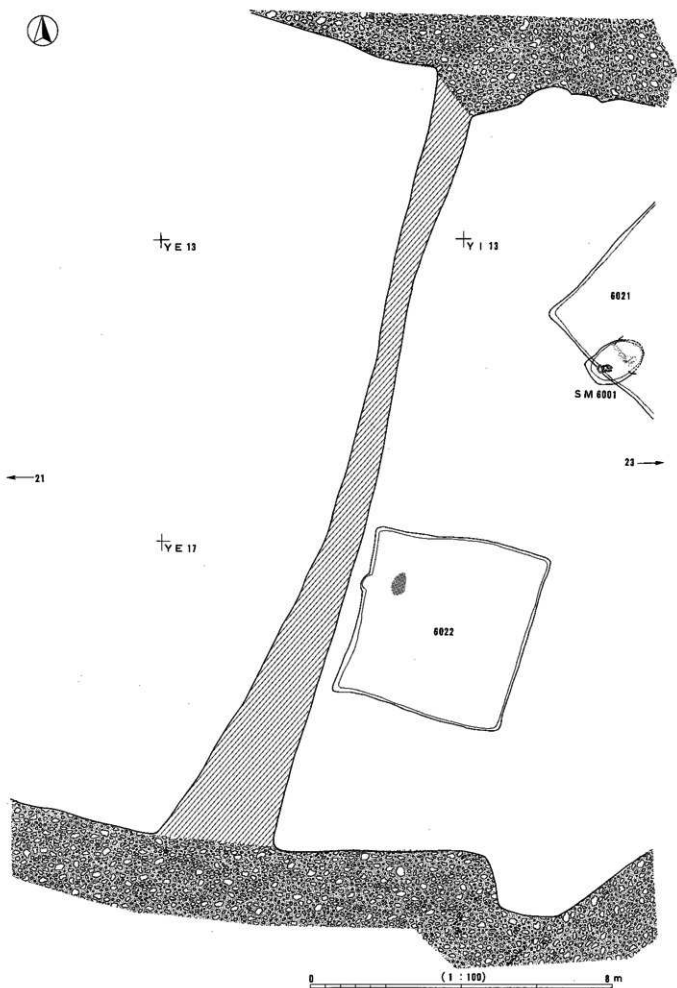

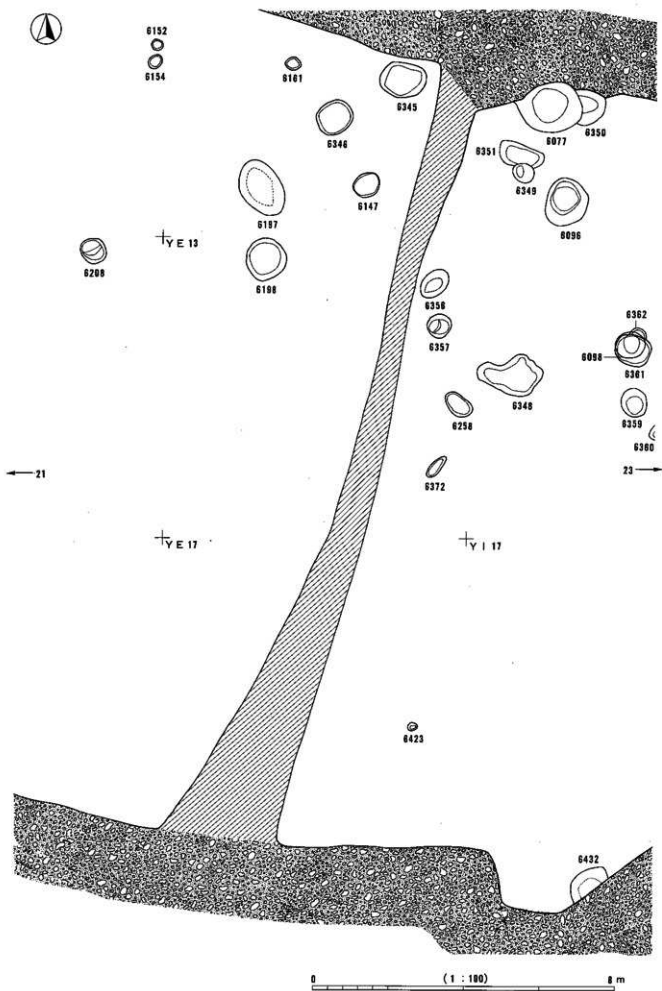

図版260 古代割付図23 (SK以外)

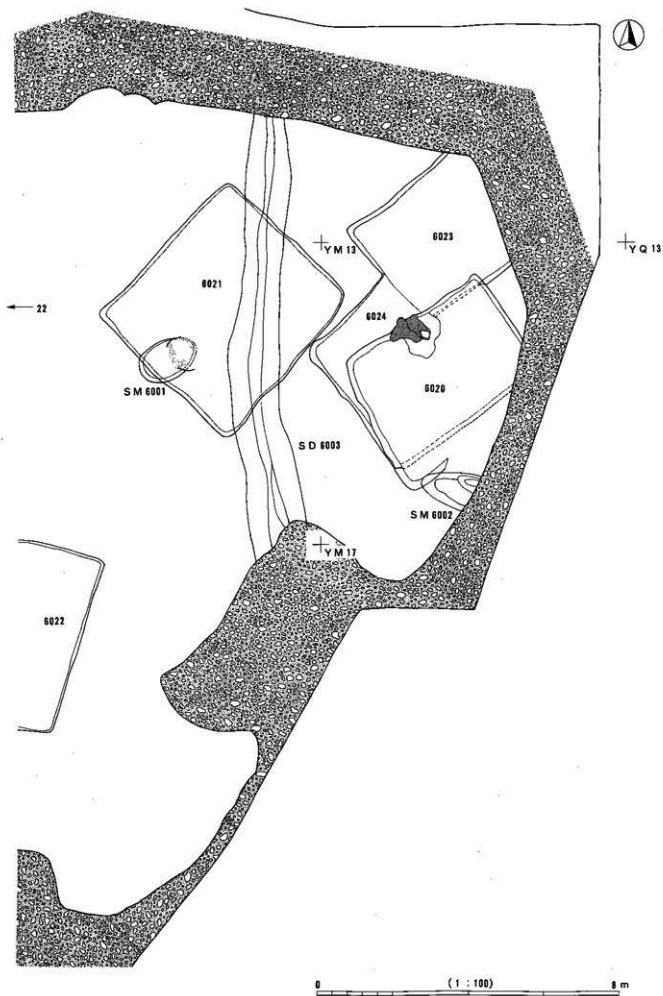

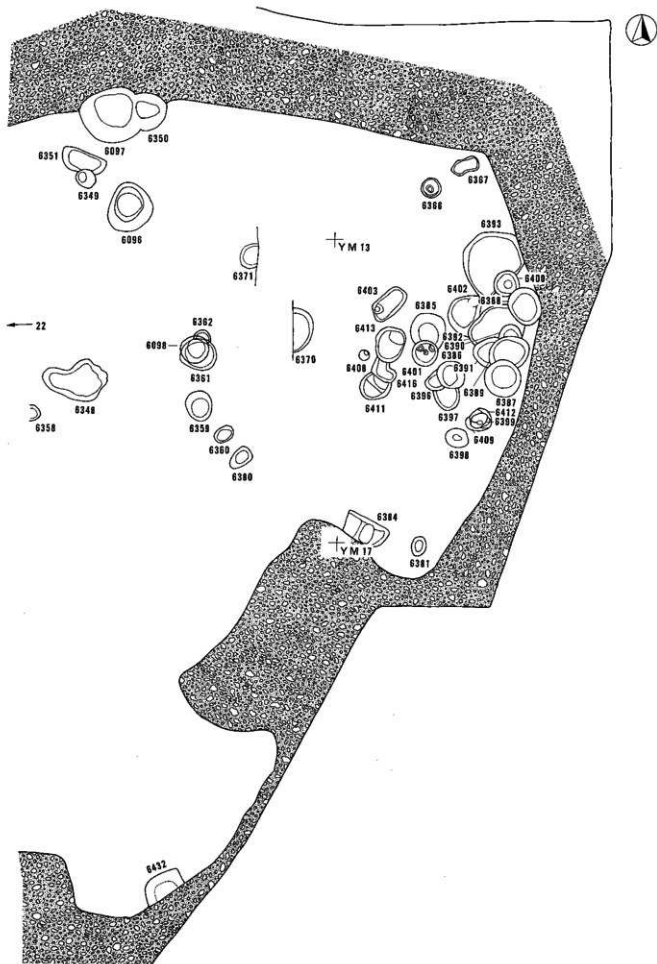



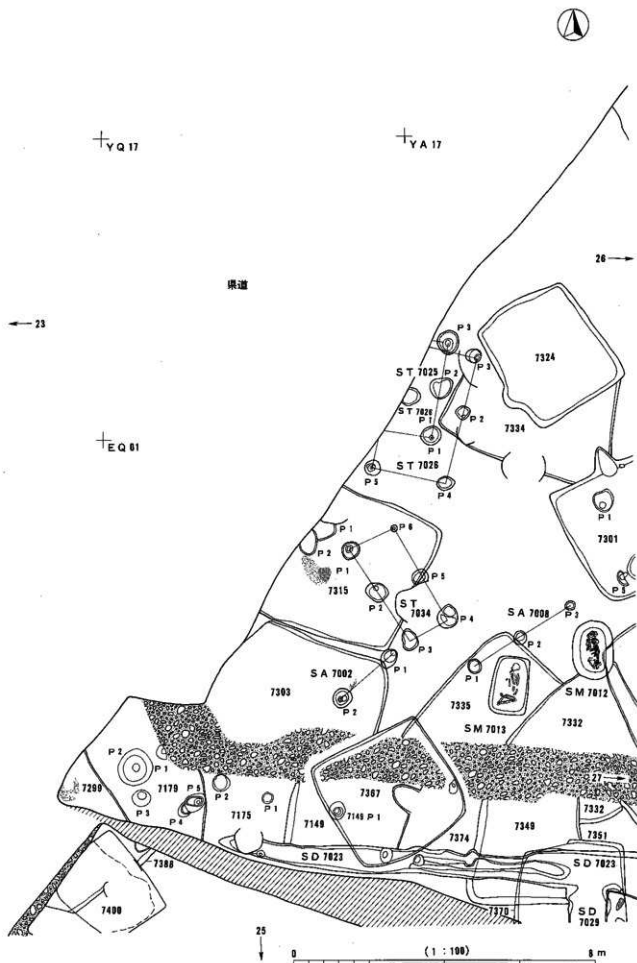

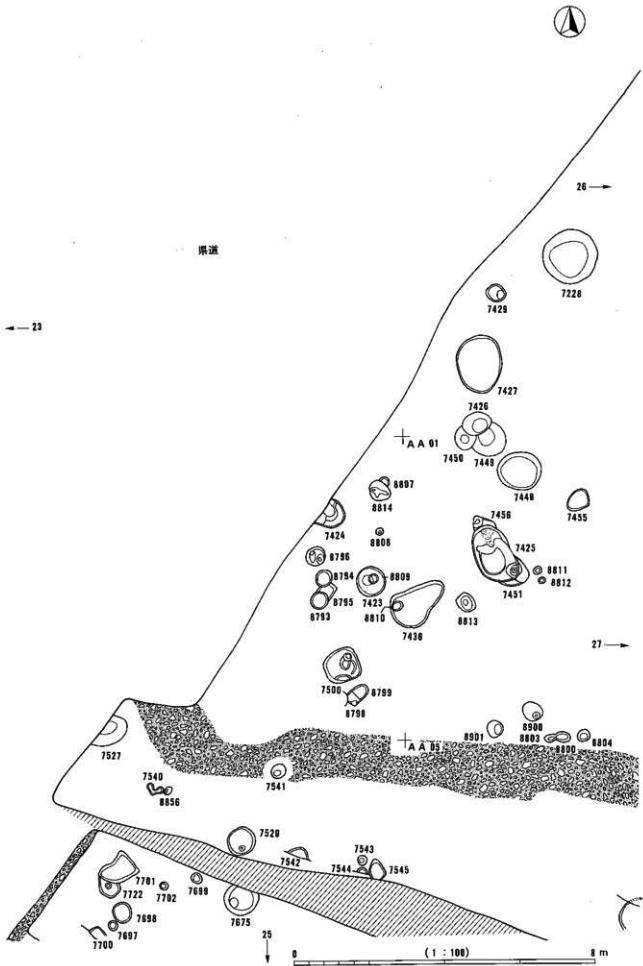

図版264 古代割付図25 (SK以外)

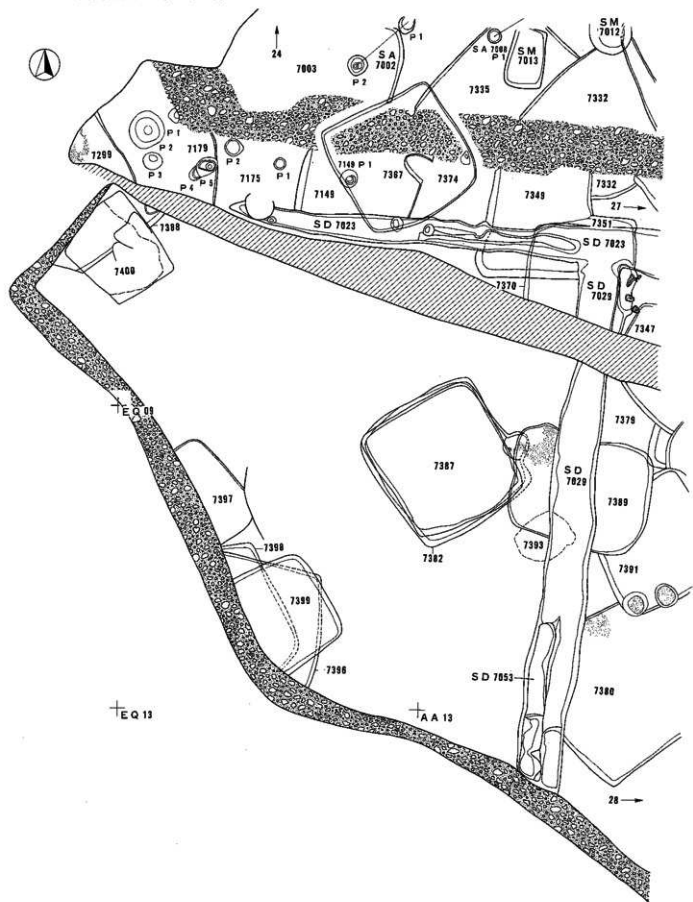

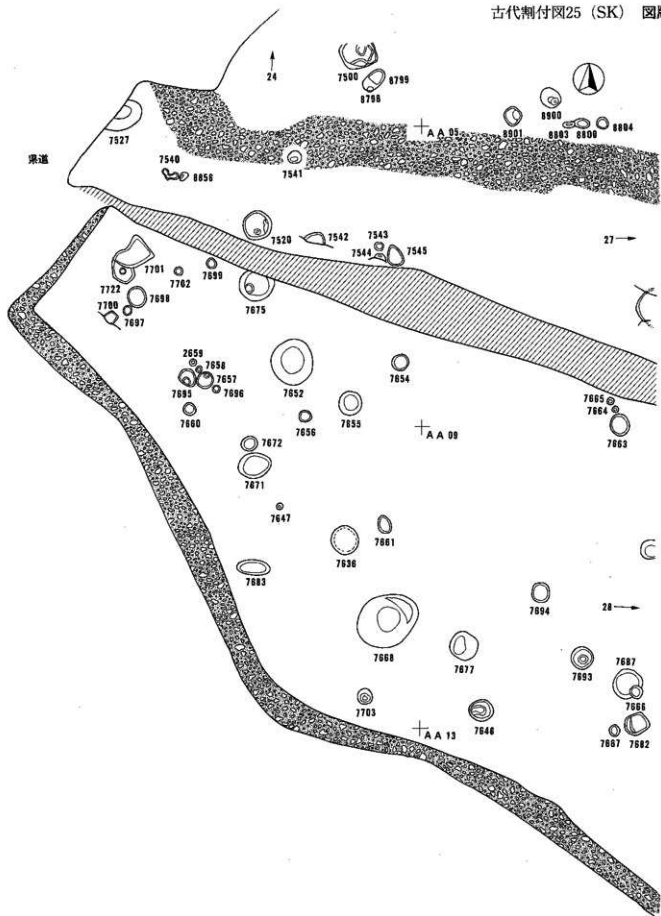

図版266 古代割付図26 (SK以外)

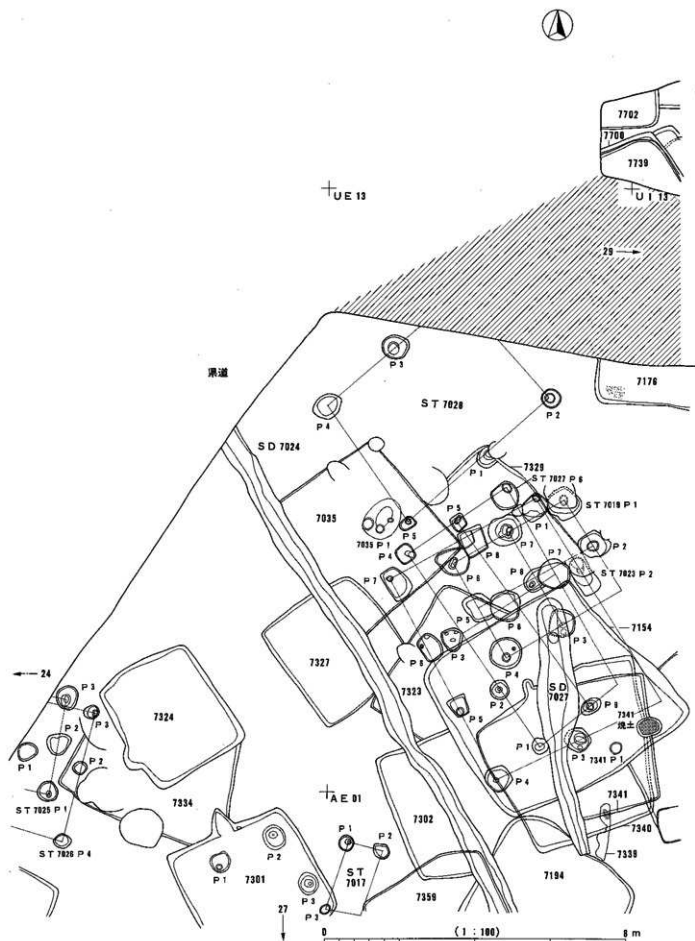

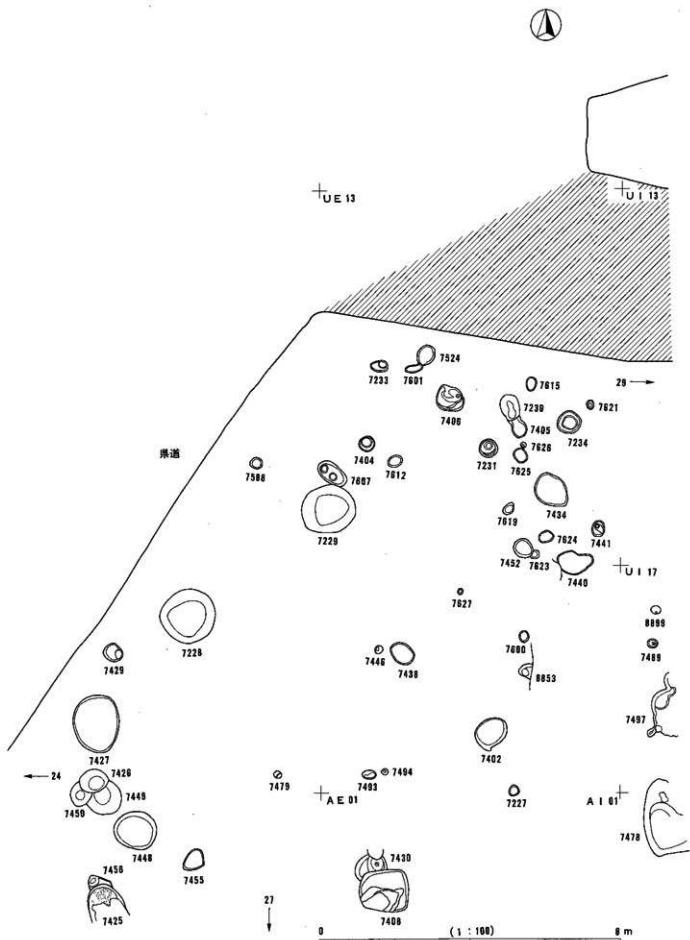

図版268 古代割付図27 (SK以外)

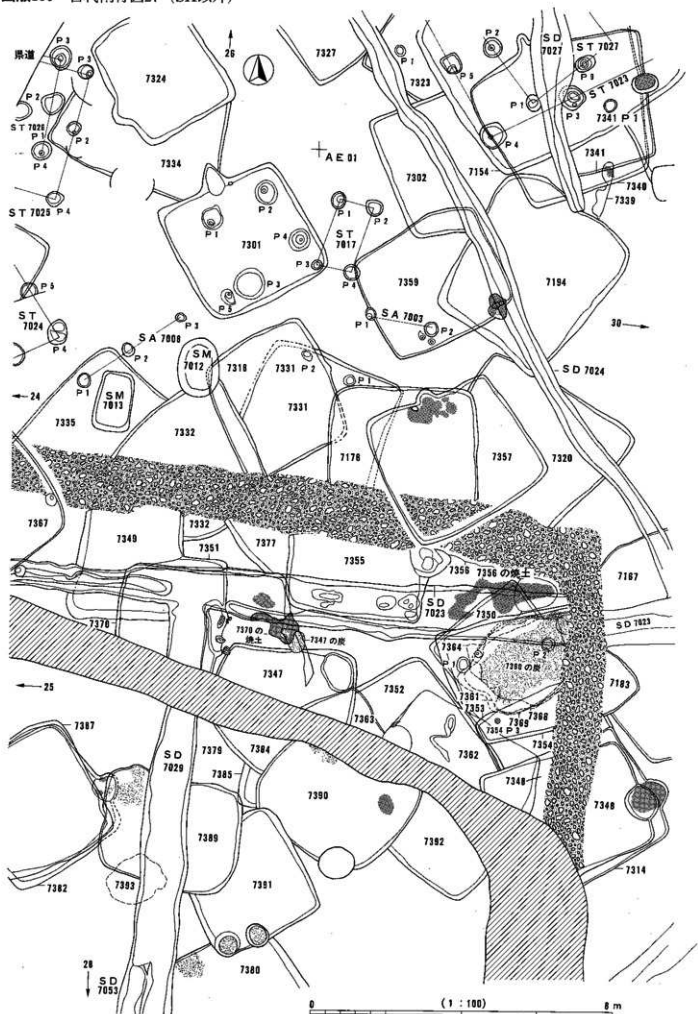

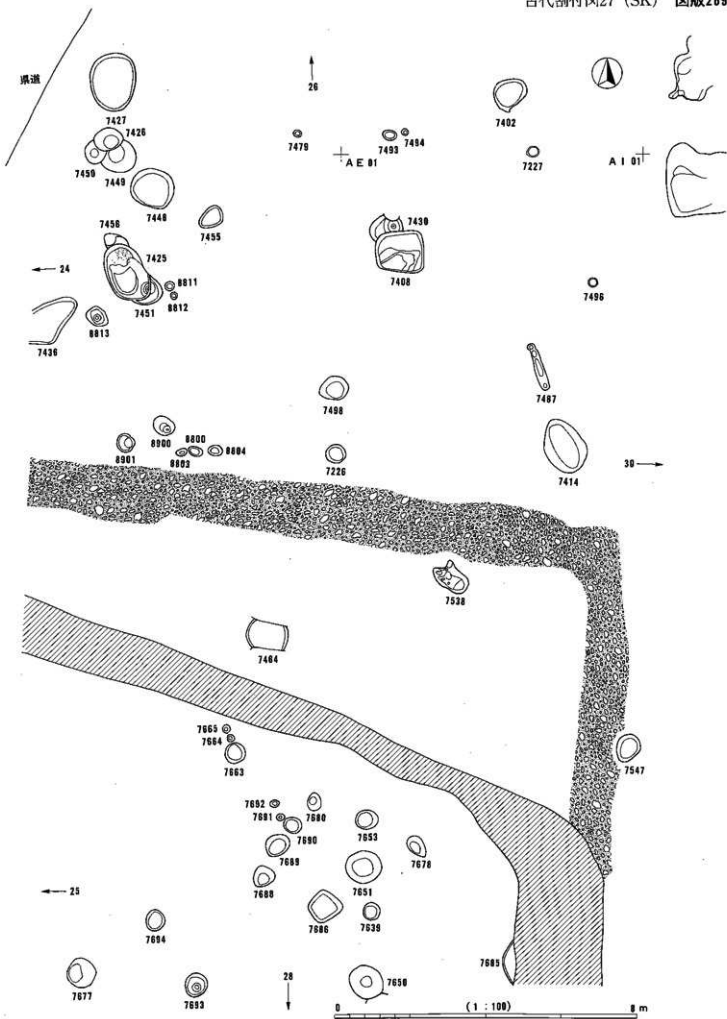



図版270 古代割付図28 (SK以外)

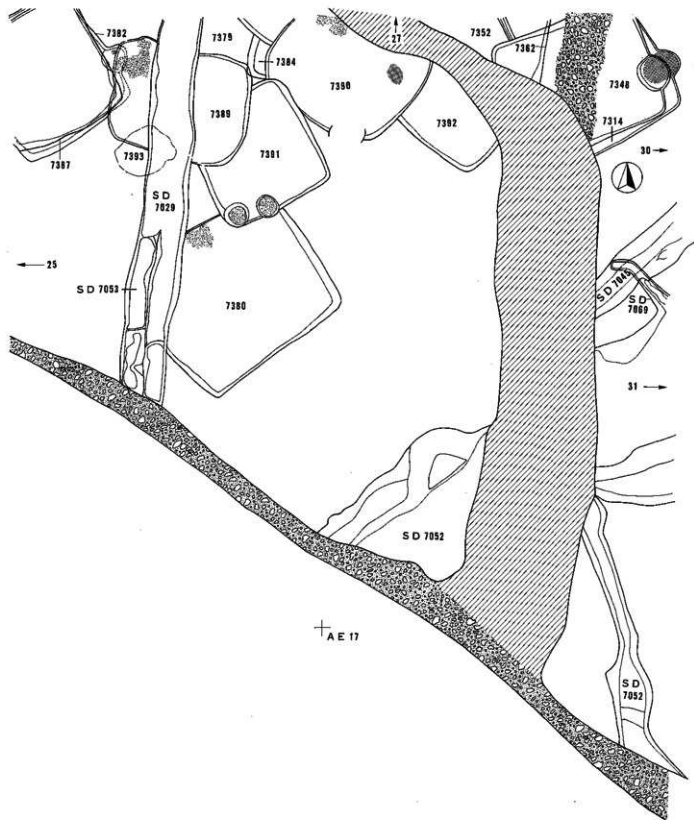

+ AE 17

+ FE 01

0 ( 1 : 100 ) 8 m

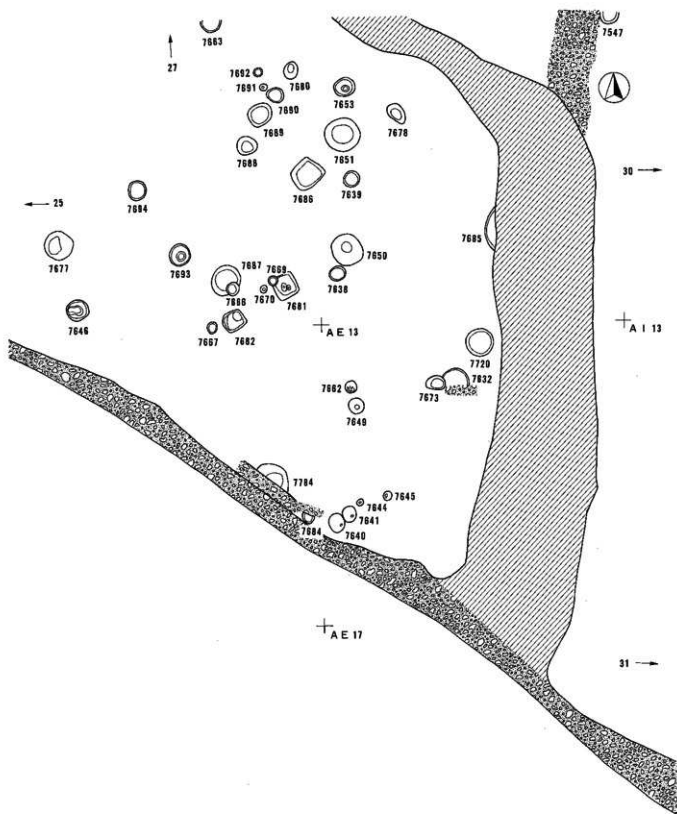

図版272 古代割付図29 (SK以外)

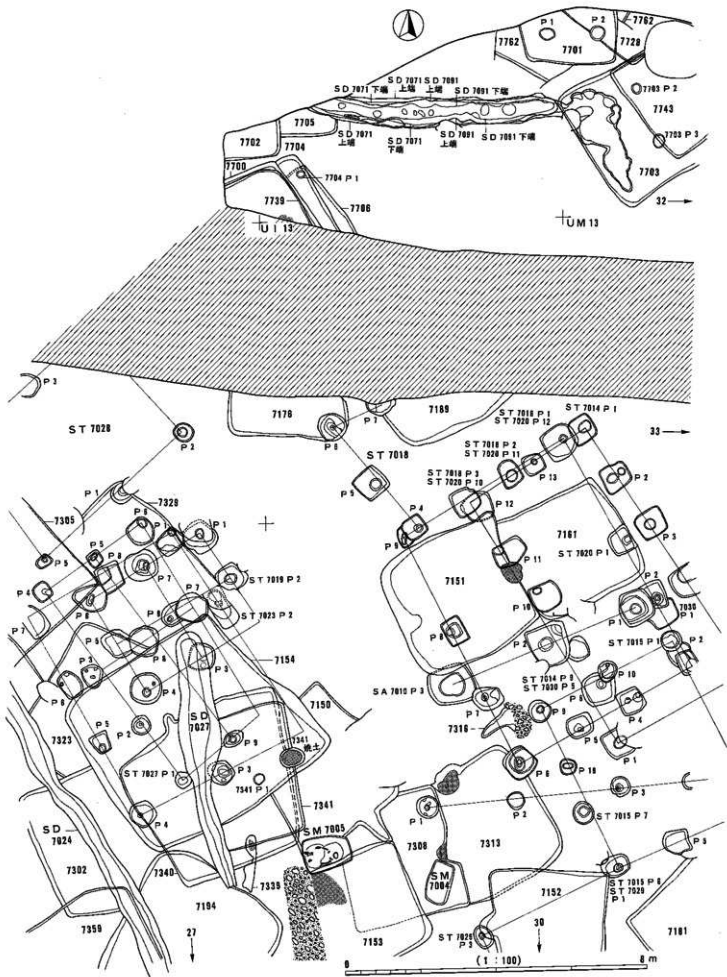

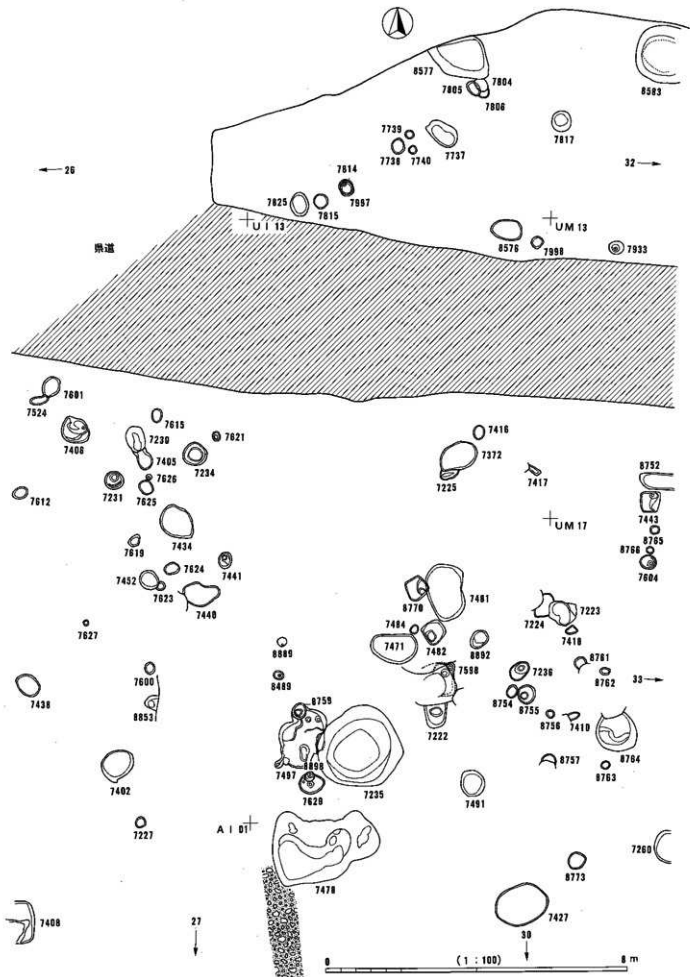

図版274 古代柁付図30 (SK以外)

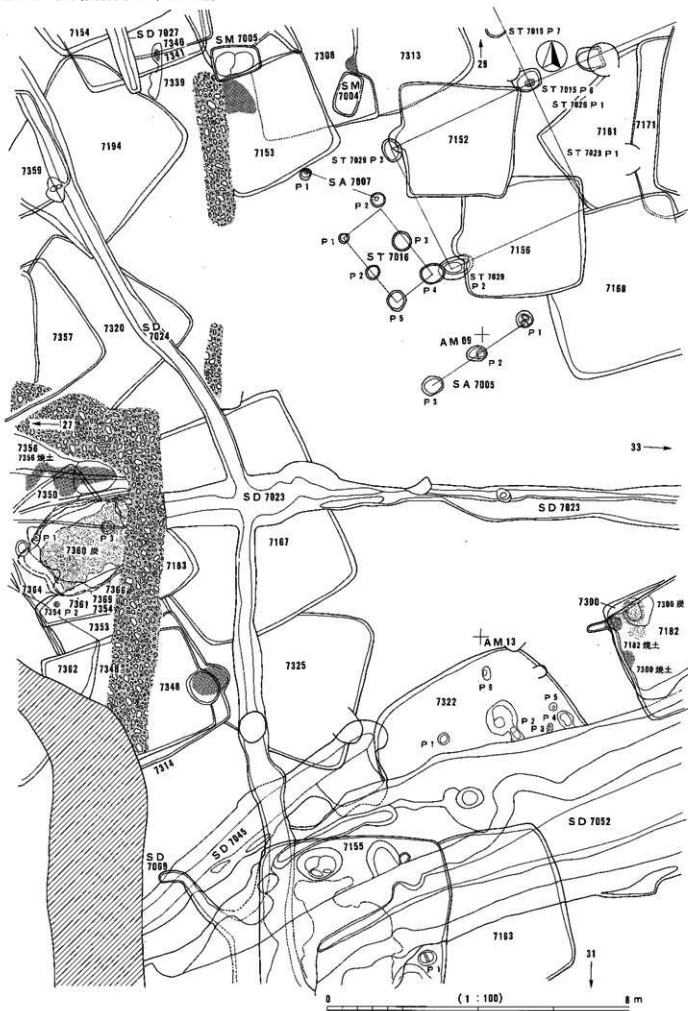

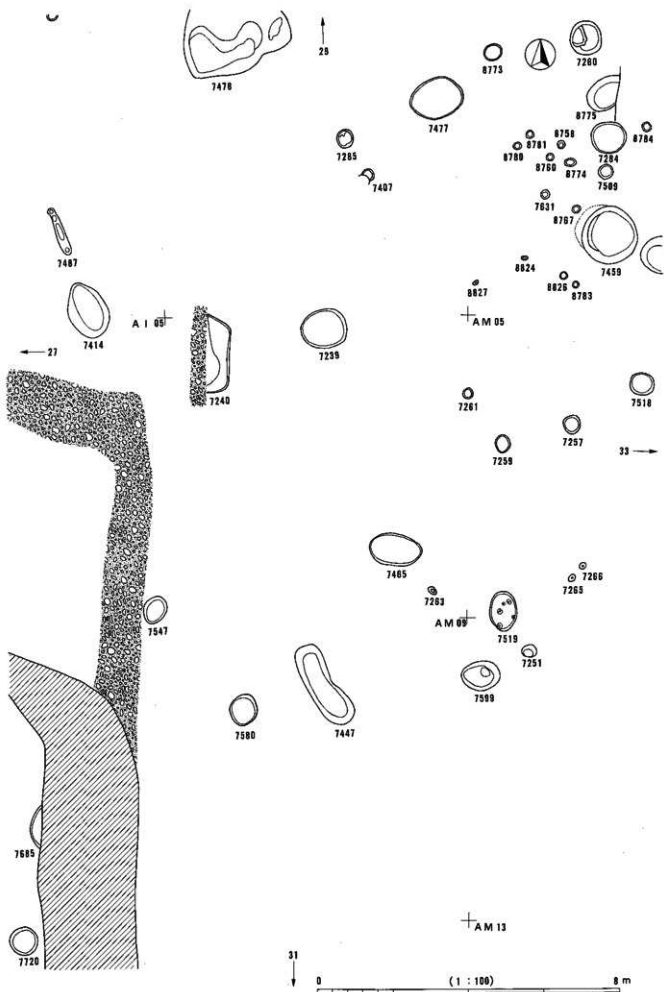

図版276 古代割付図31 (SK以外)

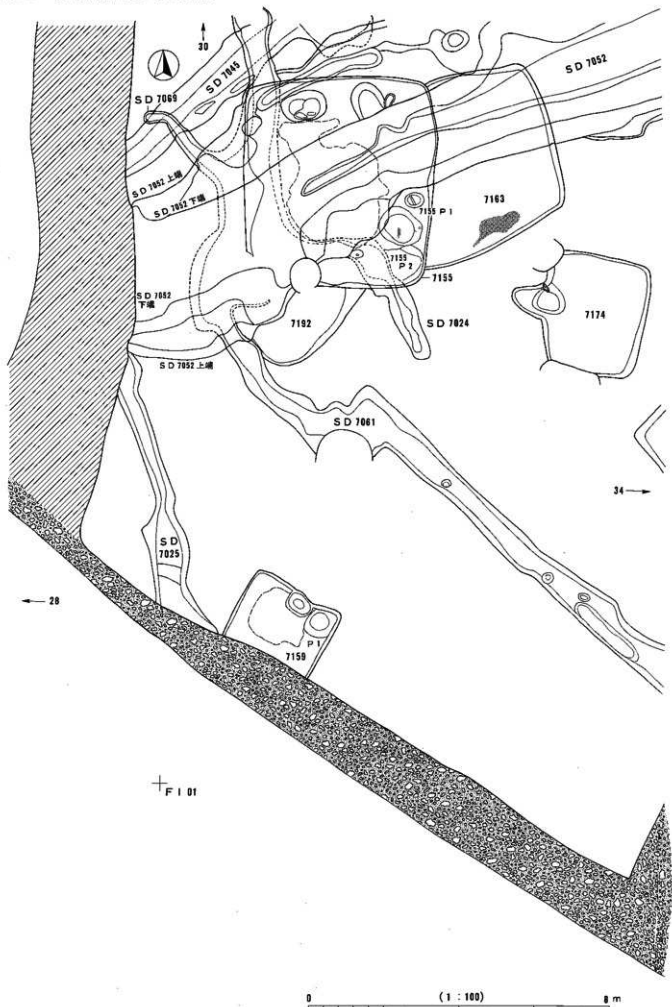

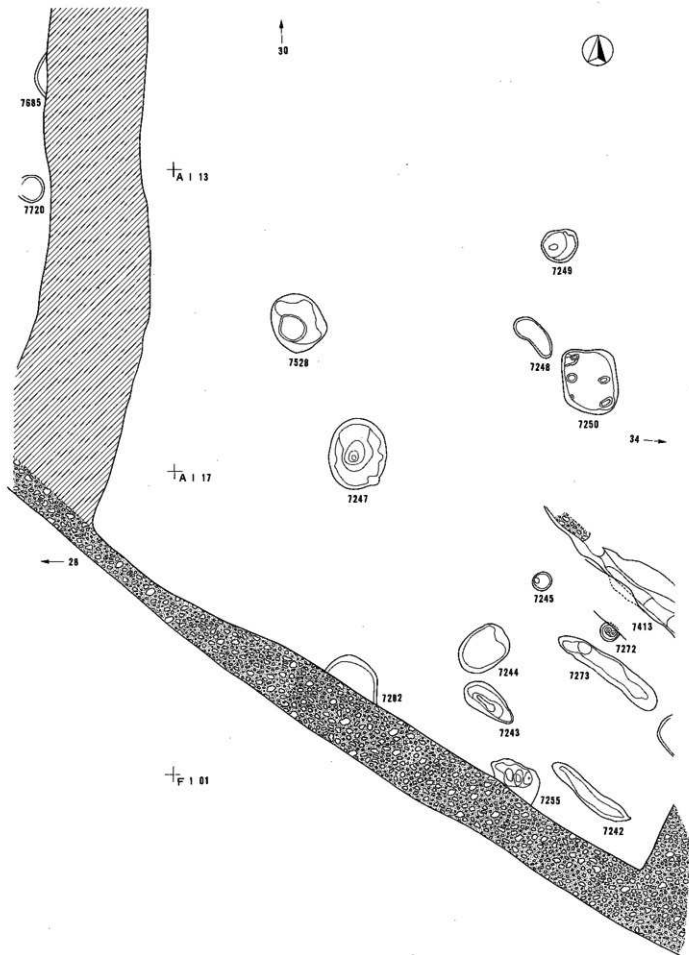



図版278 古代割付図32 (SK以外)

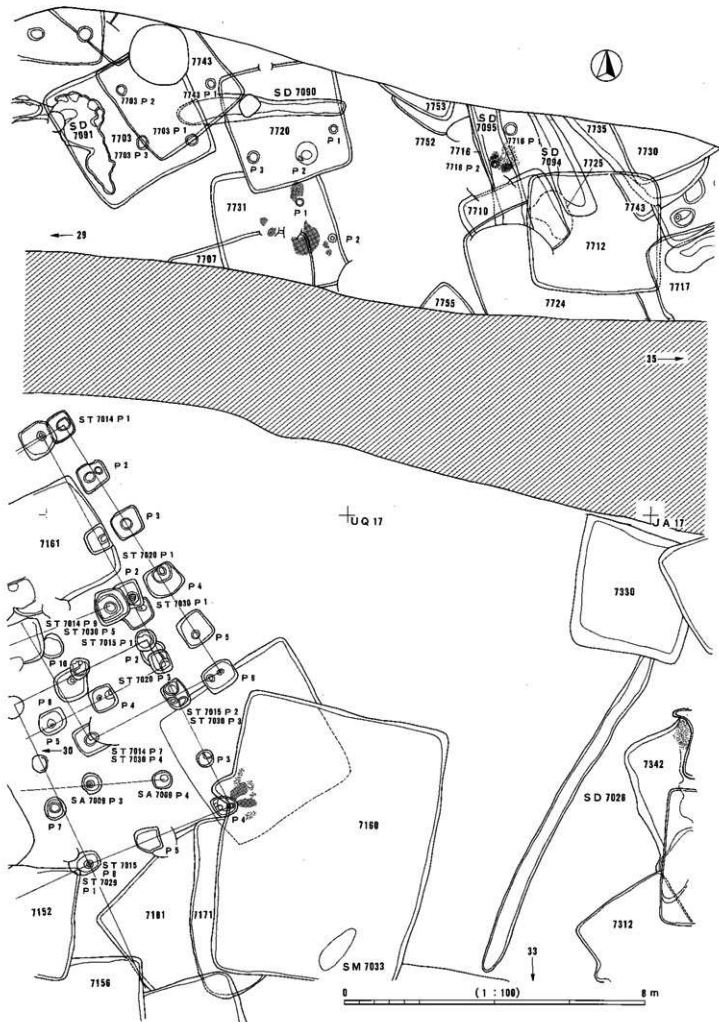

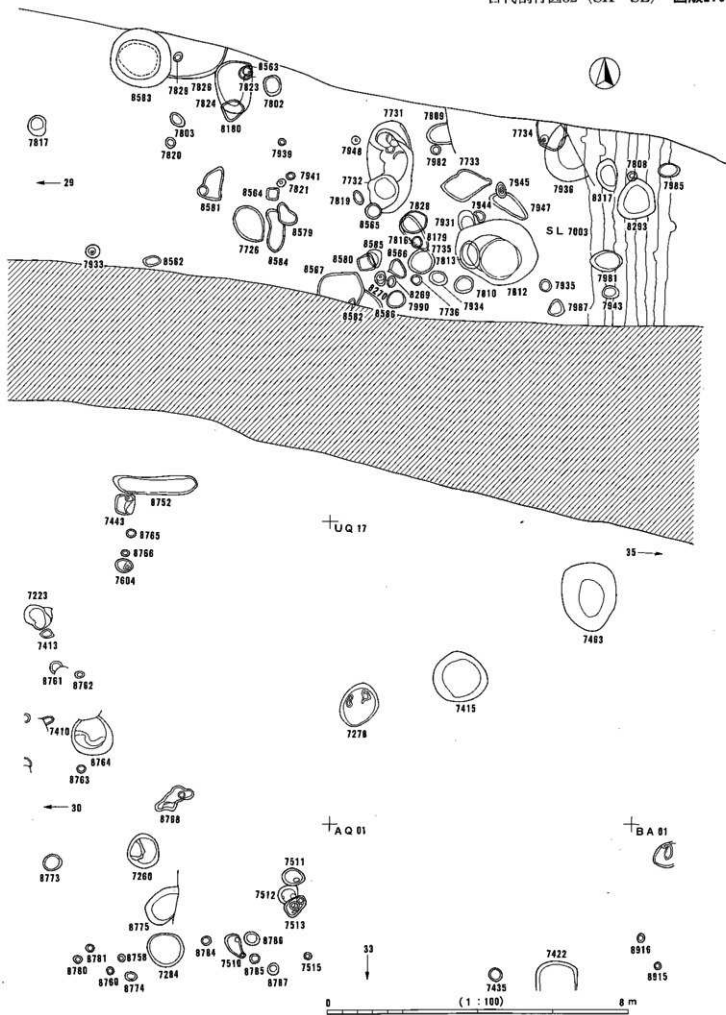

図版280 古代割付図33 (SK以外)

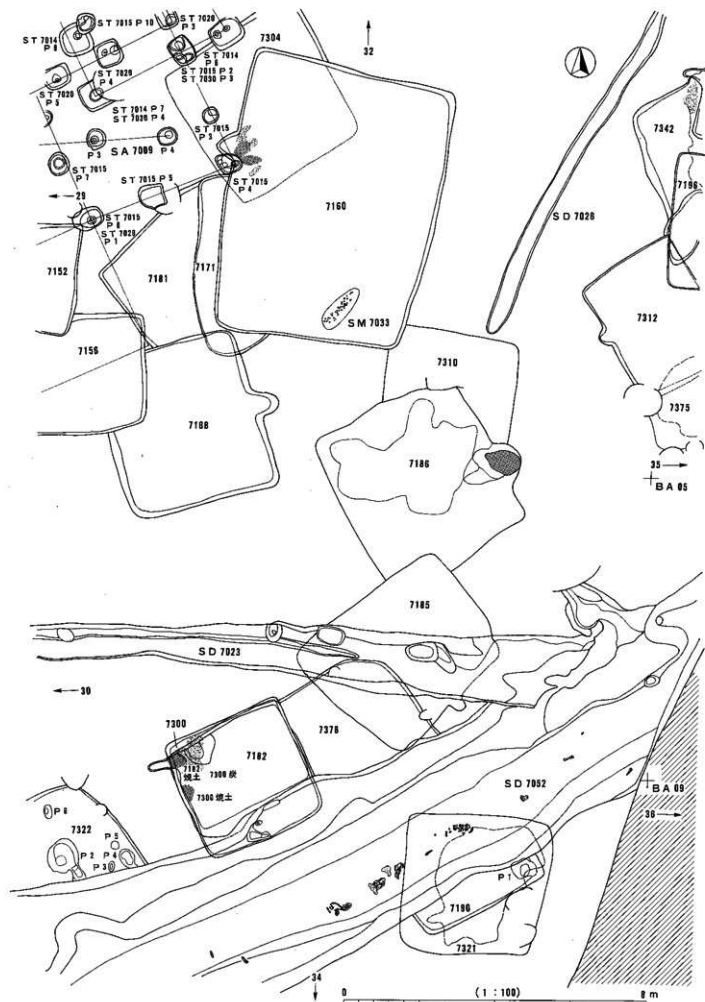

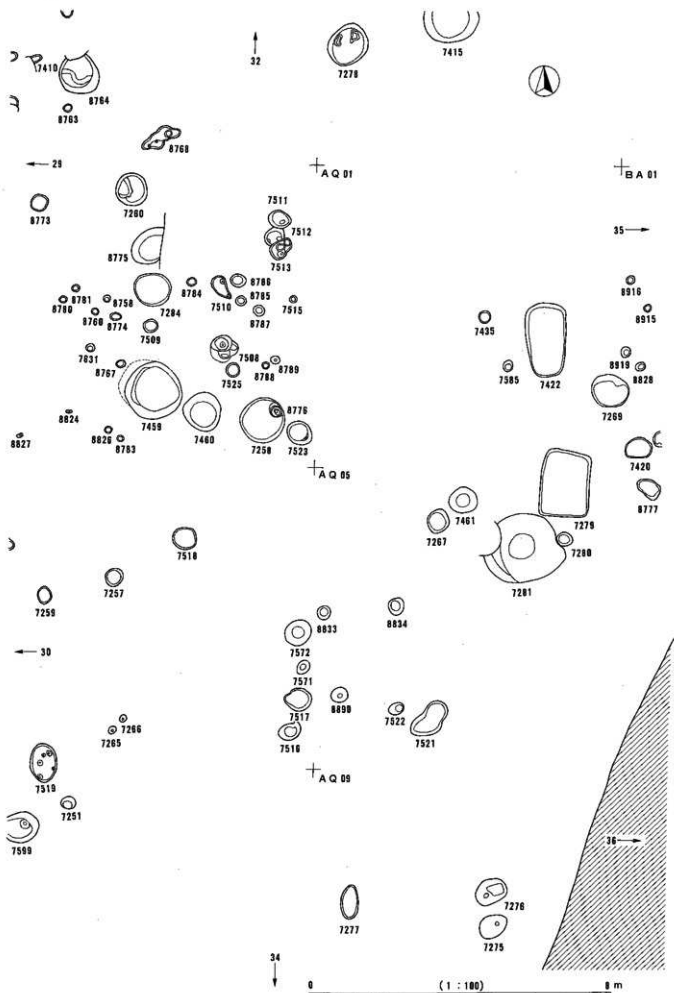

図版282 古代割付図34 (SK以外)

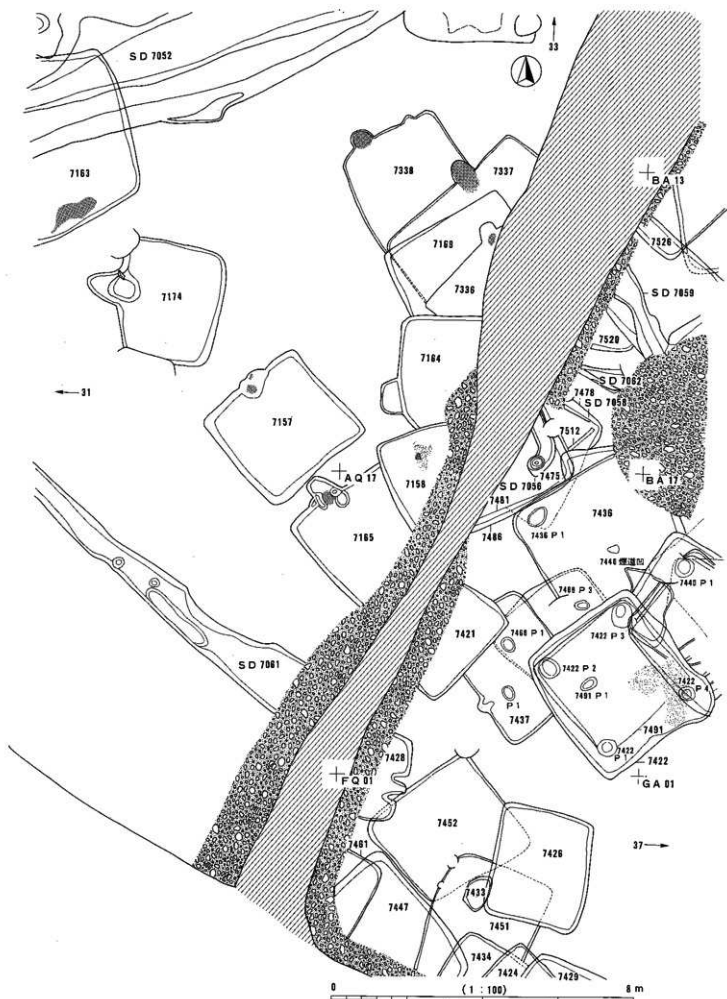

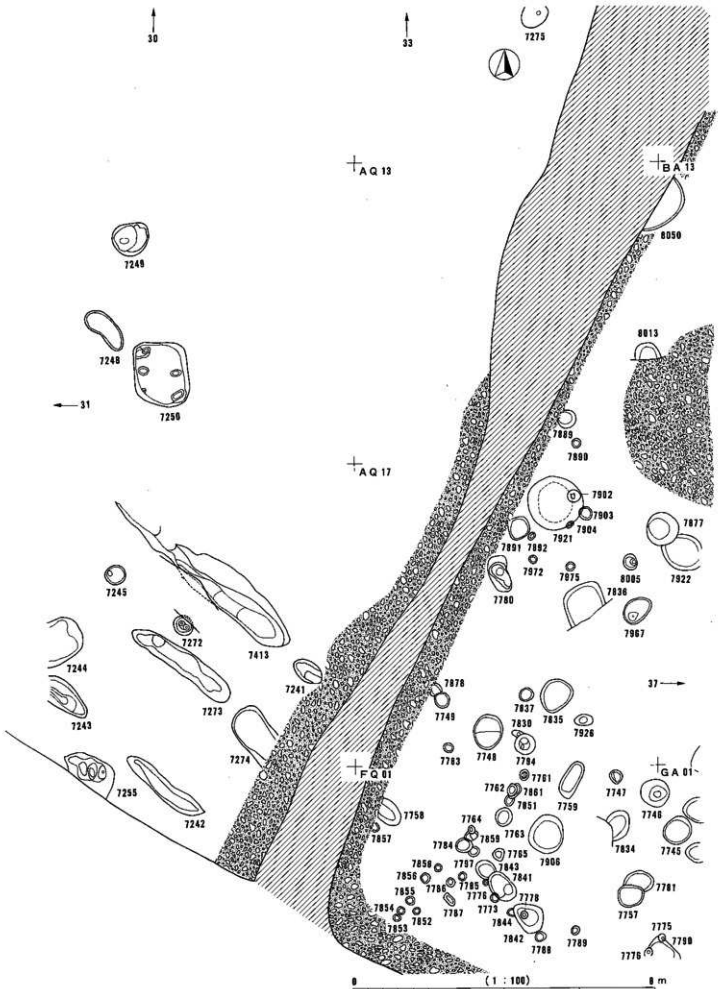

図版284 古代割付図35 (SK以外)

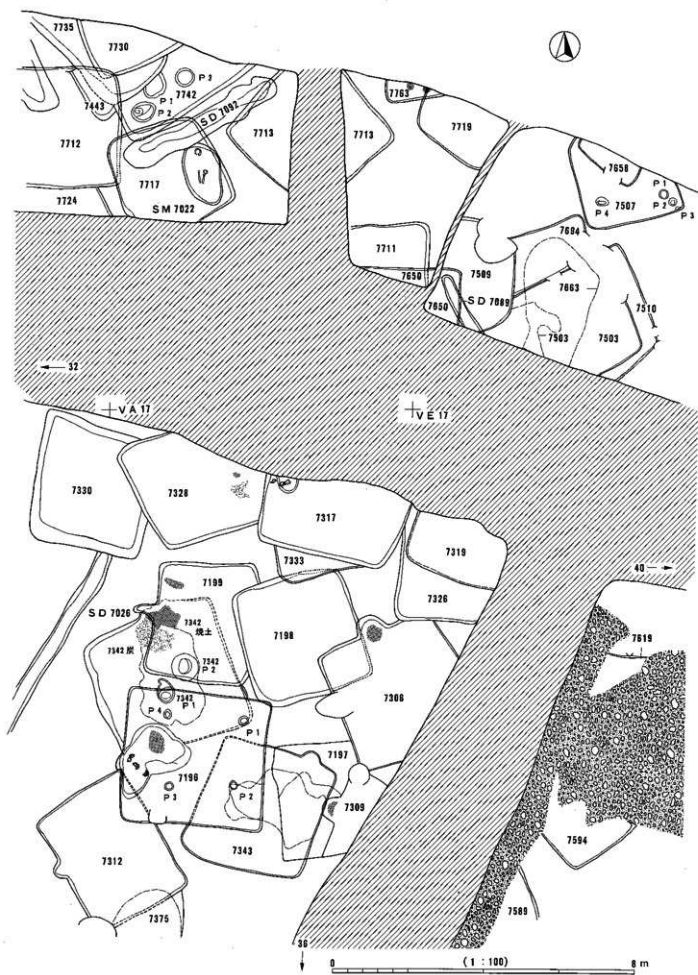

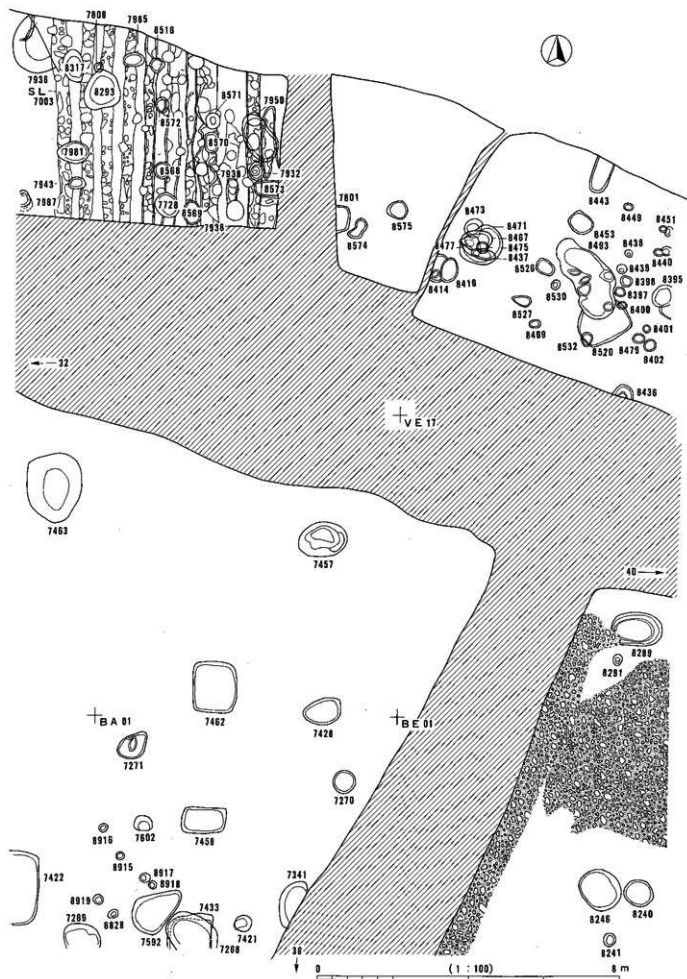



図版286 古代割付図36 (SK以外)

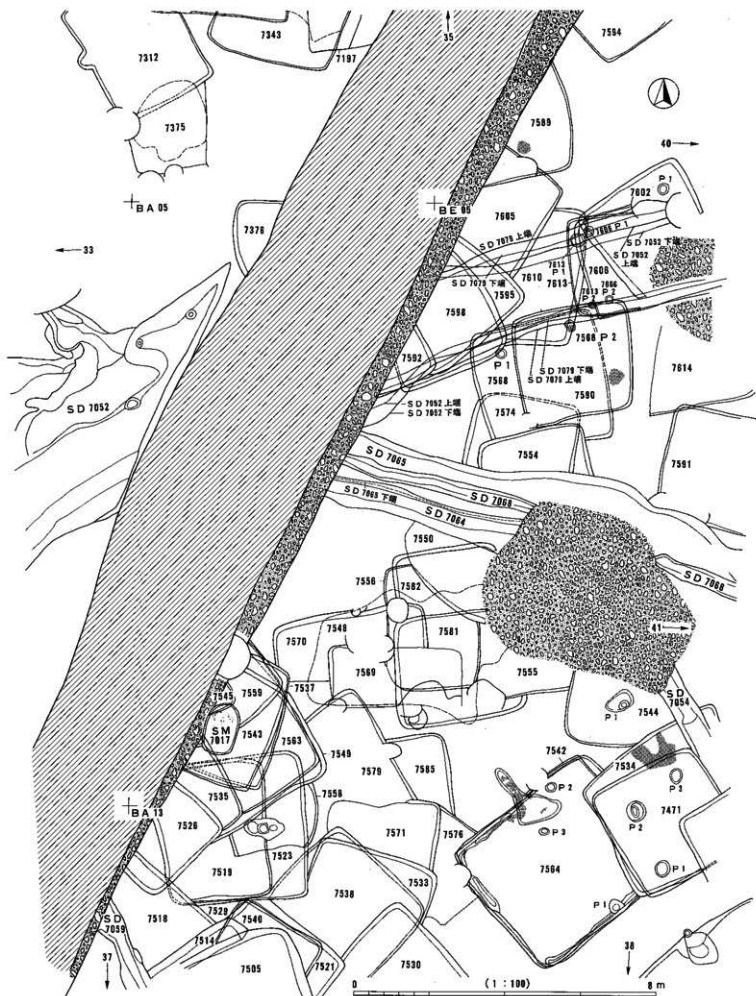

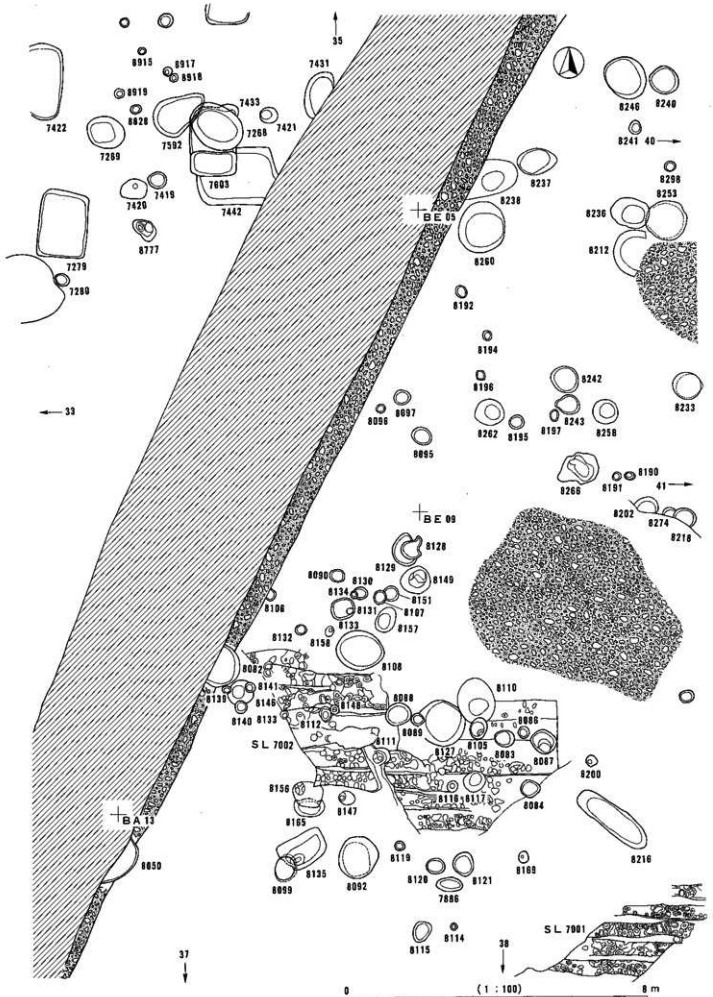

图版288 古代割付图37 (SK以外)

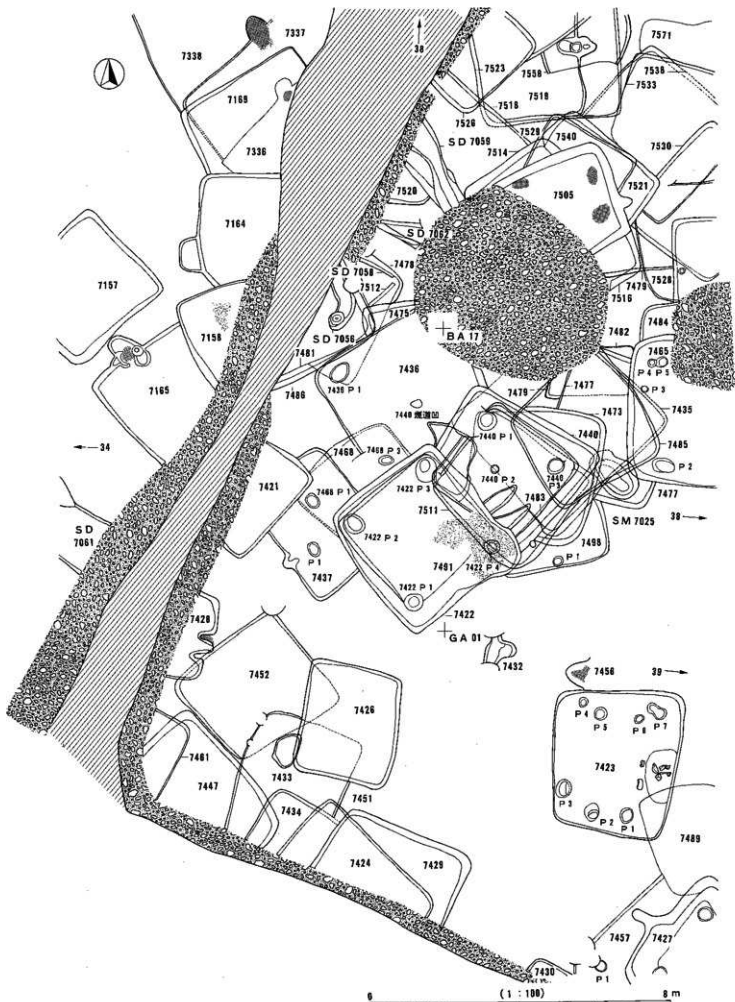

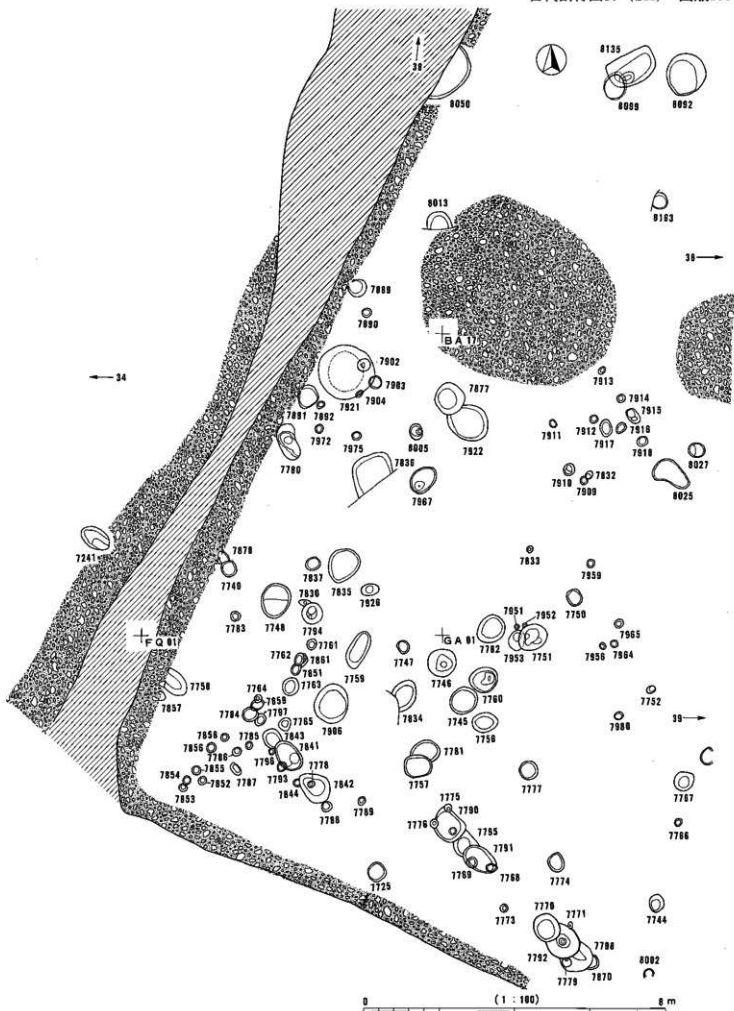

図版290 古代割付図38 (SK以外)

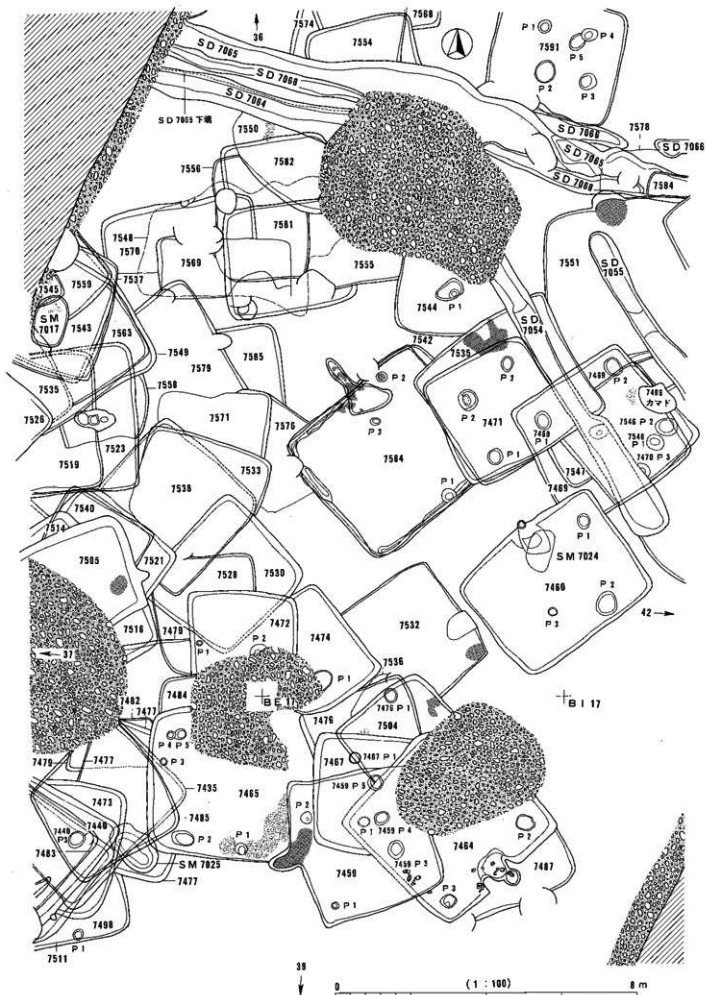

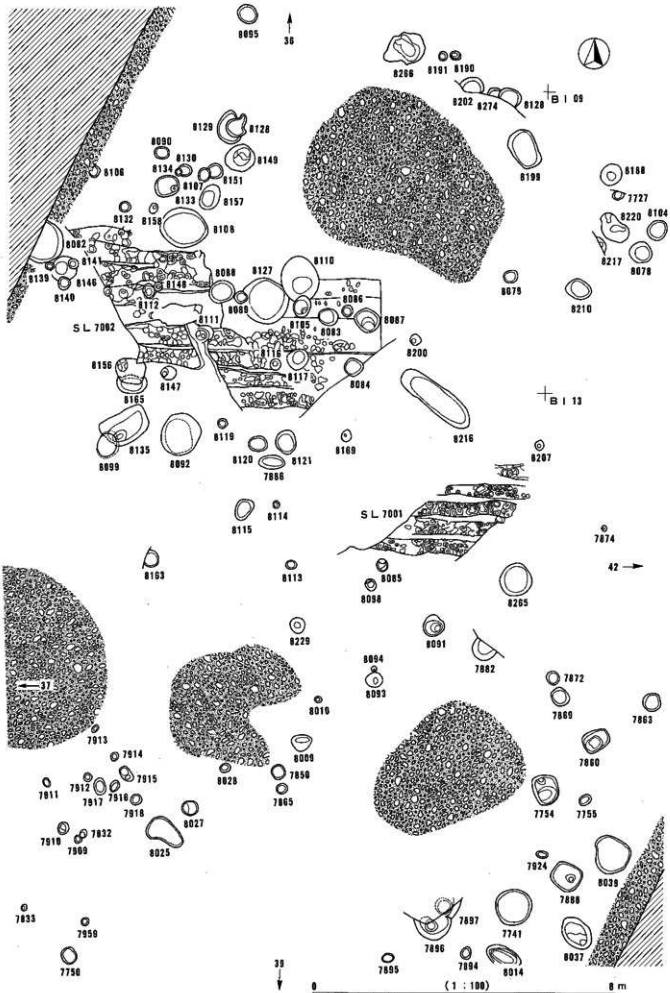

図版292 古代割付図39 (SK以外)

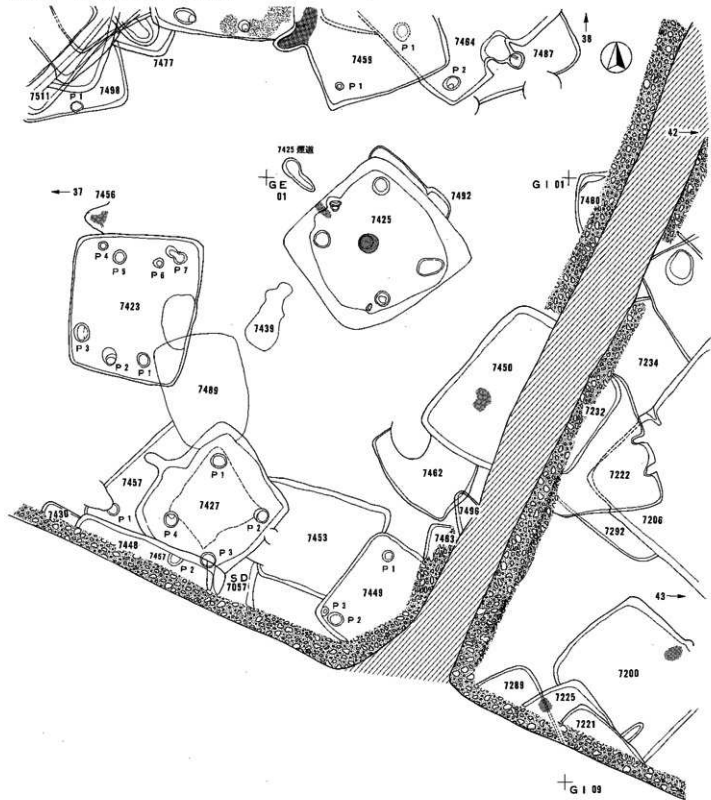

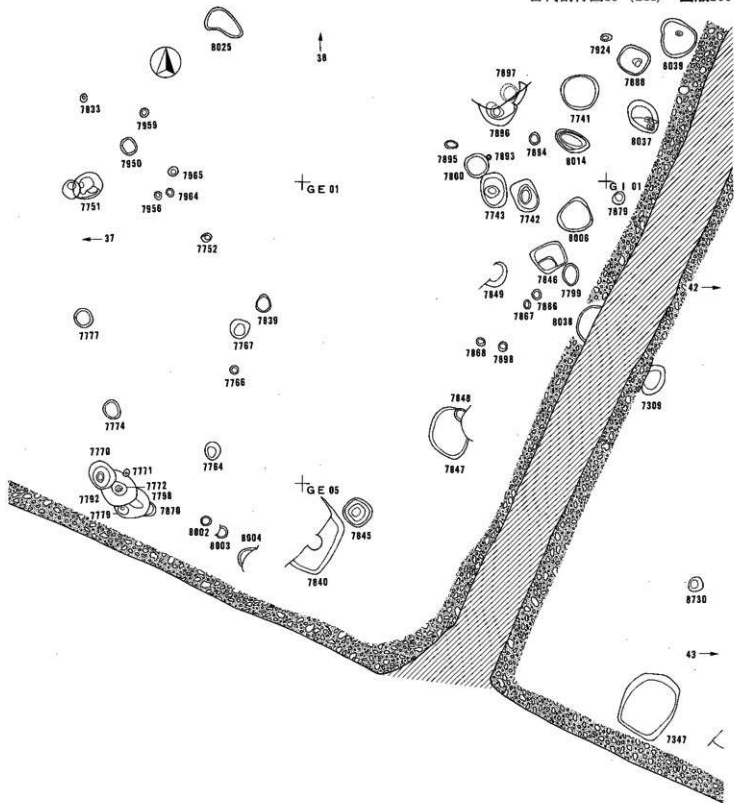



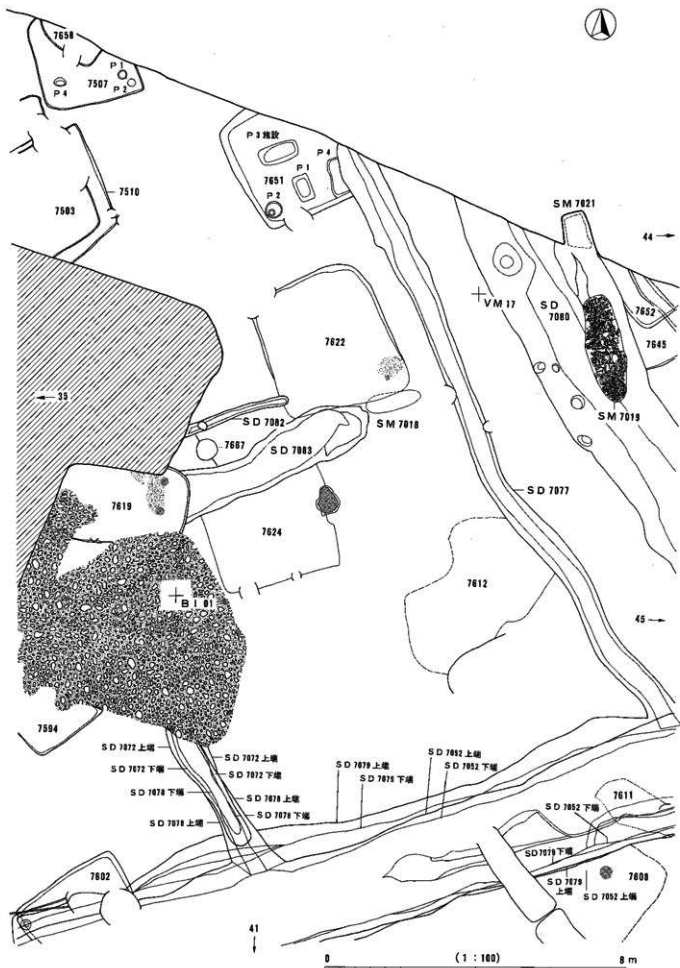

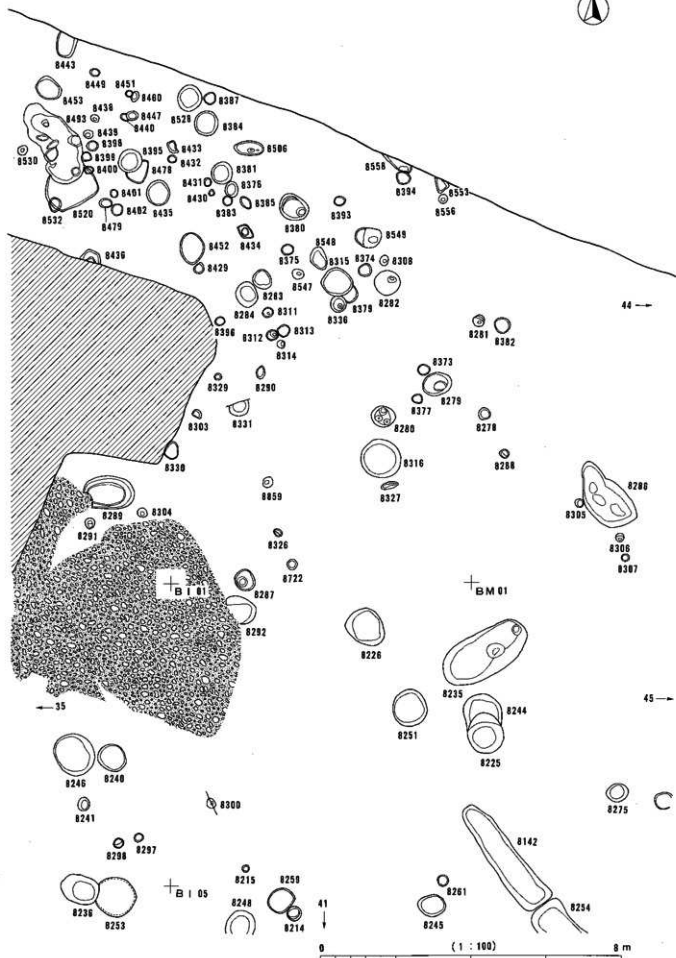

図版296 古代割付図41 (SK以外)

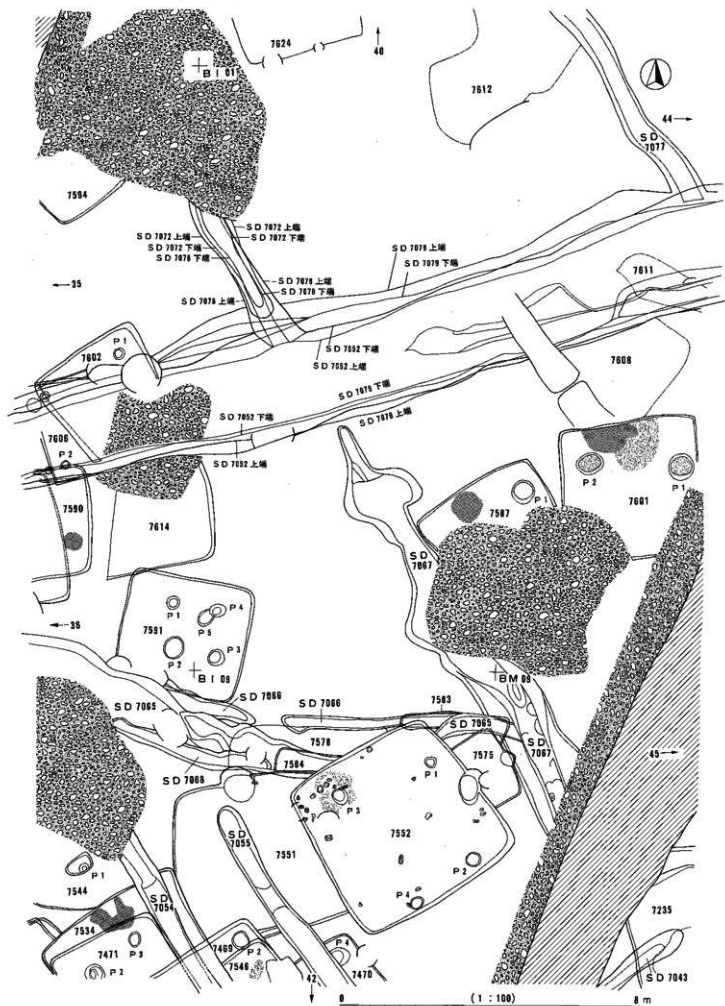

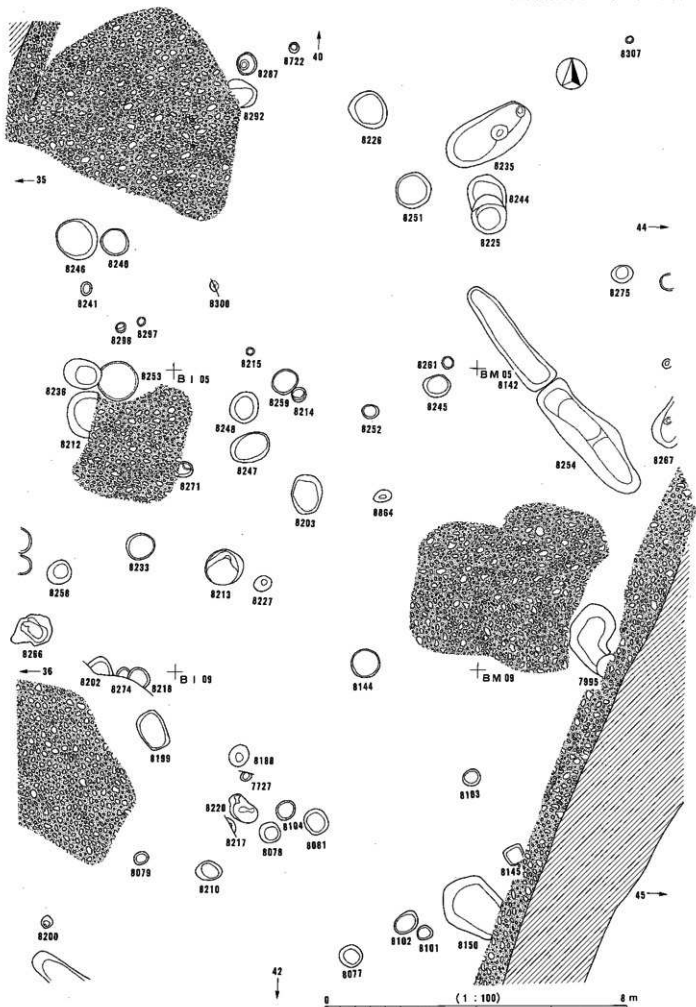

図版298 古代割付図42 (SK以外)

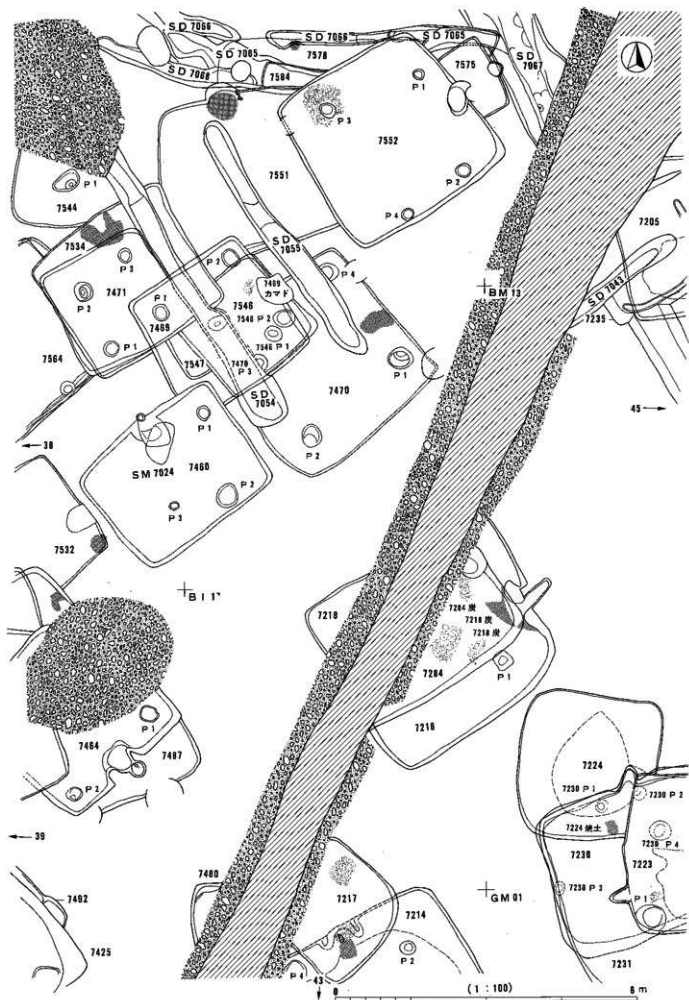



図版300 古代割付図43 (SK以外)

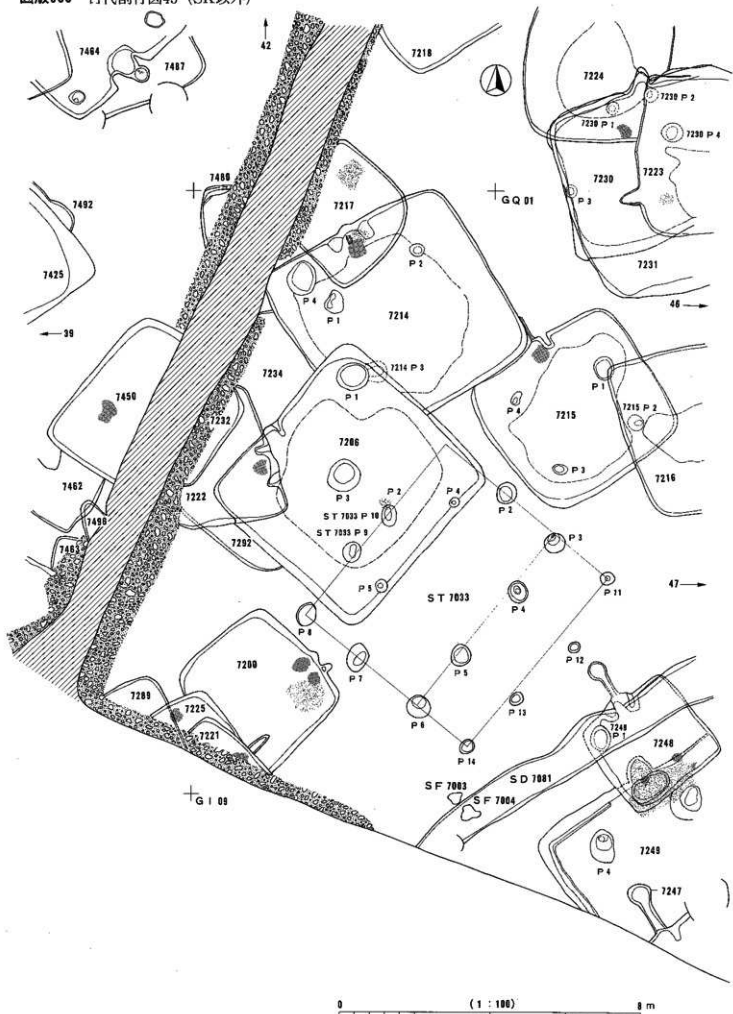

0 (1 : 100) 8 m

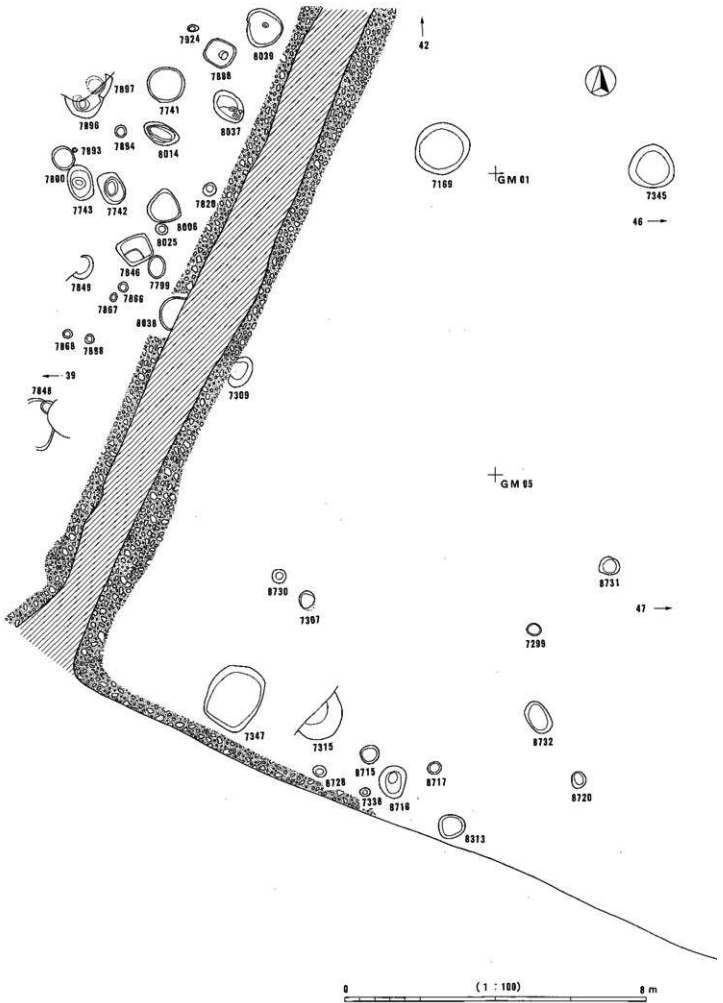



図版302 古代割付図44 (SK以外)

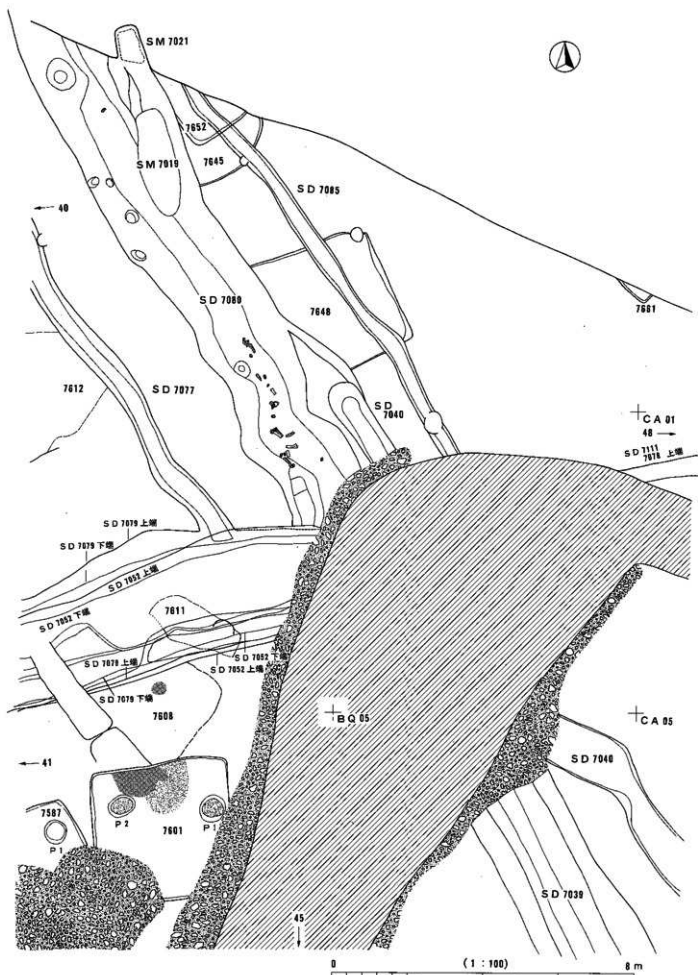

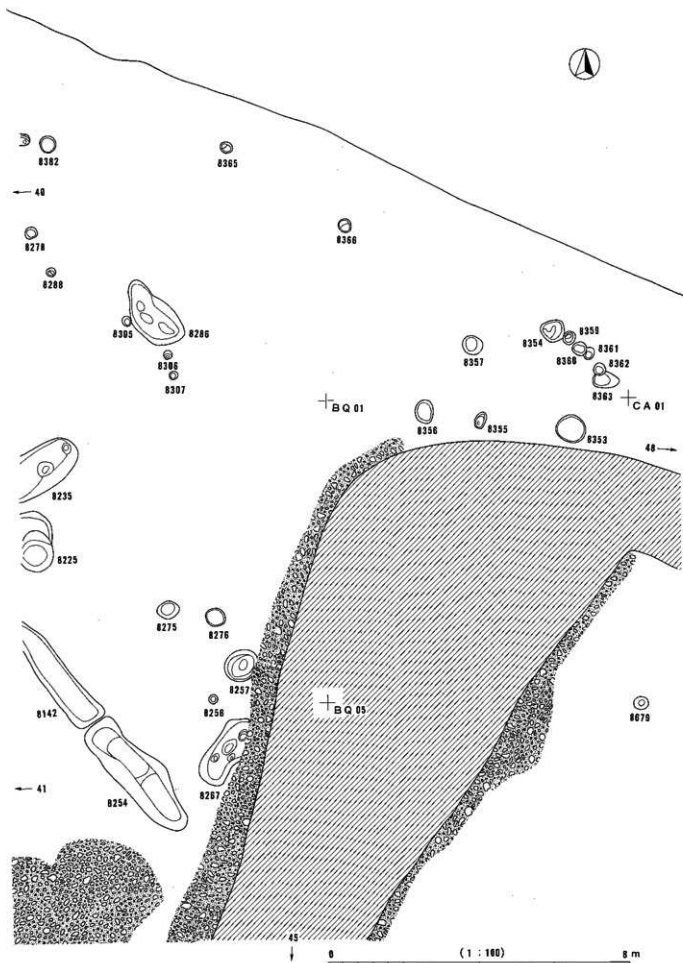

図版304 古代割付図45 (SK以外)

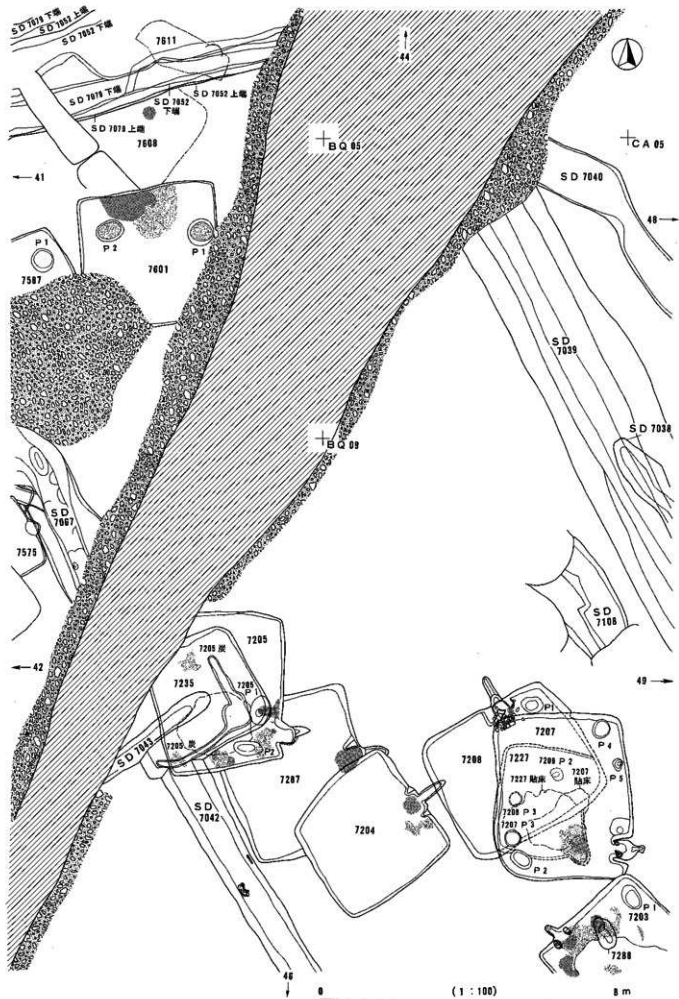

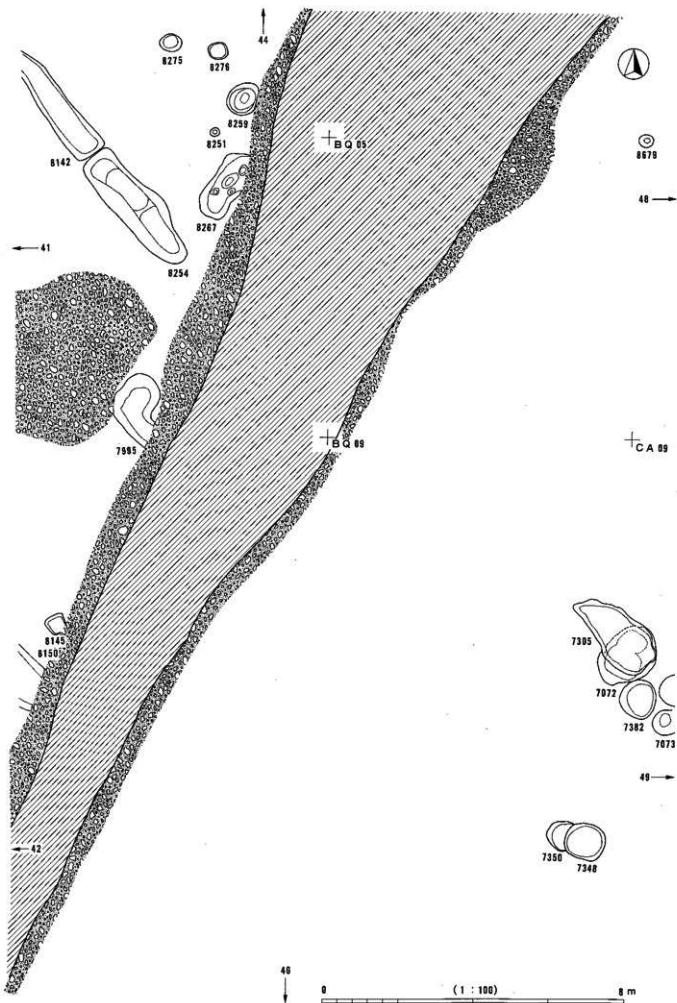

図版306 古代割付図46 (SK以外)

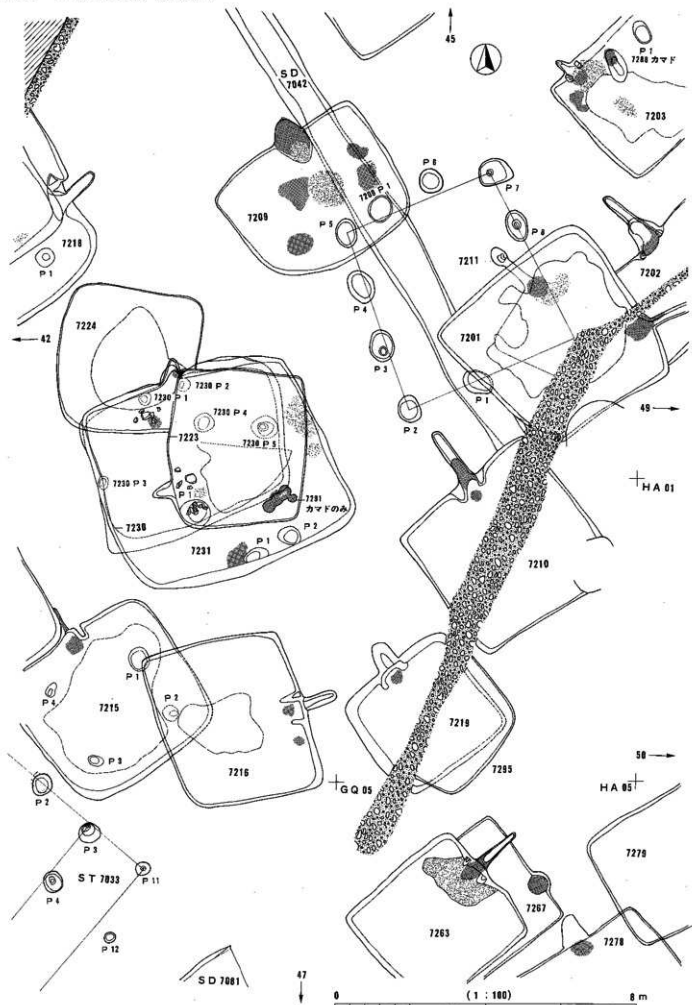



+ BQ 17



← 42

49 →



+ GQ 01



+ HA 01

← 43



8725

8714

8727

50 →

7363

+ GQ 05

8713

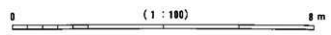

図版308 古代割付図47 (SK以外)

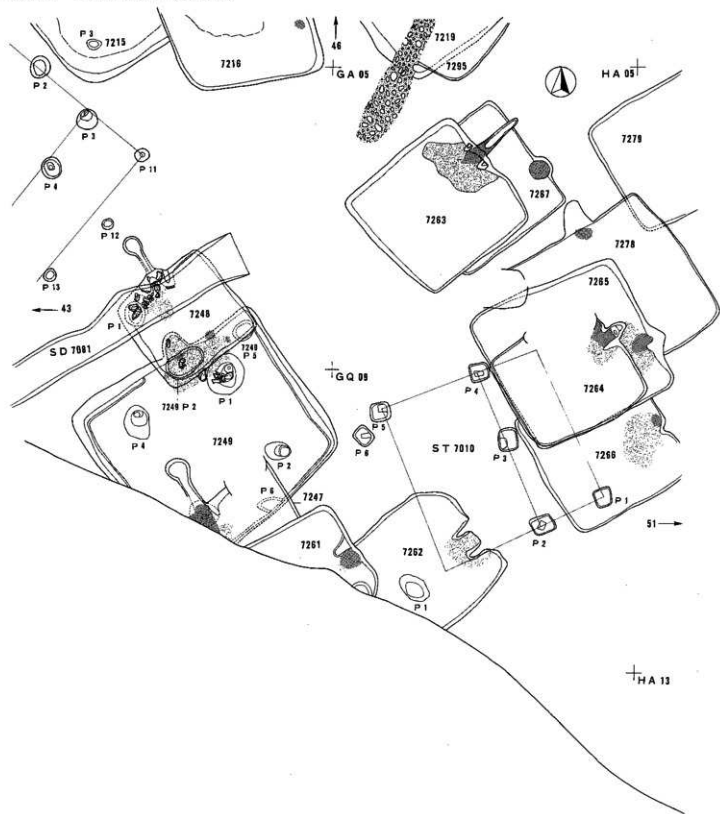

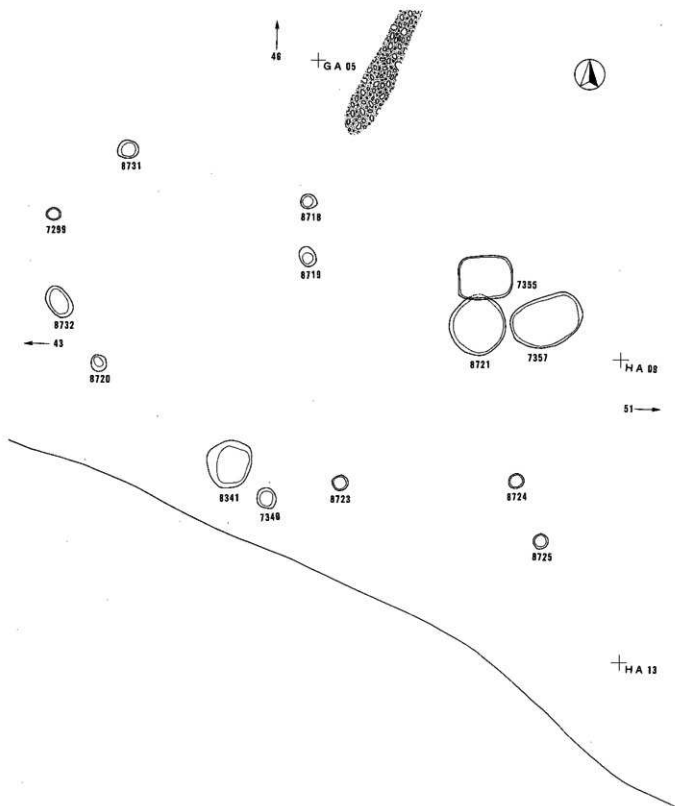



図版310 古代割付図48 (SK以外)

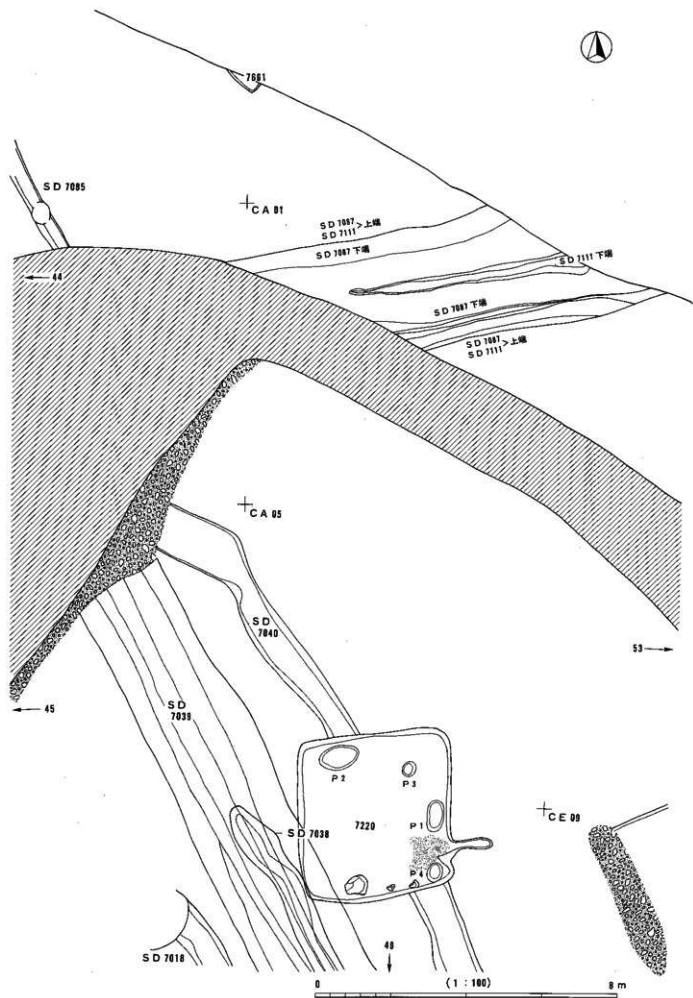

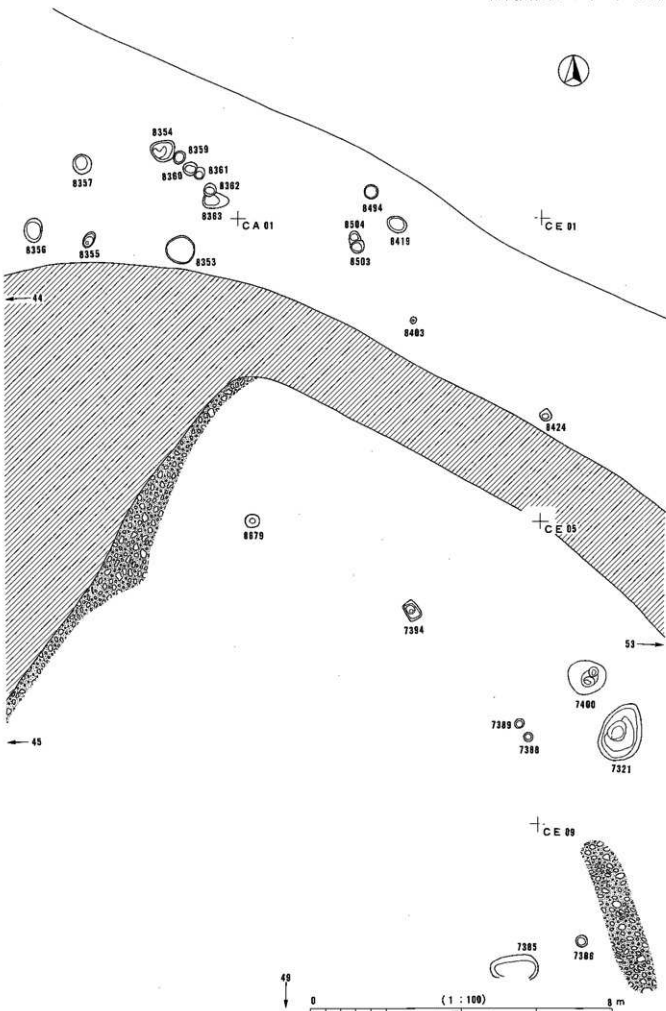

図版312 古代割付図49 (SK以外)

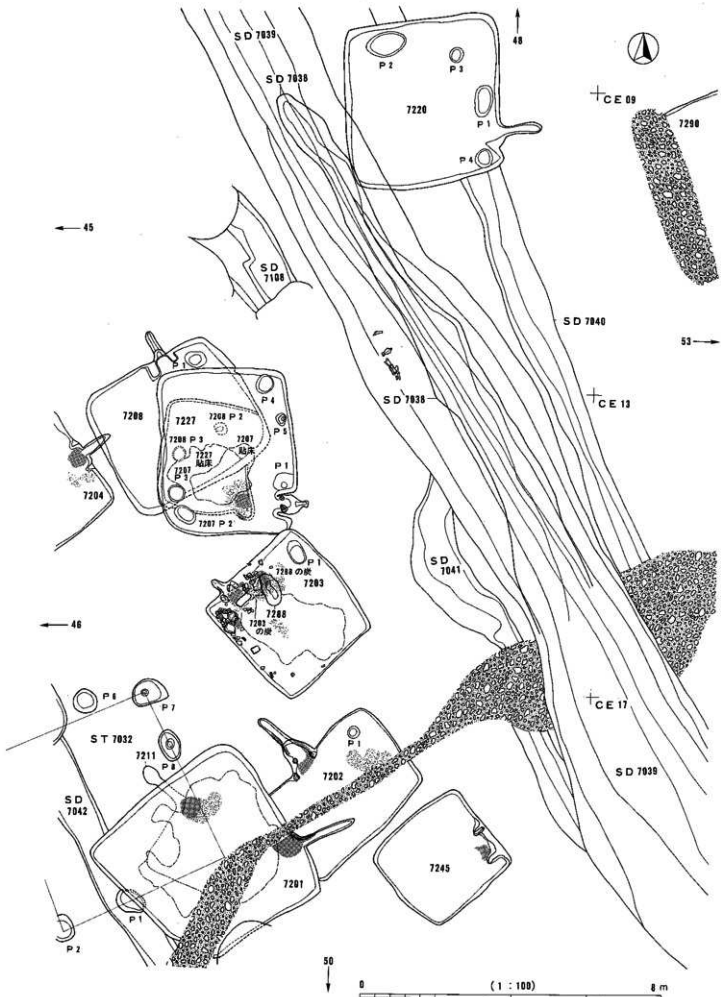

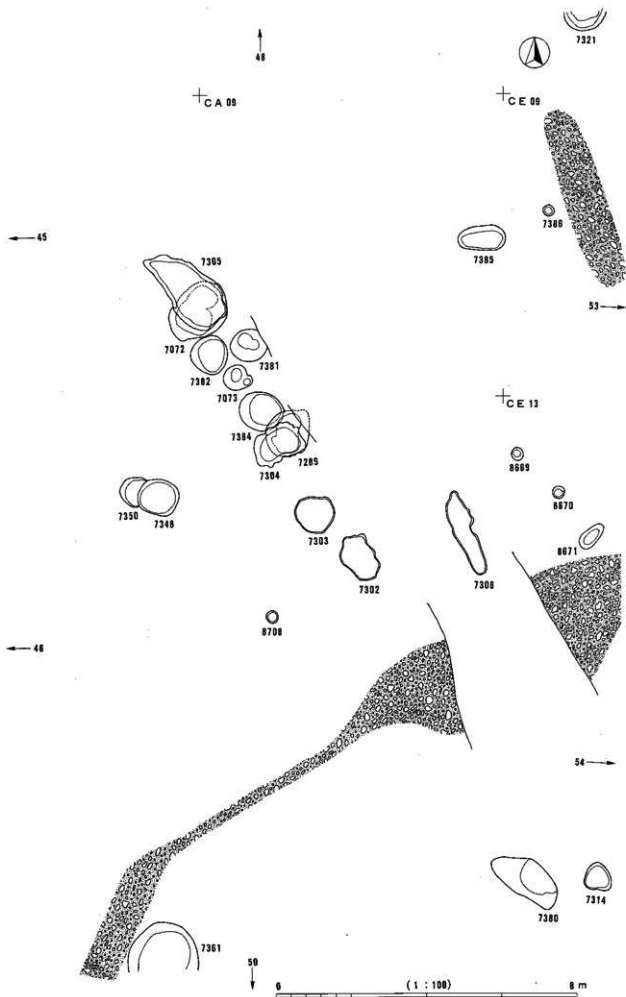

図版314 古代割付図50 (SK以外)

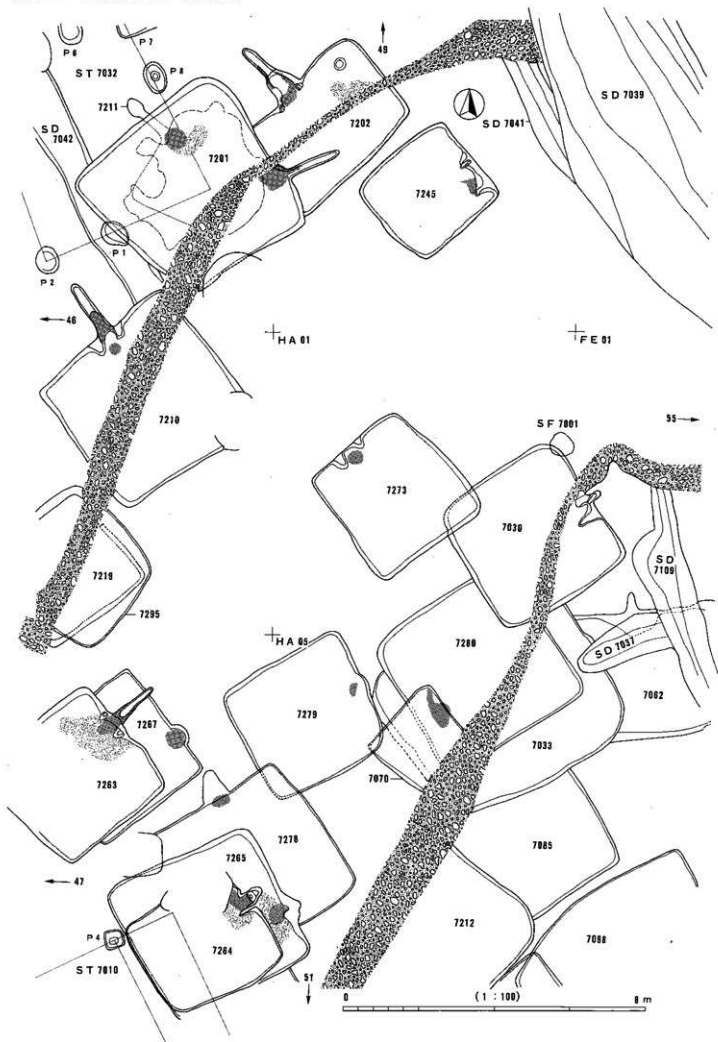

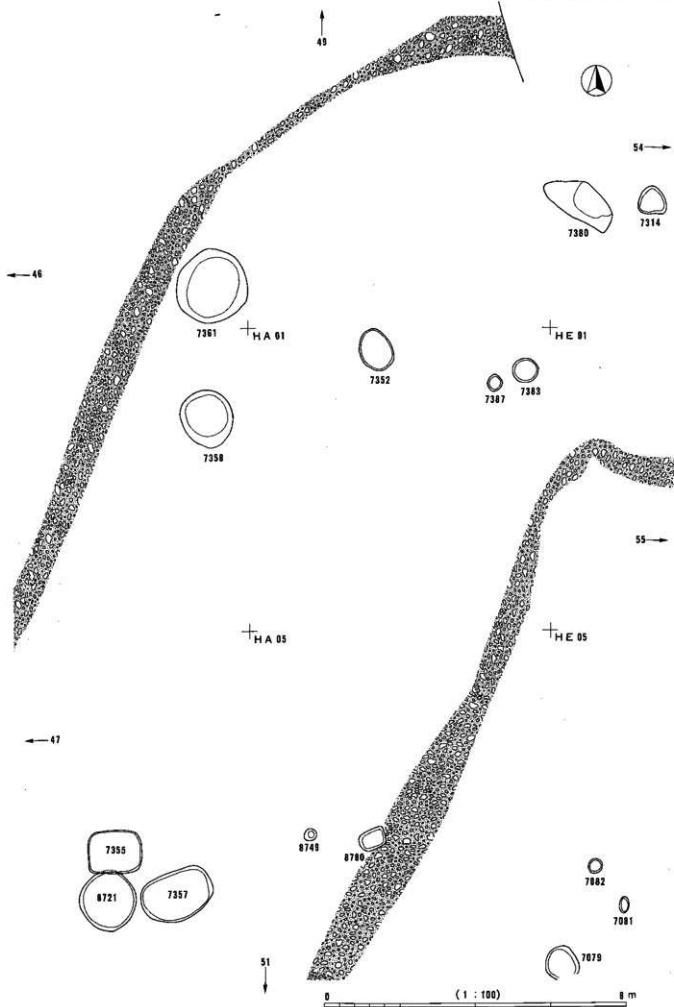

図版316 古代割付図51 (SK以外)

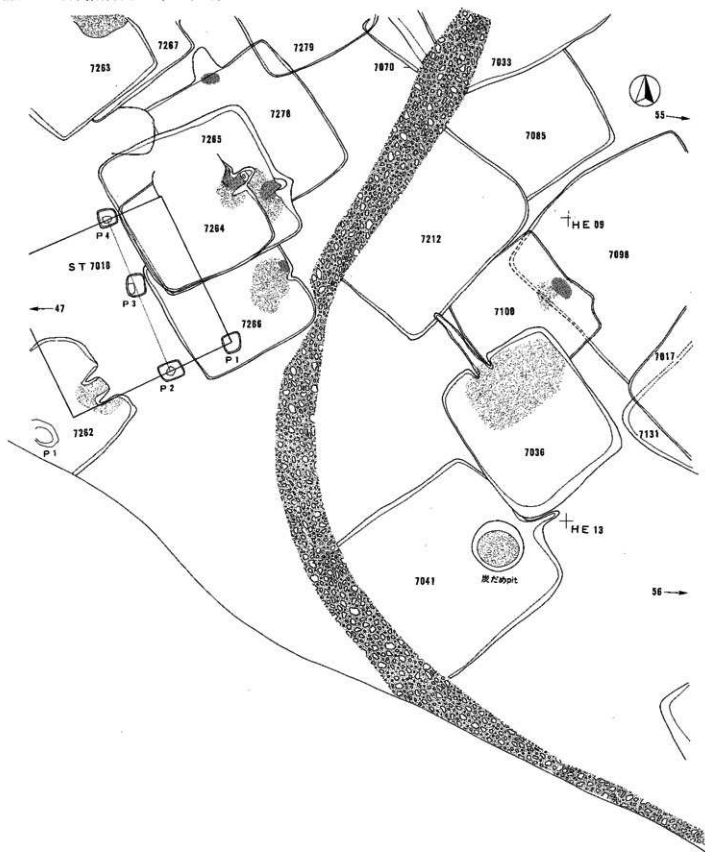

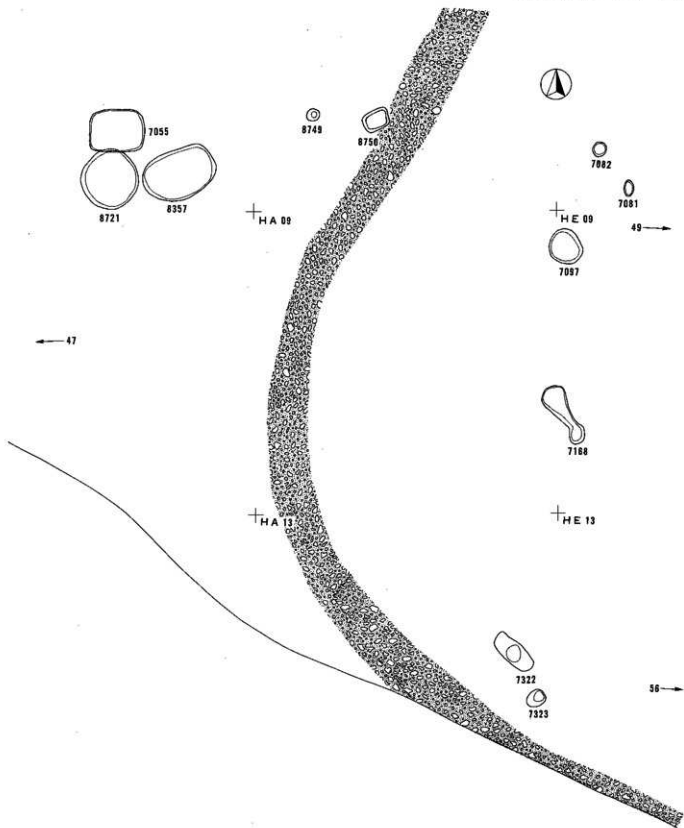



図版318 古代割付図53 (SK以外)

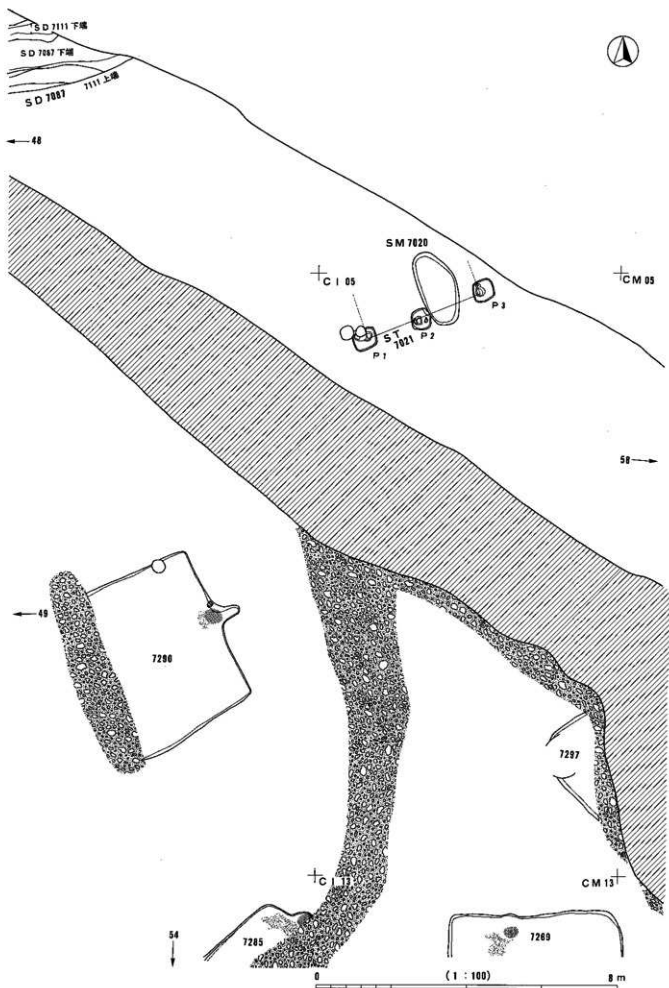

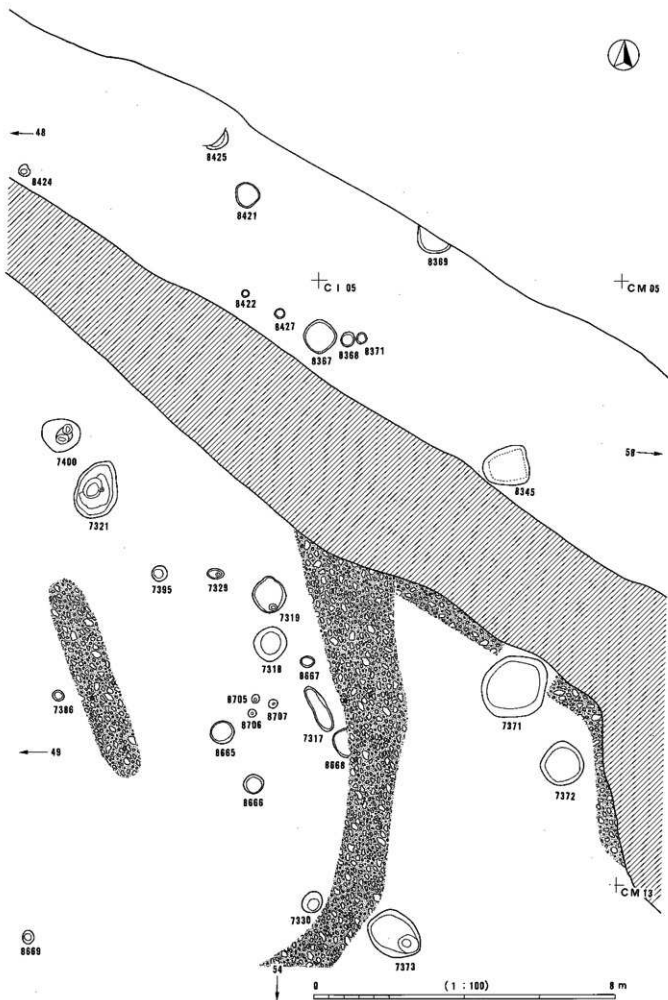

図版320 古代割付図54 (SK以外)

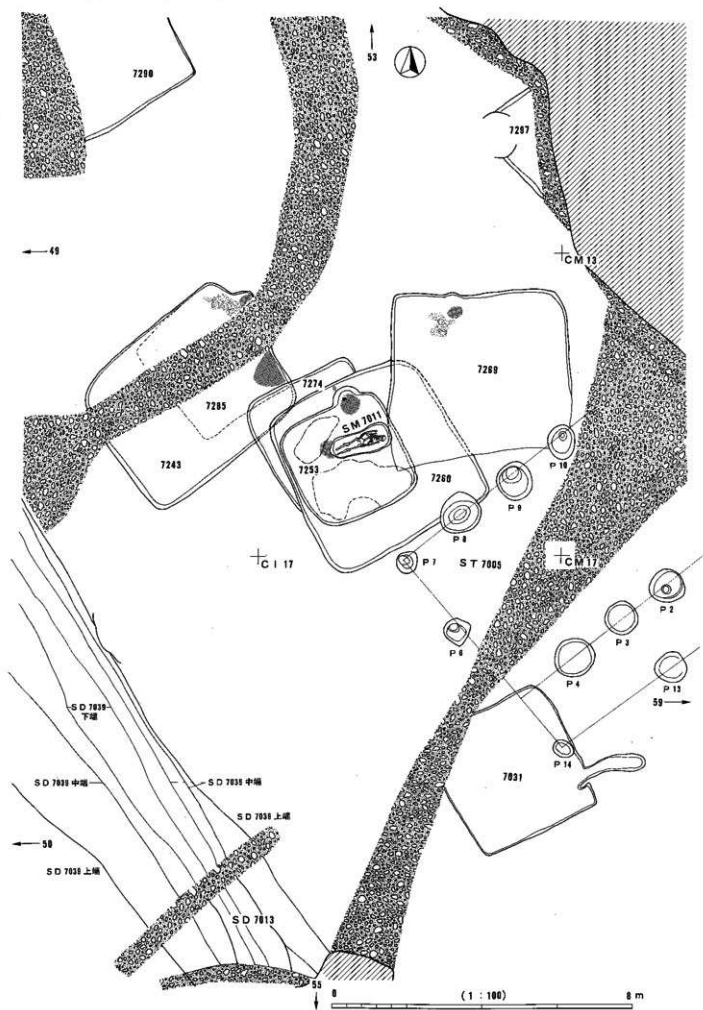

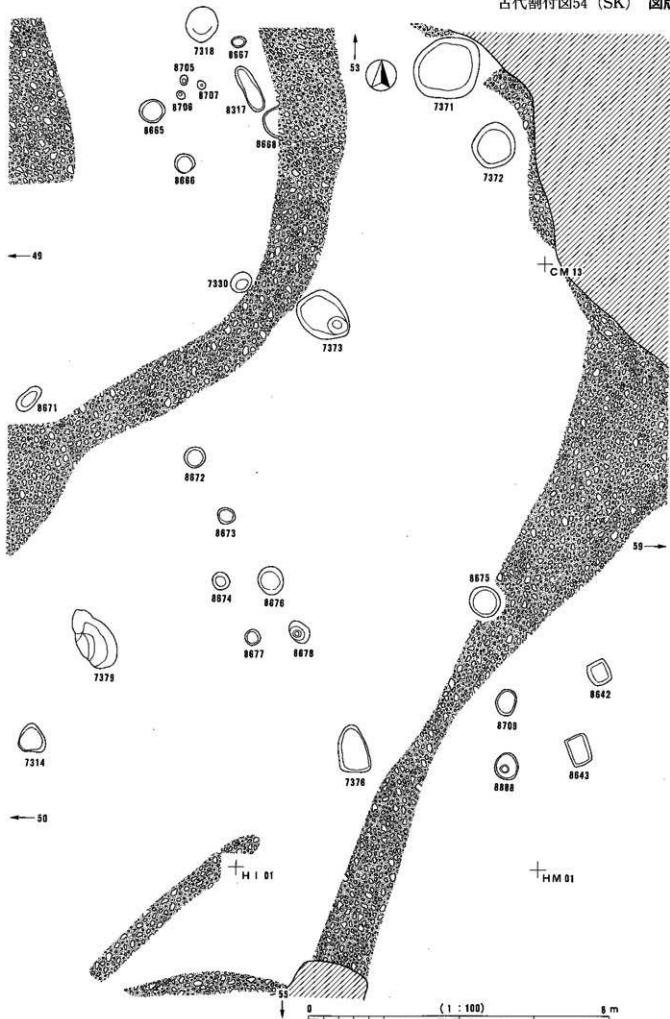

図版322 古代割付図55 (SK以外)

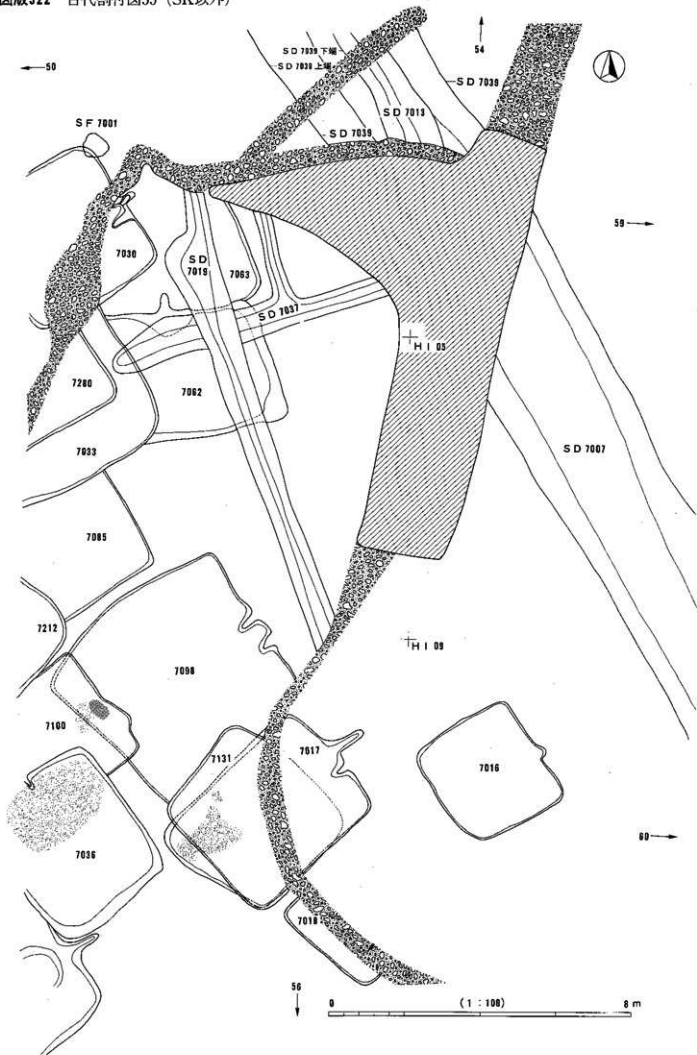

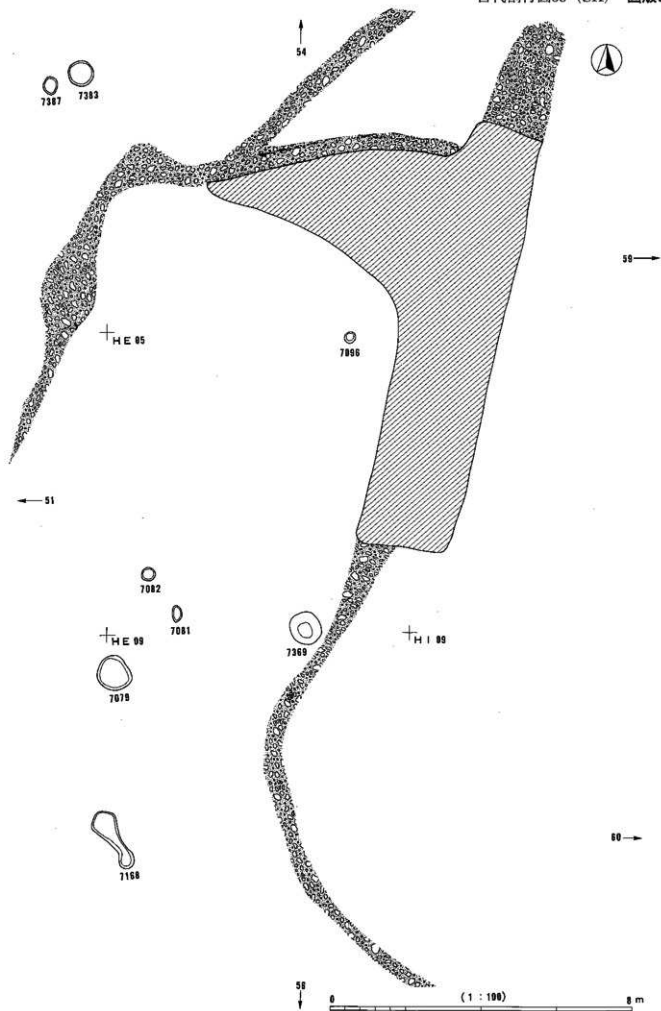

図版324 古代割付図56 (SK以外)

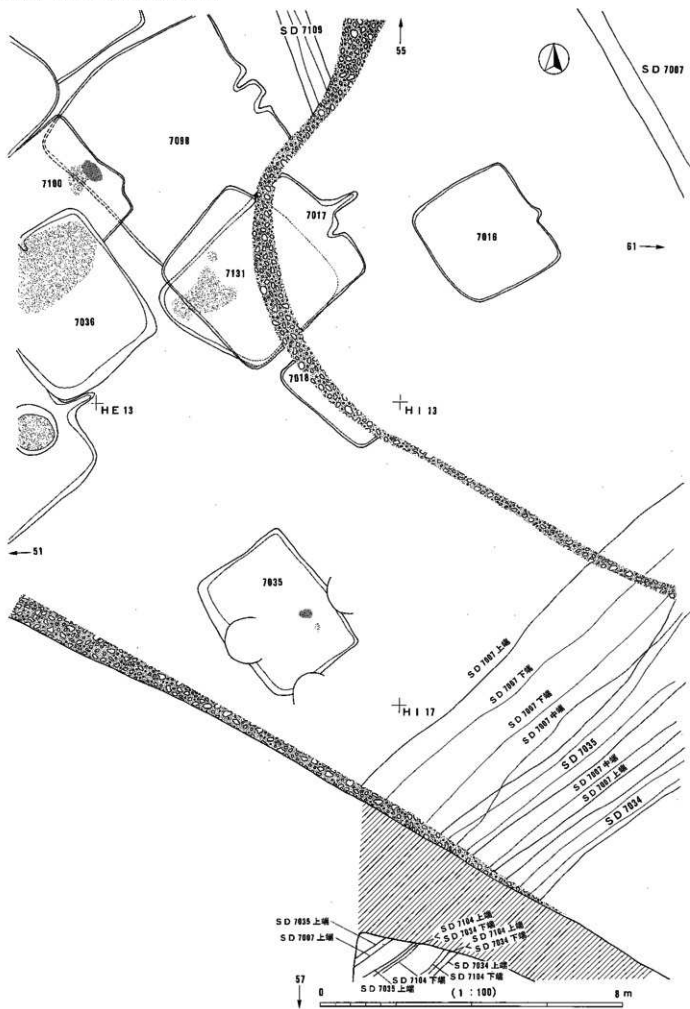

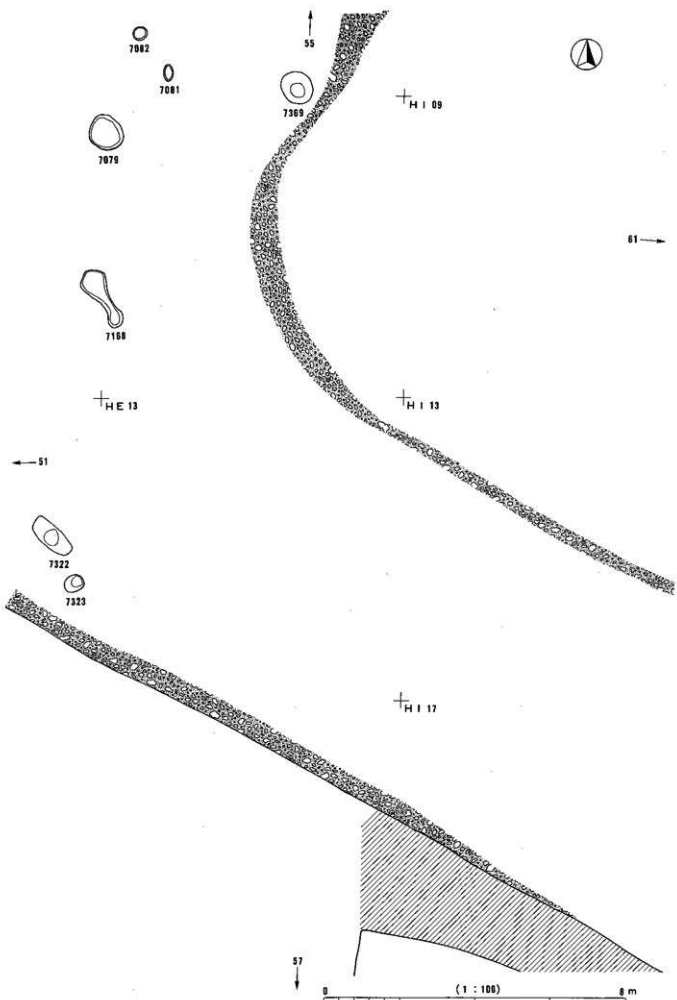



図版326 古代割付図57 (SK以外)

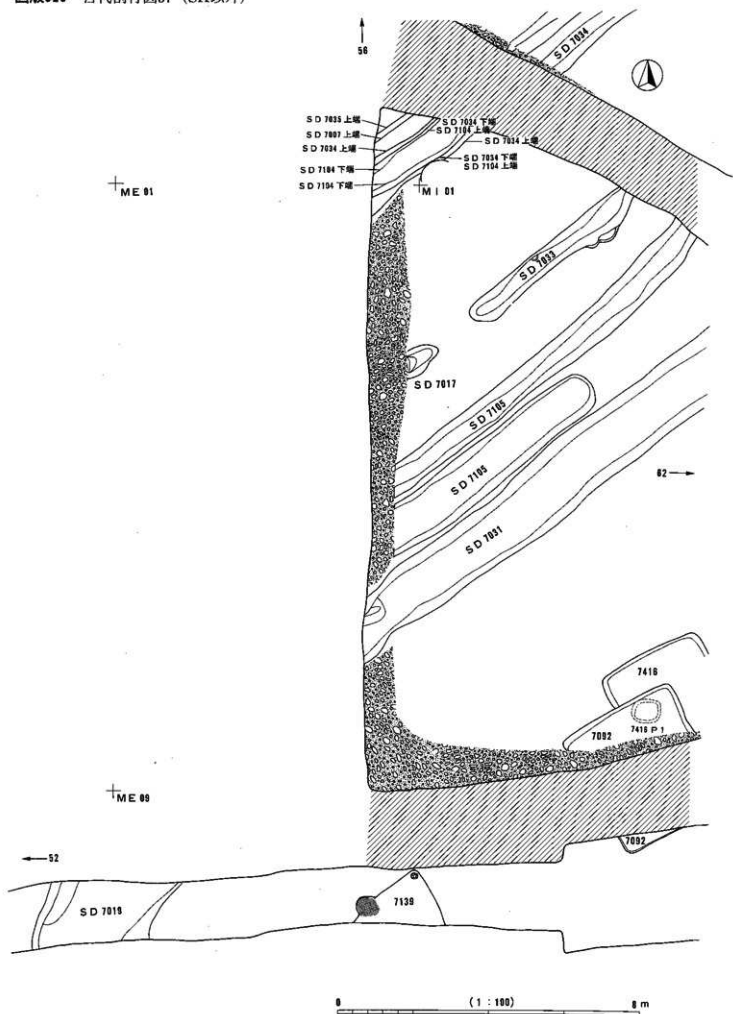

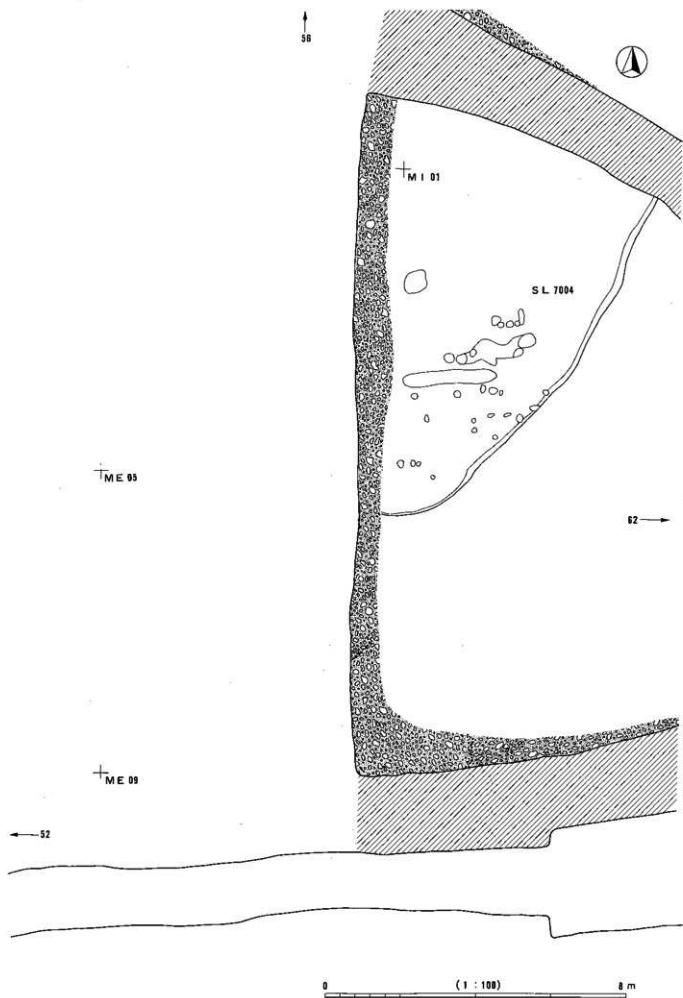

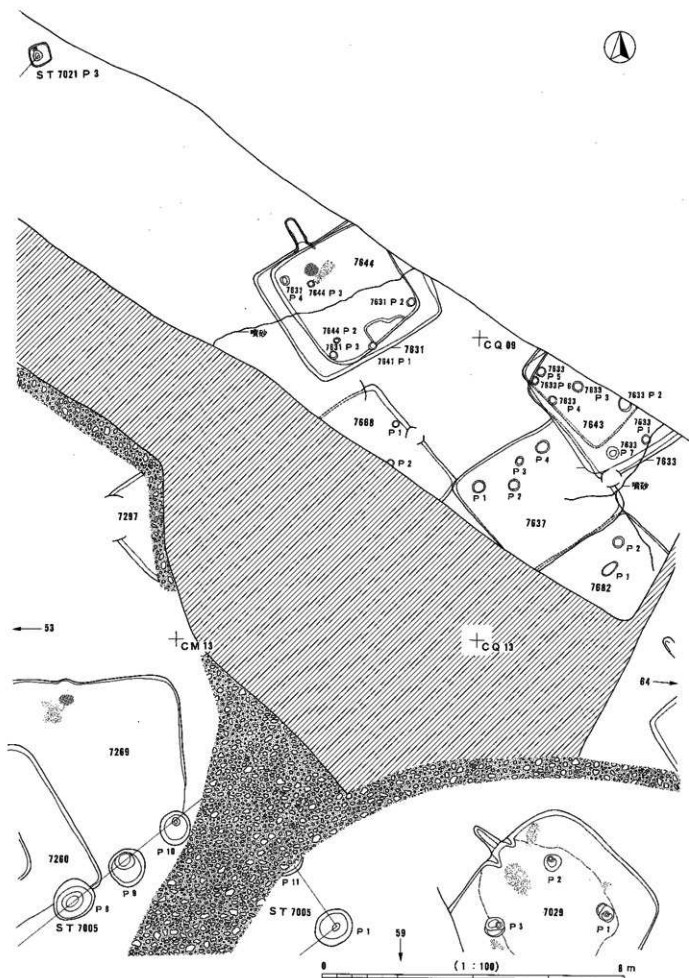

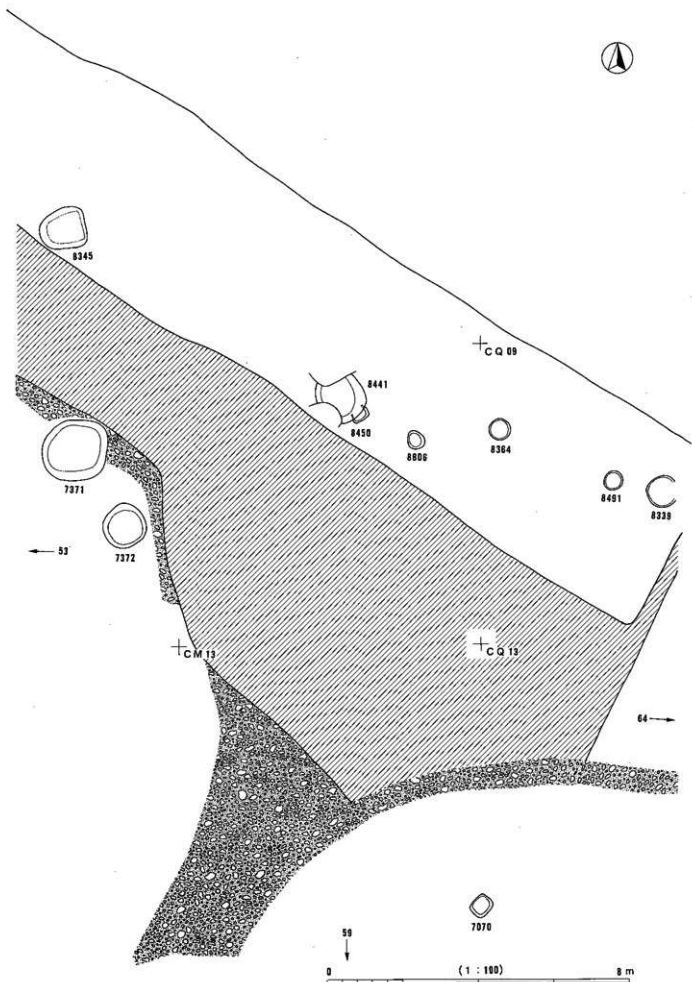

図版330 古代割付図59 (SK以外)

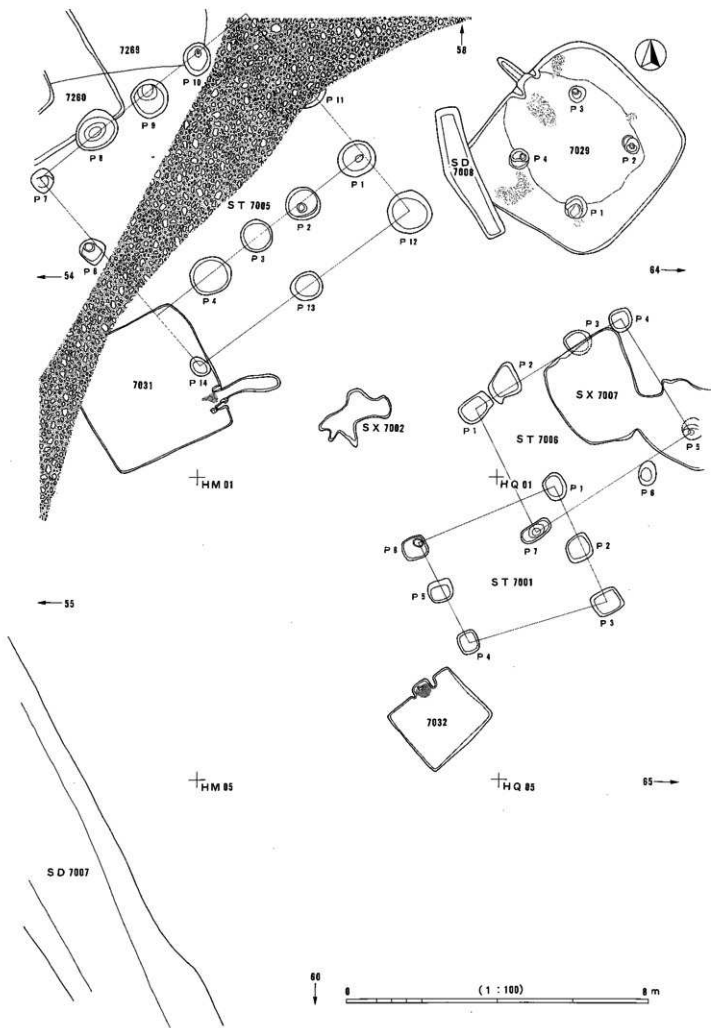

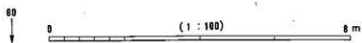
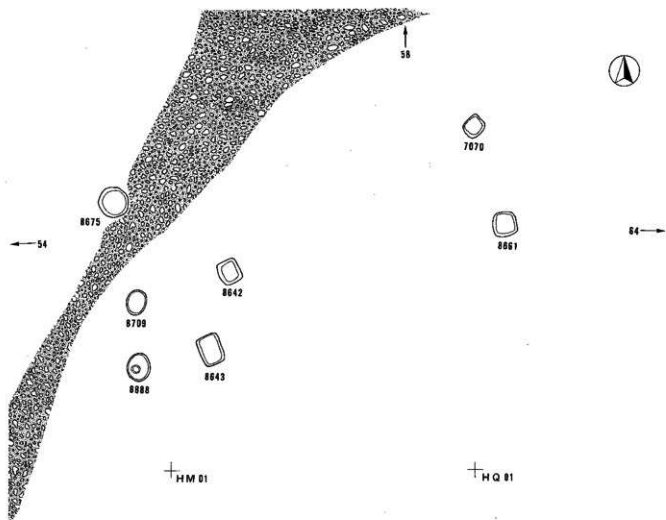

図版332 古代割付図61 (SK以外)

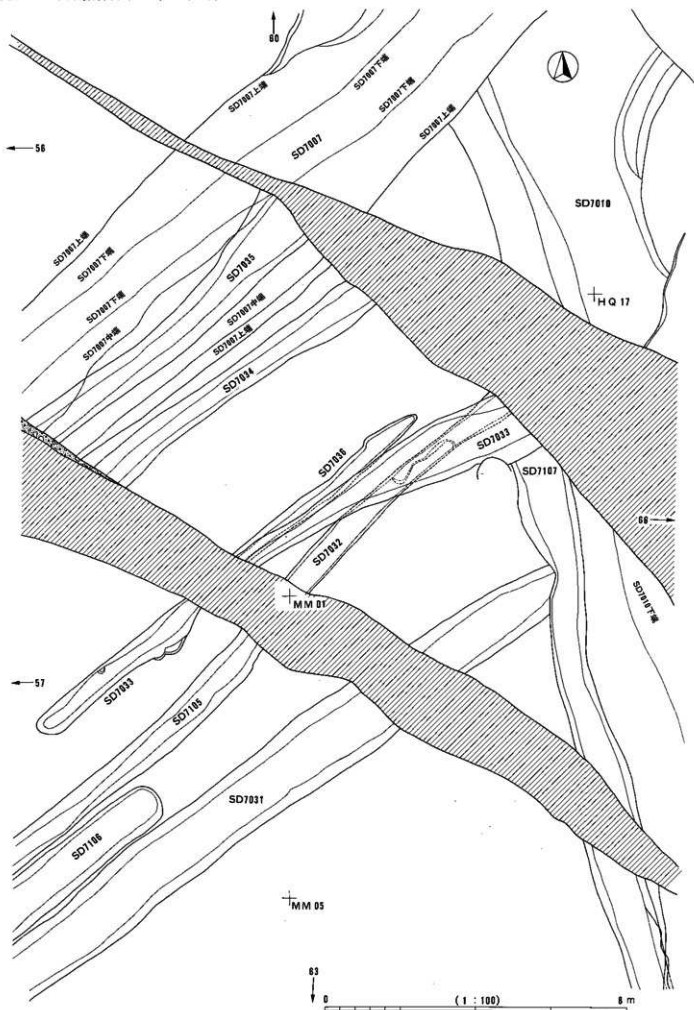

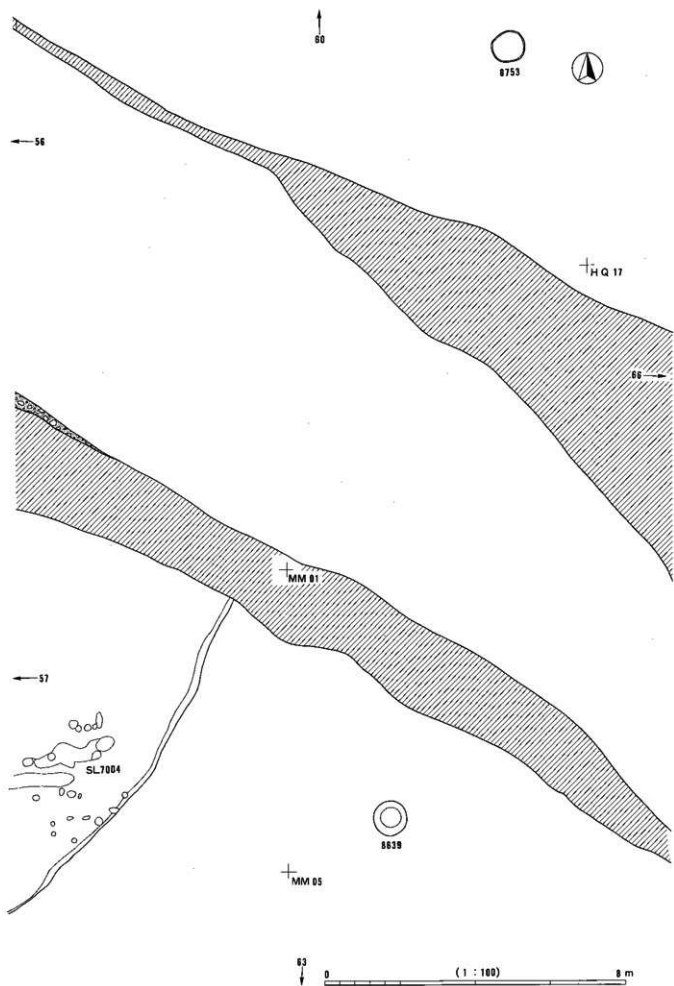



図版334 古代割付図62 (SK以外)

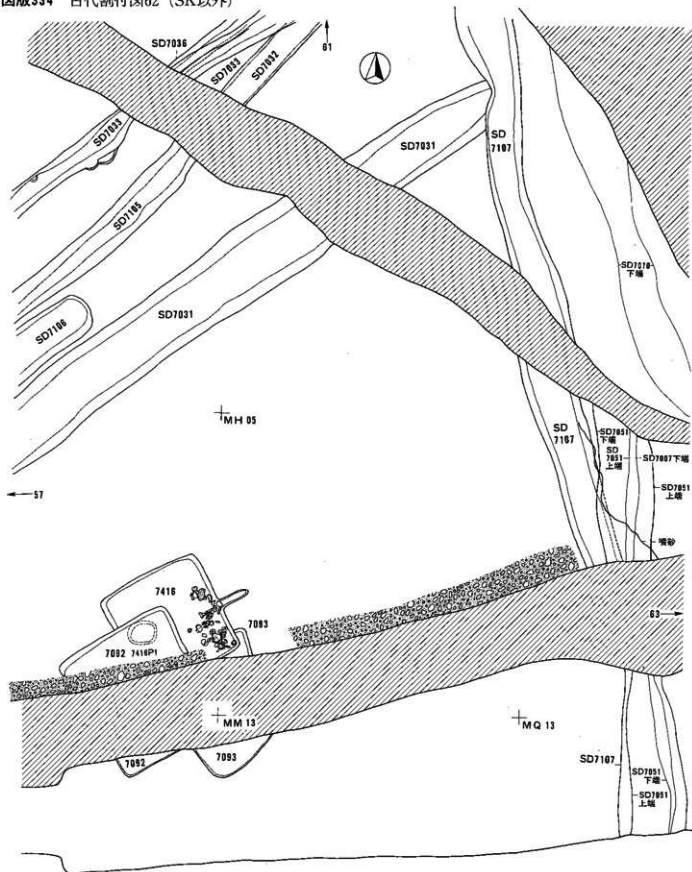

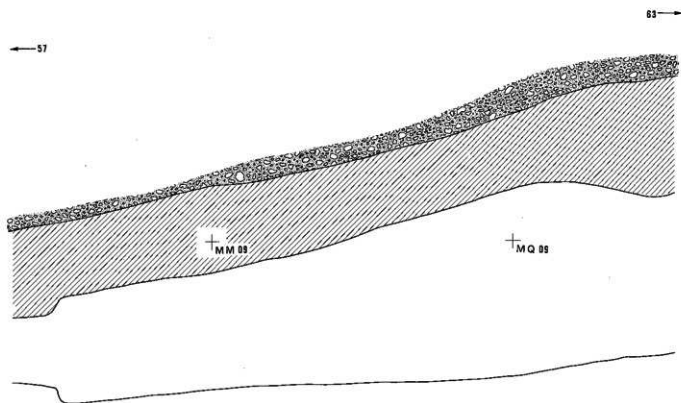
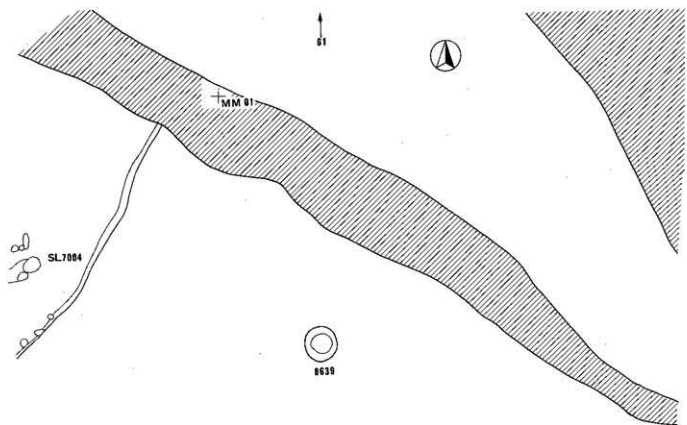

図版336 古代削付図63 (SK以外)

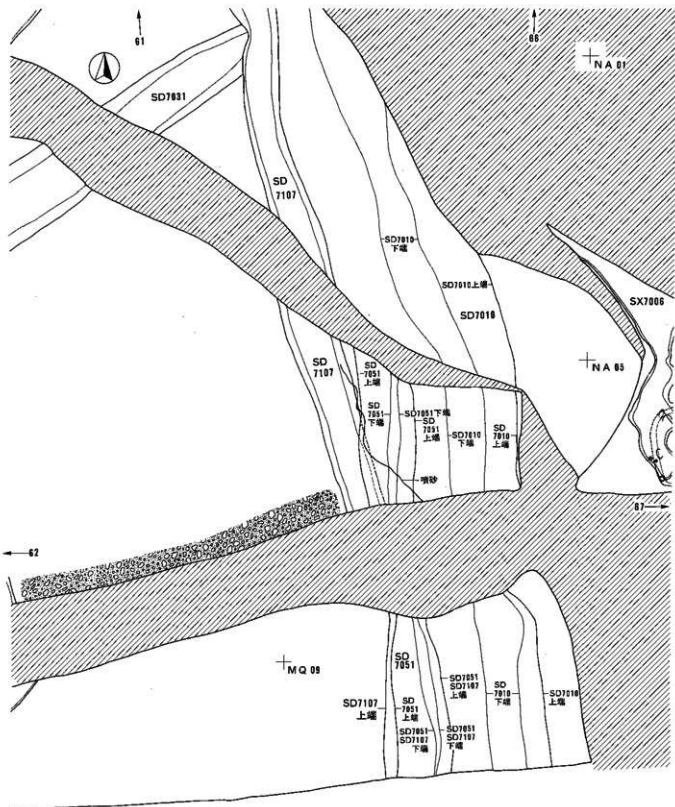

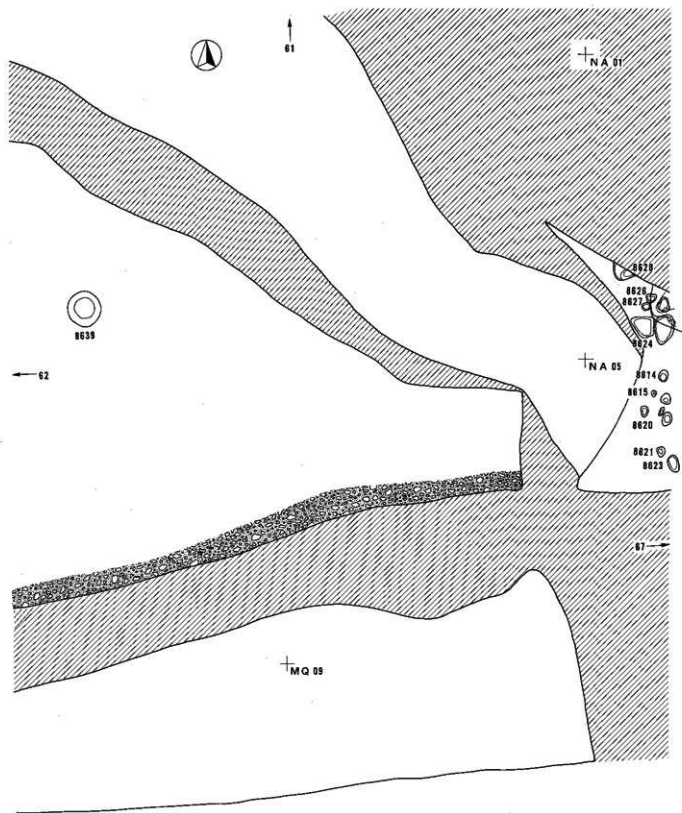

図版338 古代割付図67 (SK以外)

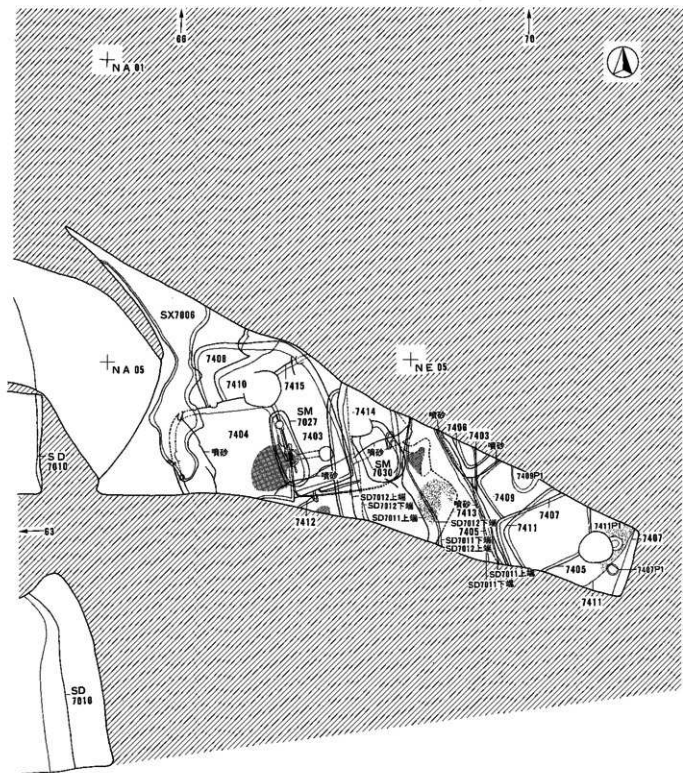

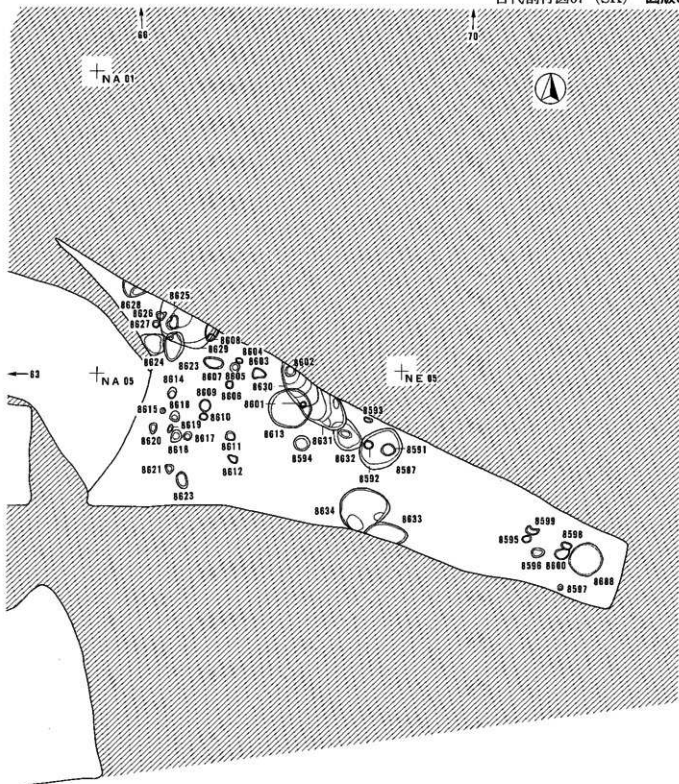

图版340 古代割付图71 (SK以外)

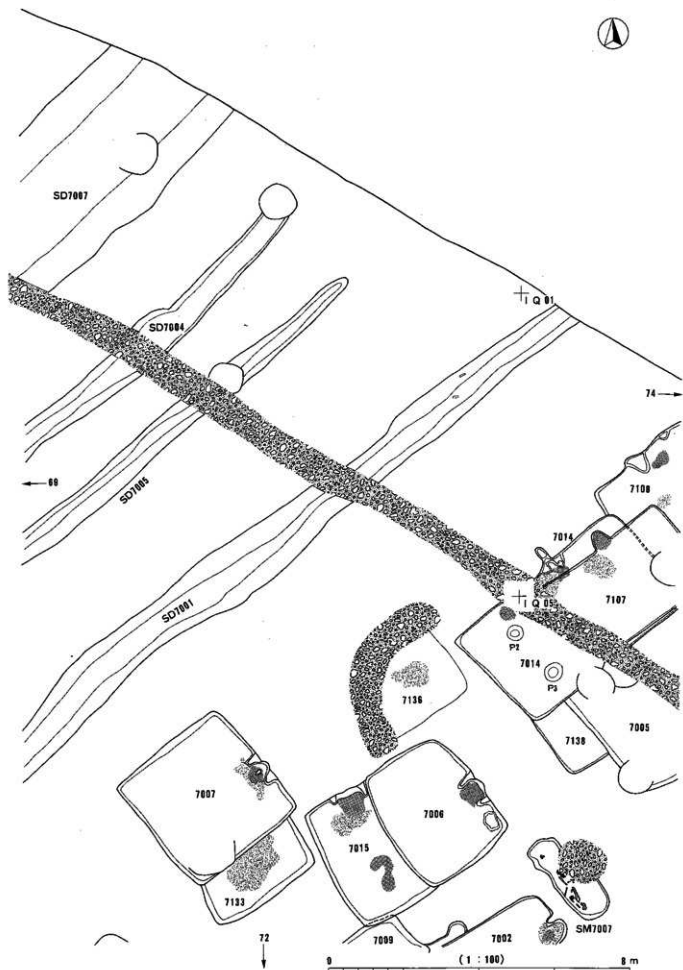

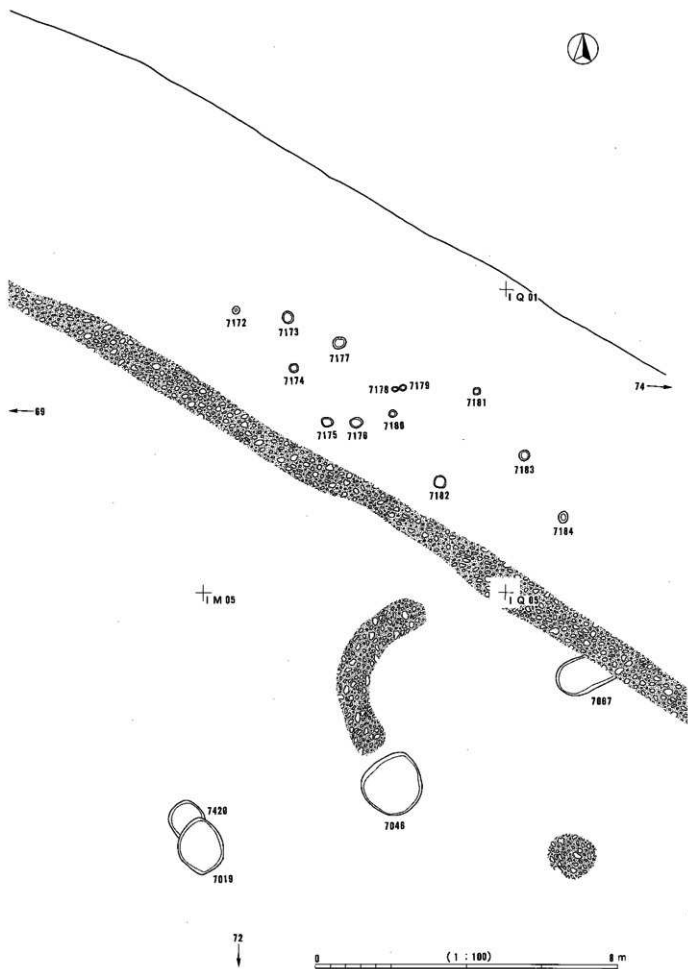



图版342 古代割付图74 (SK以外)

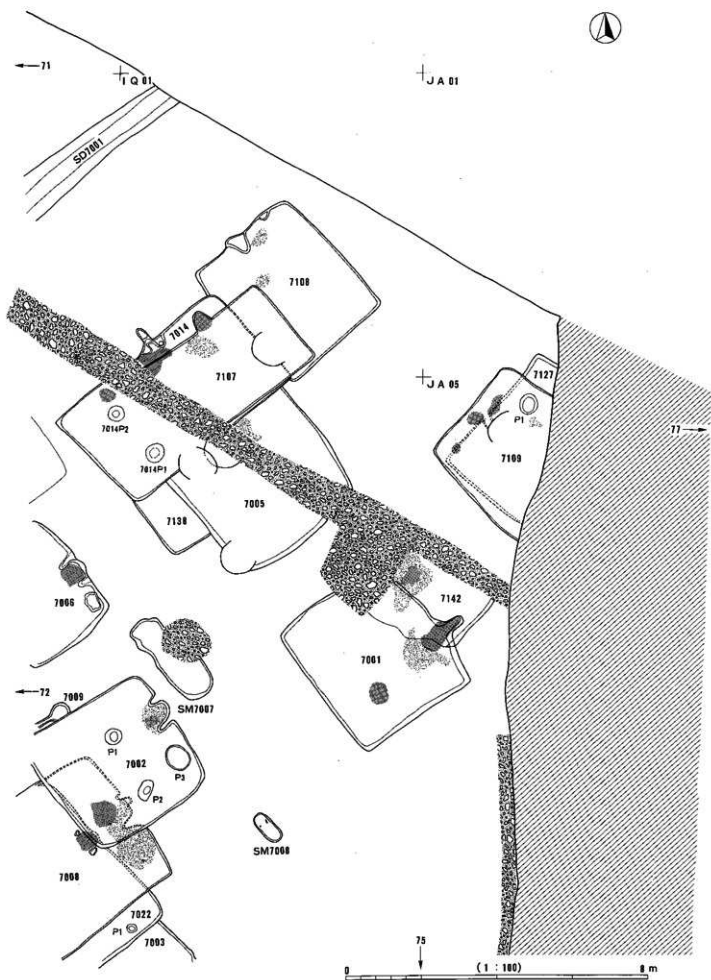

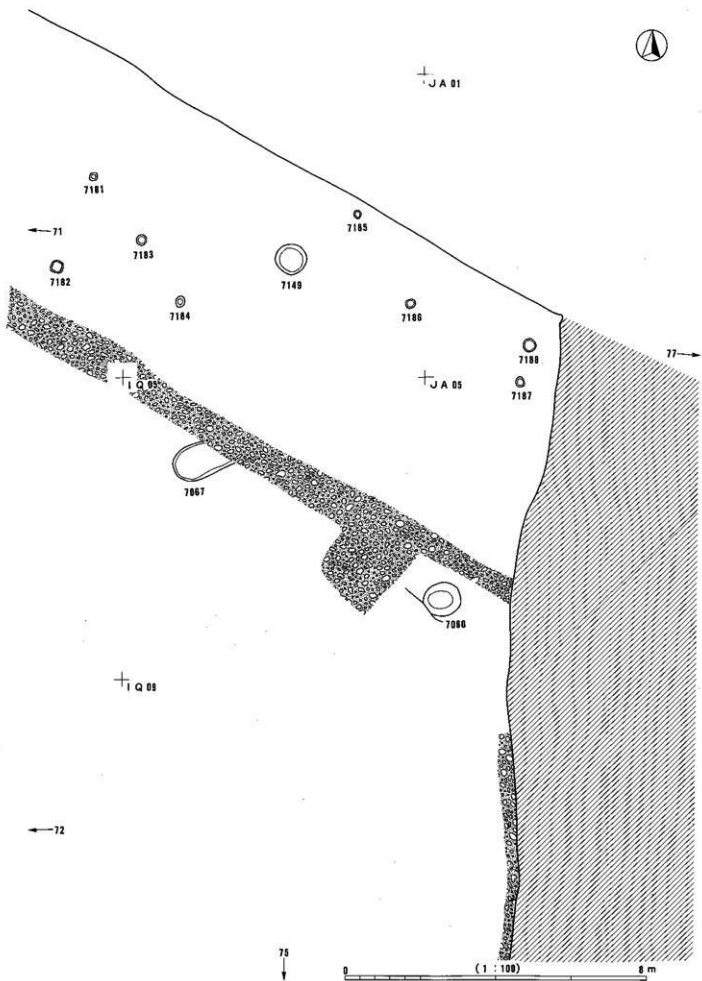

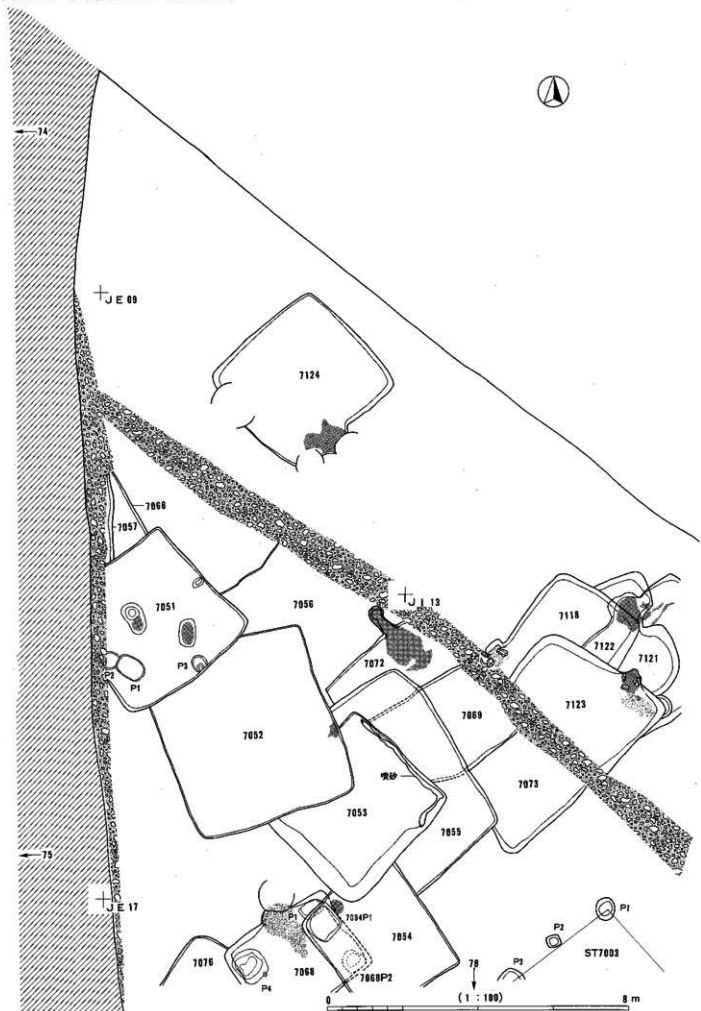

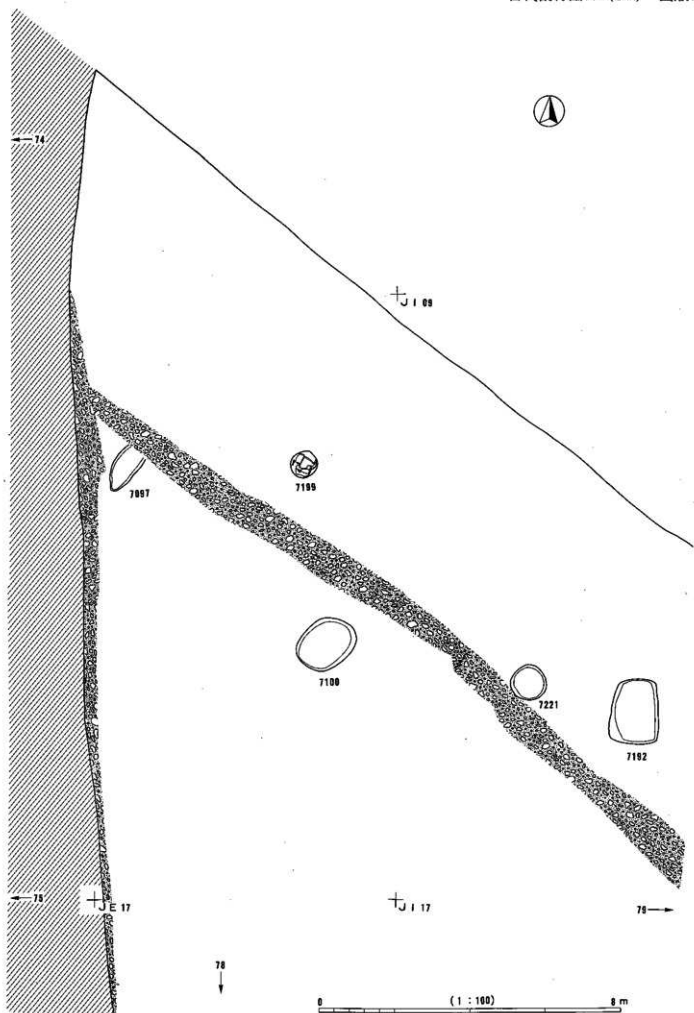

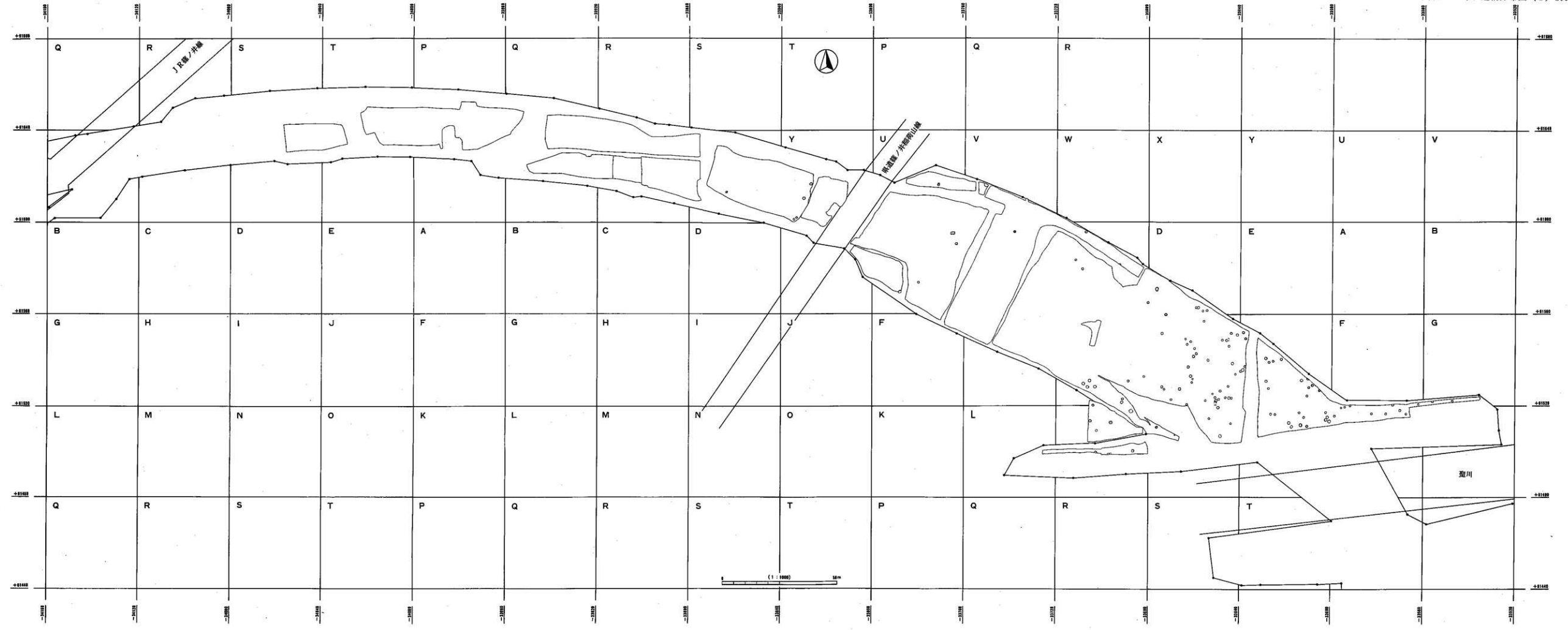

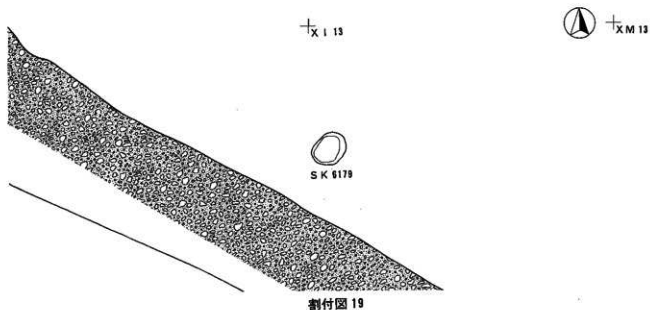

割付図 19

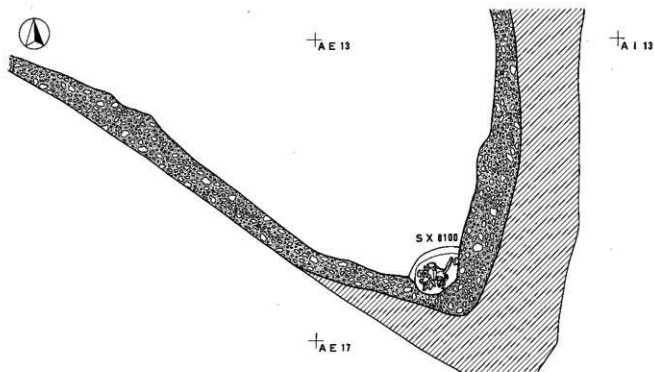

割付図 28



割付図 31

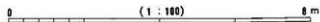

図版348 中世割付図22 (一括)

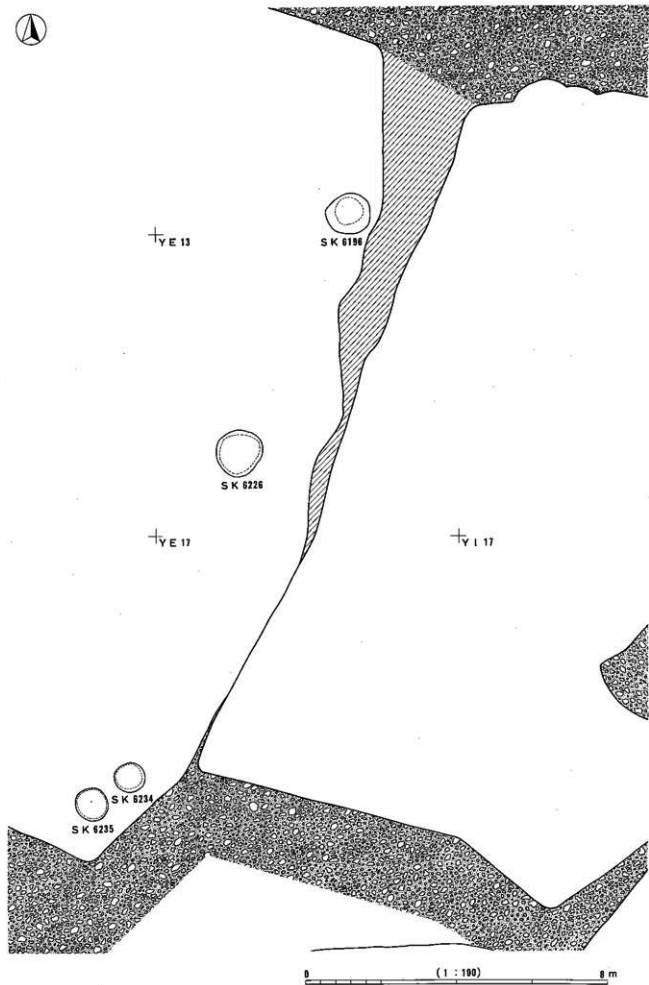

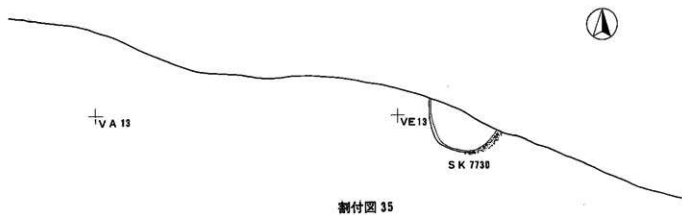
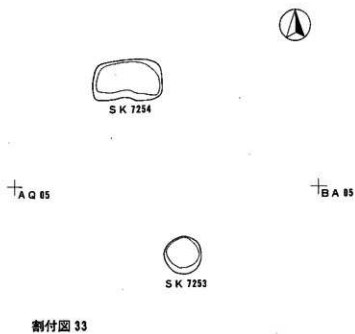
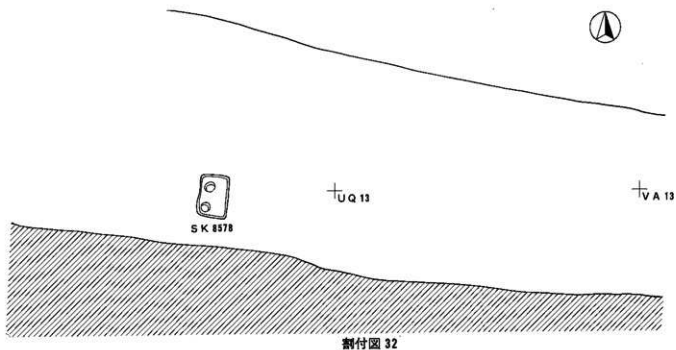

0 (1 : 100) 8 m





+B 1 01

+BM 01



SK 8224

割付図 40

+CA 09



SK 7311



53 →



+CA 11

+CE 13

割付図 49



81 →



SK 7124



SK 7125

+HE 17



SK 7133



SK 7134

割付図 56

0 (1 : 100) 8 m



SK 8372

+C 1 05

+C 1 05

+C 1 11

49



SK 7312

0 (1 : 100) 8 m

図版352 中世割付図57 (一括)

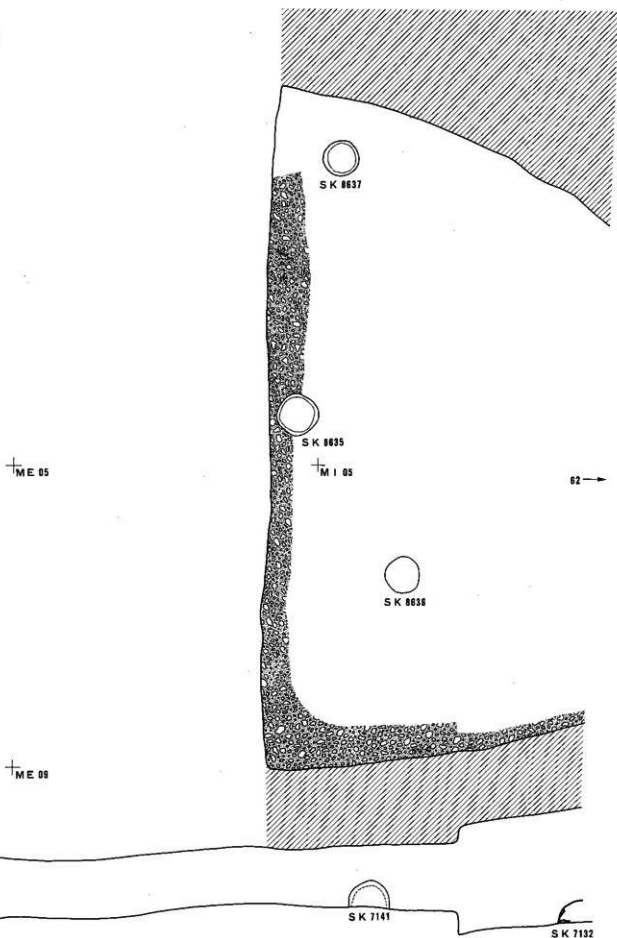

0 (1 : 100) 8 m

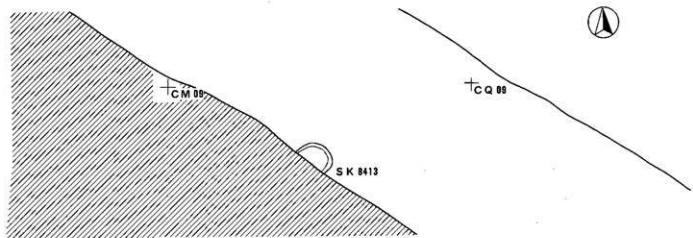

割付図 58

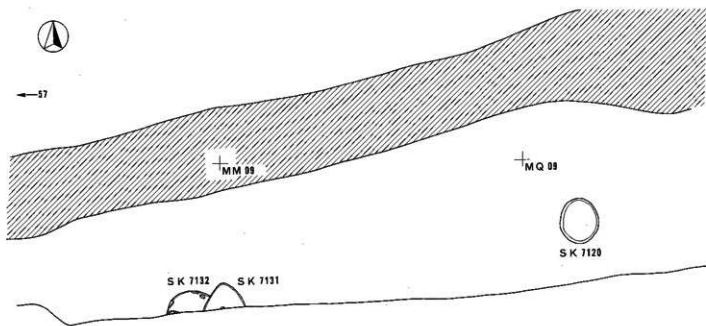

割付図 62

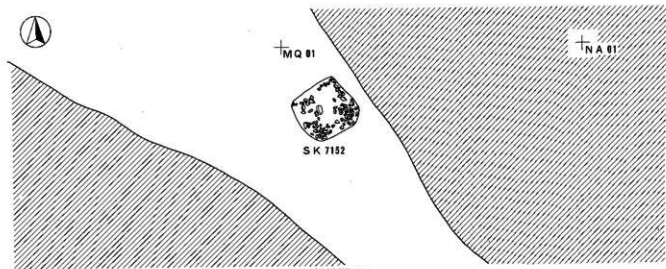

割付図 63

0 (1 : 100) 0 m

図版354 中世割付図61 (一括)

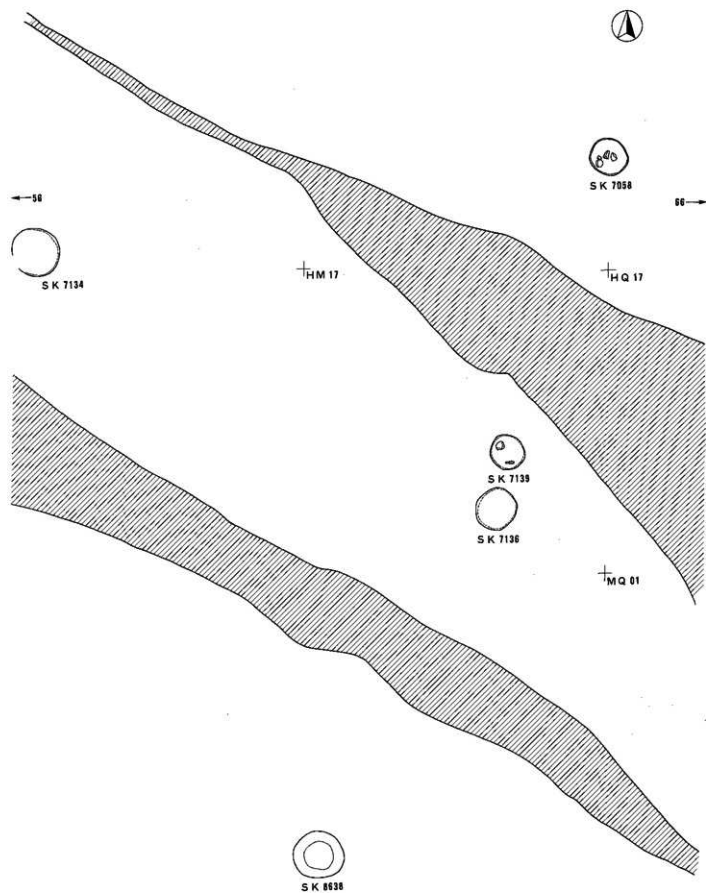

0 (1 : 100) 8 m

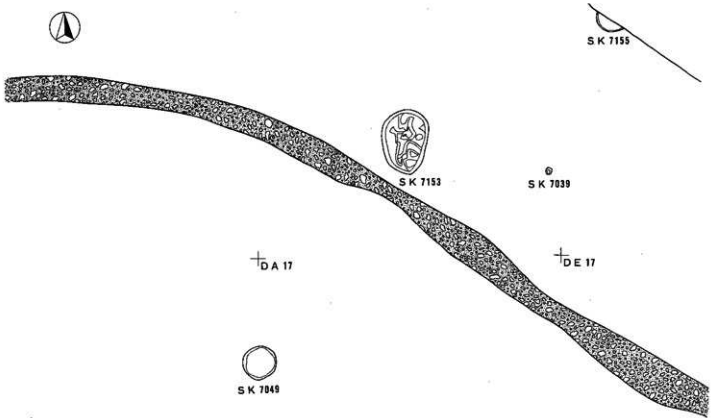

割付図 64



70 →



+ H Q 17

+ I A 17

S K 7038



割付図 66

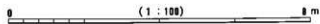

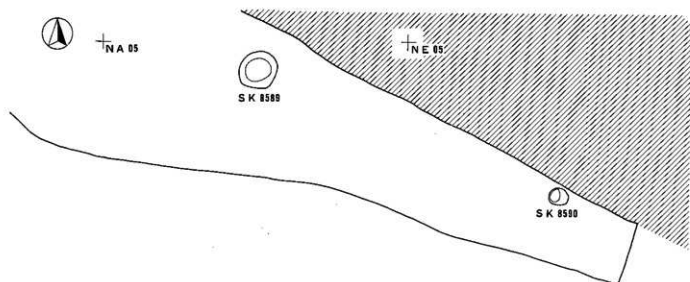

割付図 67

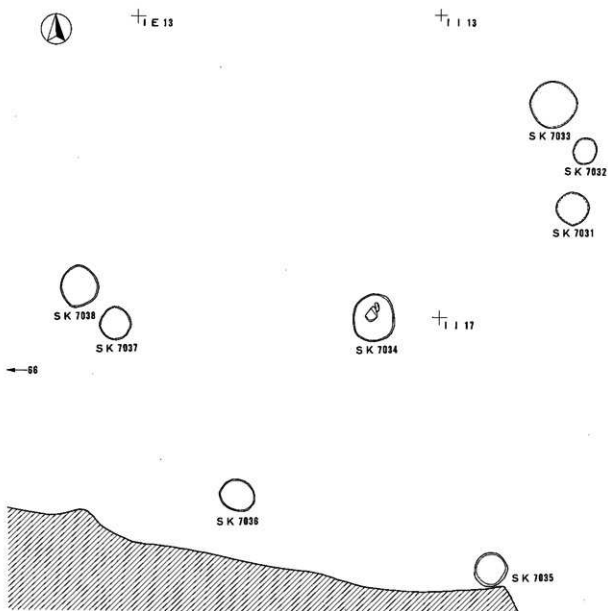

割付図 70

0 (1 : 100) 8 m



SK 7051

† I E 05

† I I 05



SK 7042



SK 7043



SK 7045

71 →



SK 7023

† I I 09



SK 7022



SK 7024



SK 7028



图版358 中世割付图71 (一括)

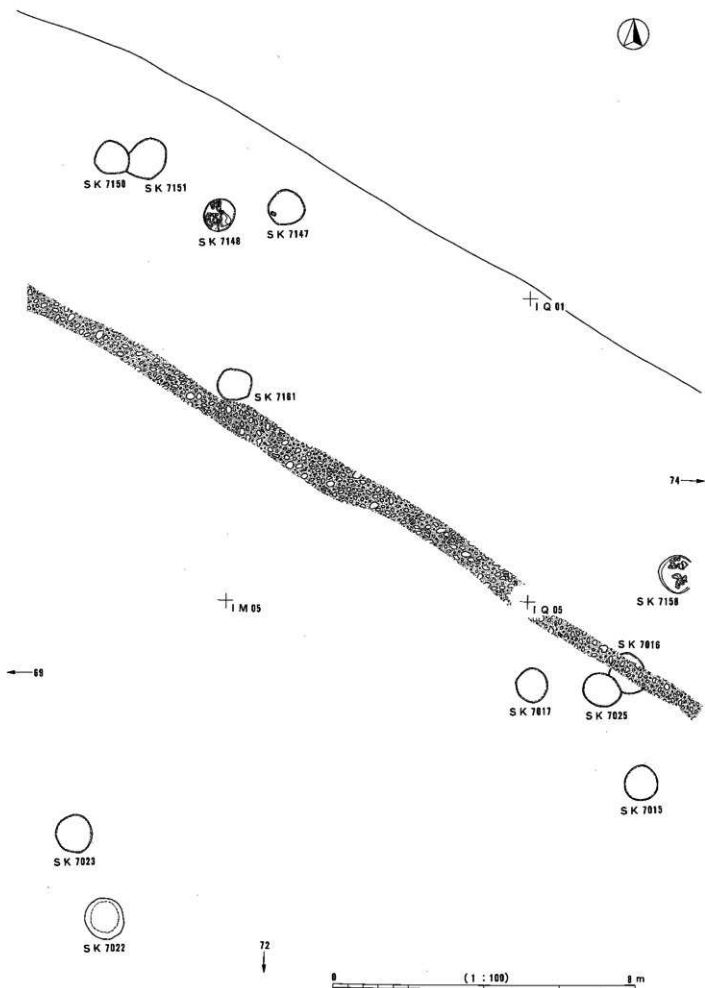

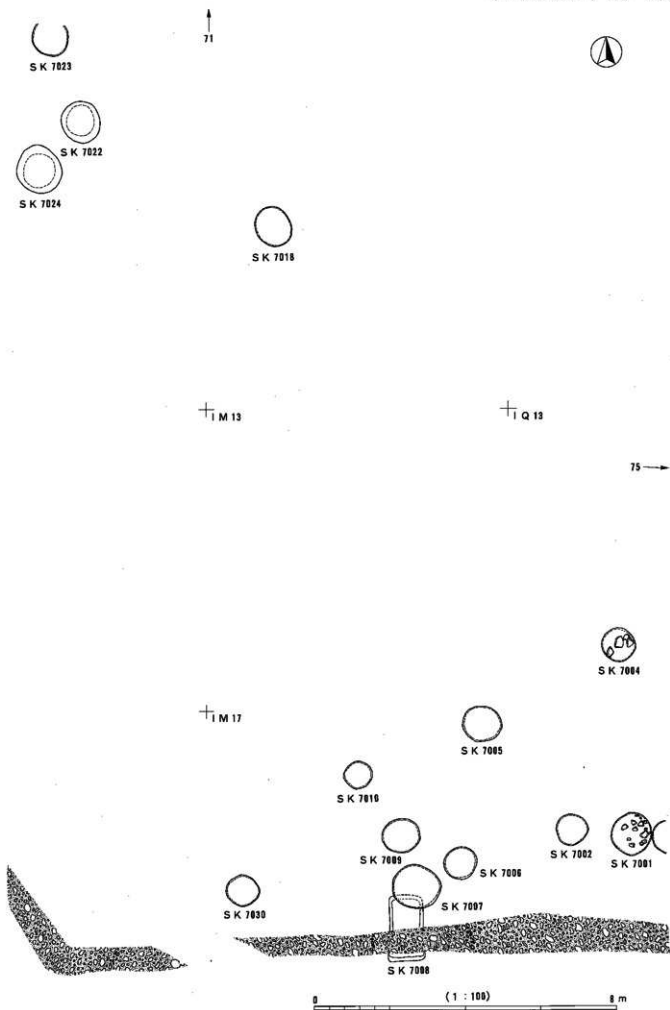

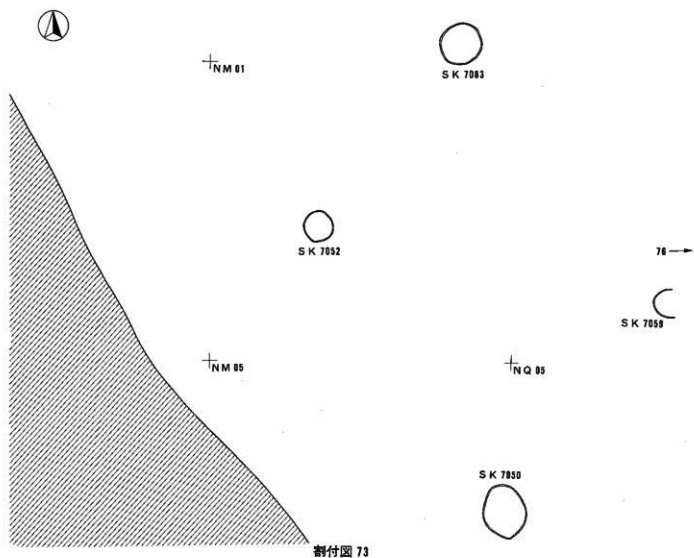

割付图 73

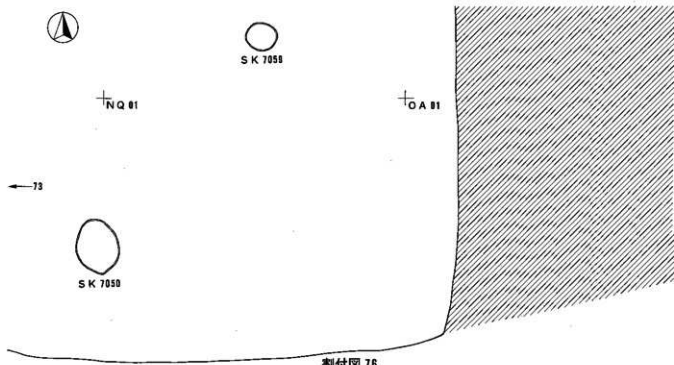

割付图 76

0 (1 : 100) 8 m



←71

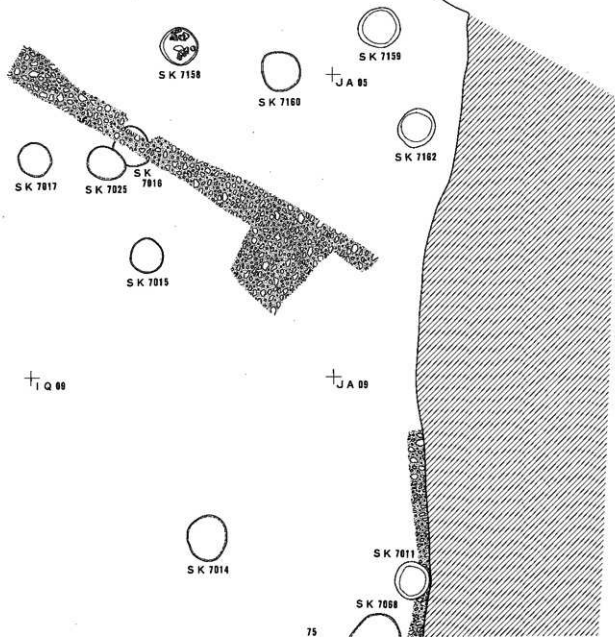

0 (1 : 100) 8 m

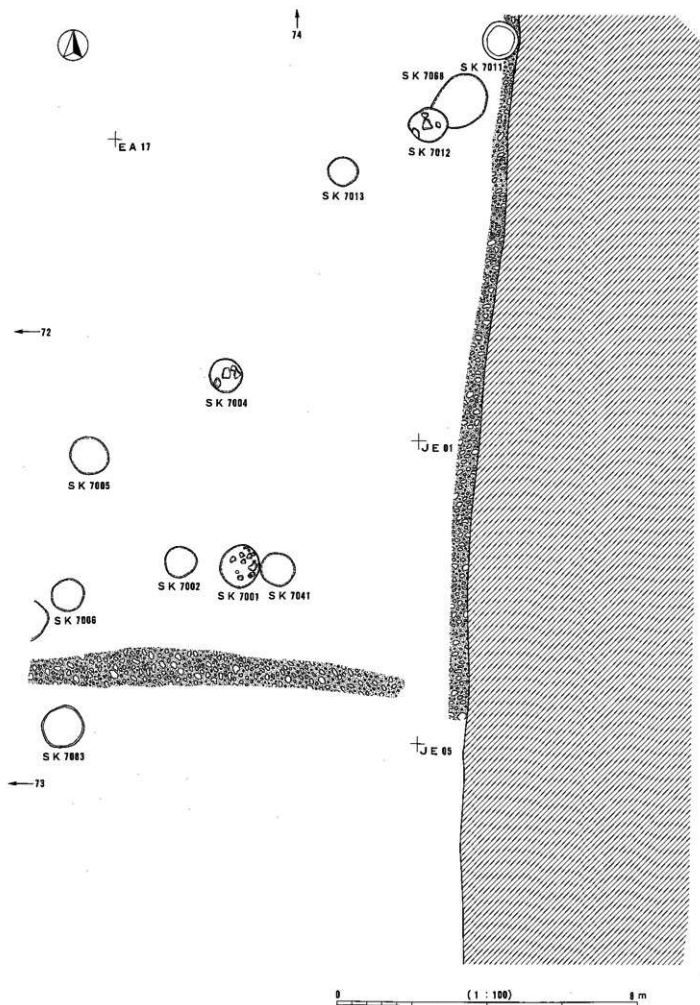

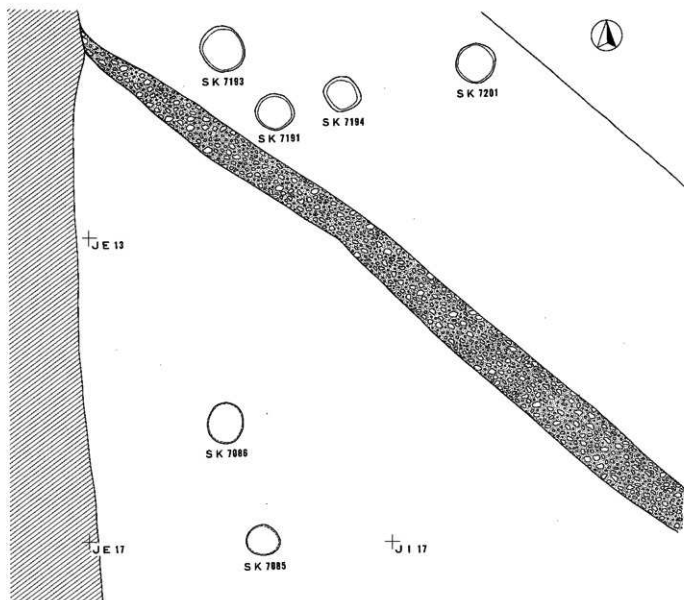

割付図 77

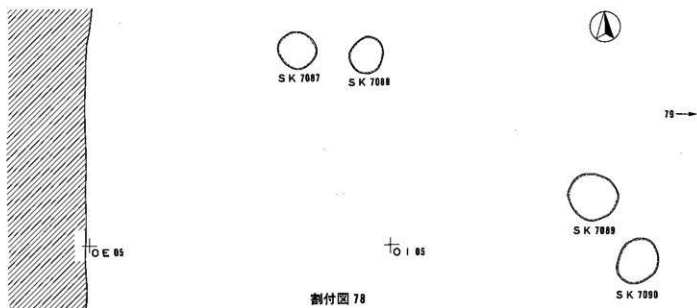

割付図 78

0 (1 : 100) 8 m

图版364 中世割付图79 (一括)

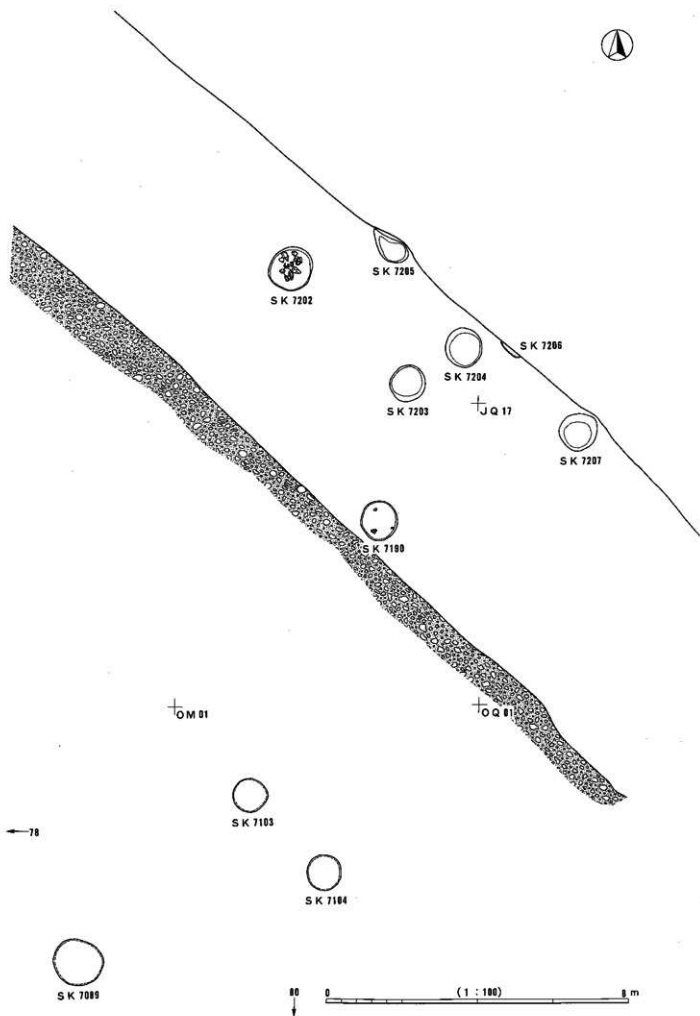

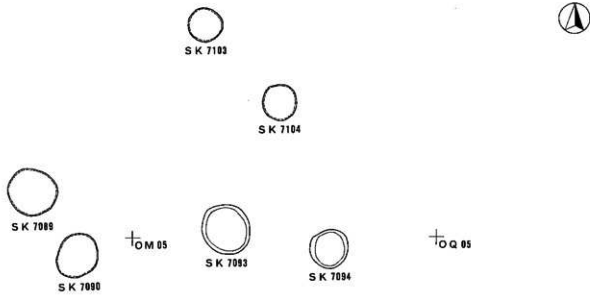

割付図 80

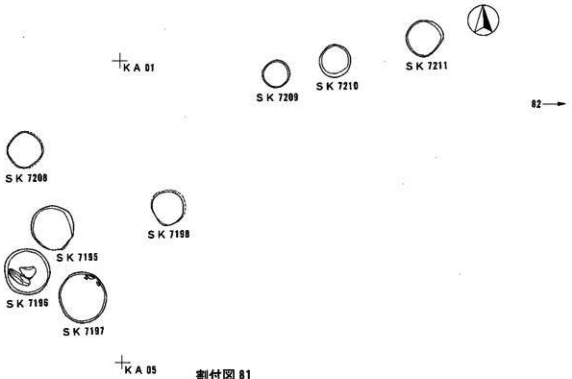

割付図 81

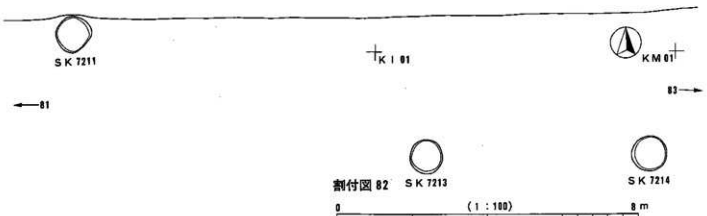

割付図 82



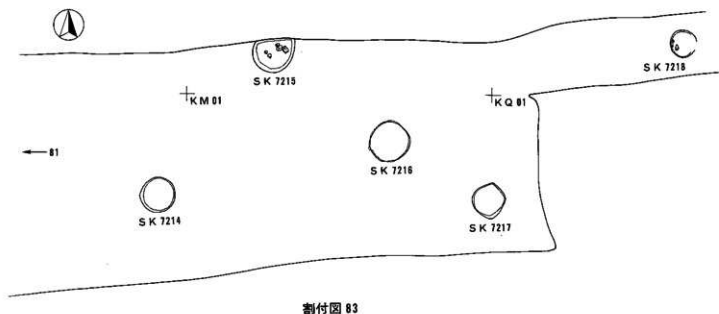

割付图 83

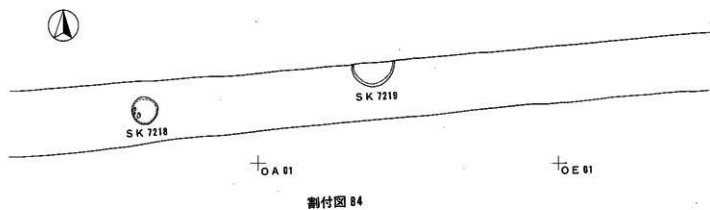

割付图 84

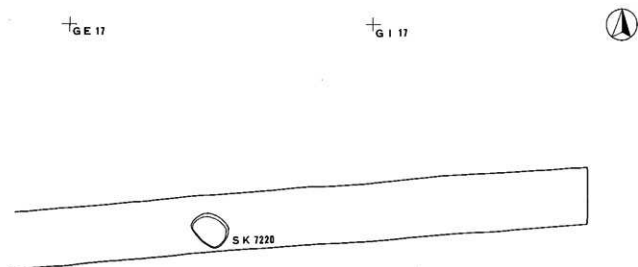

割付图 85

0 (1 : 100) 8 m

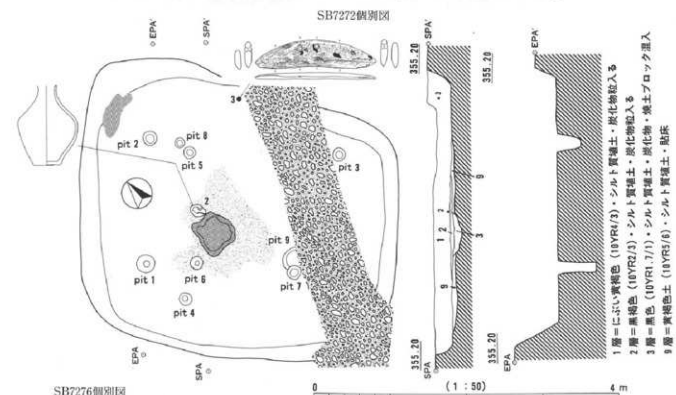
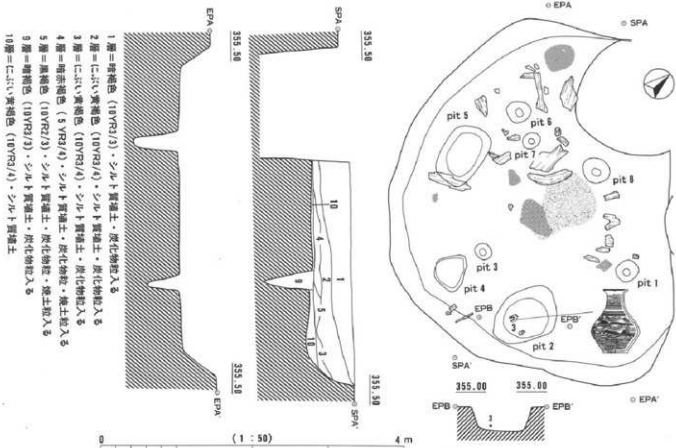

SB7276個別図

- SB7272個別図
- 1層=にぶい黄褐色 (10YR5/3)・シルト質壤土・炭化物混入る  
2層=黒褐色 (10YR2/3)・シルト質壤土・炭化物混入る  
3層=黒色 (10YR1/7/1)・シルト質壤土・炭化物・焼土混入る  
9層=黄褐色 (10YR5/6)・シルト質壤土・炭化物

- 1層=黒褐色 (10YR2/3)・シルト質壤土・炭化物混入る  
2層=にぶい黄褐色 (10YR5/4)・シルト質壤土・炭化物混入る  
3層=にぶい黄褐色 (10YR5/4)・シルト質壤土・炭化物混入る  
4層=黒褐色 (5YR2/3)・シルト質壤土・炭化物・焼土混入る  
5層=黒褐色 (10YR2/3)・シルト質壤土・炭化物・焼土混入る  
9層=黒褐色 (10YR2/3)・シルト質壤土・炭化物混入る  
10層=にぶい黄褐色 (10YR5/4)・シルト質壤土

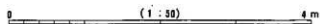
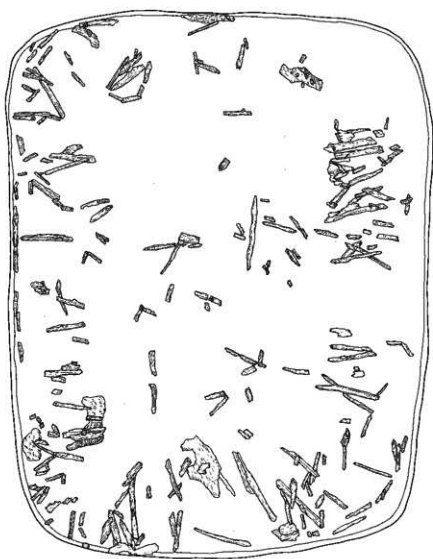

SB7078個別図-1 (炭化材出土状況)

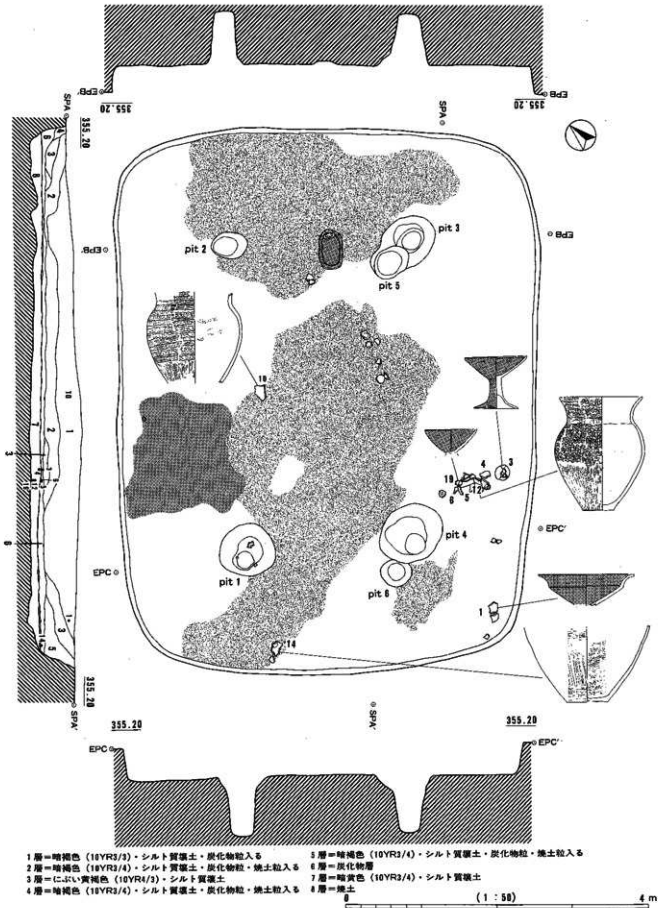

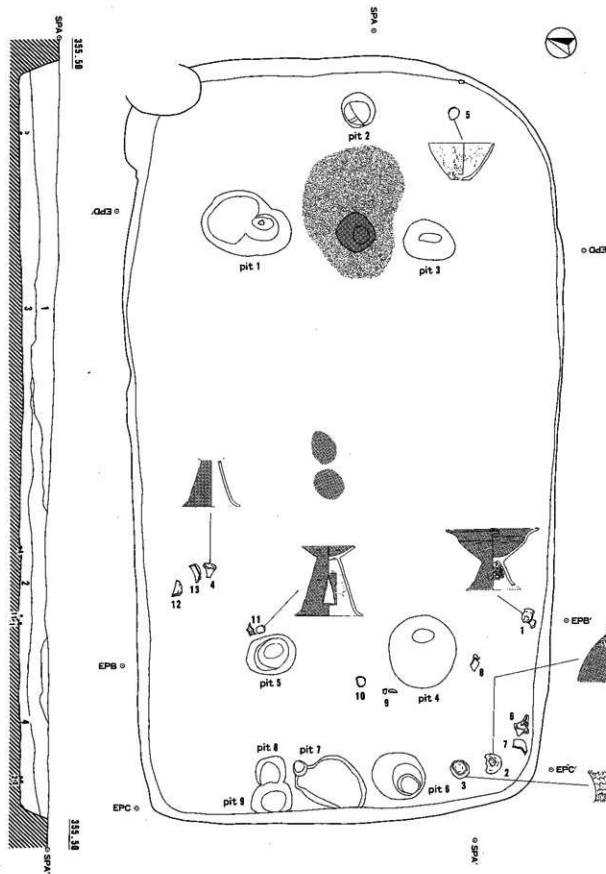

- 1層=にじい黄褐色 (10YR5/4) ~黄褐色 (10YR5/6)・シルト質礫土・炭化物粒・焼土粒入る
- 2層=黒褐色 (10YR3/1)・シルト質礫土・焼土と炭化物が主体となる層
- 3層=にじい黄褐色 (10YR5/4) ~黄褐色 (10YR5/6)・シルト質礫土・炭化物小ブロック・焼土小ブロック入る
- 4層= (平安期住居のカマド残り)

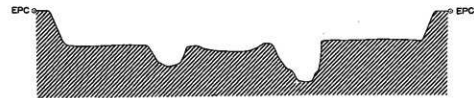
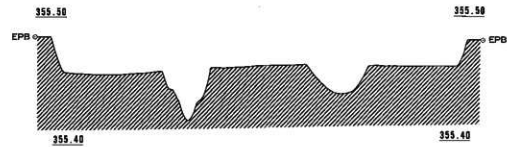
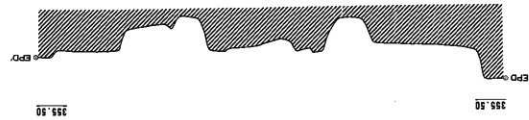

0 (1:50) 4 m

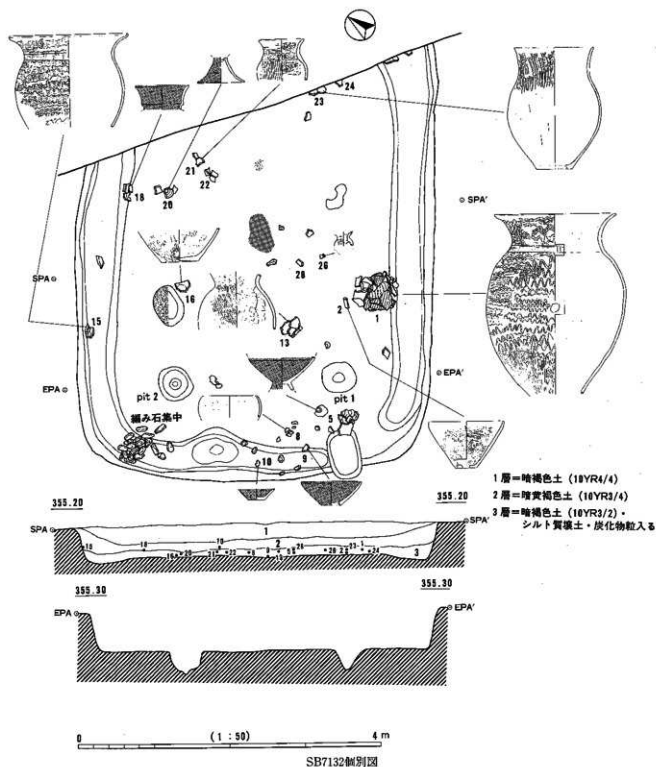

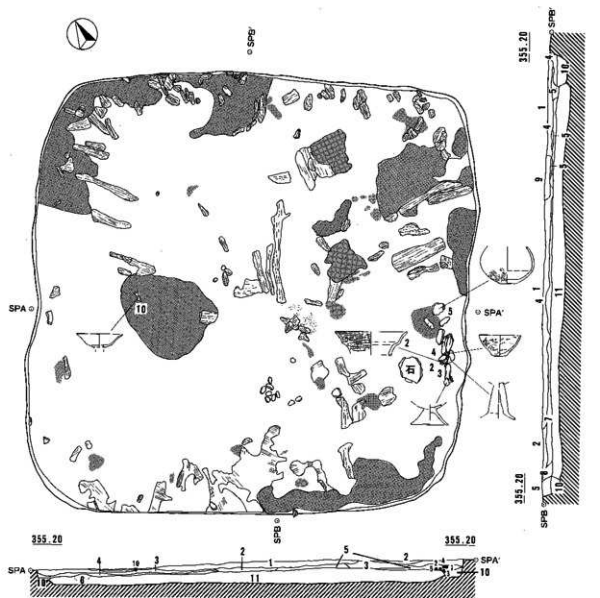

- 1層=黄灰色 (2.5Y4/1)・シルト質壤土
- 2層=浅黄色 (2.5Y7/4)+褐色 (10YR4/4)・シルト質壤土
- 3層=黄灰色 (2.5Y4/1)・シルト質壤土
- 4層=黄灰色 (2.5Y4/1)・シルト質壤壤土
- 5層=褐灰色 (10YR4/1)+黒色 (10YR1.7/1)+橙色 (7.5YR7/8-6/8)・シルト質壤土・炭化物・焼土入る
- 6層=浅黄色 (2.5Y7/4)・シルト質壤土

- 7層=暗灰青色 (2.5Y4/2)・シルト質壤土
- 8層=黄灰色 (2.5Y4/1)・壤壤土
- 9層=黄灰色 (2.5Y4/1)・壤土
- 10層(周溝土) = 黄灰色 (2.5Y4/1)・シルト質壤壤土
- 11層(床土) = 褐灰色 (10YR4/1) ~ 黒褐色 (10YR3/1)・シルト質壤壤土

0 ( 1 : 50 ) 4 m

SB6013個別図-1 (炭化材・焼土出土状況)

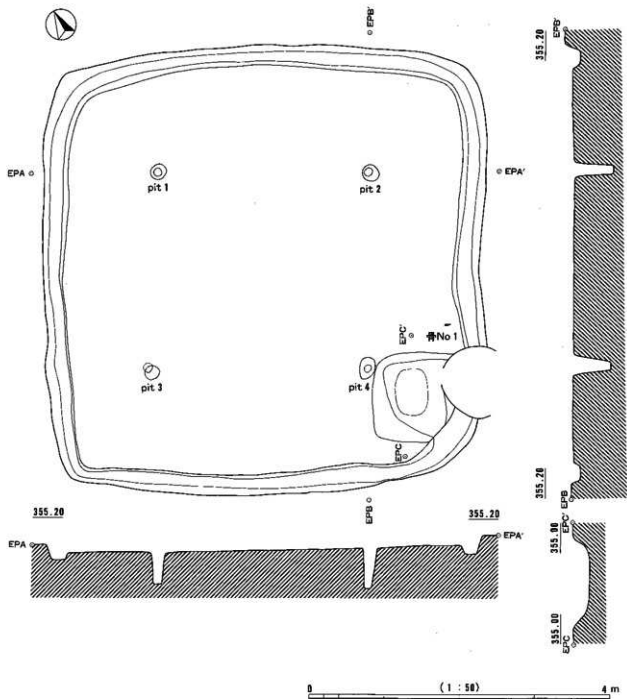

SB6013個別図-2 (完編)



図版374 古墳時代前期整穴住居跡個別図 (SB6004)

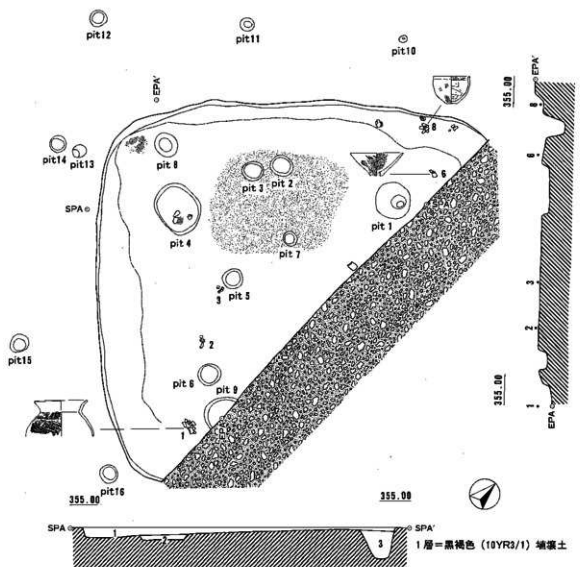

SB6004個別図

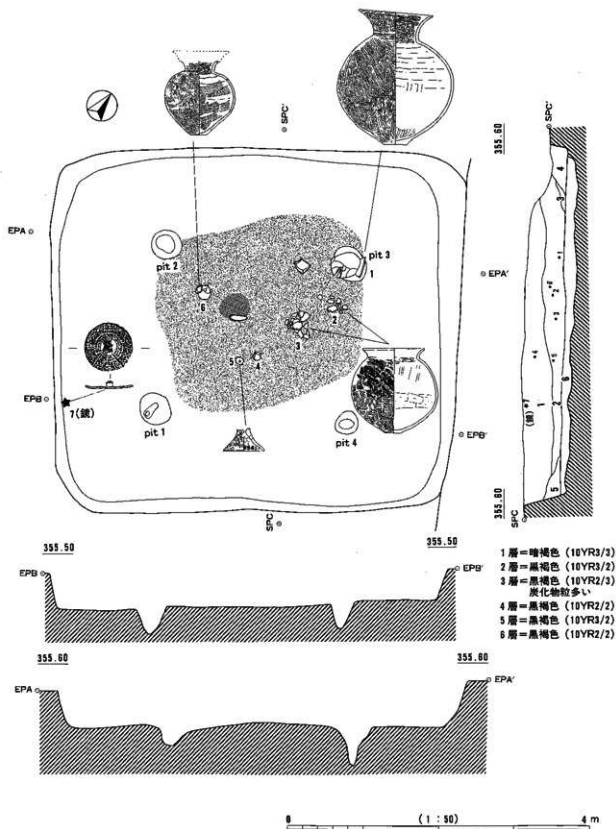

SB7250個別図

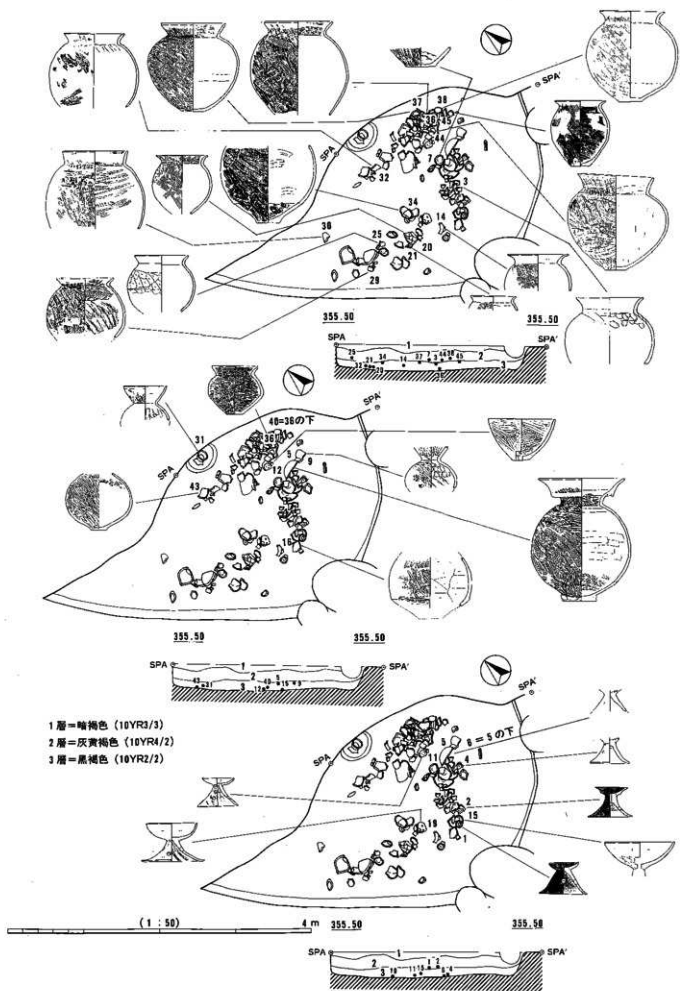

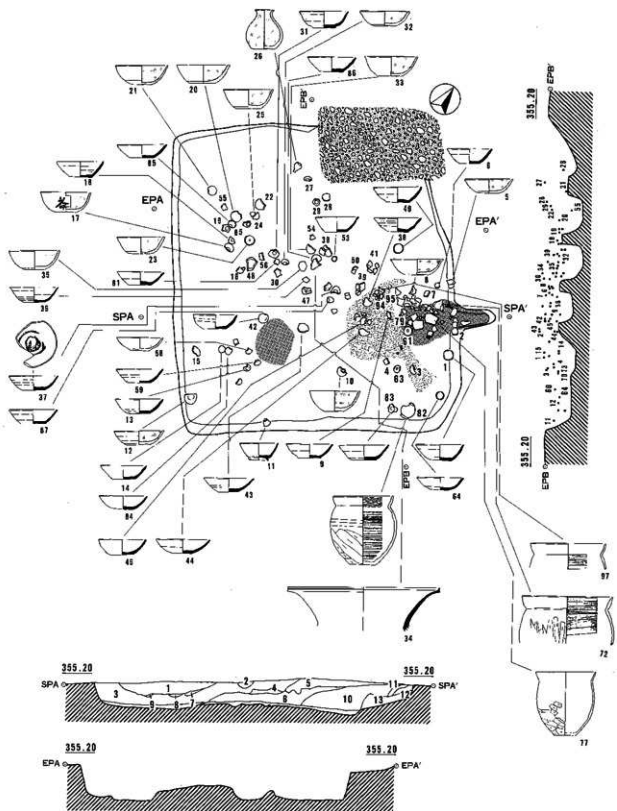

- 1層=暗褐色 (1BYR/3)・砂質壤土+黄褐色 (1BYR/5)
- 2層=にじみ黄褐色 (1BYR/3)・砂質壤土
- 3層=暗褐色 (1BYR/4)・砂質壤土
- 4層=黒褐色 (1BYR/3)・砂質壤土
- 5層=暗色 (1BYR/6)・砂質壤土+黄粒 (1BYR/3)

- 6層=にじみ黄褐色 (1BYR/3)・砂質壤土+黄粒 (1BYR/3)
- 7層=明黄褐色 (1BYR/1)・砂質壤土・炭
- 8層=褐色 (1BYR/4)・砂質壤土+黒色 (1BYR.2/1)
- 9層=黒褐色 (1BYR/3)・砂質壤土+黒色 (1BYR.7/1)

- 10層=暗褐色 (1BYR/4)・シルト質壤土
- 11層=粘土+炭化物
- 12層=焼土
- 13層=シルト質粘土

0 (1 : 50) 4 m  
SB7001個別図



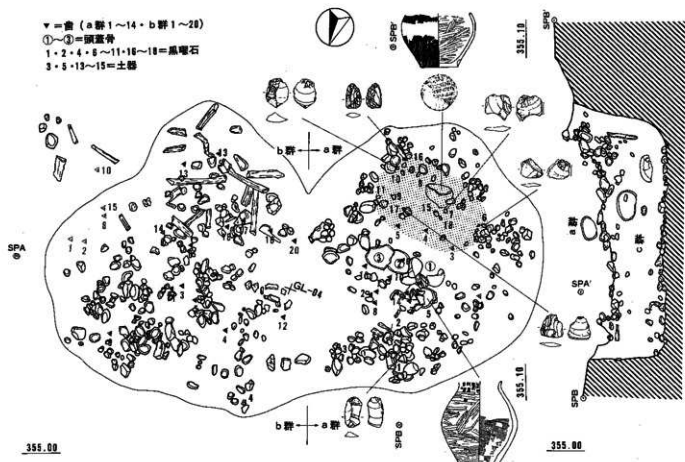

- 4=歯 (C群38~42)  
 \* =管玉  
 ⑤~⑧=頭蓋骨  
 ①~③=頸骨  
 23=天然石  
 28~22・25・29・30=黒曜石  
 31=土器

- 5層=黄褐色 (18YR5/8)・壤質砂土・少量の骨片を含む。  
 6層=暗褐色 (18YR4/6)・シルト質壤土・骨を含む。  
 7層=暗褐色 (18YR4/6)・シルト質壤土中に多量の骨を含む骨の集積層。  
 8層=赤褐色 (5YR4/6)・壤質砂土・骨は含まれず、地山が変色した層。

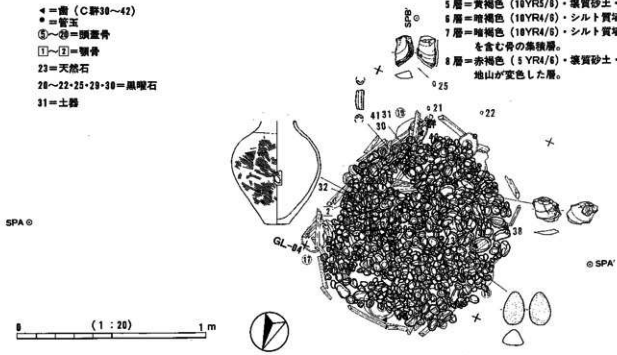

SM7010個別図

SPB

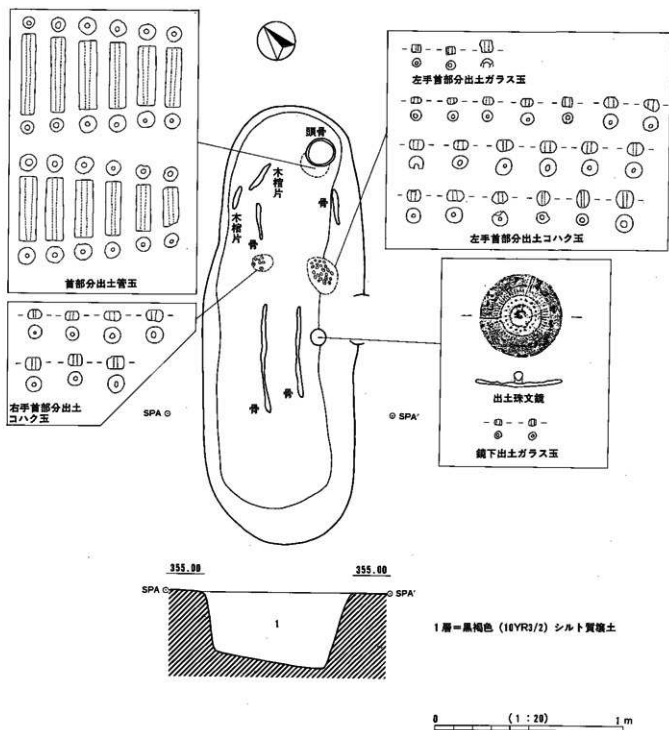

SM7016個別図

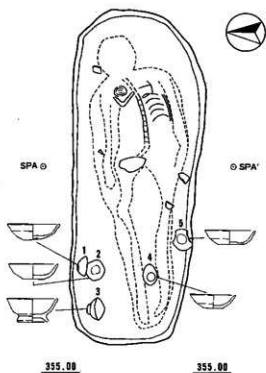

1層=褐色(10YR4/4)・砂土

SM7009個別図

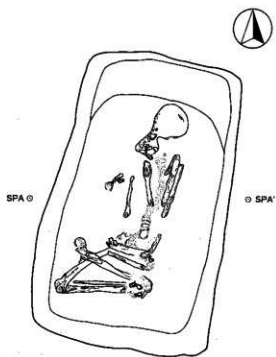

1層=褐色(10YR4/4)・砂土

SM7013個別図

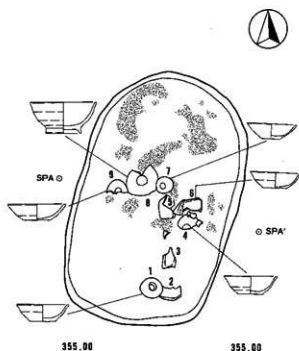

1層=褐灰色(10YR4/1)～灰木褐色(10YR4/2)・シルト質壤土・  
焼土粒・炭化物粒が多く入る

SM7017個別図

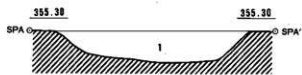
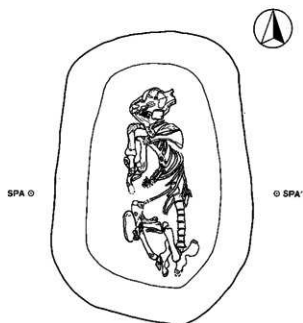

1層=褐色(10YR4/4)・砂質壤土

SM7012個別図

0 (1:20) 1m



384. 照

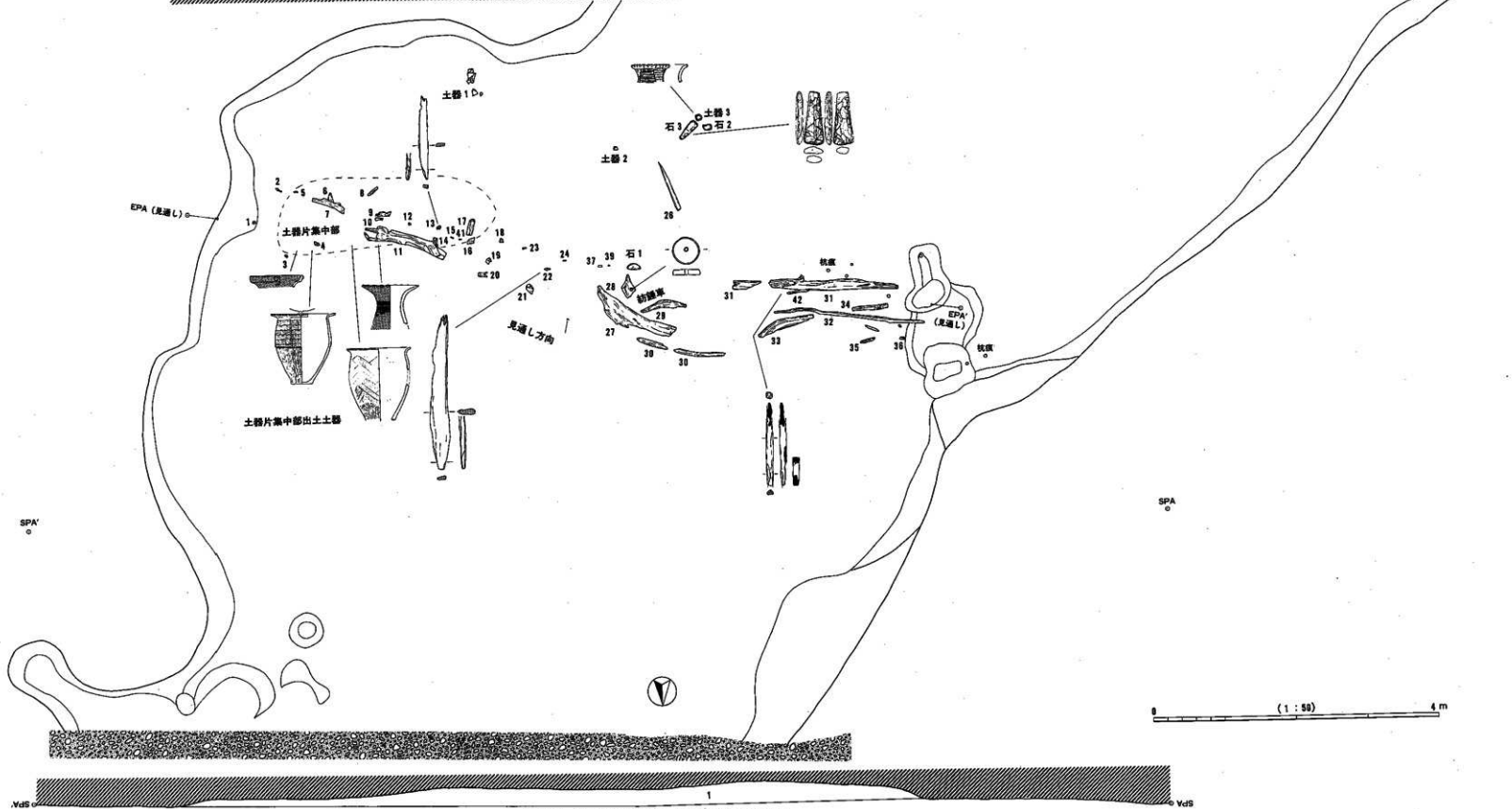
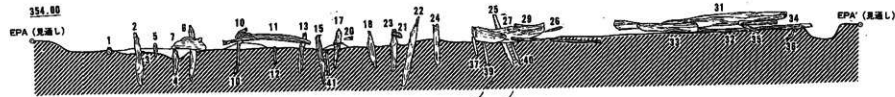

1層=暗オリーブ色 (7.4Y4/3)・砂土

SA5001・SD5003個別図 (注=Noのみは杭・木のNo)

YdS

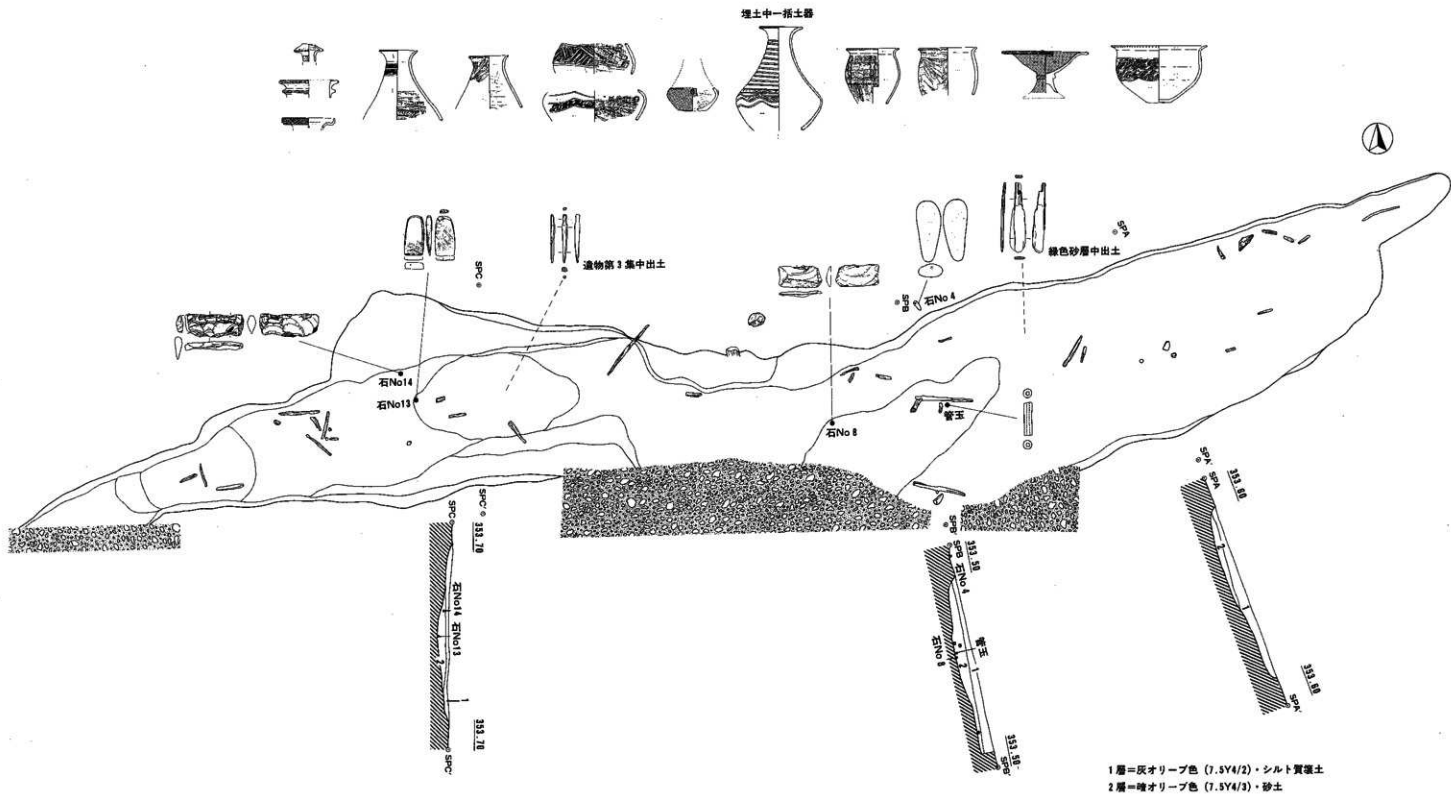

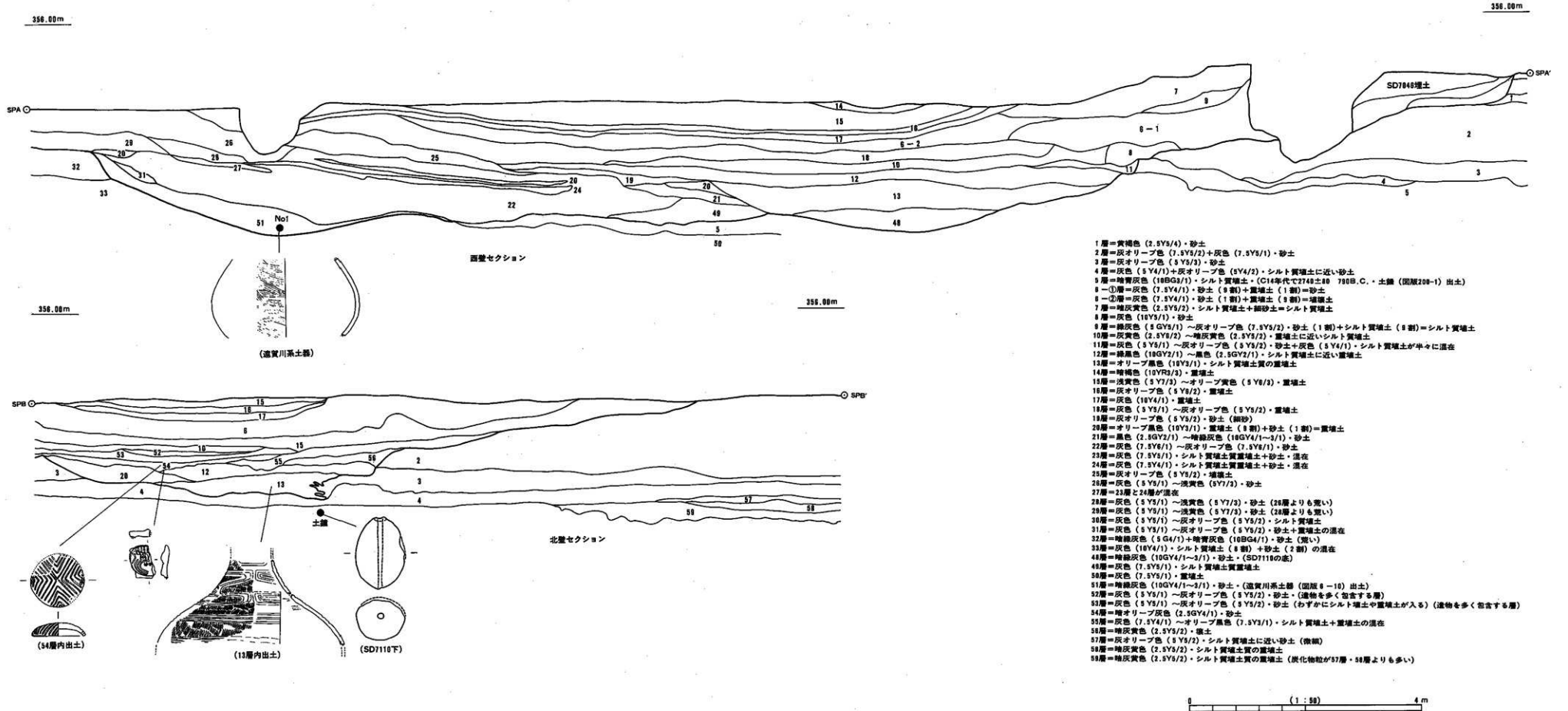

SD7110セクション図 (セクションポイントは図版12・13・14にあり)

SD7014セクション図

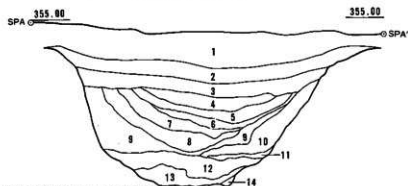

※SPの位置は図版69・71にある

- 1層=暗褐色 (10YR3/3)・壤土
- 2層=暗褐色 (10YR3/4)・壤土
- 3層=褐色 (10YR4/4)・シルト質壤土
- 4層=褐色 (10YR4/6)・シルト質壤土
- 5層=暗褐色 (10YR3/3)・シルト質壤土
- 6層=にぶい黄褐色 (10YR5/3)・シルト質壤土
- 7層=暗褐色 (10YR3/3)・シルト質壤土
- 8層=にぶい黄褐色 (10YR5/4)・シルト質壤土
- 9層=にぶい黄褐色 (10YR4/3)・シルト質壤土
- 10層=にぶい黄褐色 (10YR5/4)・シルト質壤土
- 11層=にぶい黄褐色 (10YR4/3)・シルト質壤土
- 12層=にぶい黄褐色 (10YR5/3)・シルト質壤土
- 13層=黒褐色 (10YR3/2)・シルト質壤土
- 14層=にぶい黄褐色 (10YR4/3)・シルト質壤土

SD7014遺物出土層位図

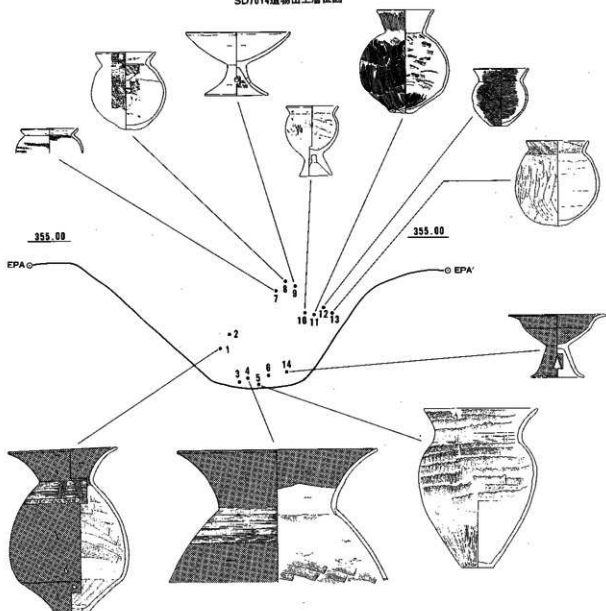

※EPの位置は図版55にある

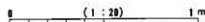

SD7014セクション図・遺物出土層位図

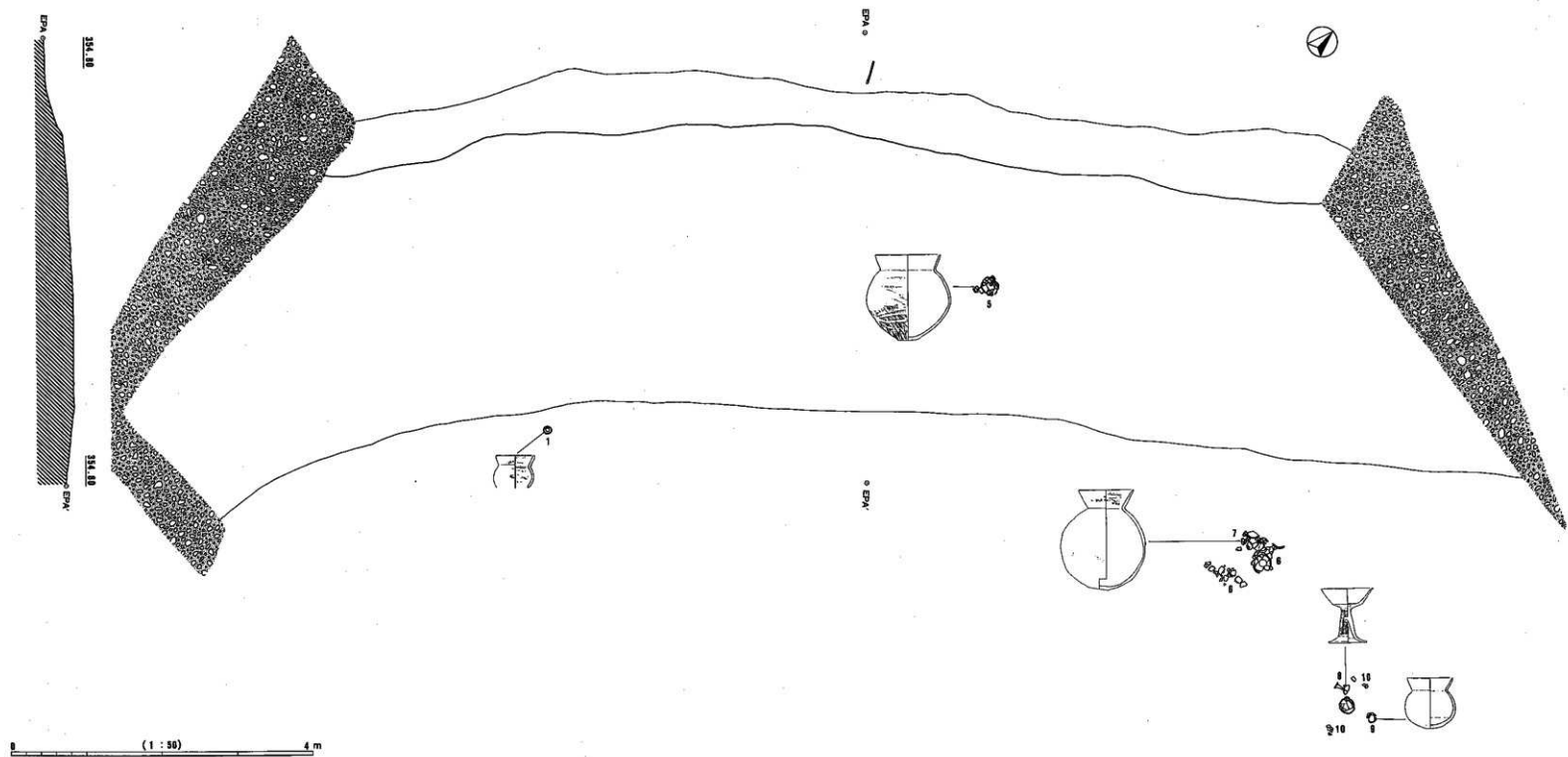

SC6001:個別図

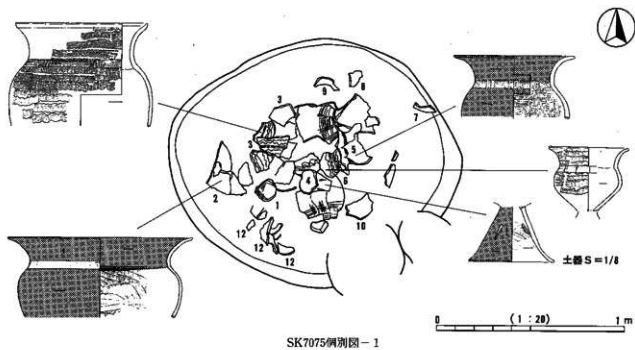
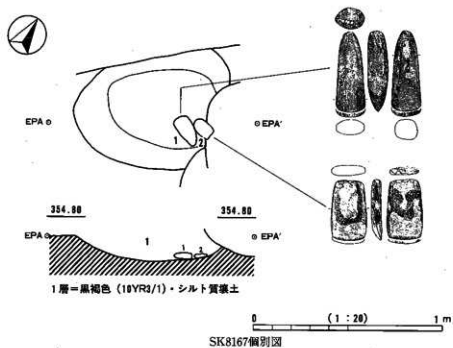

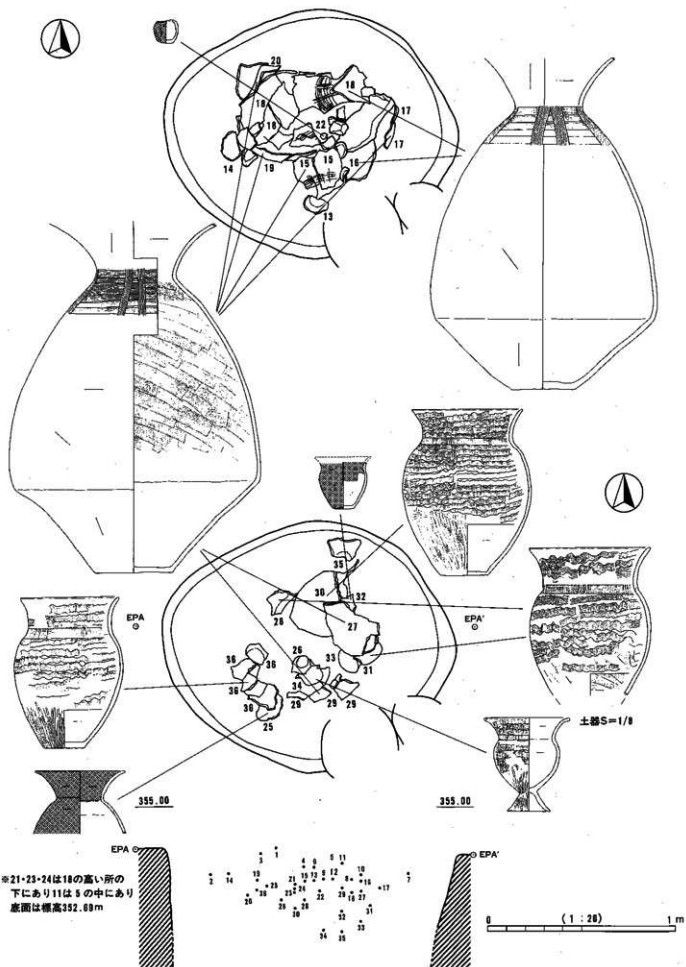

※21・23・24は18の高い所の  
下であり11は5の中であり  
底面は標高352.00m

写 真 图 版



## 航空写真

調査前の塩崎地区  
航空写真





航空写真

戦後まもなくの  
塩崎地区航空写真

調査区全景



1 B I S  
20-1区  
西側



2 B I S  
20-1区  
東側

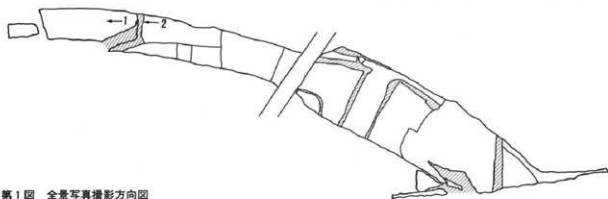

第1図 全景写真撮影方向図



調査区全景



1 1-1-a区

2 1-1-b区

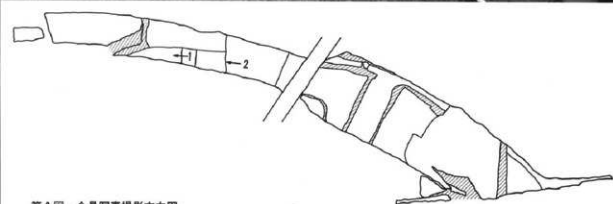

第2図 全景写真撮影方向図

調査区全景



1 1-1-c区



2 1-2区

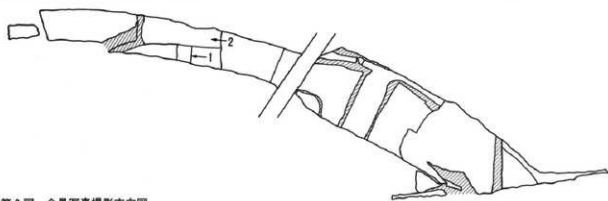

第3図 全景写真撮影方向図