

SM7016-2

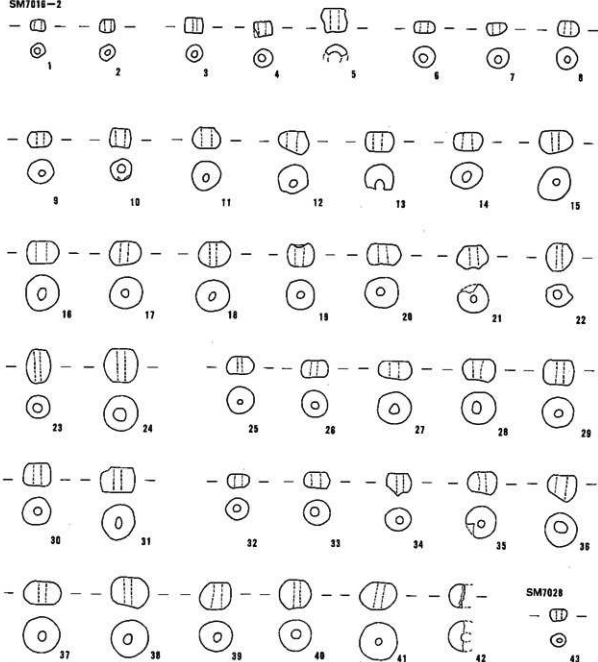

SM7036

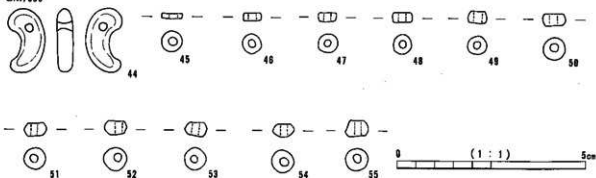

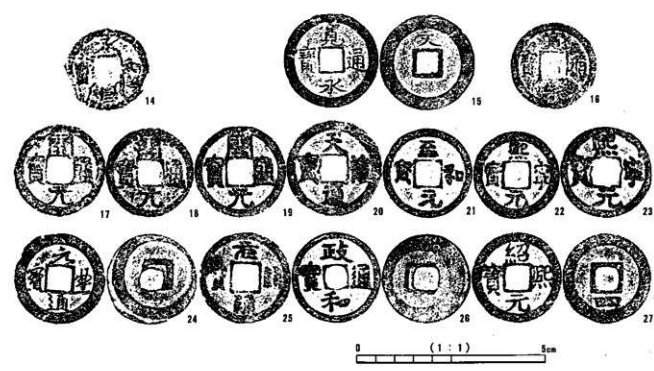
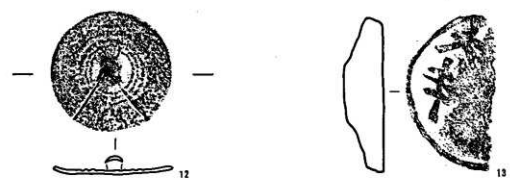
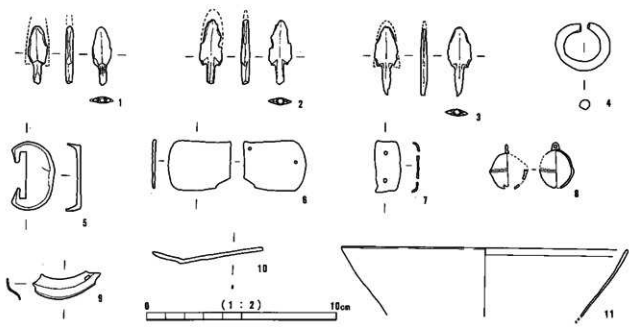

図版212 鉄製品1 (紡錘車・苧引き金具・釘)

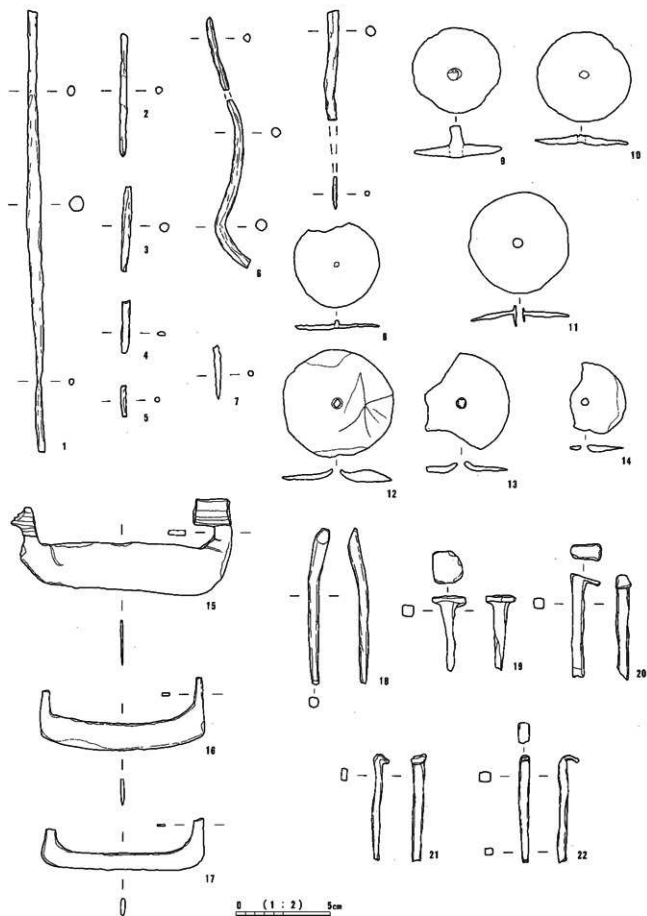

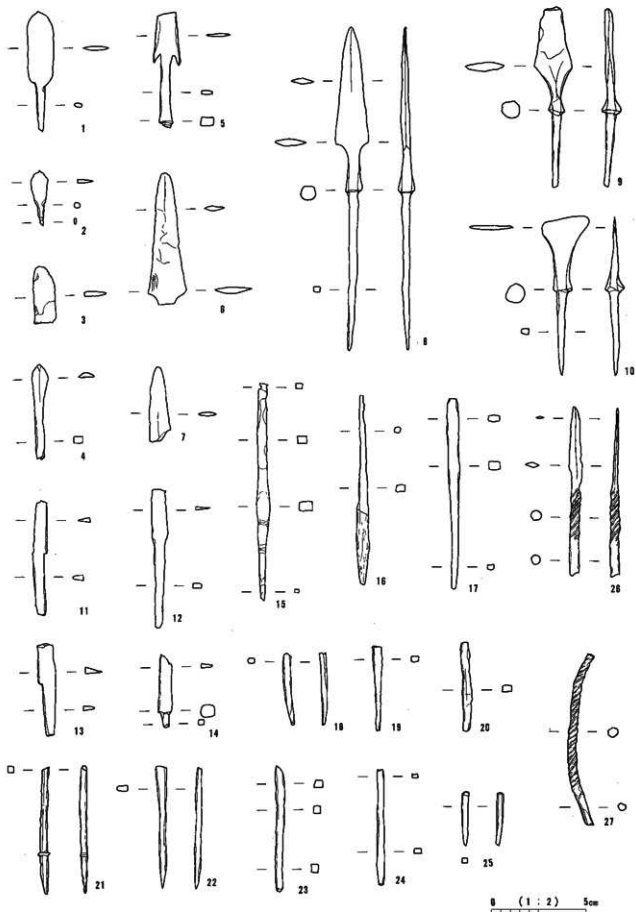

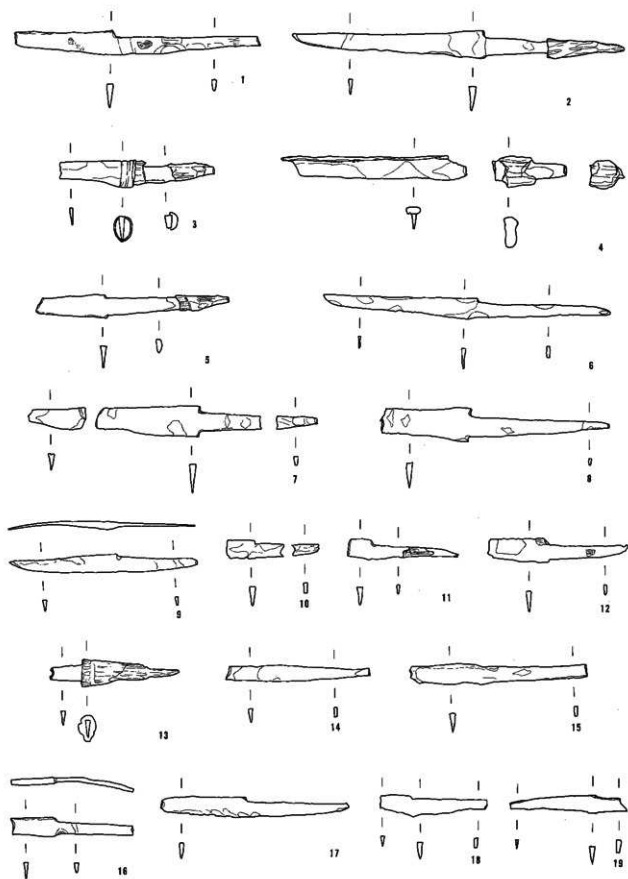

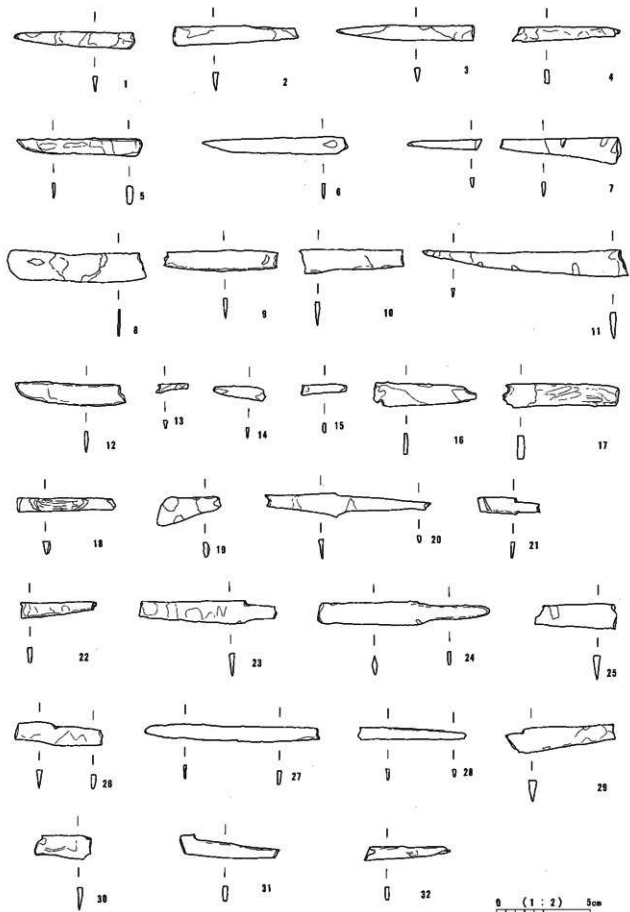

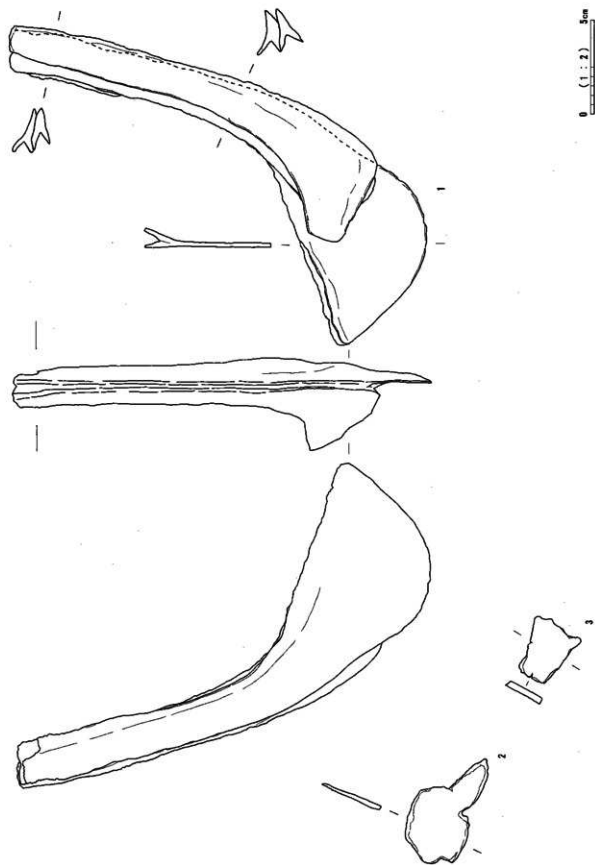

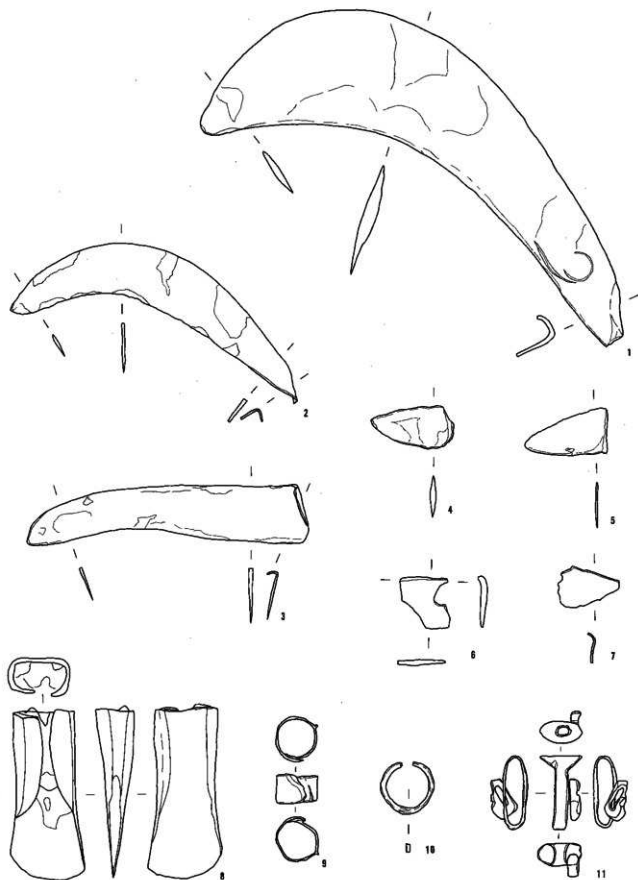

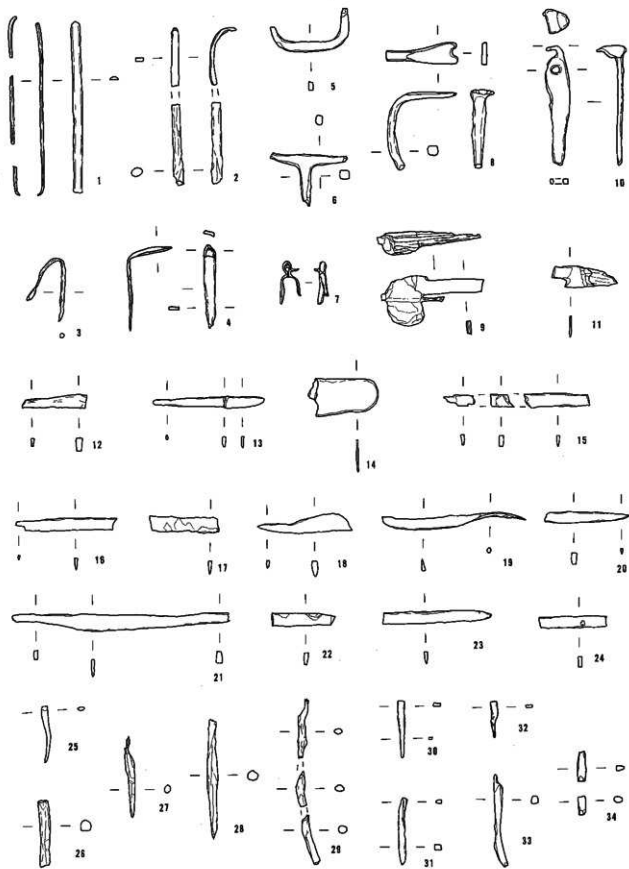

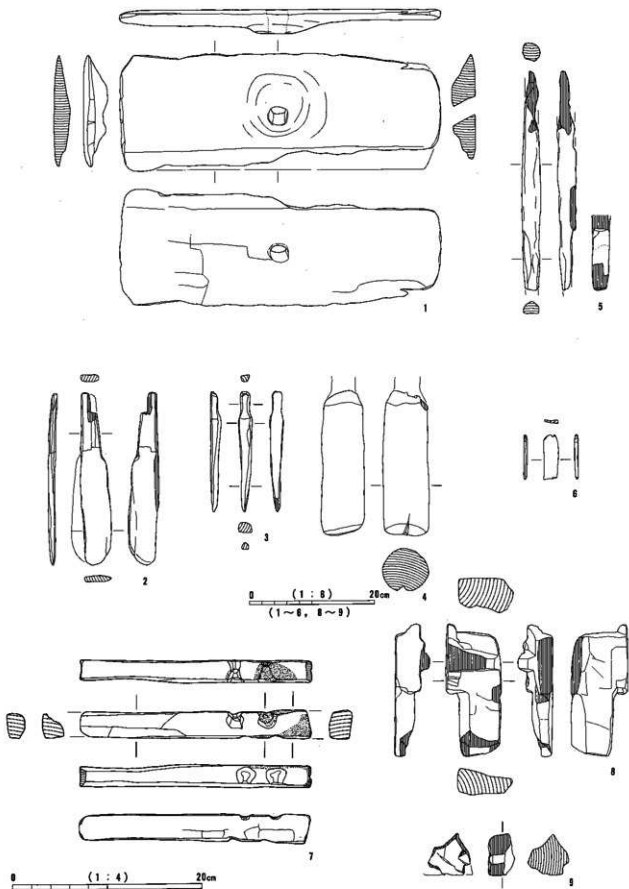

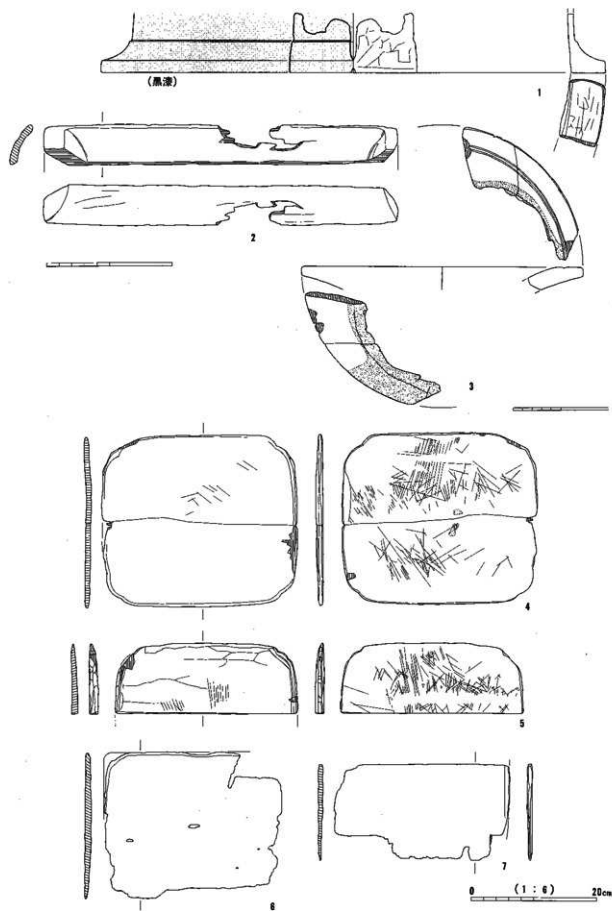

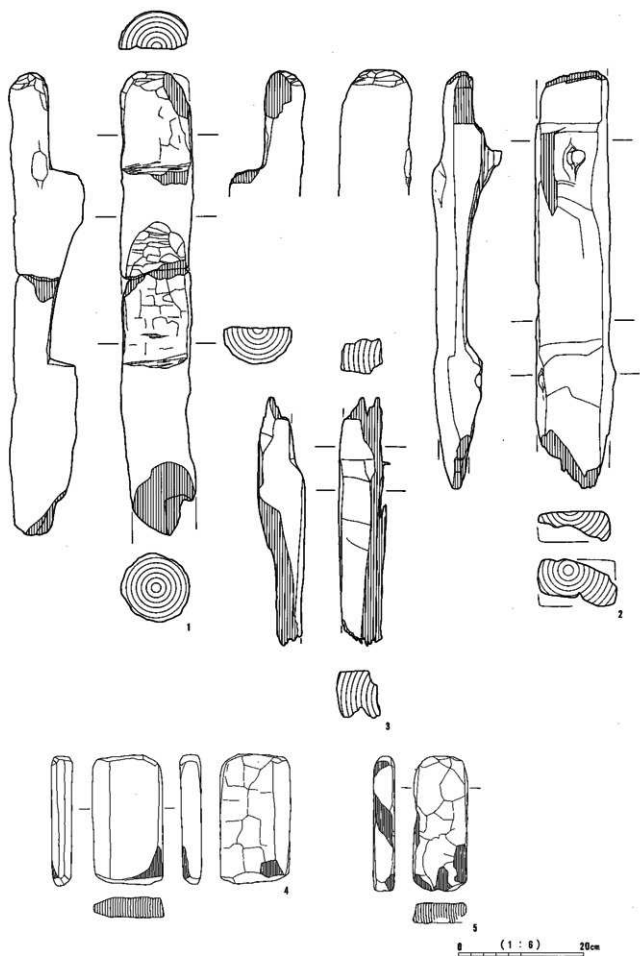

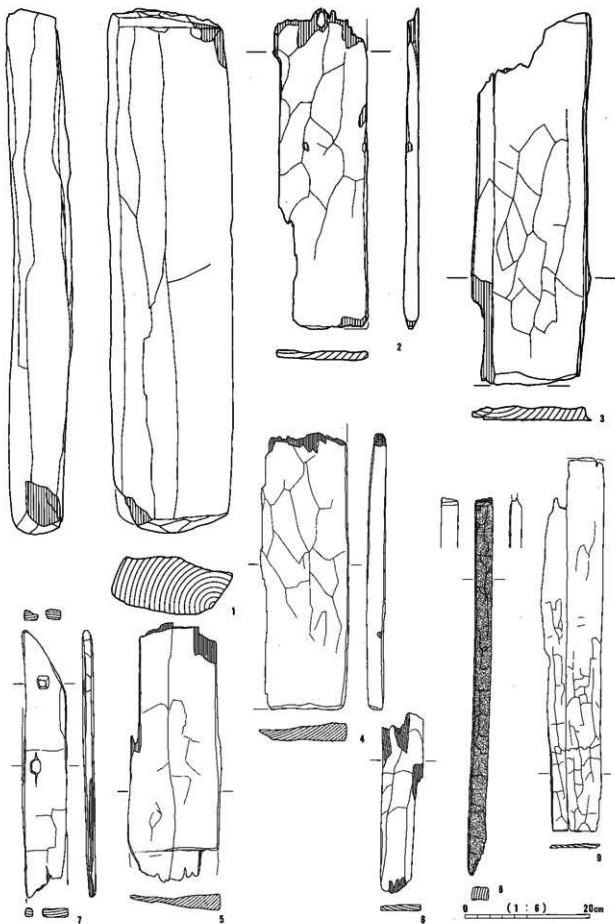

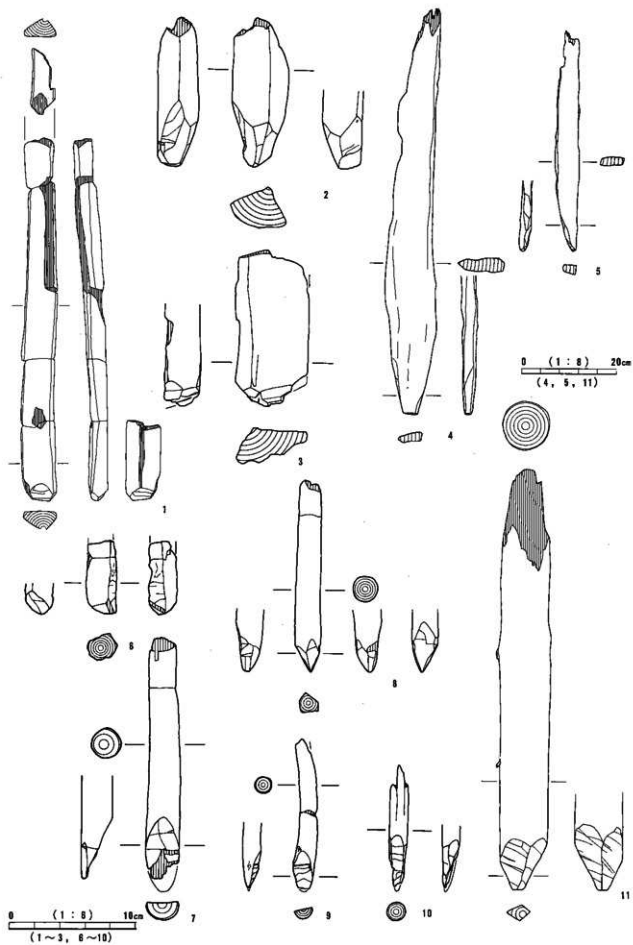

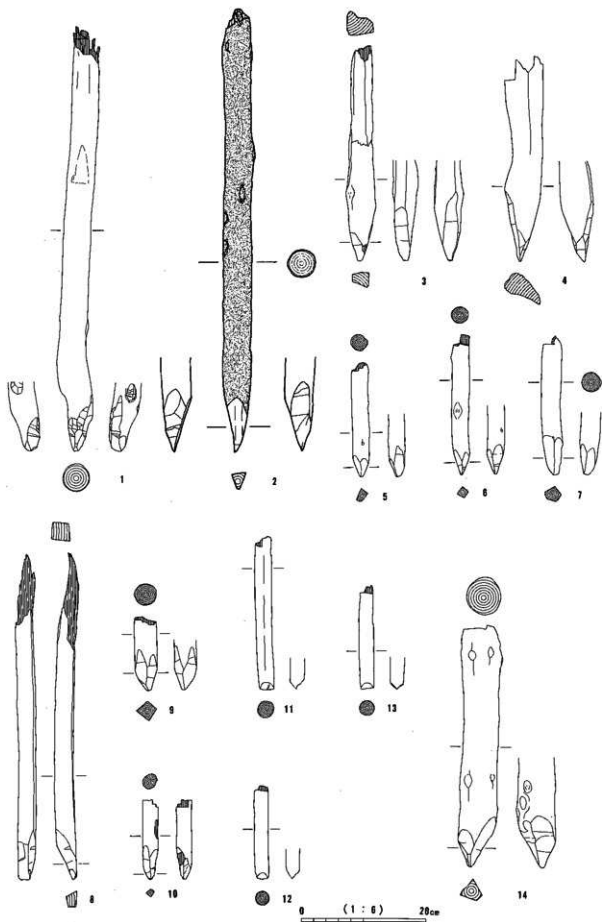

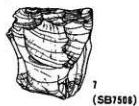
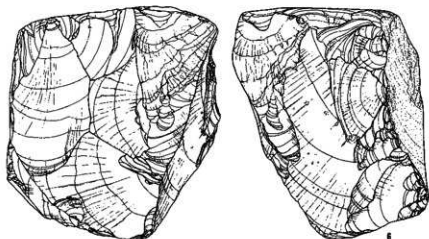
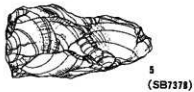
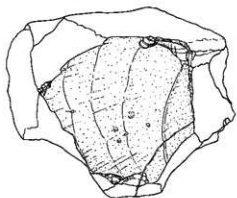
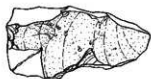
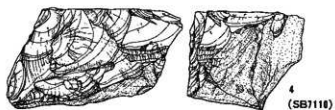
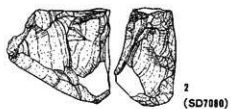
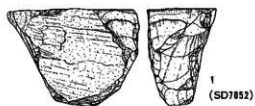

6 (2-1区 2横) 0 (1:1) 3cm

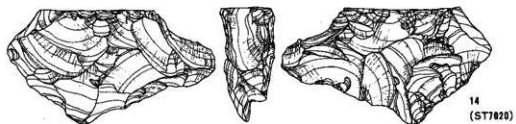
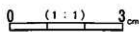
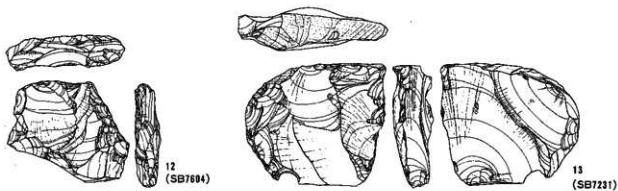
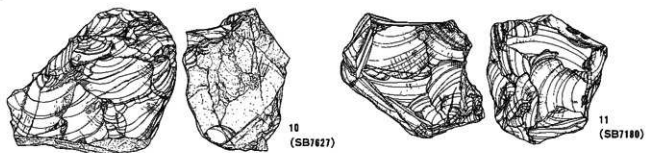
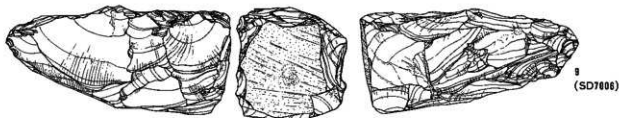

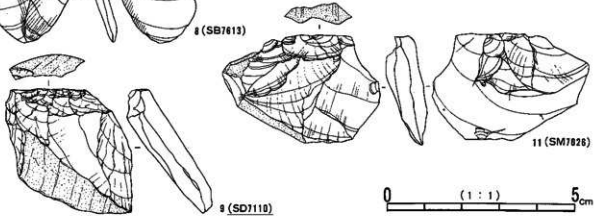
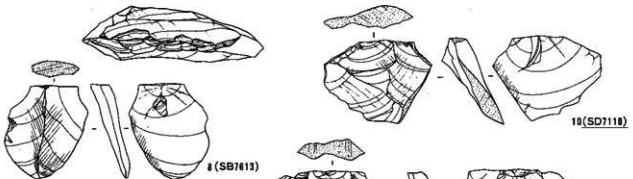
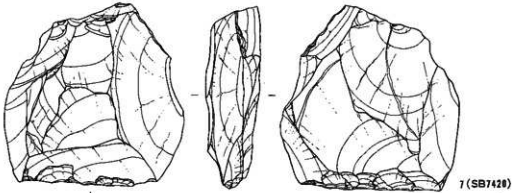
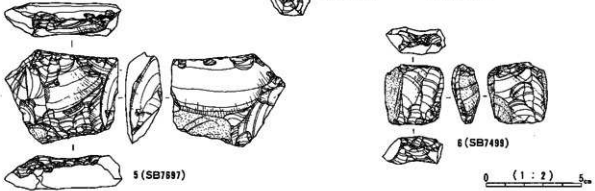
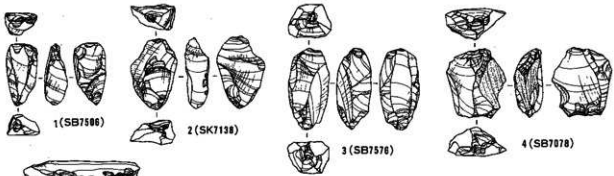

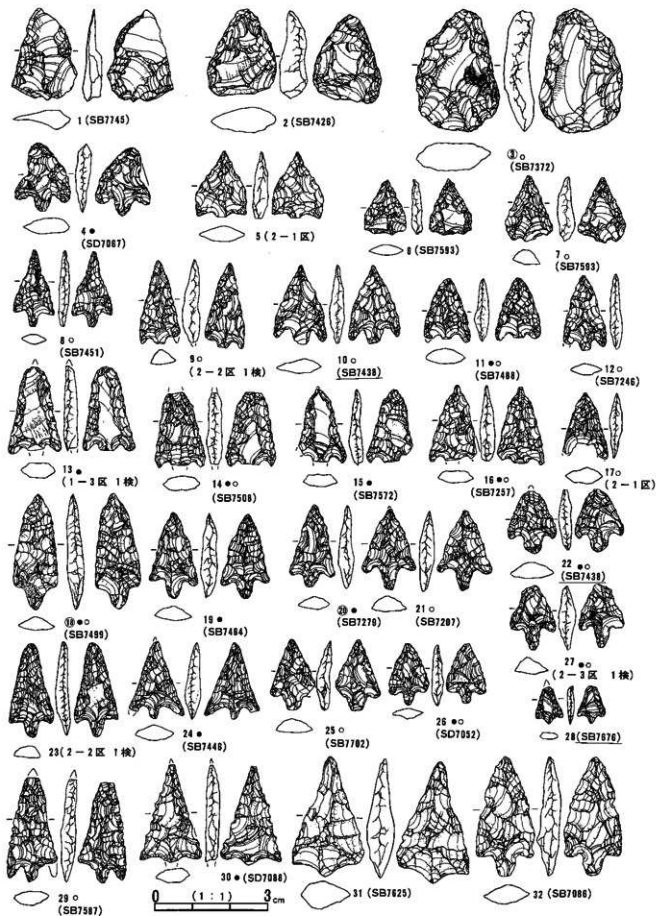

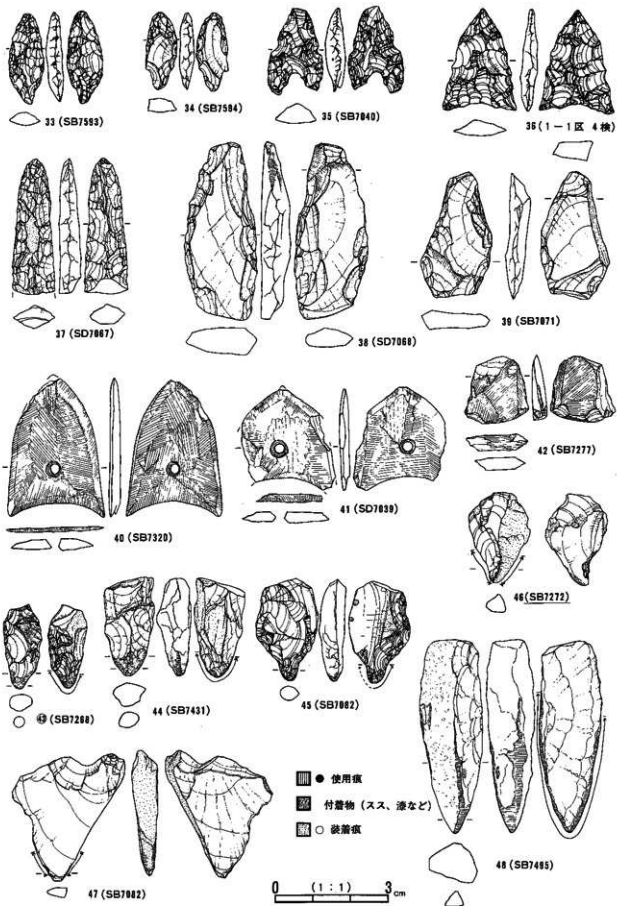

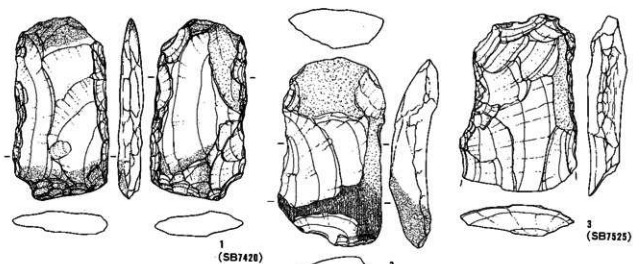

1
(SB7420)

2
(SK9238)

3
(SB7525)

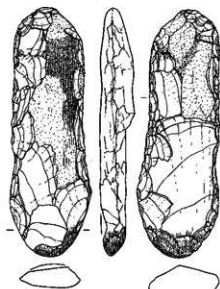

4
(SD6822)

5 (3区)

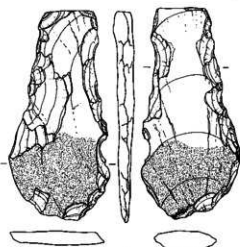

6
(SB7298)

7
(SD7811)

8 (2-3区)

■ 縞状痕 ■ 摩擦痕 ■ 剥落痕

0 (1:2) 5cm

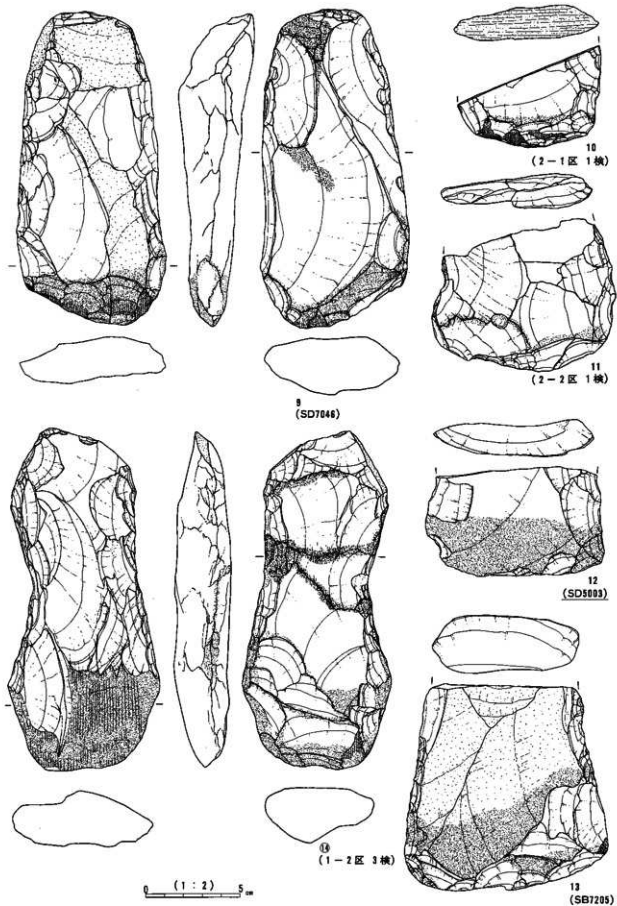

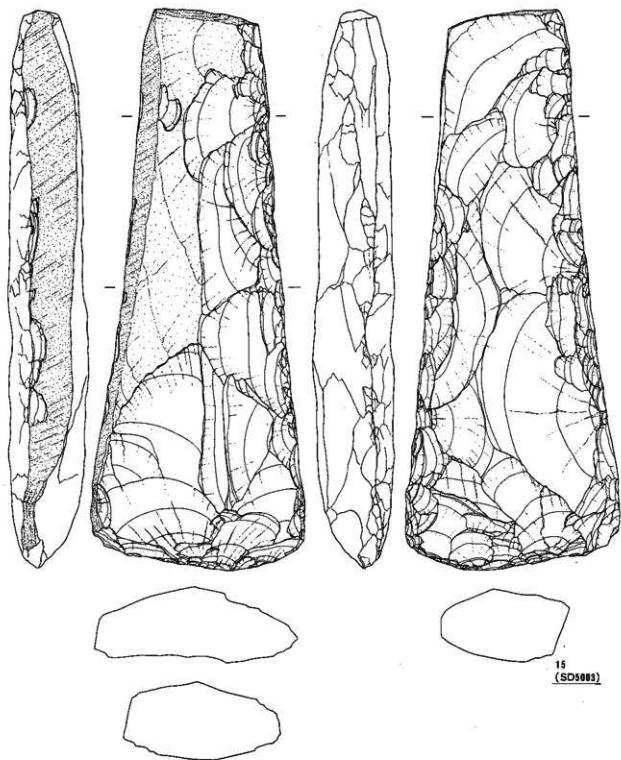

0 (1 : 2) 10 cm

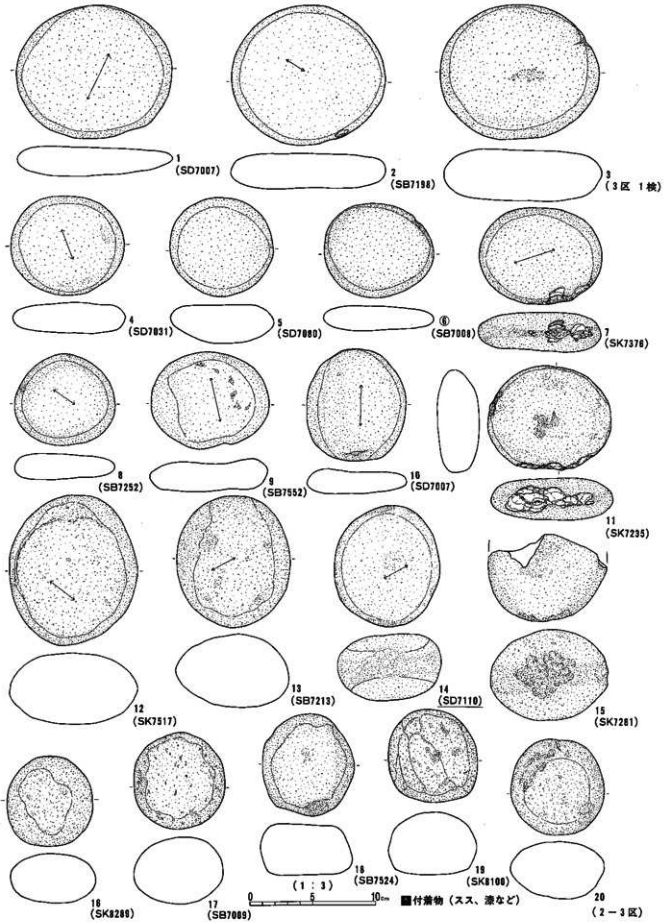

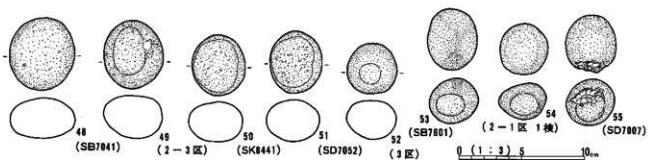
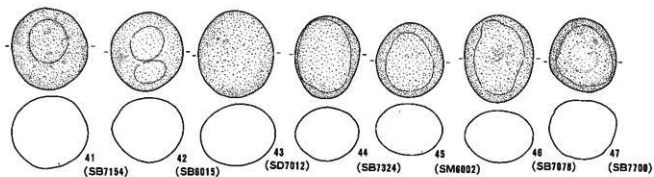
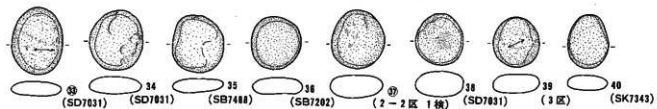
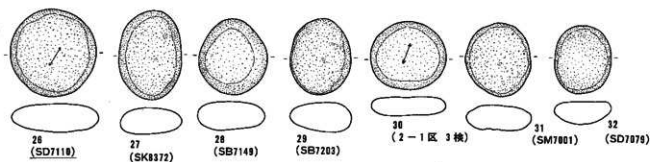
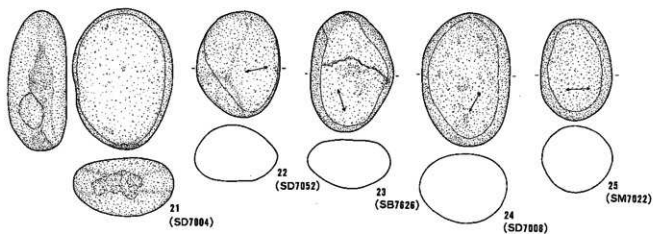

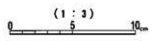
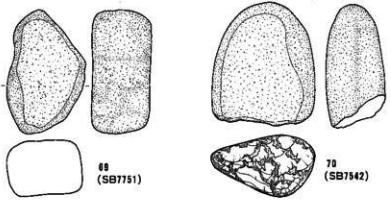
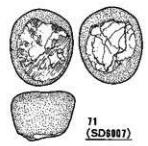
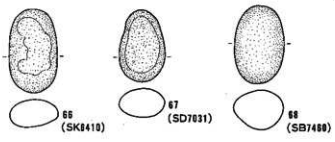
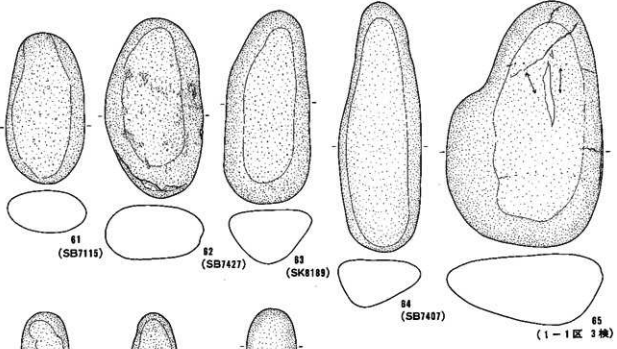
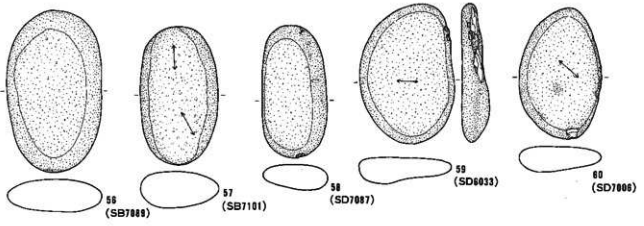

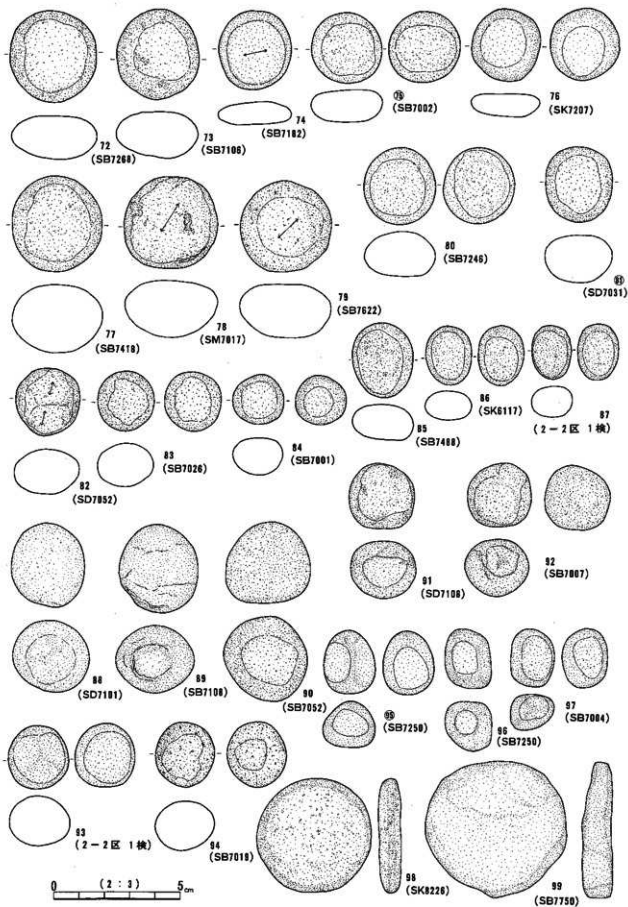

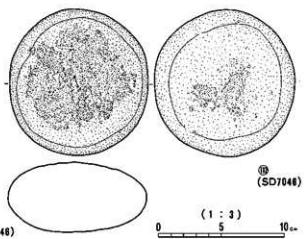
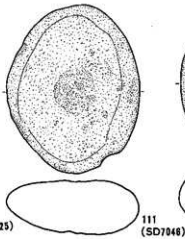
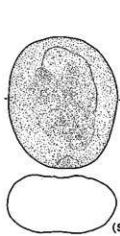
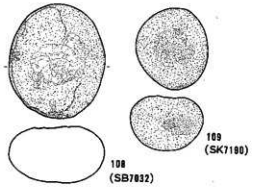
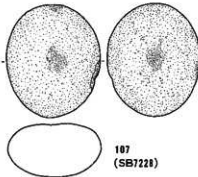
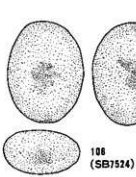
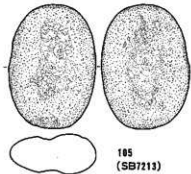
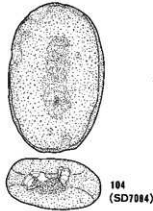
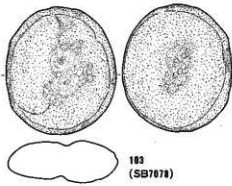
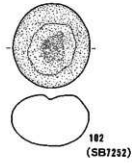
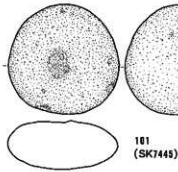
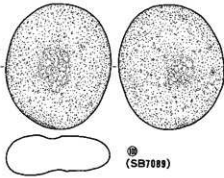

(1 : 3)
0 5 10--

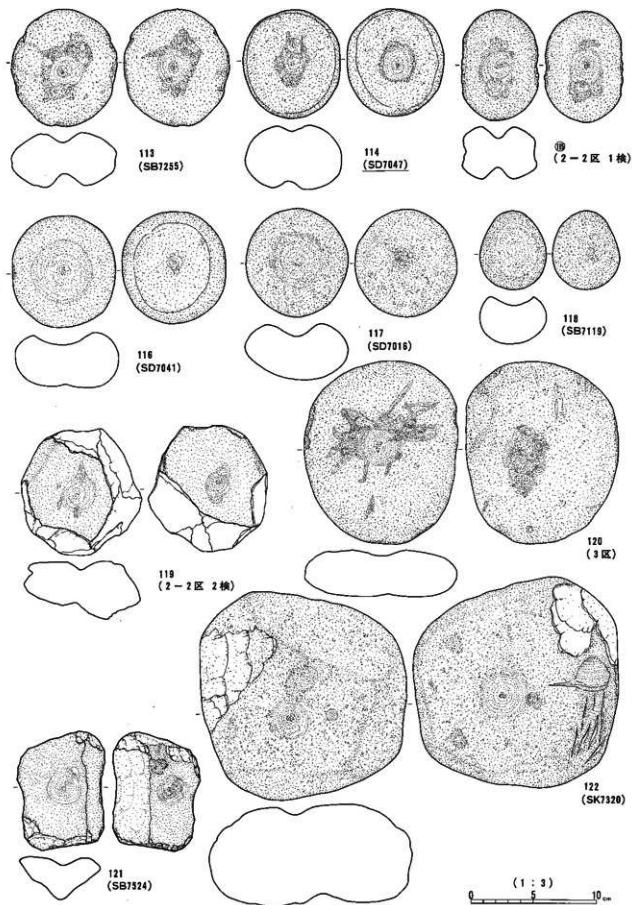

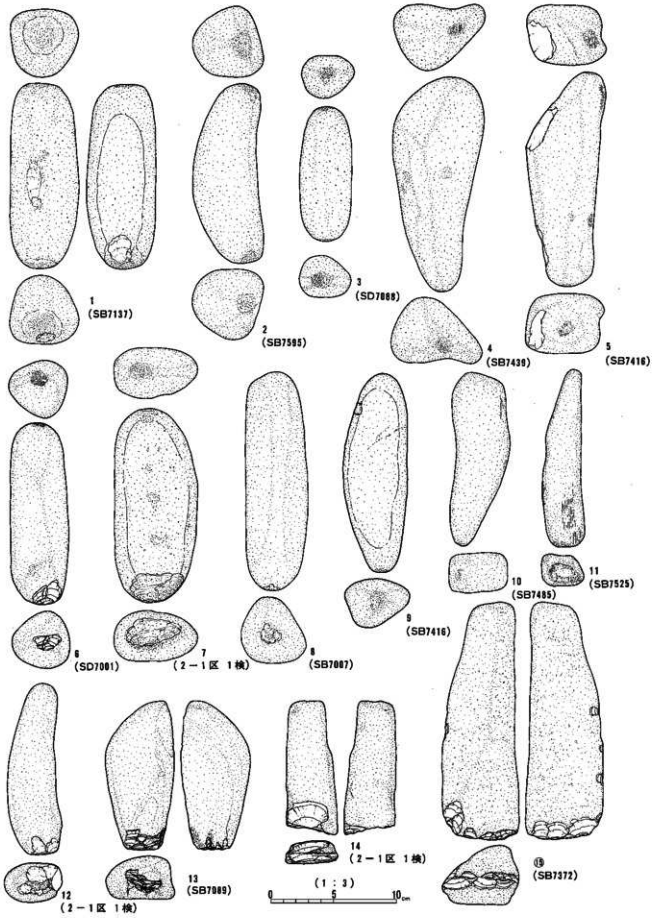

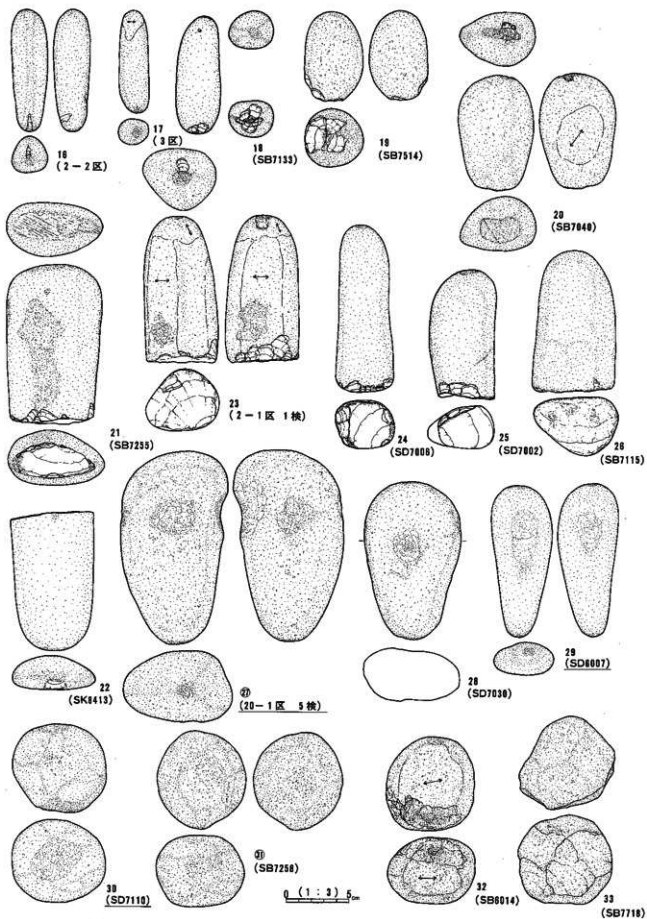

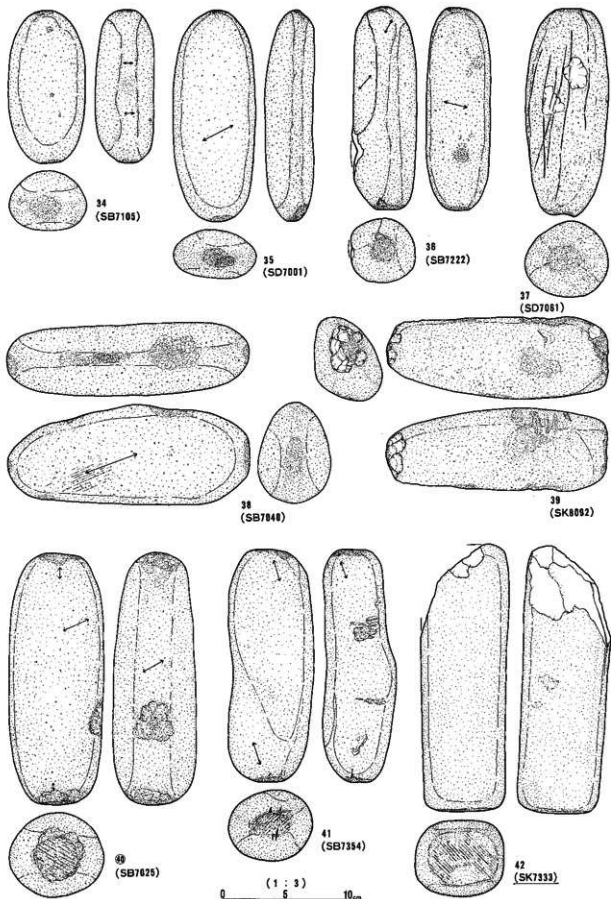

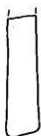
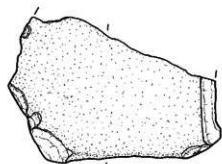

1
(SB6024)

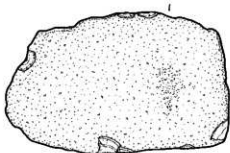

2
(SB7815)

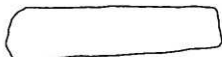
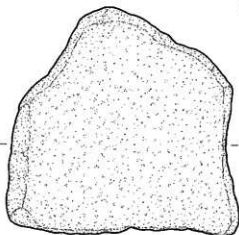

3
(SB7827)

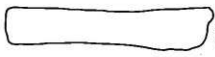
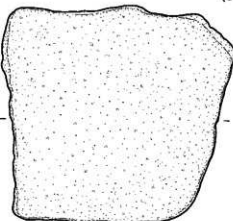

4
(SB7356)

0 (1 : 4) 10 cm

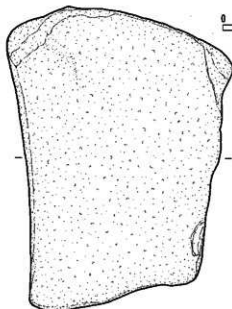

5
(SB6831)

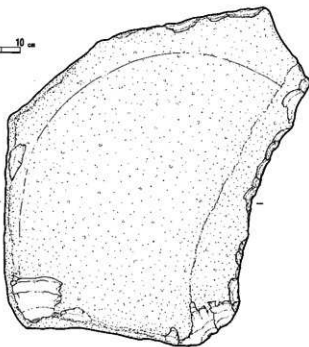

6
(SB7489)

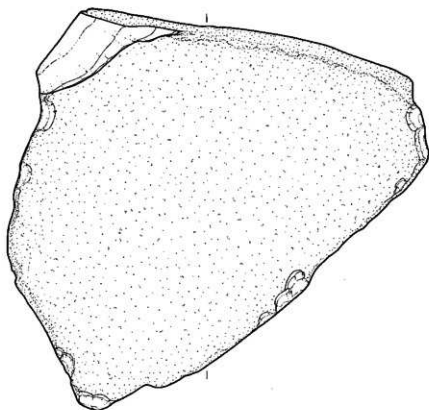

7
(SK6049)

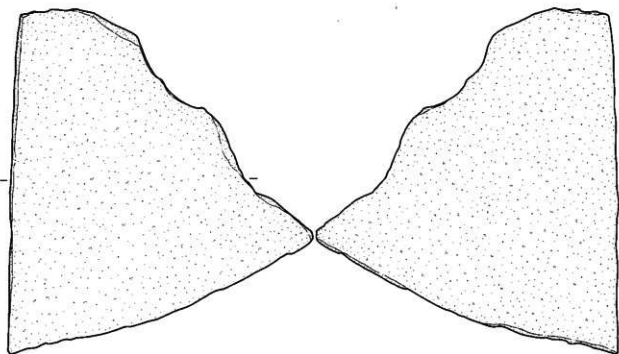

8
(SB6033)

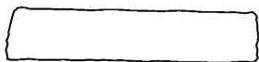

0 (1 : 4) 10 cm

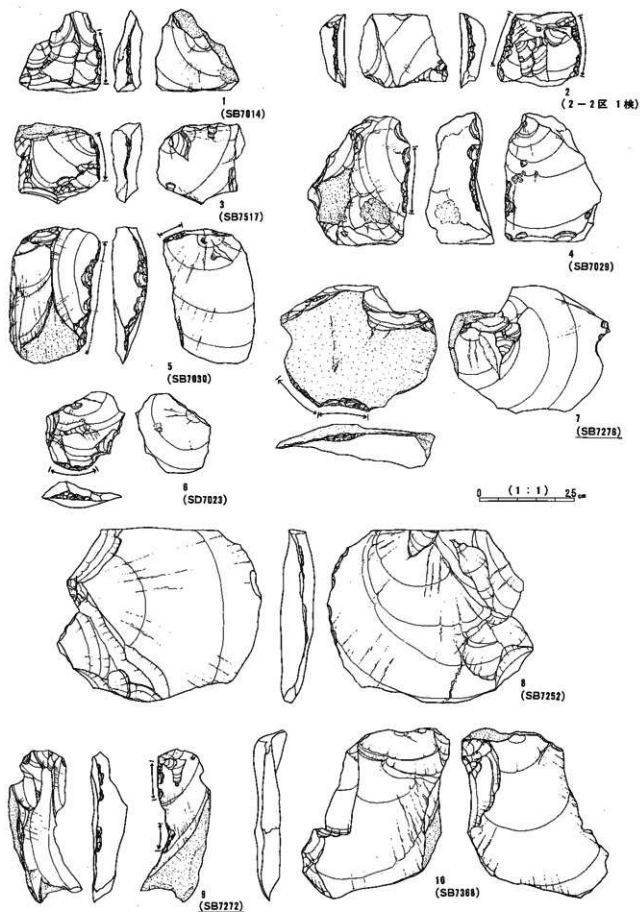

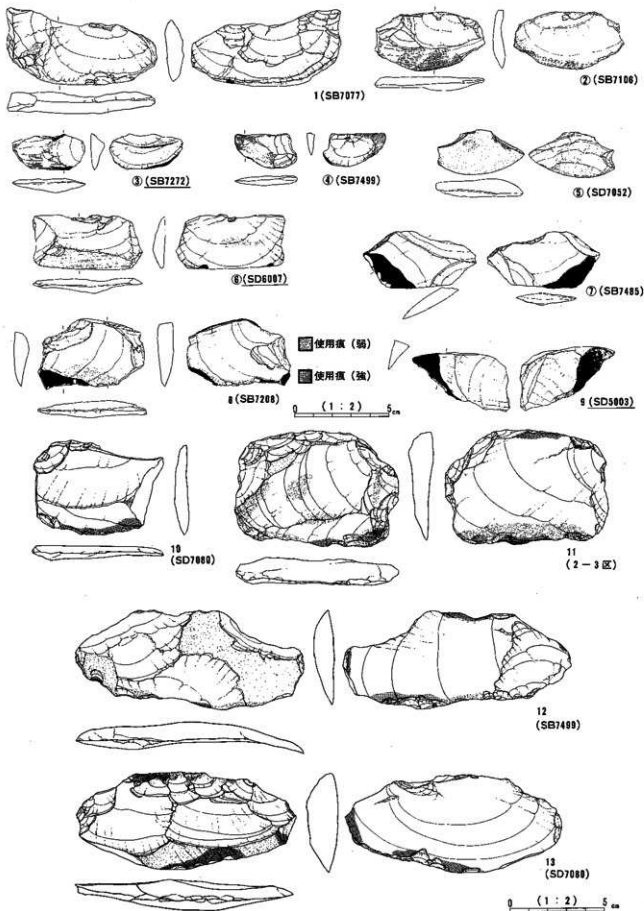

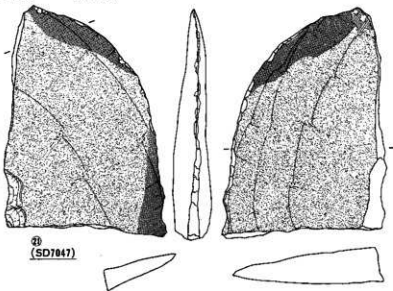
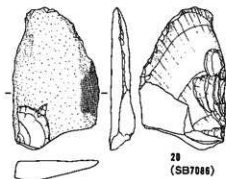
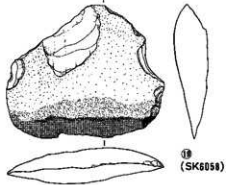
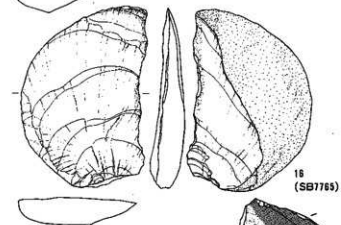
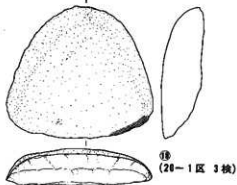
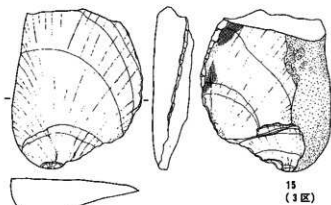
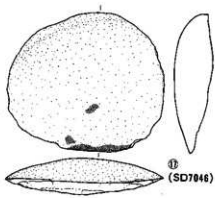
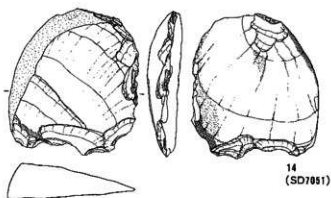

0 (1:2) 5 cm

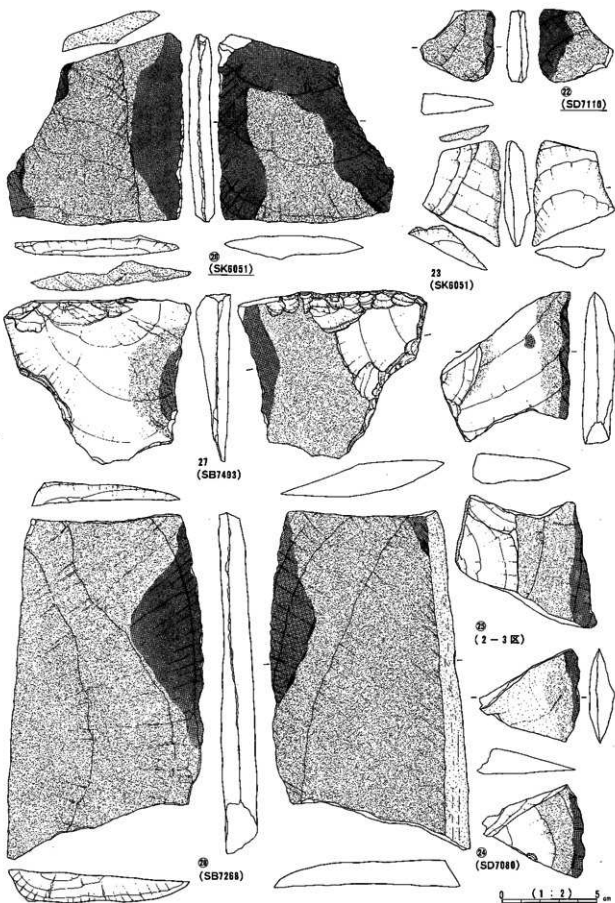

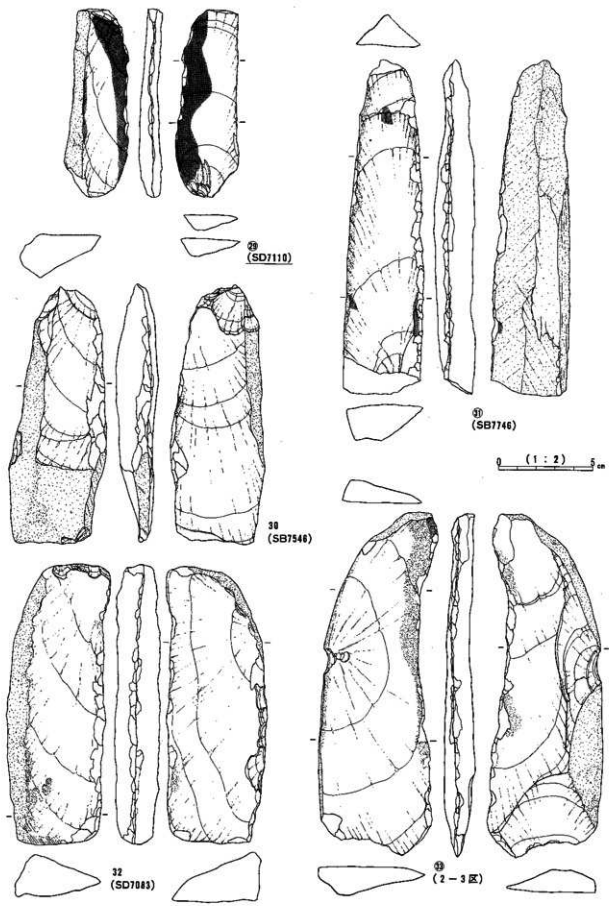

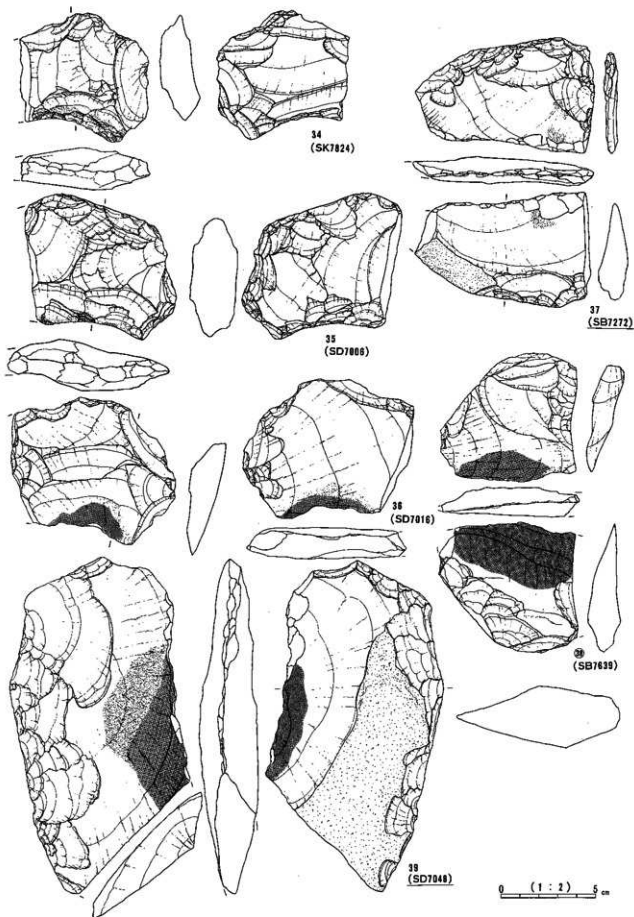

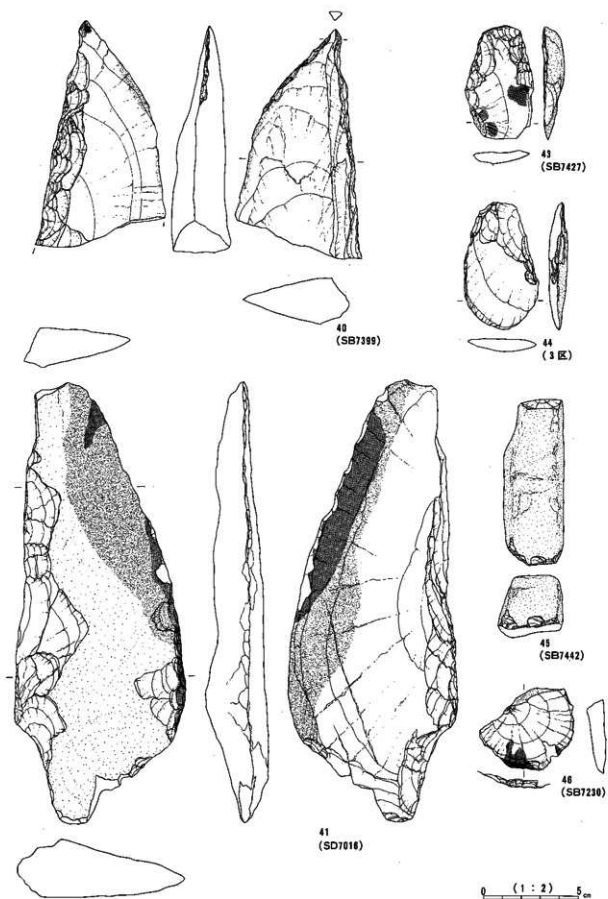

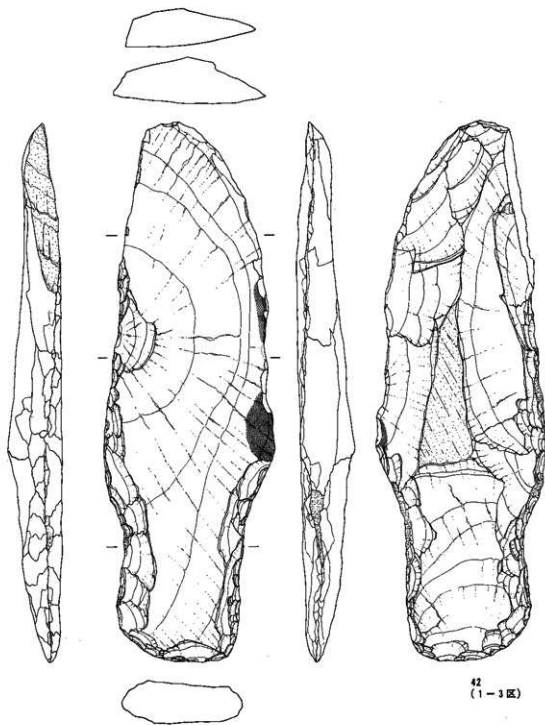

0 (1:2) 5 cm

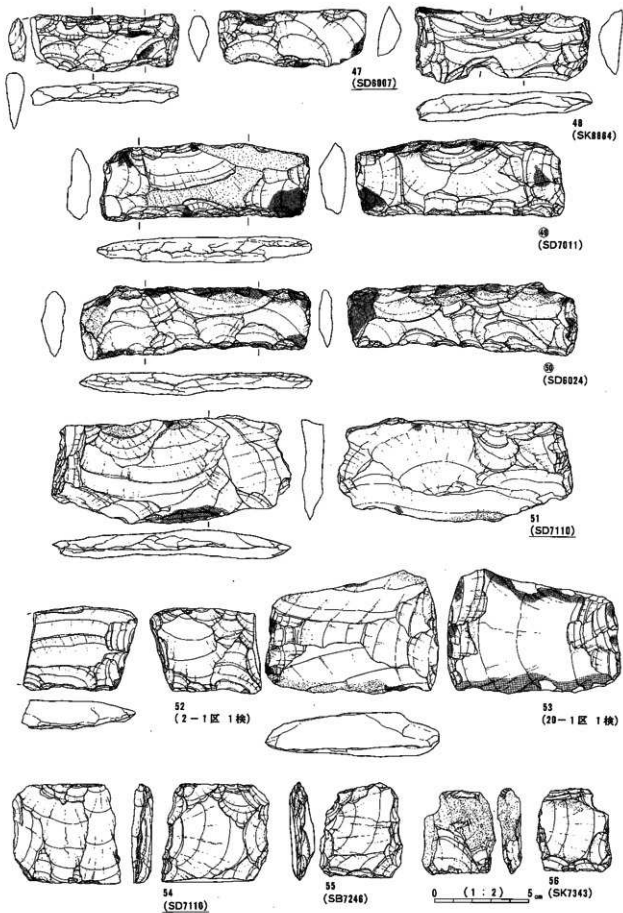

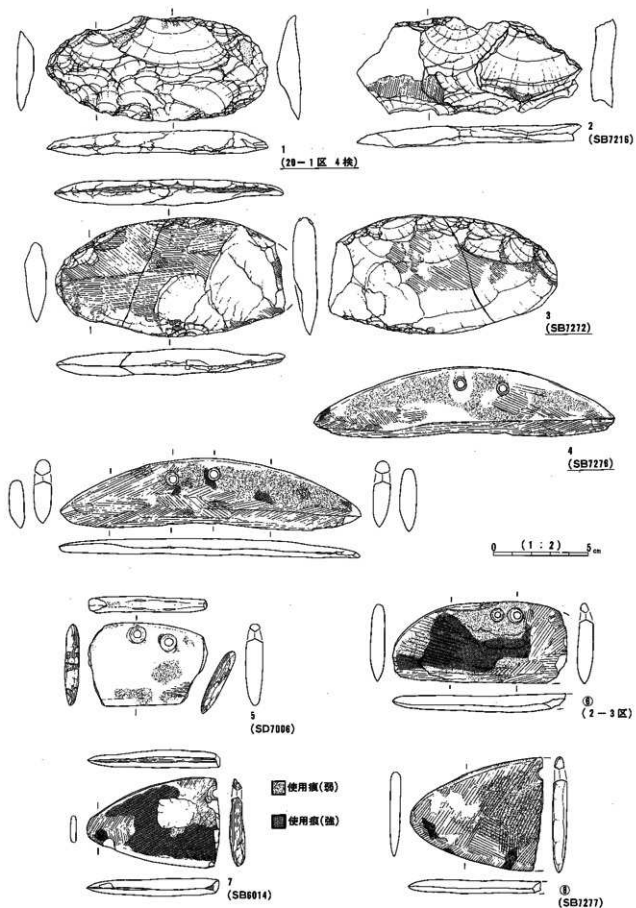

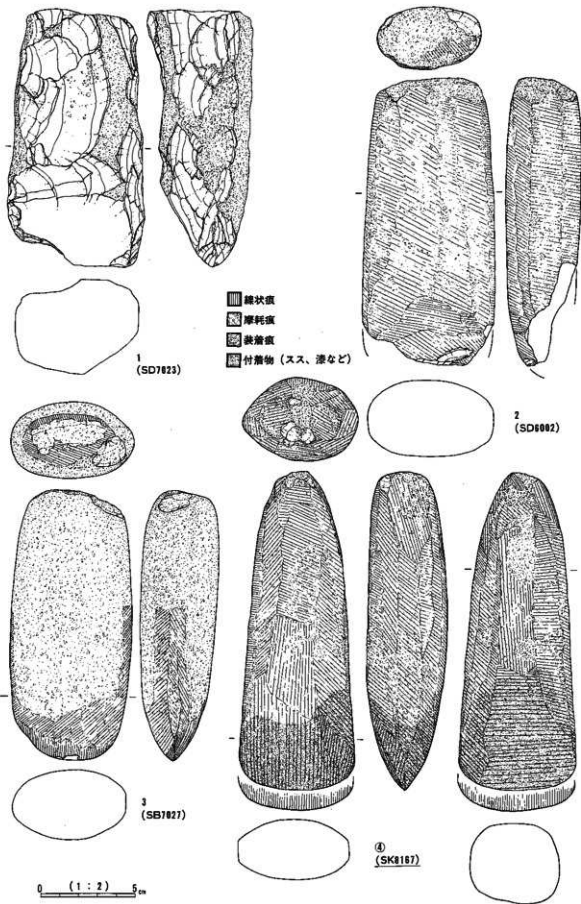

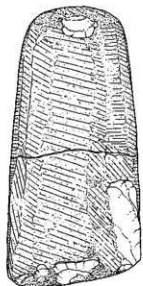

7
(SB7105+SB7021)

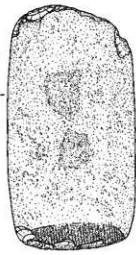

8
(SB6014)

0 (1:2) 5cm



5
(SB7627)

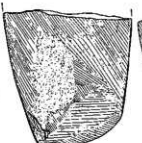

6
(3区)

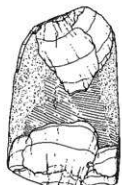

9
(2-2区 1棟)



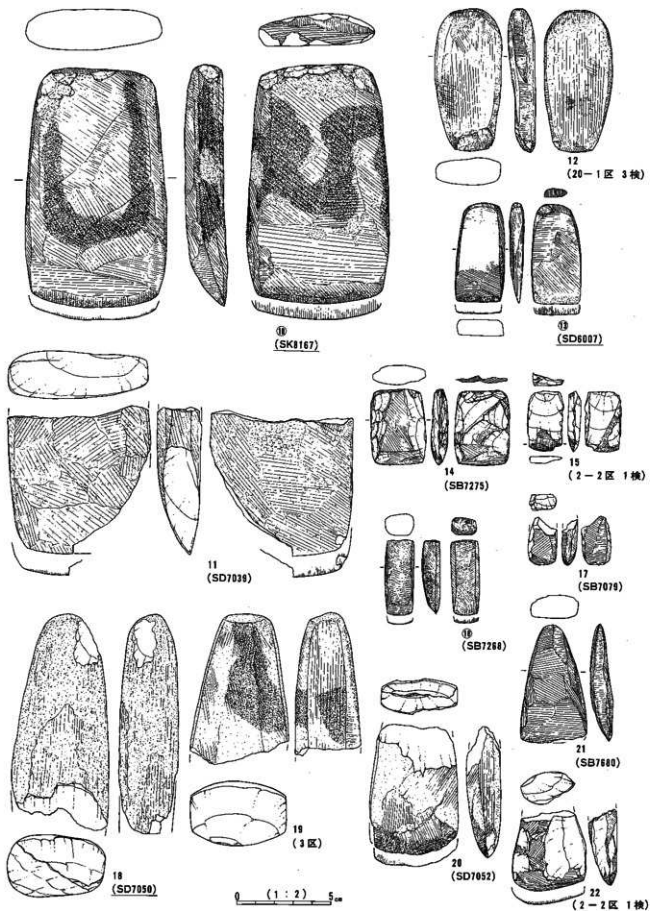

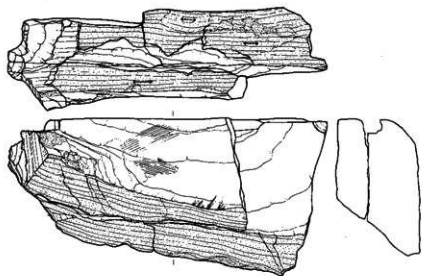

1
(SB7256+SB7854)

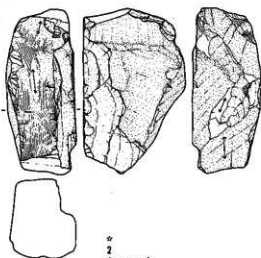

2
(SB7178)

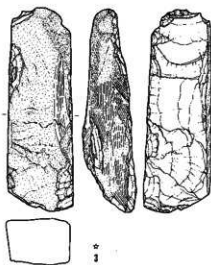

3
(SB7147)

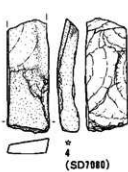

4
(SD7886)

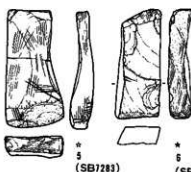

5
(SB7283)



6
(SB7181)

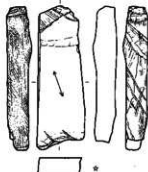

7
(2-1区 2棟)

8
(SD7886)

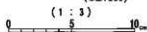

(1:3)

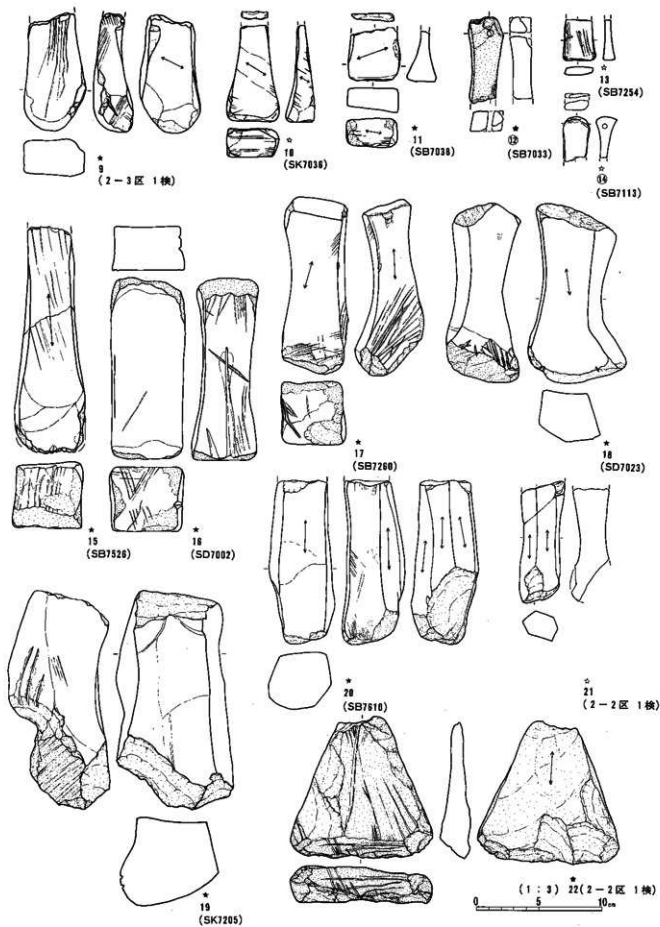

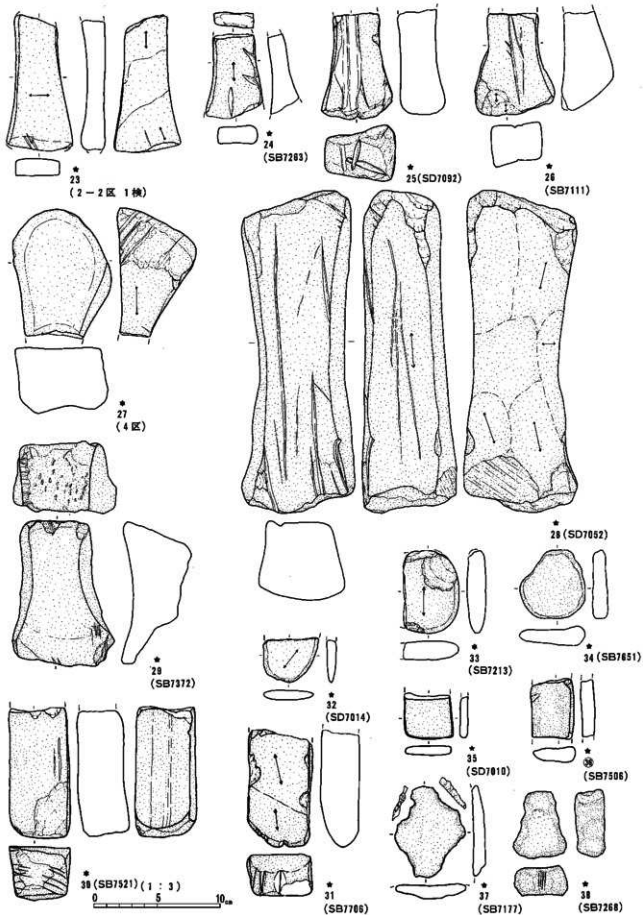

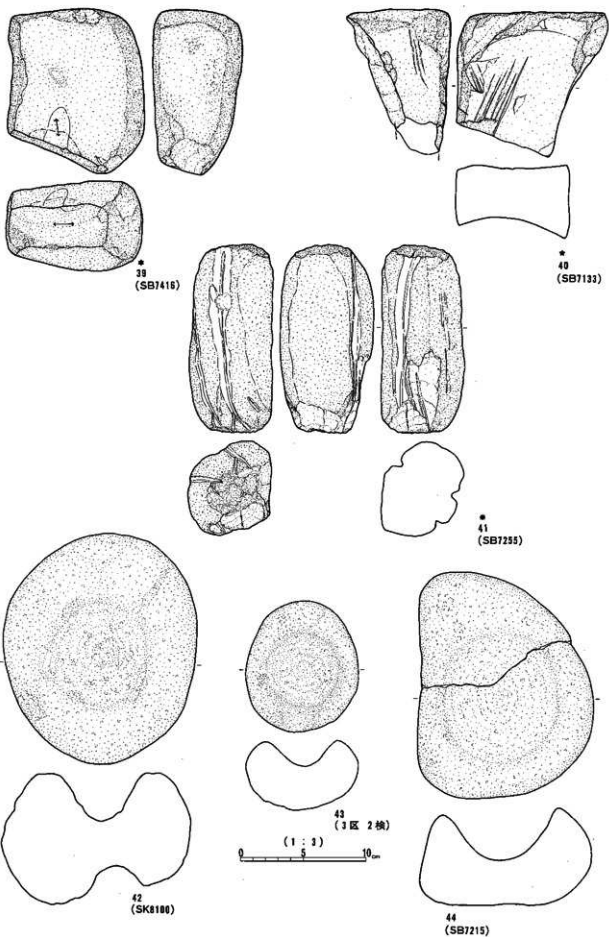

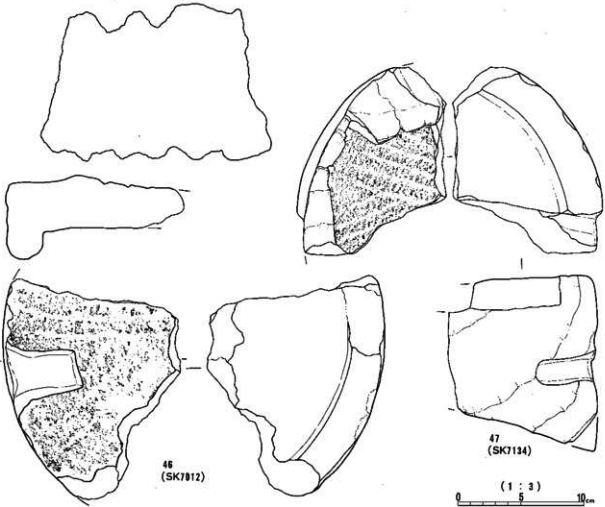
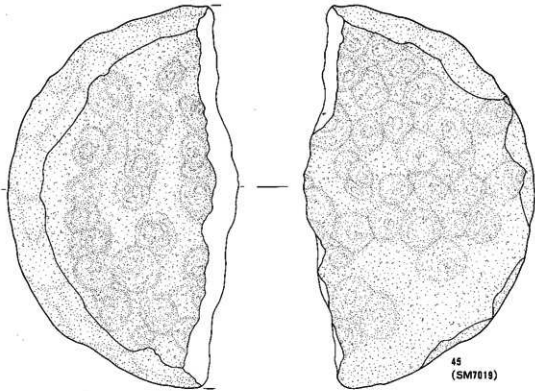



6 (SD7846)

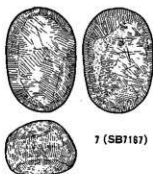

7 (SB7167)

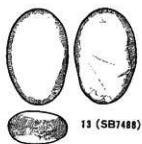

13 (SB7488)

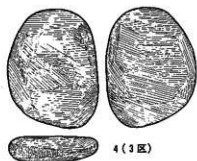

4 (3区)

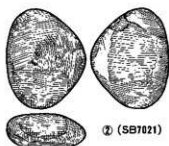

2 (SB7021)



1 (SB7126)

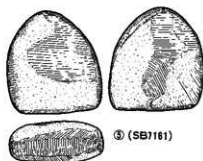

3 (SB7161)



18 (SK8476)

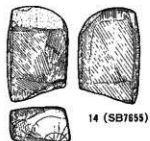

14 (SB7655)

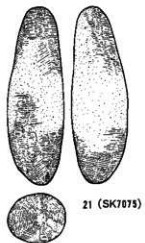

21 (SK7075)

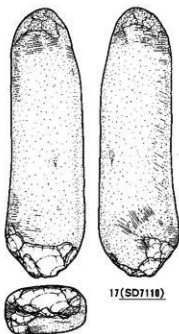

17 (SD7118)

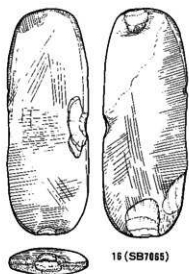

15 (SB7865)

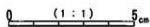

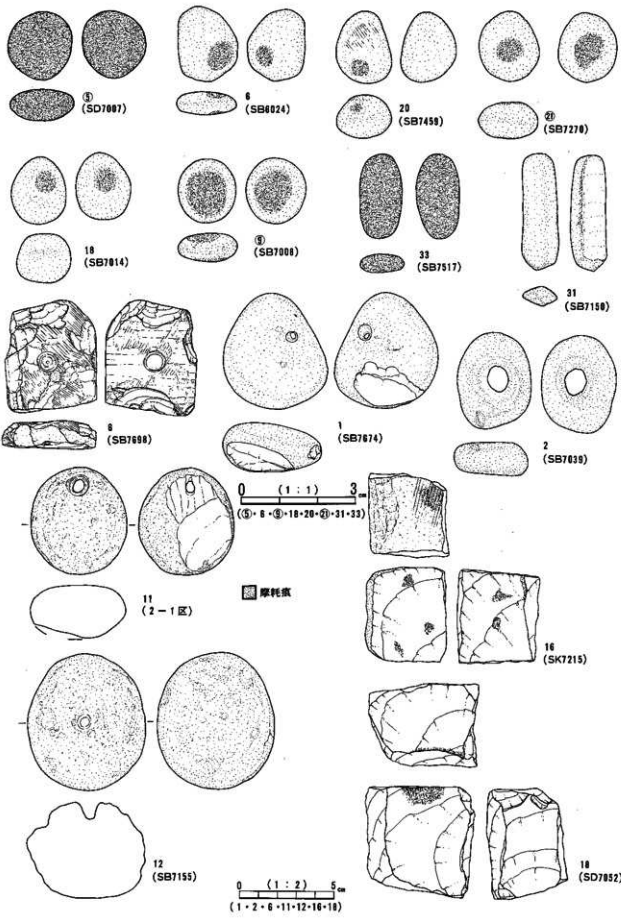

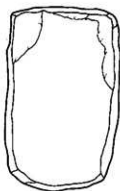
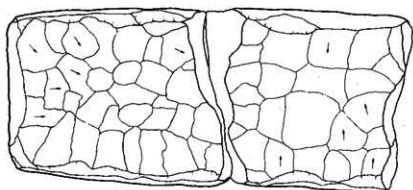

1
(SB7053)

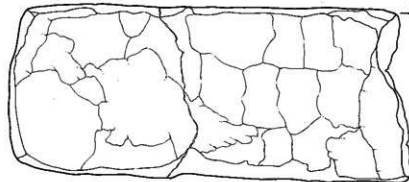
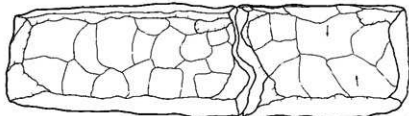

2
(SB7053)

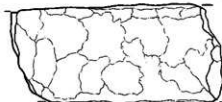
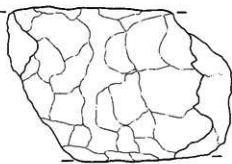
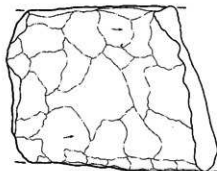
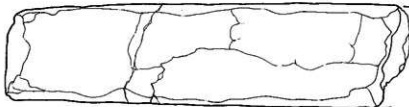

3 - 4
(SB7056)

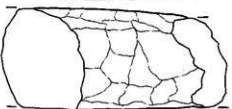

0 (1 : 4) 10 cm

写 真 图 版

弥生時代
中期以前土器

1 S B 7272

2 S B 7276

3~5

SM7010

6 SM7026

7 S K 7327



1



2



3



4



5



6



7



1



2



3



4



5



6

1~2

S D5003

3~6

S D6007

弥生時代
中期以前土器

- ※ 遺構外出
土土器 1
1 S B7531
2 S B7498
3 1-1-a区
第4検出面
4 S D6025
5 20-1区
第3検出面
6 S B7214



1



2



3



4



5



6

弥生時代
中期以前土器

※ 遺構外出土土器 2

1 S B 7499

2 1-3区第3検出面

3 S D 6002



1



2



3

弥生時代
中期以前土器

1~2

SB7276

3 SK7294

4~6

SB7438

7~12

SD6007

13 SD6030

14~19

SD7047



1

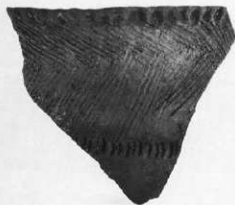

2



3



4



5



6



7



8



9



10



11



12



13



14



15



16



17



18



19



1



2



3



4



5



6



7



8



9



10



11



12



13



14



15



16



17



18



19

1~13

S D 7047

14 S D 7098

15~19

S D 6007

弥生時代
中期以前土器

1~13
SD5003
14~18
SD6007

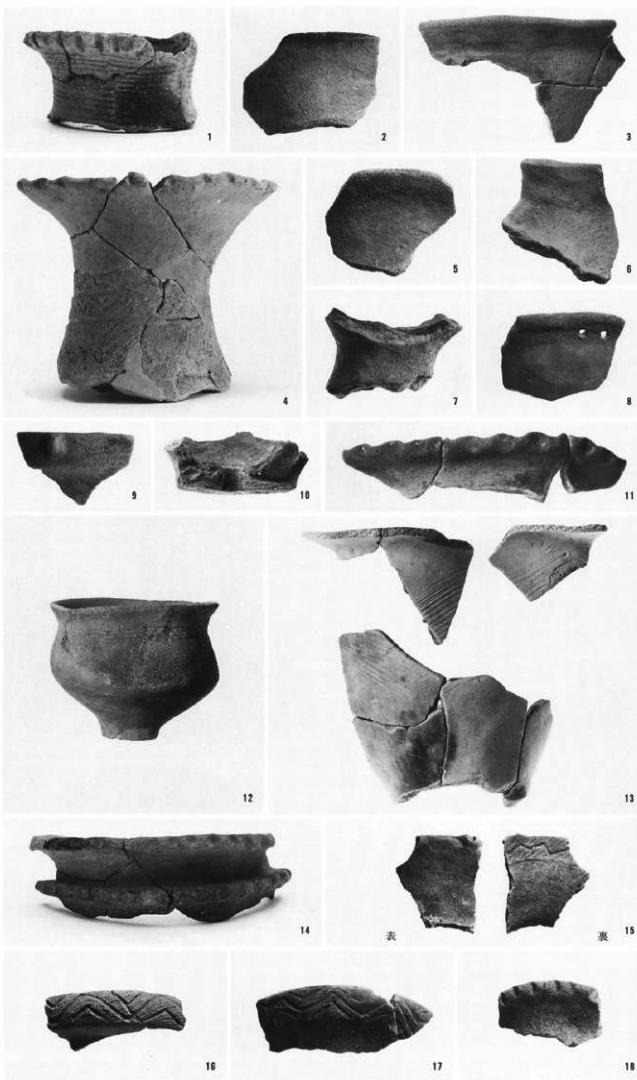

1~9

S D6007



弥生時代
中期以前土器

1~5

SD6007

6~15

SD7110



1



3



2

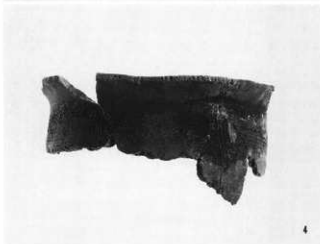

4



5

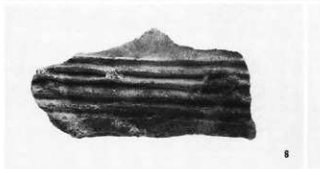

8



7



6



9



10



11



12



13

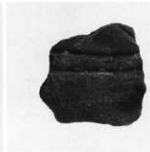

14



15

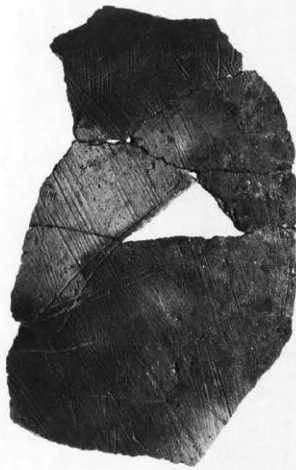

弥生時代
中期以前土器

1~11
SD7110



1



2



3



6



7



8



4



9



10



5



11

1-8

SD7110



表



裏 1



3



2



4



5



6



7



8

弥生時代
中期以前土器

1-18
SD7110

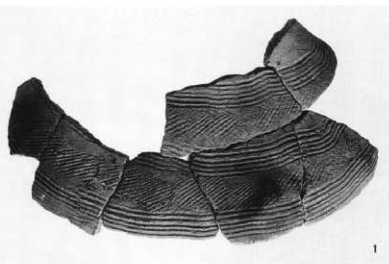

1



2



3



4



5



6



7



8



9



10



11



12



13



14



15



16



17



18

1~13
SD7110



1



2



3



4



5



6



7



8



9



10



11



12



13

弥生時代
中期以前土器

1~18
SD7110

PL 15



1



2



3



4



5



6



7



8



9



10



11



12



13

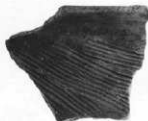

14



15



16



17



18

※ 遺構外出土土器 1

1~6

S B7294

7 S B7449

8 S K8177

9 S B7668

10 S B7257

11 2-1-b区

下層

12 S B7395

13 S B7465

14 2-2区第1検出面

15 S K7792

16 2-3区検出面

17 S B7203

18 S B7105

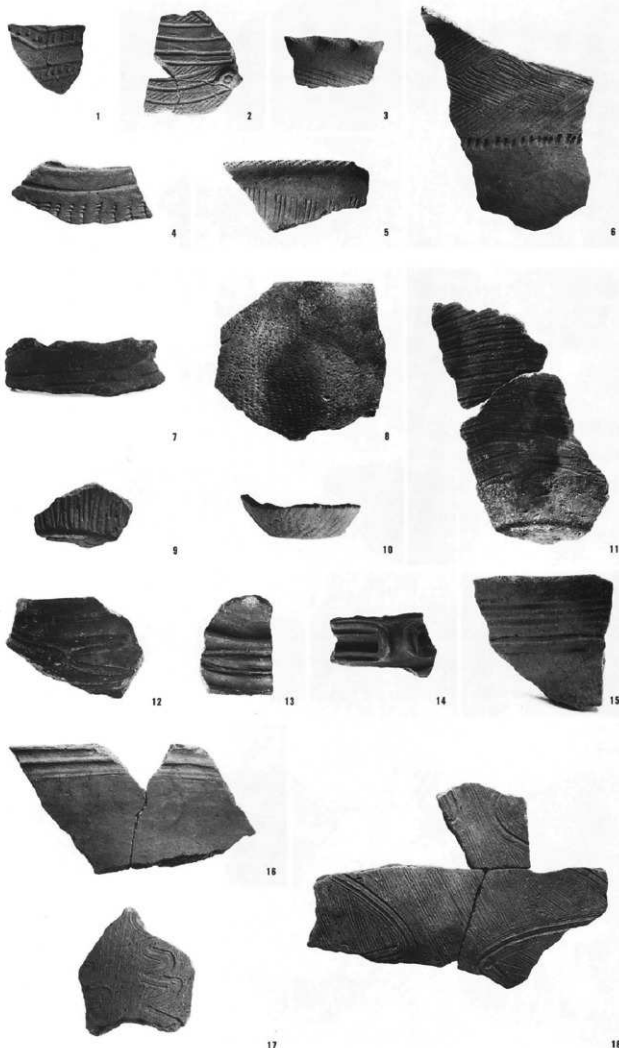

弥生時代
中期以前土器

※ 遺構外出
土土器 2

1 1-1-a区
第4検出面

2 S B7105

3 S B7456

4 S B7277

5 S D7084

6 S D7087

7 2-3区
検出面

8 1-1-a区
第4検出面

9 S B7255

10 2-3区
3層中

11 S B7499

12 1-3区
第3検出面

13 S K7326

14 S D7023

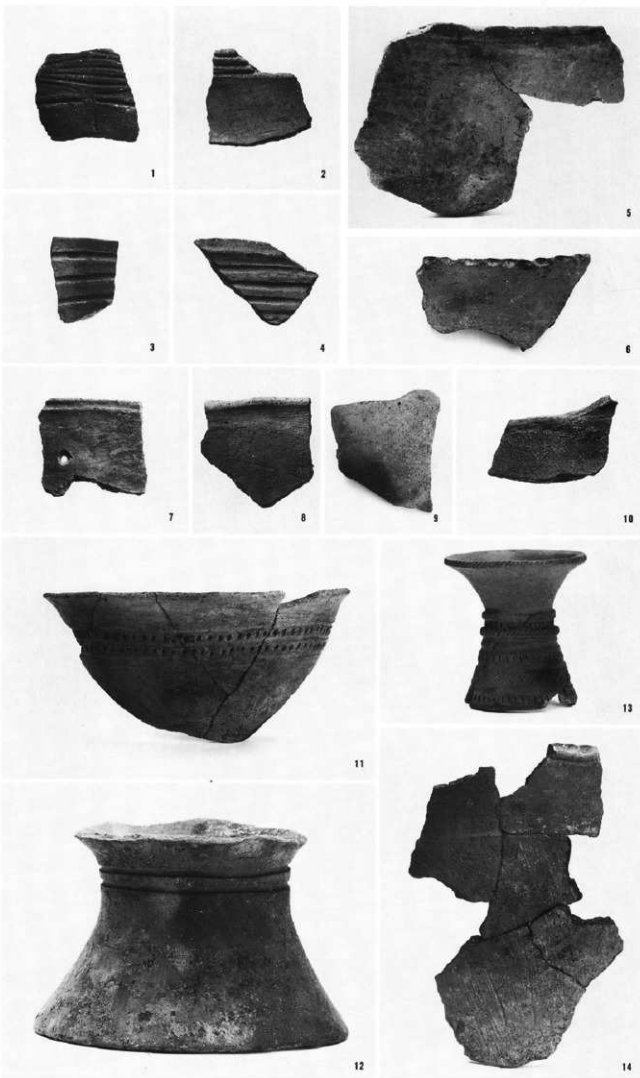

※ 遺構外出土土器 3
※ 遺構外出土の縄文
式土器

- 1 S K8489
- 2 S B7498
- 3 S K7105
- 4 S B7644
- 5 S D7014
- 6 S B7593
- 7 S B7078
- 8 S B7082
- 9 S B7644
- 10 S B7588
- 11 S B7642
- 12 S B7072
- 13 S B7105
- 14 S D7046
- 15 S B7160
- 16 S D6007
- 17 S D7025



14

15

16

17

1-4
SB6014



1



2



3



4

1~4
SB6015
5 SB6017
6~7
SB6028



1



2



3



4



5



6



7

弥生時代
後期土器

1~3

S B6030

4 S B6031

5~11

S B7021



1



3



2



4



5



6



7



8



9



10



11



1



3

1~4
SB7034
5・7
SB7040
6 SB7071



2



4



5



6



7

弥生時代
後期土器

1~5
SB7079



1



2



3



4



5



1



2



3



4

1~2

S B7078

3 S B7082

4~5

S B7089



5

弥生時代
後期土器

1~2
S B7086

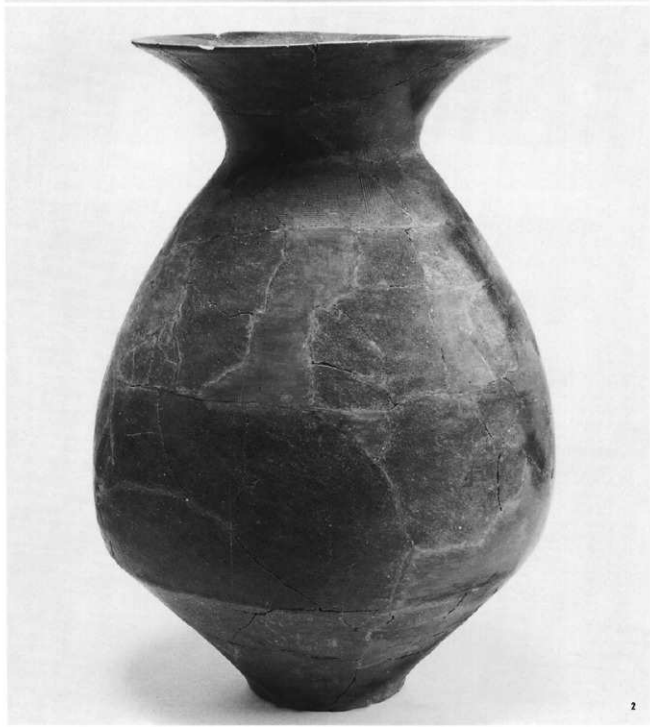



1



2



3

1~4

S B 7086

5~6

S B 7090

7~10

S B 7099



5



6



7



8



9



10

弥生時代
後期土器

1~2

S B7091

3~5

S B7094



1



2



3



4

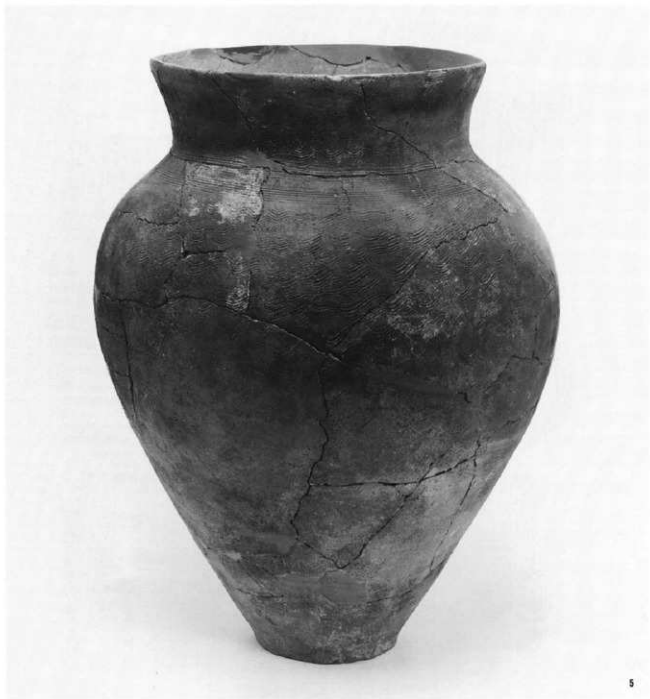

5



1



3



2



4



5



6



7



9



10



8



11

1~4

SB7101

5 SB7102

6 SB7103

7~11

SB7105

弥生時代
後期土器

1~4

SB7132



1~9

S B7162



1



4



2



5



3



6



7



8



9

弥生時代
後期土器

1~2

SB7162

3~7

SB7166



1



2



3



5



6



4



7



1



2



3

1~3

S B7173

4~7

S B7180

8~10

S B7191

11~12

S B7226



4



5



6



7



8



10



9



12



11

弥生時代
後期土器

1 SB7229

2~3

SB7236

4~7

SB7277

8 SB7293

9 SB7307



1



2



4



5



3



6



7



8



9



1



2



3

1~2

S B7358

3 S B7417

4~10

S B7488



4



7



5



8



6



10



9

弥生時代
後期土器

1~2

SB7493

3~5

SB7495

6~8

SB7497



1



2



3



4



5



6



7



8



1



2



3

1 S B 7573

2 ~ 5

S B 7627

6 ~ 8

S B 7630

9 ~ 13

S B 7655



4



5



6



8



7



9



10



11



12



13

弥生時代
後期土器

1 S B7669

2~5

S B7693

6~7

S B7673

8~9

S B7696



1



2



3



4



5



6



7



8



9



9

1~3
SD6035
4~9
SD7014



1



2



3



4



5



6



7



8



9

弥生時代
後期土器

1~6
SD7014



1



3



4



2



5



6



1



2



3



5



4



7



6



8

弥生時代
後期土器

1~6
SD7046

PL41



弥生時代
後期土器

1~2

SD7046



1



2

弥生時代
後期土器

1~3

S K 6122

4~7

S K 6222

8 S K 6415

9 S K 7105



1



2



3



4



5



6



7



8



9



1



2



3



4



5



6



7



8

弥生時代
後期土器

1~2
SK7075





弥生時代
後期土器

1 SK7075



1-2

SK7075



弥生時代
後期土器

1~3

S K7075

4~6

S K7135



1



2



3



4



5



6

1~3

S K7170

4 S K8247

5 S K7362



弥生時代
後期土器

1~3

S K7331

4 S K7353



1



2



3



4

1~2

S K7483

3 S K8152

4 S K8488



1



2



3



4

古墳時代

前期土器

1-3

SB6001

4-6

SB6004

7 SB6006

8 SB6011

9 SB6013

10-14

SB6016

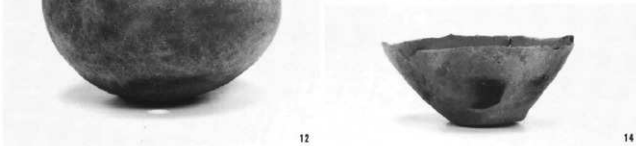
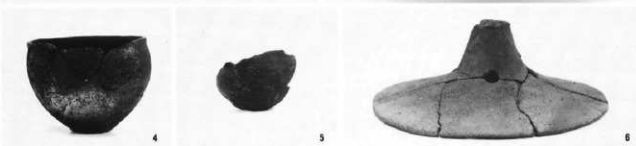

12

14



1



2

古墳時代
前期土器

1 S B6018

2 S B6019

3 S B6025

4 S B6027

5~8

S B7042

9 S B7080

10 S B7184

11~14

S B7129

15 S B7172



1



2



3



4



5



6



7



8



9



10



11



12



13



14



15

古墳時代
前期土器



1



2

1 S B 7193

2 ~ 9

S B 7213

10 ~ 11

S B 7228

12 S B 7244

13 ~ 17

S B 7246



3



6



7



4



5



8



9



10



11

前

後



12



15



13



14



16



17

古墳時代
前期土器

1~5
SB7250



1



2



3



4



5

古墳時代
前期土器

1~7

S B7254

8~12

S B7255



1



2



3



4



6



5



7



8



9



10



11



12

古墳時代
前期土器

1~14
SB7256

PL 59



1



2



3



4



5



6



7



8



9



10



12



13



11



14

1~3

S B 7256

4 S B 7257

5 S B 7346

6 S B 7311

7~9

S B 7372



1



2



3



4



6



5



7



8



9