

中央自動車道長野線
埋蔵文化財発掘調査報告書 16

—長野市内 その4—

篠ノ井遺跡群

遺物図版編

1997

日本道路公団名古屋建設局
長野県教育委員会
助長野県埋蔵文化財センター

中央自動車道長野線
埋蔵文化財発掘調査報告書 16

—長野市内 その4—

篠ノ井遺跡群

遺物図版編

1997

日本道路公団名古屋建設局
長野県教育委員会
助長野県埋蔵文化財センター



SB7177出土の土器内ベンガラ S = 不統一

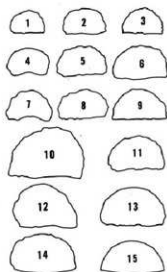
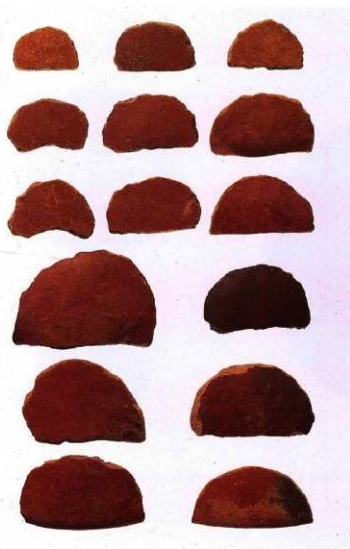

- | | |
|----------|-----------|
| 1 SB7307 | 9 SD7046 |
| 2 SD7014 | 10 SB7627 |
| 3 SB7650 | 11 SK8551 |
| 4 SB7488 | 12 SB7162 |
| 5 SB7258 | 13 SB7082 |
| 6 SK6222 | 14 SB7500 |
| 7 SB7655 | 15 SD7030 |
| 8 SB7365 | |

土器片製半円板 S = 1/2



銅針 左=SB7128・中=SB7488・右=SD7052 S=1/1



青銅鏡 左=SM7006出土獸形鏡・右上=SM7016出土珠文鏡・右下=SB7250出土重圈文鏡 S=1/1

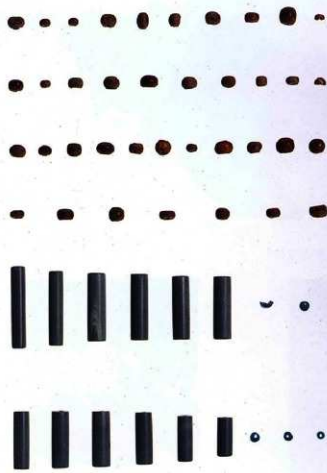

SM7016出土玉類 S=1/2

上4段=コハク玉・下2段左=管玉
・下2段右=ガラス小玉

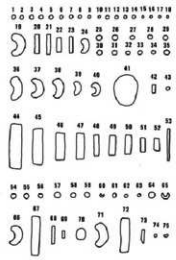
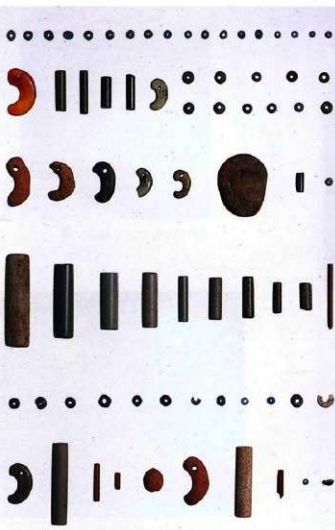

- | | | |
|-----------|-----------|---------------|
| 1 | 44 SB7716 | 62 SB7573 |
| 1 SM7006 | 45 SB7425 | 63 SB6014 |
| 23 | 46 SB6019 | 64 SB7246 |
| 24 | 47 SB7383 | 65 SB7434 |
| 1 SM7036 | 48 SB6019 | 66 SK7258 |
| 35 | 49 SB7379 | 67 SK6321 |
| 36 SB7566 | 50 SB7428 | 68 SK8109 |
| 37 SB7577 | 51 SB7387 | 69 SK7846 |
| 38 SB7551 | 52 SB7387 | 70 SD6035 |
| 39 SB7254 | 53 SB7024 | 71 2-1 区検出面 |
| 40 SB7427 | 54 | 72 2-2 区第1検出面 |
| 41 SB7189 | 1 SB6014 | 73 SM7035 |
| 42 SM7010 | 60 | 74 SB7517 |
| 43 SM7028 | 61 SB7428 | 75 2-3 区検出面 |

篠ノ井遺跡群出土玉類 S=1/2



1

SD7001出土(朱)墨書土器



2

SB7011出土(朱)墨書土器



3

SB7011出土(朱)墨書土器



4

SB7001出土(朱)墨書土器



5

SB7021出土(朱)墨書土器



6

SD7038出土(朱)墨書土器



7

SB7203出土(朱)墨書土器

1 : S = 1/2 · 2 ~ 7 : S = 不統一



SD7007出土綠釉陶器皿 S=1/2



SB7404出土綠釉陶器碗 S=1/2



篠ノ井遺跡群出土綠釉陶器片 S=1/2

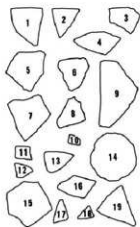

- 1 SK6097
- 2 SD7055
- 3 2-2区第1検出面
- 4 2-2区第1検出面
- 5 SD7061
- 6 2-1-b区南壁12層
- 7 2-1区第1検出面
- 8 SK6097
- 9 SD6008
- 10 2-1区第1検出面
- 11 3区3層上面
- 12 SB7263
- 13 2-3区3層中
- 14 SB7008
- 15 SD7039
- 16 SB7206
- 17 SB7280
- 18 3区3層上面
- 19 SB7041



凡 例

1、本書に掲載した実測図や写真の縮尺は、下記のように統一してある。

(1) 遺構実測図

- ・遺構全体図 = 1 : 500 · 1 : 1000
- ・遺構個別図 = 1 : 20 · 1 : 50
- ・割り付け遺構図 = 1 : 100

(2) 遺物実測図

- ・遺構出土一括図 = 1 : 4
- ・文字関係資料 = 1 : 3
- ・その他器種別実測図 = 1 : 3
- ・土偶、人面、容器形、ミニチュア、土錐、方形板、不整形板、半円板、円板 = 1 : 2
- ・玉類 = 1 : 1
- ・石鏃、原石、石核、剥片A、剥片類 = 1 : 1
- ・打製石斧、磨製石斧、刃器、石包丁 = 1 : 2
- ・磨石、凹石、敲石、砥石 = 1 : 3
- ・石錐 = 2 : 3
- ・台石、石皿 = 1 : 4
- ・カマド石 = 1 : 3
- ・鉄製品 = 1 : 2
- ・青銅製品 = 1 : 2
- ・鏡、銅印、銭貨 = 1 : 1
- ・フイゴの羽口 = 1 : 3
- ・木製品 = 1 : 6

(3) 遺構写真

- ・スケールは不統一

(4) 遺物写真

- ・遺構出土一括土器、器種別土器写真 = 1 : 3
- ・文字関係資料 = スケールは不統一
- ・土偶、人面、容器形、ミニチュア、土錐、方形板、不整形板、半円板、円板 = 1 : 1
- ・玉類 = 1 : 1
- ・石鏃、原石、石核、剥片A、剥片類 = 1 : 1
- ・打製石斧、磨製石斧、刃器、石包丁 = 1 : 2
- ・磨石、凹石、敲石、砥石 = 1 : 3
- ・石錐 = 2 : 3
- ・台石、石皿 = 1 : 6
- ・カマド石 = 1 : 3
- ・鉄製品 = 1 : 2
- ・青銅製品 = 1 : 2
- ・鏡、銅印、銭貨 = 1 : 1
- ・フイゴの羽口 = 1 : 3
- ・木製品 = 1 : 6
- ・実体顕微鏡 [観察倍率×5～×120・撮影倍率×5～×20]
- ・金属顕微鏡 [観察倍率×50～×500・撮影倍率×25～×50]
- ・走査電子顕微鏡 [観察倍率×500～×1000・撮影倍率不明]

2、遺構図中のスクリーンは以下の事項を表している。

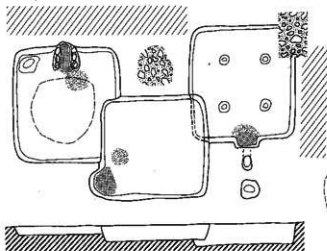

- ① = 遺構図の断面を示す。
- ② = 焼土部分を示す。
- ③ = 炭化物部分を示す。
- ④ = 攪乱部分を示す。
- ⑤ = 未調査部分を示す。



3、遺構図中の遺構番号について、SK以外プレート内での竪穴住居番号はSB記号を省略し、数字のみの標記とした。またSKプレート内での土壌番号もSK記号を省略し、数字のみの標記とした。

4、遺物実測図・遺物写真・遺構写真の番号は、石器以外はすべて図版プレートごとに通しナンバーとした。石器図版については、器種ごとに通しナンバーとした。

各調査区全景写真については、各プレートの下に調査区全体図を載せ、撮影方向を矢印で示した。ただし真上からのものについては矢印は示さなかった。

5、実測図中のスクリーントーンは以下の事項を表している。

(1) 土器

・実測図の断面は、弥生時代中期以前・弥生時代後期・古墳時代前期の土器と古代の土師器・黒色土器は白抜き、須恵器は黒塗りとした。

- ①=灰釉・緑釉・陶磁器類を示す。
- ②=赤彩土器や朱墨痕の赤彩部分を示す。
- ③=古代黒色土器A・Bの黒色処理部分を示す。
- ④=古代土師器の黒色処理部分を示す。
- ⑤=視類で明確に墨痕がわかるものを示す。
- ⑥=土器などへの付着部分を示す。



(2) 石製品

- ⑦=石製品の使用痕跡の強弱・種類を示す。
- ⑧=石製品の装着痕跡を示す。
- ⑨=石製品の付着物を示す。



(3) 木製品

- ⑩=木製品の表面炭化物を示す。
- ⑪=木製品の欠損部を示す。
- ⑫=木製品（漆製品）の黒漆部分を示す。



(4) フイゴの羽口

- ⑬=羽口の溶滓付着・タール付着・ガラス状発泡範囲を示す。
- ⑭=被熱による変色（還元青灰色）範囲を示す。



6、実測図中の線表現等は以下の事項を表している。

- ・赤彩土器の赤彩部分での矢印はミガキ方向を示す。
- ・施釉陶磁器の施釉範囲は一点鎖線で示した。
- ・石製品遺物実測図ナンバーに付けられた下線は弥生時代中期後半以前の遺構であることを示し、○付番号は使用底写真撮影遺物であることを示す。

7、遺構各説での遺構表中の時期や項目についての表記は、以下のとおりである。

(1) 時期の項で縦に並べてある数字については、

- ・明朝数字は、その時期を示す (例：1 = 1期)。
- ・明朝数字+明朝数字は、遺構の継続期間を示す (例：1 3 = 1期から3期にかけて継続)。
- ・ゴシック数字+ゴシック数字は、この範中のいずれかの時期であることを示す (例：1 3 = 1期から3期にかけてのいずれかの時期である)。
- ・数字+「新」は、示した時期の中でも新しい頃を示す (例：3新 = 3期の中でも新しい時期である)。
- ・数字+「古」は、示した時期の中でも古い頃を示す (例：3古 = 3期の中でも古い時期である)。
- ・数字+「先」は、示した時期以前の時期であることを示す (例：3先 = 3期以前の時期である)。
- ・数字+「降」は、示した時期以降の時期であることを示す (例：3降 = 3期以降の時期である)。
- ・「不明」は、時期決定ができないものである。

(2) SK (土塊跡)、SM (墓跡)、SF (火床跡)、SX (不明) については、

・平面形

円=円形 方=方形 長=長方形 楕=楕円形 長楕=長楕円形 不=不明

・断面形

A = ならかなU字形 B = 急なU字 C = 落ち込みが直で、底面がほぼ平ら D = 底面の凹凸が激しいもの E = 中央部に凹があるもの F = 壁際に凹があるもの G = その他



(3) SD (溝跡) については、

・断面形

A = 浅くならかなもの B = 深めでならかなもの C = V字状 D = U字状 E = その他



(4) SB (竪穴住居跡) については、

・平面形

円=円形 方=方形 長=長方形 隅=隅丸方形 隅長=隅丸長方形 不=不明

・カマド

粘=粘土のみで構築 石=芯材に自然石を使用 切=切石を使用

・炉

円=円形 方=方形 楕=楕円形 不=不整形

(5) 埋土については、

単層か複層かを、単=単層、複=複層と示した。

8、土性・土色については、「新版標準土色帖」(9版 1989年5月) 農林水産省農林水産技術会議事務局監修・財団法人日本色彩研究所色票監修による。

「遺物図版編」

凡例

カラー写真図版目次

- | | | | |
|-------|-----------------------------|-------|---------------|
| P L 1 | SB7177出土の土器内ベンガラ
土器片製半円板 | P L 4 | (朱) 墨青土器 |
| P L 2 | 銅鍍・青銅鍍 | P L 5 | 篠ノ井遺跡群出土の緑釉陶器 |
| P L 3 | SM7016出土玉類・篠ノ井遺跡群出土玉類 | P L 6 | 篠ノ井遺跡群出土の石器 |

実測図版目次

弥生時代中期以前の土器

- | | | | |
|------|--|-------|-------------------------|
| 図版 1 | SB7272・SB7276・SB7438・SM7010
SM7026・SK7294・SK7310・SK7327
出土土器 | 図版 6 | SD7110②出土土器 |
| 図版 2 | SB7438・SD6007①・SD6030・SD7047
SD7098出土土器 (拓本) | 図版 7 | SD7110③出土土器 (拓本) |
| 図版 3 | SD5003・SD6007②出土土器 | 図版 8 | SD7110④・SK7294出土土器 (拓本) |
| 図版 4 | SD6007③出土土器 | 図版 9 | 遺構外出土土器 1 |
| 図版 5 | SD7110①出土土器 (拓本) | 図版 10 | 遺構外出土土器 2 (拓本) |
| | | 図版 11 | 遺構外出土土器 3 |
| | | 図版 12 | 遺構外出土土器 4 (拓本) |

弥生時代後期の土器

- | | | | |
|-------|---|-------|--|
| 図版 13 | SB6014・SB6015出土土器 | 図版 30 | SB7132②・SB7166・SB7173・SB7177出
土土器 |
| 図版 14 | SB6017・SB6028・SB6030・SB6031
SB6035出土土器 | 図版 31 | SB7180・SB7187・SB7191・SB7233出
土土器 |
| 図版 15 | SB7020・SB7021・SB7024出土土器 | 図版 32 | SB7226・SB7229・SB7237出土土器 |
| 図版 16 | SB7034・SB7037・SB7038・SB7039
SB7071出土土器 | 図版 33 | SB7236・SB7238・SB7252・SB7258
SB7271出土土器 |
| 図版 17 | SB7040①出土土器 | 図版 34 | SB7277・SB7293・SB7307・SB7493出
土土器 |
| 図版 18 | SB7040②・SB7090・SB7097出土土器 | 図版 35 | SB7358・SB7365・SB7417・SB7490
SB7560・SB7573出土土器 |
| 図版 19 | SB7078出土土器 | 図版 36 | SB7488・SB7495出土土器 |
| 図版 20 | SB7079出土土器 | 図版 37 | SB7497・SB7500・SB7553・SB7580出
土土器 |
| 図版 21 | SB7082出土土器 | 図版 38 | SB7593・SB7617・SB7618・SB7630出
土土器 |
| 図版 22 | SB7086出土土器 | 図版 39 | SB7627・SB7655出土土器 |
| 図版 23 | SB7089・SB7091・SB7102・SB7103出
土土器 | 図版 40 | SB7669・SB7673・SB7675・SB7693
SB7696・SB7697出土土器 |
| 図版 24 | SB7094・SB7095出土土器 | 図版 41 | SD6003・SD6035・SD7014①出土土器 |
| 図版 25 | SB7099・SB7101①出土土器 | | |
| 図版 26 | SB7101②・SB7105・SB7110出土土器 | | |
| 図版 27 | SB7126・SB7128・SB7162①出土土器 | | |
| 図版 28 | SB7162②・SB7146・SB7147出土土器 | | |
| 図版 29 | SB7132①出土土器 | | |

図版42 SD7014②出土土器
図版43 SD7014③出土土器
図版44 SD7046①出土土器
図版45 SD7046②出土土器
図版46 SK6122・SK6184・SK6213・SK6324出土土器
図版47 SK6222・SK6352・SK6415・SK6437
SK7075①出土土器
図版48 SK7075②出土土器
図版49 SK7075③出土土器

古墳時代前期の土器

図版57 SB6001・SB6004・SB6006・SB6007
SB6009・6011出土土器
図版58 SB6016・SB7042出土土器
図版59 SB6013・SB6018・SB6019・SB6025
SB6027・SB6029出土土器
図版60 SB7080・SB7129・SB7172・SB7184
SB7188・SB7193・SB7195・SB7244出土土器
図版61 SB7213・SB7228・SB7246①出土土器
図版62 SB7246②・SB7250出土土器
図版63 SB7254①出土土器
図版64 SB7254②出土土器
図版65 SB7255出土土器
図版66 SB7256①出土土器
図版67 SB7256②出土土器
図版68 SB7256③出土土器
図版69 SB7256④・SB7257・SB7259
SB7268出土土器
図版70 SB7283・SB7311・SB7344・SB7345
SB7346・SB7372・SB7373・SB7383
SB7386・SB7394出土土器
図版71 SB7381・SB7401・SB7420出土土器
図版72 SB7418・SB7446・SB7458・SB7494
SB7517出土土器
図版73 SB7442・SB7508①出土土器
図版74 SB7508②出土土器
図版75 SB7508③出土土器
図版76 SB7508④・SB7561・SB7586・SB7596

図版50 SK7075④出土土器
図版51 SK7075⑤出土土器
図版52 SK7092・SK7105・SK7135・SK7286
SK7328出土土器
図版53 SK7170・SK7331・SK7343出土土器
図版54 SK7353・SK7359・SK7483出土土器
図版55 SK7362・SK7445・SK7470・SK8152
SK8222・SK8320・SK8476・SK8488
SK8551出土土器
図版56 遺構外出土土器
SB7634・SB7642・SB7646出土土器
図版77 SB7639・SB7649出土土器
図版78 SB7654・SB7709・SB7722・SB7726
SB7745出土土器
図版79 SB7751・SC6001・SM7001・SM7032
SM7035出土土器
図版80 SD6015・SD6016・SD6023①出土土器
図版81 SD6023②出土土器
図版82 SD6023③出土土器
図版83 SD6023④・SD7014①出土土器
図版84 SD7014②・SD7030①出土土器
図版85 SD7030②出土土器
図版86 SD7030③出土土器
図版87 SD7030④出土土器
図版88 SD7084・SD7088・SK6048・SK6108
SK6113・SK6117・SK6133出土土器
図版89 SK6099・SK6142・SK6150出土土器
図版90 SK6186・SK6202①・SK6290・SK6296
SK6310・SK6321出土土器
図版91 SK6202②出土土器
図版92 SK6202③出土土器
図版93 SK6307出土土器
図版94 SK6406・SK6441・SK7130・SK7146出土土器
図版95 SK7157・SK7256・SK7326・SK7364
SK7403・SK7469・SK7480・SK7596出土土器
図版96 SK7367・SK7608・SK7822・SK8011出土

土器

図版97 SK8250・SK8310・SK8397・SK8404
SK8405・SK8442・SK8502・SK8511

SK8855・SK8893出土土器

図版98 遺構外出土土器

古代(7世紀・奈良時代・平安時代)の土器・中世の焼き物

図版99 SB6020・SB6023・SB6024・SB7001①
出土土器

図版100 SB7001②・SB7002・SB7003出土土器

図版101 SB7004・SB7005・SB7006出土土器

図版102 SB7007・SB7008出土土器

図版103 SB7009・SB7010・SB7011・SB7012
SB7014出土土器

図版104 SB7013・SB7015・SB7016・SB7018
SB7022出土土器

図版105 SB7019・SB7025・SB7026出土土器

図版106 SB7029・SB7030出土土器

図版107 SB7031・SB7033・SB7036・SB7041
SB7046・SB7047・SB7059出土土器

図版108 SB7048・SB7052・SB7053出土土器

図版109 SB7054・SB7058・SB7092・SB7098
出土土器

図版110 SB7068・SB7100・SB7106・SB7108
SB7111出土土器

図版111 SB7109・SB7112・SB7113・SB7114
SB7115出土土器

図版112 SB7118・SB7120・SB7121・SB7122
SB7123出土土器

図版113 SB7127・SB7133・SB7134・SB7136
SB7137・SB7141・SB7143出土土器

図版114 SB7144・SB7150・SB7152・SB7153
SB7154・SB7155・SB7156出土土器

図版115 SB7158・SB7159・SB7160・SB7161
SB7164・SB7165・SB7169・SB7171
SB7174・SB7179・SB7185出土土器

図版116 SB7181・SB7196・SB7199・SB7200
出土土器

図版117 SB7201・SB7202・SB7203・SB7204
出土土器

図版118 SB7207・SB7208・SB7210・SB7211
SB7212出土土器

図版119 SB7205・SB7206①出土土器

図版120 SB7206②出土土器

図版121 SB7209・SB7214出土土器

図版122 SB7215・SB7216・SB7218・SB7219
出土土器

図版123 SB7220・SB7221・SB7223出土土器

図版124 SB7222・SB7227・SB7231・SB7235
出土土器

図版125 SB7230・SB7245・SB7248出土土器

図版126 SB7234・SB7249出土土器

図版127 SB7253・SB7260・SB7261・SB7263
出土土器

図版128 SB7264・SB7265・SB7266・SB7267
SB7269・SB7278・SB7279・SB7280
SB7288出土土器

図版129 SB7270・SB7273・SB7287出土土器

図版130 SB7299・SB7301・SB7305・SB7306
SB7308・SB7313・SB7314・SB7315
SB7318出土土器

図版131 SB7317・SB7320・SB7324・SB7325
SB7326・SB7330・SB7331出土土器

図版132 SB7332・SB7335・SB7337・SB7340
SB7341・SB7342・SB7348・SB7354
SB7356出土土器

図版133 SB7357・SB7360・SB7367出土土器

図版134 SB7370・SB7380出土土器

図版135 SB7387・SB7389・SB7390・SB7391
SB7392・SB7396出土土器

図版136 SB7398・SB7399・SB7404・SB7405
SB7407・SB7408出土土器

図版137 SB7409・SB7410・SB7411・SB7412
SB7413・SB7415・SB7421・SB7423
SB7426・SB7428出土土器

図版138 SB7416出土土器

図版139 SB7422・SB7434・SB7435出土土器

- 図版140 SB7425・SB7437出土土器
- 図版141 SB7427出土土器
- 図版142 SB7440・SB7449・SB7450・SB7459
SB7460・SB7469出土土器
- 図版143 SB7464・SB7470・SB7477・SB7478
SB7485・SB7486・SB7505・SB7518
SB7519・SB7521出土土器
- 図版144 SB7528・SB7530・SB7532・SB7533
SB7534・SB7535・SB7537出土土器
- 図版145 SB7538・SB7543・SB7546・SB7549
SB7551・SB7554・SB7568・SB7571
SB7587・SB7591出土土器
- 図版146 SB7552出土土器
- 図版147 SB7601・SB7605・SB7606・SB7610
SB7619・SB7622・SB7645・SB7667出
土土器
- 図版148 SB7644・SB7651・SB7700・SB7703
SB7716・SB7717・SB7735出土土器
- 図版149 ST7020・SM7005・SM7007・SM7008
SM7009・SM7015・SM7017・SM7019
SM7020・SM7021・SM7022・SM7025
出土土器
- 図版150 SD6008・SD6033・SD7001出土土器
- 図版151 SD7002出土土器
- 図版152 SD7006①出土土器
- 図版153 SD7006②出土土器
- 図版154 SD7006③出土土器
- 図版155 SD7007出土土器
- 図版156 SD7010・SD7011・SD7023・SD7024
出土土器
- 図版157 SD7027・SD7029・SD7031・SD7032
SD7033・SD7036・SD7037・SD7038
SD7040・SD7041・SD7042出土土器
- 図版158 SD7039①出土土器
- 図版159 SD7039②・SD7051・SD7052①出土土器
- 図版160 SD7052②出土土器
- 図版161 SD7054・SD7055・SD7061・SD7067
SD7068・SD7069・SD7072・SD7078
SD7079・SD7092・SD7094・SD7101
SD7102・SD7104出土土器
- 図版162 SD7080・SD7083・SD7087・SD7109
出土土器
- 図版163 SK6033・SK6034・SK6035・SK6044
SK6046・SK6097・SK6154・SK6160
SK6163・SK6208・SK6398・SK6408
SK6432・SK7137・SK7154出土土器
- 図版164 SK7199・SK7229出土土器
- 図版165 SK7228・SK7235・SK7275・SK7303
SK7305・SK7314・SK7330・SK7361
SK7369・SK7376・SK7420・SK7422
SK7425出土土器
- 図版166 SK7414・SK7447・SK7459・SK7461
SK7465・SK7650・SK7683出土土器
- 図版167 SK7824・SK7877・SK7995・SK8050
SK8092・SK8110・SK8135・SK8142
SK8150・SK8192・SK8226・SK8235
SK8254・SK8494・SK8577・SK8587
SK8770出土土器
- 図版168 遺構外出土土器・中世以降出土焼き物

その他の土器と土製品

- 図版169 土偶 人面付土器
容器形土製品
- 図版170 北陸系土器1 (弥生後期)
- 図版171 北陸系土器2 (弥生後期)
- 図版172 北陸系土器3 (古墳前期)
東海系土器1 (古墳前期)
- 図版173 東海系土器2 (古墳前期)
- 図版174 畿内系土器1 (古墳前期)
- 図版175 畿内系土器2 (古墳前期)
- 図版176 ミニチュア土器1
- 図版177 ミニチュア土器2
- 図版178 榎痕付土器
- 図版179 付着物(漆等)土器
- 図版180 へら書き 線刺 刻印土器1
- 図版181 へら書き 線刺 刻印土器2
- 図版182 へら書き 線刺 刻印土器3

図版183 墨書土器 1
図版184 墨書土器 2
図版185 墨書土器 3
図版186 墨書土器 4
図版187 墨書土器 5
図版188 墨書土器 6
図版189 墨書土器 7
図版190 墨書土器 8
図版191 墨書土器 9
図版192 墨書土器10
図版193 墨書土器11
図版194 墨書土器12
図版195 硯類 1

図版196 硯類 2
図版197 硯類 3 緑釉陶器
図版198 特異な内面ヘラミガキ土器 底部木葉痕
土器
図版199 紡錘車
図版200 石錘・土錘 1
図版201 石錘・土錘 2
図版202 石錘・土錘 3
図版203 石錘・土錘 4 土器片製方形板・不製形
板
図版204 土器片製半円板
図版205 土器片製円板
図版206 フィゴの羽口

鏡類・玉類・古代石製品

図版207 SM7006出土の鏡と玉
図版208 SM7016出土の鏡と玉 1
図版209 SM7016出土の玉 2 SM7028出土の玉

SM7036出土の玉
図版210 その他の玉類 古代の石製品

青銅製品と鉄製品

図版211 青銅製品 (銅鏡・鏡・銅印・錢貨・その
他の青銅製品)
図版212 鉄製品 1 (紡錘車・苧引き金具・釘)
図版213 鉄製品 2 (鉄鎖類)
図版214 鉄製品 3 (刀子 1)

図版215 鉄製品 4 (刀子 2)
図版216 鉄製品 5 (鋸先)
図版217 鉄製品 6 (鎌・斧・その他の鉄製品 1)
図版218 鉄製品 7 (その他の鉄製品 2)

木製品

図版219 木製品 1 (農具・生活具 1)
図版220 木製品 2 (生活具 2)
図版221 木製品 3 (建築材 1)

図版222 木製品 4 (建築材 2)
図版223 木製品 5 (杭 1)
図版224 木製品 6 (杭 2)

石製品

図版225 弥生時代石器 1 (原石・石核 1)
図版226 弥生時代石器 2 (原石・石核 2)
図版227 弥生時代石器 3 (剝片A類・剝片B類)
図版228 弥生時代石器 4 (石鎌 1)
図版229 弥生時代石器 5 (石鎌 2・石錘)
図版230 弥生時代石器 6 (打製石斧 1)
図版231 弥生時代石器 7 (打製石斧 2)
図版232 弥生時代石器 8 (打製石斧 3)

図版233 弥生時代石器 9 (磨石 1)
図版234 弥生時代石器10 (磨石 2)
図版235 弥生時代石器11 (磨石 3)
図版236 弥生時代石器12 (磨石 4)
図版237 弥生時代石器13 (凹石 1)
図版238 弥生時代石器14 (凹石 2)
図版239 弥生時代石器15 (敲石 1)
図版240 弥生時代石器16 (敲石 2)

- 図版241 弥生時代石器17 (敲石 3)
 図版242 弥生時代石器18 (台石 1)
 図版243 弥生時代石器19 (台石 2)
 図版244 弥生時代石器20 (使有石屑)
 図版245 弥生時代石器21 (刃器 1)
 図版246 弥生時代石器22 (刃器 2)
 図版247 弥生時代石器23 (刃器 3)
 図版248 弥生時代石器24 (刃器 4)
 図版249 弥生時代石器25 (刃器 5)
 図版250 弥生時代石器26 (刃器 6)
 図版251 弥生時代石器27 (刃器 7)
 図版252 弥生時代石器28 (刃器 8)
 図版253 弥生時代石器29 (磨製石包丁)
 図版254 弥生時代石器30 (磨製石斧 1)
 図版255 弥生時代石器31 (磨製石斧 2)
 図版256 弥生時代石器32 (磨製石斧 3)
 図版257 弥生時代～古代石器33 (砥石 1)
 図版258 弥生時代～古代石器34 (砥石 2)
 図版259 弥生時代～古代石器35 (砥石 3)
 図版260 弥生時代～古代石器36 (砥石 4・くほみ石 1)
 図版261 弥生時代～古代石器37 (くほみ石 2・石臼)
 図版262 弥生時代石器38 (みがき石)
 図版263 弥生時代石器39 (玉石・穴開石・軽石・角礫)
 図版264 古代カマド石40 (切石)

写真図版目次

弥生時代中期以前

- P L 1 SB7272・SB7276(1)・SM7010
 SM7026・SK7327出土土器
 P L 2 SD5003(1)・SD6007(1)出土土器
 P L 3 遺構外出土土器 1
 P L 4 遺構外出土土器 2
 P L 5 SB7276(2)・SB7438・SD6007(2)
 SD6030・SD7047(1)・SK7294出土土器
 P L 6 SD6007(3)・SD7047(2)・SD7098出土土器
 P L 7 SD5003(2)・SD6007(4)出土土器
 P L 8 SD6007(5)出土土器
 P L 9 SD6007(6)・SD7110(1)出土土器

- P L 10 SD7110(2)出土土器
 P L 11 SD7110(3)出土土器
 P L 12 SD7110(4)出土土器
 P L 13 SD7110(5)出土土器
 P L 14 SD7110(6)出土土器
 P L 15 SD7110(7)出土土器
 P L 16 遺構外出土土器 1
 P L 17 遺構外出土土器 2
 P L 18 遺構外出土土器 3
 遺構外出土の縄文式土器

弥生時代後期

- P L 19 SB6014出土土器
 P L 20 SB6015・SB6017・SB6028出土土器
 P L 21 SB6030・SB6031・SB7021出土土器
 P L 22 SB7034・SB7040・SB7071出土土器
 P L 23 SB7079出土土器
 P L 24 SB7078・SB7082・SB7089出土土器
 P L 25 SB7086(1)出土土器
 P L 26 SB7086(2)・SB7090・SB7099出土土器
 P L 27 SB7091・SB7094出土土器

- P L 28 SB7101・SB7102・SB7103
 SB7105出土土器
 P L 29 SB7132出土土器
 P L 30 SB7162(1)出土土器
 P L 31 SB7162(2)・SB7166出土土器
 P L 32 SB7173・SB7180・SB7191
 SB7226出土土器
 P L 33 SB7229・SB7236・SB7277・SB7293
 SB7307出土土器

P L 34 SB7358・SB7417・SB7488出土土器
P L 35 SB7493・SB7495・SB7497出土土器
P L 36 SB7573・SB7627・SB7630・SB7655
出土土器
P L 37 SB7669・SB7673・SB7693・SB7696
出土土器
P L 38 SD6035・SD7014(1)出土土器
P L 39 SD7014(2)出土土器
P L 40 SD7046(1)出土土器
P L 41 SD7046(2)出土土器
P L 42 SD7046(3)出土土器

古墳時代前期

P L 53 SB6001・SB6004・SB6006・SB6011
SB6013・SB6016(1)出土土器
P L 54 SB6016(2)出土土器
P L 55 SB6018・SB6019・SB6025・SB6027
SB7042・SB7080・SB7129・SB7172
SB7184出土土器
P L 56 SB7193・SB7213・SB7228・SB7244
SB7246出土土器
P L 57 SB7250出土土器
P L 58 SB7254・SB7255出土土器
P L 59 SB7256(1)出土土器
P L 60 SB7256(2)・SB7257・SB7311・SB7346
SB7372出土土器
P L 61 SB7418・SB7420出土土器
P L 62 SB7442・SB7508(1)出土土器
P L 63 SB7508(2)出土土器
P L 64 SB7517・SB7561・SB7586・SB7596
SB7634・SB7642・SB7646・SB7709
SB7726出土土器
P L 65 SB7654・SB7751出土土器

古代(7世紀・奈良時代・平安時代)の土器

P L 83 SB6020・SB6023・SB6024・SB7001
出土土器
P L 84 SB7001出土土器
P L 85 SB7002・SB7003・SB7004出土土器
P L 86 SB7005・SB7006出土土器

P L 43 SK6122・SK6222・SK6415・SK7105
出土土器
P L 44 SK7075(1)出土土器
P L 45 SK7075(2)出土土器
P L 46 SK7075(3)出土土器
P L 47 SK7075(4)出土土器
P L 48 SK7075(5)出土土器
P L 49 SK7075(6)・SK7135出土土器
P L 50 SK7170・SK7362・SK8247出土土器
P L 51 SK7331・SK7353出土土器
P L 52 SK7483・SK8152・SK8488出土土器

P L 66 SC6001・SM7001・SM7035出土土器
P L 67 SD6016・SD6023(1)出土土器
P L 68 SD6023(2)出土土器
P L 69 SD6023(3)出土土器
P L 70 SD6023(4)出土土器
P L 71 SD7014出土土器
P L 72 SD7030(1)出土土器
P L 73 SD7030(2)出土土器
P L 74 SD7030(3)・SD7088出土土器
P L 75 SK6048・SK6099・SK6113
SK6142・SK6186出土土器
P L 76 SK6202(1)出土土器
P L 77 SK6202(2)出土土器
P L 78 SK6202(3)出土土器
P L 79 SK6202(4)出土土器
P L 80 SK6307出土土器
P L 81 SK7130・SK7256・SK7364・SK7367
出土土器
P L 82 SK7326・SK7403・SK8011・SK8250
SK8397出土土器

P L 87 SB7007・SB7009出土土器
P L 88 SB7010・SB7011・SB7014・SB7015
SB7016出土土器
P L 89 SB7013・SB7018・SB7019出土土器
P L 90 SB7022・SB7026・SB7031出土土器

- P L 91 SB7029 · SB7030出土土器
出土土器
- P L 92 SB7036 · SB7041 · SB7046 · SB7047
出土土器
- P L 93 SB7048 · SB7052 · SB7053出土土器
- P L 94 SB7054 · SB7058 · SB7068出土土器
- P L 95 SB7059 · SB7092 · SB7098 · SB7100
SB7106 · SB7108 · SB7111出土土器
- P L 96 SB7112出土土器
- P L 97 SB7113 · SB7114 · SB7115 · SB7118
出土土器
- P L 98 SB7120 · SB7121 · SB7122 · SB7123
SB7127 · SB7133 · SB7134出土土器
- P L 99 SB7137 · SB7141 · SB7143 · SB7144
SB7150 · SB7152 · SB7153出土土器
- P L 100 SB7154 · SB7155 · SB7156 · SB7158
出土土器
- P L 101 SB7159 · SB7160 · SB7164 · SB7165
SB7169 · SB7171 · SB7174 · SB7179
SB7181 · SB7199 · SB7200出土土器
- P L 102 SB7201 · SB7203 · SB7205出土土器
- P L 103 SB7206出土土器
- P L 104 SB7207 · SB7208 · SB7210出土土器
- P L 105 SB7209 · SB7214 · SB7215出土土器
- P L 106 SB7216 · SB7218 · SB7219 · SB7220
SB7221出土土器
- P L 107 SB7222 · SB7223 · SB7227 · SB7230
SB7245出土土器
- P L 108 SB7234 · SB7235 · SB7248出土土器
- P L 109 SB7249 · SB7253 · SB7260 · SB7261
出土土器
- P L 110 SB7264 · SB7267 · SB7269 · SB7273
SB7278出土土器
- P L 111 SB7287 · SB7288 · SB7299 · SB7301
SB7306 · SB7308 · SB7314出土土器
- P L 112 SB7318 · SB7324 · SB7325 · SB7326
SB7331 · SB7332 · SB7335 · SB7357
SB7370出土土器
- P L 113 SB7367 · SB7380 · SB7387 · SB7389
出土土器
- P L 114 SB7391 · SB7392 · SB7396 · SB7404
出土土器
- P L 115 SB7407 · SB7408 · SB7421 · SB7422
SB7426 · SB7434 · SB7435 · SB7459
SB7470出土土器
- P L 116 SB7416(1)出土土器
- P L 117 SB7416(2) · SB7425出土土器
- P L 118 SB7427 · SB7477 · SB7485 · SB7505
出土土器
- P L 119 SB7469 · SB7530 · SB7535出土土器
- P L 120 SB7534出土土器
- P L 121 SB7537 · SB7543 · SB7546 · SB7549
SB7551 · SB7568 · SB7571 · SB7591
SB7605出土土器
- P L 122 SB7552 · SB7601出土土器
- P L 123 SB7610 · SB7619 · SB7622 · SB7644
SB7645 · SB7651 · SB7700 · SB7717
出土土器
- P L 124 SM7005 · SM7007 · SM7009 · SM7015
SM7017 · SM7020 · SM7021 · SM7022
SM7025出土土器
- P L 125 SD6008 · SD7001 · SD7002出土土器
- P L 126 SD7006(1)出土土器
- P L 127 SD7006(2)出土土器
- P L 128 SD7007 · SD7010 · SD7011 · SD7023
出土土器
- P L 129 SD7033 · SD7039出土土器
- P L 130 SD7052出土土器
- P L 131 SD7040 · SD7067 · SD7079 · SD7080
SD7083 · SD7101出土土器
- P L 132 SK6035 · SK6044 · SK6046 · SK7229
SK7235 · SK7275 · SK7303出土土器
- P L 133 SK7199出土土器
- P L 134 SK7376 · SK7414 · SK7420 · SK7459
SK7461 · SK7995 · SK8110 · SK8226
SK8770出土土器
遺構外出土土器

中世の焼き物

P L 135 SK6234・SK7085・SK7162・SK7194
SK7211出土焼き物
遺構外出土焼き物

P L 136 SK7048・SK7051・SK7058・SK7159
SK8578出土焼き物
遺構外出土焼き物

その他の土器と土製品

P L 137 土偶 人面付土器
容器形土製品
P L 138 北陸系土器 1 (弥生時代)
P L 139 北陸系土器 2 (弥生時代・古墳時代)
P L 140 東海系土器 1 (古墳時代)
P L 141 東海系土器 2 (古墳時代)
P L 142 東海系土器 3 (古墳時代)
P L 143 畿内系土器 1 (古墳時代)
P L 144 ミニチュア土器 1
P L 145 ミニチュア土器 2
P L 146 ミニチュア土器 3
P L 147 縄痕付土器
P L 148 付着物 (漆・炭化米等) 土器
P L 149 ヘラ書き・線刻・刻印土器 1
P L 150 ヘラ書き・線刻・刻印土器 2
P L 151 ヘラ書き・線刻・刻印土器 3
P L 152 ヘラ書き・線刻・刻印土器 4
P L 153 ヘラ書き・線刻・刻印土器 5
P L 154 ヘラ書き・線刻・刻印土器 6
P L 155 ヘラ書き・線刻・刻印土器 7
P L 156 ヘラ書き・線刻・刻印土器 8

P L 157 ヘラ書き・線刻・刻印土器 9
P L 158 墨書土器 1
P L 159 墨書土器 2
P L 160 墨書土器 3
P L 161 墨書土器 4
P L 162 墨書土器 5
P L 163 墨書土器 6
P L 164 硯類 1
P L 165 硯類 2
P L 166 紡錘車
P L 167 土練 1
P L 168 土練 2
P L 169 土練 3
P L 170 土練 4・石練
P L 171 土器片製半円板
P L 172 フイゴの羽口
粒状滓 鉄塊剥片 鍛造剥片
P L 173 特異な内面ヘラミガキ土器
土師器・須恵器杯の底部調整 底部木葉
痕土器
P L 174 不明土器

青銅製品・鉄製品

P L 175 青銅製品 (銅印・鏡貨等)
P L 176 鉄製品 1 (紡錘車・穿引き金具・鉄鍬)

P L 177 鉄製品 2 (刀子・鉄斧・不明品)
P L 178 鉄製品 3 (鋤先・鎌)

木製品

P L 179 木製品 1 (農具・生活具 1)
P L 180 木製品 2 (生活具 2)
P L 181 木製品 3 (建築材 1)

P L 182 木製品 4 (建築材 2)
P L 183 木製品 5 (杭 1)
P L 184 木製品 6 (杭 2)

石製品

P L 185 弥生時代石器 1 (原石・石核 1)
P L 186 弥生時代石器 2 (原石・石核 2)

P L 187 弥生時代石器 3 (剥片A類・剥片B類)
P L 188 弥生時代石器 4 (石鏃 1)

- P L 189 弥生時代石器5 (石鏃2・石鏃)
- P L 190 弥生時代石器6 (打製石斧1・戈)
- P L 191 弥生時代石器7 (打製石斧1・裏)
- P L 192 弥生時代石器8 (磨石1)
- P L 193 弥生時代石器9 (磨石2)
- P L 194 弥生時代石器10 (凹石)
- P L 195 弥生時代石器11 (敲石1・表)
- P L 196 弥生時代石器12 (敲石1・裏)
- P L 197 弥生時代石器13 (敲石2・表)
- P L 198 弥生時代石器14 (敲石2・裏)
- P L 199 弥生時代石器15 (台石1)
- P L 200 弥生時代石器16 (台石2・打製石斧2)
- P L 201 弥生時代石器17 (使有石屑)
- P L 202 弥生時代石器18 (刃器1)
- P L 203 弥生時代石器19 (刃器2)
- P L 204 弥生時代石器20 (刃器3)
- P L 205 弥生時代石器21 (刃器4)
- P L 206 弥生時代石器22 (刃器5)
- P L 207 弥生時代石器23 (刃器6)
- P L 208 弥生時代石器24 (刃器7・刃器素材)
- P L 209 弥生時代石器25 (刃器8)
- P L 210 弥生時代石器26 (磨製石包丁)
- P L 211 弥生時代石器27 (磨製石斧1)
- P L 212 弥生時代石器28 (磨製石斧2)
- P L 213 弥生時代～古代石器29 (砥石1)
- P L 214 弥生時代～古代石器30 (砥石2)
- P L 215 弥生時代～古代石器31 (砥石3)
- P L 216 弥生時代～古代石器32 (砥石4・くぼみ石・石臼)
- P L 217 弥生時代～古代石器33 (軽石製品)
- P L 218 弥生時代石器34 (みがき石)
- P L 219 弥生時代石器35 (玉石)
- P L 220 弥生時代石器36 (穴開石・付着物のある石・角礫)
- P L 221 弥生時代石器37 (玉関係1)
- P L 222 弥生時代石器38 (玉関係2)
- P L 223 弥生時代石器39 (SK8189出土の河原石)
- P L 224 古代カマド石1 (切石1)
- P L 225 古代カマド石2 (切石2)
- P L 226 弥生時代石器40 (使用痕写真1)
- P L 227 弥生時代石器41 (使用痕写真2)
- P L 228 弥生時代石器42 (使用痕写真3)
- P L 229 弥生時代石器43 (使用痕写真4)
- P L 230 弥生時代石器44 (使用痕写真5)
- P L 231 弥生時代石器45 (使用痕写真6)
- P L 232 弥生時代石器46 (使用痕写真7)
- P L 233 弥生時代～古代石器47 (使用痕写真8)

凶 版

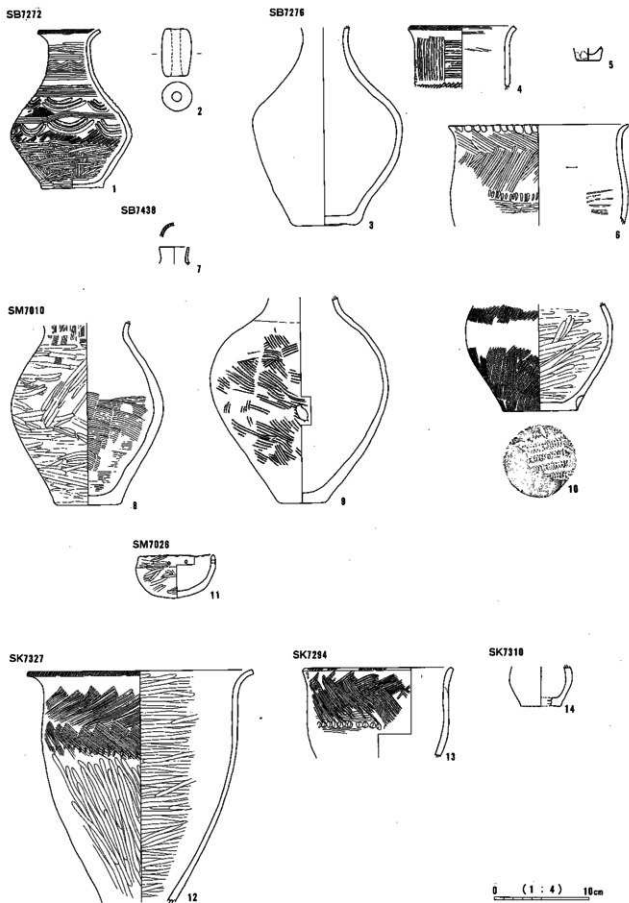

图版 2 弥生中期以前土器实测图

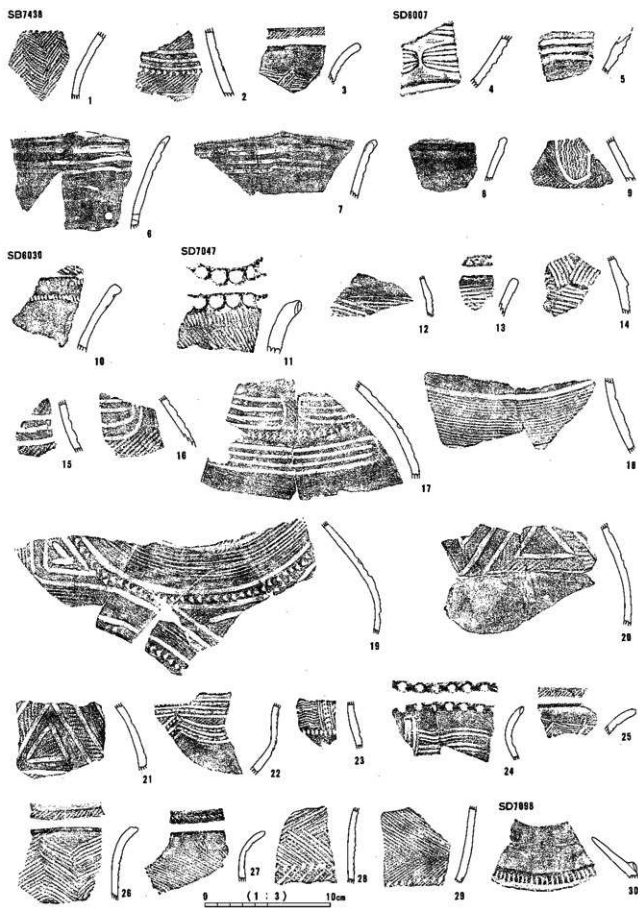

SD5003

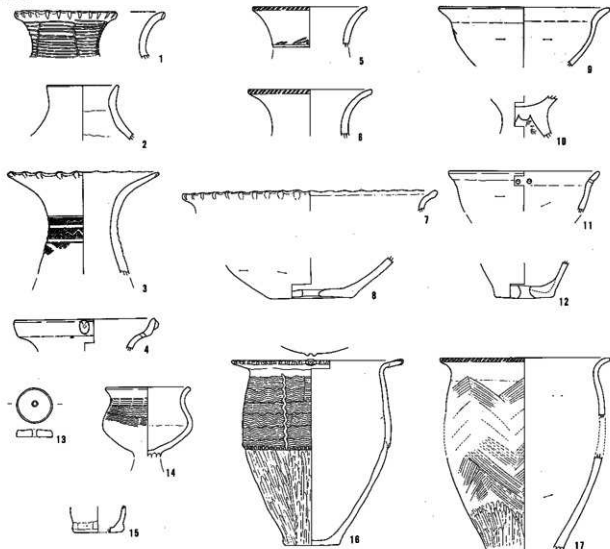

SD6007

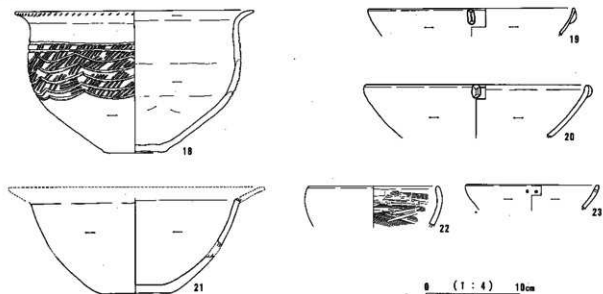

图版 4 弥生中期以前土器实测图

SD6007

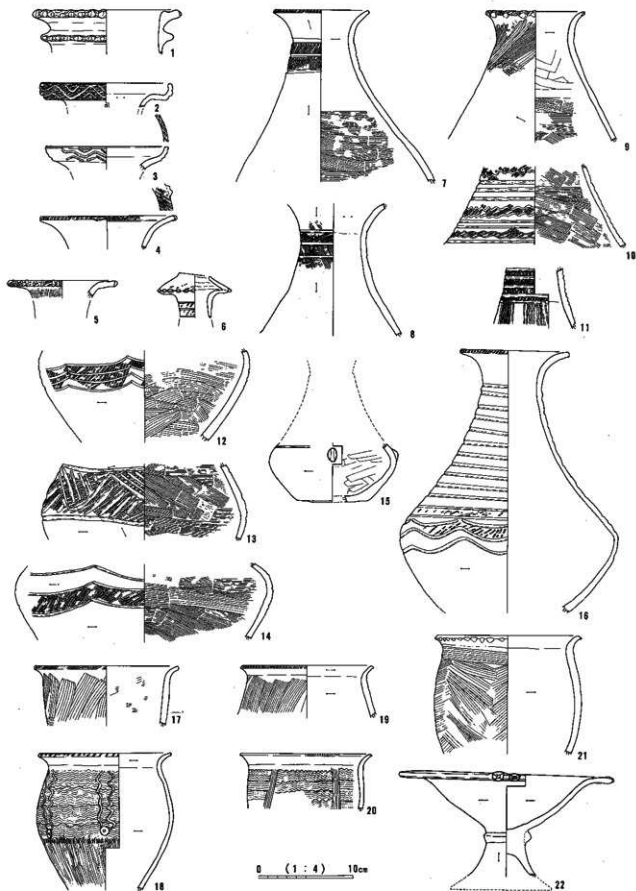

SD6007-③

SD7116

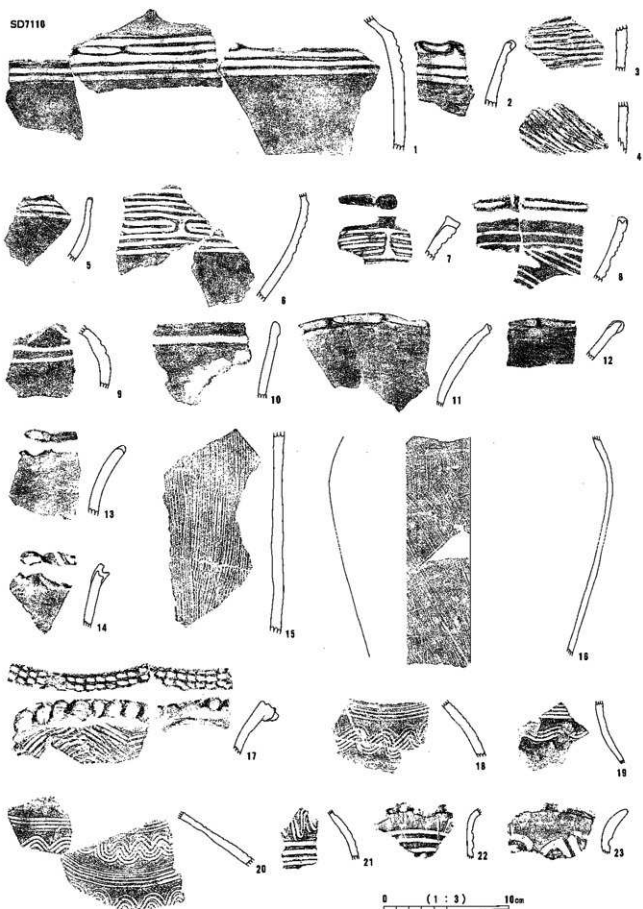

SD7110

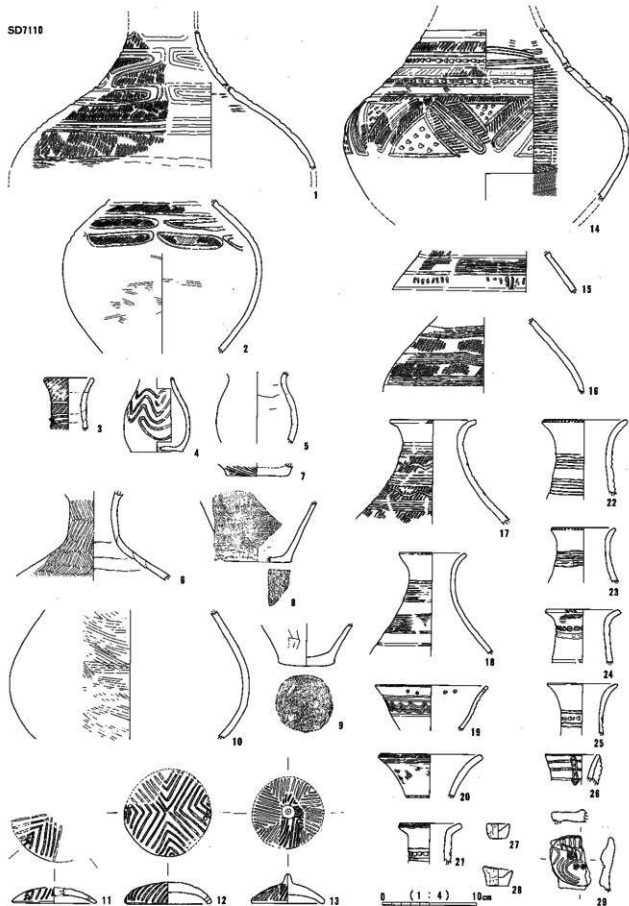

SD7110

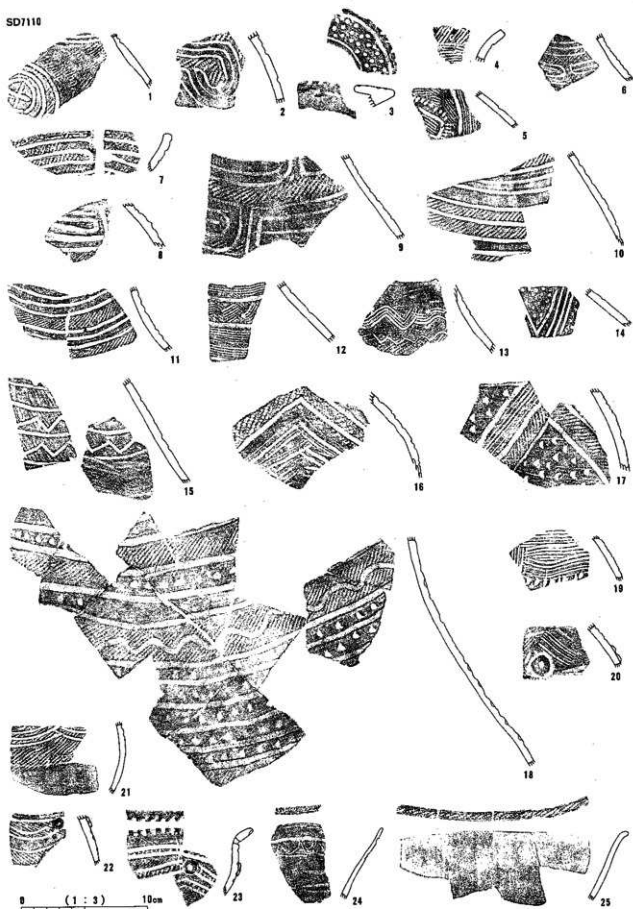

SD7110

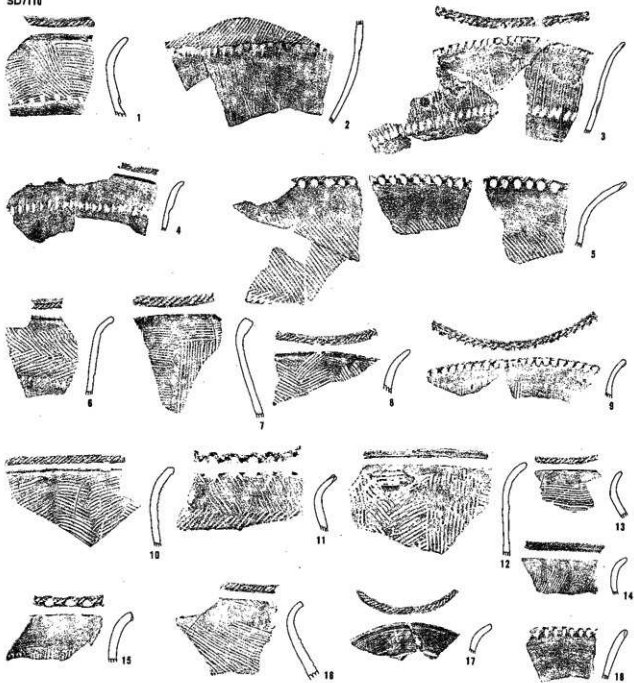

SK7294

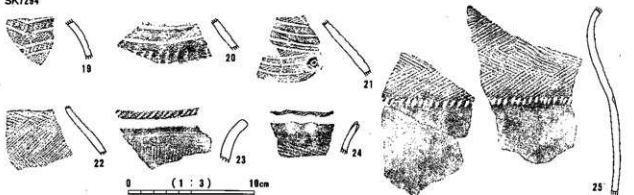

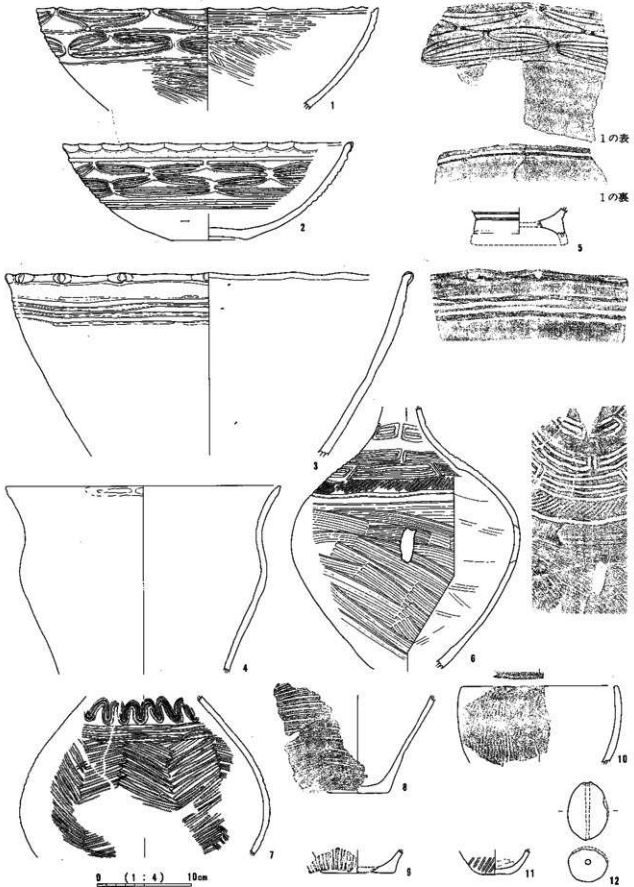

图版10 弥生中期以前土器实测图

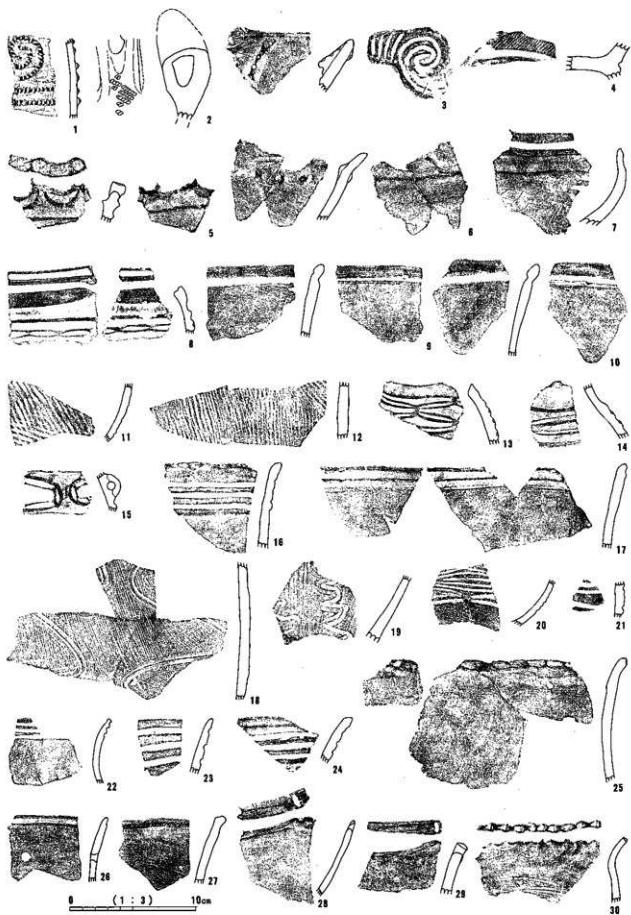

遺構外出土器2 (拓本)

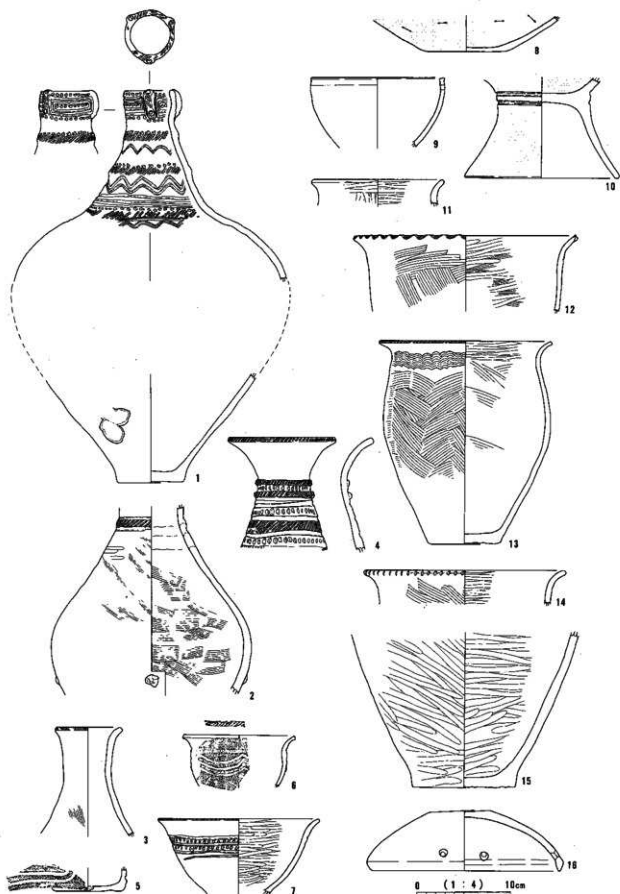

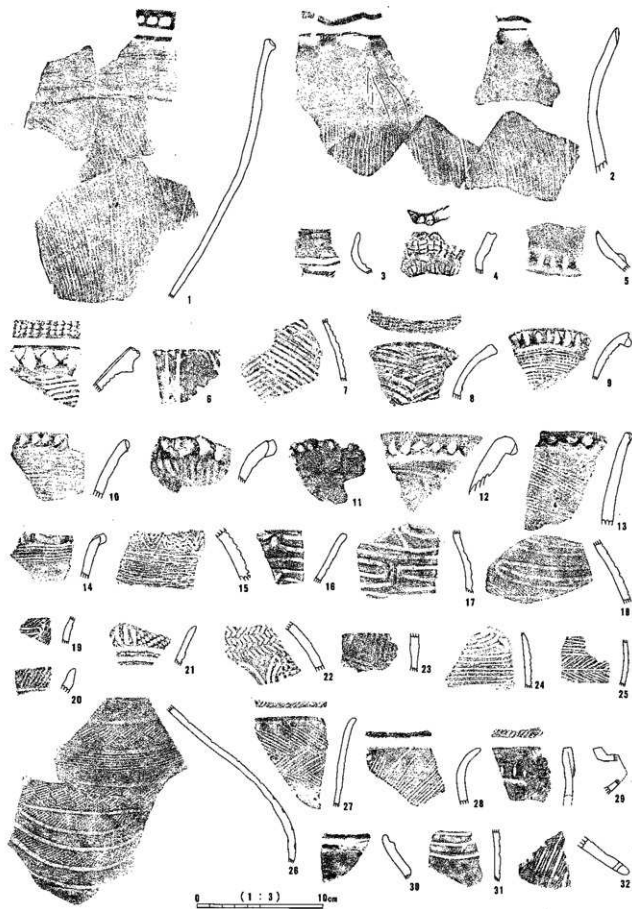

SB6014

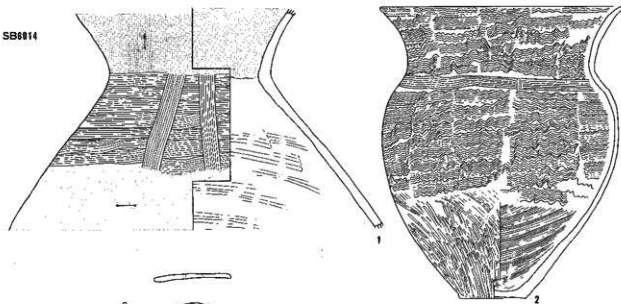

SB6015

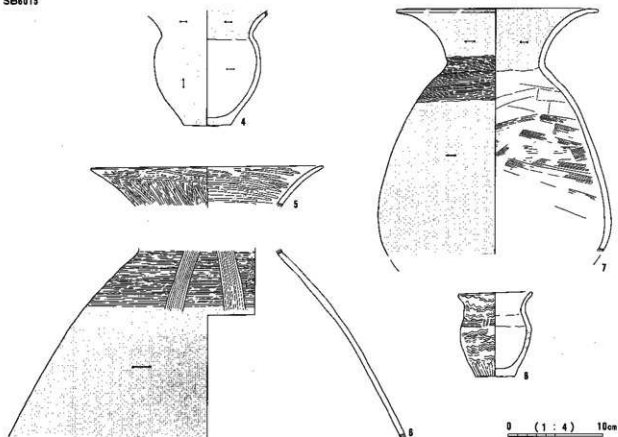

SB6017

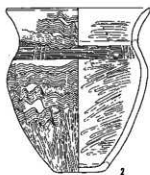

SB6028

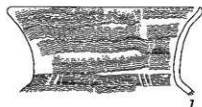
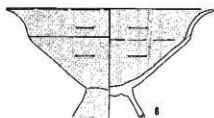

SB6030

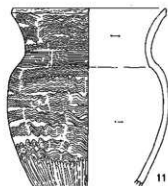
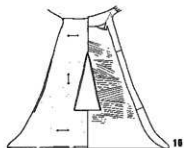
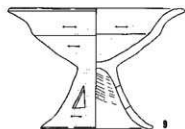

SB6031

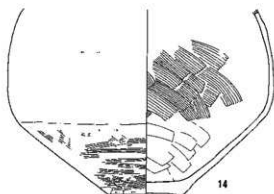
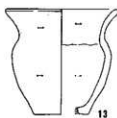
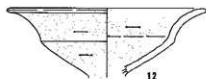

SB6035

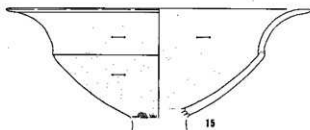

0 (1:4) 10cm

SB7020

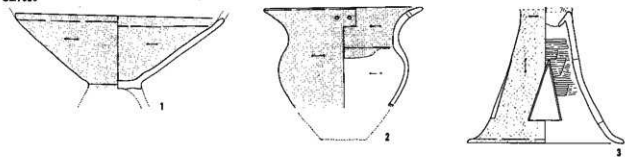

SB7021

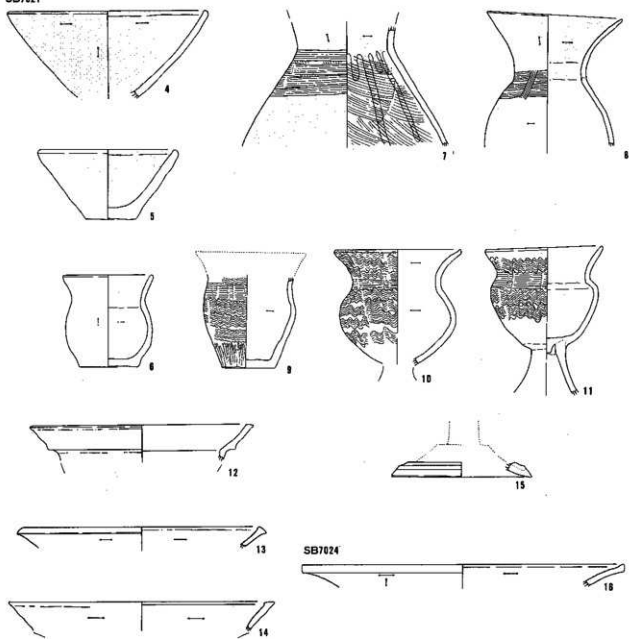

SB7024



0 (1 : 4) 10cm

SB7034

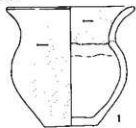

1

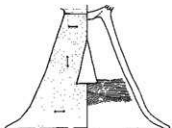

2



3

SB7037

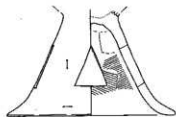

4



5



6



7

SB7038

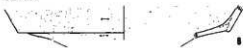

8

SB7039



9

SB7071



10

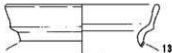

13

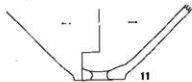

11



14

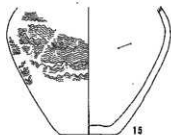

15



12

0 (1 : 4) 10cm

SB744-①

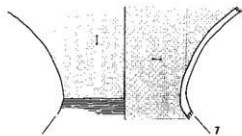
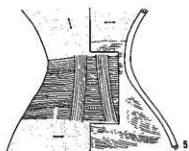
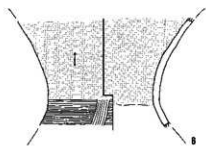
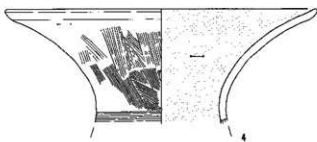
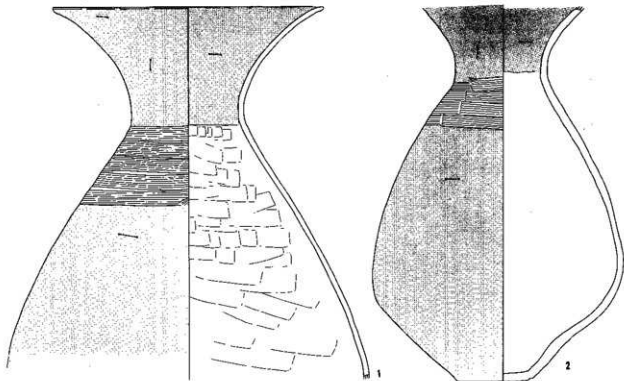

0 (1:4) 10cm

SB7040-①

SB7040-②

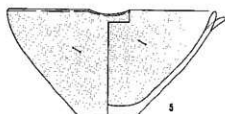
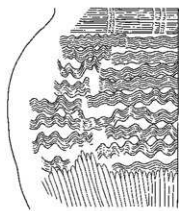
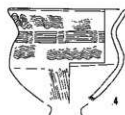
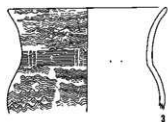
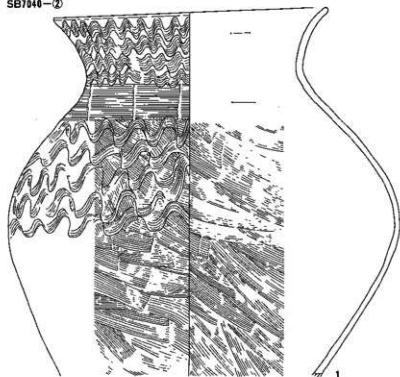

SB7090

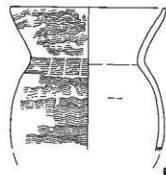

SB7097

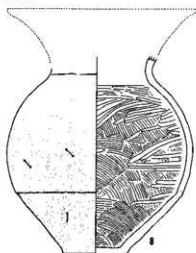

0 (1:4) 10cm

SB7078

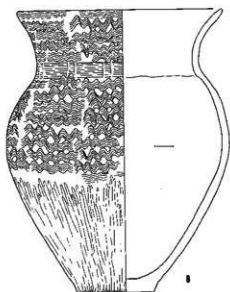
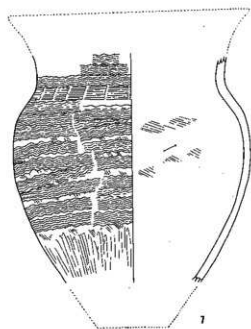
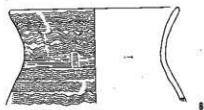
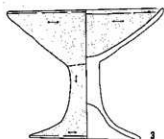
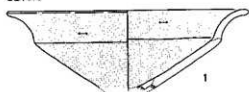

0 (1:4) 10cm

SB7078

SB7079

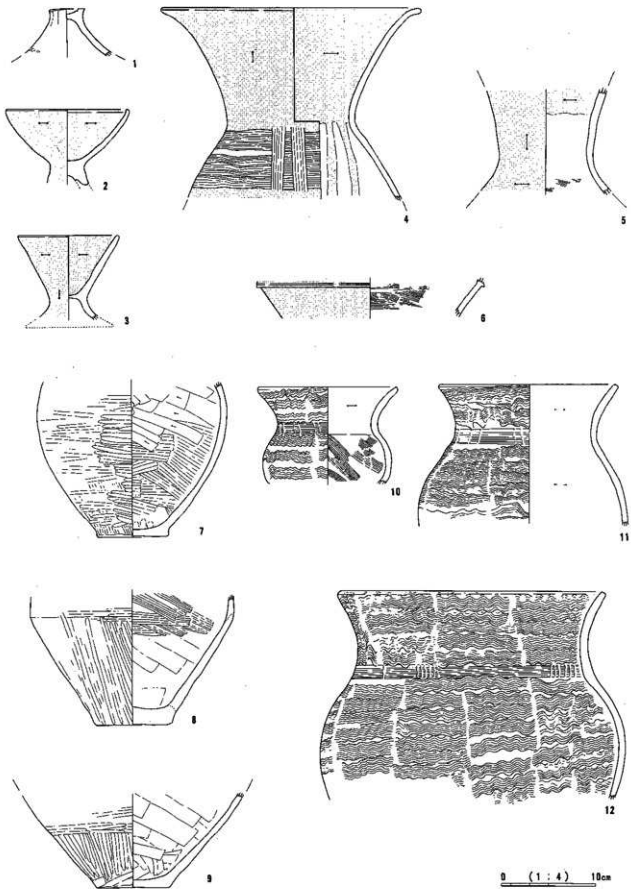

SB7082

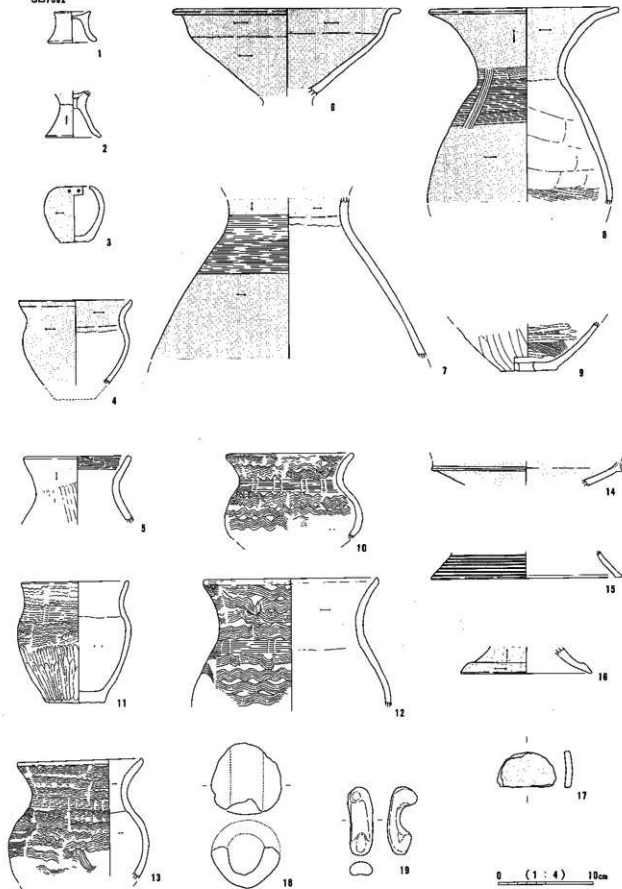

SB7082

SB7066

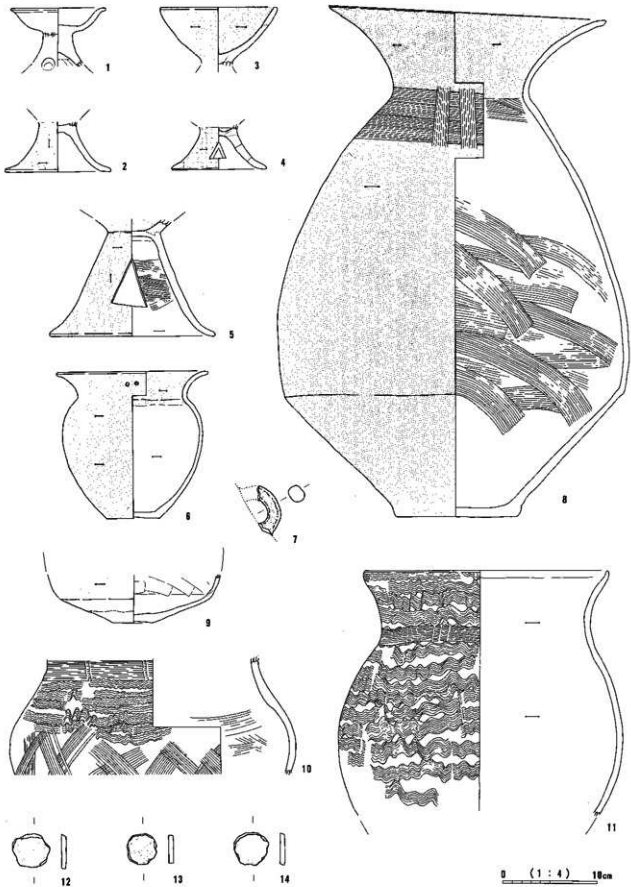

SB7066

SB7089

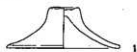

1

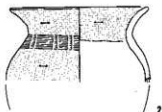

2

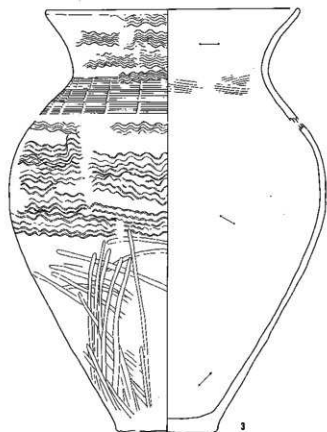

3

SB7091



4



5

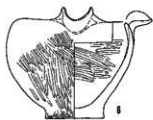

6

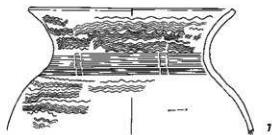

7

SB7102



8

SB7103



9

0 (1 : 4) 10cm

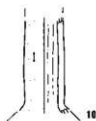

10

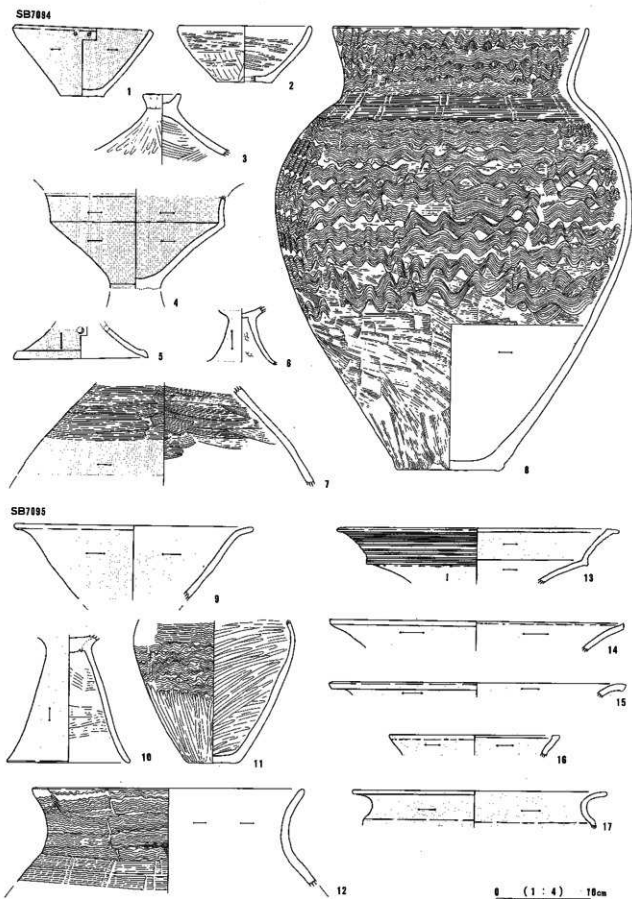

SB7099

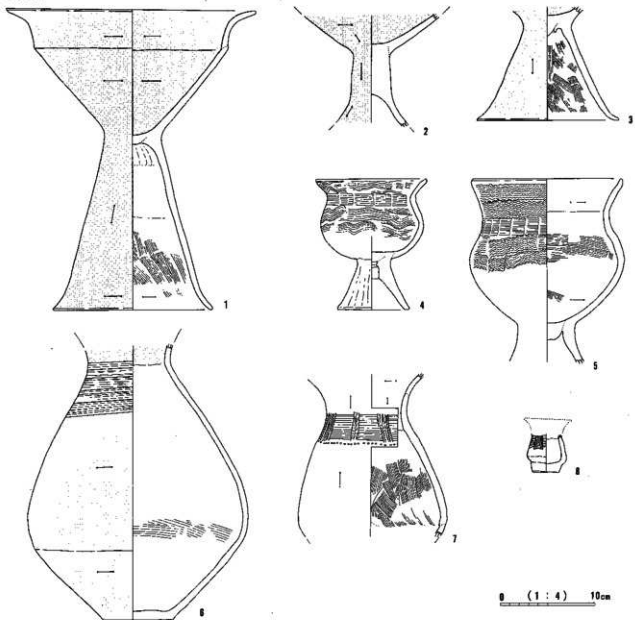

SB7101-①

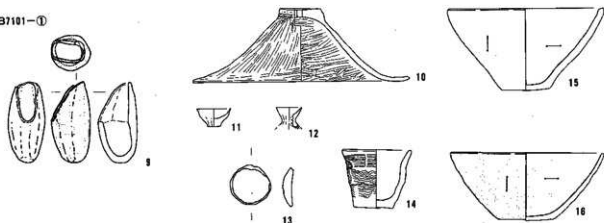

SB7101-②

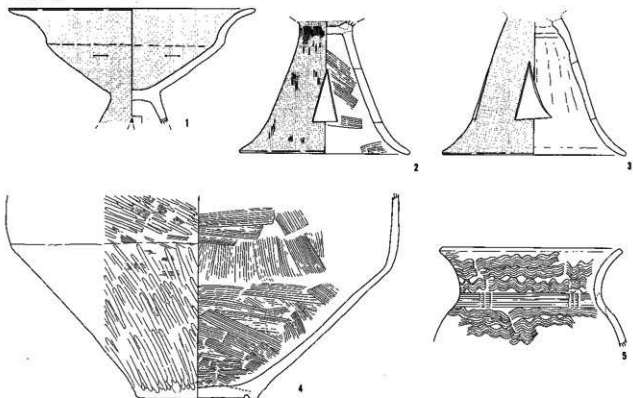

SB7105

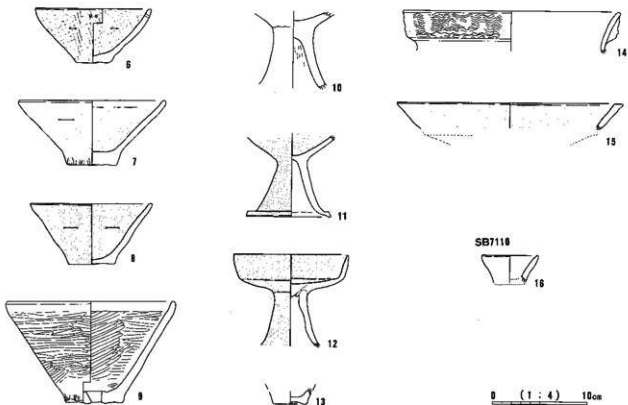

0 (1:4) 10cm

SB7128

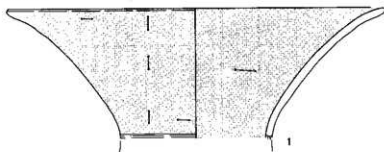

1

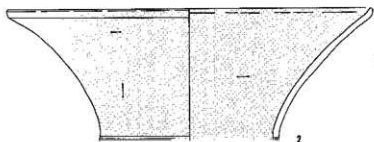

2

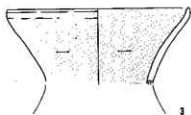

3

SB7128

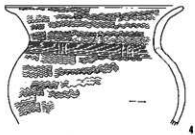

4



5



6

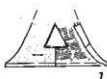

7



8

SB7162-①

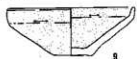

9

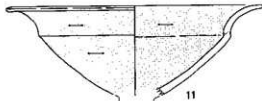

11

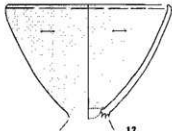

12

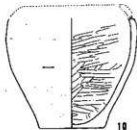

10



13

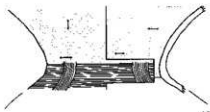
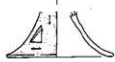

16

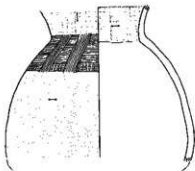

14

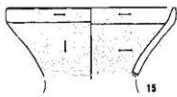

15

8 (1:4) 10cm

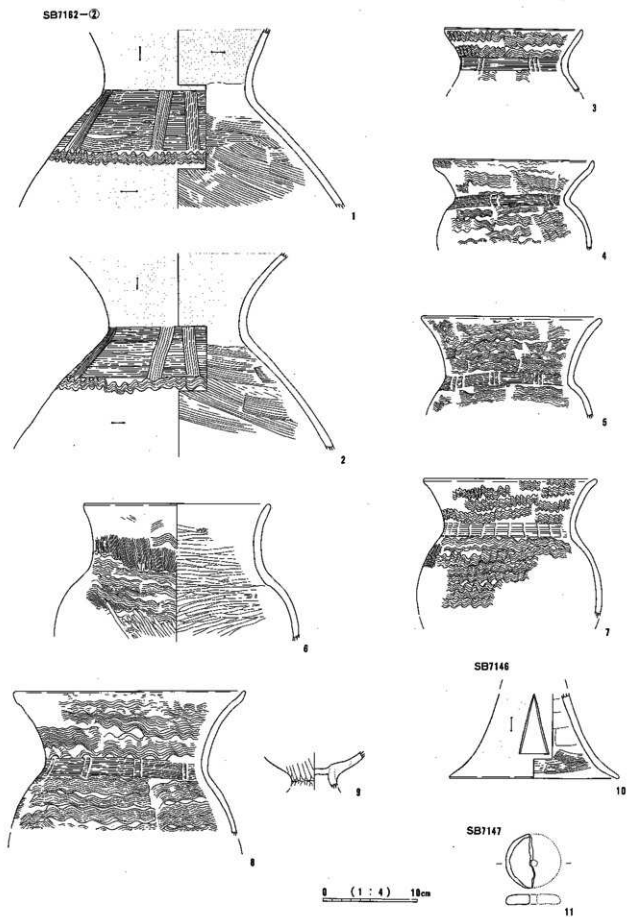

SB7132-①

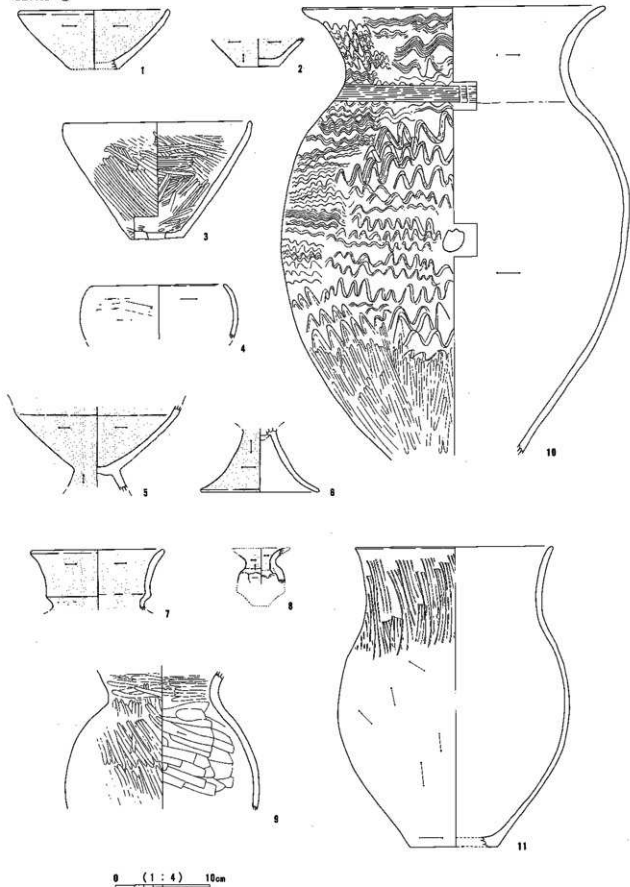

SB7132-①

SB7132-②

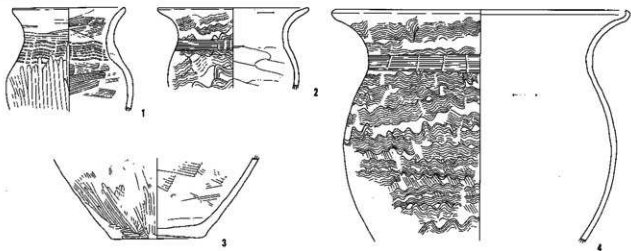

SB7166

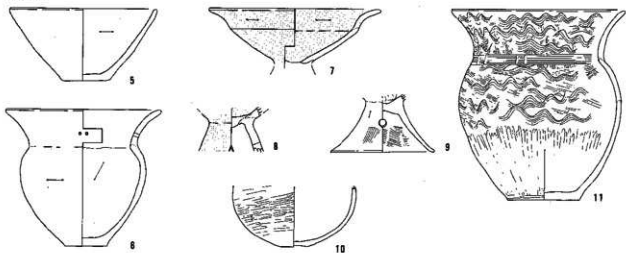

SB7173

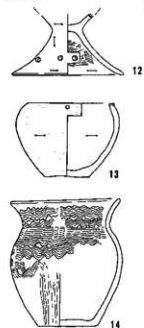

SB7177

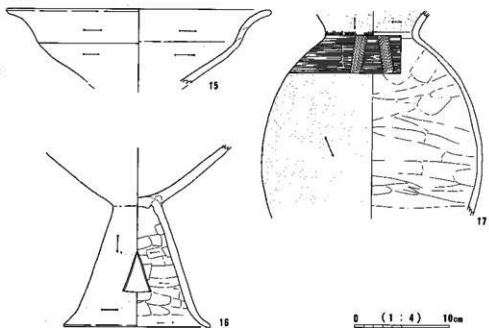

0 (1:4) 10cm

SB7180

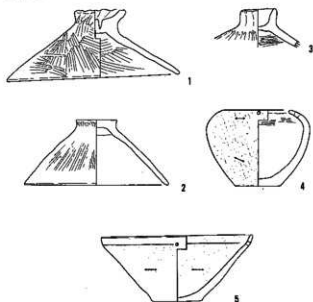

SB7187

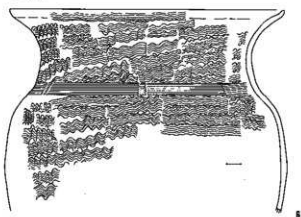

SB7191

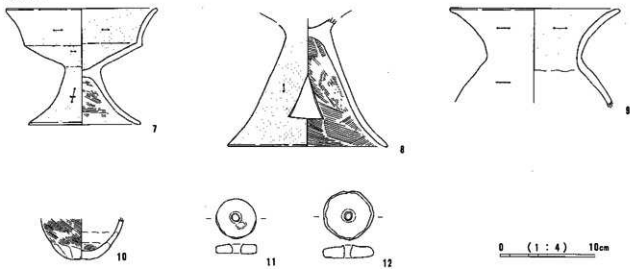

SB7233

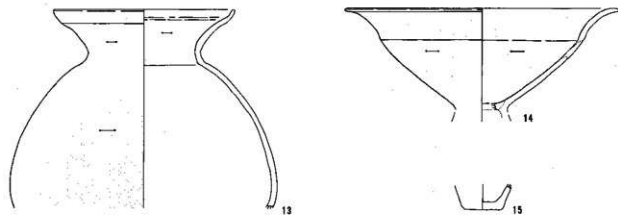

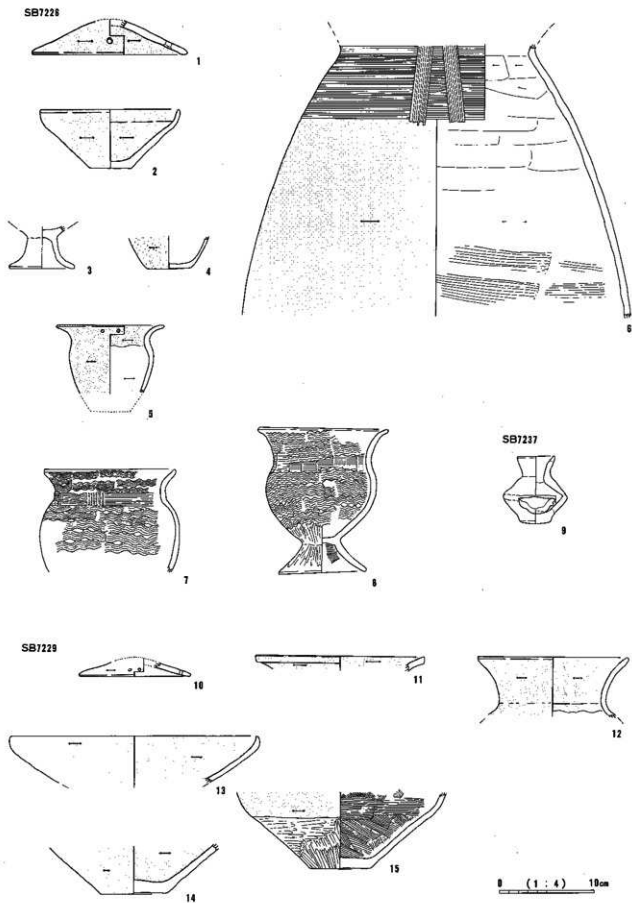

SB7236

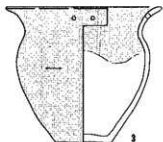
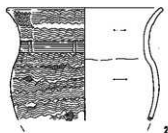

SB7238

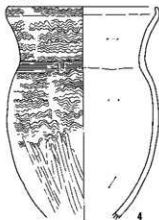

SB7252

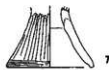

SB7258



SB7271

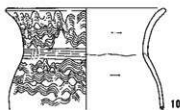
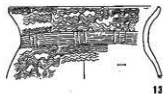
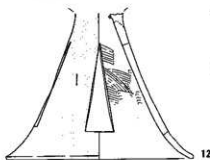

0 (1:4) 10cm

SB7277

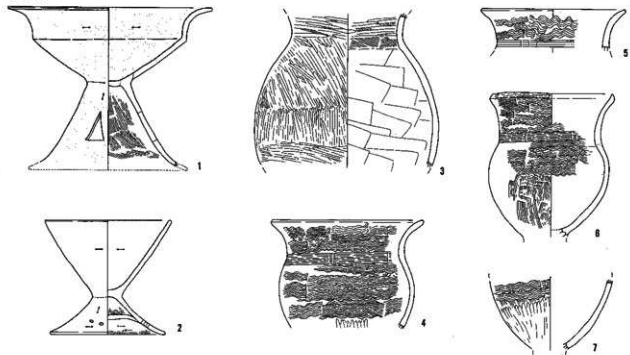

SB7293



SB7307

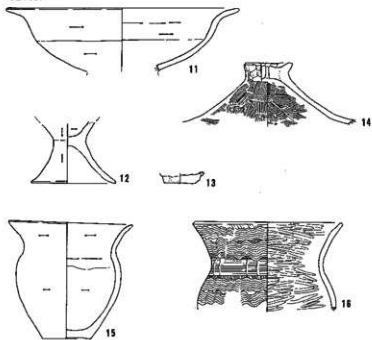

SB7493

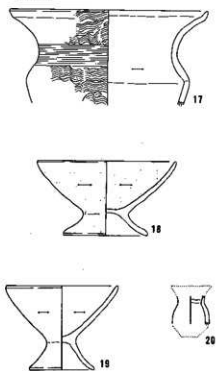

0 (1 : 4) 10cm

SB7358

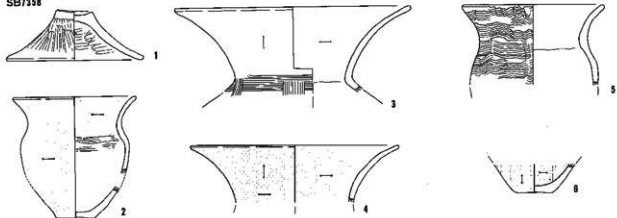

SB7365

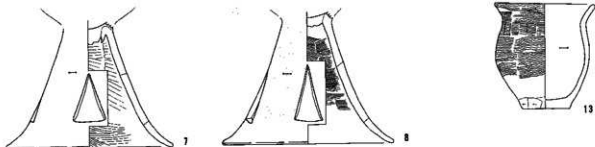

SB7417

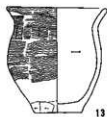

SB7490

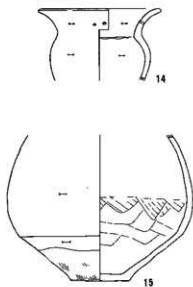

SB7560

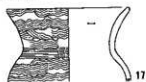

SB7573

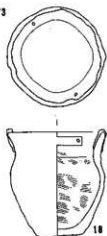

0 (1 : 4) 10cm

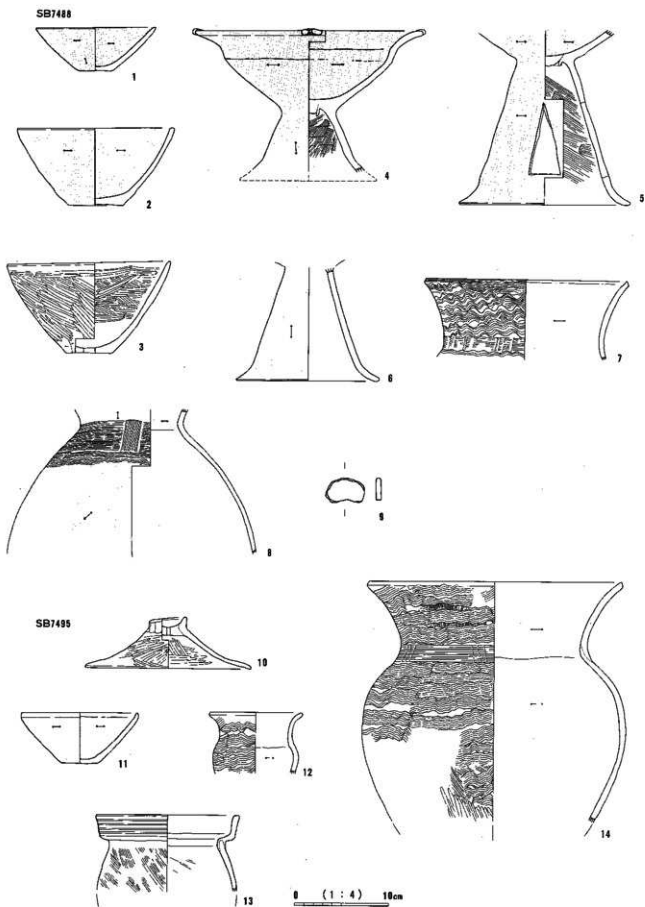

SB7487

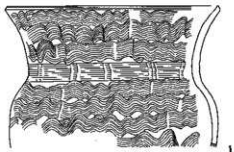

1

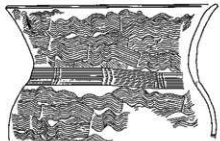

2

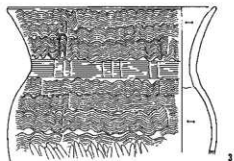

3

SB7500

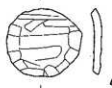

4

5

SB7553

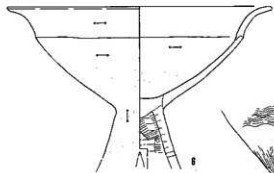

6



9

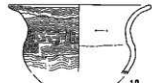

10



11



12

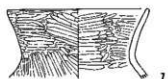

7



8

SB7580

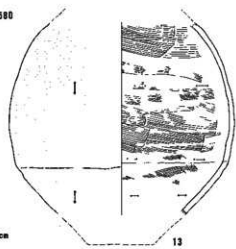

13

0 (1 : 4) 10cm

SB7593



SB7618



SB7617

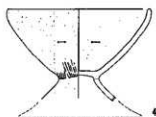
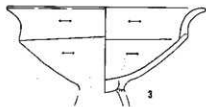

SB7630

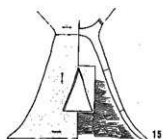
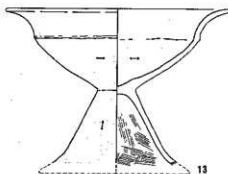
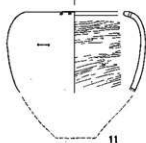
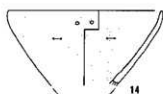
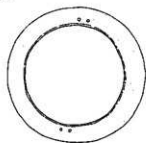

0 (1 : 4) 10cm

SB7627

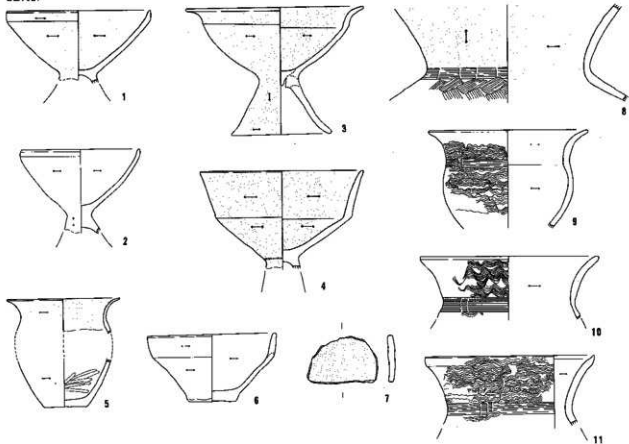

SB7655

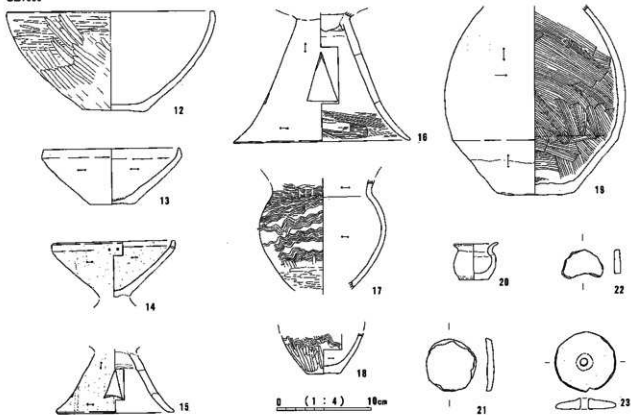

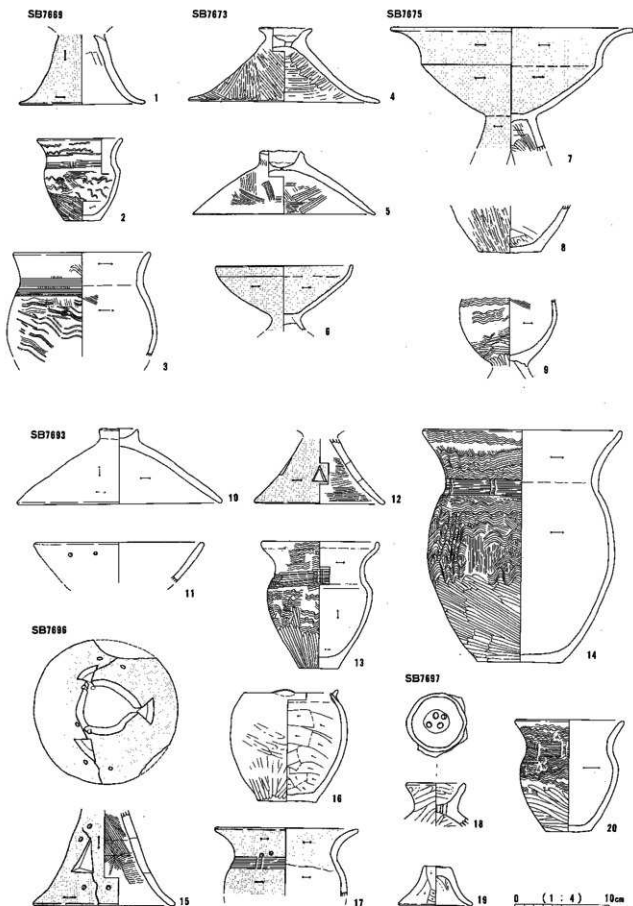

SD6003



SD6015

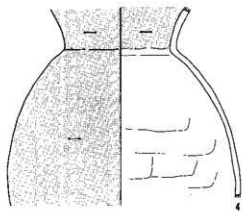
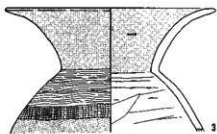
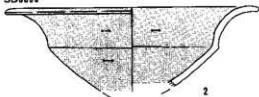

SD7014-①

0 (1:4) 10cm

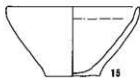
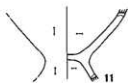
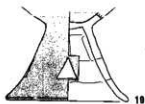
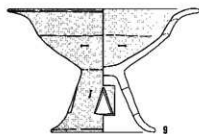
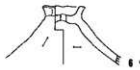

SD7014-②

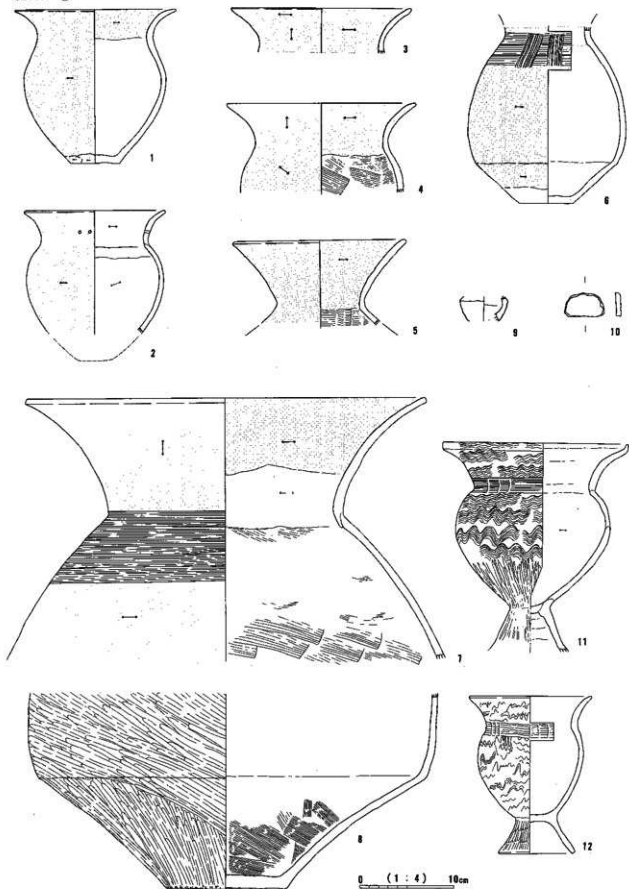

SD7014-③

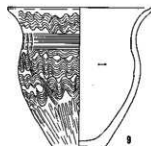
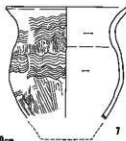
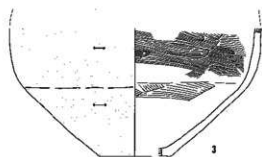
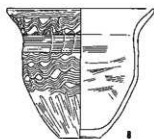
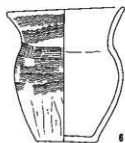
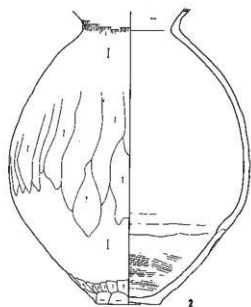
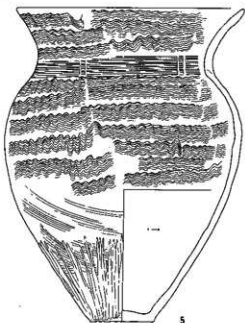
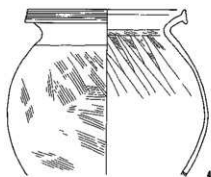
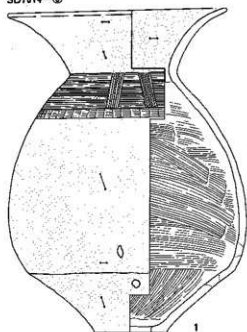

0 (1:4) 10cm

SD7014-③

SD7046-①

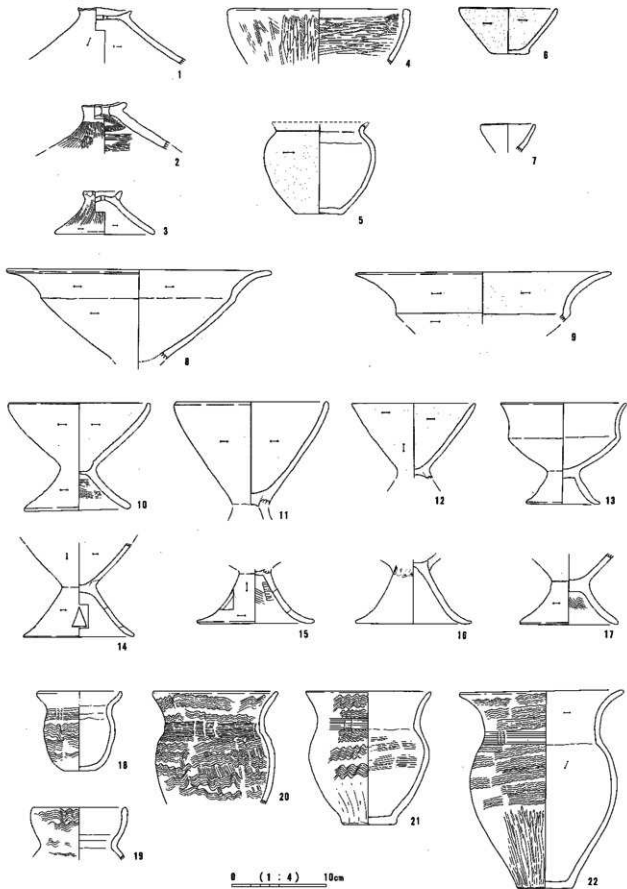

SD7046-②

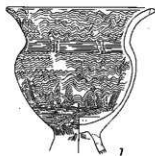
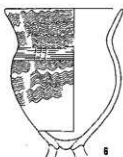
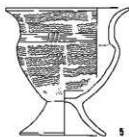
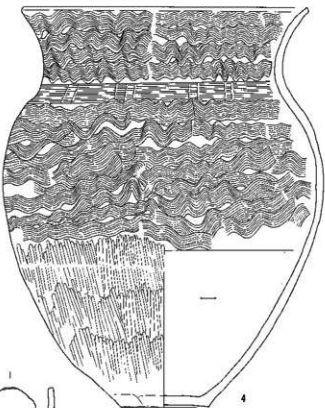
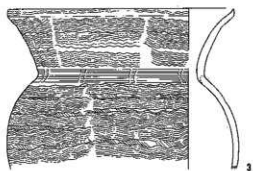
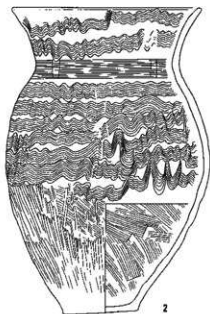
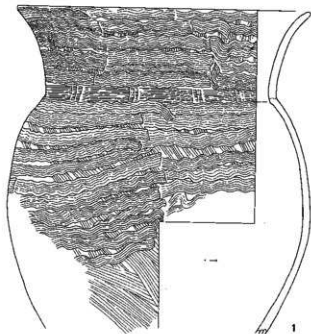

0 (1:4) 10cm

SD7046-②

SK6122

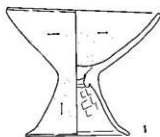

1

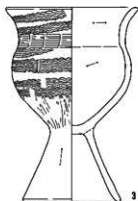

3

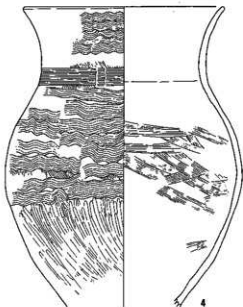

4

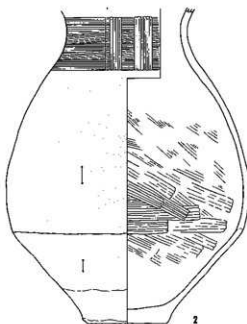

2

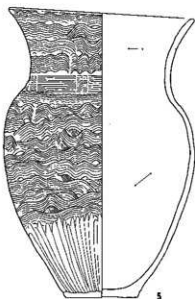

5

SK6184



6

SK6324

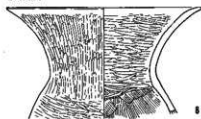

8

SK6213

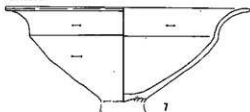

7



9

0 (1 : 4) 10cm

SK6222

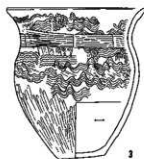
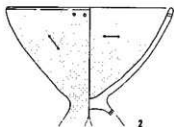
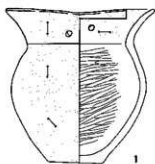

SK6352



SK6437



SK6415

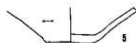
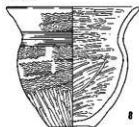

SK7075-①

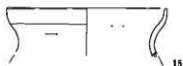
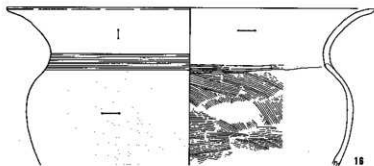
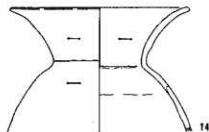
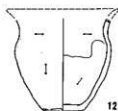
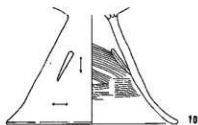
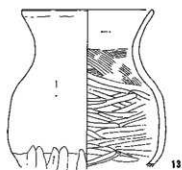
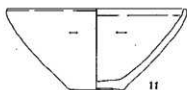

0 (1:4) 10cm

SK7075-②

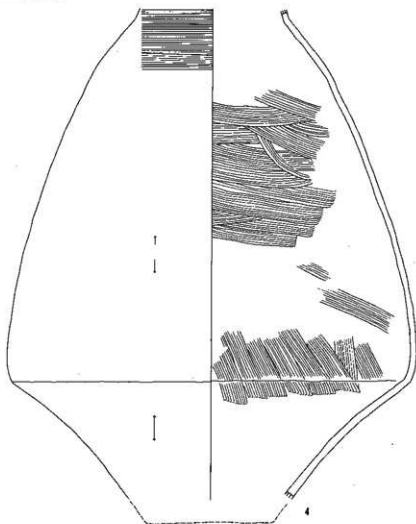
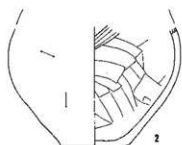
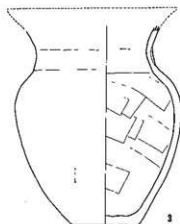
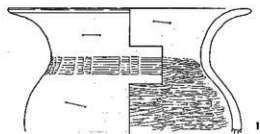

0 (1:4) 10cm

SK7075-②

SK7075-③

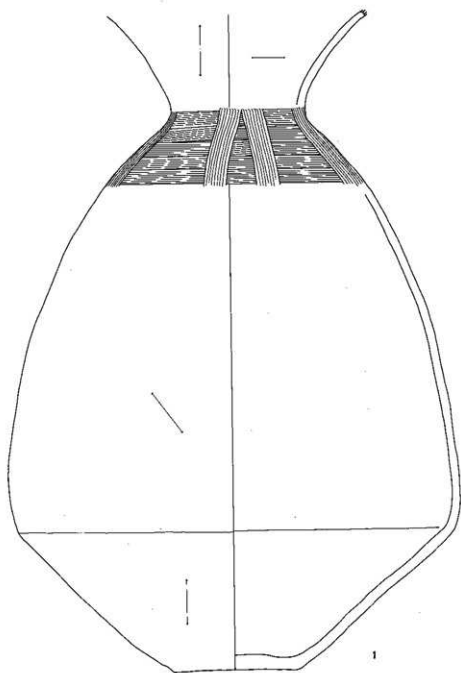

0 (1 : 4) 10cm

SK7075-③

SK7075-①

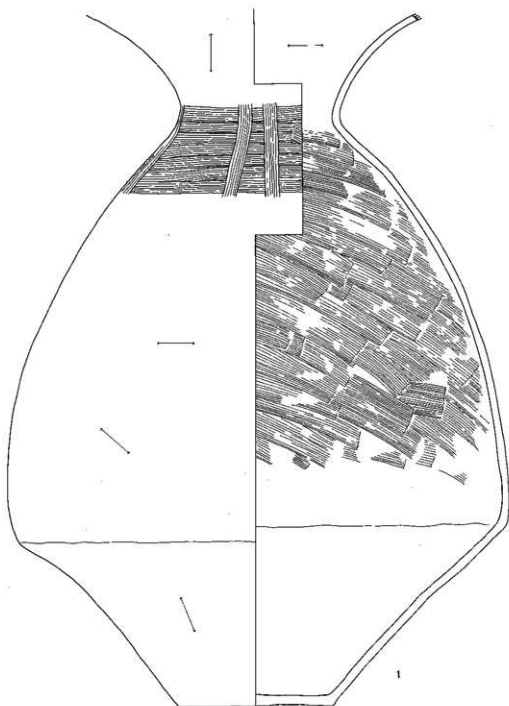

0 (1:4) 10cm

SK7075-④

SK7075-⑤

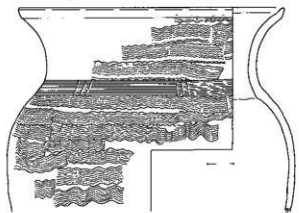

1

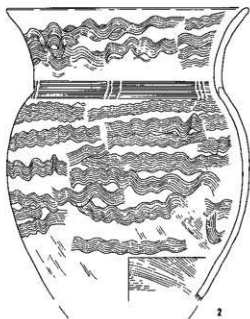

2

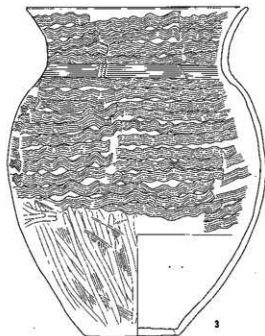

3

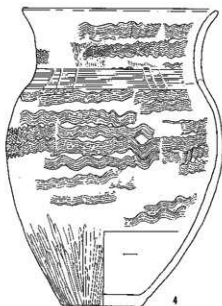

4

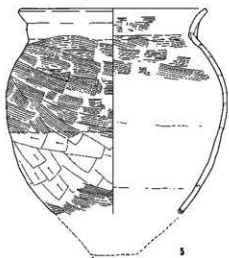

5

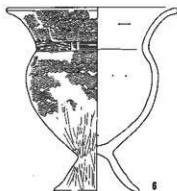

6

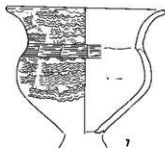

7

0 (1:4) 10cm

SK7092

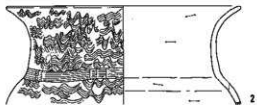
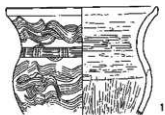

SK7105

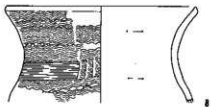
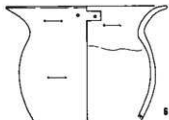
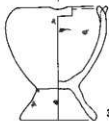
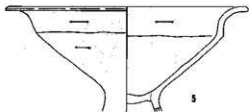

SK7135



SK7286



SK7328

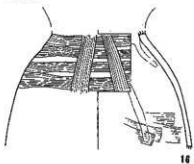

0 (1:4) 10cm

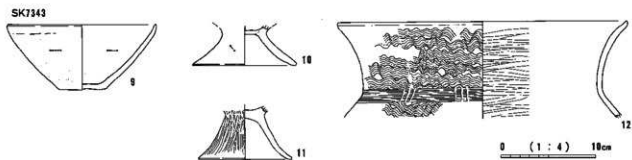
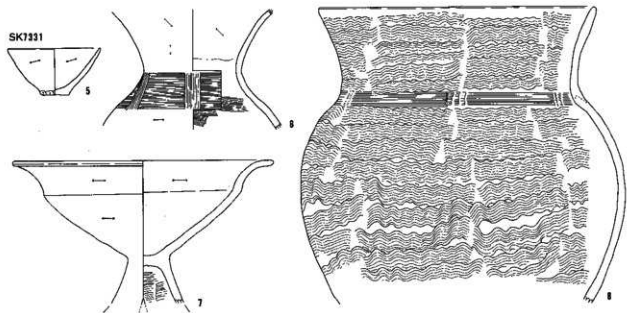
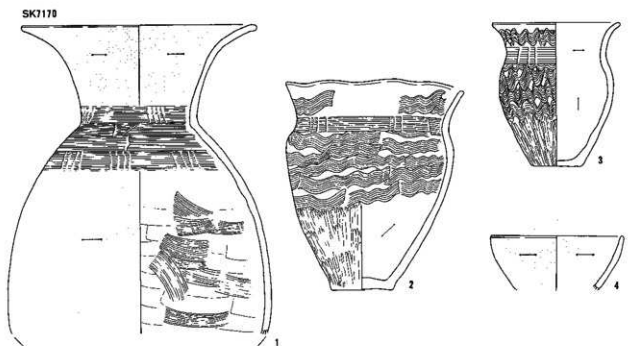

SK7359

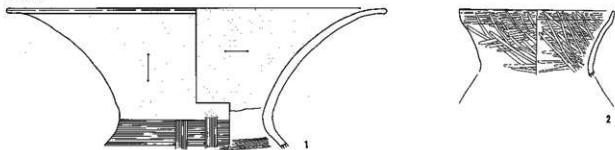

SK7483

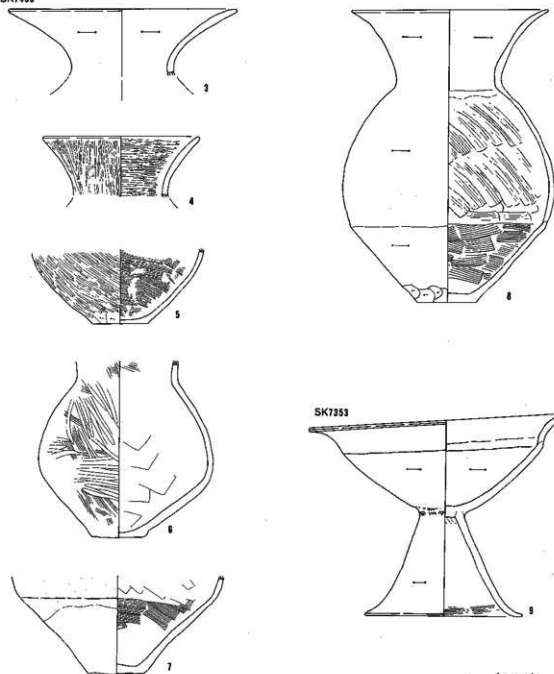

SK7353

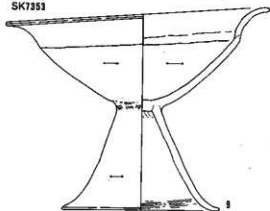

0 (1:4) 10cm

SK7362



SK7445



SK7470

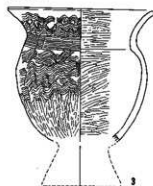

SK8152

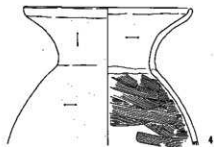

SK8320

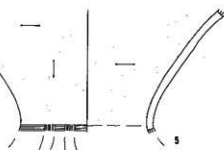

SK8222

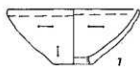

0 (1 : 4) 10cm

SK8476

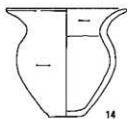

SK8488

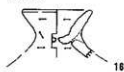

SK8551



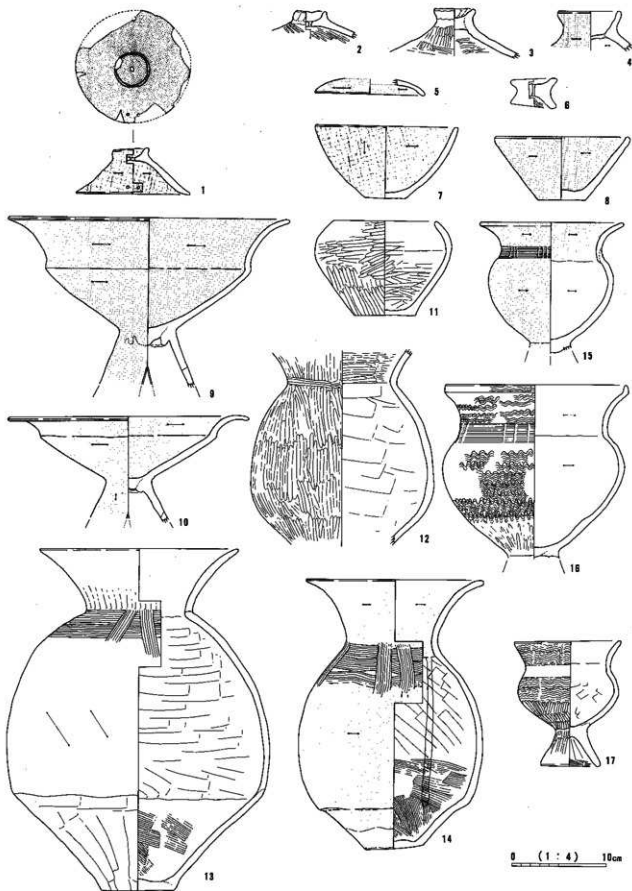

SB6001

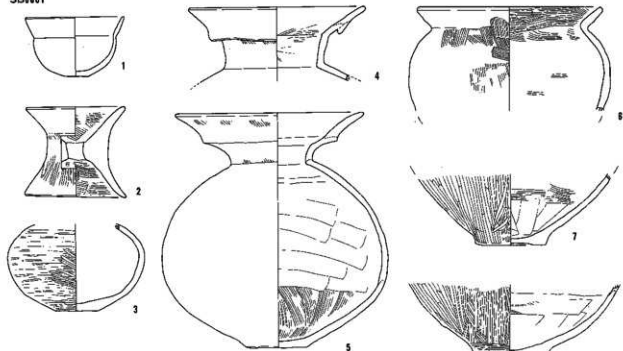

SB6004

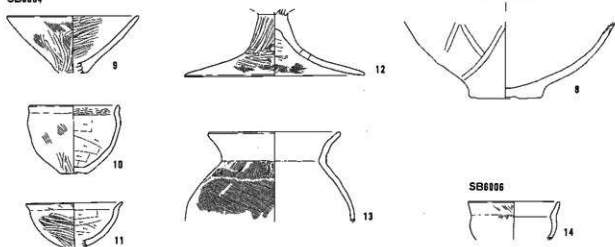

SB6006

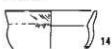

SB6007



SB6011



SB6008

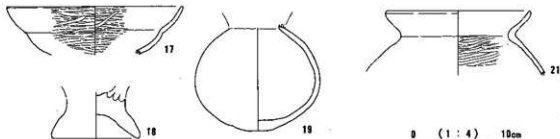

SB6016

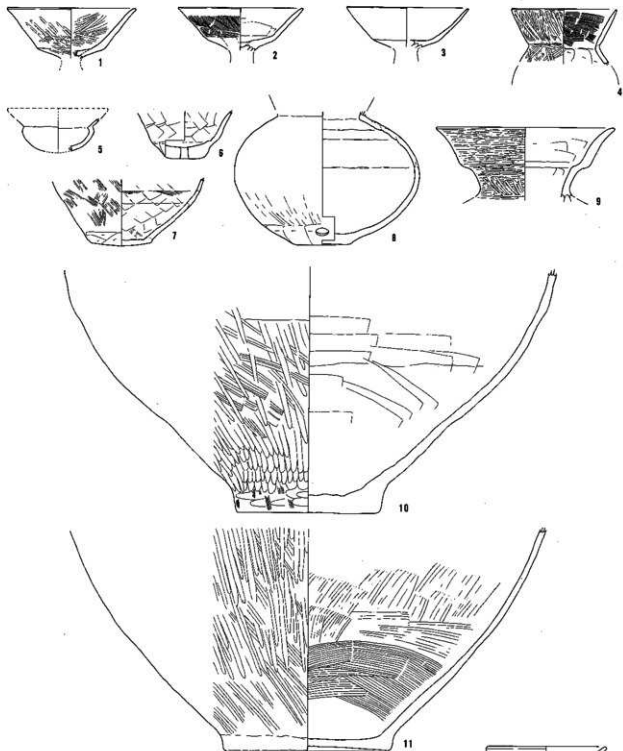

SB7842

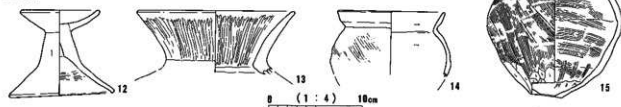

SB6013

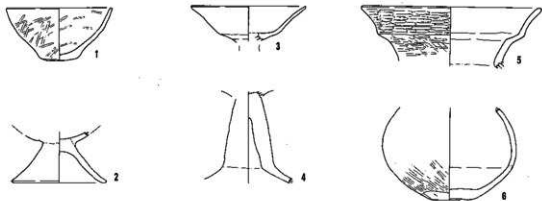

SB6018



SB6019



SB6025



SB6027

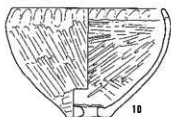

SB6029

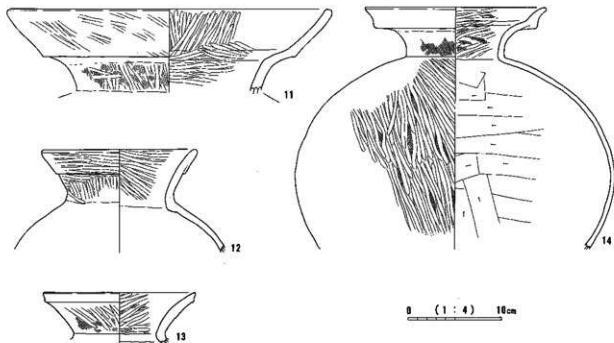

0 (1:4) 10cm

SB7080



SB7129

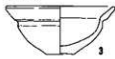

SB7195

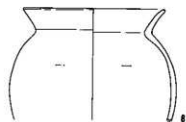

SB7172

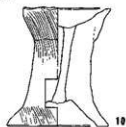

SB7184

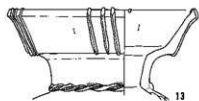

SB7193

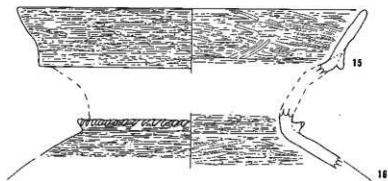
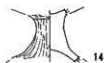

SB7244

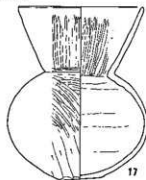

SB7188

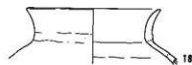

0 (1:4) 10cm

SB7213

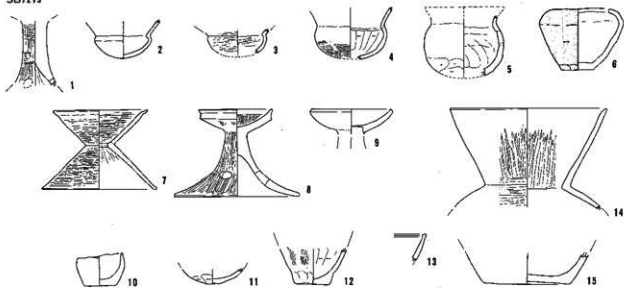

SB7228

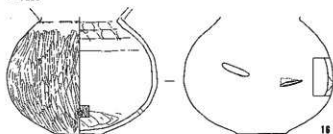

SB7246-①

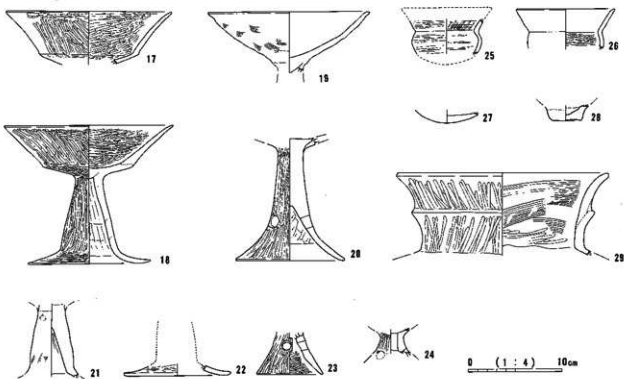

0 (1:4) 10cm

SB7246-②

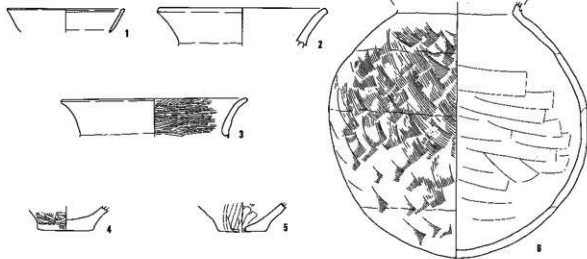

SB7250

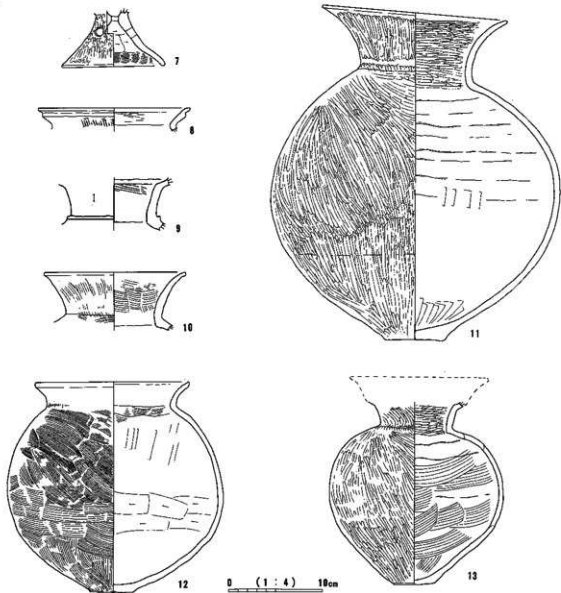

SB7254-①

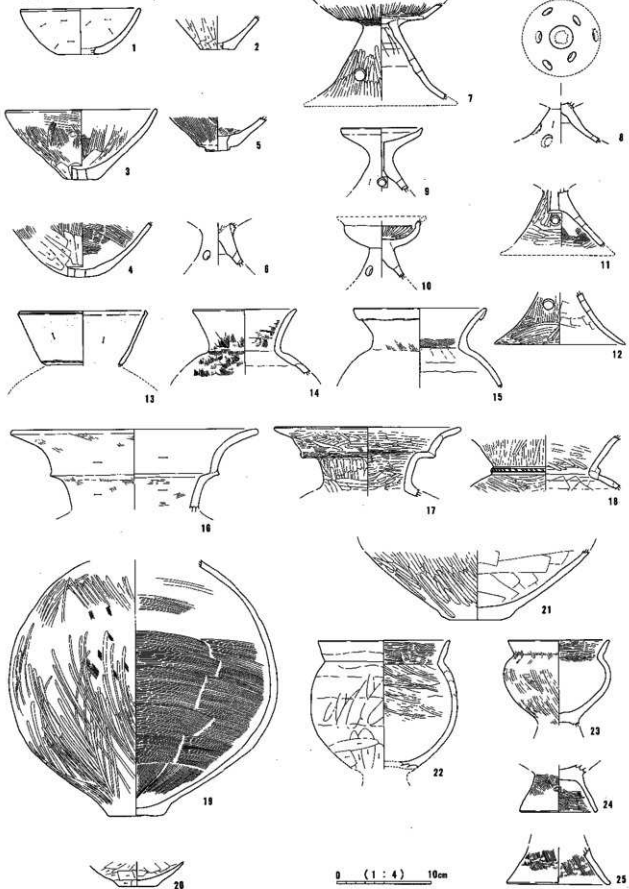

SB7254-②

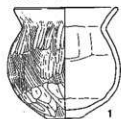

1

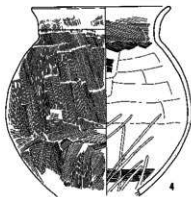

4

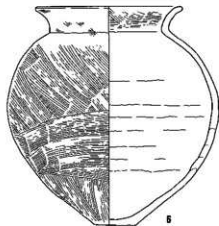

6

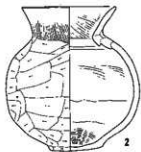

2

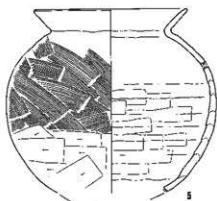

5

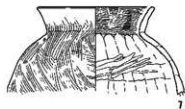

7

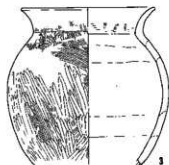

3

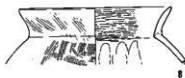

8



9



12



10



13

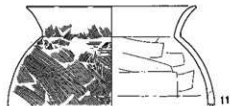

11



14

0 (1:4) 10cm

SB7255

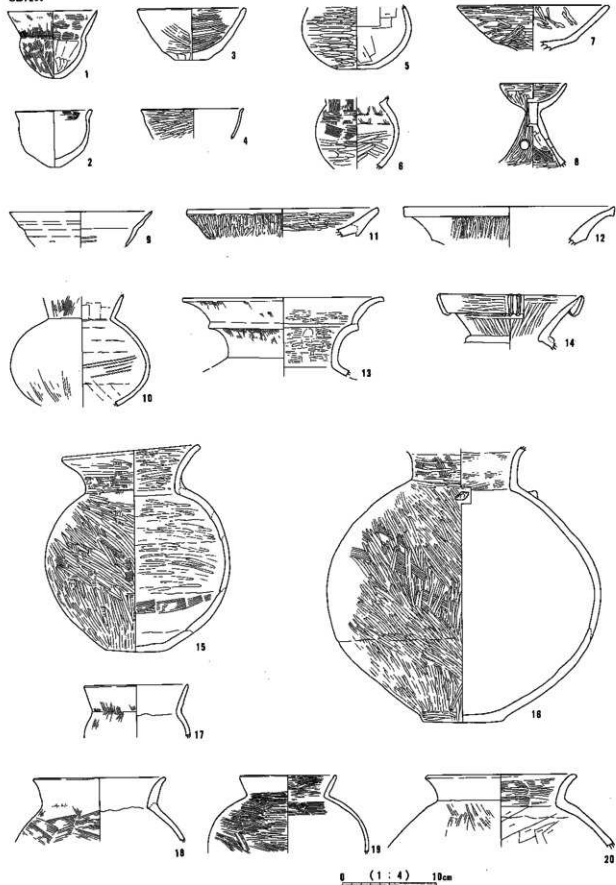

SB7255

SB7256-①

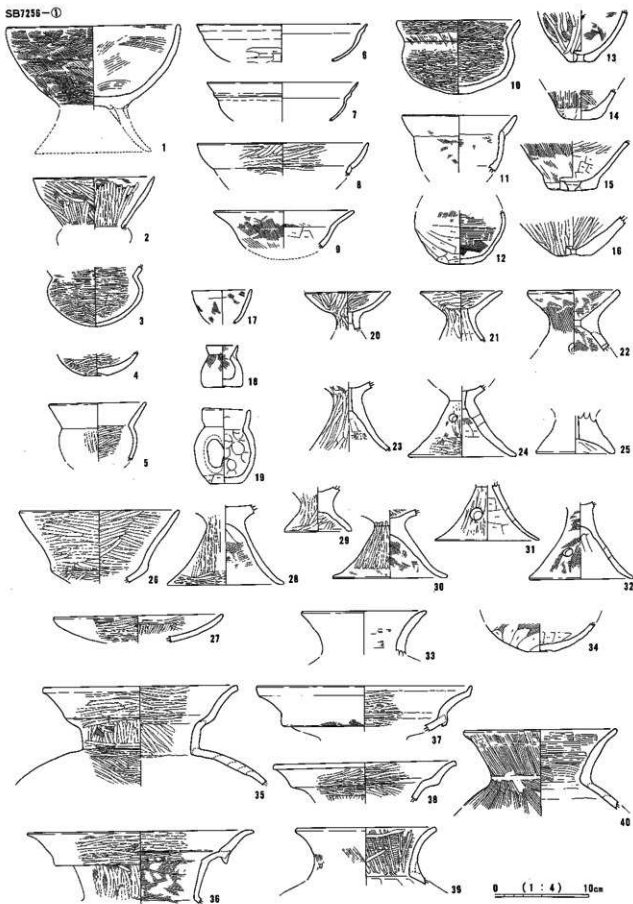

SB7256-①

SB7256-②

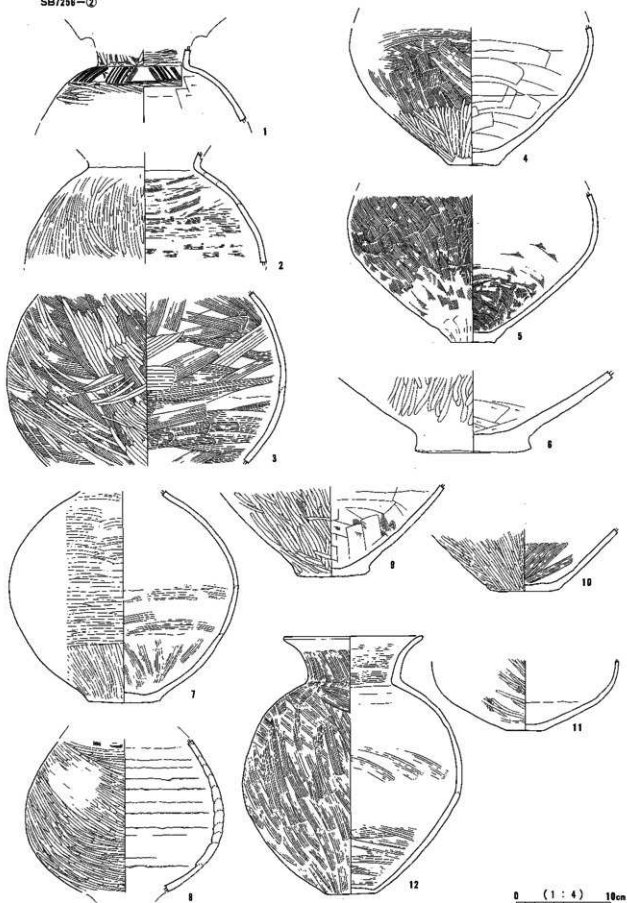

SB7256-②

SB7256-③

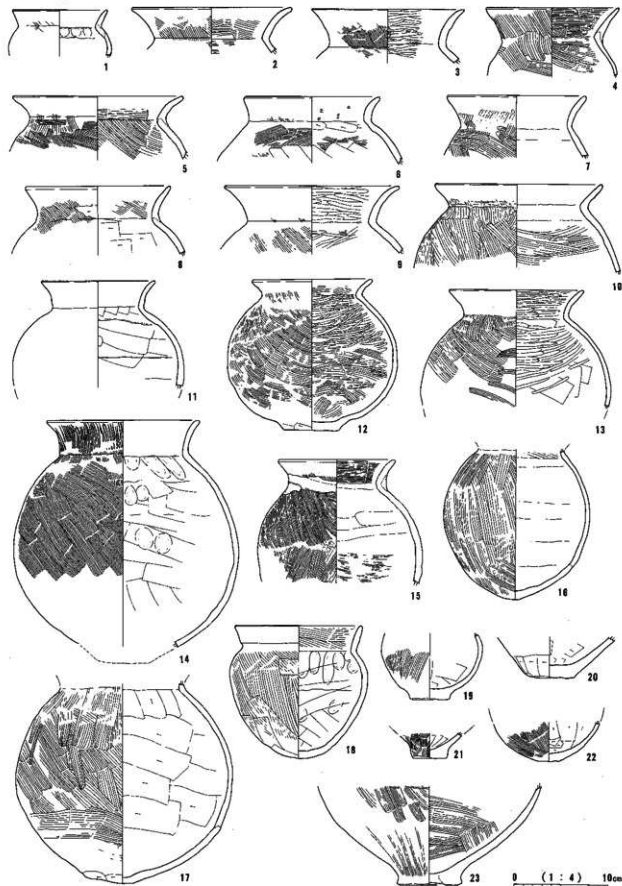

SB7256-③

SB7256-④

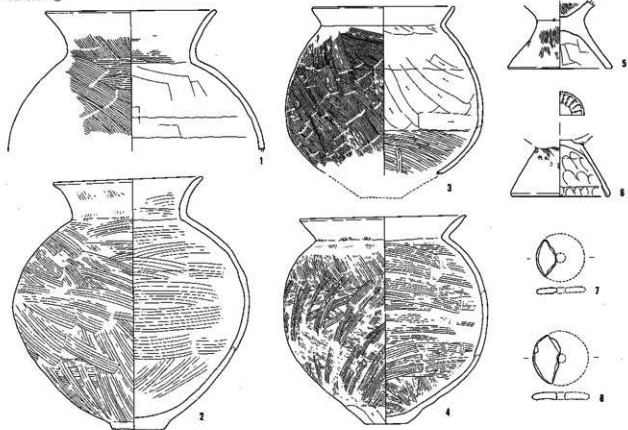

SB7257

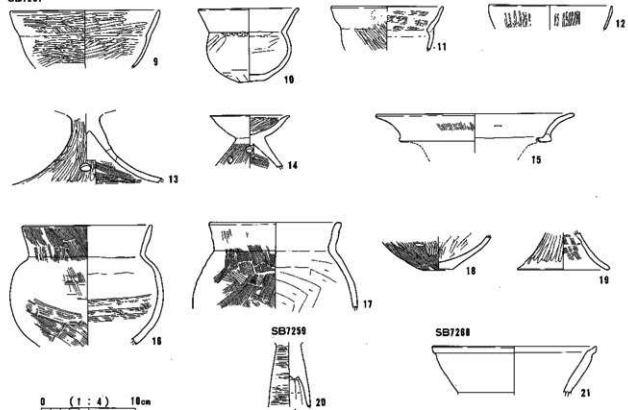

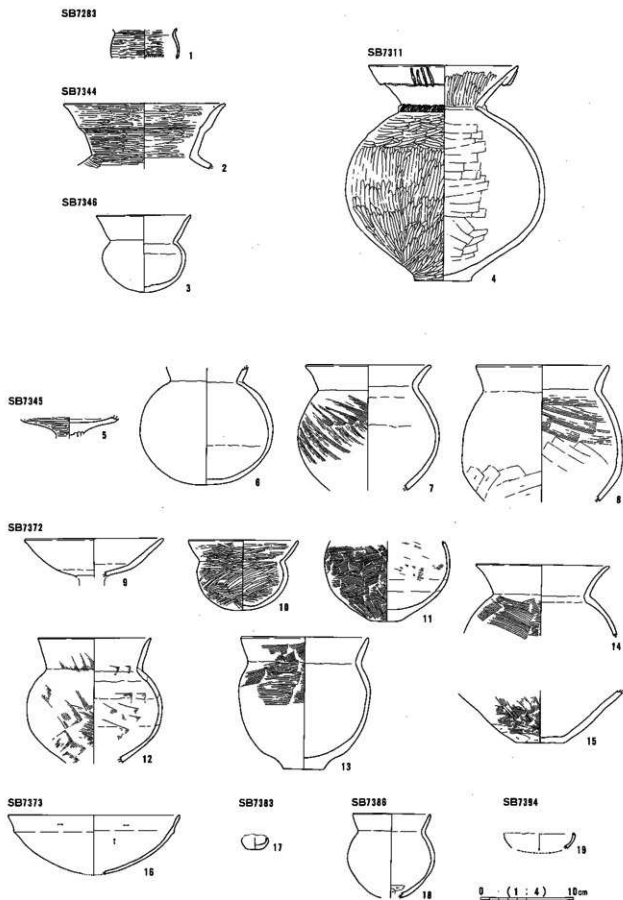

SB7381

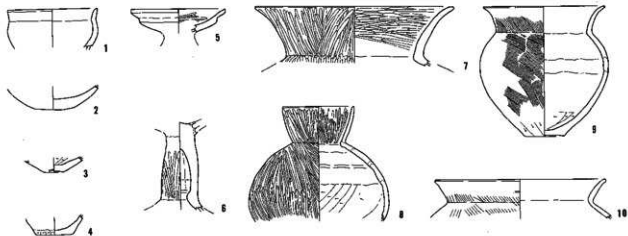

SB7401

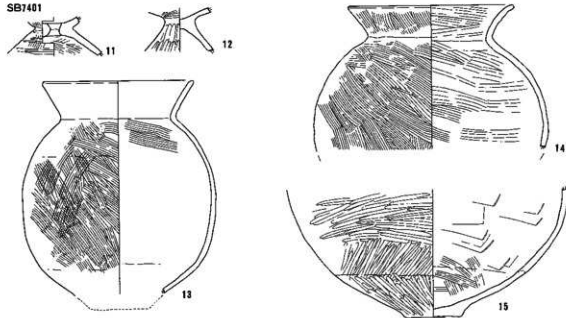

SB7420

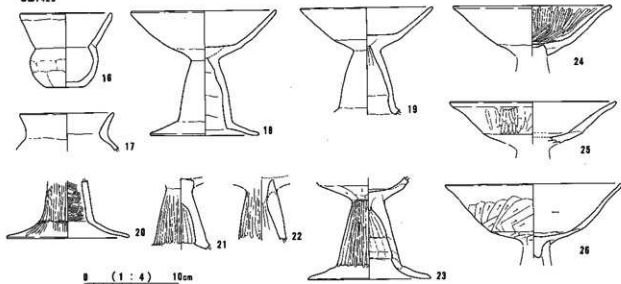

0 (1:4) 10cm

SB7418



1

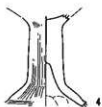

4



7



2



5

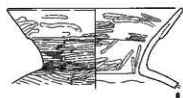

8



3



6



9



10



11



12

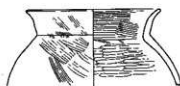

13

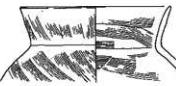

14



15

SB7446



16

SB7458



17

SB7494



18

SB7517



19



21

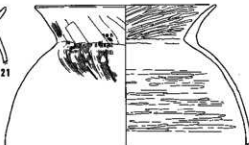

22

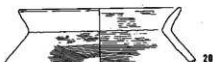

20

0 (1:4) 10cm

SB7442

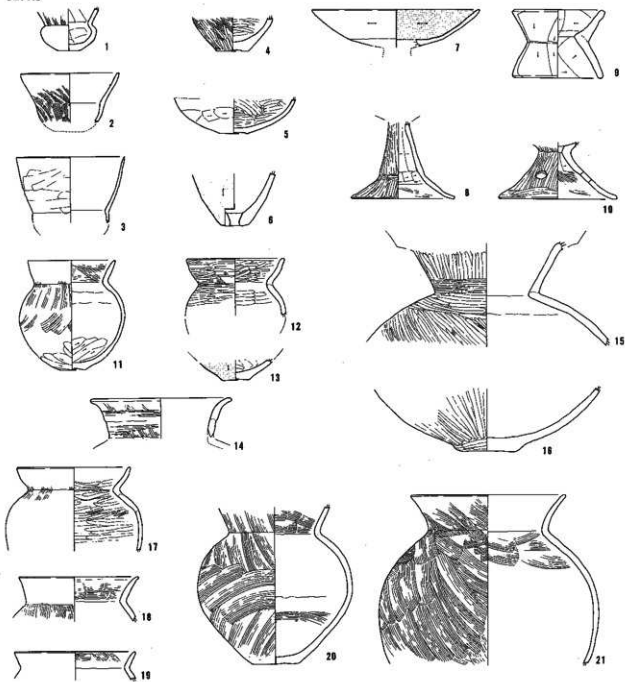

SB7508-①

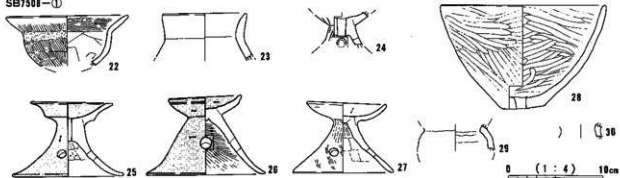

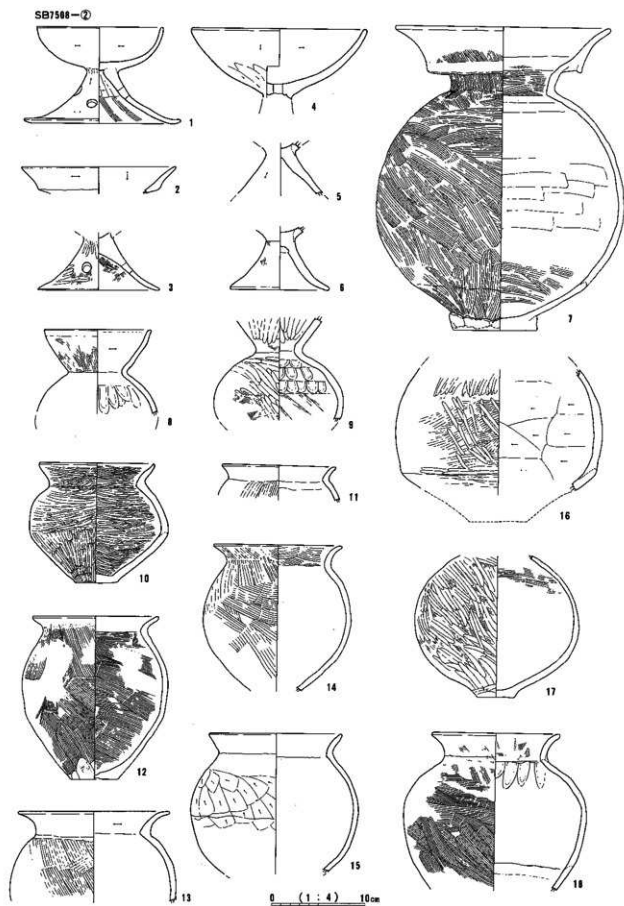

SB7508-①

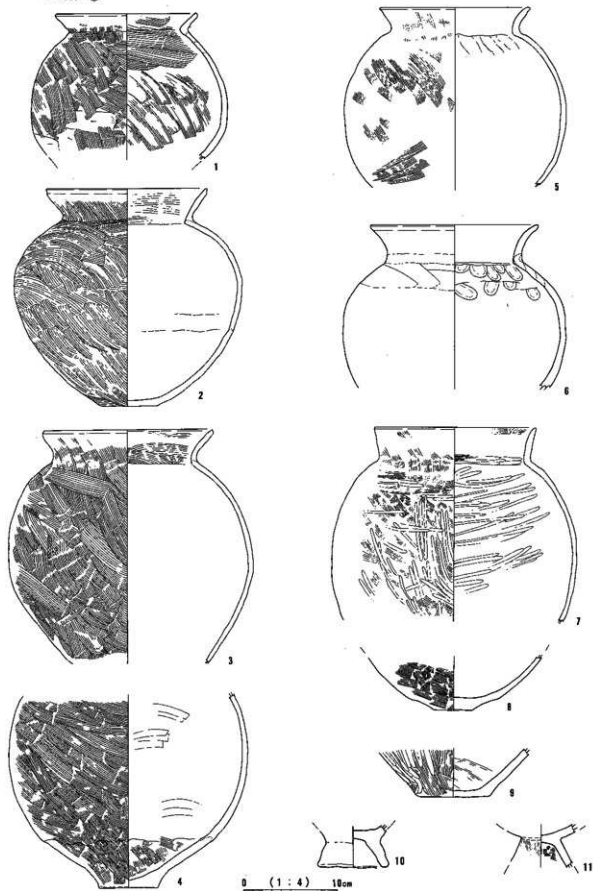

SB7508-③

SB7508-①

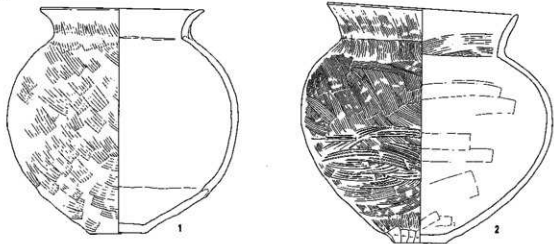

SB7581

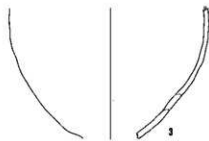

SB7586

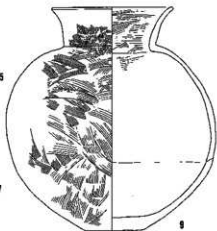
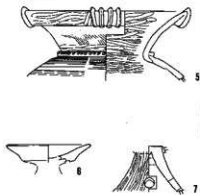

SB7588



SB7634

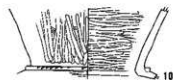

SB7642



SB7646

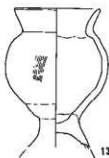

0 (1:4) 10cm

SB7639

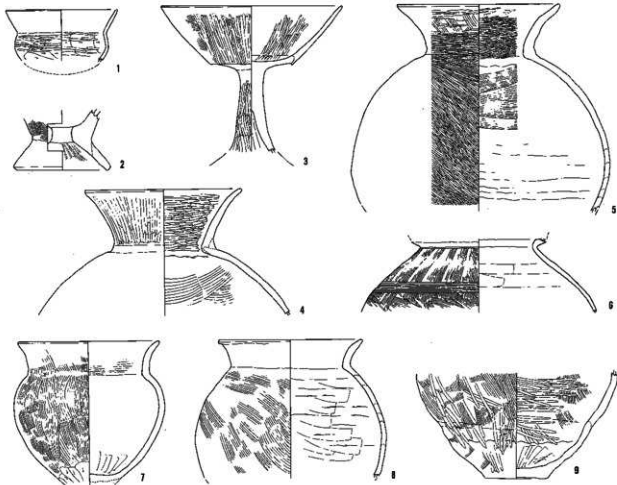

SB7649

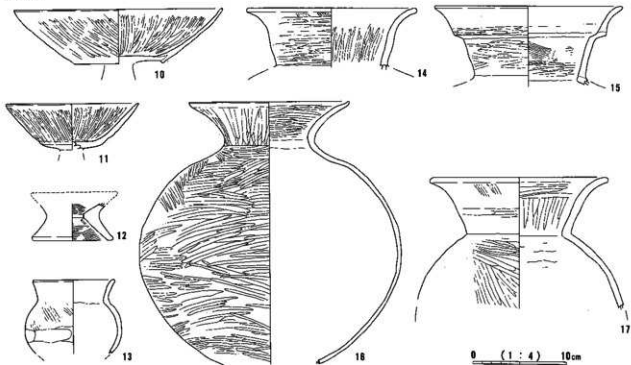

SB7654

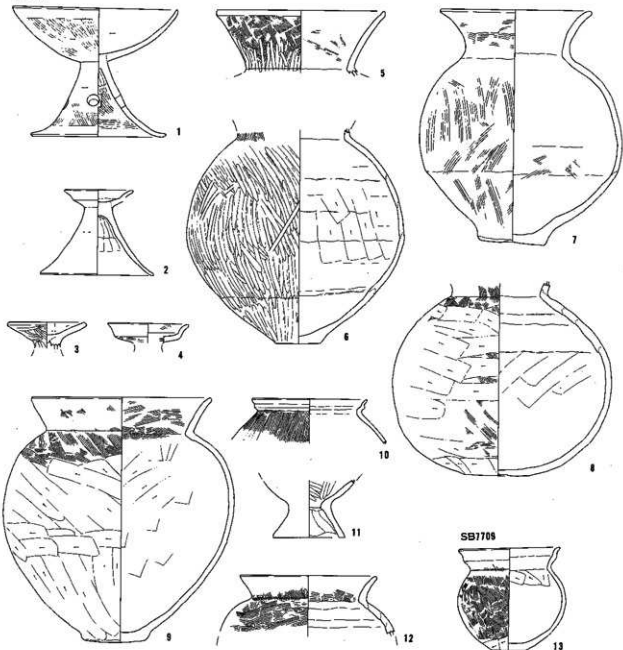

SB7722

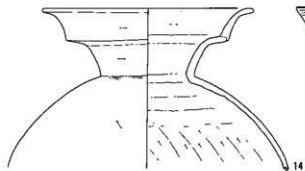

SB7726



SB7745



0 (1:4) 10cm

SB7751

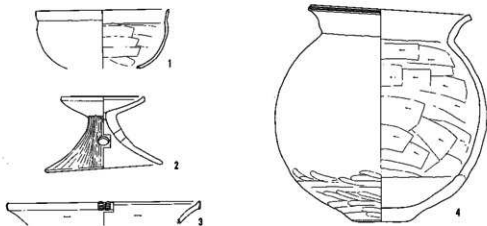

SC6001

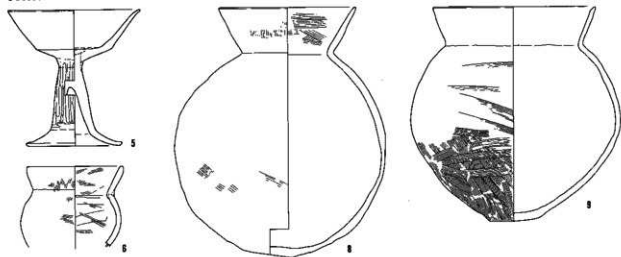

SM7001

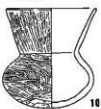

SM7035

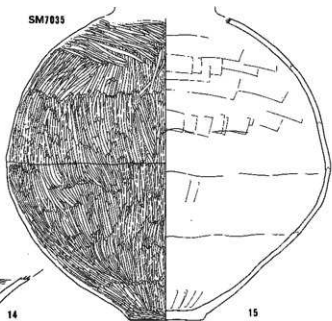

SM7032

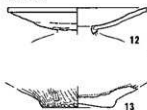

0 (1:4) 10cm

SD6015

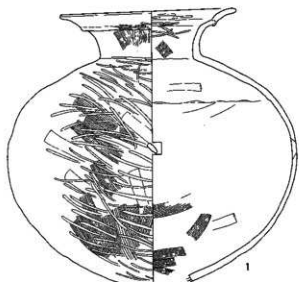

SD6016

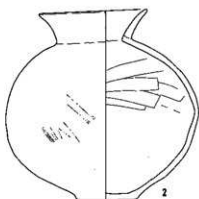

SD6023-①

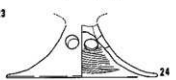
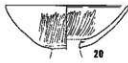
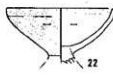
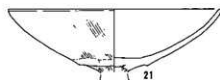
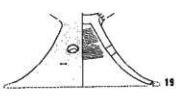
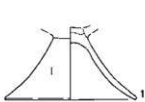
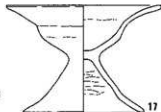
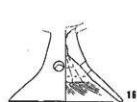
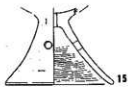
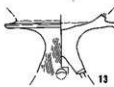
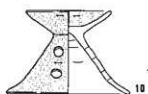
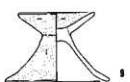
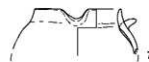
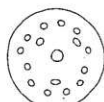
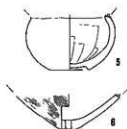

0 (1:4) 10cm

SD6023-②

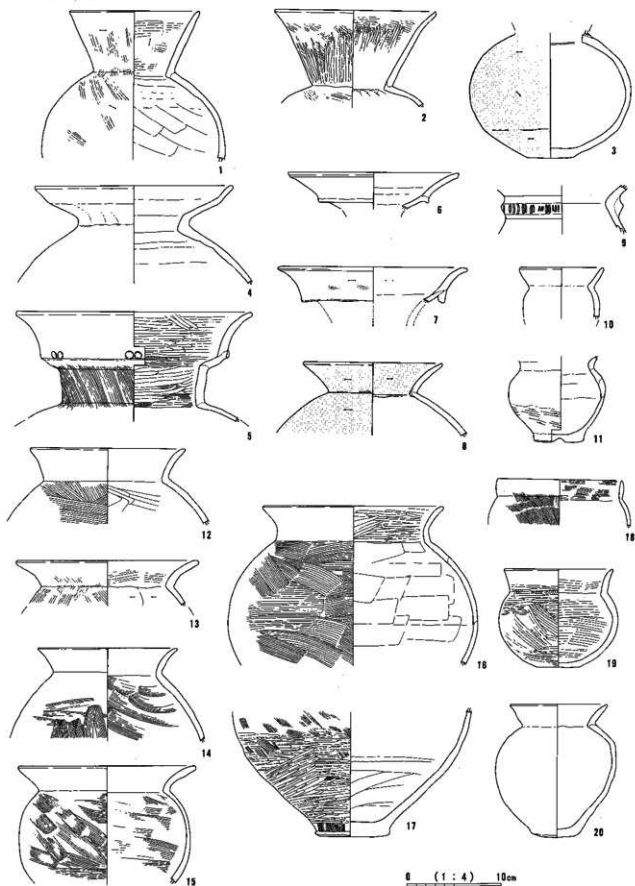

SD6023-②

SD6023-①

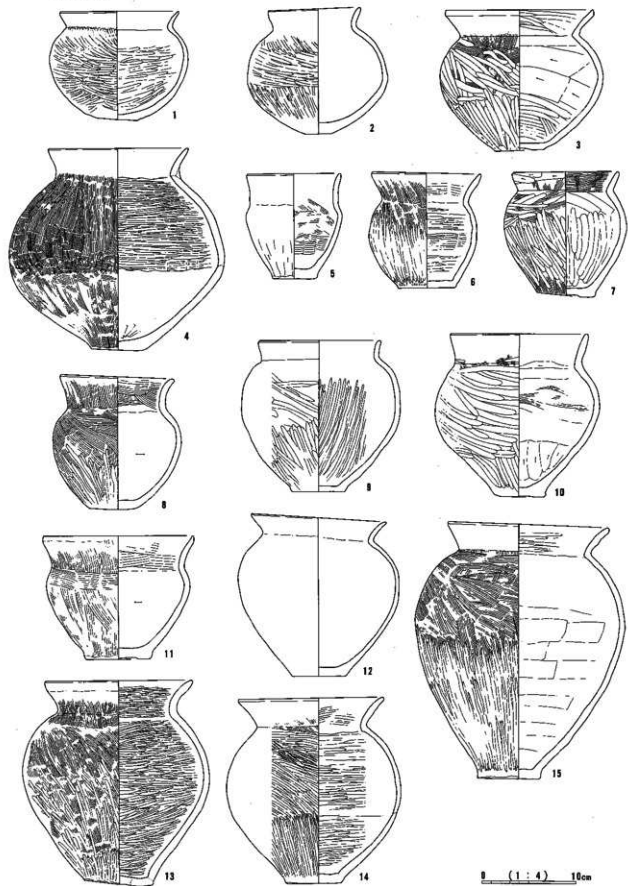

SD6023-③

SD6023-④

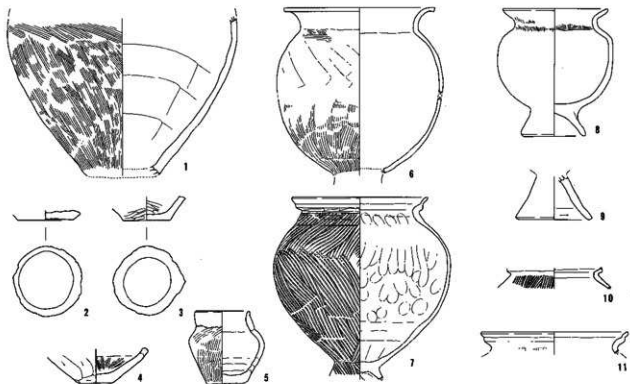

SD7014-①

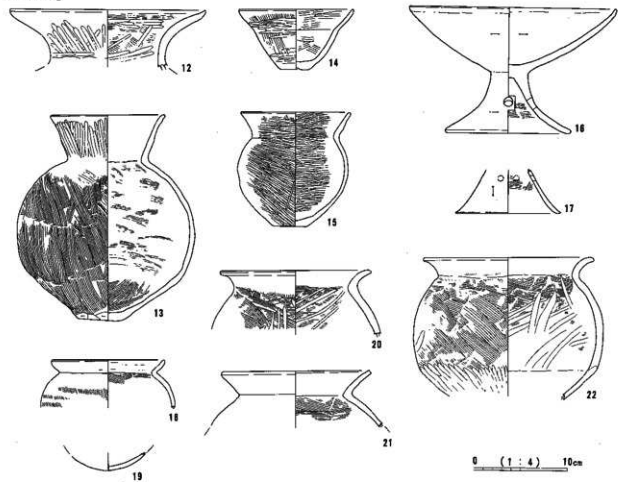

SD7814-②

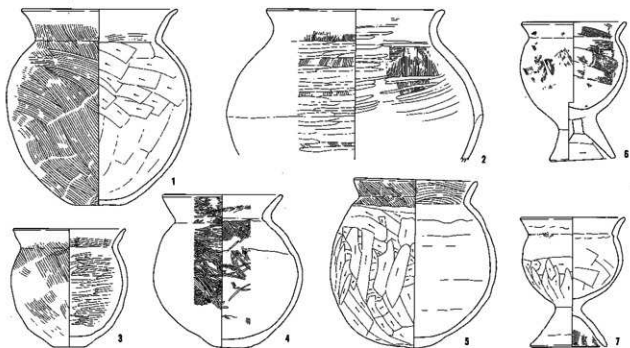

SD7830-①

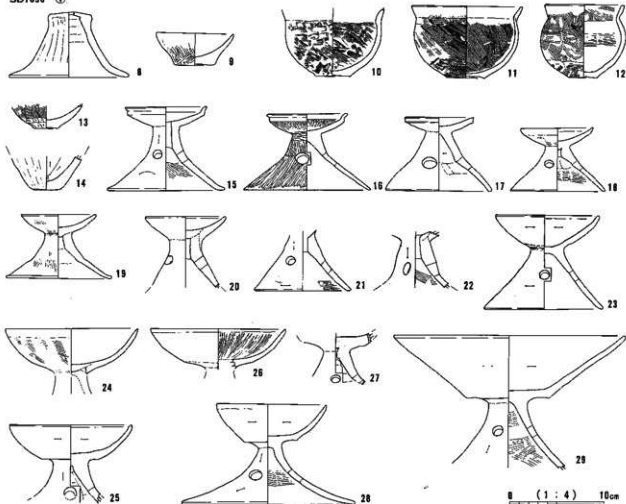

SD7030-②

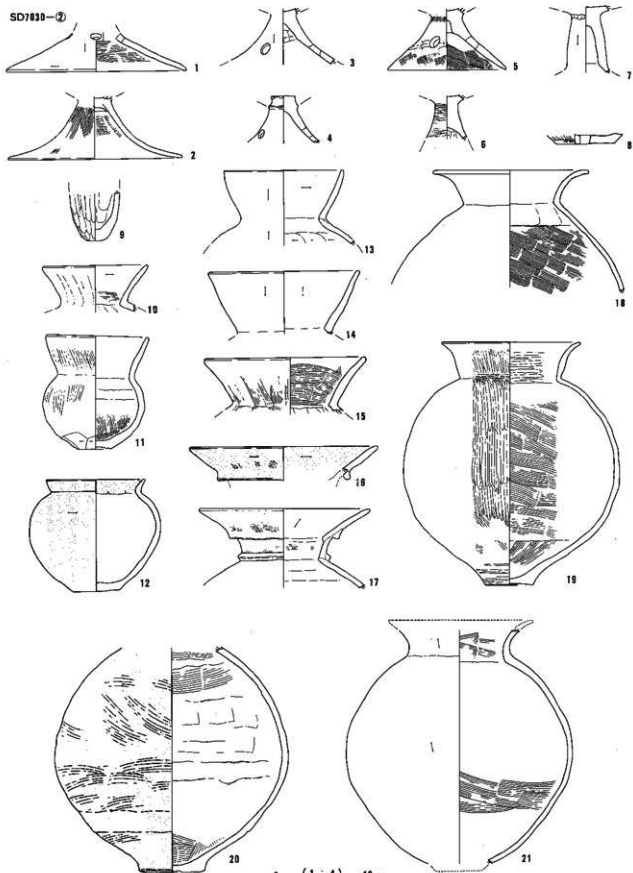

SD7030-②

SD7030-①

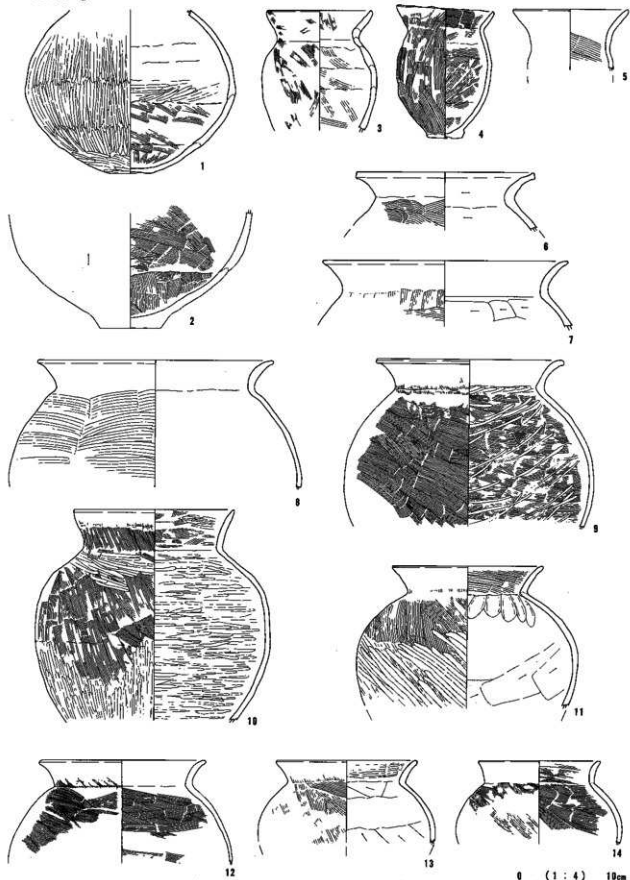

SD7030-③

SD7030-④

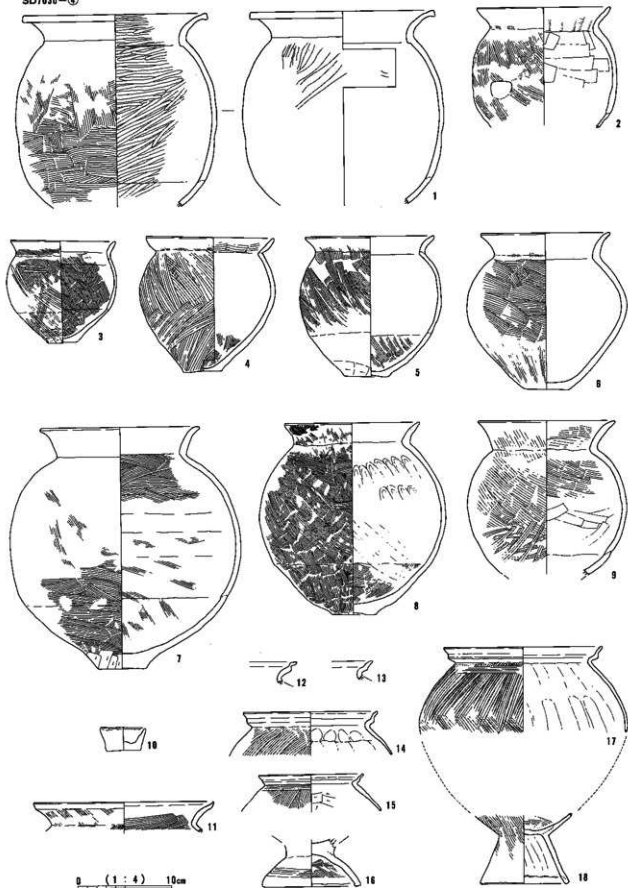

SD7030-④

SD7088



1



2



3



4

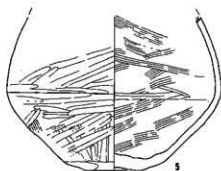

5

SD7084



6



SK6048

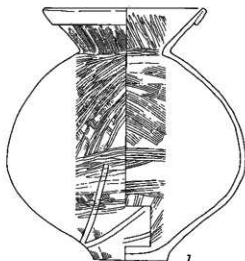

7

SK6108

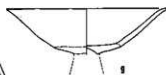

8

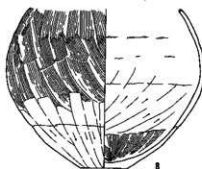

9

SK6113



10



11

SK6117

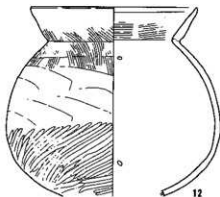

12

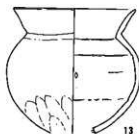

13

SK6133



14

0 (1 : 4) 10cm

SK6099

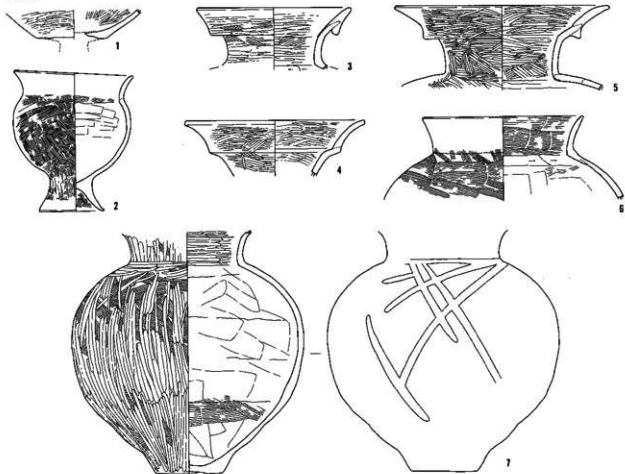

SK6142

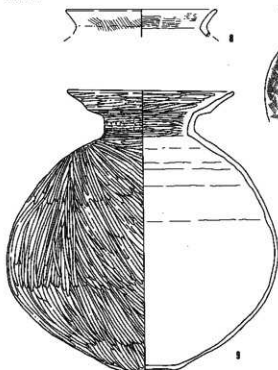

SK6180

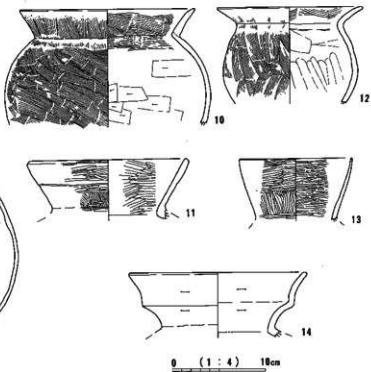

SK6186

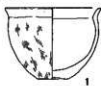

SK6290

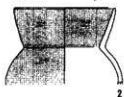

SK6298

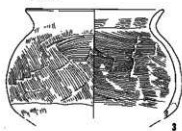

SK6310

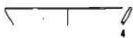

SK6321

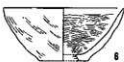

SK6202-①

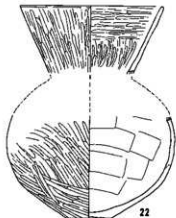
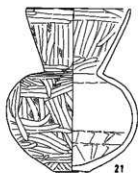
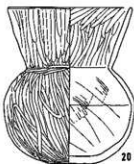
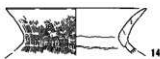
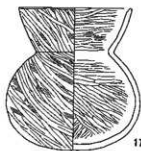
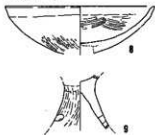

0 (1:4) 10cm

SK6202-②

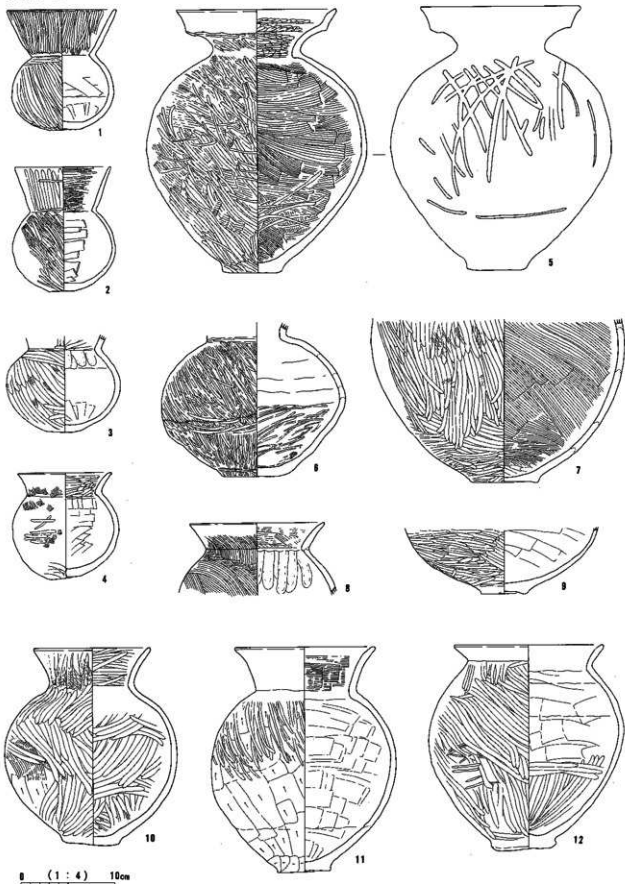

SK6202-①

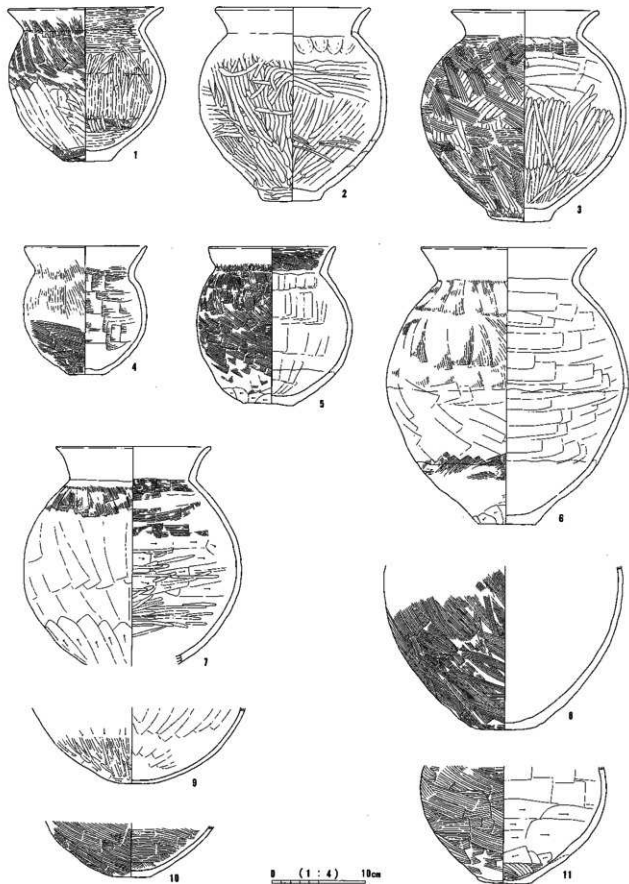

0 (1:4) 10cm

SK6202-③

SK6307

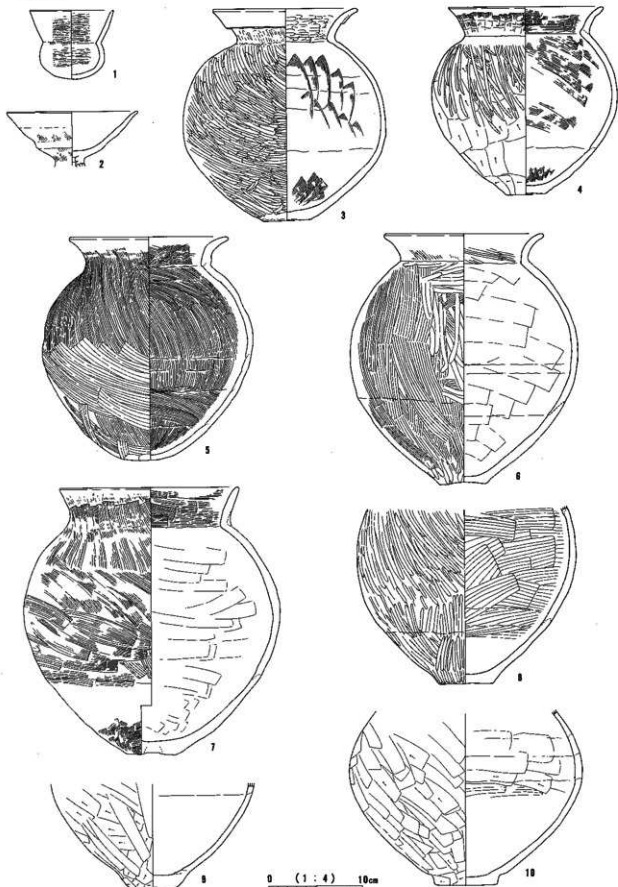

SK6307

SK6406

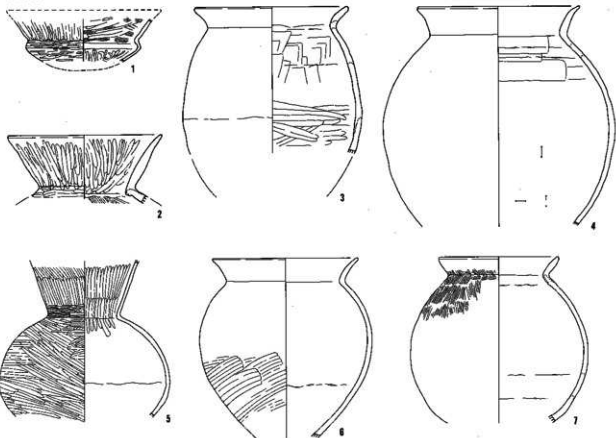

SK6441

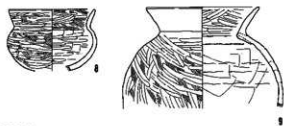

SK7146

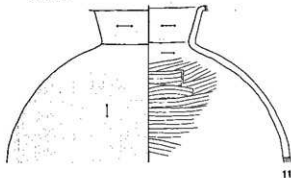

SK7130

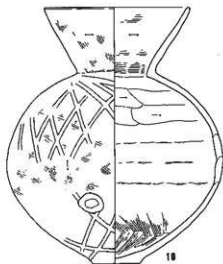

0 (1:4) 10cm

SK7256

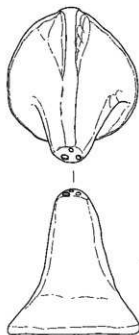

SK7187

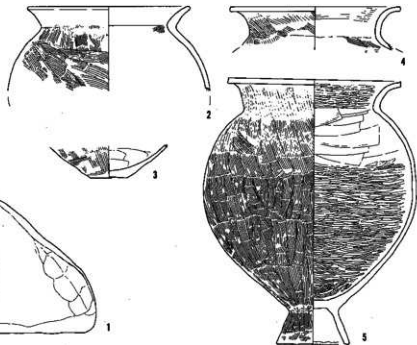

SK7328

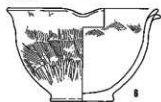

SK7384

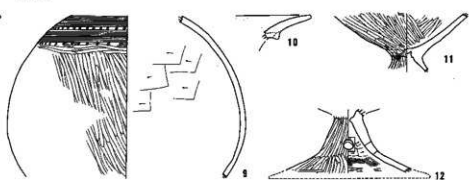

SK7483

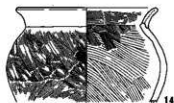

SK7588

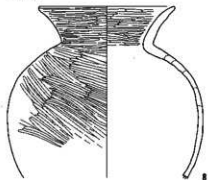

SK7488



SK7480

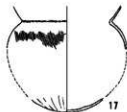

0 (1 : 4) 10cm

SK7367

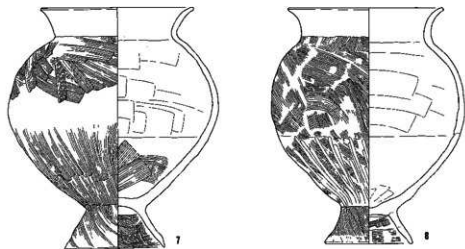
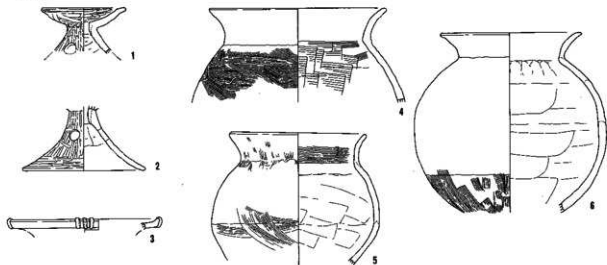

SK7608

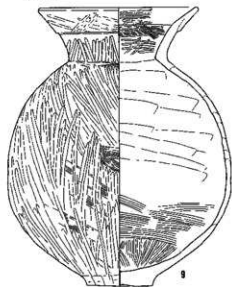

SK8011

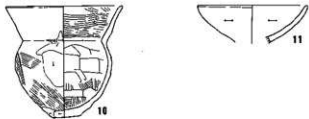

SK7822



0 (1 : 4) 10cm

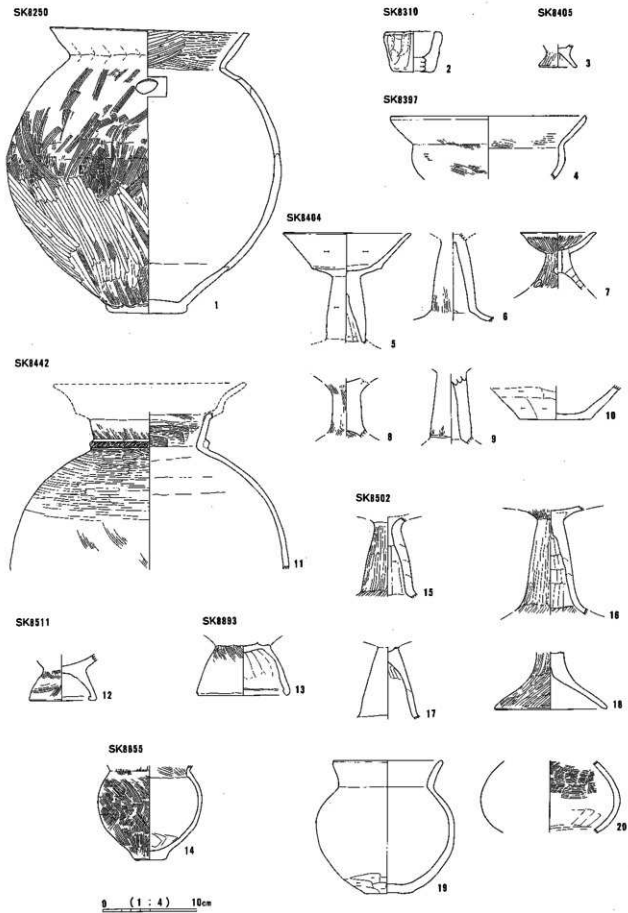

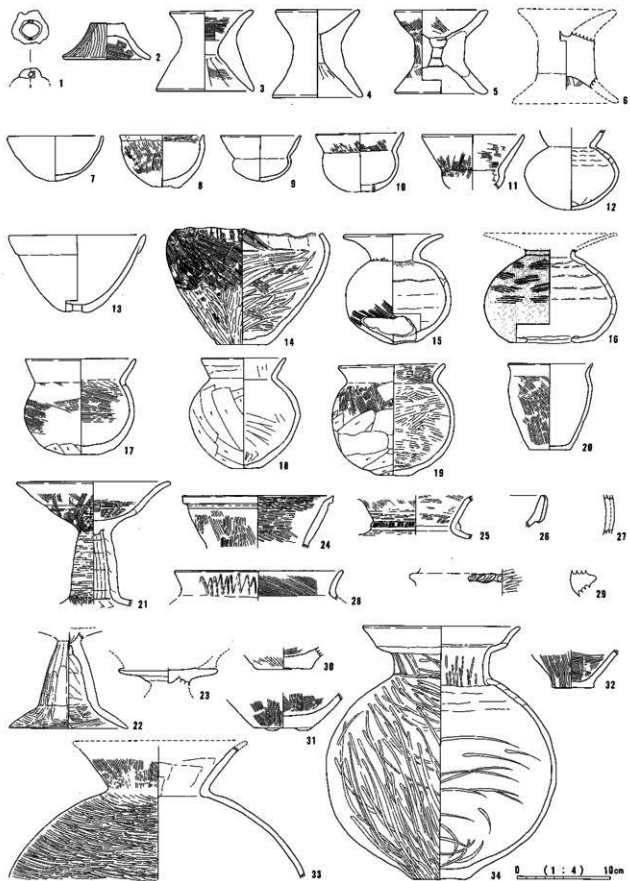

SB6020

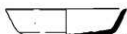

SB6023



SB6024



SB7001-①

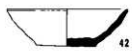
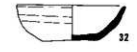
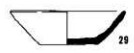
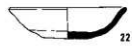
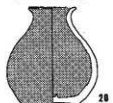
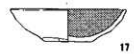
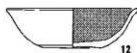
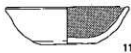
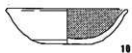
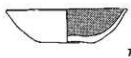
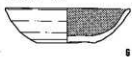

0 (1:4) 10cm

SB7001-①

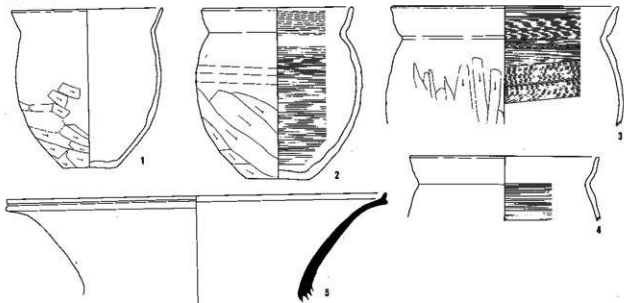

SB7002

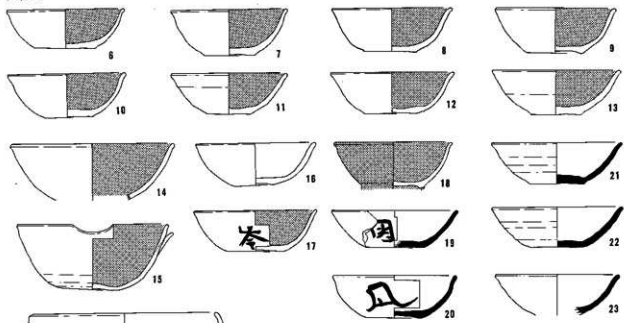

SB7003

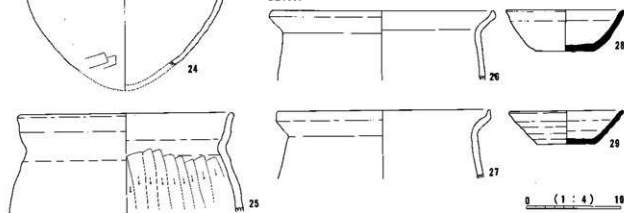

SB7004

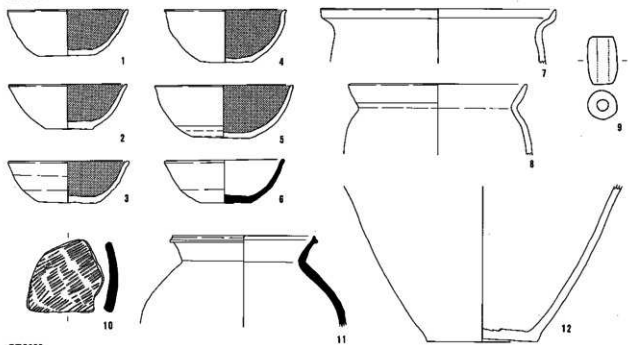

SB7005

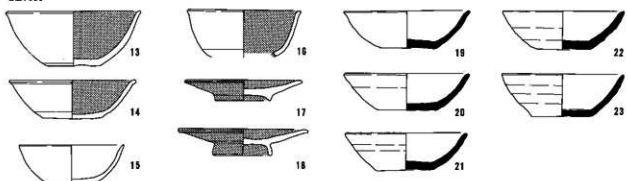

SB7006

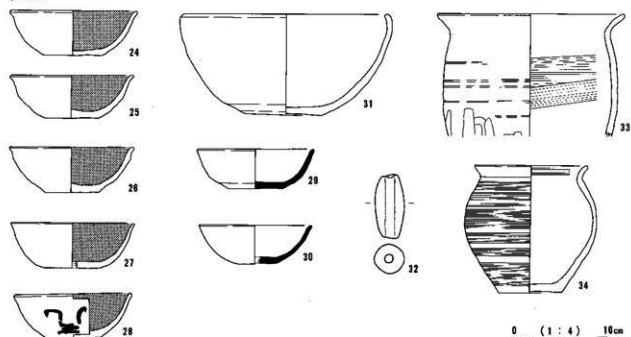

0 (1:4) 10cm

SB7007

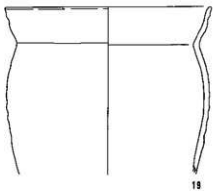
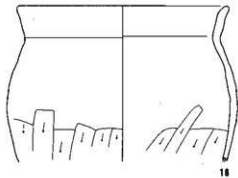
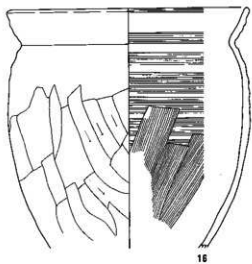
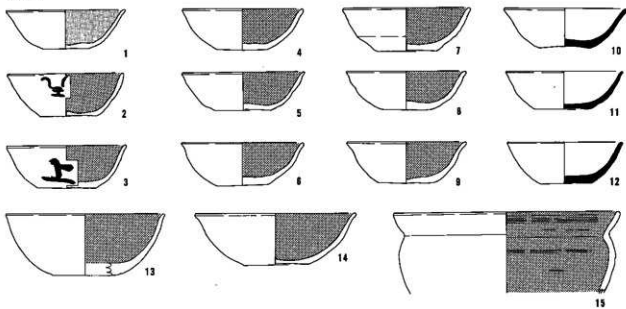

SB7008

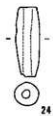
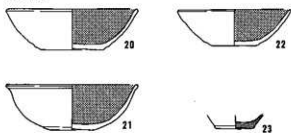

0 (1 : 4) 10cm

SB7009

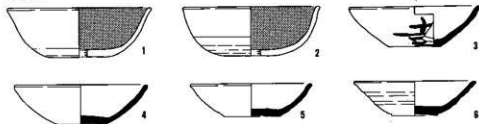

SB7010

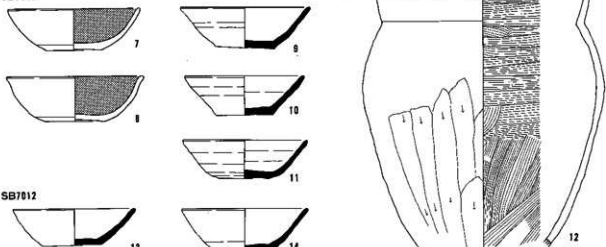

SB7012



SB7011

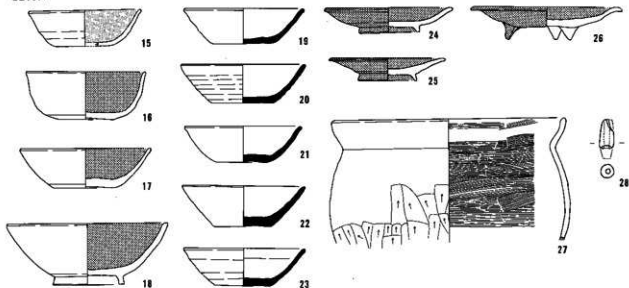

SB7014



0 (1:4) 10cm

SB7013

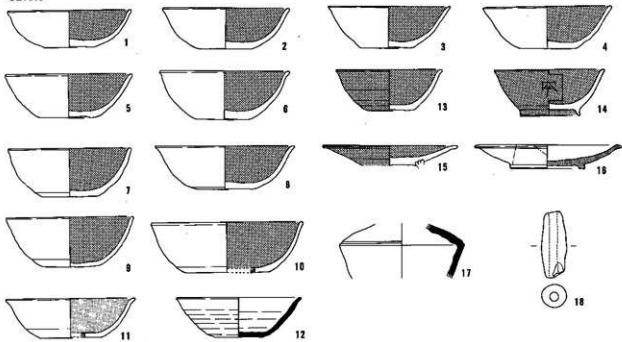

SB7015

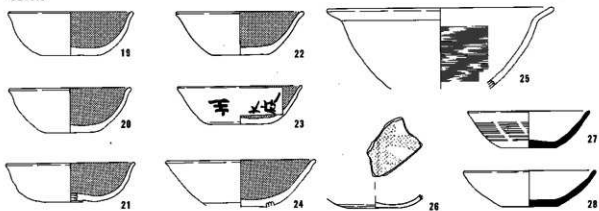

SB7016

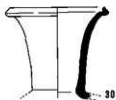

SB7018



SB7022

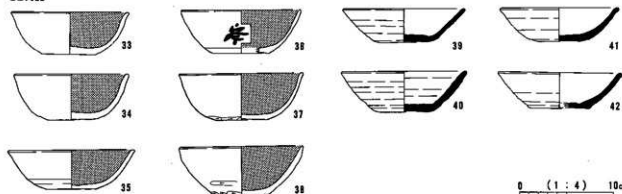

0 (1 : 4) 10cm

SB7018

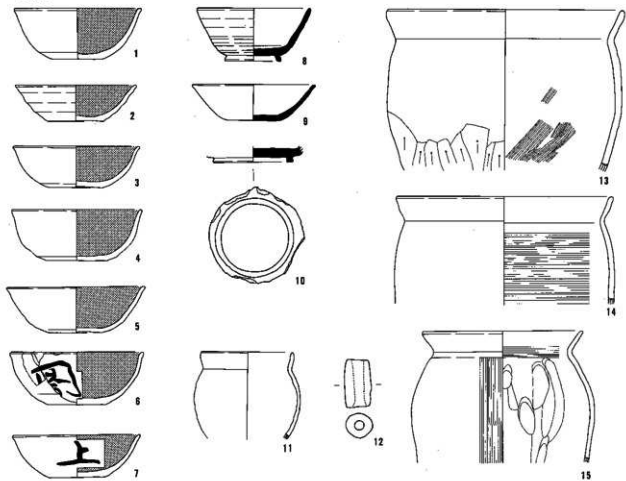

SB7025

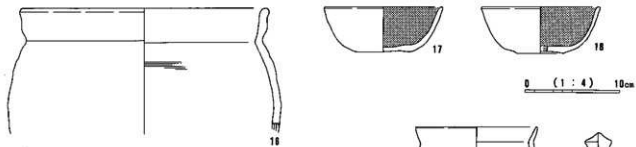

SB7026

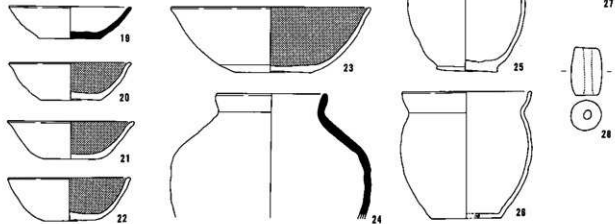

SB7029

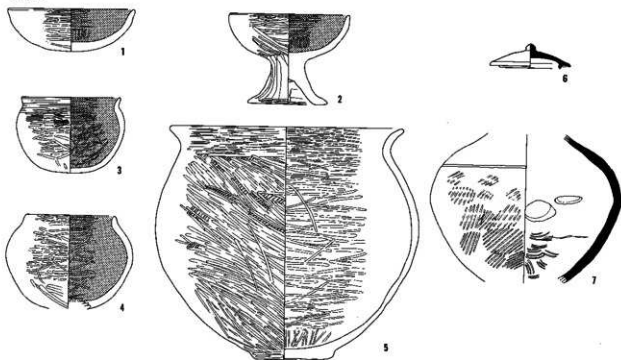

SB7030

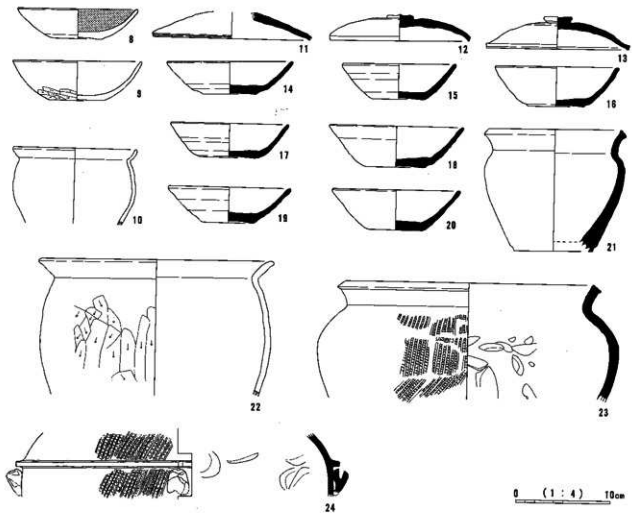

0 (1:4) 10cm

SB7031

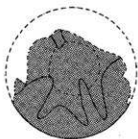
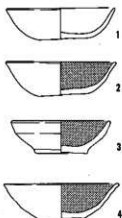

SB7033

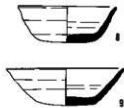
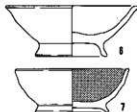

SB7036



SB7041

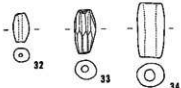
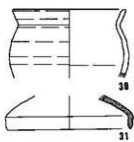
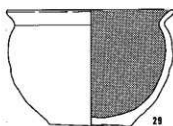
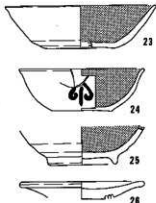
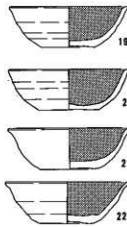
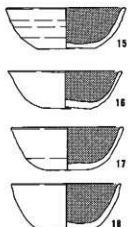
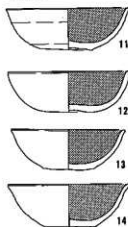

SB7046



SB7047

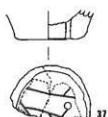
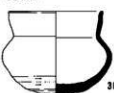

SB7059

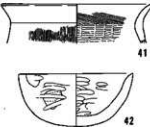
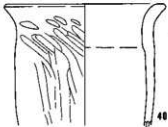
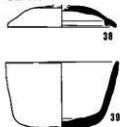

0 (1:4) 10cm

SB7048

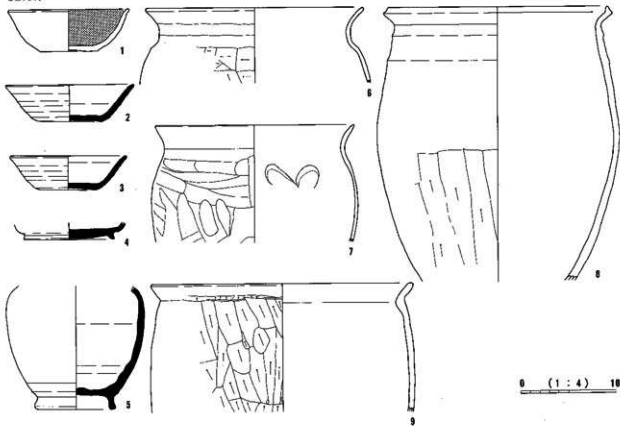

SB7052



SB7053

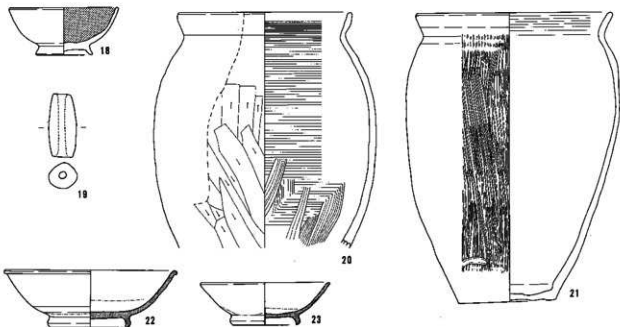

SB7054

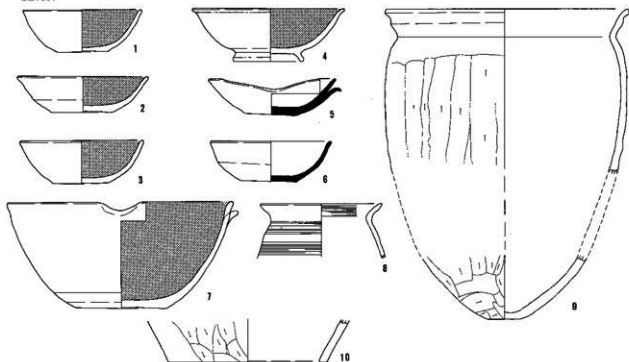

SB7058

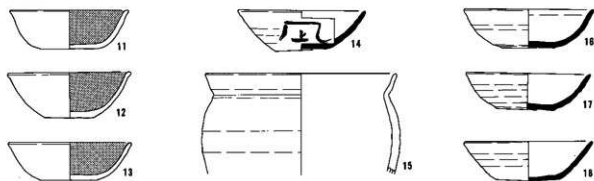

SB7092



SB7088

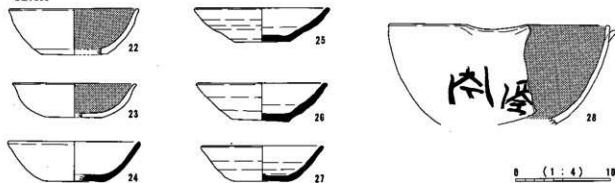

0 (1:4) 10cm

SB7068

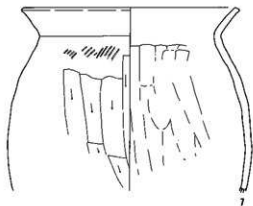
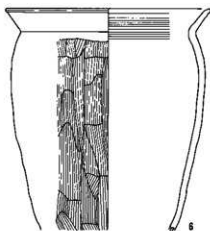
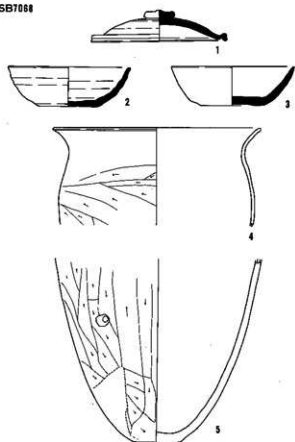

SB7100



SB7100



SB7100

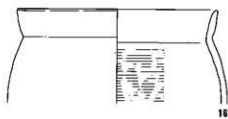
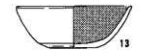
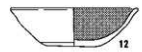

SB7111

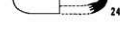
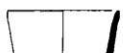
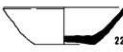
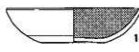

0 (1:4) 10cm

SB7109

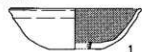

1



2



3

SB7113



4

SB7112

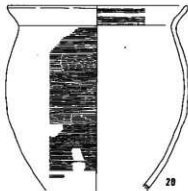
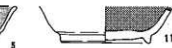
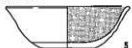

20

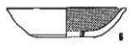

18

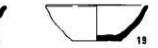

19

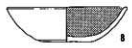

15

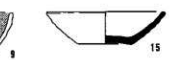

21

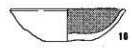

16

SB7114



22



24

SB7115



29



30

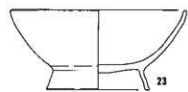

23



25

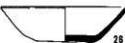

28

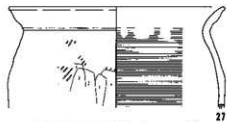

27

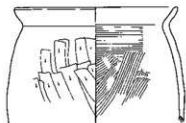

28

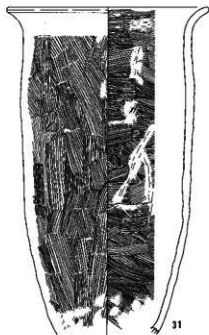

31

0 (1:4) 10cm

SB7118

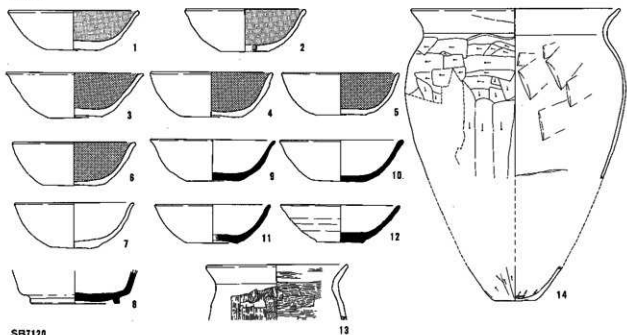

SB7120

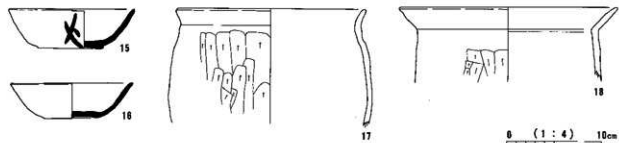

SB7121

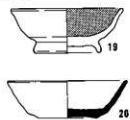

SB7123

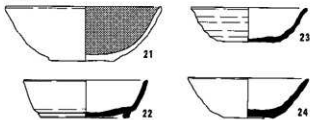

SB7122

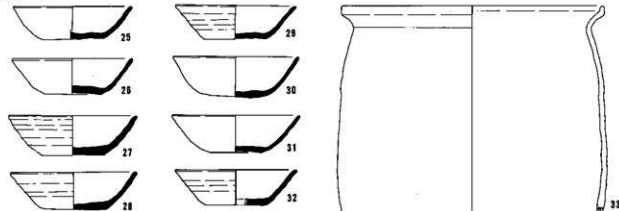

SB7127

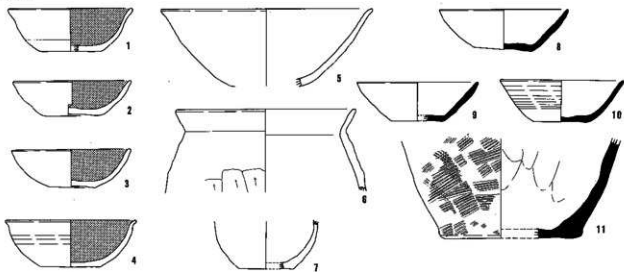

SB7133



SB7134



SB7136

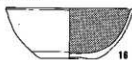

SB7137

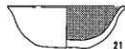
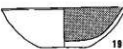
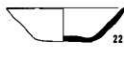
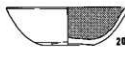

SB7141

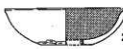
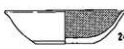

SB7143

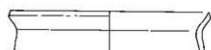
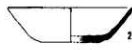

0 (1 : 4) 10cm

SB7144

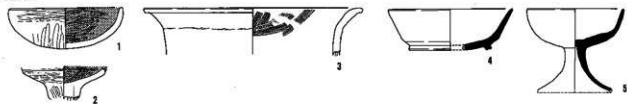

SB7150



SB7152

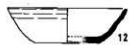

SB7153

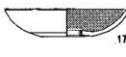
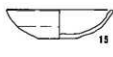
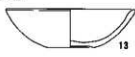

SB7154

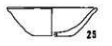
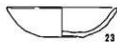
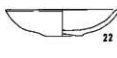
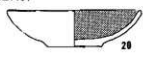

SB7155

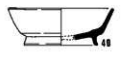
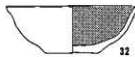
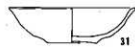
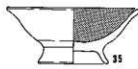
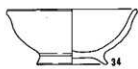
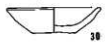
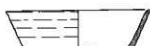
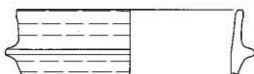
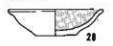

0 (1:4) 10cm



SB7158

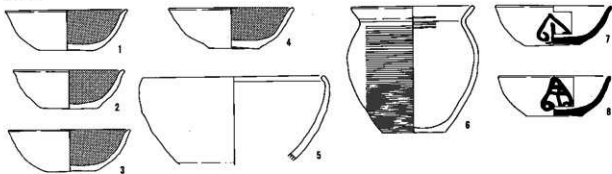

SB7159

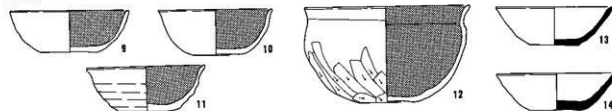

SB7160



SB7161

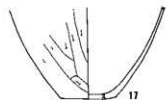

SB7165



SB7164



SB7169

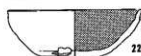

SB7171



SB7174

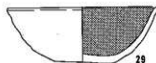
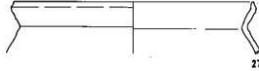
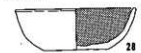

SB7179



SB7185

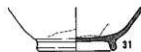

0 (1:4) 10cm

SB7181

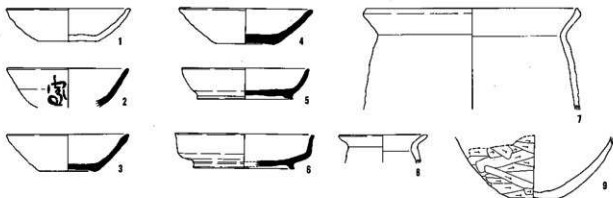

SB7196

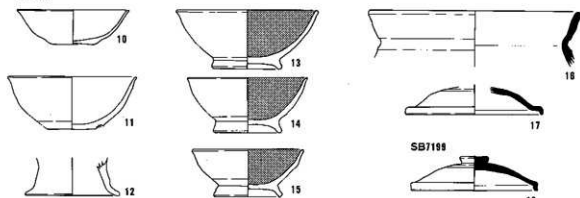

SB7199

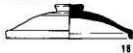

SB7200

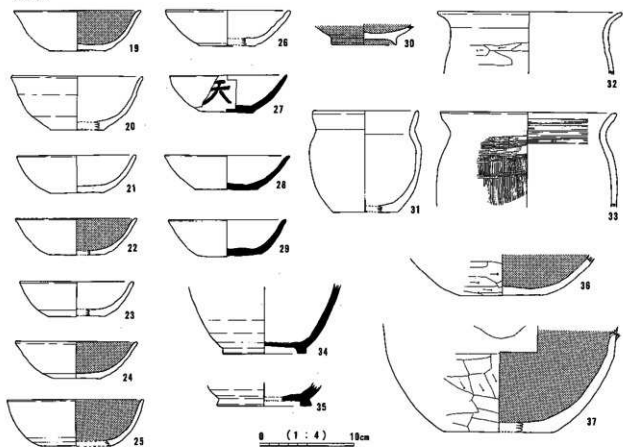

0 (1 : 4) 10cm

SB7201

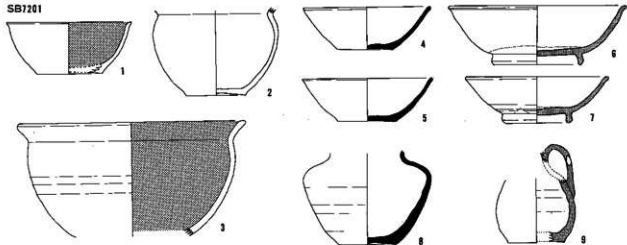

SB7202



SB7203

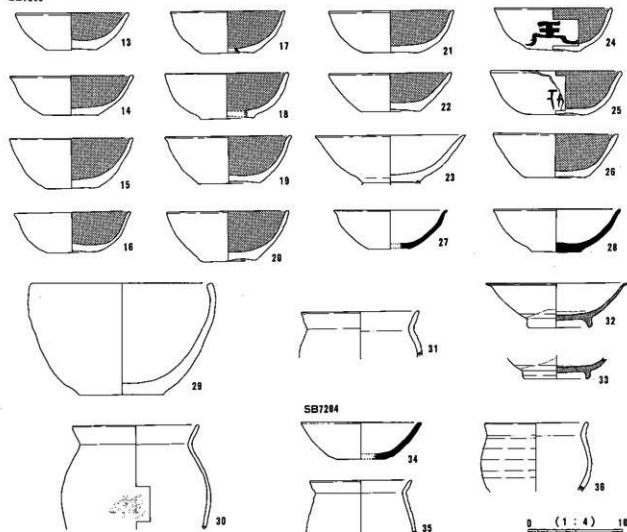

SB7204

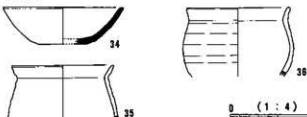

0 (1:4) 10cm

SB7207

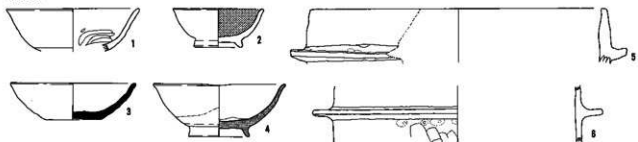

SB7208

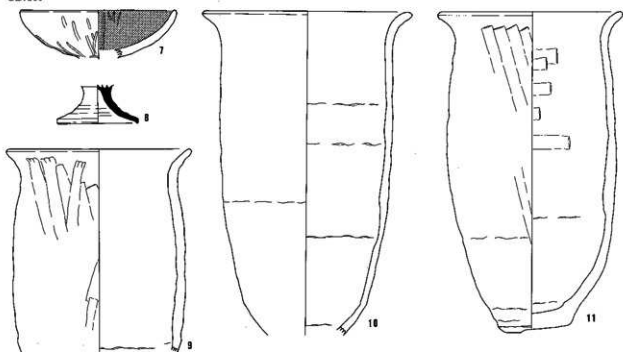

SB7210

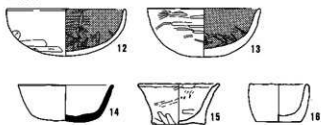

SB7211

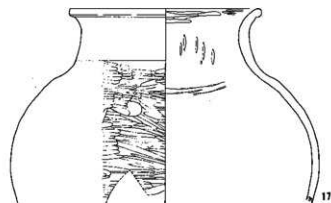

SB7212



0 (1:4) 10cm

SB7205

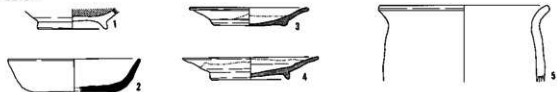

SB7206-①

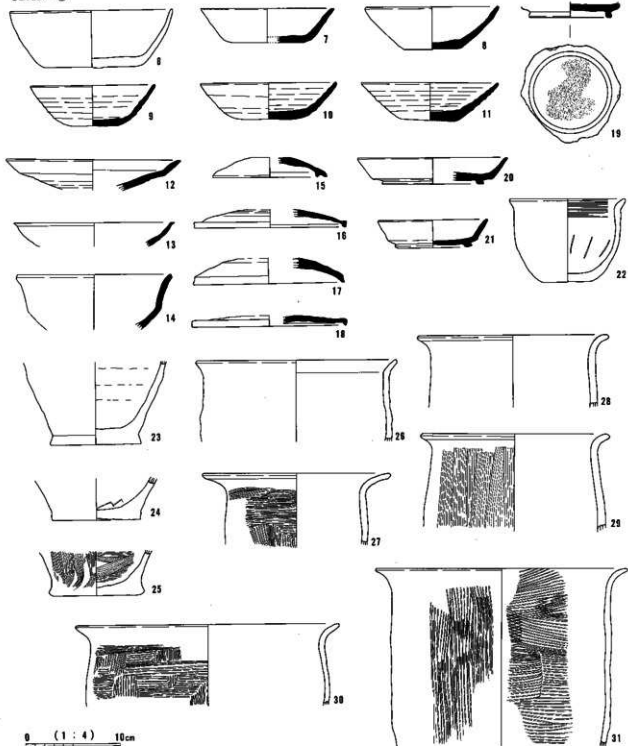

0 (1:4) 10cm

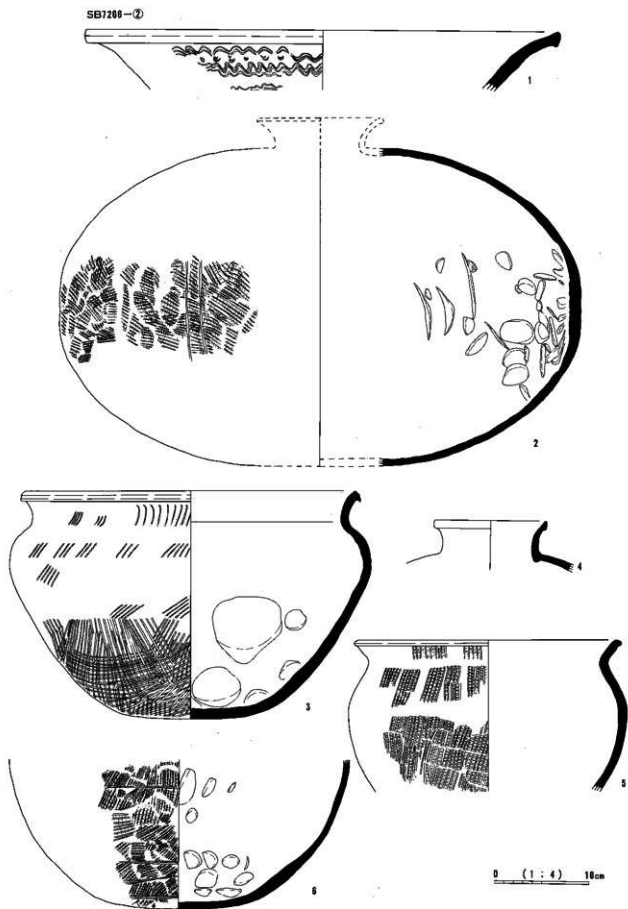

SB7209

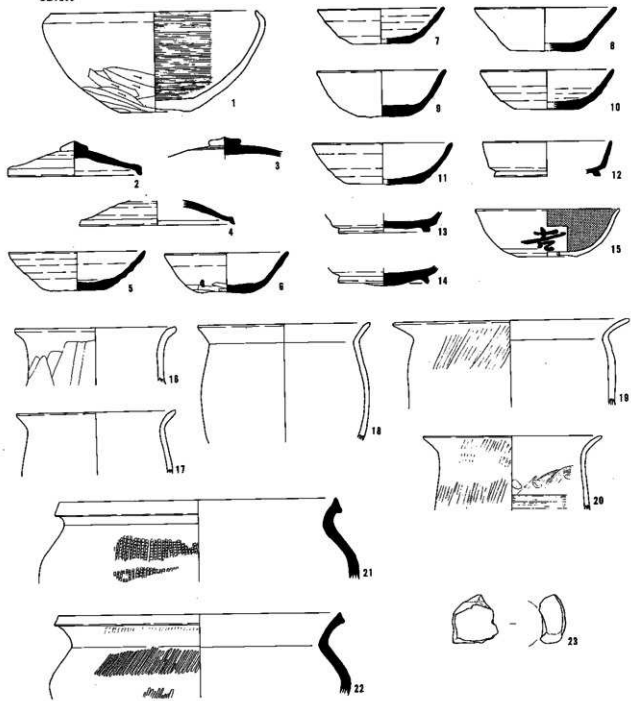

SB7214

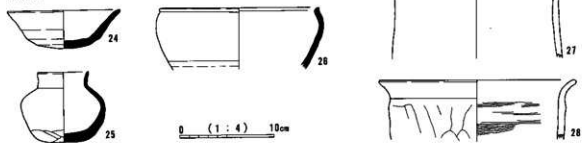

SB7215

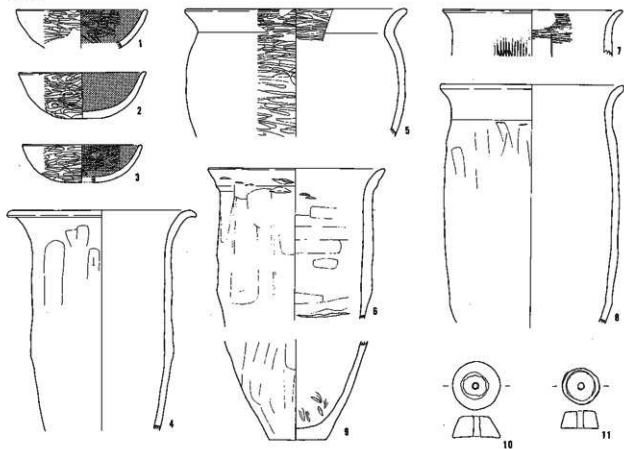

SB7216

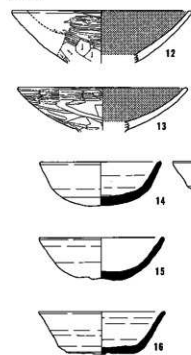

SB7218

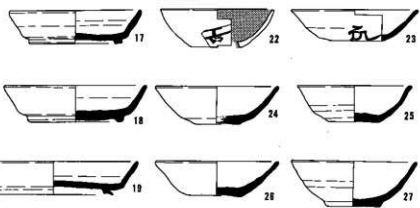

SB7219

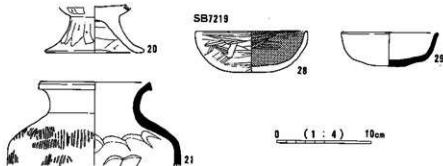

SB7220

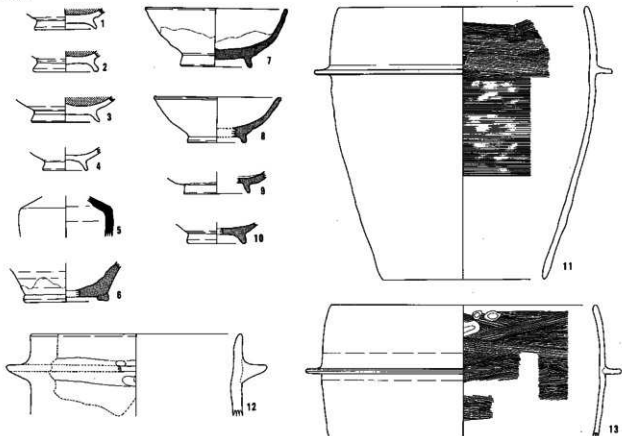

SB7221

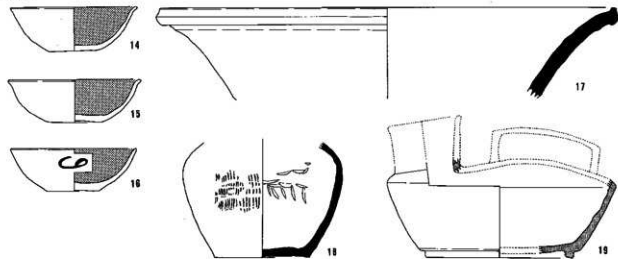

SB7223

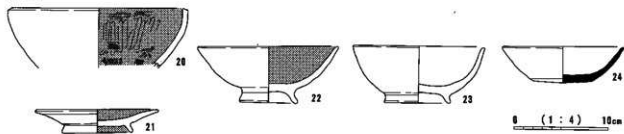

SB7222

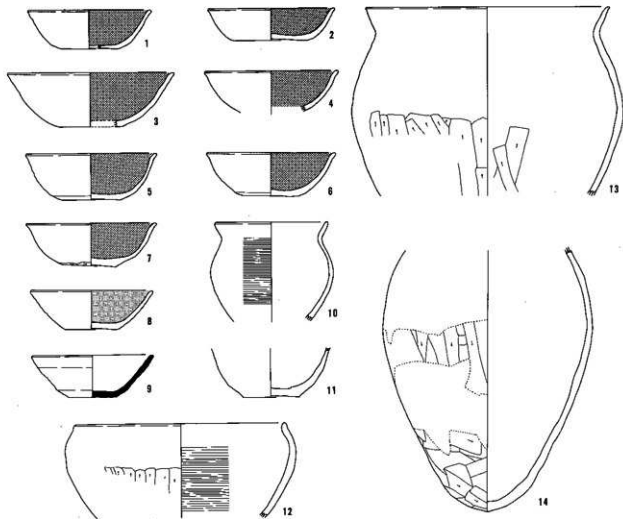

SB7235

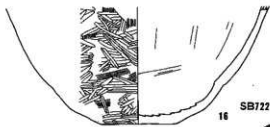
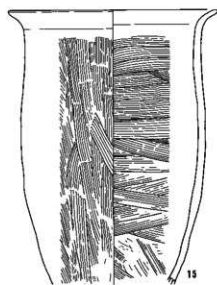

SB7227

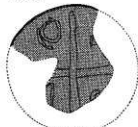

SB7231



17



18



19



20

0 (1 : 4) 10cm

SB7230

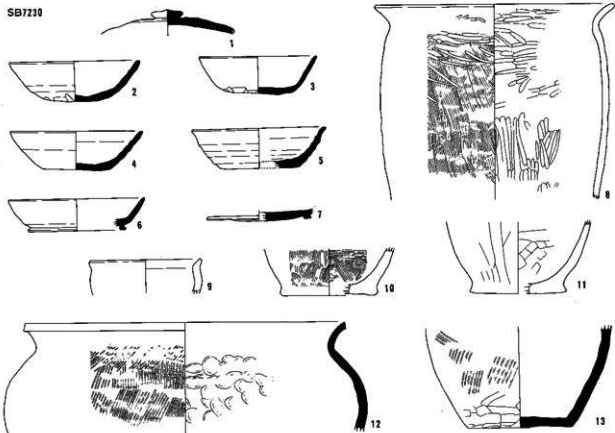

SB7245

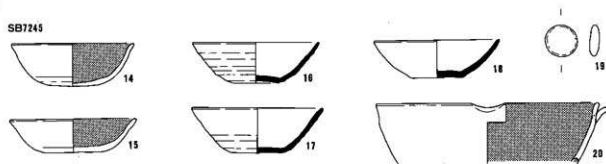

SB7248

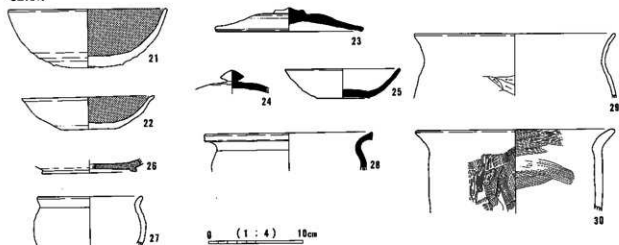

SB7234

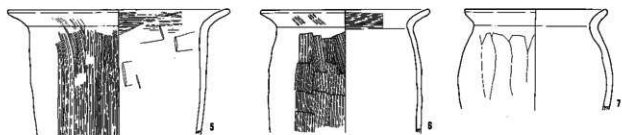
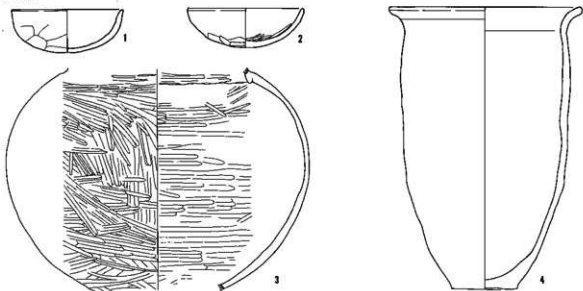

SB7249

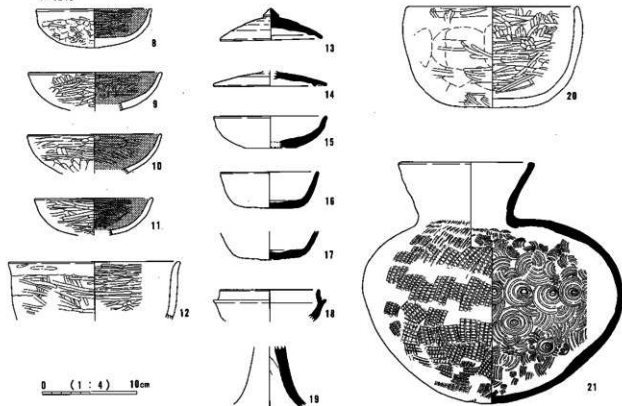

0 (1:4) 10cm

SB7253

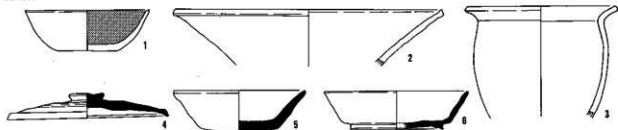

SB7261

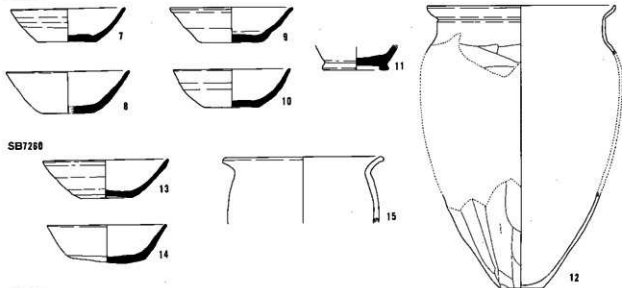

SB7260

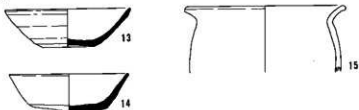

SB7263

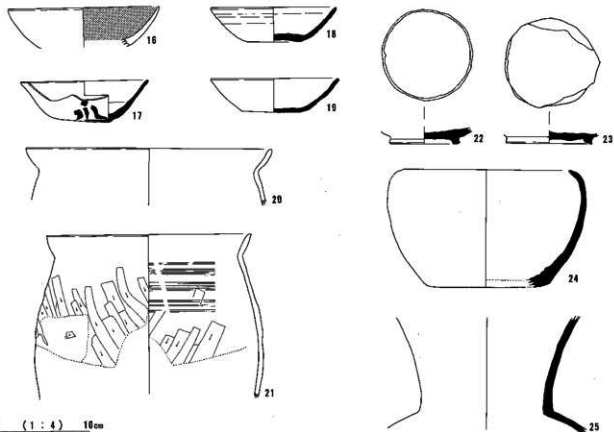

0 (1:4) 10cm

SB7264



1



3



5



2



4

SB7266



6

SB7265

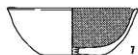

7



9



11



12



8



10



13

SB7267



14

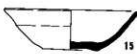

15

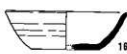

16



17

SB7269



18

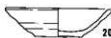

20



22



24

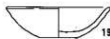

19



21



23

SB7276



25



26

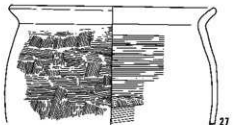

27

SB7280



28



29

SB7279

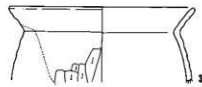

30

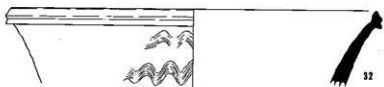

32

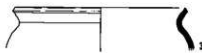

31



33

0 (1:4) 10cm

SB7273

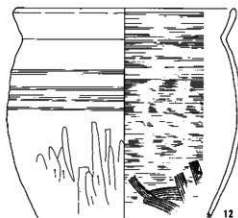
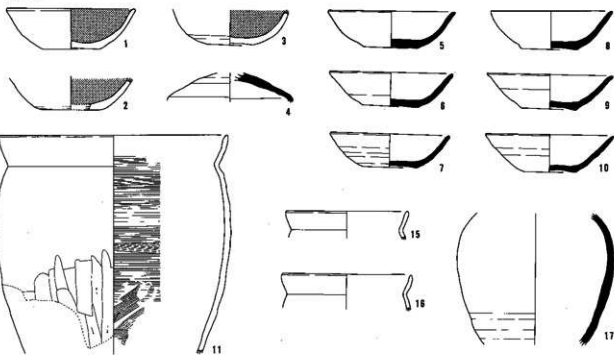

0 (1 : 4) 10cm

SB7270



SB7287

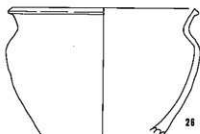
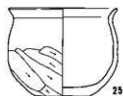

SB7299

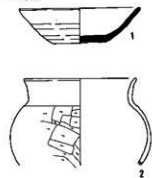

SB7301

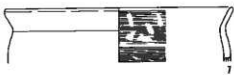
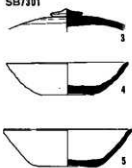

SB7305



SB7306

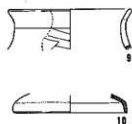

SB7308



SB7314

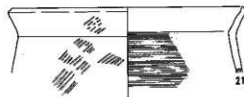
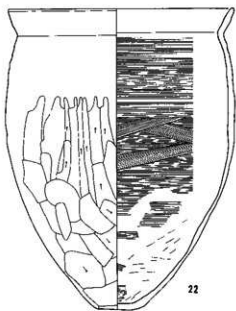
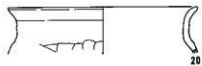

SB7313



SB7315

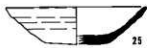

SB7318



0 (1:4) 10cm



SB7317

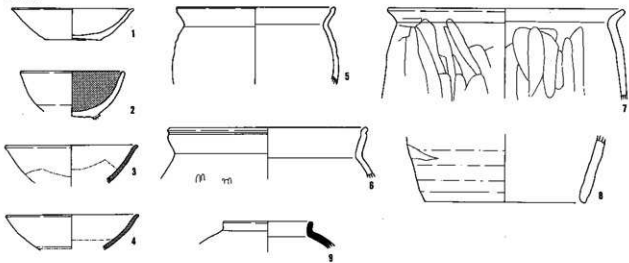

SB7320



SB7324

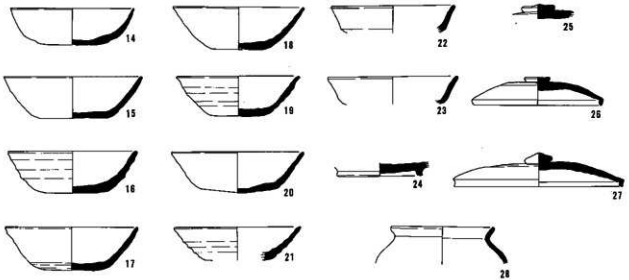

SB7325



SB7326

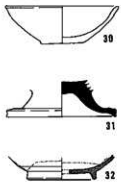

SB7330

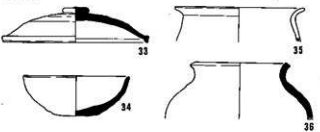

SB7331



0 (1:4) 10cm

SB7332



SB7340



SB7335



10

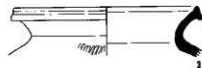

3



7



8



9



11

SB7337



4

SB7341

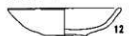

12

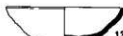

13



14

SB7348



17



18



19

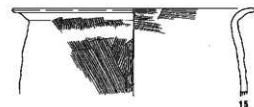

15

SB7354



20

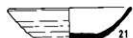

21

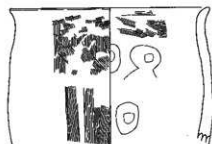

16



22

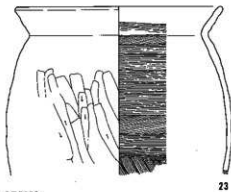

23

SB7342



24



25



26



27



28

0 (1:4) 10cm

SB7357

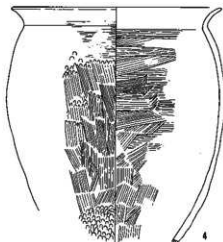
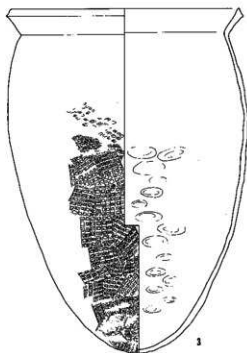

SB7360

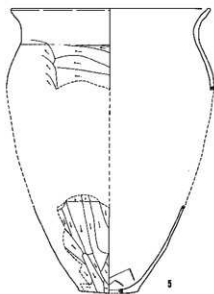

SB7367

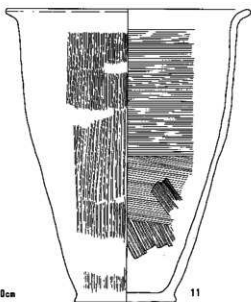
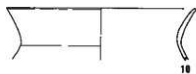

0 (1:4) 10cm

SB7370

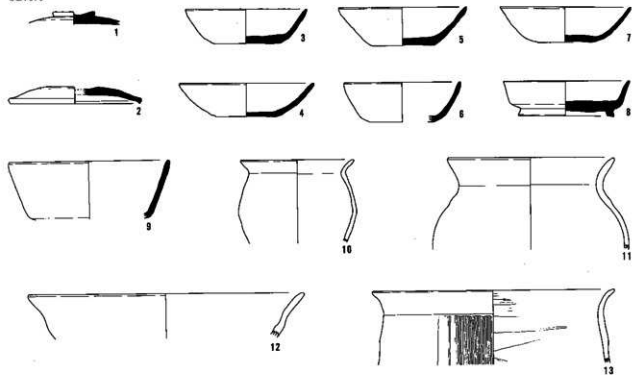

SB7380

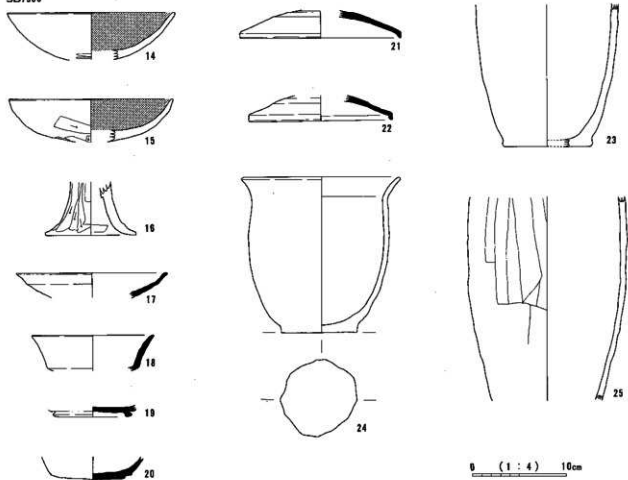

SB7387



1

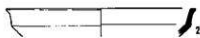

2

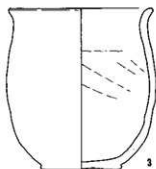

3

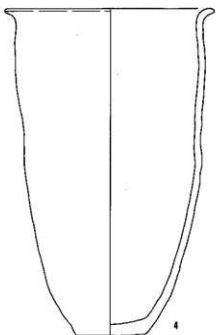

4

SB7388

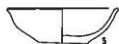

5



6

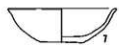

7



8



9



10

SB7390



11



12



13



14

SB7391



15



16



17



18

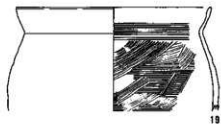

19

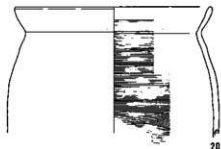

20

SB7392



21



22



23

SB7396

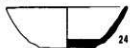

24



25



27



28

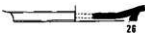

26

0 (1:4) 10cm

SB7398

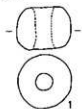

SB7399

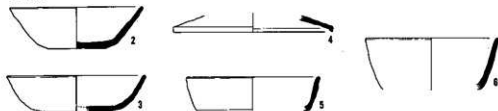

SB7404

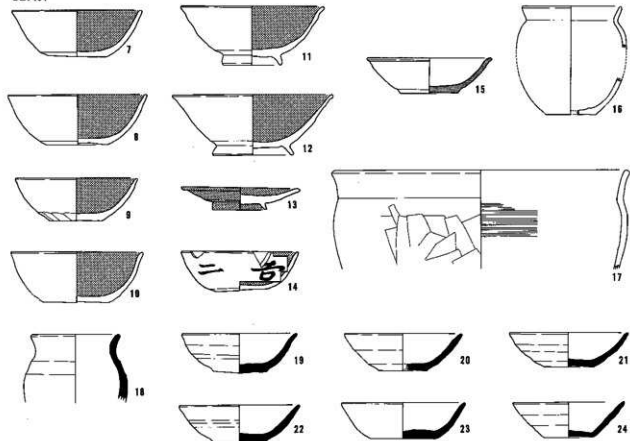

SB7405

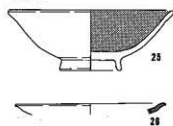

SB7407

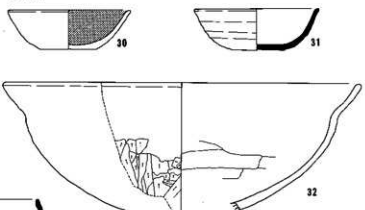

SB7408

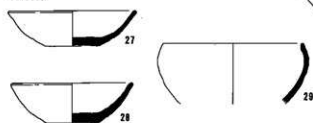

0 (1 : 4) 10cm

SB7409



SB7410



SB7412

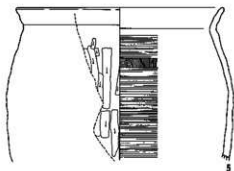

SB7411

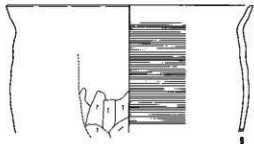
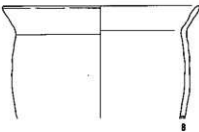

SB7413



SB7415

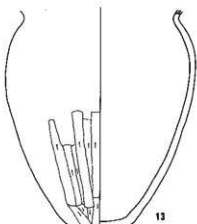
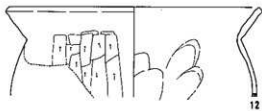

SB7421



SB7423



SB7426

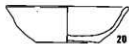

SB7428

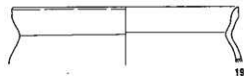
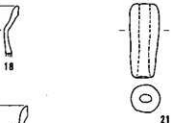
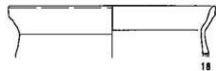

0 (1:4) 10cm

SB7416

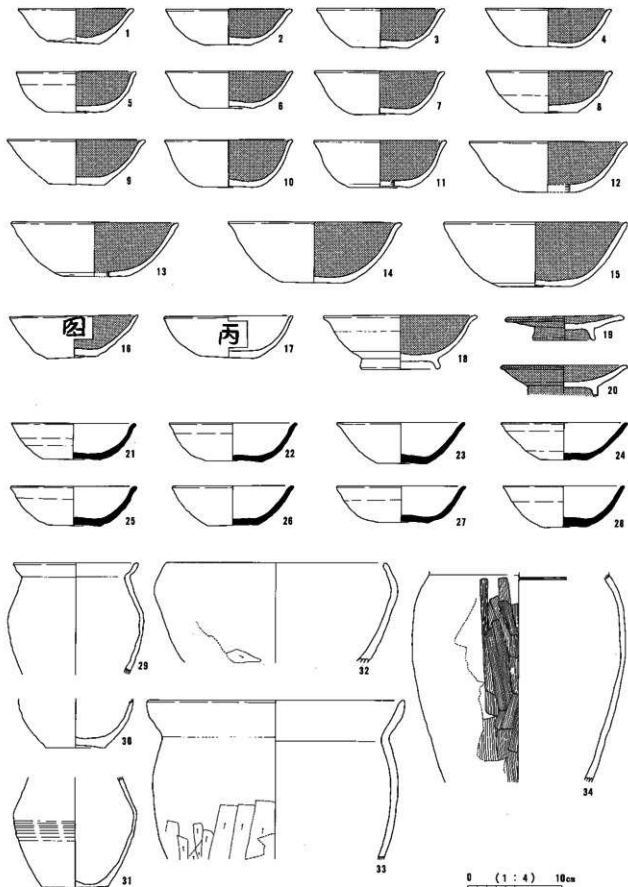

SB7422

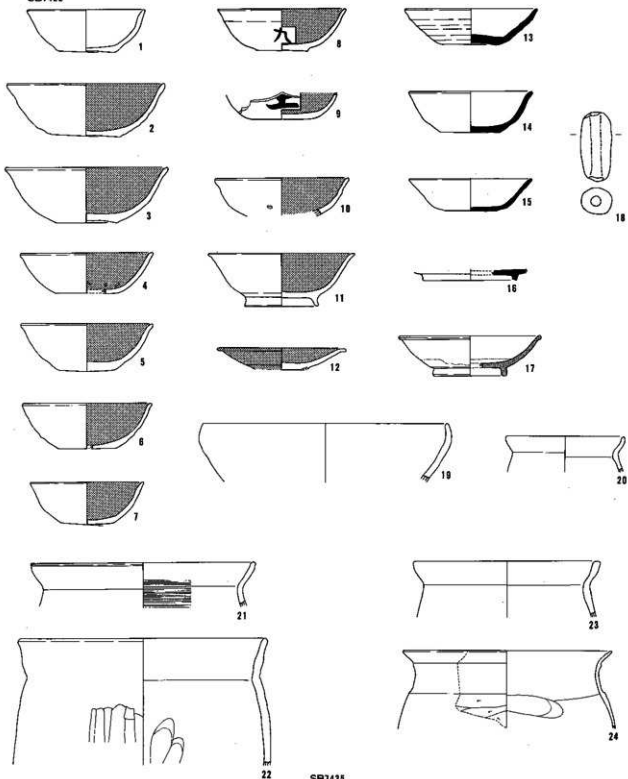

SB7434

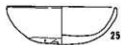

SB7435

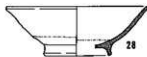
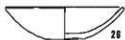

0 (1 : 4) 10cm

SB7425

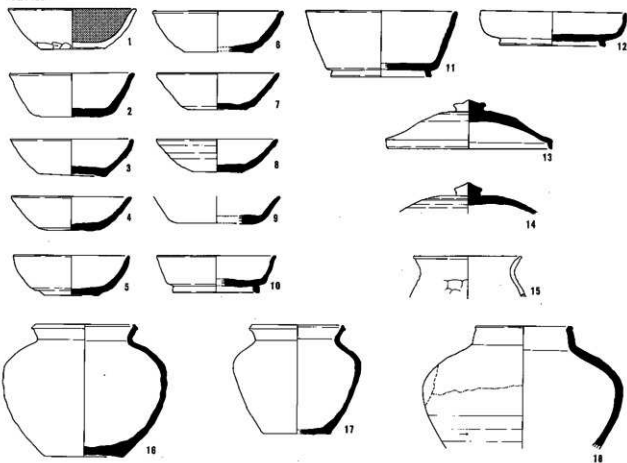

SB7437

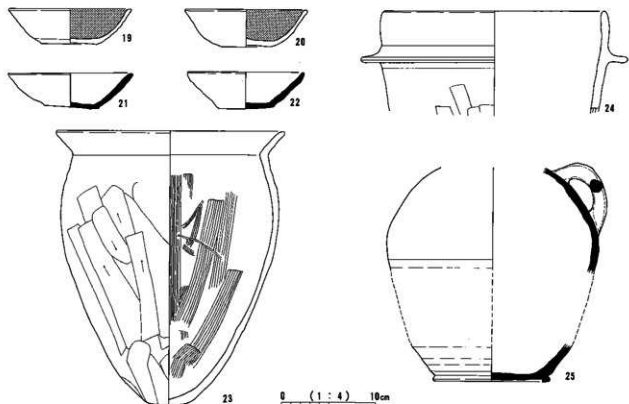

SB7427

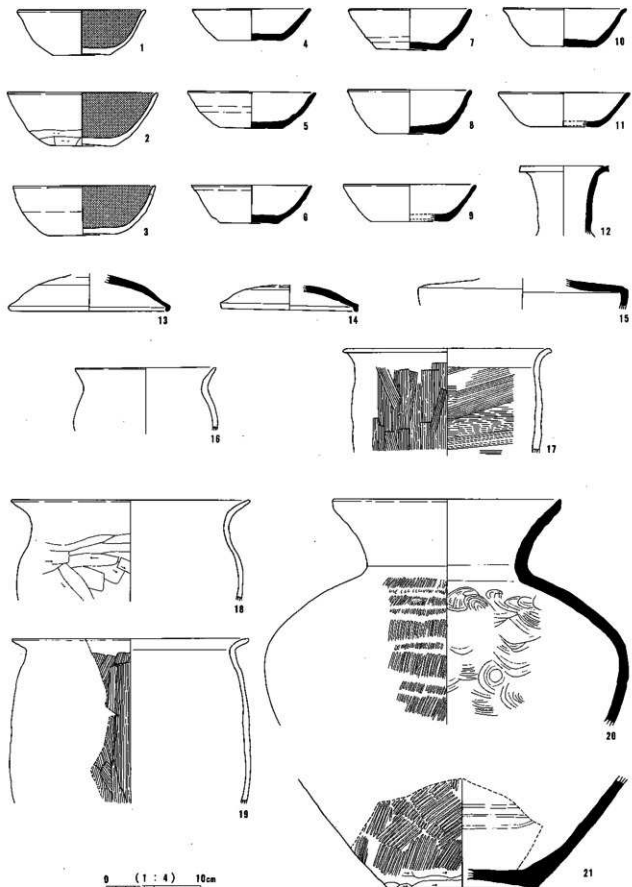

SB7427

SB7440



SB7449

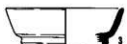

SB7456

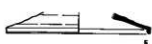

SB7459

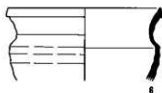
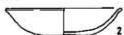

SB7468

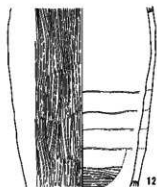
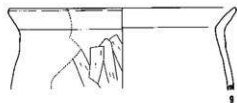

SB7469

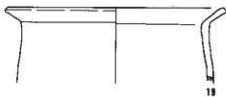
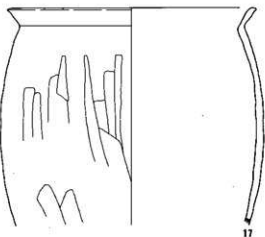
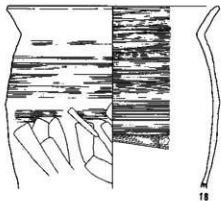
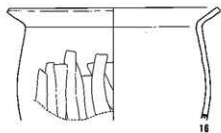
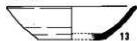

0 (1:4) 10cm

SB7464

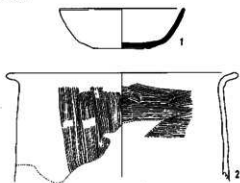

SB7470

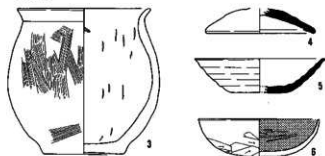

SB7477



SB7478

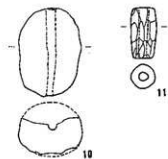

SB7485

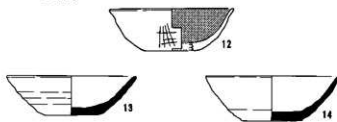

SB7486



SB7505

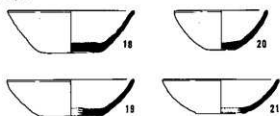

SB7519

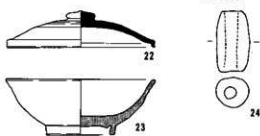

SB7518



SB7521



0 (1:4) 10cm

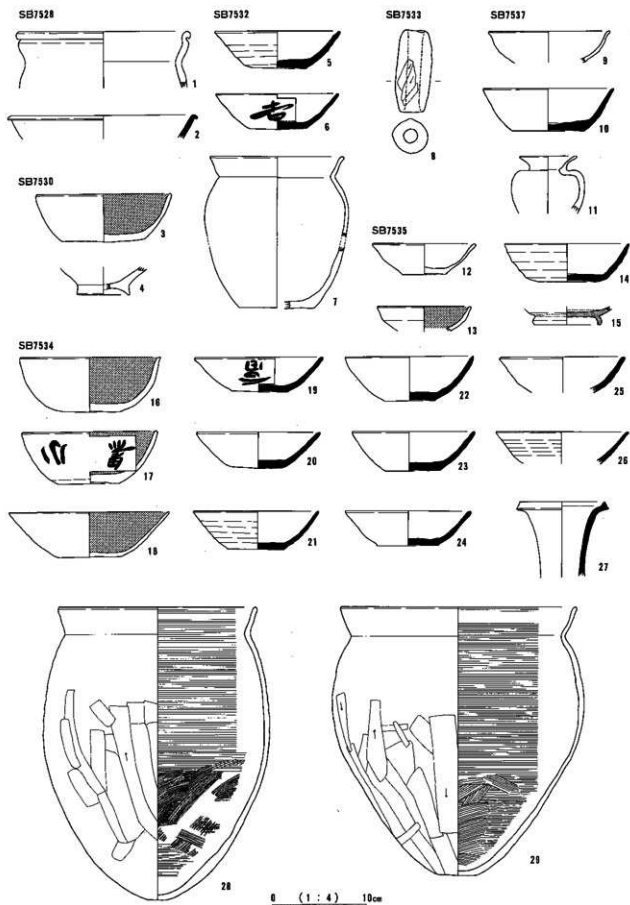

SB7538

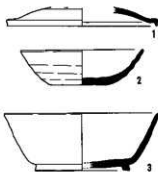

SB7543

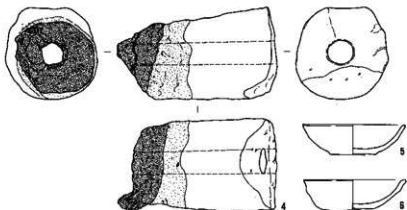

SB7546

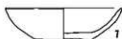

SB7549

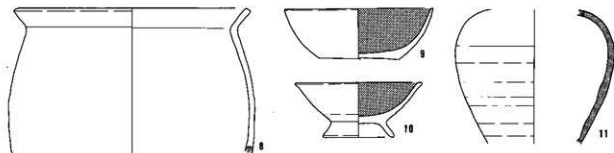

SB7551



SB7568



SB7554



SB7581

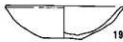

SB7571

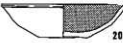

SB7587

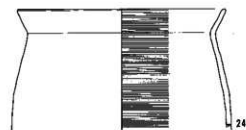
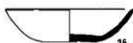

9 (1:4) 16cm

SB7552

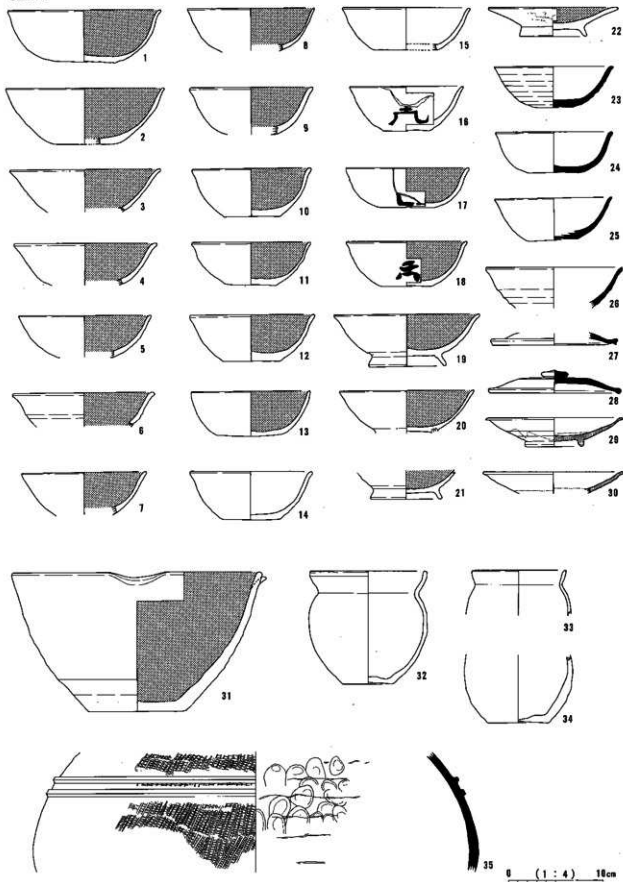

SB7552

SB7601

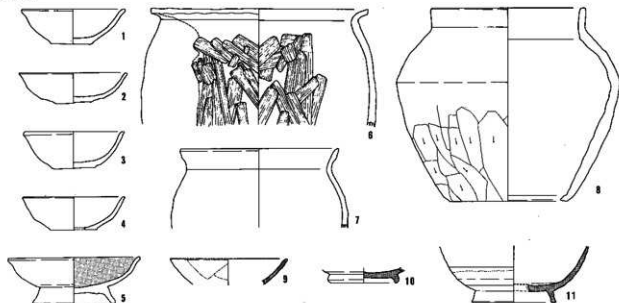

SB7605



SB7610

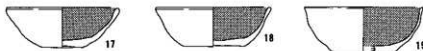
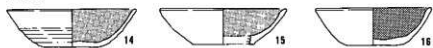

SB7606



SB7619

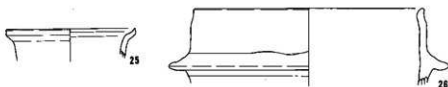
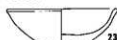

SB7622

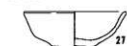

SB7645



SB7667

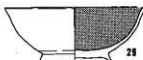

0 (1:4) 10cm

SB7644



1



2

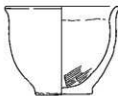

3

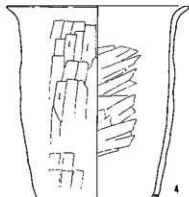

4

SB7700



5



6

SB7651

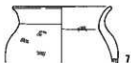

7

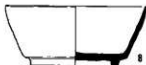

8

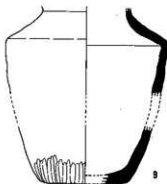

9

SB7703



10



11



12

SB7716



14



15



13

SB7717

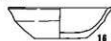

16



17



18

SB7735



19

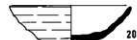

20



21

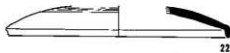

22



23



24



25

0 (1:4) 10cm

ST7020



SM7005



SM7007



SM7008



SM7015

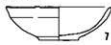

SM7009

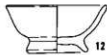
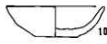

SM7017

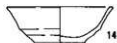
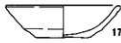
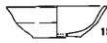

SM7019



SM7020

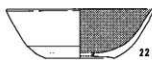

SM7021

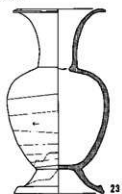

SM7022



SM7025

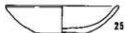

0 (1:4) 10cm

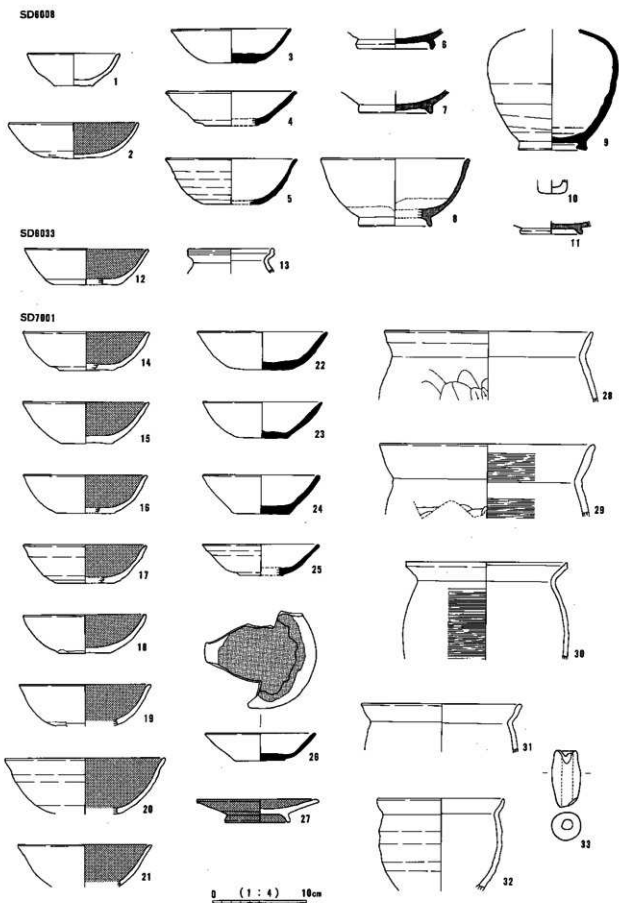

SD7802

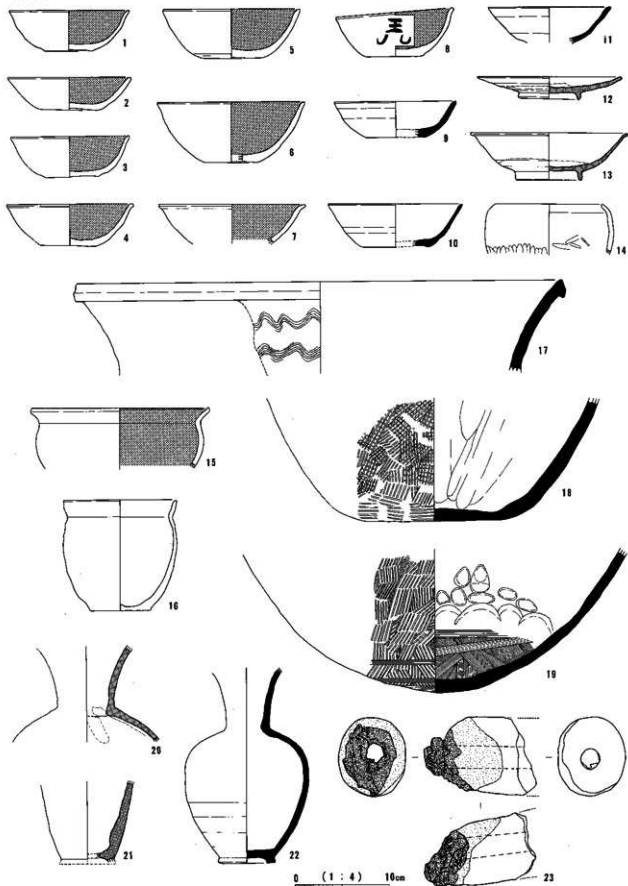

SD7002

SD7006-①

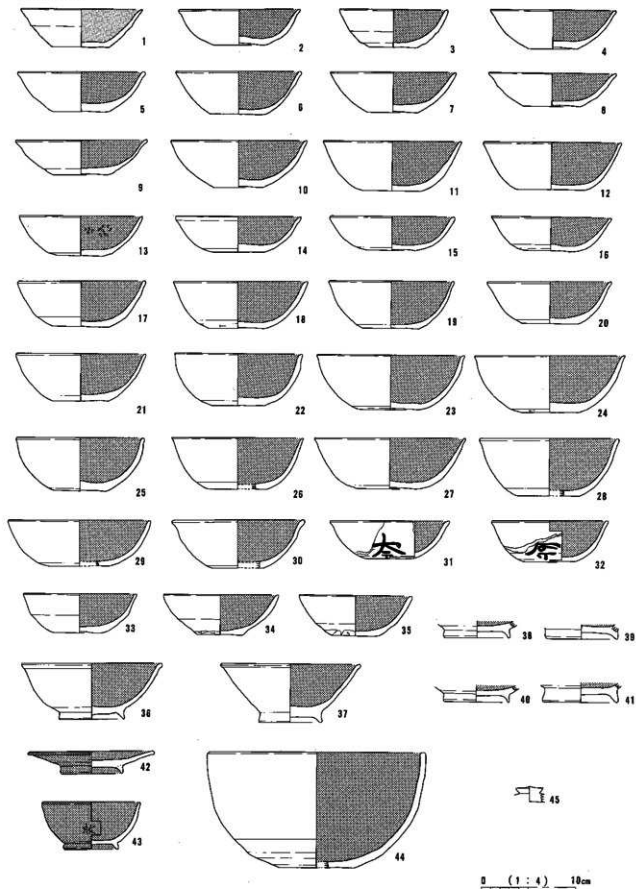

SD7006-②

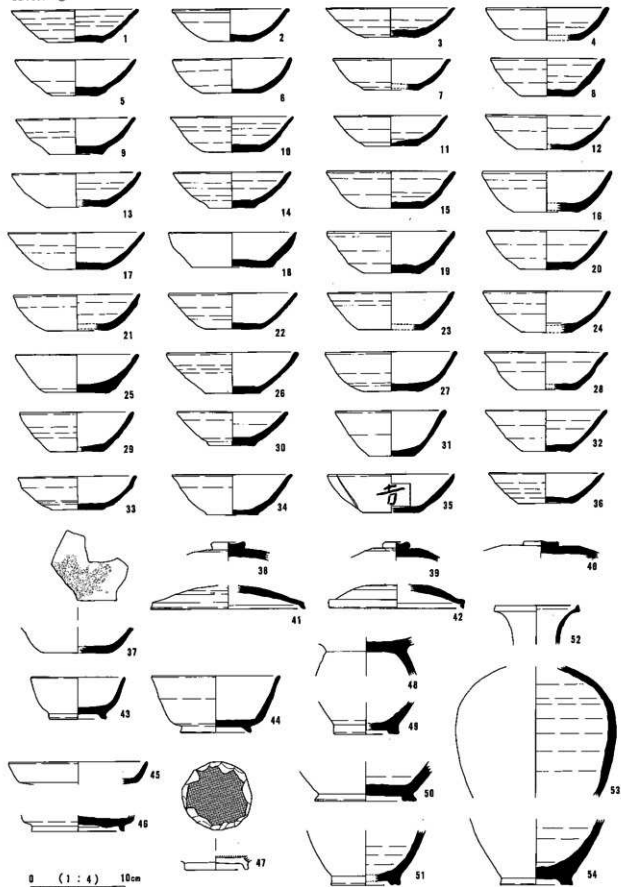

SD7006-①

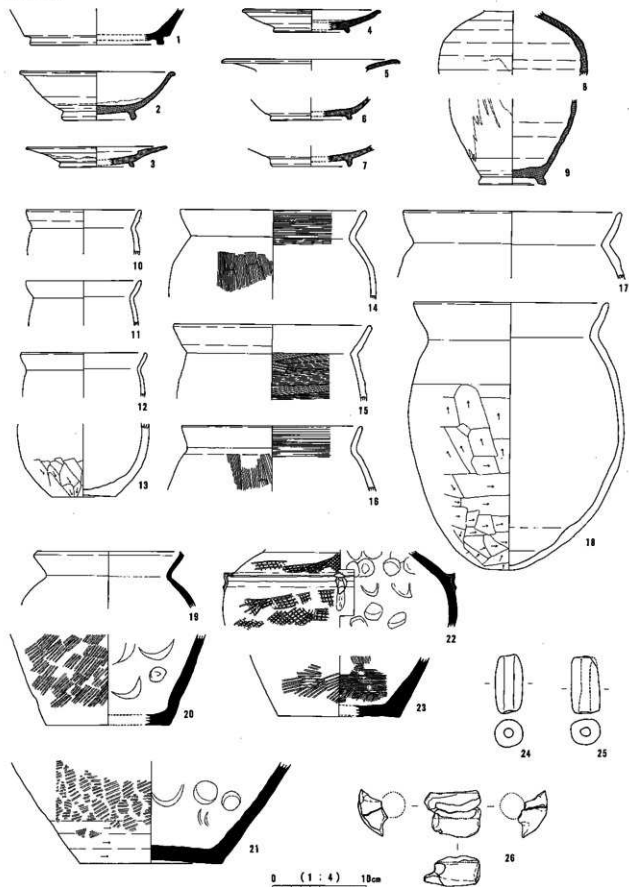

SD7006-②

SD7007

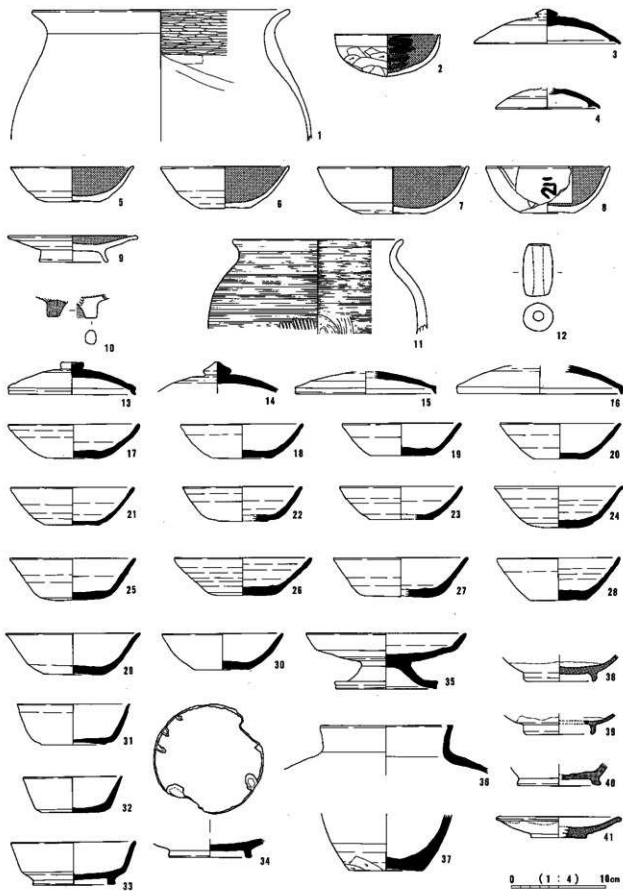

SD7007

SD7010

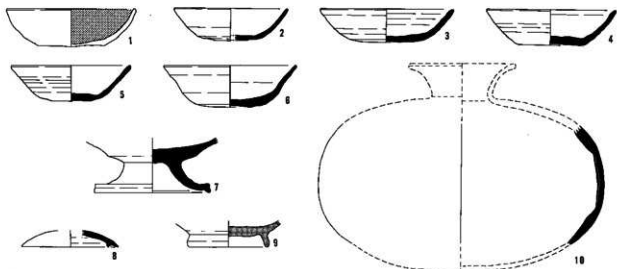

SD7011

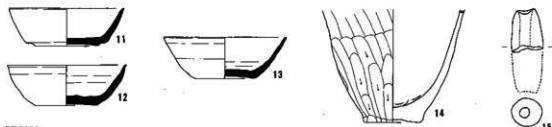

SD7023

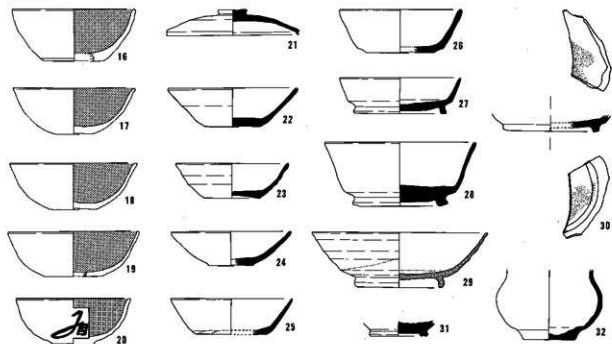

SD7024

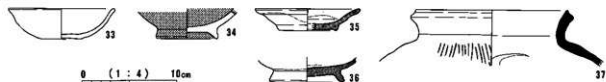

0 (1:4) 10cm

SD7027

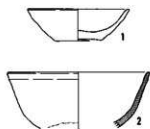

SD7029



SD7031

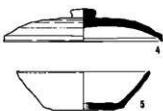

SD7032

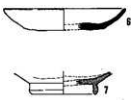

SD7033

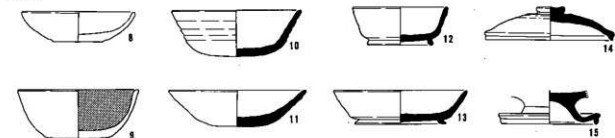

SD7036

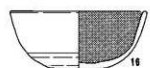

SD7037



SD7038

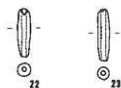
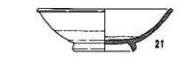

SD7040



SD7041

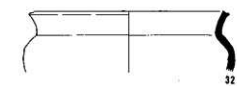

SD7042

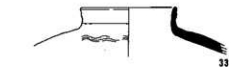
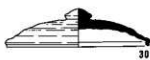
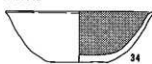

0 (1 : 4) 10cm

SD7039-①

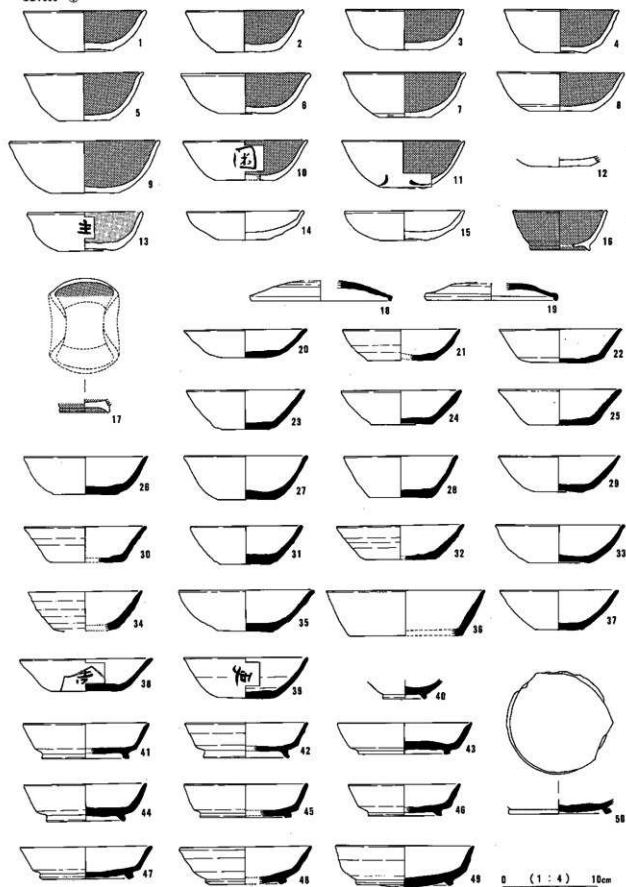

SD7031-②

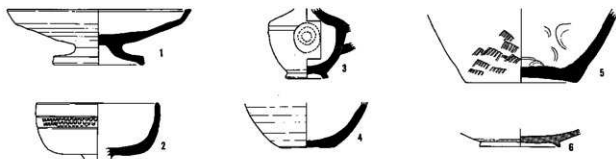

SD7051



SD7052-①

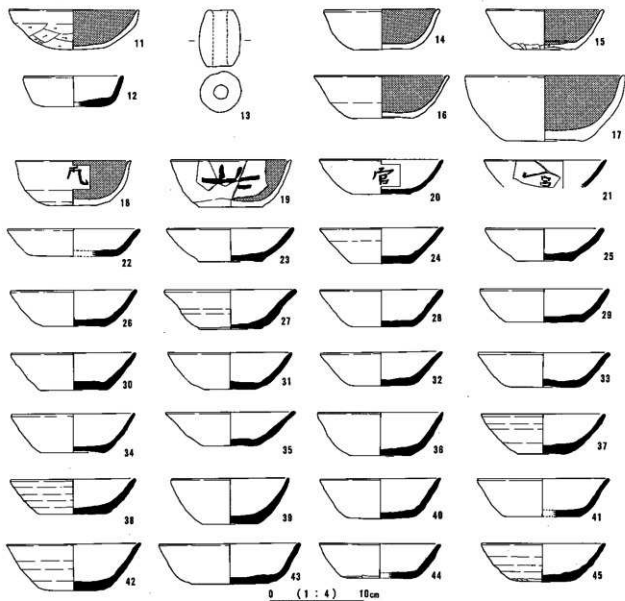

SD7052-②

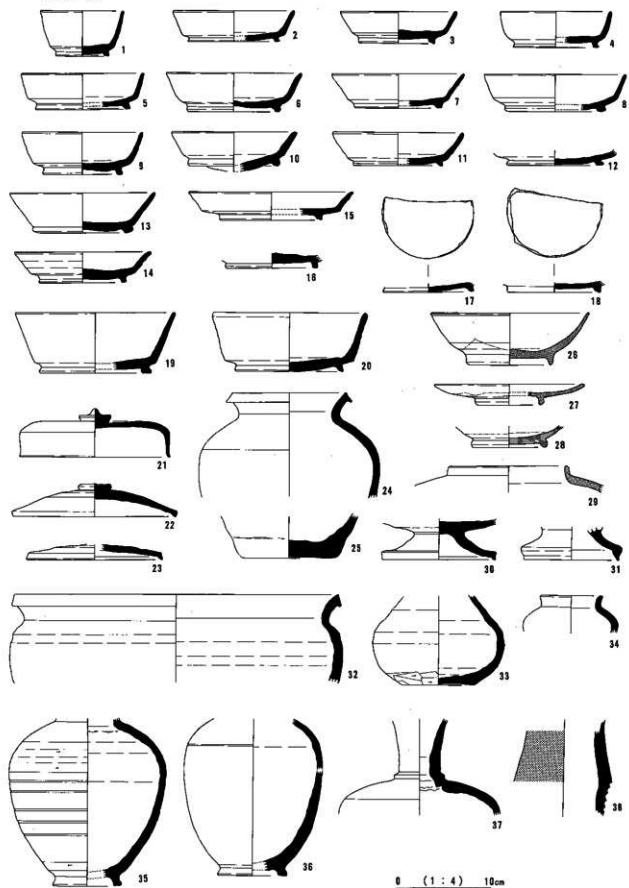

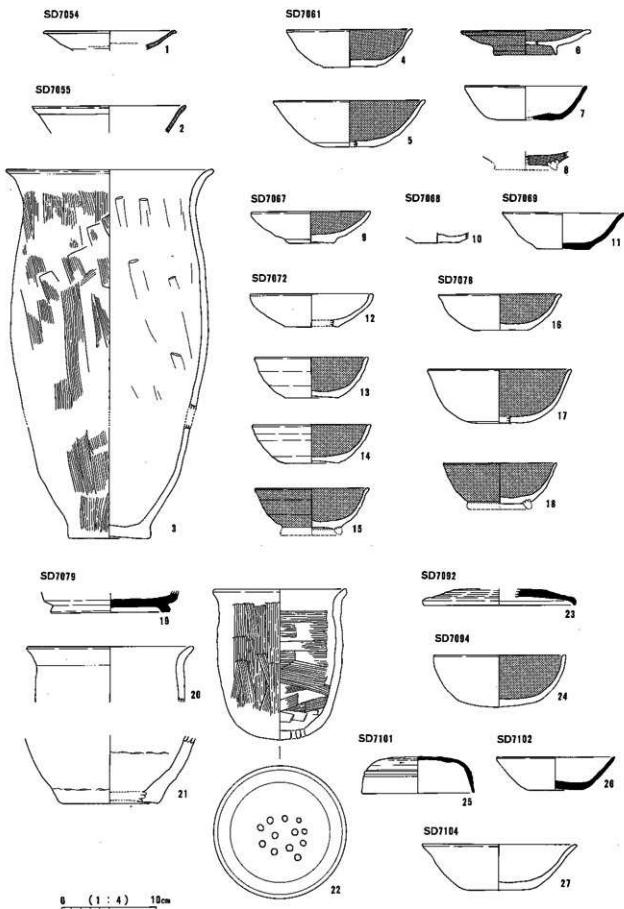

SD7080

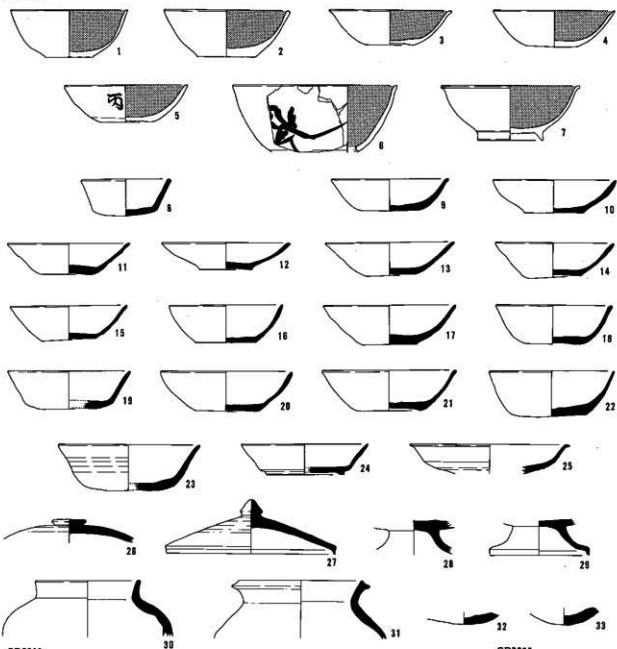

SD7083

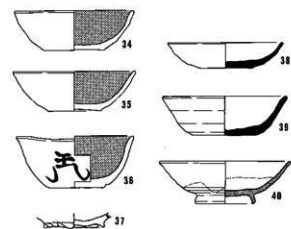

SD7087



SD7109

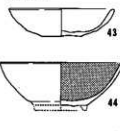

0 (1:4) 10cm

SK6033

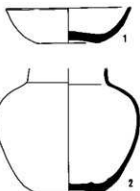

SK6035

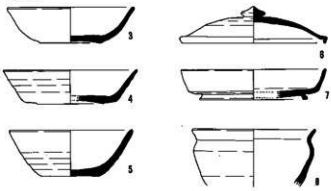

SK6034



SK6046



SK6044



SK6097

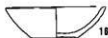

SK6154



SK6208

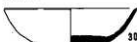

SK6408



SK6398



SK6432

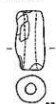

SK6160

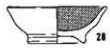

SK7137



SK6183



SK7154

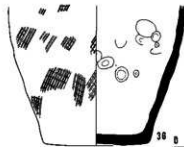
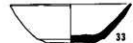

0 (1:4) 10cm

SK7199

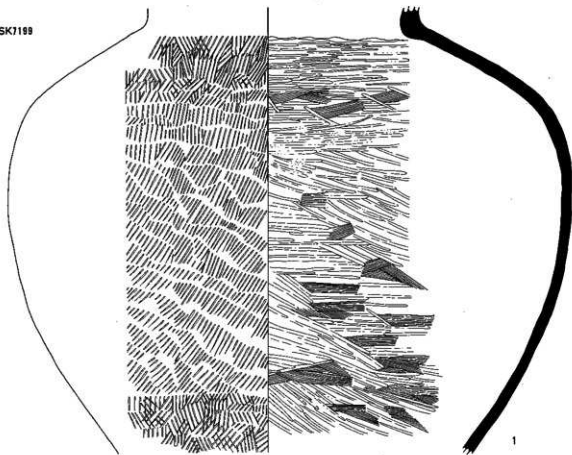

SK7229

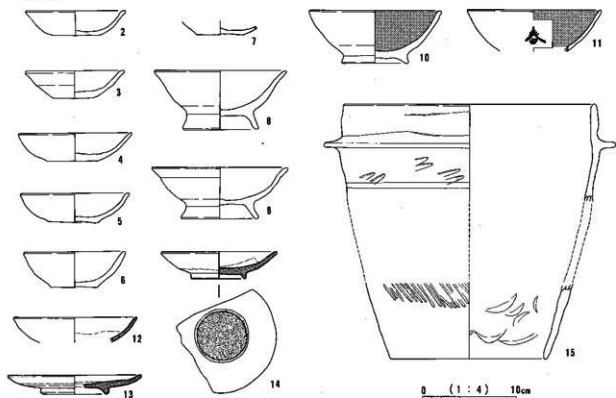

SK7228

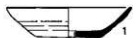

SK7275



SK7303



SK7330



SK7305

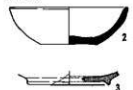

SK7235

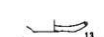
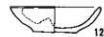
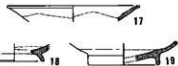
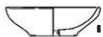

SK7314



SK7361

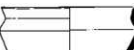
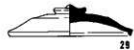
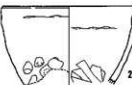
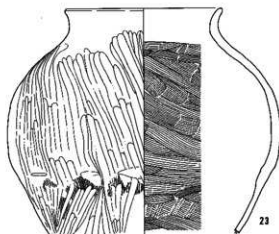
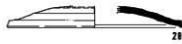

SK7388



SK7376



SK7425



SK7420

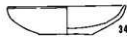

SK7422

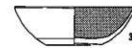

0 (1 : 4) 10cm

SK7414

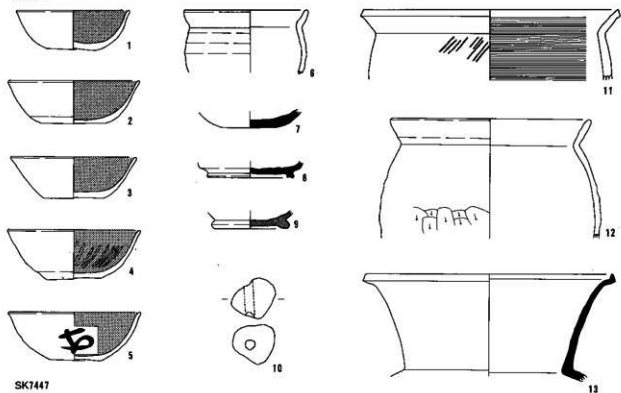

SK7447

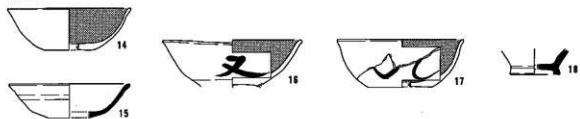

SK7459



SK7461

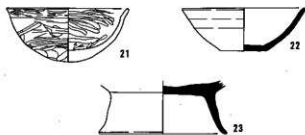

SK7465



SK7683



SK7650



0 (1:4) 10cm

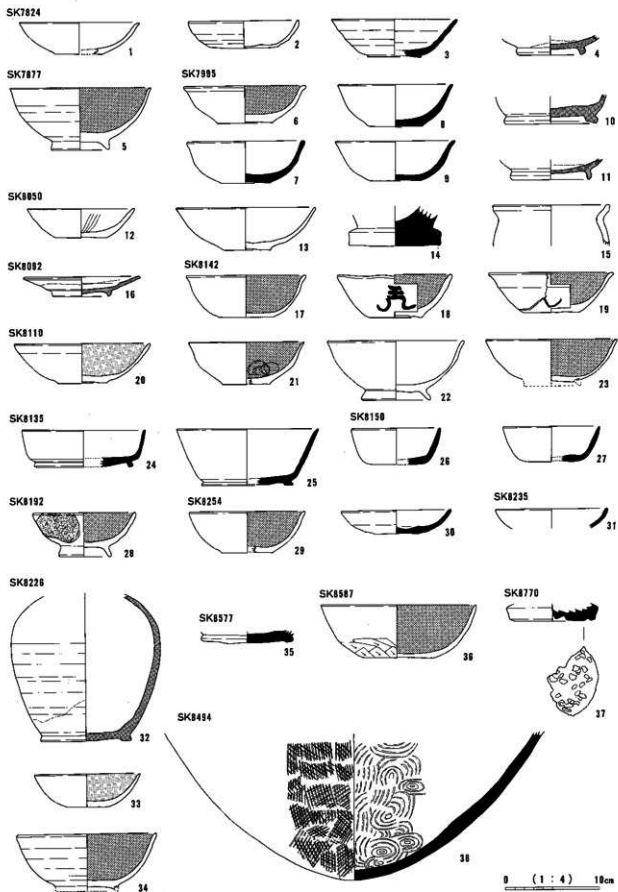

遺構外

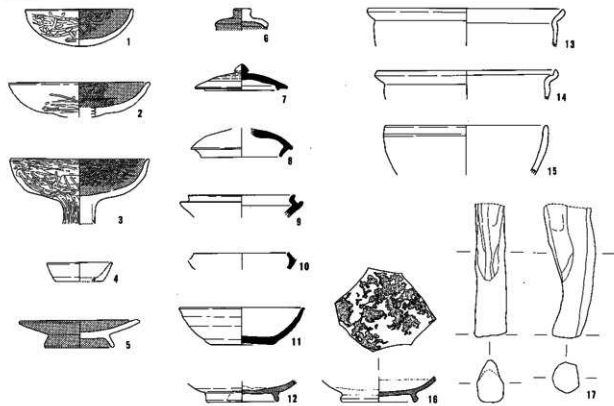

中世以降

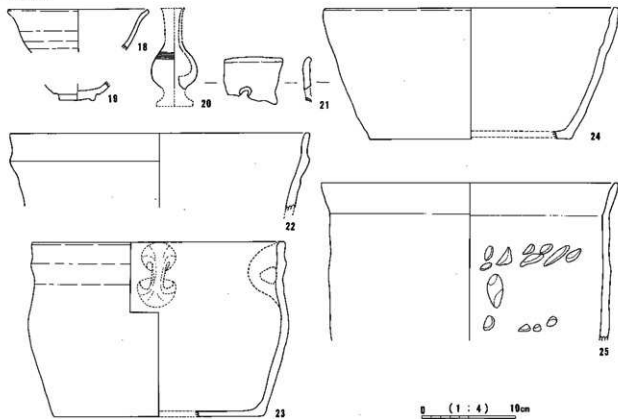

土偶

SB7465

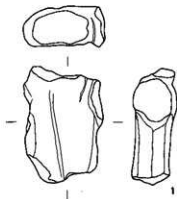

SD7087

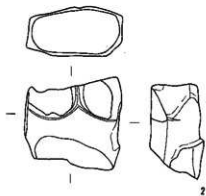

人面付土器

SD7110

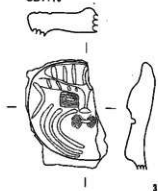

2-3区横出面

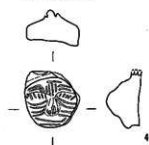

容器形土製品

SB7101

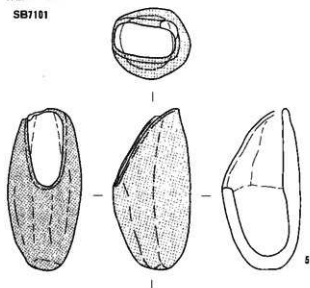

SD7001



SD7030

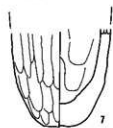

SK8222

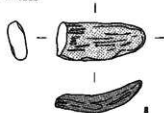

0 (1:2) 5cm

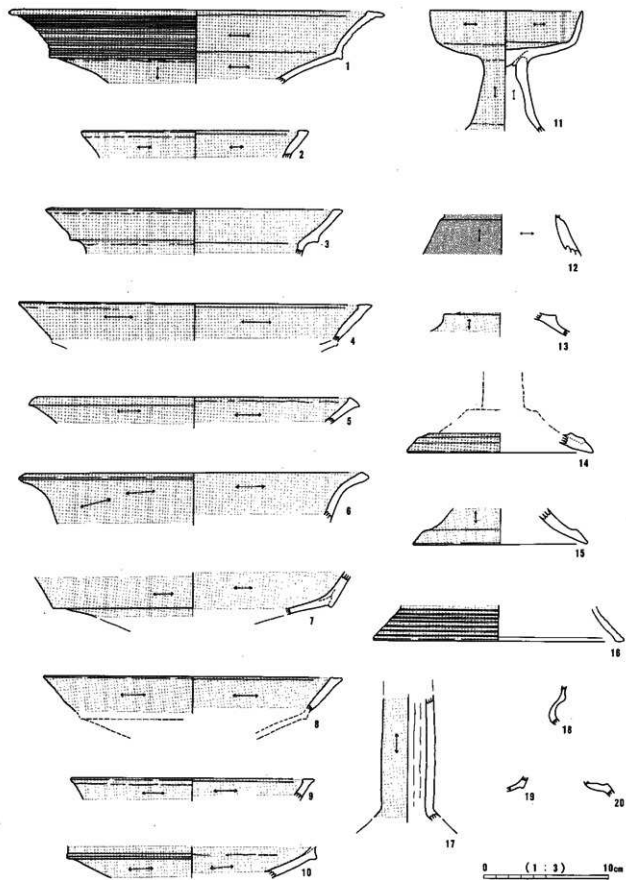

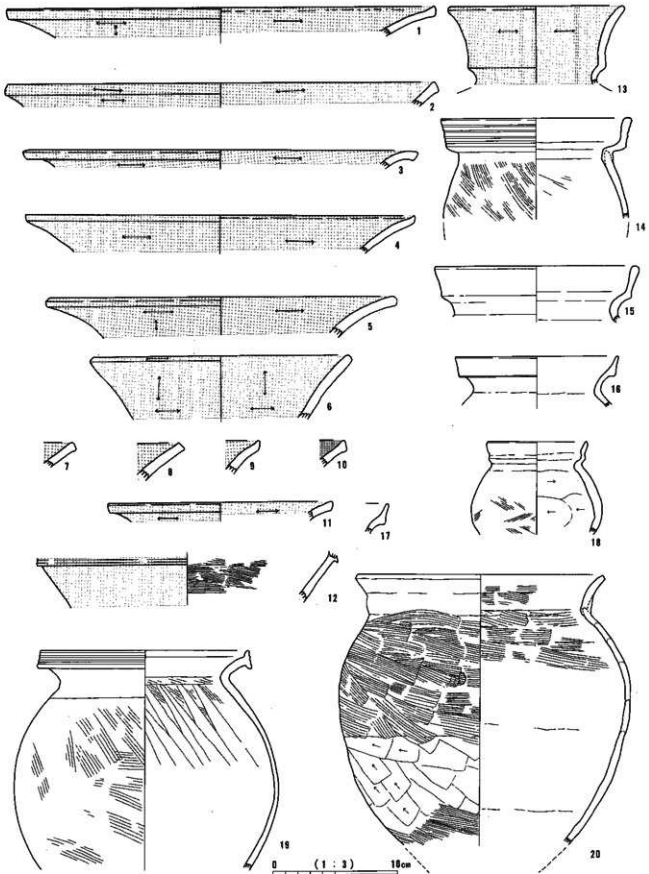

图版172 北陸系土器 3 (古墳前期) 東海系土器 1 (古墳前期)

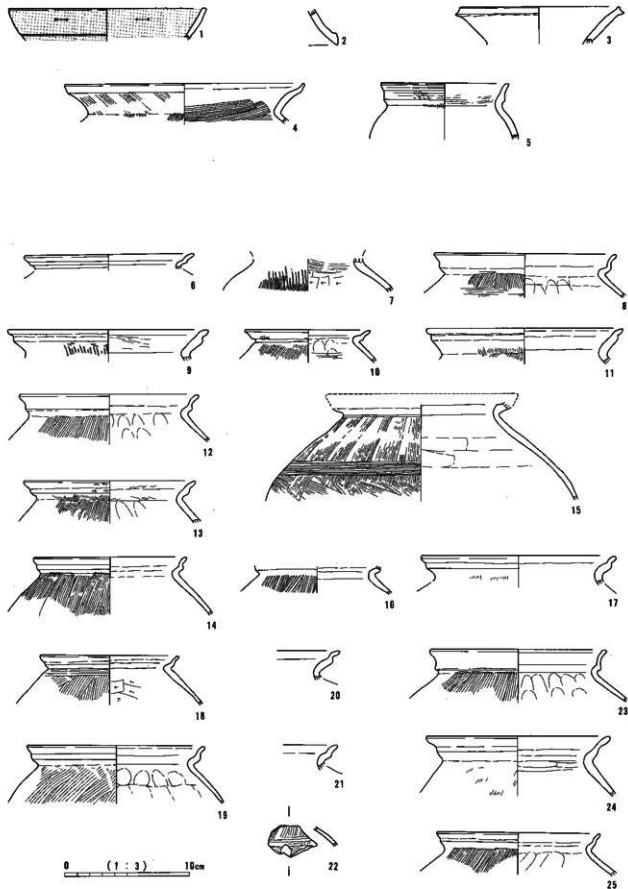

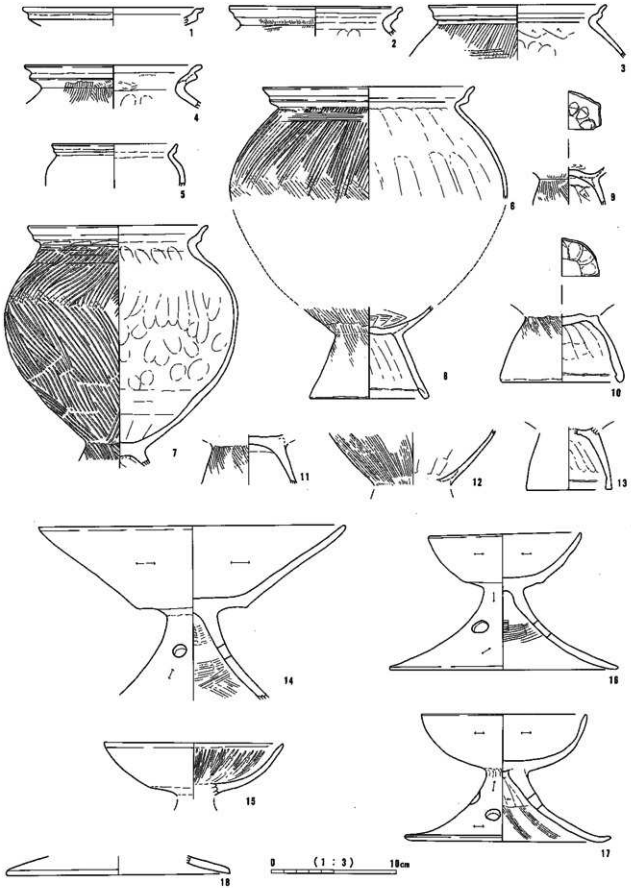

図版174 畿内系土器 1 (古墳前期)

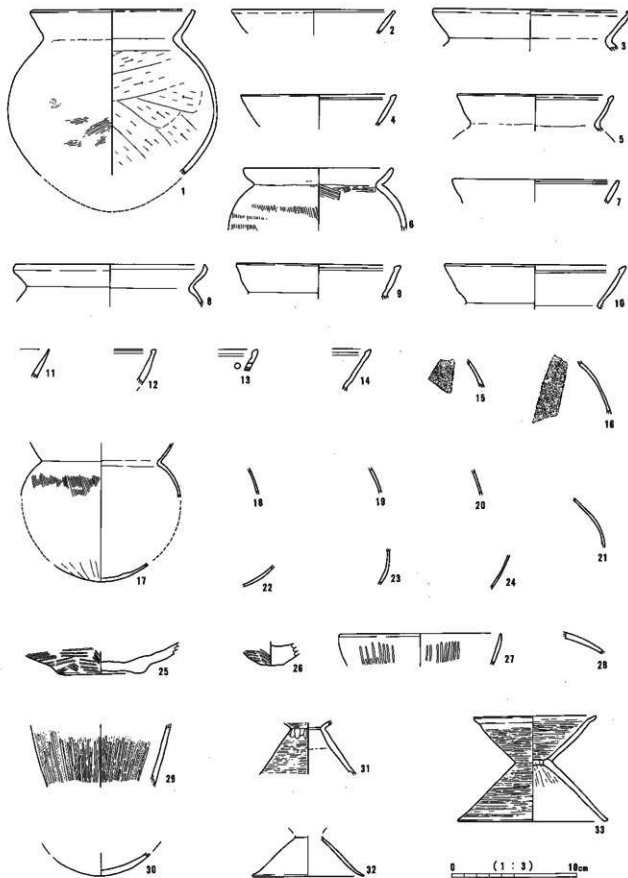

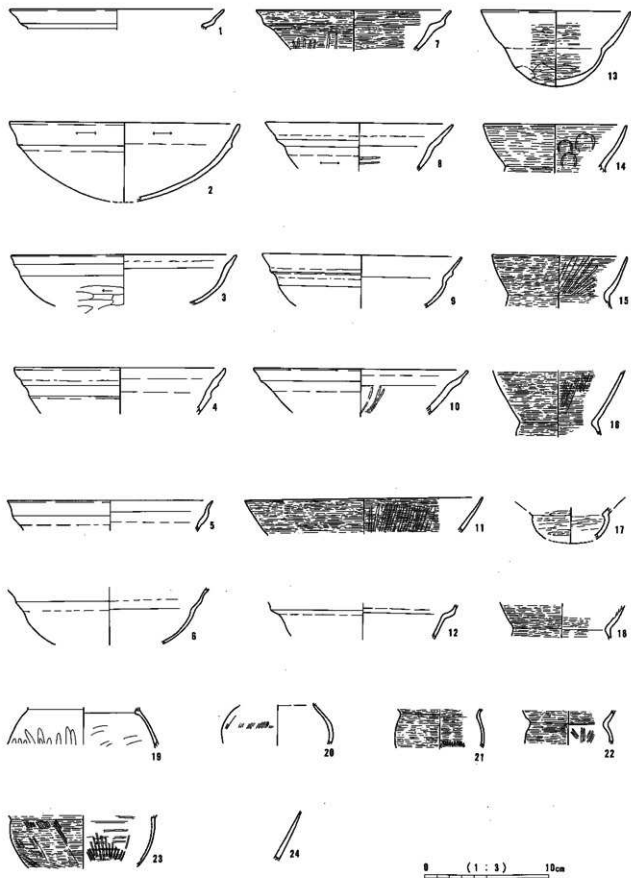

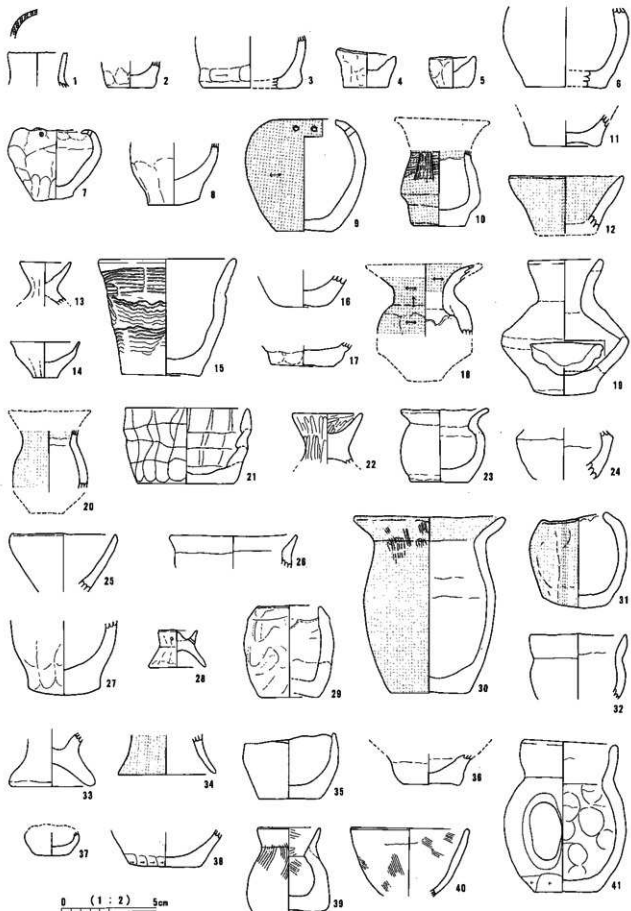

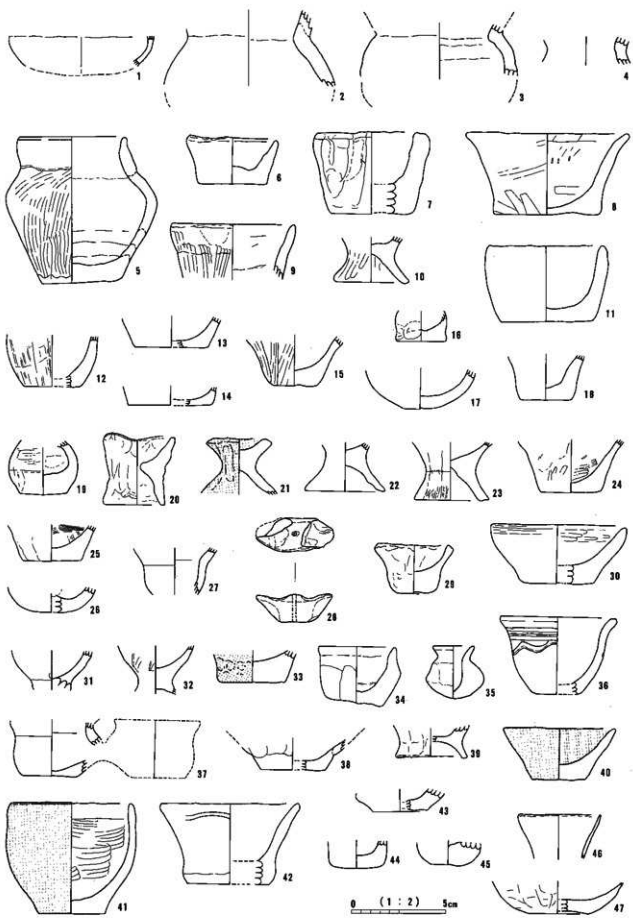

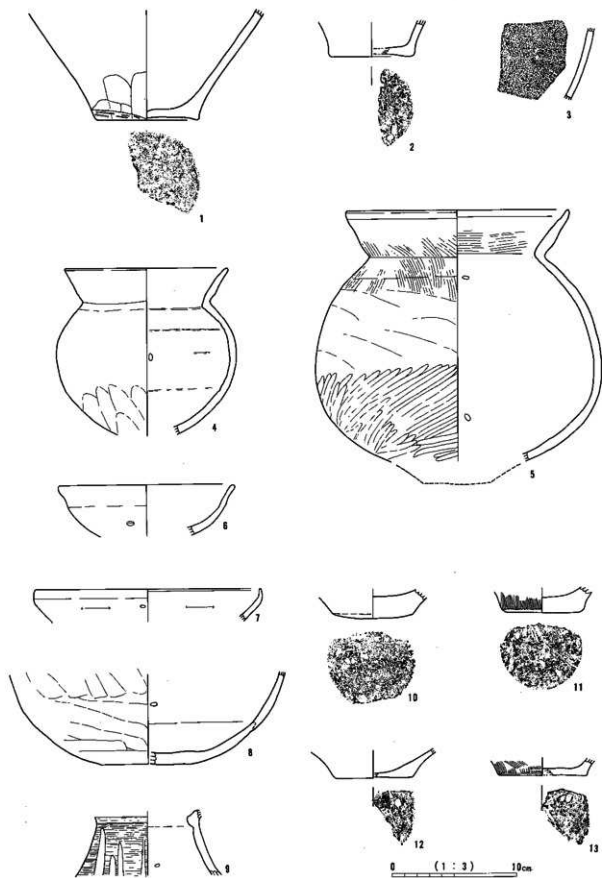

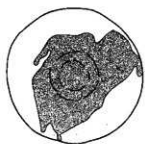

1



2



3



4

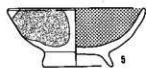

5

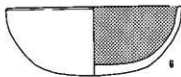
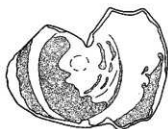

6



7

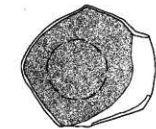

8

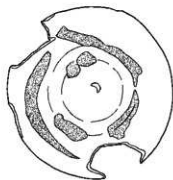

9



10

0 (1 : 3) 10cm

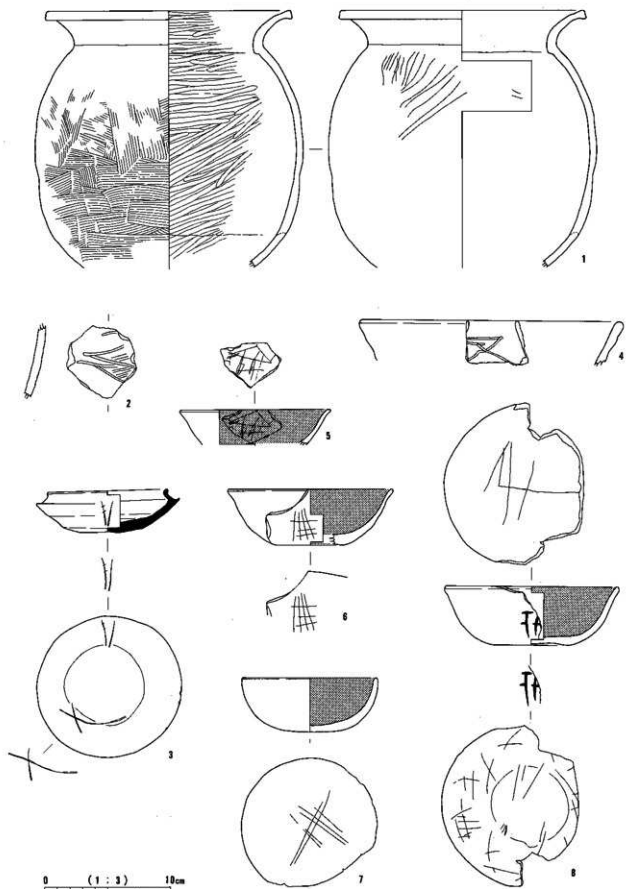

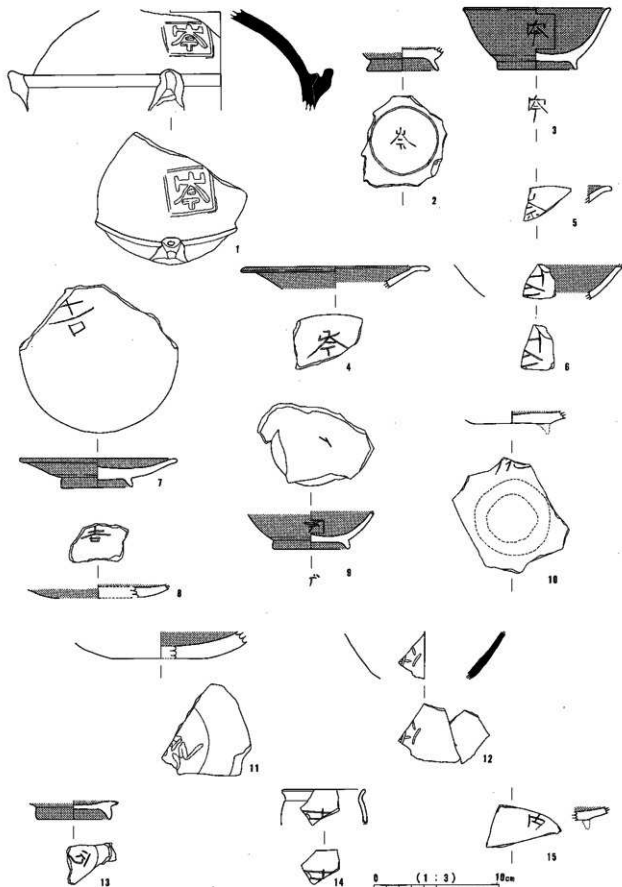

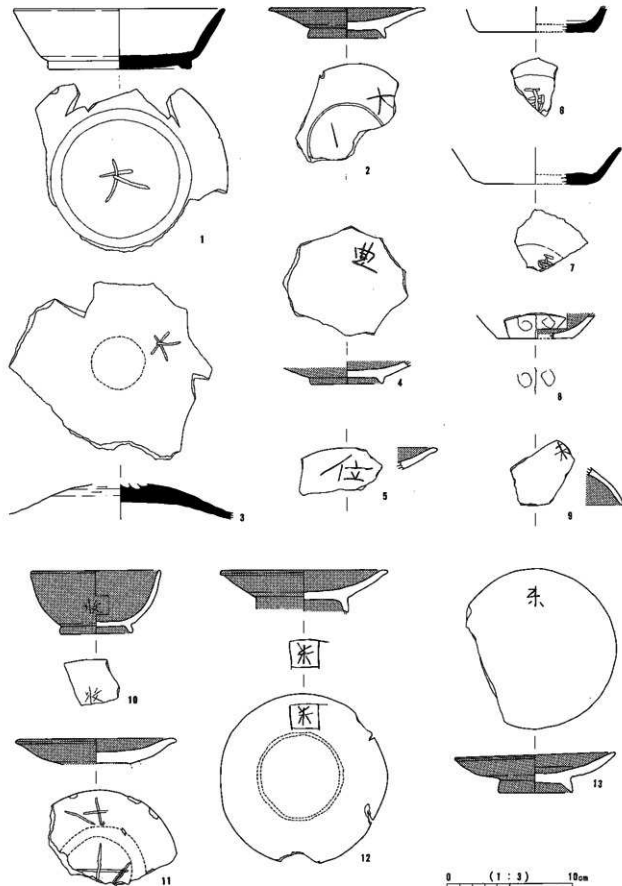

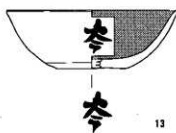
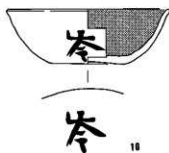
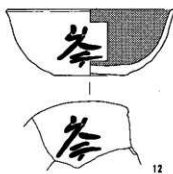
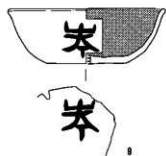
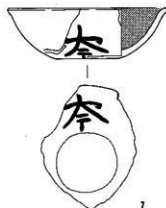
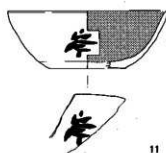
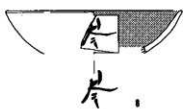
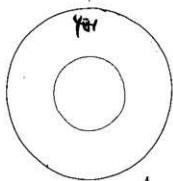
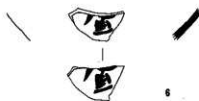
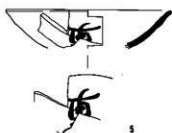
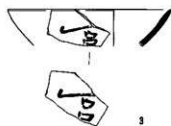
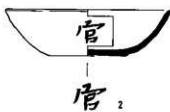

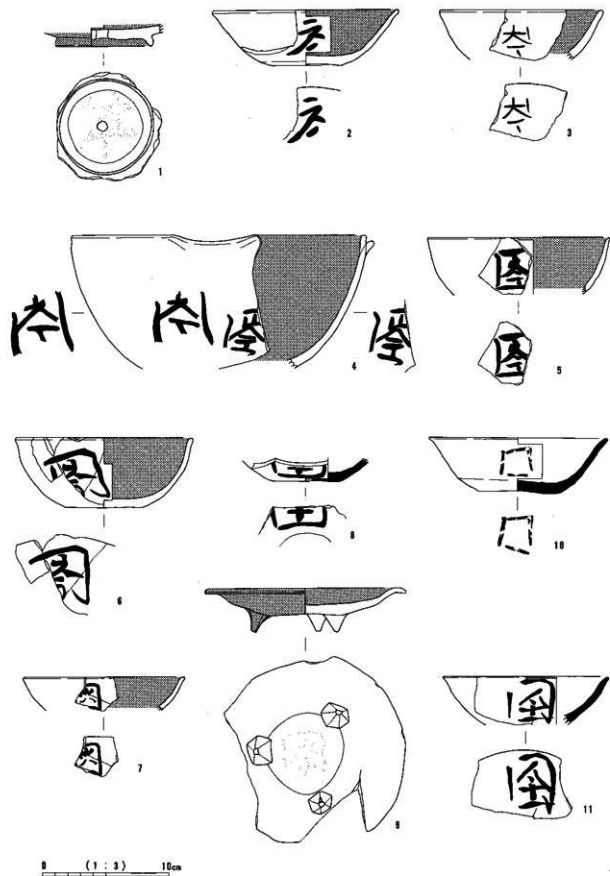

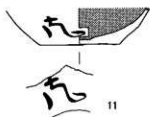
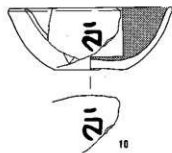
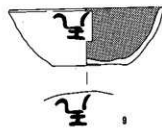
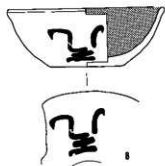
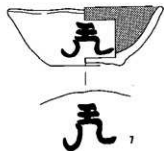
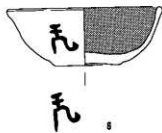
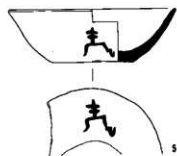
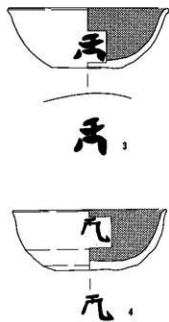
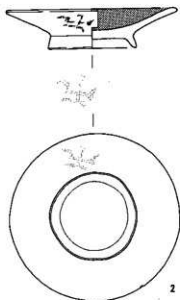
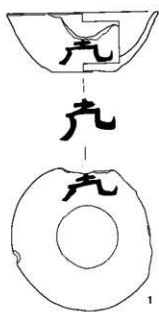

0 (1:3) 10cm



虎

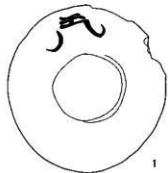

1



虎



虎

2

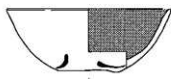

八



3

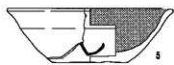

九

4



五

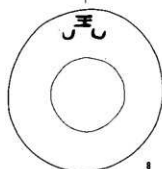

5



八



6



五

7



吉 1



吉 5



吉 8



10



吉 11



吉 2



吉 6



吉 7



吉 12



吉 13



14

0 (1:3) 10cm



吉 3



吉 4

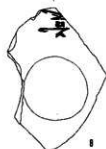

9



吉 1



吉 14



15



瓦₁



瓦



瓦

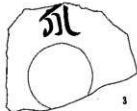

3



瓦₁



2



瓦



4



丙



丙₁



丙

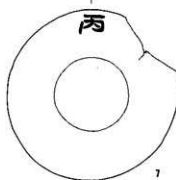

7



丙₁₀



丙

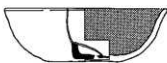

丙₁₂



11

0 (1:3) 10cm

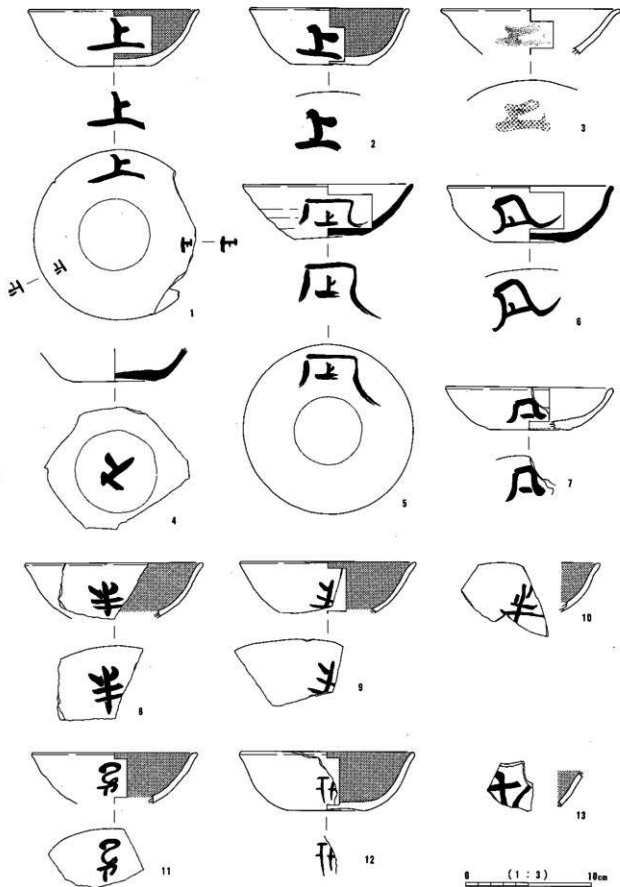

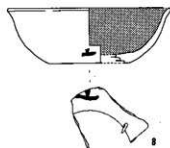
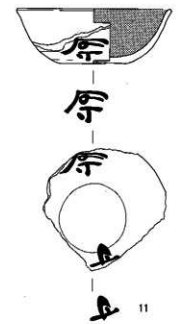
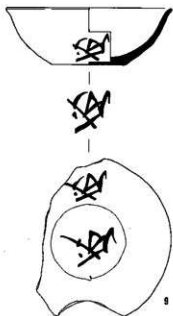
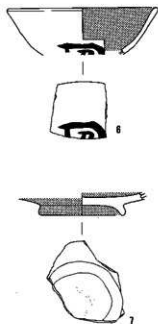
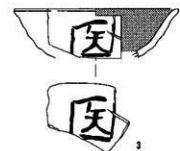
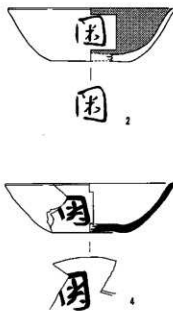
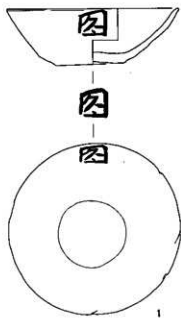

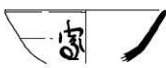
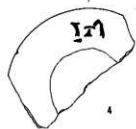
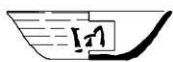
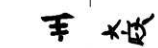
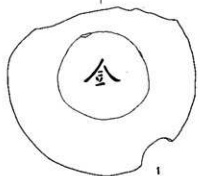
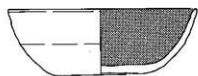

0 (1:3) 10cm

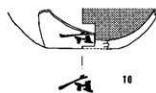
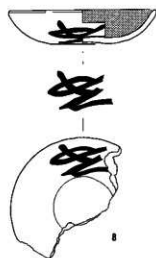
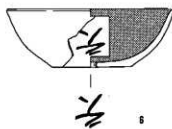
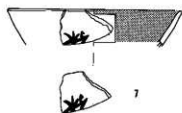
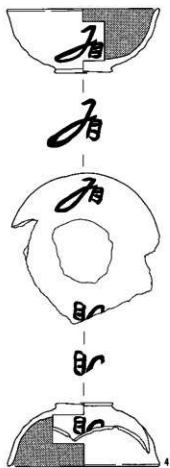
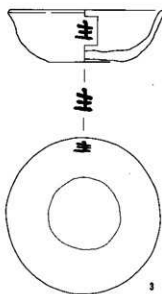
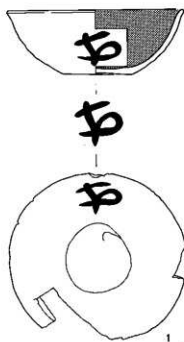

0 (1:3) 10cm

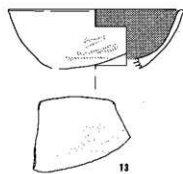
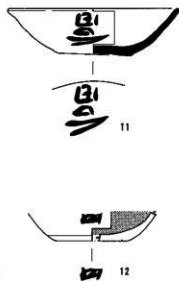
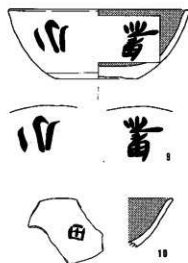
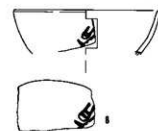
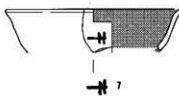
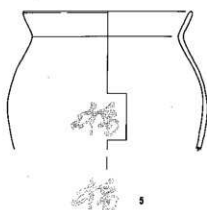
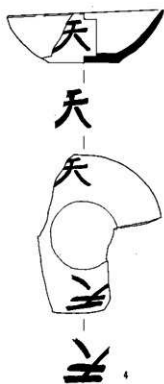
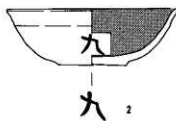
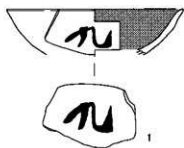

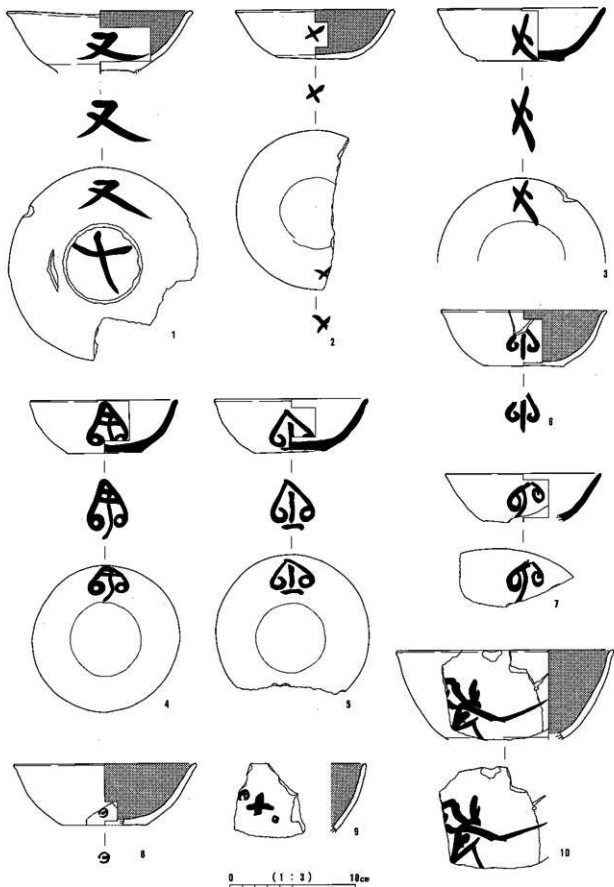

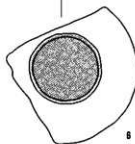
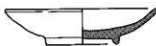
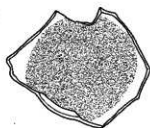
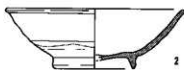
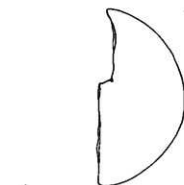
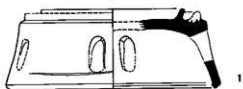
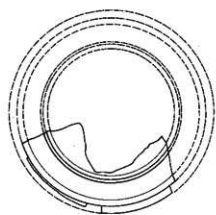

0 (1:3) 10cm

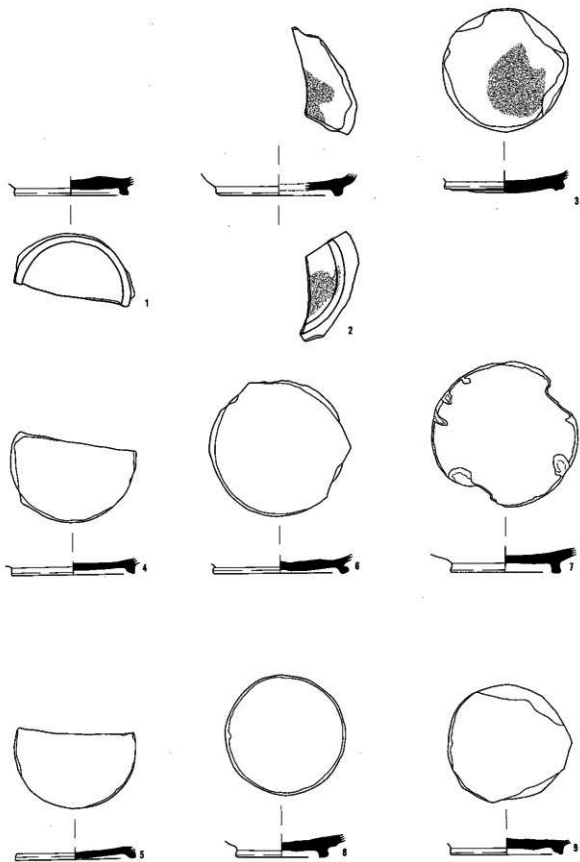

0 (1 : 3) 10cm

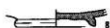
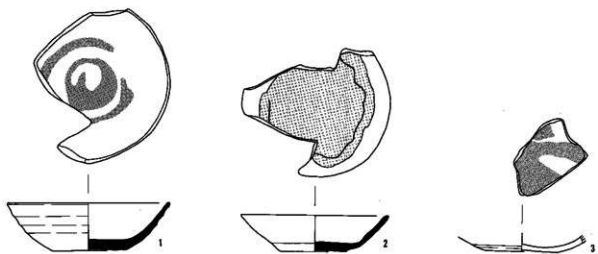

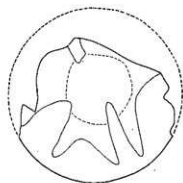

1

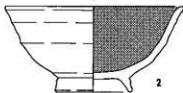
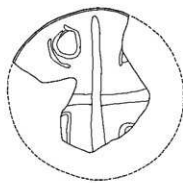

2



3

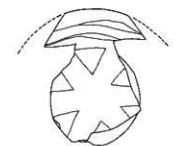

4



5



6



7

0 (1:3) 10cm

弥生中期

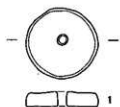

弥生後期

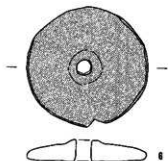
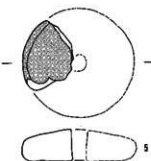
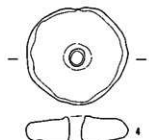
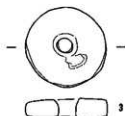
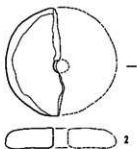

古墳前期

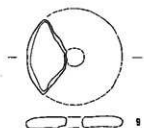
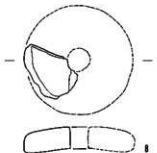
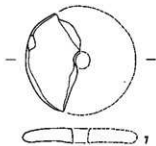

古墳後期 (1C)

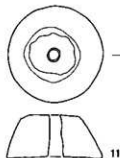
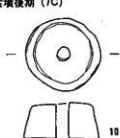

混入

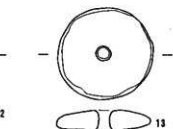
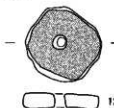

0 (1:2) 5cm

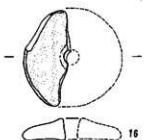
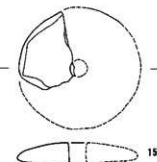
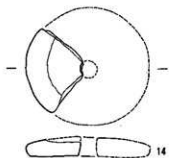

縄文

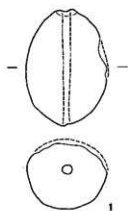

弥生中期

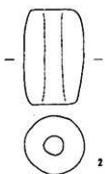

弥生後期

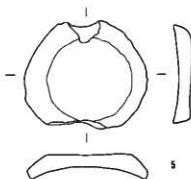
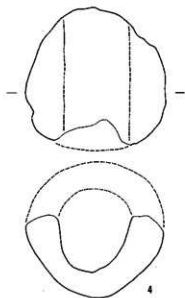
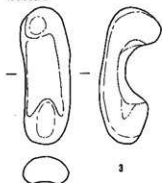

古墳前期

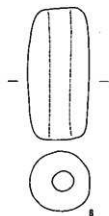

古代

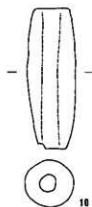
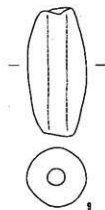
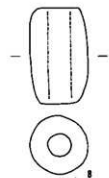
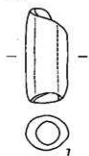

0 (1:2) 5cm

古代

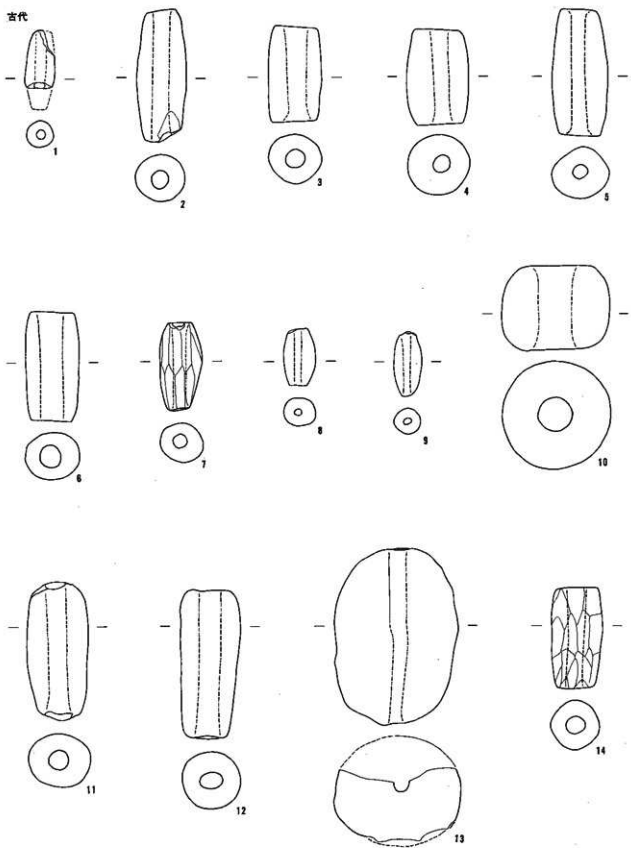

0 (1:2) 5cm

古代

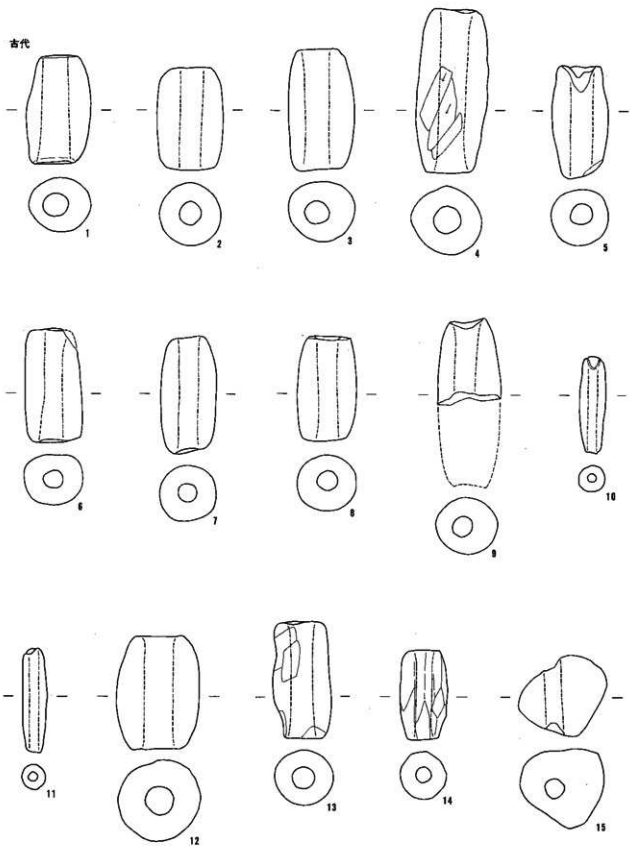

0 (1:2) 5cm

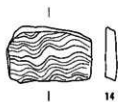
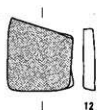
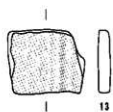
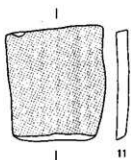
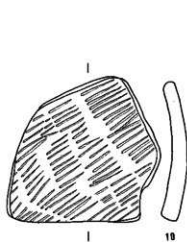
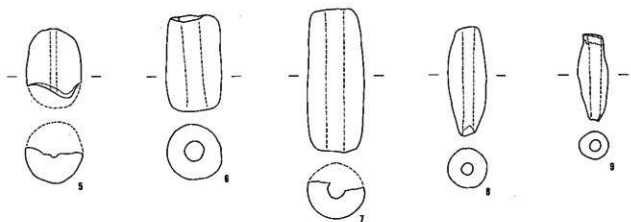
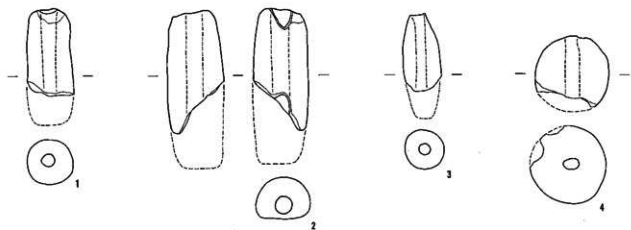

0 (1 : 2) 5cm

