

浅川扇状地遺跡群

MAYUMIDA SITE

檀 田 遺 跡 (2)

長野市檀田土地区画整理事業
(仮称) 西友檀田店店舗建設工事
アクロスプラザ長野北建設工事
にともなう埋蔵文化財発掘調査報告書

第2分冊 (図版編)

2004年3月

長野市教育委員会

第2分冊 (図版編) 目次

図版

図版1 縄文時代中期の遺構 (1)1 45② SA1, 45② SA2, 45② SA3, 45② SA4, 45② SA5/6, 45② SA7	図版23 弥生時代後期の遺構 (1)23 33① SA2, 49① SA1, 46① SA2, 46① SA3, 50① SA7
図版2 縄文時代中期の遺構 (2)2 63② SA1, 63② SA2, 63② SA3, E② SA1, E② SA2	図版24 弥生時代後期の遺構 (2)24 50② SA1, 50② SA2, 50② SA3, 50② SA4
図版3 縄文時代中期の遺構 (3)3 E② SA3	図版25 弥生時代後期の遺構 (3)25 50② SA6, 50② SA7, 50② SA8, 51① SA1, 51② SA1
図版4 縄文時代中期の遺構 (4)4 E② SA4	図版26 弥生時代後期の遺構 (4)26 51② SA2, 52① SA5, 52① SA7, 52② SA2, 53② SA1
図版5 縄文時代中期の遺構 (5)5 E② SA5	図版27 弥生時代後期の遺構 (5)27 53② SA4/5, 55① SA3, 55② SA1, 56② SA1, 56② SA3
図版6 縄文時代中期の遺構 (6)6 E② SA6, E② SA7, E② SA8	図版28 弥生時代後期の遺構 (6)28 57② SA1, 57② SA5, 60② SA2, 60② SA4
図版7 縄文時代中期の遺構 (7)7 E② SK8, E② SK9, E② SK39, E② SK47, 63② SP79, E② SP28, E② SX1	図版29 弥生時代後期の遺構 (7)29 61① SA4, 61① SA6, 61① SA8, 62① SA1, 70① SA1, 78 ① SA2
図版8 縄文時代中期の遺構 (8)8 E② SJ1, E② SJ2, E② SJ3, E② SJ4, 63② SR1, E② SR 2	図版30 弥生時代後期の遺構 (8)30 78① SA6, 79① SA2/10, B② SA2
図版9 縄文時代中期の遺構 (9)9 E② SN1	図版31 弥生時代後期の遺構 (9)31 B② SA3
図版10 弥生時代中期の遺構 (1)10 3① SA1, 3① SA2, 4① SA1/2, 10① SA1, 18① SA1	図版32 弥生時代後期の遺構 (10)32 B② SA7, B② SA8
図版11 弥生時代中期の遺構 (2)11 25① SA1, 29① SA1, 29① SA2, 30① SA1, 32① SA1, 34 ① SA4	図版33 弥生時代後期の遺構 (11)33 B② SA9
図版12 弥生時代中期の遺構 (3)12 37① SA1, 43① SA2, 50① SA10, 51① SA2, 52② SA1, 52② SA3, 53② SA3	図版34 弥生時代後期の遺構 (12)34 B② SA10, B② SA11, B② SA12, B② SA14
図版13 弥生時代中期の遺構 (4)13 53② SA7, 53② SA11, 55① SA2, 55① SA4, 64① SA1/ 2	図版35 弥生時代後期の遺構 (13)35 B② SA15, B② SA16, B② SA18, C② SA1
図版14 弥生時代中期の遺構 (5)14 65① SA1, 69① SA1, 69① SA2, 74① SA1, 74① SA2, 75 ① SA1	図版36 弥生時代後期の遺構 (14)36 C② SA2, C② SA4
図版15 弥生時代中期の遺構 (6)15 B② SA4, B② SA5, B② SA6, C② SA13/14	図版37 弥生時代後期の遺構 (15)37 C② SA6, C② SA7
図版16 弥生時代中期の遺構 (7)16 C② SA19, C② SA20, C② SA27, E① SA1	図版38 弥生時代後期の遺構 (16)38 C② SA8, C② SA9
図版17 弥生時代中期の遺構 (8)17 60① SK3, C② SK109, C② SK111, 3① SX1, 25① SX1	図版39 弥生時代後期の遺構 (17)39 C② SA10, C② SA12
図版18 弥生時代中期の遺構 (9)18 48① SJ5, 61K SJ 群遺構配置図	図版40 弥生時代後期の遺構 (18)40 C② SA11, C② SA15, C② SA17
図版19 弥生時代中期の遺構 (10)19 61② SJ1, 61② SJ2	図版41 弥生時代後期の遺構 (19)41 C② SA18, C② SA21, C② SA22, C② SA23, C② SA25
図版20 弥生時代中期の遺構 (11)20 61② SJ3, 61② SJ4, 61② SJ5	図版42 弥生時代後期の遺構 (20)42 25① SJ1, 48① SJ7, 50② SK4, 64① SJ1
図版21 弥生時代中期の遺構 (12)21 61② SJ6, 61② SJ7	図版43 弥生時代後期の遺構 (21)43 4① SC2/SDZ1, 37① SDZ1
図版22 弥生時代中期の遺構 (13)22 61② SJ8, 61② SJ9	図版44 弥生時代後期の遺構 (22)44 19① SDZ1, 48K SJ/SDZ 群遺構配置図
	図版45 弥生時代後期の遺構 (23)45 48① SDZ1
	図版46 弥生時代後期の遺構 (24)46 48① SDZ2, 48① SDZ4, 48① SDZ5/7, 48① SDZ6, 48① SDZ8
	図版47 弥生時代後期の遺構 (25)47

48① SD1, 55① SD6, B ② SD2, B ② SD6, B ② SD8, 62 ① SX4	
図版48 古墳時代前期～中期の遺構 (1)	48
6① SA1, 34① SA3, 48① SA2, 50② SA5	
図版49 古墳時代前期～中期の遺構 (2)	49
48① SA1, 48① SA3	
図版50 古墳時代前期～中期の遺構 (3)	50
54① SA1, 57① SA3, 60② SA3, 61① SA9/10	
図版51 古墳時代前期～中期の遺構 (4)	51
62① SA2, 62① SA3, 63① SA1, 79① SA5/8	
図版52 古墳時代前期～中期の遺構 (5)	52
B ② SA13, C ① SA30, C ② SA16, 34① SB1, 48① SK3	
図版53 古墳時代前期～中期の遺構 (6)	53
65① SDZ1	
図版54 古墳時代前期～中期の遺構 (7)	55
75① SDZ1, 75① SDZ4	
図版55 古墳時代前期～中期の遺構 (8)	57
6① SD1, 23① SD5, 33① SD7, 34① SD7, 52① SD1, 52① SD4, 62① SD2, 63① SD2, 63① SD6, 63① SD12, 46① SX 1, 75① SX1, C ① SX1	
図版56 古墳時代後期の遺構 (1)	58
23① SA1, 33① SA1	
図版57 古墳時代後期の遺構 (2)	59
33① SA4/5, 34① SA1, 48① SA4, 50① SA1	
図版58 古墳時代後期の遺構 (3)	60
50① SA2, 50① SA3, 50① SA4, 50① SA6, 50① SA9, 52 ① SA1	
図版59 古墳時代後期の遺構 (4)	61
52① SA2, 52① SA3, 52① SA4, 52① SA6, 53① SA1, 53 ① SA3	
図版60 古墳時代後期の遺構 (5)	62
53① SA4, 53① SA5	
図版61 古墳時代後期の遺構 (6)	63
53① SA9, 53① SA10	
図版62 古墳時代後期の遺構 (7)	64
53① SA11, 53② SA6, 54① SA2/3	
図版63 古墳時代後期の遺構 (8)	65
55① SA1, 55① SA5, 56① SA1, 56① SA4	
図版64 古墳時代後期の遺構 (9)	66
57① SA1, 57① SA2	
図版65 古墳時代後期の遺構 (10)	67
60① SA1, 61① SA1, 61① SA2/3, 61① SA5	
図版66 古墳時代後期の遺構 (11)	68
78① SA1, 78① SA3, 78① SA5, 79① SA4/7	
図版67 古墳時代後期の遺構 (12)	69
79① SA6, 79① SA9, B ① SA1, B ① SA3, B ① SA4	
図版68 古墳時代後期の遺構 (13)	70
B ① SA5, B ① SA8	
図版69 古墳時代後期の遺構 (14)	71
B ① SA6, B ① SA7, B ① SA9	
図版70 古墳時代後期の遺構 (15)	72
B ① SA11, B ① SA12, B ① SA13, B ① SA14	
図版71 古墳時代後期の遺構 (16)	73
B ① SA16	
図版72 古墳時代後期の遺構 (17)	74
C ① SA2, C ① SA3, C ① SA4	
図版73 古墳時代後期の遺構 (18)	75
C ① SA5	

図版74 古墳時代後期の遺構 (19)	76
C ① SA6, C ① SA7, C ① SA8	
図版75 古墳時代後期の遺構 (20)	77
C ① SA9	
図版76 古墳時代後期の遺構 (21)	78
C ① SA10/14	
図版77 古墳時代後期の遺構 (22)	79
C ① SA11	
図版78 古墳時代後期の遺構 (23)	80
C ① SA12, C ① SA13	
図版79 古墳時代後期の遺構 (24)	81
C ① SA15, C ① SA16	
図版80 古墳時代後期の遺構 (25)	82
C ① SA17, C ① SA18	
図版81 古墳時代後期の遺構 (26)	83
C ① SA19, C ① SA20, C ① SA21, C ① SA22	
図版82 古墳時代後期の遺構 (27)	84
C ① SA23, C ① SA24/27, C ① SA26	
図版83 古墳時代後期の遺構 (28)	85
C ① SA25, C ① SA28, C ① SA29	
図版84 古墳時代後期の遺構 (29)	86
55① SB1, C ① SK76, 23① SD1/2, 34① SD1, 34① SD2, 49① SD1, 52② SD1, 55① SD2/3, 71① SD2, D ① SD1, E ① SD17	
図版85 平安時代～中世の遺構 (1)	87
16① SD1, 26① SB2, 39① SB1/SH1, 54① SB1, 56② SB1, 76① SB1, C ① SB1, 53① SJ1	
図版86 平安時代～中世の遺構 (2)	88
4① SE1, 4① SE2, 14① SE1, 52① SE1, 70① SE1, B ① SE 1, B ① SE2	
図版87 平安時代～中世の遺構 (3)	89
B ① SE3, B ① SE4, B ① SE5, B ① SE6	
図版88 平安時代～中世の遺構 (4)	90
C ① SU3	
図版89 縄文時代中期の遺物 (1)	91
45② SA2, 45② SA6, 45② SA7, 63② SA1	
図版90 縄文時代中期の遺物 (2)	92
63② SA2, 63② SP79, 63② SR1	
図版91 縄文時代中期の遺物 (3)	93
48② SR1	
図版92 縄文時代中期の遺物 (4)	94
45② SD1, 遺構外 (1)	
図版93 縄文時代中期の遺物 (5)	95
遺構外 (2)	
図版94 縄文時代中期の遺物 (6)	96
E ② SA1, E ② SA2, E ② SA3 (1)	
図版95 縄文時代中期の遺物 (7)	97
E ② SA3 (2)	
図版96 縄文時代中期の遺物 (8)	98
E ② SA3 (3)	
図版97 縄文時代中期の遺物 (9)	99
E ② SA3 (4)	
図版98 縄文時代中期の遺物 (10)	100
E ② SA3 (5)	
図版99 縄文時代中期の遺物 (11)	101
E ② SA4 (1)	
図版100 縄文時代中期の遺物 (12)	102
E ② SA4 (2)	

図版101 縄文時代中期の遺物 (13)	103
E②SA4 (3) E②SA5	
図版102 縄文時代中期の遺物 (14)	104
E②SA6	
図版103 縄文時代中期の遺物 (15)	105
E②SA7, E②SA8, E②SK9, E②SP28	
図版104 縄文時代中期の遺物 (16)	106
E②SJ1, E②SJ2	
図版105 縄文時代中期の遺物 (17)	107
E②SJ3, E②SJ4	
図版106 縄文時代中期の遺物 (18)	108
E②SR1, E②SR2	
図版107 縄文時代中期の遺物 (19)	109
E②SN1, 遺構外 (3)	
図版108 縄文時代中期の遺物 (20)	110
遺構外 (4)	
図版109 縄文時代中期の遺物 (21)	111
遺構外 (5)	
図版110 縄文時代中期の遺物 (22)	112
遺構外 (6)	
図版111 縄文時代中期の遺物 (23)	113
遺構外 (7)	
図版112 縄文時代中期の遺物 (24)	114
遺構外 (8)	
図版113 縄文時代中期の遺物 (25)	115
石製品 (1)	
図版114 縄文時代中期の遺物 (26)	116
石製品 (2)	
図版115 縄文時代中期の遺物 (27)	117
石製品 (3)	
図版116 縄文時代中期の遺物 (28)	118
石製品 (4)	
図版117 縄文時代中期の遺物 (29)	119
石製品 (5)	
図版118 縄文時代中期の遺物 (30)	120
石製品 (6)	
図版119 縄文時代中期の遺物 (31)	121
石製品 (7)	
図版120 縄文時代中期の遺物 (32)	122
石製品 (8), 装身具	
図版121 縄文時代中期の遺物 (33)	123
土製品	
図版122 弥生時代中期の遺物 (1)	124
3①SA1, 3①SA2	
図版123 弥生時代中期の遺物 (2)	125
4①SA1, 4①SA2, 10①SA1	
図版124 弥生時代中期の遺物 (3)	126
18①SA1, 25①SA1, 29①SA1, 29①SA2, 30①SA1, 32①SA1 (1)	
図版125 弥生時代中期の遺物 (4)	127
32①SA1 (2)	
図版126 弥生時代中期の遺物 (5)	128
34①SA4, 43①SA2, 50①SA10, 51①SA2, 52②SA1	
図版127 弥生時代中期の遺物 (6)	129
52②SA3, 53②SA3, 53②SA7	
図版128 弥生時代中期の遺物 (7)	130
53②SA11 (1)	
図版129 弥生時代中期の遺物 (8)	131

53②SA11 (2)	
図版130 弥生時代中期の遺物 (9)	132
53②SA11 (3)	
図版131 弥生時代中期の遺物 (10)	133
53②SA11 (4), 64①SA1, 69①SA1, 74①SA1	
図版132 弥生時代中期の遺物 (11)	134
74①SA2, 75①SA1	
図版133 弥生時代中期の遺物 (12)	135
B②SA5, B②SA6, C②SA13	
図版134 弥生時代中期の遺物 (13)	136
C②SA14, C②SA19	
図版135 弥生時代中期の遺物 (14)	137
C②SA20 (1)	
図版136 弥生時代中期の遺物 (15)	138
C②SA20 (2)	
図版137 弥生時代中期の遺物 (16)	139
C②SA20 (3), C②SA27, E①SA1	
図版138 弥生時代中期の遺物 (17)	140
18①SK4, 60①SK3	
図版139 弥生時代中期の遺物 (18)	141
26①SK10, 29①SK2, 64①SK1	
図版140 弥生時代中期の遺物 (19)	142
C②SK109, C②SK111, 27①SD1, 3①SX1, 25①SX1	
図版141 弥生時代中期の遺物 (20)	143
石製品 (1)	
図版142 弥生時代中期の遺物 (21)	144
石製品 (2)	
図版143 弥生時代中期の遺物 (22)	145
石製品 (3)	
図版144 弥生時代中期の遺物 (23)	146
土製品	
図版145 弥生時代中期の遺物 (24)	147
装身具	
図版146 弥生時代後期の遺物 (1)	148
33①SA2, 46①SA1, 46①SA2, 46①SA3, 50①SA7, 50②SA1	
図版147 弥生時代後期の遺物 (2)	149
50②SA2, 50②SA3	
図版148 弥生時代後期の遺物 (3)	150
50②SA4, 50②SA6	
図版149 弥生時代後期の遺物 (4)	151
50②SA7 (1)	
図版150 弥生時代後期の遺物 (5)	152
50②SA7 (2)	
図版151 弥生時代後期の遺物 (6)	153
50②SA7 (3)	
図版152 弥生時代後期の遺物 (7)	154
50②SA7 (4)	
図版153 弥生時代後期の遺物 (8)	155
50②SA8, 51①SA1, 51②SA1	
図版154 弥生時代後期の遺物 (9)	156
51②SA2, 52①SA5, 52①SA7, 52②SA2, 53②SA1	
図版155 弥生時代後期の遺物 (10)	157
53②SA5, 55①SA3, 55②SA1 (1)	
図版156 弥生時代後期の遺物 (11)	158
55②SA1 (2), 56②SA1	
図版157 弥生時代後期の遺物 (12)	159
56②SA3, 57②SA1	

図版158 弥生時代後期の遺物 (13)	160	62① SX4、遺構外	
57② SA5 (1)		図版187 弥生時代後期の遺物 (42)	189
図版159 弥生時代後期の遺物 (14)	161	石製品	
57② SA5 (2)、60② SA2、61① SA6		図版188 弥生時代後期の遺物 (43)	190
図版160 弥生時代後期の遺物 (15)	162	土製品、装身具 (1)	
60② SA4、62① SA1、70① SA1		図版189 弥生時代後期の遺物 (44)	191
図版161 弥生時代後期の遺物 (16)	163	装身具 (2)	
78① SA2、78① SA6		図版190 弥生時代後期の遺物 (45)	192
図版162 弥生時代後期の遺物 (17)	164	装身具 (3)	
79① SA2		図版191 古墳時代前期～中期の遺物 (1)	193
図版163 弥生時代後期の遺物 (18)	165	6① SA1、34① SA3、48① SA1	
B② SA2 (1)		図版192 古墳時代前期～中期の遺物 (2)	194
図版164 弥生時代後期の遺物 (19)	166	48① SA2、48① SA3、50② SA5	
B② SA2 (2)、B② SA3 (1)		図版193 古墳時代前期～中期の遺物 (3)	195
図版165 弥生時代後期の遺物 (20)	167	54① SA1、57① SA3、60② SA3、61① SA9、63① SA1 (1)	
B② SA3 (2)、B② SA7 (1)		図版194 古墳時代前期～中期の遺物 (4)	196
図版166 弥生時代後期の遺物 (21)	168	63① SA1 (2)、79① SA5、B② SA13、C① SA30 (1)	
B② SA7 (2)		図版195 古墳時代前期～中期の遺物 (5)	197
図版167 弥生時代後期の遺物 (22)	169	C① SA30 (2)、C② SA16	
B② SA8、B② SA9 (1)		図版196 古墳時代前期～中期の遺物 (6)	198
図版168 弥生時代後期の遺物 (23)	170	34① SB1、48① SK3、65① SDZ1、75① SDZ4、6① SD1 (1)	
B② SA9 (2)		図版197 古墳時代前期～中期の遺物 (7)	199
図版169 弥生時代後期の遺物 (24)	171	6① SD1 (2)	
B② SA10		図版198 古墳時代前期～中期の遺物 (8)	200
図版170 弥生時代後期の遺物 (25)	172	23① SD5、33① SD7、50① SD2、50② SD3、52① SD1、52① SD4	
B② SA11、B② SA12		図版199 古墳時代前期～中期の遺物 (9)	201
図版171 弥生時代後期の遺物 (26)	173	34① SD7	
B② SA14		図版200 古墳時代前期～中期の遺物 (10)	202
図版172 弥生時代後期の遺物 (27)	174	62① SD2、63① SD2、63① SD6、63① SD12、46① SX1	
B② SA15、B② SA16、B② SA18		図版201 古墳時代前期～中期の遺物 (11)	203
図版173 弥生時代後期の遺物 (28)	175	75① SX1	
C② SA1、C② SA2、C② SA4		図版202 古墳時代前期～中期の遺物 (12)	204
図版174 弥生時代後期の遺物 (29)	176	C① SX1、遺構外	
C② SA6		図版203 古墳時代前期～中期の遺物 (13)	205
図版175 弥生時代後期の遺物 (30)	177	土製品、装身具	
C② SA7、C② SA8 (1)		図版204 古墳時代後期の遺物 (1)	206
図版176 弥生時代後期の遺物 (31)	178	23① SA1、33① SA1、33① SA5	
C② SA8 (2)、C② SA9		図版205 古墳時代後期の遺物 (2)	207
図版177 弥生時代後期の遺物 (32)	179	33① SA4、34① SA1、50① SA1、50① SA4	
C② SA10 (1)		図版206 古墳時代後期の遺物 (3)	208
図版178 弥生時代後期の遺物 (33)	180	48① SA4	
C② SA10 (2)、C② SA11		図版207 古墳時代後期の遺物 (4)	209
図版179 弥生時代後期の遺物 (34)	181	50① SA2、50① SA3	
C② SA12		図版208 古墳時代後期の遺物 (5)	210
図版180 弥生時代後期の遺物 (35)	182	50① SA6、52① SA2、52① SA6	
C② SA15、C② SA17、C② SA18、C② SA21		図版209 古墳時代後期の遺物 (6)	211
図版181 弥生時代後期の遺物 (36)	183	52① SA4、53① SA1	
C② SA22、C② SA25		図版210 古墳時代後期の遺物 (7)	212
図版182 弥生時代後期の遺物 (37)	184	53① SA3、53① SA5	
25① SJ1、48① SJ7		図版211 古墳時代後期の遺物 (8)	213
図版183 弥生時代後期の遺物 (38)	185	53① SA4、53① SA9、53① SA10、53① SA11、53① SA6	
64① SJ1		図版212 古墳時代後期の遺物 (9)	214
図版184 弥生時代後期の遺物 (39)	186	54① SA2、55① SA1、55① SA5、56① SA1	
50② SK4、4① SDZ1		図版213 古墳時代後期の遺物 (10)	215
図版185 弥生時代後期の遺物 (40)	187	56① SA4、57① SA1	
19① SDZ1、48① SDZ5、48① SDZ6、48① SD1、B② SD2、B② SD6、B② SD8		図版214 古墳時代後期の遺物 (11)	216
図版186 弥生時代後期の遺物 (41)	188	57① SA2、60① SA1	

図版215 古墳時代後期の遺物 (12)	217
61① SA1, 61① SA2	
図版216 古墳時代後期の遺物 (13)	218
61① SA3, 61① SA5, 78① SA1, 78① SA3	
図版217 古墳時代後期の遺物 (14)	219
79① SA4, 79① SA6, 79① SA9	
図版218 古墳時代後期の遺物 (15)	220
B① SA2, B① SA3, B① SA4	
図版219 古墳時代後期の遺物 (16)	221
B① SA5	
図版220 古墳時代後期の遺物 (17)	222
B① SA6, B① SA7, B① SA8	
図版221 古墳時代後期の遺物 (18)	223
B① SA9, B① SA11, B① SA12, B① SA13, B① SA14, B① SA16 (1)	
図版222 古墳時代後期の遺物 (19)	224
B① SA16 (2)	
図版223 古墳時代後期の遺物 (20)	225
C① SA2	
図版224 古墳時代後期の遺物 (21)	226
C① SA3, C① SA4, C① SA6	
図版225 古墳時代後期の遺物 (22)	227
C① SA5	
図版226 古墳時代後期の遺物 (23)	228
C① SA7, C① SA8 (1)	
図版227 古墳時代後期の遺物 (24)	229
C① SA8 (2), C① SA9 (1)	
図版228 古墳時代後期の遺物 (25)	230
C① SA9 (2), C① SA10	
図版229 古墳時代後期の遺物 (26)	231
C① SA11 (1)	
図版230 古墳時代後期の遺物 (27)	232
C① SA11 (2)	
図版231 古墳時代後期の遺物 (28)	233
C① SA12, C① SA13, C① SA14	

図版232 古墳時代後期の遺物 (29)	234
C① SA15, C① SA16 (1)	
図版233 古墳時代後期の遺物 (30)	235
C① SA16 (2), C① SA17, C① SA18 (1)	
図版234 古墳時代後期の遺物 (31)	236
C① SA18 (2), C① SA19	
図版235 古墳時代後期の遺物 (32)	237
C① SA21	
図版236 古墳時代後期の遺物 (33)	238
C① SA20, C① SA22, C① SA23	
図版237 古墳時代後期の遺物 (34)	239
C① SA24, C① SA25	
図版238 古墳時代後期の遺物 (35)	240
C① SA26, C① SA27, C① SA28, C① SA29	
図版239 古墳時代後期の遺物 (36)	241
55① SB1, 56① SK5, C① SK76, 23① SD1, 23① SD2	
図版240 古墳時代後期の遺物 (37)	242
34① SD1, 34① SD2	
図版241 古墳時代後期の遺物 (38)	243
49① SD1, 52① SD1, 55① SD2, 55① SD3, 71① SD2, C① SD8	
図版242 古墳時代後期の遺物 (39)	244
D① SD1	
図版243 古墳時代後期の遺物 (40)	245
E① SD17 (1)	
図版244 古墳時代後期の遺物 (41)	246
E① SD17 (2), 62② SU2, 62① SX3	
図版245 古墳時代後期の遺物 (42)	247
石製品	
図版246 古墳時代後期の遺物 (43)	248
土製品, 装身具	
図版247 平安時代～中世の遺物	249
53① SK1, 16① SD1, C① SD1, C① SD2, C① SU3	
図版248 時期不明の遺物	250
石製品, 土製品, 装身具	

写真図版

写真図版1 縄文時代中期の遺構 (1)	251
45② SA1, 45② SA2, 45② SA3, 45② SA4, 45② SA5 / 6, 45② SA7, 63② SA1, 63② SA1土偶出土状況, 63② SA1土器出土状況, 63② SA2, 63② SA2土器出土状況, 63② SA3, E② SA1, E② SA2遺物出土状況, E② SA2完掘	
写真図版2 縄文時代中期の遺構 (2)	252
E② SA3遺物出土状況 (1), E② SA3遺物出土状況 (2), E② SA3土器出土状況 (1), E② SA3土器出土状況 (2), E② SA3完掘, E② SA4上層遺物出土状況, E② SA4中層遺物出土状況 (1), E② SA4中層遺物出土状況 (2), E② SA4中層石棒出土状況, E② SA4石器出土状況, E② SA4完掘, E② SA5遺物出土状況, E② SA5ピット内遺物出土状況, E② SA5完掘, E② SA5印	
写真図版3 縄文時代中期の遺構 (3)	253
E② SA6上層遺物出土状況, E② SA6遺物出土状況, E② SA6土器出土状況, E② SA6完掘, E② SA7, E② SA7印, E② SA8, E② SA8印, E② SK8, E② SK9遺物出土状況, E② SK9完掘, E② SK1, E② SJ1, E② SJ2, E② SJ3	
写真図版4 縄文時代中期の遺構 (4), 弥生時代中期の遺構	

(1)	254
E② SJ4, 48② SR1, 63② SR1, E② SR1, E② SR2, E② SN1検出状況, E② SN1完掘, 3① SA1, 3① SA2, 4① SA1, 10① SA1, 18① SA1, 25① SA1, 29① SA2, 30① SA1	
写真図版5 弥生時代中期の遺構 (2)	255
32① SA1, 34① SA4, 37① SA1, 43① SA2, 50① SA10, 51① SA2, 52② SA1, 52② SA3, 53② SA3, 53② SA7, 53② SA11遺物出土状況 (1), 53② SA11遺物出土状況 (2), 53② SA11完掘, 55① SA2, 55① SA4	
写真図版6 弥生時代中期の遺構 (3)	256
64① SA1 (外) / 2 (内), 65① SA1, 69① SA1, 74① SA1 (左) / 2 (右), 75① SA1, B② SA4, B② SA5, B② SA6, C② SA13 (外) / 14 (内) (1), C② SA13 (外) / 14 (内) (2), C② SA19, C② SA20遺物出土状況 (1), C② SA20遺物出土状況 (2), C② SA20完掘, E① SA1印遺物出土状況	
写真図版7 弥生時代中期の遺構 (4)	257
E① SA1完掘, 18① SK4, 29① SK10, 29① SK2, 60① SK3, 64① SK1, C② SK111, 48① SJ5, 61K SJ 群, 61K SJ	

群掘り方、61区 SJ 群埋葬時復元状況、61② SJ1、61③ SJ1掘り方、61④ SJ2、61⑤ SJ2掘り方

写真図版 8 弥生時代中期の遺構 (5)258
61② SJ3 (1)、61② SJ3 (2)、61② SJ3掘り方、61② SJ4、61② SJ4掘り方、61② SJ5、61② SJ6、61② SJ6掘り方、61② SJ7、61② SJ7掘り方、61② SJ8、61② SJ8掘り方、61② SJ9、61② SJ9掘り方、61② SD3

写真図版 9 弥生時代中期の遺構 (6)、弥生時代後期の遺構 (1)259
27① SD1、73① SU2、3① SX1、43① SX1、55① SX1、33① SA2、46① SA1、46② SA2、46③ SA3、50① SA7、50② SA1、50③ SA2 (1)、50④ SA2 (2)、50⑤ SA3炭化材出土状況、50⑥ SA3完掘

写真図版 10 弥生時代後期の遺構 (2)260
50⑦ SA4、50⑧ SA6、50⑨ SA7炭化材・遺物出土状況、50⑩ SA7完掘、50⑪ SA8、51① SA1、51② SA1、51③ SA2、51④ SA3、52① SA5、52② SA7、52③ SA2、53① SA1、53② SA4/5、55① SA3

写真図版 11 弥生時代後期の遺構 (3)261
55② SA1、55③ SA1#2、55④ SA1#半截、56② SA1炭化材・遺物出土状況、56③ SA3、57② SA1、57③ SA5、60② SA2、60③ SA4炭化材出土状況、60④ SA完掘、61① SA4、61① SA6、61① SA8、62① SA1、70① SA1

写真図版 12 弥生時代後期の遺構 (4)262
78① SA2、78② SA6、79① SA2、79② SA10、B② SA2、B③ SA2遺物出土状況、B④ SA3炭化材出土状況、B⑤ SA3石庭丁出土状況、B⑥ SA3完掘、B⑦ SA7覆土集石出土状況、B⑧ SA7完掘、B⑨ SA8覆土集石出土状況、B⑩ SA8完掘、B⑪ SA9炭化材・遺物出土状況 (1)、B⑫ SA9炭化材・遺物出土状況 (2)

写真図版 13 弥生時代後期の遺構 (5)263
B⑬ SA9完掘、B⑭ SA10覆土集石出土状況、B⑮ SA10防蝕車出土状況、B⑯ SA10土器出土状況、B⑰ SA10完掘、B⑱ SA11遺物出土状況、B⑲ SA11完掘、B⑳ SA12土層断面、B㉑ SA12完掘、B㉒ SA14、B㉓ SA15、B㉔ SA16、B㉕ SA17、B㉖ SA18、C㉗ SA1

写真図版 14 弥生時代後期の遺構 (6)264
C㉘ SA2炭化材出土状況、C㉙ SA2完掘、C㉚ SA2壁面被熱状況、C㉛ SA4勾玉出土状況、C㉜ SA4石器出土状況、C㉝ SA4完掘、C㉞ SA4#、C㉟ SA6、C㊱ SA7、C㊲ SA7土器出土状況、C㊳ SA8 (1)、C㊴ SA8 (2)、C㊵ SA9、C㊶ SA9#、C㊷ SA10

写真図版 15 弥生時代後期の遺構 (7)265
C㊸ SA10遺物出土状況、C㊹ SA11、C㊺ SA11遺物出土状況、C㊻ SA12 (1)、C㊼ SA12 (2)、C㊽ SA15、C㊾ SA17、C㊿ SA18、C㊽ SA21、C㊽ SA22、C㊽ SA23、C㊽ SA25、50② SK4、48③ SJ3、48④ SJ7

写真図版 16 弥生時代後期の遺構 (8)266
64① SJ1出土状況、64② SJ1棺内遺物出土状況、64③ SJ1棺支え出土状況、4① SC2 (手前) / SDZ1 (奥)、4② SDZ1遺物出土状況、4③ SD2 / SDZ1土層断面、19① SDZ1、37① SDZ1、48① SJ / SDZ 群 (東から)、48② SJ / SDZ 群 (西から)、48③ SDZ1、48④ SDZ1主体部、48⑤ SDZ1主体部遺物出土状況 (1)、48⑥ SDZ1主体部遺物出土状況 (2)、48⑦ SDZ1主体部遺物出土状況 (3)

写真図版 17 弥生時代後期の遺構 (9)、古墳時代前期～中期の遺構 (1)267
48⑧ SDZ2、48⑨ SDZ2主体部、48⑩ SDZ2主体部遺物出土

状況、48⑪ SDZ4、48⑫ SDZ4主体部、48⑬ SDZ6、48⑭ SDZ8主体部、4① SD2、26② SD7、48⑮ SD1、B② SD6土層断面、B③ SU2、62② SX4、6③ SA1、6④ SA1遺物出土状況

写真図版 18 古墳時代前期～中期の遺構 (2)268
34① SA3、48① SA1、48② SA2、48③ SA2、50① SA8、50② SA5、54① SA1、57① SA3、60② SA3、61① SA9、61② SA10、62① SA2、62② SA3、63① SA1、79① SA5

写真図版 19 古墳時代前期～中期の遺構 (3)269
79① SA8、B② SA13炭化材出土状況、B③ SA13完掘、C㉑ SA30、C㉒ SA30遺物出土状況、C㉓ SA16、34① SB1、48① SK3、65① SDZ1 (65区西から)、65② SDZ1 (65区東から)、65③ SDZ1 (75区検出)、65④ SDZ1土層断面 (74区検出)、75① SDZ1、75② SDZ4、75③ SDZ4土層断面

写真図版 20 古墳時代前期～中期の遺構 (4)270
6① SD1、13① SD1、23① SD5、33① SD7、34① SD7、34② SD7土層断面、50① SD3 / 4、52① SD1、52② SD4、63① SD1 / 2、46① SX1、75① SX1、75② SX1遺物出土状況 (1)、75③ SX1遺物出土状況 (2)、C㉑ SX1

写真図版 21 古墳時代後期の遺構 (1)271
23② SA1炭化材出土状況、23③ SA1カマド出土状況、23④ SA1完掘、33① SA1、33② SA1カマド、33③ SA4 (奥) / 5 (手前)、34① SA1炭化材出土状況、34② SA1完掘、48① SA4、50① SA1、50② SA2、50③ SA3、50④ SA4、50⑤ SA6、50⑥ SA9

写真図版 22 古墳時代後期の遺構 (2)272
52② SA1、52③ SA2、52④ SA3、52⑤ SA6、53① SA1、53② SA2、53③ SA3カマド出土状況、53④ SA3、53⑤ SA4、53⑥ SA5カマド出土状況、53⑦ SA5、53⑧ SA9、53⑨ SA10カマド出土状況、53⑩ SA10、53⑪ SA11

写真図版 23 古墳時代後期の遺構 (3)273
53⑫ SA6、54① SA2 (奥) / 3 (手前)、55① SA1、55② SA5カマド出土状況、55③ SA5、56① SA1、56② SA4、57① SA1、57② SA2、60① SA1、61① SA1カマド出土状況、61② SA1、61③ SA2、61④ SA3、78① SA1

写真図版 24 古墳時代後期の遺構 (4)274
78② SA3、78③ SA4、78④ SA5、79① SA4、79② SA6、79③ SA7、79④ SA9、B① SA1、B② SA3遺物出土状況、B③ SA3完掘、B④ SA4カマド出土状況、B⑤ SA4、B⑥ SA5カマド出土状況、B⑦ SA5、B⑧ SA6カマド出土状況

写真図版 25 古墳時代後期の遺構 (5)275
B⑨ SA6、B⑩ SA6#石出土状況、B⑪ SA7カマド出土状況、B⑫ SA7、B⑬ SA8、B⑭ SA9、B⑮ SA11、B⑯ SA12、B⑰ SA13カマド出土状況、B⑱ SA13、B⑲ SA14、B⑳ SA16カマド出土状況、B㉑ SA16遺物出土状況、B㉒ SA17、C㉑ SA2カマド出土状況

写真図版 26 古墳時代後期の遺構 (6)276
C㉒ SA2、C㉓ SA3、C㉔ SA4、C㉕ SA4カマド、C㉖ SA5カマド出土状況、C㉗ SA5完掘 (カマド F)、C㉘ SA5完掘 (カマド F)、C㉙ SA5カマド F / 3、C㉚ SA6カマド出土状況、C㉛ SA6、C㉜ SA7、C㉝ SA8カマド出土状況、C㉞ SA8、C㉟ SA9カマド出土状況 (1)、C㊱ SA9カマド出土状況 (2)

写真図版 27 古墳時代後期の遺構 (7)277
C㊲ SA9遺物出土状況、C㊳ SA9完掘、C㊴ SA10カマド出土状況、C㊵ SA10カマド F2、C㊶ SA10 (左) / 14 (右)、C㊷ SA11遺物出土状況 (1)、C㊸ SA11遺物出土状況 (2)、C㊹ SA11カマド出土状況、C㊺ SA11、C㊻ SA12、C㊼ SA13カマド出土状況、C㊽ SA13カマド完掘、C㊾ SA

13 (1), C①SA13 (2), C①SA15	
写真図版28 古墳時代後期の遺構 (8)	278
C①SA15カマF1, C①SA15カマF2, C①SA16カマF出土状況, C①SA16, C①SA16土製支脚出土状況, C①SA16遺物出土状況, C①SA17, C①SA18カマF出土状況, C①SA18, C①SA19カマF出土状況, C①SA19, C①SA20, C①SA21カマF出土状況, C①SA21, C①SA22	
写真図版29 古墳時代後期の遺構 (9)	279
C①SA23, C①SA24カマF出土状況, C①SA24 (外) / 27 (内), C①SA25カマF出土状況, C①SA25, C①SA26, C①SA28カマF内土器出土状況, C①SA28, C①SA28カマF, C①SA29, 55①SB1, C①SK76, 12①SD2, 23①SD1 (右) / 2 (左), 34①SD2	
写真図版30 古墳時代後期の遺構 (10)、平安時代～中世の遺構 (1)	280
46①SD2, 49①SD1, 52②SD1, 55①SD2 (手前) / 3 (奥), D①SD1, D①SD2, E①SD17, 62①SK3, 26①SR2, 39①SB1 / SH1, 54②SB1, C①SB1, 33①SH1, 52①SH1 / 2, 53①SK1	
写真図版31 平安時代～中世の遺構 (2)	281
53①SJ1, 16①SD1, 53①SD1 (右) / 2 (左), 4①SE1 / 2, 14①SE1, 52①SE1, 70①SE1, B①SE1, B①SE2, B①SE4, B①SE5, B①SE6, C①SU3石組み検出状況, C①SU3石組み完掘, C①SU3断面	
写真図版32 縄文時代中期の遺物 (1)	282
63②SA1, 63②SA2, 63②SP79, 48①SR1, 63②SR1, 遺構外, E②SA3 (1)	
写真図版33 縄文時代中期の遺物 (2)	283
E②SA3 (2), E②SA4, E②SA5	
写真図版34 縄文時代中期の遺物 (3)	284
E②SA6, E②SK9, E②SJ1, E②SJ2, E②SJ3, E②SR1, E②SR2, E②SN1	
写真図版35 縄文時代中期の遺物 (4)	285
石製品 (1)	
写真図版36 縄文時代中期の遺物 (5)	286
石製品 (2)	
写真図版37 縄文時代中期の遺物 (6)	287
石製品 (3)	
写真図版38 縄文時代中期の遺物 (7)	288
石製品 (4)、土製品	
写真図版39 弥生時代中期の遺物 (1)	289
3①SA2, 32①SA1, 53②SA11	
写真図版40 弥生時代中期の遺物 (2)	290
75①SA1, C②SA20, E①SA1	
写真図版41 弥生時代中期の遺物 (3)	291
石製品 (1)	
写真図版42 弥生時代中期の遺物 (4)	292

石製品 (2)	
写真図版43 弥生時代中期の遺物 (5)	293
土製品、装身具	
写真図版44 弥生時代後期の遺物 (1)	294
50②SA4, 50②SA7, 51②SA2, 56②SA3, 78①SA2 (1)	
写真図版45 弥生時代後期の遺物 (2)	295
78①SA2 (2), B②SA2, B②SA3	
写真図版46 弥生時代後期の遺物 (3)	296
B②SA7, B②SA8, B②SA9 (1)	
写真図版47 弥生時代後期の遺物 (4)	297
B②SA9 (2), B②SA18, C②SA11, C②SA12 (1)	
写真図版48 弥生時代後期の遺物 (5)	298
C②SA12 (2), 25①SJ1, 48①SJ7, 64①SJ1, 50②SK4, 4①SD21, 19①SD21, 48①SD25, 62①SX4	
写真図版49 弥生時代後期の遺物 (6)	299
石製品、土製品	
写真図版50 弥生時代後期の遺物 (7)	300
装身具	
写真図版51 古墳時代前期～中期の遺物 (1)	301
6①SA1, 34①SA3, 61①SA9, 63①SA1, 79①SA5, C①SA30 (1)	
写真図版52 古墳時代前期～中期の遺物 (2)	302
C①SA30 (2), C②SA16, 65①SD21, 75①SD24, 6①SD1, 33①SD7, 34①SD7 (1)	
写真図版53 古墳時代前期～中期の遺物 (3)	303
34①SD7 (2), 75①SX1, C①SX1, 土製品、装身具	
写真図版54 古墳時代後期の遺物 (1)	304
23①SA1, 33①SA1, 34①SA1, 50①SA6	
写真図版55 古墳時代後期の遺物 (2)	305
53①SA3, 56①SA4, 79①SA6	
写真図版56 古墳時代後期の遺物 (3)	306
B①SA5, B①SA11, B①SA16, C①SA2 (1)	
写真図版57 古墳時代後期の遺物 (4)	307
C①SA2 (2), C①SA9, C①SA10	
写真図版58 古墳時代後期の遺物 (5)	308
C①SA11, C①SA13, C①SA16 (1)	
写真図版59 古墳時代後期の遺物 (6)	309
C①SA16 (2), C①SA19, C①SA21 (1)	
写真図版60 古墳時代後期の遺物 (7)	310
C①SA21 (2), C①SA25	
写真図版61 古墳時代後期の遺物 (8)	311
34①SD2, 55①SD3, D①SD1, 石製品	
写真図版62 古墳時代後期の遺物 (9)、平安時代～中世の遺物、時期不明の遺物	312
土製品、装身具 [平安時代～中世の遺物] 16①SD1 [時期不明の遺物] 石製品、装身具	

図版1 縄文時代中期の遺構 (1)

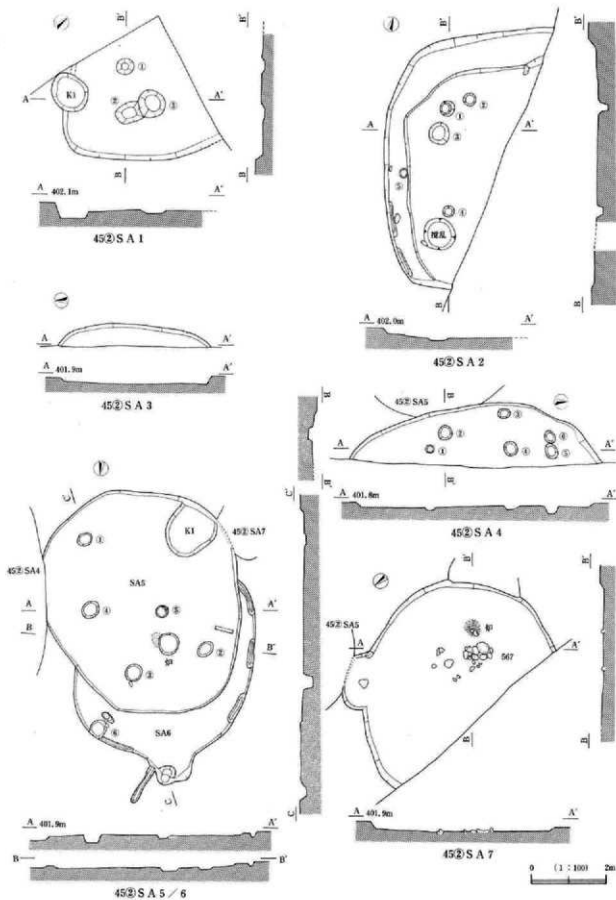

図版2 縄文時代中期の遺構 (2)

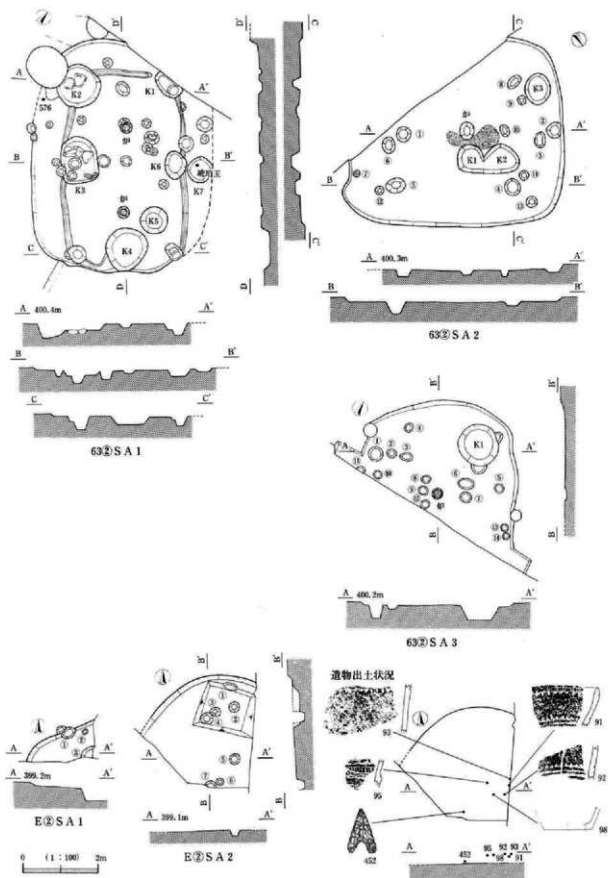

図版3 縄文時代中期の遺構 (3)

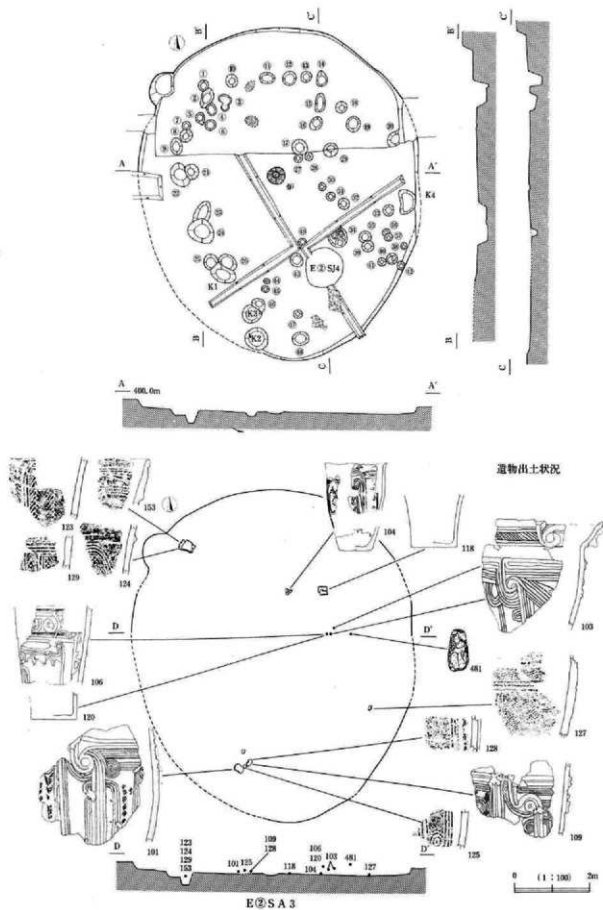

図版4 縄文時代中期の遺構(4)

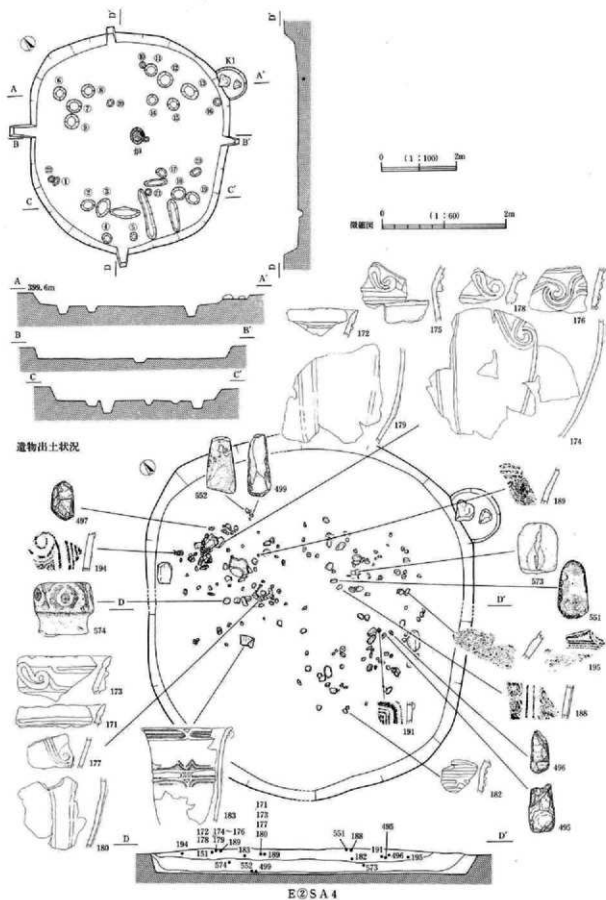

図版5 縄文時代中期の遺構 (5)

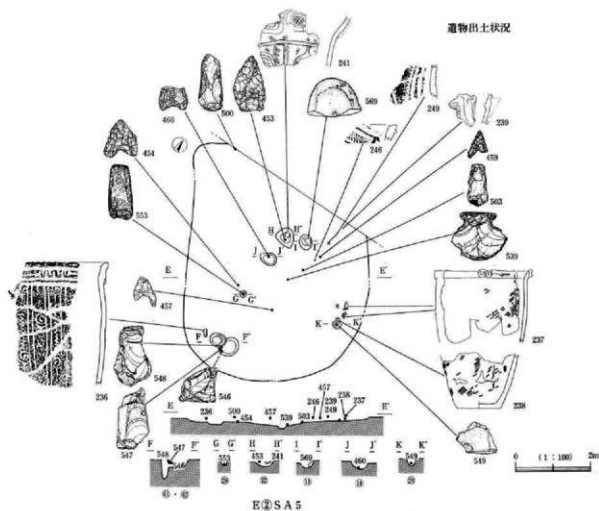
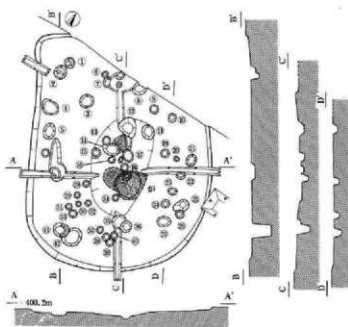

図版6 縄文時代中期の遺構 (6)

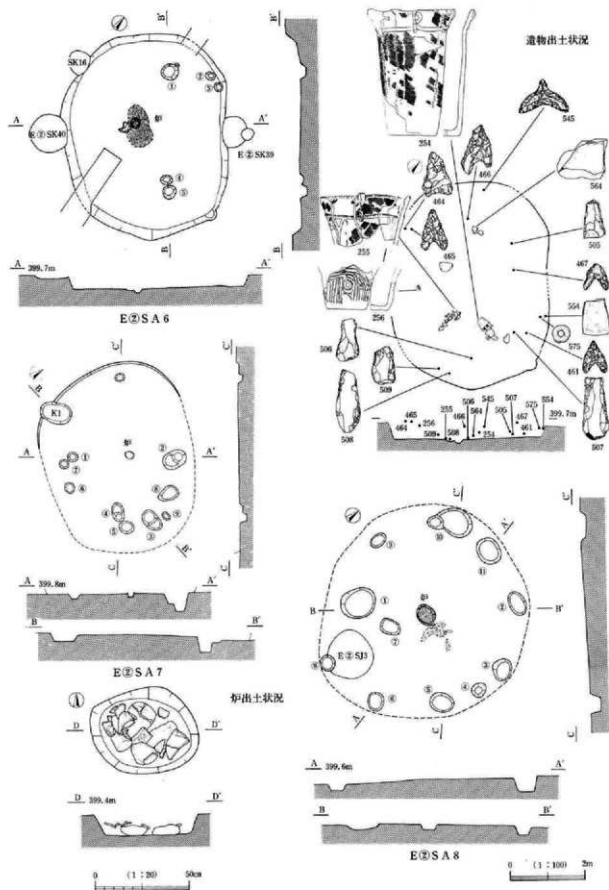

図版7 縄文時代中期の遺構 (7)

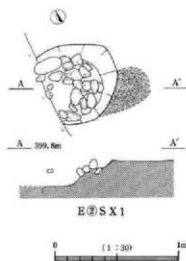
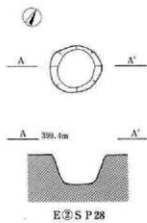
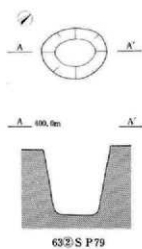
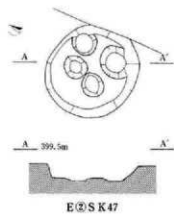
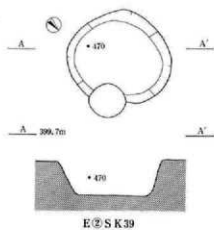
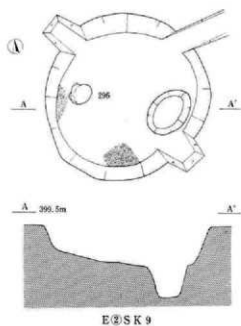
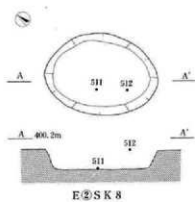

0 (1:30) 3m

図版 8 縄文時代中期の遺構 (8)

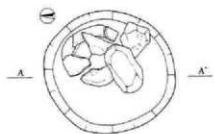

E2SJ1

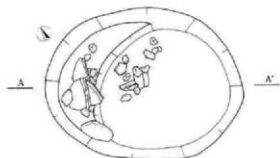

E2SJ2

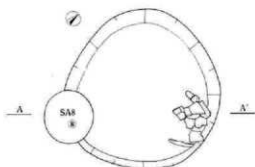

E2SJ3

(1:20)

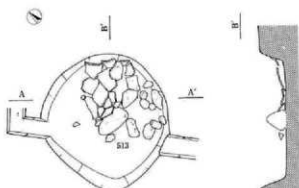
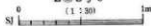

E2SJ4

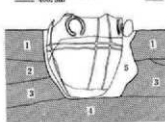
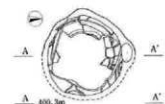

63SR1

- 1 暗褐色砂質土層 (炭分多く含む)
- 2 黄褐色砂質土層
- 3 黄褐色砂質土層
- 4 褐色砂質土層
- 5 黒褐色砂質土層

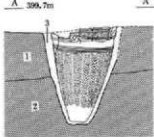
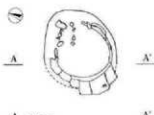

E2SR2

- 1 黒褐色粘質土層 (直径1~2cmの小礫多く含む、縄文遺物を含む)
- 2 黄褐色砂質土
- 3 黒灰色粘質土 (粘性強)



SR

図版9 縄文時代中期の遺構(9)

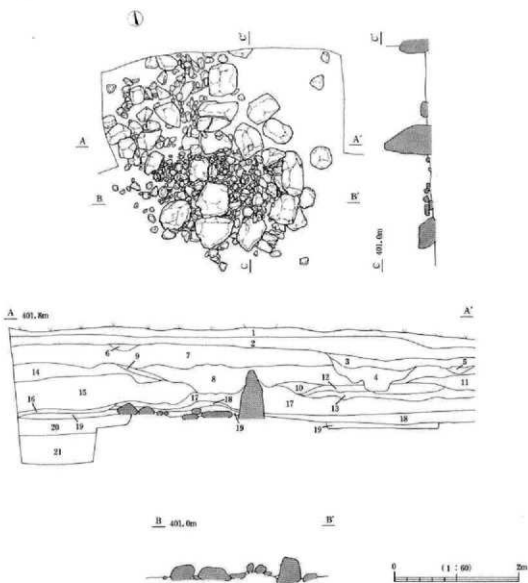

- 1 表土
- 2 紫褐色土層 [10YR 3/1] しまり強 粘性中
- 3 紫褐色土層 [10YR 2/2] しまり強 粘性中
- 4 におい黄褐色砂質土層 [10YR 6/3] しまり強 粘性なし
- 5 紫褐色土層 [10YR 3/2] しまり強 粘性中
- 6 紫褐色土層 [10YR 3/2] しまり強 粘性中
- 7 紫褐色砂質土層 [10YR 3/3] しまり中 粘性中 一部に礫の混入
- 8 紫褐色砂質土層 [10YR 3/2] しまり中 粘性中
- 9 におい黄褐色砂質土層 [10YR 4/3] しまり中 粘性中
- 10 褐色砂質土層 [10YR 4/4] しまり中 粘性弱
- 11 におい黄褐色砂質土層 [10YR 4/3] しまり弱 粘性なし 礫の混入多量
- 12 明黄褐色砂質土層 [10YR 6/6] しまり弱 粘性弱
- 13 褐色砂質土層 [10YR 4/4] しまり弱 粘性弱 直径3cm程度の礫多く含む
- 14 灰黄褐色砂質土層 [10YR 4/2] しまり強 粘性中
- 15 におい黄褐色砂質土層 [10YR 5/3] しまり強 粘性なし 礫の混入多量
- 16 明褐色砂質土層 [7.5YR 5/6] しまり弱 粘性なし 直径2cm程度の礫多く含む
- 17 におい黄褐色 [10YR 5/4] しまり中 粘性なし
- 18 灰黄褐色砂質土層 [10YR 5/2] しまり強 粘性中 砂子細かい
- 19 褐色粘質土層 [10YR 4/1] しまり弱 粘性中 縄文遺物を含む
- 20 紫褐色粘質土層 [10YR 3/1] しまり中 粘性中 炭化物微量を含む、縄文遺物を含む
- 21 灰黄褐色粘質土層 [10YR 4/2] しまり中 粘性強

E②SN1

図版 10 弥生時代中期の遺構 (1)

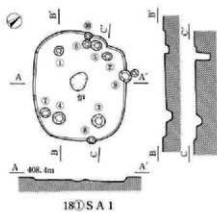
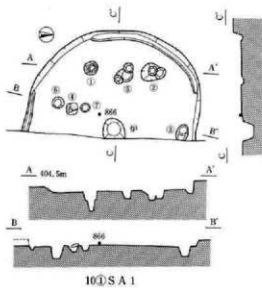
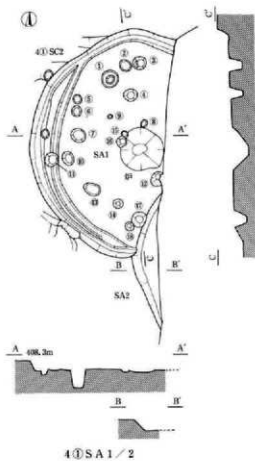
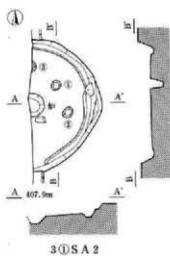
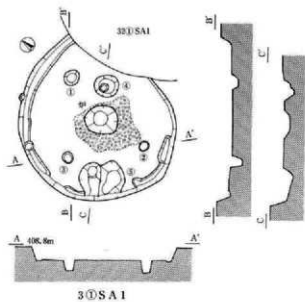

0 1 : 1000 2m

図版 11 弥生時代中期の遺構 (2)

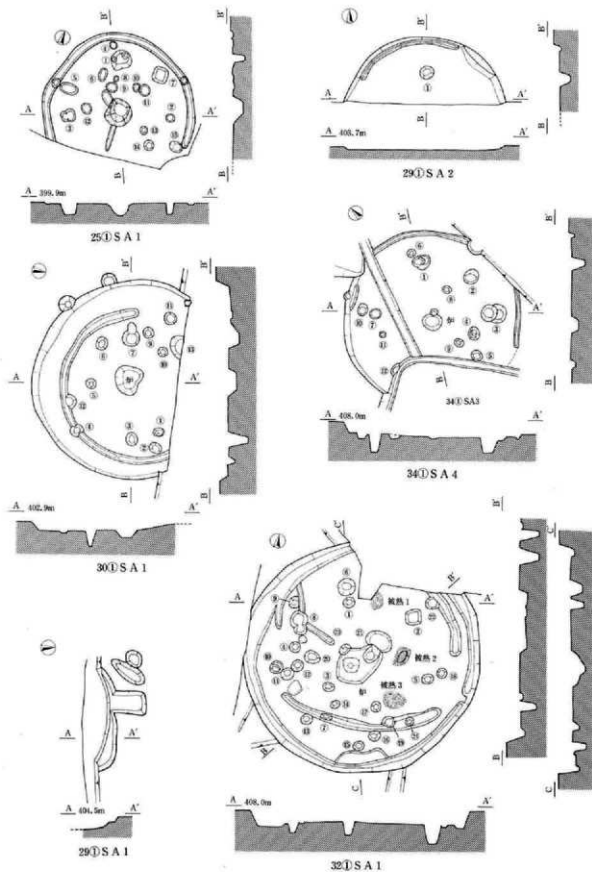

図版 12 弥生時代中期の遺構 (3)

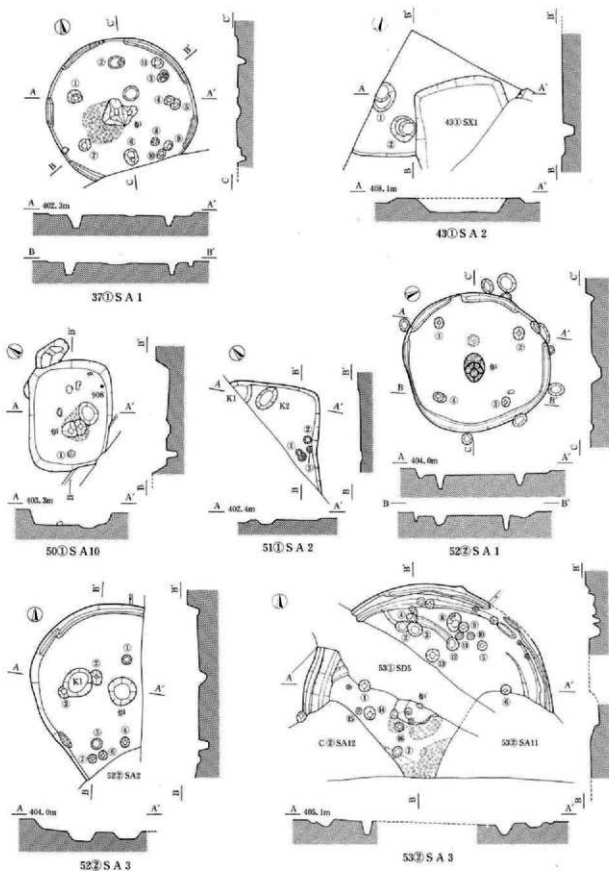

0 1:100 2m

図版 13 弥生時代中期の遺構 (4)

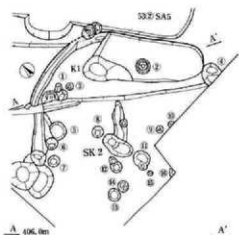

406.8m



53② SA 7

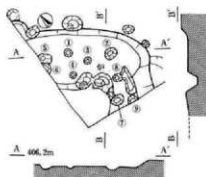

406.2m

53② SA 11

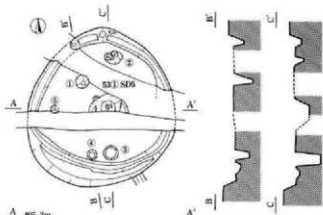

405.2m



55① SA 2



406.2m

55① SA 4

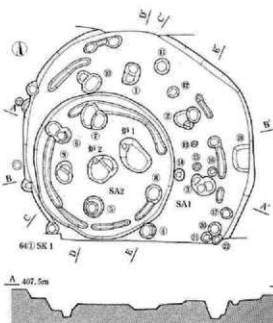

407.5m

64① SA 1 / 2

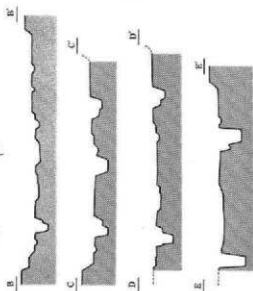

0 (1:100) 2m

図版 14 弥生時代中期の遺構 (5)

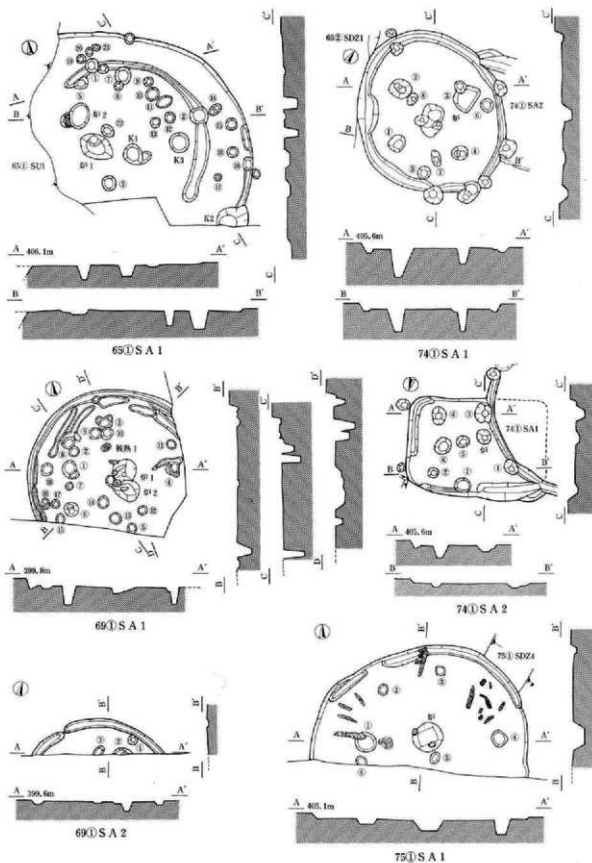

0 1:100 2m

図版 15 弥生時代中期の遺構 (6)

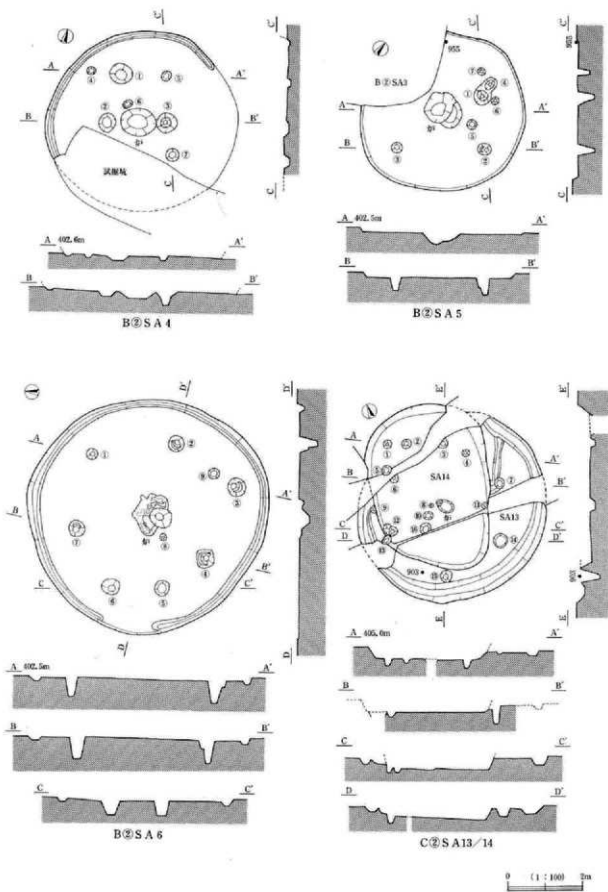

図版 16 弥生時代中期の遺構 (7)

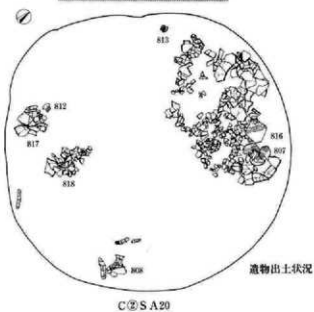
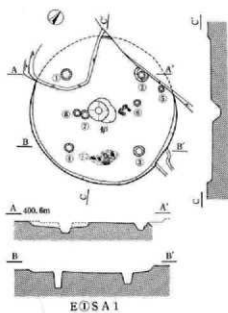
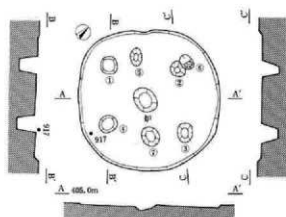
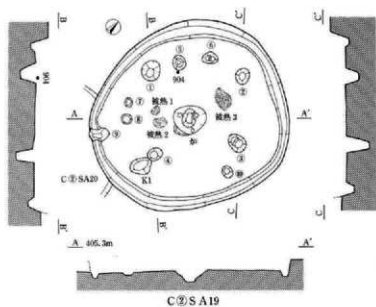

図版 17 弥生時代中期の遺構 (8)

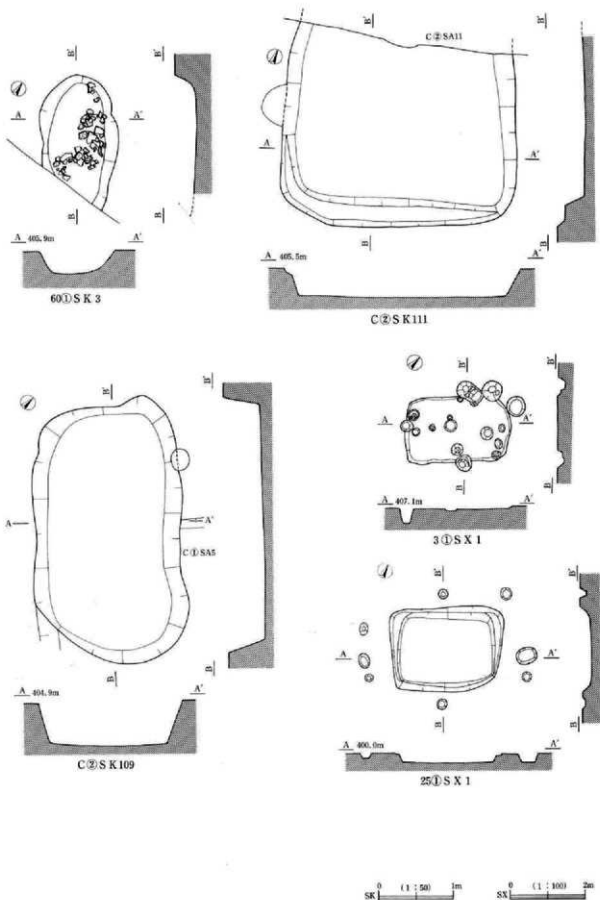

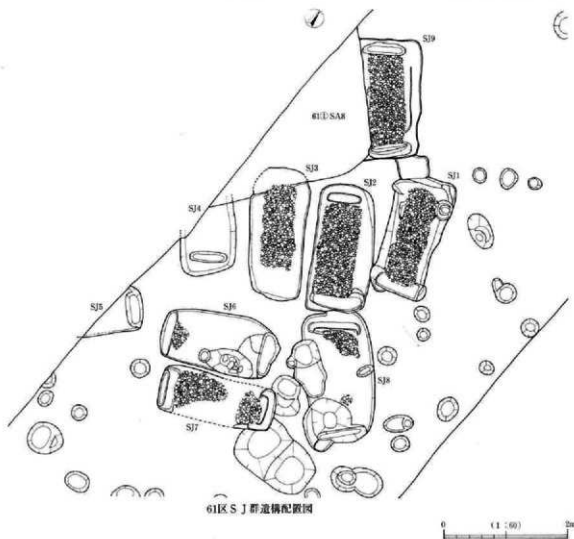
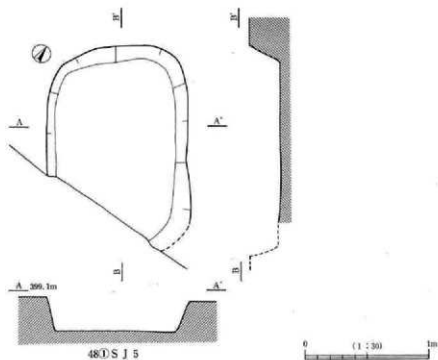

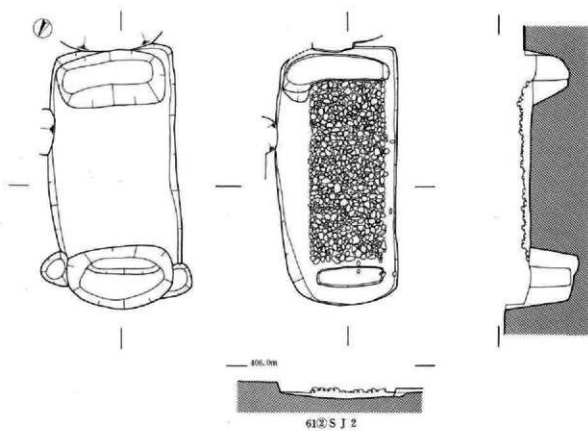
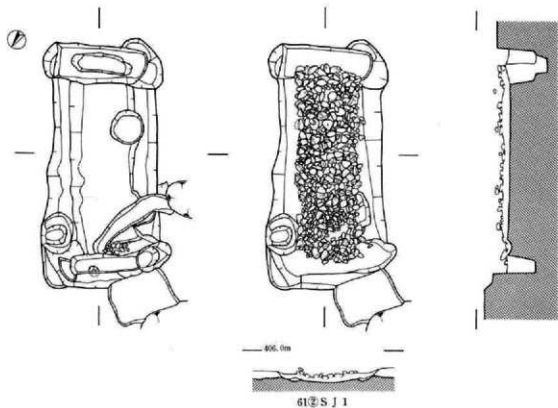

0 (1:30) 1m

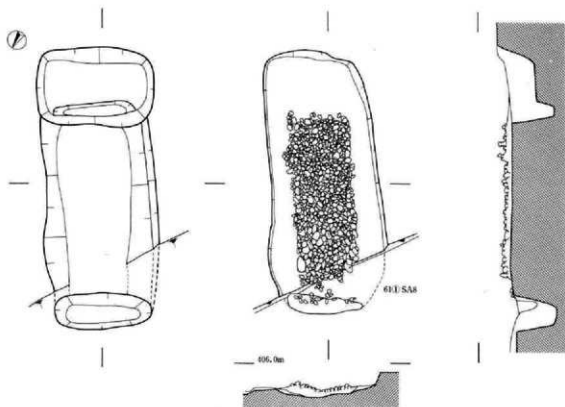

61② S J 3

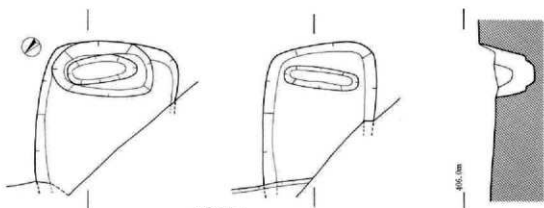

61② S J 4

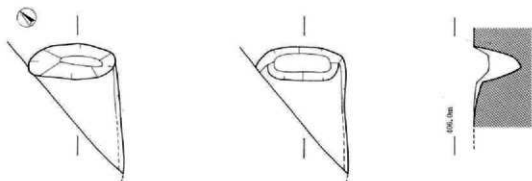

61② S J 5



図版 21 弥生時代中期の遺構 (12)

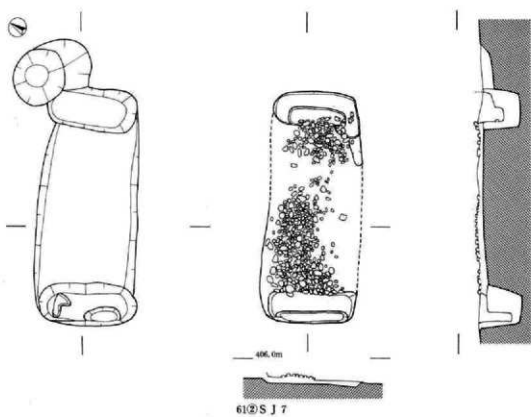
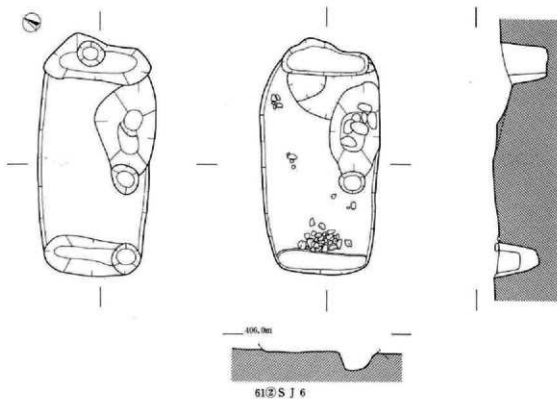

0 (1:30) 1m

図版 22 弥生時代中期の遺構 (13)

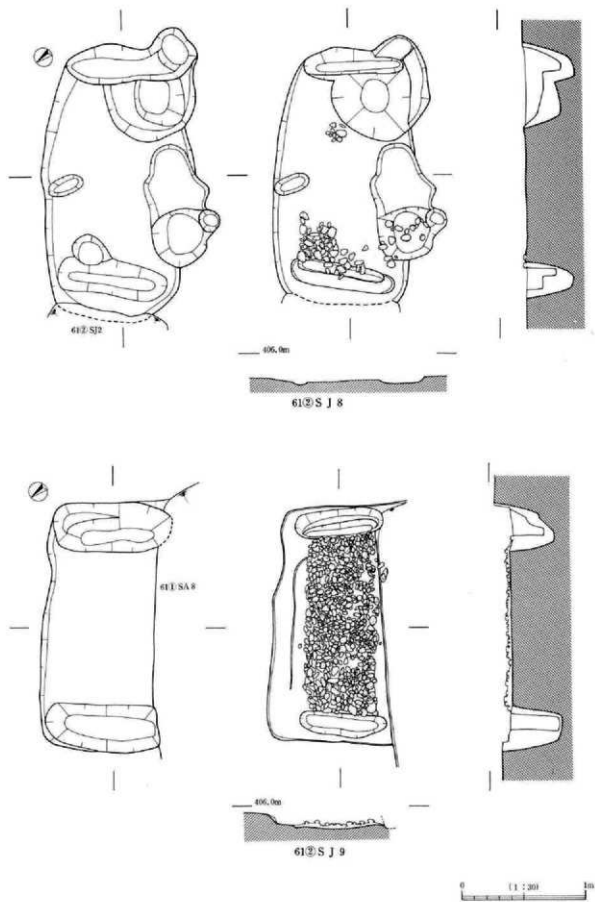

図版 23 弥生時代後期の遺構 (1)

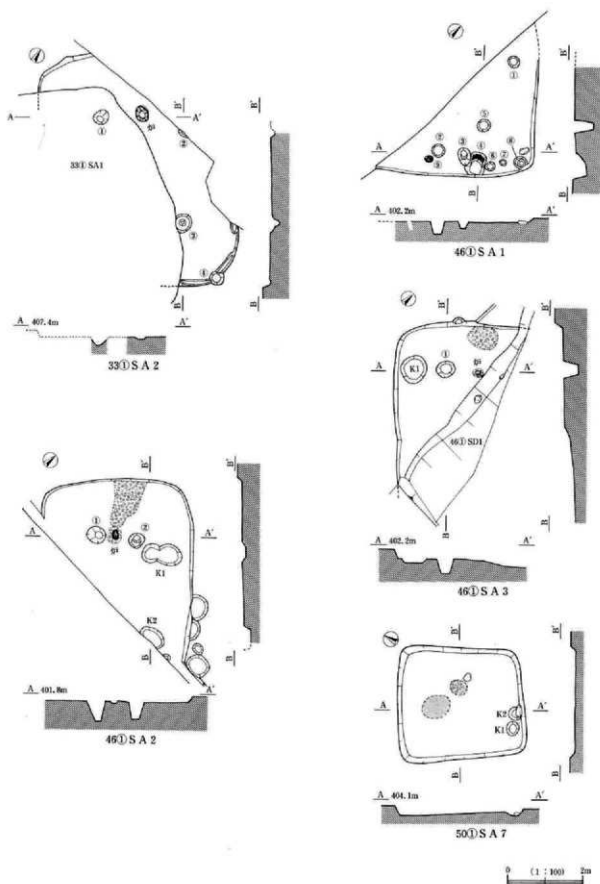

図版 24 弥生時代後期の遺構 (2)

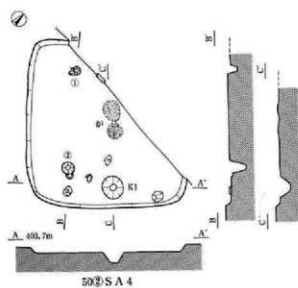
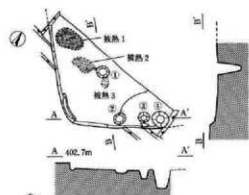
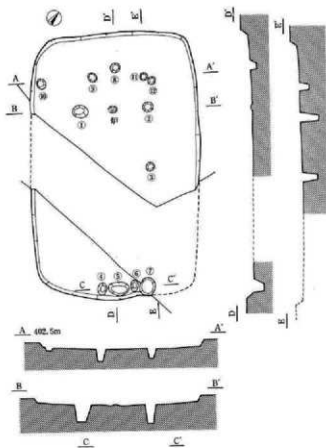
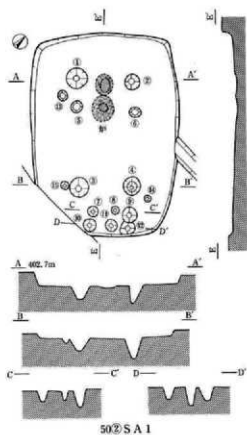

図版 25 弥生時代後期の遺構 (3)

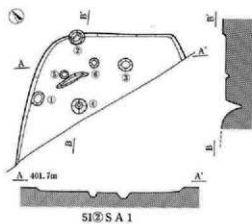
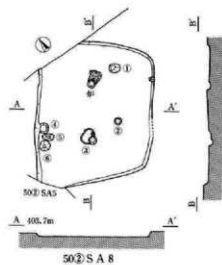
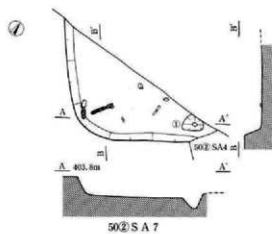
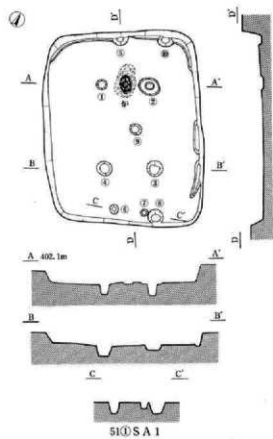
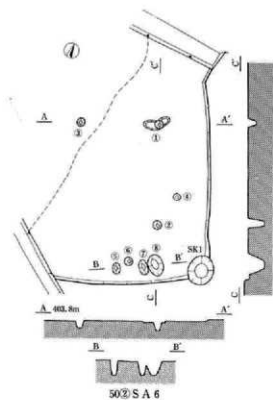

0 (1:100) 2m

図版 26 弥生時代後期の遺構 (4)

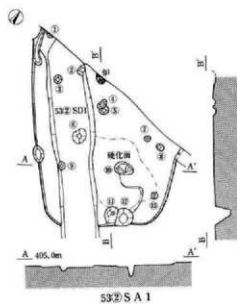
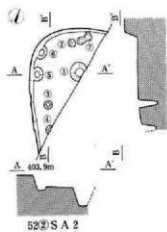
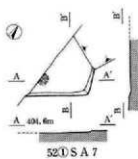
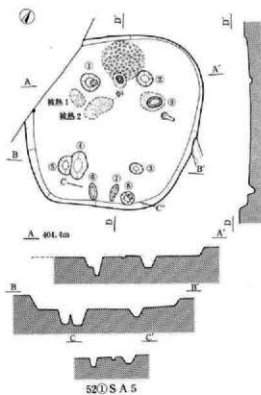
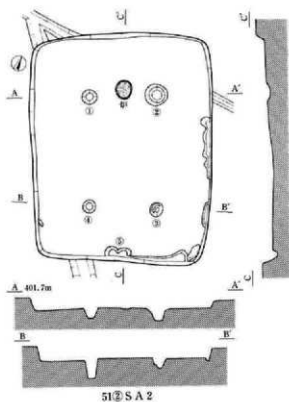

0 1:100 2m

図版 27 弥生時代後期の遺構 (5)

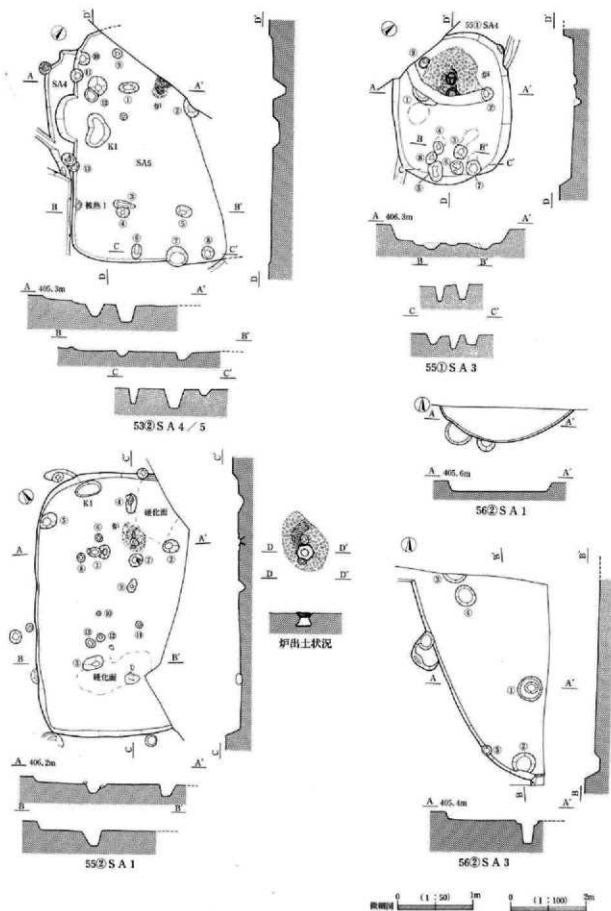

図版 28 弥生時代後期の遺構 (6)

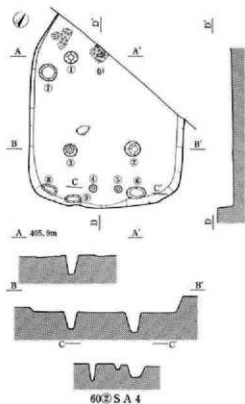
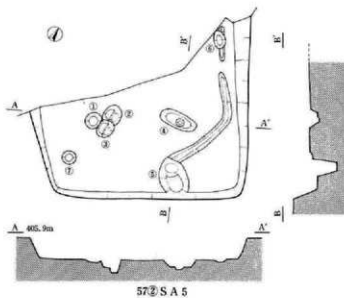
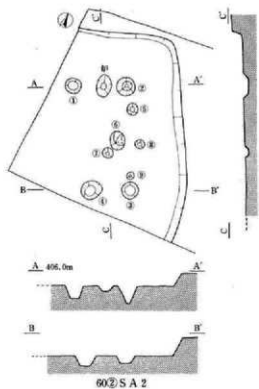
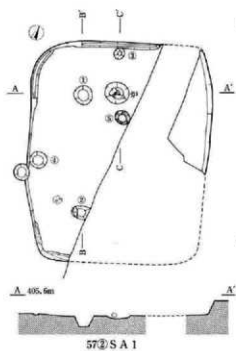

0 1 : 1000 3m

図版 29 弥生時代後期の遺構 (7)

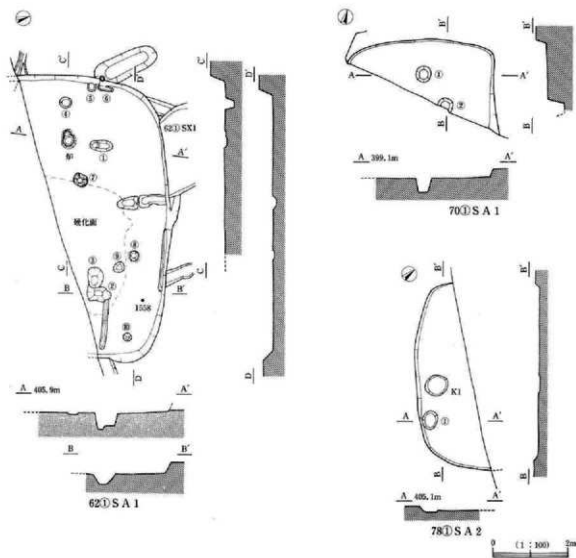
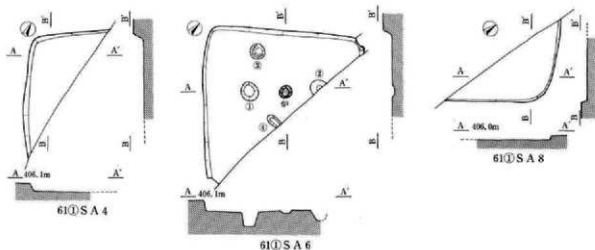

図版 30 弥生時代後期の遺構 (8)

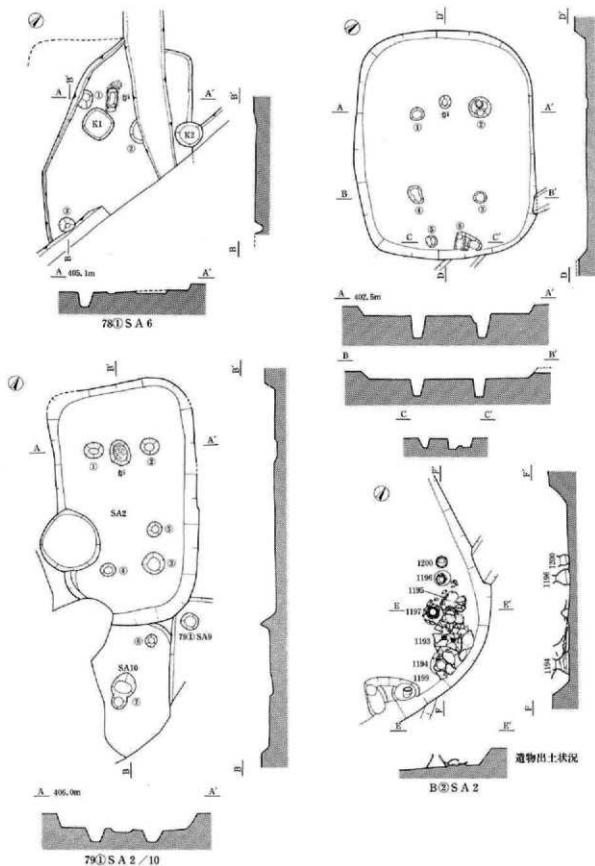

0 (1:50) 1m 0 (1:100) 2m

図版 31 弥生時代後期の遺構 (9)

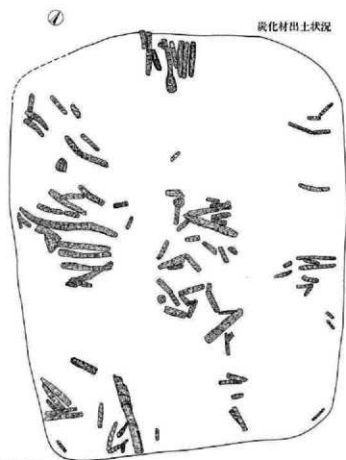
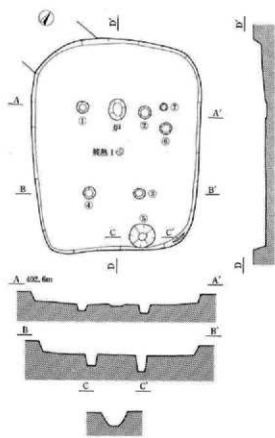

B②SA3



図版 32 弥生時代後期の遺構 (10)

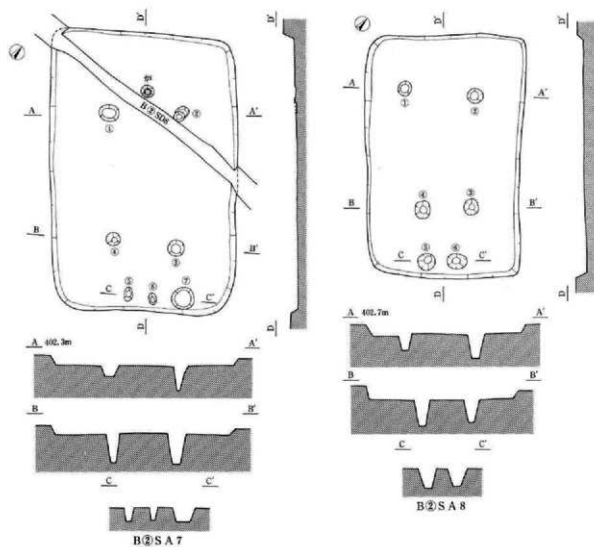

図版 33 弥生時代後期の遺構 (11)

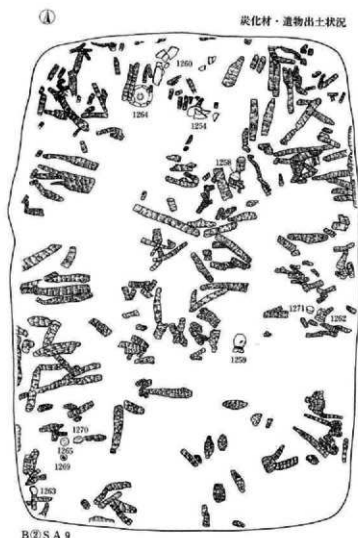
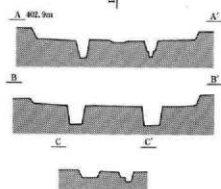
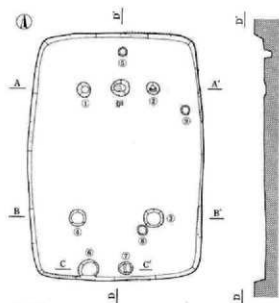

B②SA 9



図版 34 弥生時代後期の遺構 (12)

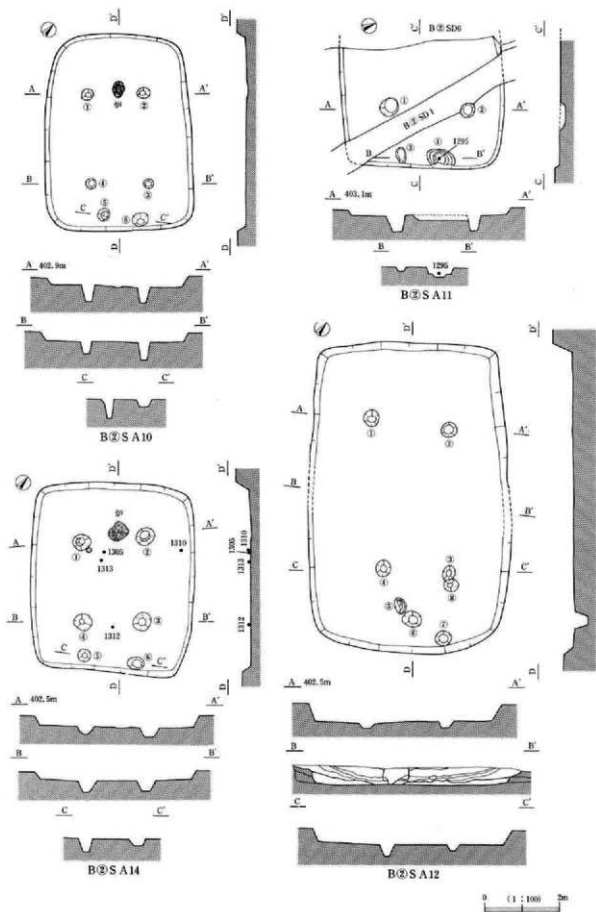

図版 35 弥生時代後期の遺構 (13)

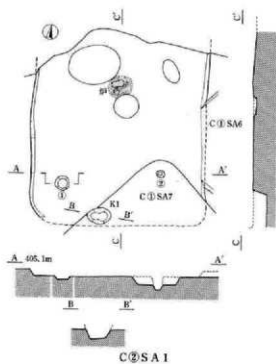
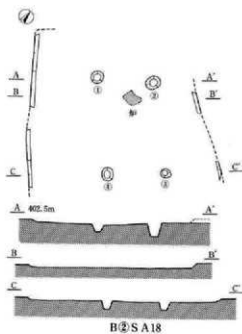
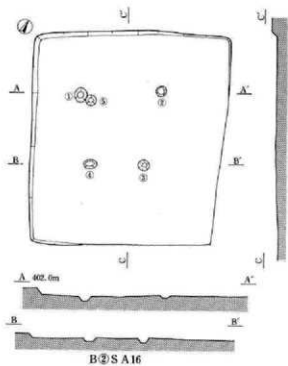
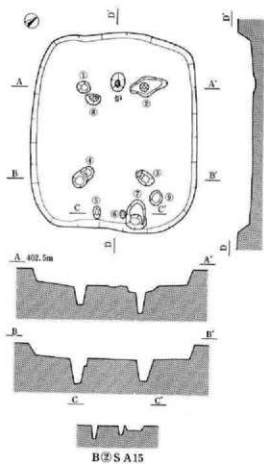

0 (1:100) 2m

図版 36 弥生時代後期の遺構 (14)

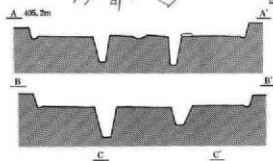
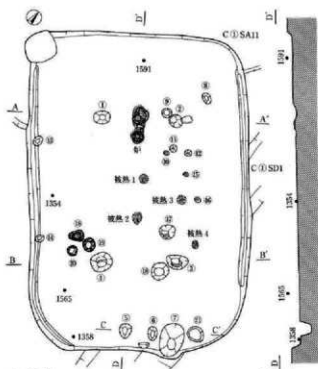
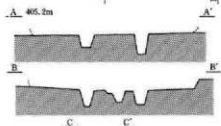
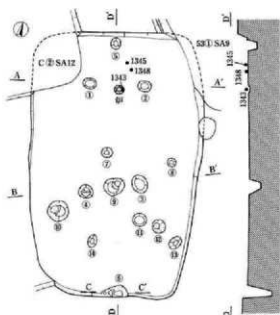

C②SA4

0 (1:100) 2m

図版 37 弥生時代後期の遺構 (15)

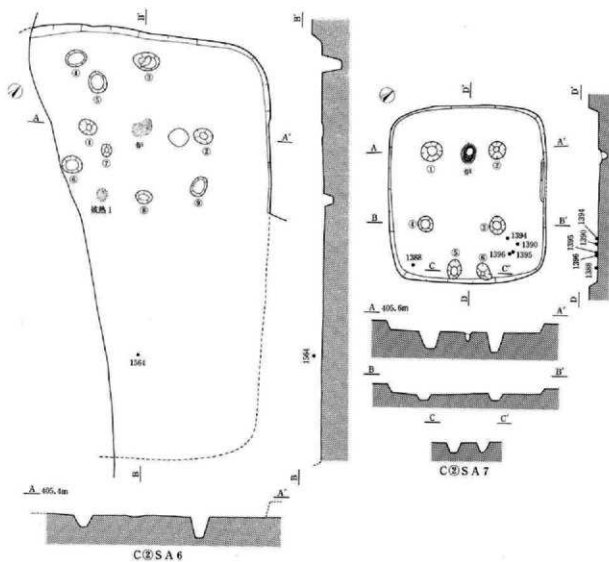

0 1 : 1000 2m

図版 38 弥生時代後期の遺構 (16)

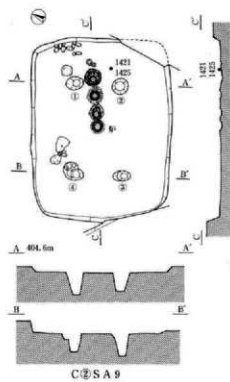
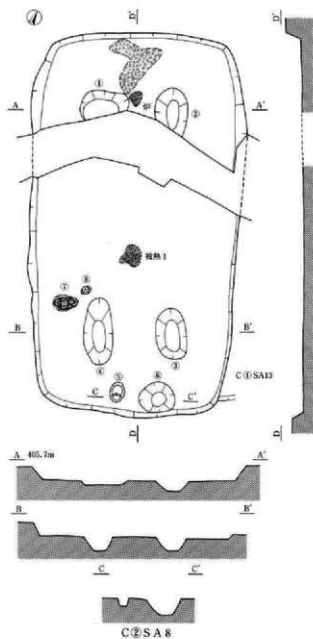

0 11 : 1000 2m

図版 39 弥生時代後期の遺構 (17)

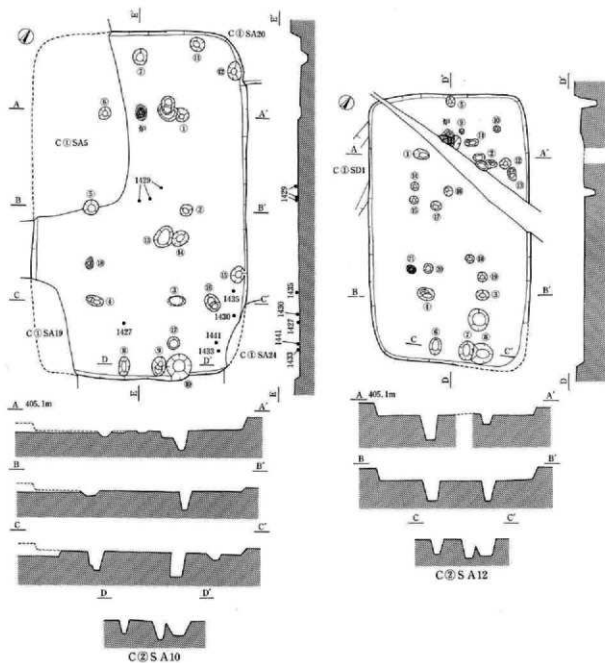

図版 40 弥生時代後期の遺構 (18)

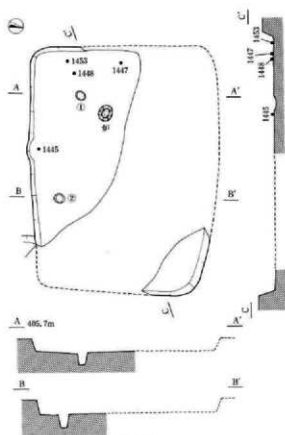

C②SA11

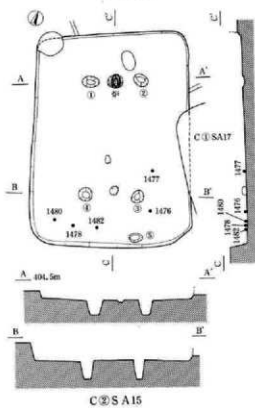

C②SA15

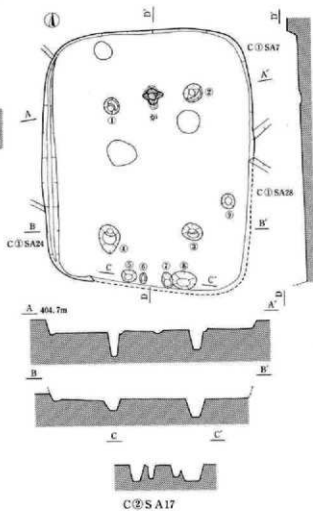

C②SA17

0 1:100 2m

図版 41 弥生時代後期の遺構 (19)

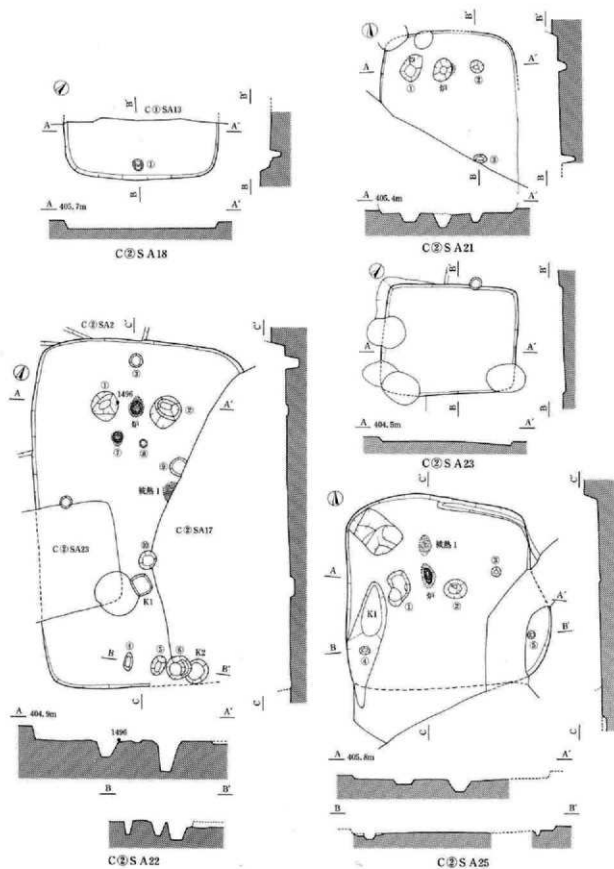

図版 42 弥生時代後期の遺構 (20)

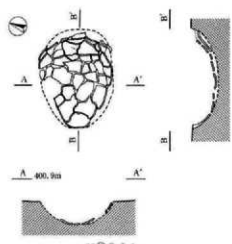

25 S J 1

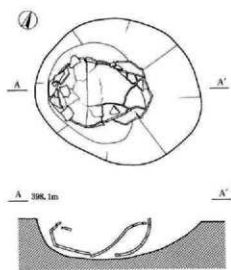

48 S J 7

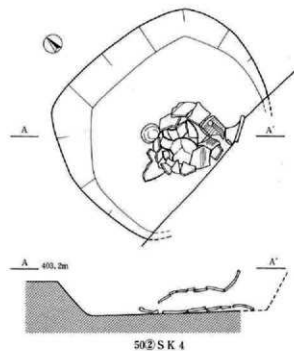

50 S K 4

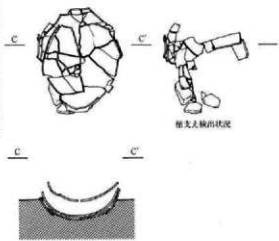
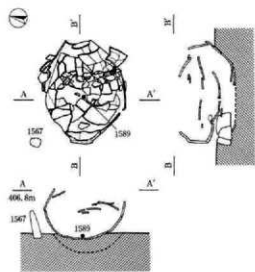

64 S J 1



図版 43 弥生時代後期の遺構 (21)

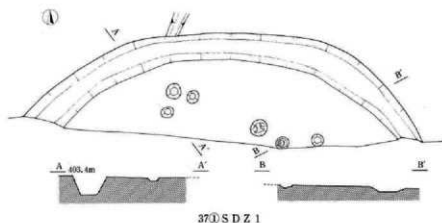
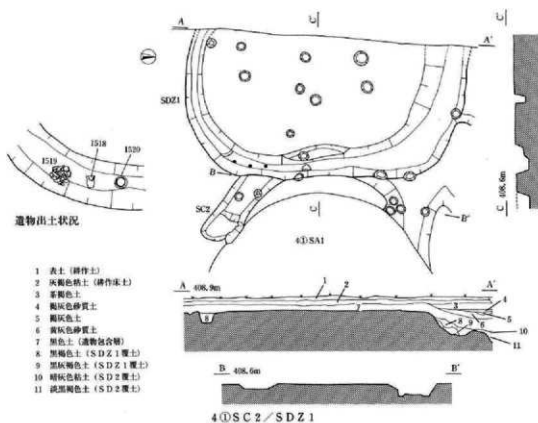

図版 44 弥生時代後期の遺構 (22)

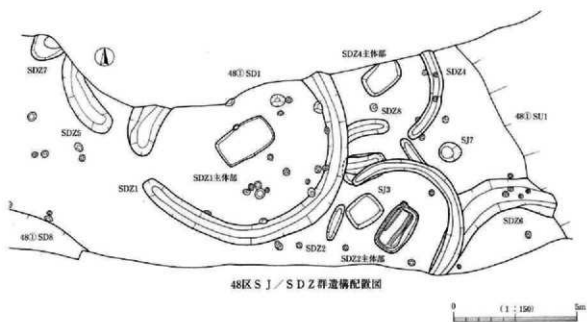
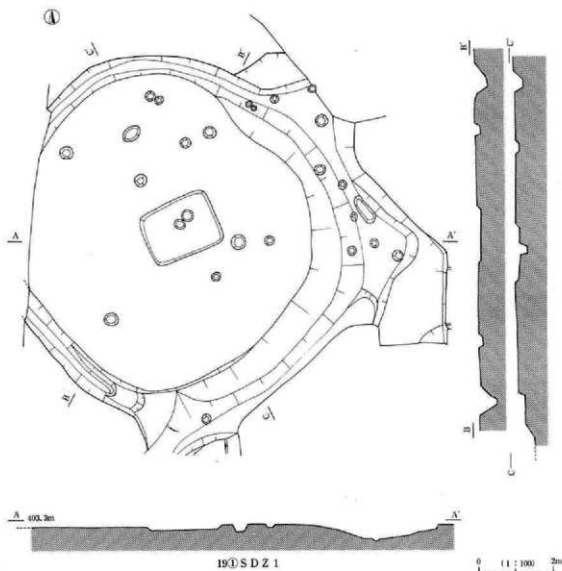

図版 45 弥生時代後期の遺構 (23)

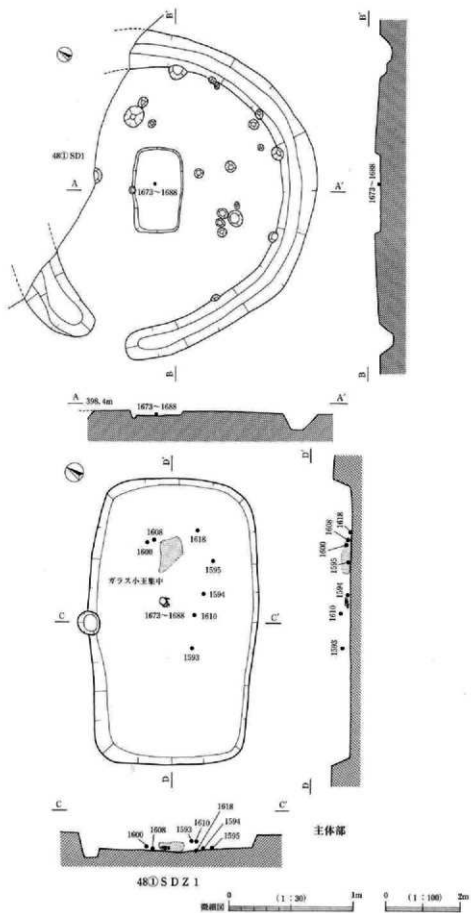

図版 46 弥生時代後期の遺構 (24)

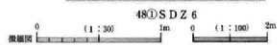
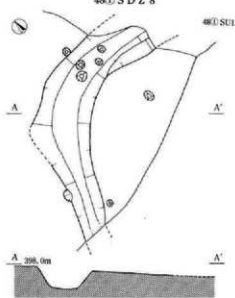
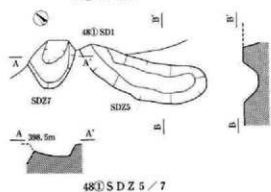
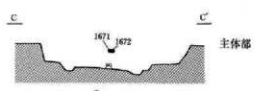
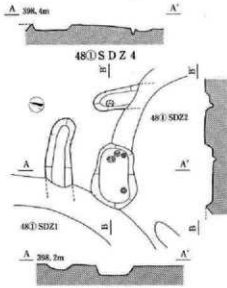
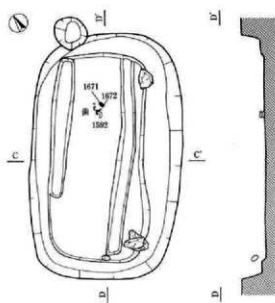
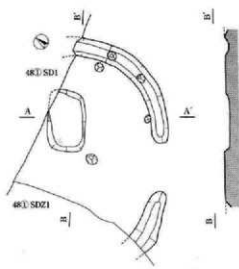
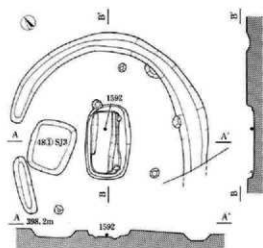

図版 47 弥生時代後期の遺構 (25)

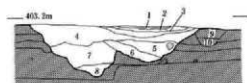

- 1 黄褐色砂 粘性弱、しまり弱、酸化鉄微量含む
- 2 灰色粘土 粘性強、しまり強、酸化鉄微量含む
- 3 黄褐色土 粘性やや強、しまりやや強、酸化鉄・炭化物微量含む
- 4 灰褐色砂質土 粘性やや弱、しまりやや弱、酸化鉄・炭化物少量含む
- 5 灰褐色砂 粘性弱、しまり弱、礫を多量に含む
- 6 黒褐色砂 (6層より4層より) 粘性弱、しまり弱、下部に礫を多量に含む
- 7 黒褐色砂 (6層より4層より) 粘性弱、しまり弱、下部に礫を多量に含む
- 8 黒褐色砂 粘性やや強、しまりやや強、礫を多量に含む
- 9 暗褐色砂 粘性弱、しまり弱、酸化鉄少量・礫少量含む
- 10 暗褐色砂 粘性弱、しまり弱、酸化鉄少量・礫少量含む

B②SD 6



48①SD 1



55①SD 6



B②SD 2



B②SD 8

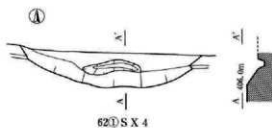

62①S X 4



図版 48 古墳時代前期～中期の遺構 (1)

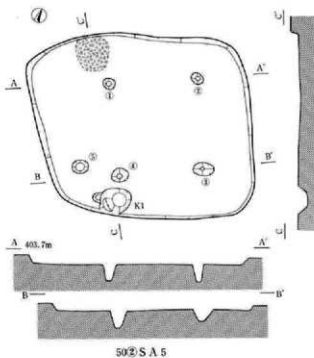
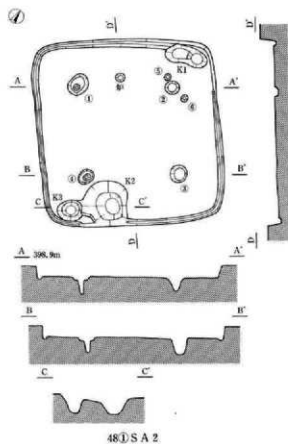
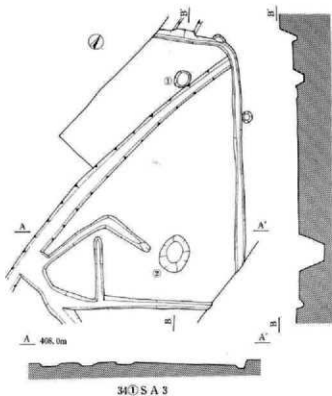
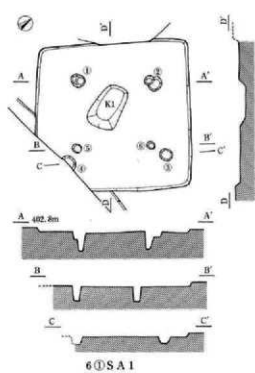

0 1:1000 2m

図版 49 古墳時代前期～中期の遺構 (2)

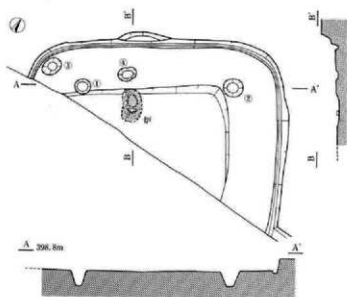

48D SA 1

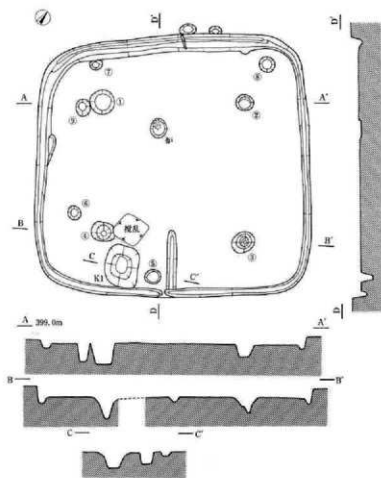

48D SA 3

0 (1:100) 20m

図版 50 古墳時代前期～中期の遺構 (3)

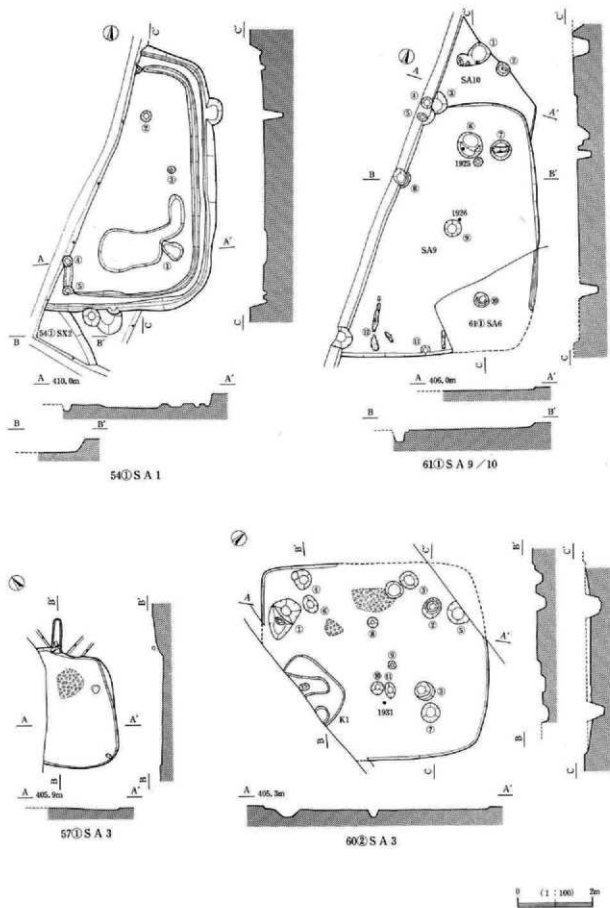

図版 51 古墳時代前期～中期の遺構 (4)

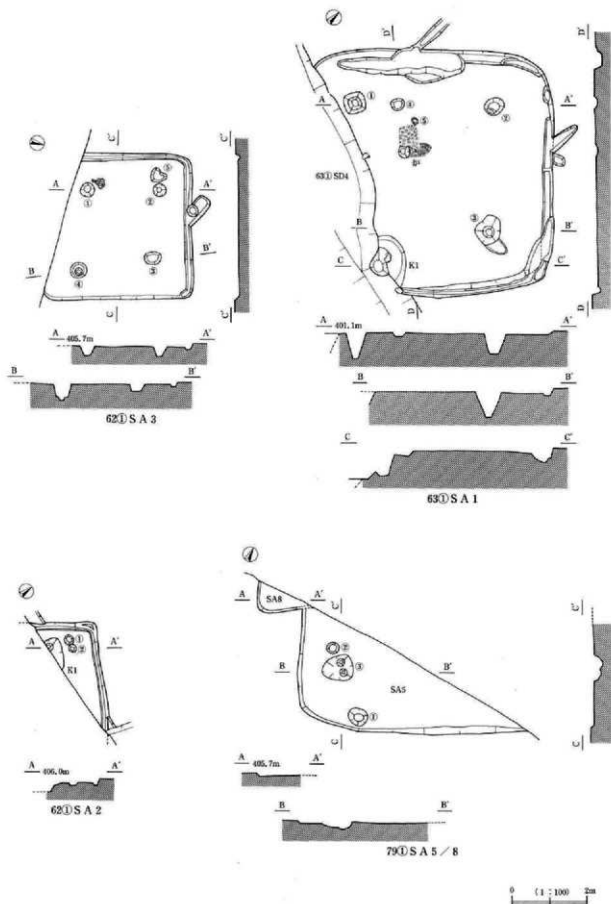

図版 52 古墳時代前期～中期の遺構 (5)

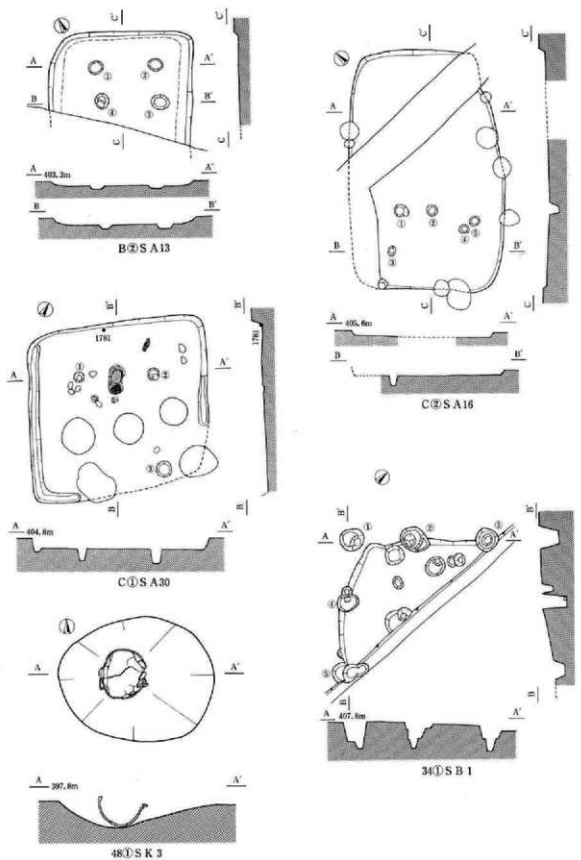

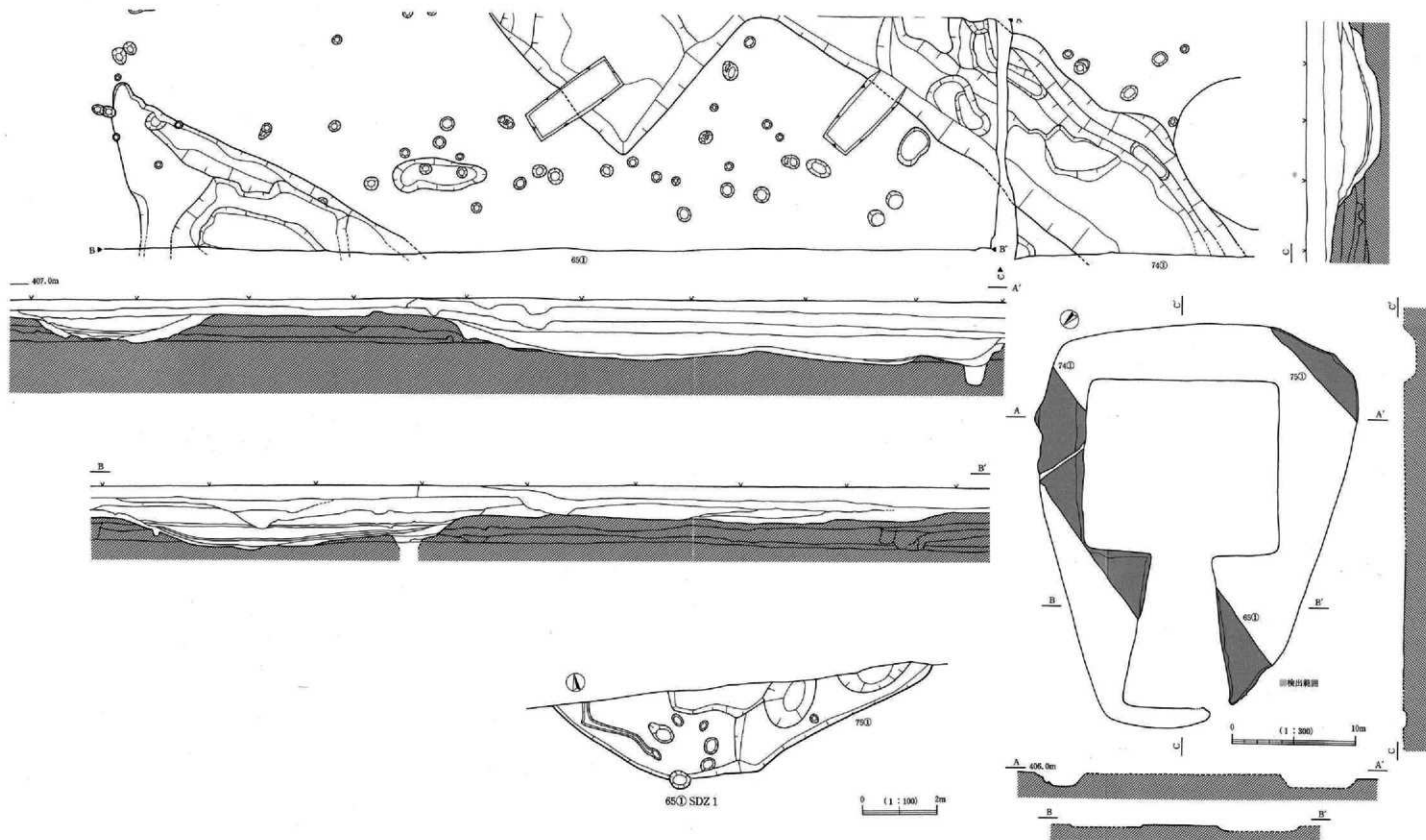

図版 54 古墳時代前期～中期の遺構 (7)

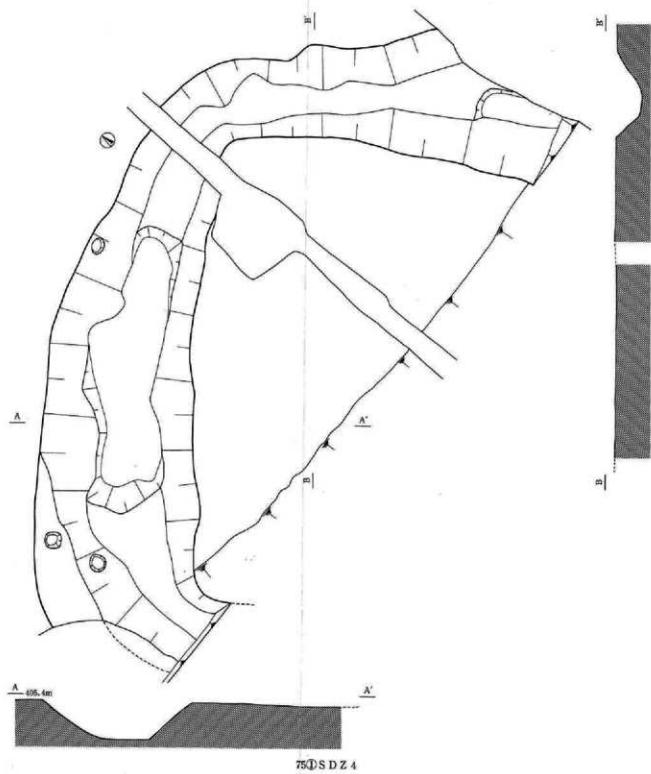
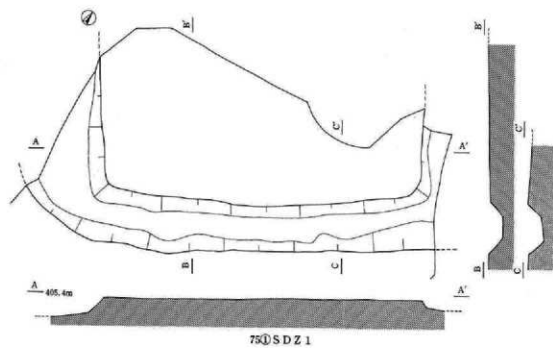

0 (1:100) 2m

図版 55 古墳時代前期～中期の遺構 (8)

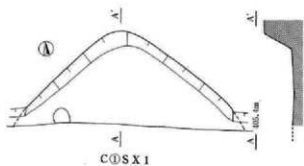
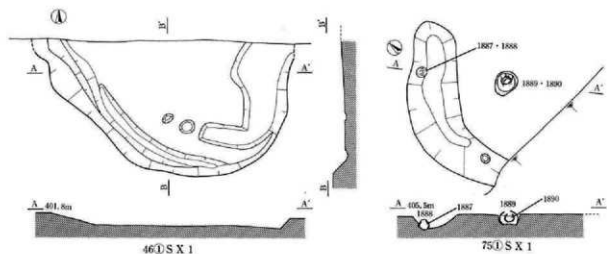
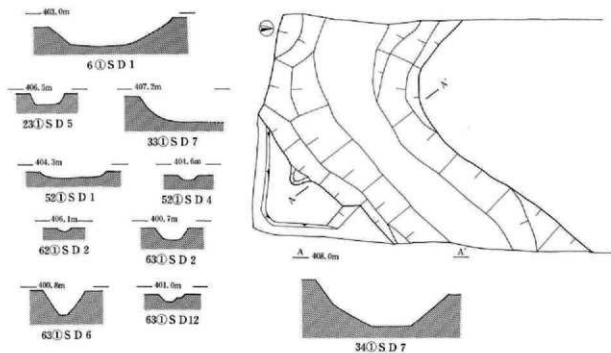

0 (1:100) 2m

図版 56 古墳時代後期の遺構 (1)

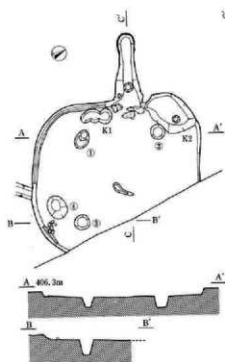

23D SA 1

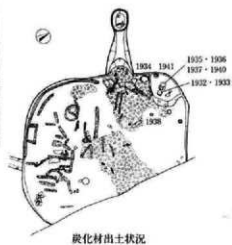

炭化材出土状況

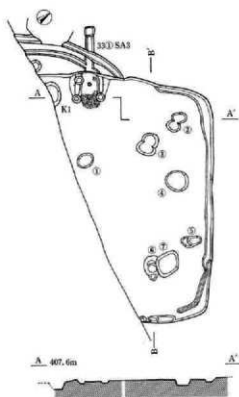

33D SA 1

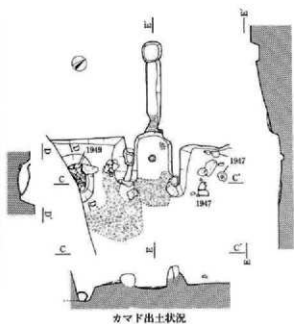

カマド出土状況

0 (1:50) 1m 0 (1:100) 2m

図版 57 古墳時代後期の遺構 (2)

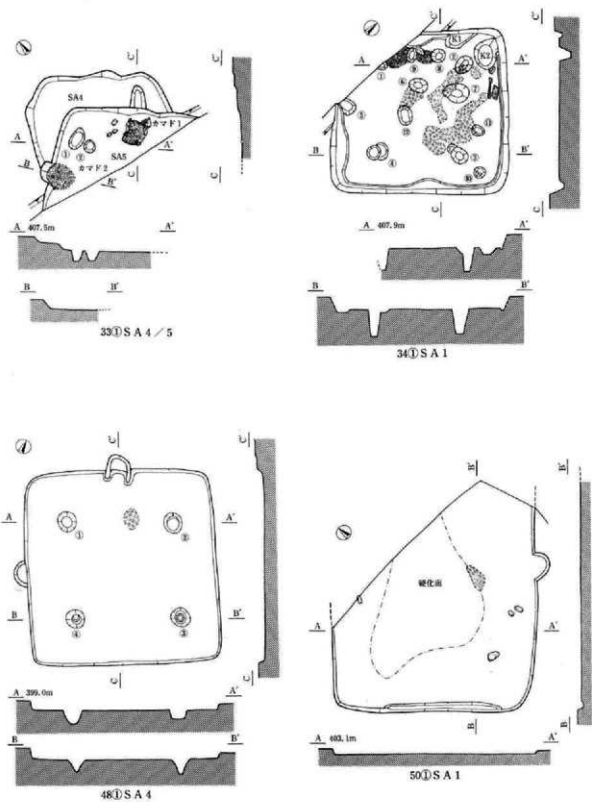

図版 58 古墳時代後期の遺構 (3)

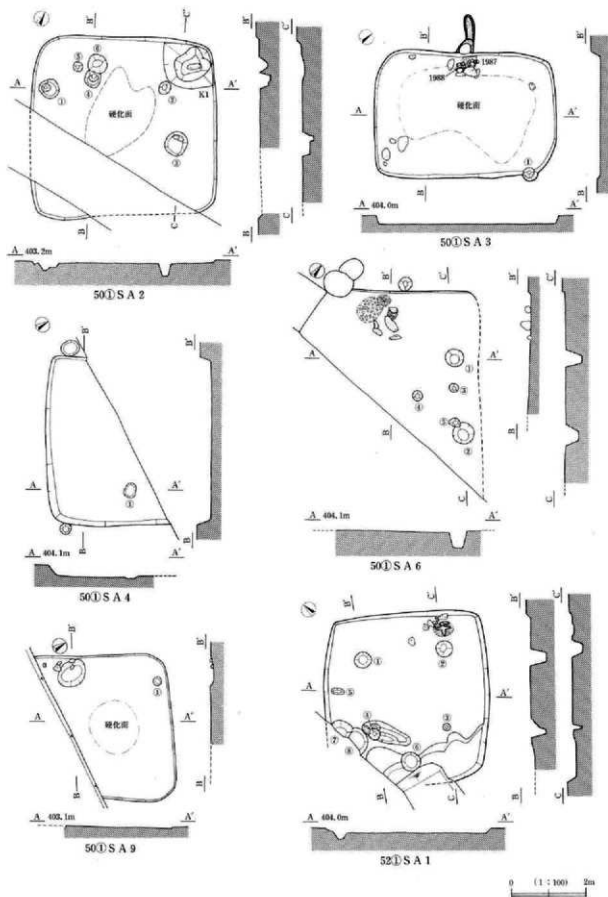

図版 59 古墳時代後期の遺構 (4)

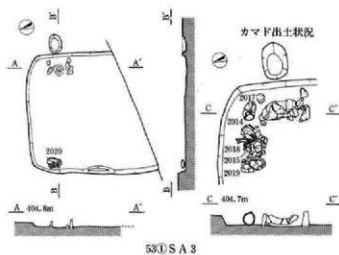
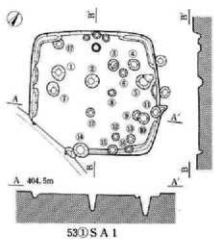
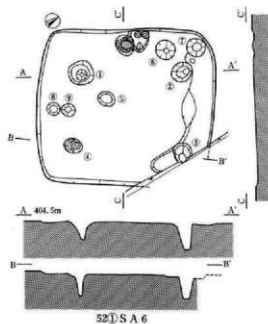
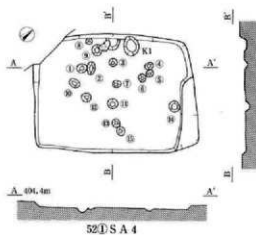
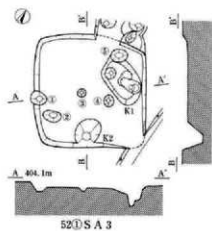
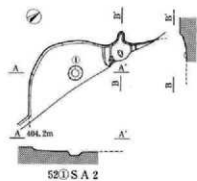

図版 60 古墳時代後期の遺構 (5)

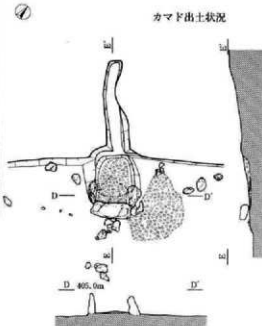
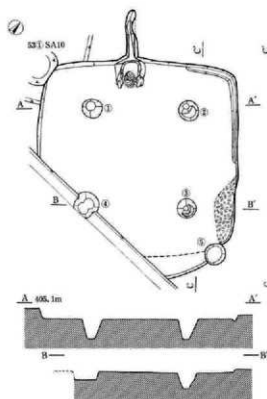
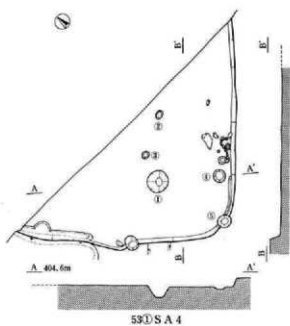

0 (1:50) 2m 0 (1:100) 2m

図版 61 古墳時代後期の遺構 (6)

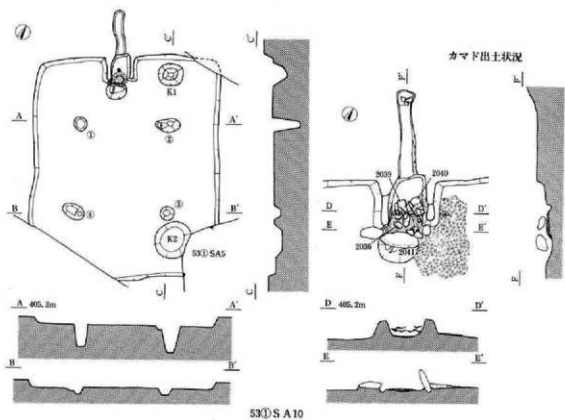
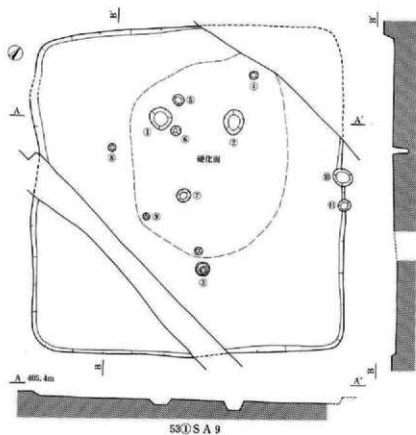

図版 62 古墳時代後期の遺構 (7)

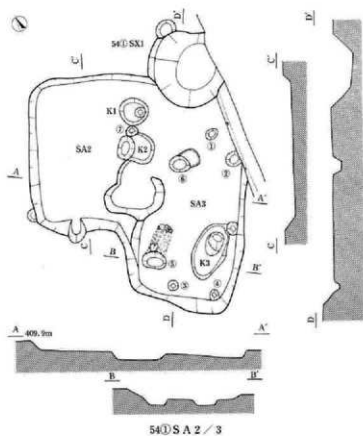
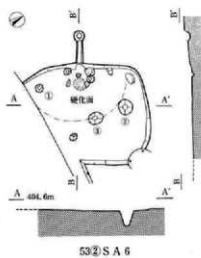
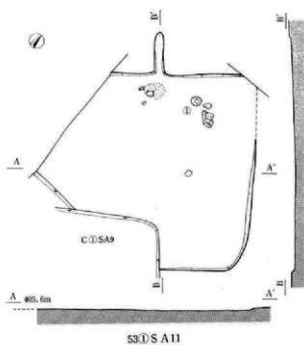

0 (1:100) 2m

図版 63 古墳時代後期の遺構 (8)

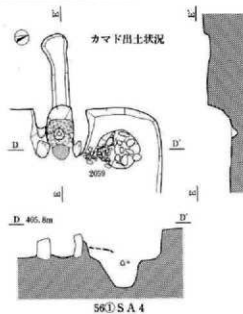
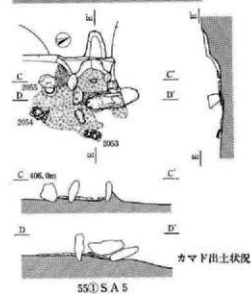
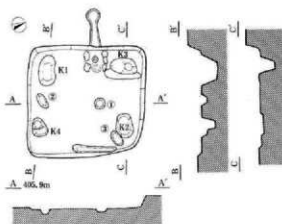
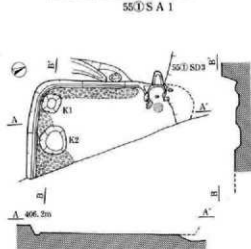
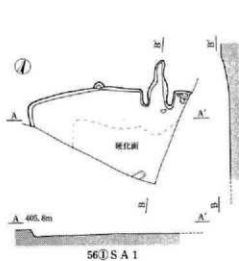
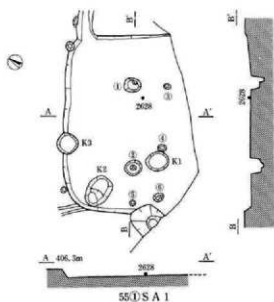

図版 64 古墳時代後期の遺構 (9)

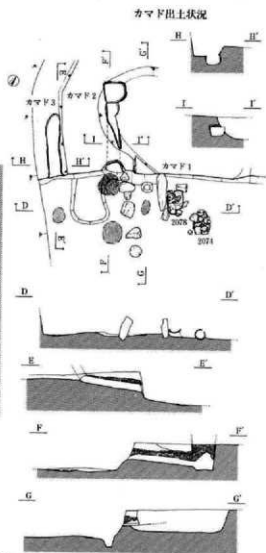
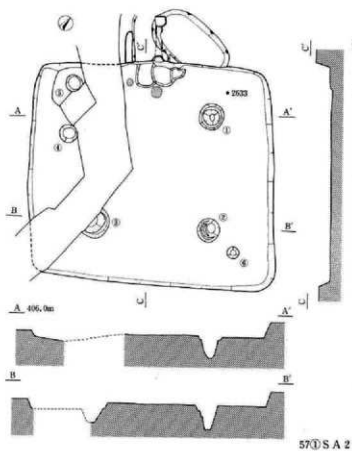
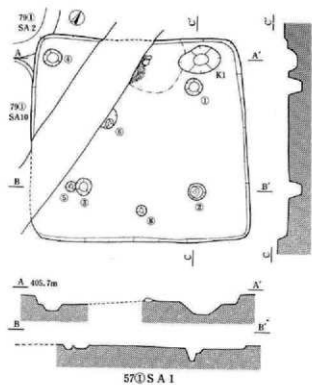

図版 55 古墳時代後期の遺構 (10)

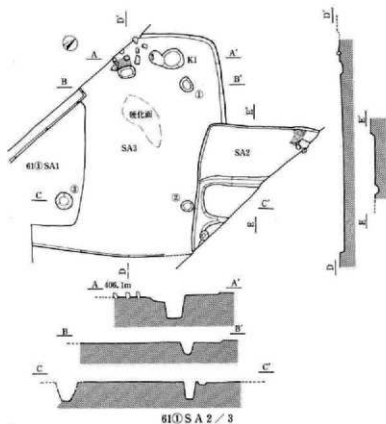
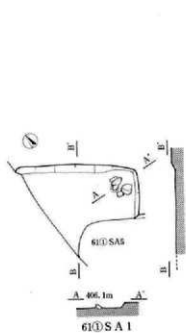
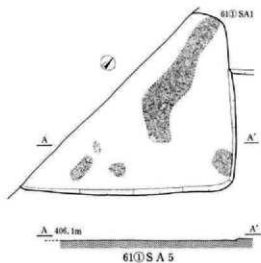
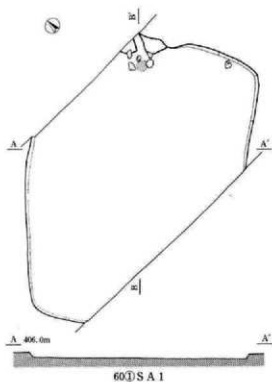

0 1:100 2m

図版 66 古墳時代後期の遺構 (11)

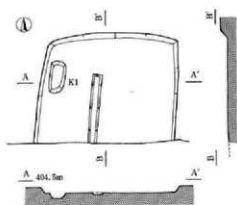

78D SA 1

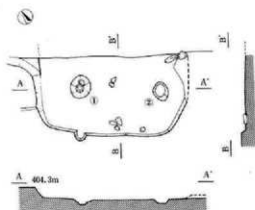

78D SA 5

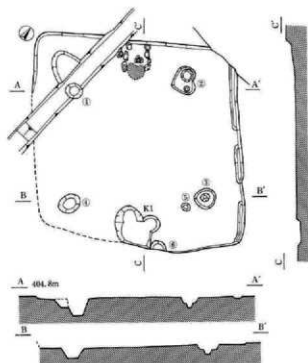

A 404.8m

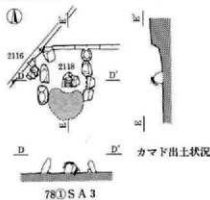

78D SA 3

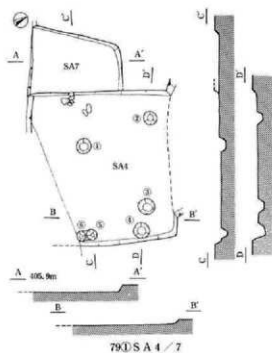

A 406.9m

79D SA 4 / 7

0 (1:50) 1m 0 (1:100) 2m

図版 67 古墳時代後期の遺構 (12)

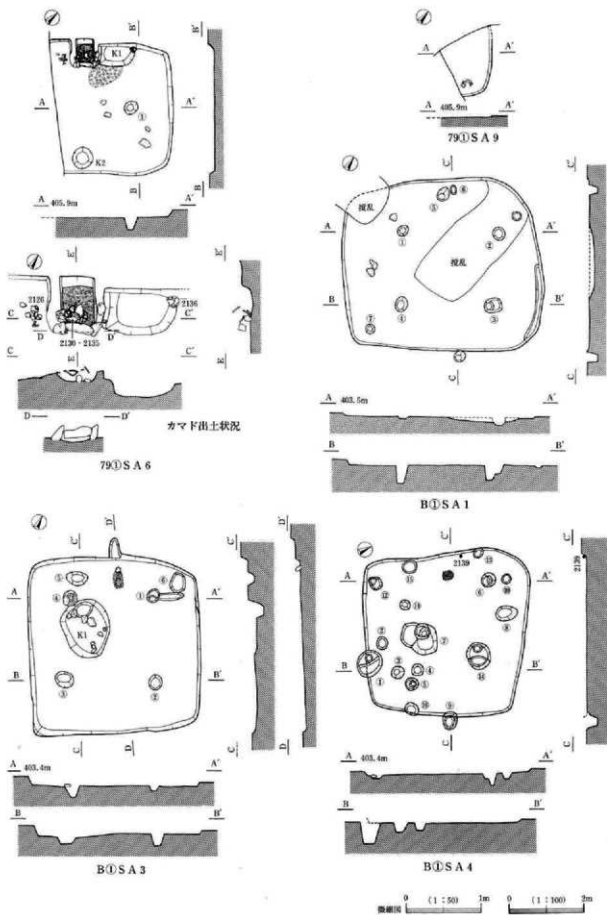

図版 68 古墳時代後期の遺構 (13)

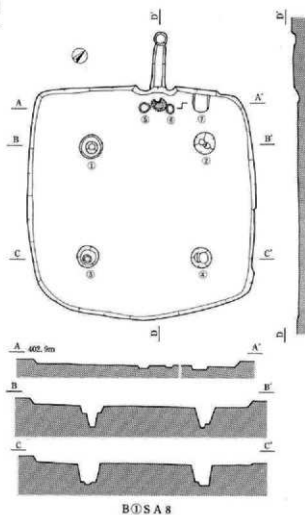
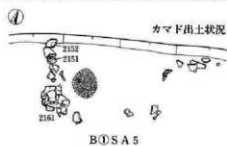
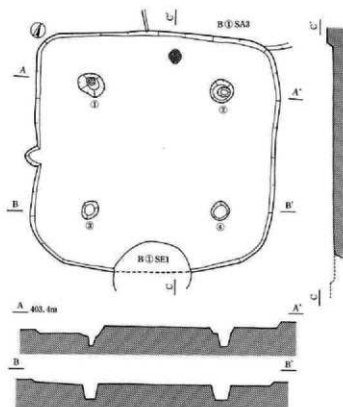

図版 69 古墳時代後期の遺構 (14)

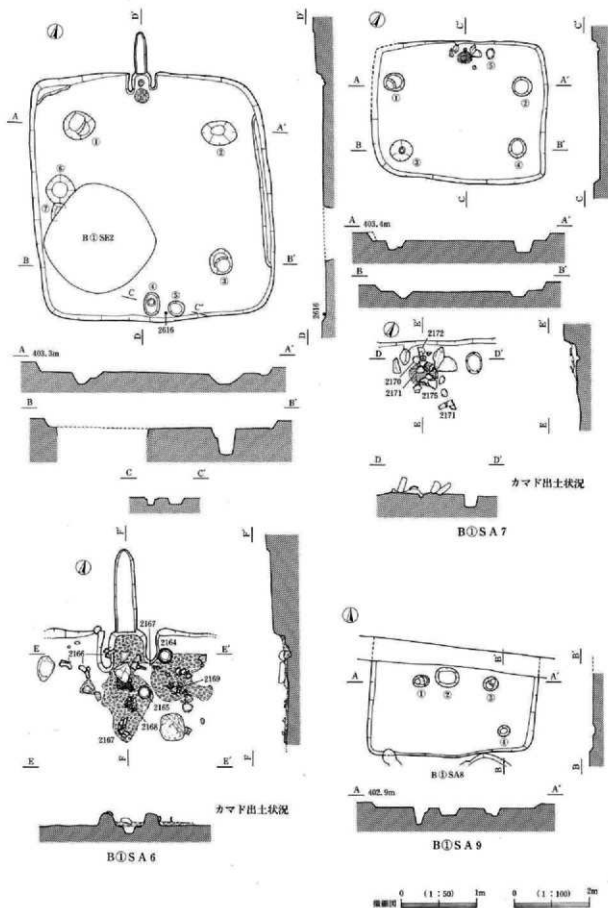

図版 70 古墳時代後期の遺構 (15)

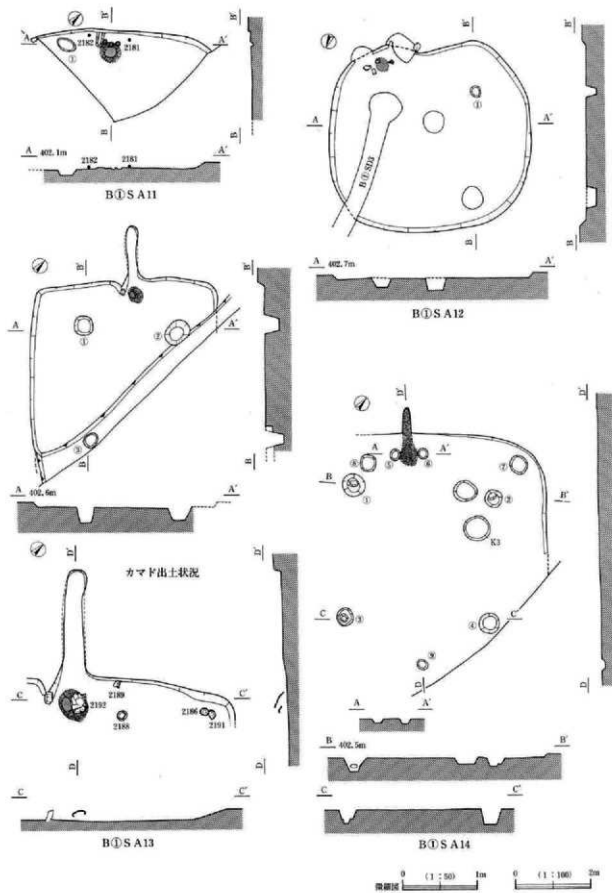

図版 71 古墳時代後期の遺構 (16)

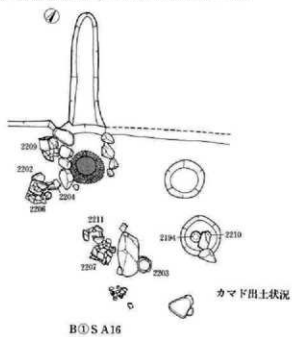
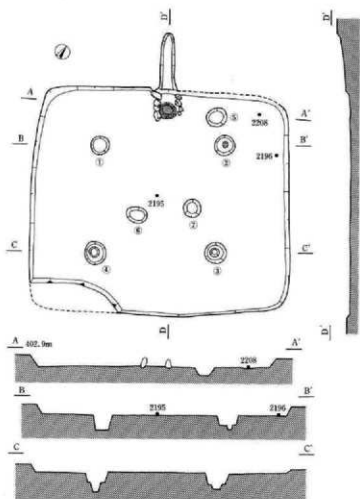

B①SA16



図版 72 古墳時代後期の遺構 (17)

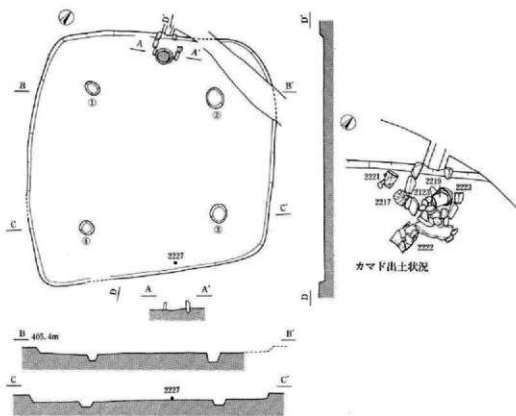

C1SA2

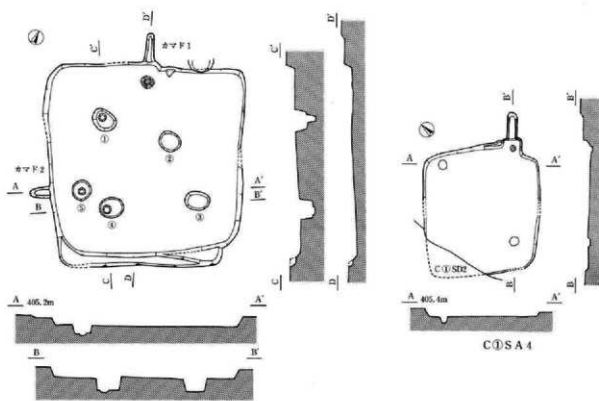

C1SA3

C1SA4



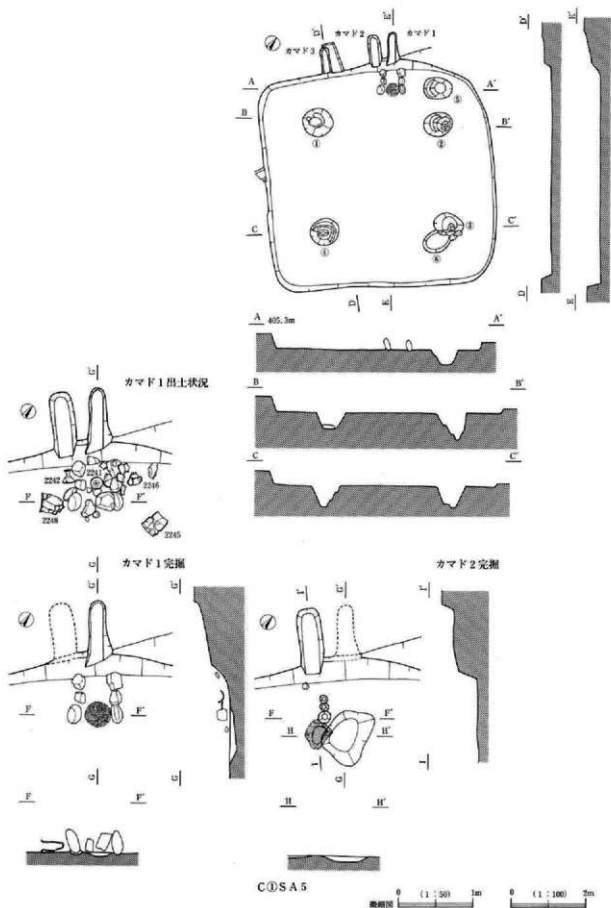

図版 74 古墳時代後期の遺構 (19)

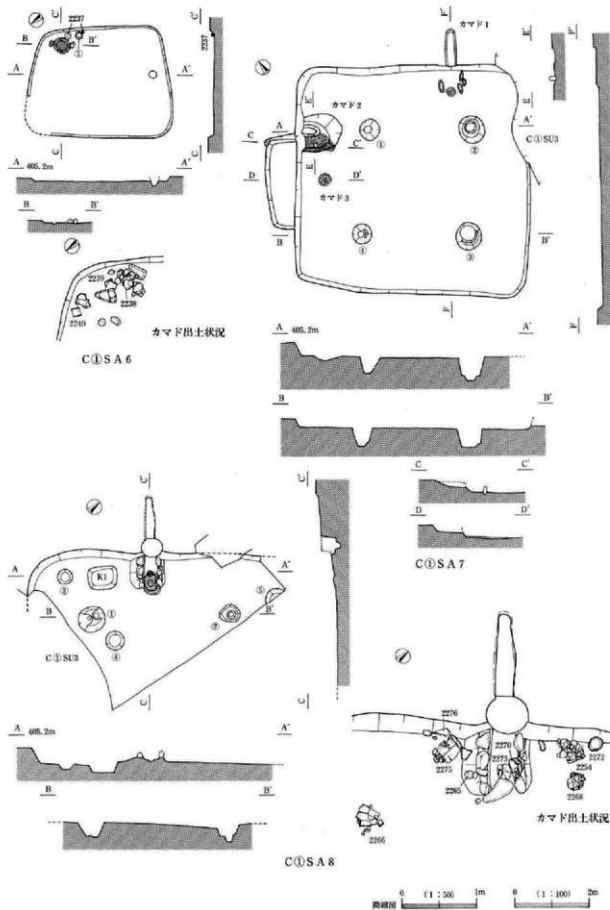

図版 75 古墳時代後期の遺構 (20)

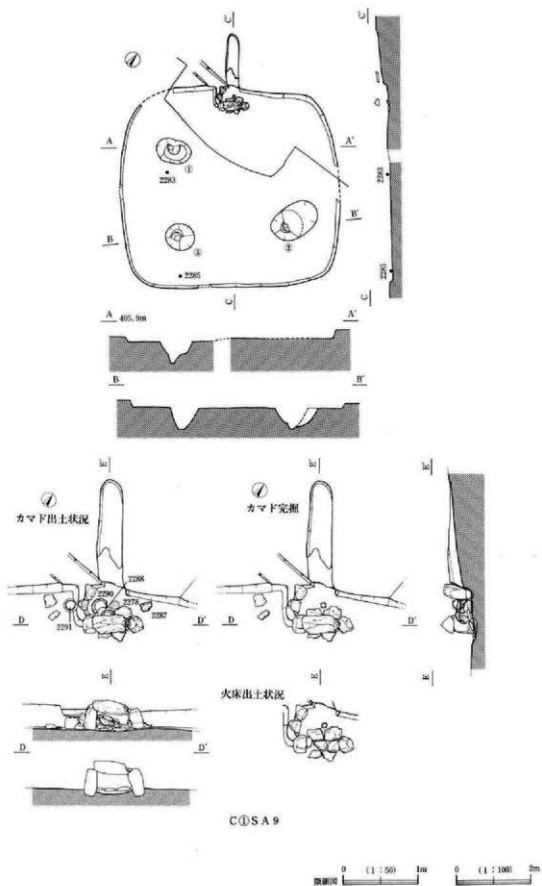

C①SA9

図版 76 古墳時代後期の遺構 (21)

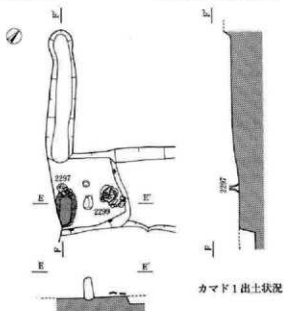
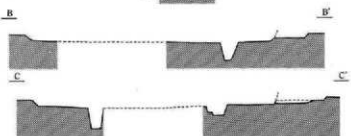
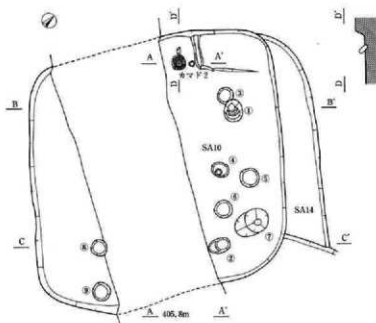

カマド 1 出土状況

C① SA10/14



図版 77 古墳時代後期の遺構 (22)

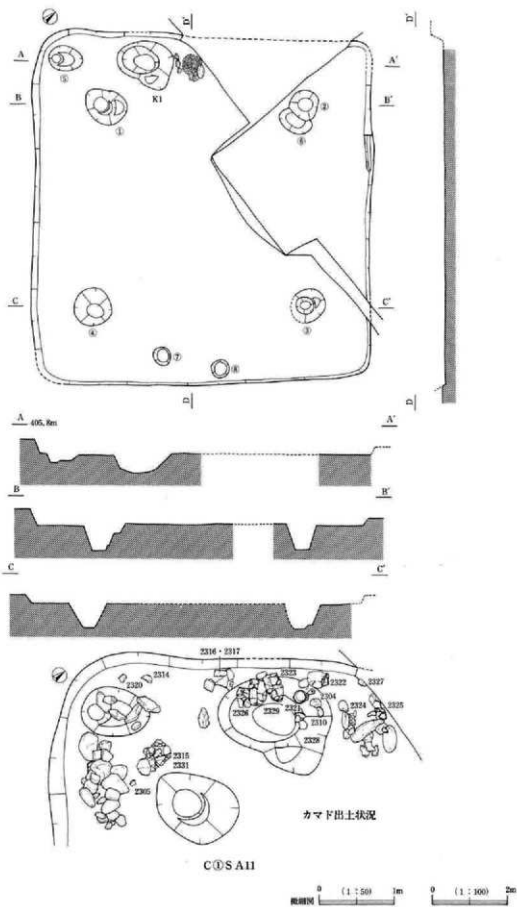

図版 78 古墳時代後期の遺構 (23)

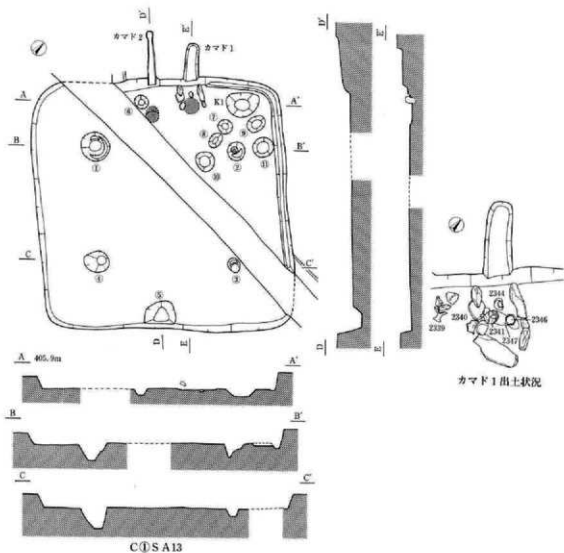
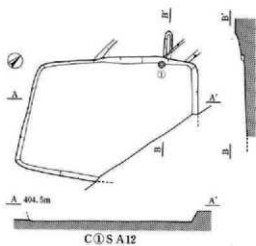

カマド1出土状況



図版 79 古墳時代後期の遺構 (24)

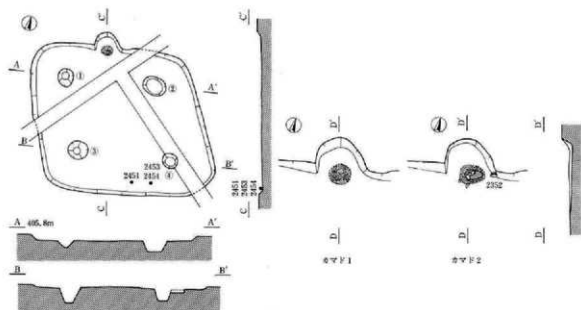

C①SA15

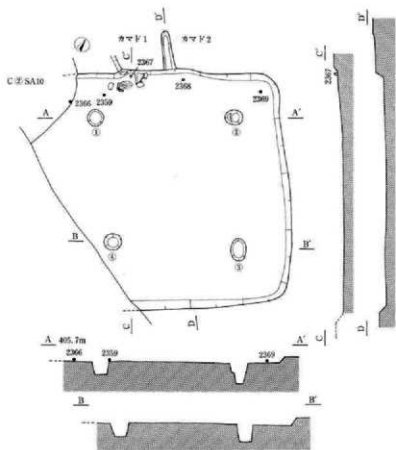

C①SA16



図版 80 古墳時代後期の遺構 (25)

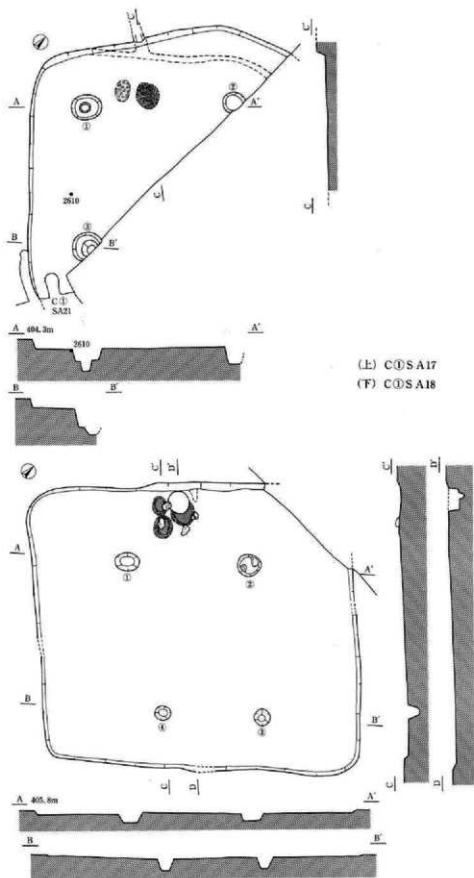

(上) CDS A17

(下) CDS A18

0 1 : 100 2m

図版 81 古墳時代後期の遺構 (26)

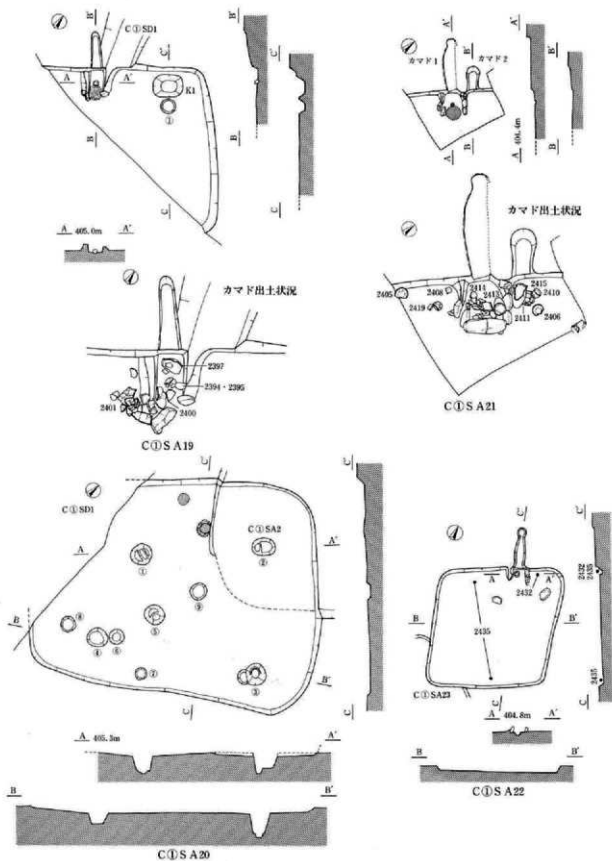

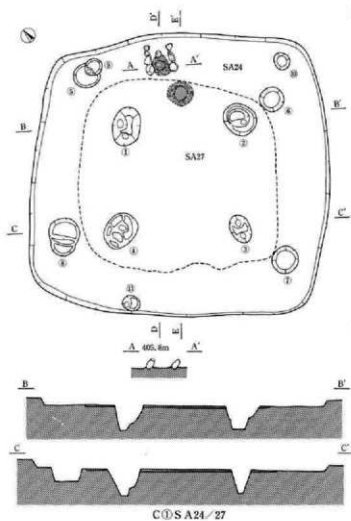
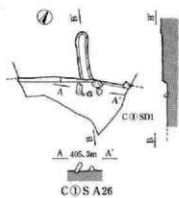
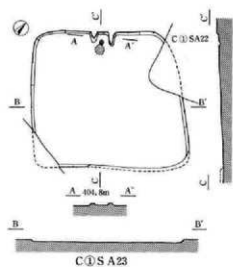

原縮尺 0 (1:50) 3m 0 (1:100) 2m

図版 83 古墳時代後期の遺構 (28)

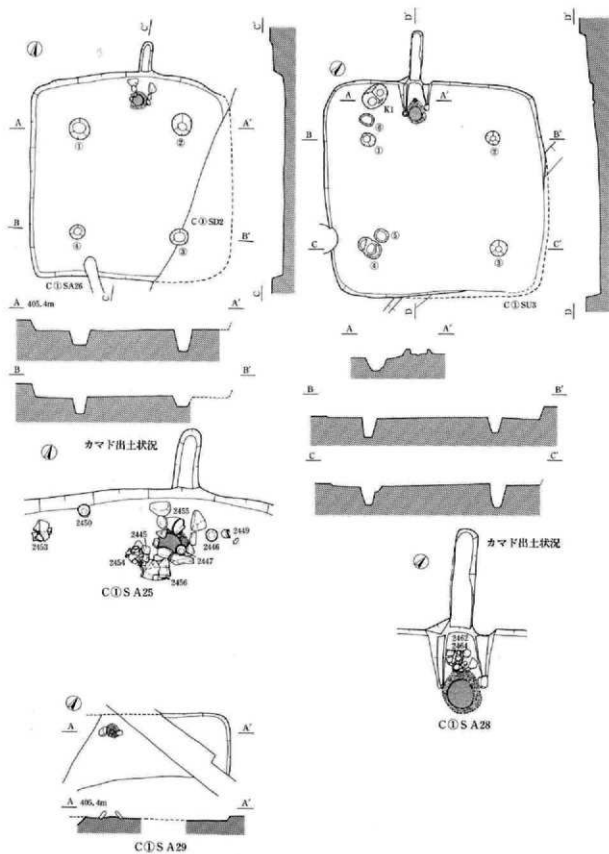

図版 84 古墳時代後期の遺構 (29)

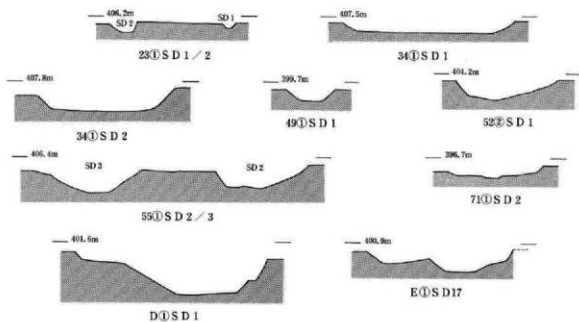
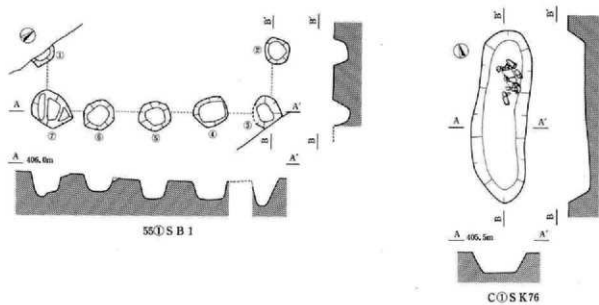

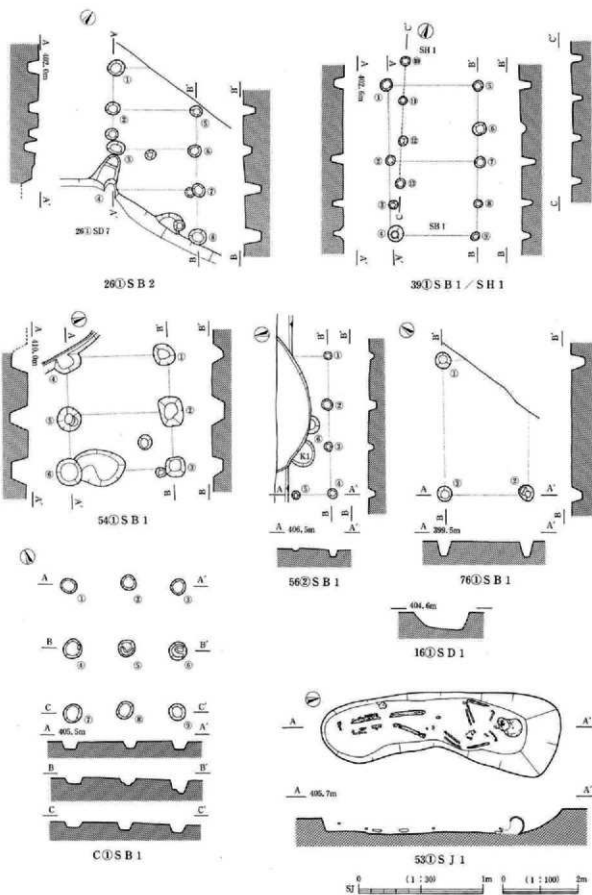

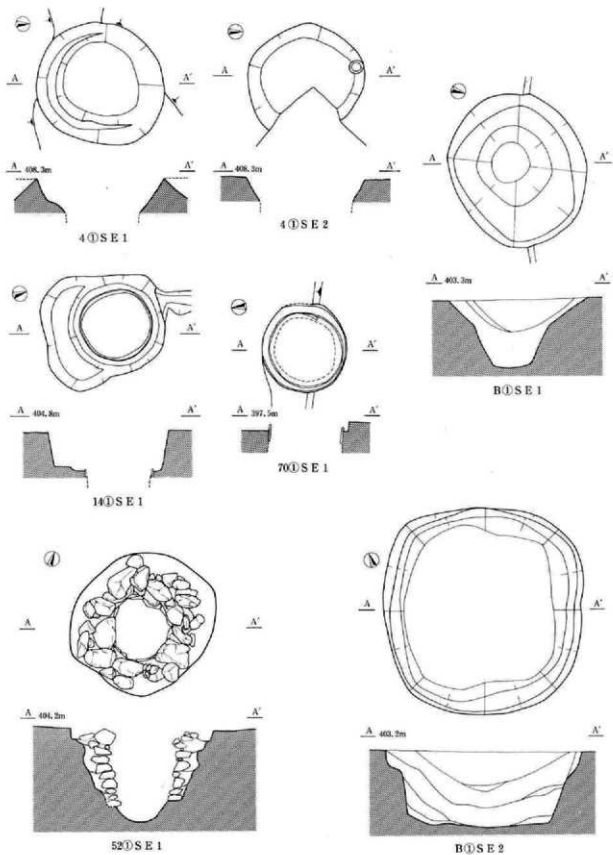

0 (1:50) 1m

図版 67 平安時代～中世の遺構 (3)

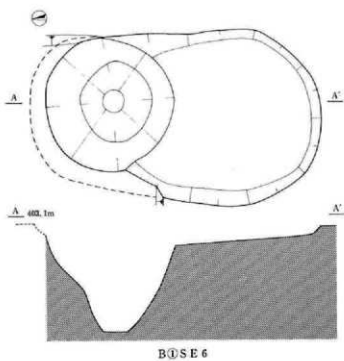
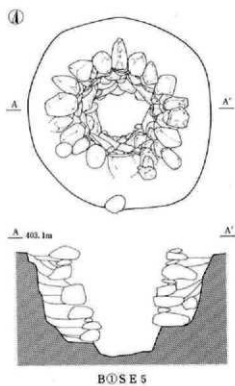
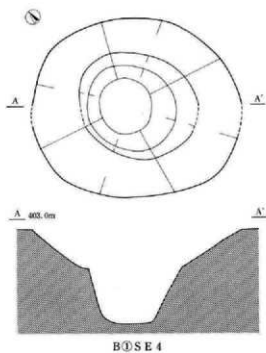
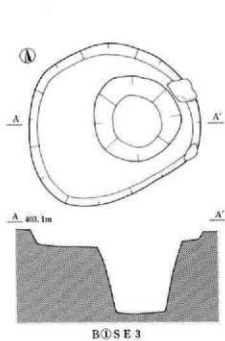

0 1 : 50 1m

図版 88 平安時代～中世の遺構 (4)

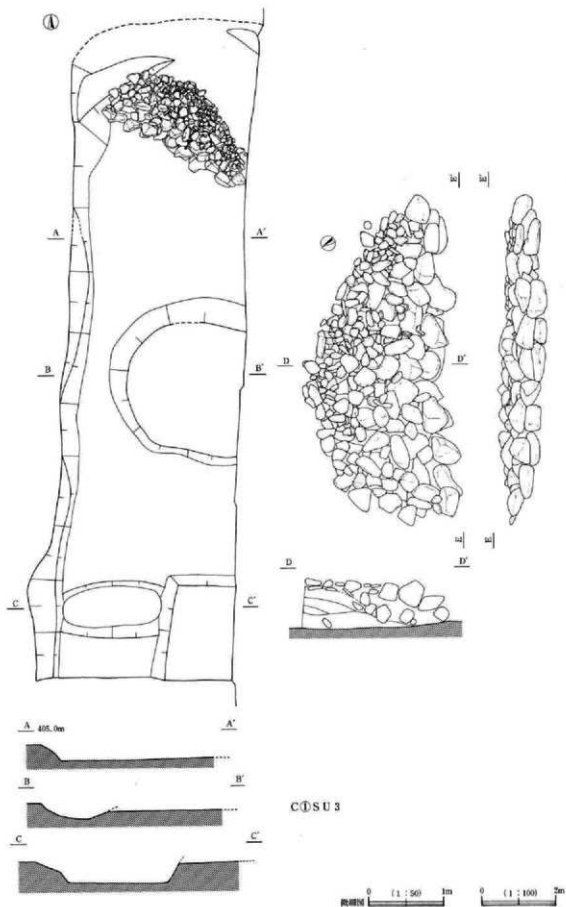

図版 89 縄文時代中期の遺物 (1)

45② SA 2



45② SA 6



45② SA 7

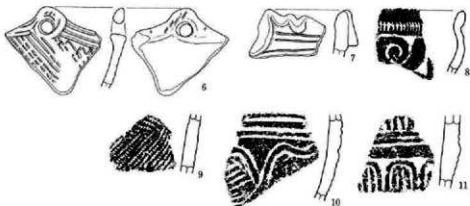

63② SA 1

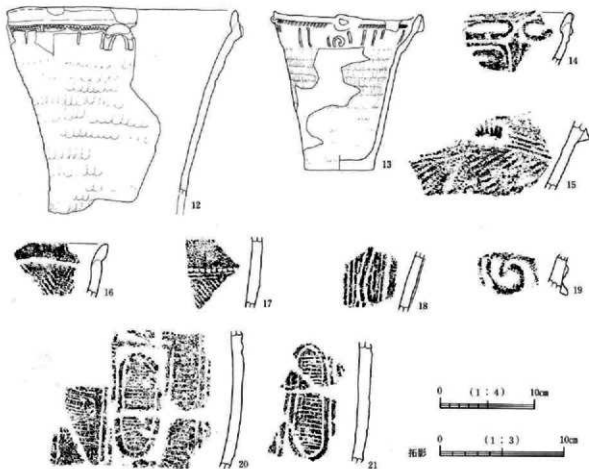

図版 90 縄文時代中期の遺物 (2)

63② SA 2

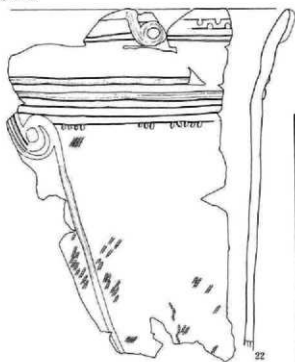

63② SI79



0 (1:4) 10cm

63② SR 1

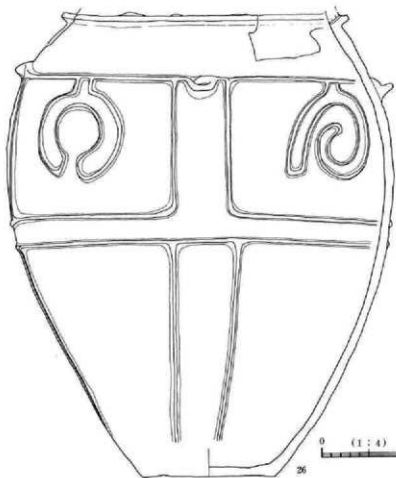

0 (1:4) 10cm

図版 91 縄文時代中期の遺物 (3)

48② SR 1

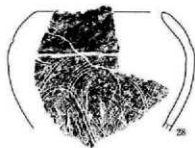
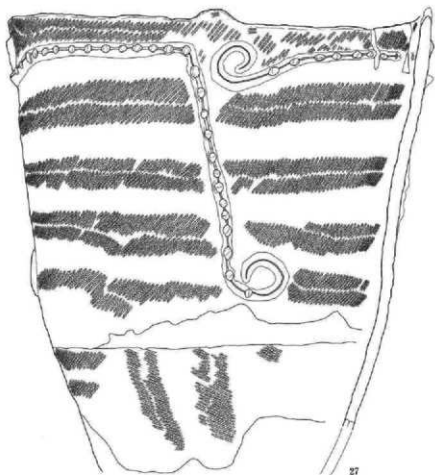

0 (1:4) 10cm

拓影 0 (1:3) 10cm

図版 92 縄文時代中期の遺物 (4)

45②SD1

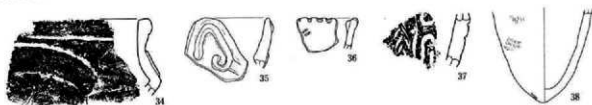

遺物外 (1)

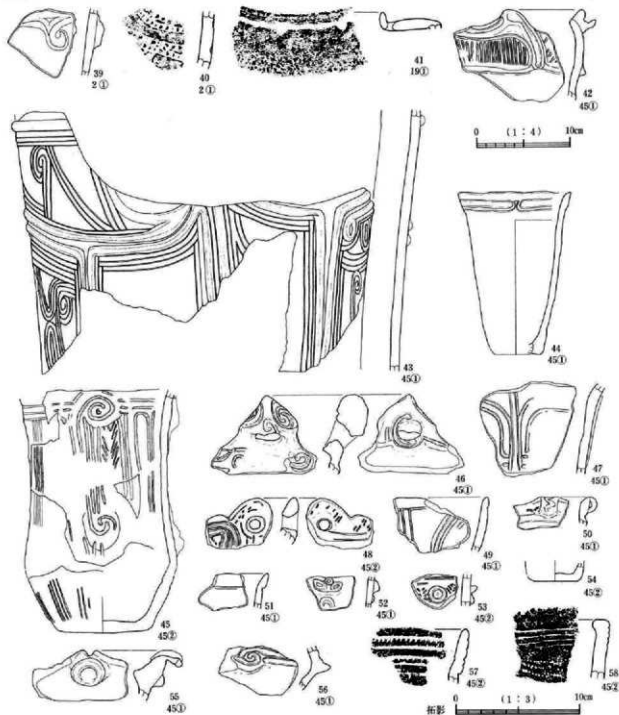

遺物外 (2)

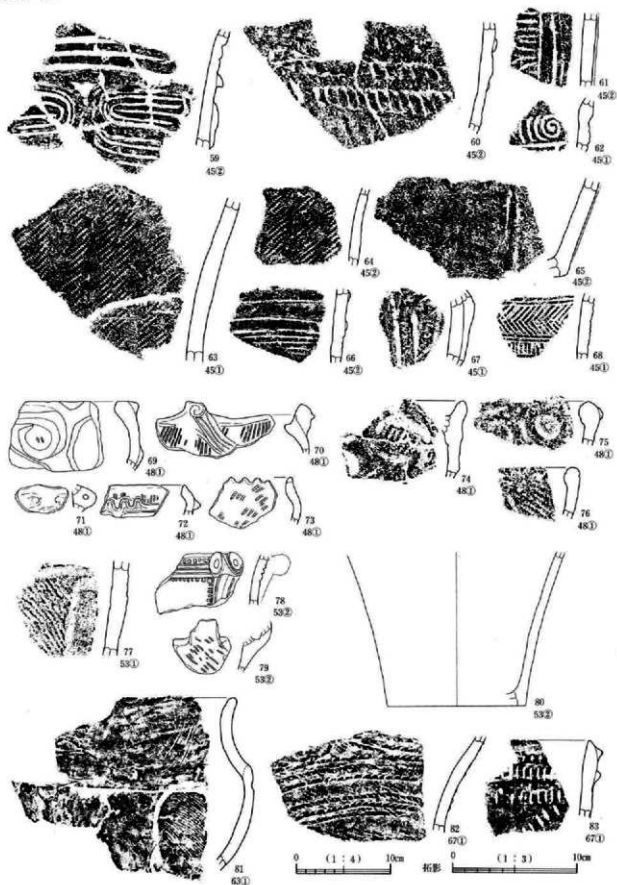

E②SA1

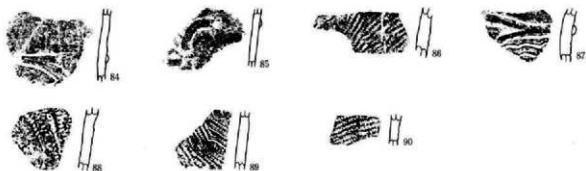

E②SA2

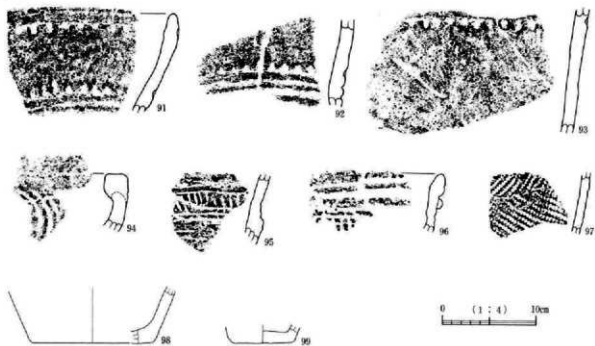

E②SA3 (1)

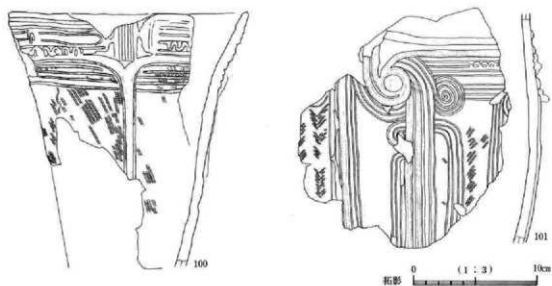

E②SA3 (2)

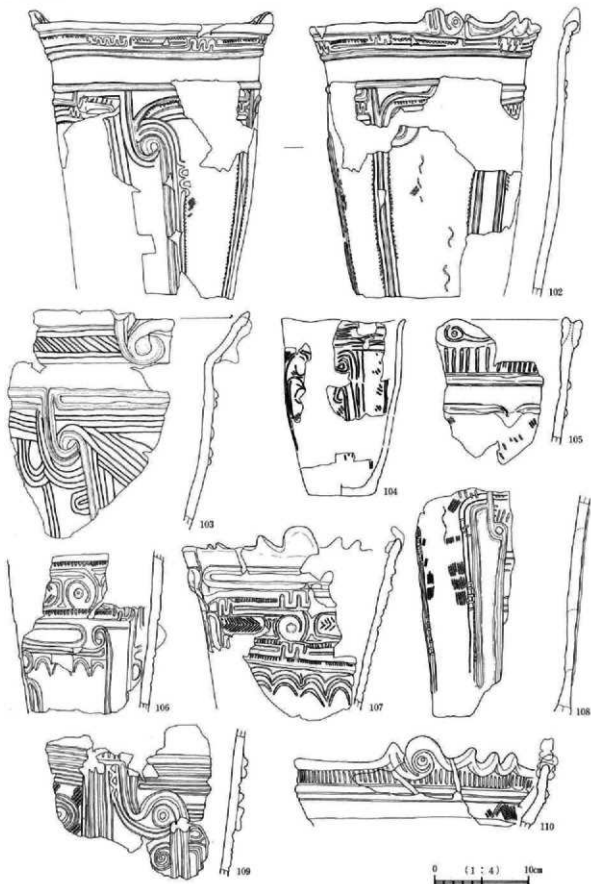

E②SA3 (3)

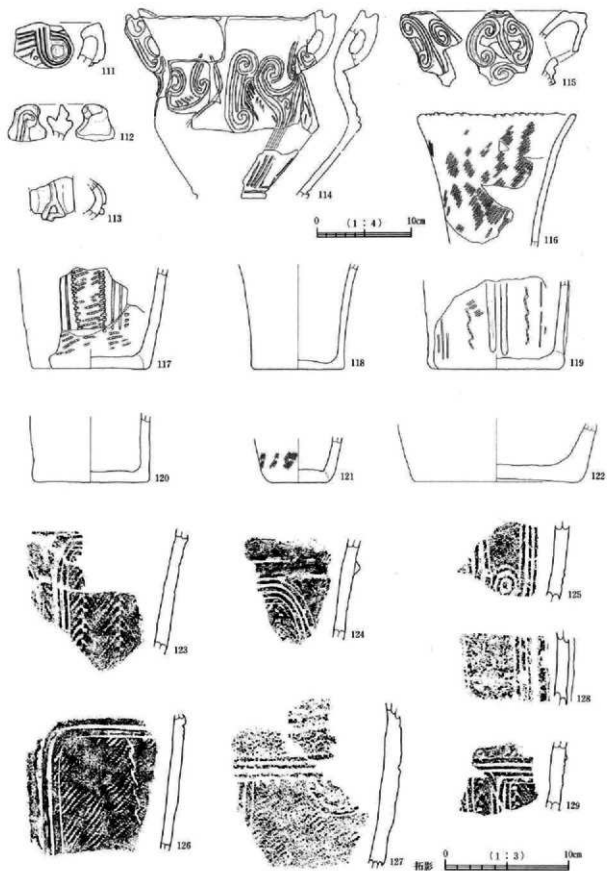

E②SA3 (4)

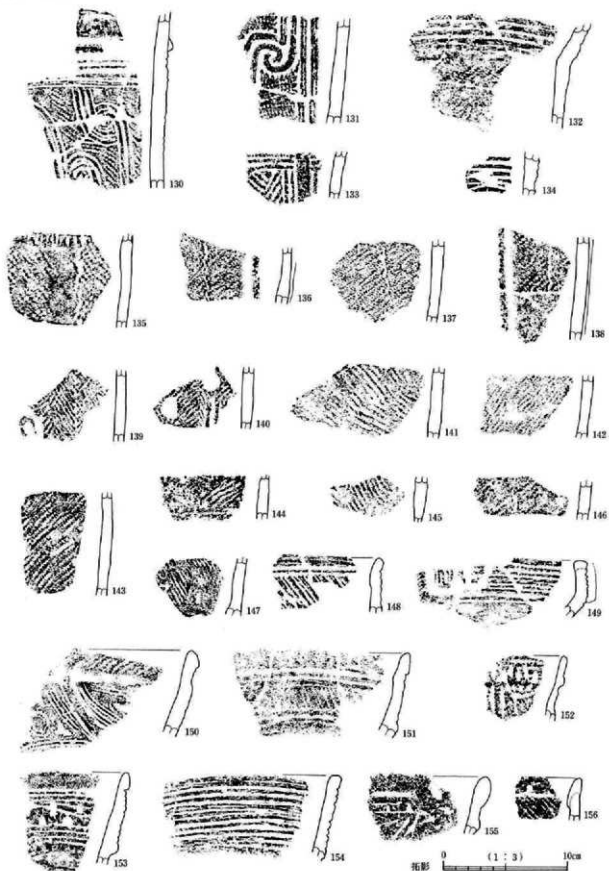

E②SA3 (5)

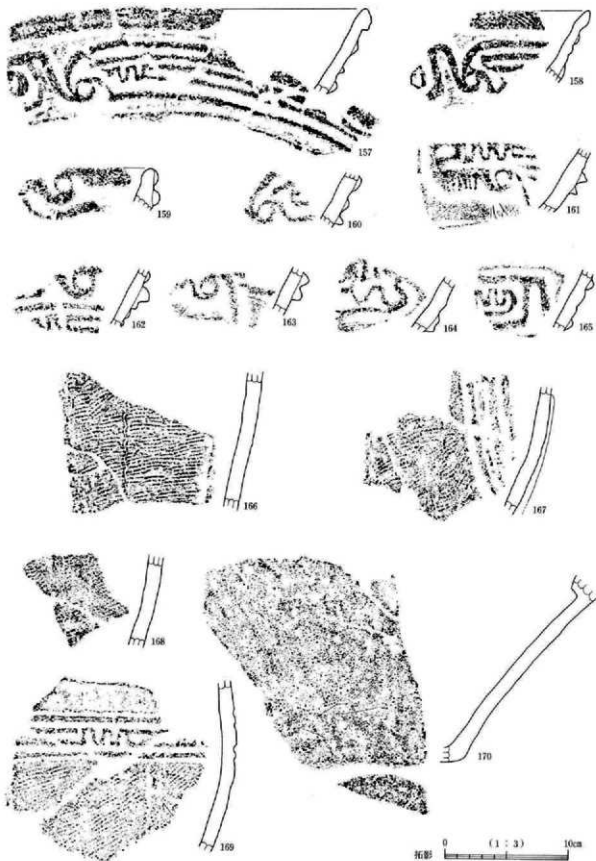

E②SA4 (1)

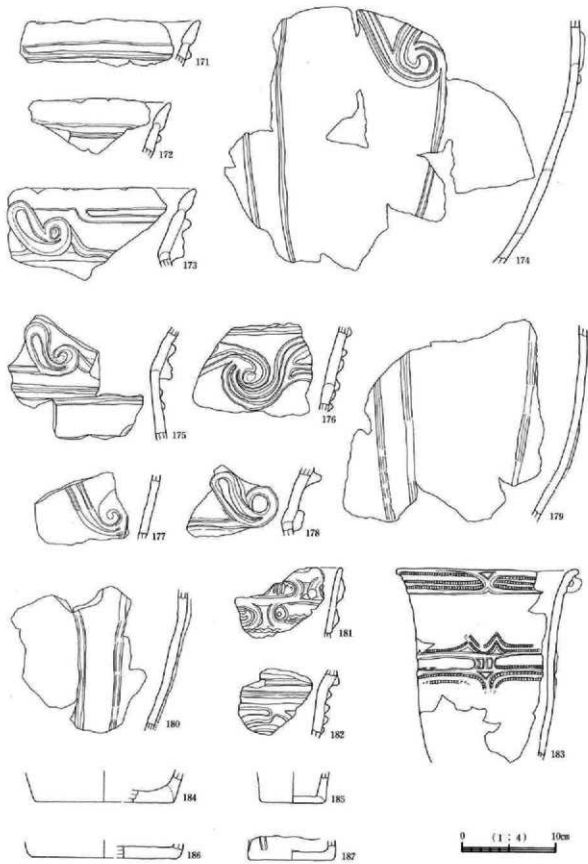

E②SA4 (2)

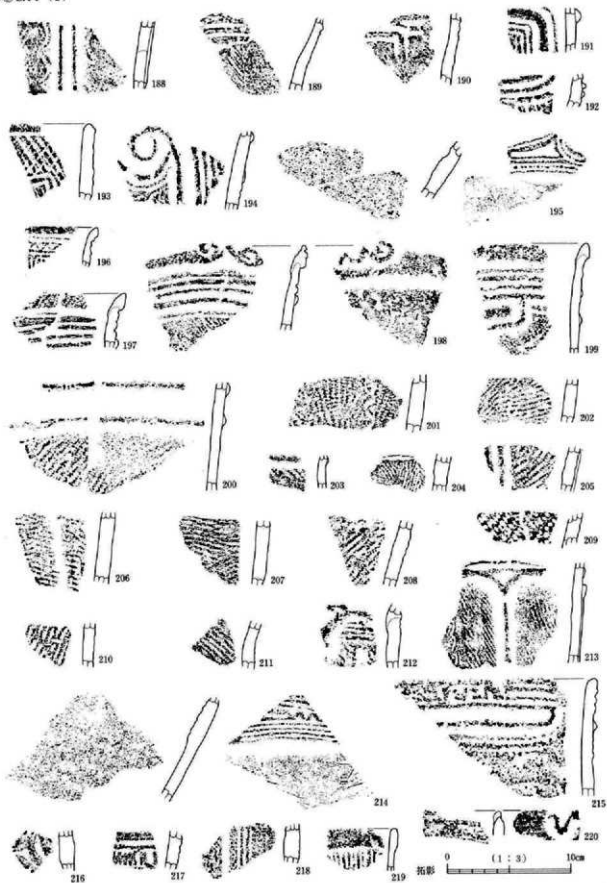

E ④ SA 4 (3)

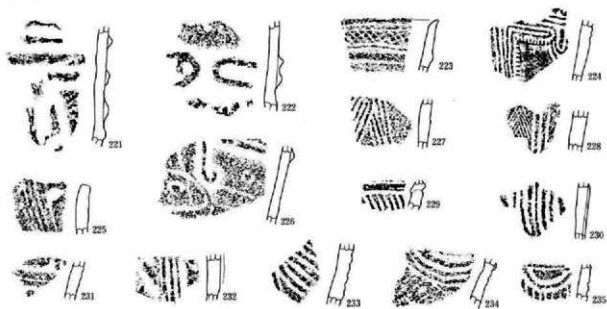

E ④ SA 5

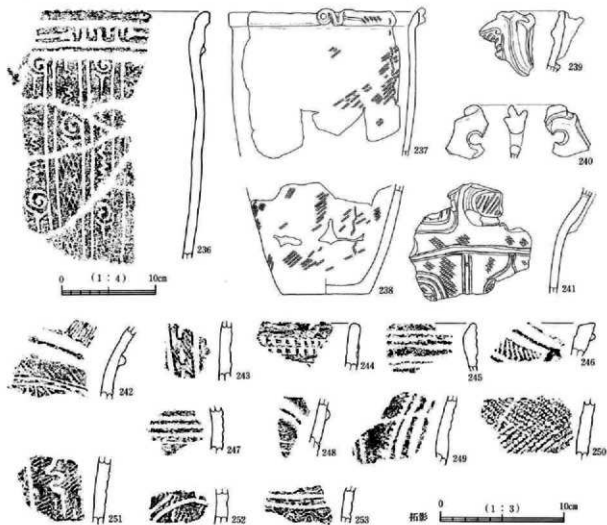

三② SA 6

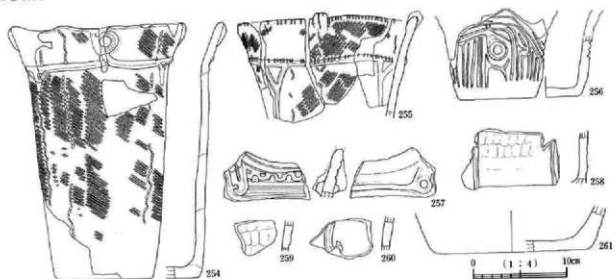

E② SA 7



E② SA 8

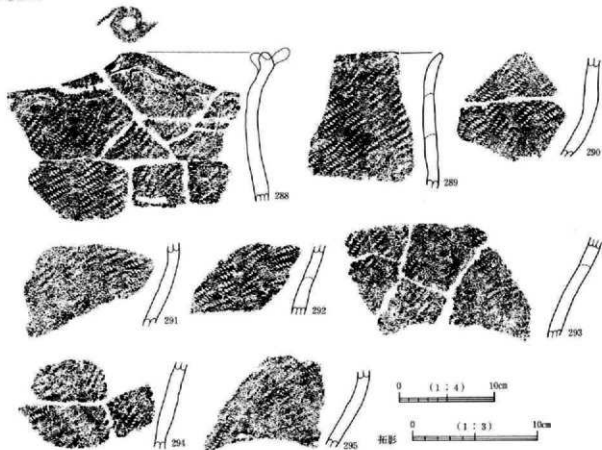

E② SK 9

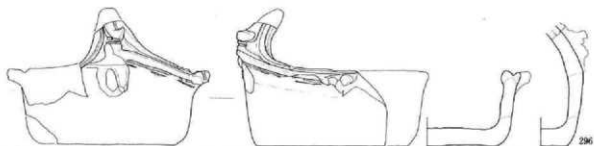

E② SP28



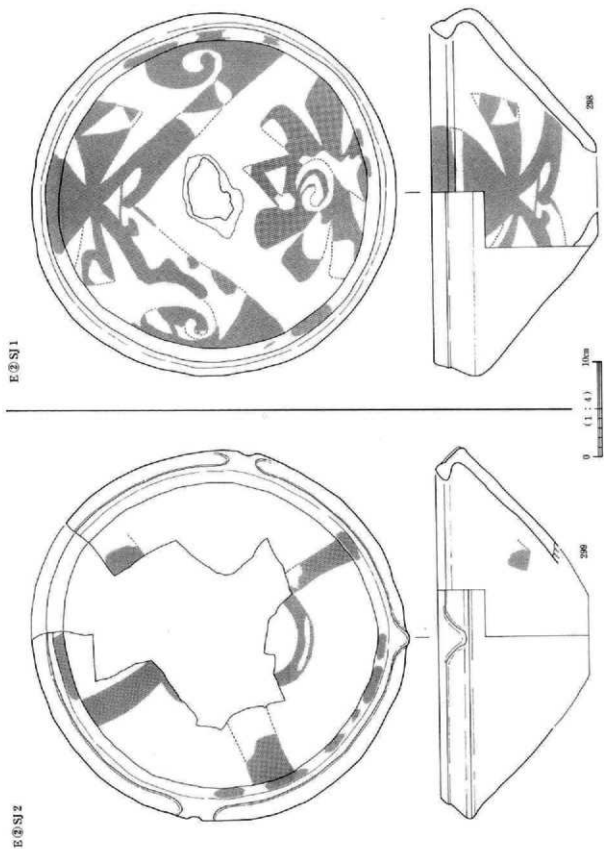

図版 105 縄文時代中期の遺物 (17)

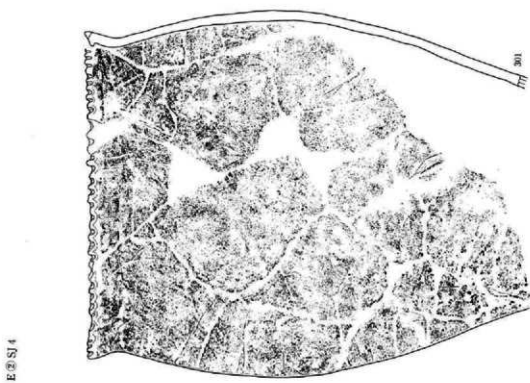
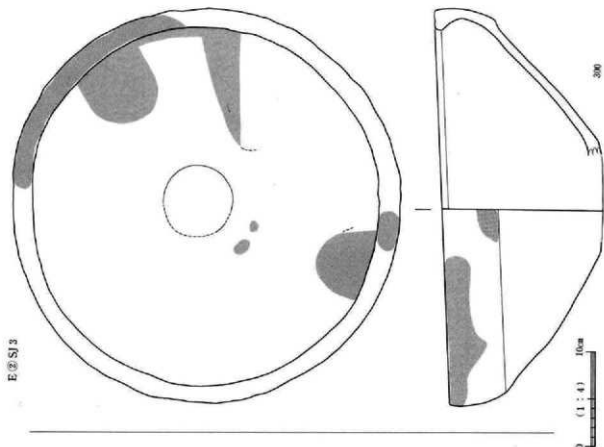

E②SR1

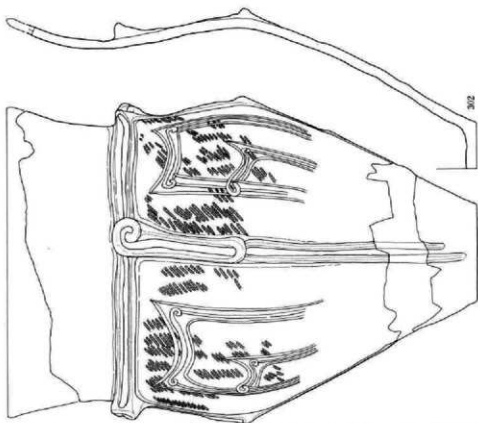

E②SR2

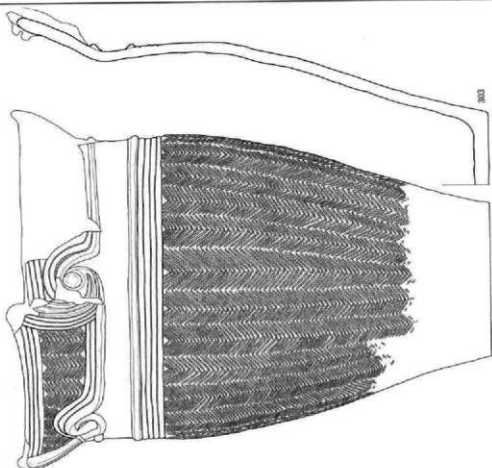

図版 107 縄文時代中期の遺物 (19)

E ② SN 1

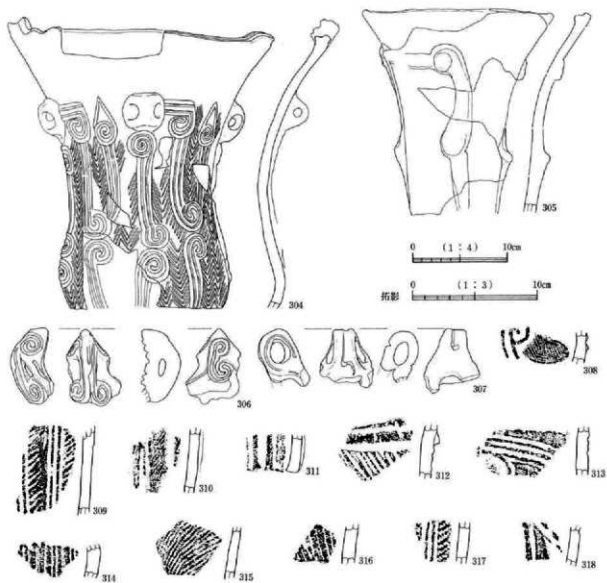

遺構外 (3)

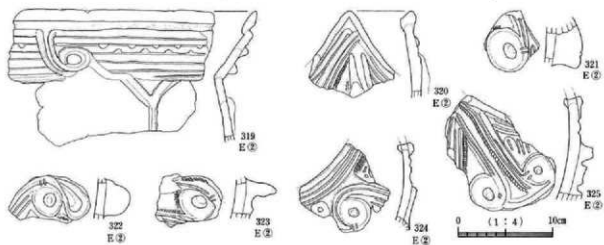

遺物外 (4)

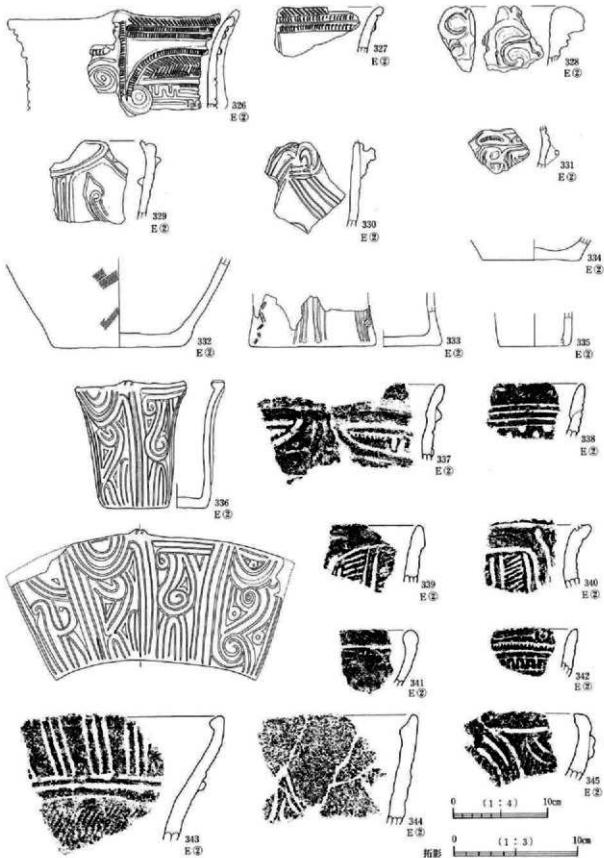

遺物外 (5)

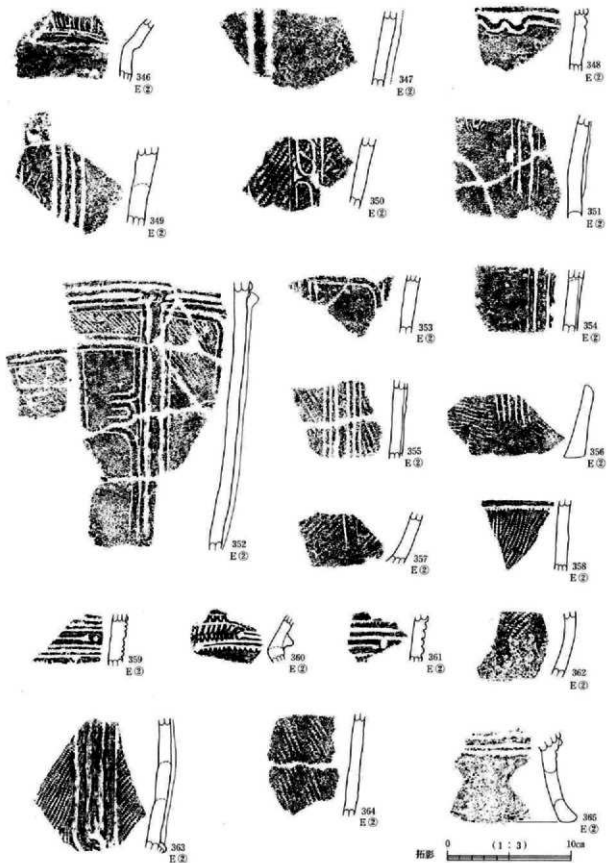

遺物外 (6)

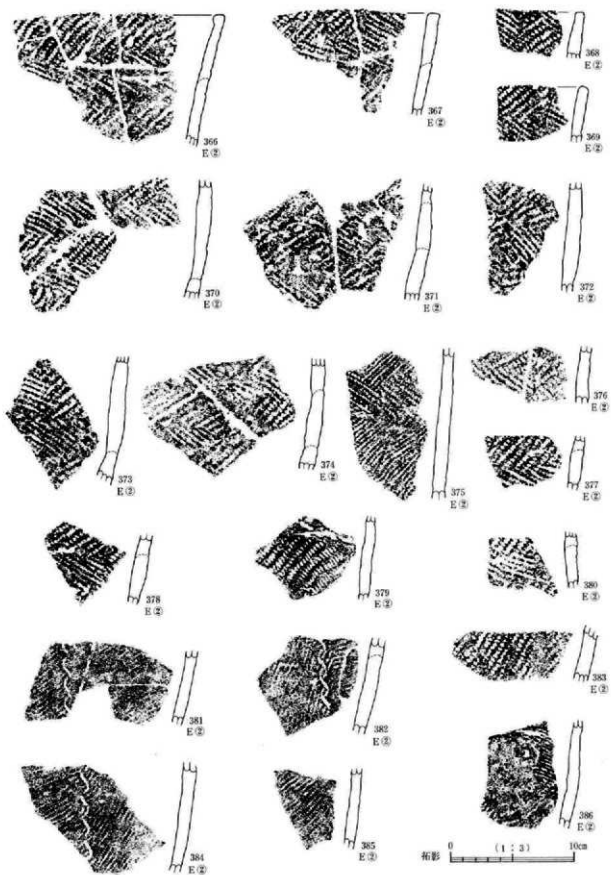

遺物外 (7)

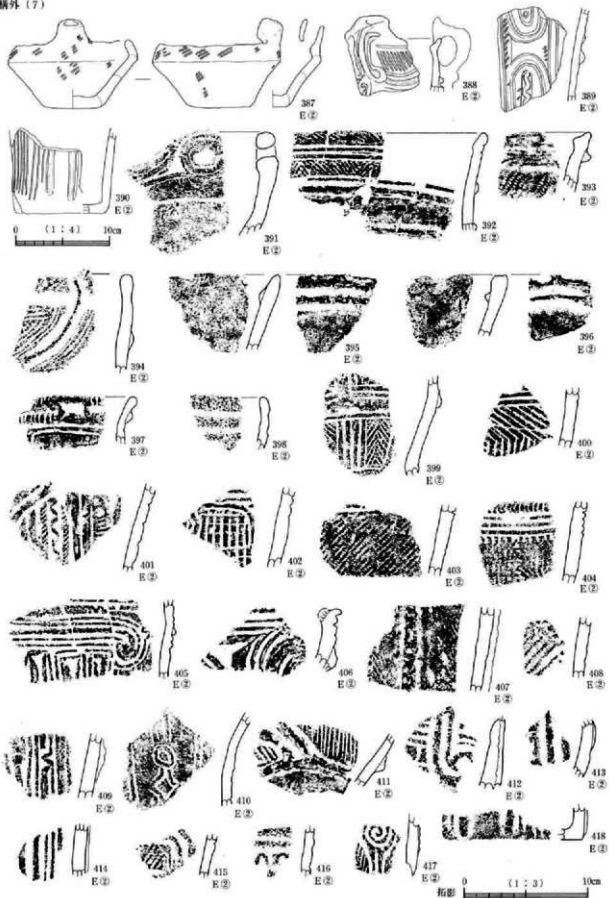

遺物外 (8)

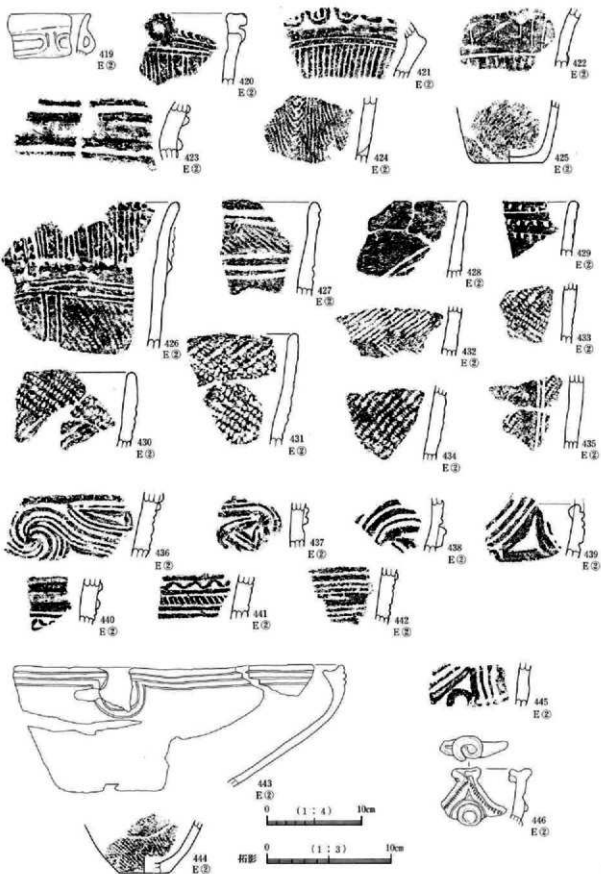

石製品 (1)

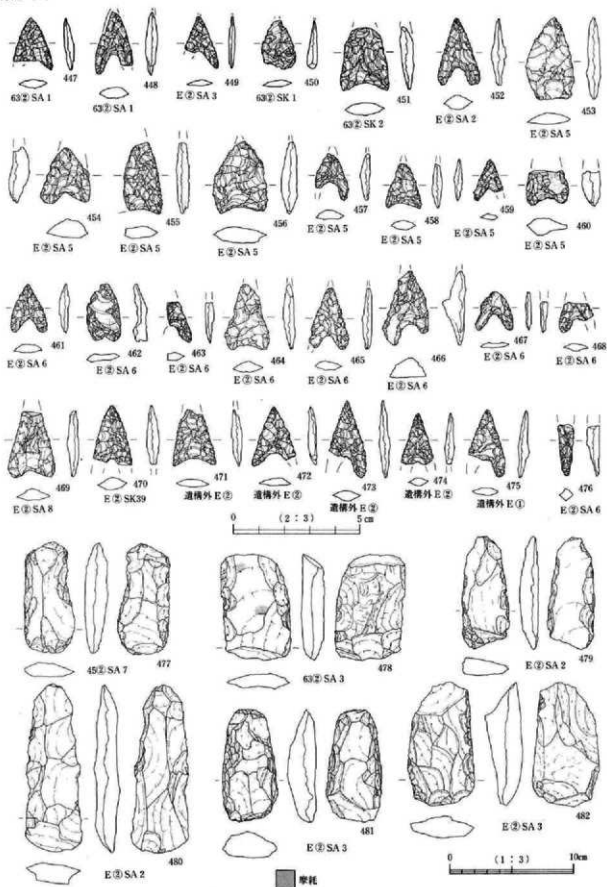

石製品 (2)

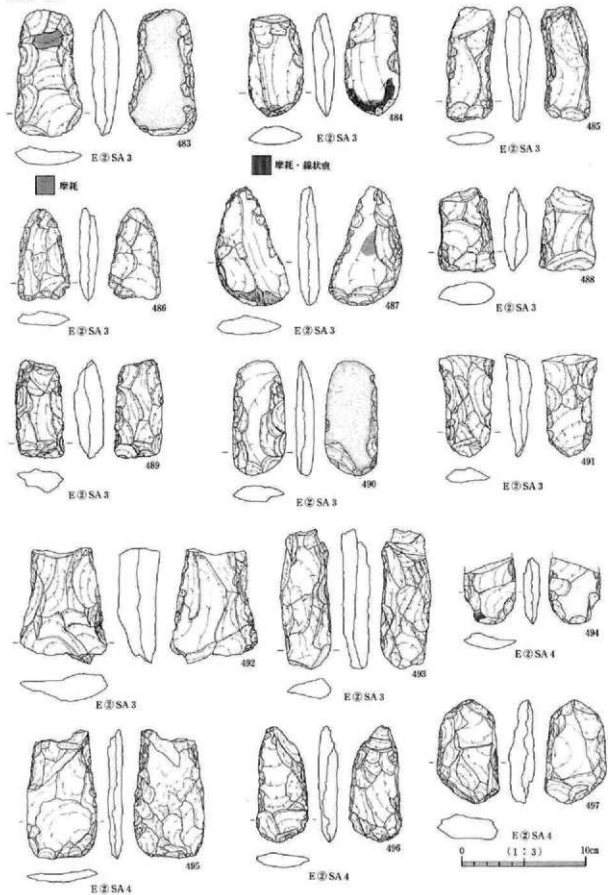

石製品 (3)

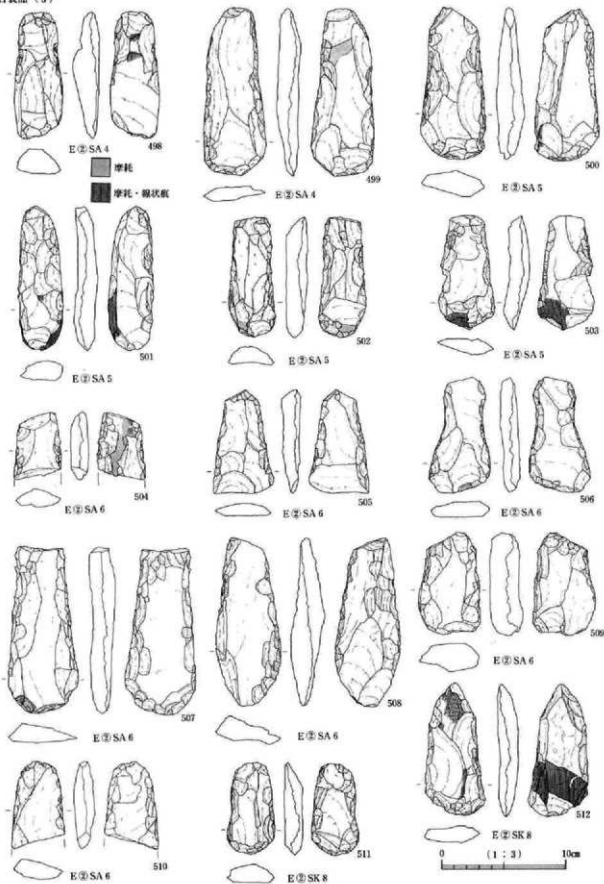

石製品 (4)

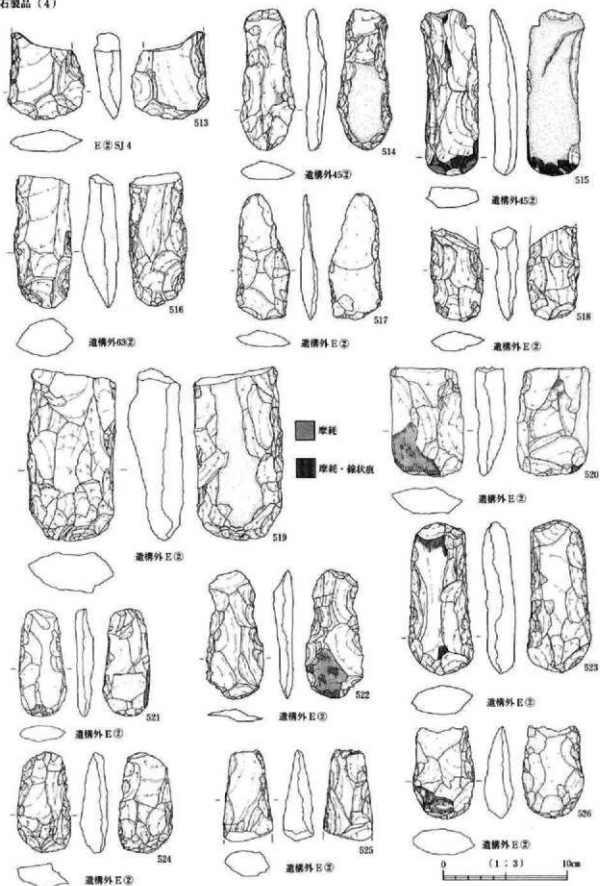

図版 117 縄文時代中期の遺物 (29)

石製品 (5)

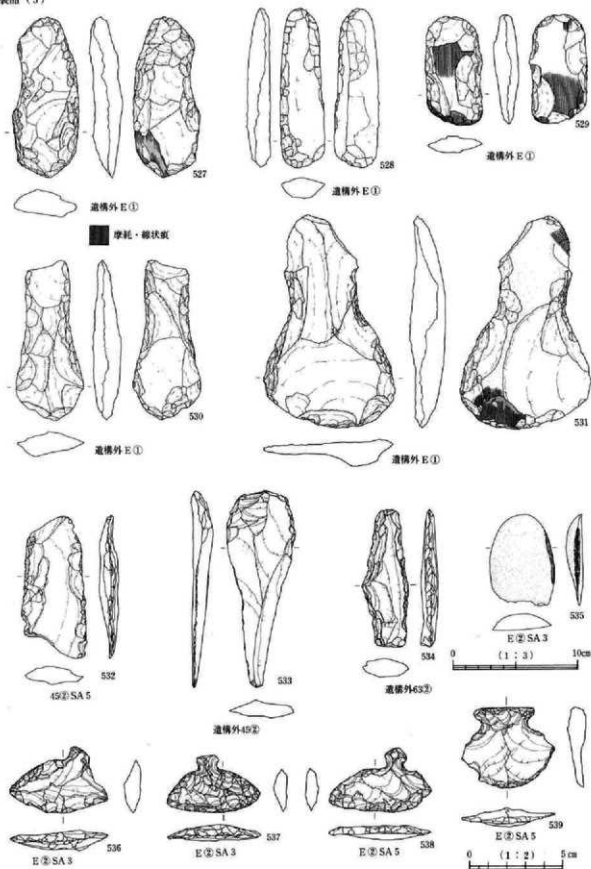

石器品 (6)

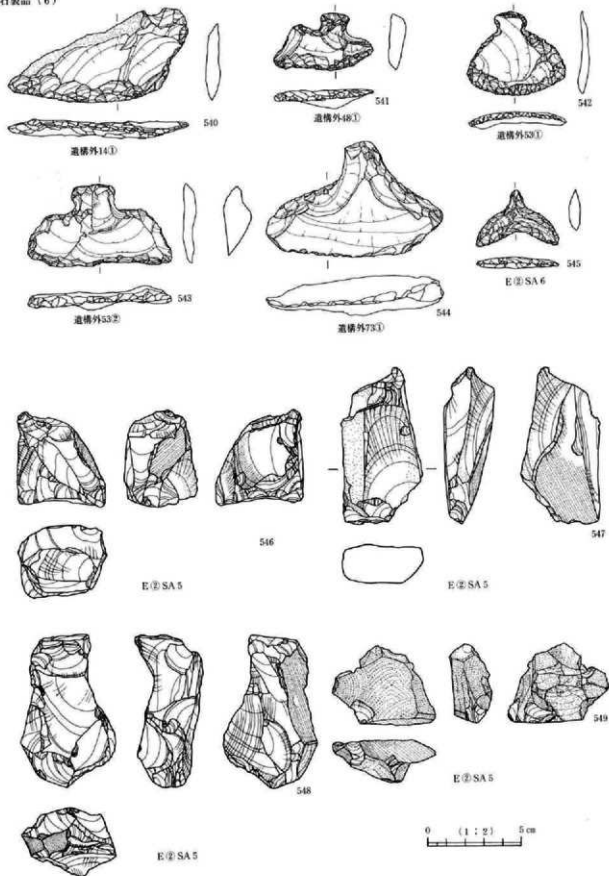

石製品 (7)

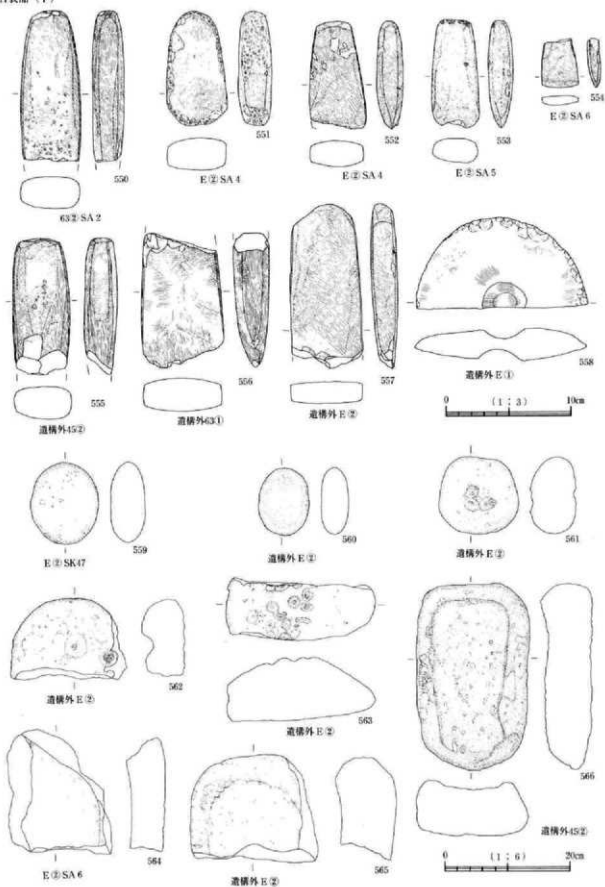

石製品 (8)

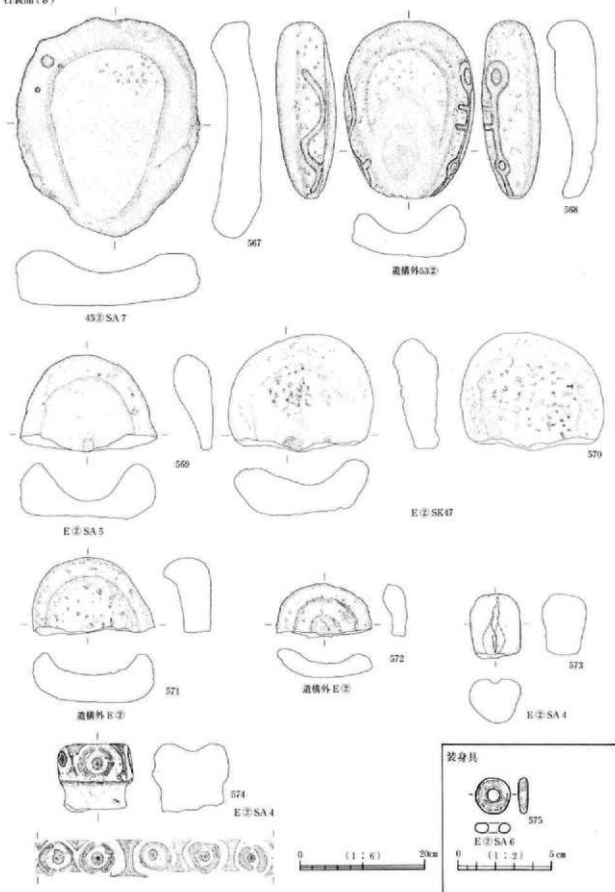

土製品

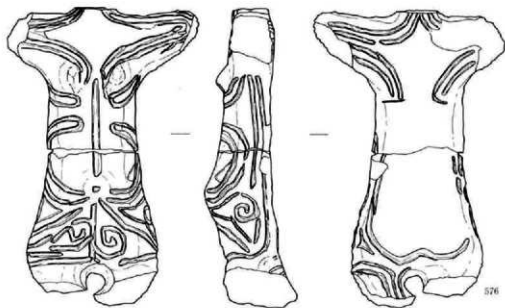

632 SA 1

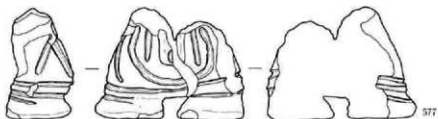

E 2 SA 4



E 2 SA 3

遺構外 E 2



E 2 SA 6

遺構外 E 2

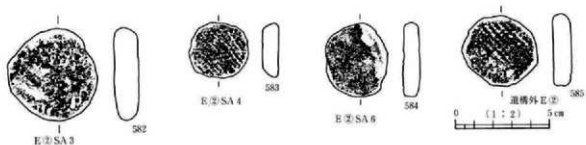

E 2 SA 3

E 2 SA 4

E 2 SA 5

遺構外 E 2

0 1 2 5 cm

1① SA 1

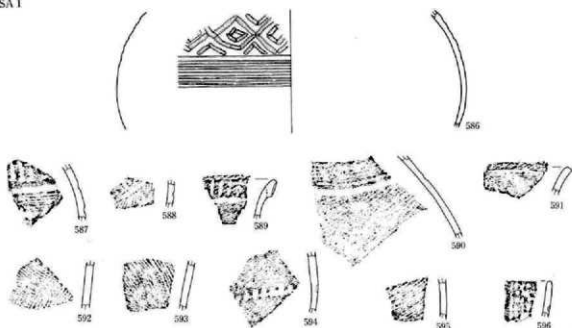

1① SA 2

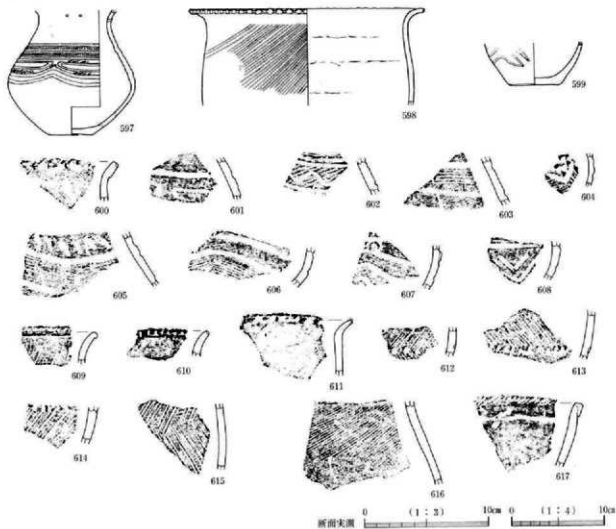

図版 123 弥生時代中期の遺物 (2)

4① SA 1

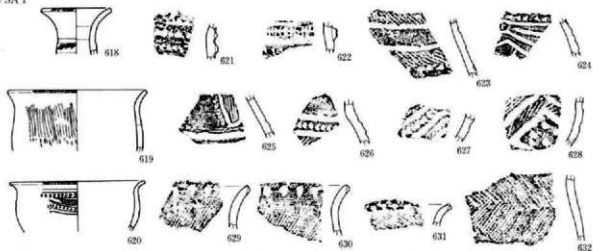

4① SA 2

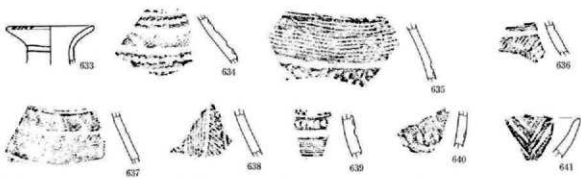

10① SA 1

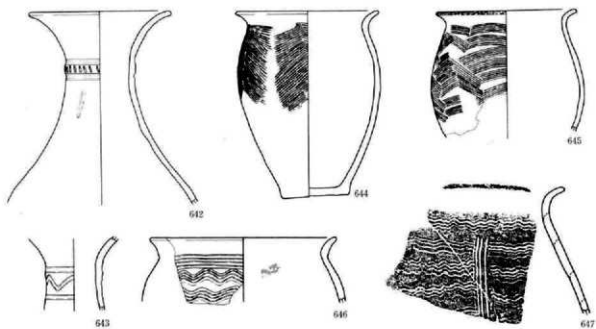

断面実測 0 (1:3) 10cm 0 (1:4) 10cm

図版 124 弥生時代中期の遺物 (3)

18① SA 1

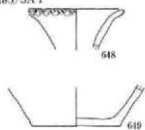

29① SA 1

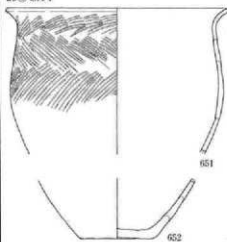

29① SA 2

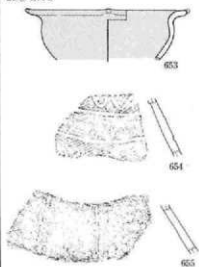

25① SA 1



30① SA 1

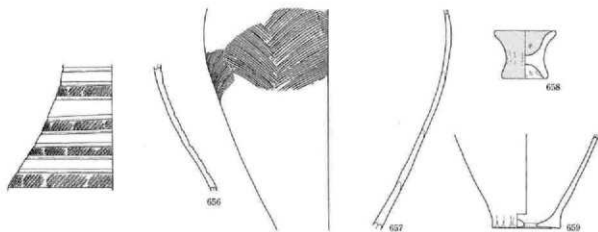

32① SA 1 (1)

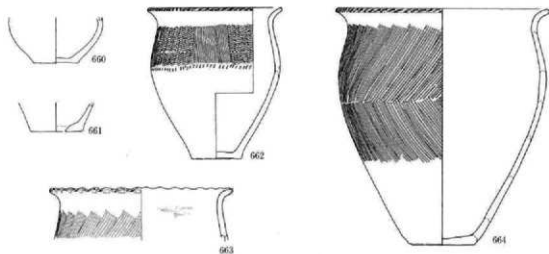

0 (1:3) 10cm 0 (1:4) 10cm
断面実測

3E1 SA1 (2)

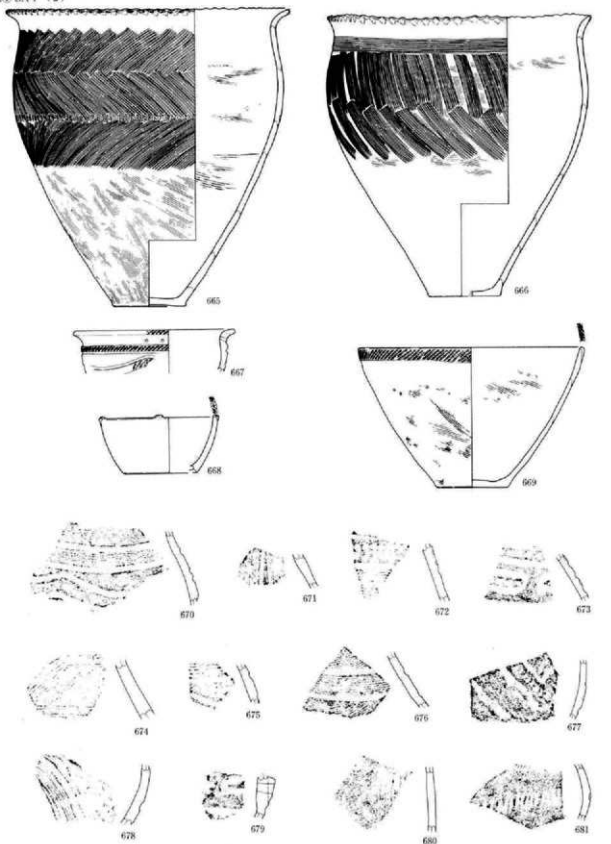

画面実測 0 (1:3) 10cm 0 (1:4) 10cm

図版 126 弥生時代中期の遺物 (5)

34① SA 4



43① SA 2

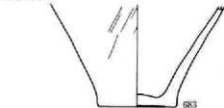

50① SA10



内面



51① SA 2

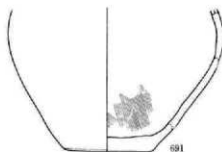

52② SA 1

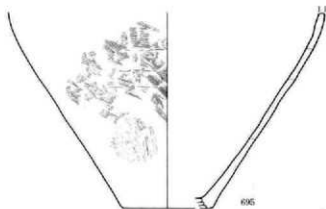
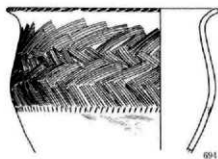

断面実測 0 (1:3) 10cm 0 (1:4) 10cm

図版 127 弥生時代中期の遺物 (6)

52 SA 3

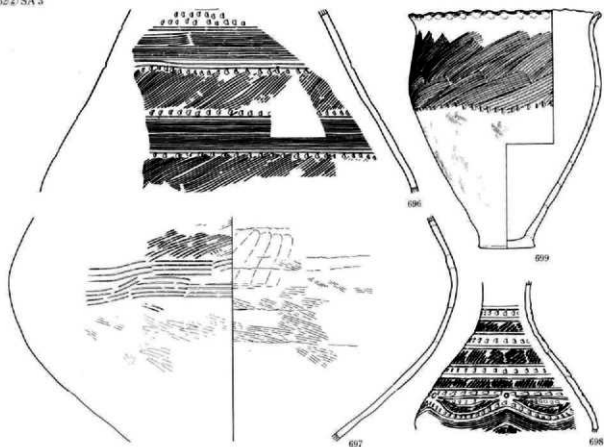

53 SA 3

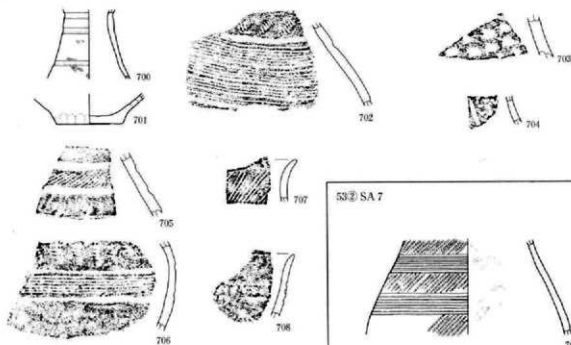

53 SA 7

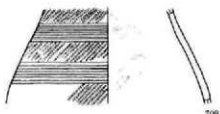

0 (1:3) 10cm 0 (1:4) 10cm
断面実測

53㉔ SA11 (1)

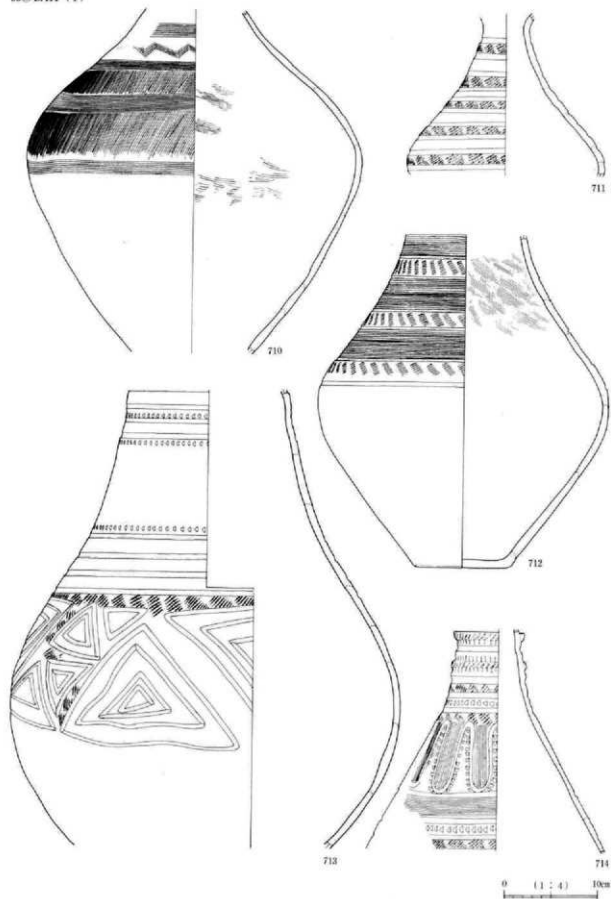

図版 129 弥生時代中期の遺物 (8)

332 SA11 (2)

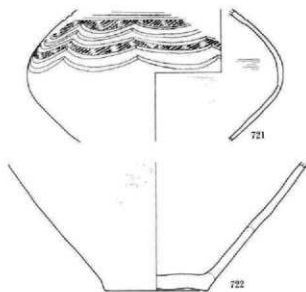
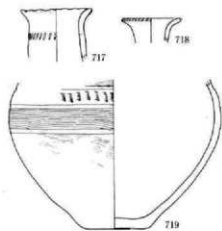
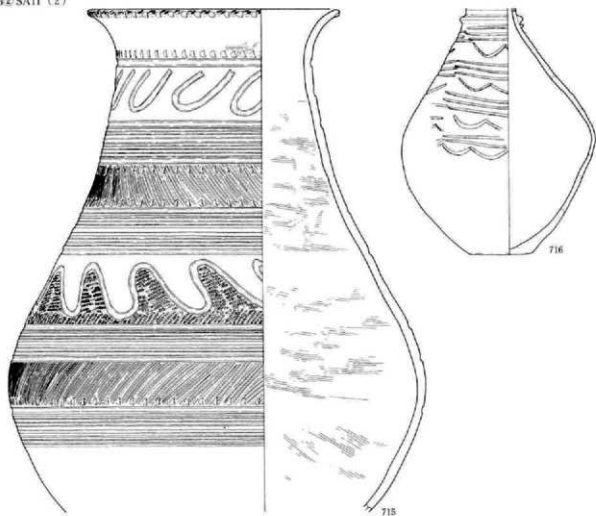

0 (1:4) 10cm

図版 130 弥生時代中期の遺物 (9)

832 SAH (3)

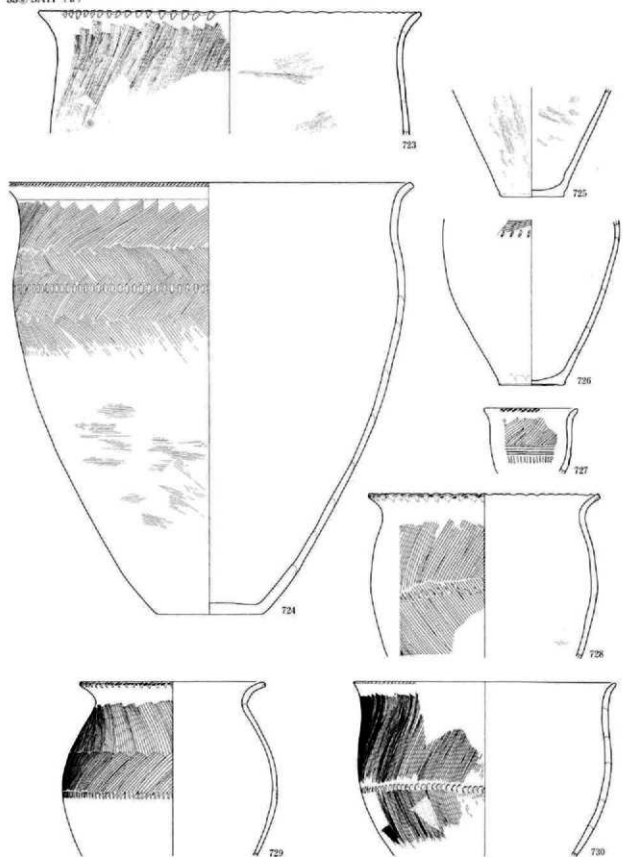

0 (1:4) 10c

図版 131 弥生時代中期の遺物 (10)

532 SAII (4)

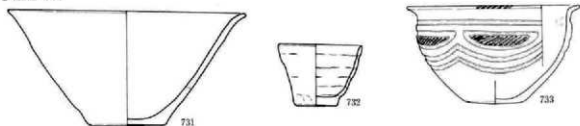

64 SA I

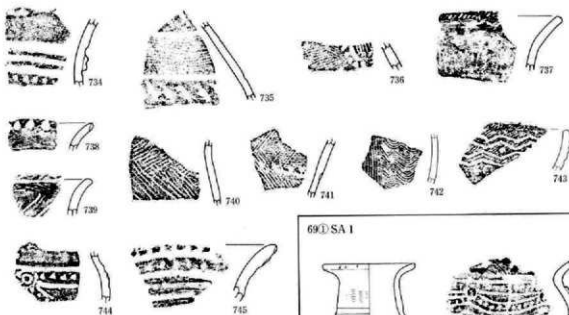

69 SA I



74 SA I

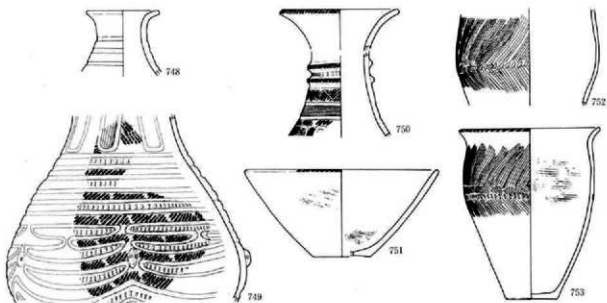

断面実測 0 (1:3) 10cm 0 (1:4) 10cm

図版 132 弥生時代中期の遺物 (11)

74) SA 2

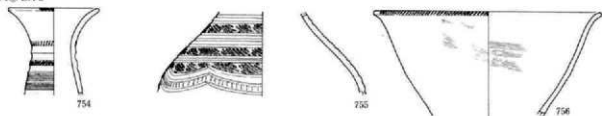

75) SA 1

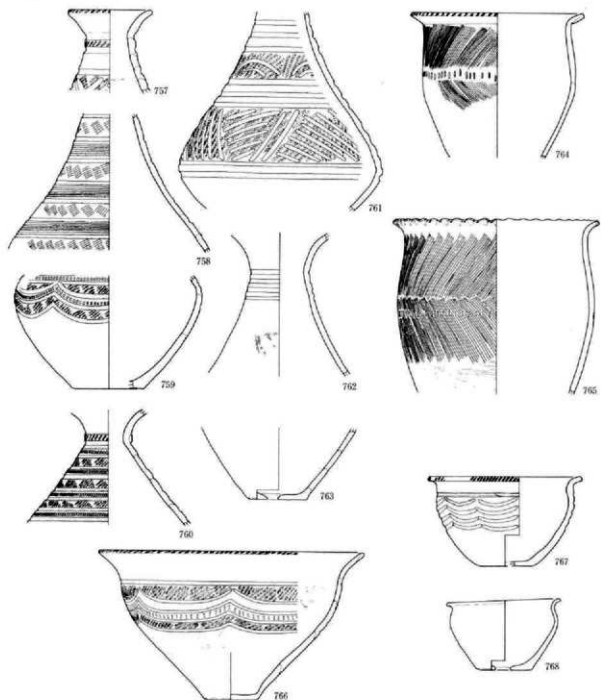

0 (1 : 4) 10cm

図版 133 弥生時代中期の遺物 (12)

B② SA 5

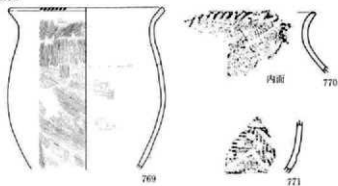

B② SA 6



C② SA13

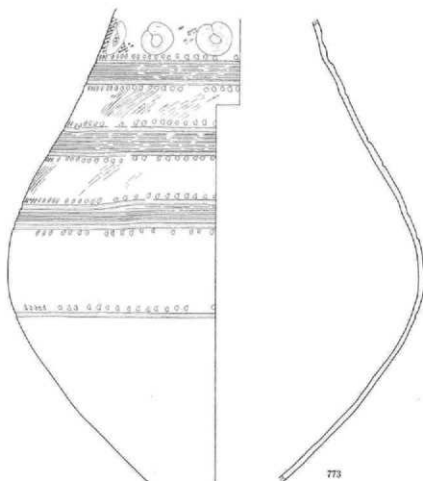

断面実測 0 (1:3) 10cm 0 (1:4) 10cm

図版 134 弥生時代中期の遺物 (13)

C② SA14

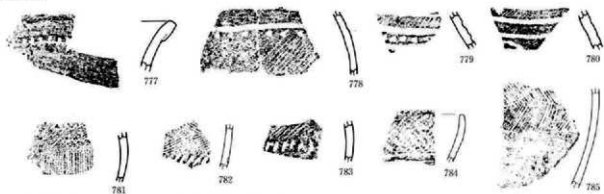

C② SA19

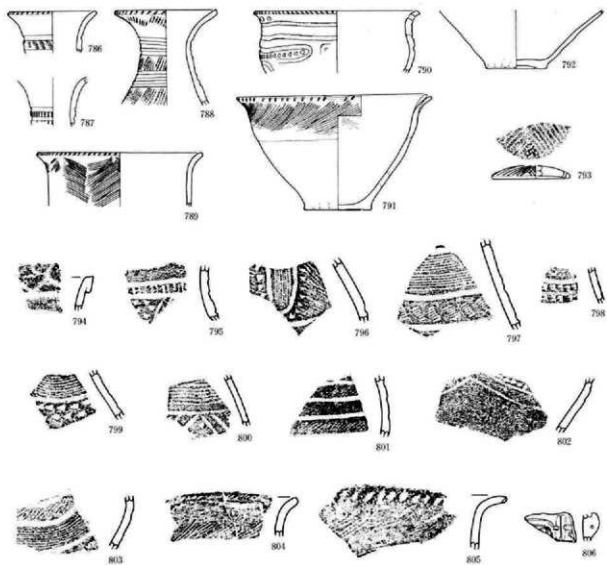

断面実測 0 (1:3) 10cm 0 (1:4) 10cm

C②SA20 (1)

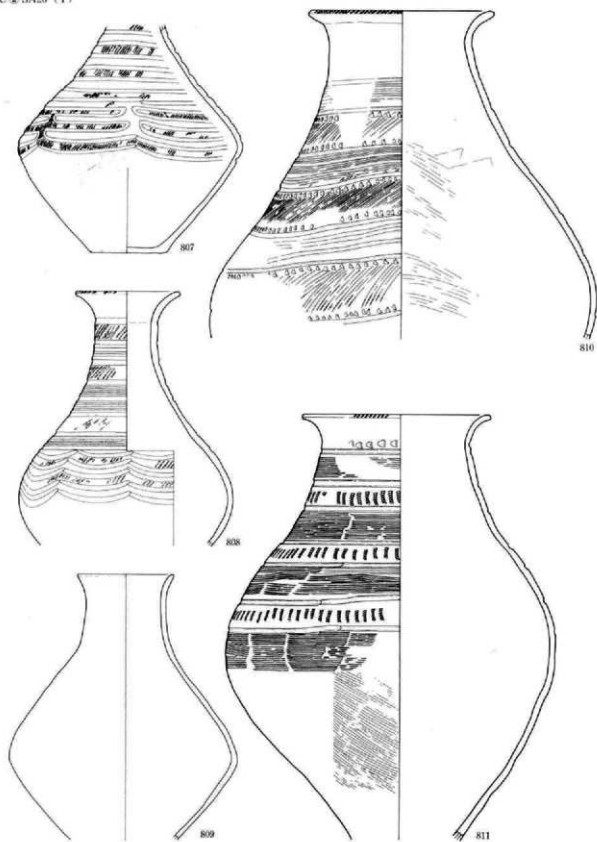

0 (1:4) 10cm

図版 136 弥生時代中期の遺物 (15)

C ⑦ SA20 (2)

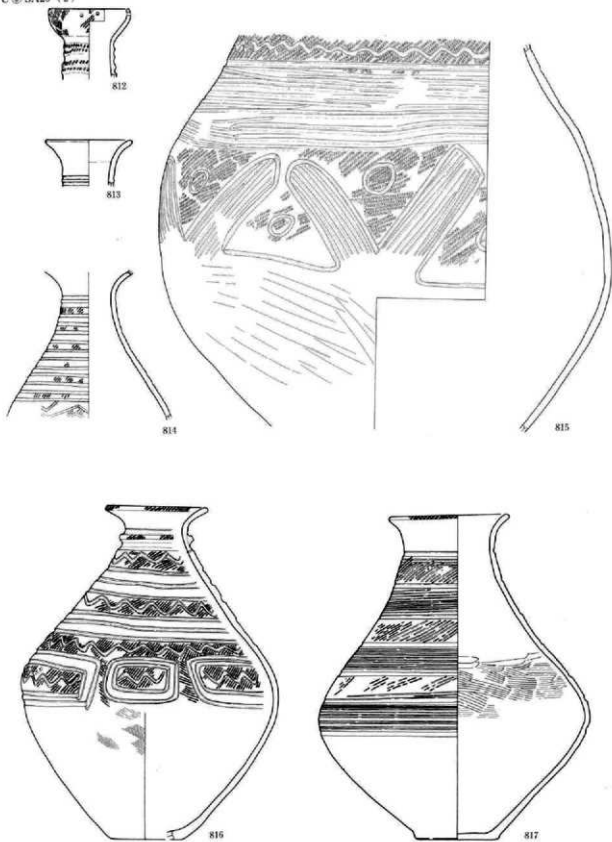

図版137 弥生時代中期の遺物 (16)

C② SA20 (3)

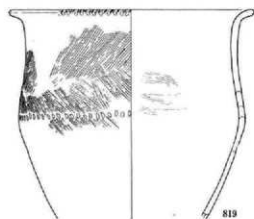
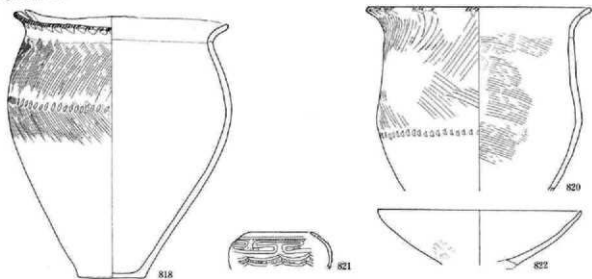

C② SA27

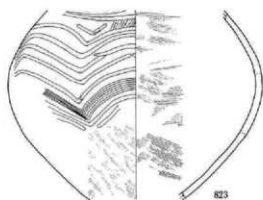

E① SA 1

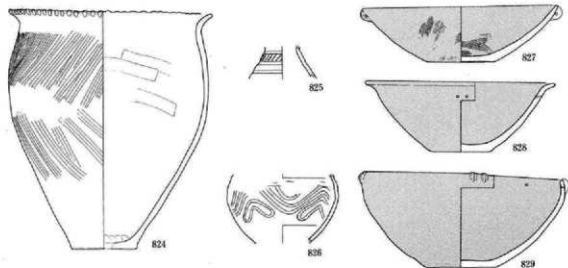

0 (1:4) 10cm

181 SK 4

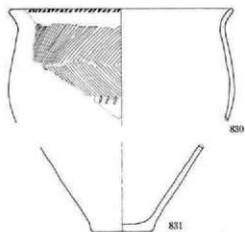

601 SK 3

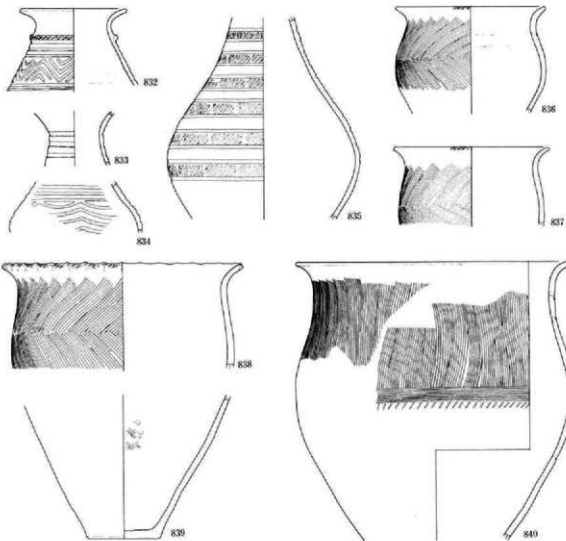

図版 139 弥生時代中期の遺物 (18)

26.1 SK10

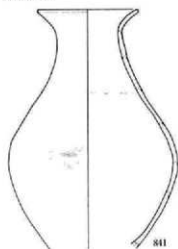

29.0 SK 2

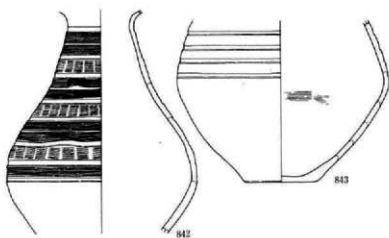

64.0 SK 1

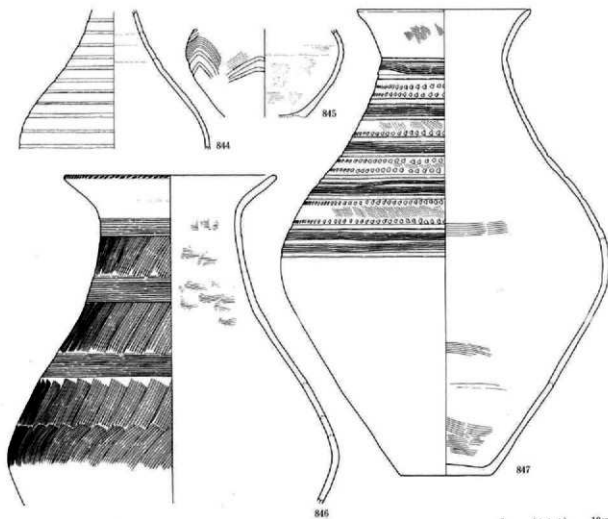

0 (1 : 4) 10cm

図版 140 弥生時代中期の遺物 (19)

こ② SK109

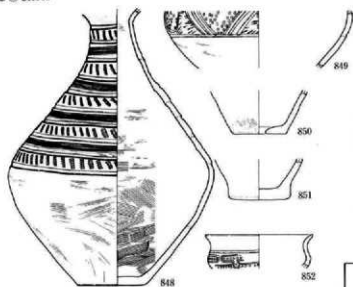

C② SK111

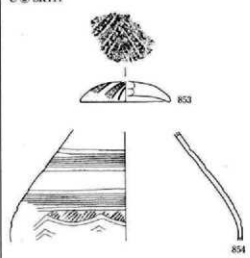

27① SD 1

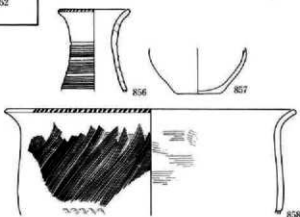
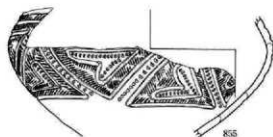

3① SX 1

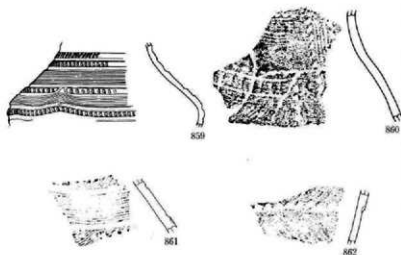

25① SX 1



断面実測 0 (1:3) 10cm 0 (1:4) 10cm

図版 141 弥生時代中期の遺物 (20)

石製品 (1)

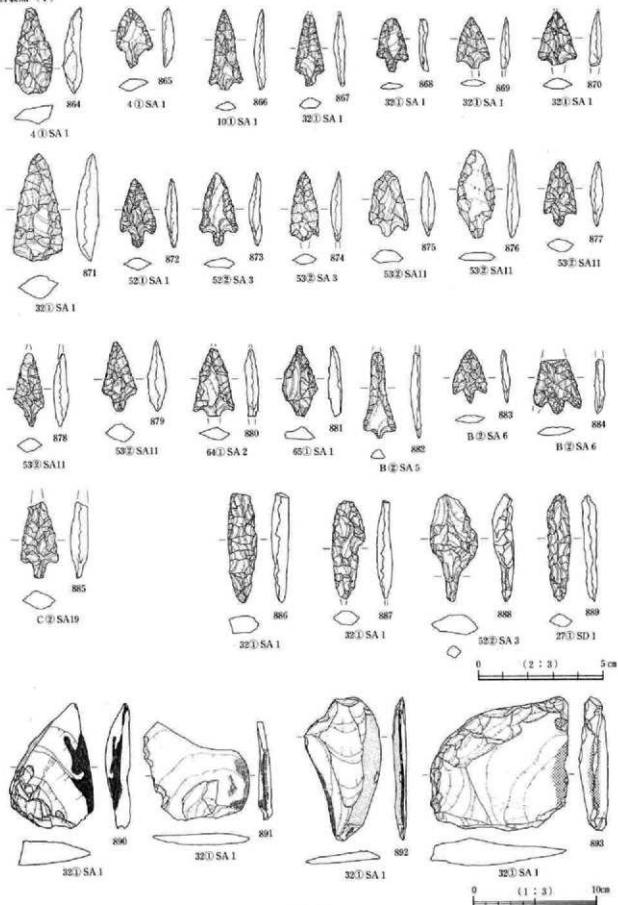

石製品 (2)

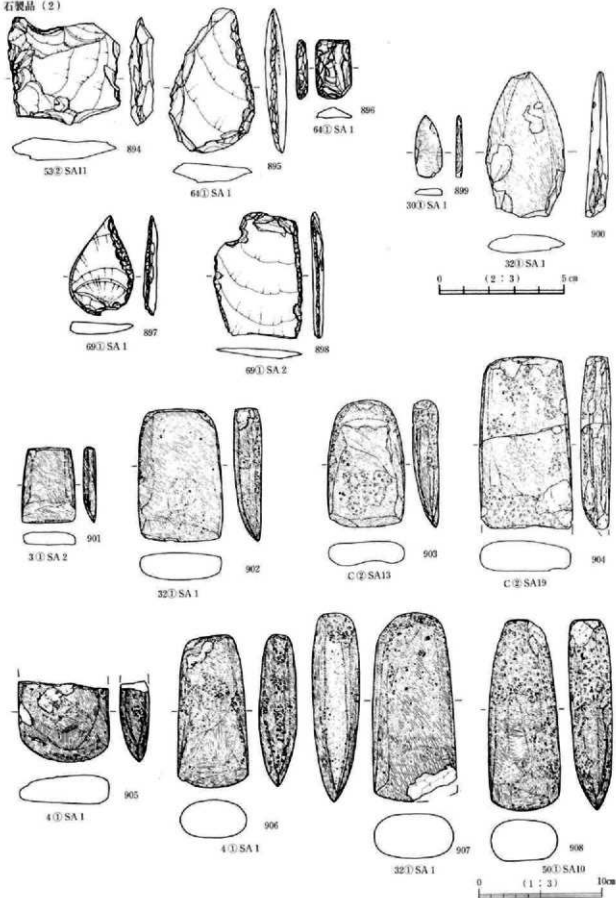

石製品 (3)

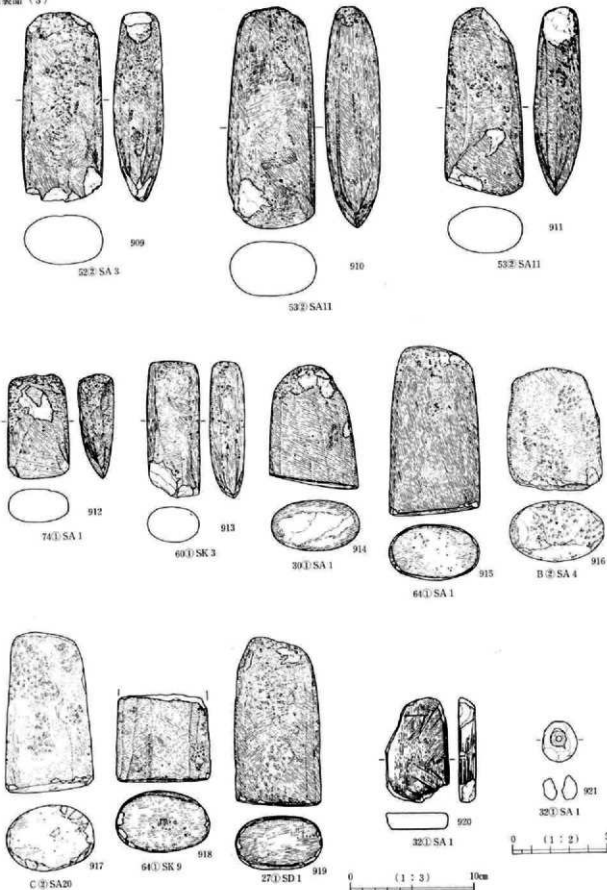

図版 144 弥生時代中期の遺物 (23)

土製品

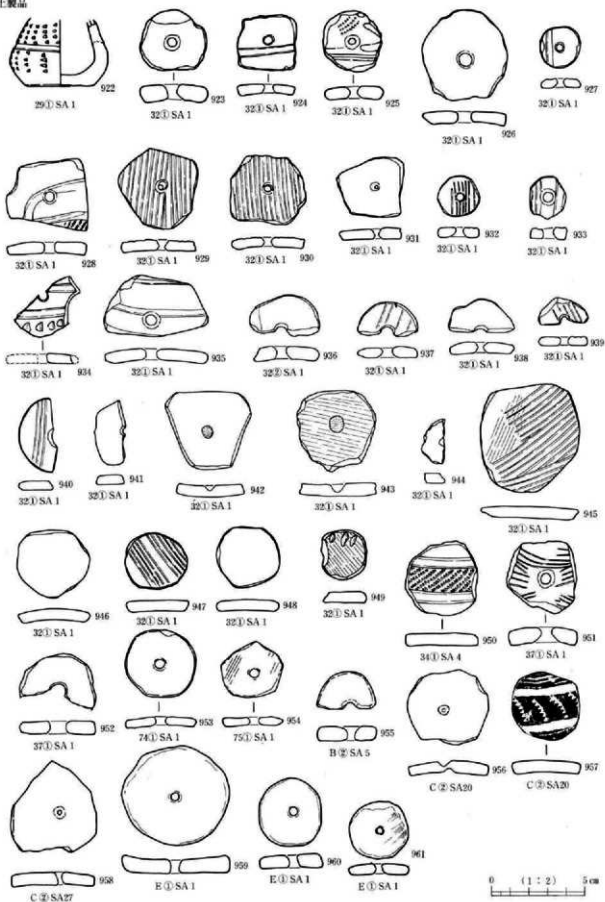

図版 145 弥生時代中期の遺物 (24)

装身具

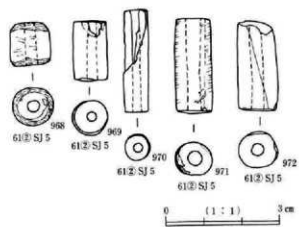
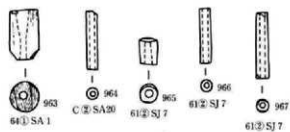
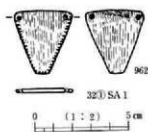

図版 146 弥生時代後期の遺物 (1)

33㉔ SA 2

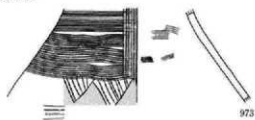

46㉔ SA 2

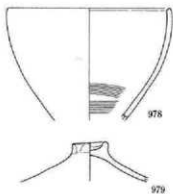

46㉔ SA 3



50㉔ SA 1

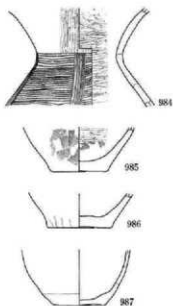

46㉔ SA 1

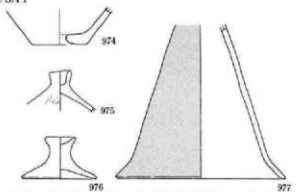

50㉔ SA 7

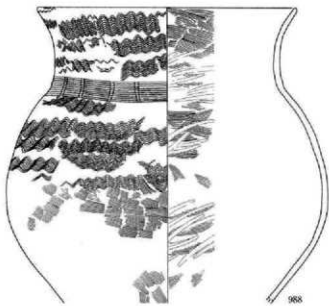
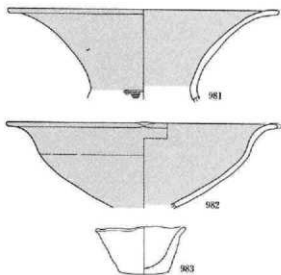

0 (1 : 4) 10cm

図版 147 弥生時代後期の遺物 (2)

50② SA 2

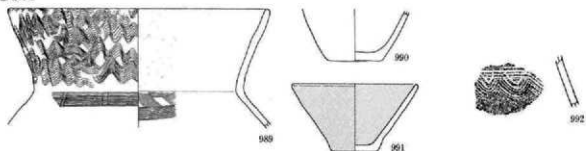

50② SA 3

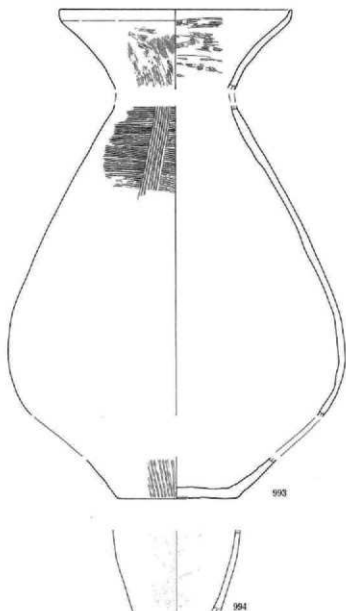

断面実測 0 (1:2) 10cm 0 (1:4) 10cm

50㉔ SA 4

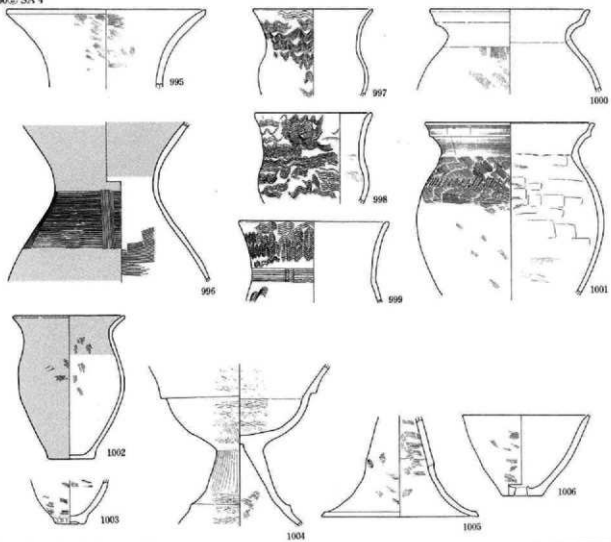

50㉔ SA 6

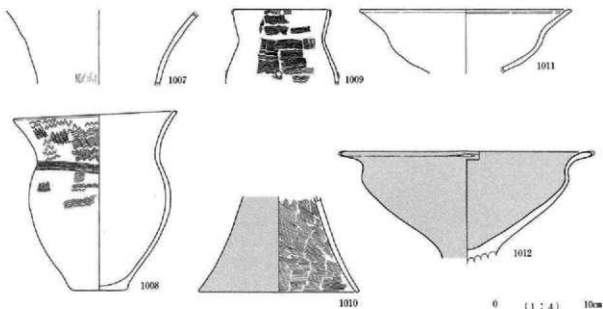

0 (1 : 4) 10cm

図版 149 弥生時代後期の遺物 (4)

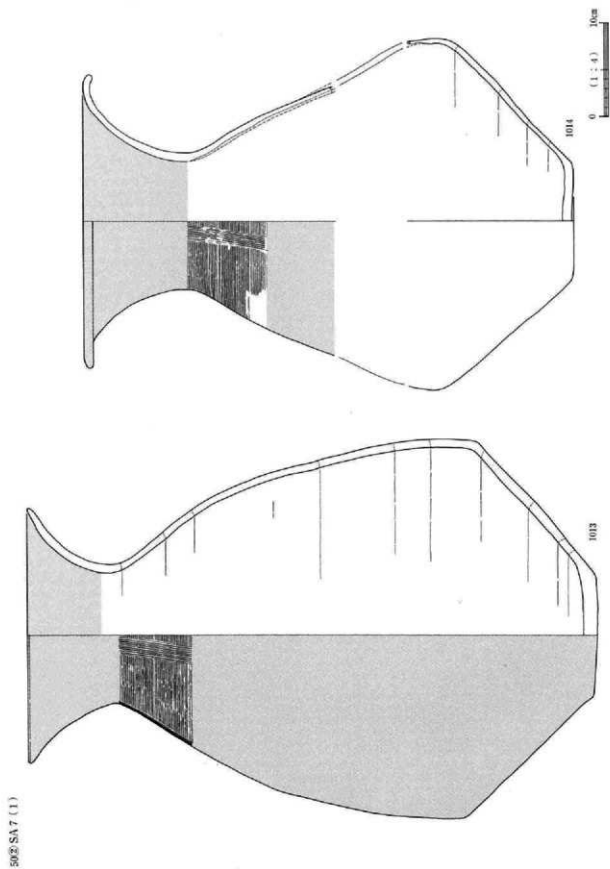

図版 150 弥生時代後期の遺物 (5)

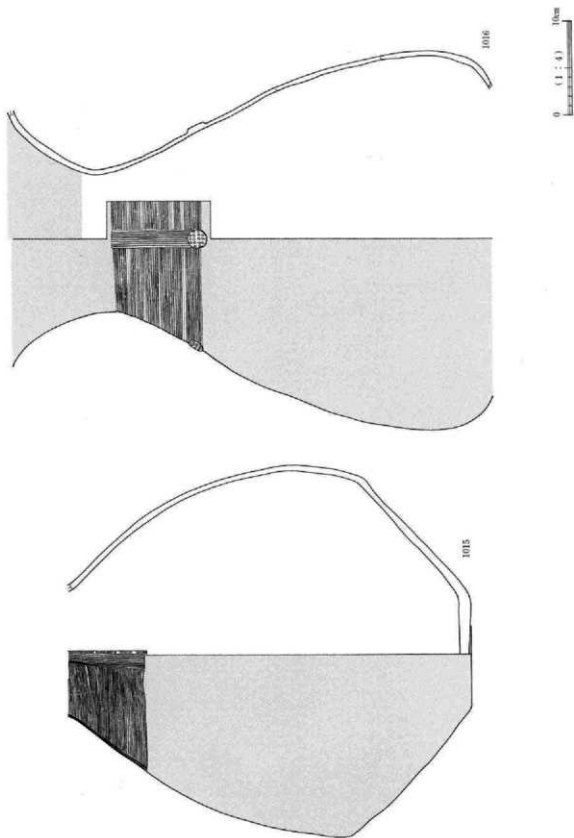

50 SA7 (2)

50㉔ SA7 (3)

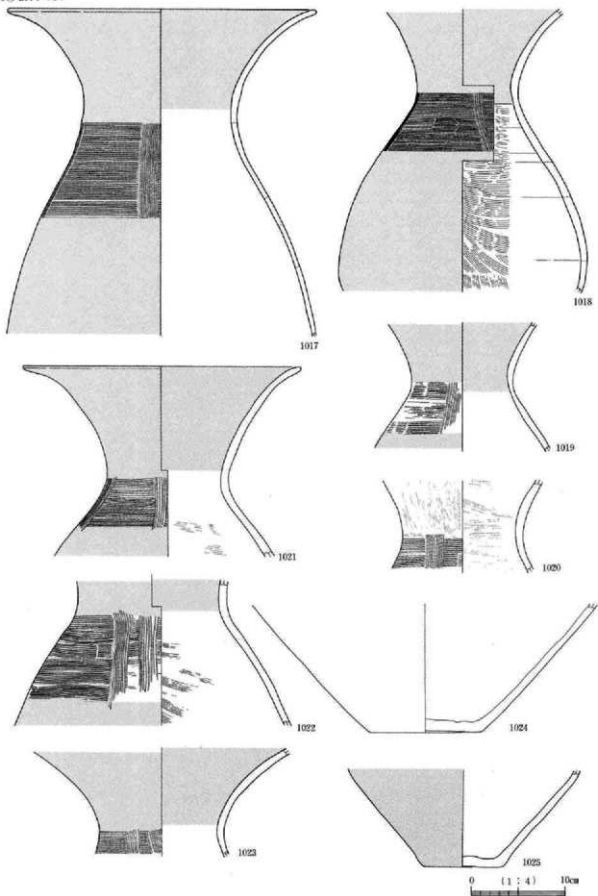

図版 152 弥生時代後期の遺物 (7)

50 SA 7 (4)

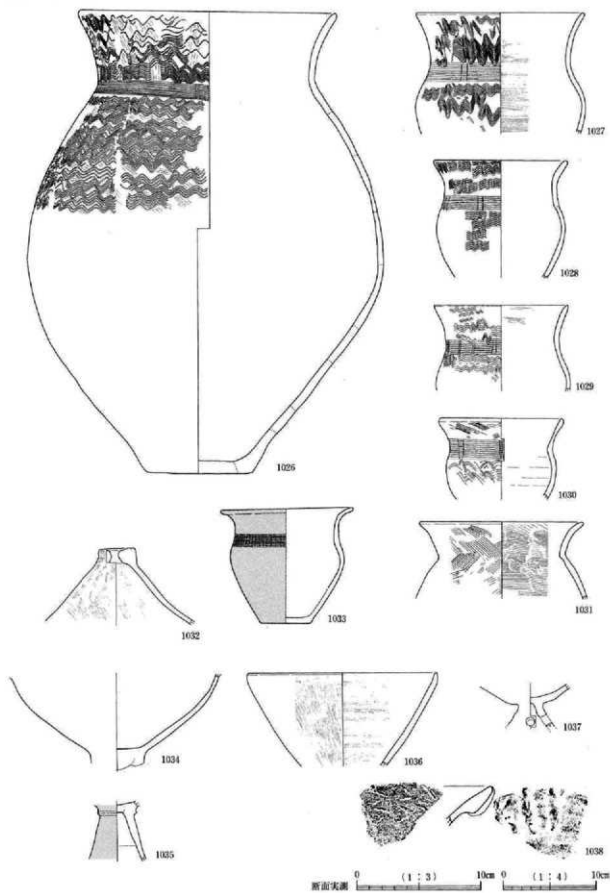

図版 153 弥生時代後期の遺物 (8)

50㉔ SA 8

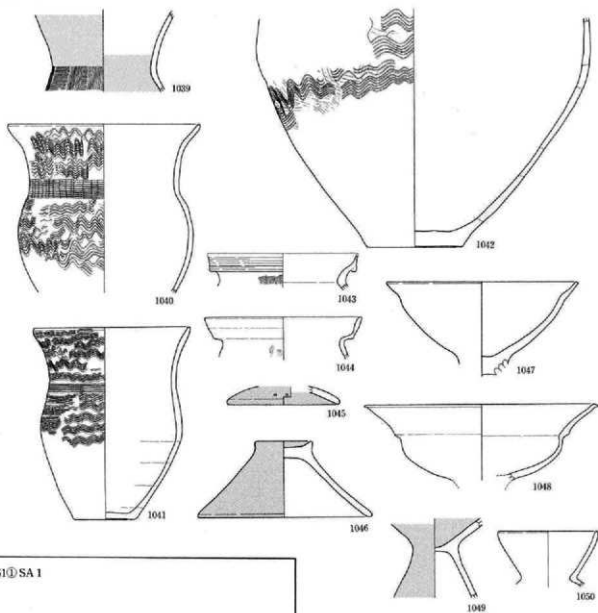

51㉑ SA 1

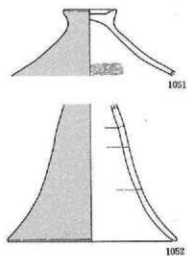

51㉒ SA 1

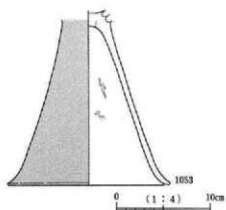

図版 154 弥生時代後期の遺物 (9)

51㊦ SA 2

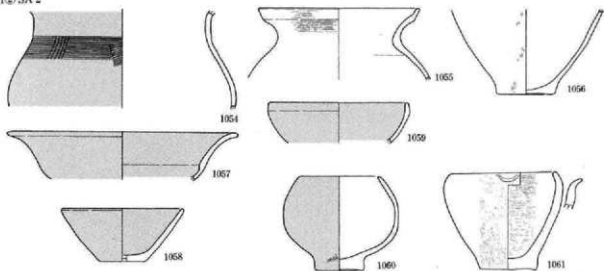

52㊦ SA 5

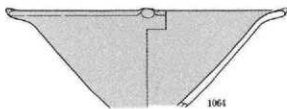
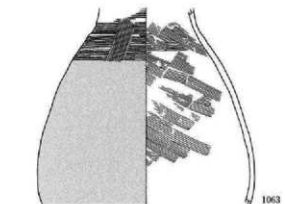
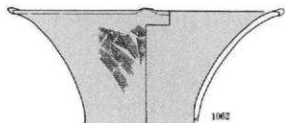

52㊦ SA 7



52㊦ SA 2

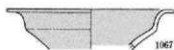

53㊦ SA 1

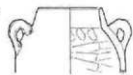
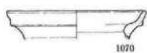
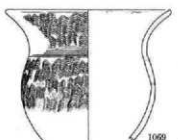
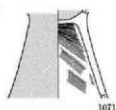
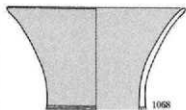

0 (1 : 4) 10cm

図版 155 弥生時代後期の遺物 (10)

53㉔ SA 5

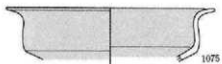

1075



1076

55㉔ SA 3

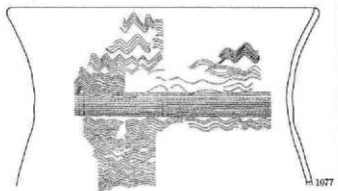

1077

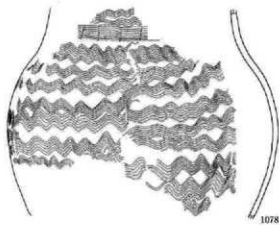

1078

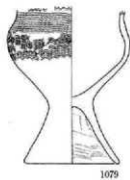

1079



1080

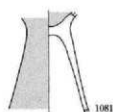

1081

55㉔ SA 1 (1)

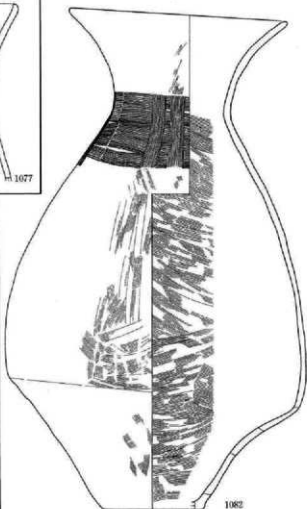

1082

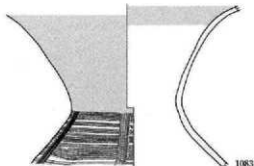

1083

0 (1:4) 10cm

55② SA 1 (2)

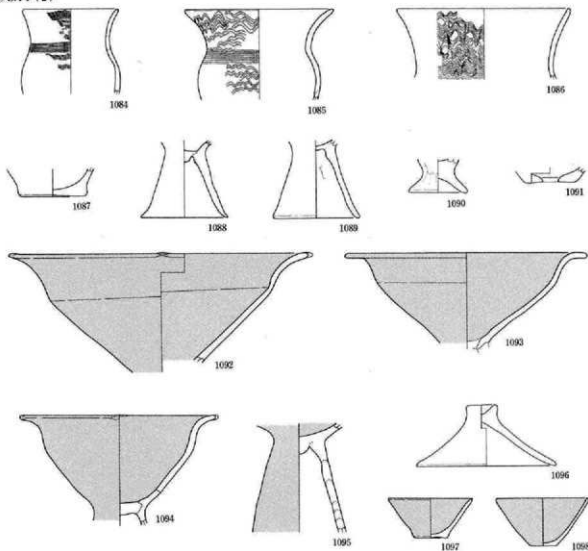

56② SA 1

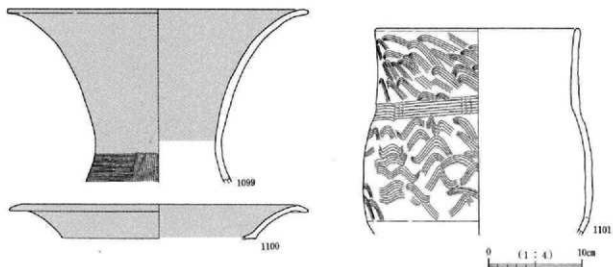

図版 157 弥生時代後期の遺物 (12)

56 SA 3

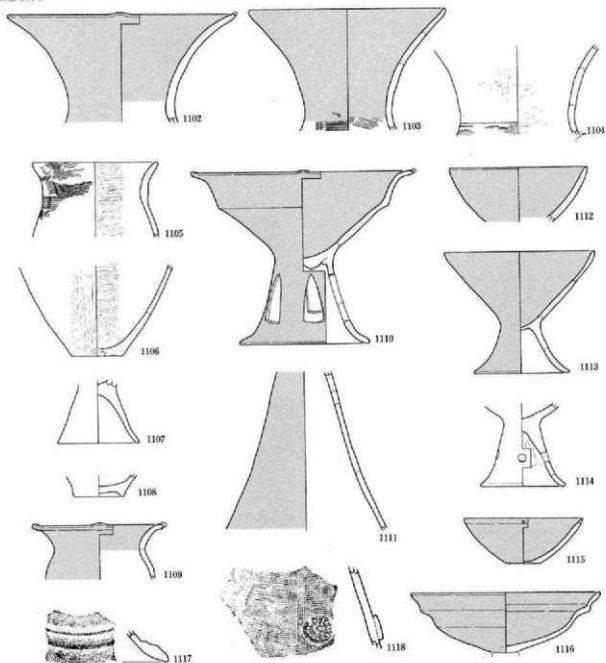

57 SA 1

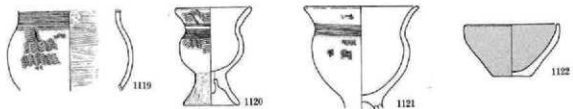

断面実測 0 (1:3) 10cm 0 (1:4) 10cm

57㉔ SA 5 (1)

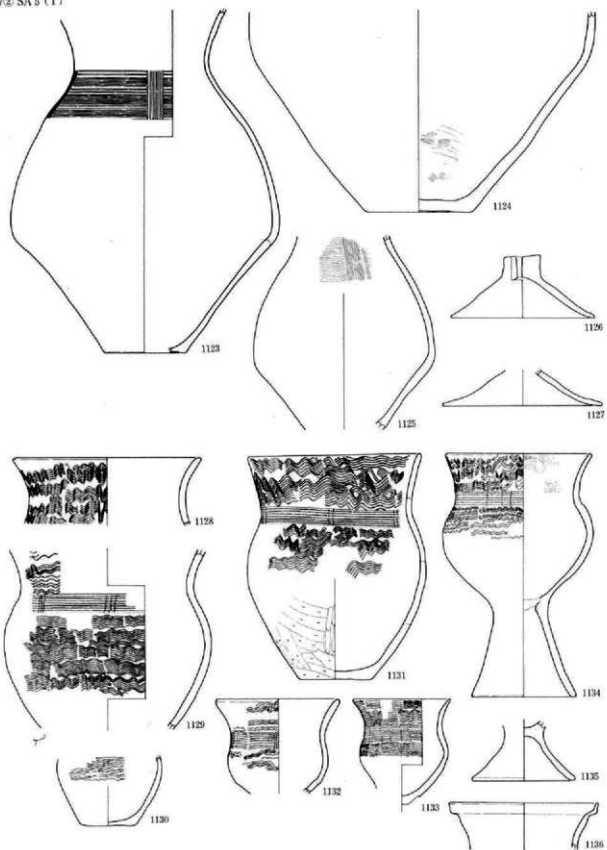

0 (1:4) 10cm

図版 159 弥生時代後期の遺物 (14)

57㉔ SA 5 (2)

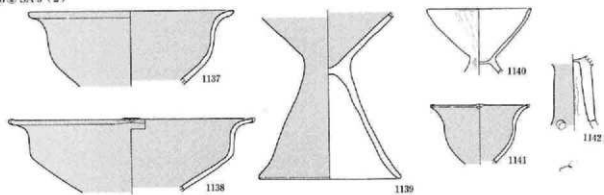

60㉔ SA 2

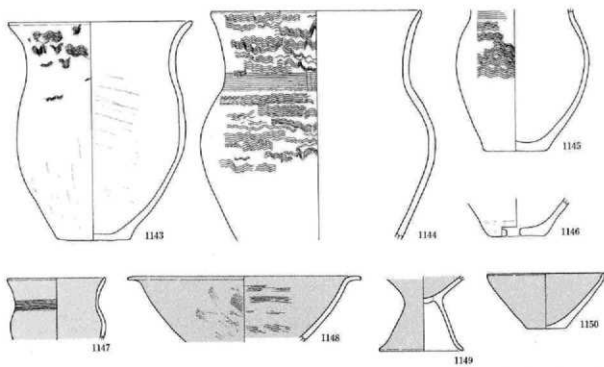

61㉔ SA 6

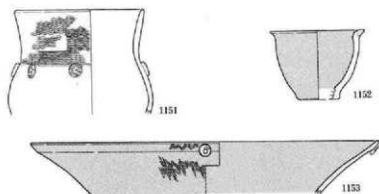

0 (1 : 4) 10cm

図版 160 弥生時代後期の遺物 (15)

60② SA 4

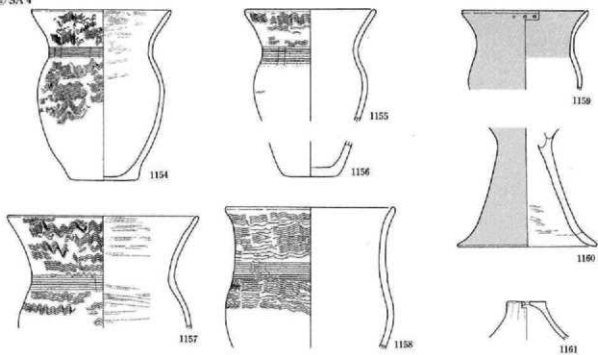

62① SA 1

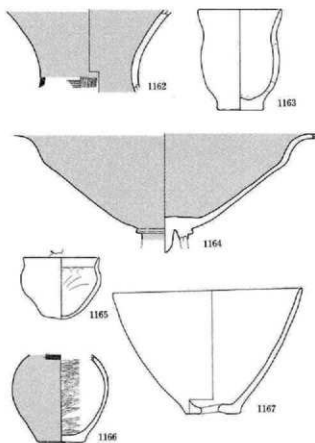

70① SA 1

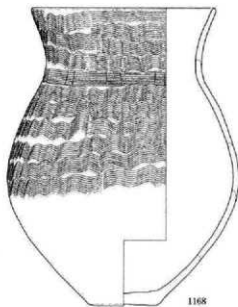

0 (1:4) 10cm

図版 161 弥生時代後期の遺物 (16)

78D SA 2

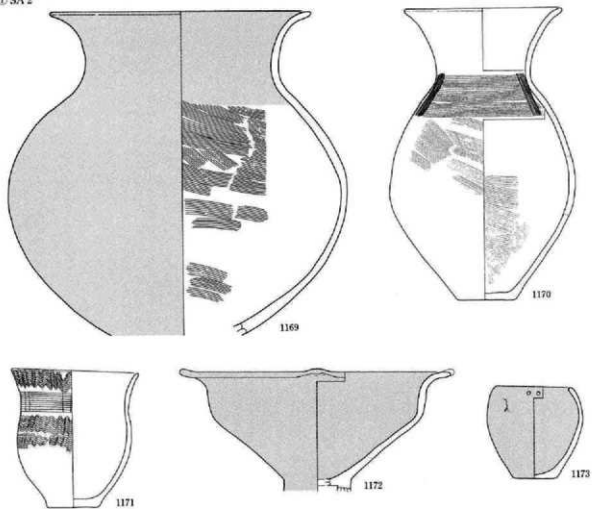

78D SA 6

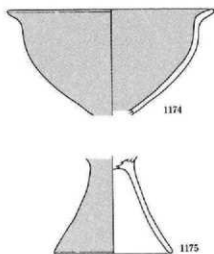

0 (1:4) 10cm

図版 162 弥生時代後期の遺物 (17)

79 SA 2

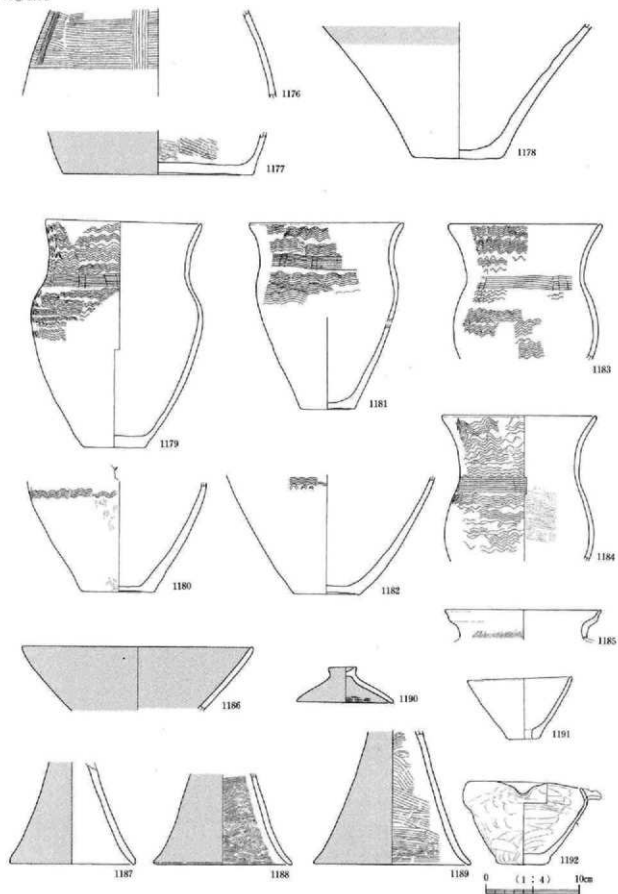

B ② SA 2 (1)

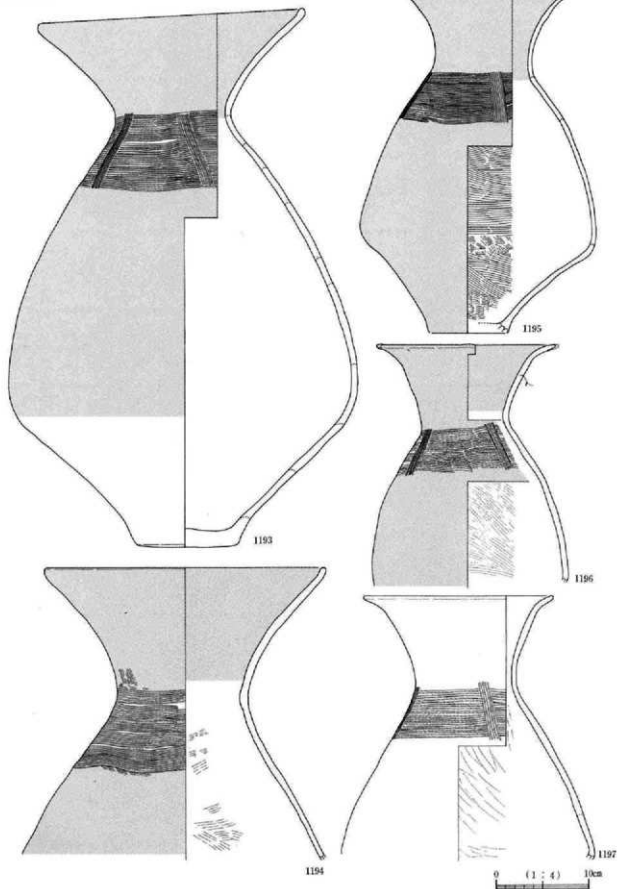

B②SA 2 (2)

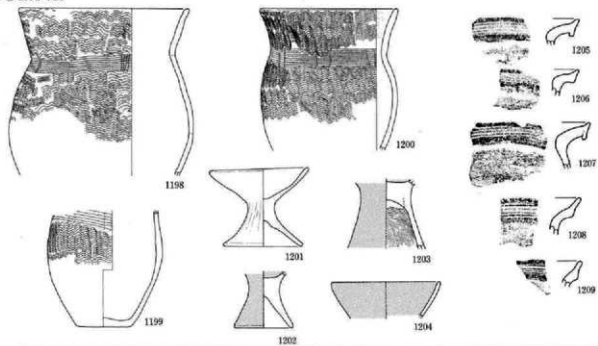

B②SA 3 (1)

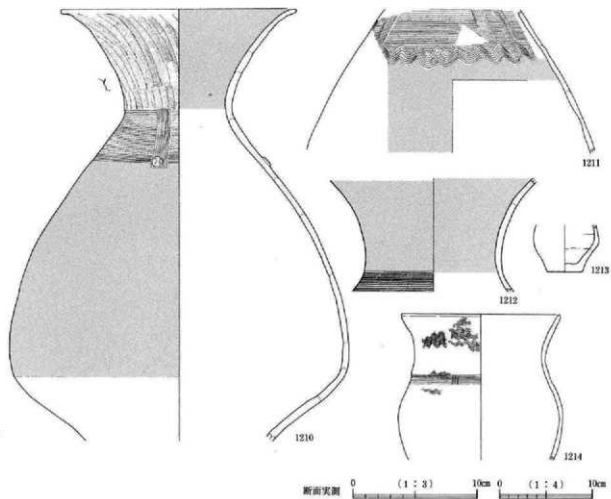

B②SA3 (2)

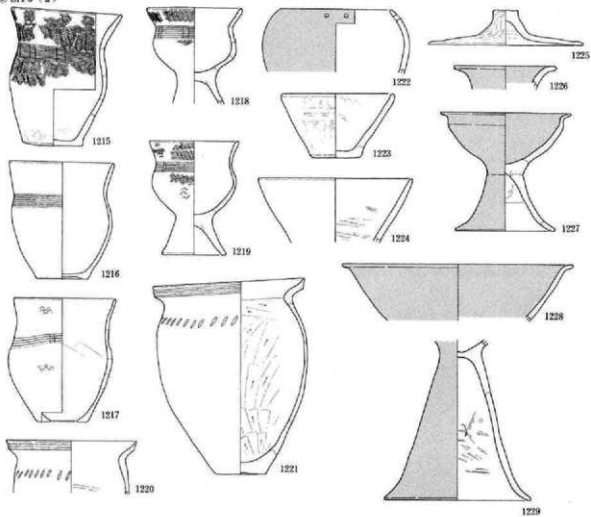

B②SA7 (1)

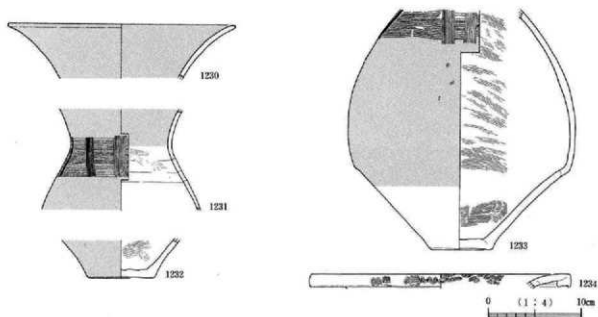

B②SA7 (2)

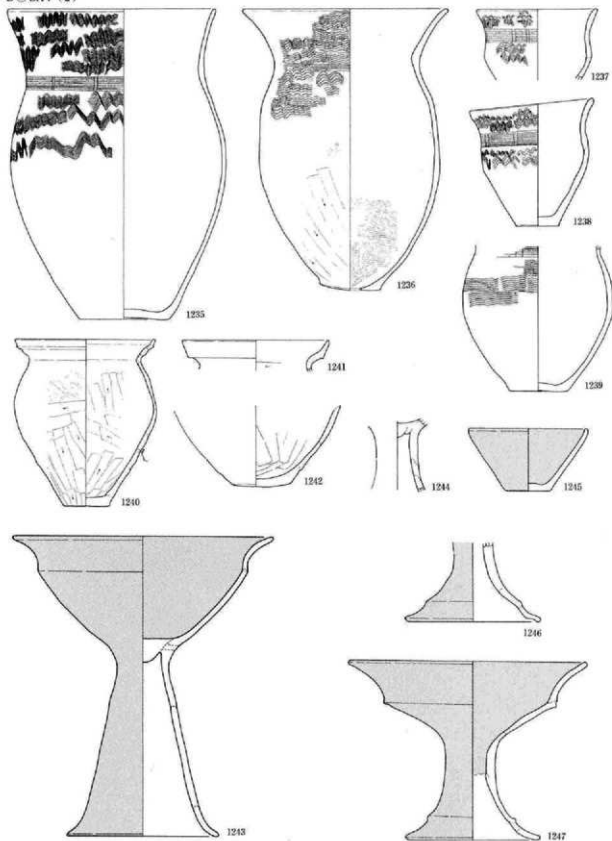

0 (1:4) 10cm

図版 167 弥生時代後期の遺物 (22)

B ② SA 8

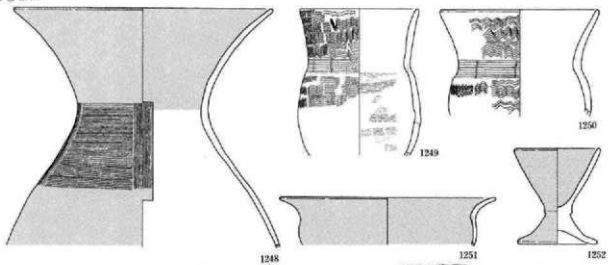

B ② SA 9 (1)

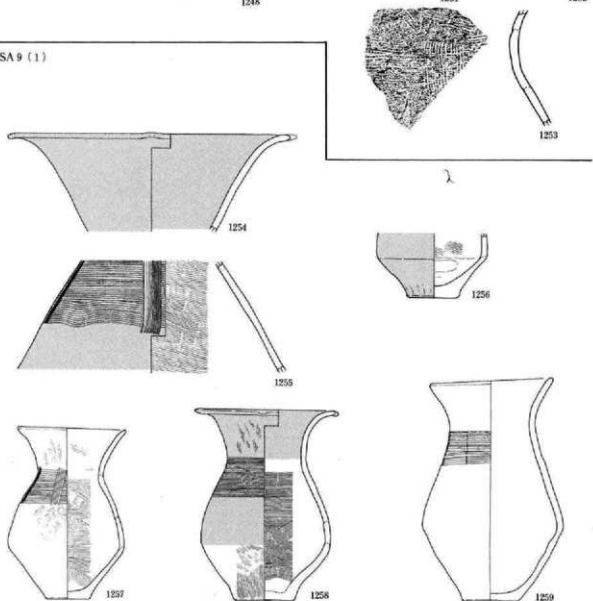

断面実測 0 (1:3) 10cm 0 (1:4) 10cm

B② SA 9 (2)

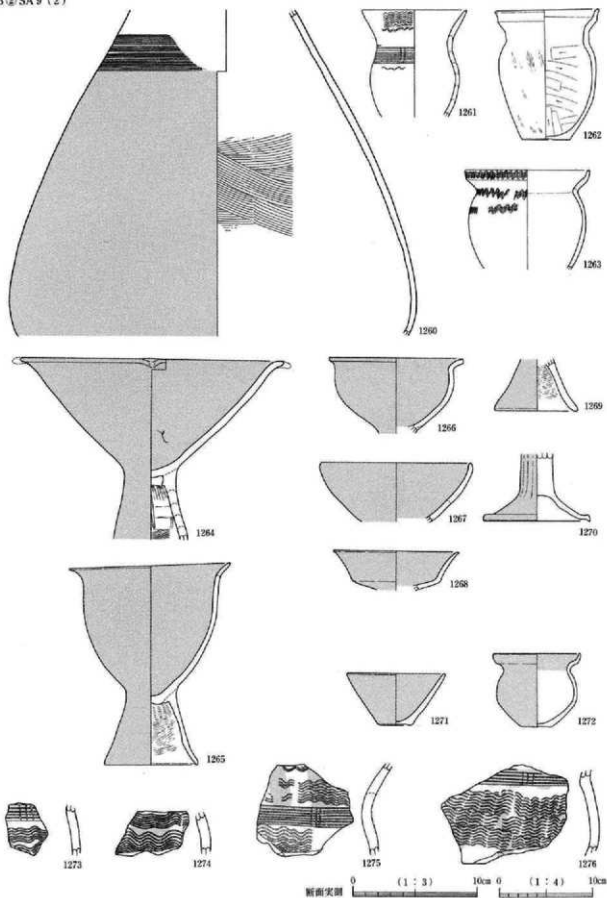

B ② SA10

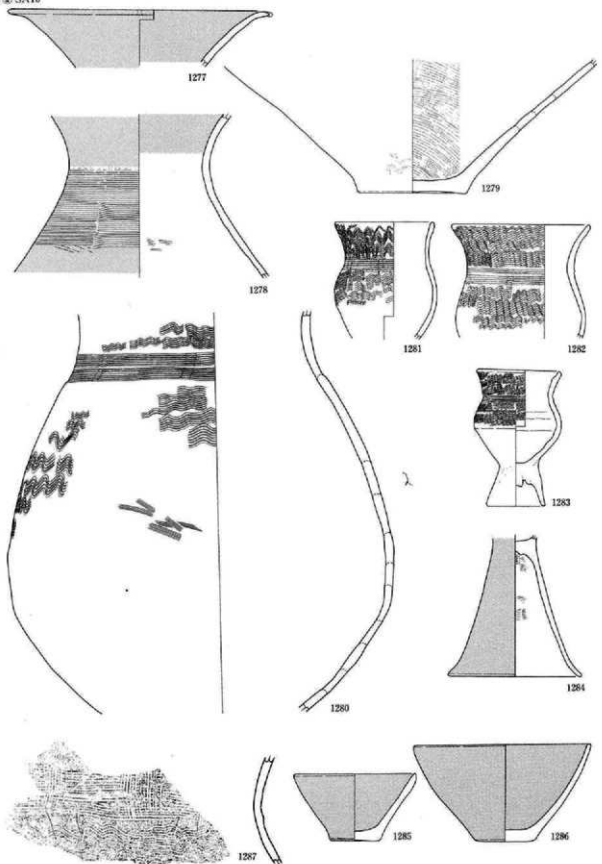

断面実測 0 (1:3) 10cm 0 (1:4) 10cm

B② SA11

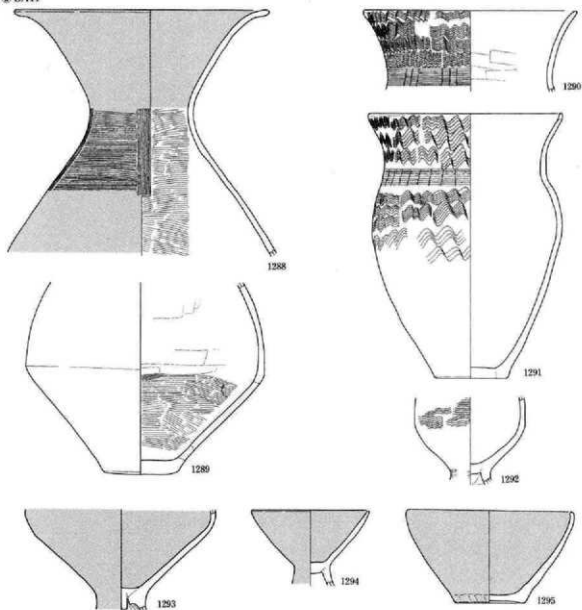

B② SA12

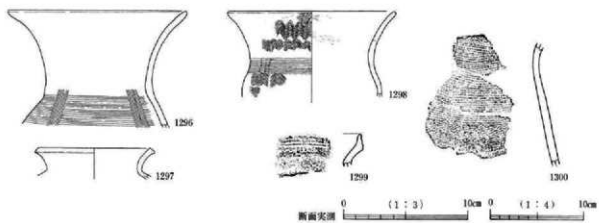

B ㊦ SA14

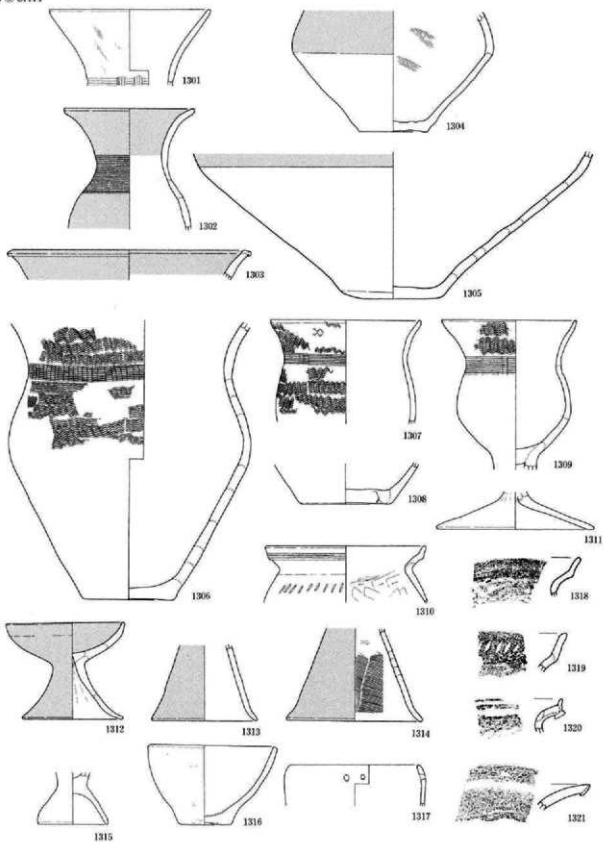

断面実測 0 (1:3) 10cm 0 (1:4) 10cm

図版 172 弥生時代後期の遺物 (27)

B ② SA15

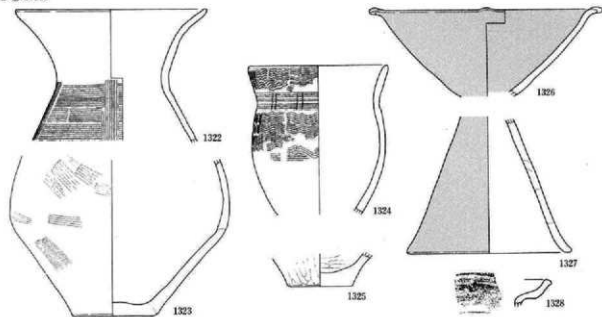

B ② SA16

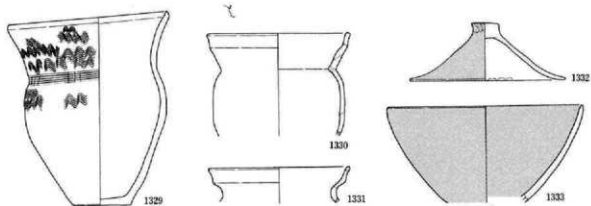

B ② SA18

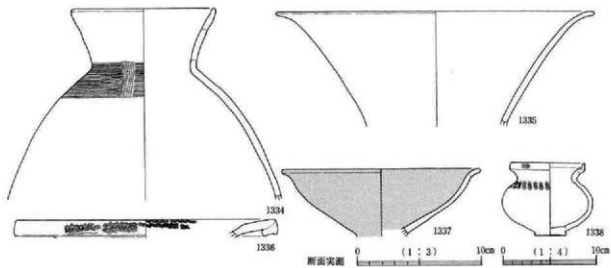

C②SA 1

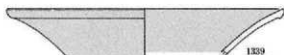

C②SA 2

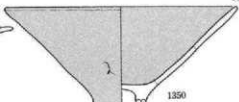
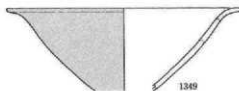
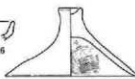
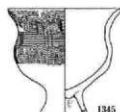
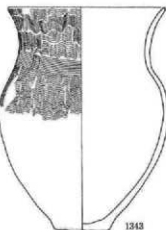
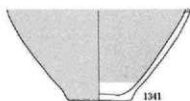

C②SA 4

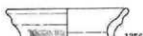
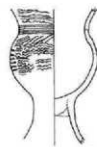
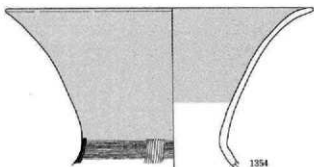

© SA 6

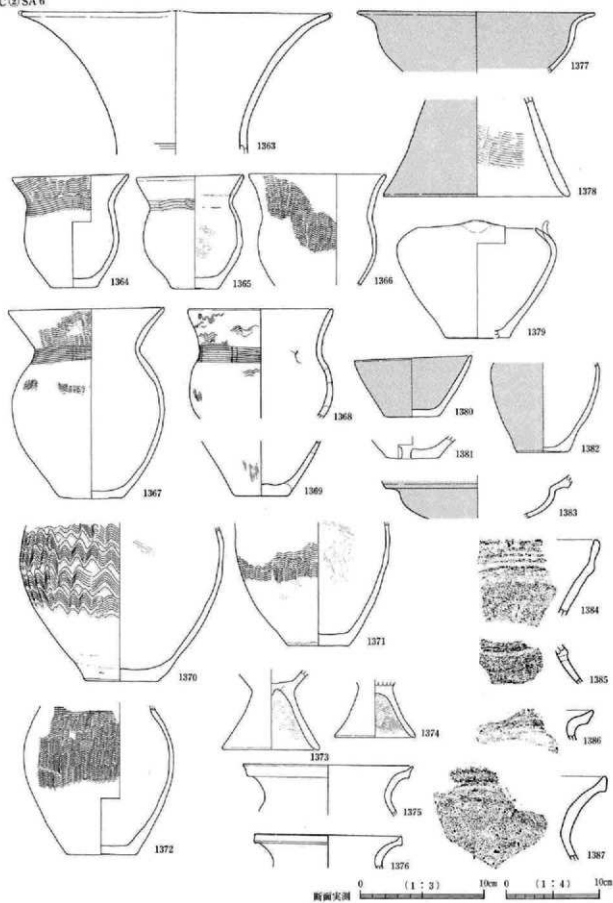

図版 175 弥生時代後期の遺物 (30)

C② SA 7

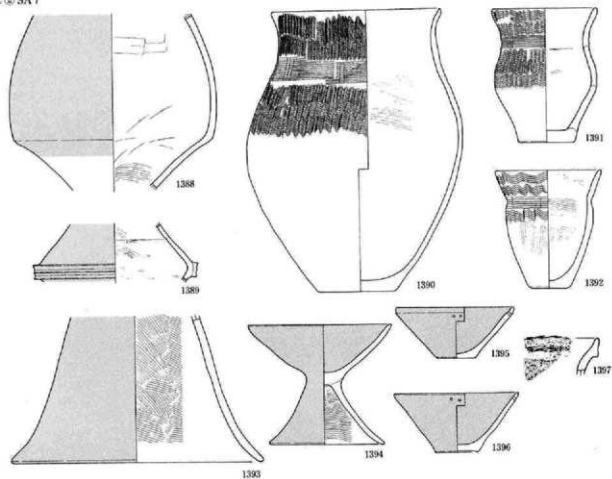

C② SA 8 (1)

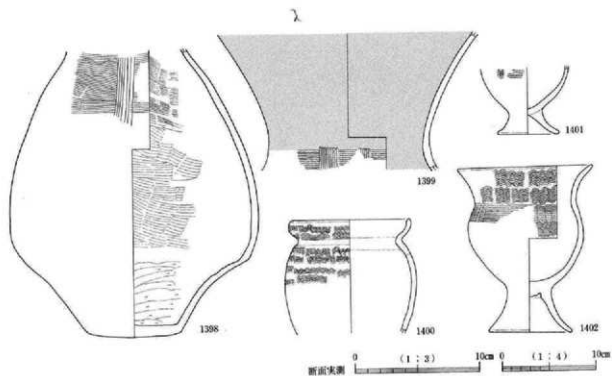

図版 176 弥生時代後期の遺物 (31)

C ② SA 8 (2)

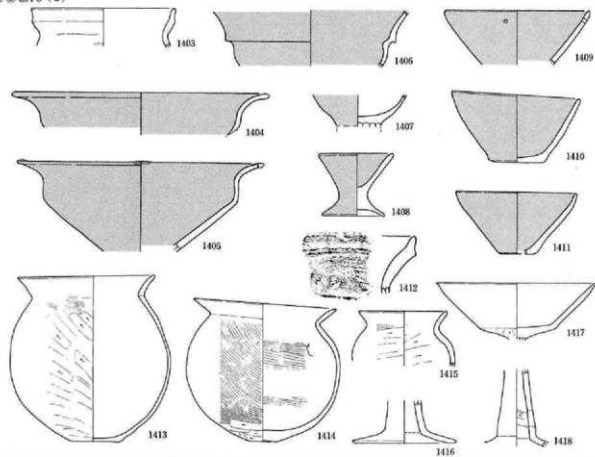

C ② SA 9

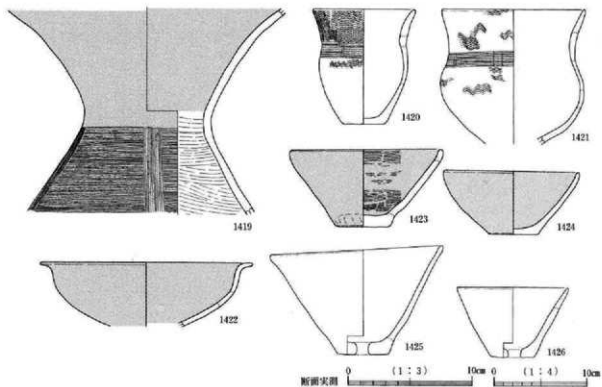

図版 177 弥生時代後期の遺物 (32)

C ② SA10 (1)

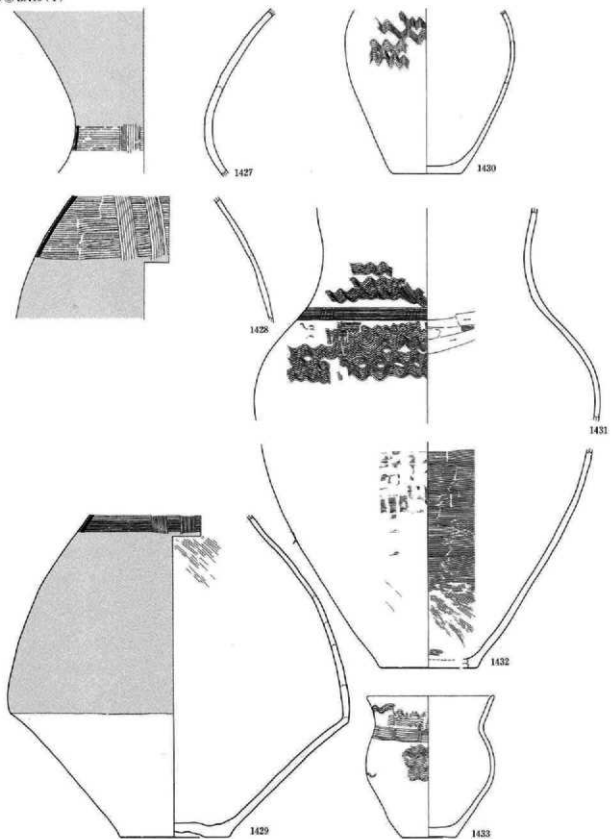

0 (1:4) 10cm

C ② SA10 (2)

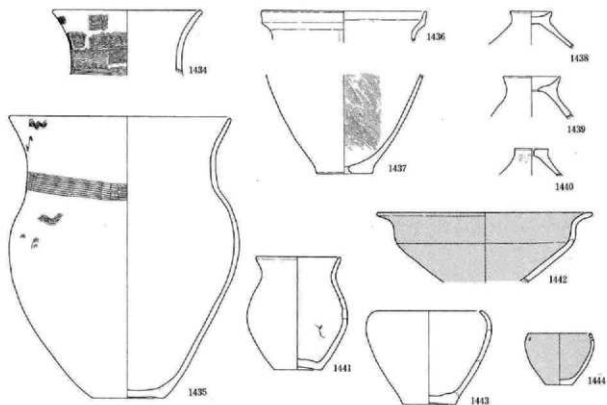

C ② SA11

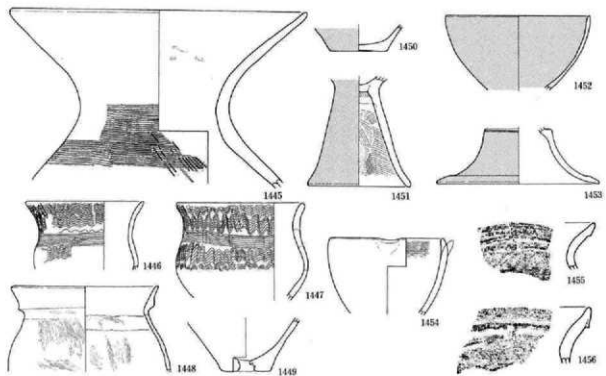

0 (1:3) 10cm 0 (1:4) 10cm
 断面実測

図版 179 弥生時代後期の遺物 (34)

C ② SA12

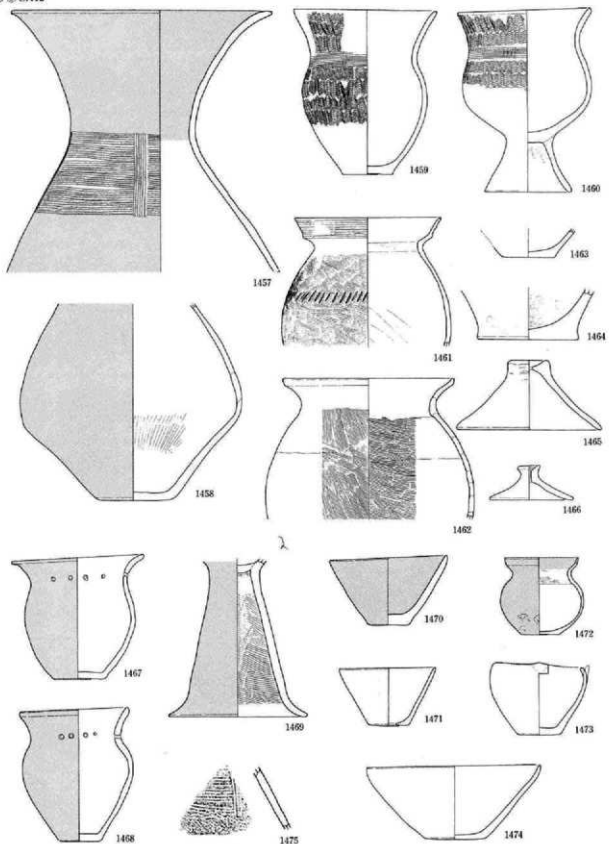

断面実測 0 (1:3) 10cm 0 (1:4) 10cm

C②SA15

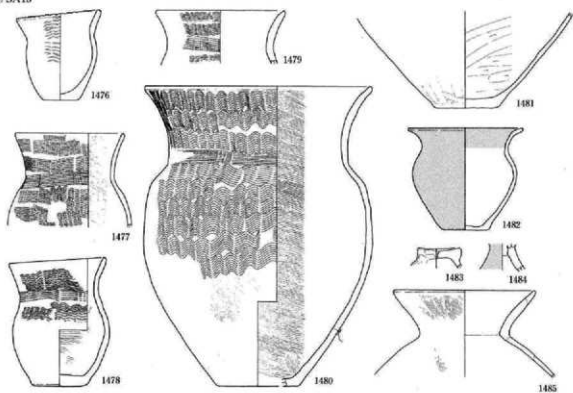

C②SA17

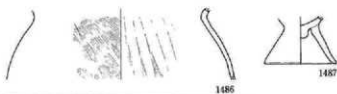

C②SA18

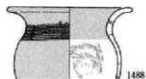

C②SA21

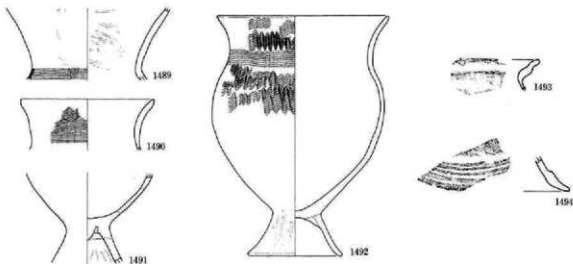

断面実測 0 (1:3) 10cm 0 (1:4) 10cm

C② SA22

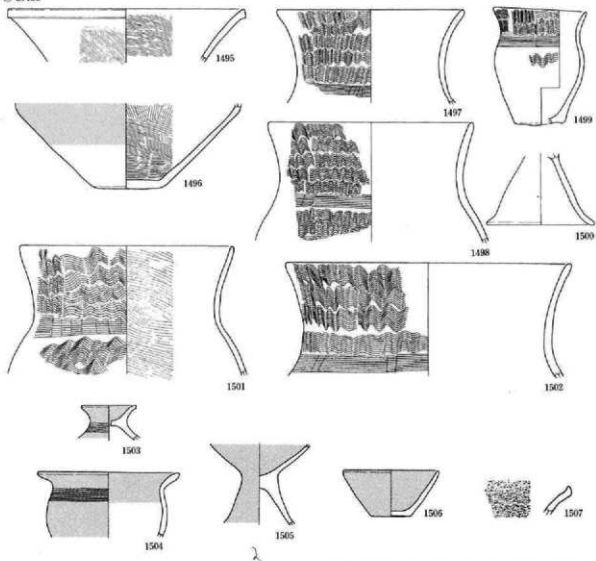

C② SA25

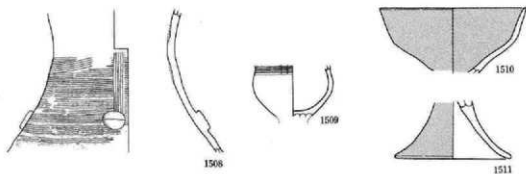

断面実測 0 (1:3) 10cm 0 (1:4) 10cm

48D SJ7

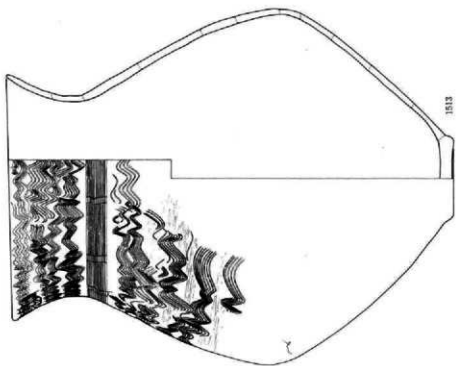

1513



25D SJ1

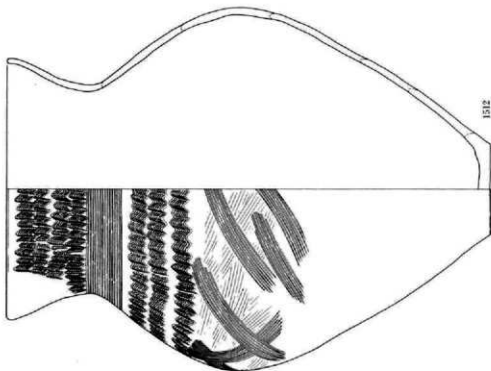

1512

64(S) SJ1

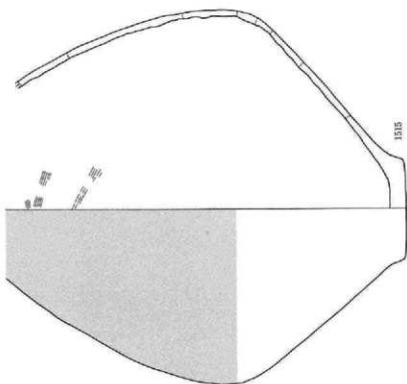
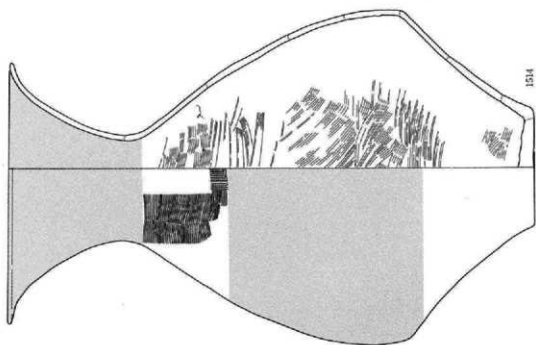

50② SK 4

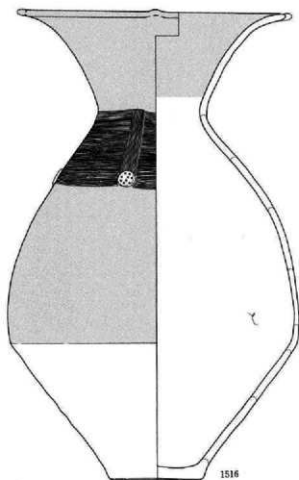

4① SDZ 1

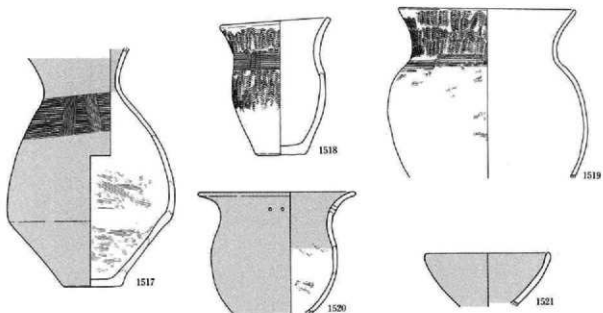

0 (1:4) 10cm

図版 185 弥生時代後期の遺物 (40)

19① SDZ 1

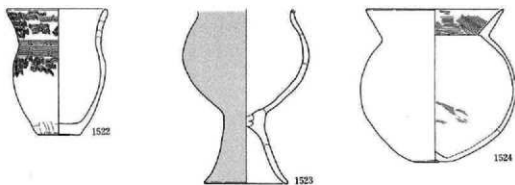

48① SDZ 5

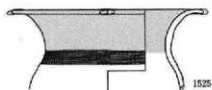

48① SDZ 6

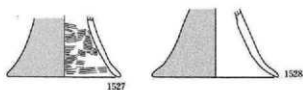

48① SD 1

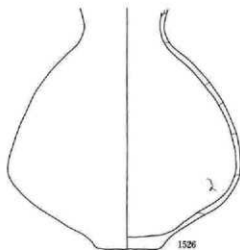
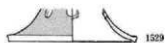

B② SD 2

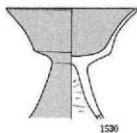

B② SD 8

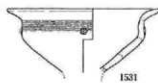

B② SD 6

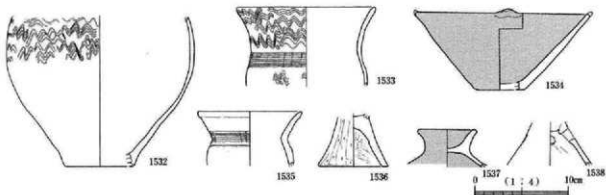

62① SX 4

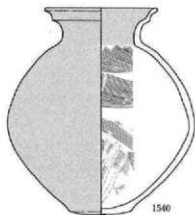

遺構外

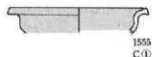
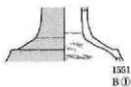
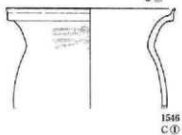
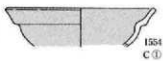
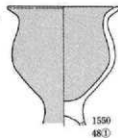
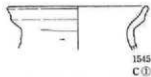
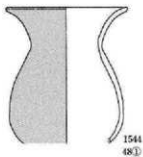
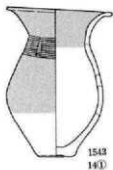
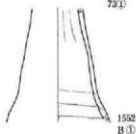
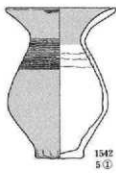
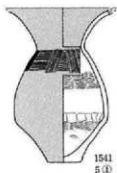

0 (1 : 4) 10cm

石製品

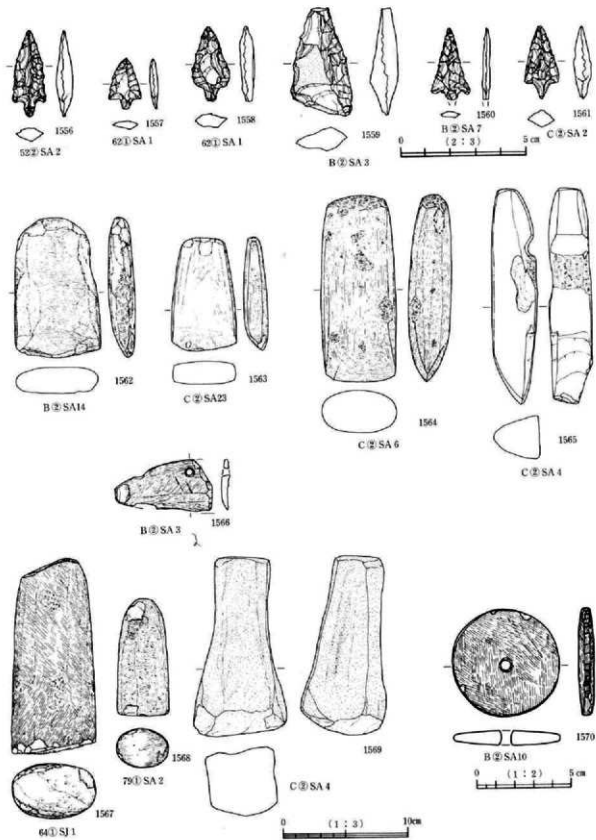

土製品

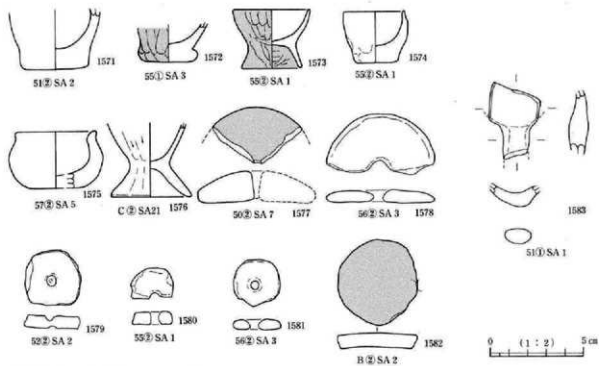

鉄身具 (1)

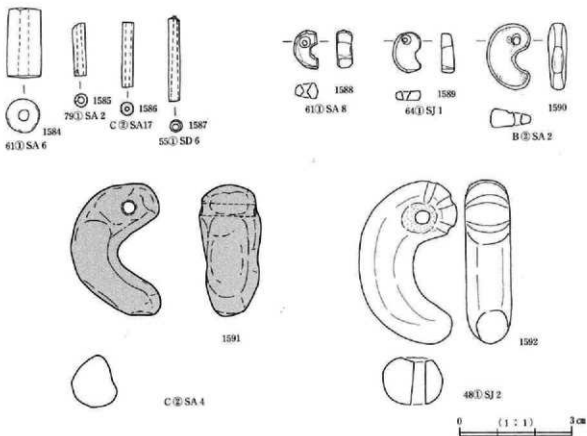

装身具 (2)

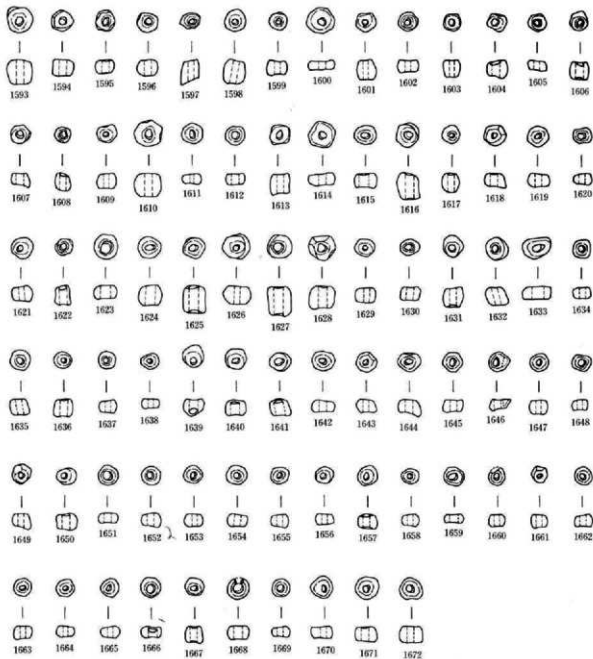

1593-1670
48① SJ 1

1671-1672
48① SJ 2

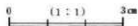

装身具 (3)

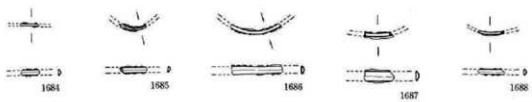
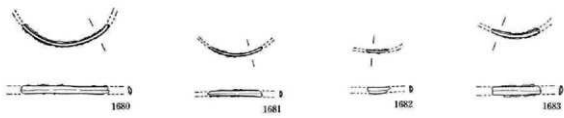
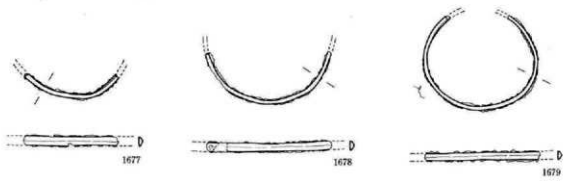
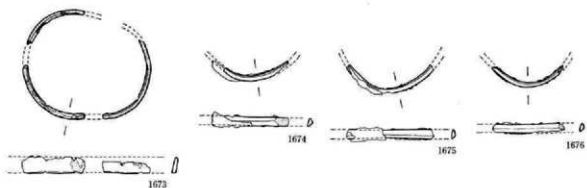

すべて480 SJ 1

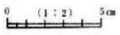

図版 191 古墳時代前期～中期の遺物 (1)

6① SA 1

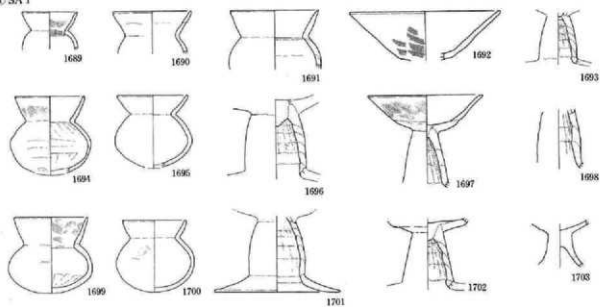

34① SA 3

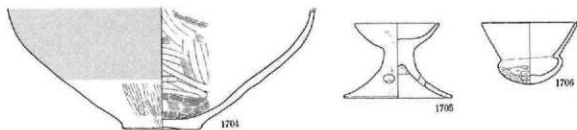

48① SA 1

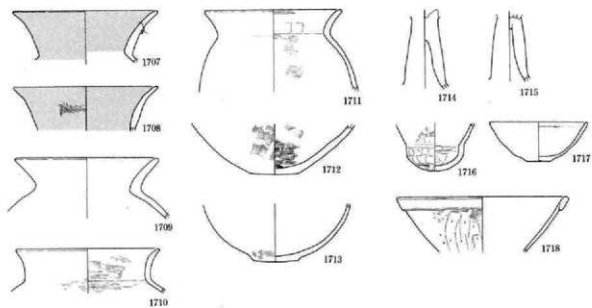

0 (1:4) 10cm

図版 192 古墳時代前期～中期の遺物 (2)

48D SA 2

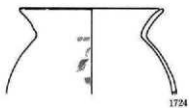
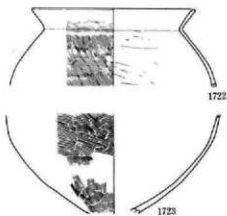
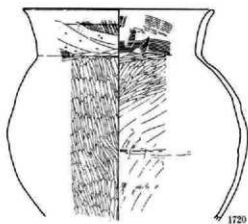
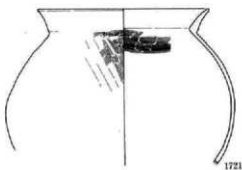
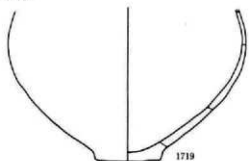

48D SA 3



50D SA 5

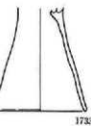
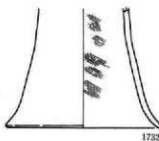
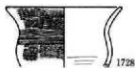

0 (1:4) 10cm

54① SA 1

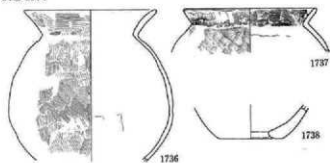

57① SA 3

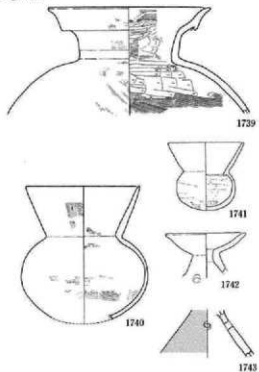

61① SA 9

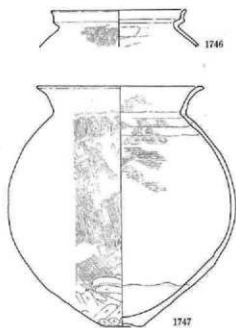

60② SA 3

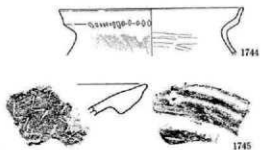

63① SA 1 (1)

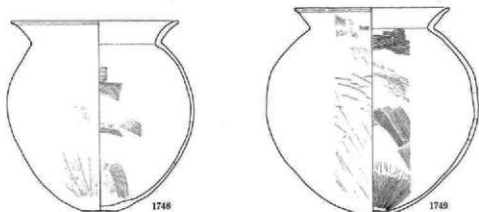

図版 194 古墳時代前期～中期の遺物 (4)

63① SA 1 (2)

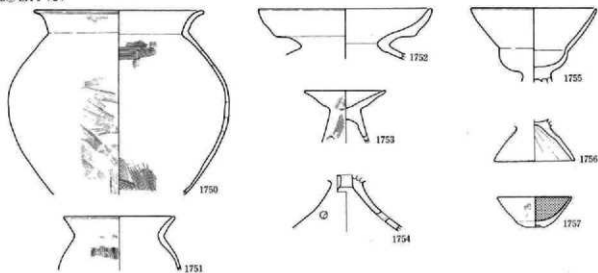

79① SA 5



B② SA13

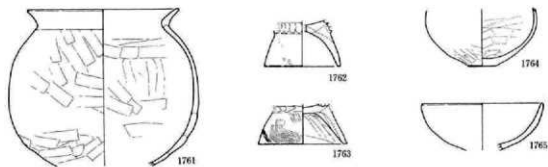

C① SA30 (1)

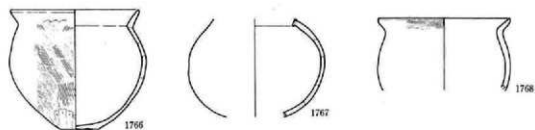

0 (1:4) 10cm

C①SA30(2)

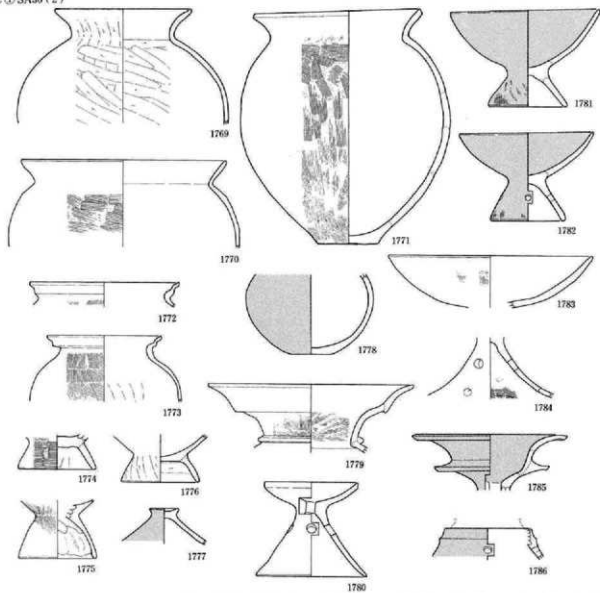

C②SA16

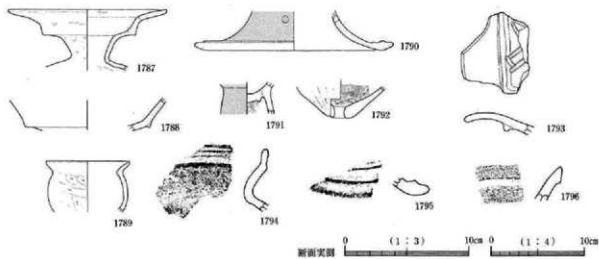

図版 196 古墳時代前期～中期の遺物 (6)

34① SB 1

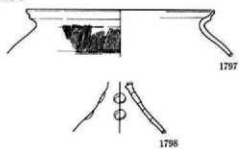

48① SK 3

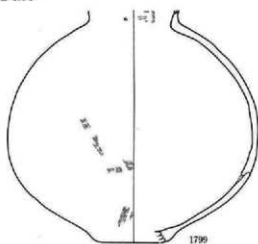

65① SDZ 1

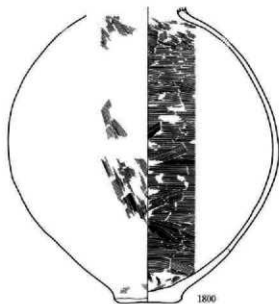

75① SDZ 4

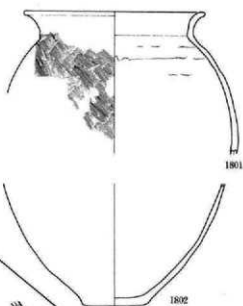

6① SD 1 (1)

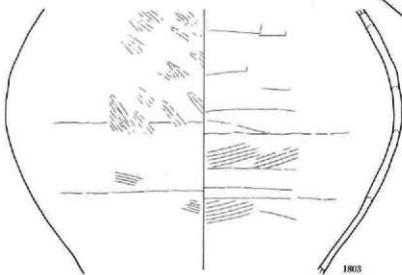

0 (1 : 4) 10cm

6①SD1 (2)

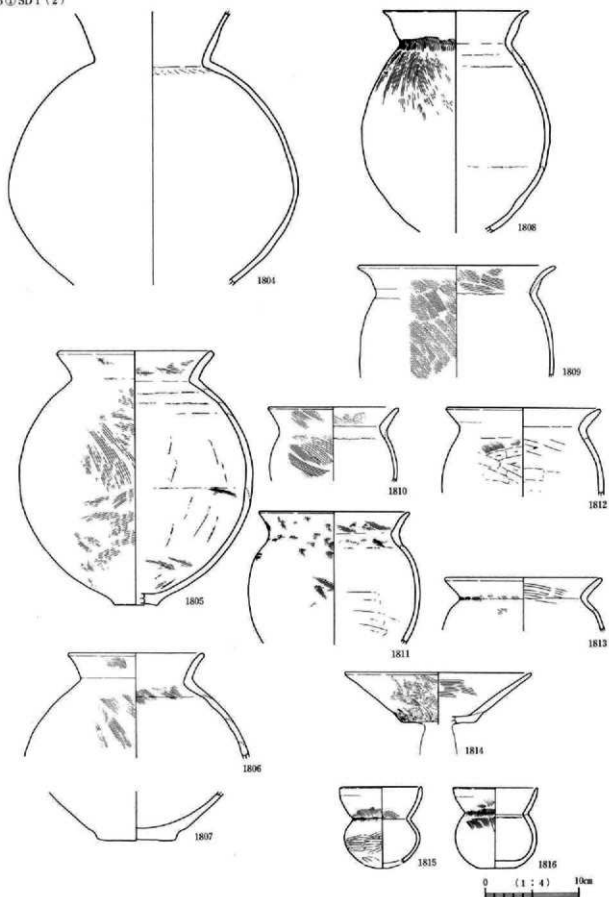

図版 198 古墳時代前期～中期の遺物 (8)

28① SD 5

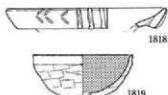
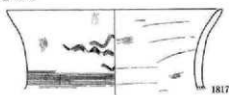

50① SD 2



33① SD 7

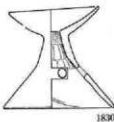
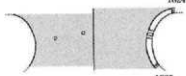
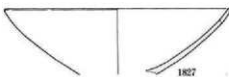
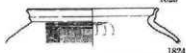
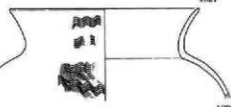
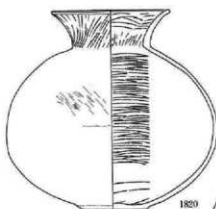

50② SD 3

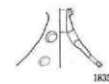
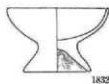

52① SD 4



52② SD 1

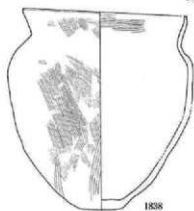

0 (1:4) 10cm

340 SD 7

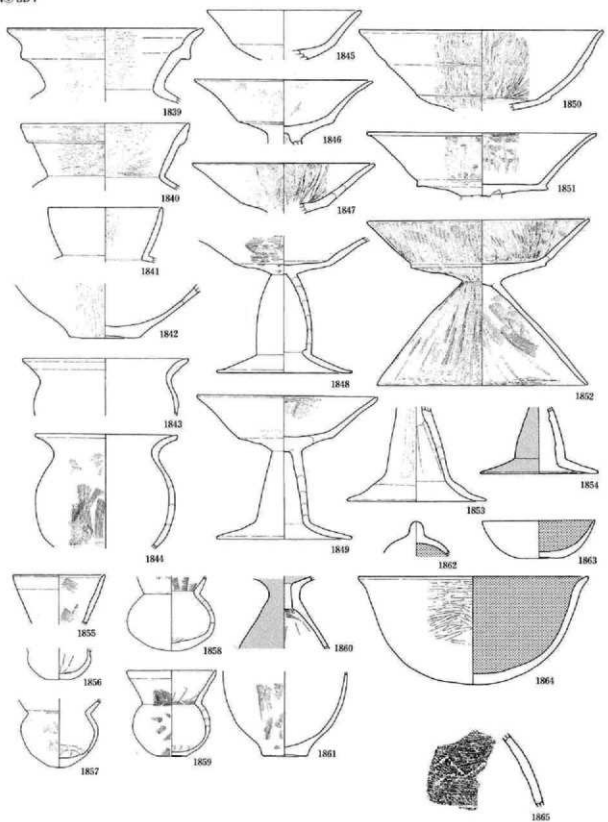

0 (1:3) 10cm 0 (1:4) 10cm
断面実測

62① SD 2

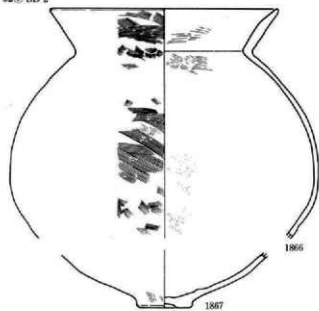

63① SD 2

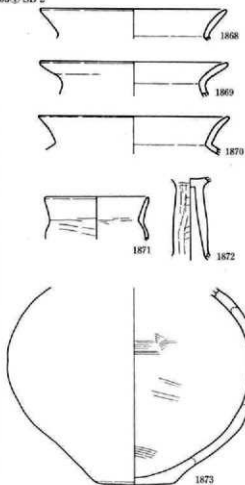

63① SD 6

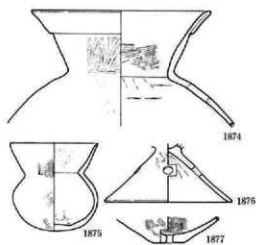

46① SX 1

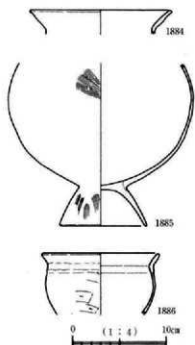

63① SD12

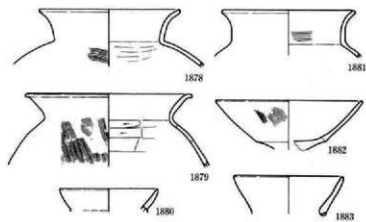

75①SX 1

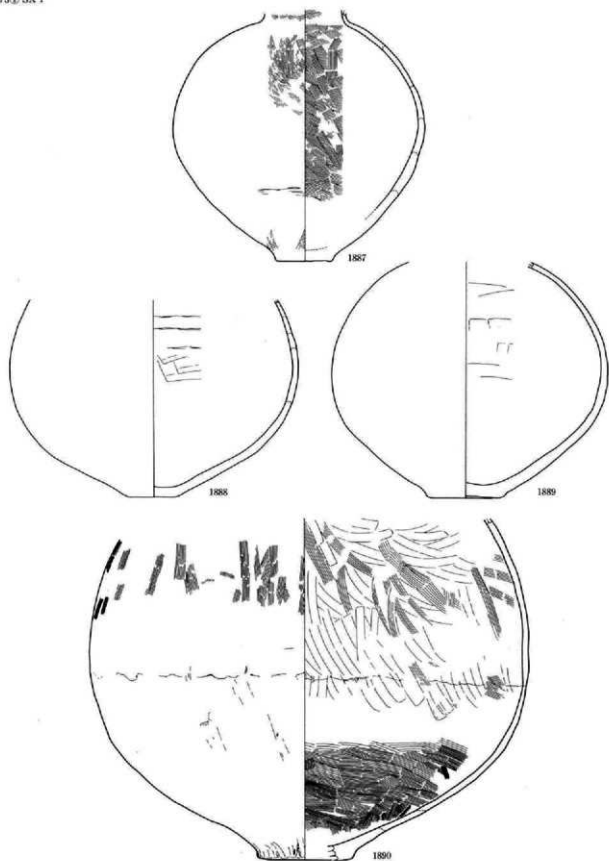

0 (1:4) 10cm

C(1) SX 1

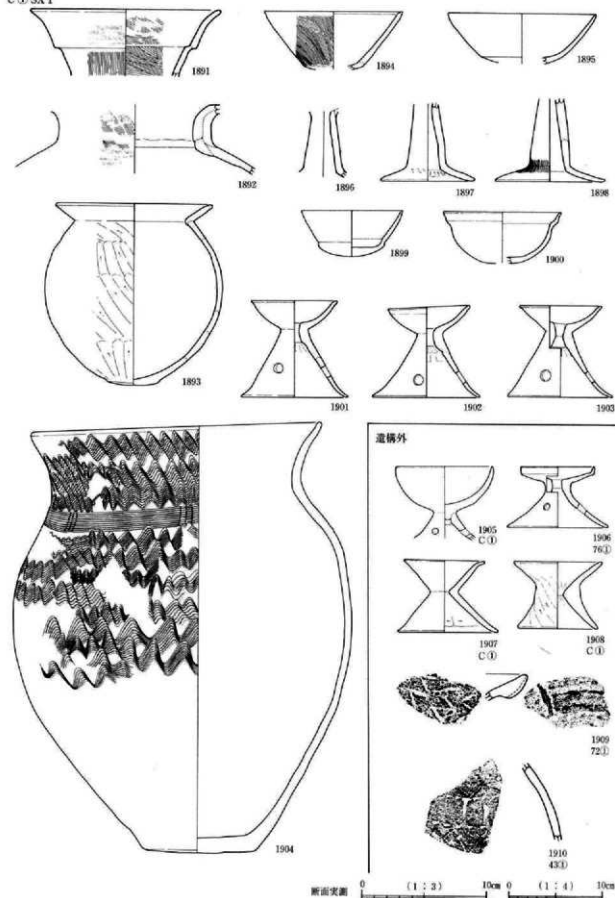

土製品

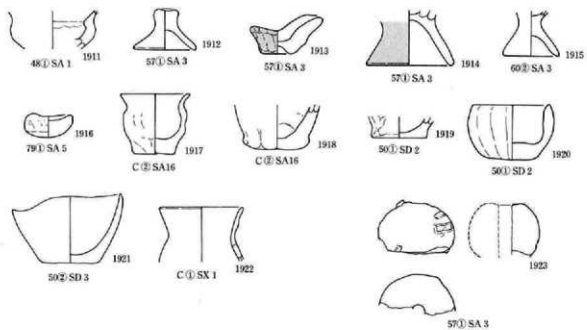

0 (1 : 2) 5 cm

装身具

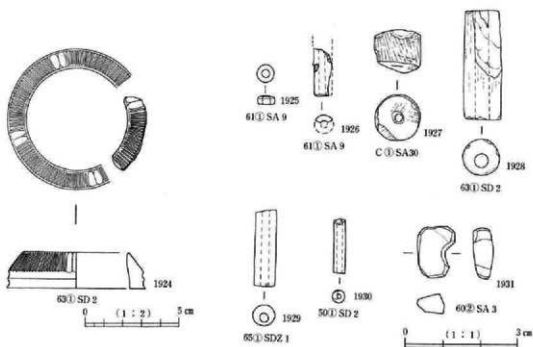

0 (1 : 2) 5 cm

0 (1 : 1) 3 cm

23① SA 1

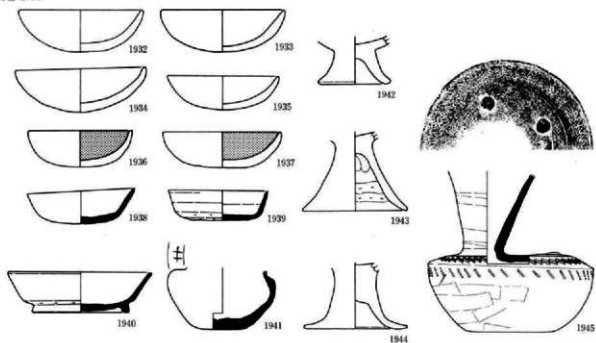

33① SA 1

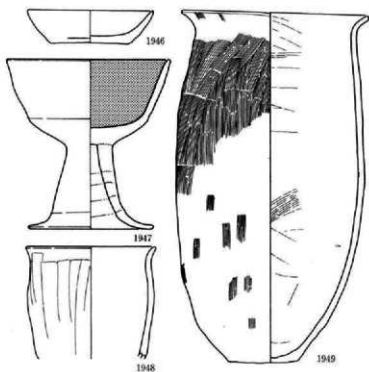

33① SA 5

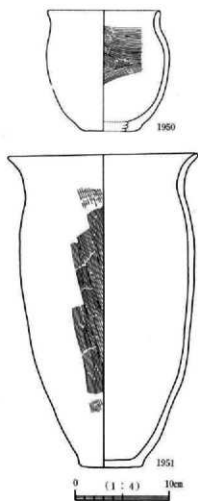

図版 205 古墳時代後期の遺物 (2)

33① SA 4

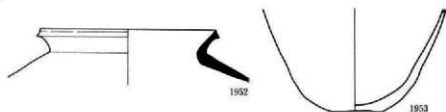

34① SA 1

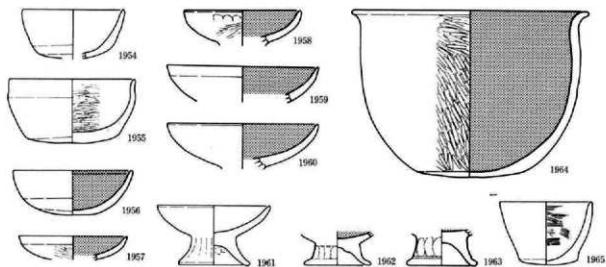

50① SA 1

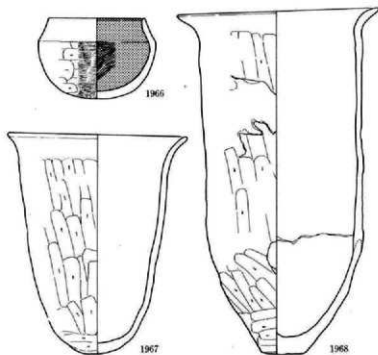

50① SA 4

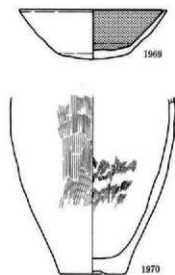

0 (1 : 4) 10cm

48D SA 4

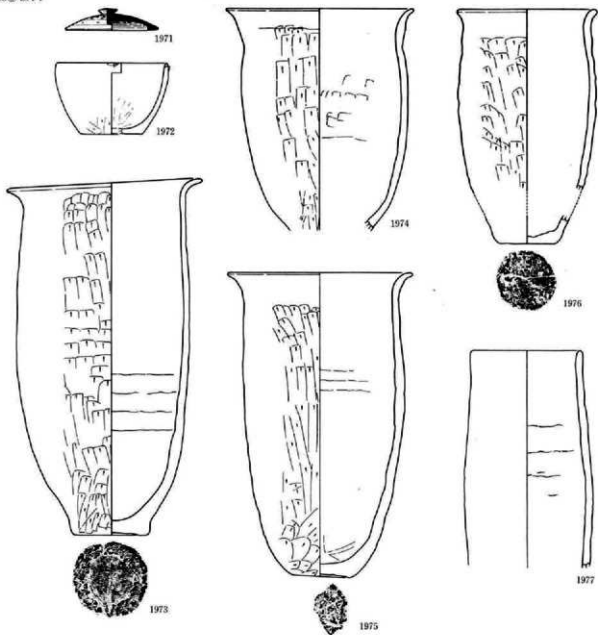

0 (1:4) 10cm

図版 207 古墳時代後期の遺物 (4)

500 SA 2

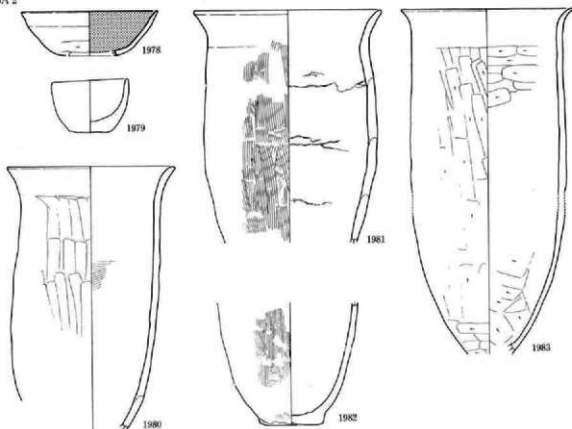

500 SA 3

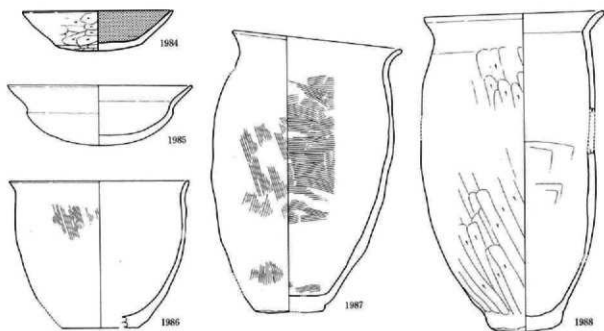

0 (1:4) 10cm

50① SA 6

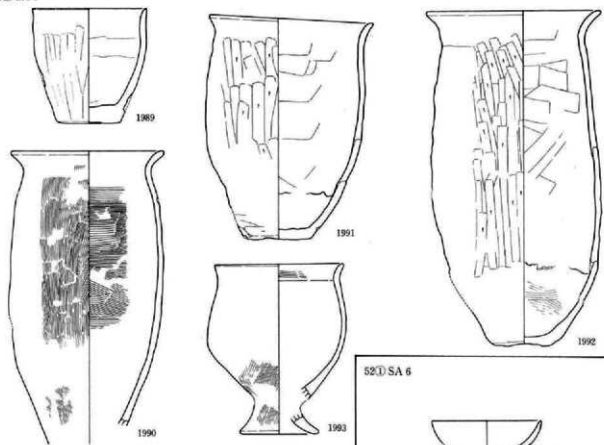

52① SA 6

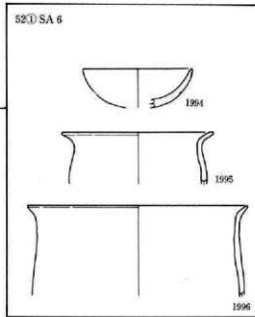

52① SA 2

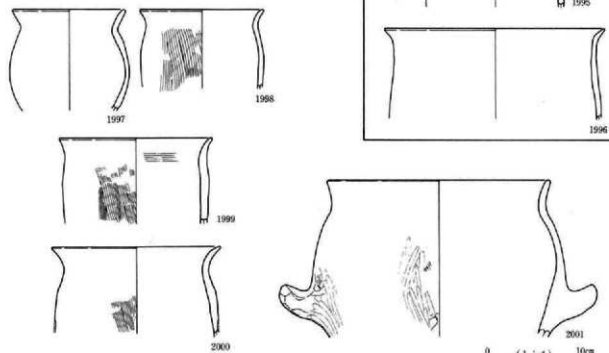

0 (1:4) 10cm

52① SA 4

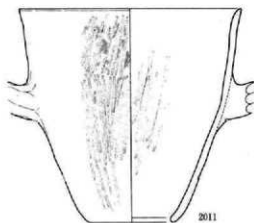
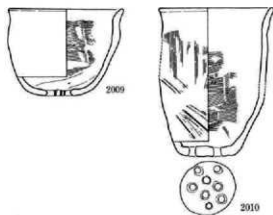
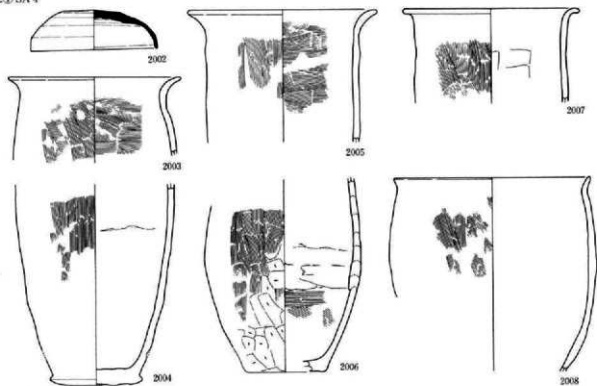

53① SA 1

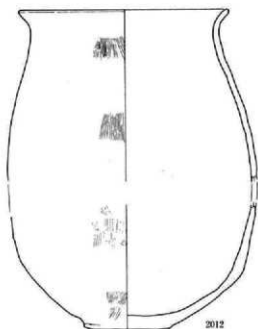

0 (1:4) 10cm

図版 210 古墳時代後期の遺物 (7)

53① SA 3

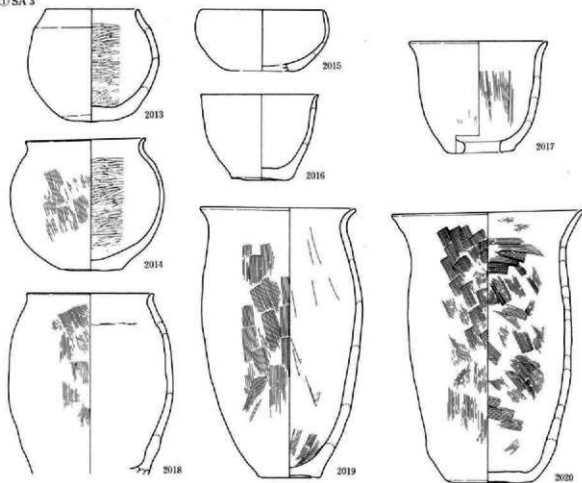

53① SA 5

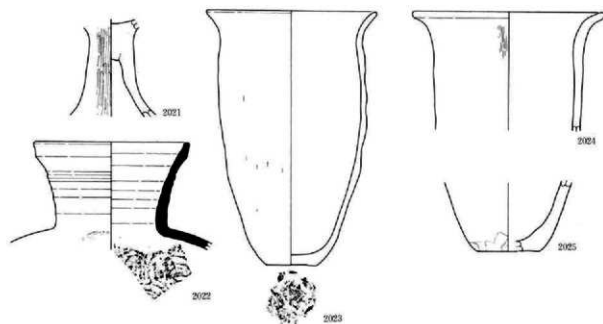

0 (1:4) 10cm

図版 211 古墳時代後期の遺物 (8)

53① SA 4

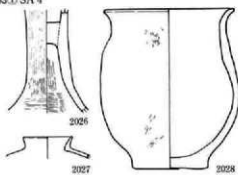

53① SA 11

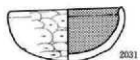

53① SA 9



53② SA 6



53① SA 10

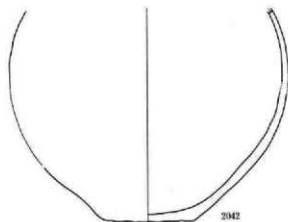
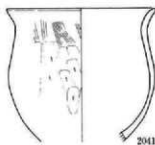
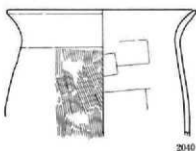
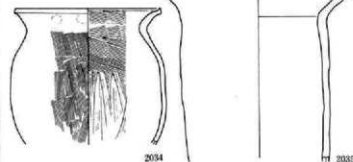
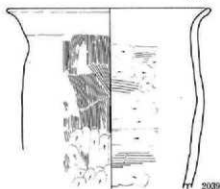
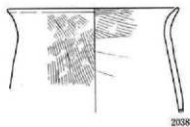

0 (1:4) 10cm

図版 212 古墳時代後期の遺物 (9)

54① SA 2

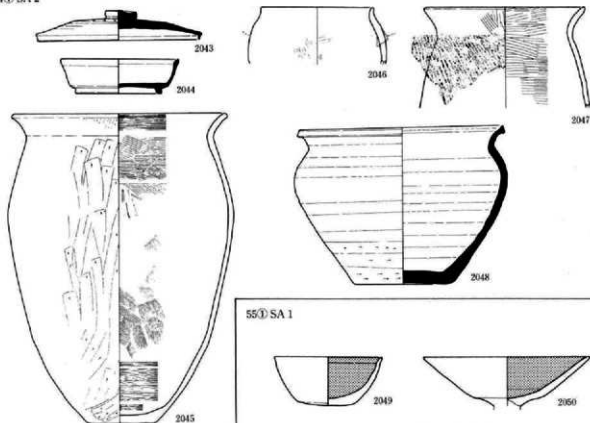

55① SA 5

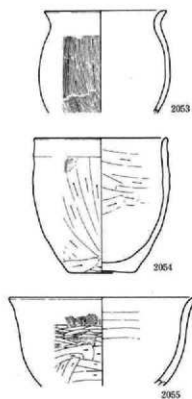

55① SA 1

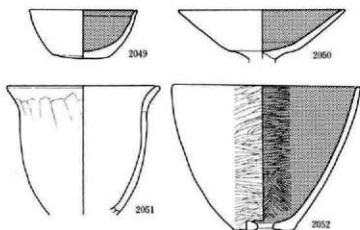

56① SA 1

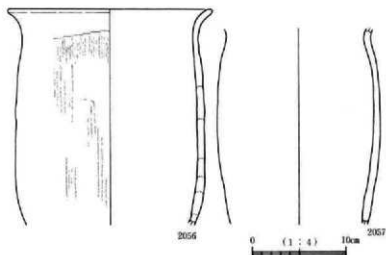

図版 213 古墳時代後期の遺物 (10)

56① SA 4

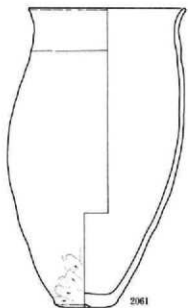
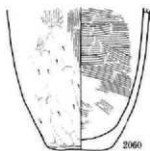
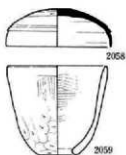

57① SA 1

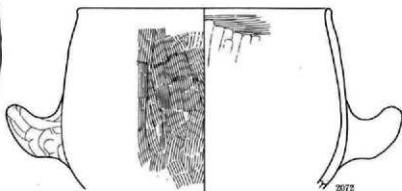
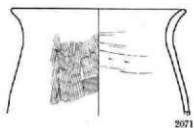
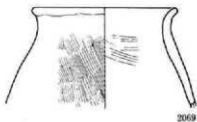
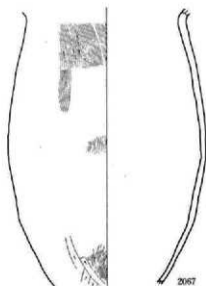
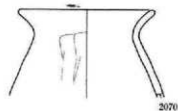
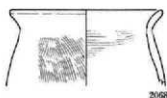
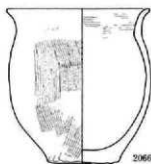
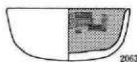
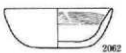

0 (1:4) 10cm

図版 214 古墳時代後期の遺物 (11)

57㉔ SA 2

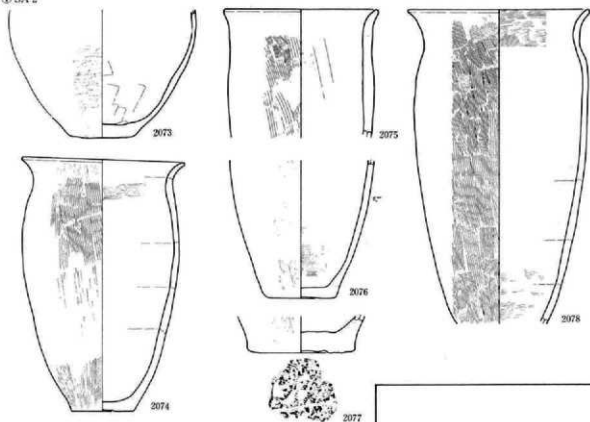

60㉔ SA 1

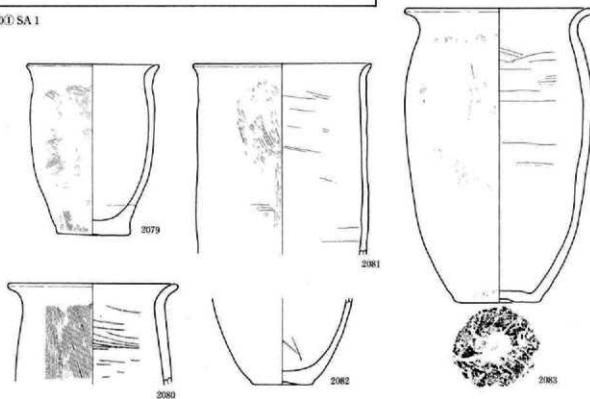

0 (1:4) 10cm

図版 215 古墳時代後期の遺物 (12)

61① SA 1

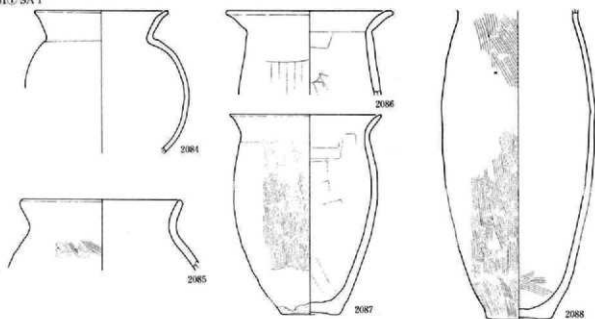

61① SA 2

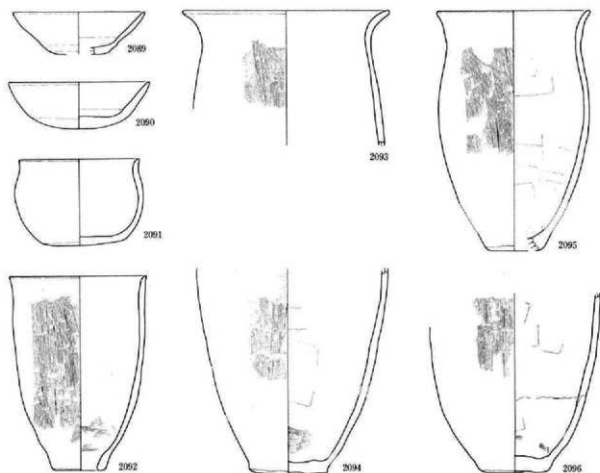

0 (1 : 4) 10cm

図版 216 古墳時代後期の遺物 (13)

61① SA 3

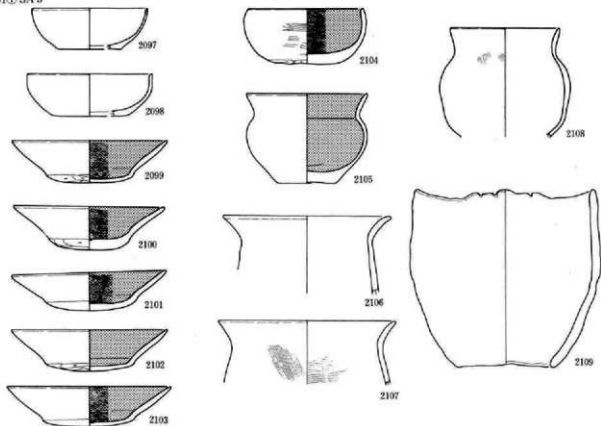

61① SA 5

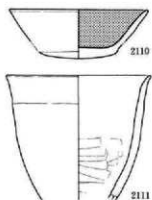

78① SA 3

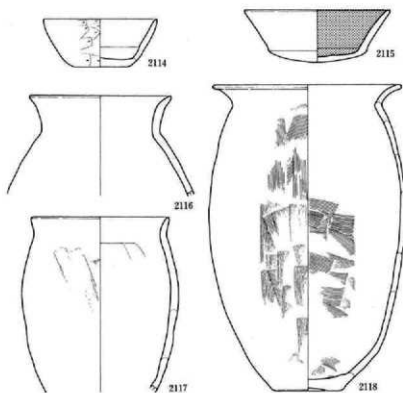

78① SA 1

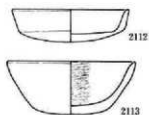

0 (1:4) 10cm

図版 217 古墳時代後期の遺物 (14)

79① SA 4

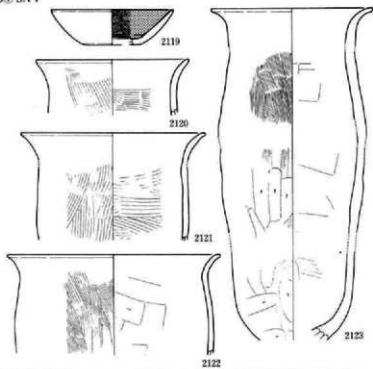

79① SA 9

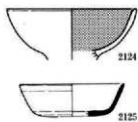

79① SA 6

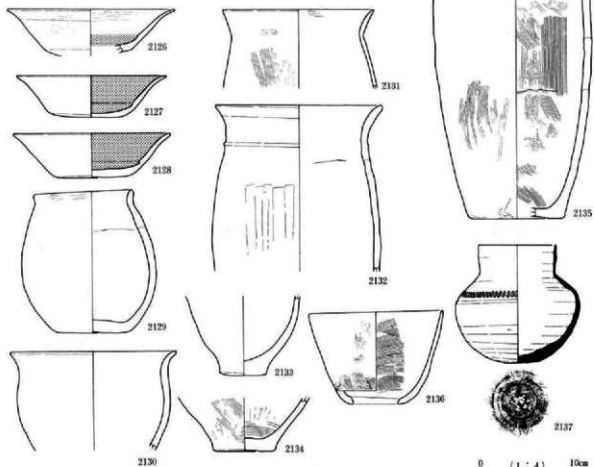

0 (1 : 4) 10cm

図版 218 古墳時代後期の遺物 (15)

B①SA 2



B①SA 4

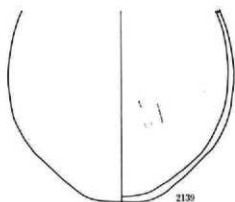

B①SA 3

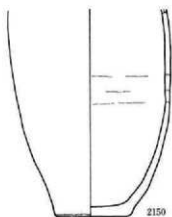
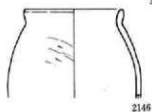
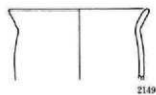
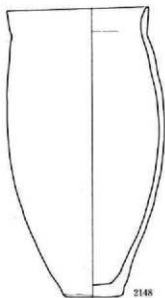
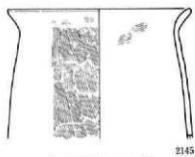
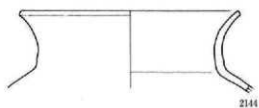
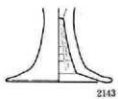
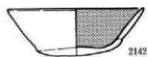
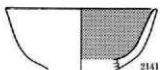
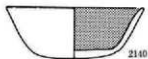

0 (1:4) 10cm

図版 219 古墳時代後期の遺物 (16)

B① SA 5



2151

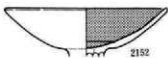

2152



2156

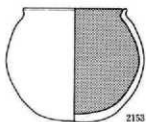

2153

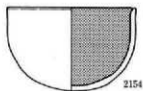

2154

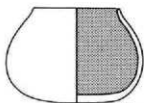

2155

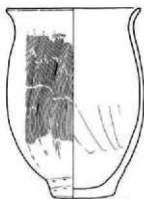

2157

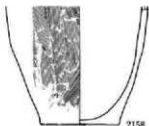

2158

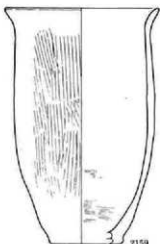

2159

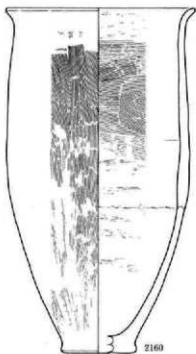

2160

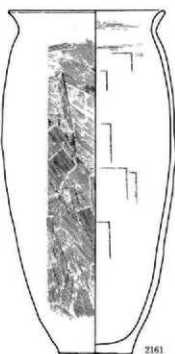

2161

0 (1 : 4) 10cm

図版 220 古墳時代後期の遺物 (17)

B① SA 6

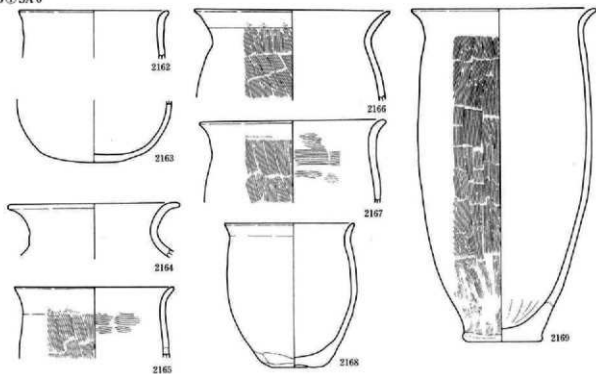

B① SA 7

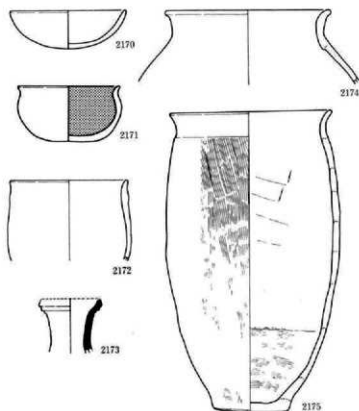

B① SA 8

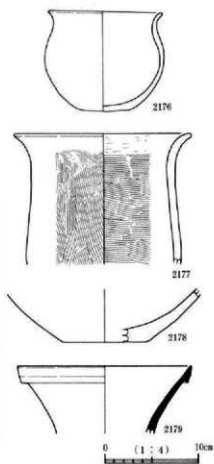

図版 221 古墳時代後期の遺物 (18)

B ① SA 9

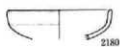

B ① SA11

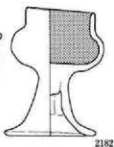
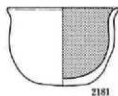

B ① SA12

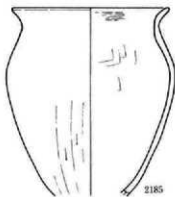
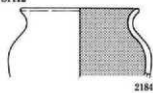

B ① SA14



B ① SA13

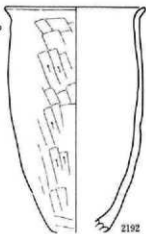
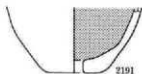
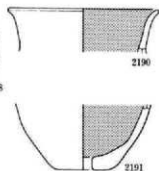
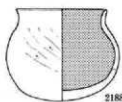
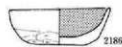

B ① SA16 (1)

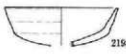
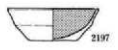
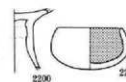
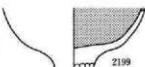

B①SA16 (2)

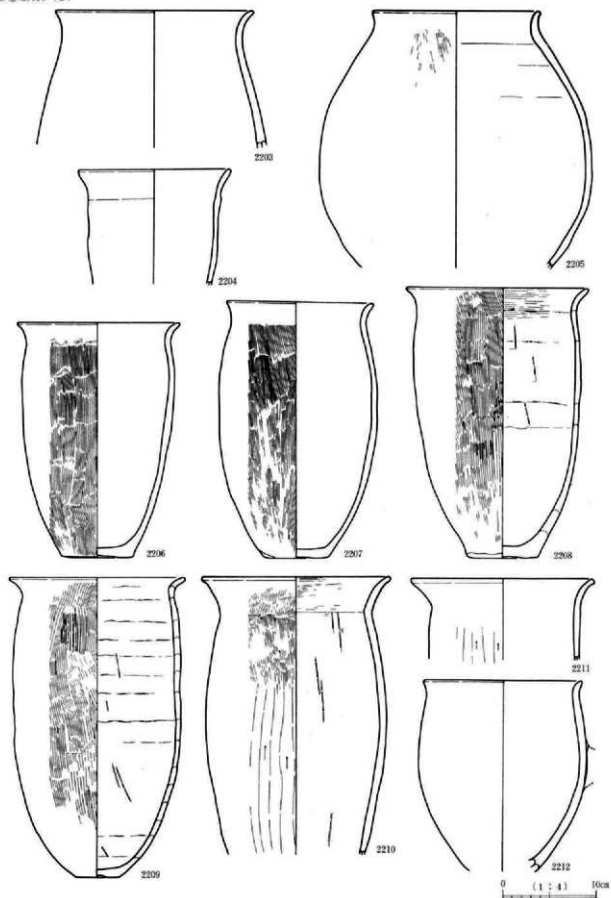

C①SA 2

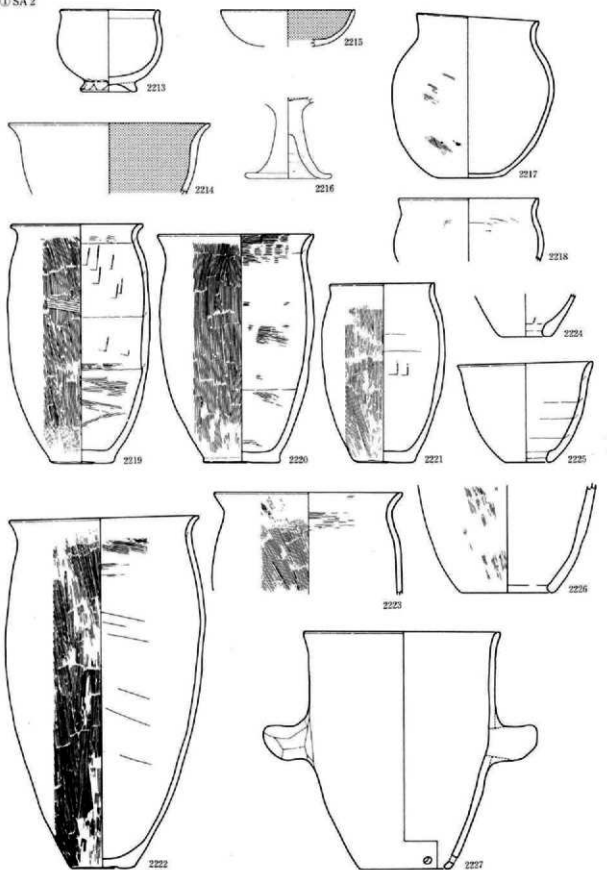

図版 224 古墳時代後期の遺物 (21)

C① SA 3

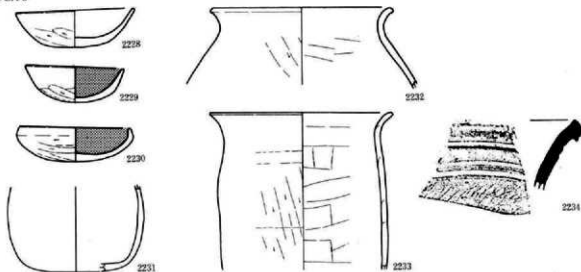

C① SA 4

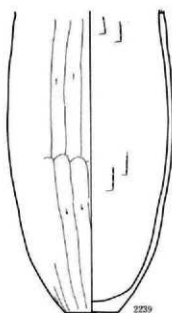
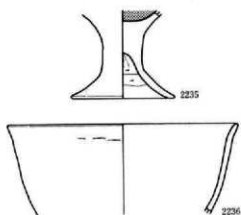

C① SA 6

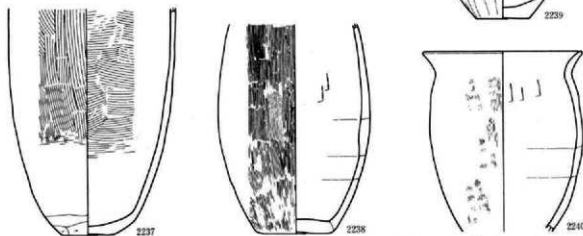

断面実図 0 (1:3) 10cm 0 (1:4) 10cm

図版 225 古墳時代後期の遺物 (22)

C ① SA 5

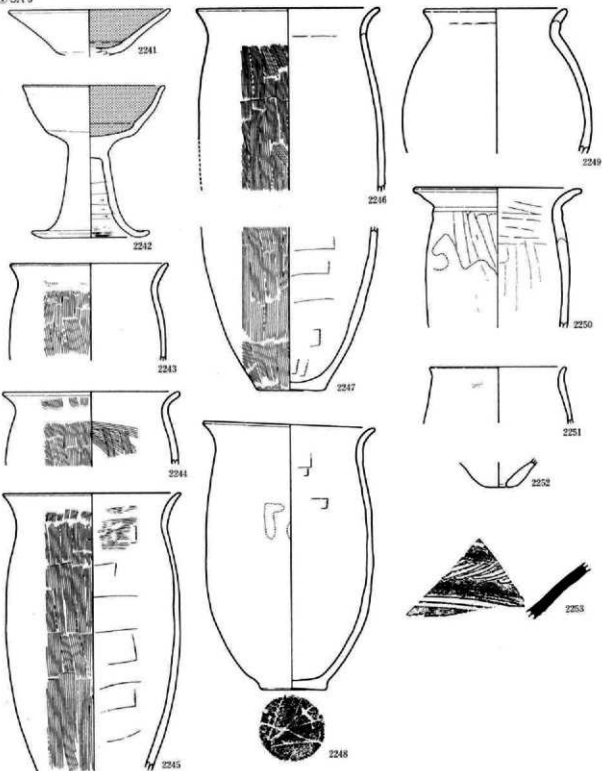

0 (1 : 3) 10cm 0 (1 : 4) 10cm
断面実測

C①SA7

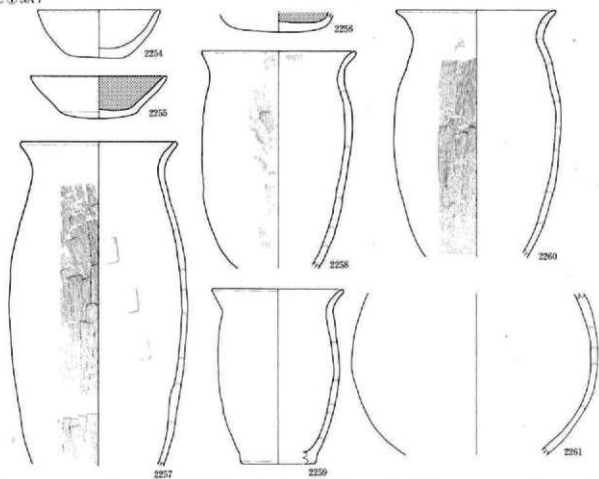

C①SA8 (1)

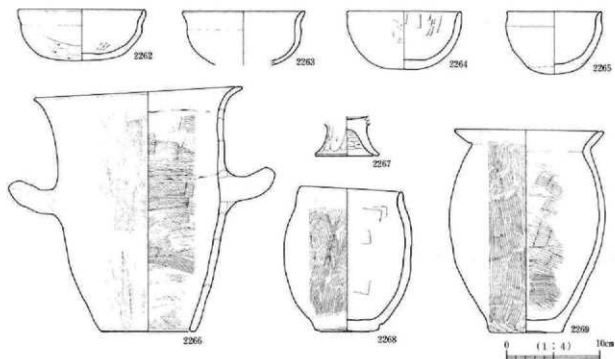

図版 227 古墳時代後期の遺物 (24)

C①SA 8 (2)

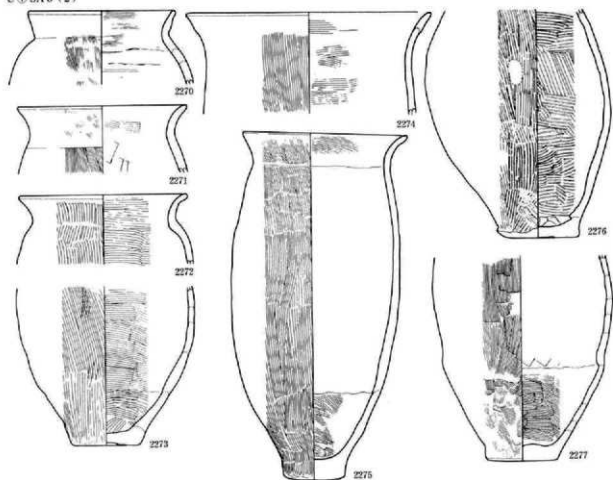

C①SA 9 (1)

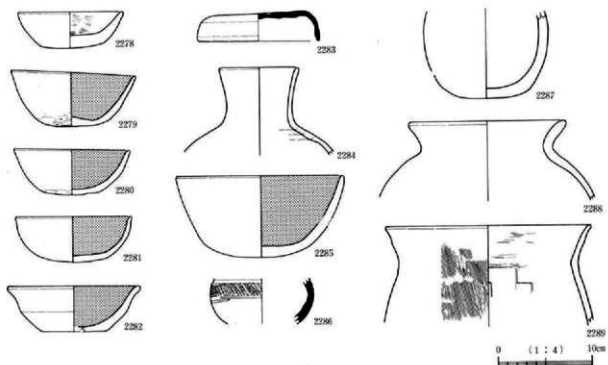

C①SA9(2)

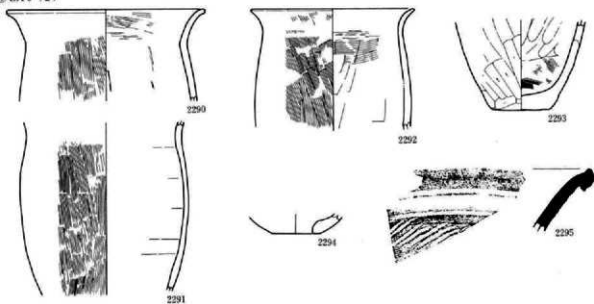

C①SA10

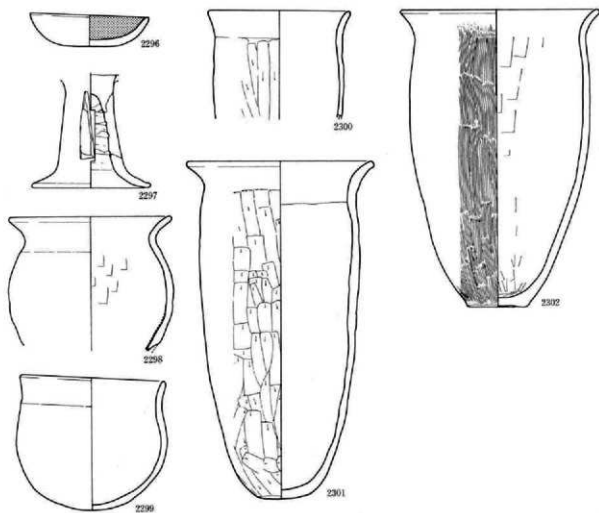

0 (1:3) 10cm 0 (1:4) 10cm
断面実測

C ① SA11 (1)

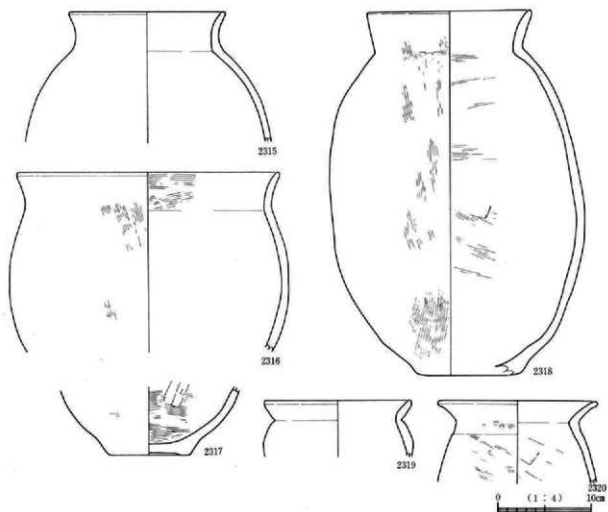
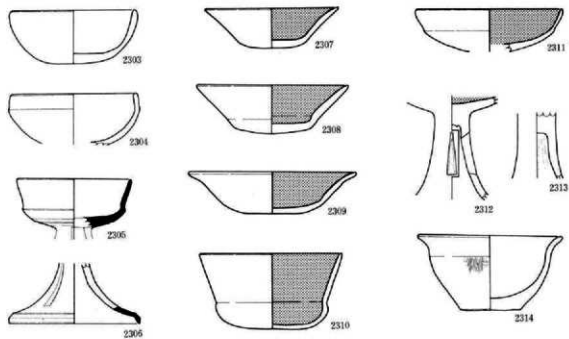

図版 230 古墳時代後期の遺物 (27)

C①SA11(2)

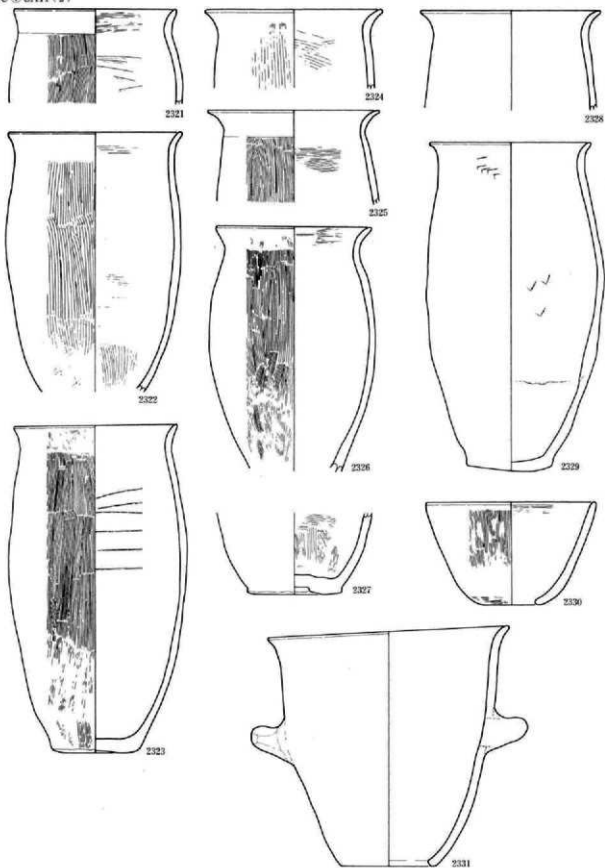

図版 231 古墳時代後期の遺物 (28)

C① SA13



2332



2333

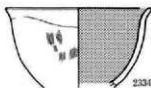

2334



2335

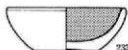

2336

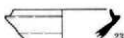

2337



2338



2339

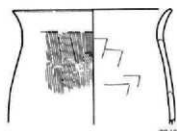

2340

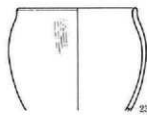

2343

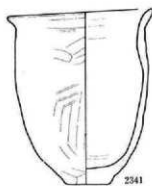

2341



2344



2345



2342

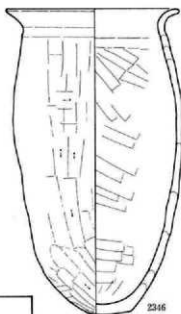

2346

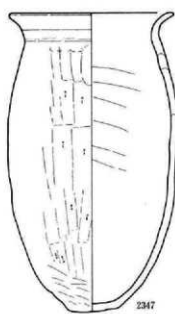

2347

C① SA12

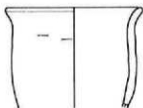

2348

C① SA14

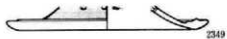

2349

0 (1:4) 10cm

図版 232 古墳時代後期の遺物 (29)

C①SA15

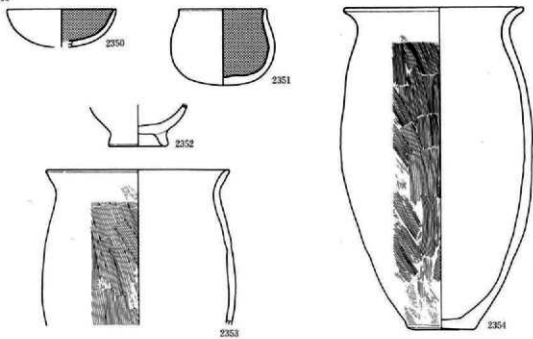

C①SA16(1)

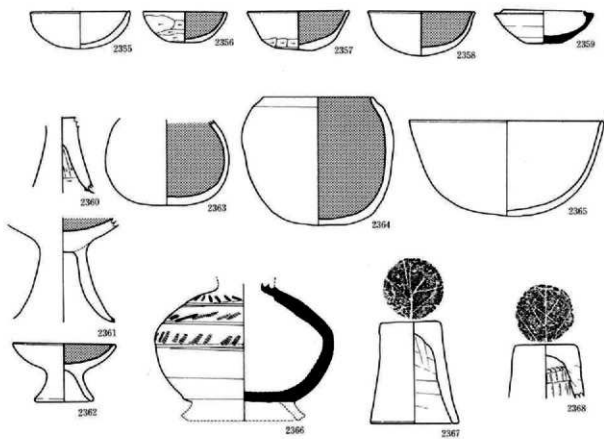

0 (1:4) 10cm

C① SA16 (2)

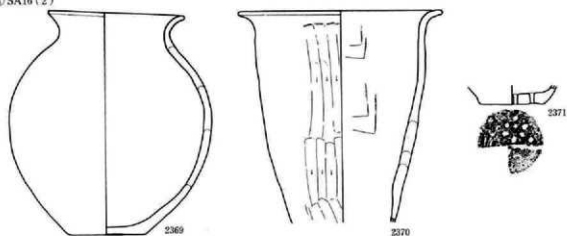

C① SA17

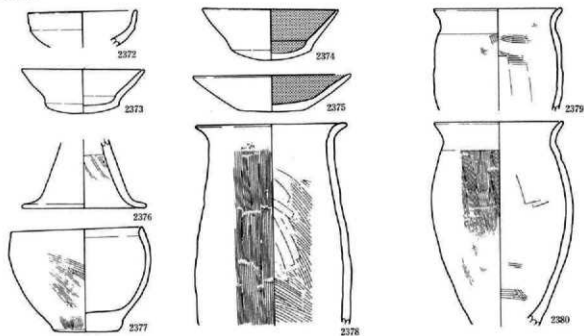

C① SA18 (1)

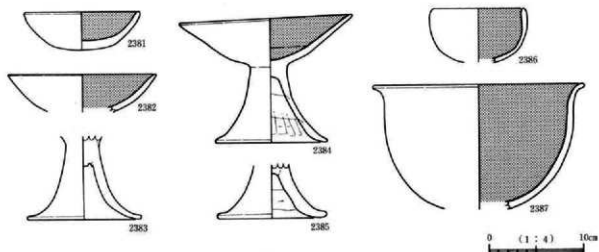

図版 234 古墳時代後期の遺物 (31)

C①SA18(2)

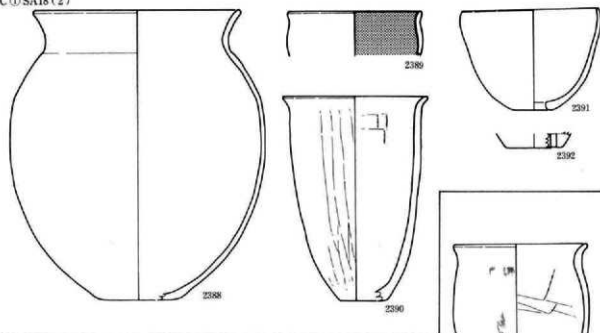

C①SA19

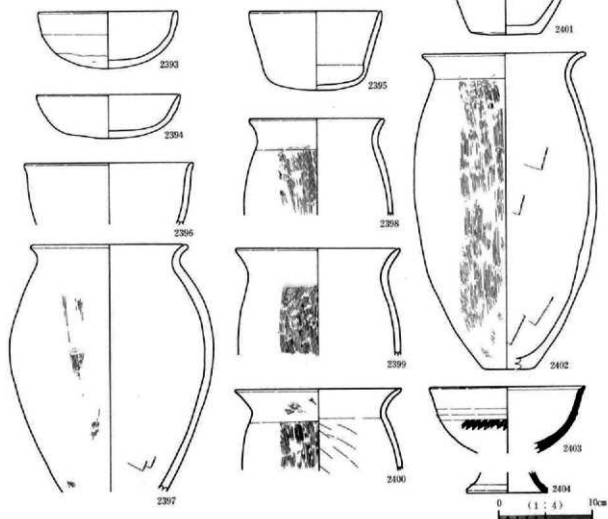

図版 235 古墳時代後期の遺物 (32)

C ① SA21

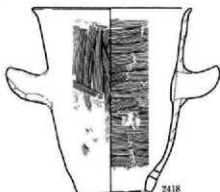
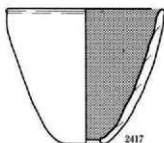
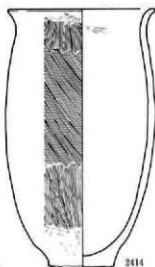
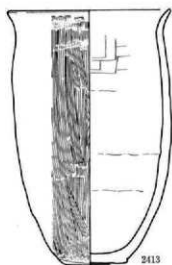
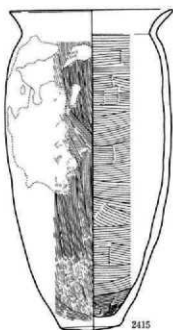
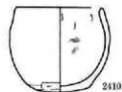
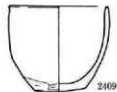
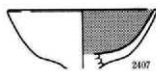
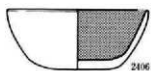

断面実図 0 (1:3) 10cm 0 (1:4) 10cm

図版 236 古墳時代後期の遺物 (33)

C① SA20

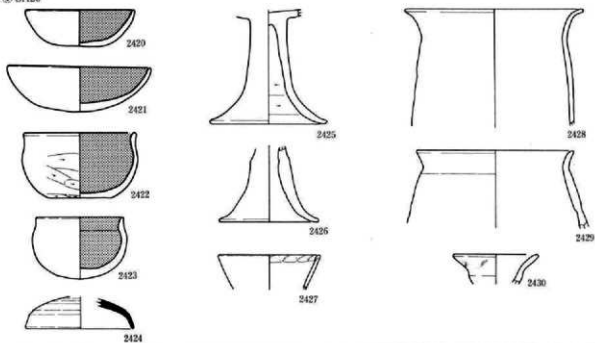

C① SA22

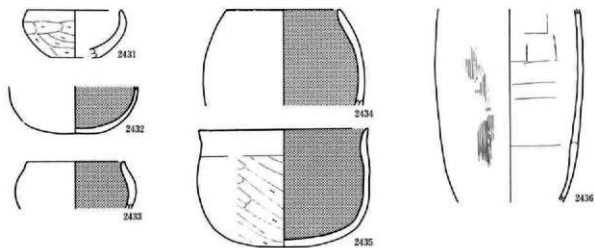

C① SA23



0 (1:4) 10cm

図版 237 古墳時代後期の遺物 (34)

C ① SA24

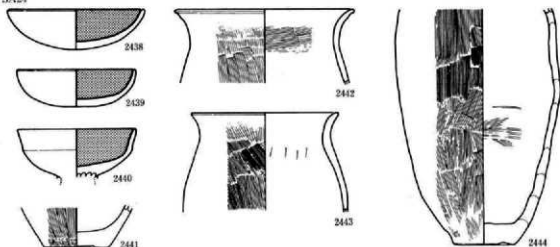

C ① SA25

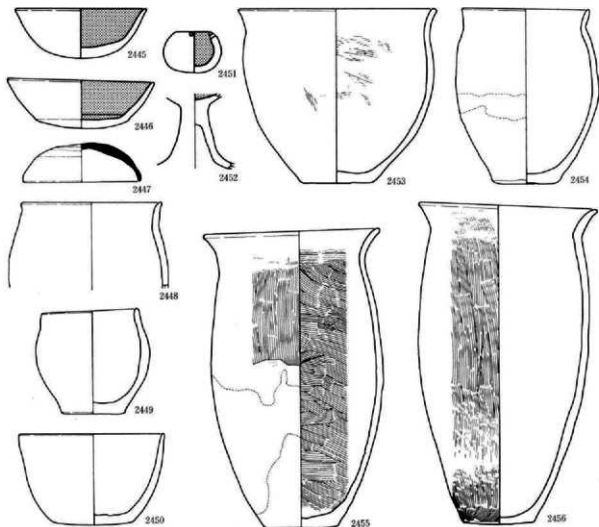

0 (1:4) 10cm

C ① SA26

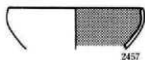

C ① SA27

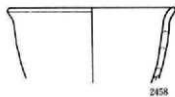

C ① SA28

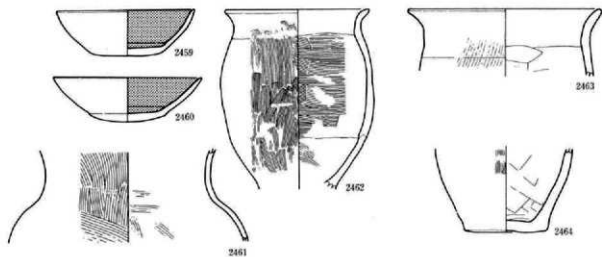

C ① SA29

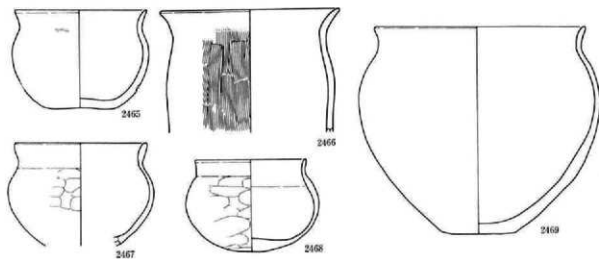

0 (1:4) 10cm

図版 239 古墳時代後期の遺物 (36)

59① SB 1



56① SK 5



C ① SK76

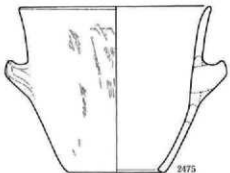
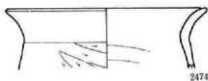

23① SD 1

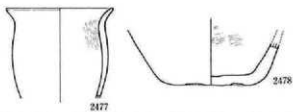

23① SD 2

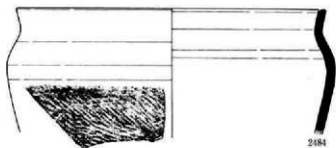
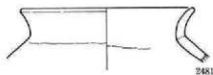
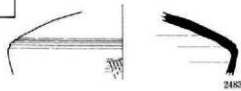

断面実測 0 (1:3) 10cm 0 (1:4) 10cm

図版 240 古墳時代後期の遺物 (37)

34①SD 1

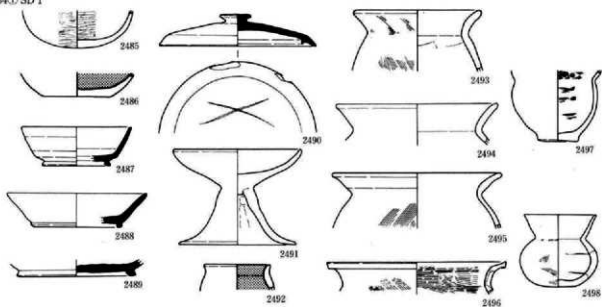

34①SD 2

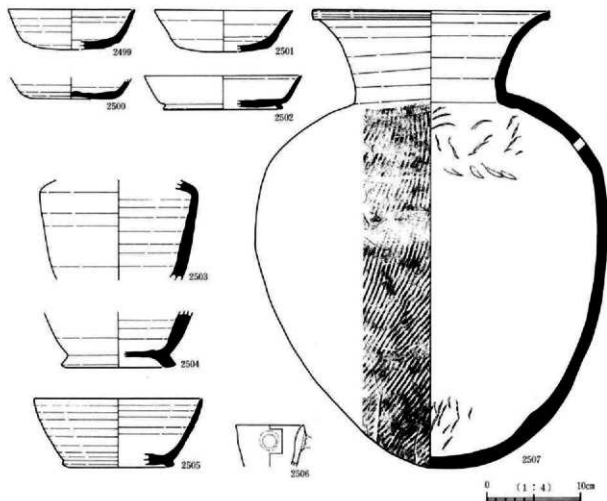

図版 241 古墳時代後期の遺物 (38)

49① SD 1

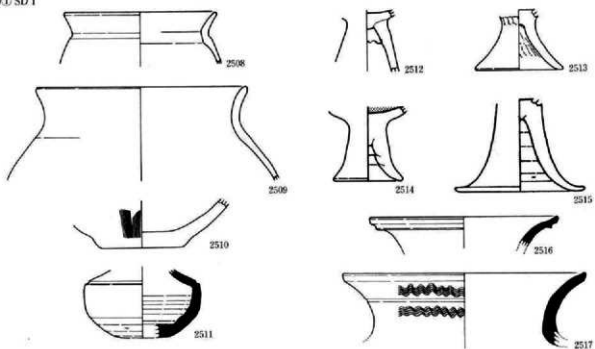

52② SD 1

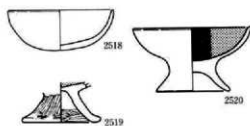

55① SD 2



55① SD 3

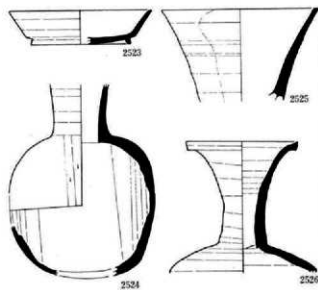

71① SD 2



C① SD 8

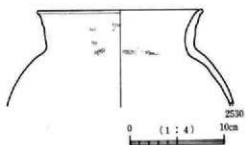

図版 242 古墳時代後期の遺物 (39)

D①SD1

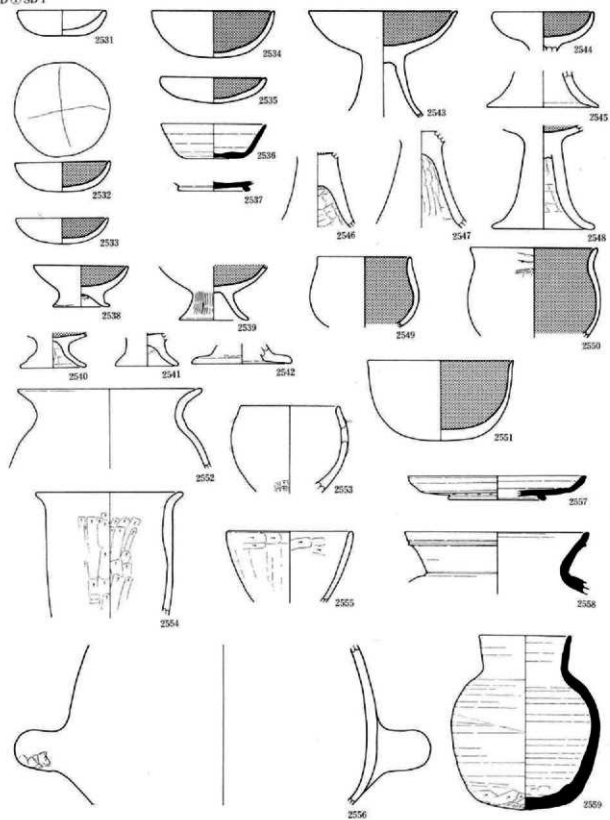

図版 243 古墳時代後期の遺物 (40)

E①SD17 (1)

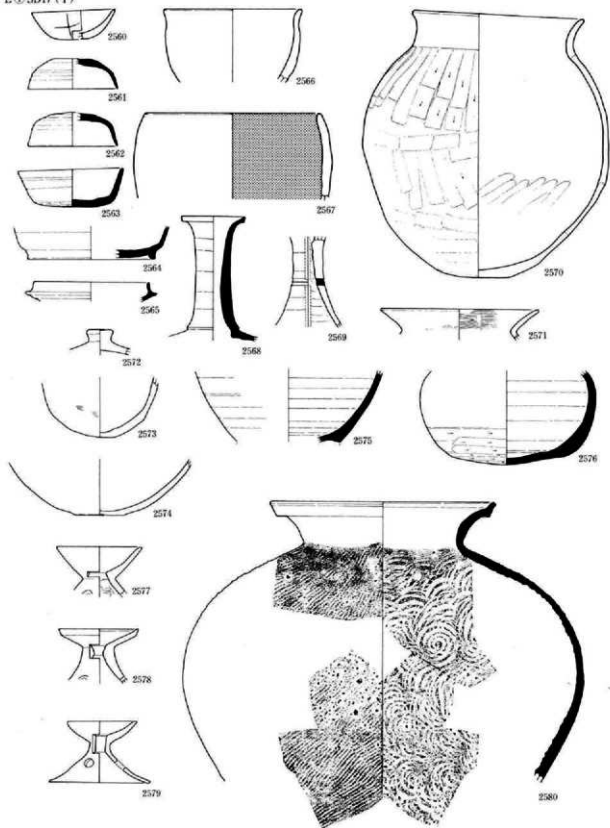

0 (1:4) 10cm

図版 244 古墳時代後期の遺物 (41)

E①SD17 (2)

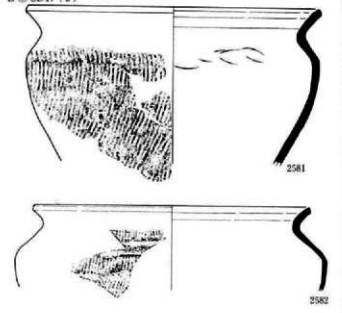

62③SU 2

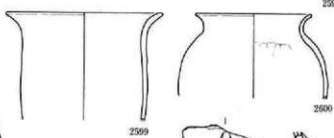
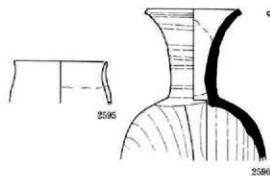
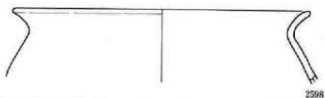
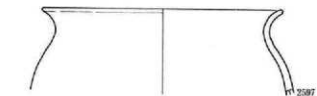
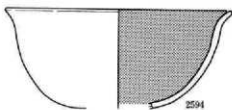
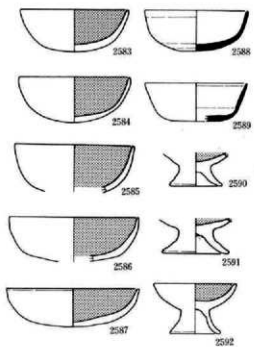

62①SX 3



図版 245 古墳時代後期の遺物 (42)

石製品

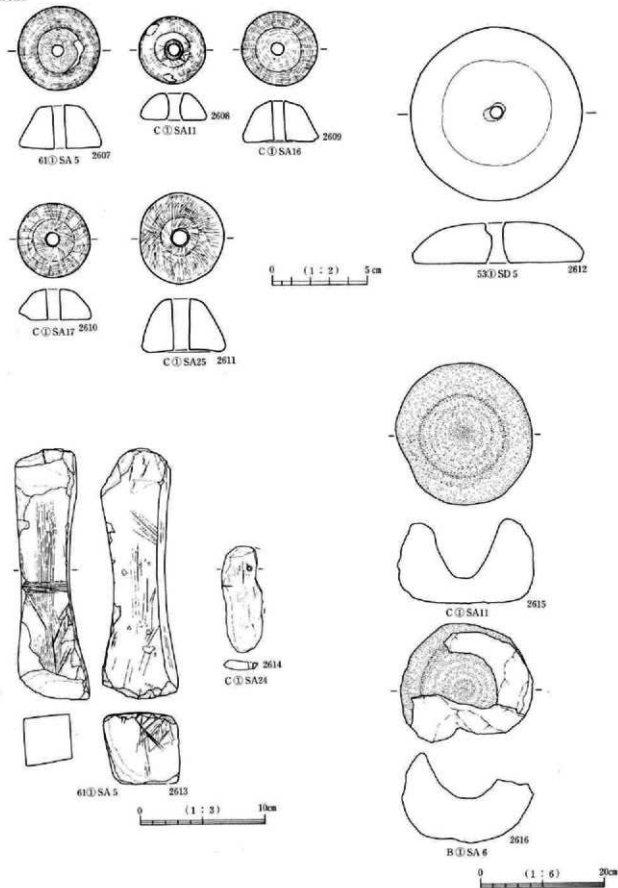

土製品

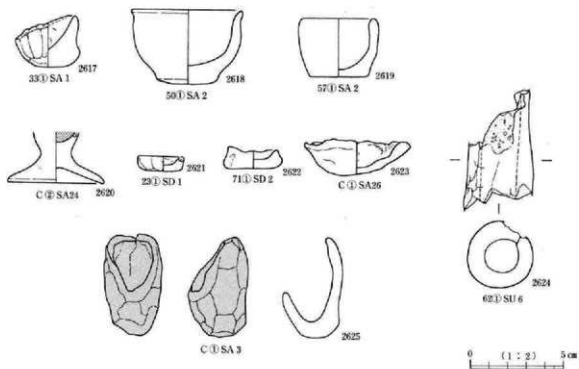

装身具

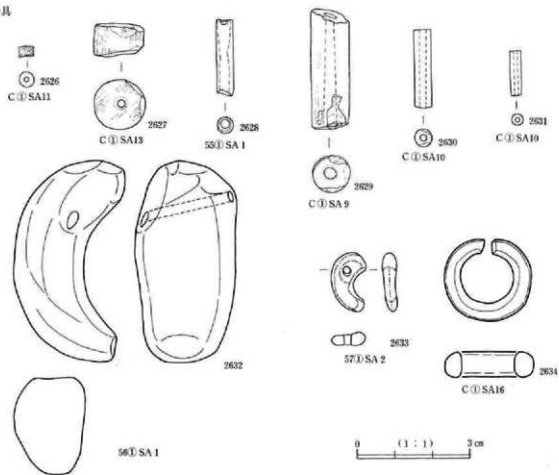

図版 247 平安時代～中世の遺物

53.① SK 1



C ① SD 1



C ① SD 2



16.① SD 1

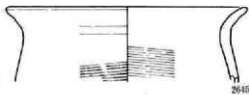
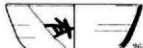

C ① SU 3

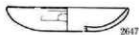

断面実測 0 (1:3) 10cm 0 (1:4) 10cm

図版 248 時期不明の遺物

石製品

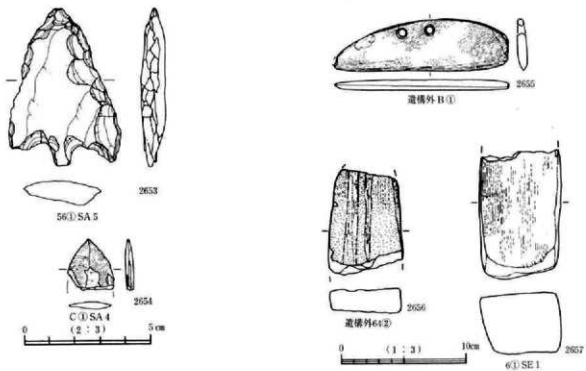

土製品

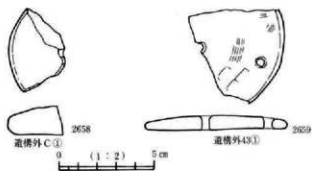

装身具

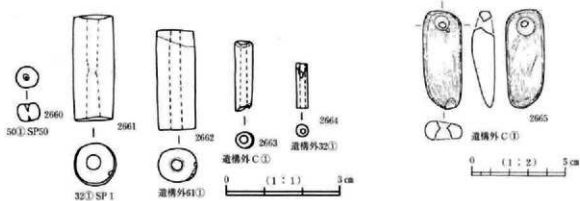



45㉔S A1

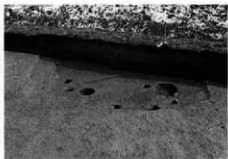

45㉔S A2

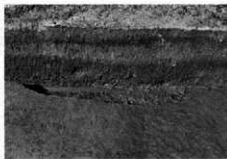

45㉔S A3



45㉔S A4



45㉔S A5/6



45㉔S A7



63㉔S A1



63㉔S A1土器出土状況



63㉔S A1土器出土状況



63㉔S A2



63㉔S A2土器出土状況



63㉔S A3



E㉔S A1



E㉔S A2遺物出土状況

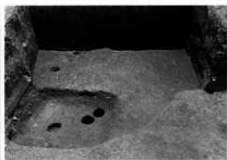

E㉔S A2定掘



E②SA3遺物出土状況 (1)



E②SA3遺物出土状況 (2)



E②SA3土器出土状況 (1)



E②SA3土器出土状況 (2)



E②SA3完掘



E②SA4上層遺物出土状況



E②SA4中層遺物出土状況 (1)



E②SA4中層遺物出土状況 (2)



E②SA4中層石棒出土状況



E②SA4石器出土状況



E②SA4完掘



E②SA5遺物出土状況



E②SA5ピット内遺物出土状況



E②SA5完掘

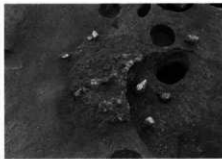

E②SA5P1

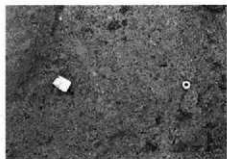

E2SA6上層遺物出土状況



E2SA6遺物出土状況



E2SA6土器出土状況



E2SA6完掘

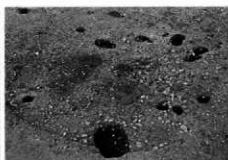

E2SA7

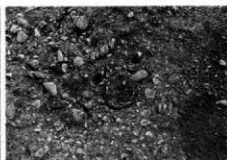

E2SA7a



E2SA8



E2SA8a



E2SK8



E2SK9遺物出土状況

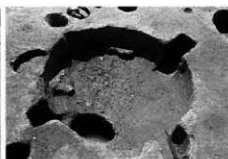

E2SK9完掘



E2SX1



E2SJ1



E2SJ2



E2SJ3



E②S J4



48②SR1



63②SR1



E②SR1



E②SR2



E②SN1検出状況



E②SN1完掘



3①SA1



3①SA2



4①SA1



10①SA1

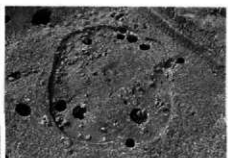

18①SA1



25①SA1



29①SA2



30①SA1



32① S A1



34① S A4



37① S A1



43① S A2



50① S A10



51① S A2

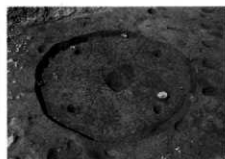

52② S A1

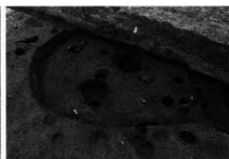

52② S A3

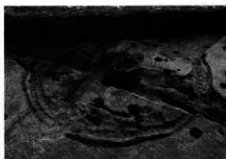

53② S A3



53② S A7



53② S A11遺物出土状況 (1)



53② S A11遺物出土状況 (2)



53② S A11完掘



55① S A2



55① S A4



64①S A1 (外) / 2 (内)



65①S A1



69①S A1



74①S A1 (左) / 2 (右)

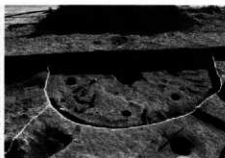

75①S A1



B②S A4



B②S A5



B②S A6



C②S A13 (外) / 14 (内) (1)



C②S A13 (外) / 14 (内) (2)



C②S A19

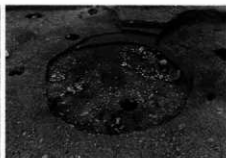

C②S A20遺物出土状況 (1)



C②S A20遺物出土状況 (2)



C②S A20完掘



E①S A19遺物出土状況

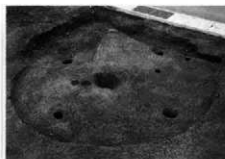

E①SA1完掘



18①SK4



26①SK10



29①SK2



60①SK3



64①SK1



C②SK111



48①SJ5



61KS J群



61区SJ群掘り方



61区SJ群埋葬時復元状況



61②SJ1

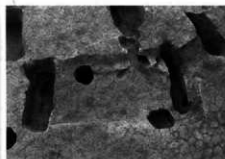

61②SJ1掘り方



61②SJ2



61②SJ2掘り方

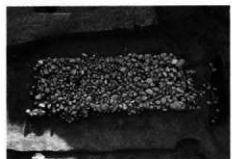

61②S J3 (1)



61②S J3 (2)



61②S J3掘り方



61②S J4



61②S J4掘り方

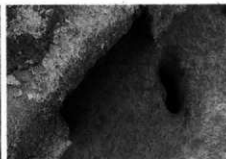

61②S J5

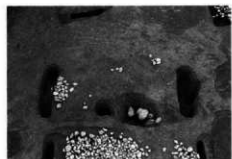

61②S J6

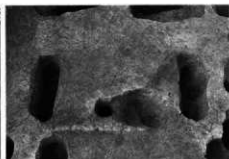

61②S J6掘り方

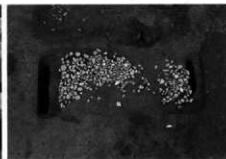

61②S J7



61②S J7掘り方

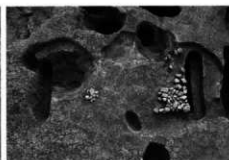

61②S J8

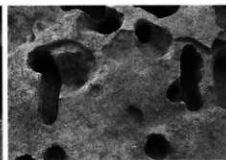

61②S J8掘り方

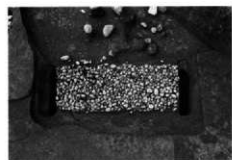

61②S J9



61②S J9掘り方



61②S D3



27㊦ S D1



73㊦ S U2

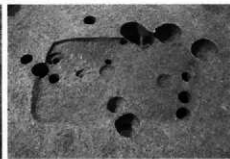

30㊦ S X1



43㊦ S X1

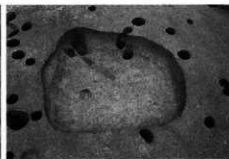

55㊦ S X1



33㊦ S A2

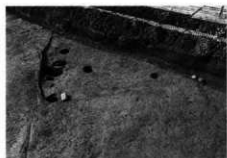

46㊦ S A1



46㊦ S A2



46㊦ S A3

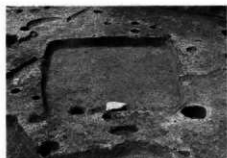

50㊦ S A7



50㊦ S A1

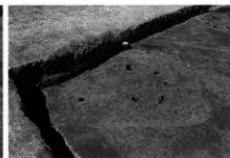

50㊦ S A2 (1)



50㊦ S A2 (2)

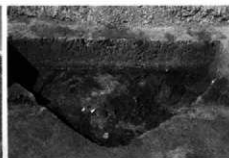

50㊦ S A3炭化材出土状況



50㊦ S A3完測

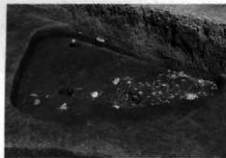

50㉔S A4



50㉔S A6



50㉔S A7炭化材・遺物出土状況



50㉔S A7完掘



50㉔S A8



51㉔S A1



51㉔S A1



51㉔S A2



51㉔S A3



52㉔S A5



52㉔S A7



52㉔S A2

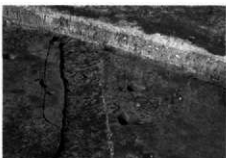

53㉔S A1



53㉔S A4/5



55㉔S A3



55㉔S A1

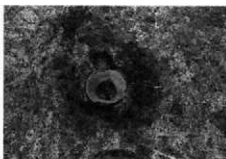

55㉔S A1甲



55㉔S A1甲平截



56㉔S A1炭化材・遺物出土状況



56㉔S A3



57㉔S A1



57㉔S A5



60㉔S A2



60㉔S A4炭出土状況



60㉔S A4完掘



61㉔S A4



61㉔S A6



61㉔S A8



62㉔S A1

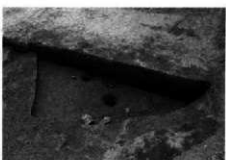

70㉔S A1



78① S A2



78① S A6



79① S A2



79① S A10



B② S A2



B② S A2遺物出土状況



B② S A3炭化材出土状況



B② S A3石釘出土状況



B② S A3完掘



B② S A7覆土集石出土状況



B② S A7完掘



B② S A8覆土集石出土状況



B② S A8完掘



B② S A9炭化材・遺物出土状況 (1)



B② S A9炭化材・遺物出土状況 (2)



B②S A9完掘



B②S A10覆土集石出土状況

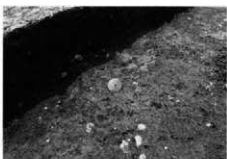

B②S A10粘棒車出土状況



B②S A10土器出土状況



B②S A10完掘



B②S A11遺物出土状況



B②S A11完掘



B②S A12土層断面



B②S A12完掘



B②S A14



B②S A15



B②S A16



B②S A17



B②S A18



C②S A1



C2S A2炭出土状況



C2S A2完掘



C2S A2壁面被熱状況



C2S A4埴玉出土状況



C2S A4石器出土状況



C2S A4完掘



C2S A4b



C2S A6



C2S A7



C2S A7土器出土状況



C2S A8 (1)



C2S A8 (2)



C2S A9



C2S A9b

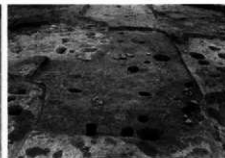

C2S A10



C②SA10遺物出土状況



C②SA11



C②SA11遺物出土状況



C②SA12 (1)



C②SA12 (2)



C②SA15



C②SA17

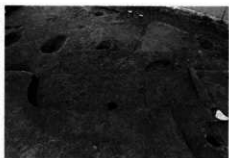

C②SA18



C②SA21

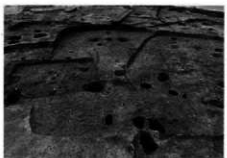

C②SA22



C②SA23



C②SA25



502SK4

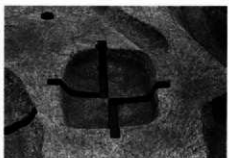

481SJ3

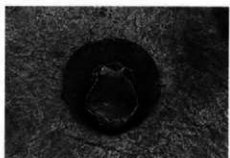

481SJ7



64①S J1出土状況



64①S J1棺内遺物出土状況

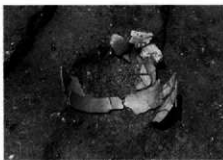

64①S J1棺支え出土状況



4①S C2 (手前) / S D Z1 (奥)



4①S D Z1遺物出土状況



4①S D2 / S D Z1土層断面



19①S D Z1

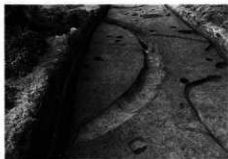

37①S D Z1



48①S J / S D Z1群 (東から)



48①S J / S D Z1群 (西から)

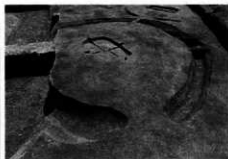

48①S D Z1

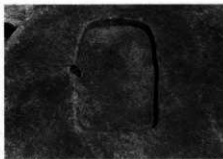

48①S D Z1主体部



48①S D Z1主体部遺物出土状況 (1)



48①S D Z1主体部遺物出土状況 (2)



48①S D Z1主体部遺物出土状況 (3)



48①SDZ2



48①SDZ2主体部



48①SDZ2主体部遺物出土状況



48①SDZ4



48①SDZ4主体部



48①SDZ6

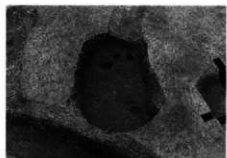

48①SDZ8主体部



4①SD2



26①SD7



48①SD1



B②SD6土層断面

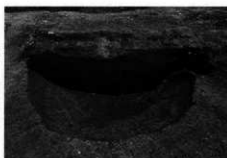

B②SU2



6②SX4



6①SA1



6①SA1遺物出土状況

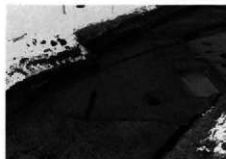

34 S A3



48 S A1



48 S A2



48 S A3

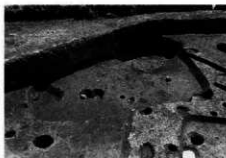

50 S A8



50 S A5



54 S A1



57 S A3



60 S A3



61 S A9

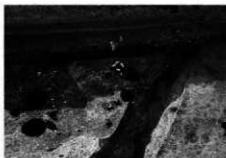

61 S A10



62 S A2



62 S A3



63 S A1



79 S A5



79①S A8



B②S A13発出土状況



B②S A13完掘



C①S A30



C①S A30遺物出土状況



C②S A16



34①S B1

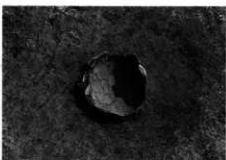

48①S K3



65①S D Z1 (65区西から)

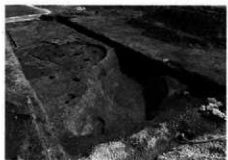

65①S D Z1 (65区東から)



65①S D Z1 (75区検出)



65①S D Z1土層断面 (74区検出)

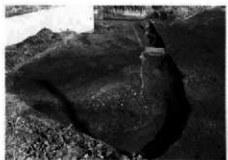

75①S D Z1



75①S D Z4



75①S D Z4土層断面



61 S D1



131 S D1



231 S D5

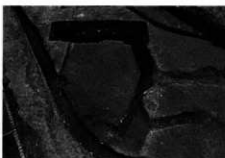

331 S D7



341 S D7



341 S D7土層断面

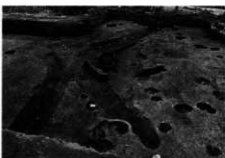

501 S D3/4

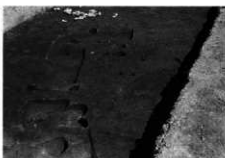

521 S D1



521 S D4

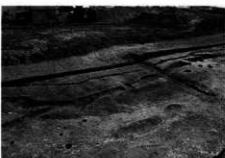

631 S D1/2



461 S X1



751 S X1



751 S X1遺物出土状況 (1)



751 S X1遺物出土状況 (2)



C1 S X1



23① S A1炭化材出土状況



23① S A1カマド出土状況



23① S A1完掘



33① S A1



33① S A1カマド



33① S A4 (奥) / 5 (手前)



34① S A1炭化材出土状況



34① S A1完掘

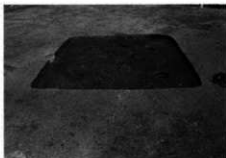

48① S A4



50① S A1



50① S A2

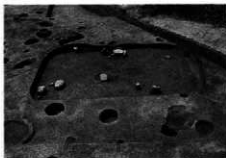

50① S A3



50① S A4

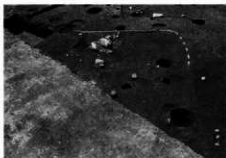

50① S A6



50① S A9

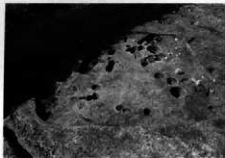

52①S A1



52①S A2



52①S A3



52①S A6

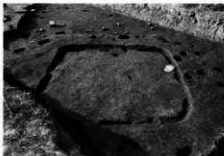

53①S A1

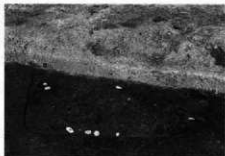

53①S A2



53①S A3カマド出土状況

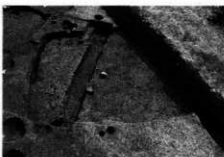

53①S A3



53①S A4



53①S A5カマド出土状況



53①S A5



53①S A9



53①S A10カマド出土状況



53①S A10



53①S A11



53㊦S A6



54㊦S A2 (奥) /3 (手前)



55㊦S A1



55㊦S A5カマド出土状況



55㊦S A5

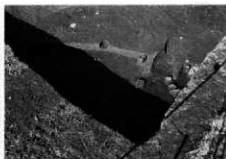

56㊦S A1



56㊦S A4



57㊦S A1



57㊦S A2



60㊦S A1



61㊦S A1カマド出土状況



61㊦S A1

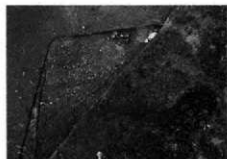

61㊦S A2



61㊦S A3



78㊦S A1



78①S A3



78①S A4



78①S A5



79①S A4



79①S A6



79①S A7



79①S A9

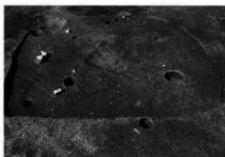

B①S A1



B①S A3遺物出土状況

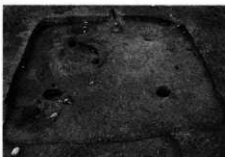

B①S A3完掘



B①S A4カマフ出土状況



B①S A4



B①S A5カマフ出土状況

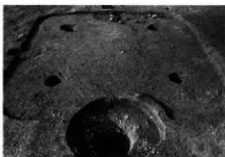

B①S A5



B①S A6カマフ出土状況

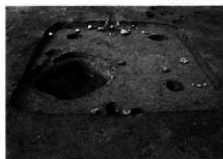

B1SA6



B1SA6石出土状況



B1SA7カマド出土状況



B1SA7



B1SA8



B1SA9



B1SA11

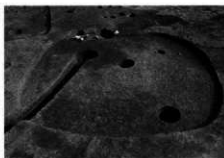

B1SA12



B1SA13カマド出土状況



B1SA13

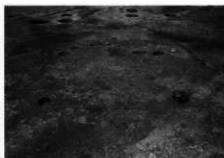

B1SA14



B1SA16カマド出土状況



B1SA16遺物出土状況



B1SA17



C1SA2カマド出土状況



C1S A2



C1S A3



C1S A4



C1S A4カマド



C1S A5カマド1出土状況

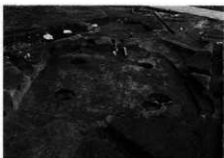

C1S A5完掘(カマド1)

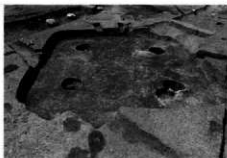

C1S A5完掘(カマド2)



C1S A5カマド2/3



C1S A6カマド出土状況

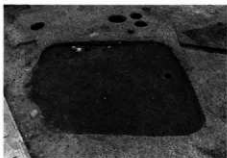

C1S A6



C1S A7



C1S A8カマド出土状況

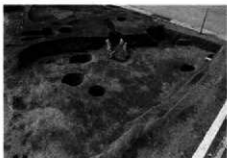

C1S A8



C1S A9カマド出土状況(1)



C1S A9カマド出土状況(2)



C1S A9遺物出土状況



C1S A9完掘



C1S A10カマド出土状況

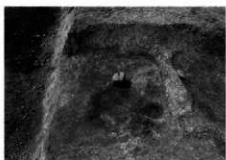

C1S A10カマド2



C1S A10 (左) / 14 (右)



C1S A11遺物出土状況 (1)



C1S A11遺物出土状況 (2)



C1S A11カマド出土状況



C1S A11



C1S A12



C1S A13カマド出土状況



C1S A13カマド完掘



C1S A13 (1)



C1S A13 (2)



C1S A15

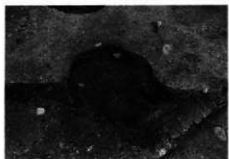

C①S A15カマF1



C①S A15カマF2



C①S A16カマF出土状況

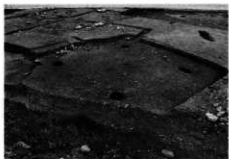

C①S A16



C①S A16カマF1土製支脚出土状況



C①S A16遺物出土状況



C①S A17

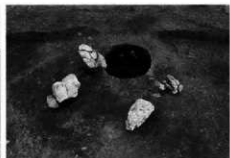

C①S A18カマF出土状況



C①S A18



C①S A19カマF出土状況



C①S A19

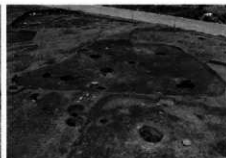

C①S A20



C①S A21カマF出土状況



C①S A21



C①S A22

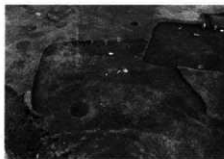

C1S A23



C1S A24カマド出土状況



C1S A24 (外) / 27 (内)



C1S A25カマド出土状況



C1S A25

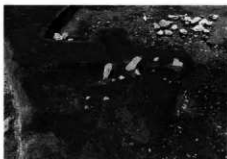

C1S A26



C1S A28カマド内土器出土状況



C1S A28



C1S A28カマド



C1S A29



55S B1



C1S K76



12S D2



23S D1 (右) / 2 (左)



34S D2



46① S D2



49① S D1



52② S D1



55① S D2 (手前) / 3 (奥)



D① S D1



D① S D2



E① S D17



62① S X3



26① S B2



39① S B1 / SH1



54① S B1



C① S B1

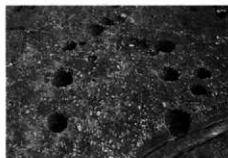

33① S H1

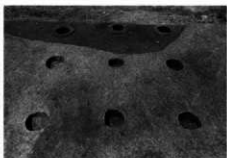

52① S H1 / 2



53① S K1



53①S J1



16①S D1



53①S D1 (右) / 2 (左)



40①S E1/2

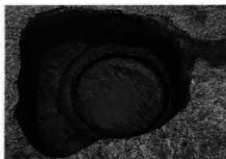

14①S E1



52①S E1



70①S E1

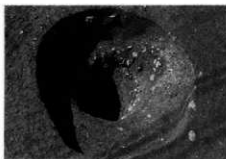

B①S E1



B①S E2

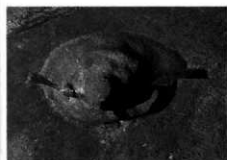

B①S E4

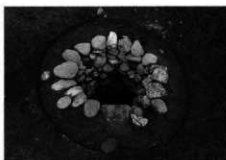

B①S E5

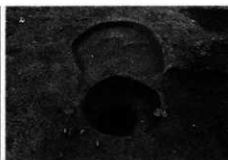

B①S E6



C①S U3石組み検出状況



C①S U3石組み完了



C①S U3断面

写真図版32 縄文時代中期の遺物 (1)

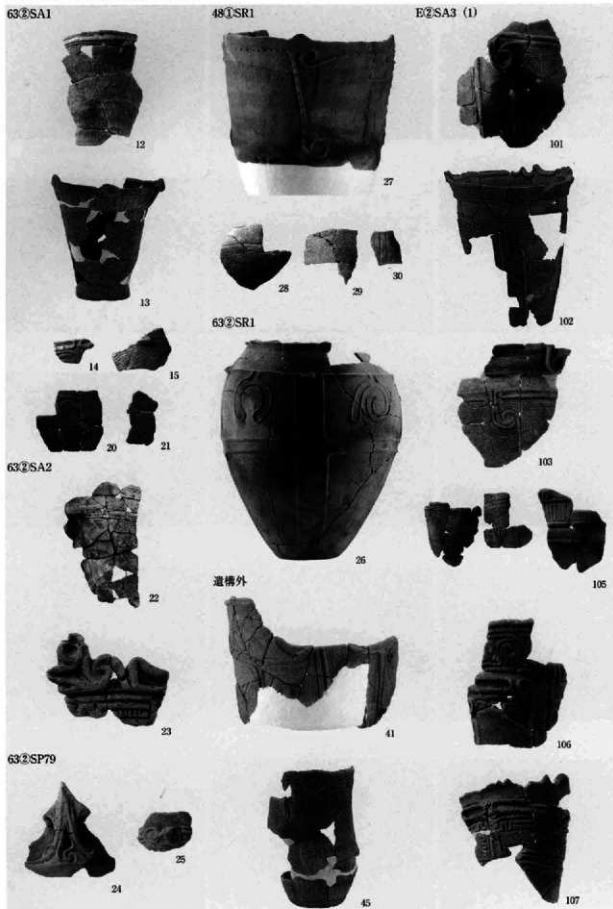

写真図版33 縄文時代中期の遺物 (2)

E2SA3 (2)

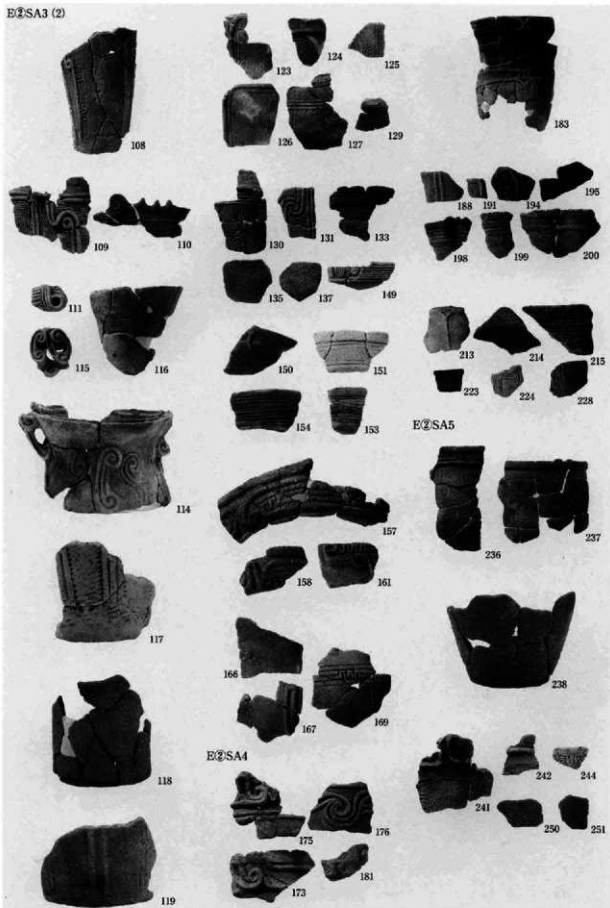

E2SA6



E2SK9



E2SJ1



E2SJ2



E2SJ3



E2SR1



E2SR2



E2SN1



写真図版35 縄文時代中期の遺物 (4)

石製品 (1)

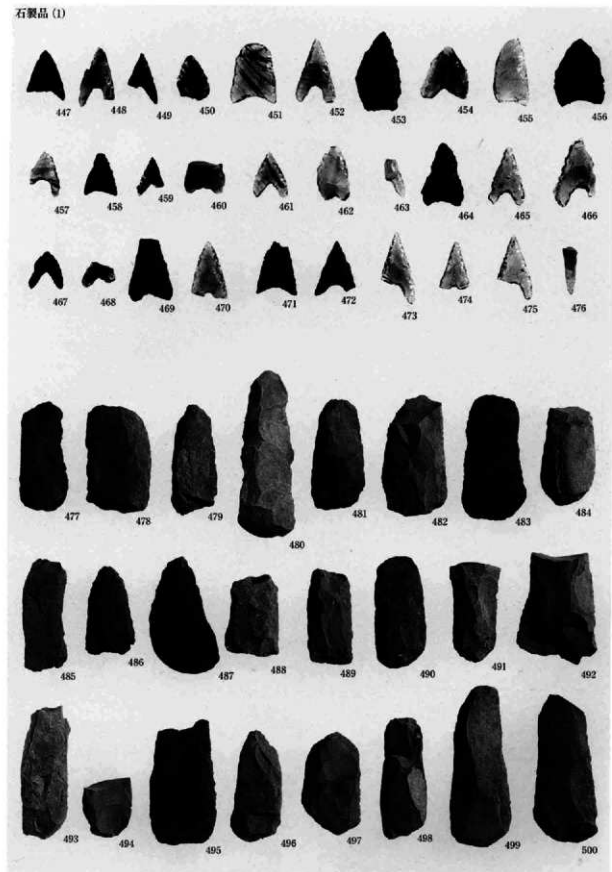

写真図版36 縄文時代中期の遺物 (5)

石製品 (2)

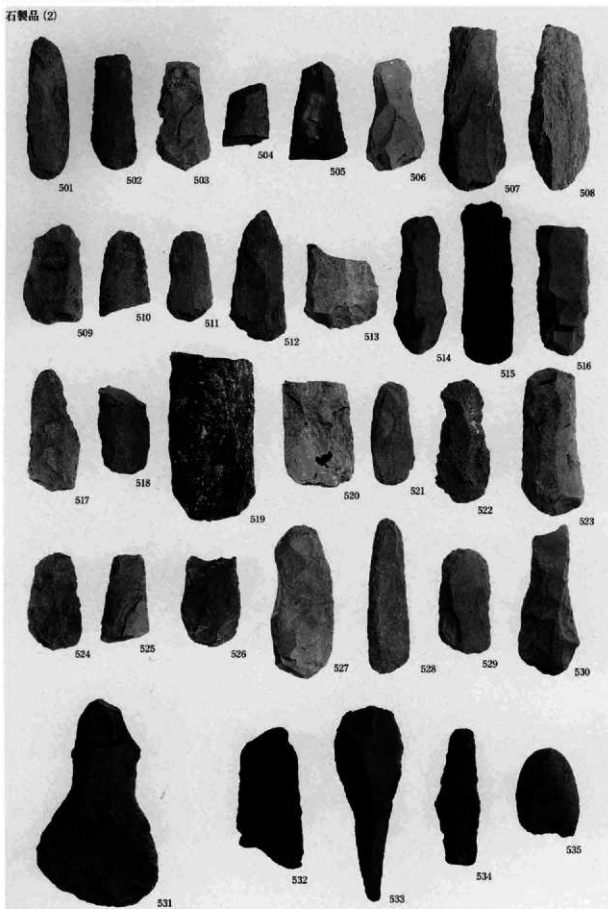

写真図版37 縄文時代中期の遺物 (6)

石製品 (3)

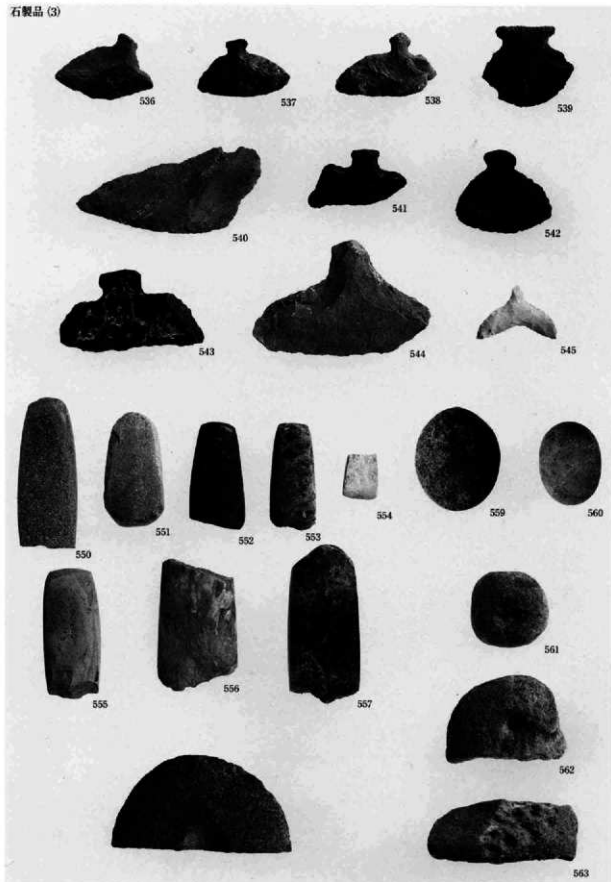

石製品 (4)

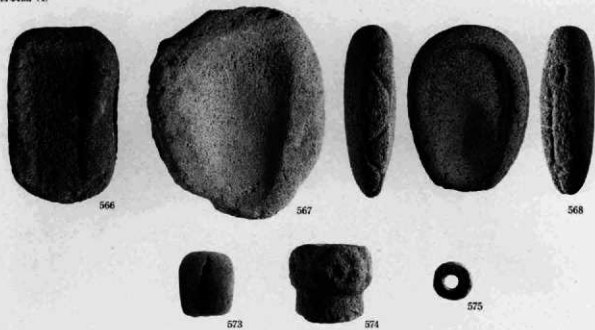

土製品



31①SA2



397

53②SA11



711



32①SA1



662



712



664



715



665



728



666



729

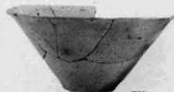

731



733

75.1SA1



755



810



817



765



811



818

C2SA20



807



815

E1SA1



824



808



827



809



816



828



829

写真図版41 弥生時代中期の遺物 (3)

石製品 (1)

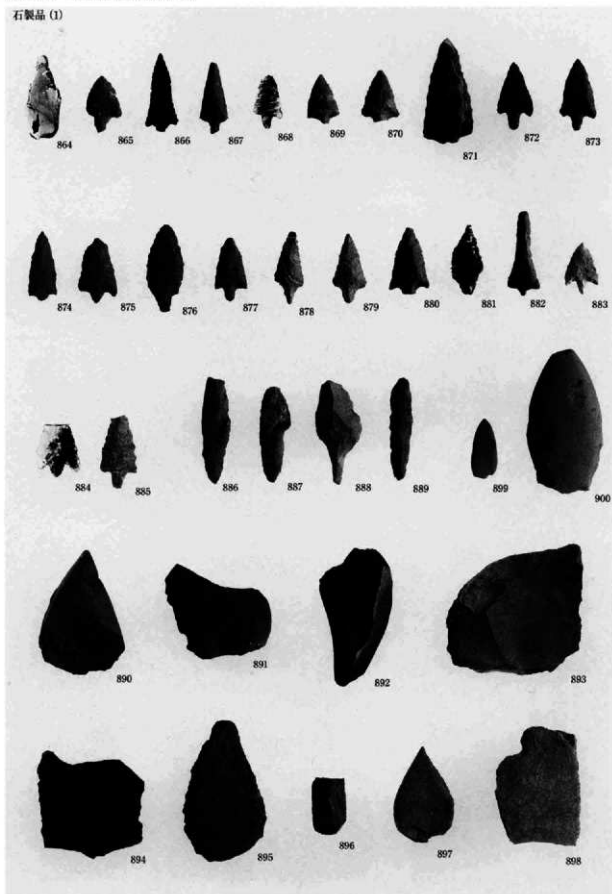

写真図版42 弥生時代中期の遺物 (4)

石製品 (2)

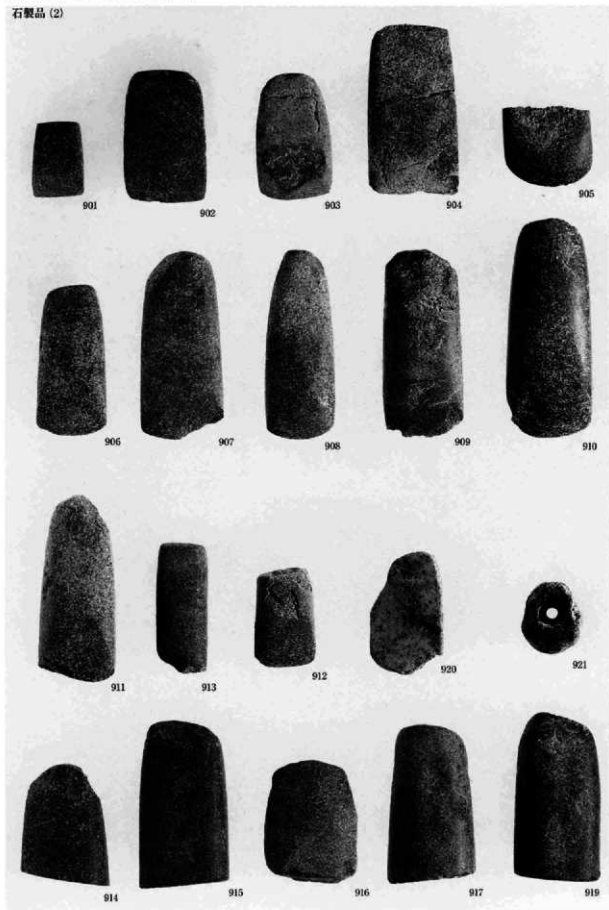

土製品

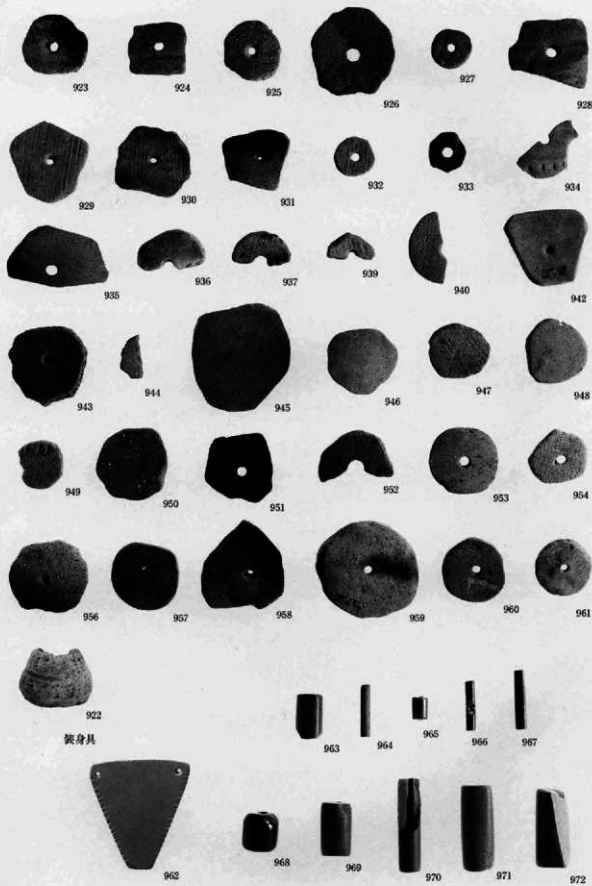

50㉔SA4



1002



1004



1006

50㉔SA7



1015



1016



1017



1026

51㉔SA2



1033



1060



1061

56㉔SA3



1084



1113



1116

78㉔SA2 (1)



1169



1170



1171

写真図版45 弥生時代後期の遺物 (2)

781SA2 (2)

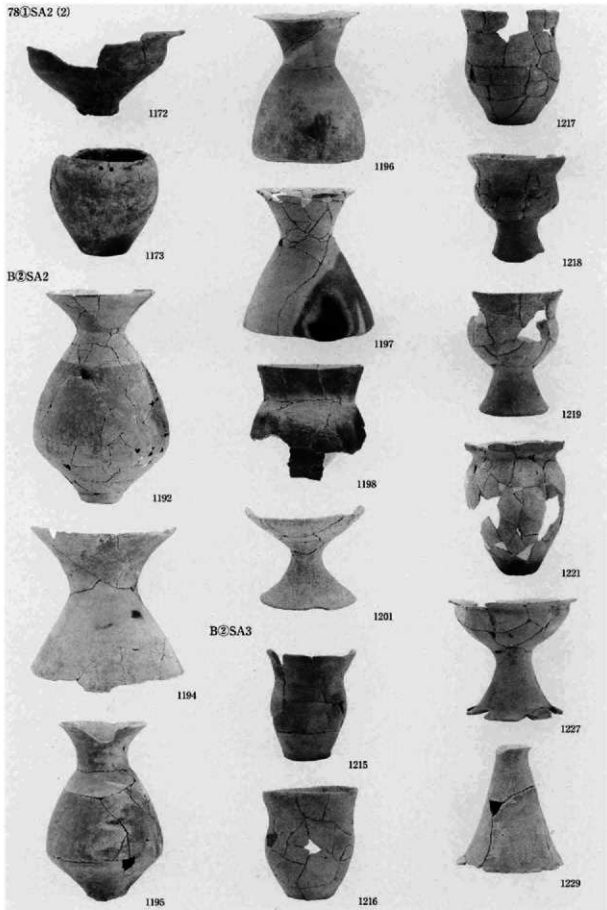

B2SA7



1233



1246



1259



1234



1247



1262

B2SA8



1235



1248



1263



1239



1252



1265

B2SA9 (1)



1240



1257



1270



1243



1258



1271

写真図版47 弥生時代後期の遺物 (4)

B②SA9 (2)



B②SA18

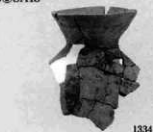

C②SA11



C②SA12 (1)



C2SA12 (2)

64ISJ1



1518



1471



1514



1519



1474



1515



1520

25ISJ1



1512

19ISDZ1



1521

50SK4



1516

48ISDZ5



1529

48ISJ7



1513

4ISDZ1



1517

62ISX4



1540

石製品

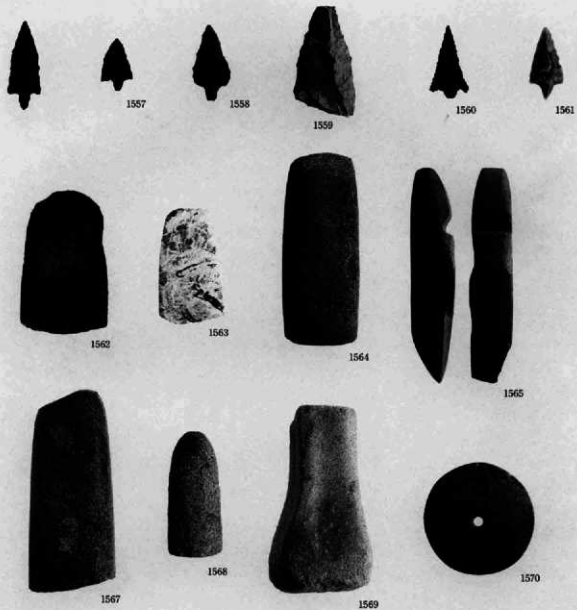

土製品

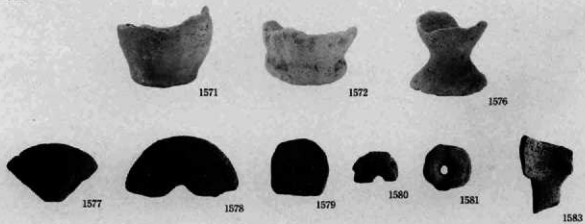

装身具

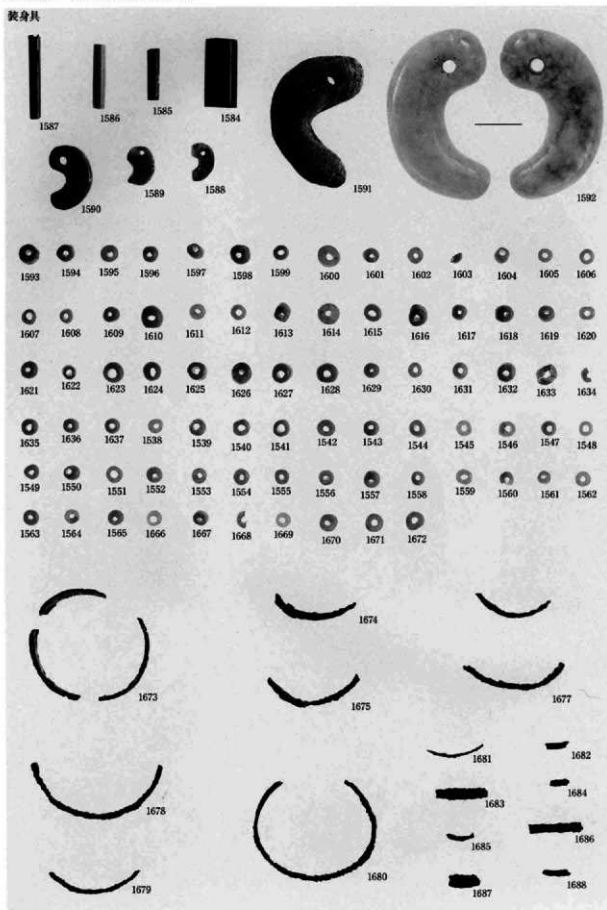

写真図版51 古墳時代前期～中期の遺物 (1)

6①SA1



1699



1700



1697

34①SA3



1705



1706

61①SA9



1747

63①SA1



1749



1750



1755



1757

79①SA5



1758



C①SA30 (1)



1969



1766



1771



1773



1779



1781

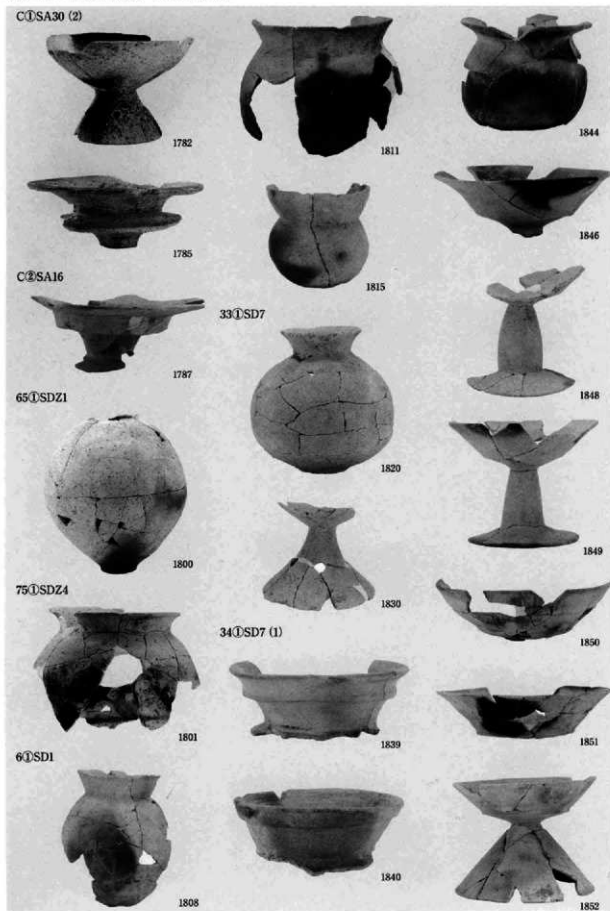

34①SD7 (2)

75①SX1



1854



1853



1858



1859



1887



1888



1889



1890

C①SX1



1901

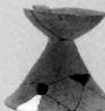

1902



1903

土製品



1917



1919



1920



1921



1922

装身具



1925



1926



1927



1928



1929



1930



1931



1924

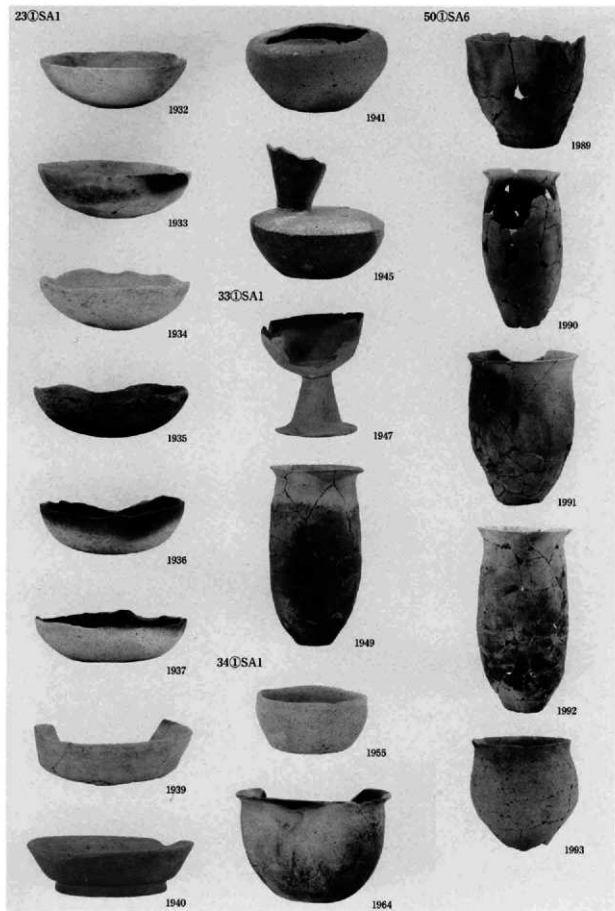

写真図版55 古墳時代後期の遺物 (2)

53①SA3



2013

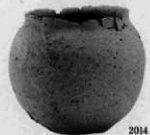

2014



2015



2016



2017



2019



2020



2058



2061



2126



2127



2128



2129



2135



2136



2137

56①SA4

79①SA6

B \odot SA5



2151



2154



2155



2157



2159



2160



2161

B \odot SA11



2181



2182

B \odot SA16



2193



2194



2195



2196



2206



2207



2208



2209

C \odot SA2 (1)



2213

写真図版57 古墳時代後期の遺物 (4)

C1SA2 (2)

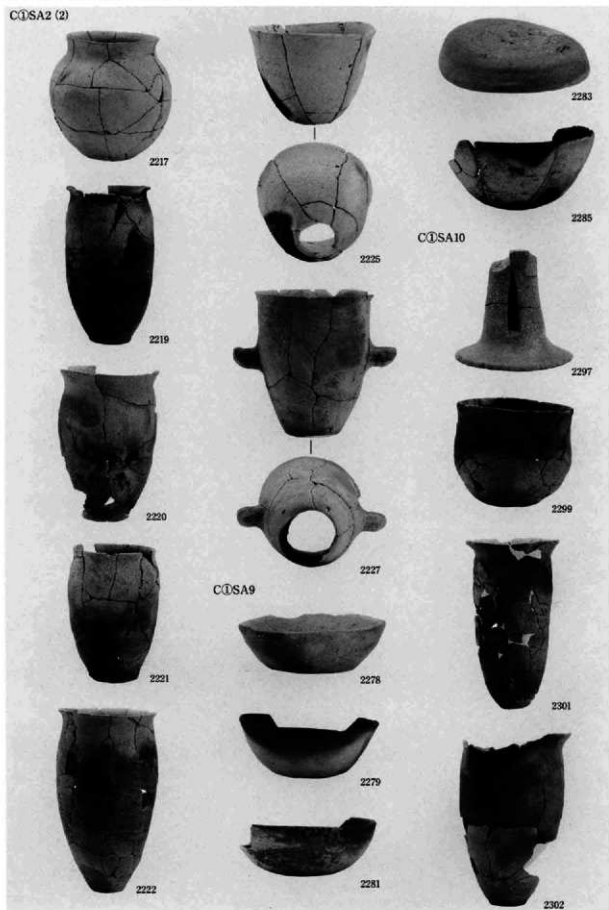

CQSA11



2303



2304



2305



2312



2314



2316

CQSA13



2323



2322



2329



2331



2339



2341



2346



2347

CQSA16 (1)



2355



2359

CISA16 (2)



2362



2368



2401



2363



2369



2402



2364

CISA19



2393

CISA21 (1)



2405



2365



2394



2406



2366



2395



2408



2367



2397



2409

CISA21 (2)



2410



2419



2450



2411



2453



2414



2454



2413



2418

CISA25



2455



2446



2415



2447



2456



2449

写真図版61 古墳時代後期の遺物 (8)

34①SD2



2507



2538



2557



2524

55①SD3



2526

D①SD1



2532



2559

石製品



2607



2608



2609



2612



2610



2611



2613



2614



2615



2616

土製品



装身具



平安時代～中世の遺物

16①SD1



時期不明の遺物

石製品



石製品

装身具



長野市の埋蔵文化財第105集

浅川扇状地遺跡群
檀田遺跡（2）

長野市檀田土地区画整理事業
（仮称）西友檀田店店舗建設工事
アクロスプラザ長野北建設工事
にともなう埋蔵文化財発掘調査報告書
第2分冊（図版編）

平成16年3月18日 印刷

平成16年3月22日 発行

編集 長野市教育委員会
発行 文化財課埋蔵文化財センター
印刷 信毎書籍印刷株式会社