

豆腐町遺跡

—中播都市計画事業姫路駅周辺土地区画整理事業に伴う発掘調査報告書Ⅱ—

(図版編)

2022

姫路市教育委員会

遺物 図 版



1次1区 SK01出土遺物(1)

遺物図版 2



1次1区 SK01出土遺物(2)

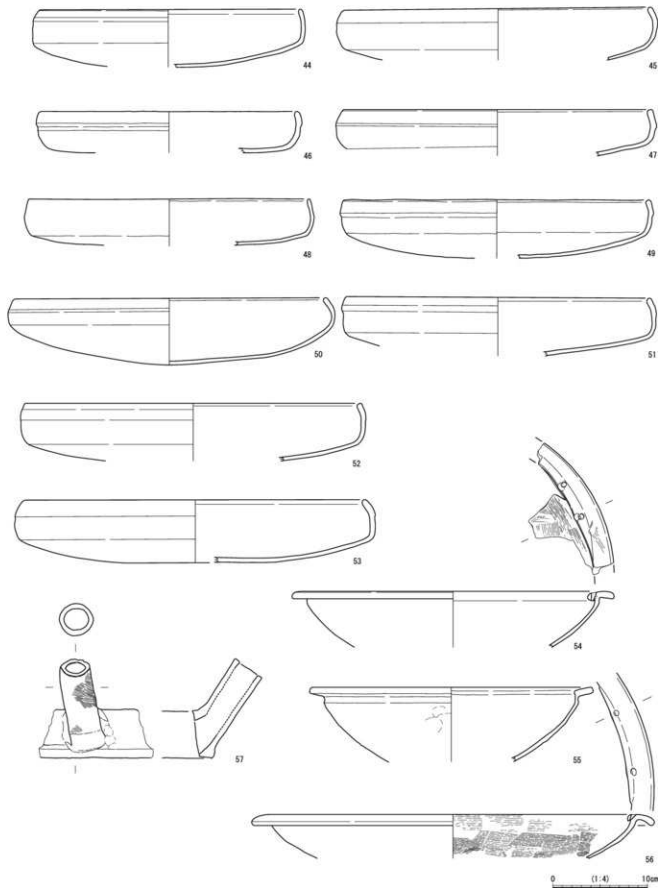

1次1区 SK01出土遺物(3)

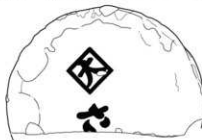
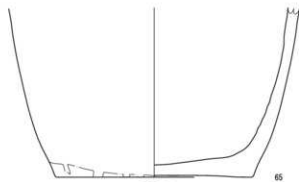
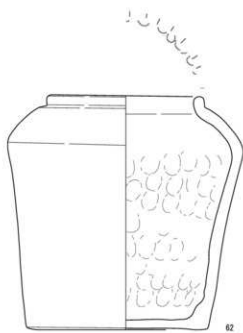
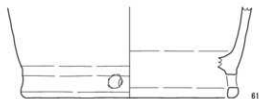
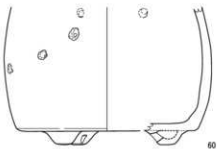
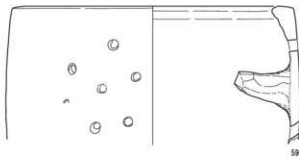
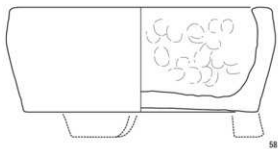

0 (1:4) 10cm

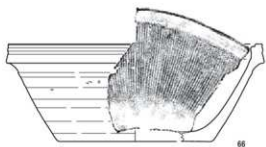

66

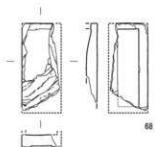

68

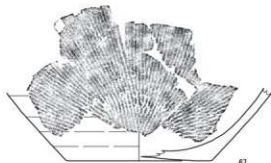

67



69



70

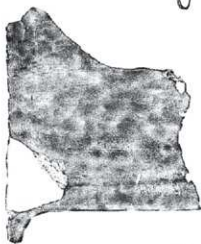

72

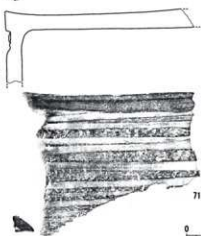

71



73

0 (1:4) 10cm

0 (1:1) 2cm

1次1区 SK01出土遺物(5)

遺物図版 6

SK03

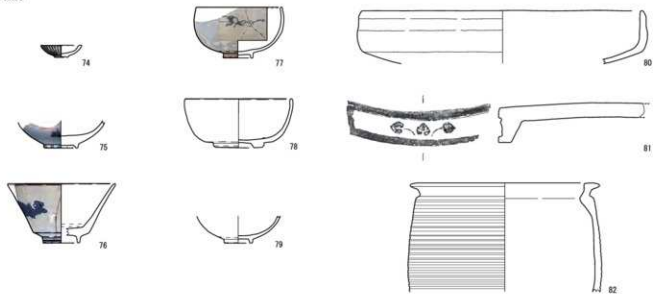

SK04

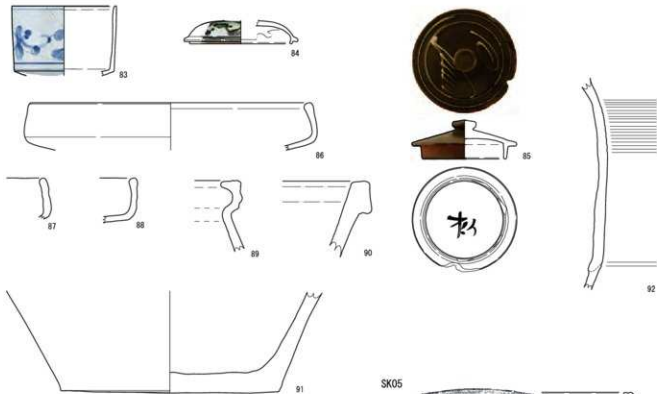

SK02



SK05

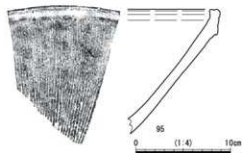

1次1区 SK02・SK03・SK04・SK05出土遺物

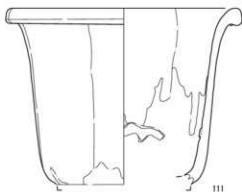
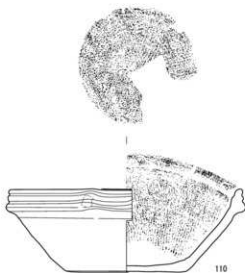
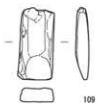
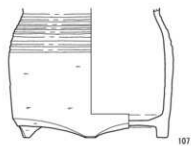
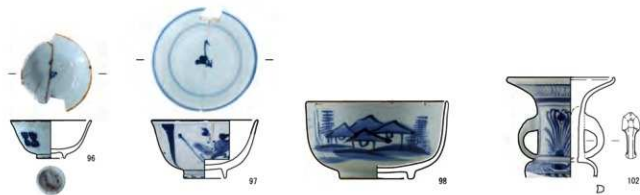

0 (1:4) 10cm

1次1区 SK08出土遺物

遗物图版 8

SK09



112



113



115



116



114

SK39



117

SK40

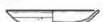

118



119



120



121



124



125



122



123



126

SX01



127



128



129



130



134



127



128



133



131



132



135



136

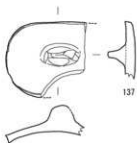

137



138

0 (1:4) 10cm

1次1区 SK09・SK39・SK40、SX01出土遺物



1次2区 SP05 · SP40 · SP69 · SK13 · SK19 · SK31 · SK34 · SK35出土遗物

遺物図版 10

SK17



1次2区 SK17出土遺物



1次2区 SK38出土遺物(1)



199
(87)



200



201



202



203



206

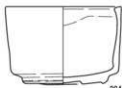

204



205



207



208

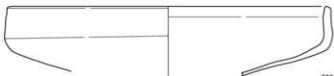

209

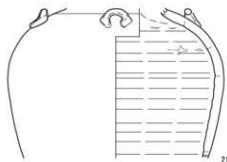

211

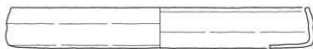

210

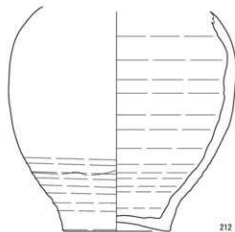

212



213

0 (1:4) 10cm

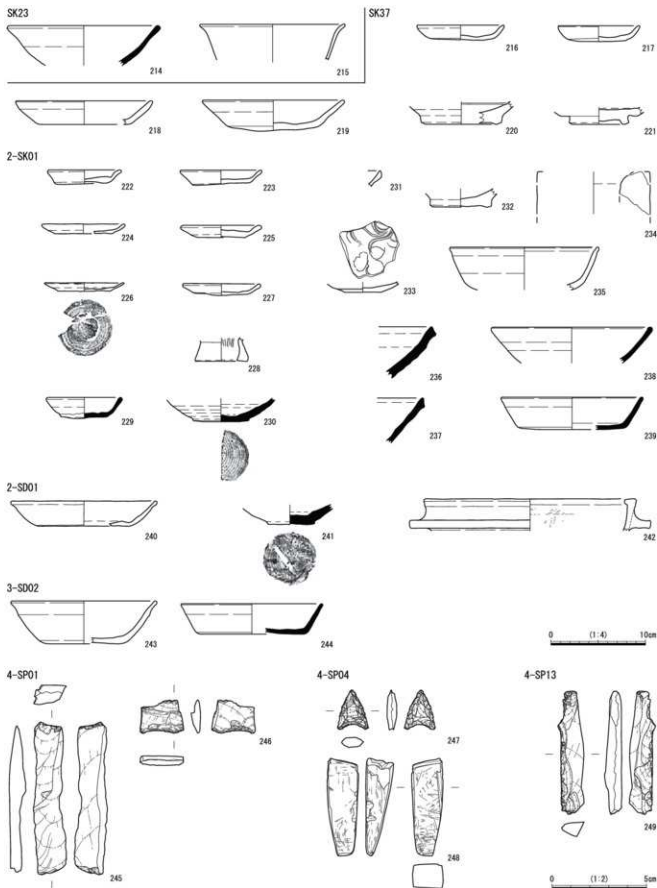

1次2区 SK23・SK37・2-SK01、2-SD01・3-SD02、4-SP01・4-SP04・4-SP13出土遺物

遺物図版 14

SE01



250

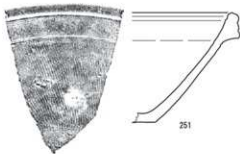

251

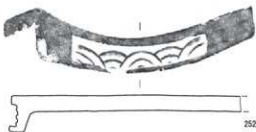

252

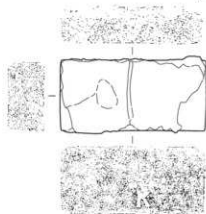

255

0 (1:6) 10cm



253

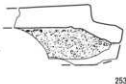

254



SE02



256



257

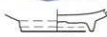

258



SE03



259



260



261



262

SE04



263



264

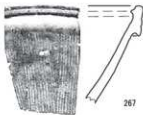

267

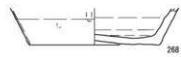

268



265

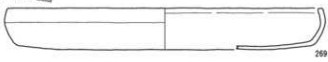

269



266

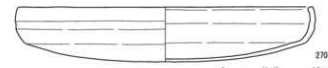

270

0 (1:4) 10cm

2次3区 SE01・SE02・SE03・SE04出土遺物

SF01



271

SF03



272



273



274



SK01



275



276

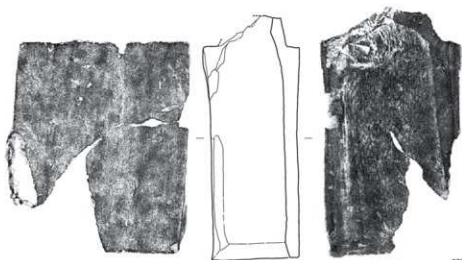

277



SK02



278



280

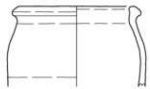

281



279



282



283

SK04



284



285



286

0 (1/4) 10cm

2次3区 SF01・SF03・SK01・SK02・SK04出土遺物

遺物図版 16

SK05

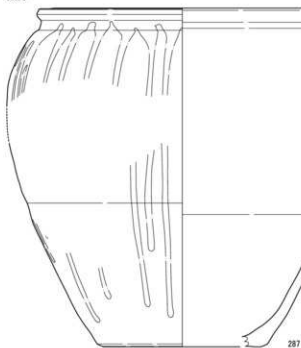

SK07

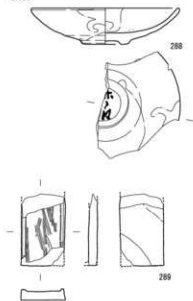

SK09

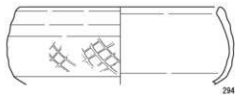

SK15

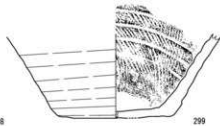
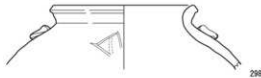
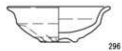
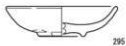

SK16



SK19



0 (1:4) 10cm

2次3区 SK05・SK07・SK09・SK15・SK16・SK19出土遺物

SP12



302

SP13

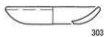

303

SP15



304

SX01

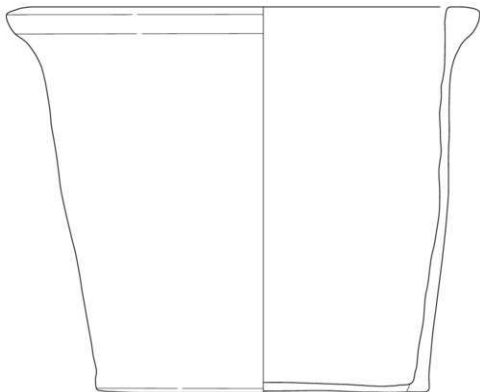

305

2-SK01



306



307



310



311

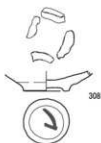

308



309



312

2-SK02



313

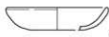

314

0 (1:4) 10cm

2次3区 SP12・SP13・SP15、SX01、2-SK01・2-SK02出土遺物

遺物図版 18

2-SP01

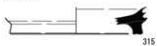

2-SP03



2-SP05

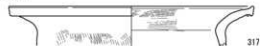

2-SP20



2-SP23



2-SP73



2-SP100



2-SP21



2-SP24



3-SP05



遺構に伴わない遺物



0 (1:2) 5cm

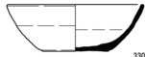
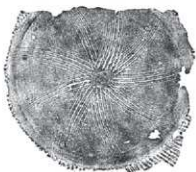

0 (1:4) 10cm

2次3区 2-SP01・2-SP03・2-SP05・2-SP20・2-SP21・2-SP23・2-SP24・2-SP73・2-SP100・3-SP05出土遺物、遺構に伴わない遺物

SX01



SX09

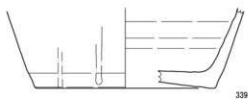

SX10

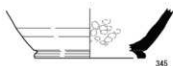
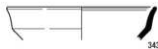
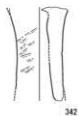
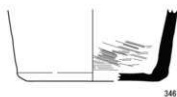
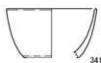

SX13

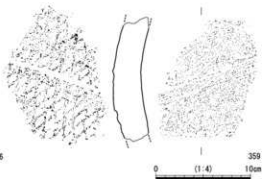
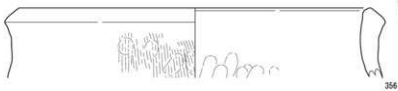
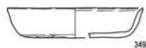
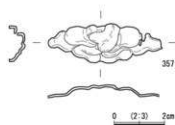

3次1区 SX01・SX09・SX10・SX13出土遺物

遺物図版 20

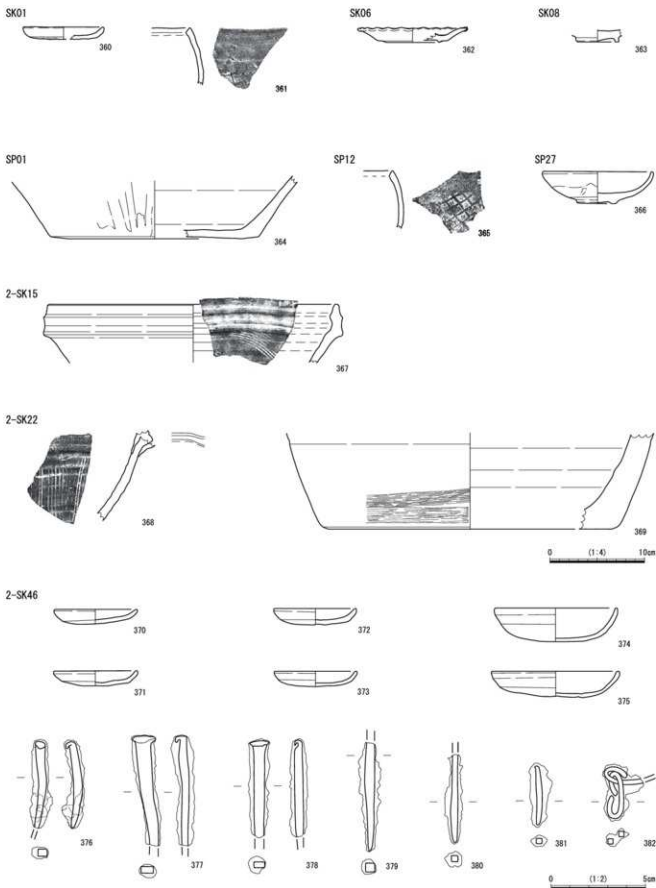

3次3区 SK01・SK06・SK08、SP01・SP12・SP27、2-SK15・2-SK22・2-SK46出土遺物

2-SK48

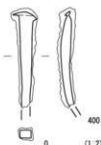
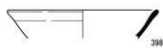
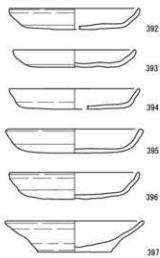
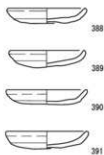
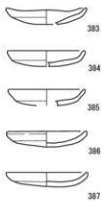

3-SD01

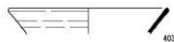

3-SP53

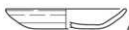

3-SP86



遺構に伴わない遺物

1区

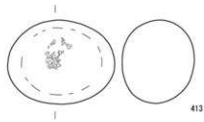
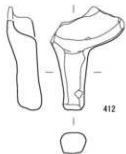
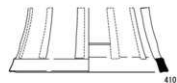
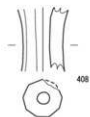

3区



3次3区 2-SK48、3-SD01、3-SP53・3-SP86出土遺物、遺構に伴わない遺物

遺物図版 22

煉瓦構造物



417



418

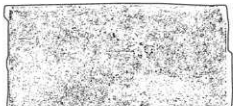

419

0 (1:4) 10cm

SX01



420



421

SK11

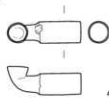

422

0 (1:2) 5cm

SK22



424

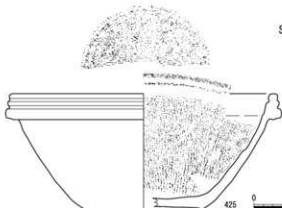

425

0 (1:4) 10cm

SK09



423

0 (1:2) 5cm

4次 煉瓦構造物、SX01、SK09・SK11・SK22出土遺物

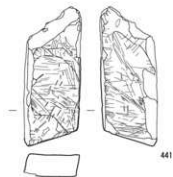
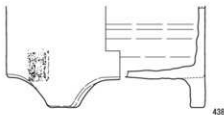
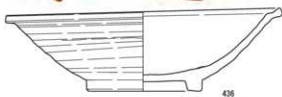
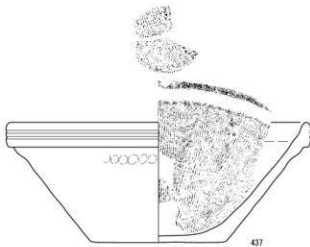
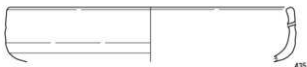
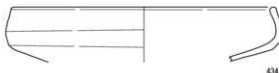
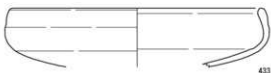
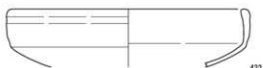
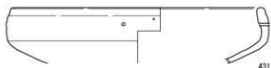

0 (1:4) 10cm

4次 SK03出土遺物

遺物図版 24

SK04



442



443



444



445

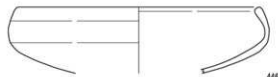

446

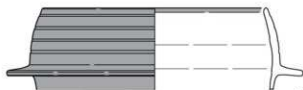

447

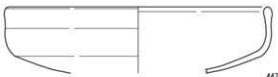

448

0 (1-4) 10cm



449

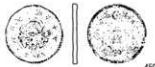

450

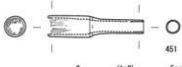

451

0 (1-2) 5cm

SK05



452



453



454



455



456

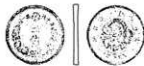

457

0 (1-2) 5cm

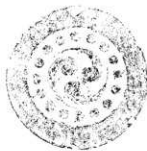

458



459



460

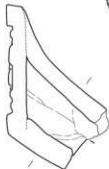

461



462



463

0 (1-4) 10cm

4次 SK04・SK05出土遺物

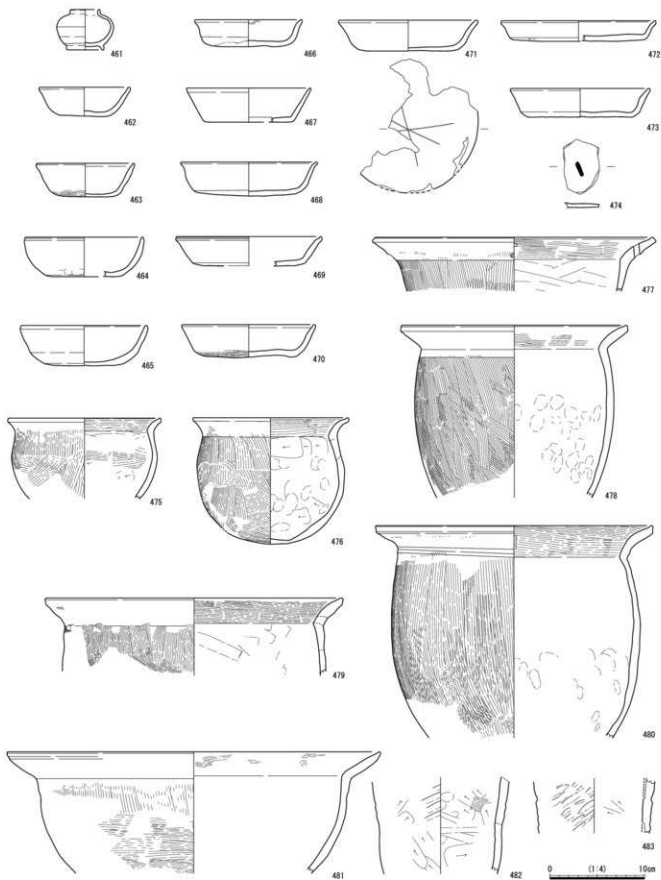

4次 SE01出土遺物(1)

遺物図版 26

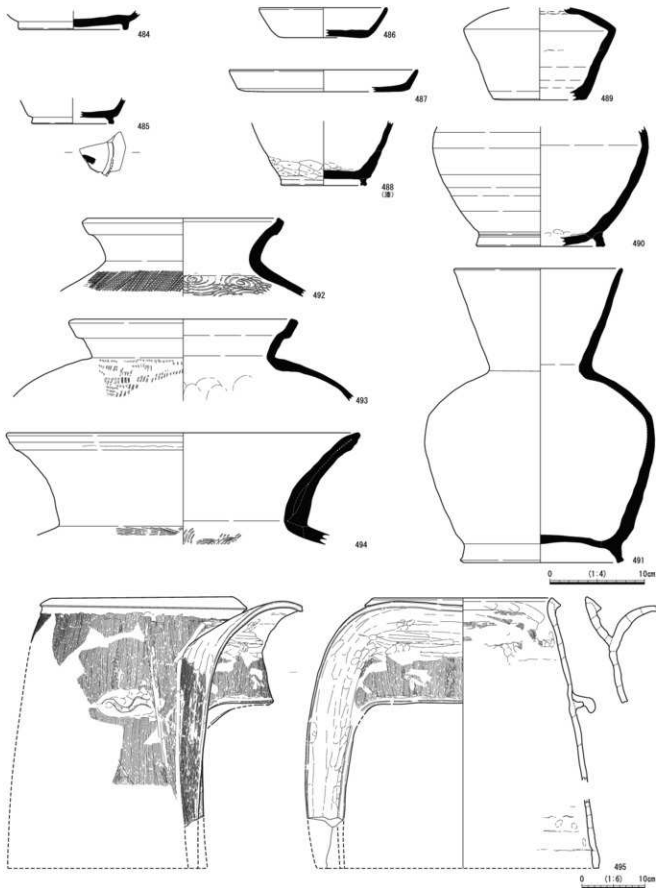

4次 SE01出土遺物(2)

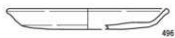

496

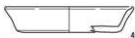

499
(原)



503



497

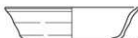

500



504
(原)

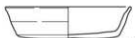

501



505
(原)



498



502



506
(原)



507



508

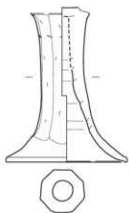

509

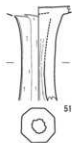

510

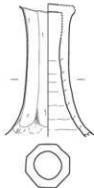

511

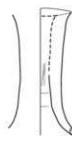

512

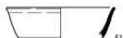

513

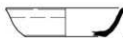

514



519



515



517

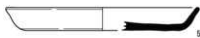

516



518



520

0 (1:4) 19cm

4次 SE02出土遺物(1)



521

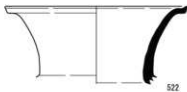

522

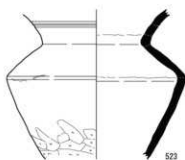

523

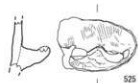

525



526

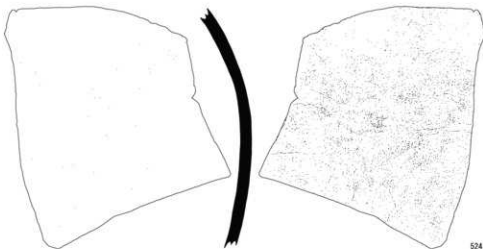

524



527

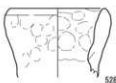

528



529



530



531

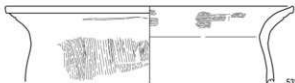

532



533

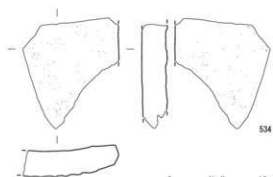

534

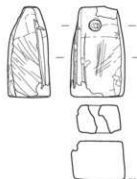

535

0 (1:4) 10cm

0 (1:2) 5cm

4次 SE02出土遺物(2)

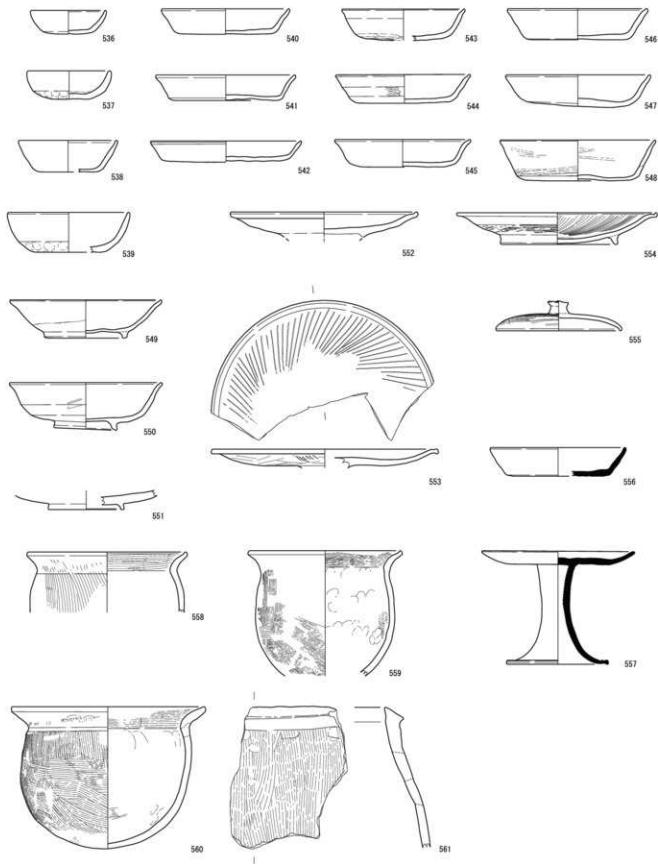

4次 SK52出土遺物(1)

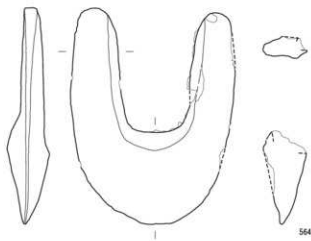
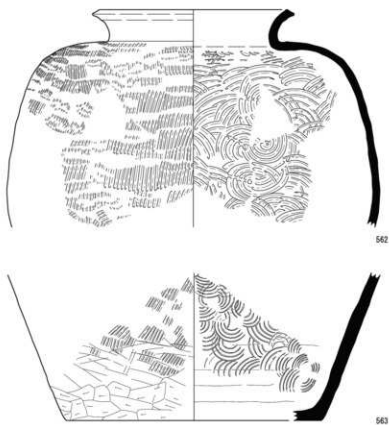

0 (1:4) 10cm

4次 SK52出土遺物(2)

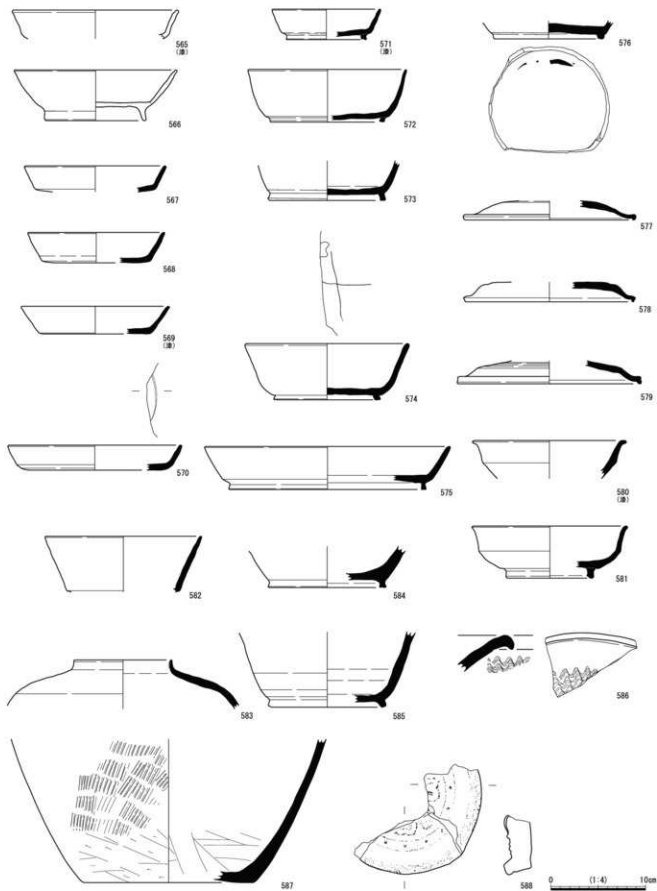

4次 SR01出土遺物

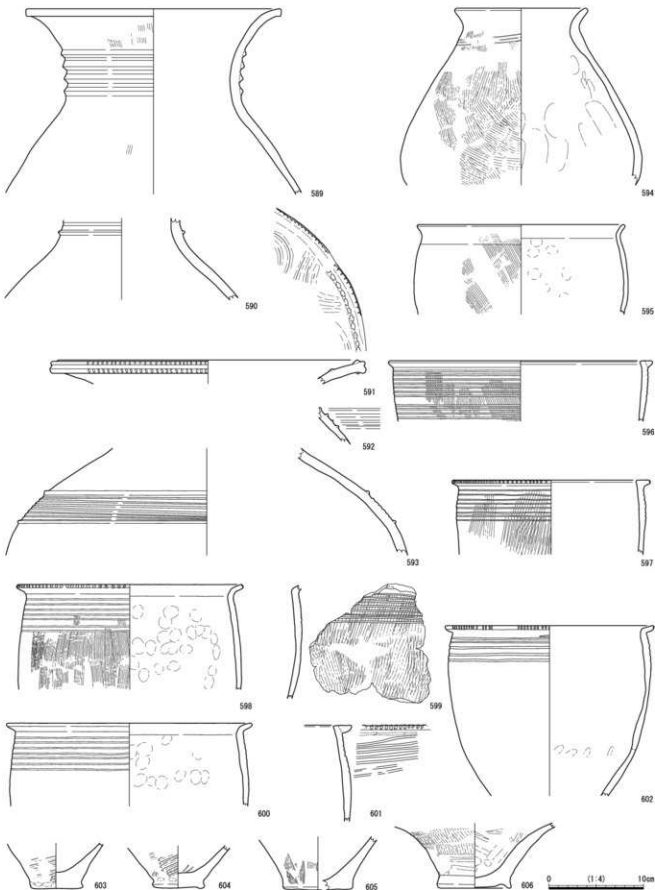

4次 下層SD01出土遺物

下層 SD01

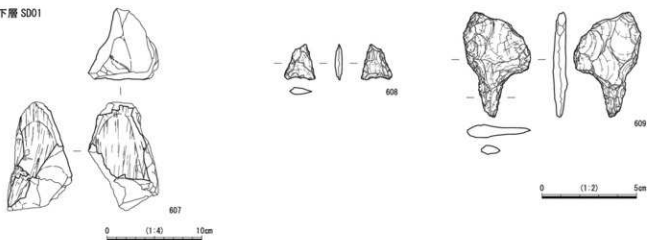

下層 SD02

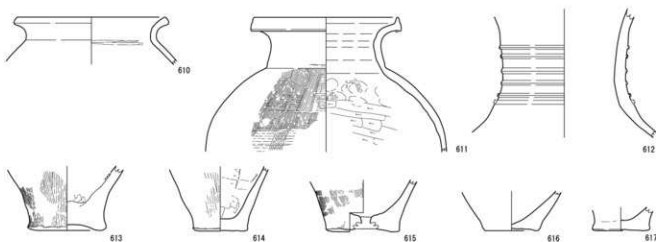

下層 SD03

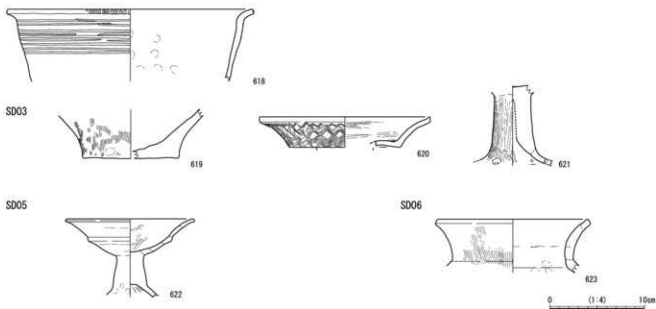

4次 下層SD01・下層SD02・下層SD03・SD03・SD05・SD06出土遺物

遗物图版 34

SK06

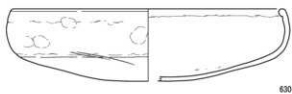
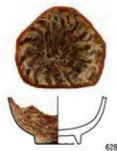

SK11



SK17

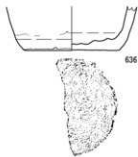
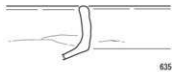

SK19

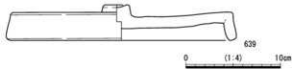

5次1区 SK06・SK11・SK17・SK19出土遺物

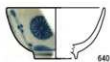

640



641



642

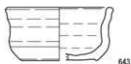

643

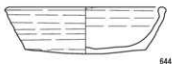

644

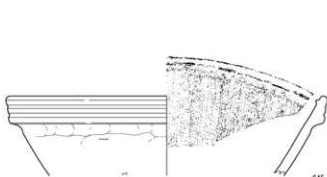

645

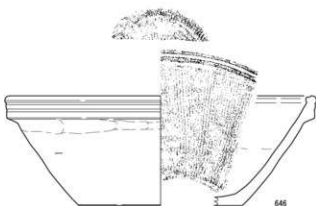

646



647

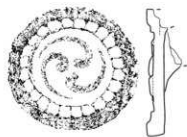

648

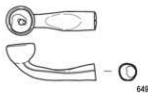

649



650

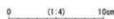

5次1区 SK14出土遺物



651



652



653



654



655

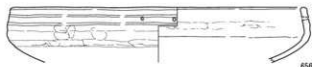

656

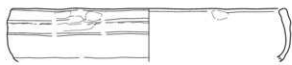

657

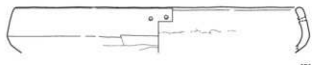

658



659

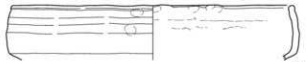

660

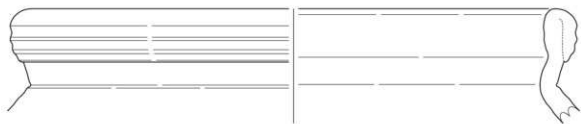

661



662



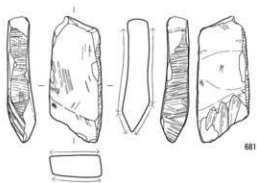
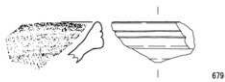
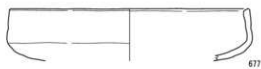
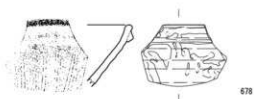
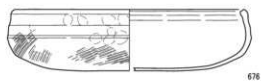
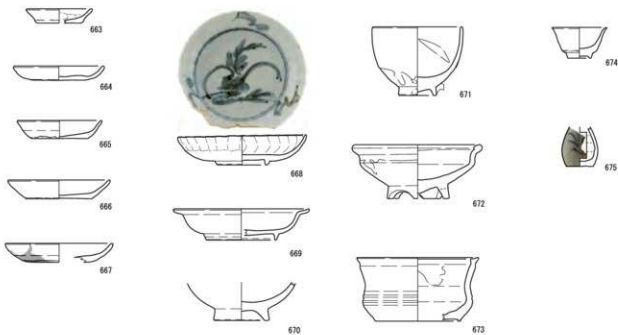

0 (1:1) 2cm

0 (1:4) 10cm

遺物図版 38

SK24



682



683



684



685



686



687



688



689



690



692

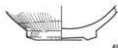

693

SK30



694



695



696



697



698



699



(87)



700



701



702



703



704



705



0 (1:4) 10cm

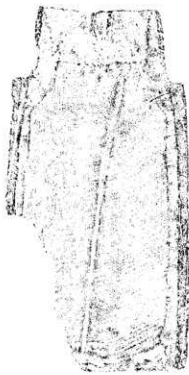
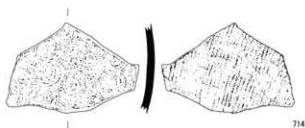
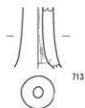
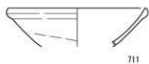
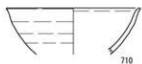
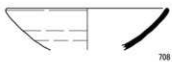

0 (1:4) 10cm

5次1区 SK30出土遺物

遺物図版 40

SE06



716
(KT)



718

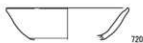

720



717



719



721

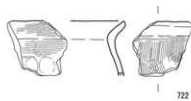

722



723

SK47



724

SP06



725

SP11



726

SP13



727

SP14

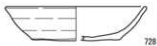

728

SP18



729

SP24



730

SP25



731

SP62



732

SP69



733

SP72

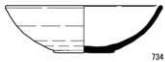

734

SP118

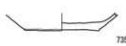

735

SP172



736

SP174

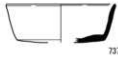

737

SP180

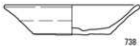

738

SP199



739

0 (1:4) 10cm

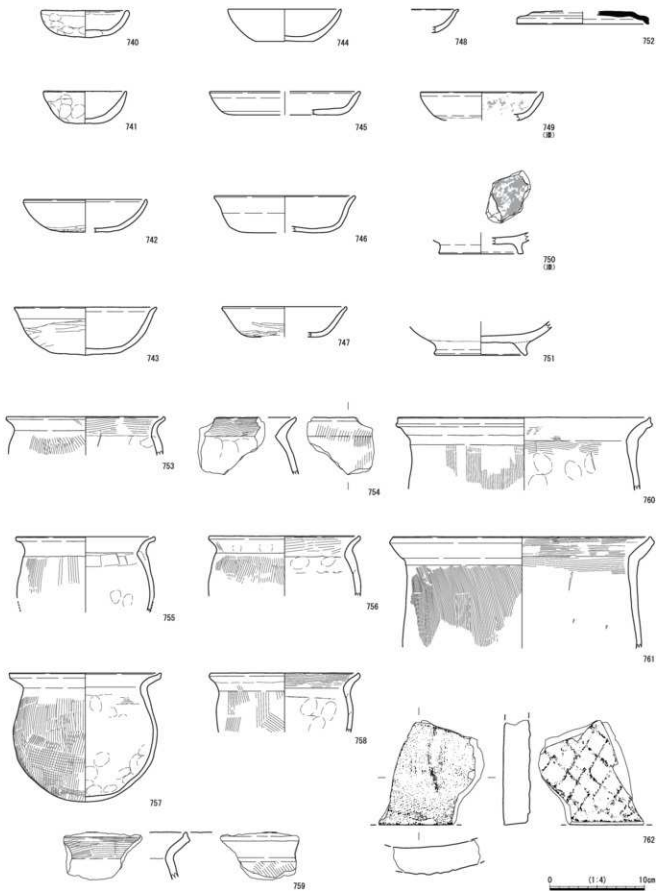

5次1区 SK52出土遺物

遺物図版 42

2-SK01

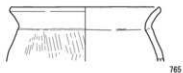

763

764
(47)

765

2-SK02



766

2-SK04

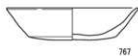

767

2-SK05

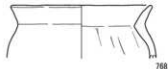

768

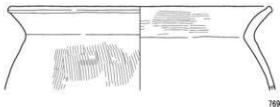

769

遺構に伴わない遺物



770



771

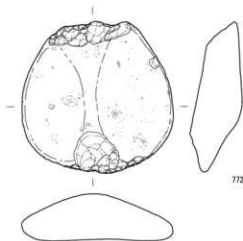

772

0 (1:4) 10cm

SD01

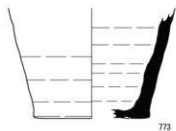

SK03



SK06



SK10



SK16

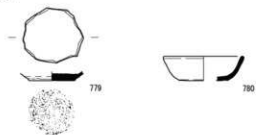

SK21



SP05



SP34

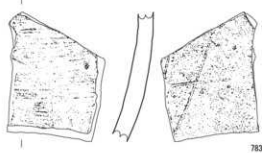

SP36



SP66



SP76

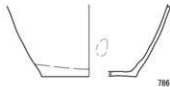

SP79



SP91

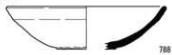

SP98



0 (1:4) 10cm

5次2区 SD01、SK03・SK06・SK10・SK16・SK21、SP05・SP34・SP36・SP66・SP76・SP79・SP91・SP98出土遺物

遺物図版 44

SP100



790

SP113



791

SP122



792

SP135



793

SP164



794

(正)

SP173



795

SP176



796

SP197



797



798



799

遺構に伴わない遺物



800



801



802



803



804

0 (1:2) 5cm



805

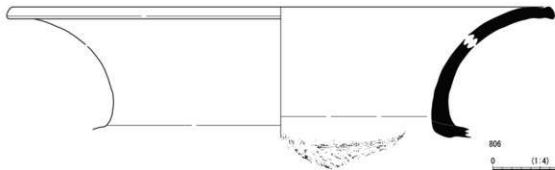

806

0 (1:4) 10cm

5次2区 SP100・SP113・SP122・SP135・SP164・SP173・SP176・SP197出土遺物。遺構に伴わない遺物



807



808



809

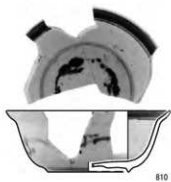

810



811

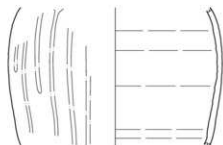

812

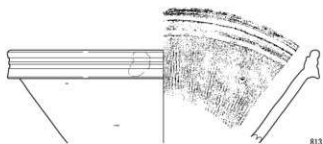

813

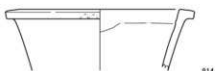

814



815

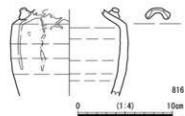

816

5次3区 SK01出土遺物

遺物図版 46

SK02

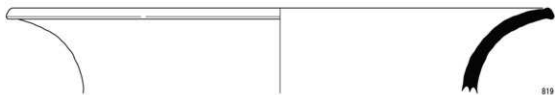
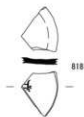

SR01

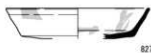
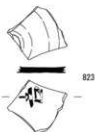
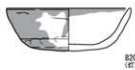

0 (1:4) 10cm

5次3区 SK02、SR01出土遺物(1)



836



837



838

(續)

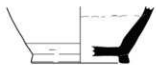

839

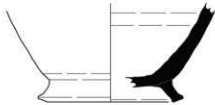

840

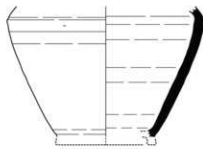

841



842



843

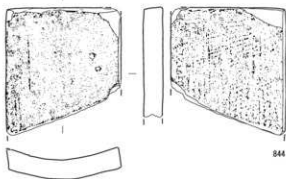

844

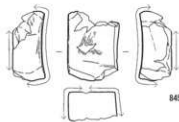

845

0 (1:4) 10cm

遺物図版 48

SR01

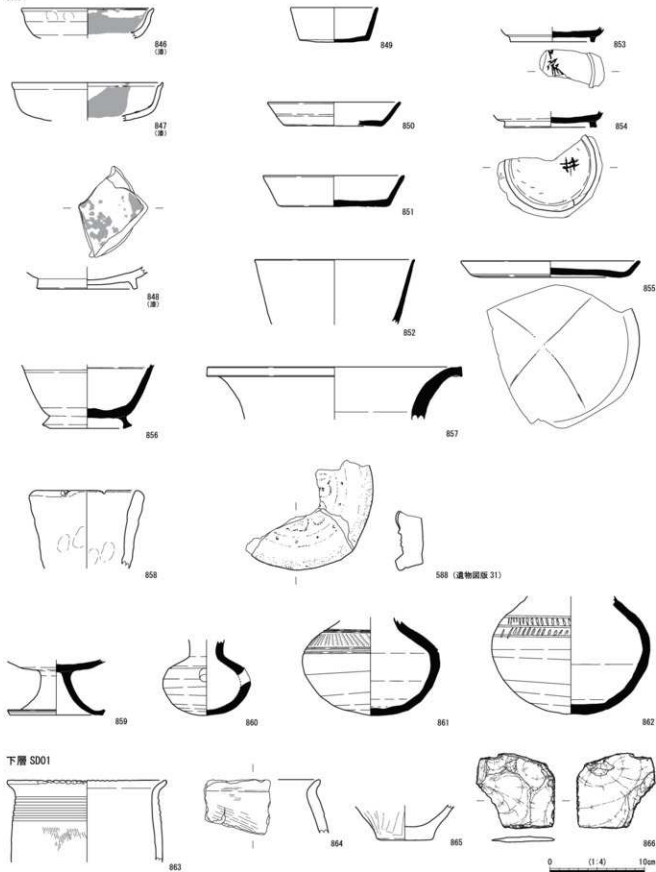

6次2区 SR01、下層SD01出土遺物

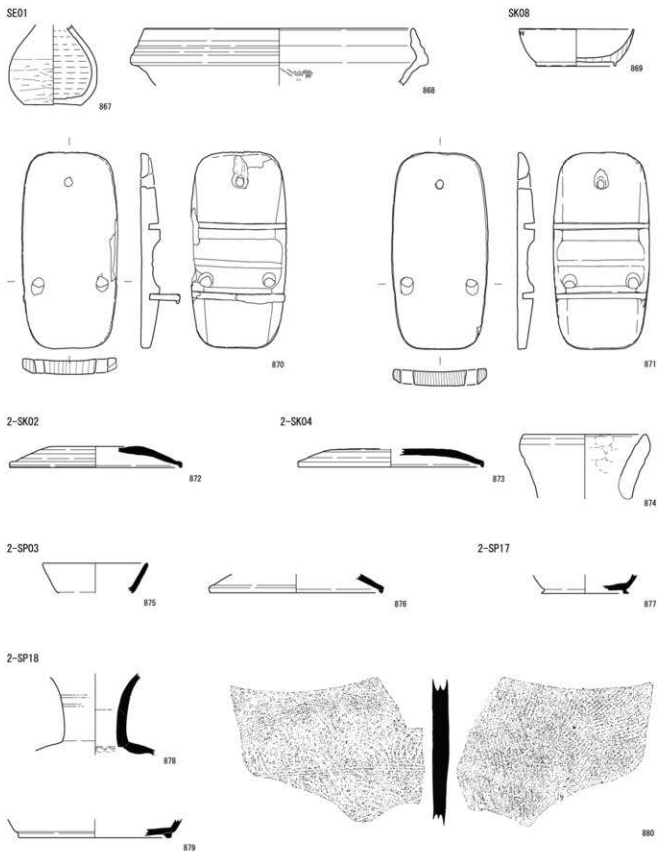

0 (1:4) 10cm

6次3区 SE01、SK08・2-SK02・2-SK04、2-SP03・2-SP17・2-SP18出土遺物

遺物図版 50

2-SP24

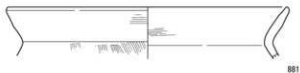

881

2-SP27

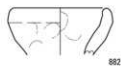

882

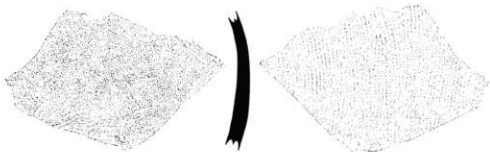

883

2-SP33



884

2-SP39



885

2-SP41



886

2-SP43



887

2-SP45



888

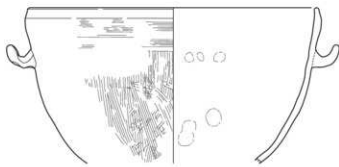

889

2-SD03

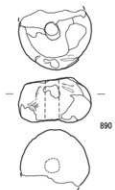

890

3-SK01



891

0 (1:4) 10cm

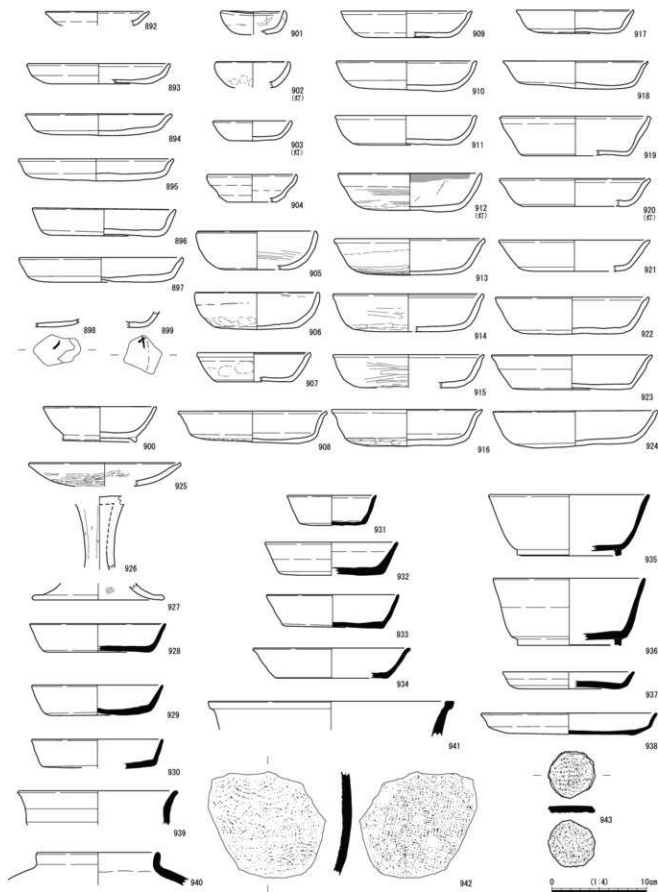

6次3区 2-SD01出土遺物(1)

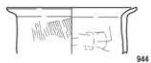

944

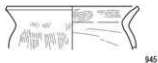

945

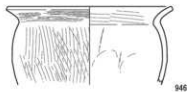

946

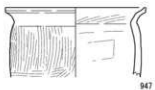

947

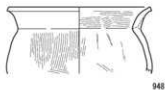

948



949

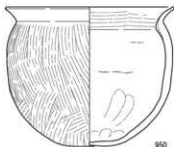

950

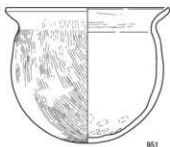

951

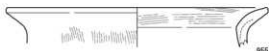

955

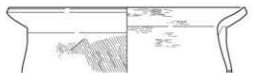

956

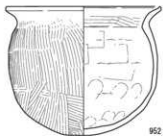

952



953

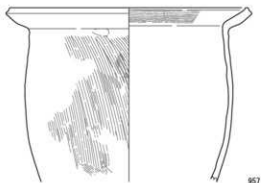

957

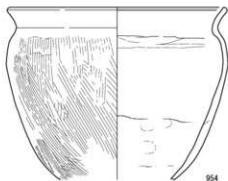

954

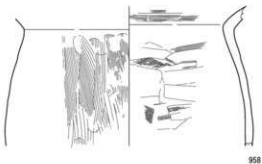

958

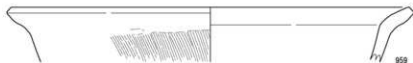

959

0 (1:4) 10cm

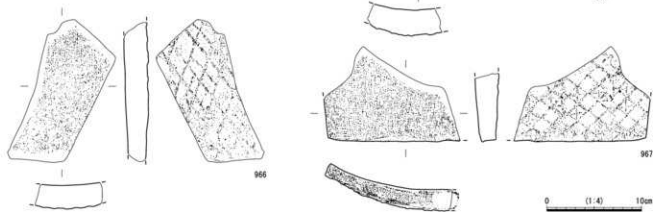
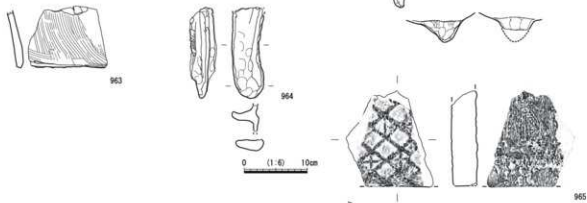
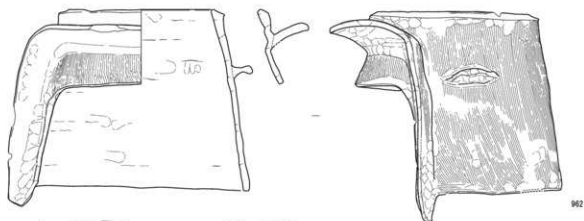
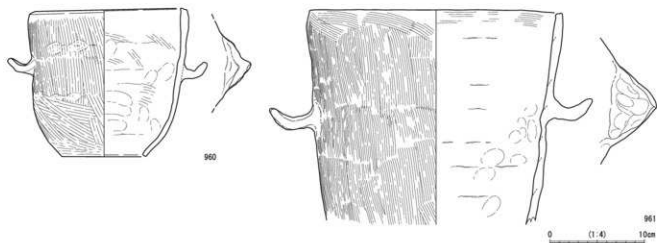

6次3区 2-SD01出土遺物(3)

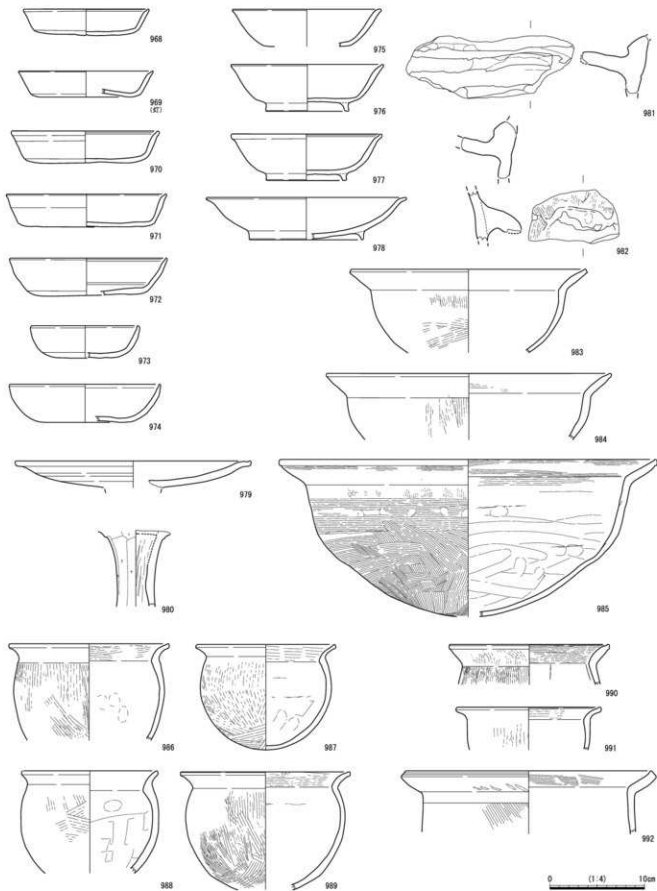

6次3区 2-SD02出土遺物(1)

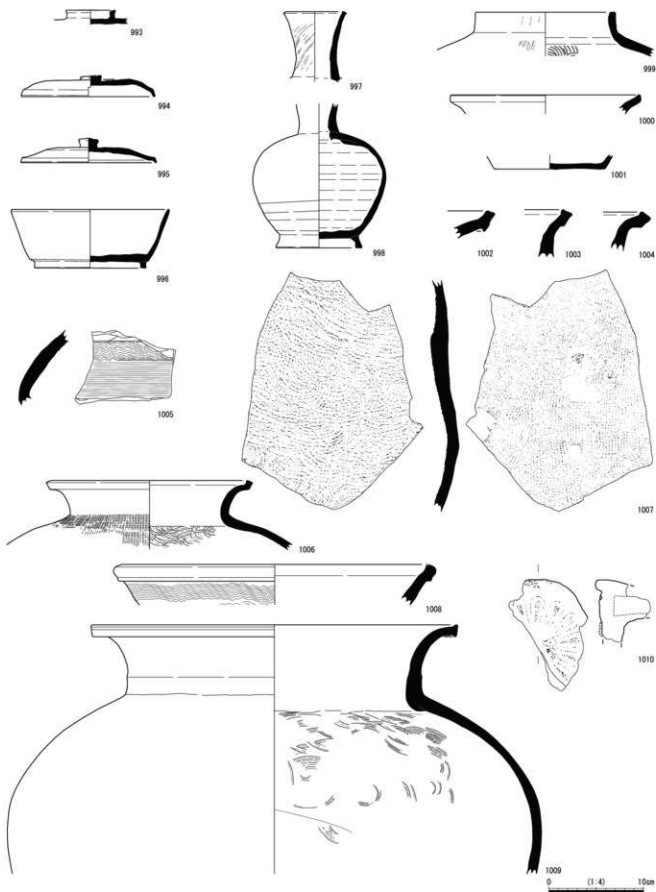

6次3区 2-SD02出土遺物(2)

遺物図版 56

SE01



1011

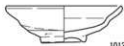

1012

SK08

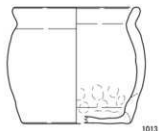

1013

SK07



1014



1015

SK19

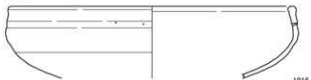

1016



1017

2-SD05



1018

2-SD07



1022



1023

2-SD06

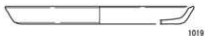

1019



1020

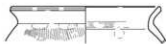

1021

2-SK02



1024



1025

2-SK04



1026

2-SK05

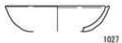

1027



1028

2-SK06



1029

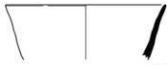

1030

0 (1:4) 10cm

2-SB01-SP07



2-SP13

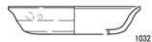

2-SP18



2-SP14

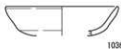
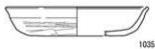
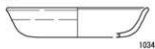

2-SP15

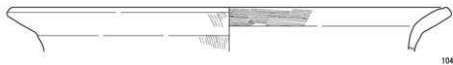
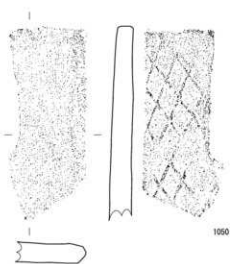
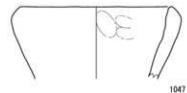

0 (1:4) 10cm

6次4区 2-SB01、2-SP13・2-SP18・2-SP14・2-SP15出土遺物

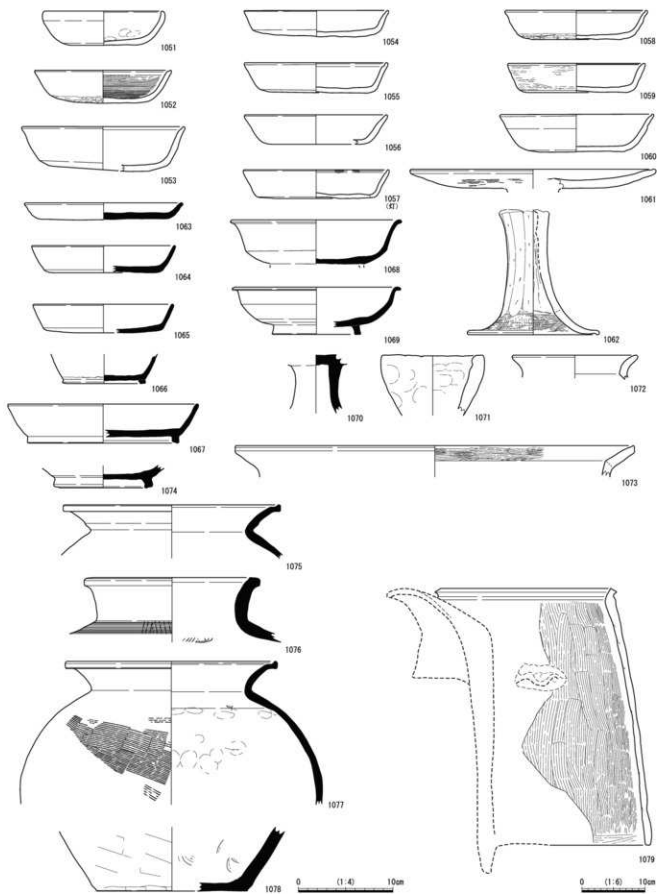

6次4区 2-SD01出土遺物

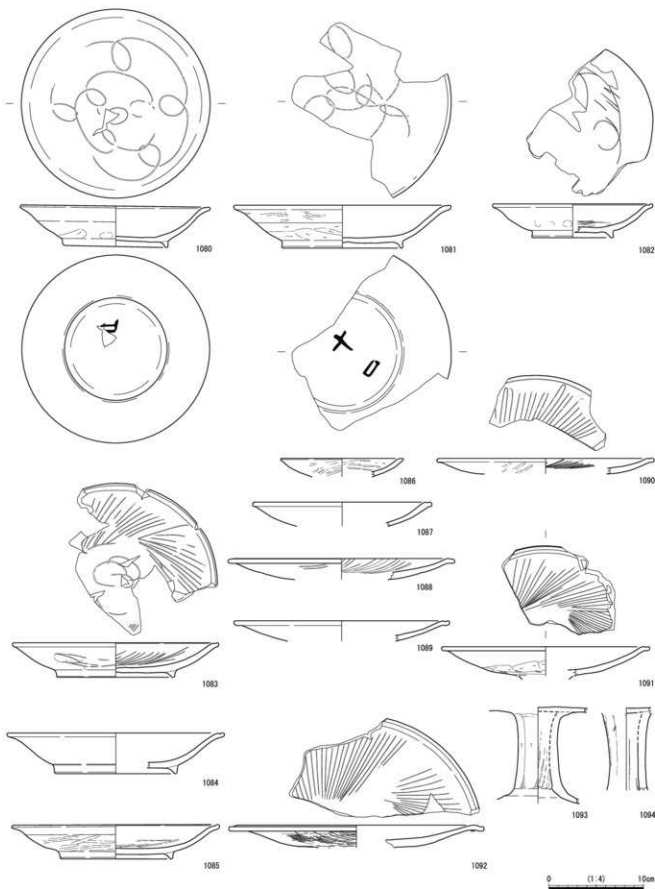

6次4区 2-SD02出土遺物(1)

遺物図版 60

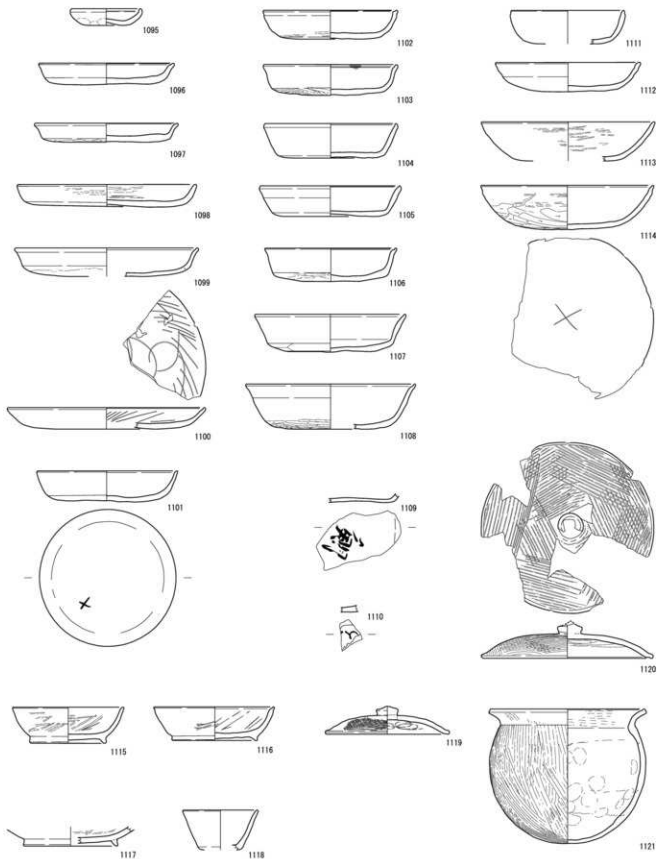

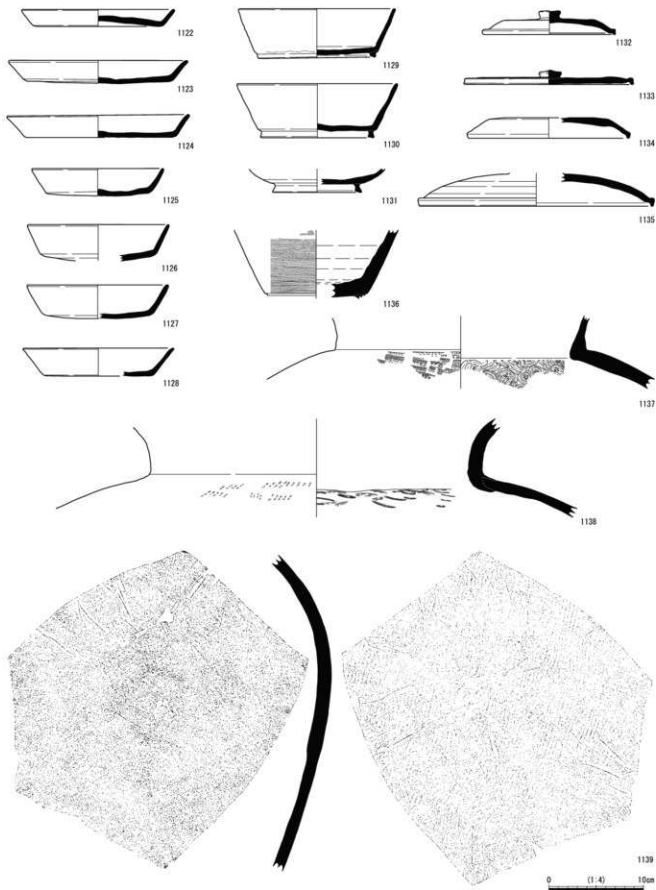

6次4区 2-SD02出土遺物(3)

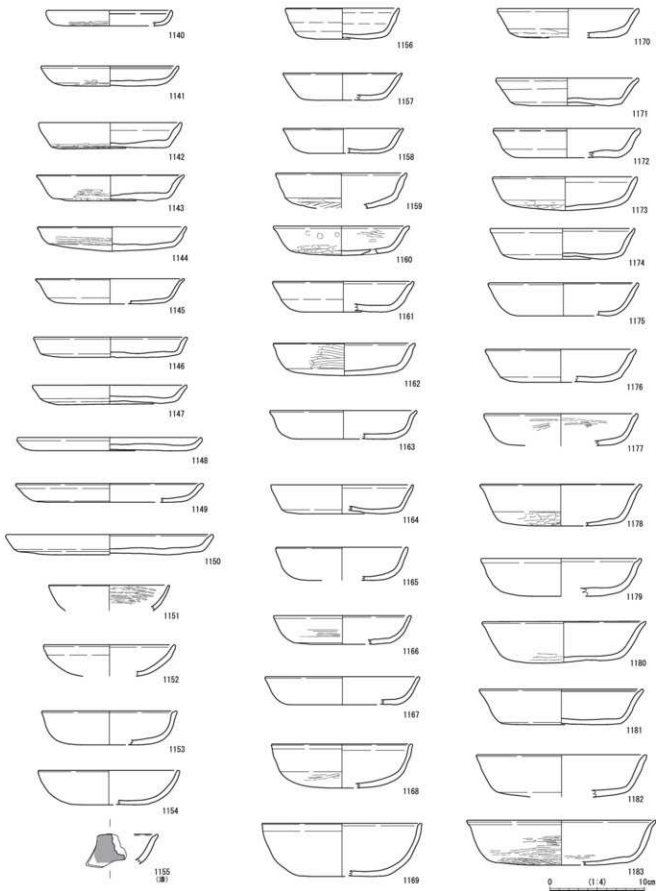

6次4区 2-SX01出土遺物(1)

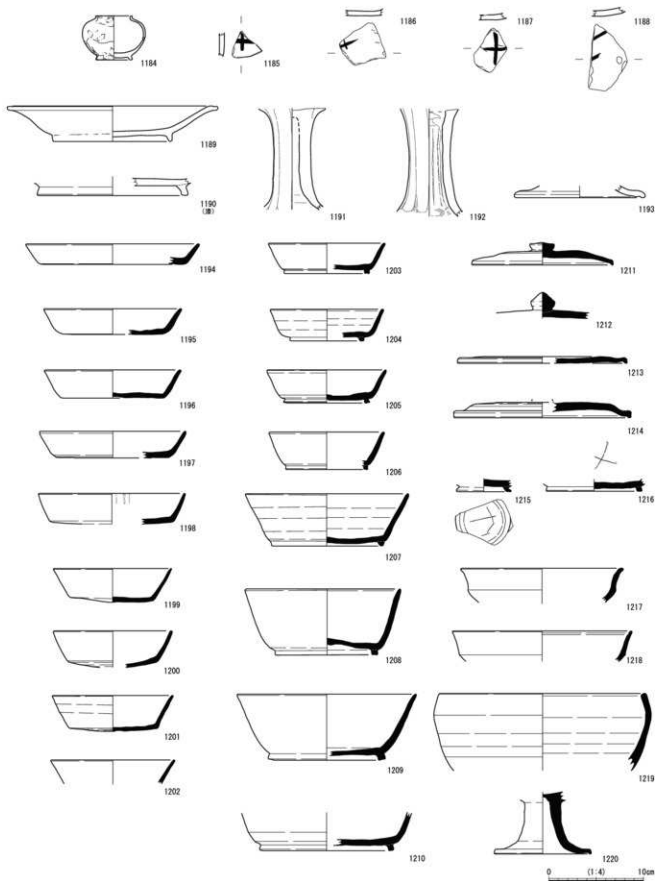

6次4区 2-SX01出土遺物(2)

遺物図版 64

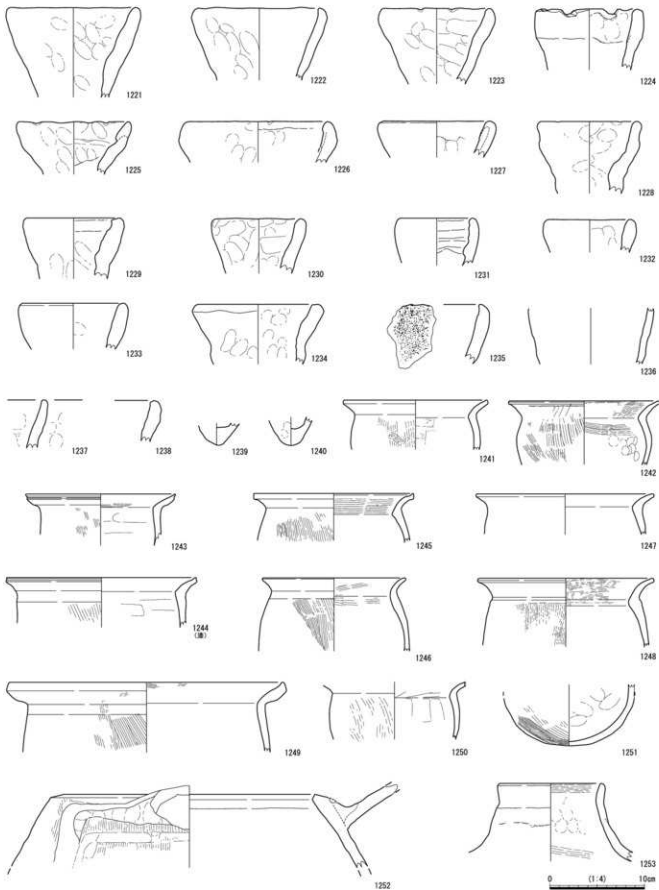

6次4区 2-SX01出土遺物(3)



0 (1:4) 10cm

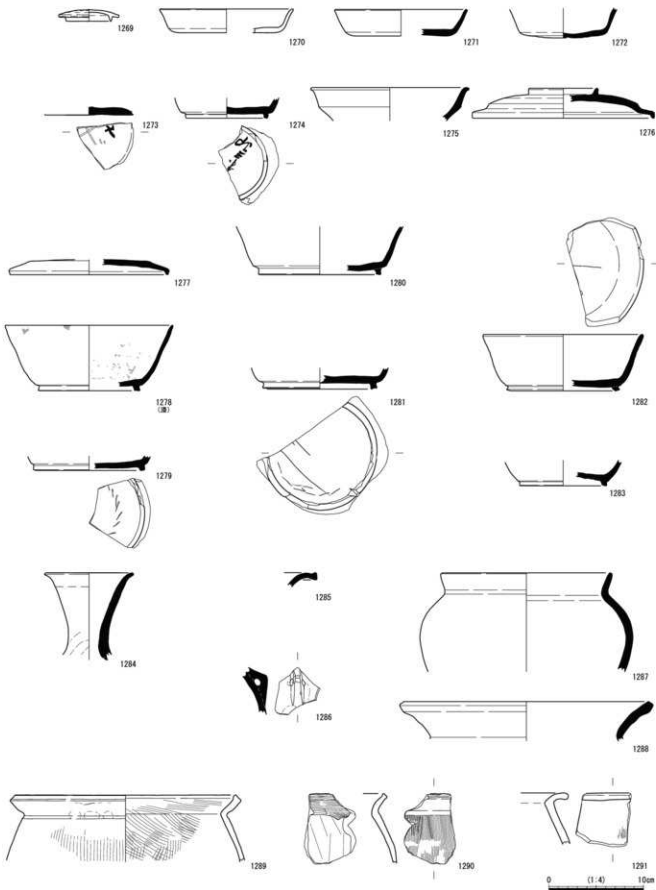

8次1区 SR01出土遺物(1)

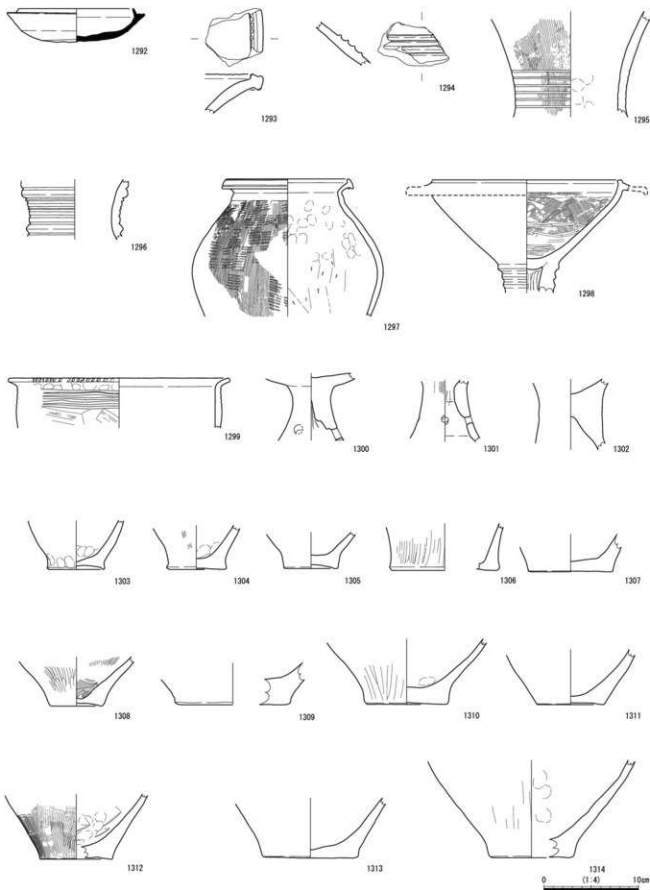

8次1区 SR01出土遺物(2)

遺物図版 68

下層 S002

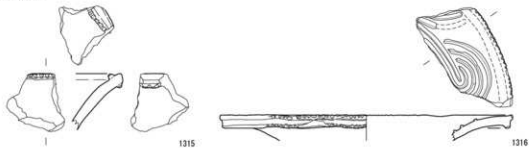

SK02

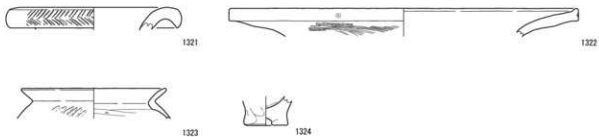

SR01 上層

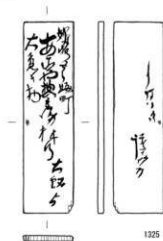

0 (1:4) 10cm



1326



1327

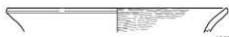

1329



1328
(破)

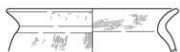

1330



1331



1332

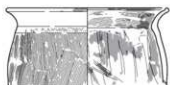

1332
(破)

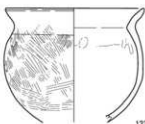

1334



1335



1338

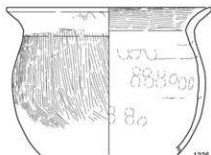

1336

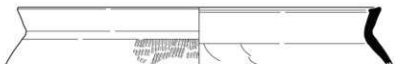

1339

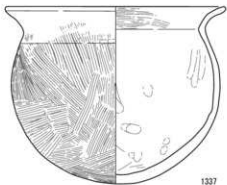

1337

0 (1:4) 10cm



0 (1:8) 10cm

5次4区 SE01出土遺物(1)



1341



1342



1343



1344



1345



1346



1347

0 (1:4) 10cm



1348



1349

0 (1:1) 2cm

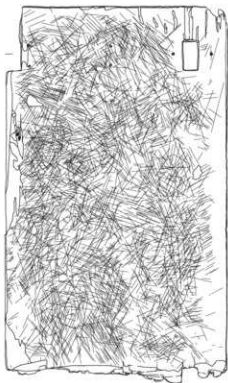

1350

0 (1:6) 10cm

SE02

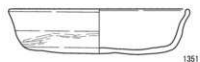

1351



1352



1353



1355

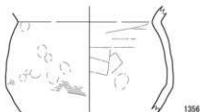

1356



1354



1357

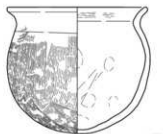

1358

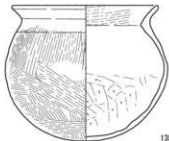

1359



1360

SB01-SP77



1361



1362

SB01-SP86



1363

0 (1:4) 10cm

SK01



1364

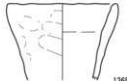

1365

SK03



1366



1367
(B)



1368

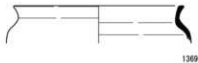

1369

SK08

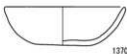

1370



1371

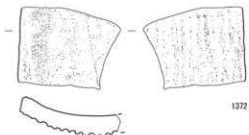

1372

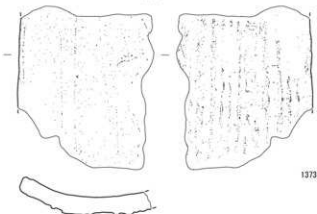

1373

SK14



1374



1375

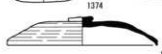

1376



1377

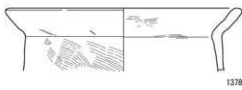

1378

SK23



1379

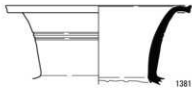

1381



1382



1383



1380
(B)



1384

0 (1:4) 10cm

SK24



1385



1387

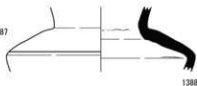

1388

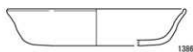

1386

SK31



1389



1390



1391

SK41



1392

SK43



1393

SK44



1394

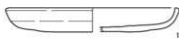

1395

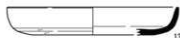

1396

SK59



1397

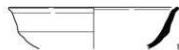

1398



1399

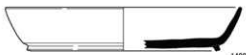

1400



1401

SK61



1402

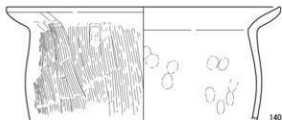

1403

0 (1:4) 10cm

5次4区 SK24・SK31・SK41・SK43・SK44・SK59・SK61出土遺物

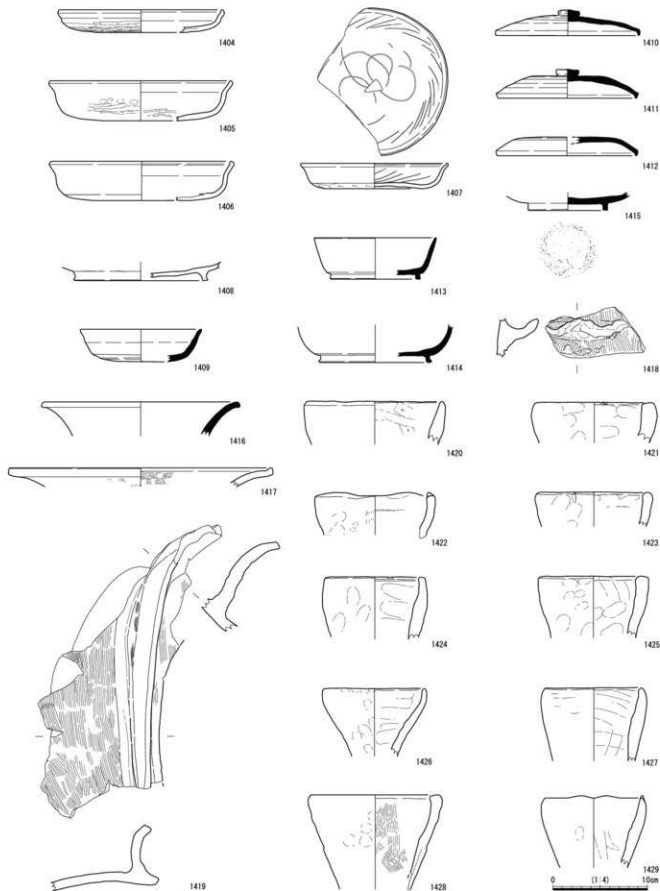

5次4区 SK62出土遺物

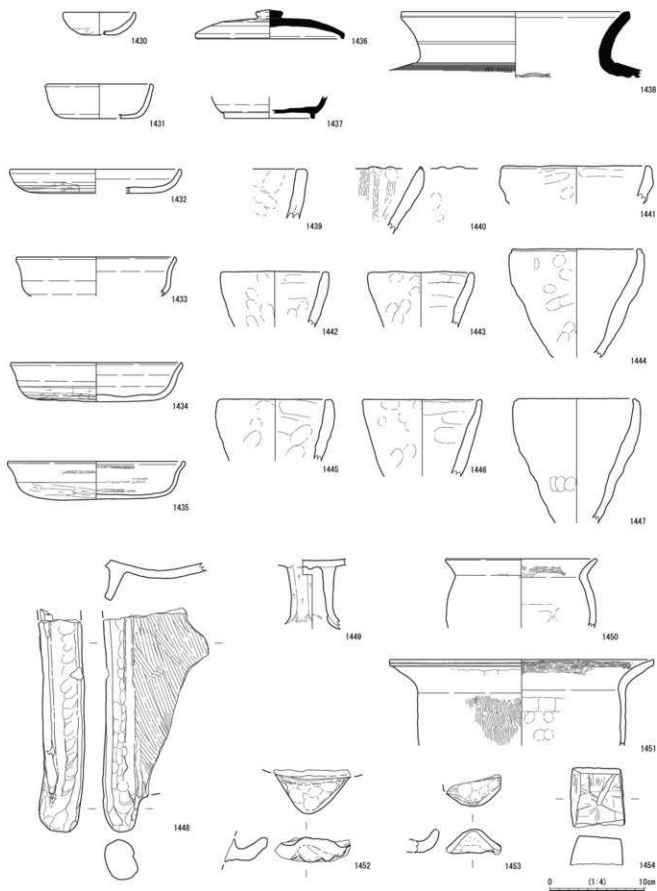

5次4区 SK63出土遺物

遺物図版 76

SK75

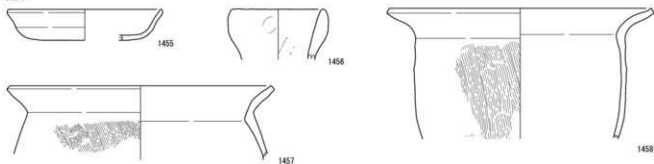

SK100

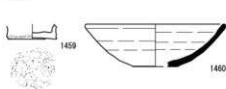

SP68



SP72

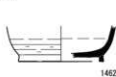

SP79

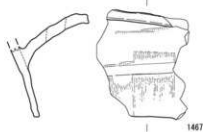
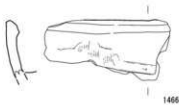
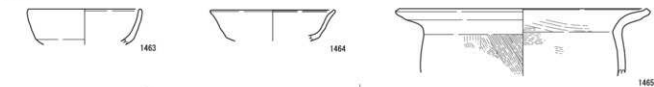

SP84



SP99

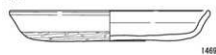

SX01

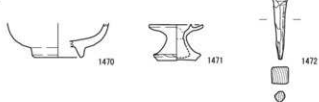

5次5区 SK03

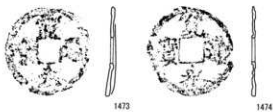

0 (1:1) 2cm

0 (1:4) 10cm

5次4区 SK75・SK100、SP68・SP72・SP79・SP84・SP99、SX01、5次5区 SK03出土遺物

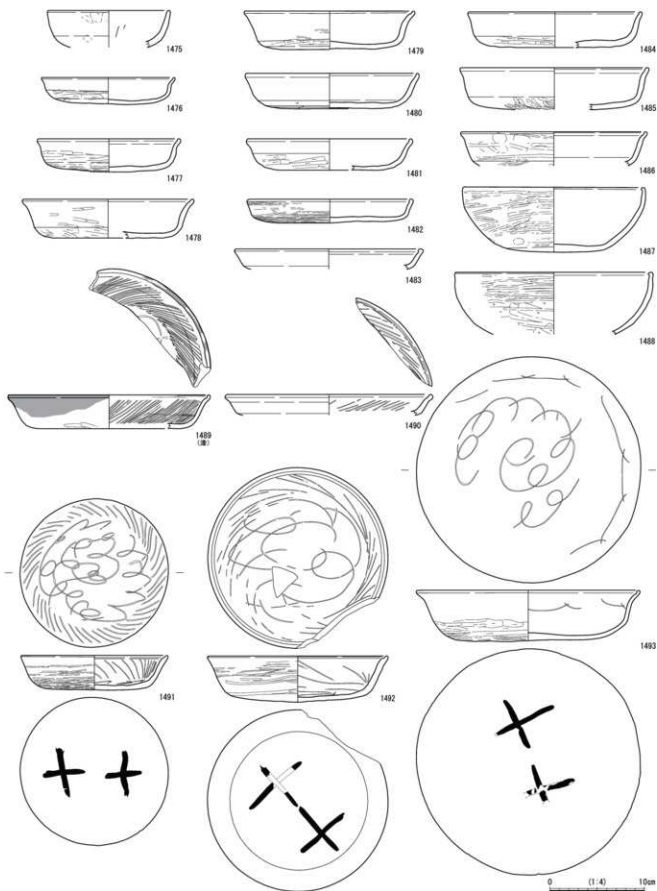

5次5区 SE01出土遺物(1)

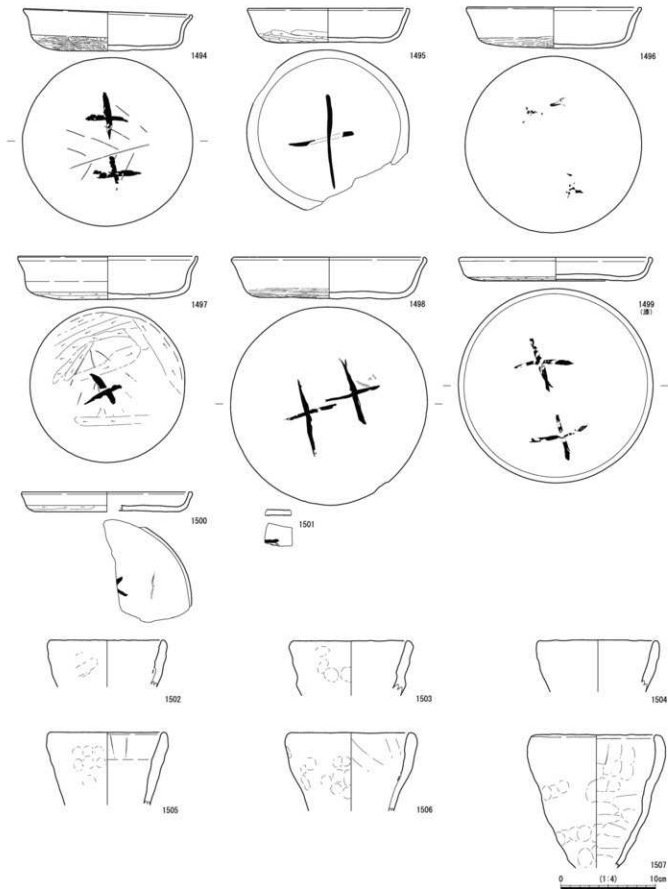

5次5区 SE01出土遺物(2)

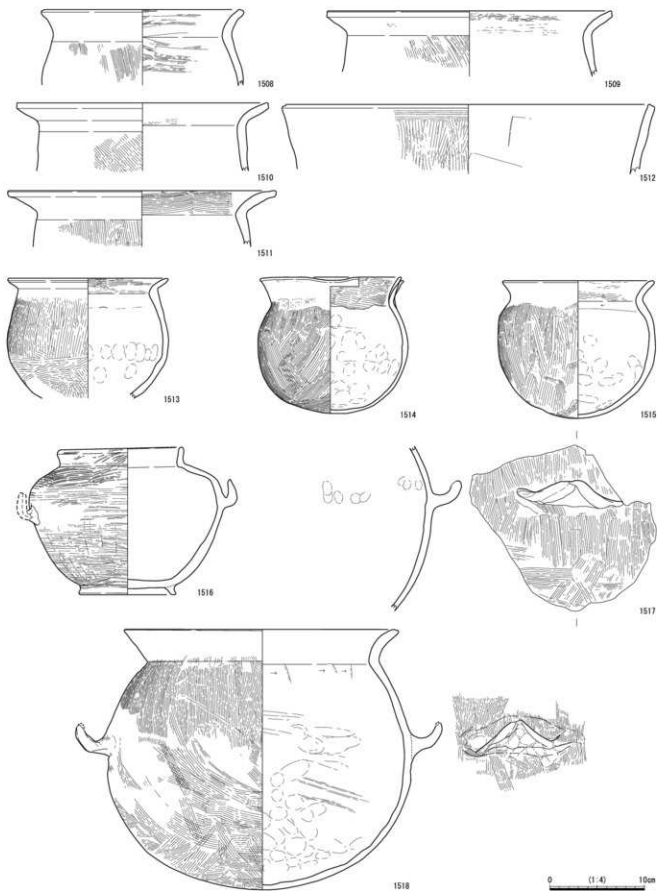

5次5区 SE01出土遺物(3)



1519



1525

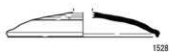

1528



1520



1526



1527



1529



1521

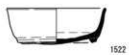

1522



1527



1530



1523



1527



1531



1524



1532



1533

0 (1:4) 10cm

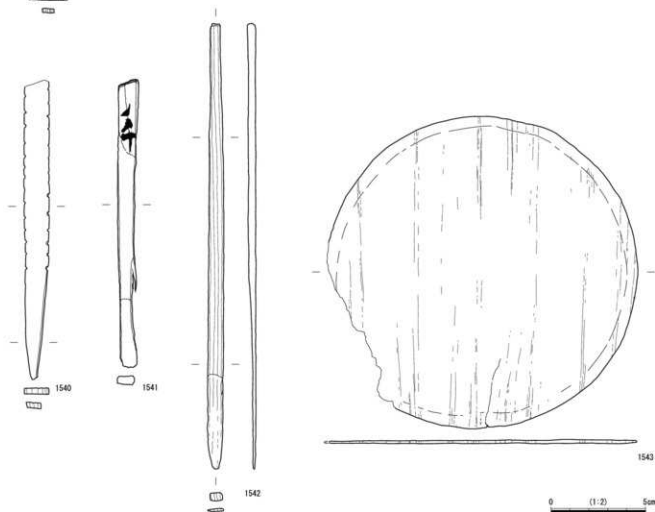
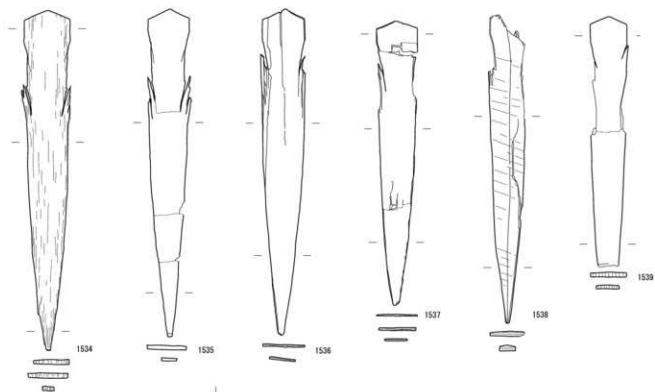

5次5区 SE01出土遺物(5)

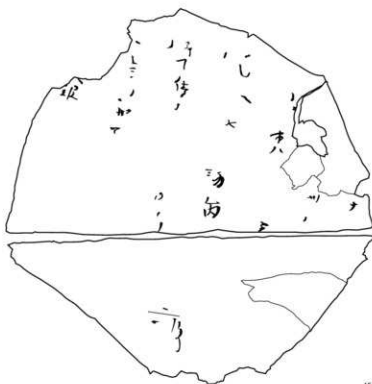

1544

0 (2:3) 2cm

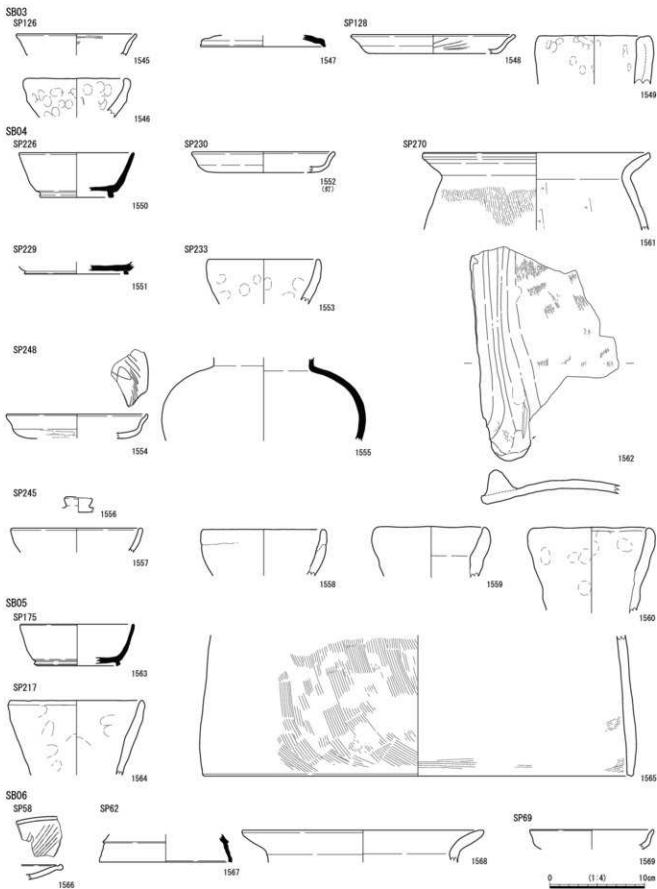

6次1区 SB03・SB04・SB05・SB06出土遺物

SB07
SP88

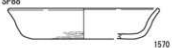

1570



1571
(裏)

SP94



1572

SB08
SP274



1573

SP275



1575



1579



1574



1576



1577



1578



1580

SP276



1581

SP279



1582

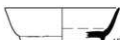

1583



1584

SP282



1587

SP281



1585



1586

SP284



1588

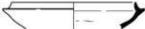

1589

SA01

SP133



1590

SA02

SP52



1591

SP60



1592



1593

SP93

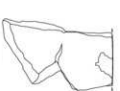

1584



1595

0 (1:4) 10cm

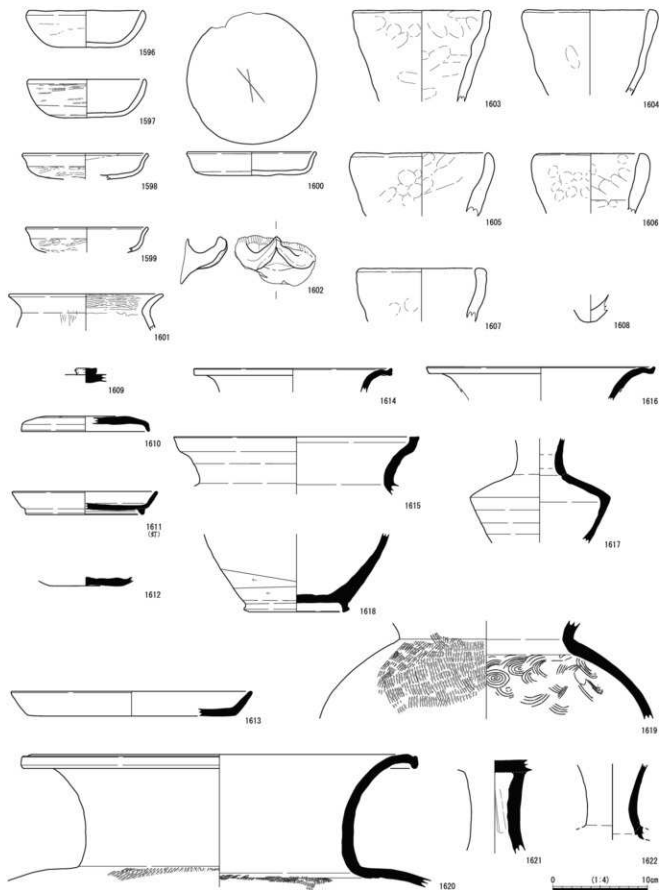

6次1区 SE01出土遺物(1)

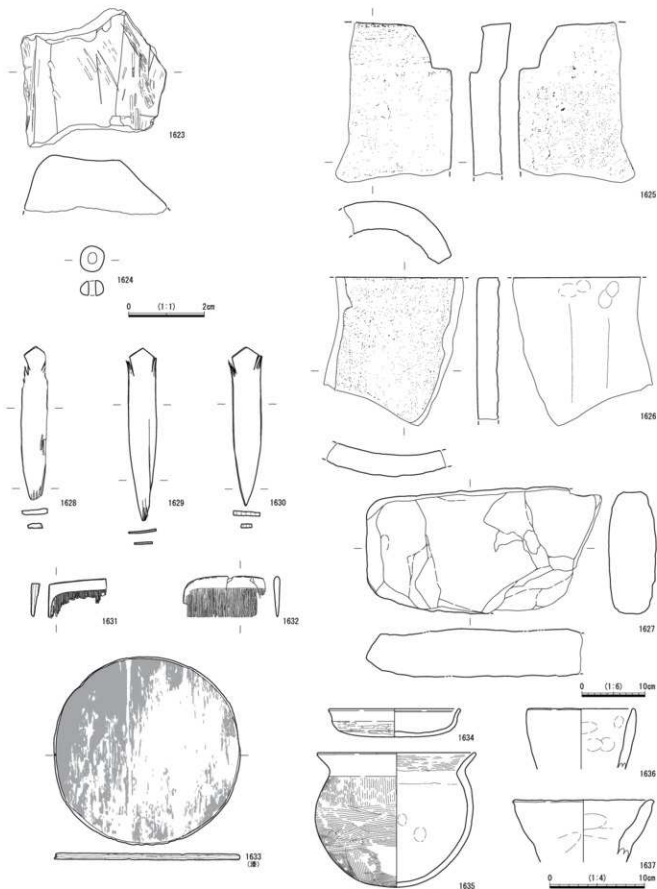

6次1区 SE01出土遺物(2)

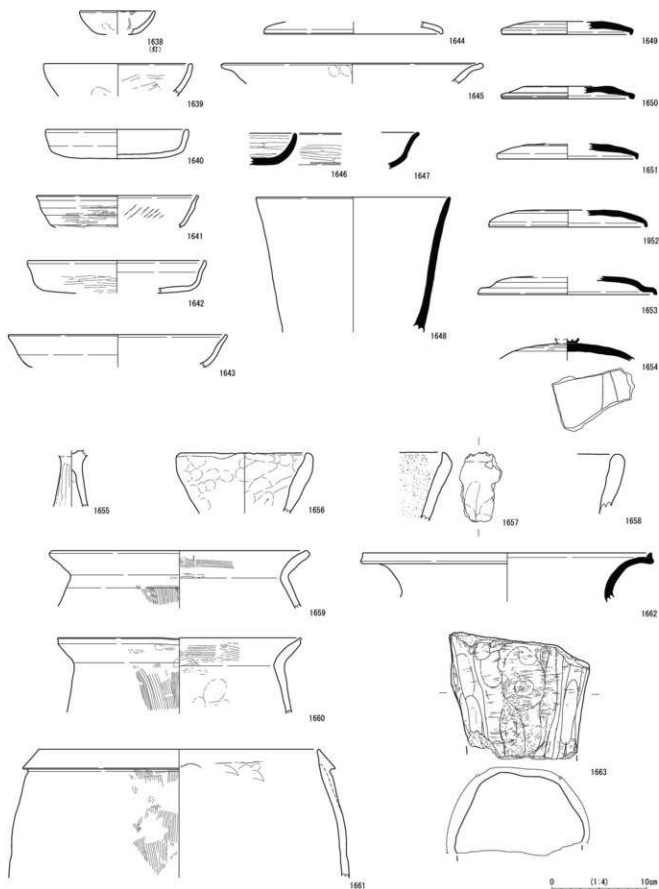

6次1区 SE02出土遺物

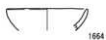

1664



1667



1670



1665
(87)



1668



1671
(8)

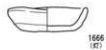

1666
(87)



1669



1672

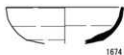

1674

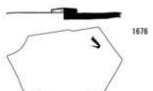

1676

1678

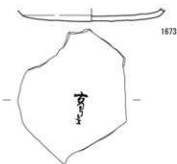

1673

宮

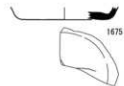

1675



1677

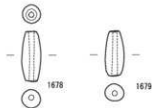

1678

1679

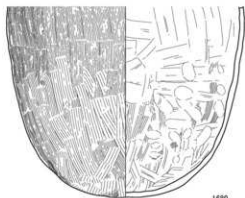

1680

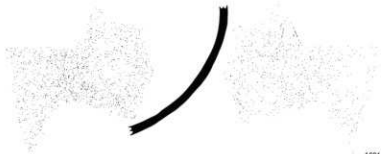

1681

0 (1:4) 10cm



1682



1684

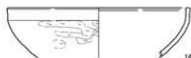

1686

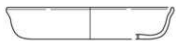

1683



1685



1687



1688



1689



1691



1694

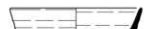

1692



1695

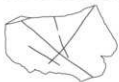

1690



1693



1696



0 (1/4) 10cm

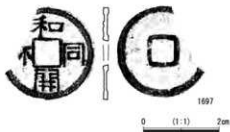

1697

0 (1:1) 2cm

SR01

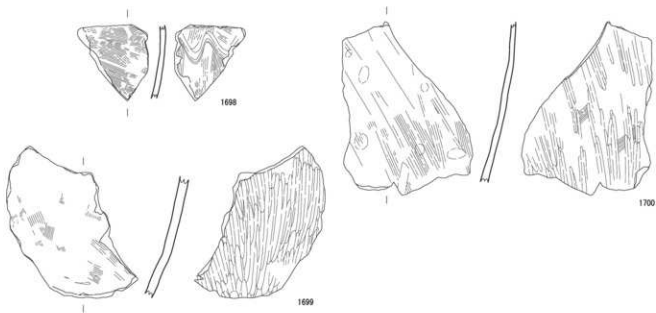

SD02

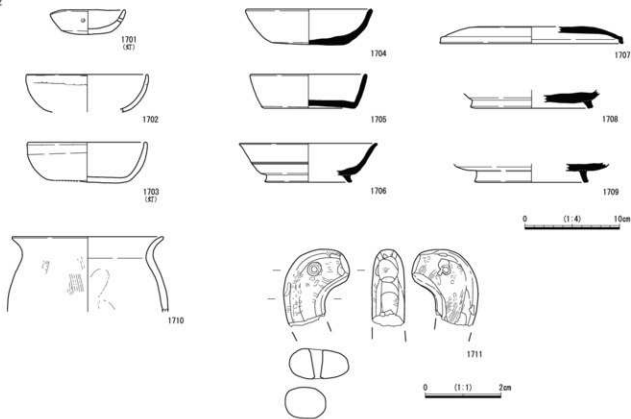

6次I区 SR01・SD02出土遺物

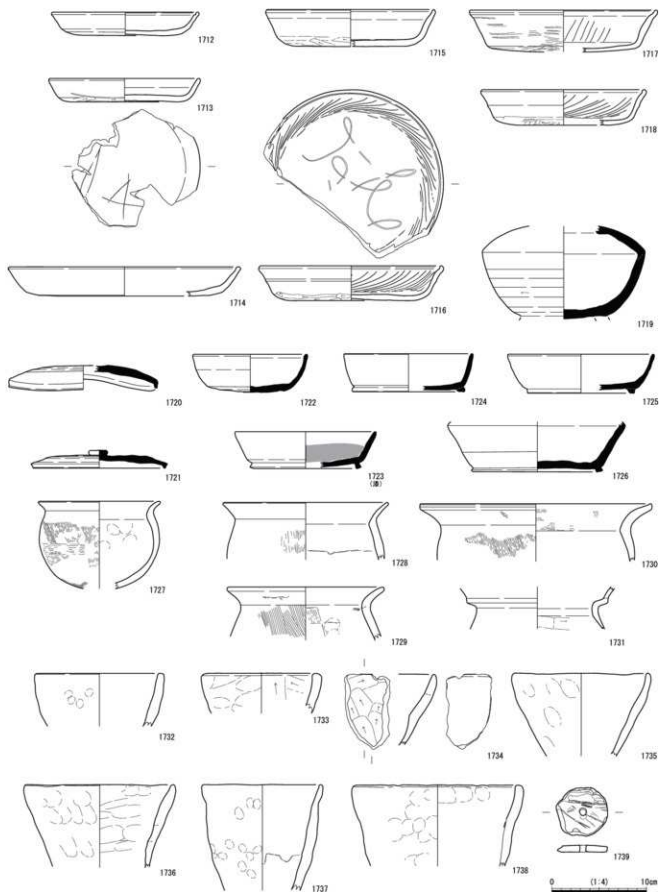

6次1区 SD03出土遺物

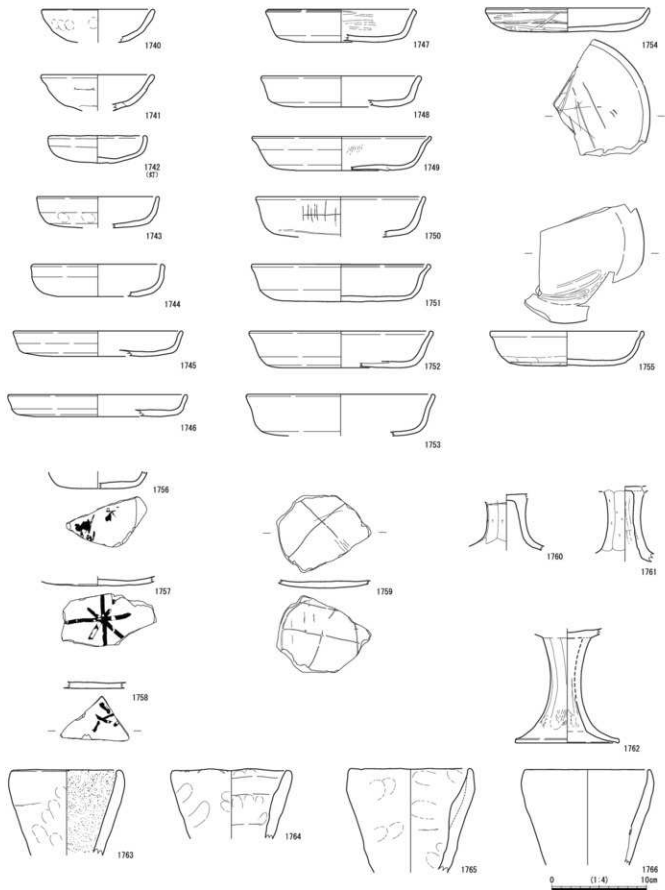

6次1区 SD04出土遺物(1)

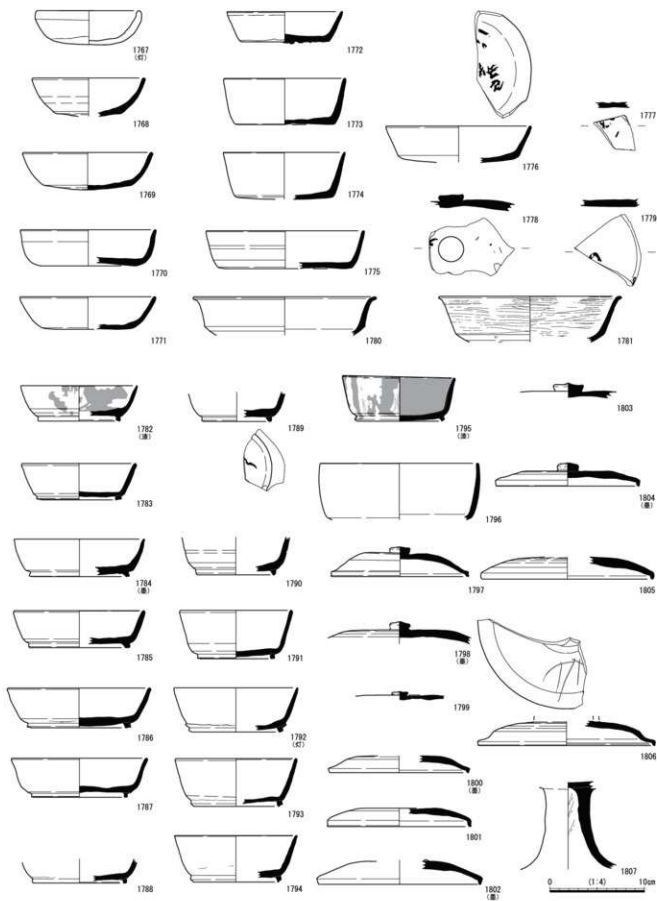

6次1区 SD04出土遺物(2)

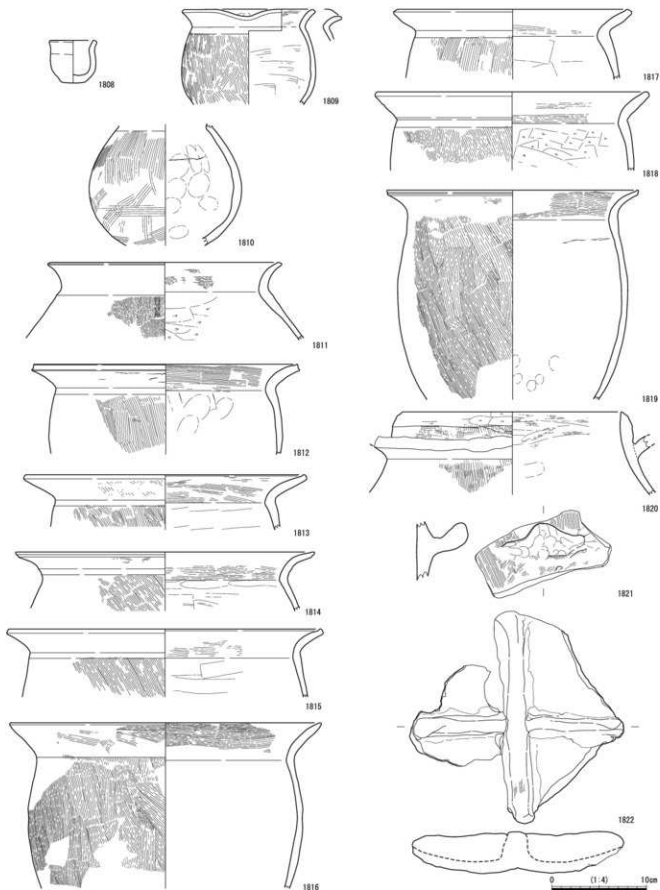

6次1区 SD04出土遺物(3)

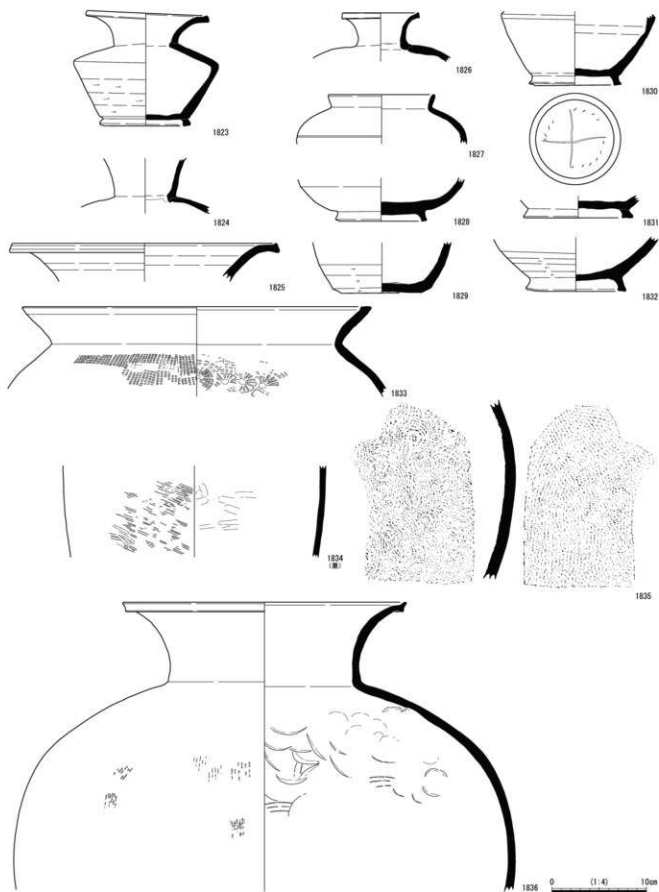

6次1区 SD04出土遺物(4)

SD04

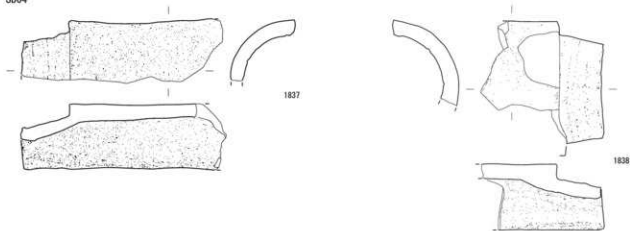

SD05

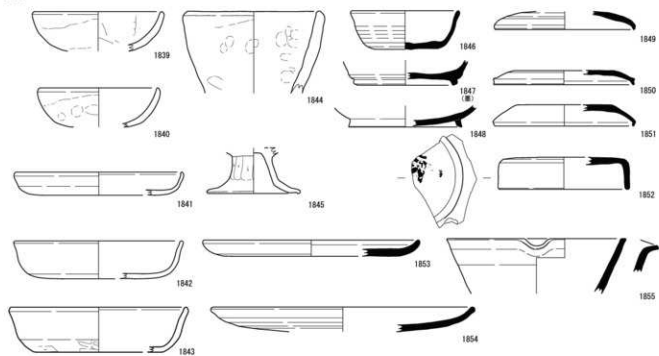

SD06

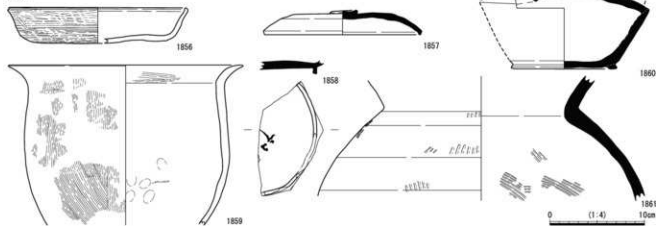

6次1区 SD04出土遺物(5)、SD05・SD06出土遺物

SD75

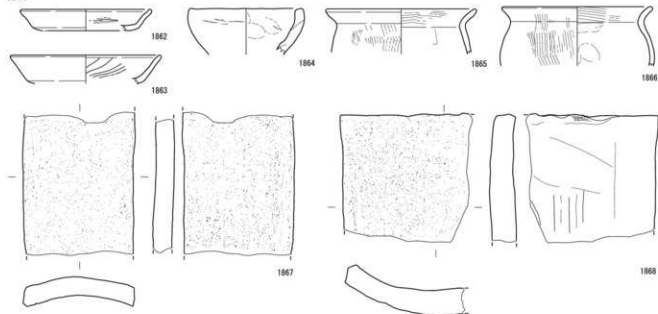

SD78

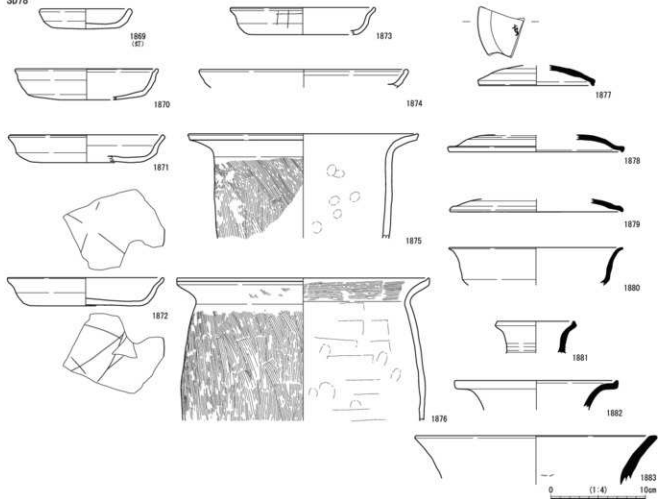

6次1区 SD75・SD78出土遺物

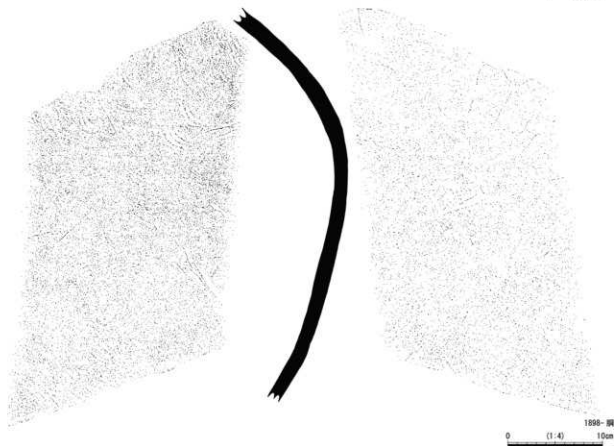
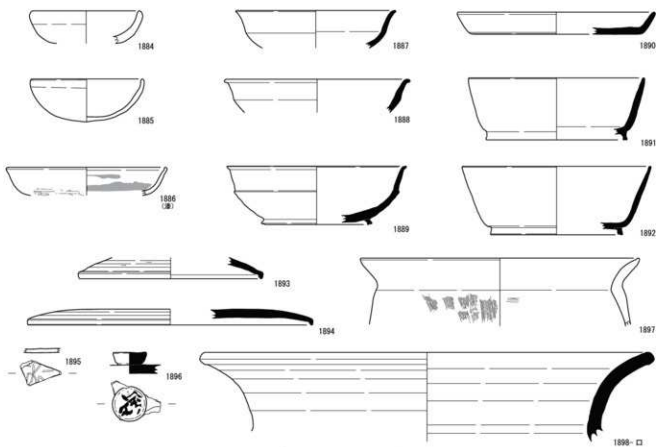

6次1区 SD61出土遺物

SD171

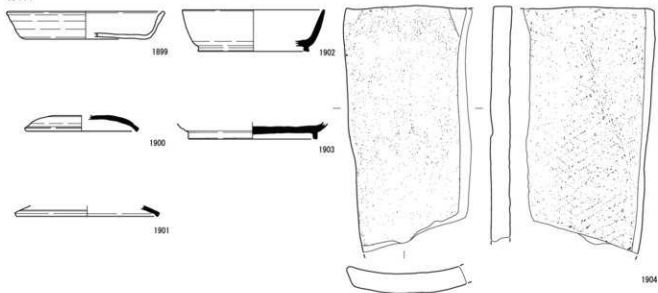

SD178

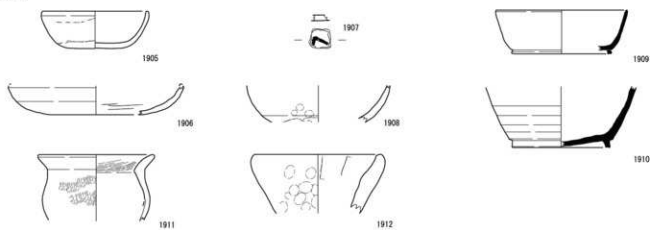

SD187

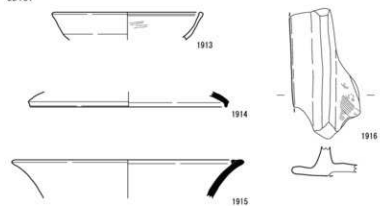

SD189



0 (1:4) 10cm

6次1区 SD171・SD178・SD187・SD189出土遺物

SD188

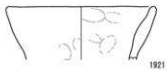
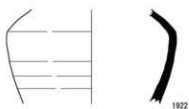
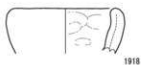

SD193



SD194

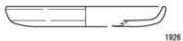
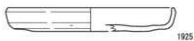

SD249

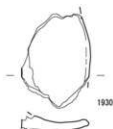

SD250



SD260

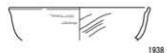

SD327

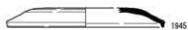
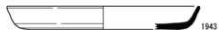

0 (1:4) 10cm

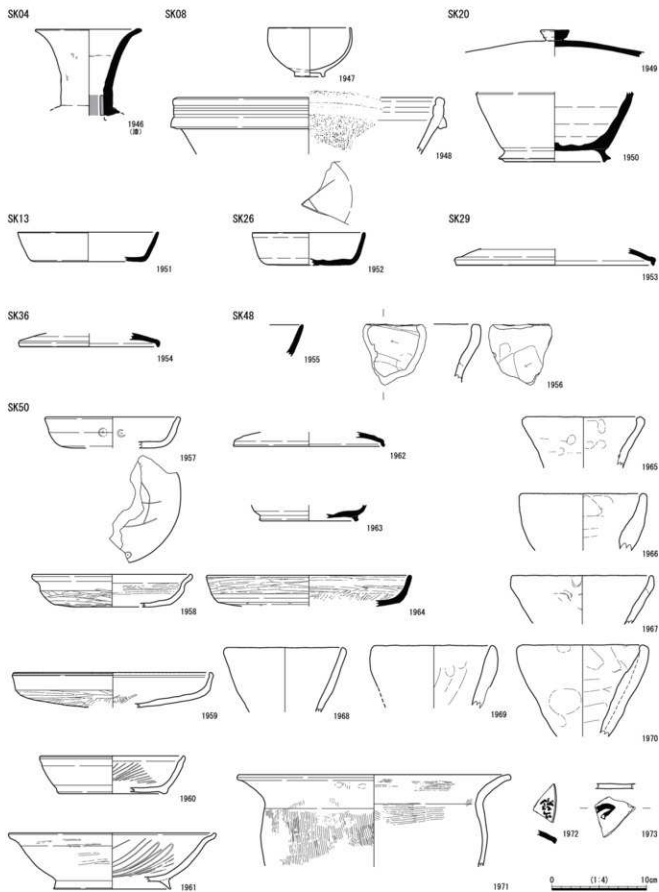

6次1区 SK04・SK08・SK13・SK20・SK26・SK29・SK36・SK48・SK50出土遺物

SK76



SK77

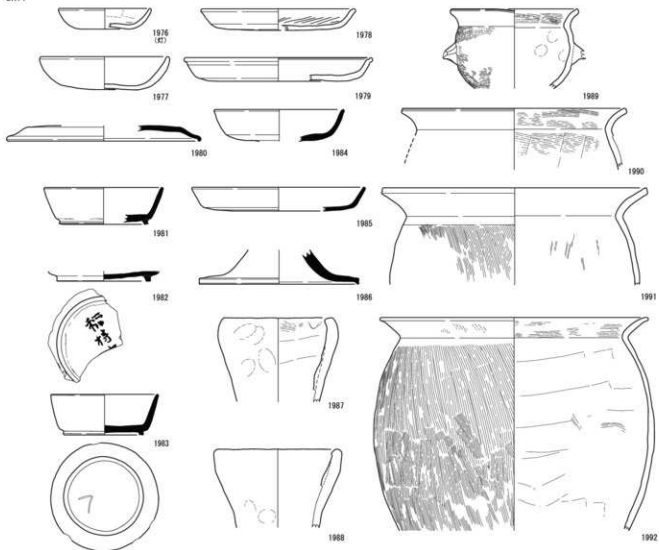

SK79

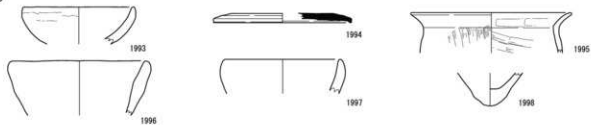

SK80



0 (1:4) 10cm

6次1区 SK76・SK77・SK79・SK80出土遺物

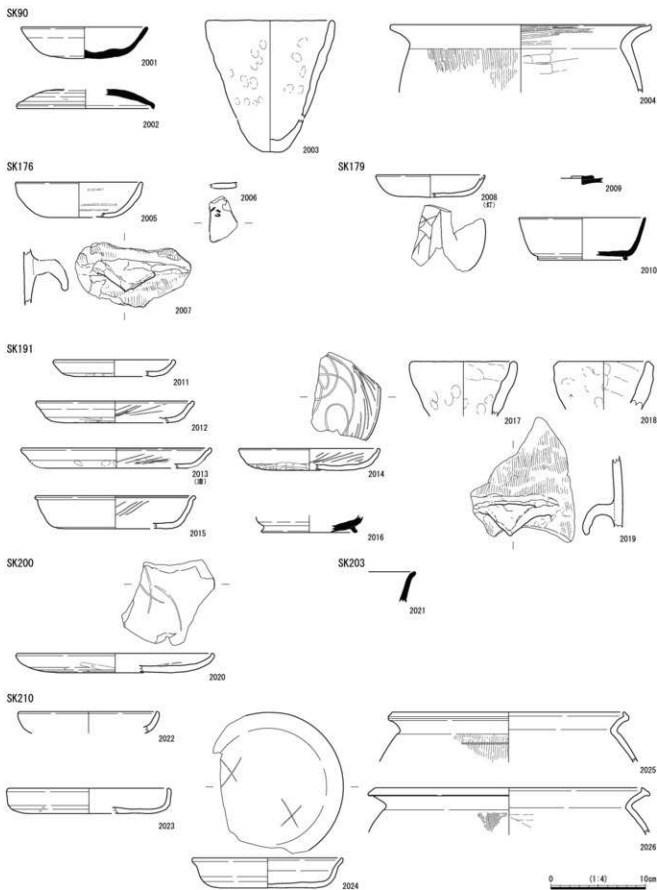

6次1区 SK90・SK176・SK179・SK191・SK200・SK203・SK210出土遺物

SK208

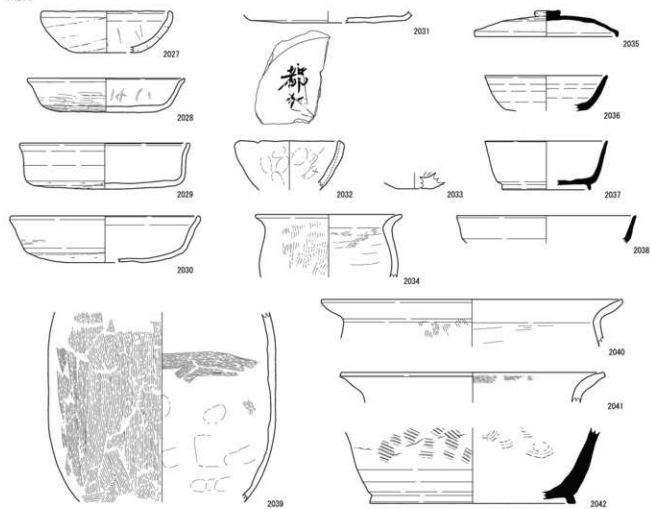

SK240



SK243



6次1次 SK208・SK240・SK243出土遺物

SK244

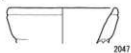

SK251

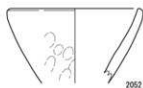
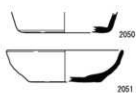
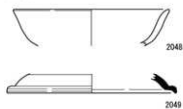

SK253

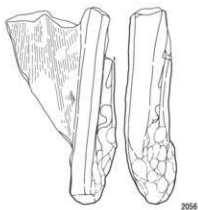
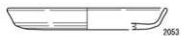

SK285



SK288

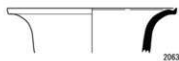

SK302



0 (1:4) 10cm

6次1区 SK244・SK251・SK253・SK285・SK288・SK302出土遺物

SP65

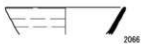

SP66

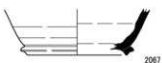

SP71



SP130



SP173

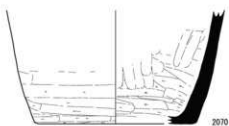

SP181



SP182



SP184



SP190

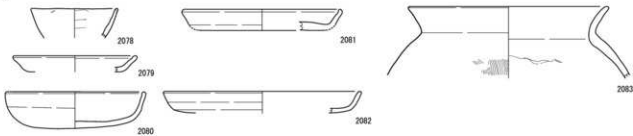

SP202

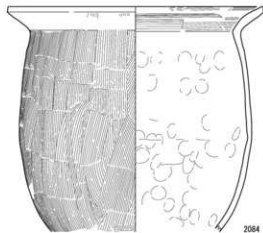

SP216



SP225

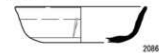

SP228

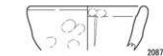

0 (1:4) 10cm

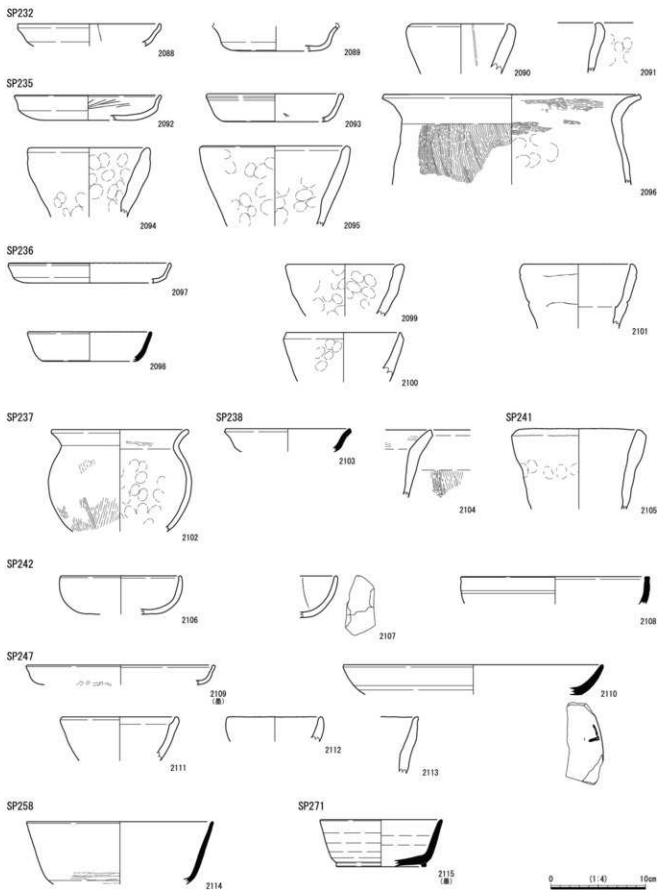

6次1区 SP232・SP235・SP236・SP237・SP238・SP241・SP242・SP247・SP258・SP271出土遺物

SP272

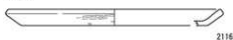

2116



2117
(裏)



2118

SP290



2119



2121



2123



2120



2122
(裏)

SP294



2124



2126

SP297



2127

SP298



2128

SP300

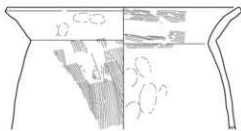

2129

SP303

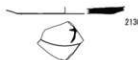

2130

SP304

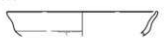

2131



2132



2133

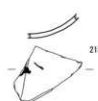

2134

SP308



2135



2136

SP313



2137

SP315



2138

SP320



2139



2141



2140



2142

SP323

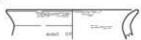

2143

SP333

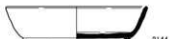

2144



2145

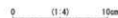

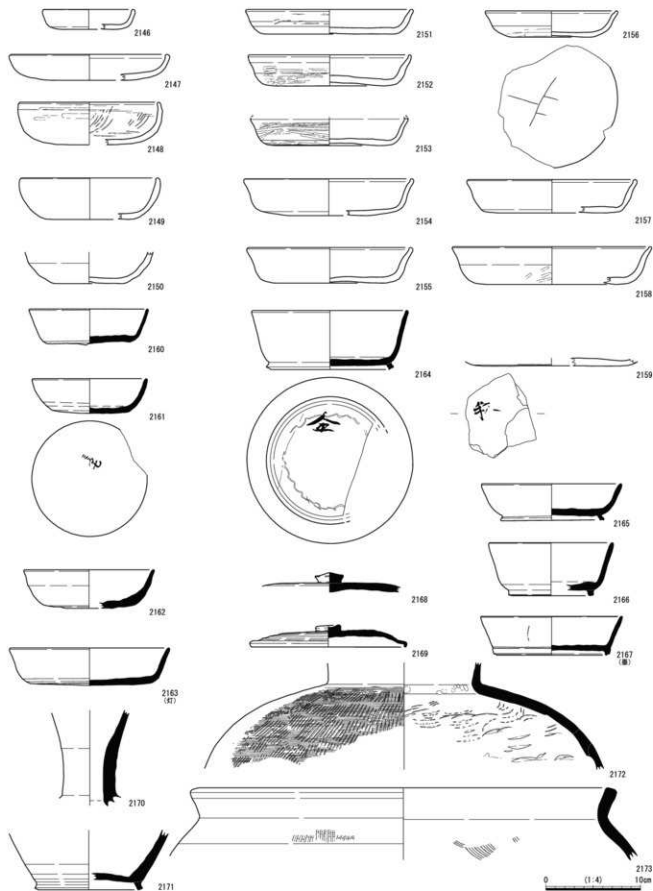

6次1次 整地層 (SK177) 出土遺物(1)



2174



2175

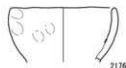

2176



2177

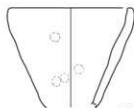

2178

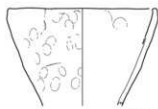

2179



2181



2182

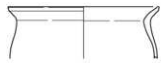

2183

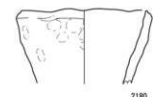

2180

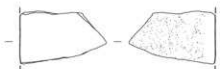

2189

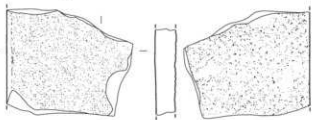

2190



2184



2185

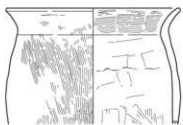

2186

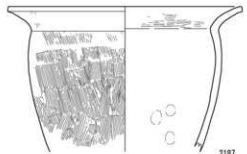

2187

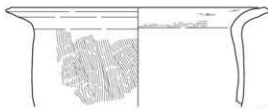

2188

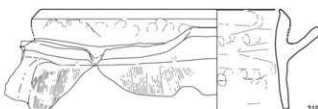

2191

0 (1:4) 10cm

6次1区 整地層 (SK177) 出土遺物(2)

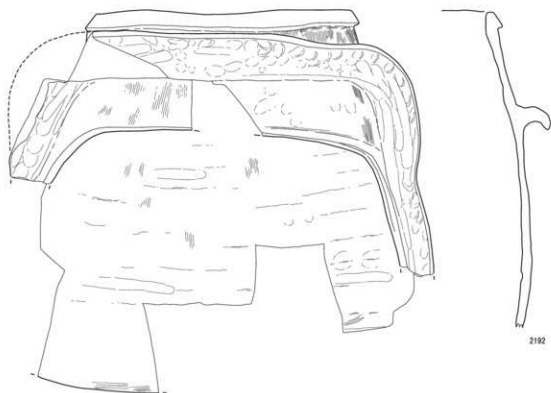

2192

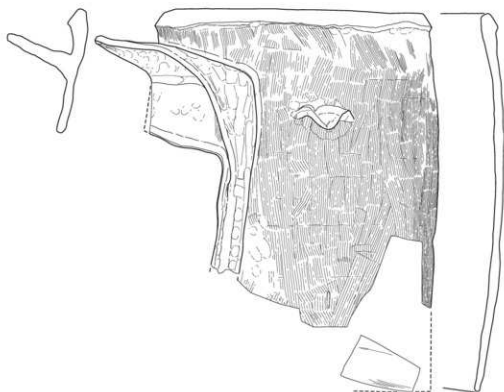

2192

0 (1:4) 10cm

6次1区 整地層 (SK177) 出土遺物(3)

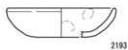

2193

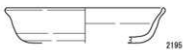

2195



2199



2194

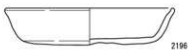

2196

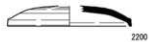

2200

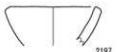

2197

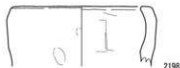

2198



2201



2202

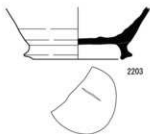

2203

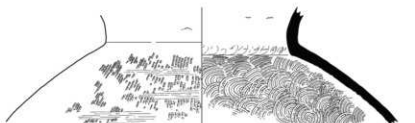

2204



2205



2207

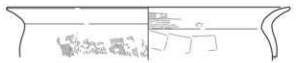

2206

0 (1:4) 10cm

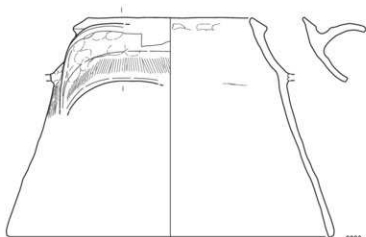

2208



2208

0 (1:4) 10cm

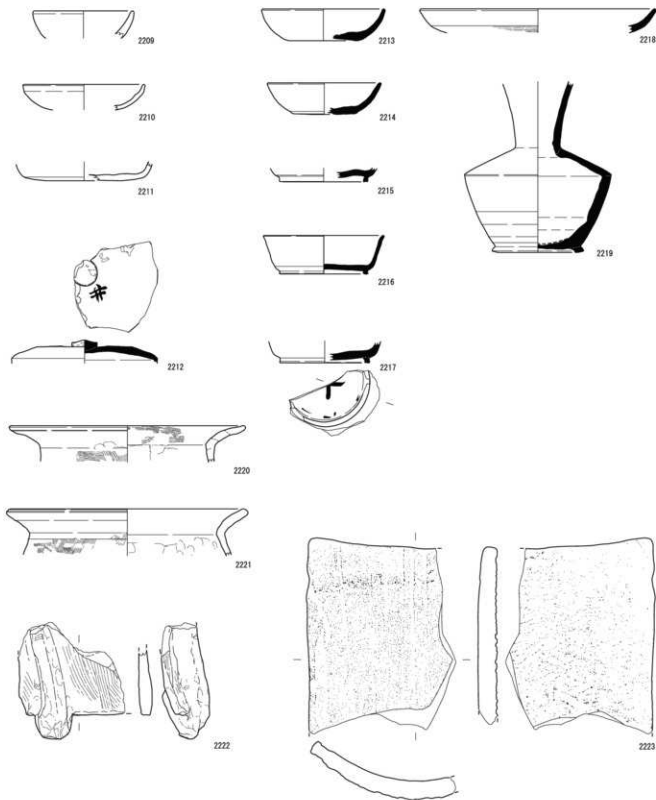

0 (1:4) 10cm

炭層 1

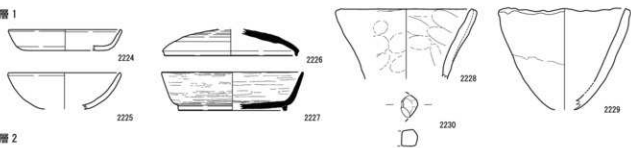

炭層 2

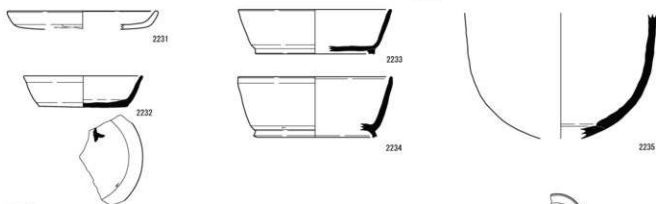

炭層 3

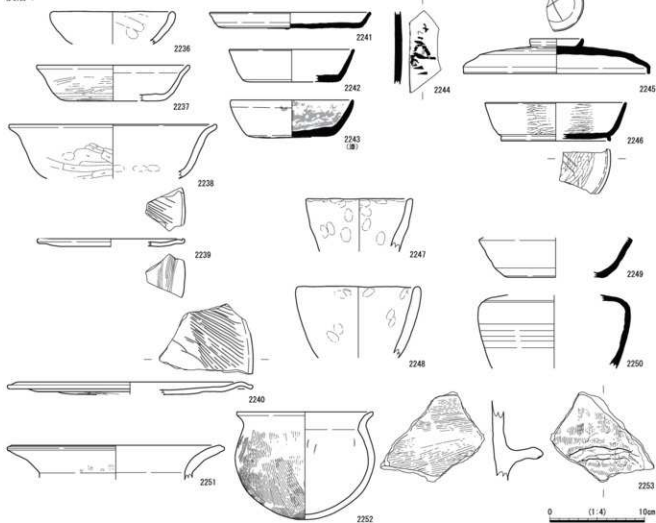

6次1区 炭層1・炭層2・炭層3出土遺物

炭層 4

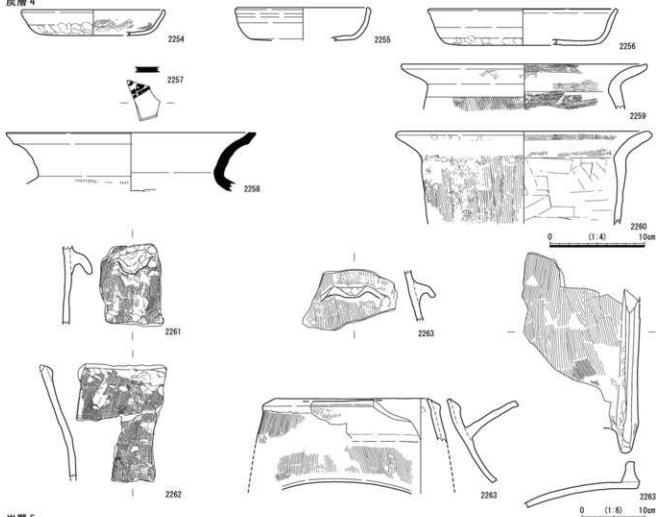

炭層 5

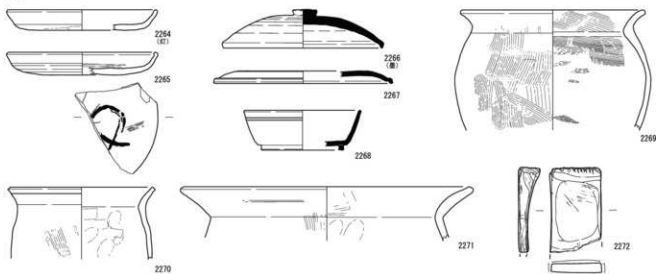

炭層 6



6次1区 炭層4・炭層5・炭層6出土遺物

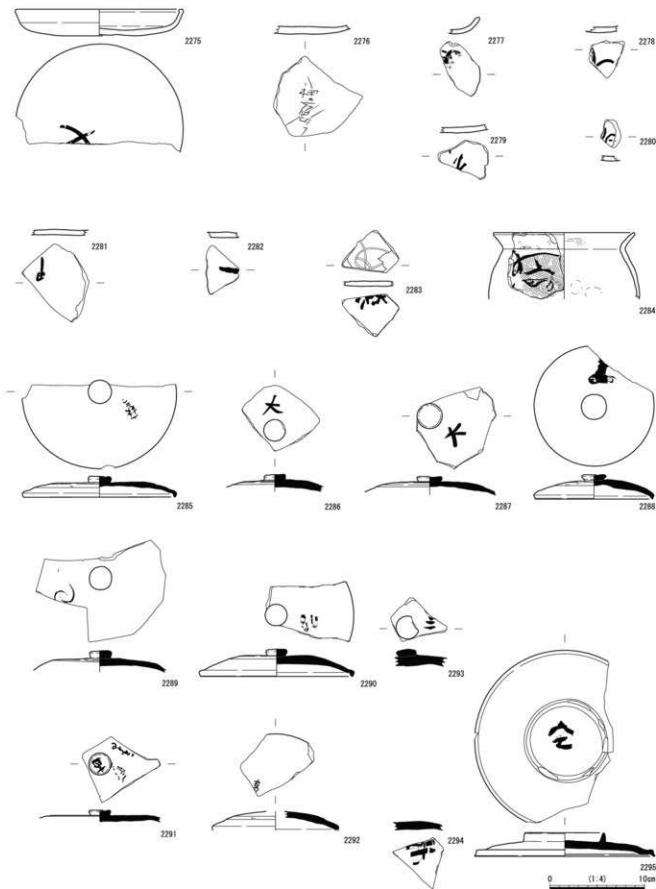

6次1区 遺構に伴わない遺物(1)

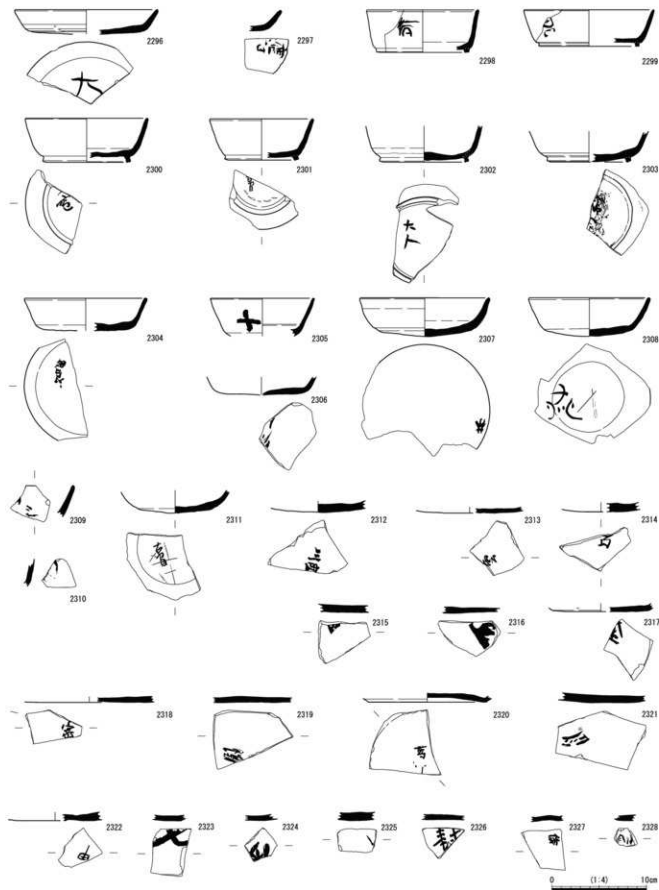

6次1区 遺構に伴わない遺物(2)

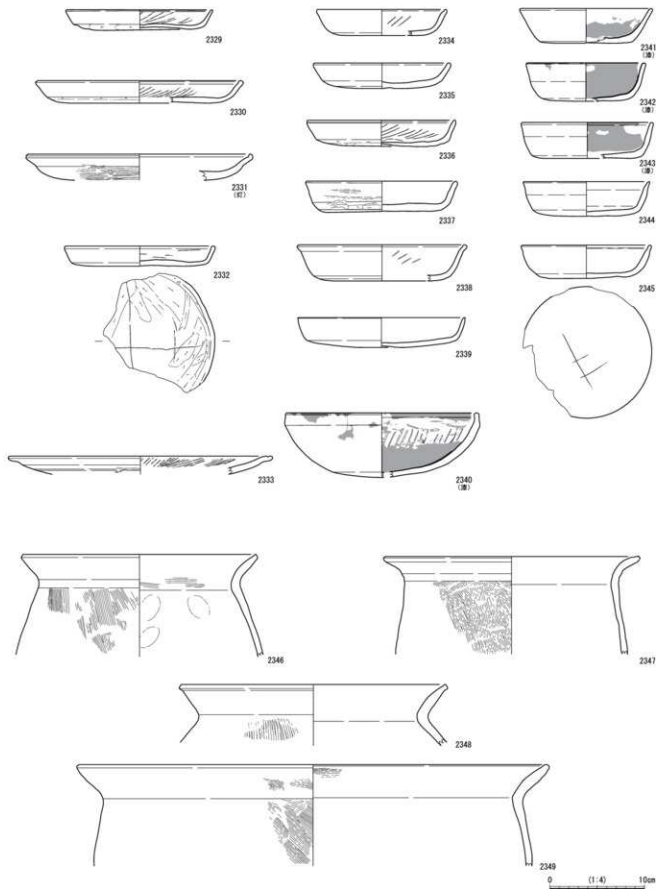

6次1区 遺構に伴わない遺物(3)

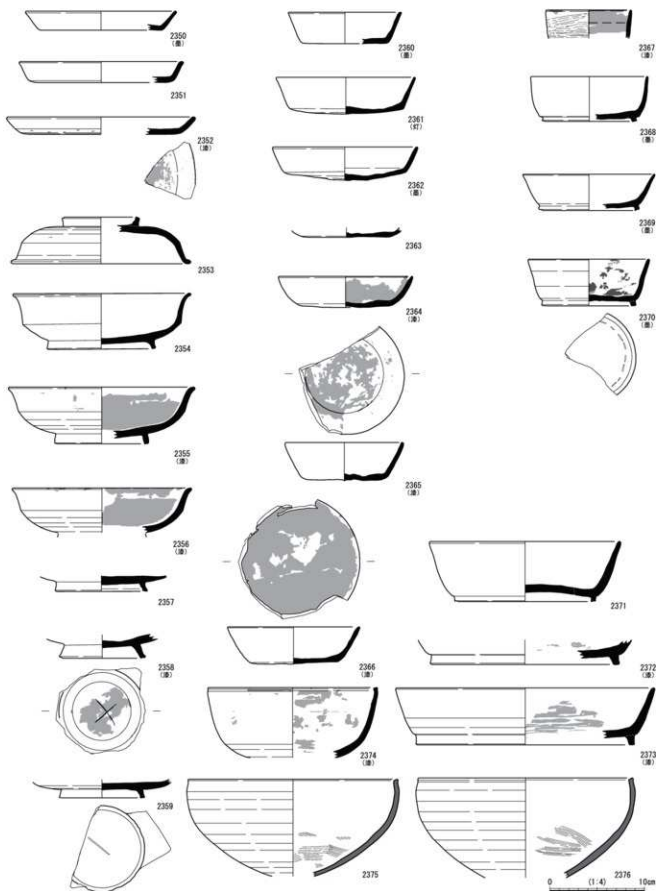

6次1区 遺構に伴わない遺物(4)

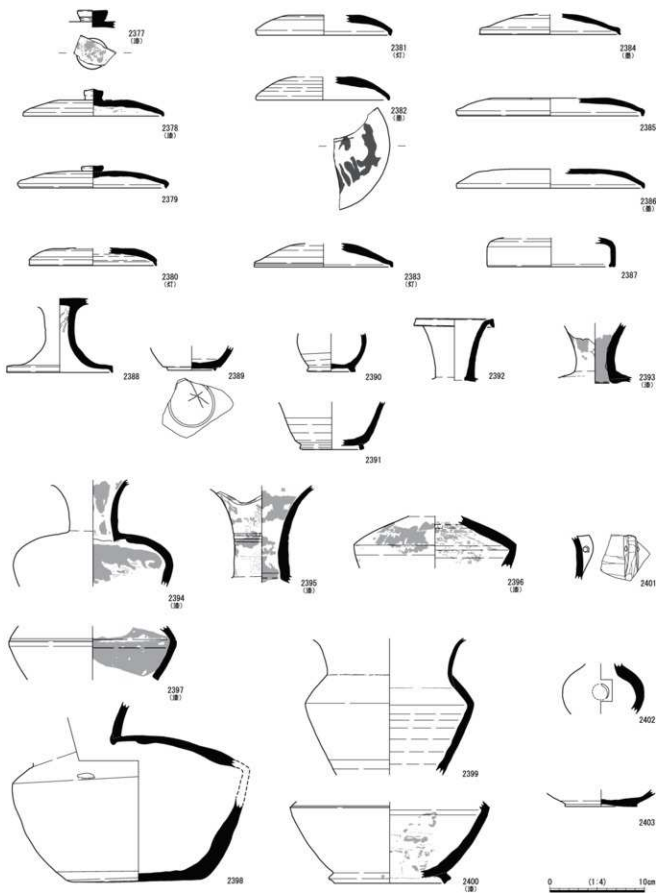

6次1区 遺構に伴わない遺物(5)

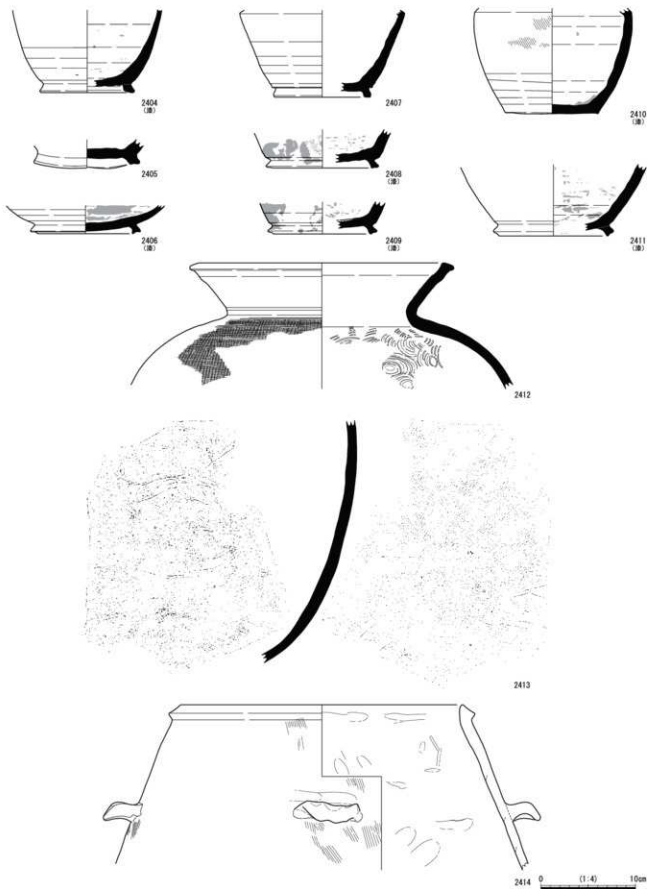

6次1区 遺構に伴わない遺物(6)

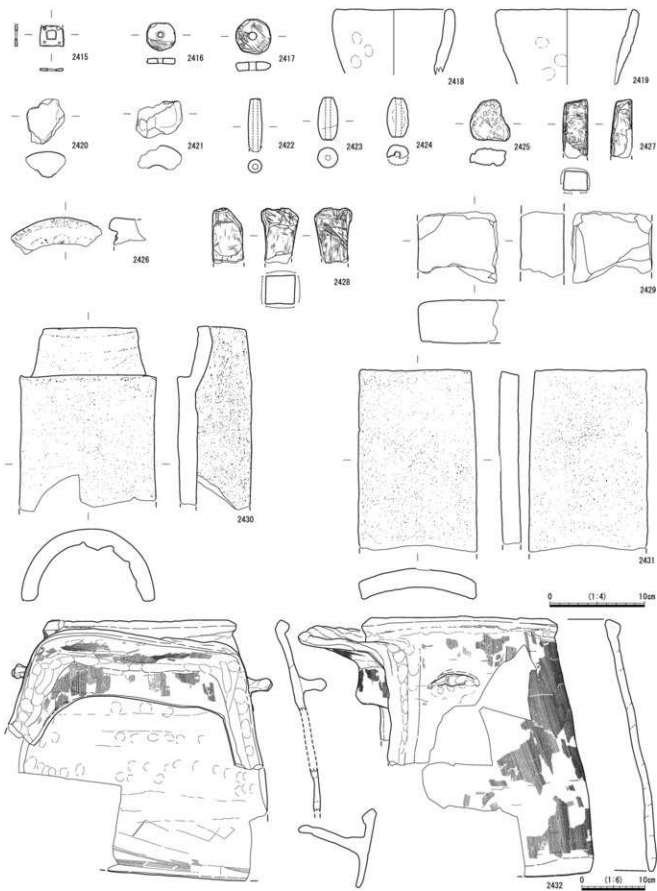

6次1区 遺物に伴わない遺物(7)

SK38

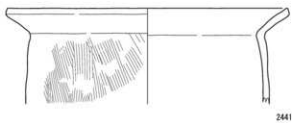
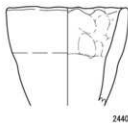
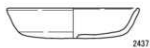
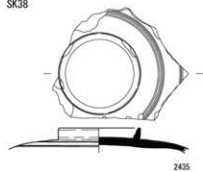

SK42

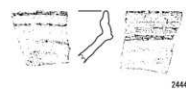
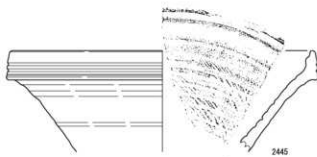

遺構に伴わない遺物

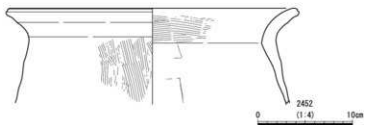
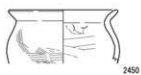
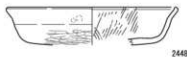

0 (1:4) 10cm

6次5区 SK38・SK42出土遺物、遺構に伴わない遺物

SB16-SP67



SB17-SP71



SB17-SP74



SB17-SP76

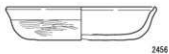

SB18-SP224

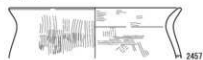

SP18



SP19



SP217

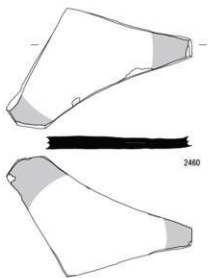

SP239

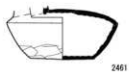

SD01



SD04

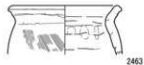

SD06

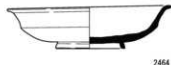

0 (1:4) 10cm

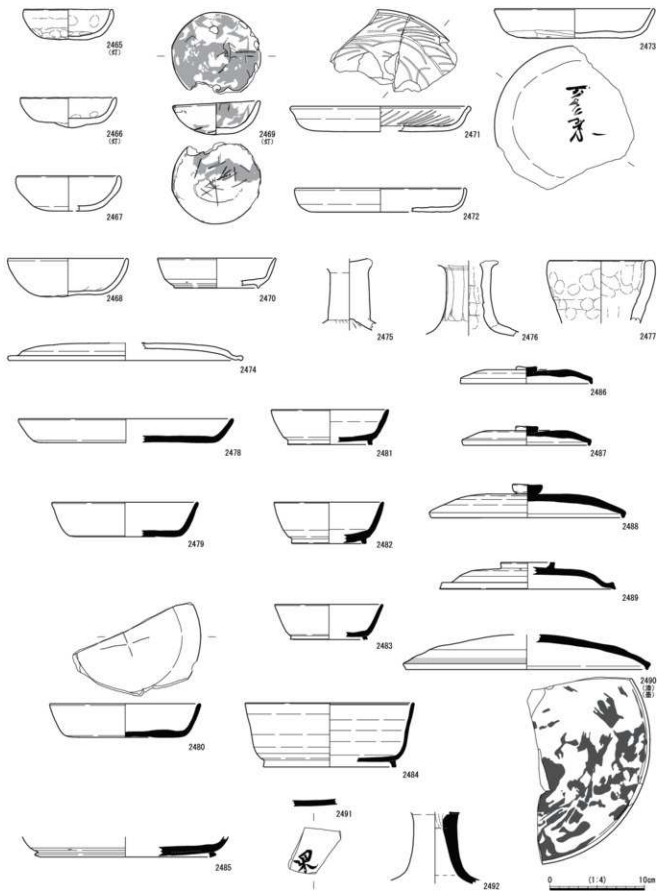

7次1区 SD05出土遺物(1)

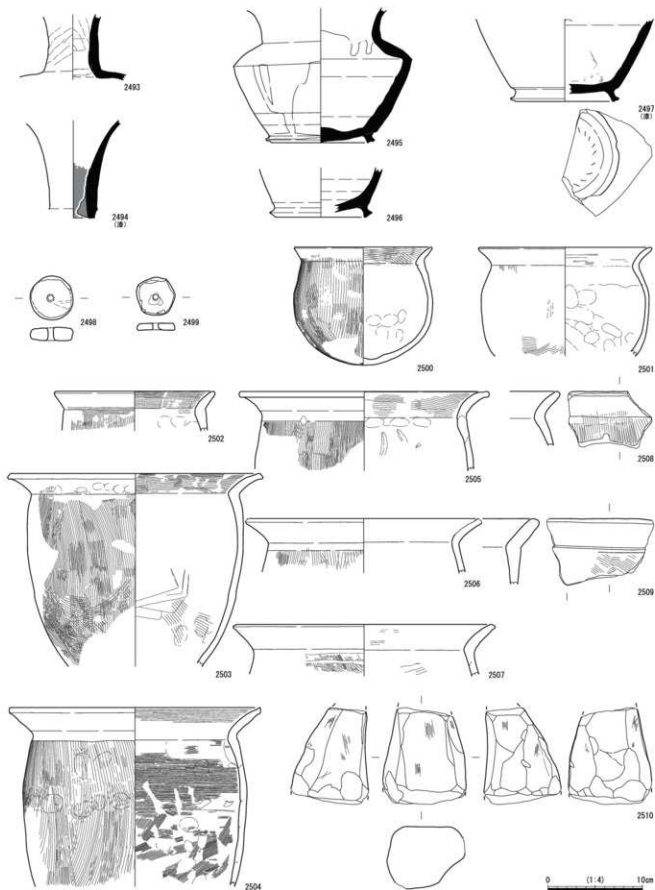

7次1区 SD05出土遺物(2)

SK01



2511



2512

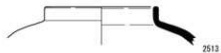

2513

SK07

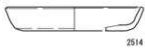

2514

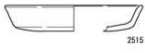

2515

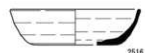

2516

SK08



2517

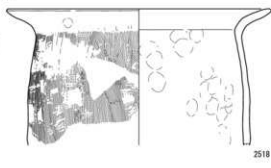

2518

SK10



2519

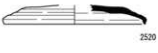

2520



2523

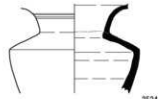

2524



2525



2521

(裏)

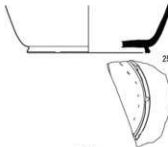

2522

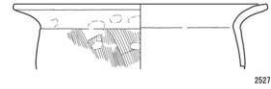

2527

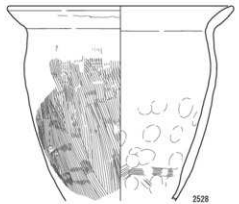

2528



2526

(裏)

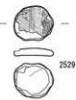

2529

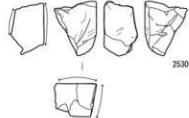

2530

SK12



2531

(裏)

SK269

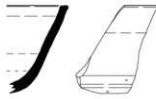

2532

0 (1:4) 10cm

7次1区 SK01・SK07・SK08・SK10・SK12・SK269出土遺物

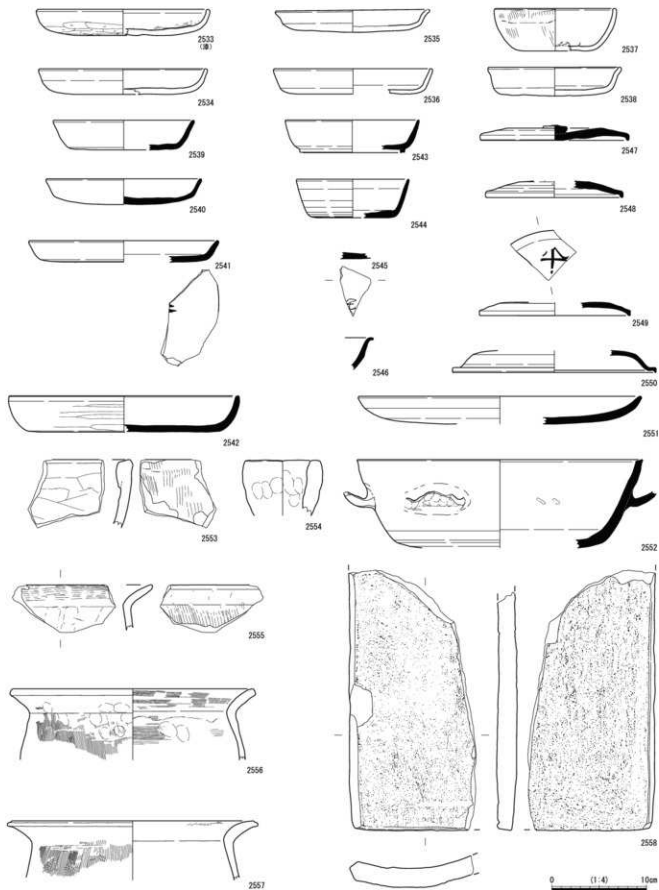

7次1区 SK11出土遺物

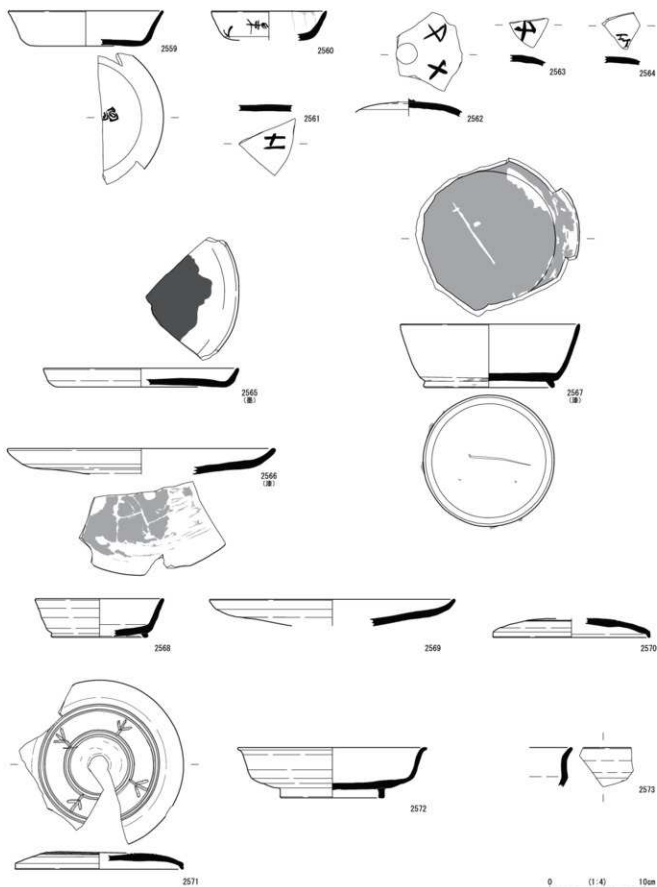

7次1区 遺構に伴わない遺物(1)



2574
(破)

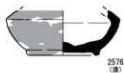

2576
(破)



2578
(破)

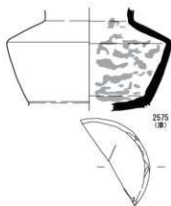

2575
(破)

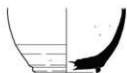

2577
(破)

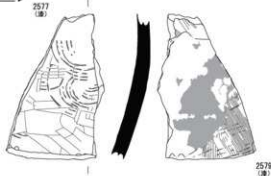

2579
(破)

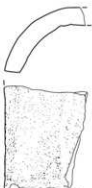

2582

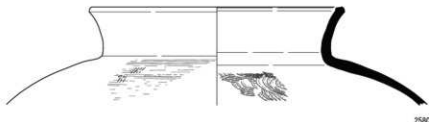

2580

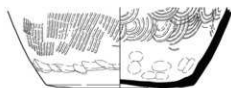

2581

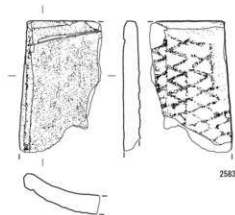

2583

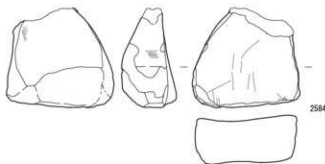

2584

0 (1:4) 10cm

7次1区 遺構に伴わない遺物(2)

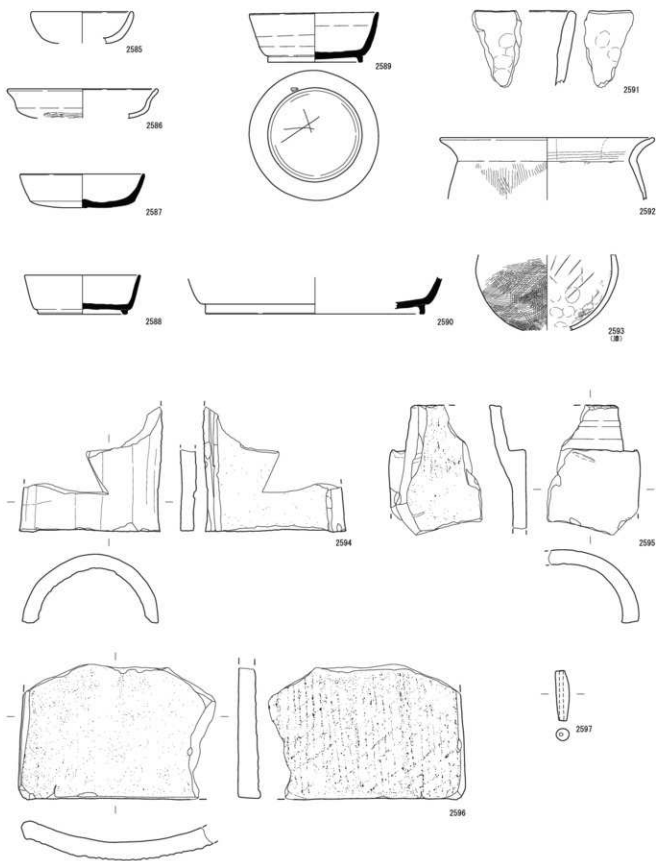

0 (1:4) 10cm

SP16

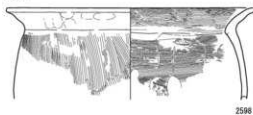

2598

SD01

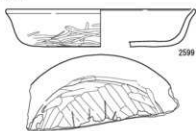

2599



2600



2601



SX02

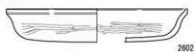

2602



2603



2604



2605

SX03

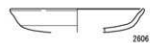

2606

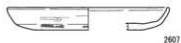

2607



2612



2608



2609



2610

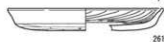

2611



2613

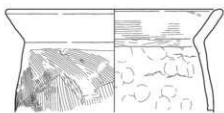

2614



2615

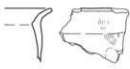

2616

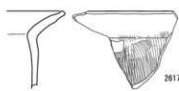

2617

0 (1:4) 10cm

7次2区 SP16、SD01、SX02出土遺物、SX03出土遺物(1)

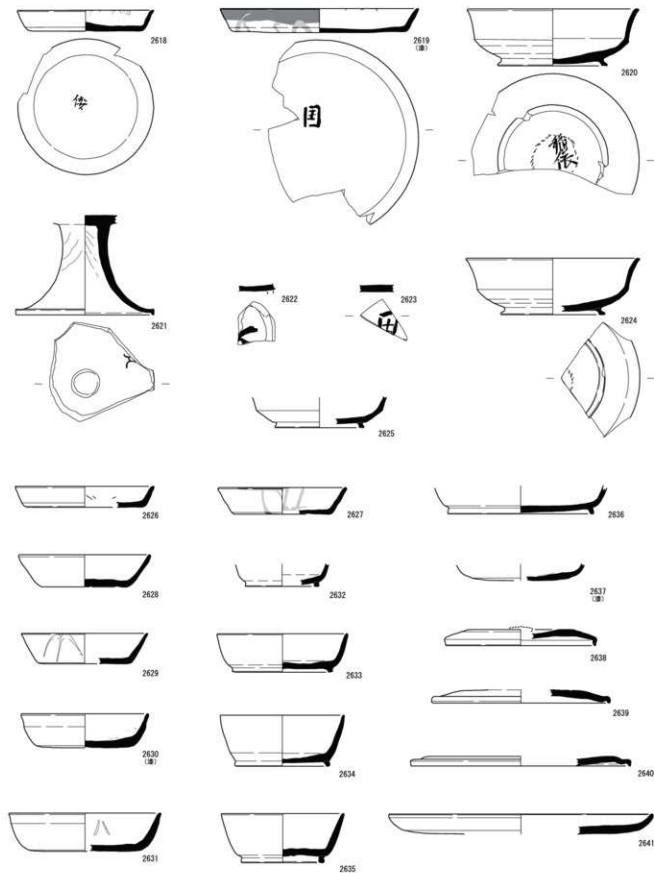

0 (1:4) 10cm

7次2区 SX03出土遺物(2)

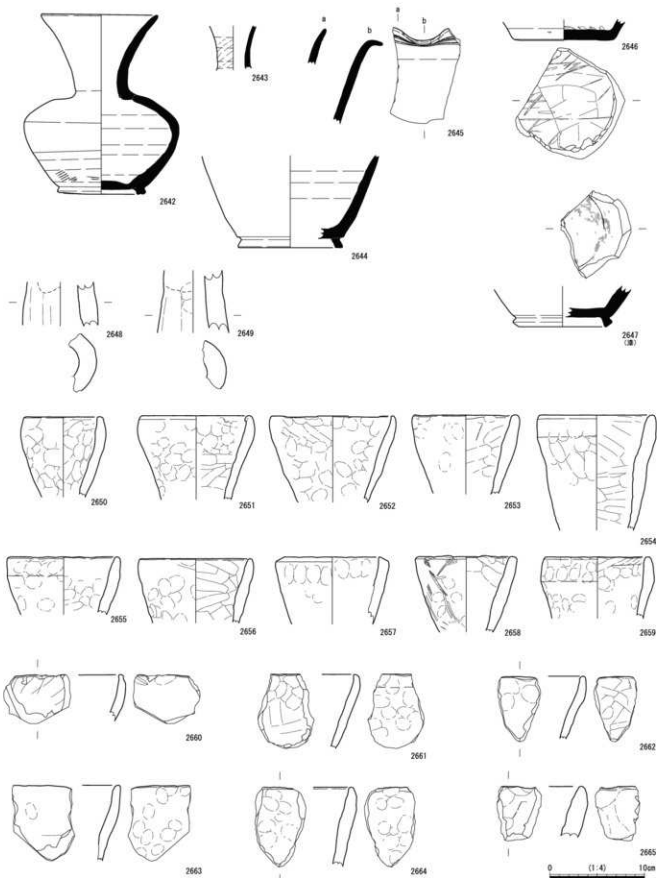

7次2区 SX03出土遺物(3)

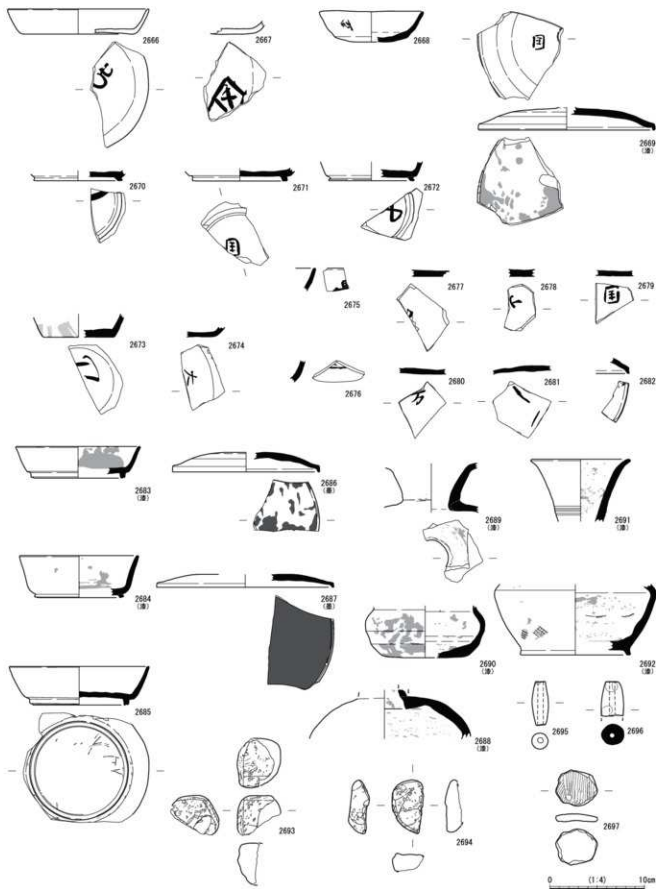

7次2区 遺構に伴わない遺物

SB13-SP60

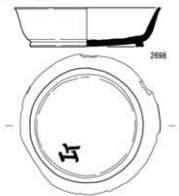

2688

SB14-SP31



2699

SP28



2701

SB15-SP37

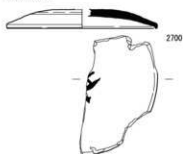

2700

SP48



2702

SD04

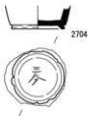

2704

SP108



2703

SD05



2705



2707



2708



2709

(裏)



2710

(裏)



2706



2711

(裏)



2712

0 (1:4) 10cm

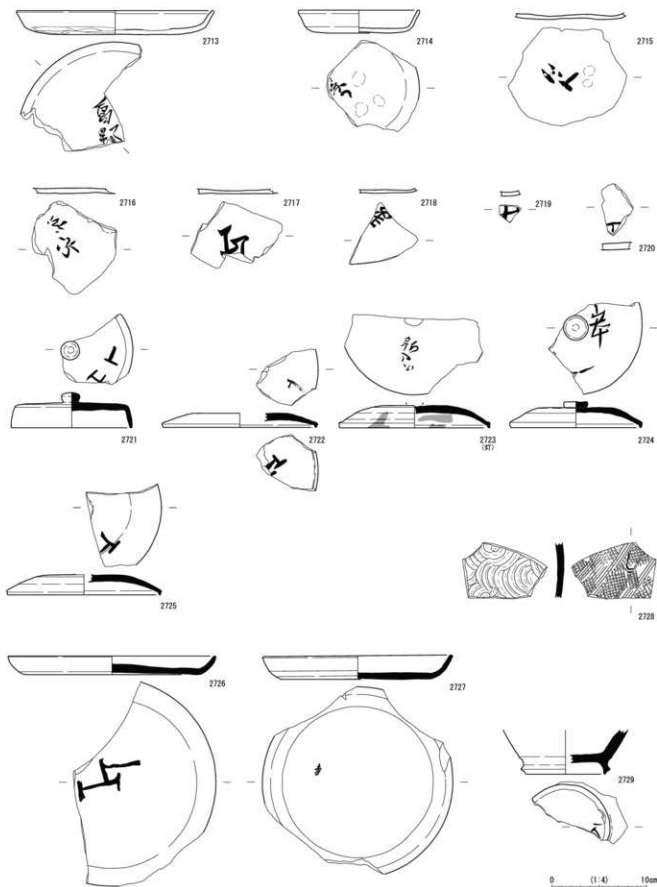

7次3区 SD02出土遺物(1)

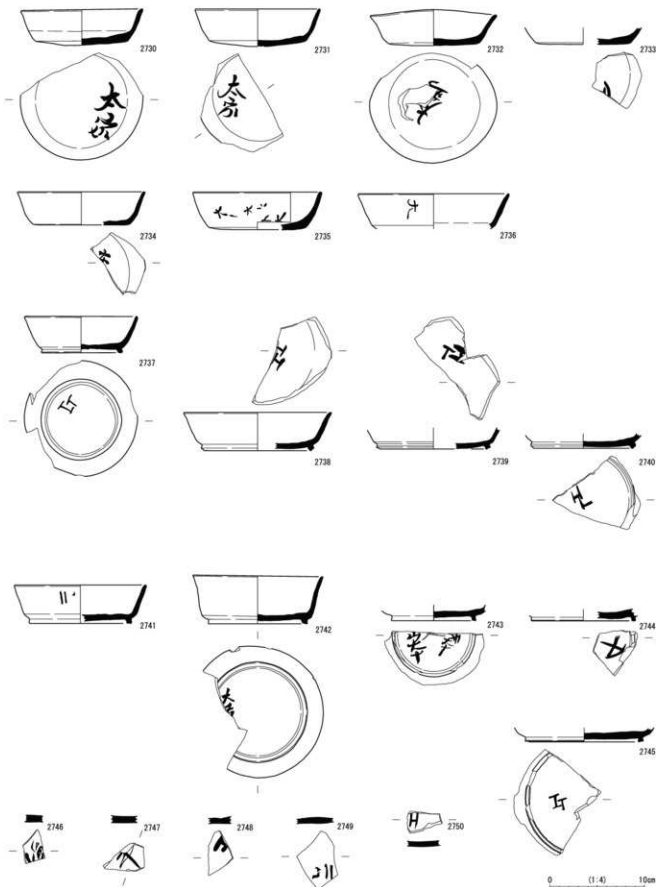

7次3区 SD02出土遺物(2)

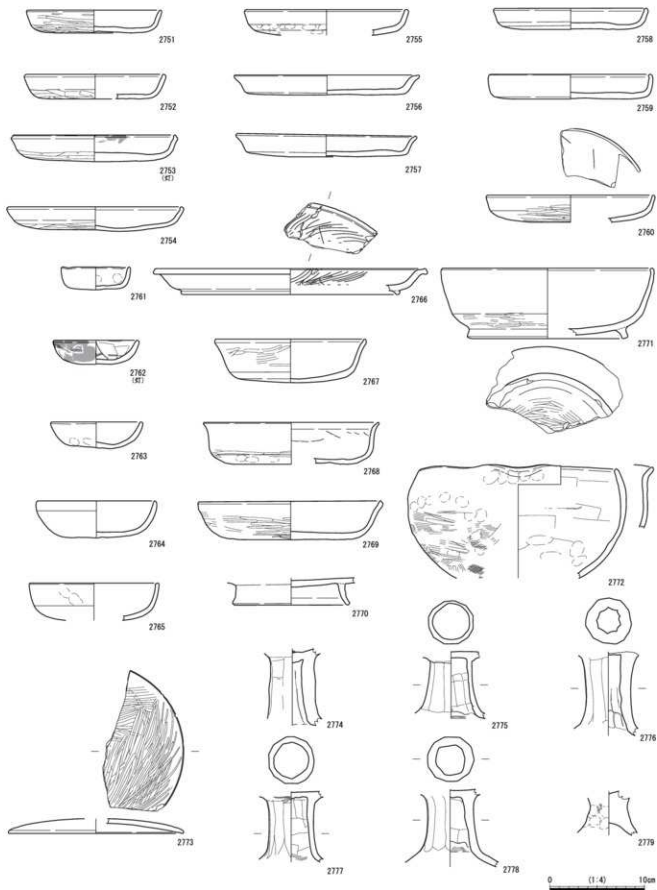

7次3区 SD02出土遺物(3)

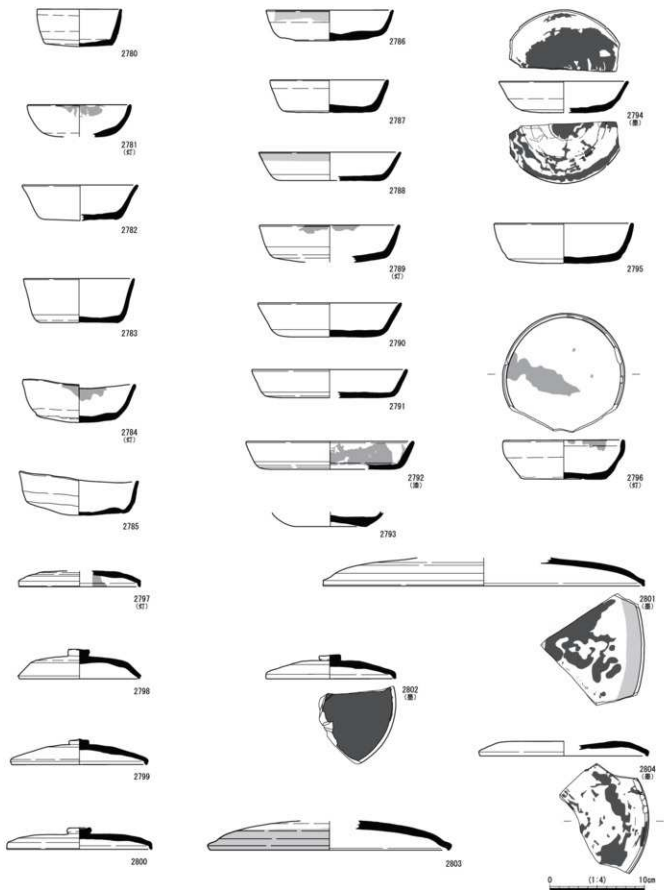

7次3区 SD02出土遺物(4)

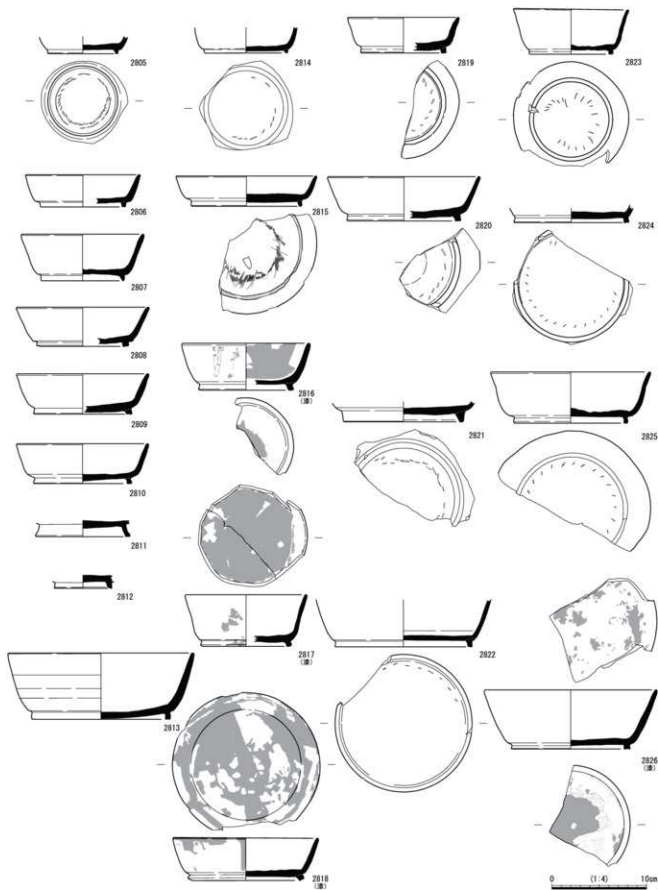

7次3区 SD02出土遺物(5)

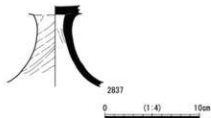
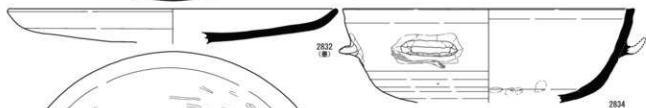
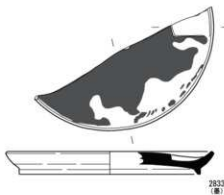
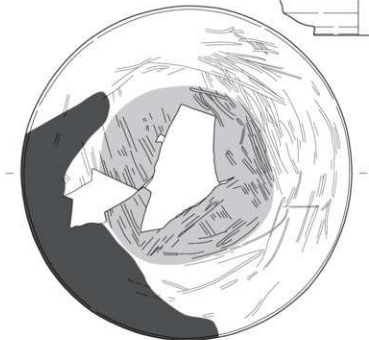
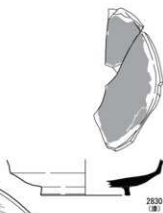
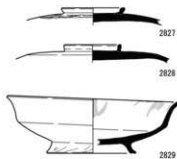

7次3区 SD02出土遺物(6)

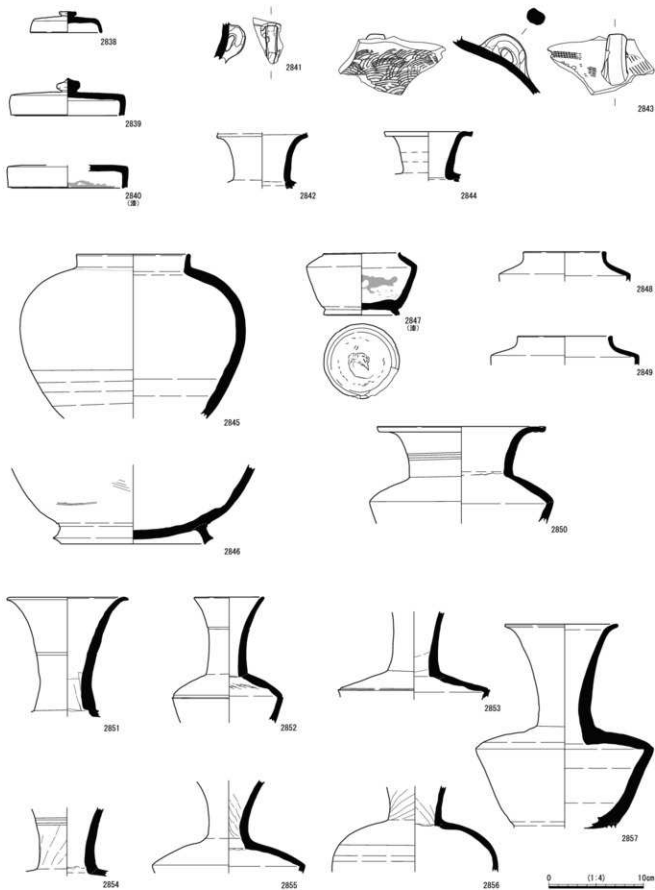

7次3区 SD02出土遺物(7)



2858

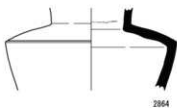

2864

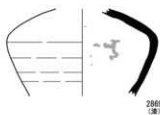

2869
(裏)

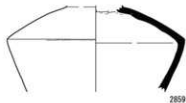

2859

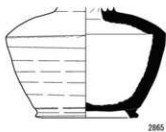

2865

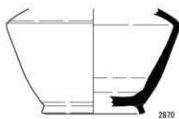

2870

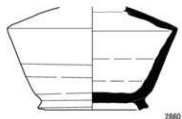

2860



2866



2871



2861



2867
(裏)

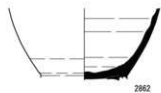

2862



2868
(裏)

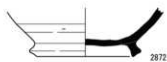

2872

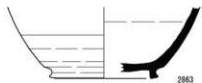

2863



0 (1:4) 10cm

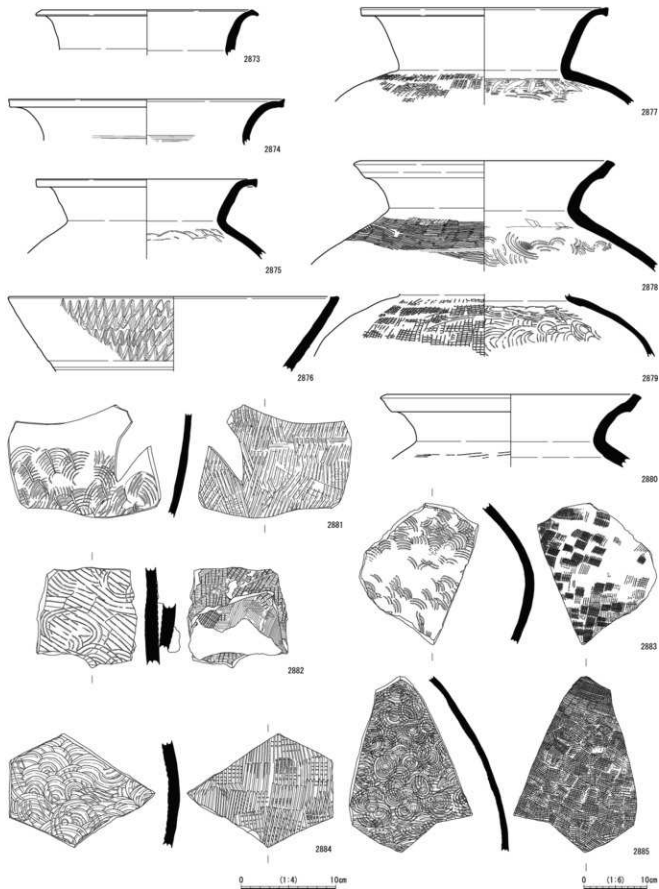

7次3区 SD02出土遺物(9)



2886

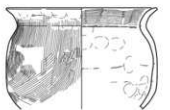

2887

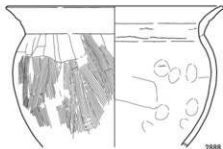

2888

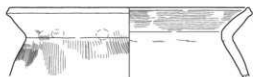

2889



2892



2890

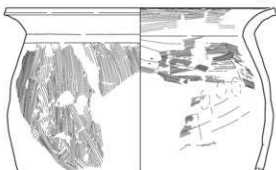

2891

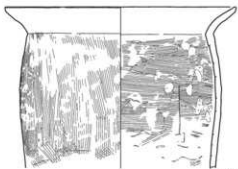

2893

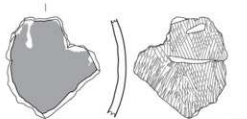

2894

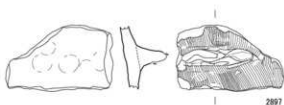

2897



2895



2898

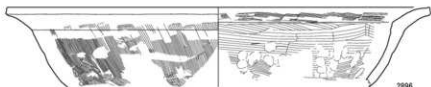

2896



7次3区 SD02出土遺物(10)

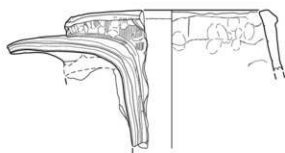
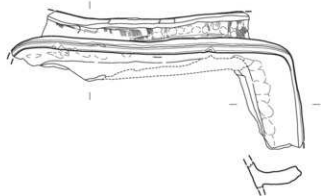
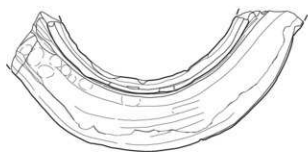

2899

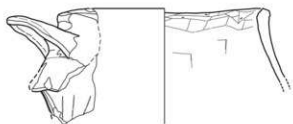
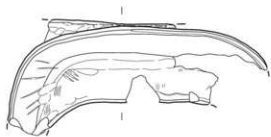

2900

0 (1/5) 10cm

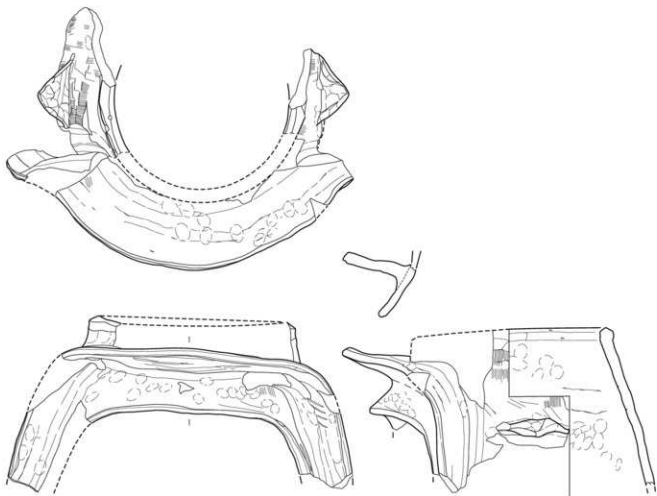

2901

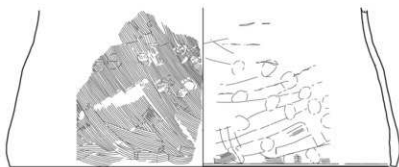

2902

0 (1:5) 10cm



7次3区 SD02出土遺物(13)

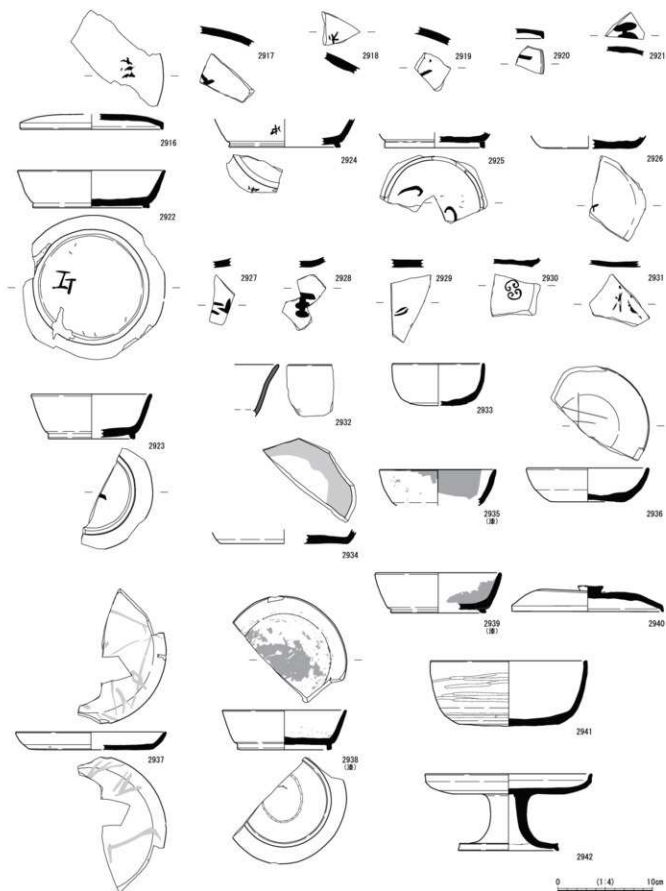

7次3区 遺構に伴わない遺物(1)

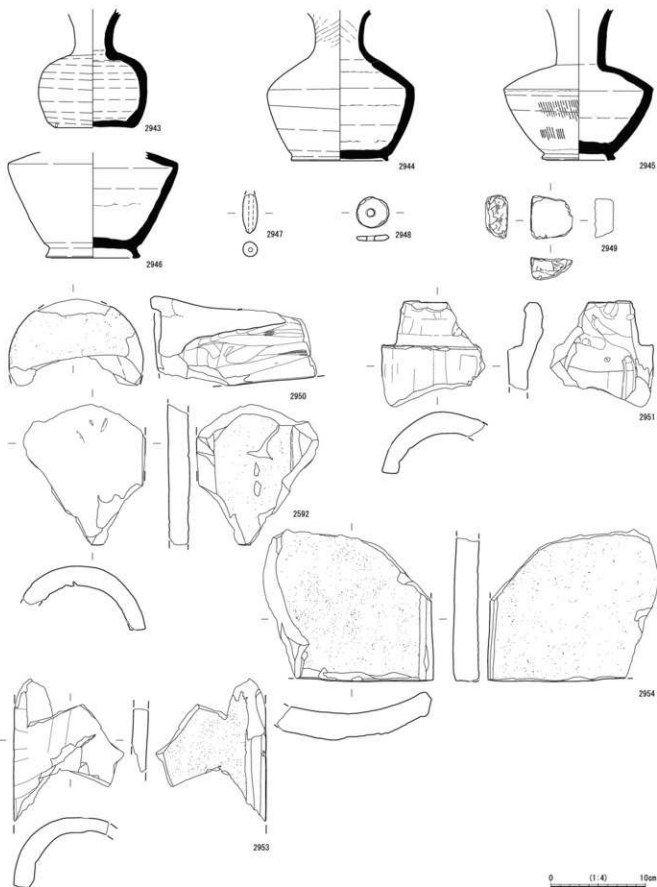

7次3区 遺構に伴わない遺物(2)

SK01

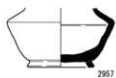

SK02

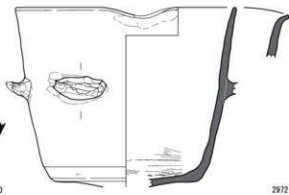
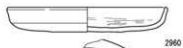
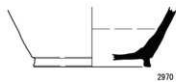
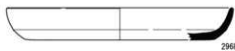
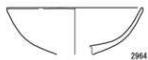
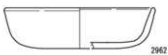
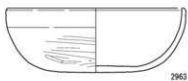
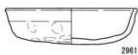
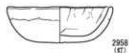

SD02

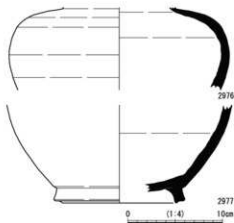
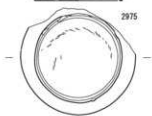
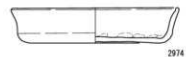
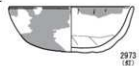

0 (1:4) 10cm

SP01



SP02

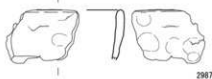
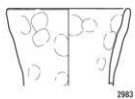
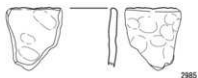
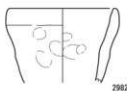

SP11

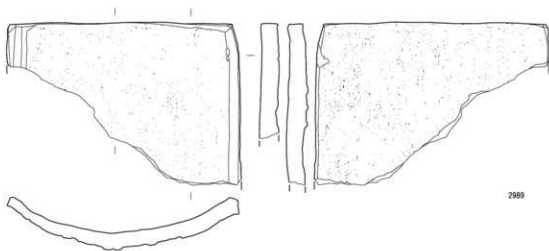

SK01



0 (1:4) 10cm

8次3区 SP01・SP02・SP11、SK01出土遺物

SD04

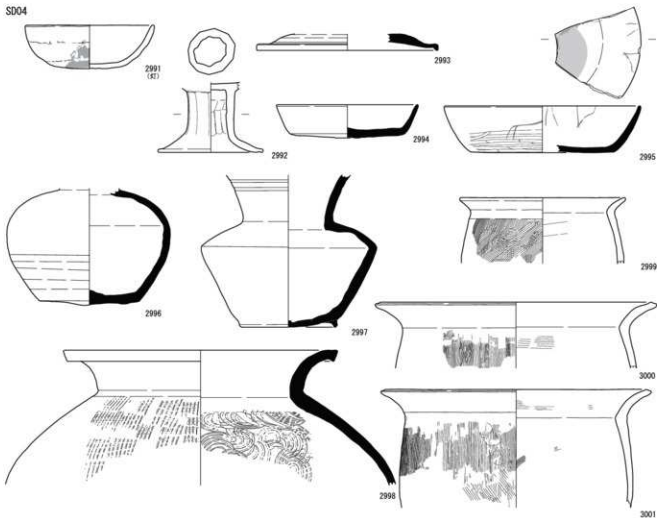

SX01

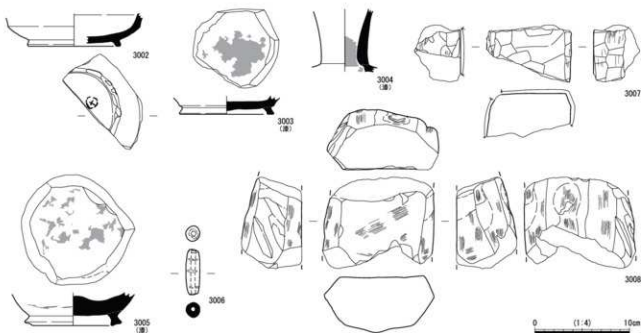

8次3区 SD04、SX01出土遺物

遺物 観 察 表

番号	年度	月	日	時間	性別	種別	個体	種別	性別	目録	種別	種名	種名
1	1.18.18	18	18	18:00	60	60	60	60	2.5	60	60	60	60
2	1.18.18	18	18	18:00	60	60	60	60	2.2	60	60	60	60
3	1.18.18	18	18	18:00	60	60	60	60	2.7	60	60	60	60
4	1.18.18	18	18	18:00	60	60	60	60	2.1	60	60	60	60
5	1.18.18	18	18	18:00	60	60	60	60	2.3	60	60	60	60
6	1.18.18	18	18	18:00	60	60	60	60	2.4	60	60	60	60
7	1.18.18	18	18	18:00	60	60	60	60	2.5	60	60	60	60
8	1.18.18	18	18	18:00	60	60	60	60	2.6	60	60	60	60
9	1.18.18	18	18	18:00	60	60	60	60	2.8	60	60	60	60
10	1.18.18	18	18	18:00	60	60	60	60	2.9	60	60	60	60
11	1.18.18	18	18	18:00	60	60	60	60	2.10	60	60	60	60
12	1.18.18	18	18	18:00	60	60	60	60	2.11	60	60	60	60
13	1.18.18	18	18	18:00	60	60	60	60	2.12	60	60	60	60
14	1.18.18	18	18	18:00	60	60	60	60	2.13	60	60	60	60
15	1.18.18	18	18	18:00	60	60	60	60	2.14	60	60	60	60
16	1.18.18	18	18	18:00	60	60	60	60	2.15	60	60	60	60
17	1.18.18	18	18	18:00	60	60	60	60	2.16	60	60	60	60
18	1.18.18	18	18	18:00	60	60	60	60	2.17	60	60	60	60
19	1.18.18	18	18	18:00	60	60	60	60	2.18	60	60	60	60
20	1.18.18	18	18	18:00	60	60	60	60	2.19	60	60	60	60
21	1.18.18	18	18	18:00	60	60	60	60	2.20	60	60	60	60
22	1.18.18	18	18	18:00	60	60	60	60	2.21	60	60	60	60
23	1.18.18	18	18	18:00	60	60	60	60	2.22	60	60	60	60
24	1.18.18	18	18	18:00	60	60	60	60	2.23	60	60	60	60
25	1.18.18	18	18	18:00	60	60	60	60	2.24	60	60	60	60
26	1.18.18	18	18	18:00	60	60	60	60	2.25	60	60	60	60
27	1.18.18	18	18	18:00	60	60	60	60	2.26	60	60	60	60
28	1.18.18	18	18	18:00	60	60	60	60	2.27	60	60	60	60
29	1.18.18	18	18	18:00	60	60	60	60	2.28	60	60	60	60
30	1.18.18	18	18	18:00	60	60	60	60	2.29	60	60	60	60

遺物製表表 4

番号	内容	出土位置	時期	部材	寸法	重量	長さ	直径	断面形状	材質	形状	特徴	所在地
156	1.8. 210	5822	銅	靱	84.0	3.4	137.1	1.7	1.7	銅	銅	長径 84.0mm、短径 3.4mm、厚さ 1.7mm、表面に細かな刻み模様あり	福岡県 太宰府市
157	1.8. 210	5823	銅	靱	86.0	3.5	138.0	1.8	1.8	銅	銅	長径 86.0mm、短径 3.5mm、厚さ 1.8mm、表面に細かな刻み模様あり	福岡県 太宰府市
158	1.8. 210	5824	銅	靱	88.0	3.6	140.0	1.9	1.9	銅	銅	長径 88.0mm、短径 3.6mm、厚さ 1.9mm、表面に細かな刻み模様あり	福岡県 太宰府市
159	1.8. 210	5825	銅	靱	90.0	3.7	142.0	2.0	2.0	銅	銅	長径 90.0mm、短径 3.7mm、厚さ 2.0mm、表面に細かな刻み模様あり	福岡県 太宰府市
160	1.8. 210	5826	銅	靱	92.0	3.8	144.0	2.1	2.1	銅	銅	長径 92.0mm、短径 3.8mm、厚さ 2.1mm、表面に細かな刻み模様あり	福岡県 太宰府市
161	1.8. 210	5827	銅	靱	94.0	3.9	146.0	2.2	2.2	銅	銅	長径 94.0mm、短径 3.9mm、厚さ 2.2mm、表面に細かな刻み模様あり	福岡県 太宰府市
162	1.8. 210	5828	銅	靱	96.0	4.0	148.0	2.3	2.3	銅	銅	長径 96.0mm、短径 4.0mm、厚さ 2.3mm、表面に細かな刻み模様あり	福岡県 太宰府市
163	1.8. 210	5829	銅	靱	98.0	4.1	150.0	2.4	2.4	銅	銅	長径 98.0mm、短径 4.1mm、厚さ 2.4mm、表面に細かな刻み模様あり	福岡県 太宰府市
164	1.8. 210	5830	銅	靱	100.0	4.2	152.0	2.5	2.5	銅	銅	長径 100.0mm、短径 4.2mm、厚さ 2.5mm、表面に細かな刻み模様あり	福岡県 太宰府市
165	1.8. 210	5831	銅	靱	102.0	4.3	154.0	2.6	2.6	銅	銅	長径 102.0mm、短径 4.3mm、厚さ 2.6mm、表面に細かな刻み模様あり	福岡県 太宰府市
166	1.8. 210	5832	銅	靱	104.0	4.4	156.0	2.7	2.7	銅	銅	長径 104.0mm、短径 4.4mm、厚さ 2.7mm、表面に細かな刻み模様あり	福岡県 太宰府市
167	1.8. 210	5833	銅	靱	106.0	4.5	158.0	2.8	2.8	銅	銅	長径 106.0mm、短径 4.5mm、厚さ 2.8mm、表面に細かな刻み模様あり	福岡県 太宰府市
168	1.8. 210	5834	銅	靱	108.0	4.6	160.0	2.9	2.9	銅	銅	長径 108.0mm、短径 4.6mm、厚さ 2.9mm、表面に細かな刻み模様あり	福岡県 太宰府市
169	1.8. 210	5835	銅	靱	110.0	4.7	162.0	3.0	3.0	銅	銅	長径 110.0mm、短径 4.7mm、厚さ 3.0mm、表面に細かな刻み模様あり	福岡県 太宰府市
170	1.8. 210	5836	銅	靱	112.0	4.8	164.0	3.1	3.1	銅	銅	長径 112.0mm、短径 4.8mm、厚さ 3.1mm、表面に細かな刻み模様あり	福岡県 太宰府市
171	1.8. 210	5837	銅	靱	114.0	4.9	166.0	3.2	3.2	銅	銅	長径 114.0mm、短径 4.9mm、厚さ 3.2mm、表面に細かな刻み模様あり	福岡県 太宰府市
172	1.8. 210	5838	銅	靱	116.0	5.0	168.0	3.3	3.3	銅	銅	長径 116.0mm、短径 5.0mm、厚さ 3.3mm、表面に細かな刻み模様あり	福岡県 太宰府市
173	1.8. 210	5839	銅	靱	118.0	5.1	170.0	3.4	3.4	銅	銅	長径 118.0mm、短径 5.1mm、厚さ 3.4mm、表面に細かな刻み模様あり	福岡県 太宰府市
174	1.8. 210	5840	銅	靱	120.0	5.2	172.0	3.5	3.5	銅	銅	長径 120.0mm、短径 5.2mm、厚さ 3.5mm、表面に細かな刻み模様あり	福岡県 太宰府市
175	1.8. 210	5841	銅	靱	122.0	5.3	174.0	3.6	3.6	銅	銅	長径 122.0mm、短径 5.3mm、厚さ 3.6mm、表面に細かな刻み模様あり	福岡県 太宰府市
176	1.8. 210	5842	銅	靱	124.0	5.4	176.0	3.7	3.7	銅	銅	長径 124.0mm、短径 5.4mm、厚さ 3.7mm、表面に細かな刻み模様あり	福岡県 太宰府市
177	1.8. 210	5843	銅	靱	126.0	5.5	178.0	3.8	3.8	銅	銅	長径 126.0mm、短径 5.5mm、厚さ 3.8mm、表面に細かな刻み模様あり	福岡県 太宰府市
178	1.8. 210	5844	銅	靱	128.0	5.6	180.0	3.9	3.9	銅	銅	長径 128.0mm、短径 5.6mm、厚さ 3.9mm、表面に細かな刻み模様あり	福岡県 太宰府市
179	1.8. 210	5845	銅	靱	130.0	5.7	182.0	4.0	4.0	銅	銅	長径 130.0mm、短径 5.7mm、厚さ 4.0mm、表面に細かな刻み模様あり	福岡県 太宰府市
180	1.8. 210	5846	銅	靱	132.0	5.8	184.0	4.1	4.1	銅	銅	長径 132.0mm、短径 5.8mm、厚さ 4.1mm、表面に細かな刻み模様あり	福岡県 太宰府市
181	1.8. 210	5847	銅	靱	134.0	5.9	186.0	4.2	4.2	銅	銅	長径 134.0mm、短径 5.9mm、厚さ 4.2mm、表面に細かな刻み模様あり	福岡県 太宰府市
182	1.8. 210	5848	銅	靱	136.0	6.0	188.0	4.3	4.3	銅	銅	長径 136.0mm、短径 6.0mm、厚さ 4.3mm、表面に細かな刻み模様あり	福岡県 太宰府市
183	1.8. 210	5849	銅	靱	138.0	6.1	190.0	4.4	4.4	銅	銅	長径 138.0mm、短径 6.1mm、厚さ 4.4mm、表面に細かな刻み模様あり	福岡県 太宰府市
184	1.8. 210	5850	銅	靱	140.0	6.2	192.0	4.5	4.5	銅	銅	長径 140.0mm、短径 6.2mm、厚さ 4.5mm、表面に細かな刻み模様あり	福岡県 太宰府市
185	1.8. 210	5851	銅	靱	142.0	6.3	194.0	4.6	4.6	銅	銅	長径 142.0mm、短径 6.3mm、厚さ 4.6mm、表面に細かな刻み模様あり	福岡県 太宰府市
186	1.8. 210	5852	銅	靱	144.0	6.4	196.0	4.7	4.7	銅	銅	長径 144.0mm、短径 6.4mm、厚さ 4.7mm、表面に細かな刻み模様あり	福岡県 太宰府市
187	1.8. 210	5853	銅	靱	146.0	6.5	198.0	4.8	4.8	銅	銅	長径 146.0mm、短径 6.5mm、厚さ 4.8mm、表面に細かな刻み模様あり	福岡県 太宰府市
188	1.8. 210	5854	銅	靱	148.0	6.6	200.0	4.9	4.9	銅	銅	長径 148.0mm、短径 6.6mm、厚さ 4.9mm、表面に細かな刻み模様あり	福岡県 太宰府市
189	1.8. 210	5855	銅	靱	150.0	6.7	202.0	5.0	5.0	銅	銅	長径 150.0mm、短径 6.7mm、厚さ 5.0mm、表面に細かな刻み模様あり	福岡県 太宰府市
190	1.8. 210	5856	銅	靱	152.0	6.8	204.0	5.1	5.1	銅	銅	長径 152.0mm、短径 6.8mm、厚さ 5.1mm、表面に細かな刻み模様あり	福岡県 太宰府市
191	1.8. 210	5857	銅	靱	154.0	6.9	206.0	5.2	5.2	銅	銅	長径 154.0mm、短径 6.9mm、厚さ 5.2mm、表面に細かな刻み模様あり	福岡県 太宰府市
192	1.8. 210	5858	銅	靱	156.0	7.0	208.0	5.3	5.3	銅	銅	長径 156.0mm、短径 7.0mm、厚さ 5.3mm、表面に細かな刻み模様あり	福岡県 太宰府市
193	1.8. 210	5859	銅	靱	158.0	7.1	210.0	5.4	5.4	銅	銅	長径 158.0mm、短径 7.1mm、厚さ 5.4mm、表面に細かな刻み模様あり	福岡県 太宰府市
194	1.8. 210	5860	銅	靱	160.0	7.2	212.0	5.5	5.5	銅	銅	長径 160.0mm、短径 7.2mm、厚さ 5.5mm、表面に細かな刻み模様あり	福岡県 太宰府市
195	1.8. 210	5861	銅	靱	162.0	7.3	214.0	5.6	5.6	銅	銅	長径 162.0mm、短径 7.3mm、厚さ 5.6mm、表面に細かな刻み模様あり	福岡県 太宰府市
196	1.8. 210	5862	銅	靱	164.0	7.4	216.0	5.7	5.7	銅	銅	長径 164.0mm、短径 7.4mm、厚さ 5.7mm、表面に細かな刻み模様あり	福岡県 太宰府市
197	1.8. 210	5863	銅	靱	166.0	7.5	218.0	5.8	5.8	銅	銅	長径 166.0mm、短径 7.5mm、厚さ 5.8mm、表面に細かな刻み模様あり	福岡県 太宰府市
198	1.8. 210	5864	銅	靱	168.0	7.6	220.0	5.9	5.9	銅	銅	長径 168.0mm、短径 7.6mm、厚さ 5.9mm、表面に細かな刻み模様あり	福岡県 太宰府市
199	1.8. 210	5865	銅	靱	170.0	7.7	222.0	6.0	6.0	銅	銅	長径 170.0mm、短径 7.7mm、厚さ 6.0mm、表面に細かな刻み模様あり	福岡県 太宰府市
200	1.8. 210	5866	銅	靱	172.0	7.8	224.0	6.1	6.1	銅	銅	長径 172.0mm、短径 7.8mm、厚さ 6.1mm、表面に細かな刻み模様あり	福岡県 太宰府市
201	1.8. 210	5867	銅	靱	174.0	7.9	226.0	6.2	6.2	銅	銅	長径 174.0mm、短径 7.9mm、厚さ 6.2mm、表面に細かな刻み模様あり	福岡県 太宰府市
202	1.8. 210	5868	銅	靱	176.0	8.0	228.0	6.3	6.3	銅	銅	長径 176.0mm、短径 8.0mm、厚さ 6.3mm、表面に細かな刻み模様あり	福岡県 太宰府市

番号	地区名	指定位置	所有者	資料	量	規格	用途	形状	材質	内容	特徴	調査事項
422	4区	116	西郷 隆平	1000	60	200	0.5	0.1	銅	銅製	銅製	-
423	4区	118	西郷 隆平	1000	60	200	0.5	0.1	銅	銅製	銅製	銅製
424	4区	120	西郷 隆平	1000	60	200	0.5	0.1	銅	銅製	銅製	銅製
425	4区	122	西郷 隆平	1000	60	200	0.5	0.1	銅	銅製	銅製	銅製
426	4区	124	西郷 隆平	1000	60	200	0.5	0.1	銅	銅製	銅製	銅製
427	4区	126	西郷 隆平	1000	60	200	0.5	0.1	銅	銅製	銅製	銅製
428	4区	128	西郷 隆平	1000	60	200	0.5	0.1	銅	銅製	銅製	銅製
429	4区	130	西郷 隆平	1000	60	200	0.5	0.1	銅	銅製	銅製	銅製
430	4区	132	西郷 隆平	1000	60	200	0.5	0.1	銅	銅製	銅製	銅製
431	4区	134	西郷 隆平	1000	60	200	0.5	0.1	銅	銅製	銅製	銅製
432	4区	136	西郷 隆平	1000	60	200	0.5	0.1	銅	銅製	銅製	銅製
433	4区	138	西郷 隆平	1000	60	200	0.5	0.1	銅	銅製	銅製	銅製
434	4区	140	西郷 隆平	1000	60	200	0.5	0.1	銅	銅製	銅製	銅製
435	4区	142	西郷 隆平	1000	60	200	0.5	0.1	銅	銅製	銅製	銅製
436	4区	144	西郷 隆平	1000	60	200	0.5	0.1	銅	銅製	銅製	銅製
437	4区	146	西郷 隆平	1000	60	200	0.5	0.1	銅	銅製	銅製	銅製
438	4区	148	西郷 隆平	1000	60	200	0.5	0.1	銅	銅製	銅製	銅製
439	4区	150	西郷 隆平	1000	60	200	0.5	0.1	銅	銅製	銅製	銅製
440	4区	152	西郷 隆平	1000	60	200	0.5	0.1	銅	銅製	銅製	銅製
441	4区	154	西郷 隆平	1000	60	200	0.5	0.1	銅	銅製	銅製	銅製
442	4区	156	西郷 隆平	1000	60	200	0.5	0.1	銅	銅製	銅製	銅製
443	4区	158	西郷 隆平	1000	60	200	0.5	0.1	銅	銅製	銅製	銅製
444	4区	160	西郷 隆平	1000	60	200	0.5	0.1	銅	銅製	銅製	銅製
445	4区	162	西郷 隆平	1000	60	200	0.5	0.1	銅	銅製	銅製	銅製
446	4区	164	西郷 隆平	1000	60	200	0.5	0.1	銅	銅製	銅製	銅製
447	4区	166	西郷 隆平	1000	60	200	0.5	0.1	銅	銅製	銅製	銅製
448	4区	168	西郷 隆平	1000	60	200	0.5	0.1	銅	銅製	銅製	銅製
449	4区	170	西郷 隆平	1000	60	200	0.5	0.1	銅	銅製	銅製	銅製
450	4区	172	西郷 隆平	1000	60	200	0.5	0.1	銅	銅製	銅製	銅製
451	4区	174	西郷 隆平	1000	60	200	0.5	0.1	銅	銅製	銅製	銅製
452	4区	176	西郷 隆平	1000	60	200	0.5	0.1	銅	銅製	銅製	銅製
453	4区	178	西郷 隆平	1000	60	200	0.5	0.1	銅	銅製	銅製	銅製
454	4区	180	西郷 隆平	1000	60	200	0.5	0.1	銅	銅製	銅製	銅製
455	4区	182	西郷 隆平	1000	60	200	0.5	0.1	銅	銅製	銅製	銅製
456	4区	184	西郷 隆平	1000	60	200	0.5	0.1	銅	銅製	銅製	銅製
457	4区	186	西郷 隆平	1000	60	200	0.5	0.1	銅	銅製	銅製	銅製
458	4区	188	西郷 隆平	1000	60	200	0.5	0.1	銅	銅製	銅製	銅製
459	4区	190	西郷 隆平	1000	60	200	0.5	0.1	銅	銅製	銅製	銅製
460	4区	192	西郷 隆平	1000	60	200	0.5	0.1	銅	銅製	銅製	銅製

番号	所在地	出土時期	形状	材料	長さ	幅	厚さ	重量	備考	図録	説明	制作時期
461	1-18	191302	丸底平鉢	土器	11.5	11.5	0.57	10.5	丸底平鉢	100	丸底平鉢	191302
462	1-18	191302	丸底平鉢	土器	11.5	11.5	0.57	10.5	丸底平鉢	100	丸底平鉢	191302
463	1-18	191302	丸底平鉢	土器	11.5	11.5	0.57	10.5	丸底平鉢	100	丸底平鉢	191302
464	1-18	191302	丸底平鉢	土器	11.5	11.5	0.57	10.5	丸底平鉢	100	丸底平鉢	191302
465	1-18	191302	丸底平鉢	土器	11.5	11.5	0.57	10.5	丸底平鉢	100	丸底平鉢	191302
466	1-18	191302	丸底平鉢	土器	11.5	11.5	0.57	10.5	丸底平鉢	100	丸底平鉢	191302
467	1-18	191302	丸底平鉢	土器	11.5	11.5	0.57	10.5	丸底平鉢	100	丸底平鉢	191302
468	1-18	191302	丸底平鉢	土器	11.5	11.5	0.57	10.5	丸底平鉢	100	丸底平鉢	191302
469	1-18	191302	丸底平鉢	土器	11.5	11.5	0.57	10.5	丸底平鉢	100	丸底平鉢	191302
470	1-18	191302	丸底平鉢	土器	11.5	11.5	0.57	10.5	丸底平鉢	100	丸底平鉢	191302
471	1-18	191302	丸底平鉢	土器	11.5	11.5	0.57	10.5	丸底平鉢	100	丸底平鉢	191302
472	1-18	191302	丸底平鉢	土器	11.5	11.5	0.57	10.5	丸底平鉢	100	丸底平鉢	191302
473	1-18	191302	丸底平鉢	土器	11.5	11.5	0.57	10.5	丸底平鉢	100	丸底平鉢	191302
474	1-18	191302	丸底平鉢	土器	11.5	11.5	0.57	10.5	丸底平鉢	100	丸底平鉢	191302
475	1-18	191302	丸底平鉢	土器	11.5	11.5	0.57	10.5	丸底平鉢	100	丸底平鉢	191302
476	1-18	191302	丸底平鉢	土器	11.5	11.5	0.57	10.5	丸底平鉢	100	丸底平鉢	191302
477	1-18	191302	丸底平鉢	土器	11.5	11.5	0.57	10.5	丸底平鉢	100	丸底平鉢	191302
478	1-18	191302	丸底平鉢	土器	11.5	11.5	0.57	10.5	丸底平鉢	100	丸底平鉢	191302
479	1-18	191302	丸底平鉢	土器	11.5	11.5	0.57	10.5	丸底平鉢	100	丸底平鉢	191302
480	1-18	191302	丸底平鉢	土器	11.5	11.5	0.57	10.5	丸底平鉢	100	丸底平鉢	191302
481	1-18	191302	丸底平鉢	土器	11.5	11.5	0.57	10.5	丸底平鉢	100	丸底平鉢	191302
482	1-18	191302	丸底平鉢	土器	11.5	11.5	0.57	10.5	丸底平鉢	100	丸底平鉢	191302
483	1-18	191302	丸底平鉢	土器	11.5	11.5	0.57	10.5	丸底平鉢	100	丸底平鉢	191302
484	1-18	191302	丸底平鉢	土器	11.5	11.5	0.57	10.5	丸底平鉢	100	丸底平鉢	191302
485	1-18	191302	丸底平鉢	土器	11.5	11.5	0.57	10.5	丸底平鉢	100	丸底平鉢	191302
486	1-18	191302	丸底平鉢	土器	11.5	11.5	0.57	10.5	丸底平鉢	100	丸底平鉢	191302

番号	氏名	性別	生年	身長		種別	用途	重量	備考	出土状況	状態	所蔵	用途	備考	形状
				肩高	身長										
722	三木 正二	男	1891	169	169	短剣	近衛	1.9	4	15	15	4.0	0.7	刀身は平ら、腰を切った。刃先は鋭い。柄は木製。長さ約15cm。	近衛 近衛正二
723	三木 正二	男	1891	169	169	短剣	近衛	1.9	4	15	15	4.0	0.7	刀身は平ら、腰を切った。刃先は鋭い。柄は木製。長さ約15cm。	近衛 近衛正二
724	三木 正二	男	1891	169	169	短剣	近衛	1.9	4	15	15	4.0	0.7	刀身は平ら、腰を切った。刃先は鋭い。柄は木製。長さ約15cm。	近衛 近衛正二
725	三木 正二	男	1891	169	169	短剣	近衛	1.9	4	15	15	4.0	0.7	刀身は平ら、腰を切った。刃先は鋭い。柄は木製。長さ約15cm。	近衛 近衛正二
726	三木 正二	男	1891	169	169	短剣	近衛	1.9	4	15	15	4.0	0.7	刀身は平ら、腰を切った。刃先は鋭い。柄は木製。長さ約15cm。	近衛 近衛正二
727	三木 正二	男	1891	169	169	短剣	近衛	1.9	4	15	15	4.0	0.7	刀身は平ら、腰を切った。刃先は鋭い。柄は木製。長さ約15cm。	近衛 近衛正二
728	三木 正二	男	1891	169	169	短剣	近衛	1.9	4	15	15	4.0	0.7	刀身は平ら、腰を切った。刃先は鋭い。柄は木製。長さ約15cm。	近衛 近衛正二
729	三木 正二	男	1891	169	169	短剣	近衛	1.9	4	15	15	4.0	0.7	刀身は平ら、腰を切った。刃先は鋭い。柄は木製。長さ約15cm。	近衛 近衛正二
730	三木 正二	男	1891	169	169	短剣	近衛	1.9	4	15	15	4.0	0.7	刀身は平ら、腰を切った。刃先は鋭い。柄は木製。長さ約15cm。	近衛 近衛正二
731	三木 正二	男	1891	169	169	短剣	近衛	1.9	4	15	15	4.0	0.7	刀身は平ら、腰を切った。刃先は鋭い。柄は木製。長さ約15cm。	近衛 近衛正二
732	三木 正二	男	1891	169	169	短剣	近衛	1.9	4	15	15	4.0	0.7	刀身は平ら、腰を切った。刃先は鋭い。柄は木製。長さ約15cm。	近衛 近衛正二
733	三木 正二	男	1891	169	169	短剣	近衛	1.9	4	15	15	4.0	0.7	刀身は平ら、腰を切った。刃先は鋭い。柄は木製。長さ約15cm。	近衛 近衛正二
734	三木 正二	男	1891	169	169	短剣	近衛	1.9	4	15	15	4.0	0.7	刀身は平ら、腰を切った。刃先は鋭い。柄は木製。長さ約15cm。	近衛 近衛正二
735	三木 正二	男	1891	169	169	短剣	近衛	1.9	4	15	15	4.0	0.7	刀身は平ら、腰を切った。刃先は鋭い。柄は木製。長さ約15cm。	近衛 近衛正二
736	三木 正二	男	1891	169	169	短剣	近衛	1.9	4	15	15	4.0	0.7	刀身は平ら、腰を切った。刃先は鋭い。柄は木製。長さ約15cm。	近衛 近衛正二
737	三木 正二	男	1891	169	169	短剣	近衛	1.9	4	15	15	4.0	0.7	刀身は平ら、腰を切った。刃先は鋭い。柄は木製。長さ約15cm。	近衛 近衛正二
738	三木 正二	男	1891	169	169	短剣	近衛	1.9	4	15	15	4.0	0.7	刀身は平ら、腰を切った。刃先は鋭い。柄は木製。長さ約15cm。	近衛 近衛正二
739	三木 正二	男	1891	169	169	短剣	近衛	1.9	4	15	15	4.0	0.7	刀身は平ら、腰を切った。刃先は鋭い。柄は木製。長さ約15cm。	近衛 近衛正二
740	三木 正二	男	1891	169	169	短剣	近衛	1.9	4	15	15	4.0	0.7	刀身は平ら、腰を切った。刃先は鋭い。柄は木製。長さ約15cm。	近衛 近衛正二

番号	所在地 町 丁目	種別	11	12	13	14	15	16	17	18	19	20	21	22	23	24	25	26	27	28	29	30	31	32	33	34	35	36	37	38	39	40	41	42	43	44	45	46	47	48	49	50	51	52	53	54	55	56	57	58	59	60	61	62	63	64	65	66	67	68	69	70	71	72	73	74	75	76	77	78	79	80	81	82	83	84	85	86	87	88	89	90	91	92	93	94	95	96	97	98	99	100	101	102	103	104	105	106	107	108	109	110	111	112	113	114	115	116	117	118	119	120	121	122	123	124	125	126	127	128	129	130	131	132	133	134	135	136	137	138	139	140	141	142	143	144	145	146	147	148	149	150	151	152	153	154	155	156	157	158	159	160	161	162	163	164	165	166	167	168	169	170	171	172	173	174	175	176	177	178	179	180	181	182	183	184	185	186	187	188	189	190	191	192	193	194	195	196	197	198	199	200	
801	東区 2-10-12	遺物	瓦	11	12	13	14	15	16	17	18	19	20	21	22	23	24	25	26	27	28	29	30	31	32	33	34	35	36	37	38	39	40	41	42	43	44	45	46	47	48	49	50	51	52	53	54	55	56	57	58	59	60	61	62	63	64	65	66	67	68	69	70	71	72	73	74	75	76	77	78	79	80	81	82	83	84	85	86	87	88	89	90	91	92	93	94	95	96	97	98	99	100	101	102	103	104	105	106	107	108	109	110	111	112	113	114	115	116	117	118	119	120	121	122	123	124	125	126	127	128	129	130	131	132	133	134	135	136	137	138	139	140	141	142	143	144	145	146	147	148	149	150	151	152	153	154	155	156	157	158	159	160	161	162	163	164	165	166	167	168	169	170	171	172	173	174	175	176	177	178	179	180	181	182	183	184	185	186	187	188	189	190	191	192	193	194	195	196	197	198	199	200
802	東区 2-10-12	遺物	瓦	11	12	13	14	15	16	17	18	19	20	21	22	23	24	25	26	27	28	29	30	31	32	33	34	35	36	37	38	39	40	41	42	43	44	45	46	47	48	49	50	51	52	53	54	55	56	57	58	59	60	61	62	63	64	65	66	67	68	69	70	71	72	73	74	75	76	77	78	79	80	81	82	83	84	85	86	87	88	89	90	91	92	93	94	95	96	97	98	99	100	101	102	103	104	105	106	107	108	109	110	111	112	113	114	115	116	117	118	119	120	121	122	123	124	125	126	127	128	129	130	131	132	133	134	135	136	137	138	139	140	141	142	143	144	145	146	147	148	149	150	151	152	153	154	155	156	157	158	159	160	161	162	163	164	165	166	167	168	169	170	171	172	173	174	175	176	177	178	179	180	181	182	183	184	185	186	187	188	189	190	191	192	193	194	195	196	197	198	199	200

遺物観察表 19

番号	所在地	出土時期	資料	目録	数量	形状	製造	用途	備考
1181	1181-6-6	1181-6-6	銅貨	銅貨	1.5	銅貨	銅貨	銅貨	銅貨
1182	1182-6-6	1182-6-6	銅貨	銅貨	1.5	銅貨	銅貨	銅貨	銅貨
1183	1183-6-6	1183-6-6	銅貨	銅貨	1.5	銅貨	銅貨	銅貨	銅貨
1184	1184-6-6	1184-6-6	銅貨	銅貨	1.5	銅貨	銅貨	銅貨	銅貨
1185	1185-6-6	1185-6-6	銅貨	銅貨	1.5	銅貨	銅貨	銅貨	銅貨
1186	1186-6-6	1186-6-6	銅貨	銅貨	1.5	銅貨	銅貨	銅貨	銅貨
1187	1187-6-6	1187-6-6	銅貨	銅貨	1.5	銅貨	銅貨	銅貨	銅貨
1188	1188-6-6	1188-6-6	銅貨	銅貨	1.5	銅貨	銅貨	銅貨	銅貨
1189	1189-6-6	1189-6-6	銅貨	銅貨	1.5	銅貨	銅貨	銅貨	銅貨
1190	1190-6-6	1190-6-6	銅貨	銅貨	1.5	銅貨	銅貨	銅貨	銅貨
1191	1191-6-6	1191-6-6	銅貨	銅貨	1.5	銅貨	銅貨	銅貨	銅貨
1192	1192-6-6	1192-6-6	銅貨	銅貨	1.5	銅貨	銅貨	銅貨	銅貨
1193	1193-6-6	1193-6-6	銅貨	銅貨	1.5	銅貨	銅貨	銅貨	銅貨
1194	1194-6-6	1194-6-6	銅貨	銅貨	1.5	銅貨	銅貨	銅貨	銅貨
1195	1195-6-6	1195-6-6	銅貨	銅貨	1.5	銅貨	銅貨	銅貨	銅貨
1196	1196-6-6	1196-6-6	銅貨	銅貨	1.5	銅貨	銅貨	銅貨	銅貨
1197	1197-6-6	1197-6-6	銅貨	銅貨	1.5	銅貨	銅貨	銅貨	銅貨
1198	1198-6-6	1198-6-6	銅貨	銅貨	1.5	銅貨	銅貨	銅貨	銅貨
1199	1199-6-6	1199-6-6	銅貨	銅貨	1.5	銅貨	銅貨	銅貨	銅貨
1200	1200-6-6	1200-6-6	銅貨	銅貨	1.5	銅貨	銅貨	銅貨	銅貨
1201	1201-6-6	1201-6-6	銅貨	銅貨	1.5	銅貨	銅貨	銅貨	銅貨
1202	1202-6-6	1202-6-6	銅貨	銅貨	1.5	銅貨	銅貨	銅貨	銅貨
1203	1203-6-6	1203-6-6	銅貨	銅貨	1.5	銅貨	銅貨	銅貨	銅貨
1204	1204-6-6	1204-6-6	銅貨	銅貨	1.5	銅貨	銅貨	銅貨	銅貨
1205	1205-6-6	1205-6-6	銅貨	銅貨	1.5	銅貨	銅貨	銅貨	銅貨
1206	1206-6-6	1206-6-6	銅貨	銅貨	1.5	銅貨	銅貨	銅貨	銅貨
1207	1207-6-6	1207-6-6	銅貨	銅貨	1.5	銅貨	銅貨	銅貨	銅貨
1208	1208-6-6	1208-6-6	銅貨	銅貨	1.5	銅貨	銅貨	銅貨	銅貨
1209	1209-6-6	1209-6-6	銅貨	銅貨	1.5	銅貨	銅貨	銅貨	銅貨
1210	1210-6-6	1210-6-6	銅貨	銅貨	1.5	銅貨	銅貨	銅貨	銅貨
1211	1211-6-6	1211-6-6	銅貨	銅貨	1.5	銅貨	銅貨	銅貨	銅貨
1212	1212-6-6	1212-6-6	銅貨	銅貨	1.5	銅貨	銅貨	銅貨	銅貨
1213	1213-6-6	1213-6-6	銅貨	銅貨	1.5	銅貨	銅貨	銅貨	銅貨
1214	1214-6-6	1214-6-6	銅貨	銅貨	1.5	銅貨	銅貨	銅貨	銅貨
1215	1215-6-6	1215-6-6	銅貨	銅貨	1.5	銅貨	銅貨	銅貨	銅貨
1216	1216-6-6	1216-6-6	銅貨	銅貨	1.5	銅貨	銅貨	銅貨	銅貨
1217	1217-6-6	1217-6-6	銅貨	銅貨	1.5	銅貨	銅貨	銅貨	銅貨
1218	1218-6-6	1218-6-6	銅貨	銅貨	1.5	銅貨	銅貨	銅貨	銅貨
1219	1219-6-6	1219-6-6	銅貨	銅貨	1.5	銅貨	銅貨	銅貨	銅貨
1220	1220-6-6	1220-6-6	銅貨	銅貨	1.5	銅貨	銅貨	銅貨	銅貨

遺物観察表 26

Table with columns for No., 年代 (Year), 出土位置 (Location), 種類 (Type), 数量 (Quantity), 長さ (Length), 幅 (Width), 高さ (Height), 重量 (Weight), 観察 (Observation), 材料 (Material), 寸法 (Dimensions), 解説 (Remarks), 出所 (Source), 内題 (Internal Title), 外題 (External Title), 分析 (Analysis), 制作時期 (Production Period).

番号	表層	高さ	方位	面積	形状	重量	色澤	内径	特徴	製作時期
252	7.8	11	S45E	1.8	丸型	790	黄銅	φ20×20	銀色の小片(内径)	銀器
253	7.8	11	S45E	1.9	丸型	790	黄銅	φ20×20	銀色の小片(内径)	銀器
254	7.8	11	S45E	1.8	丸型	790	黄銅	φ20×20	銀色の小片(内径)	銀器
255	7.8	11	S45E	1.8	丸型	790	黄銅	φ20×20	銀色の小片(内径)	銀器
256	7.8	11	S45E	1.8	丸型	790	黄銅	φ20×20	銀色の小片(内径)	銀器
257	7.8	11	S45E	1.8	丸型	790	黄銅	φ20×20	銀色の小片(内径)	銀器
258	7.8	11	S45E	1.8	丸型	790	黄銅	φ20×20	銀色の小片(内径)	銀器
259	7.8	11	S45E	1.8	丸型	790	黄銅	φ20×20	銀色の小片(内径)	銀器
260	7.8	11	S45E	1.8	丸型	790	黄銅	φ20×20	銀色の小片(内径)	銀器
261	7.8	11	S45E	1.8	丸型	790	黄銅	φ20×20	銀色の小片(内径)	銀器
262	7.8	11	S45E	1.8	丸型	790	黄銅	φ20×20	銀色の小片(内径)	銀器
263	7.8	11	S45E	1.8	丸型	790	黄銅	φ20×20	銀色の小片(内径)	銀器
264	7.8	11	S45E	1.8	丸型	790	黄銅	φ20×20	銀色の小片(内径)	銀器
265	7.8	11	S45E	1.8	丸型	790	黄銅	φ20×20	銀色の小片(内径)	銀器
266	7.8	11	S45E	1.8	丸型	790	黄銅	φ20×20	銀色の小片(内径)	銀器
267	7.8	11	S45E	1.8	丸型	790	黄銅	φ20×20	銀色の小片(内径)	銀器
268	7.8	11	S45E	1.8	丸型	790	黄銅	φ20×20	銀色の小片(内径)	銀器
269	7.8	11	S45E	1.8	丸型	790	黄銅	φ20×20	銀色の小片(内径)	銀器
270	7.8	11	S45E	1.8	丸型	790	黄銅	φ20×20	銀色の小片(内径)	銀器
271	7.8	11	S45E	1.8	丸型	790	黄銅	φ20×20	銀色の小片(内径)	銀器
272	7.8	11	S45E	1.8	丸型	790	黄銅	φ20×20	銀色の小片(内径)	銀器
273	7.8	11	S45E	1.8	丸型	790	黄銅	φ20×20	銀色の小片(内径)	銀器
274	7.8	11	S45E	1.8	丸型	790	黄銅	φ20×20	銀色の小片(内径)	銀器
275	7.8	11	S45E	1.8	丸型	790	黄銅	φ20×20	銀色の小片(内径)	銀器
276	7.8	11	S45E	1.8	丸型	790	黄銅	φ20×20	銀色の小片(内径)	銀器
277	7.8	11	S45E	1.8	丸型	790	黄銅	φ20×20	銀色の小片(内径)	銀器
278	7.8	11	S45E	1.8	丸型	790	黄銅	φ20×20	銀色の小片(内径)	銀器
279	7.8	11	S45E	1.8	丸型	790	黄銅	φ20×20	銀色の小片(内径)	銀器
280	7.8	11	S45E	1.8	丸型	790	黄銅	φ20×20	銀色の小片(内径)	銀器
281	7.8	11	S45E	1.8	丸型	790	黄銅	φ20×20	銀色の小片(内径)	銀器
282	7.8	11	S45E	1.8	丸型	790	黄銅	φ20×20	銀色の小片(内径)	銀器
283	7.8	11	S45E	1.8	丸型	790	黄銅	φ20×20	銀色の小片(内径)	銀器
284	7.8	11	S45E	1.8	丸型	790	黄銅	φ20×20	銀色の小片(内径)	銀器
285	7.8	11	S45E	1.8	丸型	790	黄銅	φ20×20	銀色の小片(内径)	銀器
286	7.8	11	S45E	1.8	丸型	790	黄銅	φ20×20	銀色の小片(内径)	銀器
287	7.8	11	S45E	1.8	丸型	790	黄銅	φ20×20	銀色の小片(内径)	銀器
288	7.8	11	S45E	1.8	丸型	790	黄銅	φ20×20	銀色の小片(内径)	銀器
289	7.8	11	S45E	1.8	丸型	790	黄銅	φ20×20	銀色の小片(内径)	銀器
290	7.8	11	S45E	1.8	丸型	790	黄銅	φ20×20	銀色の小片(内径)	銀器

遺物観察表 50

Table with columns: 番号 (Number), 地域 (Region), 発見者 (Discoverer), 発見時期 (Discovery Period), 形状 (Shape), 長さ (Length), 幅 (Width), 重量 (Weight), 材質 (Material), 用途 (Use), 状態 (Condition), 出土状況 (Excavation Context), 調査者 (Investigator), 調査機関 (Institution), 備考 (Remarks).

番号	所在地	出土位置	時期	形状	重量	長さ	幅	厚さ	底径	高さ	直径	備考	付属品	保存方法
2056	7.8	245	5330	土師器	甕	18.2	2.3						口ノリナシ	縦向き保存
2057	7.8	245	5330	土師器	甕	15.6	2.1						口ノリナシ	縦向き保存
2058	7.8	245	5330	土師器	甕	15.6	2.1						口ノリナシ	縦向き保存
2059	7.8	245	5330	土師器	甕	15.6	2.1						口ノリナシ	縦向き保存
2060	7.8	245	5330	土師器	甕	15.6	2.1						口ノリナシ	縦向き保存
2061	7.8	245	5330	土師器	甕	15.6	2.1						口ノリナシ	縦向き保存
2062	7.8	245	5330	土師器	甕	15.6	2.1						口ノリナシ	縦向き保存
2063	7.8	245	5330	土師器	甕	15.6	2.1						口ノリナシ	縦向き保存
2064	7.8	245	5330	土師器	甕	15.6	2.1						口ノリナシ	縦向き保存
2065	7.8	245	5330	土師器	甕	15.6	2.1						口ノリナシ	縦向き保存
2066	7.8	245	5330	土師器	甕	15.6	2.1						口ノリナシ	縦向き保存
2067	7.8	245	5330	土師器	甕	15.6	2.1						口ノリナシ	縦向き保存
2068	7.8	245	5330	土師器	甕	15.6	2.1						口ノリナシ	縦向き保存
2069	7.8	245	5330	土師器	甕	15.6	2.1						口ノリナシ	縦向き保存
2070	7.8	245	5330	土師器	甕	15.6	2.1						口ノリナシ	縦向き保存
2071	7.8	245	5330	土師器	甕	15.6	2.1						口ノリナシ	縦向き保存
2072	7.8	245	5330	土師器	甕	15.6	2.1						口ノリナシ	縦向き保存
2073	7.8	245	5330	土師器	甕	15.6	2.1						口ノリナシ	縦向き保存
2074	7.8	245	5330	土師器	甕	15.6	2.1						口ノリナシ	縦向き保存
2075	7.8	245	5330	土師器	甕	15.6	2.1						口ノリナシ	縦向き保存
2076	7.8	245	5330	土師器	甕	15.6	2.1						口ノリナシ	縦向き保存
2077	7.8	245	5330	土師器	甕	15.6	2.1						口ノリナシ	縦向き保存
2078	7.8	245	5330	土師器	甕	15.6	2.1						口ノリナシ	縦向き保存
2079	7.8	245	5330	土師器	甕	15.6	2.1						口ノリナシ	縦向き保存
2080	7.8	245	5330	土師器	甕	15.6	2.1						口ノリナシ	縦向き保存
2081	7.8	245	5330	土師器	甕	15.6	2.1						口ノリナシ	縦向き保存
2082	7.8	245	5330	土師器	甕	15.6	2.1						口ノリナシ	縦向き保存
2083	7.8	245	5330	土師器	甕	15.6	2.1						口ノリナシ	縦向き保存
2084	7.8	245	5330	土師器	甕	15.6	2.1						口ノリナシ	縦向き保存
2085	7.8	245	5330	土師器	甕	15.6	2.1						口ノリナシ	縦向き保存
2086	7.8	245	5330	土師器	甕	15.6	2.1						口ノリナシ	縦向き保存
2087	7.8	245	5330	土師器	甕	15.6	2.1						口ノリナシ	縦向き保存
2088	7.8	245	5330	土師器	甕	15.6	2.1						口ノリナシ	縦向き保存
2089	7.8	245	5330	土師器	甕	15.6	2.1						口ノリナシ	縦向き保存
2090	7.8	245	5330	土師器	甕	15.6	2.1						口ノリナシ	縦向き保存
2091	7.8	245	5330	土師器	甕	15.6	2.1						口ノリナシ	縦向き保存
2092	7.8	245	5330	土師器	甕	15.6	2.1						口ノリナシ	縦向き保存
2093	7.8	245	5330	土師器	甕	15.6	2.1						口ノリナシ	縦向き保存
2094	7.8	245	5330	土師器	甕	15.6	2.1						口ノリナシ	縦向き保存
2095	7.8	245	5330	土師器	甕	15.6	2.1						口ノリナシ	縦向き保存
2096	7.8	245	5330	土師器	甕	15.6	2.1						口ノリナシ	縦向き保存
2097	7.8	245	5330	土師器	甕	15.6	2.1						口ノリナシ	縦向き保存
2098	7.8	245	5330	土師器	甕	15.6	2.1						口ノリナシ	縦向き保存
2099	7.8	245	5330	土師器	甕	15.6	2.1						口ノリナシ	縦向き保存
2100	7.8	245	5330	土師器	甕	15.6	2.1						口ノリナシ	縦向き保存

