

# 写真図版





1 畑全景(南から)



2 畑(北から)



3 畑(南から)



4 全景(南から)



5 畑断面(東から)



6 畑断面(南から)



7 畑断面(南から)



8 トレンチ(南から)



9 トレンチ(北から)



10 南側調査状況(南東から)



11 トレンチ(西から)

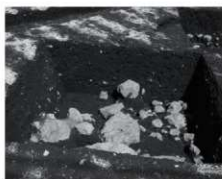

12 トレンチ(西から)



1 1号トレンチ発掘前(東から)



2 1号トレンチ(東から)



3 1号トレンチ(東から)



4 1号トレンチ(東から)



5 1号トレンチ(南から)



6 1号トレンチ出土木銭(南西から)



7 2号トレンチ調査前(東から)



8 2号トレンチ(西から)



9 2号トレンチ(東から)



10 2号トレンチ(南西から)



11 3号トレンチ調査前(南東から)



12 3号トレンチ(南東から)



13 3号トレンチ(南西から)



14 3号トレンチ調査状況(南東から)



15 3号トレンチ(南東から)



1 発掘地点(南から)



2 調査前(北東から)



3 調査前(南東から)



4 トレンチ調査(北西から)



5 トレンチ調査(南東から)



6 調査状況(西から)



7 調査状況(北から)



8 トレンチA-A'(北東から)



9 旧石器試掘(西から)



A区1



A区2



A区3



A区4



A区5



A区6



A区7



A区8



A区9



A区10



A区11



A区12



A区13



B区1



C区1



C区2



C区3



C区4



A区14



A区15



1 52区1号住居全景(東から)

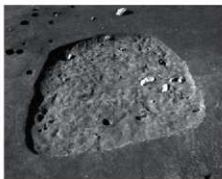

2 52区1号住居掘り方全景(東から)



3 52区1号住居掘り方土層断面(南から)



4 52区1号住居土層断面(西から)



5 52区1号住居P3土層断面(西から)



6 53区1号住居全景(北から)



7 53区1号住居全景(北から)



8 53区1号住居土層断面(南から)



9 53区1号住居遺物出土状態(西から)



1 1号住居跡全景(北から)



2 1号住居跡土層断面(西から)



3 1号住居掘り方土層断面(南から)



4 2号住居跡全景(南東から)



5 2号住居跡全景(北東から)



6 2号住居掘り方土層断面(南西から)



7 3号住居跡全景(北から)



8 3号住居跡全景(南から)



9 3号住居土層断面(北から)



1 53区3号住居炉土層断面(北西から)



2 53区3号住居炉出土遺物(北から)



3 53区3号住居炉出土遺物(南から)



4 53区3号住居炉全景(南から)



5 53区3号住居炉遺物出土状態(南から)



6 53区3号住居炉掘り方全景(南から)



7 54区1号住居全景(西から)



8 54区1号住居土層断面(南から)



9 54区1号住居土層断面(東から)



10 54区1号住居炉(西から)



11 54区1号住居焼土(北西から)



12 53区1号整穴状遺構全景(北から)





1 第1区画37号土坑全景(北から)



2 第1区画38号土坑全景(西から)



3 第1区画39号土坑全景(南から)



4 第1区画39・40号土坑全景(南西から)



5 第1区画41号土坑全景(北から)



6 第1区画41・42・43号土坑全景(北東から)



7 第1区画42・43号土坑全景(北東から)



8 第1区画43号土坑土層断面(東から)



9 第4区画5号土坑全景(西から)



10 第4区画5号土坑土層断面(西から)



11 第4区画6号土坑全景(北から)



12 第4区画6号土坑土層断面(南から)

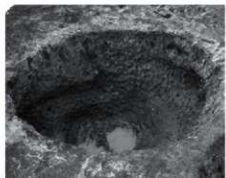

13 第4区画7号土坑全景(西から)



14 第4区画7号土坑土層断面(西から)



15 第6区画4・5号土坑全景(南から)

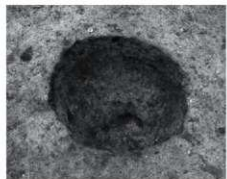

1 8号土坑全景(北から)



2 8号土坑土層断面(西から)

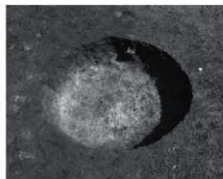

3 12号土坑全景(西から)



4 14号土坑土層断面(南東から)



5 15号土坑全景(南から)



6 17号土坑全景(南から)



7 18号土坑全景(南から)



8 19号土坑全景(南から)



9 20号土坑全景(南から)

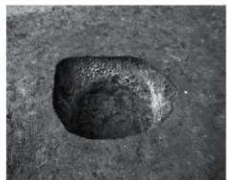

10 21号土坑全景(南から)



11 21号土坑土層断面(南から)



12 22号土坑全景(南から)



13 23号土坑全景(西から)

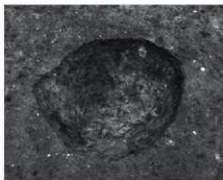

14 24号土坑全景(西から)

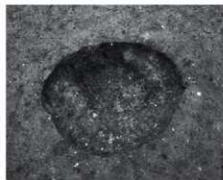

15 25号土坑全景(西から)

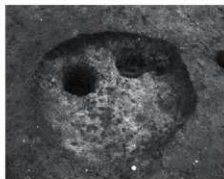

1 第6区画26号土坑全景(北から)



2 52区25・26号土坑全景(西から)



3 52区27号土坑全景(北から)



4 52区56号土坑全景(南から)



5 52区57号土坑全景(北から)



6 52区58号土坑全景(北から)



7 53区2・3号土坑全景(北東から)



8 53区4号土坑全景(北から)



9 53区5号土坑土層断面(北から)

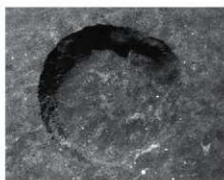

10 53区6号土坑全景(北から)



11 53区12号土坑土層断面(北から)



12 53区13号土坑全景(南西から)

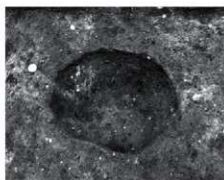

13 53区14号土坑全景(南から)



14 53区19号土坑全景(南西から)

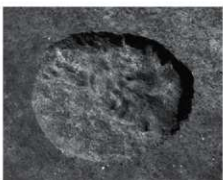

15 53区20号土坑全景(北から)



1 23号土坑全景(東から)

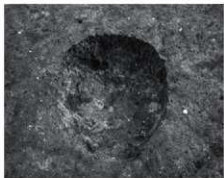

2 27号土坑全景(北から)



3 28号土坑全景(東から)

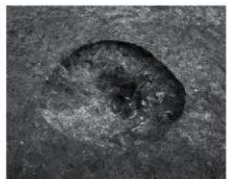

4 30号土坑全景(北から)



5 31号土坑全景(西から)



6 32号土坑全景(北から)

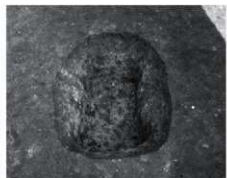

7 33号土坑全景(西から)



8 33号土坑土層断面(南東から)



9 34号土坑全景(北東から)



10 35号土坑全景(南西から)



11 36号土坑土層断面(南から)



12 37号土坑全景(南東から)



13 38号土坑全景(西から)

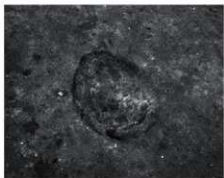

14 39号土坑全景(南から)

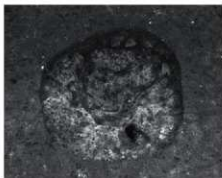

15 40号土坑全景(北から)



1 41号土坑全景(北から)

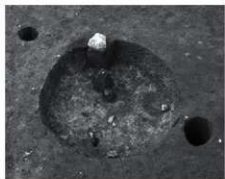

2 42号土坑全景(南東から)



3 46号土坑出土遺物(西から)

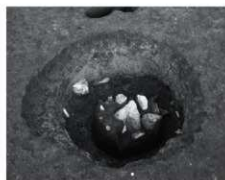

4 50号土坑遺物出土状態(西から)



5 50号土坑土層断面(南東から)



6 52号土坑全景(西から)



7 53号土坑全景(東から)

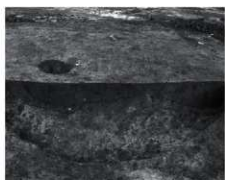

8 54号土坑土層断面(西から)



9 56号土坑全景(南から)



10 57号土坑遺物出土状態(東から)



11 58・59号土坑全景(南から)

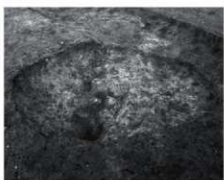

12 64号土坑全景(南から)



13 65号土坑全景(南から)

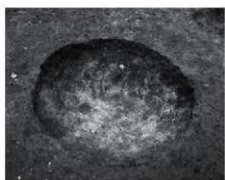

14 67号土坑全景(南から)

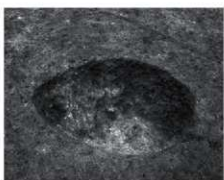

15 68号土坑全景(南から)

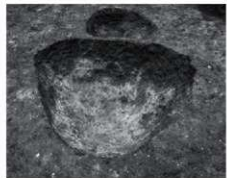

1 53区69号土坑全景(南から)



2 53区73号土坑全景(南東から)



3 54区11号土坑全景(南から)



4 54区12号土坑全景(南西から)



5 54区16号土坑全景(北から)



6 54区18号土坑全景(南から)

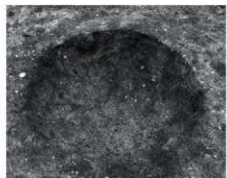

7 54区19号土坑全景(南から)



8 54区23号土坑全景(南から)



9 54区24号土坑全景(南から)

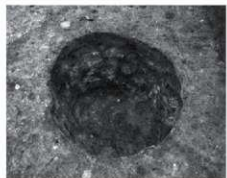

10 54区26号土坑全景(南から)



11 54区27号土坑全景(南から)



12 54区28号土坑全景(南から)



13 54区31号土坑全景(南から)



14 54区32号土坑全景(南から)



15 54区33号土坑全景(東から)

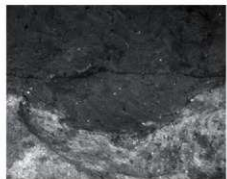

1 54区34号土坑全景(南から)



2 62区2・3号土坑全景(東から)



3 62区4号土坑全景(東から)



4 62区5号土坑全景(東から)

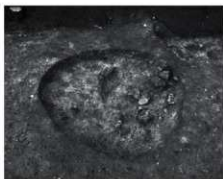

5 63区7号土坑全景(南から)



6 63区8号土坑土層断面(南から)



7 63区9号土坑全景(南から)



8 72区1号土坑全景(南から)



9 72区2号土坑全景(東から)

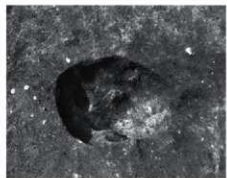

10 72区3号土坑全景(南から)



11 73区1・2号土坑全景(南から)



12 73区3号土坑土層断面(北から)



13 73区4号土坑全景(東から)



14 84区1号土坑全景(南から)



15 53区1号焼土土層断面(西から)



1 1号堀全景(北から)



2 1号堀掘り方全景(南から)



3 1号堀全景(西から)



4 1号堀土層断面(南から)



5 2号堀土層断面(北から)



6 3号堀全景(北から)

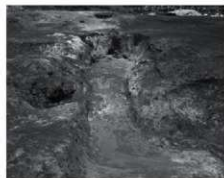

7 3号堀全景(南から)



8 3号堀土層断面(南から)



9 5号堀全景(東から)



10 5号堀出土遺物(西から)



11 6号堀全景(南東から)



12 7号堀全景(南から)





1 2号石垣と土橋全景(南から)



2 2号石垣と土橋全景(東から)



3 2号石垣と土橋全景(南から)



4 2号石垣と土橋全景(南から)



5 2号石垣解体(西から)



6 2号石垣解体(東から)



7 2号石垣解体(南から)



8 2号石垣欠跡の残る石(南から)



9 2号石垣と土橋全景(西から)

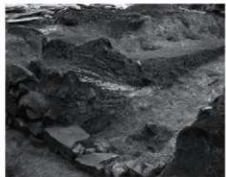

10 2号石垣と土橋土層断面(東から)



11 2号石垣と土橋土層断面(東から)



12 2号石垣と土橋土層断面(西から)

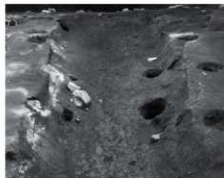

1 1号橋全景(北から)



2 2号橋全景(北から)



3 虎口全景(北から)



4 1号池全景(北から)



5 1号池全景(南西から)



6 1号池全景(南西から)



7 1・2号池全景(北から)



8 1号池出土遺物(南西から)



9 1号池全景(北から)



1 2号池全景(北から)



2 2号池全景(東から)



3 2号池全景(東から)



4 1・2号池全景(北から)



5 2号池全景(北から)



6 2号池全景(北から)



7 2号池全景(南から)



8 2号池全景(西から)



9 第1区画盛土下及びピット群(北から)



1 1号土坑土層断面(南から)

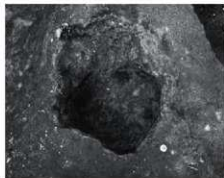

2 2号土坑土層断面(南から)



3 3号土坑全景(東から)



4 4号土坑全景(南から)



5 5号土坑全景(南から)

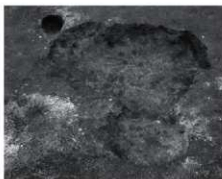

6 6・7・8・9号土坑全景(西から)



7 10号土坑全景(南から)

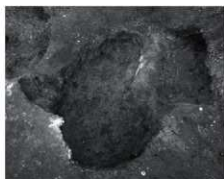

8 11・12号土坑全景(北から)



9 13・17号土坑全景(北から)



10 14号土坑全景(南から)



11 15号土坑全景(南から)



12 19号土坑全景(東から)



13 20号土坑全景(北から)



14 22号土坑全景(西から)



15 24号土坑全景(北から)



1 25号土坑全景(南から)



2 27号土坑全景(南東から)



3 29号土坑全景(西から)



4 30号土坑全景(南から)



5 31号土坑遺物出土状態(北から)



6 31号土坑土層断面(西から)



7 31号土坑炭・焼土出土状態(西から)



8 31・32号土坑土層断面(東から)

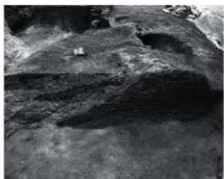

9 32・33号土坑土層断面(西から)



10 35号土坑・P14・17全景(東から)



11 36号土坑馬出土状態(南から)



12 36号土坑全景(北から)



13 44号土坑全景(東から)



14 45号土坑遺物出土状態(南から)



15 46号土坑土層断面(西から)



1 1・5号石垣全景(東から)



2 1号石垣全景(北東から)



3 1号石垣土層断面(南から)



4 1号石垣土層断面(北から)



5 1号石垣土層断面(南から)



6 1号石垣掘り方全景(東から)



7 1・5号石垣遺物出土状態(南東から)



8 5号石垣遺物出土状態(南から)



9 南斜面全景(南から)



1 5号石垣(東から)



2 5号石垣(南から)



3 5号石垣(南から)



4 5号石垣出土遺物(南から)



5 5号石垣掘り方全景(南東から)



6 1号礎石全景(東から)



7 スロープ(東から)



8 スロープ(南東から)



9 スロープ土層断面(東から)



10 スロープ土層断面(東から)



11 1号道掘り方全景(東から)



12 1号道土層断面(東から)



13 1号道土層断面(東から)



14 削平面(東から)



15 1号溝全景(北から)



1 1号礎石建物全景(西から)



2 1号礎石建物全景(西から)



3 1号礎石建物遺物出土状態(西から)



4 1号礎石建物土層断面(西から)



5 1号礎石建物土層断面(西から)



6 1号礎石建物全景(西から)



7 1～6号焼土全景(東から)

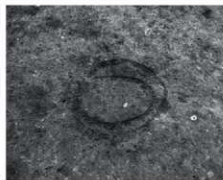

8 1号焼土全景(南から)



9 1号焼土土層断面(南東から)





1 2号坑土全景(南から)



2 2号坑土層断面(西から)

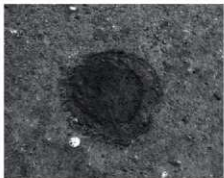

3 3号坑土全景(南から)



4 4号坑土全景(南から)



5 4号坑土掘り方全景(東から)



6 5号坑土全景(南から)



7 6号坑土全景(南から)



8 6号坑土掘り方全景(南から)



9 1号土坑土層断面(東から)



10 1・2号土坑遺物出土状態(東から)



11 2号土坑遺物出土状態(東から)



12 3号土坑遺物出土状態(南から)



13 3号土坑遺物出土状態(南から)



14 3号土坑土層断面(西から)



15 3号土坑全景(西から)



1 1～6号土取穴全景(東から)



2 1号土取穴全景(東から)

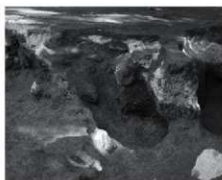

3 2号土取穴全景(北から)



4 2・4・5・6号土取穴全景(北から)



5 3号土取穴遺物出土状態(南東から)



6 3号土取穴土層断面(西から)



7 4号土取穴土層断面(北東から)



8 5号土取穴全景(北から)



9 6号土取穴全景(北から)



10 北側全景(北から)



11 北側ビット(南から)



12 北側(北西から)



1 3号石垣全景(南東から)



2 3号石垣全景(南から)



3 3号石垣全景(南から)



4 3号石垣掘り方全景(南東から)



5 3号石垣掘り方全景(南東から)



6 3号石垣土層断面(西から)



7 3号石垣掘り方土層断面(西から)



8 3号石垣掘り方土層断面(西から)



9 3号石垣遺物出土状態(西から)



1 1号掘立柱建物全景(西から)



2 1号掘立柱建物P2土層断面(西から)



3 1号掘立柱建物P12土層断面(西から)



4 1号掘立柱建物P15土層断面(南から)



5 1号掘立柱建物P20土層断面(北から)



6 2号掘立柱建物P14土層断面(北から)



7 2号掘立柱建物全景(北から)



8 2号掘立柱建物P10土層断面(南東から)



9 2号掘立柱建物P16土層断面(西から)



1 3号掘立柱建物全景(北から)



2 3号掘立柱建物P2土層断面(西から)



3 3号掘立柱建物P4土層断面(西から)

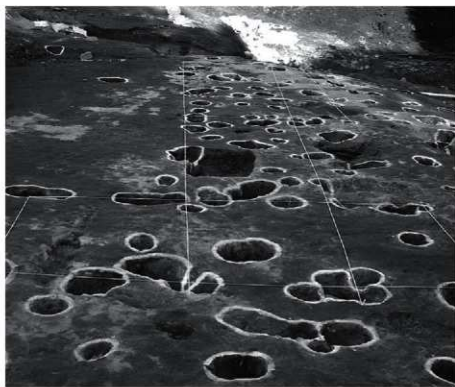

4 4号掘立柱建物全景(西から)



5 4号掘立柱建物P2土層断面(南から)



6 4号掘立柱建物P16土層断面(西から)



7 4号掘立柱建物P19土層断面(南から)



8 4号掘立柱建物P20土層断面(南から)



9 4号掘立柱建物P25土層断面(西から)



1 5号掘立柱建物全景(北から)



2 5号掘立柱建物P2土層断面(西から)



3 5号掘立柱建物P3土層断面(南から)



4 6号掘立柱建物P2土層断面(南から)



5 6号掘立柱建物P3土層断面(南から)



6 6号掘立柱建物P1土層断面(西から)



7 6号掘立柱建物全景(北から)



8 7号掘立柱建物P1土層断面(西から)



9 7号掘立柱建物P2土層断面(東から)



1 7号掘立柱建物全景(北から)



2 7号掘立柱建物P3土層断面(南から)



3 7号掘立柱建物P6土層断面(南から)



4 7号掘立柱建物P13土層断面(西から)



5 7号掘立柱建物P17土層断面(北西から)



6 1号柱穴列P1土層断面(南から)



7 1号柱穴列P4土層断面(西から)



8 1号柱穴列P5土層断面(東から)



9 1号柱穴列P6土層断面(西から)



10 5号掘立柱建物東側P166(西から)



11 6号掘立柱建物北側P200(南から)



12 1号焼土全景(南から)



1 1号土坑土層断面(南から)



2 2号土坑全景(南から)



3 3号土坑全景(南から)



4 4号土坑全景(南から)



5 5号土坑全景(西から)

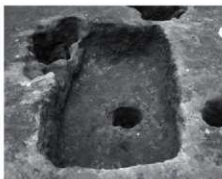

6 6号土坑全景(西から)



7 7号土坑全景(南から)

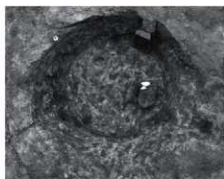

8 8号土坑全景(南から)

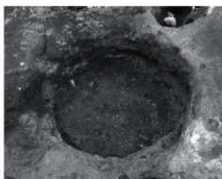

9 9号土坑全景(東から)



10 10号土坑・P91・131全景(北から)



11 11号土坑全景(北から)



12 12号土坑土層断面(西から)



13 13号土坑全景(西から)



14 14号土坑全景(東から)



15 15号土坑全景(西から)





1 16号土坑全景(南から)



2 17号土坑全景(北から)



3 18号土坑全景(北から)



4 19号土坑全景(南から)



5 20号土坑全景(北から)



6 21号土坑全景(西から)



7 1・2号溝全景(西から)



8 3号溝土層断面(東から)



9 3号溝全景(東から)



10 3号溝全景(西から)



11 4号溝全景(北から)



12 4号溝土層断面(北から)



13 5号溝土層断面(北から)



14 6号溝全景(東から)



15 6号溝土層断面(西から)

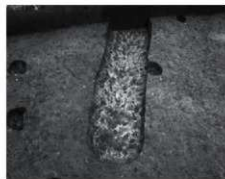

1 1号土坑全景(南から)

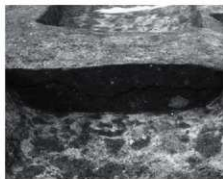

2 1号土坑土層断面(南から)



3 2号土坑全景(東から)



4 2号土坑土層断面(東から)



5 3号土坑全景(南から)



6 3号土坑土層断面(南から)



7 2・3・4号溝全景(北から)



8 4号土坑全景(南から)



9 4号土坑土層断面(南から)

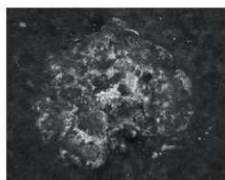

10 1号焼土全景(北から)



11 1号焼土土層断面(南西から)



12 1号焼土掘り方全景(南から)



1 第5区画全景(垂直)



2 4号石垣全景(西から)



3 4号石垣全景(西から)



4 第5区画全景(北東から)



5 4号石垣全景(西から)



6 遺物出土状態(北東から)



7 遺物出土状態(北から)



8 遺物出土状態(北から)



9 遺物出土状態(西から)



1 1・2号掘立柱建物全景(南から)



2 1号掘立柱建物P1土層断面(南西から)



3 1号掘立柱建物P3土層断面(南から)



4 2号掘立柱建物全景(南から)



5 1号掘立柱建物P12土層断面(西から)



6 2号掘立柱建物P3土層断面(西から)



7 2号掘立柱建物P6土層断面(西から)



8 2号掘立柱建物P7土層断面(西から)



9 2号掘立柱建物P8土層断面(西から)



1 3号掘立柱建物P4土層断面(西から)



2 3号掘立柱建物P5土層断面(北西から)



3 3号掘立柱建物P7土層断面(南から)



4 4号掘立柱建物P1土層断面(西から)



5 4号掘立柱建物P3土層断面(西から)



6 4号掘立柱建物P4土層断面(南東から)



7 5号掘立柱建物全景(西から)



8 5号掘立柱建物P2土層断面(西から)



9 5号掘立柱建物P5土層断面(西から)



10 5号掘立柱建物P8土層断面(西から)



11 6号掘立柱建物P2土層断面(西から)



12 6号掘立柱建物P3土層断面(西から)



1 6号掘立柱建物全景(西から)



2 6号掘立柱建物P4土層断面(西から)



3 7号掘立柱建物P6土層断面(西から)



4 7号掘立柱建物全景(東から)



5 7号掘立柱建物P7土層断面(北から)



6 7号掘立柱建物P14土層断面(南から)



7 7号掘立柱建物P15土層断面(南から)



8 7号掘立柱建物P28土層断面(南東から)



9 7号掘立柱建物P31土層断面(南から)



1 8号掘立柱建物全景(東から)



2 8号掘立柱建物P1土層断面(西から)



3 8号掘立柱建物P3土層断面(北から)



4 8号掘立柱建物P7土層断面(北から)



5 8号掘立柱建物P21土層断面(南東から)



6 8号掘立柱建物P22土層断面(西から)

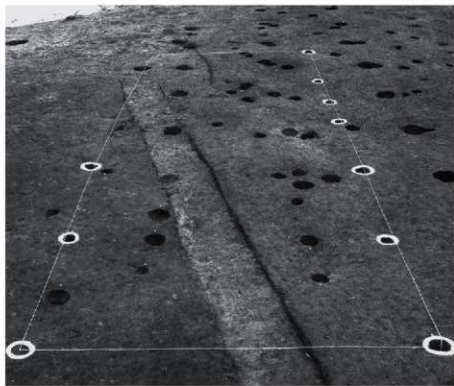

7 9号掘立柱建物全景(東から)



8 9号掘立柱建物P5土層断面(北から)



9 9号掘立柱建物P10土層断面(南から)



1 10号掘立柱建物全景(北から)



2 10号掘立柱建物P2土層断面(南から)



3 10号掘立柱建物P3土層断面(西から)



4 10号掘立柱建物P8土層断面(南西から)



5 1号柱穴列全景(南から)



6 1号柱穴列P3土層断面(西から)



7 3号柱穴列全景(東から)



8 3号柱穴列P4土層断面(南から)



9 3号柱穴列P7土層断面(南から)



10 4号柱穴列全景(東から)



11 4号柱穴列P4土層断面(西から)

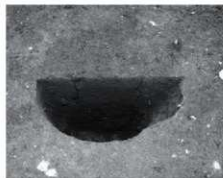

12 4号柱穴列P2土層断面(北から)





1 1号配石全景(南から)



2 1号配石土層断面(南から)



3 1号土坑全景(南から)



4 2号土坑全景(南から)



5 6号土坑全景(北から)



6 7号土坑全景(北から)



7 9号土坑全景(北から)



8 10号土坑全景(西から)



9 10号土坑土層断面(北西から)



10 11号土坑全景(西から)



11 13号土坑全景(北から)

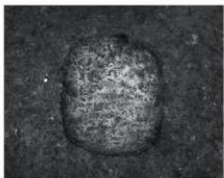

12 16号土坑全景(北東から)



13 1号溝全景(南西から)



14 2号溝全景(西から)



15 1号坑土全景(北から)

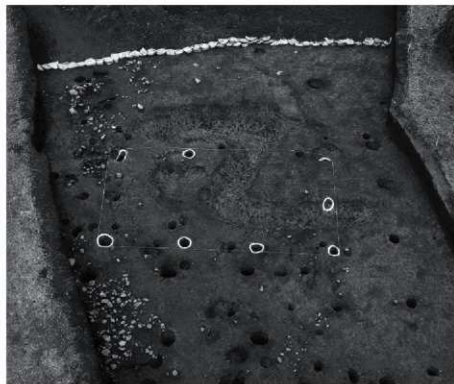

1 1号掘立柱建物全景(南から)

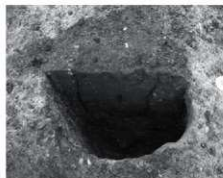

2 1号掘立柱建物P1土層断面(南から)



3 1号掘立柱建物P8土層断面(南から)



4 1号掘立柱建物P9土層断面(南から)



5 1号掘立柱建物P10土層断面(南から)



6 2号掘立柱建物P1土層断面(南西から)

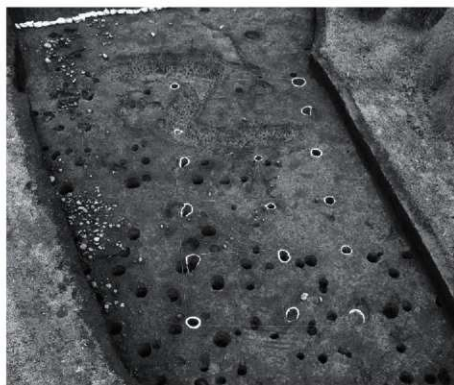

7 2号掘立柱建物全景(南から)

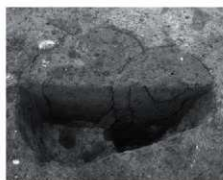

8 2号掘立柱建物P12土層断面(南から)



9 2号掘立柱建物P17土層断面(南から)



1 3号掘立柱建物全景(南から)



2 3号掘立柱建物P7土層断面(南から)



3 3号掘立柱建物P13土層断面(東から)



4 3号掘立柱建物P18土層断面(南から)



5 3号掘立柱建物北西側P499(南から)

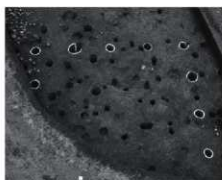

6 4号掘立柱建物全景(南から)



7 4号掘立柱建物全景(南から)



8 4号掘立柱建物P3土層断面(南から)



9 4号掘立柱建物P4土層断面(南から)



1 5号掘立柱建物全景(南から)



2 5号掘立柱建物全景(南から)



3 5号掘立柱建物P5土層断面(西から)



4 5号掘立柱建物P13土層断面(南から)



5 5号掘立柱建物P14土層断面(南から)



6 6号掘立柱建物P3土層断面(西から)



7 6号掘立柱建物全景(南から)



8 6号掘立柱建物P4土層断面(南から)



9 6号掘立柱建物P7土層断面(南から)



1 7号掘立柱建物全景(南から)

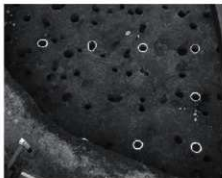

2 7号掘立柱建物全景(南から)



3 7号掘立柱建物P1土層断面(東から)



4 7号掘立柱建物P4土層断面(南から)



5 8号掘立柱建物P3土層断面(南西から)



6 8号掘立柱建物P4土層断面(南から)

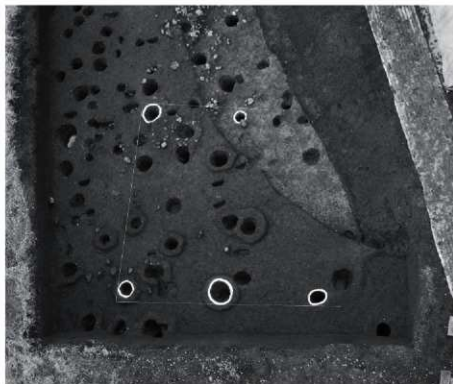

7 8号掘立柱建物全景(南から)



8 8号掘立柱建物全景(南から)



9 8号掘立柱建物P6土層断面(北から)



1 9号掘立柱建物全景(南から)



2 9号掘立柱建物P1土層断面(南から)

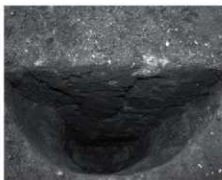

3 9号掘立柱建物P3土層断面(東から)



4 9号掘立柱建物P4土層断面(東から)



5 10号掘立柱建物P1土層断面(南から)



6 10号掘立柱建物P2土層断面(西から)



7 10号掘立柱建物P4土層断面(西から)



8 10号掘立柱建物P6土層断面(西から)



9 10号掘立柱建物P8土層断面(西から)



10 11号掘立柱建物P2土層断面(南から)



11 11号掘立柱建物P3土層断面(南から)



12 11号掘立柱建物P4土層断面(南から)



1 2号竪穴状遺構全景(東から)

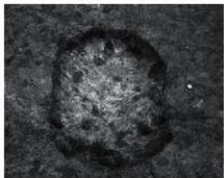

2 54区1号土坑全景(南から)



3 54区8号土坑全景(南から)



4 54区8号土坑土層断面(南から)



5 54区9号土坑全景(東から)



6 54区10号土坑全景(西から)



7 54区13号土坑遺物出土状態(東から)



8 54区13号土坑土層断面(西から)



9 54区14号土坑遺物出土状態(北から)

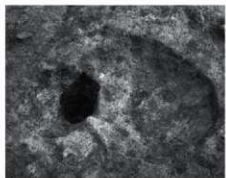

10 54区20号土坑・P335・340全景(西から)



11 54区21号土坑全景(南から)



12 54区21号土坑土層断面(南から)



13 54区25号土坑遺物出土状態(南から)

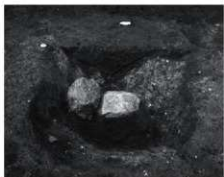

14 54区25号土坑土層断面(南から)

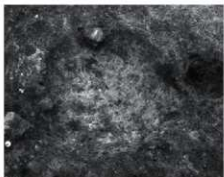

15 54区30号土坑全景(南から)



1 1号溝全景(北から)

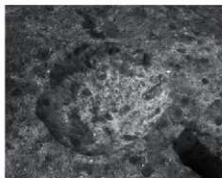

2 54区35号土坑全景(東から)



3 1号溝全景(西から)



4 2・3・5・6号溝全景(南から)



5 1号溝土層断面(東から)



6 2～6号溝全景(西から)



7 3号溝全景(南から)



8 3号溝土層断面(南から)



9 4号溝全景(南から)





1 5・6号溝全景(北から)



2 5・6号溝全景(南から)



3 1号礎石建物出土遺物(東から)



4 5・6号溝土層断面(北から)



5 1号礎石建物出土遺物(南から)



6 1号礎石建物S1柱跡(南から)



7 1号礎石建物S2柱跡(南から)



8 1号礎石建物S3柱跡(南から)



9 1号礎石建物S5柱跡(南から)



10 1号礎石建物S6柱跡(南から)



11 2号礎石建物出土遺物(南から)



12 2号礎石建物S2柱跡(南から)



1 1～4号掘立柱建物全景(北から)



2 1号掘立柱建物P5土層断面(南から)



3 1号掘立柱建物P8土層断面(南から)



4 1・4・5・6・8号掘立柱建物全景(北から)



5 1号掘立柱建物P11土層断面(西から)



6 1号掘立柱建物P15土層断面(東から)



7 2号掘立柱建物P3土層断面(南西から)



8 2号掘立柱建物P4全景(北から)



9 2号掘立柱建物P5土層断面(西から)



1 1号掘立柱建物全景(北から)



2 2号掘立柱建物P10土層断面(西から)

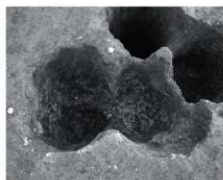

3 2号掘立柱建物P18全景(北から)

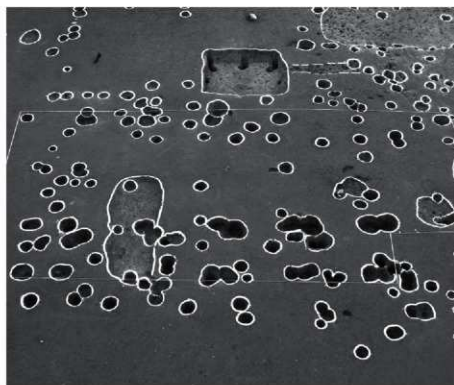

4 2号掘立柱建物全景(北から)



5 2号掘立柱建物P23土層断面(南から)

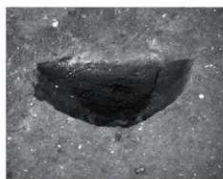

6 2号掘立柱建物P25土層断面(南から)



7 3号掘立柱建物P2土層断面(北から)



8 3号掘立柱建物P8土層断面(南西から)



9 3号掘立柱建物P9土層断面(北東から)

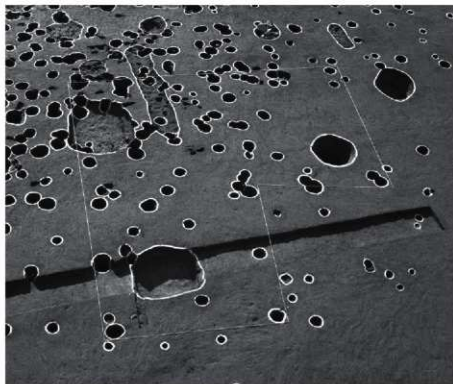

1 3号掘立柱建物全景(北から)



2 3号掘立柱建物P11土層断面



3 4号掘立柱建物P2土層断面(西から)

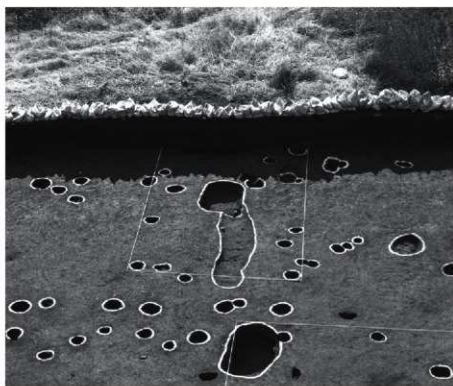

4 4号掘立柱建物全景(北から)



5 4号掘立柱建物P5土層断面(西から)



6 4号掘立柱建物P6土層断面(西から)



7 5号掘立柱建物P2土層断面(南から)



8 5号掘立柱建物P3土層断面(西から)



9 5号掘立柱建物P5土層断面(南から)

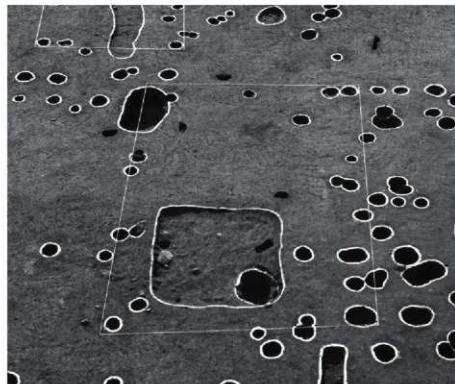

1 5号掘立柱建物全景(北から)



2 6号掘立柱建物P2土層断面(北東から)



3 6号掘立柱建物P3土層断面(南西から)



4 6号掘立柱建物全景(北から)



5 6号掘立柱建物P5土層断面(南から)

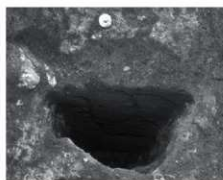

6 6号掘立柱建物P7土層断面(北東から)



7 6号掘立柱建物P9土層断面(南から)



8 7号掘立柱建物P4土層断面(南から)



9 7号掘立柱建物P5土層断面(南から)

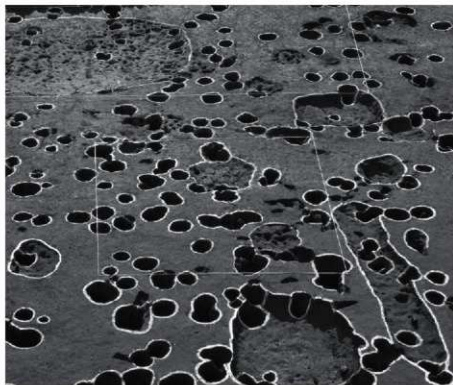

1 8号掘立柱建物全景(北から)



2 8号掘立柱建物P7土層断面(東から)



3 8号掘立柱建物P8土層断面(南から)



4 9号掘立柱建物P2土層断面(北から)



5 9号掘立柱建物P6土層断面(南から)



6 9号掘立柱建物P10土層断面(南東から)

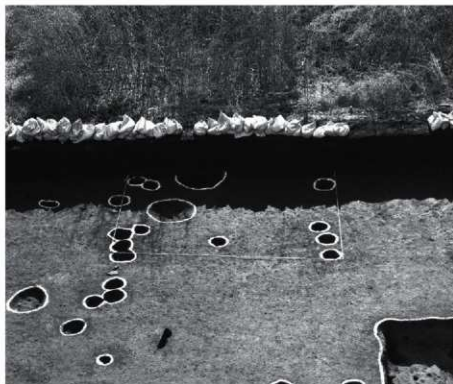

7 10号掘立柱建物全景(北から)



8 10号掘立柱建物P3土層断面(北から)



9 10号掘立柱建物P5土層断面(北から)

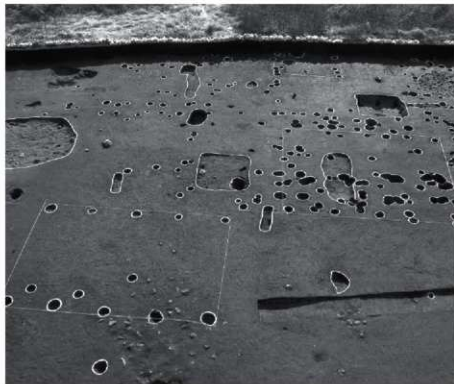

1 10~12号掘立柱建物全景(北から)



2 10号掘立柱建物P7土層断面(西から)



3 11号掘立柱建物P1土層断面(北から)

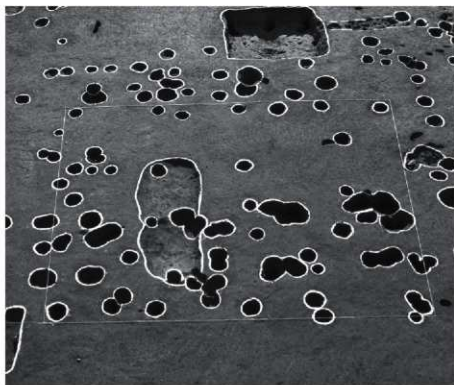

4 11号掘立柱建物全景(北から)



5 11号掘立柱建物P5土層断面(南から)



6 11号掘立柱建物P6土層断面(南から)



7 12号掘立柱建物P3土層断面(北西から)



8 12号掘立柱建物P4土層断面(北から)



9 12号掘立柱建物P5土層断面(北から)

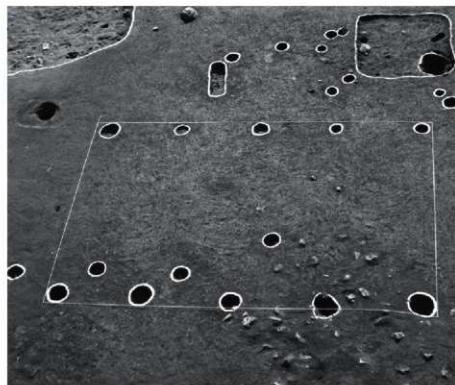

1 12号掘立柱建物全景(北から)



2 13号掘立柱建物P6土層断面(西から)



3 13号掘立柱建物P7土層断面(南から)



4 13~16・23号掘立柱建物全景(北から)



5 14号掘立柱建物P1土層断面

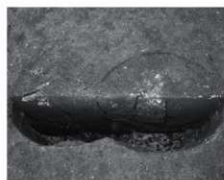

6 14号掘立柱建物P3土層断面(南から)



7 14号掘立柱建物P4土層断面(南から)



8 14号掘立柱建物P5土層断面(南から)



9 14号掘立柱建物P6土層断面(南から)



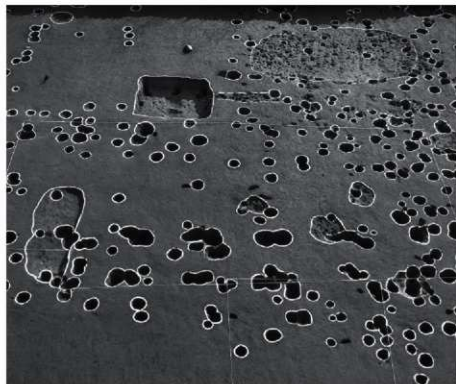

1 14号掘立柱建物全景(北から)

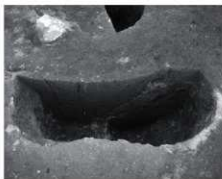

2 14号掘立柱建物P7土層断面(北から)

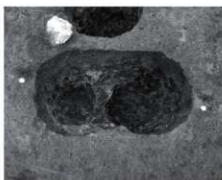

3 14号掘立柱建物P7全景(北から)

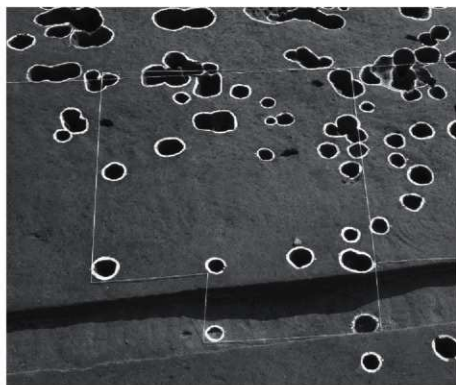

4 15号掘立柱建物全景(北から)



5 14号掘立柱建物P18土層断面(南から)



6 14号掘立柱建物P19土層断面(北から)



7 14号掘立柱建物P20土層断面(南から)



8 15号掘立柱建物P4土層断面(南から)



9 15号掘立柱建物P6土層断面(南から)

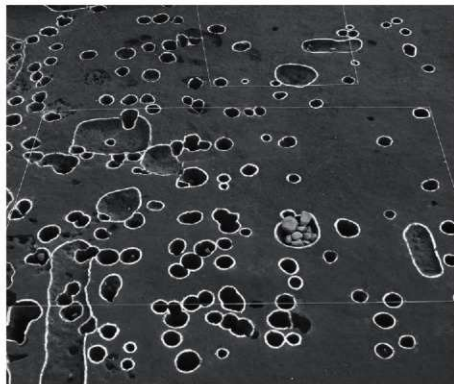

1 16号掘立柱建物全景(北から)



2 16号掘立柱建物2土層断面(南西から)



3 16号掘立柱建物P6土層断面(西から)

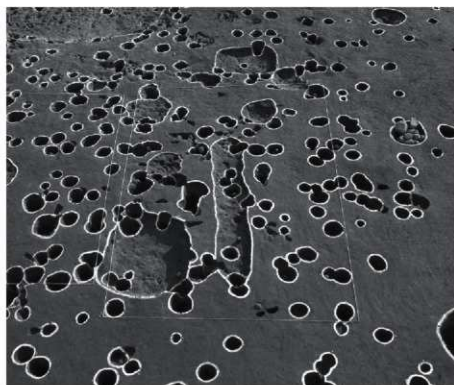

4 17号掘立柱建物全景(北から)



5 16号掘立柱建物P12土層断面(南から)

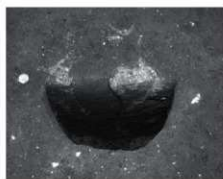

6 17号掘立柱建物P1土層断面(南から)

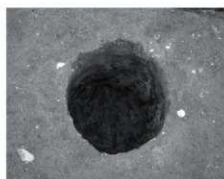

7 17号掘立柱建物P1全景(北から)



8 17号掘立柱建物P3土層断面(南から)



9 17号掘立柱建物P4土層断面(東から)

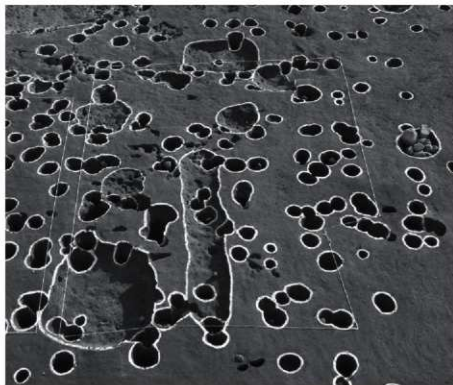

1 18号掘立柱建物全景(北から)



2 17号掘立柱建物P5土層断面(南から)



3 18号掘立柱建物P4土層断面(南から)

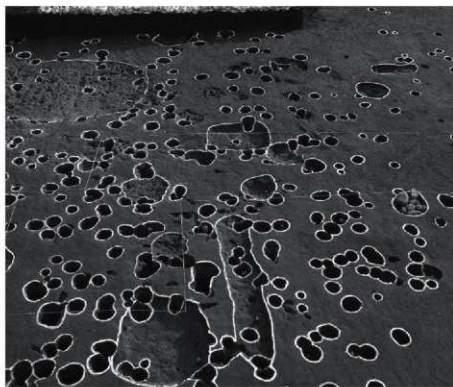

4 19号掘立柱建物全景(北から)



5 18号掘立柱建物P5土層断面(東から)



6 18号掘立柱建物P6土層断面(西から)



7 19号掘立柱建物P3土層断面(南から)



8 19号掘立柱建物P4土層断面(南から)



9 19号掘立柱建物P5土層断面(南から)



1 20号掘立柱建物P1土層断面(西から)



2 20号掘立柱建物P4土層断面(西から)



3 20号掘立柱建物P7土層断面(南西から)

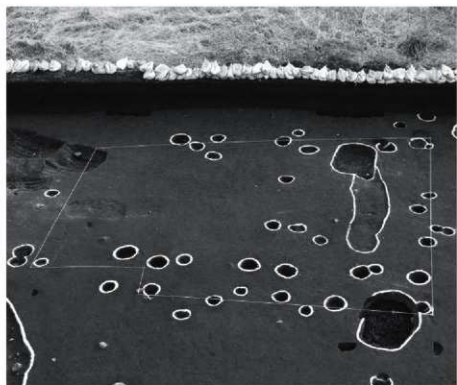

4 21号掘立柱建物全景(北から)



5 21号掘立柱建物P3土層断面(北から)



6 21号掘立柱建物P1土層断面(東から)

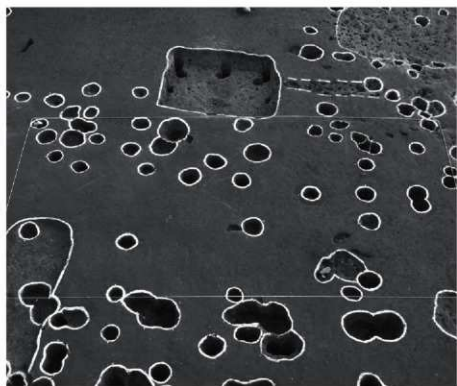

7 22号掘立柱建物全景(北から)



8 22号掘立柱建物P1土層断面(東から)



9 22号掘立柱建物P11土層断面(西から)

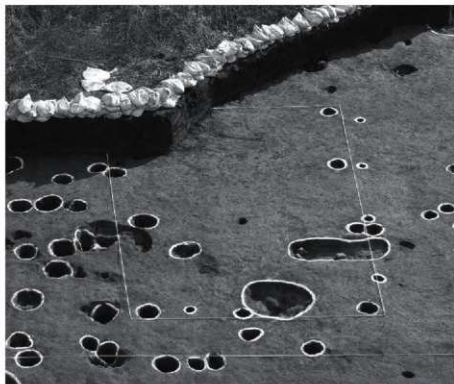

1 23号掘立柱建物全景(北から)



2 22号掘立柱建物P12土層断面(南から)



3 23号掘立柱建物P1土層断面(南から)



4 23号掘立柱建物P2土層断面(南から)



5 23号掘立柱建物P3土層断面(北から)

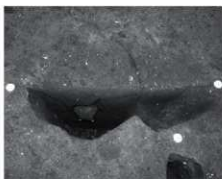

6 24号掘立柱建物P2土層断面(西から)

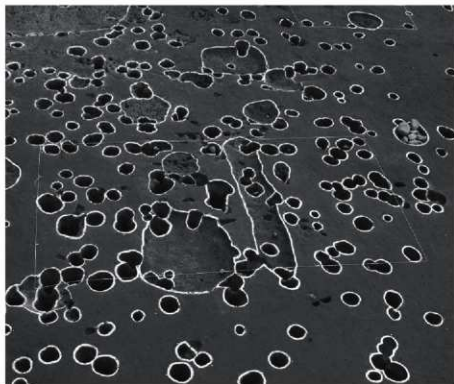

7 24号掘立柱建物全景(北から)

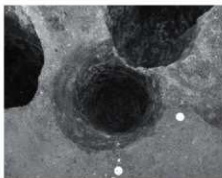

8 24号掘立柱建物P5全景(南から)



9 24号掘立柱建物P7全景(南から)

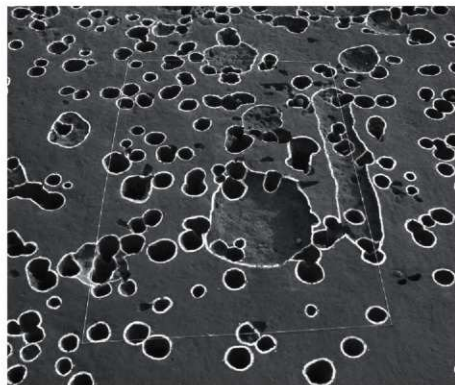

1 25号掘立柱建物全景(北から)



2 24号掘立柱建物P9土層断面(南東から)



3 24号掘立柱建物P10土層断面(北西から)

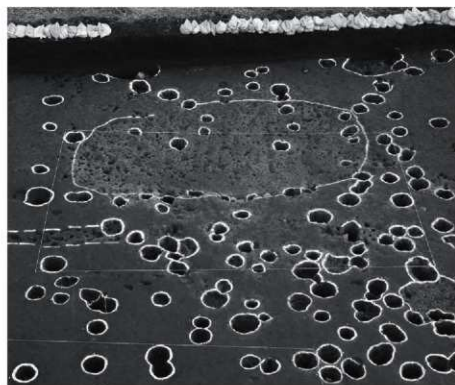

4 26号掘立柱建物全景(北から)



5 25号掘立柱建物P3土層断面(南から)

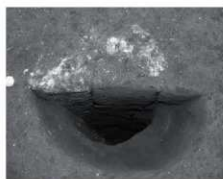

6 25号掘立柱建物P12土層断面(北西から)



7 26号掘立柱建物P2土層断面(南西から)

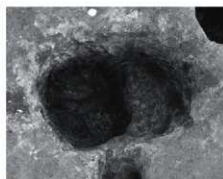

8 26号掘立柱建物P2全景(北から)



9 26号掘立柱建物P3土層断面(南から)

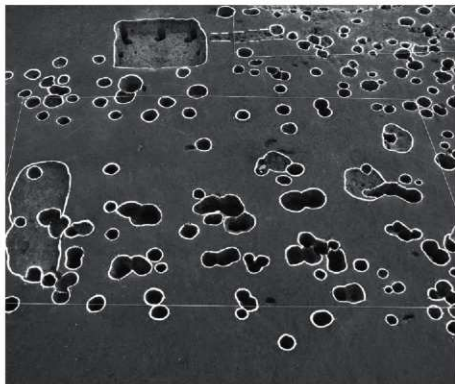

1 27号掘立柱建物全景(北から)



2 26号掘立柱建物P7土層断面(南から)



3 27号掘立柱建物P1土層断面(西から)



4 27号掘立柱建物P2全景(西から)



5 27号掘立柱建物P2土層断面(西から)



6 27号掘立柱建物P10土層断面(西から)



7 27号掘立柱建物P14土層断面(南から)



8 27号掘立柱建物P15土層断面(北東から)



9 28号掘立柱建物P4土層断面(南から)



10 28号掘立柱建物P7土層断面(西から)



11 29号掘立柱建物P6土層断面(南から)



12 29号掘立柱建物P9土層断面(南西から)

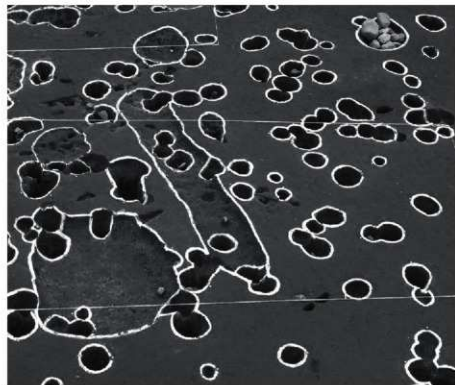

1 29号掘立柱建物全景(北から)



2 30号掘立柱建物P1土層断面(南東から)



3 30号掘立柱建物P2土層断面(南から)

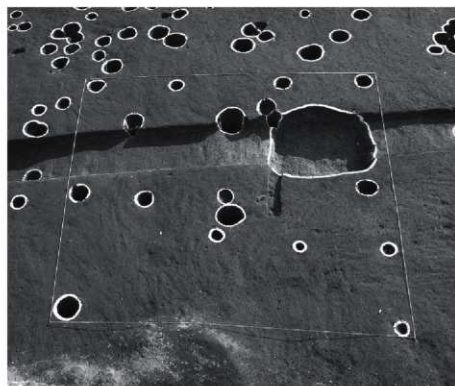

4 30号掘立柱建物全景(北から)



5 30号掘立柱建物P6土層断面(南から)



6 31号掘立柱建物P1土層断面(北東から)



7 31号掘立柱建物P5土層断面(南から)



8 31号掘立柱建物P7全景(北から)



9 32号掘立柱建物P3土層断面(北から)



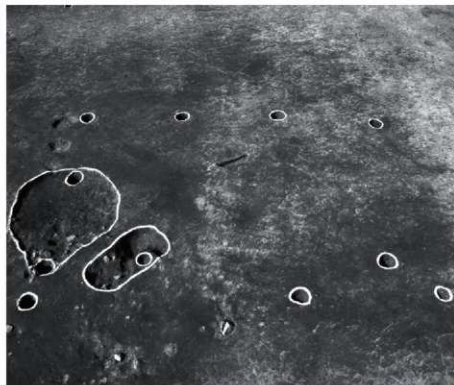

1 53区1号掘立柱建物全景(南から)



2 52区32号掘立柱建物P8土層断面(南西から)



3 52区32号掘立柱建物P9土層断面(西から)

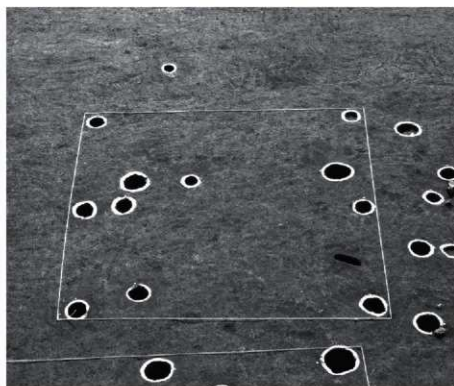

4 53区5号掘立柱建物全景(北から)



5 52区33号掘立柱建物P1土層断面(南から)

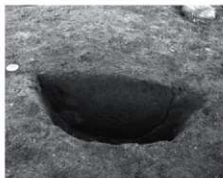

6 52区33号掘立柱建物P4土層断面(西から)



7 53区1号掘立柱建物P1土層断面(南から)



8 53区1号掘立柱建物P8土層断面(西から)

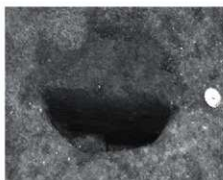

9 53区5号掘立柱建物P3土層断面(西から)

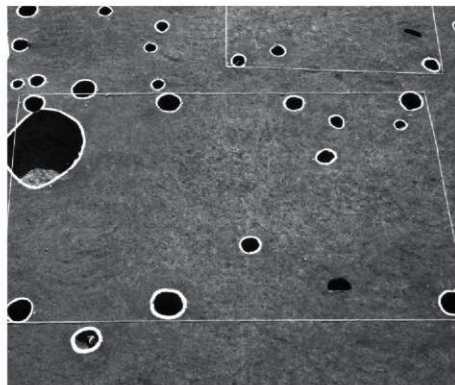

1 6号掘立柱建物全景(北から)

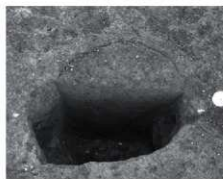

2 5号掘立柱建物P6土層断面(西から)



3 6号掘立柱建物P1土層断面(西から)

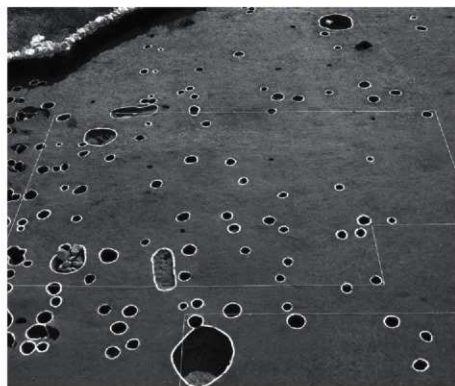

4 7号掘立柱建物全景(北から)



5 6号掘立柱建物P2土層断面(南から)



6 6号掘立柱建物P3土層断面(南から)



7 7号掘立柱建物P1土層断面(南から)



8 1号柱穴列P3土層断面(南から)



9 4号柱穴列P2土層断面(南から)



1 1号竪穴状遺構全景(南から)



2 1号竪穴状遺構土層断面(東から)



3 1号竪穴状遺構土層断面(南から)



4 1号竪穴状遺構全景(北から)



5 1号竪穴状遺構掘り方全景(北から)



6 1号竪穴状遺構遺物出土状態(南から)



7 1号竪穴状遺構遺物出土状態(南から)



8 1号竪穴状遺構土層断面(南西から)



9 1号竪穴状遺構出土遺物(北から)



1 1号竪穴状遺構如掘り方全景(北から)



2 1号竪穴状遺構P1全景(南東から)



3 1号竪穴状遺構P3全景(南西から)



4 1号竪穴状遺構P5・12・13全景(南西から)



5 1号竪穴状遺構P6・10全景(北から)



6 1号竪穴状遺構P7・11・14全景(北東から)

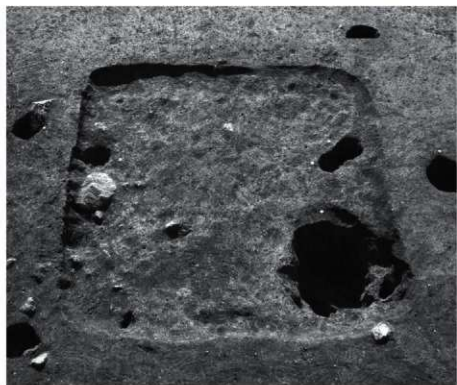

7 2号竪穴状遺構全景(北から)



8 1号竪穴状遺構P9全景(西から)



9 2号竪穴状遺構P2土層断面(北から)



10 2号竪穴状遺構P2・3全景(北西から)



11 3号竪穴状遺構全景(北から)



12 4号竪穴状遺構全景(北から)



1 1号落ち込み遺物出土状態(北から)

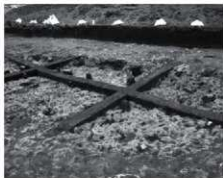

2 1号落ち込み土層断面(南から)

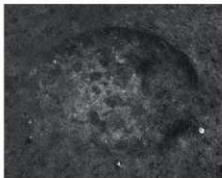

3 1号土坑全景(北から)



4 2号土坑全景(北から)



5 3号土坑土層断面(南から)

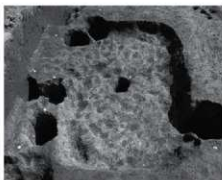

6 4号土坑全景(西から)



7 5号土坑・P343土層断面(南東から)



8 6号土坑遺物出土状態(北から)



9 6号土坑全景(北から)



10 7号土坑全景(北から)



11 8号土坑全景(南から)



12 9号土坑全景(北から)



13 10号土坑遺物出土状態(南から)

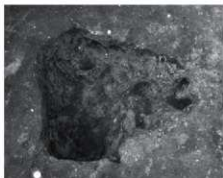

14 11号土坑全景(南から)



15 12号土坑全景(南から)



1 12号土坑土層断面(南から)



2 13号土坑全景(南から)



3 14号土坑・P155全景(東から)



4 15号土坑全景(南から)



5 16・17号土坑全景(南から)



6 16・17号土坑土層断面(東から)

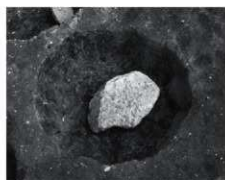

7 18号土坑全景(北から)



8 19・24号土坑全景(東から)



9 20号土坑全景(北から)

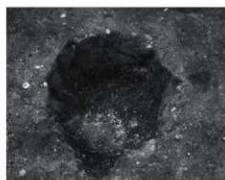

10 21号土坑全景(東から)



11 22号土坑全景(北東から)



12 22号土坑土層断面(南東から)

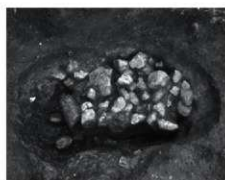

13 23号土坑出土遺物(北から)



14 23号土坑土層断面(北から)



15 24号土坑土層断面(東から)

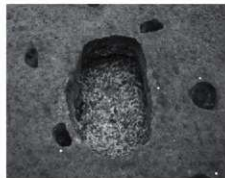

1 29号土坑全景(南から)



2 29号土坑土層断面(南から)



3 30号土坑全景(北から)



4 31・55号土坑全景(北から)



5 32号土坑全景(東から)



6 32号土坑土層断面(南から)

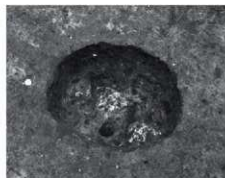

7 33号土坑全景(南から)

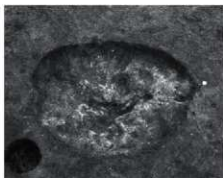

8 34号土坑全景(北から)



9 35号土坑土層断面(西から)

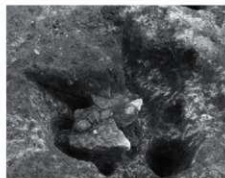

10 36号土坑土層断面(西から)



11 38号土坑遺物出土状態(西から)

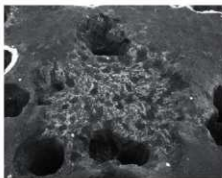

12 38号土坑全景(北から)



13 39号土坑全景(東から)

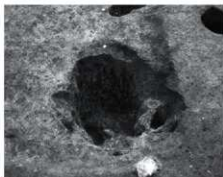

14 40号土坑全景(北から)



15 41号土坑出土遺物(西から)

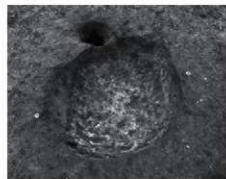

1 52区41号土坑・P377全景(北から)



2 52区42号土坑全景(南から)



3 52区42号土坑土層断面(南から)

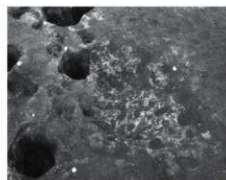

4 52区43号土坑全景(西から)

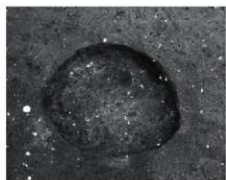

5 52区44号土坑全景(東から)



6 52区44号土坑土層断面(西から)



7 52区45号土坑全景(南から)



8 52区47号土坑全景(南から)



9 52区50号土坑全景(南から)



10 52区51号土坑全景(北から)



11 52区52号土坑全景(北から)



12 52区53号土坑全景(西から)



13 52区53号土坑土層断面(西から)

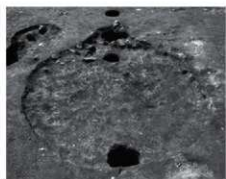

14 53区1号土坑全景(北から)



15 53区43号土坑土層断面(南から)





1 53区44号土坑全景(南から)



2 53区44号土坑土層断面(南から)



3 53区45号土坑全景(南から)



4 53区45号土坑土層断面(南から)



5 53区47号土坑全景(西から)



6 53区49号土坑全景(南から)



7 53区49号土坑土層断面(南から)



8 53区51号土坑全景(南から)



9 52区1号溝全景(南から)



10 52区3号溝全景(北から)



11 52区4号溝全景(北から)

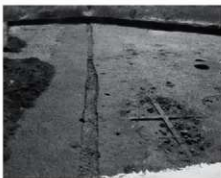

12 53区1号溝全景(北から)



13 52区1号焼土全景(東から)

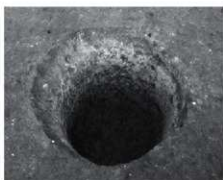

14 52区1号井戸全景(西から)



15 52区1号井戸土層断面(西から)



1 72区全景(西から)



2 72区全景(東から)



3 72区A s - K k 灰層堆積状況



4 73区全景(西から)



5 72区プレ試掘(北から)



6 73区全景(東から)



7 73区土層堆積状況(南から)



8 84区トレンチ調査(東から)



9 84区トレンチ調査(東から)



10 62区西側2面全景(東から)



11 62区西側全景(東から)



12 53・63区町道2面東部全景(東から)



1 53・63区町道2面東部全景(西から)



2 53・63区町道東部全景(東から)



3 53区町道北半分(東から)



4 53区町道全景(西から)



5 53区町道西部2面全景(西から)



6 53区町道西部2面全景(東から)



7 54区町道全景(東から)

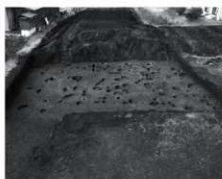

8 54区町道2面ピット群全景(東から)



9 54区町道全景(東から)

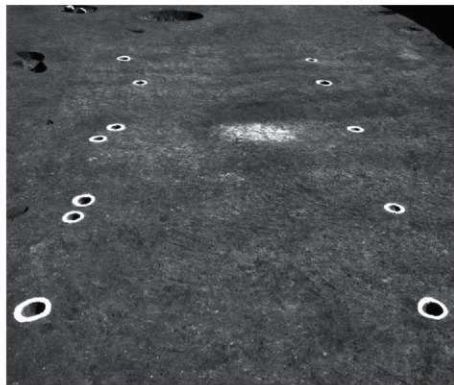

1 2号掘立柱建物全景(西から)



2 2号掘立柱建物P8土層断面(南から)



3 2号掘立柱建物P9土層断面(南から)

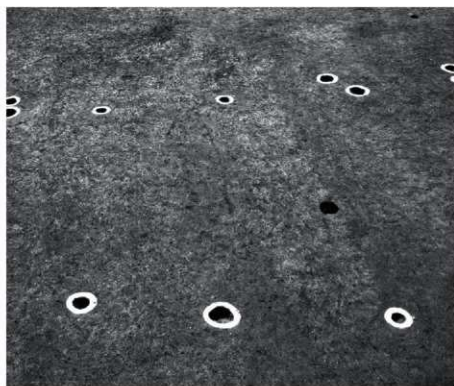

4 3号掘立柱建物全景(北から)



5 3号掘立柱建物P2土層断面(北から)



6 3号掘立柱建物P8土層断面(南から)



7 3号掘立柱建物P9土層断面(南から)



8 4号掘立柱建物P1土層断面(西から)



9 4号掘立柱建物P2土層断面(北から)

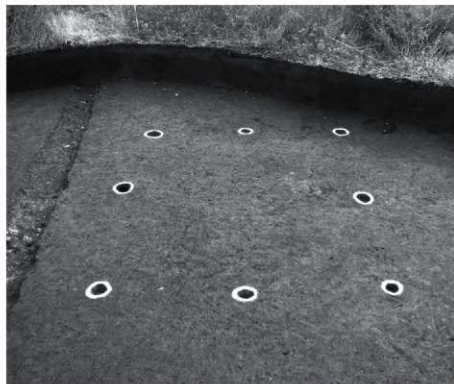

1 53区4号掘立柱建物全景(北から)



2 53区4号掘立柱建物P4土層断面(西から)



3 53区4号掘立柱建物P5土層断面(南から)



4 54区1号竪穴状遺構全景(北から)



5 54区1号竪穴状遺構土層断面(東から)

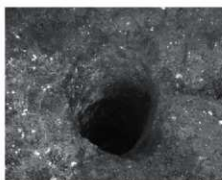

6 54区1号竪穴状遺構P2全景(西から)



7 54区1号竪穴状遺構P2土層断面(南から)



8 54区1号竪穴状遺構P5全景(東から)



9 54区1号竪穴状遺構P5土層断面(南から)



1 7号土坑全景(東から)



2 7号土坑土層断面(西から)



3 9号土坑全景(南から)



4 10号土坑全景(南東から)



5 11号土坑全景(北から)



6 15号土坑全景(北から)



7 16号土坑全景(南から)



8 17号土坑全景(北から)



9 18号土坑全景(北から)



10 22号土坑全景(南から)



11 22号土坑土層断面(南から)



12 24号土坑全景(北から)



13 24号土坑土層断面(南から)



14 25号土坑全景(南から)



15 26号土坑全景(北から)



1 26号土坑土層断面(東から)



2 29号土坑全景(北から)



3 29号土坑土層断面(南から)



4 60号土坑全景(南から)



5 61号土坑土層断面(南から)



6 63号土坑全景(南から)



7 66号土坑全景(南から)



8 66号土坑土層断面(南から)

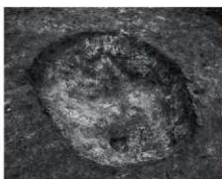

9 70号土坑全景(南から)



10 70号土坑土層断面(南から)



11 71号土坑土層断面(北から)



12 72号土坑全景(北から)



13 72号土坑土層断面(北から)



14 74号土坑全景(南から)

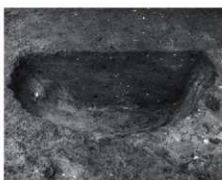

15 74号土坑土層断面(南から)



1 54区1号土坑土層断面(南から)



2 54区2号土坑水道管(南から)



3 54区3号土坑全景(南から)



4 54区3号土坑土層断面(南から)



5 54区5号土坑全景(南から)



6 54区5号土坑土層断面(南から)



7 54区6号土坑全景(南から)



8 54区6号土坑土層断面(南から)



9 54区7号土坑全景(南から)



10 54区22号土坑全景(南から)



11 54区22号土坑土層断面(南から)



12 62区1号土坑全景(南から)



13 62区1号土坑土層断面(南から)



14 63区1号土坑全景(南から)



15 63区1号土坑土層断面(南から)





1 63区2号土坑全景(南から)



2 63区3号土坑全景(南から)

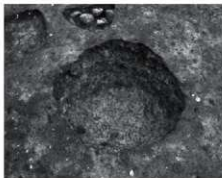

3 63区4号土坑全景(南から)



4 63区5号土坑全景(西から)



5 63区6号土坑全景(南から)



6 第1区画1号墓人骨出土状態(西から)



7 第2区画1号墓全景(北から)



8 第2区画4号墓全景(南から)

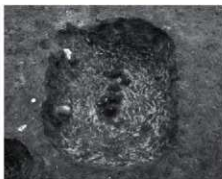

9 52区1号墓全景(南から)



10 52区1号墓人骨及び遺物出土状態(西から)



11 53区1号墓出土全景(南から)



12 53区1号墓人骨及び遺物出土状態(西から)



13 53区2号墓全景(北から)



14 53区2号墓人骨及び遺物出土状態(北から)



15 53区3号墓人骨出土状態(南から)



1 第2区画1・2・3・6号馬骨出土状態(西から)



2 第2区画1号馬骨出土状態(北から)



3 第2区画1号馬骨出土状態(南から)



4 第2区画2号馬骨出土状態(南から)



5 第2区画3号馬骨出土状態(東から)



6 第2区画3号馬骨出土状態(北から)



7 第2区画4号馬骨出土状態(南から)



8 第2区画5号馬骨出土状態(西から)



9 第2区画6号馬骨出土状態(東から)



10 53区2号溝全景(北から)



11 53区3号溝土層断面(北から)



12 53区町道遺物出土P231(南から)

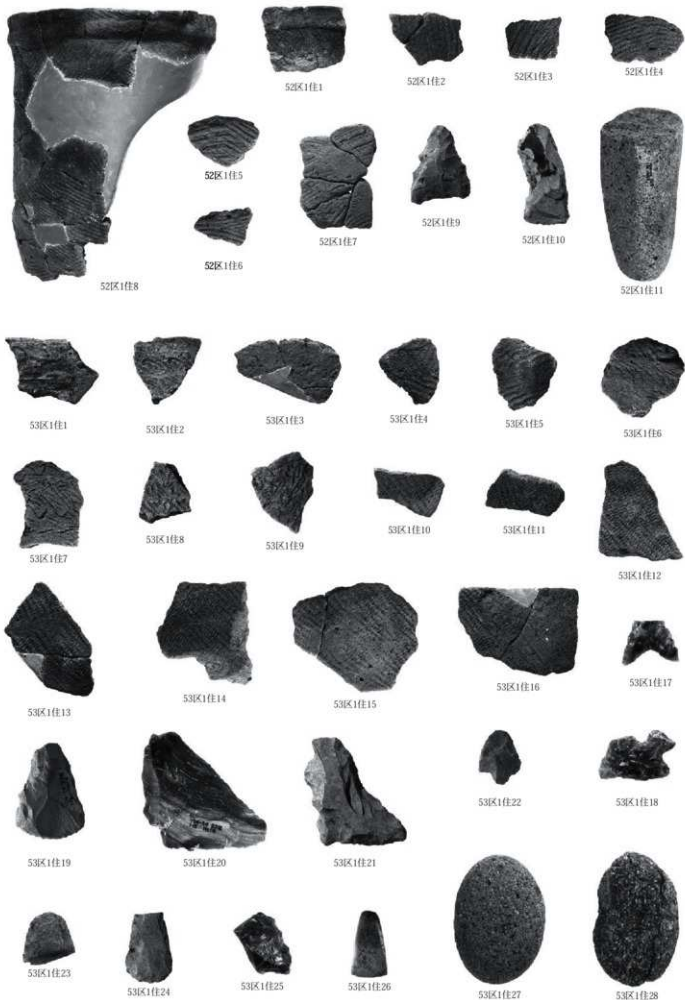

52K1 号住居 53K1 号住居(1) 出土遺物



53K1住29



53K1住30



53K1住33

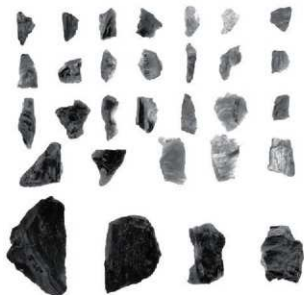

53K1住埋化木



53K1住32



53K1住31



53K2住4



53K2住5



53K2住6



53K2住7



53K2住8



53K2住9



53K2住10



53K2住11



53K2住12



53K2住13



53K2住14



53K3住1



53K3住2



53K2住15

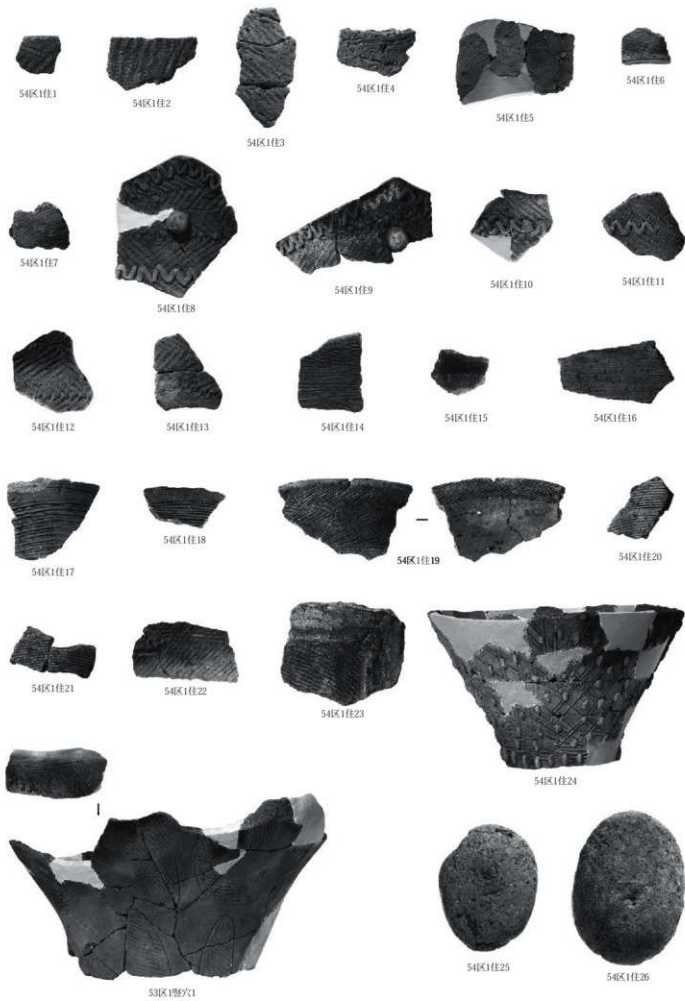

54区 1 号住居 53区 1 号壘穴状遺構 出土遺物

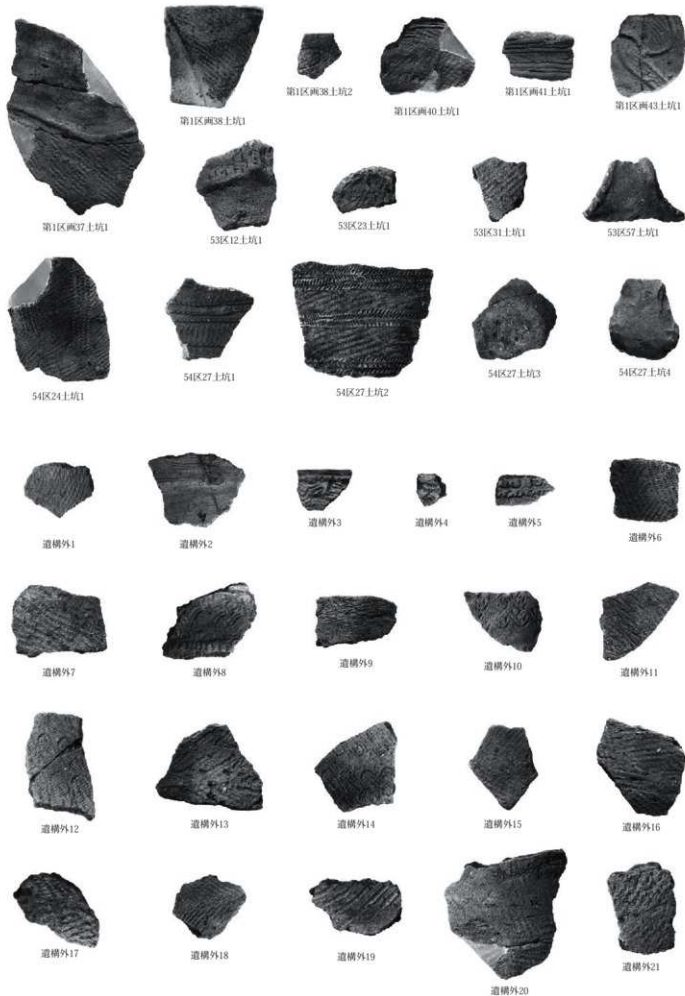

土坑・遺構外(1) 出土遺物



道構外22



道構外23



道構外24



道構外25



道構外26



道構外27



道構外28



道構外29



道構外30



道構外31



道構外32



道構外33



道構外34



道構外35



道構外36



道構外37



道構外38



道構外39



道構外40



道構外41



道構外42



道構外43



道構外44



道構外45



道構外46



道構外47



道構外48



道構外53



道構外49



道構外50



道構外51



道構外52



道構外54



道構外55



道構外56



道構外57



道構外58



道構外59



道構外60



道構外61



道構外62



道構外63



道構外64



道構外65



道構外66



道構外67



道構外68



道構外69



道構外70



道構外71



道構外72



道構外73



道構外74



道構外75



道構外76



道構外77



道構外78



道構外79



道構外80



道構外81



道構外82



道構外83



道構外84



道構外85



道構外86



道構外87



道構外88



道構外89



道構外90



道構外91



道構外92



道構外93



道構外94



道構外95



道構外96



道構外97



道構外98



道構外99

道構外(3) 出土遺物



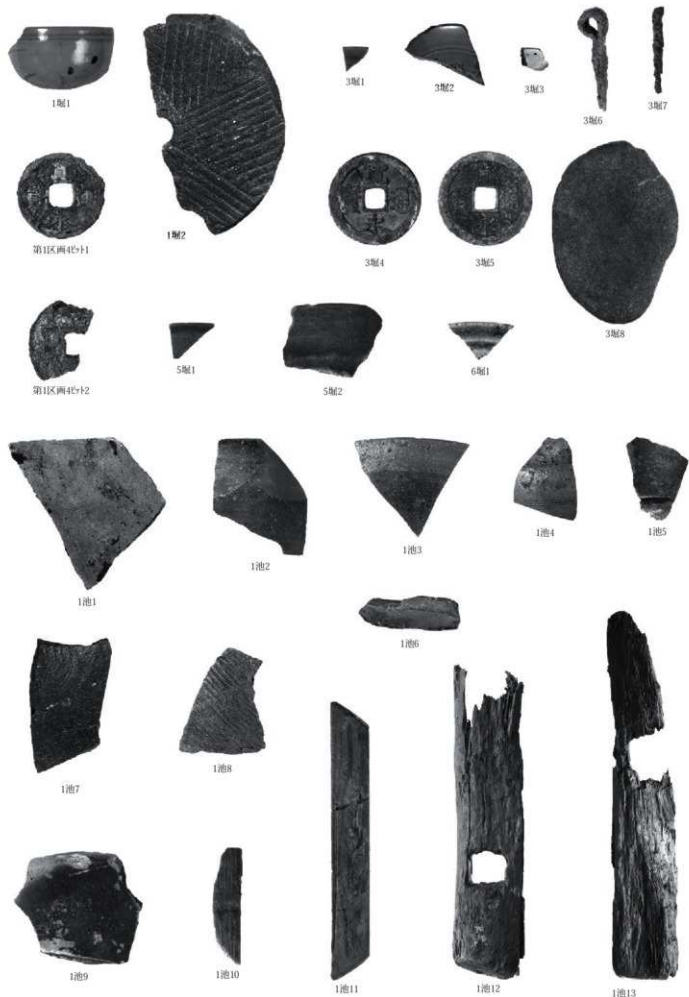

林城 堀・ビット・1号池(1) 出土遺物



1池14



1池15



1池16



1池17



1池18



1池19



1池20



1池22



1池26



1池28



1池29



1池23



1池24



1池25



1池27



1池30



1池31



1池32



1池33



1池34



1池35



林城 1号池(3)・2号池 出土遺物



盛土1



1土坑1



3土坑1



4土坑1



4土坑3



盛土2



10土坑1



11土坑1



31土坑1



4土坑2



32土坑1



33土坑2



16土坑1



27土坑1



30土坑1



44土坑1



33土坑1



1石垣1



1石垣2



1石垣3



5石垣3



5石垣1



5石垣2



5石垣4



5石垣5



道横71



道横72



道横73



道横74



道横75



道横76



道横77



削平面1



道横外4



道横外5



道横外6



道横外7



道横外8



道横外1



道横外2



道横外3



道横外9



道横外10



道横外11



道横外12



道横外13



道横外14



道横外15



道横外16



道横外17



道横外18



道横外19



第2区画 1号礎石建物・焼土・土坑・土取穴 出土遺物



第2区画遺構外1



第2区画遺構外2



第3区画3石組1



第3区画3石組2



第3区画3石組3



第3区画3石組4



第3区画3石組5



第3区画3石組6



第3区画3石組8



第3区画3石組9



第3区画3石組10



第3区画3石組7



第3区画 掘立柱建物・ピット・土坑・6号溝・道溝外  
第5区画4号石垣 出土遺物



## 林中原1道跡中近世



第5区西道横外 第6区西1号配石 出土遺物



第6区画遺構外1



第6区画遺構外2



第7区画(54区)378E+H



第7区画(54区)499E+H



第7区画(54区)25土坑1



第7区画3掘立1



第7区画9掘立1



第7区画2掘1



第7区画2溝2



第7区画3溝1



第7区画1礎石1



第7区画1礎石2



第7区画2礎石1



第7区画5掘1



第7区画6掘1



中近世屋敷52区2掘立1



中近世屋敷52区2掘立2



中近世屋敷52区3掘立1



中近世屋敷52区8掘立1



中近世屋敷52区16掘立1



中近世屋敷52区18掘立1



中近世屋敷52区25掘立1



中近世屋敷52区16掘立2



中近世屋敷52区538E+H



中近世屋敷52区547E+H

第6区画遺構外  
 第7区画 掘立柱建物・ピット・土坑・溝・礎石建物  
 中近世屋敷 52区掘立柱建物・ピット 出土遺物



中近世屋敷52区1号壑穴状遺構 出土遺物

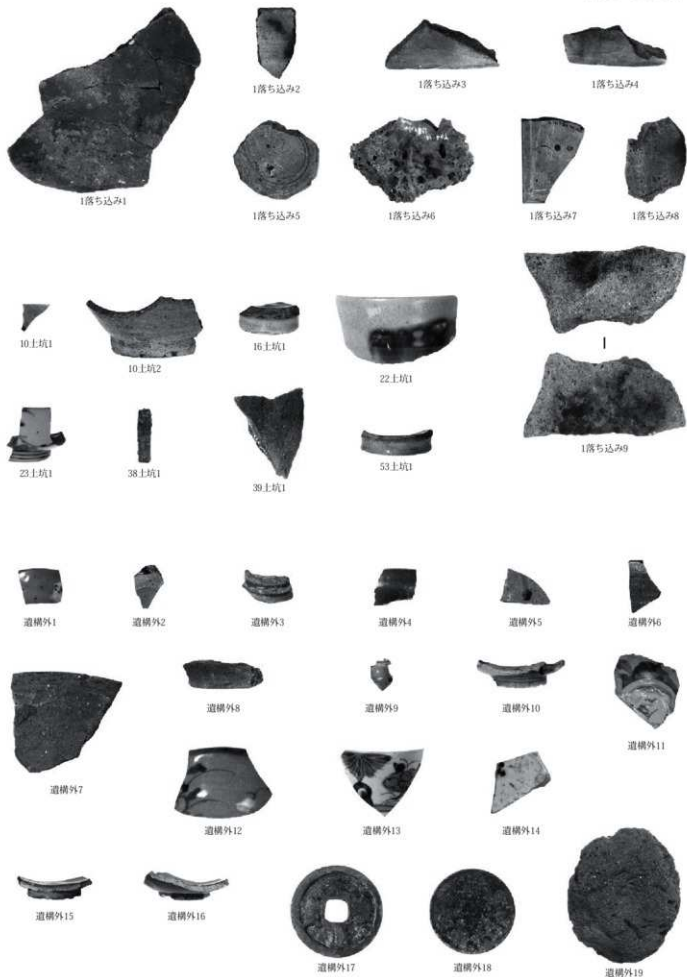

中近世屋敷 52区1号落ち込み・土坑・道橋外(1) 出土遺物



中近世屋敷52区遺構外20

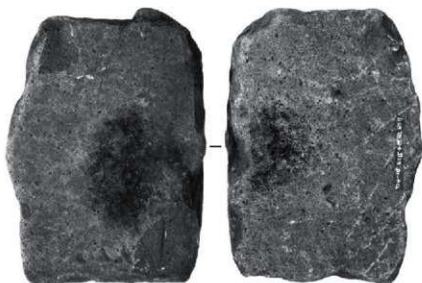

中近世屋敷52区遺構外21



その他第1区画1墓1



その他第1区画1墓2



その他54区1型穴1



その他第1区画1墓4



その他第1区画1墓3



その他第2区画4墓1

その他第2区画4墓2



その他第1区画1墓5



その他第1区画1墓6



その他第2区画4墓3



その他第2区画1墓1



その他第2区画1墓2



その他第2区画4墓4



その他第2区画1墓3



その他第2区画1墓4



その他第2区画1墓5



その他第2区画4墓5

中近世屋敷52区遺構外(2) その他54区1号型穴状遺構  
第1区画1号墓 第2区画 1号墓・4号墓(1) 出土遺物



第2区画4墓6



第2区画4墓7



第2区画4墓8



第2区画4墓9



第2区画4墓10



第2区画4墓11



52区1墓1



52区1墓2



53区1墓1



53区1墓2



53区1墓3



53区1墓4



53区1墓5



53区2墓1



53区2墓2



53区2墓3



53区道構外1



53区道構外2



53区2316号1



54区116号1



54区306号1



54区766号1



53区道構外3



54区道構外1



54区道構外2



54区道構外3



54区道構外4



表採1

## 報告書抄録

書名ふりがな	ながのはらじょうあと・はやしなかはらいちいせき
書名	長野原城跡・林中原1遺跡
副書名	八ッ場ダム建設工事に伴う埋蔵文化財発掘調査報告書
巻次	43
シリーズ名	公益財団法人群馬県埋蔵文化財調査事業団調査報告書
シリーズ番号	586
編著者名	飯森康広／黒沢照弘／中沢 悟／藤巻幸男
編集機関	公益財団法人群馬県埋蔵文化財調査事業団
発行機関	公益財団法人群馬県埋蔵文化財調査事業団
発行年月日	20140318
作成法人ID	21005
郵便番号	377-8555
電話番号	0279-52-2511
住 所	群馬県渋川市北楯町下箱田784番地2

遺跡名ふりがな	ながのはらじょうあと
遺跡名	長野原城跡
所在地ふりがな	ぐんまけんあがつまぐんながのはらまちおおあざながのはら
遺跡所在地	群馬県吾妻郡長野原町大字長野原
市町村コード	10424
遺跡番号	0085
北緯（日本測地系）	363249
東経（日本測地系）	1383852
北緯（世界測地系）	363300
東経（世界測地系）	1383841
調査期間	20110401－20110430/20110801－20110831
調査面積	5,867 m <sup>2</sup>
調査原因	ダム建設工事に伴う国道林長野原線建設工事
種 別	城・畑
主な時代	縄文/中世/近世
遺跡概要	中世－城跡1+道－内耳土器+銭貨/近世－畑2+道－陶磁器
特記事項	中世長野原城の一部発掘調査 江戸時代畑の調査 天明泥流

遺跡名ふりがな	はやしなかはらいちいせき
遺跡名	林中原1遺跡
所在地ふりがな	ぐんまけんあがつまぐんながのはらまちおおあざはやし
遺跡所在地	群馬県吾妻郡長野原町大字林
市町村コード	10424
遺跡番号	0045
北緯（日本測地系）	363224
東経（日本測地系）	1384047
北緯（世界測地系）	363235
東経（世界測地系）	1384035
調査期間	20030506-20030531/20070801-20071228/20080401-20080630/20091101-20091228
調査面積	13,309 m <sup>2</sup>
調査原因	ダム建設工事に伴う国道林長野原線、林地区町道、専用道路建設工事
種別	集落・城
主な時代	縄文/中世/近世
遺跡概要	集落-縄文-住居5+竪穴1+土坑108+焼土1-土器+石器/中近世-堀6+石垣5+土橋1+橋2+虎口1+池2+盛土1+遺物出土ビット13+ビット群1+土坑179+スロープ1+道1+削平面1+溝26+礎石1+礎石建物3+焼土10+土取穴多数+掘立柱建物68+柱穴列15+竪穴状遺構6+落ち込み1+配石1+井戸1+墓7+獣骨8-土器+石器+陶磁器+木製品+古銭+金属器+石製品
特記事項	中世林城の堀・石垣・池・掘立柱建物の他に中近世の掘立柱建物・土坑等多数調査。中近世68棟の掘立柱建物はこの地域最大数である。



公益財団法人群馬県埋蔵文化財調査事業団調査報告書 第586集

## 長野原城跡・林中原 I 遺跡

ハツタム建設工事に伴う埋蔵文化財発掘調査報告書第43集

---

平成26(2014)年3月6日 印刷

平成26(2014)年3月18日 発行

編集・発行／公益財団法人群馬県埋蔵文化財調査事業団

〒377-8555 群馬県渋川市北碓町下箱田784番地2

電話(0279)52-2511(代表)

ホームページアドレス <http://www.gunmaibm.org/>

印刷／上毛新聞社事業局出版部

---



付図1 林中原 I 遺跡全体図 縄文時代 (1:800)

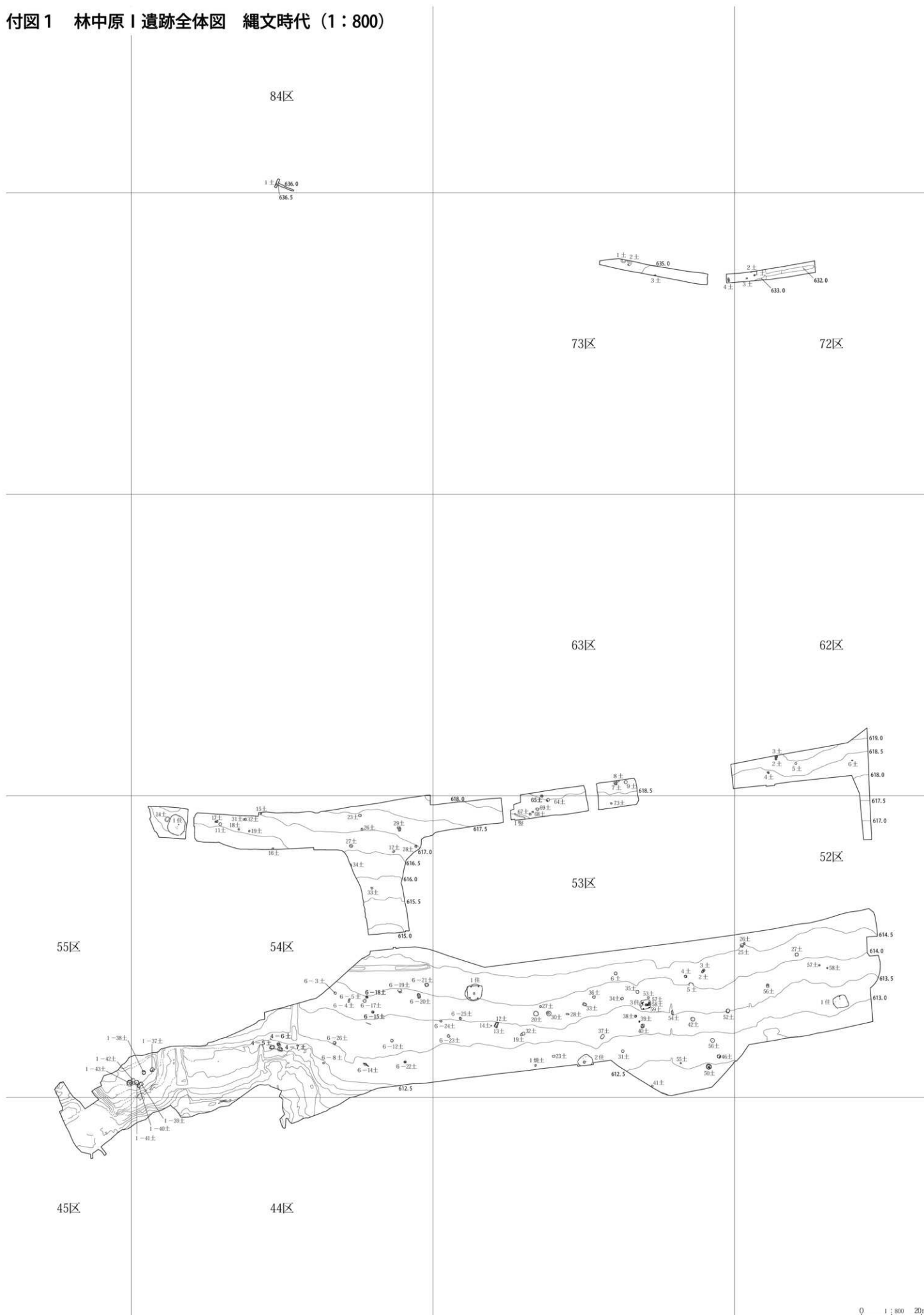

付図2 林中原I遺跡全体図 中近世 (1:600)

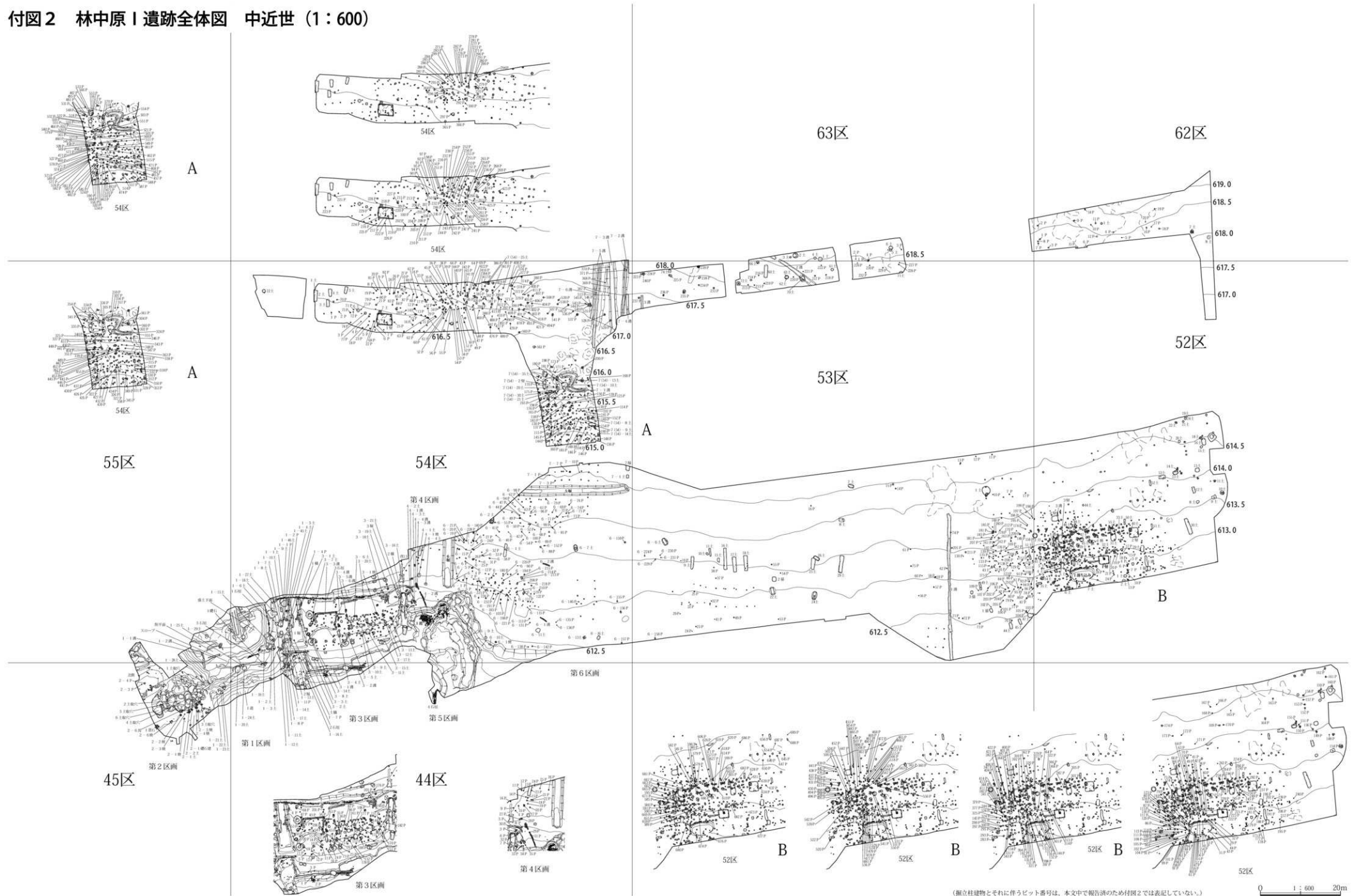

(欄立柱建物とそれに伴うセット番号は、本文中で報告済のため付図2では表記していない。)