

中里見遺跡群

中里見中川遺跡
中里見根岸遺跡
中里見原遺跡
上里見井ノ下遺跡

北陸新幹線建設に伴う
埋蔵文化財発掘調査報告書第15集

《写真図版編》

2000

群馬県教育委員会
財団法人群馬県埋蔵文化財調査事業団
日本鉄道建設公団

なか さと み い せき ぐん
中里見遺跡群

中里見中川遺跡
中里見根岸遺跡
中里見原遺跡
上里見井ノ下遺跡

北陸新幹線建設に伴う
埋蔵文化財発掘調査報告書第15集

《写真図版編》

2000

群馬県教育委員会
財団法人群馬県埋蔵文化財調査事業団
日本鉄道建設公団

中里見遺跡群

北陸新幹線





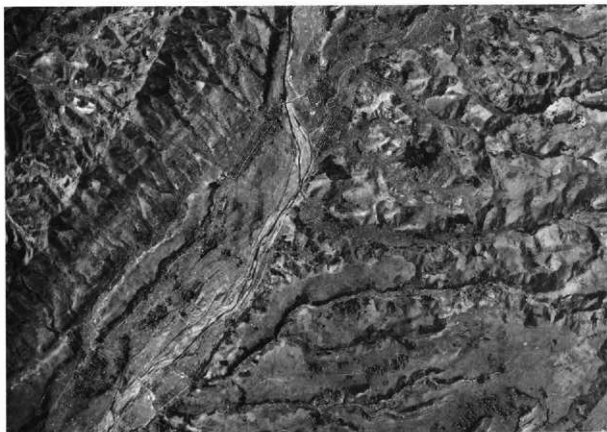

1 旧里見村・旧室田村全景（USAF昭和23年頃）

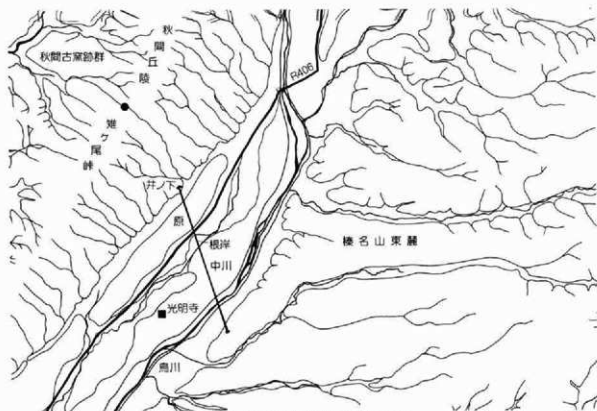

2 写真中の発掘調査遺跡所在地点概略図



1 調査地区全景（北東から）



2 安中市中秋園地区（中央新幹線経路・南から）



1 雉子峠（雉ヶ尾峠）を臨む（中里見原遺跡から南西方向）

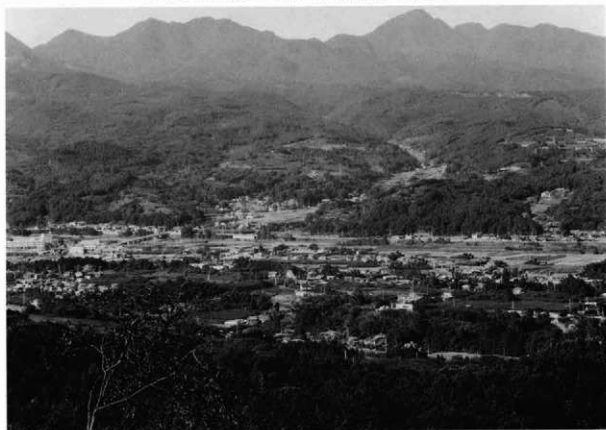

2 浅間神社から臨む中里見原遺跡と榛名山（南西から）



1 中里見根岸遺跡から中里見中川遺跡を眺む（北から）

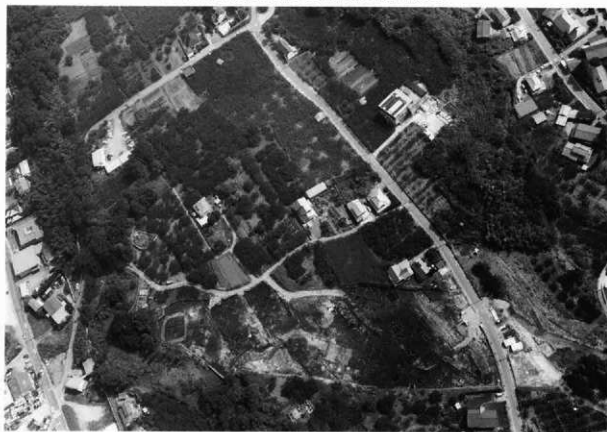

2 里見高寺遺跡（上空から）



1 浅間神社から臨む中里見地区と榛名山（南西から）



2 浅間神社から臨む中里見地区と榛名山（南西から）



3 浅間神社から臨む下秋間吉ヶ谷（北西から）



4 浅間神社から臨む相水谷（北から）



5 下里見中原所在する「原住遺」の道標



6 調査区隔地の原住遺の馬頭観音石像



1 下里見中原の「原住遷」と県道



2 中里見・天台宗里見山光明寺 (南から)



3 上里見・真言宗毘那山東光寺 (南から)



4 中里見・天台宗里光山泉福寺



5 中里見泉福寺古墳群遠景 (南から)

中里見中川遺跡

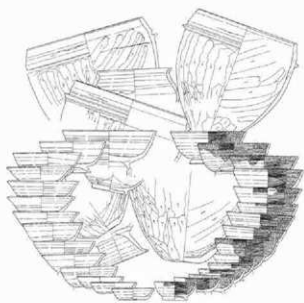

中里見中川第8号住居跡出土



1 1区近・現代畝水田跡全景(西から)



2 1区近・現代畝水田跡全景(東から)



3 1区畝跡(南から)



4 1区畝跡耕作痕出土状態(東から)



5 2区石列全景(東から)



6 2区1・2・16~19号土坑全景(南から)



7 2区3号土坑石出土状態(南から)



8 2区3号土坑全景(南から)



1 2区4~7・25~28号土坑全景(東から)

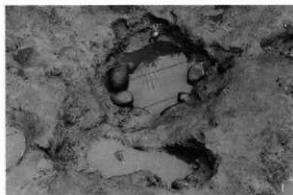

2 2区4・5・25号土坑全景(東から)



3 2区6号土坑全景(東から)



4 2区7・27・28号土坑全景(東から)



5 2区8~10・29~35号土坑全景(東から)



6 2区8・29~31号土坑全景(東から)



7 2区9・32~35号土坑全景(東から)



8 2区10号土坑全景(東から)



1 2区11号土坑全景(北から)



2 2区12~15号土坑全景(北から)



3 2区1・2号不明遺構全景(南から)



4 2区AS-C下水田跡全景(南西から)



5 2区AS-C下水田跡蛙群出土状態(南西から)



6 2区AS-C下水田跡足跡出土状態(西から)



7 2区塚群1面全景(南西から)



8 2区塚群2面全景(南東から)



1 2区3面全景(南西から)



2 2区3面近撮(南東から)

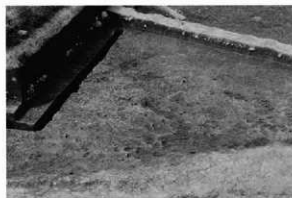

3 2区3面足跡出土状態(南西から)



4 2区3面足跡出土状態(南東から)

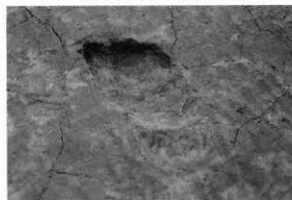

5 2区3面足跡近景(北西から)



6 2区5面全景(南西から)



7 2区5面流木出土状態(南西から)



8 2区5面柄出土状態(西から)



1 2区西側AS-C混土下り水田全景(南から)



2 2区西第2面礫群全景(南から)



3 2区西側礫群全景(南西から)



4 2区西2面下り水田全景(南から)



5 3区AS-B下り水田跡全景(西から)



6 3区AS-B下り水田跡全景(南から)

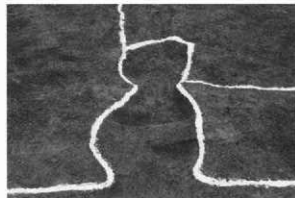

7 3区AS-B下り水田跡水口近景(南から)



8 3区集石全景(東から)



1 3区集石全景(南西から)



2 3区集石全景(南から)



3 3区集石北壁土層断面(南から)



4 3区集石底面出土状態(南から)



5 4区1号溝全景(北から)

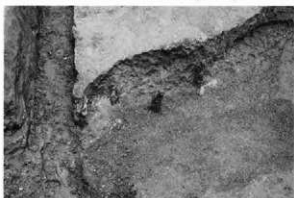

6 4区1号溝杭列近景(西から)



7 4区AS-B降下面全景(東から)



8 4区AS-B堆積状態(北東から)



1 4区3・4号溝全景(南から)



2 4区5号溝全景(東から)



3 4区縄文時代面全景(東から)



4 4区1~3号土坑全景(東から)



5 4区1号土坑全景(北から)



6 4区2号土坑全景(北から)



7 5区1~4号土坑全景(南から)



8 5区1~4号土坑全景(北から)



1 5区AS-B下水田跡全景(西から)



2 5区AS-B下水田跡畦畔出土状態(東から)



3 5区AS-B下水田跡西側近景(南から)



4 5区AS-B下水田跡(拡張区)全景(北から)



5 5区1号溝遺物出土状態(北東から)



6 5区1号溝全景(北東から)



7 5区4号住居全景(南から)



8 5区4号住居カマド近景(南から)



1 5区4号住居掘り方全景(南から)



2 5区4号住居カマド掘り方近景(南から)



3 5区5号住居全景(西から)



4 5区5号住居カマド近景(西から)



5 5区6号住居全景(西から)



6 5区7号住居全景(西から)



7 5区8号住居全景(北東から)



8 5区5号土坑全景(北から)



1 5区6号土坑確認状態(南から)



2 5区6号土坑全景(東から)

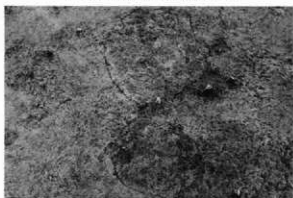

3 5区鍛冶炉確認状態(北から)



4 5区鍛冶炉1面全景(北から)



5 5区鍛冶炉1面近景(北西から)



6 5区鍛冶炉2面近景(北から)



7 5区鍛冶炉3面全景(北から)



8 5区鍛冶炉4面全景(北から)



1 5区鍛冶炉掘り方全景(北から)



2 5区鍛冶炉掘り方全景(南から)



3 5区5号小鍛冶確認状態(西から)

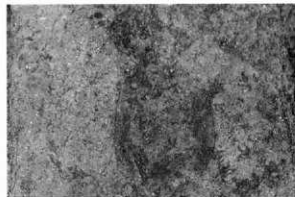

4 5区6号小鍛冶確認状態(南から)

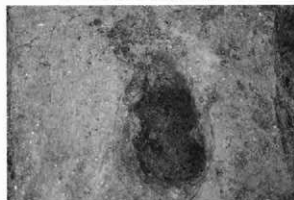

5 5区6号小鍛冶全景(南から)



6 5区7号小鍛冶確認状態(東から)



7 5区7号小鍛冶全景(東から)

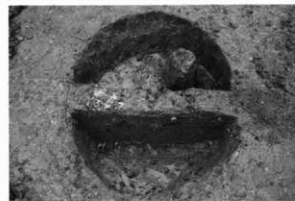

8 5区8号小鍛冶全景(南から)



1 5区AS-C下水田跡全景(東から)



2 5区AS-C下水田跡近景(東から)



3 5区AS-C下水田跡近景(北東から)



4 5区AS-C下黒色土直下面全景(西から)



5 5区AS-C下黒色土直下面土層断面(北から)



6 5区AS-C下黒色土直下面杭出土状態(西から)



7 5区AS-C下黒色土直下面流木出土状態(北東から)



8 5区5号溝全景(北東から)



1 6区1号住居全景(西から)



2 6区1号住居カマド近景(西から)



3 6区1号住居掘り方全景(西から)



4 6区2号住居跡全景(西から)



5 6区1~5号土坑全景(南から)



6 6区2号溝全景(南東から)



7 6区縄文晩期包含層遺物出土状態(南から)



8 6区縄文晩期包含層下落ち込み(南から)



1 6区縄文晩期包含層下落ち込み(東から)



2 6区泥流下1面全景(西から)



3 6区泥流下2面全景(東から)



4 6区泥流下3面全景(東から)



5 7区1号溝全景(南東から)



6 7区1号土坑全景(東から)



7 7区縄文晩期包含層遺物出土状態(東から)



8 7区縄文晩期包含層遺物出土状態(東から)

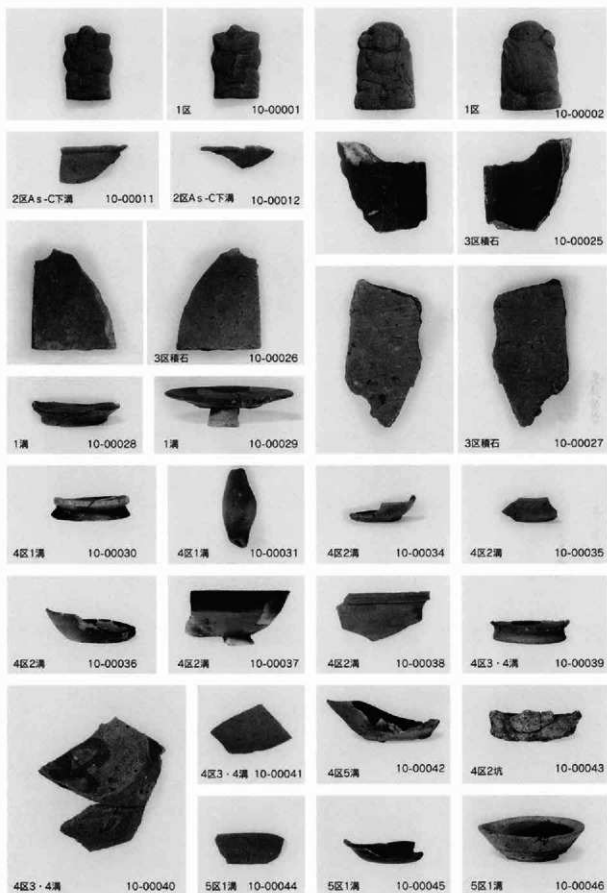

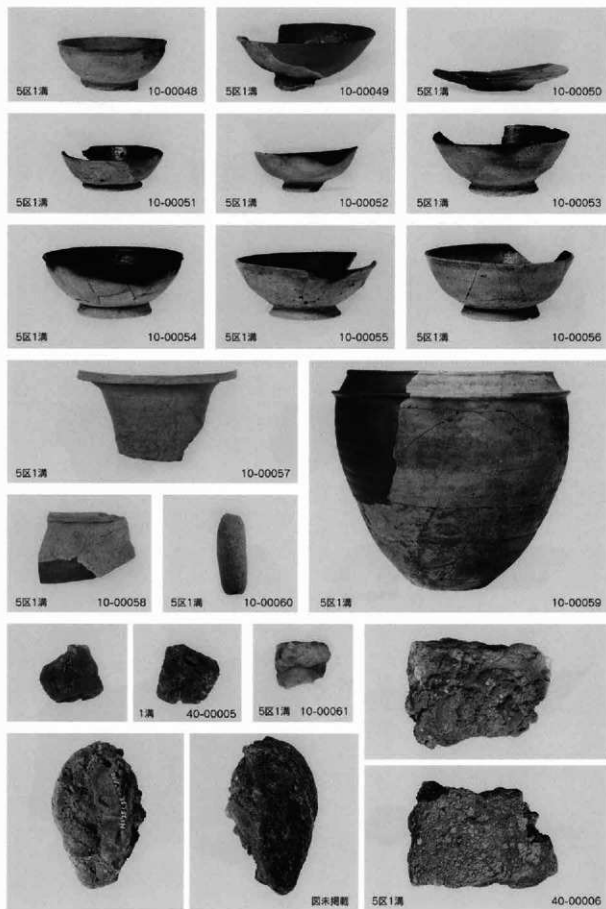



5区1溝

40-00007

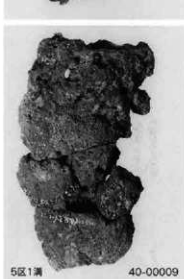

5区1溝

40-00008

5区1溝

40-00009



5区4住

10-00062

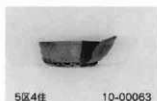

5区4住

10-00063



5区4住

10-00064

5区1溝

20-00012

5区1溝

20-00013



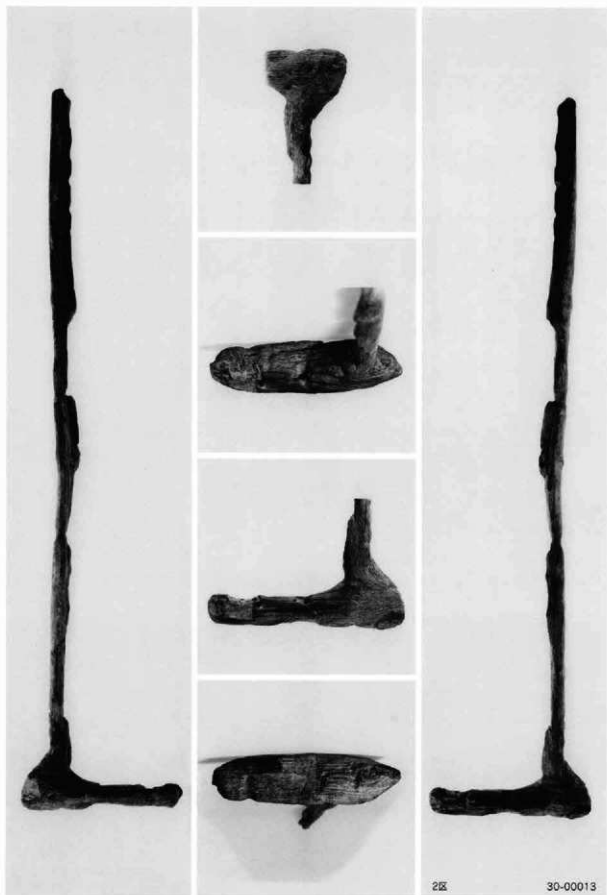





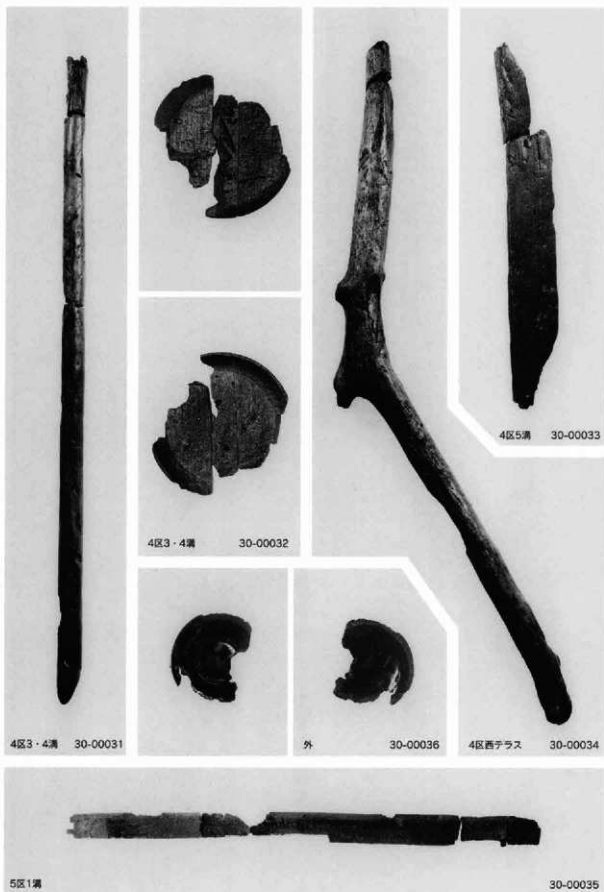

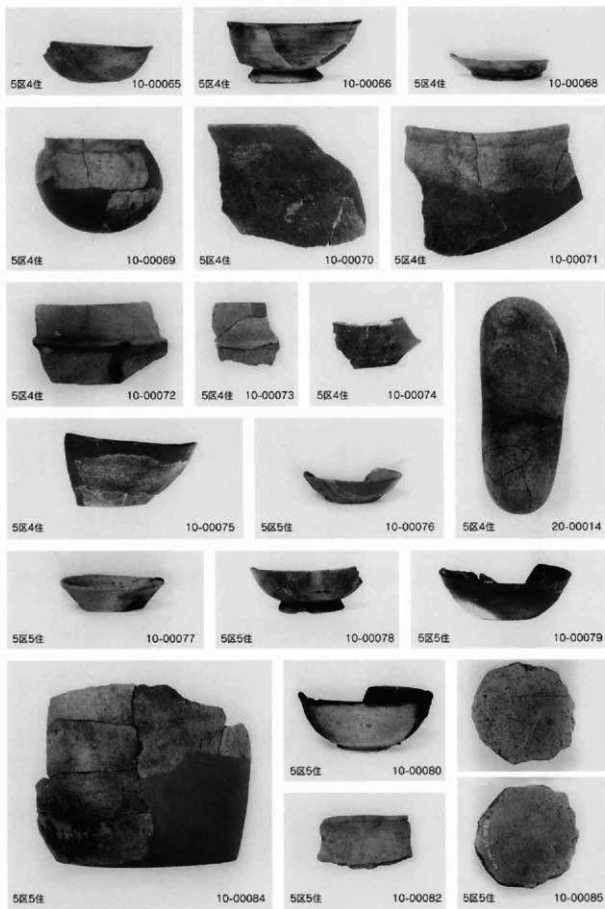

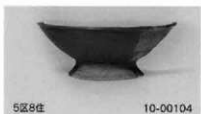
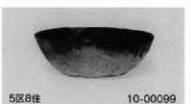
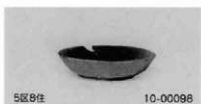
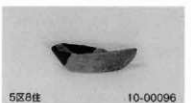
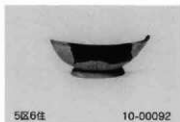
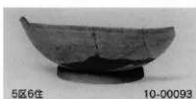

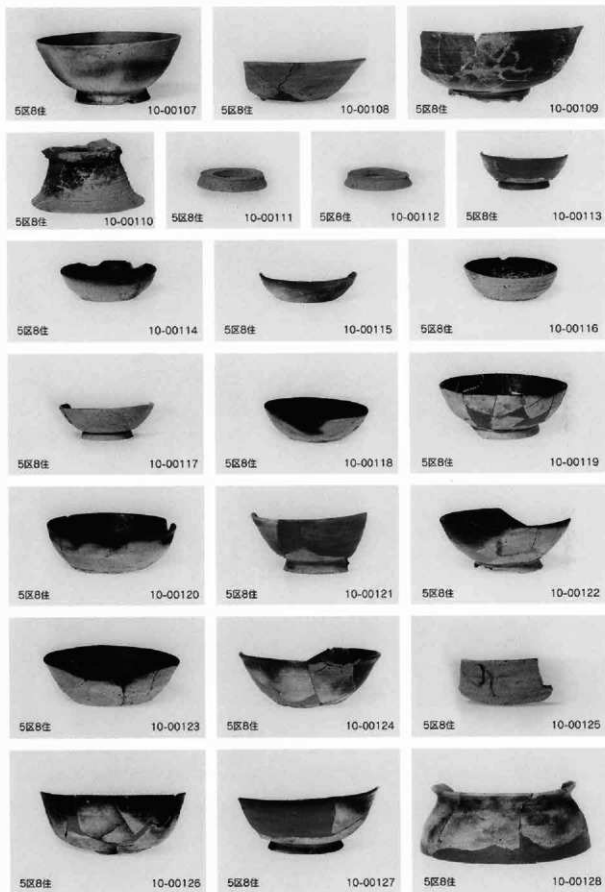

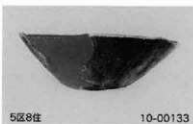
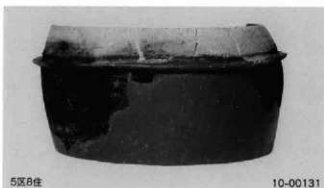

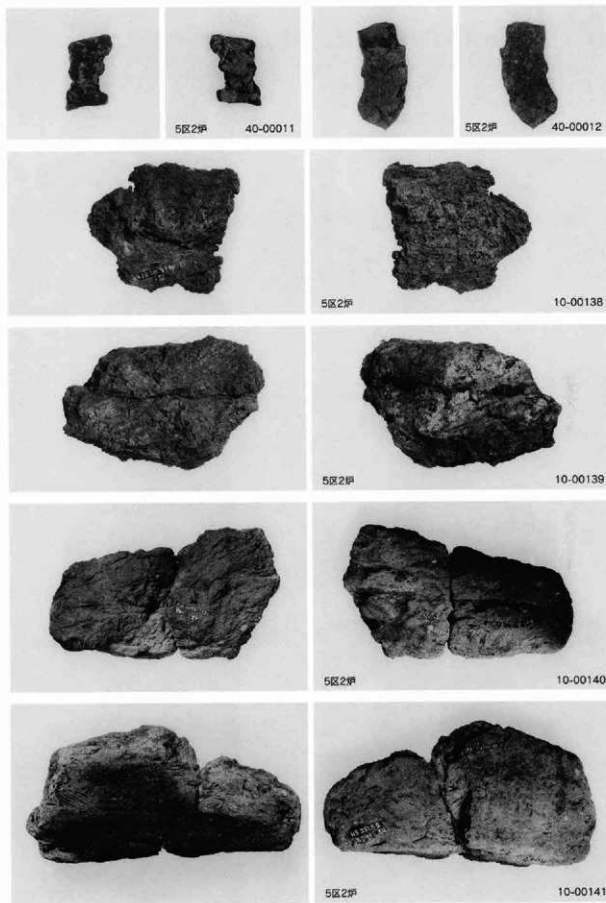



5区2甲



10-00143



5区2甲

10-00144



5区2甲

10-00145



5区2甲



10-00146

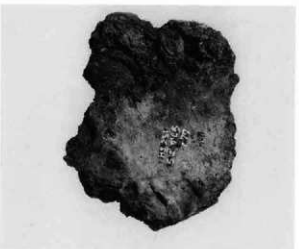

5区2甲



10-00148



5区2甲

10-00149



5区2甲

10-00150

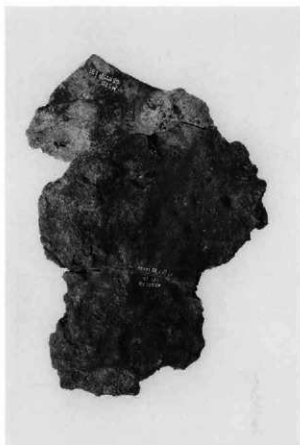

5区2甲

10-00147

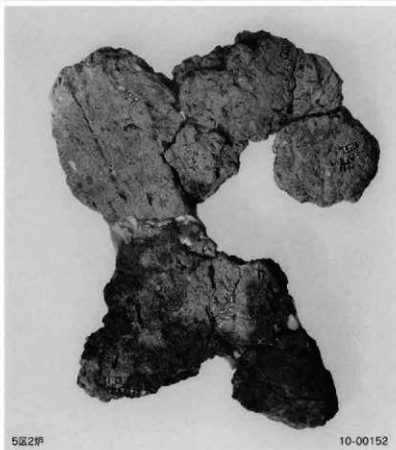
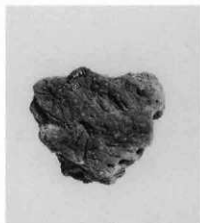



5区2伊

10-00151



5区2伊

1



5区2伊

2

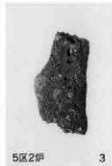

5区2伊

3



5区2伊

4

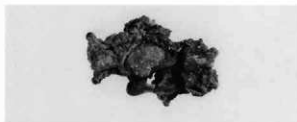

5区2伊

5



5区2伊

6



5区2伊

7



5区2号

8

5区2号

9



5区2号

10



5区2号

12

5区2号

11

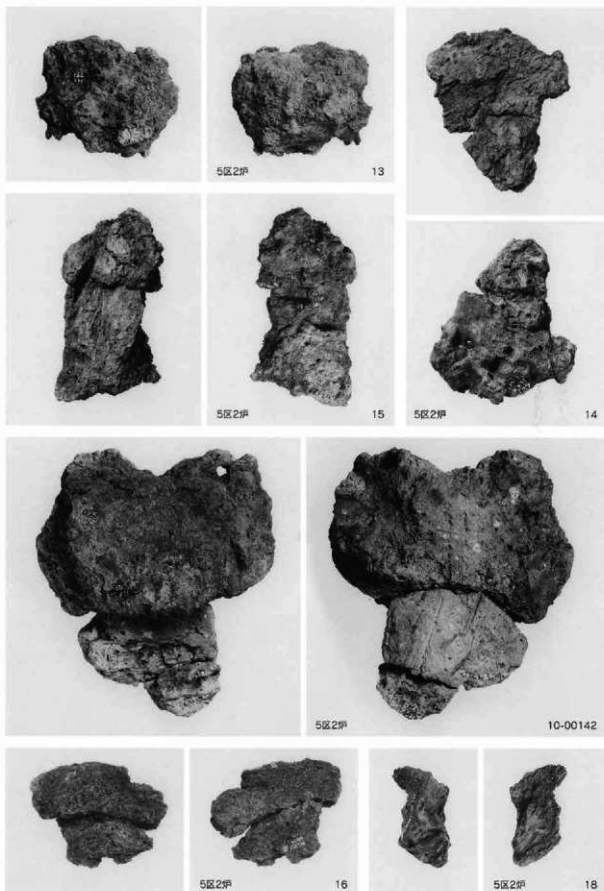

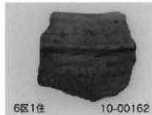
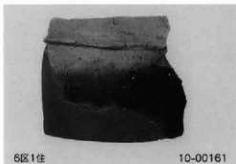
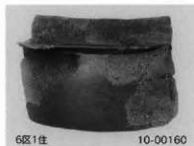
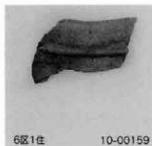
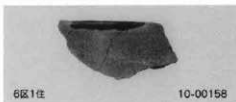

中里見根岸遺跡



中里見根岸V層出土



1 AS-B下水田検出状態(東から)



2 畦上AS-B堆積状態(東から)



3 平安面調査終了状態全景(西から)



4 1号溝全景(南から)



5 1号溝近景(西側部分)(北から)



6 1号溝近景(東側部分)(西から)



7 2・3号溝全景(東から)



1 1号住居全景(西から)



2 1号住居カマド近景遺物出土状態(北西から)



3 1号住居カマド近景石相出土状態(北西から)



4 1号住居廻り方全景(西から)

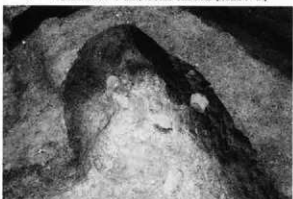

5 1号住居カマド廻り方近景(北西から)



6 1号住居内床下土坑遺物出土状態(北から)



7 2号住居全景(西から)



8 2号住居カマド近景(西から)



1 2号住居掘り方全景(西から)



2 2号住居カマド掘り方近景(西から)



3 3号住居遺物出土状態(西から)



4 3号住居全景(西から)



5 3号住居内2号土坑石出土状態(南東から)



6 3号住居瓦出土状態(南から)



7 9~13・15・16号土坑全景(南東から)

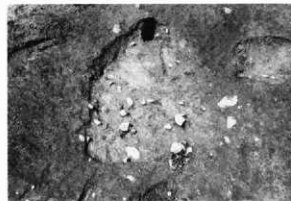

8 1号竪穴状遺構全景(東から)

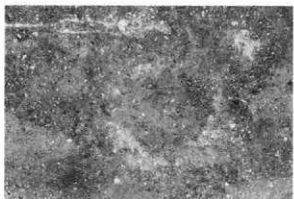

1 1号炉跡確認状態(北から)



2 1号炉跡掘り方全景(北から)



3 1号炉跡確認状態及び6号土坑遺物出土状態(北から)



4 6号土坑遺物出土状態(北から)



5 6号土坑スケール出土状態(北から)



1 縄文晩期包舎層全景遺物出土状態(東から)



2 16~17-0~Pグリッド遺物出土状態(南西から)



3 16-0~Pグリッド遺物出土状態(北東から)



4 東側部分遺物出土状態(南西から)



5 16-0グリッド遺物出土状態(北西から)



6 中里見根岸遺跡から中里見原遺跡を臨む(東から)



7 2区試掘トレンチ全景(東から)

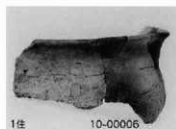

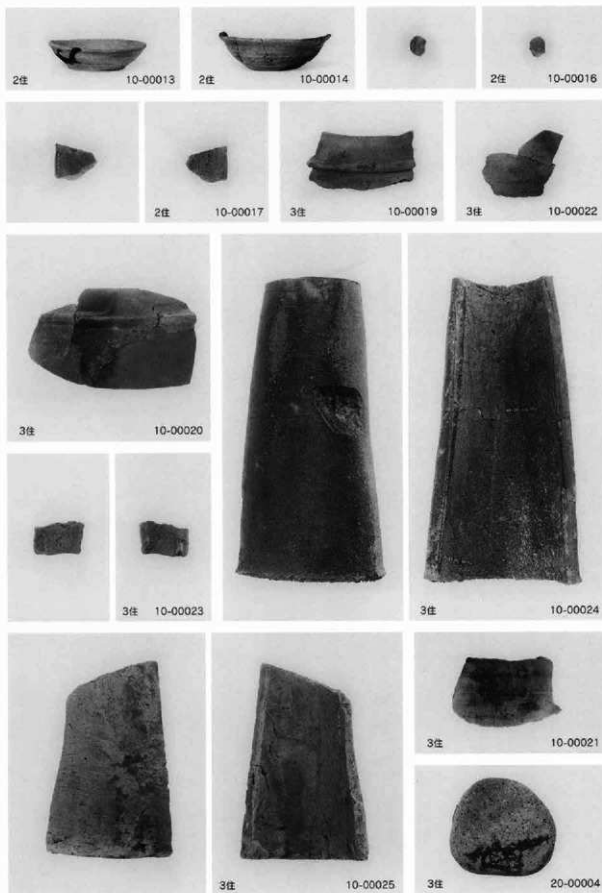

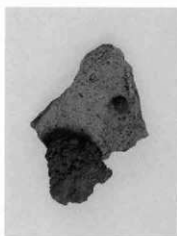

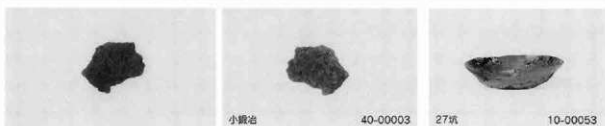
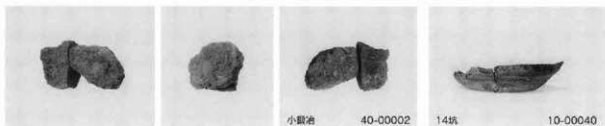

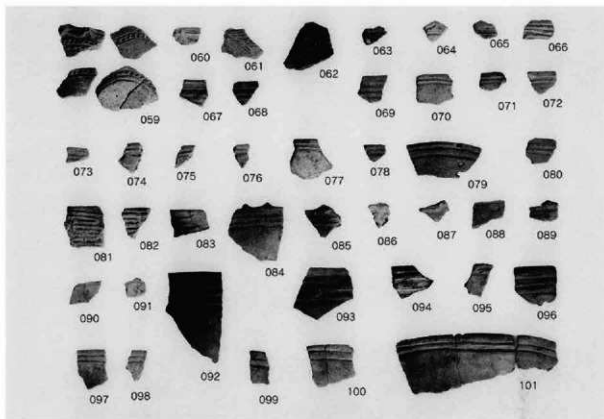

遺物包含層

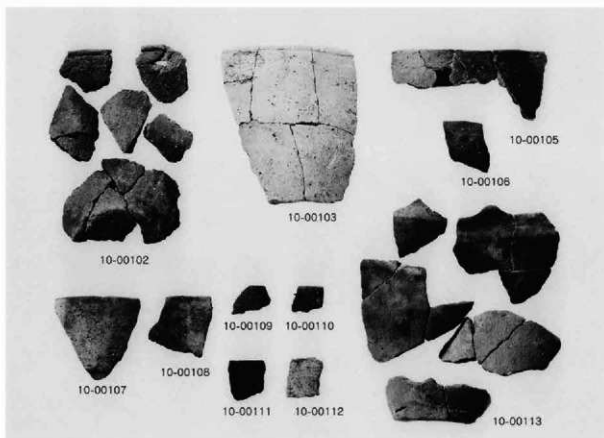

遺物包含層

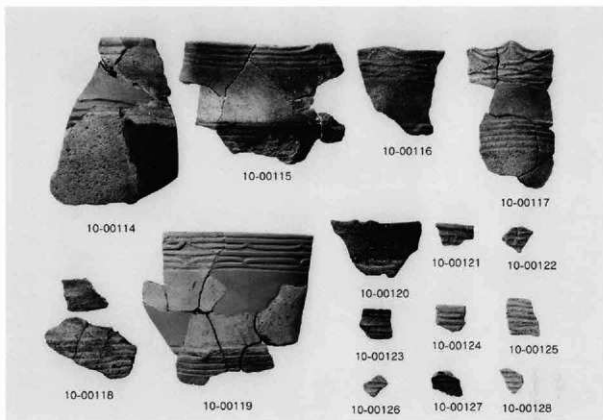

遺物包含層

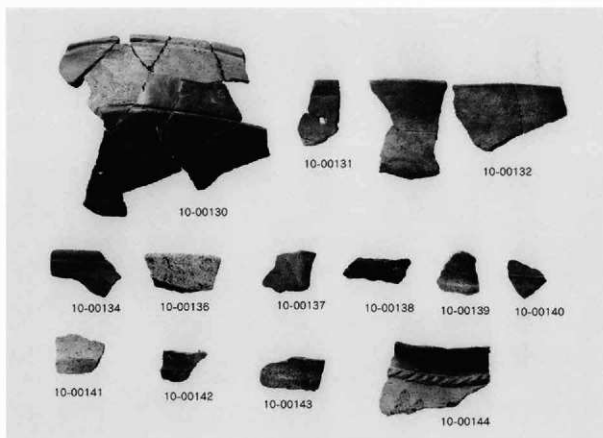

遺物包含層

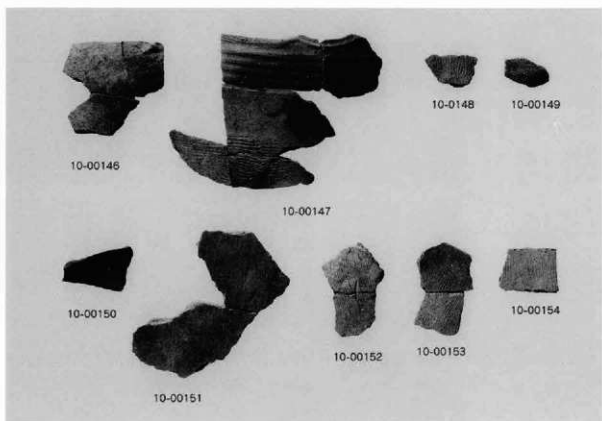

遺物包含層

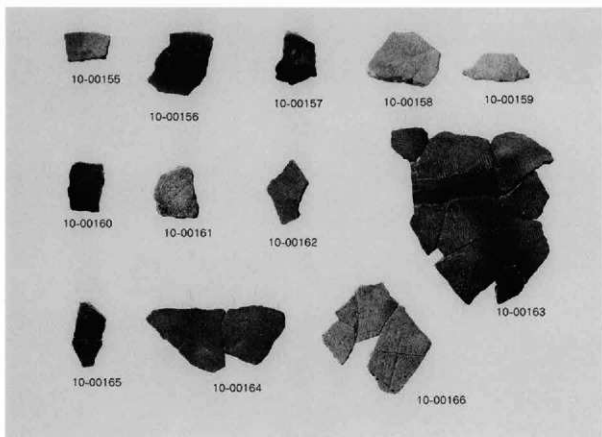

遺物包含層

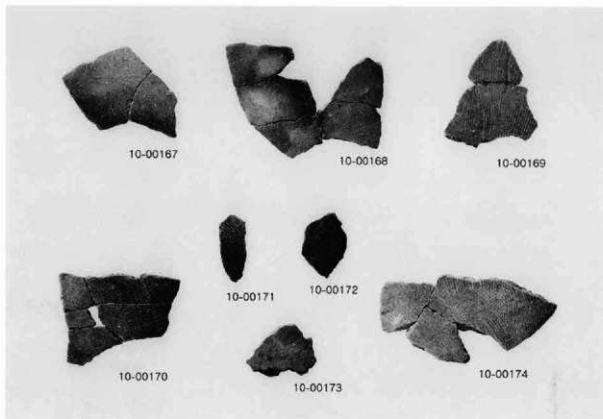

遺物包含層

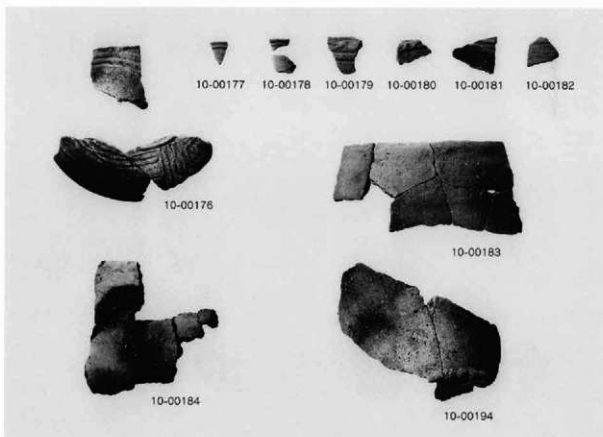

遺物包含層

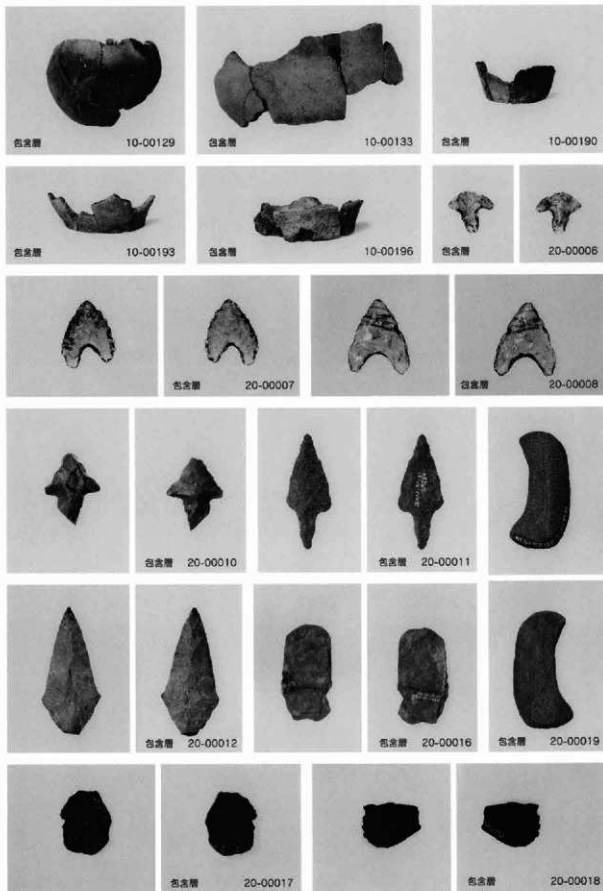

中里見 原 遺跡

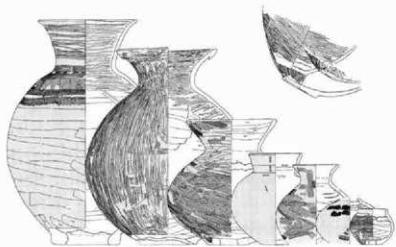

中里見 原 第1号古墳出土





1 調査状況（着手当初・北西から）



2 調査状況（北西から）



1 調査状況 (南から)



2 調査状況 (南東から)



1 調査状況 (西から)

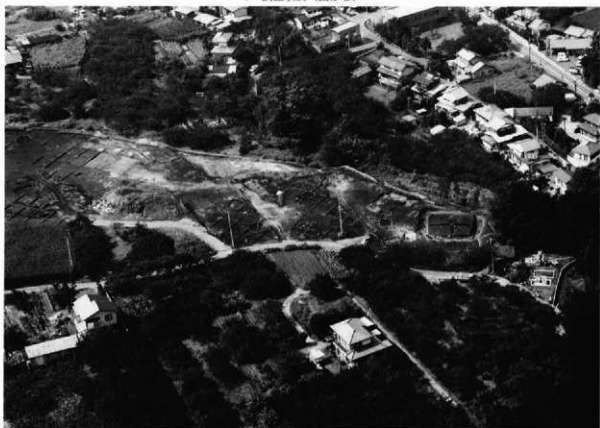

2 調査状況 (南から)



1 調査状況（東北東から）



2 調査状況（北北西から）



1 1号住居全景(北西から)



2 1号住居掘り方全景(北西から)



3 1号住居カマド近景(北西から)



4 2号住居全景(南から)



5 2号住居掘り方全景(南から)



6 3号住居全景(北西から)



7 3号住居カマド近景(北西から)



8 3号住居掘り方全景(北西から)



1 4号住居全景(南東から)



2 4号住居カマド近景(南東から)



3 4号住居掘り方全景(南東から)



4 4号住居カマド掘り方近景(東から)



5 5号住居全景遺物出土状態(南東から)



6 6号住居全景(南東から)



7 6号住居カマド遺物出土状態(南西から)



8 6号住居カマド近景(南西から)



1 6号住居掘り方全景(南東から)



2 6号住居カマド掘り方近景(南西から)



3 7号住居全景(北西から)



4 7号住居カマド近景(西から)

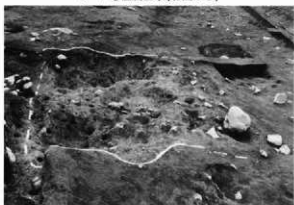

5 7号住居掘り方全景(南東から)



6 8号住居全景(南西から)



7 8号住居カマド近景(西から)



8 8号住居掘り方全景(南西から)



1 9号住居掘り方全景(南西から)



2 10・13号住居全景(南から)



3 10号住居カマド近景(北から)



4 10・13号住居掘り方全景(南西から)



5 11号住居北カマド近景(南西から)



6 11号住居東カマド近景(北西から)



7 11号住居北カマド掘り方近景(南西から)



8 11号住居東カマド掘り方近景(北西から)



1 11号住居全景(北西から)



2 11号住居掘り方全景(南西から)



3 11号住居調査風景(北西から)



4 12号住居全景(北西から)



5 12号住居カマド近景(北西から)



1 12号住居掘り方全景(北西から)



2 12号住居カマド掘り方近景(北西から)



3 14号住居全景(南西から)



4 14号住居カマド近景(南西から)



5 14号住居掘り方全景(南西から)



6 15号住居全景(北東から)



7 15号住居カマド近景(北西から)



8 15号住居掘り方全景(北東から)



1 16号住居カマド近景石組出土状態(北西から)



2 16号住居柱穴土層断面(北から)



3 16号住居全景(北西から)



4 16号住居掘り方全景(北西から)



5 16号住居カマド掘り方近景(北西から)



1 17号住居全景(北西から)



2 17号住居掘り方全景(北西から)



3 18号住居全景遺物出土状態(北西から)



4 18号住居カマド近景(北西から)

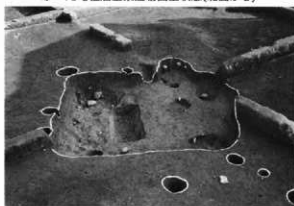

5 18号住居掘り方全景(北西から)

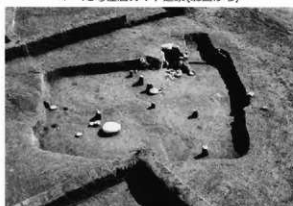

6 19号住居全景(北西から)



7 19号住居カマド遺物出土状態(北西から)



8 19号住居掘り方全景(北西から)



1 20号住居全景(西から)



2 20号住居カマド近景(西から)



3 20号住居掘り方全景(西から)



4 20号住居カマド掘り方近景(西から)



5 21号住居全景(東から)



6 21号住居掘り方全景(東から)



7 22号住居全景(南から)



8 22号住居カマド遺物出土状態(南から)



1 22号住居カマド石組近景(南から)



2 22号住居掘り方全景(南から)



3 23号住居全景(北東から)



4 23号住居カマド遺物出土状態(北西から)



5 23号住居カマド近景(北西から)



6 23号住居掘り方全景(北西から)



7 24号住居全景(南西から)



8 24号住居掘り方全景(南西から)



1 25号住居全景(北西から)



2 25号住居カマド近景(北西から)



3 26号住居遺物出土状態(北東から)



4 26号住居全景(北東から)



5 26号住居カマド近景(南から)



6 26号住居廻り方全景(北から)



7 27・28・40号住居全景(東から)



8 27号住居全景(西から)



1 27号住居掘り方全景(西から)



2 28号住居全景(北東から)



3 28号住居掘り方全景(南西から)

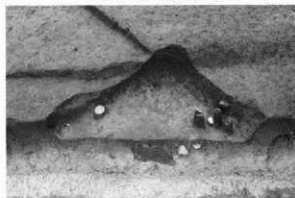

4 29号住居全景(東から)



5 29号住居掘り方全景(西から)

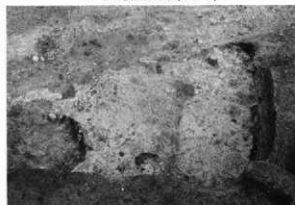

6 30号住居掘り方全景(南西から)



7 31号住居全景(北西から)



8 31号住居カマド遺物出土状態(北西から)



1 31号住居掘り方全景(北西から)



2 31号住居カマド掘り方近景(北西から)



3 32号住居遺物出土状態(東から)



4 32号住居全景(東から)



5 32号住居東カマド遺物出土状態(西から)



6 32号住居東カマド近景(西から)



7 32号住居北カマド遺物出土状態(南東から)



8 32号住居北カマド近景(南東から)



1 33号住居遺物出土状態(北西から)



2 33号住居カマド遺物出土状態(西から)



3 33号住居全景(北西から)



4 33号住居カマド近景(西から)



5 34号住居全景(西から)



6 34号住居カマド近景(南から)



7 34号住居掘り方全景(西から)



8 34号住居カマド掘り方近景(南から)

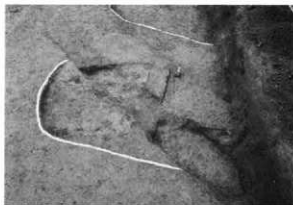

1 35号住居全景(西から)



2 36号住居カマド近景(西から)



3 36・42・43号住居全景(西から)



4 36号住居カマド掘り方近景(西から)



5 36・42・43号住居掘り方全景(西から)



1 37号住居全景(北西から)



2 37号住居カマド近景(北から)



3 37号住居掘り方全景(北から)



4 38号住居全景(南西から)



5 38号住居カマド近景(西から)



6 38号住居掘り方全景(南西から)



7 39号住居全景(南東から)



8 39号住居カマド遺物出土状態(北西から)



1 39号住居カマド近景(北西から)



2 40・46号住居全景(東から)



3 40・46号住居全景(西から)



4 40・46号住居掘り方全景(東から)



5 44号住居全景(西から)



6 44号住居カマド近景(西から)



7 44号住居掘り方全景(西から)



8 44号住居カマド掘り方近景(西から)

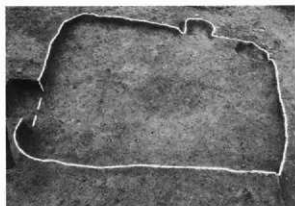

1 45号住居全景(南から)



2 45号住居貯蔵穴遺物出土状態(南西から)

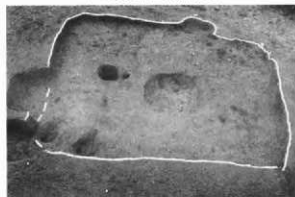

3 45号住居掘り方全景(南から)



4 47号住居全景(西から)



5 47号住居カマド近景(西から)



6 47号住居掘り方全景(西から)



7 47号住居カマド掘り方近景(西から)



8 48号住居全景(北西から)



1 48号住居カマド遺物出土状態(北西から)



2 48号住居掘り方全景(北西から)



3 48号住居カマド掘り方近景(北西から)



4 49号住居全景(西から)



5 49号住居カマド近景(西から)



6 49号住居掘り方全景(西から)



7 49号住居カマド掘り方近景(西から)



8 50号住居全景遺物出土状態(西から)



1 50号住居カマド近景(西から)

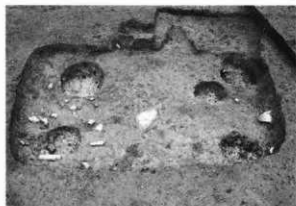

2 50号住居掘り方全景(西から)



3 50号住居カマド掘り方近景(西から)



4 51号住居全景(南から)



5 51号住居カマド遺物出土状態(西から)

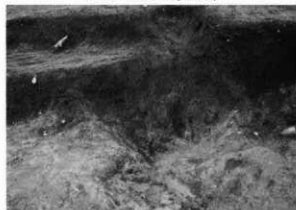

6 51号住居カマド掘り方近景(西から)



7 52号住居全景(南西から)



8 52号住居カマド石組出土状態(南西から)



1 53号住居全景(北西から)



2 53号住居カマド瓦出土状態(北西から)



3 53号住居掘り方全景(北西から)

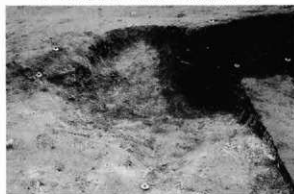

4 53号住居カマド掘り方近景(北西から)



5 54・57号住居遺物出土状態(西から)



6 54・57号住居全景(西から)



7 55号住居カマド近景(北西から)



8 56号住居カマド近景(北西から)



1 55・56号住居全景(西から)



2 55号住居貯蔵穴遺物出土状態(南西から)



3 55・56号住居掘り方全景(西から)



4 55号住居カマド掘り方近景(北西から)



5 56号住居カマド掘り方近景(北西から)



1 1号竪穴状遺構全景(南西から)



2 2号竪穴状遺構全景(北西から)



3 3号竪穴状遺構炉部出土状態(南から)



4 3号竪穴状遺構全景(南から)



5 3号竪穴状遺構遺物出土状態(南から)



1 4号竪穴状遺構遺物出土状態(北東から)



2 4号竪穴状遺構全景遺物出土状態(北東から)



3 4号竪穴状遺構掘り方全景(北東から)



4 5号竪穴状遺構遺物出土状態(東から)



5 北東斜面土坑群(垂直)



1 1号堀立柱建物全景(北西から)

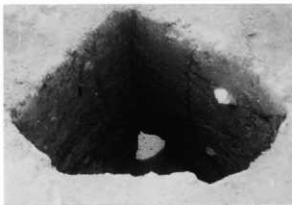

2 1号堀立柱建物柱穴1土層断面(北から)



3 2号堀立柱建物および柵列(北北西から)

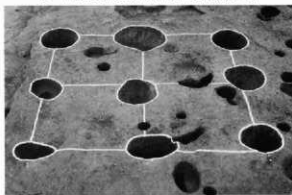

4 3号堀立柱建物全景(南東から)



5 4号堀立柱建物全景(北西から)



6 5号堀立柱建物全景(南西から)



7 6号堀立柱建物全景(南から)



8 7号堀立柱建物全景(北西から)



1 1号基礎(南東から)



2 1号基礎確認状態(南東から)



3 1号基礎根石(イ)(南から)



4 1号基礎根石(ロ)(南から)



5 1号基礎根石(ハ)(南から)



1 橋列遺景(井ノ下山から臨む・南西から)



2 橋列全景(南東から)



3 2号掘立柱建物・橋列全景(北西から)



4 1号竪穴状遺構全景(門跡か・南西から)



1 1号道路状遺構北西部近景(北西から)



2 1号道路状遺構遺物出土状態北西部(北西から)



3 1号道路状遺構南東部近景(北西から)



4 1号道路状遺構遺物出土状態(南から)



5 1号道路状遺構南東部土層断面(北西から)



1 2号道路状遺構全景(南西から)



2 2号道路状遺構全景(北東から)



3 2号道路状遺構近景(南西から)



4 2号道路状遺構土層断面(南西から)



1 古代道路状遺構全景(北西から)



2 古代道路状遺構土層断面(東から)



3 古代道路状遺構土層断面(東から)



4 古代道路状遺構土層断面(東から)



5 古代道路状遺構土層断面(東から)



1 1号墓出土状態(西から)



2 2号墓出土状態(東から)



3 3号墓出土状態(東から)



4 4号墓出土状態(北から)

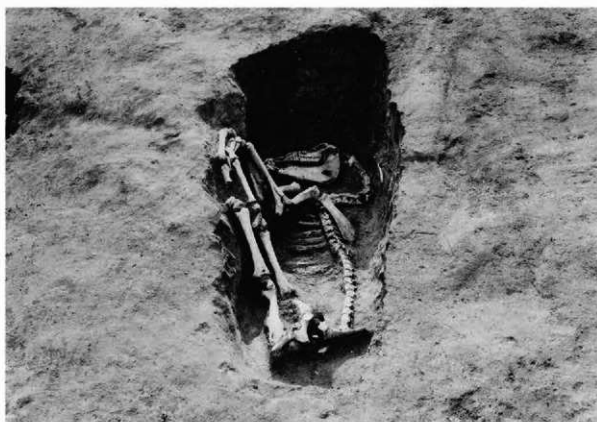

5 5号土壇墓出土状態(北東から)



1 5号土壇墓馬骨前半身出土状態(南から)



2 5号土壇墓馬骨出土状態(南から)



3 5号土壇墓馬骨脚部(南東から)



4 石組状遺構全景(北西から)



5 石組状遺構確認状態(北西から)

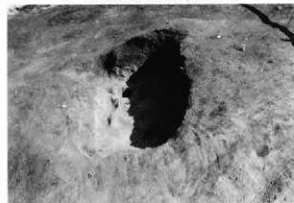

6 石組状遺構掘り方全景(北西から)



2 1号古墳南側内環溝内遺物出土状況(南から)



1 1号古墳全貌(北西から)



1 1号古墳遠景(西から)

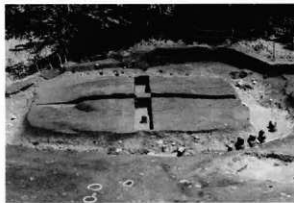

2 1号古墳近景(西から)



3 1号古墳遺物出土状態(西から)



4 1号古墳遺物出土状態(西から)



5 1号古墳遺物出土状態(南から)



6 1号古墳周溝土層断面・土器NO.2(南から)



7 1号古墳周溝土層断面(南東から)



8 1号古墳周溝土層断面(北から)



1 1号土坑全景(南西から)



2 4~11号土坑調査状態(南から)



3 24号土坑全景(南東から)



4 166号土坑遺物出土状態(北から)



5 198号土坑遺物出土状態(東から)



6 198号土坑遺物出土状態(西から)



7 205号土坑遺物出土状態(南から)



8 205号土坑全景遺物出土状態(南から)

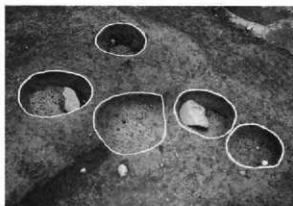

1 254~256・825・826号土坑全景(南から)



2 318号土坑遺物出土状態(北から)



3 737号土坑遺物出土状態(北東から)



4 748号土坑遺物出土状態(北東から)



5 766A号土坑炭検出状態(南西から)

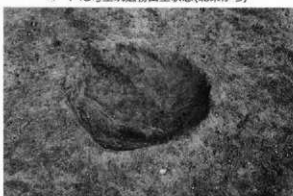

6 766B号土坑掘り方全景(南から)



7 767号土坑遺物出土状態(北東から)



8 795号土坑遺物出土状態(西から)



1 874号土坑刻字紡錘車出土状態



2 910・911号土坑全景(南西から)

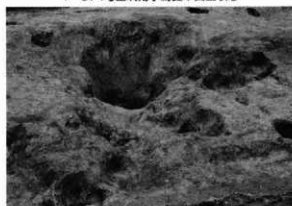

3 949～951号土坑全景(南西から)



4 982・983号土坑全景(南西から)



5 993～996号土坑全景(北東から)



6 997号土坑全景(東から)



7 999号土坑遺物出土状態(西から)



8 道西孤強区土坑群全景(東から)



1 井戸状遺構(全景)



2 井戸状遺構土層断面(南から)



3 風倒木全景(東から)

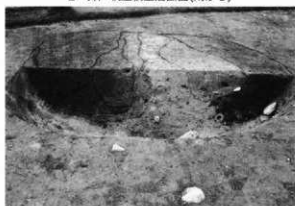

4 風倒木土層断面(東から)



5 旧石器試掘第1トレンチ全景(東から)



6 旧石器試掘第2トレンチ全景(北から)



7 旧石器試掘土層断面(北から)



8 16区試掘トレンチ全景(北から)

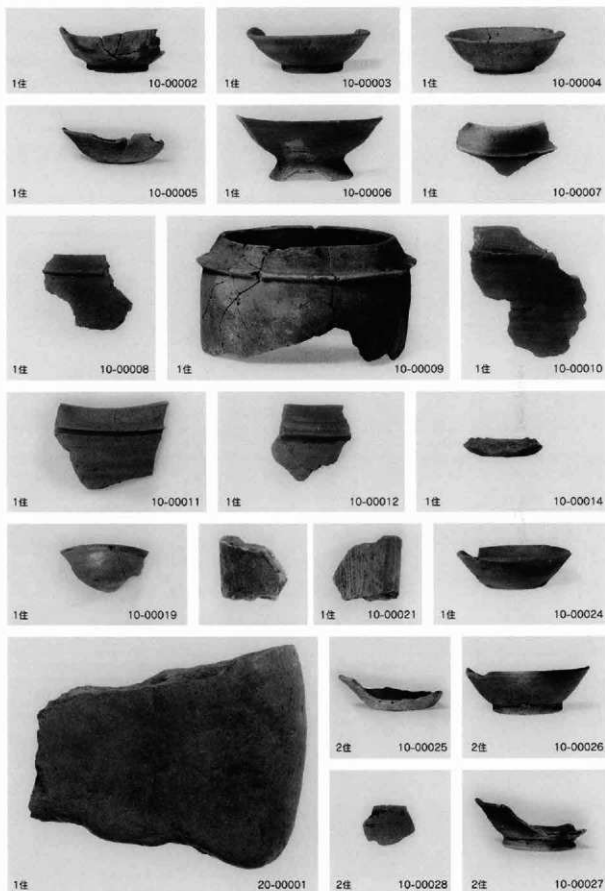

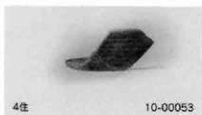
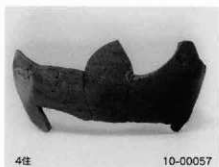
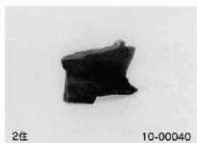
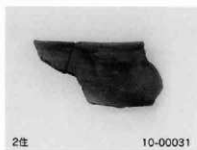
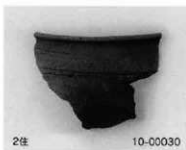

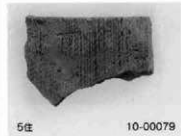
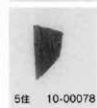
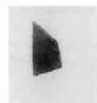
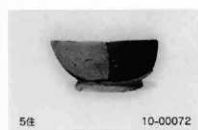
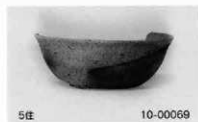
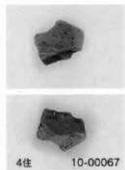
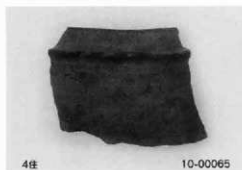

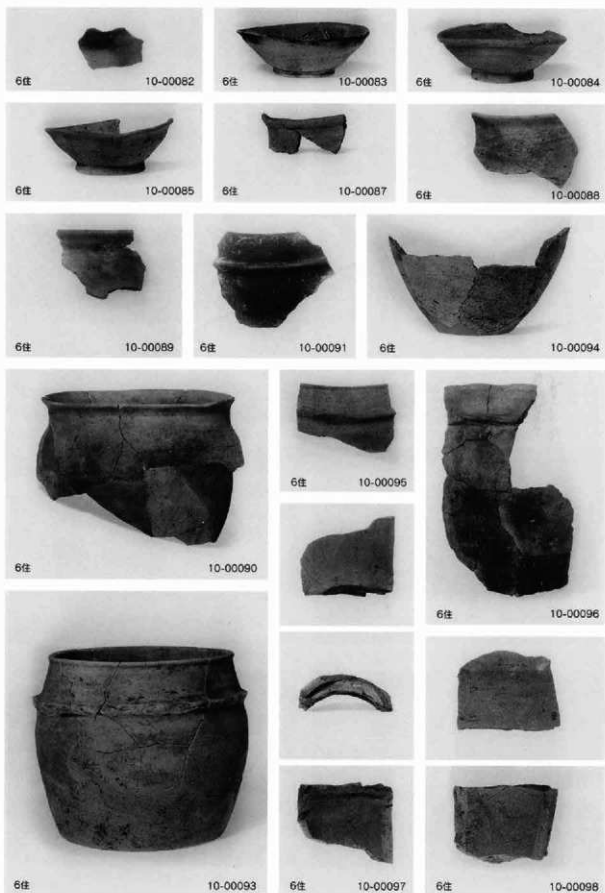

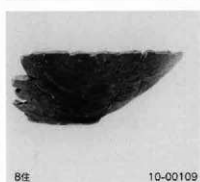
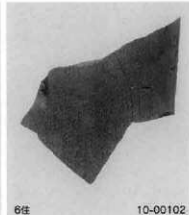
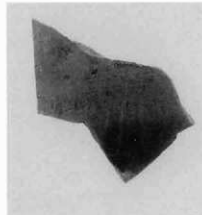

6住

10-00099

6住

10-00100

6住

10-00099

6住

20-00003

8住

10-00107

6住

10-00101

6住

10-00108

6住

10-00102

8住

10-00109

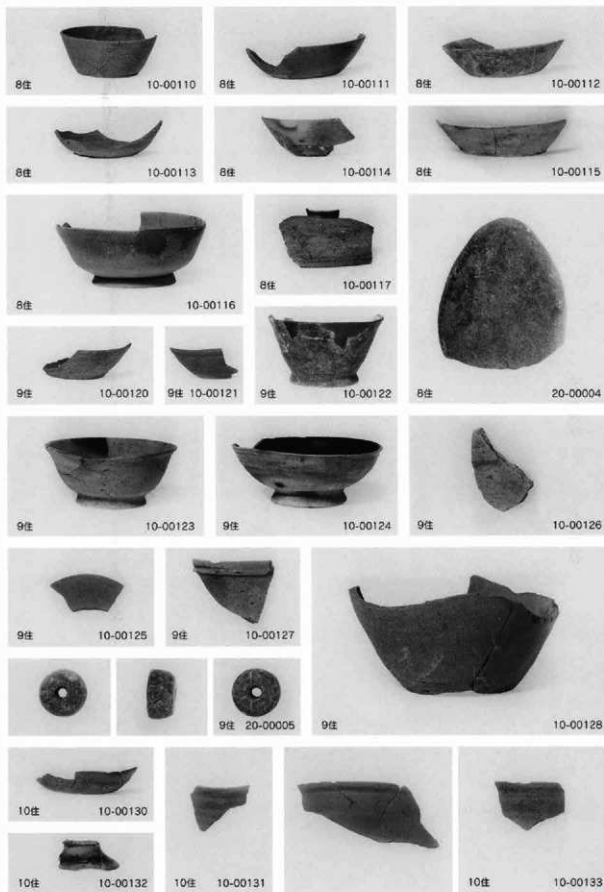

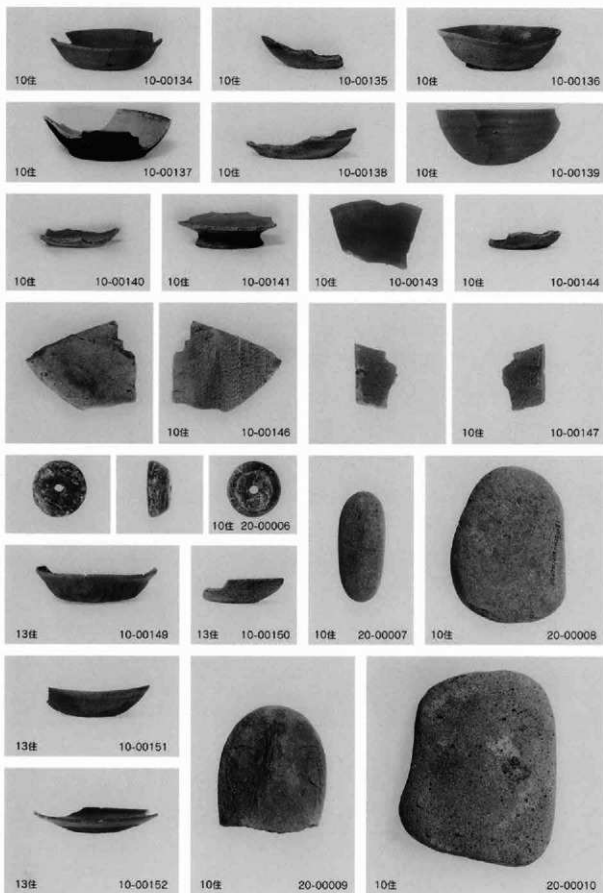

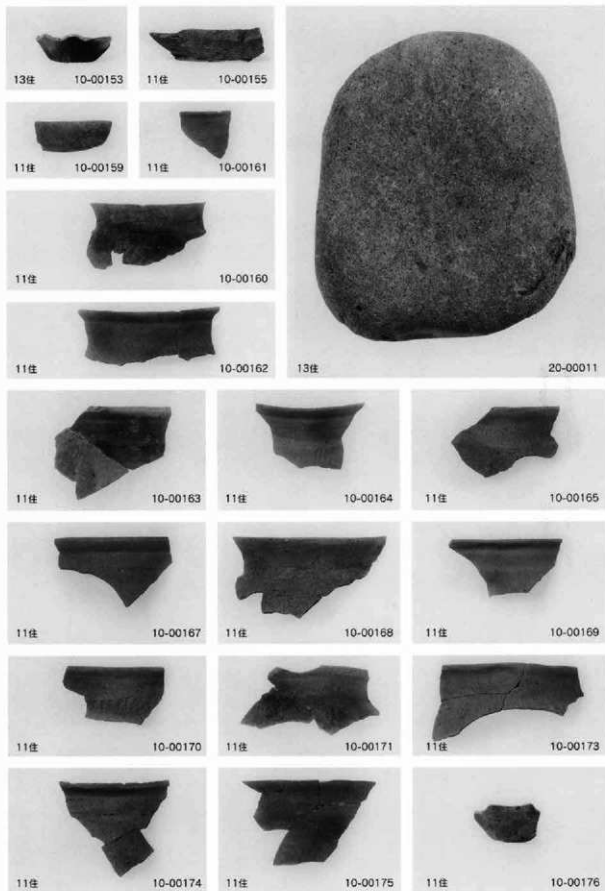

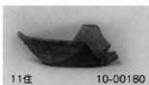
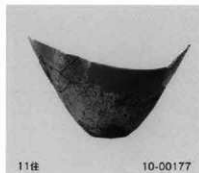

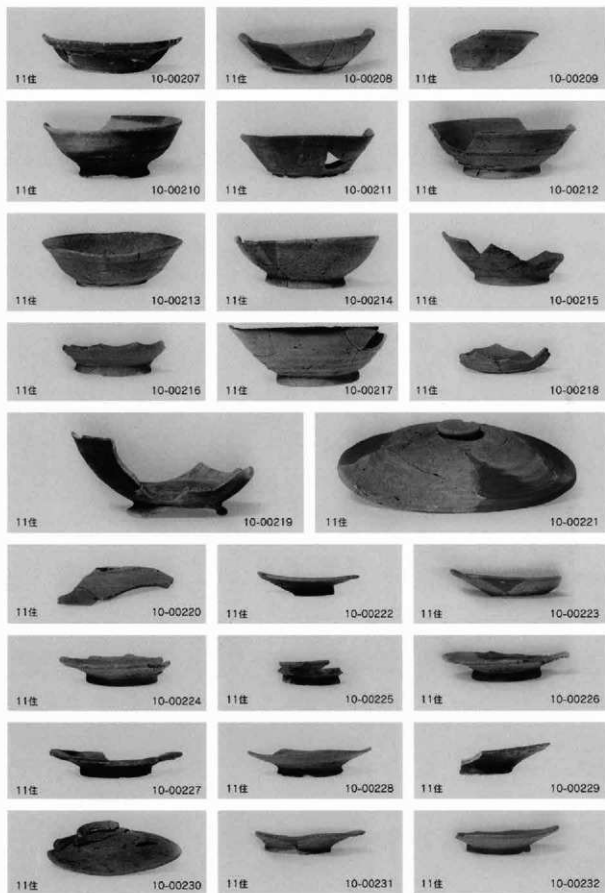

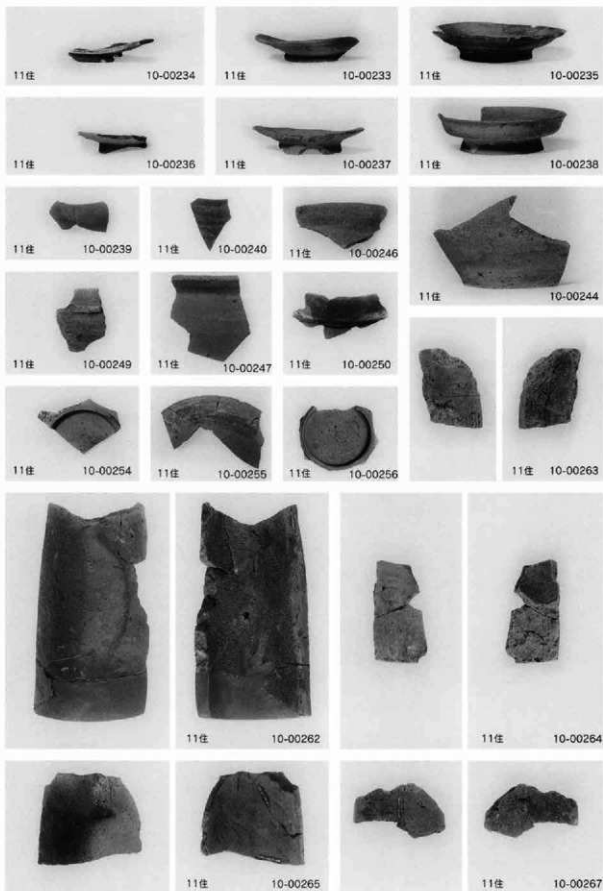



11住

10-00265



11住

10-00268



11住

10-00270

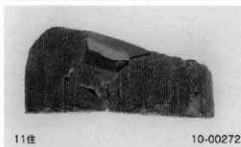

11住

10-00272



11住

10-00271

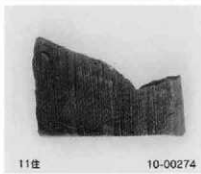

11住

10-00274

11住

10-00273

11住

10-00276



11住

10-00275

11住

20-00015

11住

20-00016



11住

20-00017

11住

20-00018

11住

20-00020

11住

20-00019

11住

20-00022

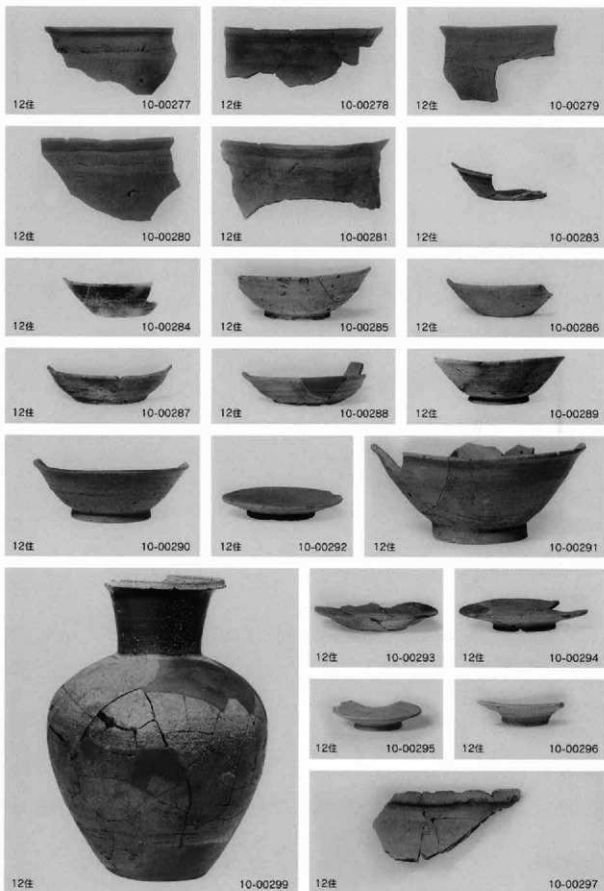

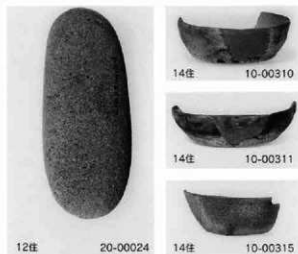
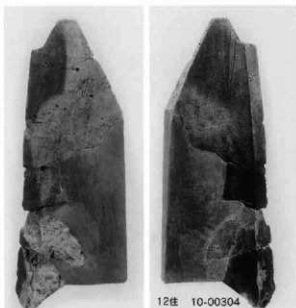
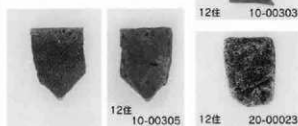

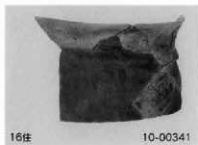
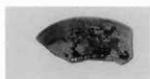

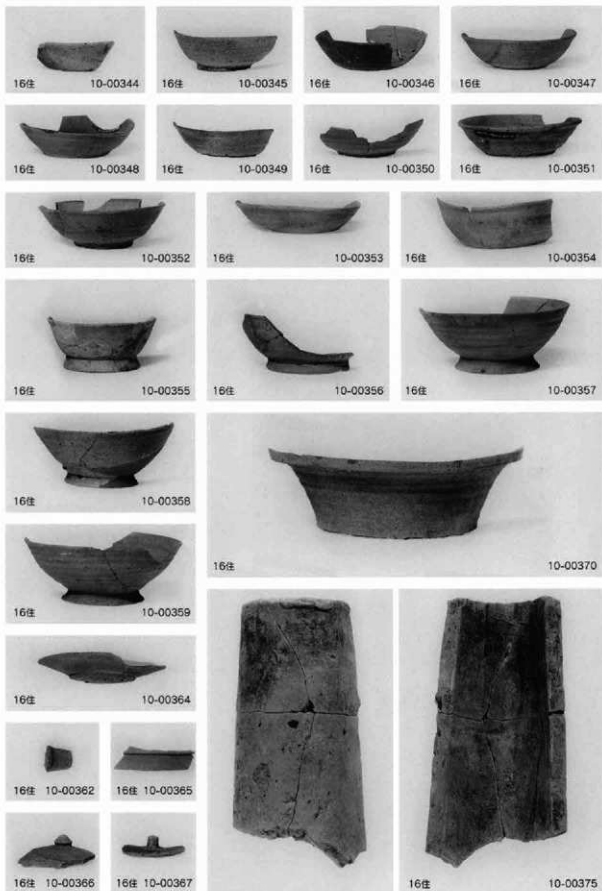

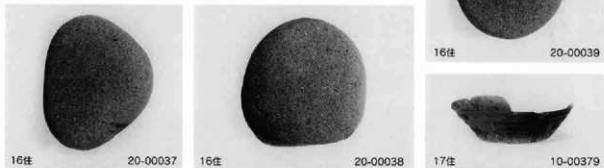
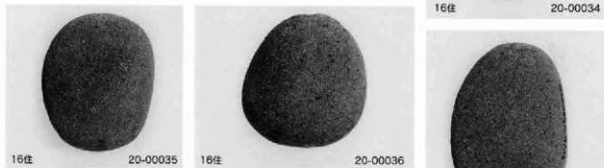
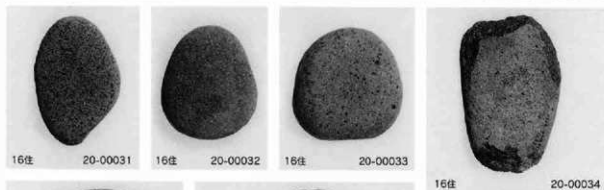
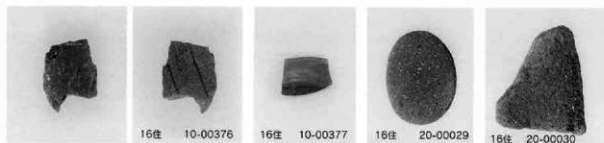

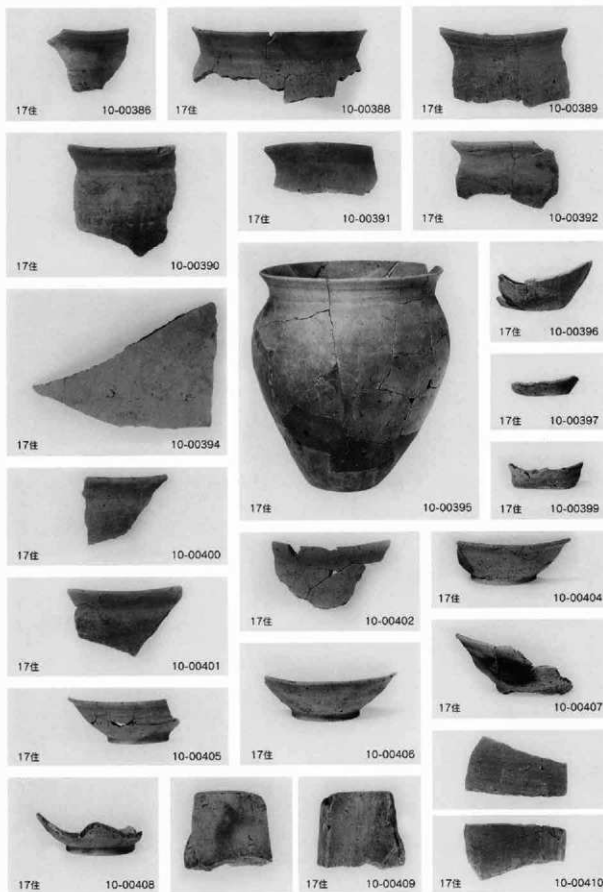



17住

10-00411



17住 20-00042



17住 20-00043



17住 20-00044



18住

10-00412



17住

20-00045



18住

10-00413



18住

10-00414

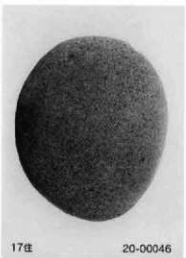

17住

20-00046



17住

20-00047

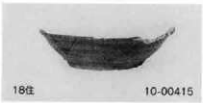

18住

10-00415



18住

10-00416

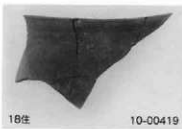

18住

10-00419

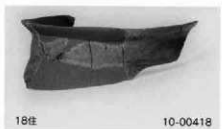

18住

10-00418

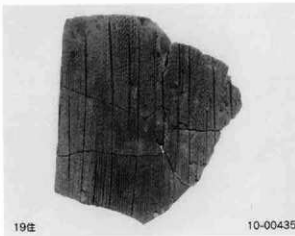

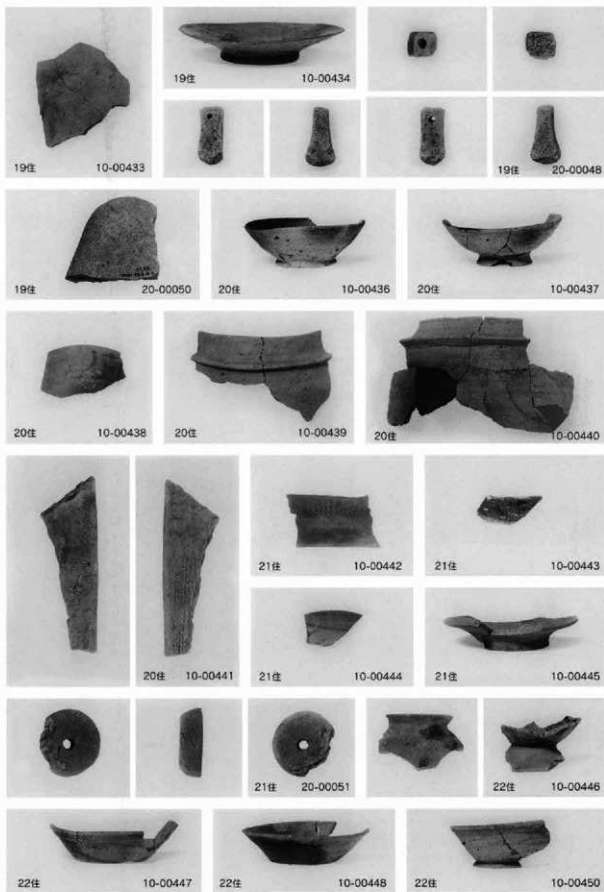

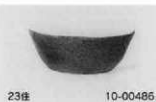
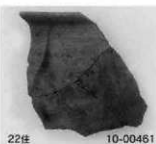
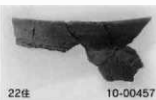
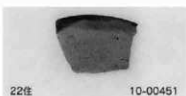

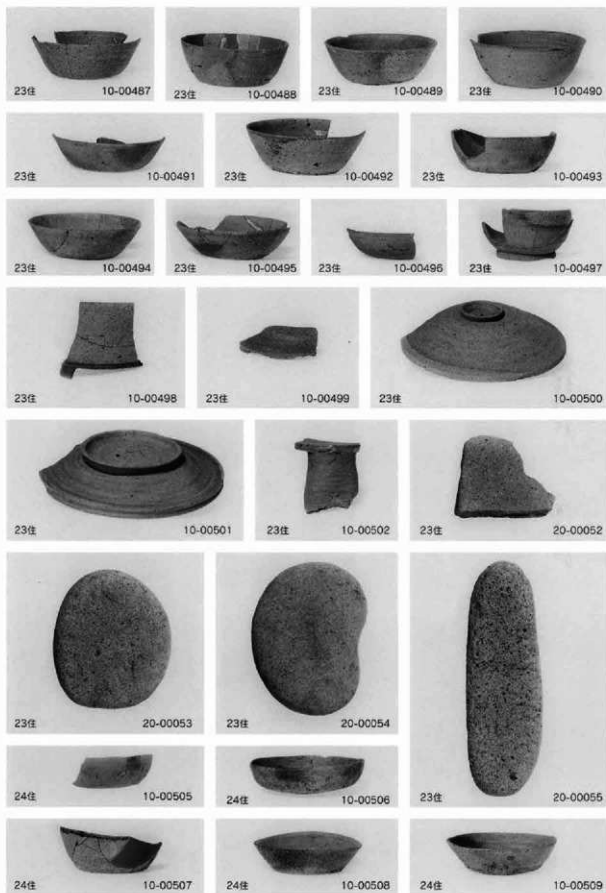

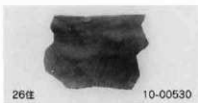
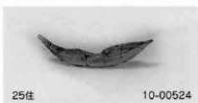
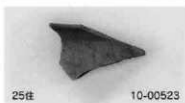
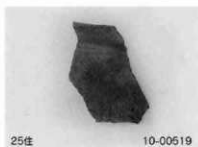
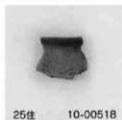
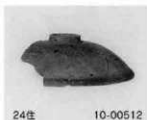
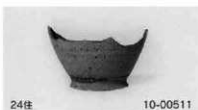

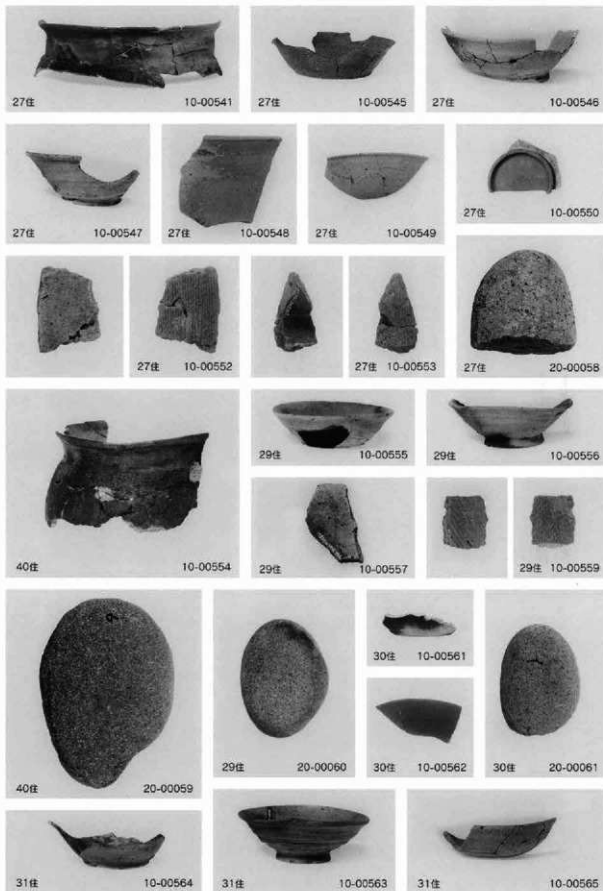

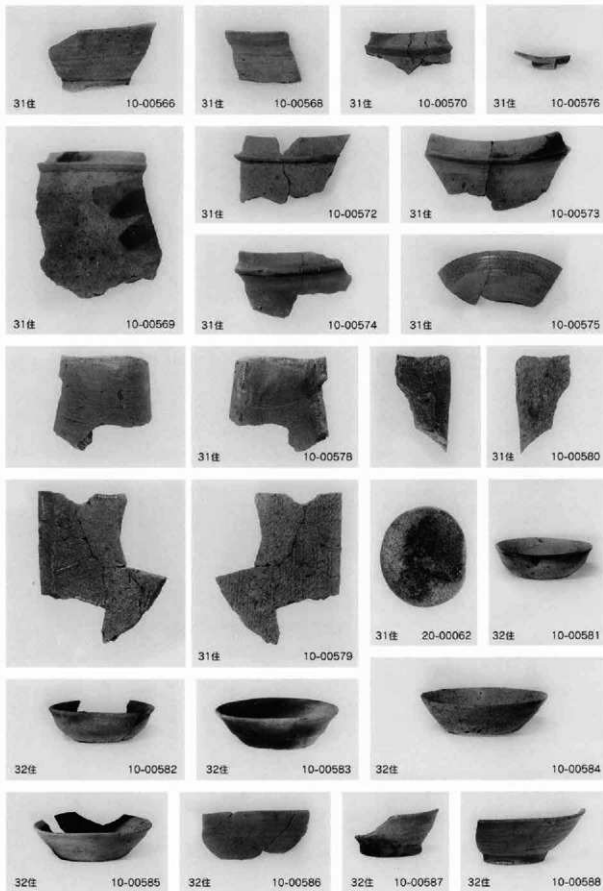



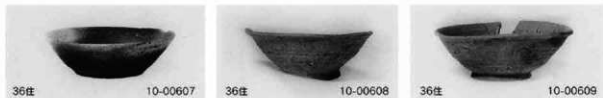
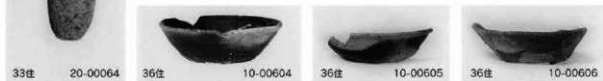
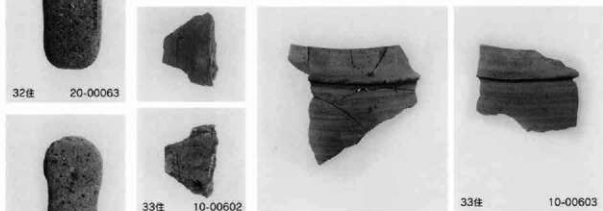
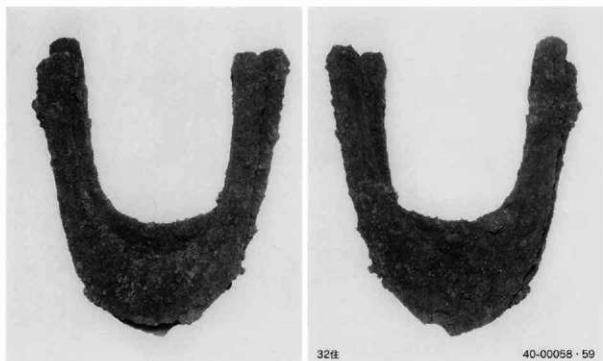

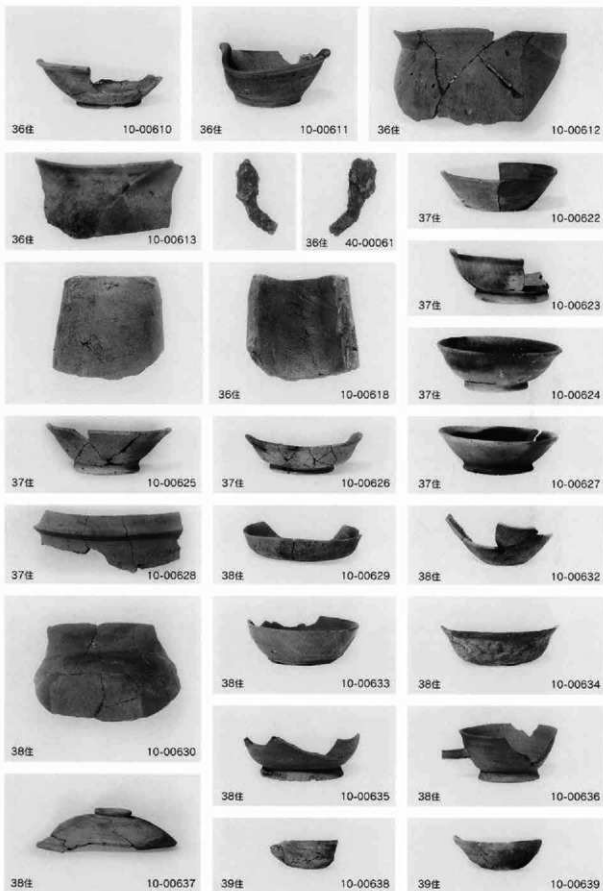

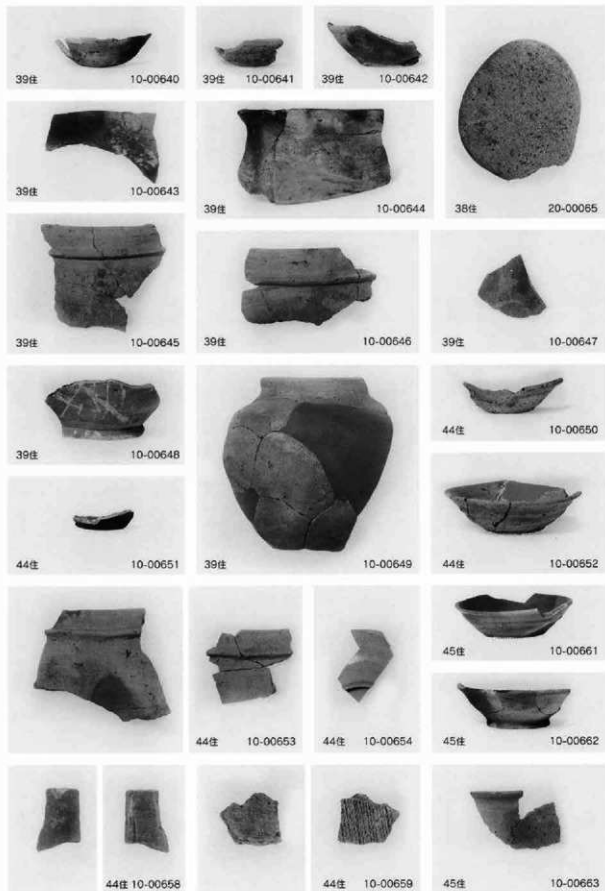

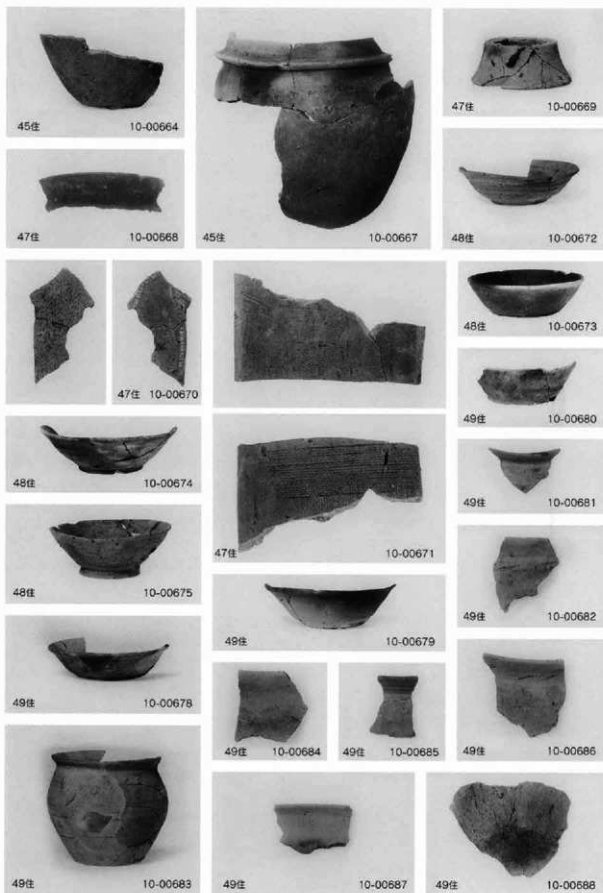

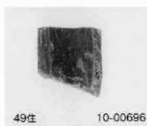
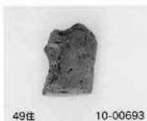



49住

10-00698

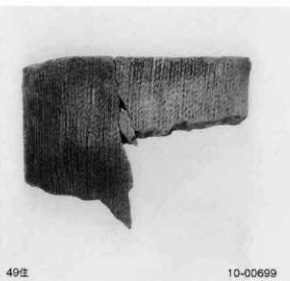

49住

10-00699



49住

10-00700

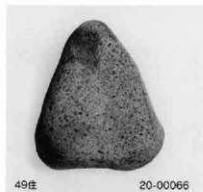

49住

20-00066

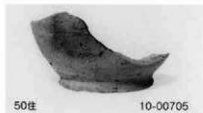

50住

10-00705

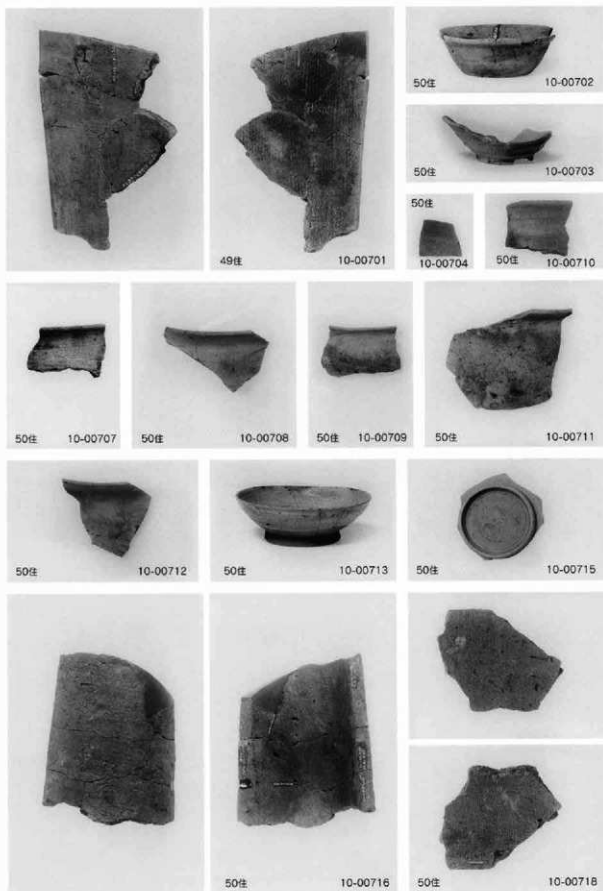

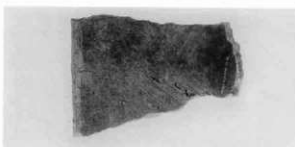
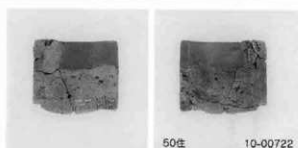
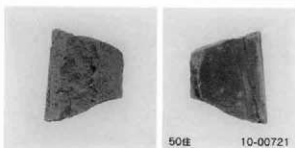
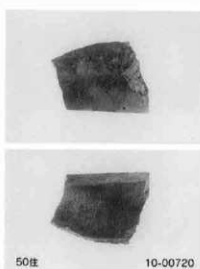
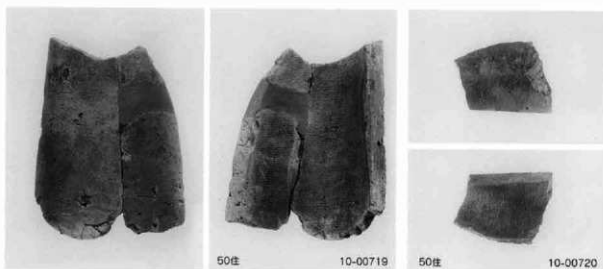

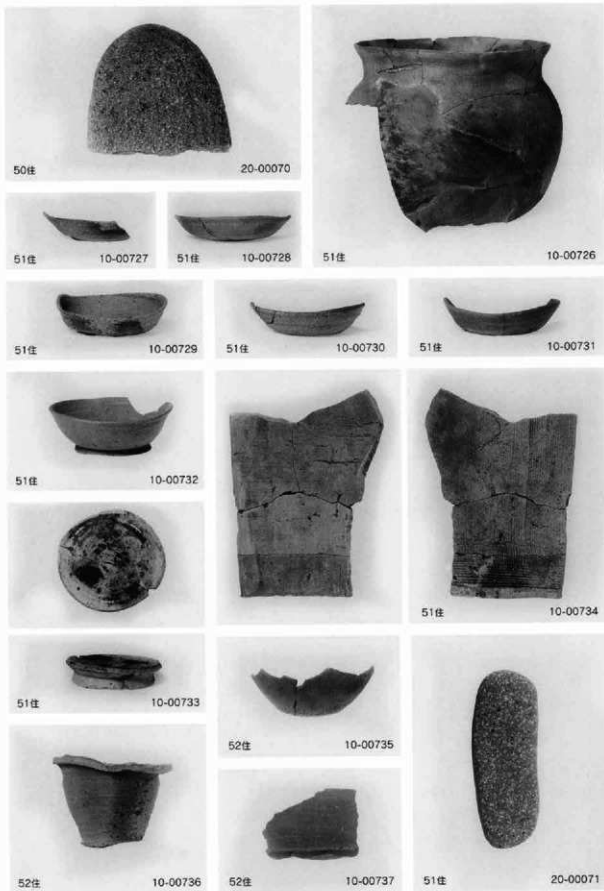

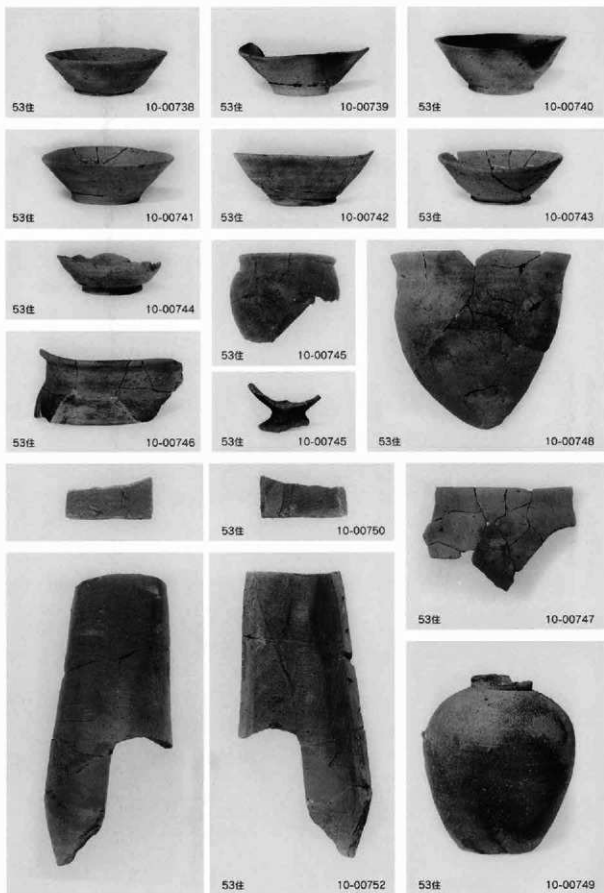



53住

10-00751



53住

10-00753



53住

10-00754



54住

10-00758

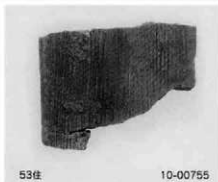

53住

10-00755

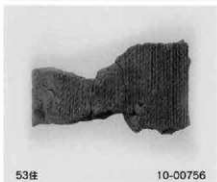

53住

10-00756



54住

10-00759



54住

10-00760

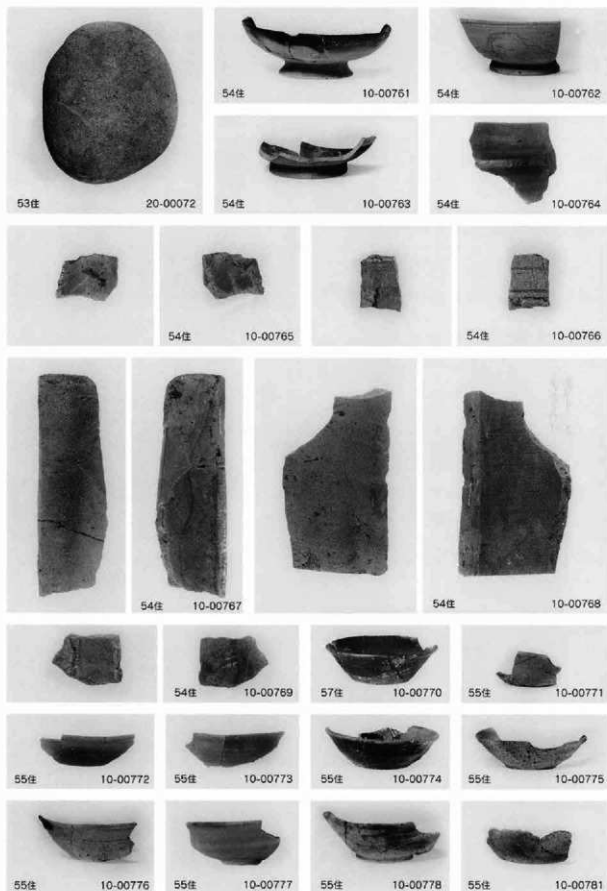

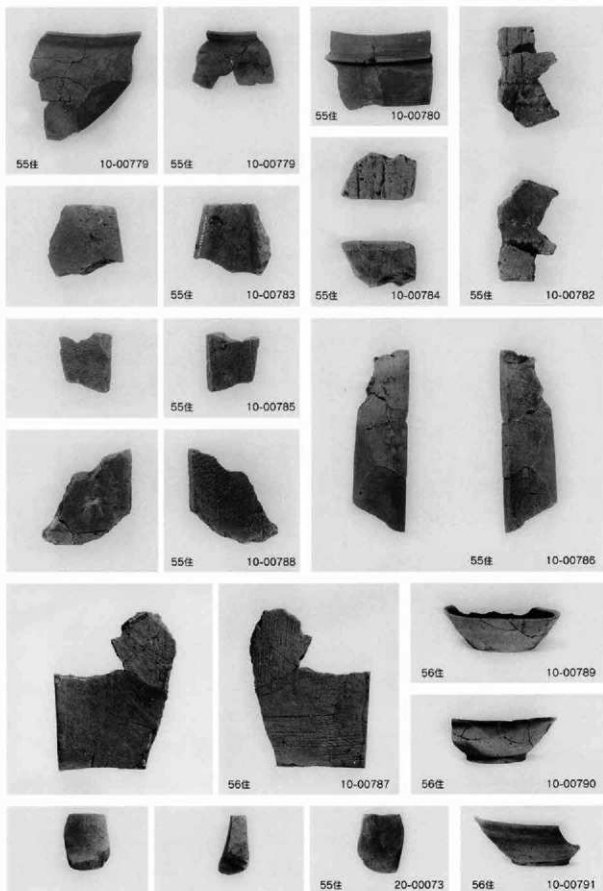

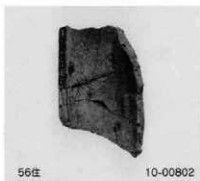
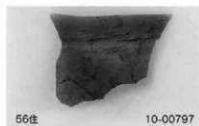

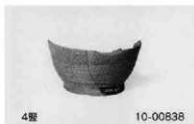
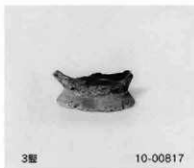
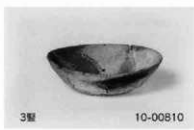
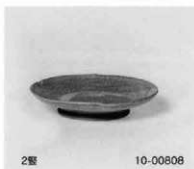

3號
10-008243號
10-008263號
10-008273號
10-008283號
10-008293號
10-008303號
10-008313號
10-008323號
10-00818

4號 10-00836



3號 10-00809

3號
10-008164號
10-008404號
10-00837

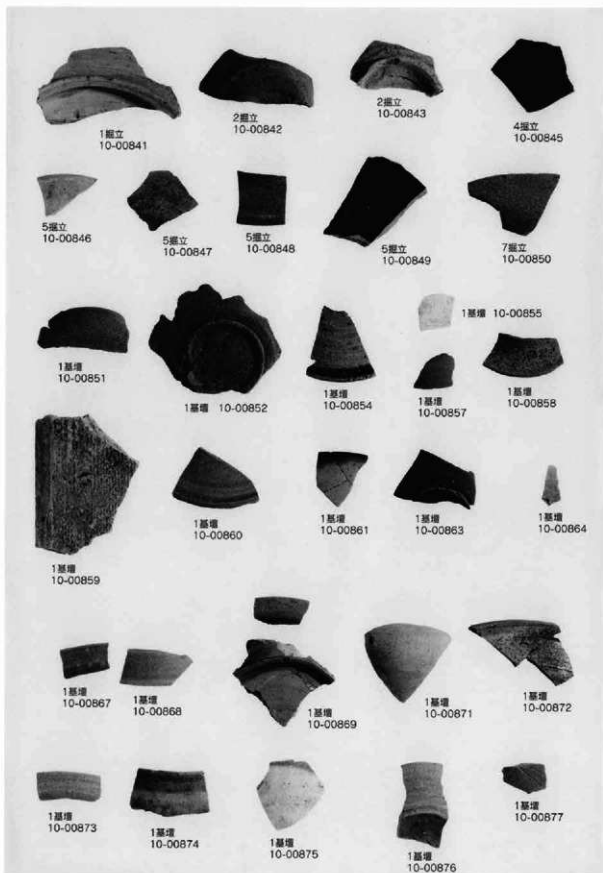

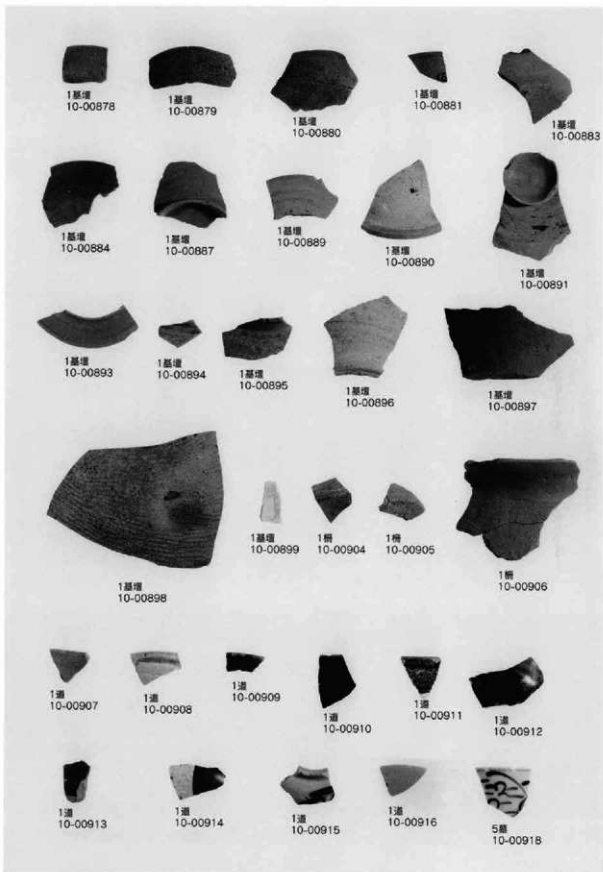

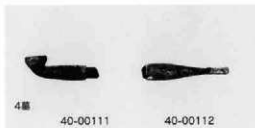
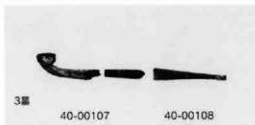
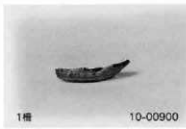
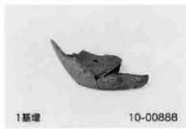
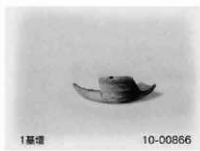

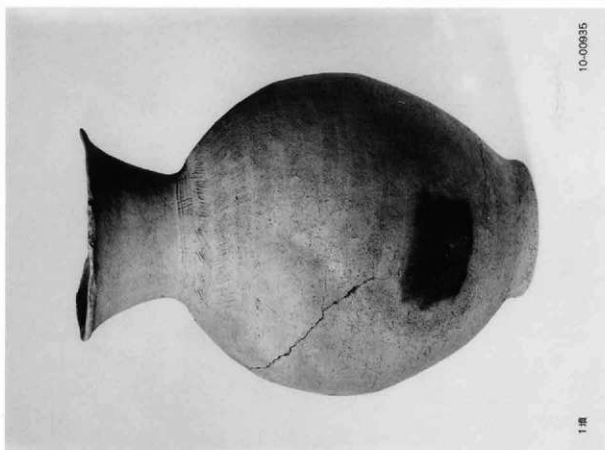
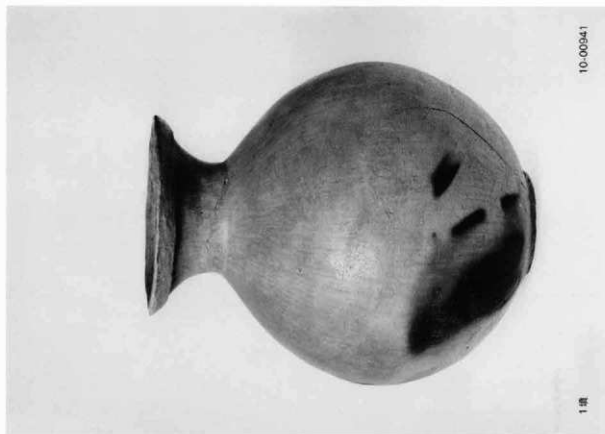



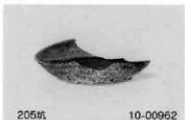
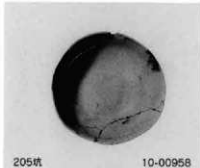
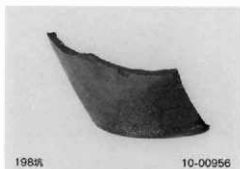
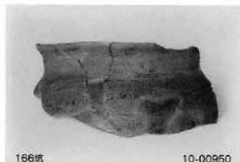
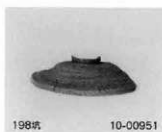

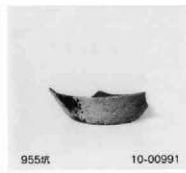
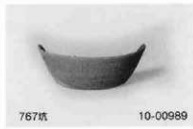
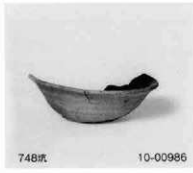
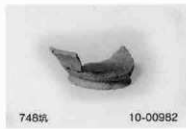
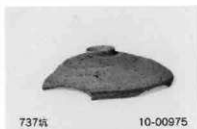

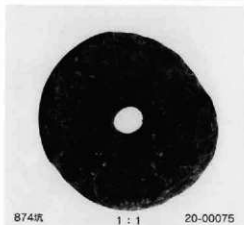
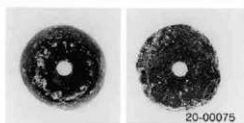

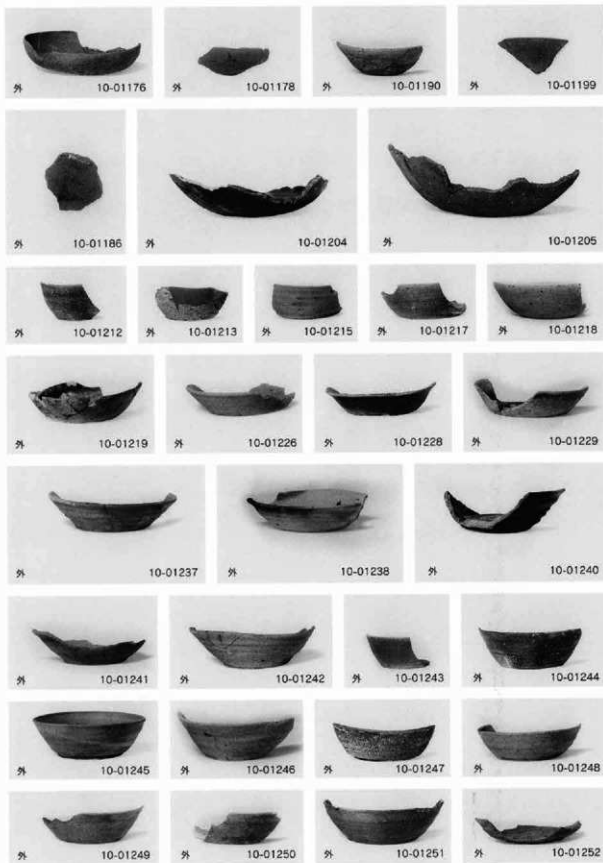

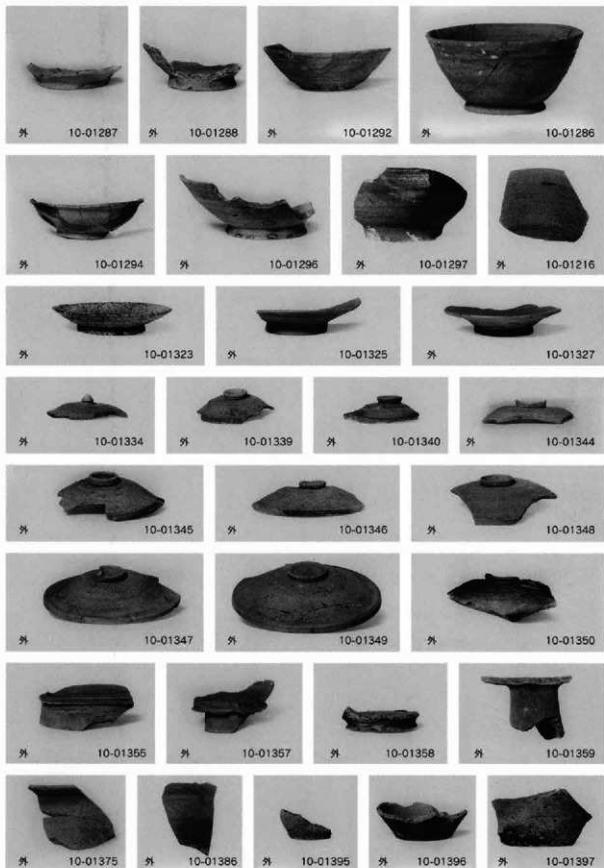

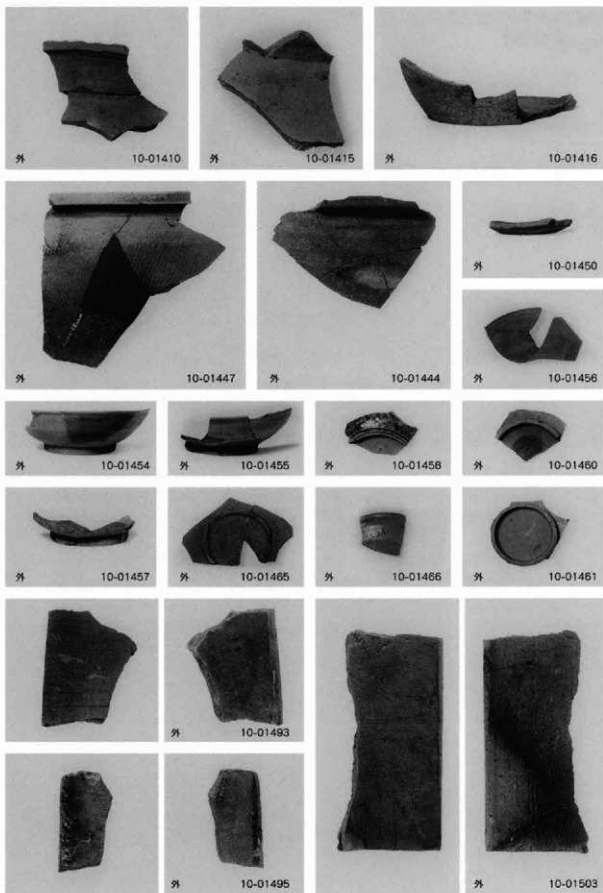

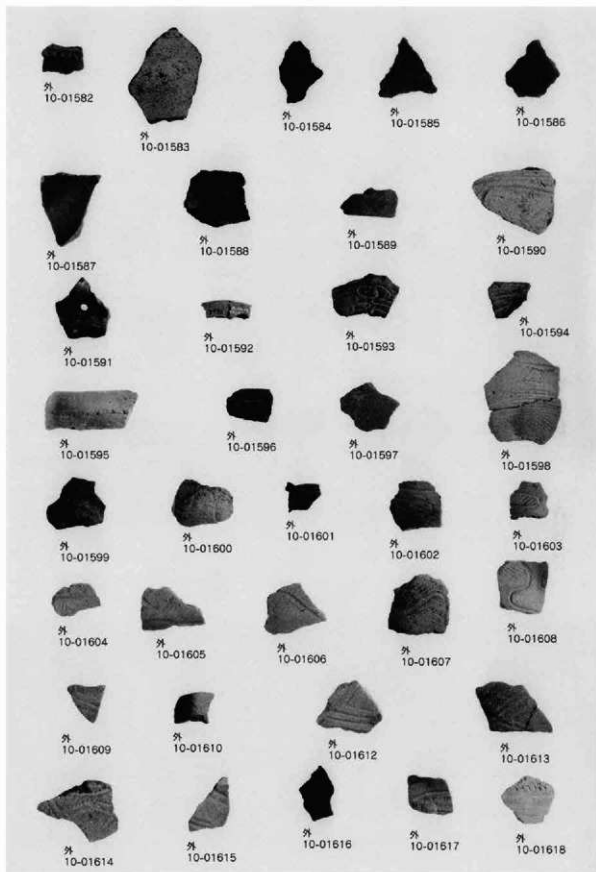





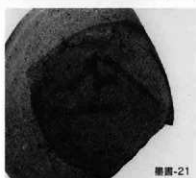
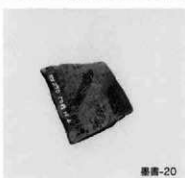
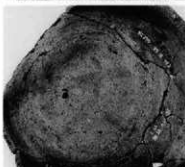
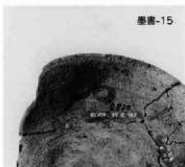
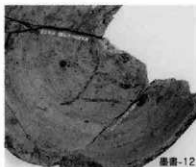
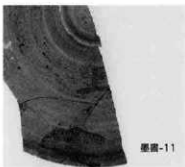
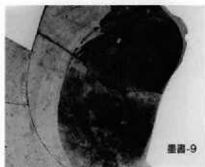
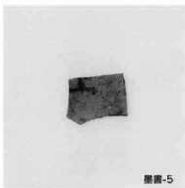
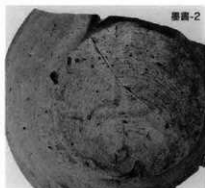

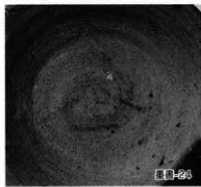
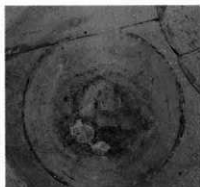

圖冊-23

圖冊-24

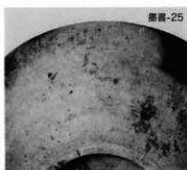
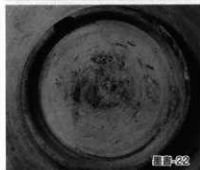

圖冊-25

圖冊-26

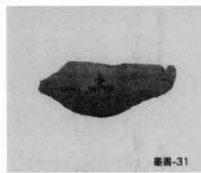
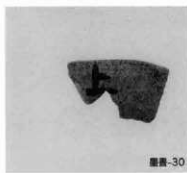

圖冊-30

圖冊-31

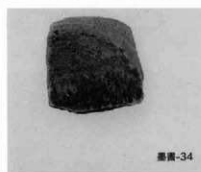
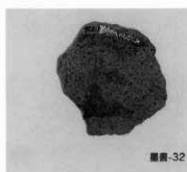

圖冊-29

圖冊-32

圖冊-34

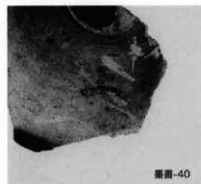
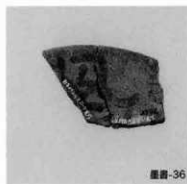

圖冊-35

圖冊-36

圖冊-40

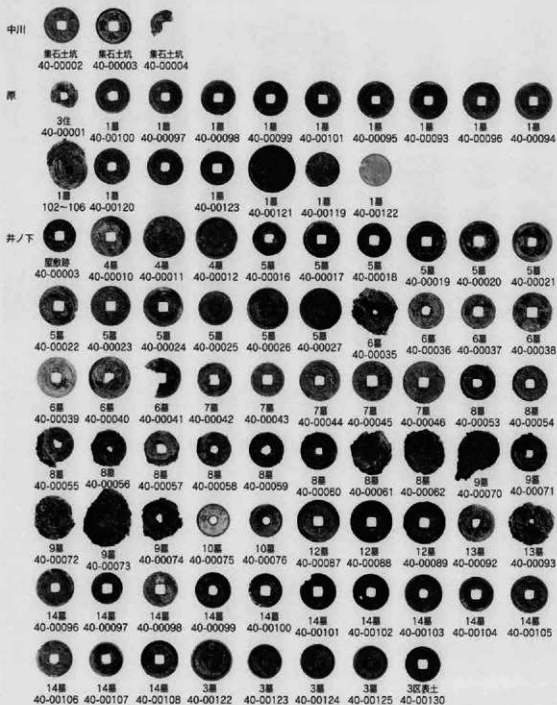

上里見井ノ下遺跡

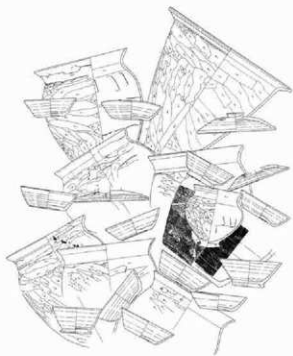

井ノ下第3号住居跡出土



1 1区全景(左台地上は中里見原道跡・北から)



2 1区全景(北から)



1 3区全景(里見トンネル入口付近・東から)



2 1区1号トレンチ(南から)



3 1区2号トレンチ(南東から)



4 1区1号溝全景(南東から)



5 1区1号溝北壁土層断面(南東から)



1 1区屋敷跡全景(西から)



2 1区屋敷跡南東部(南東から)



3 1区屋敷跡礎石1の根石(南東から)



4 1区屋敷跡礎石1(南東から)



5 1区屋敷跡礎石2(南東から)



1 1区屋敷跡掘り方全景(南西から)



2 1区屋敷跡掘り方(北西から)



3 1区屋敷跡西部掘り方(東から)



4 1区1号井戸全景(東から)



5 1区1号井戸土層断面A(北東から)



1 1区低地部As-B下面全景(西から)



2 1区低地部As-B下面(東から)



3 1区低地部全景(南西から)



4 1区2・3号溝全景(南西から)



5 1区2号溝西側部分(南東から)



6 1区2号溝土層断面B(南西から)



7 1区流水出土状態(東から)



8 1区流水出土状態(西から)

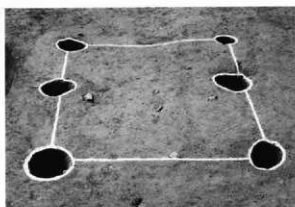

1 1区1号掘立柱建物全景(南西から)



2 1区1号住居全景(北西から)

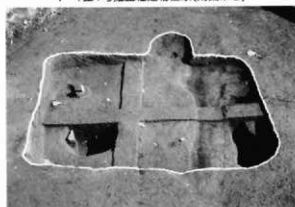

3 1区1号住居掘り方(北西から)



4 1区2号住居確認状況(南から)



5 1区1号炭焼窯 全景(北から)



6 1区1号炭焼窯 全景(西から)

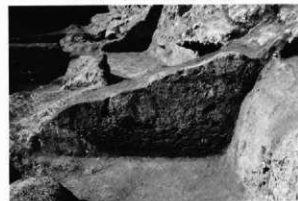

7 1区1号炭焼窯 土層断面B(南から)



1 1区2号炭焼窯 前庭部全景(西から)



2 1区5号炭焼窯 全景(西から)



3 1区2号炭焼窯 西側煙道部(南東から)



4 1区2号炭焼窯 煙道A(前庭側)



5 1区2号炭焼窯 煙道C(前庭側)



6 1区2号炭焼窯 煙道H-F-1(前庭側)

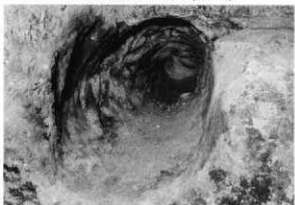

7 1区2号炭焼窯 煙道F(側面側)



8 1区2号炭焼窯 前庭部土層断面Db-d(南西から)



1 1区2号炭焼窯 前底部土層断面De-D'(南西から)



2 1区5号炭焼窯 窯体土層断面C(南から)



3 1区5号炭焼窯 窯体土層断面D(西から)



4 1区3号炭焼窯 全景(北東から)



5 1区4号炭焼窯 全景(南から)



6 1区4号炭焼窯 土層断面B(東から)



7 1区4号炭焼窯 土層断面C(南から)



1 1区6号炭焼窯 全景(南から)



2 1区6号炭焼窯 煙道部(南西から)



3 1区6号炭焼窯 窯体内部(南から)



4 1区6号炭焼窯 土層断面A(南西から)



5 1区7号炭焼窯 土層断面A(北から)



6 1区1号土坑全景(東から)



7 1区墓地部全景(東から)



8 1区1号墓全景(北から)



1 1区2号墓全景(東北から)



2 1区3号墓全景(南から)



3 1区4号墓全景(北西から)



4 1区5号墓全景(東から)



5 1区6号墓全景(北から)



6 1区7号墓全景(東から)



7 1区8号墓全景(北西から)



8 1区9号墓全景(北から)



1 2区道東(1次)As-B下面全景(西から)



2 2区道東(2次)As-B下面全景(東から)



1 2区道西全景(西から)



2 2区道西3号溝全景(東南から)



3 2区道西3号溝北壁土層断面B-B'(南から)



4 2区道西土埴器群全景(北から)



5 2区道西12号墓全景(北から)



6 2区道西12号墓木棺底部出土状態(東から)



7 2区道西13号墓全景(東から)



8 2区道西14号墓全景(西から)



1 3区8号炭窯構築面全景(東から)



2 3区8号炭窯煙道部近景(西から)



3 3区8号炭窯掘り方全景(東から)



4 3区3号住居遺物出土状態(西から)



5 3区3号住居カマド遺物出土状態(西から)



6 3区3号住居掘り方全景(西から)



7 3区土器溜まり遺物出土状態(北西から)



8 3区トレンチ調査状態(西から)



1 3区土坑群全景(西から)



2 3区14号土坑全景(東から)



3 3区15号土坑全景(東から)



4 3区16号土坑全景(南から)



5 3区17・18号土坑全景(北西から)



6 3区19号土坑全景(東から)



7 3区28号土坑全景(南から)



8 3区1号埋篋(北から)

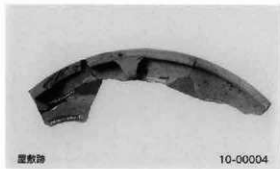
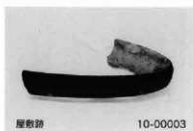

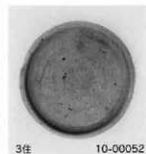
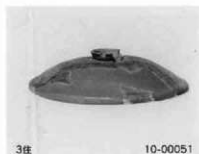
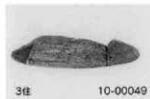
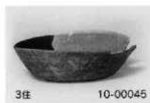
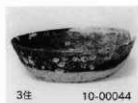

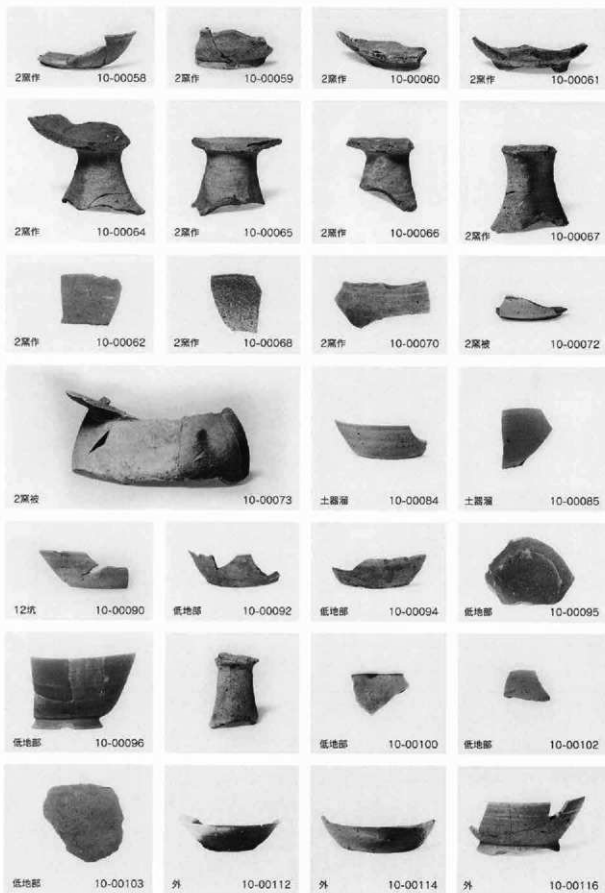

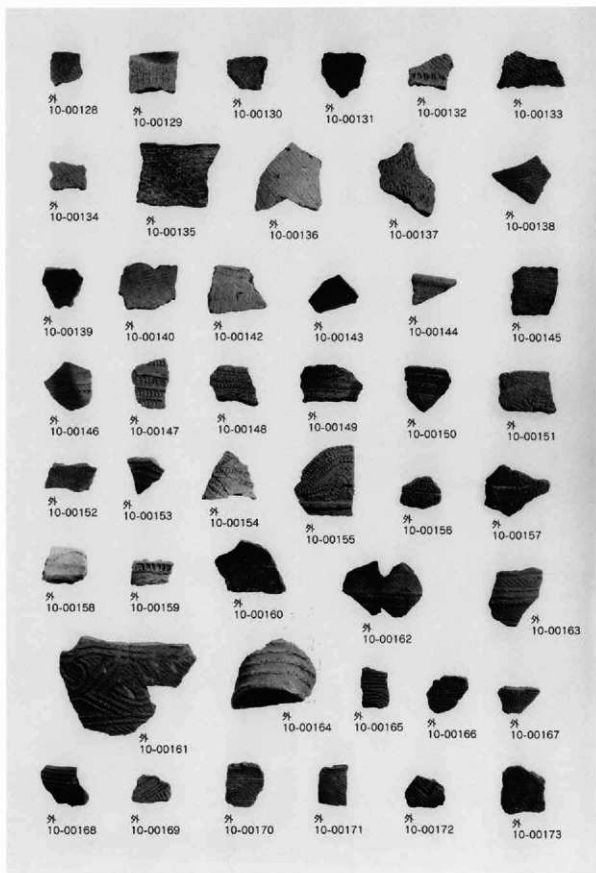



群馬県埋蔵文化財調査事業団
調査報告第 271 集

中里見遺跡群 中里見中川遺跡・中里見根岸遺跡 (写真図版編)
中里見原遺跡・上里見井ノ下遺跡

北陸新幹線建設に伴う埋蔵文化財発掘調査報告書第15集

2000年(平成12年)3月25日 印刷

2000年(平成12年)3月31日 発行

編集・発行／群馬県埋蔵文化財調査事業団
〒377-8555 勢多郡北橋村大字下箱田784番地の2
電話 (0279) 52-2511 (代表)

印刷／朝日印刷工業株式会社

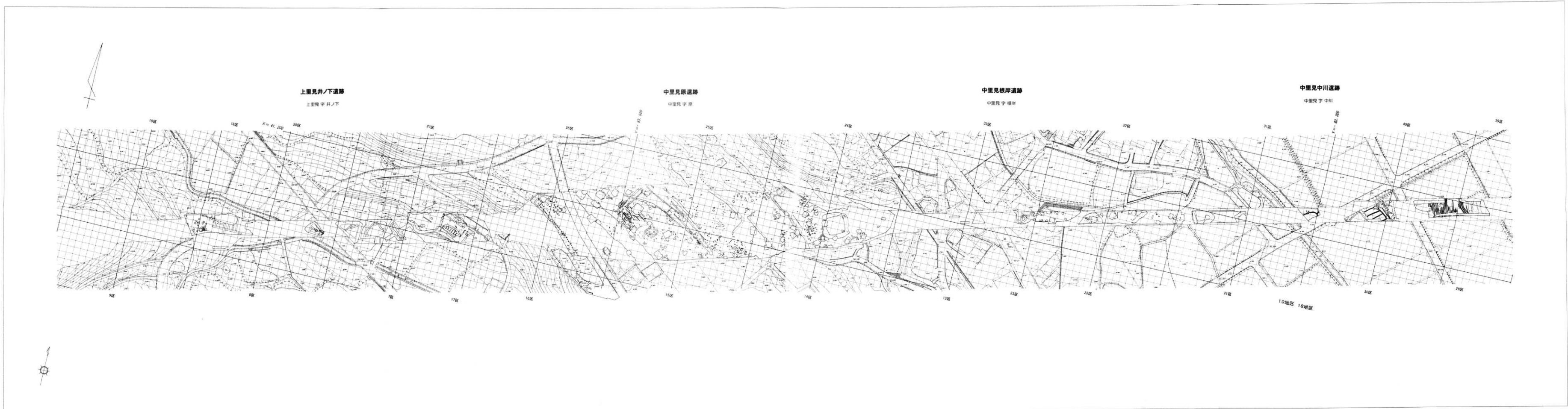

附圖1 中里見遺跡群全体圖 (1:1,200)

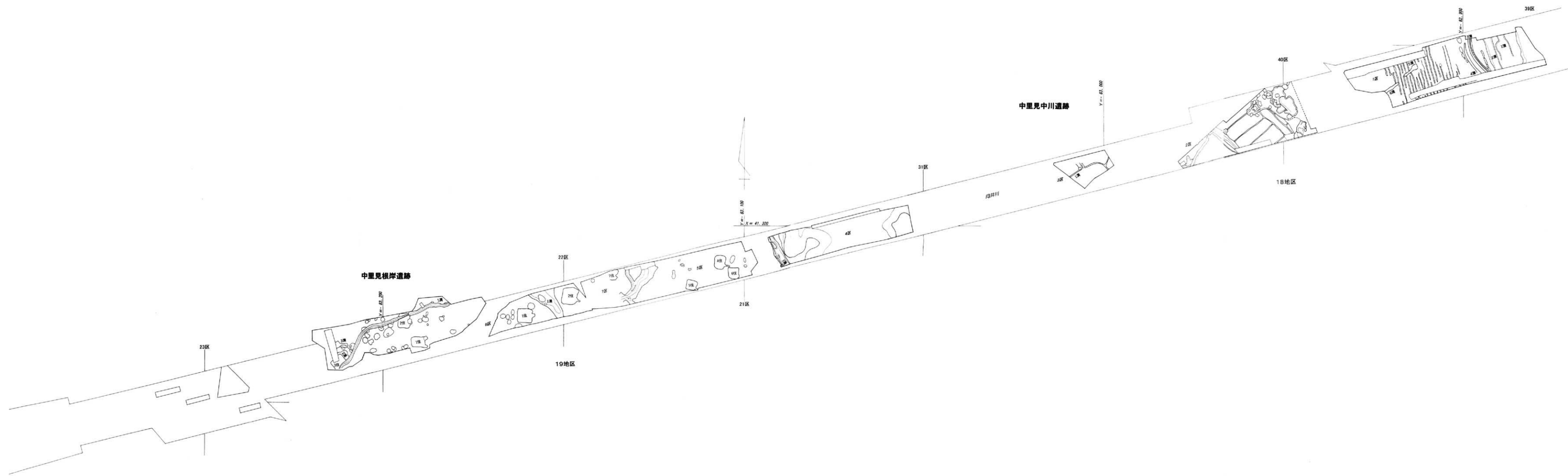

附圖2 中里見中川・中里見根岸遺跡全体圖 (1:600)

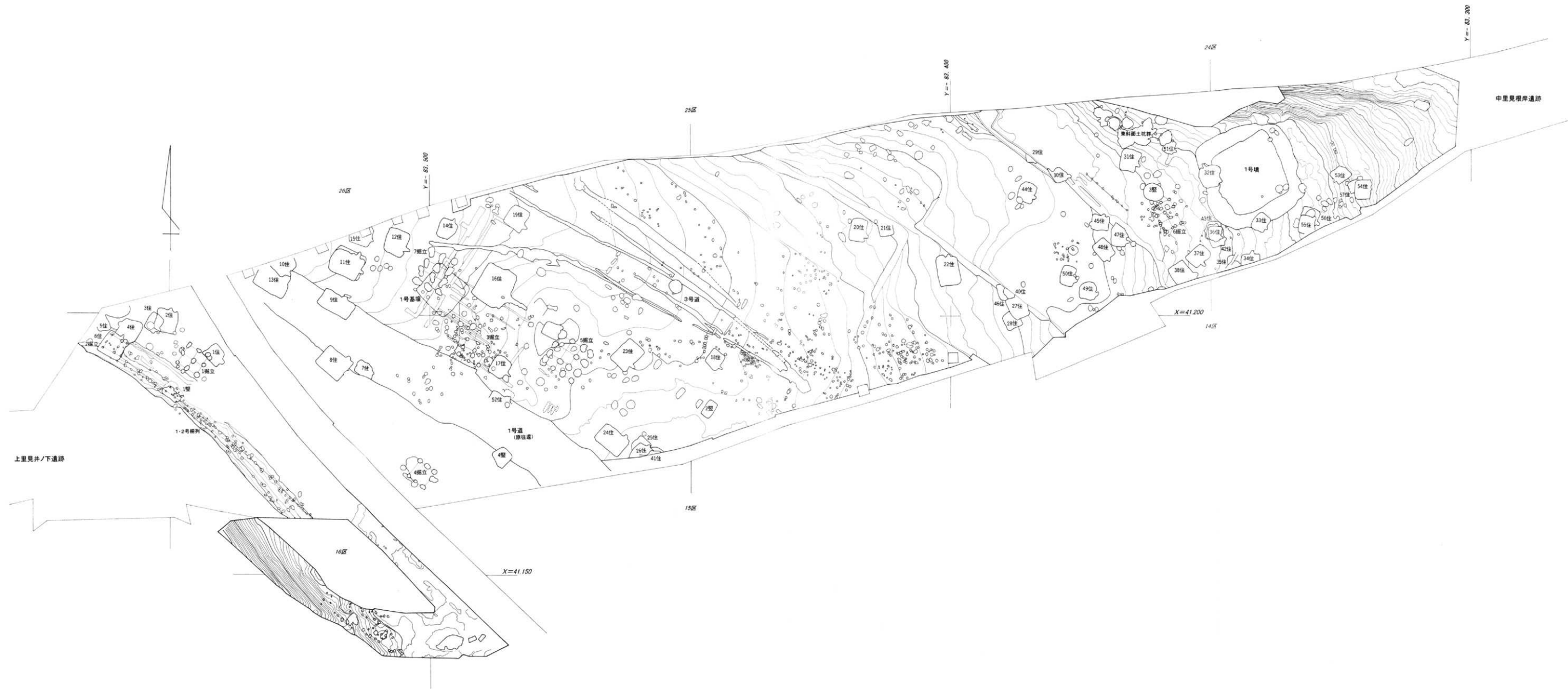

附圖3 中里見原遺跡全体圖 (1 : 400)

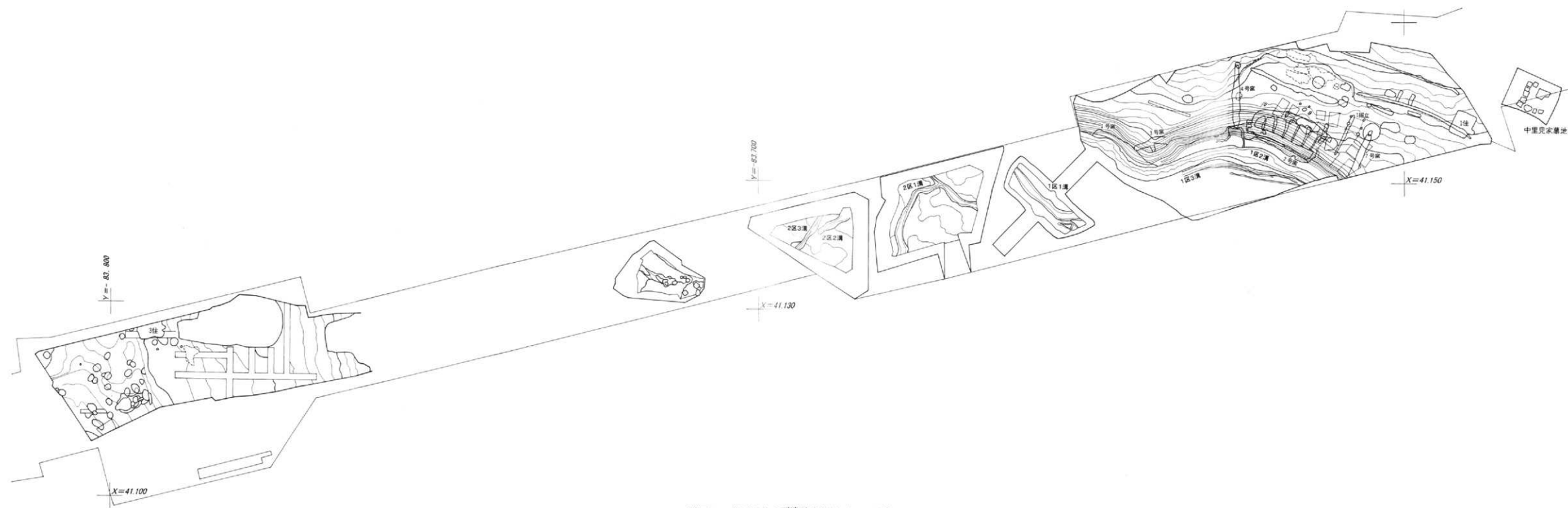

附圖4 上里見井ノ下遺跡全体圖 (1:400)

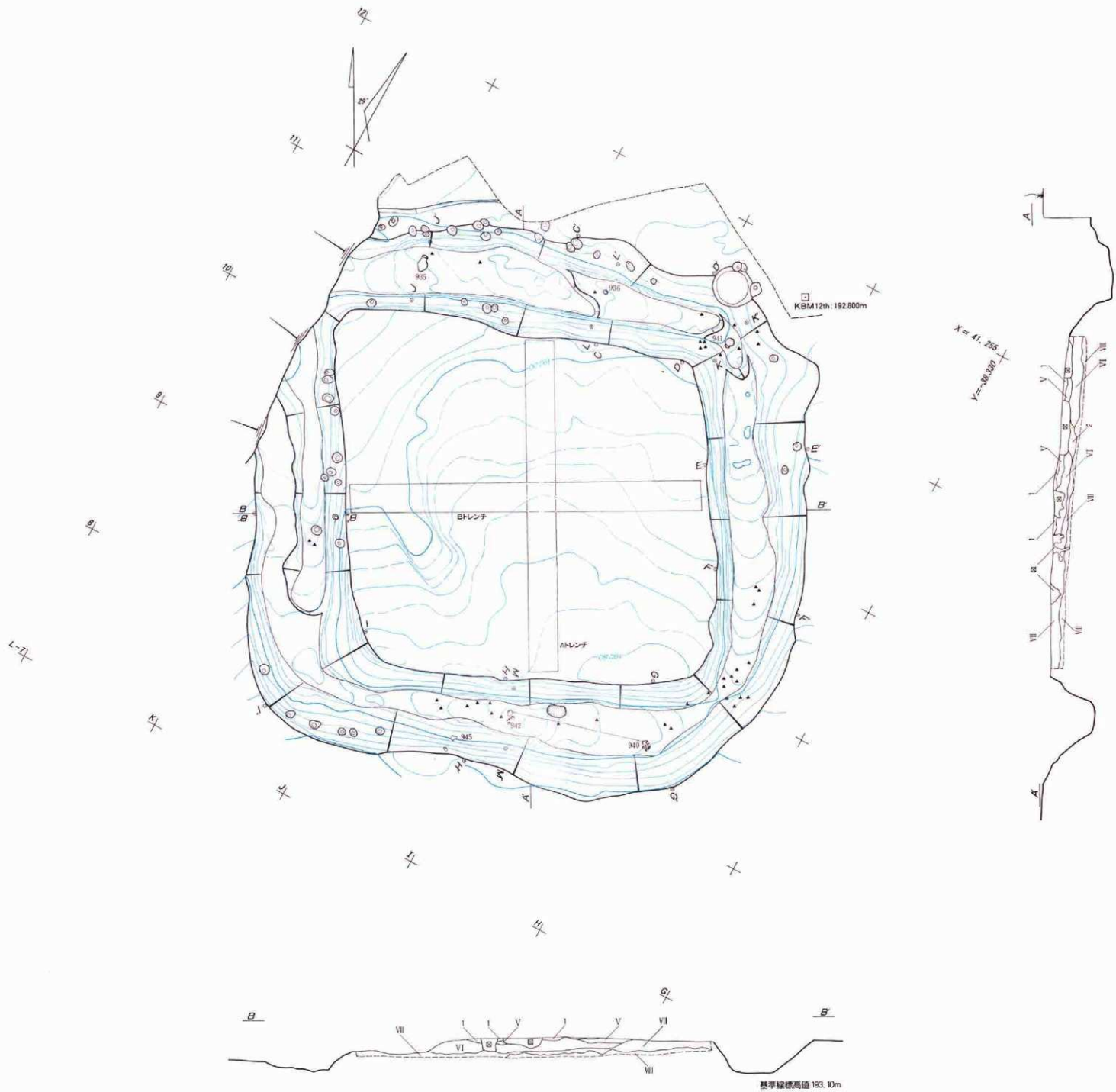

附図5 中里見原遺跡第1号古墳実測図(1:100)

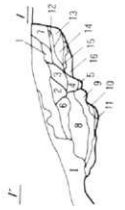
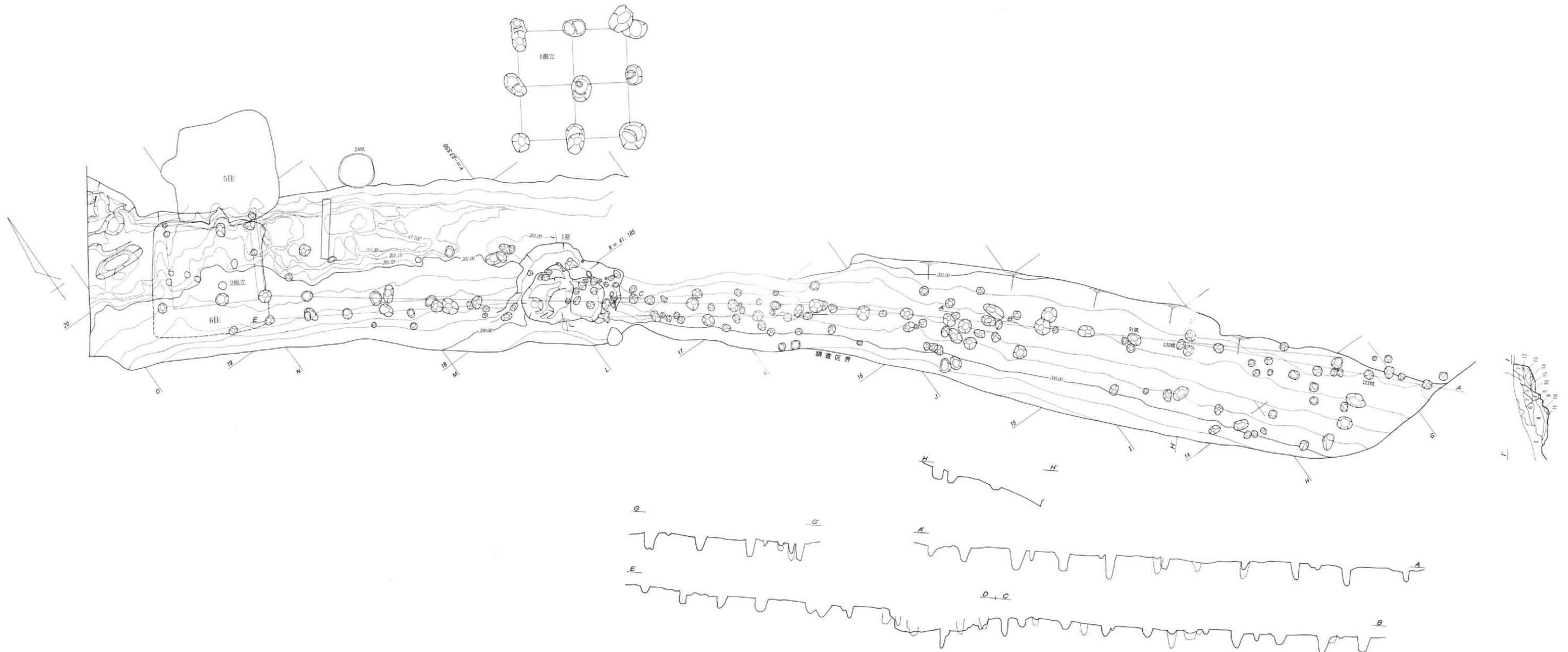

附图6 中里见原遗址棚列坑实测图 (1:80)

基准线标高 201.20m

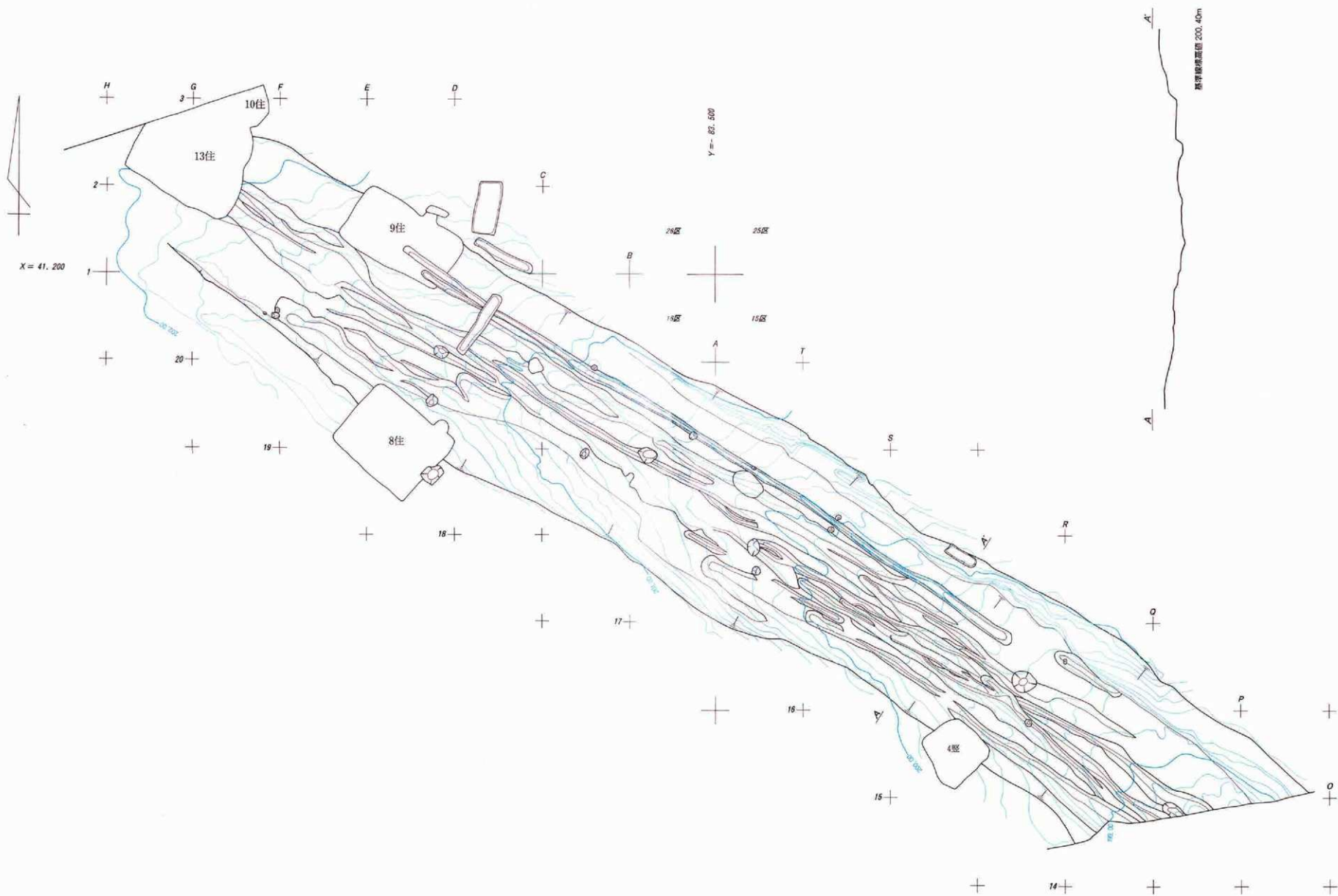

附圖7 中里見原遺跡第1道跡実測圖 (1:250)

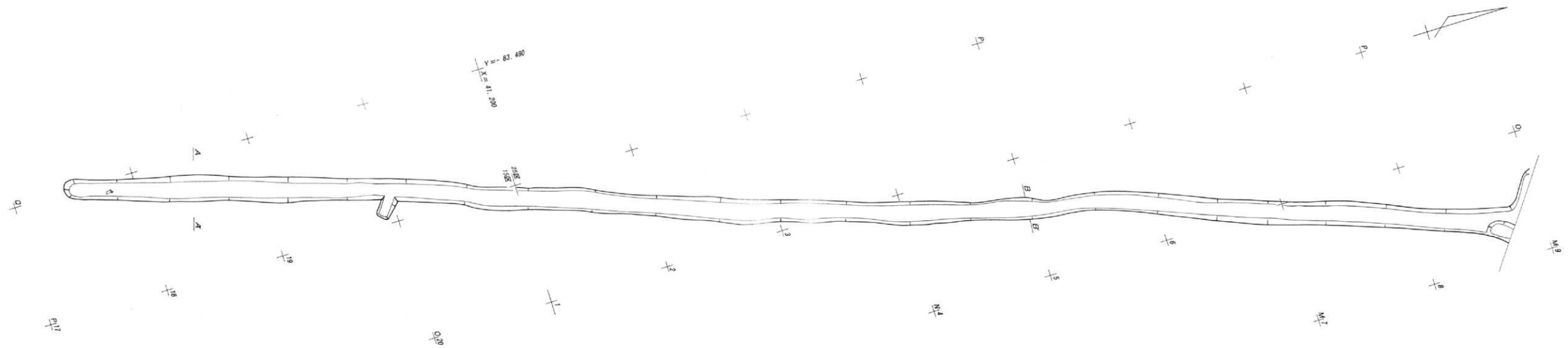

附圖8 中里兒原遺跡第2道跡實測圖 (1:100)

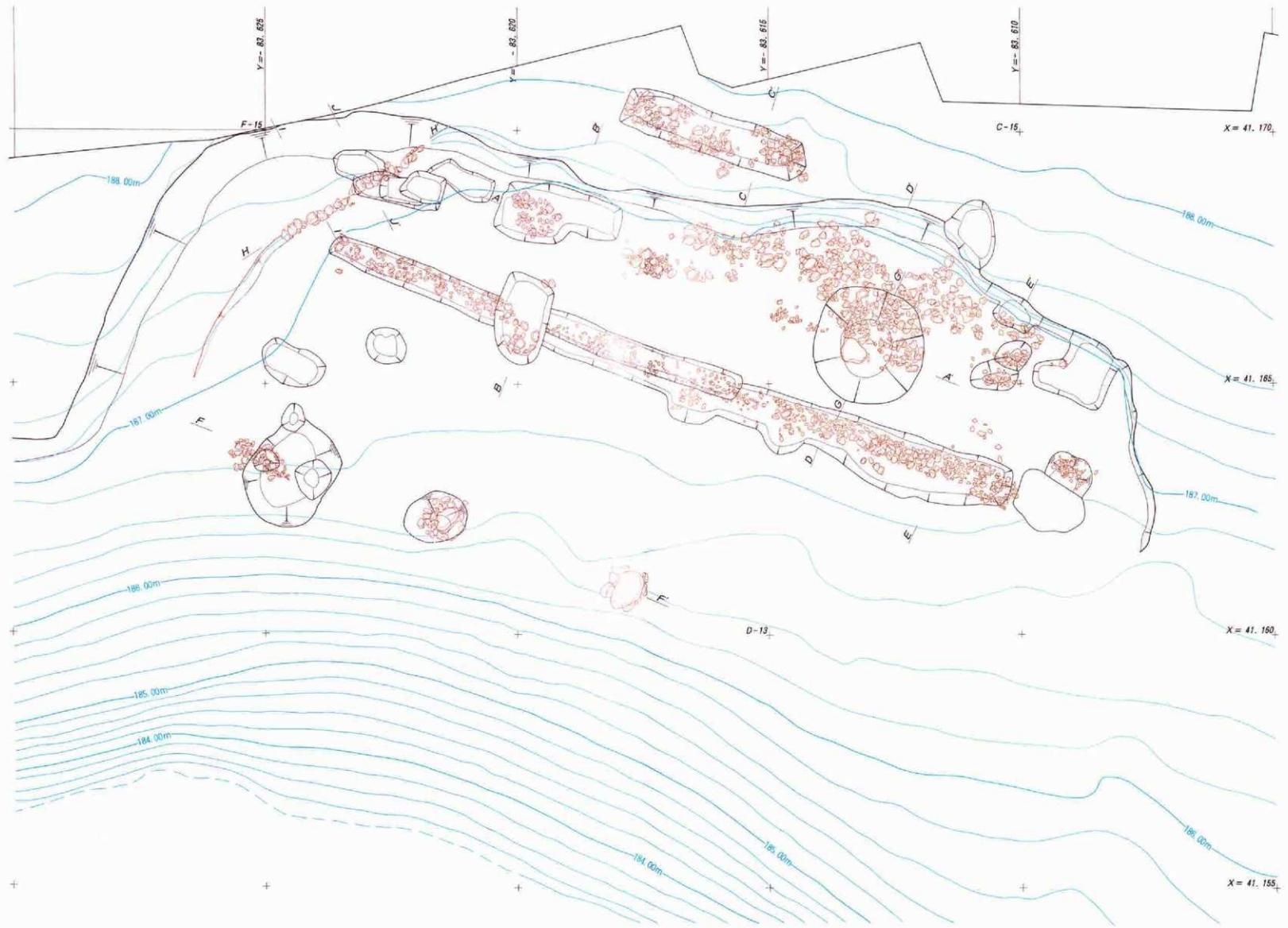

附圖9 上里見井ノ下遺跡屋敷跡実測圖 (1 : 170)