

図版 60

野間M区



野間地区M区（水田）：全景



野間M区：全景（東から）



：調査完了時全景（東から）



奈良時代水田面（東から）



水田下土坑群の位置



奈良時代水田面（西から）



水田下（西から）



野間M区
水田下
(西南から)



水田脇のピット群：東半
(北から)



水田脇のピット群：西半
(西北から)

水田下土坑群
：全景
(北から)



水田下土坑群
(南から)



水田下
土坑群
(北西から)



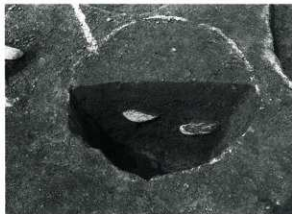

301号土坑 (南西から)

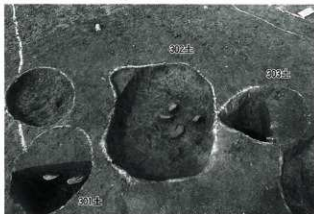

301・302・303号土坑



302号土坑 (西北から)



303・304号土坑 (北から)



304号土坑



305号土坑 (東から)

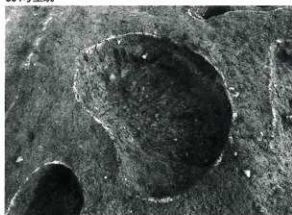

306号土坑 (北西から)



307号土坑 (西から)



308・310号土坑（東から）



309号土坑（西から）



310号土坑（北から）



311号土坑（南西から）



312号土坑（南東から）



314号土坑（西から）



315号土坑（西から）



平原地区A·B·C·D区:全景

平原A・B区

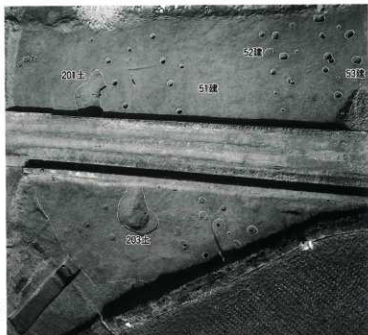

平原A・B区
：全景



平原A区
：全景
(東から)

奈良時代



51号独立柱
建物跡
(南から)

図 版 70

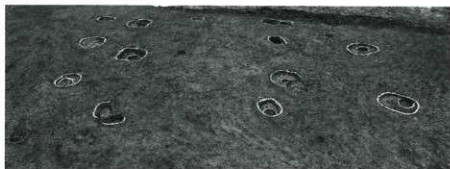

52・53号掘立柱
建物跡
(南西から)



201号土坑
(南西から)

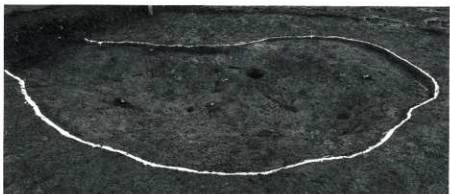

203号土坑
(西から)



51号溝
(北西から)

近世

平原C・D区



平原D区：全景
(北から)

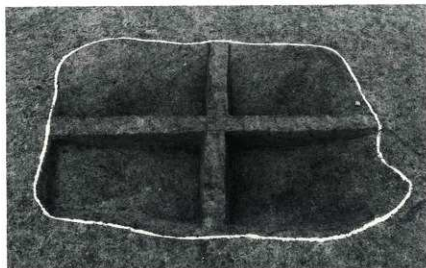

204号土坑
(南東から)

平原E・F・G区



平原E・F・G区：全景 (西から)

平原E区



平原E・F区
: 全景
(南東から)

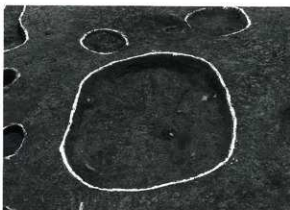

211号土坑 (西から)



213号土坑 (東から)

縄文時代



212号土坑
(東から)

近世

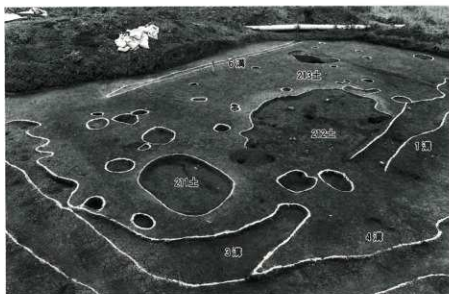

平原E区
：南半
(南から)



平原E区
：全景
(東から)

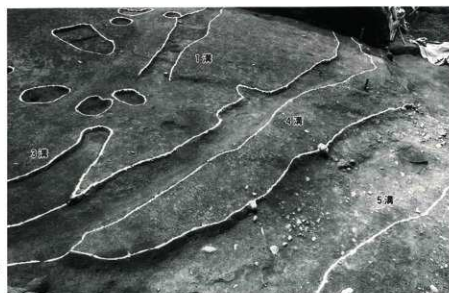

1・3・4・5号溝
(北から)



2・3・4・5溝
：断面層序
(西から)



平原F区

平原F区：全景
(東から)



平原G区

：調査風景 (東から)



：完掘状態 (東から)

米田地区



米田A区
：全景



米田A区
：トレンチ



：A区トレンチ南壁
断面
(北から)



米田B区
(東から)



上野第2遺跡

A地区
(南から)



B地区からA地区を望む
(西から)

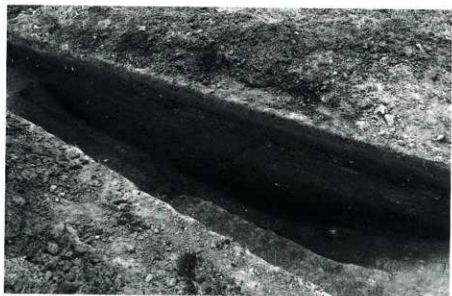

B地区
トレンチ層序
(北から)

東原A区 1号土坑



1

東原A区 2号溝



1



6

東原B区 4号孤立柱建物跡

東原B区 1号土器棺蓋



1



4 (外面)



5 (外面)



4 (内面)



5 (内面)

東原B区 1号壁穴建物跡



1

東原B区 4号土坑



6

東原B区 3号溝



3

3号溝

東原B区 6号溝



1



2



10



1



2



3

図版 78

東原C・D区 表面採集



東原C区 3号竪穴建物跡



東原C区 10号掘立柱建物跡



東原C区 2号竪穴建物跡



東原C区 10号土坑



10

東原C区 14号土坑



(外)



(内) 10



11



22

東原C区 8号溝



(外)



(内)



(内)



(内) 3



(外) 4



(外) 5

野間E・F区表面採集



野間F区 4号竪穴建物跡

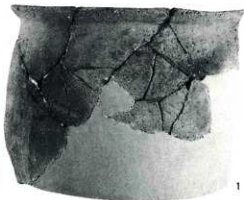

1



1

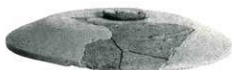

4



7

图 版 80

野間 F 区 4 号整穴建物跡

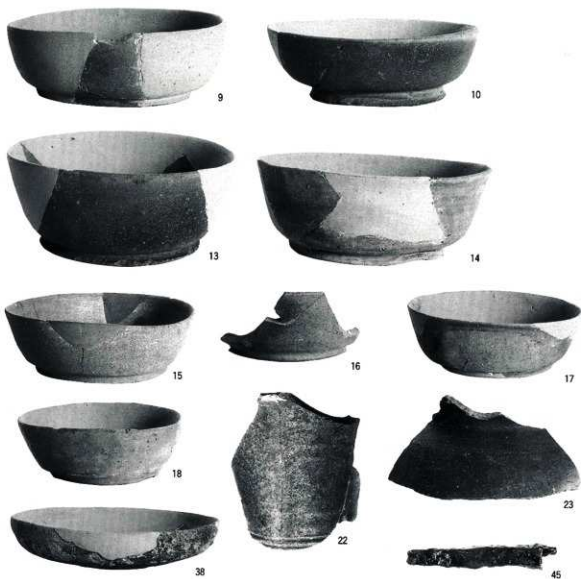

野間 E 区 52号土坑



野間 G・H 区 表面採集



野間G・H区 表面採集

野間H区 周溝建物



(外)



(内) 33



34



5



10



11



13



15



21



23



27



28

图 版 82

野間H区 周溝建物



(周溝内)

30



(5 壑穴)

31

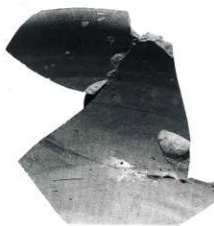

22



37

野間G区 6号壑穴建物跡



8

野間G区 5号壑穴建物跡



13



36

(5 壑穴)

(19土)



39

野間H区 7号壑穴建物跡



1

野間H区 7号竪穴建物跡



4

野間G区 25号土坑



8



1

野間H区 19号土坑



1

野間H区 31号土坑



4



1



5



16



17



18

野間G・H区 13号溝

野間H区 道路状遺構



1

野間G・H区 ピット



17



18



5

图 版 84

野間H区 道路状遺構



6

野間I・J・L区 表面採集



4

野間J区 39号土坑



1

野間I区 30号掘立柱建物跡



1

野間I区 9号竪穴建物跡



1



2



5

野間I区 8号竪穴建物跡



1



13

野間 I 区 15号竪穴建物跡



1



(外面)

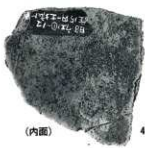

(内面)

4



3



5



2

野間 I 区 10号竪穴建物跡



1



19

野間 I 区 11号竪穴建物跡



1



5



5



5 (内面)



7



(外面)

8



7



(内面)

8

図版 86

野間 I 区 11号竪穴建物跡



野間 I 区 12号竪穴建物跡



野間 J 区 38号土坑



野間 J 区 45号土坑

野間 J・L 区 19号溝



野間 L 区 44号土坑

野間 I 区 22号溝

野間 I・J 区 ビット



野間地区 基盤層調査区

野間 M 区 16トレンチ



野間M区 17トレンチ



野間M区 水田層



野間M区 水田下302号土坑

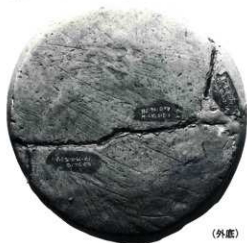

平原A区 201号土坑



图 版 88

平原 E·F 区 表土采集

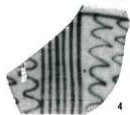

4
(外面)



(内面)

平原 E·F 区 试掘区



6



8



9

平原 G 区



5

平原 E 区 2号溝

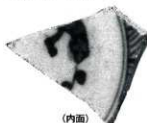

(内面)



(底面) 1

平原 E 区 5号溝



1

米田 A 区



(外面)



上野第 2 遺跡 B 地区



(内面)

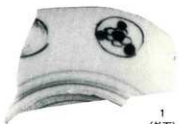

1
(外面)



(外面)



14
(内面)

フリガナ	ひたしたかせいせきぐんのちょうさ3
書名	日田市高瀬遺跡群の調査3
副書名	上野第1遺跡
巻次	3
シリーズ名	一般国道210号日田バイパス建設に伴う発掘調査報告書
シリーズ番号	Ⅲ
編著者	田中裕介・佐々木章
編集機関	大分県教育庁文化課（文化財資料室）
所在地	〒870-1113 大分県大分市大字中野田字ビワノ門1977
発行機関	大分県教育委員会（大分県大分市府内町3-10-1）
発行年月日	2001年3月31日
資料保管場所	大分県教育庁文化課（文化財資料室）

フリガナ 所収遺跡名	フリガナ 所在地	コード		北緯	東経	調査期間	調査面積	調査原因
		市町村	遺跡番号					
上野第一	大分県日田市 大字上野	44204- 6	651125	33°18'	130°55'	900706 ～901114 920507 ～930329 930422 ～930731	約15000㎡	道路建設

所収遺跡名	種別	主な時代	主な遺構	主な遺物	特記事項
上野第1	集落跡	縄文時代 古墳時代 奈良時代 中世 近世～近代	土坑5基 小児土器棺墓1基 掘立柱建物33軒、堅穴 建物15軒、土坑54基 棚列3基、周溝建物1基 水田、遺跡状遺構、水場 状遺構、粘土採取坑、溝 溝1条 土坑7基、溝26条	(奈良時代) 須恵器（転用硯ほか） ・土師器（製塩土器、土師 ほか）、刻容石製品（「豊 馬皇馬」銘）・石器・鉄器 ほか	(奈良時代) 台地上の湧水点 を中心に水田・ 道路・建物群が 展開する。 (近世) 畠地境界溝

編者付記

刊行を前にした3月9日、上野第1遺跡の調査委員として御指
導いただいた、賀川光夫別府大学名誉教授が亡くなられた。

東原地区と野間地区の調査中、二度にわたり現地で調査を検討
していただいた。堅穴建物の性格を念入りに観察するよう、繰り返
しお話しされたことは忘れがたい。

指導の主旨が報告の中で生かされたか否か、先生御自身に検討
していただくことができなくなったことは、編者の怠慢として慚
愧にたえない。(2001.3.15)

日田市高瀬遺跡群の調査 3

上野第1遺跡

一般国道210号日田バイパス建設に伴う埋蔵文化財発掘調査報告書Ⅲ

2001年3月31日

発行 大分県教育委員会

印刷 佐伯印刷株式会社

野間地区

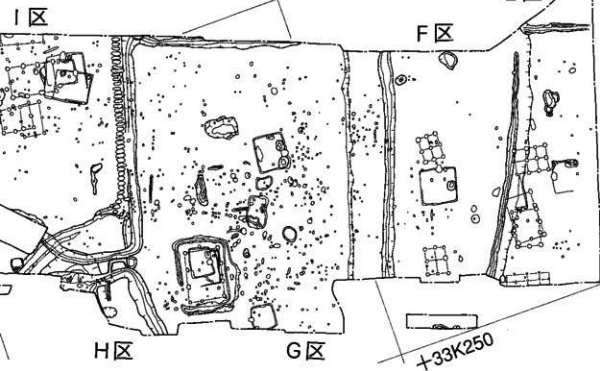

東原地区

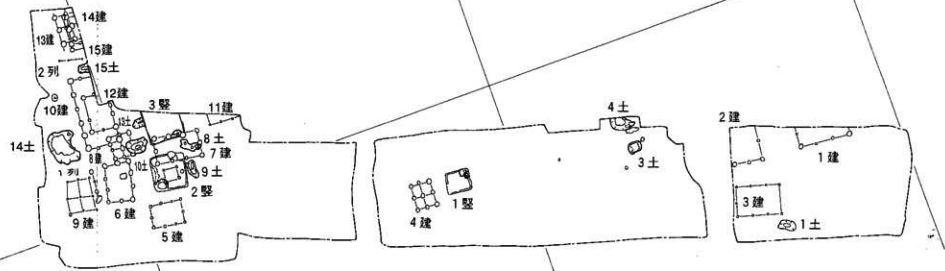
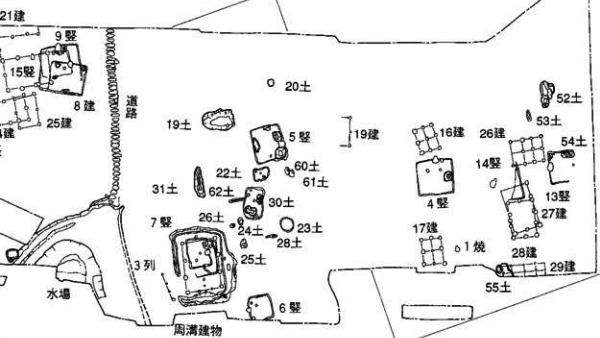
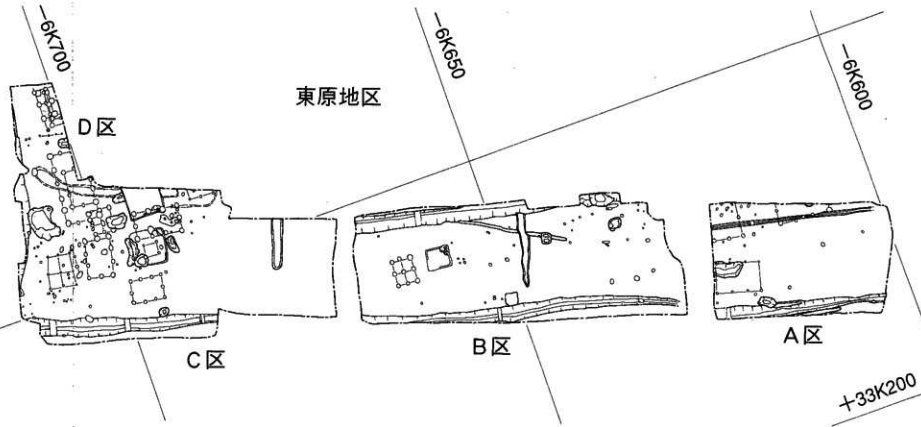

6K900

T.N

-6K850

-6K800

-6K750

野間地区

K区

J区

I区

E区

F区

L区

H区

G区

+33K300

M区

+33K250

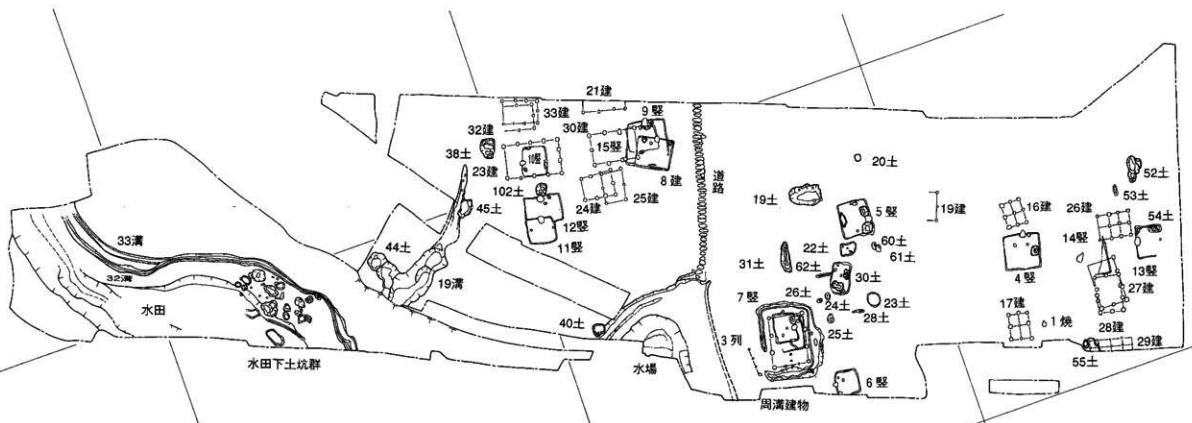
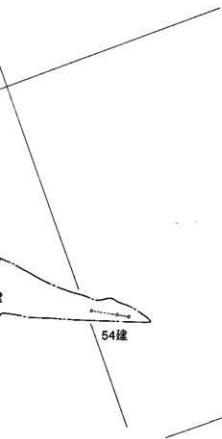

14溝

34土

付図 上野第1遺跡の遺構配置 (1/500)

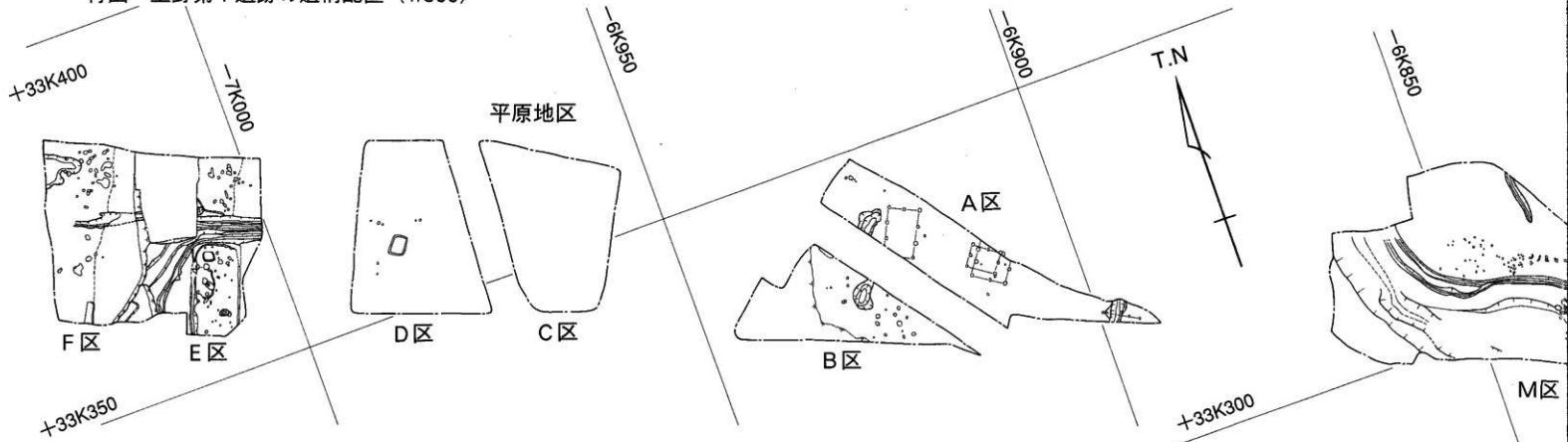

①全体

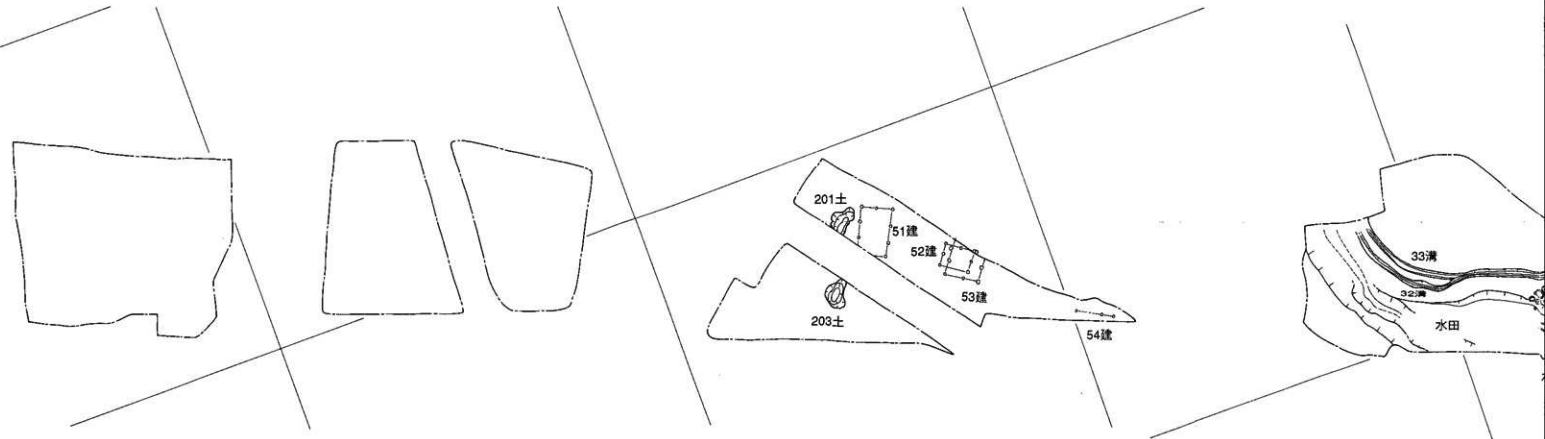

②奈良時代

③近世～近代

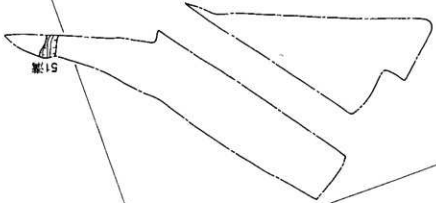
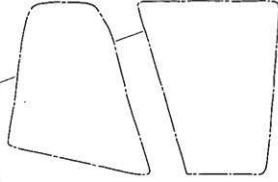
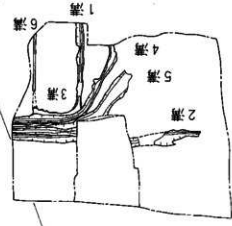

0 25 50m

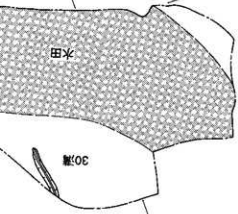

②奈良時代

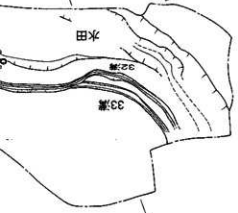
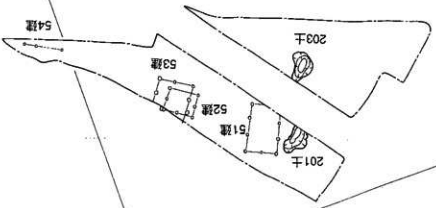
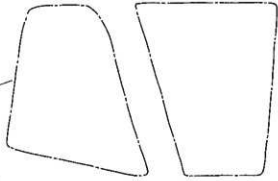
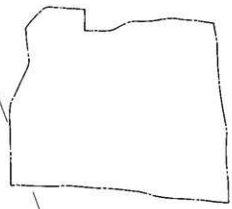

①全体

+33K350

F区

E区

B区

+33K300

M区

50m

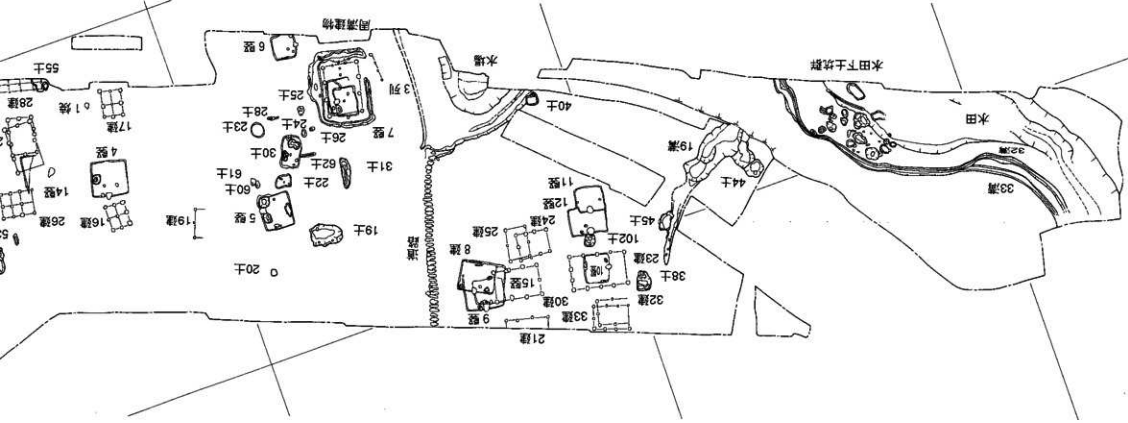
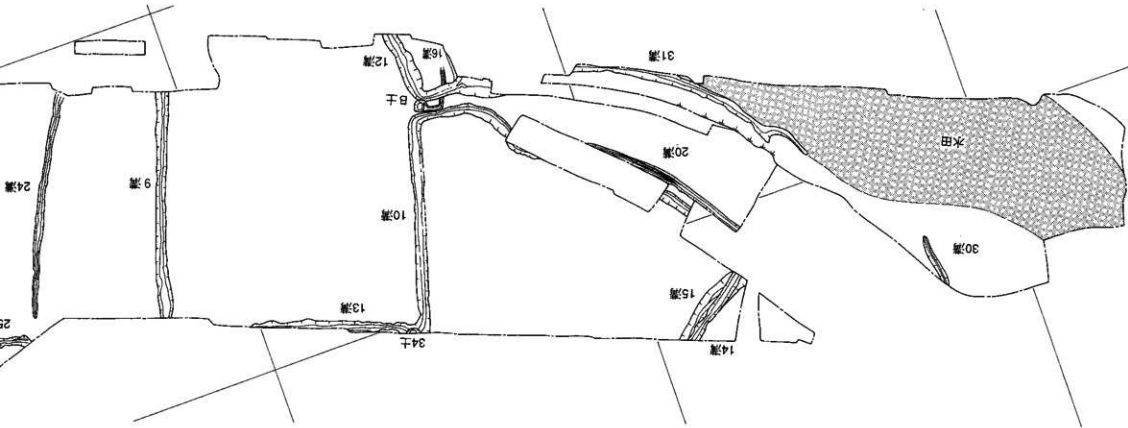

+33K250

G区

H区

M区

+33K300

