

鼎 4 出土土器

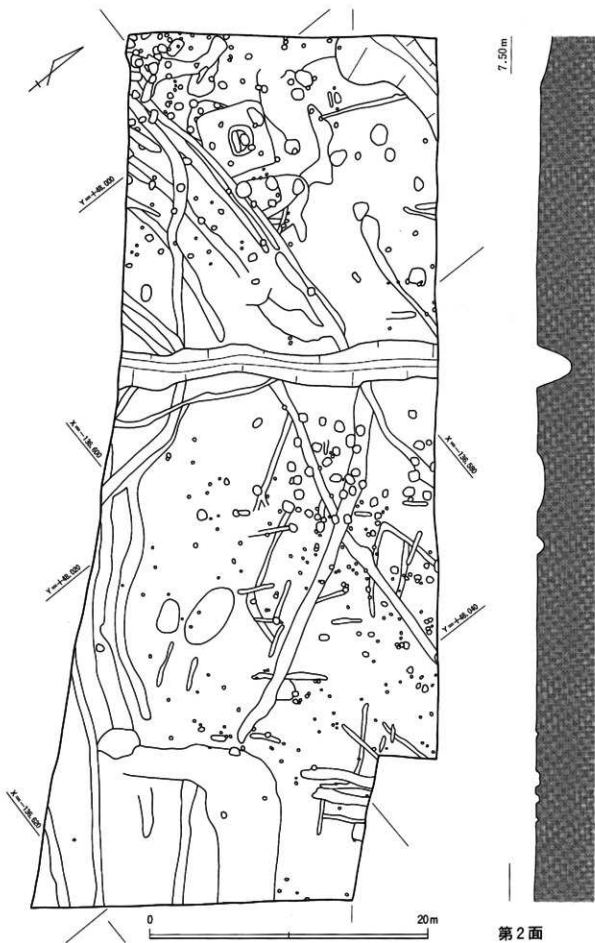

鼎 4 出土瓦



第2面

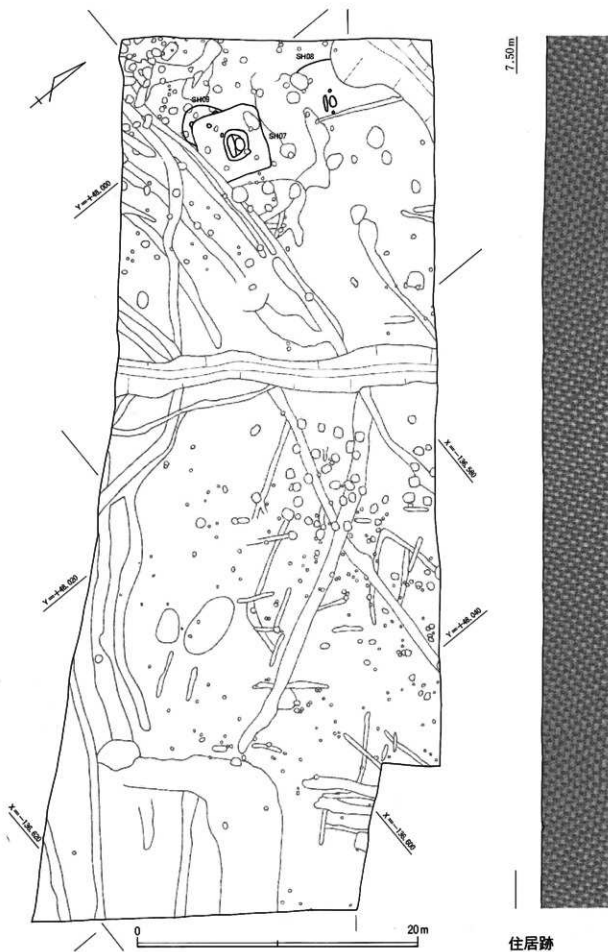

住居跡

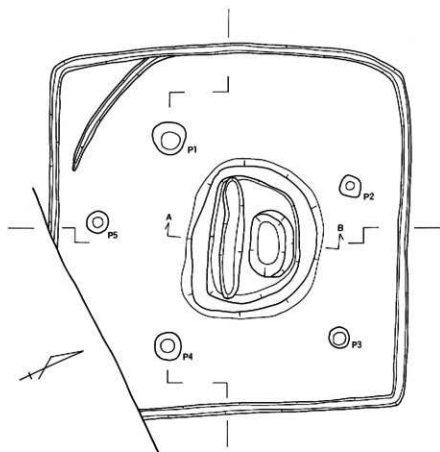

SH07

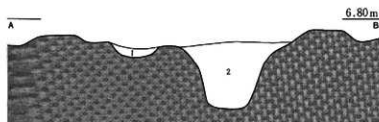

1. 7.5YR 2/1 黒 砂質シルト 炭多い 土器含む
2. 7.5YR 3/1 黒褐 砂質シルト 炭・土器含む

SH07中央土坑

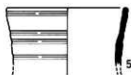
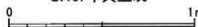

SH07出土土器

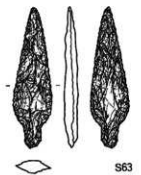

SH07出土石器

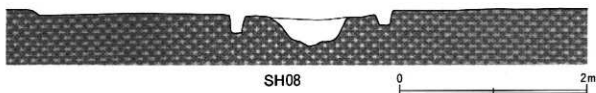
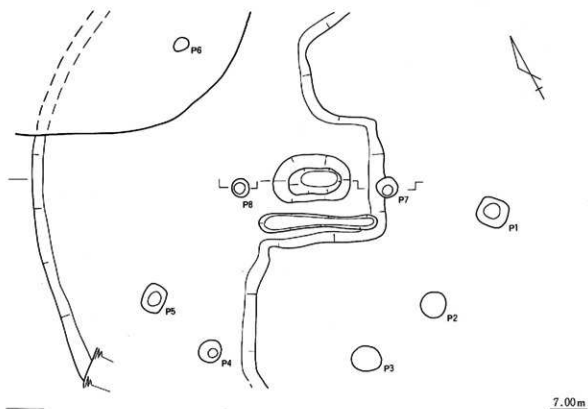

SH08

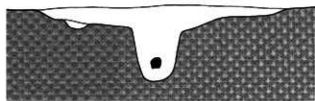
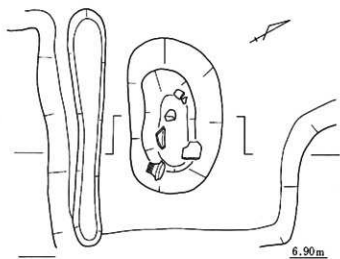

SH08中央土坑

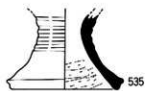

S35



S36



SH08出土土器

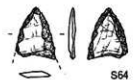

S64



SH08出土石器

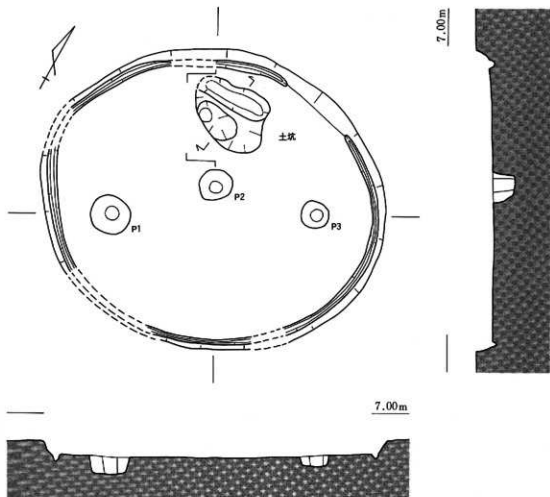

SH09

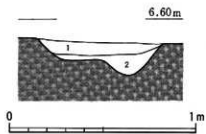

- 1. 灰色 シルト質極細砂 (炭混じり)
- 2. 褐灰色 シルト質極細砂 (炭混じり)

SH09土坑

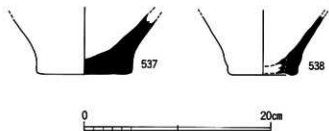

SH09出土土器

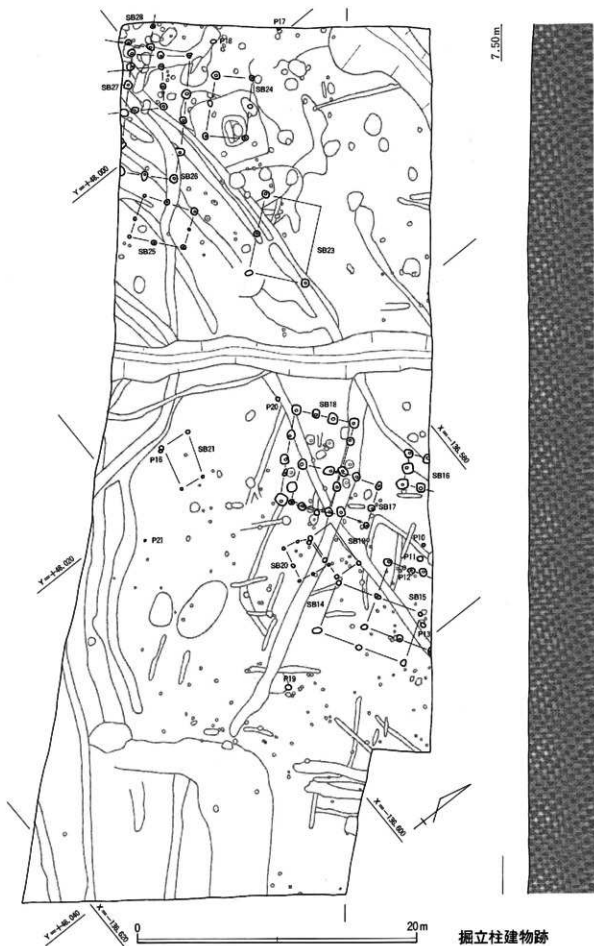

掘立柱建物跡

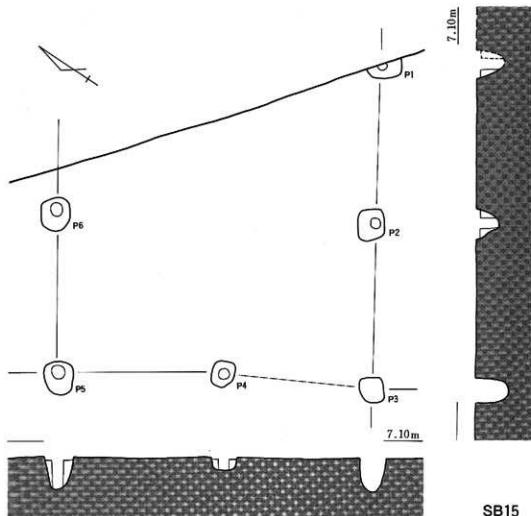

SB15

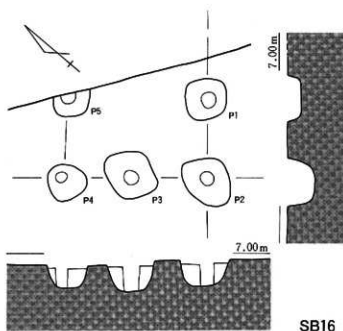

SB16





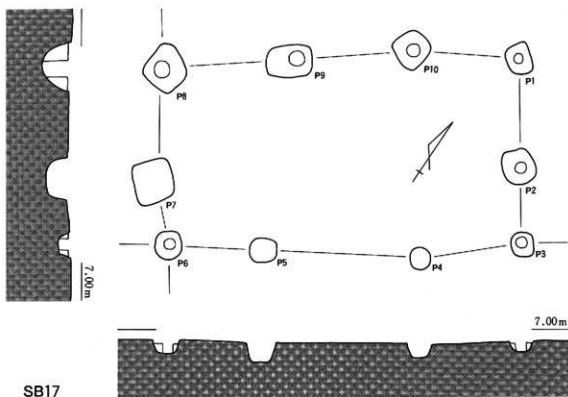

SB17

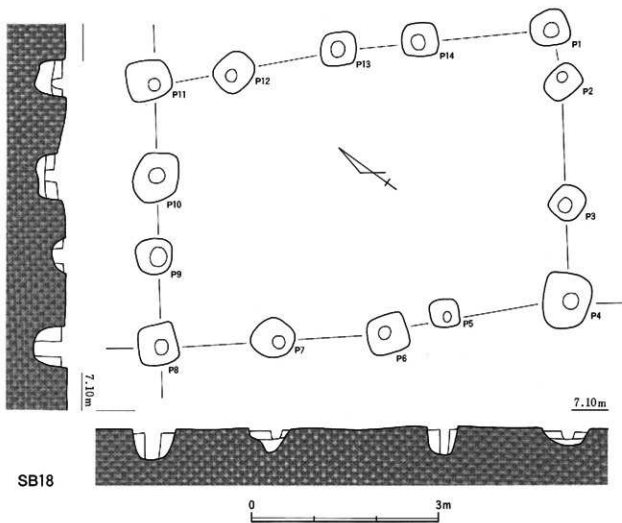

SB18

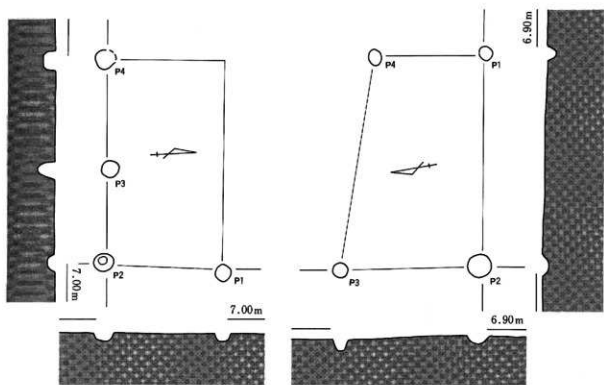

SB19

SB21

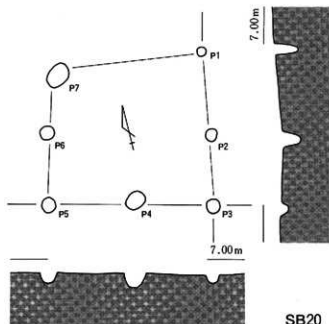

SB20



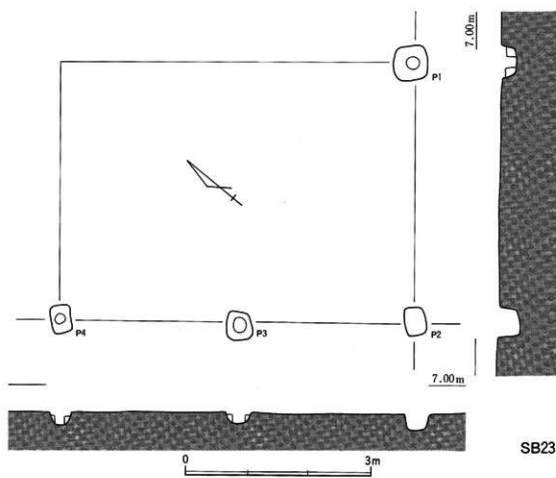
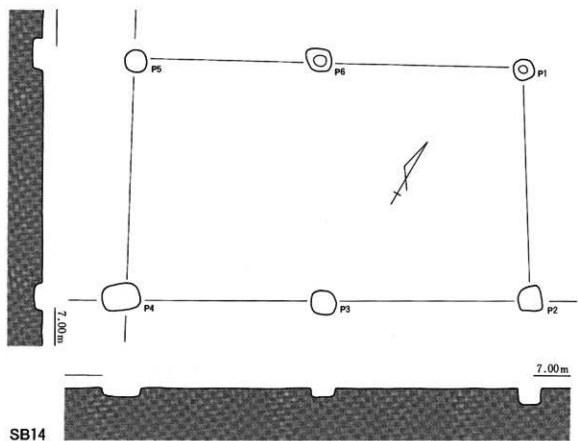

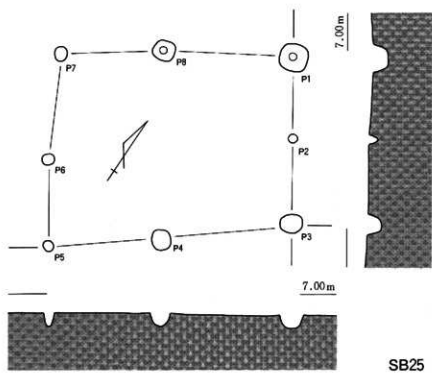
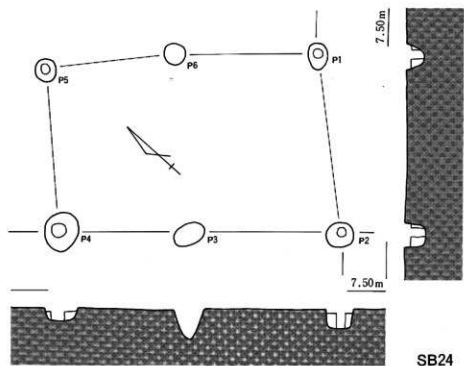

0 3m

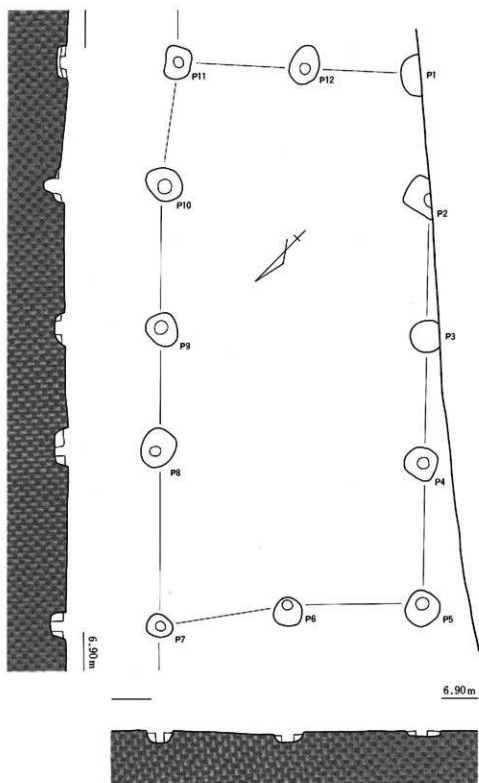

SB26

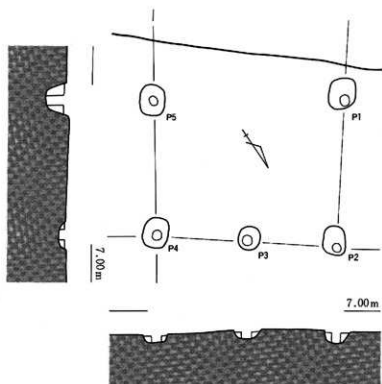

SB27

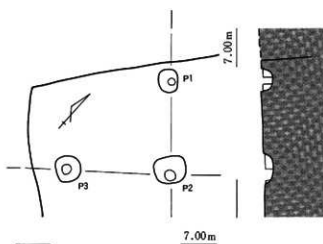

SB28

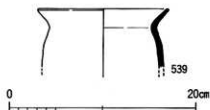

SB28出土土器

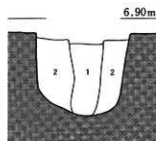

1. 焼締シルト混じり極細砂 (黄灰シルトブロック含む)
2. 焼灰シルト混じり極細砂 (黄灰シルトブロック含む)

P5

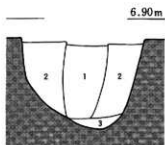

1. 焼灰シルト混じり極細砂 (黄灰砂ブロック含む)
2. 焼締シルト混じり極細砂
3. 焼灰シルト混じり極細砂 (黄灰砂ブロック含む)

P8

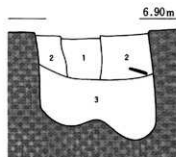

1. 焼灰シルト混じり極細砂 (黄灰砂ブロック・灰含む)
2. 焼灰シルト混じり極細砂 (炭・土器含む)
3. 焼灰シルト混じり極細砂 (黄灰砂ブロック多く含む)

P11

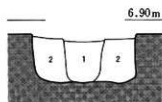

1. 洗凝灰シルト混じり極細砂
2. 焼灰シルト混じり極細砂

P13

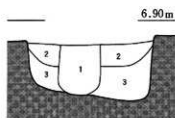

1. 焼締灰シルト混じり極細砂 (灰含む)
2. 焼灰シルト混じり極細砂
3. 黄灰極細砂

P6

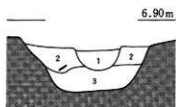

1. 焼灰シルト混じり極細砂
2. 明焼灰シルト混じり極細砂 (土器含む)
3. 黄灰極細砂 (シルトブロック混じる)

P4

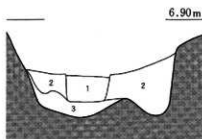

1. 洗凝灰シルト混じり極細砂 (黄灰砂ブロック含む)
2. 焼灰シルト混じり極細砂
3. 洗凝灰シルト混じり極細砂

P10

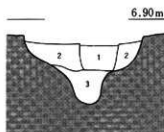

1. 焼灰シルト混じり極細砂
2. 黄灰シルト混じり極細砂 (土器シルトブロック含む)
3. 焼締シルト質極細砂 (下層にシルトたまる)

P7

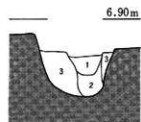

1. 明黄灰シルト混じり極細砂
2. 焼灰シルト混じり極細砂 (炭・土器含む)
3. 黄灰極細砂 (灰含む)

P3

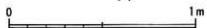

SB18柱穴断面



540

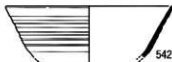

542

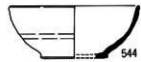

544



541



543



540 SB16出土土器

541 SB17出土土器

542~544 SB18出土土器

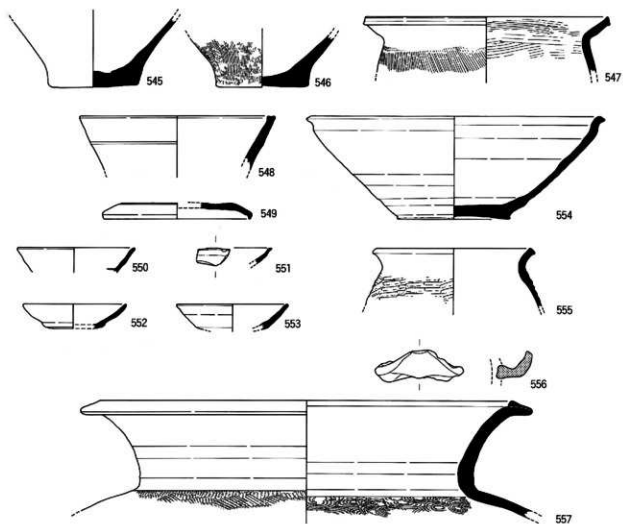

0 20cm

- |         |         |         |         |     |         |
|---------|---------|---------|---------|-----|---------|
| 545·546 | P17出土土器 | 547     | P14出土土器 | 548 | P20出土土器 |
| 549     | P18出土土器 | 550     | P19出土土器 | 551 | P11出土土器 |
| 552     | P15出土土器 | 553·557 | P13出土土器 | 554 | P16出土土器 |
| 555     | P21出土土器 | 556     | P12出土土器 |     |         |

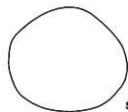
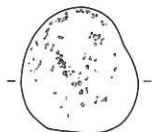

S65

0 10cm

P17出土石器



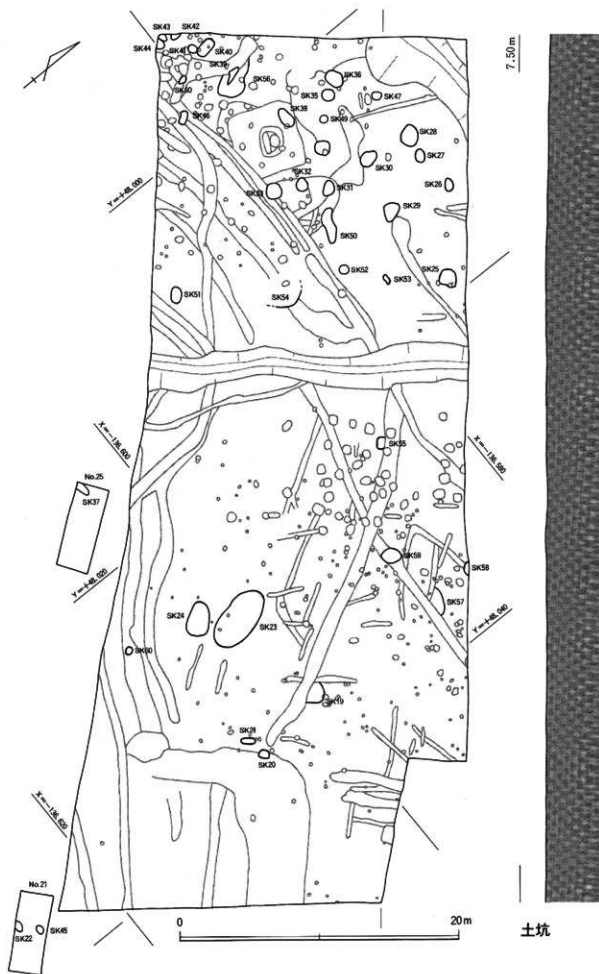

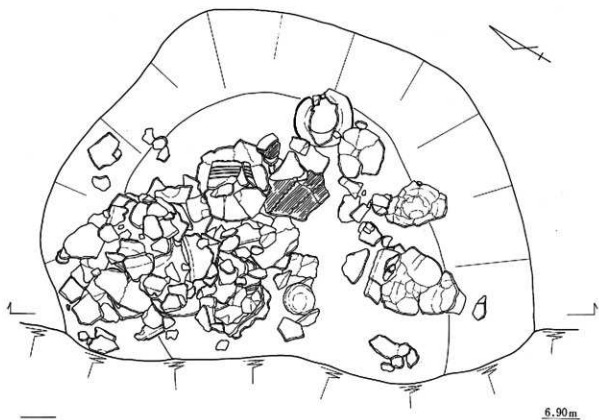

SK19

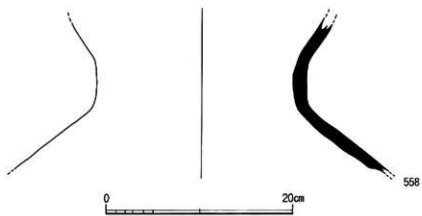

SK19出土土器 (1)

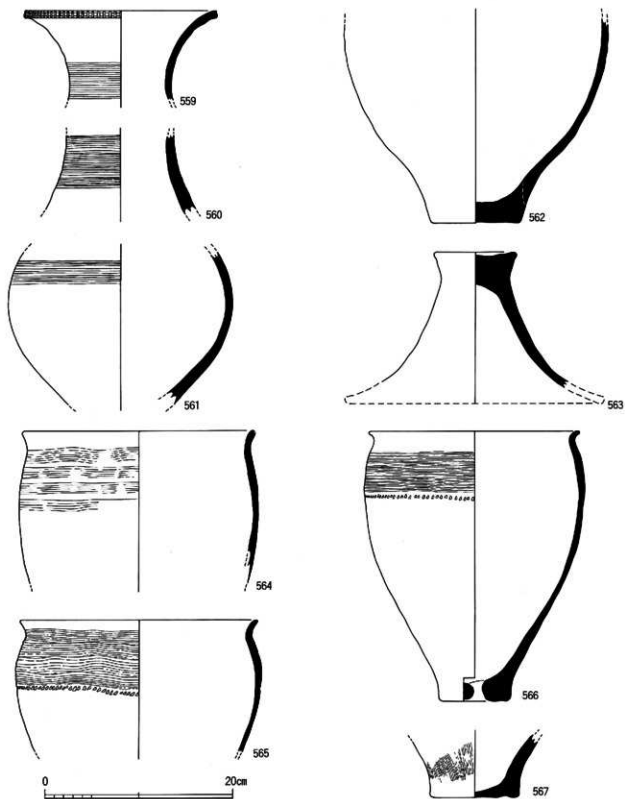

SK19出土土器(2)

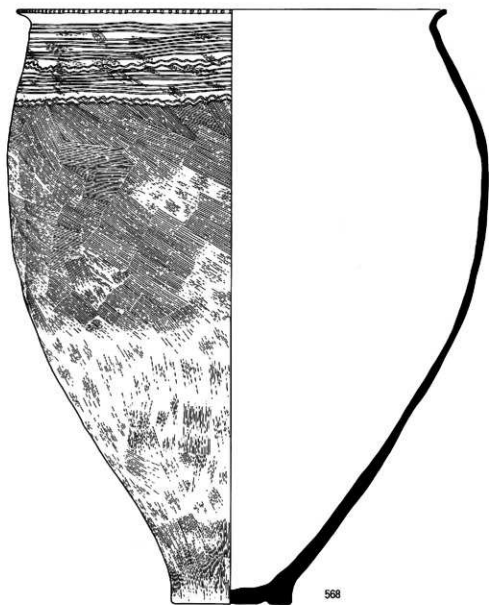

SK19出土土器 (3)

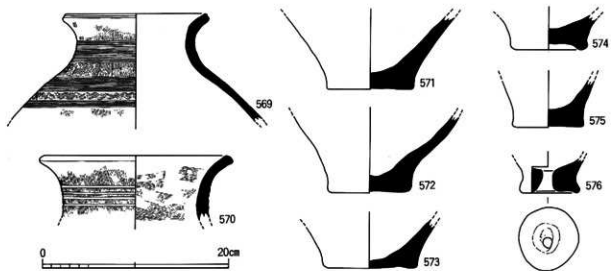

SK22出土土器

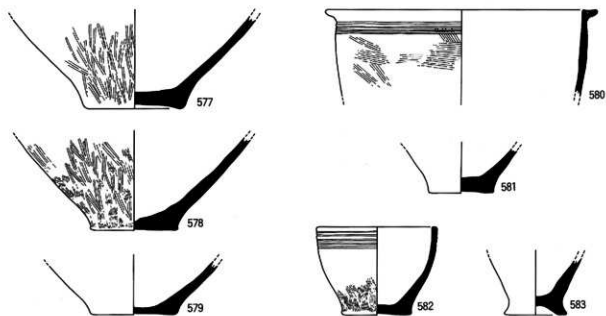

SK23出土土器

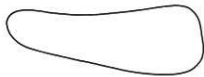
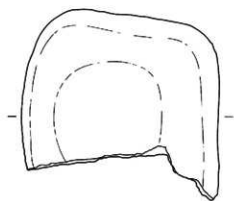

S66



SK23出土石器

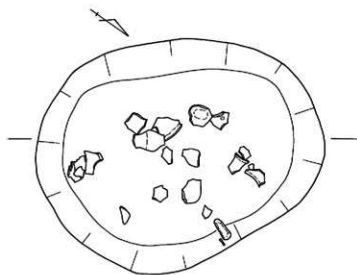

7.00m

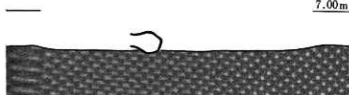

0 1m

SK28

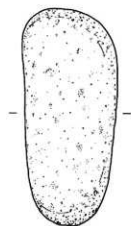

S67

0 5cm

SK28出土石器

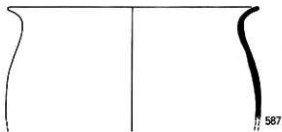
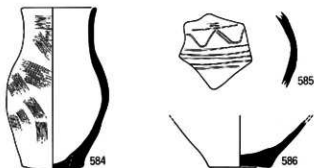

0 20cm

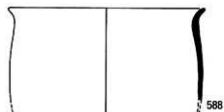

588

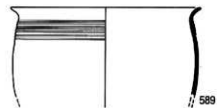

589



590

SK28出土土器

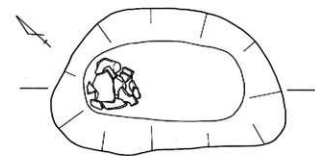

6.80m



SK31



591

0 20cm

SK31出土土器

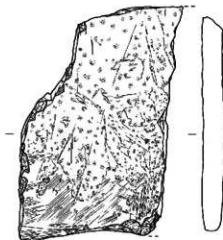

S68

SK31出土石器

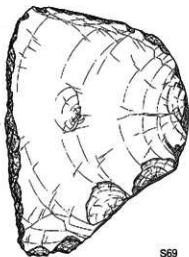
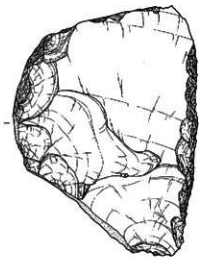

S69



0 10cm

SK32出土石器

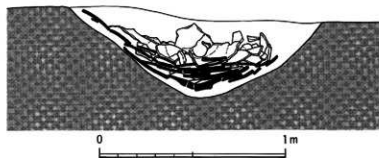
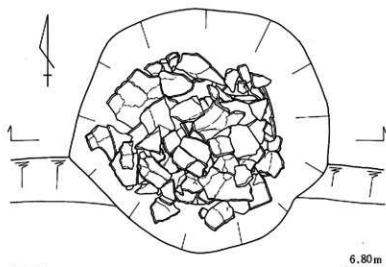

上面

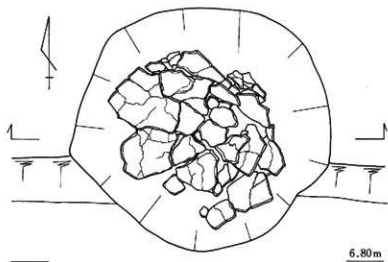

下面



SK33



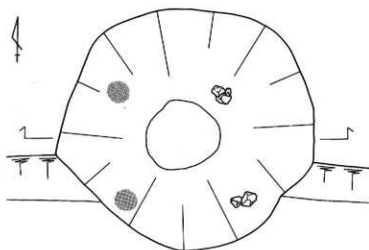

土器取り上げ後

6.80m

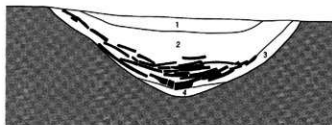

1. 暗灰色シルト質極細砂 (灰含む)
2. 黄灰褐色極細砂混じりシルト (灰含む)
3. 黒灰色シルト質極細砂 (灰含む)  
黄白色粒混じる
4. 暗灰色シルト質極細砂 (灰含む)

0 1m

SK33

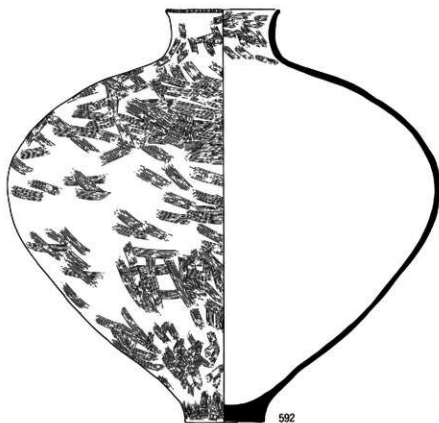

0 40cm

SK33出土土器

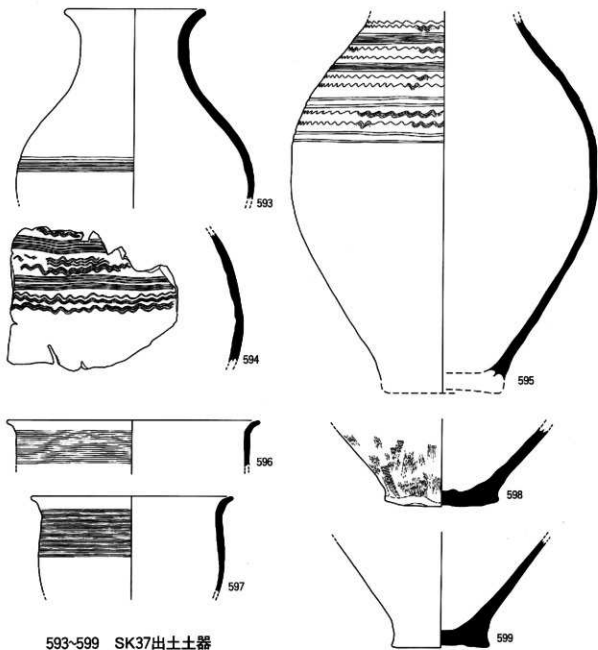

593-599 SK37出土土器

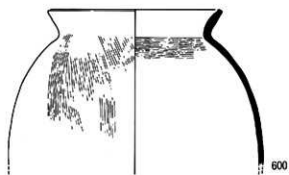

SK45出土土器



SK40出土土器

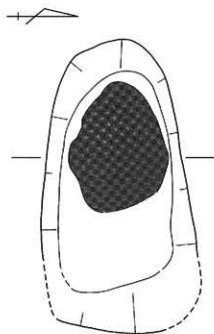

6.80m

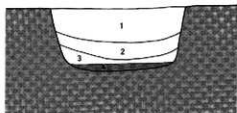

0 1m

1. 灰色シルト混じり極細砂
2. 灰褐色シルト質極細砂
3. 黒灰色シルト
4. 白色粘土

SK38

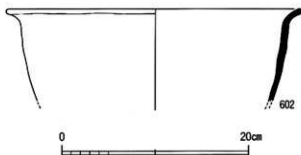

SK38出土土器

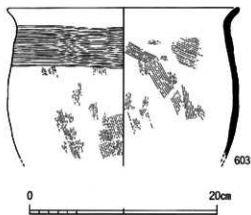

SK50出土土器

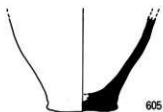
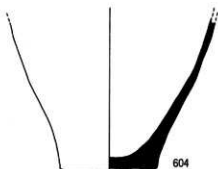

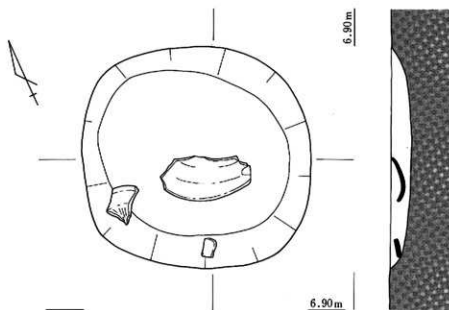

0 1m

1. 黒褐色シルト質硬凝砂

SK47

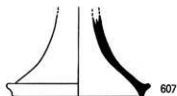
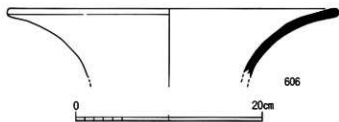

SK47出土土器

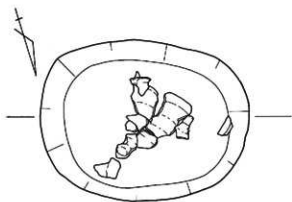

6.90m

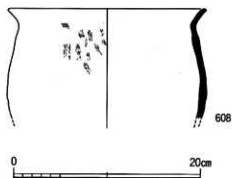

SK48出土土器



0 1m

SK48

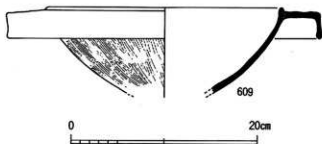
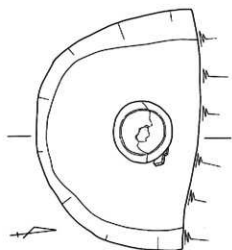

SK49出土土器

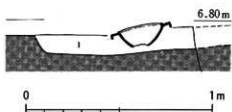

1. 10YR 3/1 砂質シルト

SK49

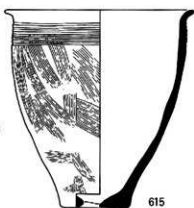
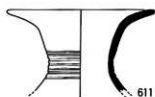
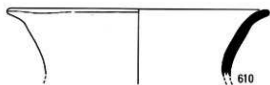

SK56出土土器 (1)

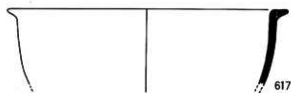

617

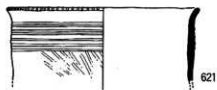

621



618

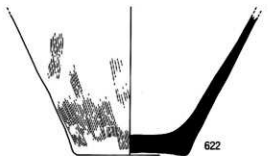

622

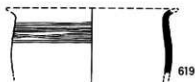

619



623



620

SK56出土土器 (2)

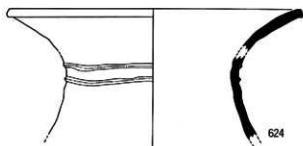

624

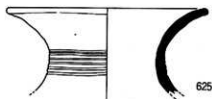

625

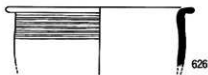

626

SK60出土土器



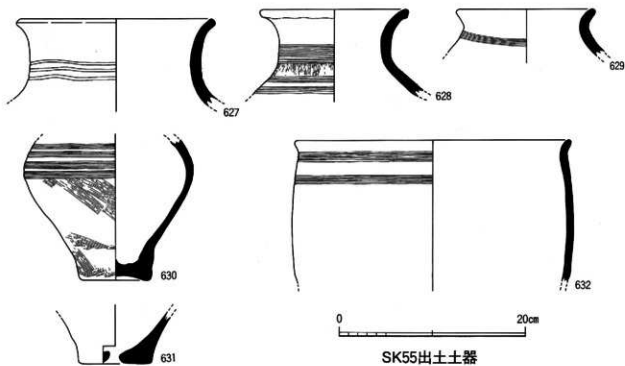
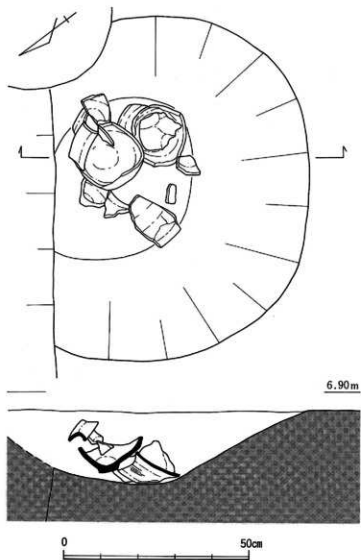

SK55出土土器

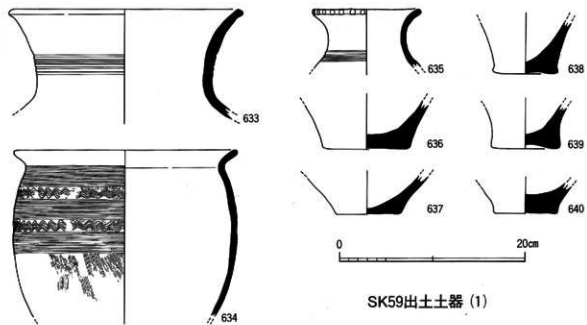
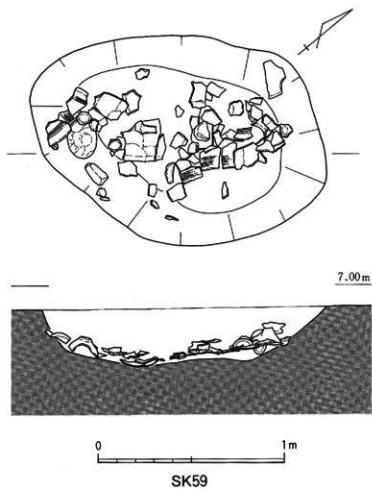



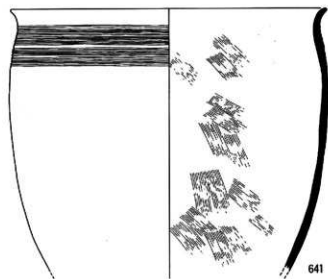

SK59出土土器 (2)

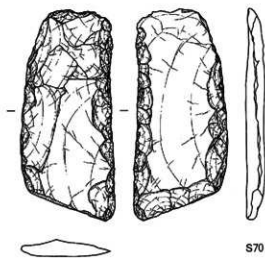

SK59出土石器

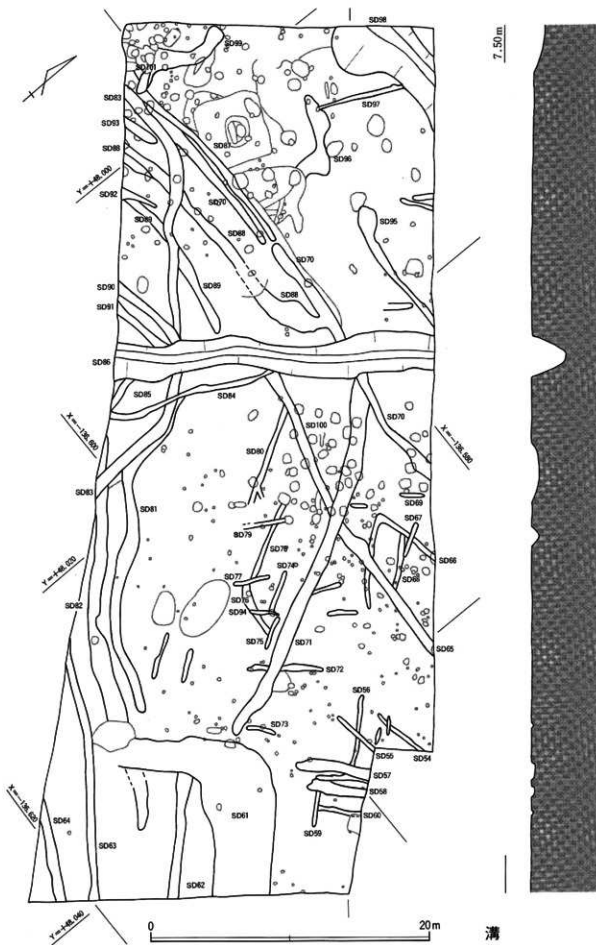

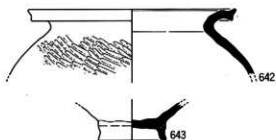
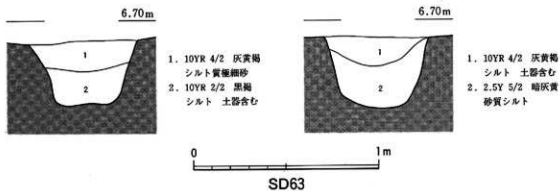

SD55出土土器



SD63出土土器

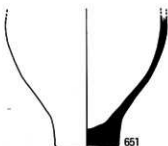
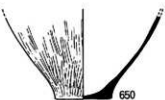
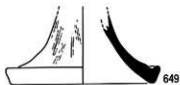
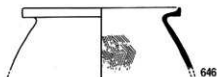
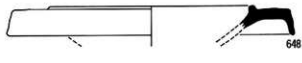
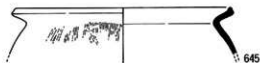

645-649 SD66出土土器

650 SD82出土土器

651-653 SD71出土土器

6.80m

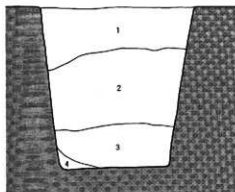

1. 褐色極細砂と灰色極細砂の混じり
2. 黄褐色シルト質極細砂と黒灰色極細砂質シルトの混じり
3. 黄褐色シルト質極細砂と黒灰色極細砂質シルトの混じり
4. 灰色極細砂～細砂

6.80m

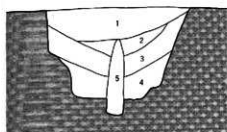

1. 灰色極細砂
2. 暗灰色極細砂（灰色極細砂がブロックで混ざる）
3. 灰色シルト混じり極細砂（ツミナ）
4. 暗灰色シルト混じり極細砂（ツミナ）
5. 暗灰色シルト混じり極細砂（下層はグライ化）

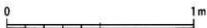

SD83

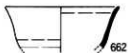
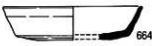
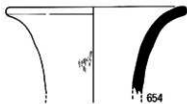

- |         |          |
|---------|----------|
| 654~658 | SD83出土土器 |
| 659~660 | SD84出土土器 |
| 661~663 | SD61出土土器 |
| 664     | SD71出土土器 |
| 665     | SD85出土土器 |
| 666     | SD94出土土器 |

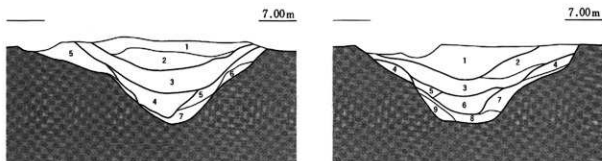

- |                 |          |           |      |
|-----------------|----------|-----------|------|
| 1. 10YR 3/2 黒褐  | 極細砂      | シルトブロック含む | } 上層 |
| 2. 10YR 4/2 灰黄褐 | 極細砂      | 炭含む       |      |
| 3. 10YR 3/2 黒褐  | シルト質極細砂  | 炭含む       | } 中層 |
| 4. 2.5Y 3/2 黒褐  | シルト      | ラミナ       |      |
| 5. 10YR 4/2 灰黄褐 | シルト混じり細砂 |           | } 下層 |
| 6. 10YR 5/2 灰黄褐 | 細砂混じりシルト |           |      |
| 7. 2.5Y 5/2 暗灰黄 | 細砂       | 上方シルト     | ラミナ  |

- |                  |          |      |      |
|------------------|----------|------|------|
| 1. 7.5YR 4/2 灰褐  | 極細砂      | } 上層 |      |
| 2. 7.5YR 3/2 黒褐  | シルト質極細砂  |      |      |
| 3. 10YR 3/2 黒褐   | 細砂混じりシルト | } 中層 |      |
| 4. 2.5Y 5/1 黄灰   | シルト混じり細砂 |      |      |
| 5. 10YR 4/2 灰黄褐  | 細砂混じりシルト | 炭含む  |      |
| 6. 5YR 3/1 オリーブ黒 | シルト      | ラミナ  | } 下層 |
| 7. 10YR 4/2 灰黄褐  | シルト混じり細砂 |      |      |
| 8. 5YR 4/2 灰オリーブ | 細砂       |      |      |
| 9. 10YR 4/2 灰黄褐  | シルト      |      |      |

0 20m

SD86

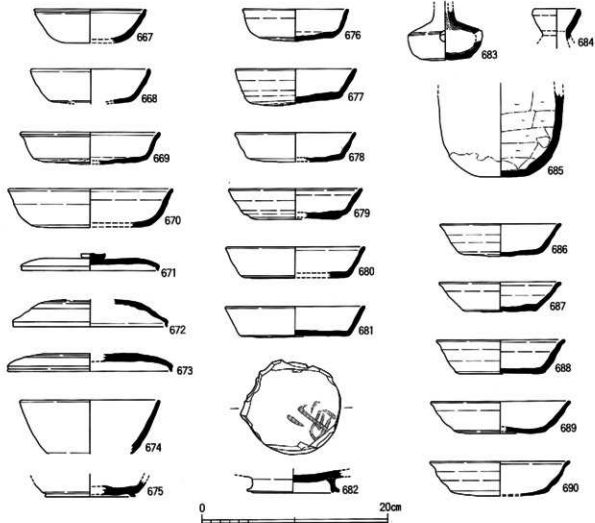

SD86出土土器 (1)

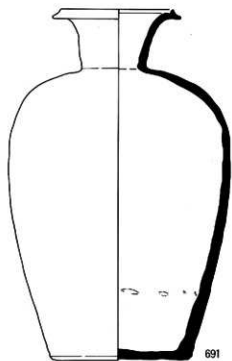

691

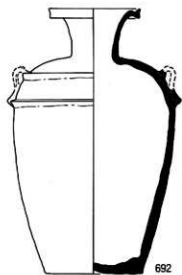

692

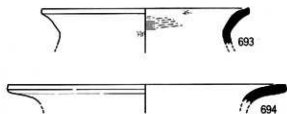

693

694

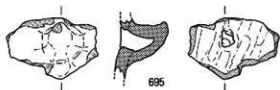

695



SD86出土土器 (2)

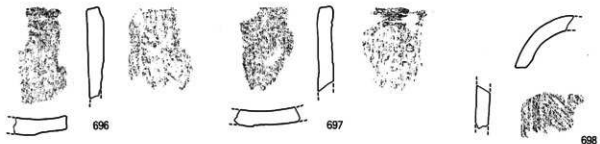

696

697

698



SD86出土瓦

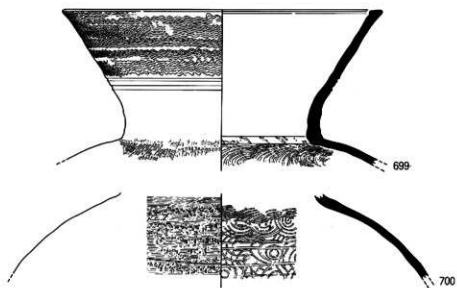

SD90出土土器

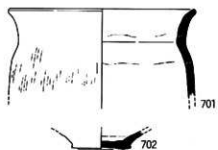

701 SD91出土土器 702 SD95出土土器

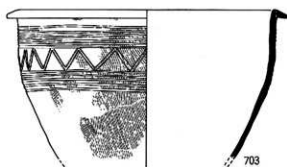

705 703~707 SD93出土土器

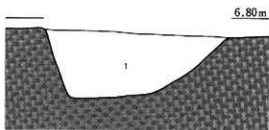

1. にぶい黄褐色 シルト質極細砂



SD99

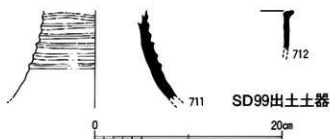
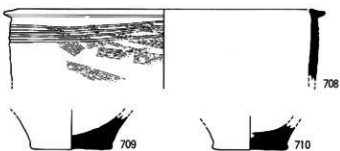

SD99出土土器

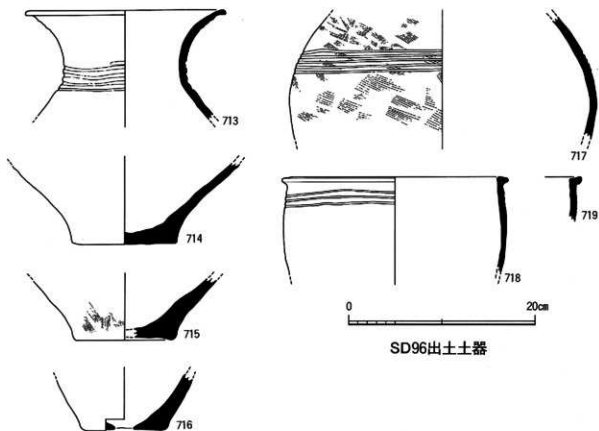

SD96出土土器

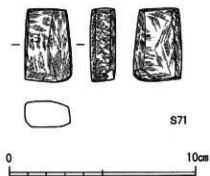

SD100出土石器



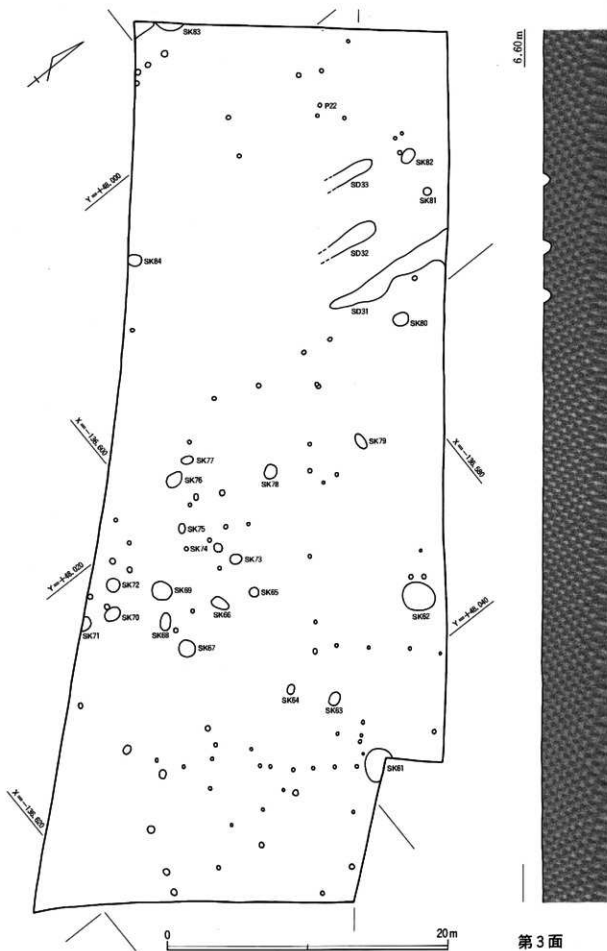

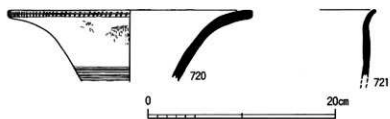

P22出土土器

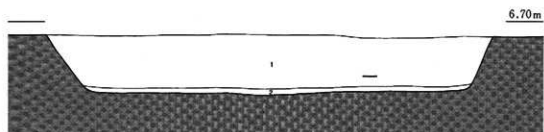
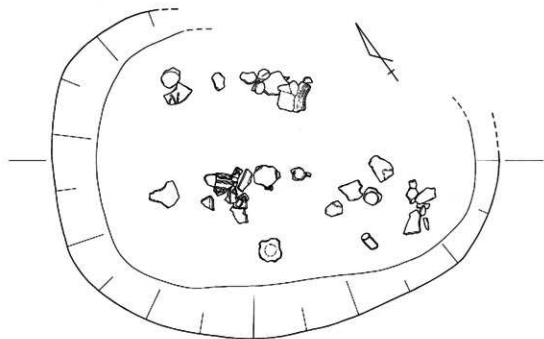

1. 暗灰色シルト質細砂 (状混じり)
2. 黒色 炭層



SK61

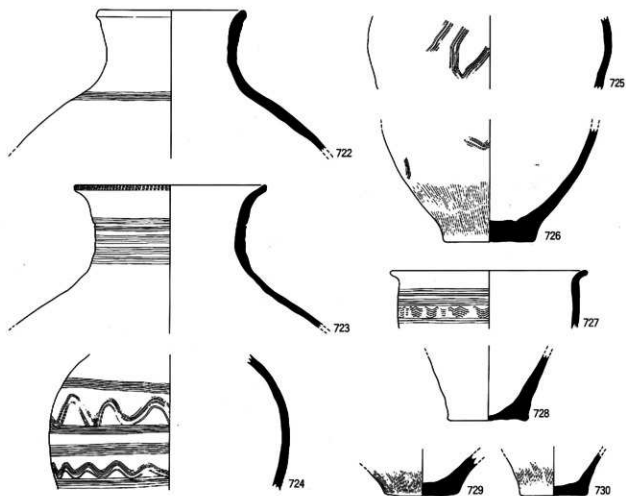

SK61出土土器

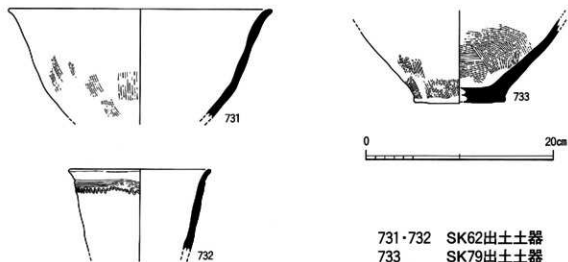

731-732 SK62出土土器  
733 SK79出土土器

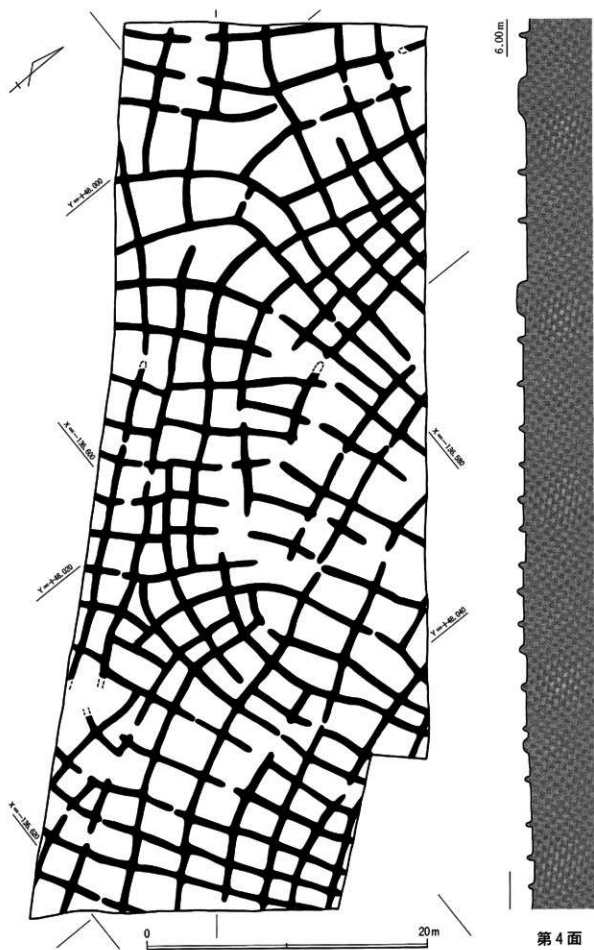

第4面

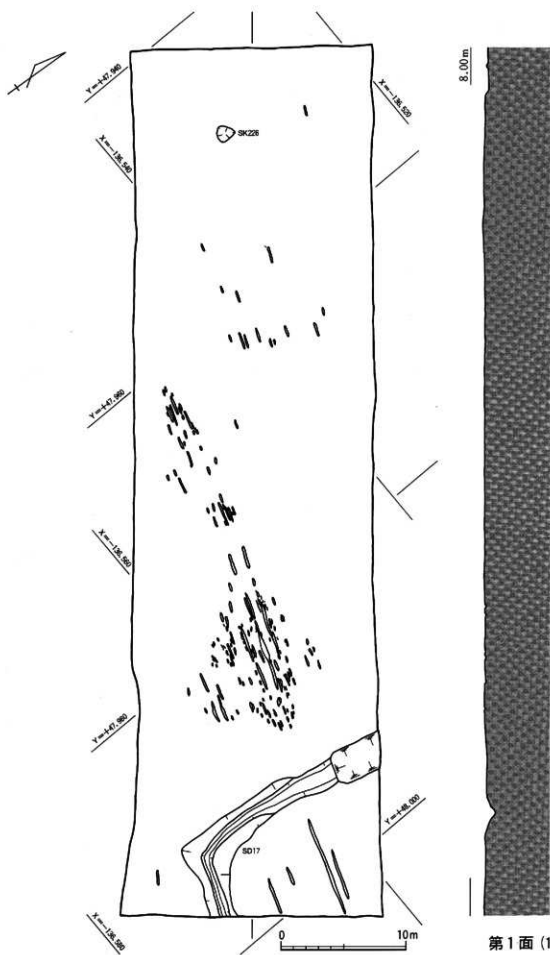

第1面(1)

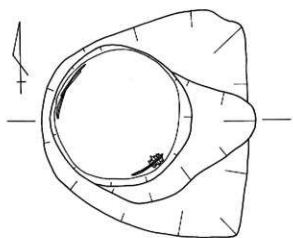

6.90m

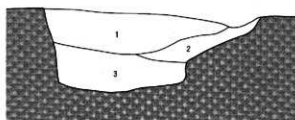

1. 明灰白色シルト混じり極細砂
2. 1層に灰褐色極細砂 (ベースの層) が混ざる
3. 灰白色シルト質極細砂

SK226

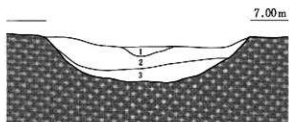

1. 極細砂混じりシルト 赤灰色
2. 極細砂混じりシルト 暗灰色
3. 極細砂混じりシルト 灰白色

SD17

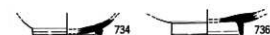

734



736



735



737



739



740



741

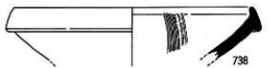

738

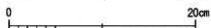

SD17出土土器・瓦

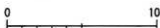

SD18出土瓦

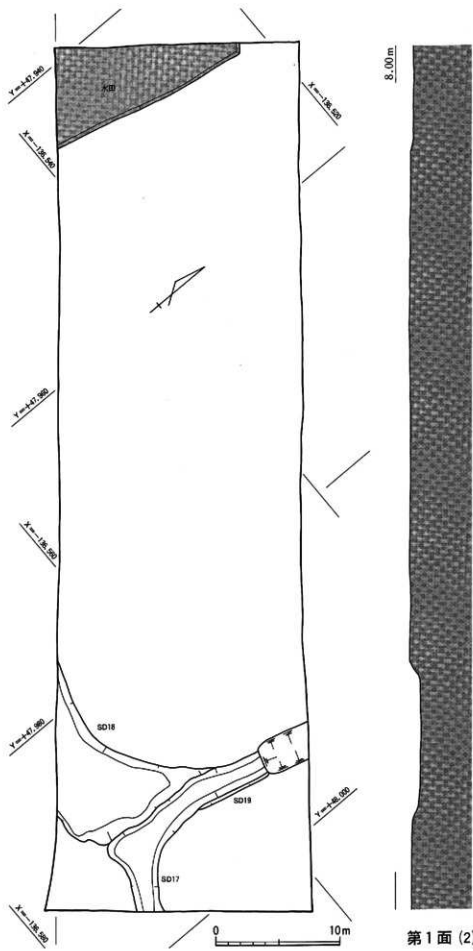

第1面(2)

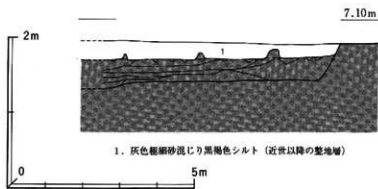
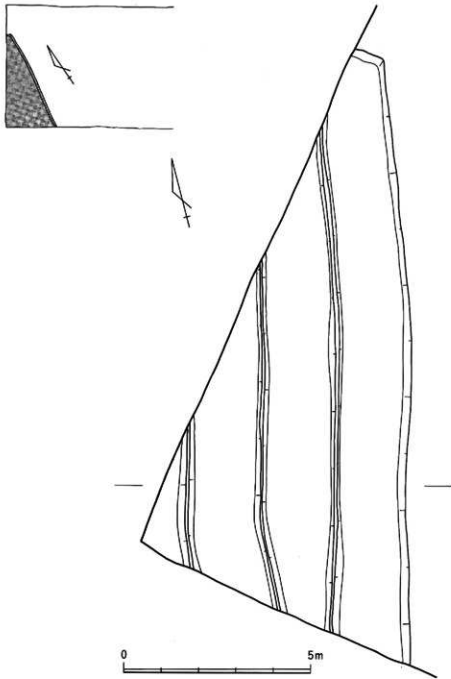

1. 灰色極細砂混じり黒褐色シルト (近世以降の整地層)

水田(上層)



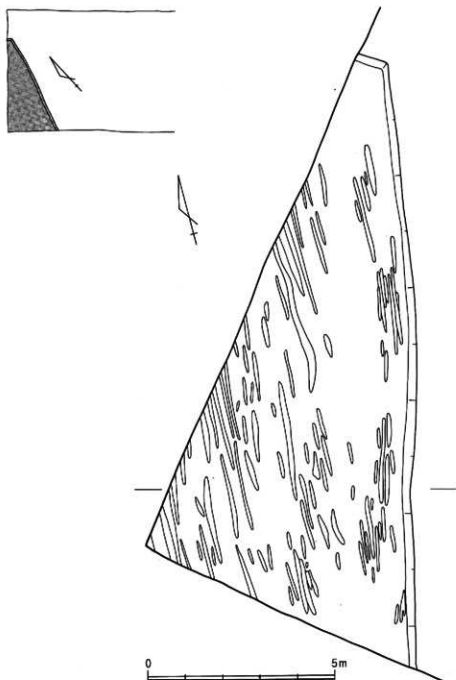

7.10m

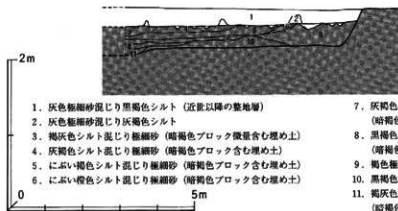

- |  |  |
|--|--|
| <p>1. 灰色極細砂混じり黒褐色シルト (近世以降の整地層)</p> <p>2. 灰色極細砂混じり灰褐色シルト</p> <p>3. 褐灰色シルト混じり極細砂 (暗褐色ブロック微量含む埋め土)</p> <p>4. 灰褐色シルト混じり極細砂 (暗褐色ブロック含む埋め土)</p> <p>5. にぶい褐色シルト混じり極細砂 (暗褐色ブロック含む埋め土)</p> <p>6. にぶい褐色シルト混じり極細砂 (暗褐色ブロック含む埋め土)</p> | <p>7. 灰褐色極細砂混じりシルト (暗褐色ブロック含む埋め土)</p> <p>8. 黒褐色極細砂混じりシルト (暗褐色ブロック含む埋め土)</p> <p>9. 褐色極細砂混じりシルト</p> <p>10. 黒褐色極細砂混じりシルト</p> <p>11. 褐灰色極細砂混じりシルト (暗褐色ブロック微量含む埋め土)</p> |
|--|--|

水田(下層)

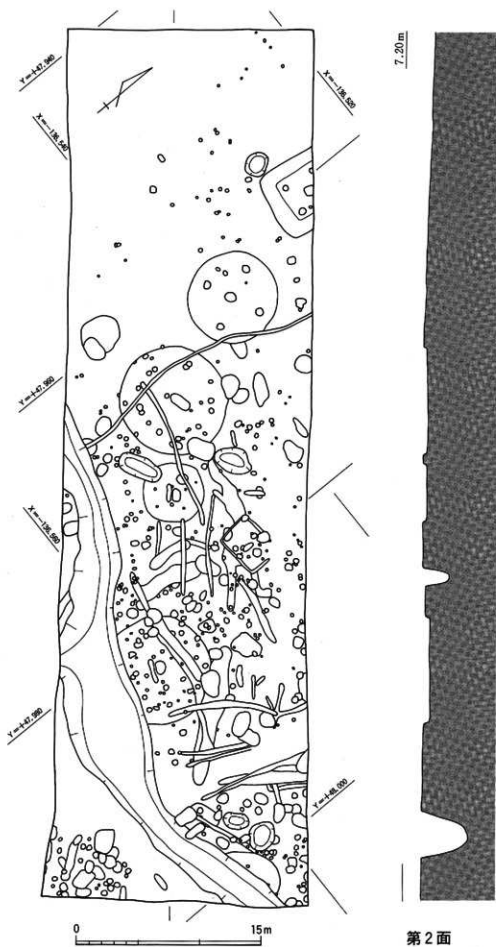

第2面

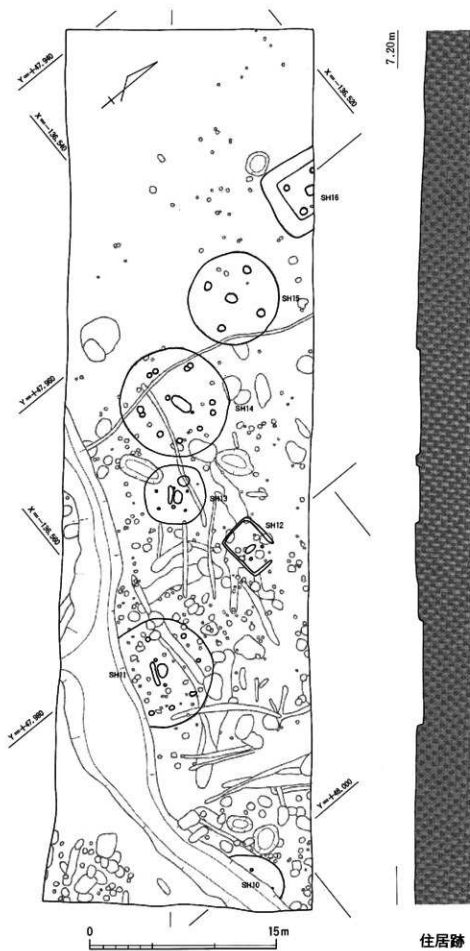

住居跡

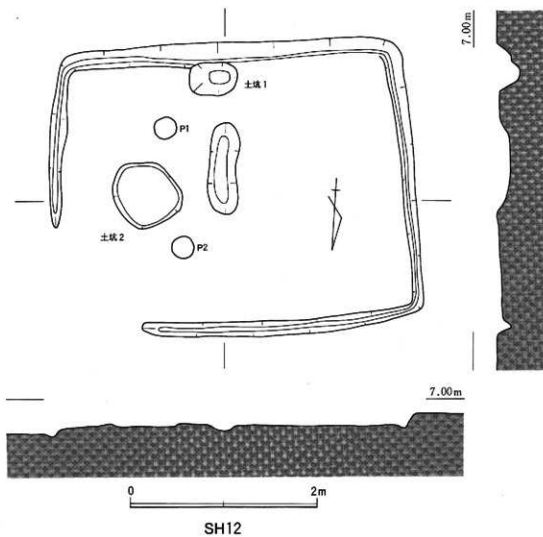
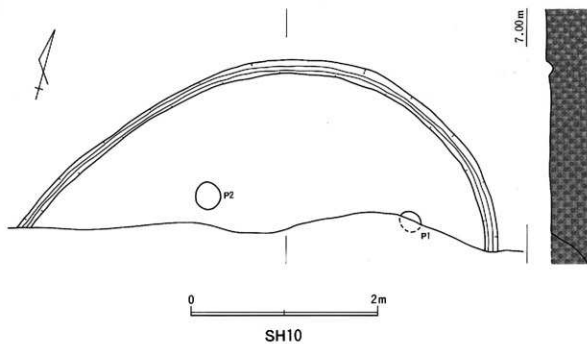

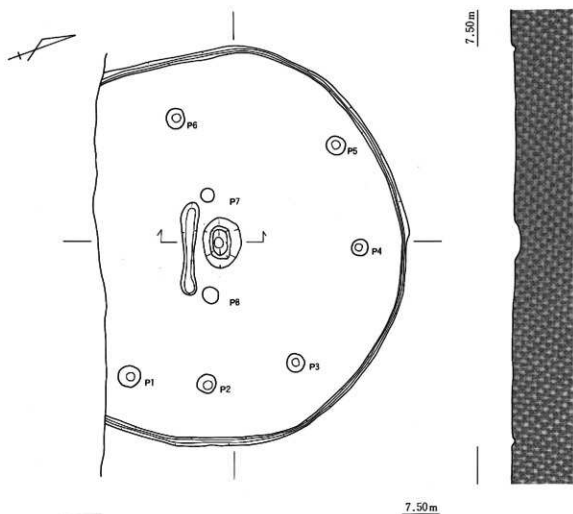

SH11

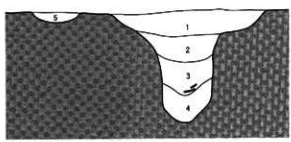
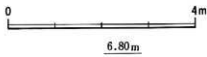

SH11中央土坑

1. 黒褐色 極細砂 (シルト・土器含む)
2. 黒褐色 シルト (炭少量含む)
3. 黒褐色 極細砂～細砂 (シルト・土器含む)
4. 黒色 シルト (炭含む)
5. 褐灰色 極細砂

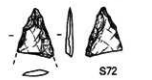

SH11出土石器

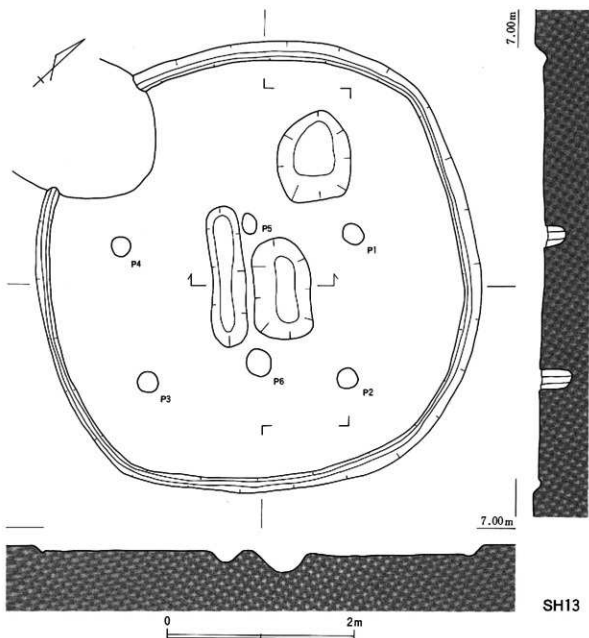

SH13

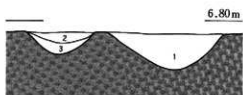

SH13中央土坑

1. 灰色 極細砂混じりシルト質極細砂
2. 灰色 シルト質極細砂 (土器多く含む・下層に炭含む)
3. 灰色 極細砂質シルト



SH13出土土器

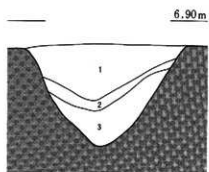
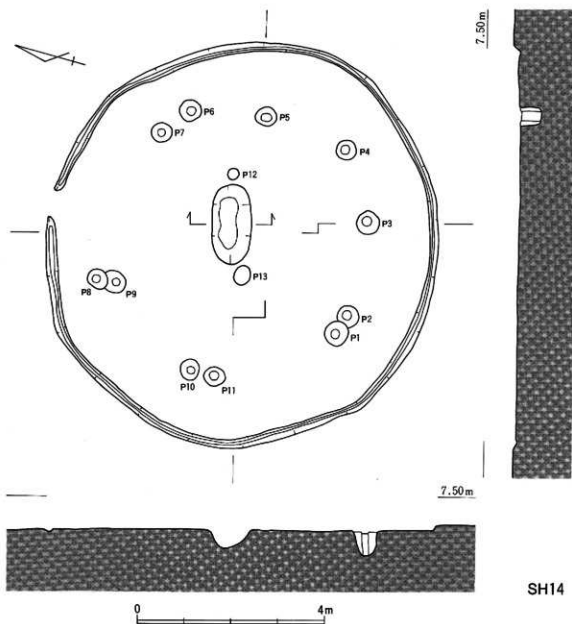

- 1. 灰色 シルト質極細砂 (土器・炭若干含む)
- 2. 暗灰色 シルト質極細砂 (炭多く含む)
- 3. 黄灰色 極細砂質シルト (土器含む)

0 50cm

SH14中央土坑



SH14出土土器



S73

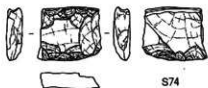

S74

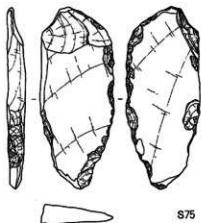

S75

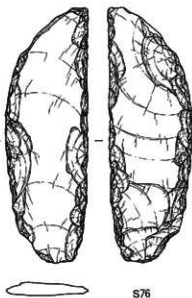

S76

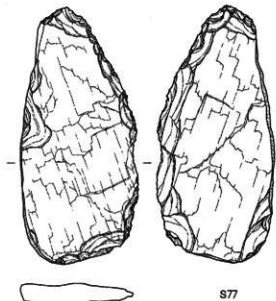

S77



SH14出土石器



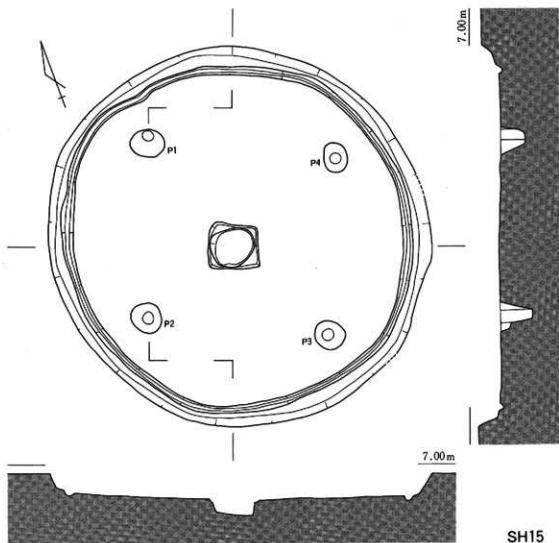

SH15

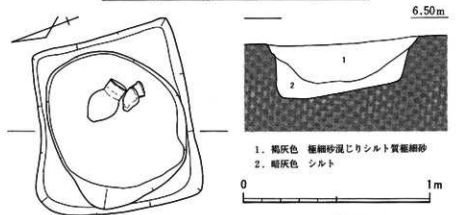
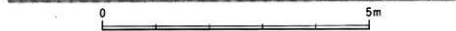

- 1. 褐灰色 極細砂混じりシルト質極細砂
- 2. 暗灰色 シルト

SH15中央土坑

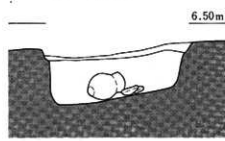

SH15中央土坑

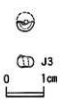

中央土坑出土玉

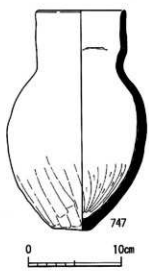

中央土坑出土土器

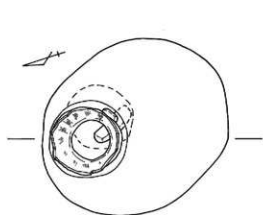

P1

6.50m

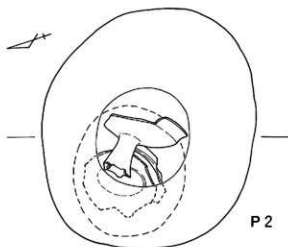

P2

6.50m

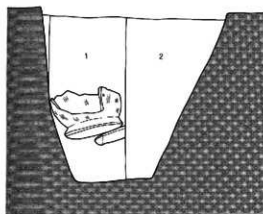

0 50cm

SH15柱穴 (1)

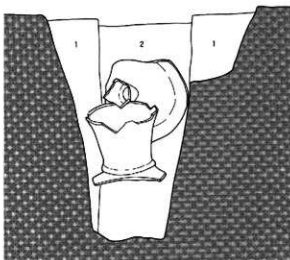

P1

1. 褐灰色 シルト質極細砂 (小礫混じり)
2. 褐灰色 シルト質極細砂

P2

1. 灰黄褐色 極細砂混じりシルト質極細砂
2. 褐灰色 シルト質極細砂

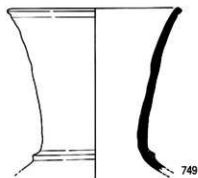

749

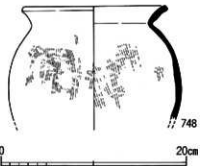

748 P1出土土器

0 20cm

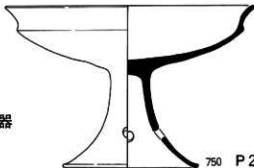

750 P2出土土器

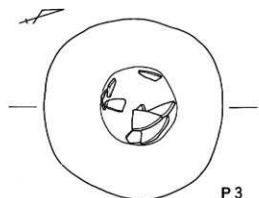

P 3

6.50m

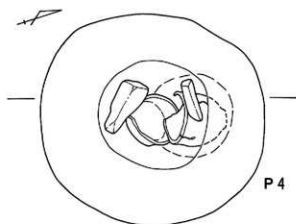

P 4

6.50m

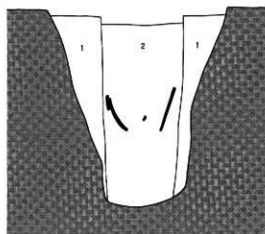

1. 灰黄褐色 極細砂混じりシルト質極細砂
2. 褐灰色 シルト質極細砂

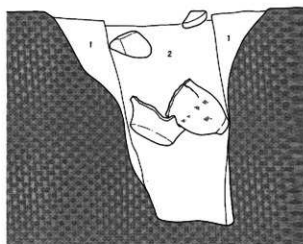

1. 黄灰色 シルト質極細砂
2. 灰色 シルト質極細砂



SH15柱穴 (2)



751 P 3 出土土器  
752・753 P 4 出土土器



752



753



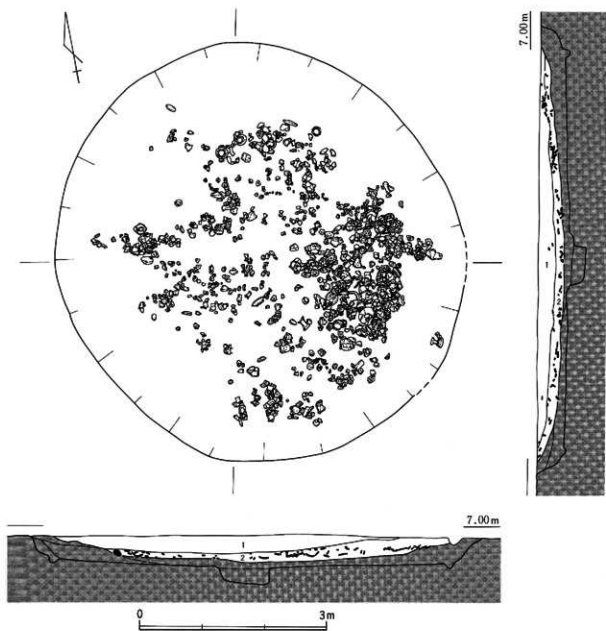

1. 黒色 シルト質極細砂 (土器若干含む)

2. 褐灰色 シルト混じりシルト質極細砂 (土器多量を含む)

SH15上層

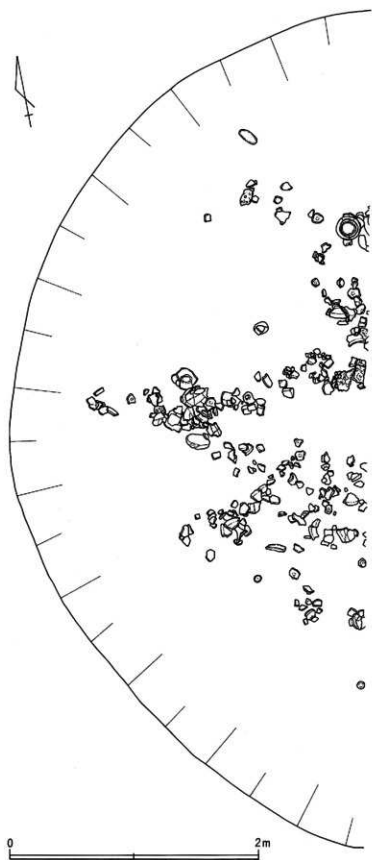

SH15上層 (1)

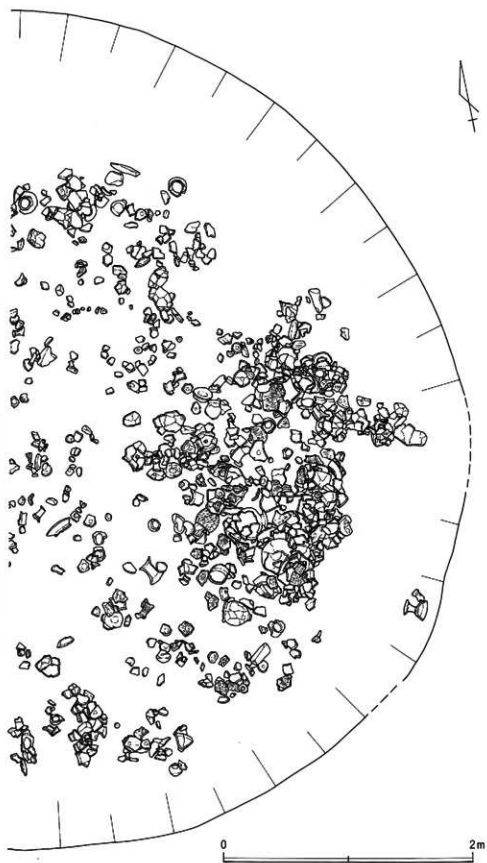

SH15上层 (2)

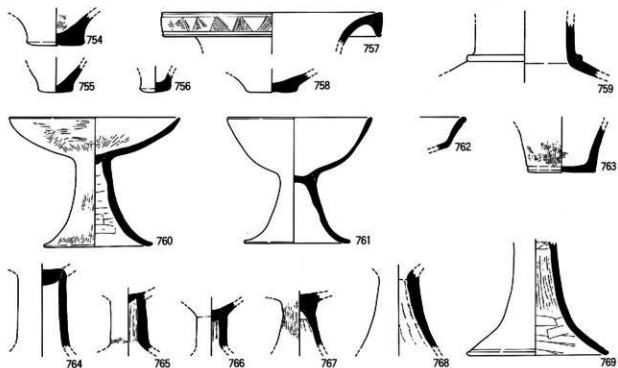

754~769 SH15下層出土土器

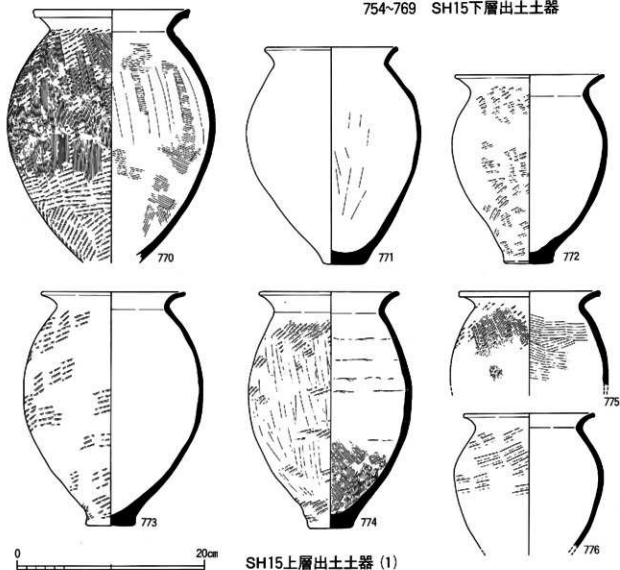

SH15上層出土土器 (1)

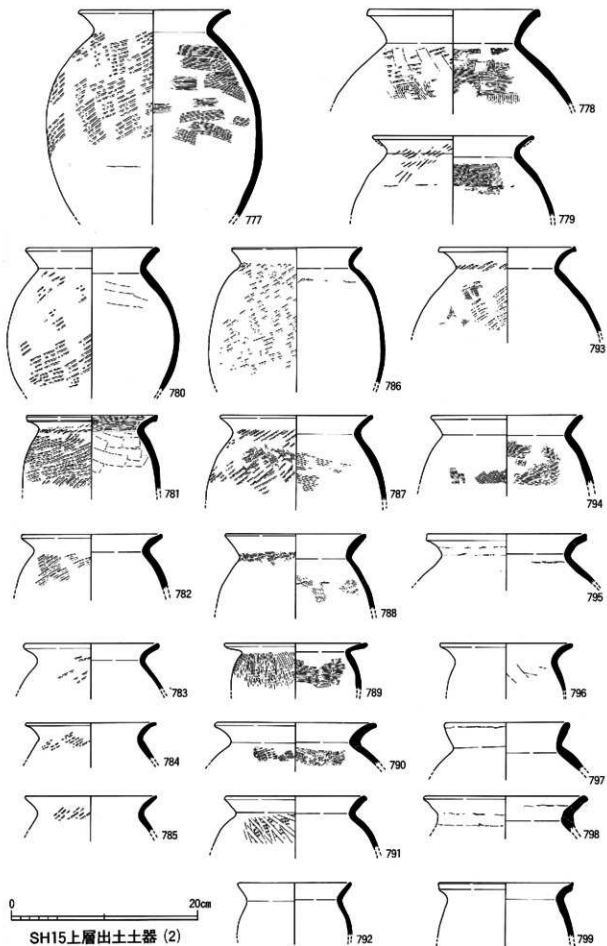

SH15上層出土土器 (2)



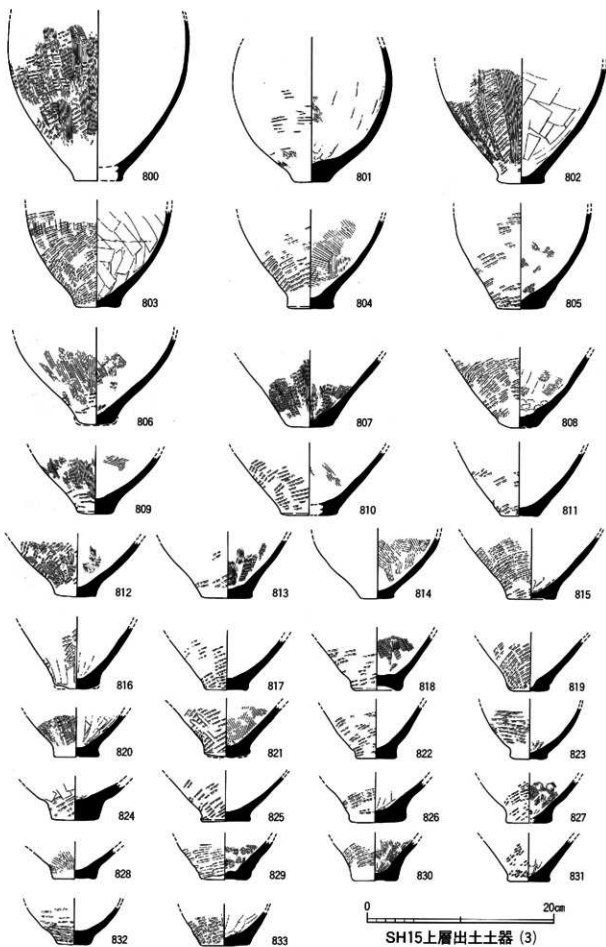

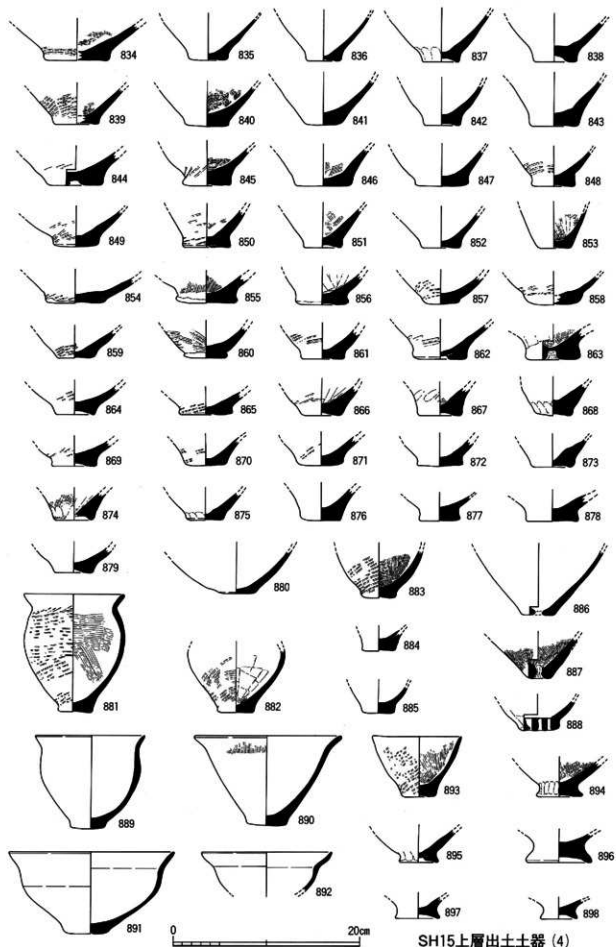

SH15上層出土土器 (4)

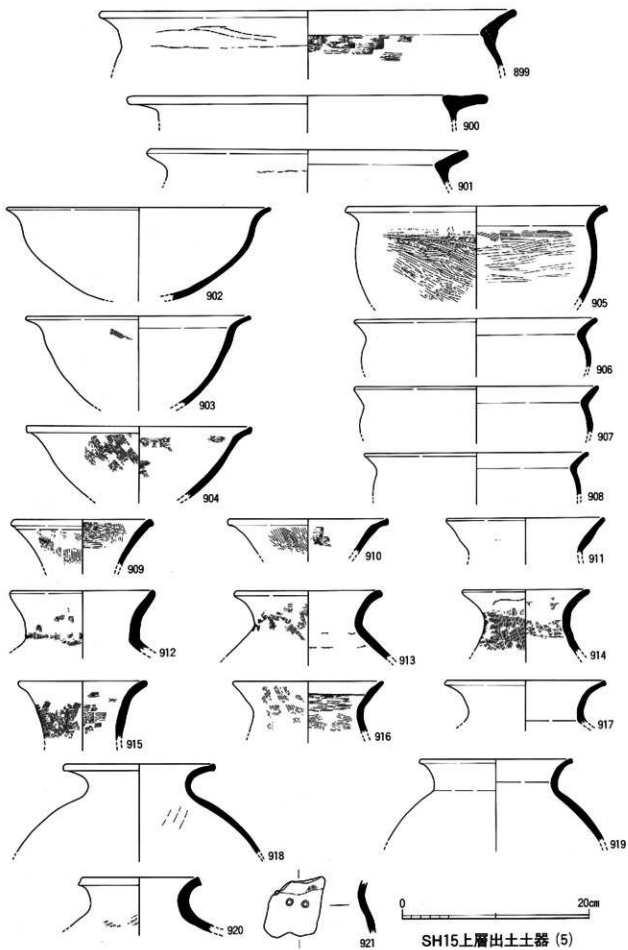

SH15上層出土土器 (5)

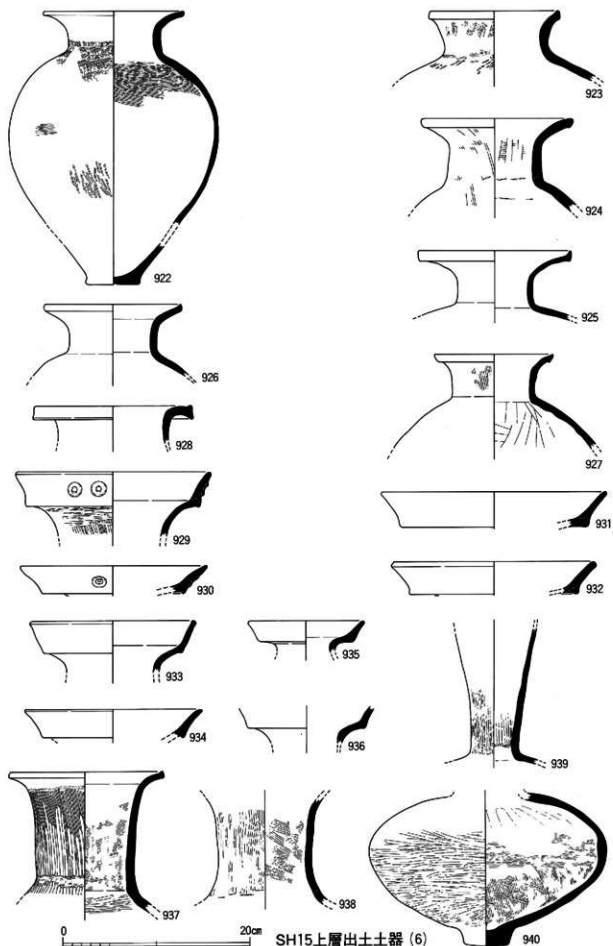

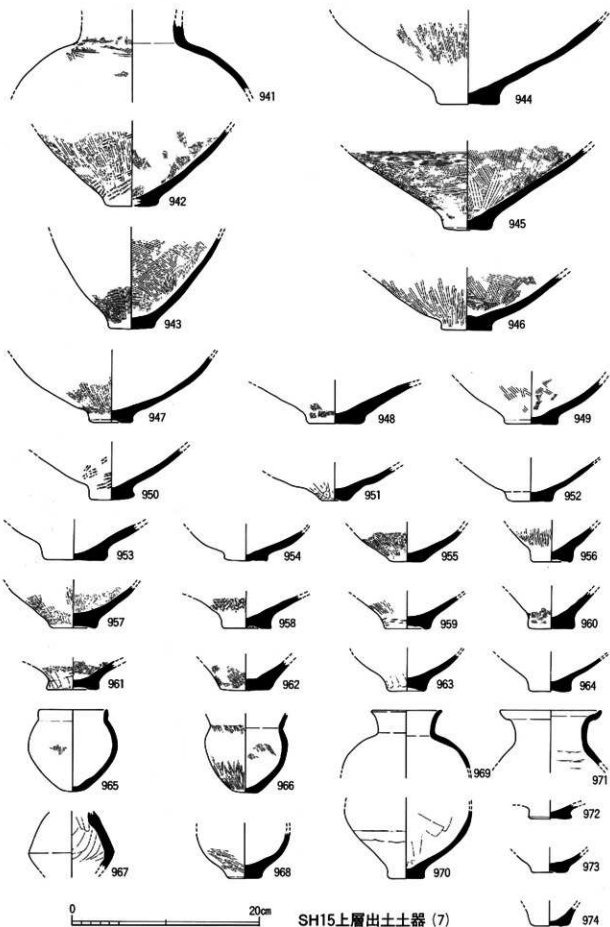

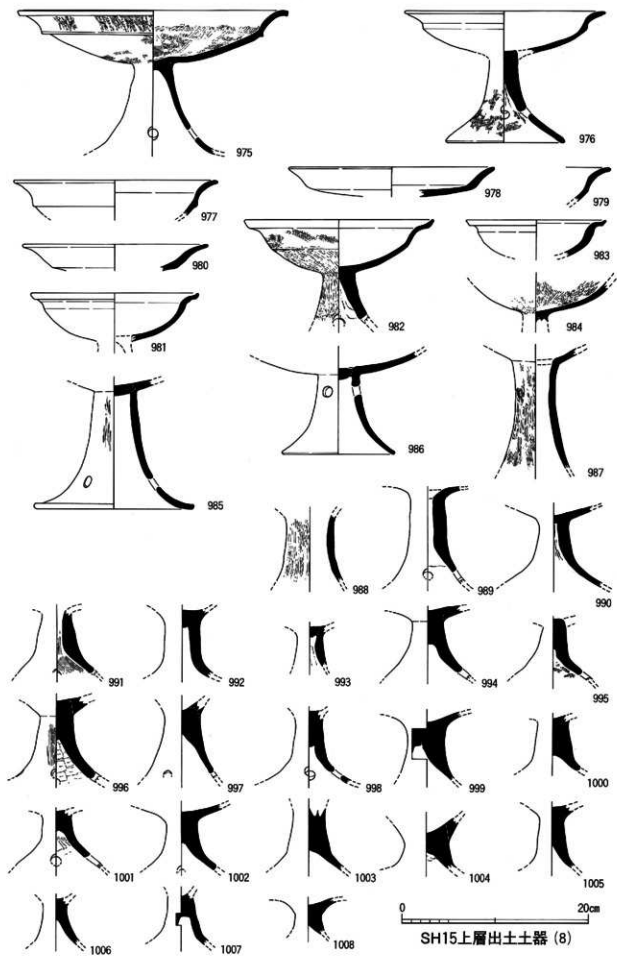

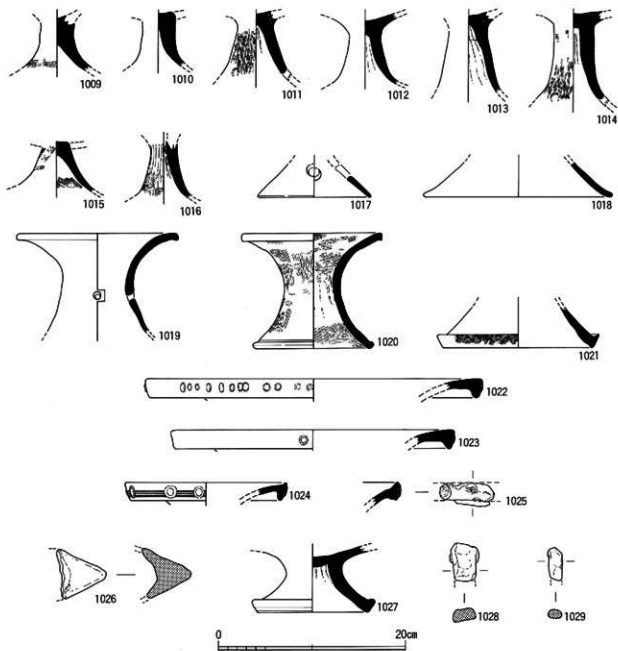

SH15上層出土土器 (9)

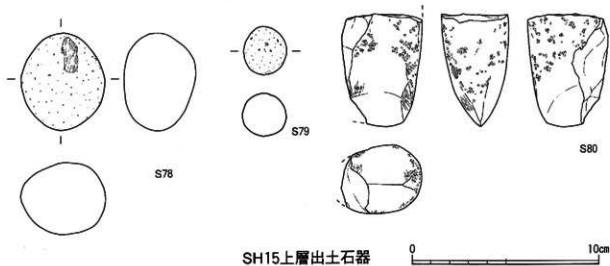

SH15上層出土土器

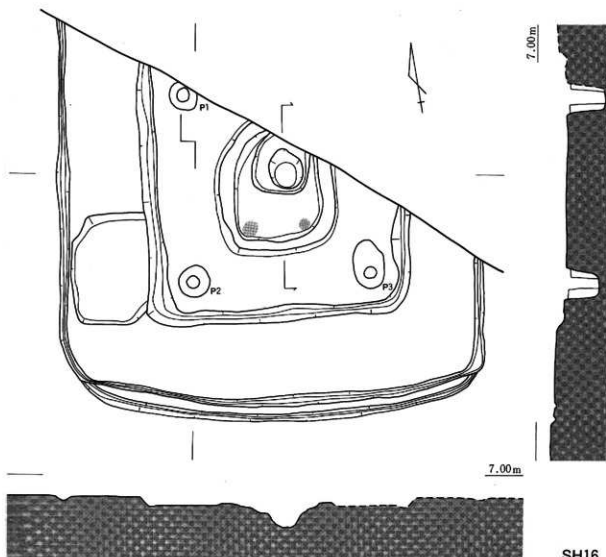

SH16

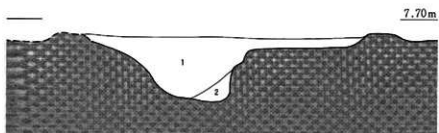

- 1. 緑褐色 シルト質粗砂  
(径2~3cmの礫混じる)
- 2. 明黄褐色 シルト質細砂

SH16中央土坑

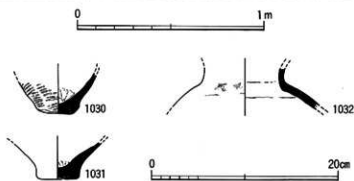

SH16出土土器



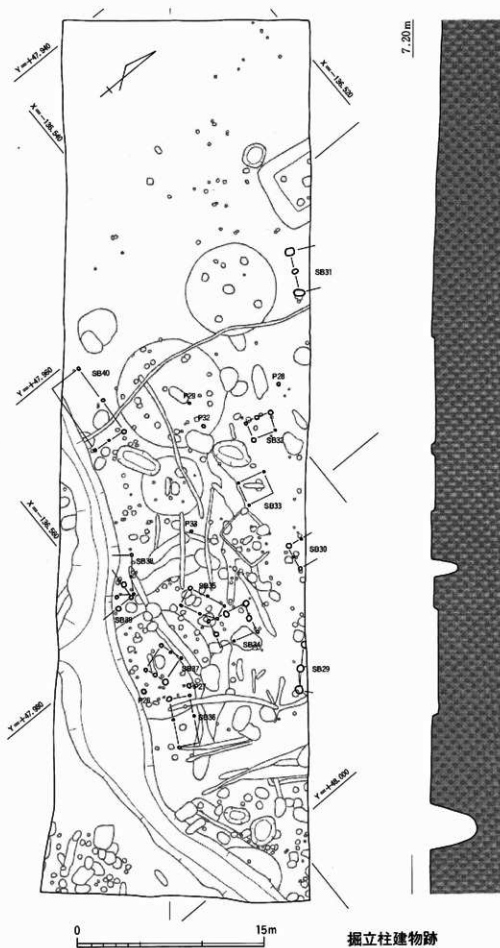

掘立柱建物跡

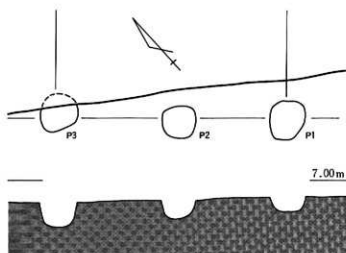

SB29

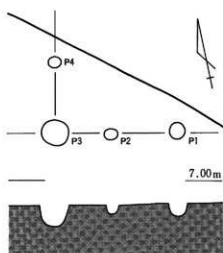

SB30

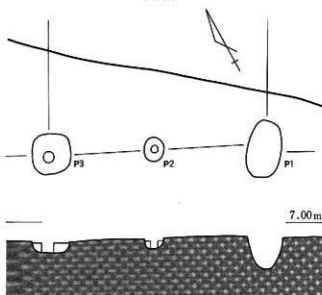

SB31

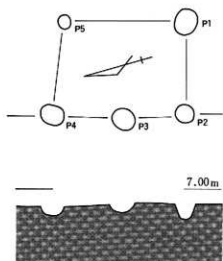

SB32

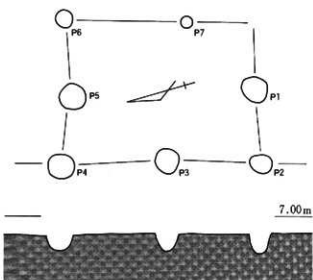

SB34

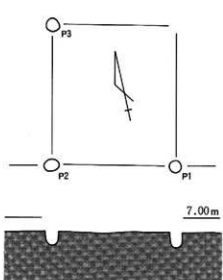

SB33



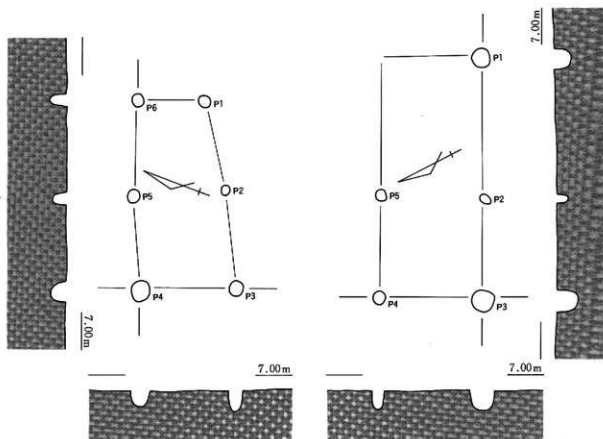

SB35

SB36

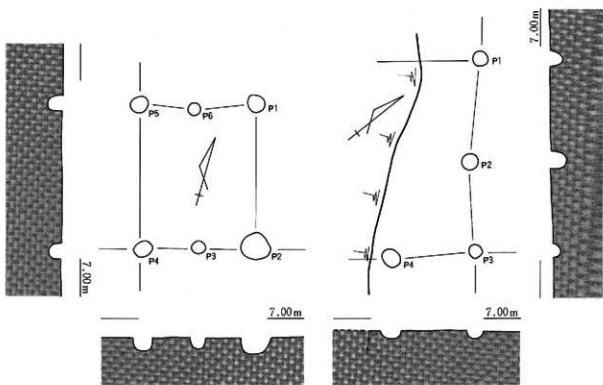

SB37

SB38



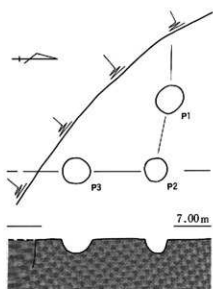

SB39

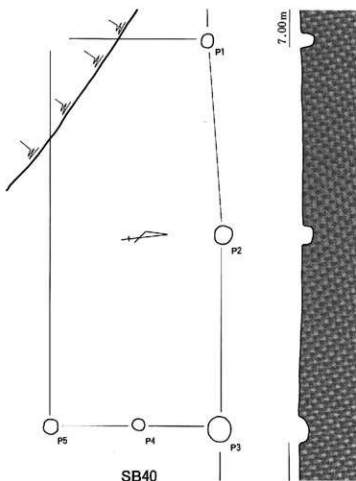

SB40

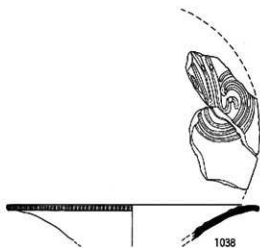
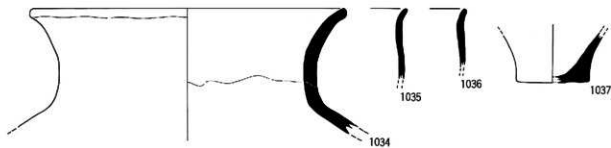

1034~1037 SB31 P1 出土土器  
1038 SB34 P5 出土土器



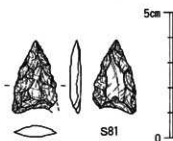
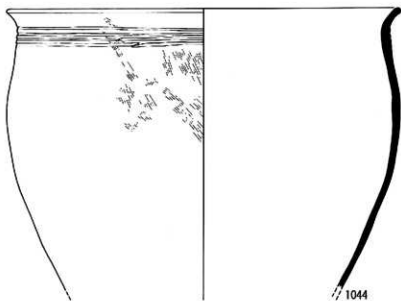
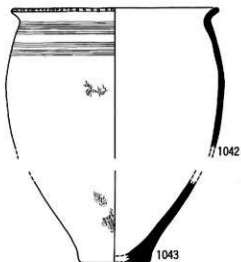
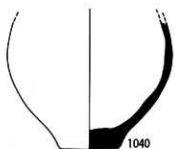
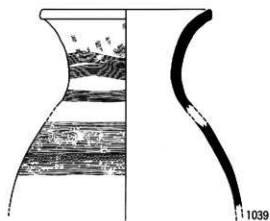

- |           |         |      |         |
|-----------|---------|------|---------|
| 1039      | P31出土土器 | 1045 | P25出土土器 |
| 1040·1044 | P28出土土器 | 1046 | P33出土土器 |
| 1041      | P26出土土器 | 1047 | P27出土土器 |
| 1042·1043 | P32出土土器 | S81  | P30出土石器 |

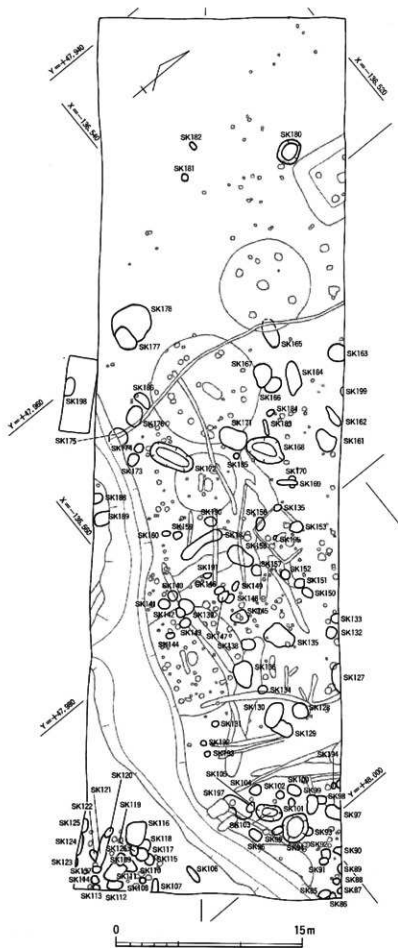

7.20m



土坑

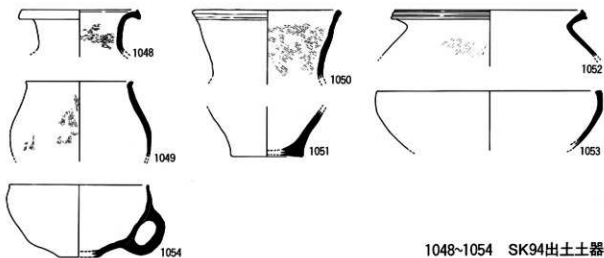

1048~1054 SK94出土土器

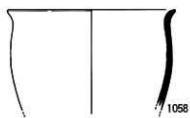
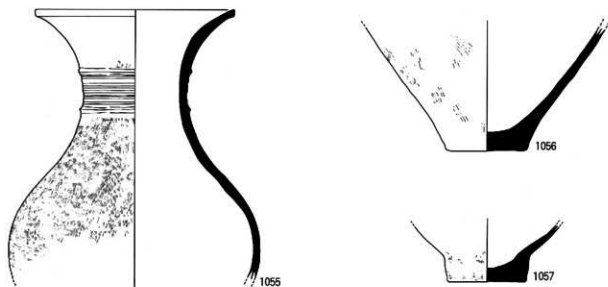

1058

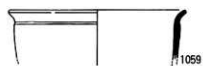

1059

1055~1059 SK99出土土器



1060



1061

1060~1061 SK100出土土器  
1062 SK106出土土器



1062



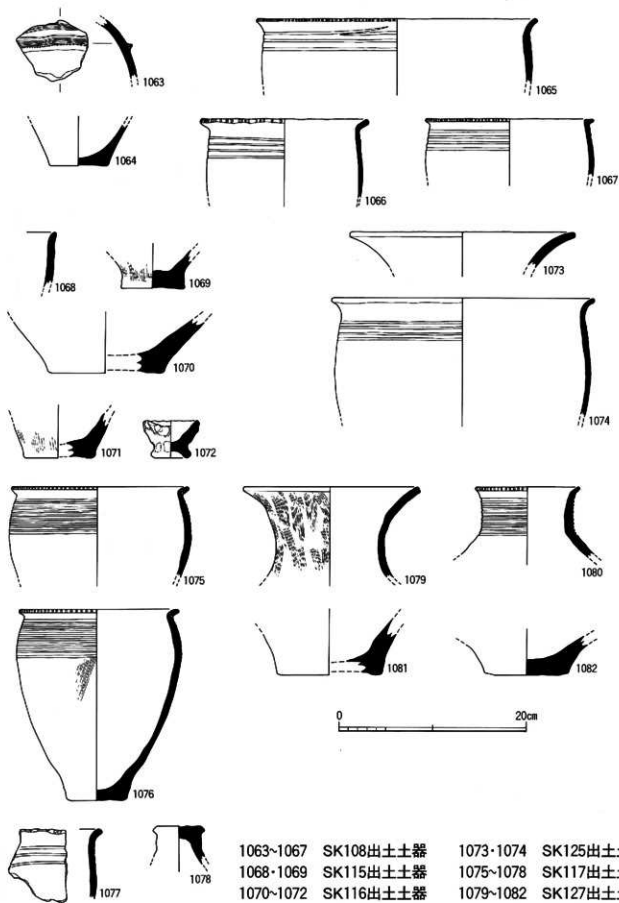

1063~1067	SK108出土土器	1073·1074	SK125出土土器
1068·1069	SK115出土土器	1075~1078	SK117出土土器
1070~1072	SK116出土土器	1079~1082	SK127出土土器