

1. 灰 燻燥分層シルト
2. 燻燥 シルト
3. 灰 シルト(燻燥分層)
4. 明灰 燻燥分層シルト (炭層)
5. 灰 シルト (燻燥)
6. 明灰燻 燻燥分層シルト (炭層)
7. 明灰 燻燥分層シルト
8. 灰 シルト
9. 明灰燻 シルト
10. 明灰 燻燥分

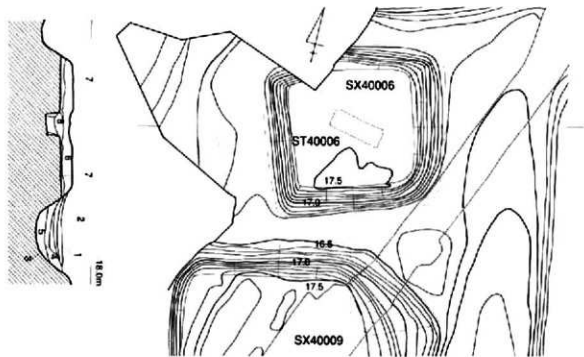

- 1 地底層 シルト質堆積物 (Fe₂O₃・R)
- 2 2層 シルト質堆積物 (Fe₂O₃・R)
- 3 3層 シルト質堆積物 (Fe₂O₃・R)
- 4 4層 シルト
- 5 5層 シルト
- 6 6層 黄灰
- 7 7層 黄灰
- 8 8層 シルト質堆積物

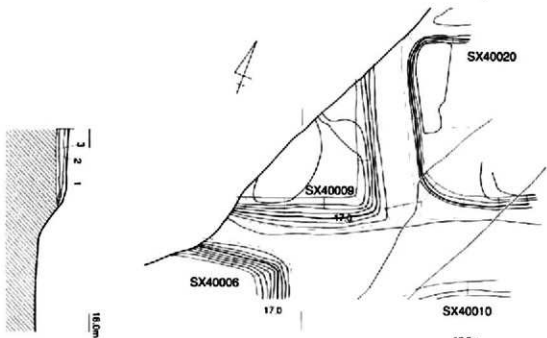
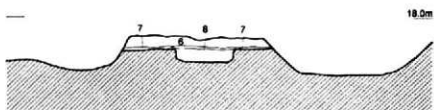

- 1 黄灰 堆積物
- 2 灰土層
- 3 シルト質堆積物



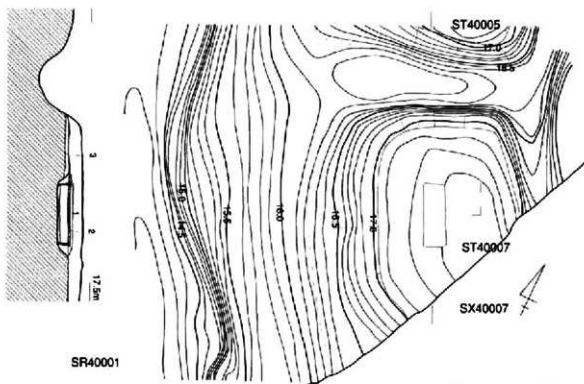

1. 土層 埋藏物 (Fe₂O₃・Mn₂O₃)
 2. 土層 埋藏物 (Fe₂O₃・Mn₂O₃)
 3. 埋藏物なし

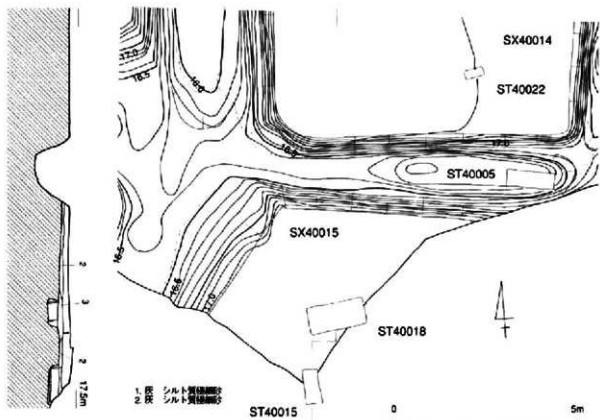
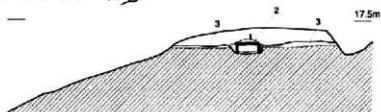

1. 埋藏物なし
 2. 埋藏物なし



方形周溝墓6 (SX40007・40015)

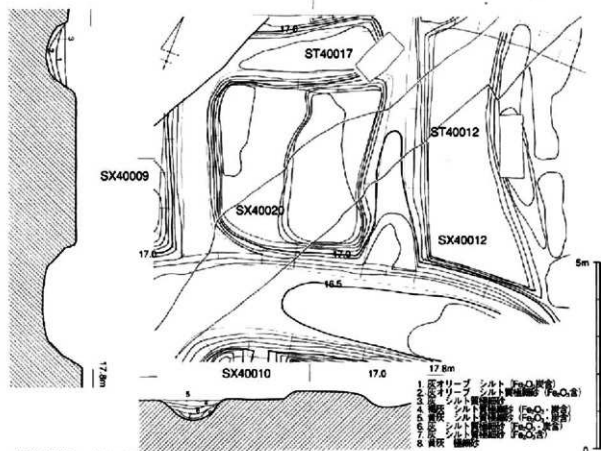
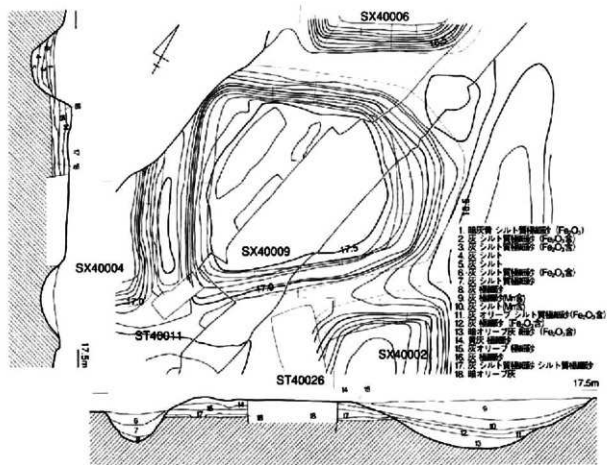

方形周溝墓7 (SX40009・40020)

圖版 47 弥生中期上層

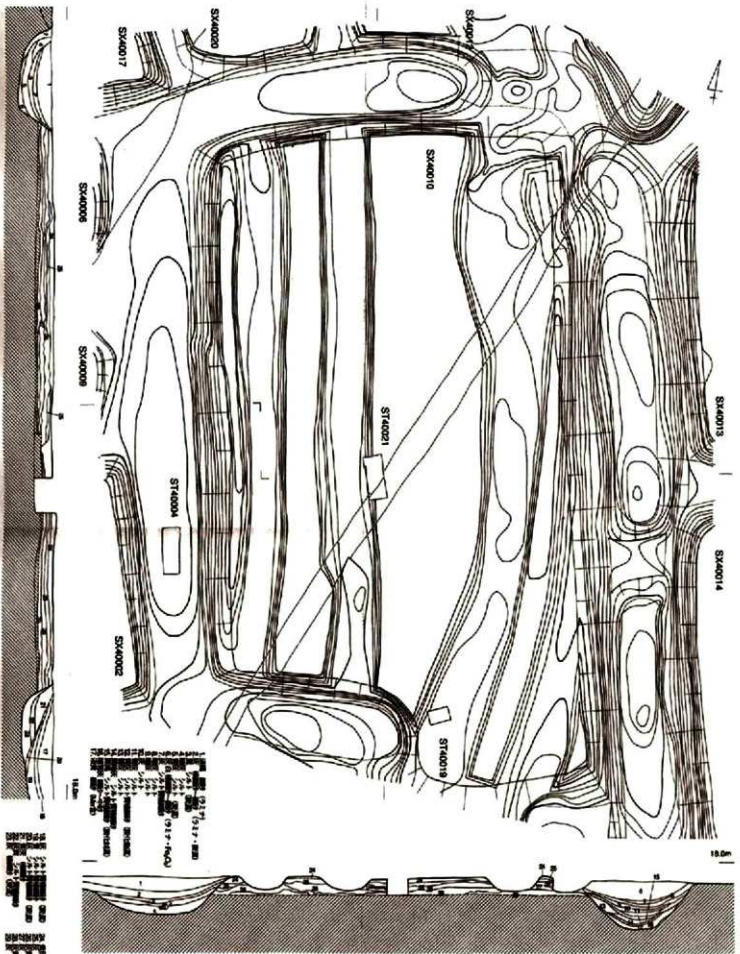

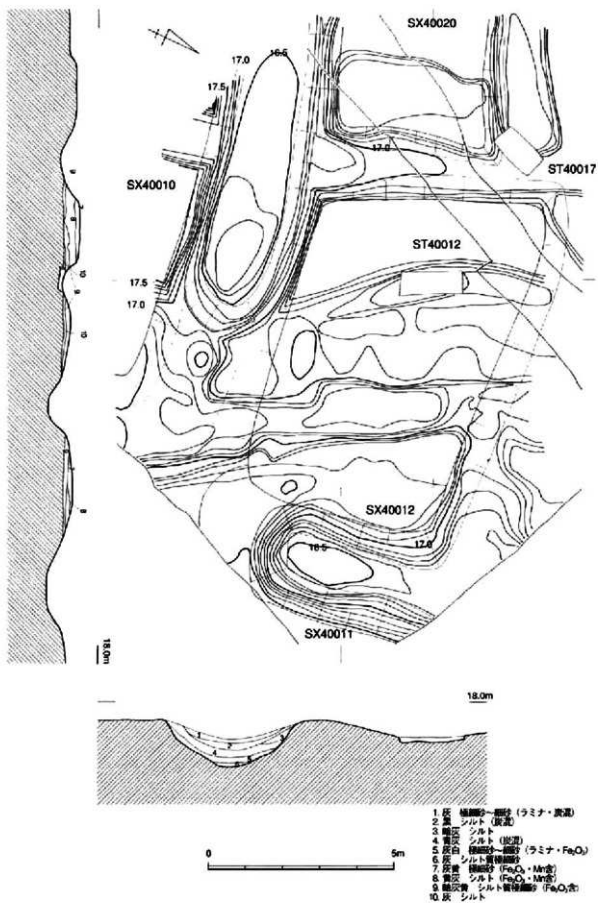

方形周溝第10 (SX40012)

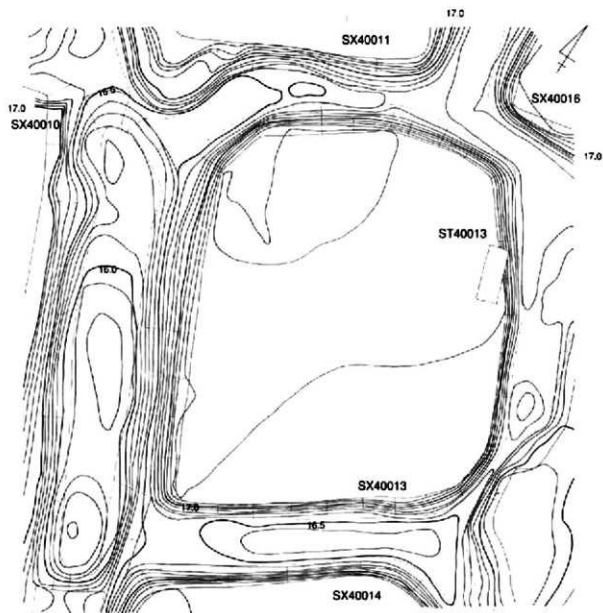

- | | | | | |
|------|---|---|------|------|
| 17.0 | 1. 灰 シルト質砂礫層 | 9. 埋戻 シルト質砂礫層 | 17.0 | 17.0 |
| | 2. 灰 シルト質砂礫層 (Fe ₂ O ₃ 含) | 10. 埋戻 シルト | | |
| | 3. 灰 礫層 | 11. 灰 礫層 (Fe ₂ O ₃ -Mn ₂ O ₃) | | |
| | 4. 土灰層 礫層 (Fe ₂ O ₃ 含) | 12. 灰 シルト質砂礫層 (Fe ₂ O ₃ -Mn ₂ O ₃) | | |
| | 5. 灰質 礫層 (Fe ₂ O ₃ 含) | 13. 灰 シルト質砂礫層 | | |
| | 6. 埋戻 埋戻 | 14. 埋戻 シルト質砂礫層 | | |
| | 7. 灰 シルト質砂礫層 (Mn ₂ O ₃ 含) | 15. 灰 礫層 | | |
| | 8. 埋戻 シルト | | | |

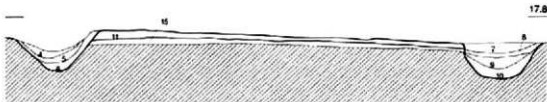

方形周溝墓11 (SX40013)

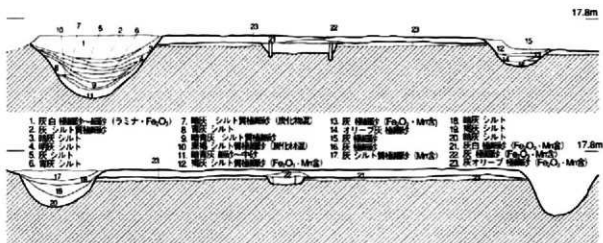
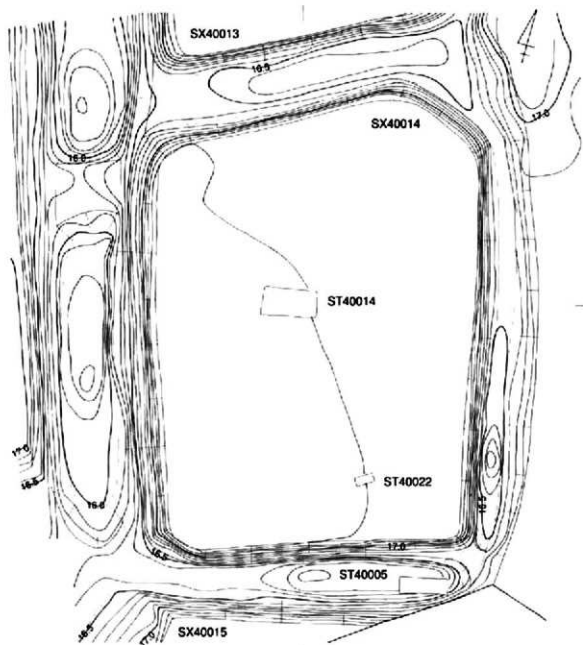

方形周溝墓12 (SX40014)

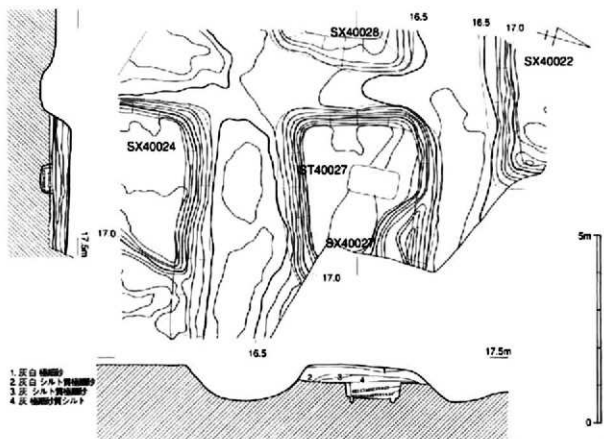
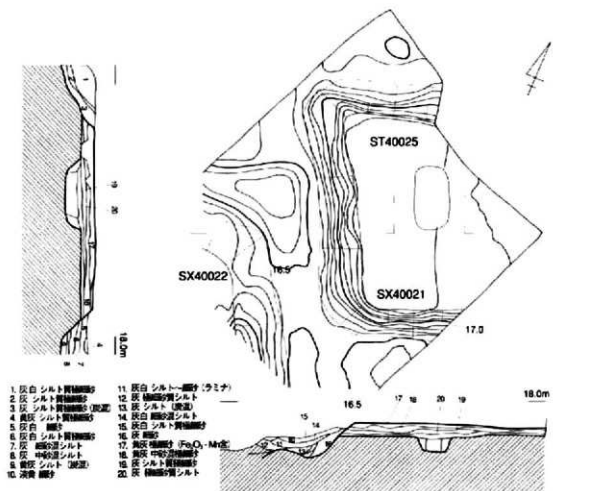

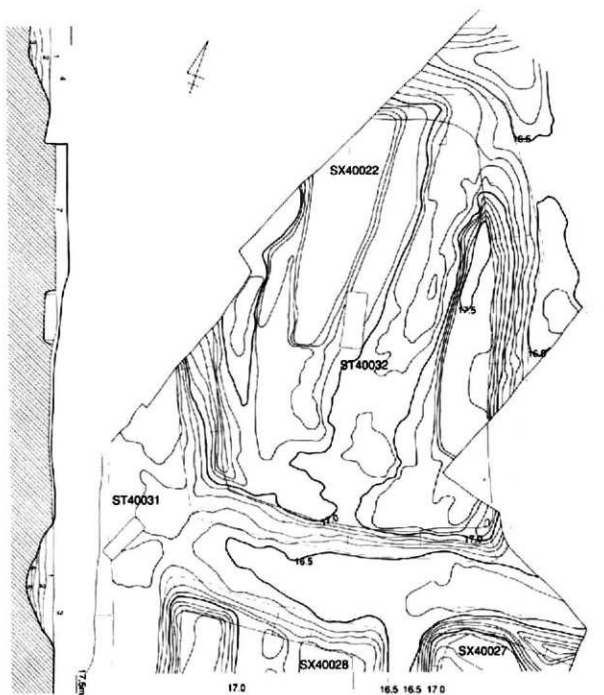

- 1 雑瓦葺 竪穴・竪石
- 2 雑瓦葺 シルト管埋設部 (少ミナ)
- 3 灰 シルト
- 4 灰 シルト 管埋設部
- 5 灰 シルト
- 6 雑瓦 埋設部質シルト (Fe₂O₃・Mn₂O₃)
- 7 灰 埋設部質シルト



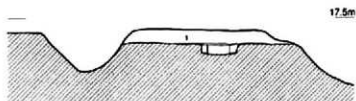
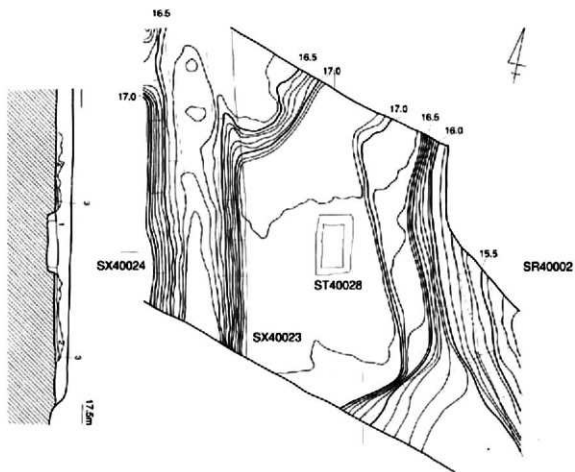

1. 粘土質 シルト質層砂一粘層分
2. 粘泥質 中砂一粘砂 (Fe₂O₃富)
3. 粘泥質 中砂一粘砂



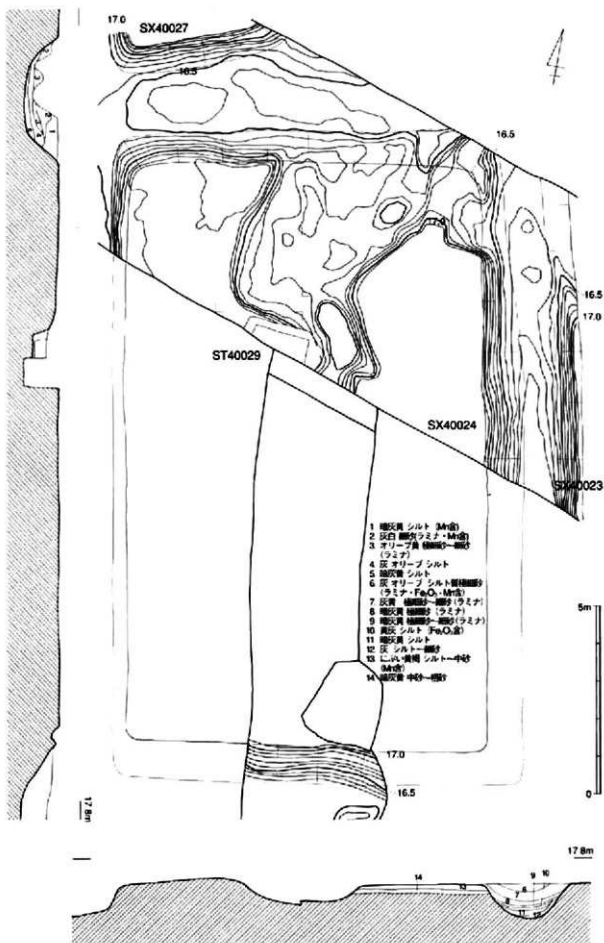

方形堀溝竪 16 (SX40024)

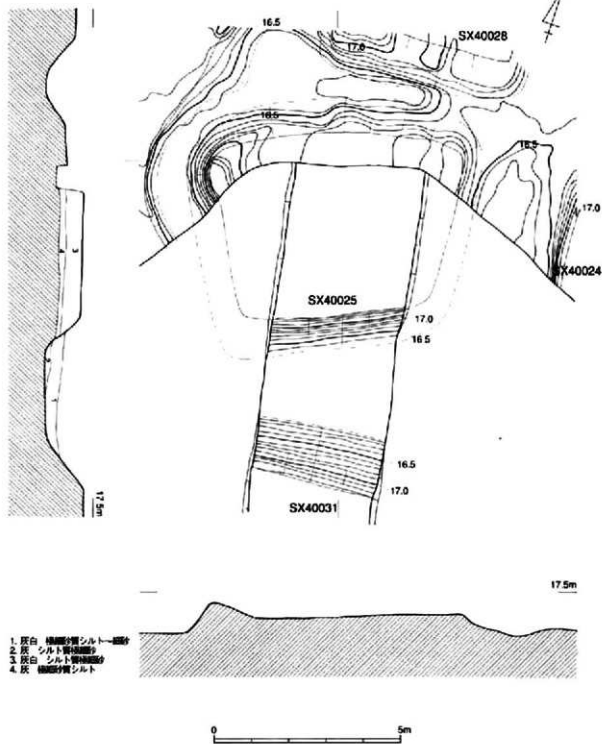

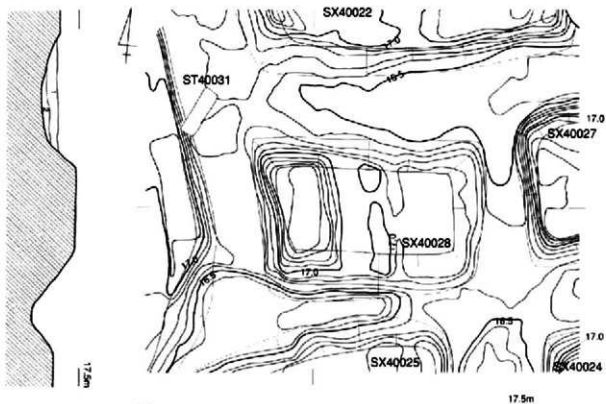

- 1 焼灰層 シルト
- 2 灰 シルト層埋藏跡

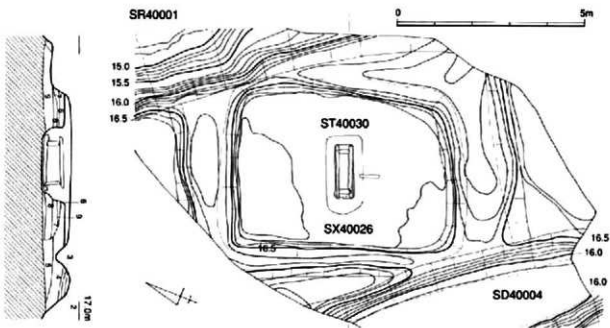

- 1 焼オリブ灰 シルト層埋藏跡
- 2 オリブ灰層埋藏跡
- 3 焼オリブ灰層埋藏跡
- 4 焼オリブ灰層埋藏跡 Fe₂O₃計
- 5 焼オリブ灰層埋藏跡
- 6 焼オリブ灰層埋藏跡
- 7 焼オリブ灰層埋藏跡 Fe₂O₃計
- 8 焼オリブ灰層埋藏跡 Fe₂O₃計
- 9 灰 シルト Fe₂O₃計
- 10 焼オリブ灰層埋藏跡 Fe₂O₃計

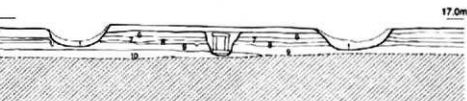

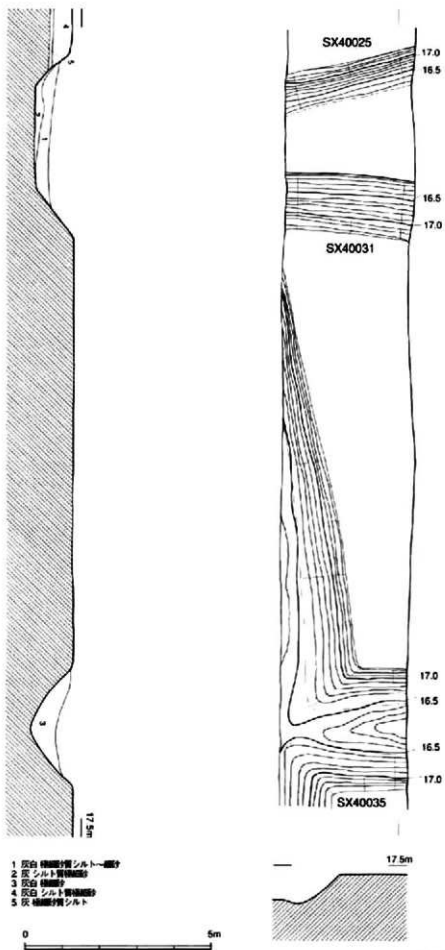

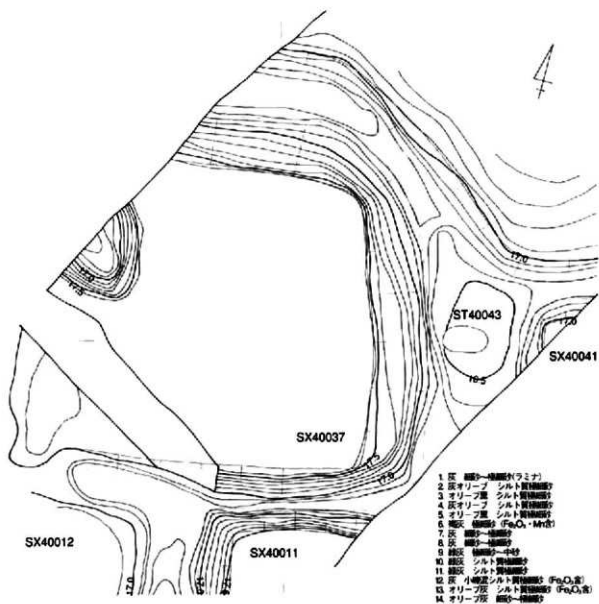

- 1 灰 凝灰-粘板状(ラミナ)
- 2 灰オリーブ シルト質凝灰層
- 3 オリーブ層 シルト質凝灰層
- 4 灰オリーブ シルト質凝灰層
- 5 オリーブ層 シルト質凝灰層
- 6 凝灰 凝灰層 (Fe₂O₃-Mn₂O₃)
- 7 灰 凝灰-粘板状
- 8 灰 凝灰-粘板状
- 9 凝灰 凝灰層-中砂
- 10 凝灰 シルト質凝灰層
- 11 凝灰 シルト質凝灰層
- 12 灰 小礫混シルト質凝灰層 (Fe₂O₃混)
- 13 オリーブ層 シルト質凝灰層 (Fe₂O₃混)
- 14 オリーブ層 凝灰-粘板状

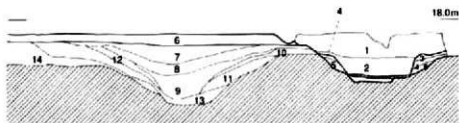

方形周溝墓21 (SX40037)

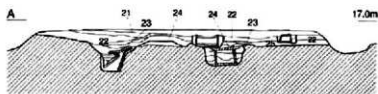
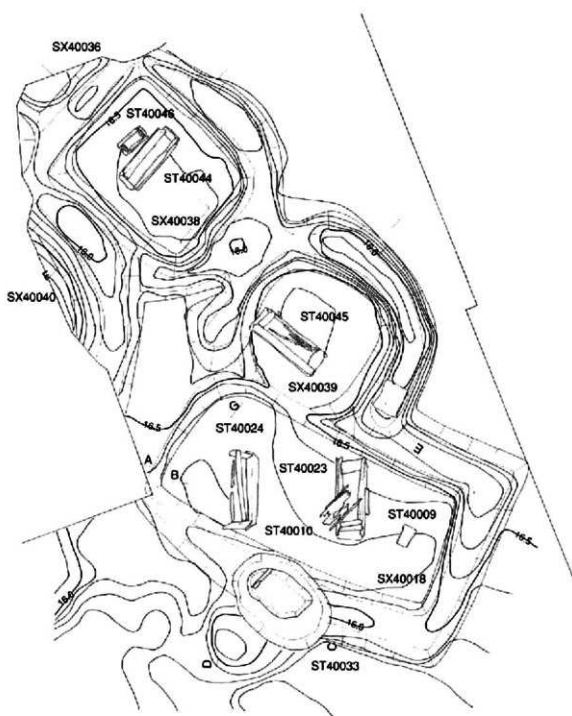

方影岡遺跡22 (SX40018・40038・40039・40040平面)

図版 64 弥生中期上層

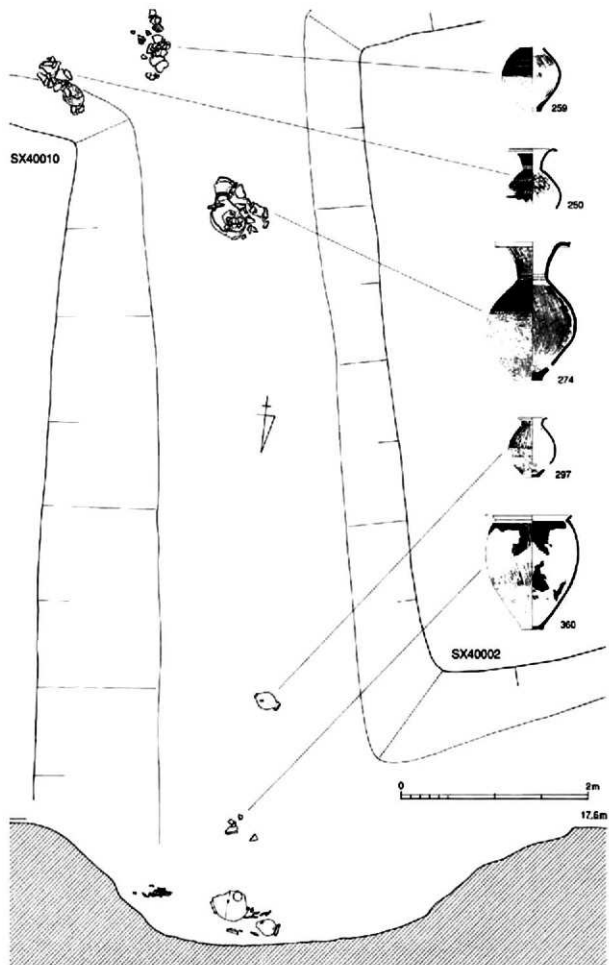

方形堀溝墓土器出土状況1 (SX40002-40010)

図版 65 弥生中期上層

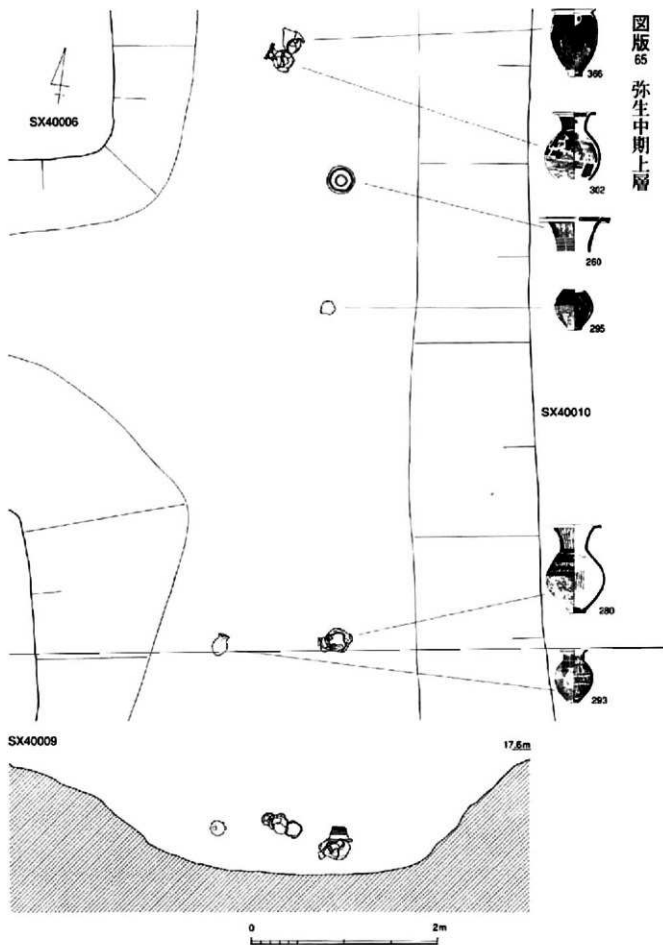

方形周溝墓土器出土状況 (SX40006・40009・40010)

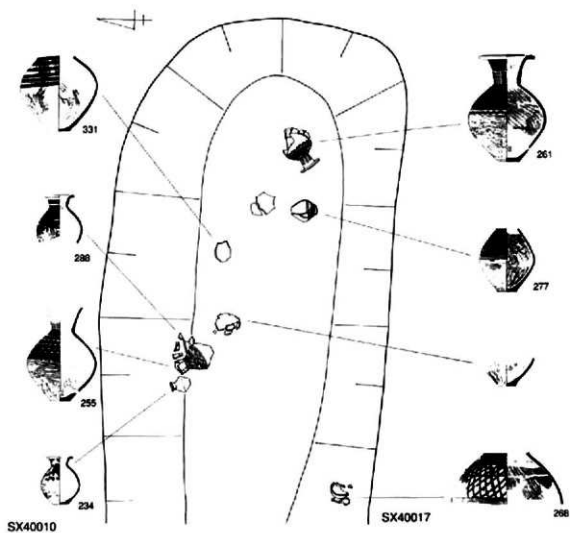

方形周溝墓土器出土状況3 (SX40010-40017西)

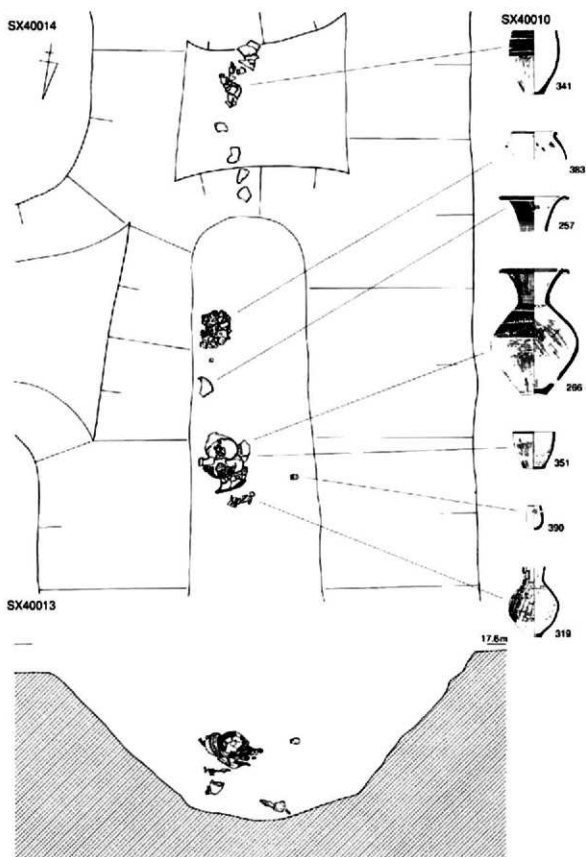

方形埴輪墓土器出土状況5 (SX40010-40013・40014)

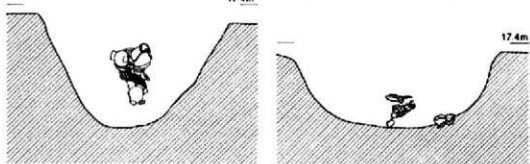
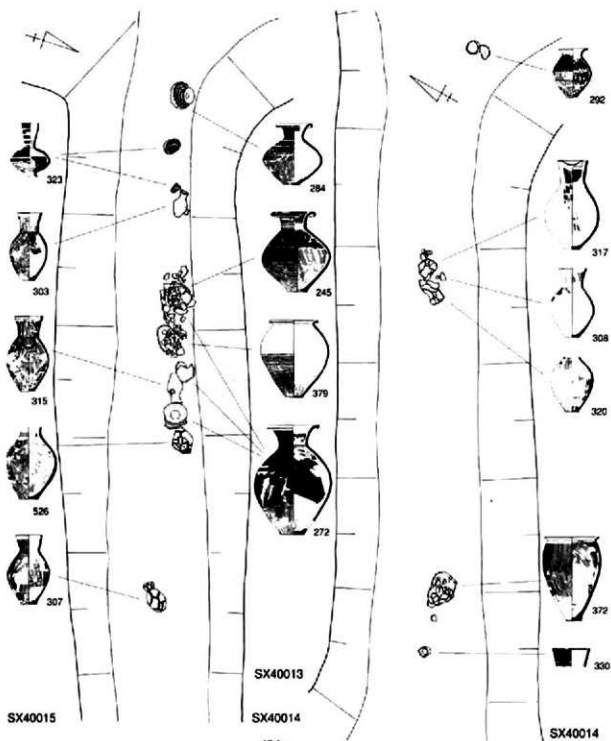

方形周溝墓土器出土状況6 (SX40014-40015・SX40013-40014)

図版 70 弥生中期上層

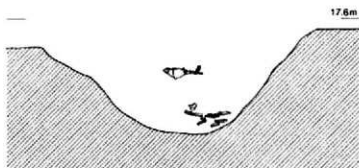
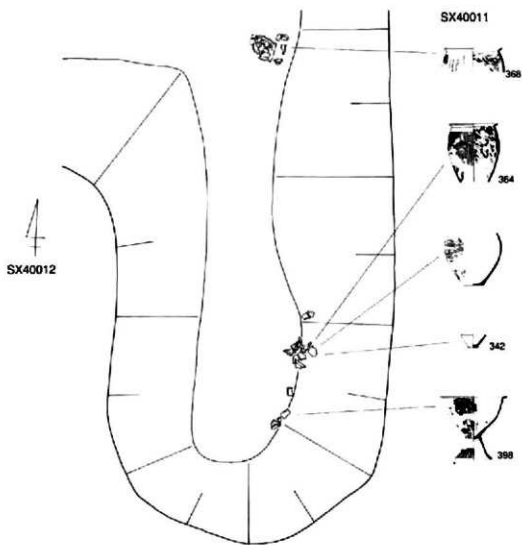

方形周溝墓土器出土状況7 (SX40011-40012)

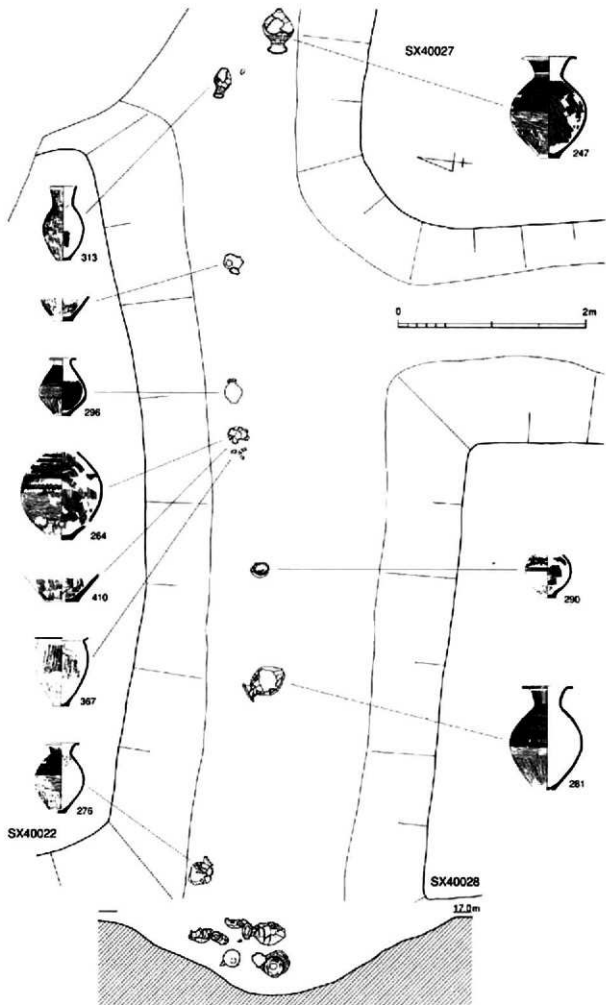

方形周溝墓土器出土状況8 (SX40022-40027・40028)

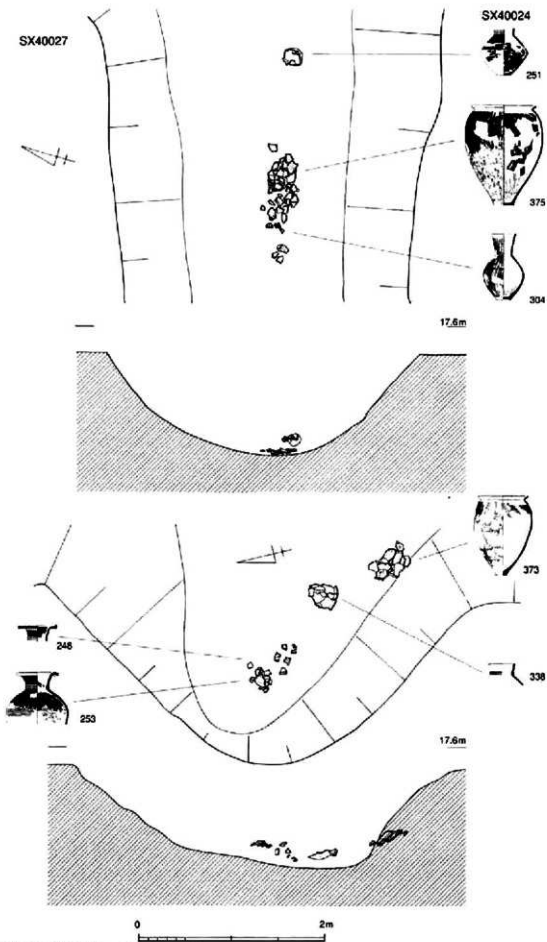

方形周溝墓土器出土状況⑨ (SX40024-40027・SX40010-40017東)

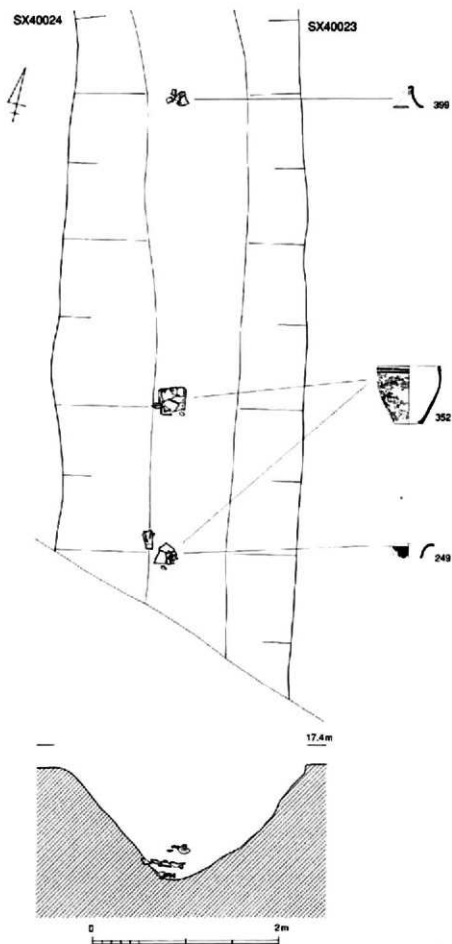

方形周溝墓土器出土状況10 (SX40023-40024)

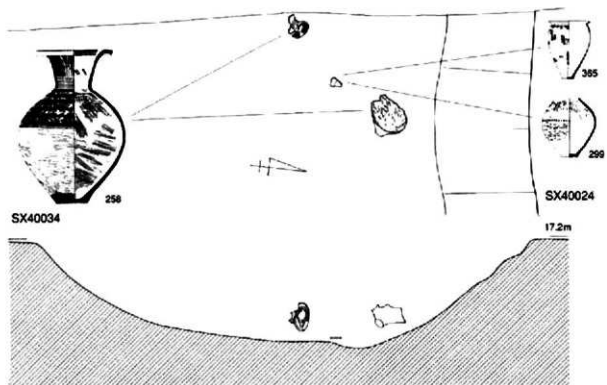

SX40034

17.2m

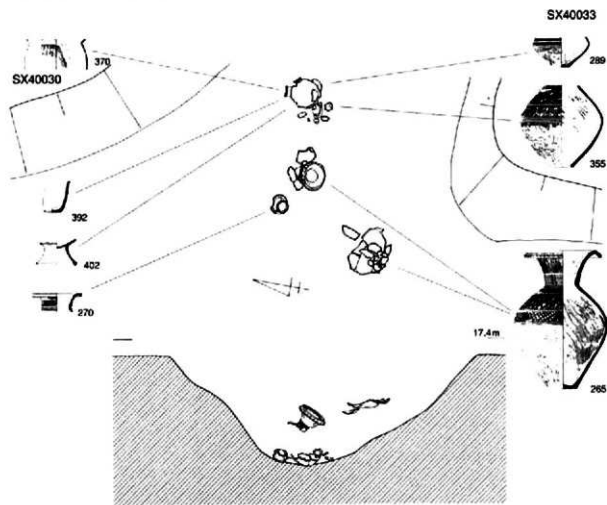

SX40033

17.4m

0 2m

方形周溝埴土器出土状況11 (SX40024-40034・SX40030-40033)

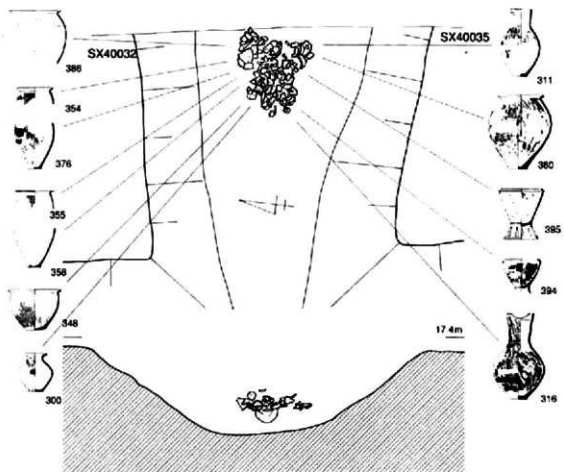
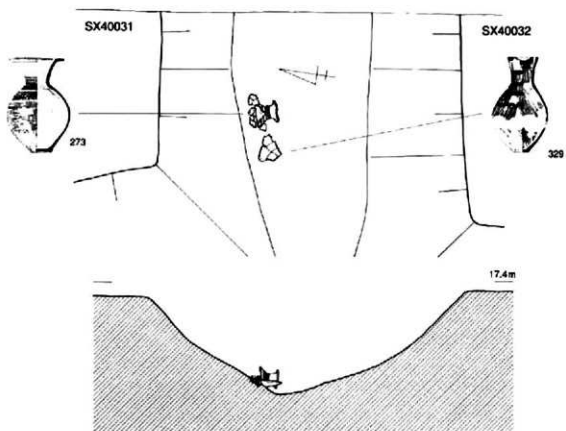

方形周溝墓土器出土状況12 (SX40031-40032・SX40032-40035)

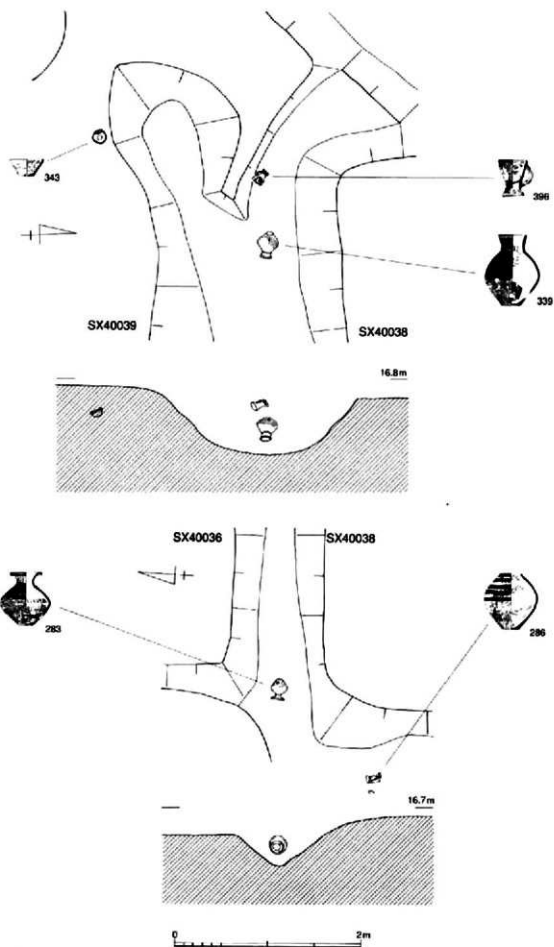

方形周溝墓土器出土状況13 (SX40038-40039・SX40036-40038)

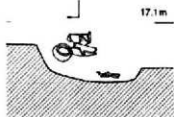
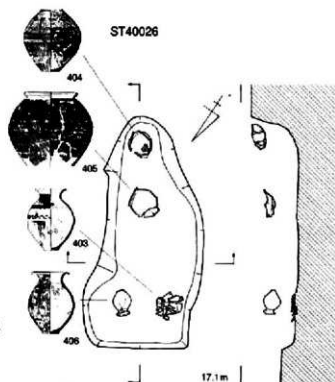
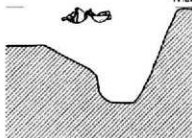
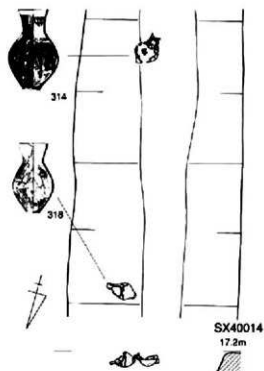
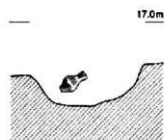
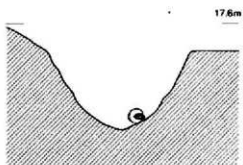
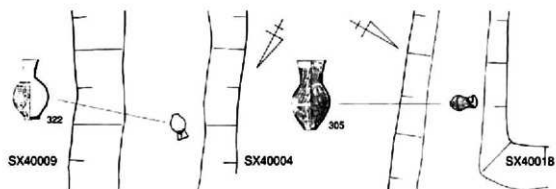

0 2m

方形周溝墓土器出土状況13 (SX40004-40009・SX40018南・SX40014東・ST40026)

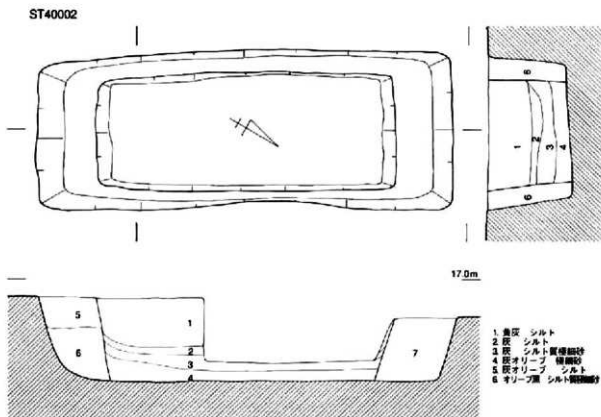
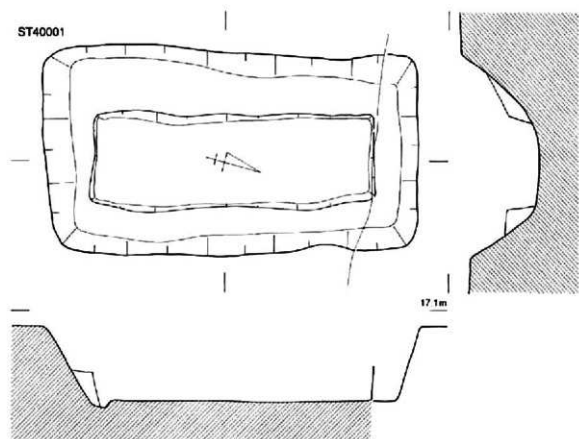

0 1m

ST40010

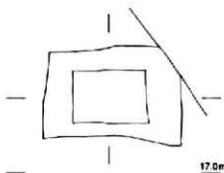

17.0m

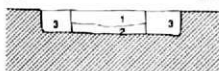
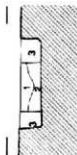

1 灰 シルト質堆積砂
2 灰 オリーブ シルト
3 オリーブ 灰 シルト

ST40003



17.1m

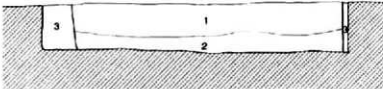
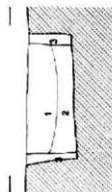

1 灰 オリーブ シルト
2 灰 オリーブ シルト
3 灰 シルト

ST40007

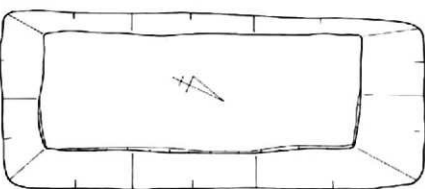

17.0m

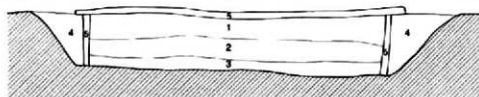

1 黄灰 シルト質堆積砂
2 灰質 堆積砂
3 黄灰 灰 シルト
4 灰 堆積砂
5 黄灰 シルト



ST40009

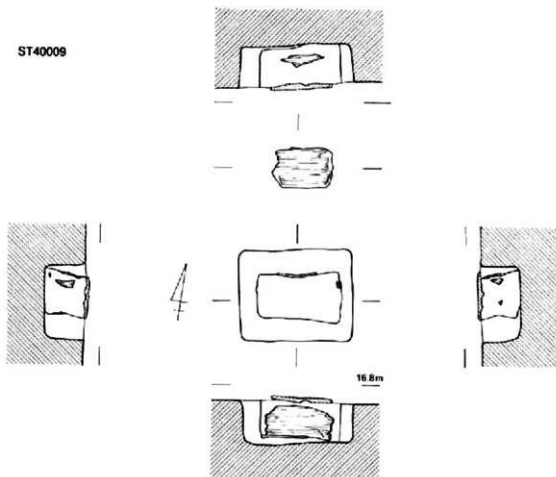

ST40008

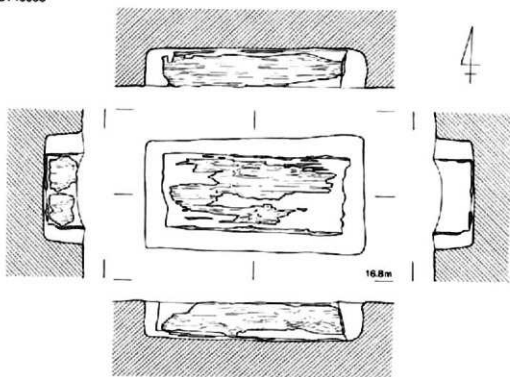

0 1m

ST40011

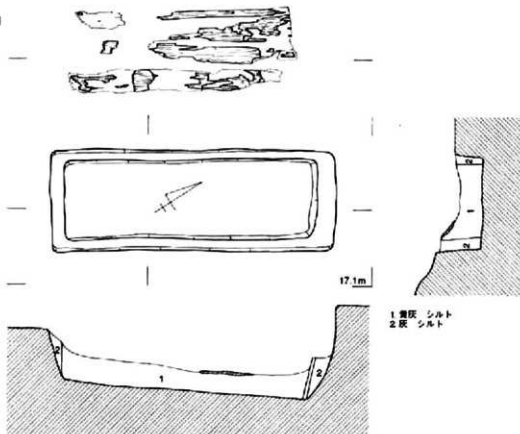

ST40006

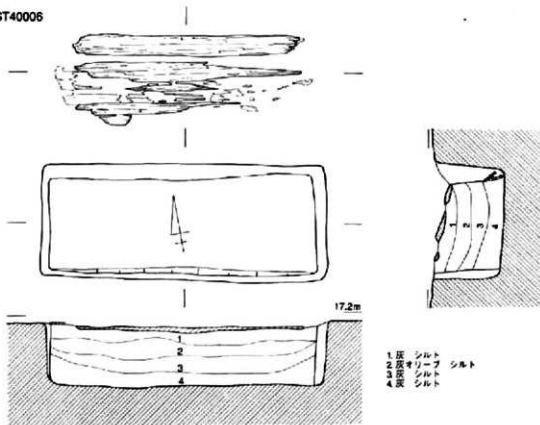

ST40013

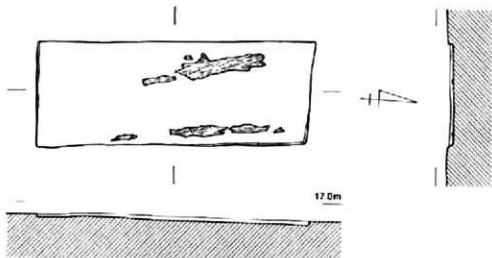

ST40022

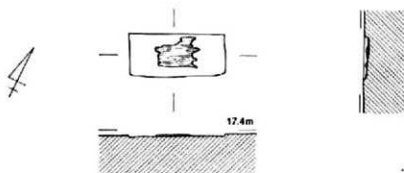

ST40014

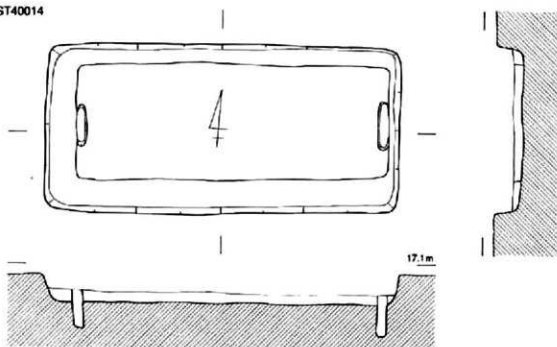

ST40017

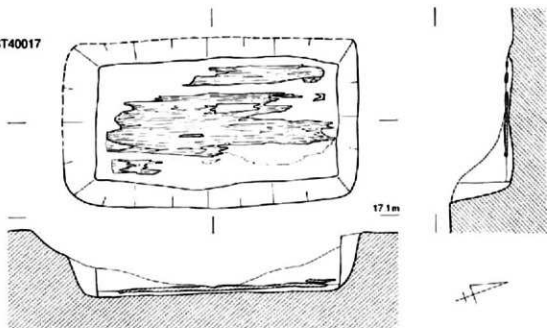

ST40005

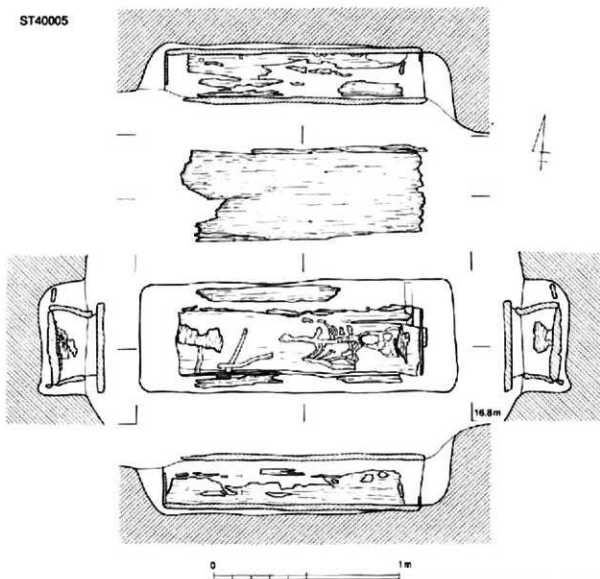

ST40018

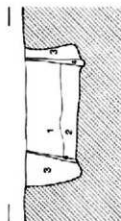
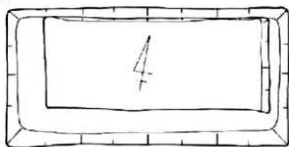

17.1m



- 1 腰板 シルト
- 2 にがい黄土 埴輪砂
- 3 腰板 シルト質硬砂
- 4 灰 シルト

ST40015

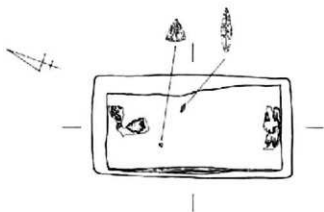
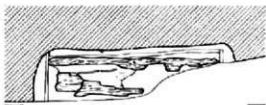

17.1m

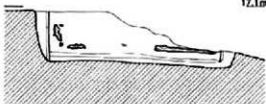

0 1m

ST40016

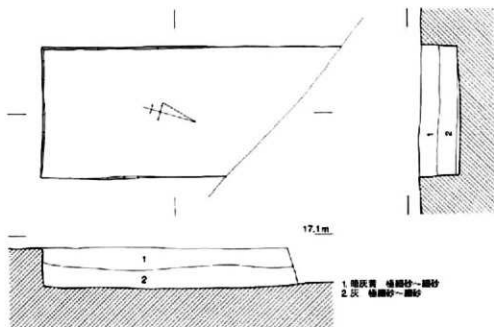

ST40020

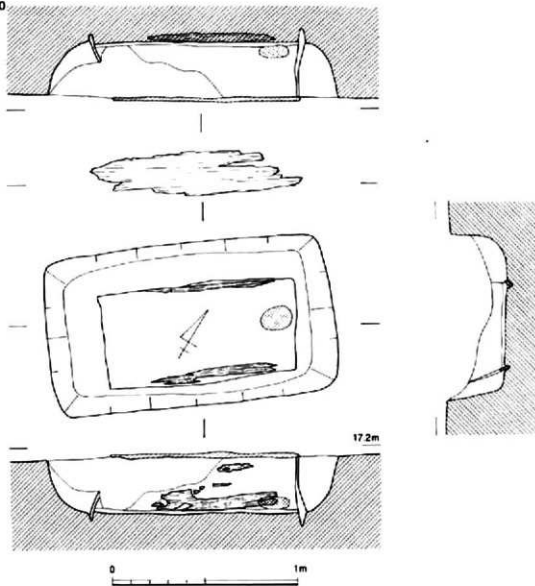

ST40019

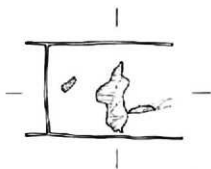

17.1m

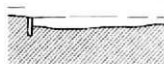

17.1m



方形周溝墓施設9 (ST40019)

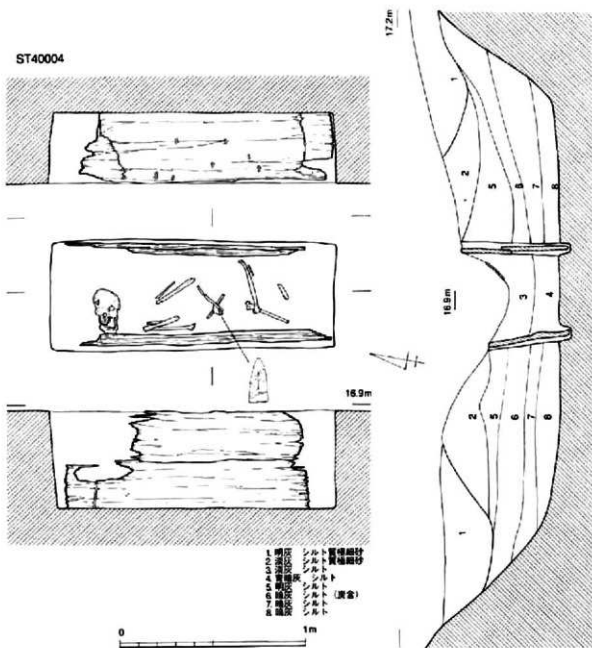
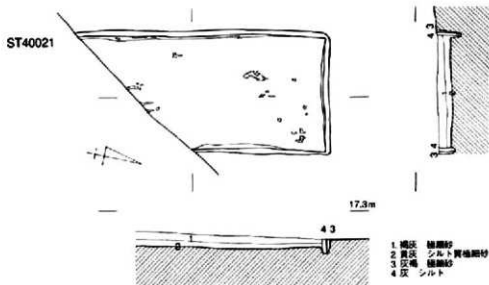

方形周溝墓埋葬施設10 (ST40021・40004)

ST40023

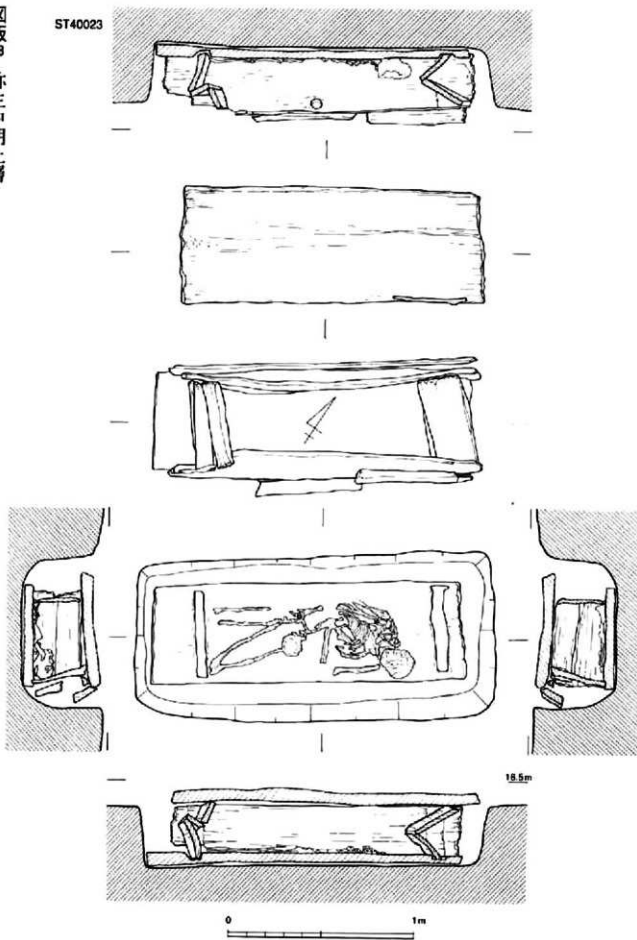

方形周溝葬埋葬施設11 (ST40023)

ST40024

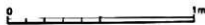
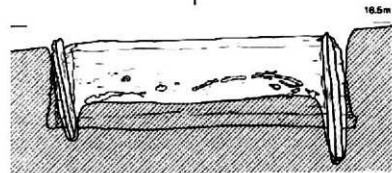
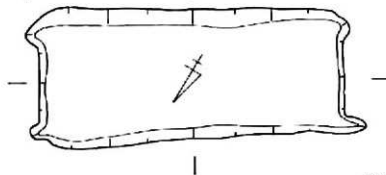
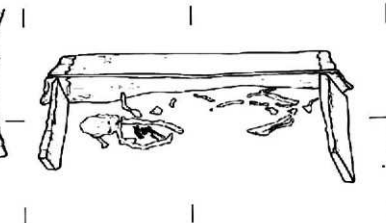
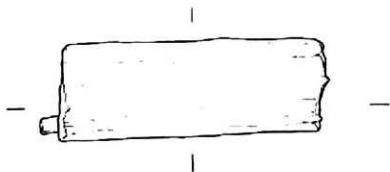

方形周溝墓施設12 (ST40024)

ST40027

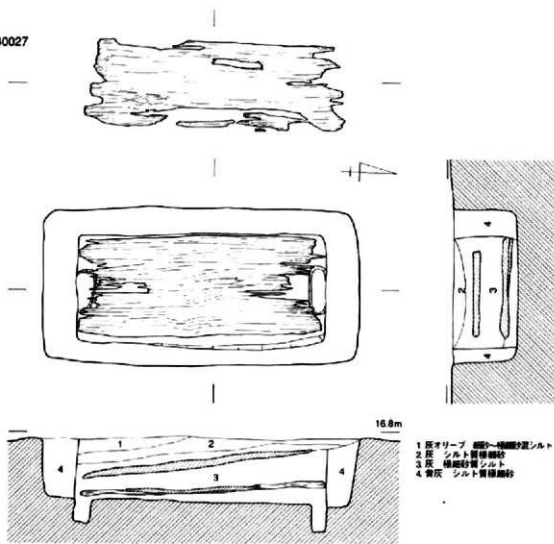

- 1 灰オリーブ 細砂-粘り砂質シルト
- 2 灰 シルト質粘り砂
- 3 灰 粘り砂質シルト
- 4 黄灰 シルト質粘り砂

ST40031

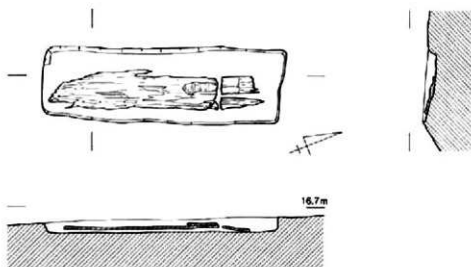

0 1m

ST40028

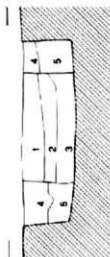
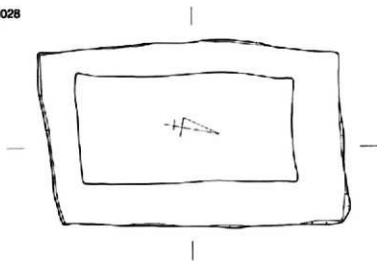

16.9m

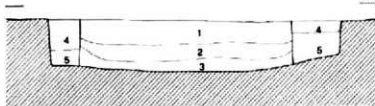

1. オリーブ灰 燧砂
2. 灰 シルト質燧砂
3. 灰 シルト
4. 灰 燧砂
5. 黄灰 燧砂

ST40029

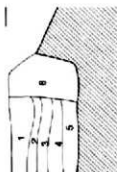
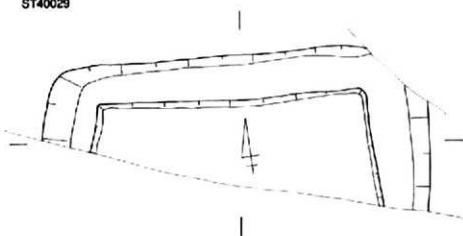

17.0m

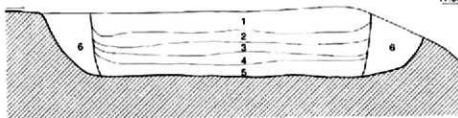

1. 灰オリーブ シルト質燧砂
2. 灰 燧砂 (Mn)
3. 灰 シルト質燧砂 (Fe₂O₃・Mn)
4. 灰 燧砂質シルト (Fe₂O₃・Mn)
5. オリーブ層 燧砂質シルト
6. 黄灰 シルト質燧砂



ST40030

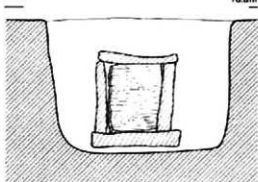
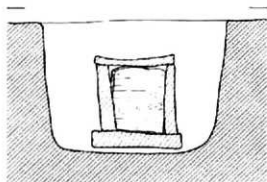
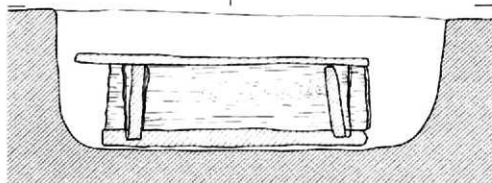
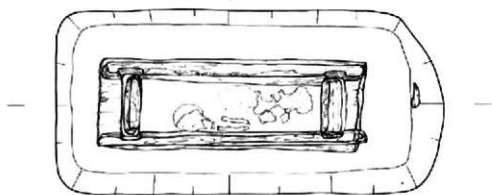
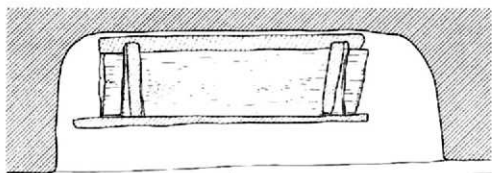

16.8m

0 1m

ST40030

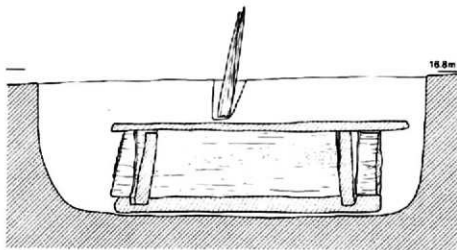
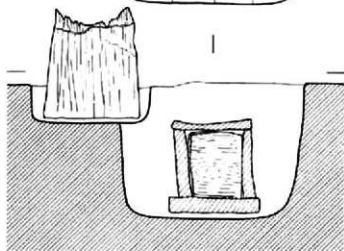
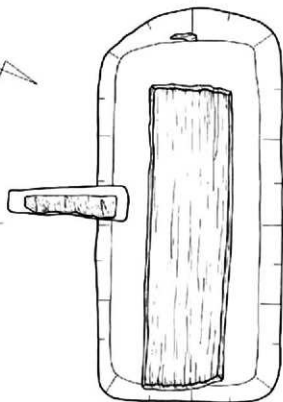

方形槨溝墓埋葬施設16 (ST40030)

ST40032

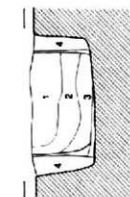
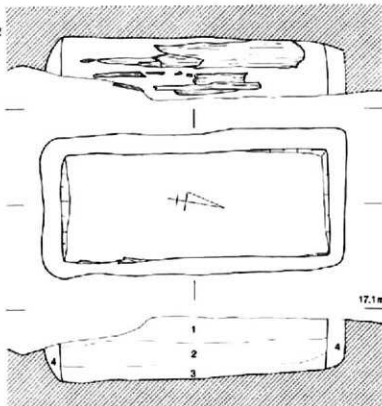

- 1 灰 シルト質粘土層 Fe₂O₃赤
2 灰 シルト質粘土層
3 灰 粘土層
4 灰 シルト質粘土層

ST40025

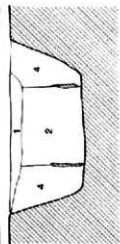
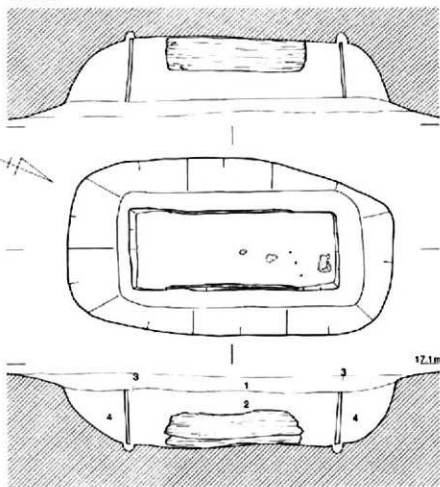

- 1 灰白 粘土層
2 灰 シルト質粘土層
3 灰 シルト質粘土層
4 灰 粘土層

0 1m

ST40033

図版 95
弥生中期上層

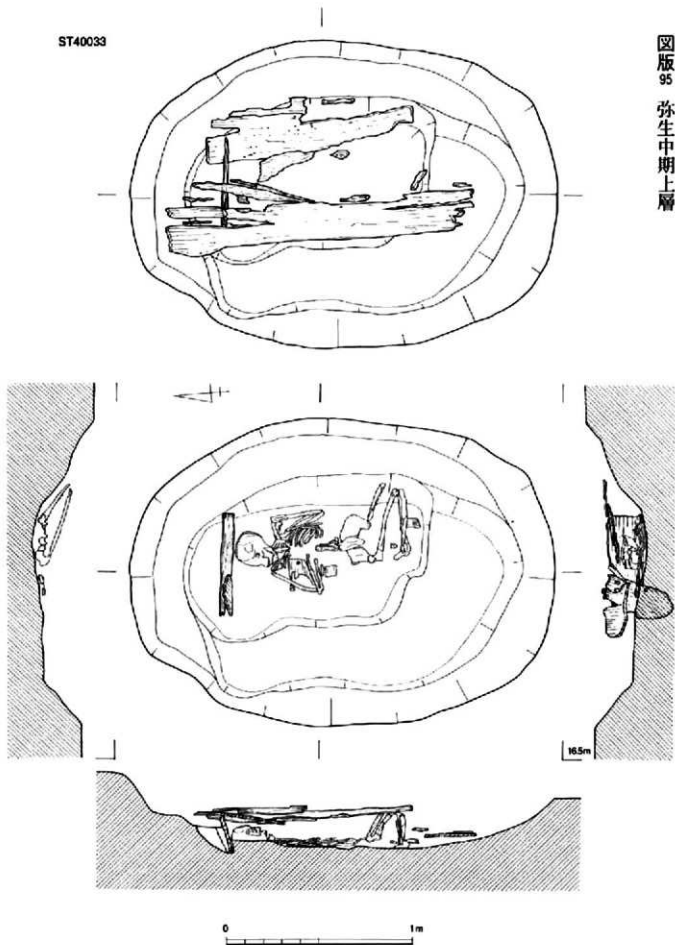

方形周溝墓埋納施設18 (ST40033)

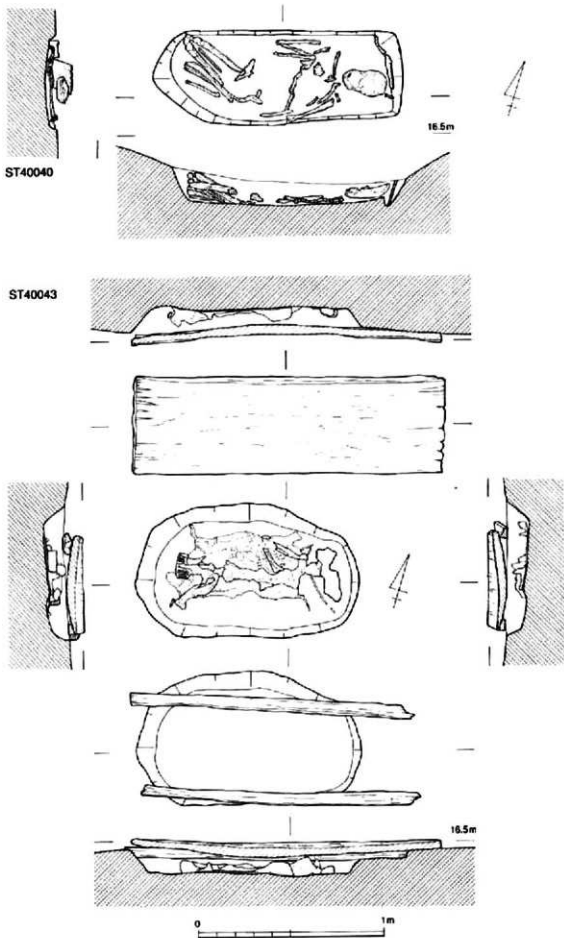

方形周溝墓埋葬施設19 (ST40040・40043)

ST40044

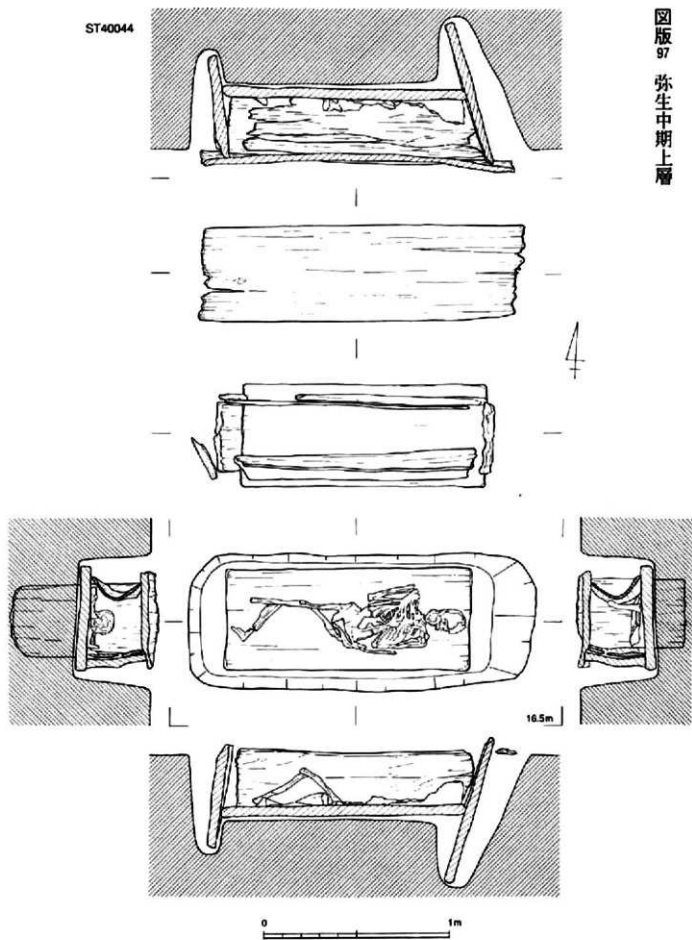

方形周溝墓埋葬施設20 (ST40044)

ST40045

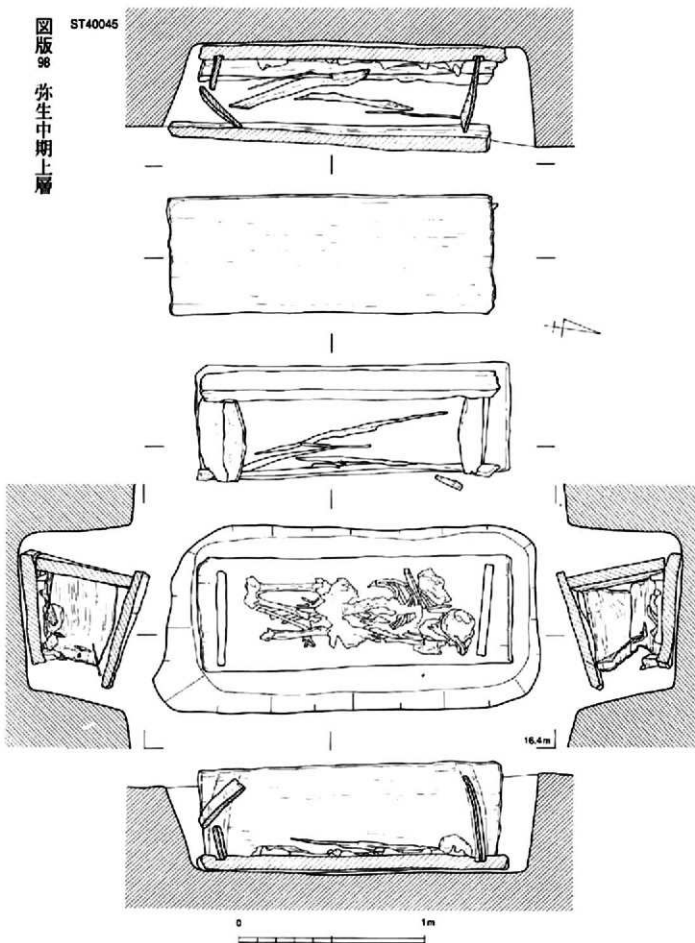

方形周溝墓埋葬施設21 (ST40045)

ST40046

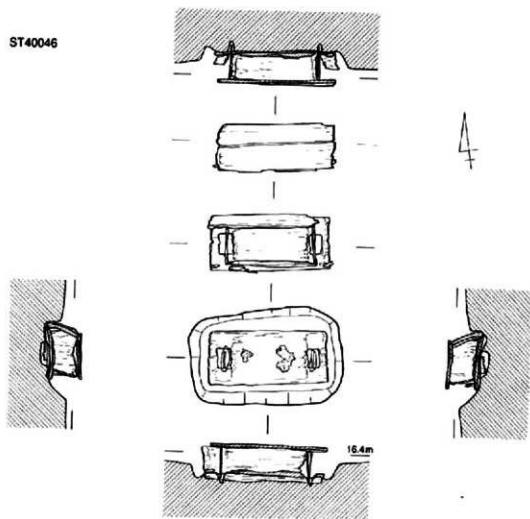

ST40012

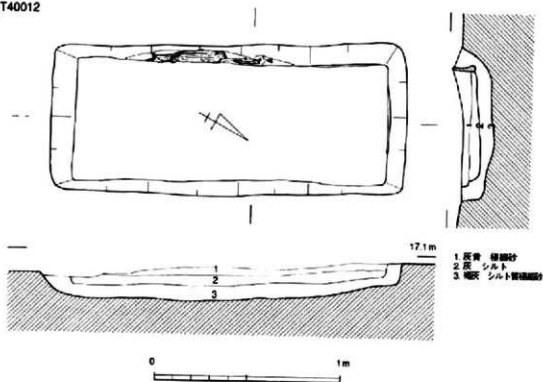

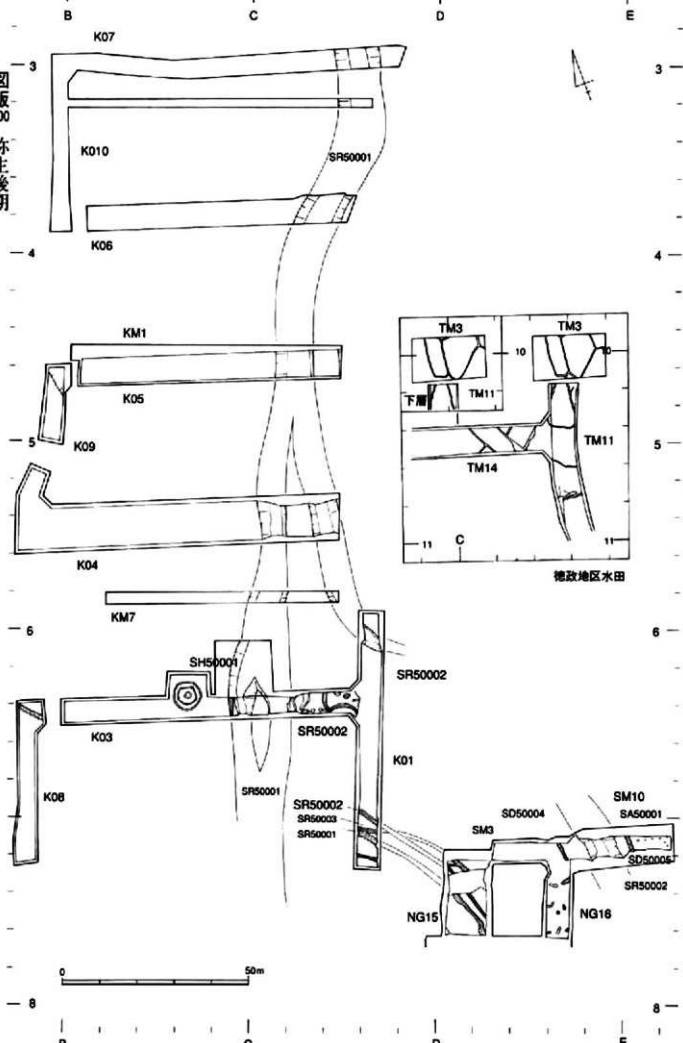

遺構全体 (黒岡・一部徳政)

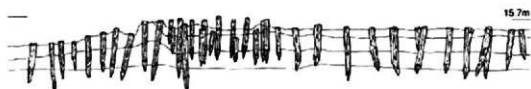
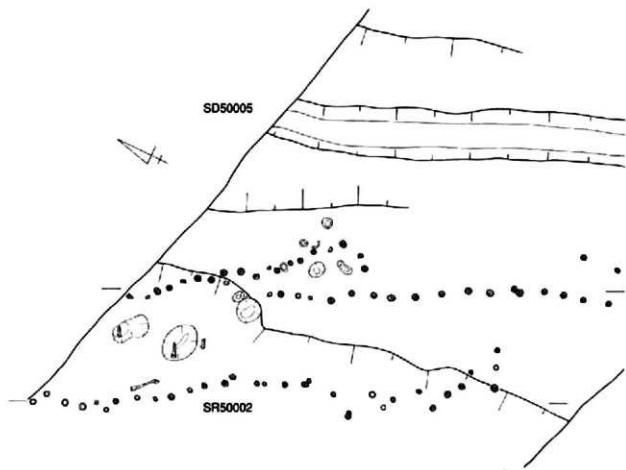

河道杭列 (SR50002)・溝 (SD50005)

SH50001

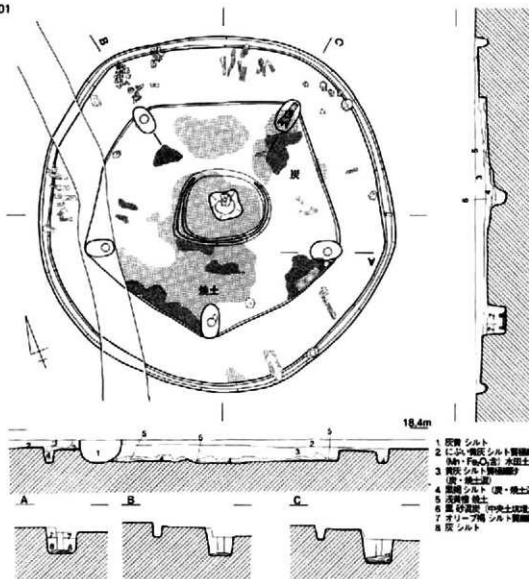

SH50002

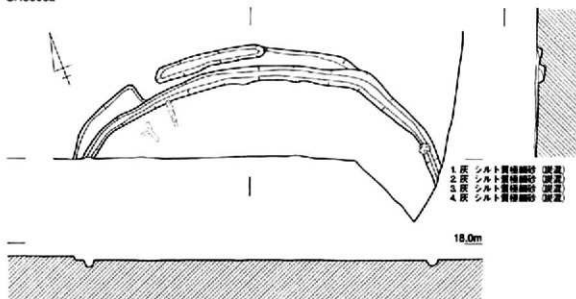

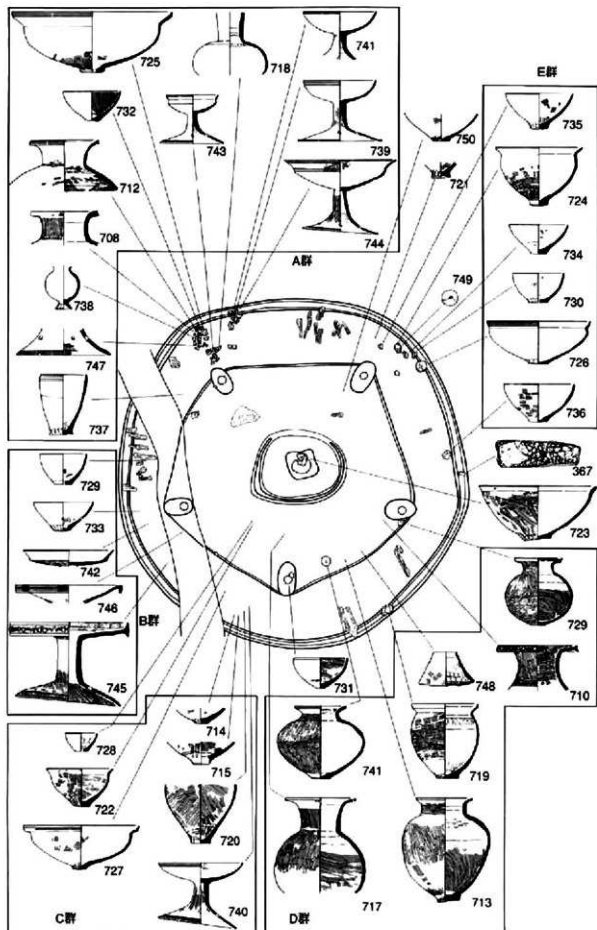

壑穴住居2 (SH50001)遺物出土状況

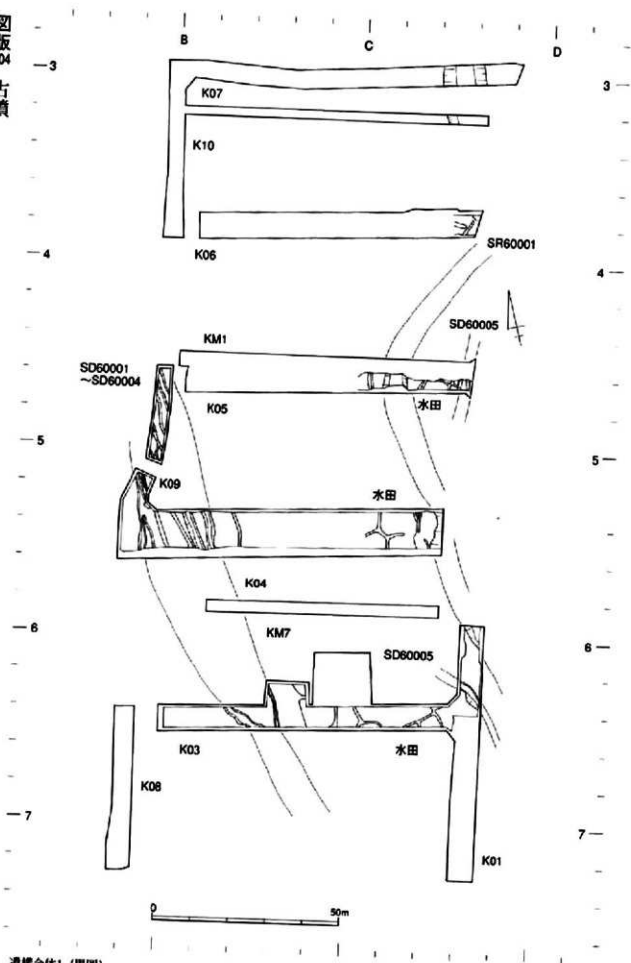

遺構全体1 (黒岡)

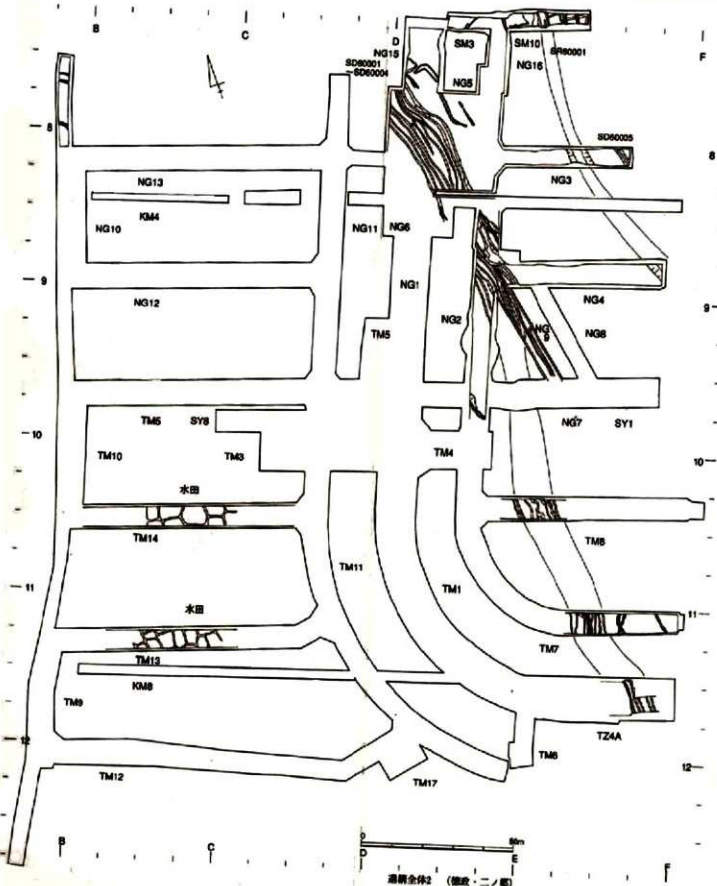

遺跡全体2 (概成・二ノ部)

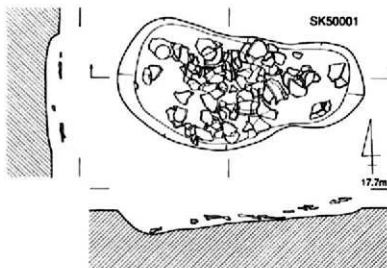

SD60001

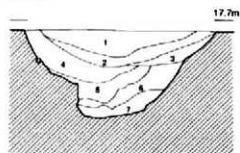

1. 赤灰 細砂～粗砂(Fe₂O₃富)
2. 灰 シルト～細砂
3. 赤灰 細砂～粗砂(シミナ)
4. 赤灰 細砂～中砂(シミナ～細砂・粘砂・赤土)
5. 赤灰 シルト～細砂(上部Fe₂O₃富)
6. 赤 中砂～粗砂(下部赤土・Fe₂O₃富)
7. 赤灰 細砂～粗砂(シミナ)

0 1m

SD60002

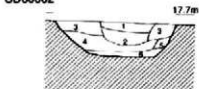

1. 灰 細砂 (Fe₂O₃富)
2. 灰白 細砂～粗砂
3. 赤灰 粗砂
4. 赤灰 中砂～粗砂 (Fe₂O₃富)
5. 赤灰 細砂 (Fe₂O₃富)
6. 赤灰 細砂 (Fe₂O₃富)

SD60003

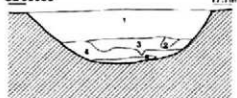

1. 赤土 細砂～粗砂
2. 赤灰 粗砂～シルト
3. 赤灰 粗砂～粗砂
4. 赤灰 中砂～小砂
5. 明黄褐色 細砂～粗砂

SD60004



1. 灰白 粗砂～粗砂
2. 赤灰 細砂～シルト
3. 赤灰 細砂～小砂(シミナ・Fe₂O₃富)
4. 灰 細砂～シルト(3M・Fe₂O₃富)
5. 灰 細砂～シルト(3M・Fe₂O₃富)

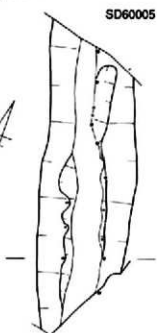

0 2m

0 4m

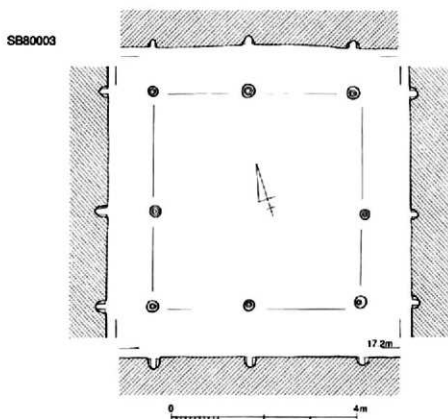
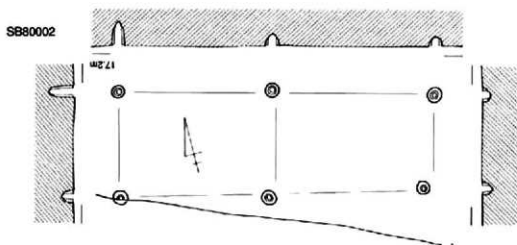
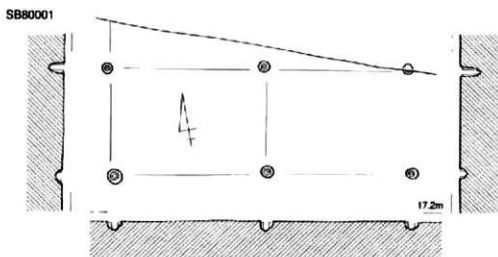

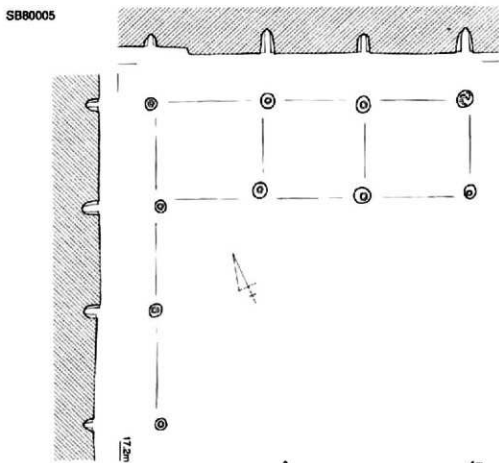
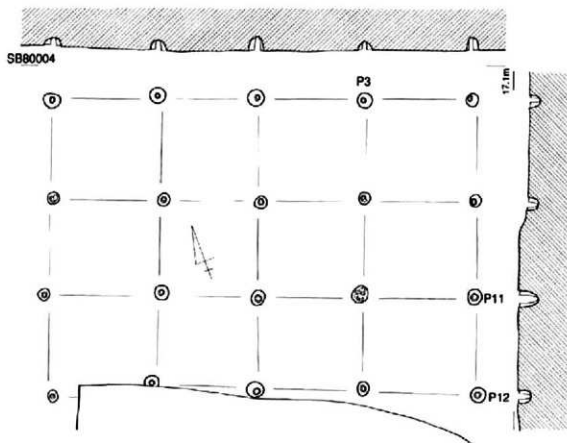

掘立柱建物2 (SB80004・80005)

SB80006

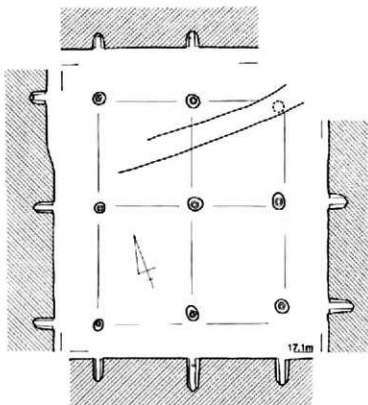

SB80007

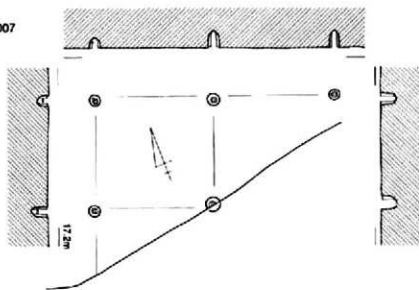

SB80008

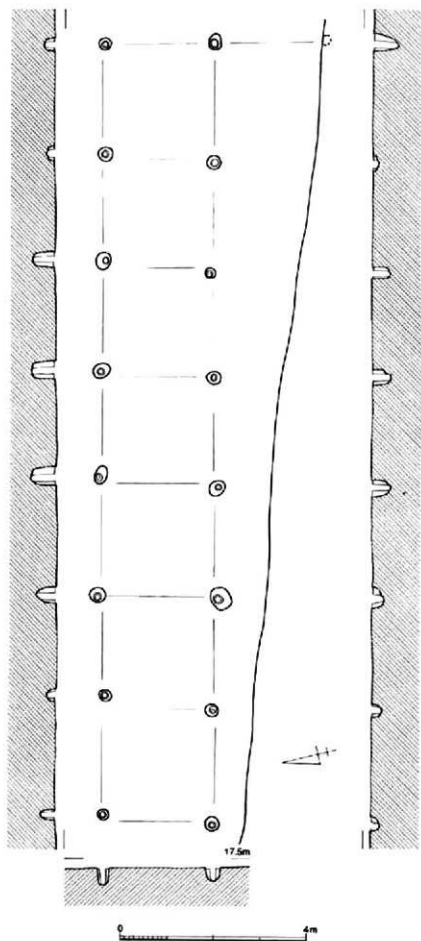

獨立柱建物4 (SB80008)

SB80009

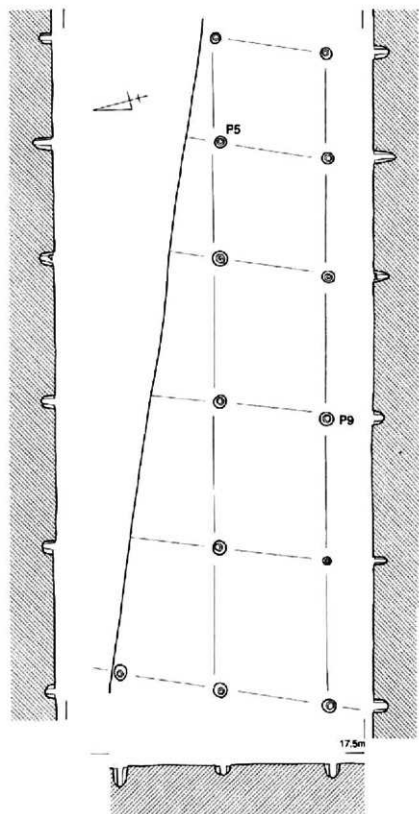

SB80010

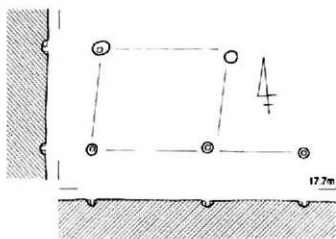

SB80011

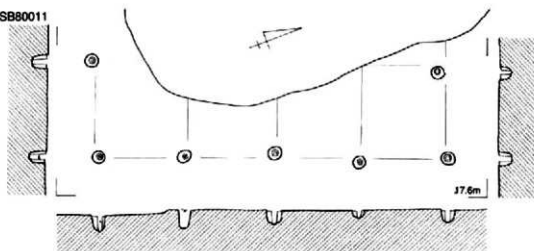

SB80012

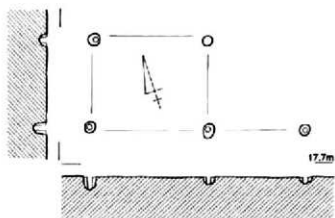

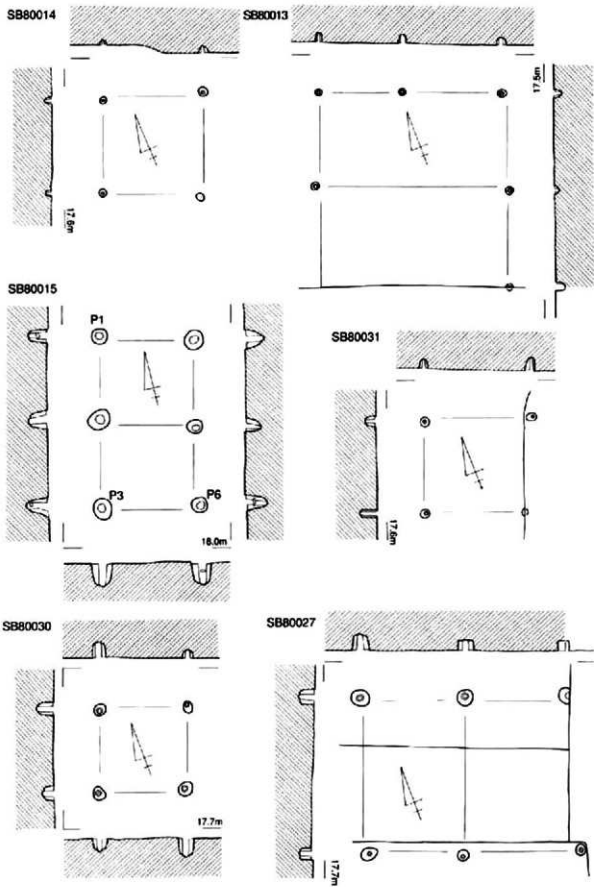

SB80016

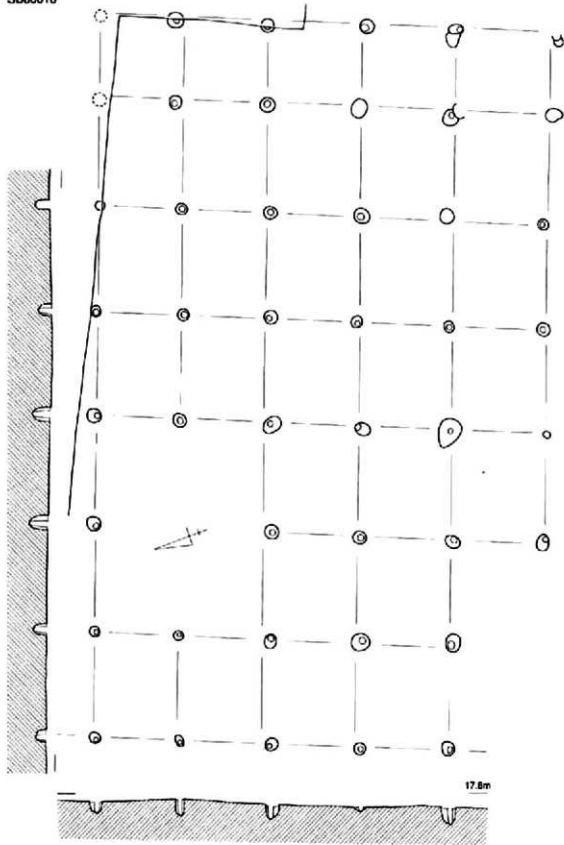

掘立柱建物8 (SB80016)

SB80018

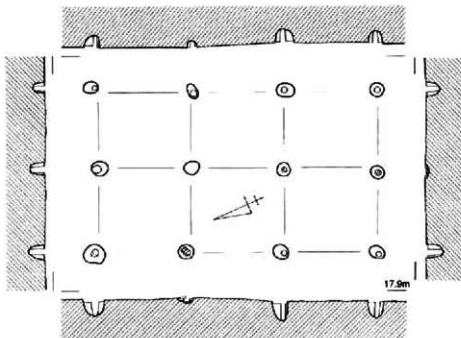

SB80019

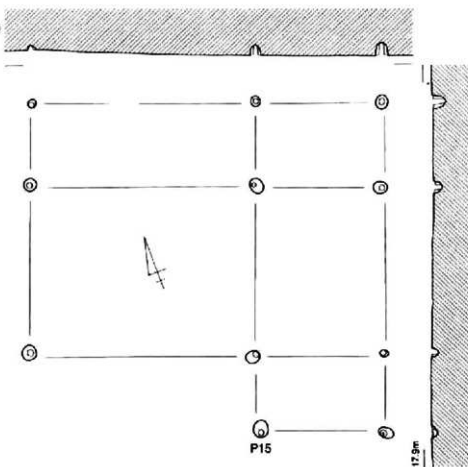

0 4m

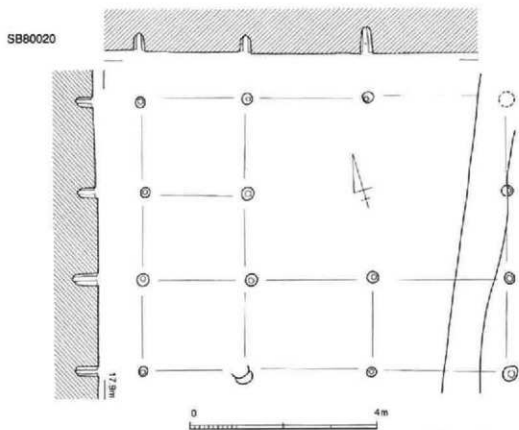
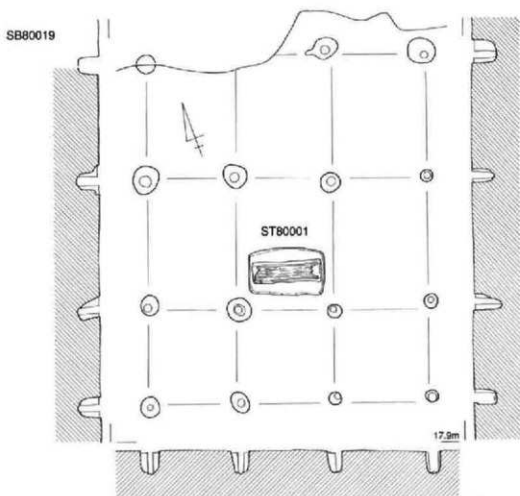

掘立柱建物10 (SB80019・80020)

図版
120
中世

SB80021

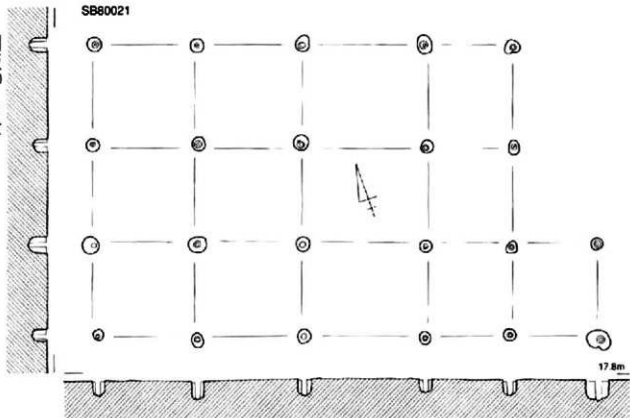

SB80022

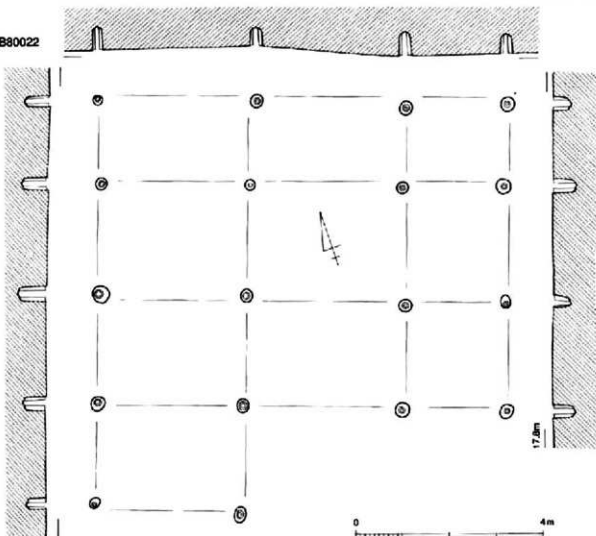

掘立柱建物11 (SB80021・80022)

0 4m

SB80023

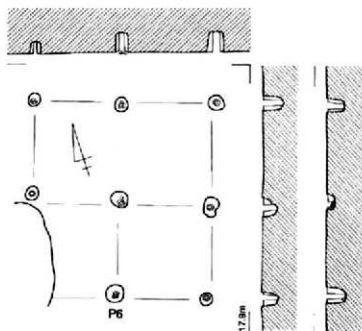

SB80024

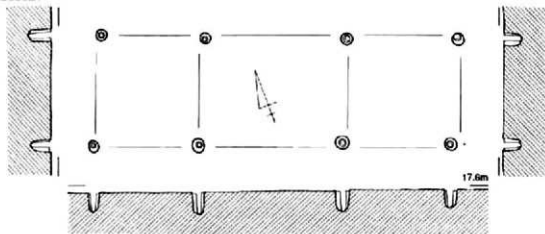

SB80025

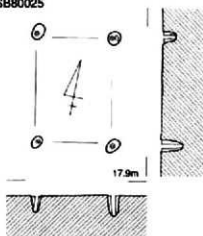

SB80026

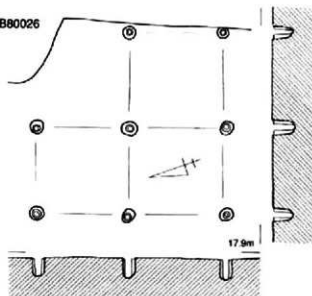

0 4m

掘立柱建物12 (SB80023~80026)

SB80028

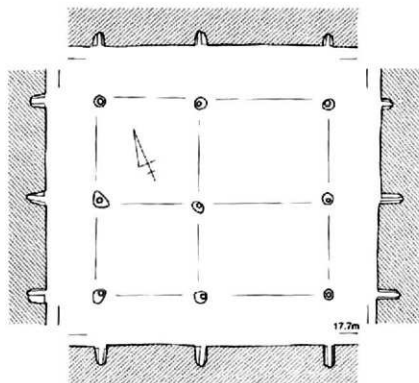

SB80029

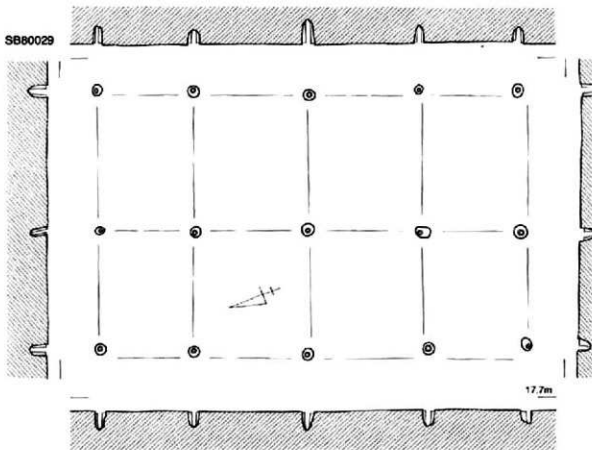

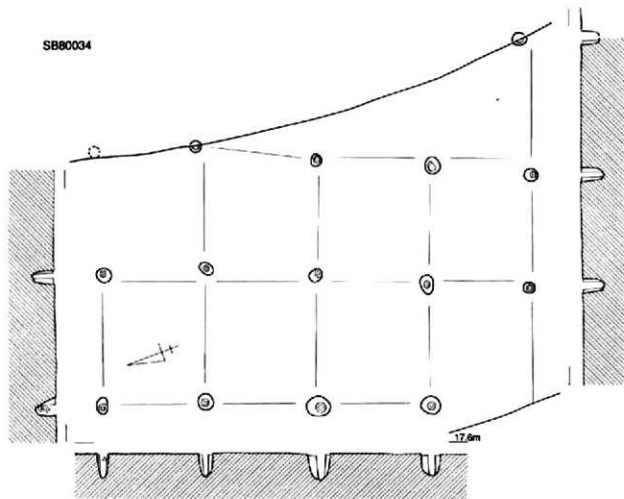
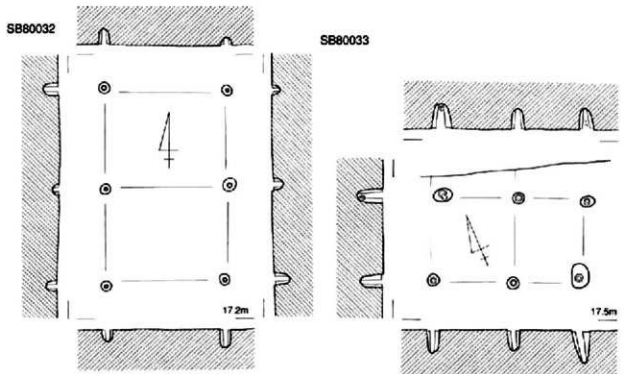

竪立柱建物14 (SB80032~80034)

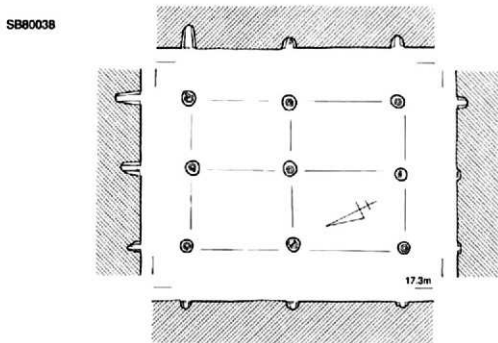
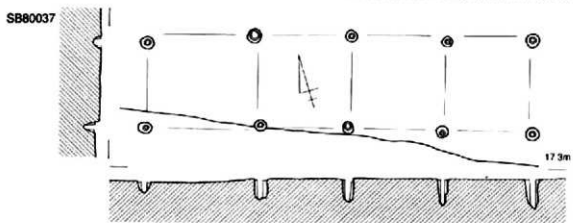
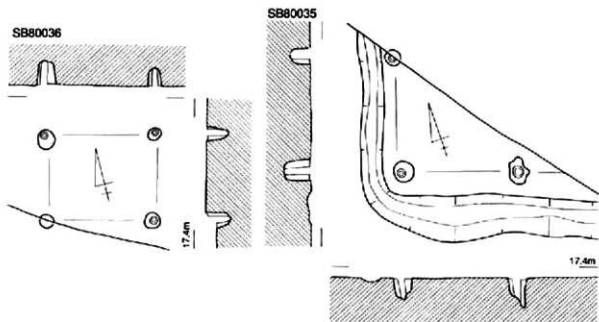

SB80039

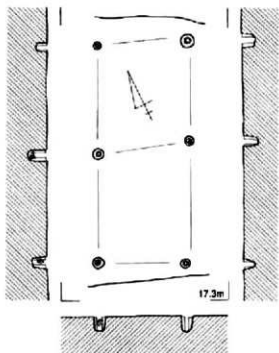

SB80047

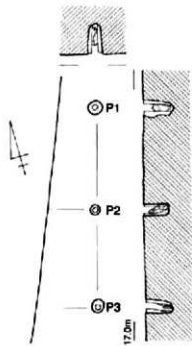

SB80041

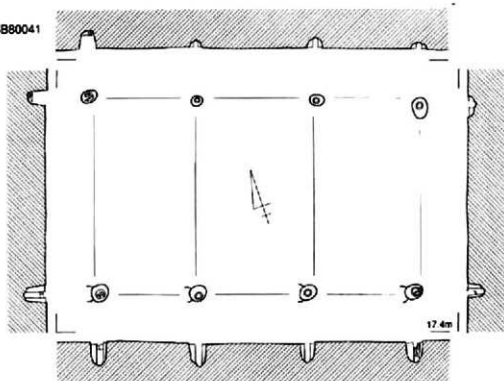

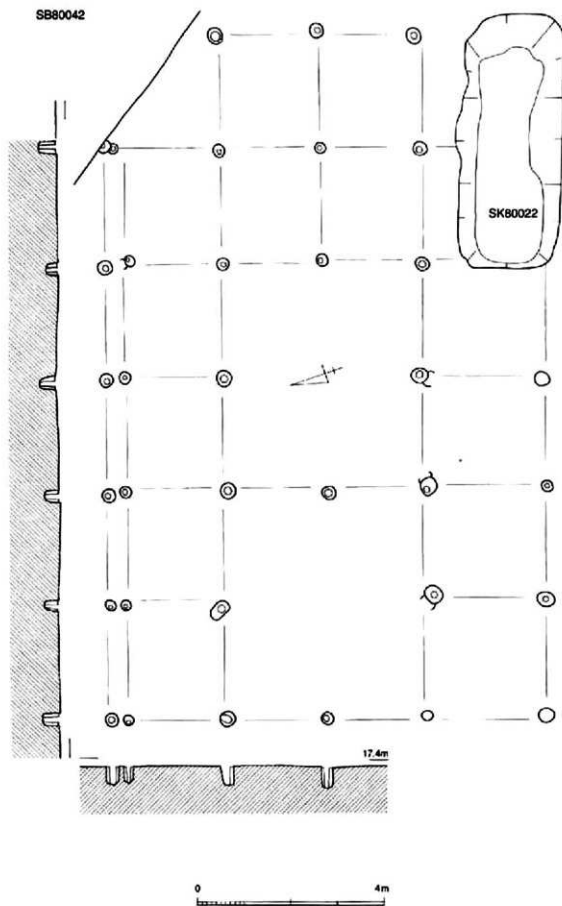

獨立柱建物17 (SB80042)

SB80043

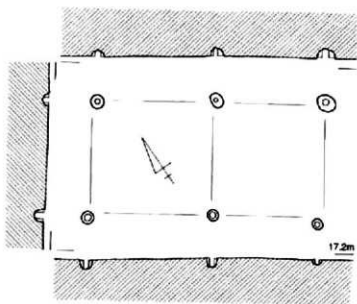

SB80040

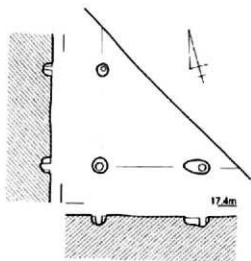

SB80044

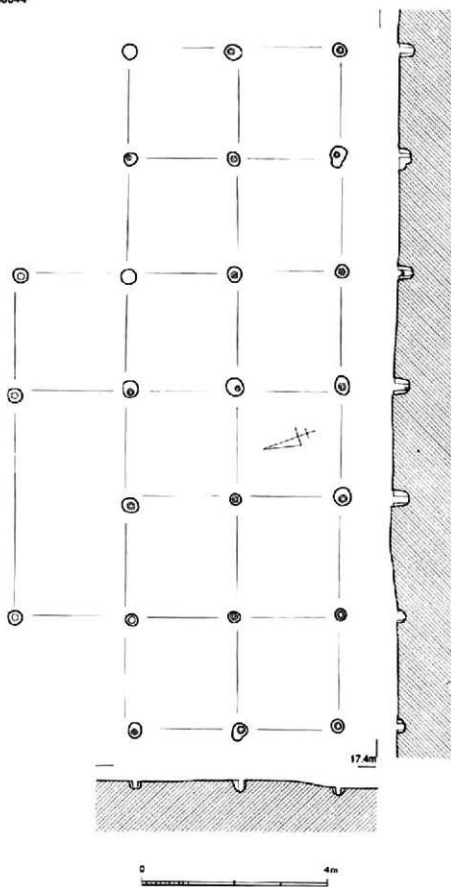

掘立柱建物19 (SB80044)

SB80045

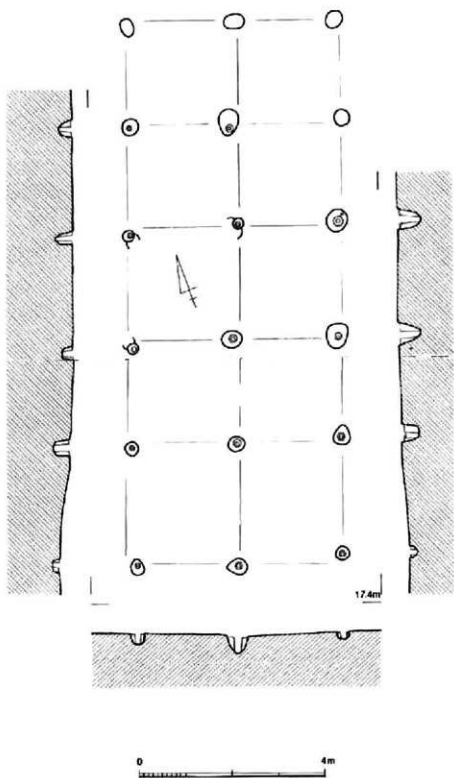

掘立柱建物20 (SB80045)

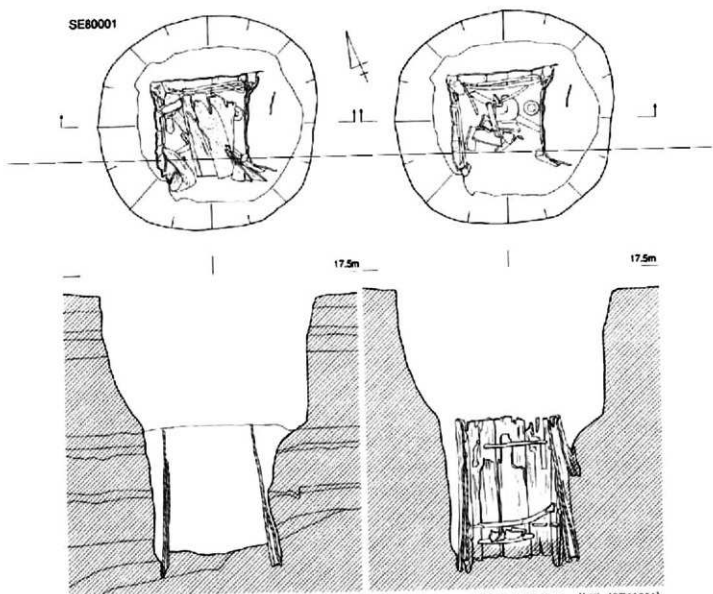
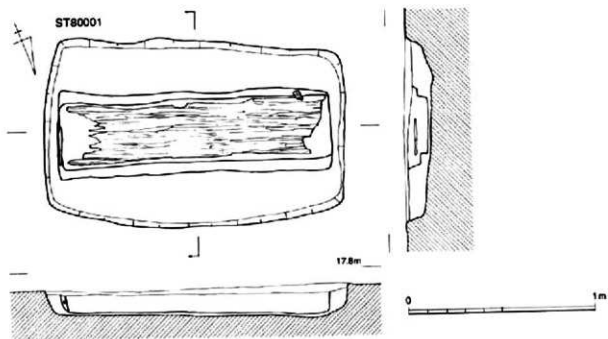

木棺墓 (ST80001). 井戸 (SE80001)

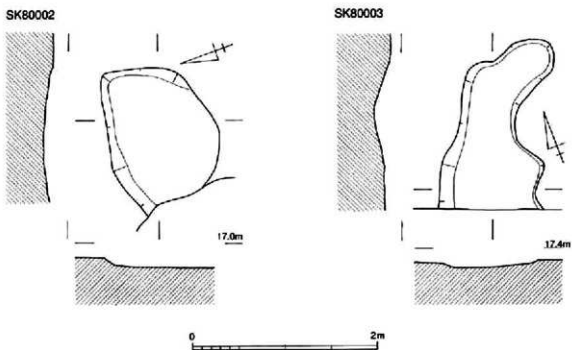
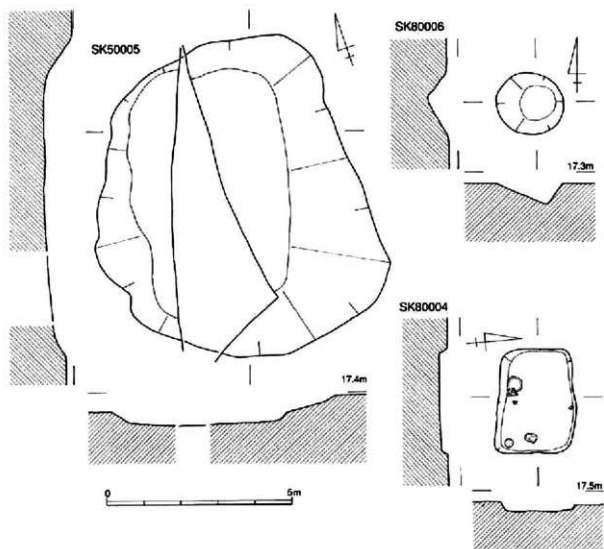

土坑1 (SK80002~80006)

SK80008

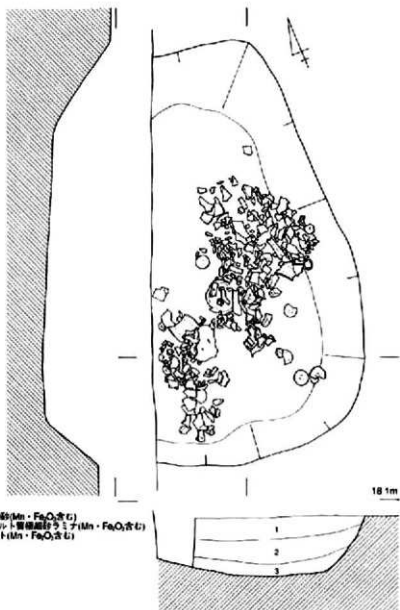

- 1 灰層 礫層(Aln・Fe₂O₃含む)
- 2 第三層 シルト(礫層の下の層)(Aln・Fe₂O₃含む)
- 3 第四層 シルト(Aln・Fe₂O₃含む)

SK80009

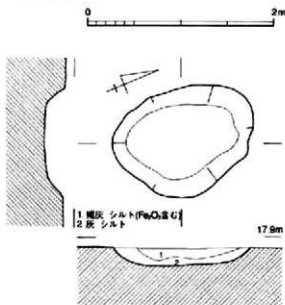

- 1 礫灰 シルト(Fe₂O₃含む)
- 2 灰 シルト

SK80007

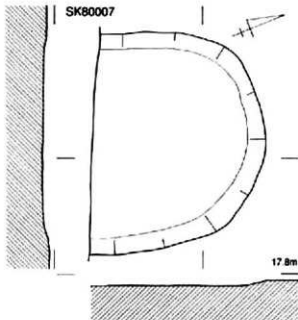

上層2 (SK80007~80009)

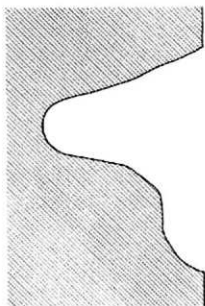

SK80010

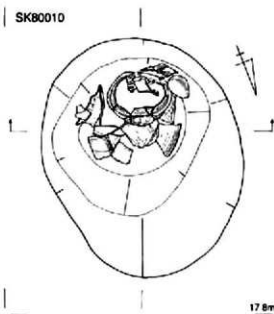

17.8m

SK80014

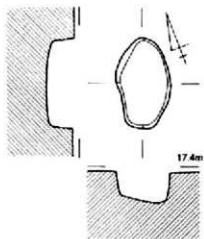

17.4m

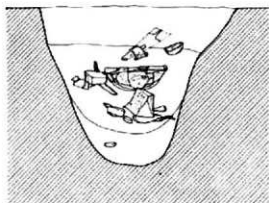

SK80015

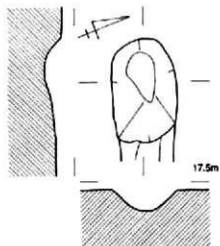

17.5m

SK80013

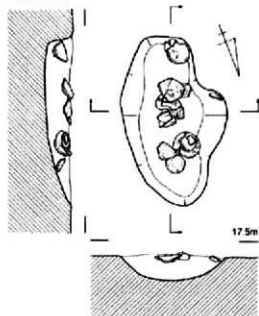

17.5m

0 2m

土坑3 (SK80010・80013~80015)

0 1m

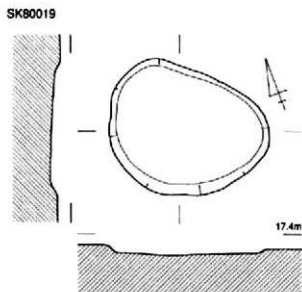
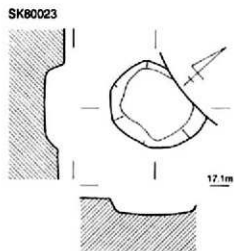
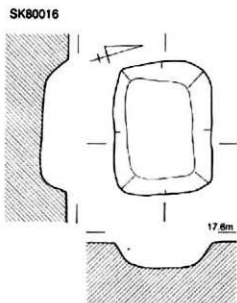
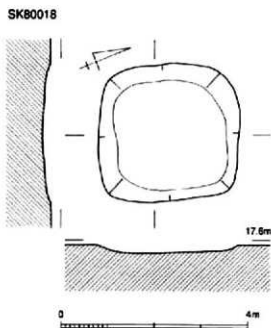
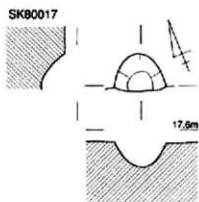
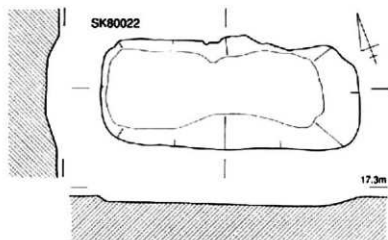

土坑4 (SK80016~80019・80022・80023)

SK80011

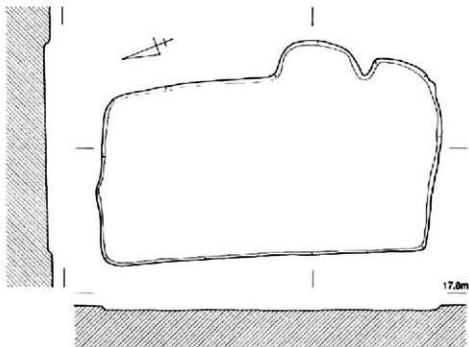

SK80020

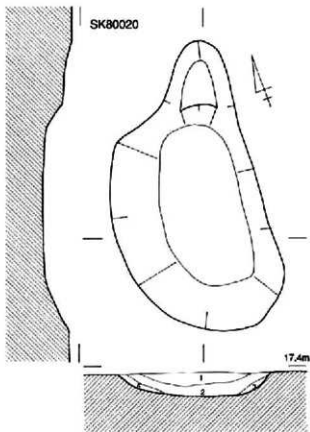

SK80012

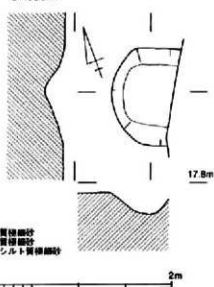

SD80004

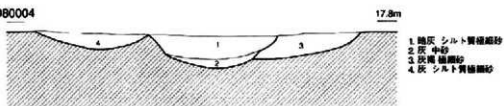

1. 灰白 シルト質緑砂
2. 灰白 シルト質緑砂
3. 灰黄 細砂質シルト質緑砂

1. 黄灰 シルト質緑砂
2. 灰 中砂
3. 灰黄 緑砂
4. 灰 シルト質緑砂



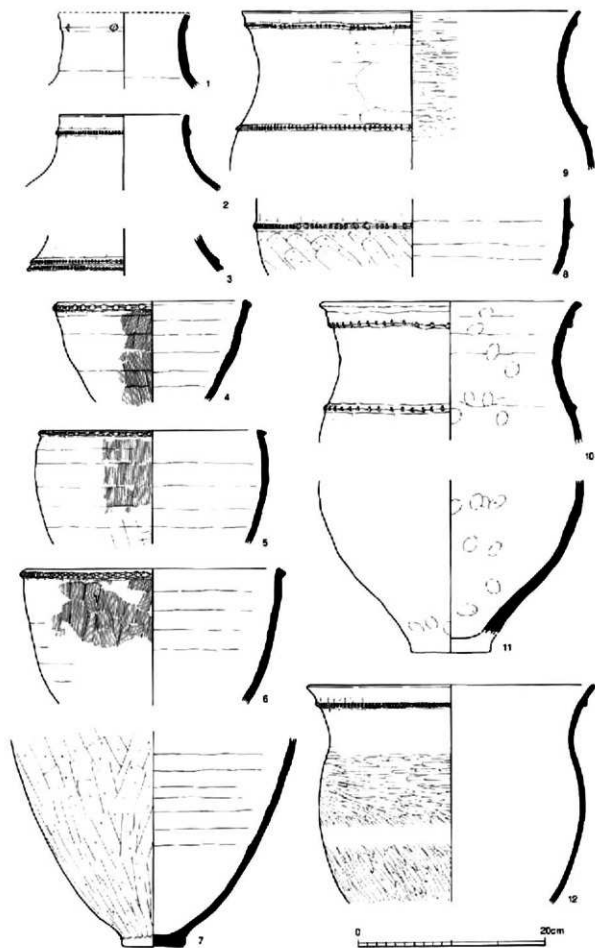



土器2 (河道/13-25)

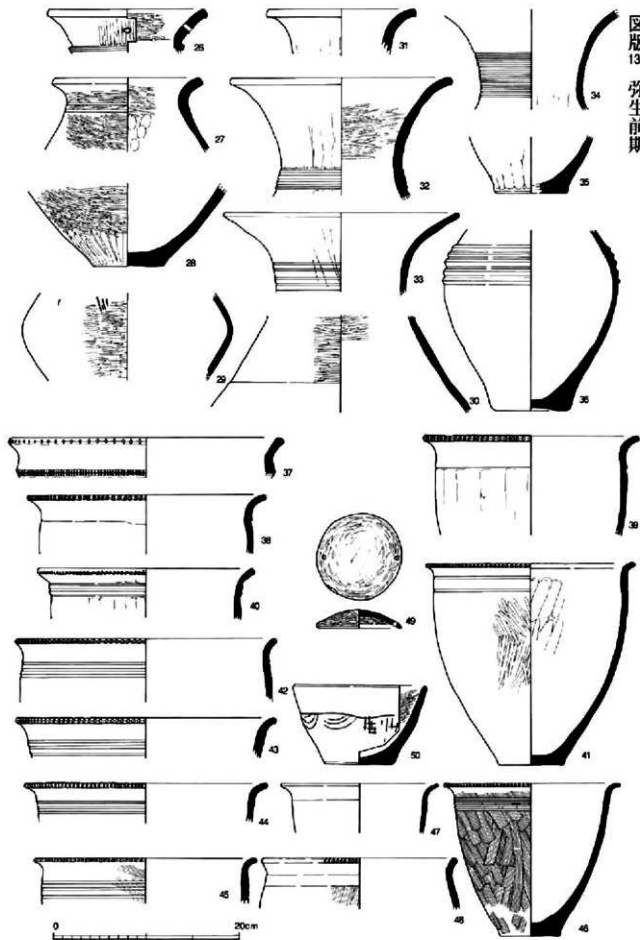

土器1 (26~50)



51



55



52



56



53



59



54



61



58



57



図版 141
弥生中期下層

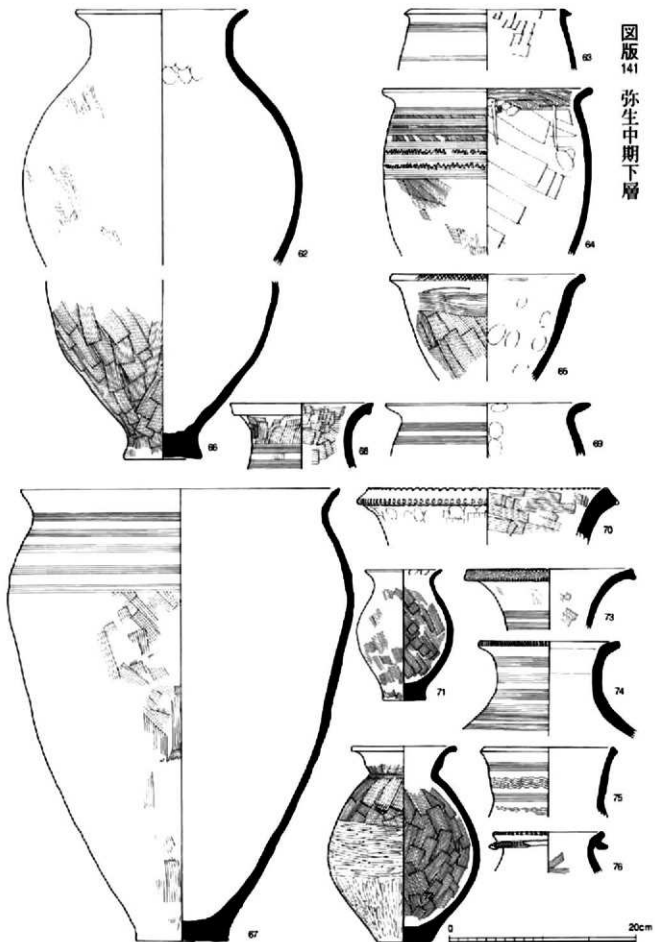

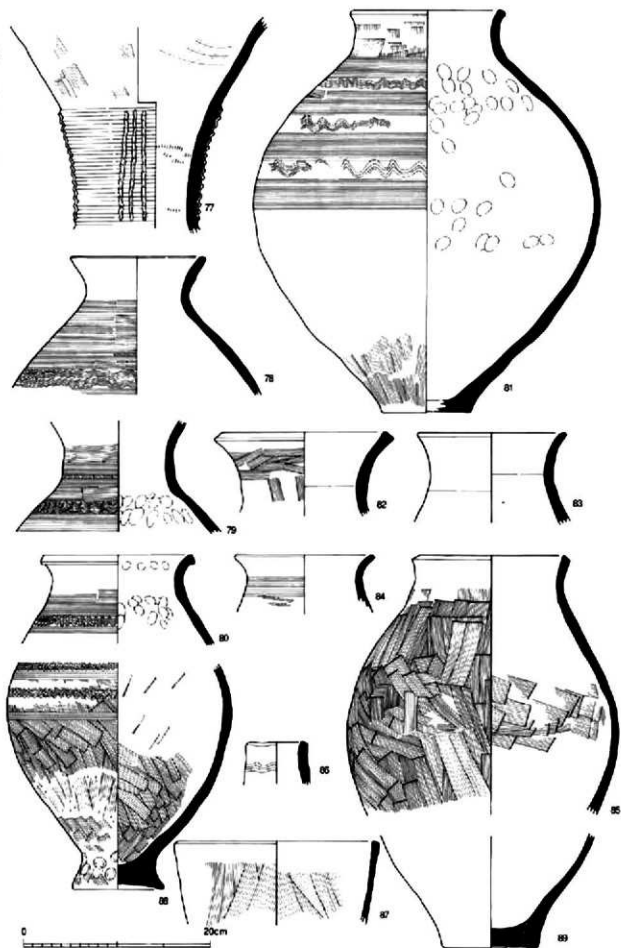

土器2 (溝・土坑・竪穴住居/77-89)

図版 143
弥生中期下層

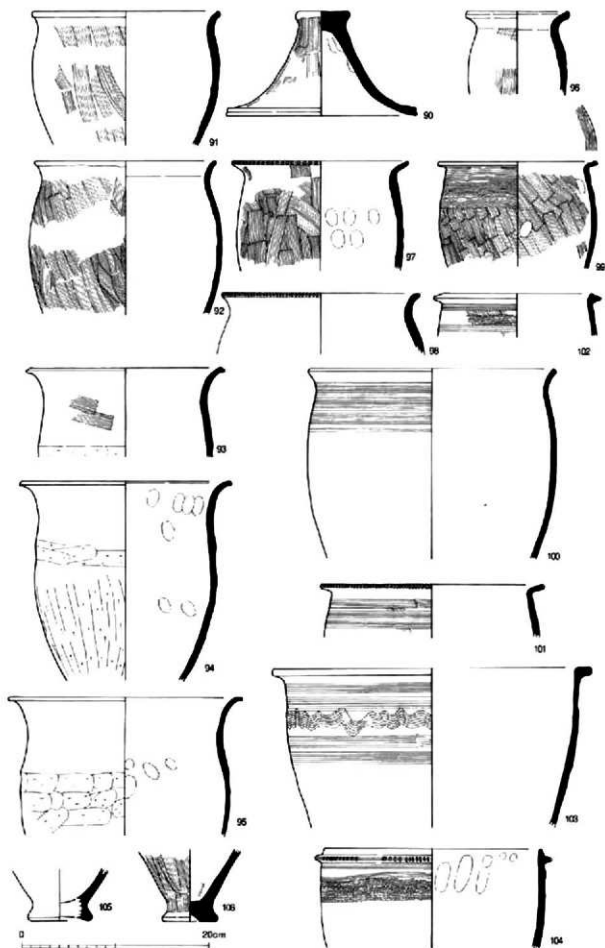

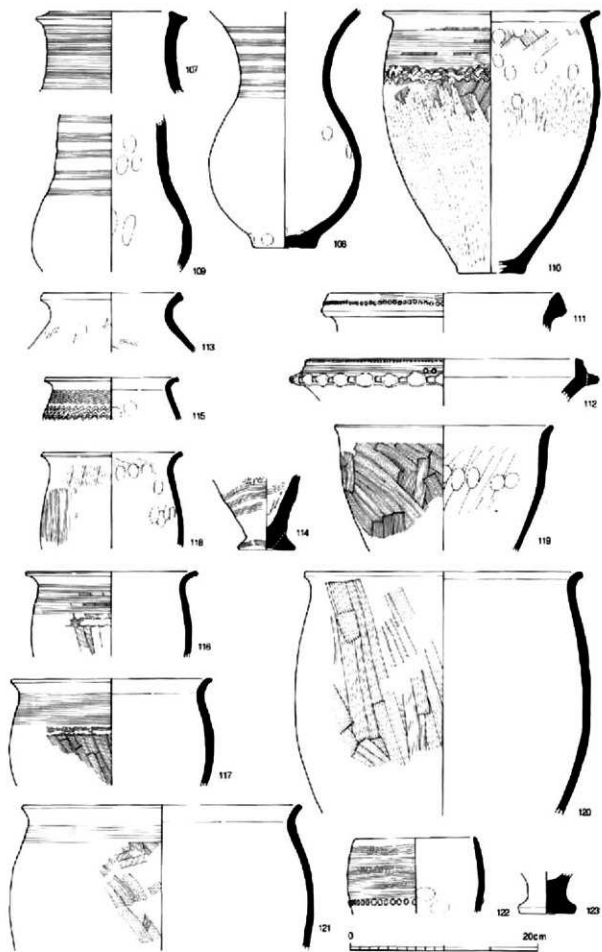

土器4 (上坑・壑穴住居/107-123)

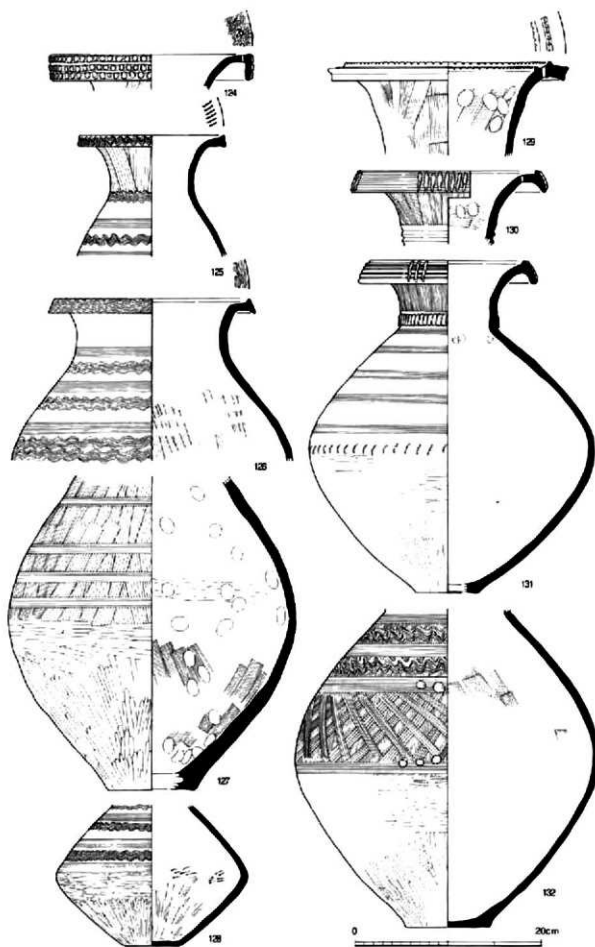

土器1 (河通/124-132)



图2 (河田/133~143)





土器4 (河廻/161-166)

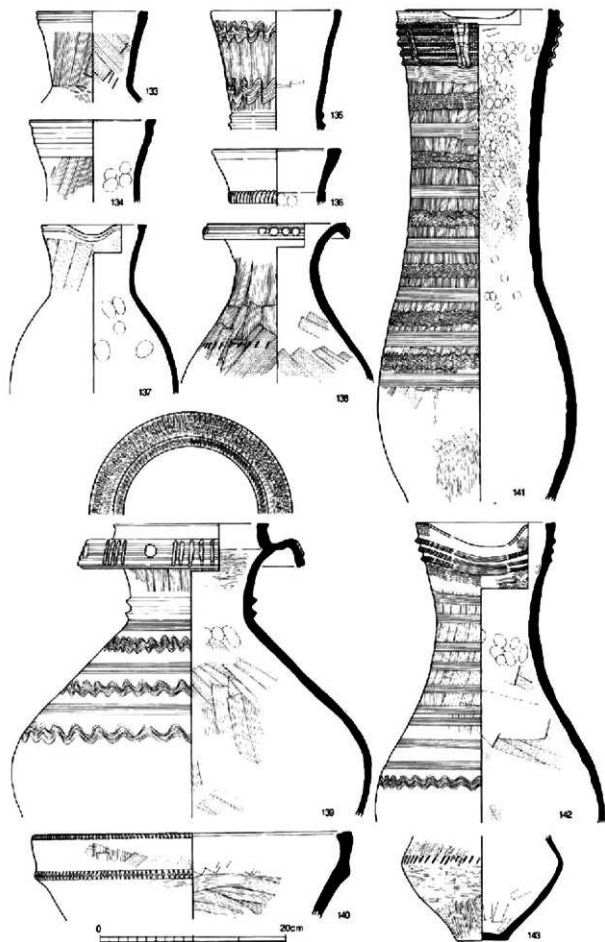
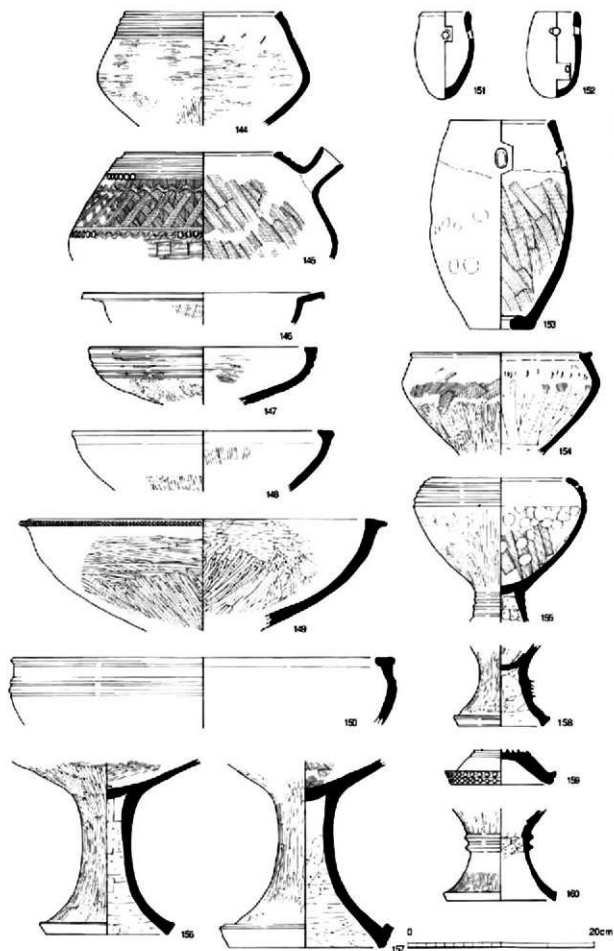
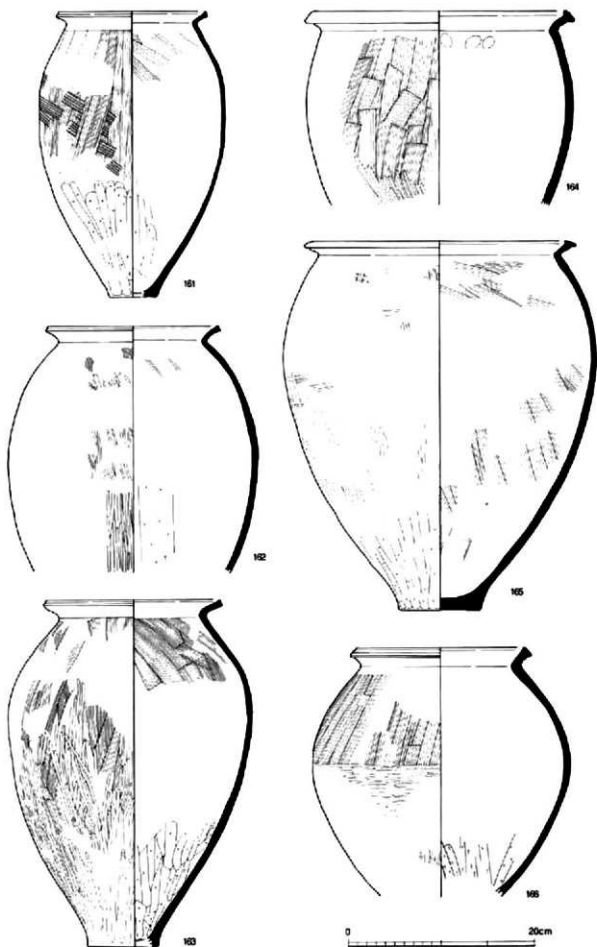
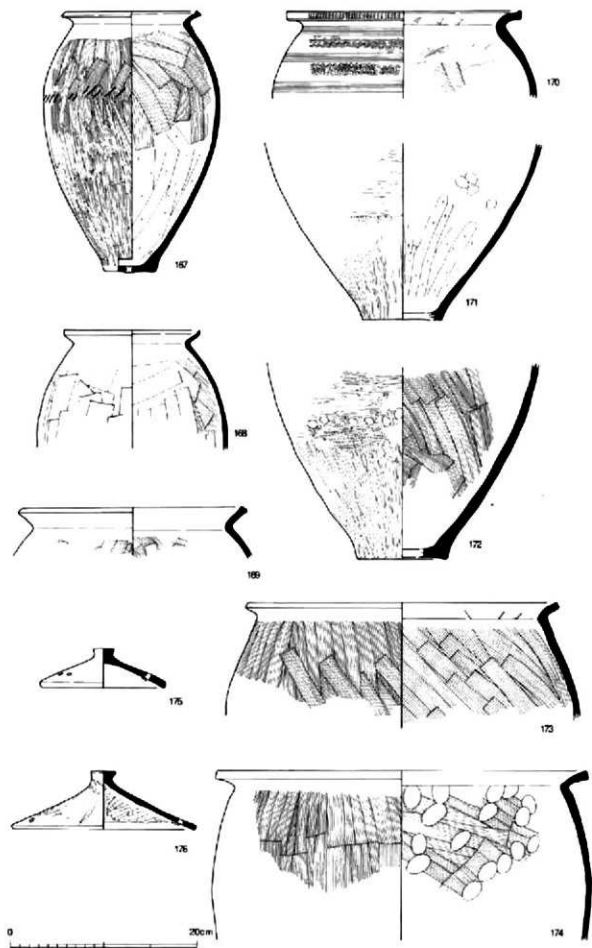

上器5 (河通/167-176)

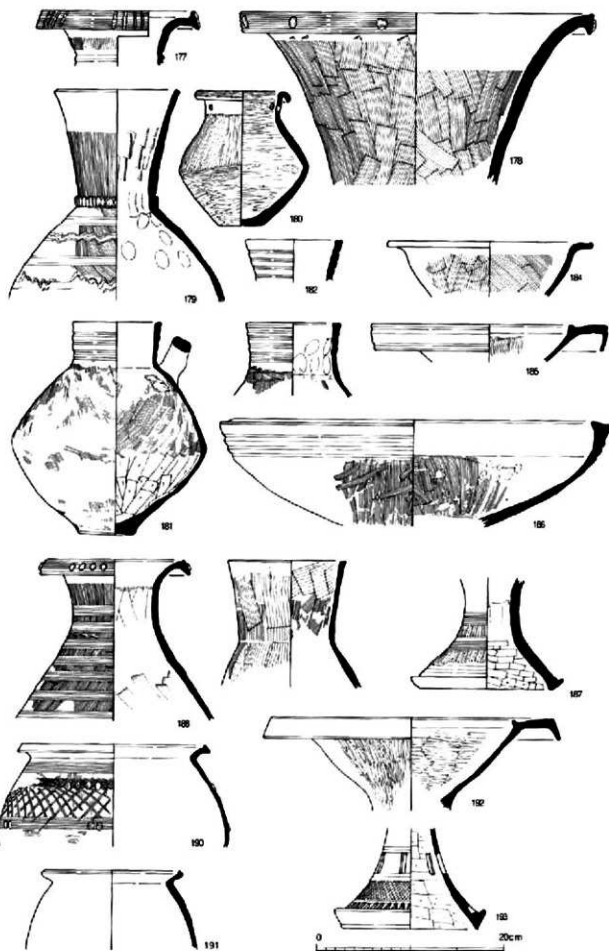

1.器6 (河道・溝/177~193)

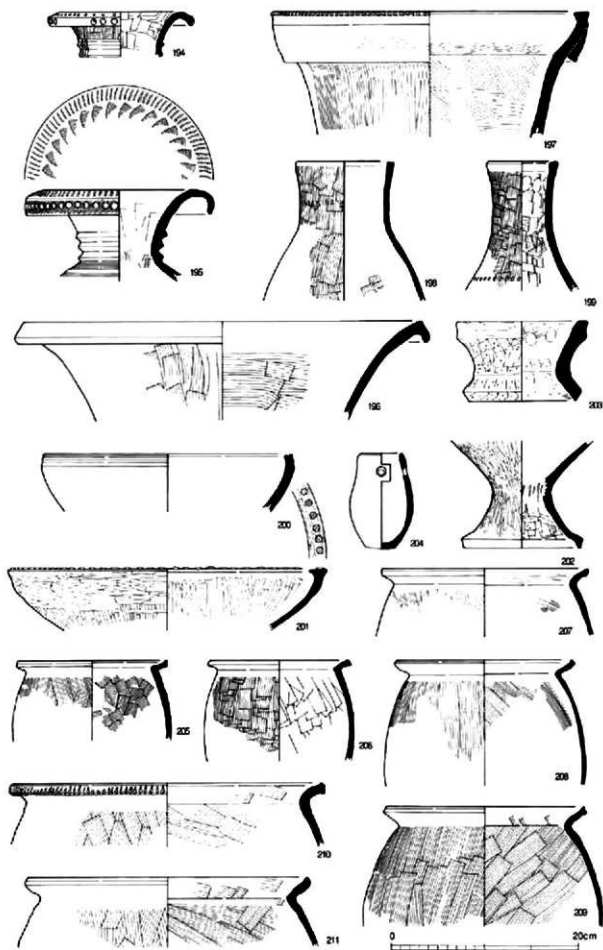

土器7 (溝/194~211)

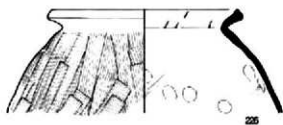
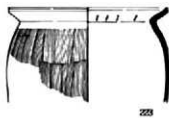
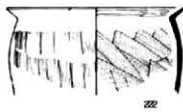
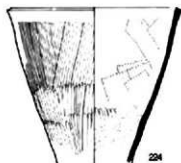
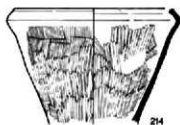
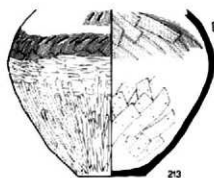
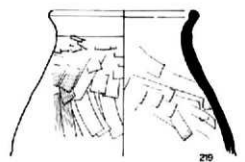
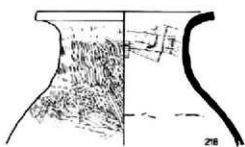
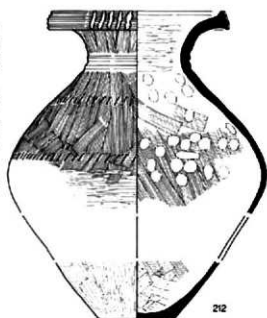

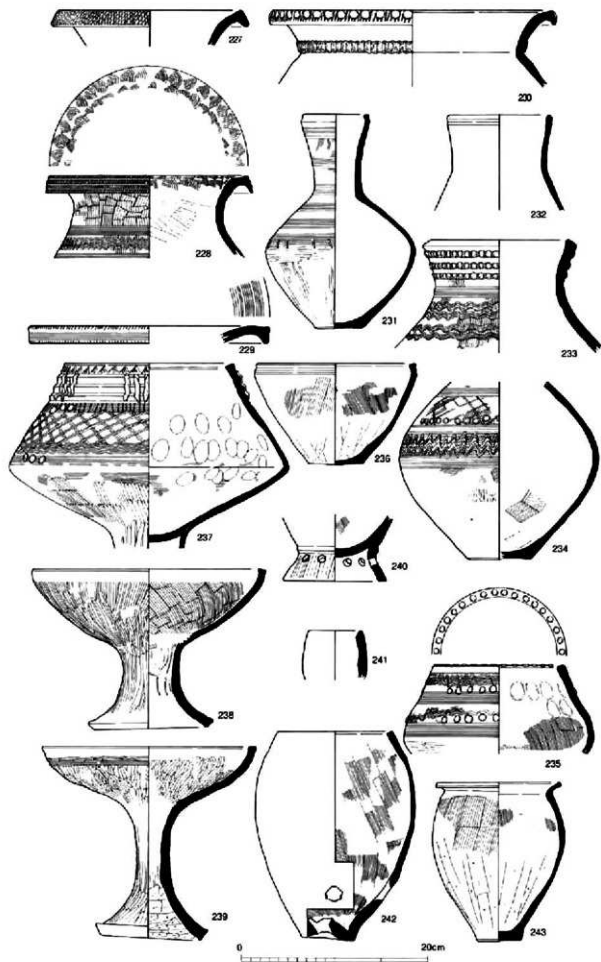

土器9 (溝・水田/227~243)

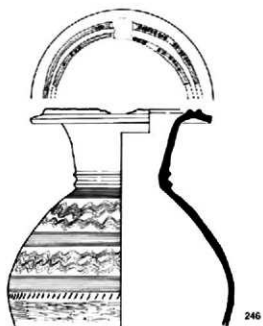
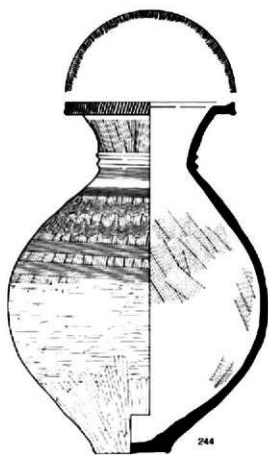

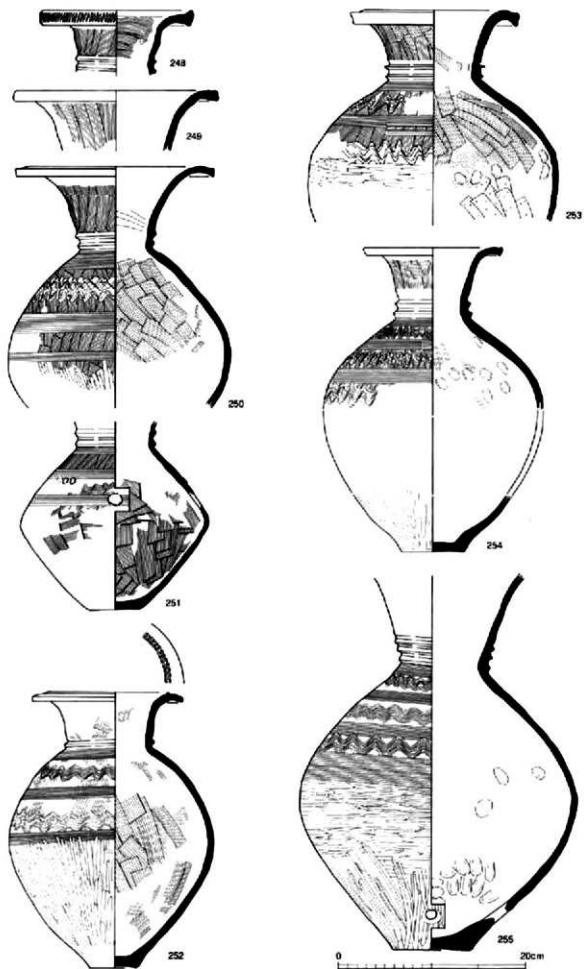

土器11 (方形周溝器/248~255)

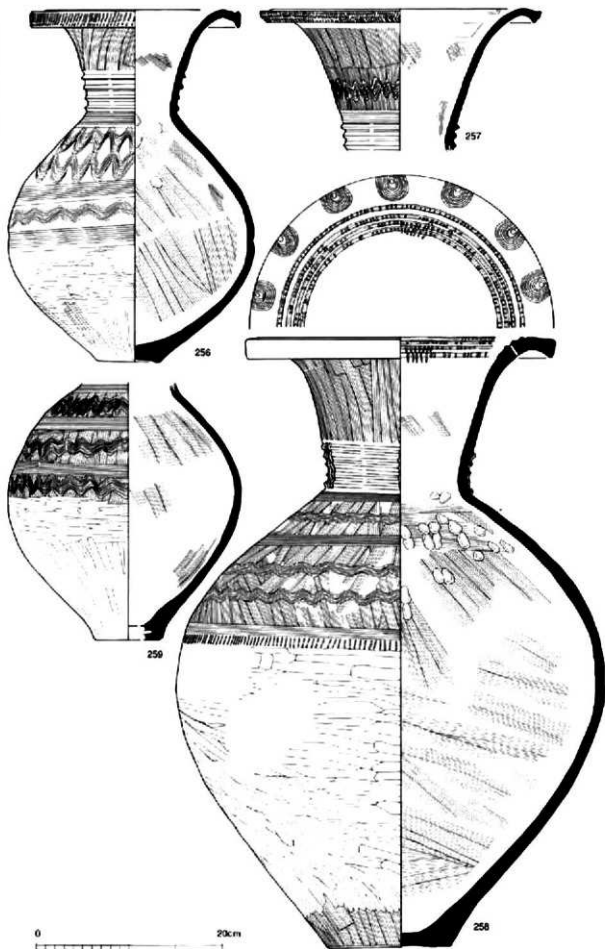

土器12 (方形肩酒甕/256-259)

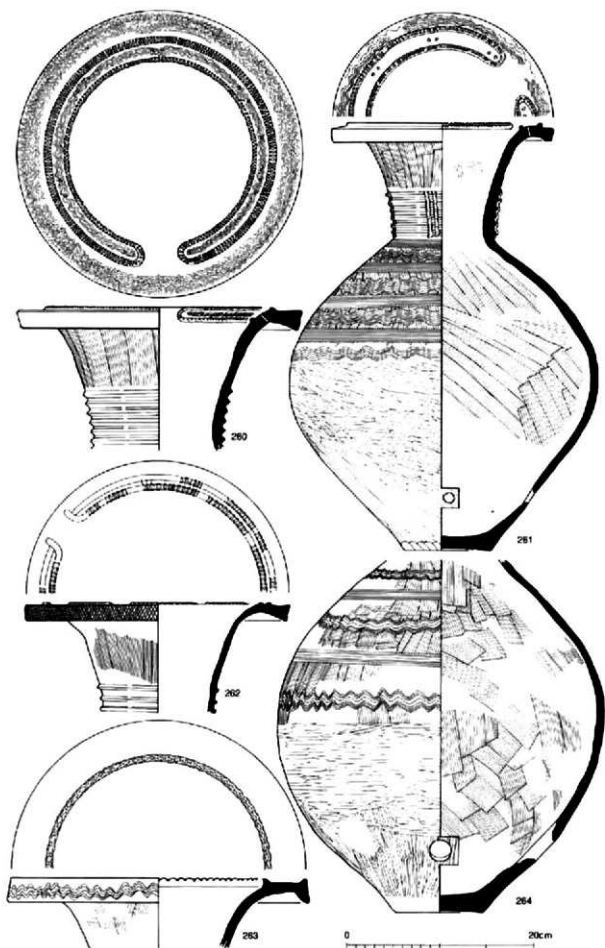

土器13 (方形周溝墓/260-264)

图版
158

弥生中期上層

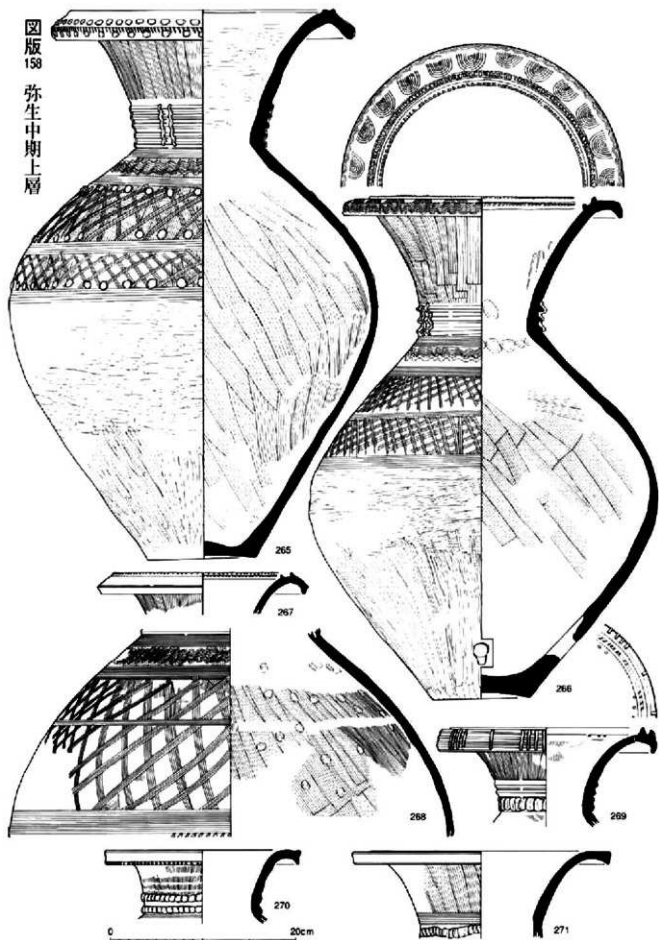

土器14 (方形肩青瓷/265~271)

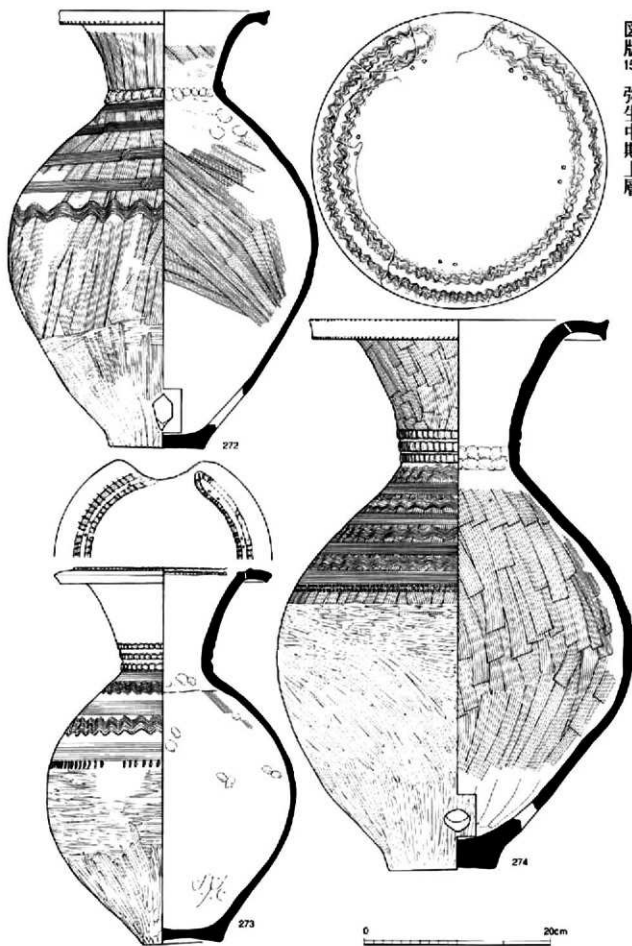

上器15 (方形埴冴墓/272~274)

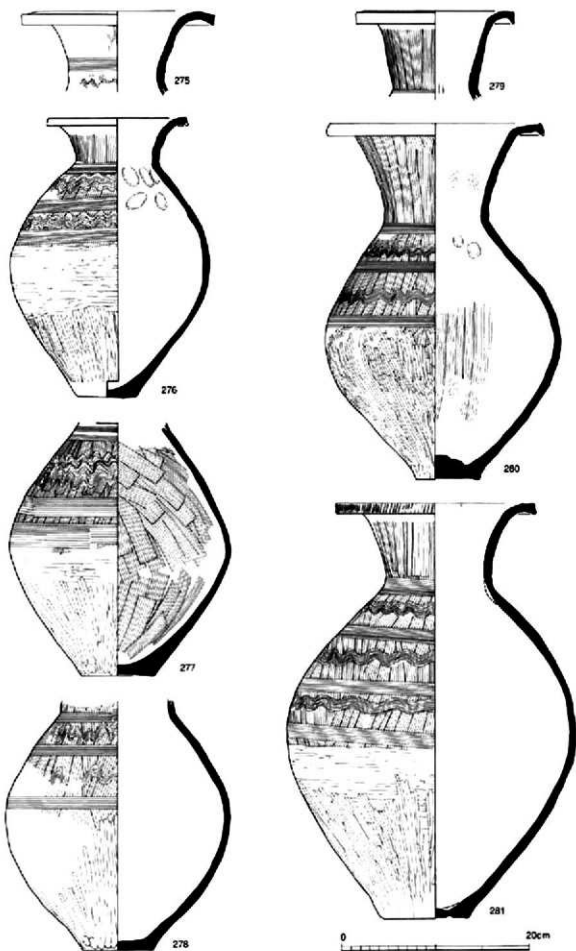

上巻16 (方形肩酒壺/275~281)



图17 (方形周溝墓/282~291)



土器18 (方形頸滿壺/292~302)

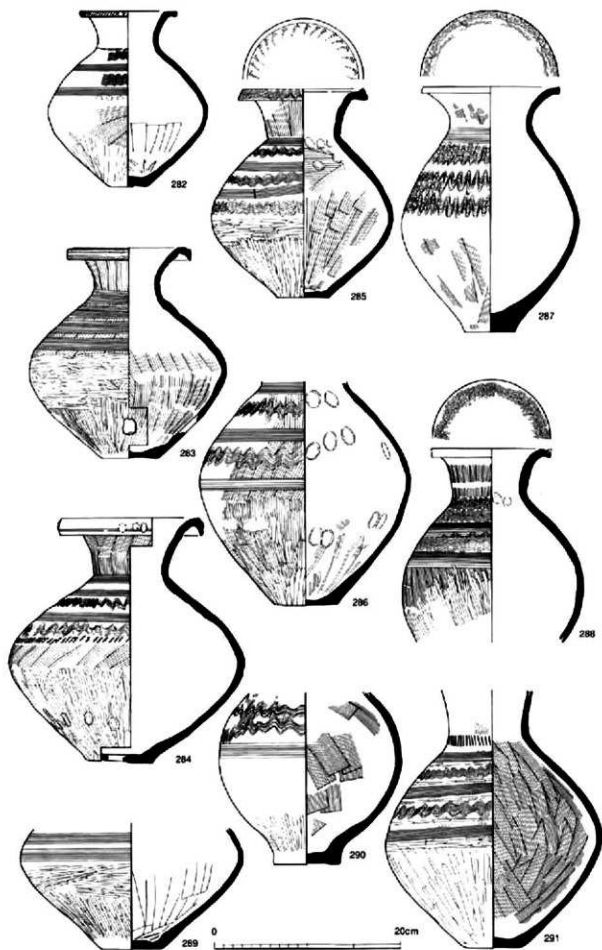
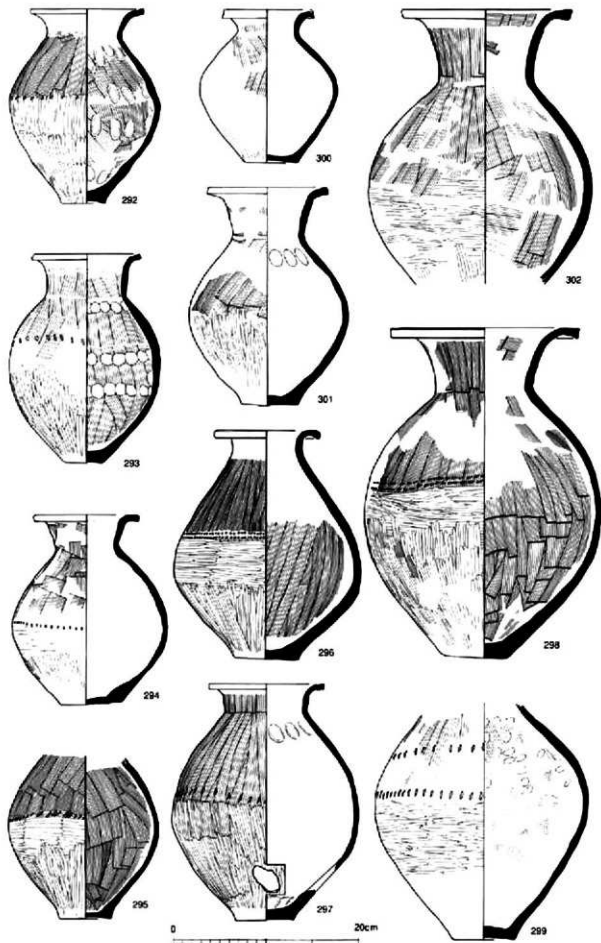
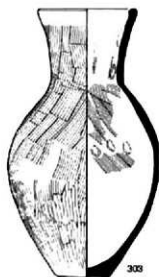

303

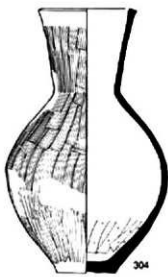

304

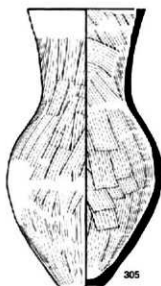

305

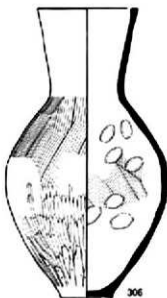

306

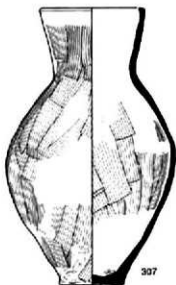

307

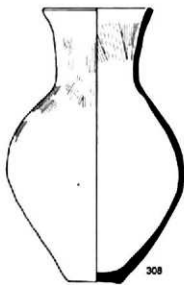

308

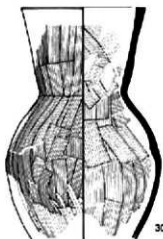

309

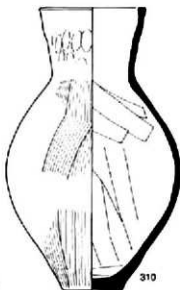

310

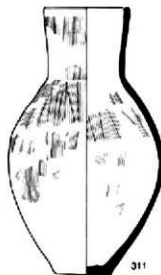

311

0 20cm

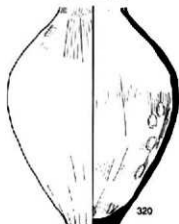
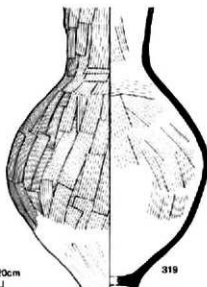
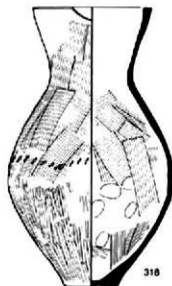
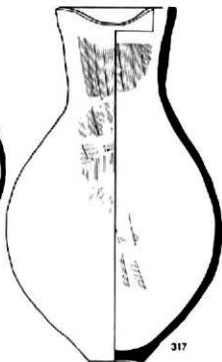
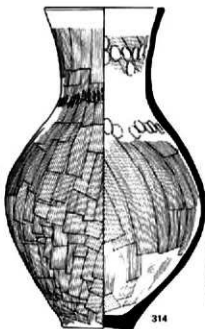
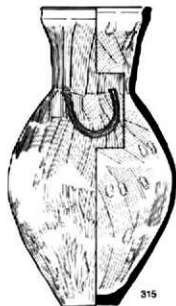
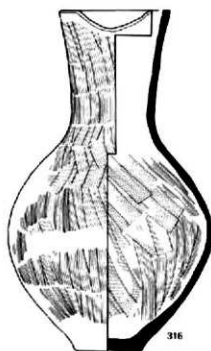
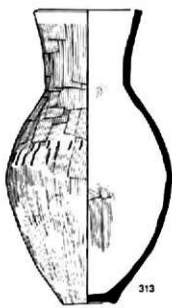
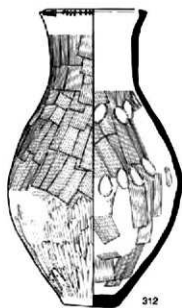

0 20cm

土器20 (方形周溝壺/312~320)

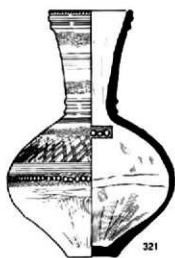

321

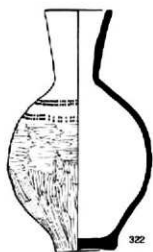

322



327



323

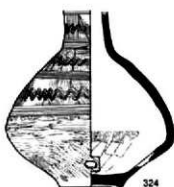

324

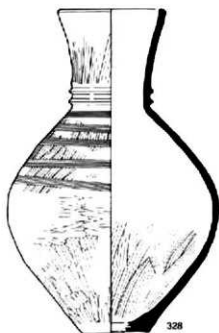

328

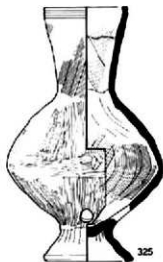

325



326

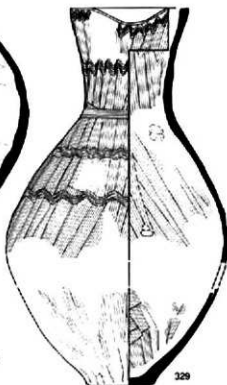

329



330



上器21 (方形肩酒甕/321~330)

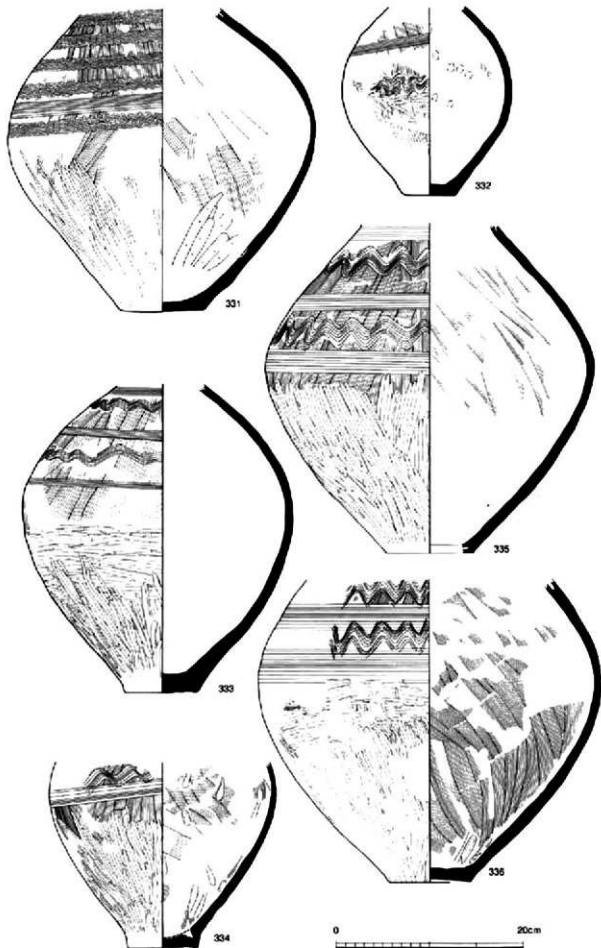

1.器22 (方形周溝壺/331~336)

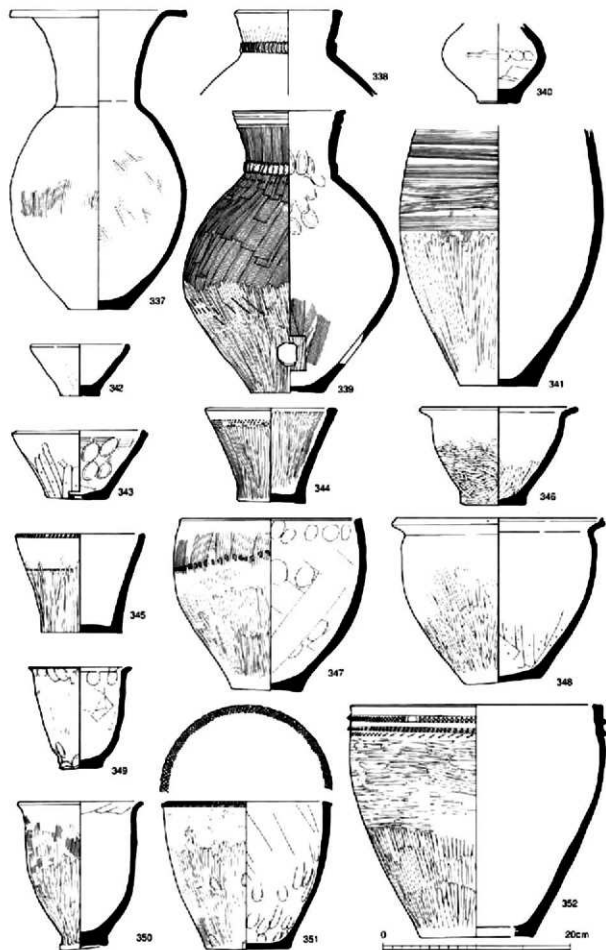

図版 23 (方形周溝壺/337-352)

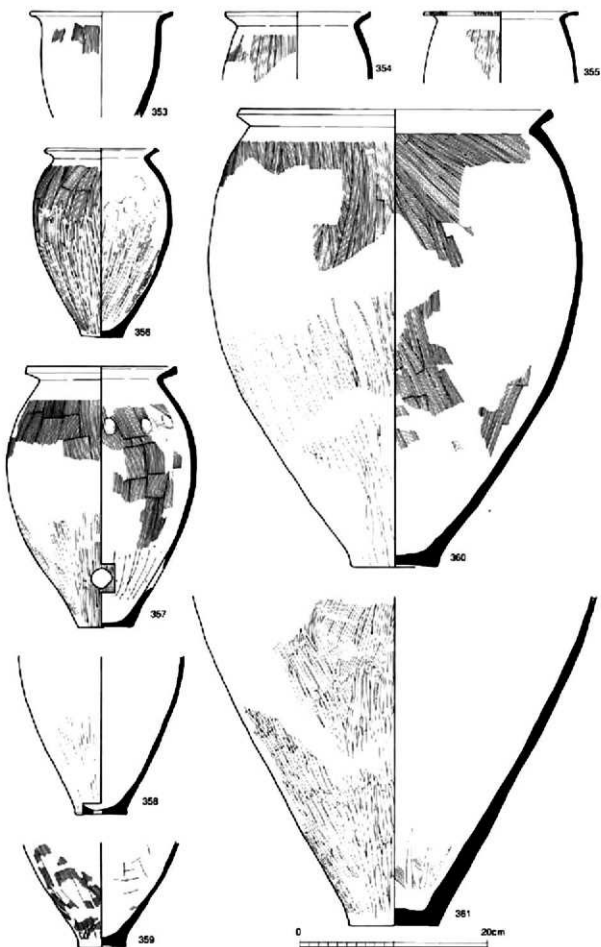

土器24 (方形周溝壺/353-361)

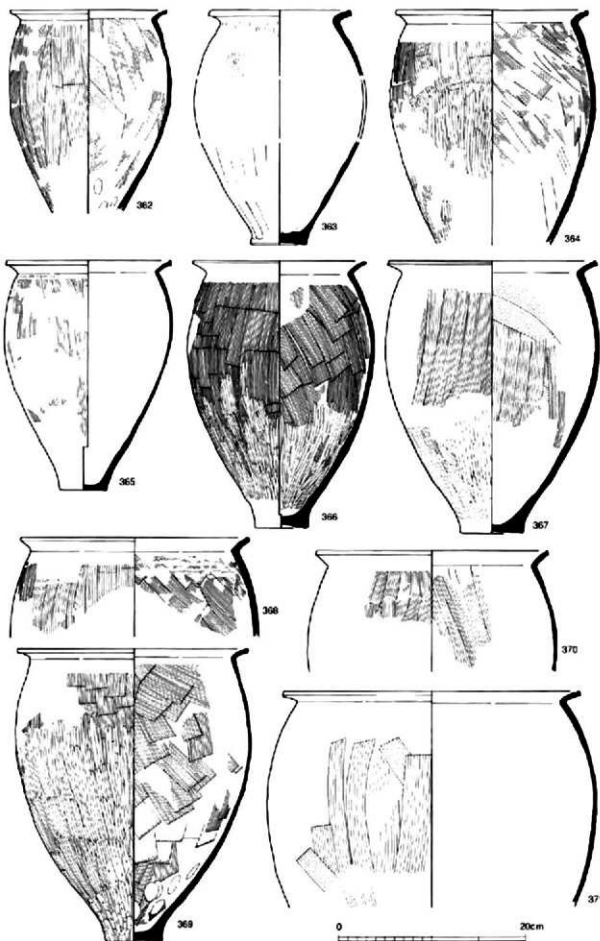

土器25 (方形周溝壺/362~371)

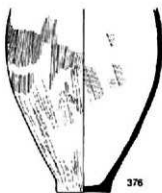
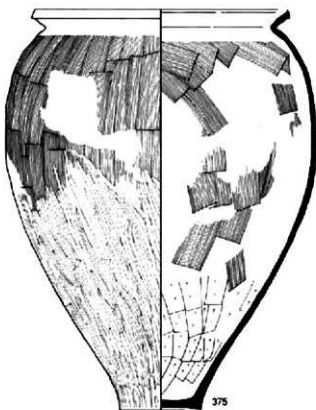
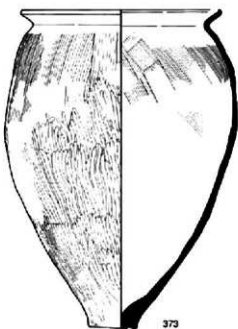
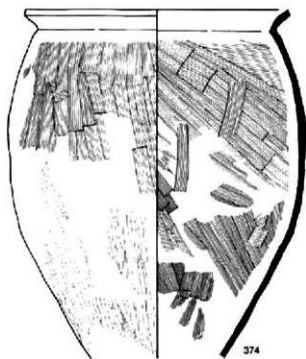
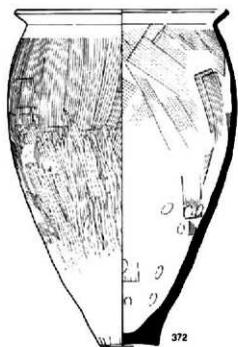

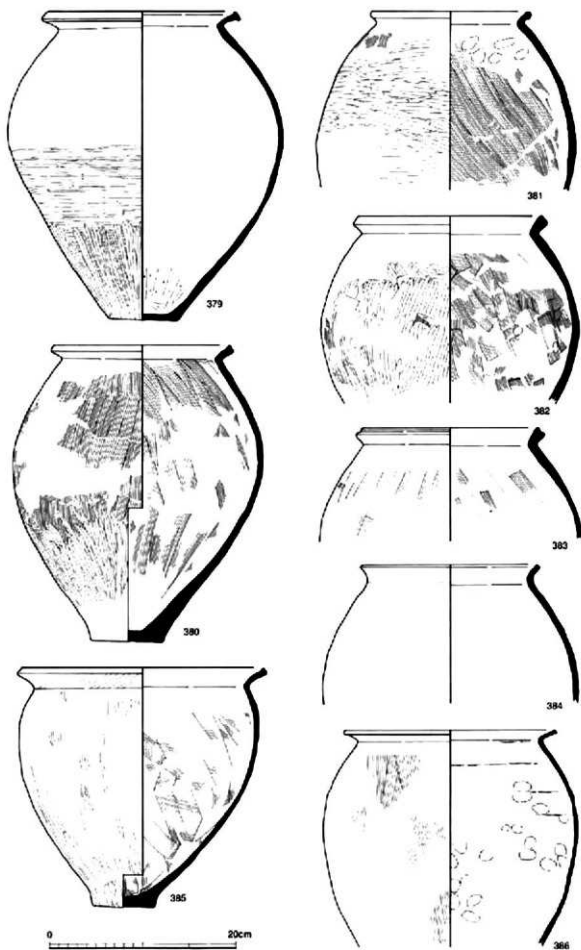

土器27 (方形肩溝壺/379~386)

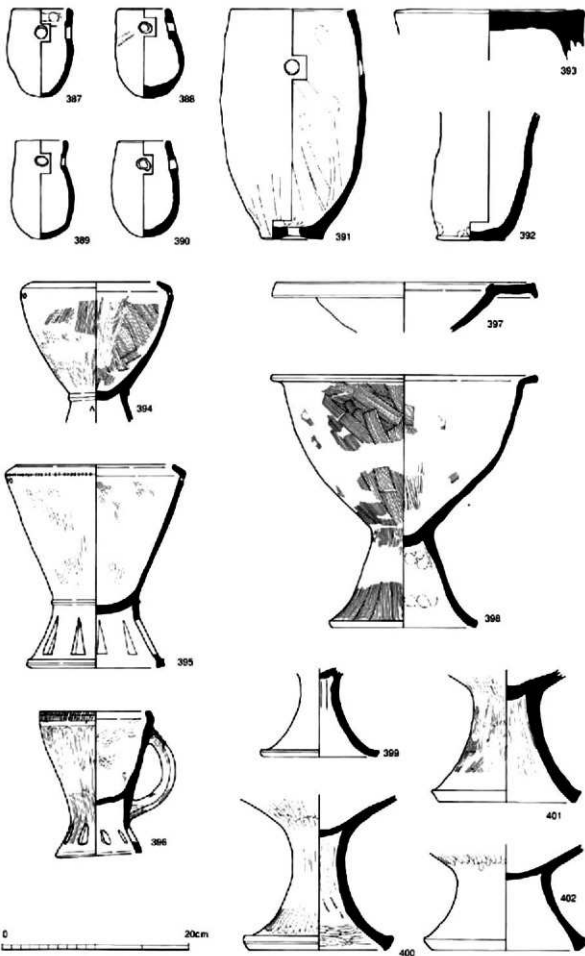

上巻28 (方形柄鐮/387-402)

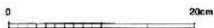
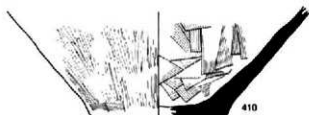
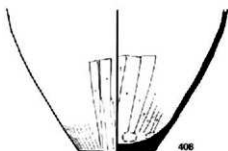
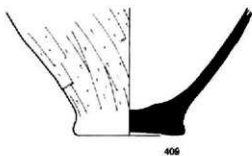
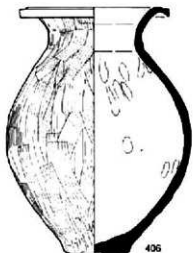
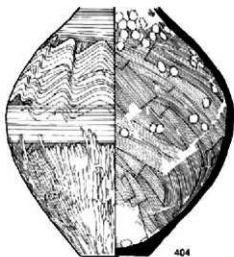
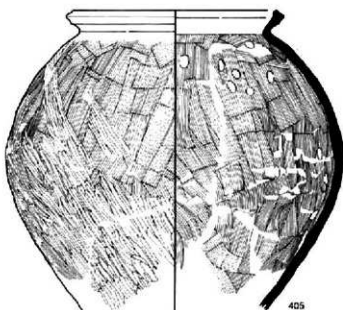
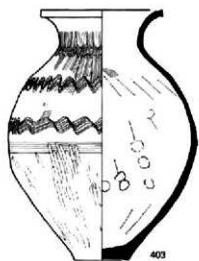

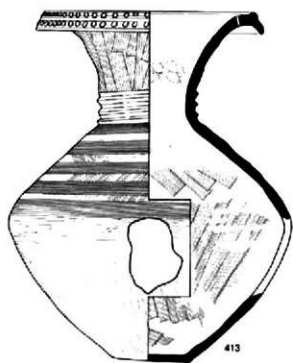
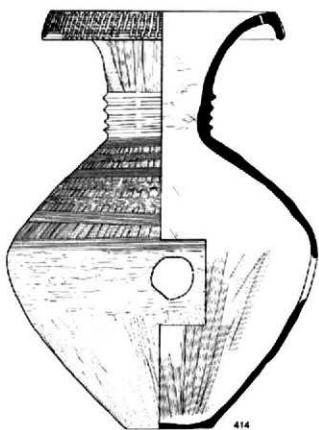
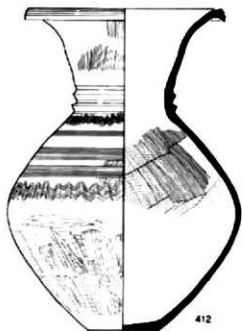

0 20cm

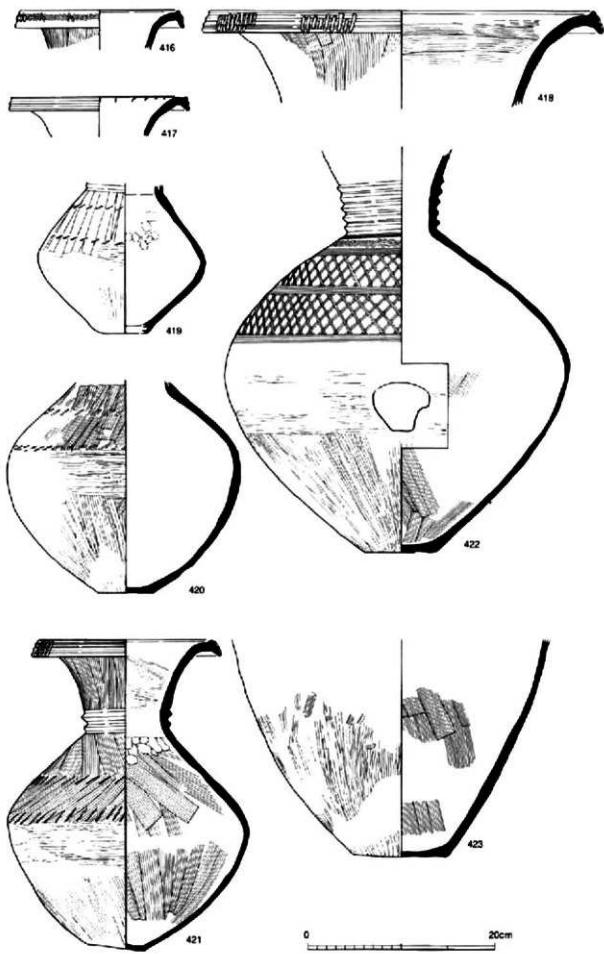

土器31 (平地住居SB40001/416-423)

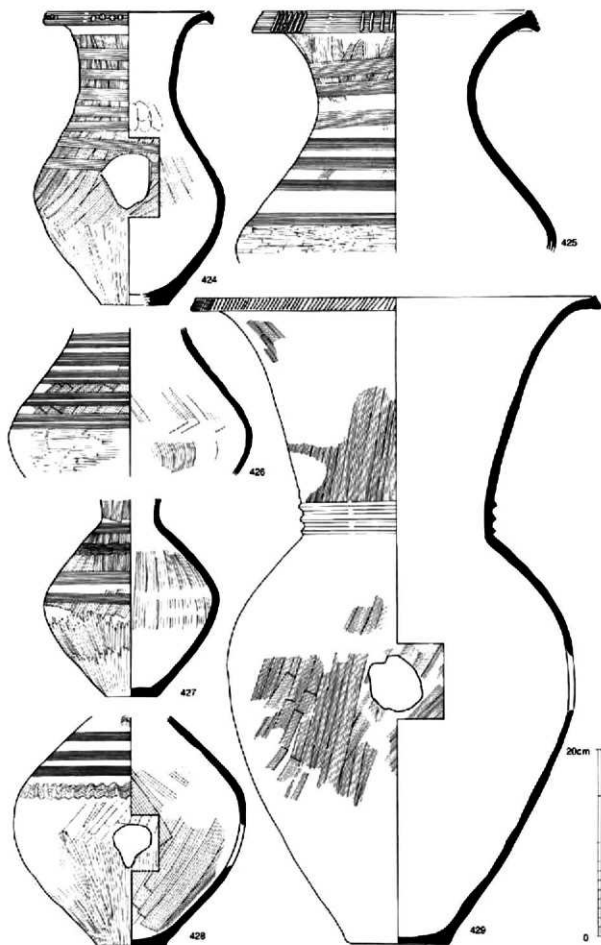

土器32 (平地住居SB40001/424-429)

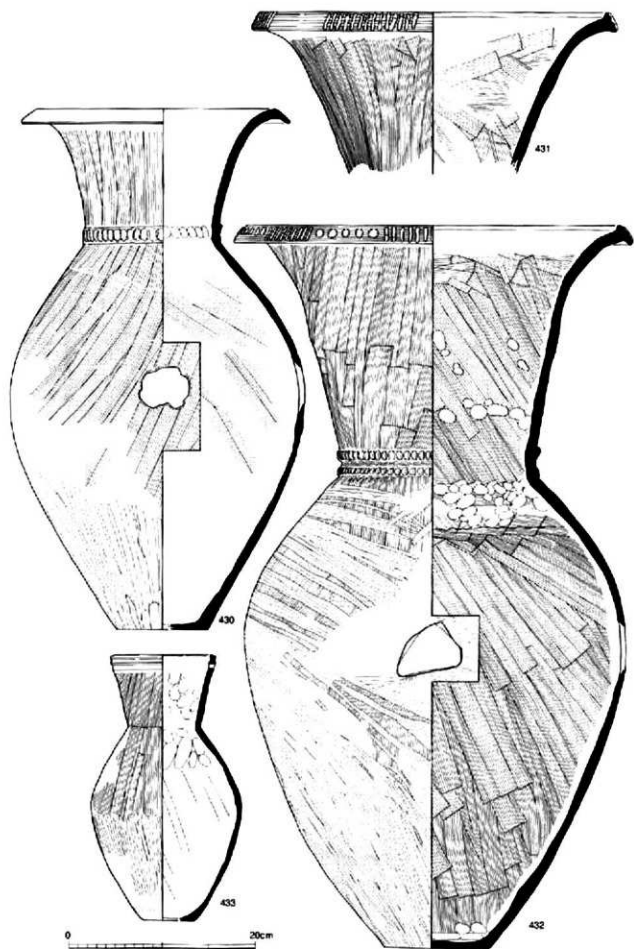

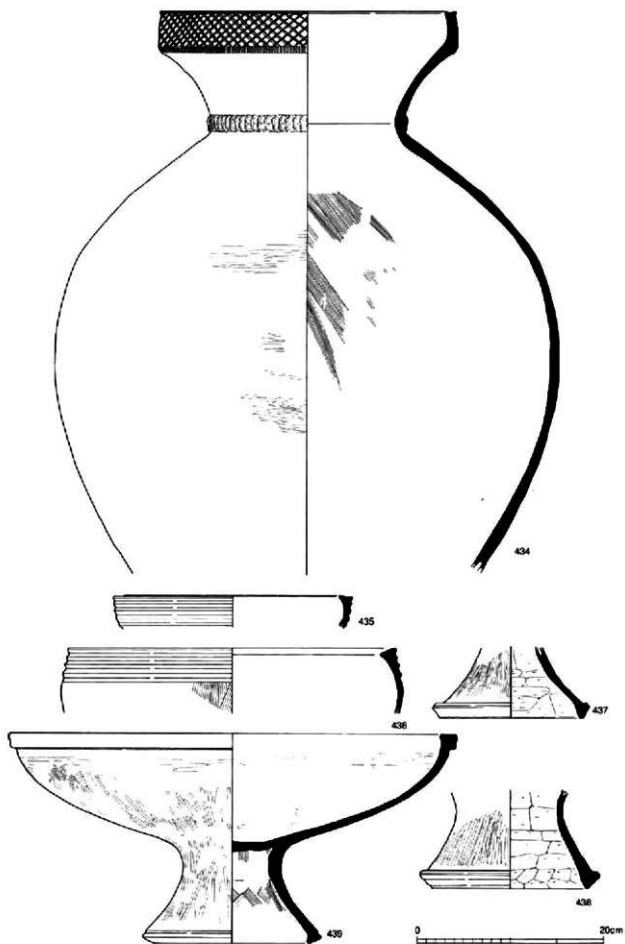

土器34 (平地住跡SB40001/434-439)

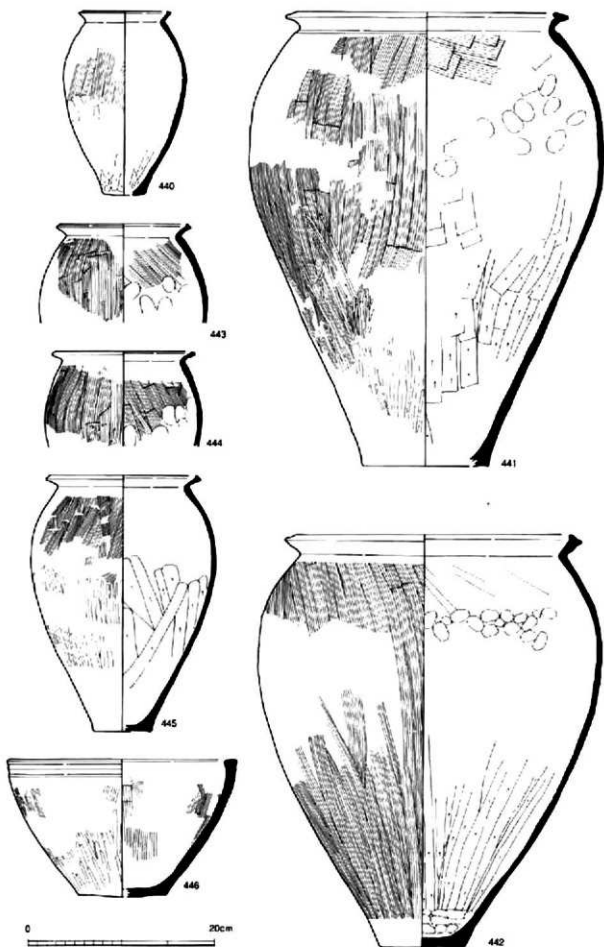

土器35 (平地住居SB40001/440~446)

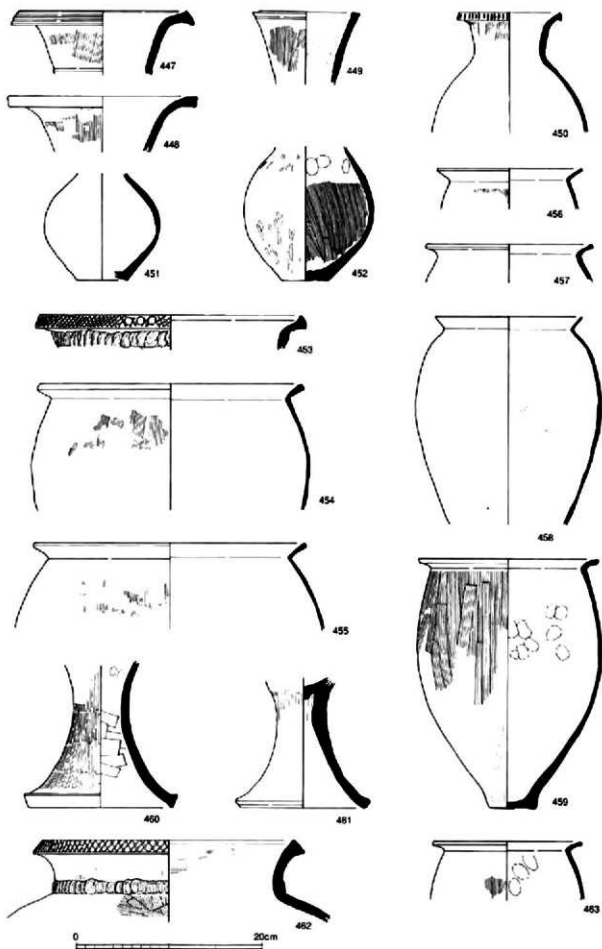

上巻36 (壺穴住居/447-463)

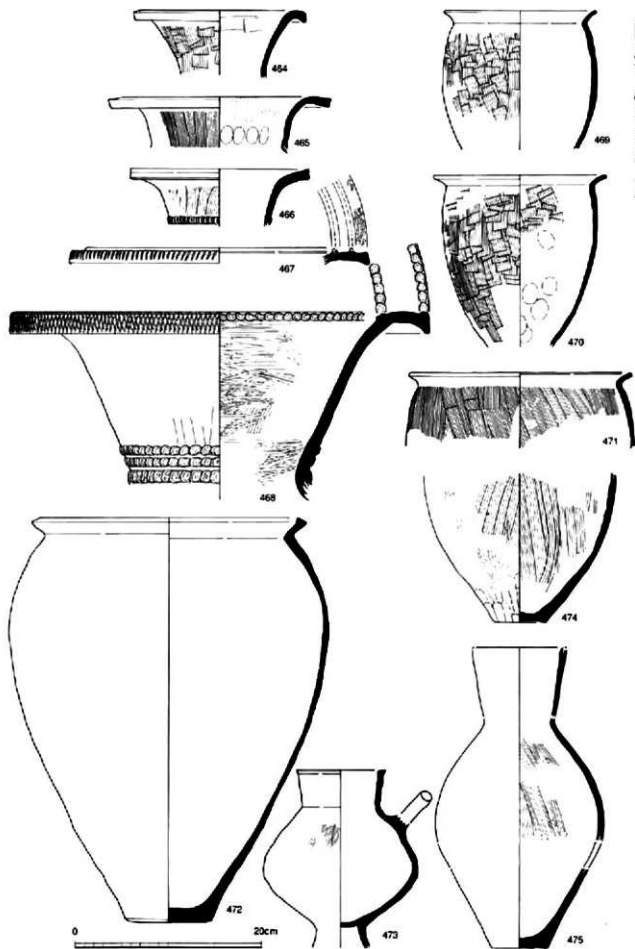

土器37 (竪穴住居・土坑/464~475)

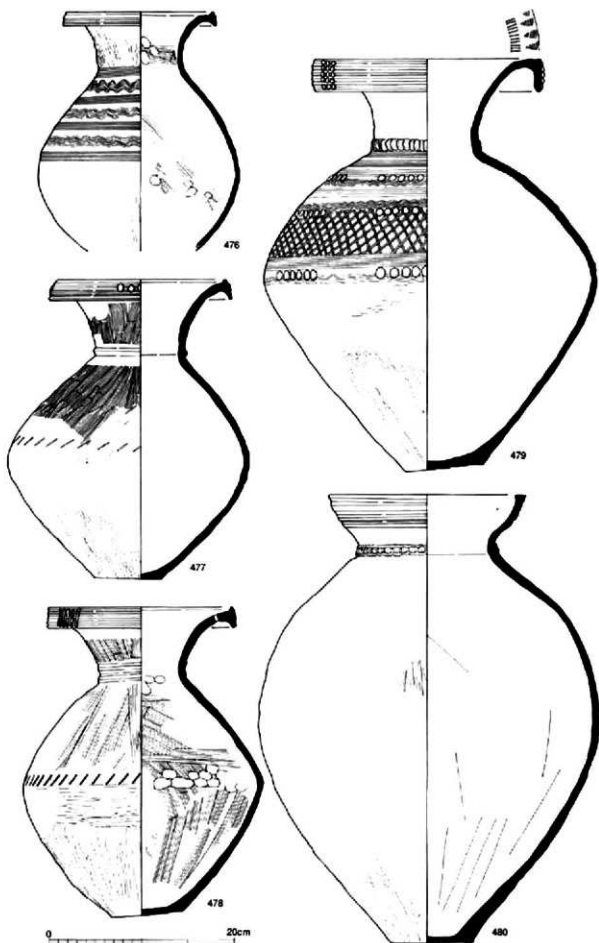

土器38 (上坑/476~480)

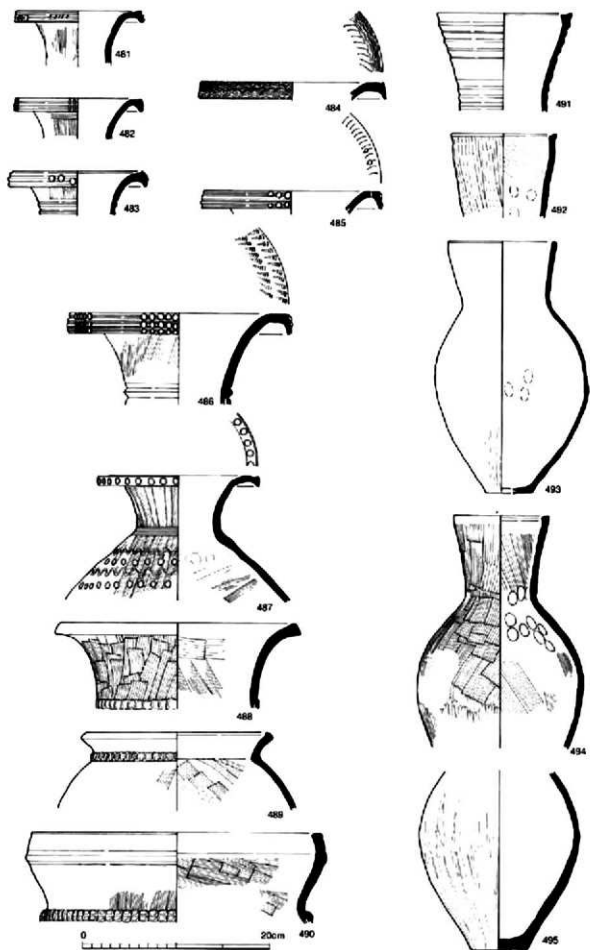

土器39 (整穴住居・土坑/481~495)

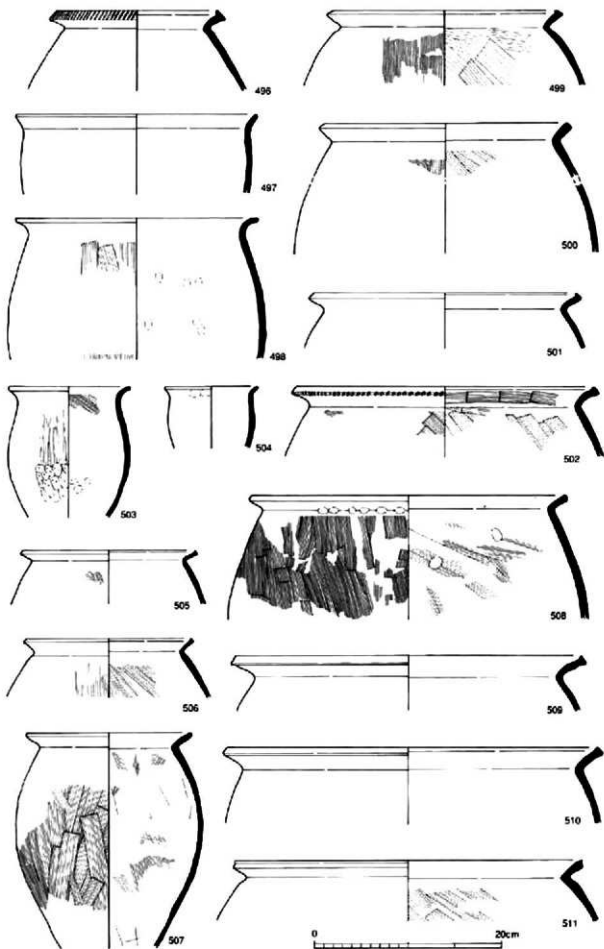

土器40 (土坑/496~511)

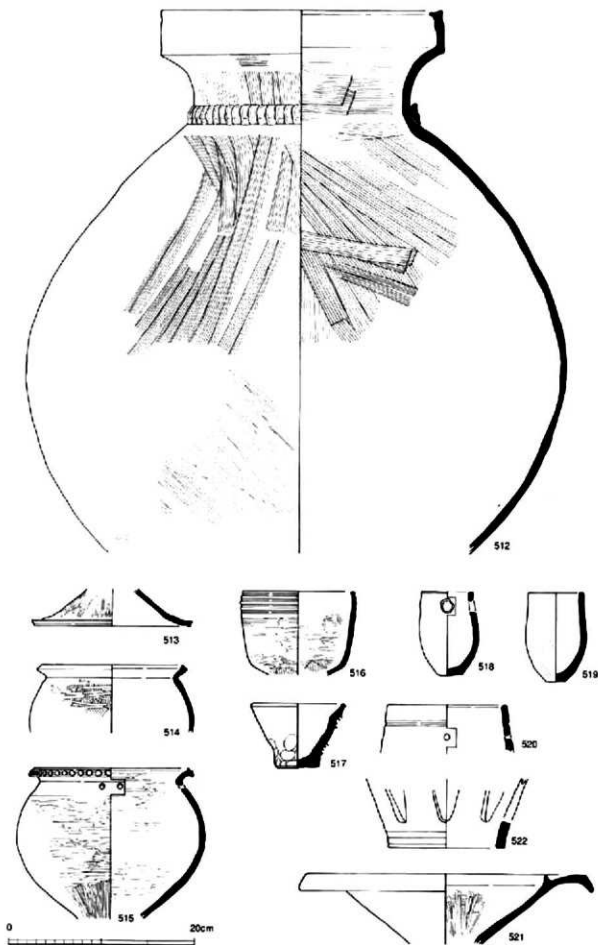

土器41 (土坑/512~522)

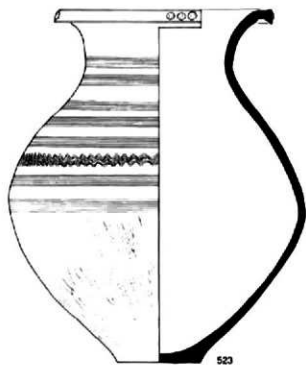

523

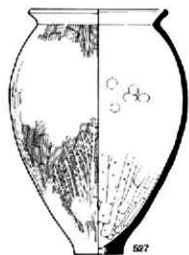

527

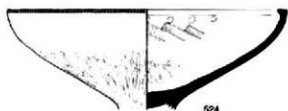

524

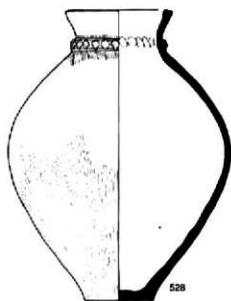

528

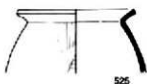

525

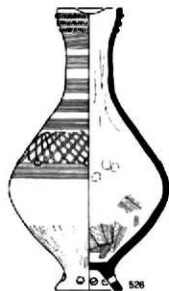

526

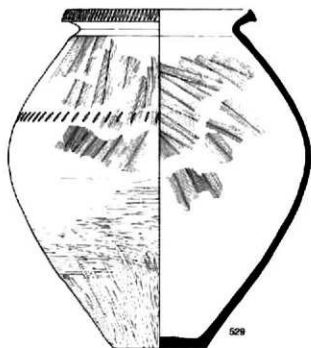

529

0 20cm

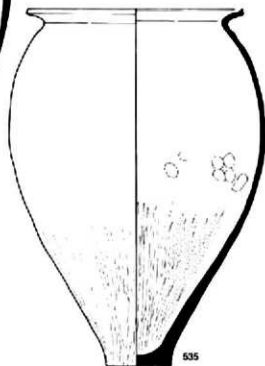
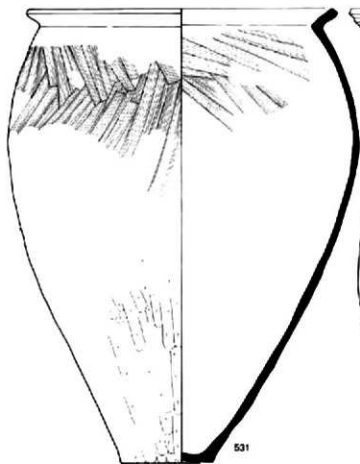
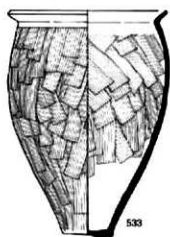
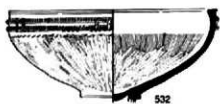
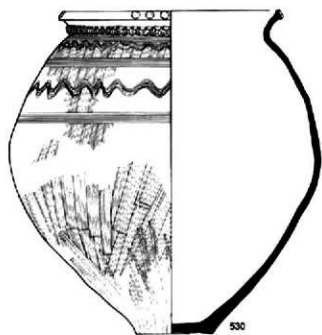

0 20cm

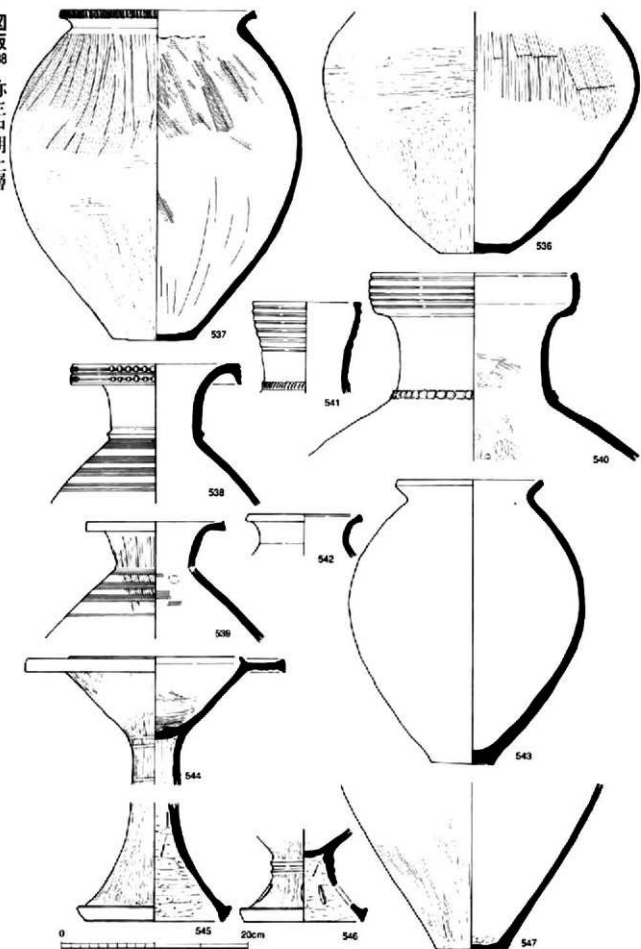

土器44 (土器箱・ビット/536~547)



图45 (包含图/548~564)



土器1 (河遺/565~581)



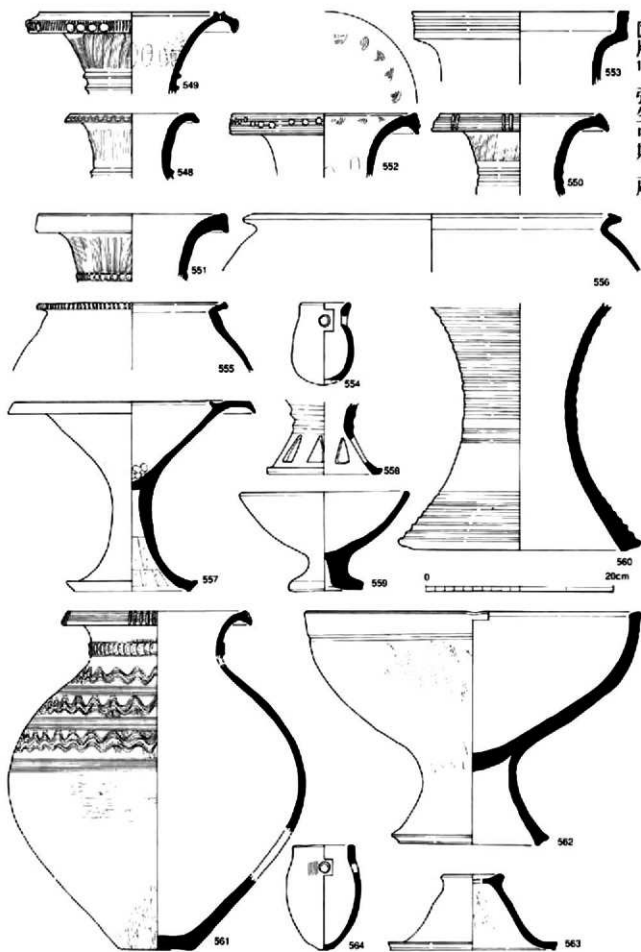
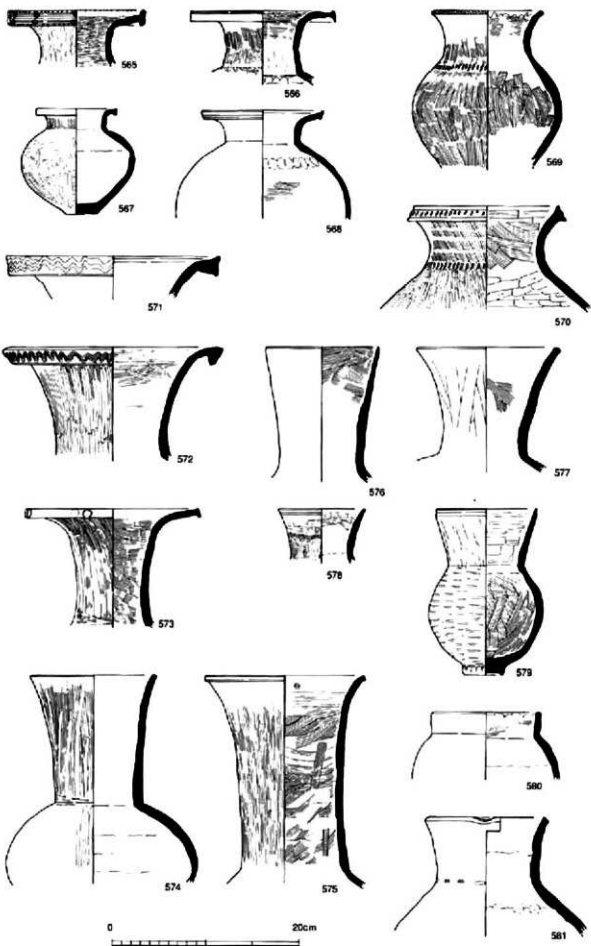
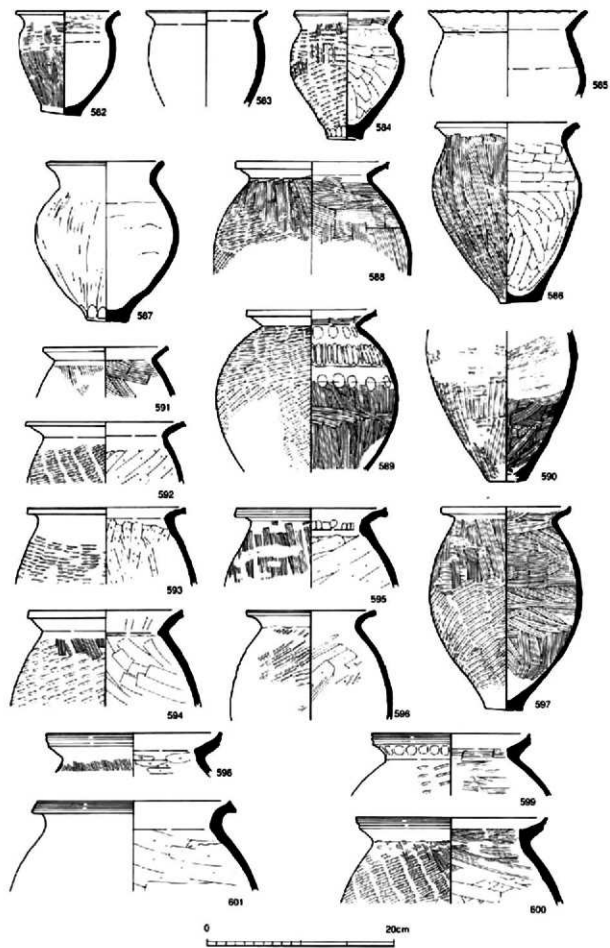
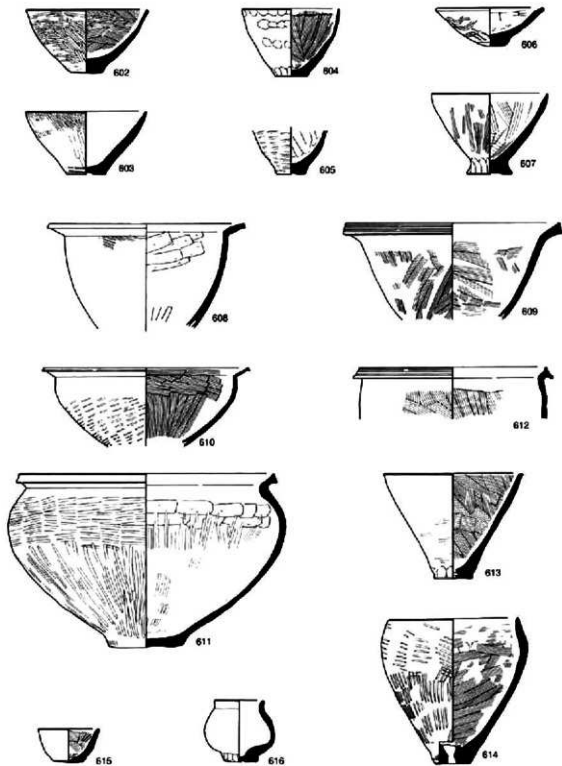

0 20cm

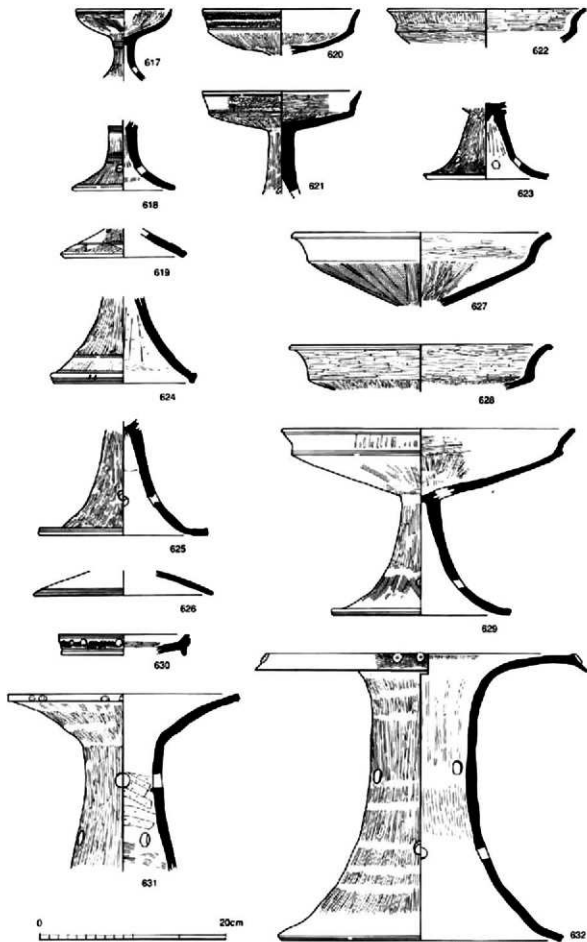

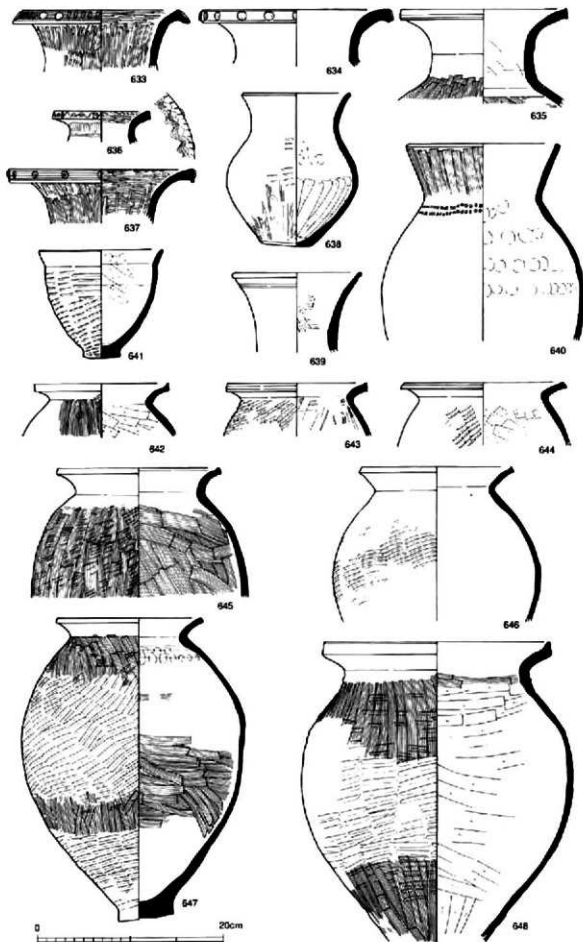

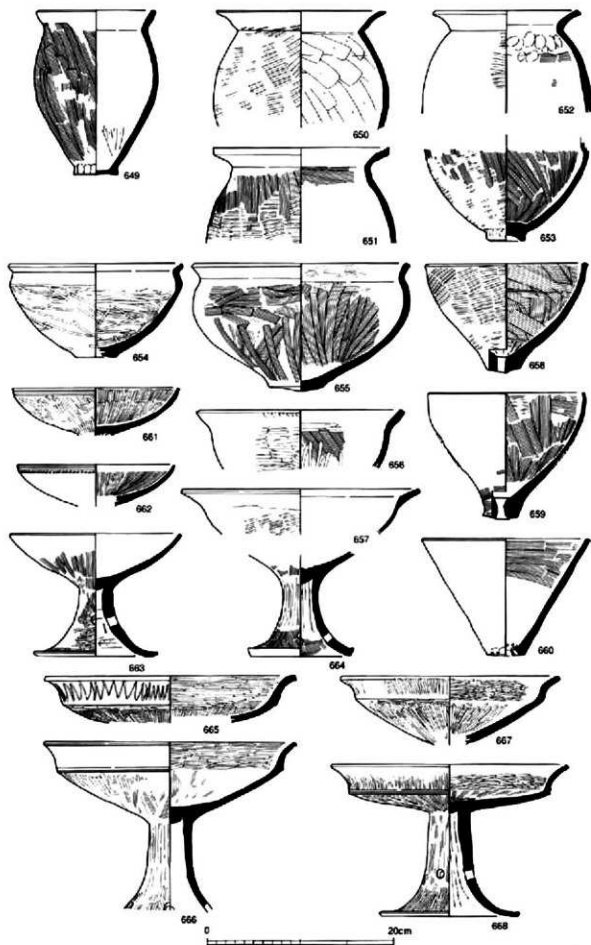

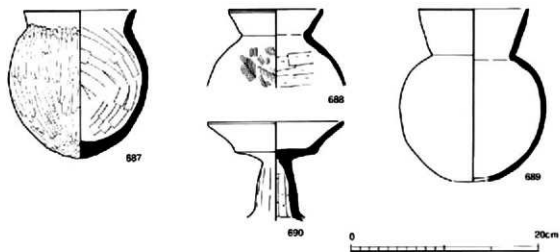
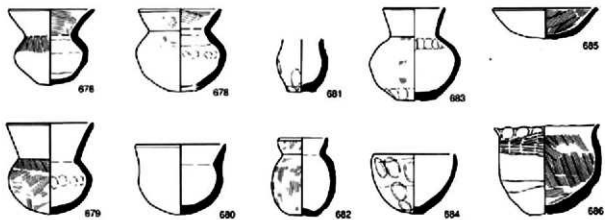
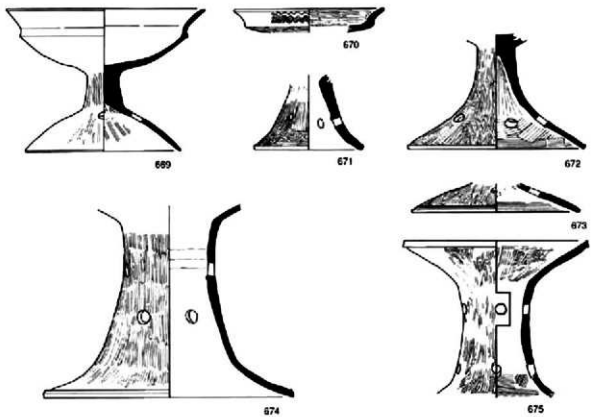

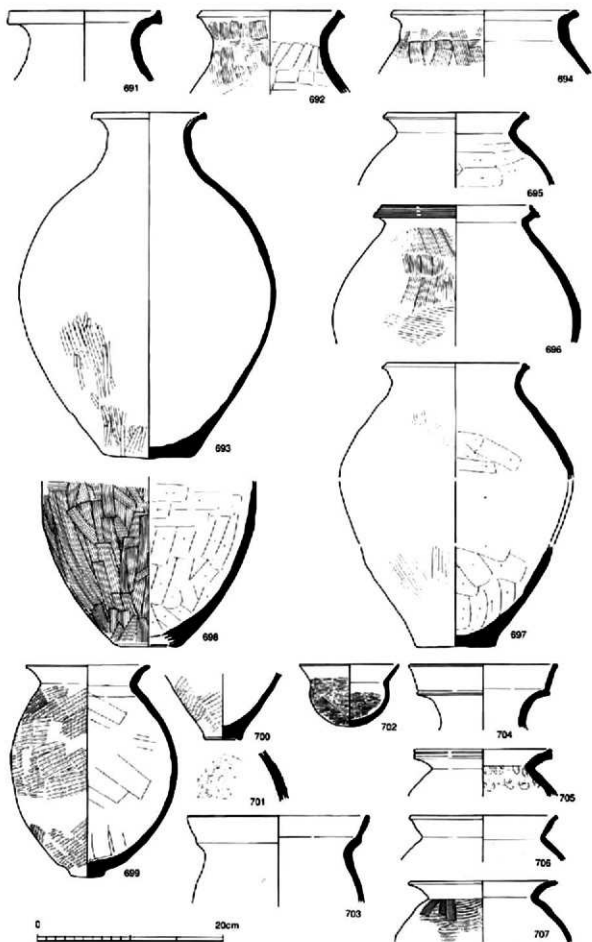

土器8 (土坑・溝/691~707)

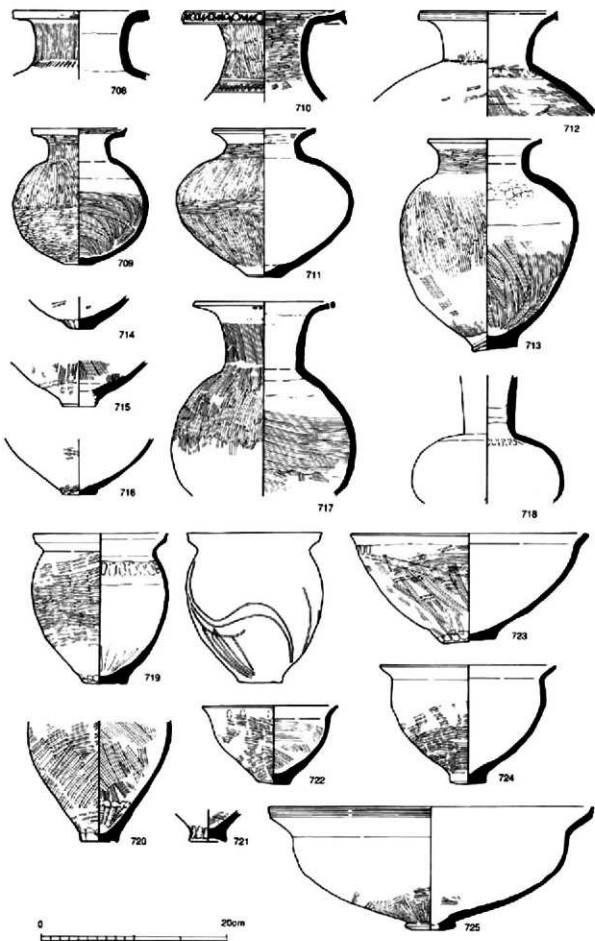

土器9 (甕穴住刷/708~725)

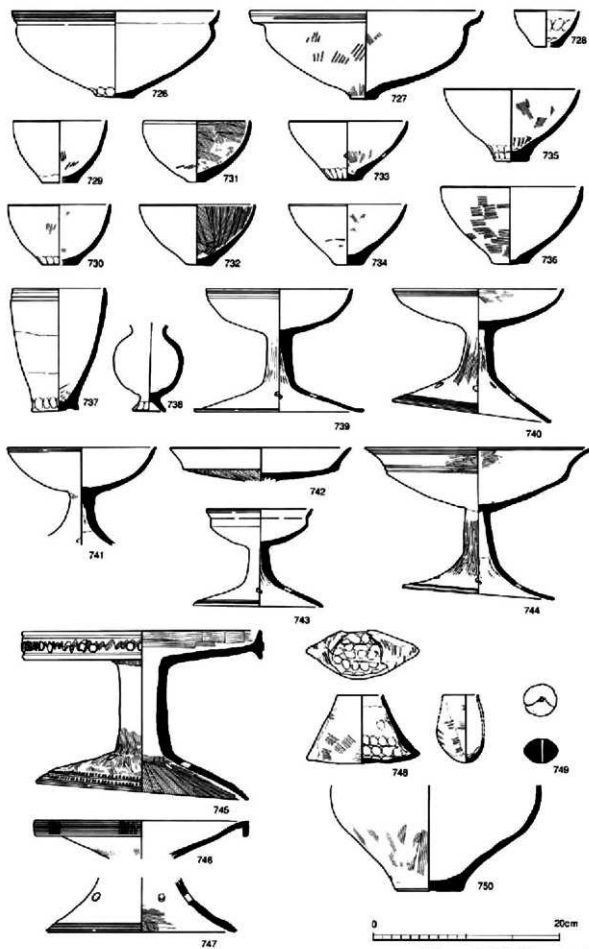

土器10 (壑穴住居/726~750)

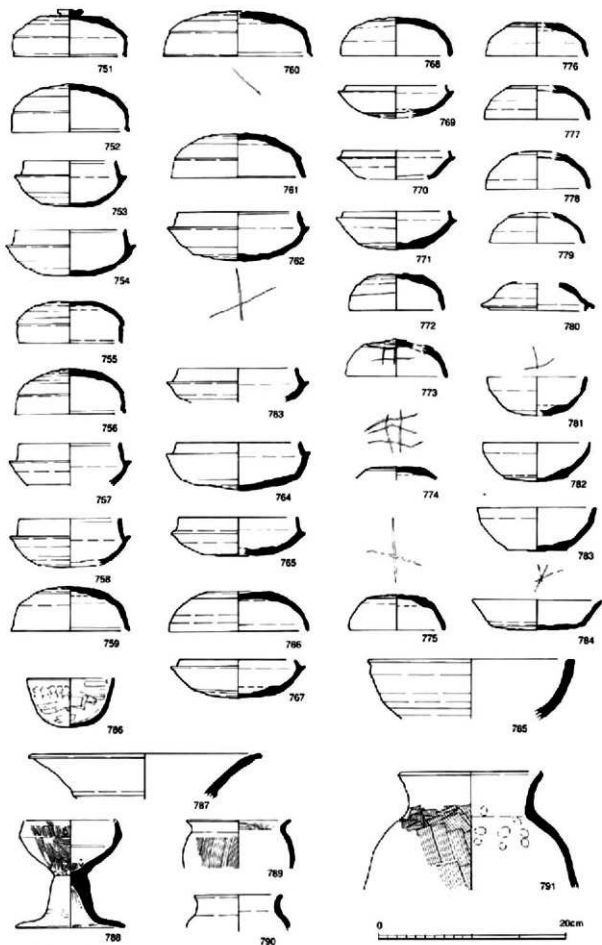

上器 (751-791)

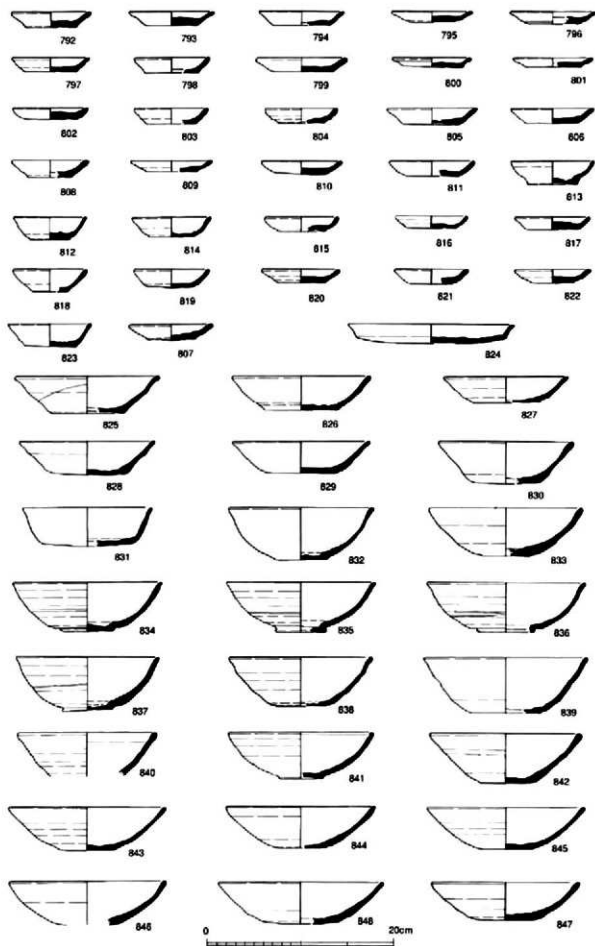

土器1 (調/792~848)

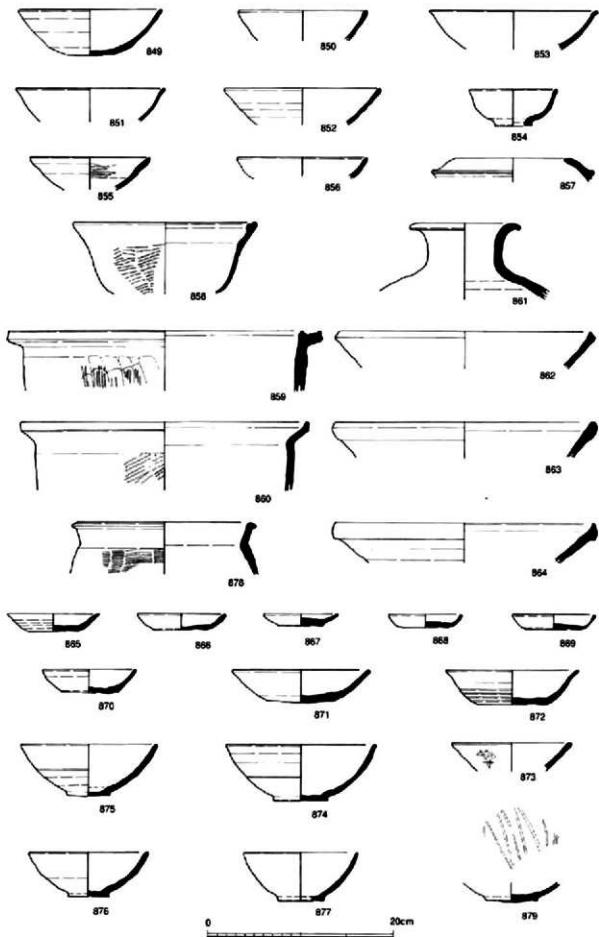

土器2 (溝・包含層/849-879)

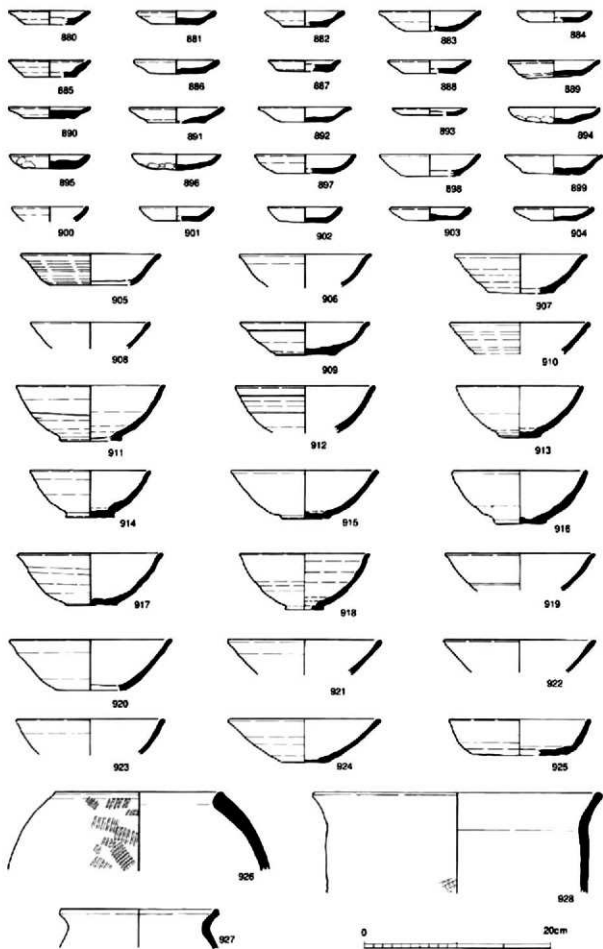

土器3 (竪立柱建物・欄/880-928)

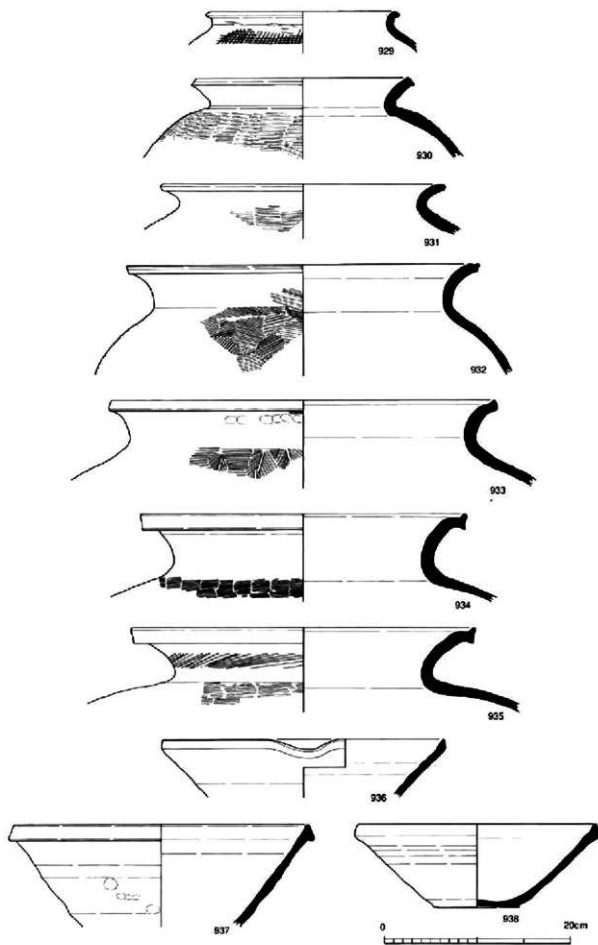

土器4 (瀬立柱建物・ピット/929~938)

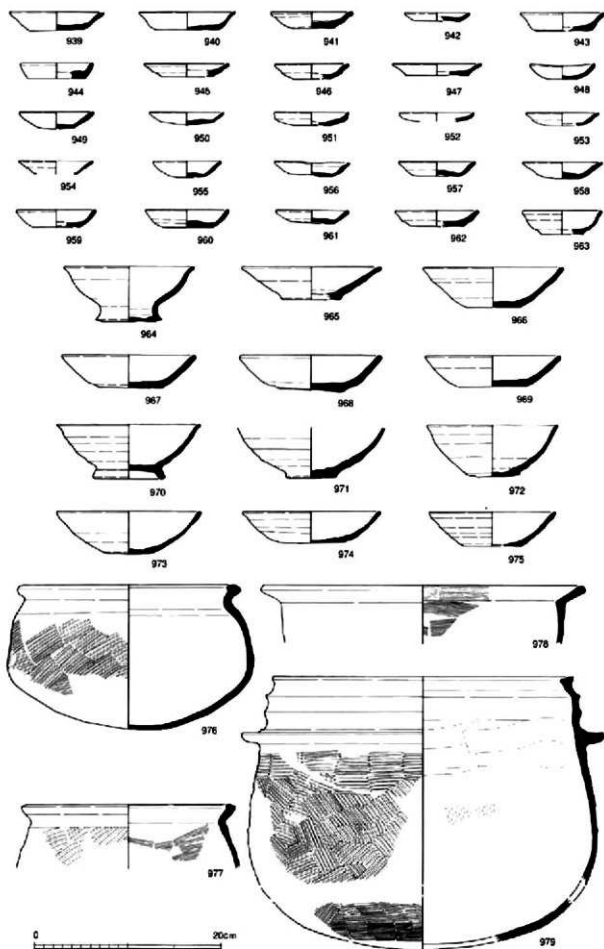

上器5 (福立村建物・ピット/939-979)

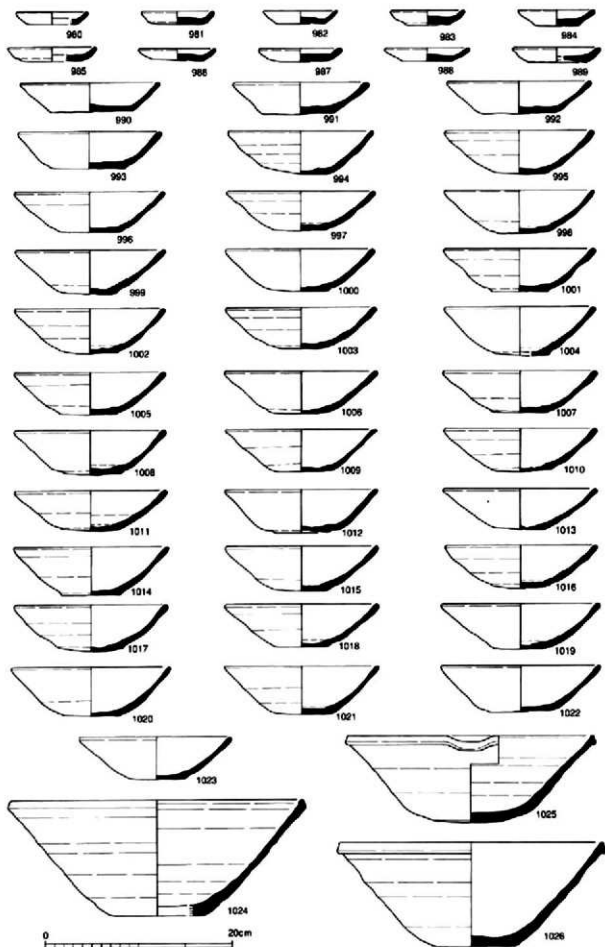

土器6 (土坑/980~1026)

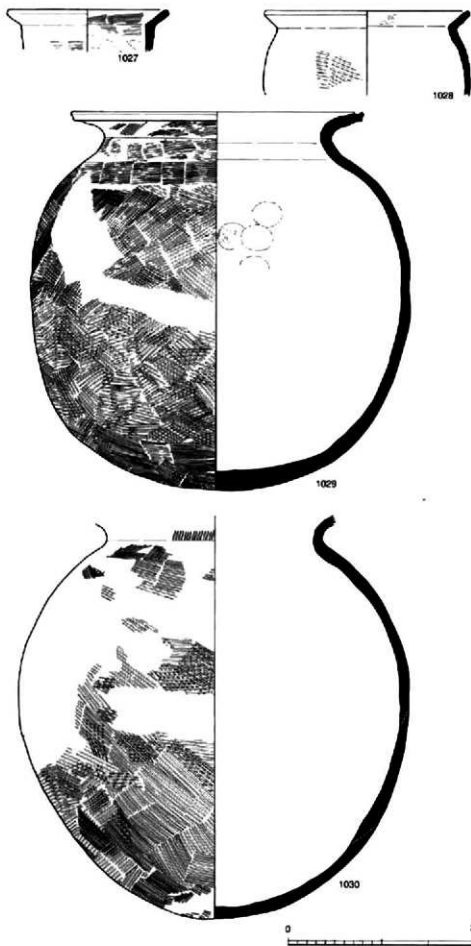

土器7 (上坑/1027~1030)



1031

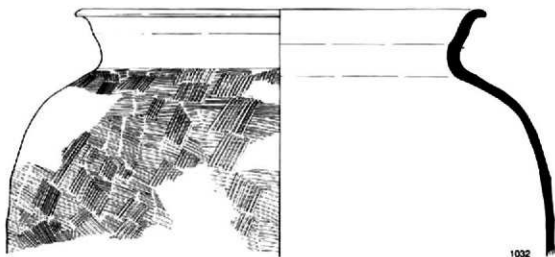

1032

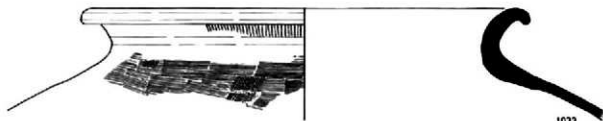

1033

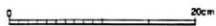

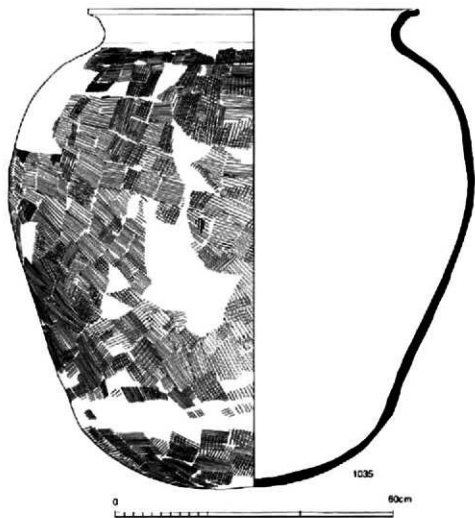

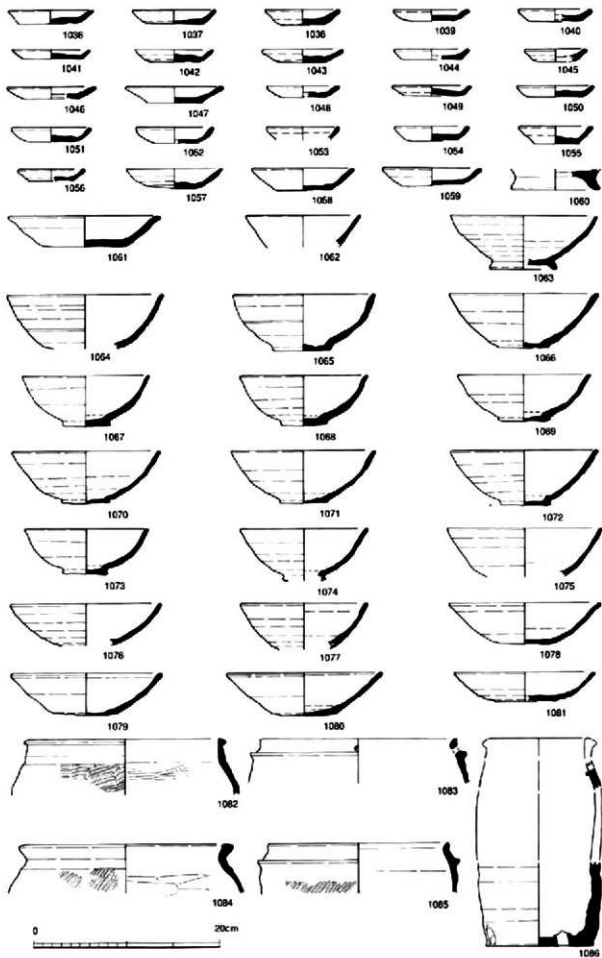

土器10 (土坑/1036-1086)

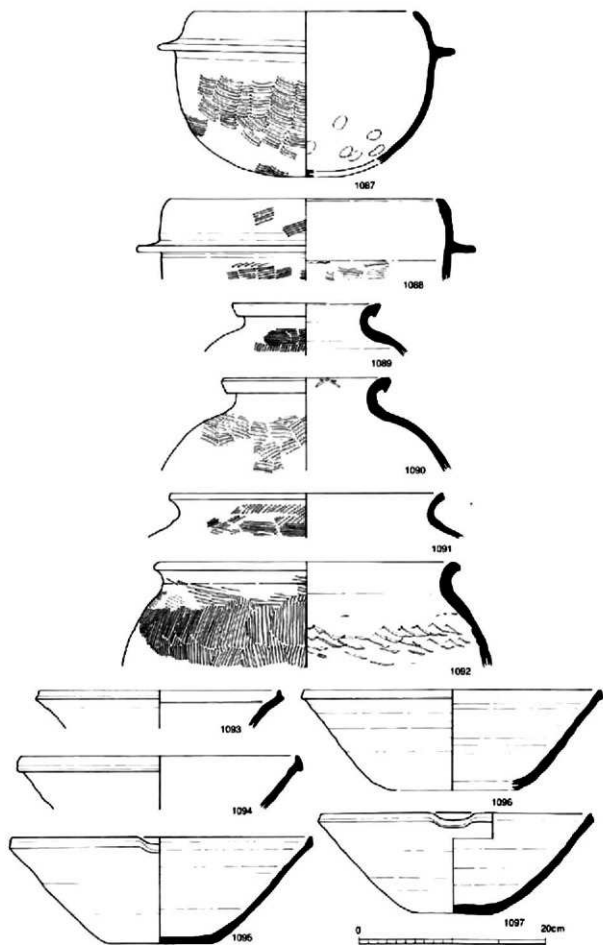

土器11 (土坑/1087~1097)

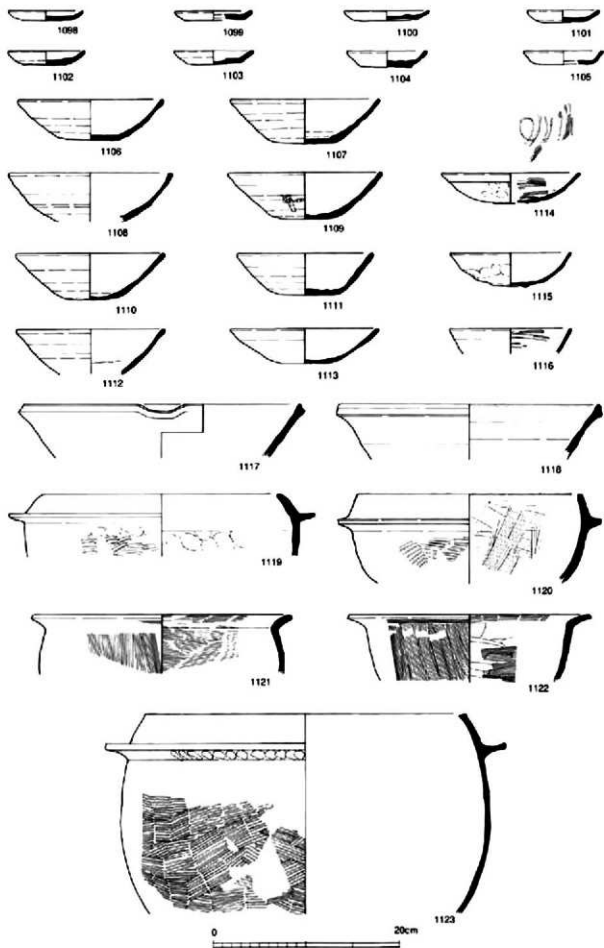

土器12 (井戸/1098-1123)

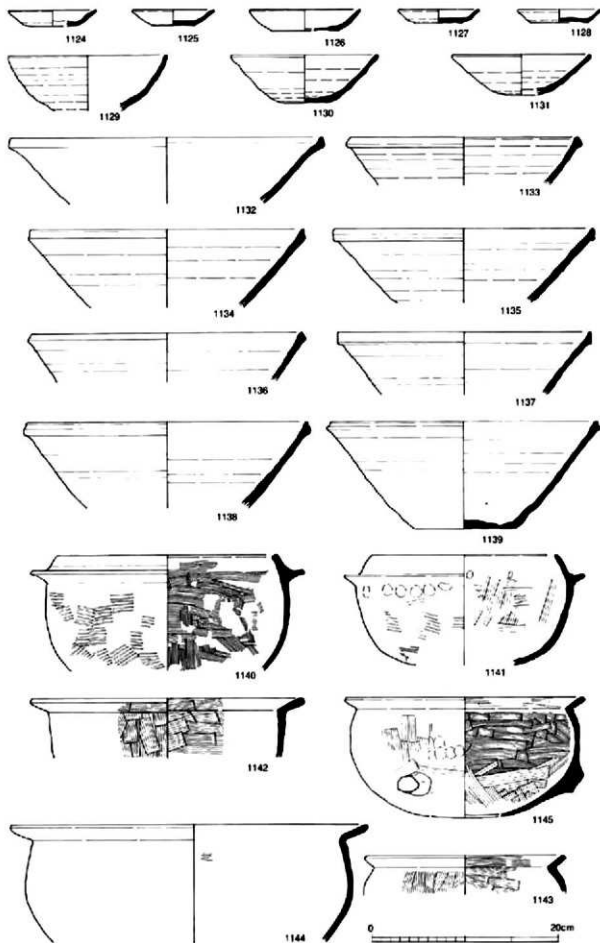

上器13 (上器群/1124~1145)

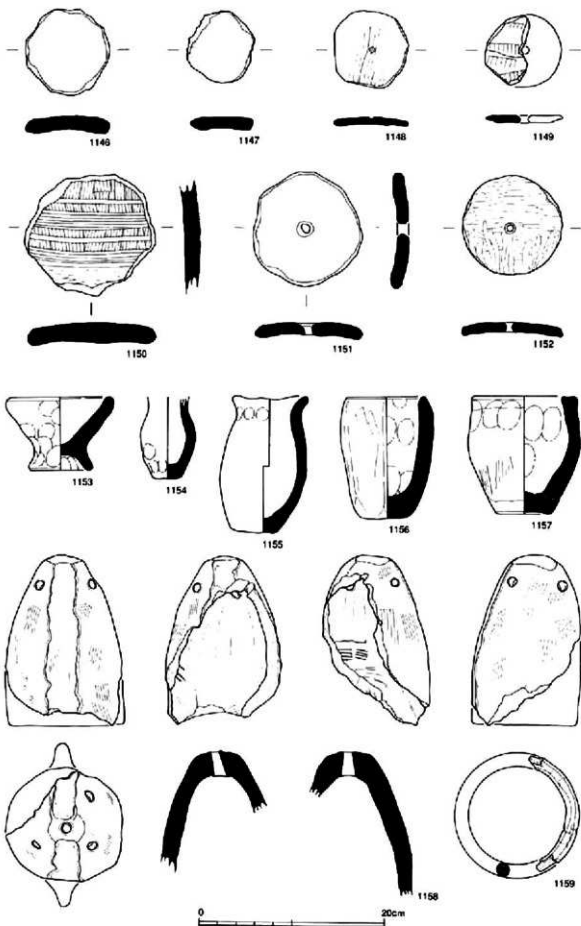

上製品 (1146~1159)

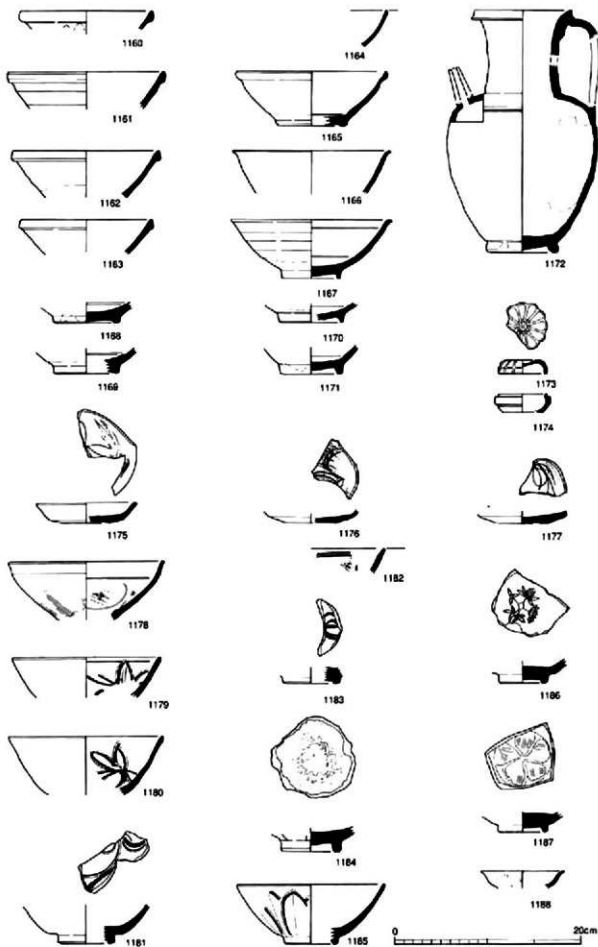

輸入磁器 (1160-1188)

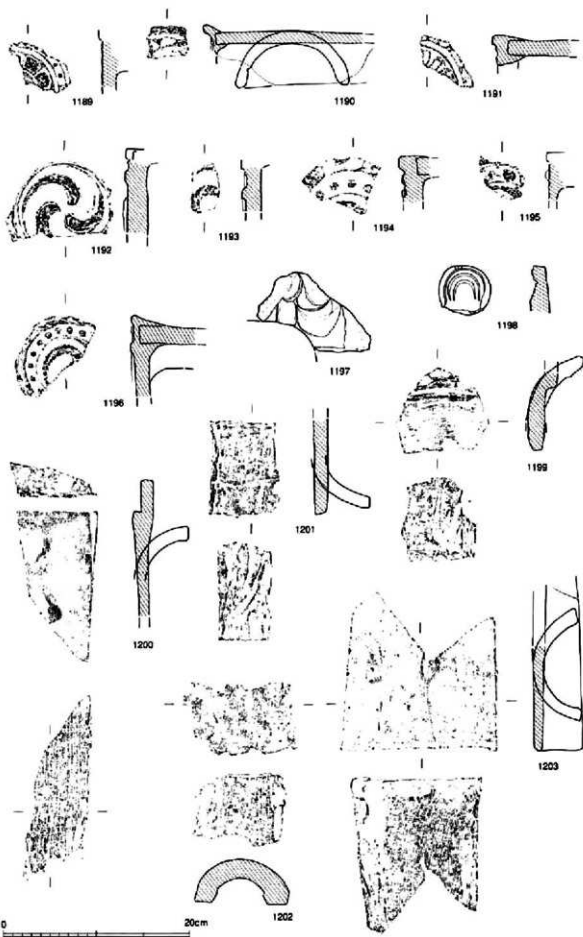

瓦1 (丸瓦・鬼瓦/1189~1203)

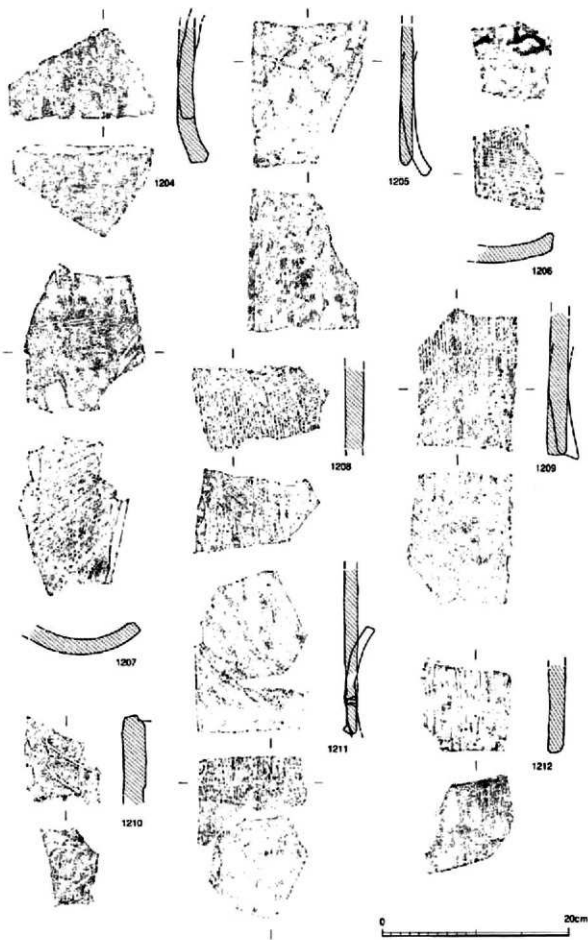

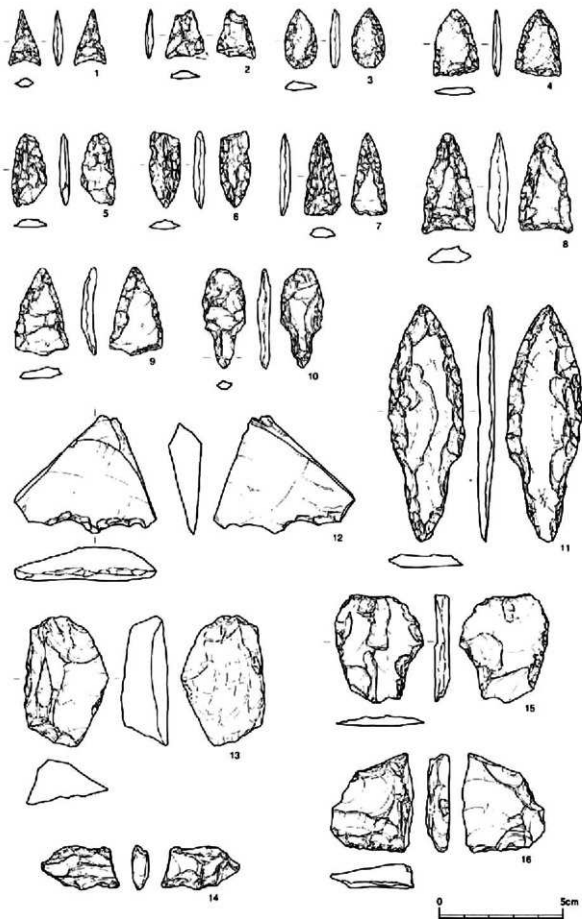

石器1 (1-16) (上層: 3·8·9·13·14·15)

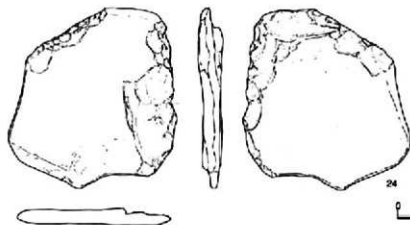
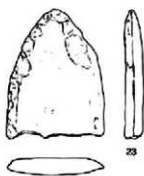
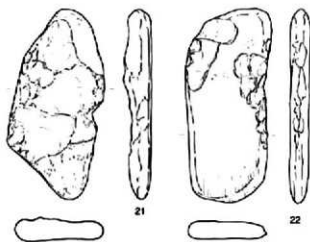
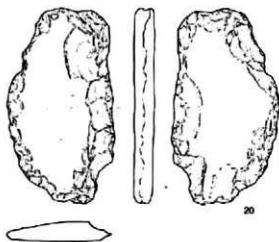
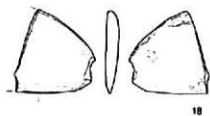
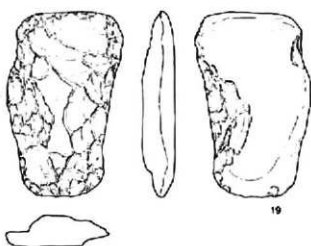
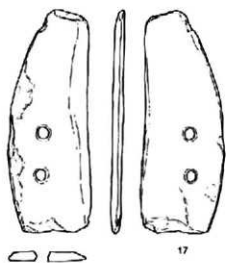

石器2 (17~24) [上層: 19]

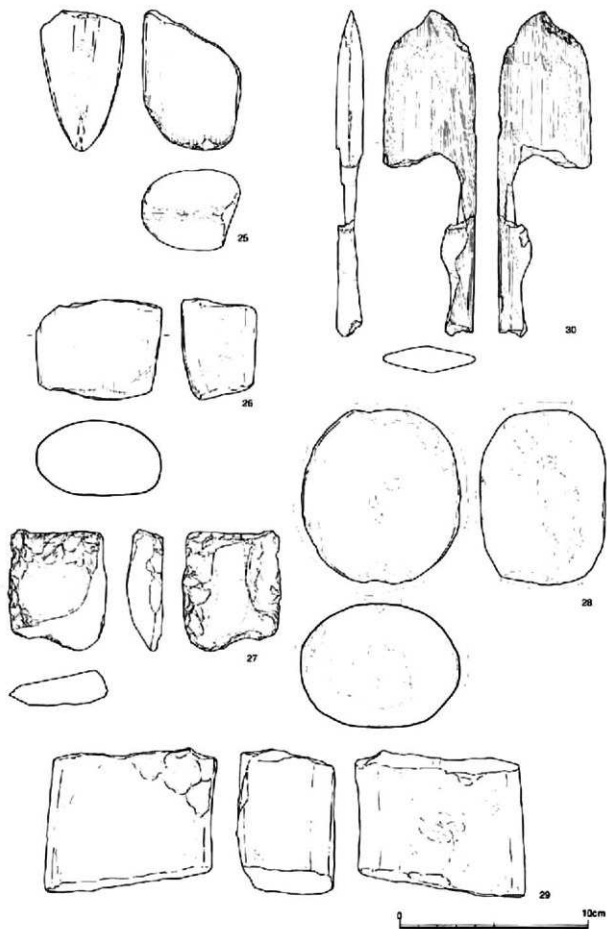

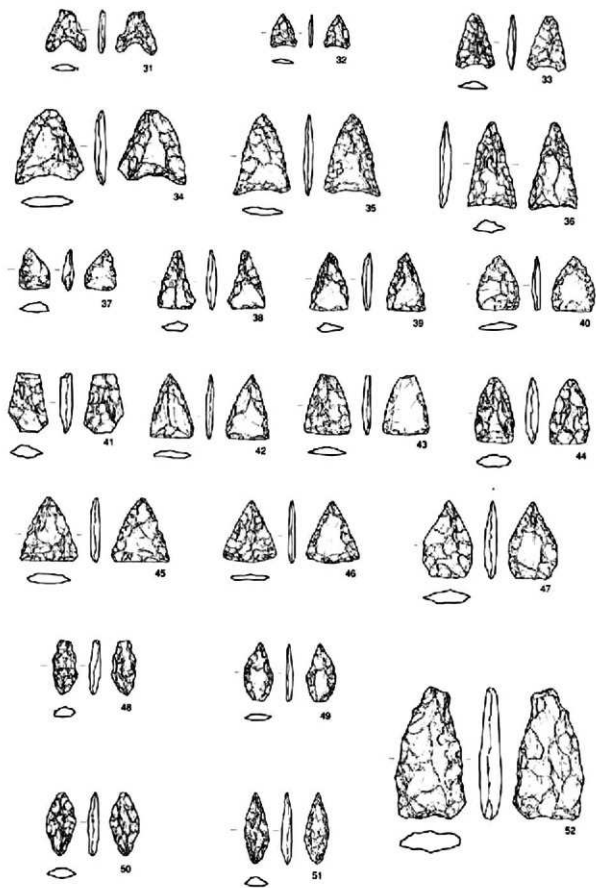

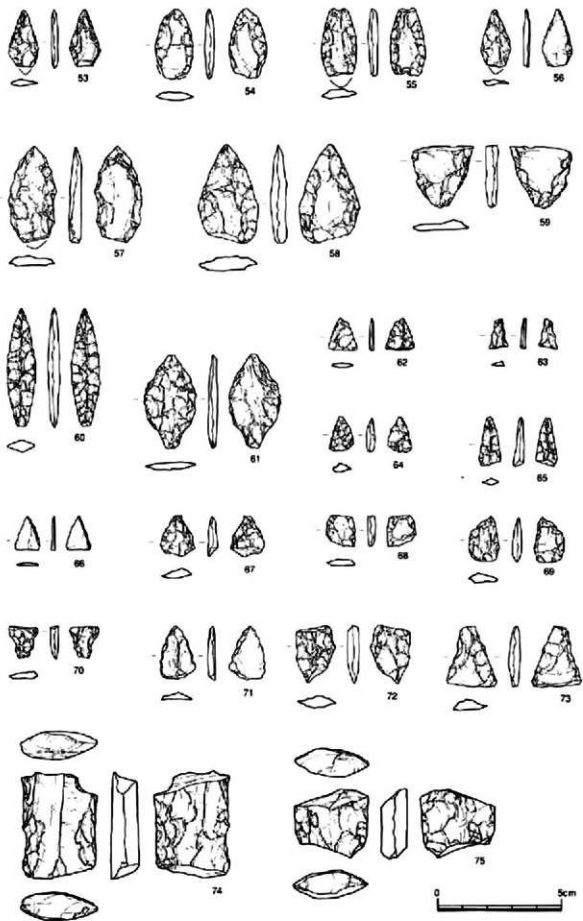

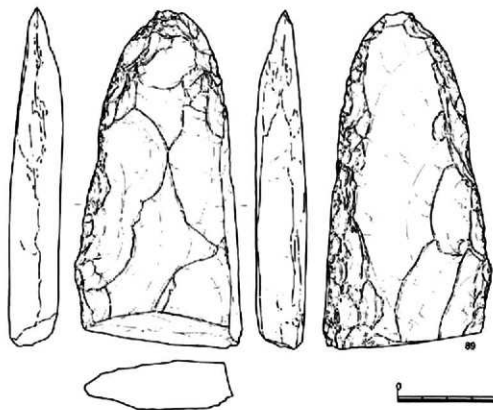

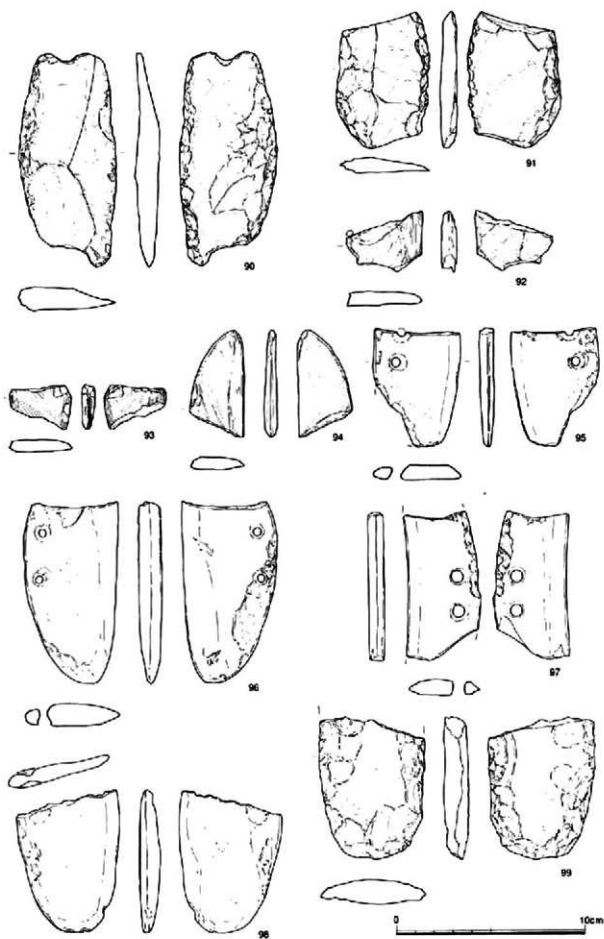

石器7 (90~99) [下層: 92]

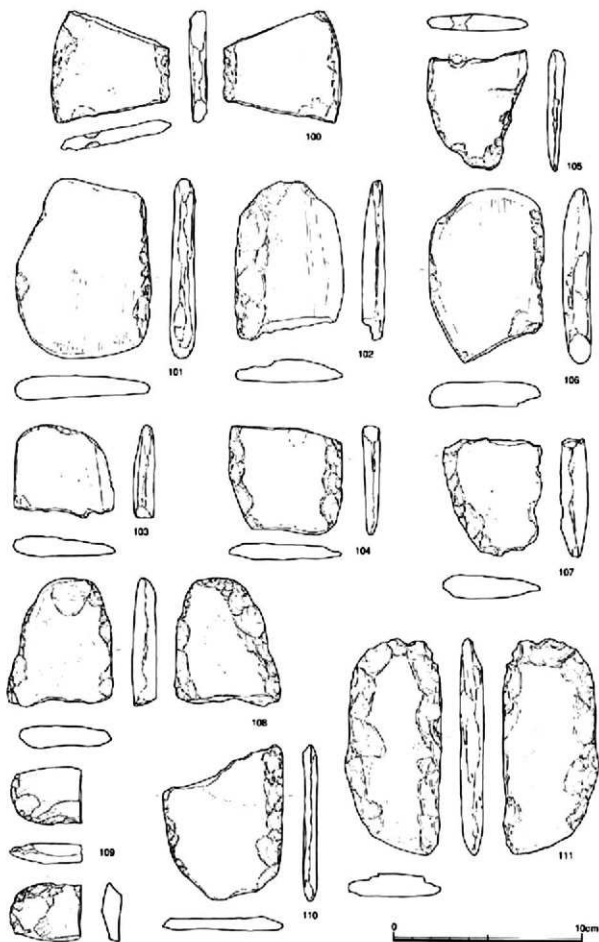

石器8 (100~111) [下層: 100・102]

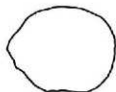
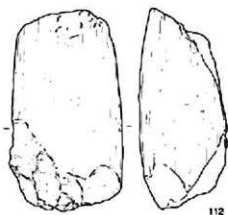

113

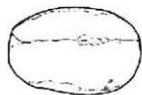

114



115



116



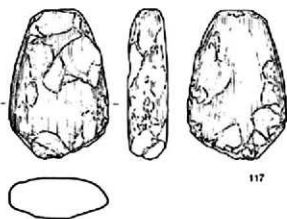

117

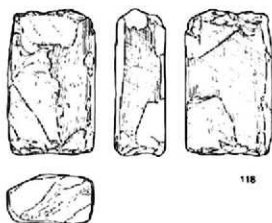

118



119



120

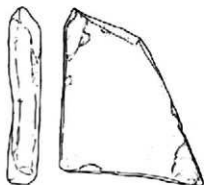
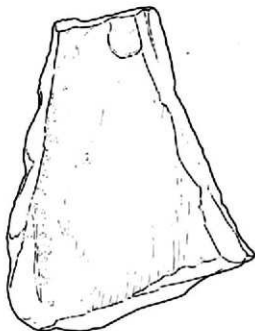

121



122



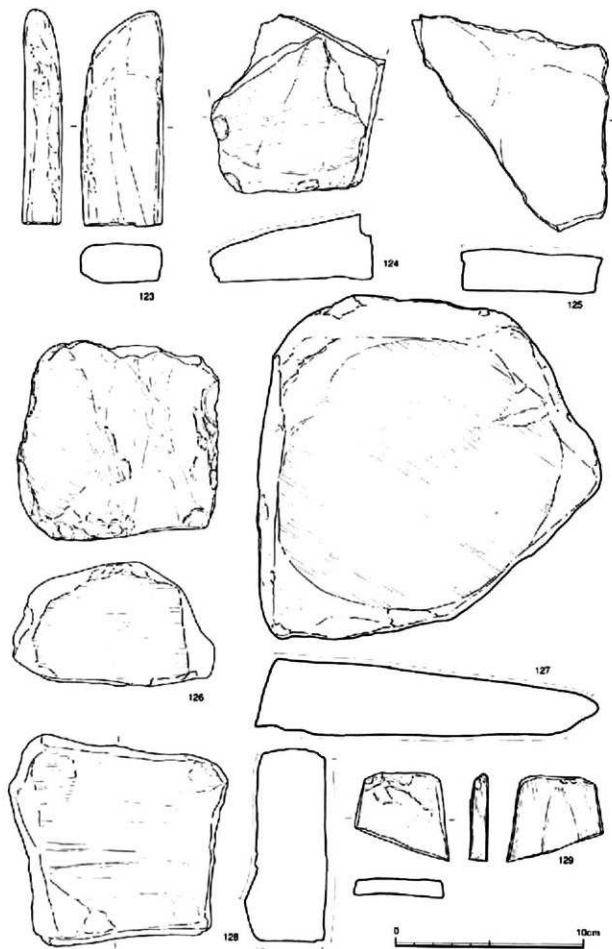

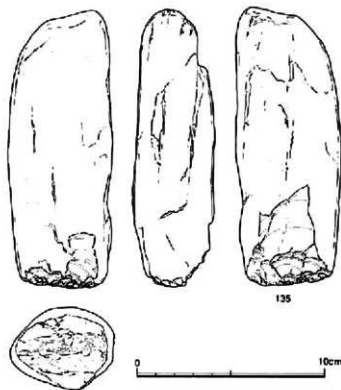
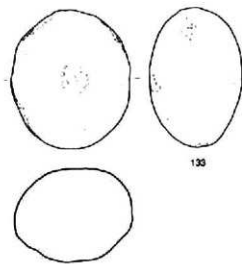
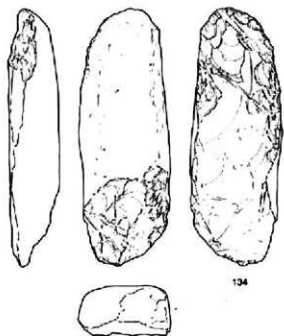
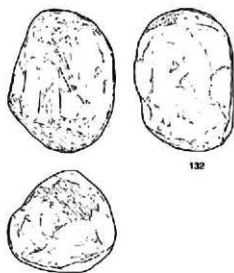
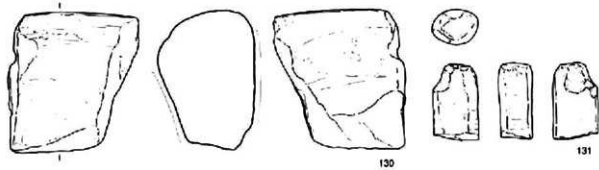

0 10cm

石器12 (130~135) [下層: 132]

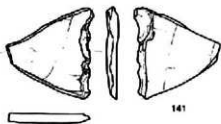
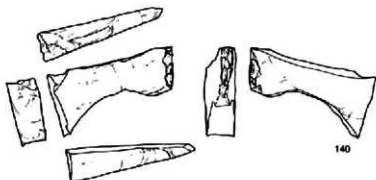
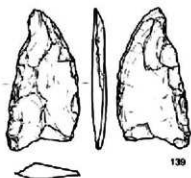
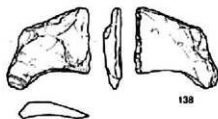
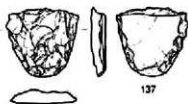
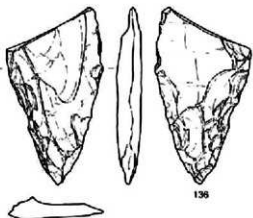

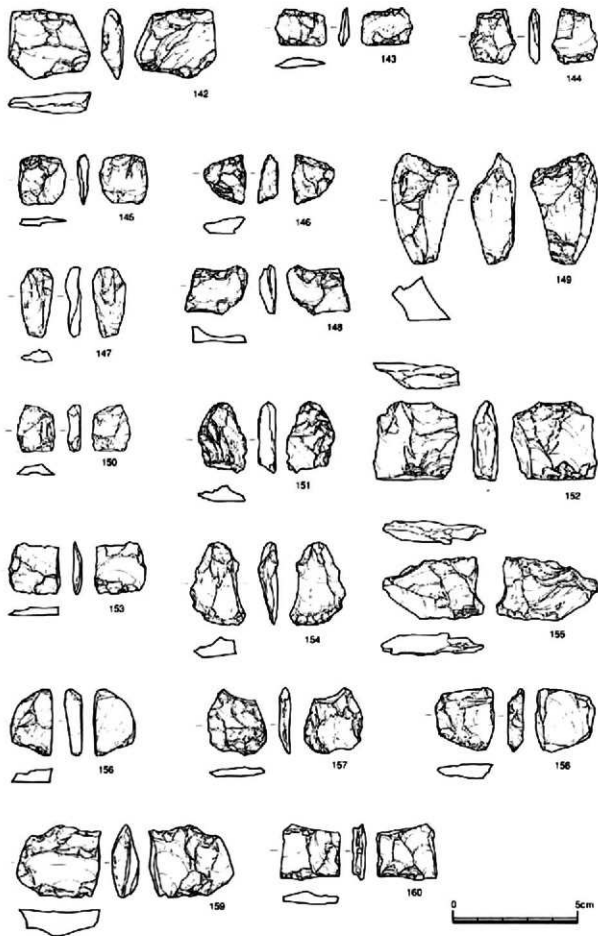

石器14 (142-160)

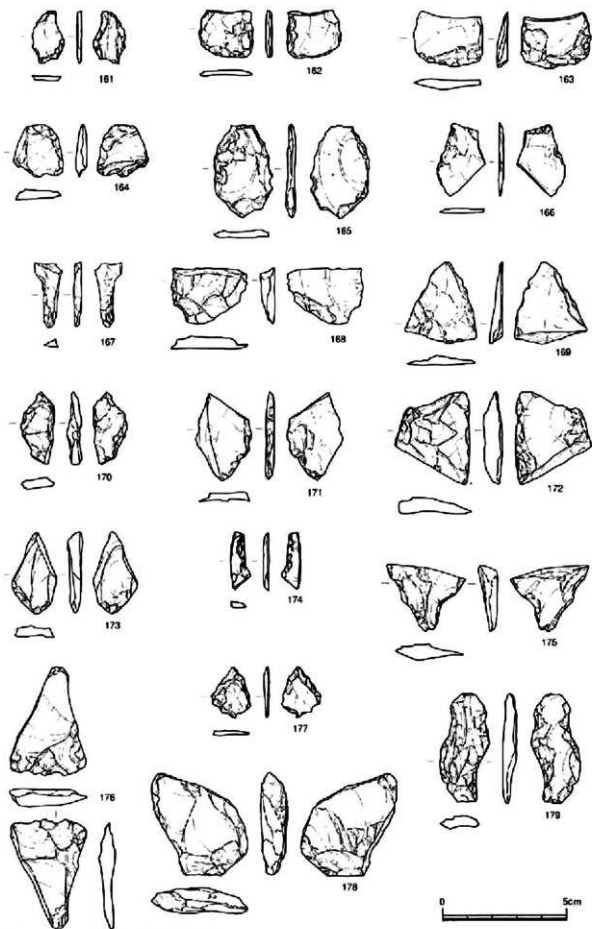

石器15 (161~179) [下層: 167・174]

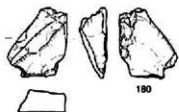

180



183

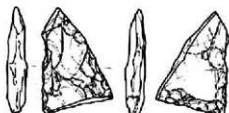

181



182



184

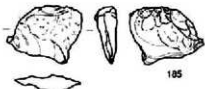

185



186



187

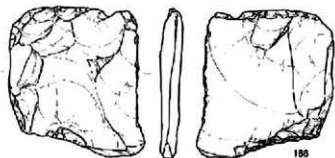

188

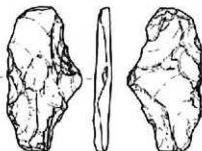

189

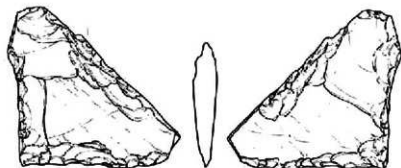

190

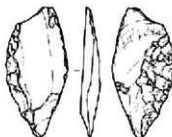

191



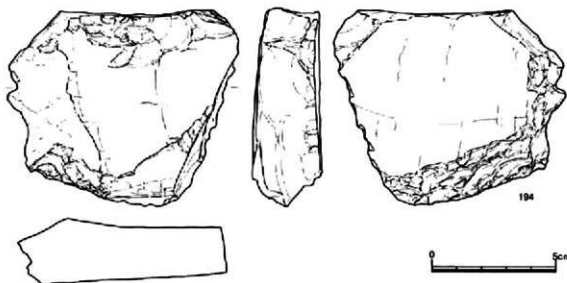
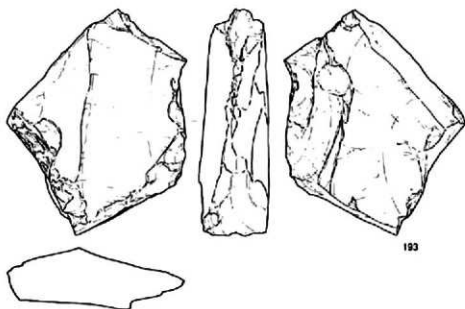
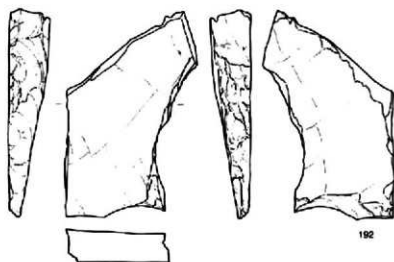

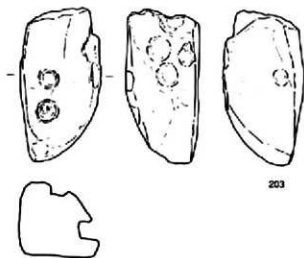
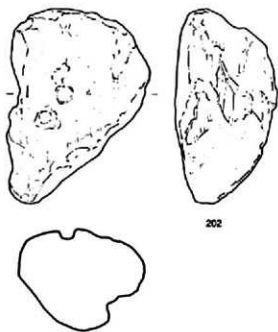
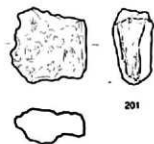
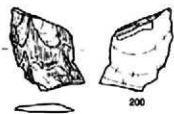
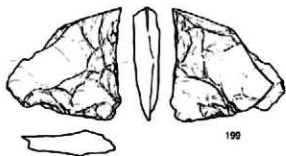
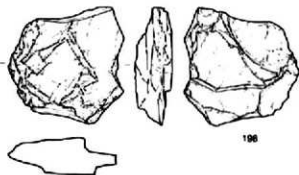
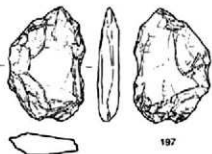
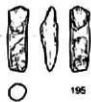

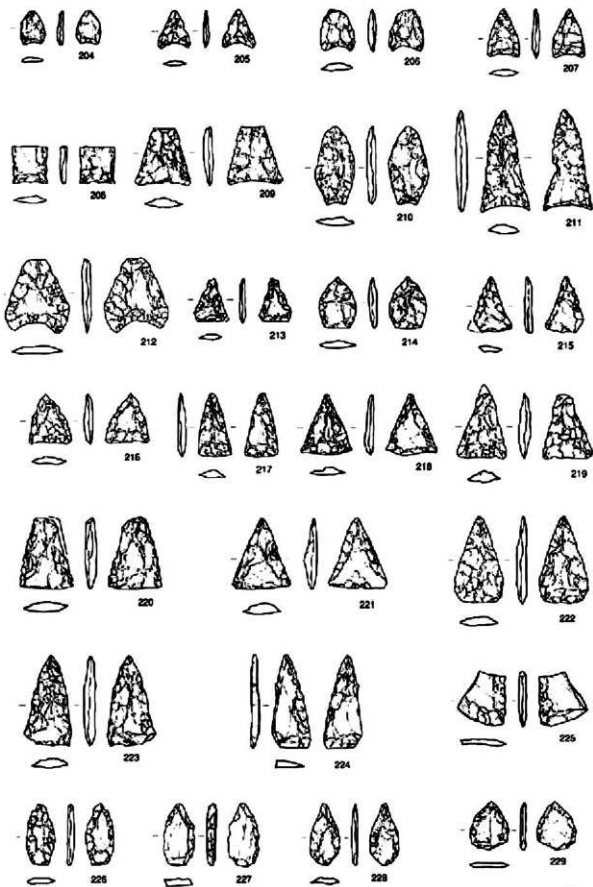

石器19 (上に包含層/204~229) [下層: 205]

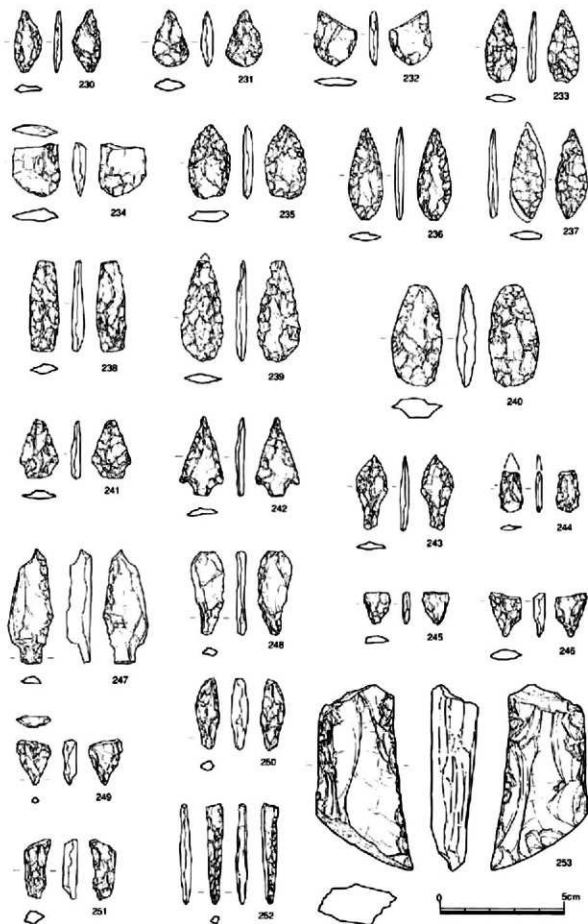

石器20 (主に包含層/230-253)

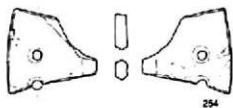

254

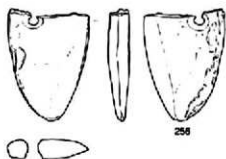

256

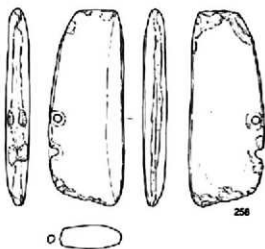

258

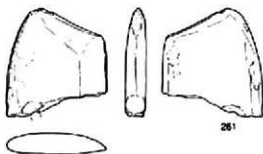

261

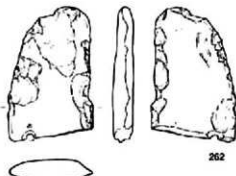

262

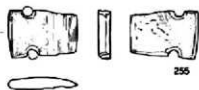

255



257

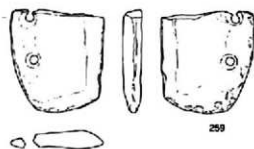

259

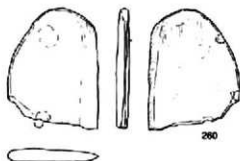

260

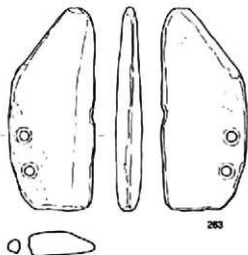

263



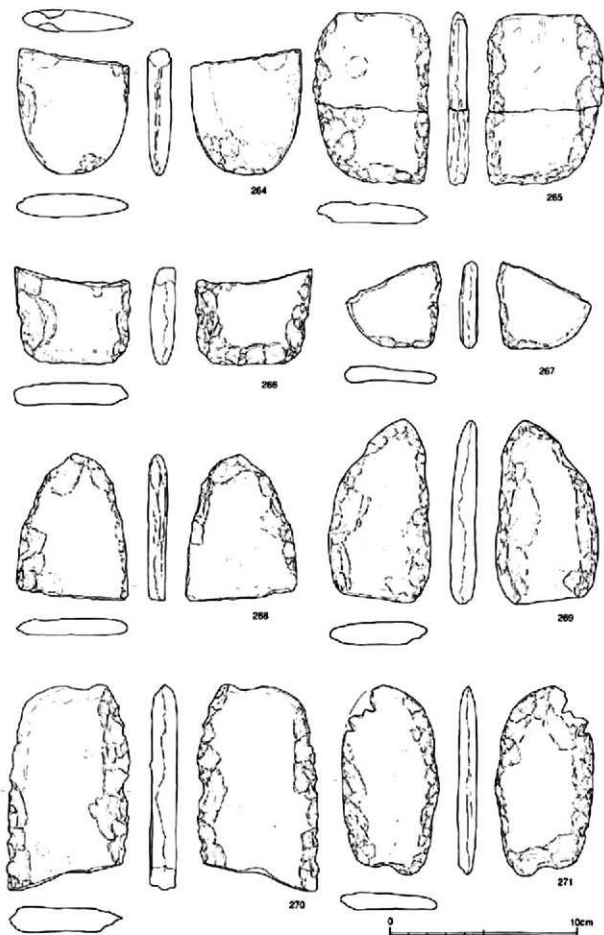

石器22 (主に包含層/264-271)

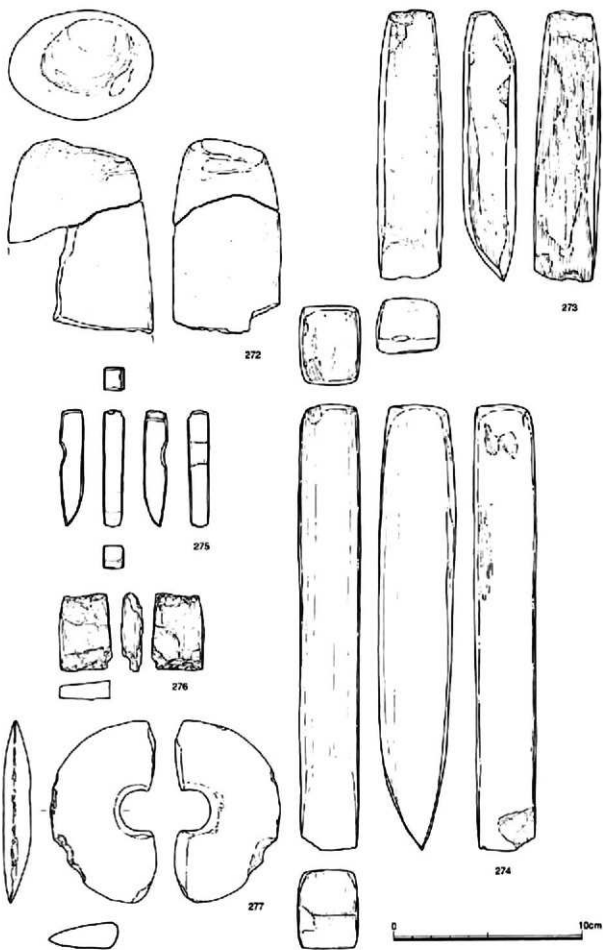

石器23 (主に包含層/272~277)



276

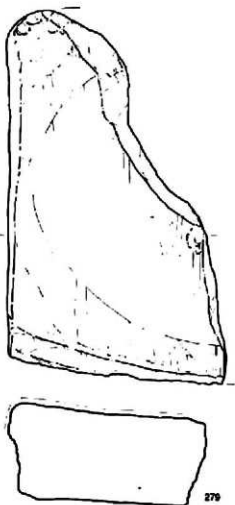

279

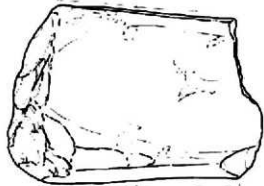

280

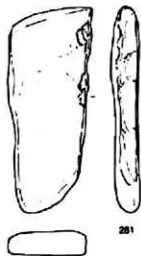

281



石器24 (主に包含層/278-281)

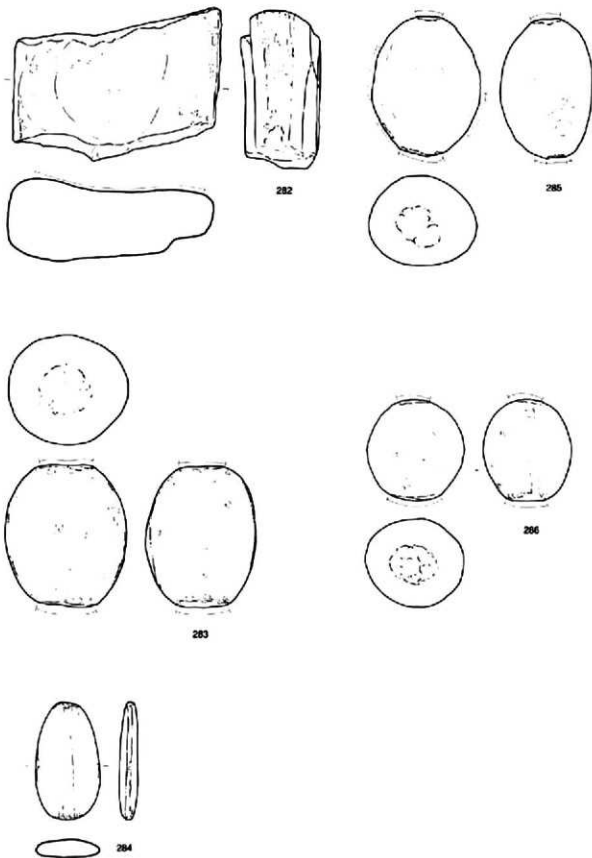

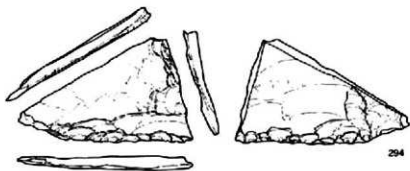
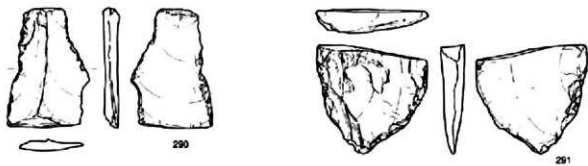
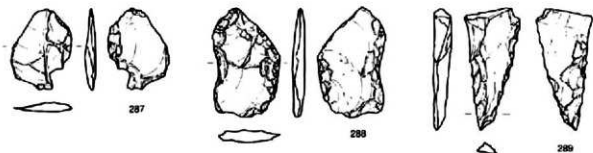

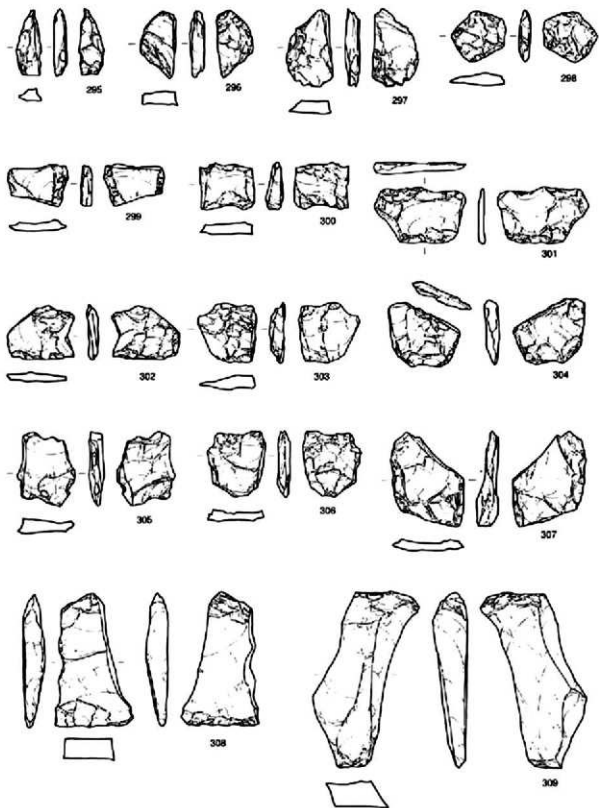

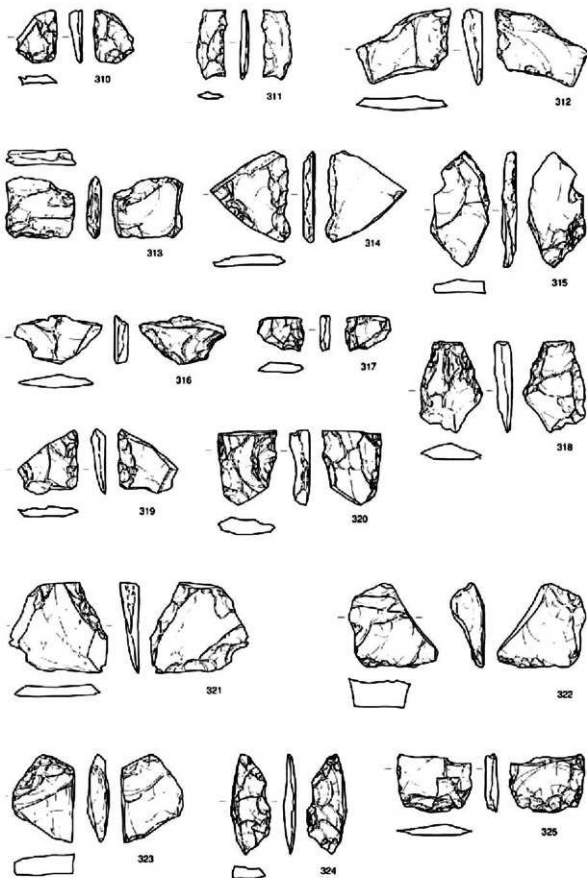

石器28 (主に包含層/310-325)