

第7図 縄文時代遺構全体図・グリッド図

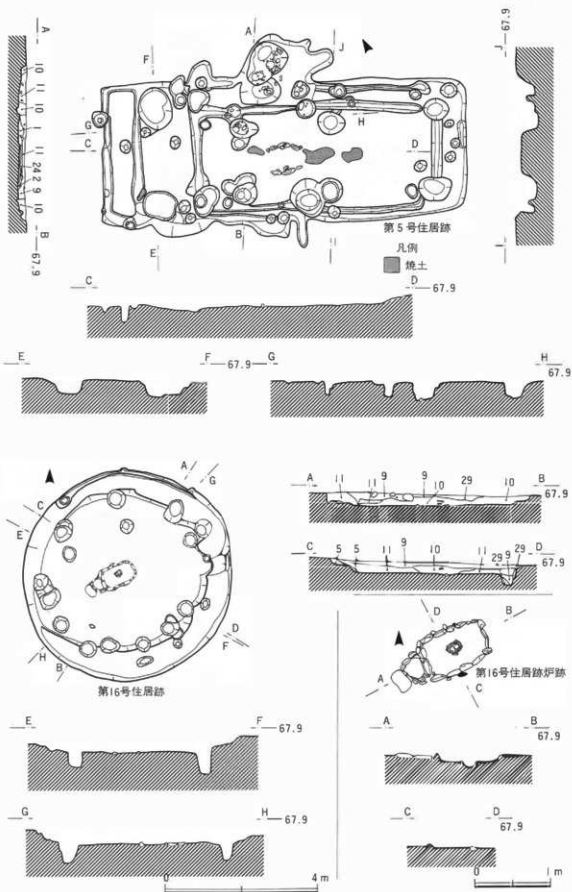

第8图 縄文中期竪穴住居跡(1)

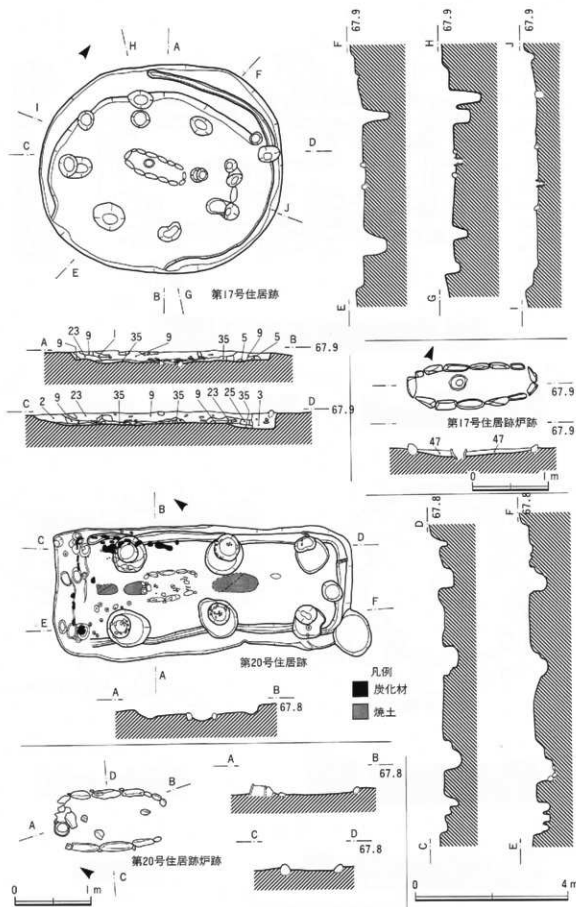

第9图 縄文中期竖穴住居跡(2)

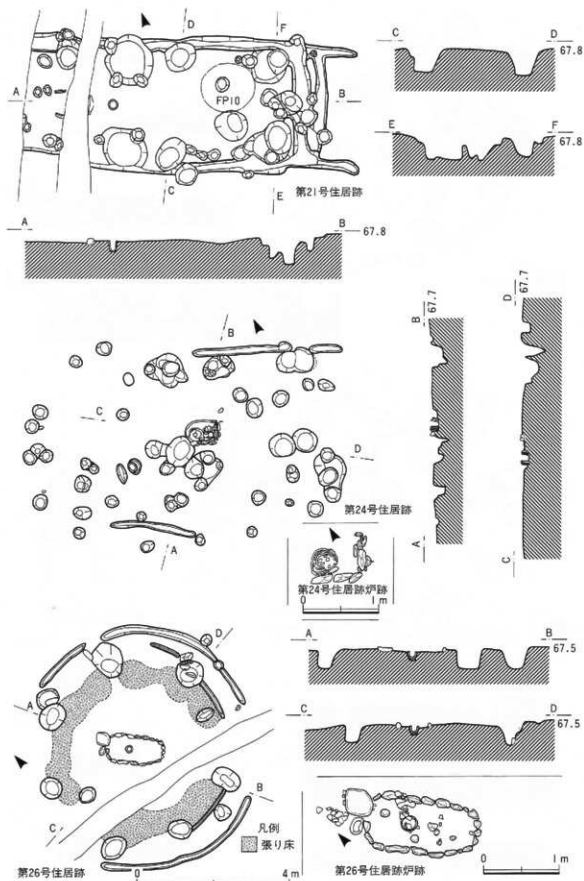

第10図 縄文中期竪穴住居跡 (3)

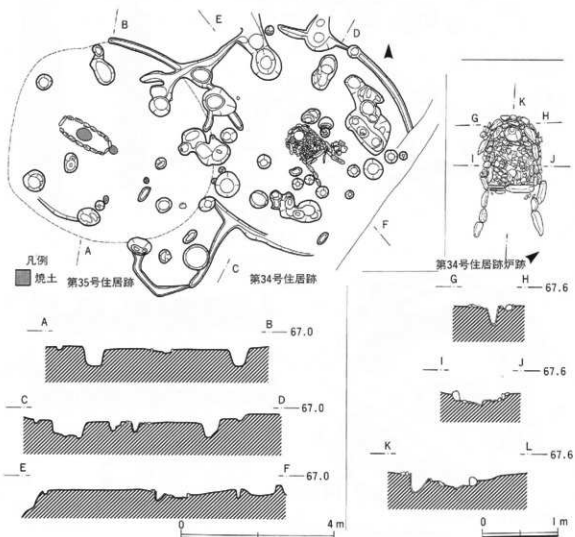
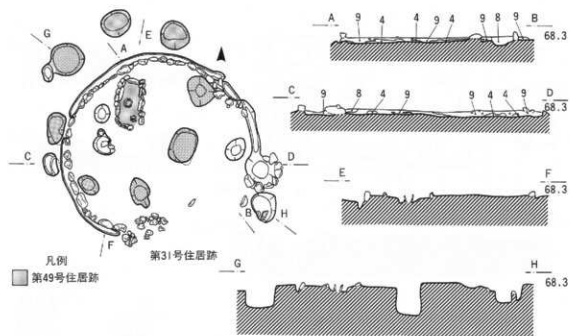

第11回 縄文中期竪穴住居跡(4)

第36号住居跡炉跡

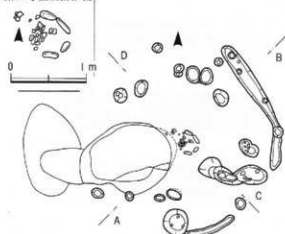

第36号住居跡



第38号住居跡



第38号住居跡炉跡

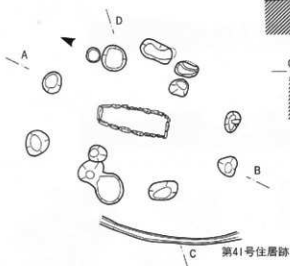
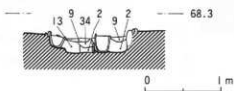

第41号住居跡

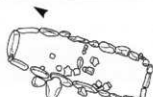

第41号住居跡炉跡

第12図 縄文中期竪穴住居跡 (5)

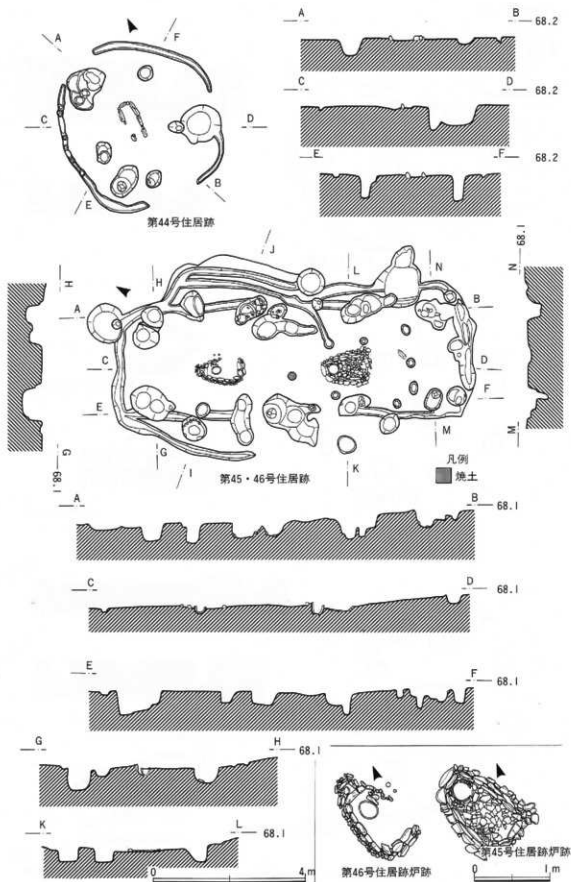

第13图 縄文中期竖穴住居跡(6)

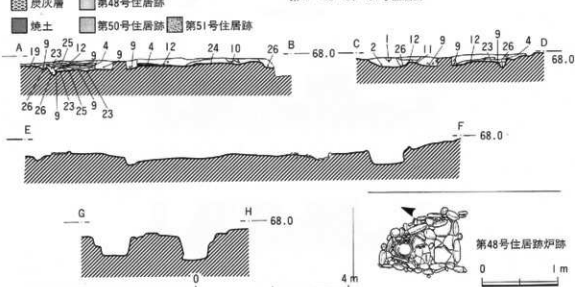
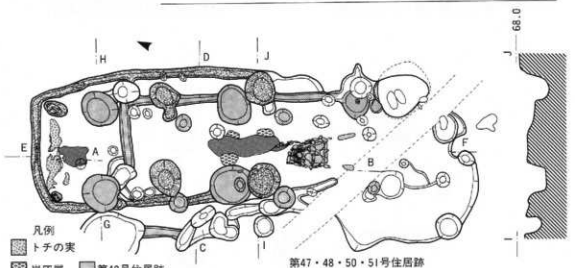
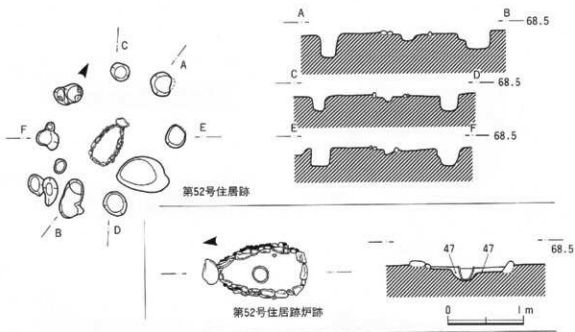

第14回 縄文中期竪穴住居跡 (7)

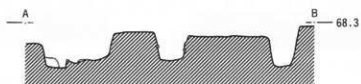
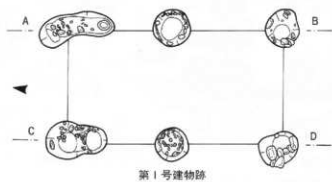
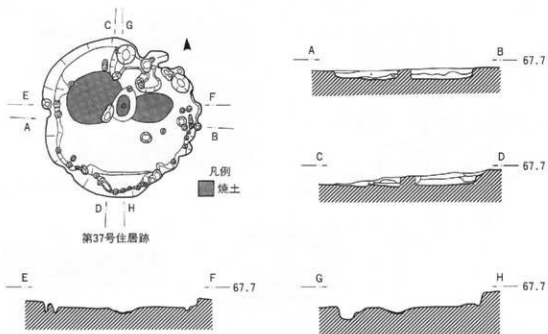

第15图 縄文後期竪穴住居跡・掘立柱建物跡(1)

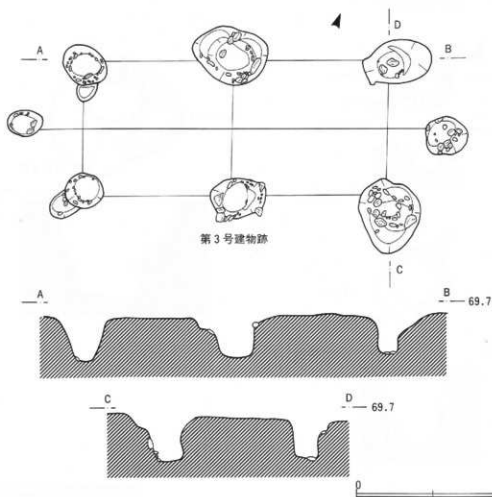
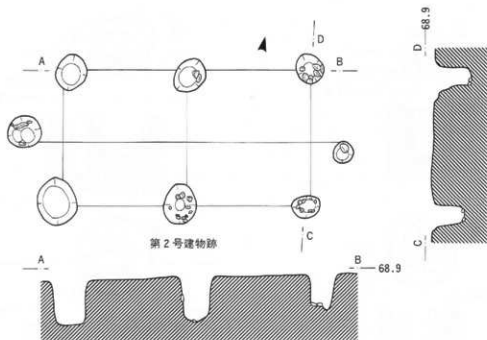

第16图 縄文後期掘立柱建物跡(2)

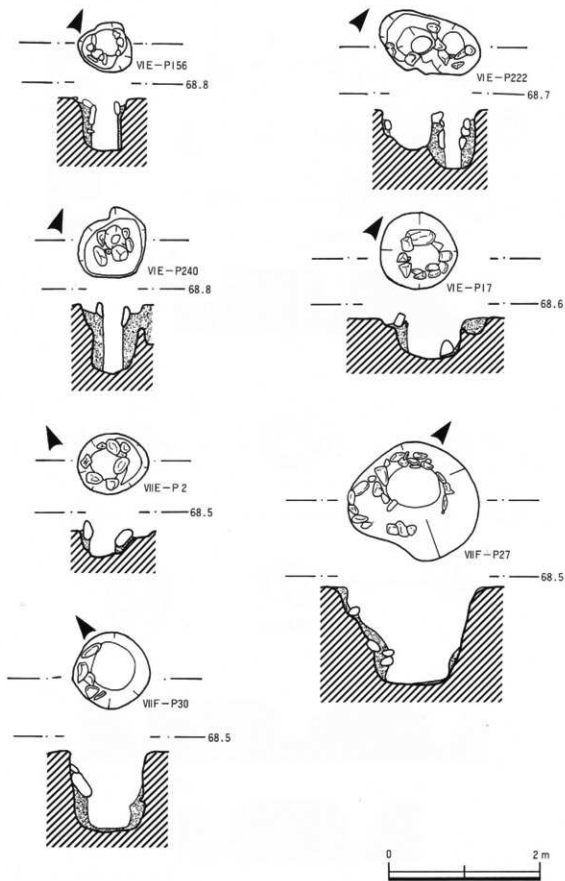

第17図 縄文後期掘立柱穴跡 (1)

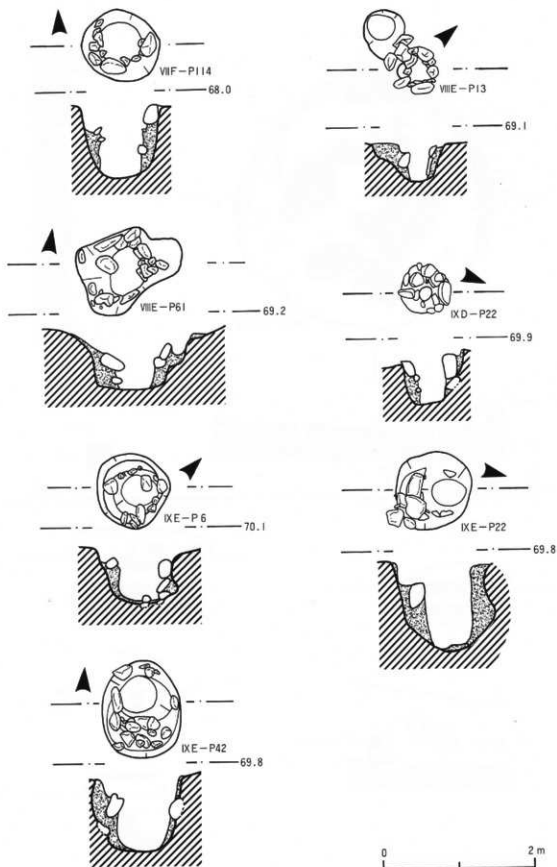

第18図 縄文後期掘立柱穴跡 (2)

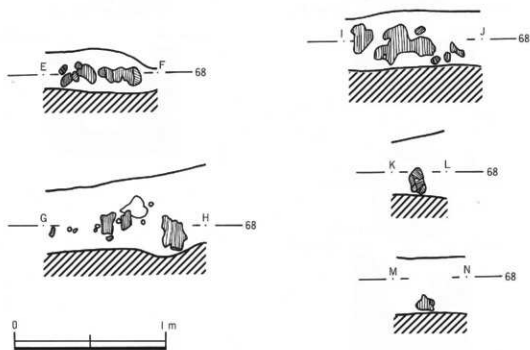
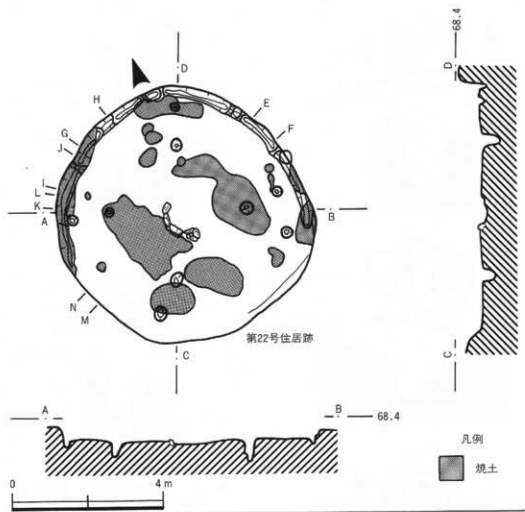

第19回 縄文晩期竪穴住居跡(1)

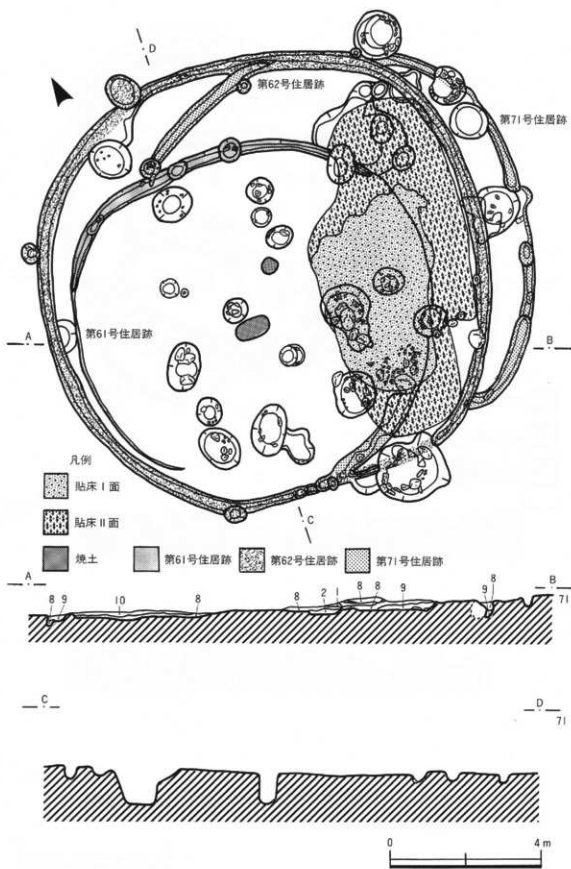

第20图 縄文晚期壑穴住居跡 (2)

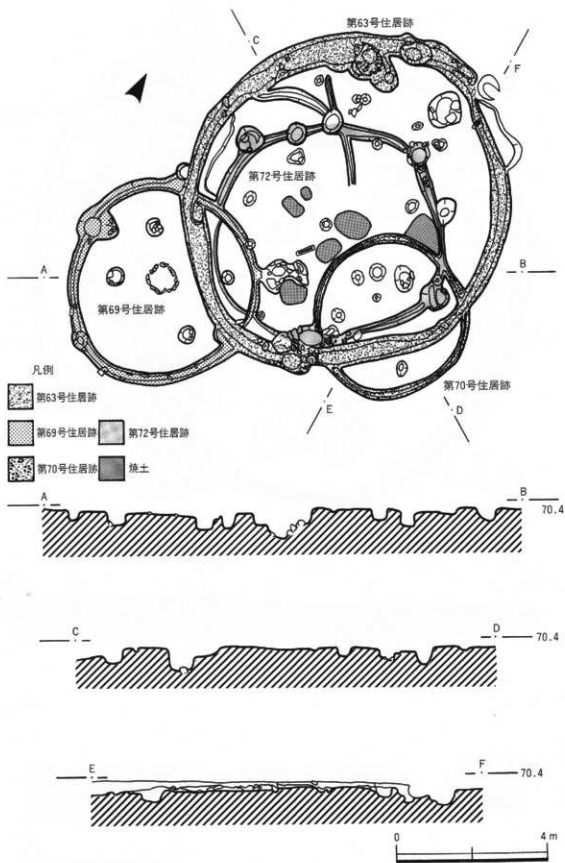

第21图 縄文晩期竪穴住居跡 (3)

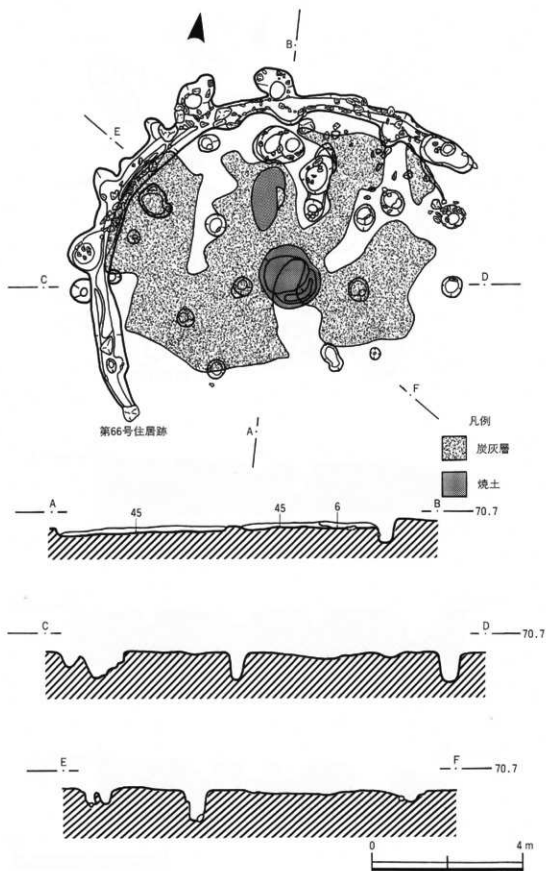

第22图 縄文晚期整穴住居跡 (4)

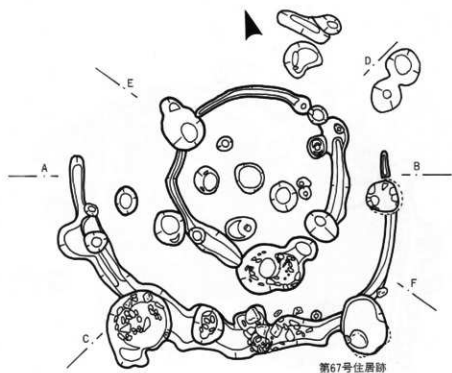

第23回 縄文晩期竪穴住居跡 (5)

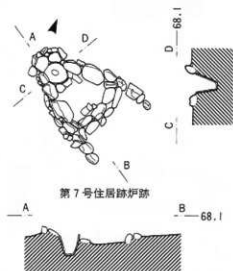
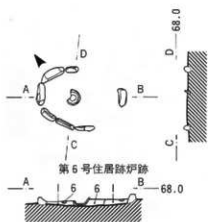
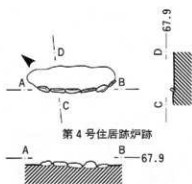
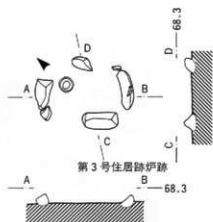
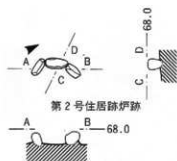
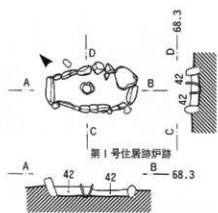

第24図 縄文中・後期炉跡(1)

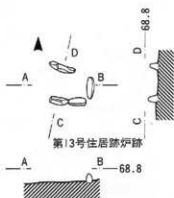
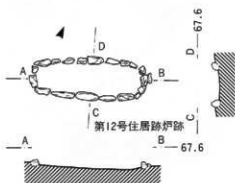
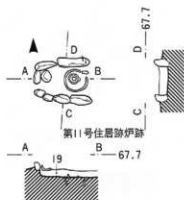
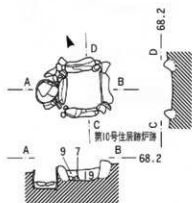
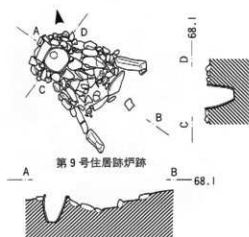
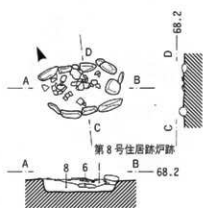

第25图 縄文中・後期炉跡(2)

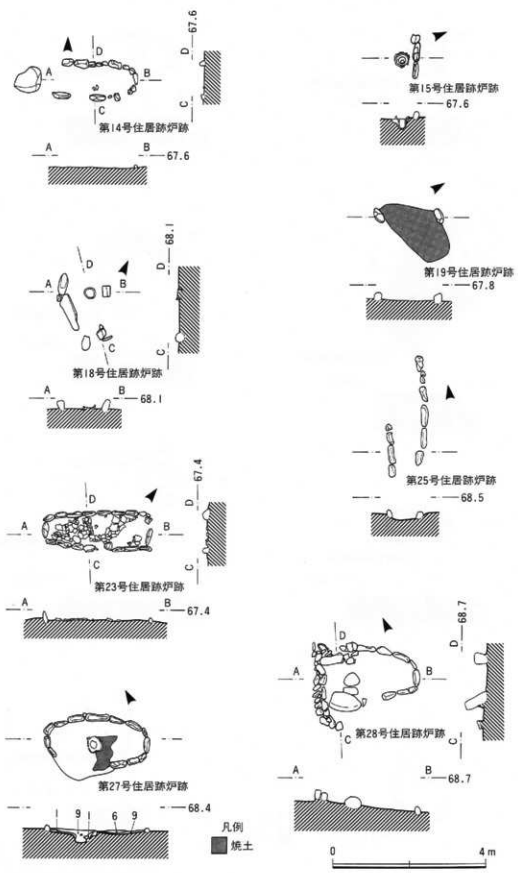

第26图 縄文中・後期炉跡 (3)

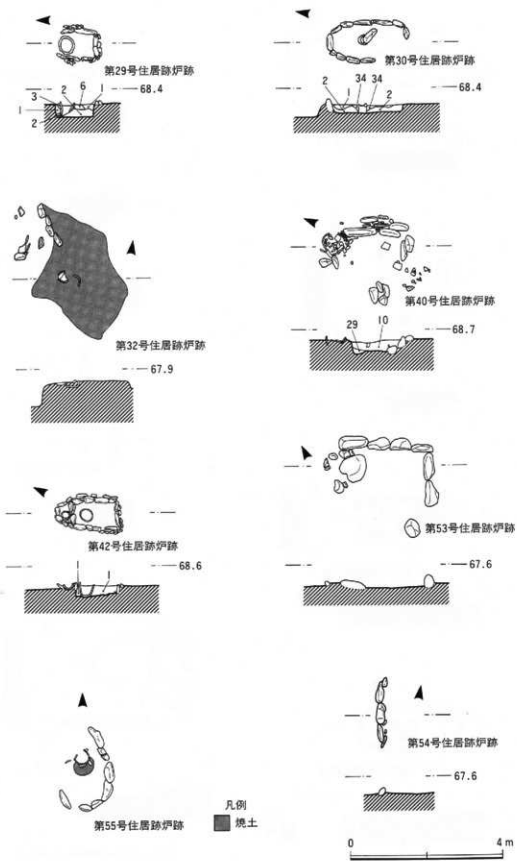

第27图 縄文中・後期炉跡(4)

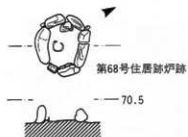
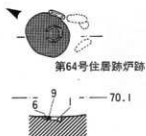
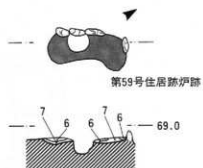
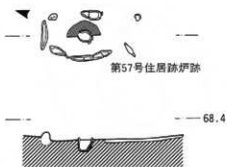
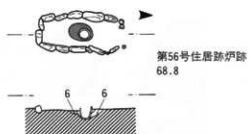

凡例
 烧土

0 ————— 4 m

第26图 縄文中・後期炉跡(5)

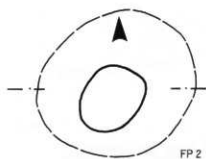

FP 2

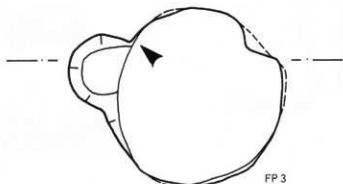
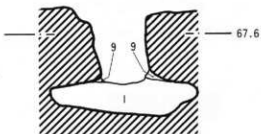

FP 3

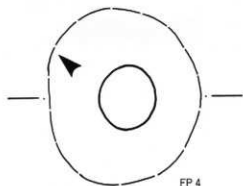
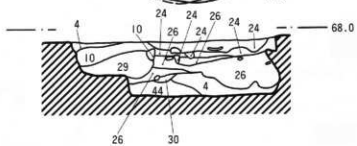

FP 4

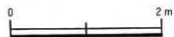
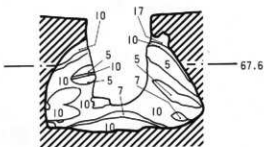

第29図 縄文中期フラスコ状ビッド (1)

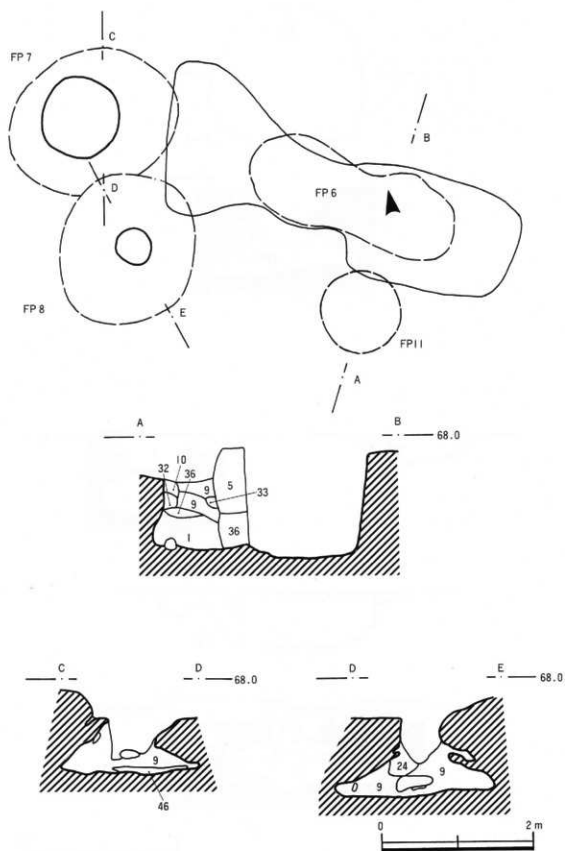

第30図 縄文中期フラスコ状ピット (2)

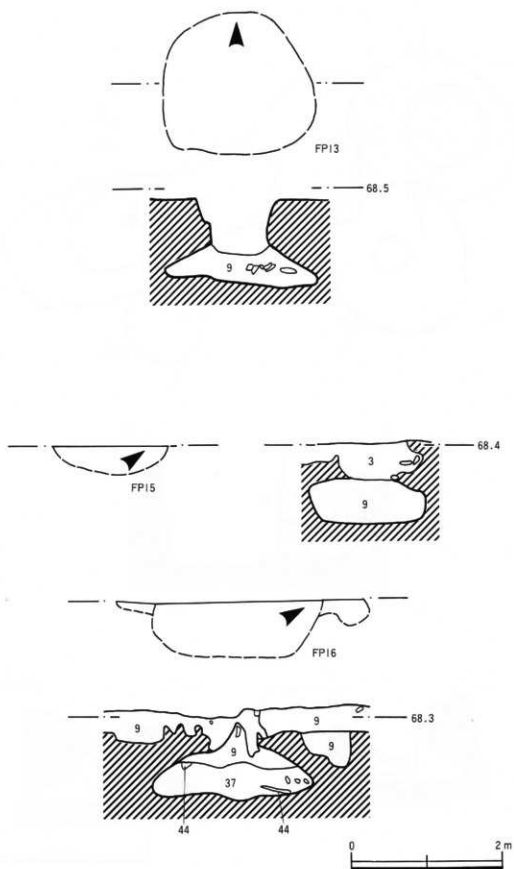

第31図 縄文中期フラスコ状ビット (3)

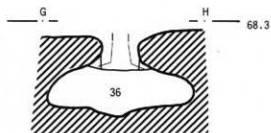
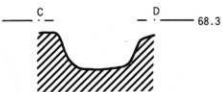
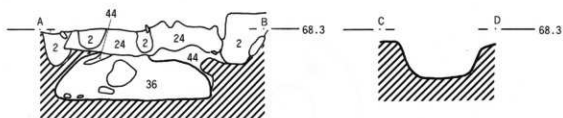
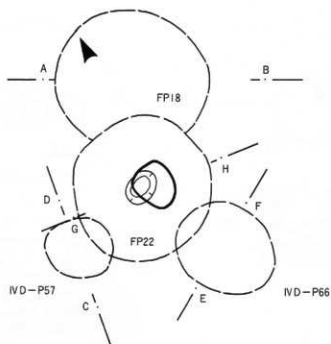

第32図 縄文中期フラスコ状ビット (4)

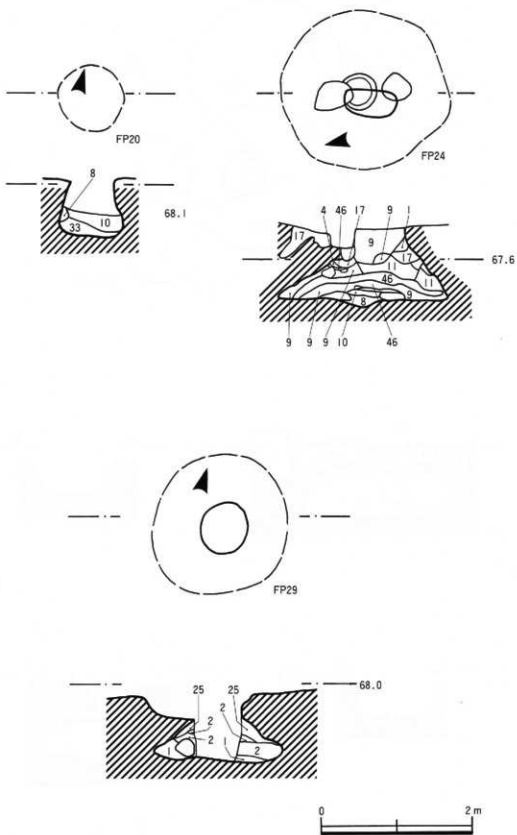

第33図 縄文中期フラスコ状ビット (5)

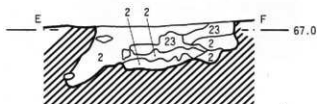
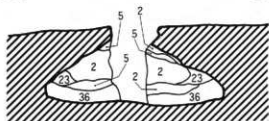
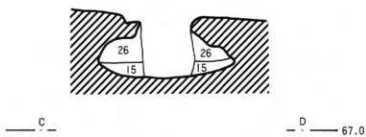
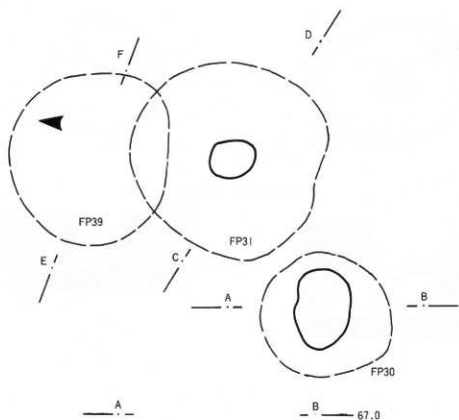

第34図 縄文中期フラスコ状ビット (6)

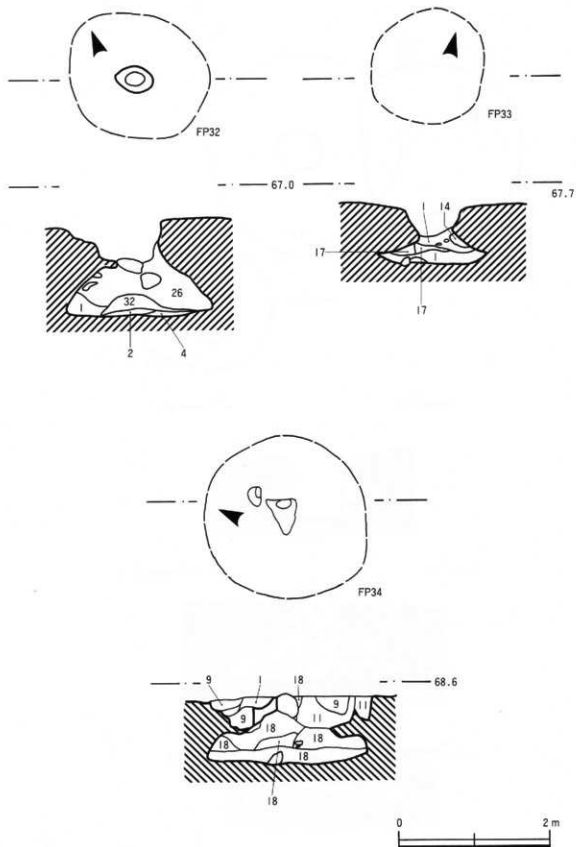

第35図 縄文中期フラスコ状ビット (7)

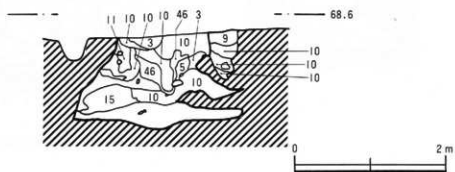
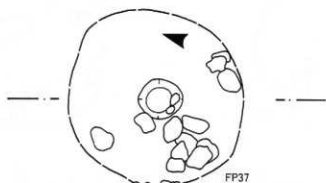
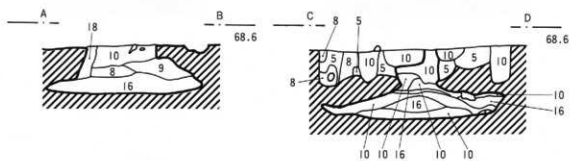
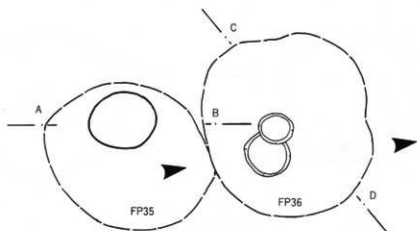

第36図 縄文中期フラスコ状ビット (8)

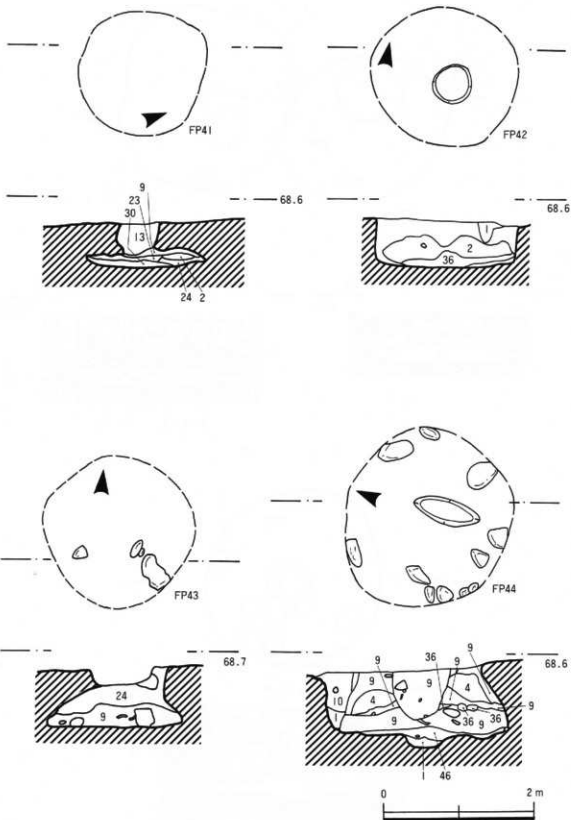

第37図 縄文中期フラスコ状ビット(9)

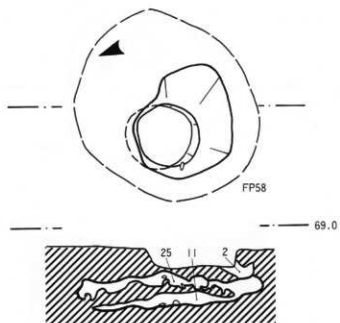
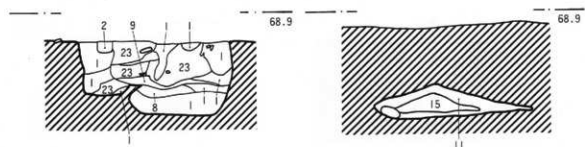
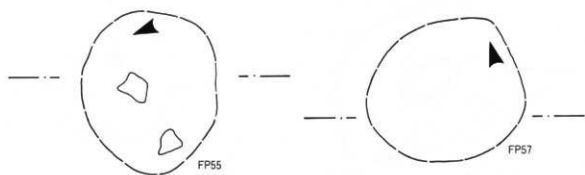

第39図 縄文中期フラスコ状ビット (11)

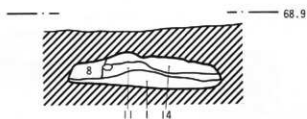
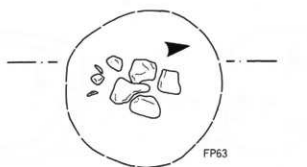
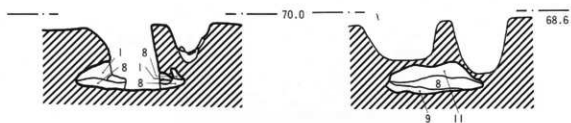
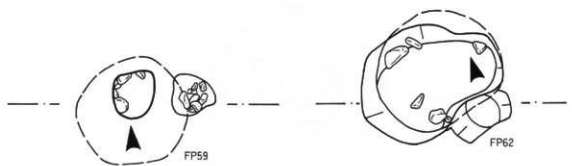

第40図 縄文中期フラスコ状ビット (12)

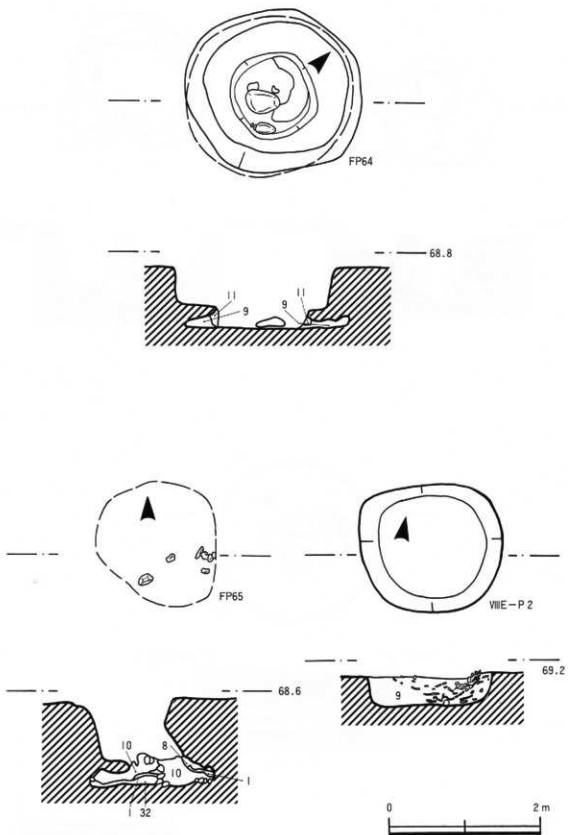

第41図 縄文中期フラスコ状ビット (13)

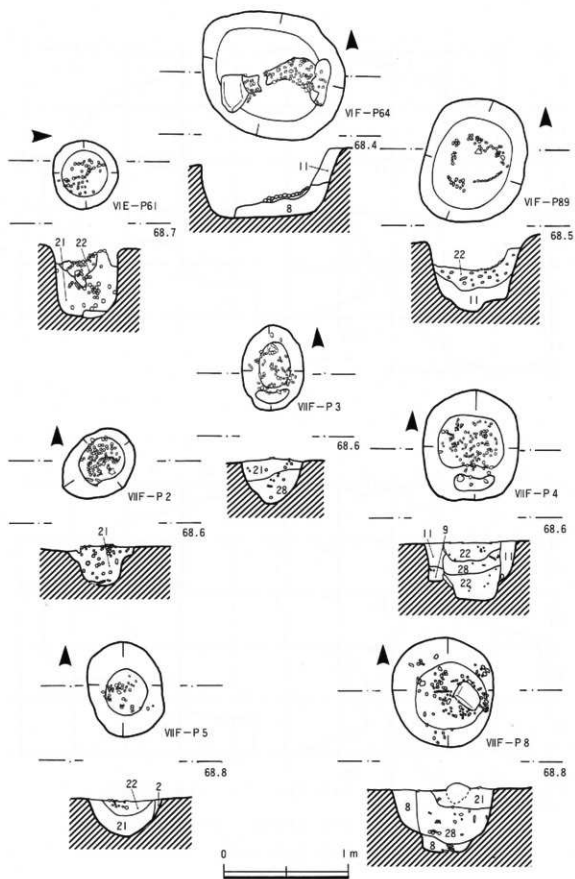

第42図 縄文中・後期トチの実ビット

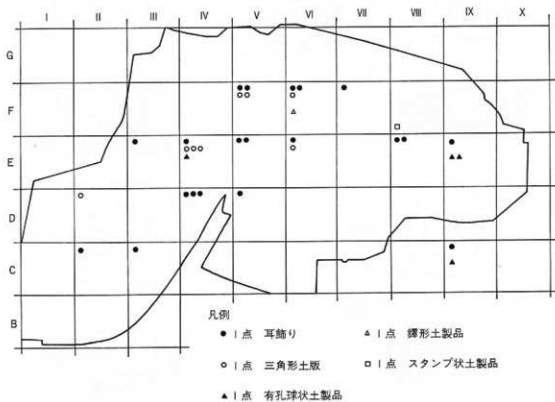
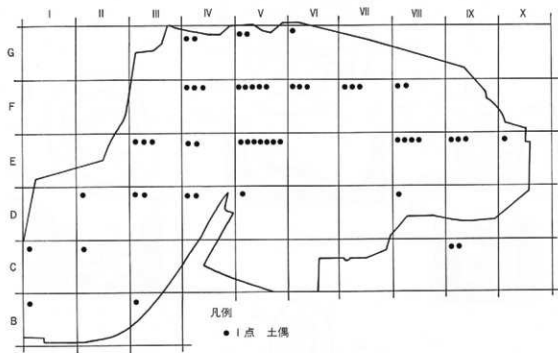

第43図 縄文遺物出土位置図(1)

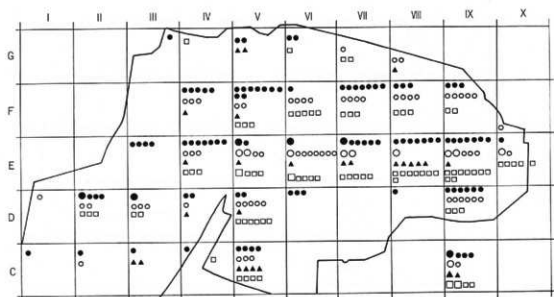

石楯

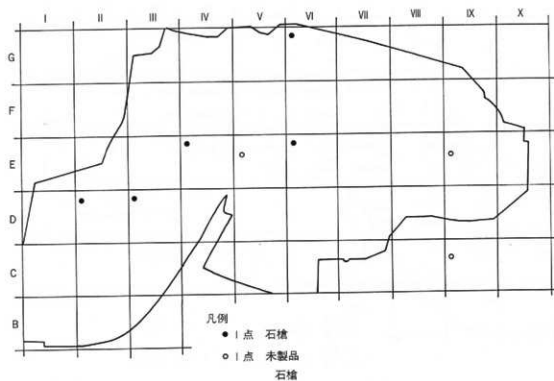

第44图 縄文遺物出土位置图(2)

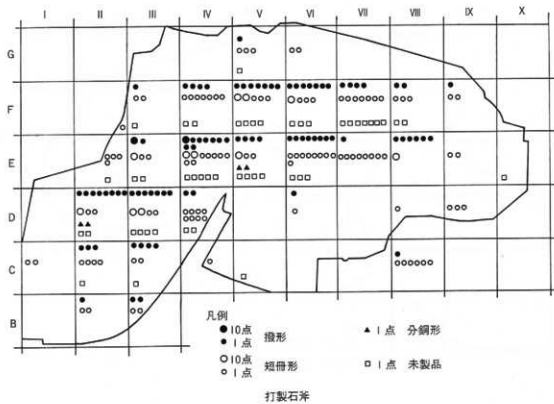
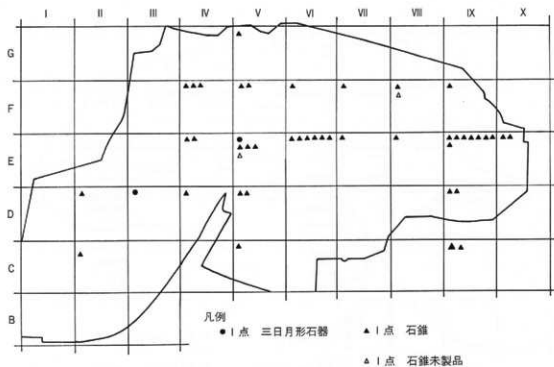

第45圖 縄文遺物出土位置圖(3)

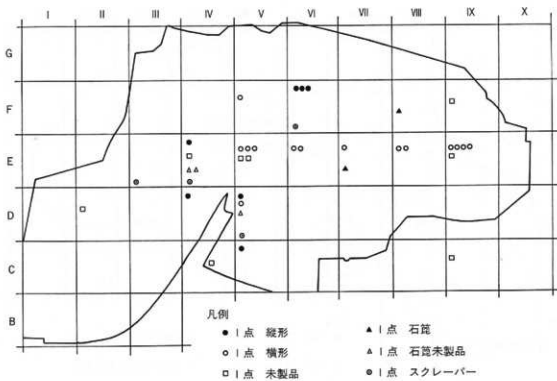
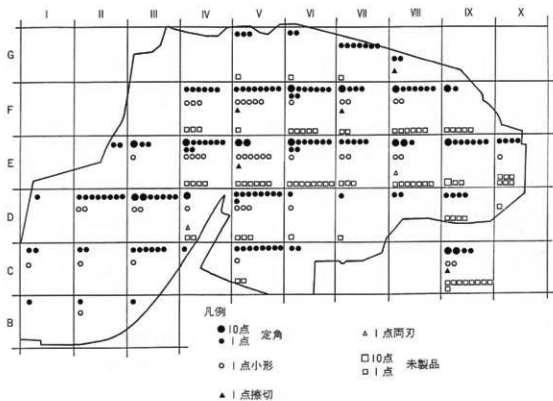

石匙

第46図 縄文遺物出土位置図(4)

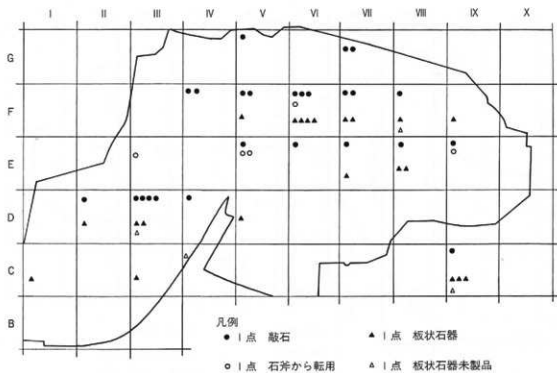
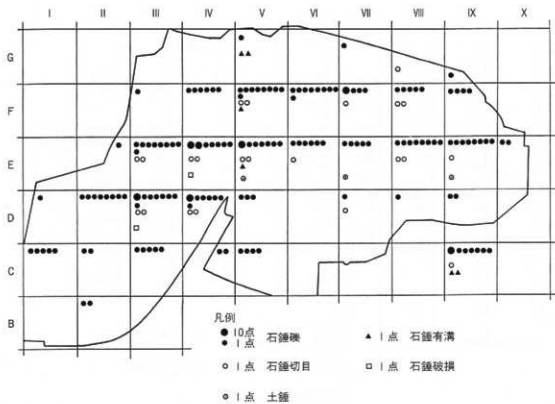

第47图 縄文遺物出土位置图(5)

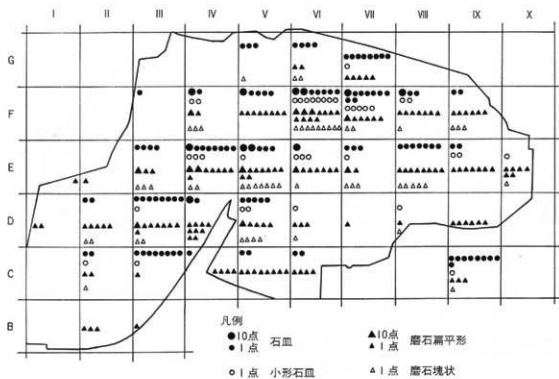
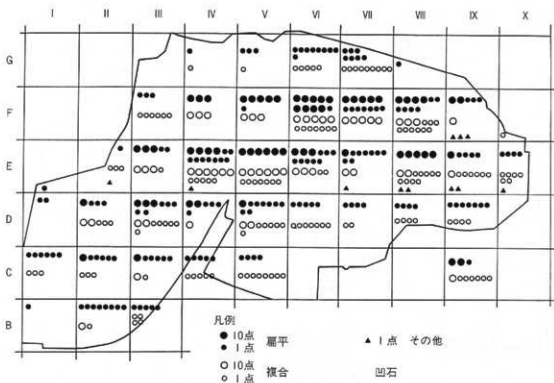

第48図 縄文遺物出土位置図(6)

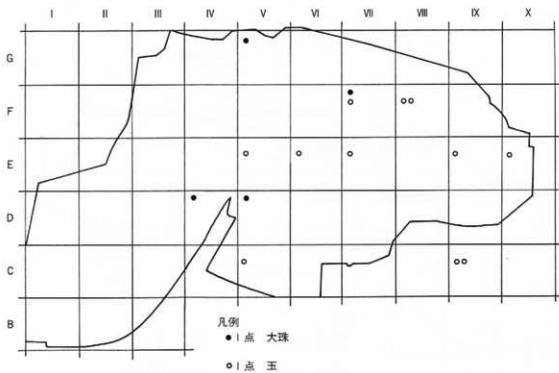
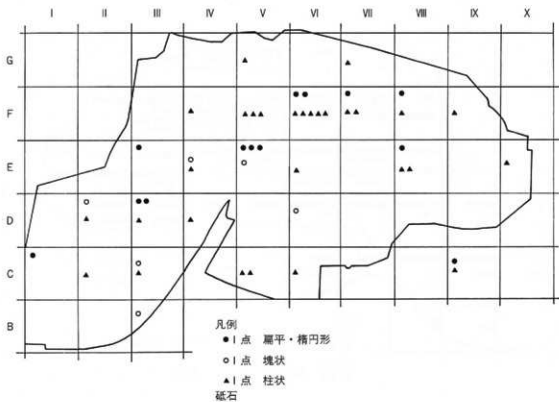

第49图 縄文遺物出土位置图(7)

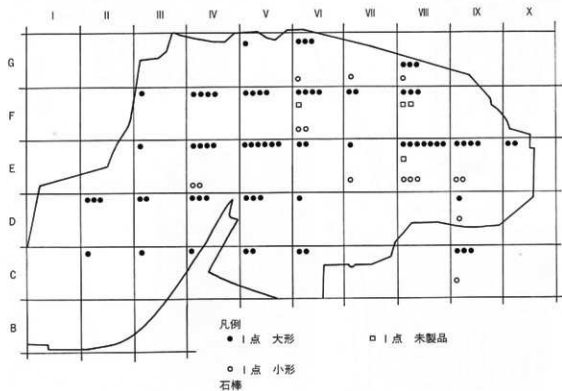
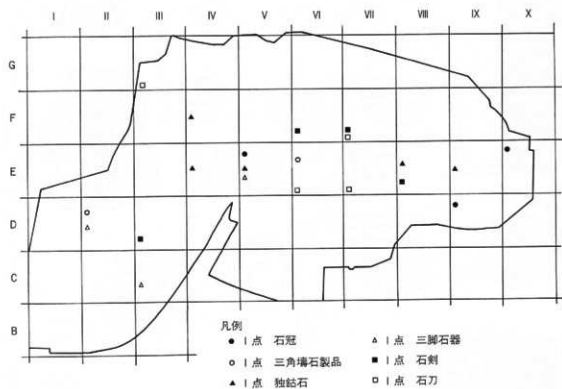

第50図 縄文遺物出土位置図(8)

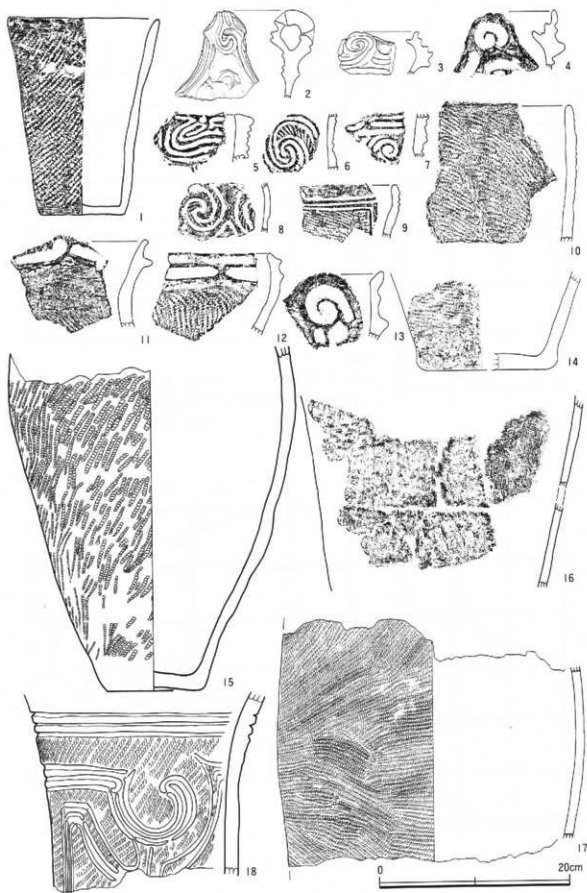

第51图 绳文土器(1) — 整穴住居跡出土—



第52圖 繩文土器（2）— 壑穴住居跡出土 —

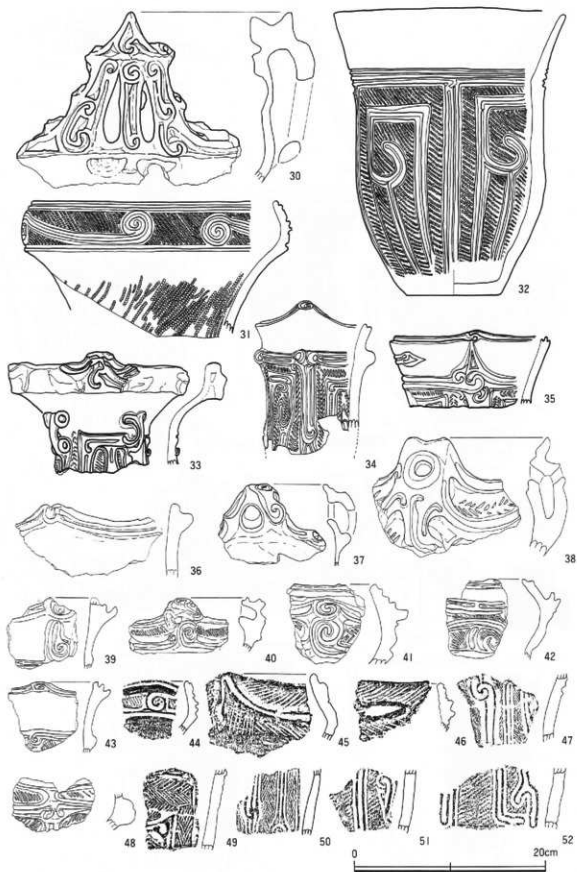

第53図 縄文土器(3) — 壱穴住居跡出土 —

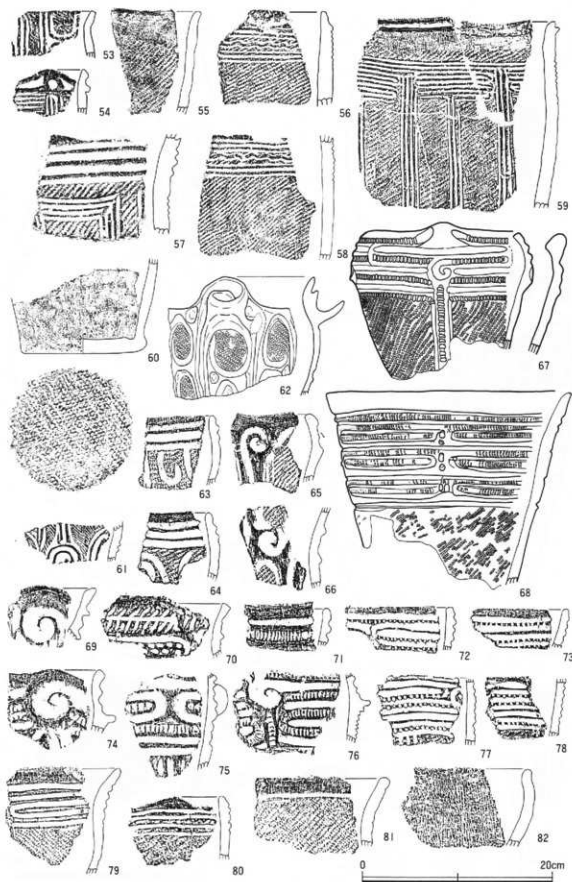

第54图 绳文土器(4) — 壹穴住居跡出土—

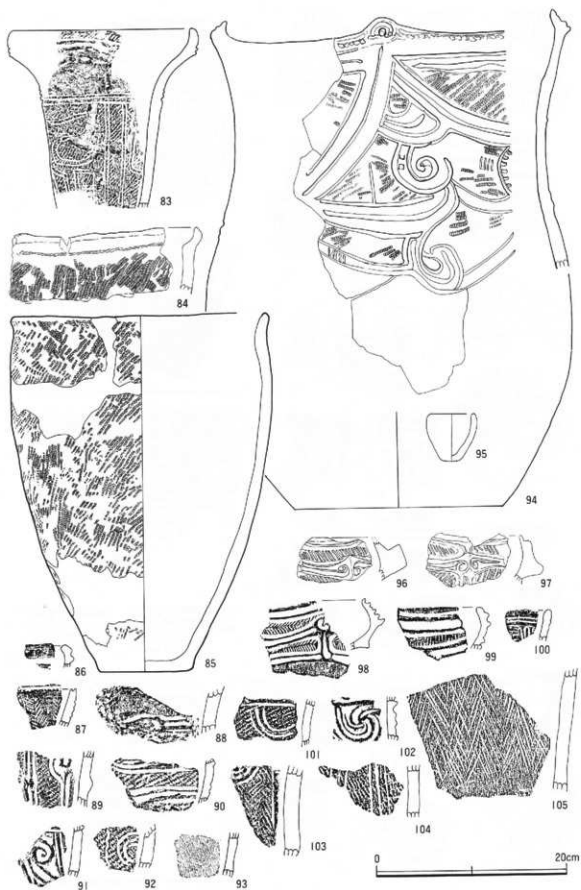

第55圖 縄文土器(5) — 竪穴住居跡出土 —



第56图 绳文土器(6) — 聚穴住居跡出土 —

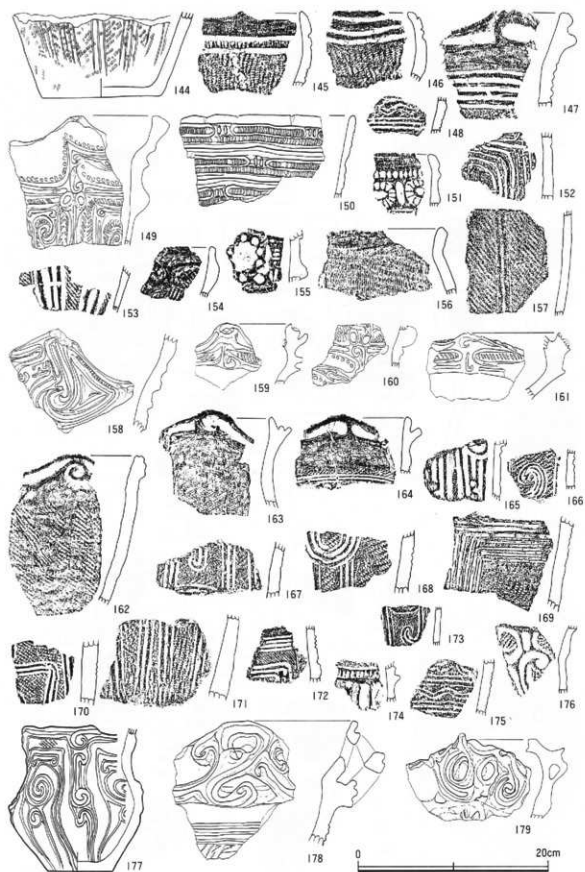

第57图 绳文土器(7) — 整穴住居跡出土 —

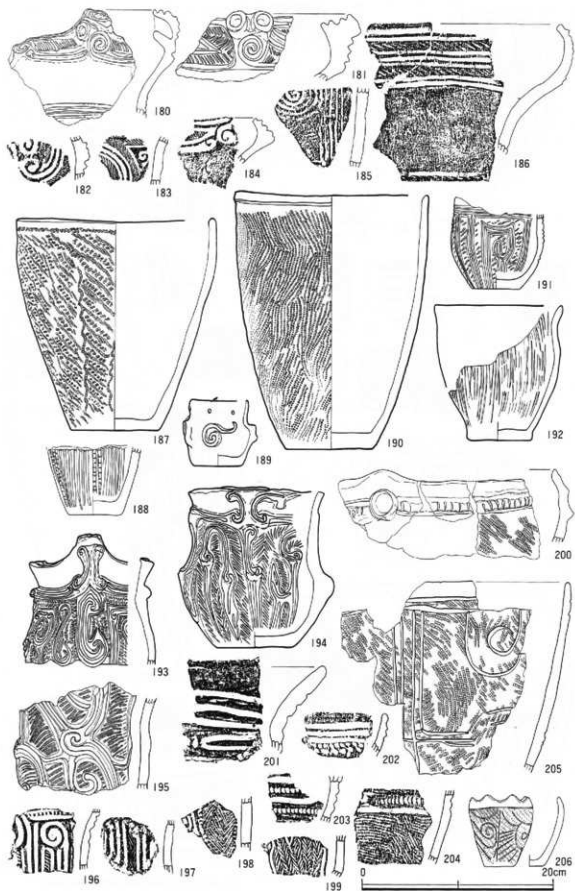

第58図 縄文土器(8) 一竪穴住居跡出土一

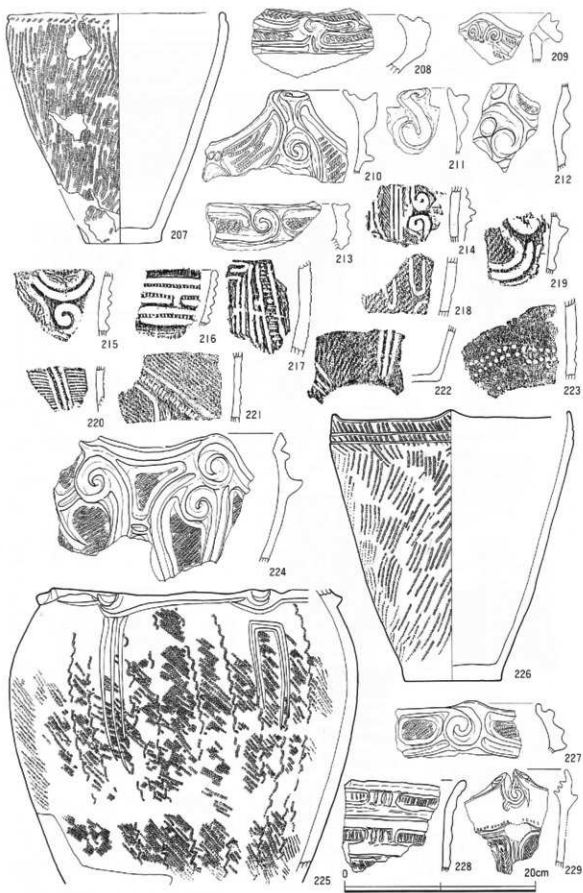

第59圖 繩文土器(9) — 壑穴住居跡出土 —



第60圖 繩文土器 (10) — 竪穴住居跡出土 —

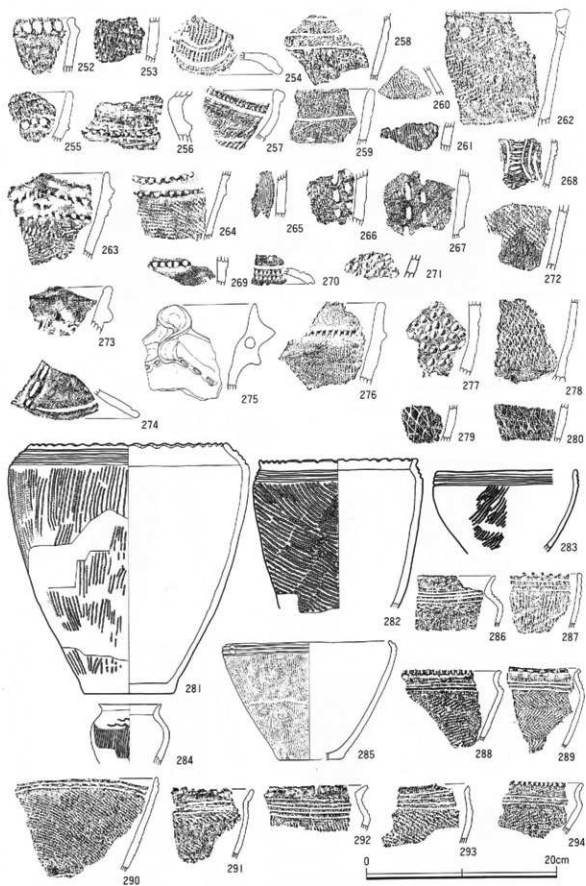

第61图 绳文土器 (11) —整穴住居跡・孤立柱建物跡出土—

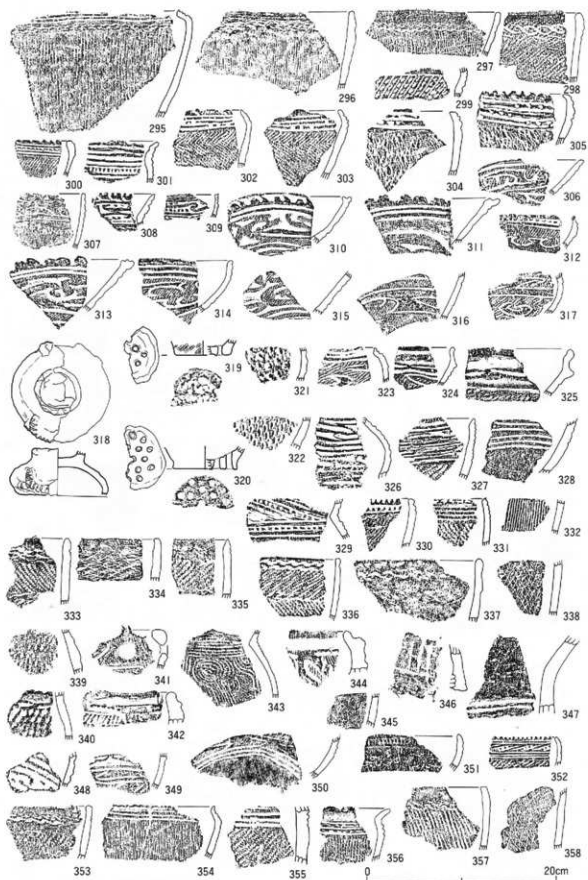

第62圖 縄文土器 (12) — 壱穴住居跡出土 —

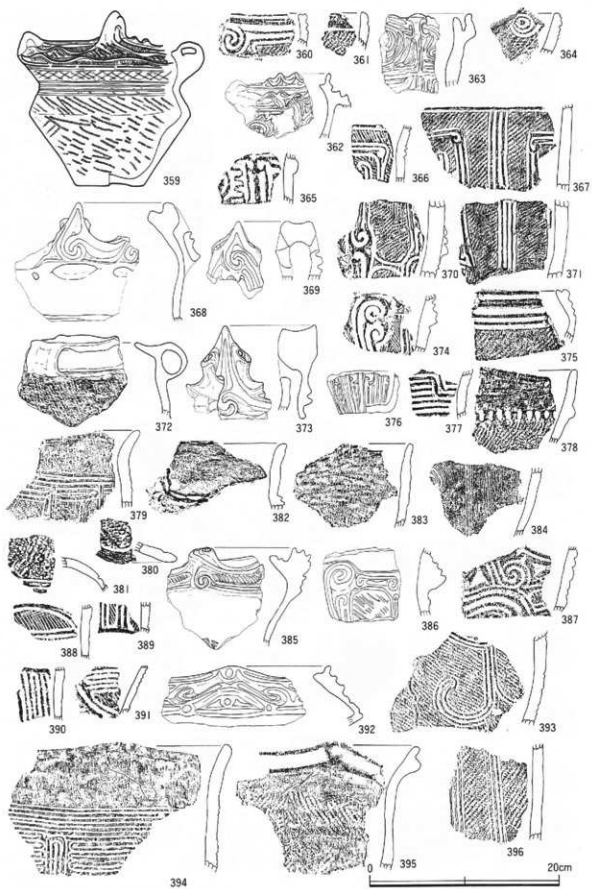

第63図 縄文土器 (13) -フラスコ状ビッド出土-

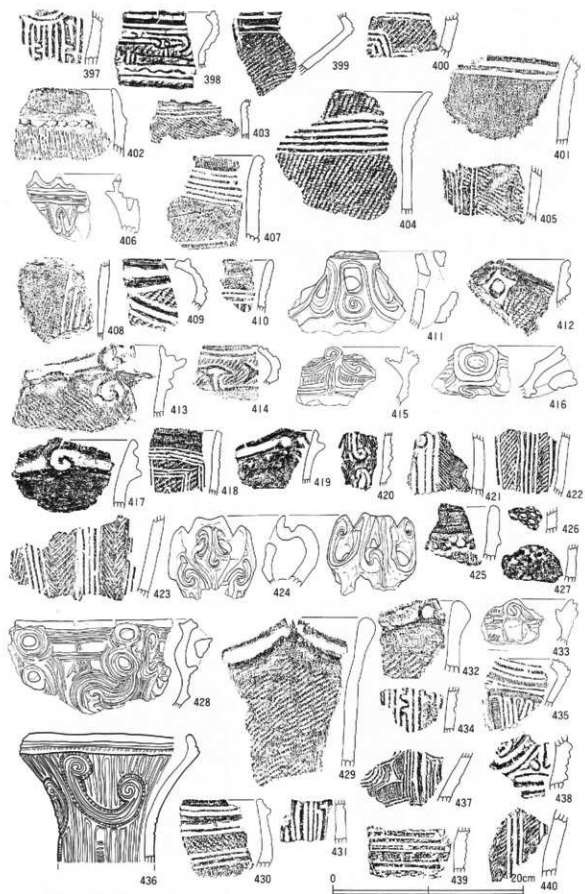

第64図 縄文土器 (14) -フラスコ状ビット出土-



第65図 縄文土器 (15) —ピット出土—

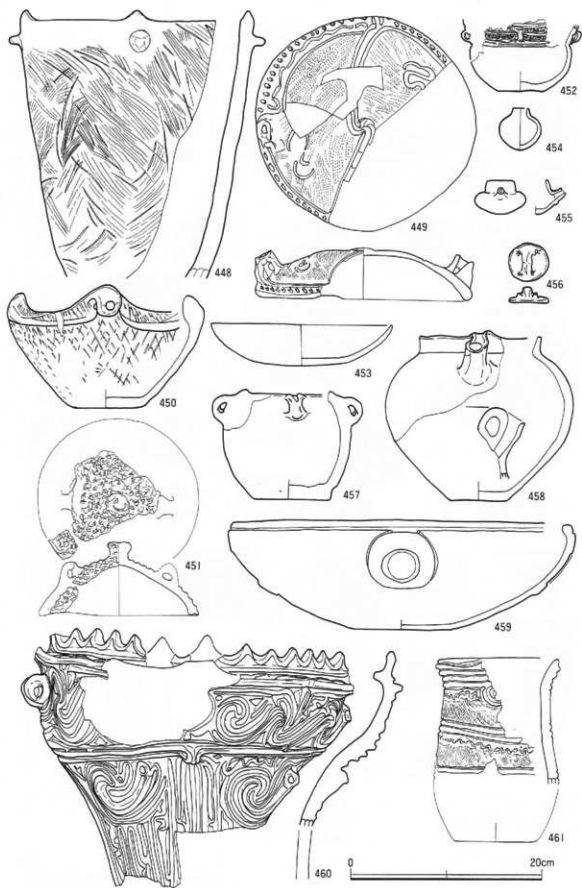

第66図 縄文土器 (16) -ピット出土-

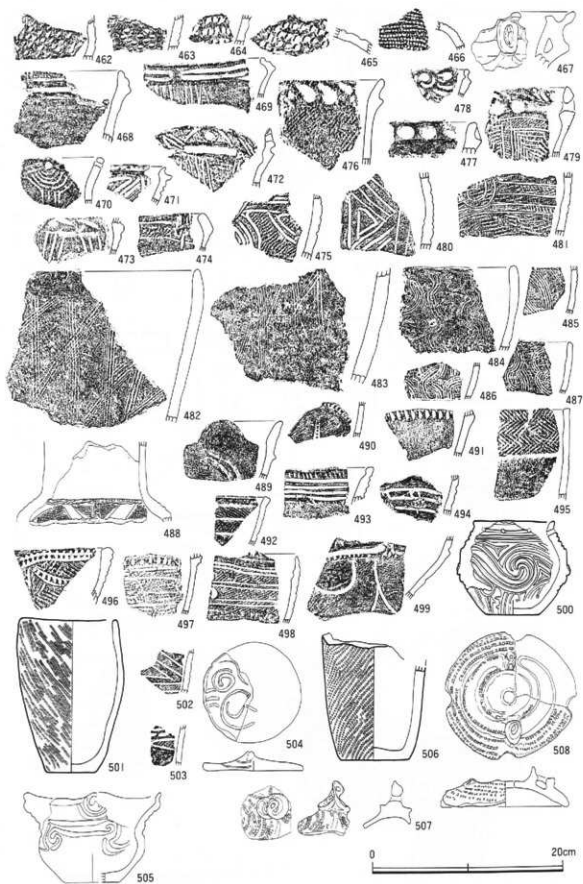

第67図 縄文土器 (17) —ピット出土—

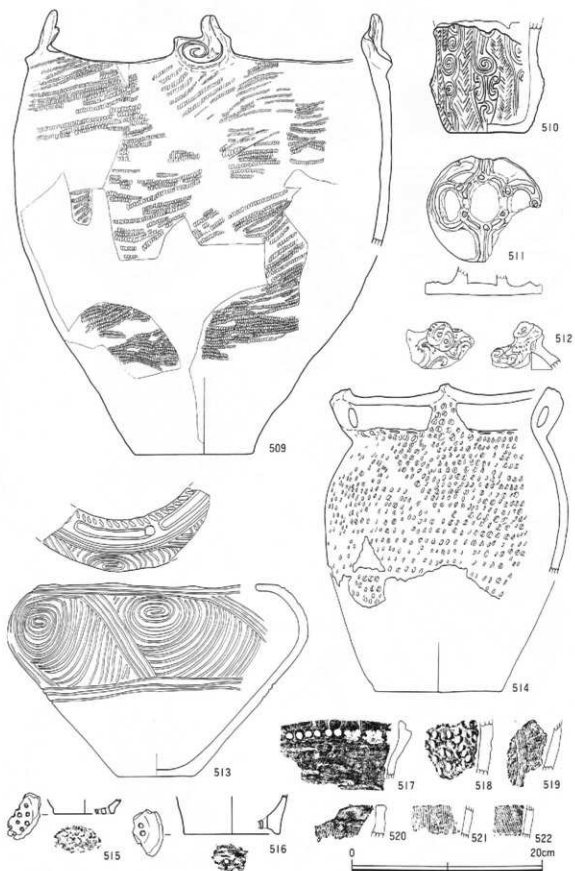

第68図 縄文土器 (18) -ピット出土-

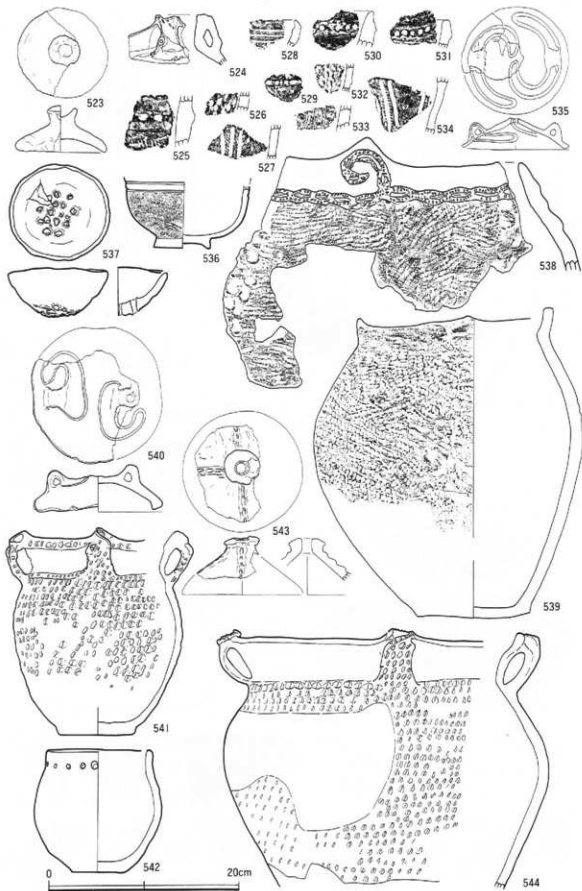

第69図 縄文土器 (19) -ピット出土-

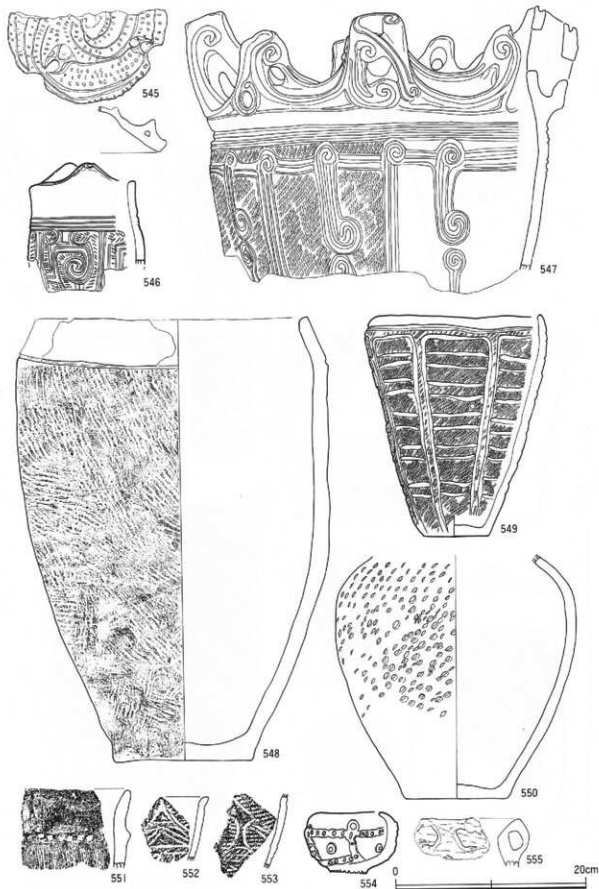

第70図 縄文土器 (20) -ピット出土-

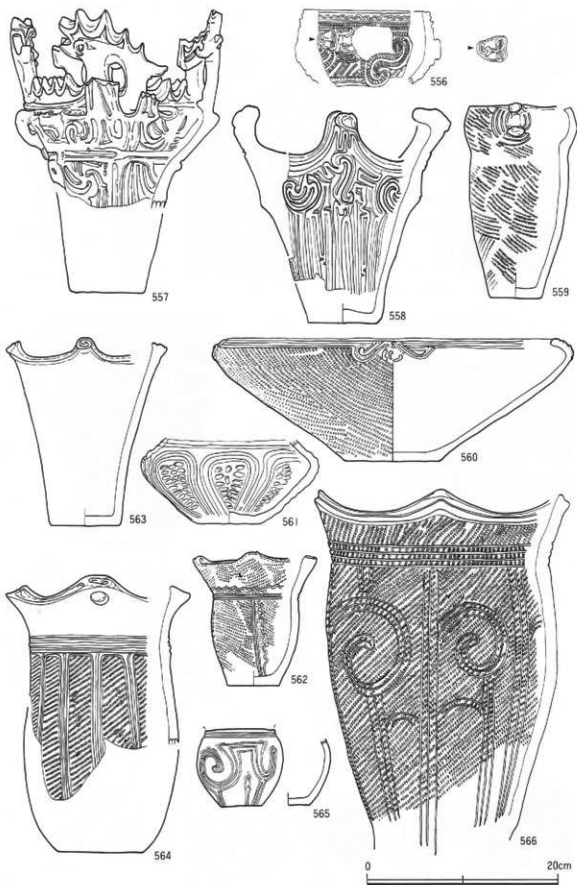

第71圖 縄文土器 (21) 一包含層出上一

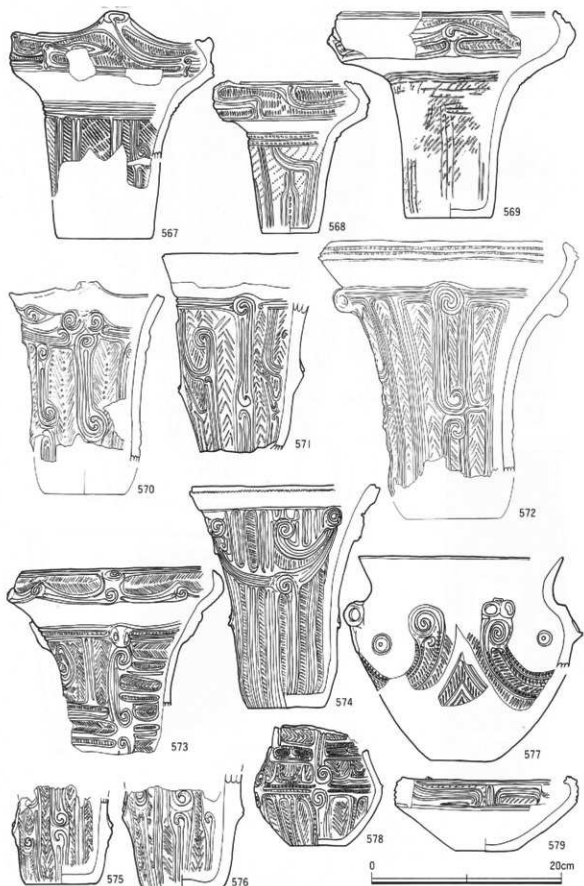

第72図 縄文土器(22) 一包含層出土一

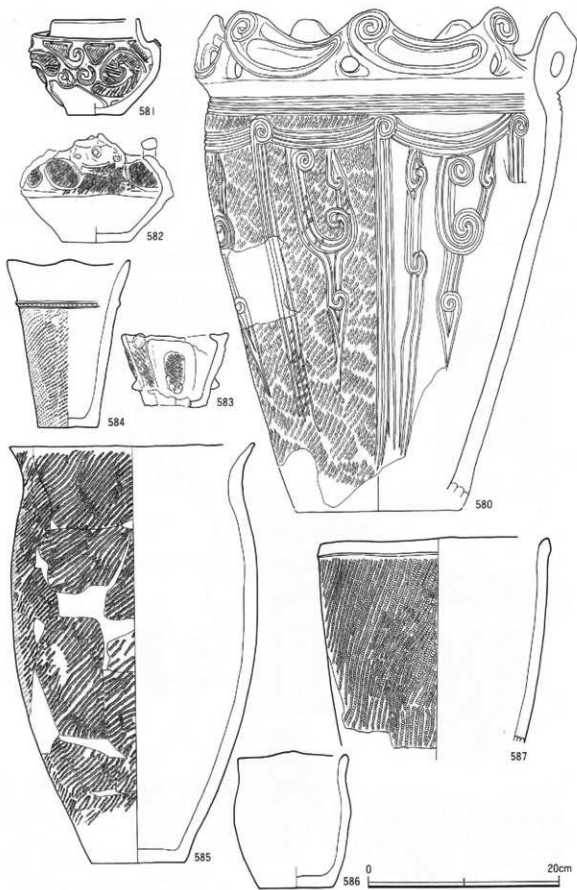

第73图 绳文土器 (23) 一包含层出土一

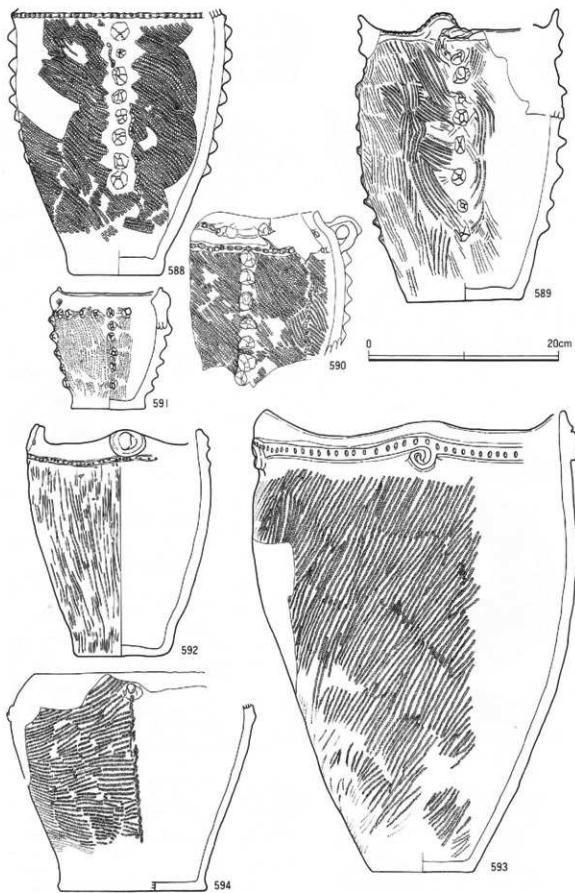

第74図 縄文土器 (24) —包含層出土—

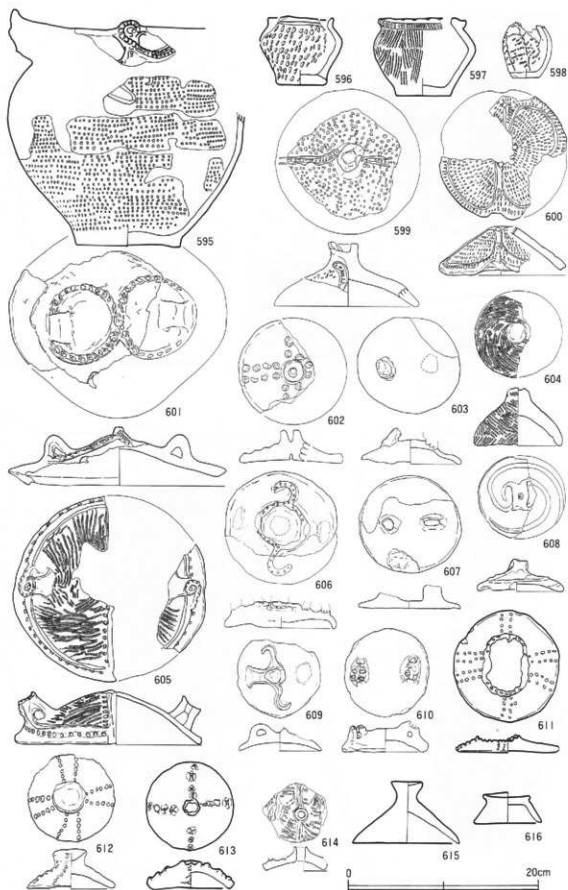

第75図 縄文土器 (25) 一包含層出土一



第76圖 繩文土器 (26) 一包含層上—

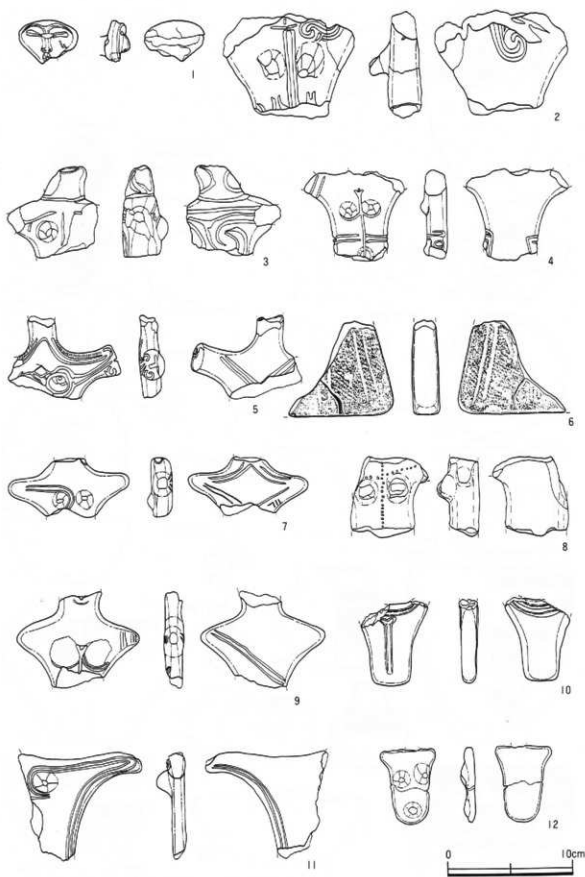

第77回 土偶 (1)

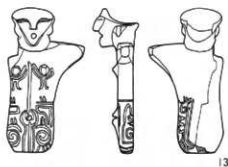

13



14

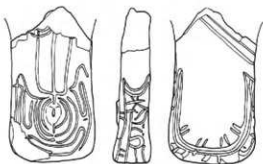

15



16



17



18



19



20



21

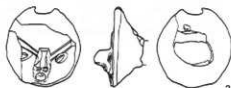

24



22



23



25



第78图 土偶 (2)

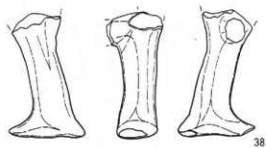
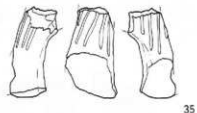
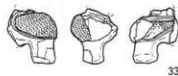
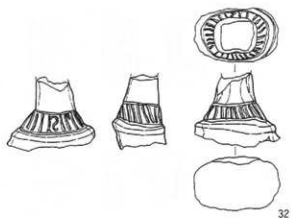
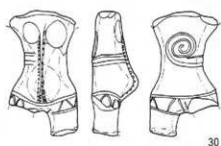
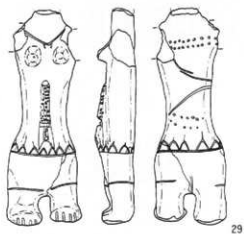

第79回 土偶 (3)

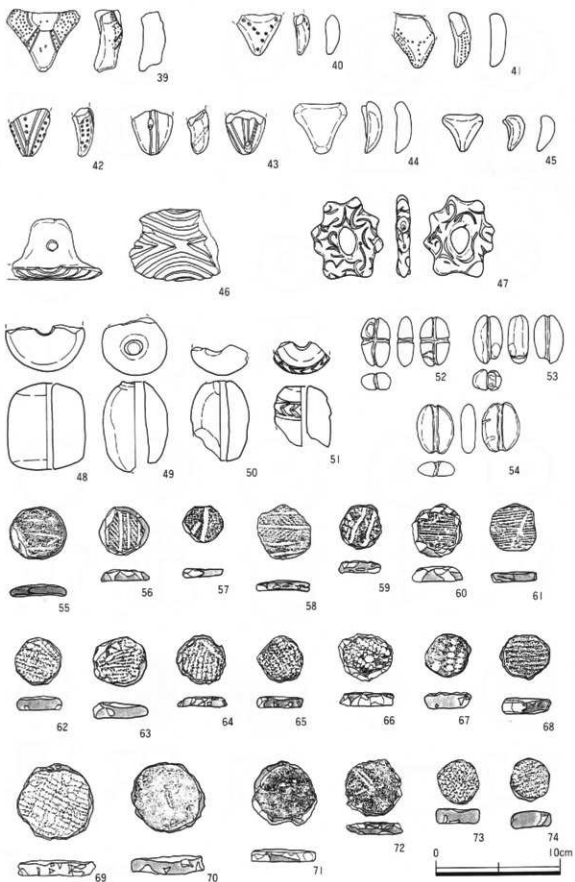

第80図 三角形土版・スタンプ状土製品・土鏝・鏝形土製品・有孔球状土製品・円板状土製品

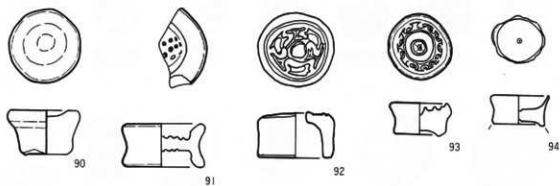
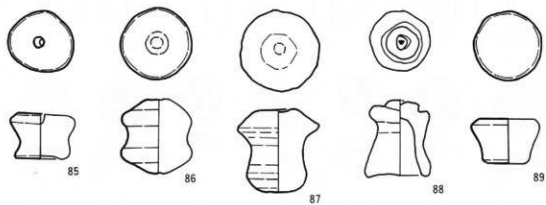
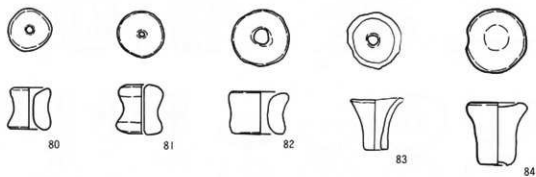
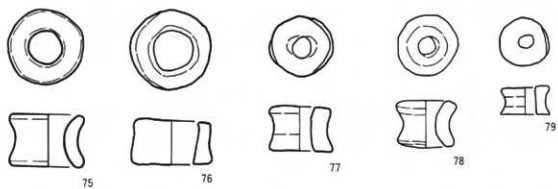

第81回 土製耳飾

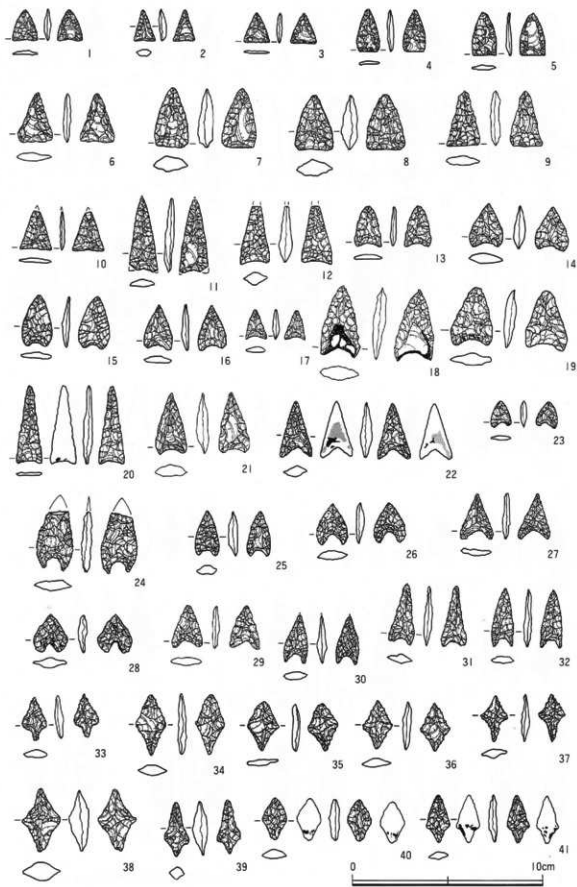

第82図 石 鏃 (1)

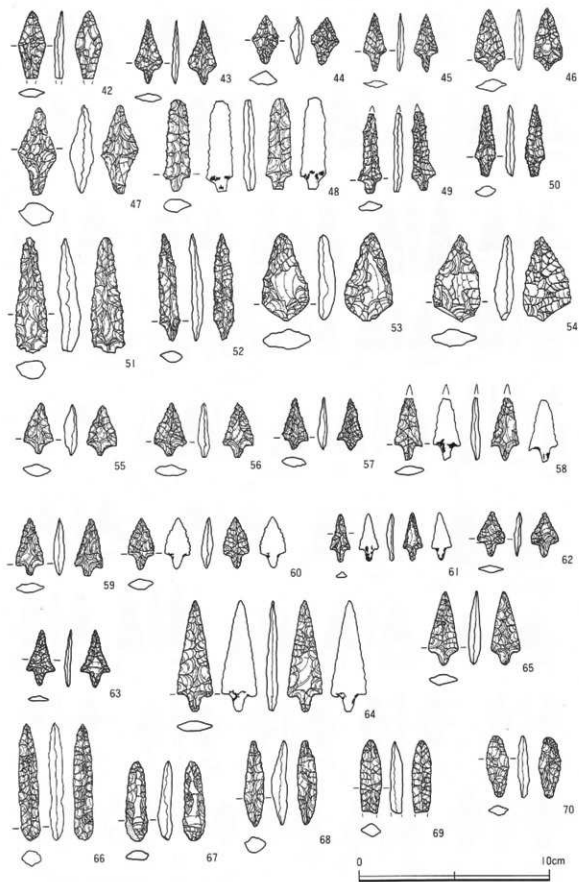

第83圖 石 鏃 (2)

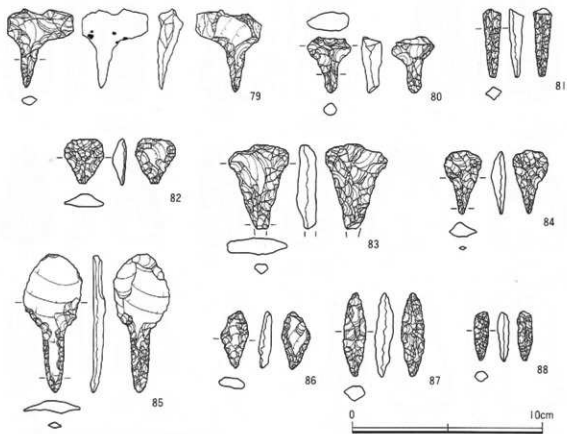
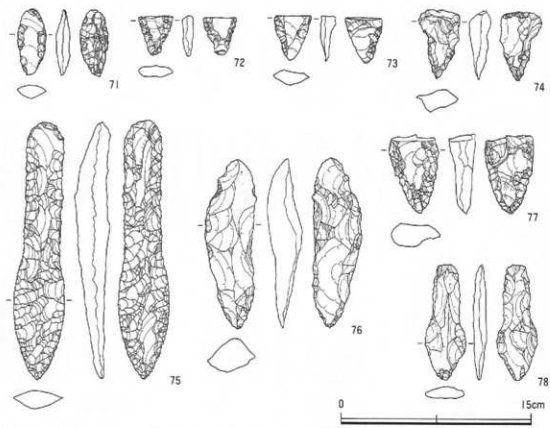

第84圖 石槍・石鏃

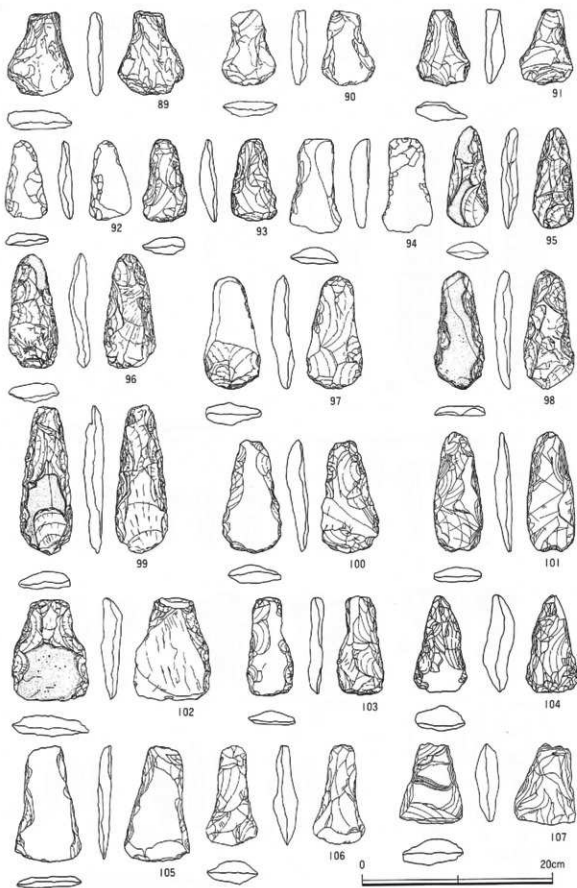

第85图 打製石斧 (1)

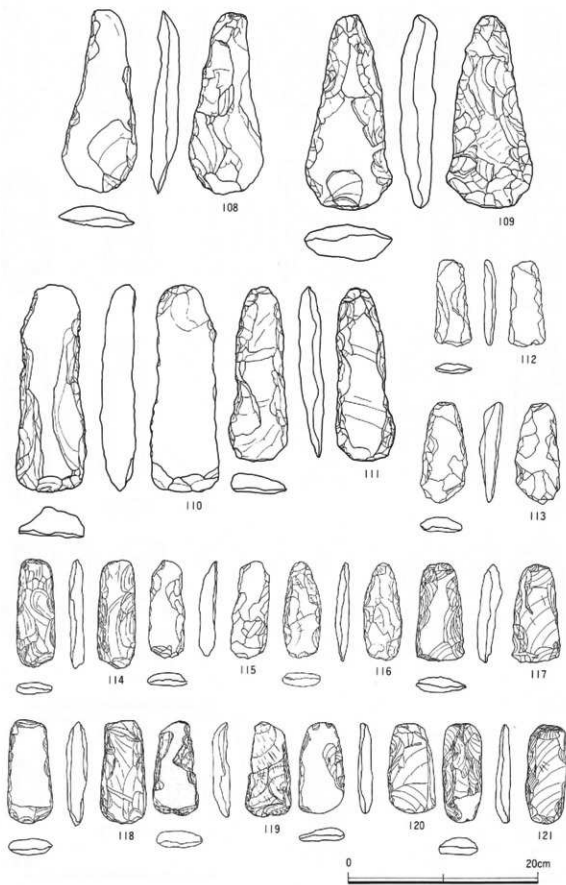

第86圖 打製石斧 (2)

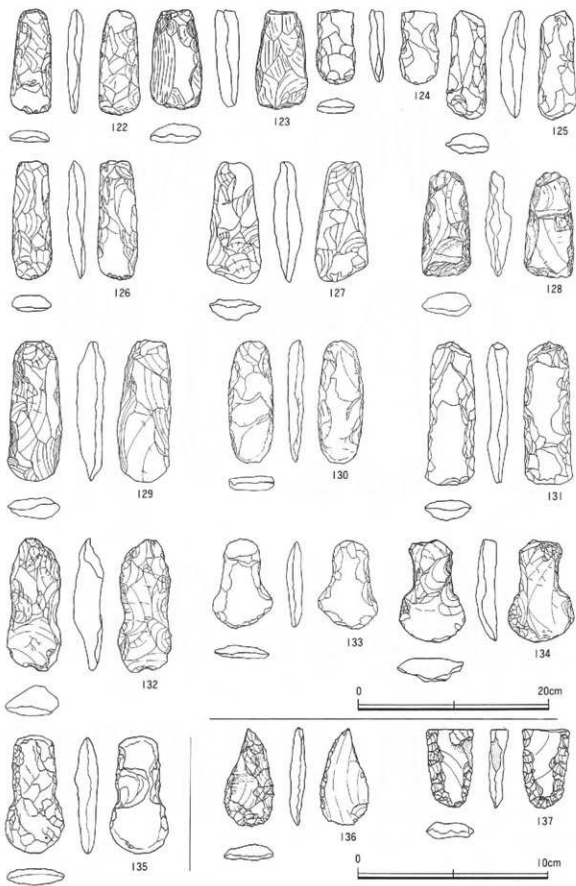

第87圖 打製石斧 (3)・石斧

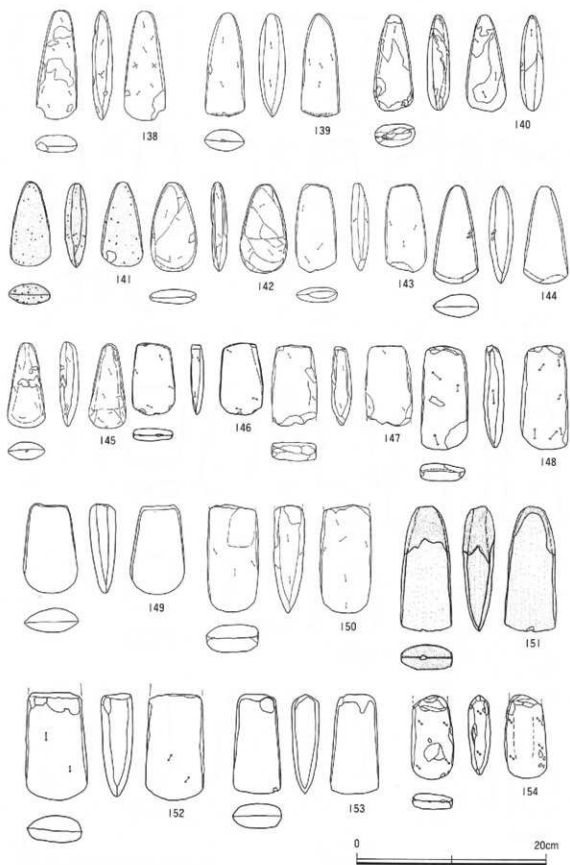

第88图 磨製石斧(1)



第89回 磨製石斧 (2)

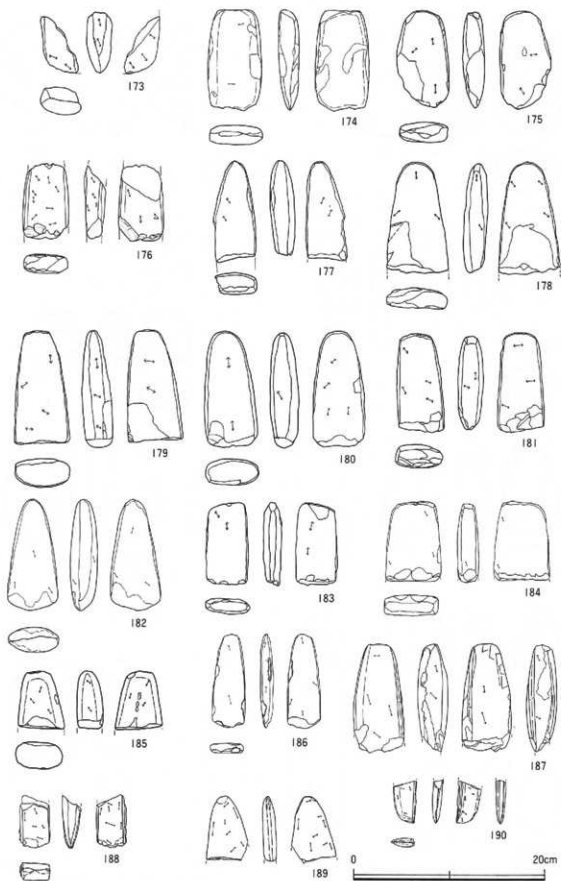

第90图 磨製石斧(3)



第91图 磨製石斧(4)

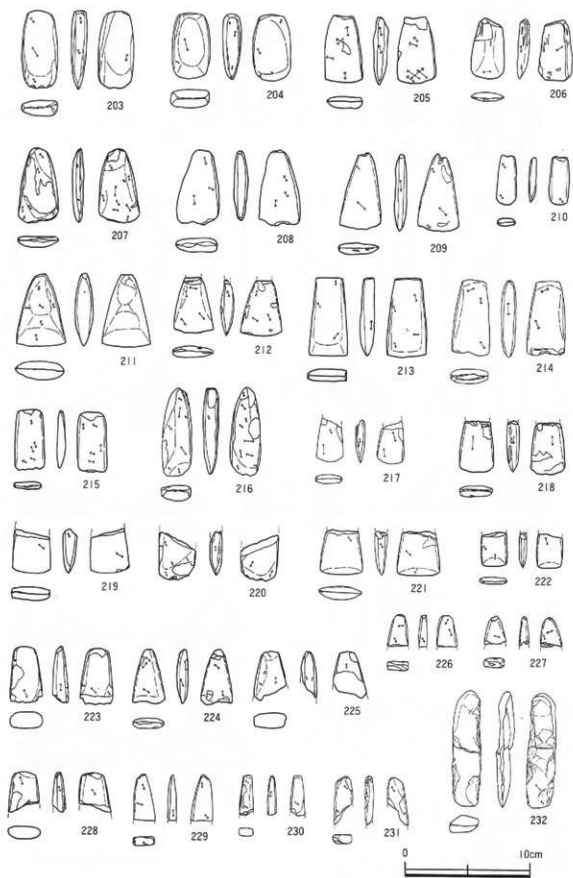

第92图 小形磨製石斧

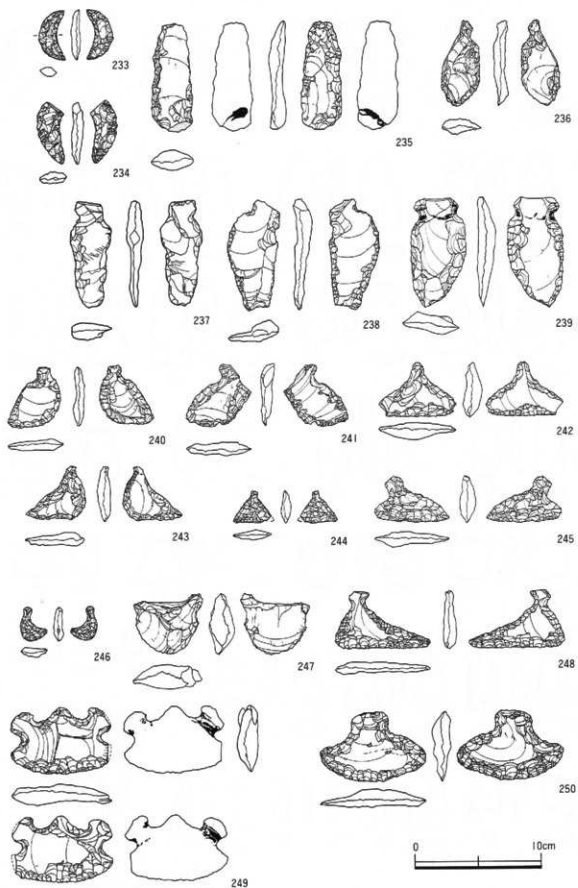

第93图 三日月形石器·石匙

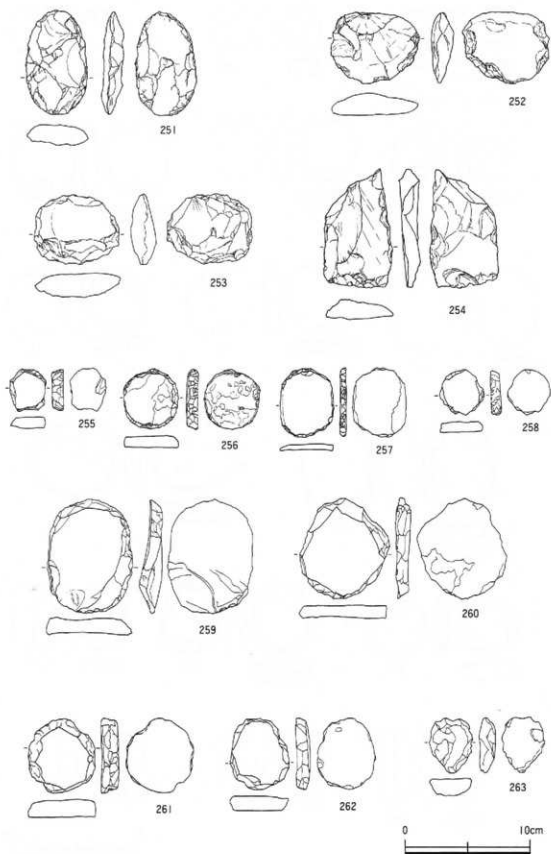

第94図 スクレーパー・板状石器

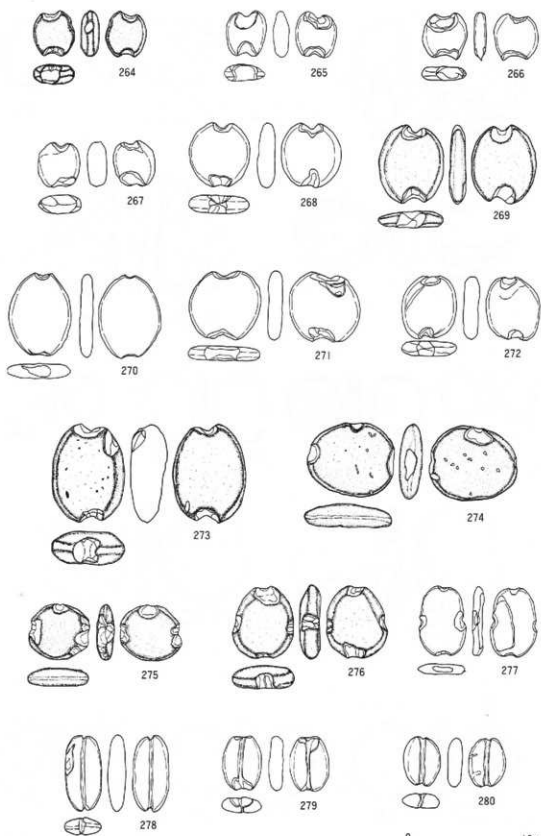

第95図 石鏃

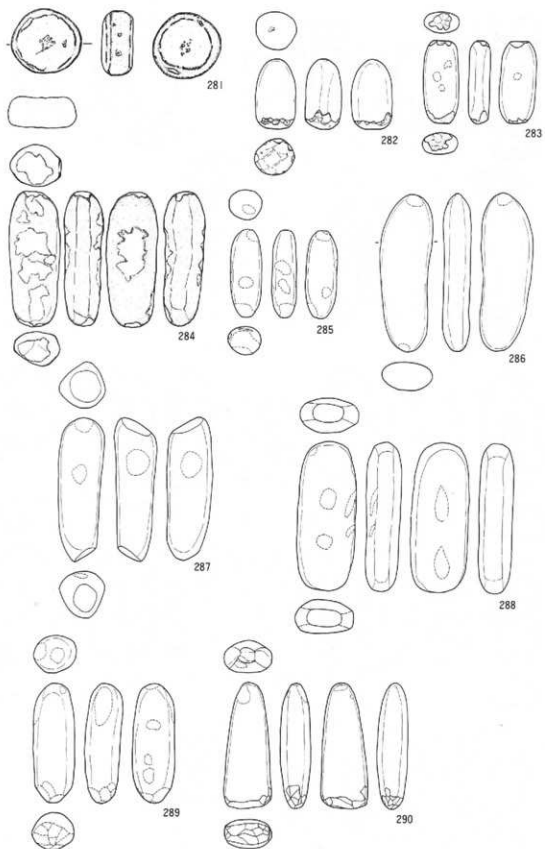

第96図 敲石(1)

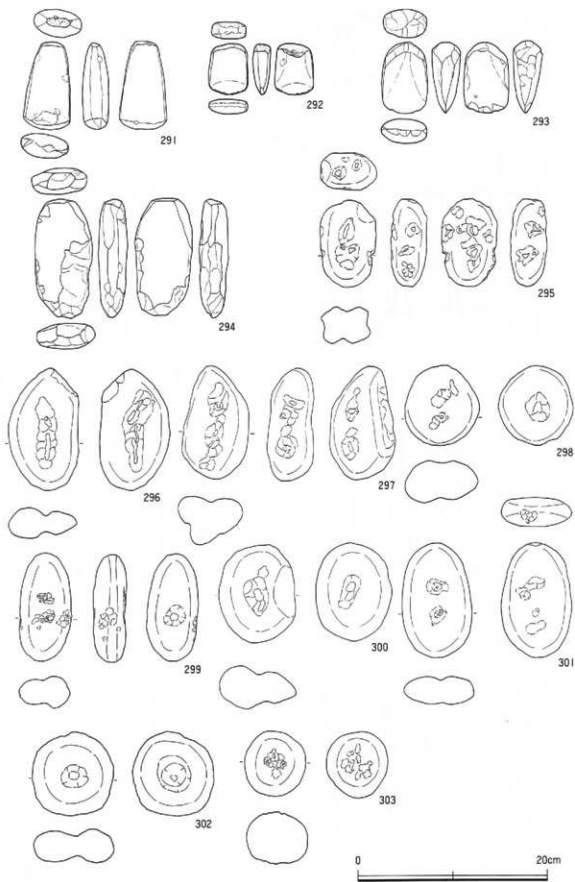

第97图 敲石(2)·凹石(1)

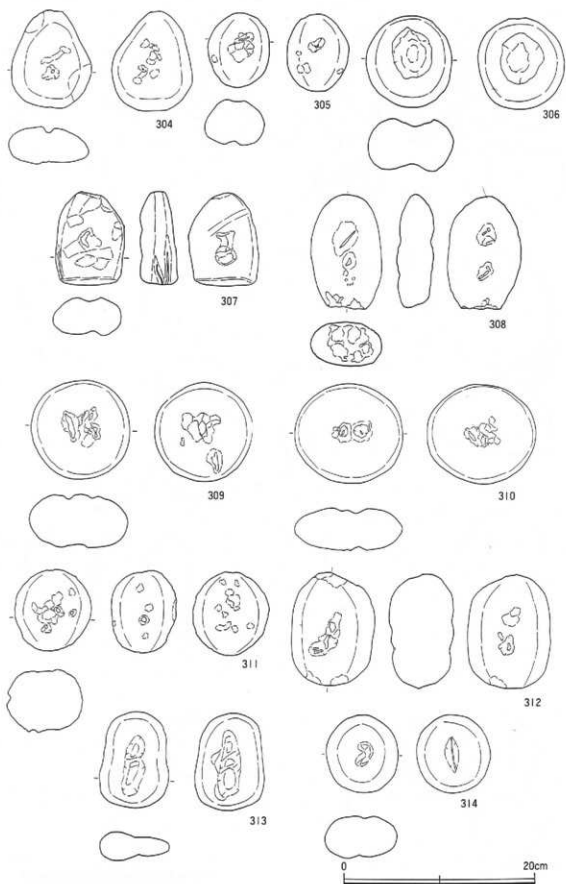

第98圖 凹石 (2)

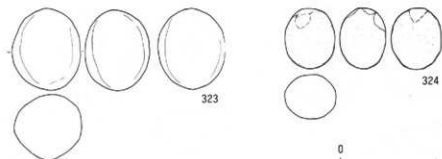
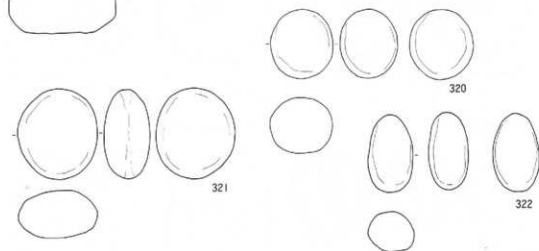
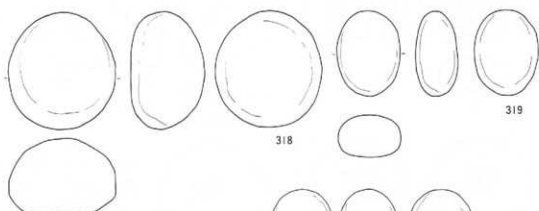
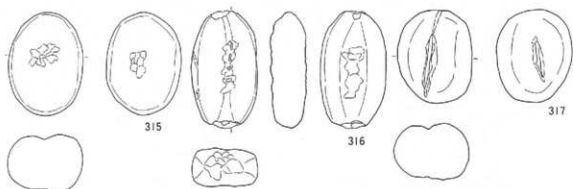

第99圖 凹石 (3)・磨石

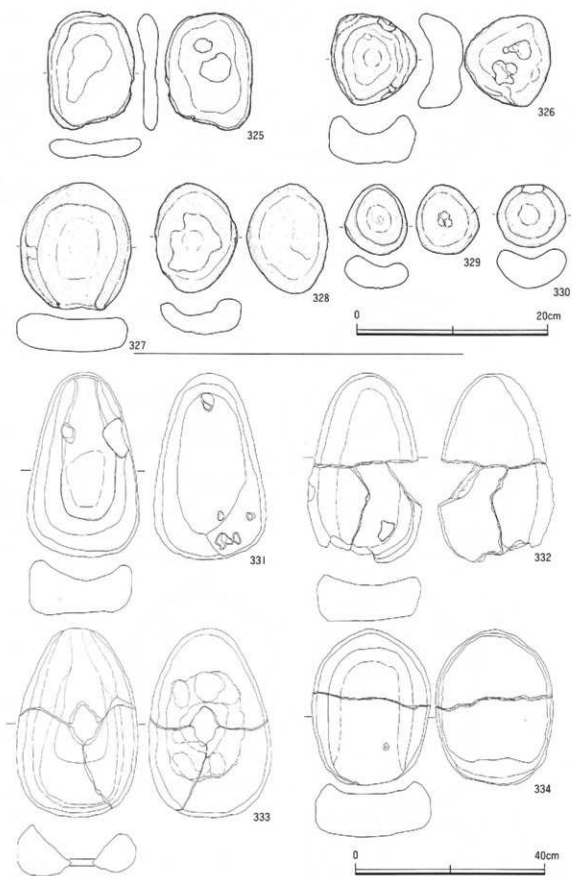

第100圖 小形石皿・石皿 (1)

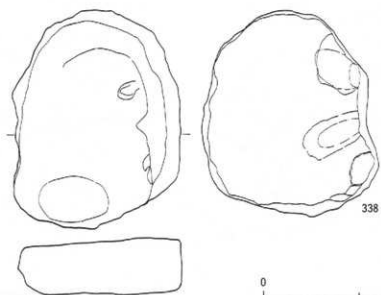
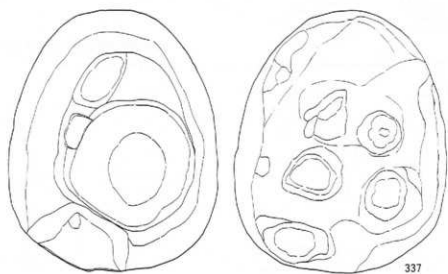
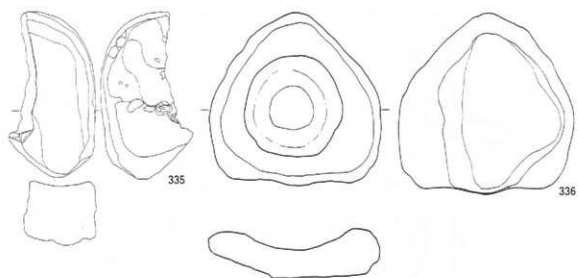

0 40cm

第101圖 石皿 (2)

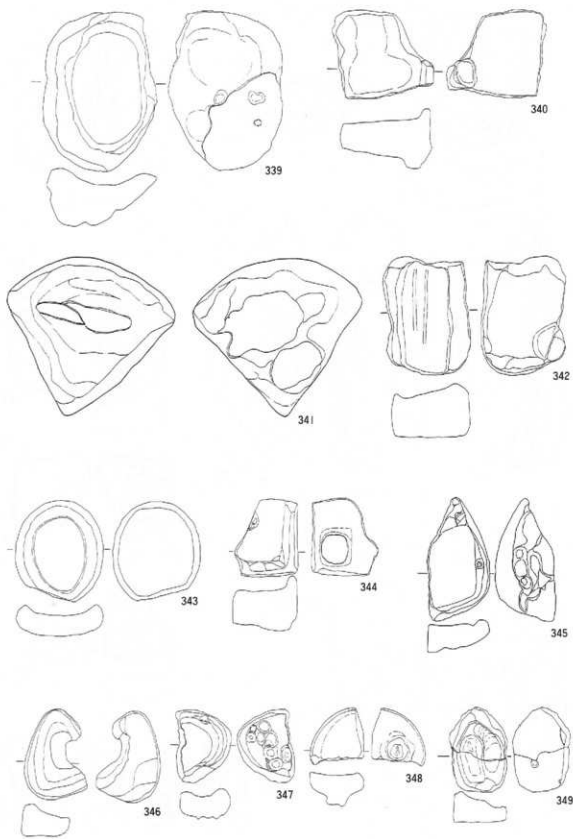

第102圖 石皿(3)



第103圖 磁石

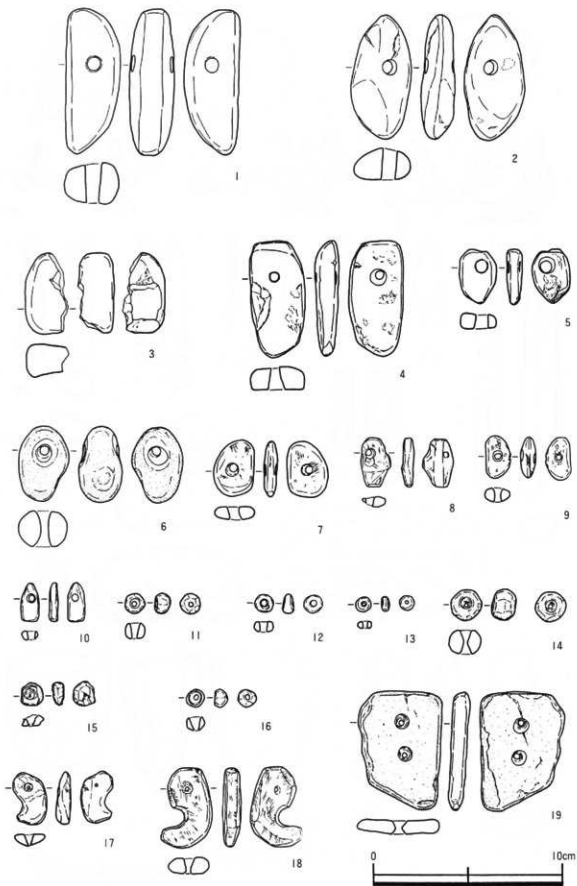

第104図 硬玉製大珠・玉類

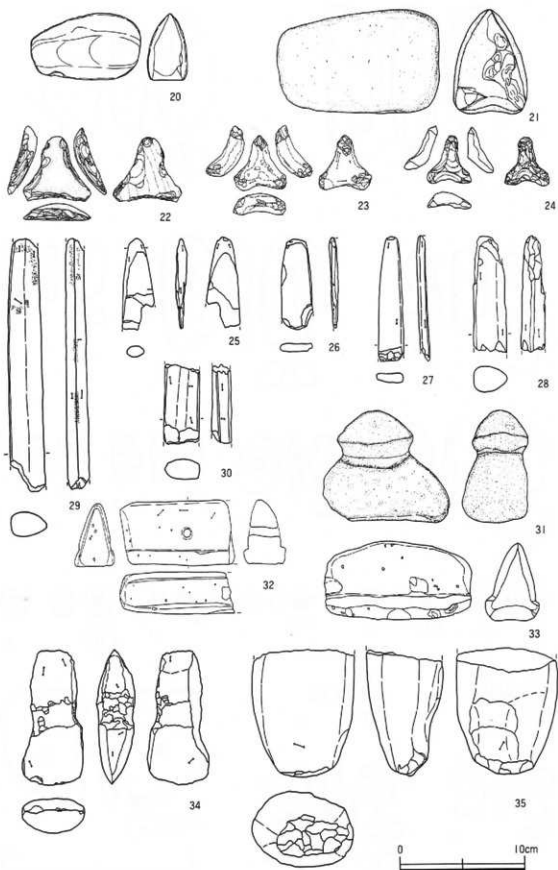

第105图 三角塘石製品・三脚石器・石刺・石刀・石冠・独鈎石(1)

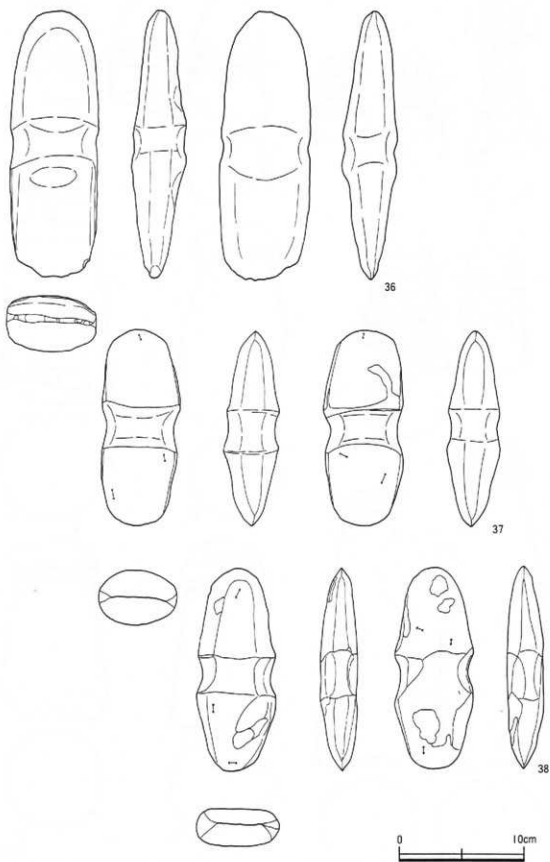

第106图 独钻石 (2)

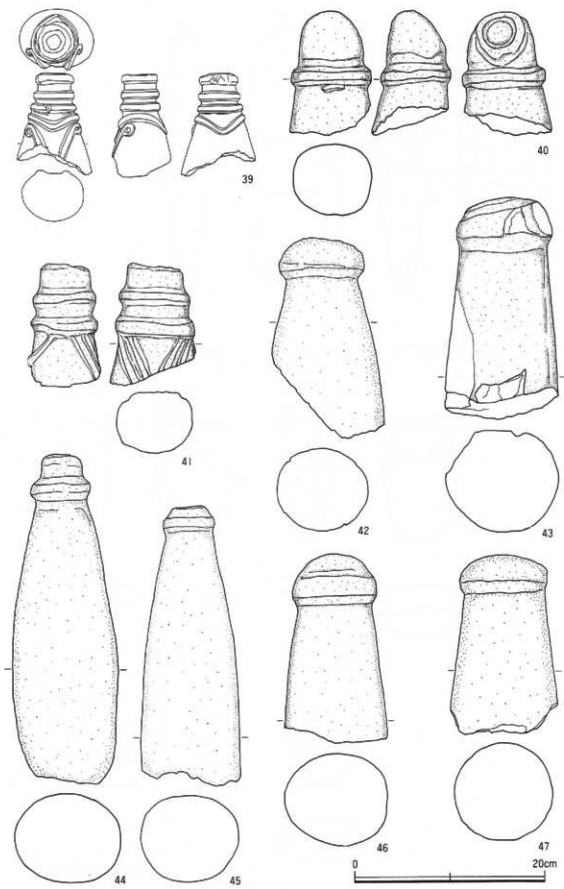

第107图 石棒 (1)

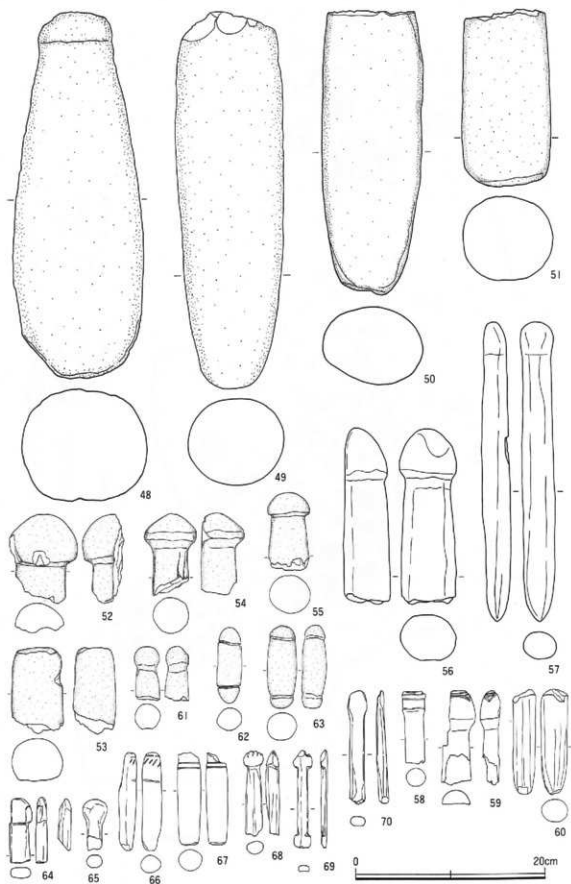

第108圖 石棒 (2)

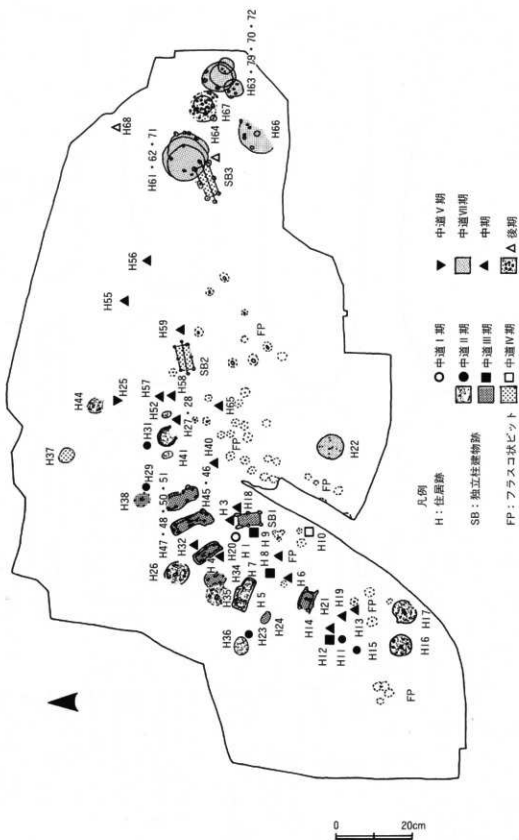

第109図 縄文集落実測図

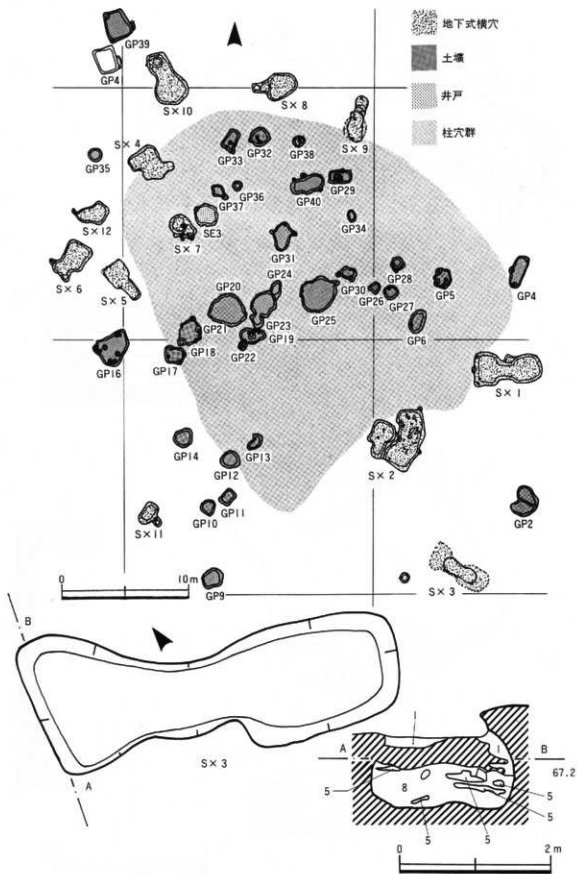

第110図 中世の遺構全体図・地下式横穴 (1)

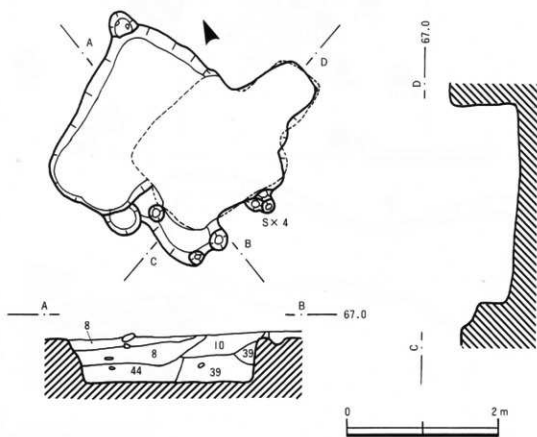
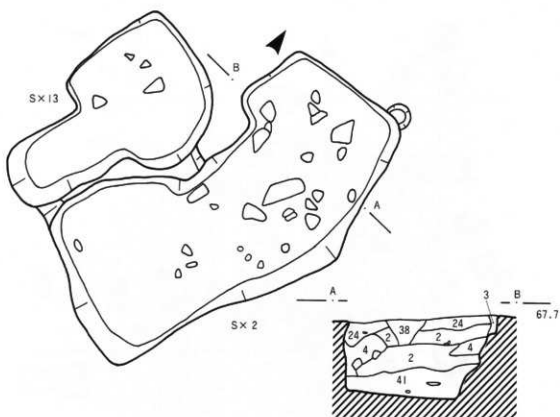

第111図 中世の地下式横穴(2)

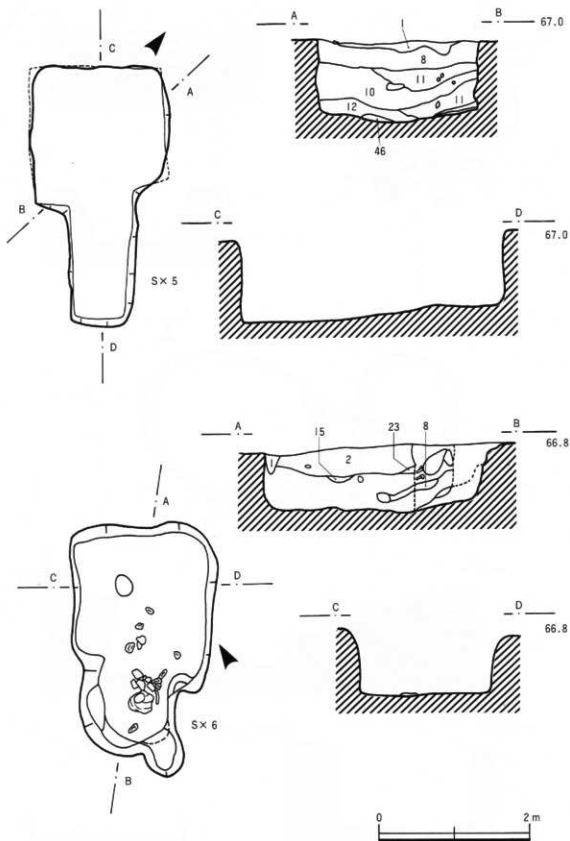

第112図 中世の地下式横穴 (3)

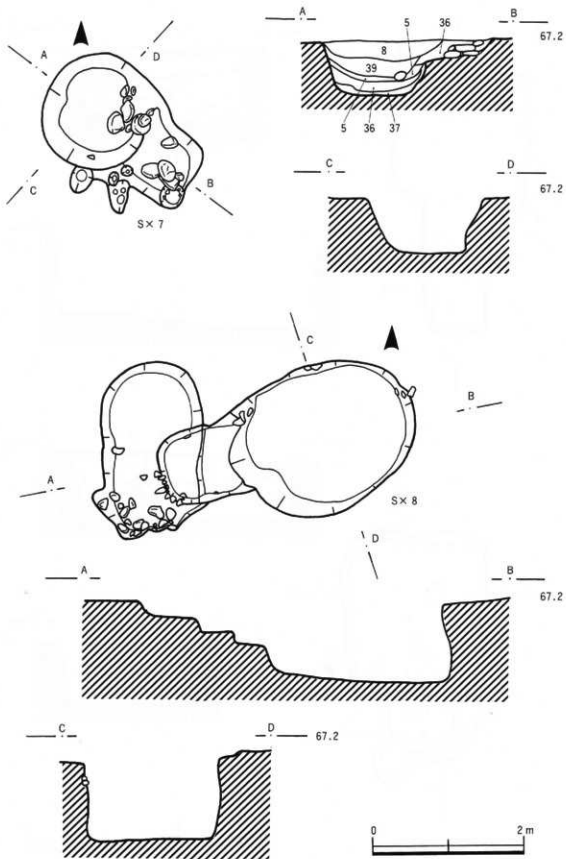

第113図 中世の地下式横穴（4）

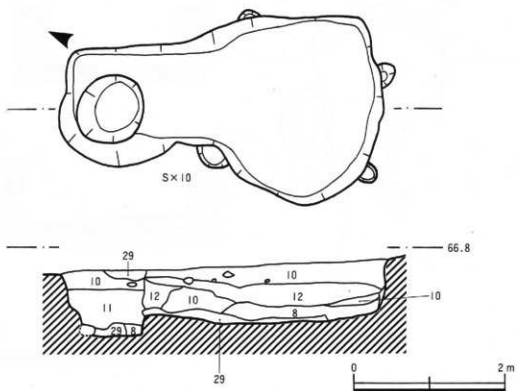
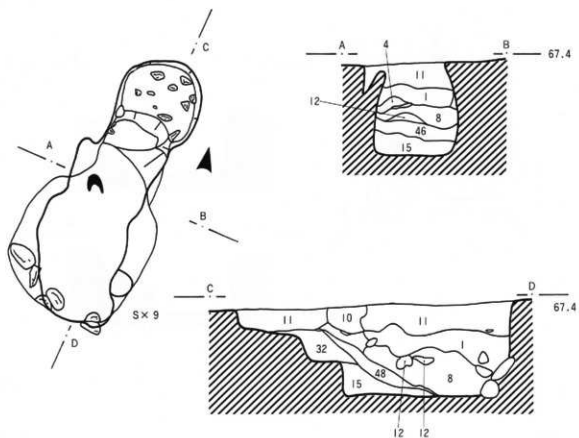

第114図 中世の地下式横穴 (5)

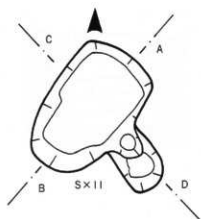

A

B 67.2



C

D 67.2

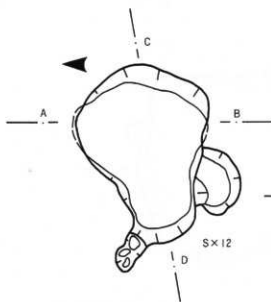

A

B 66.9



C

D 66.9



第115図 中世の地下式横穴（6）

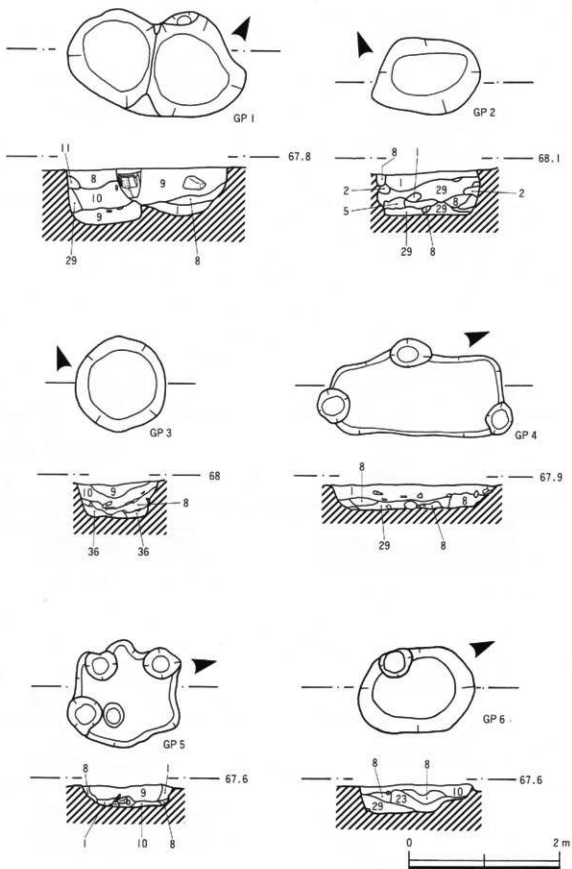

第116図 中世の土坑 (1)



GP 7

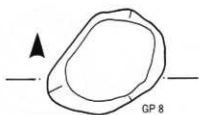
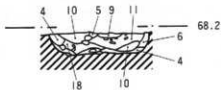

GP 8

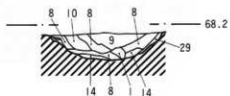

GP 9

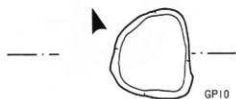

GP10

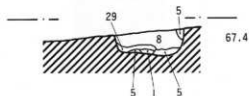

GP11

67.5

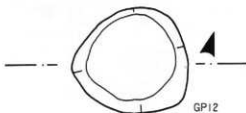
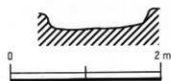

GP12

67.4

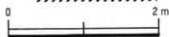

第117図 中世の土壌 (2)

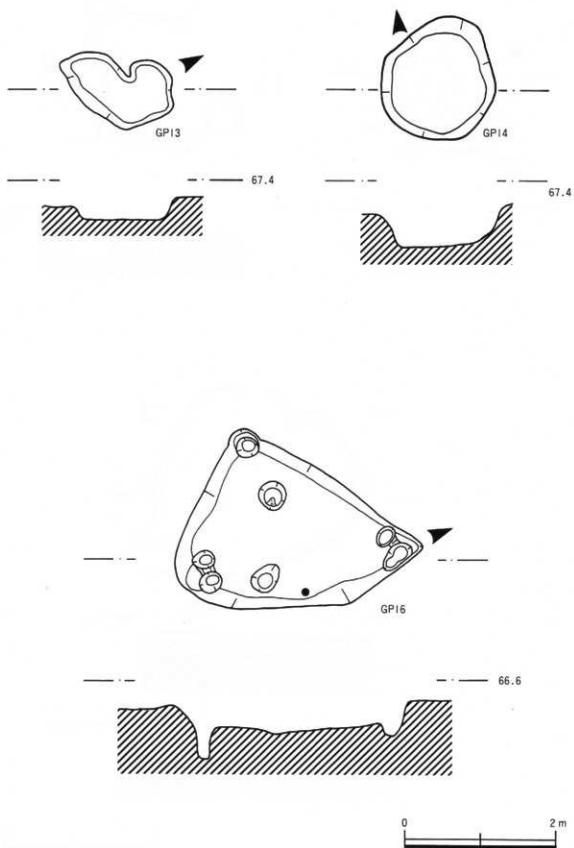

第118図 中世の土坑 (3)

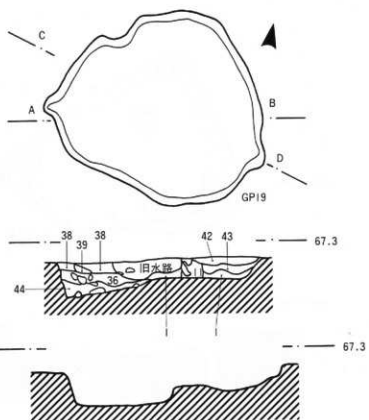
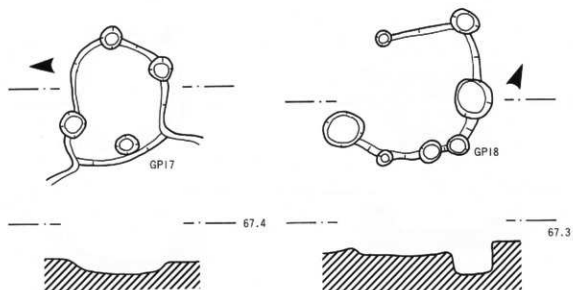

第119図 中世の土壇（4）

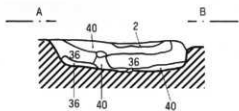
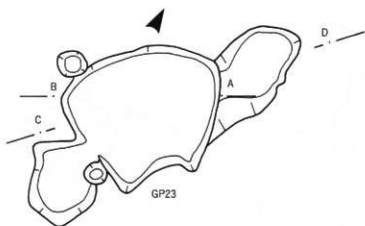
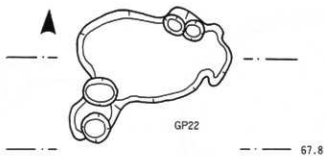

第120図 中世の土壺 (5)

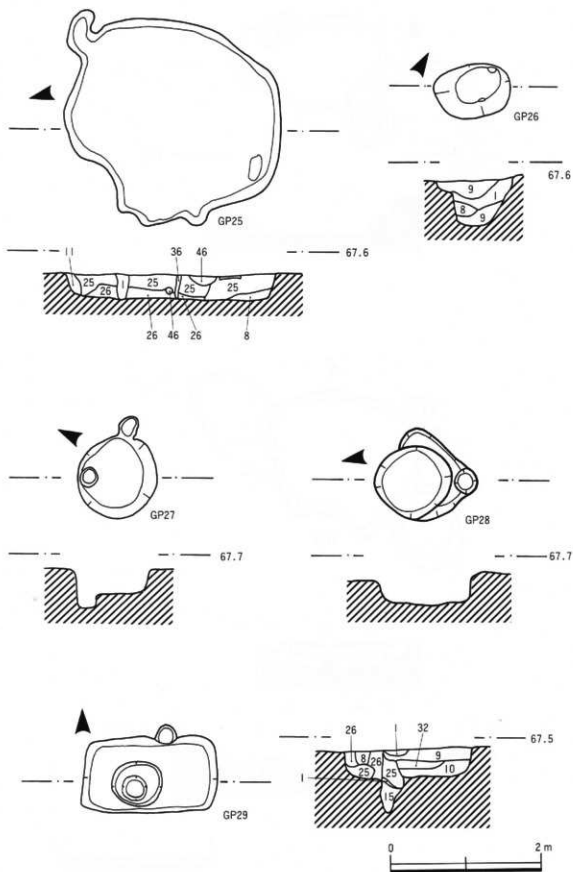

第121図 中世の土壘（6）

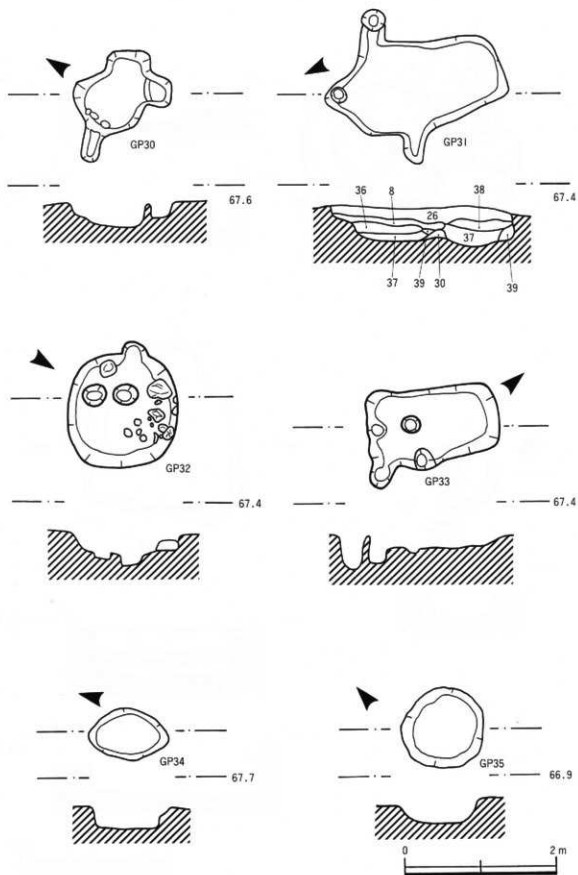

第122図 中世の土坑 (7)

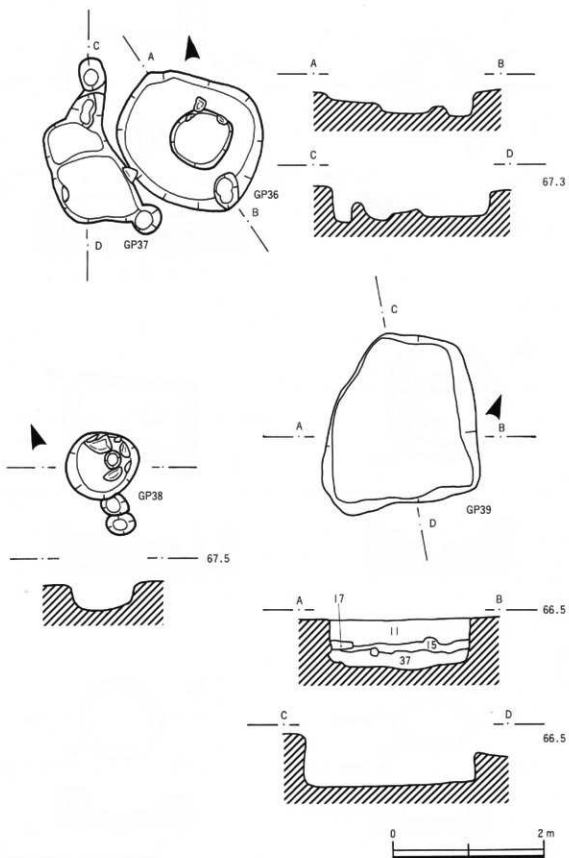

第123図 中世の土壙 (8)

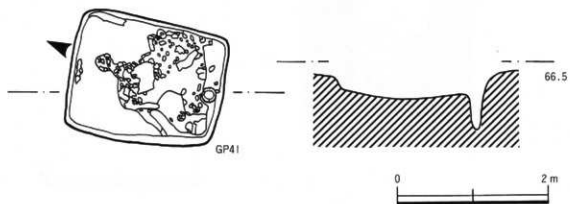
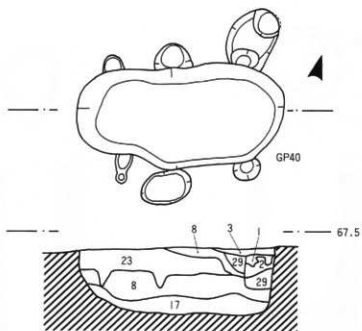

第124図 中世の土壇（9）

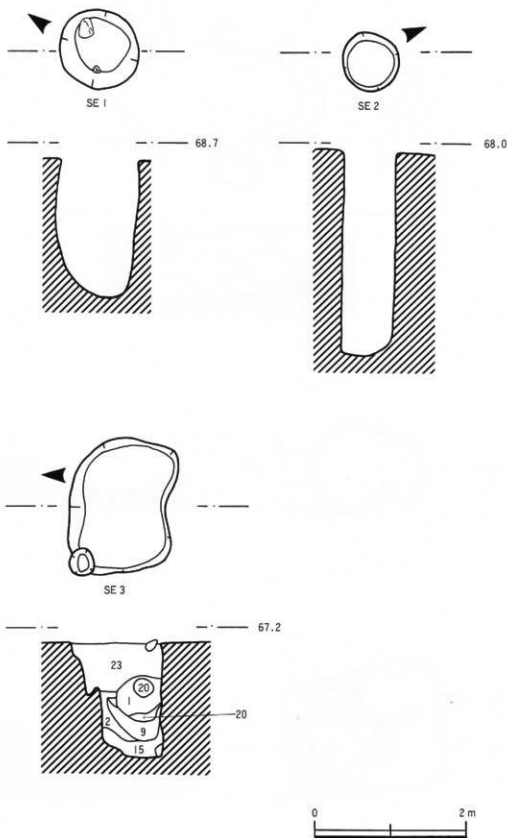

第125図 中世の井戸跡

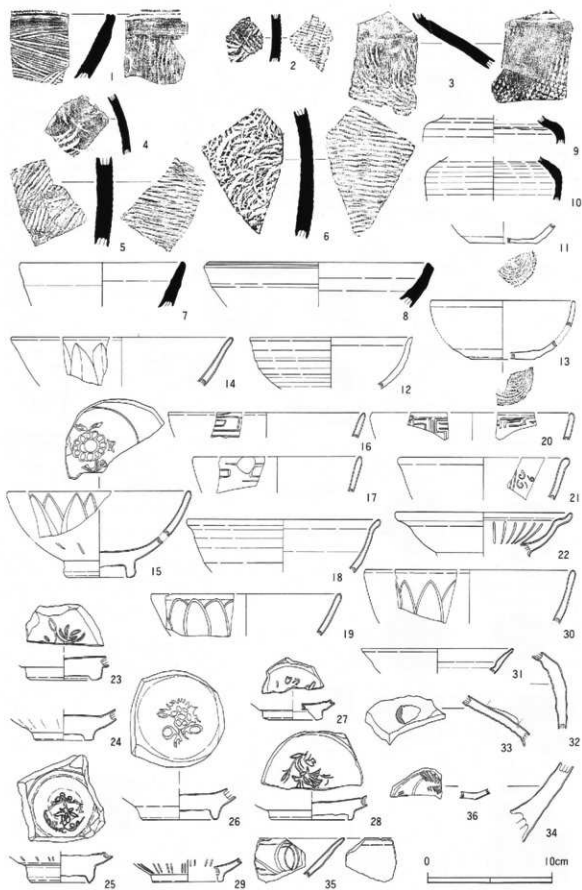

第126図 中世以前の遺物・中世の遺物(1)

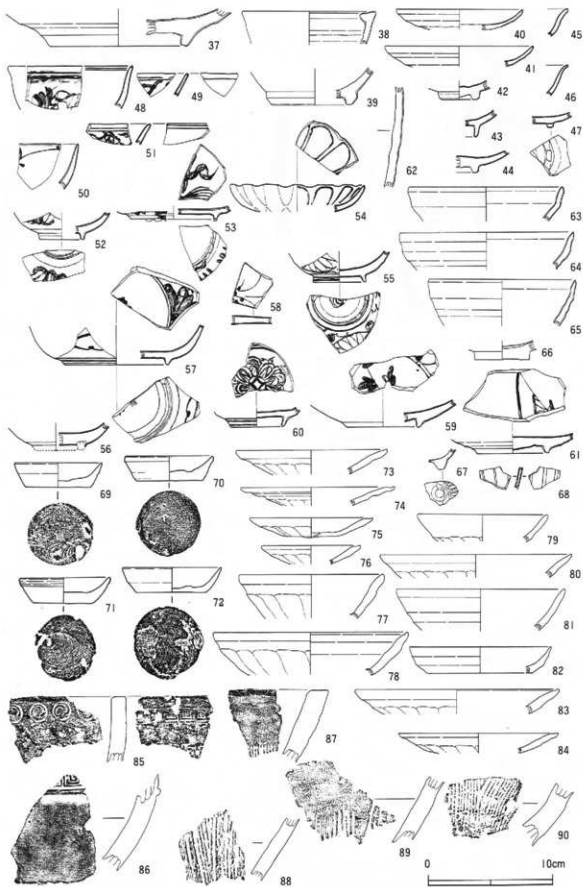

第127図 中世の遺物（2）

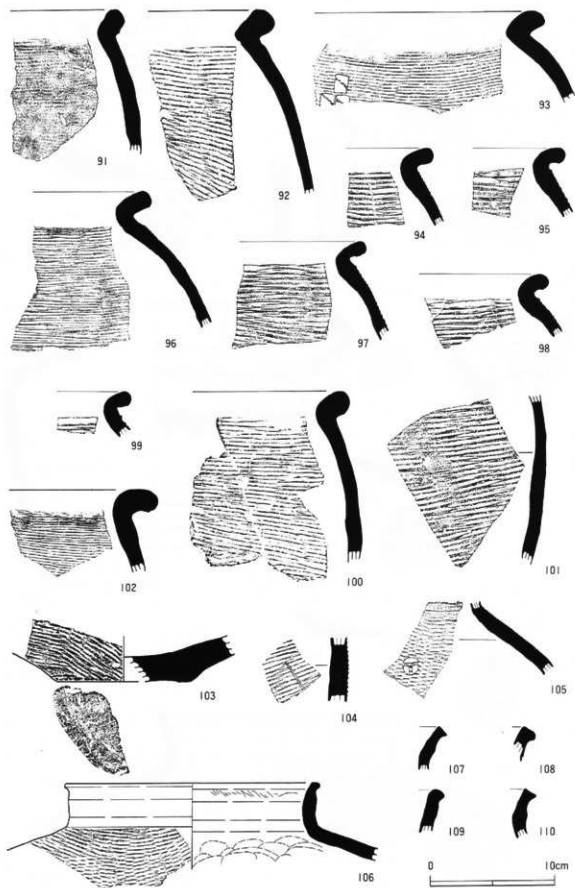

第128図 中世の遺物（3）

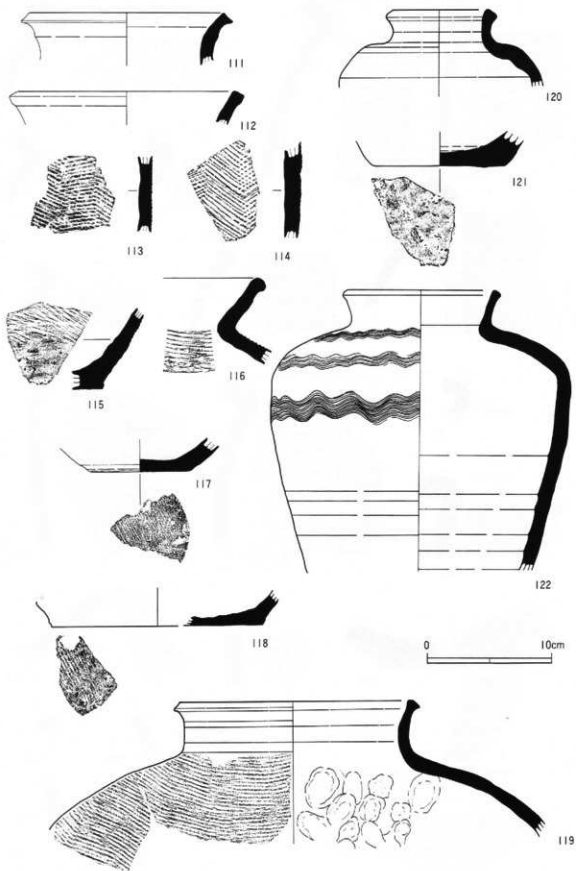

第129図 中世の遺物（4）

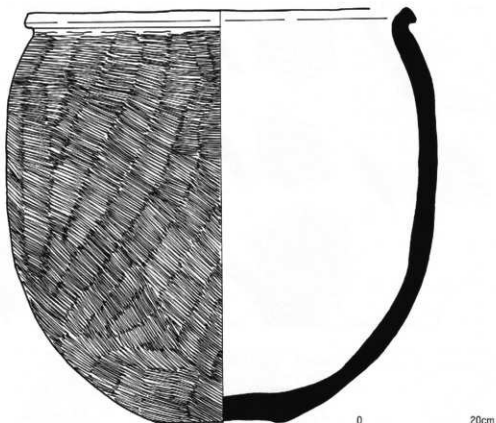

123：第6号地下式横穴

(123)



124：第6号地下式横穴

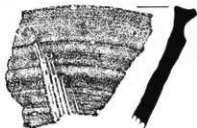

125：第6号地下式横穴

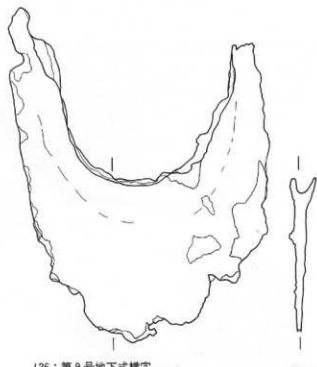

126：第9号地下式横穴

第130図 中世の遺物 (5)

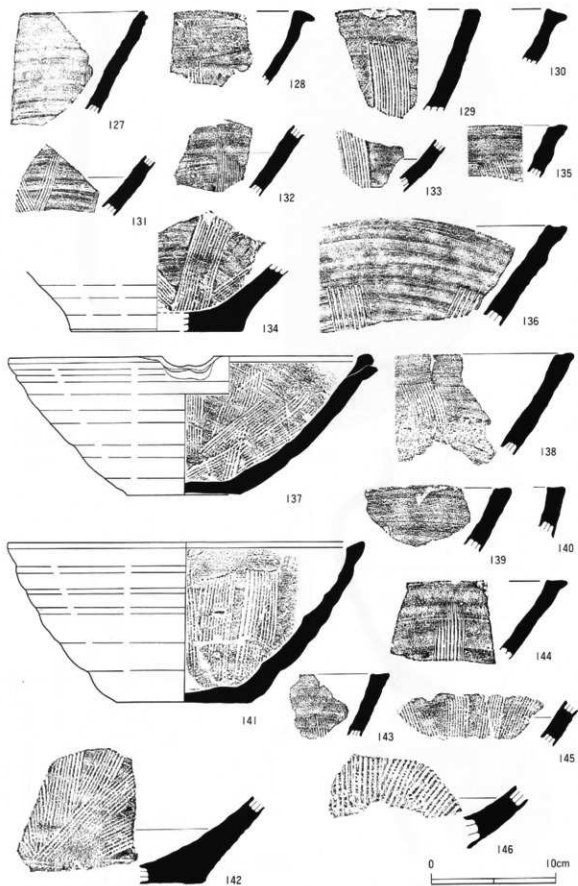

第131図 中世の遺物（6）

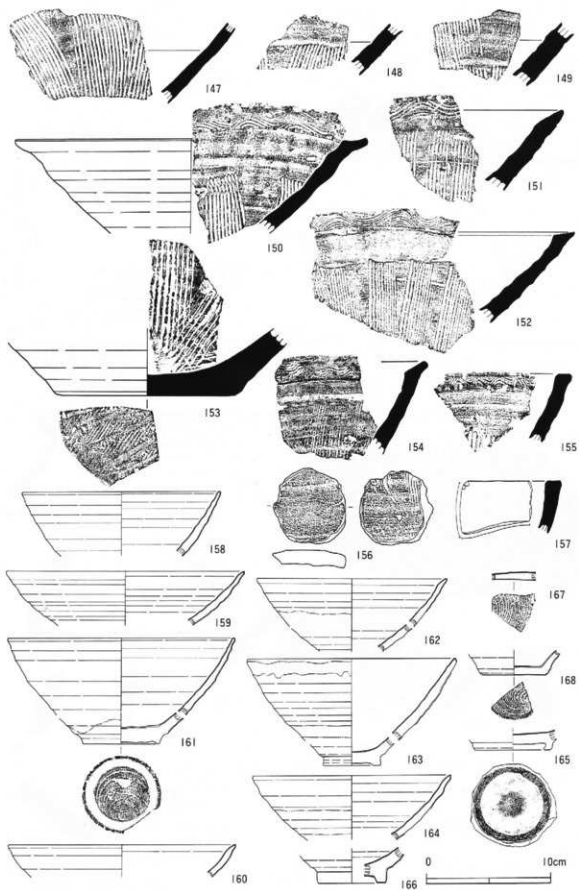

第132図 中世の遺物（7）

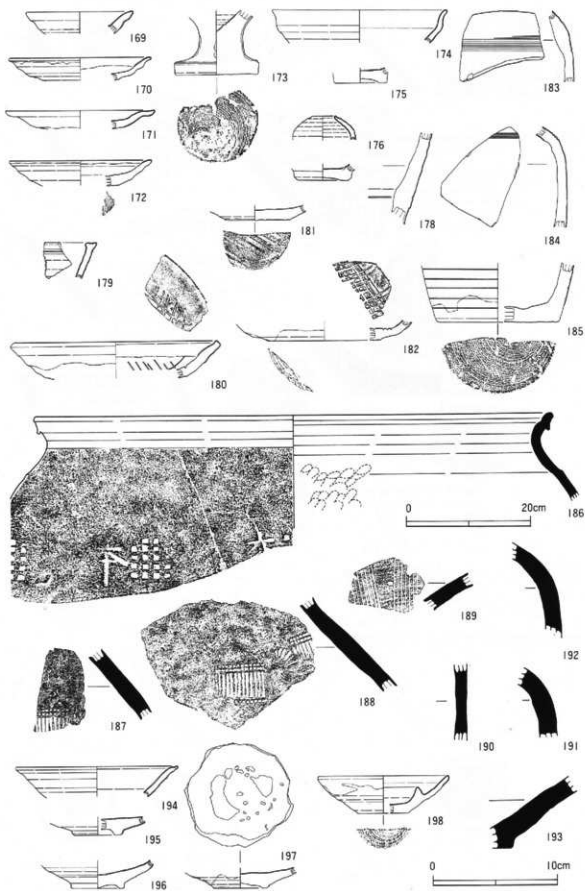

第133図 中世の遺物(8)・近世以降の遺物(1)

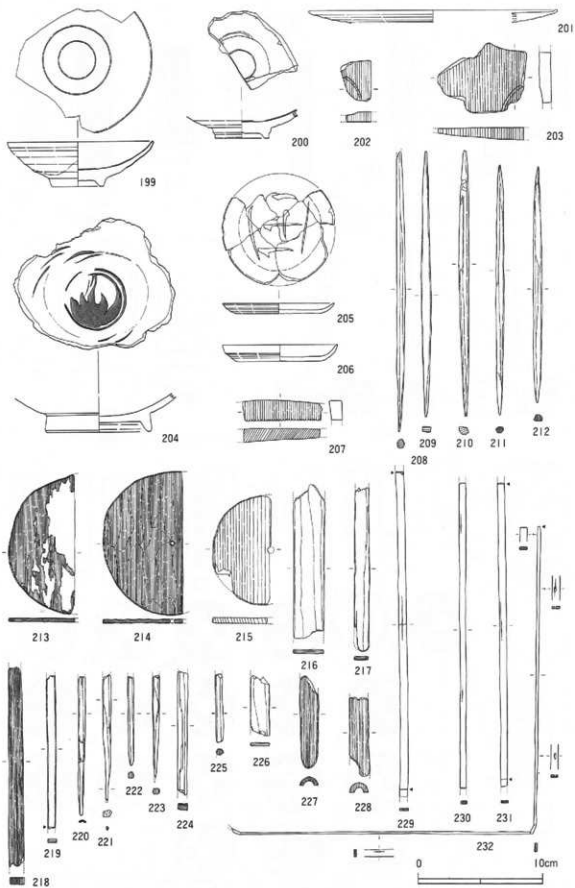

第134図 中世の遺物(9)・近世以降の遺物(2)

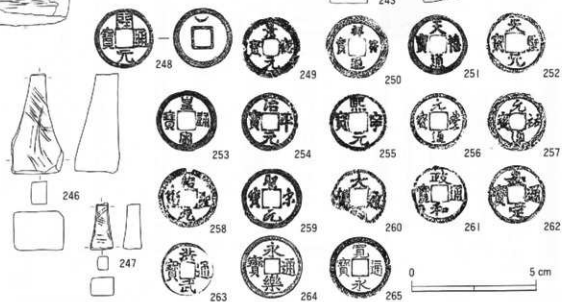
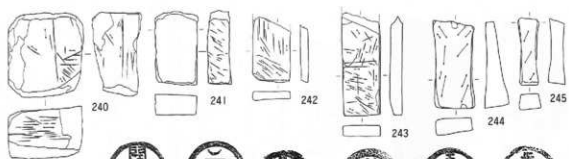
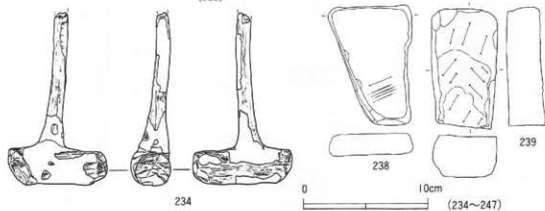
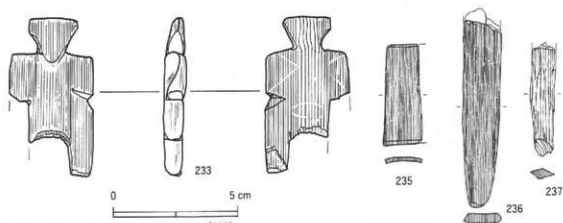

第135図 中世の遺物 (10)

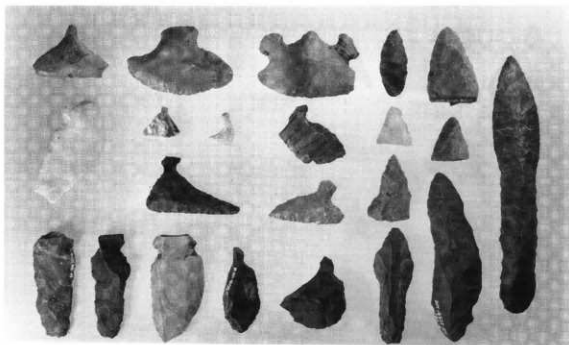

石匙・石櫛 (1/3)

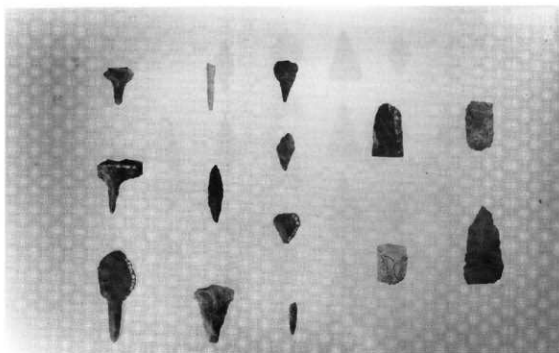

石匙・石櫛 (1/3)

写真24 石器 (2)

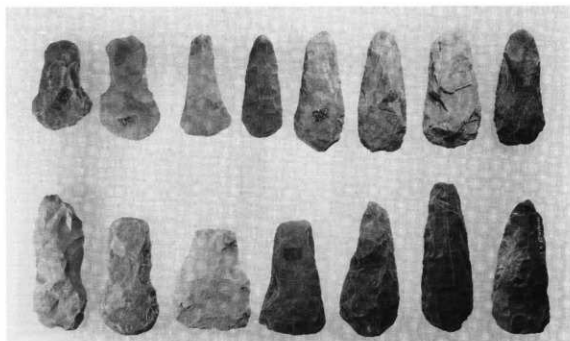

打製石斧 (1) (1/4)

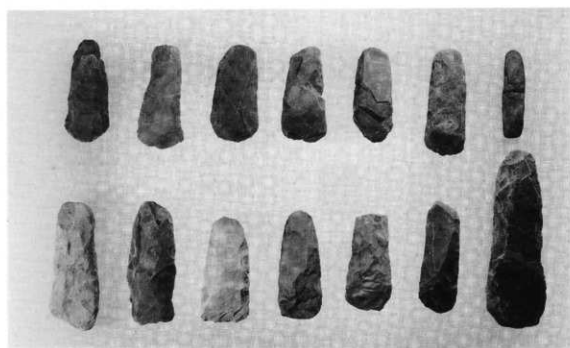

打製石斧 (2) (1/4)

写真25 石器 (3)

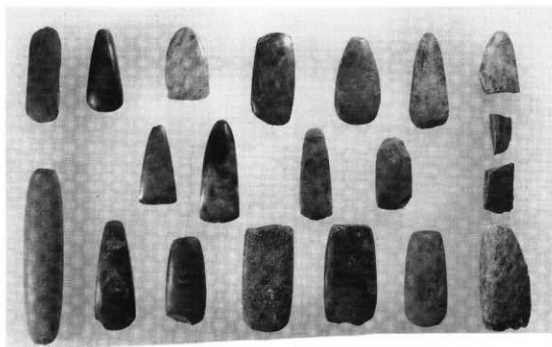

磨製石斧 (1) (1/4)

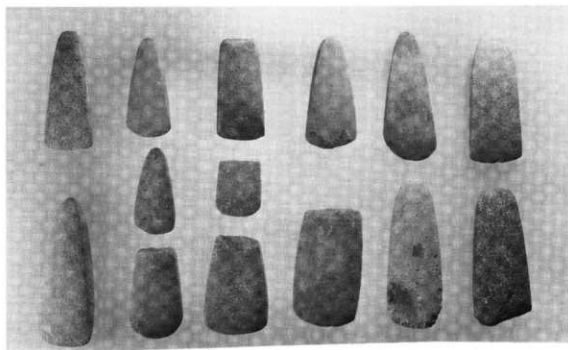

磨製石斧 (2) (1/4)

写真26 石器 (4)

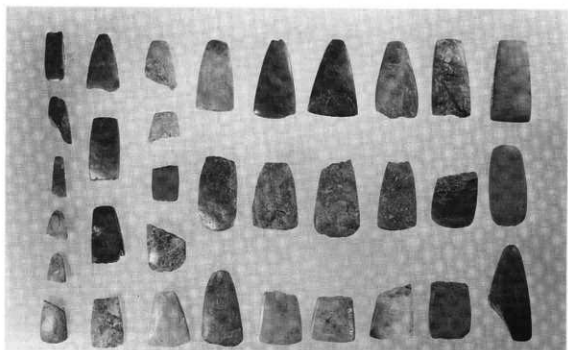

小型磨製石斧 (1/3)

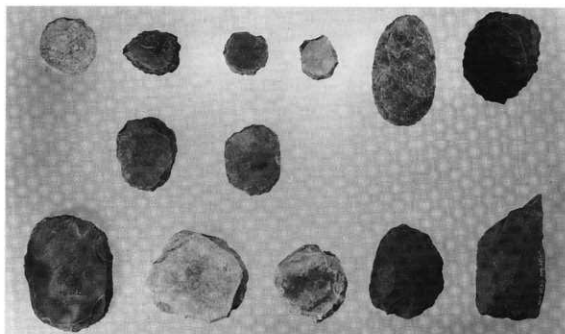

板状石器・スクレーパー (1/3)

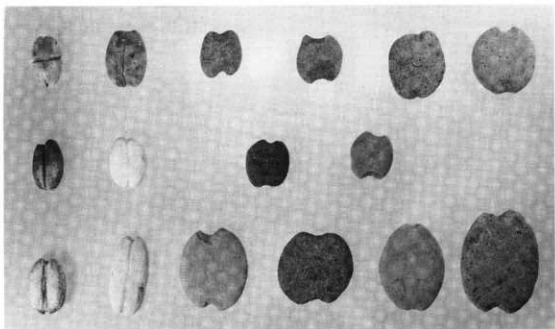

土鐘・石鐘 (1/3)

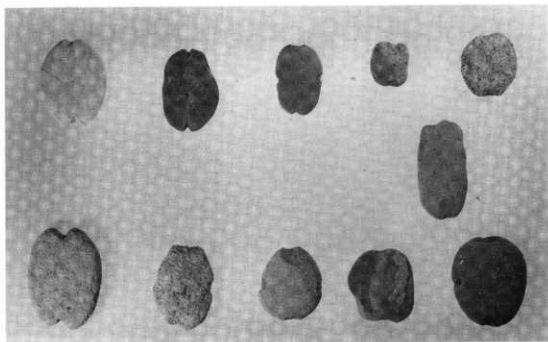

石鐘 (1/3)

写真28 土製品・石器 (6)

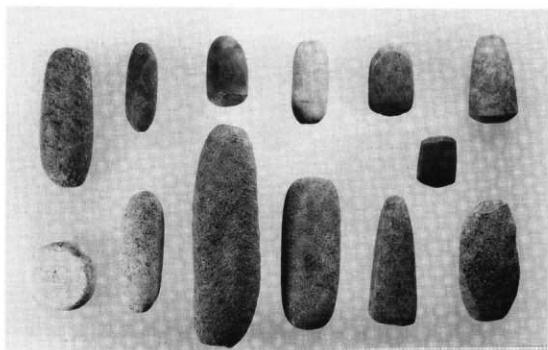

敲石 (1/4)

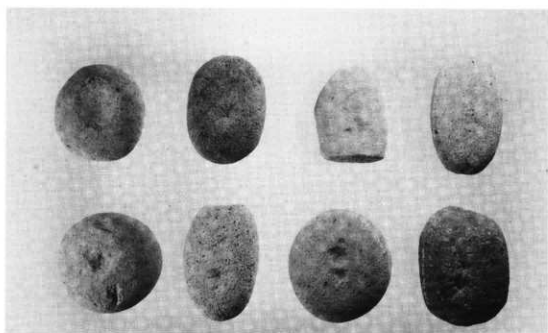

凹石 (1) (1/4)

写真29 石器 (7)

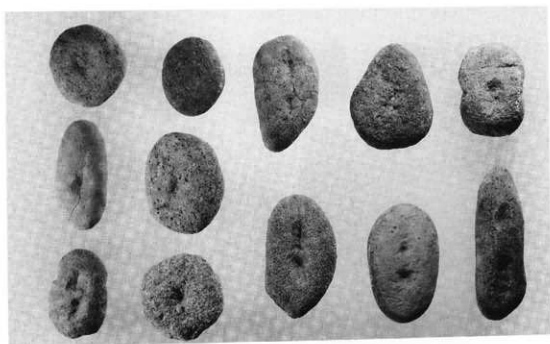

凹石(2) (1/4)

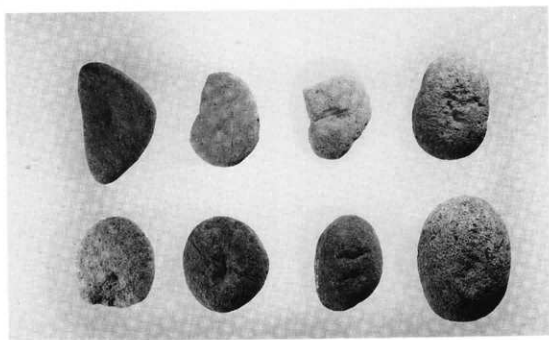

凹石(3) (1/4)

写真30 石器(8)

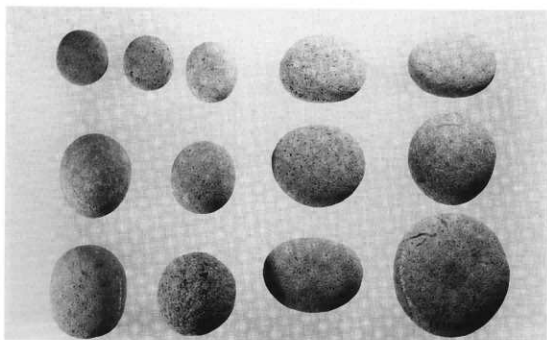

磨石 (1/4)

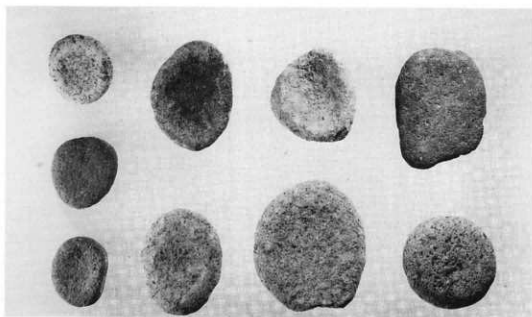

小形石皿 (1/4)

写真31 石器 (9)

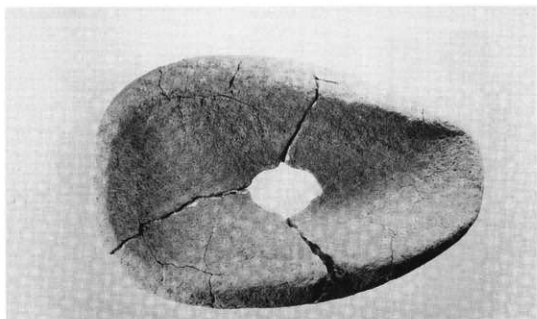

石皿(1) (1/4)

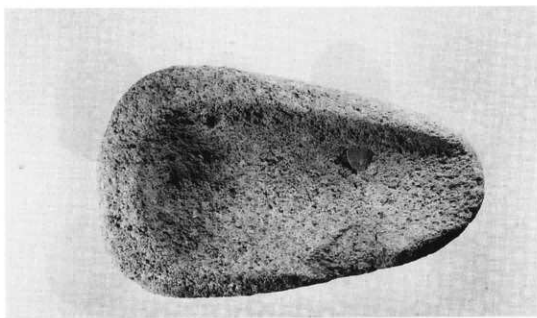

石皿(2) (1/4)

写真32 石器(10)

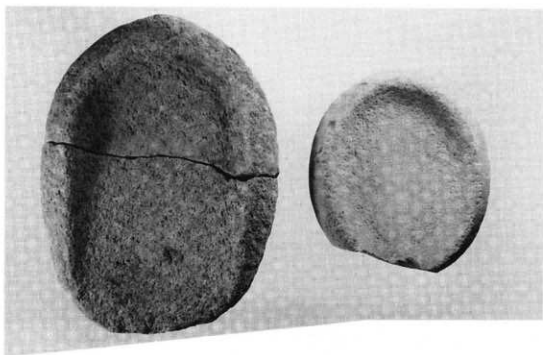

石皿(3) (1/4)

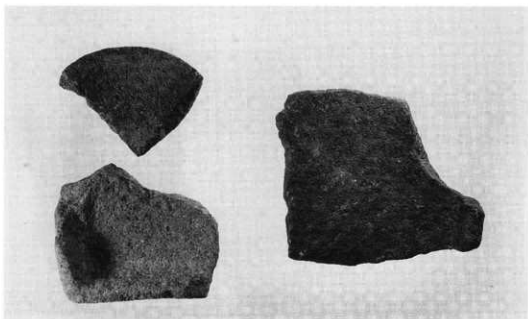

石皿(4) (1/4)

写真33 石器(11)

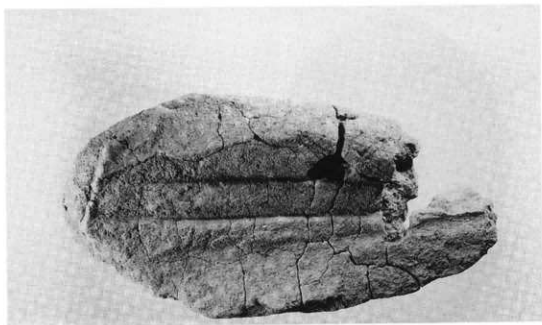

砥石(1) (1/4)

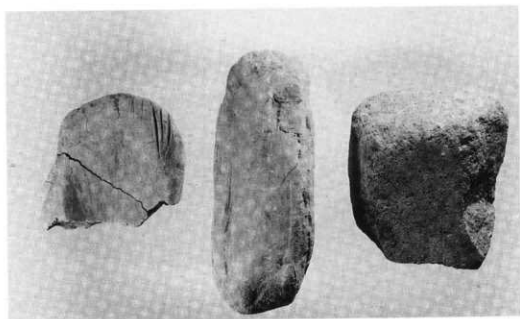

砥石(2) (1/4)

写真34 石器(12)

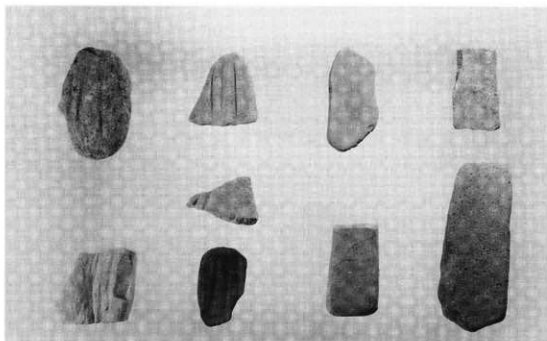

砥石(3) (1/4)

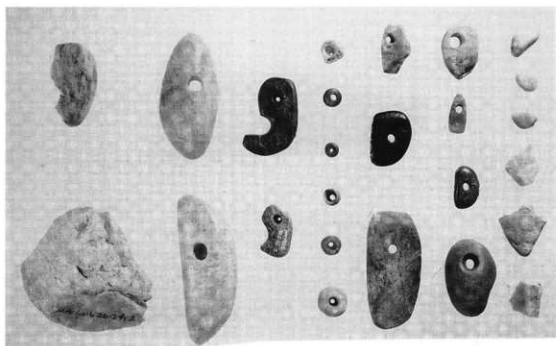

硬玉製大珠・勾玉・小玉・
垂玉・ヒスイ剥片 (1/2)

写真35 石器(13)・玉類

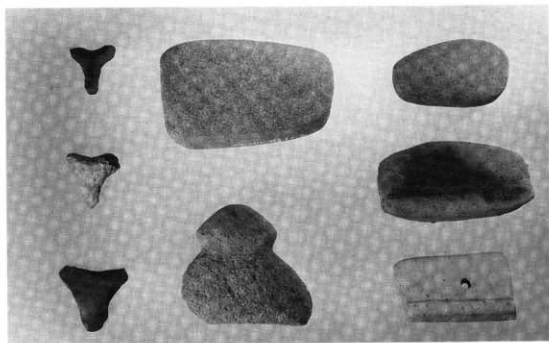

三脚石器・石冠・三角塚石製品 (1/3)

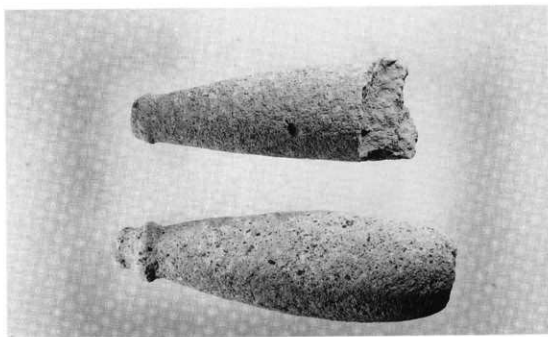

石棒(1) (1/4)

写真36 石製品(1)

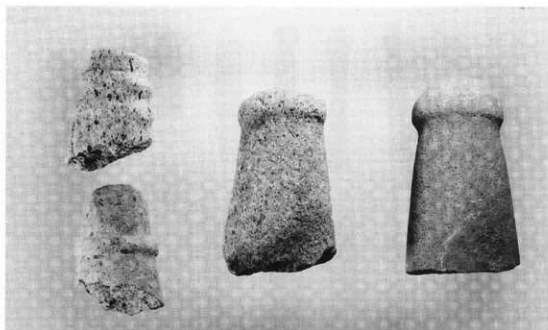

石 棒 (2) (1/4)

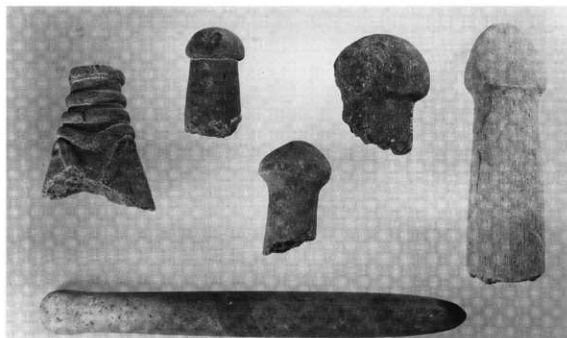

石 棒 (3) (1/3)

写真37 石製品 (2)

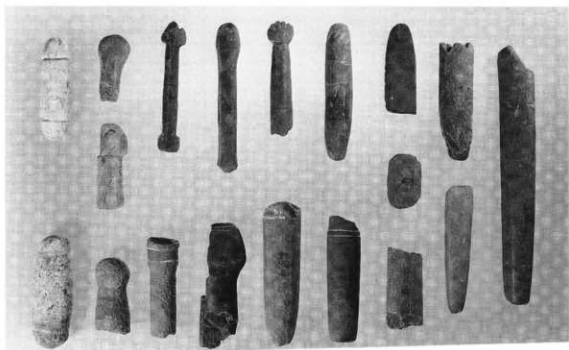

小形石棒・石剣・石刀 (1/3)

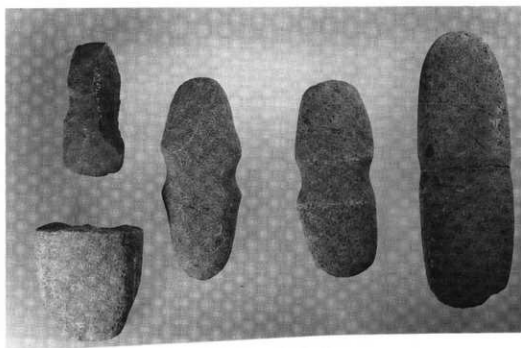

独鈷石 (1/3)

写真38 石製品 (3)



写真1 中道遺跡周辺の空中写真



写真2 中道遺跡全体空中写真

包含層発掘風景



遺構発掘風景

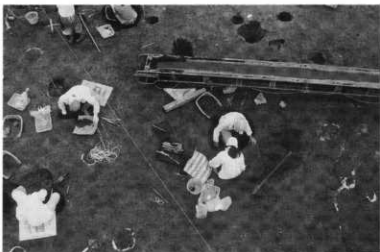

実測スナップ風景



写真3 発掘風景



第16号住居跡

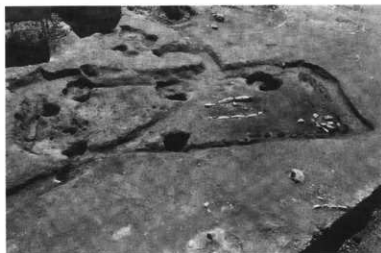

第20号住居跡



第20号住居跡
建築部材検出状況

写真4 縄文中期竪穴住居跡(1)

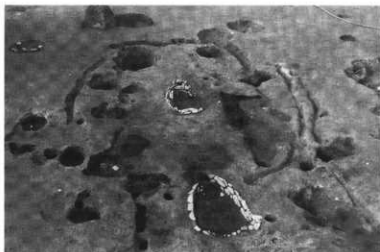

第45・46号住居跡



第20・26・47・48・50・
51号住居跡



第51号住居跡
トチの実遺構

写真5 縄文中期竪穴住居跡(2)



第17号住居跡



第26号住居跡
炉跡・埋壺



第52号住居跡
炉跡の土器

写真6 縄文中期壑穴住居跡(3)

FP4北壁（南から）



FP4
兜形土器出土状況

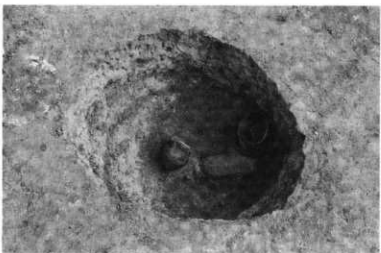

IVD-P23
石棒出土状況



写真7 縄文中期フラスコ状ピット

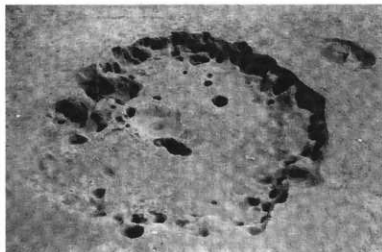

第37号住居跡（西から）



第1建物跡（北から）



VIF-P64
トチの実出土状況

写真8 縄文後期の住居跡・トチの実ピット



第22号住居跡



第22号住居跡壁板



第61・62・71号住居跡

写真9 縄文晩期竪穴住居跡



VII F-6 d
多孔底付注口土器出土状況



大珠出土状況
(VD-4c)



土器出土状況
(VF-P31)

写真10 遺物出土状況(1)

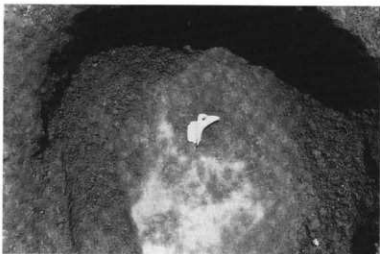

弓箭
(VIÉ-PI42)



三角埴石製品
(第36号住居跡)

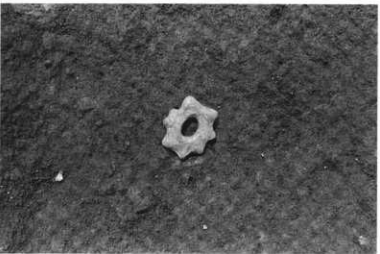

鏢形土製品
(VIF-9f)

写真11 遺物出土状況(2)



写真12 縄文土器 (1)



写真13 縄文土器（2）



248

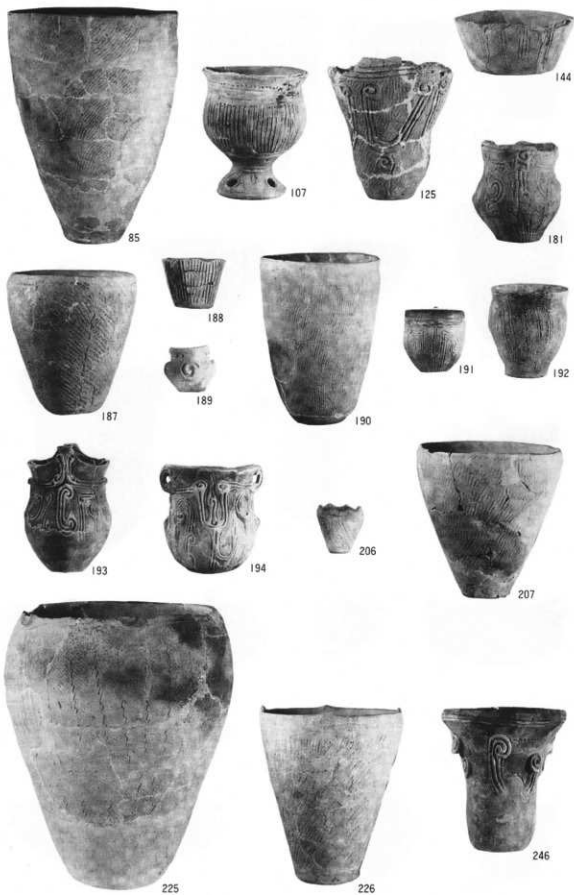

249



250



281



282



283



285



318



359



436



447



443



452



451



450



453



454



455



456



457



458



459

写真14 縄文土器(3)



461



500



503



505



501



506



508



509



510



511



513



514



523



535



537



540



542



539



541



543



545

写真15 縄文土器 (4)



写真16 縄文土器 (5)



写真17 縄文土器 (6)

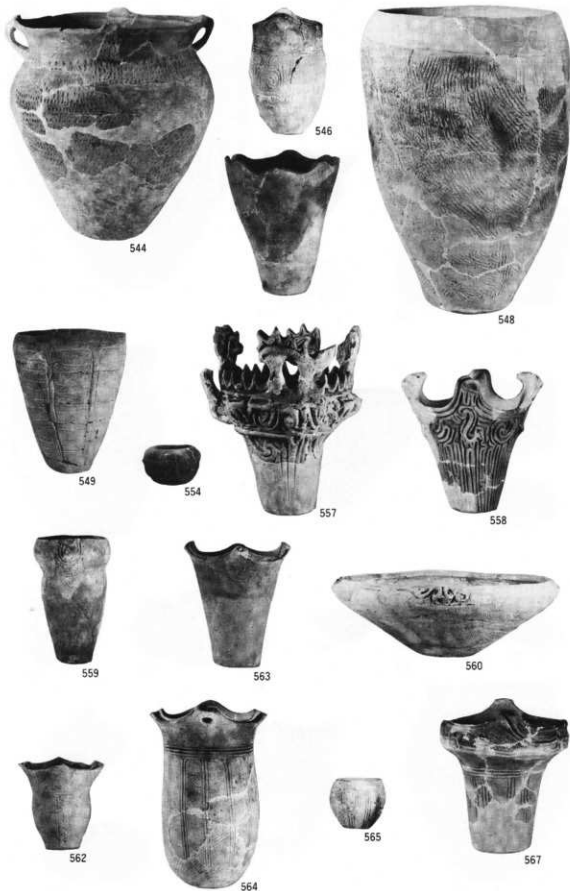

写真18 縄文土器（7）



写真19 縄文土器(8)

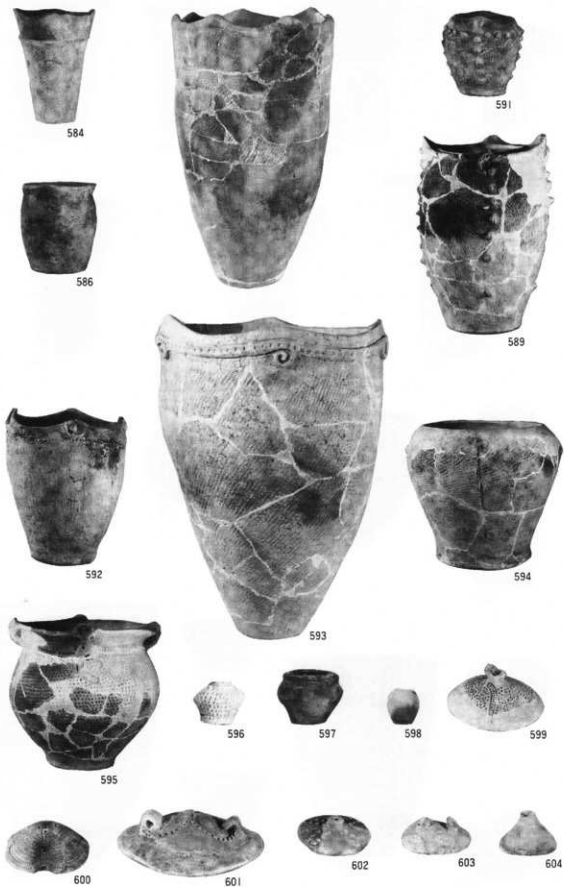

土 偶 (1) (1/3)

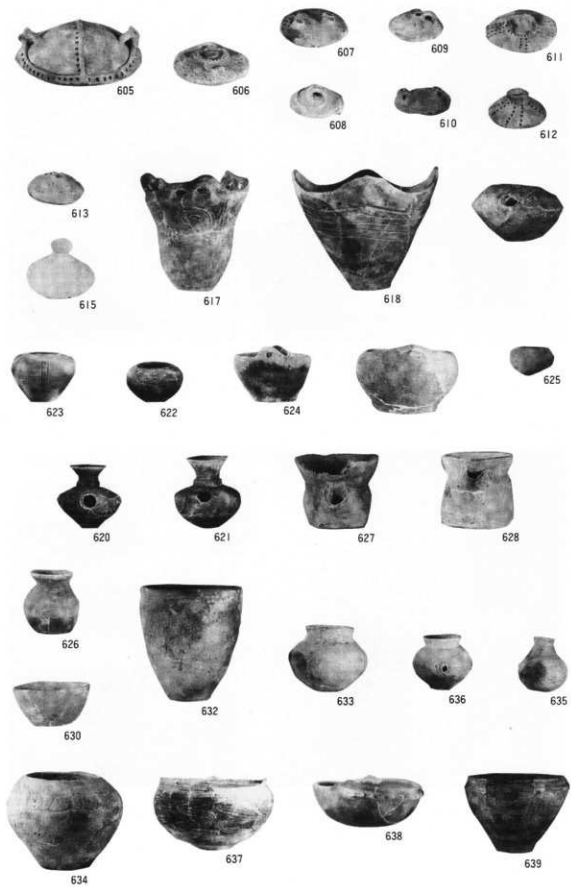
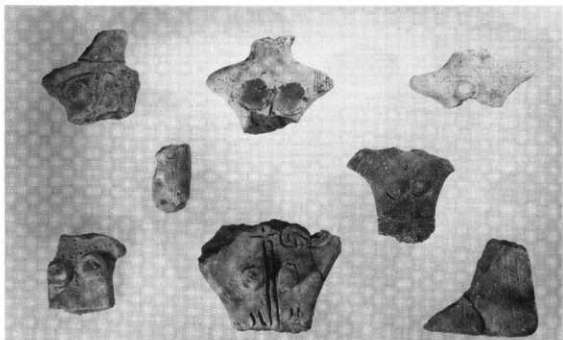

土 偶 (2) (1/3)

写真20 土製品 (1)

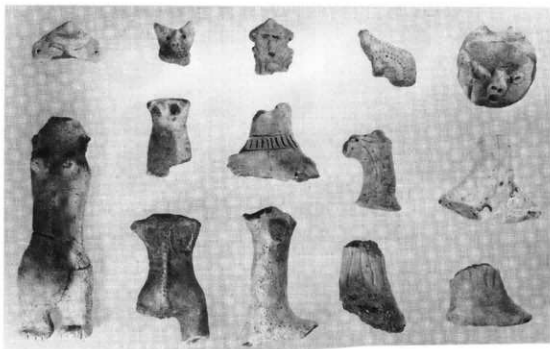

土 偶 (3) (1/3)



人面付土器・鐘形土製品・
スタンプ状製品・有孔球状土製品 (1/3)

写真21 土製品 (2)

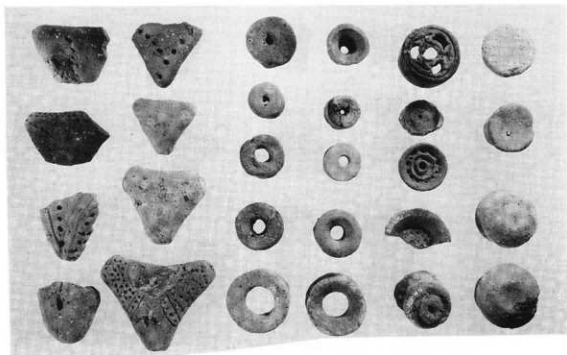

三角形土版・土製耳飾 (1/2)

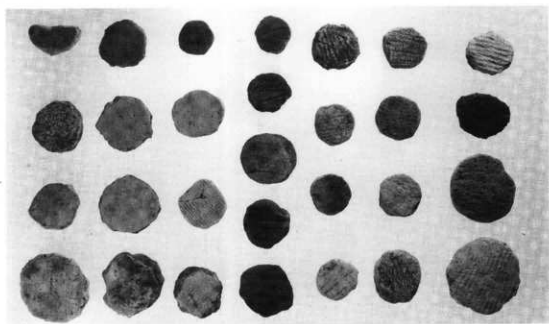

円板状土製品 (1/3)

写真22 土製品 (3)

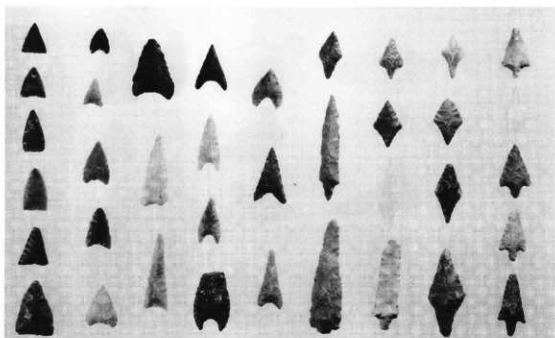

石器(1) (1/2)

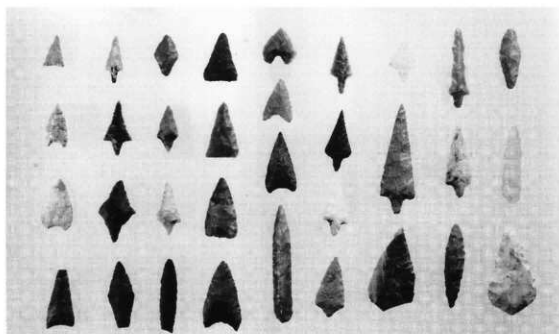

石器(2) (1/2)

写真23 石器(1)

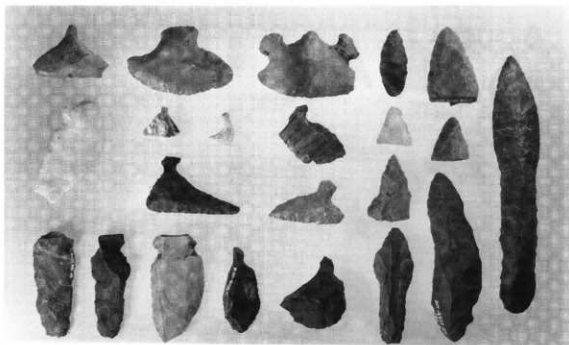

石匙・石楯 (1/3)

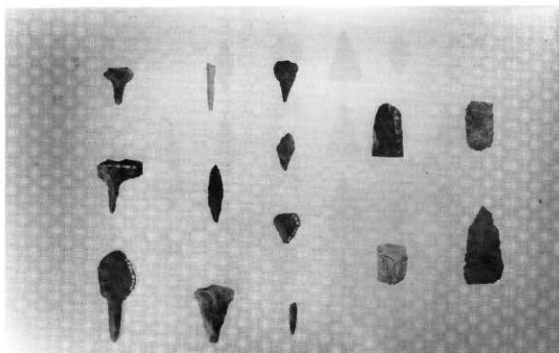

石匙・石楯 (1/3)

写真24 石器 (2)

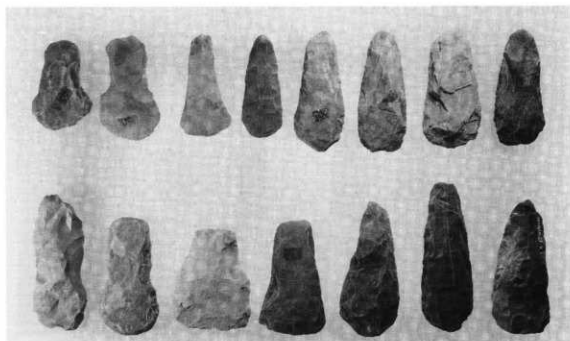

打製石斧 (1) (1/4)

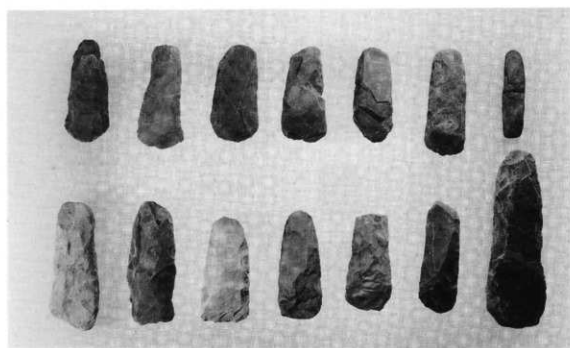

打製石斧 (2) (1/4)

写真25 石器 (3)

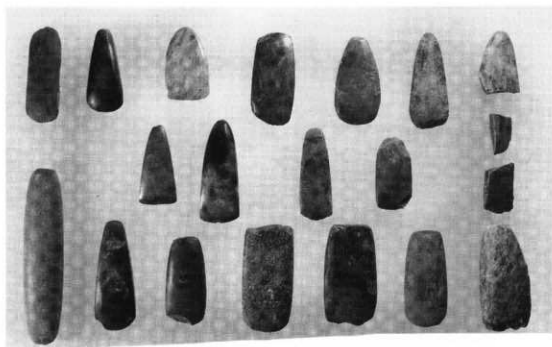

磨製石斧 (1) (1/4)

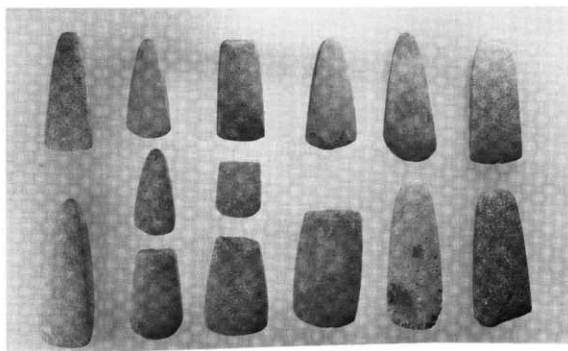

磨製石斧 (2) (1/4)

写真26 石器 (4)

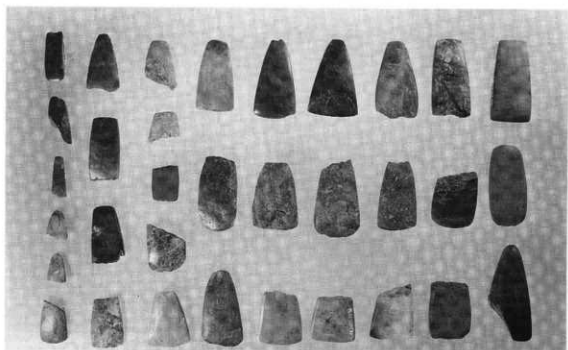

小型磨製石斧 (1/3)

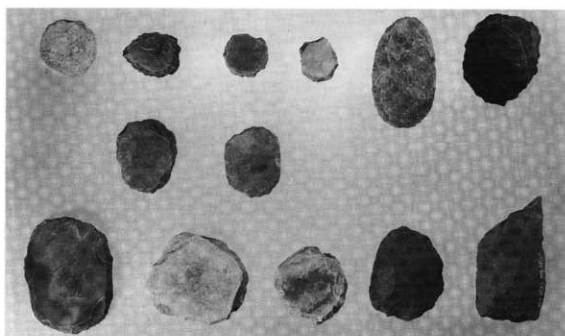

板状石器・スクレーパー (1/3)

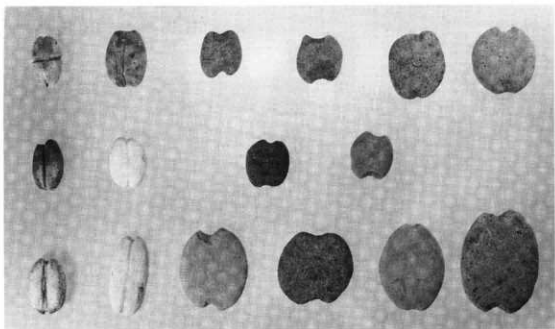

土鐘・石鐘 (1/3)

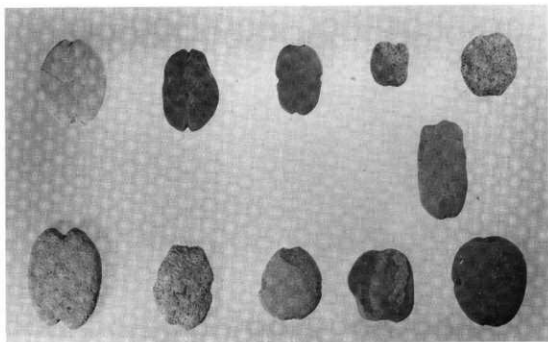

石鐘 (1/3)

写真28 土製品・石器 (6)

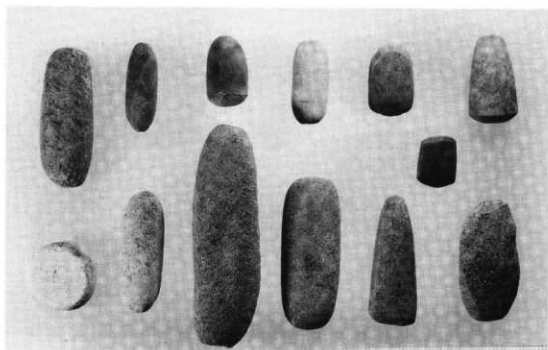

敲石 (1/4)

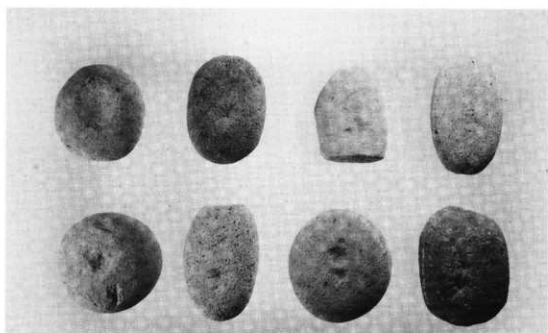

凹石 (1) (1/4)

写真29 石器 (7)

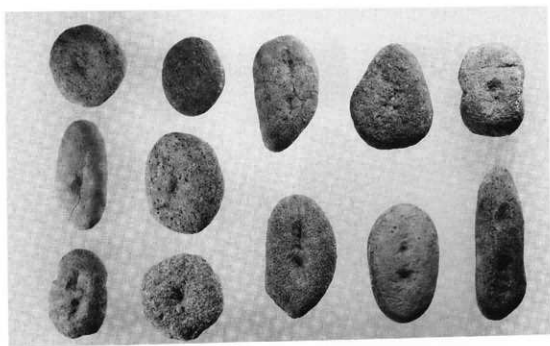

凹石(2) (1/4)

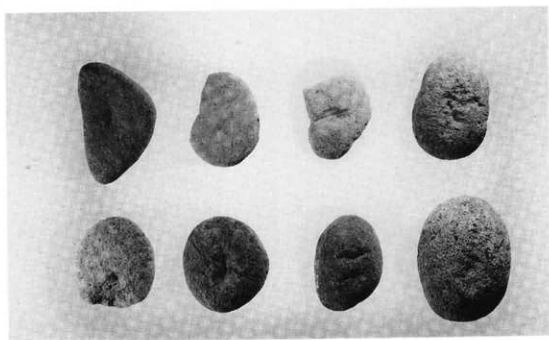

凹石(3) (1/4)

写真30 石器(8)

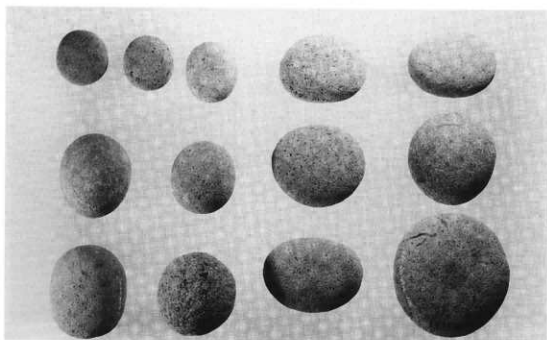

磨石 (1/4)

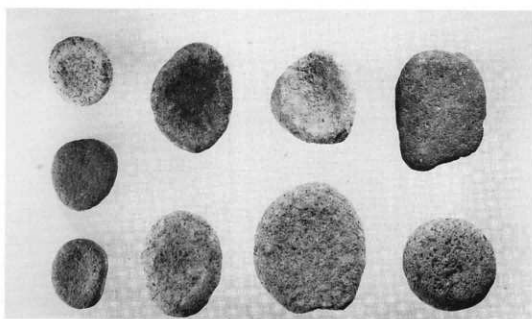

小形石皿 (1/4)

写真31 石器 (9)

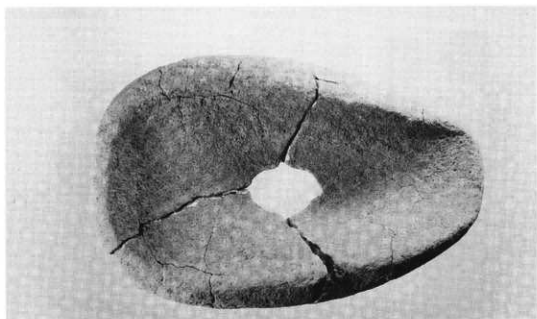

石皿(1) (1/4)

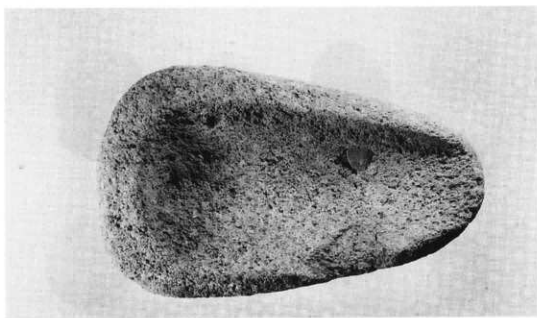

石皿(2) (1/4)

写真32 石器(10)

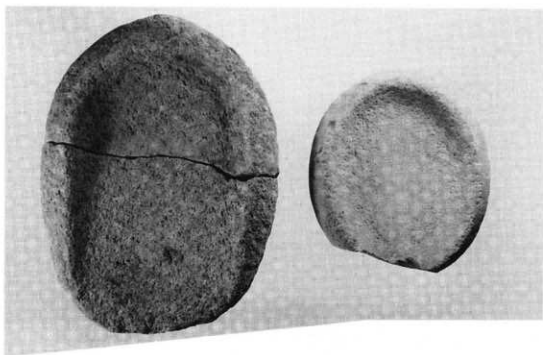

石皿(3) (1/4)

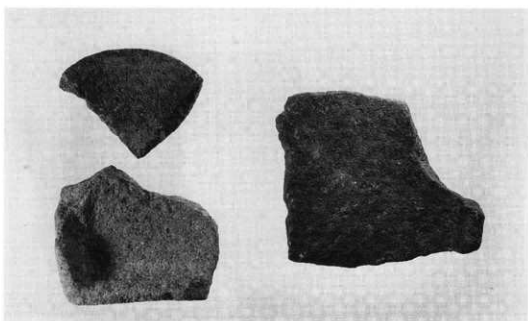

石皿(4) (1/4)

写真33 石器(11)

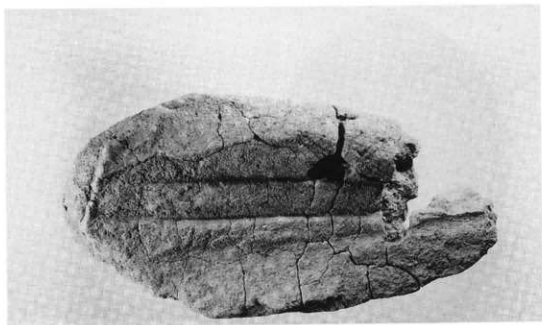

砥石(1) (1/4)

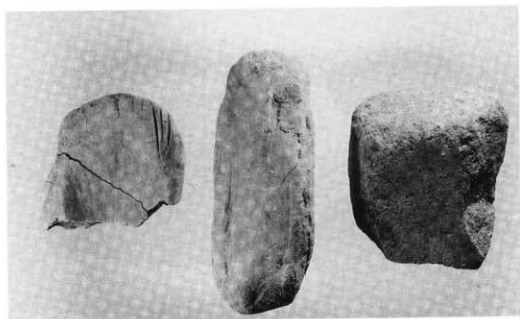

砥石(2) (1/4)

写真34 石器(12)

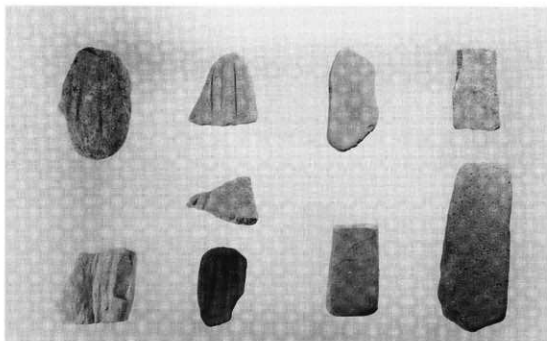

砥石(3) (1/4)

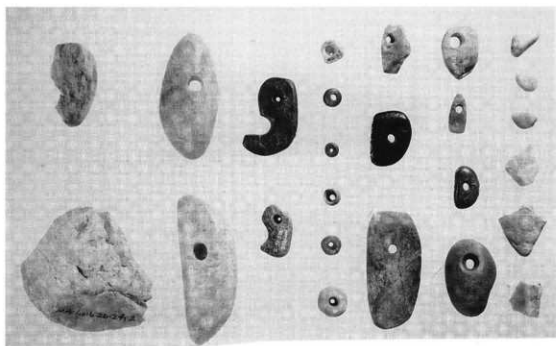

硬玉製大珠・勾玉・小玉・
垂玉・ヒスイ剥片 (1/2)

写真35 石器(13)・玉類

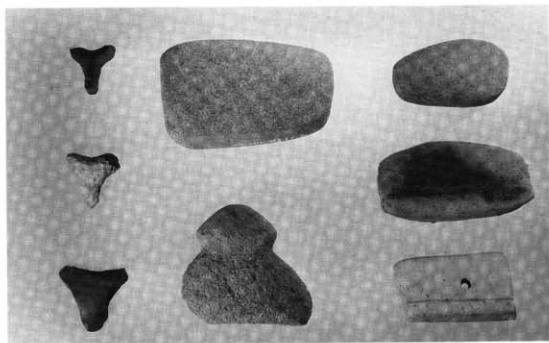

三脚石器・石冠・三角塚石製品 (1/3)

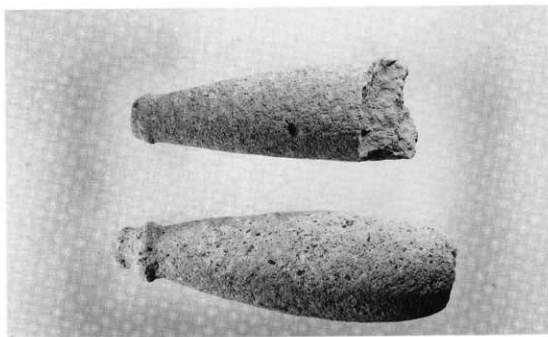

石棒(1) (1/4)

写真36 石製品(1)

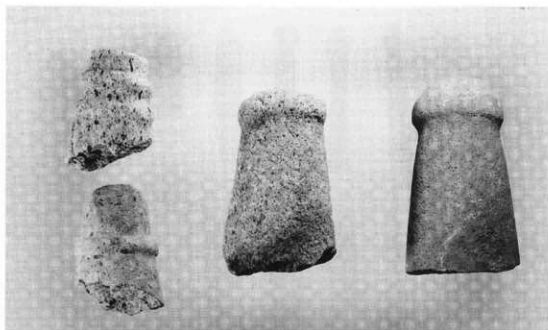

石 棒 (2) (1/4)

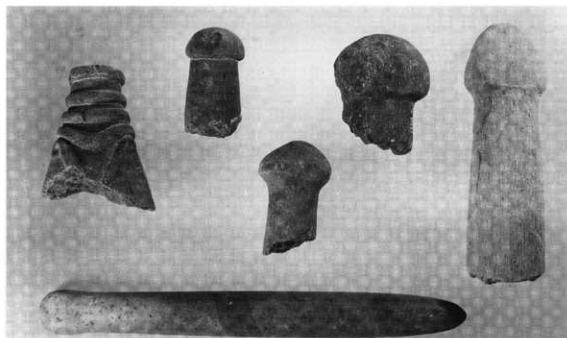

石 棒 (3) (1/3)

写真37 石製品 (2)

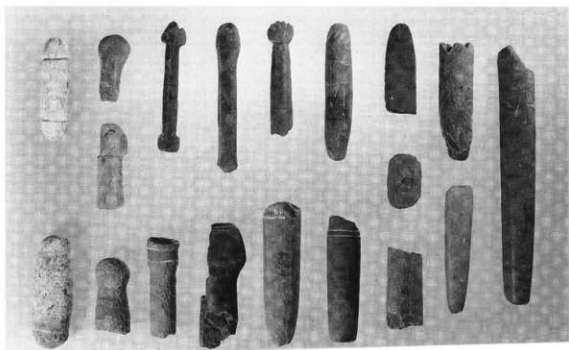

小形石棒・石剣・石刀 (1/3)

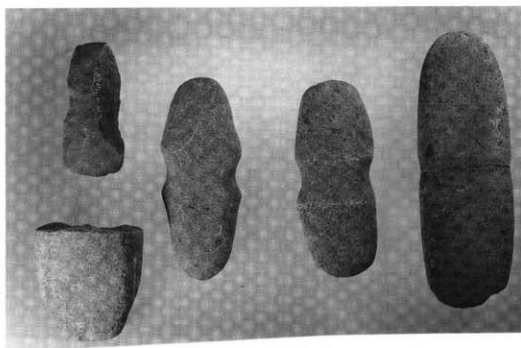

独鈷石 (1/3)

写真38 石製品 (3)



写真39 中世遺構群空中写真

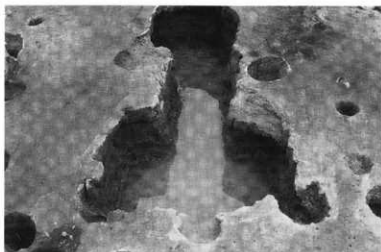

第1号地下式横穴

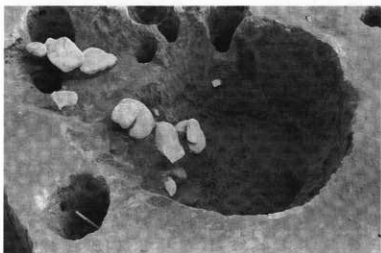

第7号地下式横穴



第9号地下式横穴
(鉄鍬出土状況)

写真40 中世地下式横穴

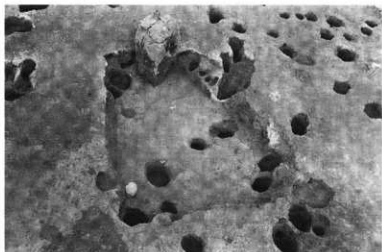

第16号土壤



第16号土壤
(六道銭出土状況)

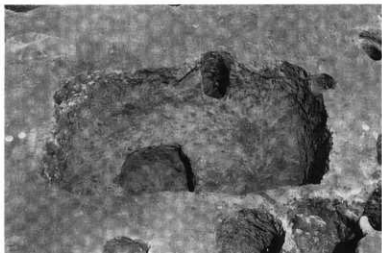

第29号土壤

写真41 中世土壤



G 5
骨・六道銭出土状況



G 3
骨出土状況



G 1
骨・六道銭出土状況

写真42 中世の骨と六道銭

珠洲焼大甕
(第6号地下式横穴)



木 杓
(第3号井戸)



人形 木製品



写真43 中世遺構と遺物出土状況

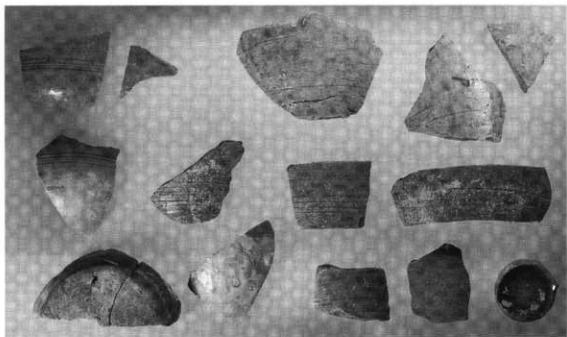

瀬戸美濃焼 (1) (1/3)

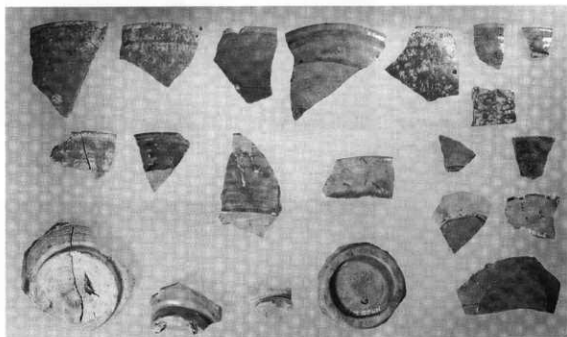

瀬戸美濃焼 (2) (1/3)

写真44 中世の遺物 (1)

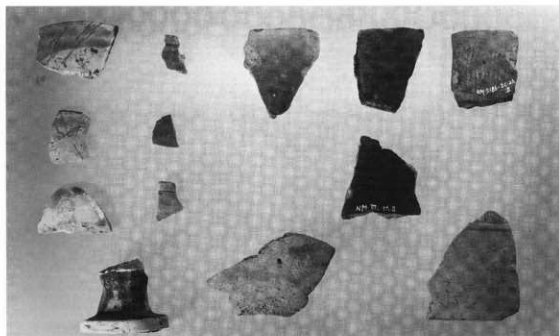

瀬戸美濃焼 (3)・瓦質土器 (1/3)



珠洲焼 (1/6)

写真45 中世の遺物 (2)

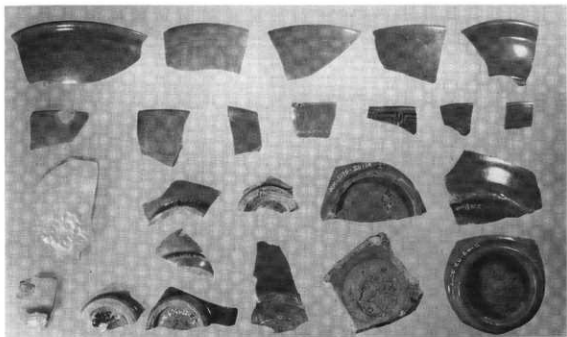

青磁(1) (1/3)

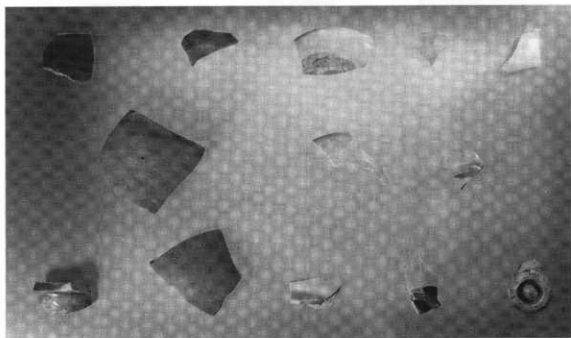

青磁(2)・白磁 (1/3)

写真46 中世の遺物(3)



秘杖・漆椀 (1/3)

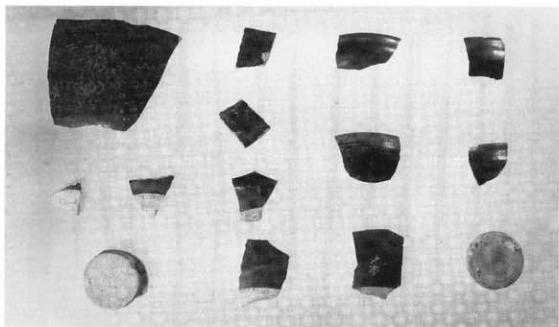

天目 (1/3)

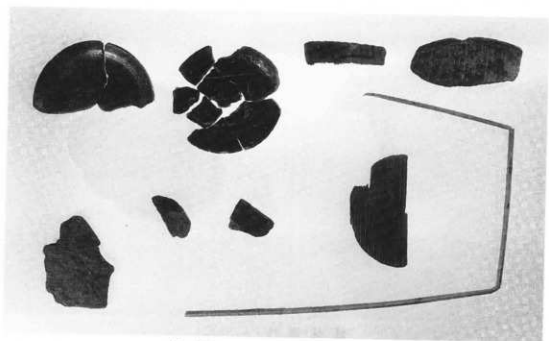

椀・曲物の底板・折敷・罎 (1/3)

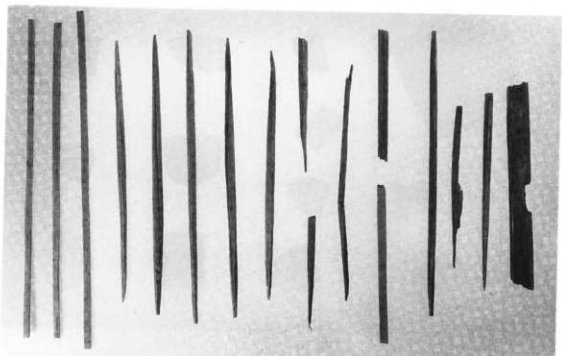

箸または箸串 (1/3)

写真48 中世の遺物 (5)

報 告 書 抄 録

ふりがな	なかみちいせき							
書名	中道遺跡							
副書名	農業基盤整備事業に伴う発掘調査							
巻次								
シリーズ名								
シリーズ番号								
編著者名	駒形敏朗・島居美栄・小熊博史・広井造							
調査機関	長岡市教育委員会							
編集機関	長岡市教育委員会							
所在地	〒940 長岡市幸町2丁目1番1号							
発行年月日	1998年3月25日							
所収遺跡	所在地	コード		北緯 ° ′ ″	東経 ° ′ ″	調査期間	調査 面積㎡	調査原因
		市町村	遺跡番号					
中道遺跡	新潟県長岡市 柄古町字中道	15202	5	37°25′ 10″	138° 53′32″	19940606 ～19961208	15,600	ほ場整備
所収遺跡名	種別	主な時代	主な遺構		主な遺物		特記事項	
中道遺跡	集落跡	縄文時代 中期～晩期 中世(15世紀)	竪穴住居跡 掘立柱建物跡 フラスコ状ピット65	72 3 72	縄文土器コンテナ1,035 土偶54、硬玉製人珠3、 石鏃476、磨製石斧456、 打製石斧368、石匙29、 弓矢1 珠洲焼800、毬杖1 渡来銭72			トチの実遺構

中道遺跡 — 農業基盤整備事業に伴う発掘調査 —

平成10年3月20日印刷 平成10年3月25日発行

発行：長岡市教育委員会 印刷：(株)第一印刷所