

第25図 RA001堅穴建物跡

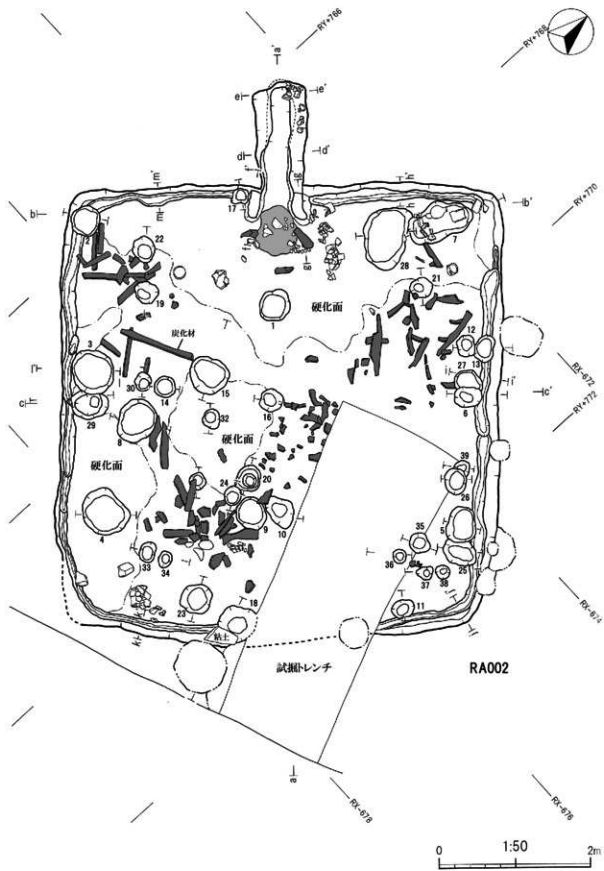

第26図 RA002竪穴建物跡(1)

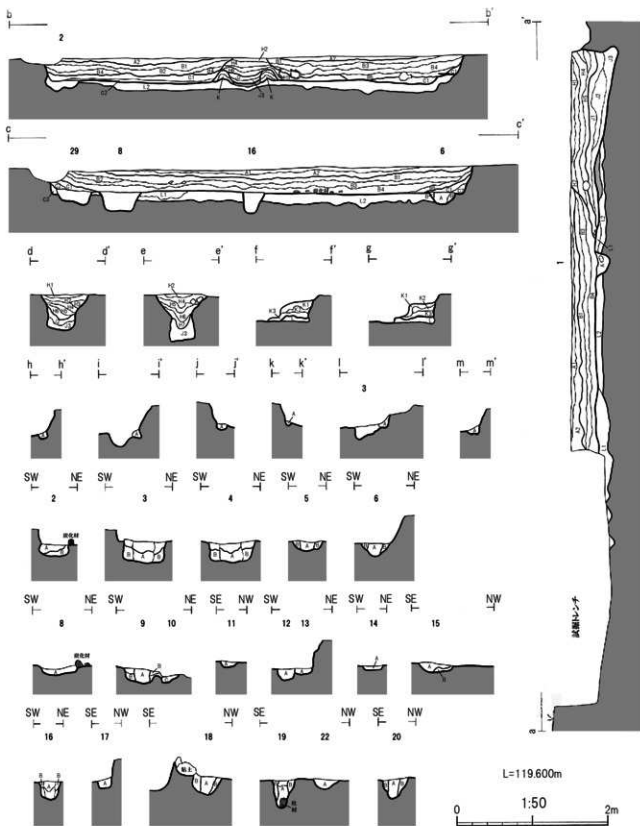

第27図 RA002竪穴建物跡(2)

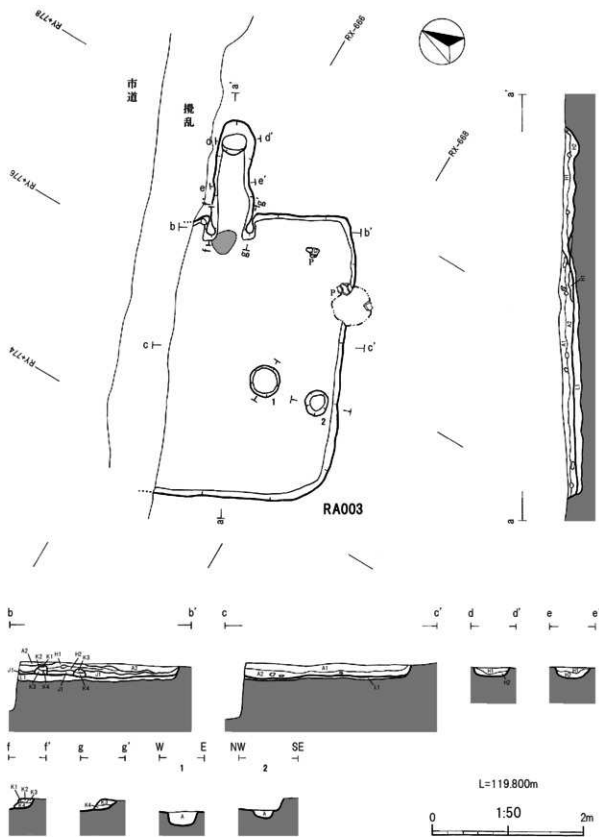

第28図 RA003竪穴建物跡

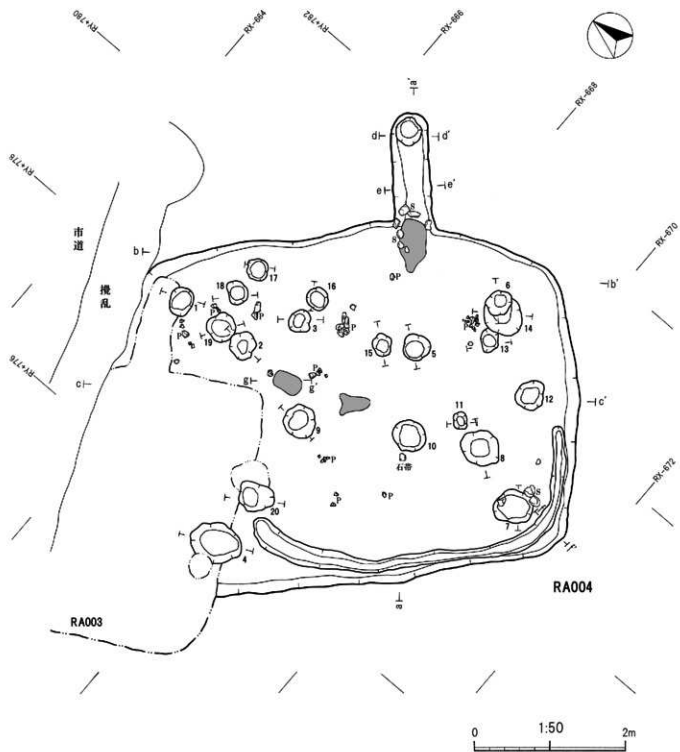

第29圖 RA004竪穴建物跡(1)

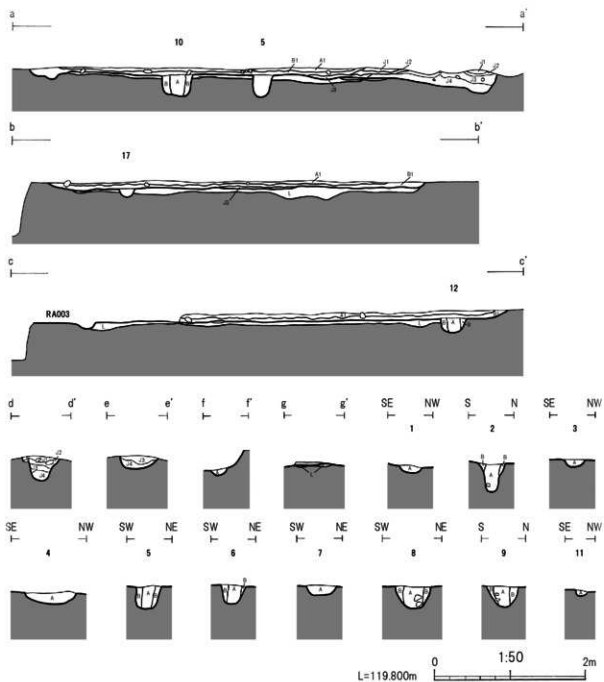

第30圖 RA004豎穴建物跡(2)

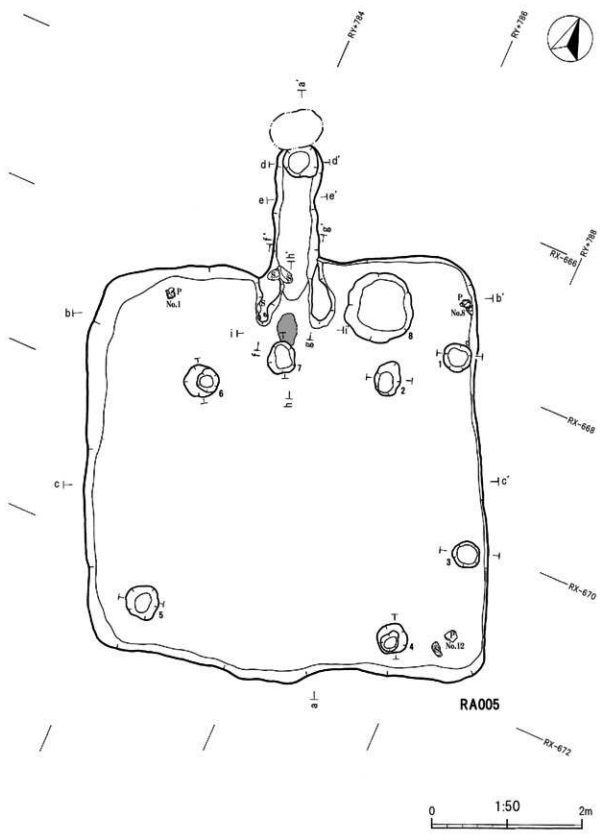

第31圖 RA005竪穴建物跡(1)

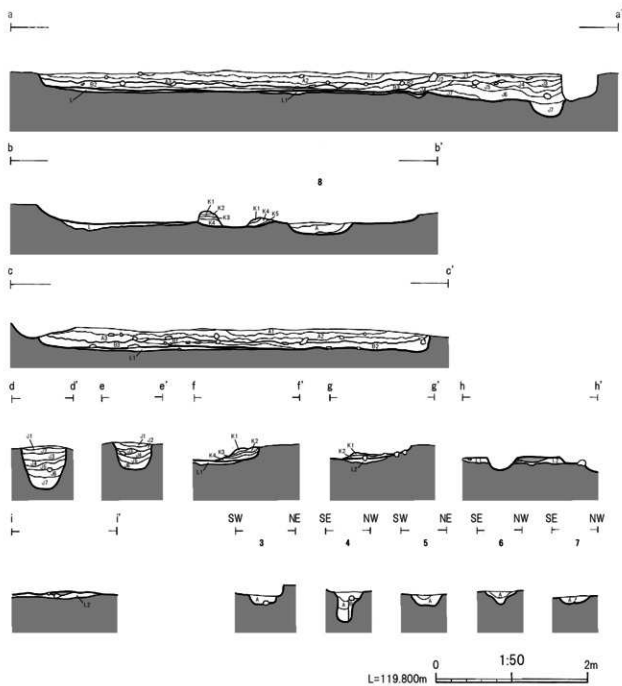

第32圖 RA005竪穴建物跡(2)

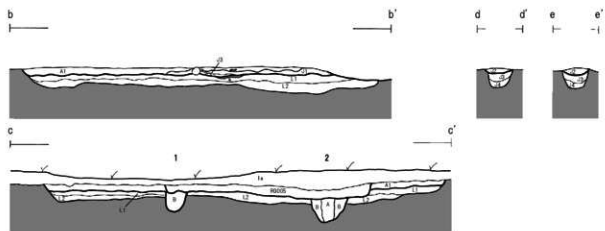
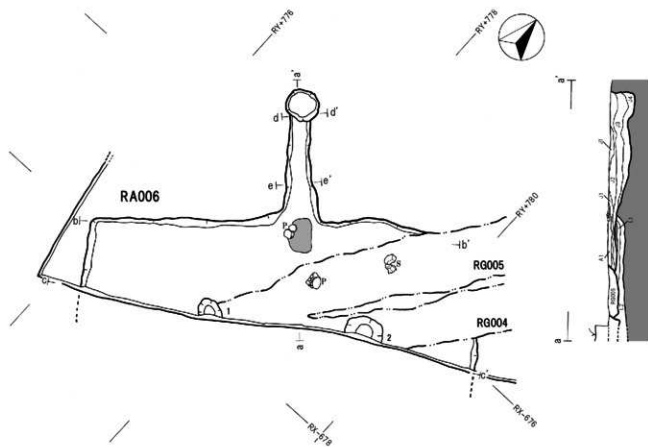

L=119.800m



第33圖 RA006竪穴建物跡

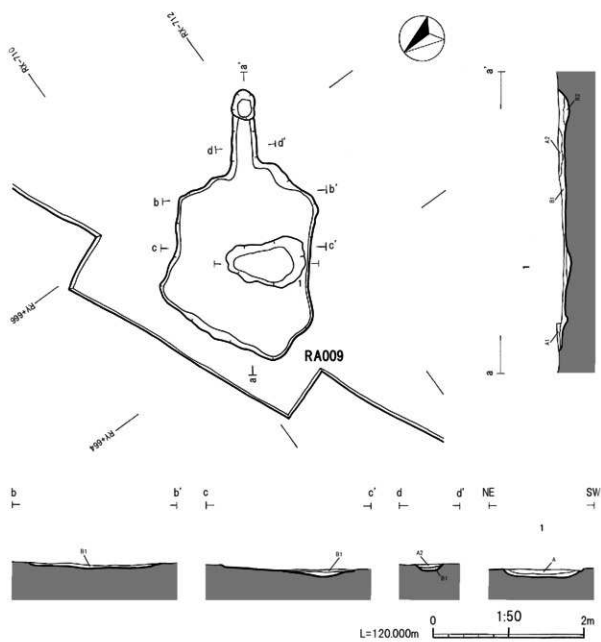

第34图 RA009竖穴建物跡

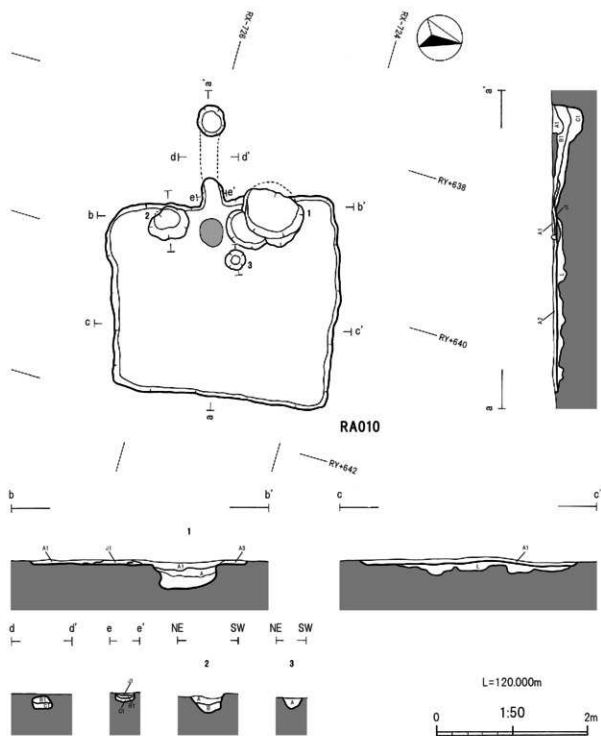

第35図 RA010竪穴建物跡

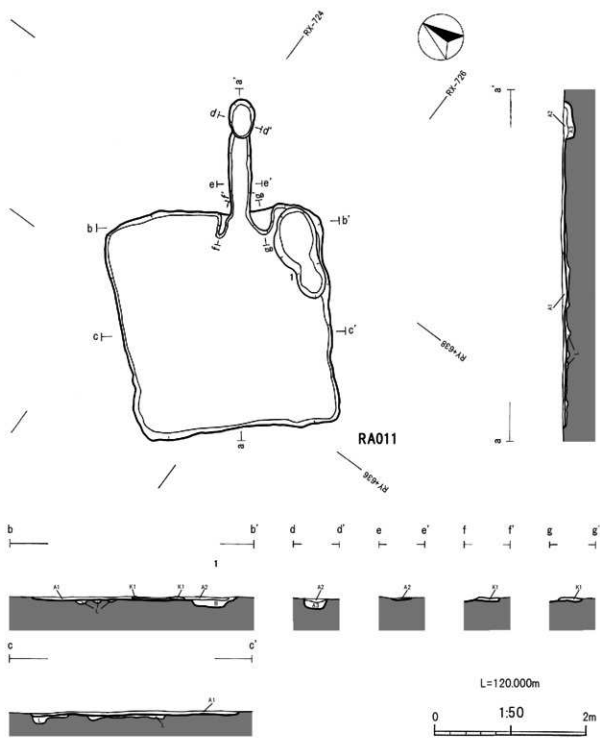

第36圖 RA011竪穴建物跡

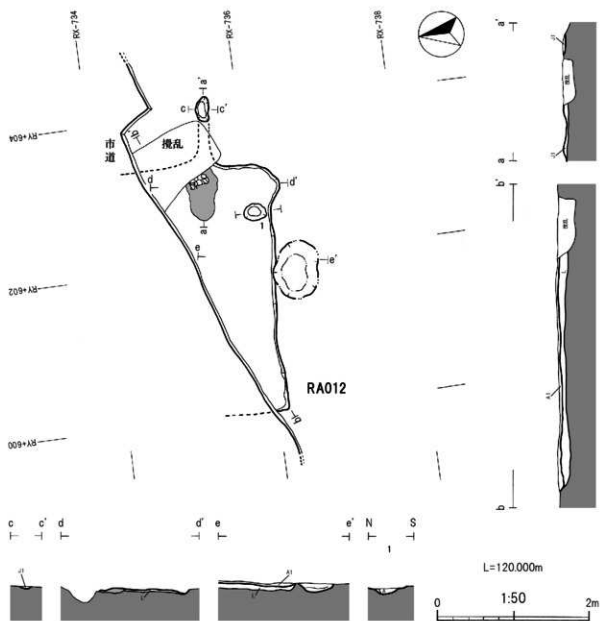

第37图 RA012竖穴建物跡

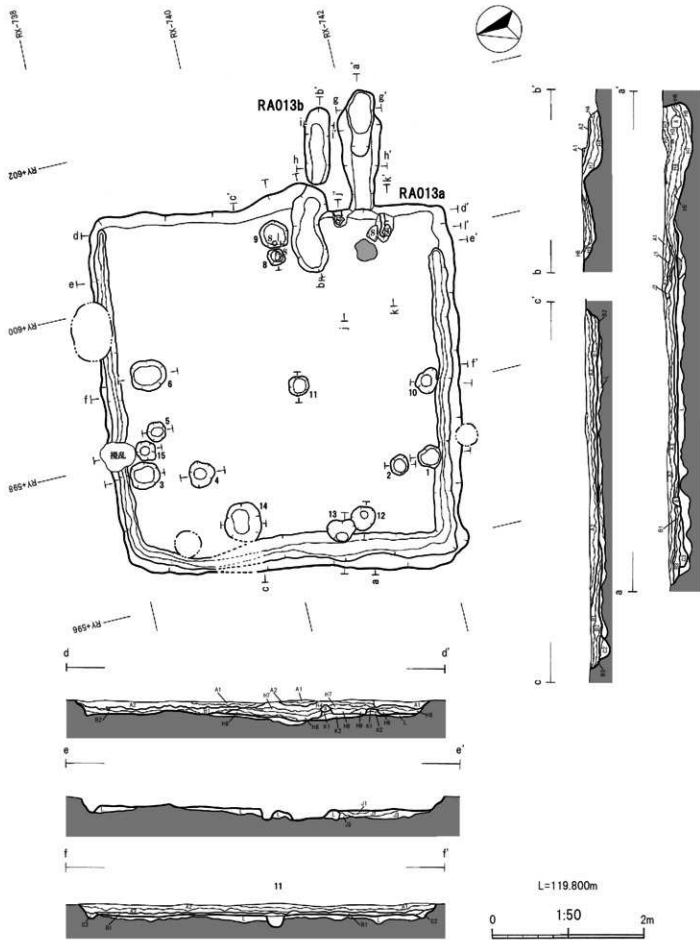

第38圖 RA013豎穴建物跡(1)

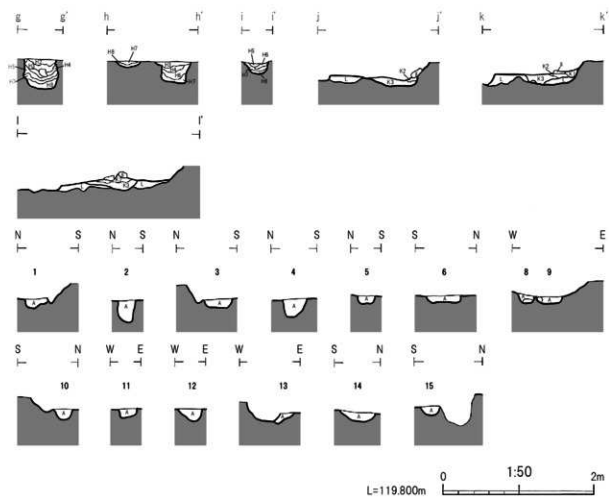

第39圖 RA013豎穴建物跡(2)

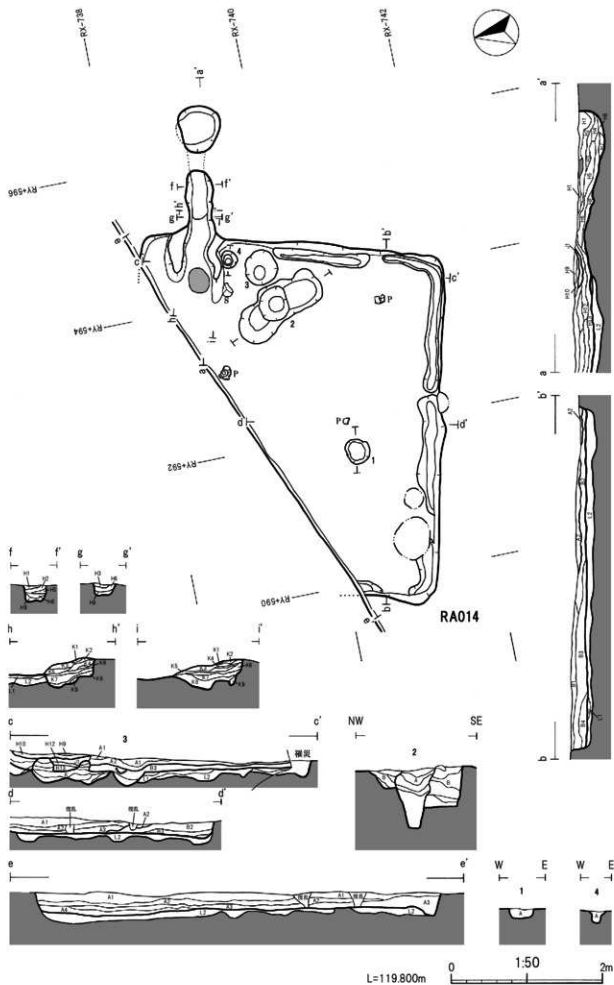

第40圖 RA014竪穴建物跡

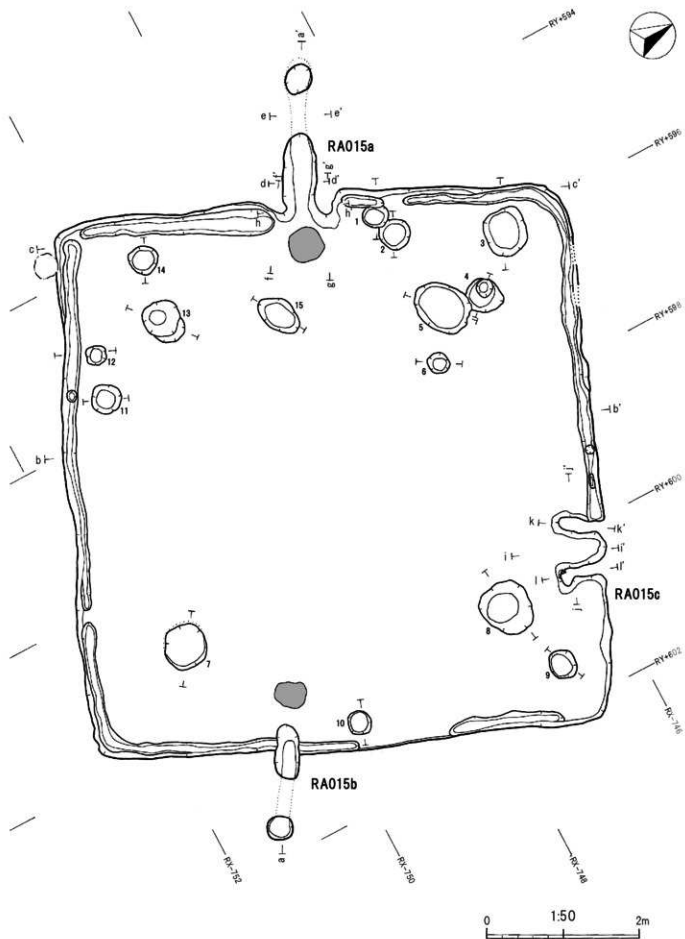

第41圖 RA015竪穴建物跡(1)

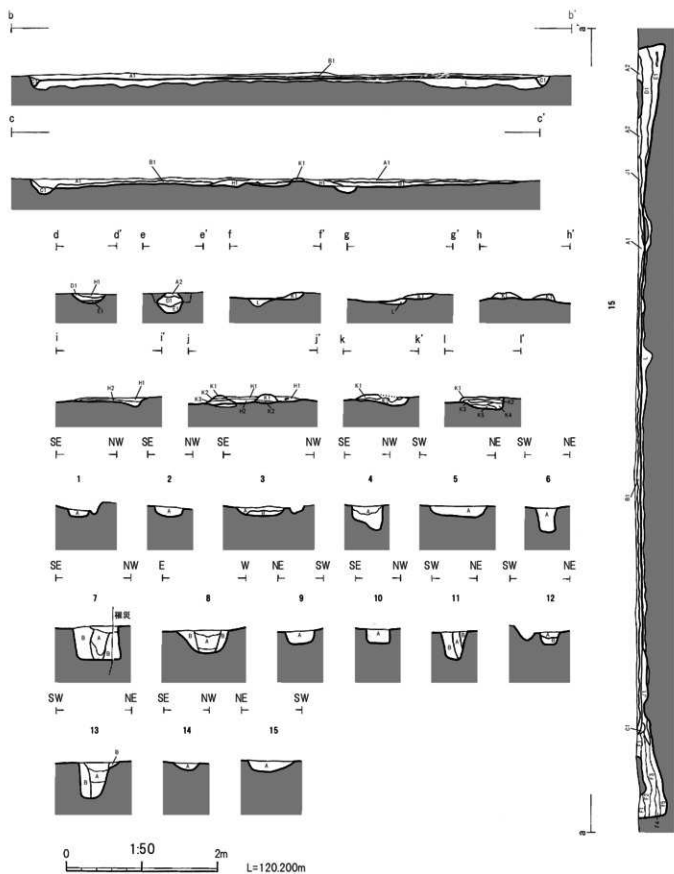

第42图 RA015竖穴建物跡(2)

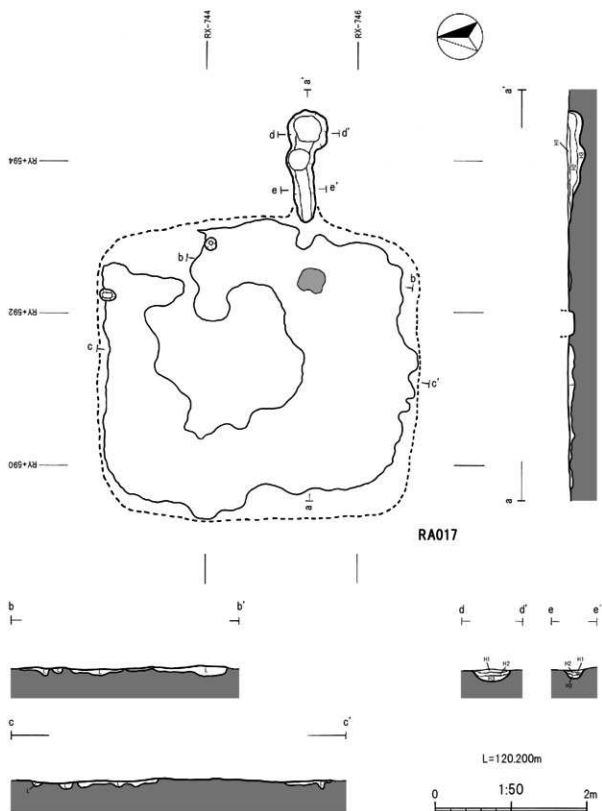

第43図 RA017竪穴建物跡

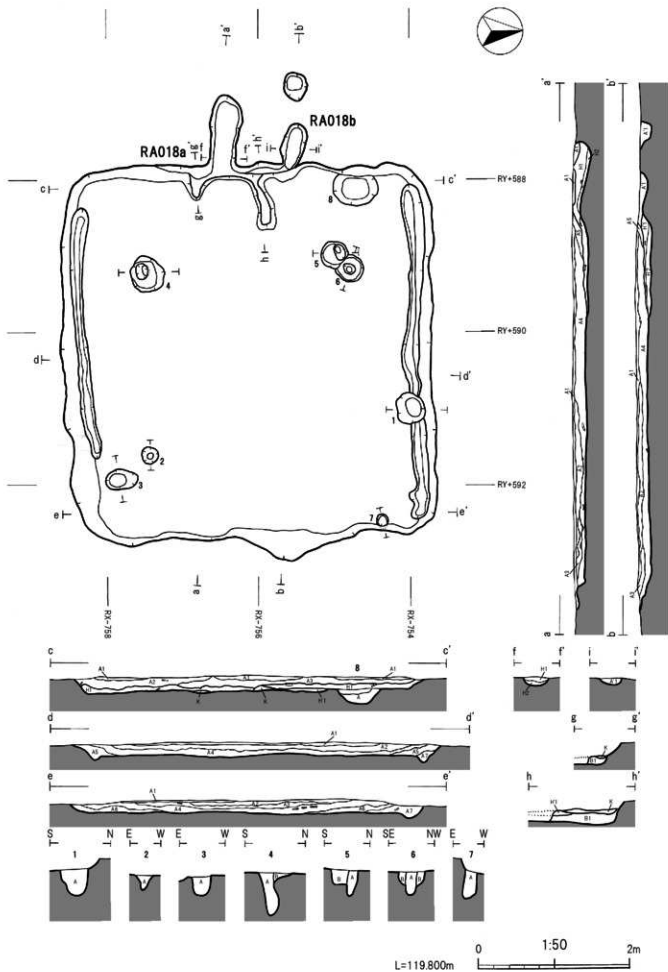

第44圖 RA018竪穴建物跡(1)

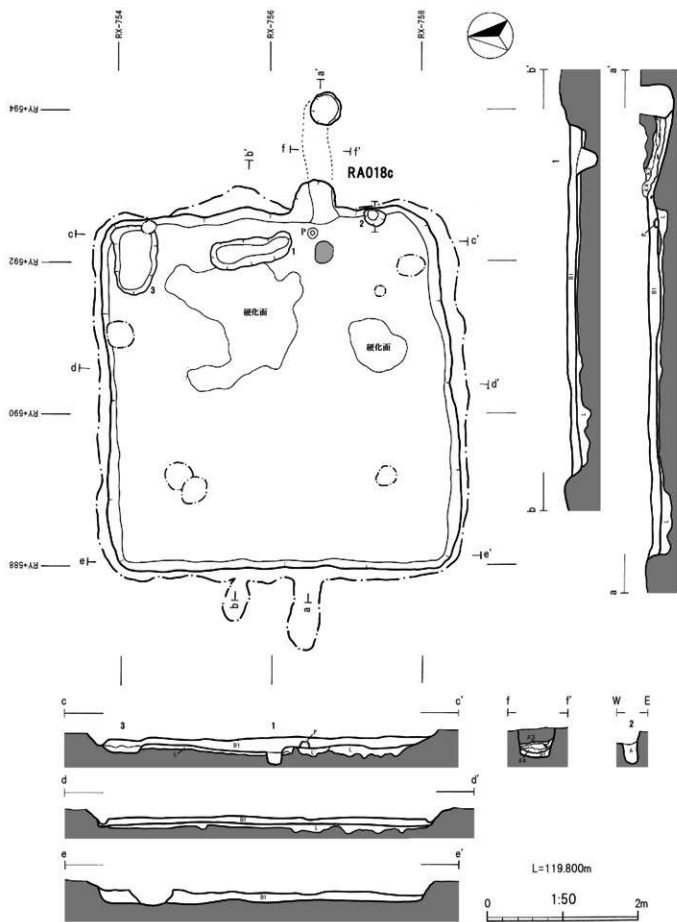

第45図 RA018竪穴建物跡(2)

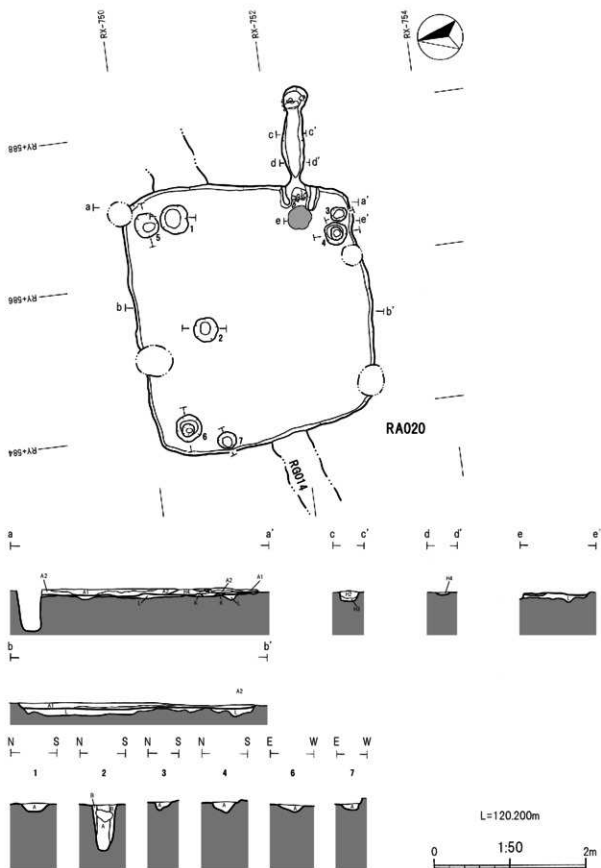

第46図 RA020竪穴建物跡

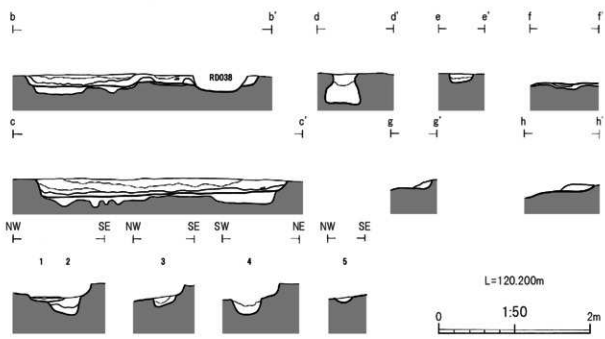
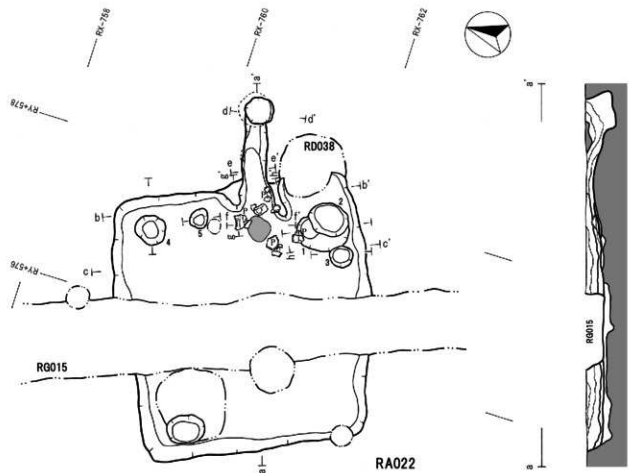

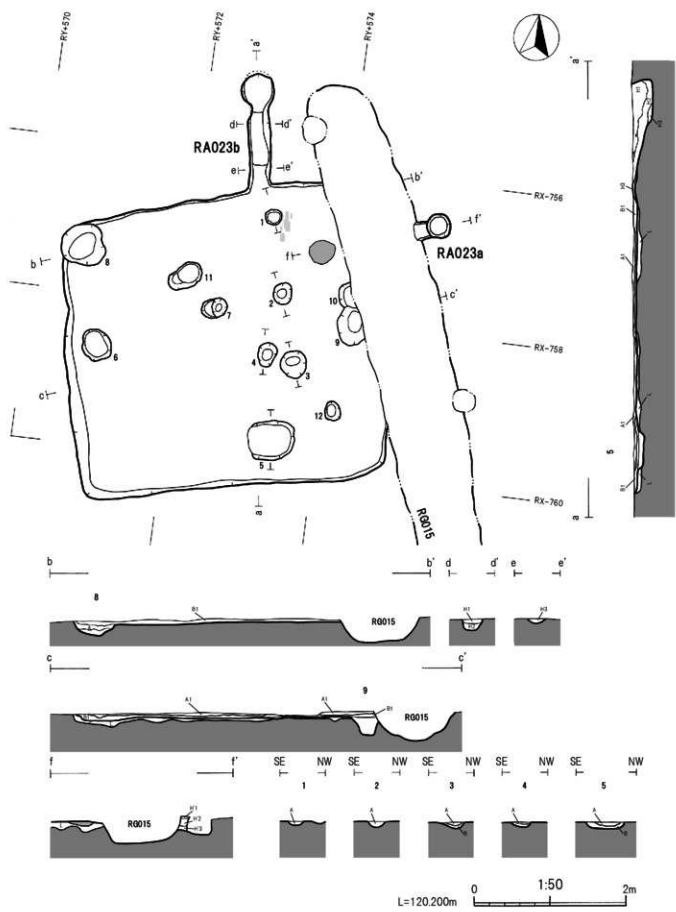

第48图 RA023竖穴建物跡

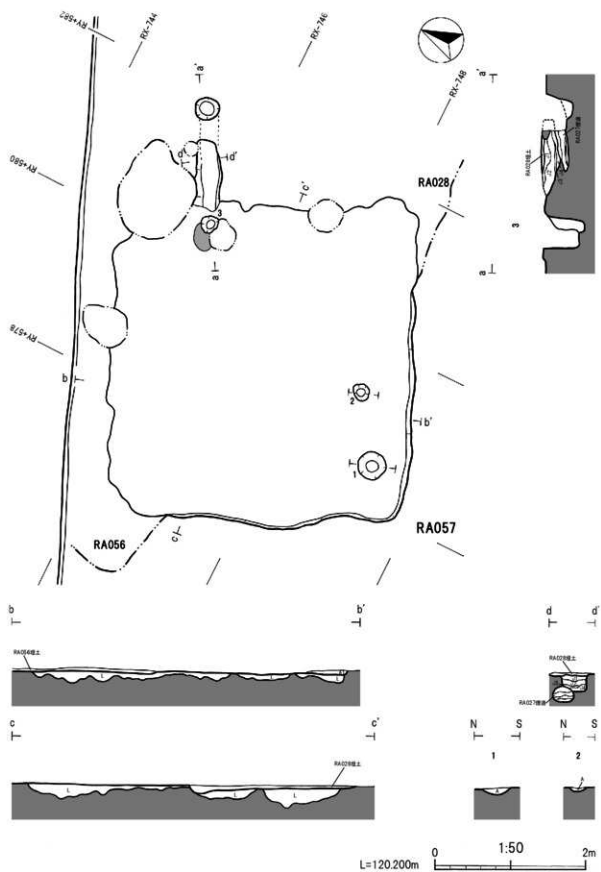

第49図 RA057竪穴建物跡

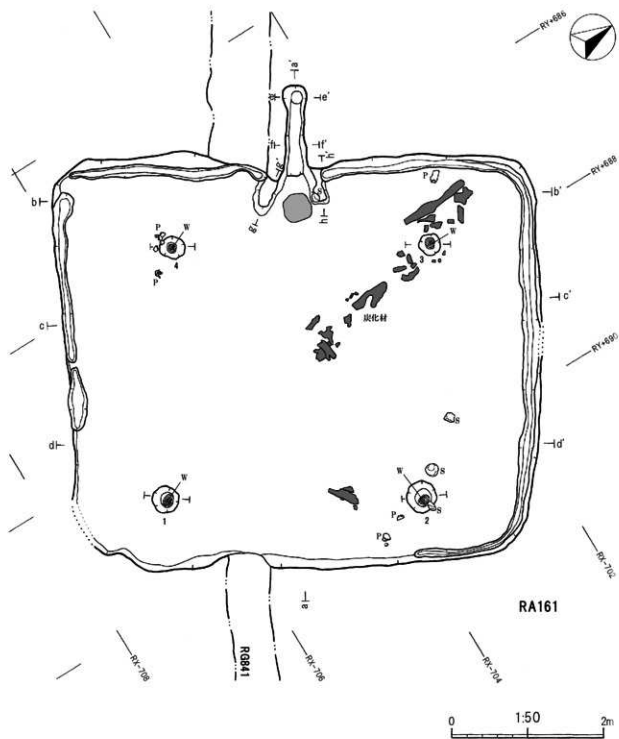

第50图 RA161 竖穴建物跡(1)

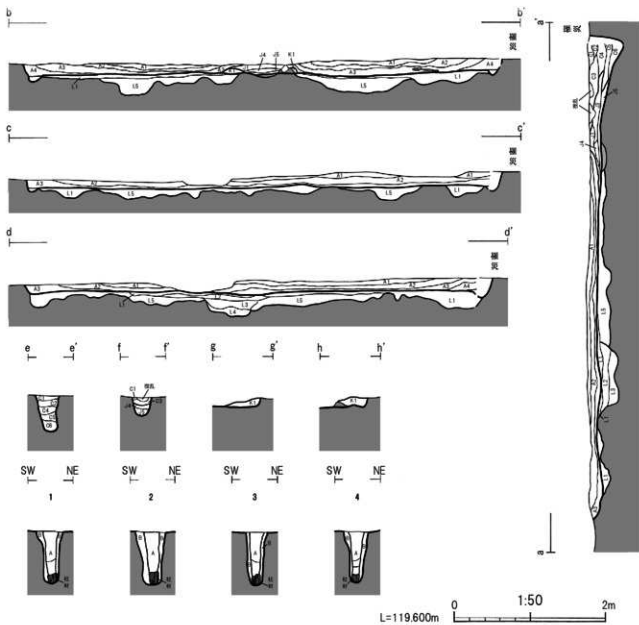

第51圖 RA161 竪穴建物跡(2)

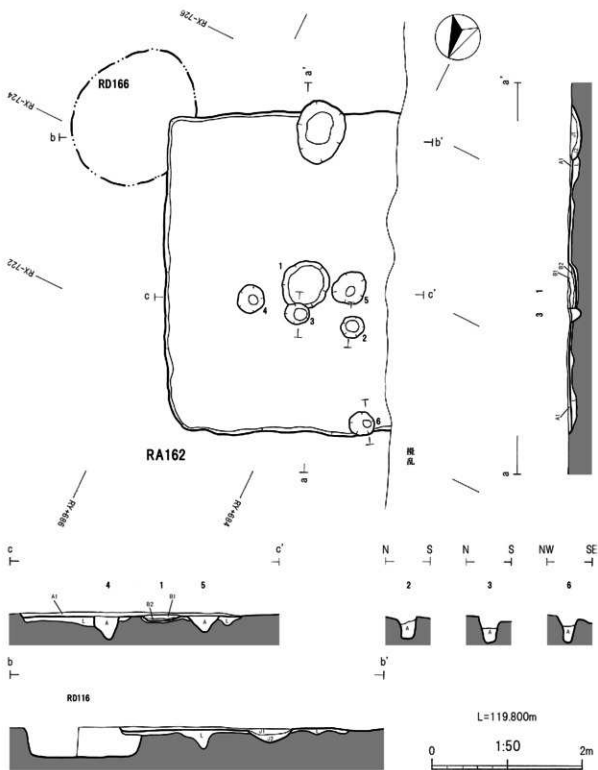

第52圖 RA162竪穴建物跡

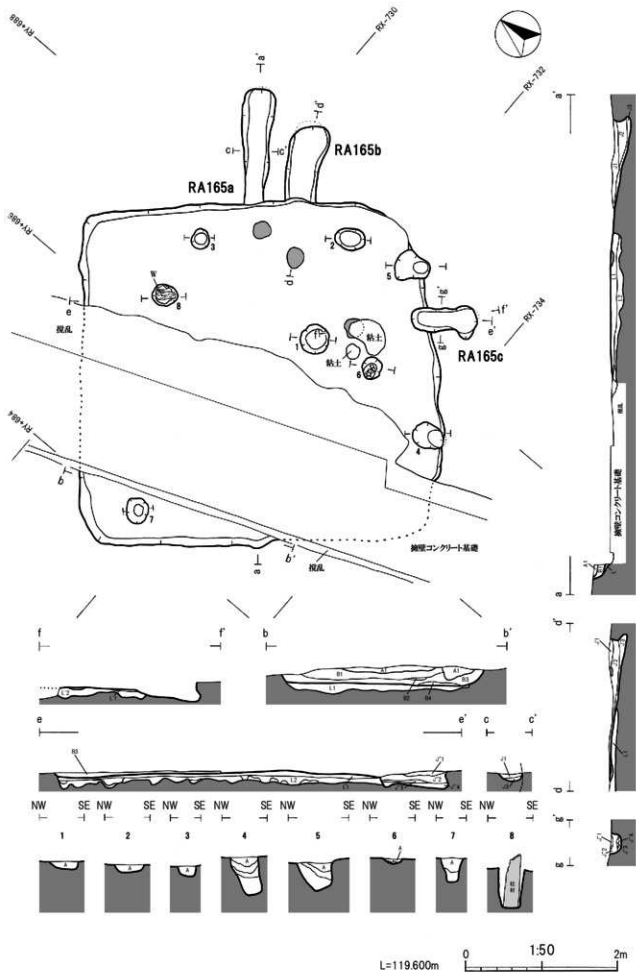

第53図 RA165竪穴建物跡

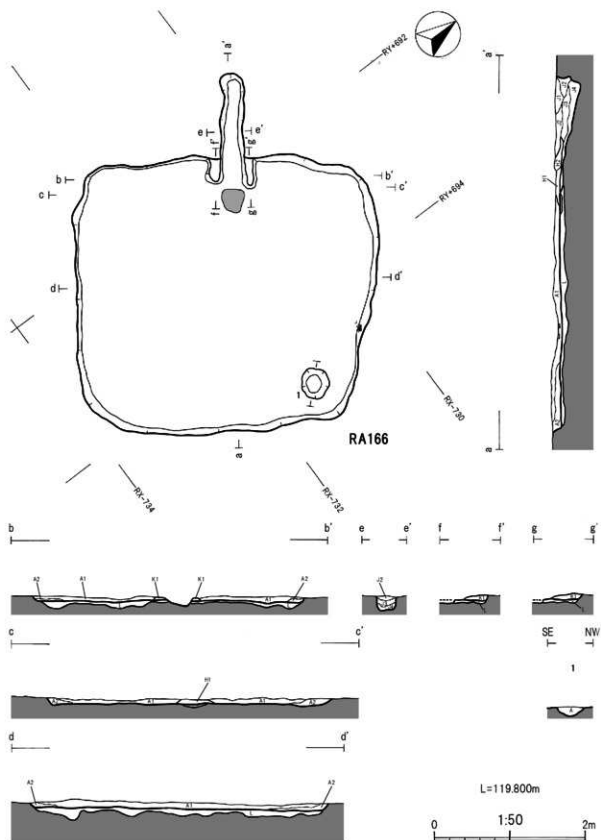

第54図 RA166竪穴建物跡

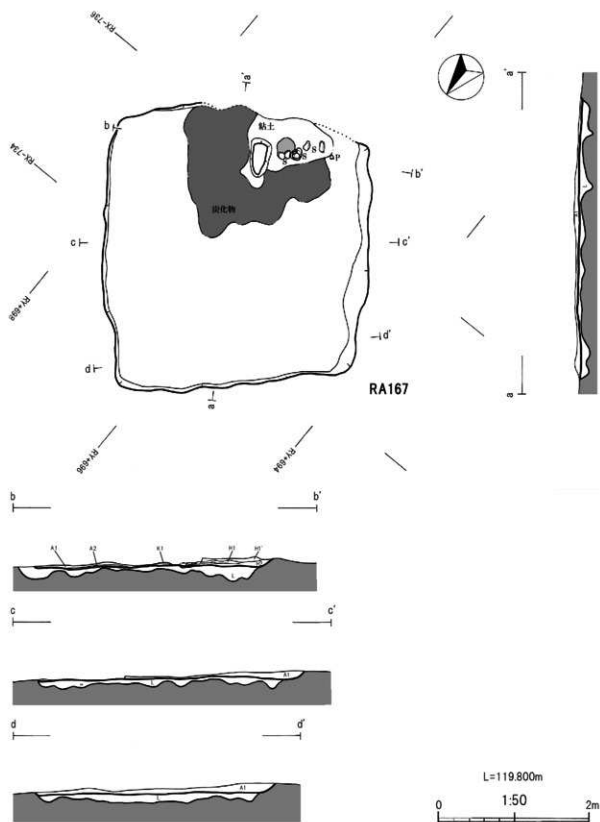

第55図 RA167竪穴建物跡

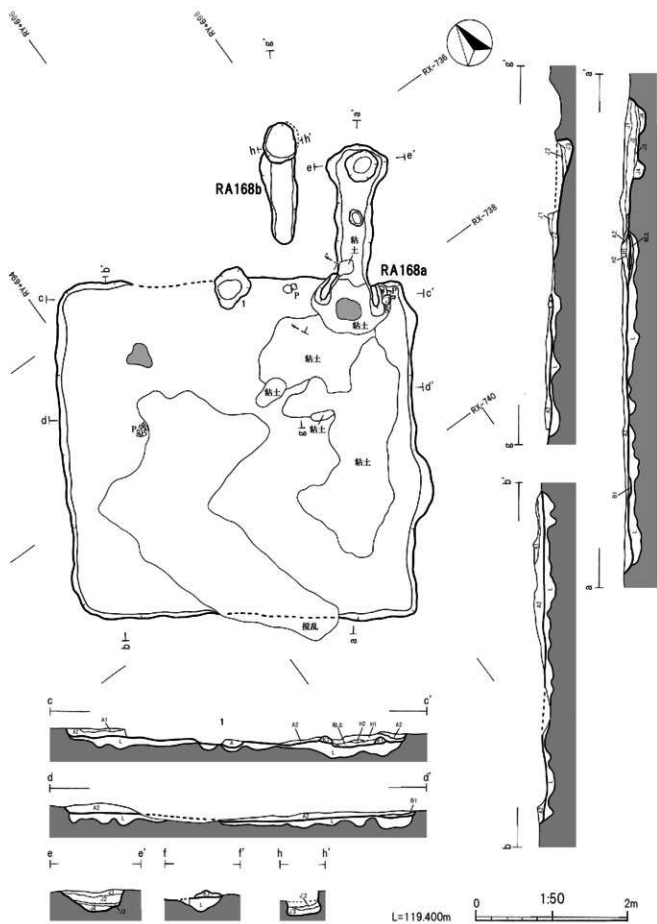

第56圖 RA168竪穴建物跡

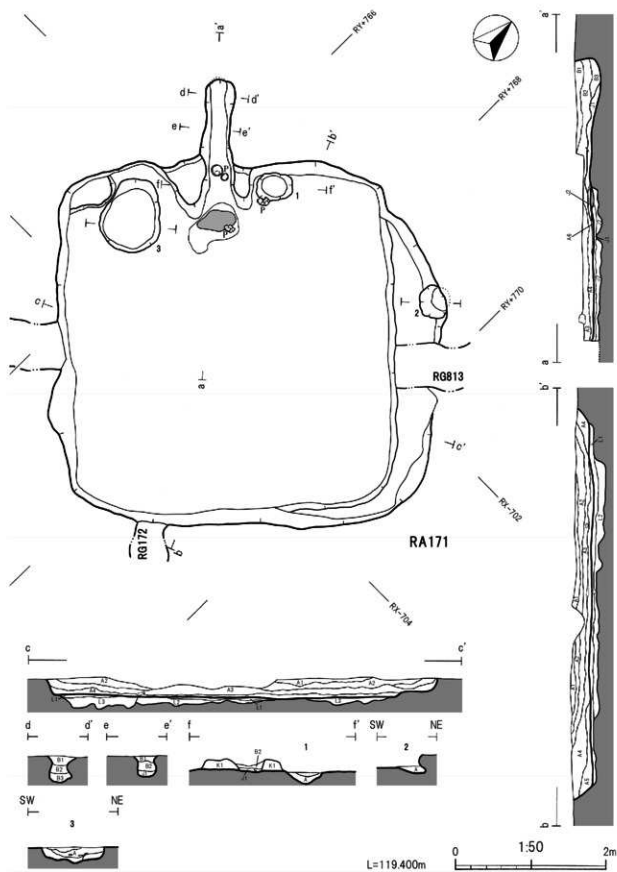

第57図 RA171竪穴建物跡

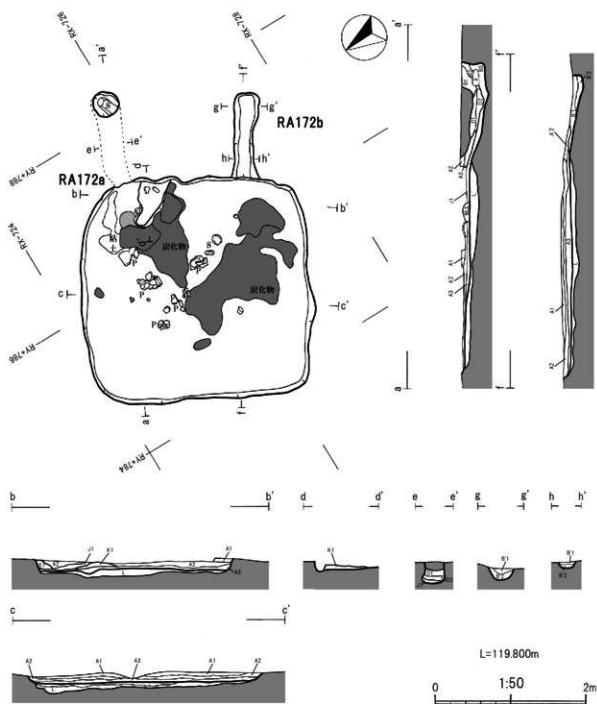

第58图 RA172竖穴建物跡

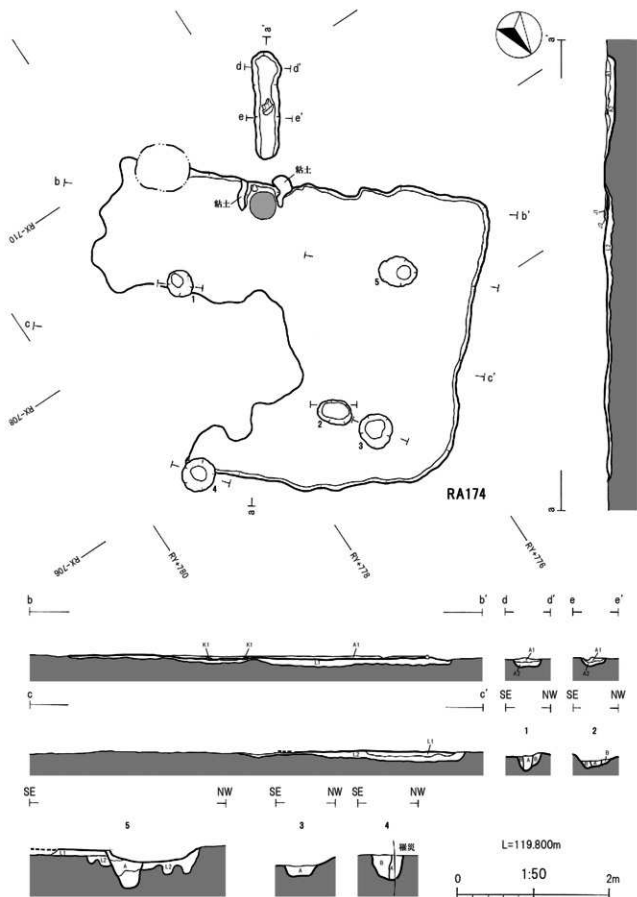

第59图 RA174竖穴建物跡

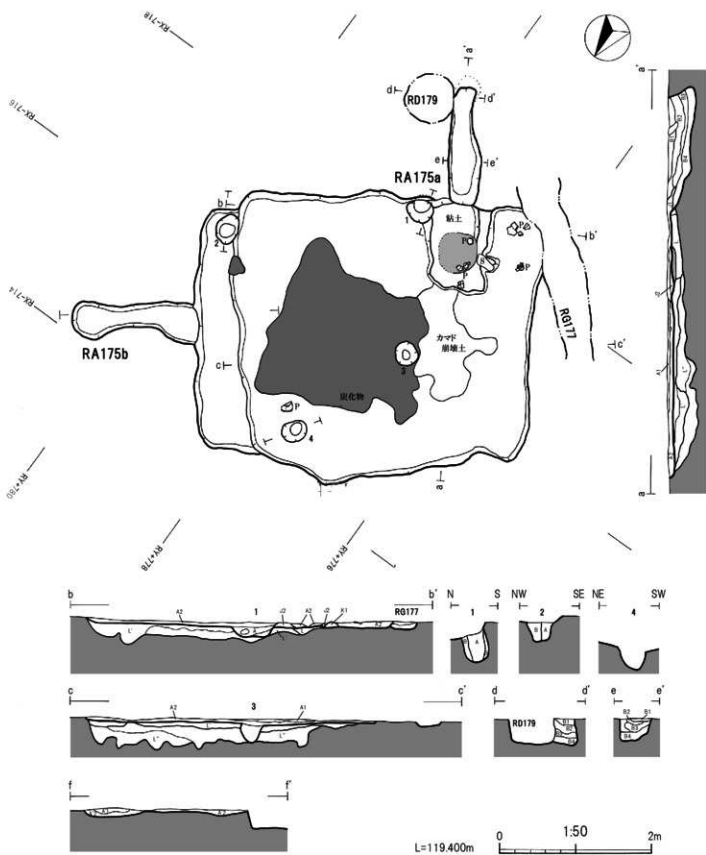

第60図 RA175竪穴建物跡

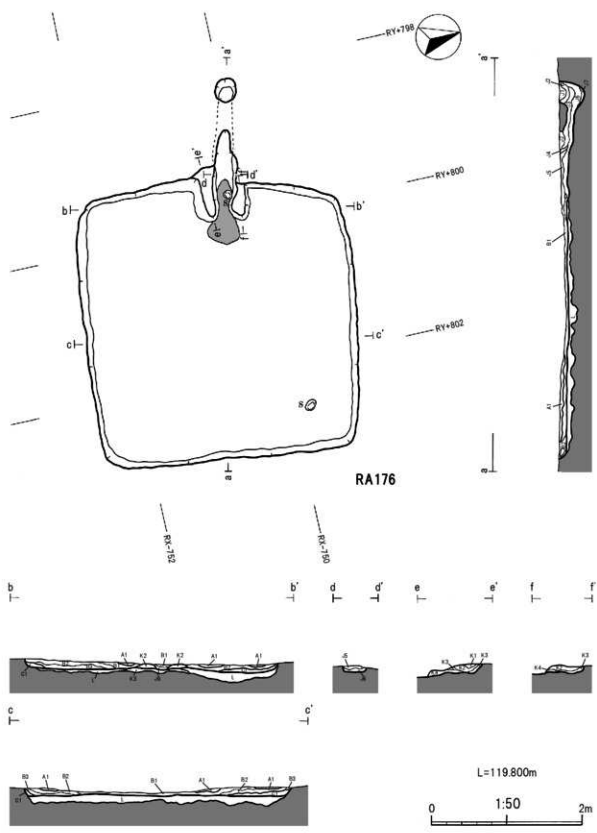

第61図 RA176竪穴建物跡

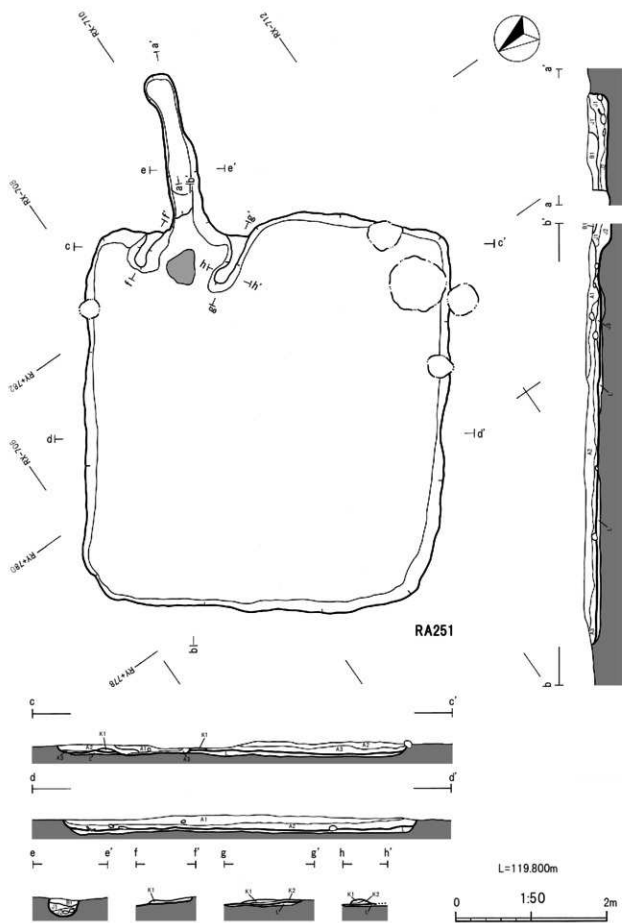

第62圖 RA251豎穴建物跡

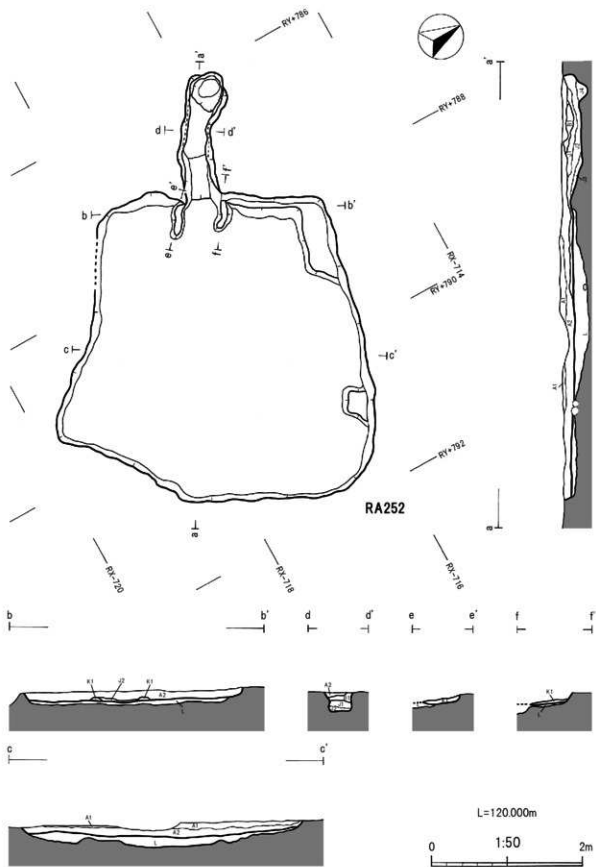

第63圖 RA252竅穴建物跡

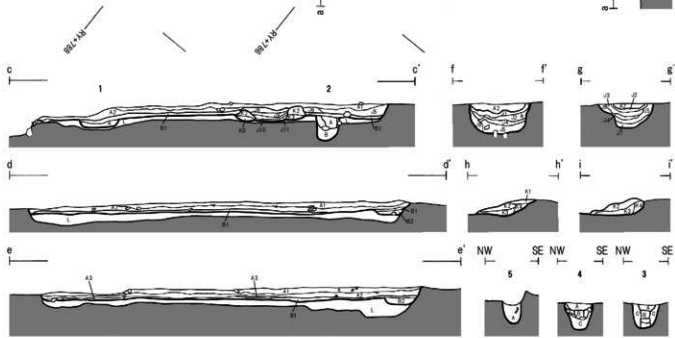
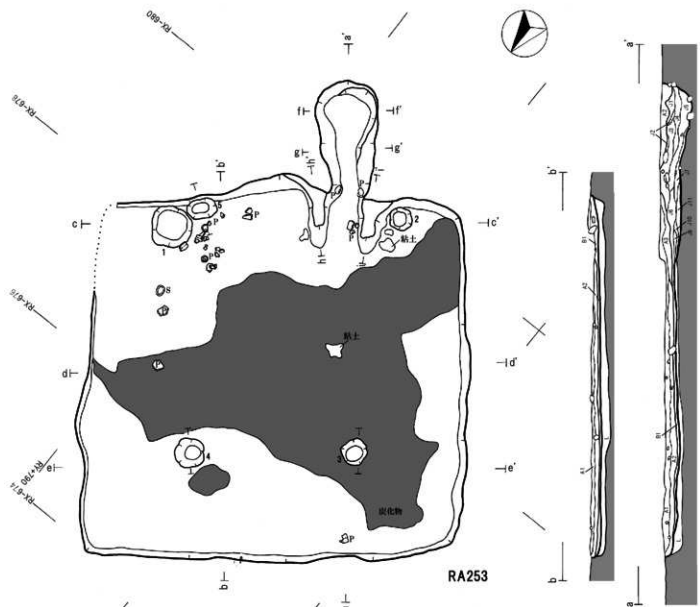

L=119.600m



第64圖 RA253竪穴建物跡

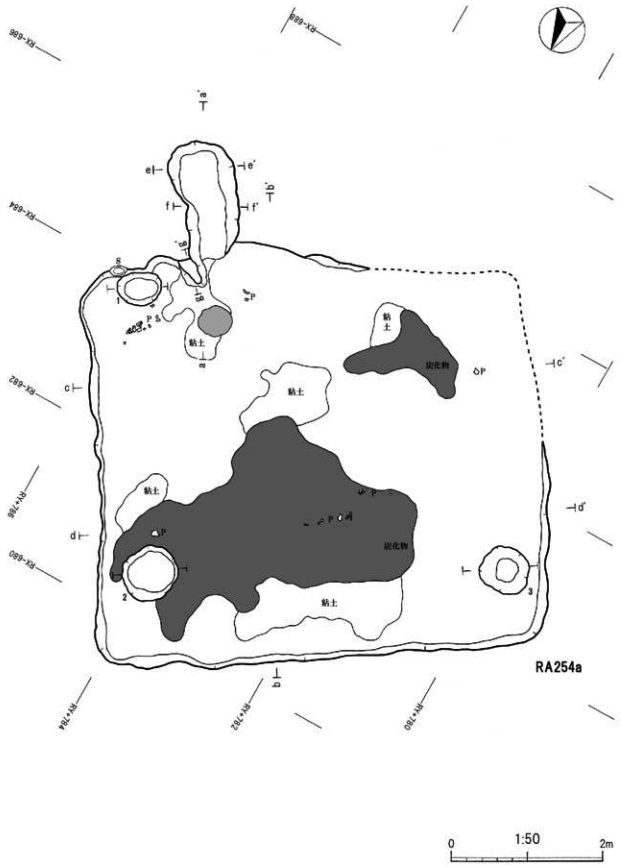

第65図 RA254竪穴建物跡

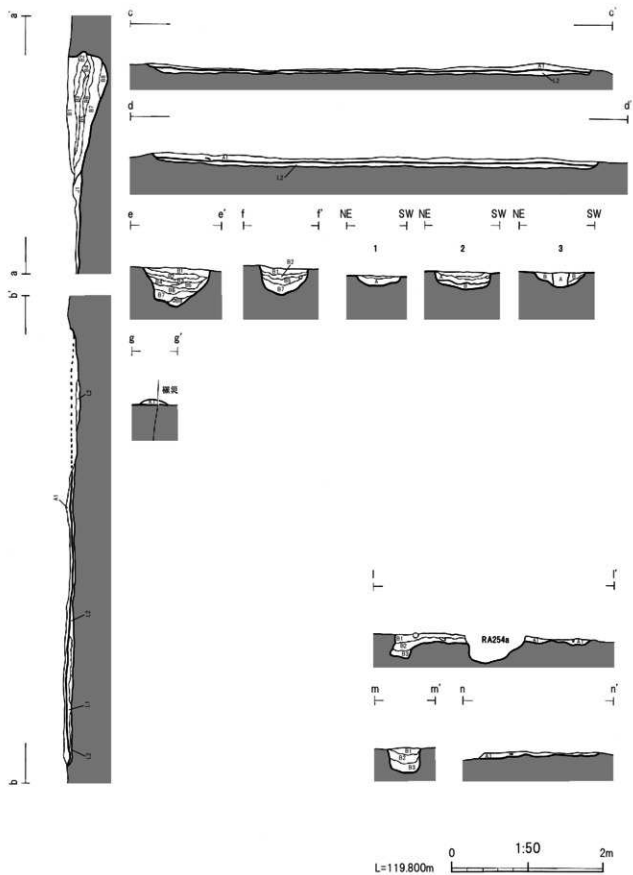

第66図 RA254・258竪穴建物跡

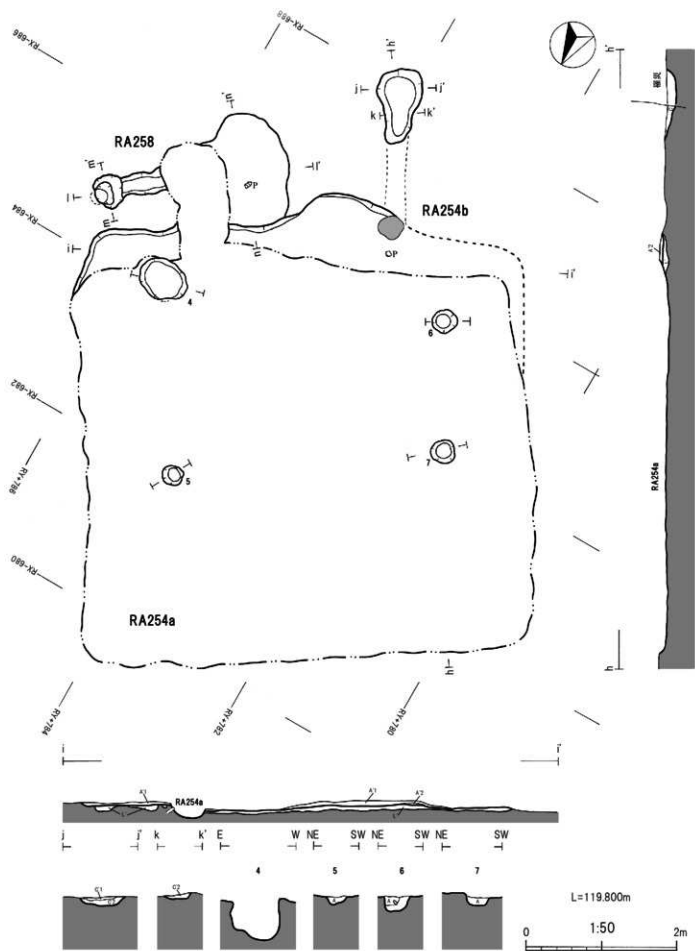

第67圖 RA254・258竪穴建物跡(2)

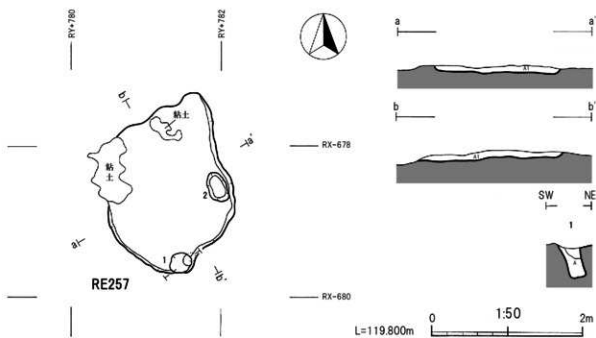
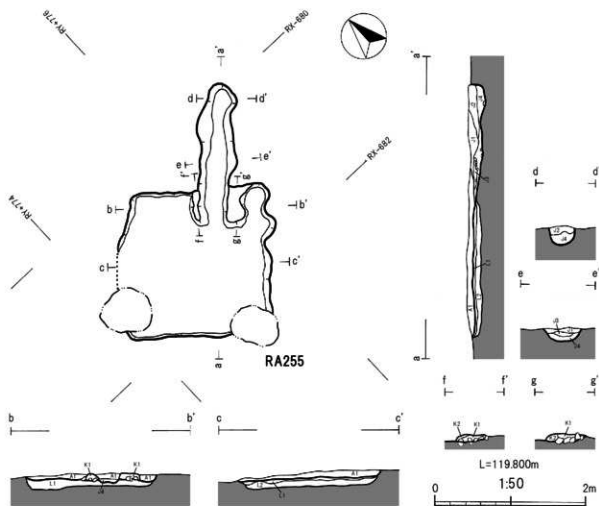

第68圖 RA255豎穴建物跡, RE257豎穴狀遺構

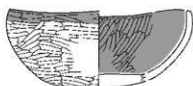

002 土師器坏-RA001-6区西ベル81層

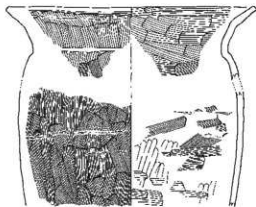

003 土師器甕-RA001-3区B層

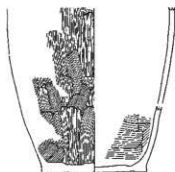

004 土師器甕-RA001-3区A層

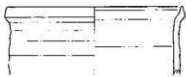

010 あかやき土器甕-RA055-pit1



011 須恵器大甕-
RA055-SW区床面

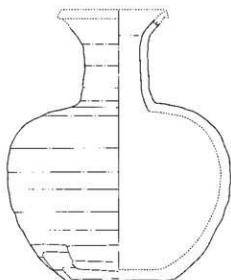

001 須恵器長頸瓶-RA002(1次)



005 土師器坏-RA051-NW区埋土



006 須恵器坏-RA056-検出面



007 あかやき土器坏-
RA057-カマド煙道入口



008 須恵器坏-RA057-SW区L層

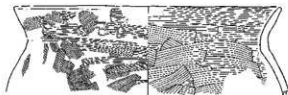

009 土師器甕-RA057-カマド煙道入口

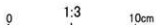

第69図 RA001・002・051・055・056・057出土土器

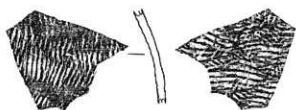

012 須恵器甕-RA053-埋土



013 須恵器甕-RA053-埋土

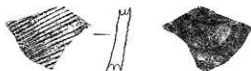

014 須恵器大甕-RA054-SE区床面

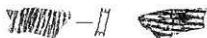

015 須恵器大甕-RA054-SE区床面

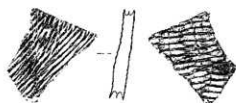

016 須恵器大甕-RA054-SW区床面



017 須恵器壺-RA054-NW区床面



018 土師器環-
RA058-SW区L層

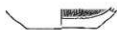

019 土師器環-
RA058-MW区L層



020 あかやき土器環-RA058-NW区床面



021 あかやき土器甕-RA058-SW区床面



022 須恵器大甕-RA058-NW区床面

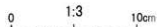

第70図 RA053・054・058出土土器

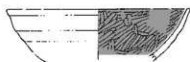

023 土師器環-RA059-NW区床面



024 土師器環-RA059-L層



025 あかやき土器環-RA059-SW区床面

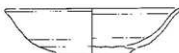

026 あかやき土器環-RA059-NE区床面



027 あかやき土器環-RA059-カマド左pit



028 あかやき土器環-RA059-床面-灯明皿

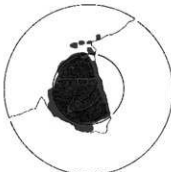

029 あかやき土器環-RA059-カマド袖区層

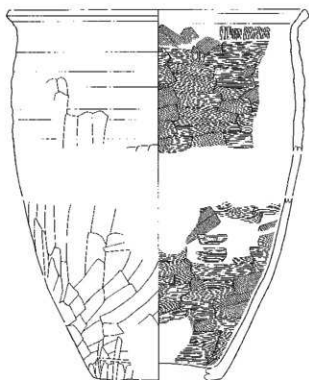

030 あかやき土器甕-RA059-カマド床面

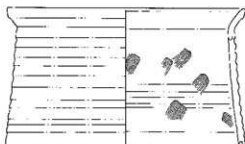

031 あかやき土器甕-RA059-カマド焼土面

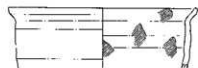

032 あかやき土器甕-RA059-カマド焼土面



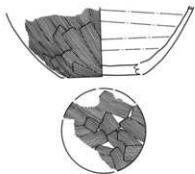

033 あかやき土器甕-RA059-カマド右床面

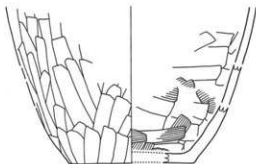

035 土師器甕-RA059-カマド右床面

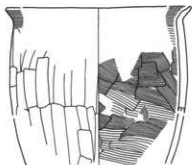

034 土師器甕-RA059-カマド焼土面

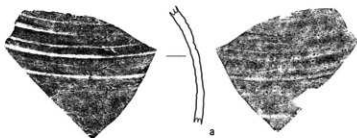

036 須恵器壺-RA059-カマド右床面

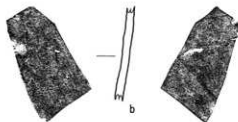

037 須恵器大甕-RA059-SW区床面



0 1:3 10cm

第72図 RA059出土土器(2)

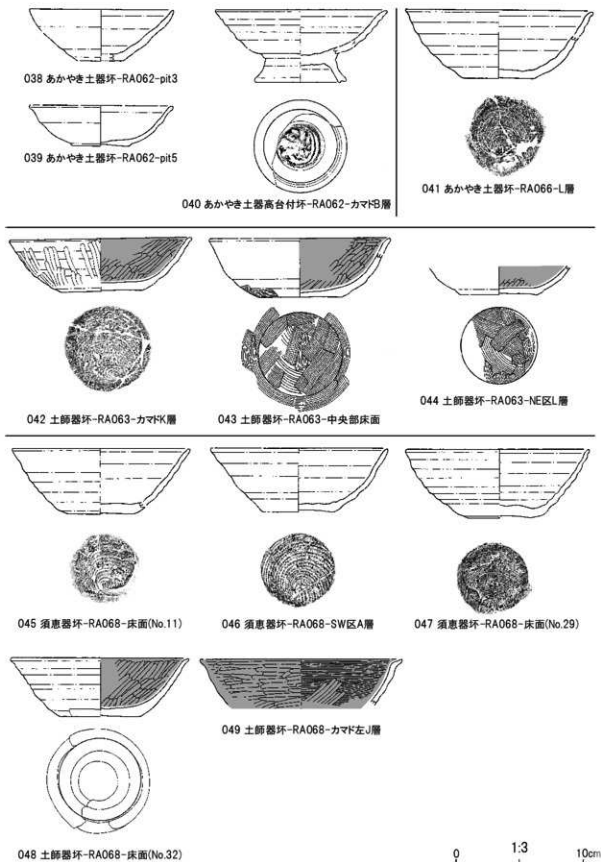

第73図 RA062-063-066出土土器, RA068出土土器(1)

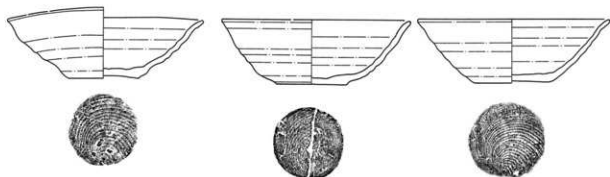

050 あかやき土器環-RA068-カマド支脚2段目 051 あかやき土器環-RA068-A4層(No.9) 052 あかやき土器環-RA068-カマド支脚3段目



053 あかやき土器環-RA068-A4層(No.16)

054 あかやき土器環-RA068-カマド層(No.21)

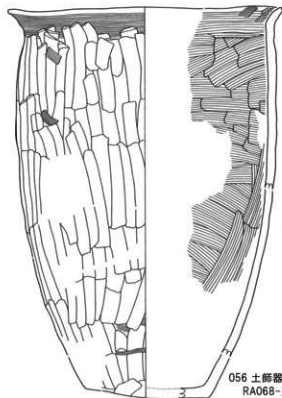

056 土師器甕-
RA068-床面(No.18)

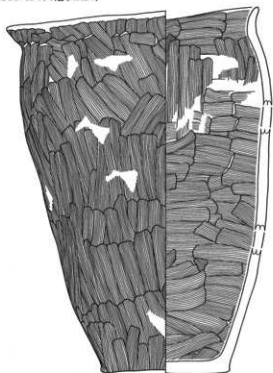

057 土師器甕-
RA068-カマド層(No.24)



0 1:3 10cm

第74図 RA068出土土器(2)

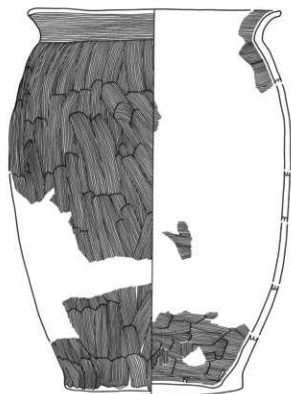

058 土師器甕-RA068-床面(No.30)



059 土師器甕-RA068-MN区A層

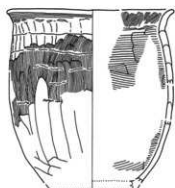

060 あかやき土器甕-RA068-床面(No.37)

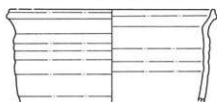
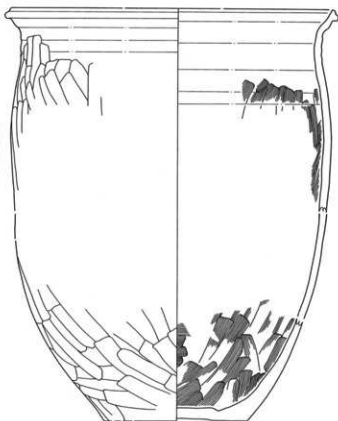

061 あかやき土器甕-RA068-カマドJ層(No.26)

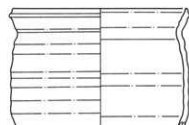

062 あかやき土器甕-RA068-カマドJ層(No.28)



063 須恵器壺-RA068-NW区A層

064 須恵器長頸瓶-RA068-カマドJ層(No.23)

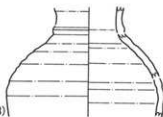

第75図 RA068出土土器(3)

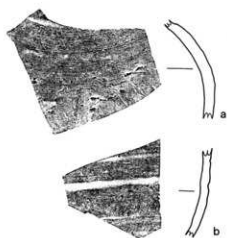

065 須恵器壺-RA068-NE区A層

066 須恵器壺-RA068-MN区A層



067 須恵器大甕-RA068-A4層(No.3)

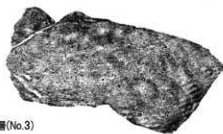

068 須恵器大甕-RA068-カマド焼土面

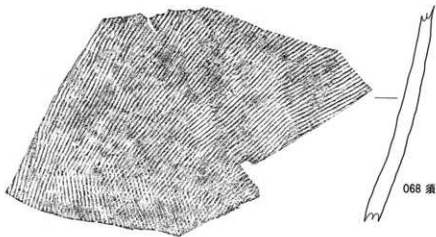

068 須恵器大甕-RA068-カマド焼土面

0 1:3 10cm

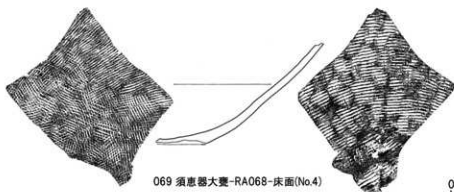

069 須恵器大甕-RA068-床面(No.4)

0 1:6 20cm

第76図 RA068出土土器(4)



070 あかやき土器環-RA069-床面(No.2)

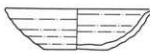

071 あかやき土器小型環-
RA070-NW区床面



072 あかやき土器環-RA070-pit2



073 須恵器壺-RA070-SW区L層



074 あかやき土器環-RA071-pit2



075 須恵器壺-
RA071-検出面

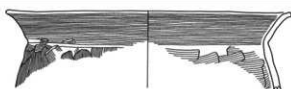

079 土師器甕-RA079-カマド右袖芯材

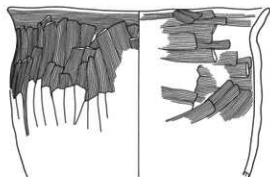

076 土師器甕-RA071-煙出上部



077 土師器環-RA072-A層



078 あかやき土器環-RA072-検出面

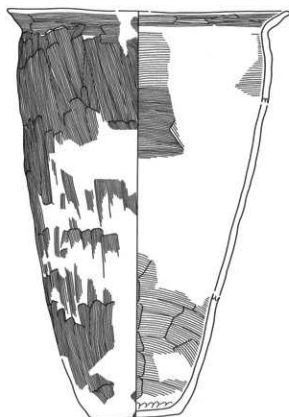

080 土師器甕-RA079-
カマド右袖芯材

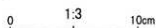

第77図 RA069-070-071-072-079出土土器

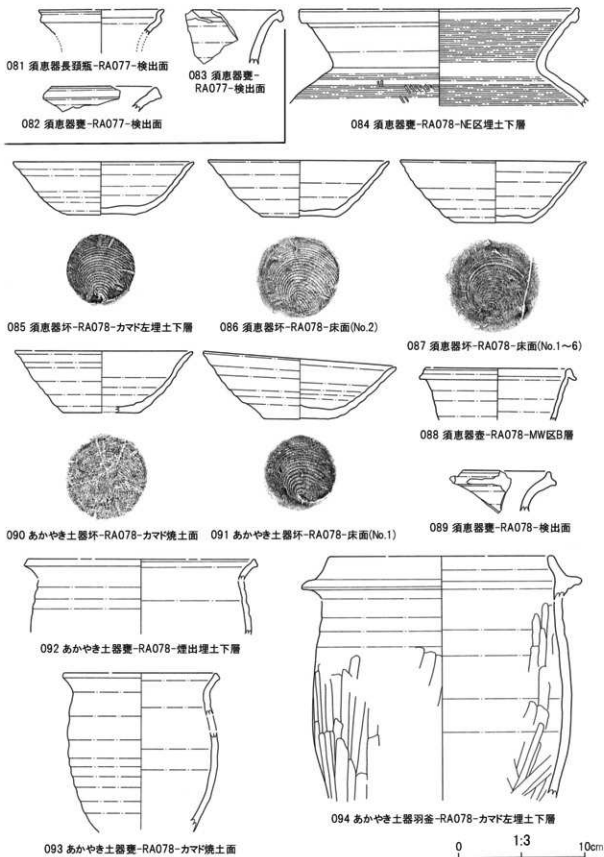

第78図 RA077-078出土土器



095 あかやき土器環-RA080-床面(No.1)

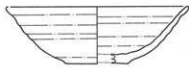

096 須恵器環-RA081a-MW区B層



098 あかやき土器環-RA081a-床面(No.4)

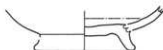

100 あかやき土器高台付環-RA081a-検出面



097 あかやき土器環-RA081a-NW区B層

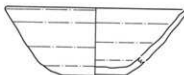

099 あかやき土器環-RA081a-床面(No.1)

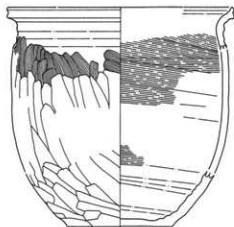

101 あかやき土器甕-RA081a-NW区床面



103 須恵器甕-RA081a-貼床



104 須恵器甕-RA081a-L層



105 須恵器長頸瓶-RA081a-SW区A層



106 須恵器壺-RA081a-SW区A層



102 あかやき土器甕(把手)-RA081a-検出面

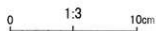

第79図 RA080-081a出土土器

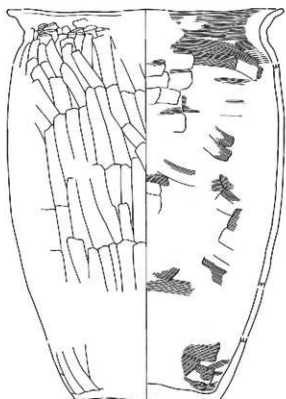

107 土師器甕-RA081b-北カマド煙道埋土



108 須恵器短頸壺-RA081b-L層

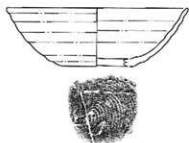

109 あかやき土器杯-RA083-NE区A1層

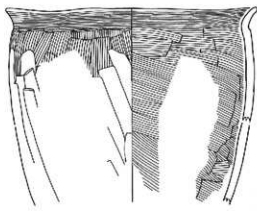

110 土師器甕-RA083-NW区A1層



111 須恵器甕-RA083-SE区A1層



112 須恵器大甕-RA085-SE区L層

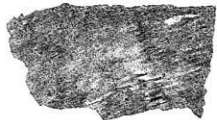

114 須恵器長頸瓶-RA085-SE区A3層

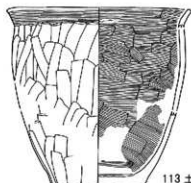

113 土師器甕-RA085-床面(No.1)

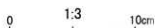

第80図 RA081b-083-085出土土器



115 土師器杯-RA082-東西ベルト東A層



116 あかやき土器小型杯-RA082-カマドJ層



117 あかやき土器小型杯-RA082-カマドJ層



118 あかやき土器小型杯-RA082-pit1



119 あかやき土器杯-RA082-床面



120 あかやき土器杯-RA082-東壁際A層

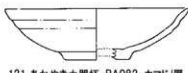

121 あかやき土器杯-RA082-カマドJ層



122 あかやき土器杯-RA082-L層



123 あかやき土器杯-RA082-カマドJ層



124 あかやき土器杯-RA082-pit2



125 あかやき土器高台付杯-RA082-カマド支脚



126 土師器甕-RA082-カマド支脚

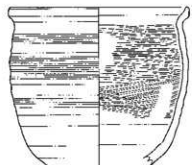

127 あかやき土器甕-RA082-pit2

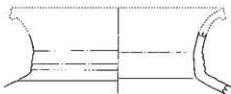

128 須恵器壺-RA082-南北ベルト南A層

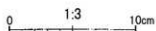

第81図 RA082出土土器

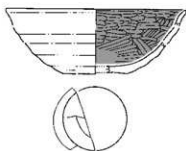

129 土師器環-RA084-A3層(No.3)

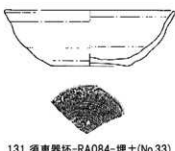

131 須恵器環-RA084-埋土(No.33)



133 あかやき土器環-RA084-SE区ベルト

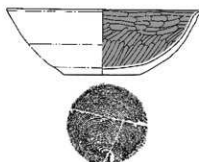

130 土師器環-RA084-A3層(No.8)



132 須恵器環-RA084-床面(No.4)



134 あかやき土器環-RA084-床面(No.5)

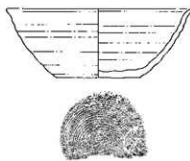

135 あかやき土器環-RA084-床面(No.1)

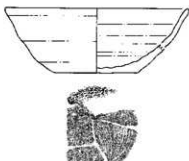

136 あかやき土器環-RA084-カマド袖(No.2)

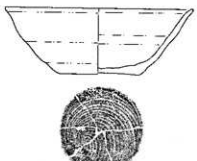

137 あかやき土器環-RA084-カマド袖J4層



138 あかやき土器環-RA084-NW区A1層



139 あかやき土器環-RA084-A3層(No.7)

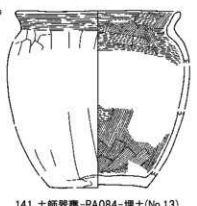

141 土師器甕-RA084-埋土(No.13)

140 あかやき土器環-RA084-NW区A3層

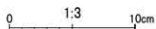

第82図 RA084出土土器(1)

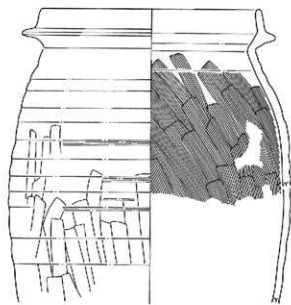

142 あかやき土器羽釜-RA084-MS区L層

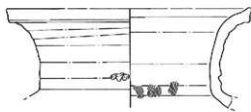

143 須恵器甕-RA084-煙出(No.5)



144 須恵器壺-RA084-pit14

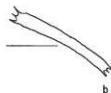

145-1 須恵器大甕-RA084-NW区A2層



第83図 RA084出土土器(2)

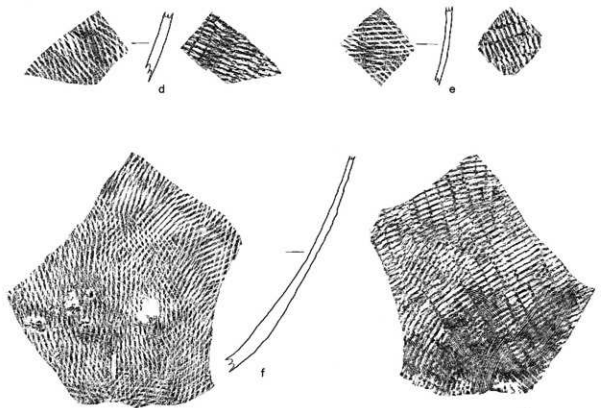

145-2 須恵器大甕-RA084-NW区A2層

第84図 RA084出土土器(3)

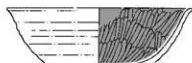

146 土師器坏-RA088-pit

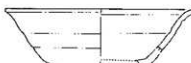

148 あかやき土器坏-RA088-カマド(No.5)

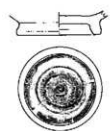

150 あかやき土器高台付坏-
RA088-MN区A3層



147 土師器坏-RA088-A4層(No.8)



149 あかやき土器坏-RA088-煙出C3層



151 土師器小型甕-
RA088-カマド左袖K1層

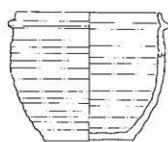

152 あかやき土器小型羽釜-RA088-床面



153 あかやき土器甕-RA088-NW区A4層



154 須恵器壺-RA088-MS区A2層

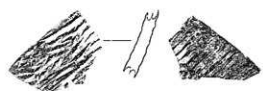

155 須恵器大甕-RA088-NW区L層



157 須恵器壺-RA088-NW区A1層

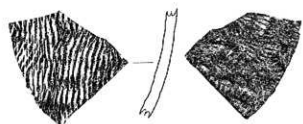

156 須恵器大甕-RA088-pit1

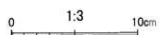

第85図 RA088出土土器

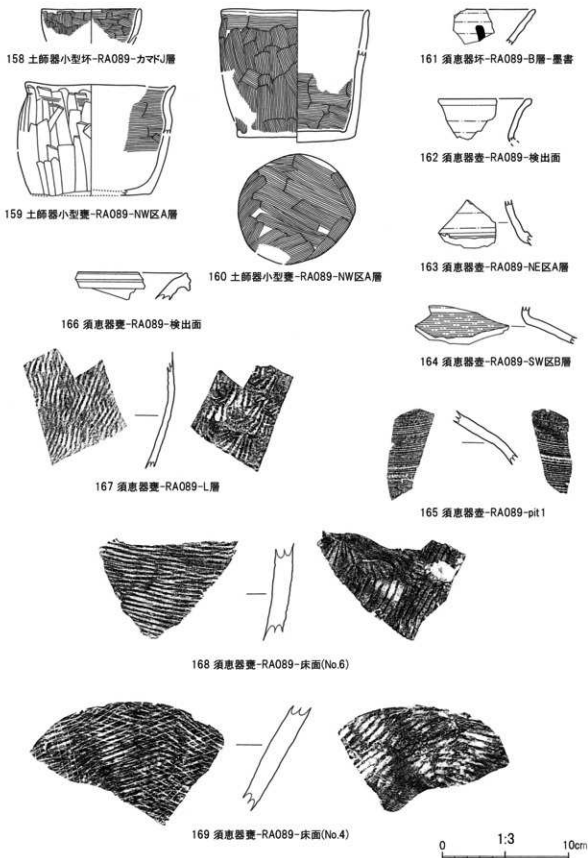

第86図 RA089出土土器



170 土師器环-RA090-A層



171 土師器环-RA090-床面(No.2)



172 土師器环-RA090-B層



173 土師器环-RA090-L層



175 土師器高台付环-RA090-床面(No.2)



176 土師器高台付环-RA090-ベルトA3層



177 土師器高台付环-RA090-ベルトA1層



174 土師器环-RA090-ベルトA2層



179 あかやき土器环-RA090-ベルトB3層



180 あかやき土器环-RA090-A層



178 須恵器环-RA090-A層



184 あかやき土器高台付环-RA090-ベルトB4層



181 あかやき土器环-RA090-L層



183 あかやき土器环-RA090-ベルトA2層



182 あかやき土器环-RA090-床面(No.5)

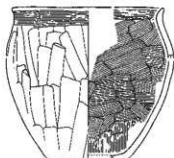

185 土師器小型甕-RA090-A層



186 あかやき土器甕-RA090-ベルトA1層



187 あかやき土器甕-RA090-A層

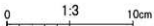

第87図 RA090出土土器(1)

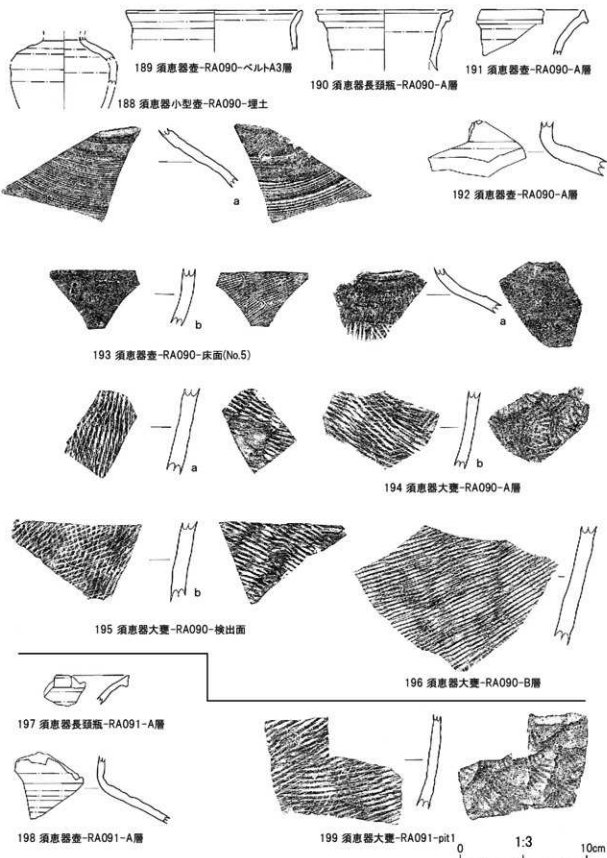

第88図 RA090出土土器(2), RA091出土土器

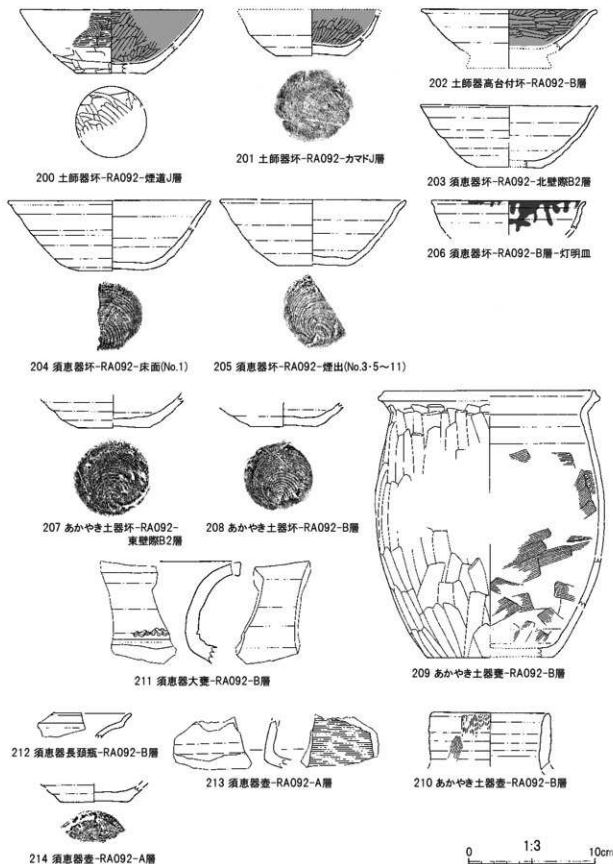

第89図 RA092出土土器(1)

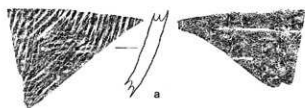

216 須恵器大甕-RA092-北壁際J層

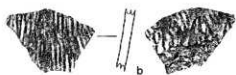

217 須恵器大甕-RA092-A層

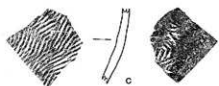

215 須恵器大甕-RA092-B層



218 須恵器壺-RA092-B層

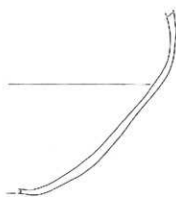
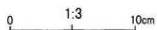

219 須恵器大甕-RA092-煙出(No.3-5~11)



第90図 RA092出土土器(2)

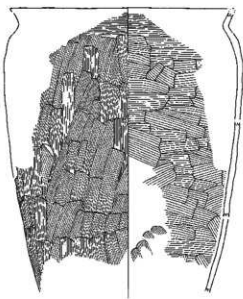

220 土師器甕-RA093-煙道(No.7)



221 土師器甕-RA095-煙出J層



222 土師器杯-RA095-B層



224 土師器高台付杯-RA095-B層



225 須恵器壺-RA095-SE区B層



226 須恵器壺-RA095-NE区L層



223 土師器杯-RA095-NE区B層



227 須恵器長頸瓶-RA095-MN区B層

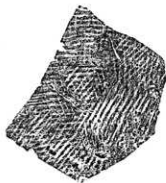

228 須恵器大甕-RA095-B層



第91図 RA093-095出土土器

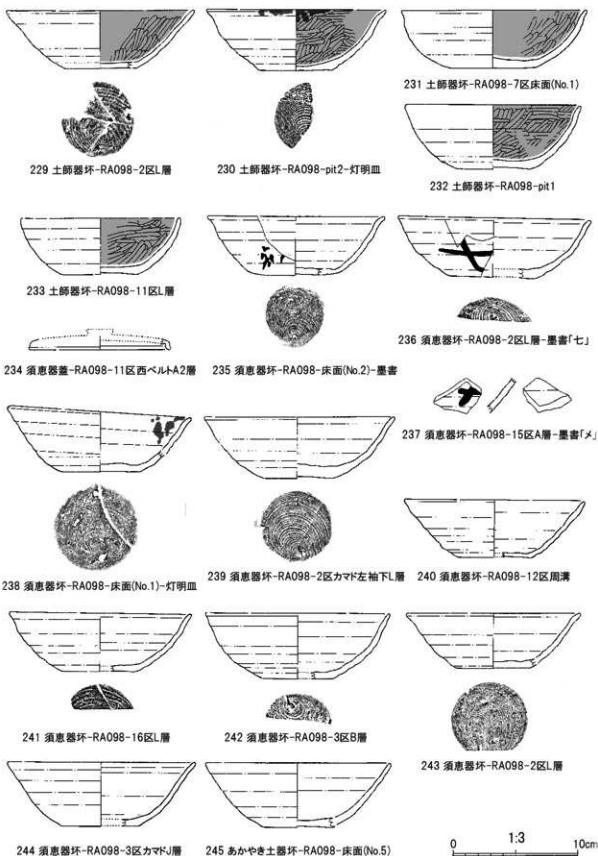

第92図 RA098出土土器(1)

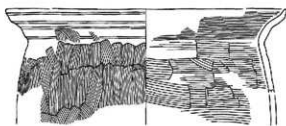

246 土師器甕-RA098-煙道J3層

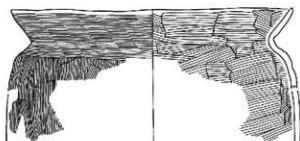

247 土師器甕-RA098-2区カマド左袖K層

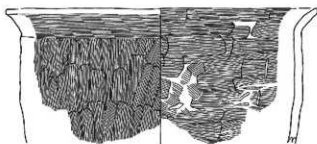

248 土師器甕-RA098-12区A層



249 土師器甕-RA098-14区周溝



254 土師器小型鉢-
RA098-pit5



255 土師器小型鉢-
RA098-1区B層

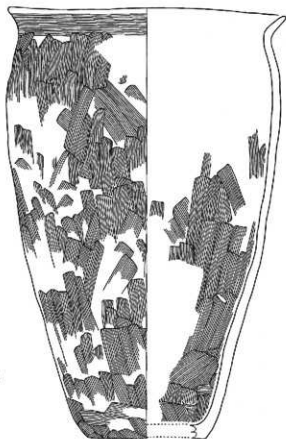

250 土師器甕-RA098-pit5

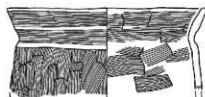

251 土師器甕-RA098-10区北ベルL層



252 土師器甕-RA098-2区B層

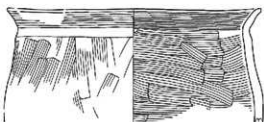

253 土師器甕-RA098-
床面(No.2)



第93図 RA098出土土器(2)

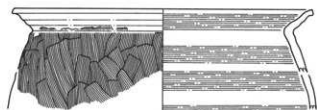

256 あかやき土器甕-RA098-2区周溝C層

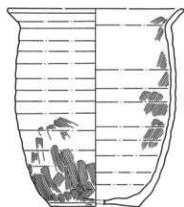

258 あかやき土器甕-RA098-pit7(No.5)



257 あかやき土器甕-RA098-1区周溝



260 あかやき土器長頸瓶-RA098-11区A層

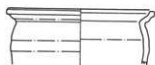

259 あかやき土器甕-RA098-pit1



261 須恵器長頸瓶-RA098-11区A層



262 須恵器長頸瓶-RA098-12区L層

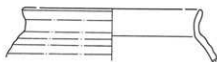

263 須恵器壺-RA098-5区L層

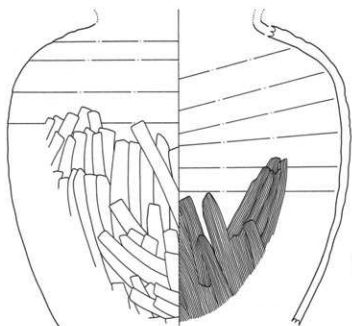

265 須恵器壺-RA098-床面(No.5)

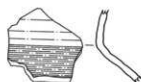

264 須恵器壺-RA098-12区A層

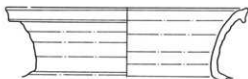

266 須恵器甕-RA098-11区A層最下部



第94図 RA098出土土器(3)



267 あかやき土器環-RA101-
カマド(No.1)

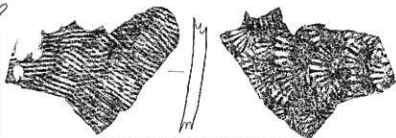

268 須恵器大甕-RA103-煙道J2層(No.2)



269 土師器環-RA104-A1層(No.1)



270 土師器環-RA104-カマド床面(No.2)

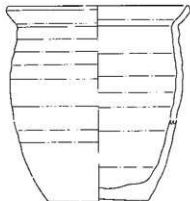

271 あかやき土器甕-RA104-SW区A2層

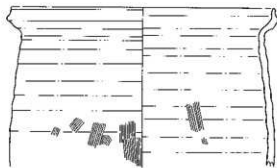

272 あかやき土器甕-RA104-NE区A2層



273 土師器甕-RA104-SW区A1層



274 須恵器大甕-RA105-SE区A1層



第95図 RA101・103・104・105出土土器



275 土師器 坏-R A152a-8区西ベルトA3層



277 土師器 坏-R A152a-10区西ベルトB層



278 土師器 高台付 坏-R A152a-東カマド 焼出 埋土 上層-灯明皿



276 土師器 坏-R A152a-15区西ベルトB層-灯明皿



279 須恵器 坏-R A152a-東カマド 焼道

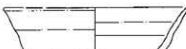

281 あかやき 土器 坏-R A152a-3区西ベルトL1層



282 あかやき 土器 坏-R A152a-1区A3層



280 須恵器 坏-R A152a-2区A1層



283 あかやき 土器 坏-R A152a-1区L層

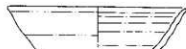

284 あかやき 土器 坏-R A152a-6区L層



285 あかやき 土器 坏-R A152a-7区L層



286 あかやき 土器 坏-R A152a-13区B層-墨書「寿」



288 あかやき 土器 小型 壺-R A152a-5区B層-赤彩



289 須恵器 長頸 瓶-R A152a-13区A2層



291 須恵器 甕-R A152a-16区L層



287 土師器 小型 壺-R A152a-3区L層



290 須恵器 長頸 瓶-R A152a-7区北ベルトA3層



292 須恵器 甕-R A152a-16区北ベルトB層

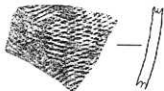

293 須恵器 大甕-R A152a-16区



第96図 RA152a出土土器



294 須恵器杯-RA152^{*}-6区西ベルL2層

295 あかやき土器杯-RA152^{*}-床面(No.30)

296 あかやき土器杯-RA152^{*}-床面(No.28)

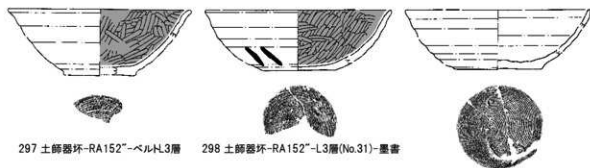

297 土師器杯-RA152^{*}-ベルL3層

298 土師器杯-RA152^{*}-L3層(No.31)-墨書

299 あかやき土器杯-RA152^{*}-L4層

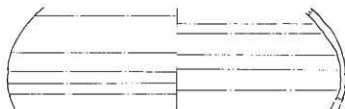

300 須恵器壺-RA152^{*}-L3層(No.31)



301 土師器杯-RA161-NW区L層

302 土師器杯-RA161-NE区床面

303 土師器杯-RA161-SE区A1層



304 土師器杯-RA161-SE区L層



306 土師器壺-RA161-SE区L層



305 土師器小型鉢-RA161-A3層(No.3)

0 1:3 10cm

307 土師器壺-RA161-床面(No.5)

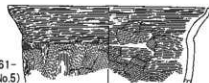

第97図 RA152^{*}・152^{*}・161出土土器

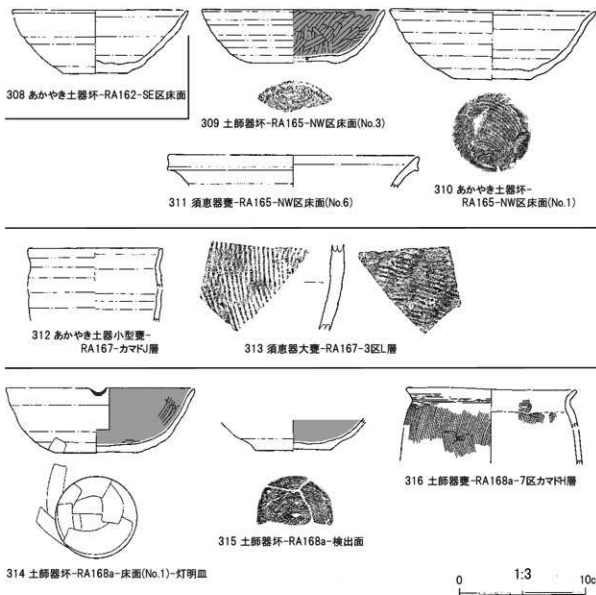

第98図 RA162・165・167・168a出土土器



317 あかやき土器高台付杯-RA171-NW区A3層



318 須恵器大甕-RA171-SW区A層



319 土師器杯-RA171-煙道(No.3)



323 土師器杯-RA171-貯蔵穴A4層



326 土師器杯-RA171-貯蔵穴A4層



320 土師器杯-RA171-貯蔵穴A4層

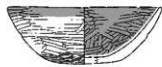

324 土師器杯-RA171-貯蔵穴A4層



327 土師器杯-RA171-pit1



321 土師器杯-RA171-貯蔵穴A4層

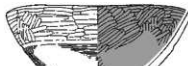

325 土師器杯-RA171-貯蔵穴A4層



328 土師器杯-RA171-貯蔵穴A4層

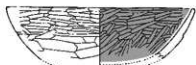

322 土師器杯-RA171-貯蔵穴A4層



329 土師器甕-RA171-床面(No.4)

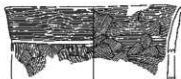

330 土師器甕-RA171-貯蔵穴埋土



331 土師器甕-RA171-SW区A3層



332 土師器甕-RA171-煙道

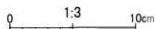

第99図 RA171出土土器

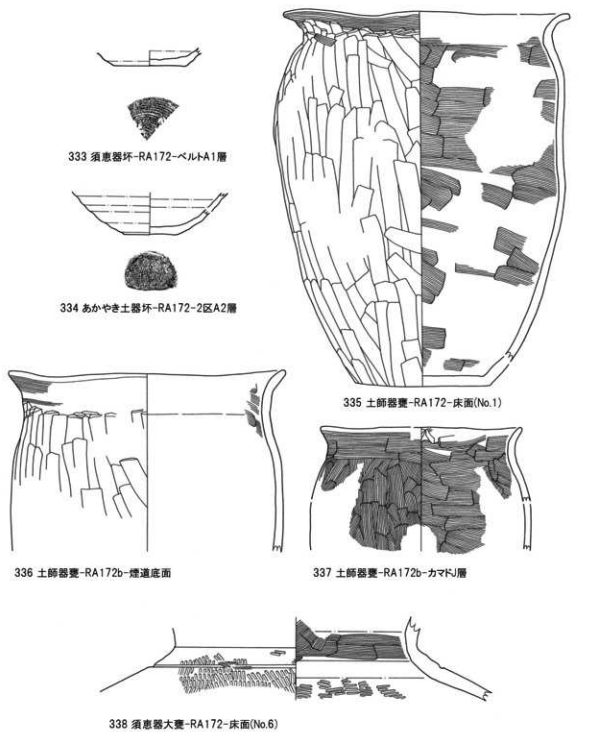

第100図 RA172出土土器

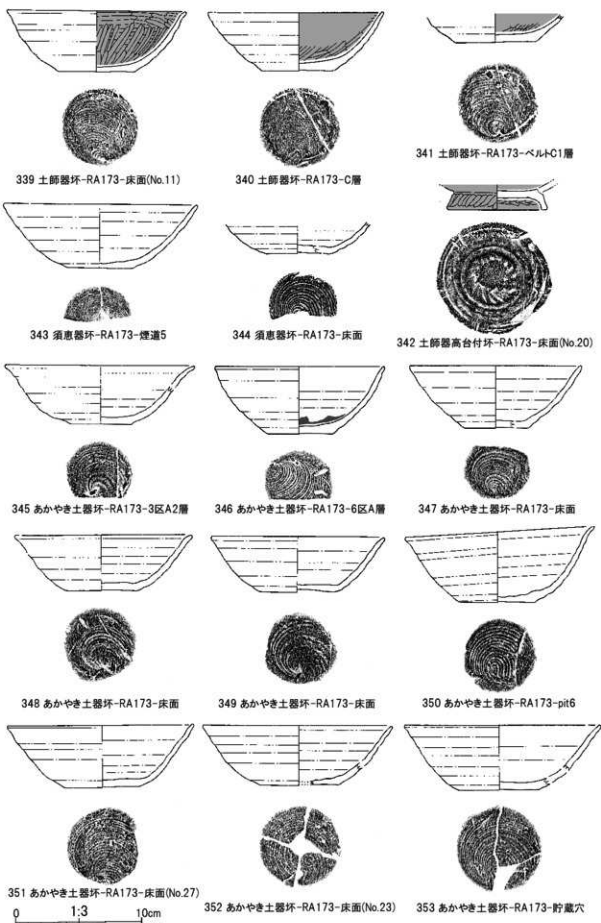

第101図 RA173出土土器(1)

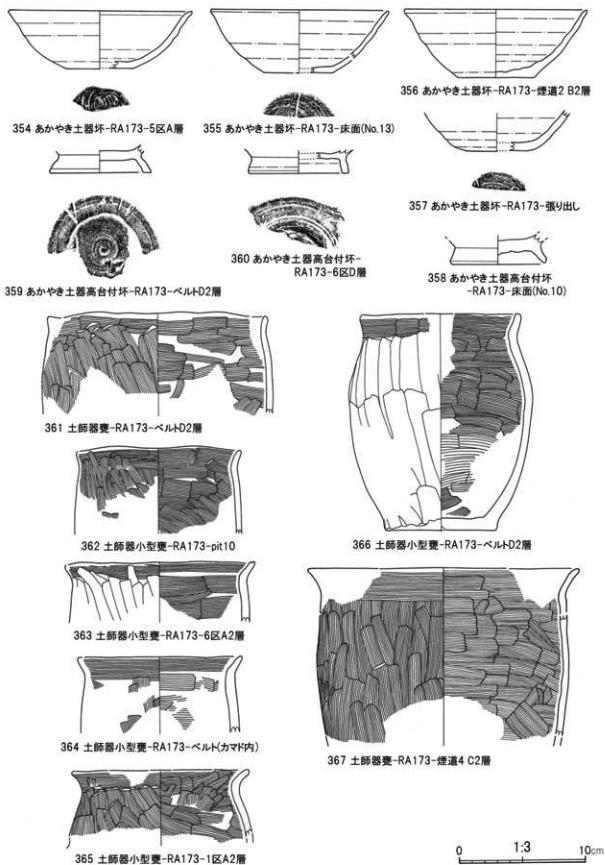

第102図 RA173出土土器(2)



368 土師器甕-RA173-床面(No.9)



369 土師器甕-RA173-5区A層

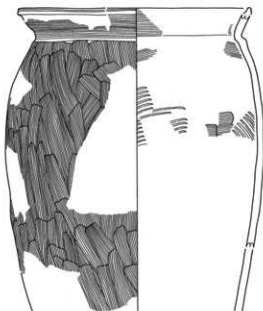

370 土師器甕-RA173-床面(No.4)

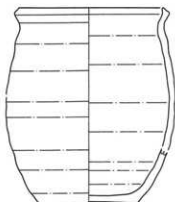

372 あかやき土器甕-
RA173-床面(No.26)

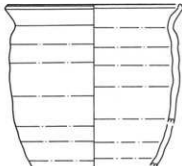

374 あかやき土器小型甕-
RA173-5区A層



371 あかやき土器甕-RA173-床面(No.21)

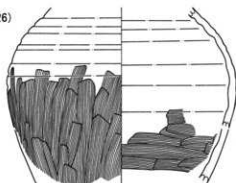

375 須恵器壺-RA173-床面(No.19)

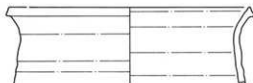

373 あかやき土器甕-RA173-ベルトD1層

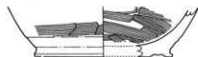

376 須恵器長頸瓶-RA173-4区A層



第103図 RA173出土土器(3)

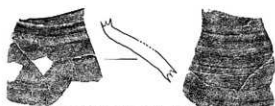

377 須惠器壺-RA173-2区A1層

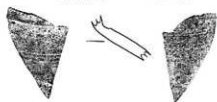

378 須惠器壺-RA173-5区A層

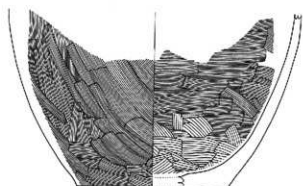

379 須惠器壺-RA173-5区A層

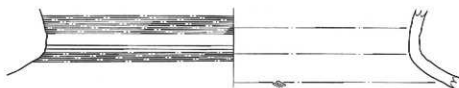

380 須惠器大甕-RA173-検出面



381 須惠器大甕-
RA173-5区A層



382 須惠器甕-RA173-貯蔵穴A1層



384 須惠器甕-RA173-床面(No.14)

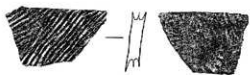

383 須惠器甕-RA173-2区A層

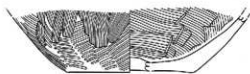

385 須惠器甕-RA173-床面(No.19)



386 須惠器大甕-RA173-床面(No.18)

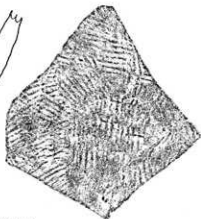

第104図 RA173出土土器(4)

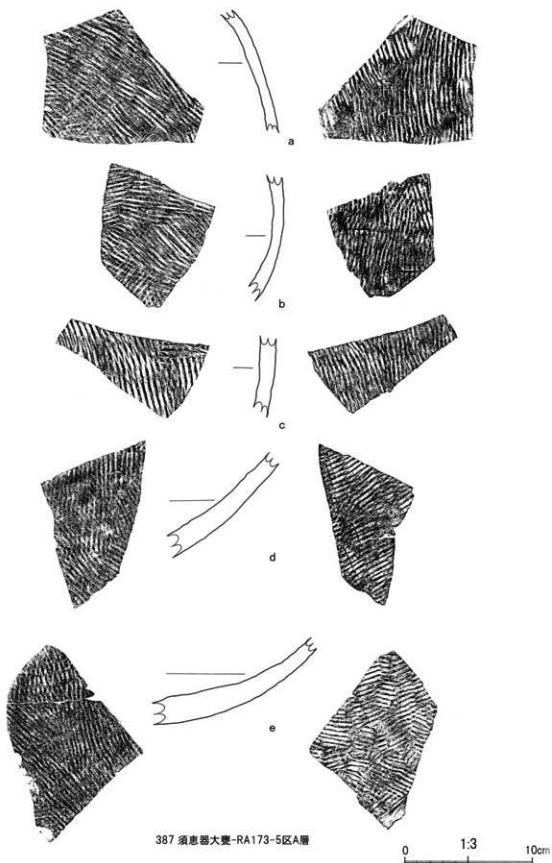

第105図 RA173出土土器(5)



388 須恵器大甕-RA173-2区A2層



389 須恵器大甕-RA173-2区A層

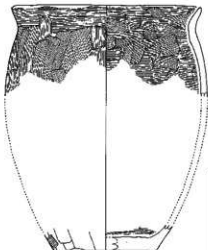

390 土師器甕-RA174-SE区検出面



391 土師器甕-RA174-煙道(No.1)



392 須恵器小型甕-
RA174-NW区L層



393 土師器甕-RA177-NE区A4層



394 須恵器坏-RA177-NE区A4層



396 須恵器長頸瓶-RA179-検出面

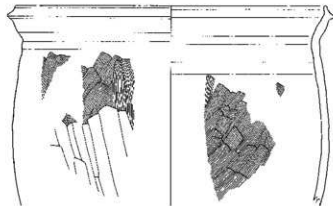

395 あかやき土器甕-RA177-検出面

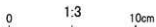

第106図 RA173出土土器(6), RA174-177-179出土土器

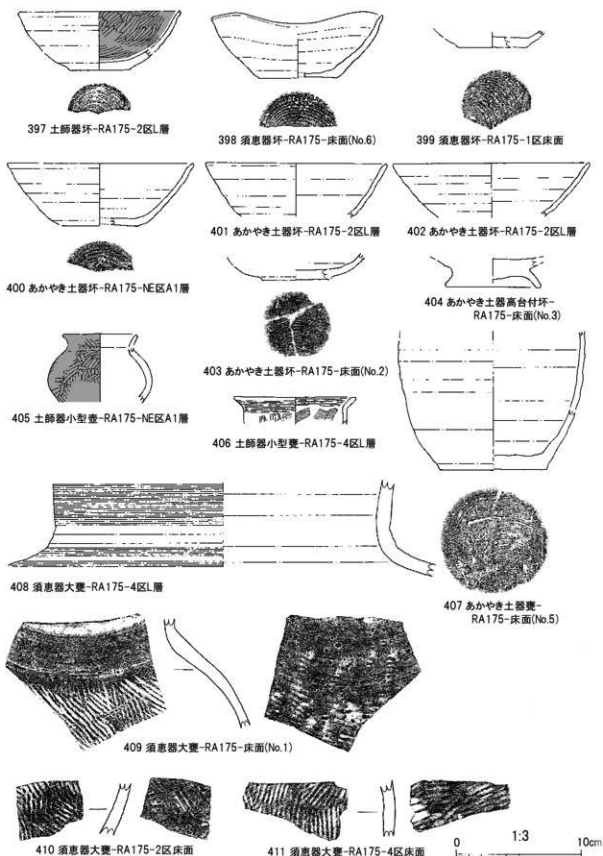

第107図 RA175出土土器(1)

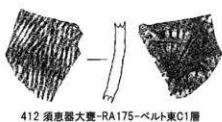

412 須恵器大甕-RA175-ベルト東C1層



414 須恵器大甕-RA175-SE区A1層



413 須恵器大甕-
RA175-SE区A1層



415 須恵器大甕-RA178-検出面

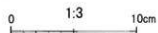

416 須恵器大甕-
RA178-検出面

第108図 RA175出土土器(2)・RA178出土土器

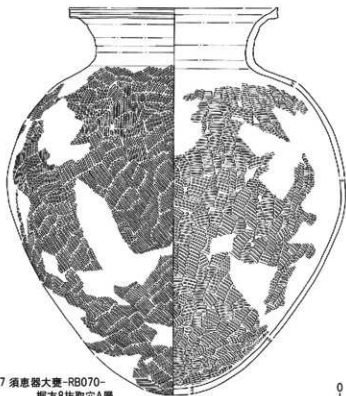

417 須恵器大甕-RB070-
掘方8採取穴A層

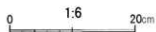

第109図 RB070出土土器(1)

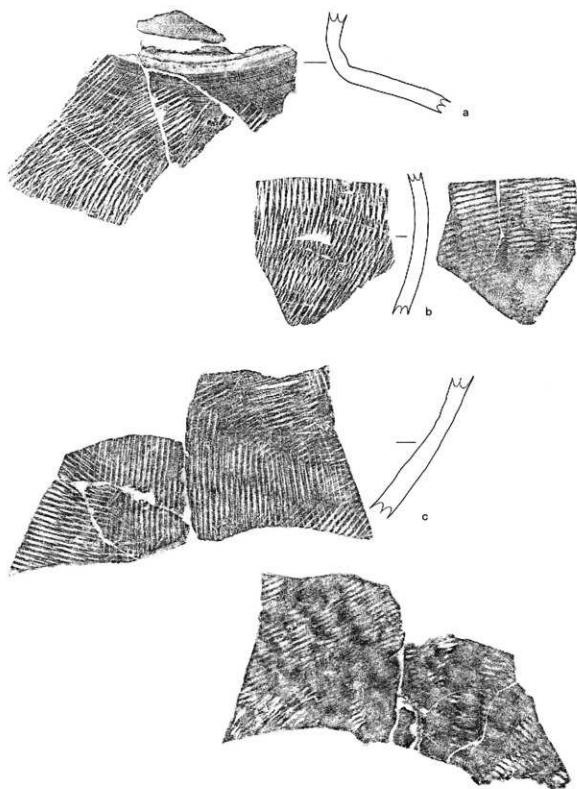

418 須恵器大甕-RB070-掘方8抜取穴A層



第110図 RB070出土土器(2)



419 須恵器壺-RB070-掘方4 C層

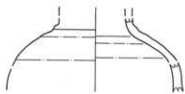

420 須恵器長頸瓶-RB070-掘方5柱痕跡

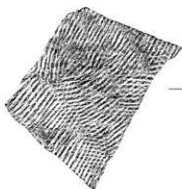

421 須恵器大甕-RB172-掘方5 B層

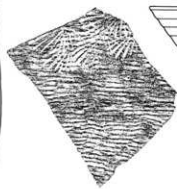

422 あかやき土器環-
RB173-掘方5 A1層



第111図 RB070出土土器(3), RB172-173出土土器

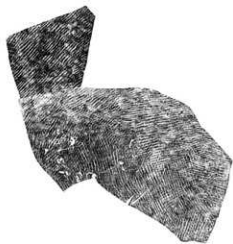

423 須恵器大甕-RD080-B層



第112図 RD080出土土器

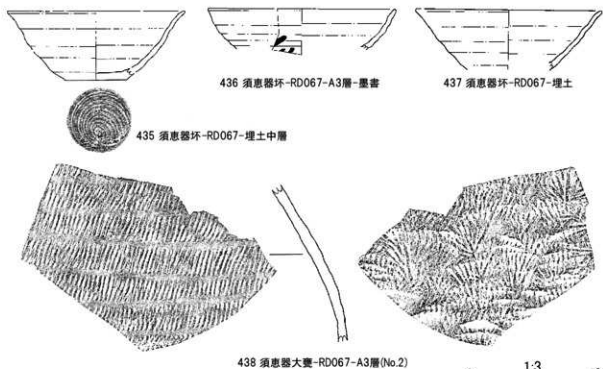
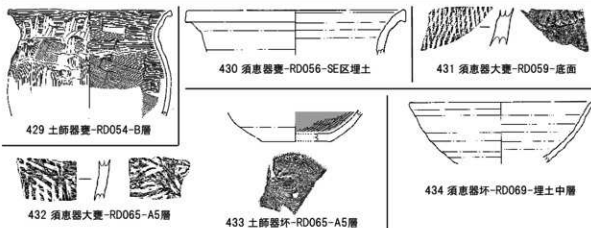

第113图 RD054-055-056-059-065-067-069出土土器

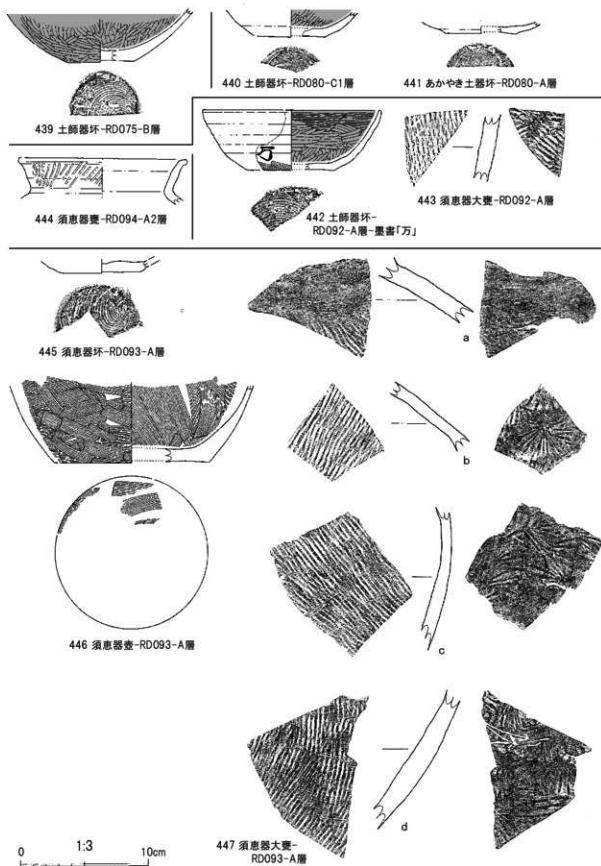

第114図 RD075-080-092-093-094出土土器

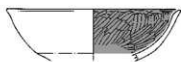

448 土師器环-RD098-A2層



449 土師器环-RD098-A2層

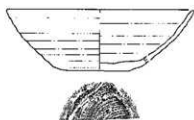

450 土師器环-RD098-A2層



a

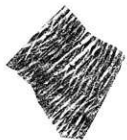

b



c



d

451 須恵器大甕-RD101-A1層

452 須恵器大甕-RD101-SW区埋土

454 須恵器环-RD111-埋土-墨書

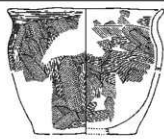

453 土師器小型甕-RD102-埋土

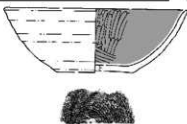

455 土師器环-RD116-A層



456 須恵器环-RD116-A層



第115図 RD098・101・102・111・116出土土器



458 須恵器坏-RD178-A1層

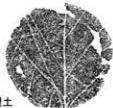
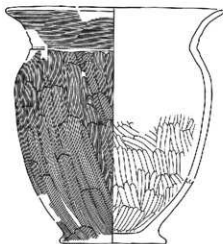

457 土師器甕-RD171-N区 埋土

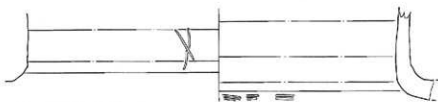

459 須恵器大甕-RD801-埋土



第116図 RD171-178-801出土土器



460 須恵器壺-RG051-埋土

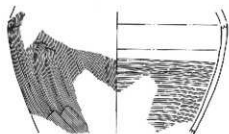

462 須恵器壺-RG068-A層



461 あかやき土器坏-RG059-埋土



第117図 RG051-059-068出土土器



463 土師器环-RG055-埋土



464 土師器环-RG055-A1層-墨書



465 須恵器环-RG055-埋土



466 須恵器大甕-RG055-検出面

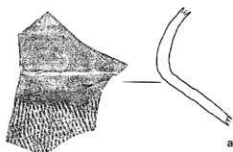

468 須恵器大甕-RG155-埋土

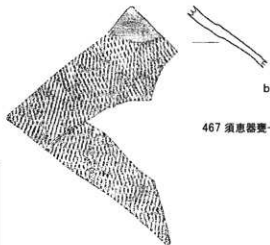

467 須恵器甕-RG055-A層

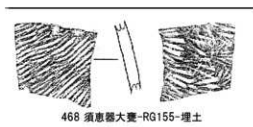

469 あかやき土器环-RG156-北辺西側埋土

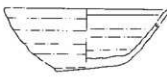

470 あかやき土器环-RG156-北辺中央埋土

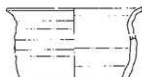

472 あかやき土器甕-RG156-北辺中央埋土



471 土師器环-RG156-北辺西側埋土

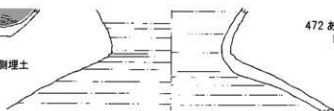

473 須恵器壺-RG156-ベル-A2層



第118図 RG055・155・156出土土器

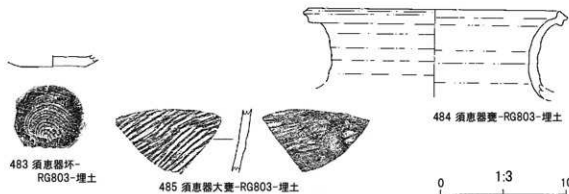
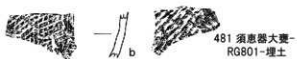
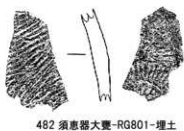
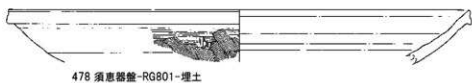
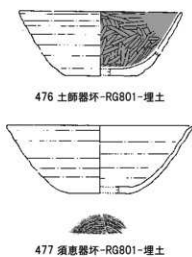

第119图 RG158-801-803出土土器

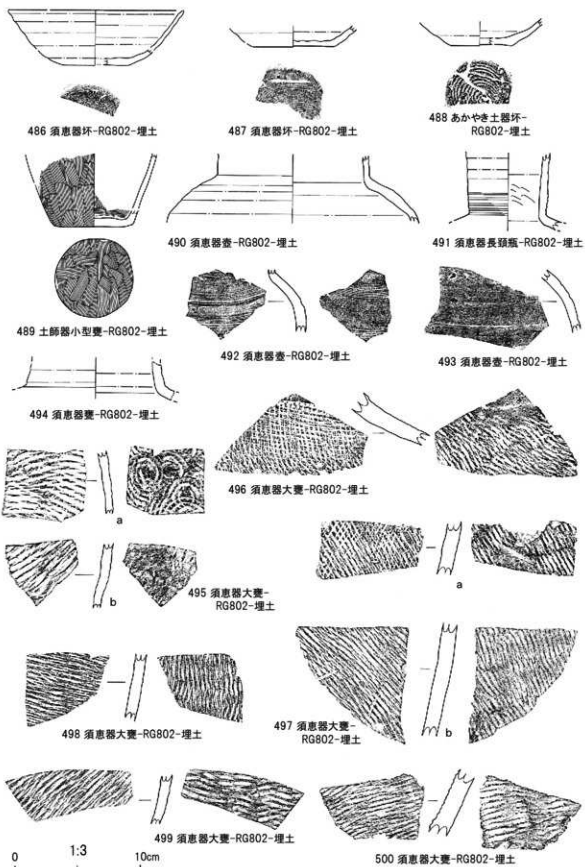

第120図 RG802出土土器

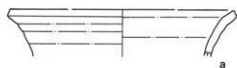
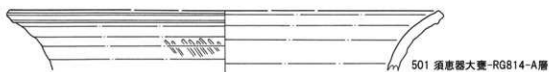

502 須惠器大甕-RG814-埋土

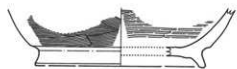

503 須惠器長頸瓶-RG814-埋土

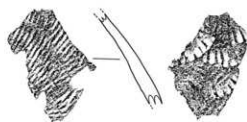
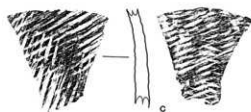
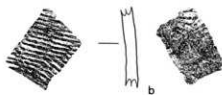

505 須惠器大甕-RG814-埋土



506 須惠器大甕-RG814-埋土



504 須惠器大甕-RG814-埋土

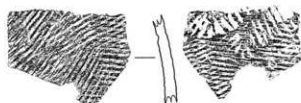

507 須惠器大甕-RG816-A層



第121図 RG814・816出土土器