

北斗市 館野2遺跡C地区

— 高規格幹線道路函館江差自動車道工事用地内埋蔵文化財発掘調査報告書 —

第3分冊
(遺構・包含層編)

平成25年度

公益財団法人 北海道埋蔵文化財センター

挿図目次

II章 遺構			
図II-451 CP-1~9	1	図II-502 CP-9・10の遺物	52
図II-452 CP-10~13	2	図II-503 CP-12・14(1)の遺物	53
図II-453 CP-14~20	3	図II-504 CP-14(2)・15・19・25の遺物	54
図II-454 CP-21~26	4	図II-505 CP-20・24・29・32の遺物	55
図II-455 CP-27~32	5	図II-506 CP-31・38・39の遺物	56
図II-456 CP-33~42	6	図II-507 CP-41・43~45・47・48の遺物	57
図II-457 CP-43~49	7	図II-508 CP-54~56・58・59の遺物	58
図II-458 CP-50~52・54~58	8	図II-509 CP-60の遺物	59
図II-459 CP-59~65	9	図II-510 CP-65の遺物	60
図II-460 CP-66~70・72	10	図II-511 CP-57・61~63・67(1)・68の遺物	61
図II-461 CP-71・73~76・78	11	図II-512 CP-67(2)・71・75・76の遺物	62
図II-462 CP-77・80・81	12	図II-513 CP-70の遺物	63
図II-463 CP-82~87	13	図II-514 CP-77・78の遺物	64
図II-464 CP-88・89・91・92	14	図II-515 CP-80・81・84・88の遺物	65
図II-465 CP-93~97	15	図II-516 CP-82・91~94の遺物	66
図II-466 CP-98~101	16	図II-517 CP-95・96の遺物	67
図II-467 CP-102~105	17	図II-518 CP-99・100・103~105・107~109の遺物	68
図II-468 CP-106~108	18	図II-519 CP-110・112・114の遺物	69
図II-469 CP-109~113	19	図II-520 CP-115・117~119・121・123の遺物	70
図II-470 CP-114~117・134	20	図II-521 CP-125の遺物	71
図II-471 CP-118~123	21	図II-522 CP-126の遺物	72
図II-472 CP-124~126	22	図II-523 CP-132の遺物	73
図II-473 CP-127~130・132	23	図II-524 CP-124・128・130・131・133~136・138・140・141・143・148の遺物	74
図II-474 CP-131・133・176	24	図II-525 CP-155の遺物	75
図II-475 CP-135・136・138~140	25	図II-526 CP-150・151・153~156・159の遺物	76
図II-476 CP-141~145	26	図II-527 CP-160・165・166・168・170の遺物	77
図II-477 CP-146~154	27	図II-528 CP-161~163の遺物	78
図II-478 CP-155~160	28	図II-529 CP-171(1)の遺物	79
図II-479 CP-161~163	29	図II-530 CP-171(2)の遺物	80
図II-480 CP-164~168	30	図II-531 CP-172の遺物	81
図II-481 CP-169~171	31	図II-532 CP-173・176~178・180・181・183の遺物	82
図II-482 CP-172・173・180	32	図II-533 CP-182の遺物	83
図II-483 CP-177~179・182~184	33	図II-534 CP-185の遺物	84
図II-484 CP-181・188・190	34	図II-535 CP-187・188・189(1)の遺物	85
図II-485 CP-185~187・191・192	35	図II-536 CP-189(2)の遺物	86
図II-486 CP-189・193・194	36	図II-537 CP-192~195・197・201~203の遺物	87
図II-487 CP-195~201	37	図II-538 CP-204~206・209・210・212・214・215の遺物	88
図II-488 CP-202~206	38	図II-539 CP-216~218・220の遺物	89
図II-489 CP-207・209~211・227	39	図II-540 CP-223・224・227・228・229・231の遺物	90
図II-490 CP-212~217	40	図II-541 CP-230の遺物	91
図II-491 CP-218~221・223	41	図II-542 CP-232(1)の遺物	92
図II-492 CP-224~226・228・229	42	図II-543 CP-232(2)・234・237・238・242・245・246・256の遺物	93
図II-493 CP-230~233	43	図II-544 CP-244の遺物	94
図II-494 CP-234~240	44	図II-545 CP-257・261・262・264の遺物	95
図II-495 CP-241・242・244~246	45	図II-546 CP-265~268・271~273の遺物	96
図II-496 CP-247~255	46	図II-547 CF-1~9	97
図II-497 CP-256~262	47	図II-548 CF-10~17	98
図II-498 CP-263・264・266・267	48		
図II-499 CP-265・268~270	49		
図II-500 CP-271~275	50		
図II-501 CP-3~6・8・10の遺物	51		

図Ⅱ-549	CF-18~27	99
図Ⅱ-550	CF-28~39	100
図Ⅱ-551	CF-40~46	101
図Ⅱ-552	CF-47~57	102
図Ⅱ-553	CF-58~69	103
図Ⅱ-554	CF-70~79	104
図Ⅱ-555	CF-80~89	105
図Ⅱ-556	CF-90~99	106
図Ⅱ-557	CF-100~109	107
図Ⅱ-558	CF-110~119	108
図Ⅱ-559	CF-120~128	109
図Ⅱ-560	CF-129~138	110
図Ⅱ-561	CF-139~147	111
図Ⅱ-562	CF-148~154・156~158	112
図Ⅱ-563	CF-159~162・CFC-1・2	113
図Ⅱ-564	CS-1~12	114
図Ⅱ-565	CSP-1~30	115
図Ⅱ-566	CSP-31~42	116
図Ⅱ-567	CSP-43~53・59・60	117
図Ⅱ-568	CSP-54~58・61~67	118
図Ⅱ-569	CSP-68~79	119
図Ⅱ-570	CF-2・3・5・13・14・16・18の遺物	120
図Ⅱ-571	CF-20~23・28・30・31の遺物	121
図Ⅱ-572	CF-41・44の遺物	122
図Ⅱ-573	CF-42・45・46・50・54・55・57の遺物	123
図Ⅱ-574	CF-58・63・64・68・69・71・73~75・77の遺物	124
図Ⅱ-575	CF-80~83・85・88・89の遺物	125
図Ⅱ-576	CF-91~95・101・103・106~108・111・115・117・118の遺物	126
図Ⅱ-577	CF-121・129・132・134・137・139・146の遺物	127
図Ⅱ-578	CF-141・142・144・145・149・150・152 CS-12の遺物	128
図Ⅱ-579	CF-156~158・162の遺物	129
図Ⅱ-580	CS-2・3・8~11 CSP-1・31の遺物	130

Ⅲ章 包含層の遺物

図Ⅲ-1-1	包含層の土器(1)	133
図Ⅲ-1-2	包含層の土器(2)	134
図Ⅲ-1-3	包含層の土器(3)	135
図Ⅲ-1-4	包含層の土器(4)	136
図Ⅲ-1-5	包含層の土器(5)	137
図Ⅲ-1-6	包含層の土器(6)	138
図Ⅲ-1-7	包含層の土器(7)	139
図Ⅲ-1-8	包含層の土器(8)	140
図Ⅲ-1-9	包含層の土器(9)	141
図Ⅲ-1-10	包含層の土器(10)	142
図Ⅲ-1-11	包含層の土器(11)	143
図Ⅲ-1-12	包含層の土器(12)	144
図Ⅲ-1-13	包含層の土器(13)	145
図Ⅲ-1-14	包含層の土器(14)	146
図Ⅲ-1-15	包含層の土器(15)	147
図Ⅲ-1-16	包含層の土器(16)	148

図Ⅲ-1-17	包含層の土器(17)	149
図Ⅲ-1-18	包含層の土器(18)	150
図Ⅲ-1-19	包含層の土器(19)	151
図Ⅲ-1-20	包含層の土器(20)	152
図Ⅲ-1-21	包含層の土器(21)	153
図Ⅲ-1-22	包含層の土器(22)	154
図Ⅲ-1-23	包含層の土器(23)	155
図Ⅲ-1-24	包含層の土器(24)	156
図Ⅲ-1-25	包含層の土器(25)	157
図Ⅲ-1-26	包含層の土器(26)	158
図Ⅲ-1-27	包含層の土器(27)	159
図Ⅲ-1-28	包含層の土器(28)	160
図Ⅲ-1-29	包含層の土器(29)	161
図Ⅲ-1-30	包含層の土器(30)	162
図Ⅲ-1-31	包含層の土器(31)	163
図Ⅲ-1-32	包含層の土器(32)	164
図Ⅲ-1-33	包含層の土器(33)	165
図Ⅲ-2-1	包含層の石器(1)	166
図Ⅲ-2-2	包含層の石器(2)	167
図Ⅲ-2-3	包含層の石器(3)	168
図Ⅲ-2-4	包含層の石器(4)	169
図Ⅲ-2-5	包含層の石器(5)	170
図Ⅲ-2-6	包含層の石器(6)	171
図Ⅲ-2-7	包含層の石器(7)	172
図Ⅲ-2-8	包含層の石器(8)	173
図Ⅲ-2-9	包含層の石器(9)	174
図Ⅲ-2-10	包含層の石器(10)	175
図Ⅲ-2-11	包含層の石器(11)	176
図Ⅲ-2-12	包含層の石器(12)	177
図Ⅲ-2-13	包含層の石器(13)	178
図Ⅲ-2-14	包含層の石器(14)	179
図Ⅲ-2-15	包含層の石器(15)	180
図Ⅲ-2-16	包含層の石器(16)	181
図Ⅲ-2-17	包含層の石器(17)	182
図Ⅲ-3-1	包含層の石製品(1)	183
図Ⅲ-3-2	包含層の石製品(2)	184
図Ⅲ-3-3	包含層の石製品(3)	185
図Ⅲ-3-4	包含層の土製品・古銭	186

図版目次

写真図版 I

- | | | | |
|---------|------------------------------|--|--|
| 図版 I-1 | 1 調査開始状況 | | |
| | 2 CH-1 遺物出土状況 | | |
| 図版 I-2 | 1 CH-2 遺物集中 | | |
| | 2 CH-2 床遺物出土状況 | | |
| 図版 I-3 | 1 CH-2 完掘 | | |
| | 2 CH-2 炉址(HF-1) | | |
| 図版 I-4 | 1 CH-4 遺物集中 | | |
| | 2 CH-4 覆土内生活面 | | |
| 図版 I-5 | 1 覆土内炉跡 | | |
| | 2 遺物集中の石棒ほか出土状況 | | |
| | 3 CP-11 完掘 | | |
| | 4 HF-1 炉跡 | | |
| | 5 CH-4 完掘 | | |
| 図版 I-6 | 1 CH-3 床検出状況とセクション | | |
| | 2 CH-3 HF-1・2 検出状況 | | |
| | 3 HP-1 セクション | | |
| | 4 HP-1 完掘 | | |
| 図版 I-7 | 1 CH-5 完掘 | | |
| | 2 CH-6 検出状況 | | |
| 図版 I-8 | 1 CH-7(H20 調査)完掘 | | |
| | 2 CH-8 完掘状況 | | |
| 図版 I-9 | 1 CH-9 完掘 | | |
| | 2 HP-2 セクション | | |
| 図版 I-10 | 1 CH-11(H19 調査)床面 | | |
| | 2 集石(右)とHF-2 検出状況 | | |
| | 3 HF-3(下位HP-1)セクションとHF-1(右) | | |
| | 4 HF-2 セクション | | |
| | 5 HP-1 完掘とHF-1(右) | | |
| 図版 I-11 | 1 CH-14(H20 調査) | | |
| | 2 CH-14(H19 調査) | | |
| 図版 I-12 | 1 CH-12 焼土と炭化材など出土状況 | | |
| | 2 CH-12 床面イモカ頭蓋出土状況 | | |
| 図版 I-13 | 1 CH-12 完掘 | | |
| | 2 床面石棒出土状況 | | |
| | 3 HF-1 検出状況 | | |
| 図版 I-14 | 1 CH-13(H20 調査) | | |
| | 2 CH-13(H19 調査) | | |
| 図版 I-15 | 1 CH-16 セクション | | |
| | 2 CH-16 床遺物出土状況 | | |
| 図版 I-16 | 1 CH-16 完掘 | | |
| | 2 HP-1 大礫出土状況 | | |
| | 3 床土器出土状況 | | |
| 図版 I-17 | 1 CH-15 床面検出状況 | | |
| | 2 HF-1 検出状況 | | |
| 図版 I-18 | 1 CH-17 床検出状況 | | |
| | 2 石囲い炉(HF-2) | | |
| | 3 HF-1とHP-37 セクション | | |
| | 4 HP-6 遺物出土状況 | | |
| 図版 I-19 | 1 CH-18 床検出状況 | | |
| | 2 HP-17 遺物出土状況 | | |
| | 3 床土器出土状況 | | |
| | 4 集石(HS-2)検出状況 | | |
| 図版 I-20 | 1 CH-19 床検出状況 | | |
| | 2 HF-1とCP-65 遺物出土状況 | | |
| 図版 I-21 | 1 CH-20 床検出状況 | | |
| | 2 HP-1・2 完掘 | | |
| | 3 床土器出土状況 | | |
| | 4 床土器出土状況 | | |
| | 5 床土器出土状況 | | |
| 図版 I-22 | 1 CH-21(手前)、CH-35(奥側)床遺物出土状況 | | |
| | 2 完掘 | | |
| | 3 CH-21 床土器出土状況 | | |
| | 4 CH-35HP-1 セクション | | |
| | 5 CH-35HP-1 完掘 | | |
| 図版 I-23 | 1 CH-23 完掘状況 | | |
| | 2 HP-1 遺物出土状況 | | |
| | 3 CH-24 完掘 | | |
| | 4 HP-3 セクション | | |
| | 5 集石(HS-4)検出状況 | | |
| 図版 I-24 | 1 CH-22 床遺物出土状況 | | |
| | 2 CH-22 セクション | | |
| 図版 I-25 | 1 CH-22 完掘 | | |
| | 2 HP-1 遺物出土状況 | | |
| | 3 HS-1 検出状況 | | |
| | 4 床土器出土状況 | | |
| | 5 石製品出土状況 | | |
| 図版 I-26 | 1 CH-25 床遺物出土状況 | | |
| | 2 CH-25 セクション | | |
| 図版 I-27 | 1 CH-25 完掘 | | |
| | 2 HP-1 遺物出土状況 | | |
| | 3 床土器出土状況 | | |
| | 4 床土製品出土状況 | | |
| 図版 I-28 | 1 CH-26 床遺物出土状況 | | |
| | 2 床土器出土状況 | | |
| | 3 床土器出土状況 | | |
| 図版 I-29 | 1 CH-26 完掘(奥手はCH-25) | | |
| | 2 床土器出土状況 | | |
| | 3 床土器出土状況 | | |
| 図版 I-30 | 1 CH-29 床検出状況 | | |
| | 2 CH-29 セクション | | |
| 図版 I-31 | 1 CH-29 完掘 | | |
| | 2 先端部のビット群 | | |
| | 3 HF-1 検出状況 | | |
| 図版 I-32 | 1 CH-30 遺物出土状況 | | |
| | 2 床土器出土状況 | | |
| | 3 床土器出土状況 | | |
| | 4 床土器出土状況 | | |
| | 5 床土器出土状況 | | |
| 図版 I-33 | 1 CH-30 完掘(奥手はCH-40) | | |
| | 2 HS-1 検出状況 | | |
| | 3 HP-1 セクションと遺物出土状況 | | |

図版 I-34	1 CH-31 床遺物出土状況	4 CH-46 床遺物出土状況
	2 土器出土状況	5 CH-46 炭化材・焼土
	3 シヤチ形土製品	図版 I-47
	4 土器出土状況	1 CH-47 床遺物出土状況
図版 I-35	1 CH-31 完掘	2 CH-47 HP-1と床の遺物出土状況
	2 HP-10 遺物とセクション	図版 I-48
	3 HP-10 盛土セクション	1 CH-48 完掘
	4 HP-9 セクション	2 CH-48HP-1と周辺の小ピット
	5 HP-9 遺物出土状況	3 HP-1 セクションと埋嚢
図版 I-36	1 CH-27 床検出状況	4 遺物出土状況
	2 HS-1 検出状況	図版 I-49
	3 HP-1 遺物出土状況	1 CH-49 完掘
	4 CH-28(壁穴中央が地溜りで分断されている)	2 CH-49 床検出状況
図版 I-37	1 CH-33 完掘	3 遺物出土状況
	2 CH-33 セクション	4 HP-2 セクション
	3 HP-1 覆土	5 HP-2 遺物出土状況
	4 土器出土状況	図版 I-50
	5 土器出土状況	1 CH-50 完掘
図版 I-38	1 CH-34 遺物出土状況	2 HP-1~3 ほか完掘
	2 土器出土状況	3 炭化材と焼土
	3 土器出土状況	4 HP-2と土器
	4 土器出土状況	5 床土器出土状況
	5 土器出土状況	図版 I-51
図版 I-39	1 CH-34 完掘	1 CH-52完掘
	2 土器出土状況	2 床土器出土状況
	3 床土器出土状況	3 床土器出土状況
	4 土器出土状況	4 床土器出土状況
	5 床土器出土状況	5 床土器出土状況
図版 I-40	1 CH-39 床遺物出土状況	図版 I-52
	2 床土器出土状況	1 CH-51(手前)・56(奥手)完掘
	3 床土器出土状況	2 床土器出土状況
	4 土器出土状況	3 床土器出土状況
	5 床土器出土状況	4 覆土中位土器出土状況
図版 I-41	1 CH-39 完掘	5 覆土土器出土状況
	2 床土器出土状況	図版 I-53
	3 HP-1 セクション	1 CH-51・56 床検出状況
	4 HP-1 完掘	2 HP-1 上面遺物出土状況
図版 I-42	1 CH-36 完掘	3 HP-1 完掘
	2 CH-38 完掘	4 床土器出土状況
図版 I-43	1 CH-40 床検出状況	5 床土器出土状況
	2 HP-1 セクション	図版 I-54
	3 CH-40内CP-92の炭化材と焼土	1 CH-53 床面検出状況
	4 CH-40 炭化材と焼土の検出状況	2 CH-53 遺物出土状況
図版 I-44	1 CH-41 完掘	図版 I-55
	2 CH-41 東西セクション	1 CH-54 完掘
	3 遺物出土状況	2 CH-54 床遺物出土状況
	4 HP-1 遺物出土状況	3 CH-54HP-1・2とHP-1
	5 HP-2 セクション	4 CH-54HP-1 セクション
図版 I-45	1 CH-43 完掘	5 CH-54HP-1・2 セクション
	2 CH-43 石製品出土状況	図版 I-56
	3 遺物出土状況	1 CH-57 完掘
	4 CH-43 セクションと遺物	2 CH-57 床遺物出土状況
	5 土器出土状況	図版 I-57
図版 I-46	1 CH-44 完掘	1 CH-58 完掘(中央・CH-57と重複)
	2 CH-45 完掘	2 CH-58 石棒出土状況
	3 CH-45 遺物出土状況	3 CH-58 床土器出土状況
		4 CH-59 焼土群セクション
		5 CH-59 遺物出土状況
		図版 I-58
		1 CH-60 床遺物出土状況
		2 CH-61 床検出状況
		3 CH-61 セクション
		図版 I-59
		1 CH-62 完掘
		2 HP-29とHP-2 検出状況
		3 HP-2とHP-29 検出状況
		4 CH-62 床検出状況

	5 CH-62 セクション		2 CH-85HP-1 セクション
図版 I-60	1 CH-63・65 完掘		3 HP-8 セクションと小竈 (HP-1 下位)
	2 CH-64 完掘	図版 I-74	1 CH-86 完掘
図版 I-61	1 CH-66 完掘		2 CH-86 床の炭化材と焼土
	2 CH-66 床遺物出土状況		3 CH-86 内の周溝
	3 CH-67・77・82 検出状況		4 CH-86 床土器出土状況
	4 CH-67 埋甕セクション		5 CH-86 床土器出土状況
	5 CH-67HP-3	図版 I-75	1 CH-86 床の遺物出土状況
図版 I-62	1 CH-68 完掘		2 CH-87 完掘
	2 HF-1 検出状況	図版 I-76	1 CH-88 完掘
	3 HF-2(埋甕)検出状況		2 CH-90 完掘
	4 床土器出土状況		3 CH-90HP-1(左)HP-10(右)埋設土器
	5 床土器出土状況	図版 I-77	1 CH-89 完掘
図版 I-63	1 CH-69 完掘		2 CH-89 床遺物出土状況
	2 HF-1 小竈出土状況		3 CH-89HP-4・5・18(上から)埋設土器
	3 HP-1 完掘	図版 I-78	1 CH-92 完掘
	4 HP-2, HF-1 完掘		2 CH-92HP-1(手前)、HP-1(奥)検出状況
	5 覆土1 炭化材出土状況	図版 I-79	1 CH-92 床遺物出土状況
図版 I-64	1 CH-70 床検出状況(奥手CH-70、手前CH-92)		2 CH-91 遺物出土状況
	2 CH-70 HP-2(先端ビット)とHF-1 検出状況	図版 I-80	1 CP-8 検出状況
			2 CP-9 大竈検出状況
図版 I-65	1 CH-71 床検出状況		3 CP-9 土器出土状況(大竈下位)
	2 CH-71 床遺物出土状況		4 CP-9 完掘
	3 HF-1と土器検出状況		5 CP-10 確認状況
	4 HF-1(中央)とHF-2(左)	図版 I-81	6 CP-10 セクション
	5 HP-46(HP-1 下位)セクション		1 CP-11 検出状況
図版 I-66	1 CH-73 東側床検出状況		2 CP-11 セクション
	2 CH-73 西側床遺物出土状況		3 CP-13(右)・14(中央)検出状況
	3 CH-77 完掘		4 CP-14 セクション
	4 CH-77 床遺物出土状況		5 CP-14 完掘
	5 CH-77 覆土遺物出土状況	図版 I-82	6 CP-13 セクション
図版 I-67	1 CH-74 完掘		1 CP-18(左)・21(右)完掘
	2 CH-74 床遺物出土状況		2 CP-19 完掘
	3 HF-3 付近の土器出土状況		3 CP-19 セクション
	4 HF-3(石圍い・竈)と旧炉跡		4 CP-26 完掘
	5 HP-44(旧炉址の下位)	図版 I-83	5 CP-26 セクション
図版 I-68	1 CH-75 完掘		1 CP-26~28・34・35 完掘
	2 CH-79 完掘		2 CP-20 遺物出土状況
図版 I-69	1 CH-78 完掘		3 CP-20 セクション
	2 CH-78 セクションと遺物出土状況		4 CP-32 完掘
図版 I-70	1 CH-82 完掘		5 CP-32 セクション
	2 CH-82 セクション	図版 I-84	1 CP-31 遺物出土状況(CH-6)
	3 CH-82 覆土遺物出土状況		2 CP-31 セクション(CH-6)
	4 CH-83 覆土の遺物		3 CP-36 完掘
	5 CH-83HP-16 埋設土器		4 CP-36 セクション
図版 I-71	1 CH-83 床面検出状況		5 CP-38 完掘
	2 CH-83 炭化材と焼土粒検出状況	図版 I-85	6 CP-38 セクション
図版 I-72	1 CH-84 床検出状況		1 CP-54 完掘
	2 CH-84 遺物出土状況		2 CP-54 セクション
	3 CH-84 大竈群出土状況		3 CP-55 検出状況
	4 HP-52 埋設土器		4 CP-55 セクション
	5 HF-1(右)とHF-2(左)		5 CP-55 竈底の遺物出土状況
図版 I-73	1 CH-85 完掘	図版 I-86	6 CP-55 完掘
			1 CP-43 ほか完掘

	2	CP-43 セクション		2	CP-130 完掘
	3	CP-59 遺物出土状況		3	CP-131 セクション
	4	CP-60 遺物出土状況		4	CP-131 完掘
	5	CP-64 完掘		5	CP-134 セクション
	6	CP-64 セクション		6	CP-134 完掘
図版 I-87	1	CP-65 セクション	図版 I-96	1	CP-136 完掘
	2	CP-65 完掘		2	HP-1 セクション
	3	CP-67 遺物出土状況		3	CP-154(左)・155(右)完掘
	4	CP-67 完掘		4	CP-154 セクション
	5	CP-68 セクション		5	CP-155 セクション
	6	CP-68 完掘	図版 I-97	1	CP-159 セクション
図版 I-88	1	CP-70 ブラシ検出状況		2	CP-159 遺物出土状況
	2	CP-70 セクション		3	CP-160 セクション
	3	CP-70 完掘		4	CP-160 遺物出土状況
	4	CP-82 検出状況		5	CP-162 セクション
	5	CP-82 セクション		6	CP-162 完掘
	6	CP-82 完掘	図版 I-98	1	CP-163 セクション
図版 I-89	1	CP-77 完掘		2	CP-163 遺物出土状況
	2	CP-77 内梯子痕?		3	CP-165 セクション
	3	CP-77 遺物出土状況		4	CP-165 完掘
	4	CP-77 セクション		5	CP-166 完掘
	5	CP-87 遺物出土状況	図版 I-99	1	CP-171 完掘
	6	CP-87 セクション		2	CP-171 遺物出土状況
図版 I-90	1	CP-88・89(CH-20・42 内) 完掘		3	CP-176 セクション
	2	CP-92(CH-38 内) 焼土と遺物		4	CP-176 遺物出土状況
	3	CP-94 完掘		5	CP-181 セクション
	4	CP-94 セクション		6	CP-181 完掘
	5	CP-95 完掘	図版 I-100	1	CP-185の上位で検出された罐集中
	6	CP-95 セクション		2	CP-185 セクション
図版 I-91	1	CP-96 遺物出土状況(CH-33 内)		3	CP-185 完掘
	2	CP-96 完掘(CH-33 内)	図版 I-101	1	CP-188 焼土と遺物の検出状況
	3	CP-101 遺物出土状況		2	CP-185 セクション
	4	CP-101 完掘		3	CP-188 完掘
	5	CP-102 検出状況	図版 I-102	1	CP-189 確認面
	6	CP-102 遺物出土状況		2	CP-189 遺物出土状況
図版 I-92	1	CP-105 セクション		3	CP-189(上位)完掘
	2	CP-105 完掘		4	CP-207(下位)完掘
	3	CP-107 遺物出土状況		5	CP-191 セクション
	4	CP-107 完掘		6	CP-191 完掘
	5	CP-108 セクション	図版 I-103	1	CP-193 セクション
	6	CP-108 完掘		2	CP-193 完掘
図版 I-93	1	CP-109 完掘		3	CP-201 セクション
	2	CP-110 遺物出土状況		4	CP-201 完掘
	3	CP-114 セクション		5	CP-202 セクション
	4	CP-114・134 完掘		6	CP-202 セクション
	5	CP-118 セクション	図版 I-104	1	CP-205 セクション
	6	CP-118 完掘		2	CP-205 完掘
図版 I-94	1	CP-125 セクション		3	CP-206 遺物出土状況
	2	CP-125 遺物出土状況		4	CP-135(下位にCP-206)
	3	CP-126 埋設土器出土状況		5	CP-206 セクション
	4	CP-126 完掘		6	CP-206 完掘
	5	CP-127・129 セクション	図版 I-105	1	CP-212 完掘
	6	CP-127・129 完掘		2	CP-216 完掘
図版 I-95	1	CP-130 セクション		3	CP-230 セクション

	4	CP-230 完掘		5	包含層土製品出土状況
	5	CP-231 セクション		6	包含層永楽通宝出土状況
	6	CP-231 完掘	図版 I-115	1	柱穴状小ピット群検出状況
図版 I-106	1	CP-232 セクション		2	基本土層(J-73~74ライン)
	2	CP-232 完掘	図版 I-116	1	平成19年度 完掘
	3	CP-237 完掘		2	平成20年度 完掘
	4	CP-238 完掘			
	5	CP-244 セクション			
	6	CP-244 完掘			
図版 I-107	1	CP-256 セクション			
	2	CP-256 完掘			
	3	CP-263 セクション			
	4	CP-263 完掘			
	5	CP-264 セクション			
	6	CP-264 完掘			
図版 I-108	1	CP-265 セクション			
	2	CP-265 完掘			
	3	CP-270 セクション			
	4	CP-270 完掘			
	5	CP-268(右)・271(左)完掘			
	6	CP-272 完掘			
図版 I-109	1	CF-17・18(手前) 検出状況			
	2	CF-21(GH-4 覆土内) 検出状況			
	3	CF-19(GH-2 覆土2層) 検出状況			
	4	CF-19 セクション			
	5	CF-25(CP-14 上位) 検出状況			
	6	CF-41 検出状況			
図版 I-110	1	CF-36 検出状況			
	2	CF-36 セクション			
	3	CF-63 検出状況			
	4	CF-74 検出状況			
	5	CF-71 検出状況			
	6	CF-71 セクション			
図版 I-111	1	CF-77 検出状況			
	2	CF-95 セクション			
	3	CF-89 検出状況			
	4	CF-89 セクション			
	5	CF-125 セクション			
	6	CF-127とCS-6 検出状況			
図版 I-112	1	CF-131(右)とCS-8(左)			
	2	CF-132 検出状況			
	3	CF-146 遺物出土状況			
	4	CF-152(CH-92内) 検出状況			
	5	CF-152 セクション			
	6	CF-161 検出状況			
図版 I-113	1	CF-156(手前)・157(奥手) 検出状況			
	2	CFC-1 検出状況			
	3	CFC-2 検出状況			
	4	CS-4 検出状況			
	5	CS-7 検出状況			
図版 I-114	1	CS-9 検出状況			
	2	CS-11 検出状況			
	3	包含層土偶出土状況			
	4	包含層大珠出土状況			

II 章 遺構

2 土塋 (CP)

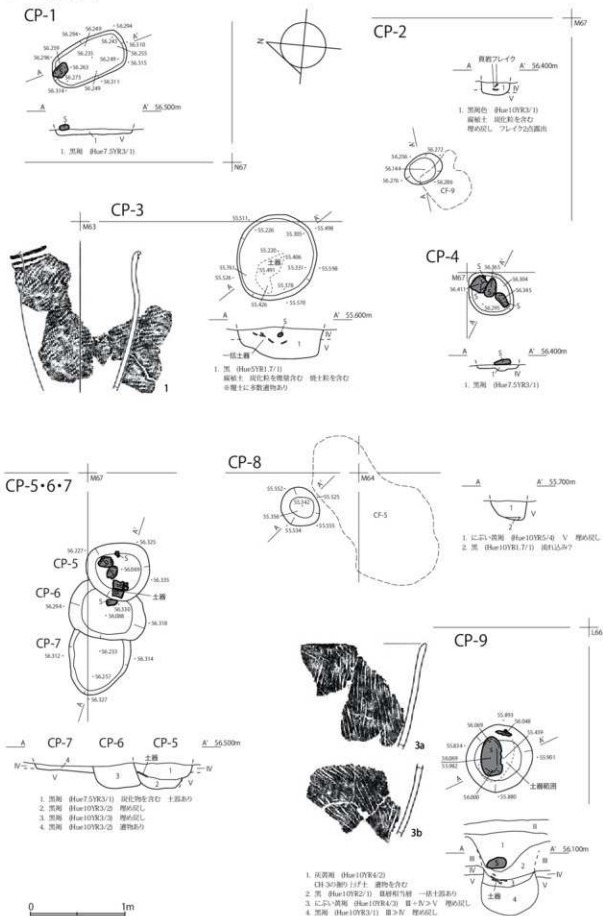

図II-451 CP-1~9



図 II-452 CP-10~13

CP-14・15



CP-15 CP-14

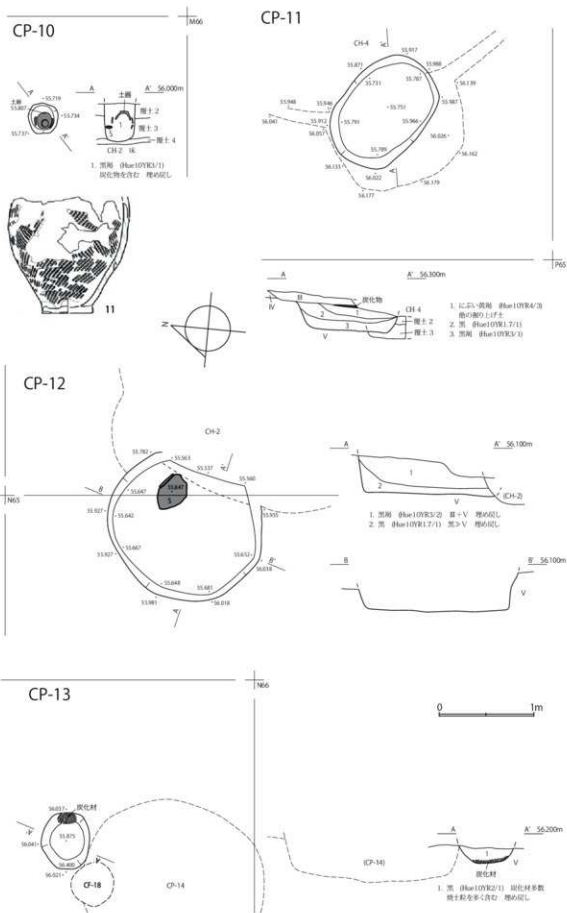
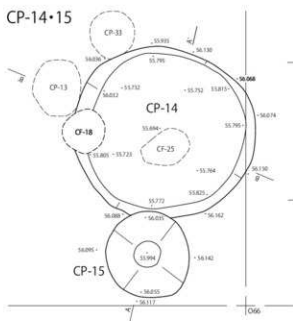

1. 基層 (Hae7.5YR3/1) 礫化粘土層を含む 壁>V
2. 北土間 (Hae10YR5/4) V ローム
3. 基層 (Hae10YR3/4) 大粒の礫化粘土層を含む 壁の底辺
4. 基 (Hae7.5YR4/6) 粘土

CP-14



CP-16

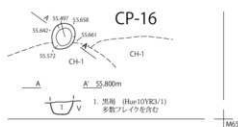

1. 基層 (Hae10YR3/1) 多量のシルトを含む

CP-17

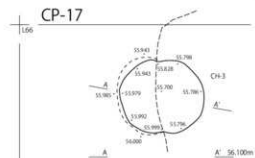

1. 基層 (Hae10YR3/2) 壁+V 礫のシルト
2. 基 (Hae10YR1.7/1) 礫の底辺

CP-18

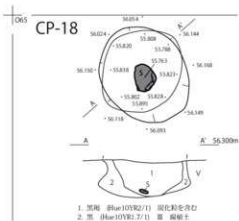

1. 基層 (Hae10YR2/1) 礫化粘土を含む
2. 基 (Hae10YR1.7/1) 礫層粘土

CP-19

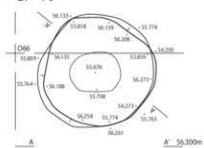

1. 基 (Hae7.5YR1.7/1) 礫の底辺の礫物を含む
2. 基層 (Hae10YR3/2) 壁>V
3. 基層 (Hae10YR2/2) 壁>V
4. 瓦葺層 (Hae10YR4/2) V ローム層底 フラズコの前縁のローム

CP-20

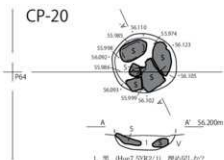

1. 基 (Hae7.5YR2/1) 礫の底辺の?

図II-453 CP-14~20



図 II-454 CP-21~26

CP-27



CP-28

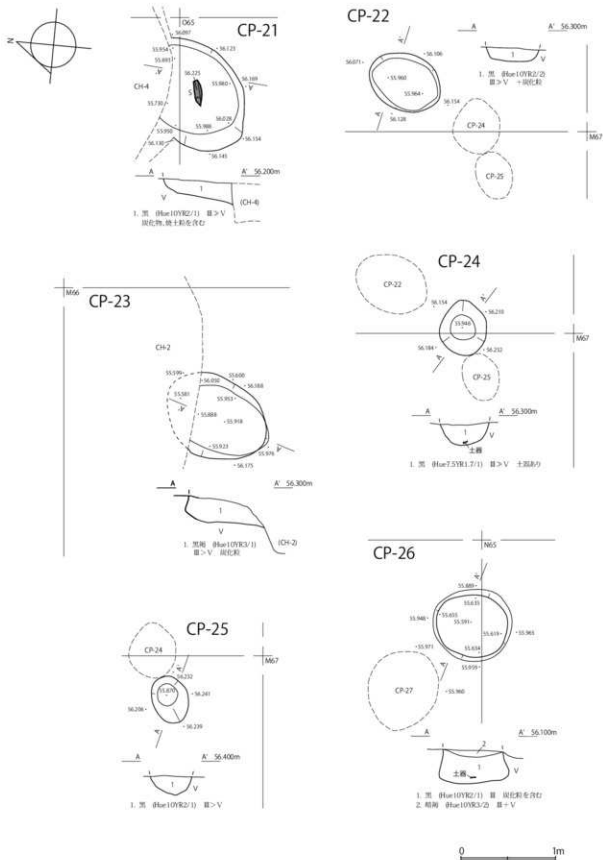
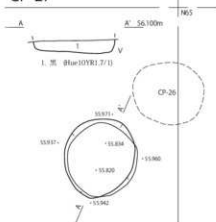
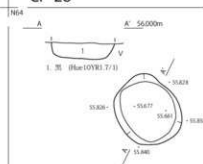

CP-29

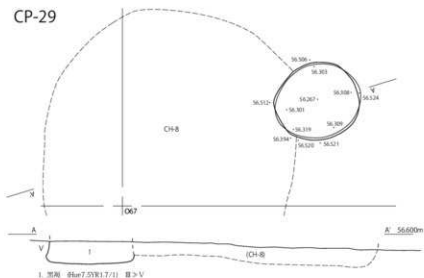

CP-30

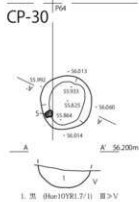

CP-31

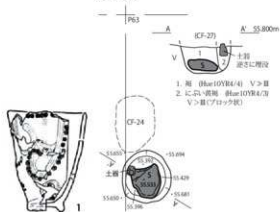

CP-32

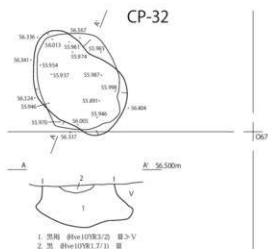

図II-455 CP-27~32



図 II-457 CP-43~49



図 II-458 CP-50~52・54~58

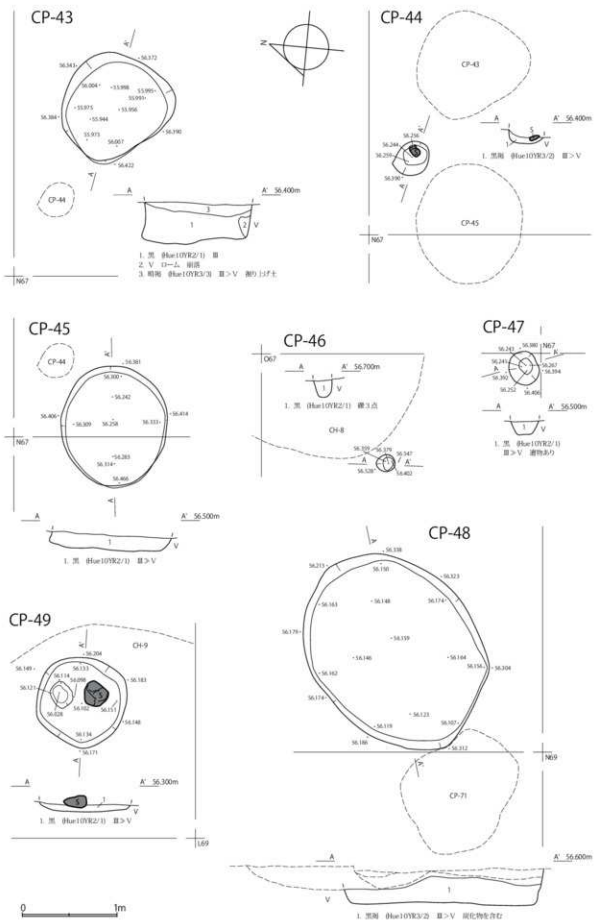

図II-459 CP-59~65

CP-66

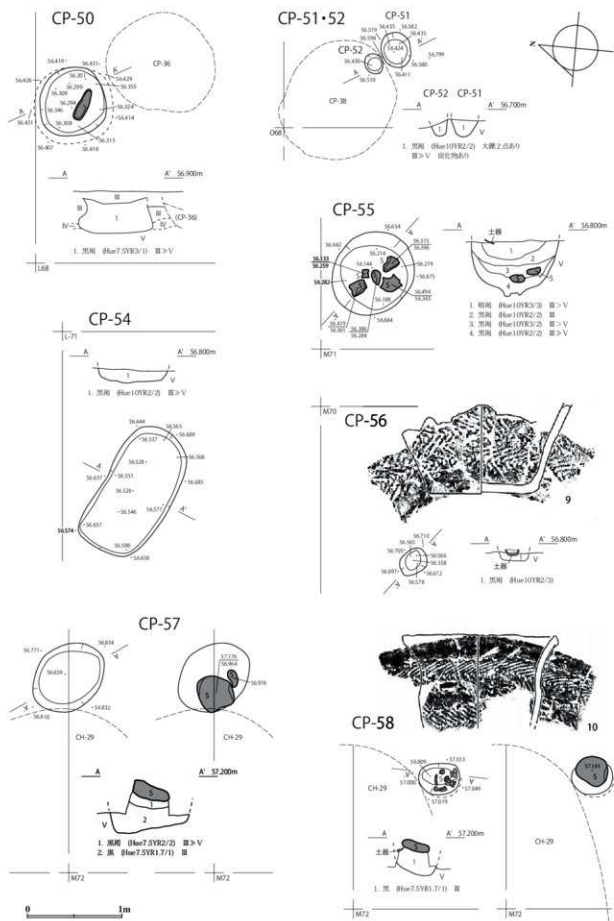
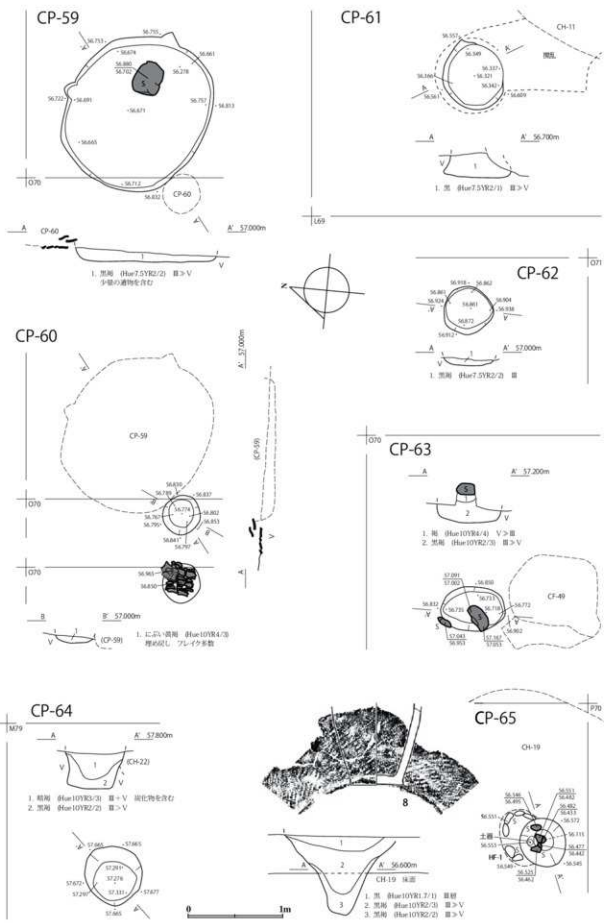
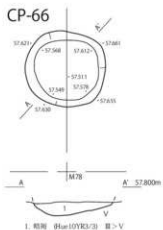

CP-67

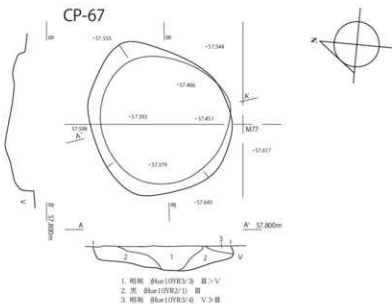

CP-68・72

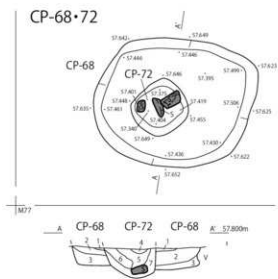

CP-69

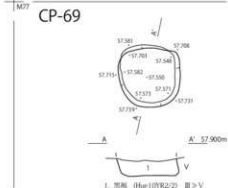

CP-70

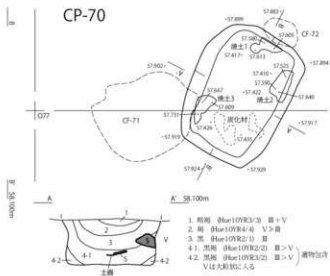

0 1m

図Ⅱ-460 CP-66～70・72



図 II-461 CP-71・73~76・78



図Ⅱ-462 CP-77・80・81

CP-82

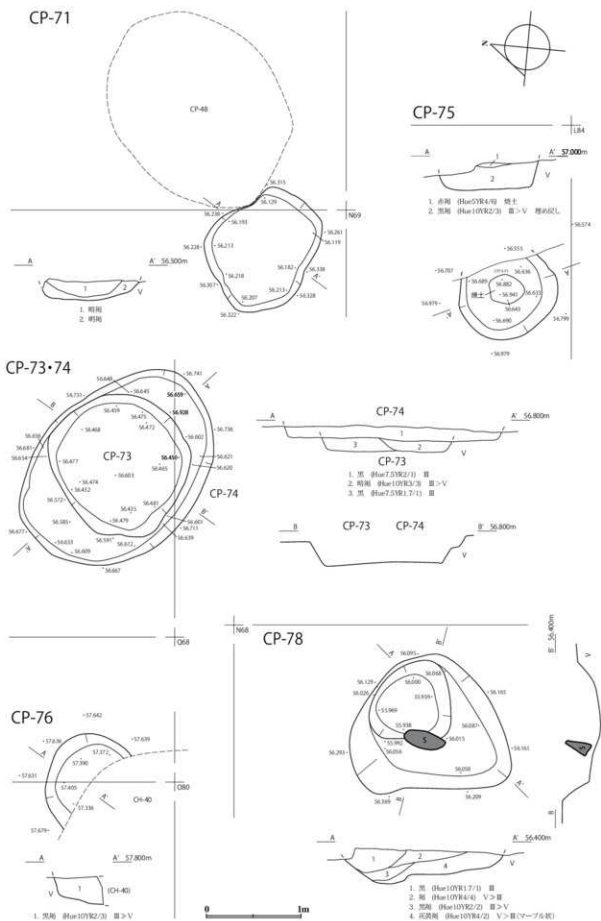
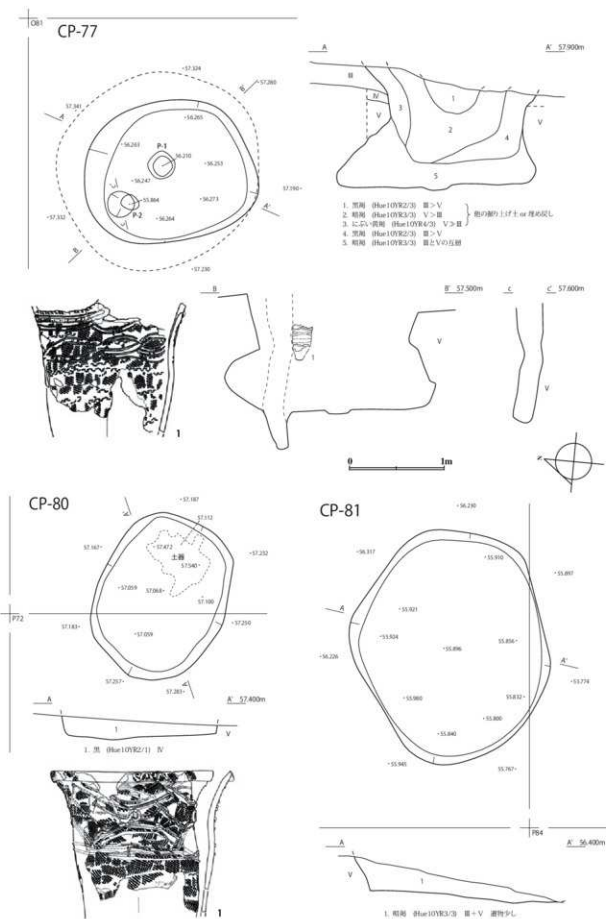
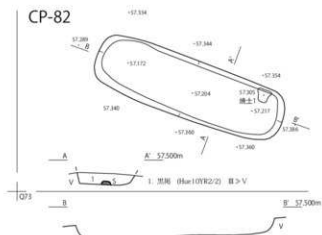

CP-83



CP-84

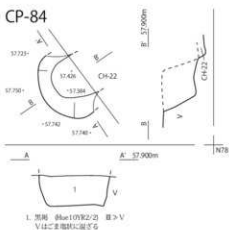

CP-85

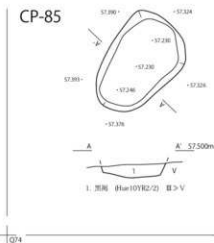

CP-86

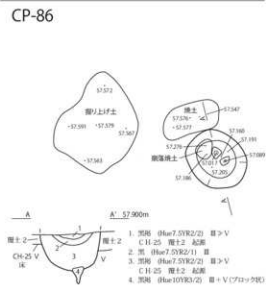

CP-87

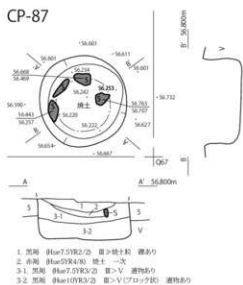

0 1m

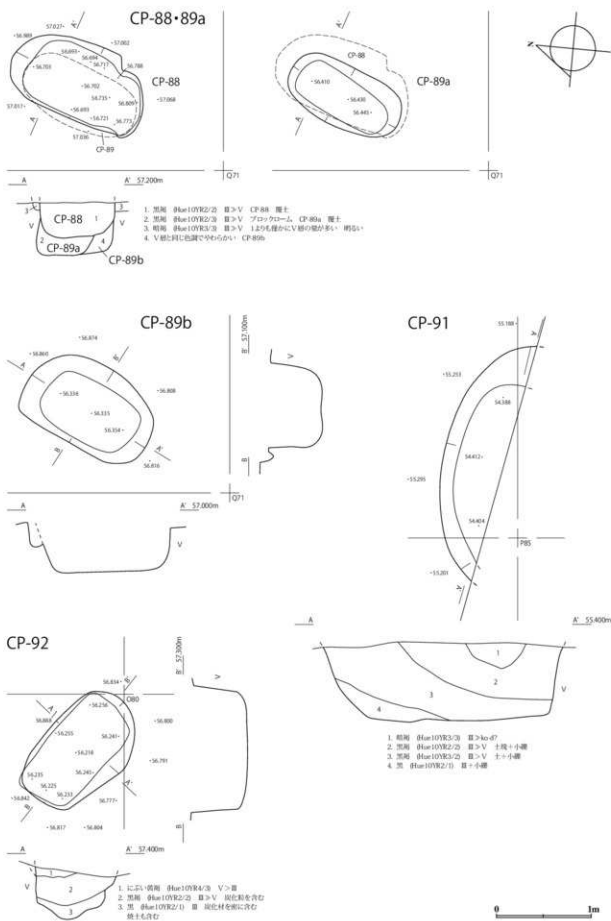

図Ⅱ-464 CP-88・89・91・92



図 II-465 CP-93~97

CP-98



CP-99

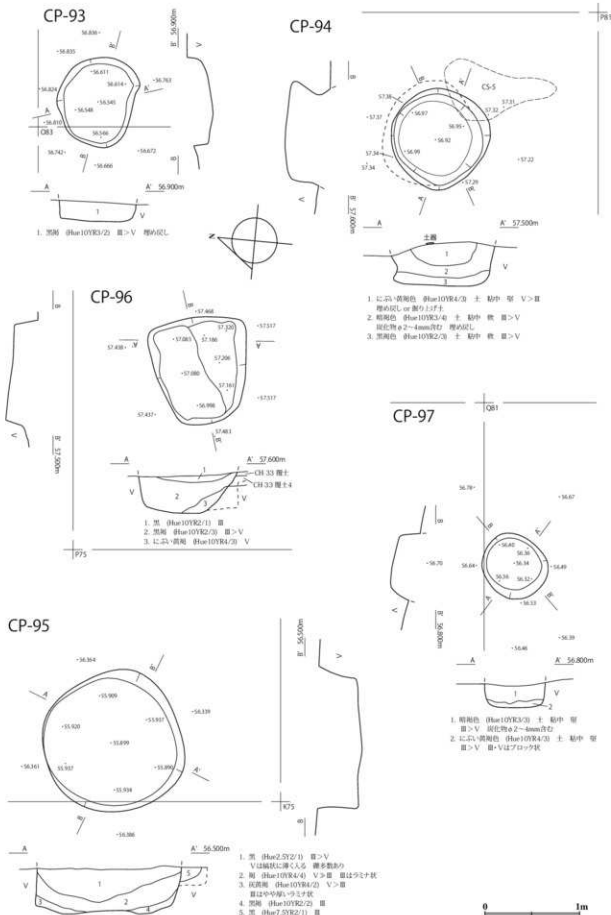
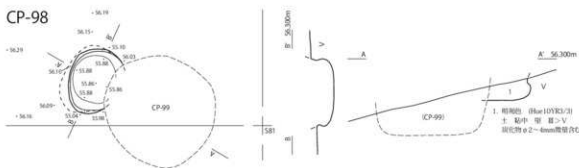
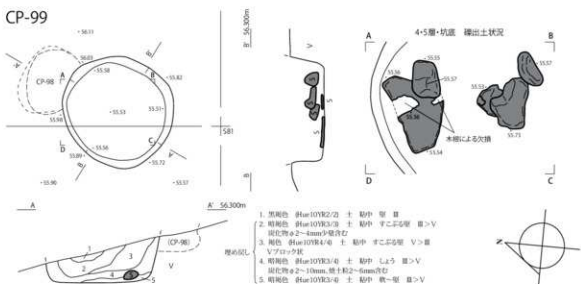

CP-100

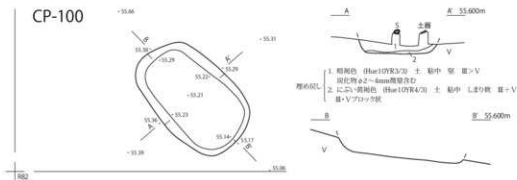

CP-101

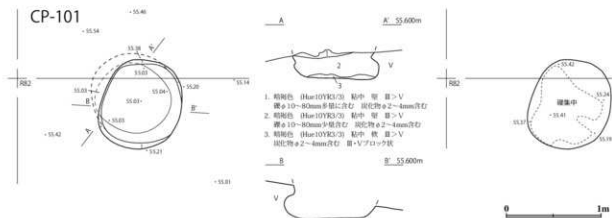

図II-466 CP-98~101

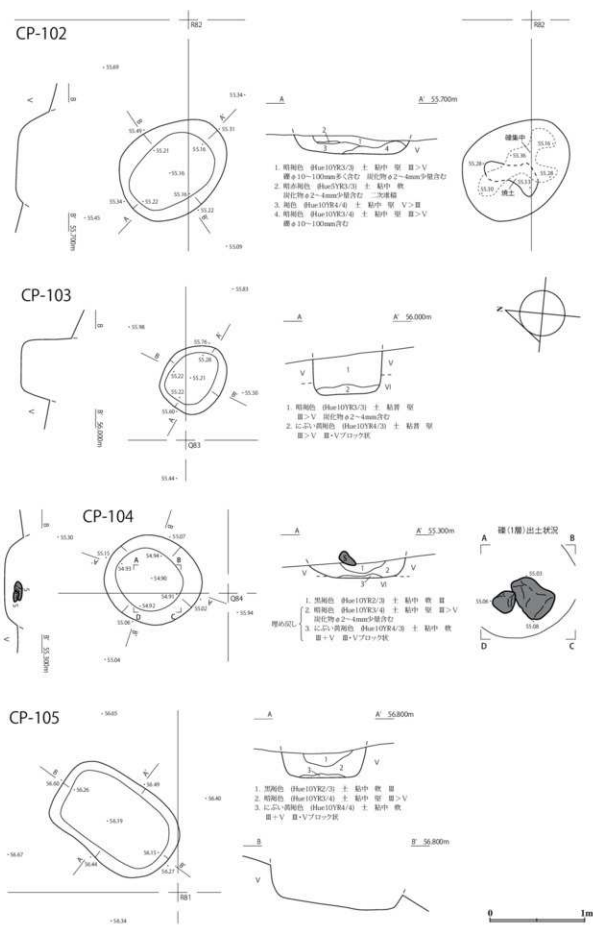

図II-467 CP-102~105

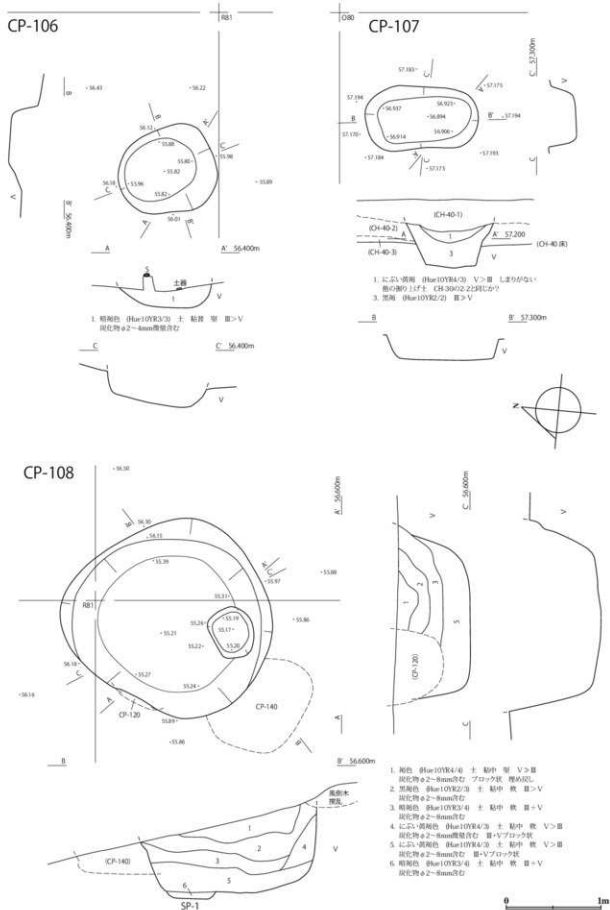

図Ⅱ-468 CP-106~108

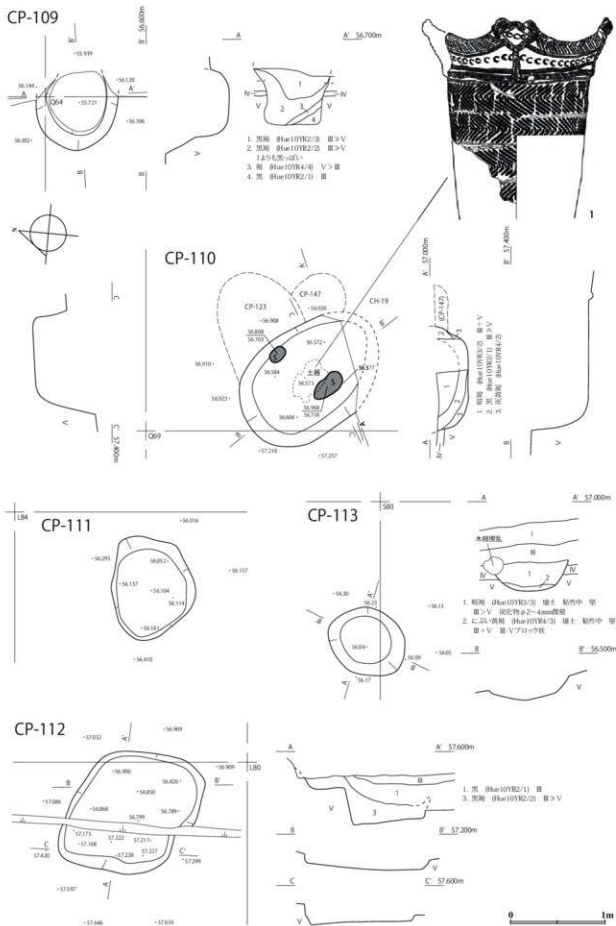

図Ⅱ-469 CP-109~113

CP-114

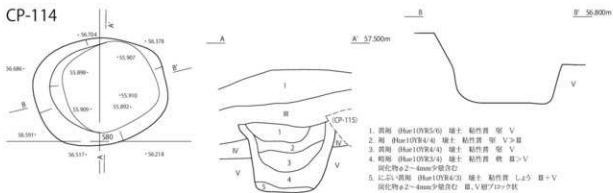

CP-115・134

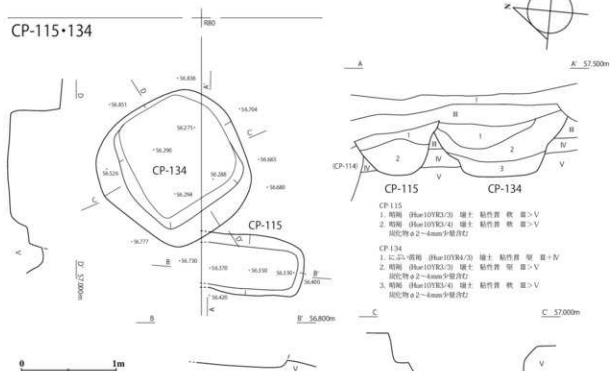

CP-116

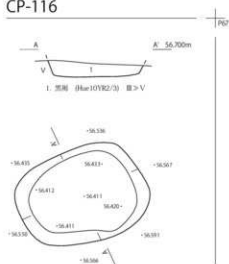

CP-117

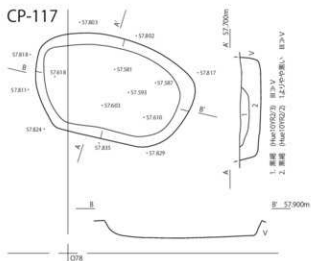

図II-470 CP-114~117・134

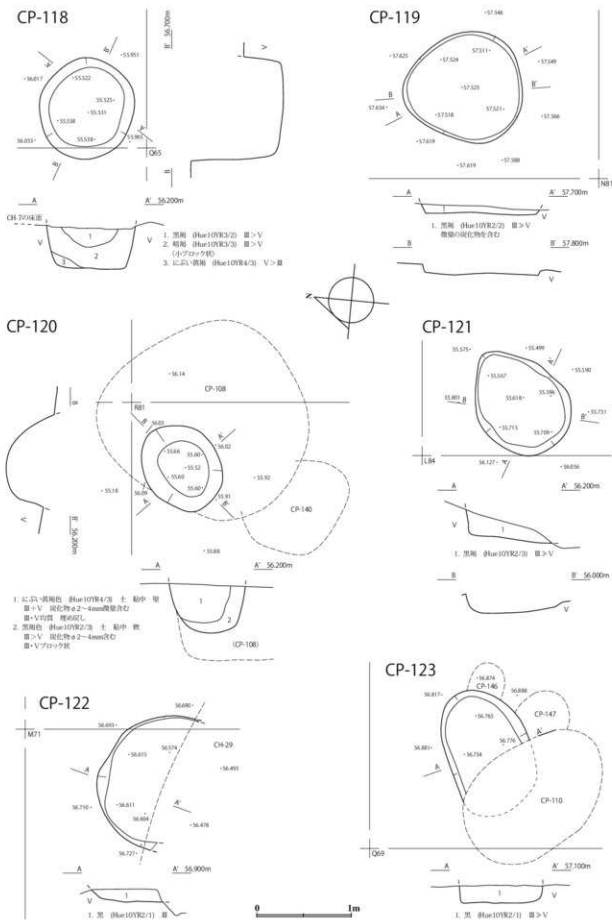

図II-471 CP-118~123

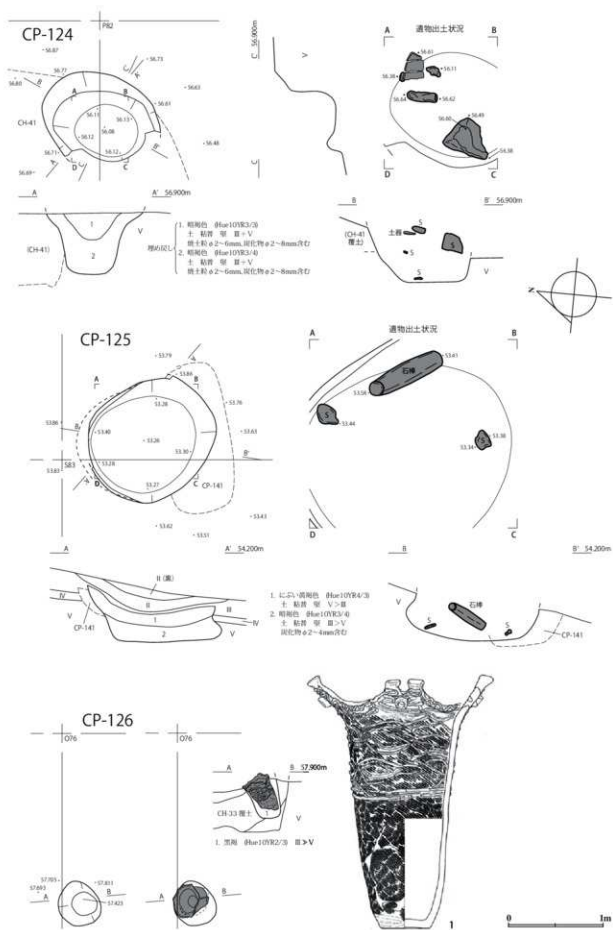

図Ⅱ-472 CP-124~126

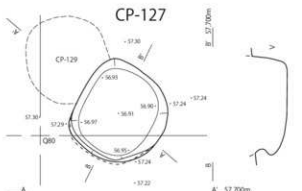

- 1. 上に、黒褐色 (Hae10YR3/4) 土 粘質 堅 V>H
絞化物φ2~4mm少量含む
- 2. 黒褐色 (Hae10YR3/3) 土 粘質 堅 量>V
絞化物φ2~4mm少量含む
- 3. 黒褐色 (Hae10YR3/4) 土 粘質 軟 量>V
絞化物φ2~4mm少量含む

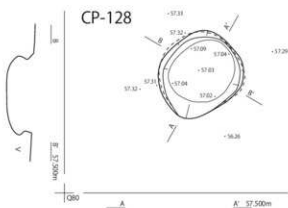

- 1. 上に、黒褐色 (Hae10YR3/4) 土 粘質 堅 V>H
絞化物φ2~10mm, 骨針2~4mm少量含む 櫛の残片
- 2. 黒褐色 (Hae10YR3/3) 土 粘質 堅 量>V
絞化物φ2~4mm含む

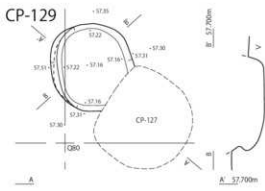

- 1. 黒褐色 (Hae10YR3/4) 土 粘質 軟 量>V
絞化物φ2~4mm少量含む

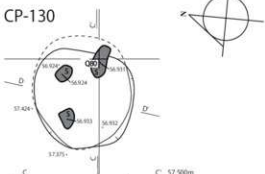

- 1. 黒褐色 (Hae7.5YR2/2) Ⅱ+Ⅲ 砂-土, 堅少量
- 2. 黒褐色 (Hae7.5YR2/2) Ⅱ+Ⅳ 砂-土, 堅少量
- 3. 黒 (Hae7.5YR4/3) V>H
- 4. 黒褐色 (Hae10YR3/2) Ⅳ+Ⅴ

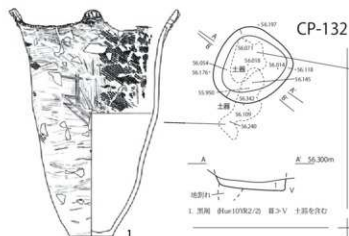

- 1. 黒褐色 (Hae10YR2/2) Ⅱ+Ⅴ 土 粘土含む

図II-473 CP-127~130・132

CP-131・176

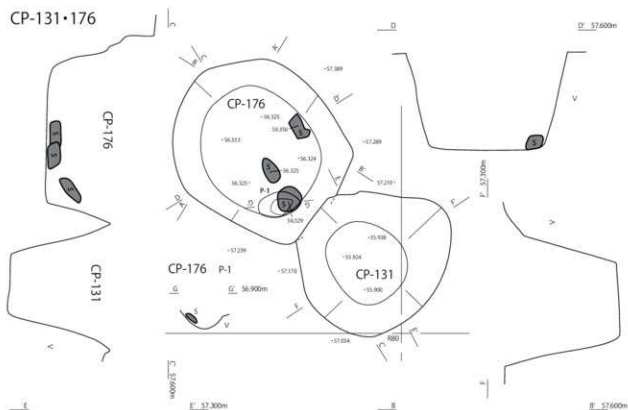

E 57.300m

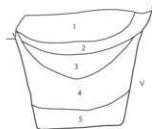

1. 黒層 (層10/R4/4)
2. 黒層 (層7/S/R2/2) 黒+N
3. 黒層 (層10/R5/4)
4. 黒層 (層10/R3/2)
5. 暗層 (層10/R3/2) V層下部に属する

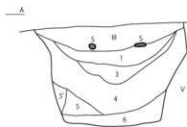

H 57.600m

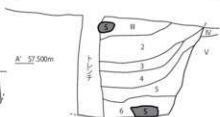

1. 黒層 (層10/R2/3) 口→人形溝縁部に属する
2. 黒層 (層10/R4/4) V層の埋め戻し土
3. 暗層 (層10/R3/2) V層
4. 黒層 (層7/S/R2/2) 黒>V 口→人形溝縁部に属する
5. 黒層 (層7/S/R3/2) 口→人形溝縁部
6. 暗層 (層7/S/R3/4) 5層に埋め戻し土に属する



CP-133



A 37.500m C 37.500m



1. 暗層 (層10/R3/3) 黒>V
2. 黒層 (層10/R2/2) 黒>V
3. 赤層 (層5/R4/4) 礎石 (CH-43) 層1

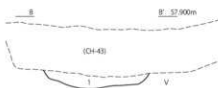

1. 黒層 (層10/R2/1) 黒>V

0 1m

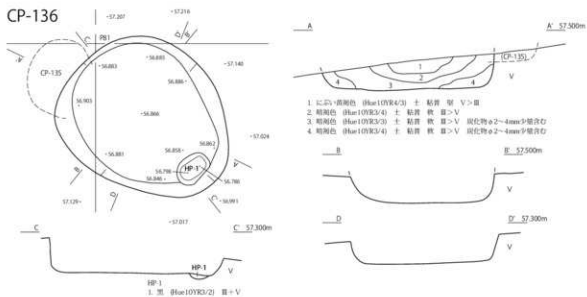
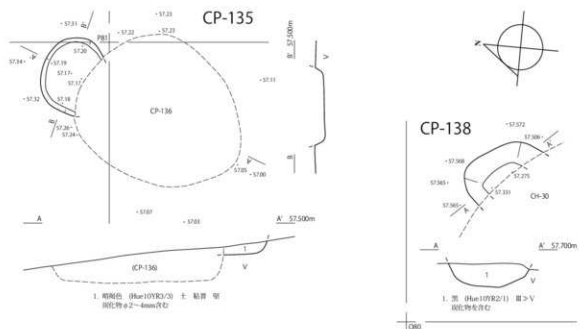

0 1m

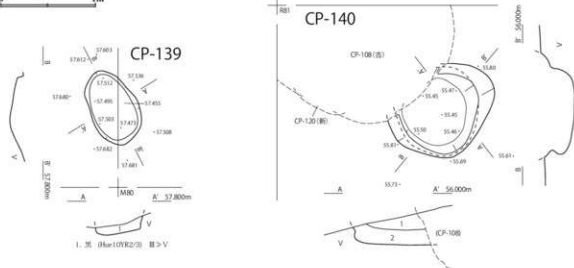

図Ⅱ-475 CP-135・136・138~140

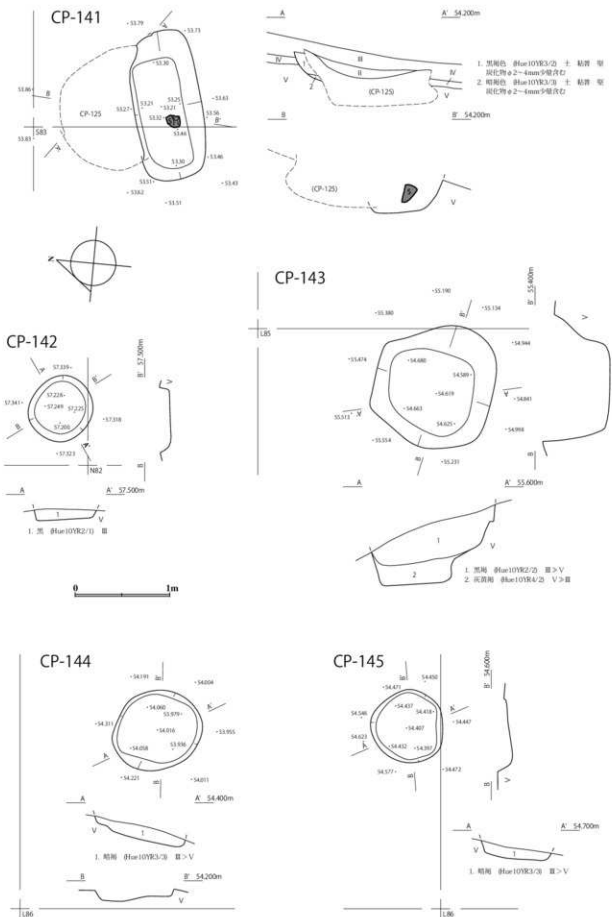

図Ⅱ-476 CP-141~145



図 II-477 CP-146~154



図Ⅱ-478 CP-155~160

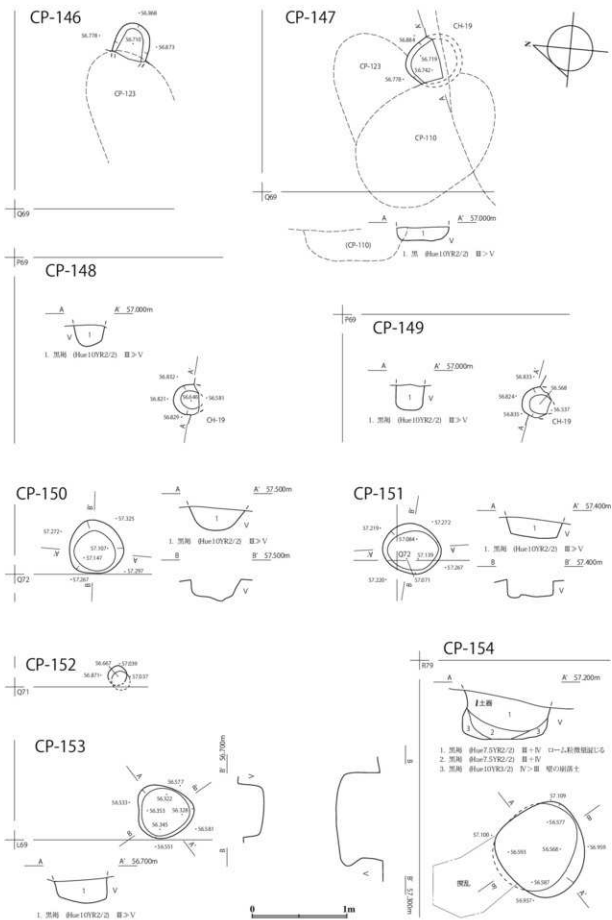
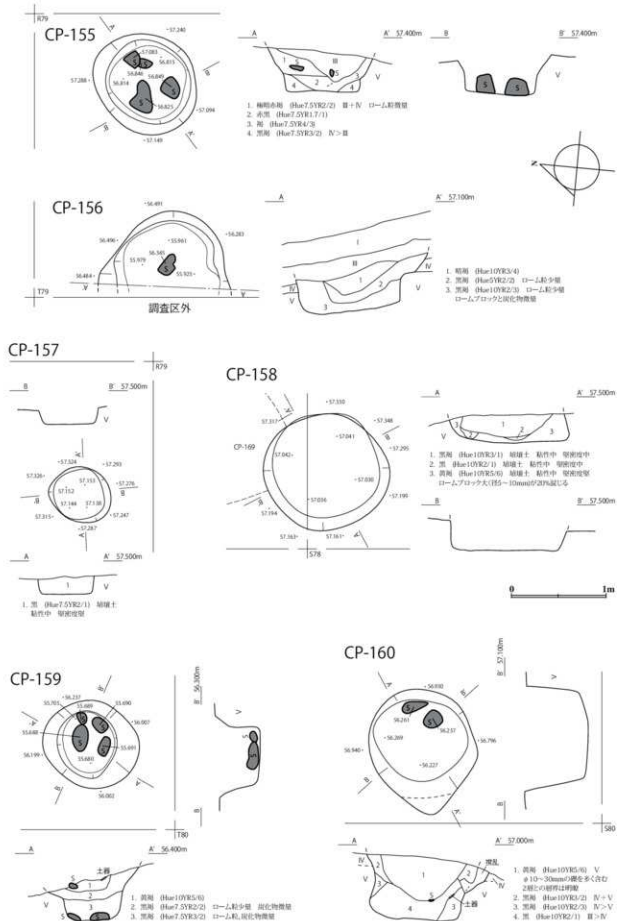
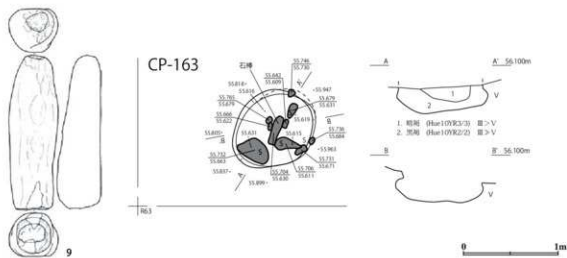
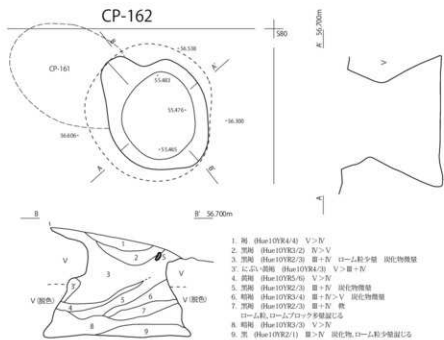

図II-479 CP-161~163

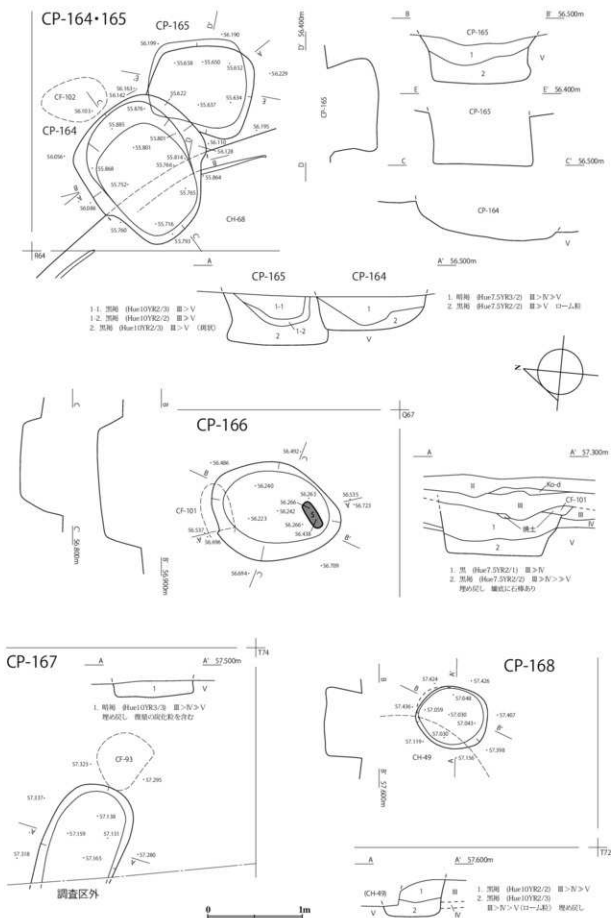

図Ⅱ-480 CP-164~168

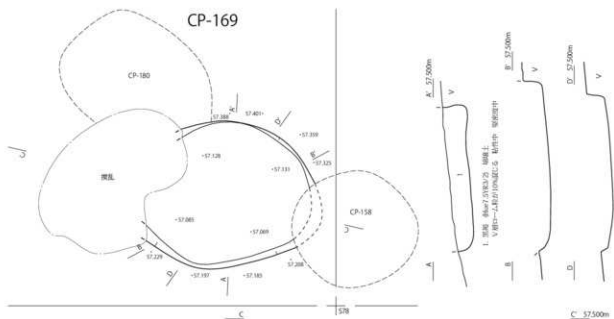

CP-170

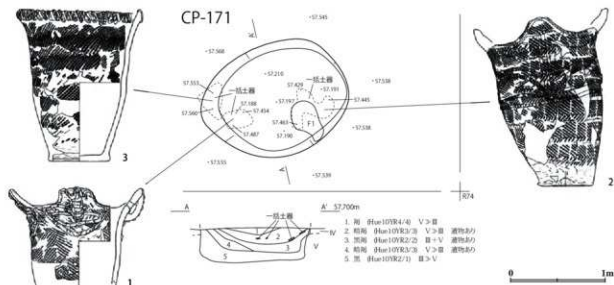
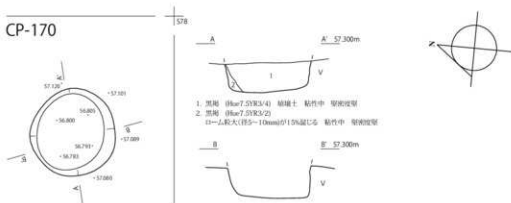

図II-481 CP-169~171

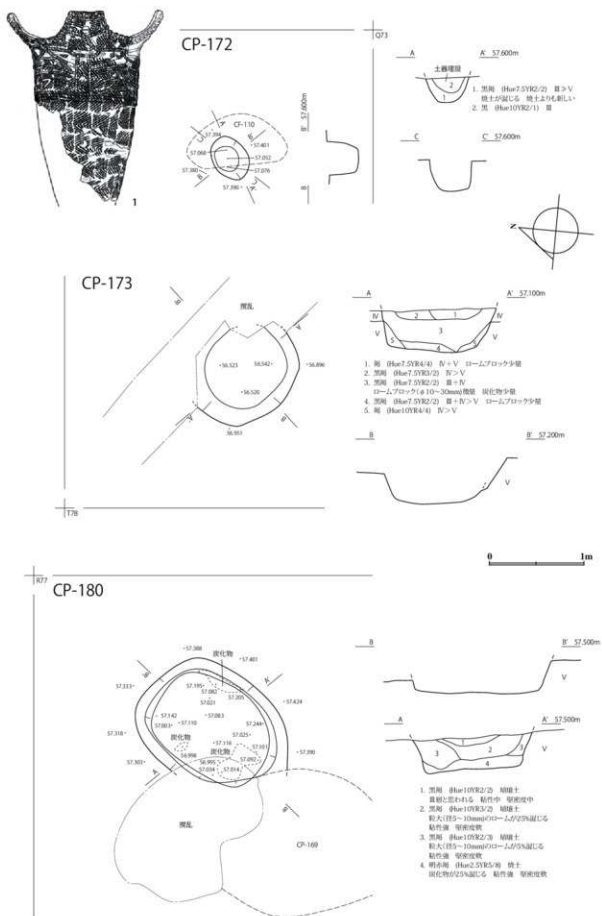

図Ⅱ-482 CP-172・173・180



図 II-483 CP-177~179・182~184



図II-484 CP-181・188・190

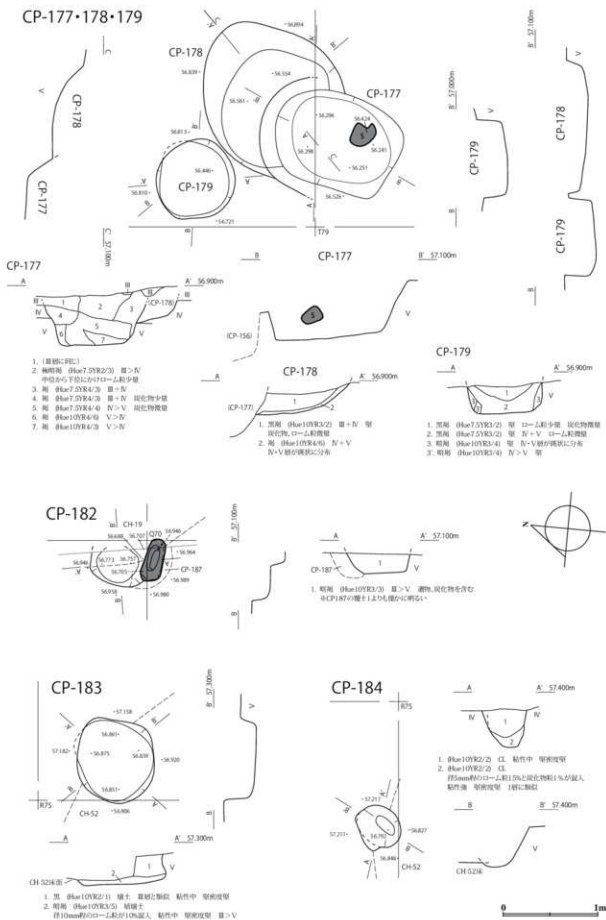
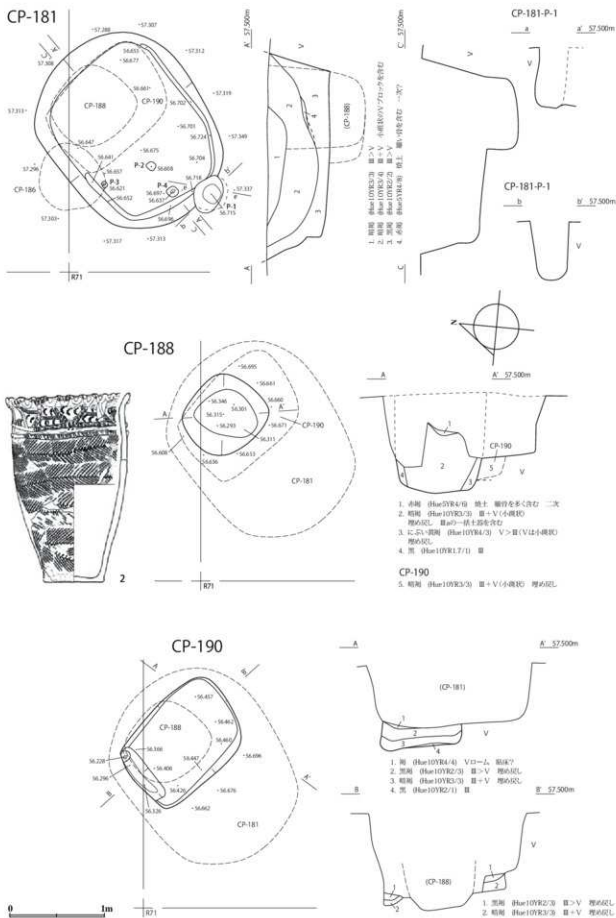
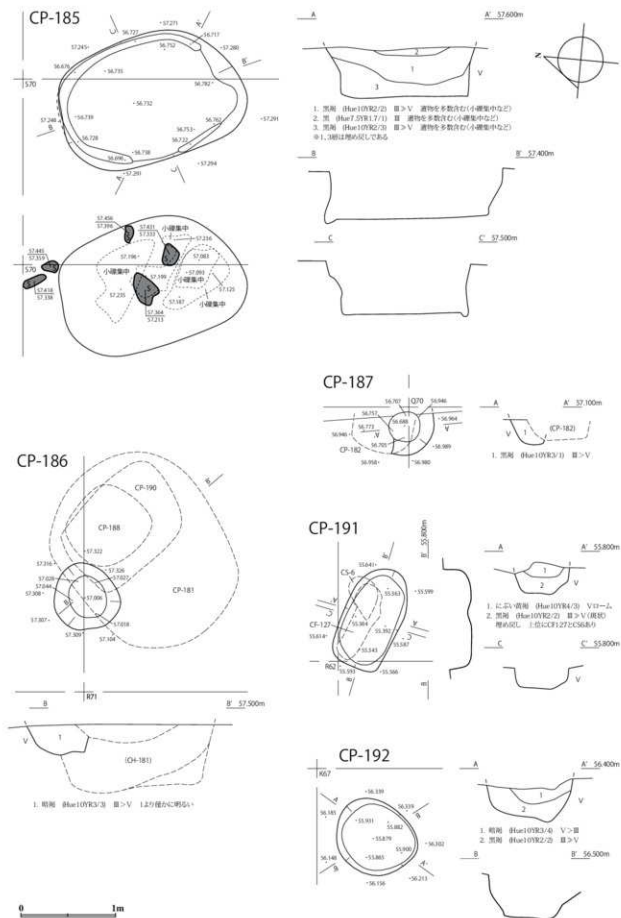

図Ⅱ-485 CP-185～187・191・192

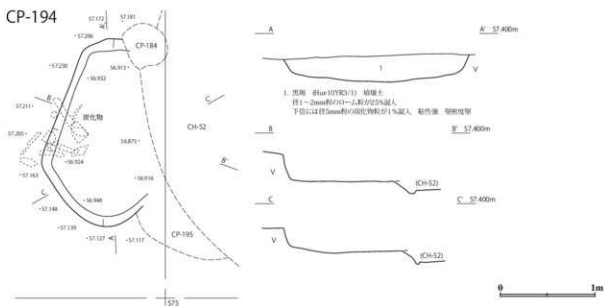
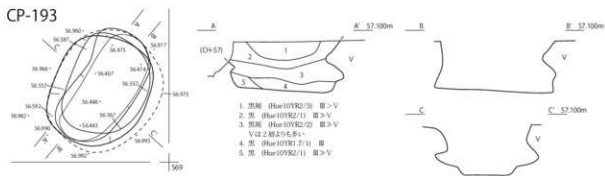
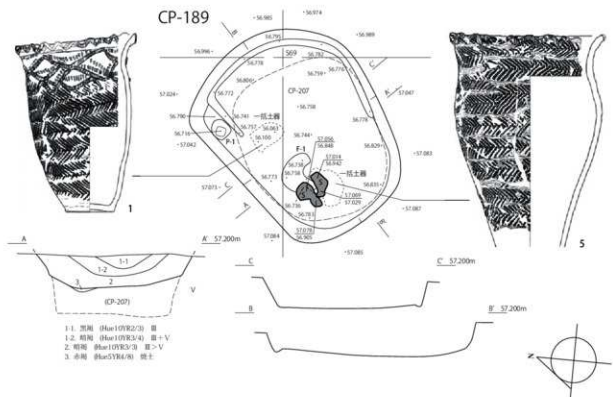

図II-486 CP-189・193・194

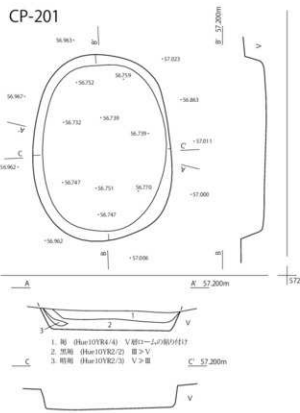
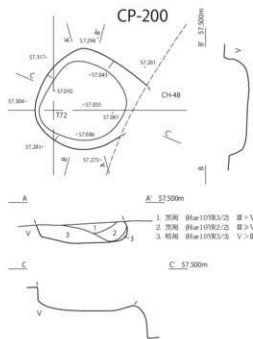
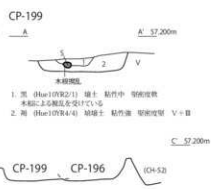
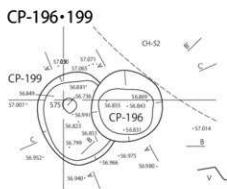
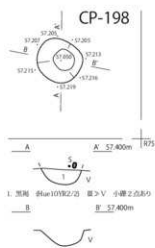
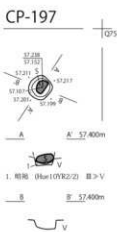
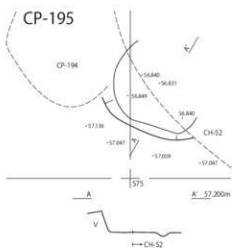

図II-487 CP-195~201

CP-202

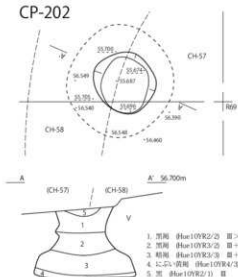

CP-203

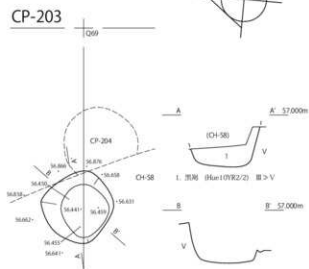

CP-204

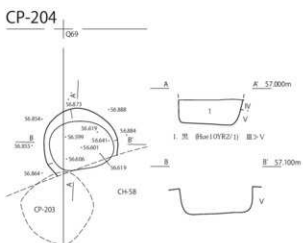

CP-206

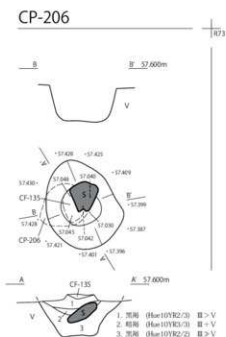

CP-205

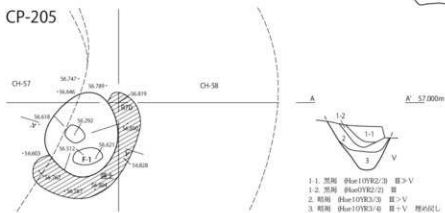

図Ⅱ-488 CP-202~206

CP-207

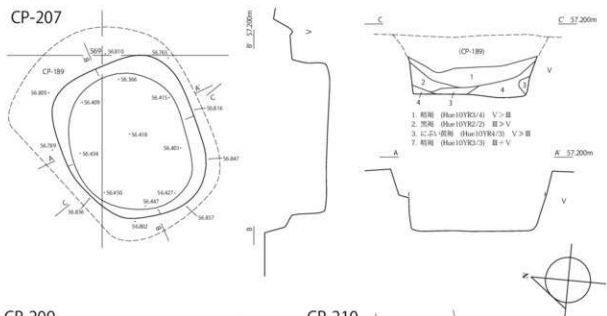

CP-209

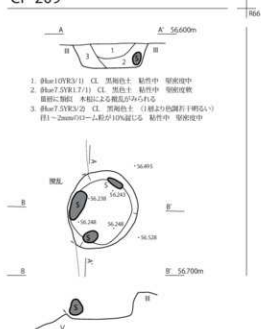

1. 粘層 (Hae10YR3/4) CL 黒褐色土 粘性中 硬質程度中
2. 粘層 (Hae7.5YR1.7/1) CL 黒色土 粘性中 硬質程度中
断面に割れ 木柱による痕跡がみられる
3. 粘層 (Hae7.5YR3/2) CL 黒褐色土 (1層より約10%減少) 粘性中 硬質程度中
径1~2mmの石・土粒が10%混入

CP-210



1. 土層
2. 粘層 (Hae7.5YR3/2) CL 黒褐色土 粘性中 硬質程度中
径1mmの石・土粒が5%混入
3. 粘層 (Hae7.5YR3/2) CL 黒褐色土 粘性中 硬質程度中
径2mmの石・土粒が10%混入
4. 粘層 (Hae7.5YR1.7/1) CL 黒色土 粘性中 硬質程度中 (断面に割れ)
5. 粘層 (Hae7.5YR3/2) CL 黒褐色土 粘性中 硬質程度中
6. 粘層 (Hae10YR3/1) CL 黒褐色土 粘性中 硬質程度中
径2~3mmの石・土粒が30%混入

CP-211・227

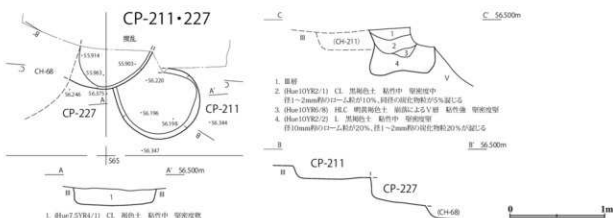

1. 粘層 (Hae7.5YR4/1) CL 褐色土 粘性中 硬質程度中

1. 土層
2. 粘層 (Hae10YR2/1) CL 黒褐色土 粘性中 硬質程度中
径1~2mmの石・土粒が10%混入、同様の硬質物の5%混入
3. 粘層 (Hae10YR2/6) 硬CL 明褐色土 粘性によるV層 粘性土 硬質程度中
4. 粘層 (Hae10YR2/2) L 黒褐色土 粘性中 硬質程度中
径10mmの石・土粒が20%、径1~2mmの硬質物20%が混入

図 II-489 CP-207・209~211・227

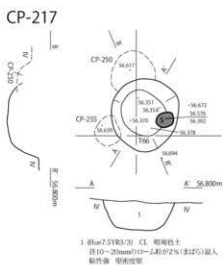
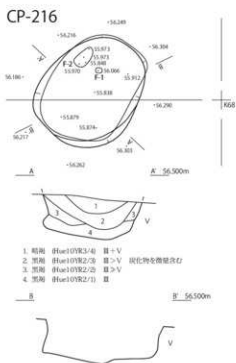
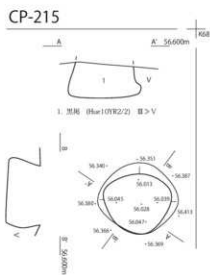
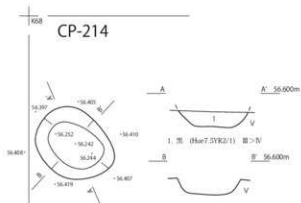
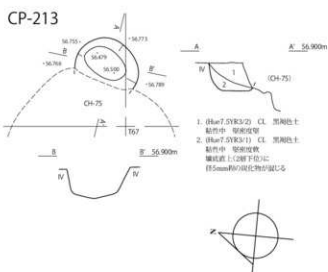

図Ⅱ-490 CP-212~217

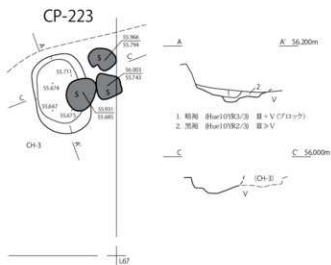
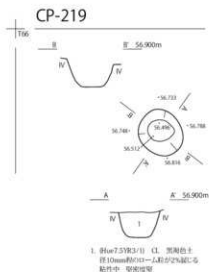
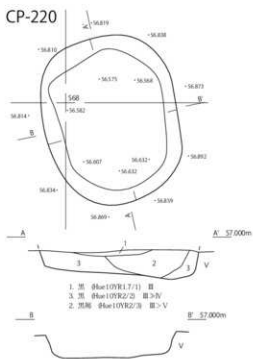
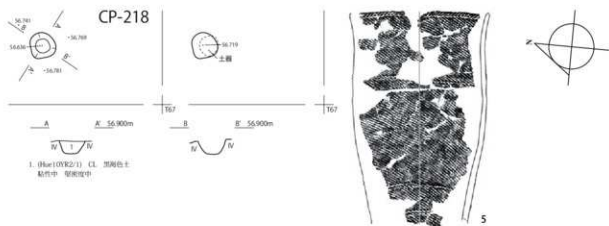

0 1m

図 II-491 CP-218~221・223



図 II-492 CP-224~226・228・229



図II-493 CP-230~233

CP-234

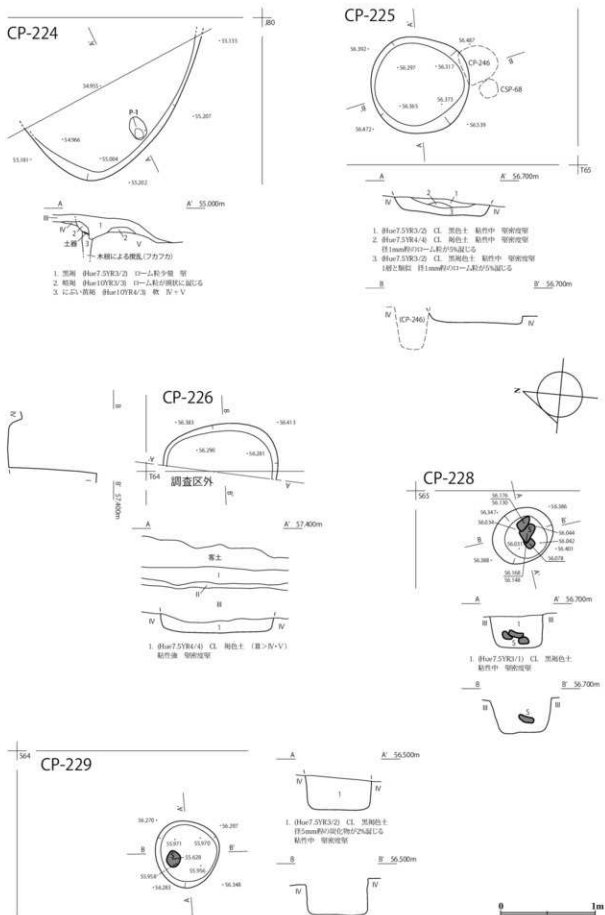
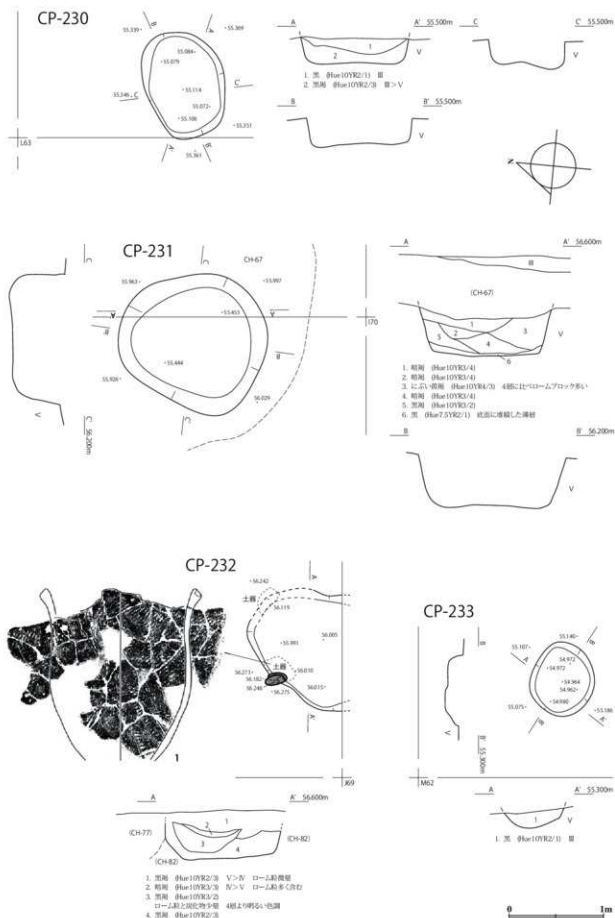
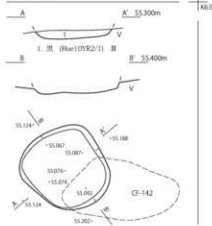

CP-235

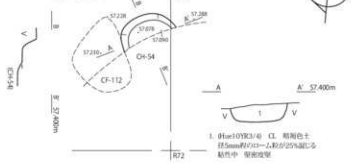

CP-236

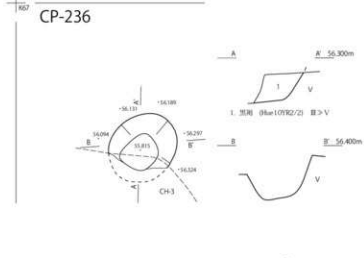

CP-237

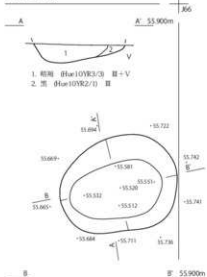

CP-238

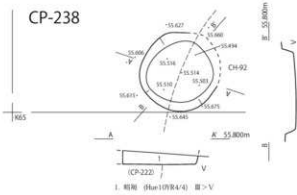

CP-239

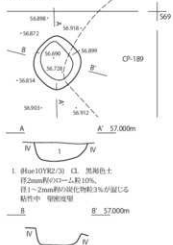

CP-240

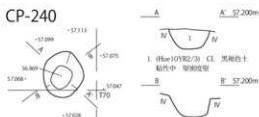

図Ⅱ-494 CP-234~240

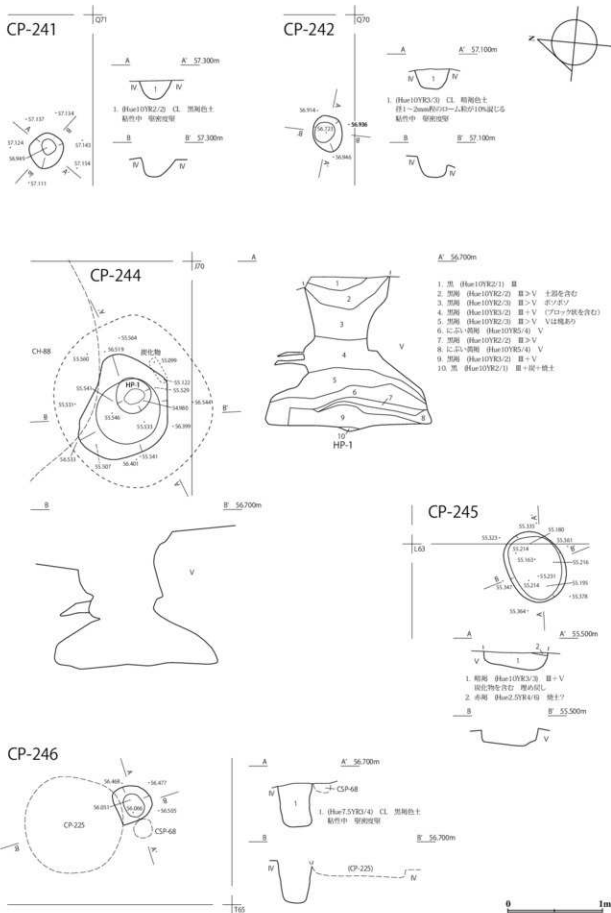

図II-495 CP-241・242・244~246

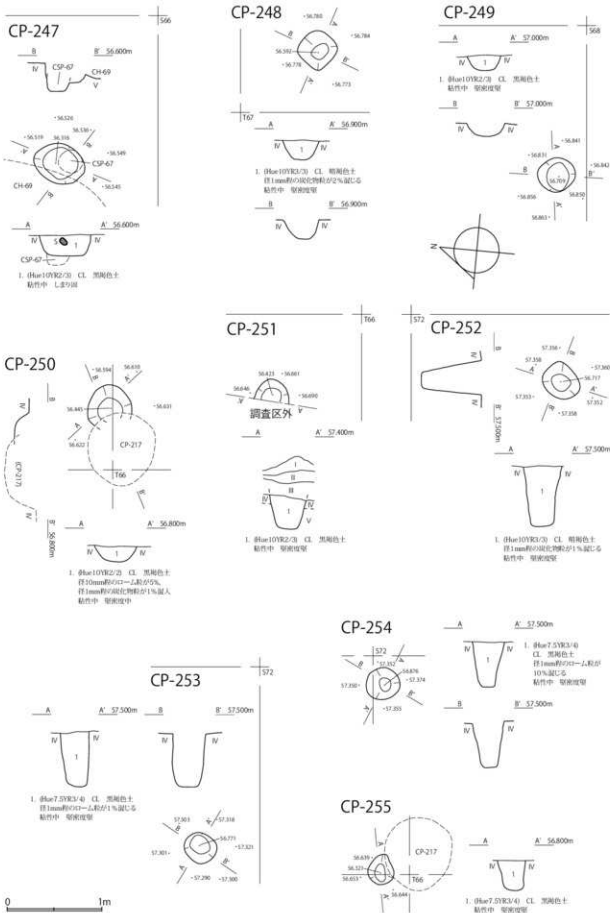

図Ⅱ-496 CP-247~255

CP-256

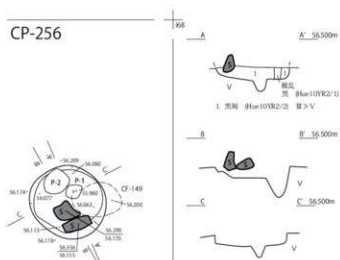

CP-258

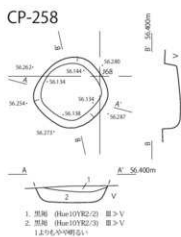

CP-257

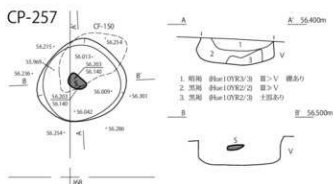

CP-259

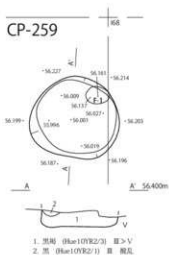

CP-260

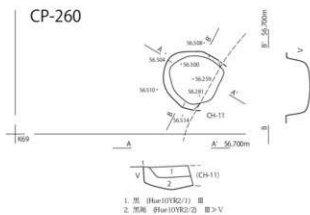

CP-261

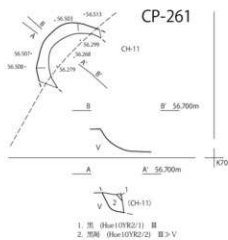

CP-262

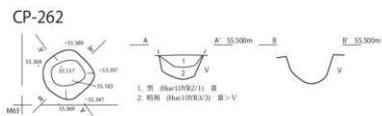

0 1m

図 II-497 CP-256~262

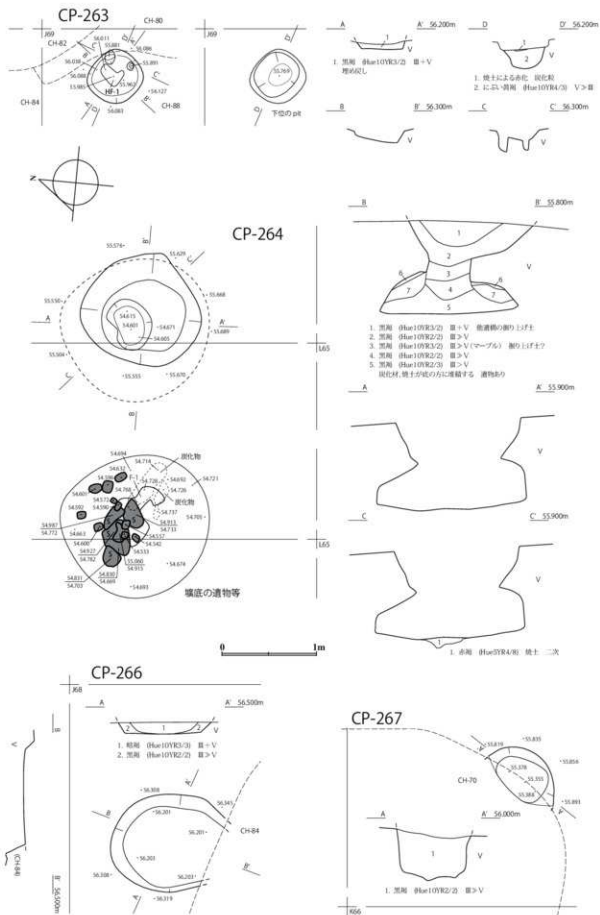

図Ⅱ-498 CP-263・264・266・267



図 II-499 CP-265・268~270



図Ⅱ-500 CP-271~275

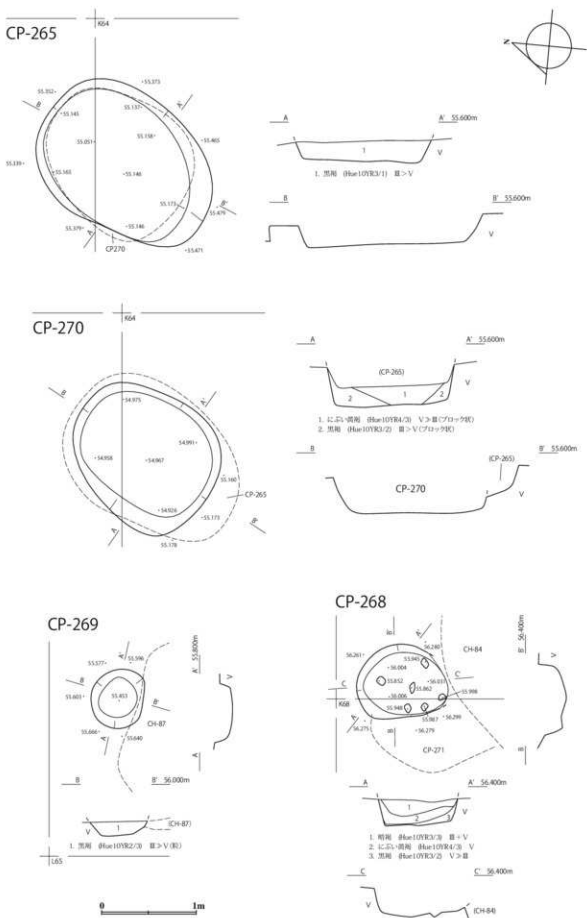
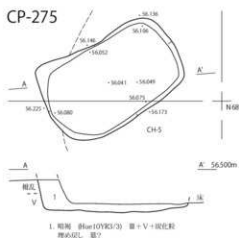
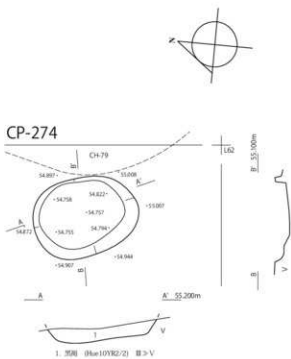
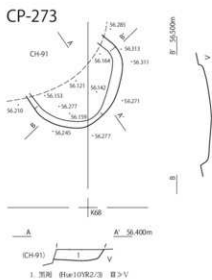
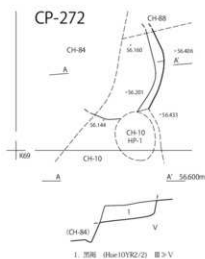
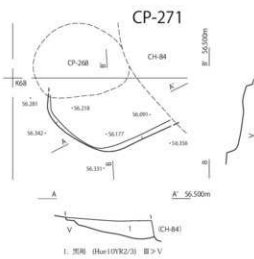
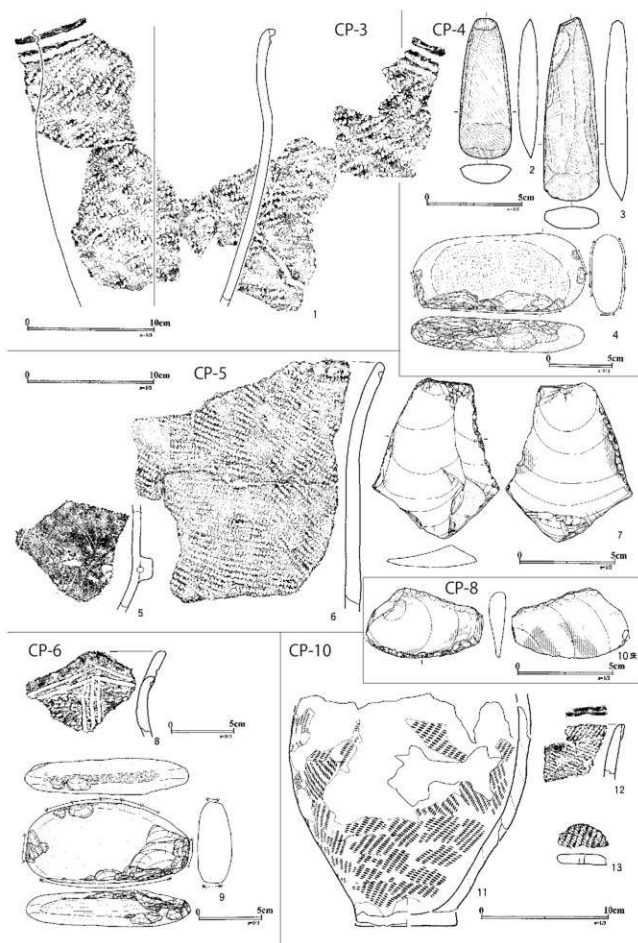

図II-501 CP-3~6・8・10の遺物

CP-9

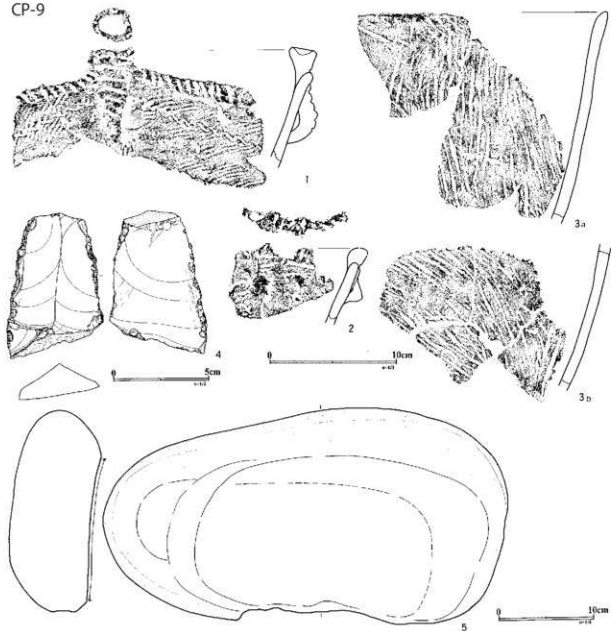

CP-11

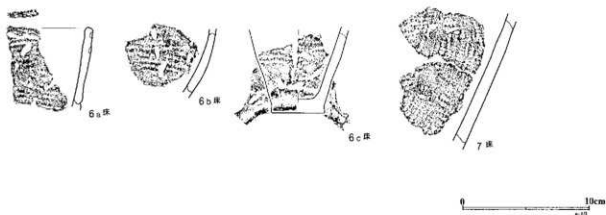

図II-502 CP-9・10の遺物

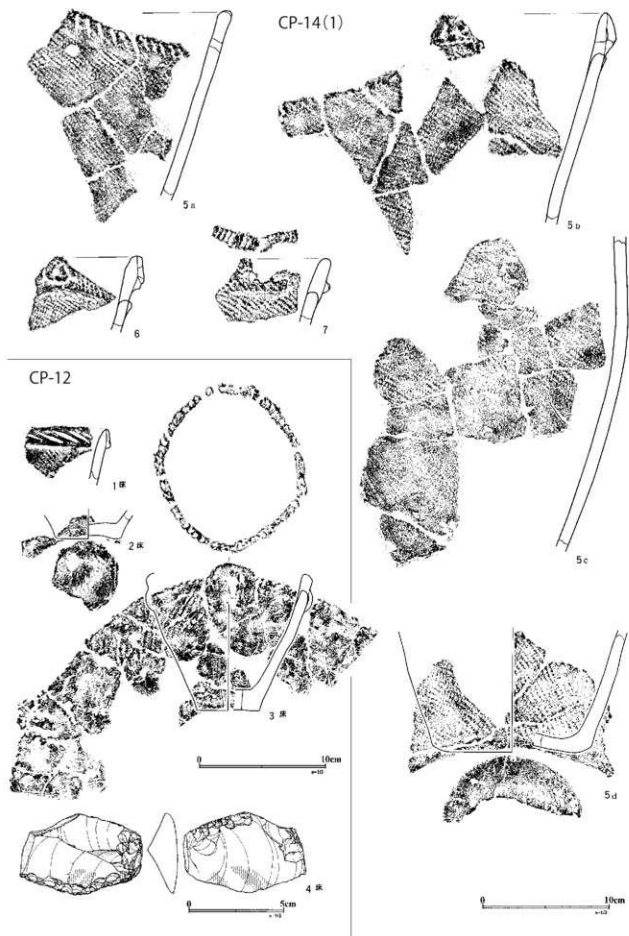

図Ⅱ-503 CP-12・14(1)の遺物

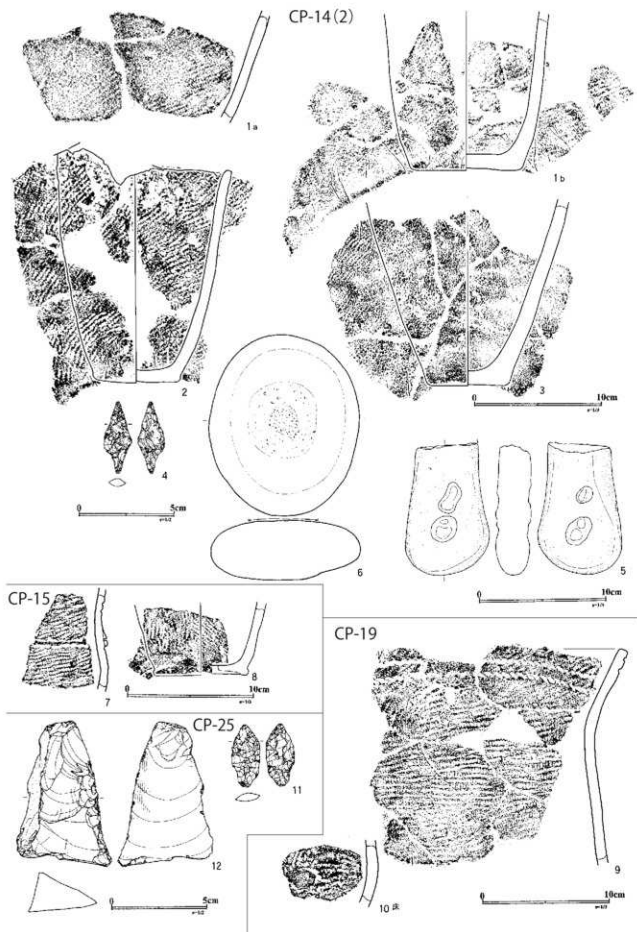

図Ⅱ-504 CP-14(2)・15・19・25の遺物



図 II-505 CP-20・24・29・32の遺物

CP-31

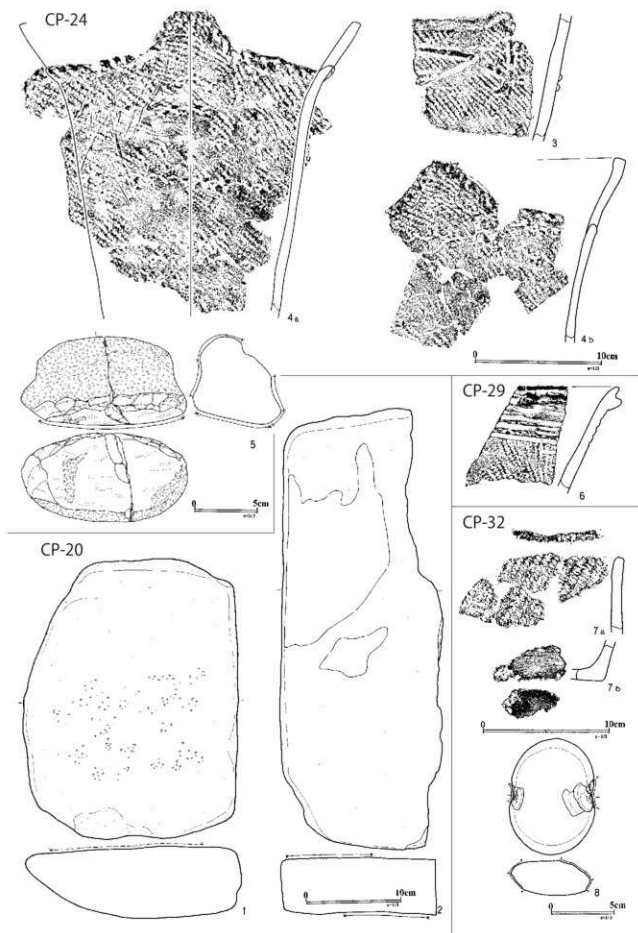
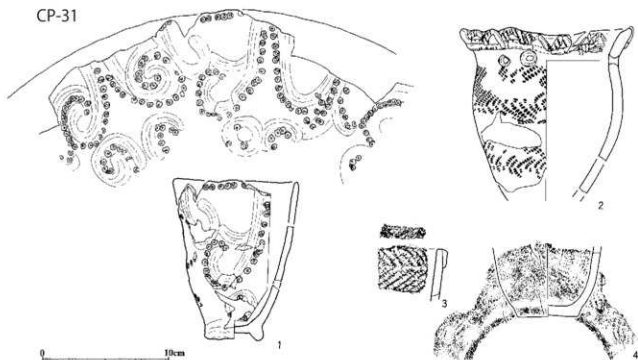

0 10cm
+107

CP-39

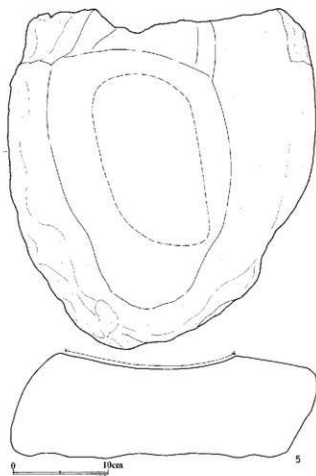

0 10cm
+107

CP-38

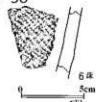

0 5cm
+107

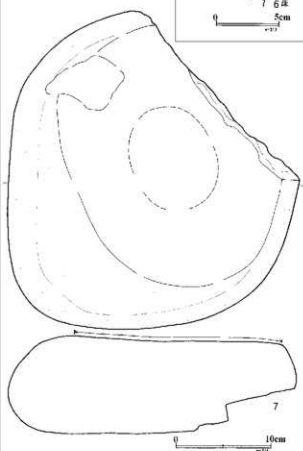

0 10cm
+107

図Ⅱ-506 CP-31・38・39の遺物

CP-41

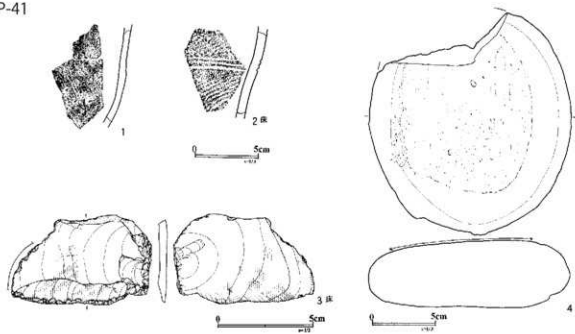

CP-43

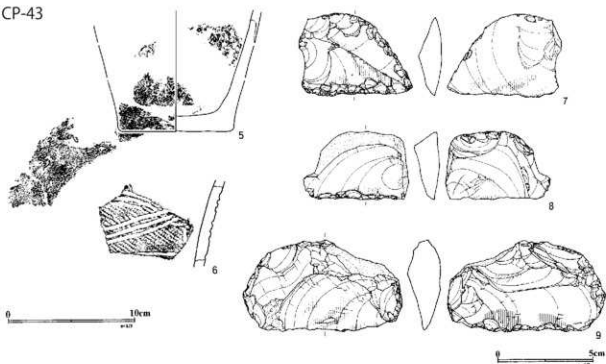

CP-44

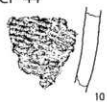

CP-45



CP-47



CP-48

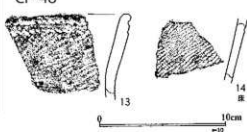

図II-507 CP-41・43～45・47・48の遺物



図 II-508 CP-54~56・58・59の遺物



図II-509 CP-60の遺物

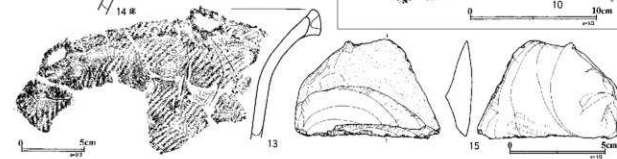
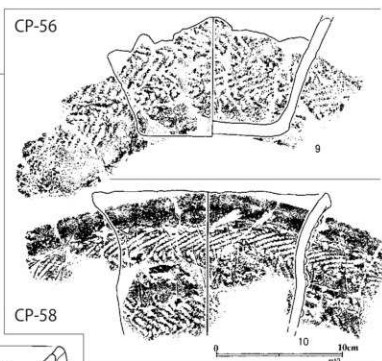
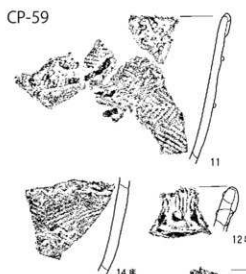
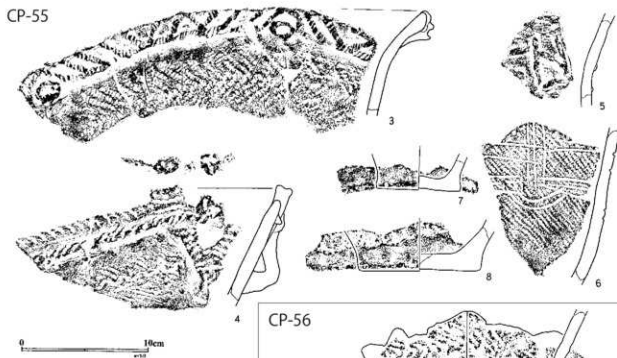
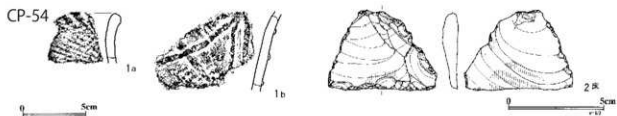
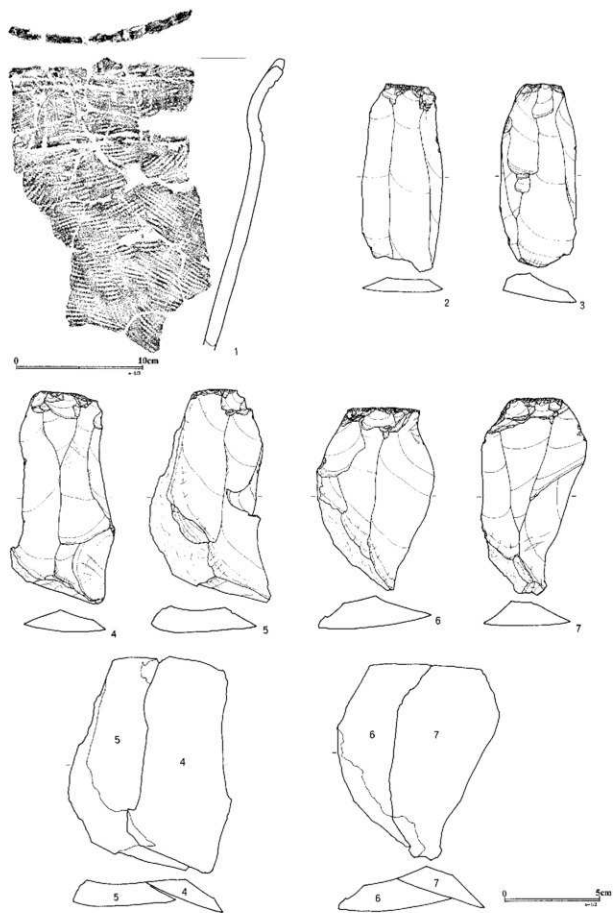
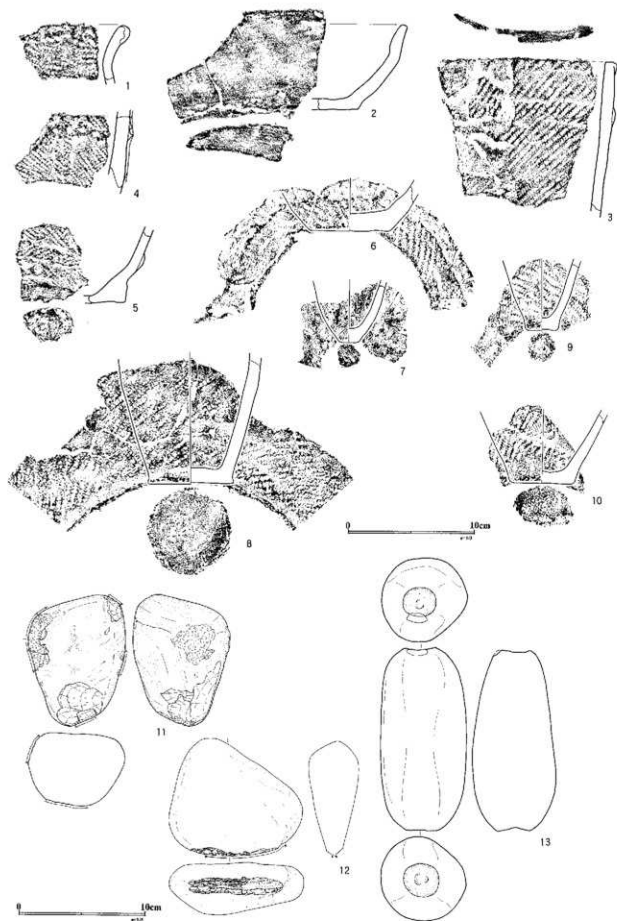

図II-510 CP-65の遺物

CP-57

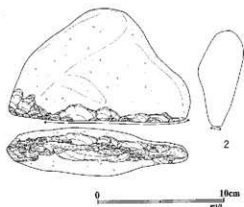
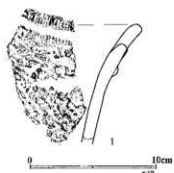
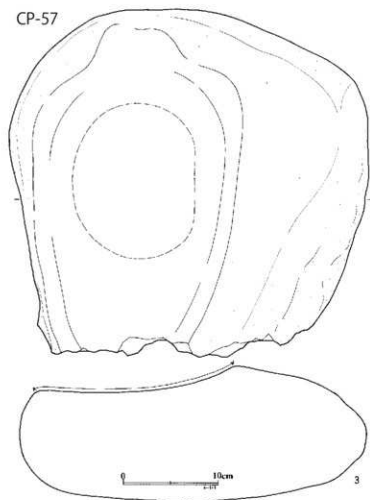

CP-61



CP-68



CP-62



CP-63



CP-67(1)

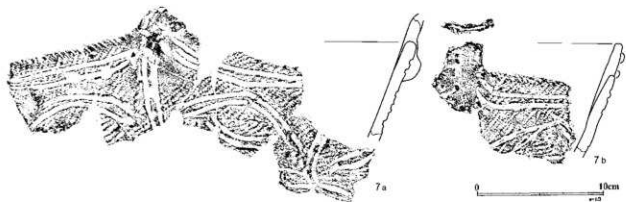

図II-511 CP-57・61~63・67(1)・68の遺物

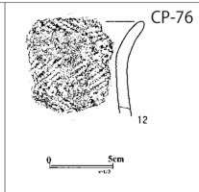
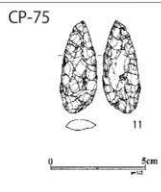
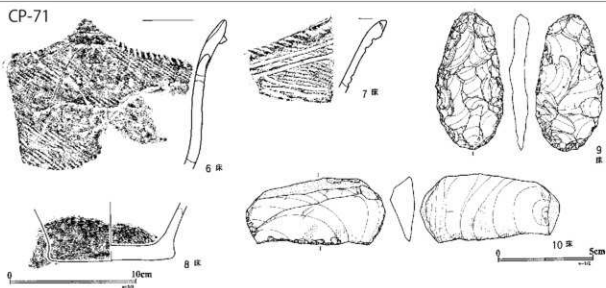
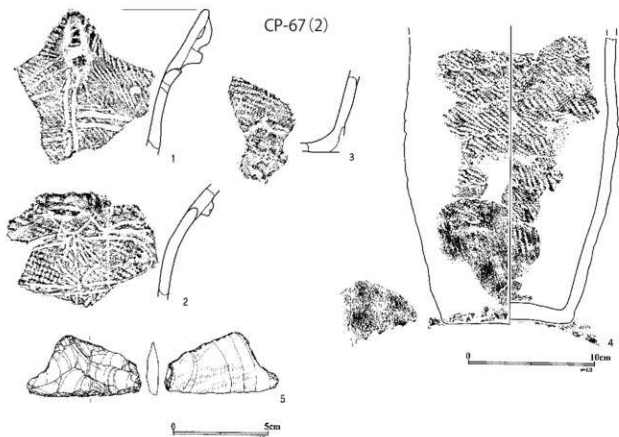

図Ⅱ-512 CP-67(2)・71・75・76の遺物

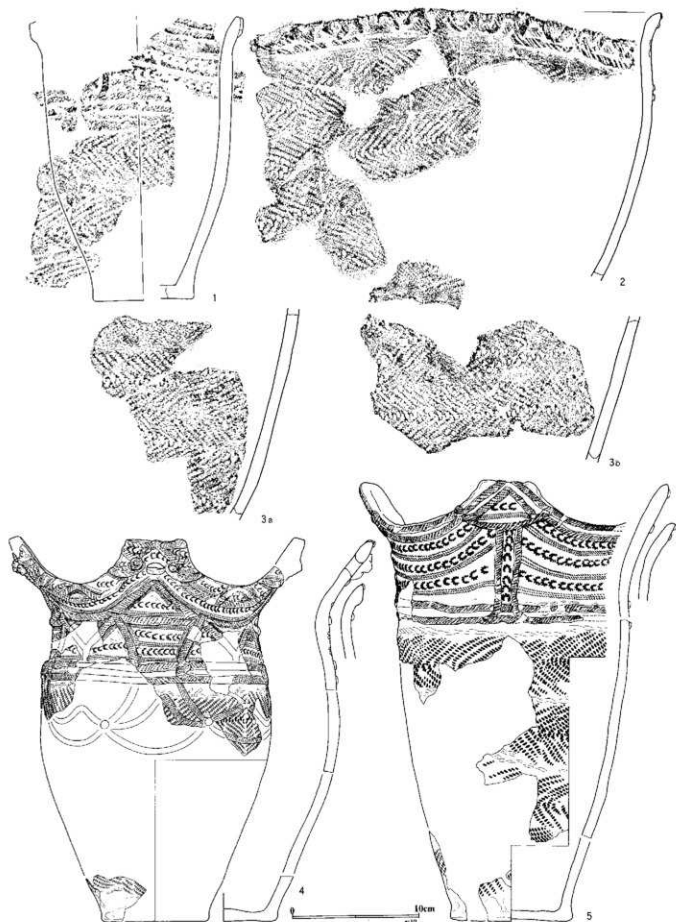

図II-513 CP-70の遺物

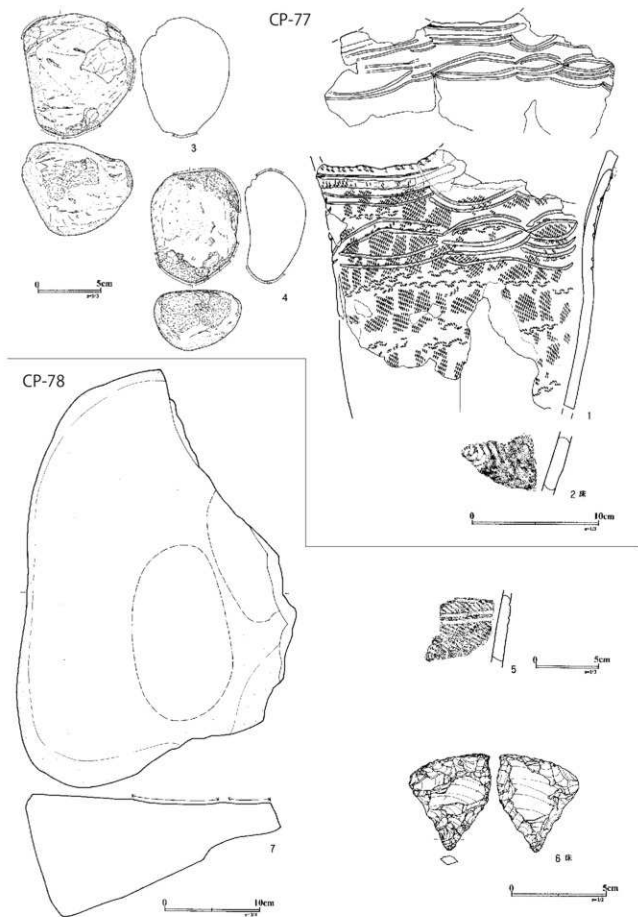

図Ⅱ-514 CP-77・78の遺物



図 II-515 CP-80・81・84・88の遺物



図Ⅱ-516 CP-82・91～94の遺物

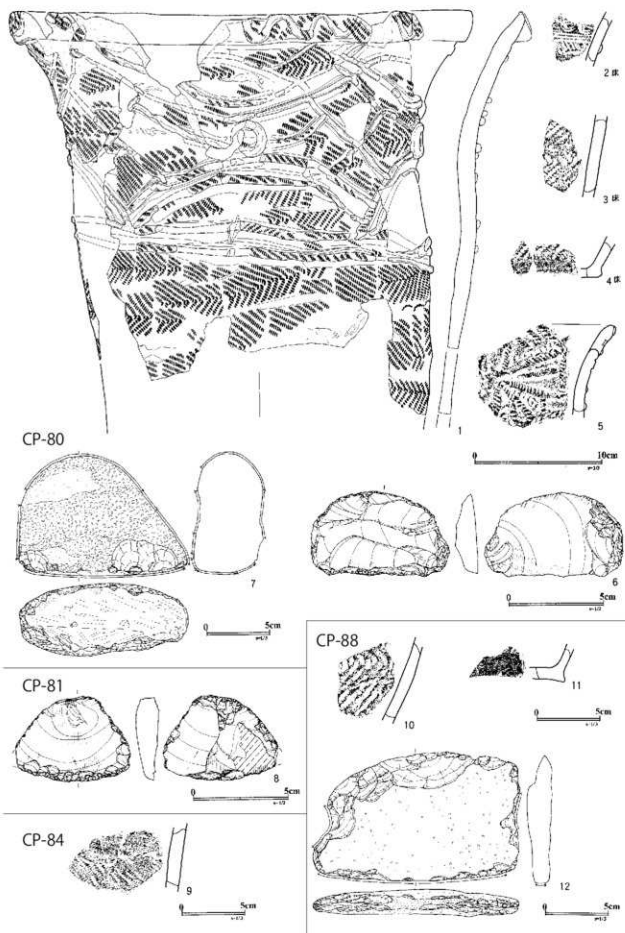
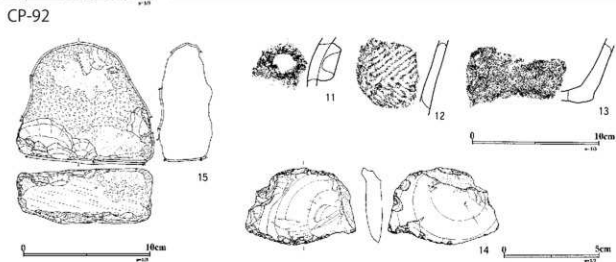
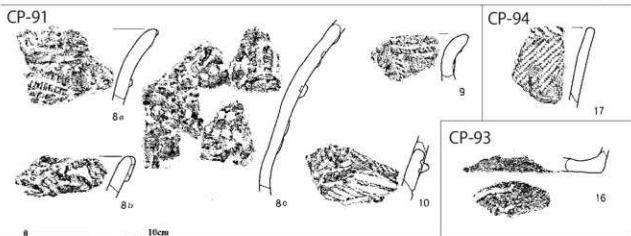
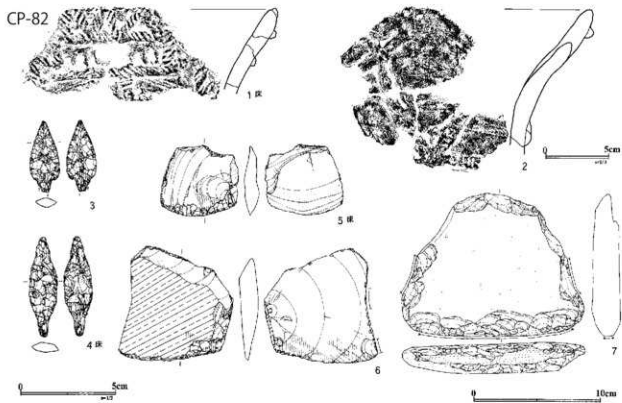
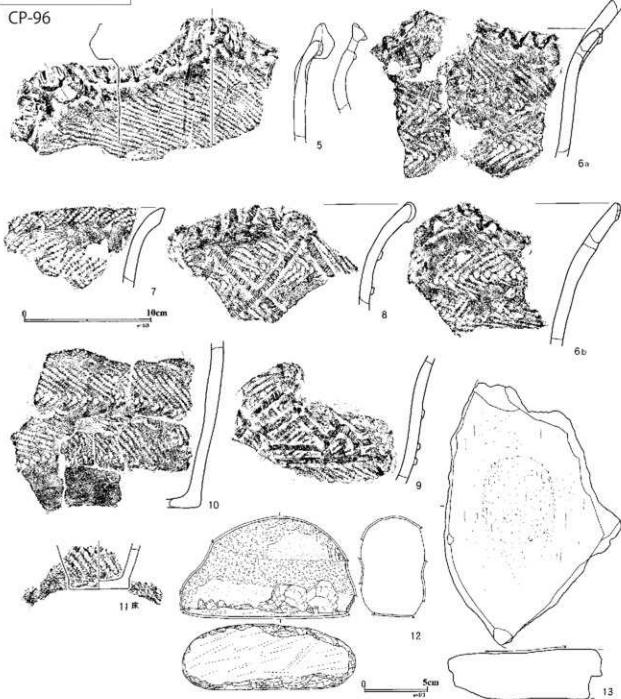
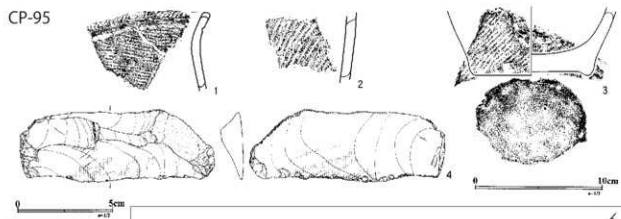

図II-517 CP-95・96の遺物

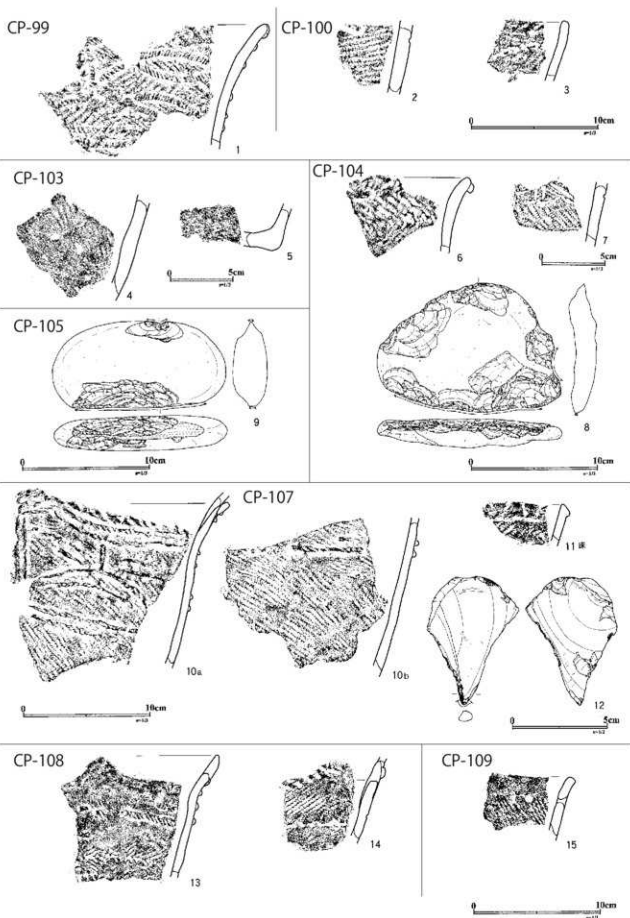

図Ⅱ-518 CP-99・100・103～105・107～109の遺物



図 II-519 CP-110・112・114の遺物

CP-123



CP-115

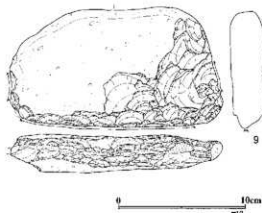
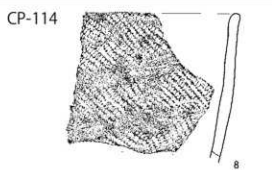
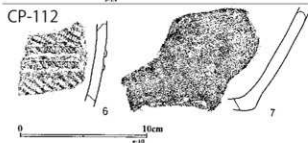
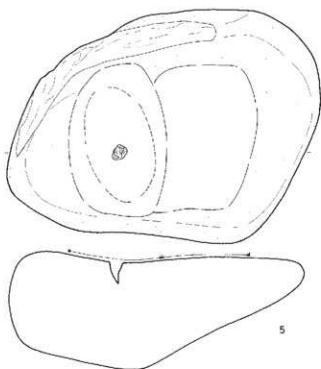
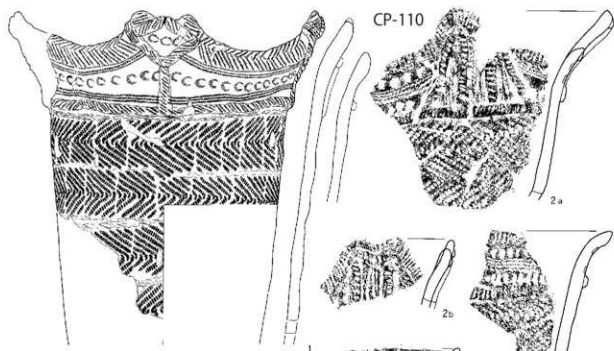
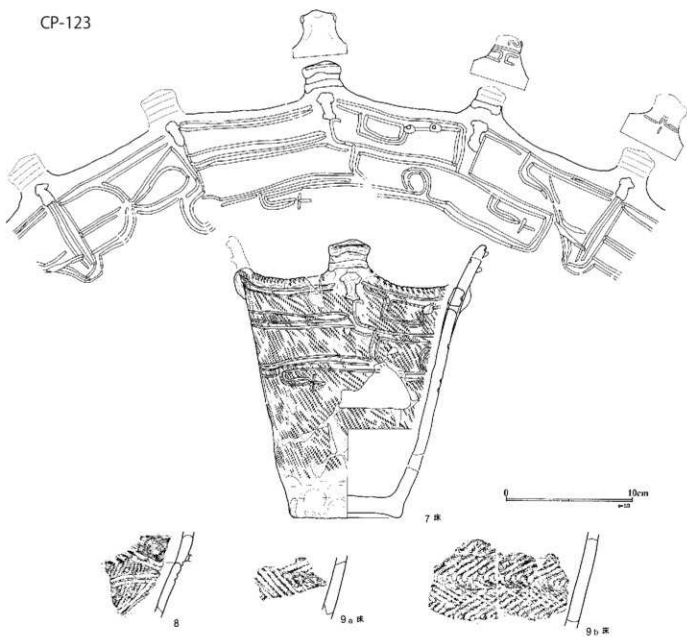

CP-117



CP-121



CP-118



CP-119

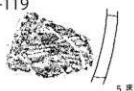

図Ⅱ-520 CP-115・117~119・121・123の遺物



図 II-521 CP-125の遺物



図 II-522 CP-126の遺物

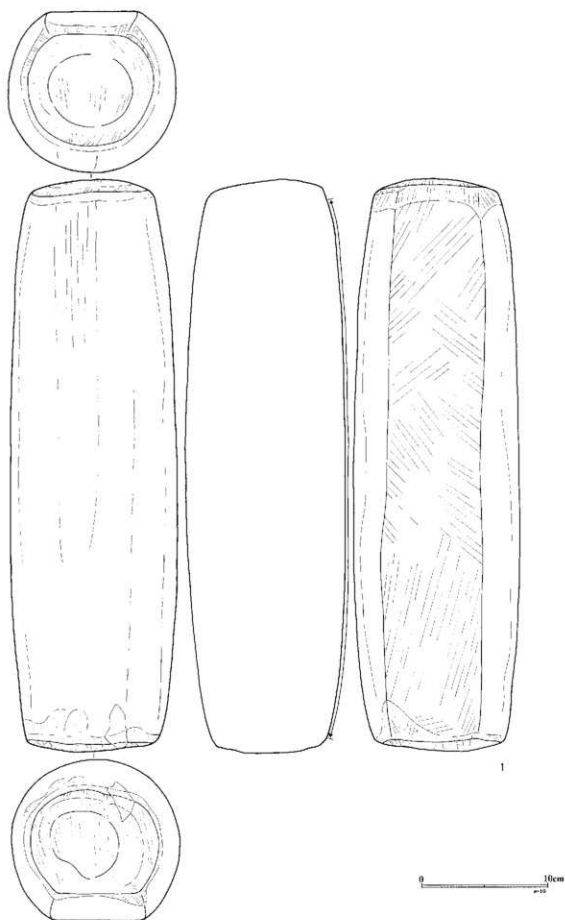

図 II-523 CP-132の遺物

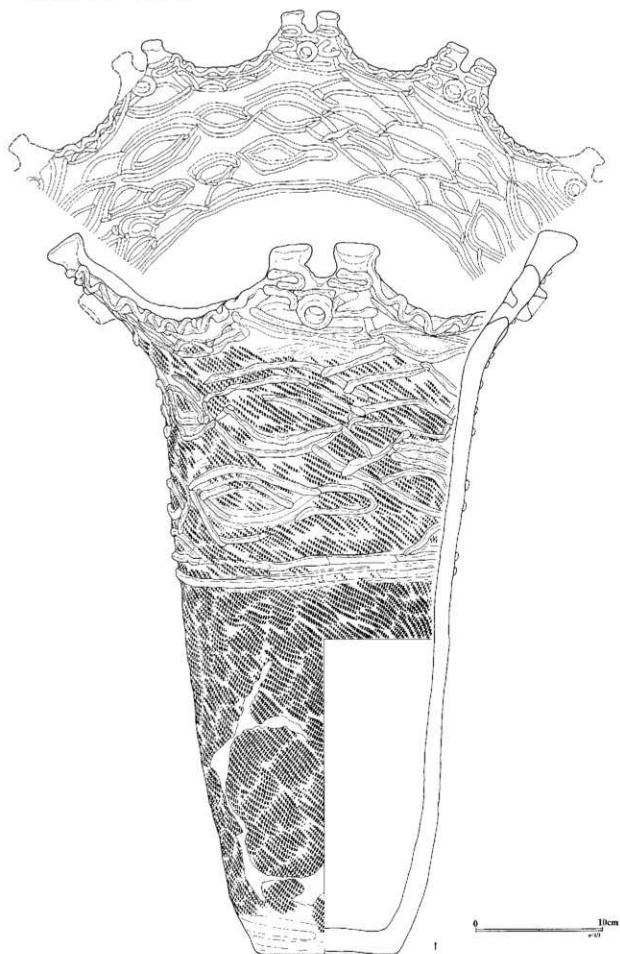
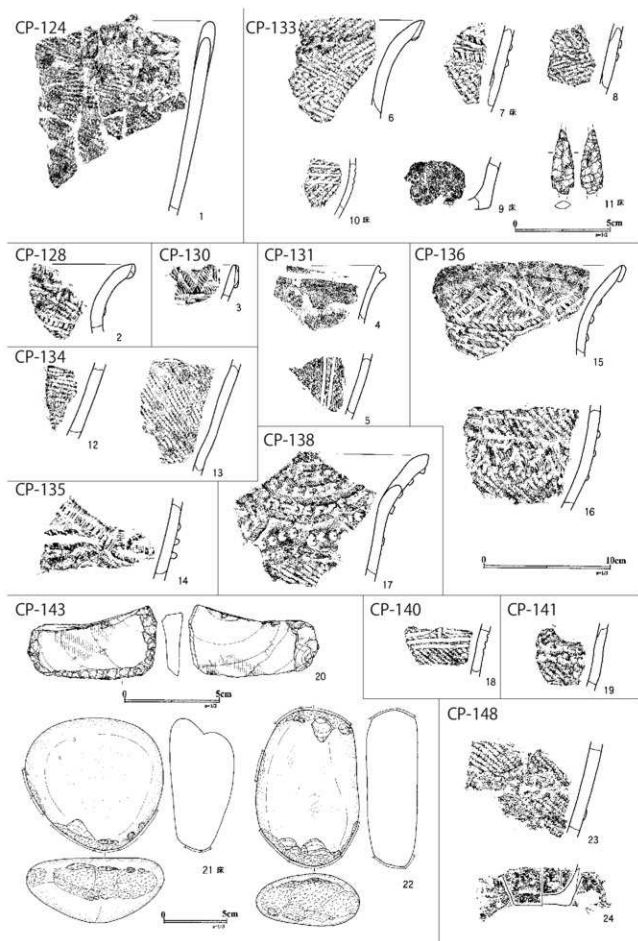

図Ⅱ-524 CP-124・128・130・131・133~136・138・140・141・143・148の遺物



図 II-525 CP-155の遺物



図Ⅱ-526 CP-150・151・153～156・159の遺物

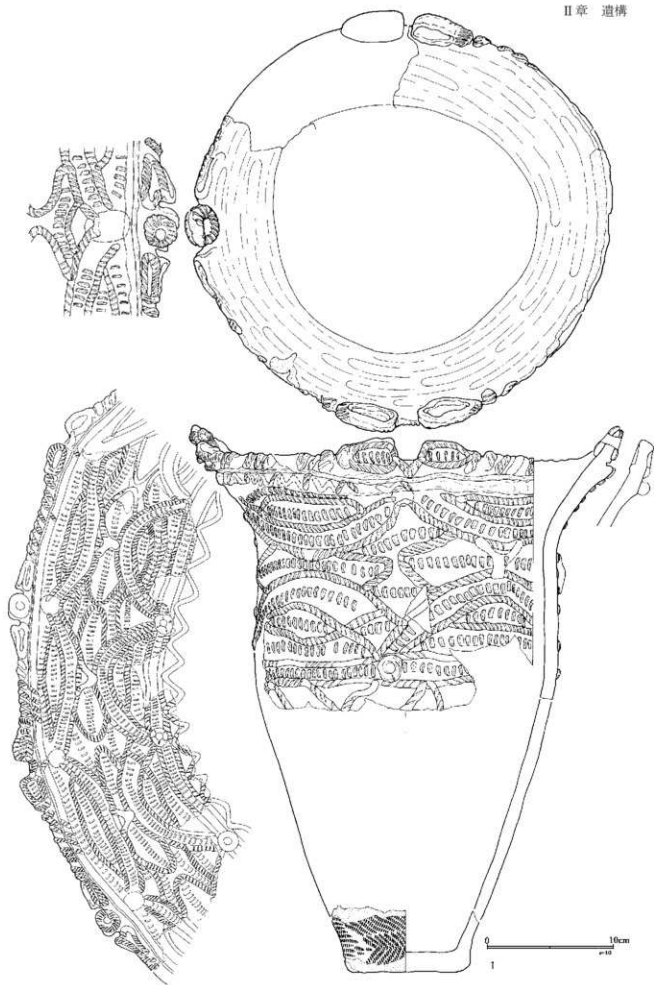
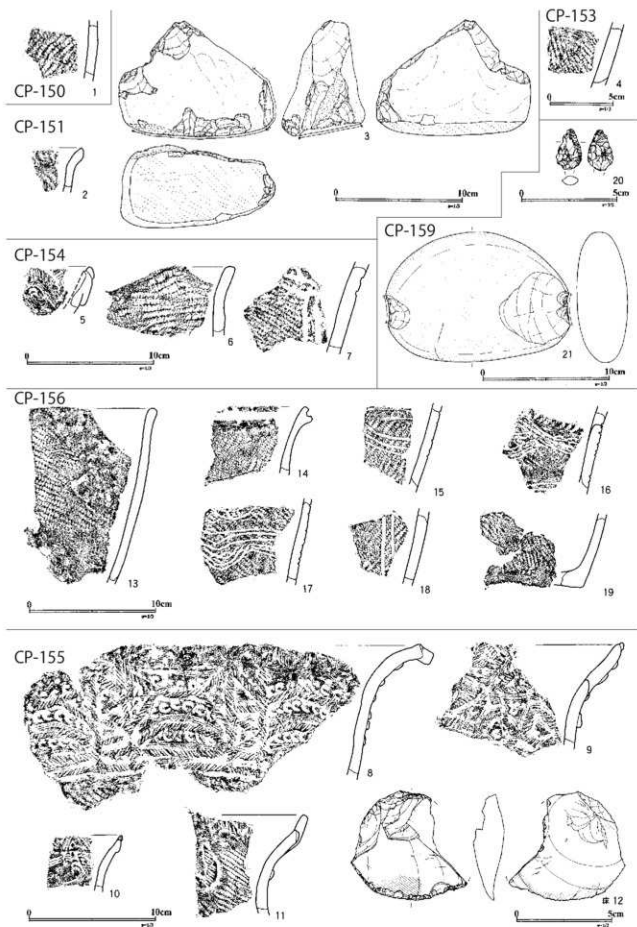
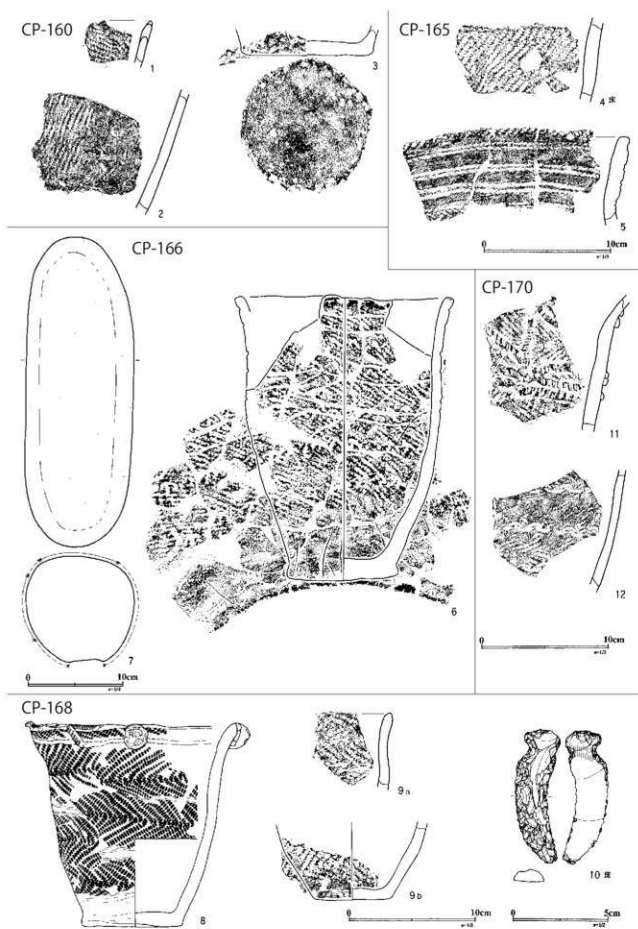

図II-527 CP-160・165・166・168・170の遺物

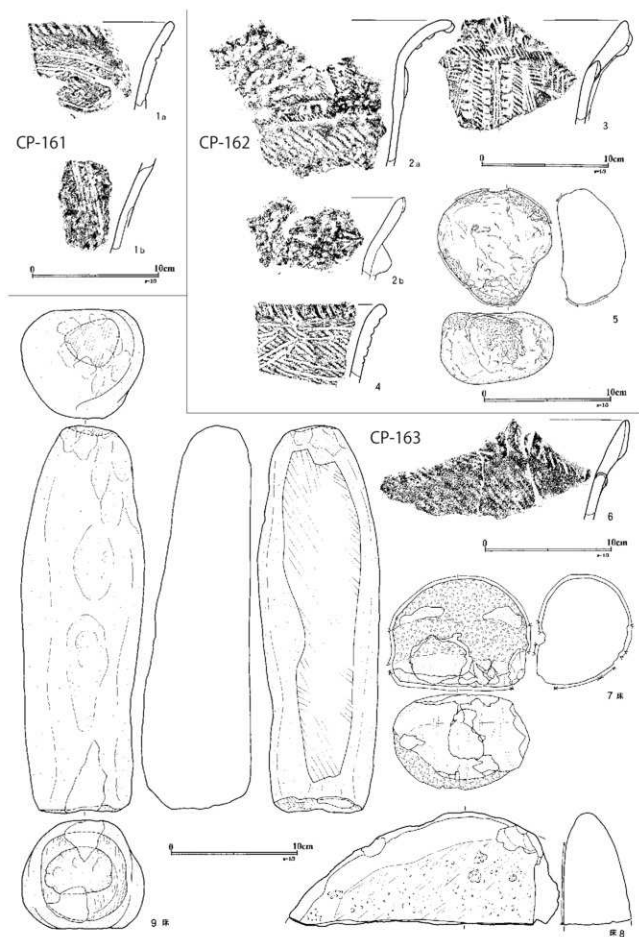

図Ⅱ-528 CP-161~163の遺物

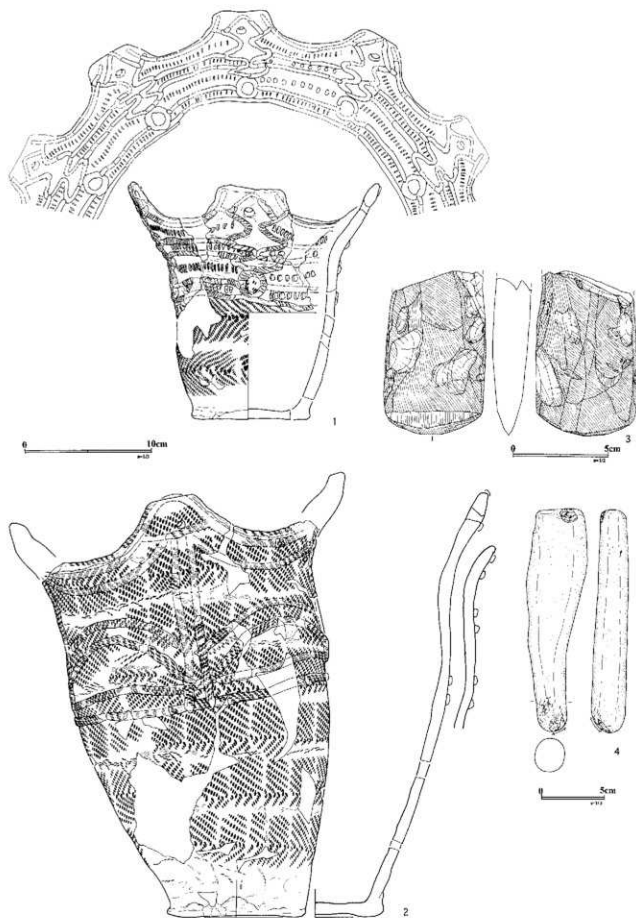

図Ⅱ-529 CP-171(1)の遺物

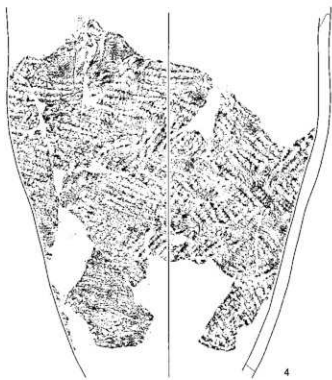
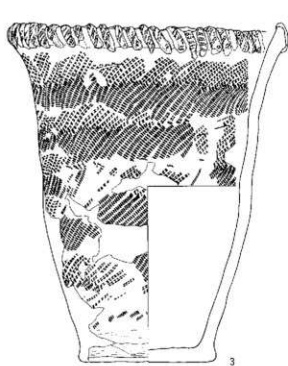
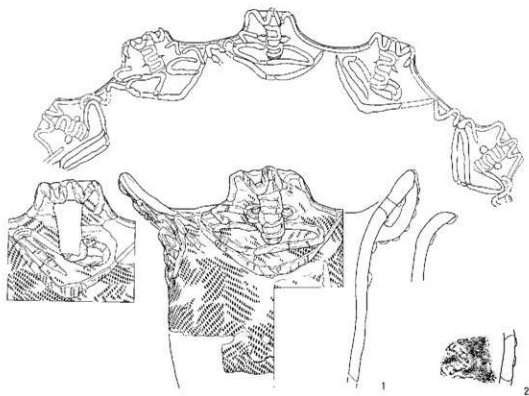

図Ⅱ-530 CP-171(2)の遺物



図 II-531 CP-172の遺物

CP-173



CP-176

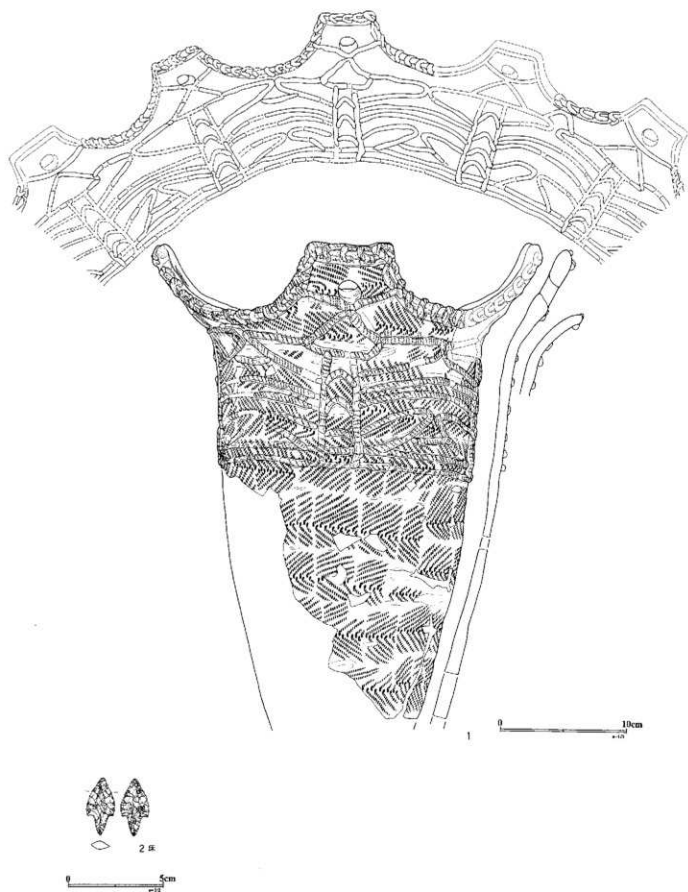
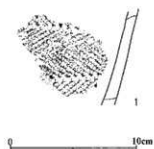
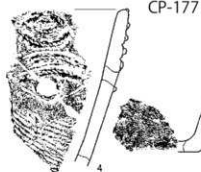
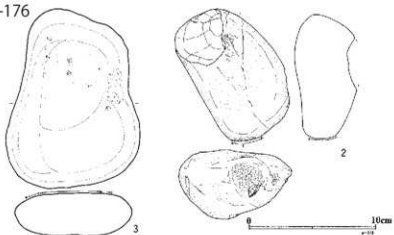

CP-177

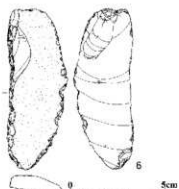

CP-178

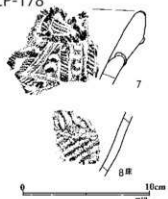

CP-180

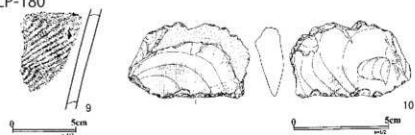

CP-183

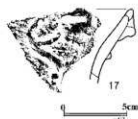

CP-181

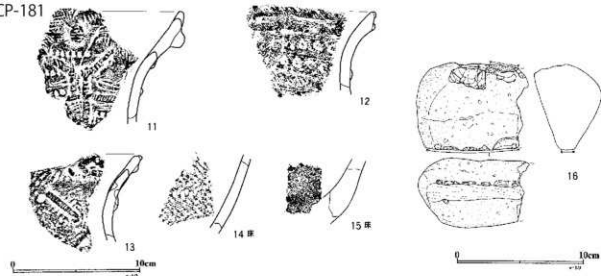

図Ⅱ-532 CP-173・176～178・180・181・183の遺物



図 II-533 CP-182の遺物



図 II-534 CP-185の遺物

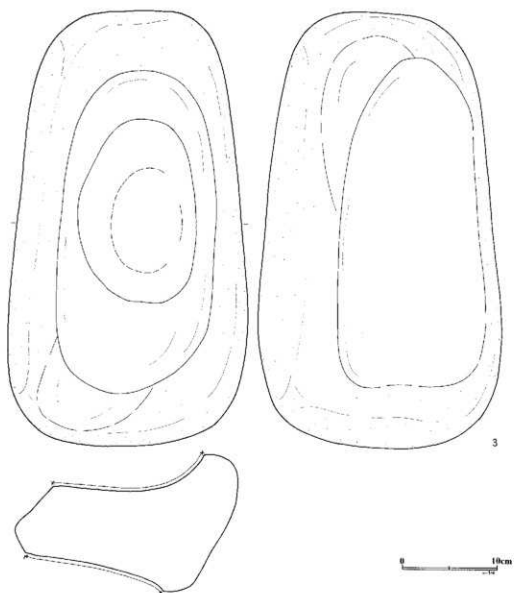

図II-535 CP-187・188・189(1)の遺物

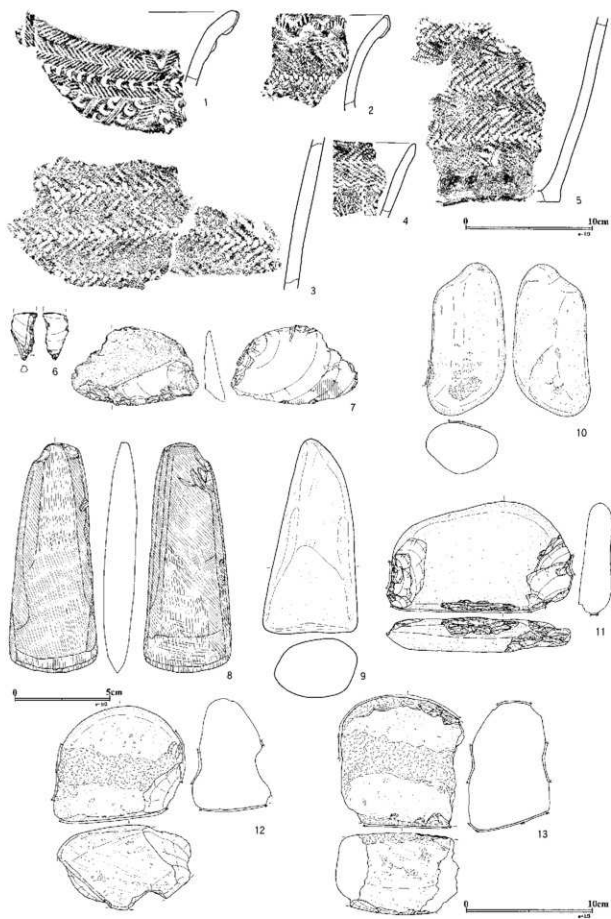
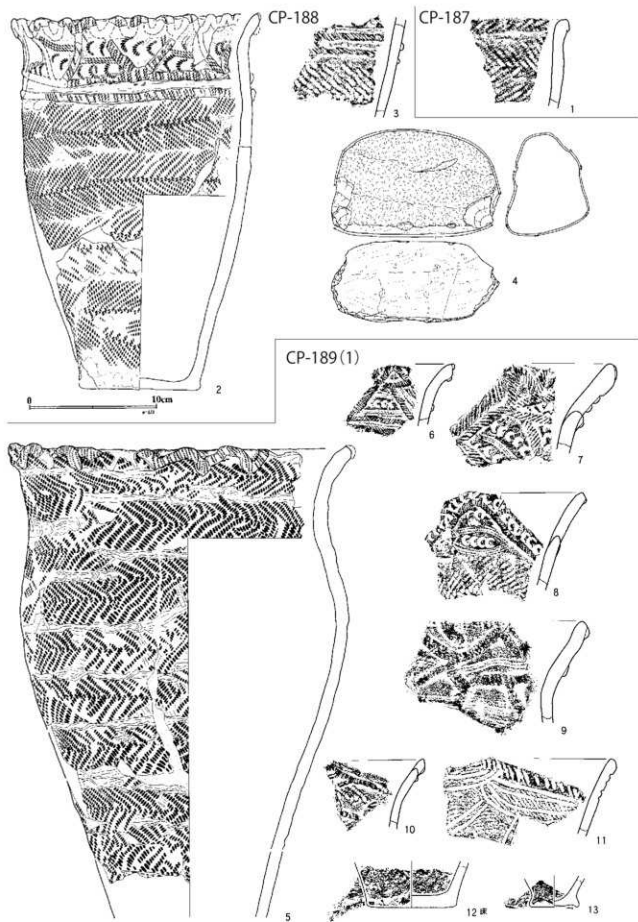
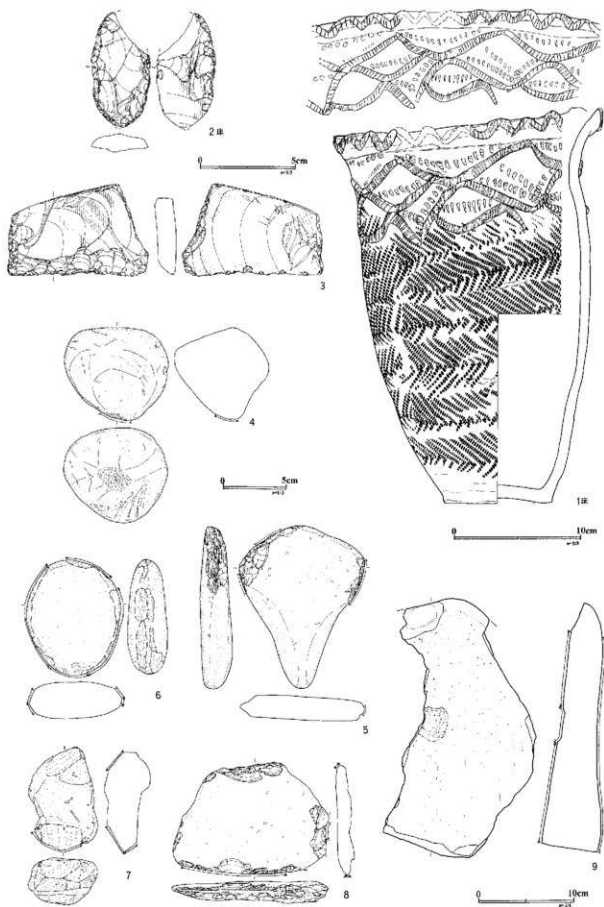

図Ⅱ-536 CP-189(2)の遺物

CP-192

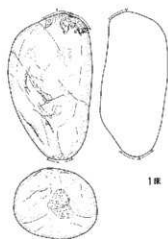

CP-194

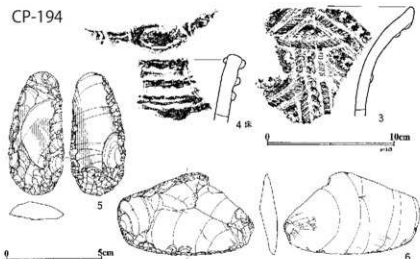

CP-195



CP-193

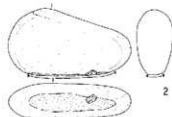

CP-197

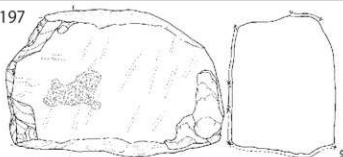

CP-202

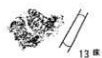

CP-201

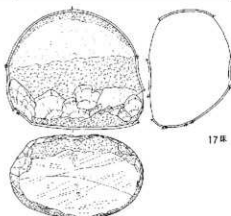
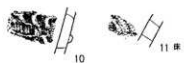

CP-203



図 II-537 CP-192~195・197・201~203の遺物



図Ⅱ-538 CP-204~206・209・210・212・214・215の遺物

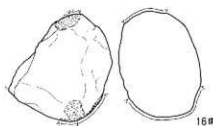
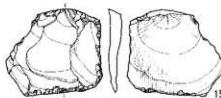
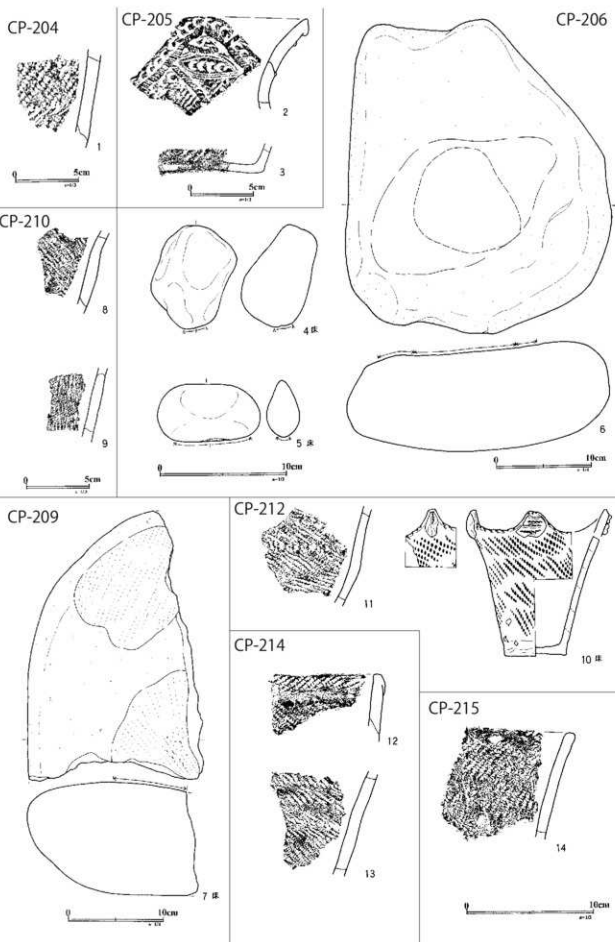

図 II-539 CP-216~218・220の遺物

CP-223



CP-224

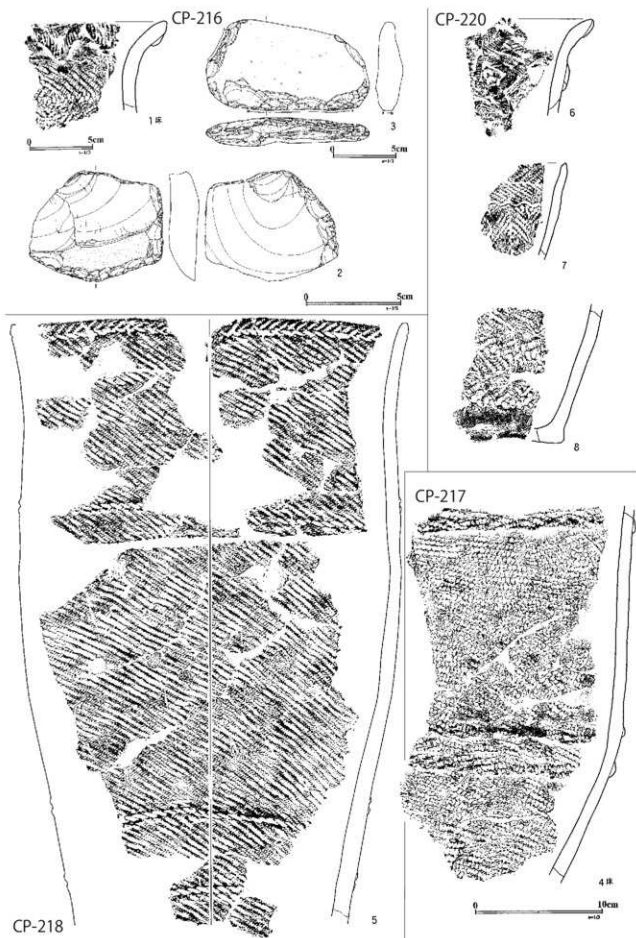
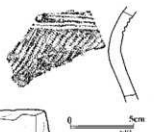
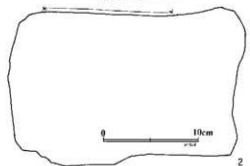
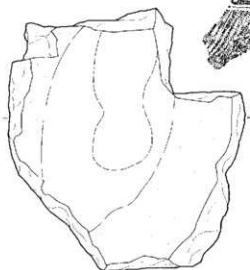
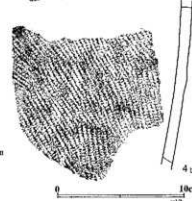
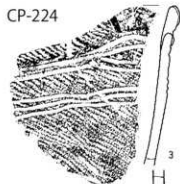

CP-227

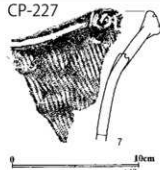

CP-229

CP-231

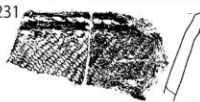
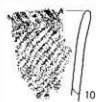

CP-228

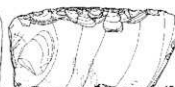
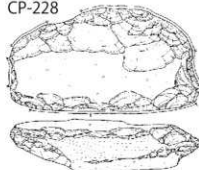

図Ⅱ-540 CP-223・224・227・228・229・231の遺物

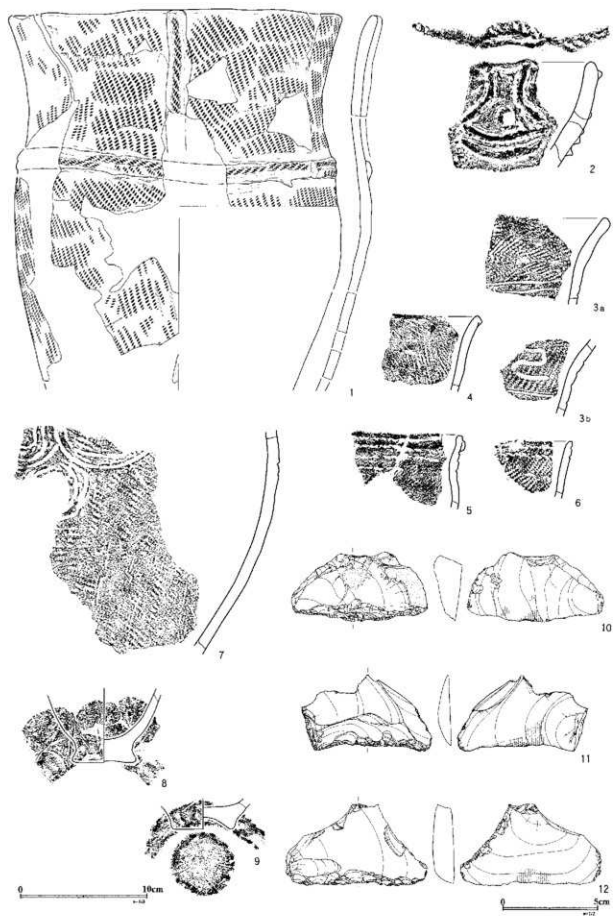

図II-541 CP-230の遺物

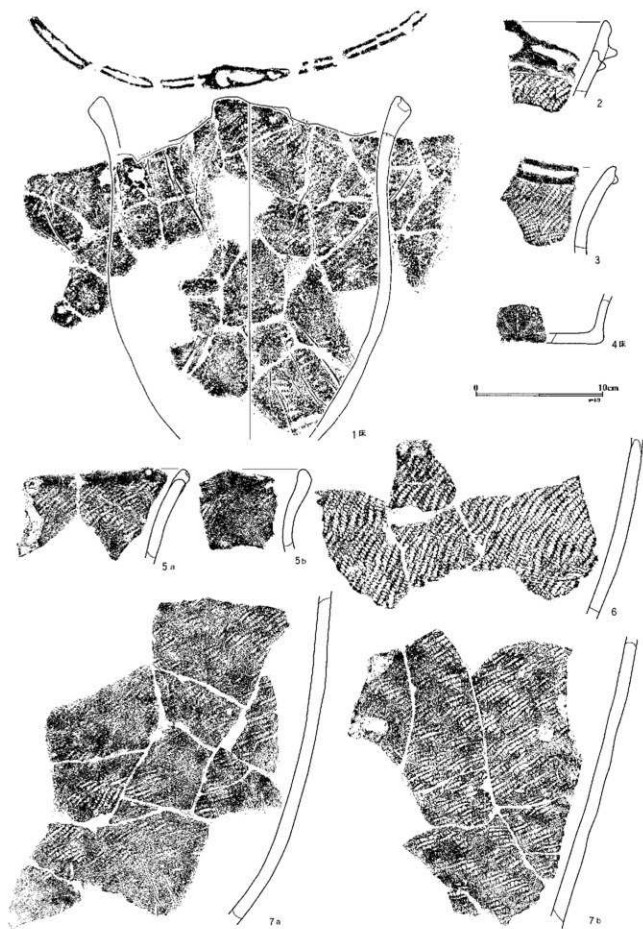

図Ⅱ-542 CP-232(1)の遺物

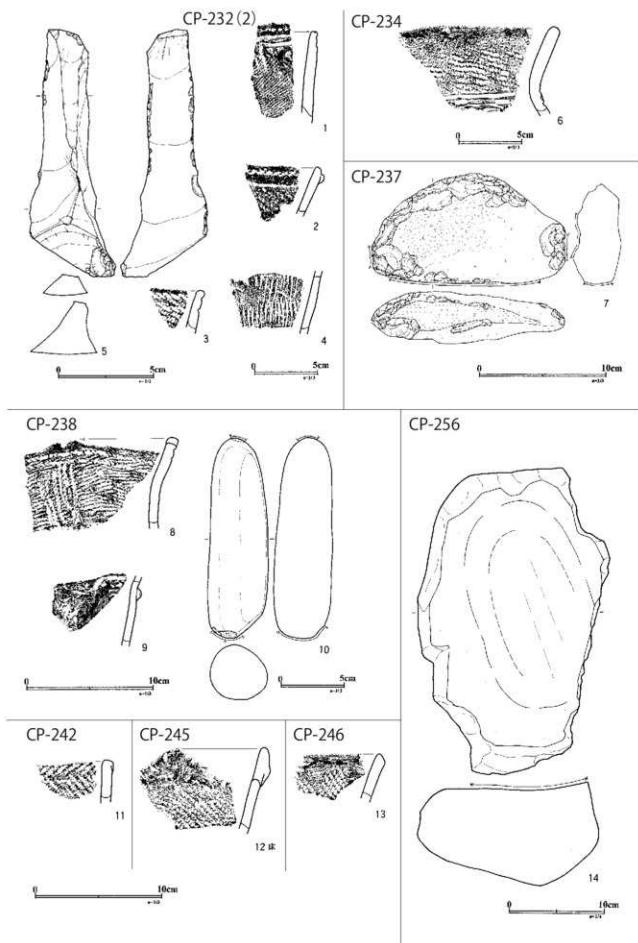

図II-543 CP-232(2)・234・237・238・242・245・246・256の遺物

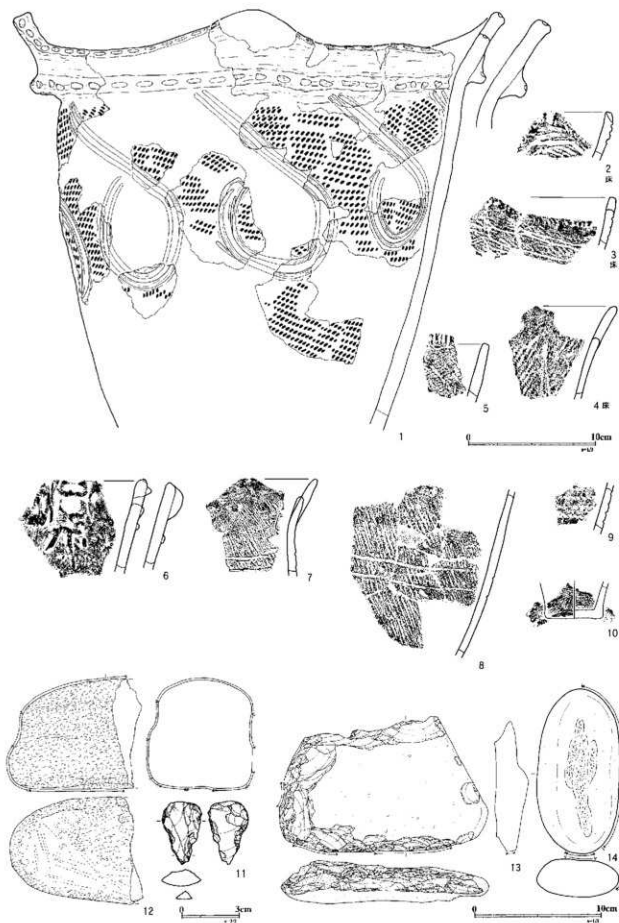

図Ⅱ-544 CP-244の遺物

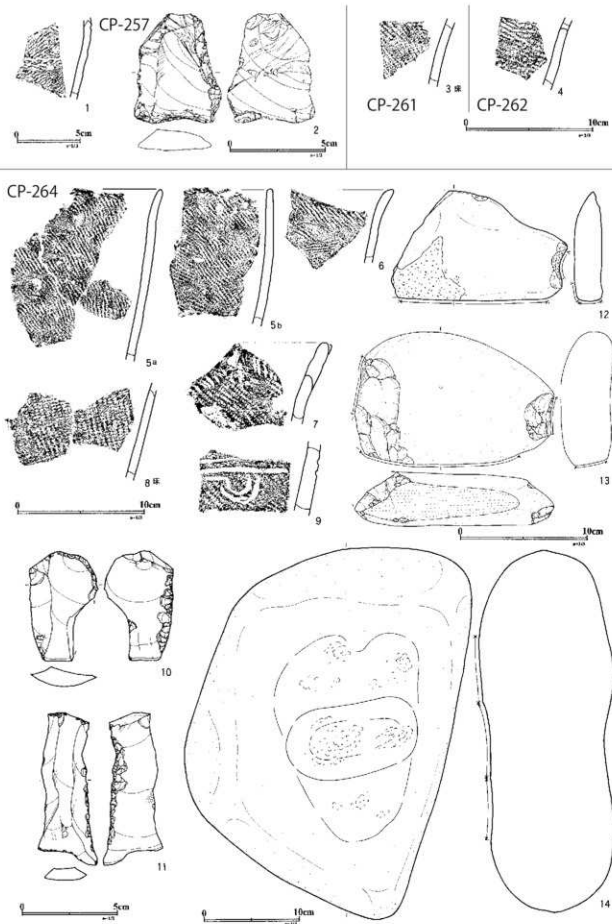

図II-545 CP-257・261・262・264の遺物

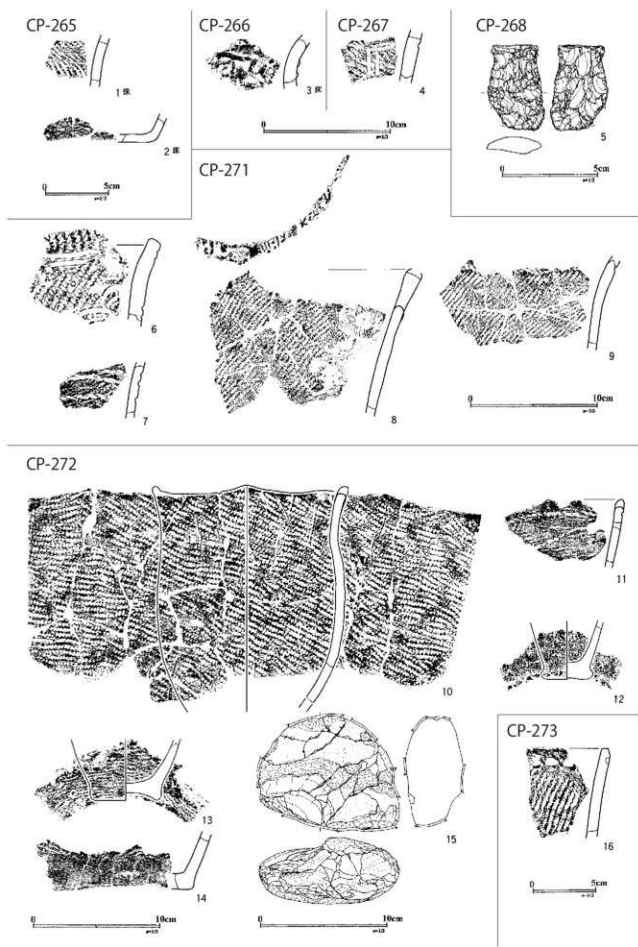

図Ⅱ-546 CP-265~268・271~273の遺物

3 焼土

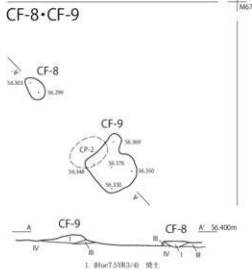
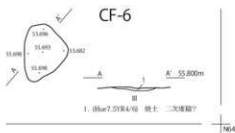
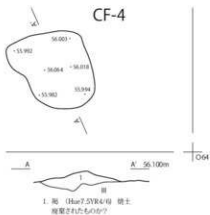
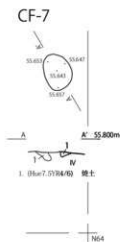
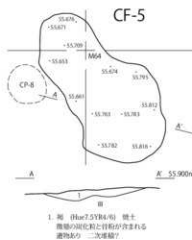
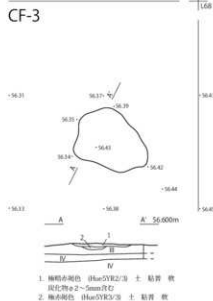
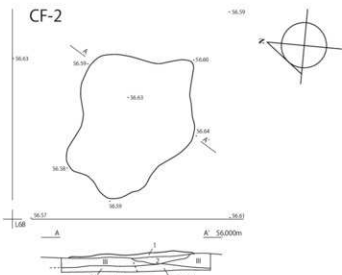
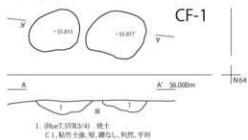

図II-547 CF-1~9



図 II-548 CF-10~17



図 II-549 CF-18~27

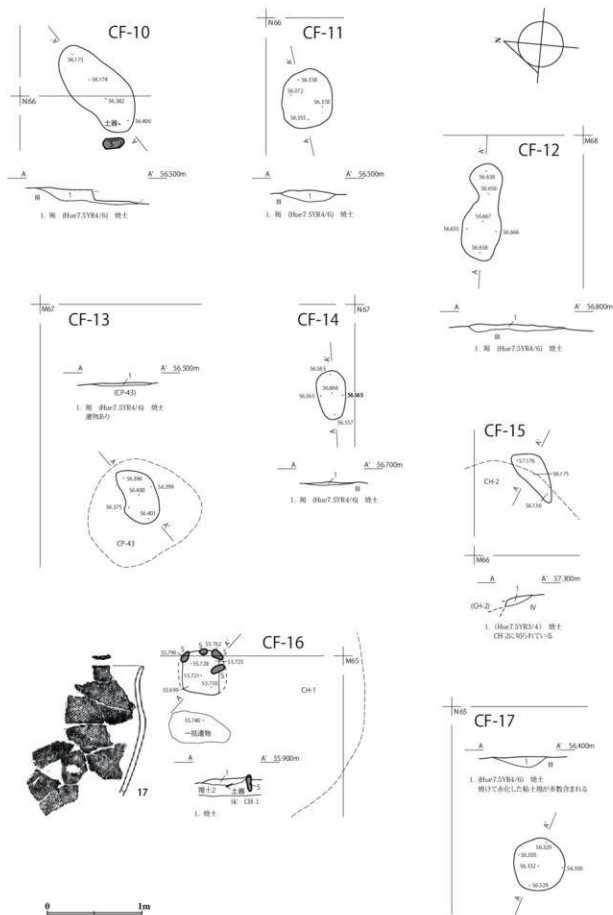

図 II -550 CF-28~39

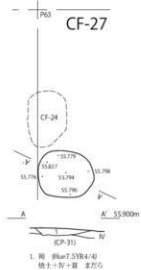
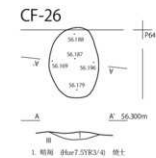
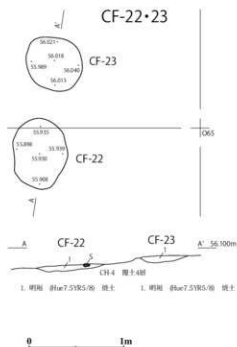
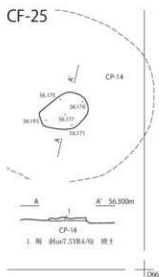
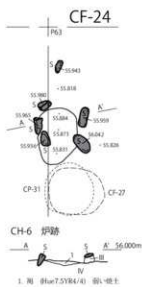
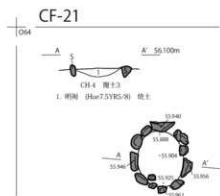
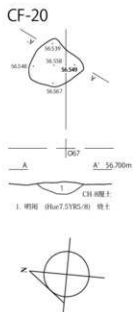
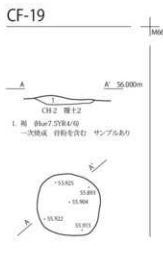
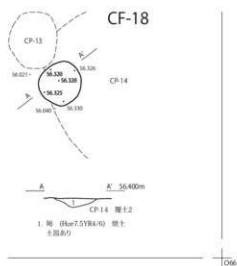

図 II -552 CF-47~57

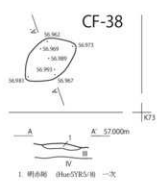
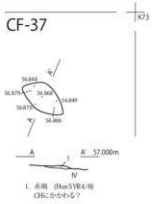
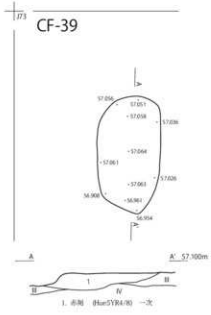
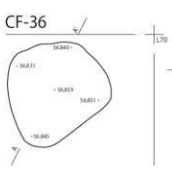
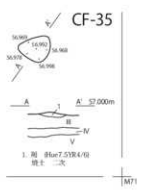
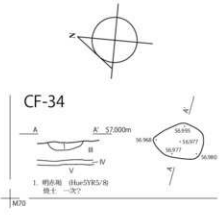
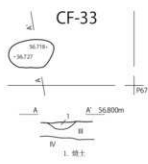
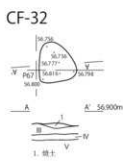
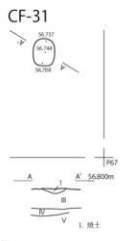
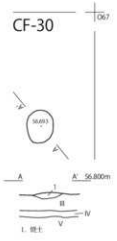
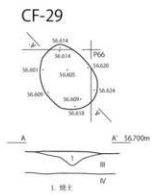

図 II-553 CF-58~69

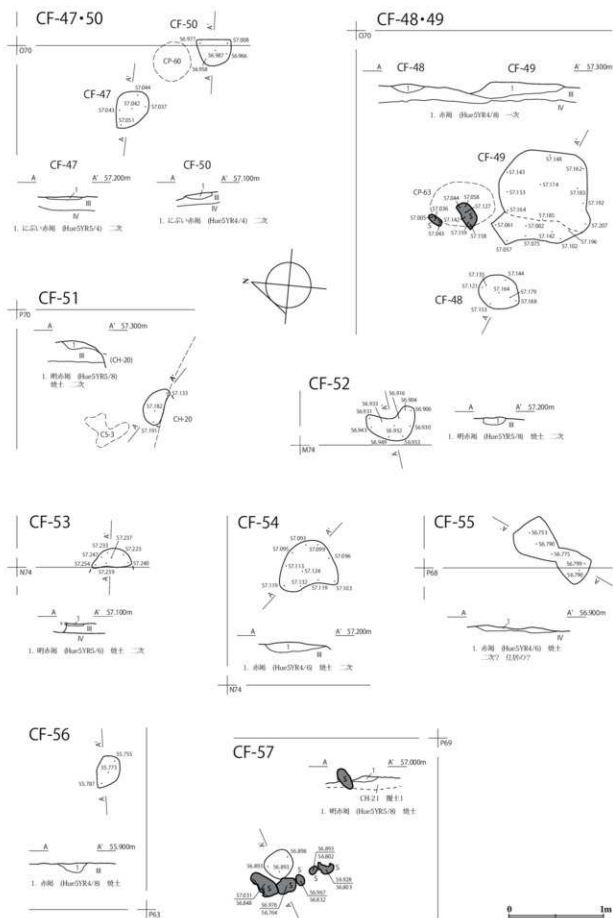

図 II-554 CF-70~79

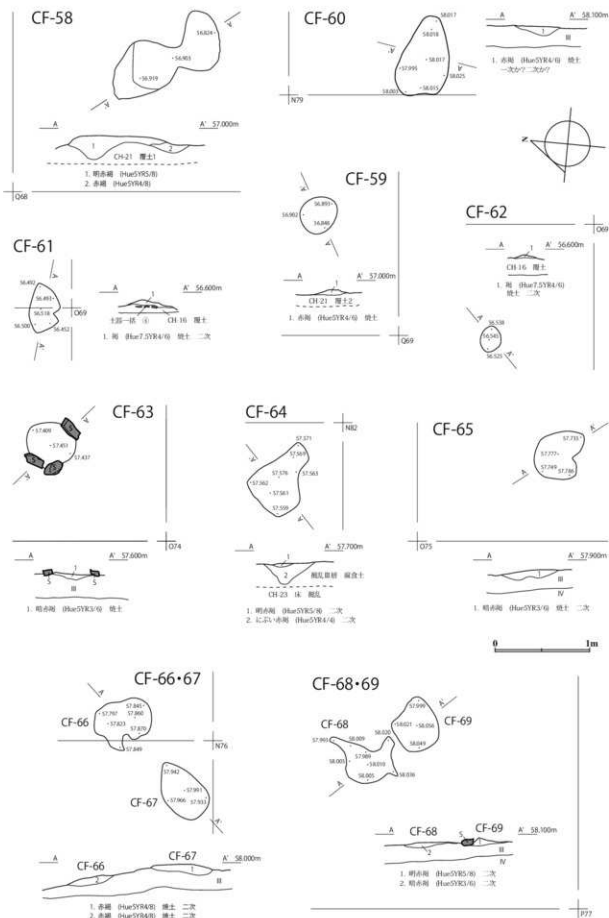

図 II-555 CF-80~89

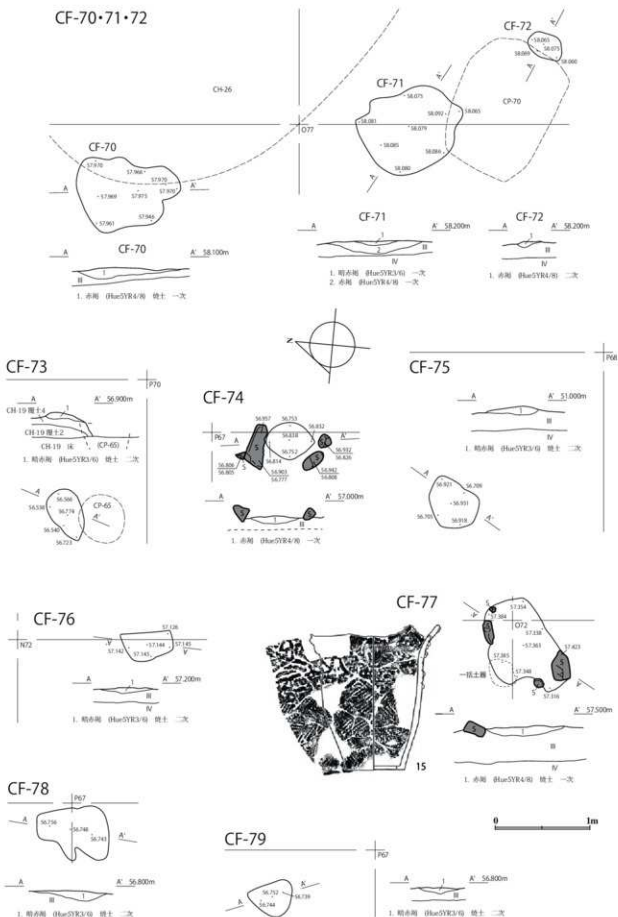

0 1m

図 II-556 CF-90~99

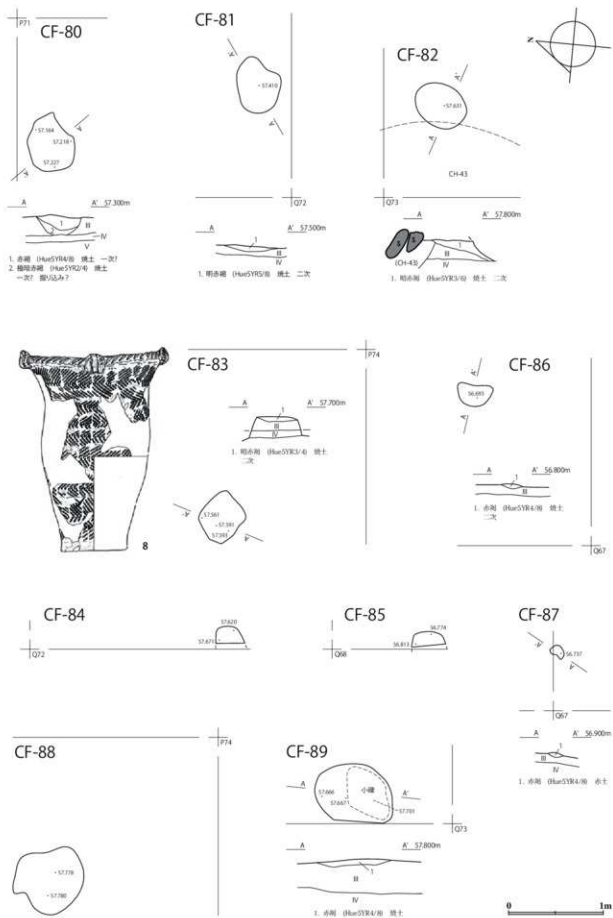
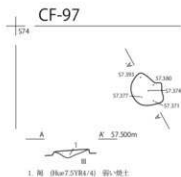
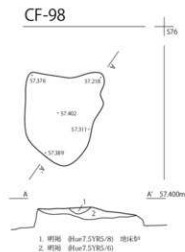
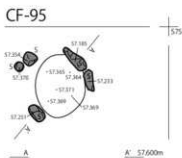
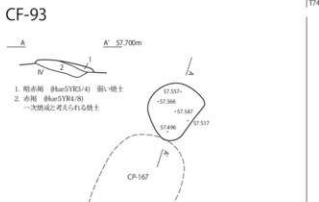
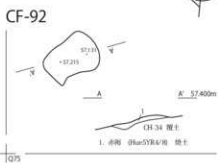
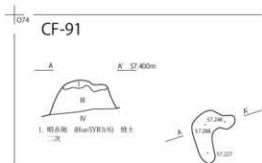
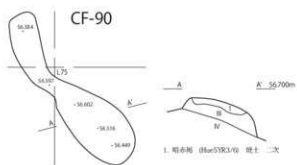
CF-110

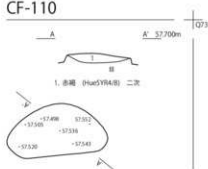

CF-112

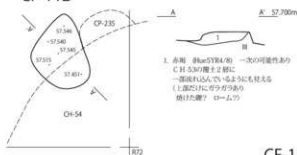

CF-113



CF-116

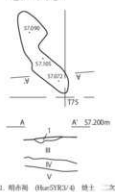

CF-117

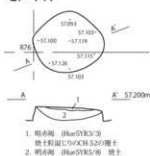

CF-114



CF-118

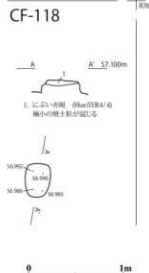

CF-119

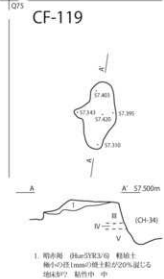

図II-558 CF-110~119

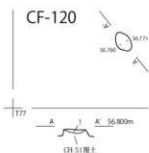

1. 粘土層 (BlueSYR3/4) 粘結土
 陶小片 (small)の出土部位に1%混入する
 流石山片が散見 粘結中 軟

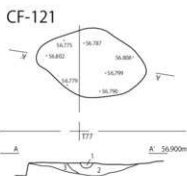

1. 粘土層 (BlueSYR5/6) 粘結土
 粘土のブロック状連続 粘性強 堅
 2. 粘土層 (BlueSYR3/4) 粘結土
 陶小片の出土が混入する 粘性強 堅
 3. 10~20%混入の陶片 (Blue10YR3/4) 粘結土
 粘結中 堅



1. BlueSYR3/4 + BlueSYR5/6
 粘土褐色土中に明赤褐色粘土が混入する
 堅。赤土上の層厚によるものか混入によるもの 粘結中 堅
 CH 52 層土
 陶片 (Blue10YR3/4) 粘結土
 径1~2mmの10~15%混入している

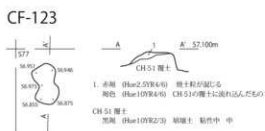

1. 赤層 (Blue2.5YR6/4) 粘土粒が混入する
 褐色 (Blue10YR4/4) CH 51の層土に混入したものである
 CH 51 層土
 黒層 (Blue10YR2/3) 粘結土 粘結中 中

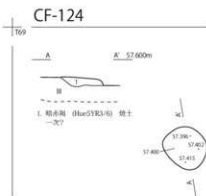

1. 粘土層 (BlueSYR3/4) 粘土
 一次?

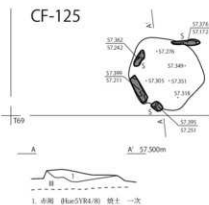

1. 赤層 (BlueSYR4/6) 粘土 一次

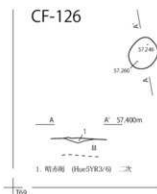

1. 粘土層 (BlueSYR3/4) 粘土
 二次

0 1m



1. 赤層 (BlueSYR4/6) 粘土
 二次?
 CS6に付する

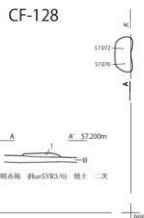

1. 粘土層 (BlueSYR3/4) 粘土
 二次

図 II-559 CF-120~128

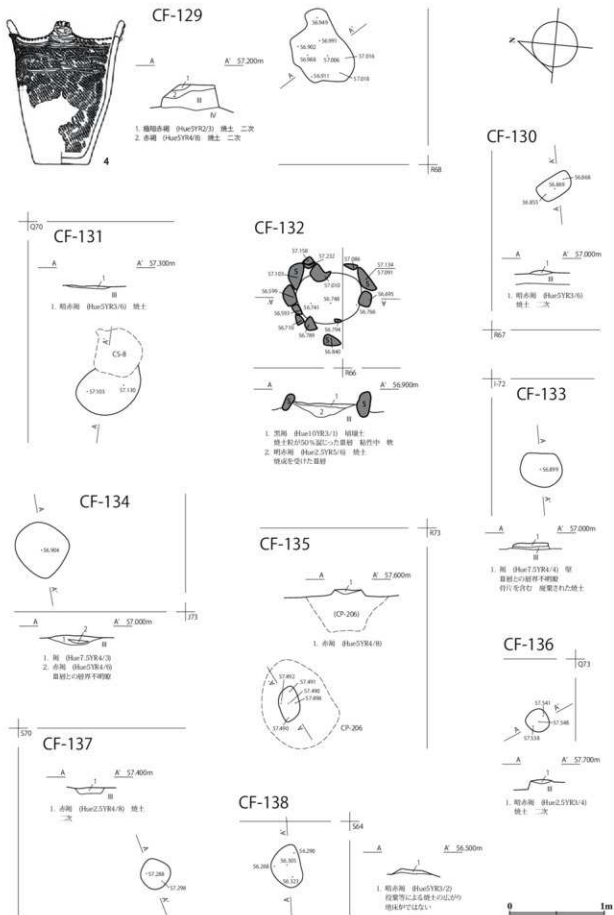

図Ⅱ-560 CF-129~138

CF-139

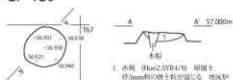

CF-140

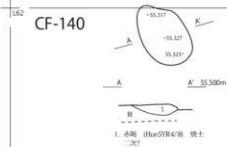

CF-141

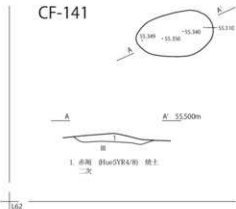

CF-143

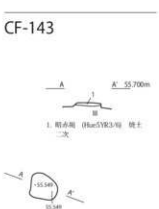

CF-142

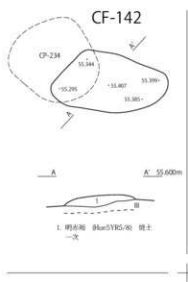

CF-145



CF-144



CF-146

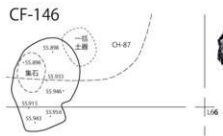

CF-147

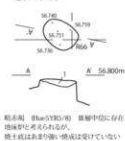

0 1m

図 II-561 CF-139~147

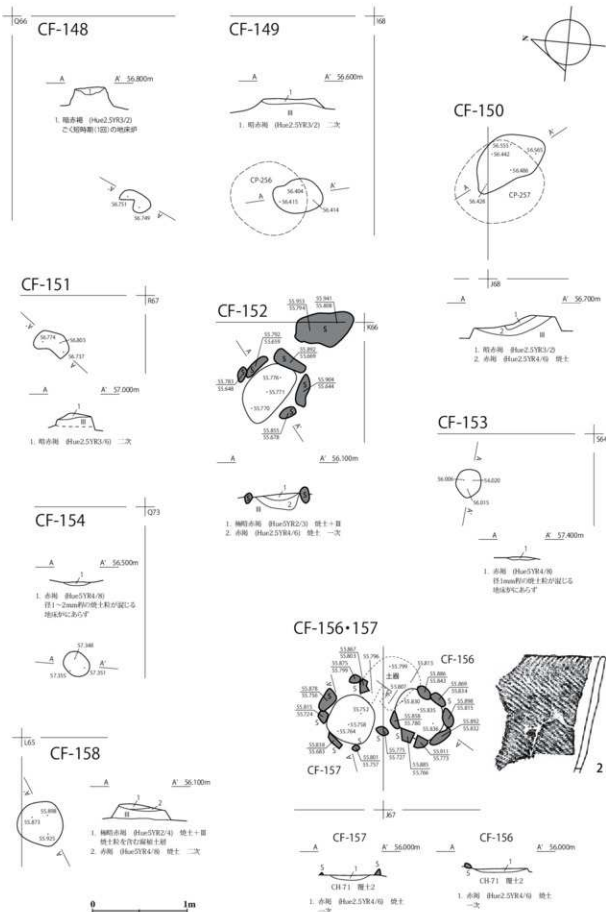

図II-562 CF-148~154・156~158

CF-159

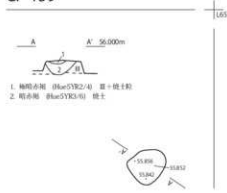

CF-160

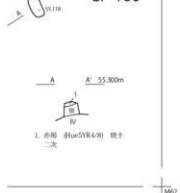

CF-161

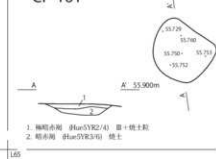

CF-162

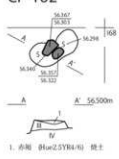

4 フレイク・チップ集中 (CFC)

CFC-1



CFC-2



図 II-563 CF-159~162・CFC-1・2

5 集石 (CS)

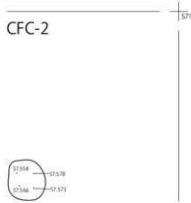

図 II-564 CS-1~12

6 柱穴状小ピット (CSP)

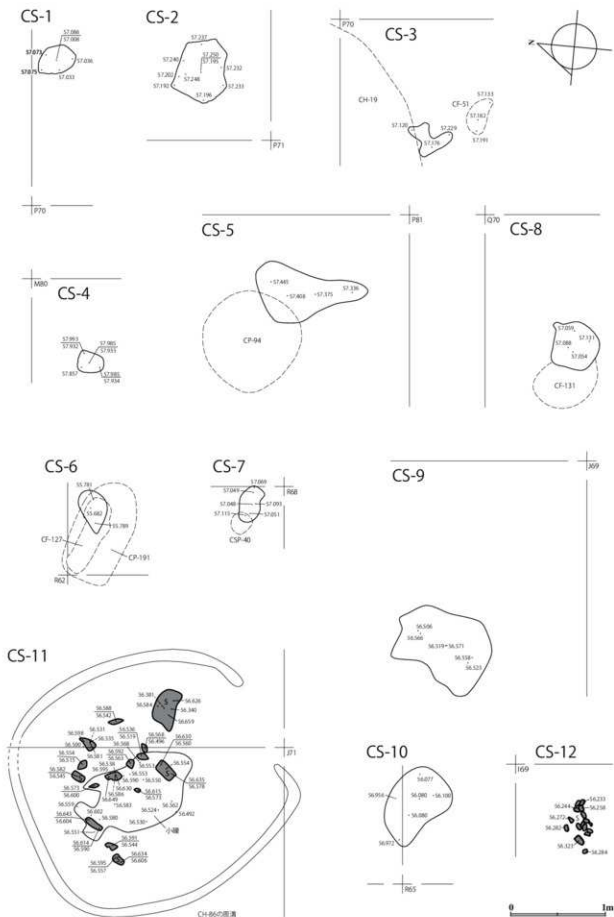

図 II-565 CSP-1~30

CSP-31



CSP-32

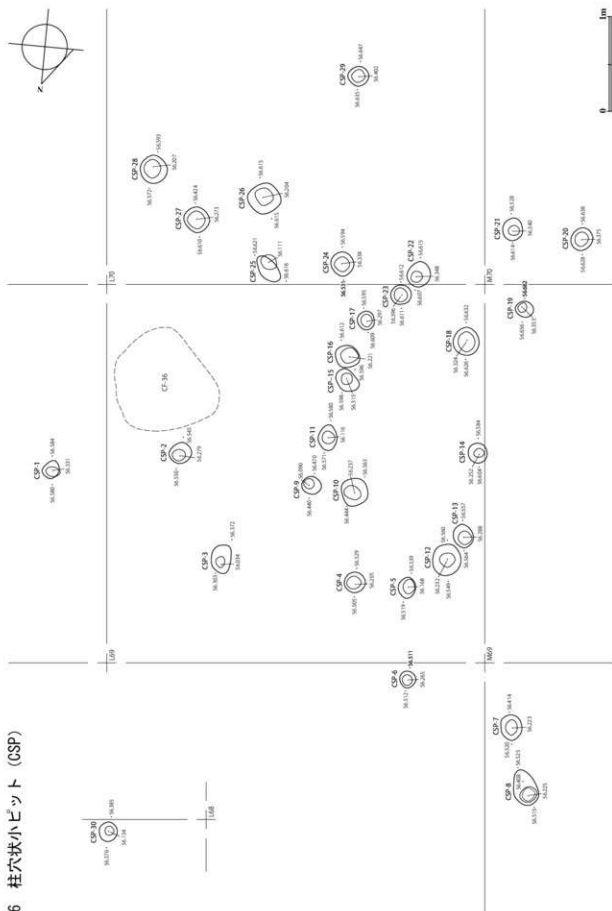
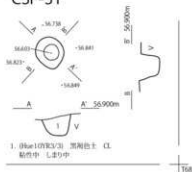

CSP-33



CSP-34



CSP-35

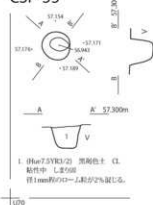

CSP-36

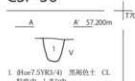

CSP-37

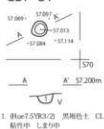

CSP-38

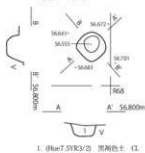

CSP-39

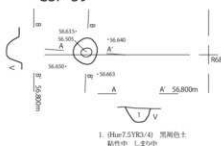

CSP-40

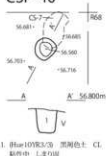

CSP-41

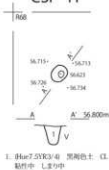

CSP-42



図 II-566 CSP-31~42



図 II-567 CSP-43~53・59・60

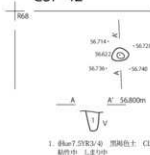

図Ⅱ-568 CSP-54~58・61~67

CSP-68

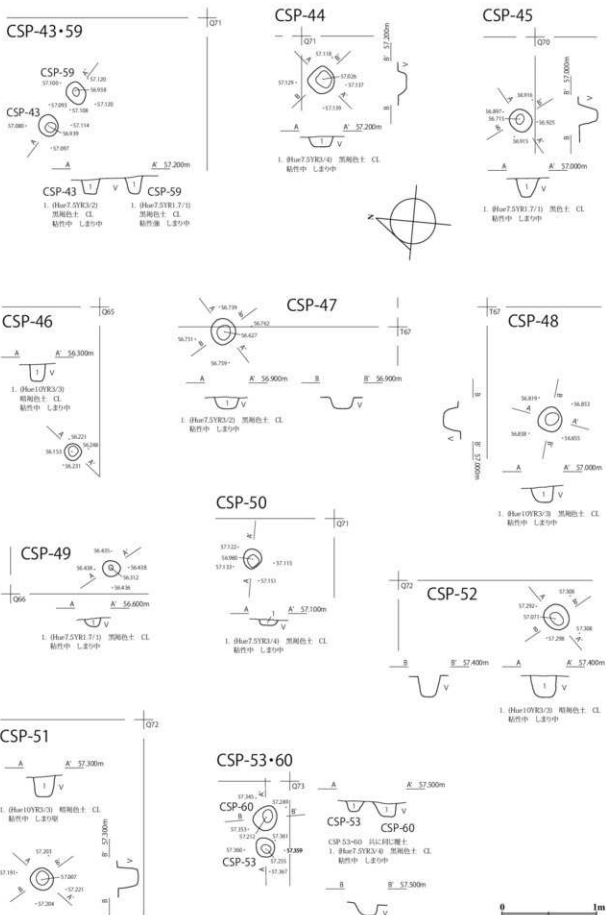
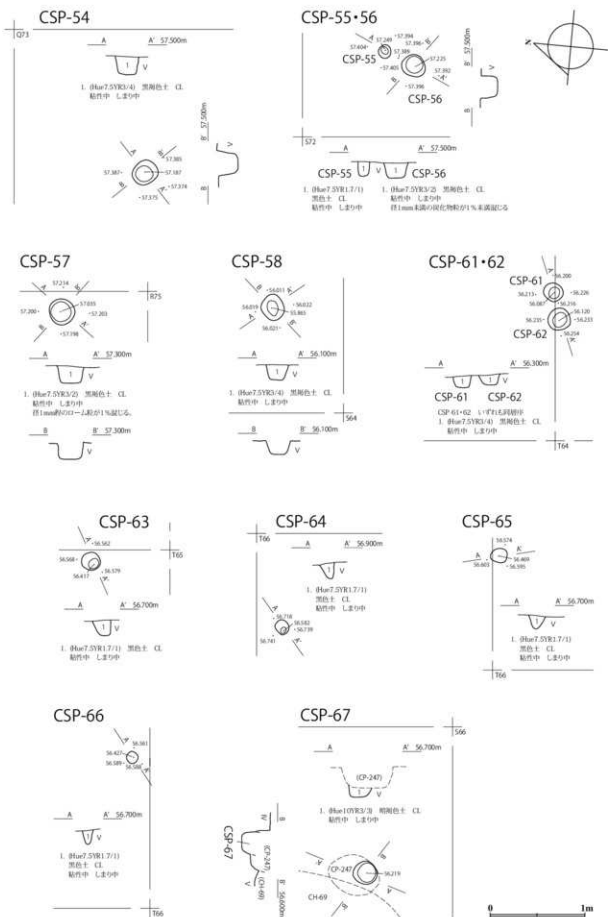
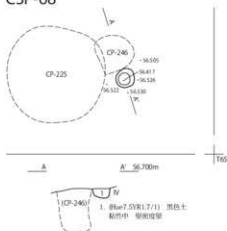

CSP-70

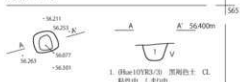

CSP-75

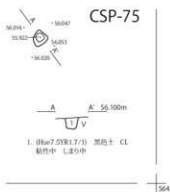

CSP-78



CSP-69

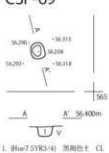

CSP-73

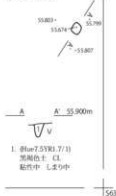

CSP-76

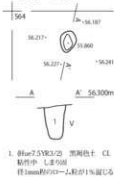

CSP-79

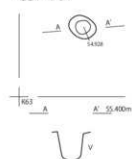

CSP-71・72

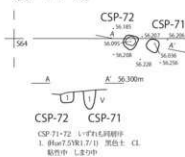

CSP-74

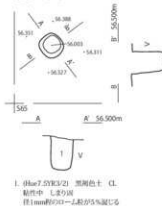

CSP-77

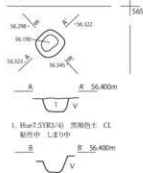

0 1m

図 II-569 CSP-68~79

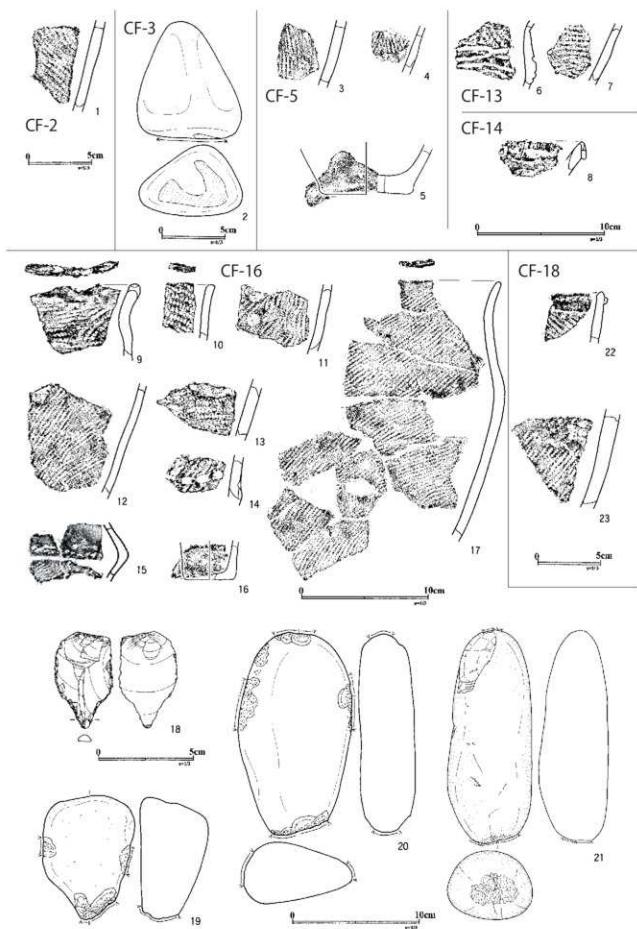

図Ⅱ-570 CF-2・3・5・13・14・16・18の遺物

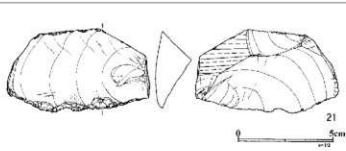
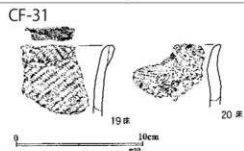
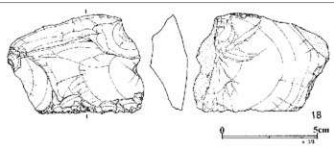
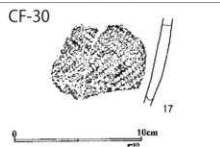
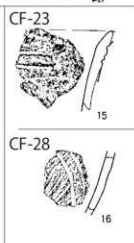
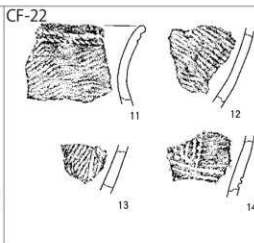
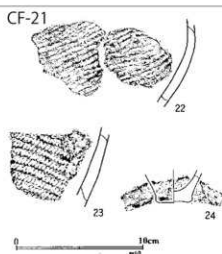
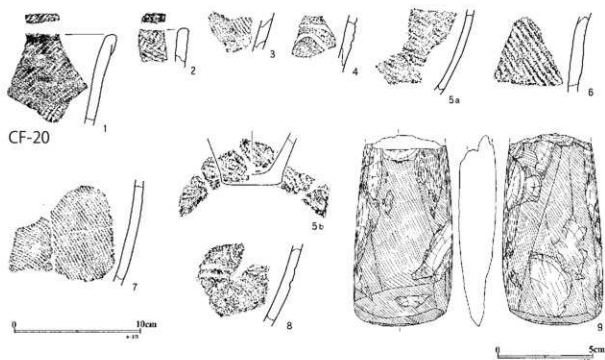

図II-571 CF-20~23・28・30・31の遺物

CF-41

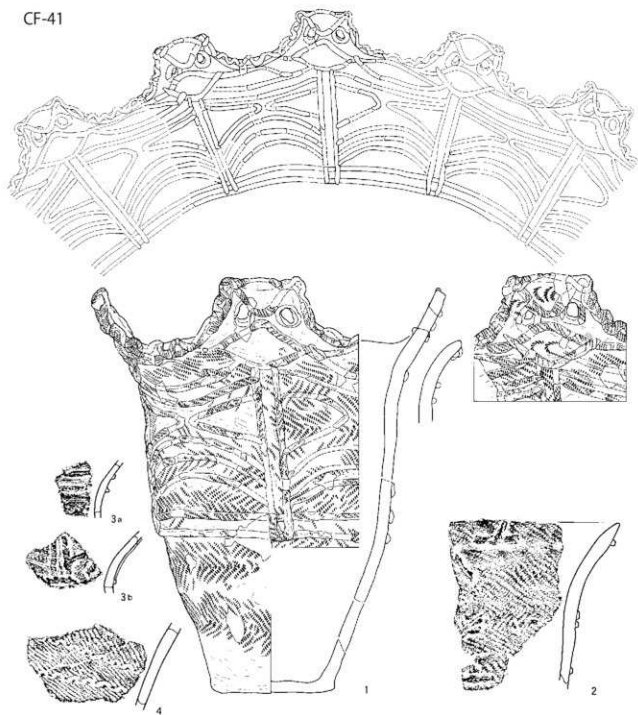

CF-44

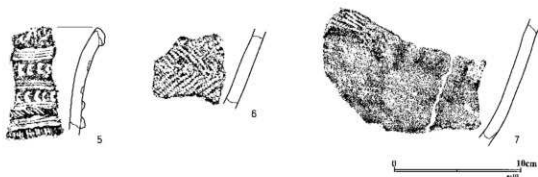

図Ⅱ-572 CF-41・44の遺物

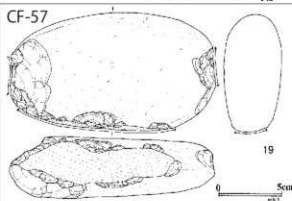
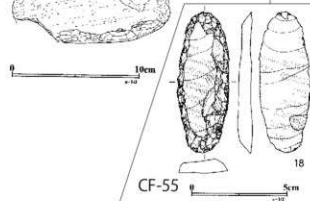
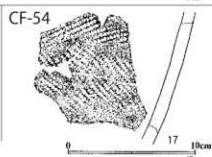
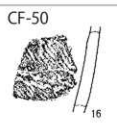
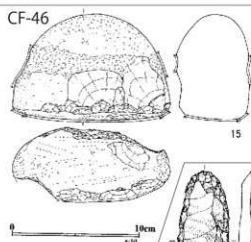
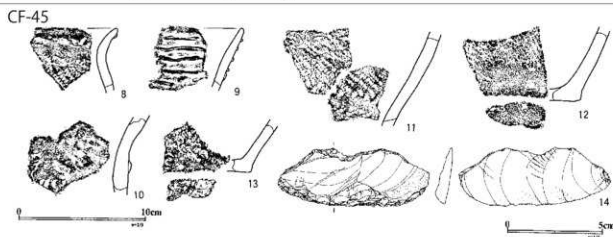
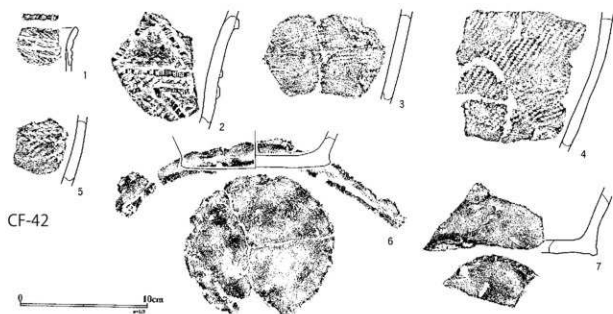

図II-573 CF-42・45・46・50・54・55・57の遺物

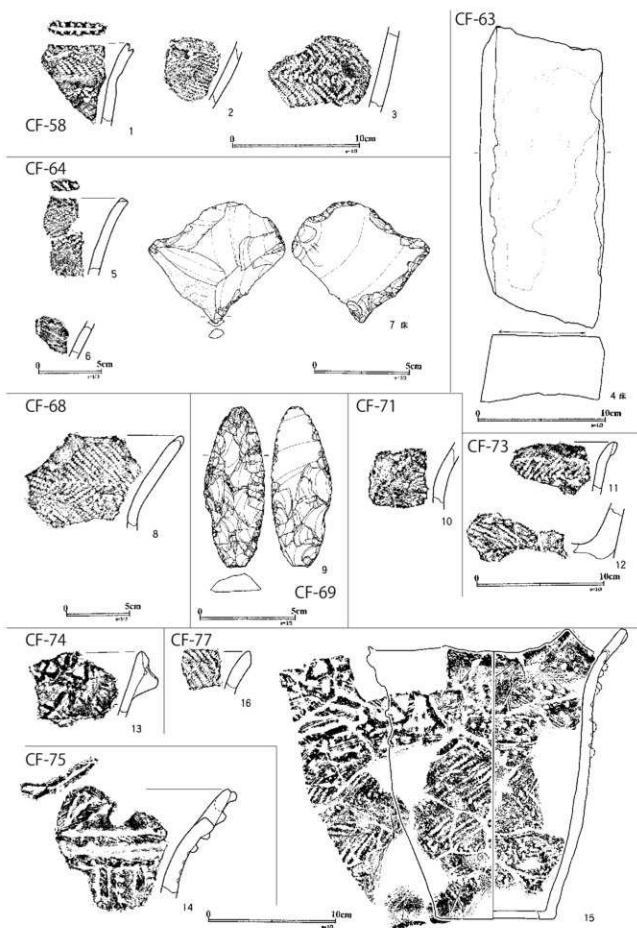

図Ⅱ-574 CF-58・63・64・68・69・71・73~75・77の遺物

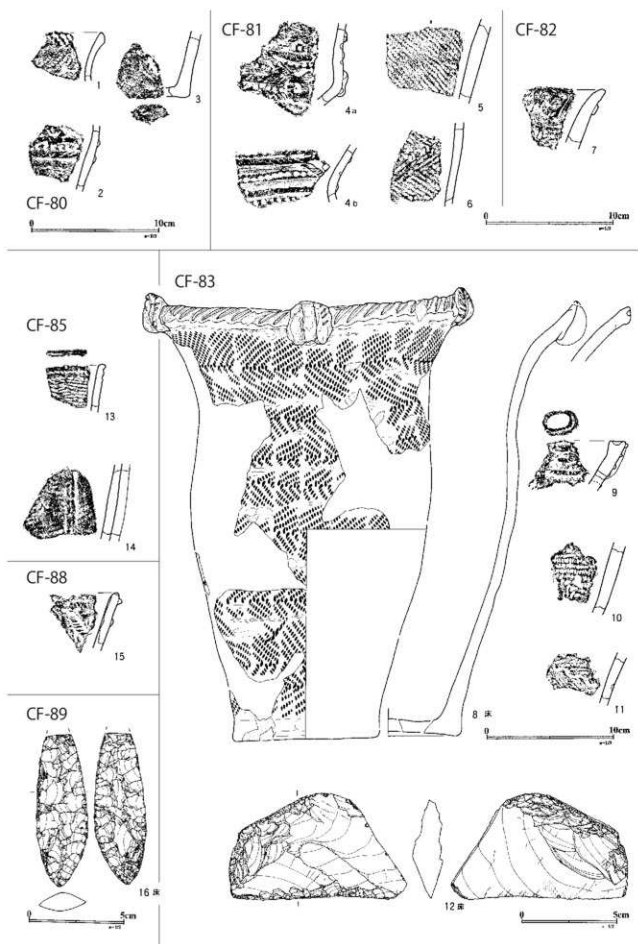

図II-575 CF-80~83・85・88・89の遺物

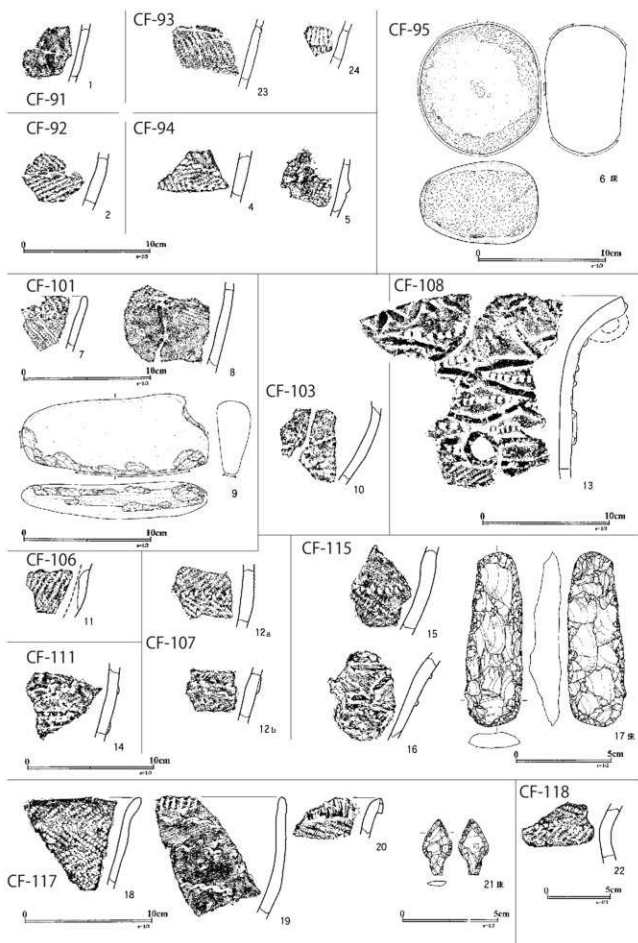

図Ⅱ-576 CF-91~95・101・103・106~108・111・115・117・118の遺物

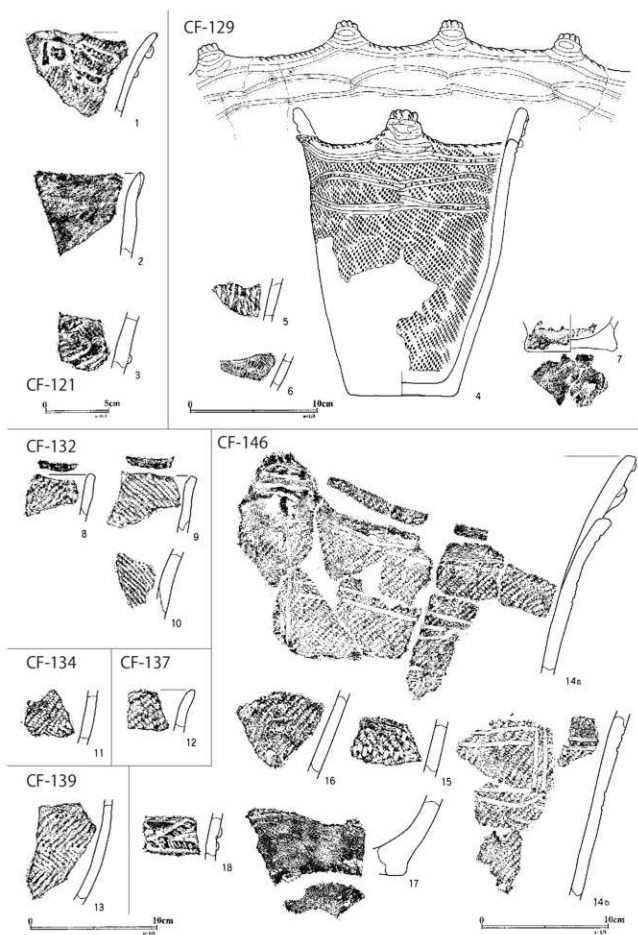

図Ⅱ-577 CF-121・129・132・134・137・139・146の遺物

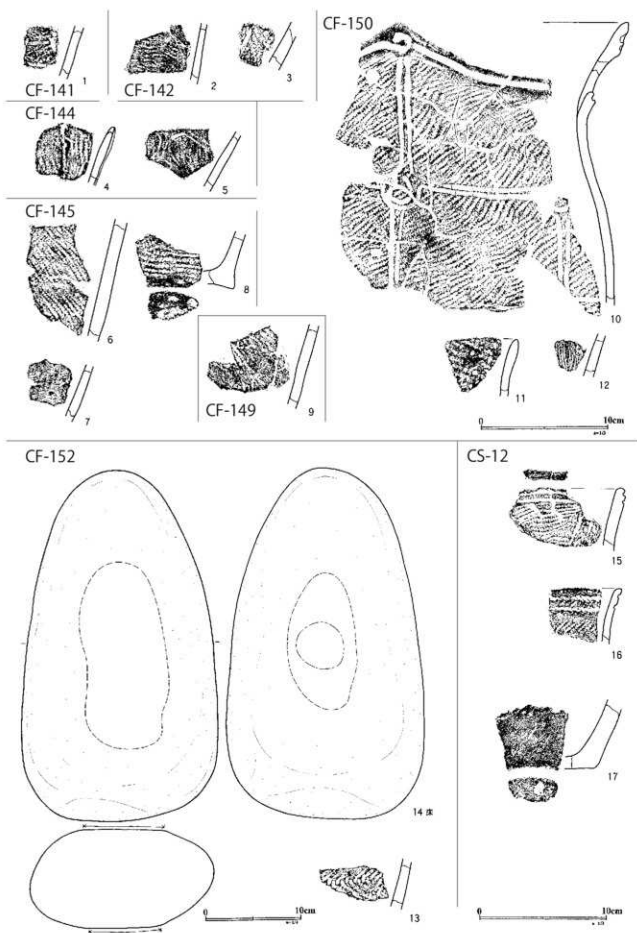

図Ⅱ-578 CF-141・142・144・145・149・150・152 CS-12の遺物

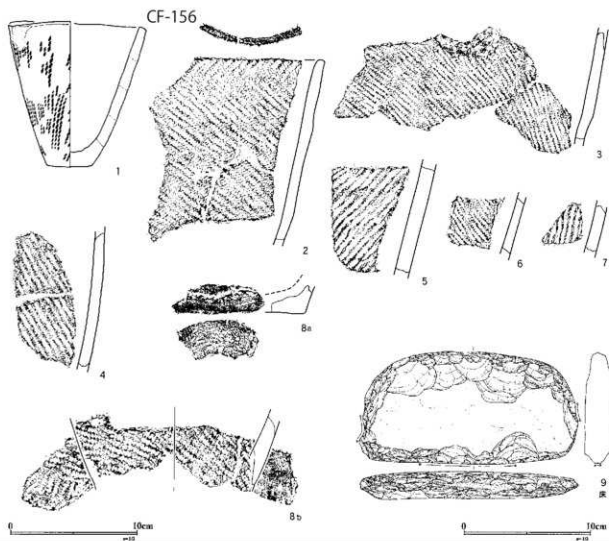

CF-157

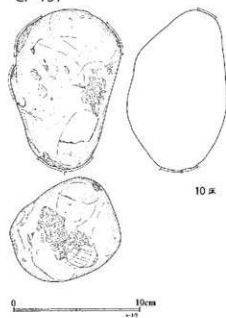

CF-158



CF-162



図 II-579 CF-156~158・162の遺物



図 II-580 CS-2・3・8~11 CSP-1・31の遺物

Ⅲ章 包含層の遺物

1 土器

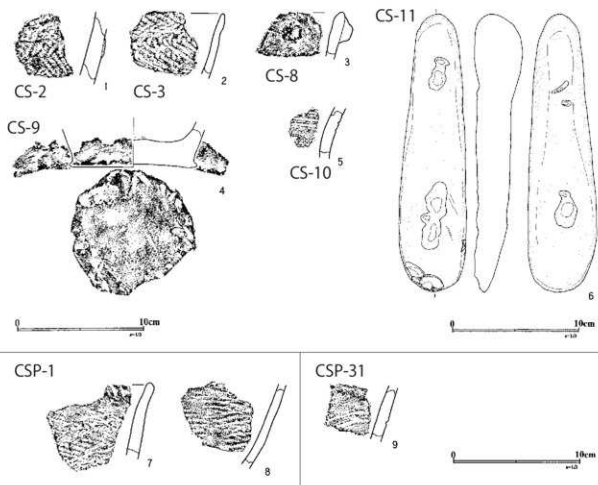
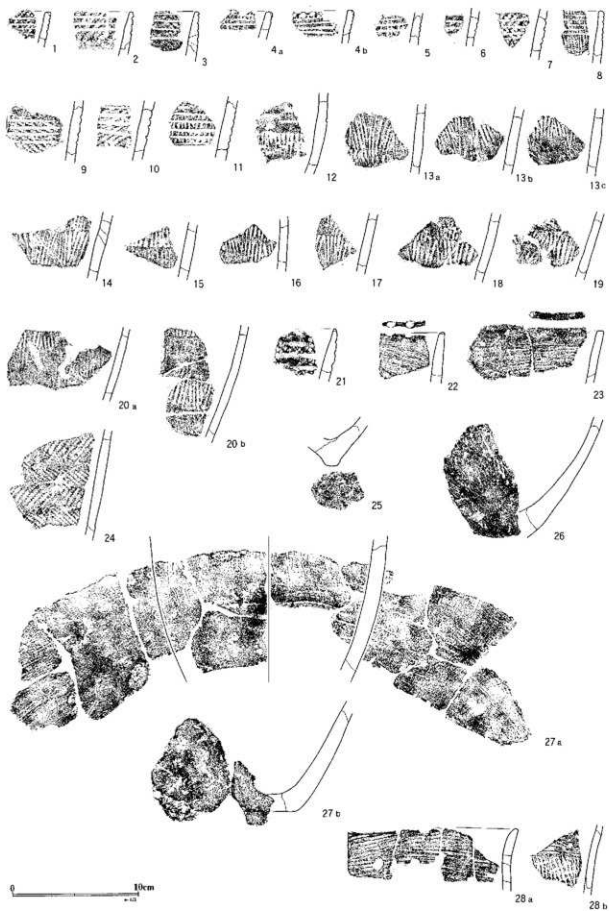

図III-1-1 包含層の土器(1)

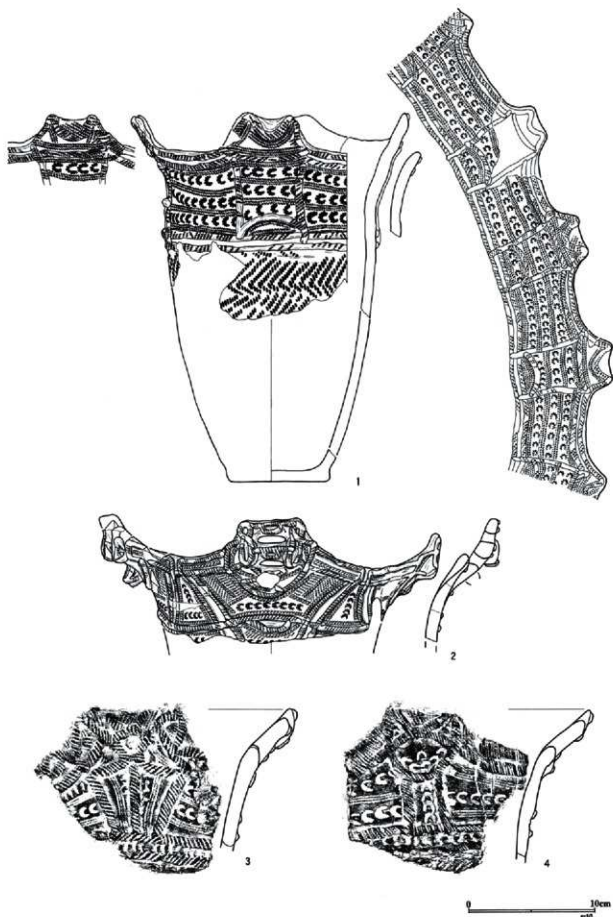

図Ⅲ-1-2 包含層の土器(2)

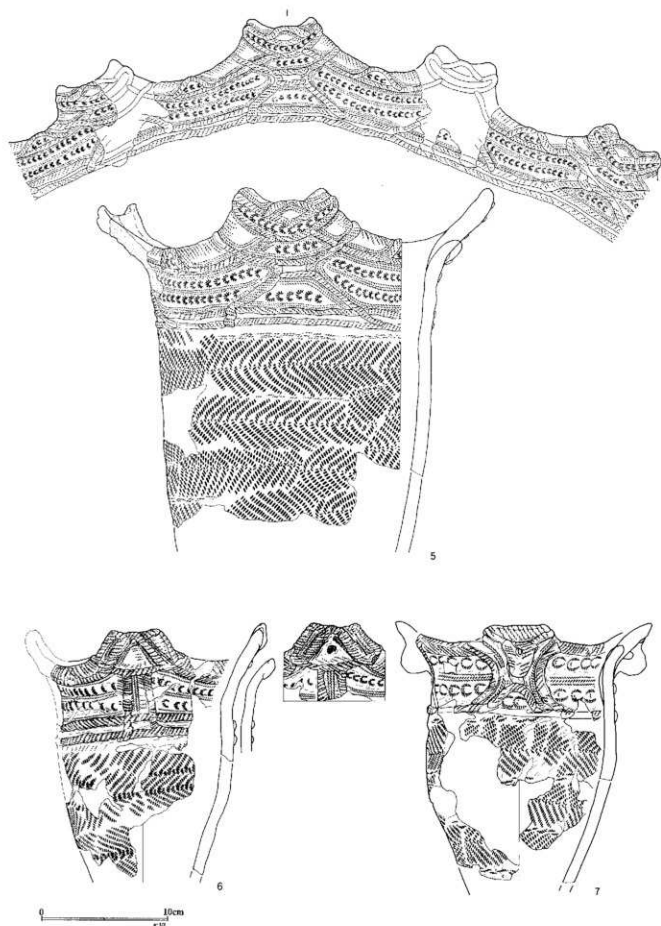

図III-1-3 包含層の土器(3)

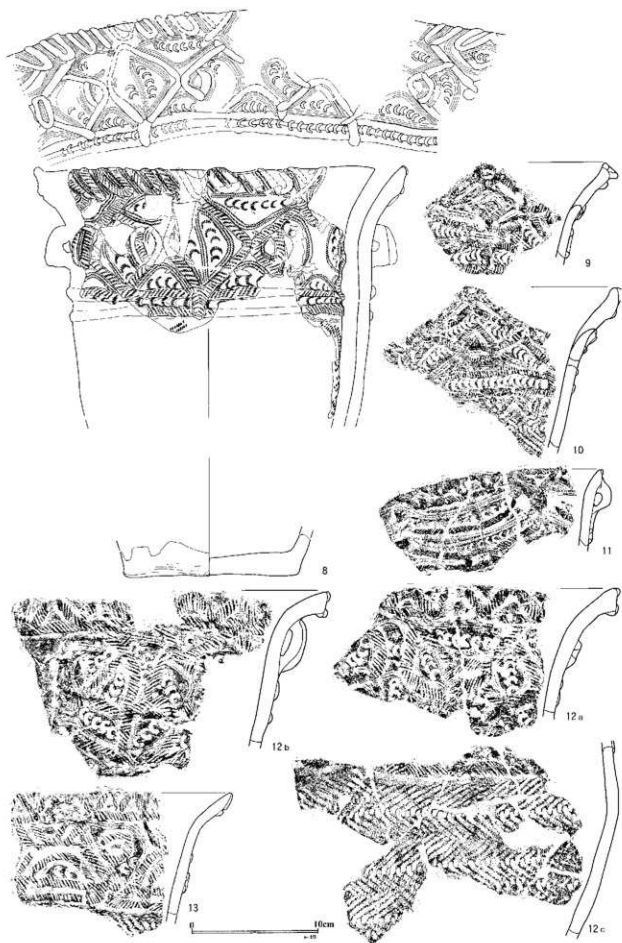

図Ⅲ-1-4 包含層の土器(4)

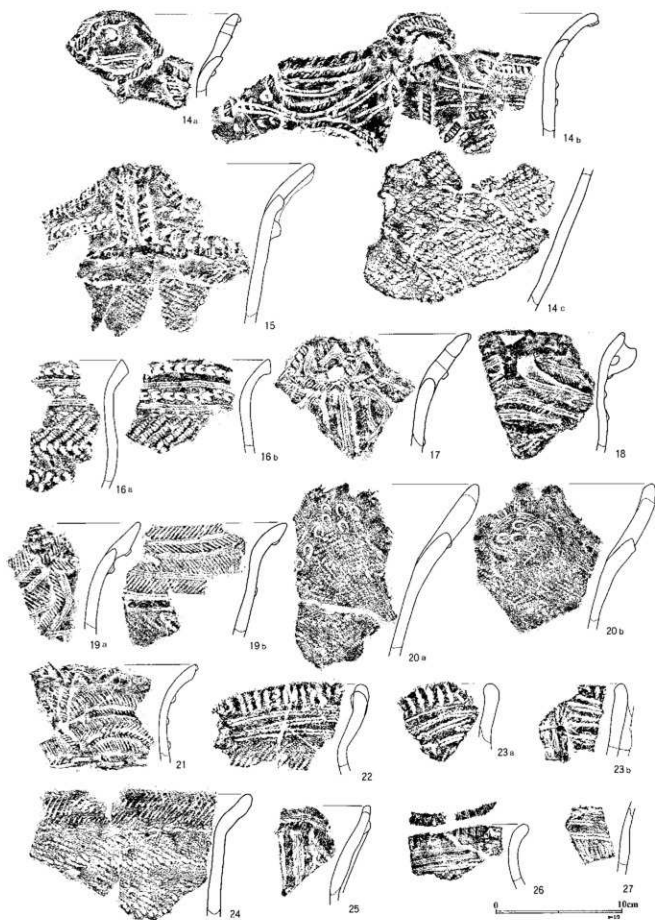

図III-1-5 包含層の土器(5)

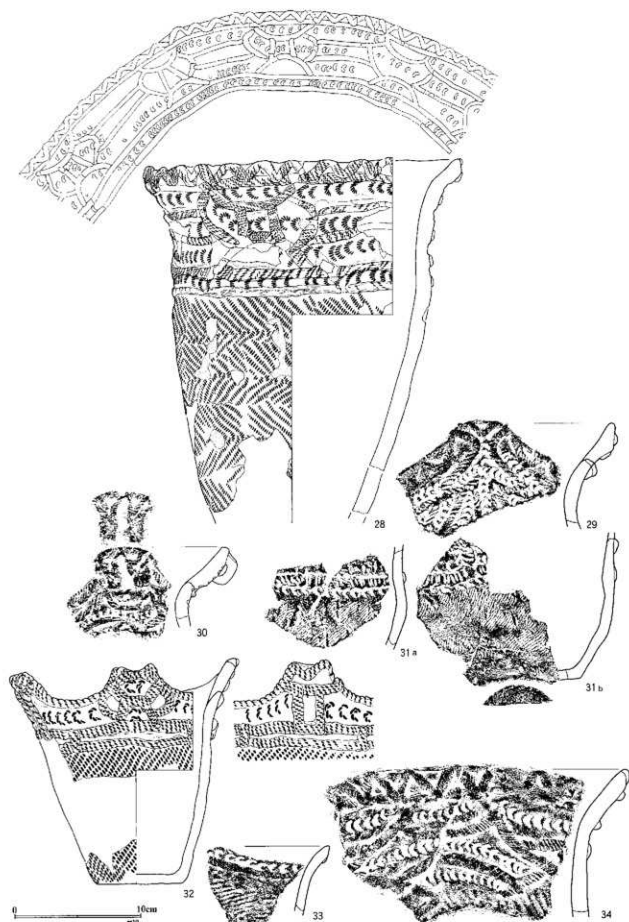

図Ⅲ-1-6 包含層の土器(6)

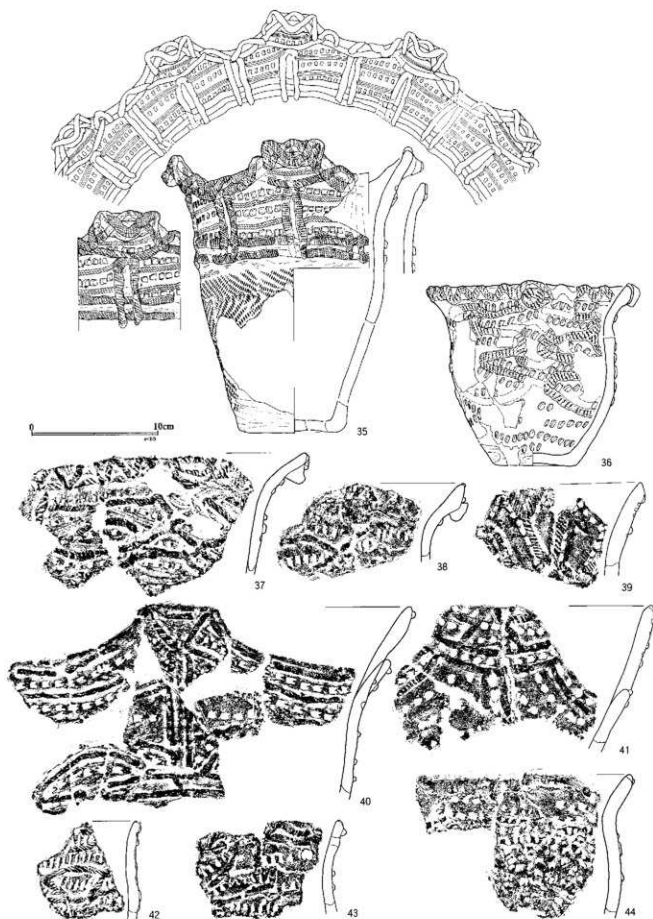

図III-1-7 包含層の土器(7)

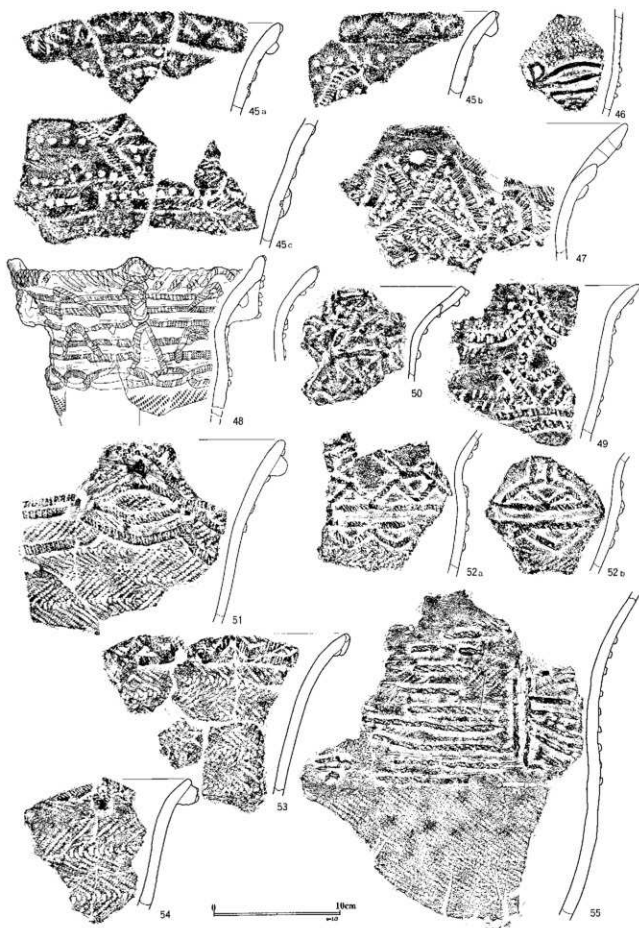

図Ⅲ-1-8 包含層の土器(8)

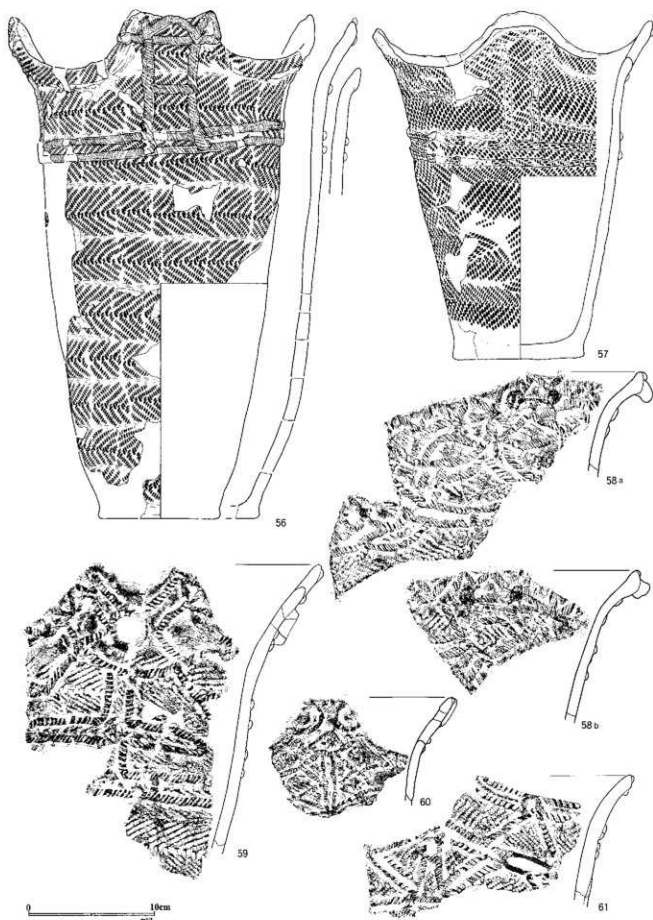

図Ⅲ-1-9 包含層の土器(9)

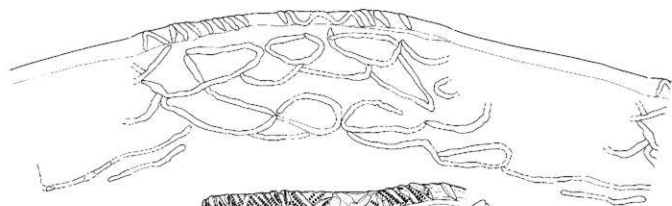

62

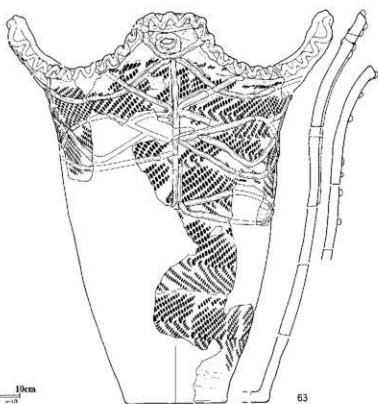

63

図Ⅲ-1-10 包含層の土器(10)

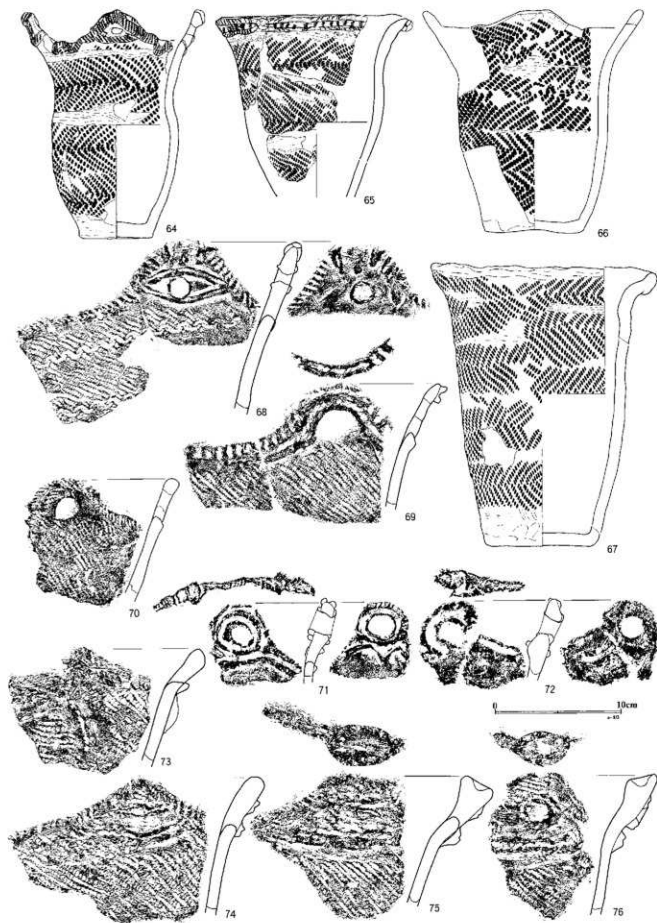

図III-1-11 包含層の土器(11)

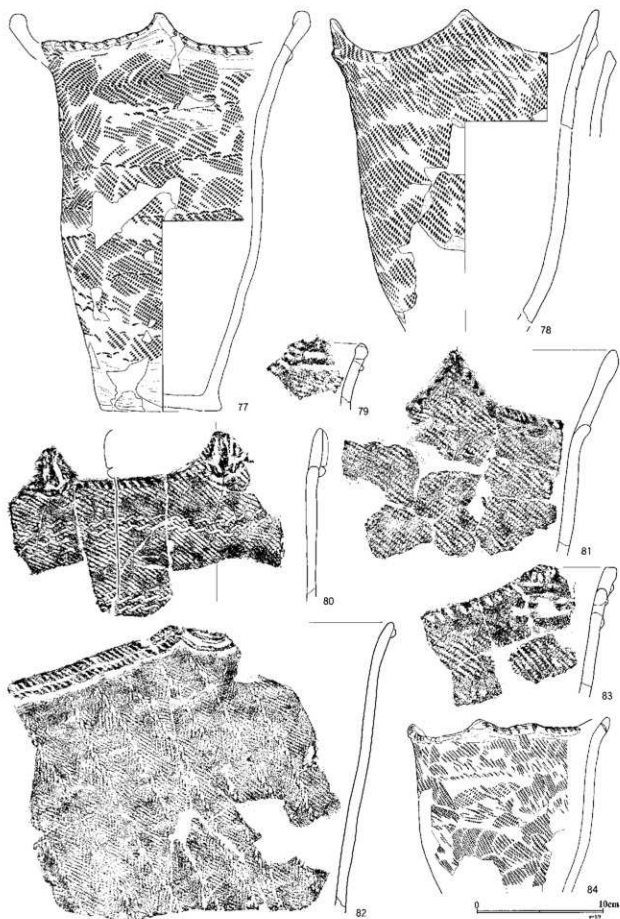

図Ⅲ-1-12 包含層の土器(12)

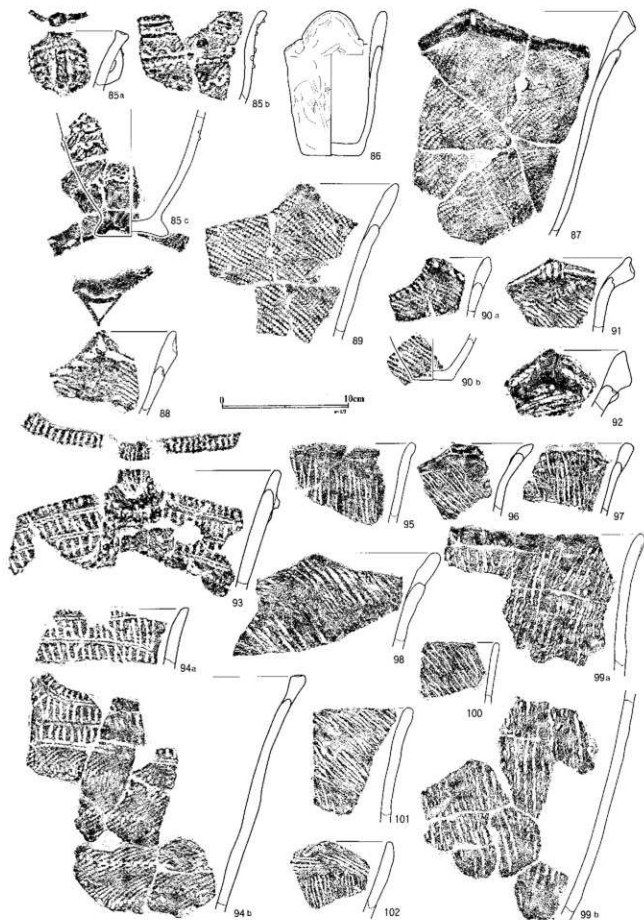

図III-1-13 包含層の土器(13)

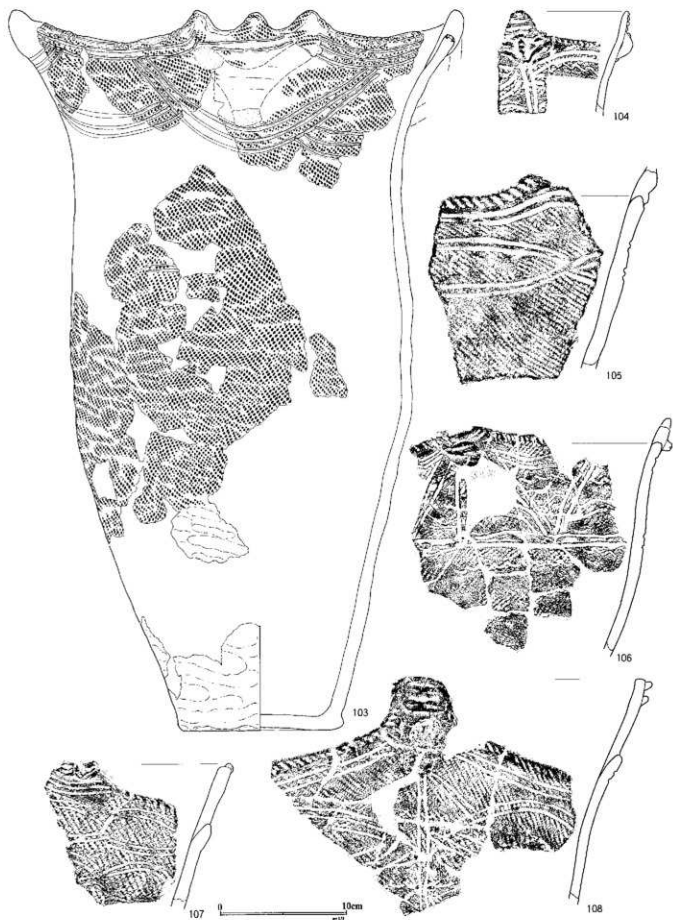

図Ⅲ-1-14 包含層の土器(14)

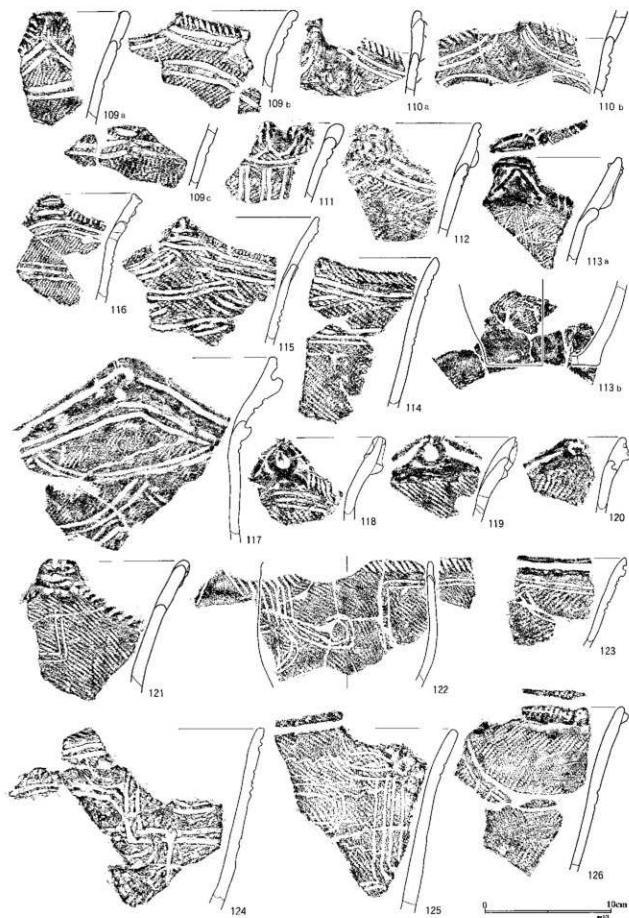

図III-1-15 包含層の土器(15)



図Ⅲ-1-16 包含層の土器(16)

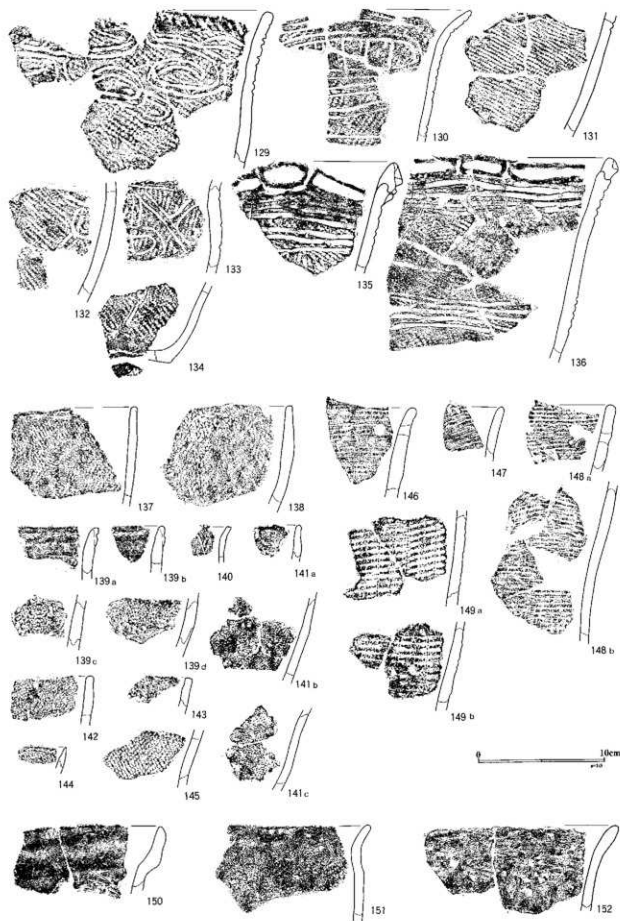

図III-1-17 包含層の土器(17)

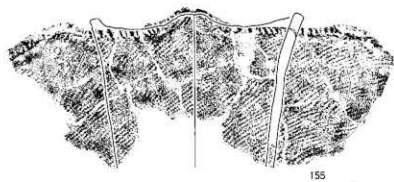
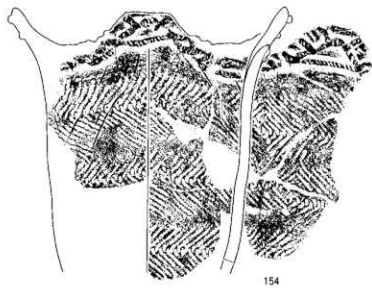
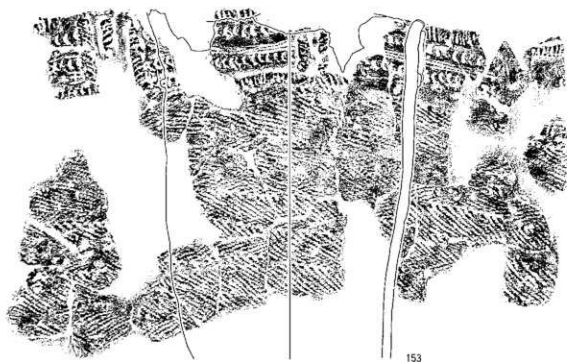

図Ⅲ-1-18 包含層の土器(18)

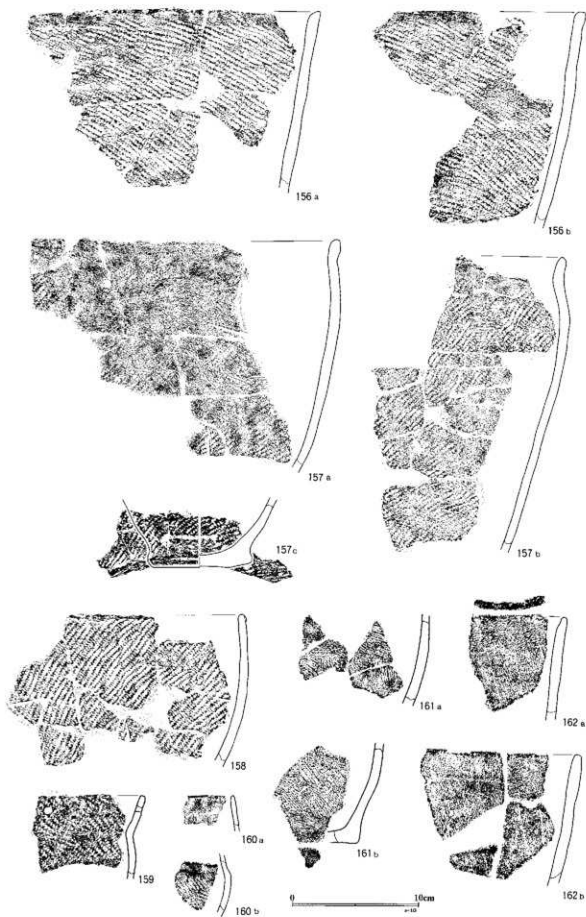

図III-1-19 包含層の土器(19)

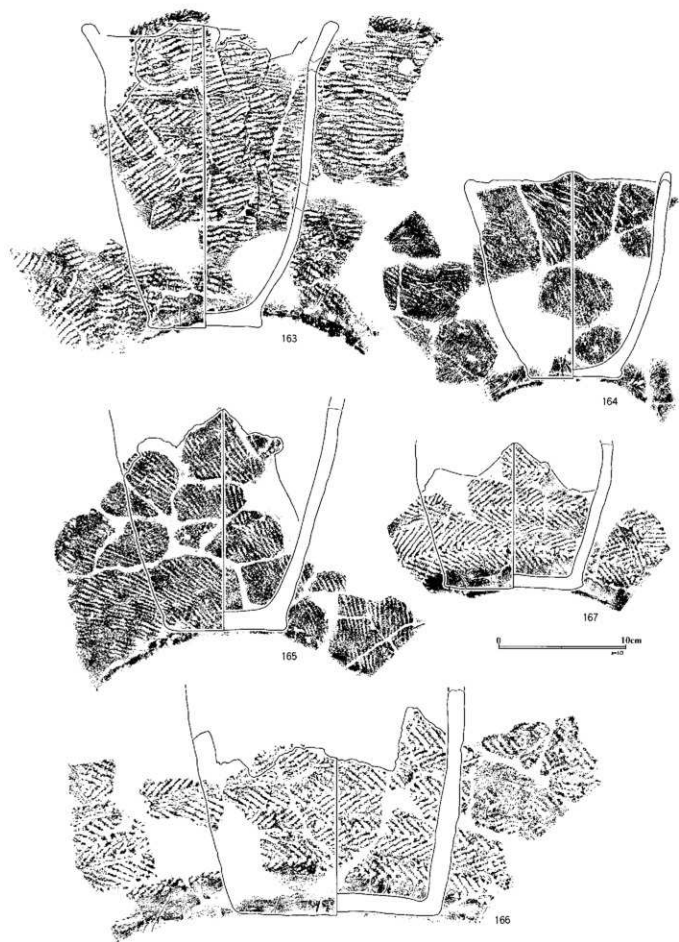

図Ⅲ-1-20 包含層の土器(20)

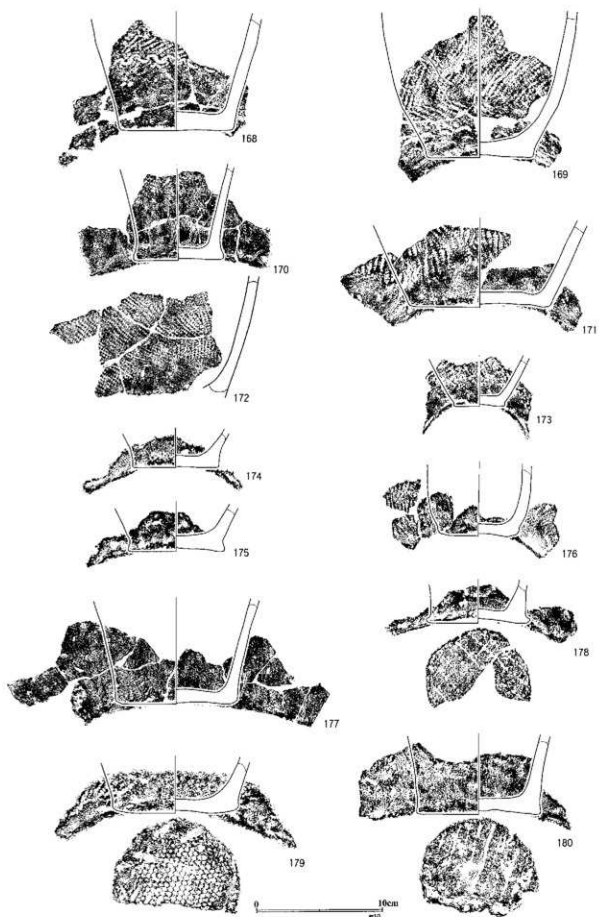

図III-1-21 包含層の土器(21)

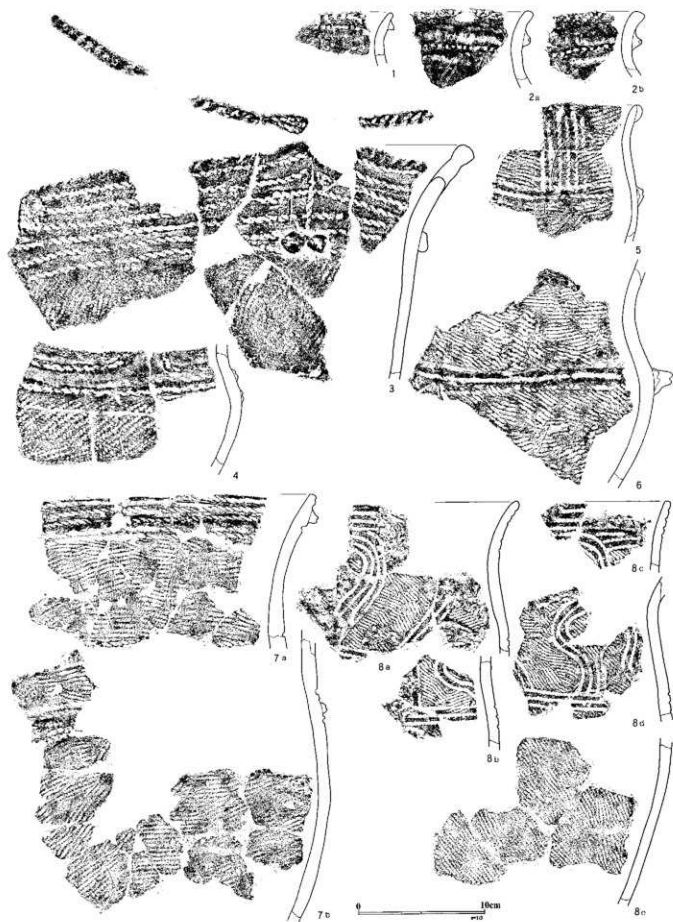

図III-1-22 包含層の土器(22)

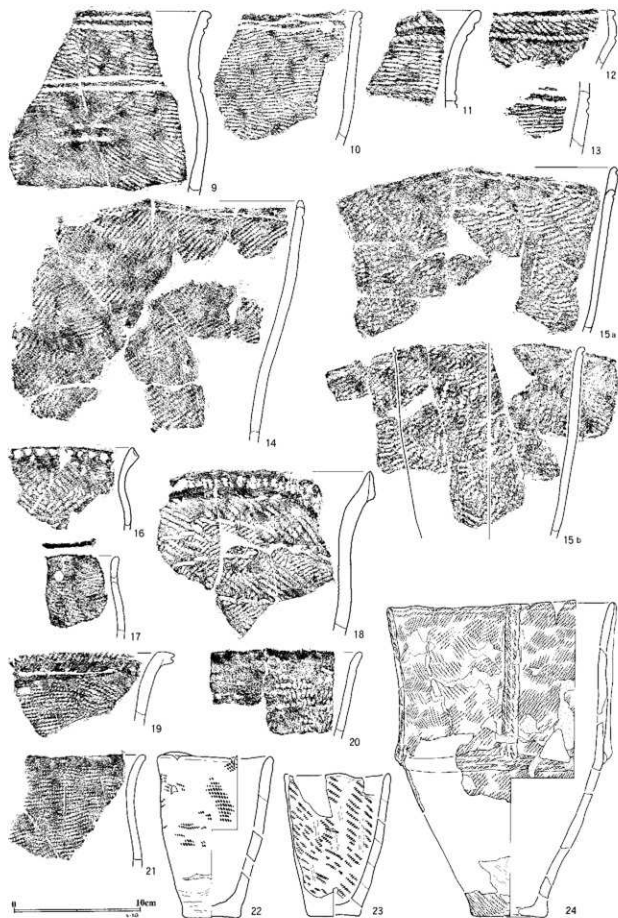

図III-1-23 包含層の土器(23)



図III-1-24 包含層の土器(24)

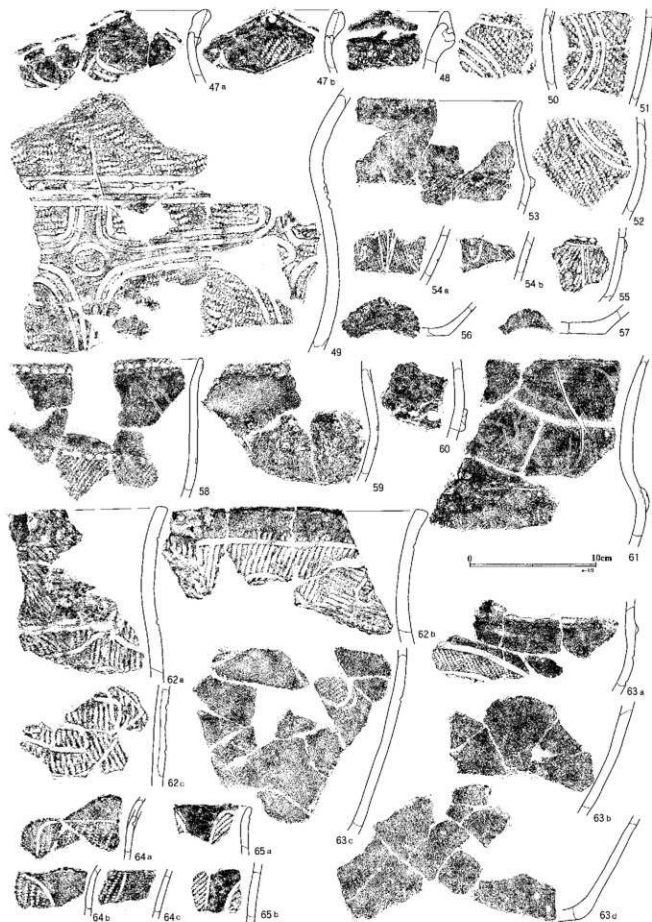

図III-1-25 包含層の土器(25)

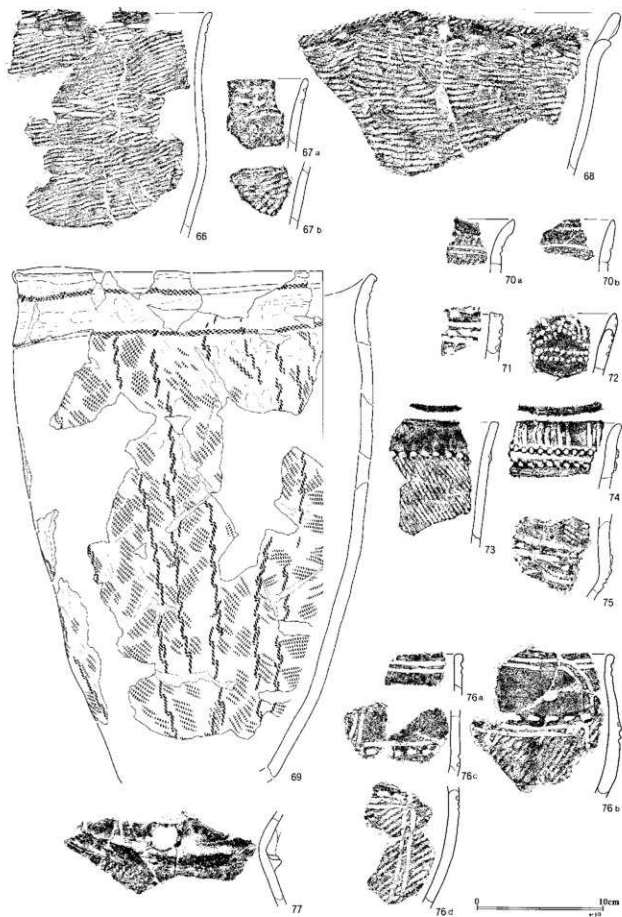

図Ⅲ-1-26 包含層の土器(26)

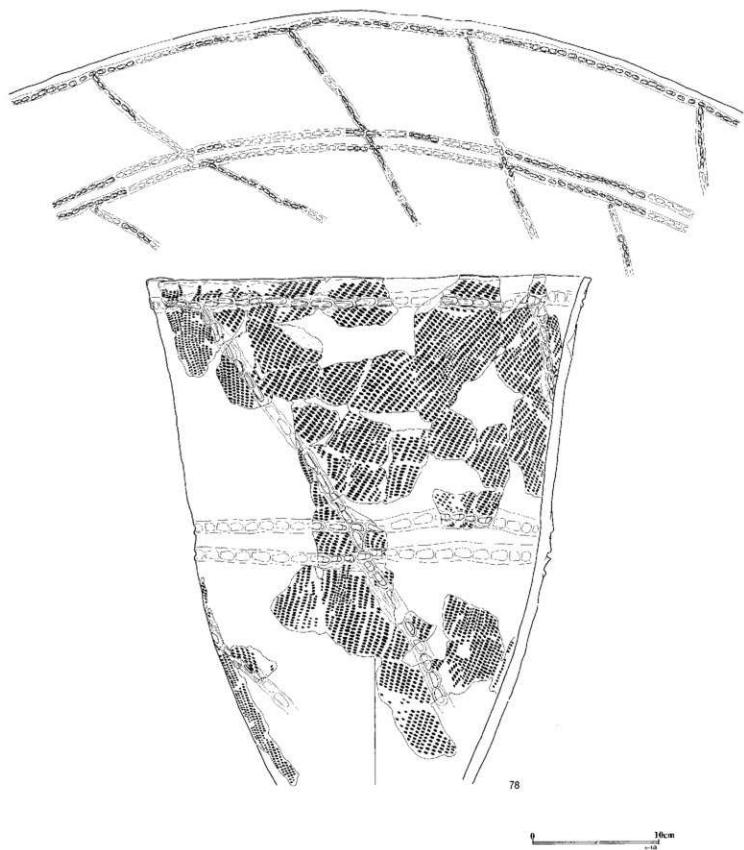

78

図III-1-27 包含層の土器(27)

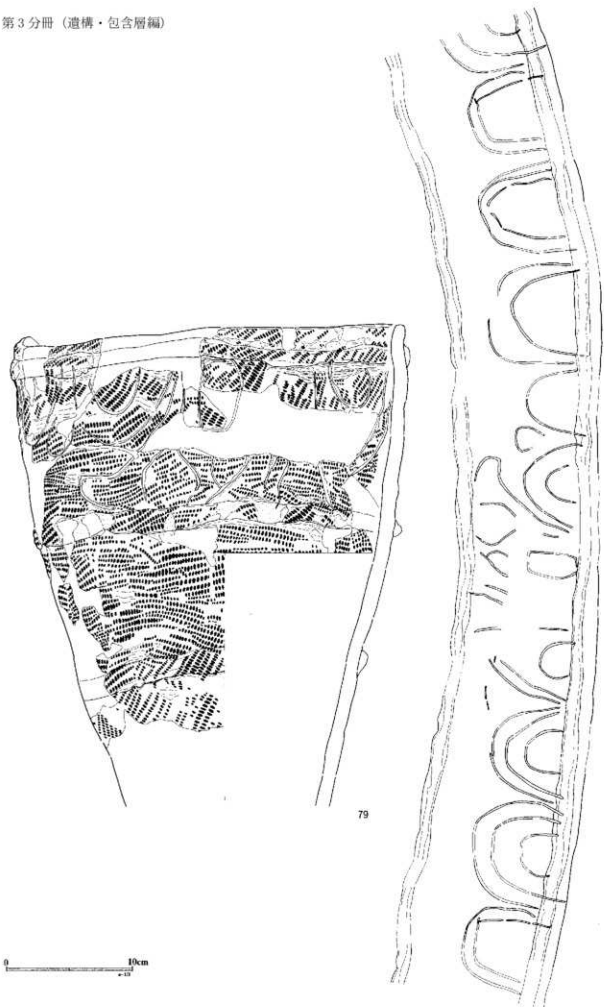

図Ⅲ-1-28 包含層の土器(28)

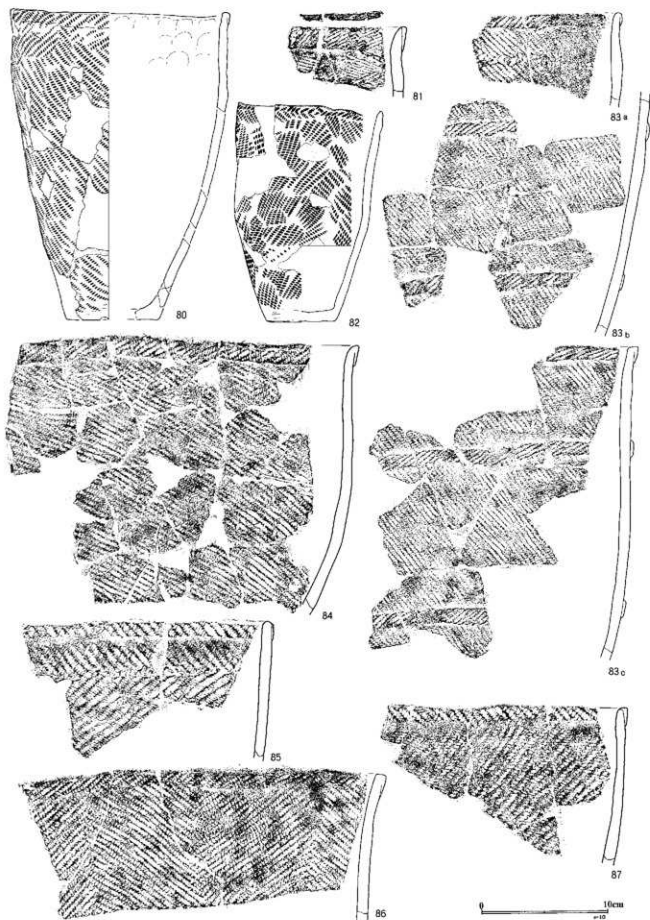

図III-1-29 包含層の土器(29)

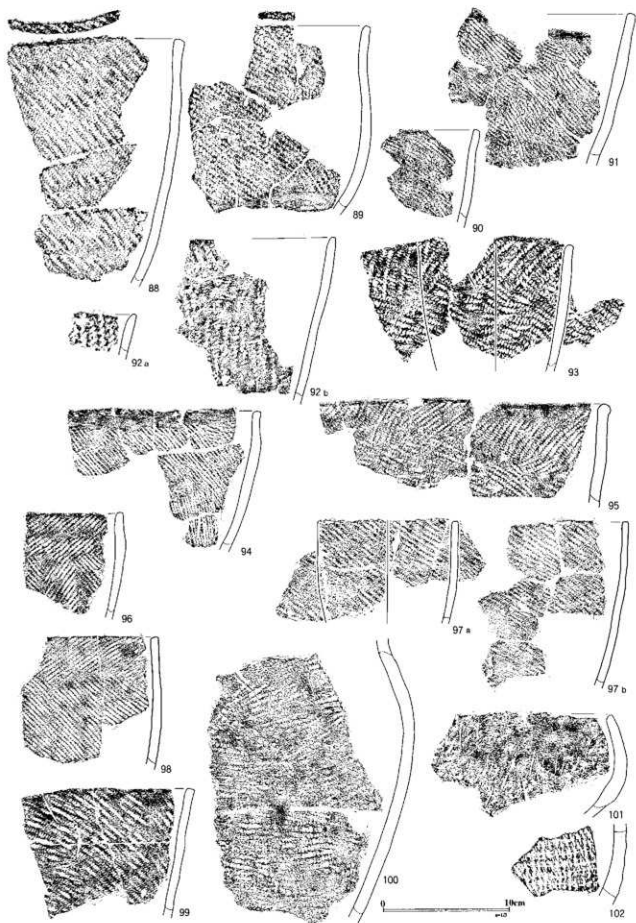

図Ⅲ-1-30 包含層の土器(30)

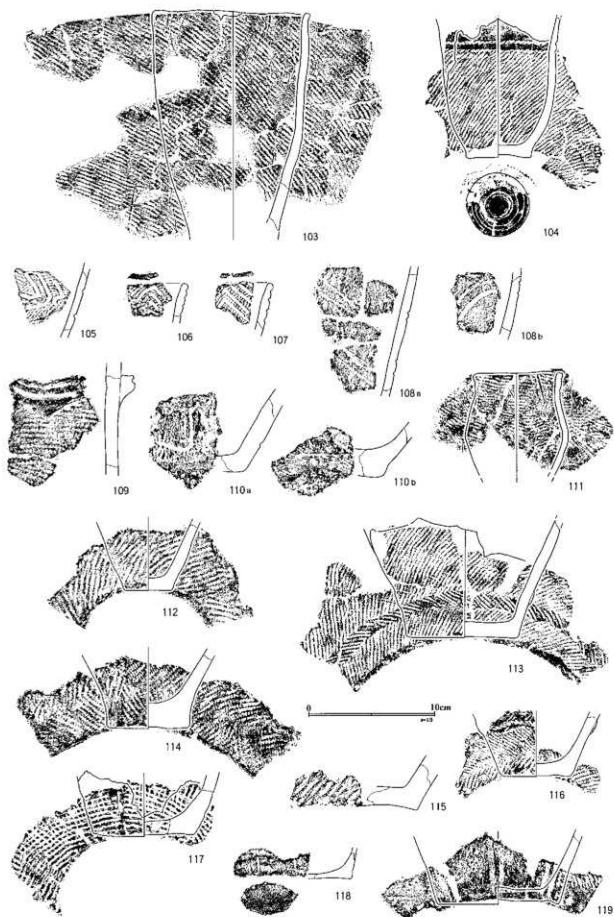

図III-1-31 包含層の土器(31)

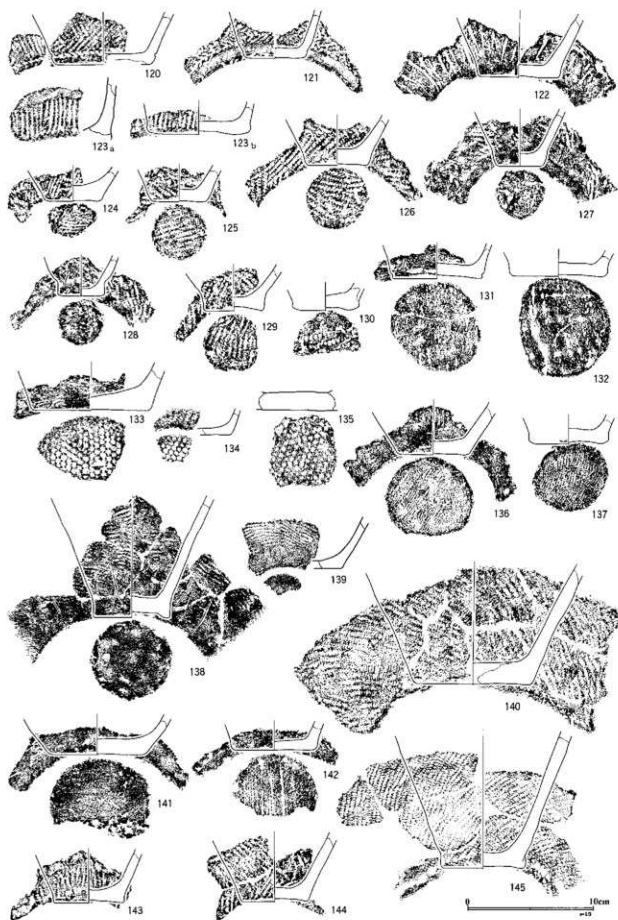

図Ⅲ-1-32 包含層の土器(32)

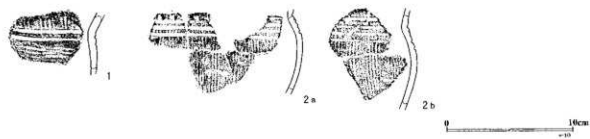

図III-1-33 包含層の土器(33)

2 石器等

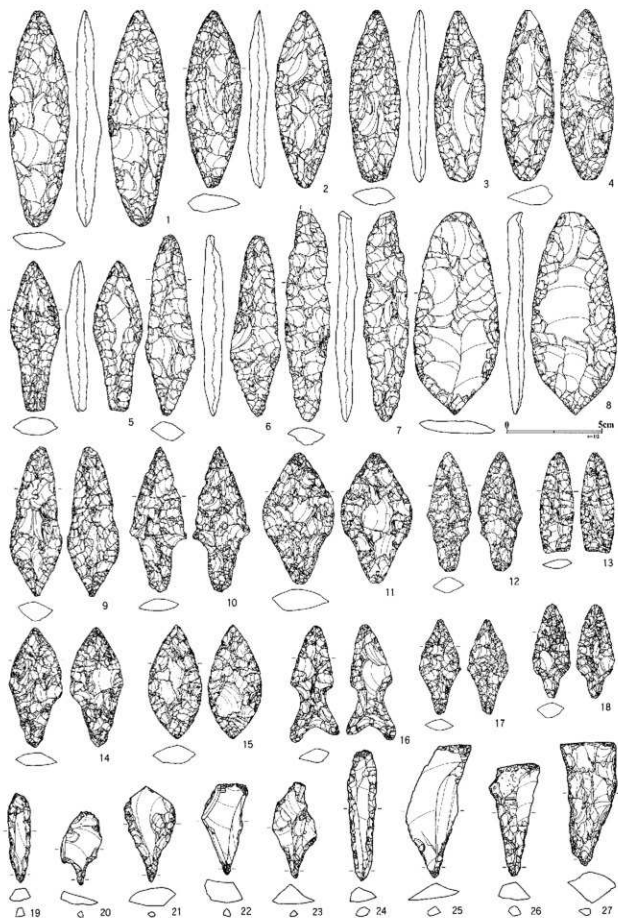

図Ⅲ-2-1 包含層の石器(1)

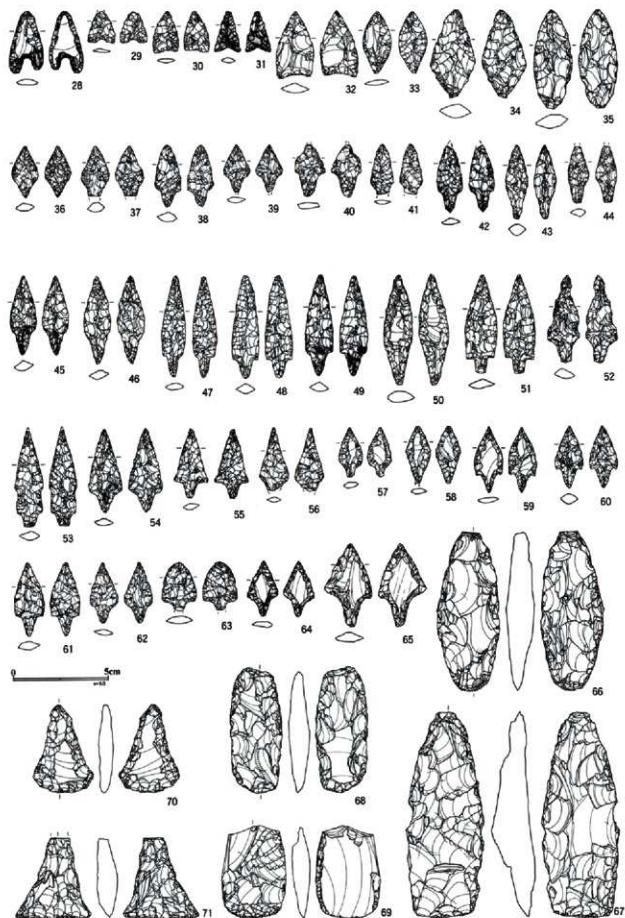

図III-2-2 包含層の石器(2)

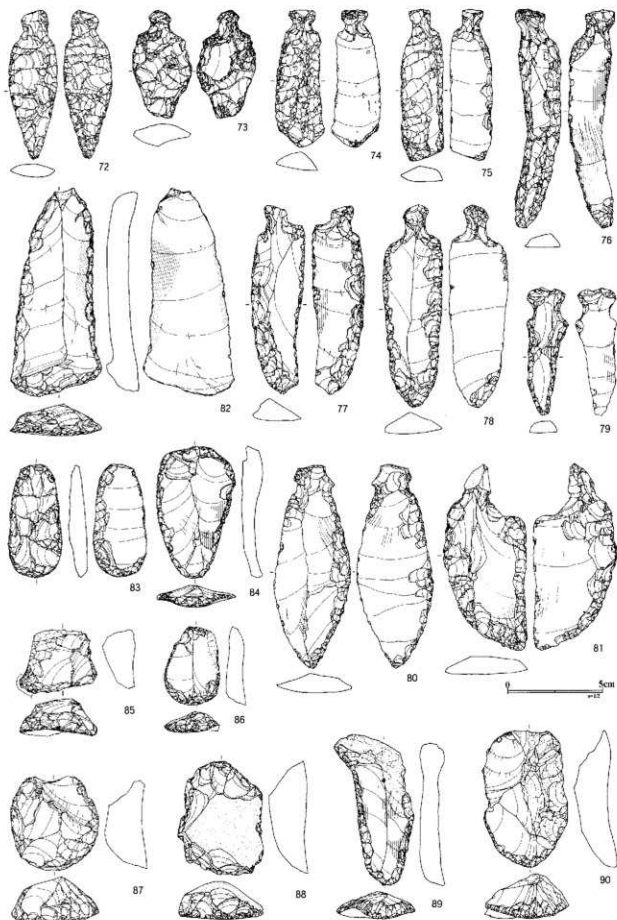

図Ⅲ-2-3 包含層の石器(3)

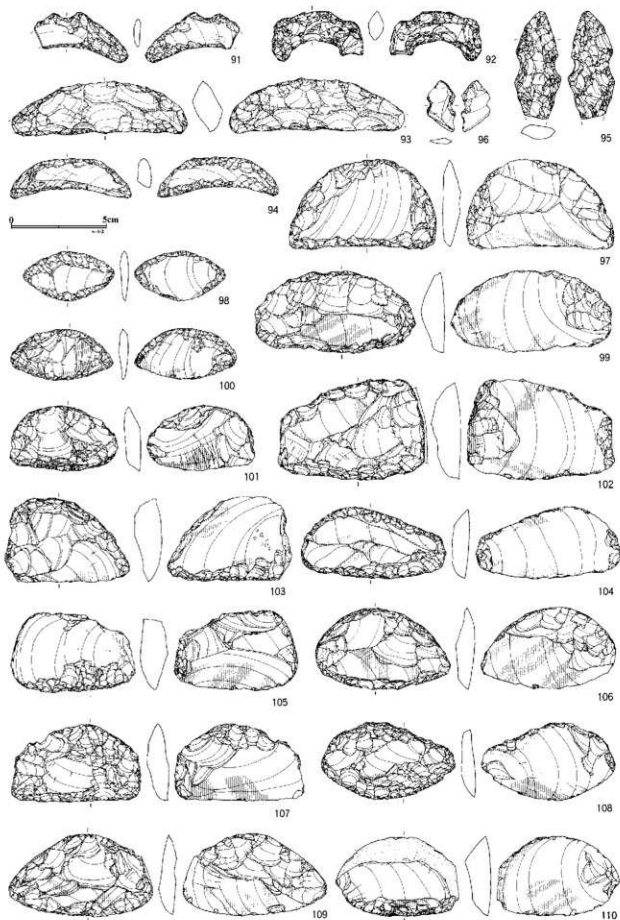

図III-2-4 包含層の石器(4)

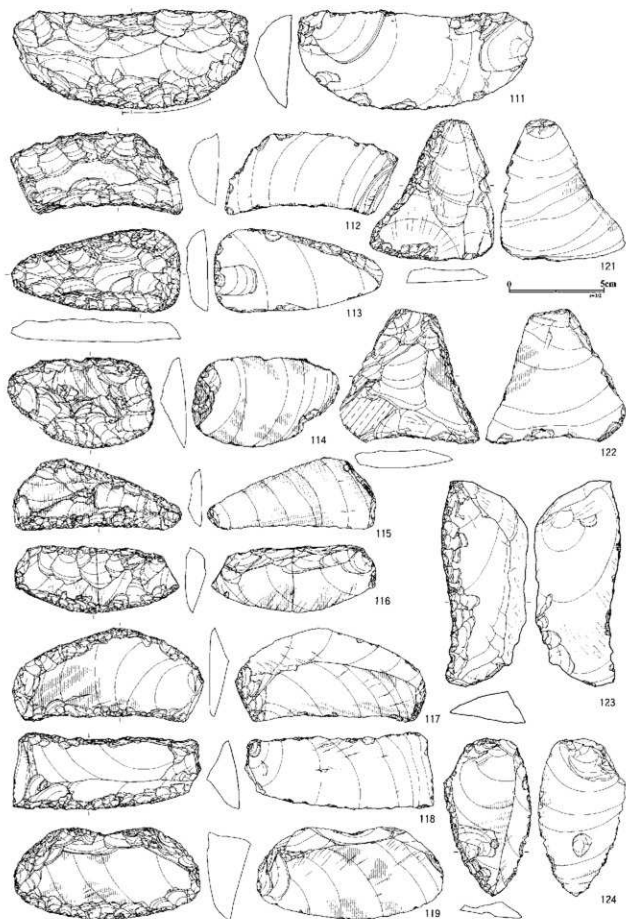

図Ⅲ-2-5 包含層の石器(5)

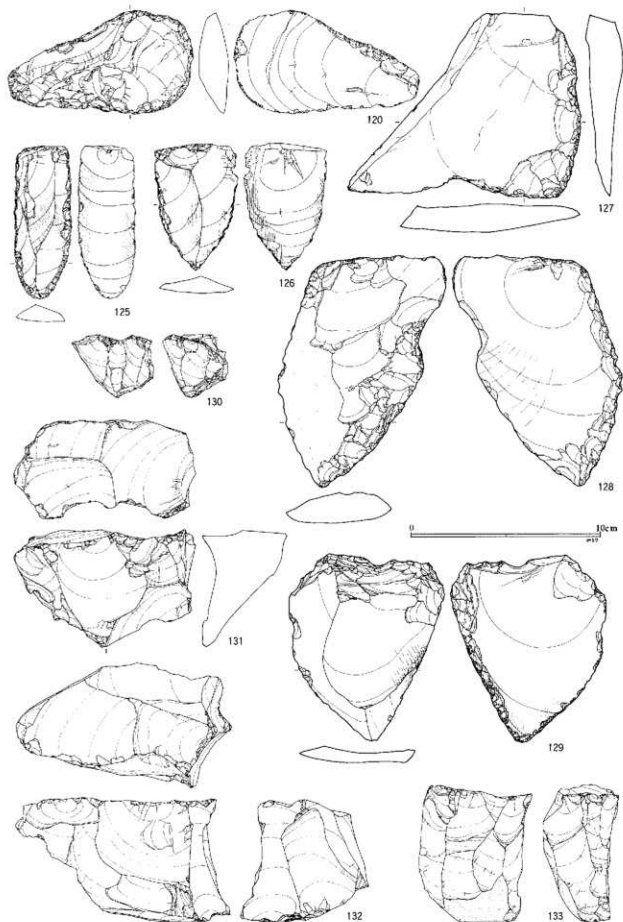

図III-2-6 包含層の石器(6)

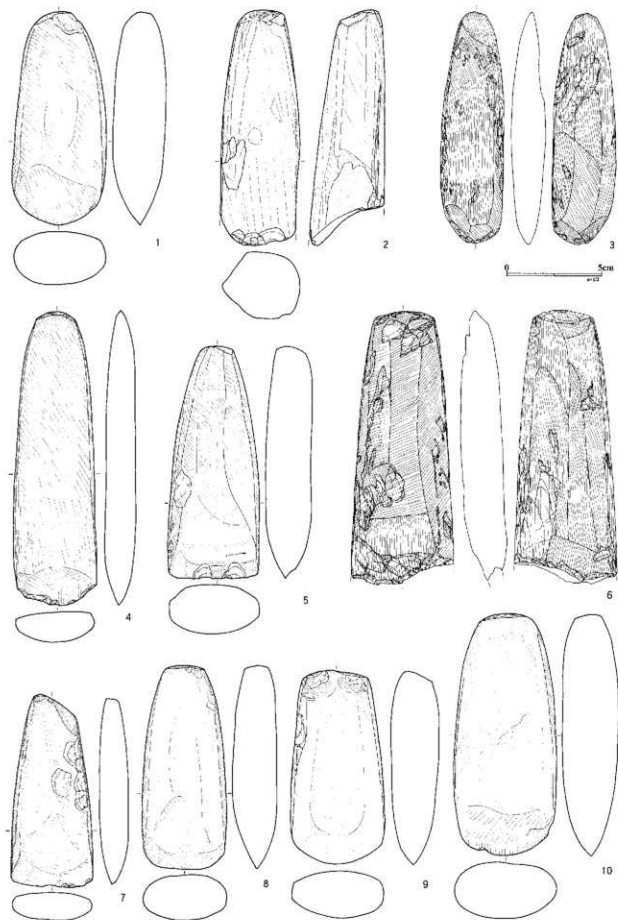

図Ⅲ-2-7 包含層の石器(7)

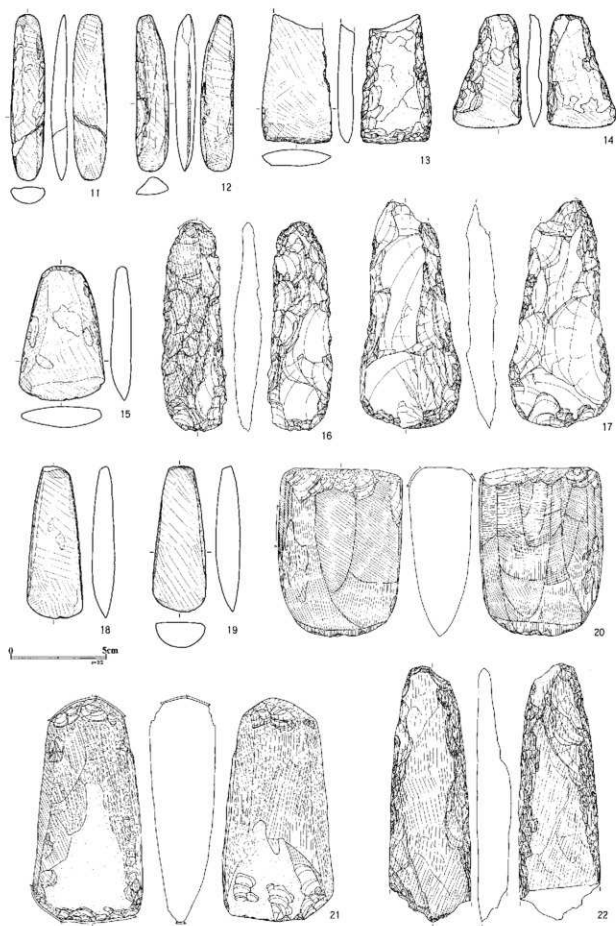

図III-2-8 包含層の石器(8)

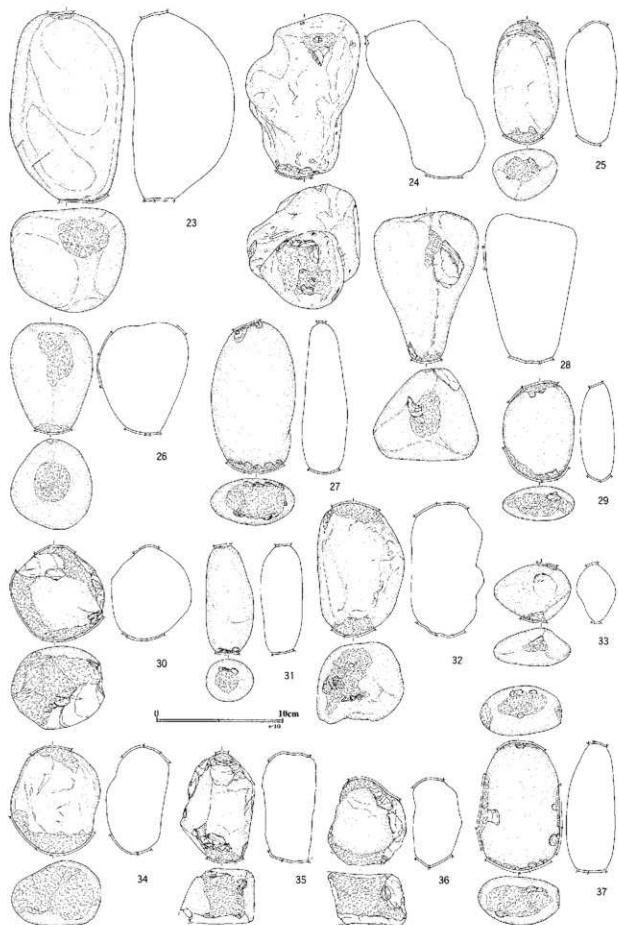

図Ⅲ-2-9 包含層の石器(9)

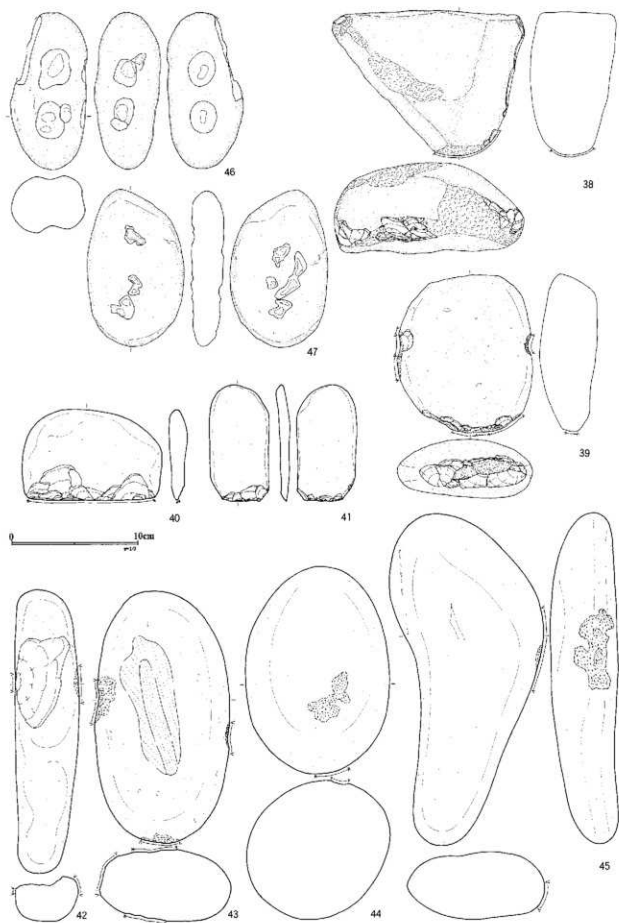

図III-2-10 包含層の石器(10)

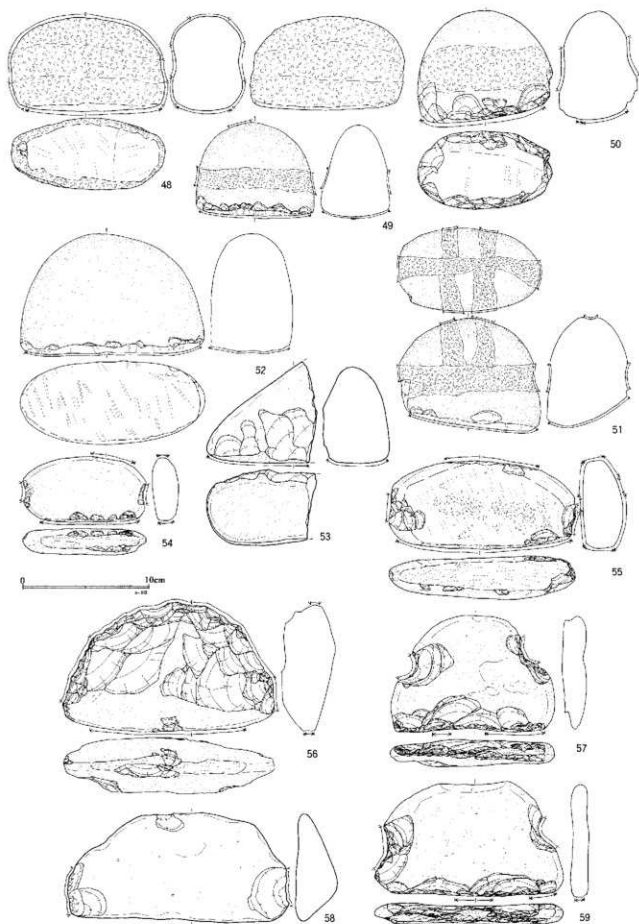

図III-2-11 包含層の石器(11)

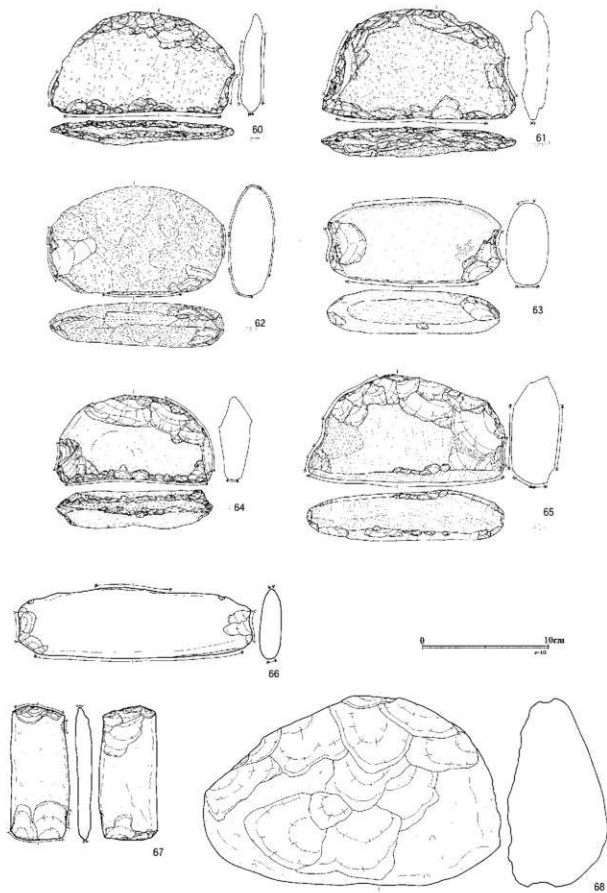

図III-2-12 包含層の石器(12)

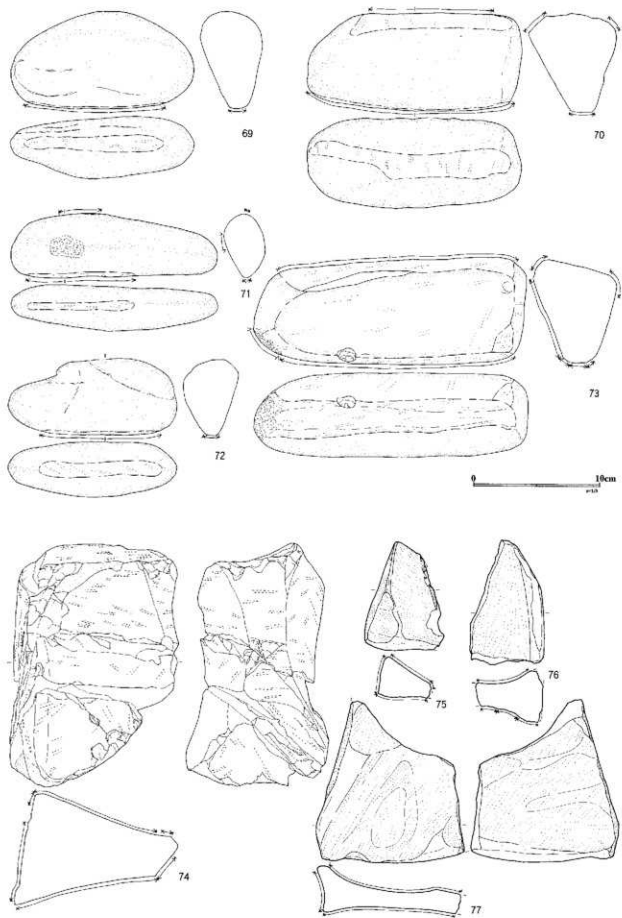

図Ⅲ-2-13 包含層の石器(13)

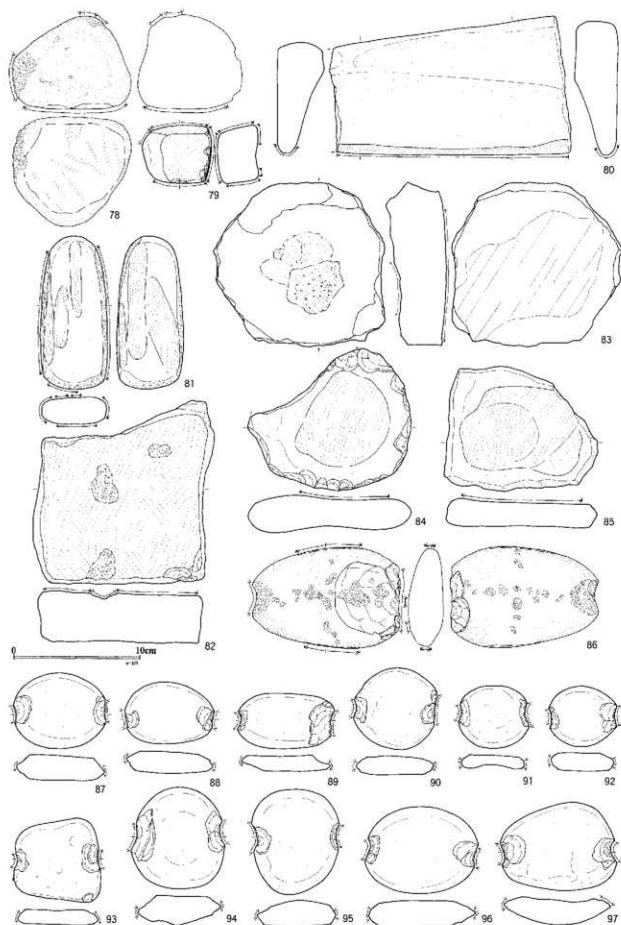

図III-2-14 包含層の石器(14)

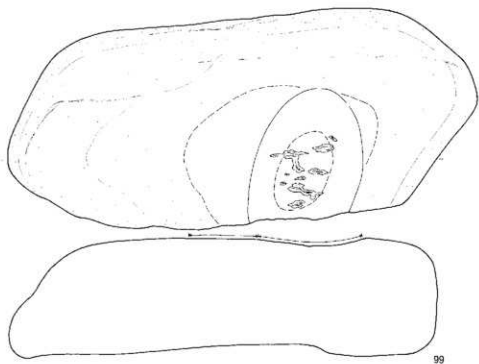
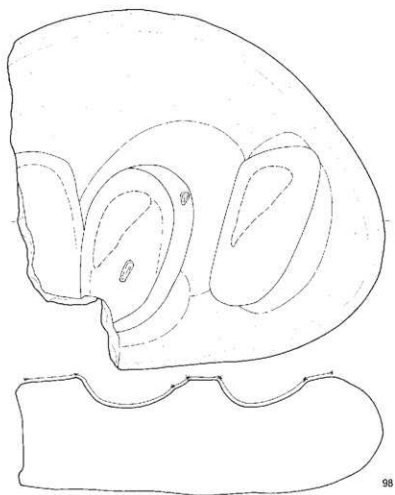

図Ⅲ-2-15 包含層の石器(15)

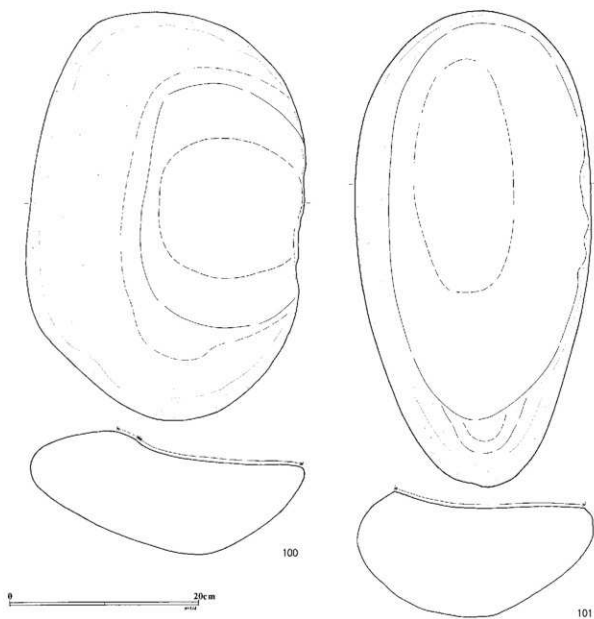

図III-2-16 包含層の石器(16)

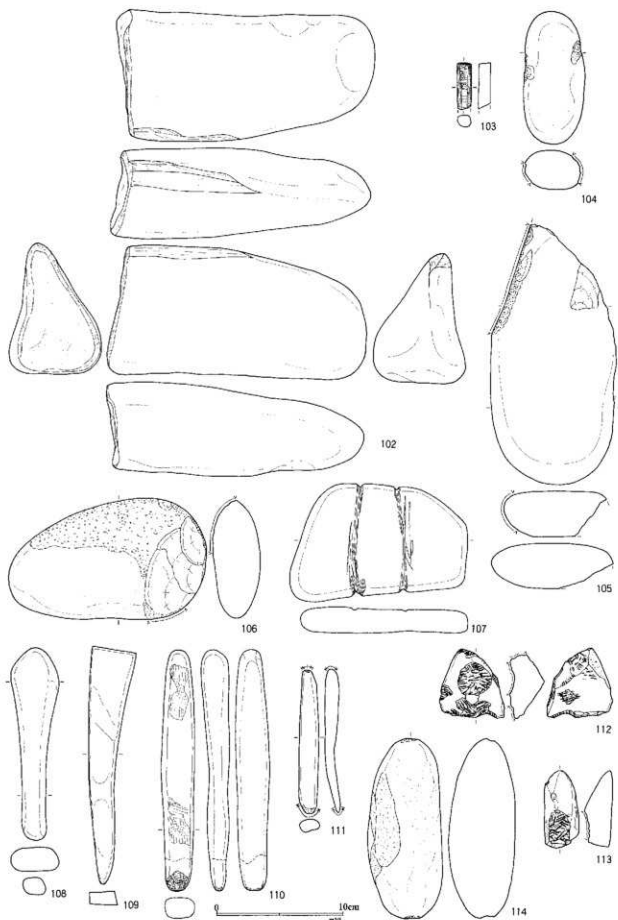

図III-2-17 包含層の石器(17)

3 石製品

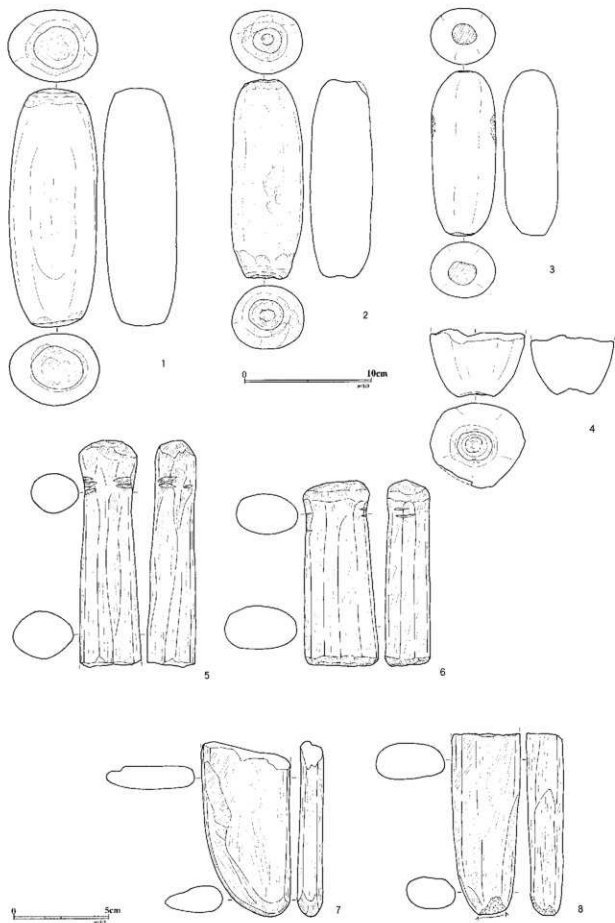

図III-3-1 包含層の石製品(1)

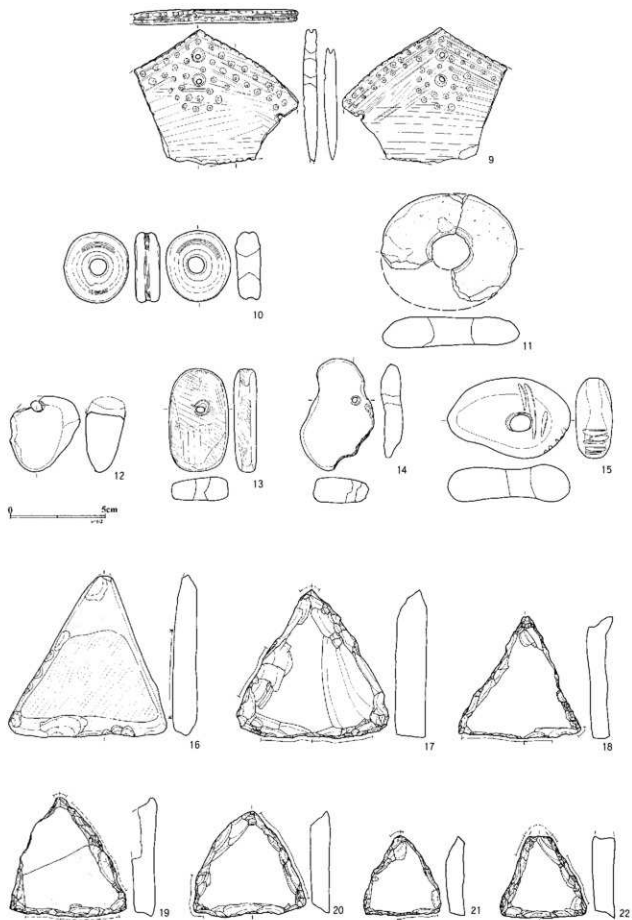

図Ⅲ-3-2 包含層の石製品(2)

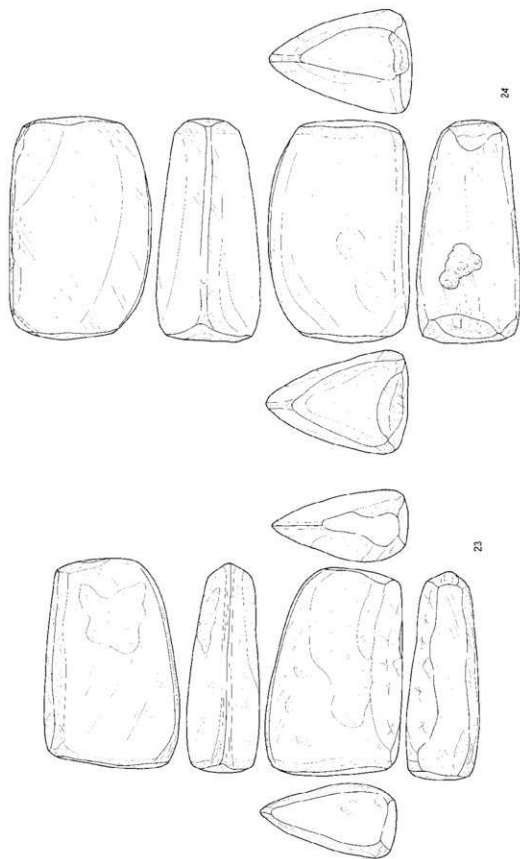

図III-3-3 包含層の石製品(3)

4 土製品 5 金属製品

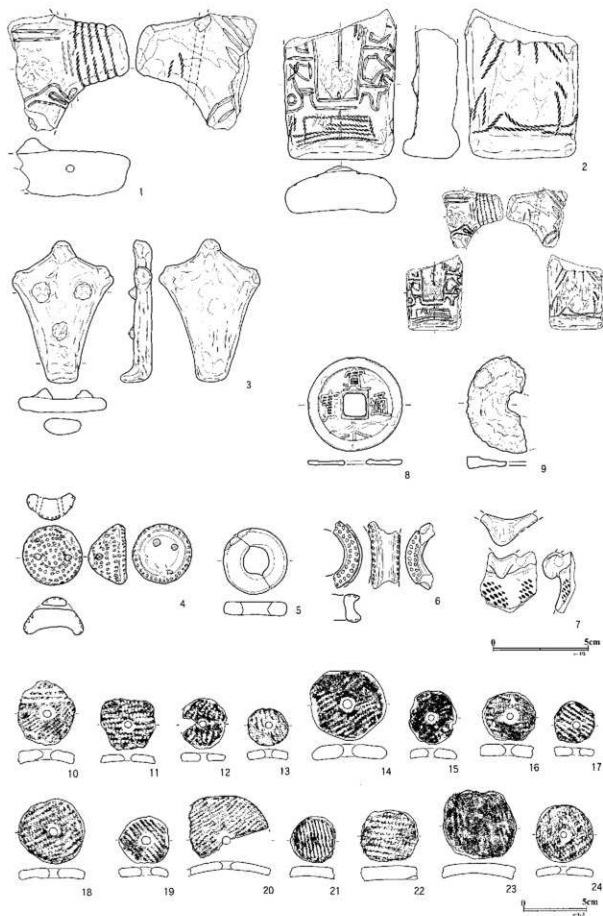

図Ⅲ-3-4 包含層の土製品・古銭

写真図版 I



1 調査開始状況

南西から



2 CH-1 遺物出土状況

北西から

図版 I-2



1 CH-2 遺物集中

北西から



2 CH-2 床遺物出土状況

北東から



1 CH-2 完掘

北から



2 CH-2 炉址 (HF-1)

北東から

図版 I-4



1 CH-4 遺物集中

東から



2 CH-4 覆土内生活面

南西から



1 覆土内炉跡

南西から



2 遺物集中の石棒ほか出土状況

南東から



3 CP-11 完掘

南から



4 HF-1 炉跡

西から



5 CH-4 完掘

北東から



1 CH-3 床検出状況とセクション

西から



2 CH-3 HF-1・2 検出状況

北西から



3 HP-1 セクション

南西から



4 HP-1 完掘

北西から



1 CH-5 完掘

北西から



2 CH-6 検出状況

北東から



1 CH-7 (H20 調査) 完掘

南東から



2 CH-8 完掘状況

北東から



1 CH-9 完掘

北西から



2 HP-2 セクション

南西から



1 CH-11 (H19 調査) 床面

西から



2 集石 (右) と HF-2 検出状況

南から



3 HF-3 (下位 HP-1) セクションと HF-1 (右) 南から



4 HF-2 セクション

南西から



5 HP-1 完掘と HF-1 (右)

南から



1 CH-14 (H20 調査)

北西から



2 CH-14 (H19 調査)

西から



1 CH-12 焼土と炭化材など出土状況

北西から



2 CH-12 床面イルカ頭蓋出土状況

東から



1 CH-12 完掘

北から



2 床面石棒出土状況

西から



3 HF-1 検出状況

北から



1 CH-13 (H20 調査)

南東から



2 CH-13 (H19 調査)

南西から



1 CH-16 セクション

西から



2 CH-16 床遺物出土状況

東から



1 CH-16 完掘

東から



2 HP-1 大礫出土状況

南西から



3 床土器出土状況

南東から



1 CH-15 床面検出状況

南東から



2 HF-1 検出状況

北東から



1 CH-17 床検出状況

西から



2 石囲い炉 (HF-2)

西から



3 HF-1 と HP-37 セクション

南から



4 HP-6 遺物出土状況

北東から



1 CH-18 床検出状況

西から

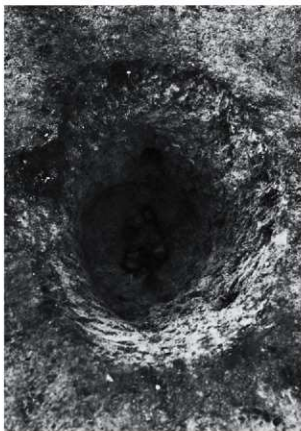

2 HP-17 遺物出土状況

東から



3 床土器出土状況

南から



4 集石 (HS-2) 検出状況

東から



1 CH-19 床検出状況

西から



2 HF-1 と CP-65 遺物出土状況

南から



1 CH-20 床検出状況

北西から



2 HP-1・2 完掘

西から



3 床土器出土状況

西から



4 床土器出土状況

東から



5 床土器出土状況

南から



1 CH-21 (手前)、CH-35 (奥側) 床遺物出土状況

東から



2 完掘

南東から



4 CH-35HP-1 セクション

南から



3 CH-21 床土器出土状況

北から



5 CH-35HP-1 完掘

北東から



1 CH-23 完掘状況

南東から



2 HP-1 遺物出土状況 南から



3 CH-24 完掘

南から



4 HP-3 セクション

西から



5 集石 (HS-4) 検出状況

北東から



1 CH-22 床遺物出土状況

北西から



2 CH-22 セクション

南から



1 CH-22 完掘

北西から



2 HP-1 遺物出土状況

南西から



3 HS-1 検出状況

南から



4 床土器出土状況

北西から



5 石製品出土状況

北から



1 CH-25 床遺物出土状況

南東から



2 CH-25 セクション

南から



1 CH-25 完掘

北西から



2 HP-1 遺物出土状況

南から



3 床土器出土状況

北東から



4 床土製品出土状況

北から



1 CH-26 床遺物出土状況

東から



2 床土器出土状況

西から



3 床土器出土状況

北から



1 CH-26 完掘 (奥手はCH-25)

北西から



2 床土器出土状況

南東から



3 床土器出土状況

西から



1 CH-29 床検出状況

北西から



2 CH-29 セクション

南から

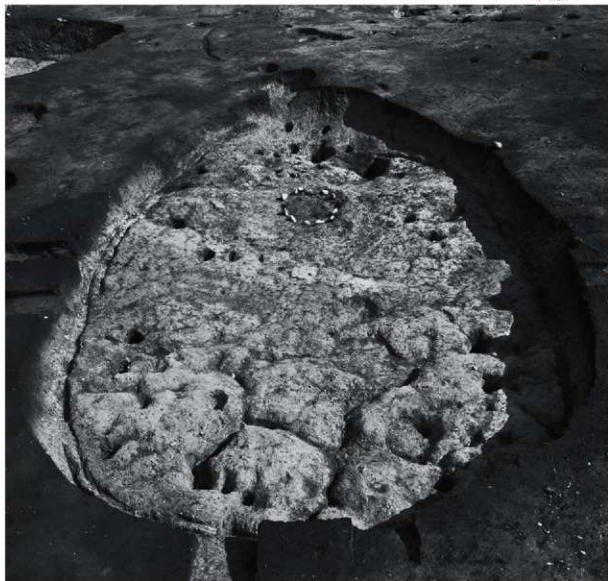

1 CH-29 完掘

北西から



2 先端部のピット群

北から



3 HF-1 検出状況

北西から



1 CH-30 遺物出土状況

北西から



2 床土器出土状況

南東から



3 床土器出土状況

西から



4 床土器出土状況

西から



5 床土器出土状況

北から



1 CH-30 完掘 (奥手は CH-40)

南東から



2 HS-1 検出状況 南東から



3 HP-1 セクションと遺物出土状況

南から



1 CH-31 床遺物出土状況

東から



2 土器出土状況

北東から



3 シャチ形土製品 東から



4 土器出土状況 北西から



1 CH-31 完掘

南東から



2 HP-10 遺物とセクション

北東から



4 HP-9 セクション

南から



3 HP-10 盛土セクション

北東から



5 HP-9 遺物出土状況

南から



1 CH-27 床検出状況



2 HS-1 検出状況 東から



3 HP-1 遺物出土状況 北から



4 CH-28 (竖穴中央が地滑りで分断されている)

東から



1 CH-33 完掘

北から



2 CH-33 セクション

東から



3 HF-1 覆土

西から



4 土器出土状況

北から



5 土器出土状況

北から



1 CH-34 遺物出土状況

北から



2 土器出土状況

南東から



3 土器出土状況

東から



4 土器出土状況

南東から



1 CH-34 完掘

東から



2 土器出土状況

南東から



3 床土器出土状況

東から



4 土器出土状況

東から



5 床土器出土状況

北から



1 CH-39 床遺物出土状況

東から



2 床土器出土状況 東から



3 床土器出土状況

北東から



1 CH-39 完掘

東から



2 床土器出土状況

西から



3 HP-1 セクション

南から



4 HP-1 完掘

西から



1 CH-36 完掘

北から



2 CH-38 完掘

南西から



1 CH-40 床検出状況

北から



2 HP-1 セクション

東から



3 CH-40 内 CP-92 の炭化材と焼土

南から



4 CH-40 炭化材と焼土の検出状況

北西から



1 CH-41 完掘

西から



2 CH-41 東西セクション

南から



3 遺物出土状況

西から



4 HP-1 遺物出土状況

西から



5 HP-2 セクション

北から



1 CH-43 完掘

南から



2 CH-43 石製品出土状況

南東から



3 遺物出土状況

南から



4 CH-43 セクションと遺物

東から



5 土器出土状況

南東から



1 CH-44 完掘

北西から



2 CH-45 完掘

西から



3 CH-45 遺物出土状況

南西から



4 CH-46 床遺物出土状況

西から



5 CH-46 炭化材・焼土

南西から



1 CH-47 床遺物出土状況

南東から



2 CH-47 HF-1 と床の遺物出土状況

北東から



1 CH-48 完掘

北東から



2 CH-48HP-1 と周辺の小ピット

北西から



3 HF-1 セクションと埋壺 南から



4 遺物出土状況 北西から



1 CH-49 完掘

南東から



2 CH-49 床検出状況

南東から



3 遺物出土状況

北西から



4 HF-2 セクション

南から

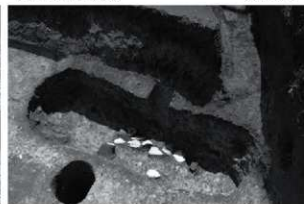

5 HF-2 遺物出土状況

北から



1 CH-50 完掘

南西から



2 HP-1 ~ 3 ほか完掘

西から



3 炭化材と焼土

南西から



4 HF-2 と土器

北東から



5 床土器出土状況

北から



1 CH-52 完掘

南東から



2 床土器出土状況

南西から



3 床土器出土状況

北西から



4 床土器出土状況

西から



5 床土器出土状況

南から



1 CH-51 (手前)・56 (奥手) 完掘

南東から



2 床土器出土状況

南から



3 床土器出土状況

南西から



4 覆土中位土器出土状況

南西から



5 覆土土器出土状況

南から



1 CH-51・56 床検出状況

東から



2 HP-1 上面遺物出土状況

南東から



3 HP-1 完掘

北東から



4 床土器出土状況

南西から



5 床土器出土状況

西から



1 CH-53 床面検出状況

西から



2 CH-53 遺物出土状況

南西から



1 CH-54 完掘

北東から



2 CH-54 床遺物出土状況

西から



3 CH-54HP-1・2 と HF-1

南から



4 CH-53HF-1 セクション

南から



5 CH-54HP-1・2 セクション

南から



1 CH-57 完掘

北東から



2 CH-57 床遺物出土状況

北東から



1 CH-58 完掘 (中央: CH-57 と重複)

北から



2 CH-58 石棒出土状況

西から



3 CH-58 床土器出土状況

南東から



4 CH-59 焼土群セクション

西から



5 CH-59 遺物出土状況

南西から



1 CH-60 床遺物出土状況

南東から

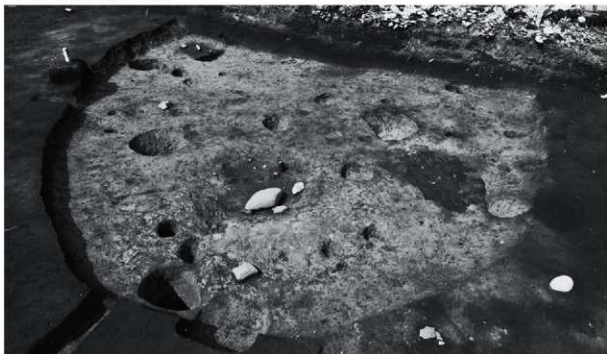

2 CH-61 床検出状況

北東から



3 CH-61 セクション

東から



1 CH-62 完掘

北西から



2 HP-29 と HF-2 検出状況

南から



3 HF-2 と HP-29 検出状況

北東から



4 CH-62 床検出状況

北西から



5 CH-62 セクション

北西から



1 CH-63・65 完掘

南東から



2 CH-64 完掘

北西から



1 CH-66 完掘

北から



2 CH-66 床遺物出土状況

西から



3 CH-67・77・82 検出状況

北から



4 CH-67 埋壘セクション

南から



5 CH-67HP-3

北東から



1 CH-68 完掘

北西から



2 HF-1 検出状況

北東から



3 HF-2 (埋壺) 検出状況

南から



4 床土器出土状況

南西から



5 床土器出土状況

東から



1 CH-69 完掘

北から



2 HF-1 小礫出土状況

東から



3 HP-1 完掘

東から



4 HP-2、HF-1 完掘

北東から



5 覆土 1 炭化材出土状況

北東から



1 CH-70 床検出状況 (奥手 CH-70、手前 CH-92)

西から



2 CH-70 HP-2 (先端ビット) と HF-1 検出状況

西から



1 CH-71 床検出状況

南東から



2 CH-71 床遺物出土状況

南西から



3 HF-1 と土器検出状況

西から



4 HF-1 (中央) と HF-2 (左)

西から



5 HP-46 (HF-1 下位) セクション

西から



1 CH-73 東側床検出状況

北から



2 CH-73 西側床遺物出土状況

北から



3 CH-77 完掘

西から



4 CH-77 床遺物出土状況

南から



5 CH-77 覆土遺物出土状況

西から



1 CH-74 完掘

北西から



2 CH-74 床遺物出土状況

北西から



3 HF-3 付近の土器出土状況

北から



4 HF-3 (石囲い炉) と旧炉跡

南から

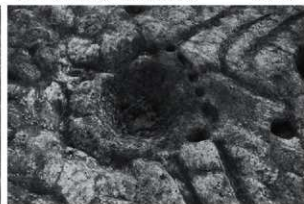

5 HP-44 (旧炉址の下位)

東から



1 CH-75 完掘

東から



2 CH-79 完掘

西から



1 CH-78 完掘

西から



2 CH-78 セクションと遺物出土状況

西から

(公財)北海道埋蔵文化財センター調査報告書 第303集

北斗市 館野2遺跡C地区 第3分冊(遺構・包含層編)

高規格幹線道路函館江差自動車道工事用地内埋蔵文化財発掘調査報告書

発行 平成26(2014)年3月20日

編集 公益財団法人 北海道埋蔵文化財センター

〒069-0832 江別市西野幌685番地1

TEL (011)386-3231 FAX (011)386-3238

<http://www.domaibun.or.jp/>

印刷 株式会社北海道機関紙印刷所

〒060-0806 札幌市北区北6条西7丁目1

TEL (011)716-6141 FAX (011)717-5431

<http://www.hki.co.jp>

