

中央自動車道長野線
埋蔵文化財発掘調査報告書 3

—塩尻市内その2—

吉田川西遺跡

図版編

1989

日本道路公団名古屋建設局
長野県教育委員会
財)長野県埋蔵文化財センター

例 言

- 1 本書は、吉田川西遺跡の発掘報告書の図版編である。
- 2 実測図をはじめとした図類には「図版」、写真には「PL」をつけ、それぞれ通し番号がふってある。
- 3 図の縮尺については、それぞれに示してある。
- 4 掲載した地図は、日本道路公団作成の中央自動車道長野線平面図(1:1000)、塩尻市発行の都市計画図(1:10000)をもとに作成したほか、建設省国土地理院発行の2万5千分の1および5万分の1地形図を使用した。
- 5 遺構図の凡例は以下に示した通りである。なお、大地区及びグリッドの設定については、本文編第1章でふれてある。
- 6 遺構の中で示す数値(例640.0m)は標高を示す。
- 7 遺物番号は図版、PLとも一致している。これは本文編も同様である。なお、図版中でII層出土の3の場合は、PLではII・3のように省略してある。また、図版中の遺物番号にアンダーラインのある遺物は、PLにも掲載されている。
- 8 遺物図の表現方法は、本文編の各遺物の項で説明されている。
- 9 PLのうち、古代の土器および中・近世の焼物、金属製品は約1:3を原則としている。
- 10 遺構写真の撮影は調査研究員が主に行ったが、PL1~15は中央航業株式会社が航空測量の際に撮影したものである。



図 版 目 次

- | | |
|--|--|
| <p>図版1 吉田川西遺跡の位置1 (1:15000)</p> <p>図版2 遺跡の位置2・遺跡の範囲 (1:10000)</p> <p>図版3 周辺の地形と発掘調査範囲 (1:3000)</p> <p>図版4 古代遺構全体図 (1:800)</p> <p>図版5 古代遺構割り付け図</p> <p>図版6 古代遺構図I (1:360)</p> <p>図版7 古代遺構図II</p> <p>図版8 古代遺構図III</p> <p>図版9 古代遺構図IV</p> <p>図版10 古代遺構図1 (1:120)</p> <p>図版11 古代遺構図2</p> <p>図版12 古代遺構図3〔古代遺構図4の断面図〕</p> <p>図版13 古代遺構図4</p> <p>図版14 古代遺構図5〔古代遺構図6の断面図〕</p> <p>図版15 古代遺構図6</p> <p>図版16 古代遺構図7</p> <p>図版17 古代遺構図8〔古代遺構図7の断面図〕</p> <p>図版18 古代遺構図9</p> <p>図版19 古代遺構図10</p> <p>図版20 古代遺構図11</p> <p>図版21 古代遺構図12〔古代遺構図11の断面図〕</p> <p>図版22 古代遺構図13</p> <p>図版23 古代遺構図14</p> <p>図版24 古代遺構図15〔古代遺構図13・14の断面図〕</p> <p>図版25 古代遺構図16</p> <p>図版26 古代遺構図17</p> <p>図版27 古代遺構図18〔古代遺構図17の断面図〕</p> <p>図版28 古代遺構図19〔古代遺構図20の断面図〕</p> <p>図版29 古代遺構図20</p> <p>図版30 古代遺構図21</p> <p>図版31 古代遺構図22</p> <p>図版32 古代遺構図23</p> <p>図版33 古代遺構図24〔古代遺構図23の断面図〕</p> <p>図版34 古代遺構図25〔古代遺構図26の断面図〕</p> <p>図版35 古代遺構図26</p> <p>図版36 古代遺構図27〔古代遺構図28の断面図〕</p> <p>図版37 古代遺構図28</p> <p>図版38 古代遺構図29</p> <p>図版39 古代遺構図30</p> <p>図版40 古代遺構図31〔古代遺構図29・30・32の断面図〕</p> | <p>図版41 古代遺構図32</p> <p>図版42 古代遺構図33〔古代遺構図34の断面図〕</p> <p>図版43 古代遺構図34</p> <p>図版44 古代遺構図35</p> <p>図版45 古代遺構図36〔古代遺構図35の断面図〕</p> <p>図版46 古代遺構図37</p> <p>図版47 古代遺構図38</p> <p>図版48 古代遺構図39〔古代遺構図37・38の断面図〕</p> <p>図版49 中世遺構全体図</p> <p>図版50 中・近世遺構割り付け図</p> <p>図版51 中・近世遺構図1</p> <p>図版52 中・近世遺構図2</p> <p>図版53 中・近世遺構図3</p> <p>図版54 中・近世遺構図4</p> <p>図版55 中・近世遺構図5</p> <p>図版56 中・近世遺構図6</p> <p>図版57 中・近世遺構図7</p> <p>図版58 中・近世遺構図8</p> <p>図版59 中・近世遺構図9</p> <p>図版60 中・近世遺構図10</p> <p>図版61 中・近世遺構図11</p> <p>図版62 中・近世遺構図12</p> <p>図版63 中・近世遺構図13</p> <p>図版64 中・近世遺構図14</p> <p>図版65 中・近世遺構図15</p> <p>図版66 中・近世遺構図16</p> <p>図版67 中・近世遺構図17</p> <p>図版68 中・近世遺構図18</p> <p>図版69 中・近世遺構図19</p> <p>図版70 中・近世遺構図20</p> <p>図版71 中・近世遺構図21</p> <p>図版72 近世整地土層上面遺構図 (1:360)</p> <p>図版73 近世整地土層上面遺構図1 (1:120)</p> <p>図版74 近世整地土層上面遺構図2</p> <p>図版75 近世整地土層上面遺構図3</p> <p>図版76 古代以前遺物1</p> <p>図版77 古代以前遺物2</p> <p>図版78 古代遺物 土器1 (SB01・02・03)</p> <p>図版79 古代遺物 土器2 (SB04・05)</p> <p>図版80 古代遺物 土器3 (SB05・06・07)</p> <p>図版81 古代遺物 土器4 (SB09・10・11)</p> |
|--|--|

- 图版82 古代造物 土器5 (SB12·13·14)
 图版83 古代造物 土器6 (SB14·15)
 图版84 古代造物 土器7 (SB16·17·18·19)
 图版85 古代造物 土器8 (SB19·20·21·22·23·24)
 图版86 古代造物 土器9 (SB25·26·27·28)
 图版87 古代造物 土器10 (SB28·29·30)
 图版88 古代造物 土器11 (SB30·31·32)
 图版89 古代造物 土器12 (SB32)
 图版90 古代造物 土器13 (SB32)
 图版91 古代造物 土器14 (SB32)
 图版92 古代造物 土器15 (SB32)
 图版93 古代造物 土器16 (SB32·33·35·36·37)
 图版94 古代造物 土器17 (SB37·38·39·40·41·42·43)
 图版95 古代造物 土器18 (SB43·44·45)
 图版96 古代造物 土器19 (SB45·46·47·48)
 图版97 古代造物 土器20 (SB49·50)
 图版98 古代造物 土器21 (SB51·52·53·55)
 图版99 古代造物 土器22 (SB55·56·57·58·59)
 图版100 古代造物 土器23 (SB59·60·61·63)
 图版101 古代造物 土器24 (SB64·65·66)
 图版102 古代造物 土器25 (SB66·67·68·69)
 图版103 古代造物 土器26 (SB70·71·72·73)
 图版104 古代造物 土器27 (SB74·75)
 图版105 古代造物 土器28 (SB76·77·78·79)
 图版106 古代造物 土器29 (SB80)
 图版107 古代造物 土器30 (SB80·81·83)
 图版108 古代造物 土器31 (SB83·84)
 图版109 古代造物 土器32 (SB85·86·87)
 图版110 古代造物 土器33 (SB87·88·89·90·91)
 图版111 古代造物 土器34 (SB91·93·94)
 图版112 古代造物 土器35 (SB94·95)
 图版113 古代造物 土器36 (SB96·97·98·99)
 图版114 古代造物 土器37 (SB99)
 图版115 古代造物 土器38 (SB100·101·102)
 图版116 古代造物 土器39 (SB102·103·104·105·106)
 图版117 古代造物 土器40 (SB107·108·109·110)
 图版118 古代造物 土器41 (SB111)
 图版119 古代造物 土器42 (SB111·112·113)
 图版120 古代造物 土器43 (SB114·115)
 图版121 古代造物 土器44 (SB115·116·117·118)
 图版122 古代造物 土器45 (SB119·120·121·122·123·124)
 图版123 古代造物 土器46 (SB125·126·127·128·129·130·132)
 图版124 古代造物 土器47 (SB133·134·135·136·137·139)
 图版125 古代造物 土器48 (SB140·141)
 图版126 古代造物 土器49 (SB141·142·143)
 图版127 古代造物 土器50 (SB144·145·146)
 图版128 古代造物 土器51 (SB147·148·150·154·156·157)
 图版129 古代造物 土器52 (SB158·159·160·161)
 图版130 古代造物 土器53 (SB162·163·164·165·166)
 图版131 古代造物 土器54 (SB167·168)
 图版132 古代造物 土器55 (SB169·170·171·172·174)
 图版133 古代造物 土器56 (SB175·176·177·178·179·180·181·182)
 图版134 古代造物 土器57 (SB183·184)
 图版135 古代造物 土器58 (SB185·186·187)
 图版136 古代造物 土器59 (SB188·189·190)
 图版137 古代造物 土器60 (SB191·192·193)
 图版138 古代造物 土器61 (SB194·195·196·197)
 图版139 古代造物 土器62 (SB198·199·200·201)
 图版140 古代造物 土器63 (SB201·202·203·204·207·209)
 图版141 古代造物 土器64 (SB209·210·211·212·213·214)
 图版142 古代造物 土器65 (SB215·216)
 图版143 古代造物 土器66 (SB217·218·219·220·221·222·224)
 图版144 古代造物 土器67 (SB225·226·227)
 图版145 古代造物 土器68 (SB227·228·230)
 图版146 古代造物 土器69 (SB232·233)
 图版147 古代造物 土器70 (SB234)
 图版148 古代造物 土器71 (SB235·236·237·238·239·240·241·242·243·244·245)
 图版149 古代造物 土器72 (SB246)
 图版150 古代造物 土器73 (SB246·247·248)
 图版151 古代造物 土器74 (SB249·250·251·252·256)
 图版152 古代造物 土器75 (SB258·259·260)
 图版153 古代造物 土器76 (SB261·262·263)
 图版154 古代造物 土器77 (SB264)
 图版155 古代造物 土器78 (SB265·266·267·268·269·271)

- 図版156 古代遺物 土器79 (SK)
 図版157 古代遺物 土器80 (SK)
 図版158 古代遺物 土器81 (SK)
 図版159 古代遺物 土器82 (SK)
 図版160 古代遺物 土器83 (SK)
 図版161 古代遺物 土器84 (SK)
 図版162 古代遺物 土器85 (墓)
 図版163 古代遺物 土器86 (SD)
 図版164 古代遺物 土器87 (SD)
 図版165 古代遺物 土器88 (SD・NR)
 図版166 古代遺物 土器89 (ST・SX)
 図版167 古代遺物 土器90 (遺構外F・G・H地区)
 図版168 古代遺物 土器91 (遺構外I・K・L・M地区)
 図版169 古代遺物 土器92 (遺構外M・N地区)
 図版170 古代遺物 土器93 (遺構外N・O地区)
 図版171 古代遺物 土器94 (遺構外O地区)
 図版172 古代遺物 土器95 (遺構外O・P・S地区)
 図版173 古代遺物 土器96 (遺構外S・T・Z地区)
 図版174 金屬製品1 (SB01~30)
 図版175 金屬製品2 (SB31~32)
 図版176 金屬製品3 (SB32~68)
 図版177 金屬製品4 (SB66~74)
 図版178 金屬製品5 (SB78~115)
 図版179 金屬製品6 (SB101~170)
 図版180 金屬製品7 (SB167~256)
 図版181 金屬製品8 (SB262~266・SK・SD・SM)
 図版182 金屬製品9 (SD・NR・II層)
 図版183 金屬製品10 (II層)
 図版184 金屬製品11 (II・I層)
 図版185 金屬製品12 (I層)
 図版186 金屬製品13 (I層)
 図版187 金屬製品14 (近世遺構)
 図版188 金屬製品15 (近世遺構)
 図版189 鉄貨
 図版190 鍛冶関係資料1 (羽口・鉄滓)
 図版191 鍛冶関係資料2 (磁石)
 図版192 鍛冶関係資料3 (磁石)
 図版193 古代遺物 文字関係資料1 (墨書土器1)
 図版194 古代遺物 文字関係資料2 (墨書土器2)
 図版195 古代遺物 文字関係資料3 (墨書土器3)
 図版196 古代遺物 文字関係資料4 (墨書土器4)
 図版197 古代遺物 文字関係資料5 (墨書土器5)
 図版198 古代遺物 文字関係資料6 (墨書土器6)
 図版199 古代遺物 文字関係資料7 (墨書土器7)
 図版200 古代遺物 文字関係資料8 (墨書土器8)
 図版201 古代遺物 文字関係資料9 (墨書土器9)
 図版202 古代遺物 文字関係資料10 (墨書土器10)
 図版203 古代遺物 文字関係資料11 (墨書土器11)
 図版204 古代遺物 文字関係資料12 (刻書・寛書土器1)
 図版205 古代遺物 文字関係資料13 (刻書・寛書土器2)
 図版206 古代遺物 文字関係資料14 (刻書・寛書土器3)
 図版207 古代遺物 文字関係資料15 (筆・硯1)
 図版208 古代遺物 文字関係資料16 (硯2)
 図版209 古代遺物 文字関係資料17 (硯3)
 図版210 古代遺物 文字関係資料18 (硯4)
 図版211 古代遺物 土製品・木製品
 図版212 中・近世遺物1 (雑物1)
 図版213 中・近世遺物2 (雑物2)
 図版214 中・近世遺物3 (雑物3)
 図版215 中・近世遺物4 (雑物4)
 図版216 中・近世遺物5 (雑物5)
 図版217 中・近世遺物6 (雑物6)
 図版218 中・近世遺物7 (雑物7)
 図版219 中・近世遺物8 (雑物8)
 図版220 中・近世遺物9 (雑物9)
 図版221 中・近世遺物10 (雑物10)
 図版222 中・近世遺物11 (雑物11)
 図版223 中・近世遺物12 (雑物12)
 図版224 中・近世遺物13 (雑物13)
 図版225 中・近世遺物14 (雑物14・石製品1)
 図版226 中・近世遺物15 (石製品2)
 図版227 中・近世遺物16 (石製品3)
 図版228 中・近世遺物17 (石製品4)

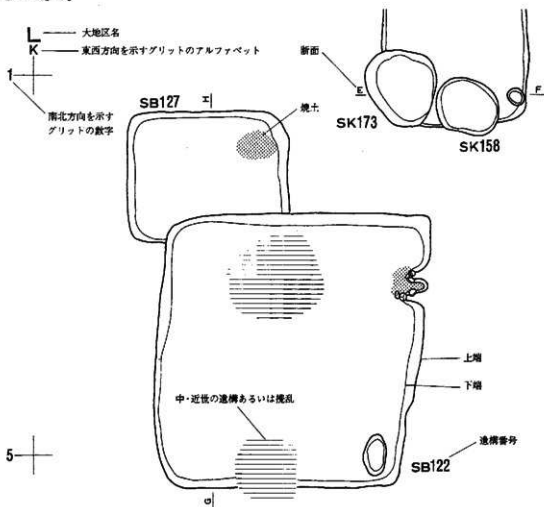
写真図版目次

- PL 1 遺跡全景
 PL 2 調査区全景
 PL 3 遺構垂直写真1 (N地区、N・S地区)
 PL 4 遺構垂直写真2 (O地区東部、O地区南部)
 PL 5 遺構垂直写真3 (M地区、K・L地区)
 PL 6 遺構垂直写真4 (L・M地区、M地区西部)
 PL 7 遺構垂直写真5 (O地区、S地区)
 PL 8 遺構垂直写真6 (O地区北部、O地区南部)
 PL 9 遺構垂直写真7 (G地区、L地区)
 PL10 遺構垂直写真8 (F・G地区、K・L地区)
 PL11 遺構垂直写真9 (O地区北部、O地区南部)
 PL12 遺構垂直写真10 (N地区北部、N地区南部)
 PL13 遺構垂直写真11 (H・M地区、M地区)
 PL14 遺構垂直写真12 (H地区、L・M地区)
 PL15 遺構垂直写真13 (G地区、M地区)
 PL16 古代遺構1 (SB05、SB14)
 PL17 古代遺構2 (SB17、SB20、SB21)
 PL18 古代遺構3 (SB22、SB23、SB26)
 PL19 古代遺構4 (SB27、SB29、SB30)
 PL20 古代遺構5 (SB19・28カマ F、SB32)
 PL21 古代遺構6 (SB32、SB33、SB40)
 PL22 古代遺構7 (SB42、SB44、SB48)
 PL23 古代遺構8 (SB45・49カマ F、SB49、SB50)
 PL24 古代遺構9 (SB56、SB59、SB58)
 PL25 古代遺構10 (SB58・83カマ F、SB63、SB66)
 PL26 古代遺構11 (SB69、SB70、SB71)
 PL27 古代遺構12 (SB73、SB74、SB76)
 PL28 古代遺構13 (SB81、SB85・86カマ F、SB86)
 PL29 古代遺構14 (SB95、SB95・112カマ F、SB98)
 PL30 古代遺構15 (SB99、SB100)
 PL31 古代遺構16 (SB102、SB108、SB115)
 PL32 古代遺構17 (SB118、SB128、SB129)
 PL33 古代遺構18 (SB132、SB139、SB139・226カマ F)
 PL34 古代遺構19 (SB142、SB156、SB160)
 PL35 古代遺構20 (SB144、SB162)
 PL36 古代遺構21 (SB167、SB168、SB170)
 PL37 古代遺構22 (SB187、SB188、SB188・230カマ F)
 PL38 古代遺構23 (SB200、SB209、SB210)
 PL39 古代遺構24 (SB213、SB227、SB232)
 PL40 古代遺構25 (SB232・234カマ F、SB234、SB249)
 PL41 古代遺構26 (SB242・249カマ F、SB250、SB258)
 PL42 古代遺構27 (SB259、SB264、SB266)
 PL43 古代遺構28 (ST201、ST204、ST206)
 PL44 古代遺構29 (ST208、O地区北東部柱穴群、ST205)
 PL45 古代遺構30 (SD17、SD19・25、SM01、SK128)
 PL46 古代遺構31 (SX21、SK21、SK42、SK73、SK84、SK218)
 PL47 中・近世遺構1 (ST05、SB1121、SB1179)
 PL48 中・近世遺構2 (SD02、ST02、SK1123、SK1252)
 PL49 中・近世遺構3 (SK1231~1236、SK1141・1142、SK1217、SK1221、SK1244)
 PL50 中・近世遺構4 (近世整地土層上面遺構)
 PL51 中・近世遺構5 (ST2004、ST2001、ST2003)
 PL52 中・近世遺構6 (整地土層上面礫分布、ST2002)
 PL53 中・近世遺構7 (SE01、SK2013)
 PL54 古代以前遺物 (縄文時代、弥生時代)
 PL55 古代土器1 (SB01~05)
 PL56 古代土器2 (SB05~16)
 PL57 古代土器3 (SB11~18)
 PL58 古代土器4 (SB17~22)
 PL59 古代土器5 (SB22~31)
 PL60 古代土器6 (SB32・33)
 PL61 古代土器7 (SB35~45)
 PL62 古代土器8 (SB45~49)
 PL63 古代土器9 (SB49~59)
 PL64 古代土器10 (SB59~66)
 PL65 古代土器11 (SB69~72)
 PL66 古代土器12 (SB73~76)
 PL67 古代土器13 (SB76~80)
 PL68 古代土器14 (SB81~84)
 PL69 古代土器15 (SB84~88)
 PL70 古代土器16 (SB91~99)
 PL71 古代土器17 (SB99~102)
 PL72 古代土器18 (SB103~114)
 PL73 古代土器19 (SB111~116)
 PL74 古代土器20 (SB115~128)
 PL75 古代土器21 (SB128~140)
 PL76 古代土器22 (SB141~144)

- PL77 古代土器23 (SB144~154)
- PL78 古代土器24 (SB158~170)
- PL79 古代土器25 (SB174~186)
- PL80 古代土器26 (SB184~188)
- PL81 古代土器27 (SB189~192)
- PL82 古代土器28 (SB194~207)
- PL83 古代土器29 (SB209~216)
- PL84 古代土器30 (SB226~227)
- PL85 古代土器31 (SB227~234)
- PL86 古代土器32 (SB237~248)
- PL87 古代土器33 (SB247~263)
- PL88 古代土器34 (SB263~268, SK128)
- PL89 古代土器35 (SK128, SM01, SK)
- PL90 古代土器36 (SK)
- PL91 古代土器37 (SX) 土製品・木製品
- PL92 金属製品1 (鎌)
- PL93 金属製品2 (鎌、鋤頭、斧、弓引鉄)
- PL94 金属製品3 (鋤頭車)
- PL95 金属製品4 (刀子)
- PL96 金属製品5 (刀子、工具、他)
- PL97 金属製品6 (鎌鉄、建築金具、馬具、鉄錘、他)
- PL98 金属製品7 (鉄鎌)
- PL99 金属製品8 (鉄鎌)
- PL100 金属製品9 (釘)
- PL101 金属製品10 (その他)
- PL102 金属製品11 (近世)
- PL103 金属製品12 (銭貨)
- PL104 鍛冶関係資料1 (羽口、鉄滓)
- PL105 鍛冶関係資料2 (鉄滓)
- PL106 文字関係資料1 (墨書土器1)
- PL107 文字関係資料2 (墨書土器2)
- PL108 文字関係資料3 (墨書土器3)
- PL109 文字関係資料4 (墨書土器4)
- PL110 文字関係資料5 (墨書土器5)
- PL111 文字関係資料6 (刻書土器・施書土器・硯・筆
穂先)
- PL112 中・近世遺物1 (焼物1)
- PL113 中・近世遺物2 (焼物2)
- PL114 中・近世遺物3 (焼物3)
- PL115 中・近世遺物4 (焼物4)
- PL116 中・近世遺物5 (焼物5)
- PL117 中・近世遺物6 (焼物6)
- PL118 中・近世遺物7 (焼物7)
- PL119 中・近世遺物8 (焼物8)
- PL120 中・近世遺物9 (焼物9)
- PL121 中・近世遺物10 (焼物10)
- PL122 中・近世遺物11 (焼物11)
- PL123 中・近世遺物12 (焼物12)
- PL124 中・近世遺物13 (焼物13)
- PL125 中・近世遺物14 (焼物14)
- PL126 中・近世遺物15 (焼物15)
- PL127 中・近世遺物16 (焼物16)
- PL128 中・近世遺物17 (焼物17・石製品1)
- PL129 中・近世遺物18 (石製品2)
- PL130 鉄滓と鉄器の金属学的解析1
- PL131 鉄滓と鉄器の金属学的解析2
- PL132 鉄滓と鉄器の金属学的解析3
- PL133 鉄滓と鉄器の金属学的解析4
- PL134 鉄滓と鉄器の金属学的解析5

図 版

財加

「財富加」

「財」と「加」とを「加える」ことを願う呪
儀に係わる墨書であろう。当時の在地仏教は
現世利益を求める傾向が強く、その一端の表
れであろう。(SB46出土 墨書土器)

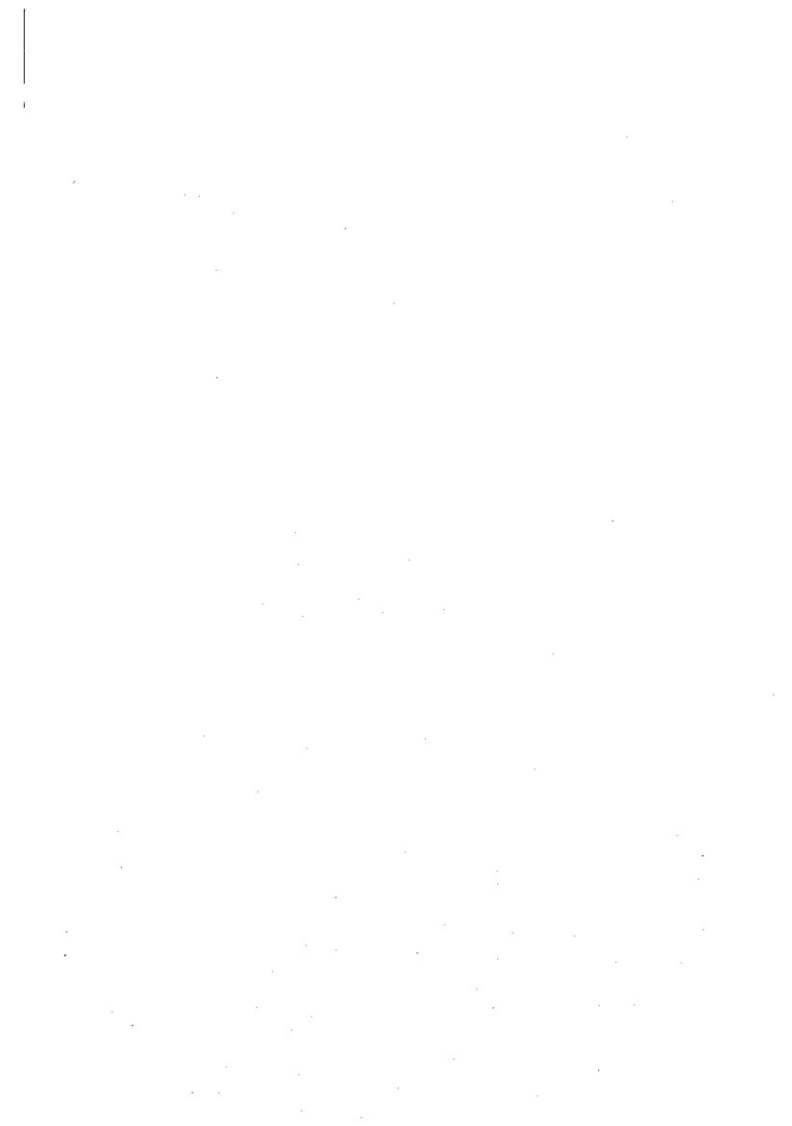



●吉田川西遺跡

国土地理院発行5万分の1地形図「豊科・松本・塩尻」より作成



—は遺跡の範囲 1:測量範囲 2:塩尻市教育委員会調査地点
 塩尻市都市計画課より作成

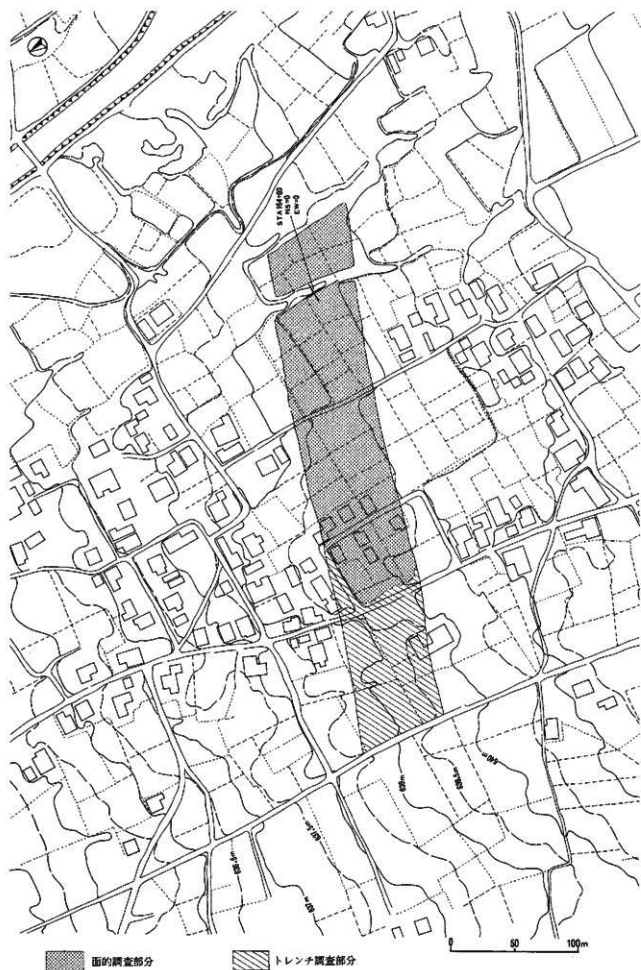

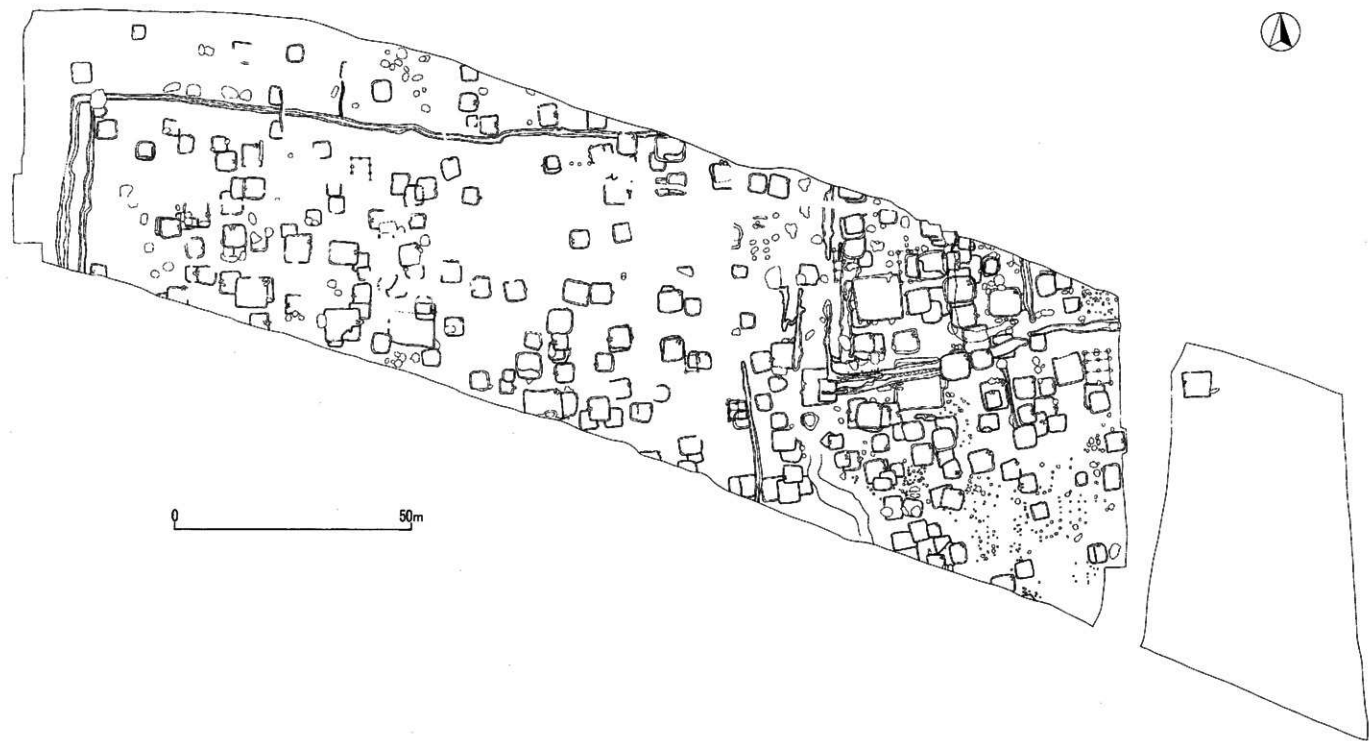

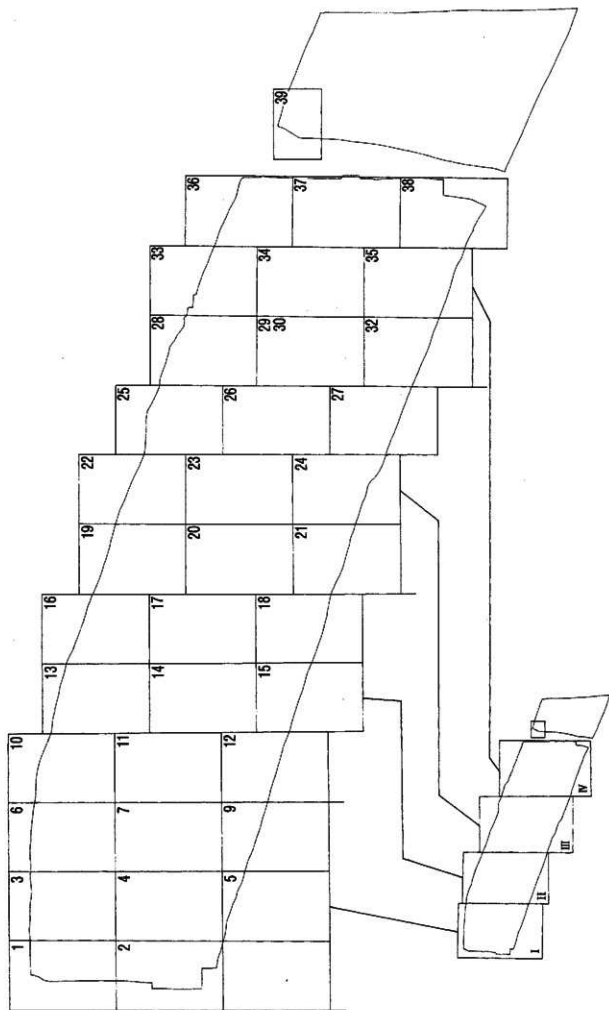

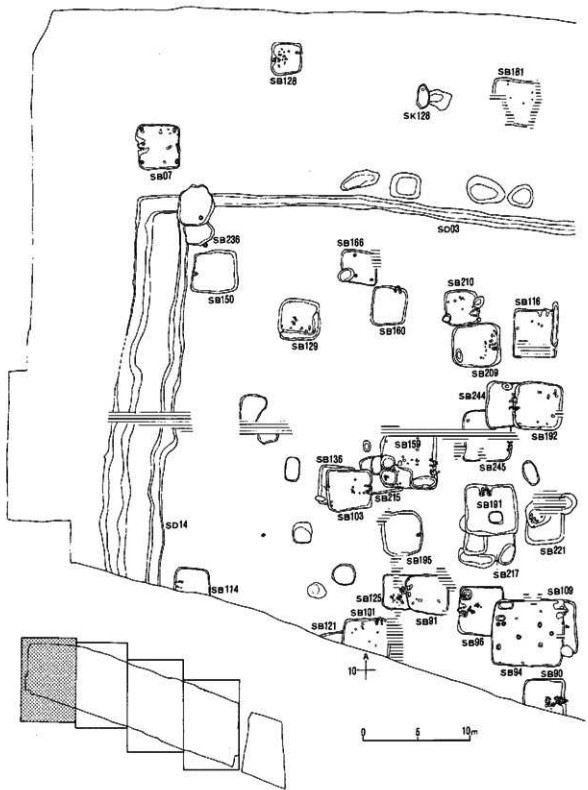

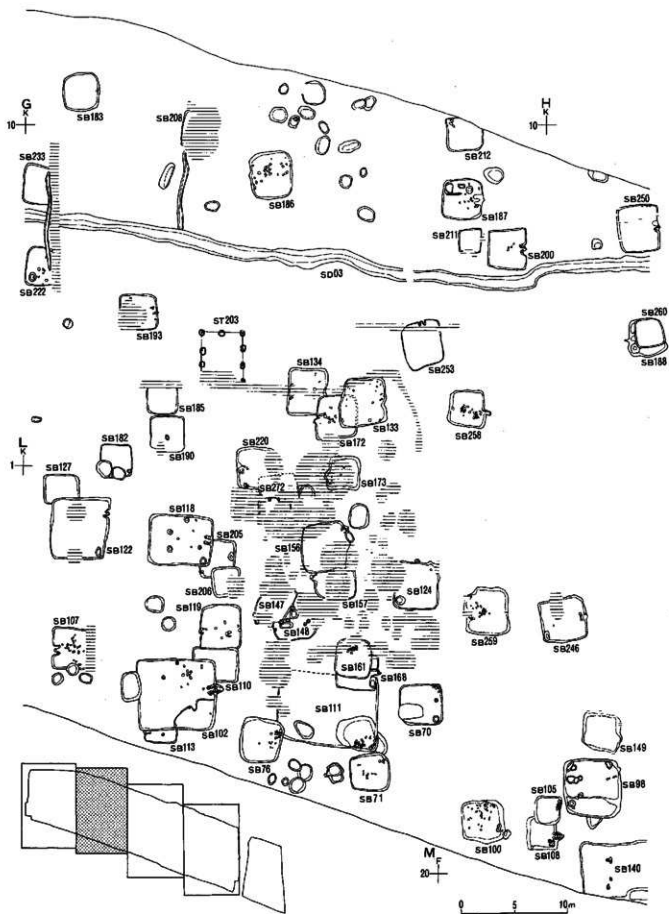

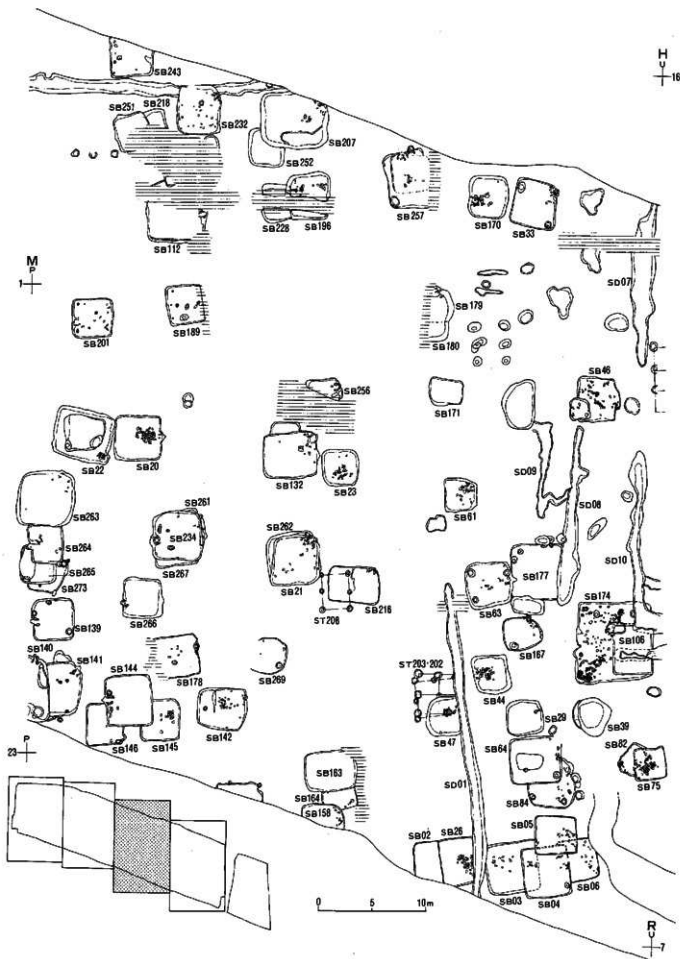

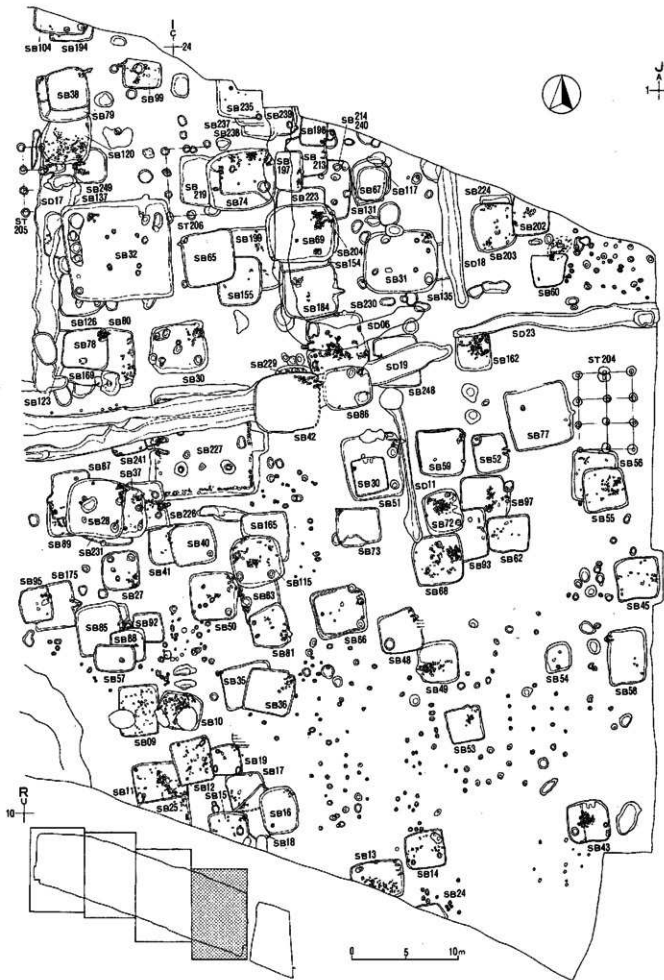

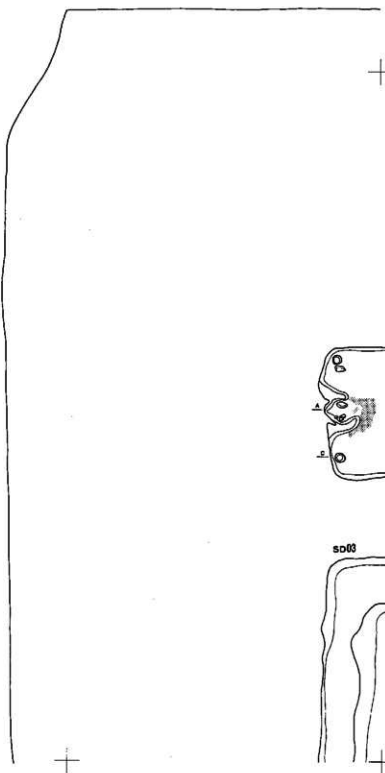
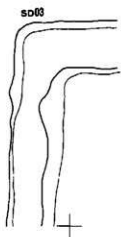
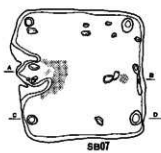
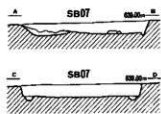
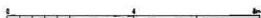

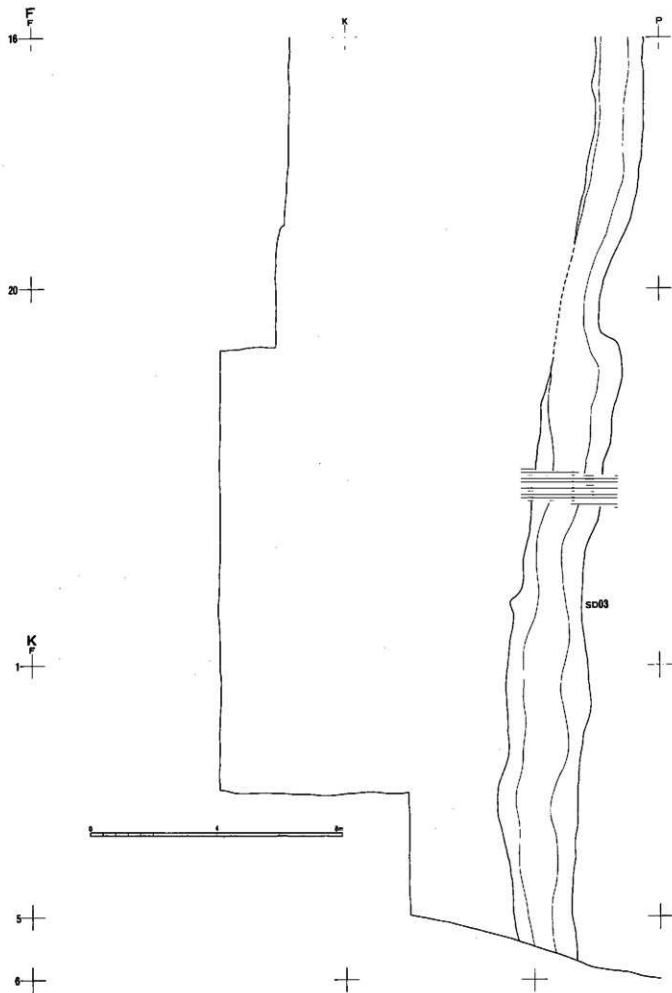



古代遺構図3 断面図

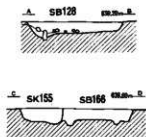

古代遺構図4 断面図

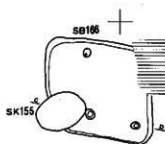
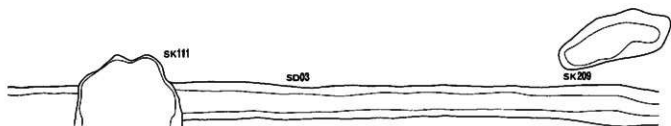
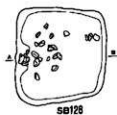
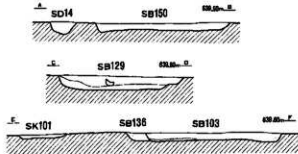

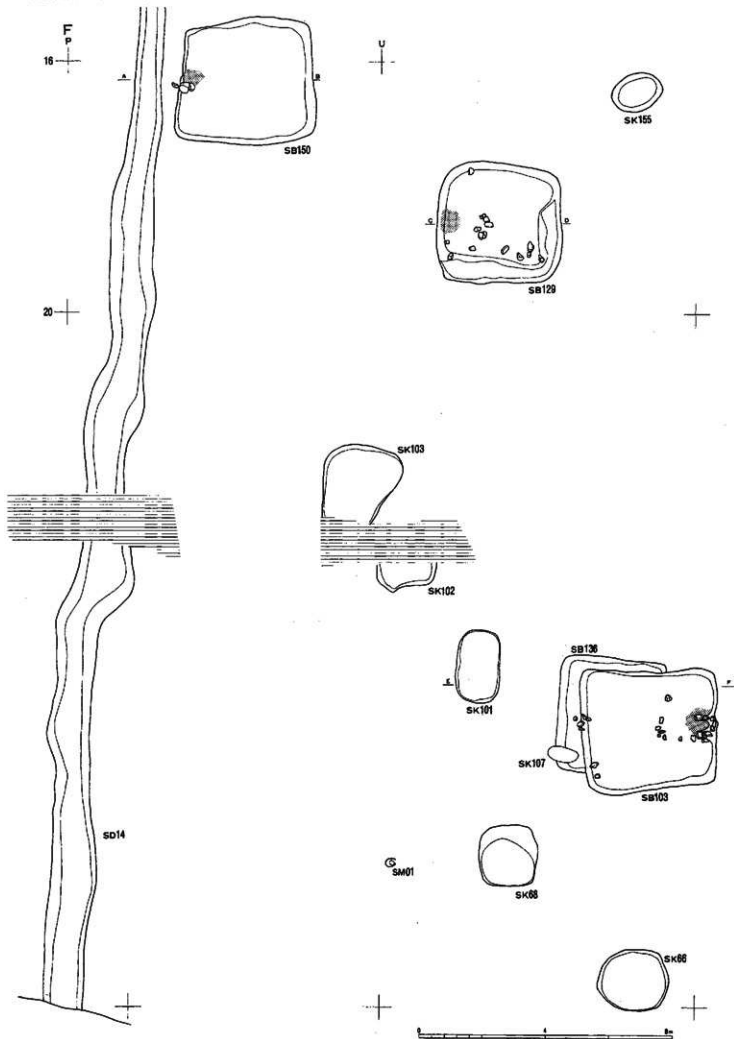

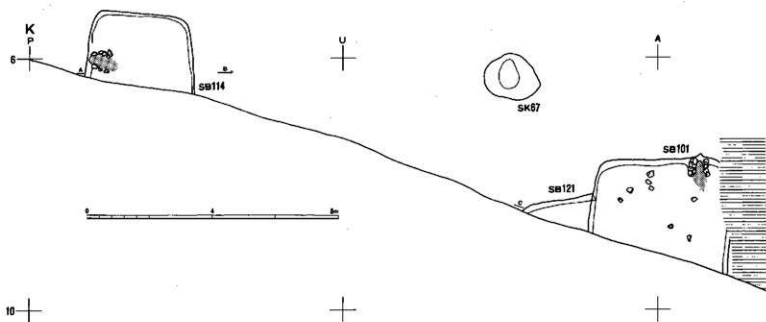

古代遺構図5 断面図

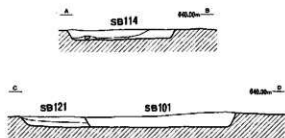

古代遺構図6 断面図



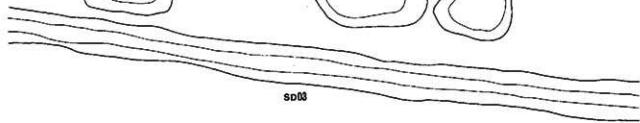
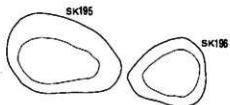
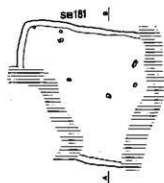
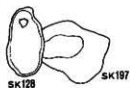

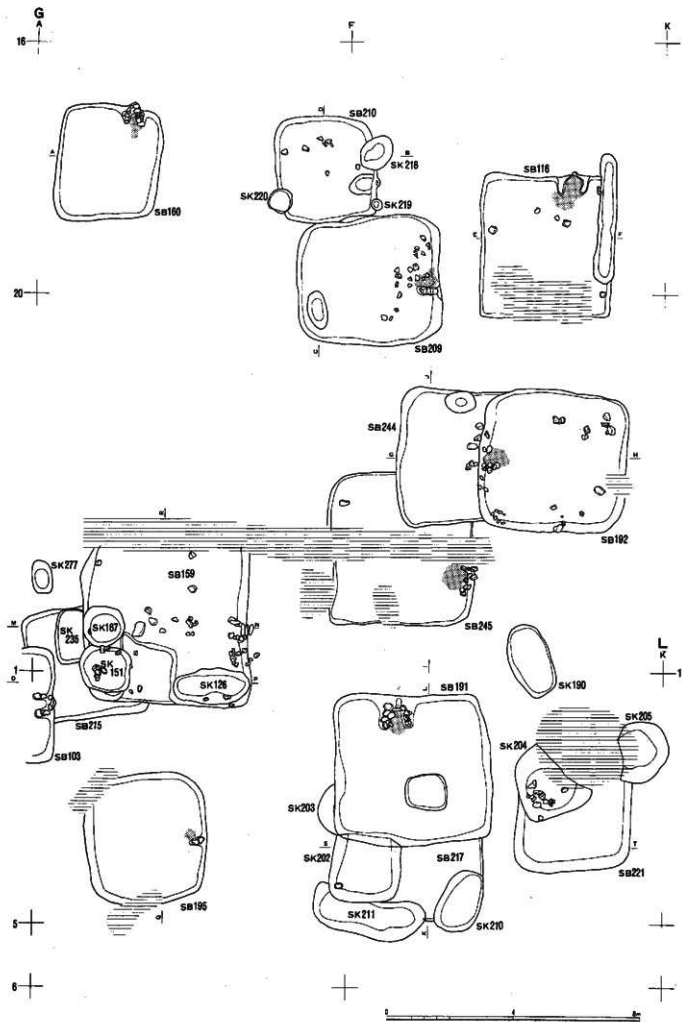

古代遺構図7 断面図

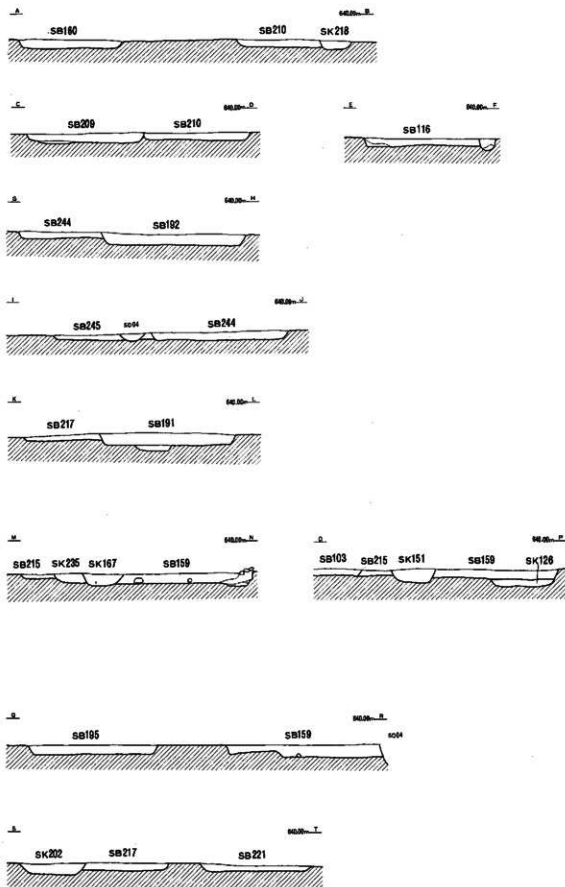

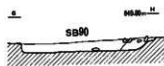
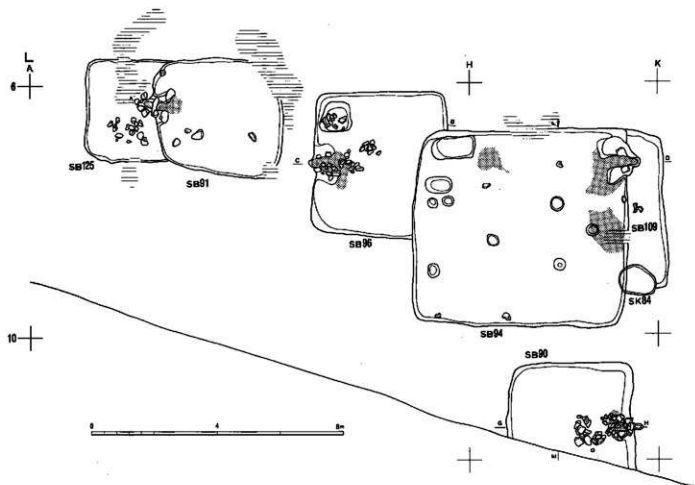

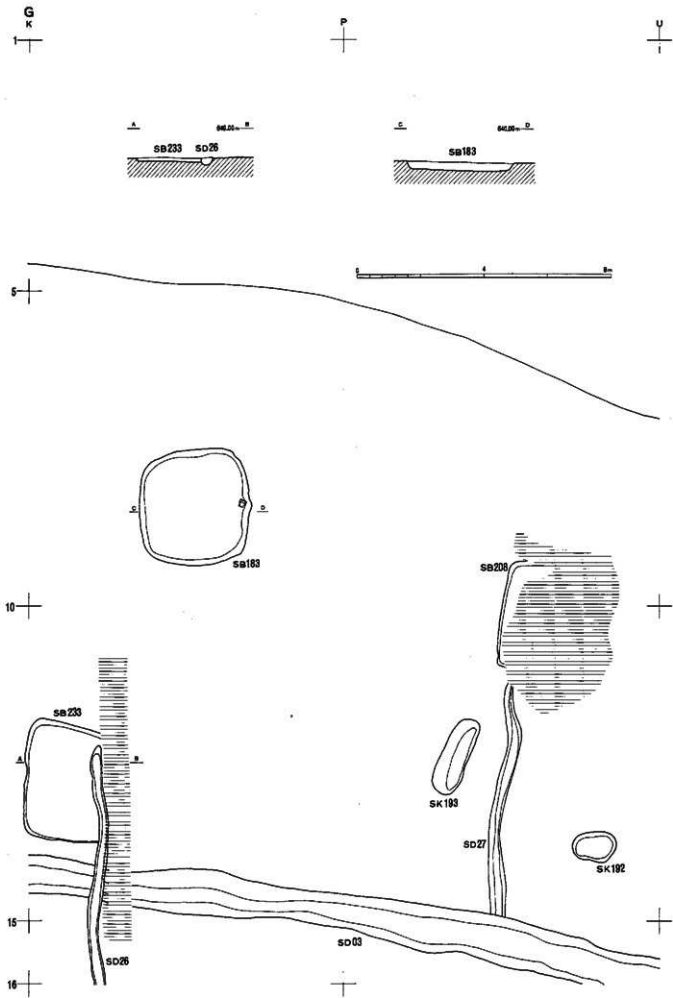

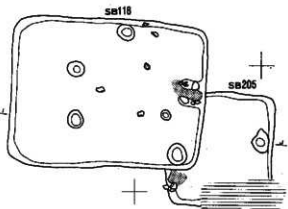
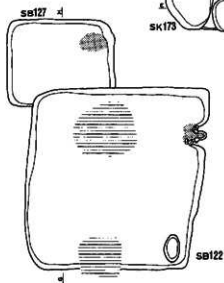
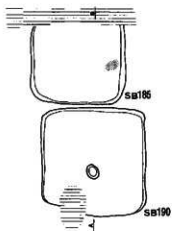
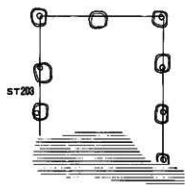
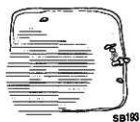
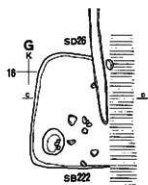

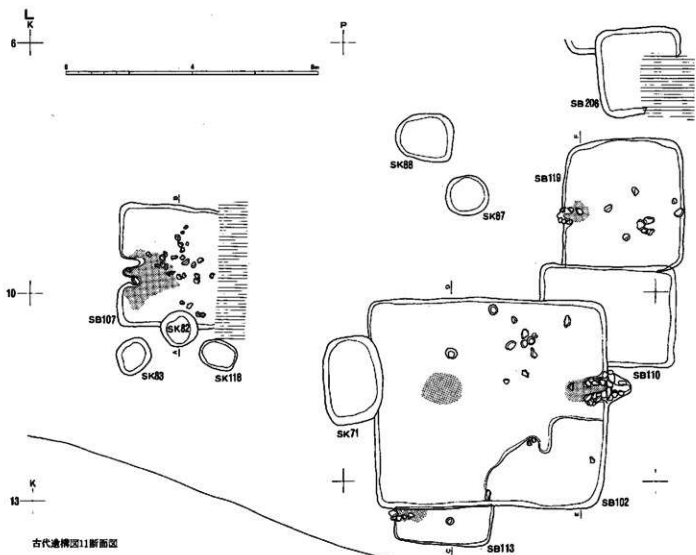

古代遺構図11断面図

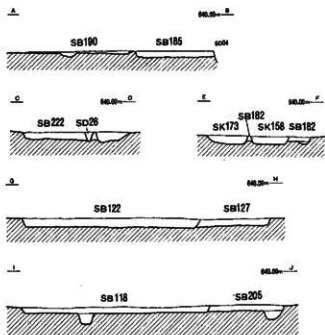

古代遺構図12断面図

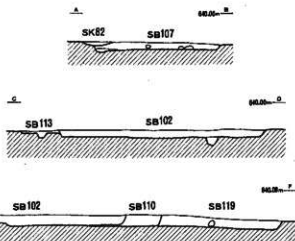

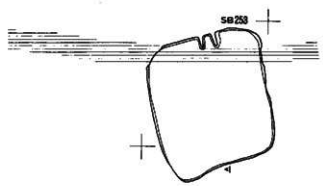
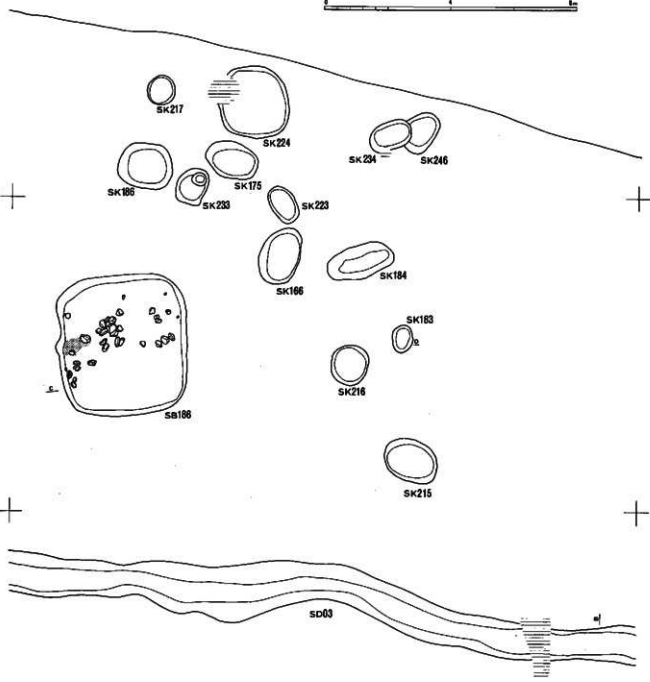

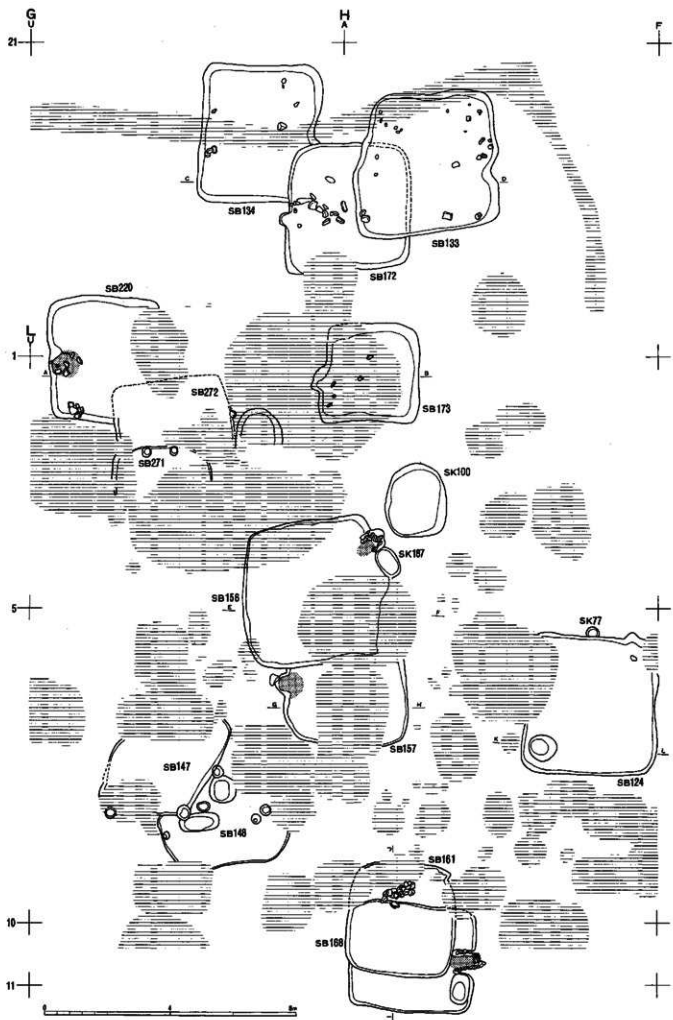

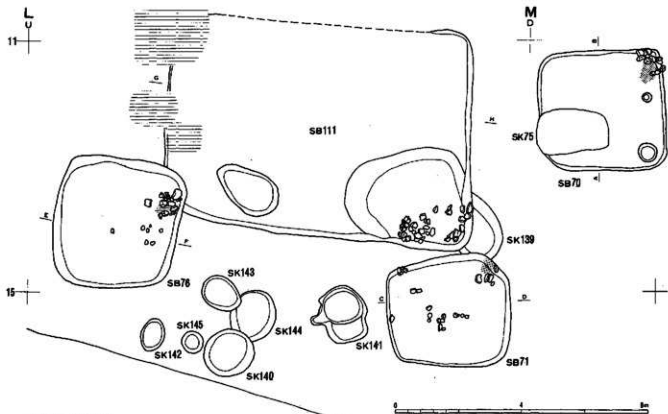

古代遺構図13断面図

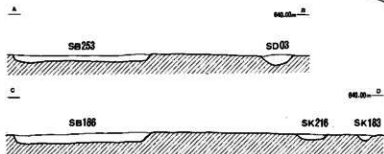

古代遺構図14断面図

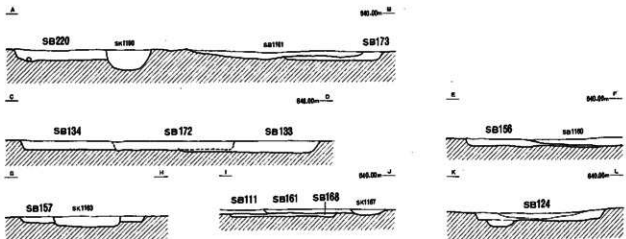

古代遺構図15断面図

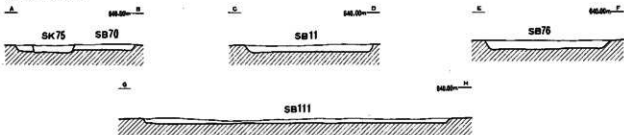

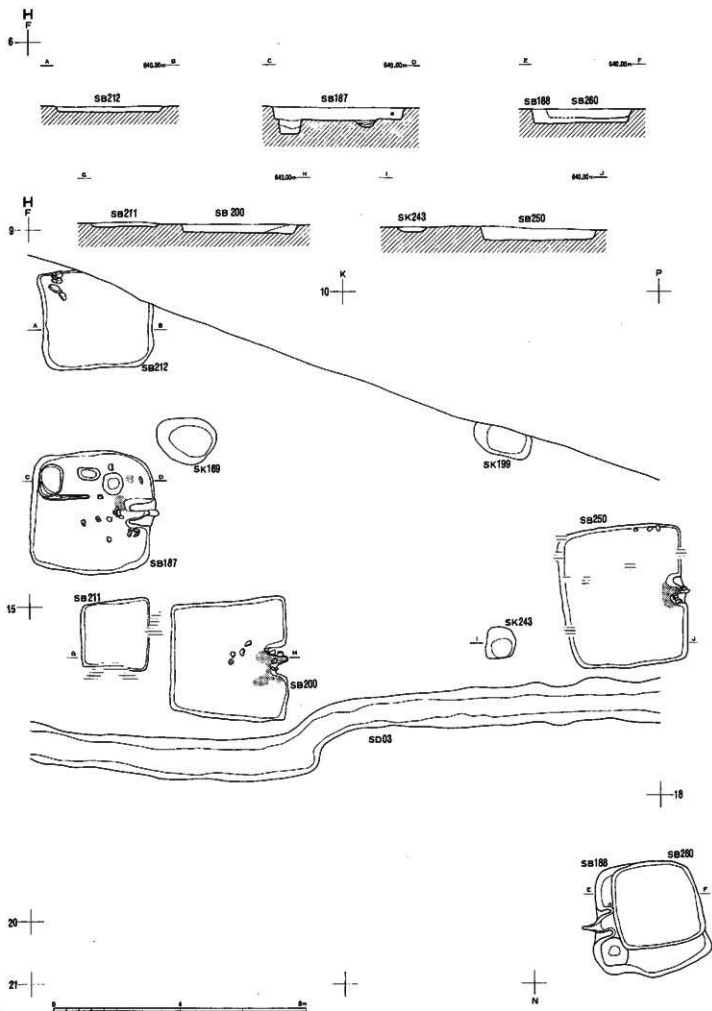

H
F
21

K

P

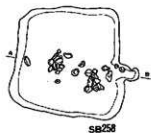

M
F
1

5

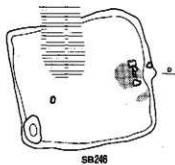
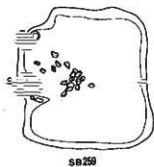

10

11



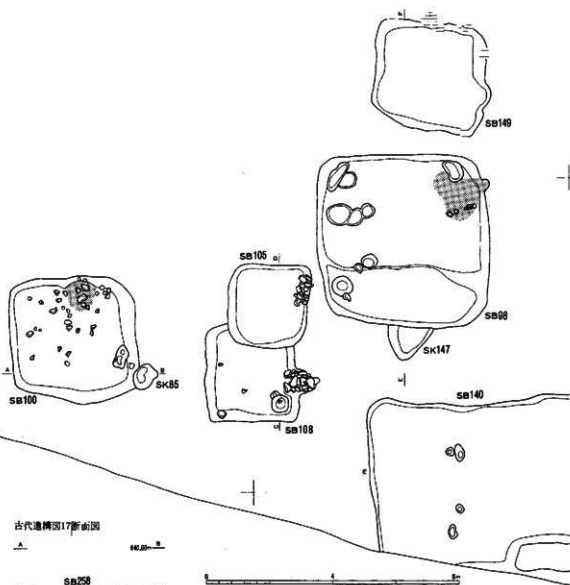

古代遺構図17断面図

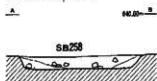

古代遺構図18断面図



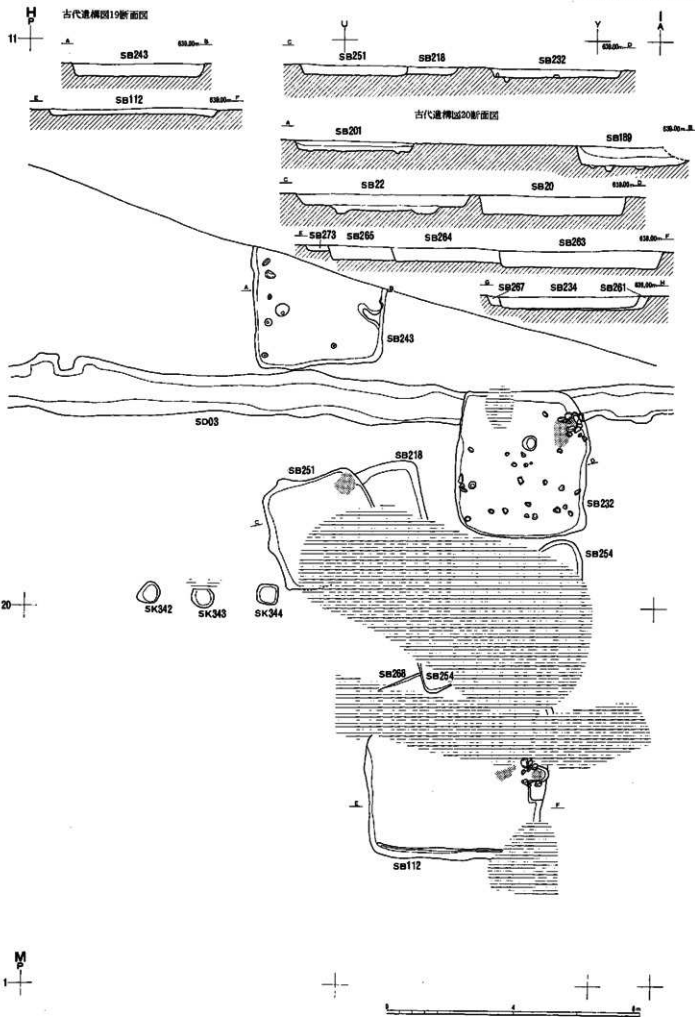

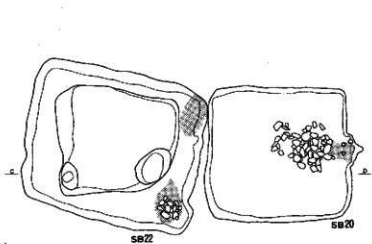
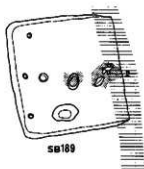
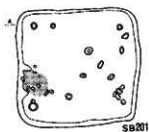

sk336



sk335

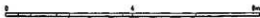
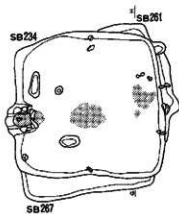
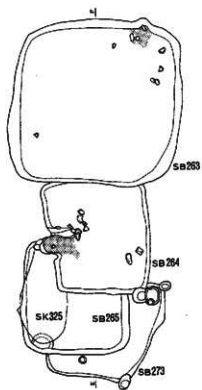

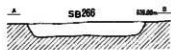
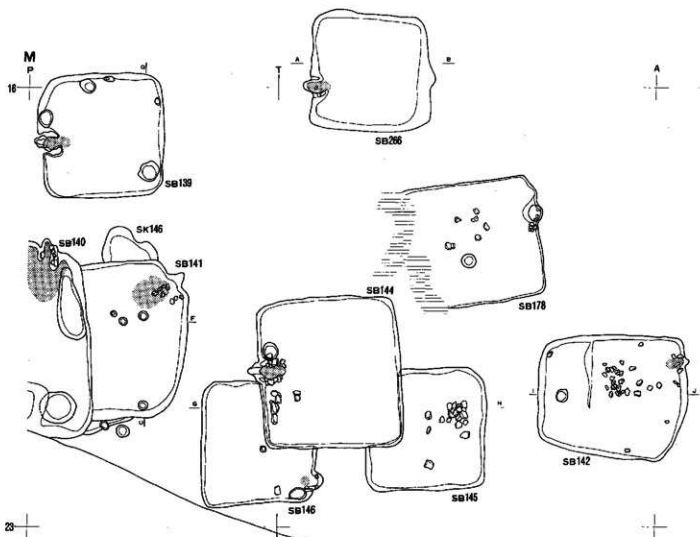

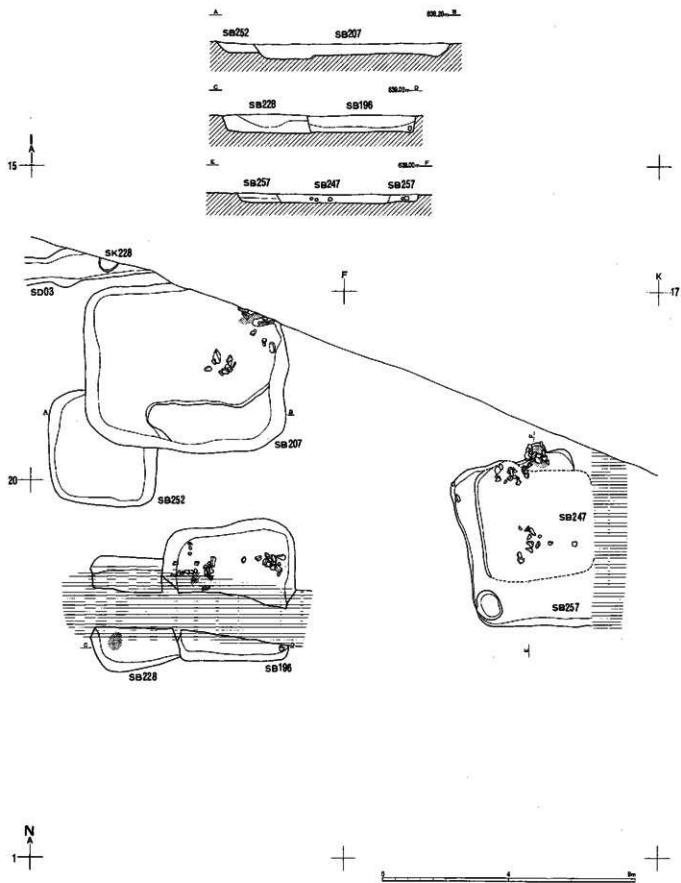

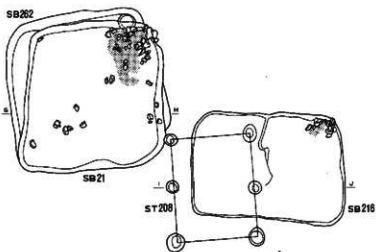
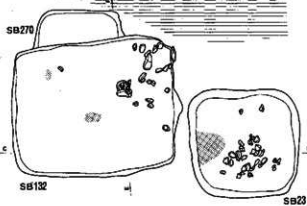
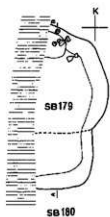

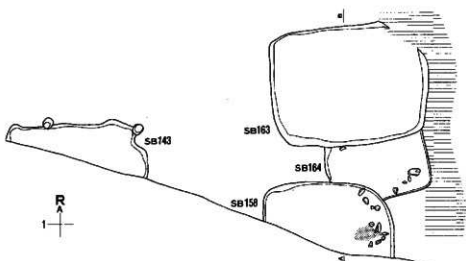
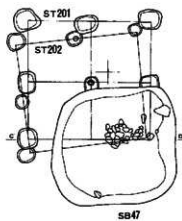
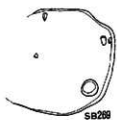
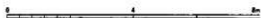

古代遺構図23断面図

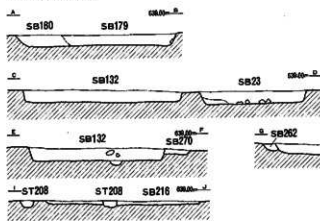

SB02

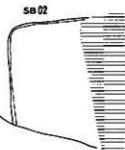

古代遺構図24断面図



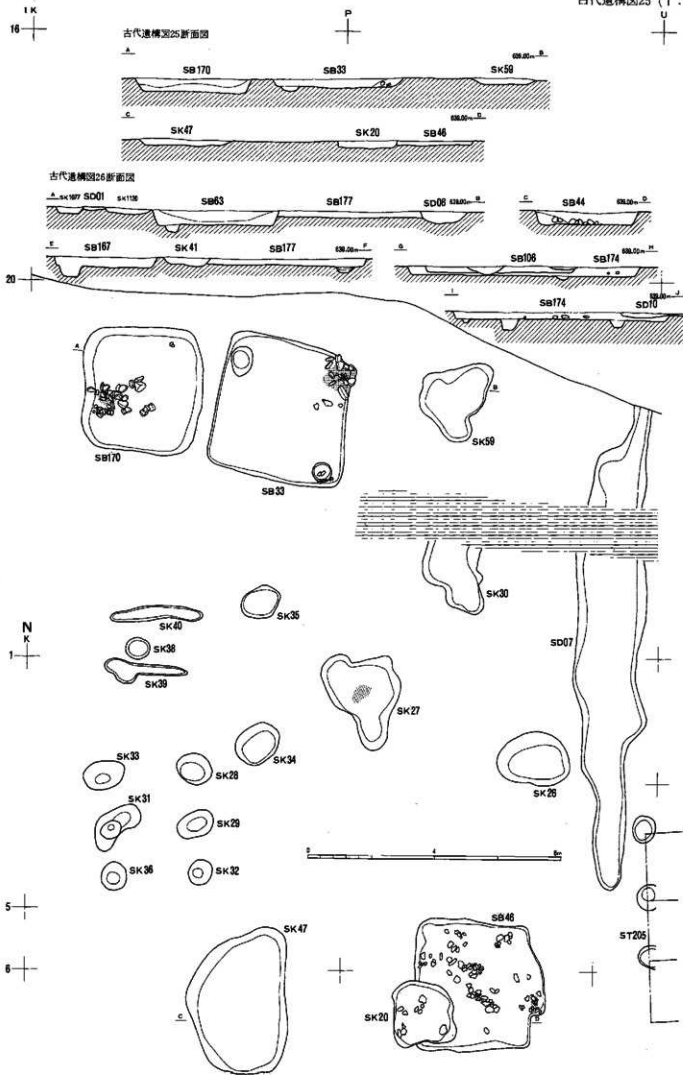

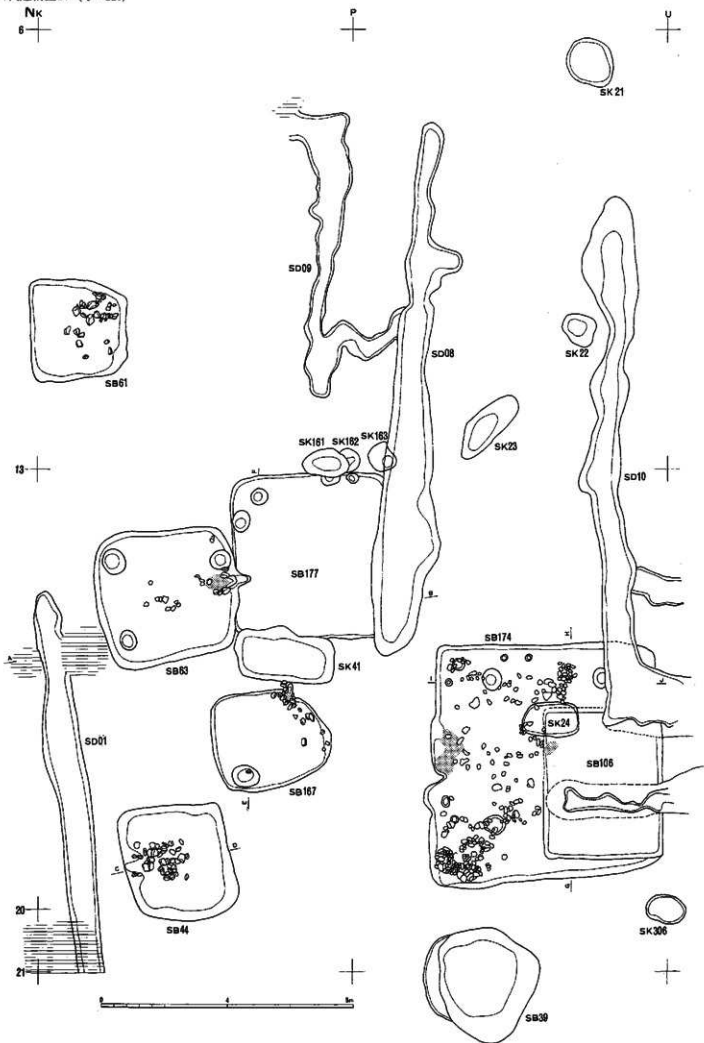

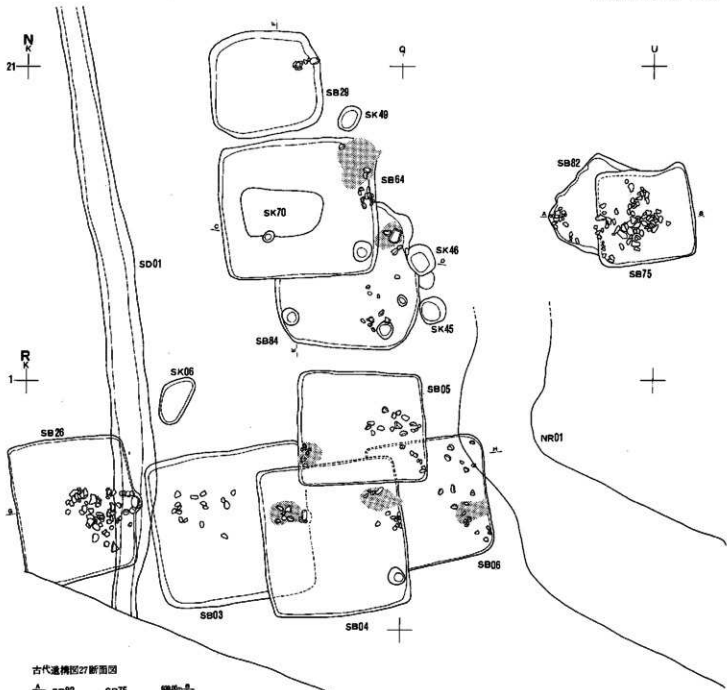

古代遺構图27断面图

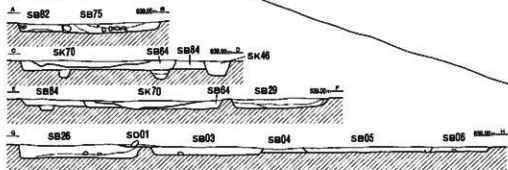

古代遺構图27断面图

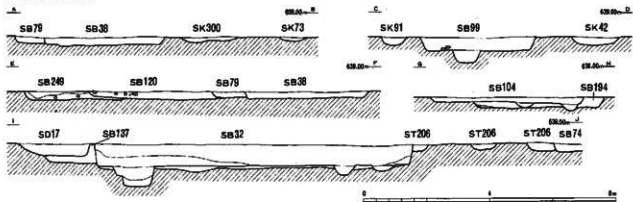

0 4 8

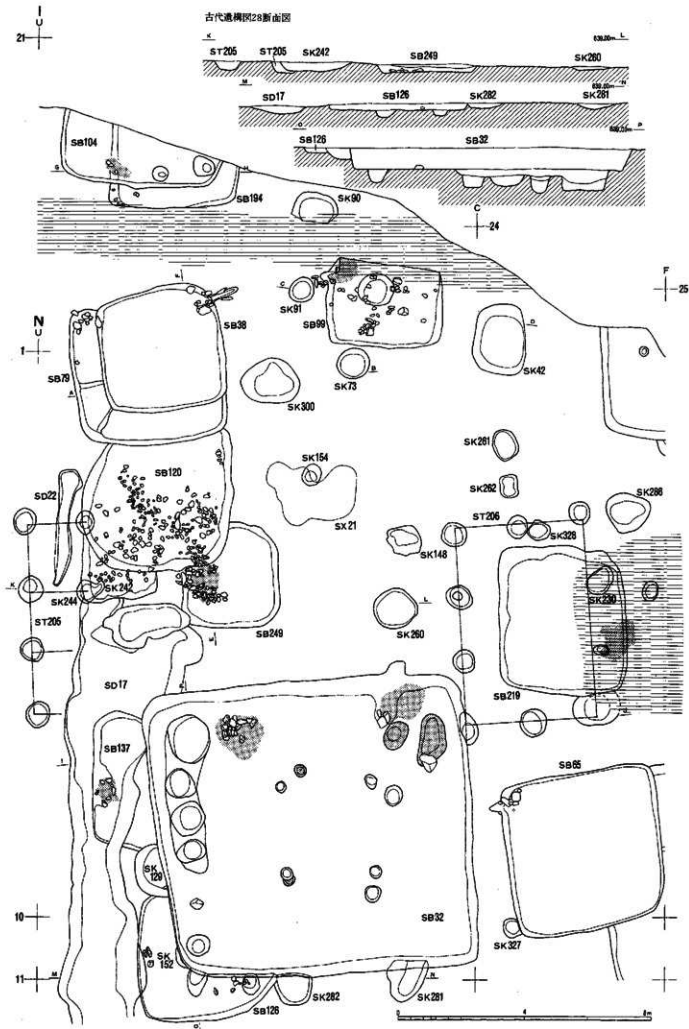

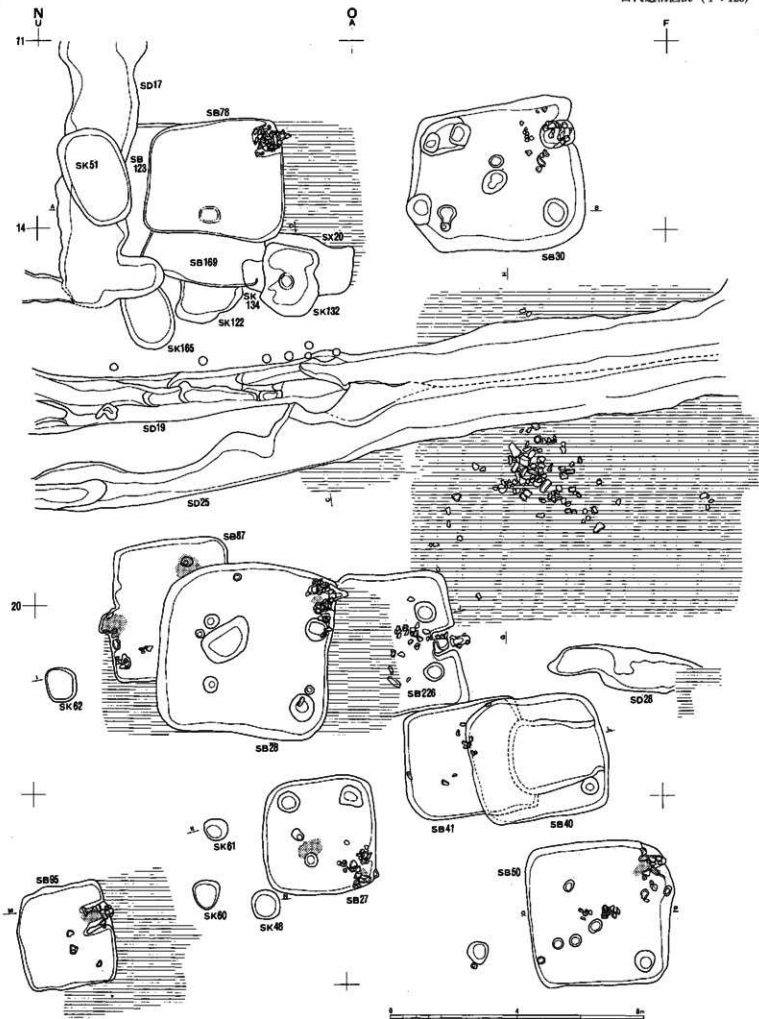

古代遺構図30 (1:120)

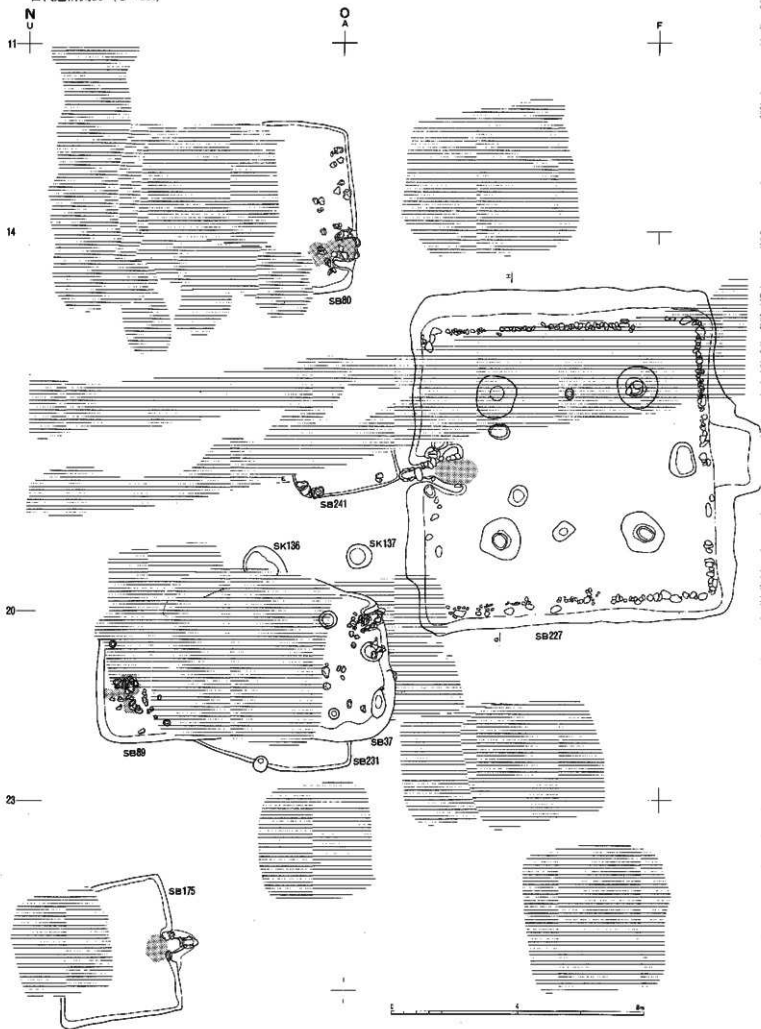

古代遺構図29-30断面図

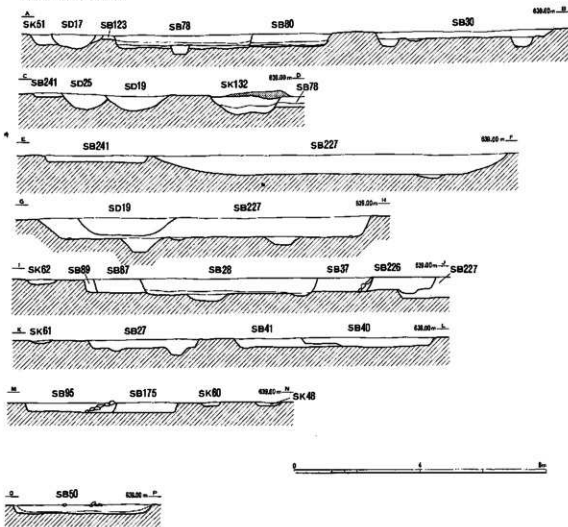

古代遺構図32断面図

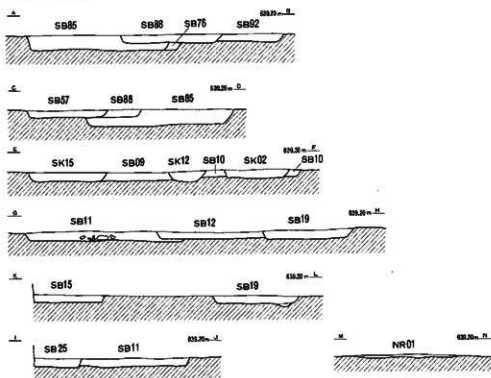

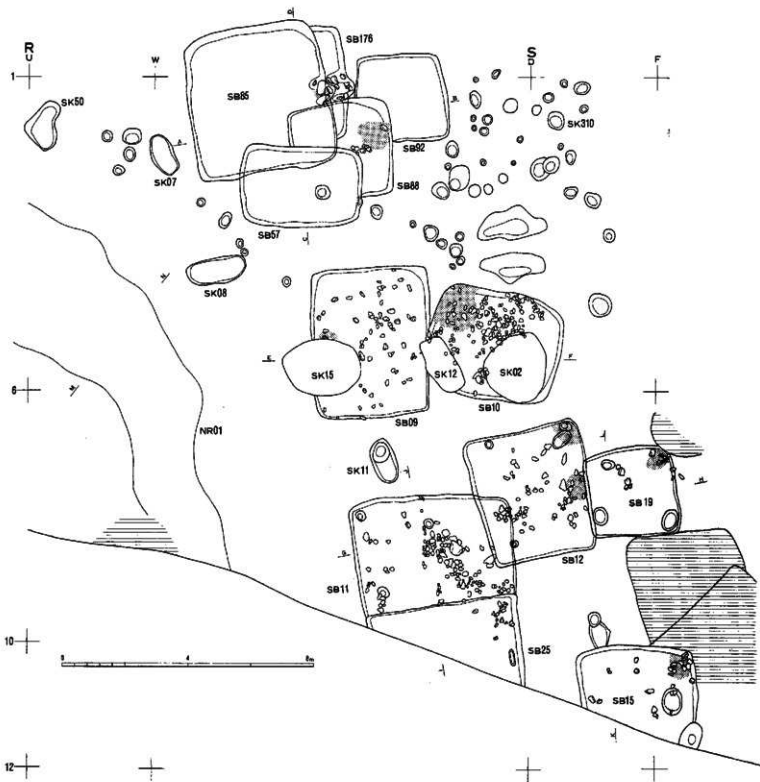

古代遺構図33断面図

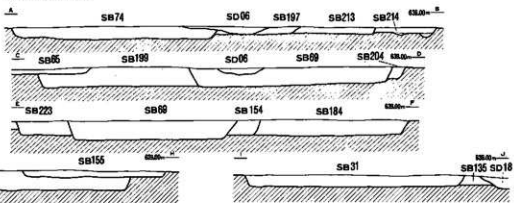

古代遺構図34断面図

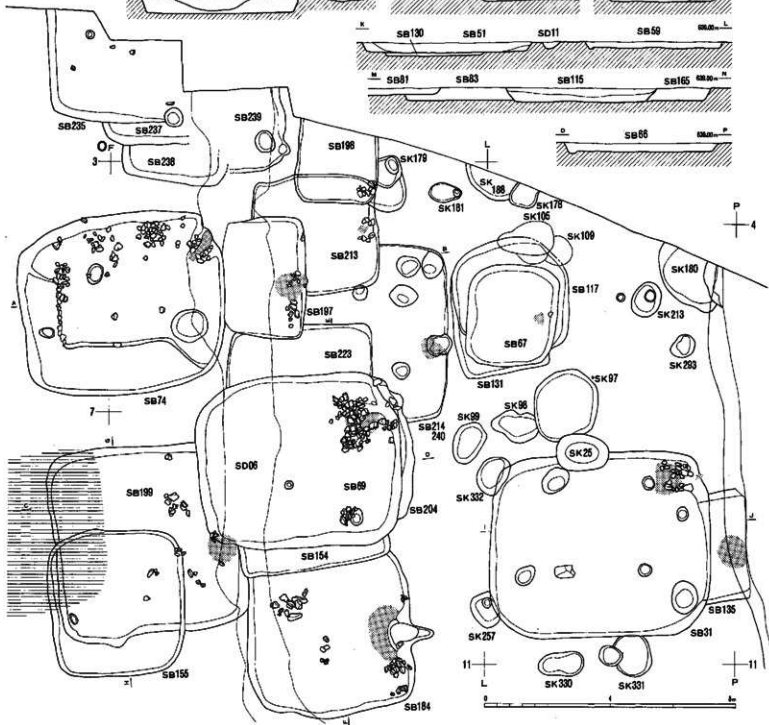
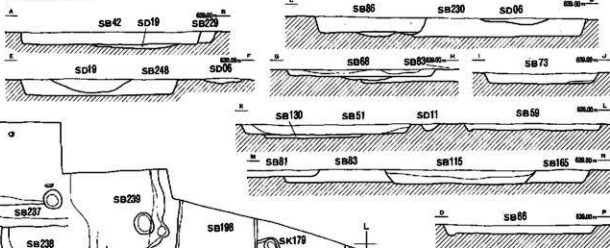

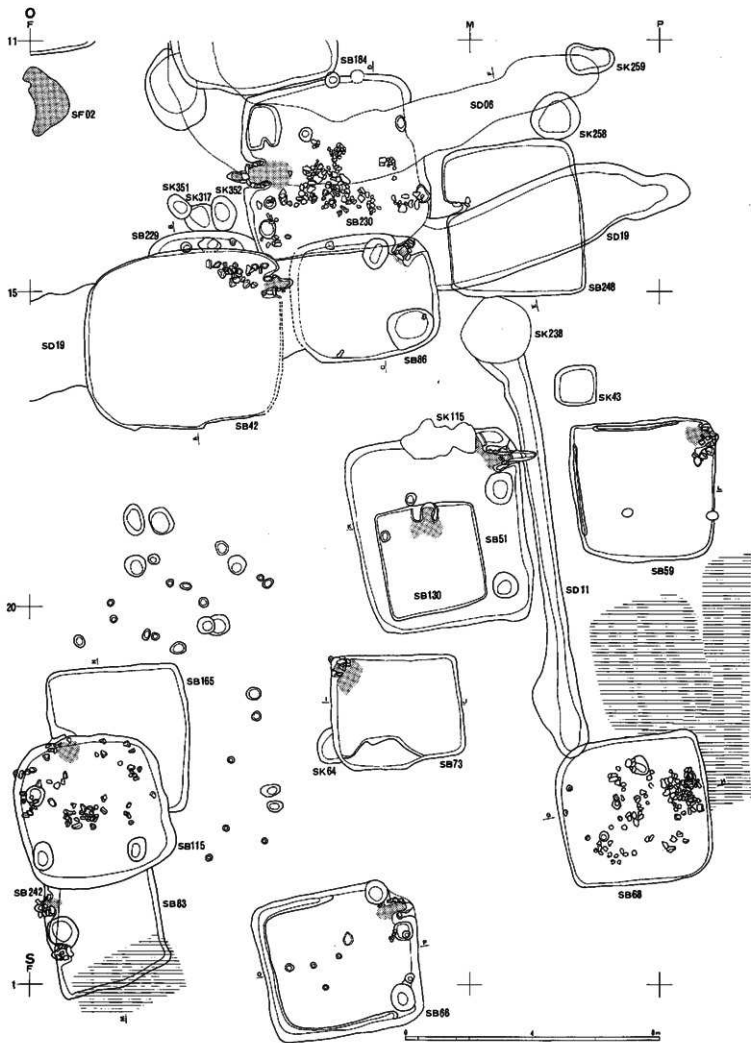

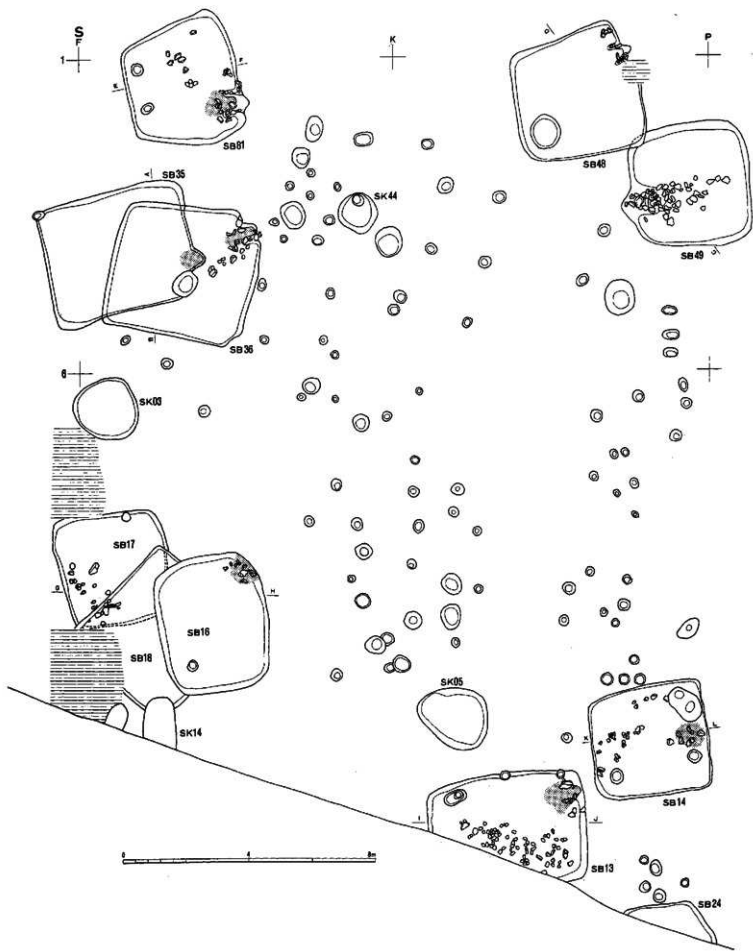



古代遺構図36断面図

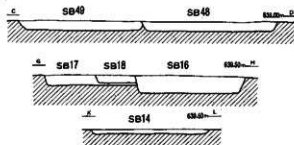
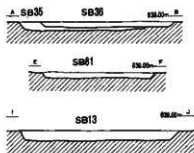

古代遺構図36断面図

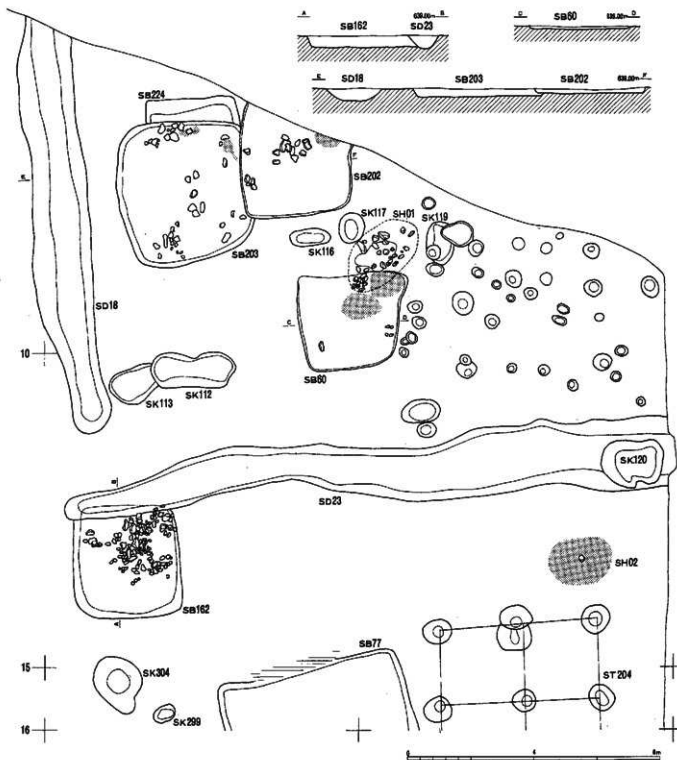
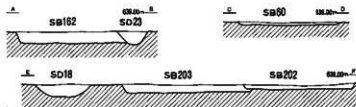

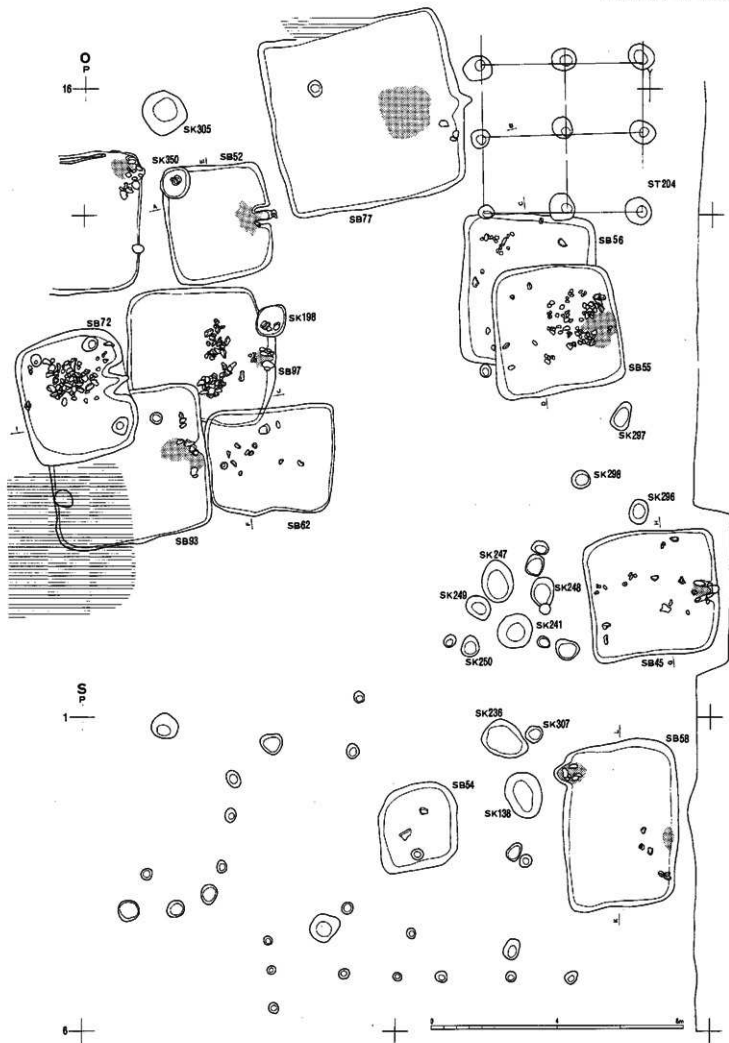

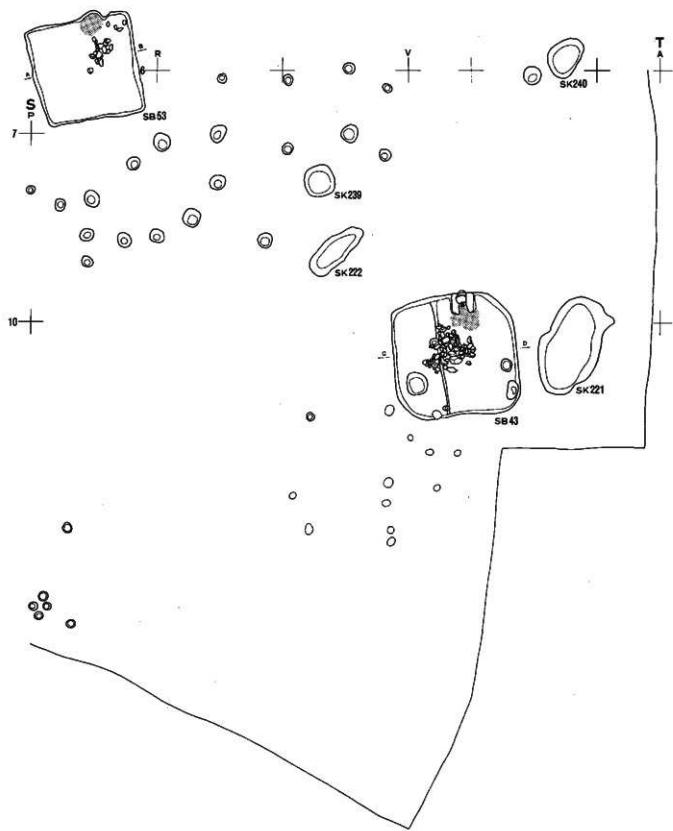

20

+

+

古代遺構図37断面図

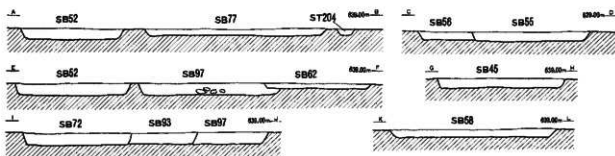

古代遺構図38断面図



古代遺構図39断面図

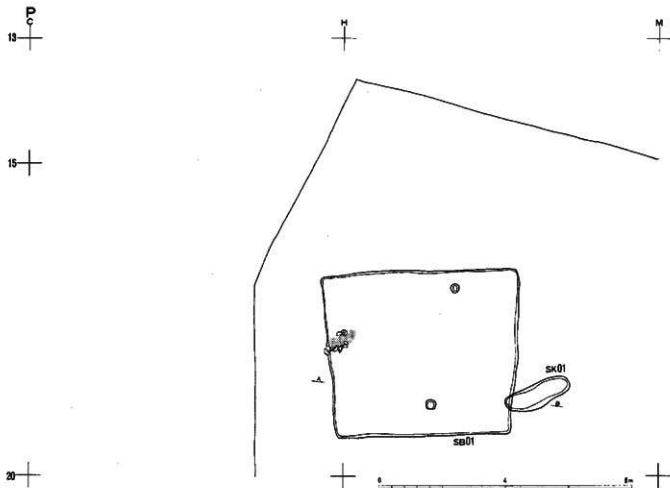

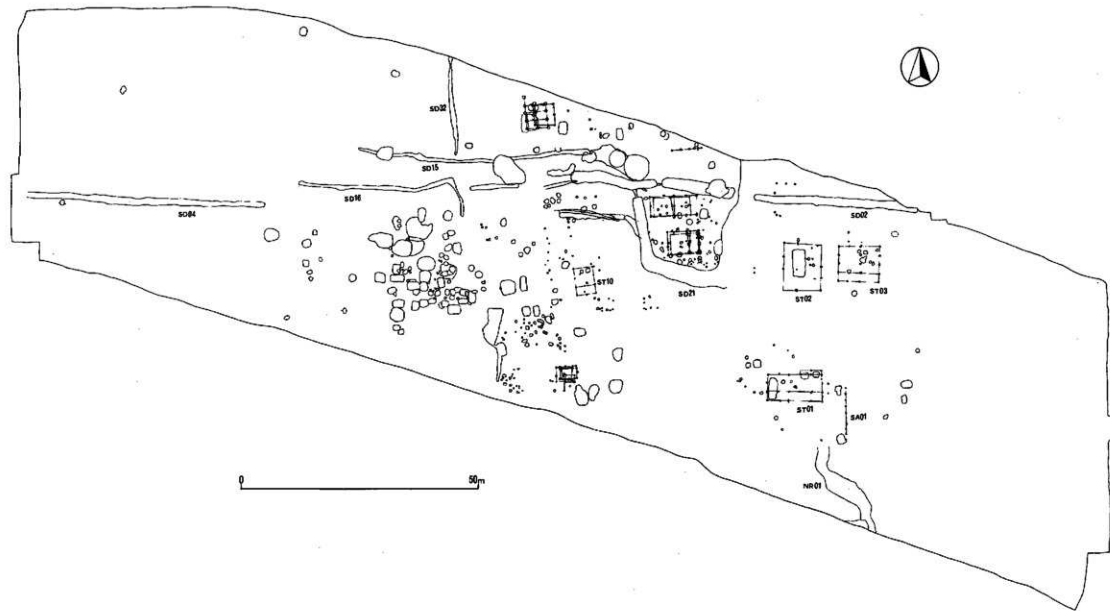

中・近世遺構割り付け図

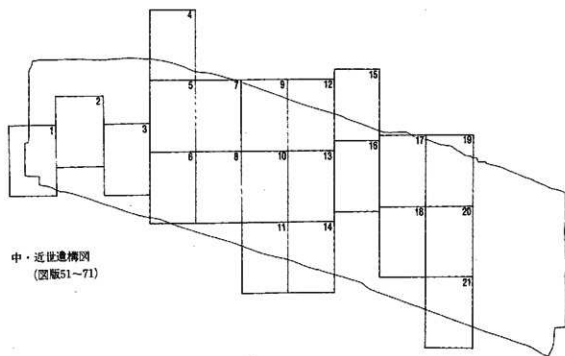

中・近世遺構図
(図版51～71)

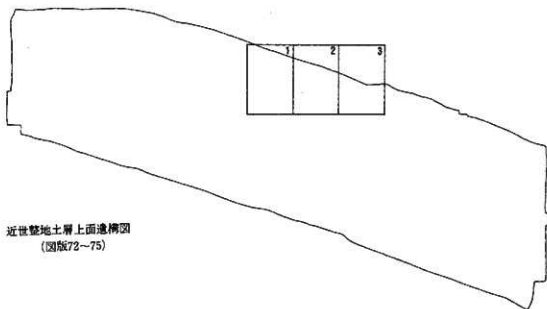

近世整地土層上面遺構図
(図版72～75)

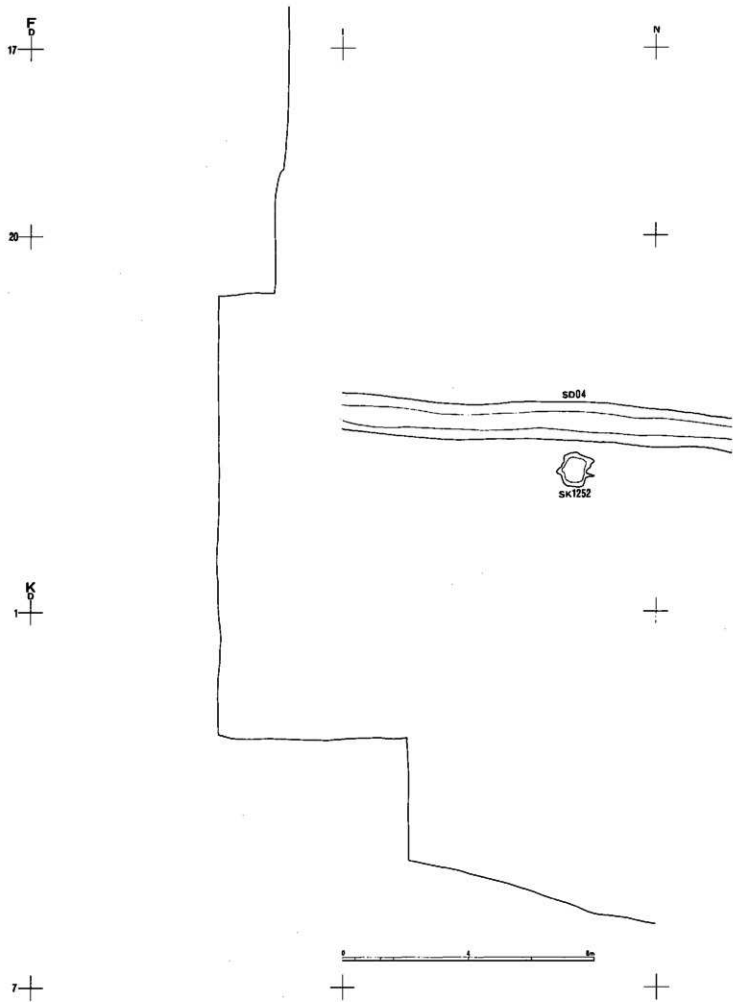

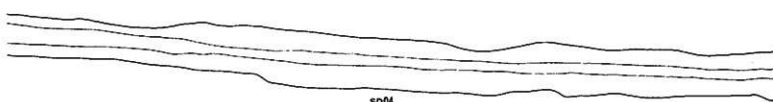

s004

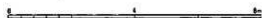

F
x
17

G
A

E

I

20

+



SD04

K
x
1

L
A

+

7

+



+

+

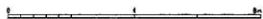

SK1178

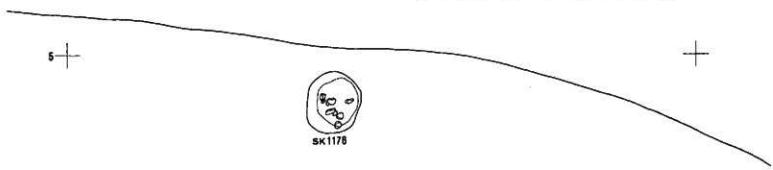



SD16

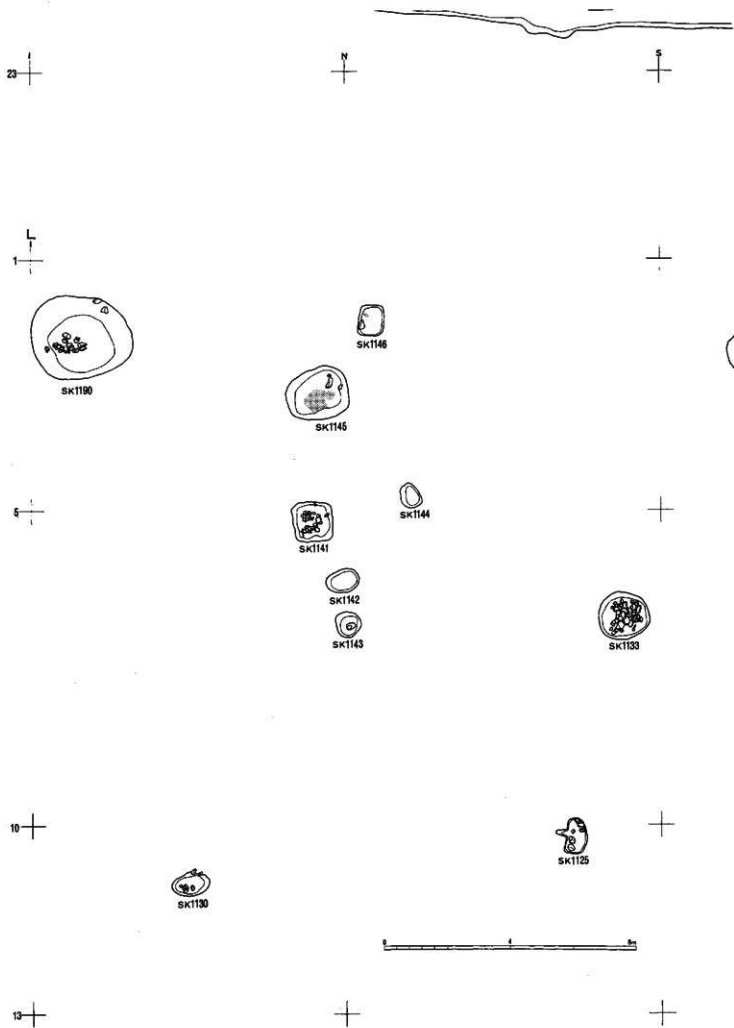



SD 32

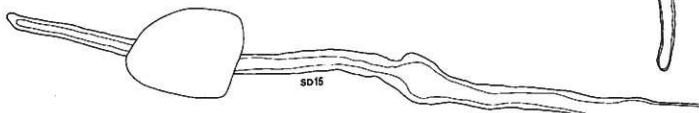

SD 15



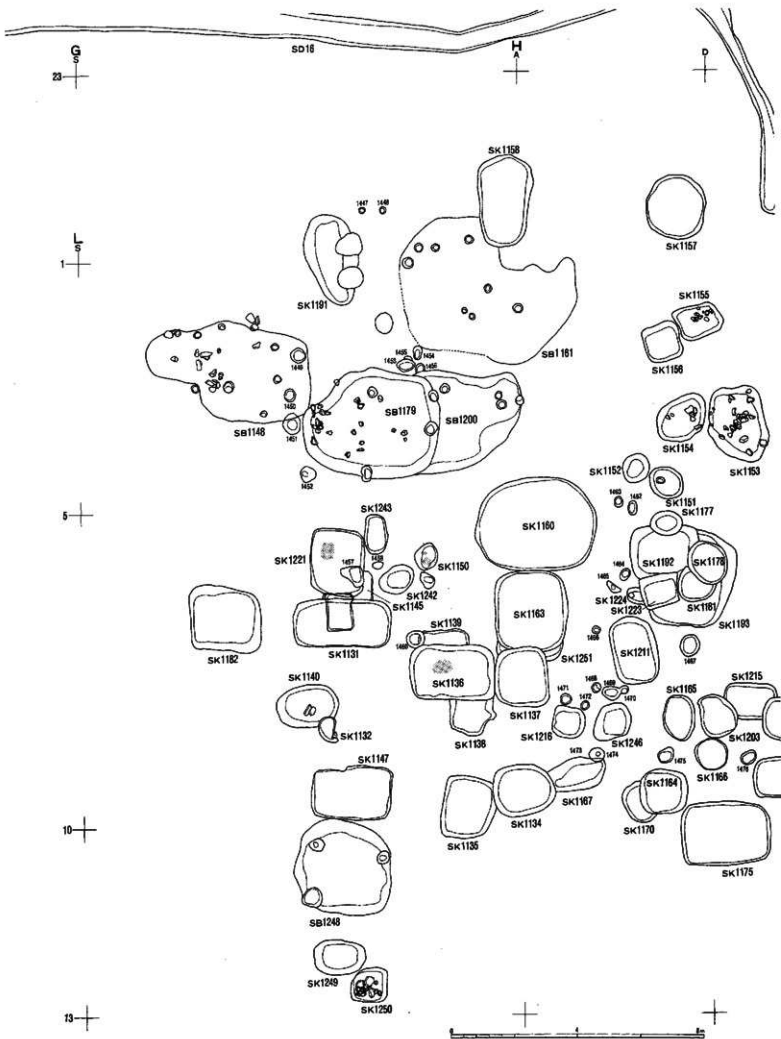

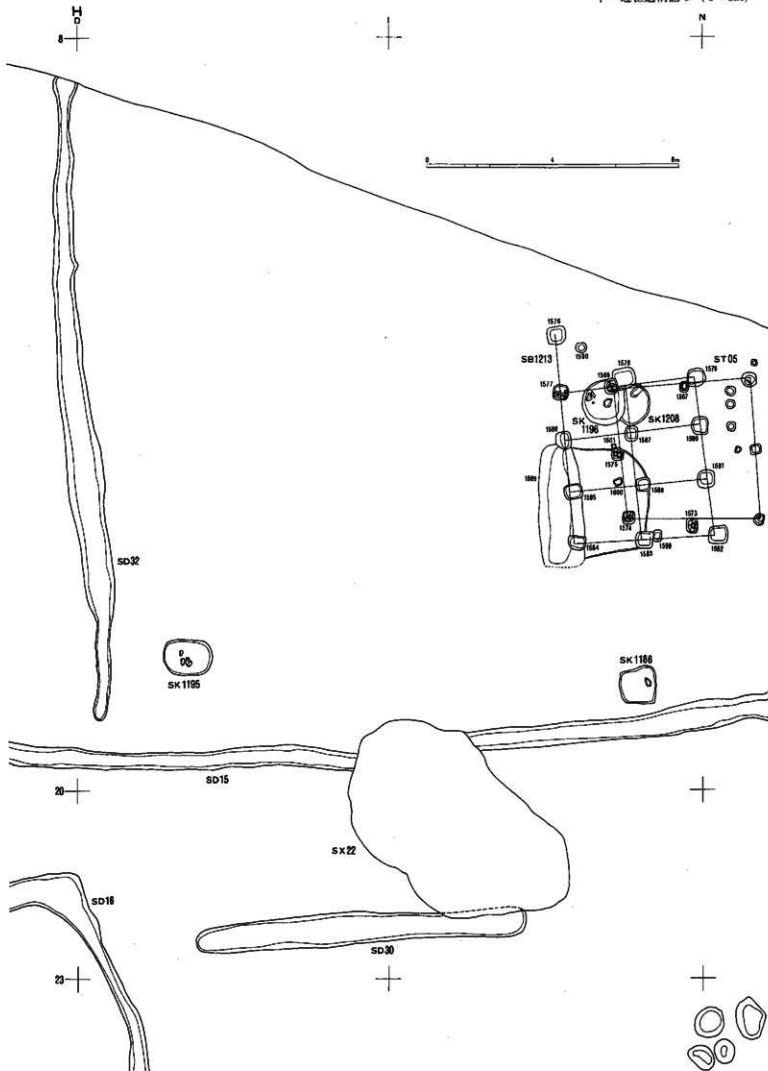

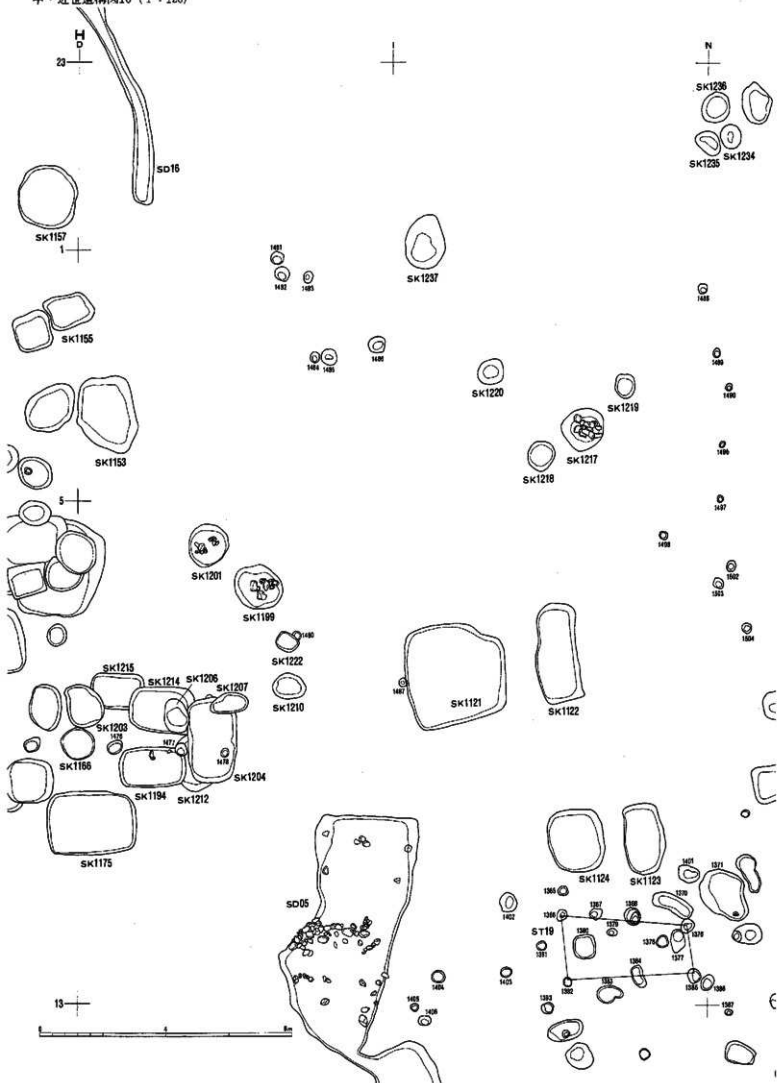

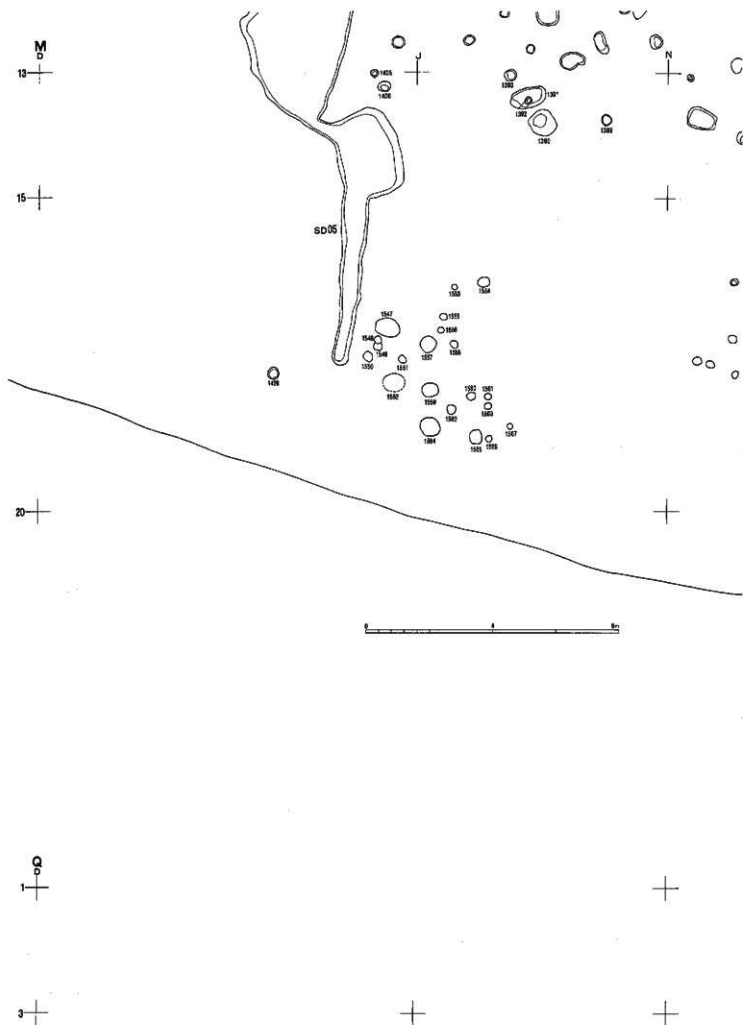

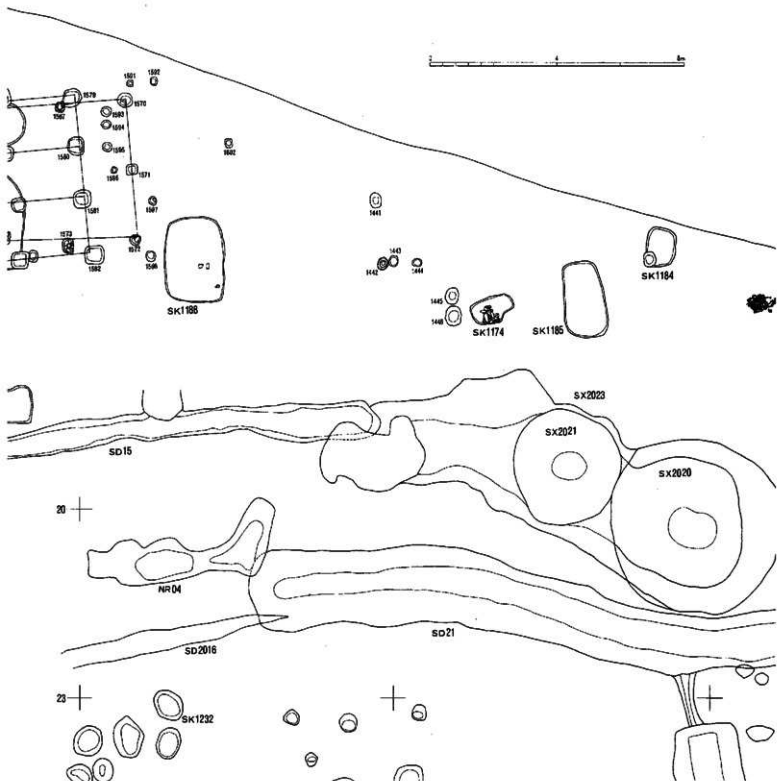

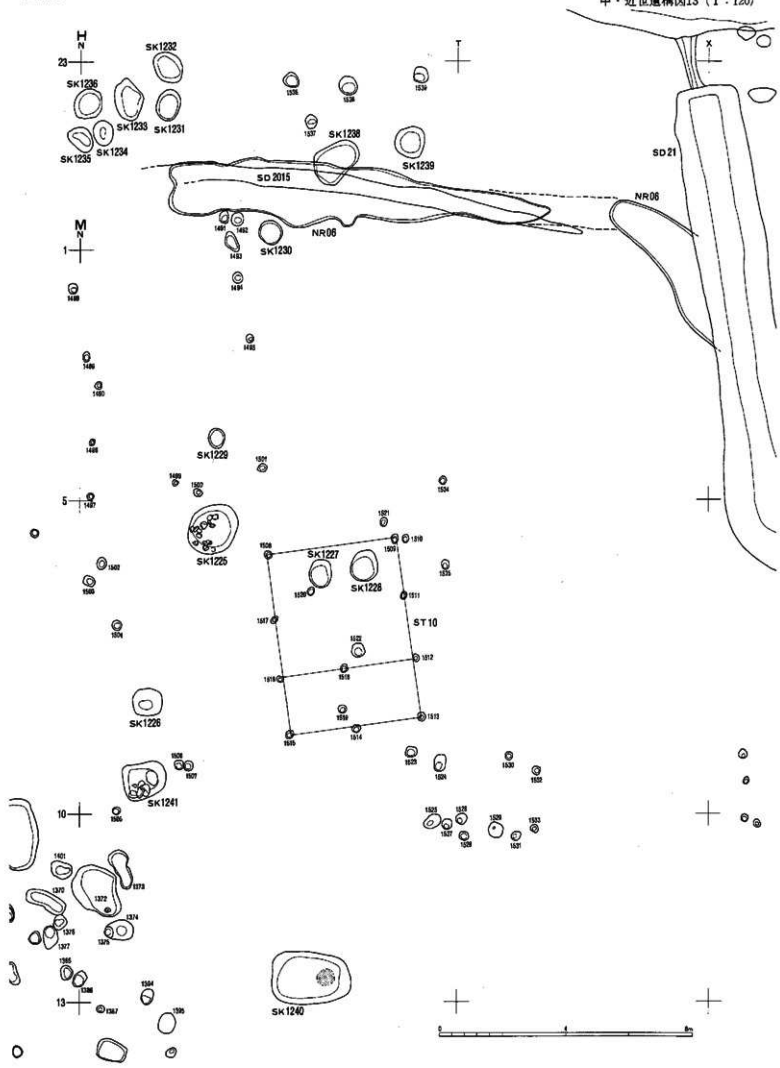

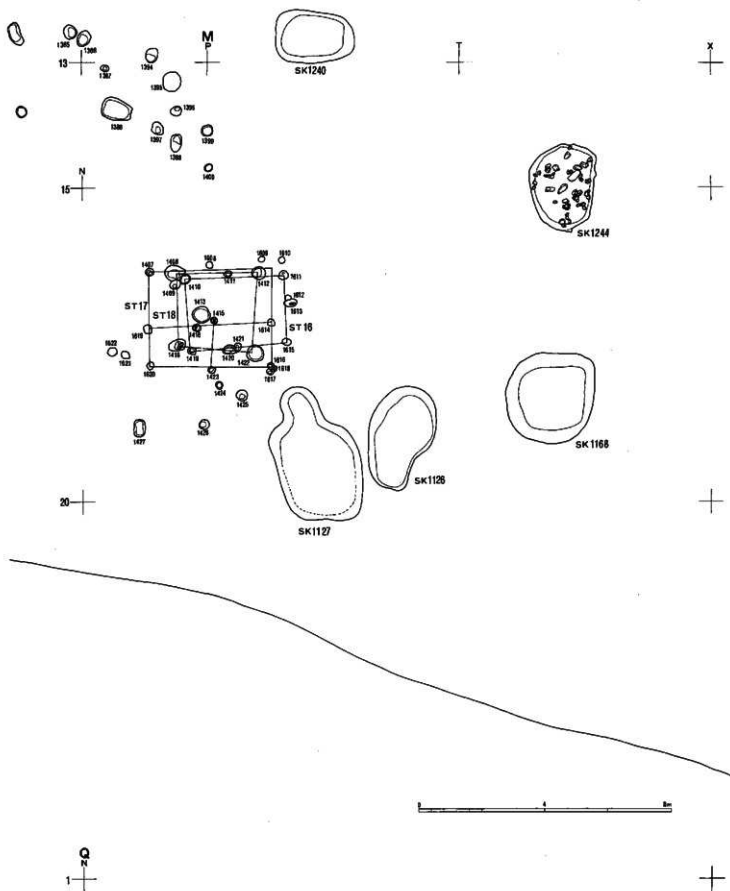

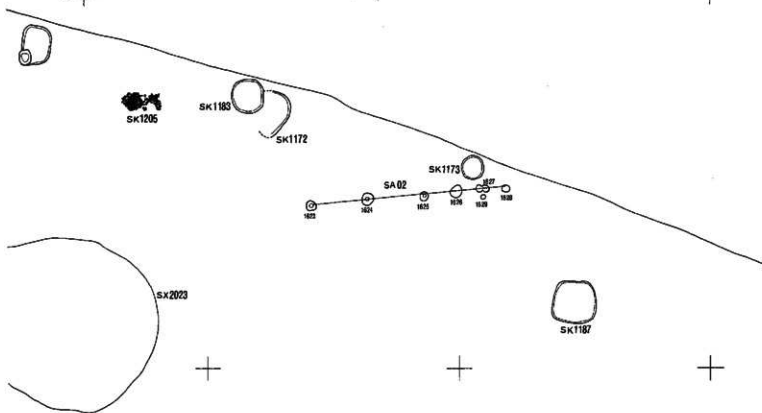
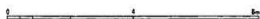

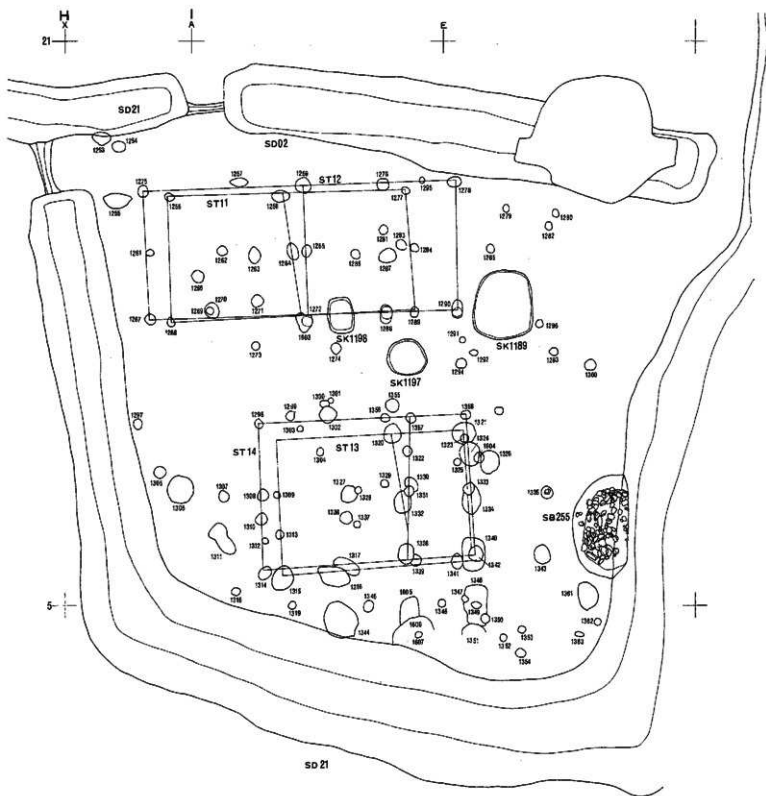

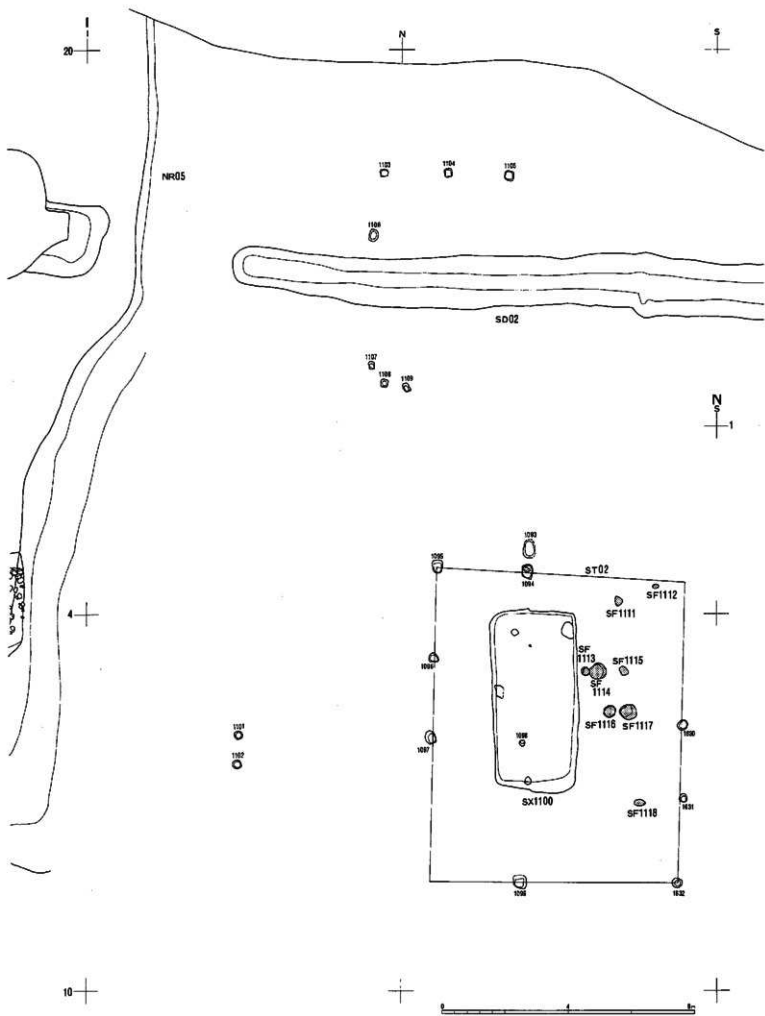

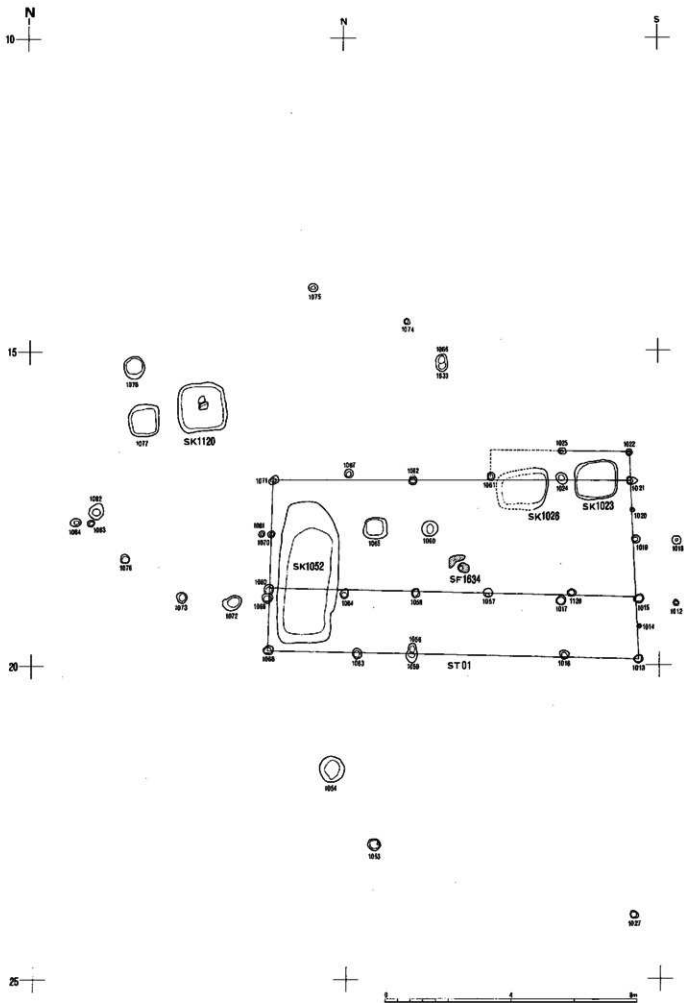

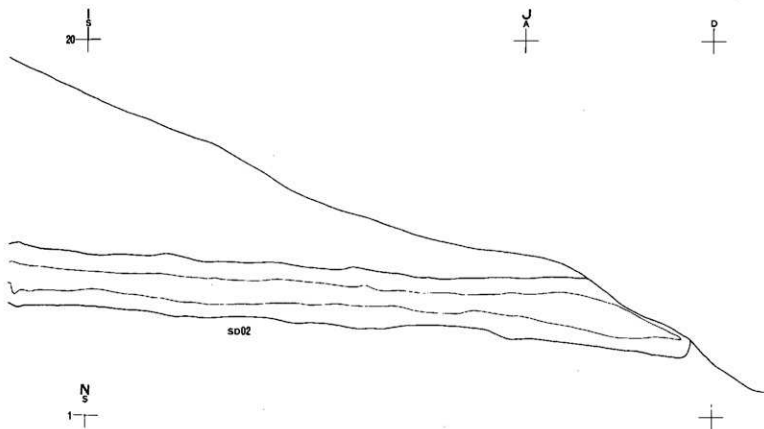



10

SK1001

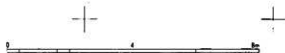

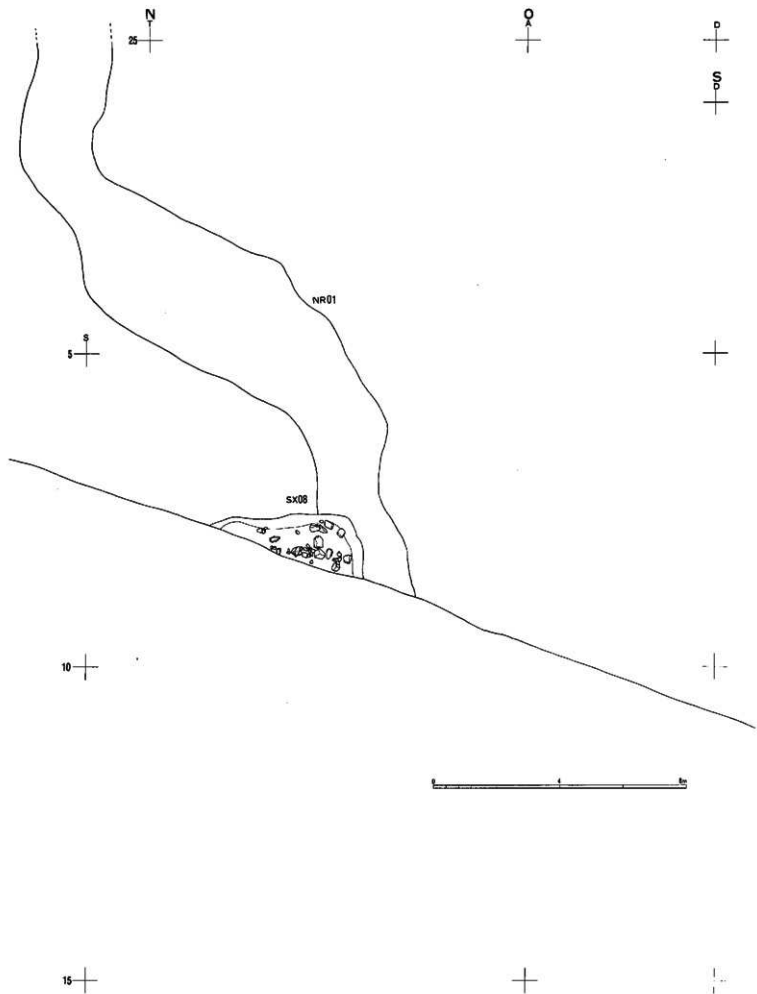

近世整地土层上面遺構図 (1:240)

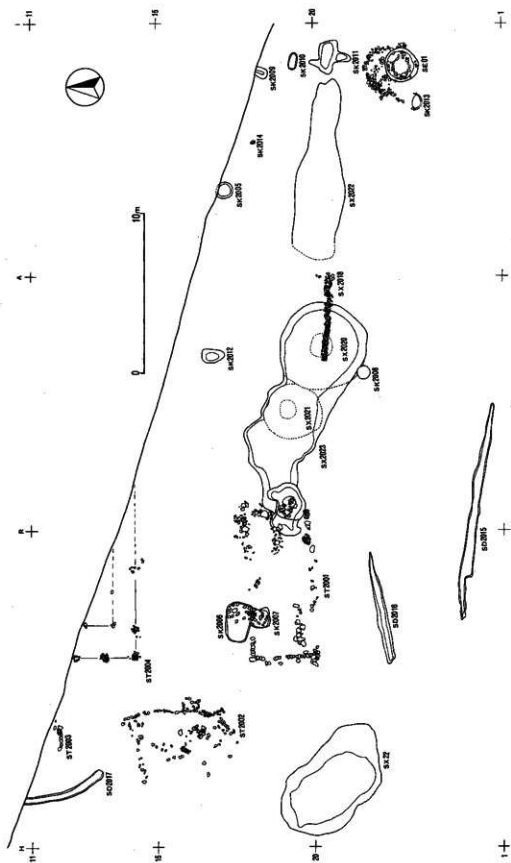

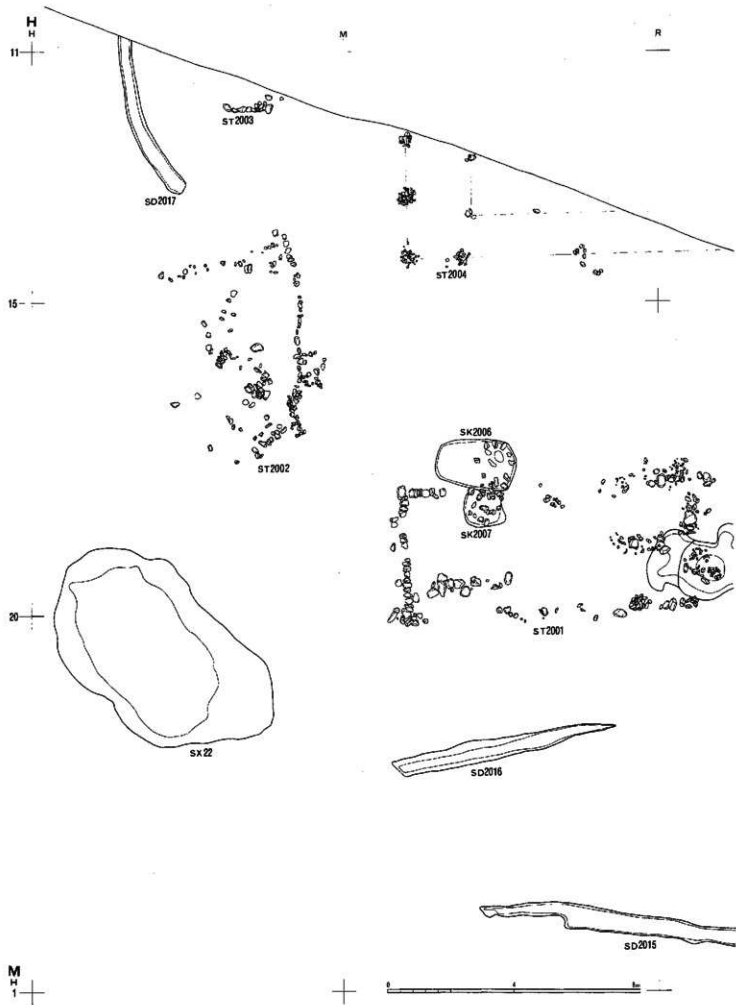

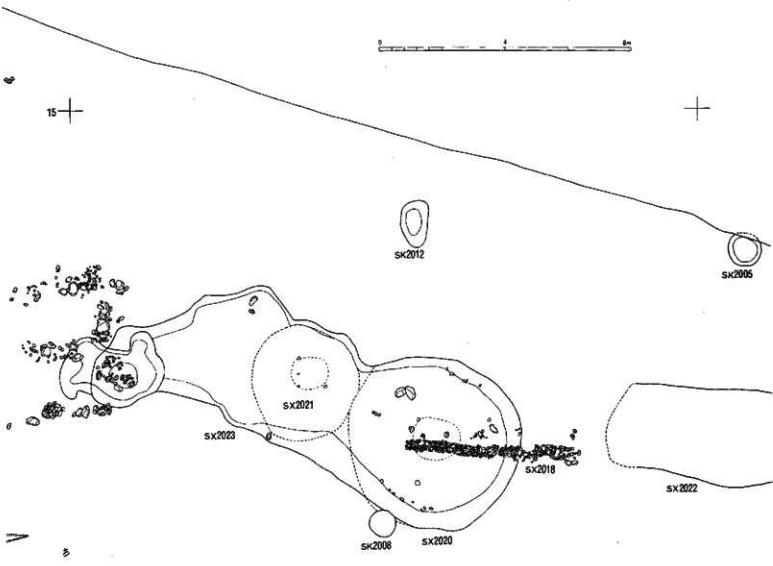

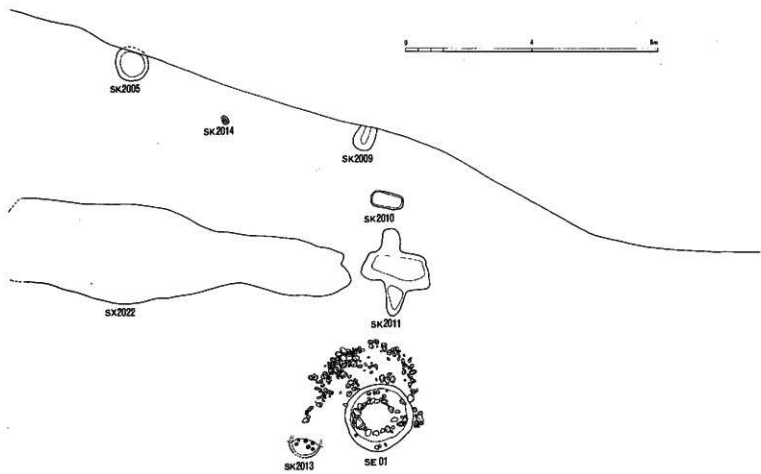

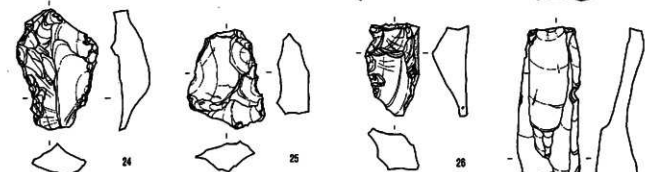
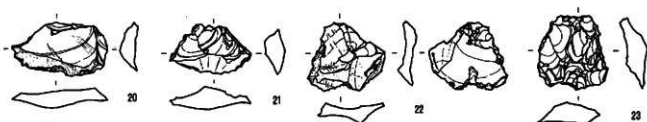
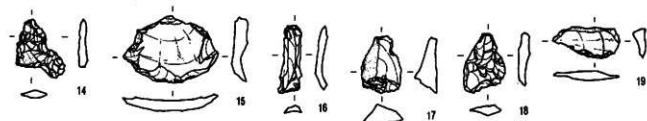
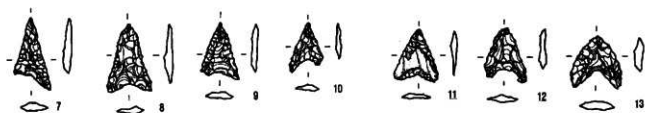

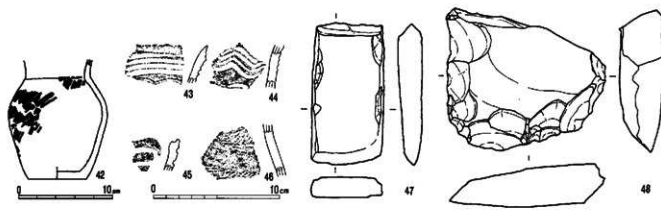
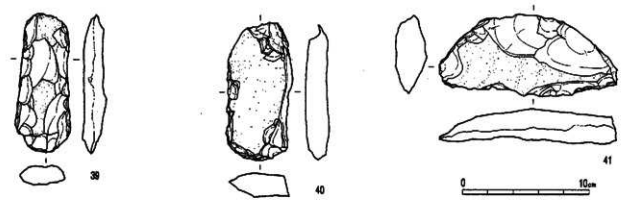
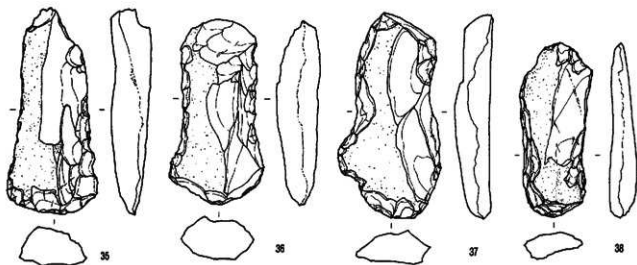
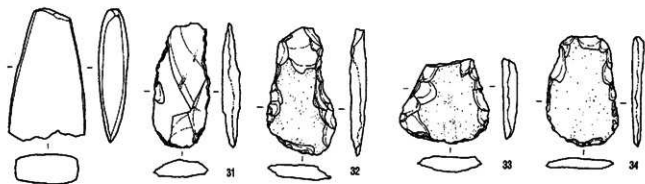

SB01 (1~26)

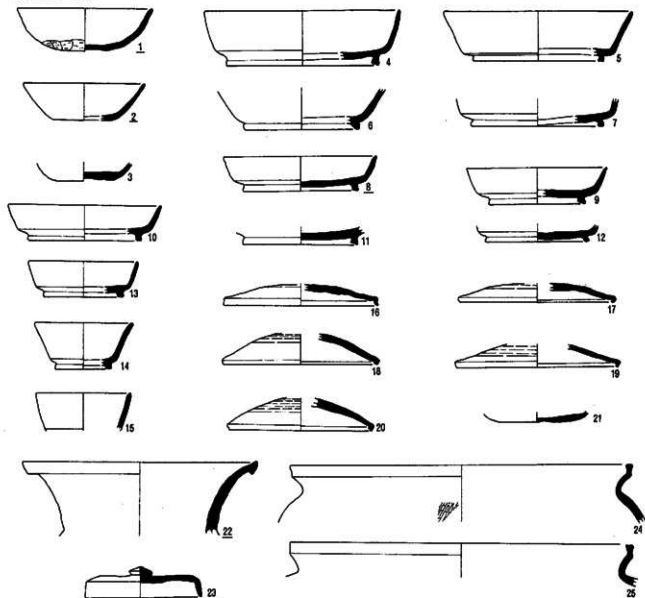

SB02 (1~4)

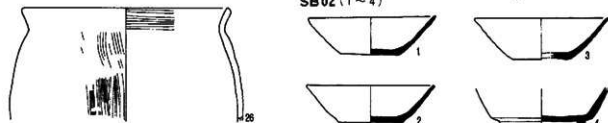

SB03 (1~8)

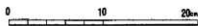
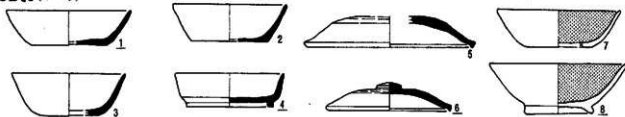

SB04 (1~21)

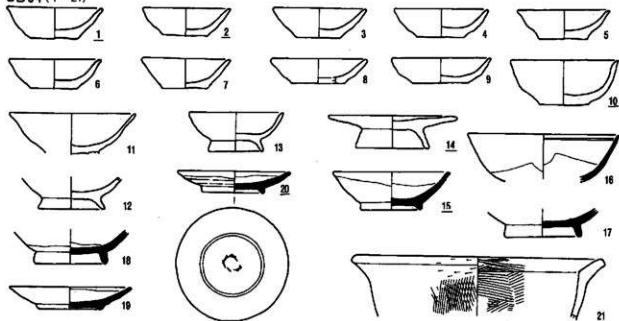

SB05 (1~57)

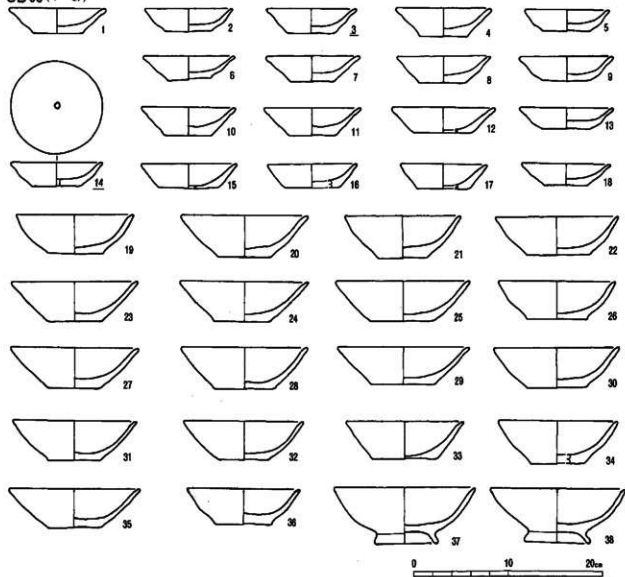

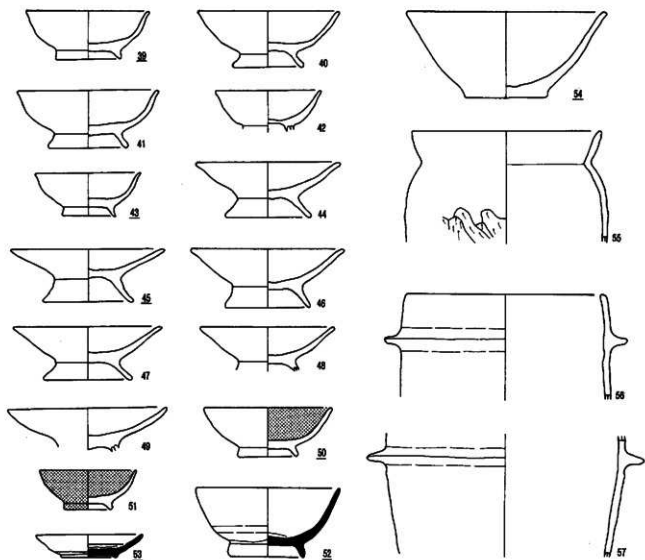

SB06 (1~8)

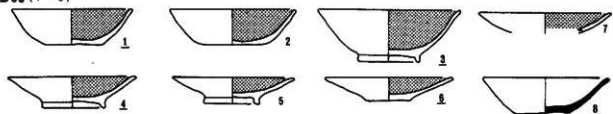

SB07 (1~13)

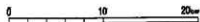
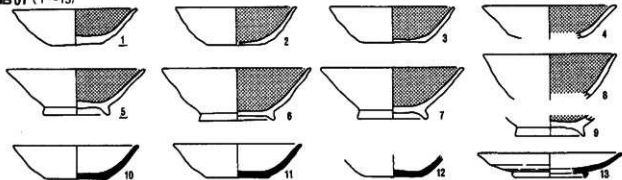

SB09 (1~6)

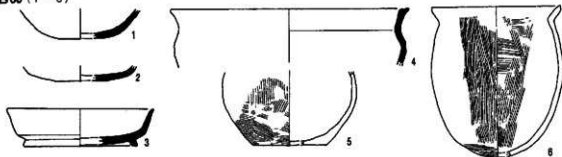

SB10 (1~12)

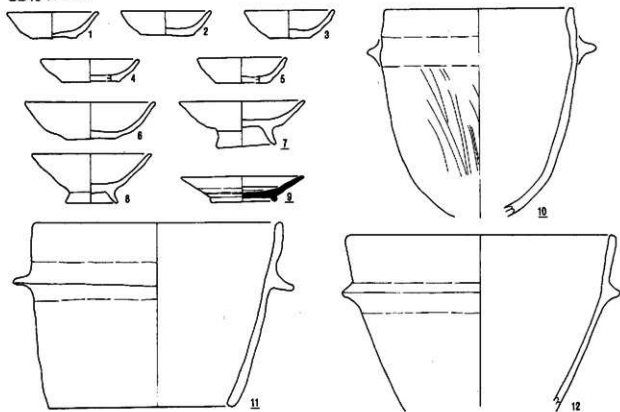

SB11 (1~8)

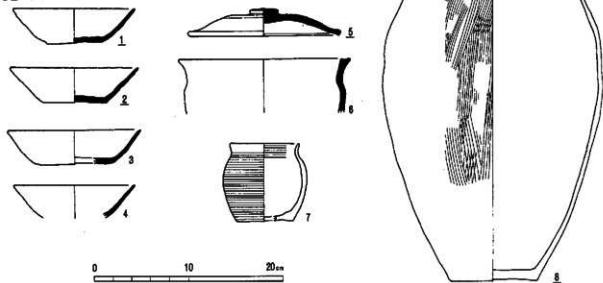

SB12 (1)

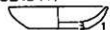

SB13 (1~18)

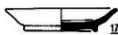
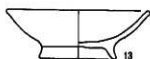
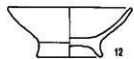
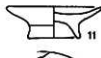
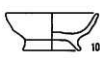
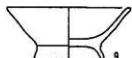
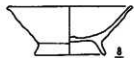
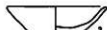
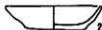
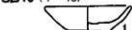

SB14 (1~42)

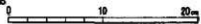
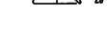
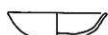
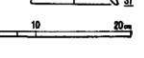
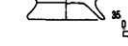
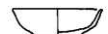
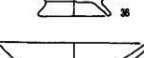
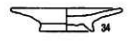
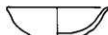
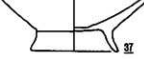
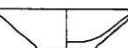
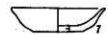
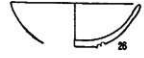
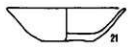
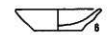
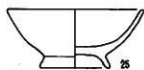
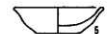
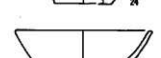
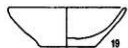
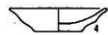
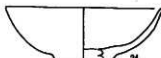
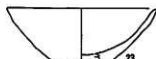
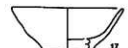
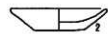
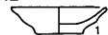

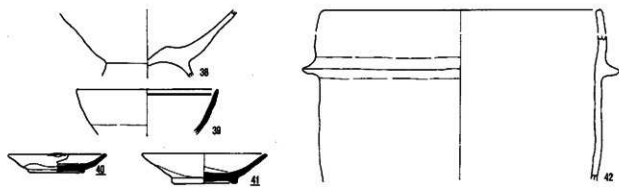

SB 15 (1~33)

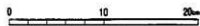
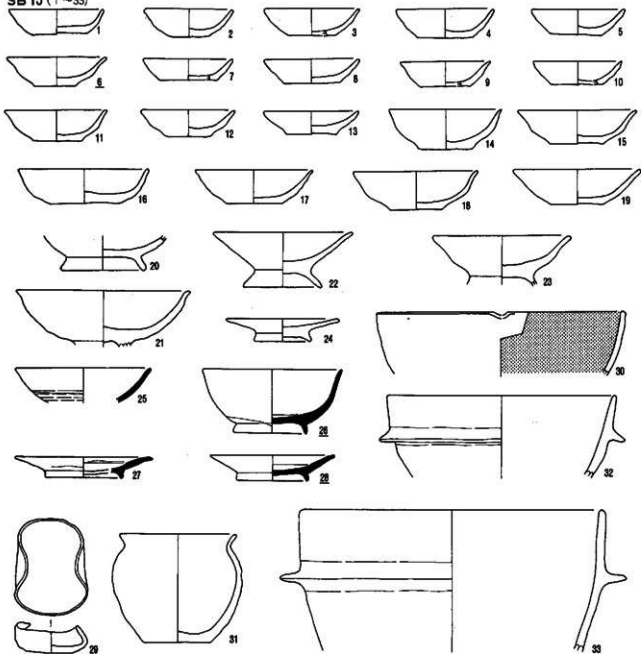

SB16 (1~12)

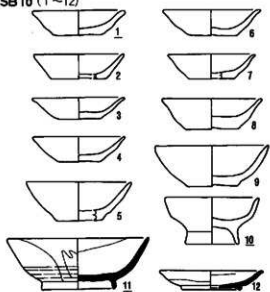

SB17 (1~9)

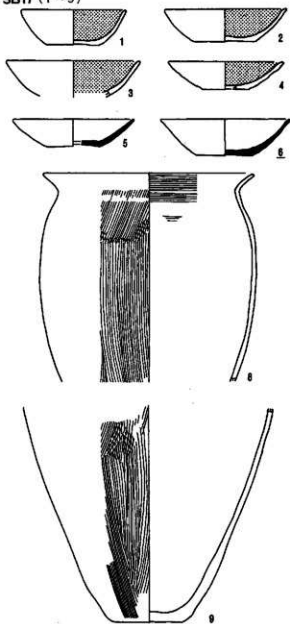

SB18 (1~6)

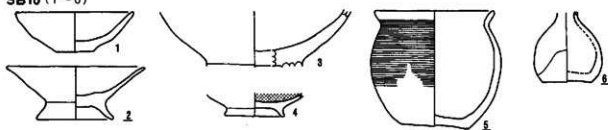

SB19 (1~7)

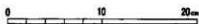
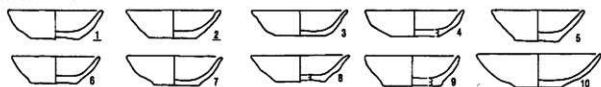

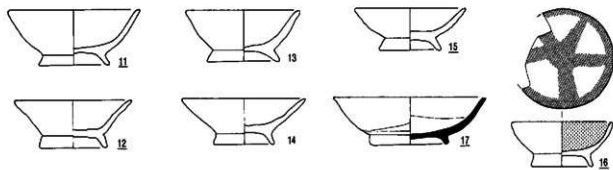

SB 20 (1~5)

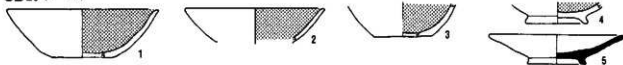

SB 21 (1~20)

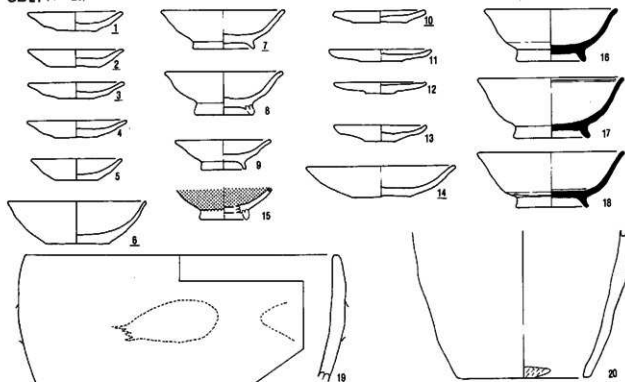

SB 22 (1~13)

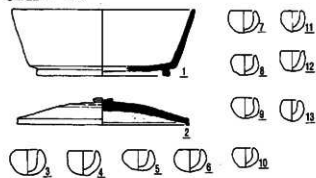

SB 23 (1, 2)



SB 24 (1~4)

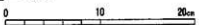
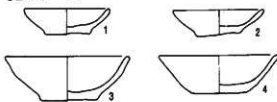

SB25 (1~3)

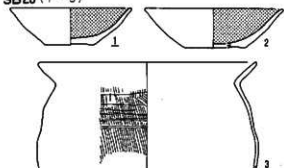

SB26 (1~12)

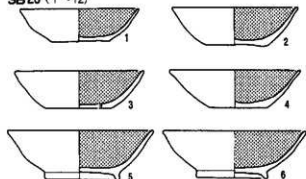

SB27 (1~7)

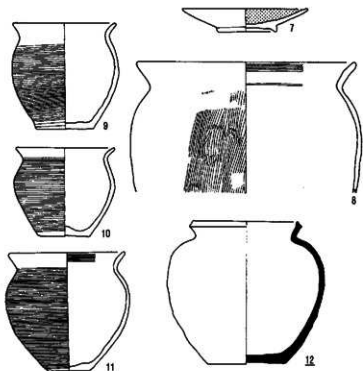
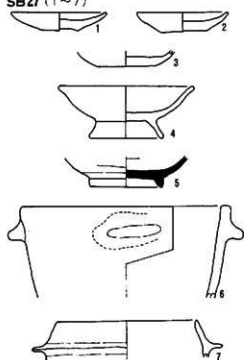

SB28 (1~22)

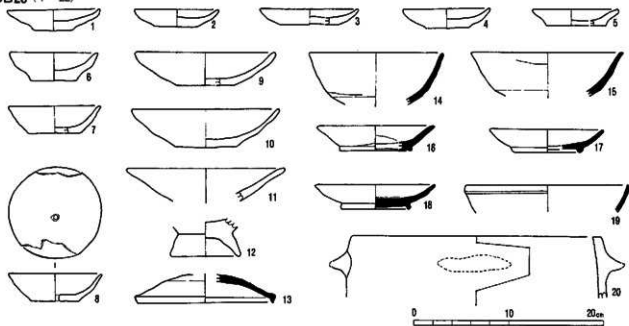



SB29 (1~29)

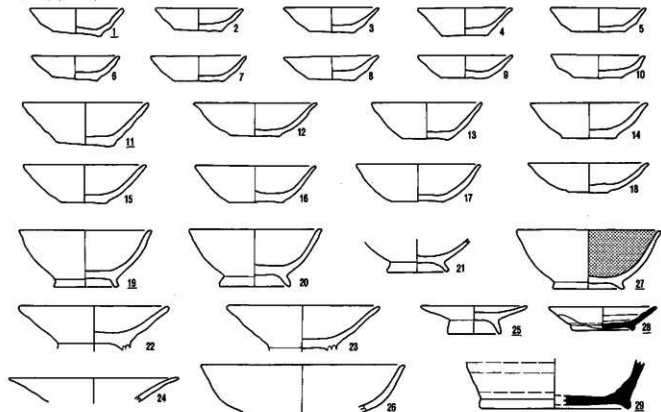

SB30 (1~54)

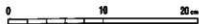
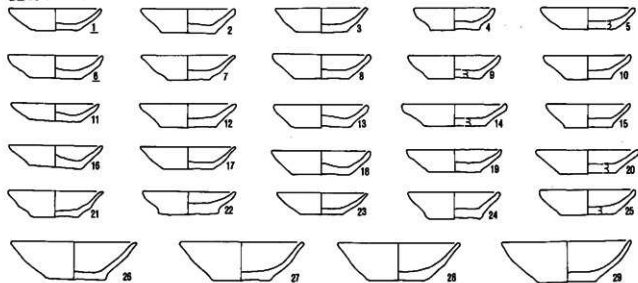

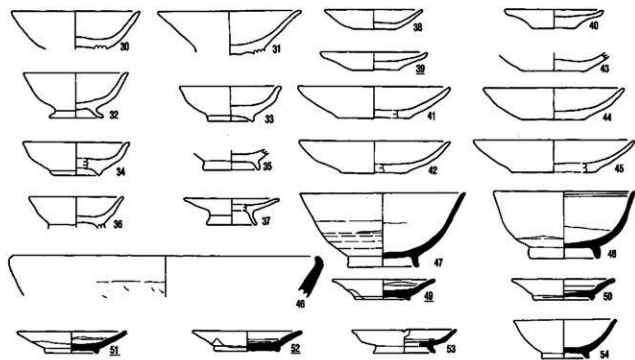

SB31 (1~24)

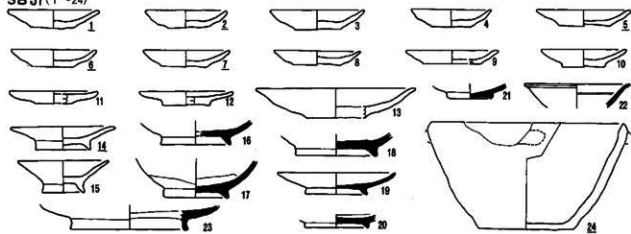

SB32 (1~34)

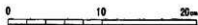
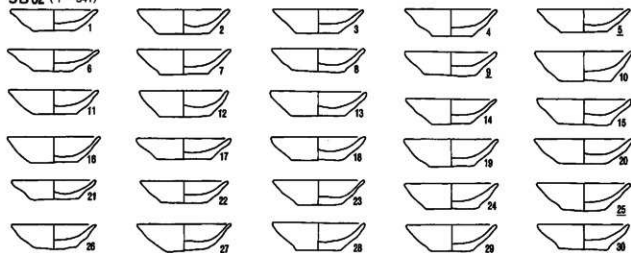

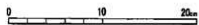
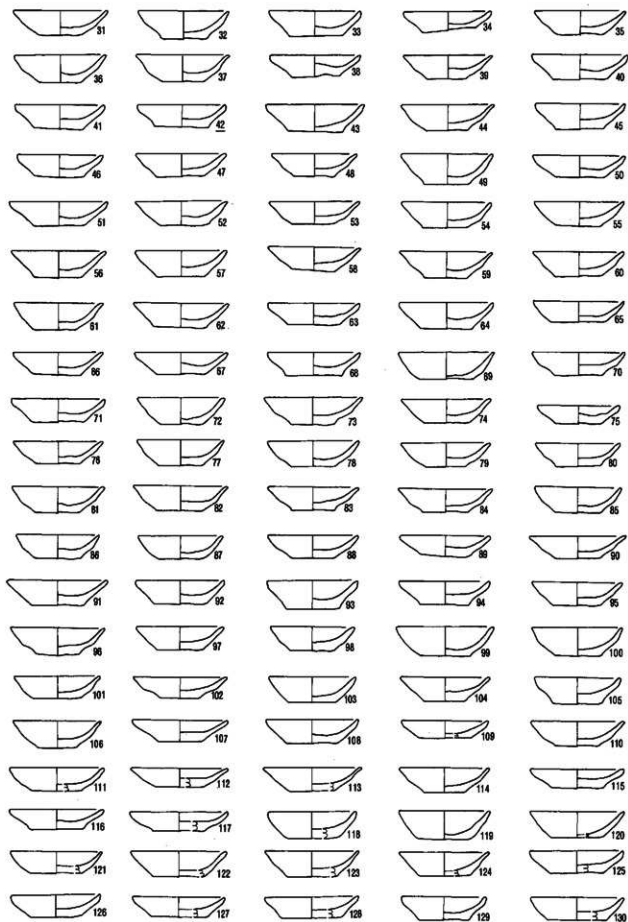

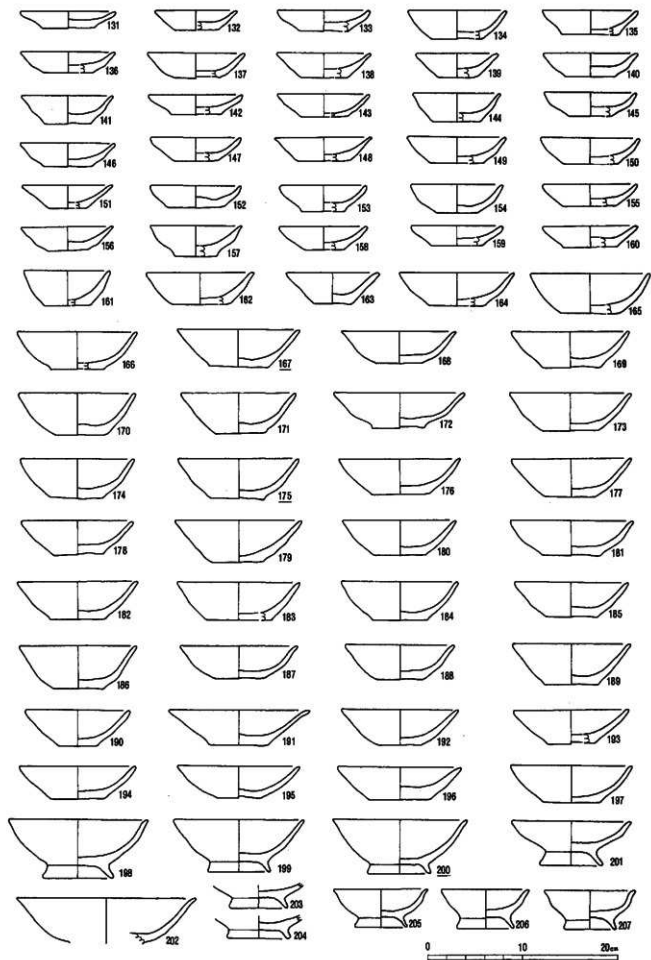

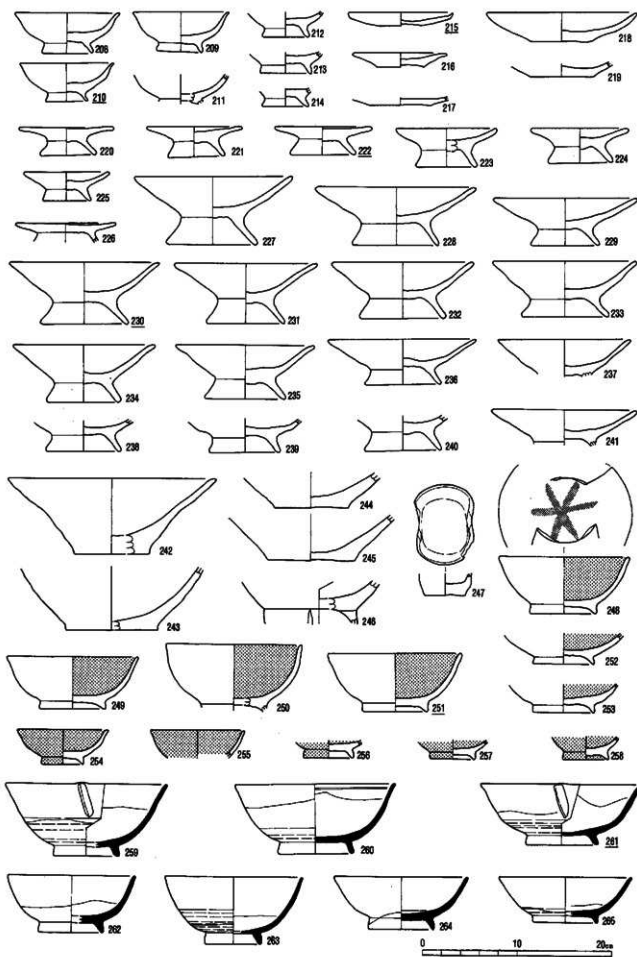

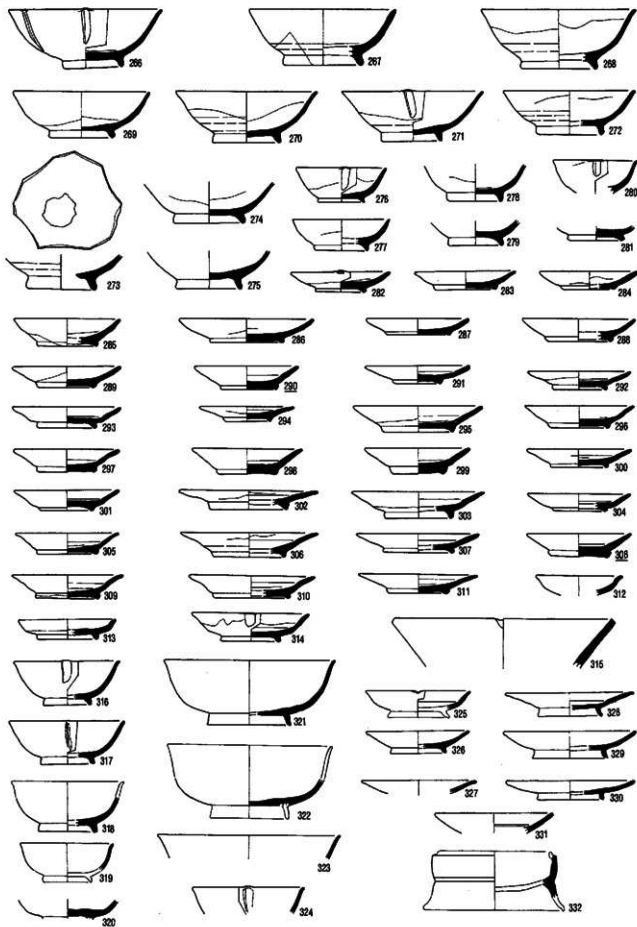

0 10 20cm

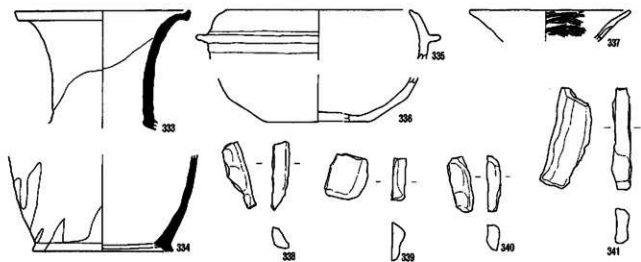

SB33 (1)

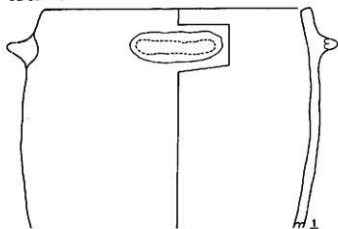

SB35 (1~3)

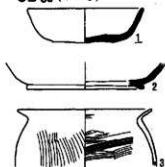

SB36 (1~5)



SB37 (1~29)

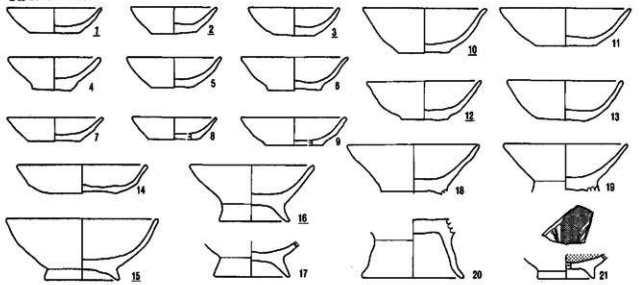

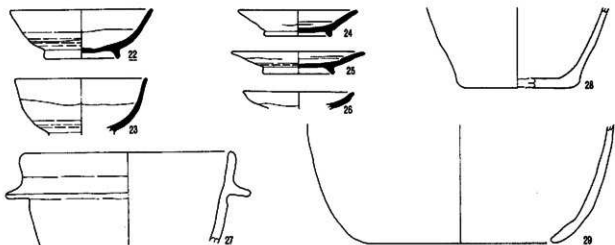

SB 38 (1~11)

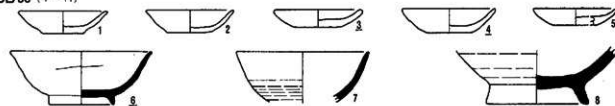

SB 39 (1)

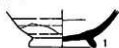

SB 42 (1~8)

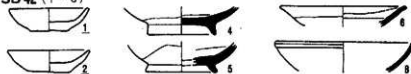

SB 40 (1~3)

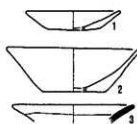

SB 41 (1~3)

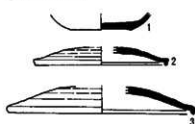

SB 43 (1~38)

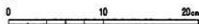
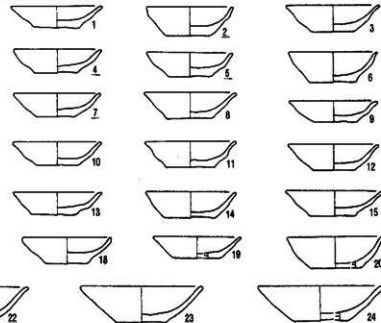

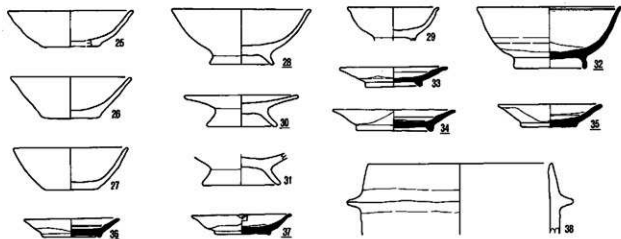

SB44 (1~23)

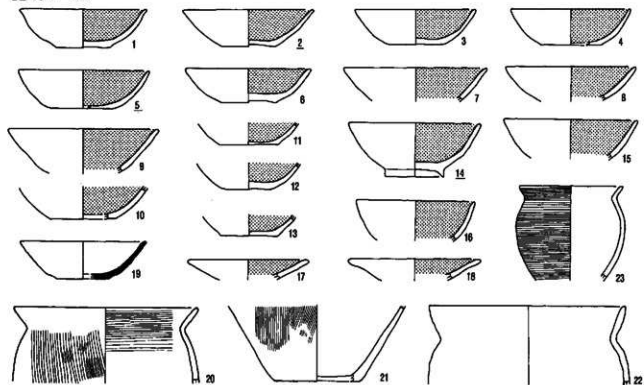

SB45 (1~8)

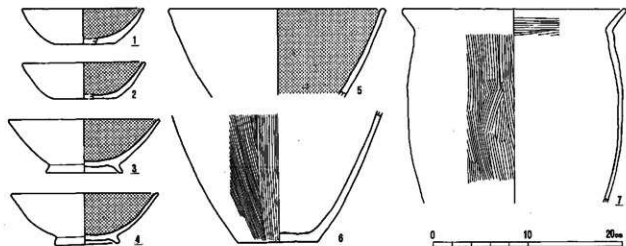

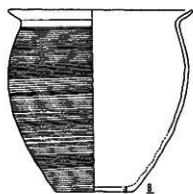

SB47 (1~19)

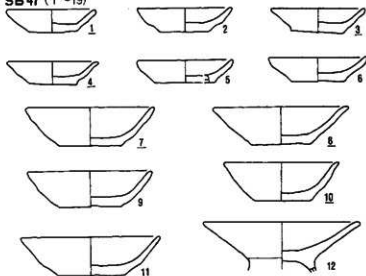

SB46

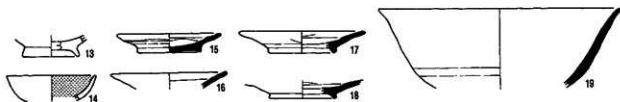

SB48 (1~19)

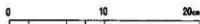
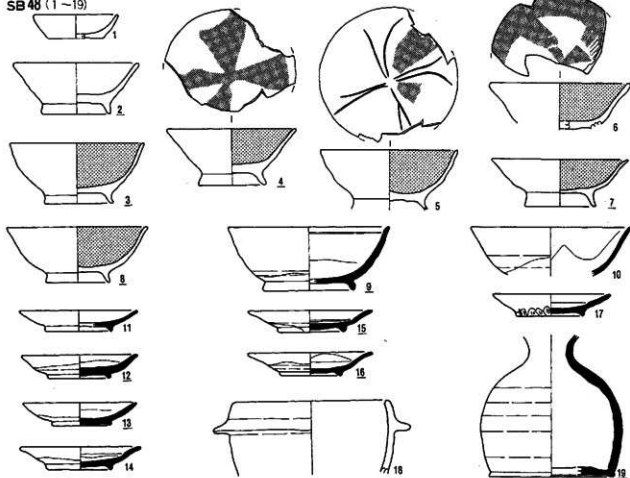

SB49 (1~21)

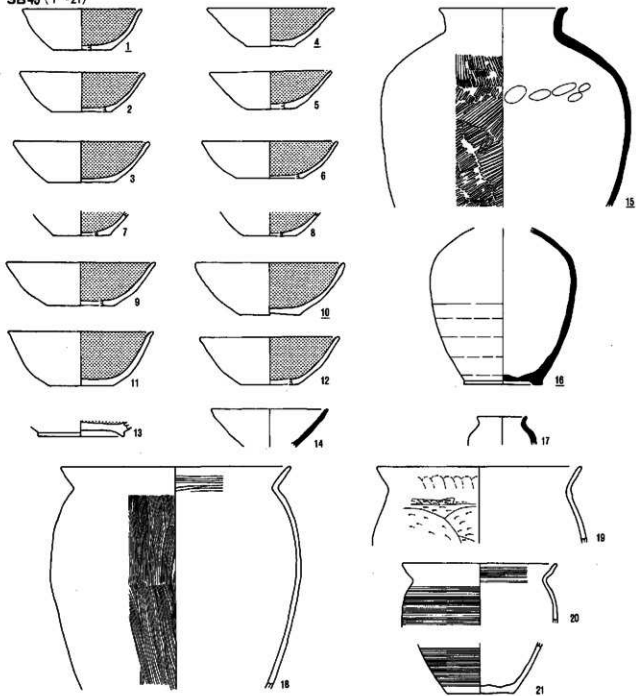

SB50 (1~8)

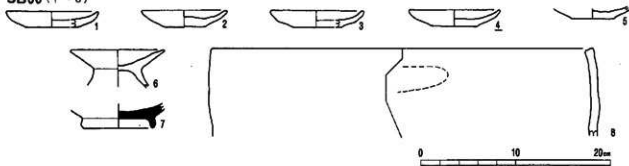

SB51 (1~8)

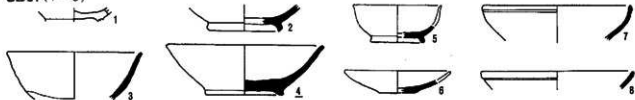

SB52 (1~26)

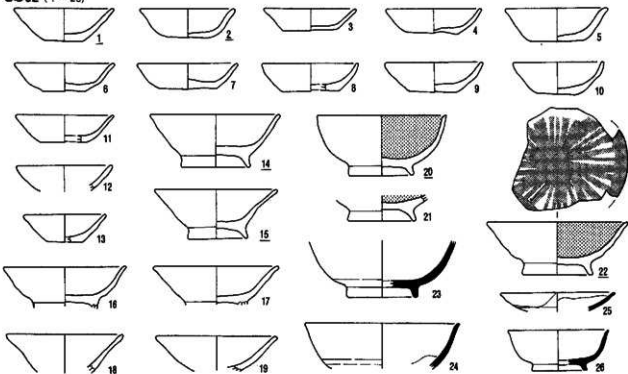

SB53 (1~6)

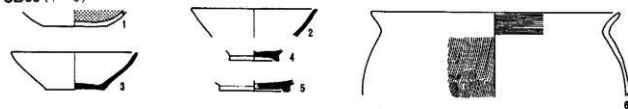

SB55 (1~13)

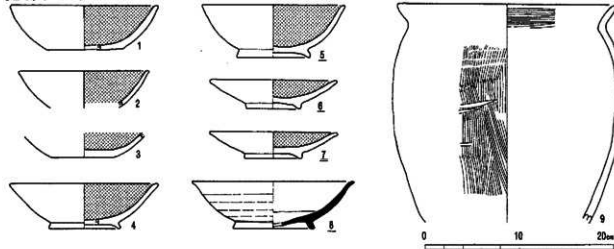

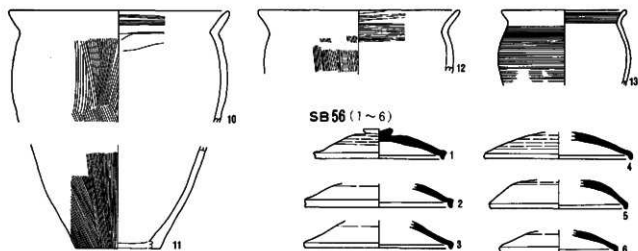

SB57 (1~5)



SB58 (1~21)

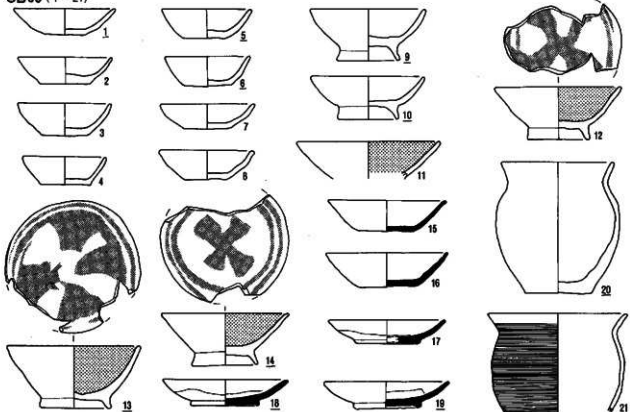

SB59 (1~13)

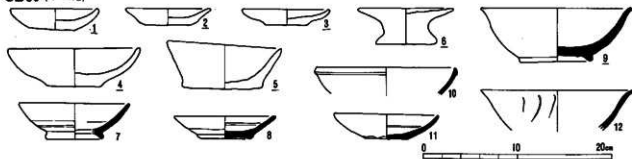

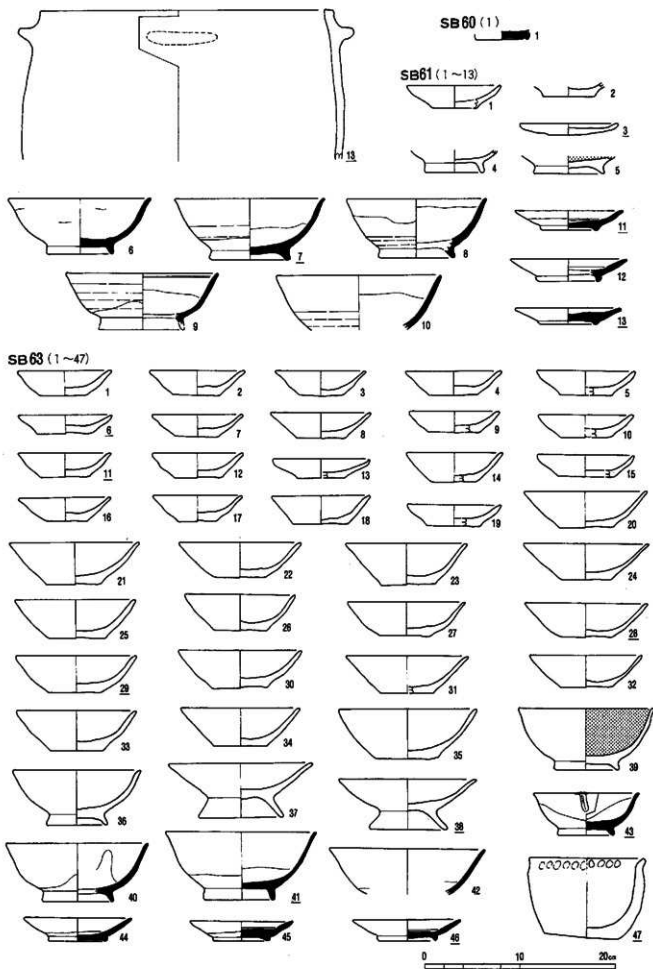

SB64 (1~10)

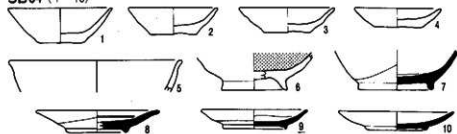

SB65 (1~3)

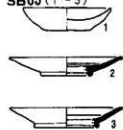

SB66 (1~40)

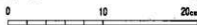
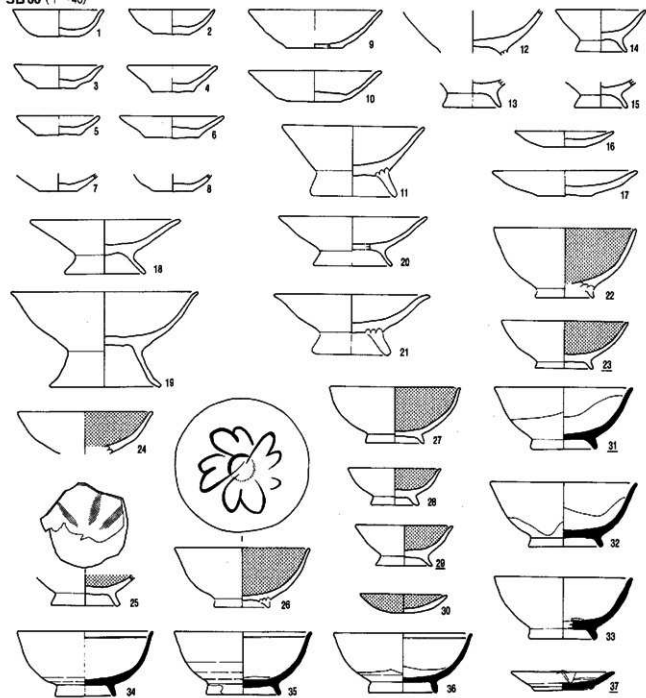

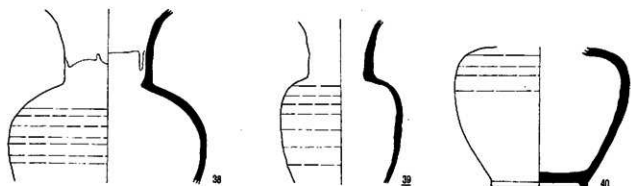

SB67 (1.2)

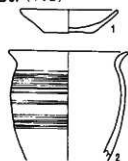

SB68 (1~8)

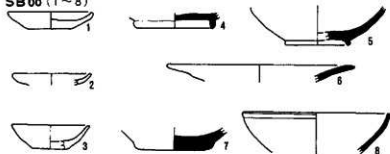

SB69 (1~40)

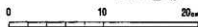
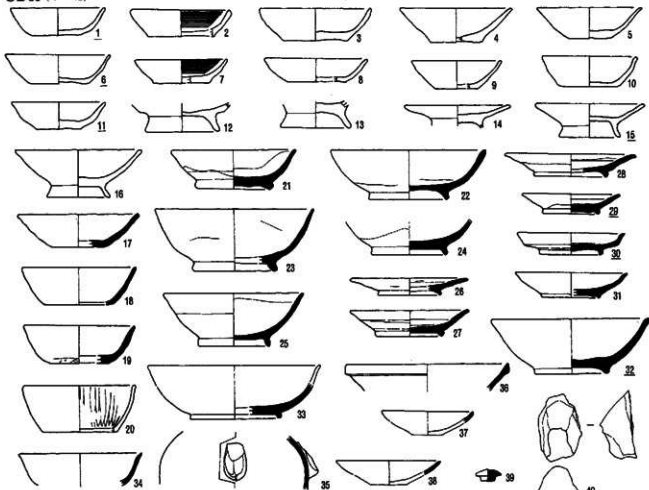

SB70 (1~5)



SB71 (1~7)

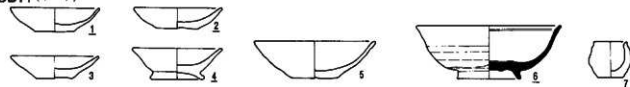

SB72 (1~11)

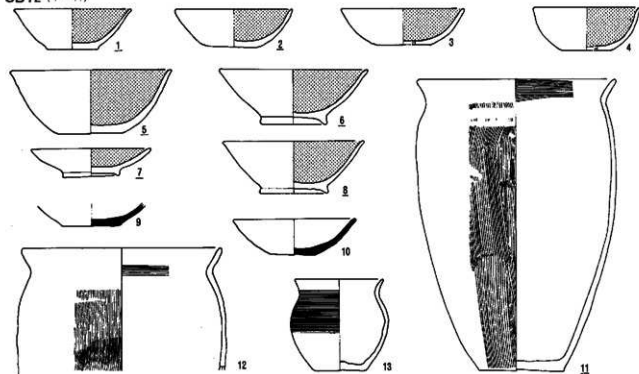

SB73 (1~12)

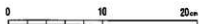
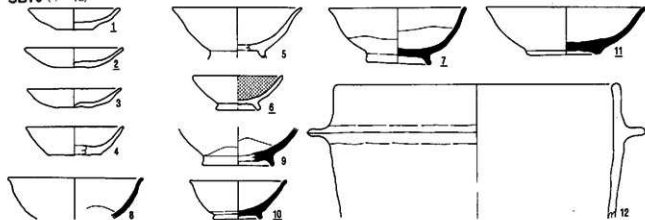

SB74 (1~47)

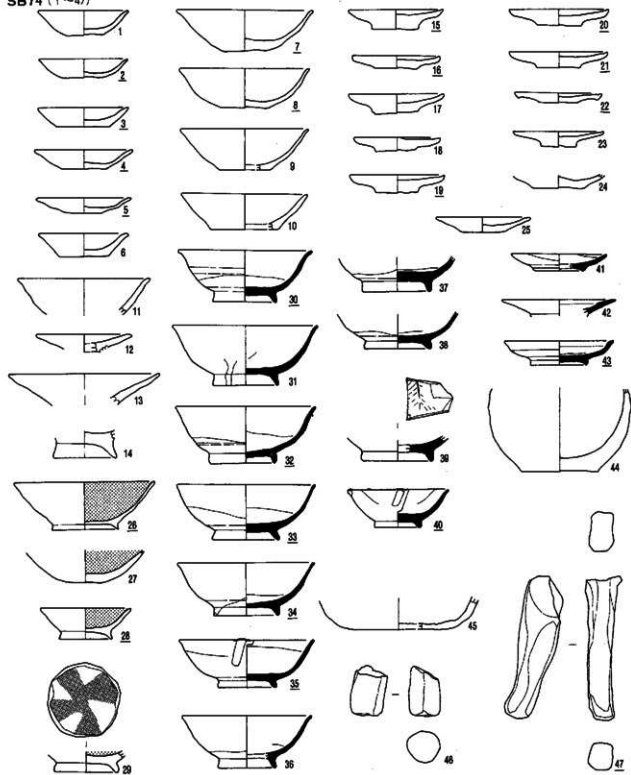

SB75 (1~4)

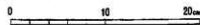
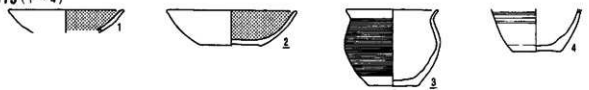

SB76 (1~11)

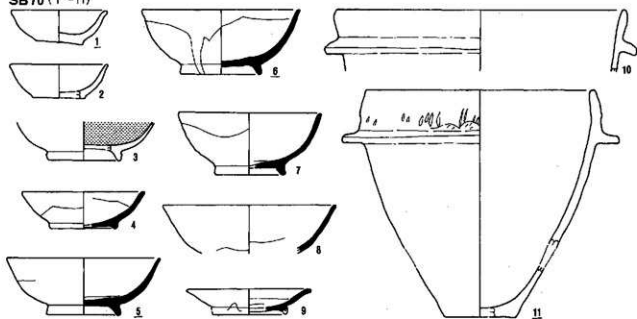

SB77 (1~11)

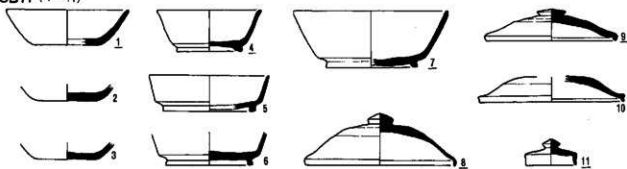

SB78 (1~14)

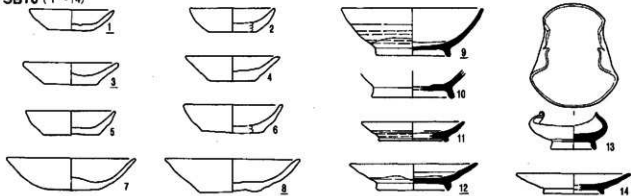

SB79 (1.2)

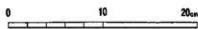

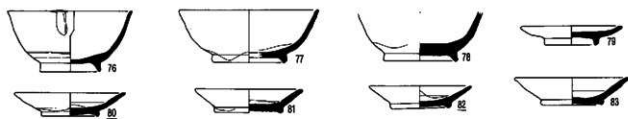

SB81 (1~38)

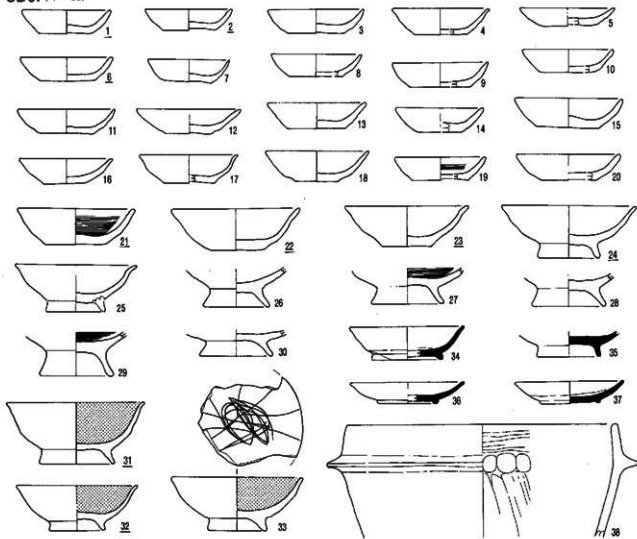

SB83 (1~16)

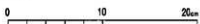
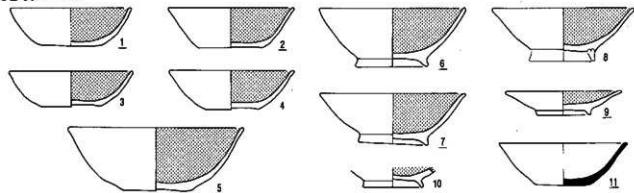

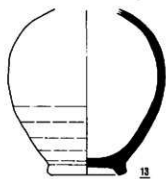
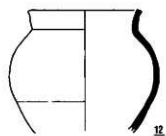

SB84 (1~40)

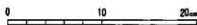
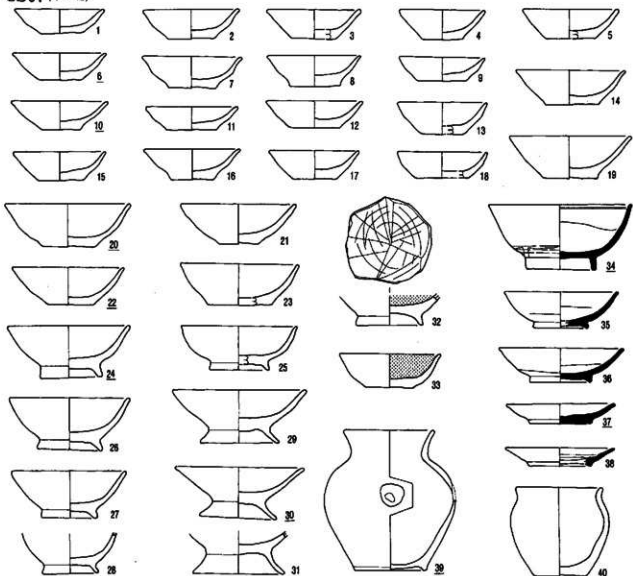

SB85 (1~16)

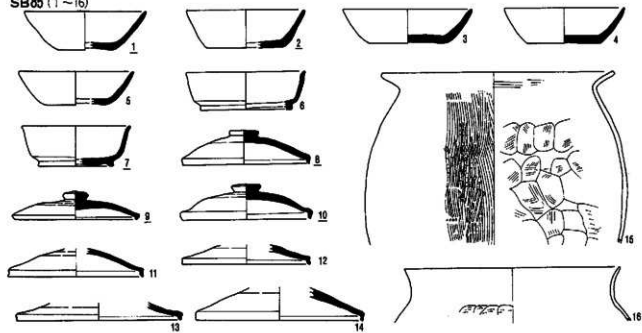

SB86 (1~25)

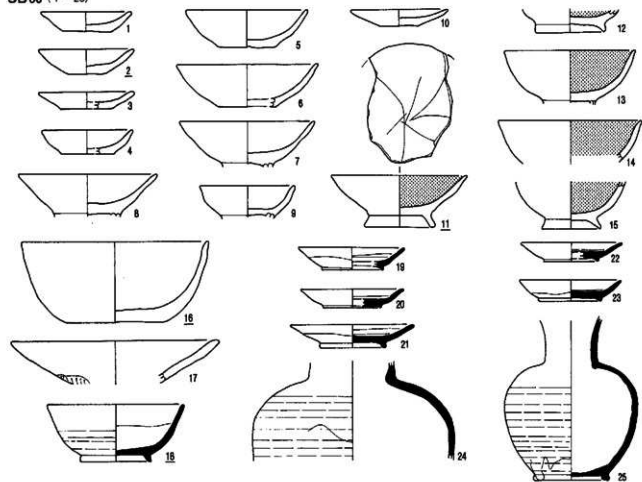

SB87 (1~10)

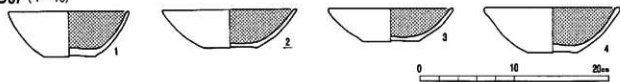

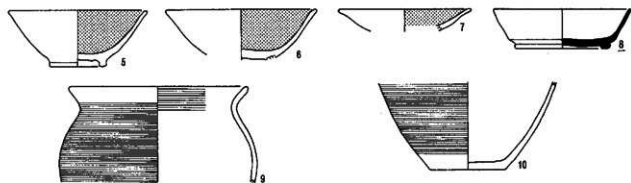

SB88 (1~22)

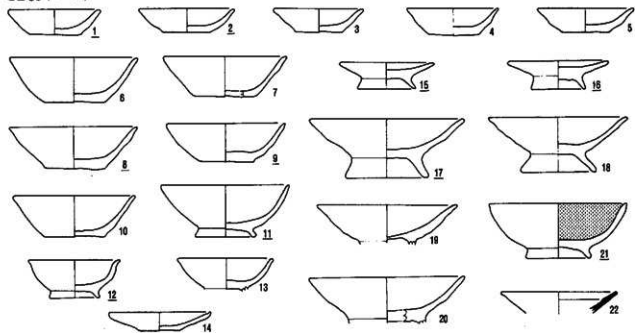

SB89 (1, 2)

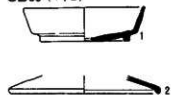

SB90 (1~5)

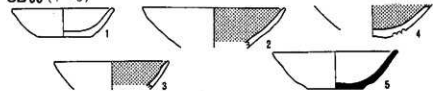

SB91 (1~29)

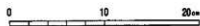
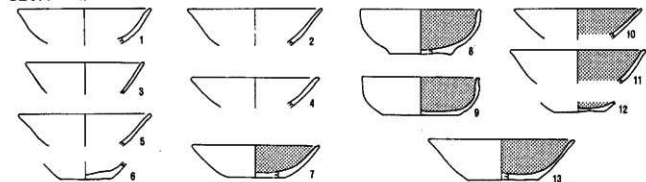

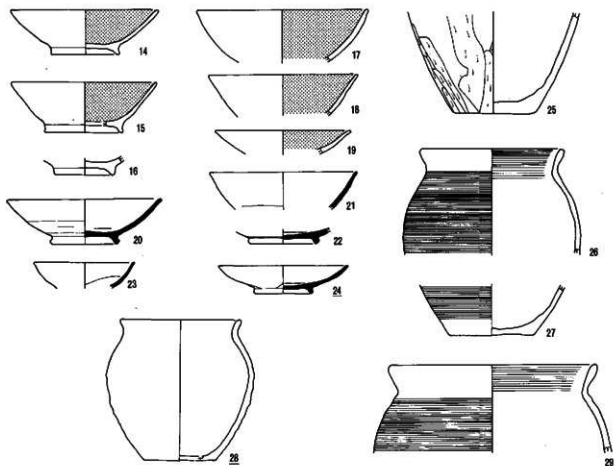

SB93 (1~13)

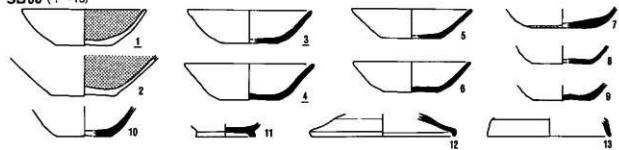

SB94 (1~41)

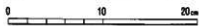
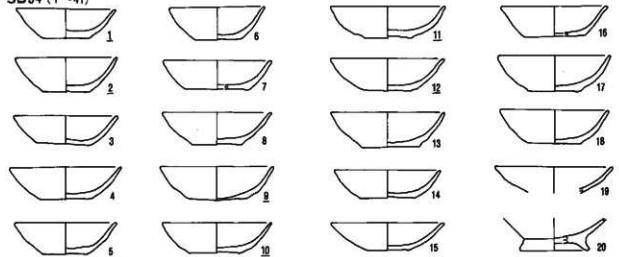

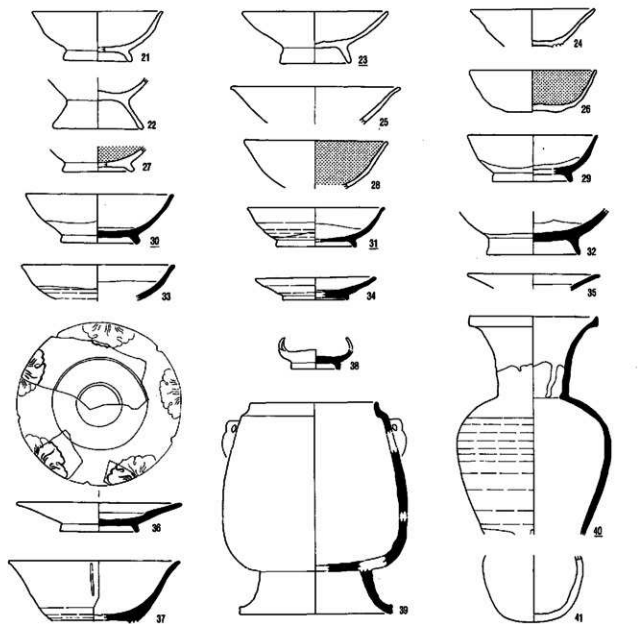

SB 95 (1~15)

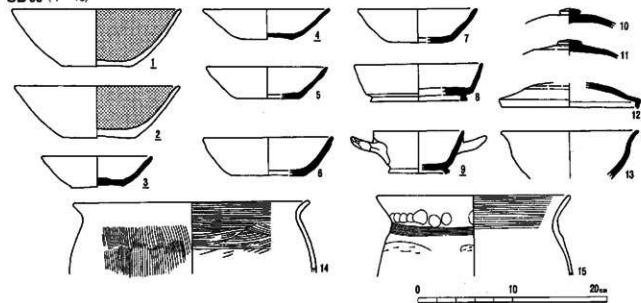

SB 96 (1~18)

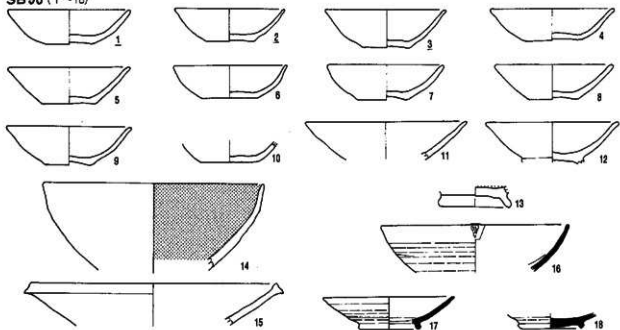

SB 97 (1~8)

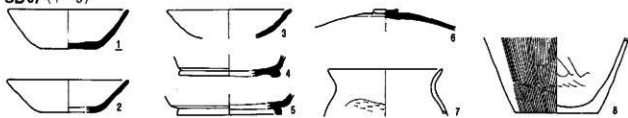

SB 98 (1~8)

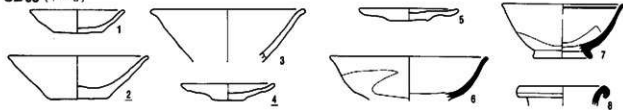

SB 99 (1~94)

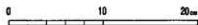
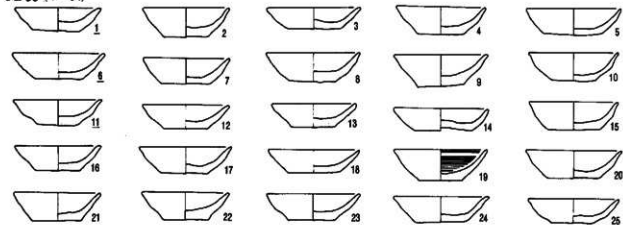

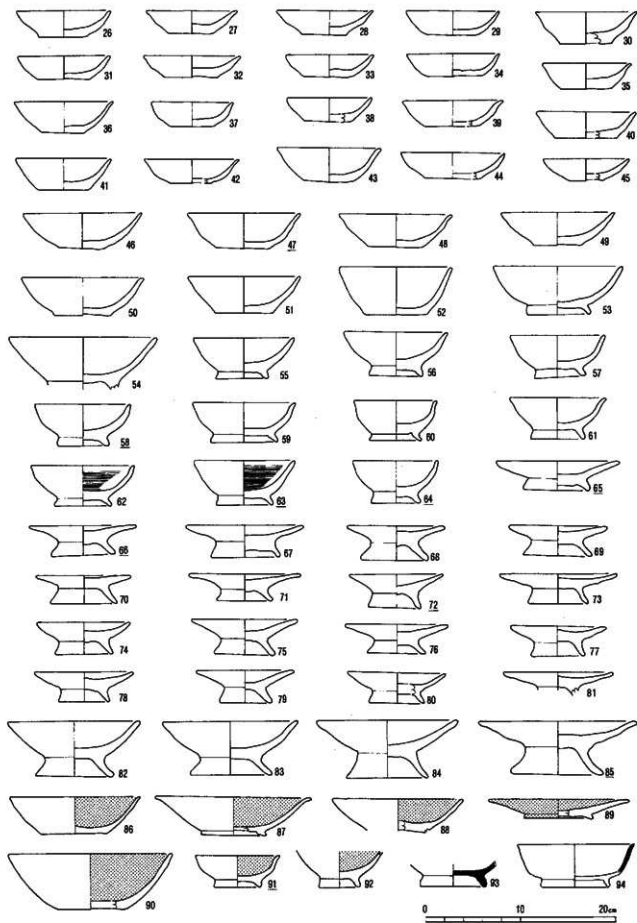

SB 100 (1~7)

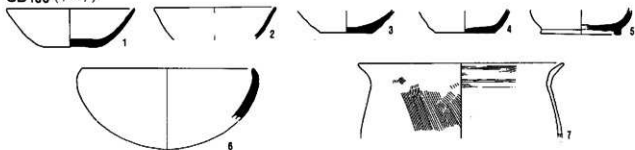

SB 101 (1~12)

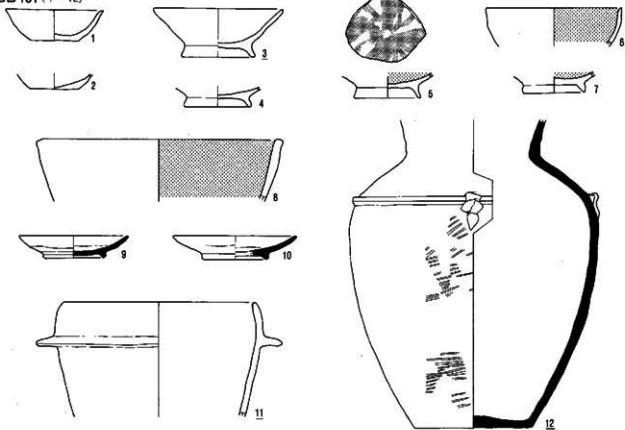

SB 102 (1~37)

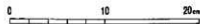
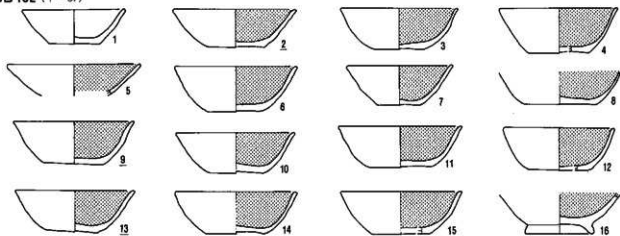

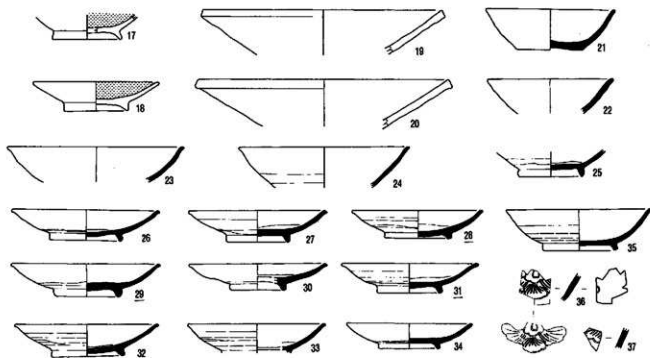

SB103 (1~18)

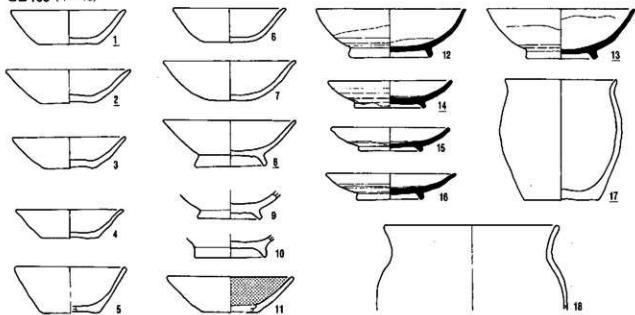

SB104 (1, 2)

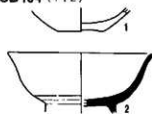

SB105 (1~3)

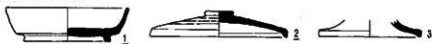

SB106 (1, 2)

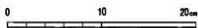

SB 107 (1~5)

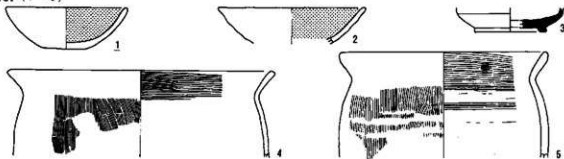

SB 108 (1~7)

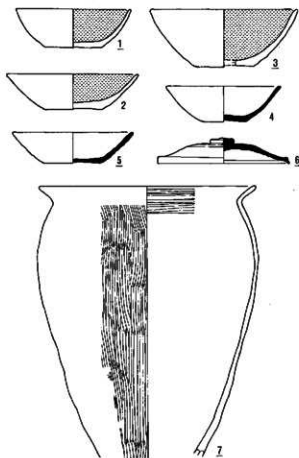

SB 109 (1~12)

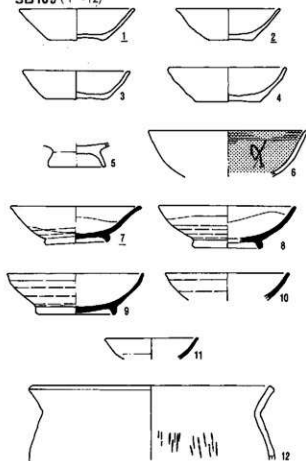

SB 110 (1~11)

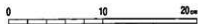
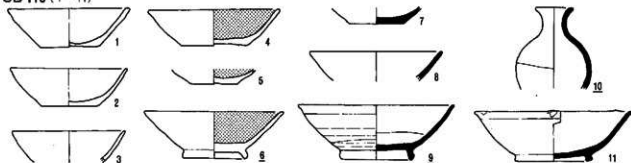

SB111 (1~86)

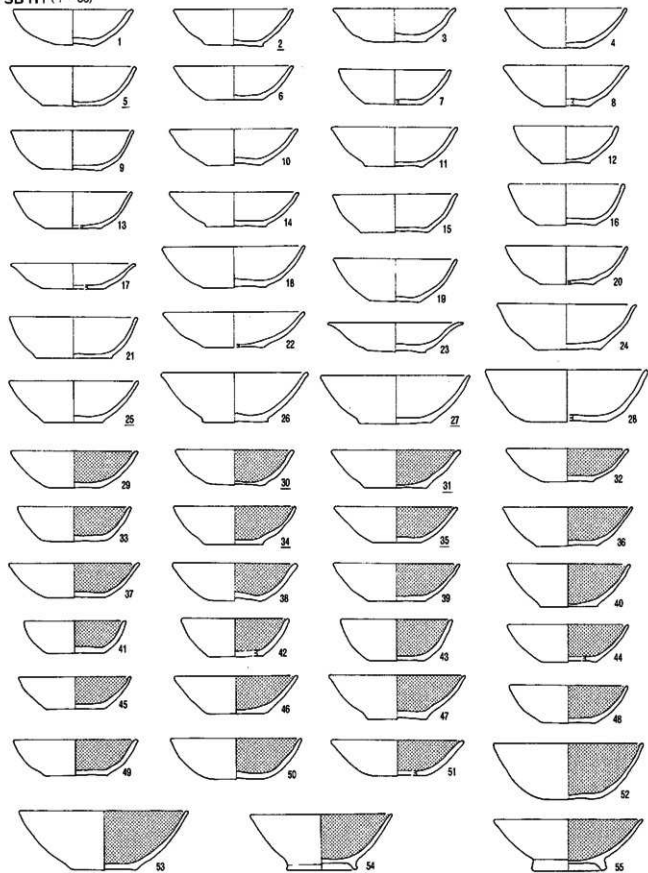

0 10 20cm

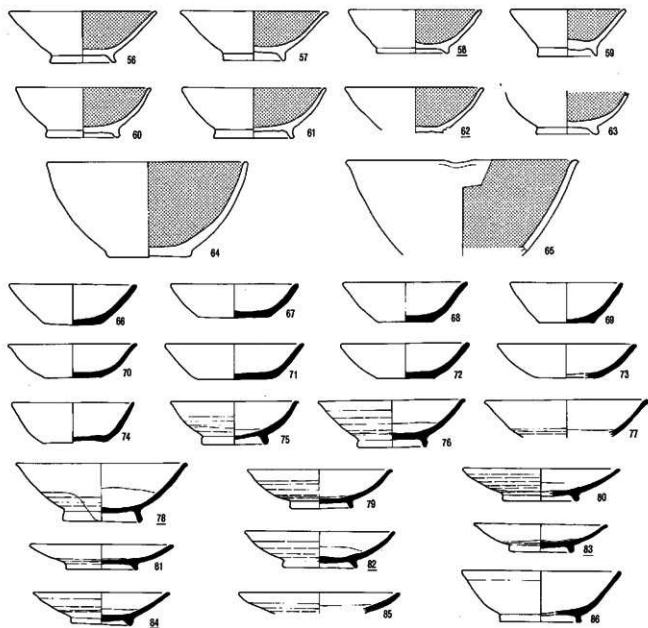

SB 112 (1~5)

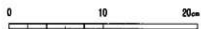
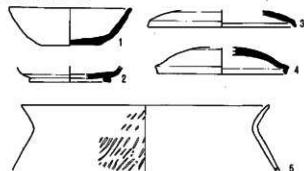

SB 113 (1~3)

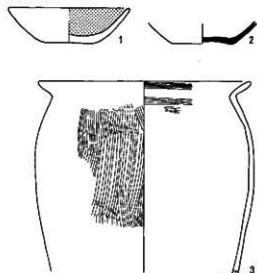

SB114 (1~23)

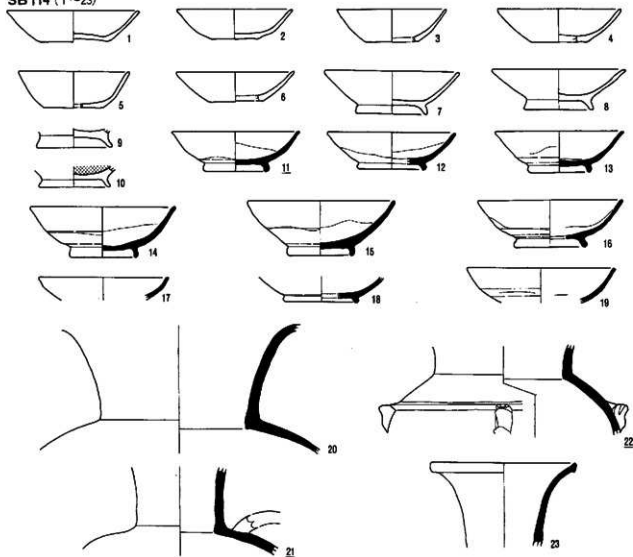

SB115 (1~36)

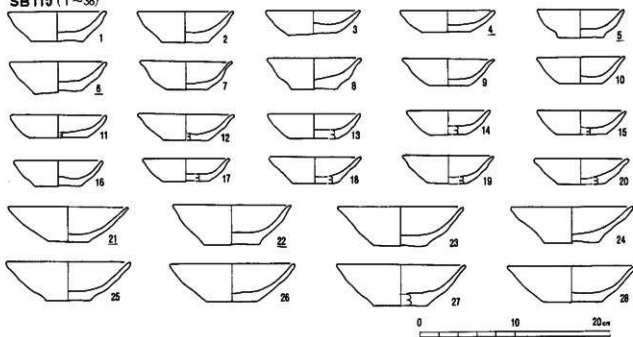

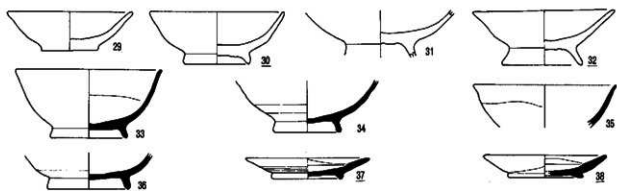

SB116 (1~17)

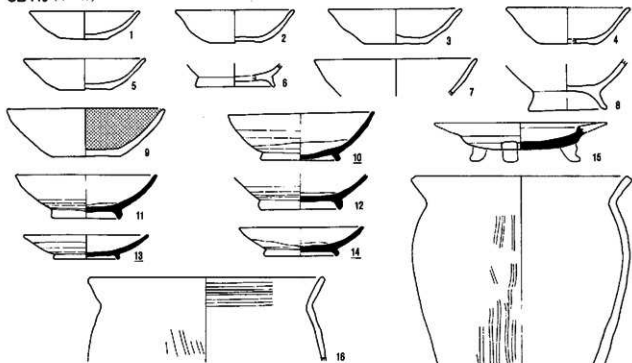

SB117 (1~3)



SB118 (1~18)

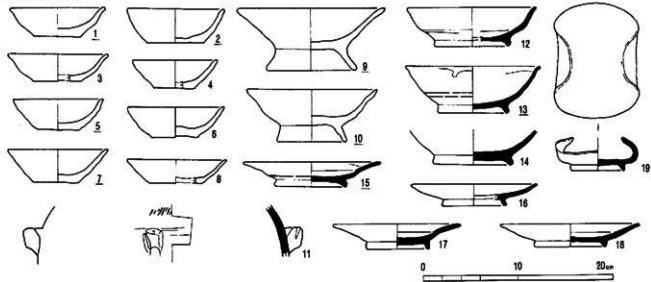

SB119 (1~8)

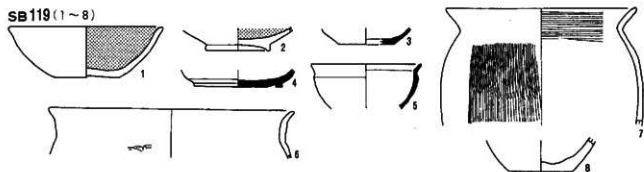

SB120 (1~23)

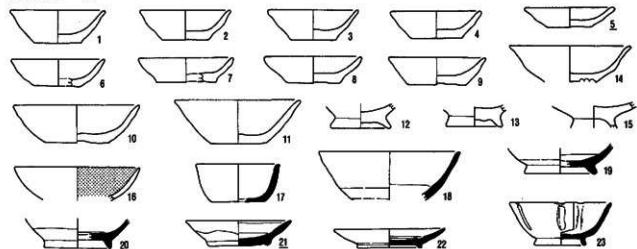

SB121 (1)



SB122 (1~5)



SB123 (1, 2)



SB124 (1~18)

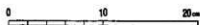
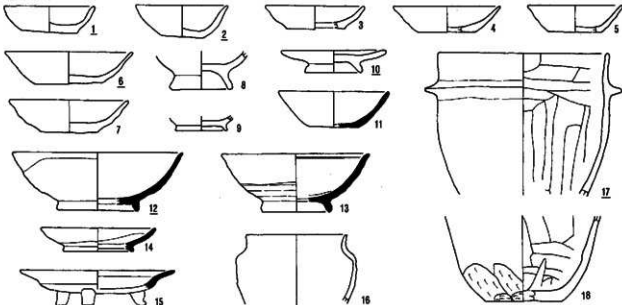

SB 125 (1~9)

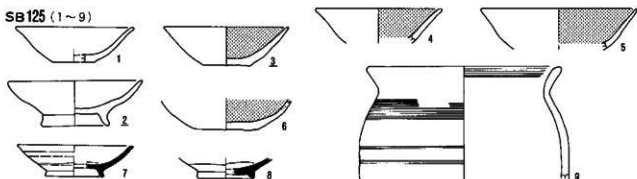

SB 126 (1~5)



SB 127 (1~5)

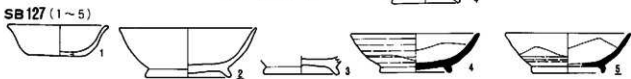

SB 128 (1~4)



SB 129 (1~17)

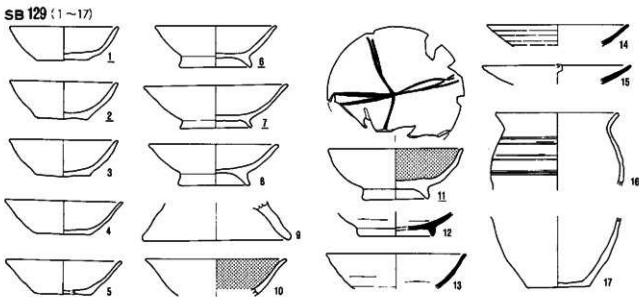

SB 130 (1)



SB 132 (1~18)

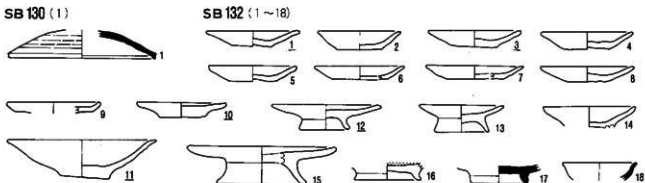

0 10 20cm

SB133 (1~6)

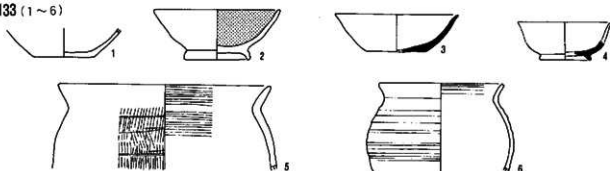

SB134 (1~3)

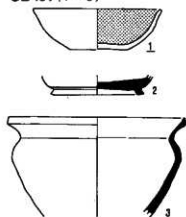

SB135 (1~8)

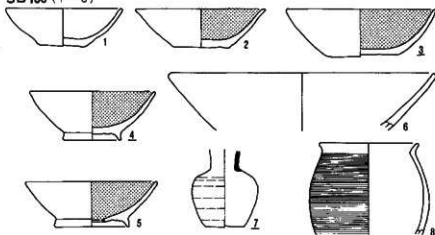

SB136 (1~4)



SB137 (1~4)



SB139 (1~14)

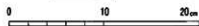
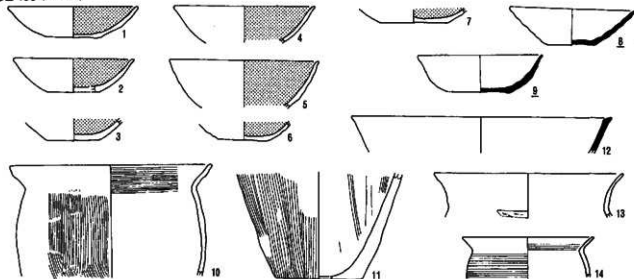

SB 140 (1~20)

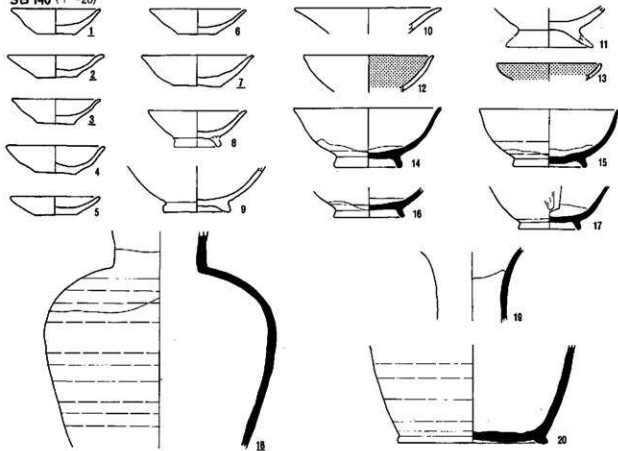

SB 141 (1~31)

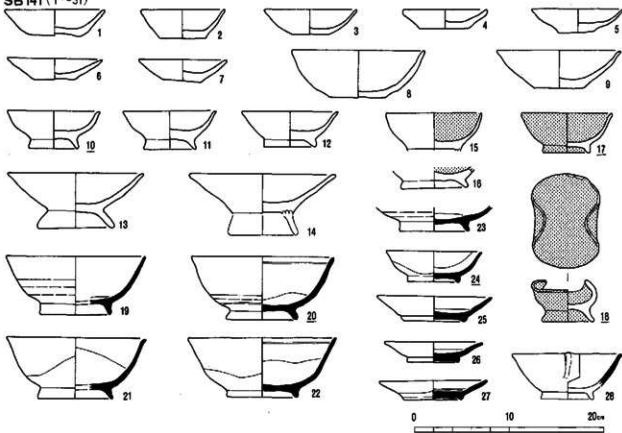

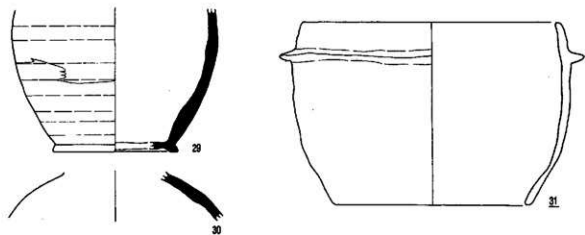

SB 142 (1~28)

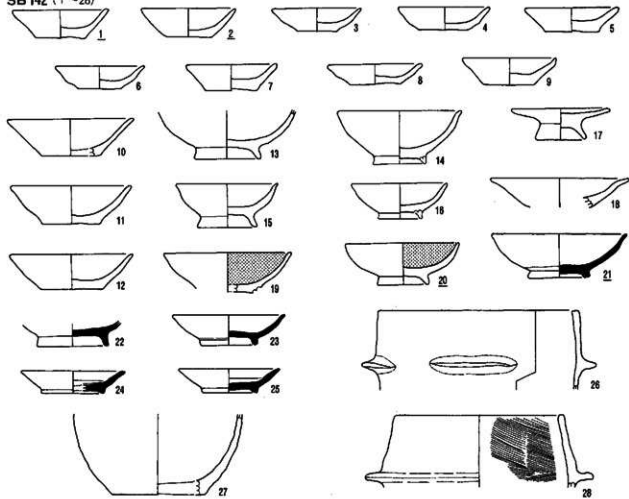

SB 143 (1~3)



SB 144 (1~28)

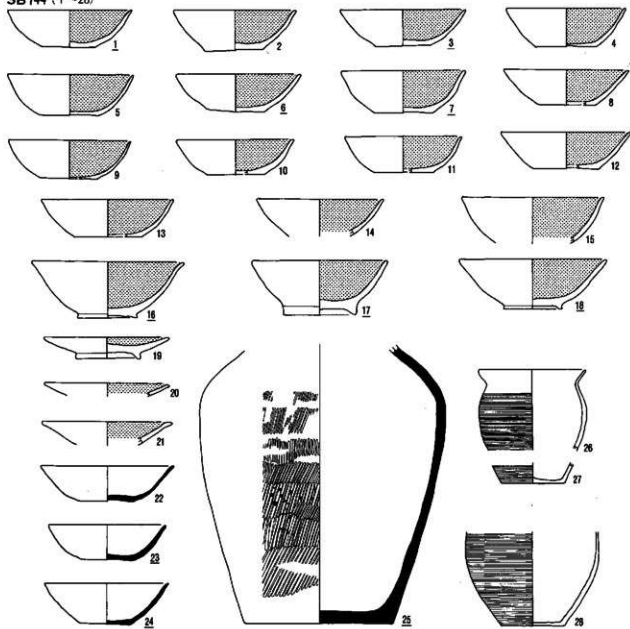

SB 145 (1~7)

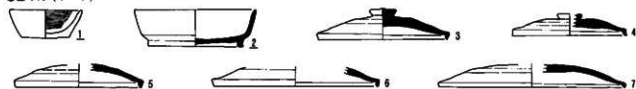

SB 146 (1~4)



0 10 20cm

SB147 (1~4)



SB148 (1~3)



SB150 (1~8)

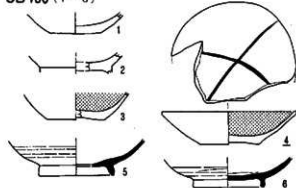

SB156 (1~8)

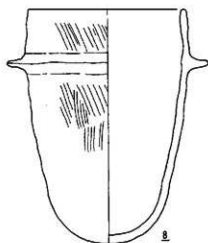
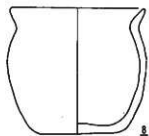
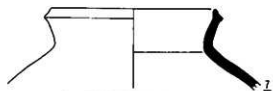
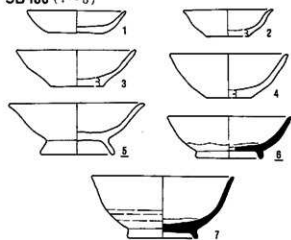

SB157 (1~5)

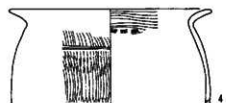

SB154 (1~8)

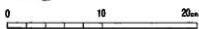
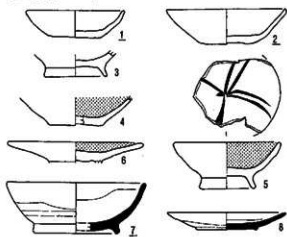

SB 158 (1~5)

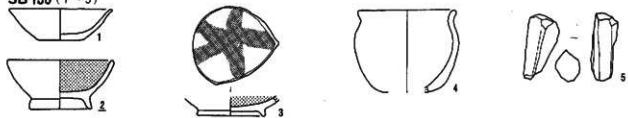

SB 159 (1~18)

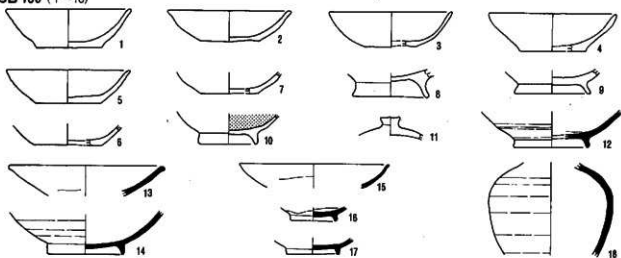

SB 160 (1~19)

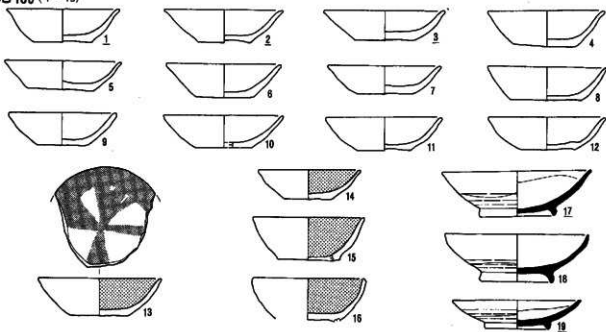

SB 161 (1~6)

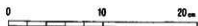
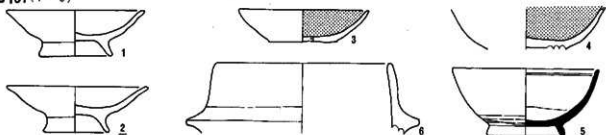

SB162 (1~5)



SB163 (1~6)

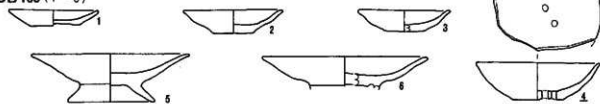

SB164 (1~12)

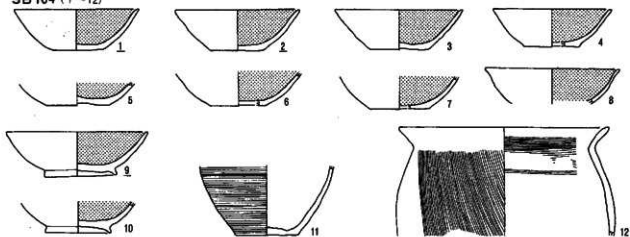

SB165 (1.2)

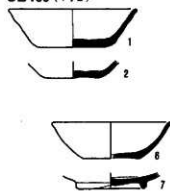

SB166 (1~10)

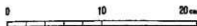
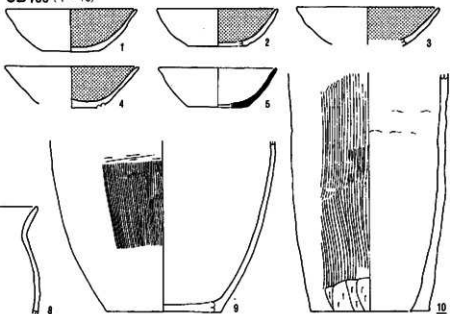

SB 167 (1~50)

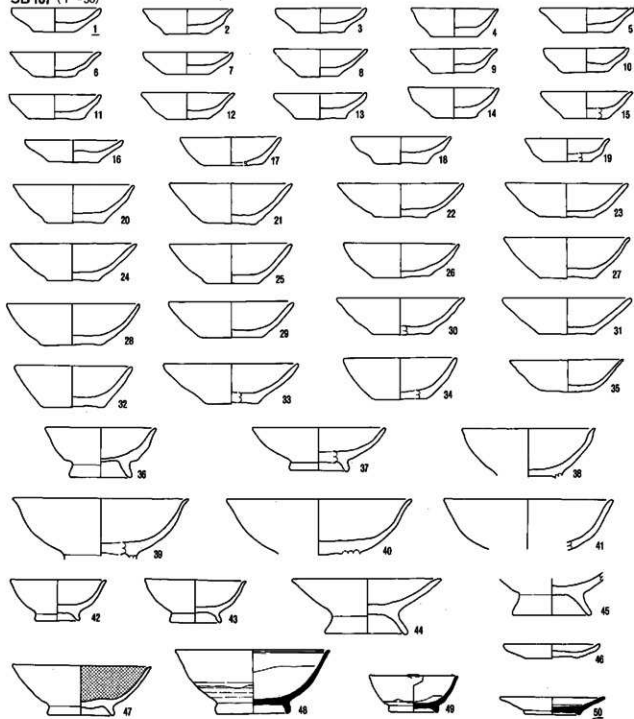

SB 168 (1~6)

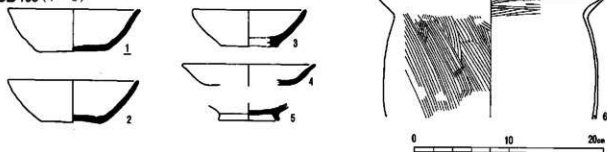

SB 169 (1~10)

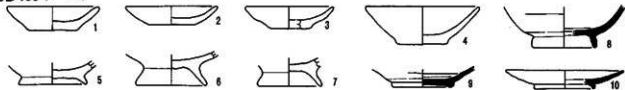

SB 170 (1~10)

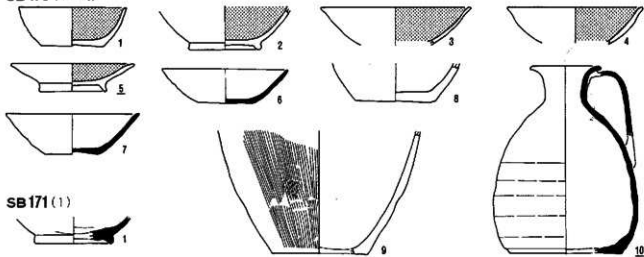

SB 171 (1)



SB 172 (1~12)

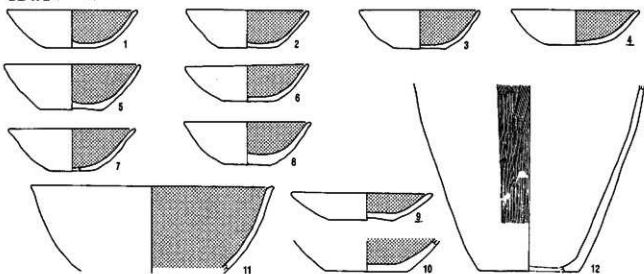

SB 174 (1~14)

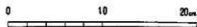
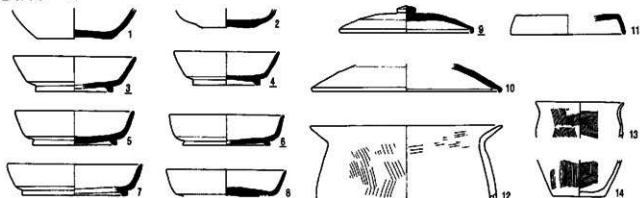

SB175 (1~9)

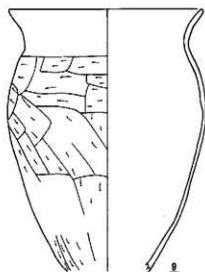
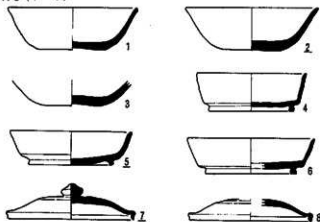

SB176 (1)

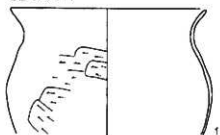

SB178 (1~8)

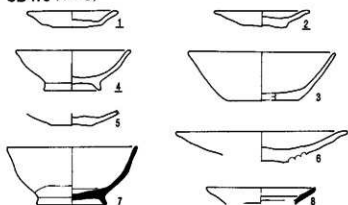

SB177 (1)

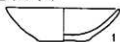

SB179 (1~7)

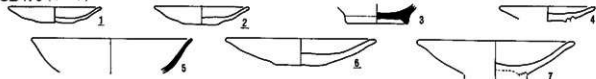

SB180 (1)



SB181 (1~12)

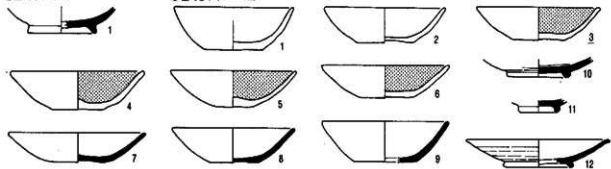

SB182 (1~3)

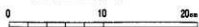

SB183 (1~13)

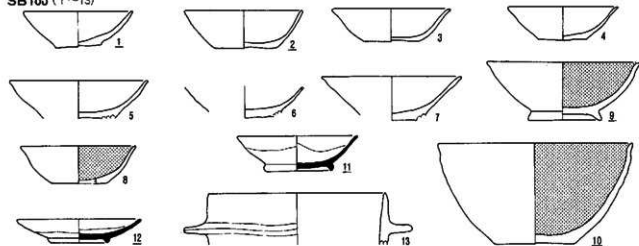

SB184 (1~20)

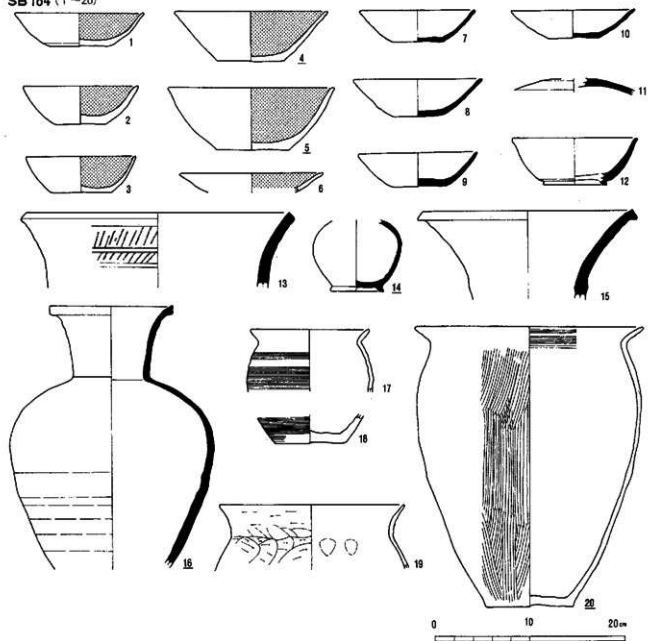

SB 185 (1~6)

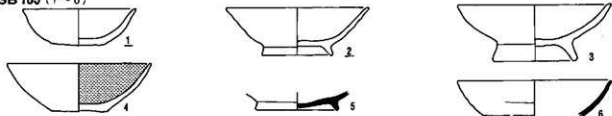

SB 186 (1~12)

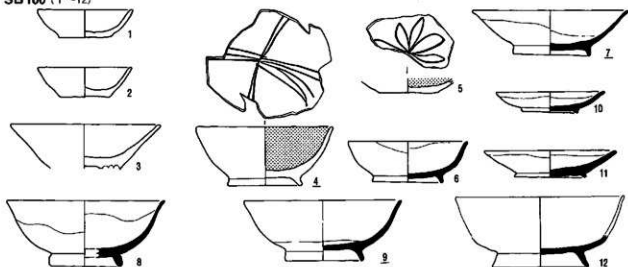

SB 187 (1~25)

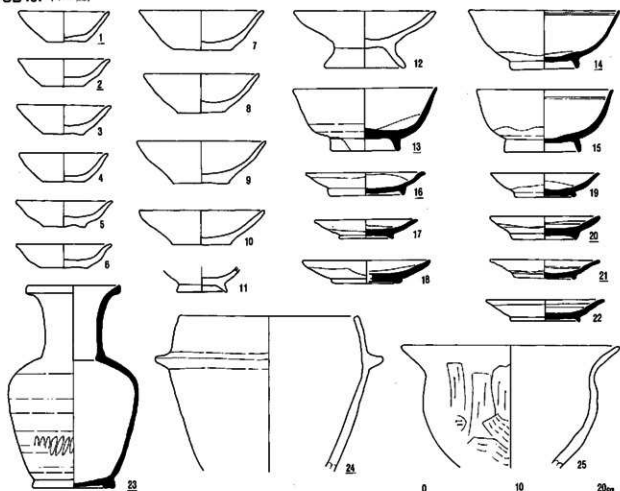

0 10 20cm

SB188 (1~10)

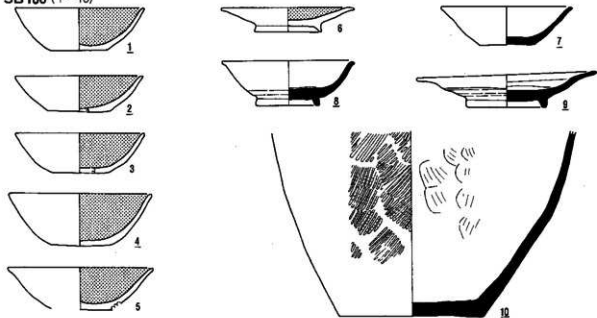

SB189 (1~15)

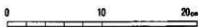
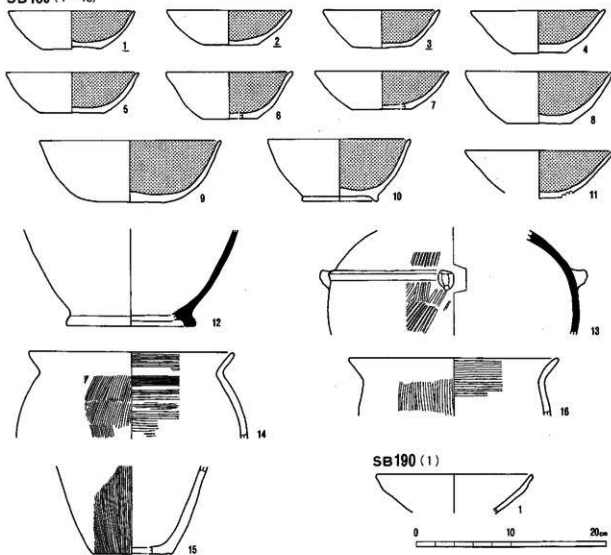

SB191 (1~18)

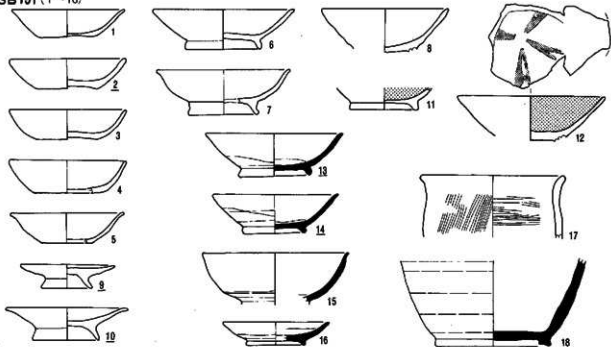

SB192 (1~10)

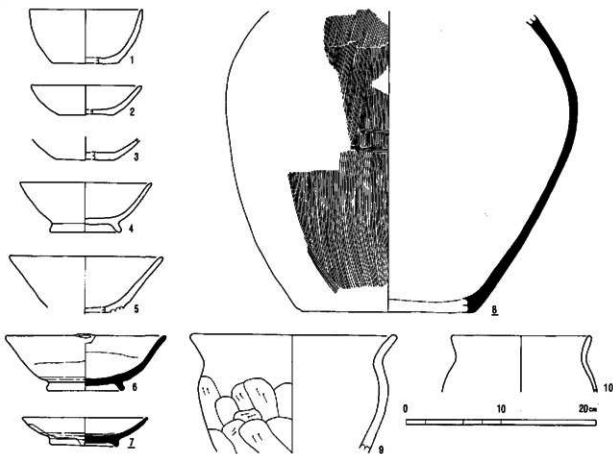

SB193 (1~4)



SB 194 (1~8)

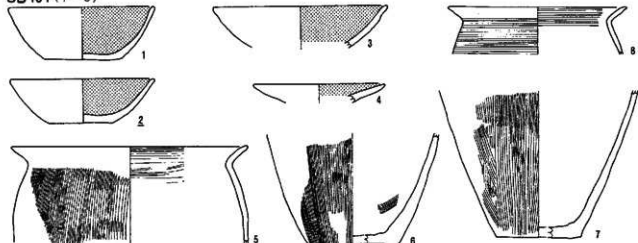

SB 195 (1~7)

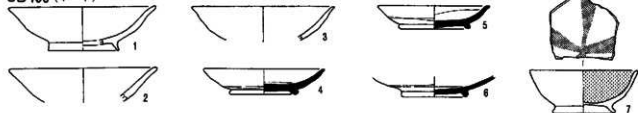

SB 196 (1~13)

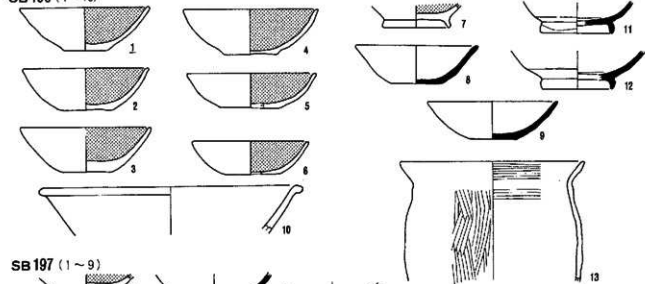

SB 197 (1~9)

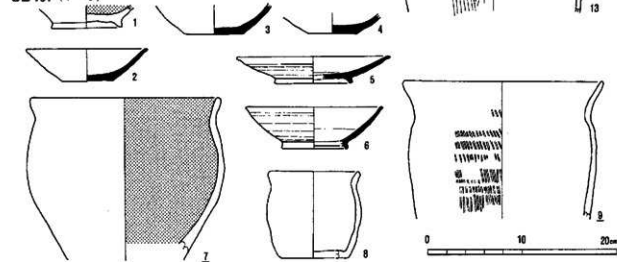

SB 198 (1~4)

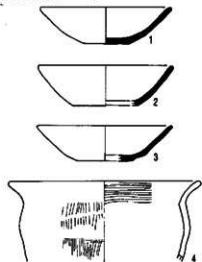

SB 199 (1~17)

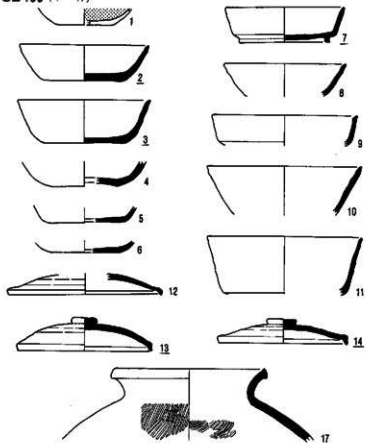

SB 200 (1~9)

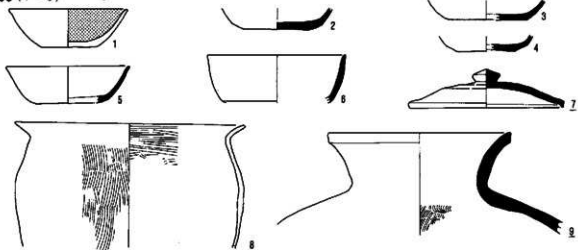

SB 201 (1~8)

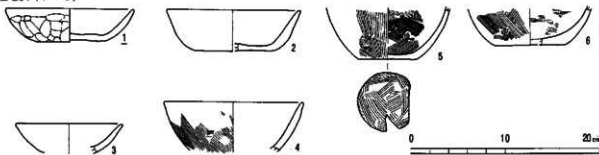

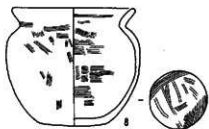
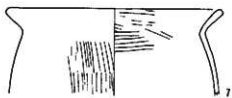

SB 202 (1~7)



SB 203 (1~7)

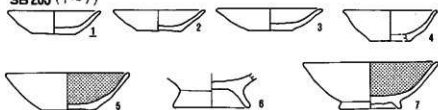

SB 204 (1, 2)

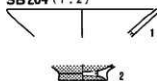

SB 207 (1~15)

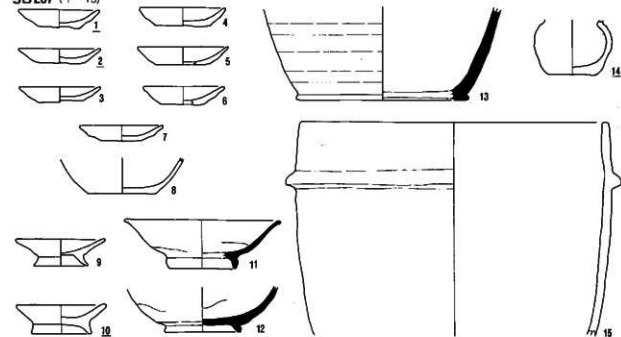

SB 209 (1~11)

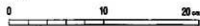
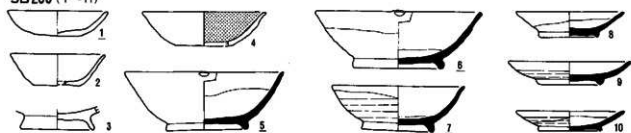

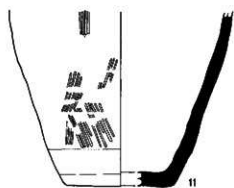

SB 210 (1~8)

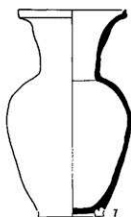
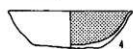

SB 211 (1~4)

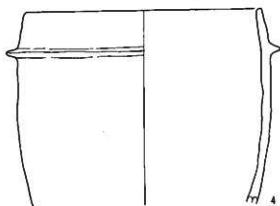
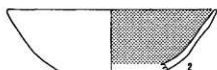
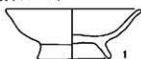

SB 213 (1~5)

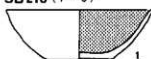

SB 212 (1)

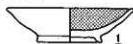

SB 214 (1)

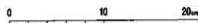
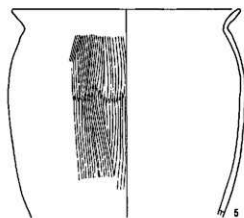
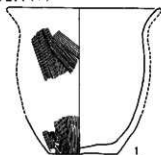

SB 215 (1~5)

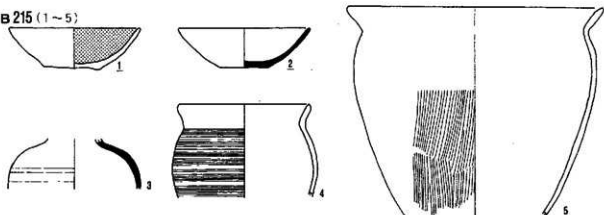

SB 216 (1~37)

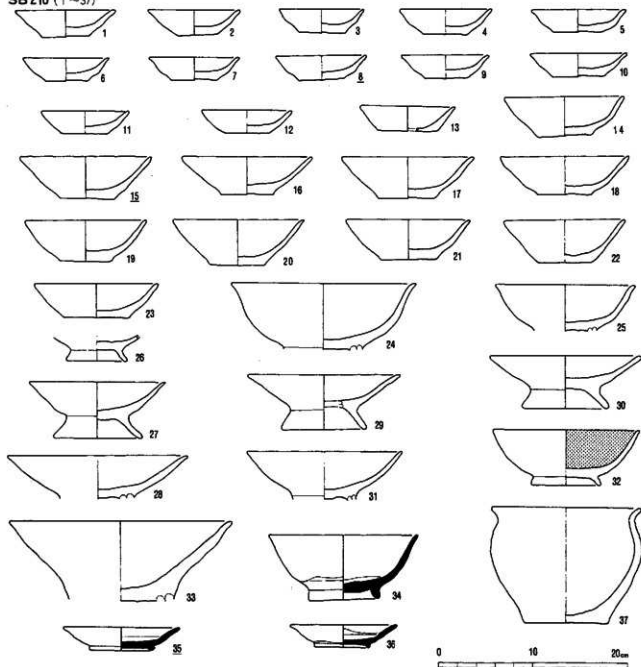

SB 217 (1~3)

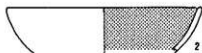
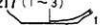

SB 218 (1)

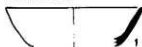

SB 219 (1~7)

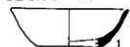

SB 220 (1)

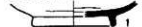

SB 221 (1, 2)

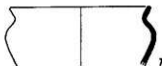
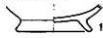

SB 222 (1~5)

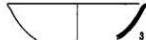
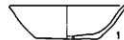

SB 224 (1~9)

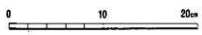
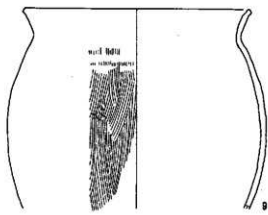
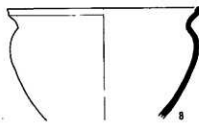
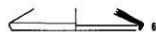
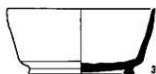

SB 225 (1~5)

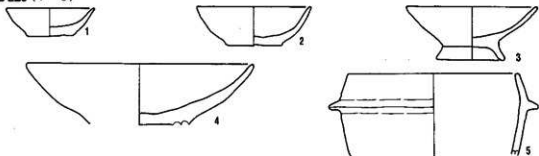

SB 226 (1~9)

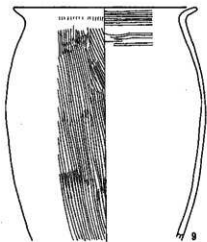
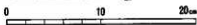
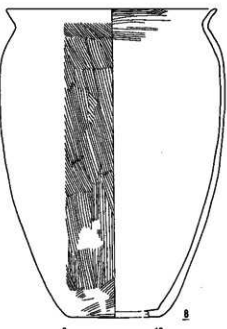
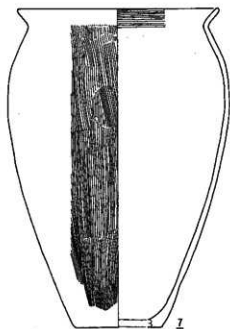
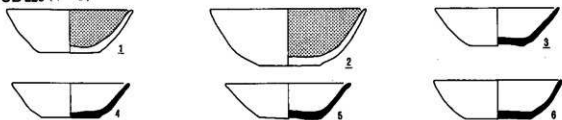

SB 227 (1~22)

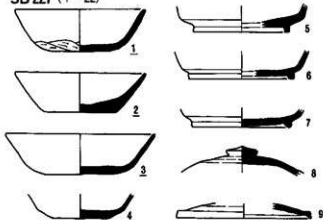

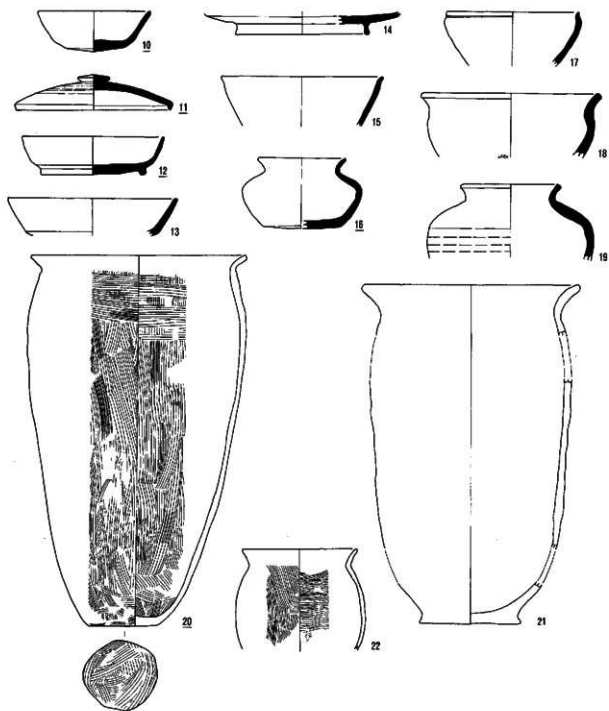

SB 228 (1)

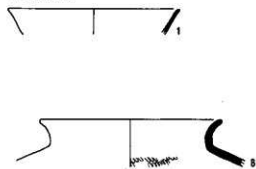

SB 230 (1~7)

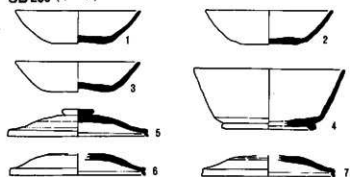

0 10 20cm

SB 232 (1~36)

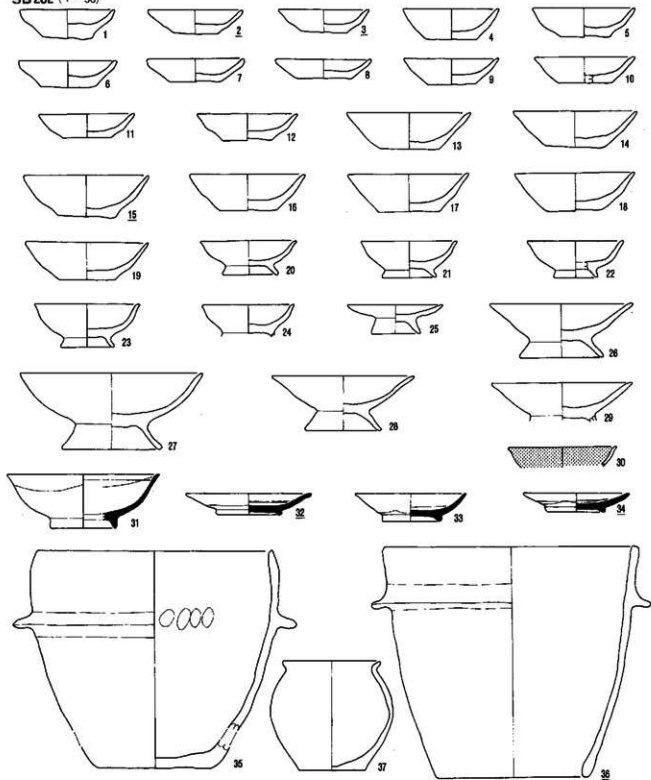

SB 233 (1~3)

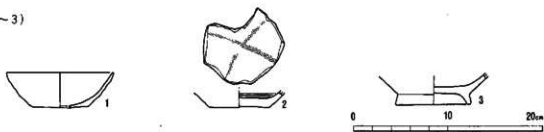

SB 234 (1~26)

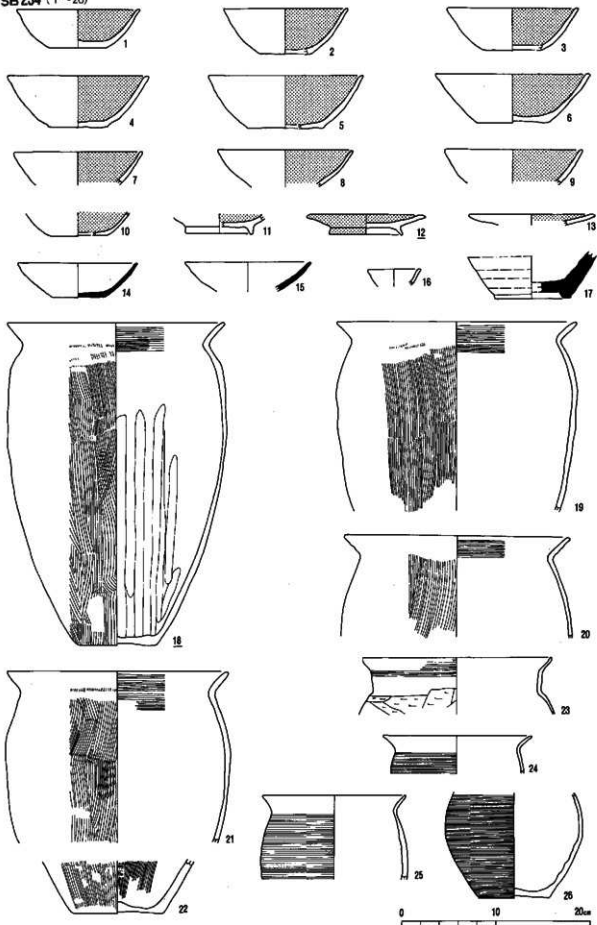

SB 235 (1~7)

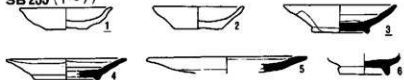

SB 236 (1~3)



SB 237 (1~4)



SB 238 (1)



SB 239 (1)

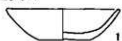

SB 240 (1.2)



SB 241 (1.2)



SB 242 (1~3)



SB 243 (1~7)

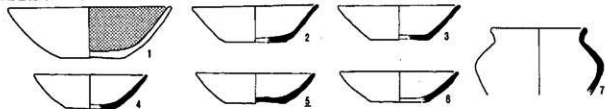

SB 244 (1~11)

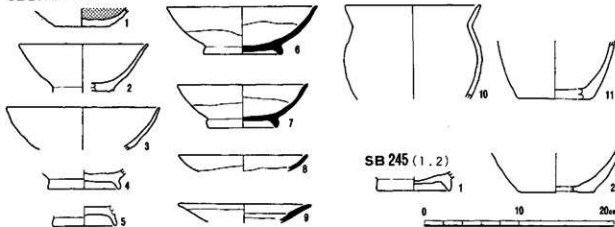

SB 245 (1.2)

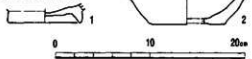

SB246 (1~16)

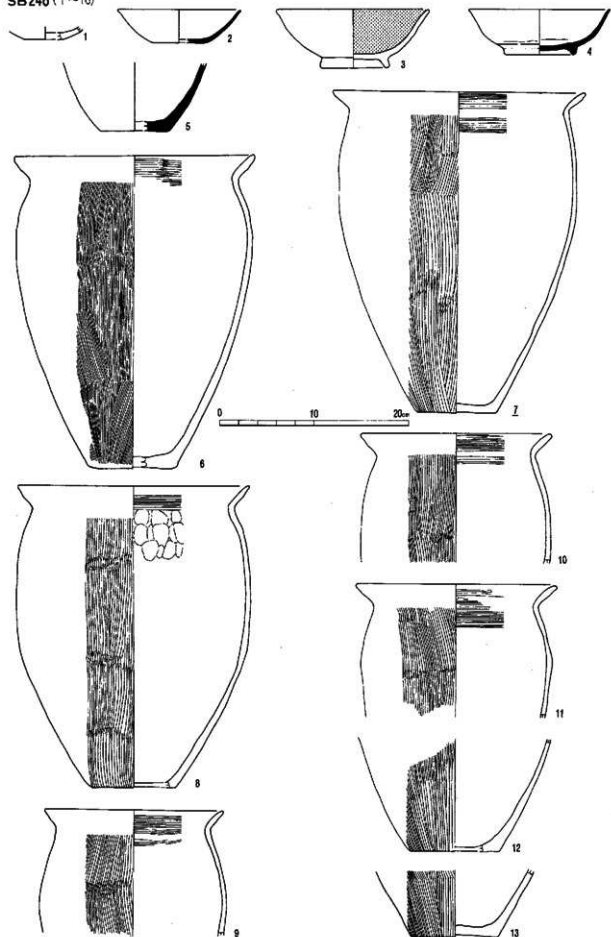

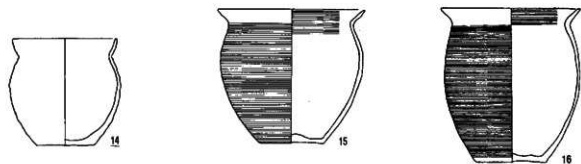

SB 247 (1~23)

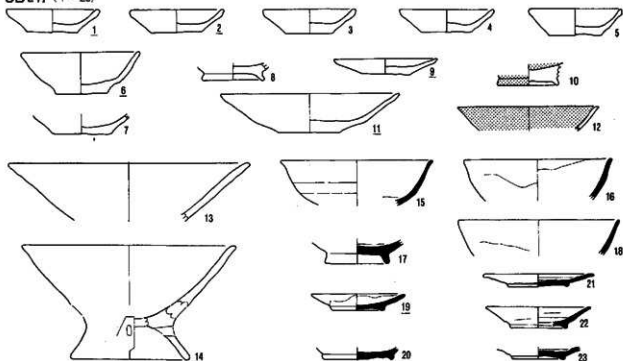

SB 248 (1~20)

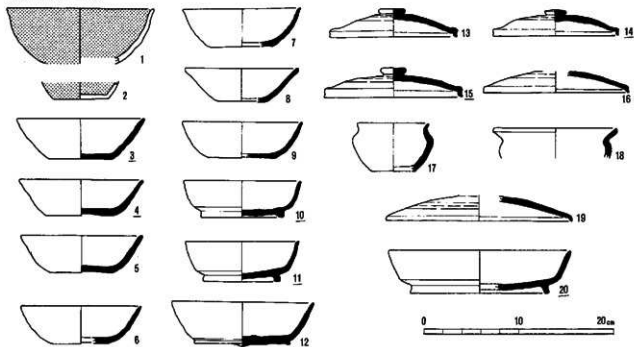

SB 249 (1~10)

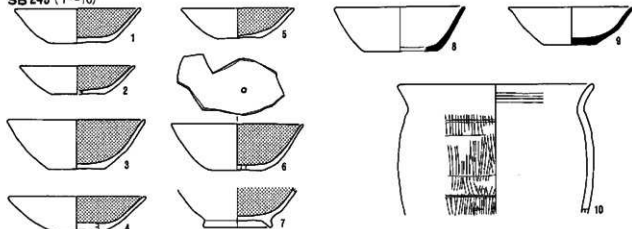

SB 250 (1~3)



SB 251 (1, 2)

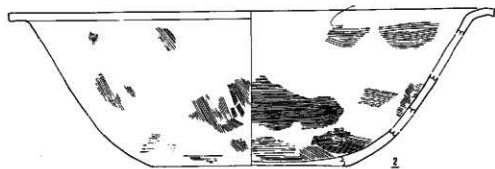
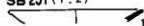

SB 252 (1~3)



SB 256 (1~15)

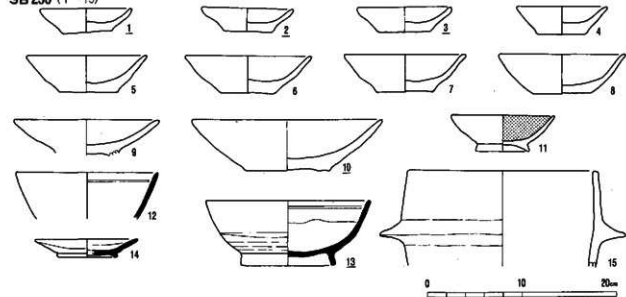

SB 258 (1~12)

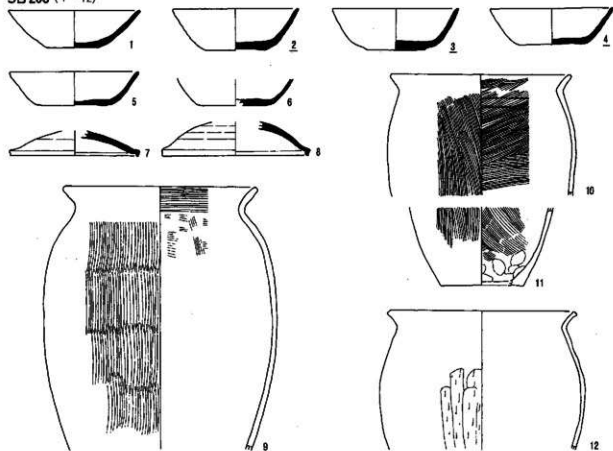

SB 259 (1~15)

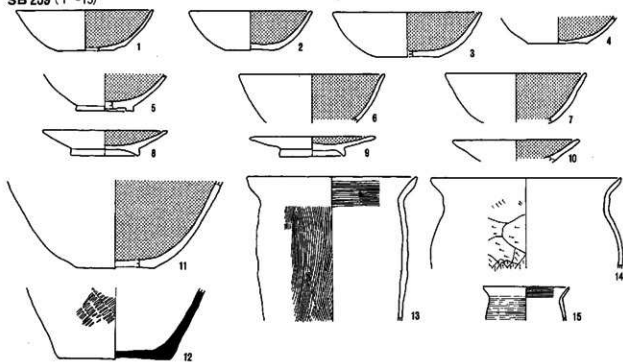

SB 260 (1~3)

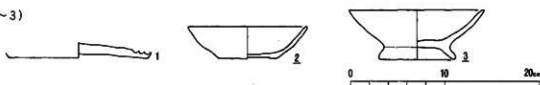

SB 261 (1, 2)



SB 262 (1~8)

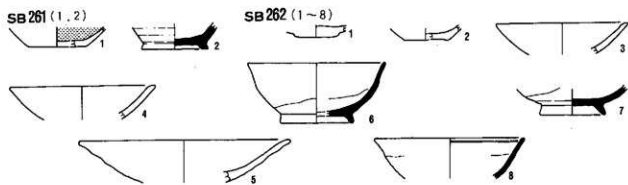

SB 263 (1~30)

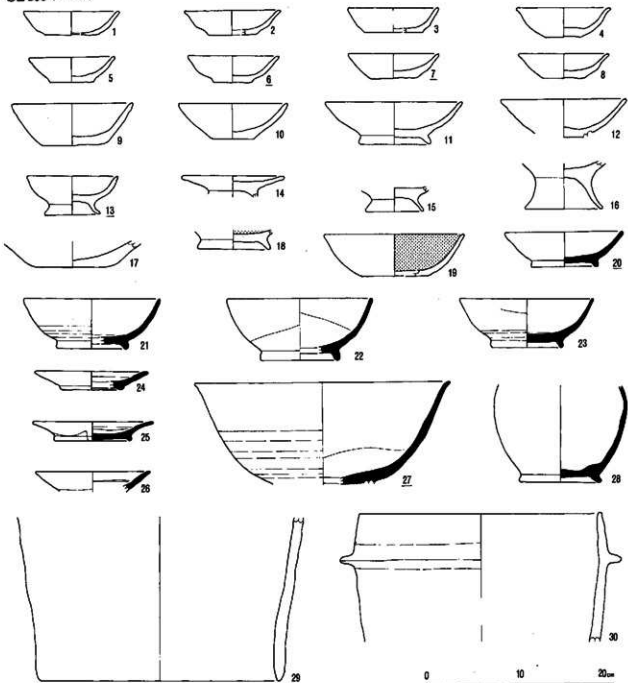

SB 264 (1~18)

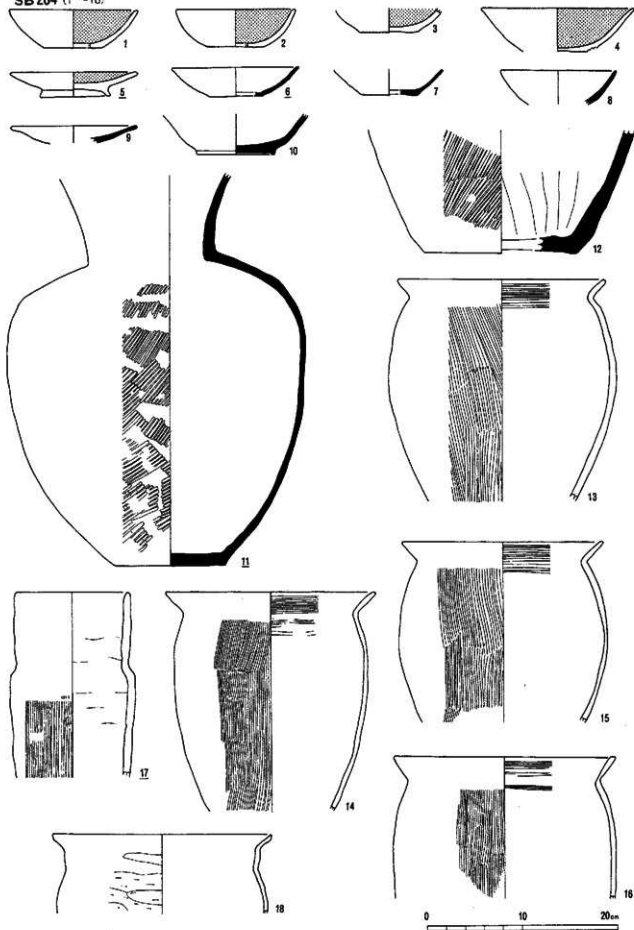

SB 265 (1~6)



SB 266 (1~13)

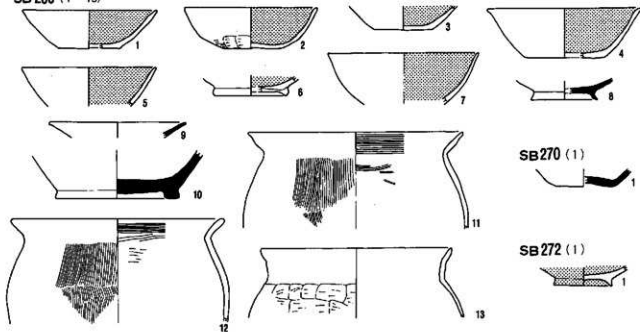

SB 270 (1)



SB 272 (1)



SB 267 (1, 2)

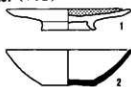

SB 269 (1, 2)



SB 268 (1)



SB 271 (1~4)

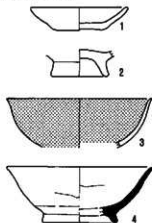

SB 26 (1)

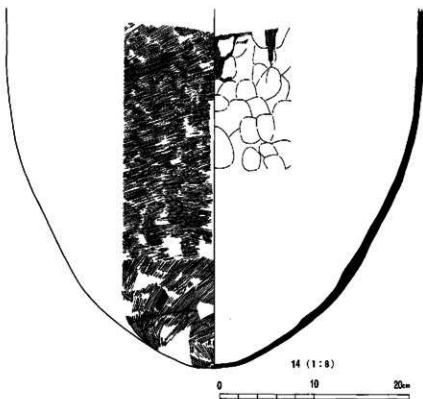

SK 01 (1~3)



SK 02 (1)

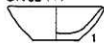

SK 06 (1~4)

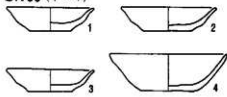

SK 12 (1)

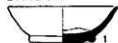

SK 20 (1~3)

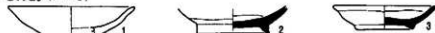

SK 25 (1)

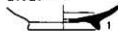

SK 26 (1~10)

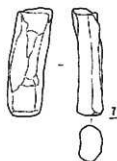
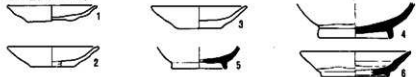

SK 42 (1~3)

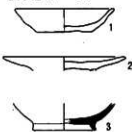

SK 27 (1.2)

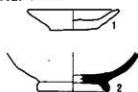

SK 43 (1~5)

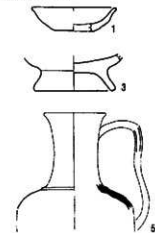

SK 47 (1)



SK 34 (1)

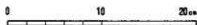
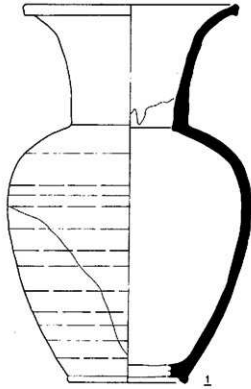

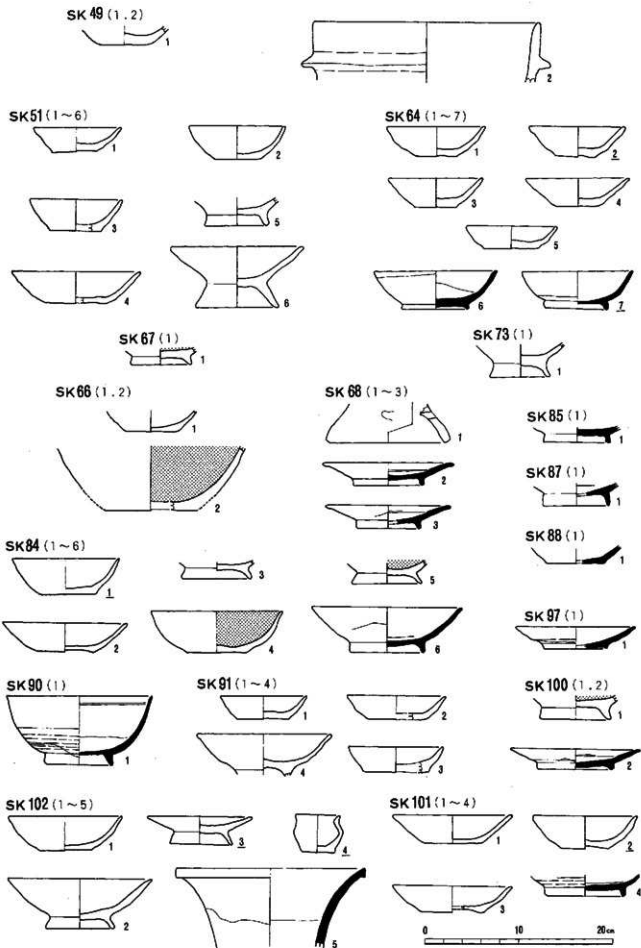

SK 103 (1~3)

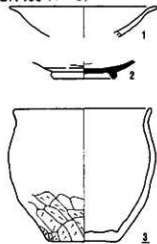

SK 107 (1~6)

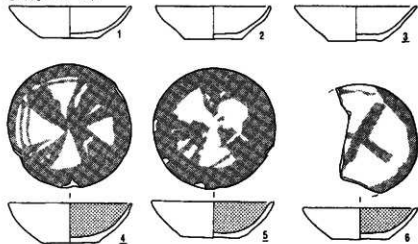

SK 104 (1)



SK 118 (1~10)

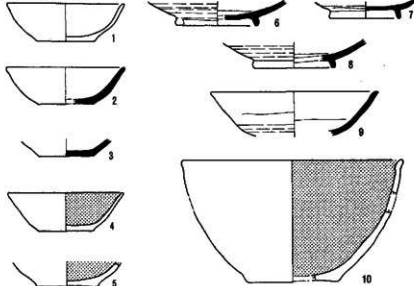

SK 112 (1, 2)

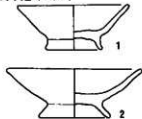

SK 115 (1)



SK 117 (1)



SK 120 (1~4)



SK 122 (1~30)

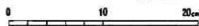
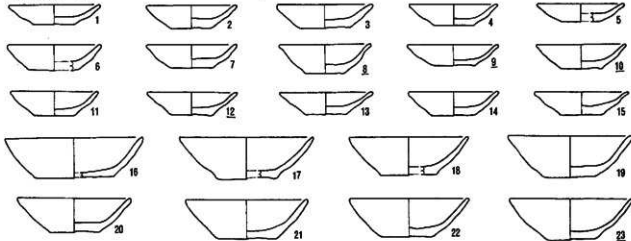

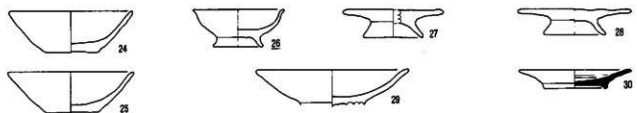

SK 126 (1~7)

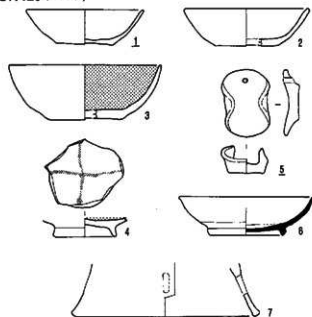

SK 129 (1~6)

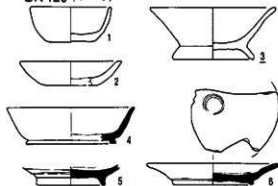

SK 141 (1)



SK 146 (1)



SK 132 (1~11)

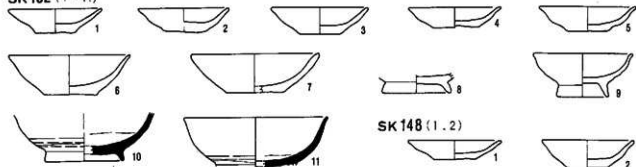

SK 148 (1.2)



SK 151 (1.2)



SK 154 (1.2)



SK 155 (1~7)

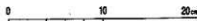
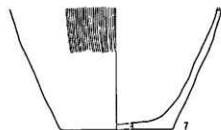
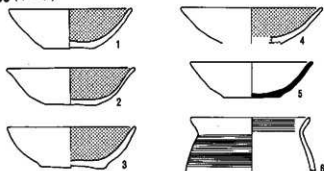

SK 158 (1)



SK 167 (1. 2)



SK 178 (1~3)

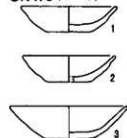

SK 199 (1)

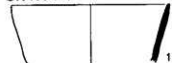

SK 203 (1~5)

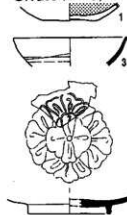

SK 209 (1~4)

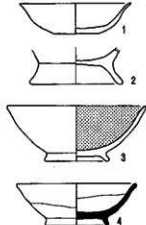

SK 182 (1. 2)

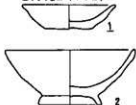

SK 188 (1)

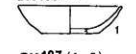

SK 187 (1. 2)

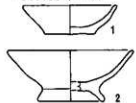

SK 211 (1~14)

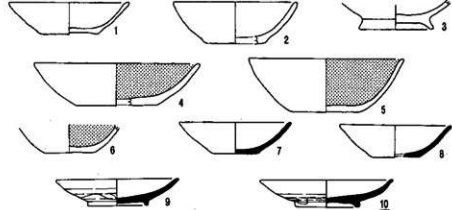

SK 202 (1~5)

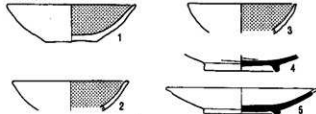

SK 204 (1~16)

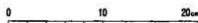
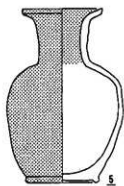
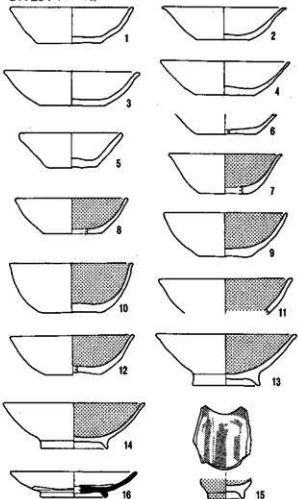

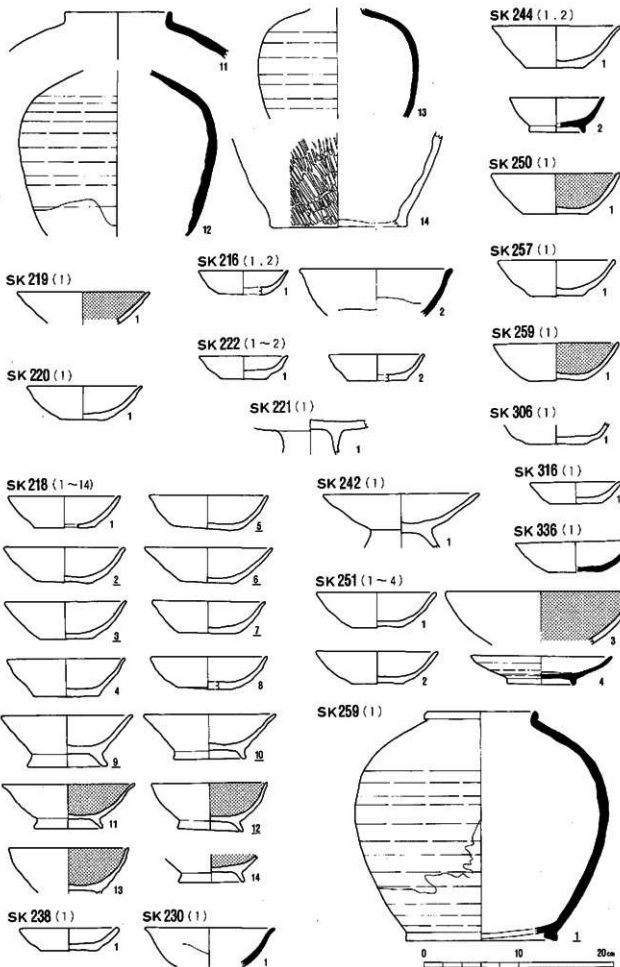

SK128 (1~25)

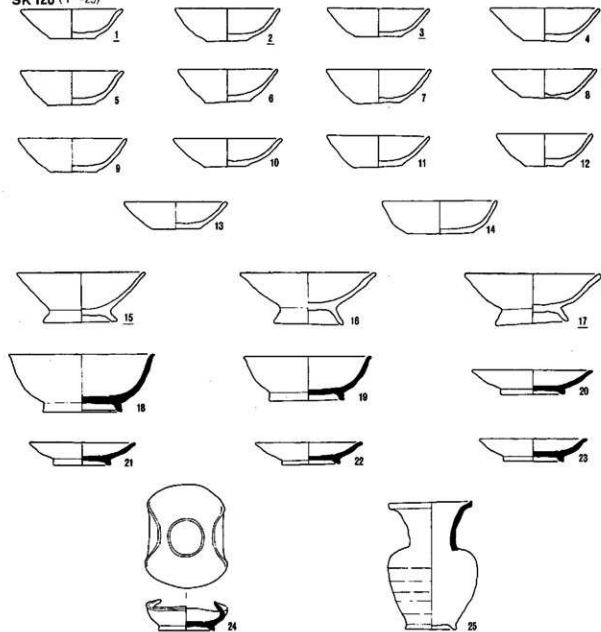

SM01 (1)

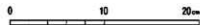
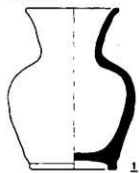

SD01 (1, 2)

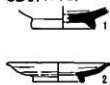

SD02 (1, 2)

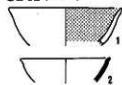

SD03 (1~14)

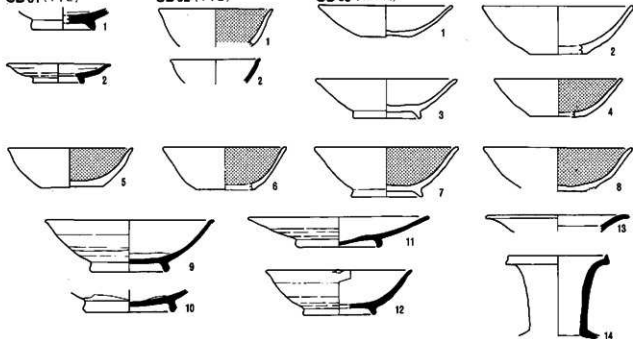

SD06 (1~8)

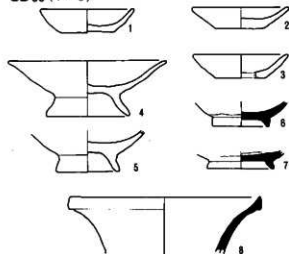

SD07 (1)



SD08 (1~9)

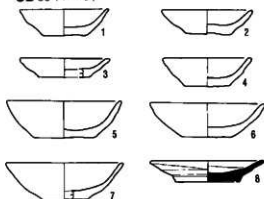

SD09 (1)



SD10 (1~4)

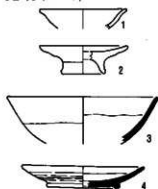

SD13 (1~3)

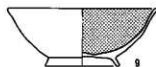
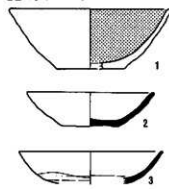

SD15 (1, 2)

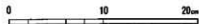
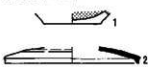

SD17 (1~65)

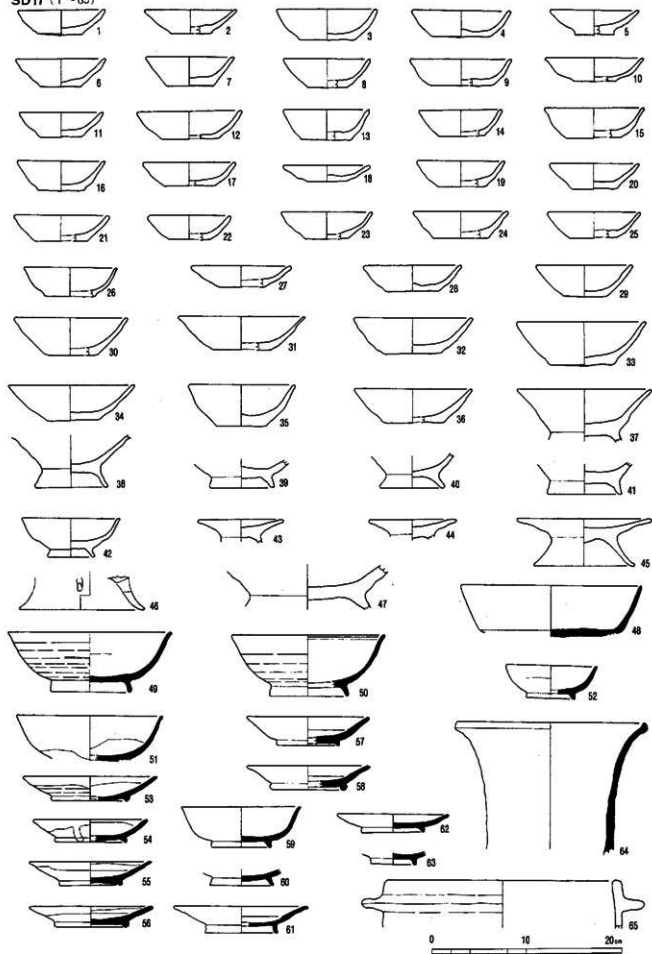

SD18 (1~10)

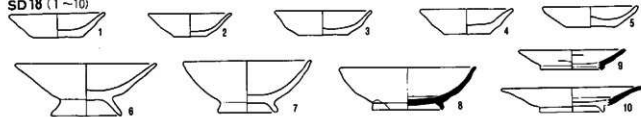

SD19 (1~9)

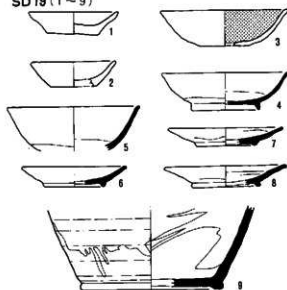

SD25 (1~18)

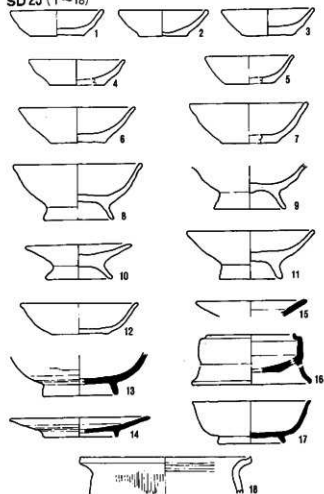

SD23 (1~4)

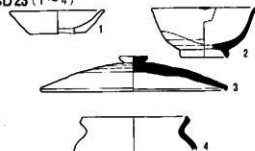

SD27 (1)



SD28 (1~3)



NR01 (1~3)



NR07 (1.2)

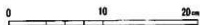
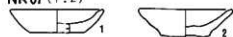

ST 203 (1)



SX 20 (1~5)

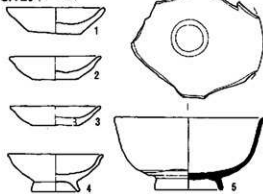

SX 21 (1~54)

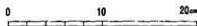
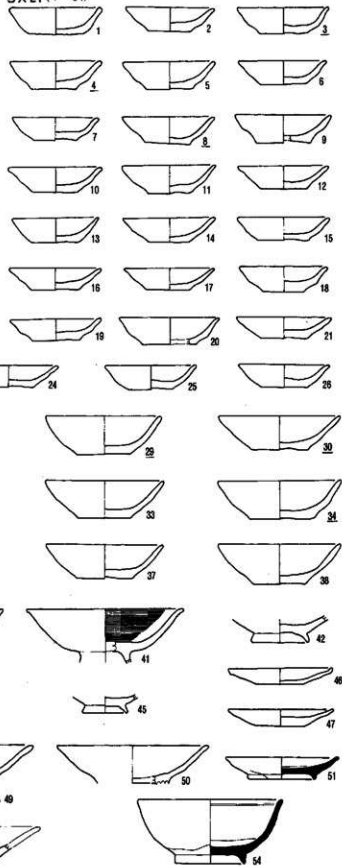

F地区 (1~8)

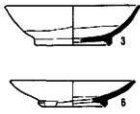
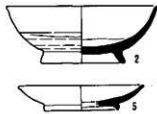
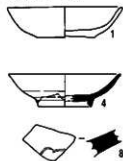

G地区 (1~17)

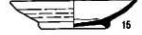
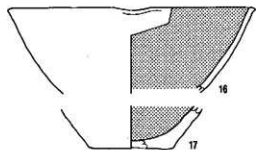
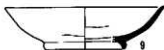
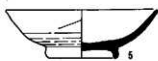
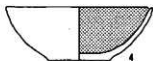
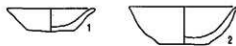

H地区 (1~17)

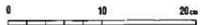
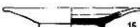
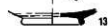
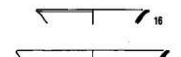
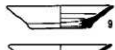
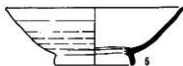
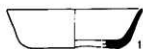

I地区 (1~14)

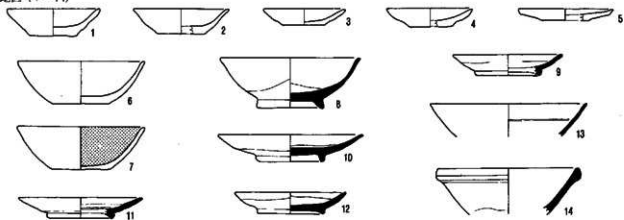

K地区 (1~6)

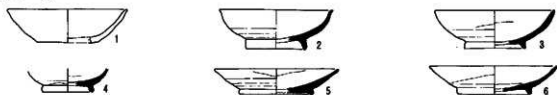

L地区 (1~28)

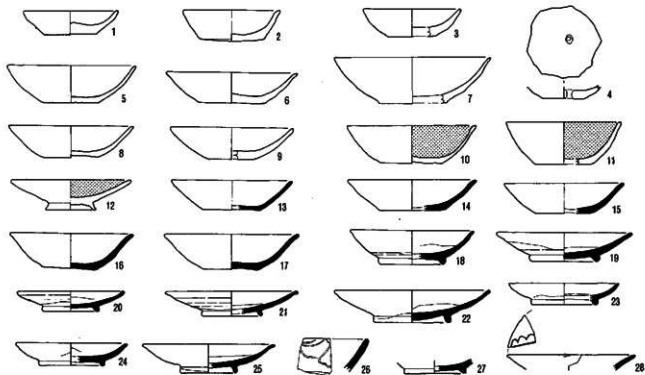

M地区 (1~40)

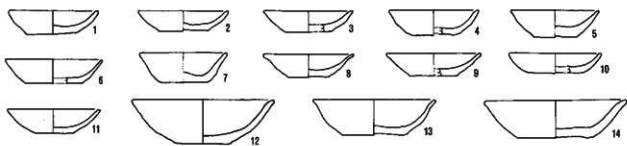

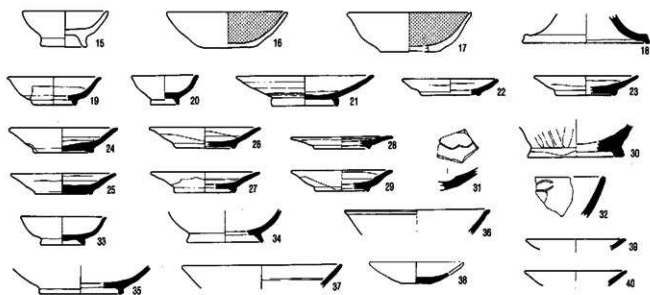

N地区 (1~79)

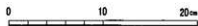
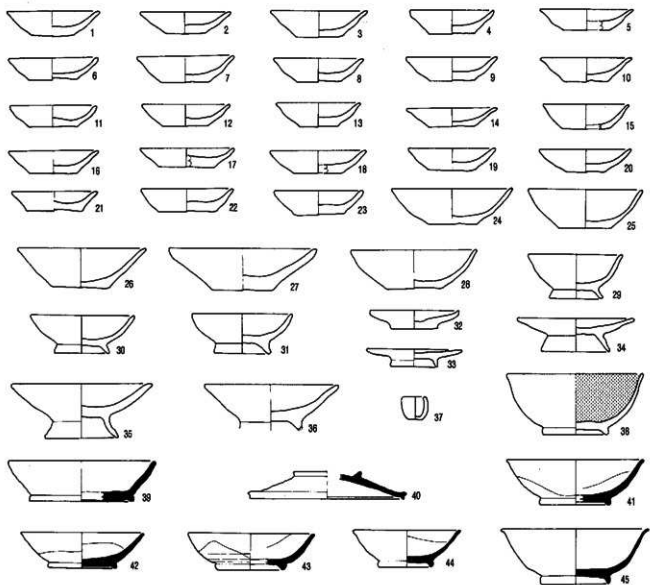

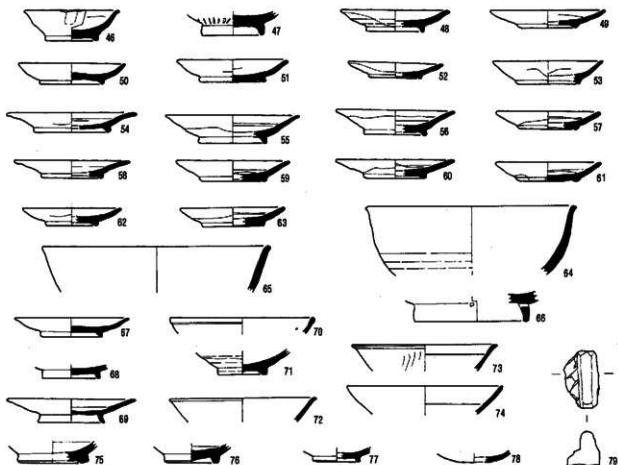

○地区 (1~129)

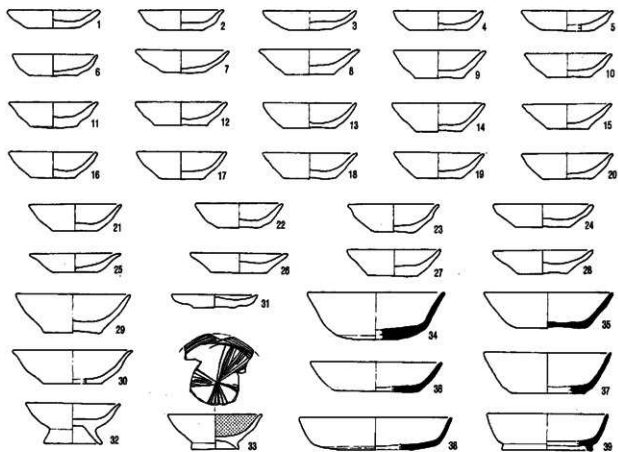

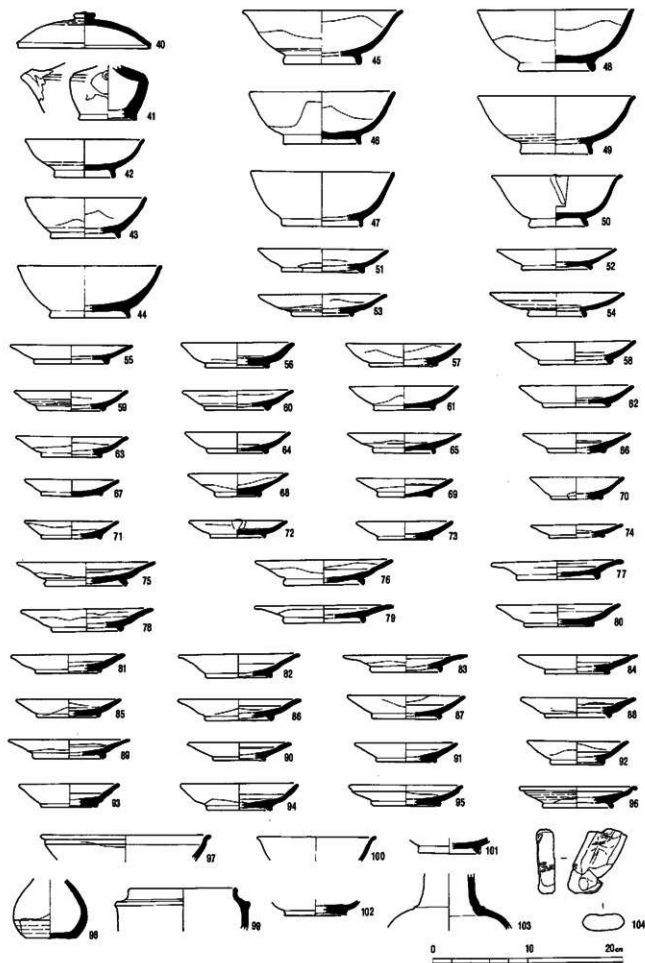

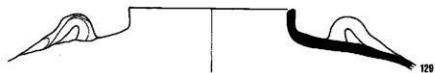
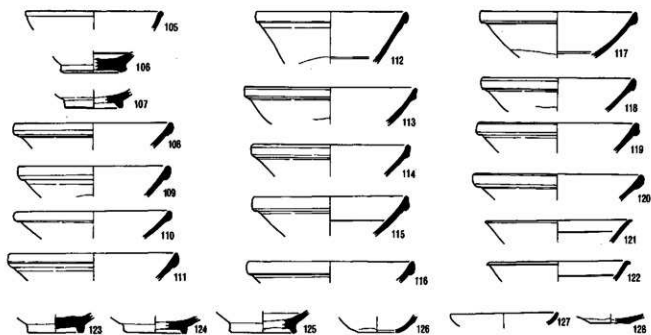

P地区 (1~7)

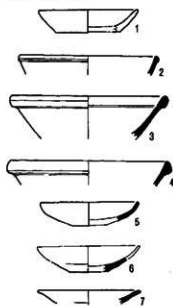

R地区 (1~10)

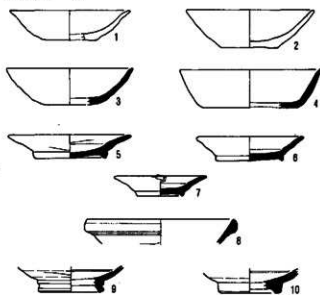

S地区 (1~44)

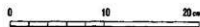
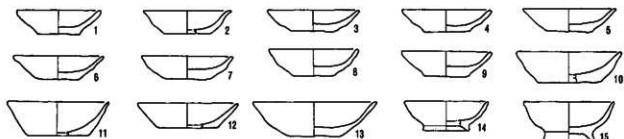

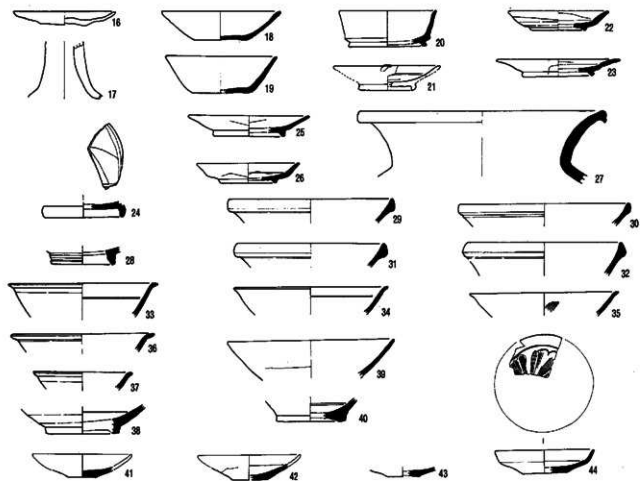

T地区 (1~7)

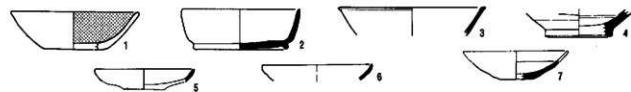

出土地点不明Z (1~20)

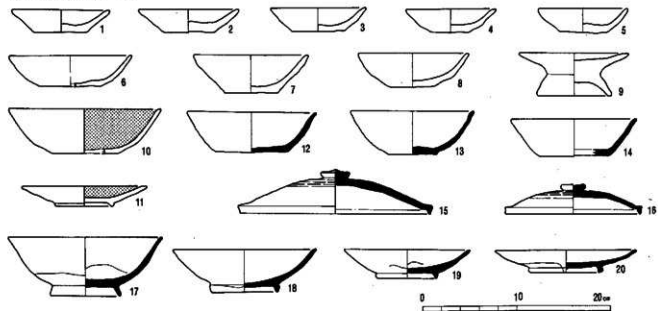

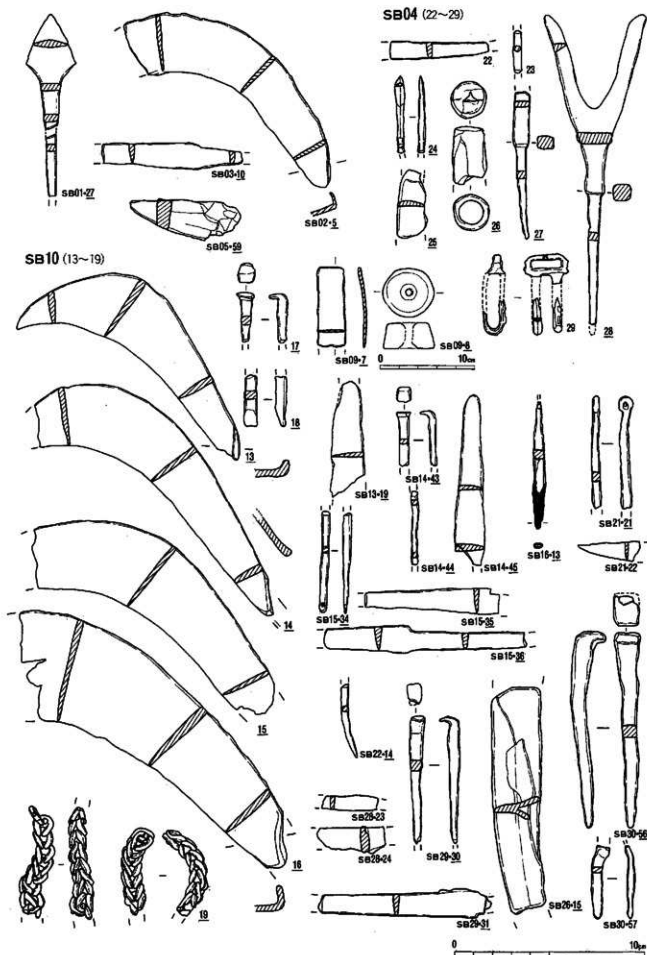

SB31 (25~34)

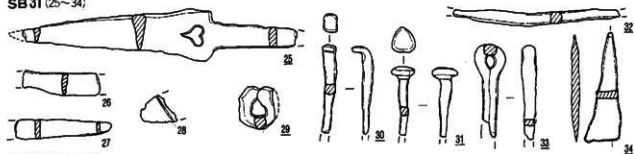

SB32 (345~393)

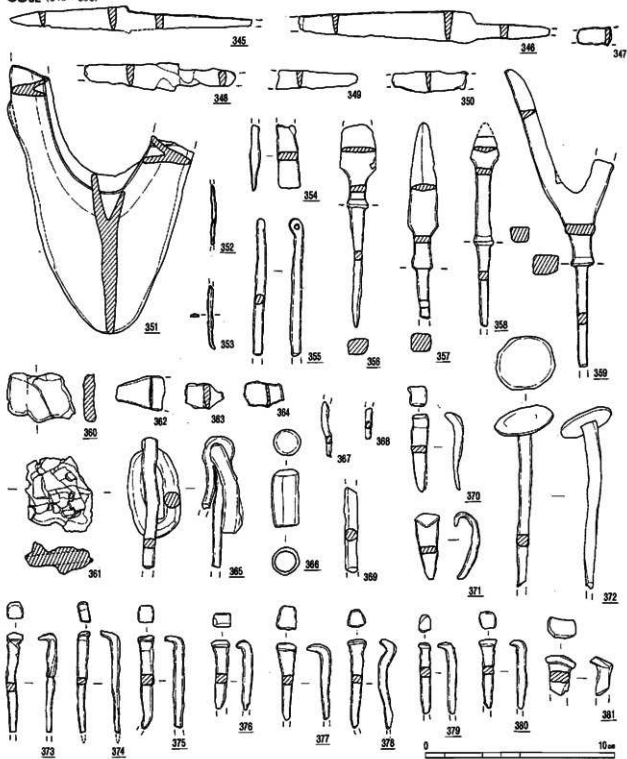

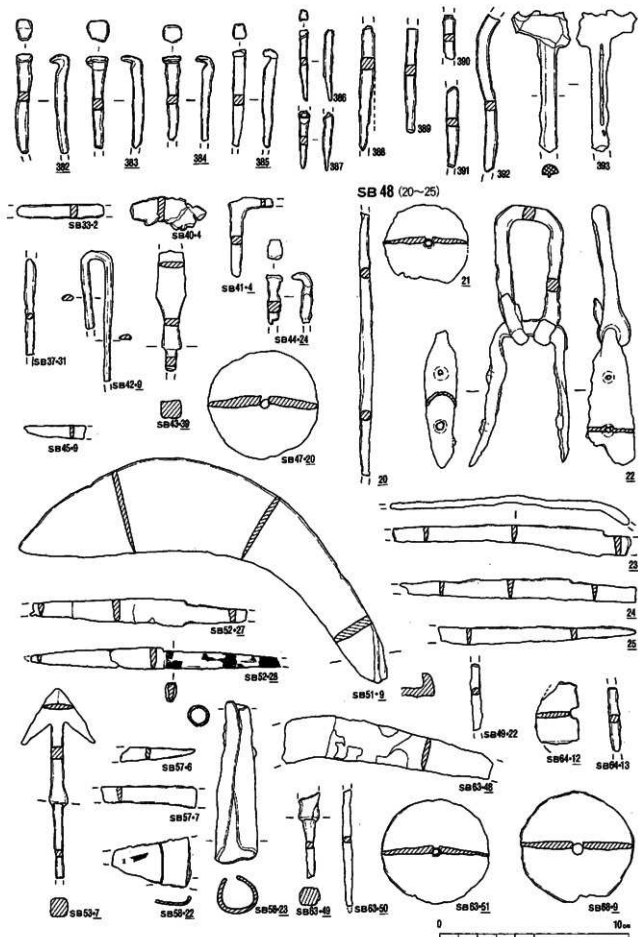

SB 66 (41~58)

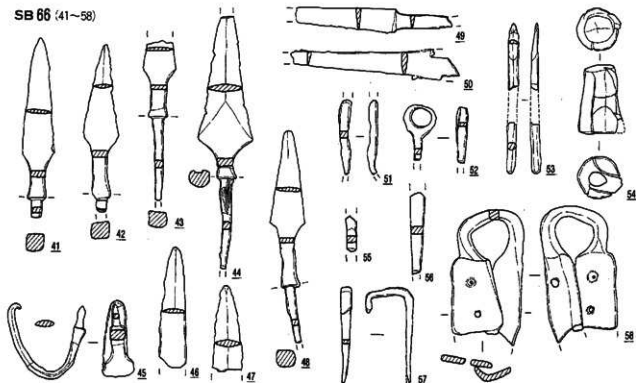

SB 69 (41~48)

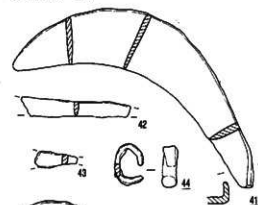

SB 71 (8~11)

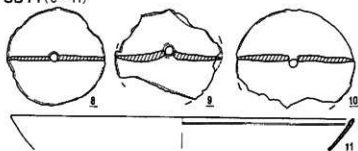

SB 72 (16.17)



SB 74 (49~56)

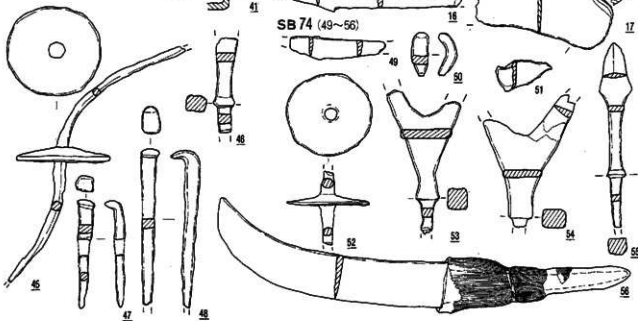

SB 78 (16~21)

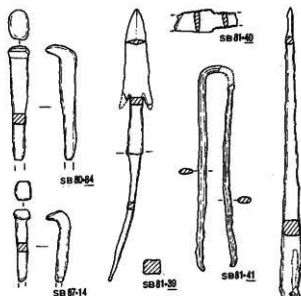
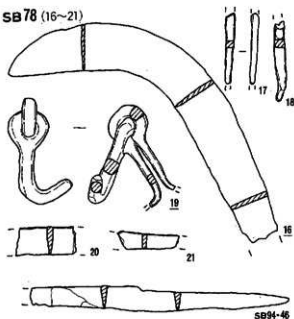

SB 86 (26~32)

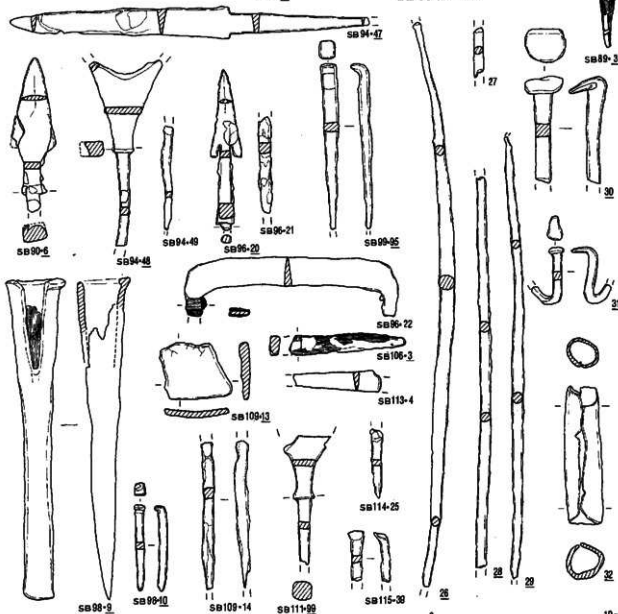

0 10cm

SB 101 (13~21)

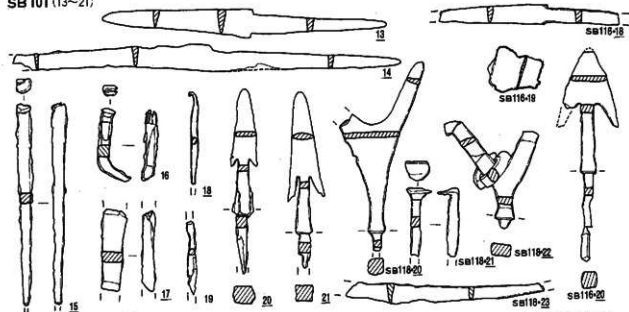

SB 129 (18~21)

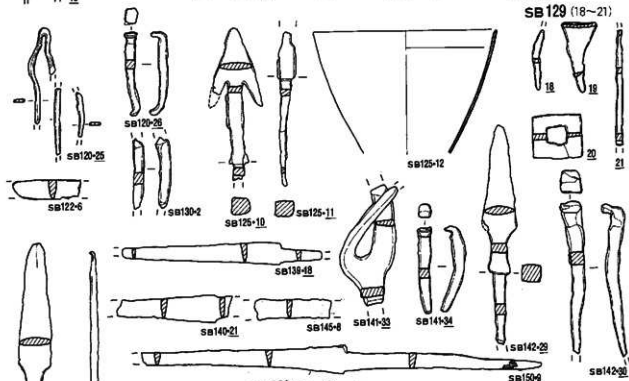

SB 163 (7~12)

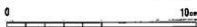
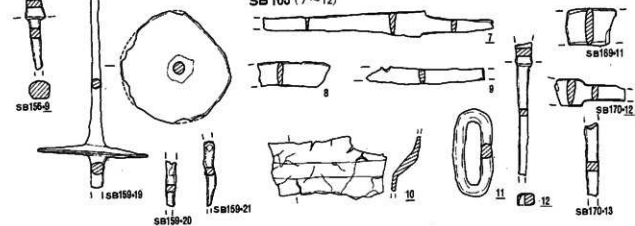

SB167 (51~55)

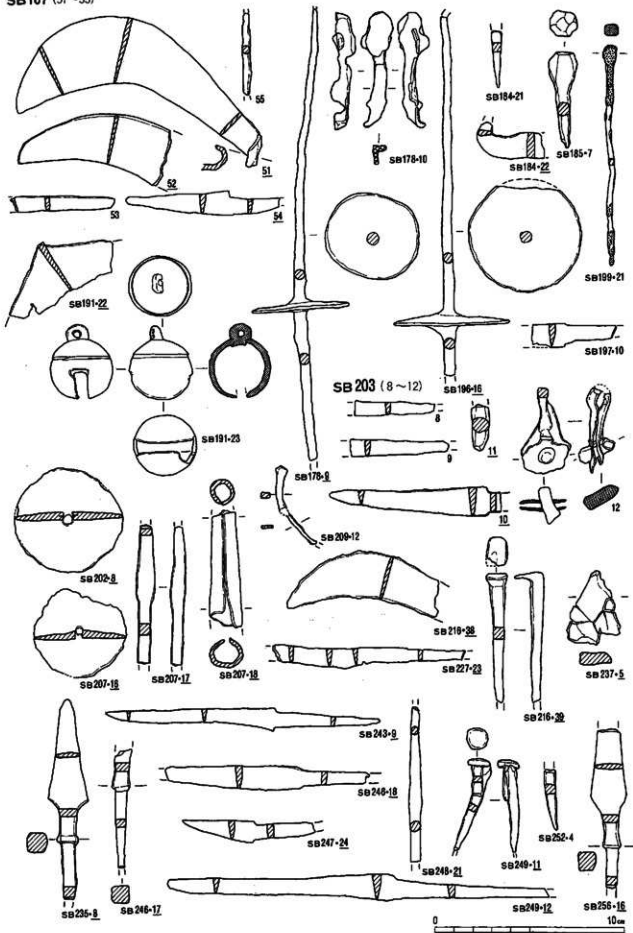

SD17 (67~73)

透博外II層
(1~92)

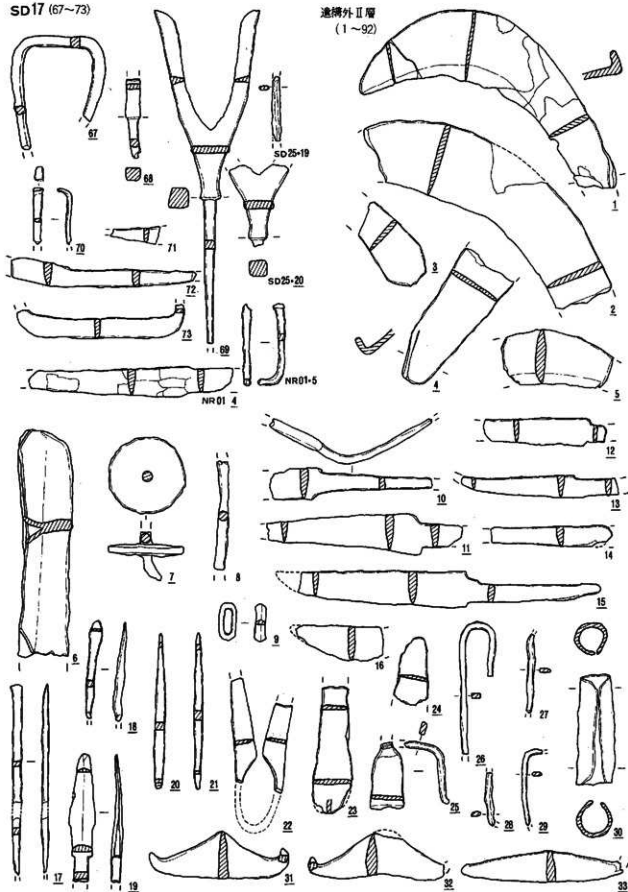

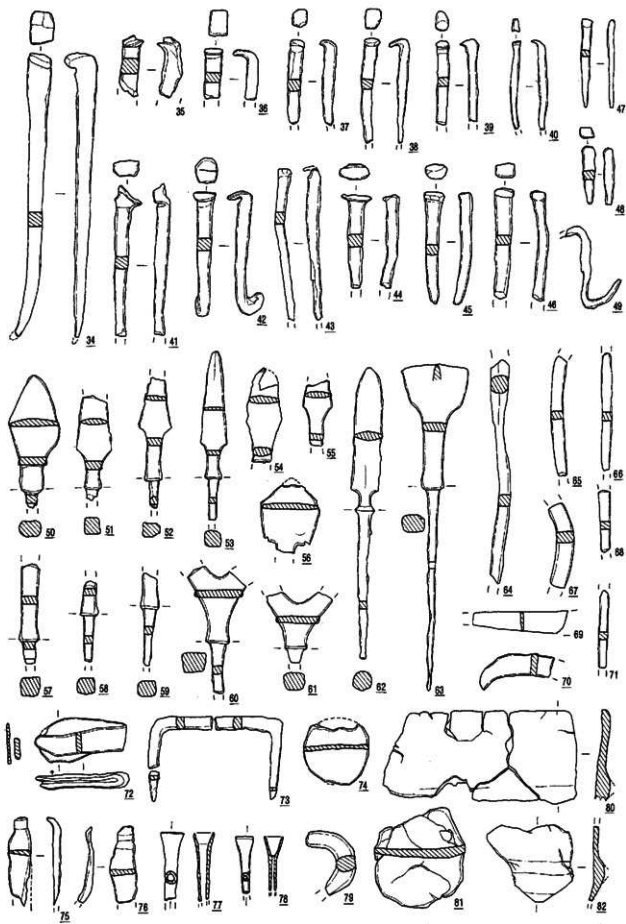

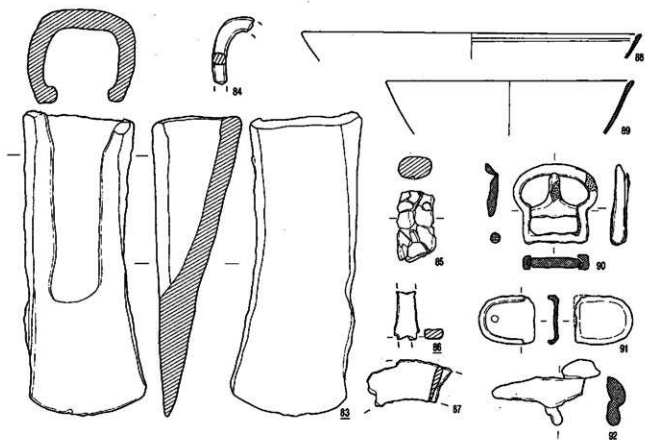

透柄外I層 (1~11)

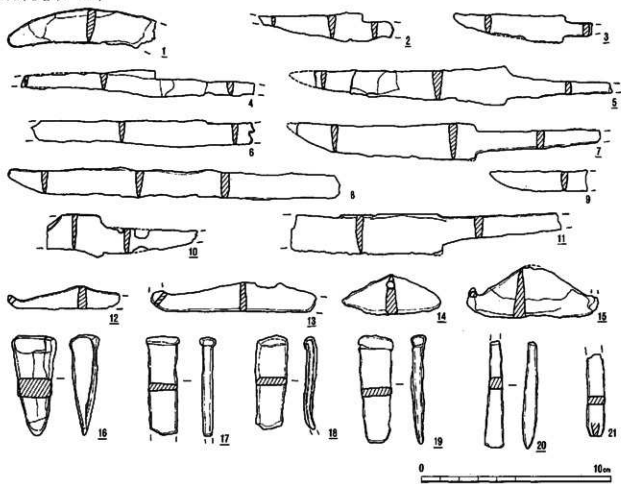

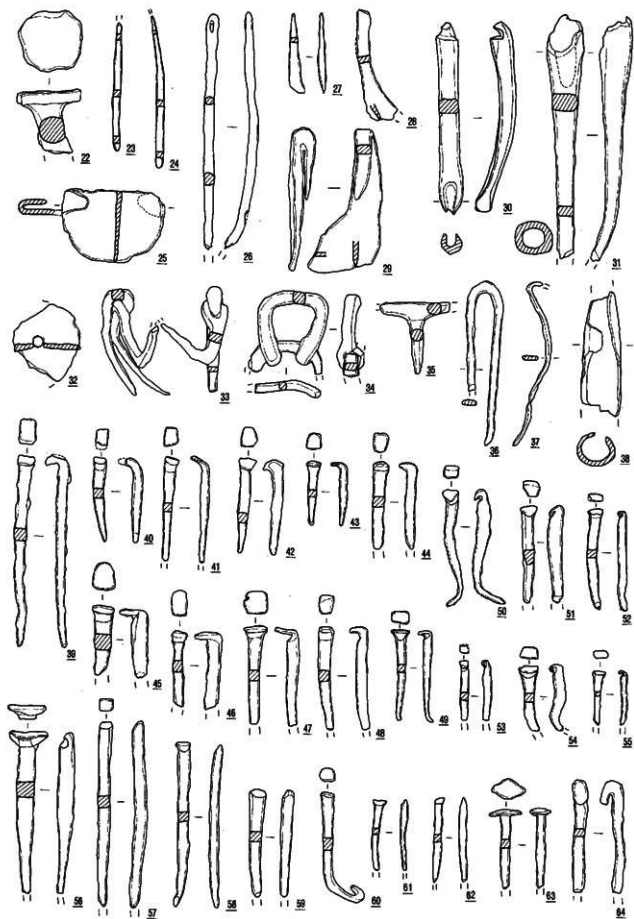

0 10cm

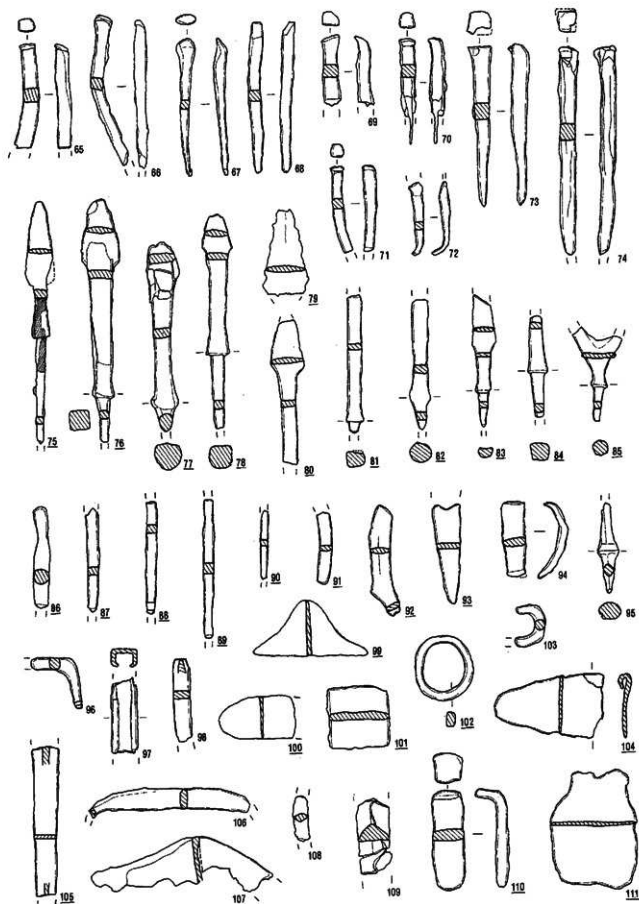

近世遺構 (1~81)

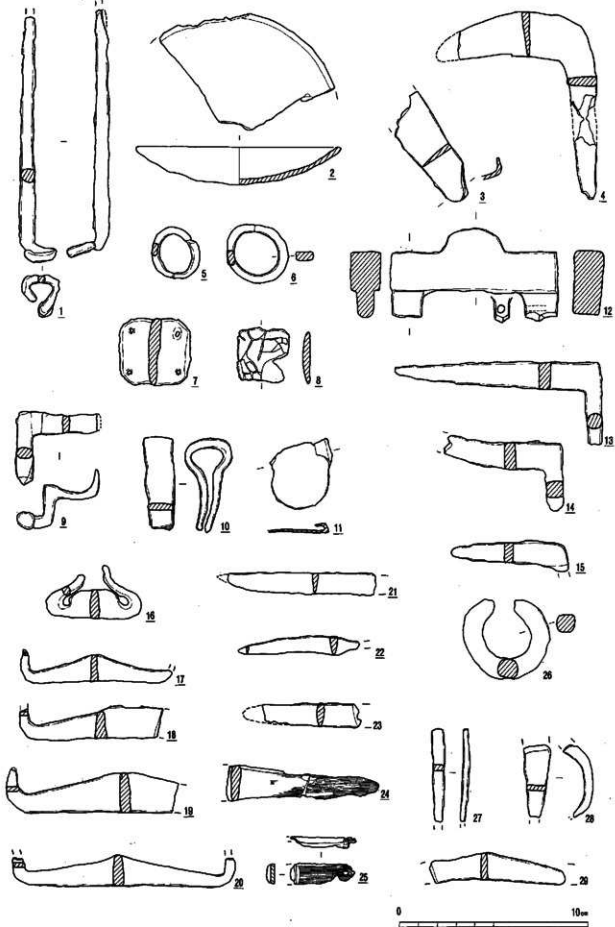

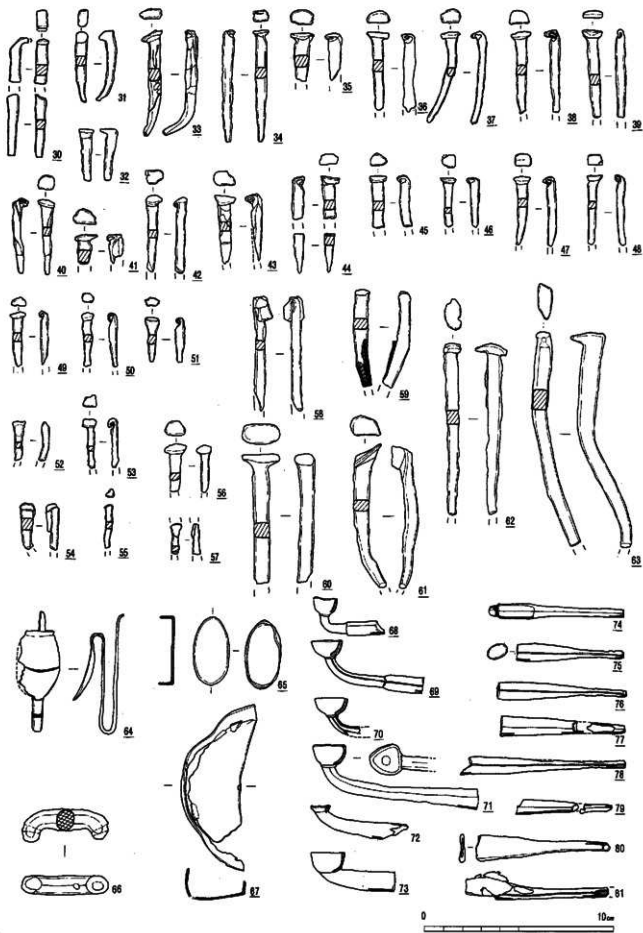

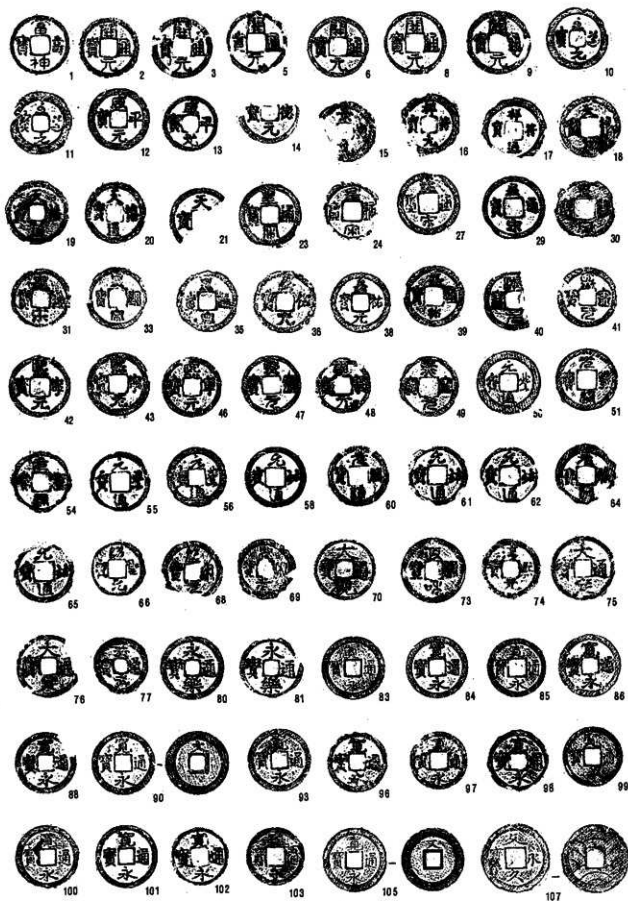

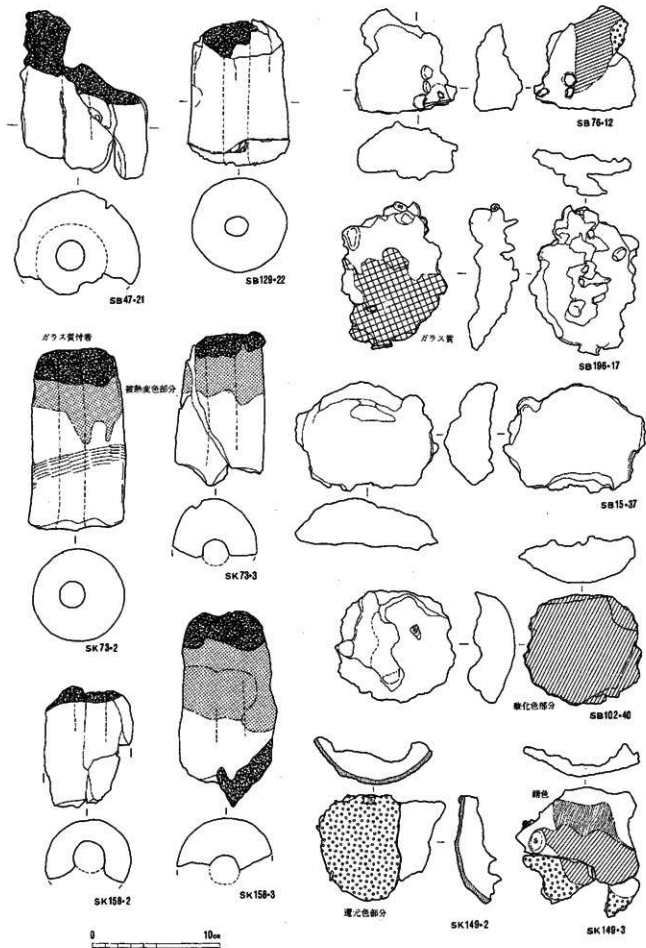

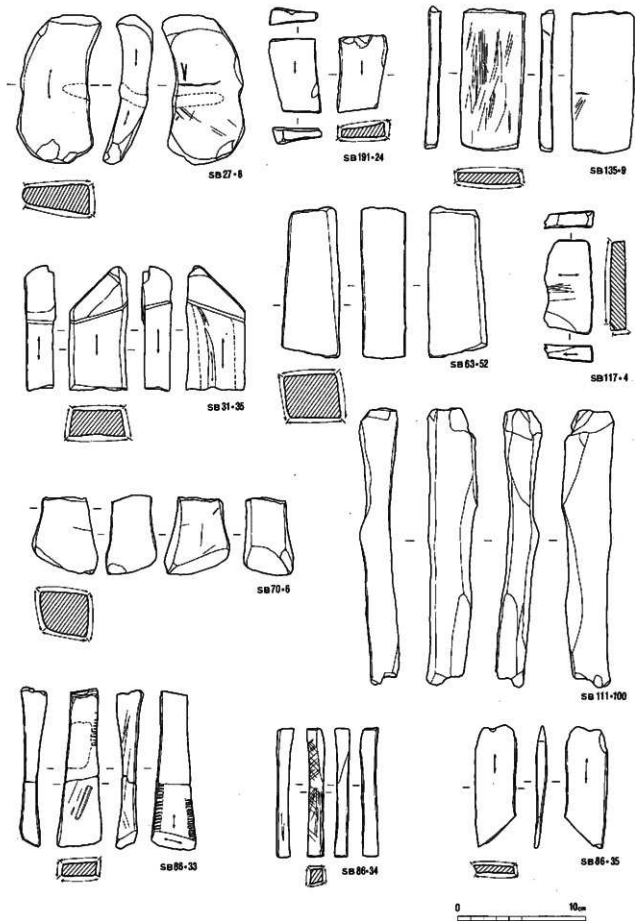

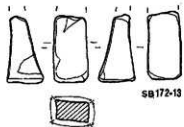
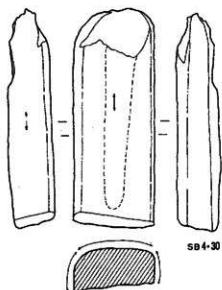

遺構外I層(1~7)

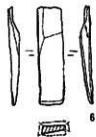
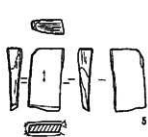
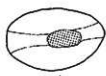
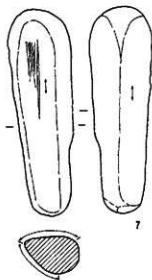
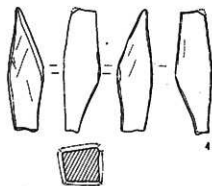
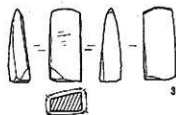
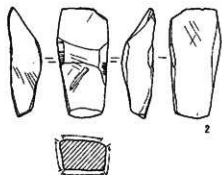
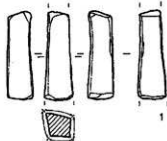
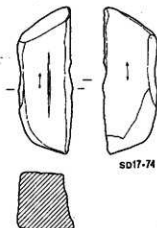

黒書土器



SB 06-1

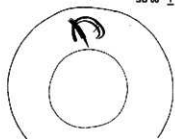

SB 06-4

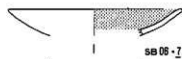
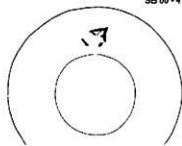

SB 06-7



SB 11-3



SB 11-4

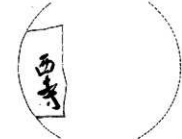

SB 17-2

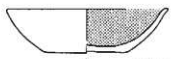
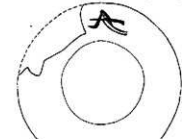

SB 17-4

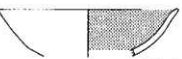
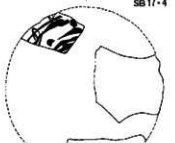

SB 17-3



SB 20-5



SB 25-1

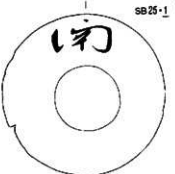

SB 25-4



SB 26-4

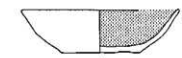

SB 26-1

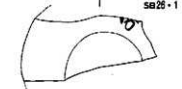

SB 20-6



SB 20-7



SB 26-13

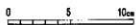

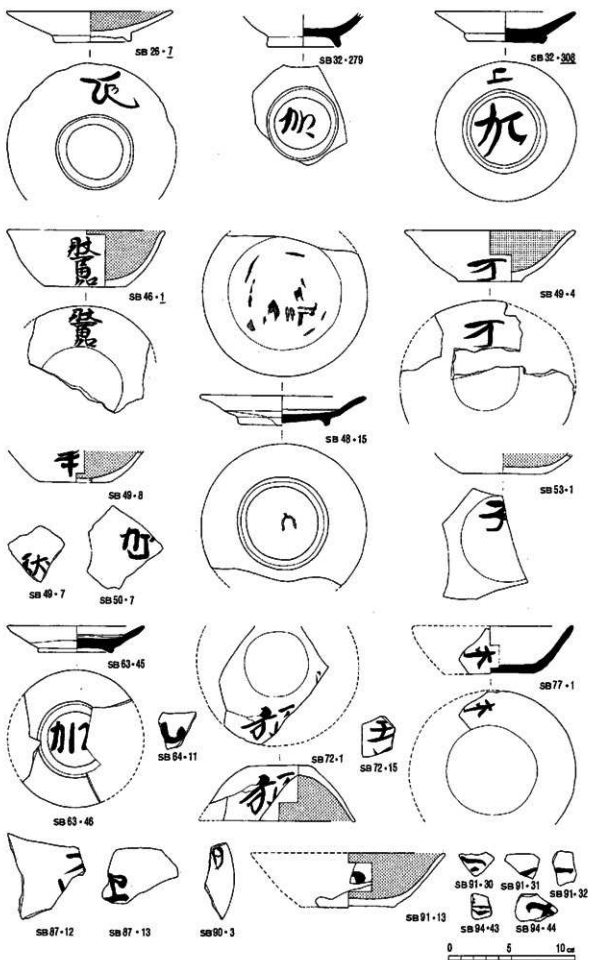



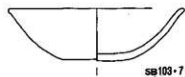

SB 103-7

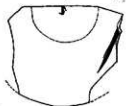

SB 103-19



SB 103-20



SB 111-1

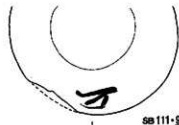

SB 111-2



SB 111-12



SB 111-15



SB 111-18

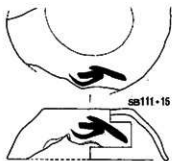

SB 111-25

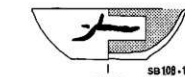

SB 108-1



SB 110-4



SB 110-12

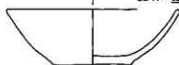

SB 110-24

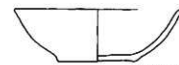

SB 111-14



SB 111-18

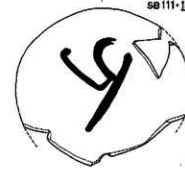
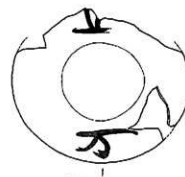
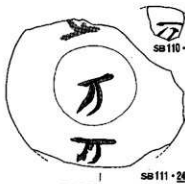
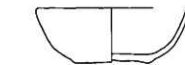

0 5 10 cm

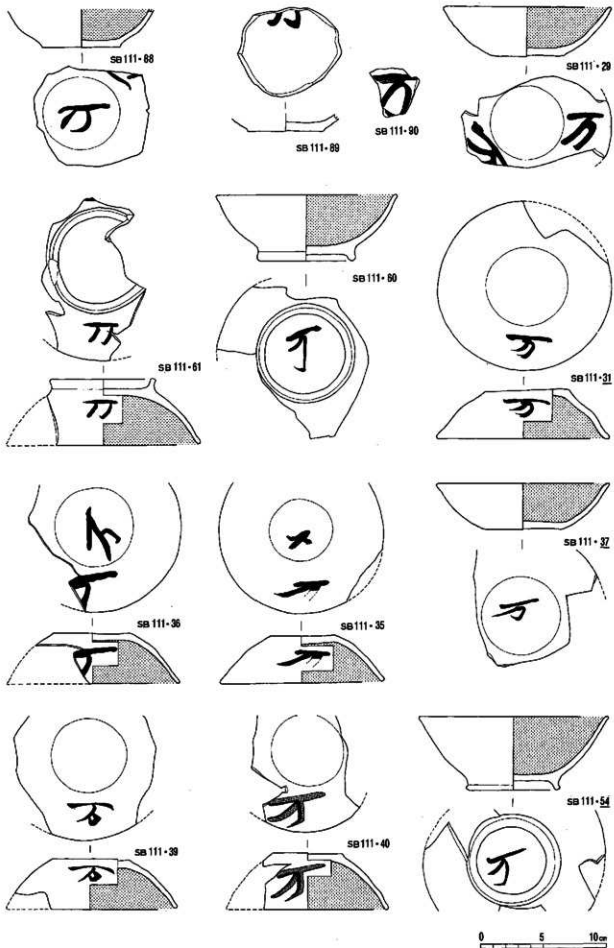

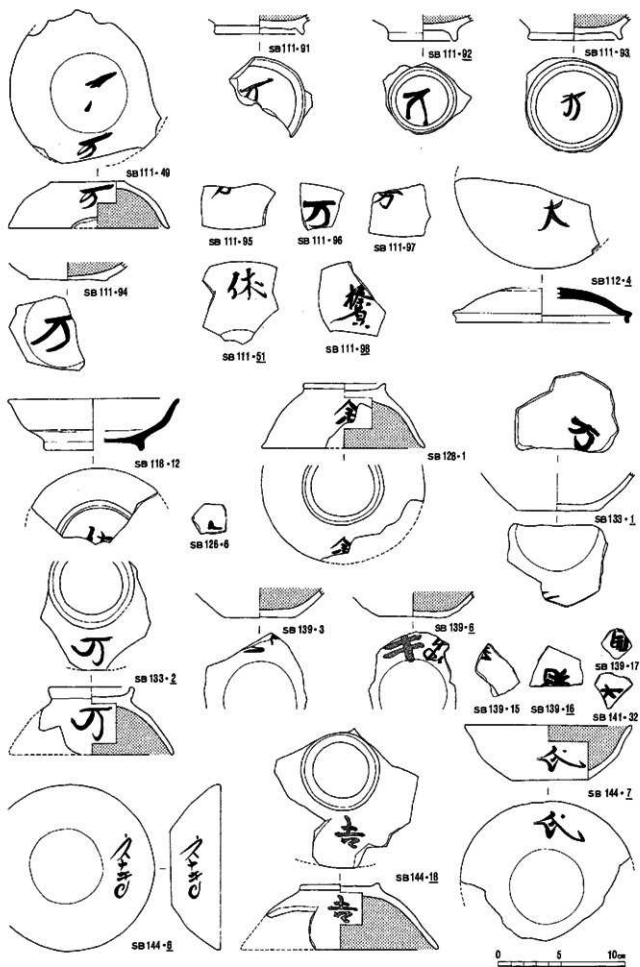

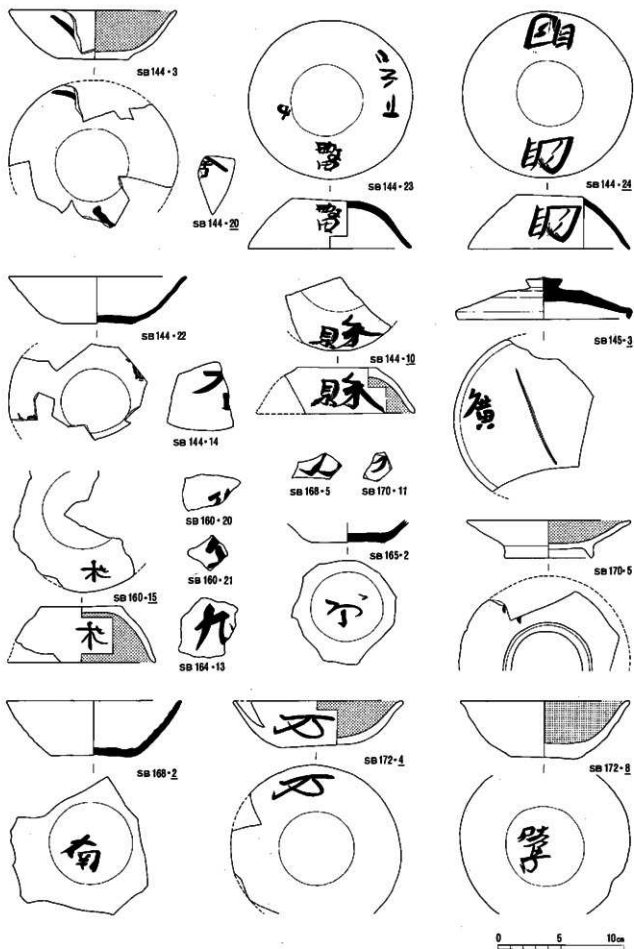

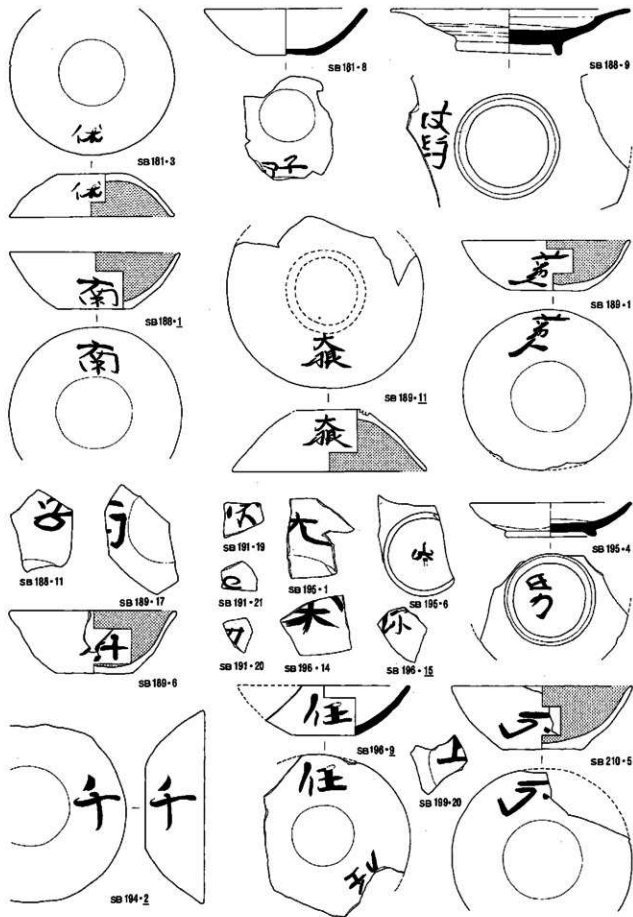

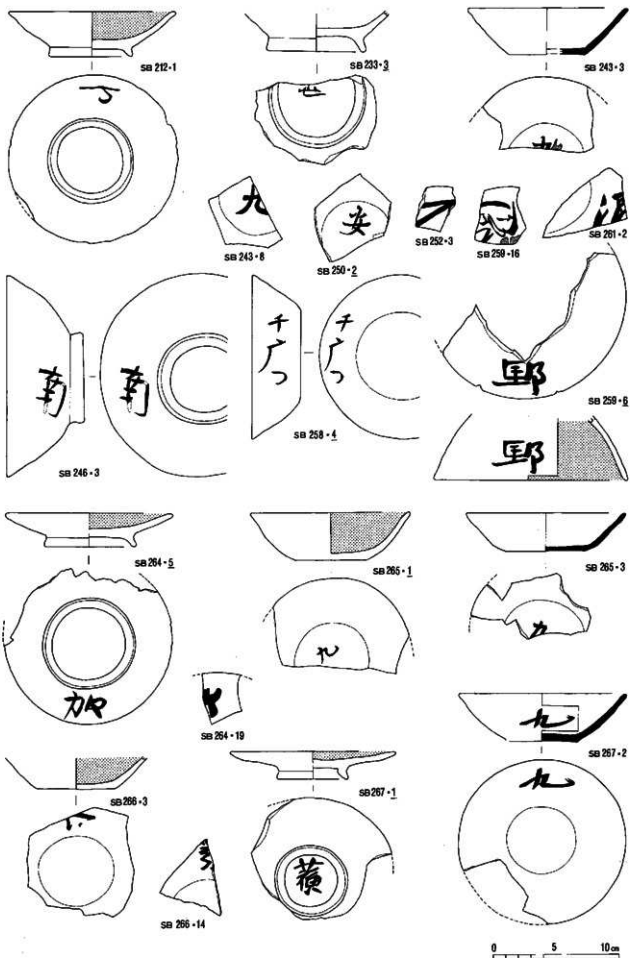

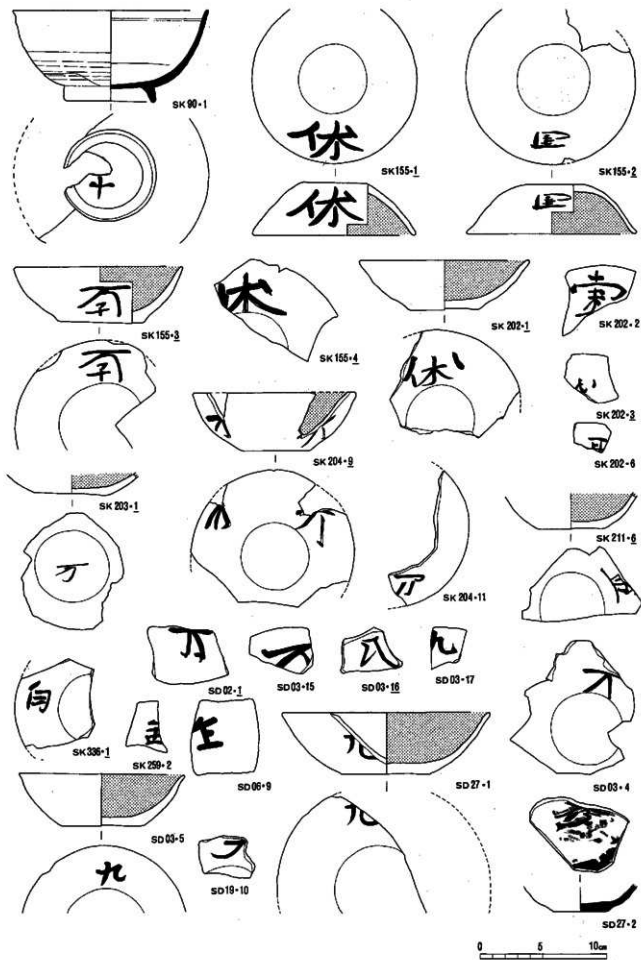

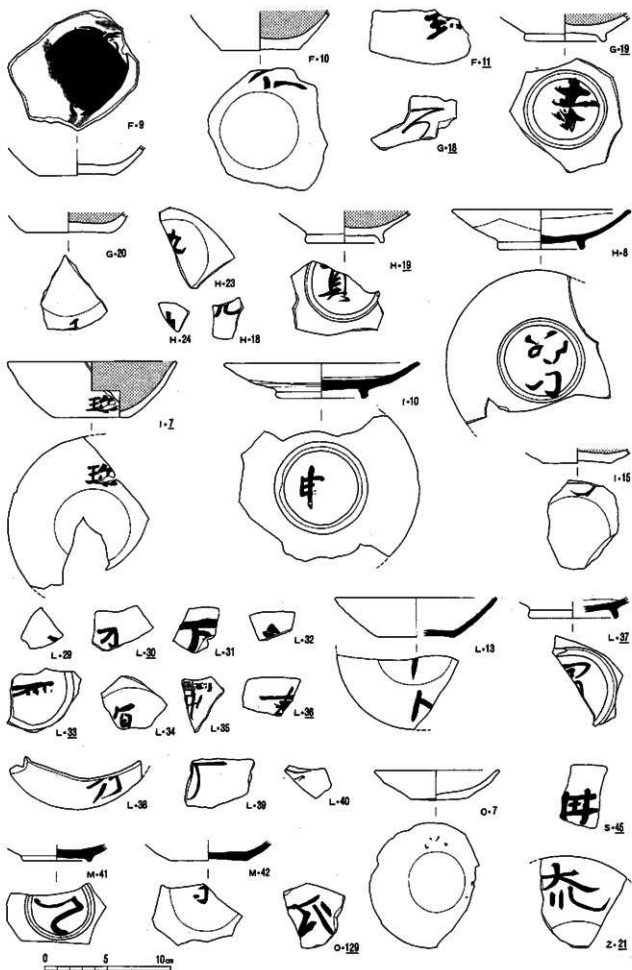

刻書土器

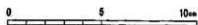
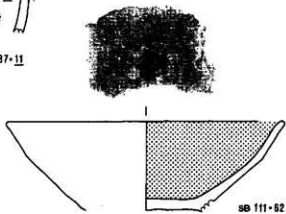
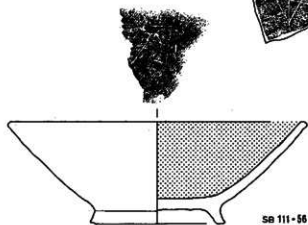
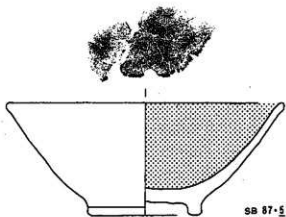
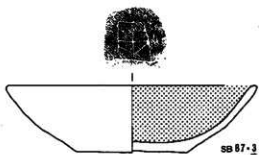
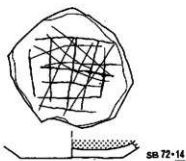
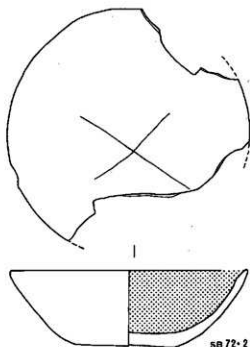
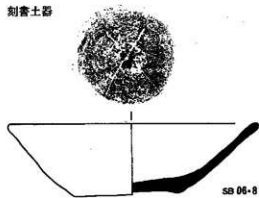

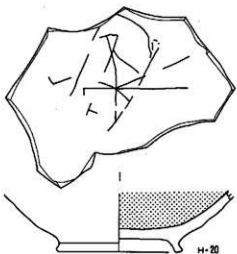
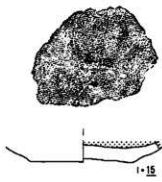
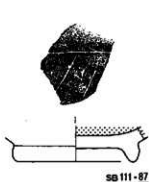
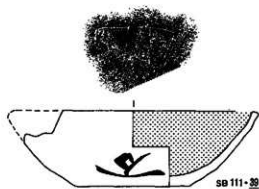

施書土器

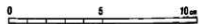
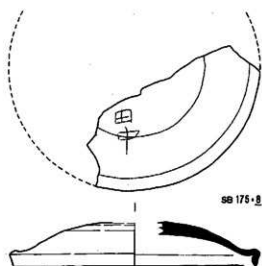
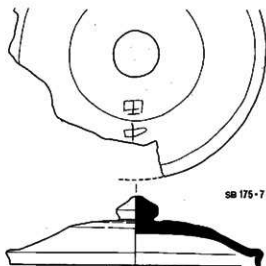
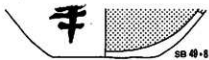



sb 199-18



sb 199-19

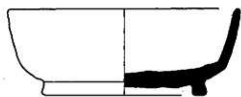

SK 254-1



sb 17-66



G-21



S-46

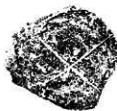

T-2

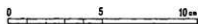
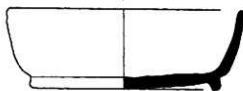

筆 硯

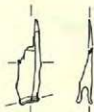

sb 32-335

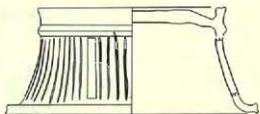

o-135

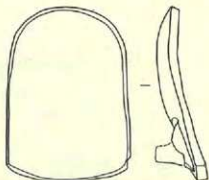

o-134

板用硯



sb 16-7

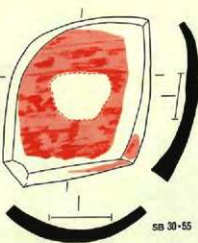

sb 30-55



sb 32-285



sb 32-283

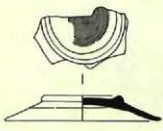

sb 32-311



sb 32-342



sb 32-343



sb 32-344

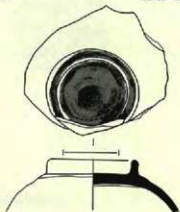

sb 30-3



sb 58-15

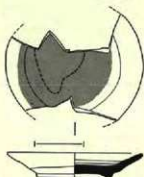

sb 83-45

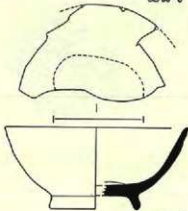

sb 86-33

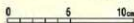



SB 73・7

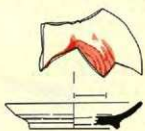

SB 76・11

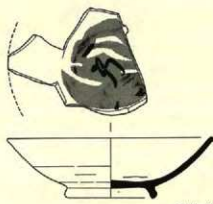

SB 91・20

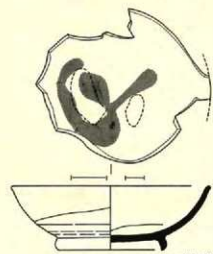

SB 103・12

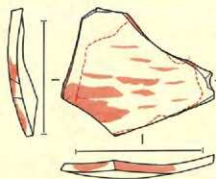

SB 74・48

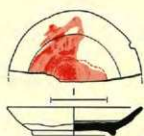

SB 86・23



SB 94・45



SB 96・10

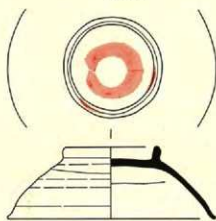

SB 110・9



SB 78・15

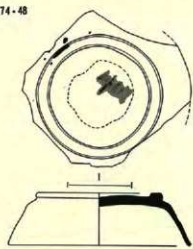

SB 87・8

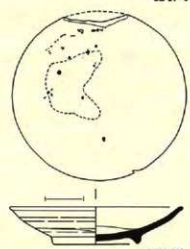

SB 102・28



SB 114・24

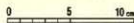

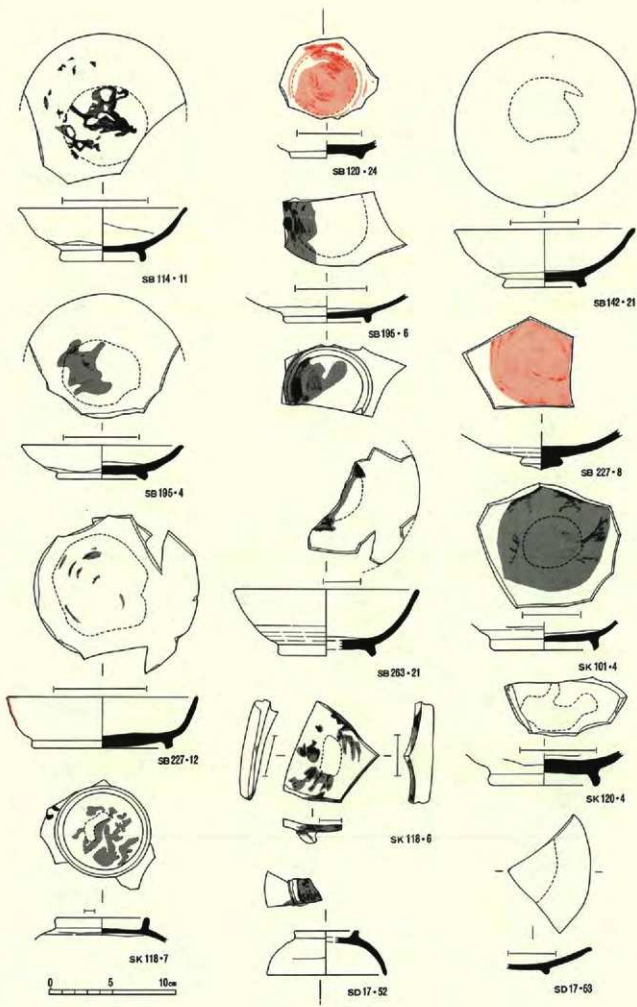

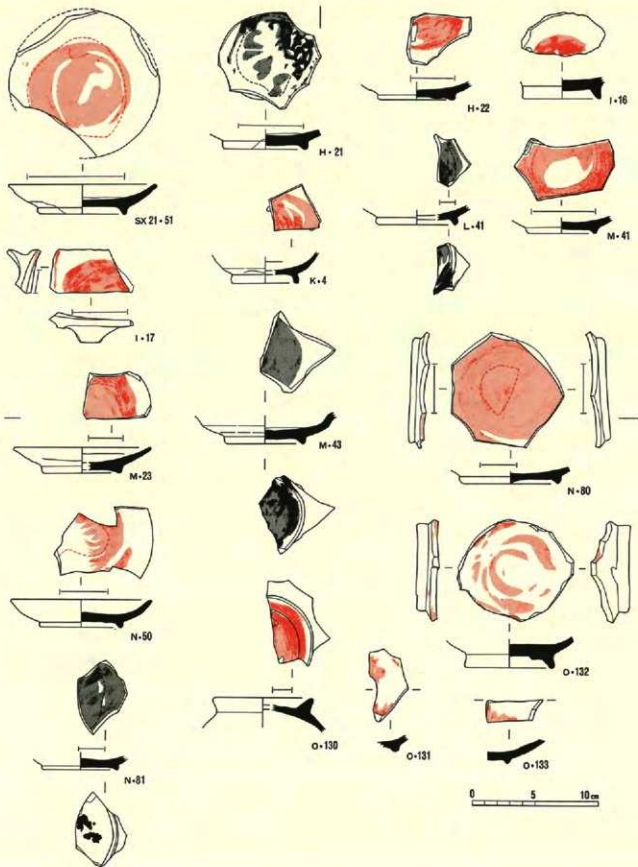

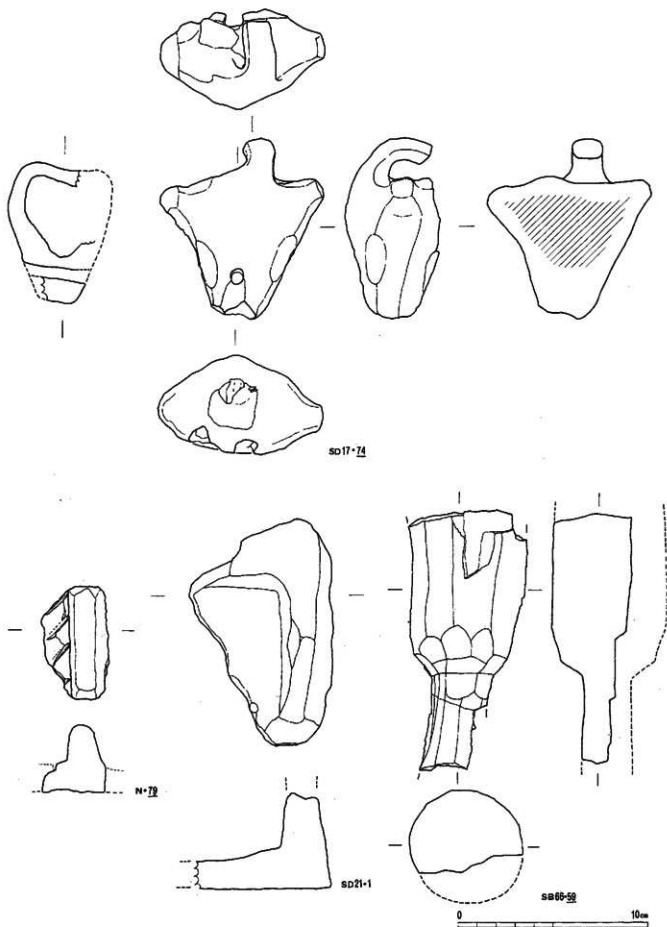

SK 1136 (1)

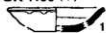

SB 1148 (1)



SK 1178 (1.2)



SK 1221 (1.2)



SK 1249 (1)



SB 1179 (1.2)



SK 1141 (1)

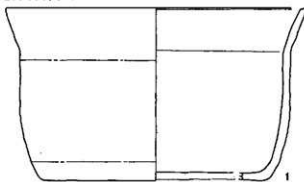

SK 1182 (1)

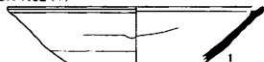

SK 1153 (1)

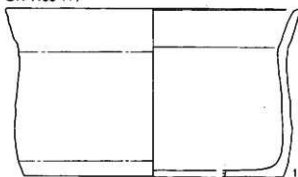

SK 1217 (1)

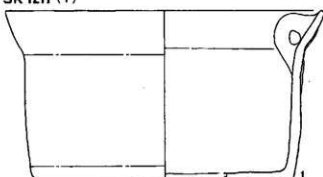

SK 1190 (1~6)

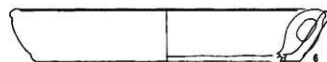

SD 04 (1~6)



SD 30 (1~5)

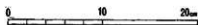

SX 08 (1~5)

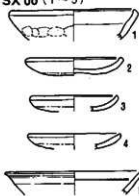

SK 1244 (1~4)

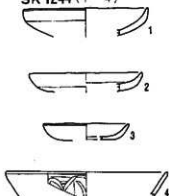

SB 255 (1)

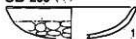

SK 1208 (1)



SK 1241 (1)



SK 1240 (1)



SK 1188 (1)

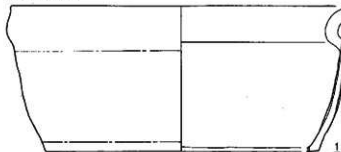

SK 1174 (1)



SK 1196 (1)



SX 22 (1, 2)



SK 2013 (1~6)



SK 2014 (1)



SK 2007 (1)



SD 21 (1~9)

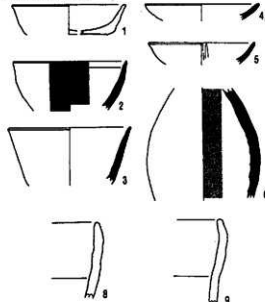

ST 03 (1, 2)



SD 17 (1)



SD 02 (1, 2)

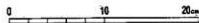

SD 32 (1)

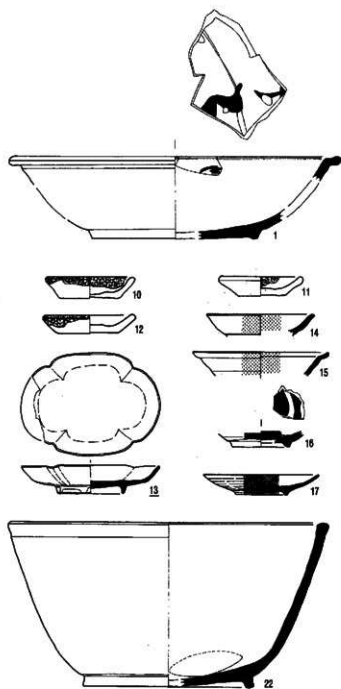

SX 2023 (1~25)

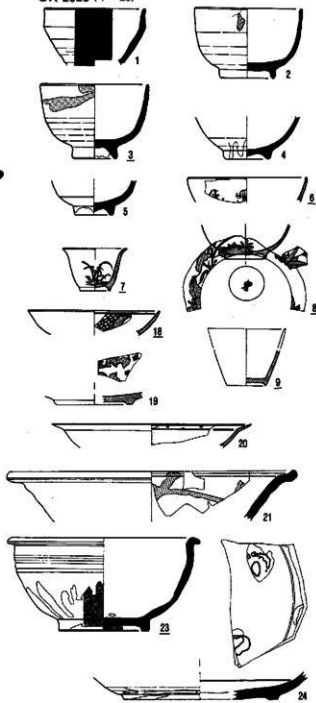

SX 2020, 2021 (1~27)

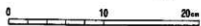
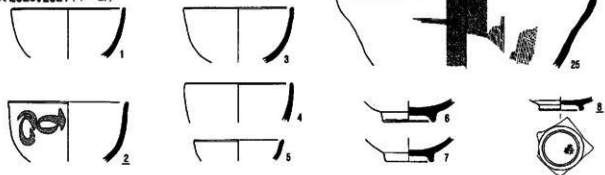

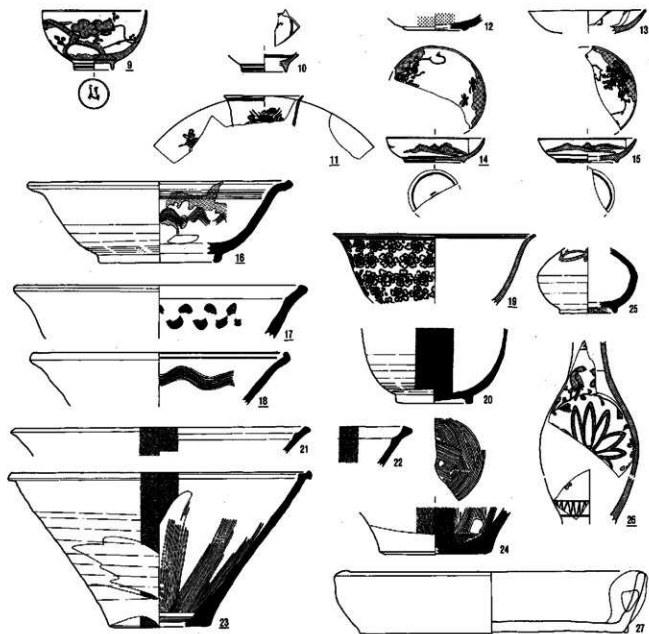

SK 2005 (1~8)

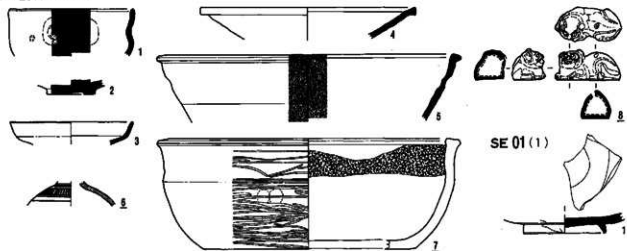

SE 01 (1)

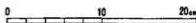
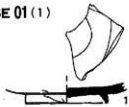

遺構外Ⅱ層 (1~36)

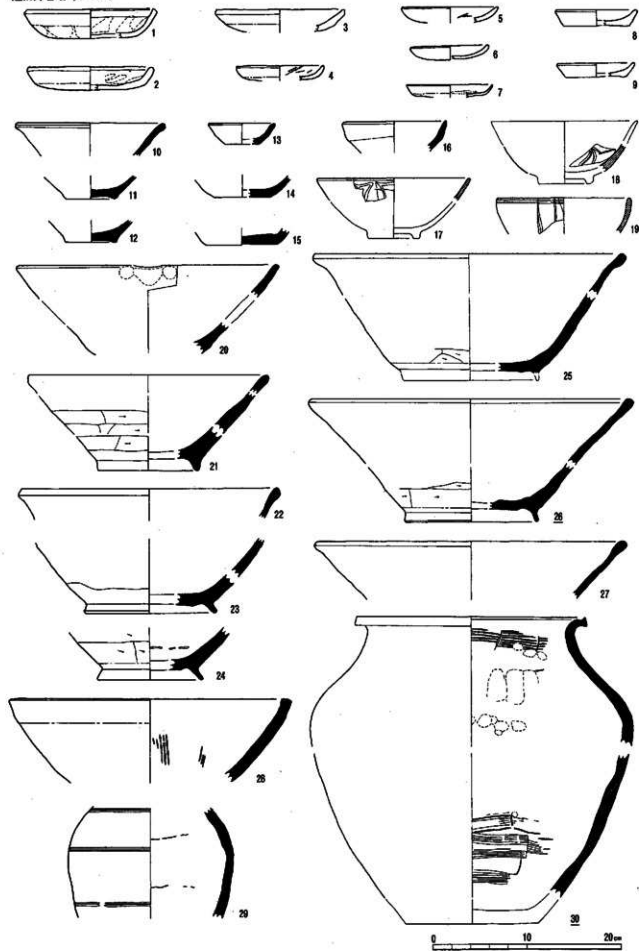

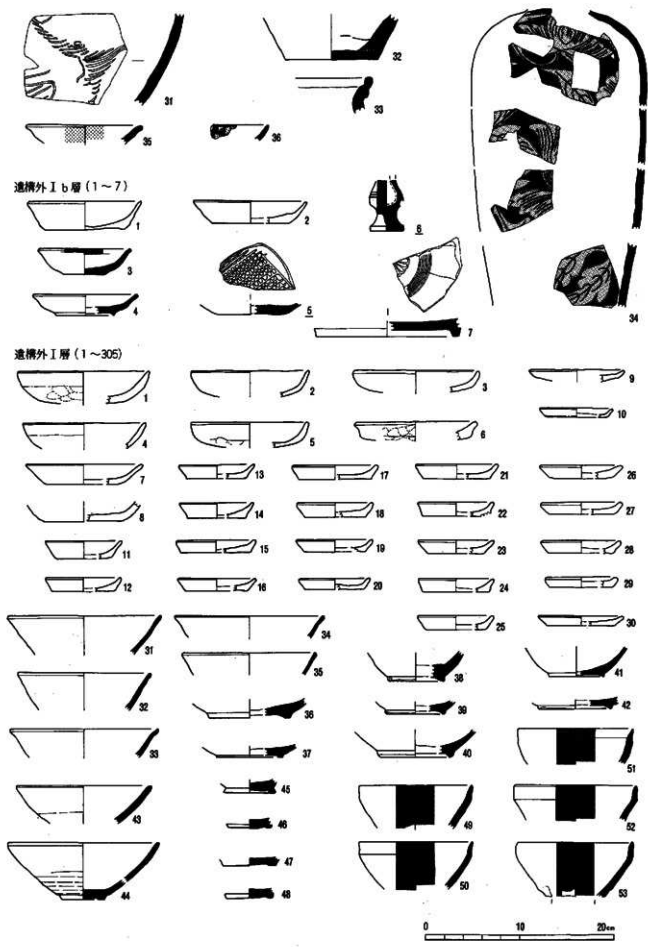

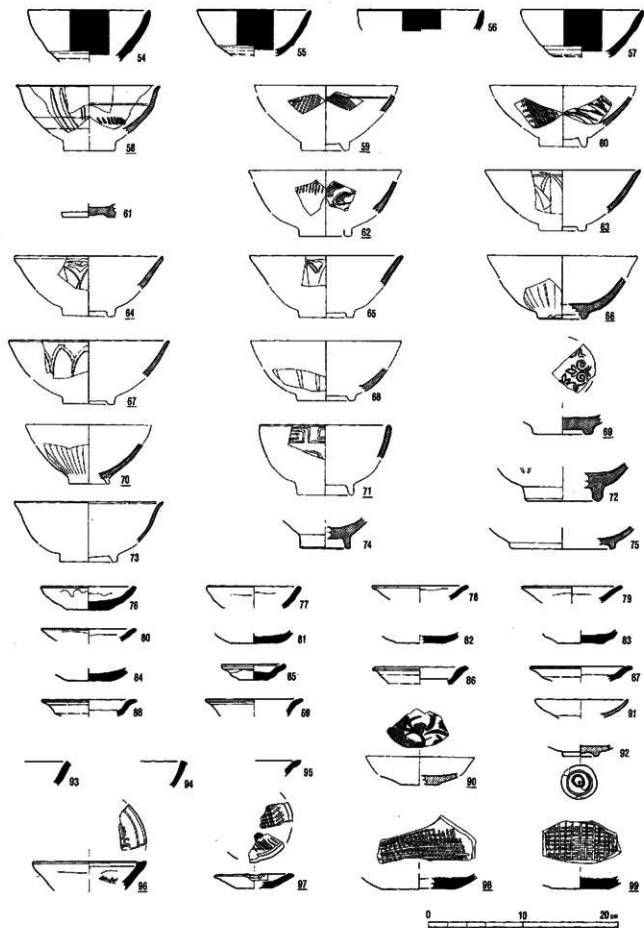

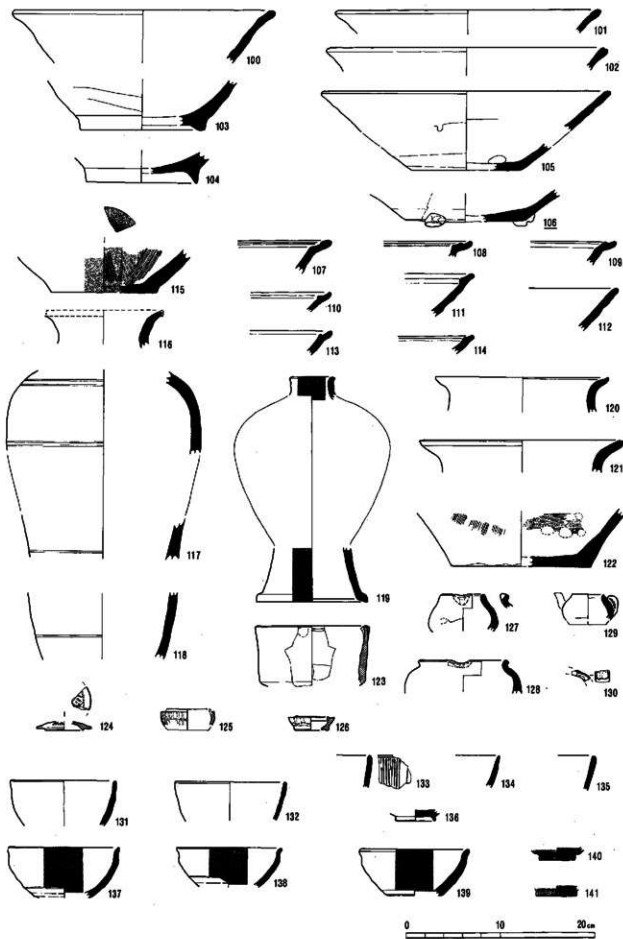

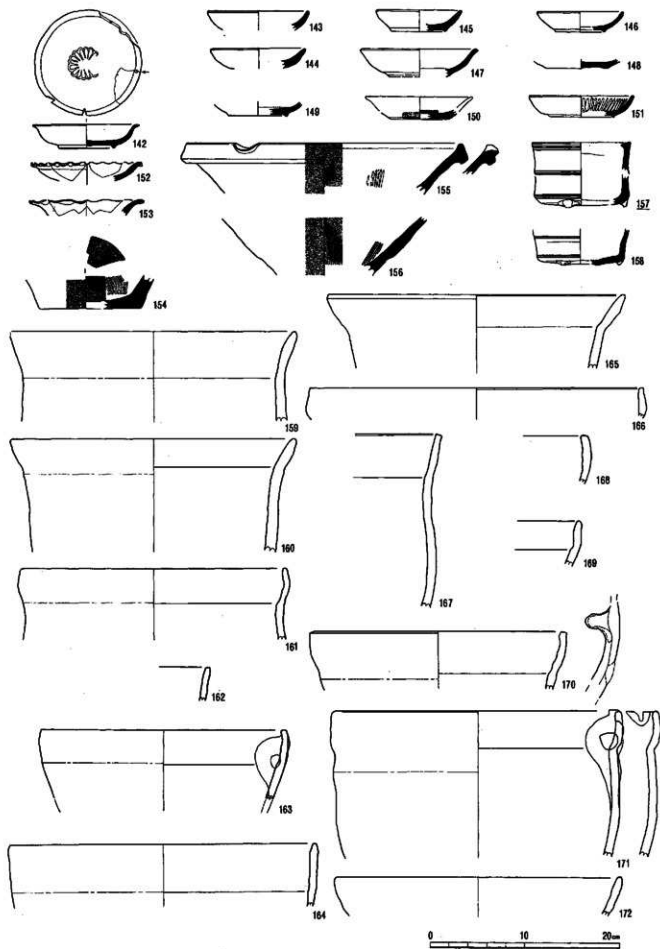

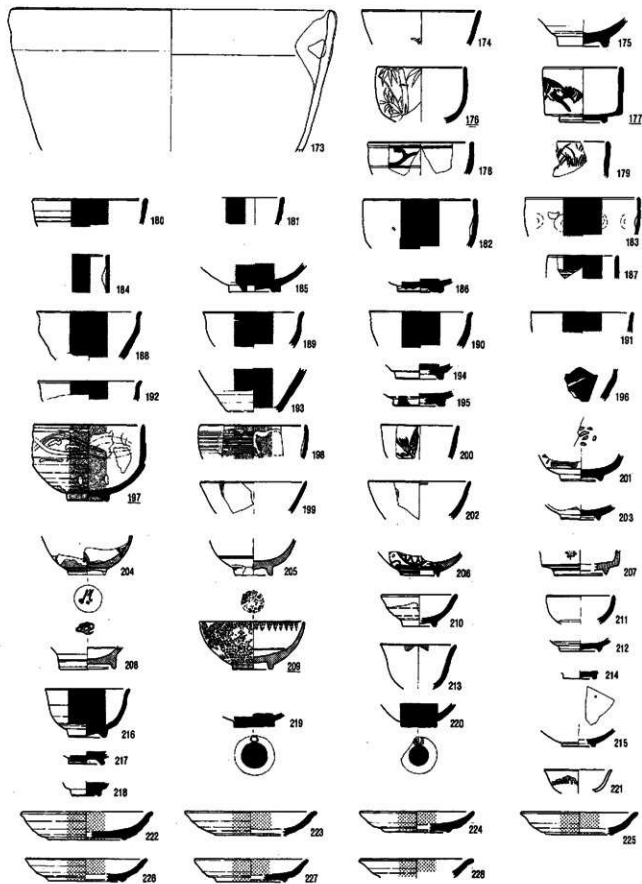

0 10 20 cm

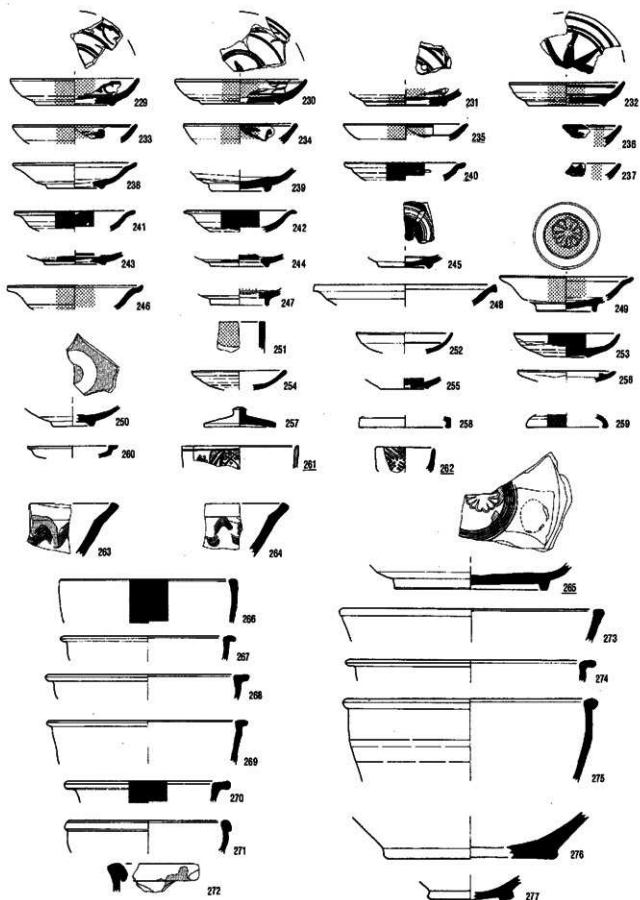

0 10 20cm

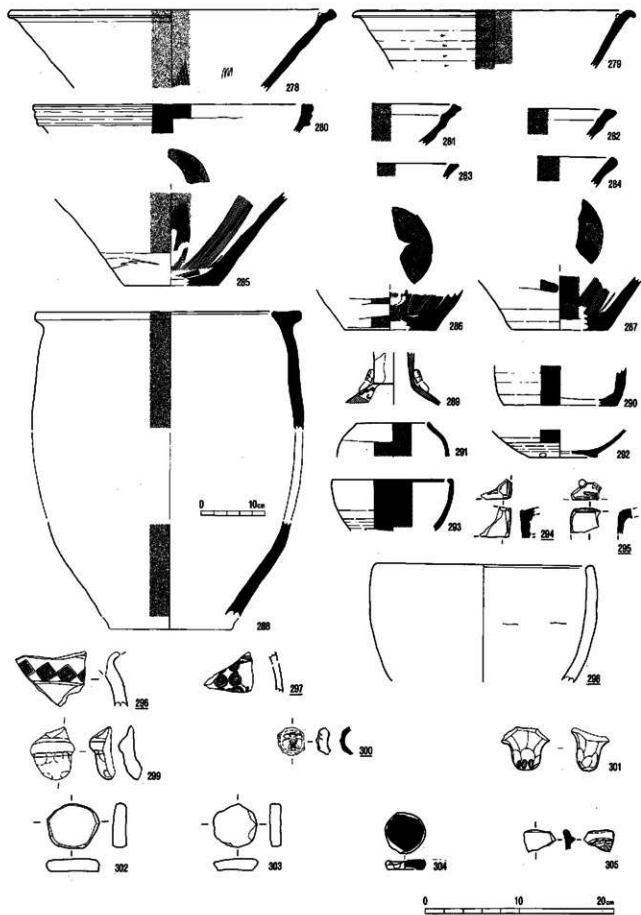

近世整地土層 (1~69)

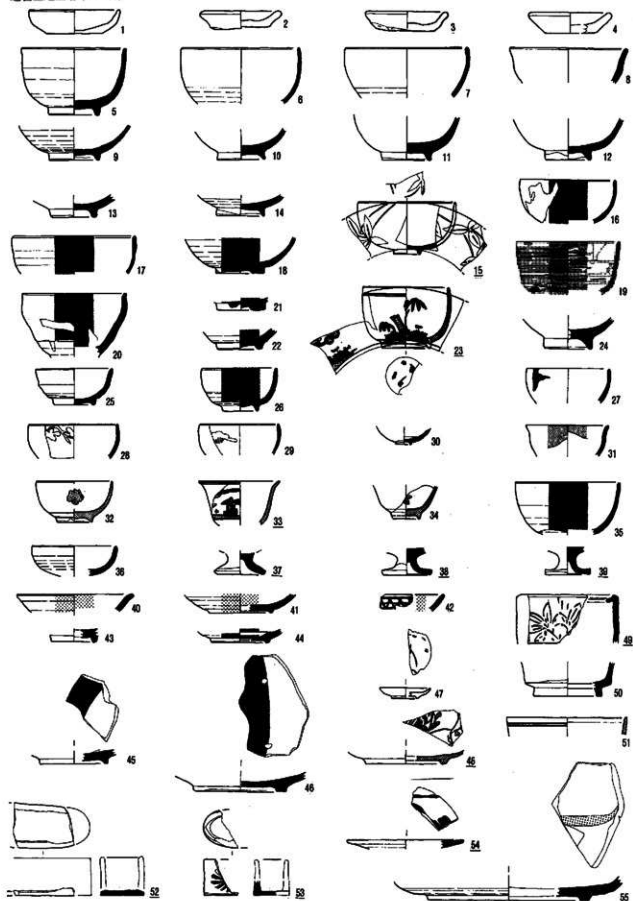

0 10 20cm

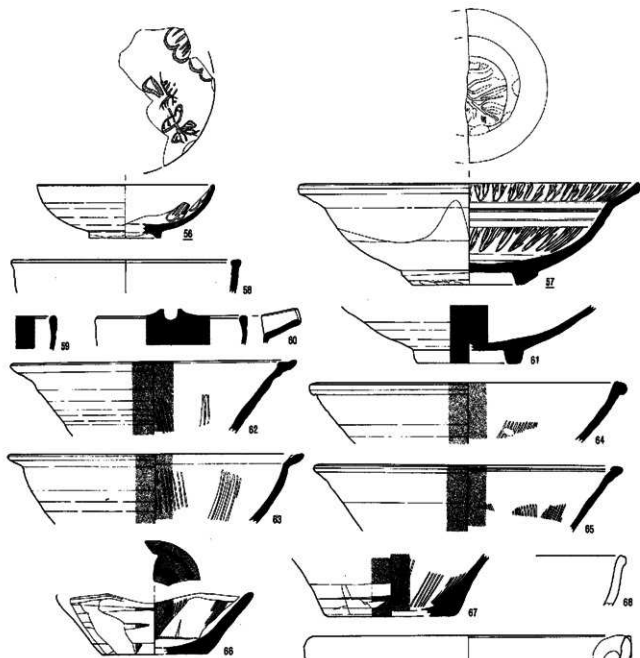

石製品

SX 2023 (1)



遺構外I層 (1~4)

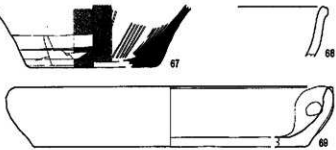

0 10 20cm

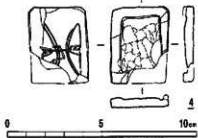

近世整地土層

(1, 2)

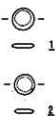

SX 22 (1)

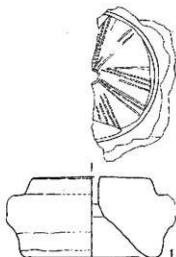

SK 1221 (1)

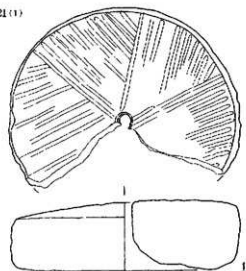

透視外 (1~22)

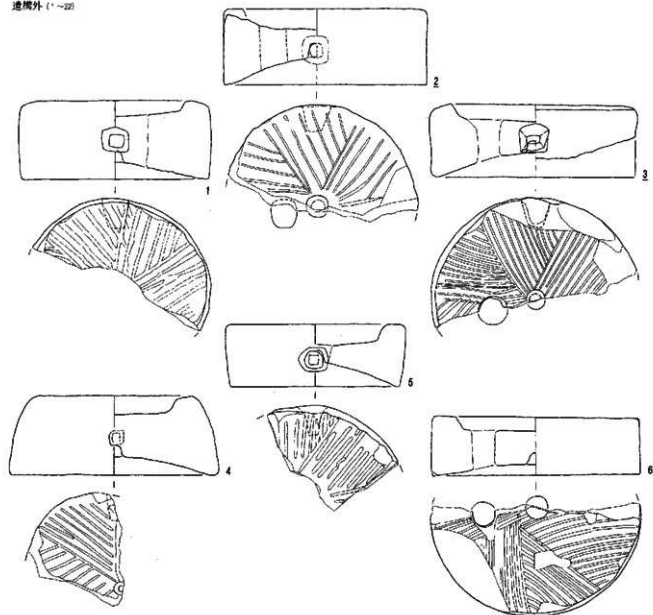

0 10 20 cm

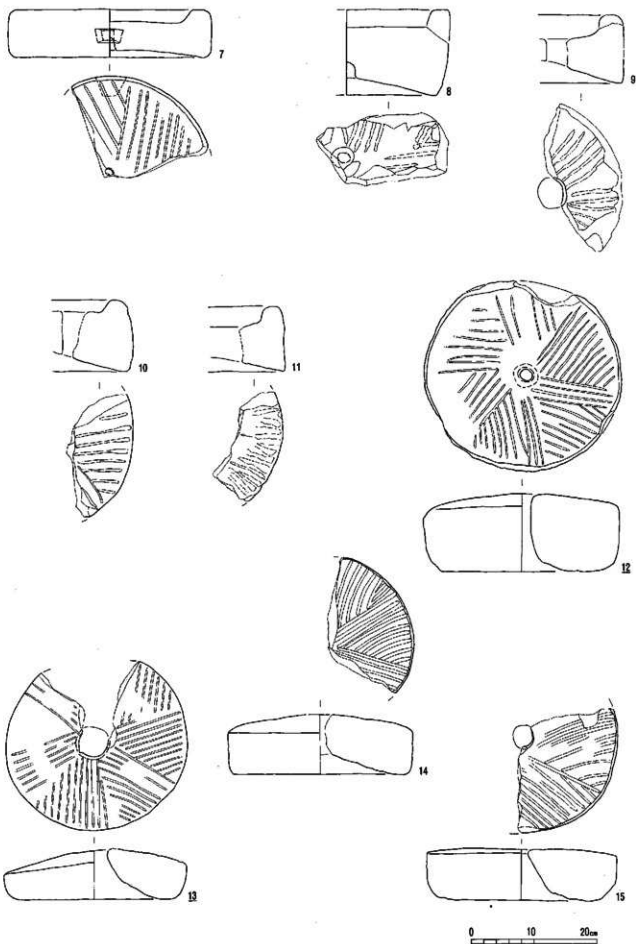

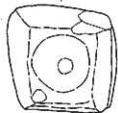
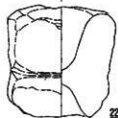
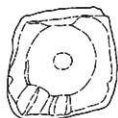
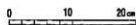
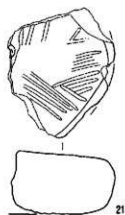
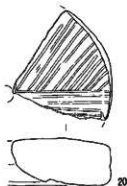
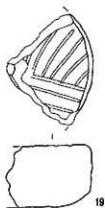
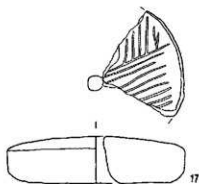
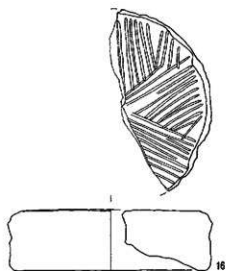

写真図版
(P L)

榛原

「榛原」

「はりはら」あるいは「はいはら」と読むことができる。後者の場合は「垣原牧」との関係が考えられる。(SB1111出土 墨書土器)



1.遺跡全景
(図より)



2.遺跡全景
(図より)

PL.2

調査区全景



1.調査区全景
(北より)



2.調査区全景
(東より)

遺構

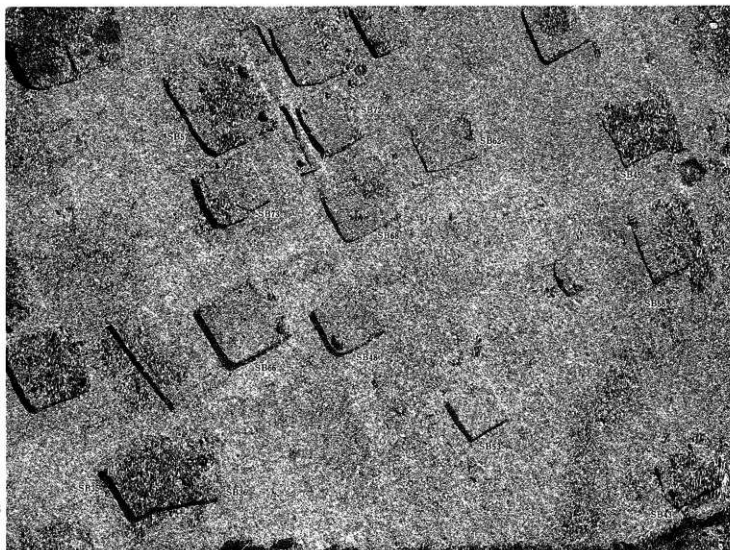
N
地区N-S
地区

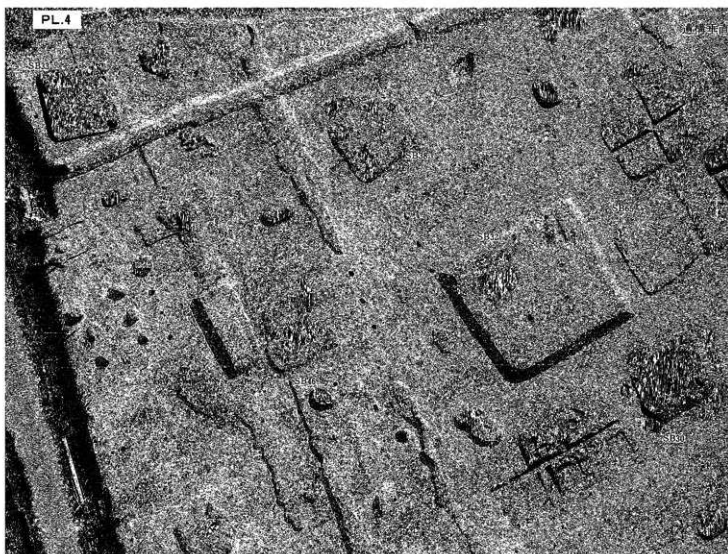
O地区
東部O地区
南部

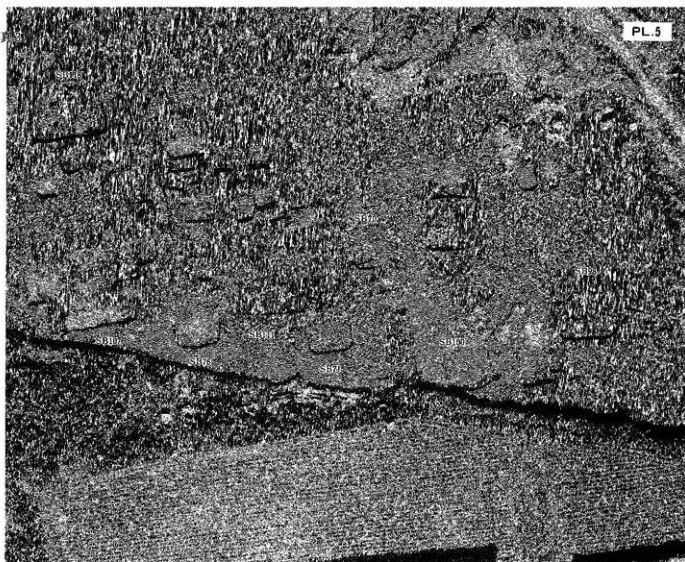

M地区



K·L地区

L·M
地区M地区
西部

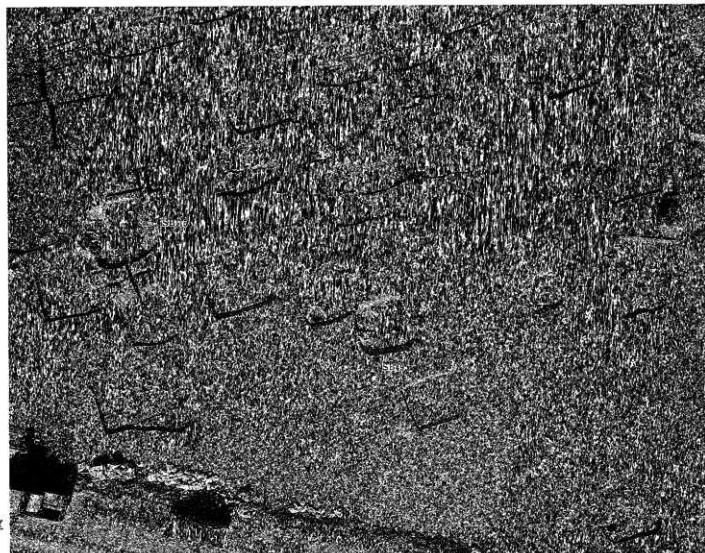

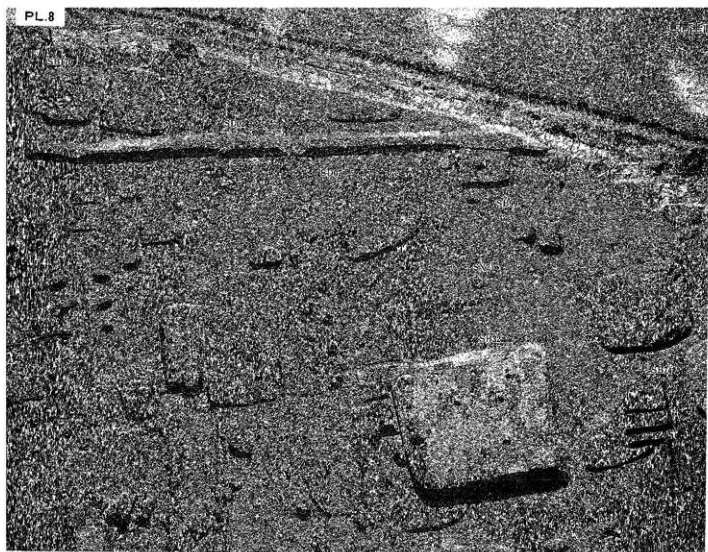
O地区
北部O地区
南部

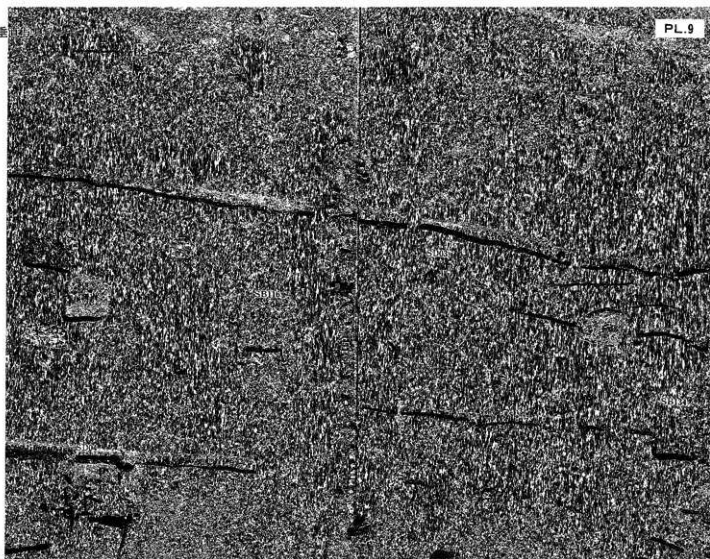

G地区



L地区



F・G地区

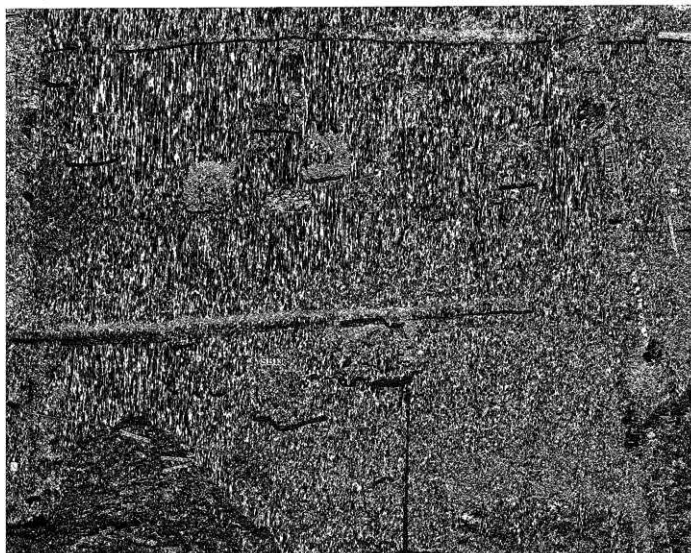

K・L地区

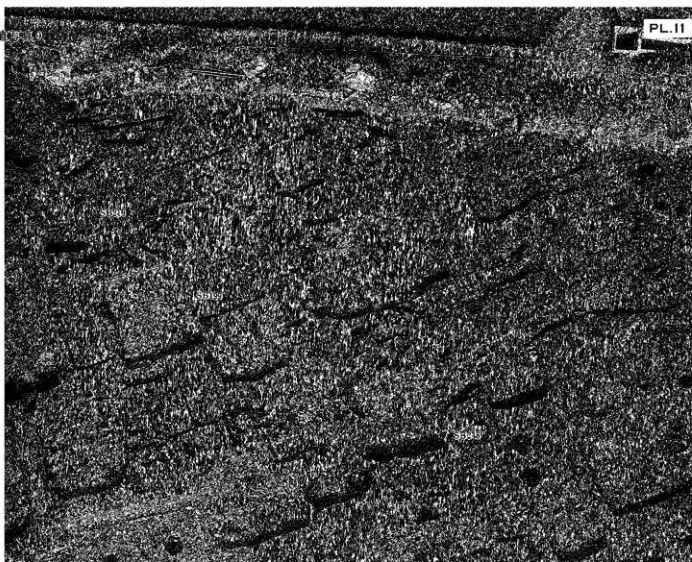

O地区
北部



O地区
南部

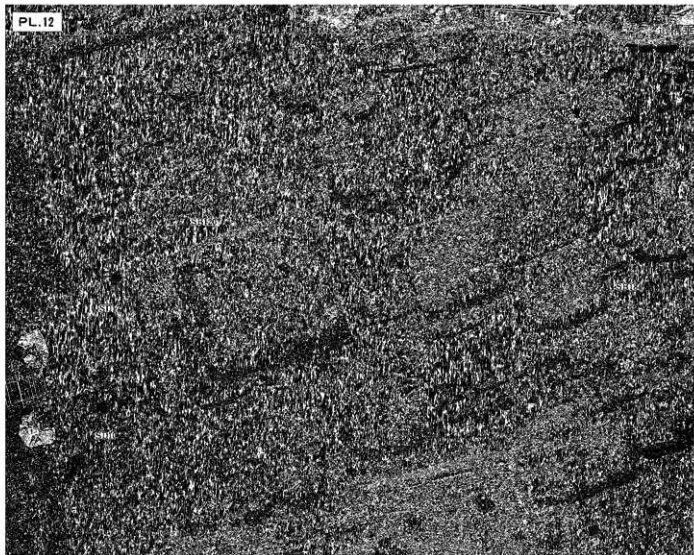

N地区



N地区
南部



H・M
地区

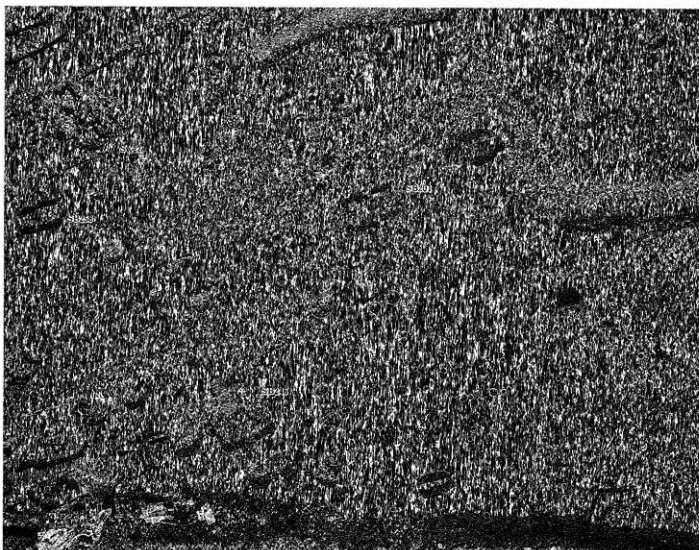

M地区

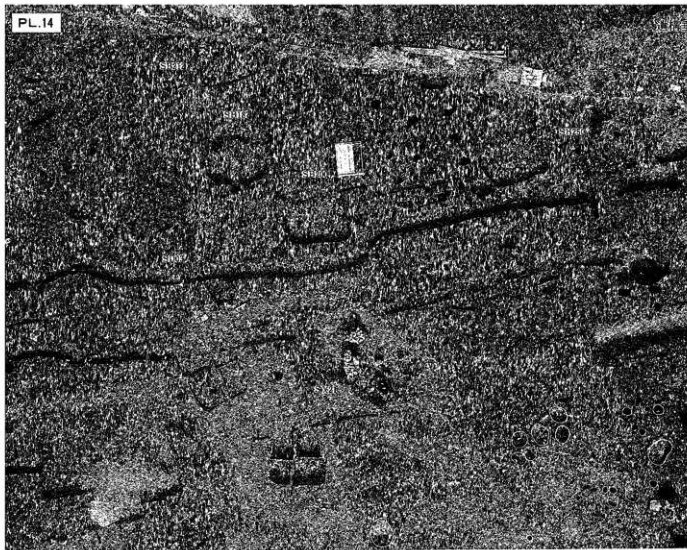

H地区



L·M地区



PL.16

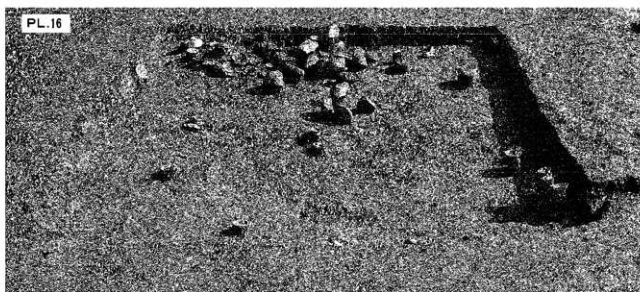

古代遺構1

SB05
(西より)

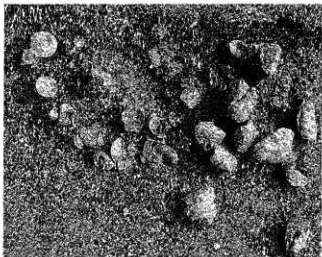
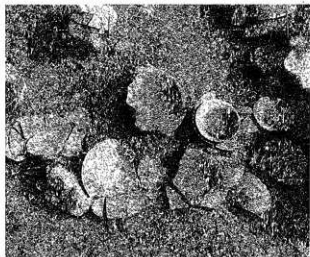

SB05 遺物出土状況



SB05
(東より)

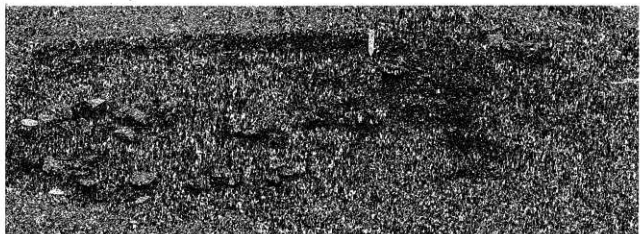

SB14
(南より)

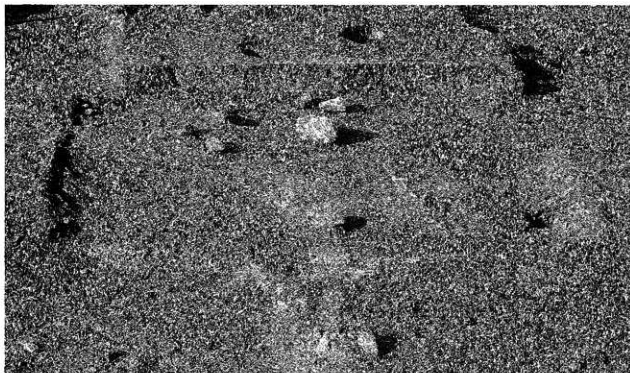

SB17
(東より)

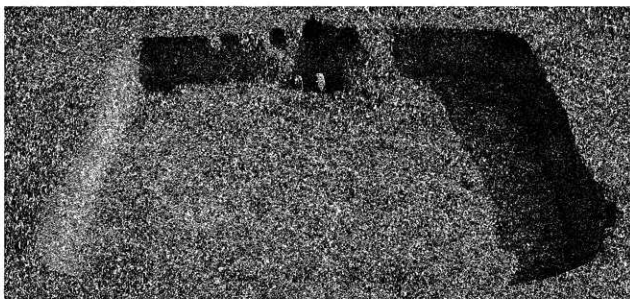

SB20
(西より)

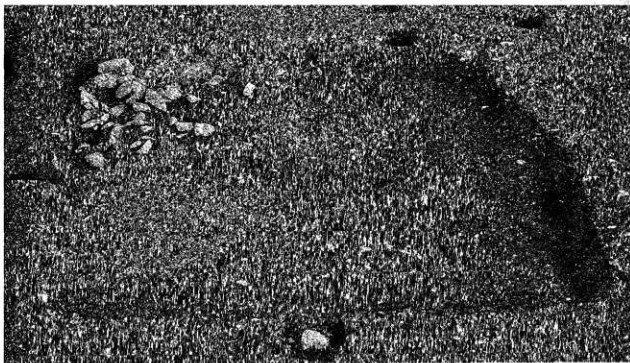

SB21
(東より)



SB22
(西より)



SB23
(北より)



SB26
(西より)



SB27
(東より)

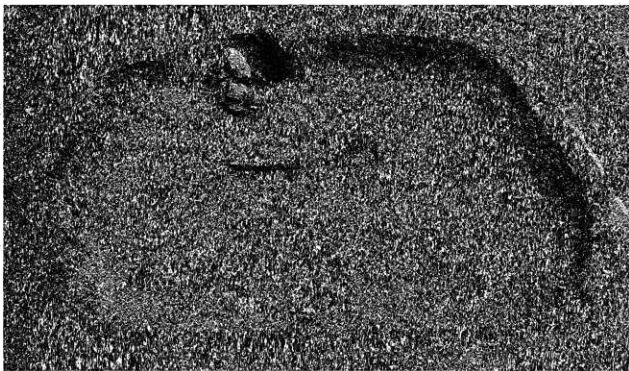

SB29
(西より)

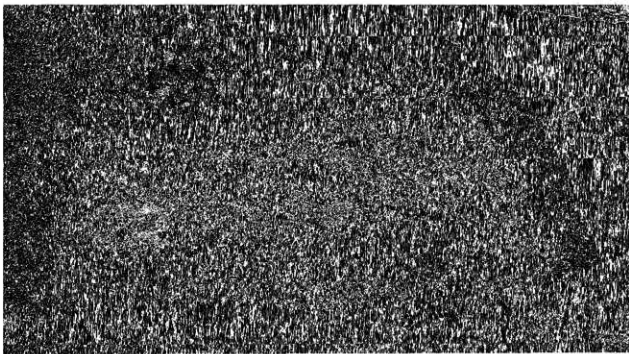

SB30
(西より)

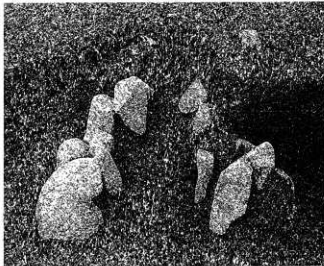

左 SB19 カマド
右 SB28 カマド

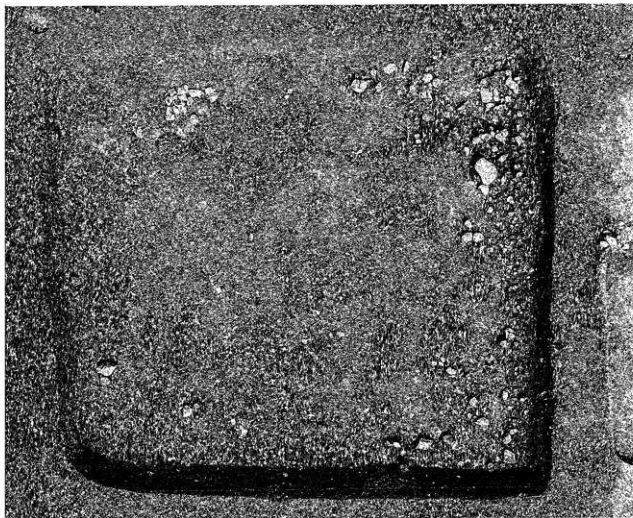

SB32 垂直写真

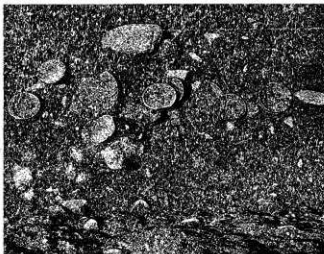

SB32
遺物出土状況



SB32
遺物出土状況

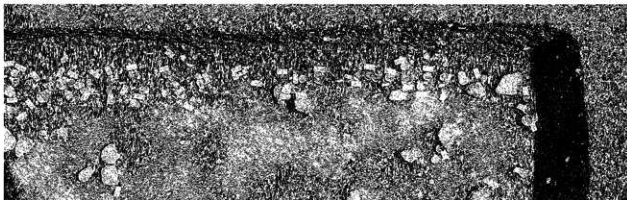

SB32
遺物出土状況

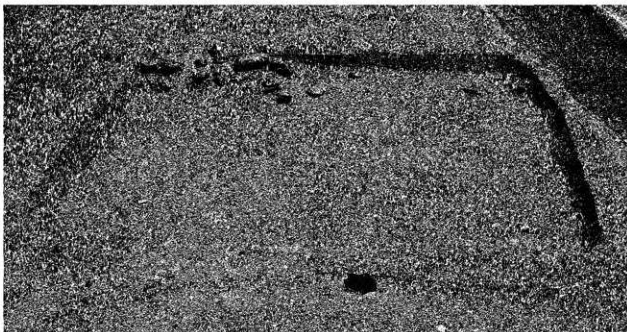

SB33
(西より)



SB40
(西より)

PL.22



古代遺構7

SB42
(西より)



SB44
(東より)

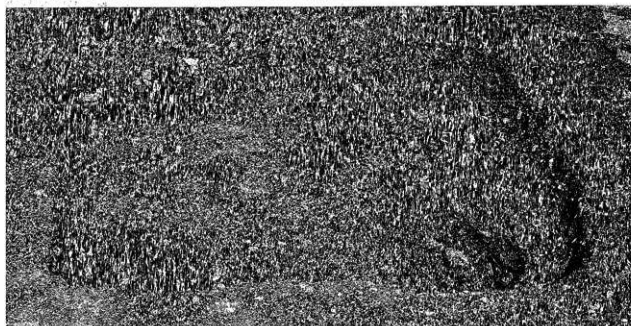

SB48
(西より)

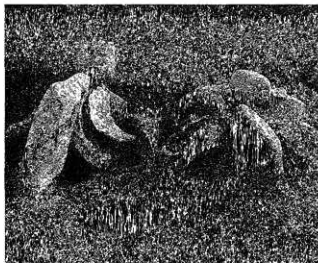

左 SB45 カマド
右 SB49 カマド

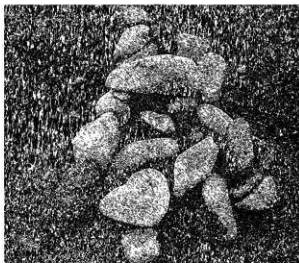

SB49
(東より)

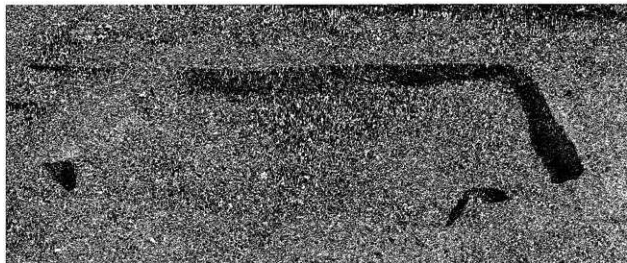
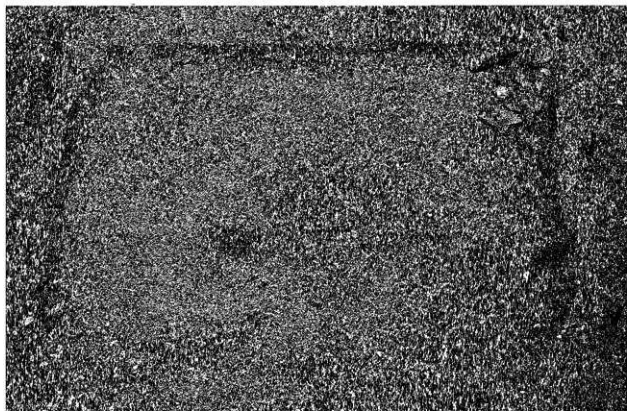

SB50
(西より)

SB56
(南より)SB59
(南より)SB58
(東より)



左 SB58 カマド
右 SB83 カマド

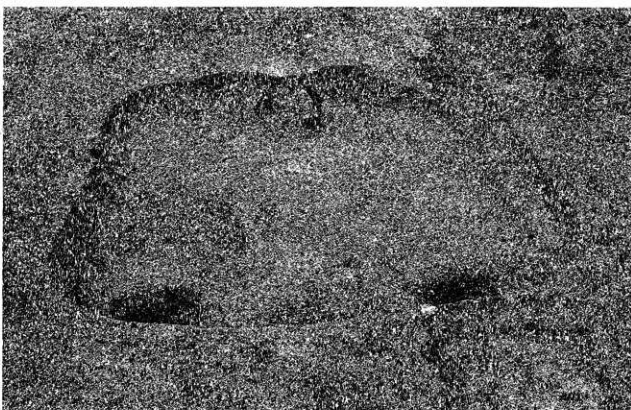

SB63
(西より)

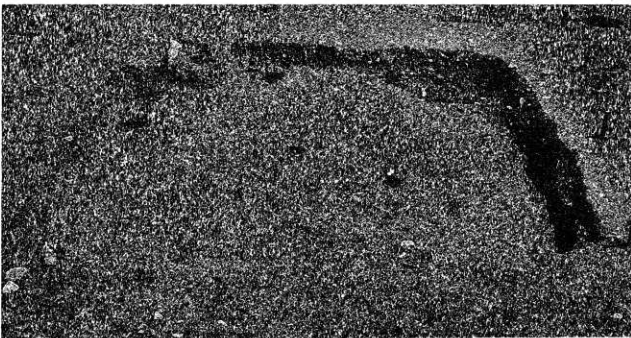

SB66
(西より)

PL.26

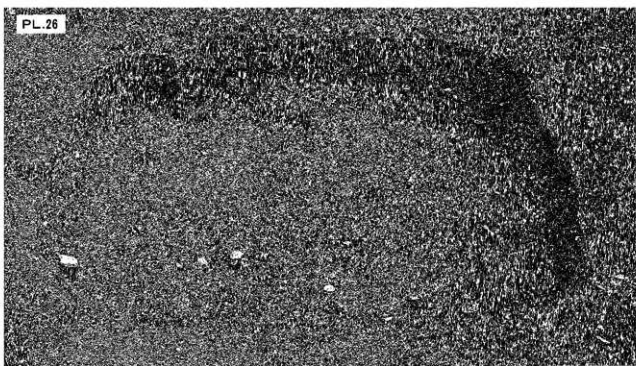

古代遺構 11

SB69
(西より)

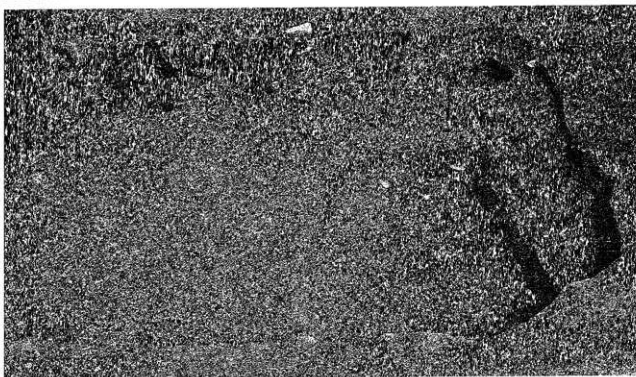

SB70
(西より)

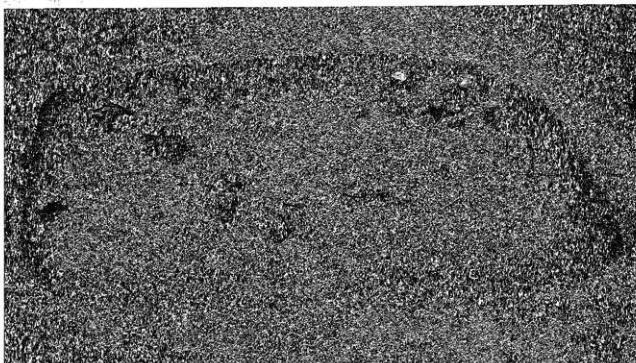

SB71
(東より)



SB73
(南より)

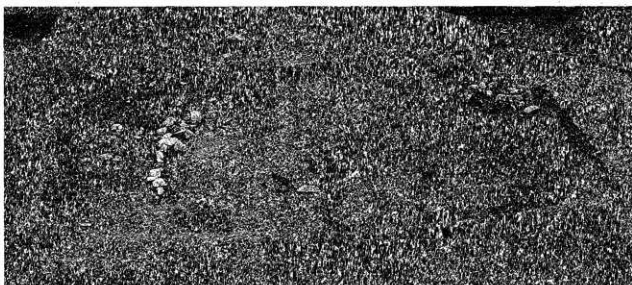

SB74
(南より)

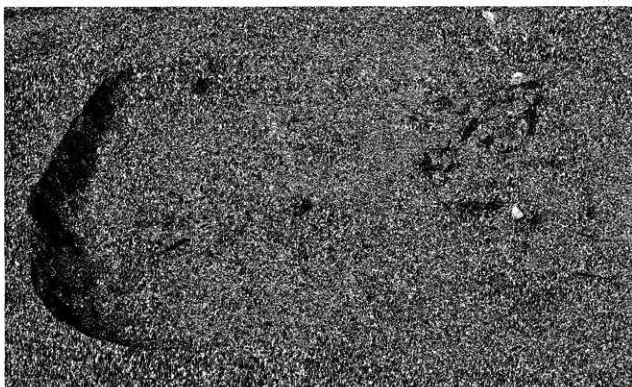

SB76
(南より)

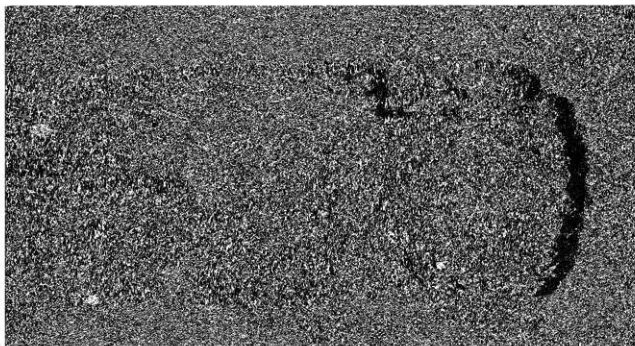

SB81
(西より)



左 SB85 カマド
右 SB86 カマド



SB86
(西より)



SB95
(西より)



左 SB95 カマド
右 SB112 カマド

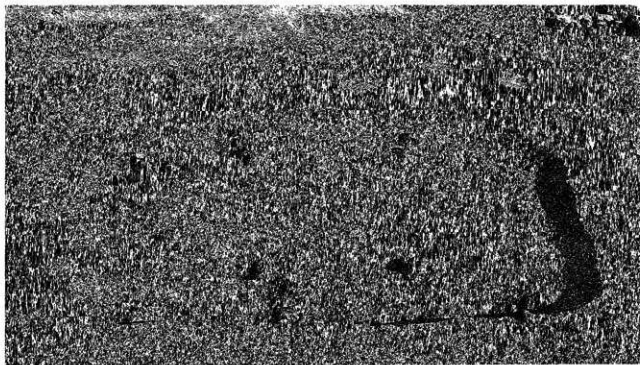
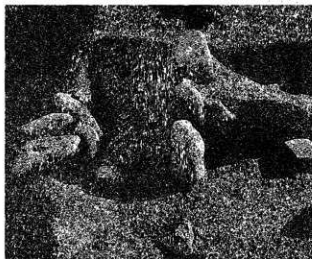

SB98
(西より)



SB99
(東より)

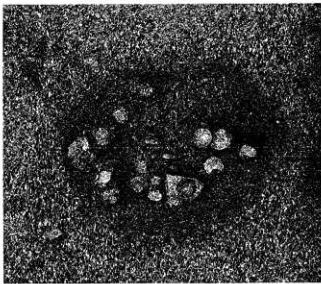
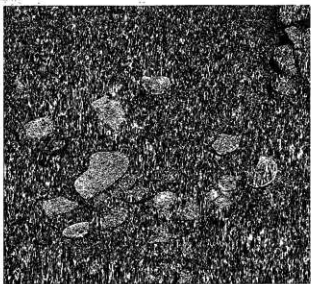

SB99
遺物出土状況

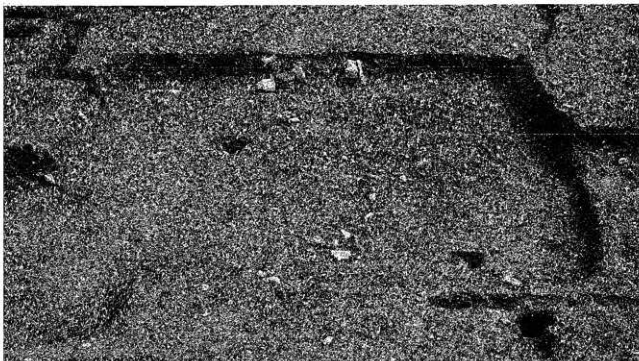

SB100
(南より)

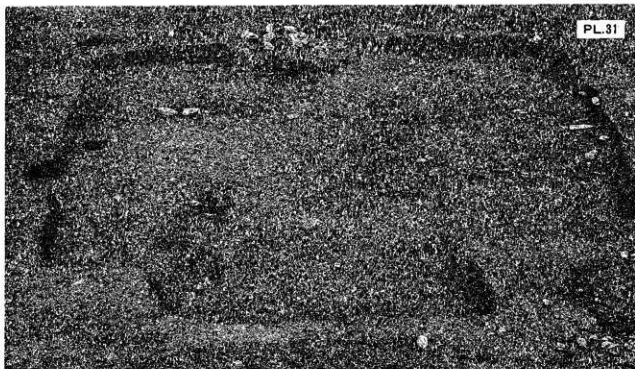

SB102
(西より)

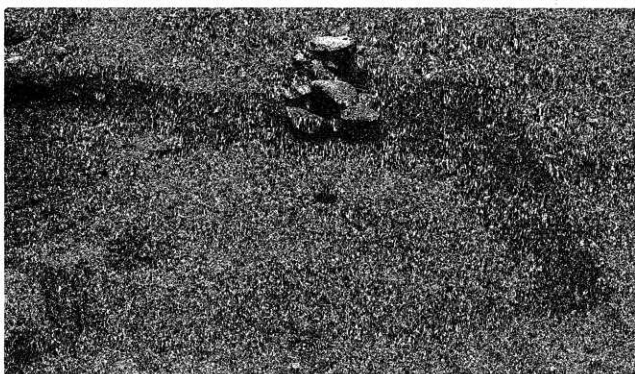

SB108
(西より)

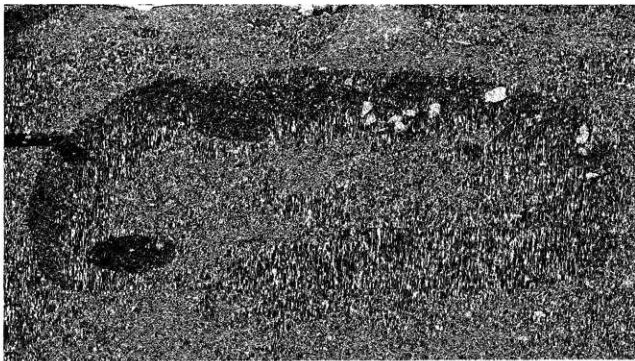

SB115
(東より)

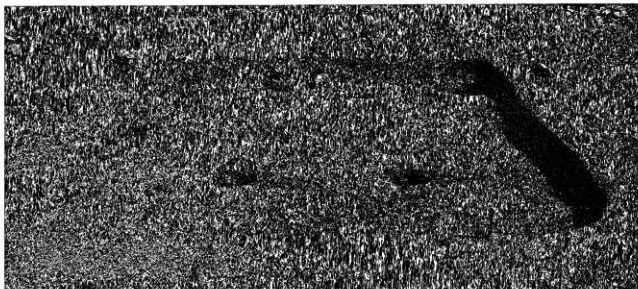

SB118
(西より)

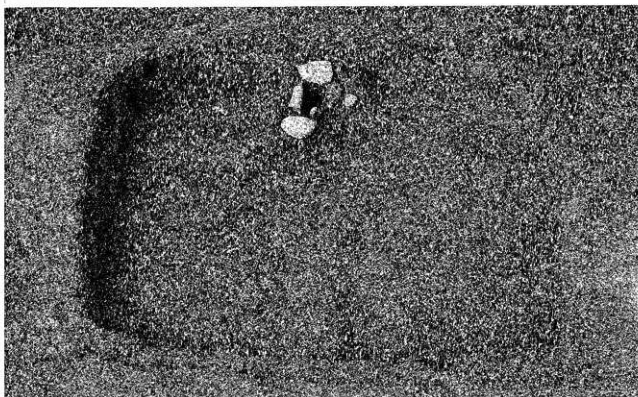

SB128
(東より)

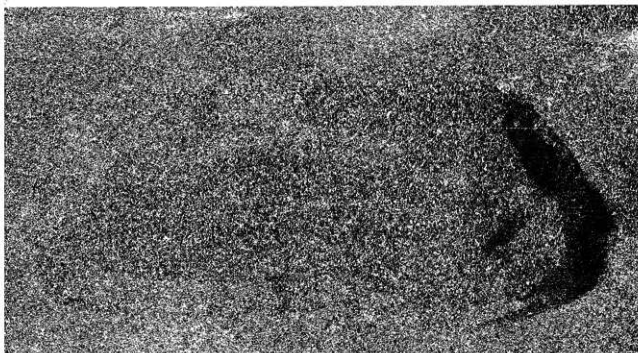

SB129
(西より)

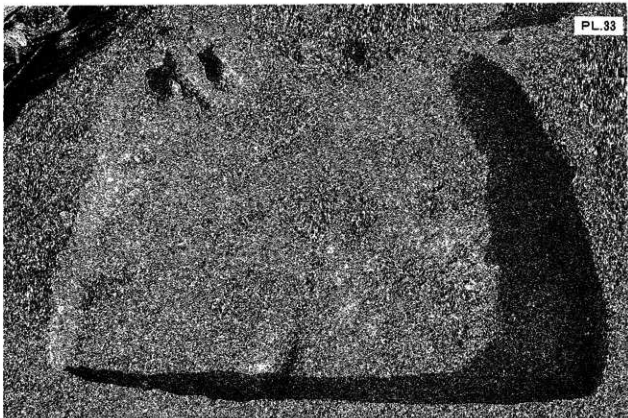

SB132
(西より)



SB139
(東より)



左 SB139 カマド

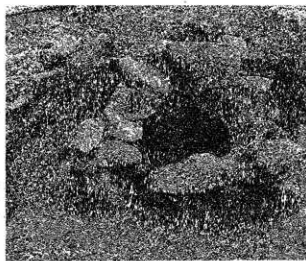

右 SB226 カマド

PL.34



古代遺構 19

SB142
(西より)

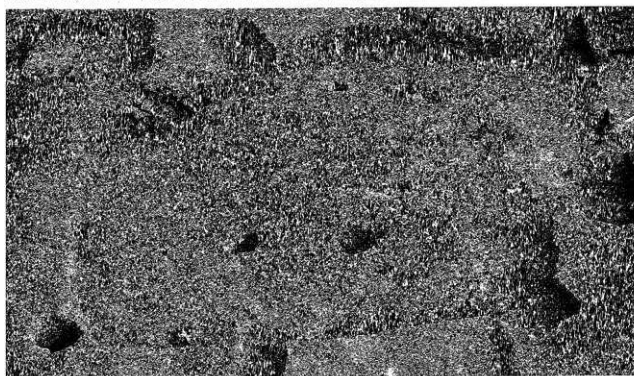

SB156
(西より)

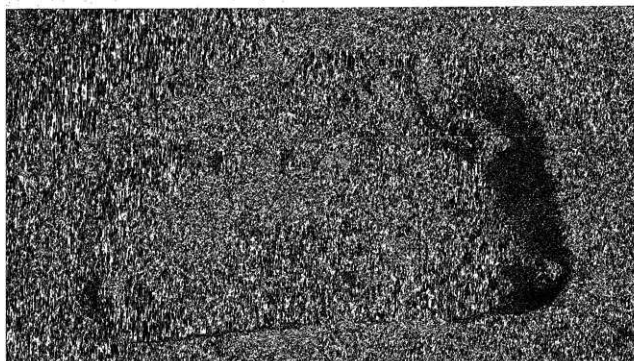

SB160
(南より)

SB144
(東より)

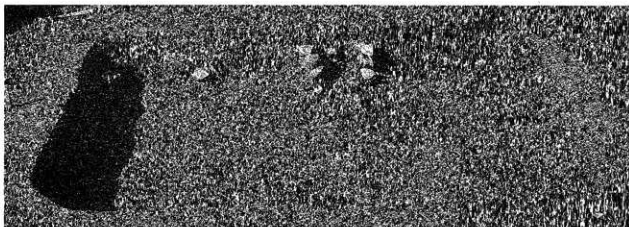

SB162
礎・遺物出土状況
(東より)

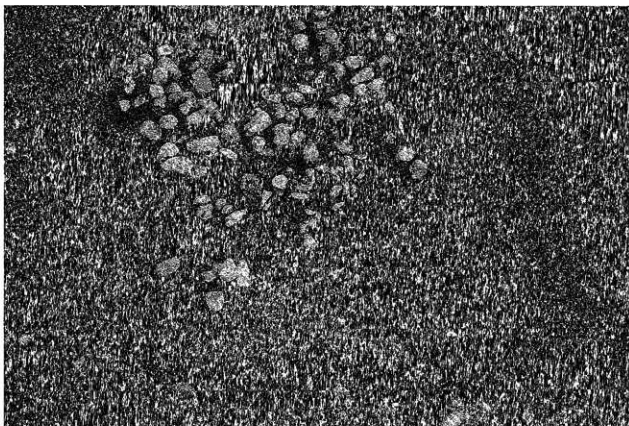

SB162
(東より)

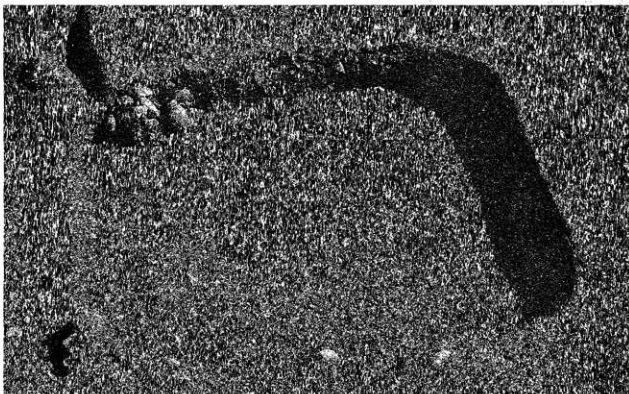

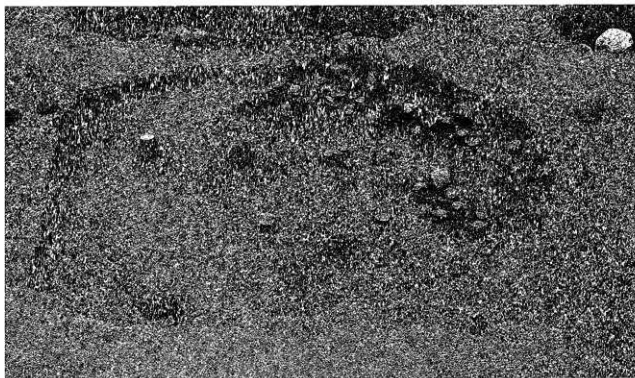

SB167
(南より)

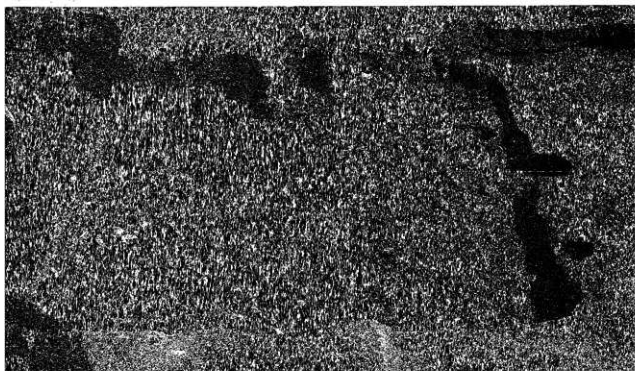

SB168
(西より)

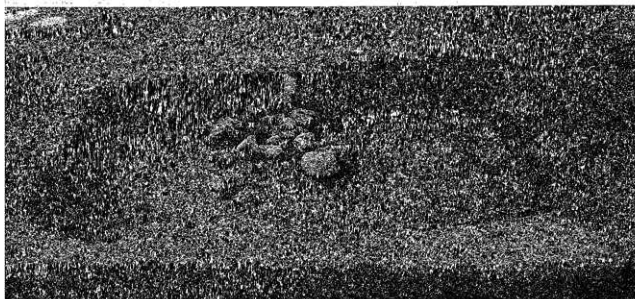

SB170
(東より)



SB187
(西より)

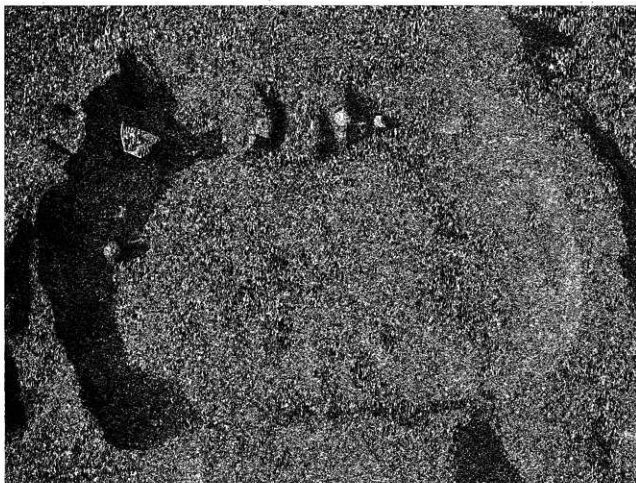

SB188
(東より)



左 SB188 カマド
右 SB230 カマド

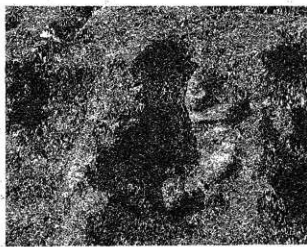

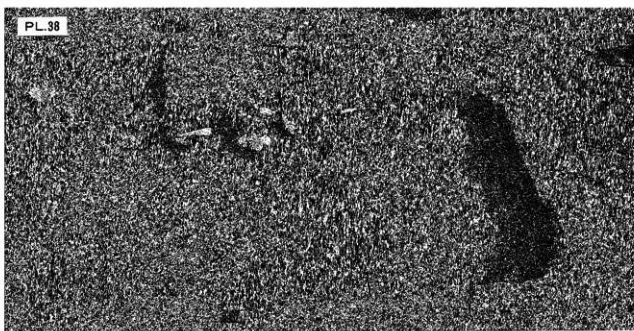
SB200
(西より)SB209
(東より)SB210
(西より)

SB213
(西より)

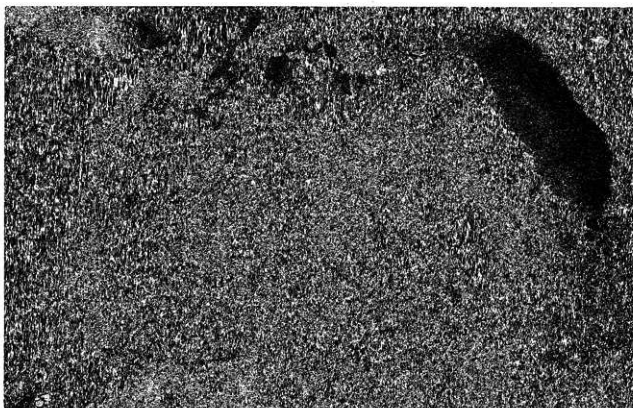

SB227
(東より)

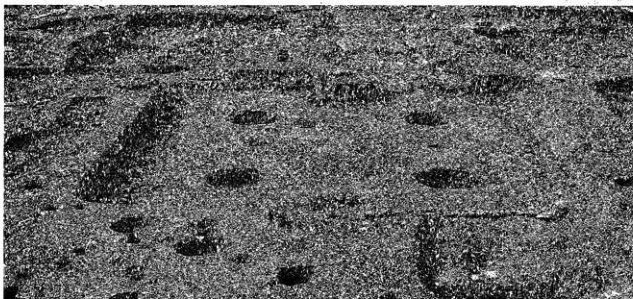

SB232
(西より)



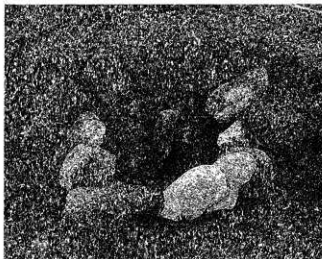
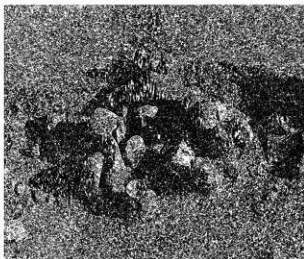

左 SB232 カマド

右 SB234 カマド



SB234
(東より)



SB249
(東より)



左 SB242 カマド
右 SB249 カマド

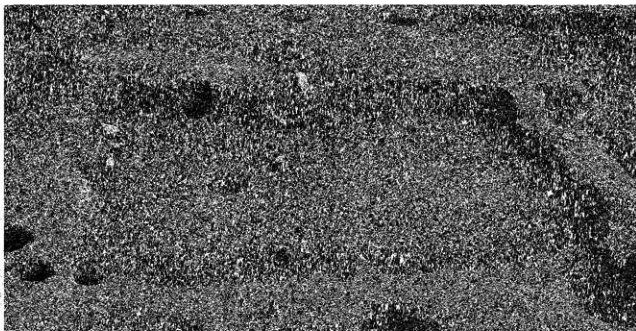

SB250
(西より)

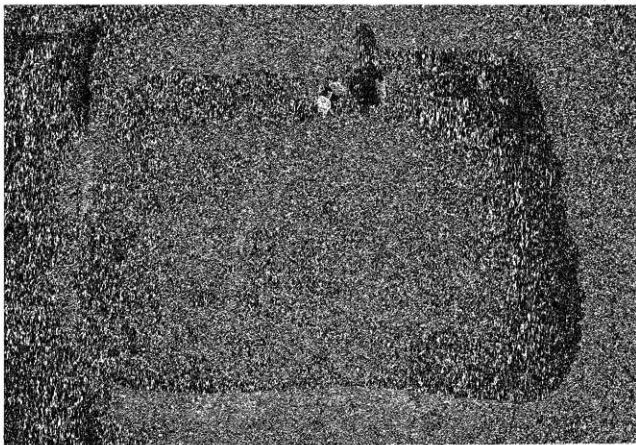

SB258
(西より)

PL.42

古代遺構 27

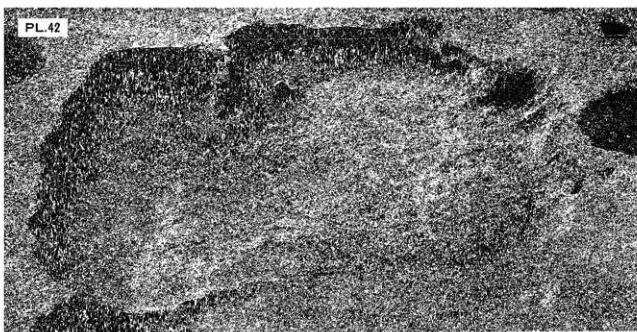

SB259
(東より)

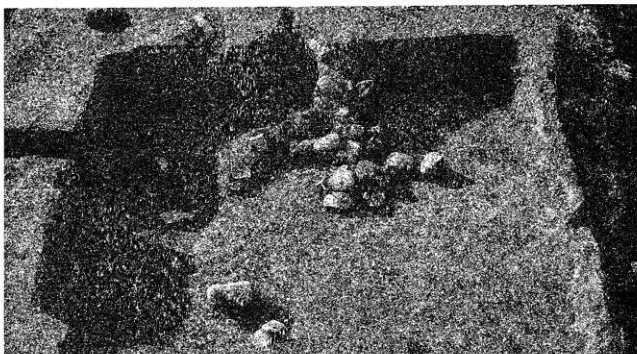

SB264
(東より)

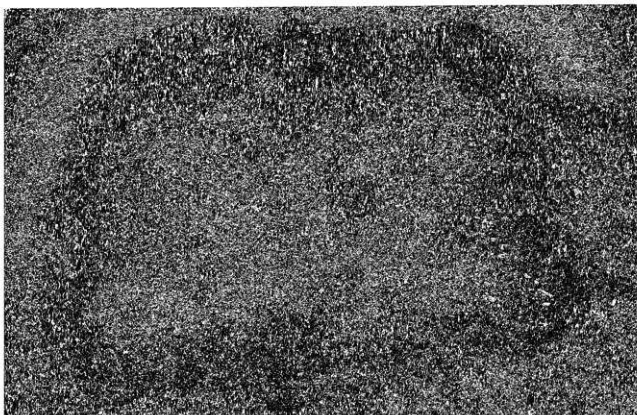

SB266
(東より)

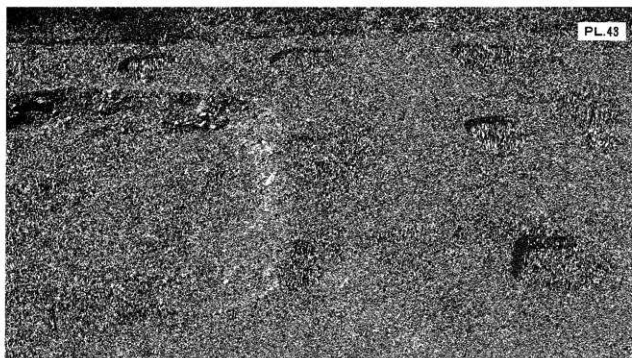

ST201
(東より)

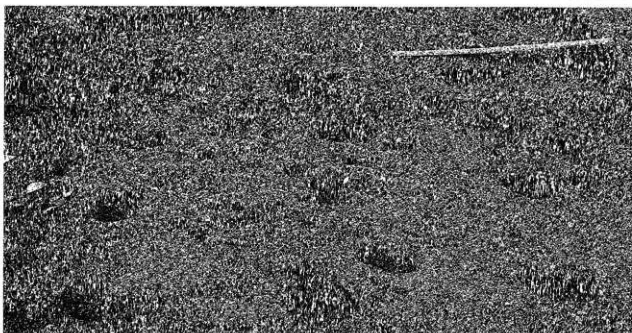

ST204
(南より)

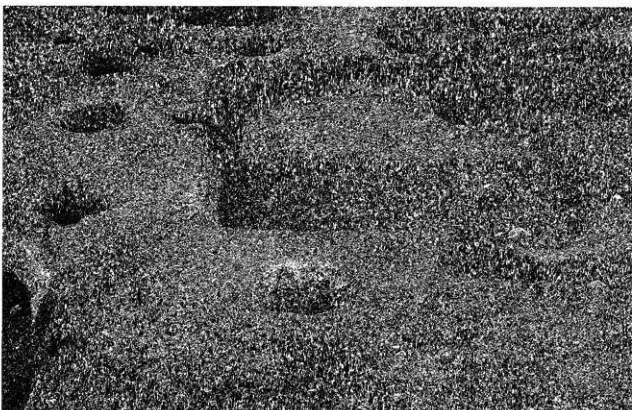

ST206
(南より)

PL.44

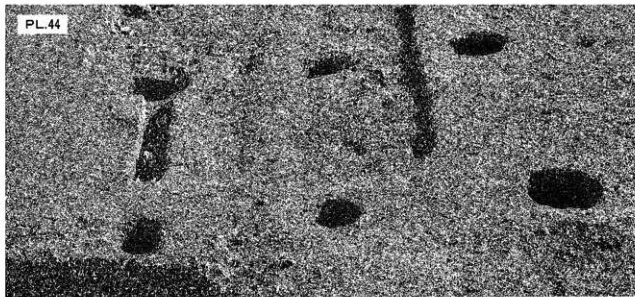

古代遺構 29

ST208
(西より)

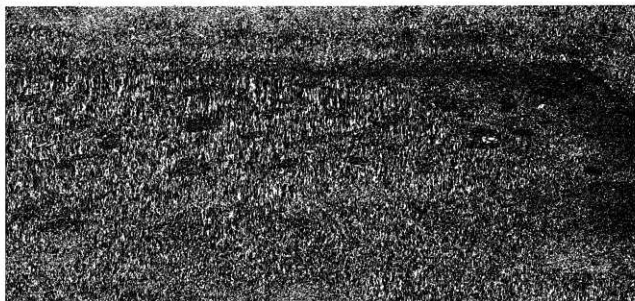

O地区北東部
柱穴群
(南より)

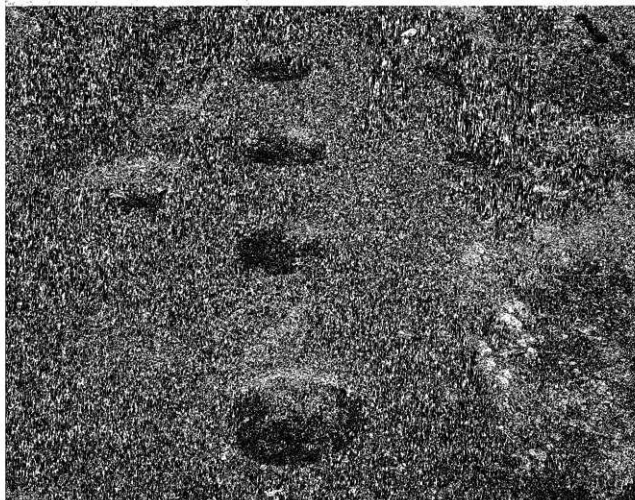

ST205
(南より)



SD17
(北より)



SD19-25
(東より)

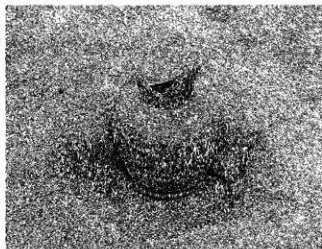

左 SM01
右 SK128

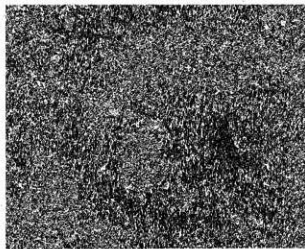

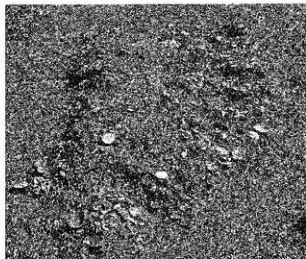

SX21

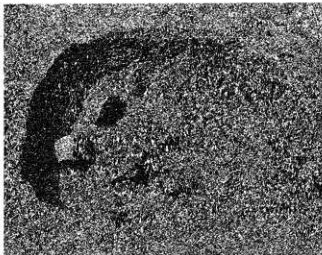
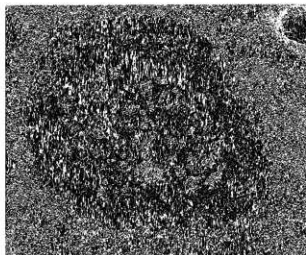

左 SK21
右 SK42

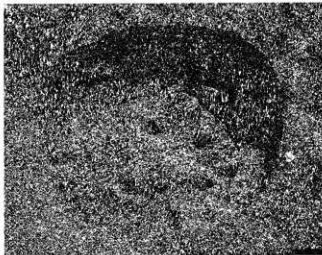

SK73

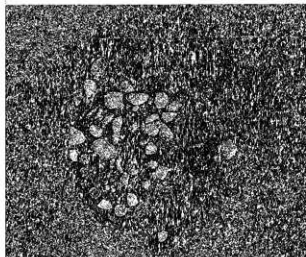

左 SK84
右 SK218

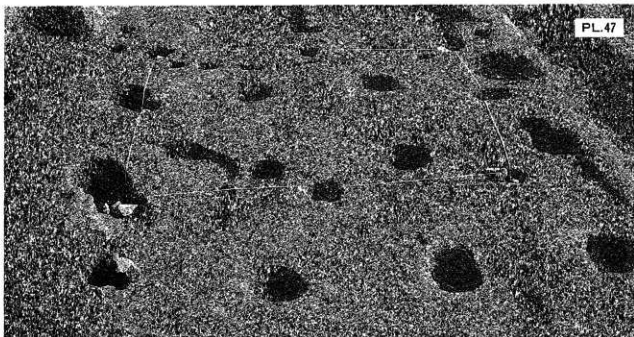

ST05
(西より)

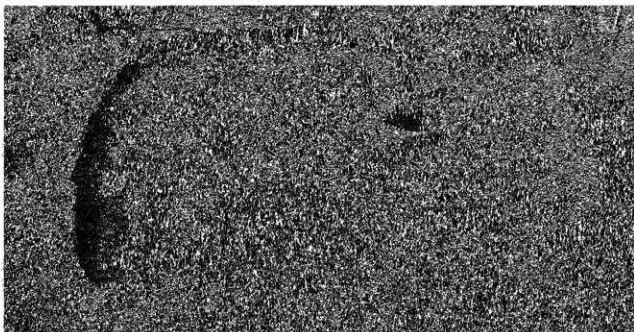

SB1121
(東より)



SB1179
(南より)



SD02
(西より)

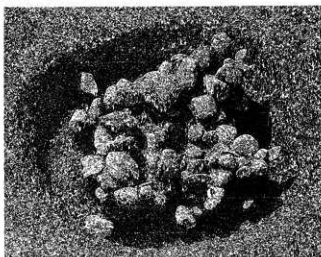

左 ST02内
SX1100
右 SK1133

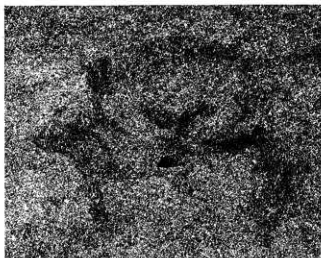

SK1252



SK1231~
1236

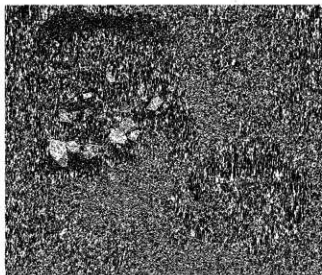

左 SK1141-1142
右 SK1217

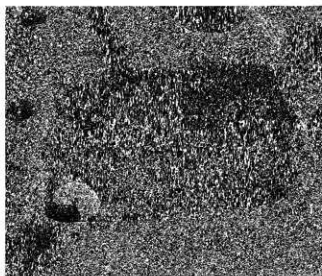
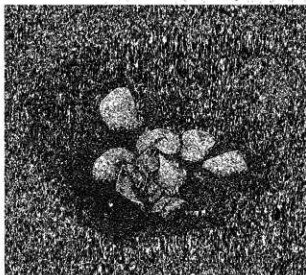

左 SK1221
右 SK1244

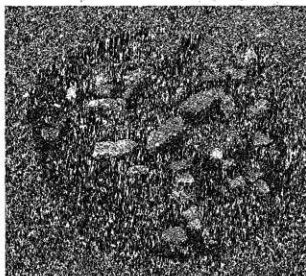

PL.50

中·近世遺構 4



整地土層
上面遺構



ST2004

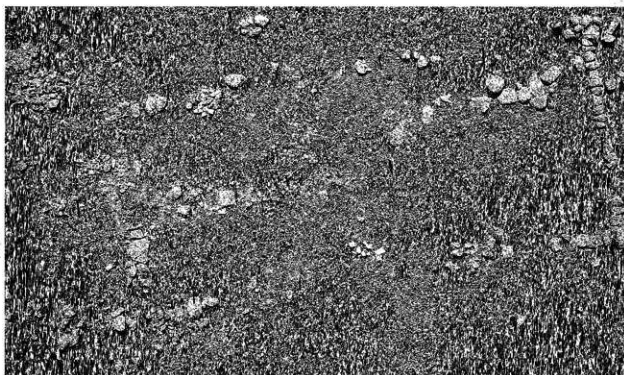

ST2001

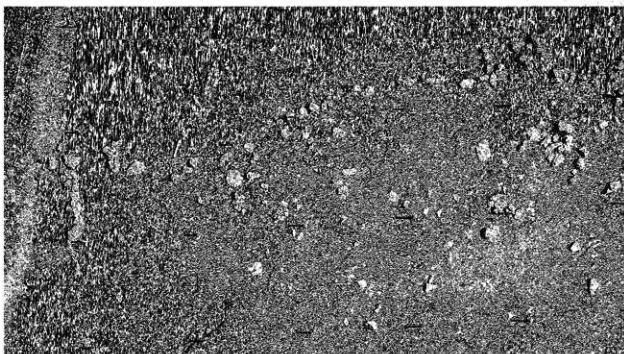

ST2003



整地土層
上面礎分布



ST2002
断面



整地土層上面
礫の分布 (東部)

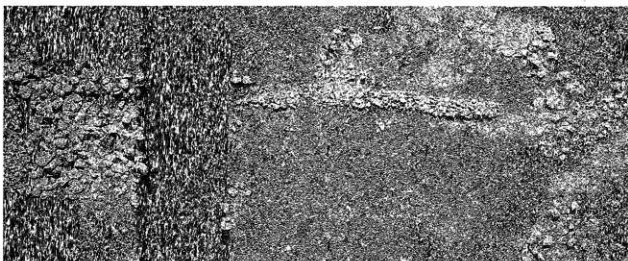

整地土層上面
礫の分布 (西部)

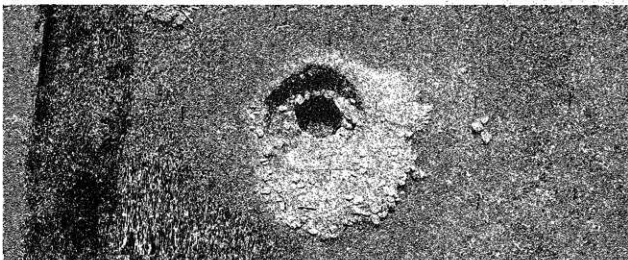

SE01

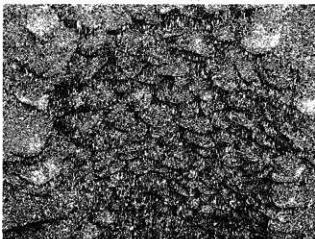

左 SE01
石組の状況
右 SK2013



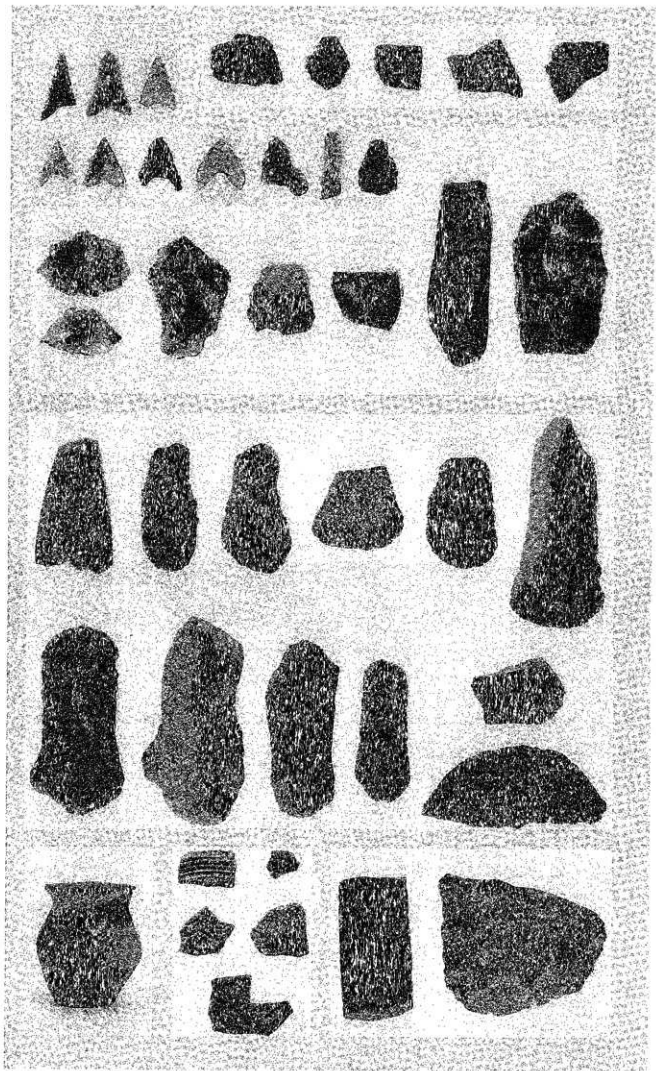

縄文時代

弥生時代

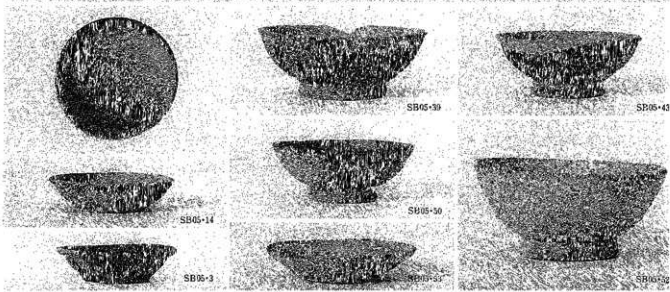
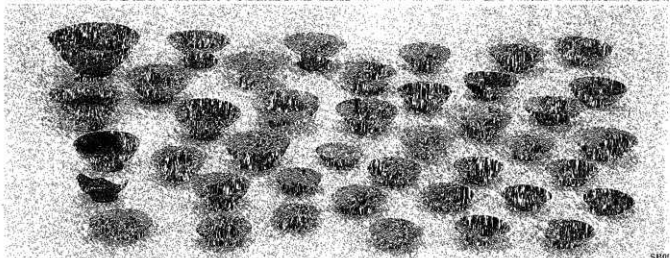
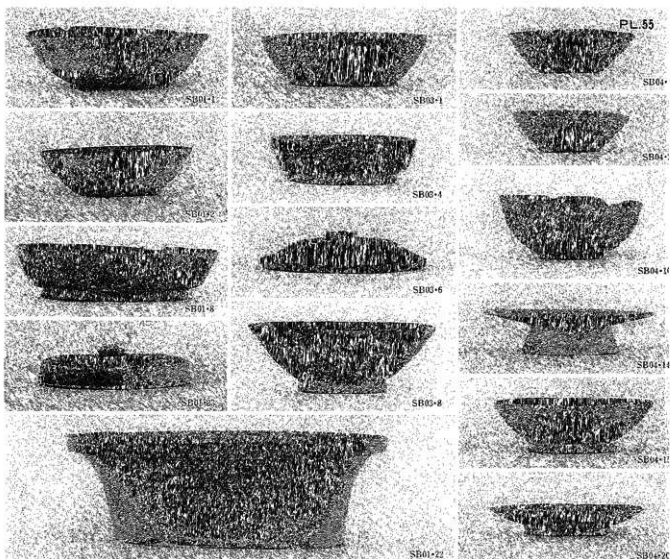



SB05-45

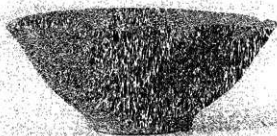

SB05-54



SB06-1



SB06-3



SB06-4



SB06-8



SB06-6



SB07-1



SB07-5



SB10-7



SB10-9

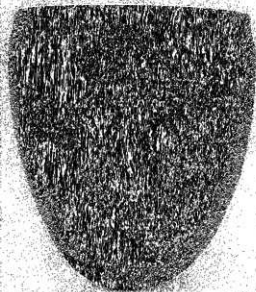

SB10-10

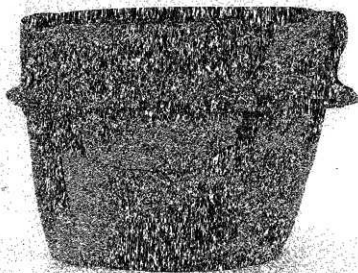

SB10-11



SB11-1



SB11-2



SB11-5



SB13-8

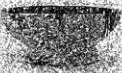

SB13-10

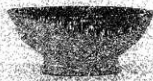

SB13-15



SB13-18



SB13-17



SB16-10

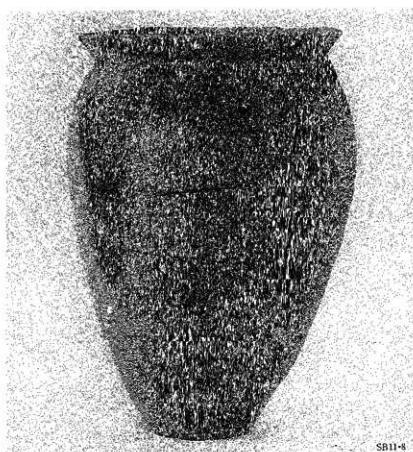

SB11-4

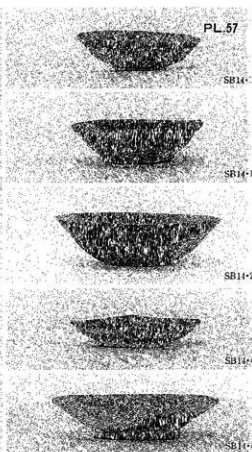

PL.57

SB14-

SB14-1

SB14-5

SB14-4

SB14-4

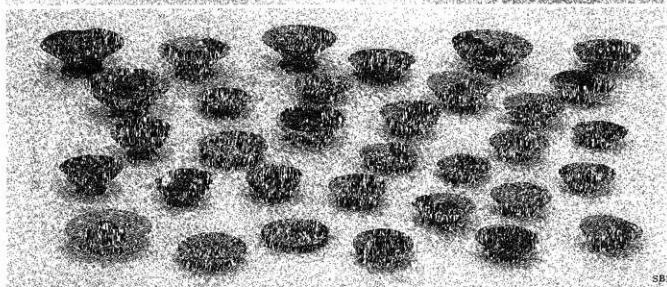

SB14

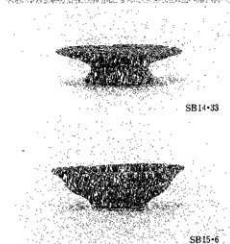

SB14-33

SB15-6



SB14-37

SB15-24

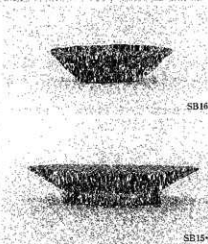

SB16-

SB15-2



SB15-11



SB17-4



SB18-



SB17-7



SB18-5



SB18-6

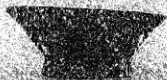

SB18-12



SB18-15



SB19-1



SB19-2



SB18-16

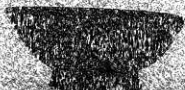

SB19-11



SB19-12



SB21-1



SB21-2



SB21-3



SB21-10



SB21-6



SB21-7

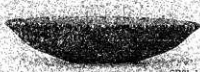

SB21-14

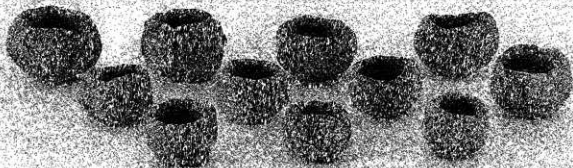

SB22

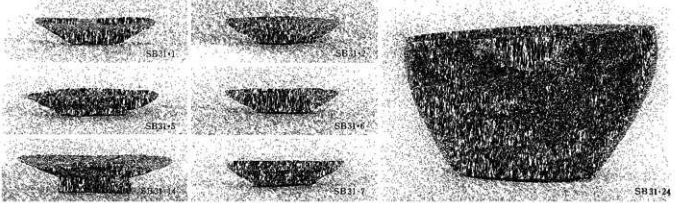
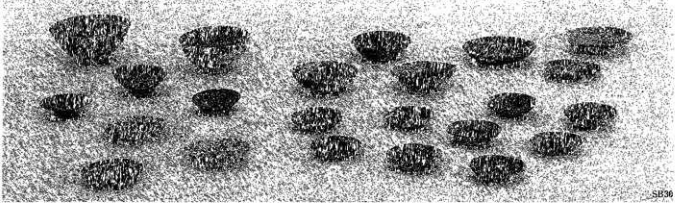
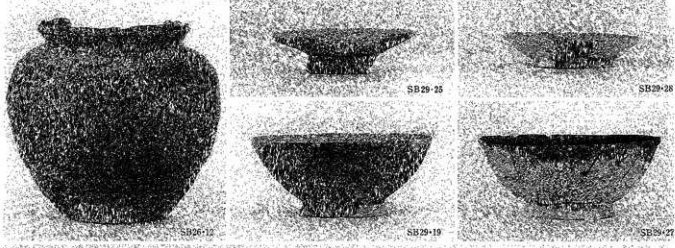
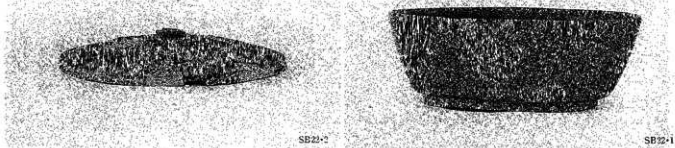

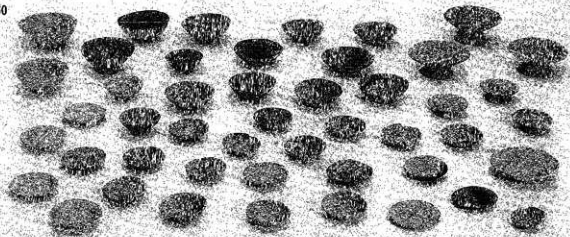

SB32



SB32-9



SB32-5



SB32-24



SB32-42



SB32-167



SB32-175

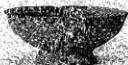

SB32-210



SB32-308



SB32-390



SB32-215



SB32-222



SB32-200



SB32-218



SB32-251

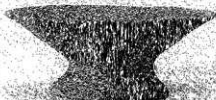

SB32-230



SB32-251

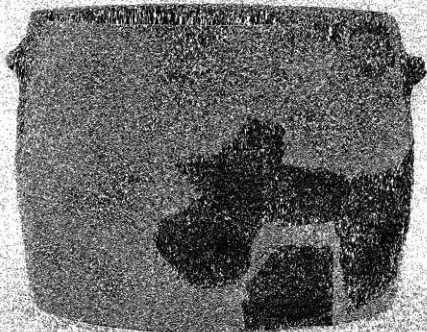

SB33-1

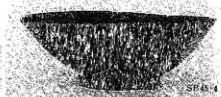
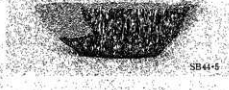
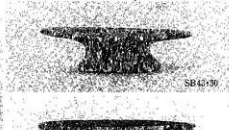
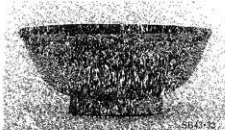
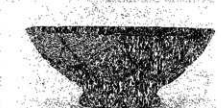
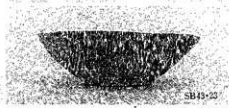
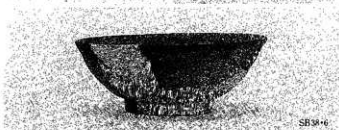
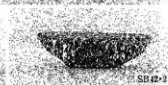
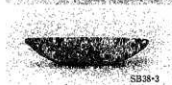
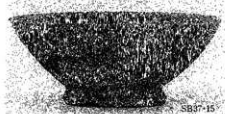
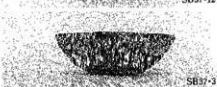
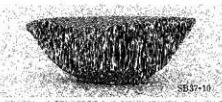

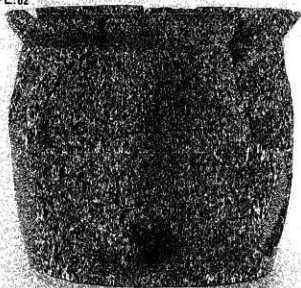

SB45-7



SB45-8



SB47-1



SB47-3



SB47-4

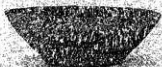

SB47-7



SB47-8



SB47-10

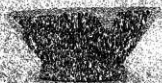

SB48-2



SB48-1

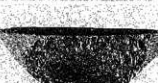

SB48-4



SB48-7

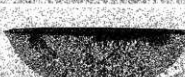

SB48-8



SB48-9



SB48-12



SB48-13



SB48-15

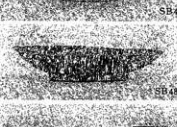

SB48-16



SB48-1



SB49-18



SB49-4



SB49-10

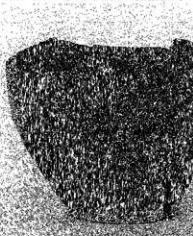

SB49-15

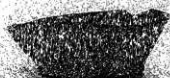
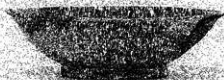
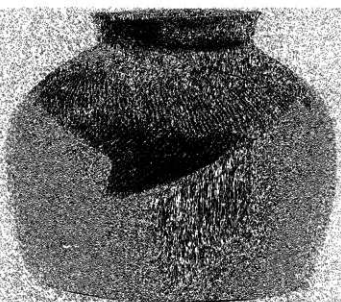

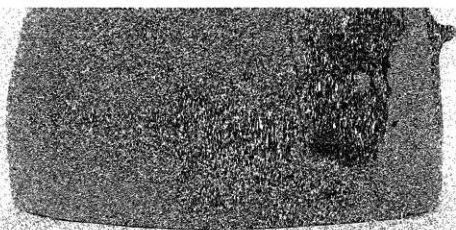

SB59-13



SB59-6



SB59-9



SB61-7



SB61-3



SB61-12



SB61-11

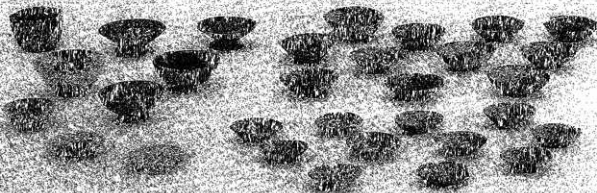

SB63



SB63-11



SB63-13



SB63-38



SB63-6

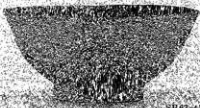

SB63-41

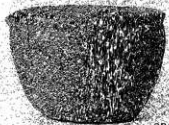

SB63-47



SB63-28



SB63-46



SB63-29



SB66-23



SB66-29



SB66-4



SB66-37

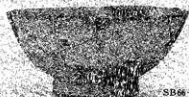

SB66-31

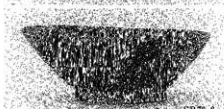
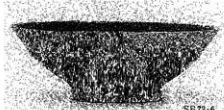
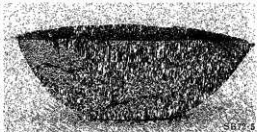
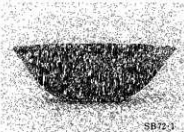
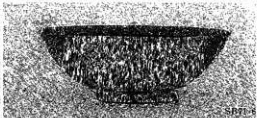
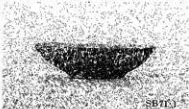
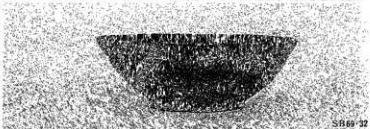
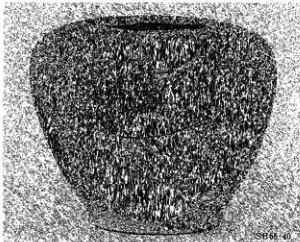
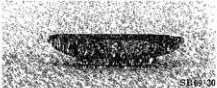
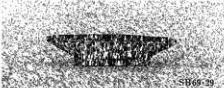
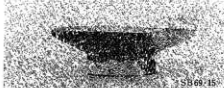
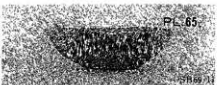
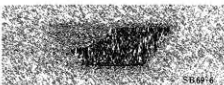
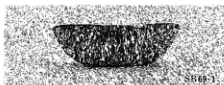



SB73-1



SB73-2



SB73-11



SB73-4



SB73-10



SB73-12



SB74-2



SB74-3



SB74-4



SB74-5



SB74-7



SB74-15



SB74-16



SB74-8



SB74-19



SB74-20



SB74-26



SB74-21



SB74-22



SB74-28



SB74-30



SB74-29



SB74-33



SB74-34



SB74-35



SB74-40



SB74-43



SB76-1



SB74-47



SB75-2

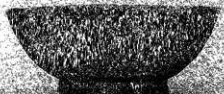

SB76-6



SB75-1

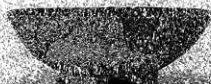

SB76-5

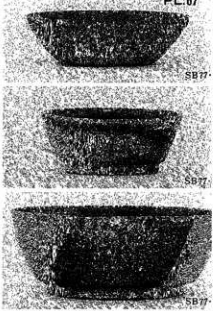

SB76-11



SB77-9



SB77-11



SB77-1



SB78-1



SB78-3



SB78-11

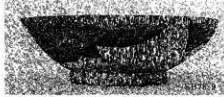

SB78-3

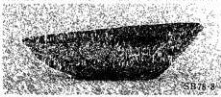

SB78-9

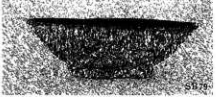

SB78-1

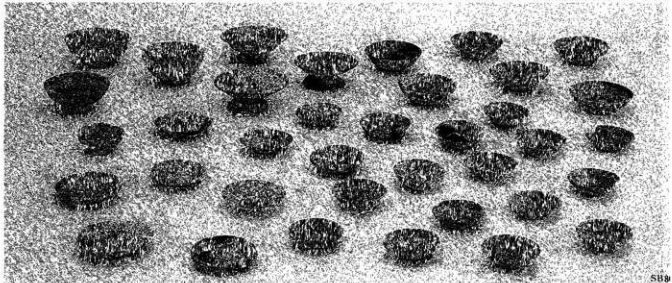

SB79



SB80-1

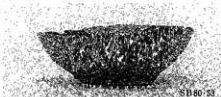

SB80-51



SB80-51

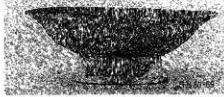

SB80-65



SB80-65

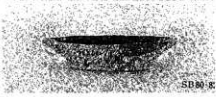

SB80-8



SB81-1



SB81-2



SB81-5



SB81-23



SB81-21



SB81-22



SB81-24

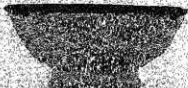

SB81-31



SB81-32



SB83-2



SB83-1



SB83-6

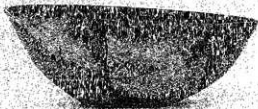

SB83-5



SB83-7



SB83-9



SB83-11

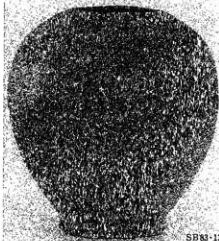

SB83-13



SB83-15



SB83-12

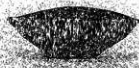

SB84-10



SB84-24



SB84-6

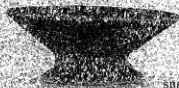

SB84-30



SB84-22

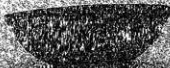

SB84-4



SB84-37

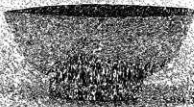

SB84-31



SB84-39

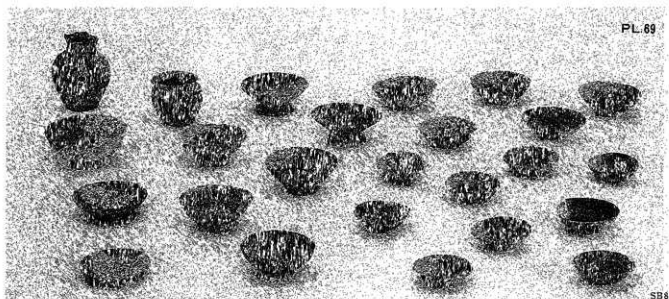

SB 6

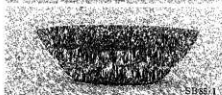

SB 65-1

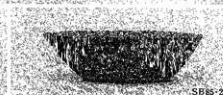

SB 65-2



SB 65



SB 65-8



SB 65-9



SB 65-1



SB 66-2

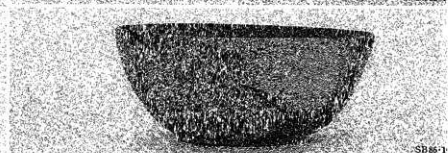

SB 66-1



SB 66-11

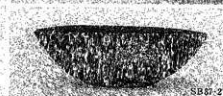

SB 67-2



SB 67-1

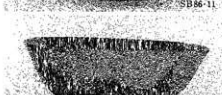

SB 68-18

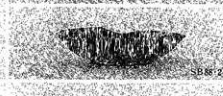

SB 68-2

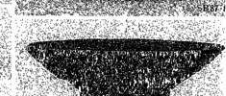

SB 68-1



SB 68-1

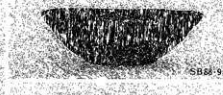

SB 68-9

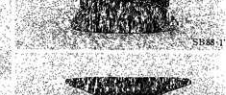

SB 68-II

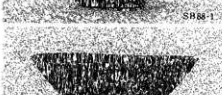

SB 68-4

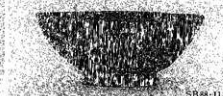

SB 68-11

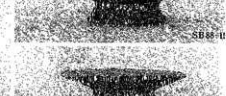

SB 68-II



SB 68-21



SB 68-13



SB 68-1

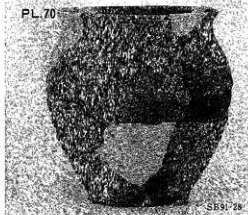

SB91-28



SB91-24



SB93-4

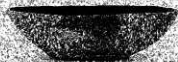

SB93-1



SB93-3



SB94-2



SB94-1



SB94-30



SB94-9



SB94-10



SB94-31



SB94-11



SB94-12



SB94-23



SB95-4



SB95-3



SB94-40



SB95-9



SB100-2



SB96-1



SB96-2



SB96-3



SB97-1



SB98-4



SB96-5



SB99-1



SB96-6



SB99-11



SB99-17



SB99-6



SB99-22



SB95-1



SB95-2

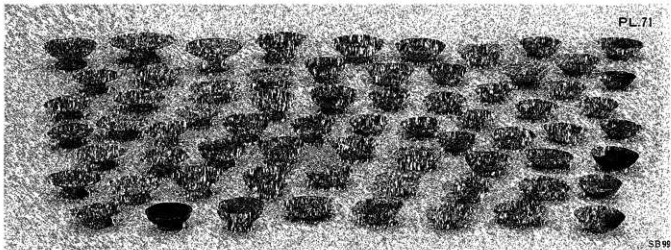

SB 99



SB 99-8

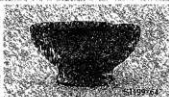

SB 99-64



SB 99-91



SB 99-77



SB 99-65

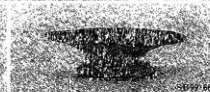

SB 99-86



SB 99-85

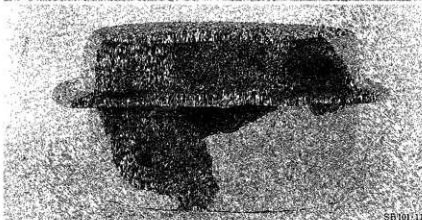

SB 101-11



SB 101-3

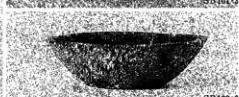

SB 102-2



SB 102-9

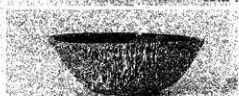

SB 102-13

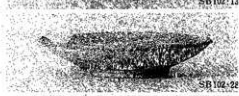

SB 102-22

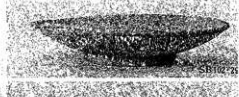

SB 102-25



SB 102-31



SB 101-12

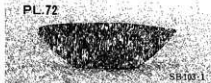

SB103-1

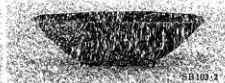

SB103-3

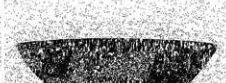

SB103-13

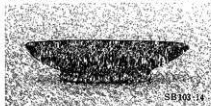

SB103-14

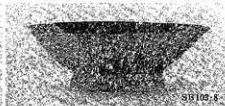

SB103-5

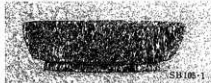

SB105-1



SB105-2



SB103-17



SB107-1



SB109-1



SB106-7

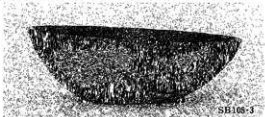

SB108-3



SB108-5



SB108-6

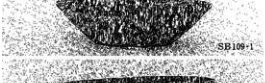

SB109-1



SB109-3

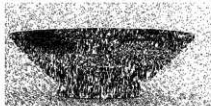

SB110-6



SB110-9



SB109-2



SB110-10

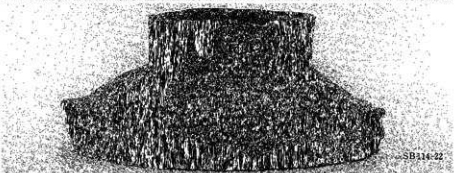

SB114-22

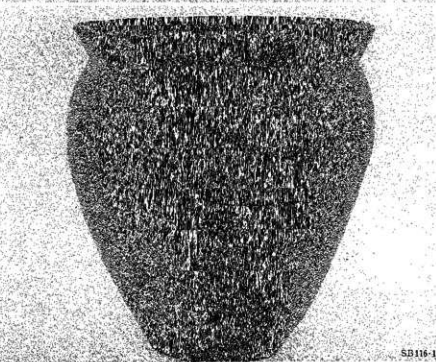
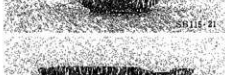
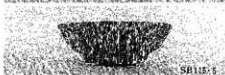
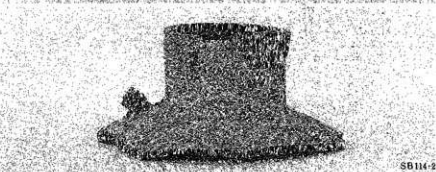
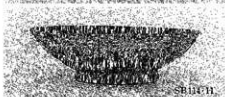
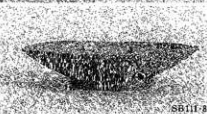
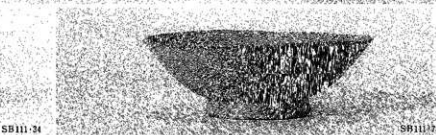
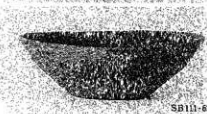
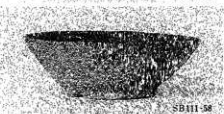
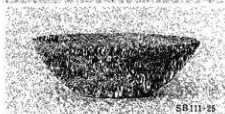
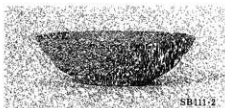



SB115-30



SB115-32

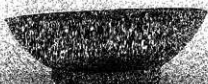

SB115-10



SB115-31



SB115-33



SB115-11



SB115-14



SB115-1

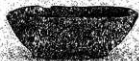

SB115-2



SB115-5



SB115-7



SB115-10



SB115-9



SB115-13



SB120-5



SB115-15



SB120-21



SB122-1



SB122-4



SB124-1



SB124-2



SB124-4



SB124-10



SB125-3



SB124-17



SB124-12



SB125-2

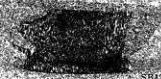

SB127-5



SB127-3



SB126-1



SB128-3



SB129-6



SB129-7



SB129-11



SB129-2

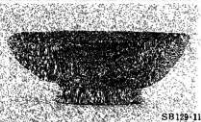

SB129-11

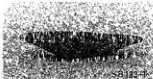

SB132-1

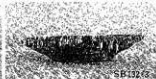

SB132-5



SB132-30



SB132-12

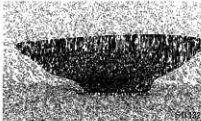

SB132-91

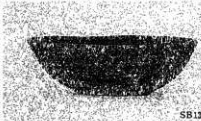

SB134-1

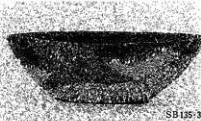

SB135-3

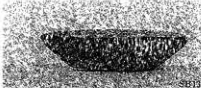

SB137-2

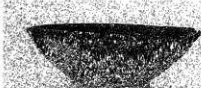

SB135-4



SB135-7

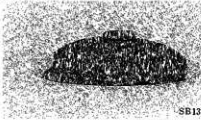

SB137-3

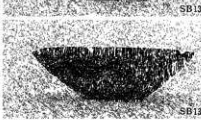

SB138-8



SB135-7



SB140-18



SB129-9



SB140-1



SB140-2



SB140-3



SB140-7

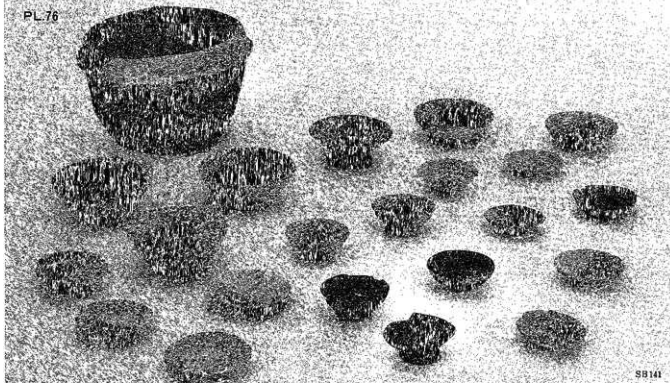

SB141

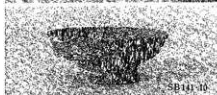

SB141-10

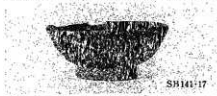

SB141-17



SB141-18



SB141-24

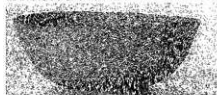

SB141-20

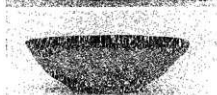

SB144-6



SB144-3

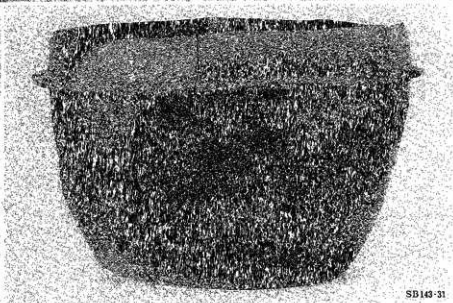

SB140-31



SB142-1



SB142-20

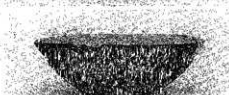

SB144-7



SB144-24



SB142-2



SB142-21



SB144-1



SB144-23

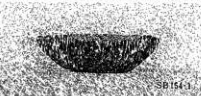
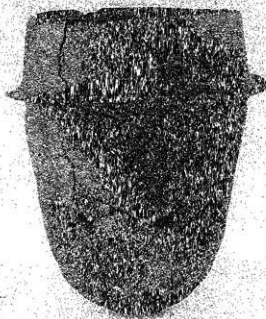
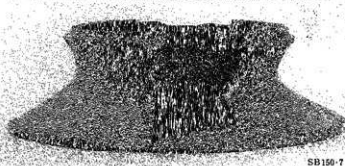
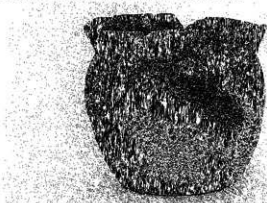
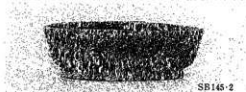
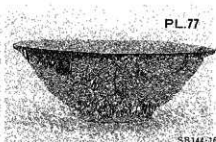
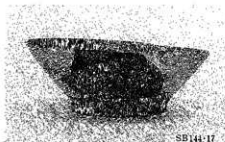

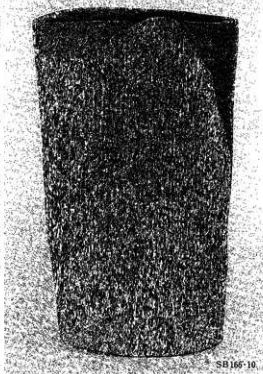
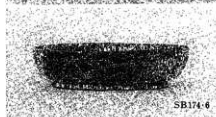
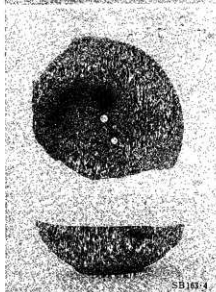
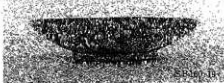
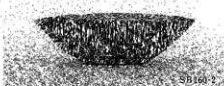
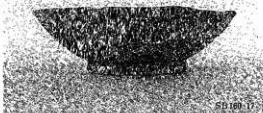

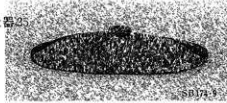

SB173-3

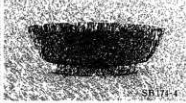

SB171-4

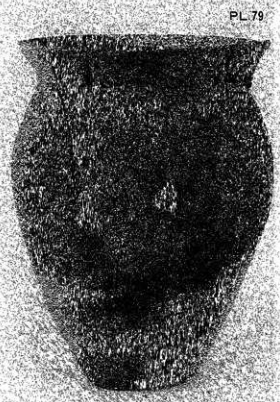

SB175-9



SB175-7



SB176-4

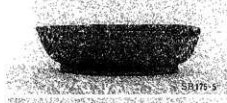

SB175-5



SB176-1



SB175-2



SB176-2

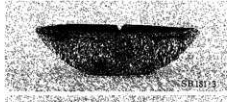

SB181-3



SB179-1



SB179-6



SB183-1

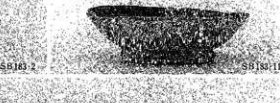

SB183-11

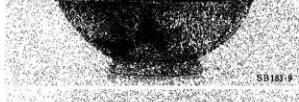

SB183-9



SB183-10



SB183-12

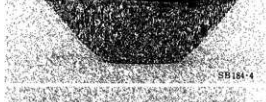

SB184-4

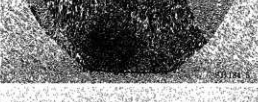

SB184-1

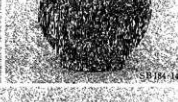

SB184-14

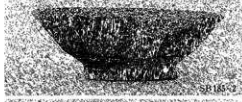

SB185-2

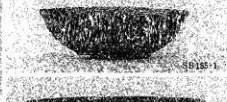

SB185-1

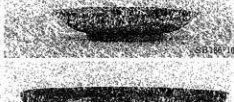

SB186-10

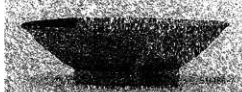

SB186-7



SB186-4



SB186-9



SB184-16



SB184-20



SB187-1



SB187-11



SB187-2



SB187-14



SB187-16



SB187-20



SB187-21



SB187-23

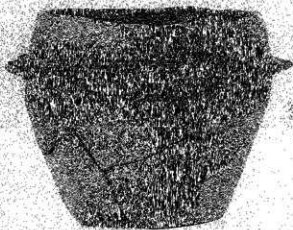

SB187-24

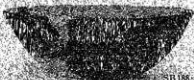

SB188-4

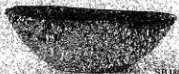

SB188-1

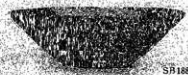

SB188-7



SB188-9



SB188-5



SB188-2

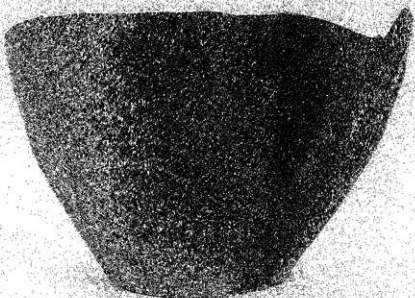
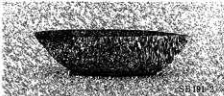
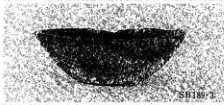
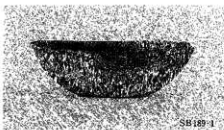

SB188-10

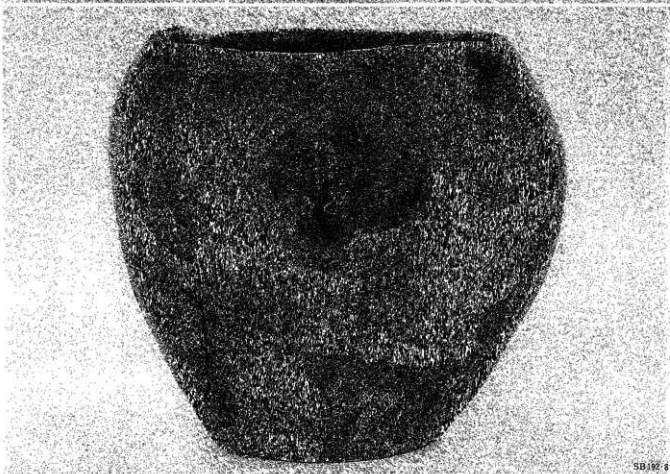
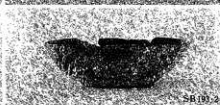
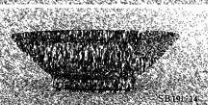
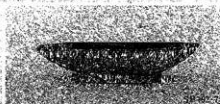
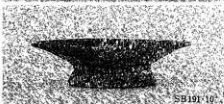

SB187-8

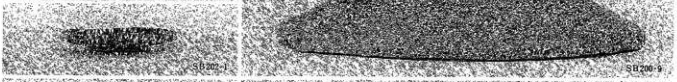
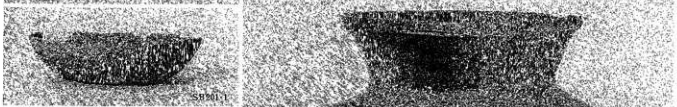
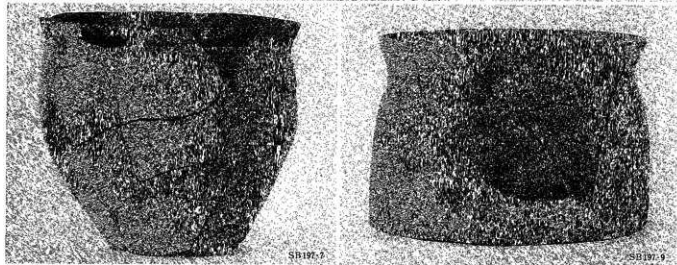
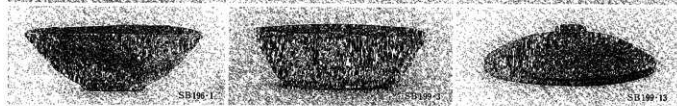
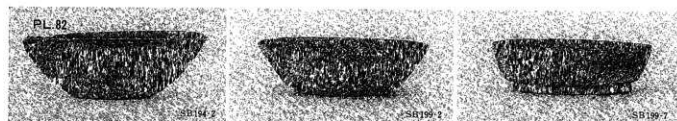



SB209-1



SB210-4



SB210



SB209-3



SB210-5

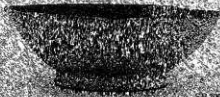

SB209-6

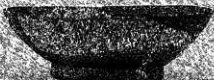

SB210-8

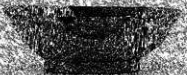

SB209-7



SB211-1

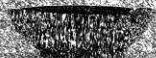

SB211

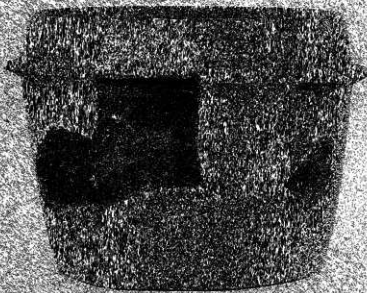

SB211-4

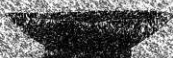

SB212



SB214



SB213-1



SB213-2



SB213



SB215-1



SB215-2



SB216-1



SB219-3



SB216-8



SB216-7



SB226-2



SB226-1



SB226-8



SB226-7

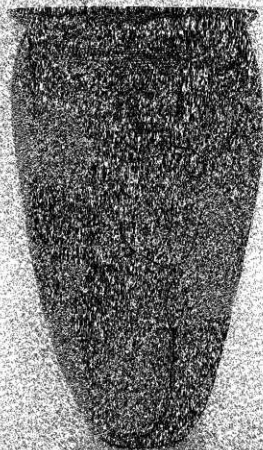

SB227-29

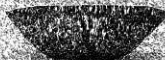

SB226-3



SB226-5



SB227-1

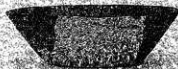

SB227-2



SB227-1

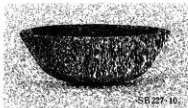

SB 227-10

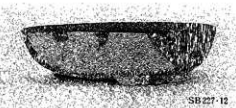

SB 227-12



SB 227



SB 227-16



SB 232-2



SB 232-3

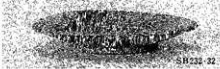

SB 232-22

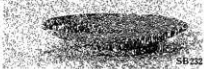

SB 232-23



SB 232-15

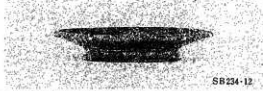

SB 234-12



SB 235-1

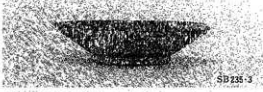

SB 235-3

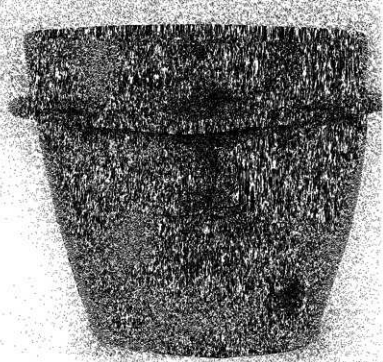

SB 232

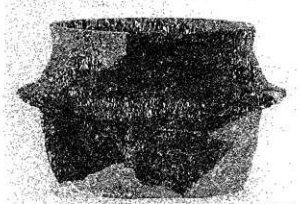

SB 235-7

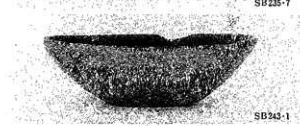

SB 243-1

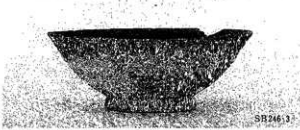

SB 246-3



SB 234



SB227-1



SB242-1



SB243-5

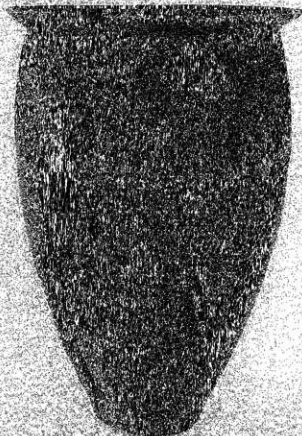

SB246-1



SB246-14



SB247-1



SB247-2



SB247-3



SB247-6



SB247-19



SB248-3



SB248-4



SB248-10

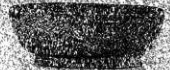

SB248-11



SB248-14

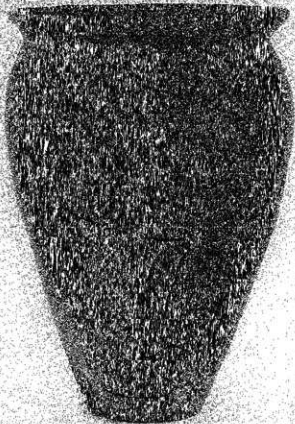

SB248-6

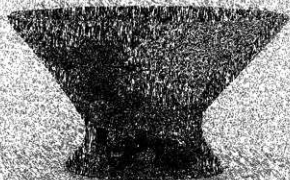

SB247-14



SB247-3



SB248-1

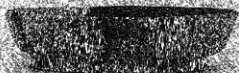

SB248-2

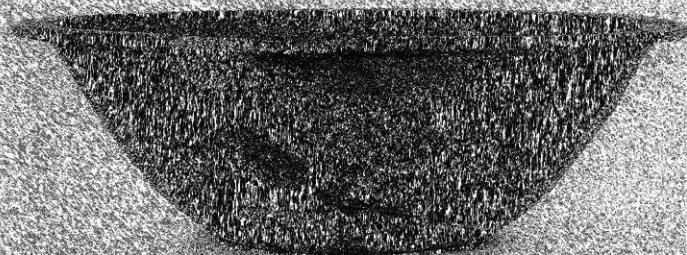

SB251



SB255-1



SB255-2



SB255-3



SB256-10

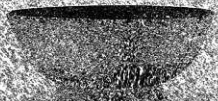

SB256-1



SB258-1



SB258-3



SB258-4



SB260-2



SB260-3



SB263-1



SB263-6



SB263-7



SB263-2



SB264-5

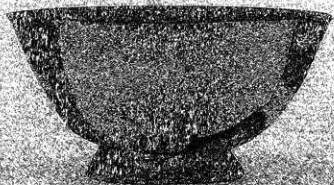

SB263-17



SB264-6



SB264-11

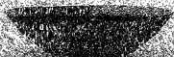

SB267-2



SB268-1

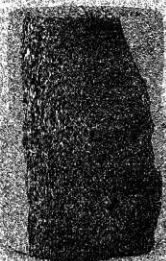

SB264-17



SK128-1

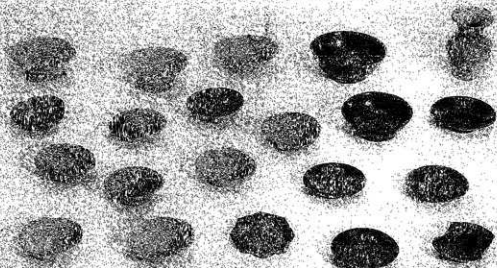

SK128



SK128-3



SK128-3



SK128-10

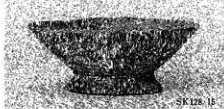

SK128-15

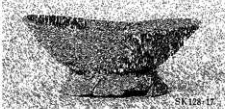

SK128-17



SK34-1



SK64-1

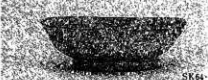

SK64-2



SK24-1

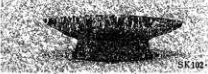

SK100-1



SK102-1



SK101-1



SK107-1



SK107-4

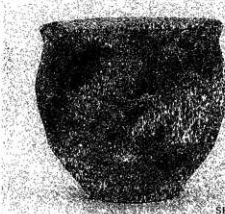

SK103-3



SK122-1

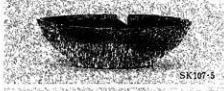

SK107-5

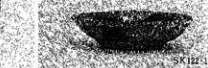

SK122-11



SK122-2

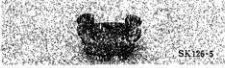

SK126-5



SK122-10



SK122-8



SK122-22



SK122-25



SK122-26



SK203-9



SK128-1



SK211-10



SK129-3



SK218-2



SK218-3

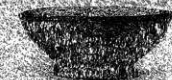

SK218-12



SK218-5



SK218-6



SK218-7



SK218-9



SK218-10

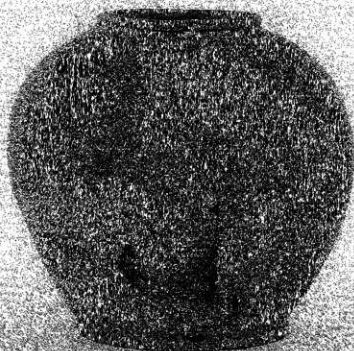

SK229-1



SX21-40

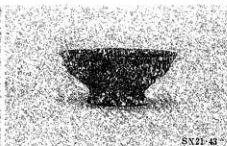

SX21-43

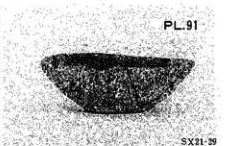

SX21-29

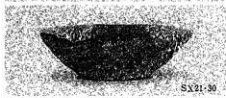

SX21-30

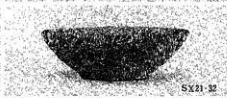

SX21-32

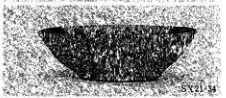

SX21-34



SX21-3



SX21-4



SX21-5

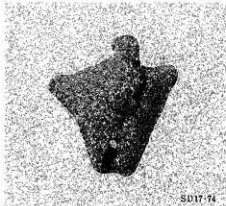

SD17-74



SD17-74

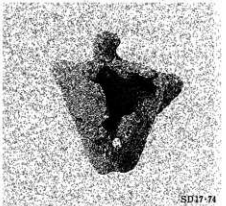

SD17-74



X-79

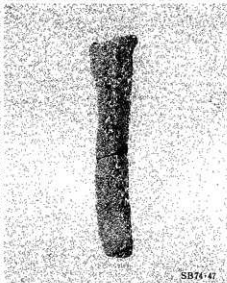

SB74-47

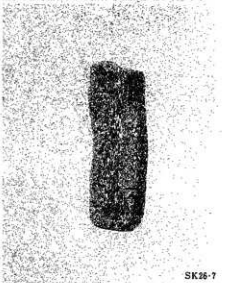

SK26-7

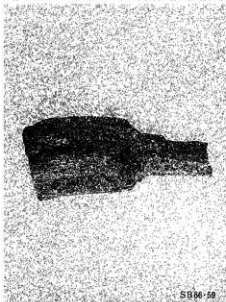

SB66-50

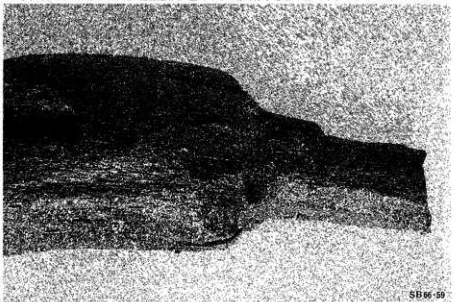

SB66-50

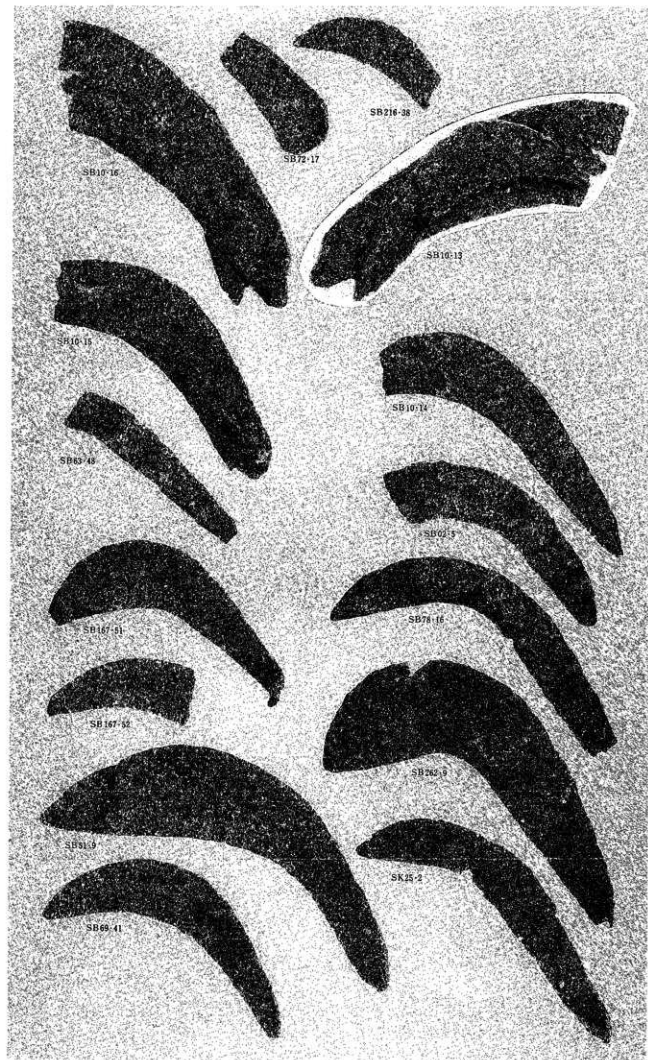

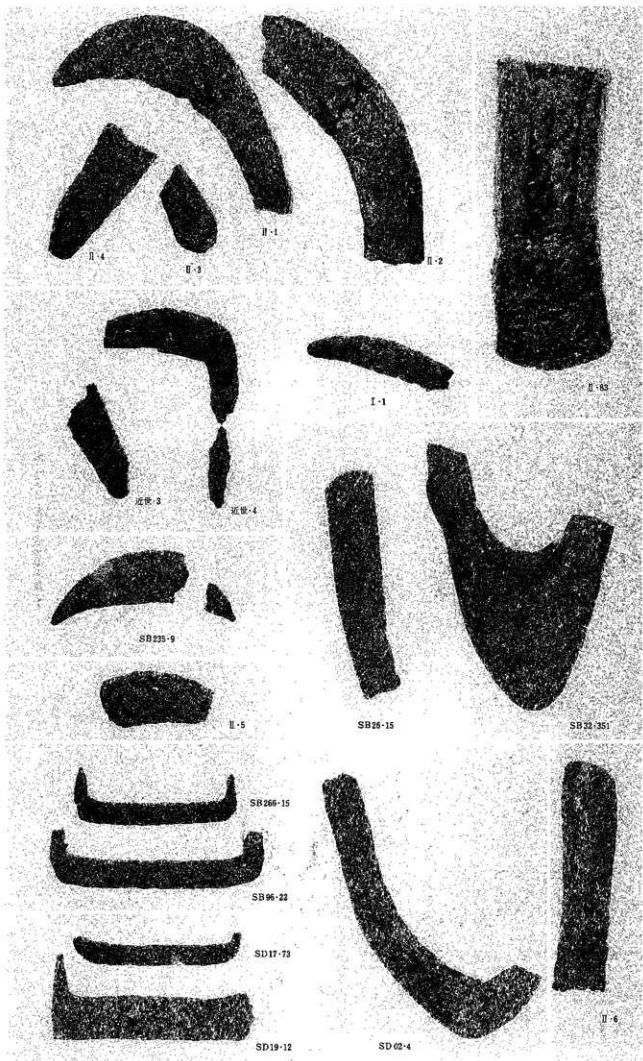

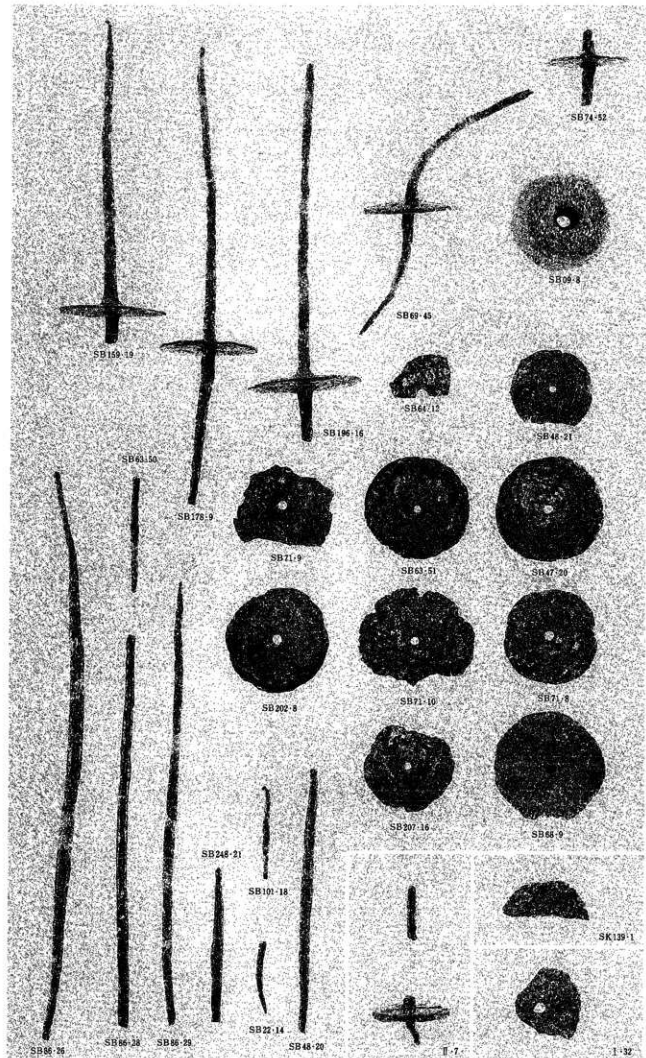

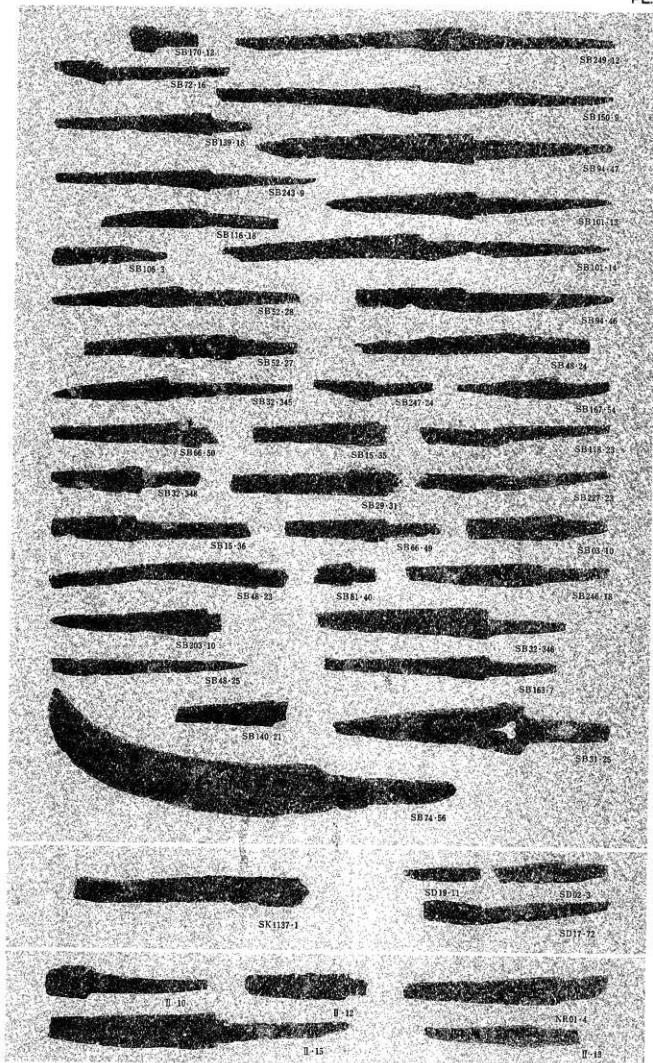

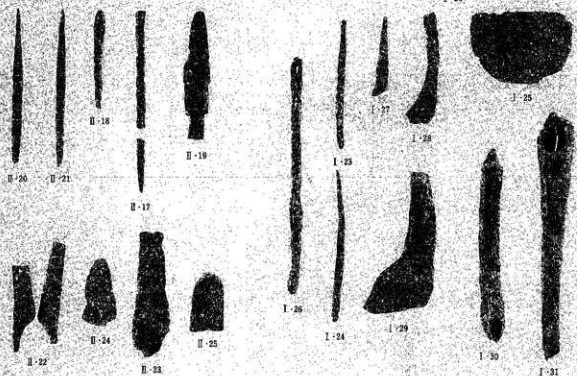
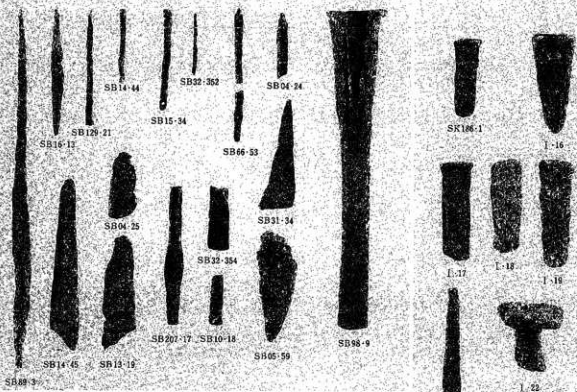
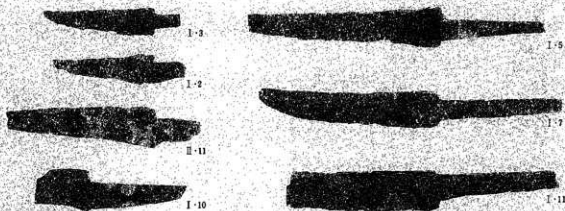



SB154-22

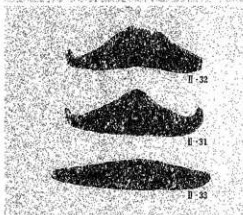

II-32

II-31

II-33



I-12

I-13

I-14

I-15

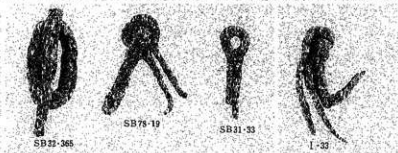

SB32-365

SB75-19

SB31-33

I-33

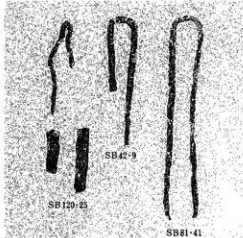

SB42-9

SB120-23

SB81-41

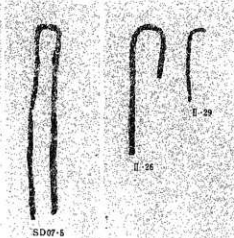

I-29

II-25

SD07-5



I-36

I-37

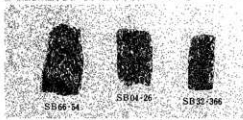

SB66-54

SB04-26

SB32-366

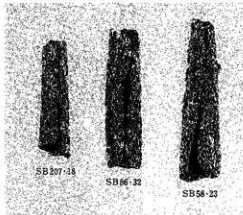

SB207-18

SB86-32

SB58-23

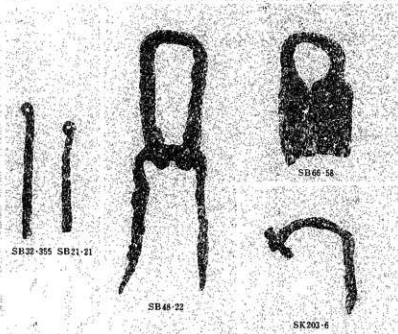

SB32-355 SB21-21

SB48-22

SB66-58

SK203-6

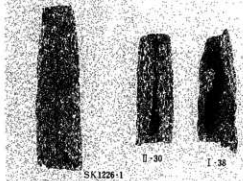

SK1226-1

II-30

I-38

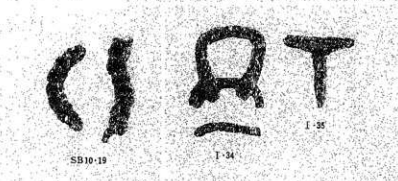

SB10-19

I-34

I-35

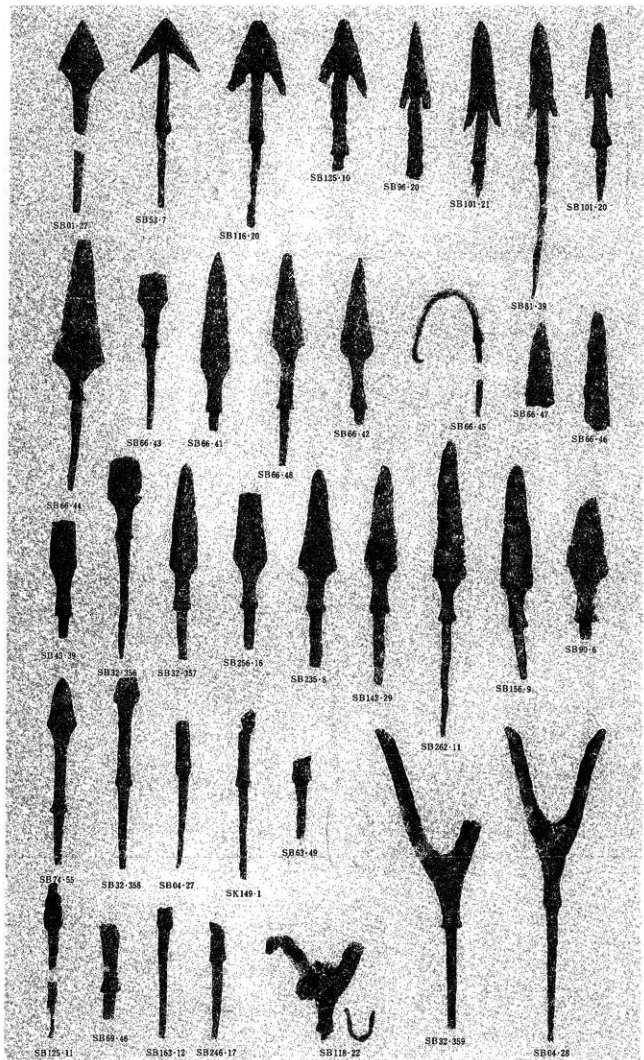

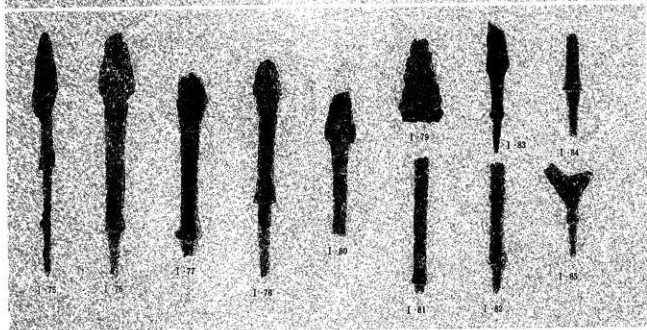
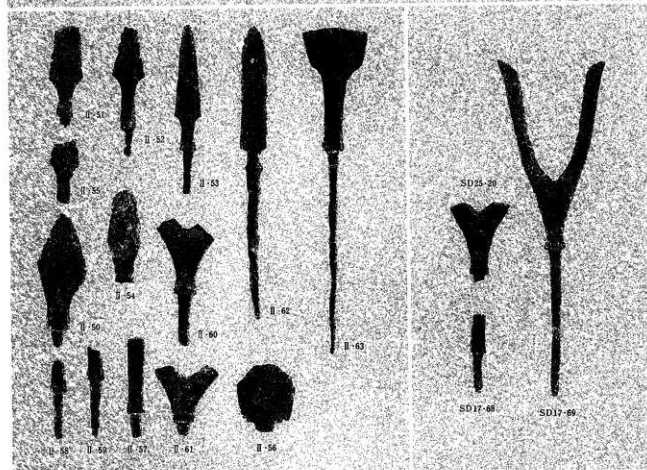
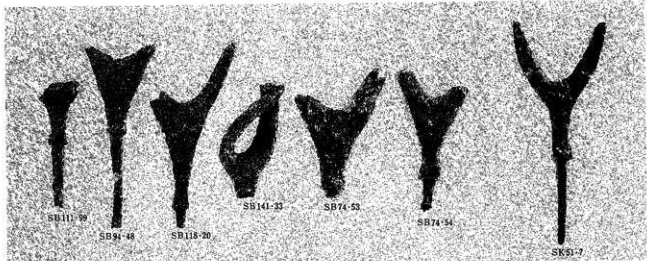

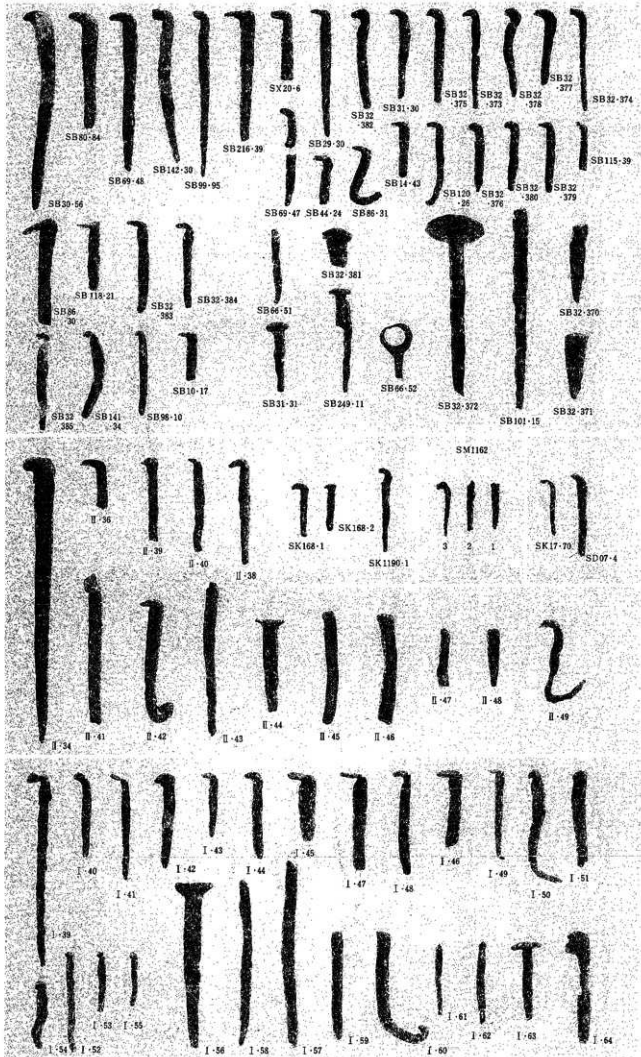

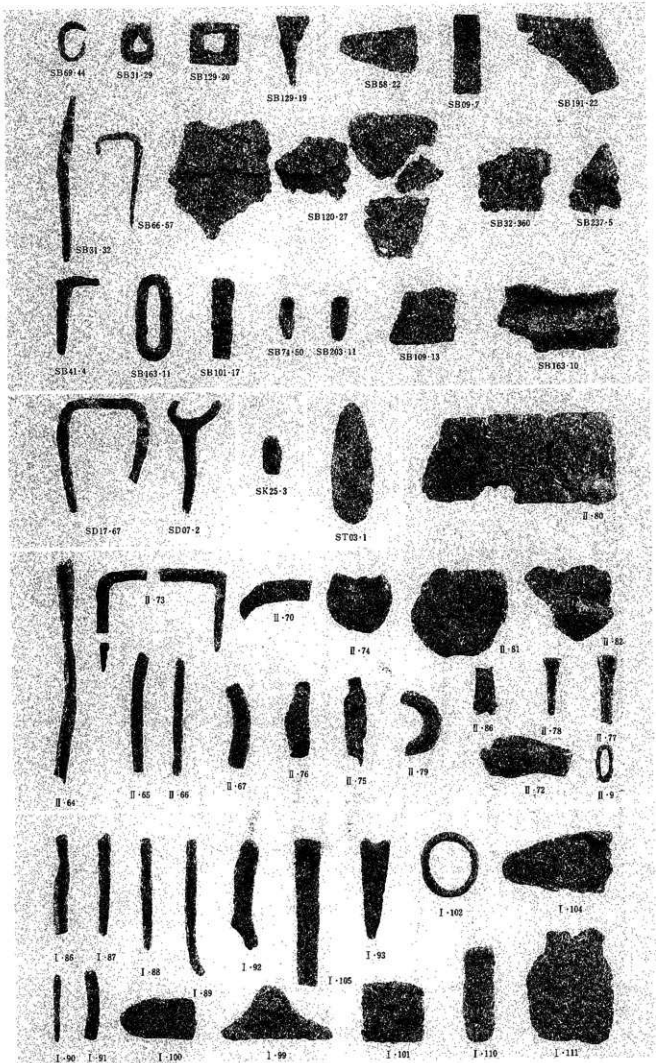

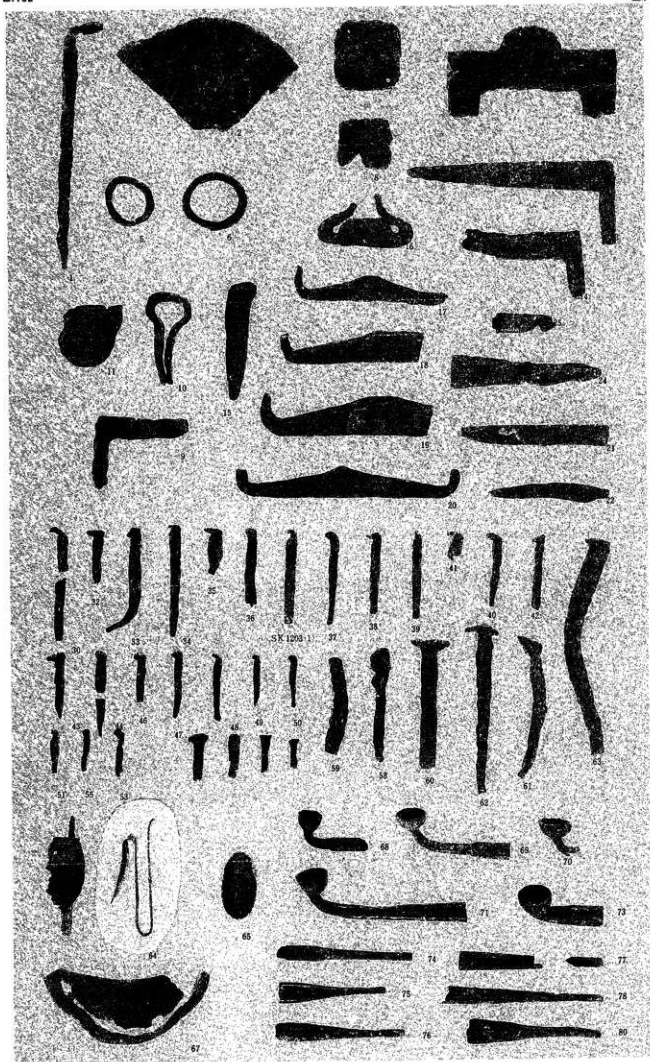

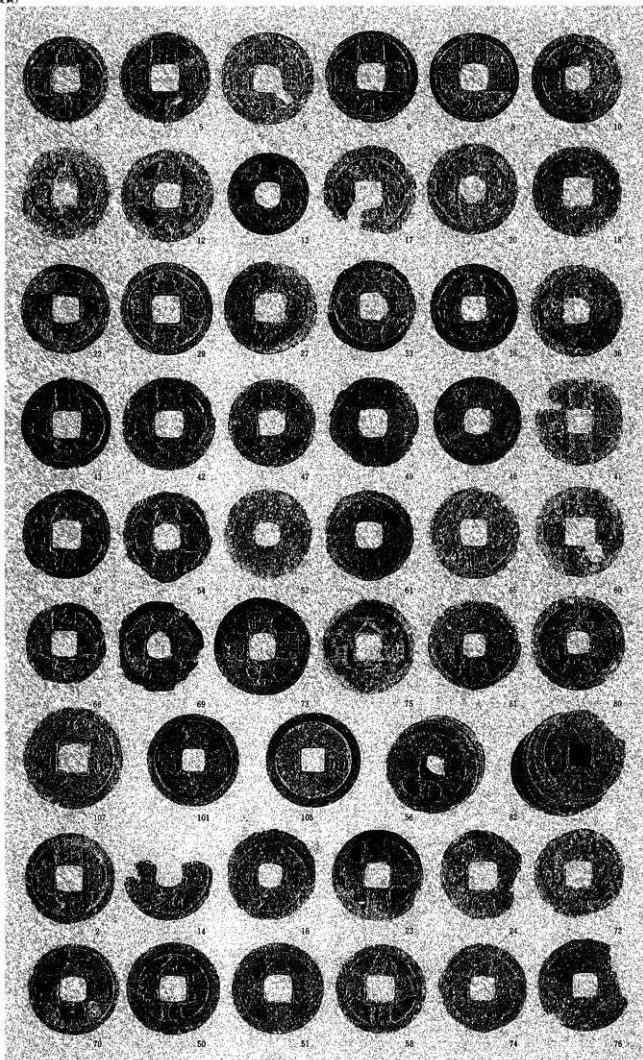

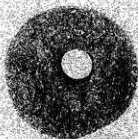
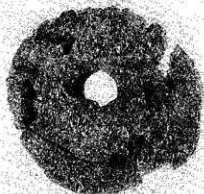

SK73

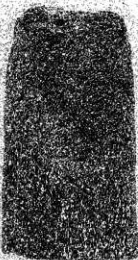

SK158

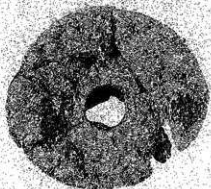

SB47

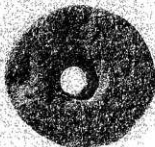

SK73

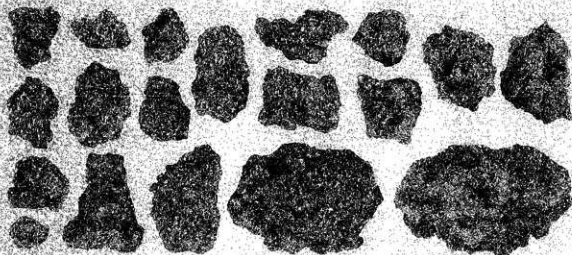

SB32

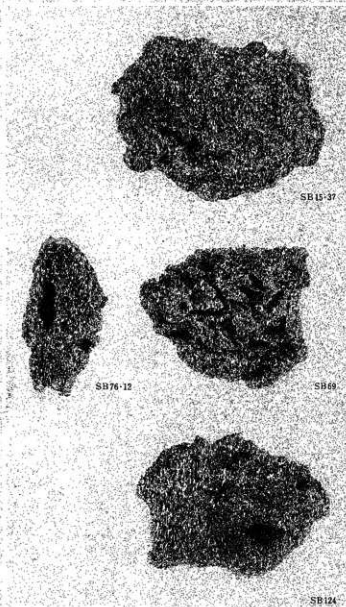
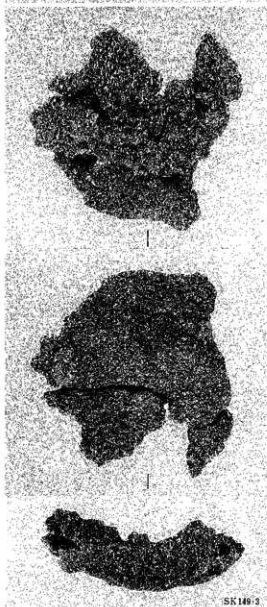
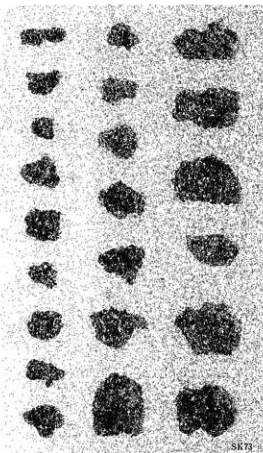
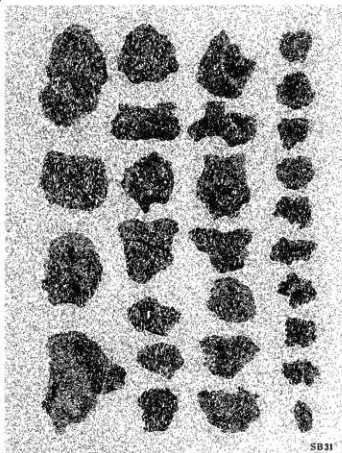

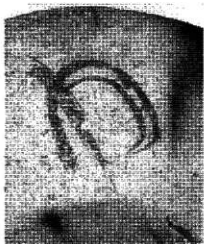

911-4

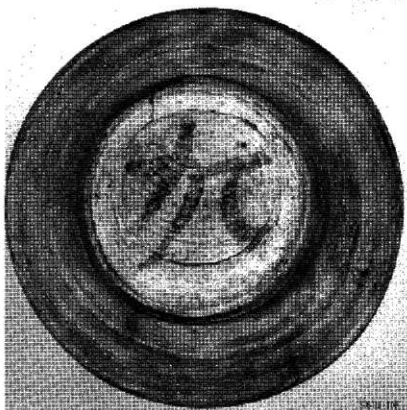

911-4



SB94-42



SB94-42

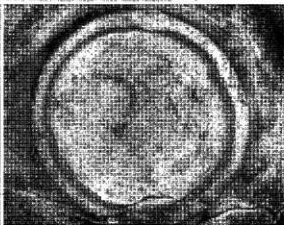

SB94-42

SB94-42



SH102-10

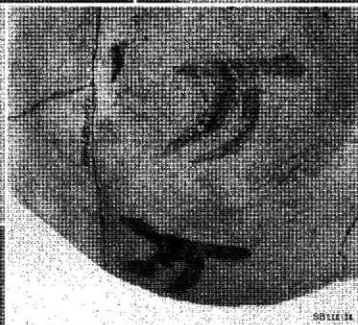
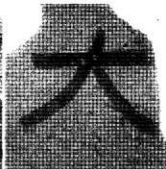
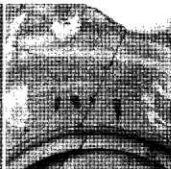

SB1112-14

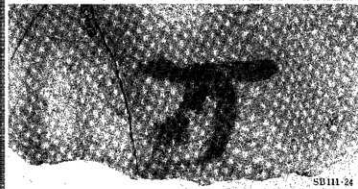
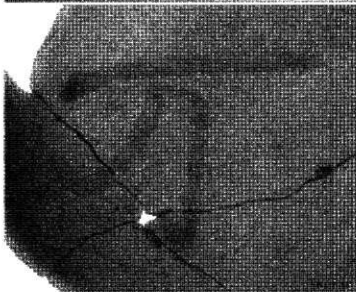

SB1111-24

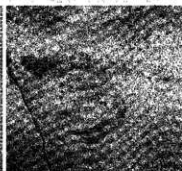

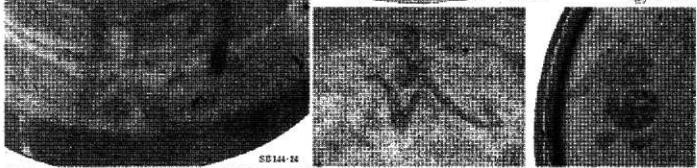
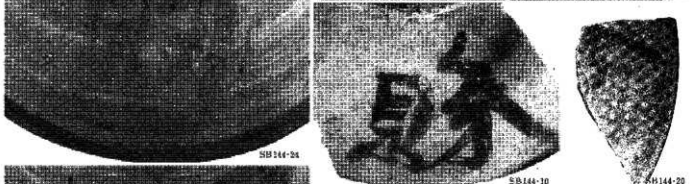
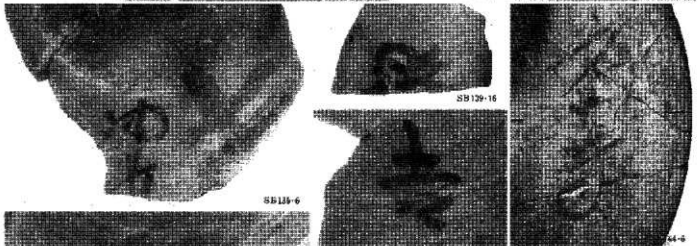

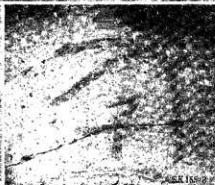
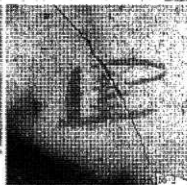
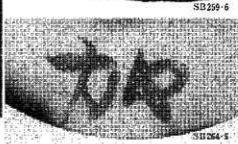
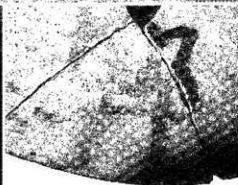
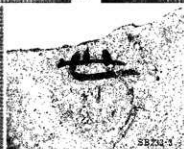
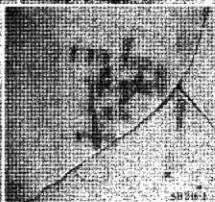

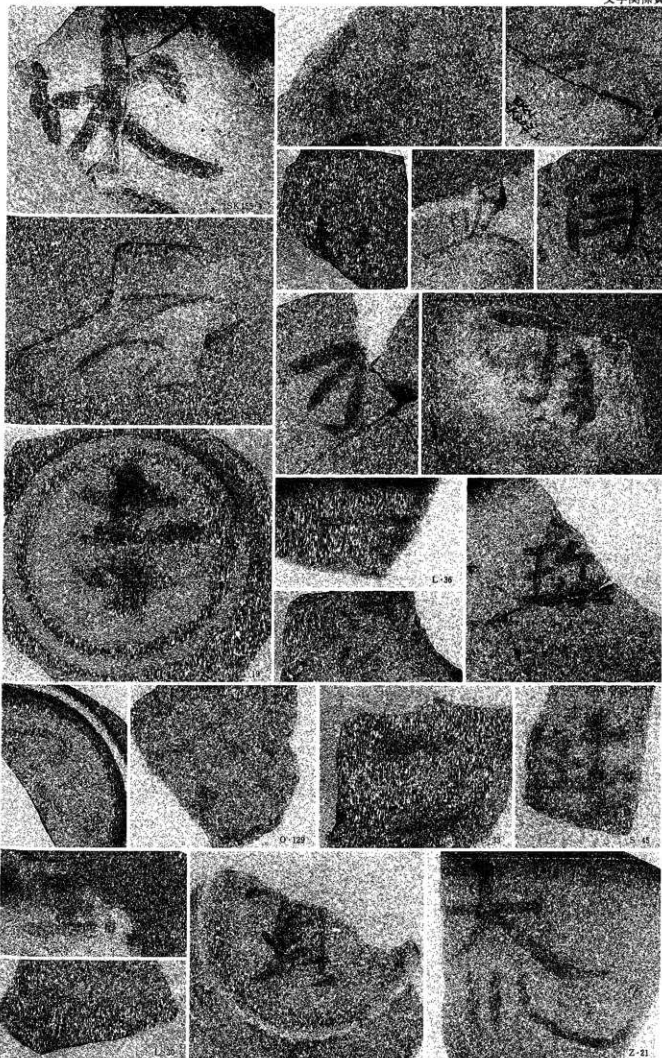

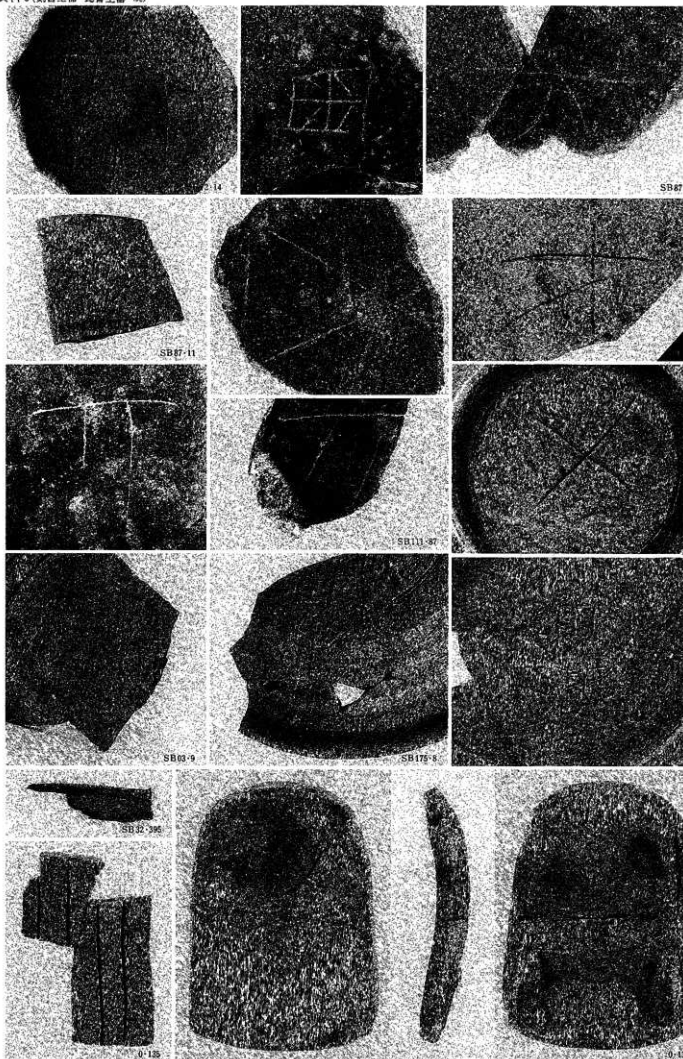



SX08-1

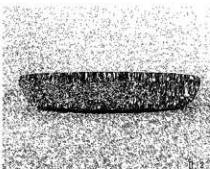

I-3



I-1

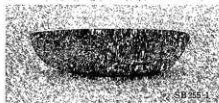

SB25-1

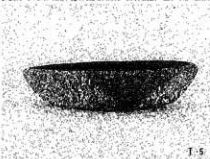

I-5

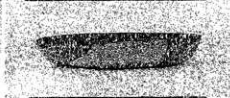

I-1



SX08-2



I-11

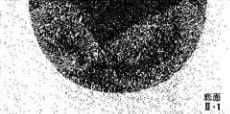

底面
I-1

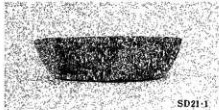

SD21-1



I-13



上面
I-1



I-17



I-18



底面
Ib-1

土器皿



山茶碗

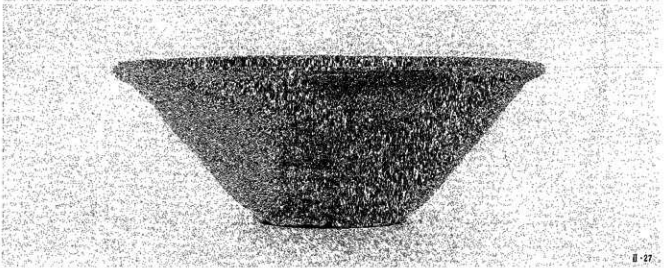

II-27

捏鉢

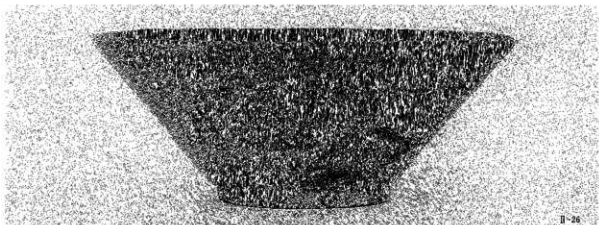

II-26

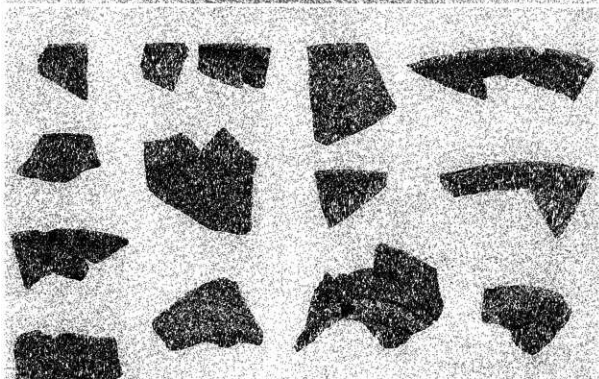

捏鉢

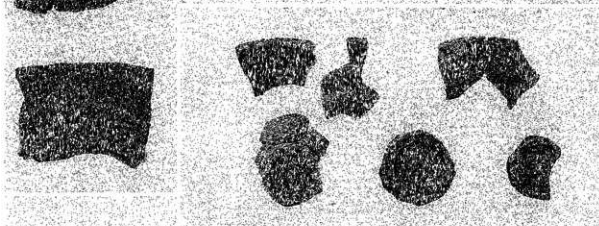

右 古瀬戸系平碗

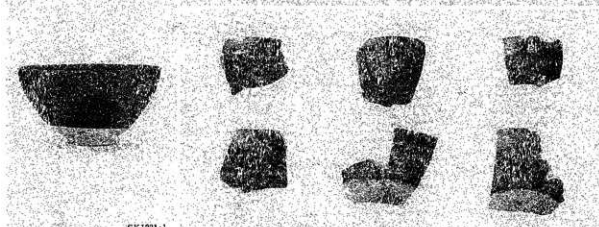

古瀬戸系天目茶碗

SK1221-1

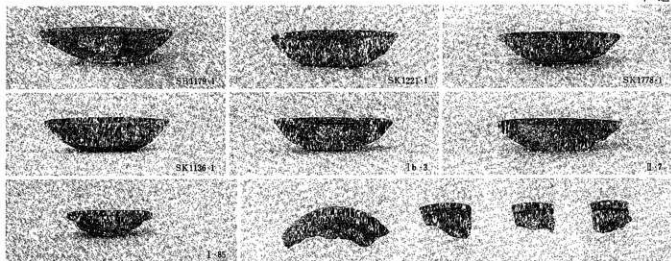

古瀬戸系
小皿

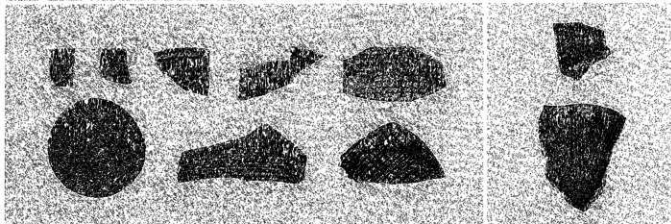

古瀬戸系
おろし皿

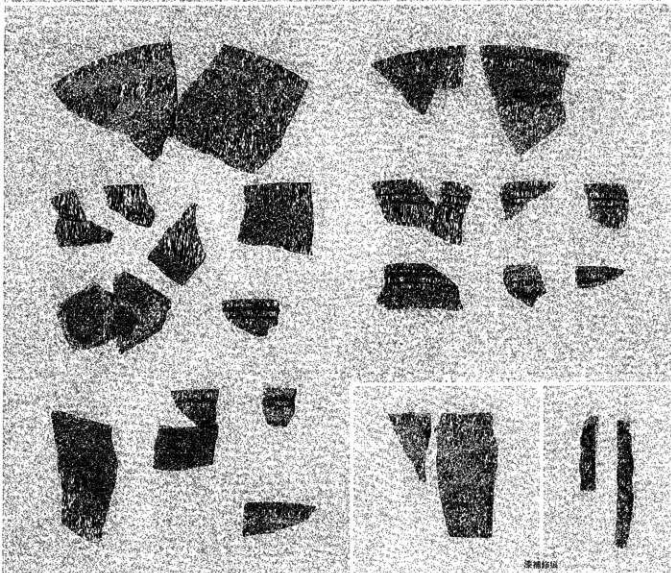

古瀬戸系
折縁深皿

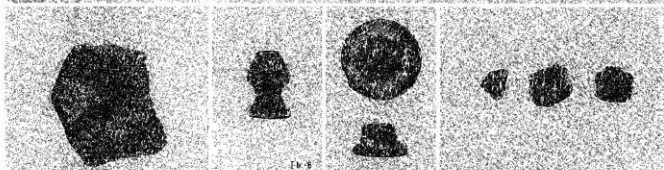
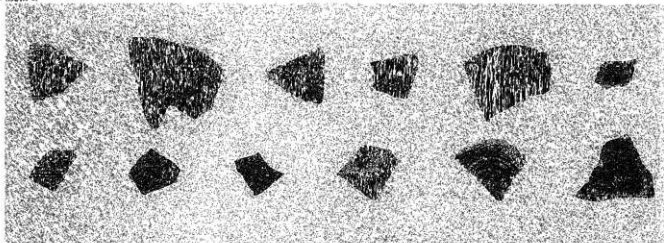

古瀬戸系
壺類

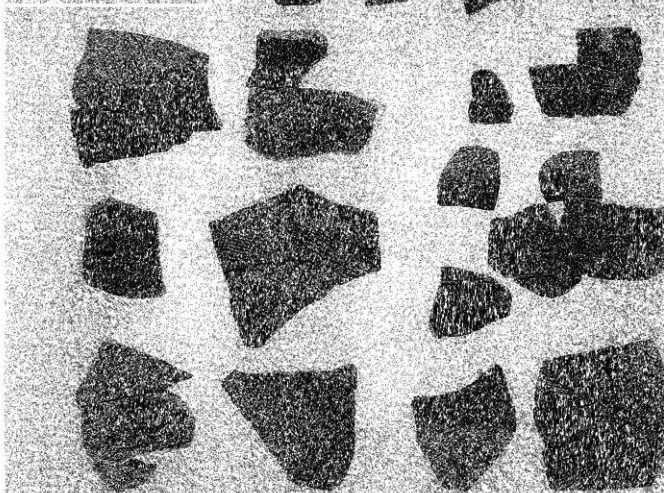

常滑系
壺・甕類

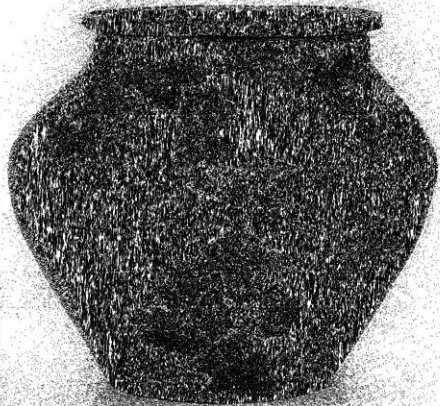

左 須恵器質
摺鉢

II-30

常滑系壺

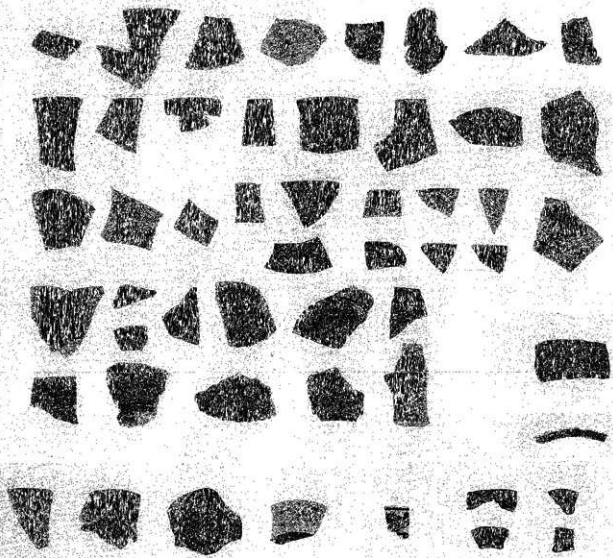

輸入陶磁器

右 銅緑釉
天目茶碗
(大塚)

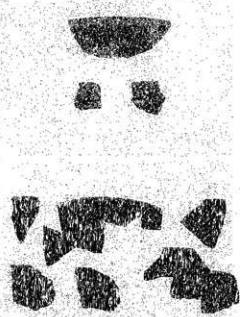
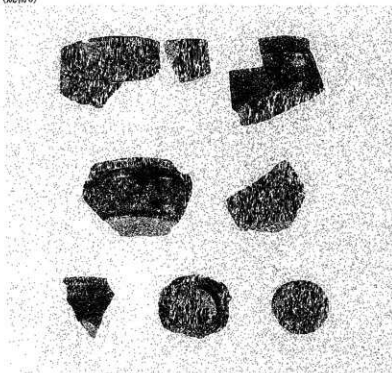

左 天目茶碗
(大塚)

右 平碗
(大塚)



I-147



SK1208-1



I-142



I-145



I-146



I-142

皿類
(大塚)

左 香炉
(大塚)

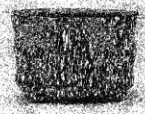
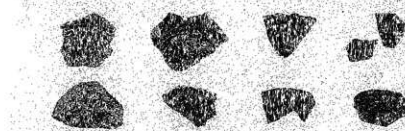

I-157

左 摺鉢
(大塚)

右 香炉
(大塚)

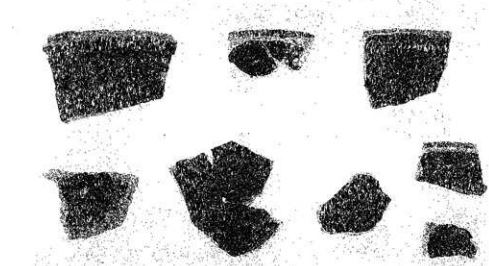

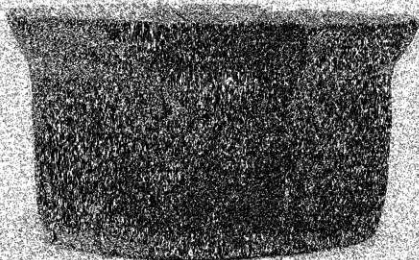

SK1207-1

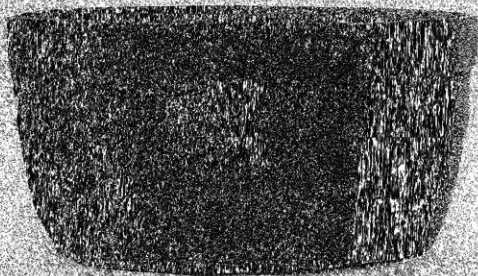

SD21-7

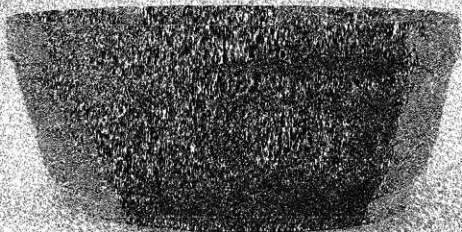

SK1188-1

内耳鍋

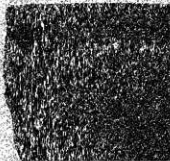
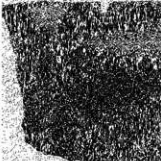
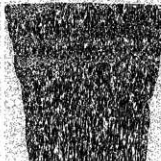
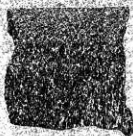
内耳鍋
口縁部内面

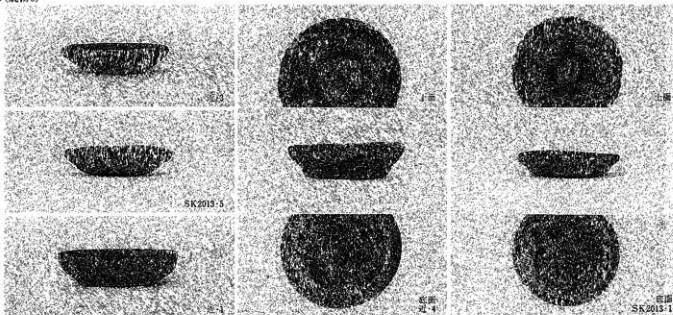

土器皿

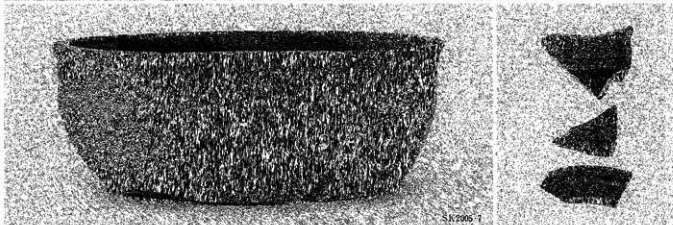

鉢 類

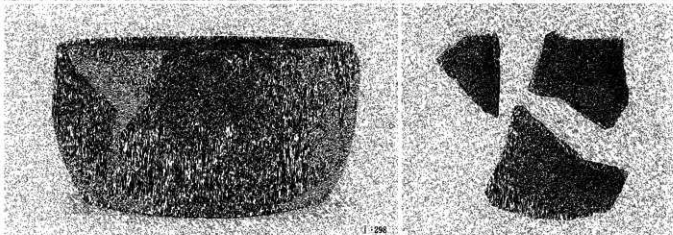

ホウロク

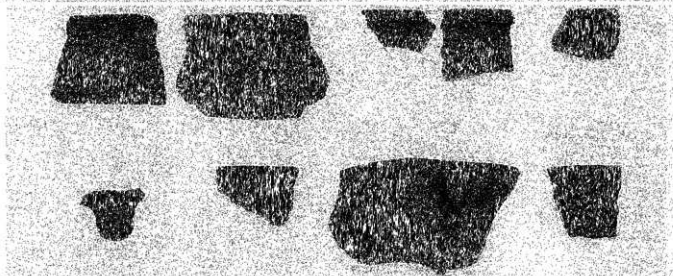

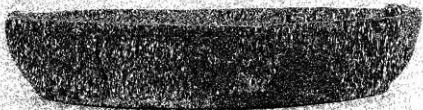

SK2020.2021-1

ホウロク



天目茶碗
(近世)

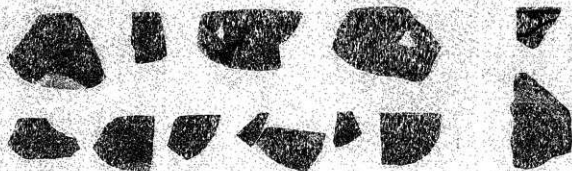

左 鉄軸丸碗
(近世)

右 鉄絵長大軸皿



近-5

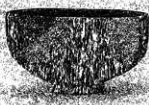

SX2023-2

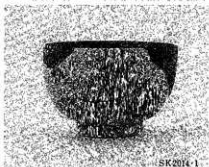

SK2014-1

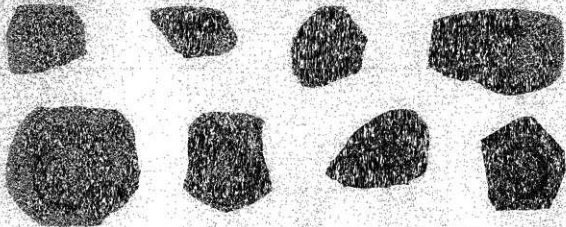

灰軸丸碗
(近世)



並-15



I-197

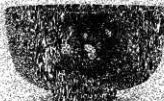

SK2005-1



並-18



SK1196-1

I-177



並-25



I-210



並-26

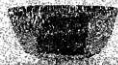

I-216



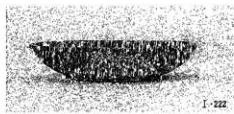

I-222



I-224

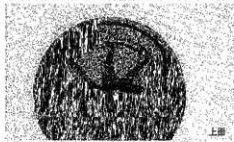

上面



I-232

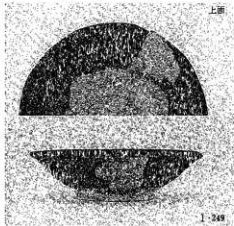

上面



I-248

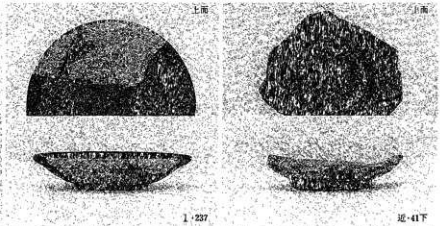
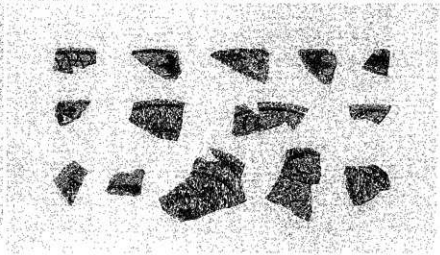
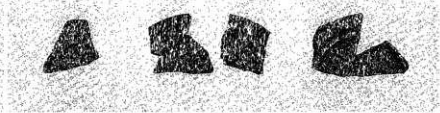
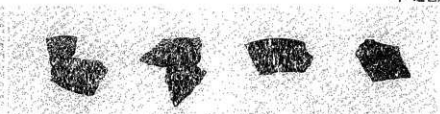

上面

下面

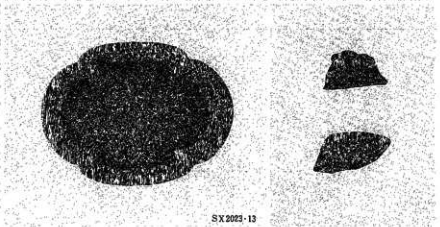

長石軸

I-237

近-41下

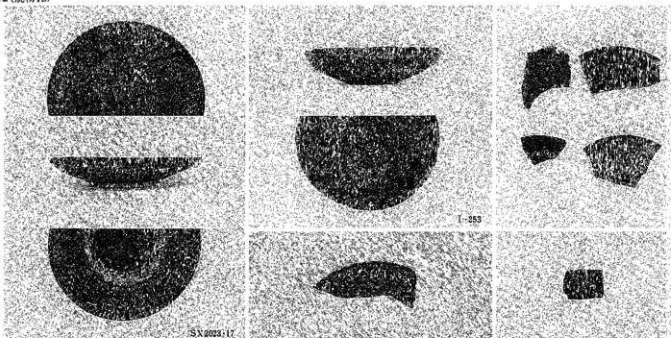

皿
(近世)

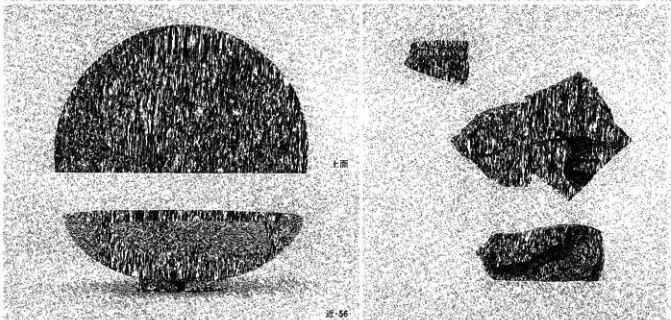
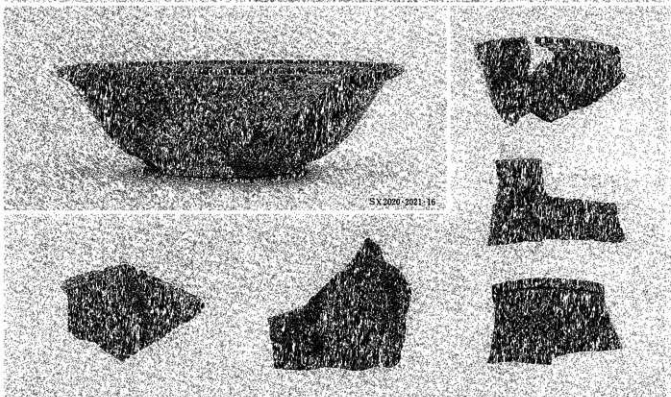

鉢
(近世)

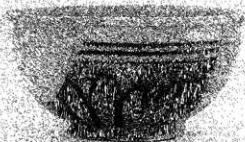
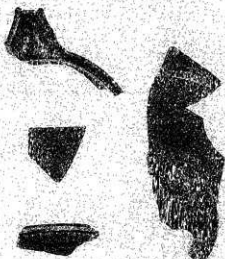
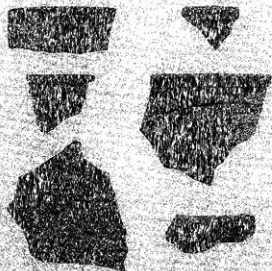

SX2003-23

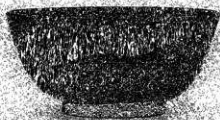

SX2020_2021-20

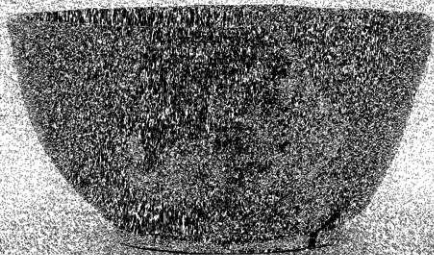

SD32722

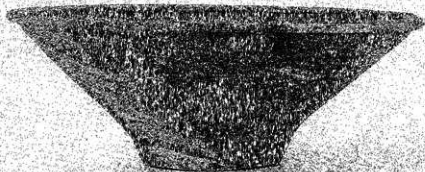
鉢
(近世)

SK1190-5

播鉢
(近世)

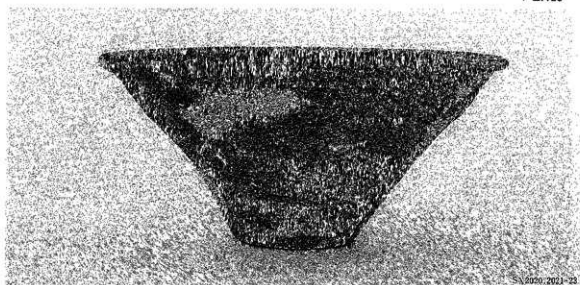

SX.2020.0011.23

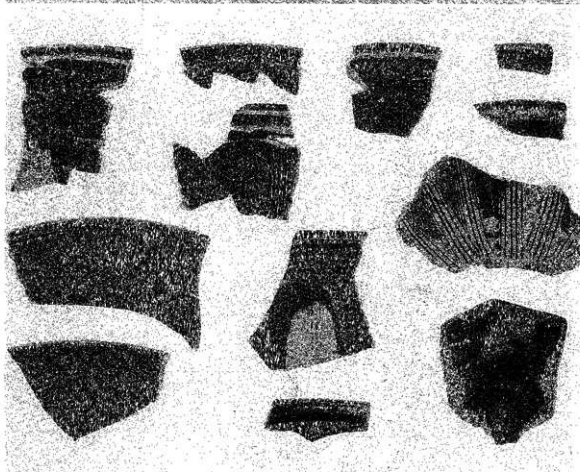

桶鉢
(近世)

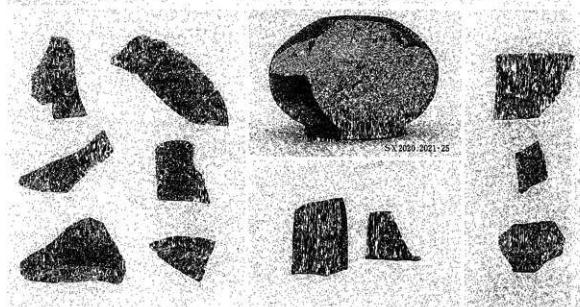

壺類
(近世)

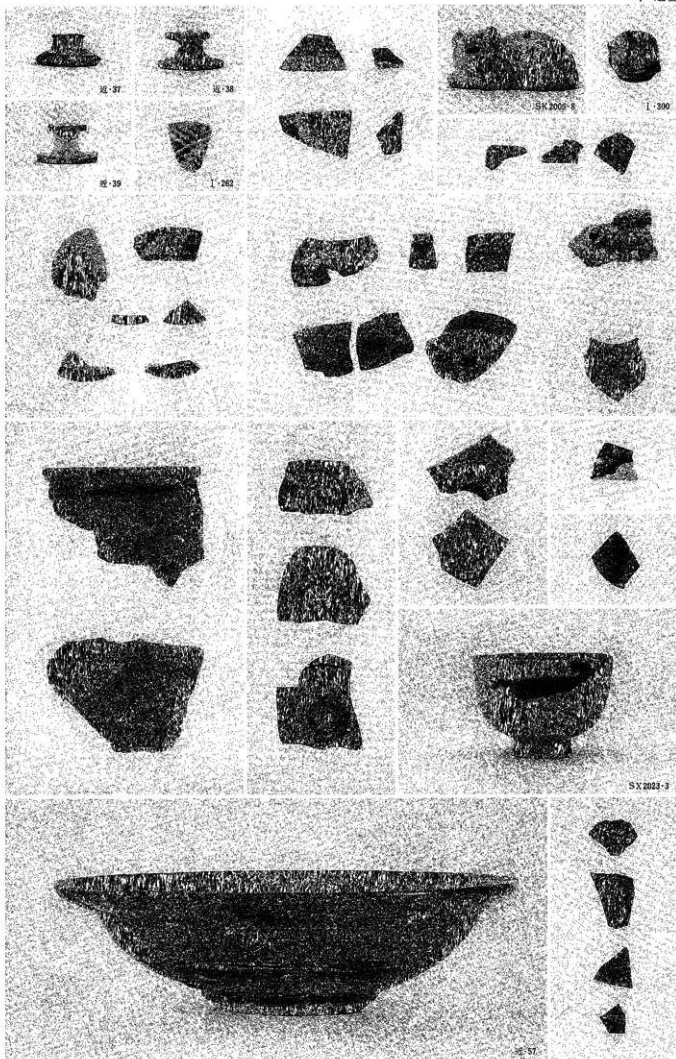

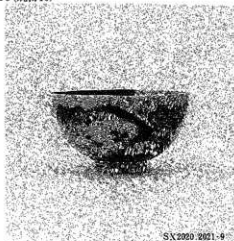

SX2020-2021-9

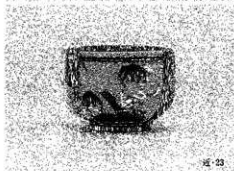
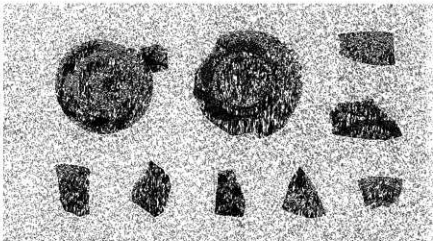

正-23

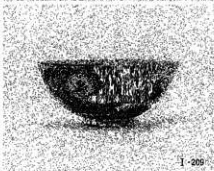

I-205

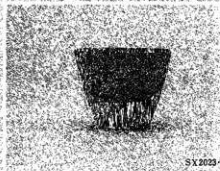

SX2023-1

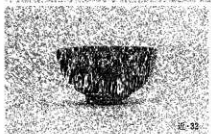
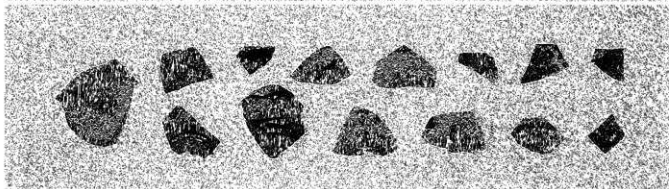

正-32



SX2023-7

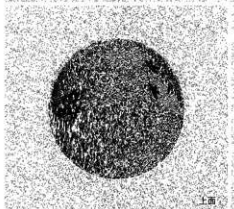

上面

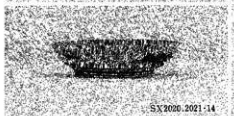
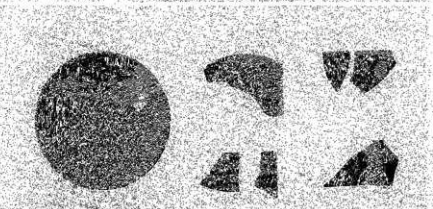

SX2020-2021-14

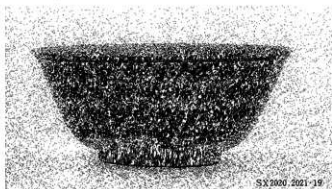

SX 2020・2021・39

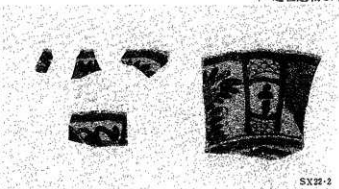

SX 22・2

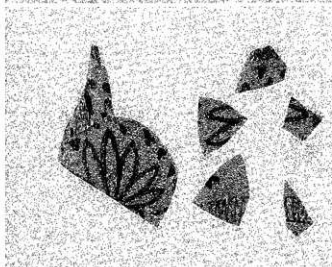

SX 2020・2021・26

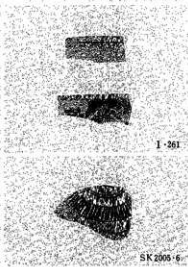

I・261

SK 2005・6

染付
鉢・徳利

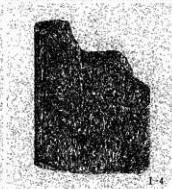
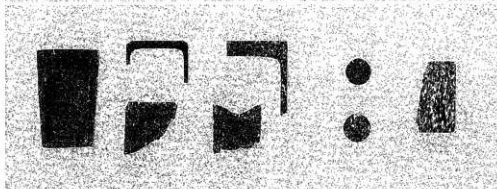

I・4

左 硯

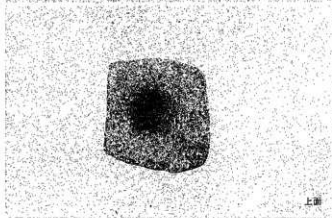

上面



上面

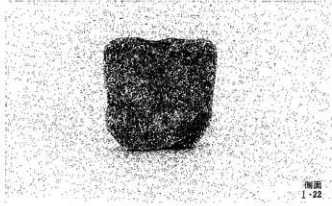

側面
I・22

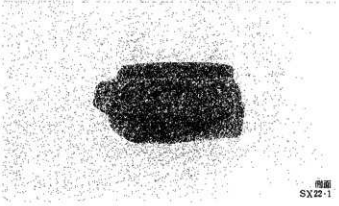

側面
SX 22・1

石製品

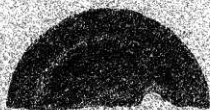

上面



側面

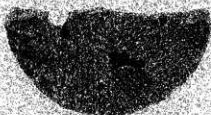

下面



外-3



外-2

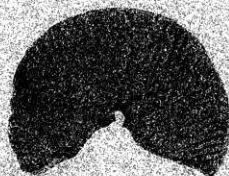

上面



側面



下面



外-13

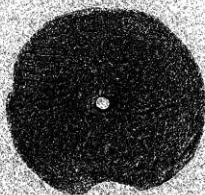

外-12

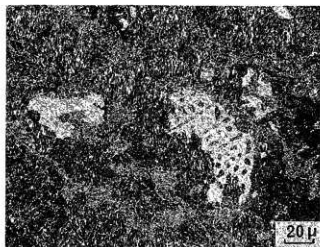

白色部が金属鉄

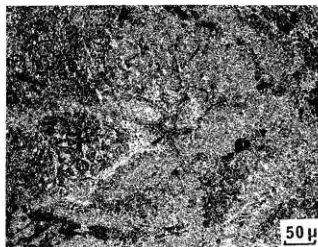

ひも状黒鉛

1 ③試料の組織



2 ⑥試料の組織

金属鉄周囲が錆化した部分
中央暗灰色部がガラス質種酸塩、他は錆層

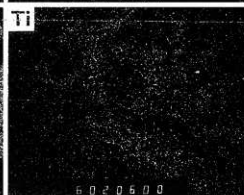

3 ⑥試料中スラグ部分の元素分布 (EPMA)

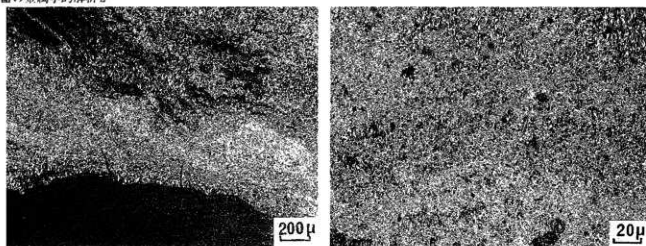

1 ②試料の組織

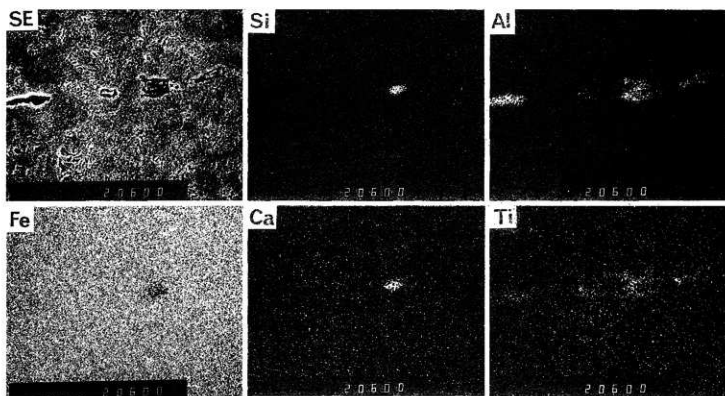

2 ②試料中在物の元素分布 (EPMA)

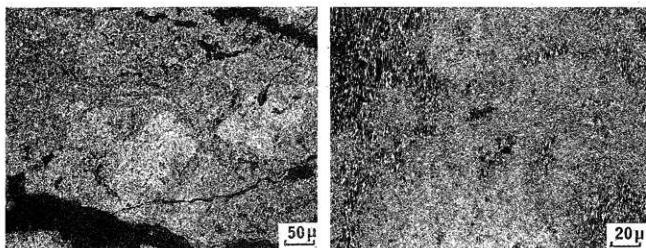

3 ③試料の断面組織

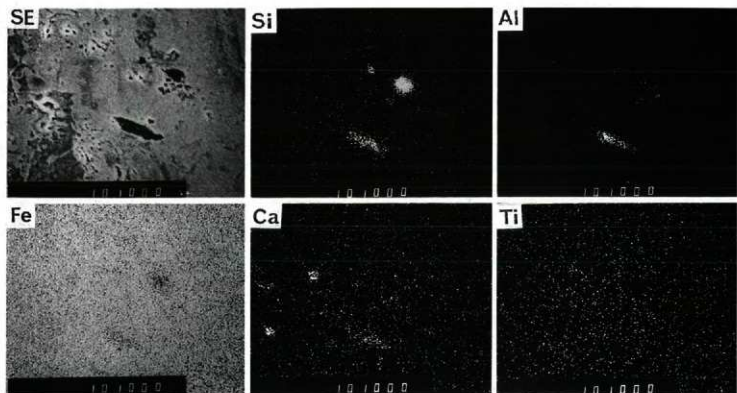

1 ⑧試料中に存在する介在物の元素分布 (EPMA)

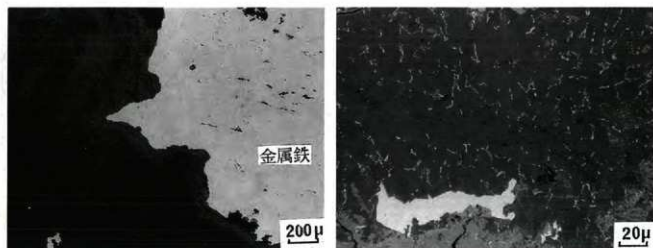

2 ⑧試料の断面組織

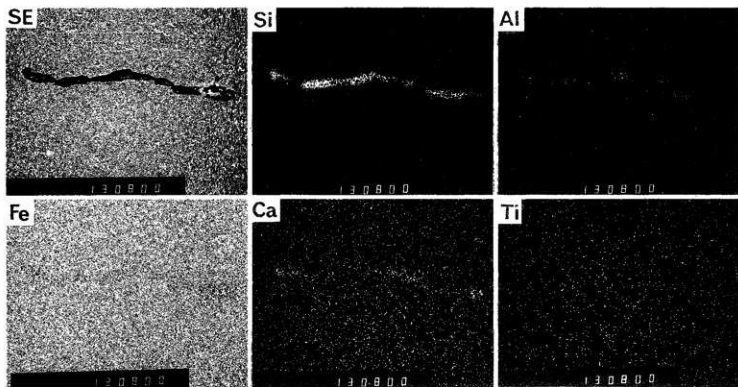

1 ⑬試料に存在する介在物の元素分布 (EPMA)

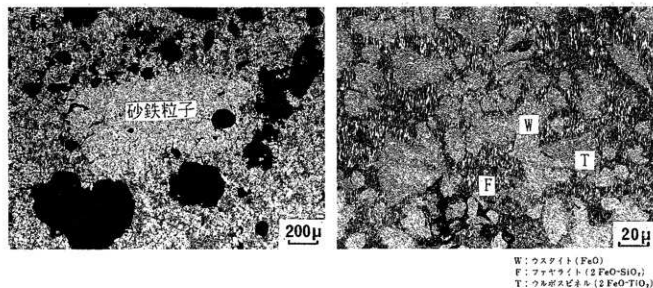

2 ⑬鉄滓の組織

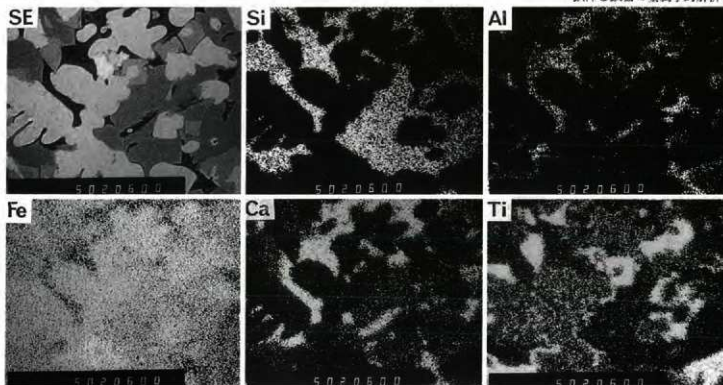

1 ③鉄滓の元素分布 (EPMA)

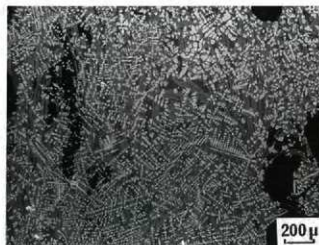

W:ウスタイト (FeO)

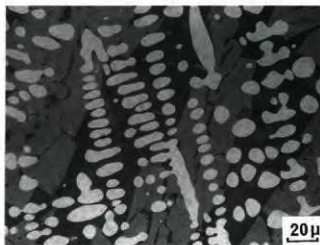
F:ファヤライト (2FeO-SiO₂)

2 ①鉄滓の組織

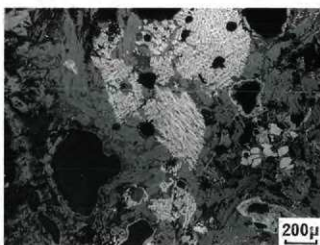
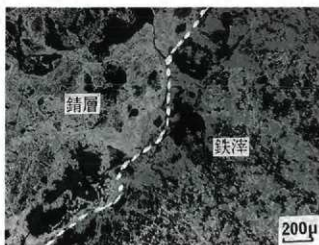

3 ④鉄滓の組織

財長野県埋蔵文化財センター発掘調査報告書 3

中央自動車道長野線埋蔵文化財発掘調査報告書 3

— 塩尻市内その2 —

吉田川西遺跡

図 版 編

発行 平成元年3月31日発行
発行者 日本道路公団名古屋建設局
長野県教育委員会
財長野県埋蔵文化財センター
印刷 電算印刷株式会社

