

上信越自動車道

埋蔵文化財発掘調査報告書 19

—小諸市内 3—

三子塚遺跡群 三田原遺跡群 岩下遺跡 石神遺跡群
郷土遺跡 東丸山遺跡 西丸山遺跡 深沢遺跡群

図 版 編

2000

日 本 道 路 公 団
長 野 県 教 育 委 員 会
長 野 県 埋 蔵 文 化 財 セ ン タ ー

上信越自動車道

埋蔵文化財発掘調査報告書 19

—小諸市内 3—

三子塚遺跡群 三田原遺跡群 岩下遺跡 石神遺跡群
郷土遺跡 東丸山遺跡 西丸山遺跡 深沢遺跡群

図 版 編

2000

日 本 道 路 公 団
長 野 県 教 育 委 員 会
長 野 県 埋 蔵 文 化 財 セ ン タ ー

例 言

- 1 本書は上信越自動車道建設工事及びそれに関連する小諸市道拡幅工事に伴い発掘調査された小諸市内に所在する8遺跡（三子塚遺跡群、三田原遺跡群、岩下遺跡、石神遺跡群、郷土遺跡、東丸山遺跡、西丸山遺跡、深沢遺跡群）の発掘調査報告書の図版編である。郷土遺跡の図版の一部と、各遺跡の写真図版を取録してある。
- 2 調査に至る経緯や結果については、本文編を併読願いたい。
- 3 遺物の展開写真は小川忠博氏に撮影していただいた。
- 4 航空写真は、縮写真測図研究所に委託して撮影した。
- 5 本書の作成にかかる分組は下記の通りである
 桜井秀雄 郷土遺跡の図版、郷土遺跡と深沢遺跡群の写真図版作成
 宇賀神誠司 三子塚遺跡群、三田原遺跡群、岩下遺跡、石神遺跡群、東丸山遺跡、西丸山遺跡の写真図版作成
 賛田明 郷土遺跡の写真図版の一部作成
 田村彬 遺物写真撮影・現像・焼き付け
 西嶋力 同上
- 6 本書に掲載した遺物写真の縮尺は、原則として下記の通りである。
 小形土器1：4、大形土器1：6、土器破片1：3、小形石器1：2～1：3、大形石器1：6、

目 次

図版

郷土遺跡割付図の配置	図版	1
遺構割付図	図版	2~ 21
縄文中期の土坑	図版	22~ 78
出土土器	図版	79~210
出土石器	図版	211~276
出土土製品・石製品	図版	277~283
石器表		1~ 5

写真図版 (P L)

三子塚遺跡群	P L	1~ 9
三田原遺跡群	P L	10~ 36
岩下遺跡	P L	37~ 65
石神遺跡群	P L	66~ 72
郷土遺跡	P L	73~226
東丸山遺跡	P L	227~232
西丸山遺跡	P L	233~234
深沢遺跡群	P L	235~236

実測図版

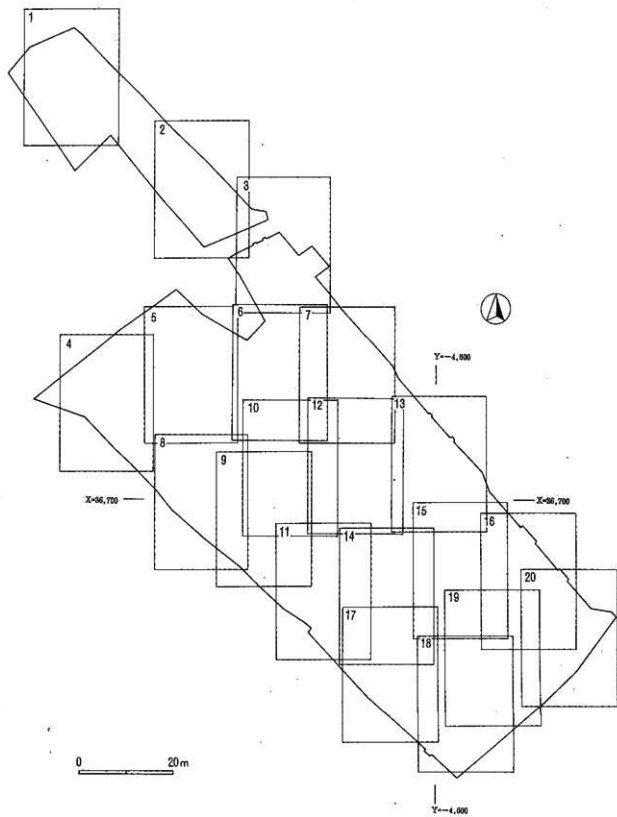

図版1 割付図の配置 1 : 800

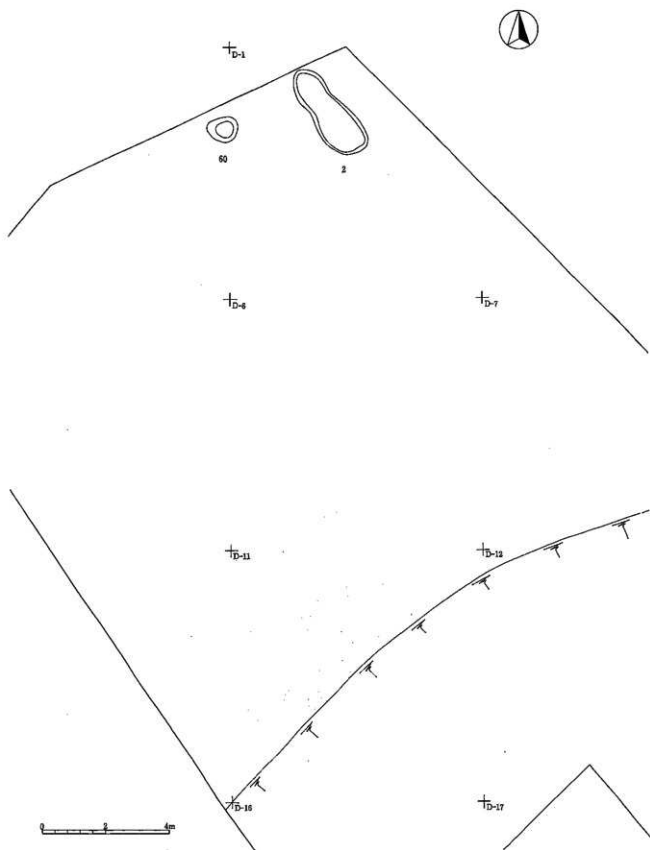

図版 2 遺構割付図(1) 1 : 120

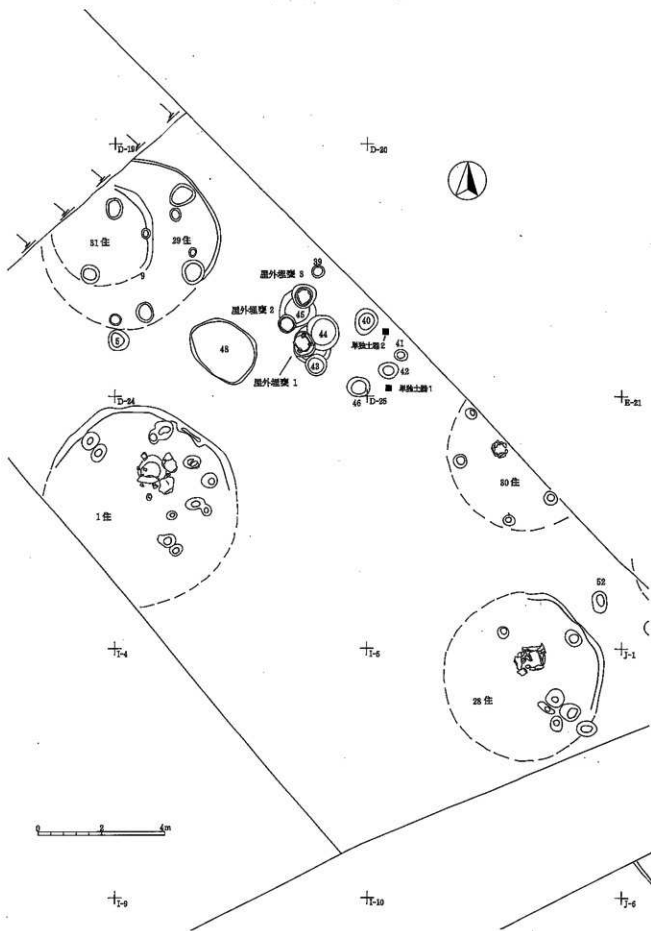

図版 3 遺構割付図(2) 1 : 120

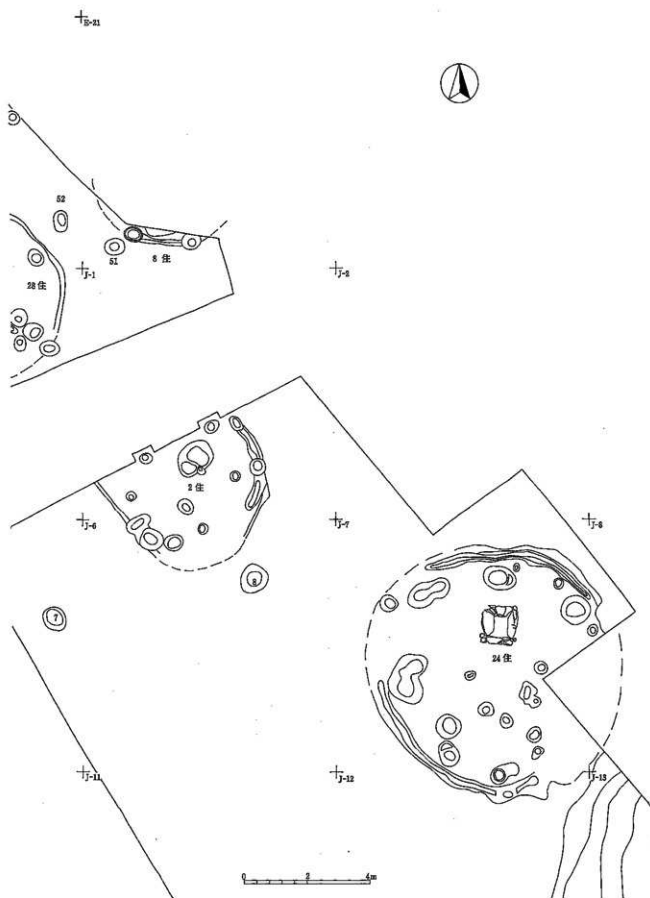

図版4 遺構割付図(3) 1 : 120

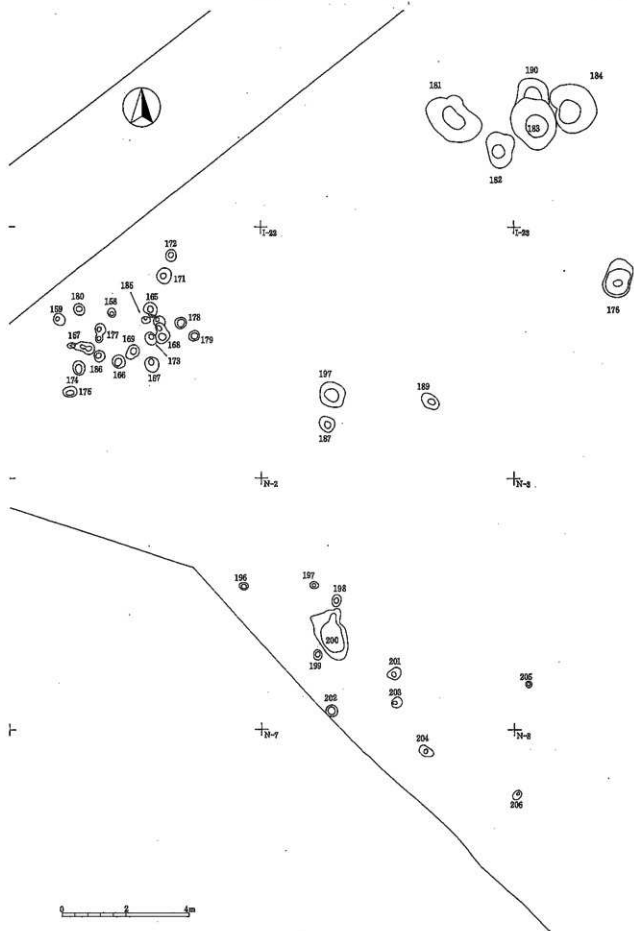

図版 5 遺跡制作図(4) 1 : 120

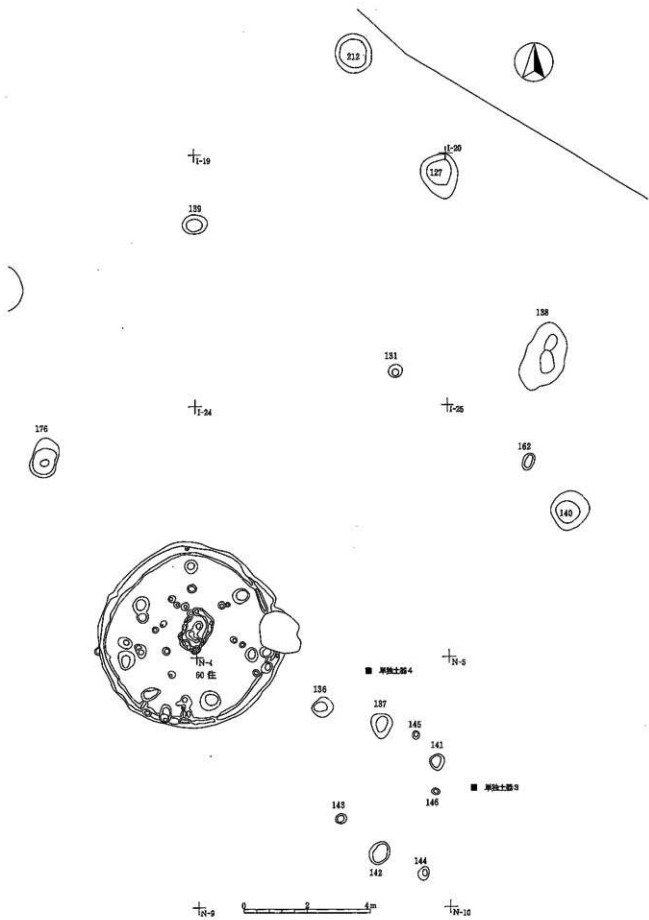

図版6 遺構割付図(5) 1 : 120

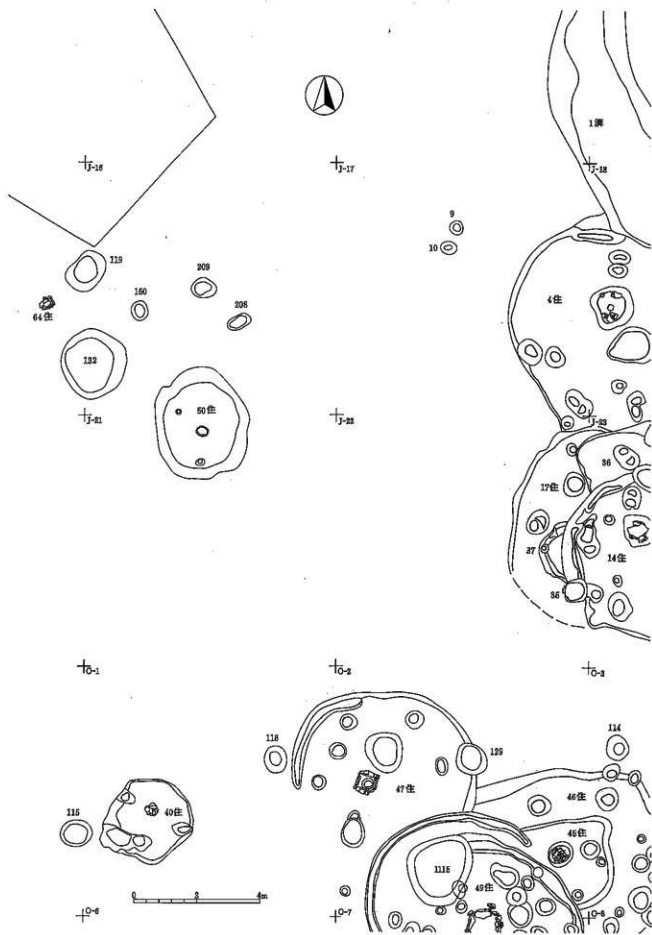

图版7 遺構制付圖(6) 1 : 120

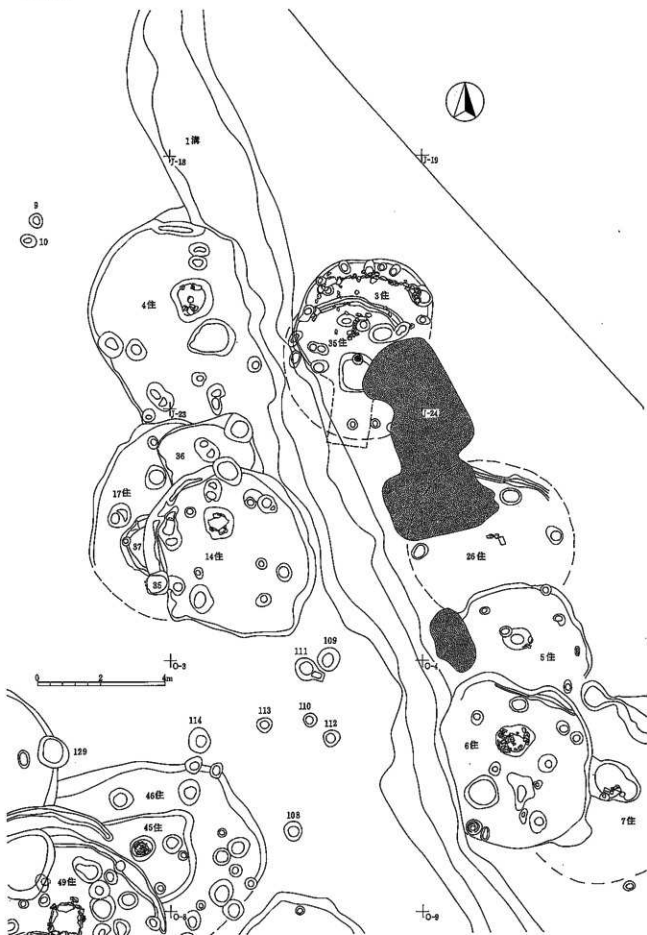

図版 8 遺構群付図(7) 1 : 120

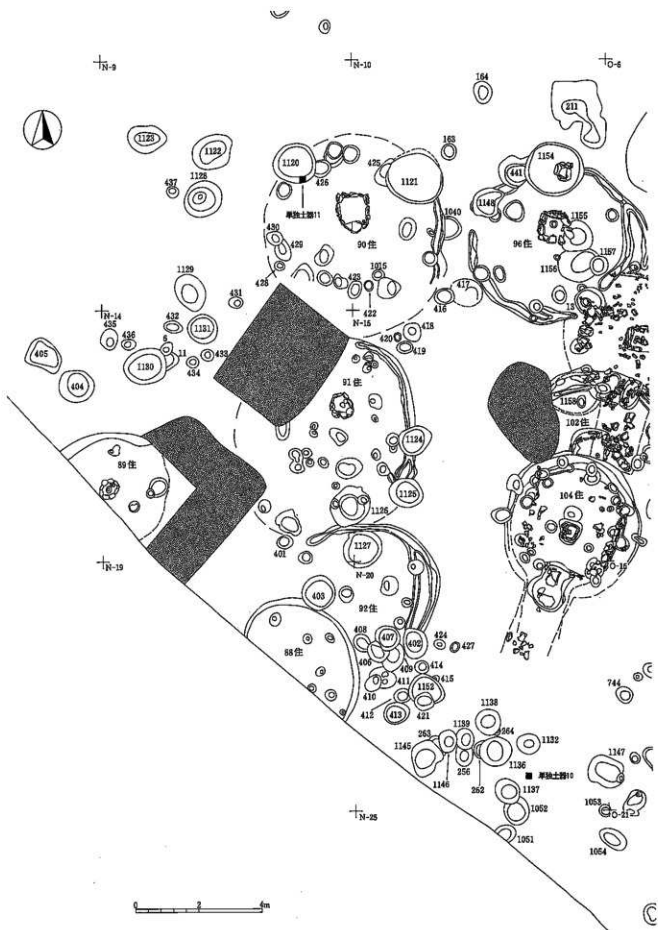

図版9 遺構割付図(B) 1:120

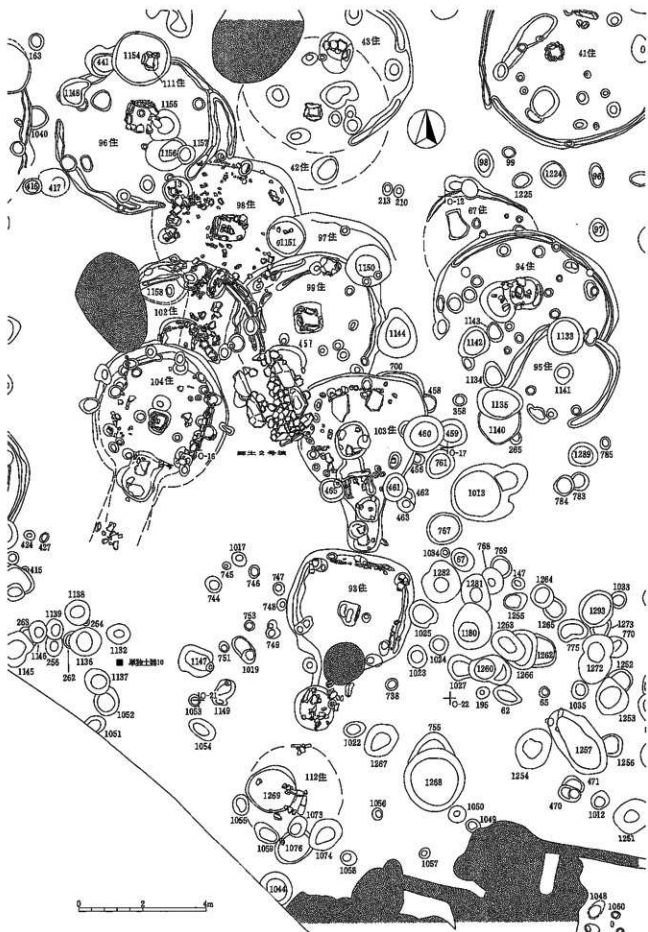

図版10 遺構新付図(9) 1 : 120

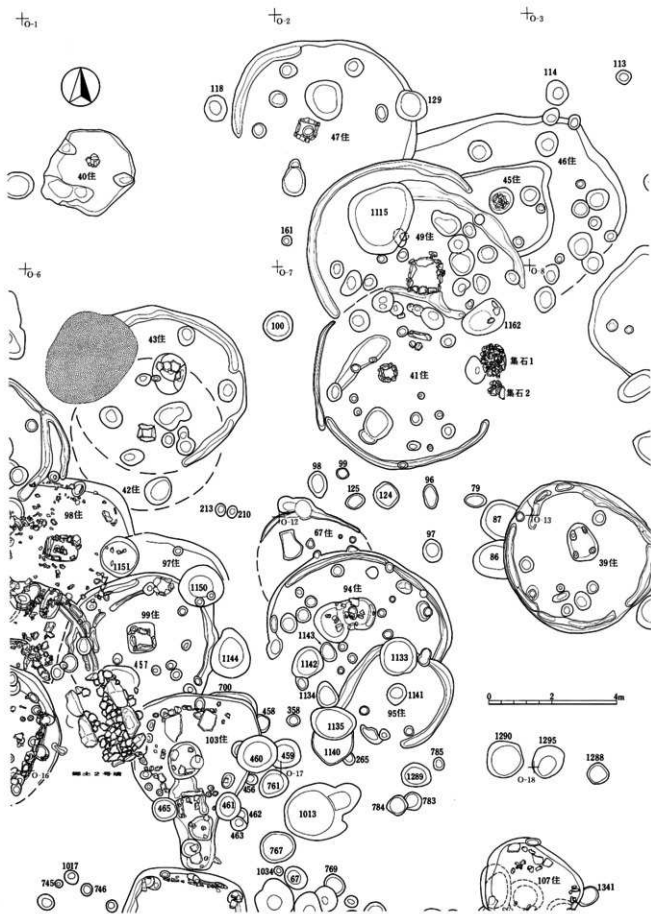

図版11 遺構割付図00 1:120

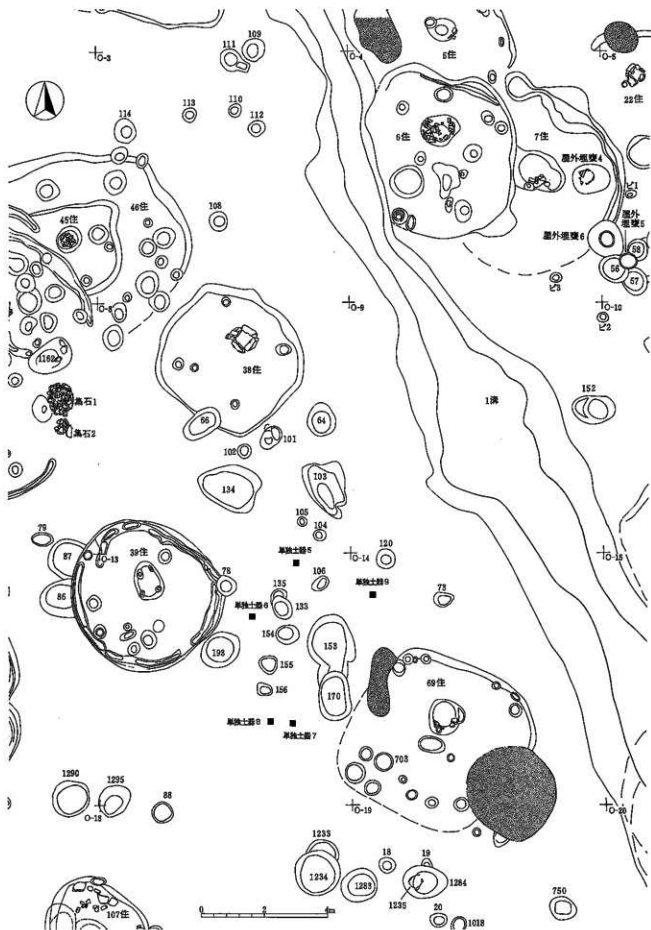

図版13 遺構割付図② 1 : 120

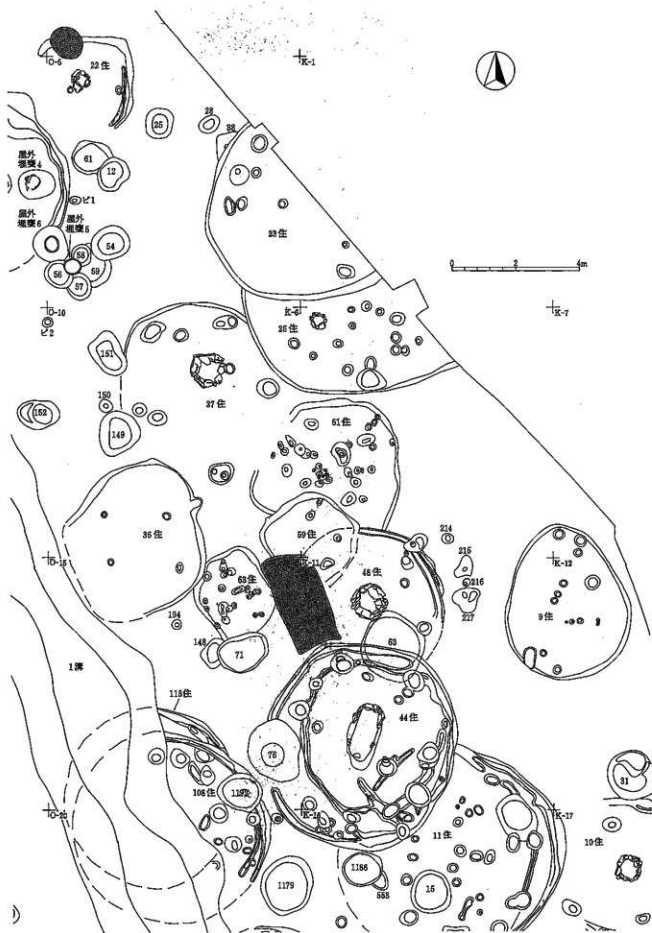

図版14 道標新付図09 1:120

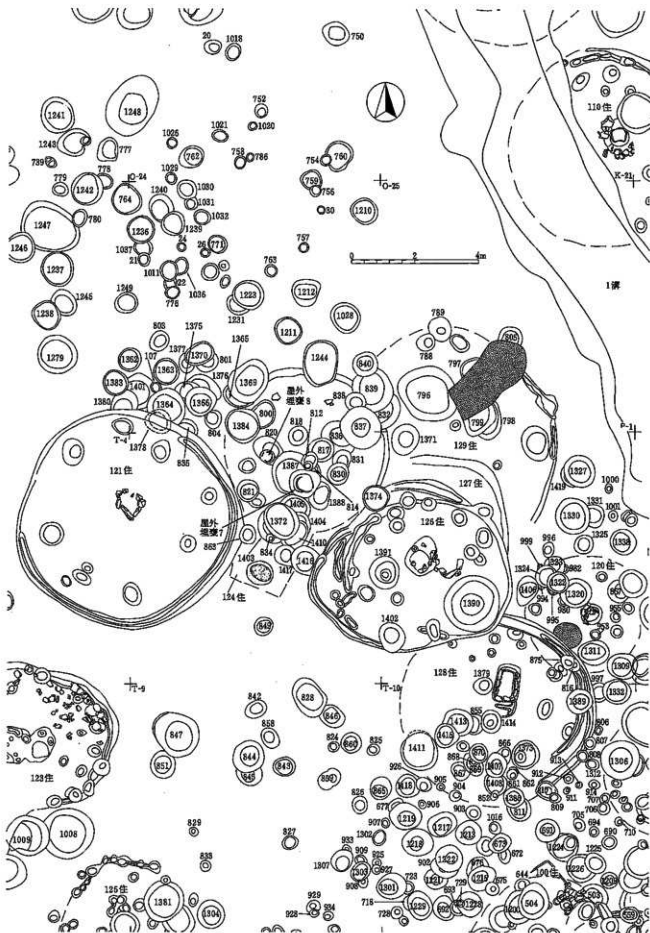

図版15 遺標新付図04 1 : 120

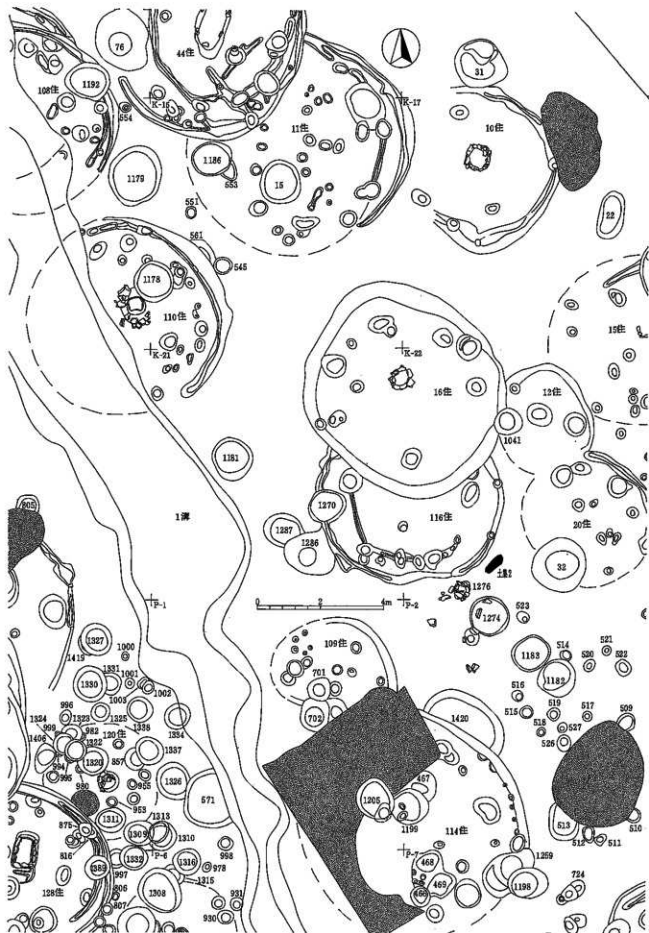

図版16 遺構制村図04 1 : 120

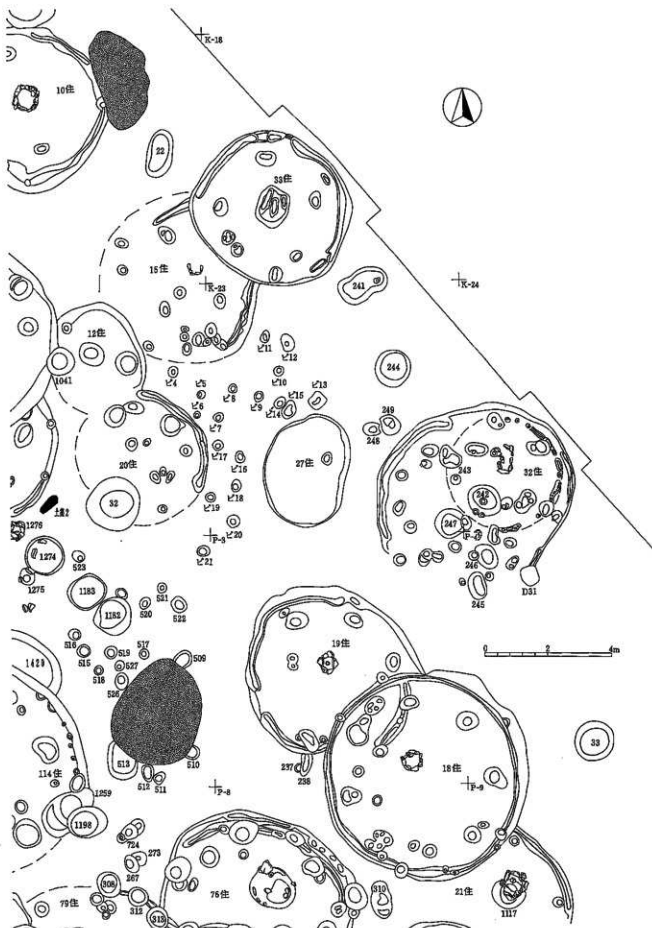

図版17 遺傳新付図06 1 : 120

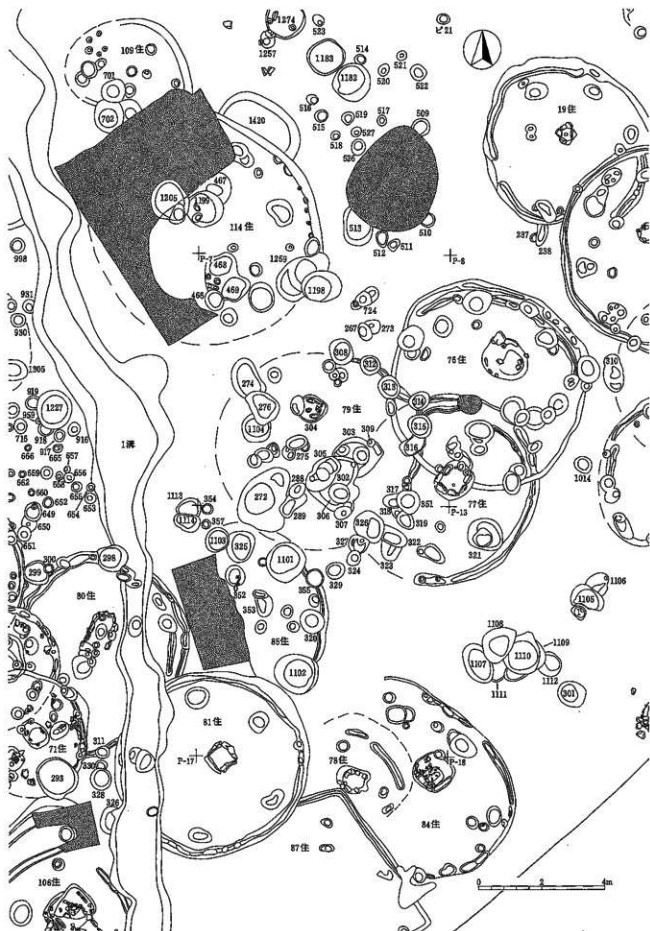

図版20 遺構割付図④ 1 : 120

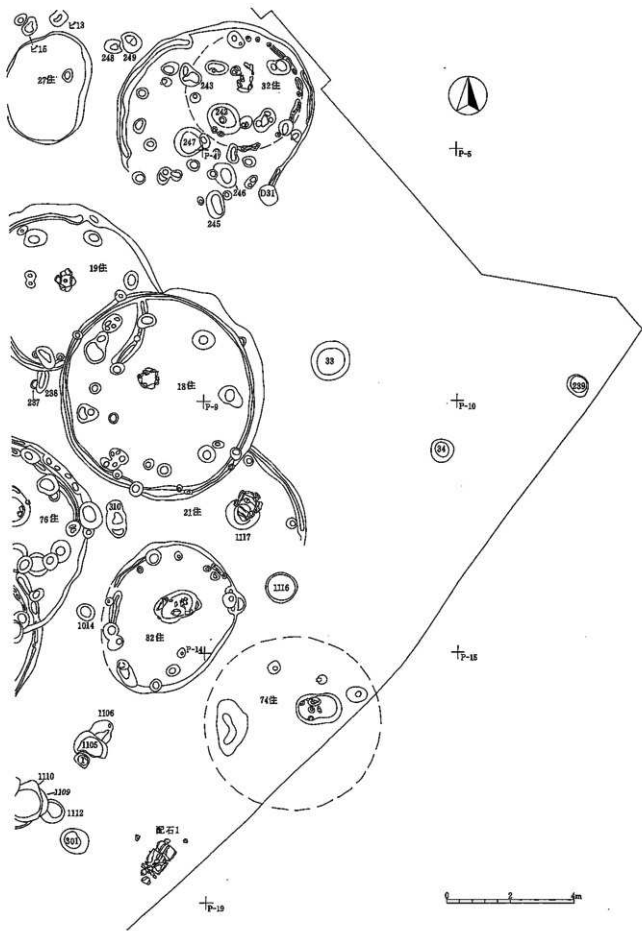

図版21 遺構割付図(仰) 1 : 120

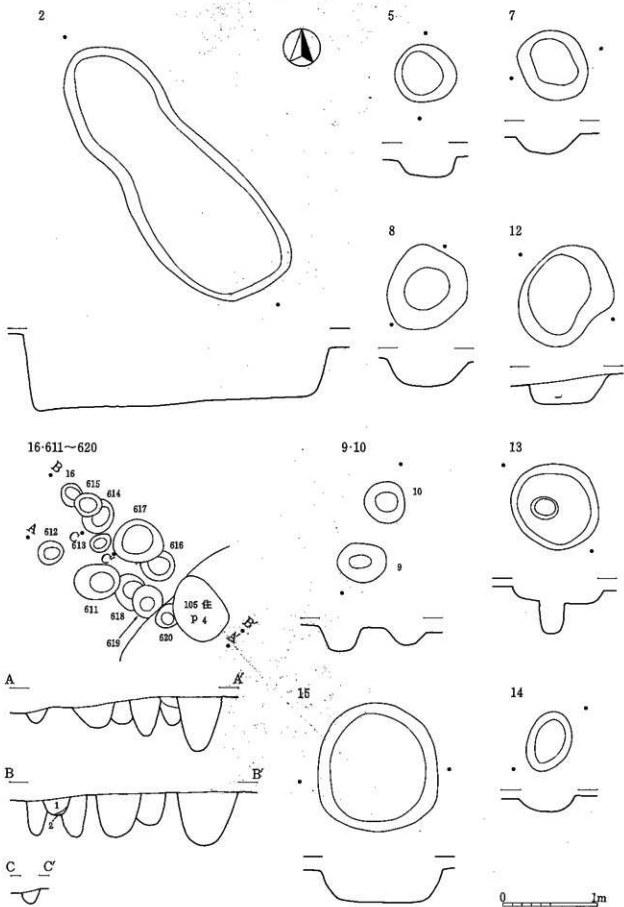

図版22 縄文中期の土坑(1) 1:40

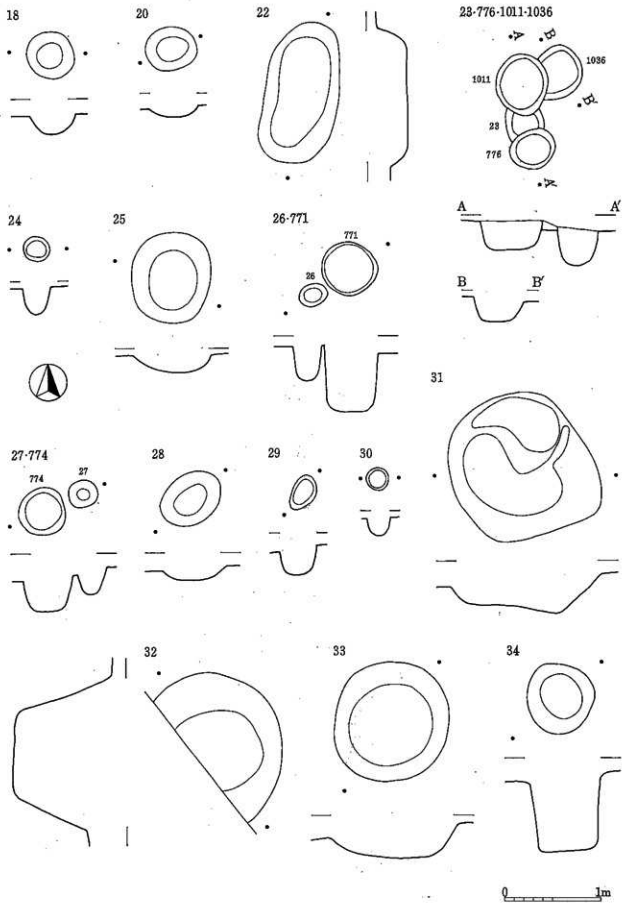

図版23 縄文中期の土坑(2) 1:40

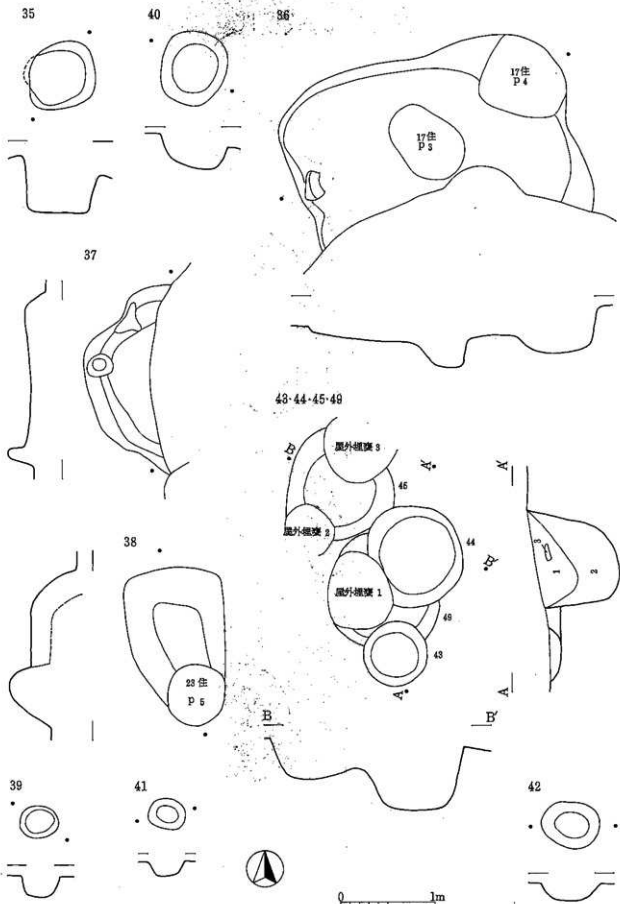

図版24 縄文中期の土坑(3) 1:40

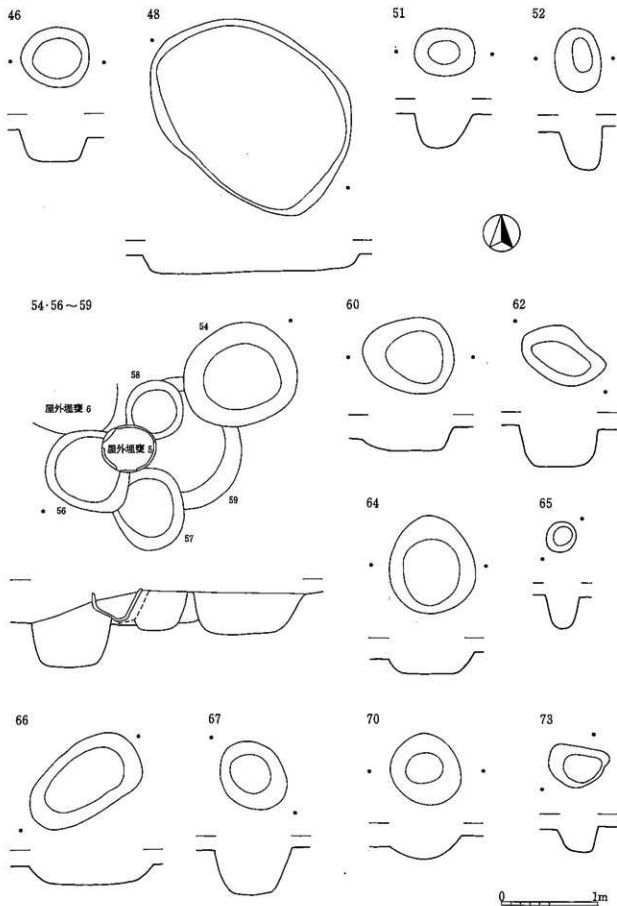

図版25 縄文中期の土坑(4) 1 : 40

71-148

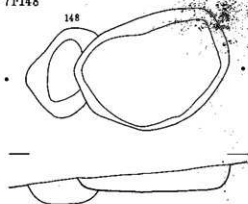

76

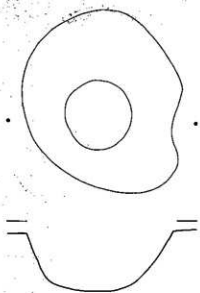

78

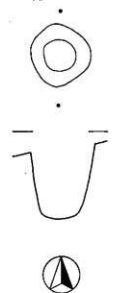

79

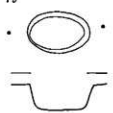

81



86-87

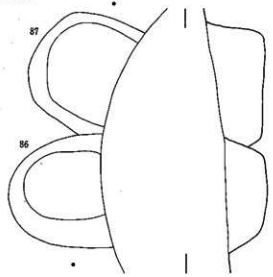

96

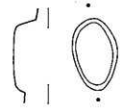

97



98

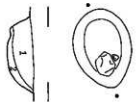

99



100

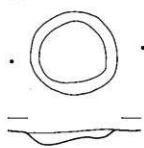

101



102



103

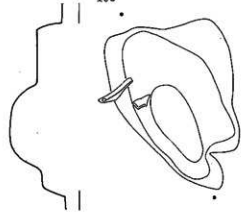

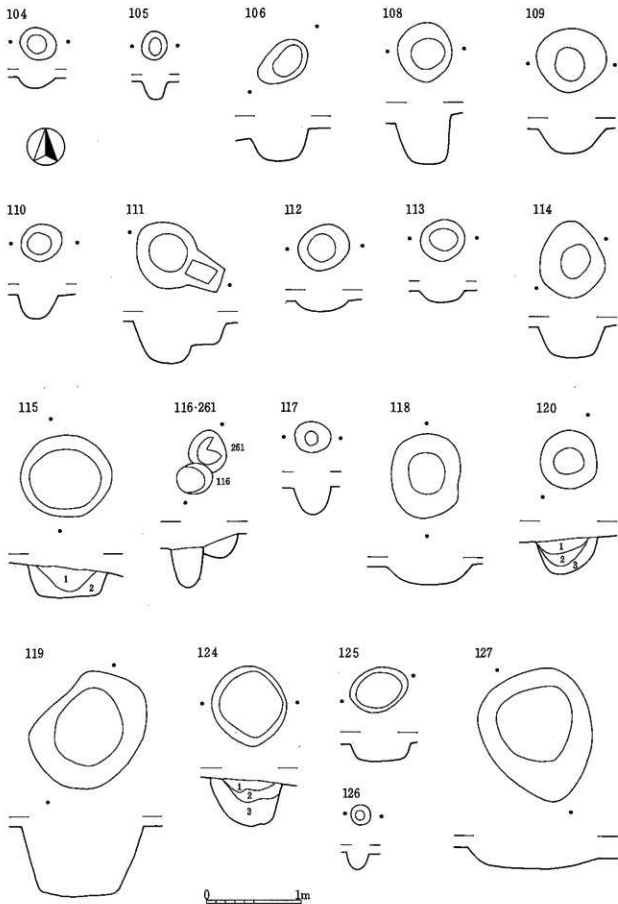

図版27 縄文中期の土坑(6) 1:40

128



129

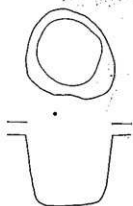

130

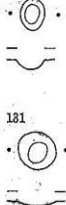

132

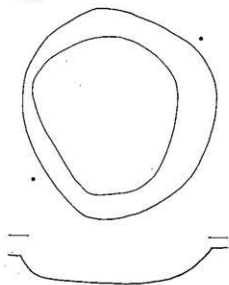

131



133-135



135

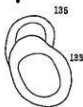

133

136

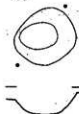

134

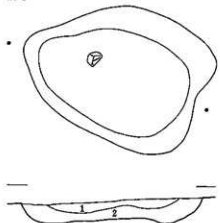

137

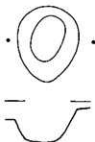

139

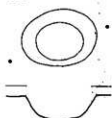

141



140

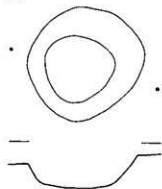

142



144



143



145



138

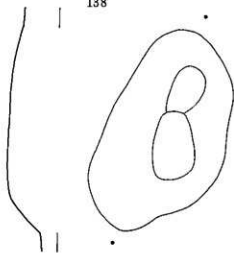

0 1m

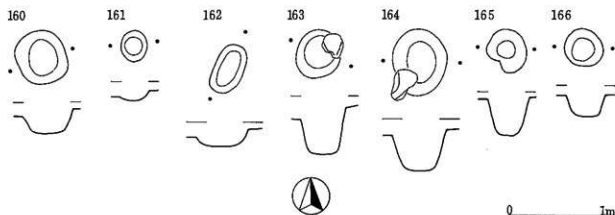
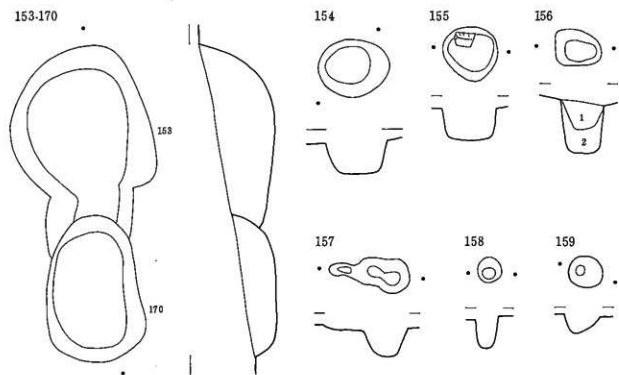
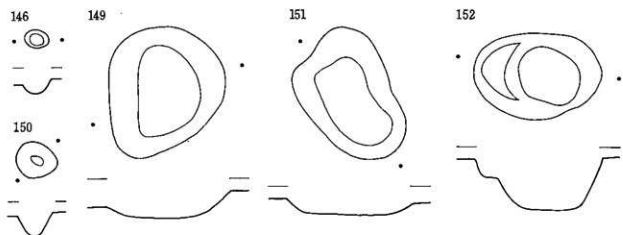

図版29 縄文中期の土坑(8) 1 : 40

郷土遺跡

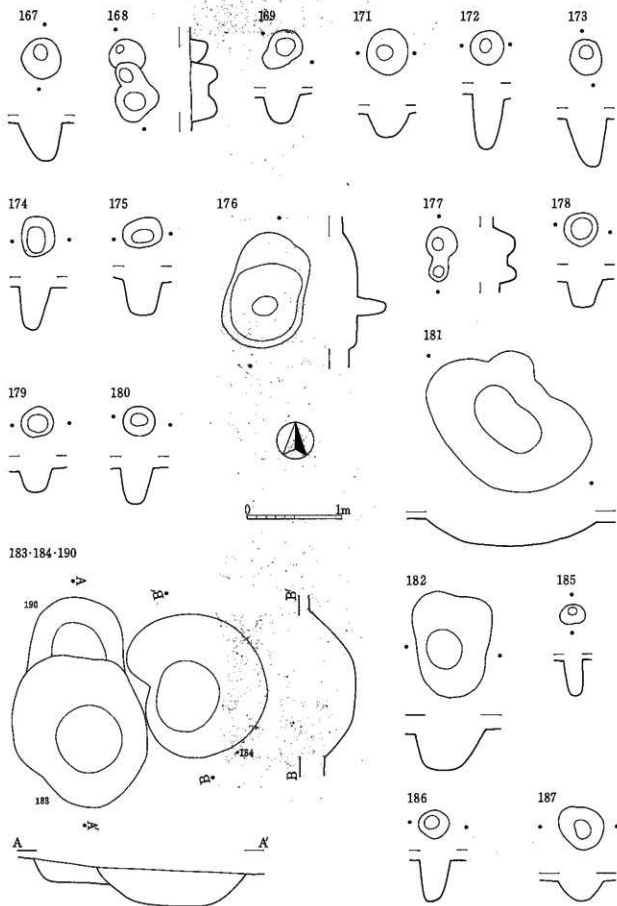

図版30 縄文中期の土坑(9) 1 : 40

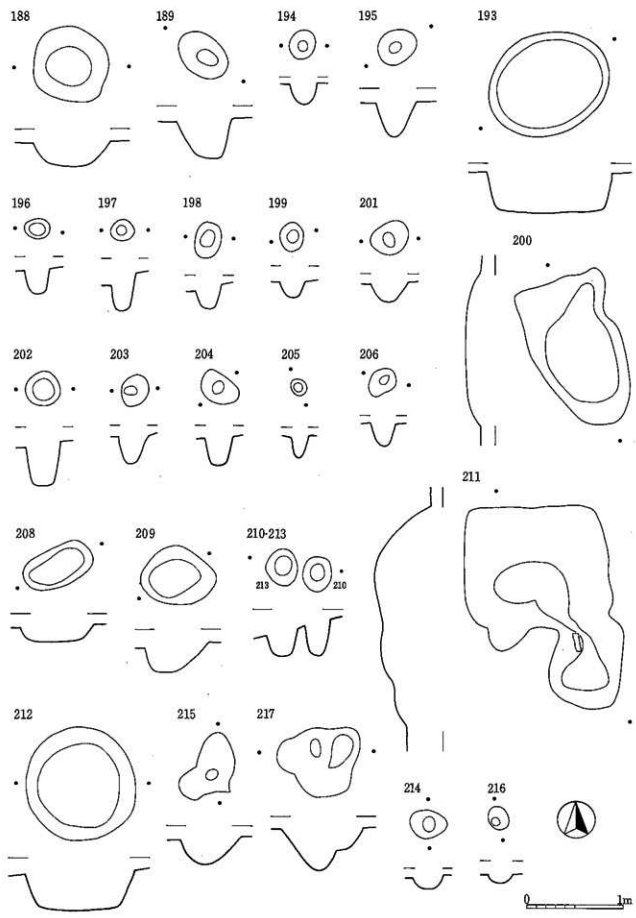

図版31 縄文中期の土坑① 1 : 40

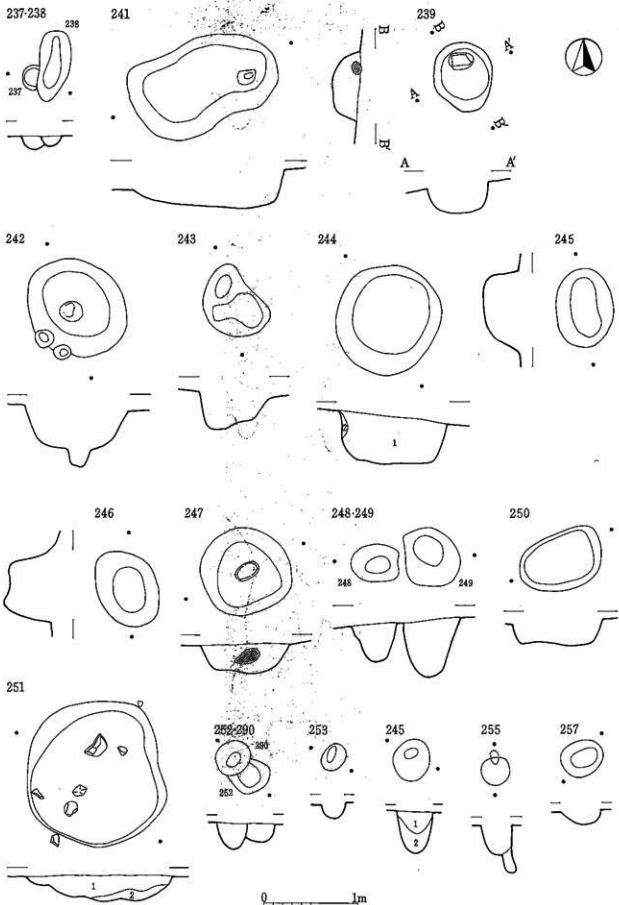

図版32 縄文中期の土坑01 1 : 40

258-259

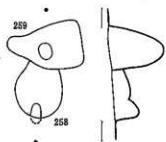

260



265

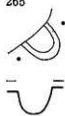

266

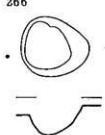

268



269



270



271



267-273

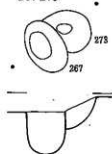

275

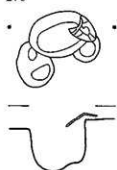

272-288-289

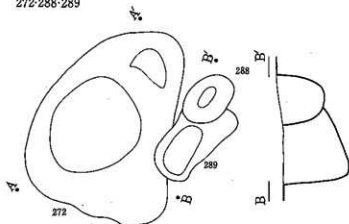

274-276

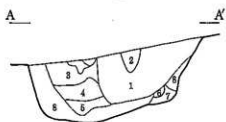
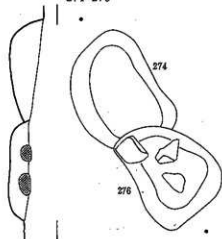

278-279-280

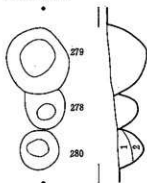

281

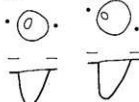

282

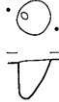

283

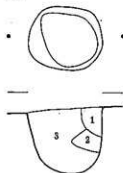

284



286



285



287



図版33 縄文中期の土坑01 1 : 40

292

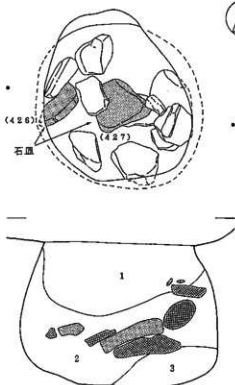

293



294

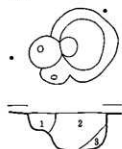

298

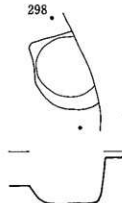

295



302-303-305-306-307-309

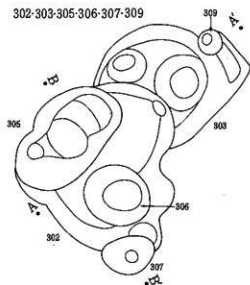

299-300

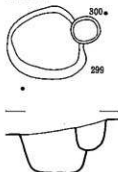

301

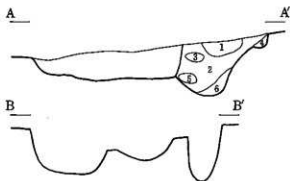
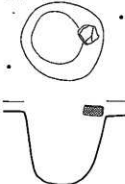

304

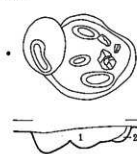

308

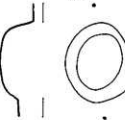

図版34 縄文中期の土坑08 1:40

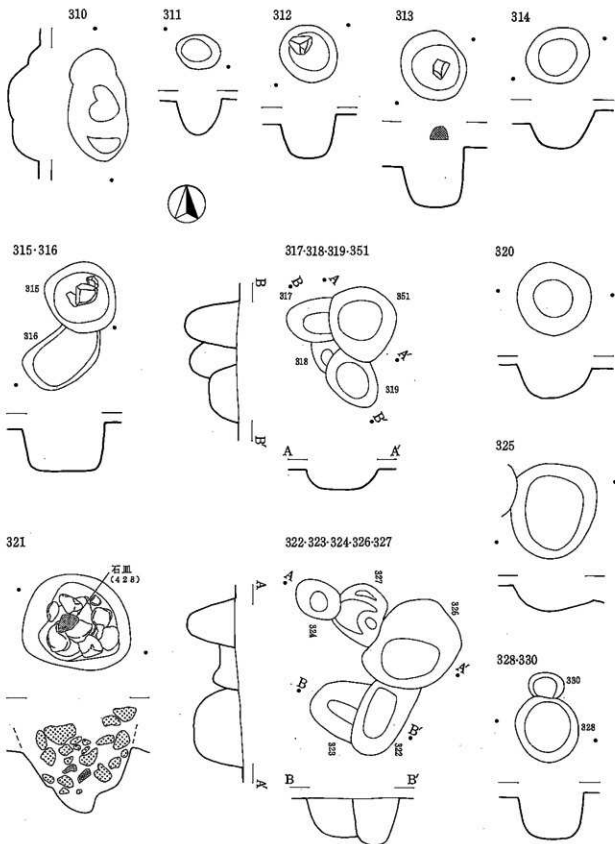

0 1m

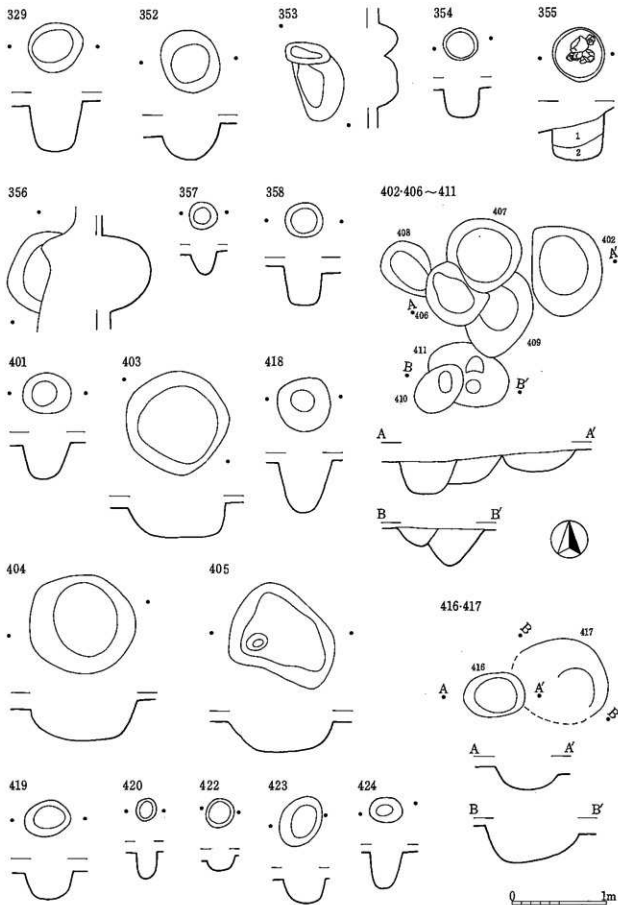

図版36 縄文中期の土坑跡 1 : 40

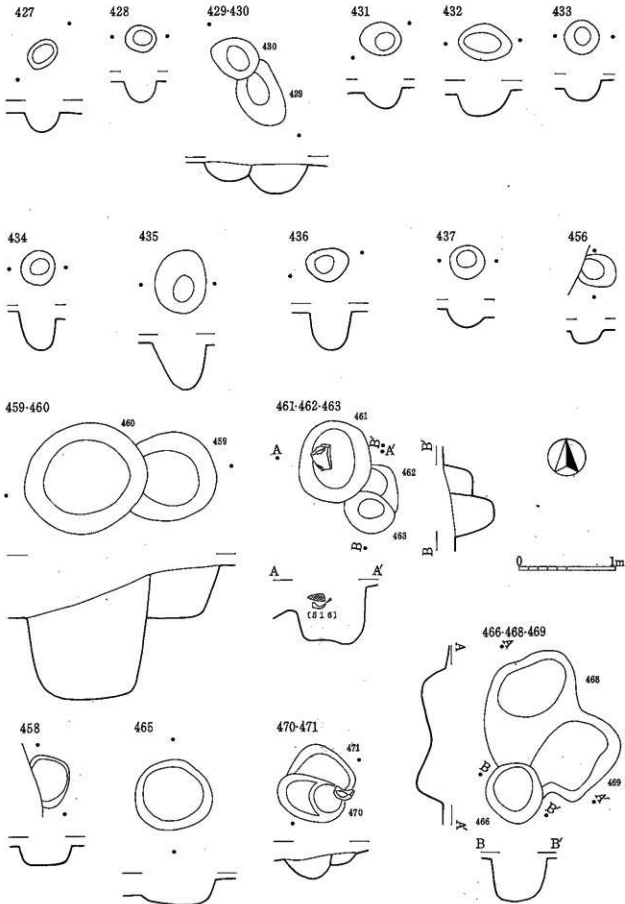

図版37 縄文中期の土坑跡 1 : 40

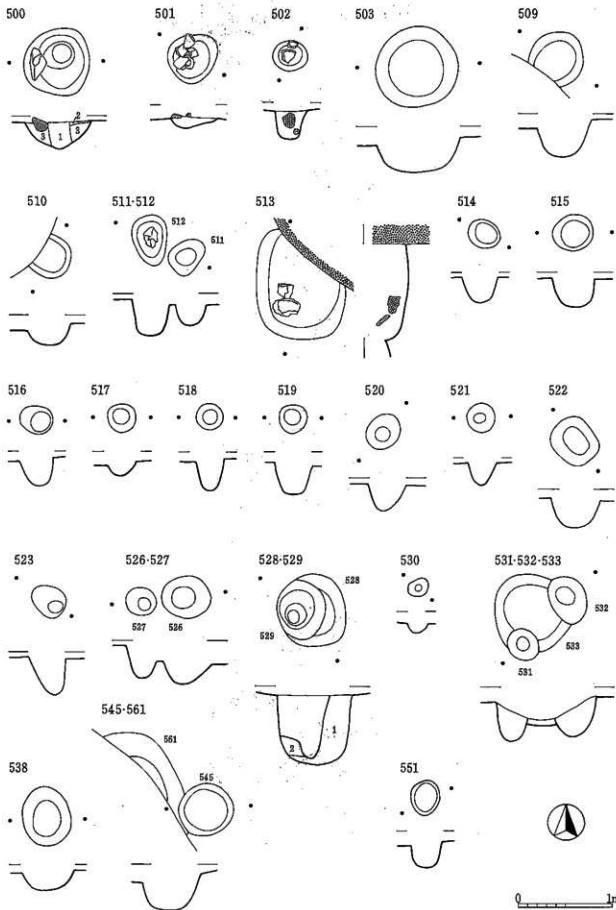

図版38 縄文中期の土坑跡 1:40

554



582-583

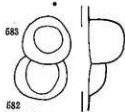

587



588



589



590-591



595



596-597

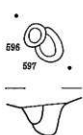

598-599



600



602-603

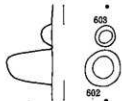

605



621

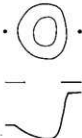

624-636

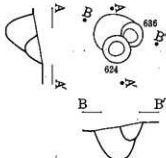

625



626



628-629-633-634-635

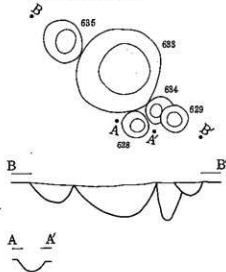

630-631-668-669

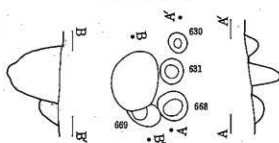

縄土遺跡

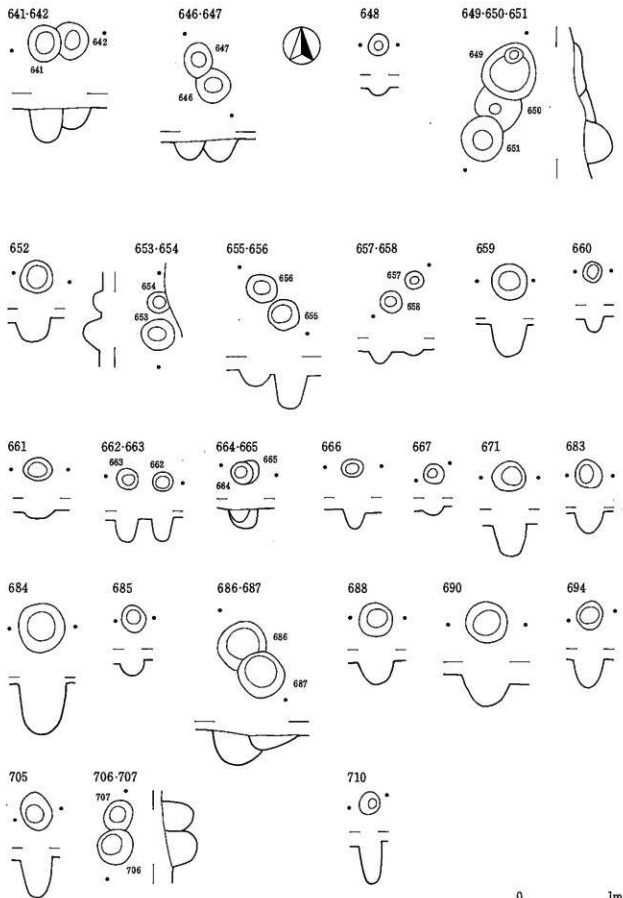

図版40 縄文中期の土坑跡 1 : 40

700

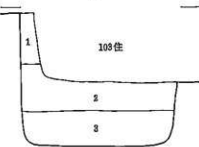
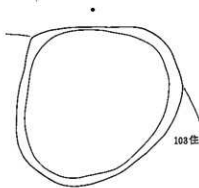

701-702-721

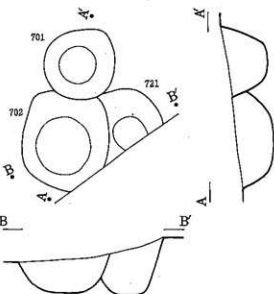

714



715



716



717

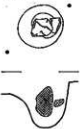

719



720



724

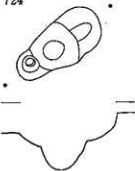

727-728



703



図版41 縄文中期の土坑② 1:40

郷土遺跡

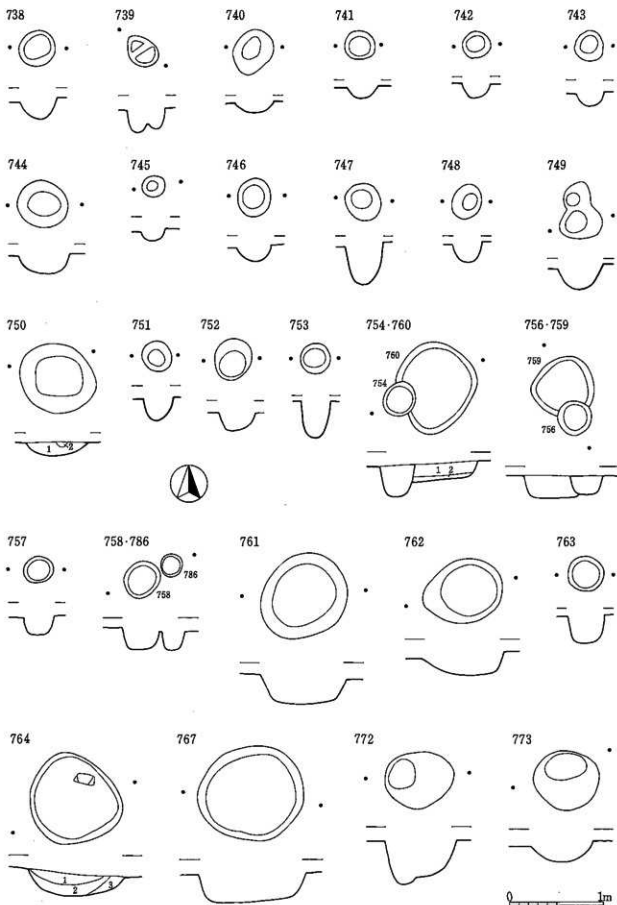

図版42 縄文中期の土坑跡 1:40

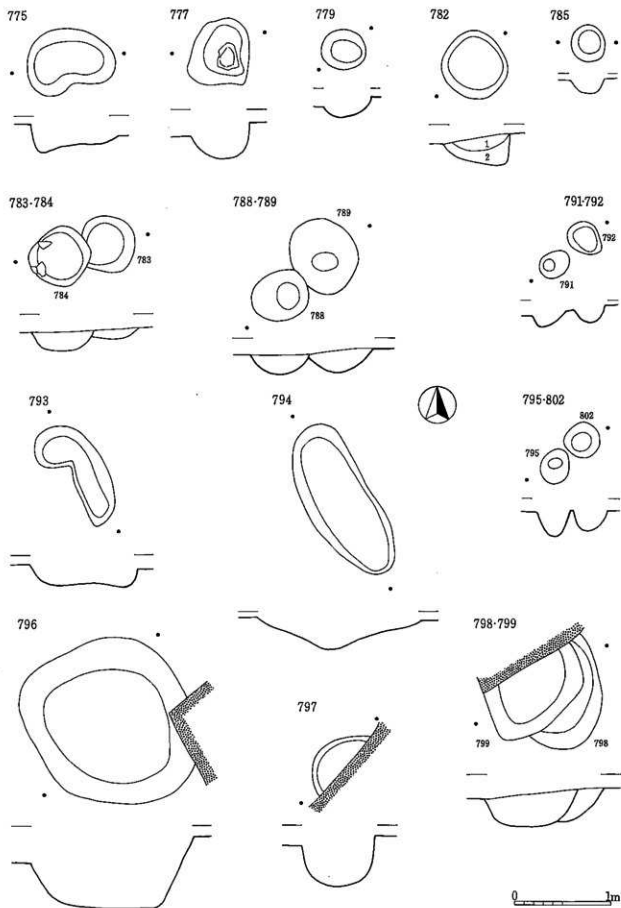

図版43 縄文中期の土坑跡 1:40

郷土遺跡

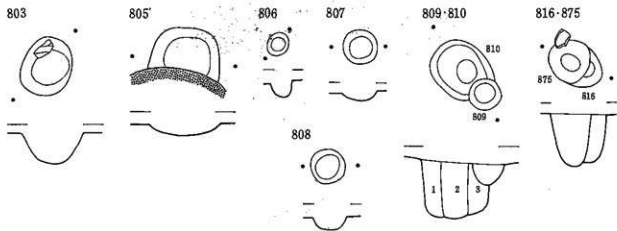

817-830-831-832-836~840

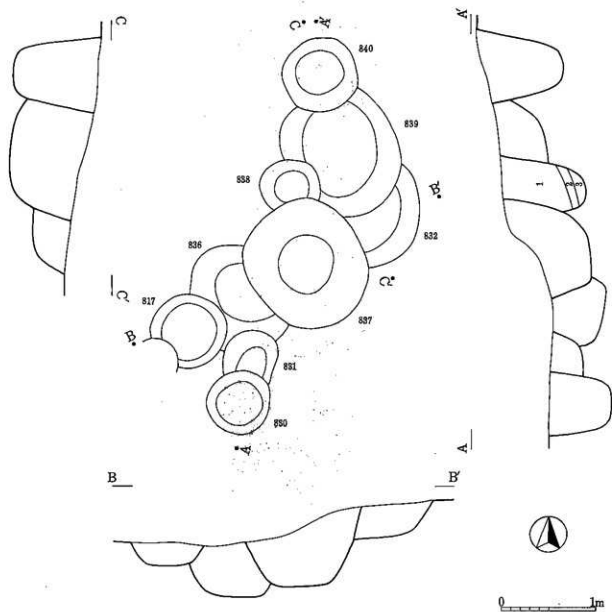

図版44 縄文中期の土坑跡 1:40

818

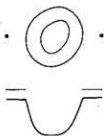

821

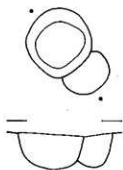

824



825



826



828-846

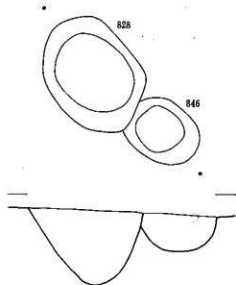

829

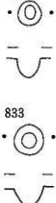

842



827



833



847-851

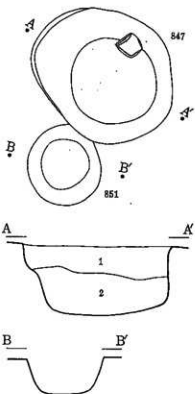

843

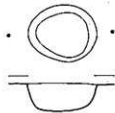

844-845

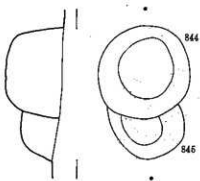

849



0 1m

図版45 縄文中期の土坑20 1 : 40

郷土遺跡

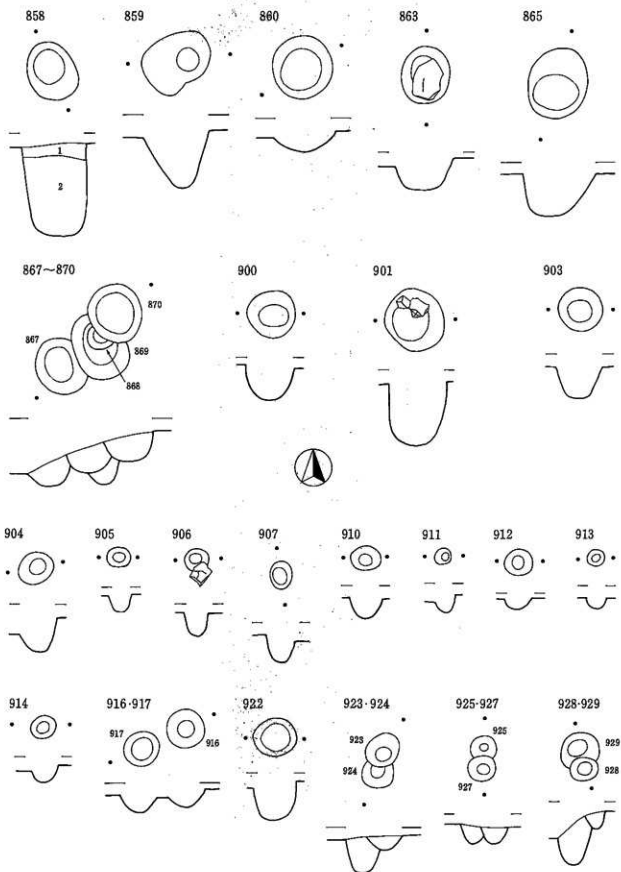

図版46 縄文中期の土坑図 1:40

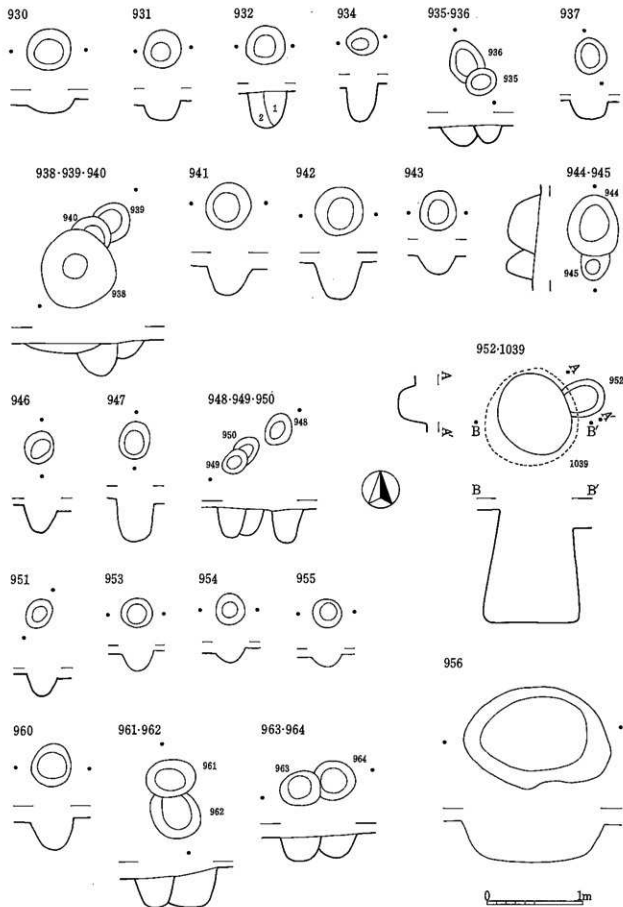

図版47 縄文中期の土坑06 1:40

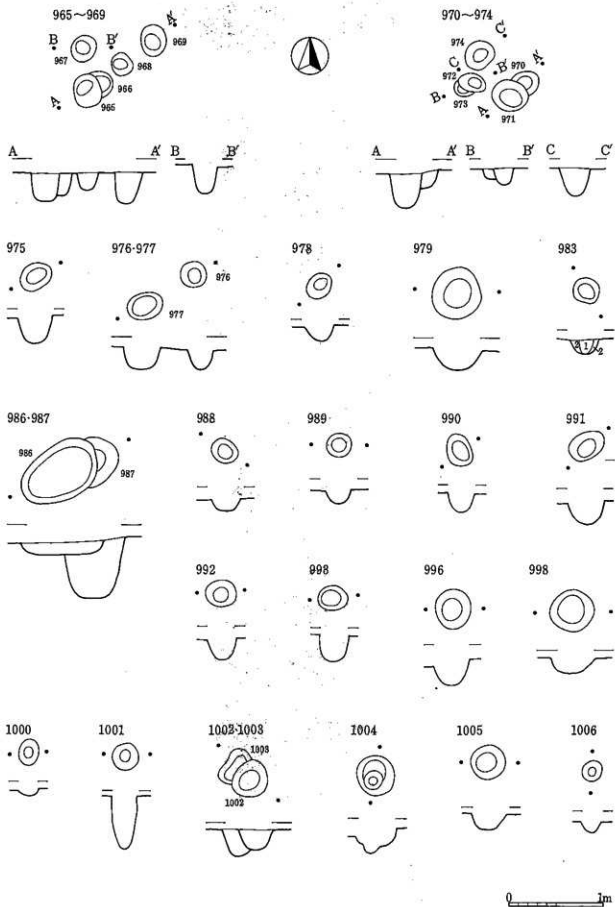

図版48 縄文中期の土坑跡 1:40

1008-1009

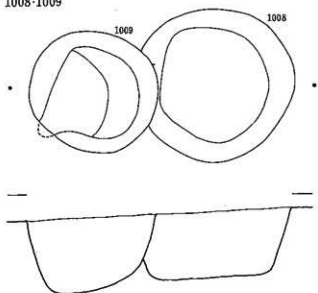

1010

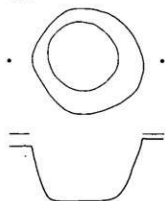

1012

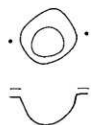

1013

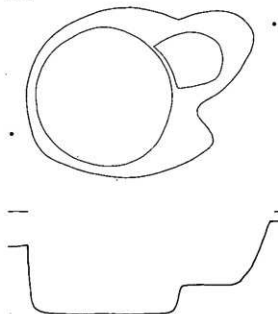

1014

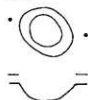

1015



1016



1017



1018



1019



1020



1021

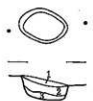

1022

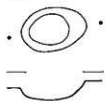

1023



1024

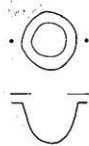

1025

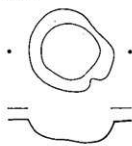

1026



1028

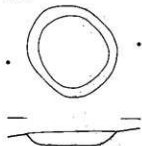

1029



1030-1031

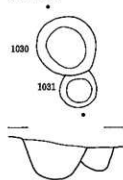

1032



1034



1035

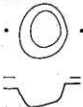

1042

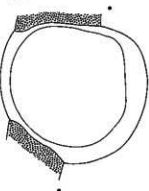

1038



1040

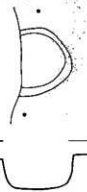

1041

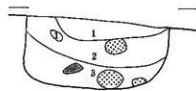
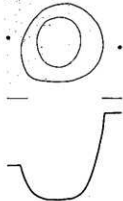

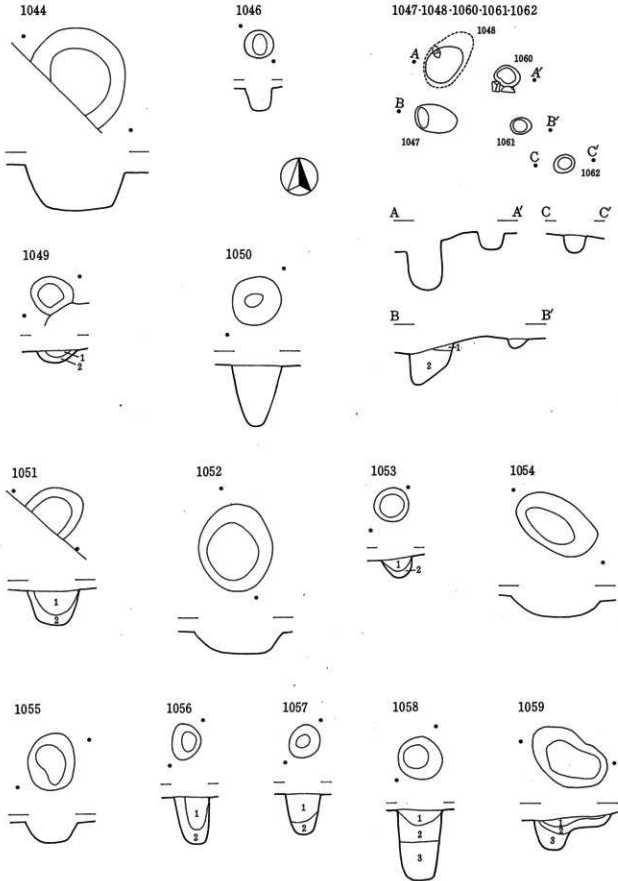

図版51 縄文中期の土坑跡 1 : 40

1063~1068

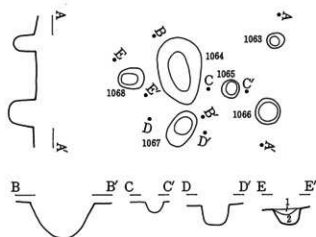

1072

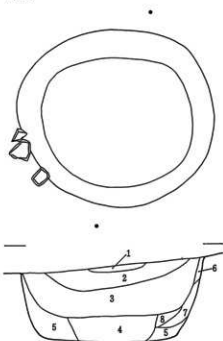

1069



1071

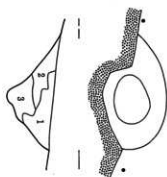

1070



1075

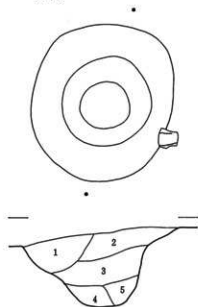

1073-1074-1076

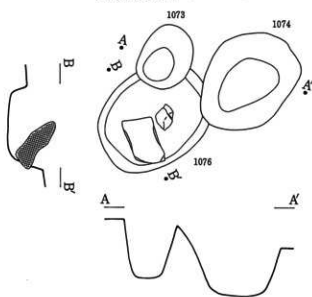

0 1m

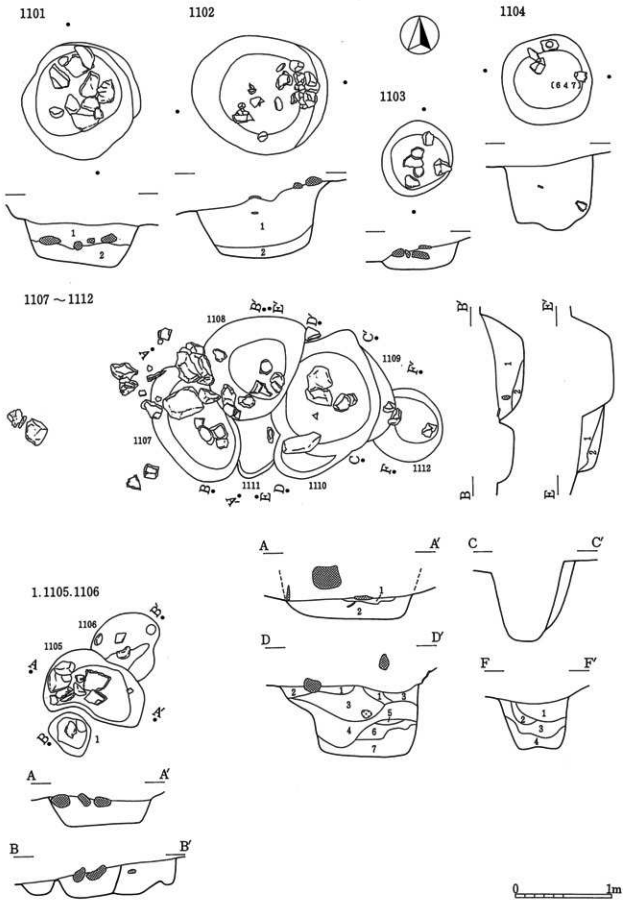

図版53 縄文中期の土坑葬 1 : 40

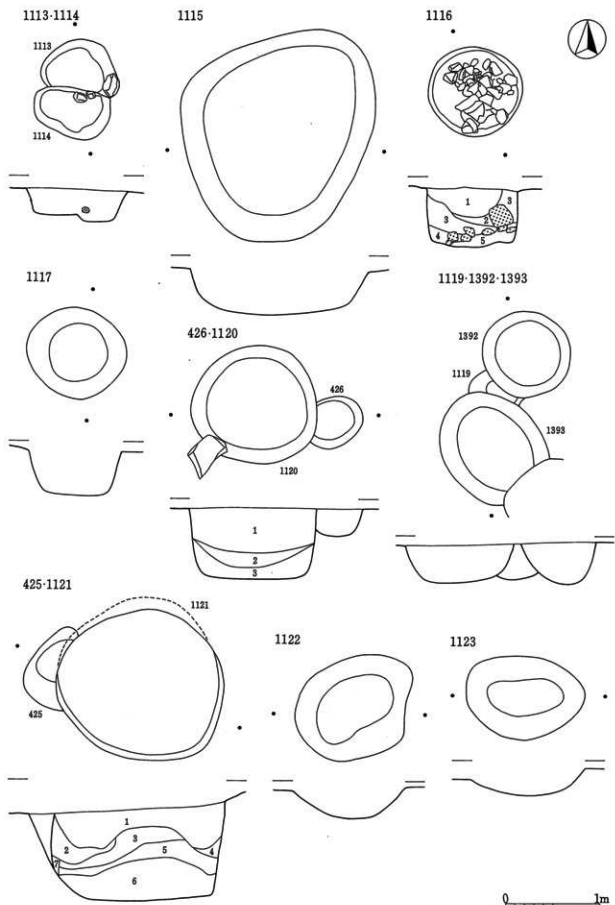

図版54 縄文中期の土坑跡 1 : 40

1124

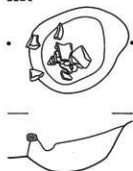

1125

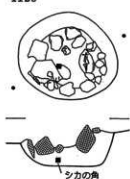

1126

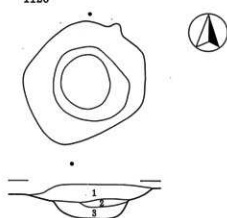

1127

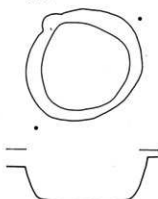

1128

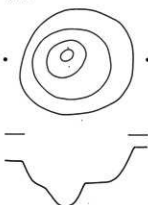

6-11-1130

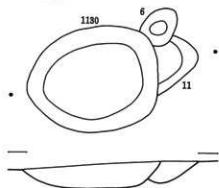

1129

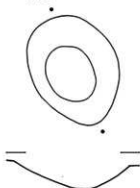

1131

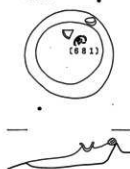

1132

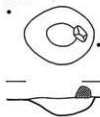

1133



1134



1135-1140

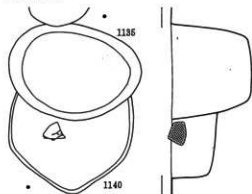

0 1m

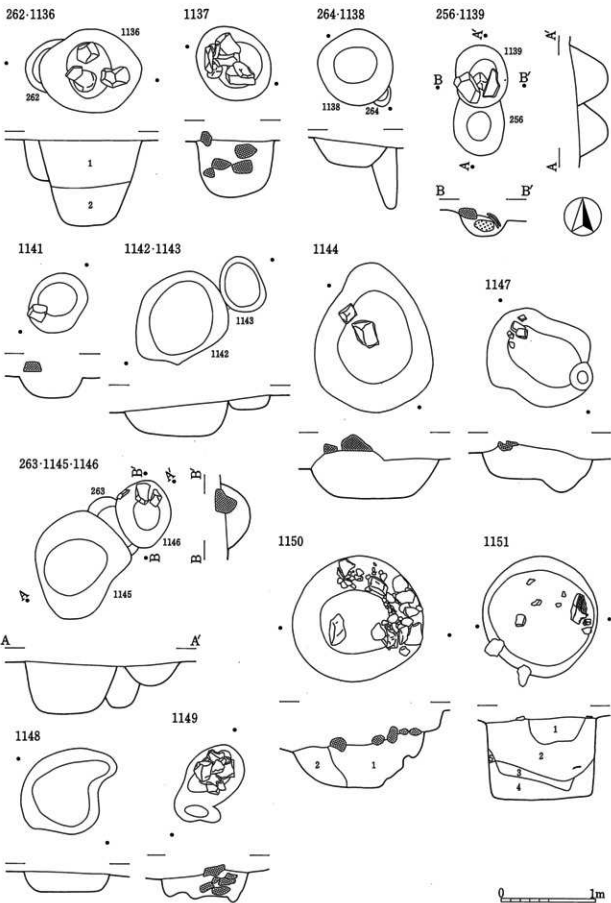

図版56 縄文中期の土坑跡 1:40

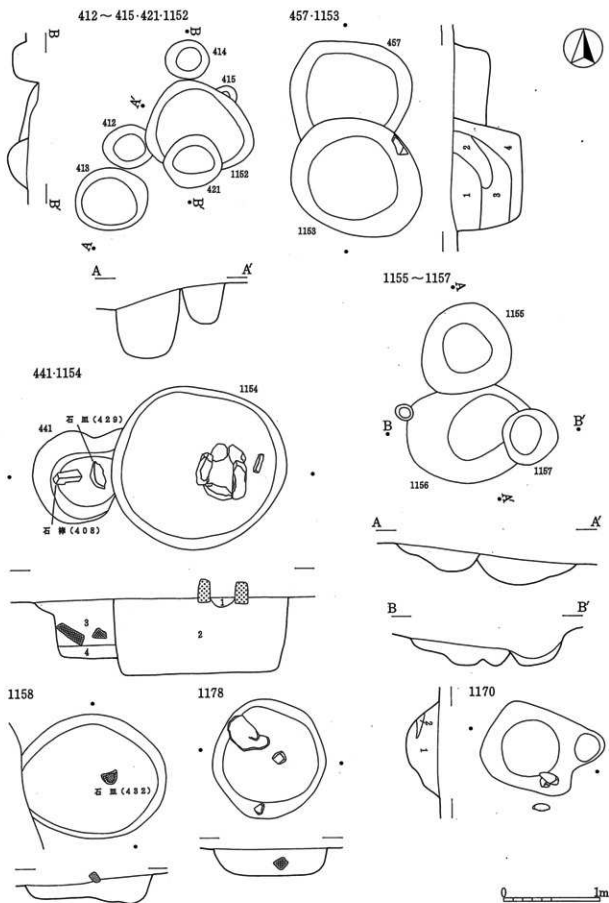

図版57 縄文中期の土坑跡 1:40

556-564~566-570-572-622-695~699-704
1176-1187~1190-1193-1220

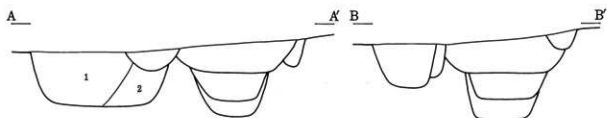
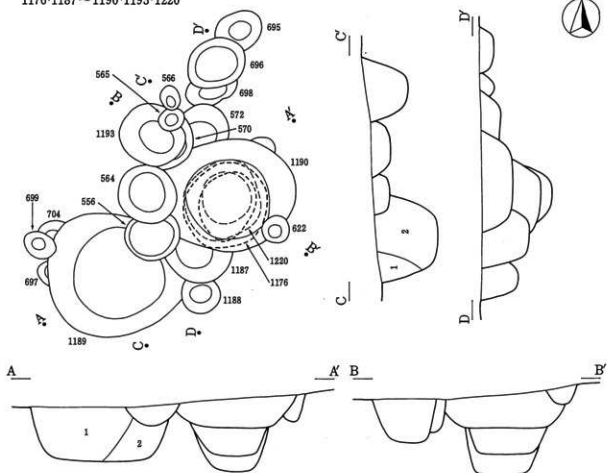

546-581-584-585-609-610-1185

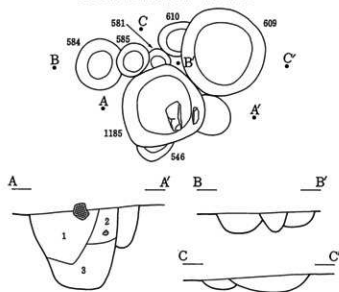

553-1186

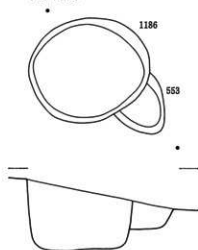

図版58 縄文中期の土坑跡 1:40

505 ~ 508 557 558 1171 ~ 1175 1180

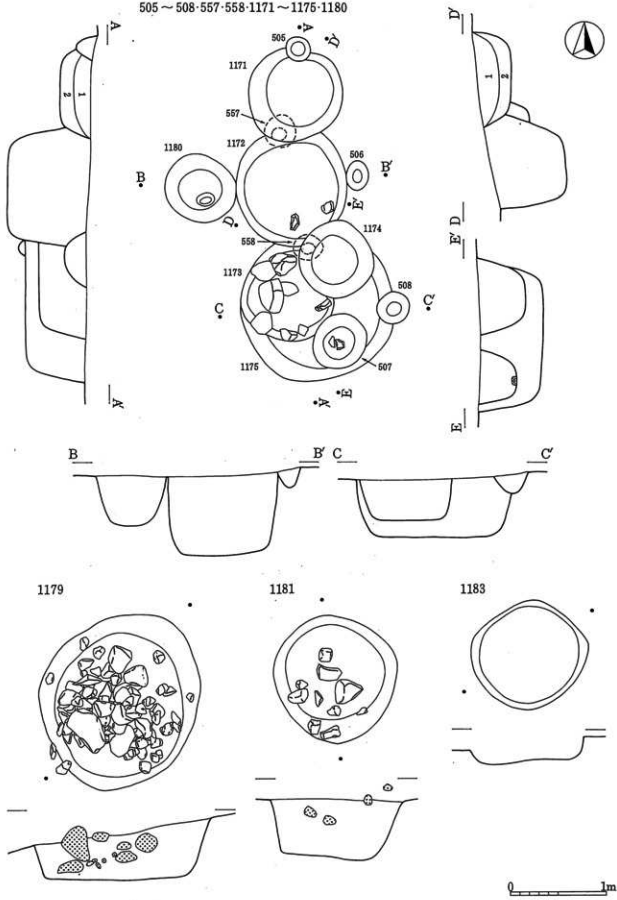

図版59 縄文中期の土坑跡 1:40

525・539～541・544・548・549・559・563
567～569・573～576・632・1184・1191

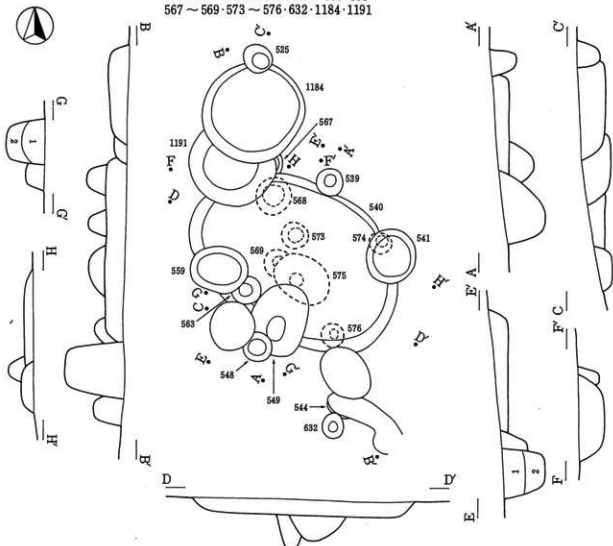

277・534・535・537・579・580・1196

1192

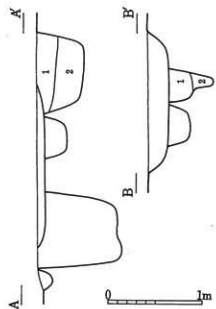
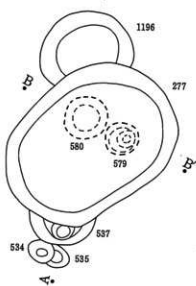
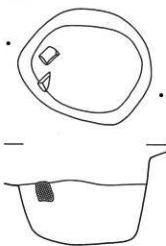

図版60 縄文中期の土坑跡 1 : 40

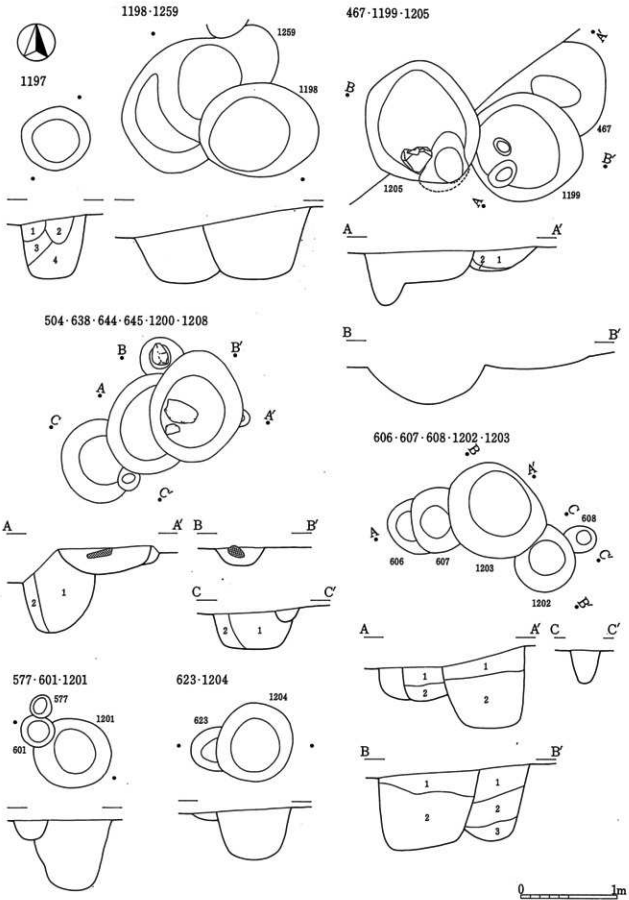

図版61 縄文中期の土坑④ 1 : 40

578・580・592～594・689・640
675・680・1207

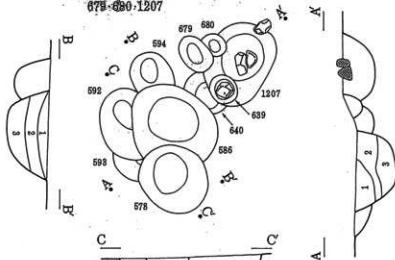

1209

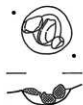

1210

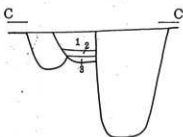

672～674・1213

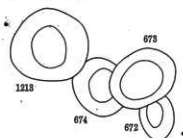

1211



1212



677・1219

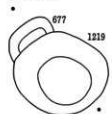

675・676・1215

1216

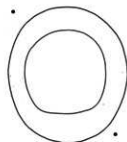
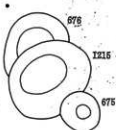

1214

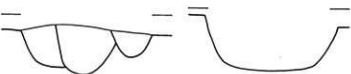
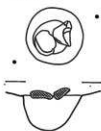

図版62 縄文中期の土坑跡 1:40

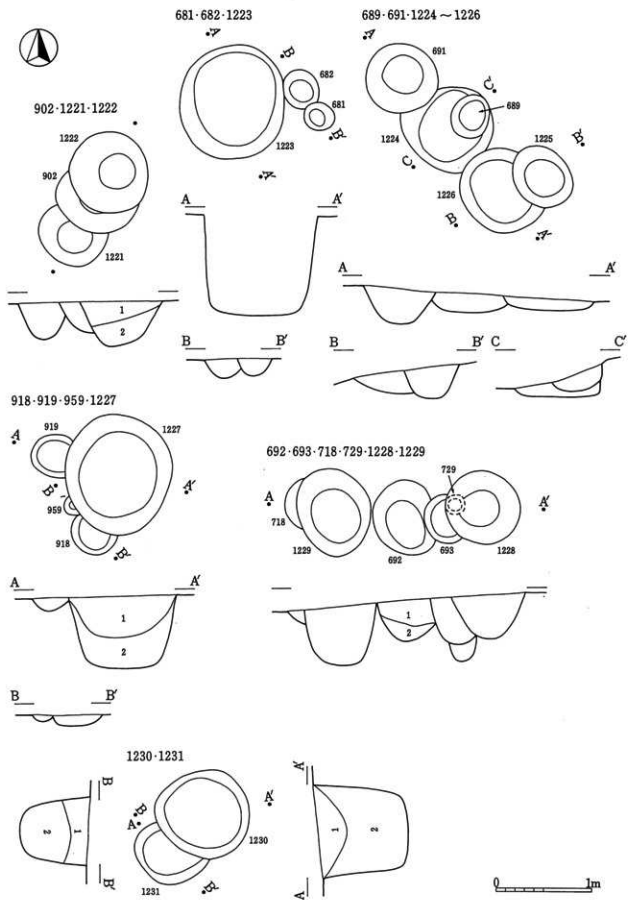

図版63 縄文中期の土坑跡 1 : 40

1233・1234

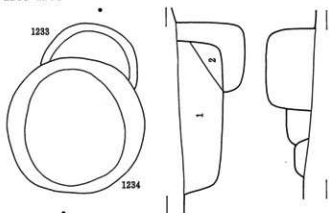

21・1037・1236

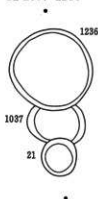

1237



1238・1245

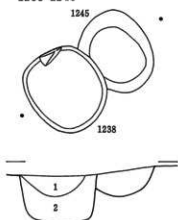

1239・1240

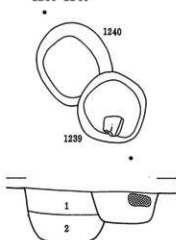

1241



778・1242

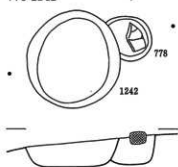

1243

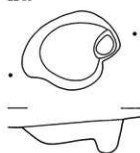

1244



1249

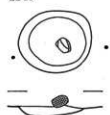

1251

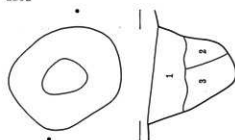

0 1m

780・1246・1247

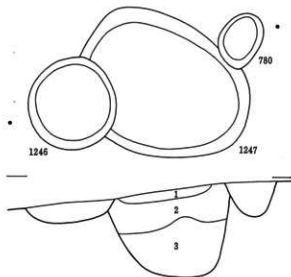

1248

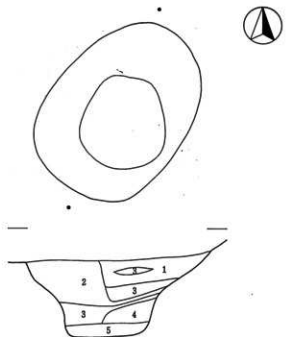

1252・1253

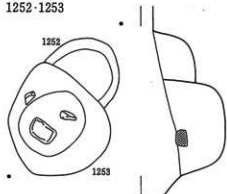

1254

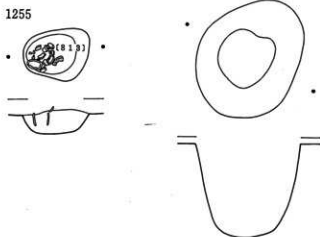

1256・1257

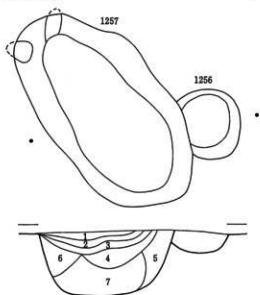

1027・1260

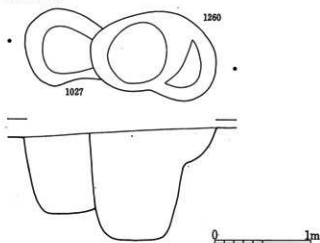

0 1m

図版65 縄文中期の土坑④ 1 : 40

69-72-74-75-77-787-1043-1045-1250-1258-1291-1292-1296-1328-1329-1335-1336-1339

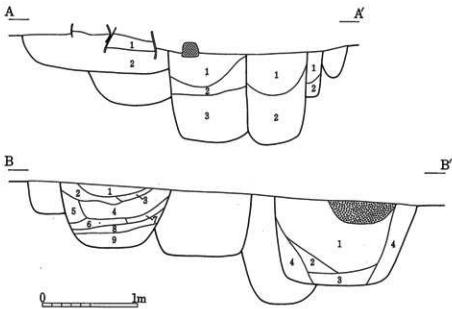
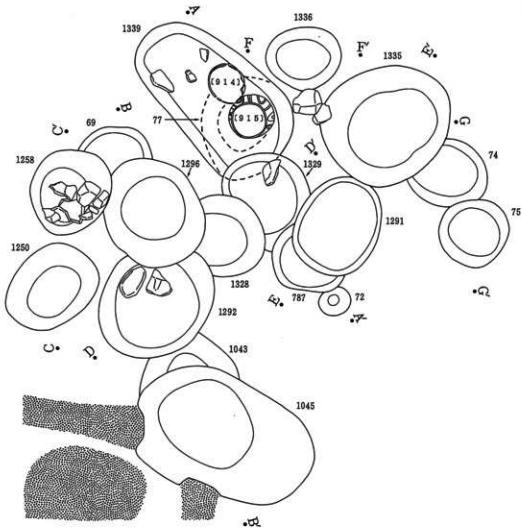

図版66 縄文中期の土坑跡 1 : 40

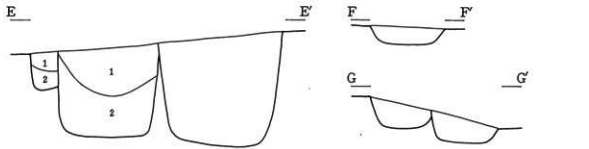
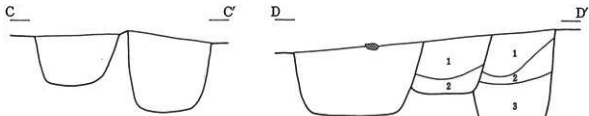

1298



1299

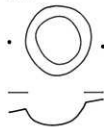

1300



723-1301

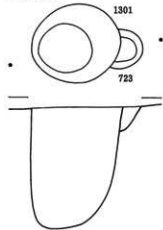

1302



908-909-1303

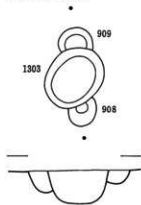

1304

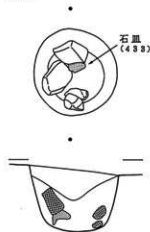

1305

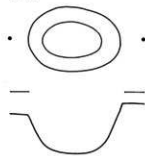

図版67 縄文中期の土坑⑩ 1 : 40

1262-1263-1266

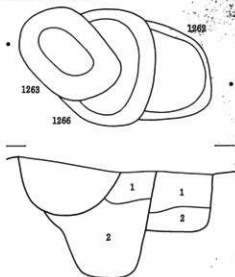

1264-1265

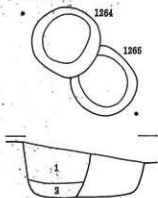

1267

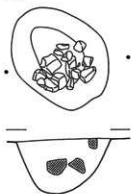

1269

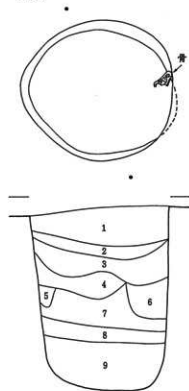

755-1268

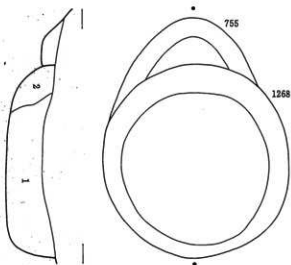

1270

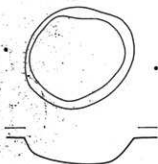

1279

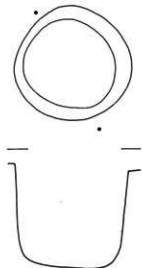

0 1m

68-766-781-1277-1278-1317~1319-1321

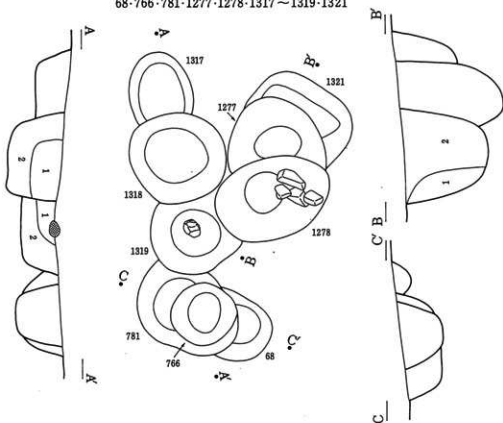

147-768-769-1280-1281

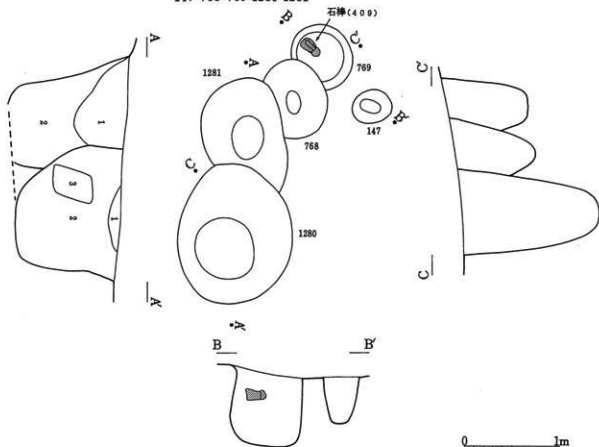

図版69 縄文中期の土坑④ 1 : 40

770-1033-1272-1273-1293

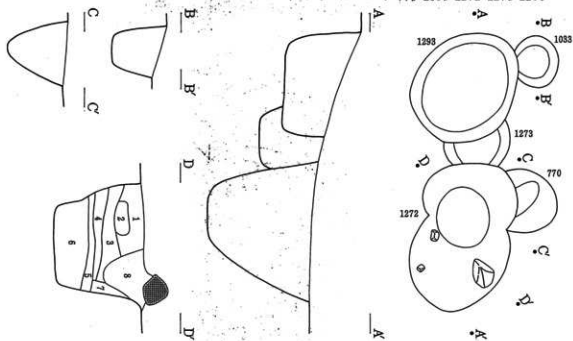

1274 ~ 1276

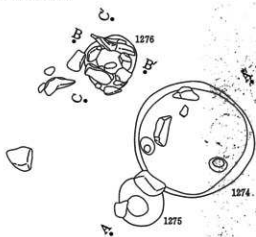

1282

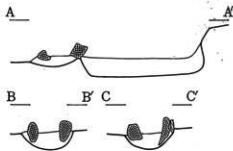
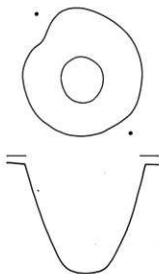

0 1m

図版70 縄文中期の土坑4号 1 : 40

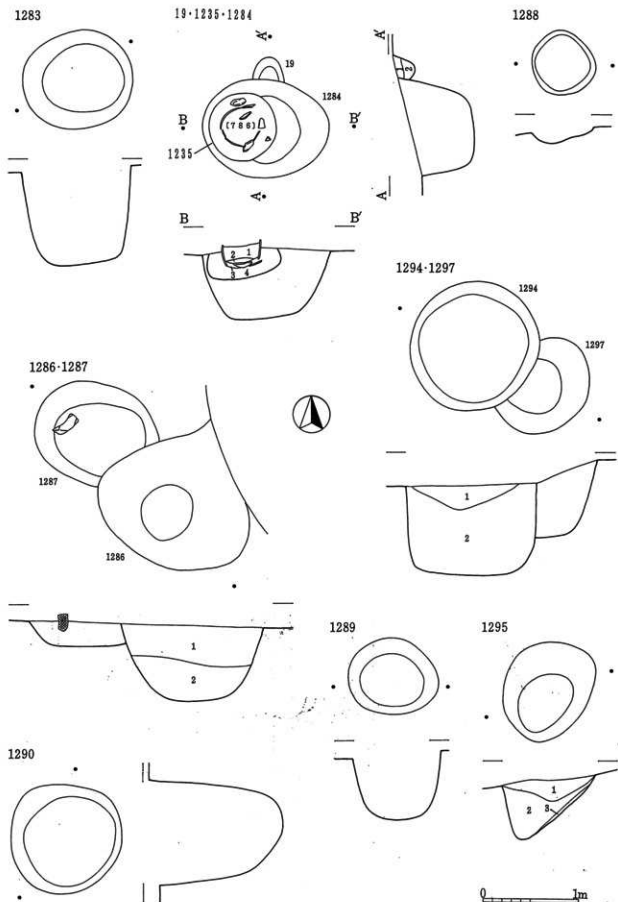

図版71 縄文中期の土坑跡 1:40

縄土遺跡

958-1306

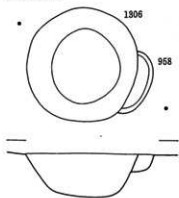

988-1307

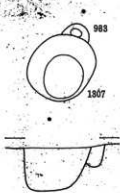

1308-1315-1316

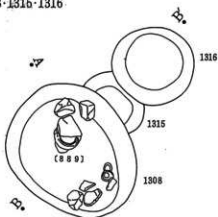

1309-1310-1313

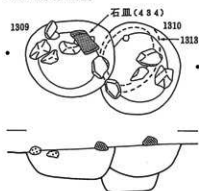

1312

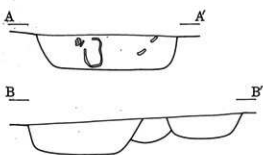
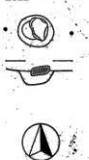

1311



980-982-994-995-999-1320-1322~1324

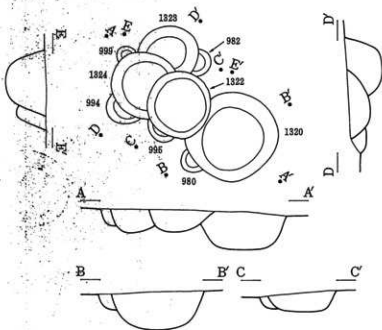

1325

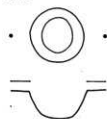

571-1326

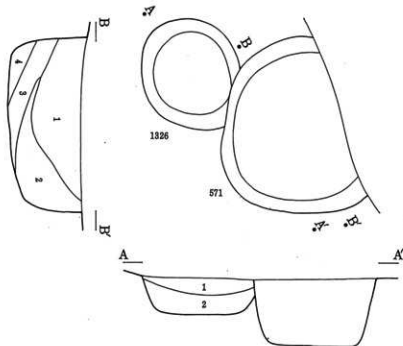

1327-1419

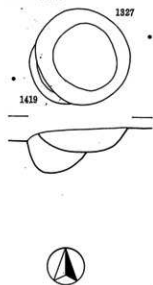

1330-1331

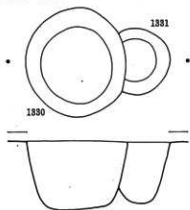

997-1332-1389

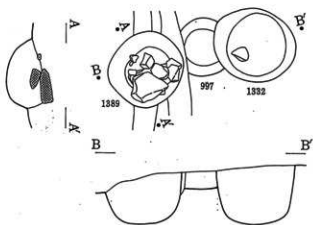

1333

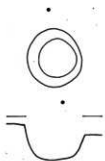

1334

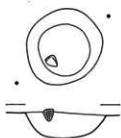

957-1337

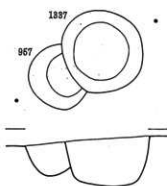

1338



図版73 縄文中期の土坑跡 1 : 40

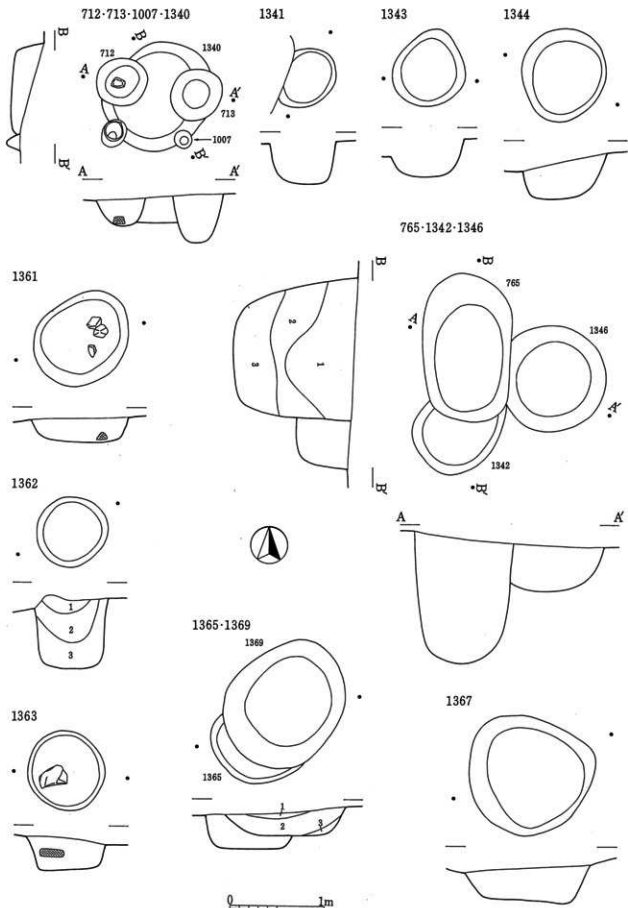

図版74 縄文中期の土坑跡 1 : 40

107·804·835·1364·1366·1375·1376·1378·1380·1383·1401

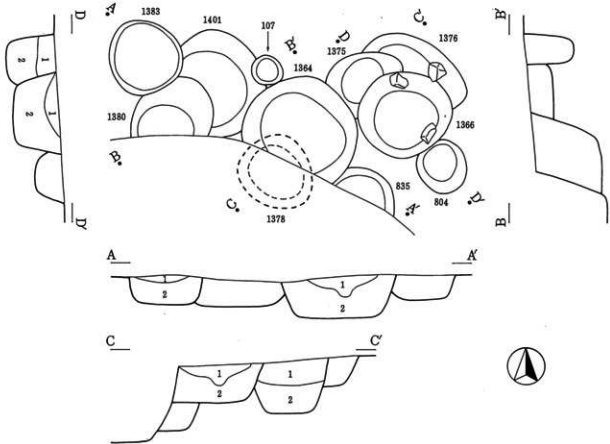

801·1370·1377

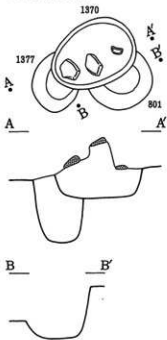

834·1372·1403~1405·1410·1416·1417

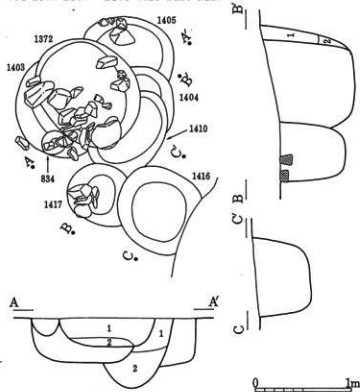

図版75 縄文中期の土坑50 1 : 40

郷土遺跡

1371

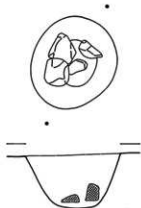

861-862-1373

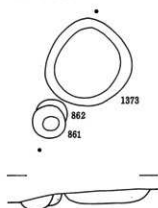

1374

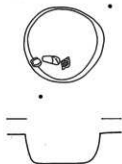

1379

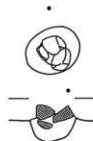

1381-1382

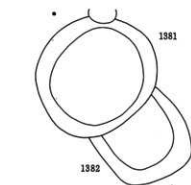

811-1386

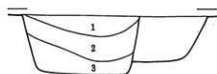
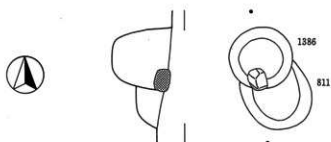

812-814-820-1387-1388

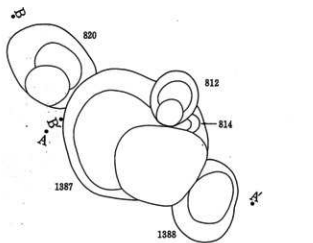

800-1384

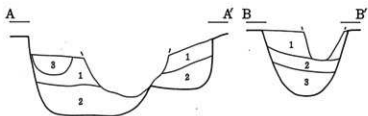
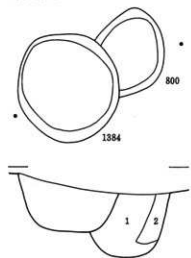

図版76 縄文中期の土坑跡 1:40

920・921・1394～1397

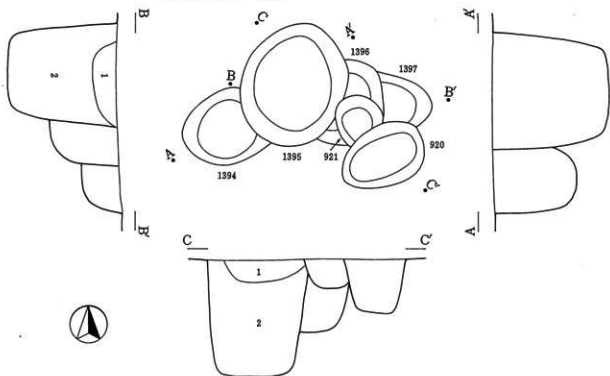

1390

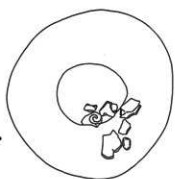

1391

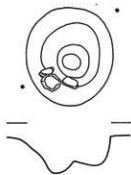

1402

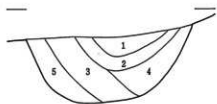

1406

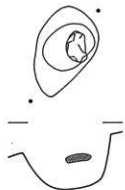

852・866・1407・1408

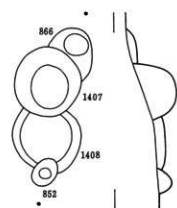

図版77 縄文中期の土坑跡 1 : 40

1411



855・1413～1415

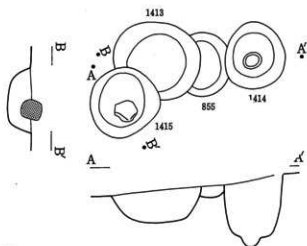

926・1418

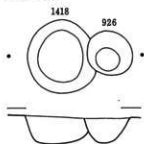

1420

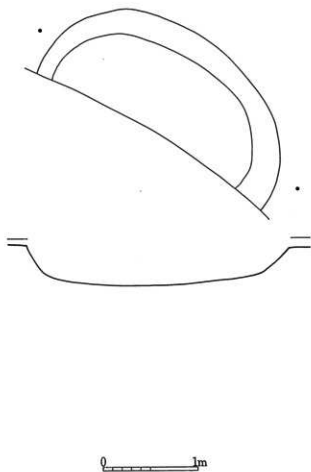

1217-1218

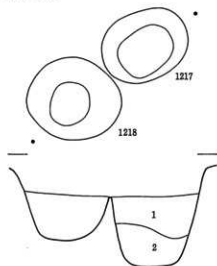

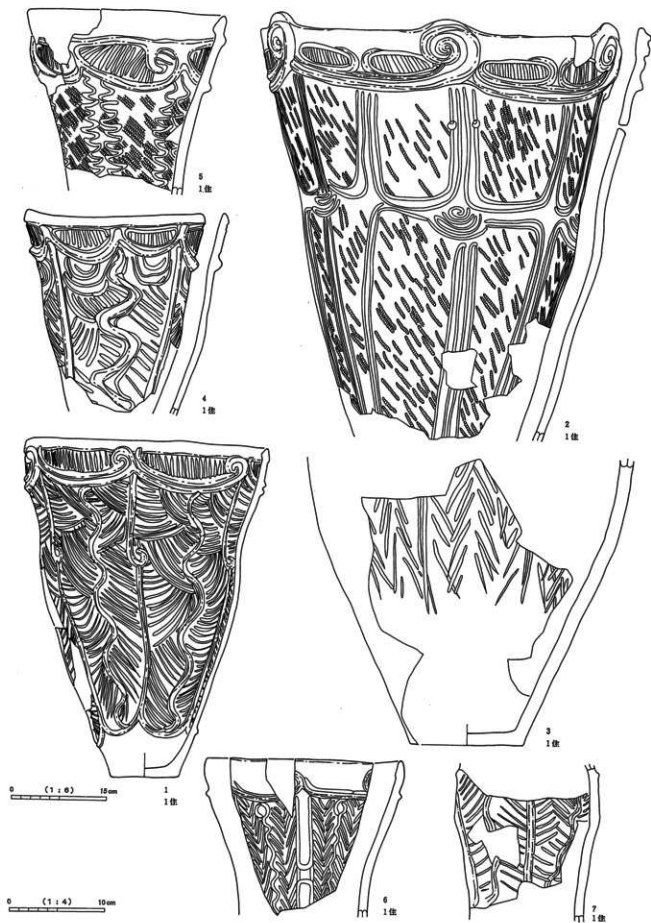

图版79 1号整穴住居跡出土土器 (1 1:6、他 1:4)

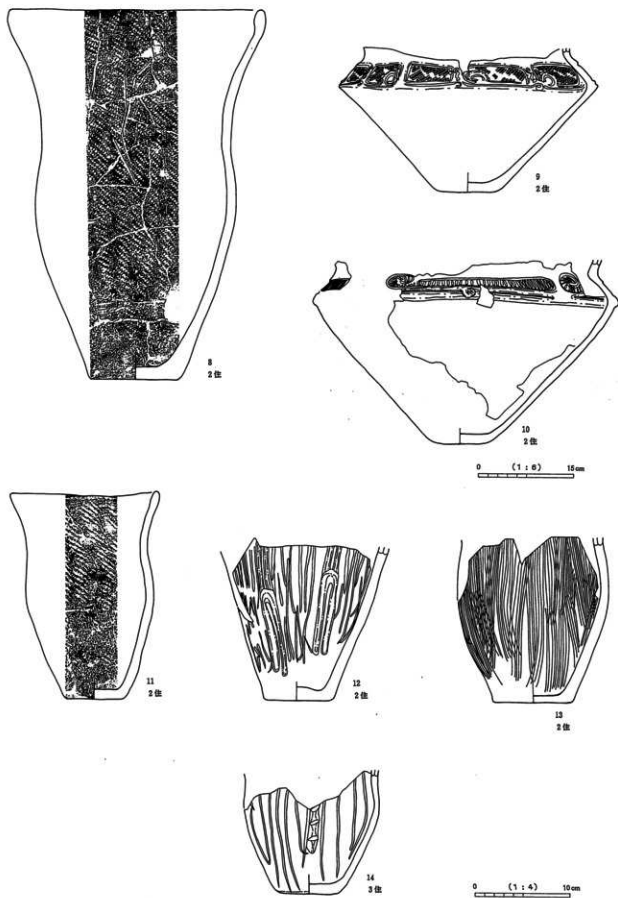

圖版80 2号、3号竪穴住居跡出土土器 (9・10 1:6、他 1:4)

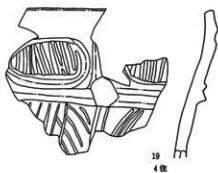
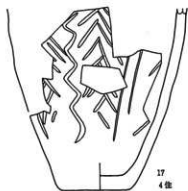
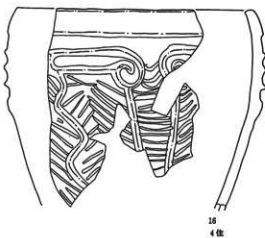
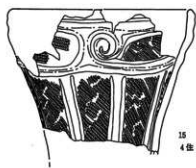

0 (1 : 4) 10cm

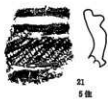
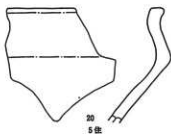

0 (1 : 3) 10cm

図版81 4号、5号竪穴住居跡出土土器 (20-22 1:3、他1:4)

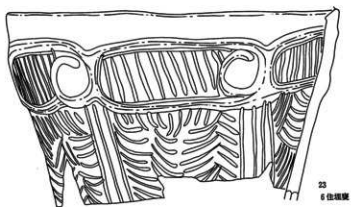

23
6位破片



24
6位破片内



25
6位

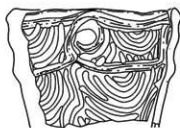

26
6位

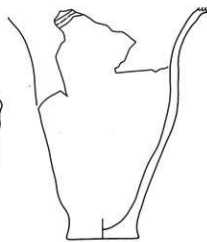

27
6位



28
7位



29
7位



30
7位



31
7位

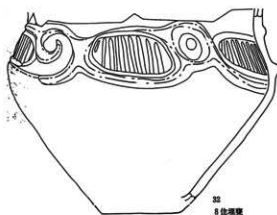

32
8位破片

0 (1:3) 10cm

0 (1:4) 10cm

図版82 6号~8号整穴住居跡出土土器 (28~31 1:3、他 1:4)

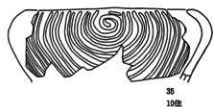
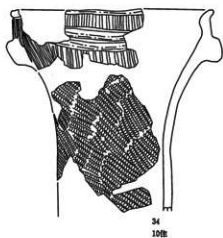
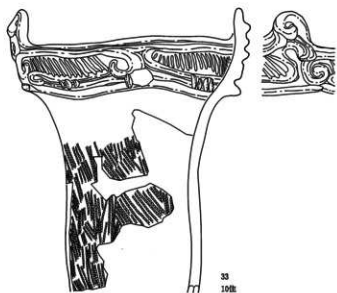

0 (1:4) 10mm



0 (1:6) 15cm

図版83 10号、11号竪穴住居跡出土土器 (36 1:6、他 1:4)

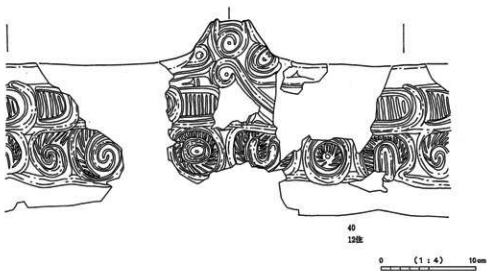
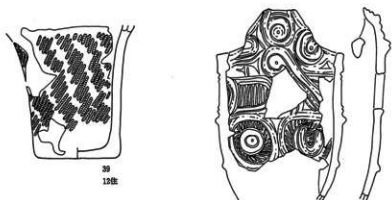
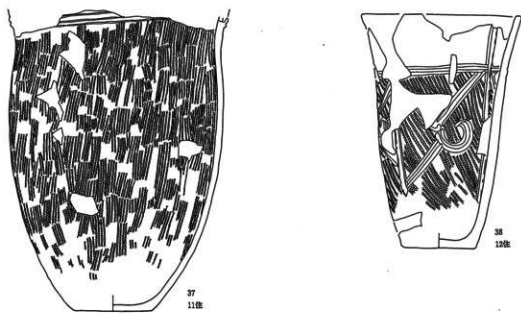

圖版84 11号、12号整穴住居跡出土土器 (37 1:6、他 1:4)

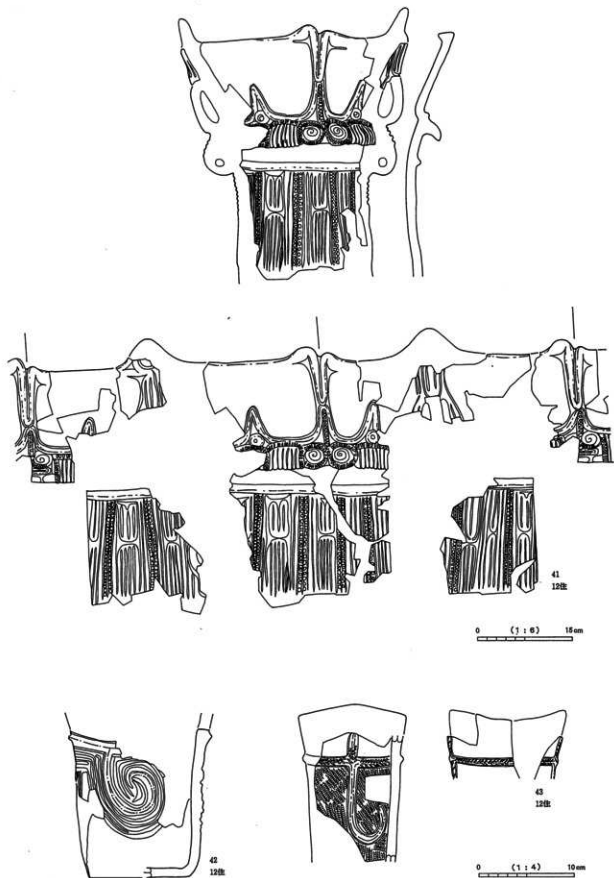

图版85 12号整穴住居跡出土土器 (41 1:6、他 1:4)

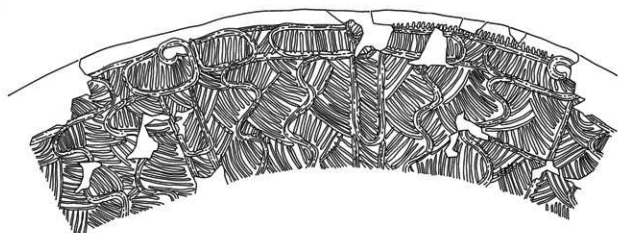

0 (1 : 4) 15cm

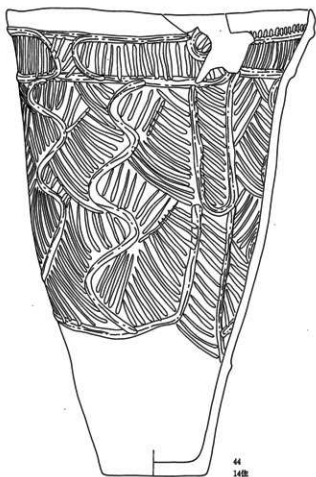

44
14B

0 (1 : 4) 10cm

図版86 14号竪穴住居跡出土土器 (1 : 4)

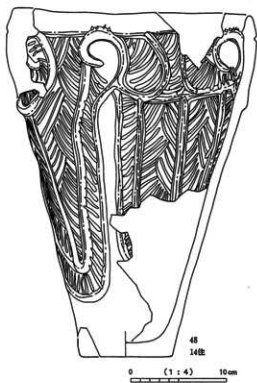
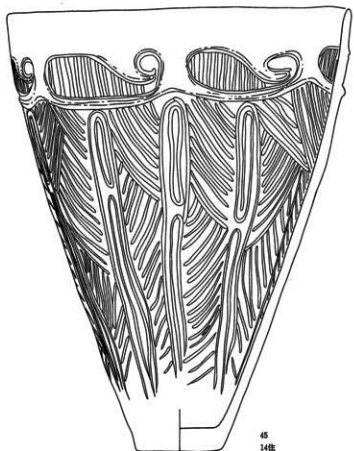

圖版87 14号壑穴住居跡出土土器 (1:4)

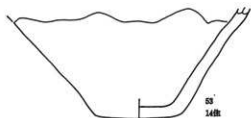
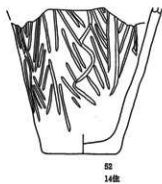
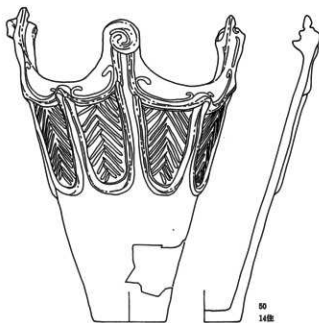
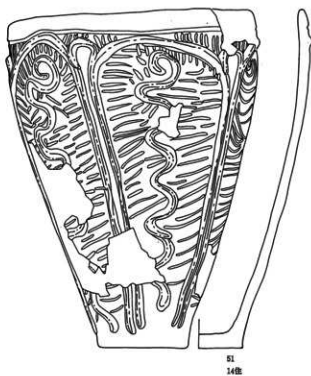
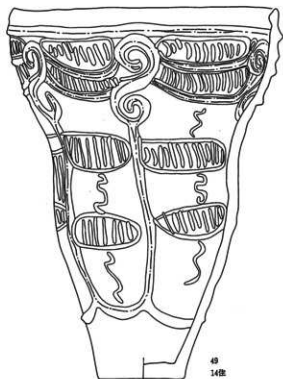

0 (1:4) 10cm

図版88 14号竖穴住居跡出土土器 (1:4)

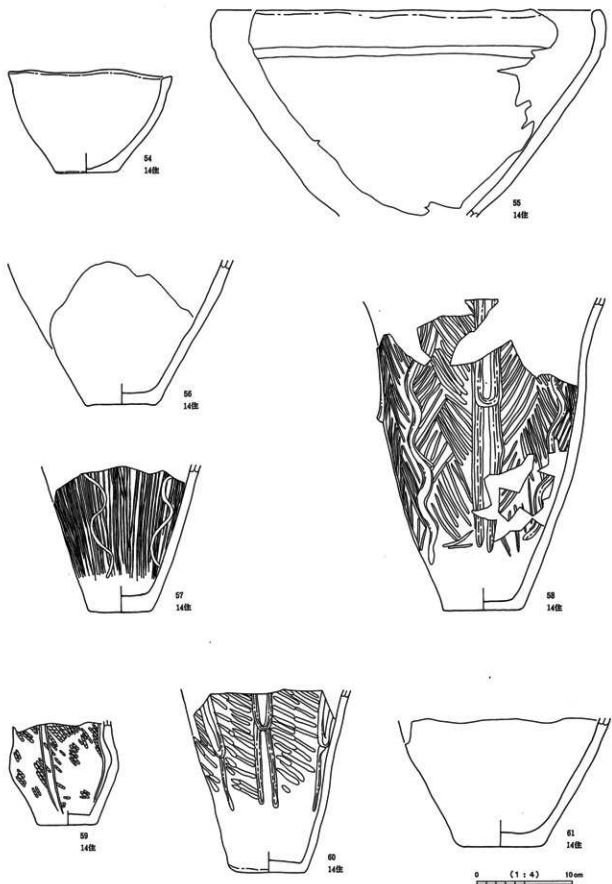

圖版89 14号整穴住居跡出土土器 (1:4)

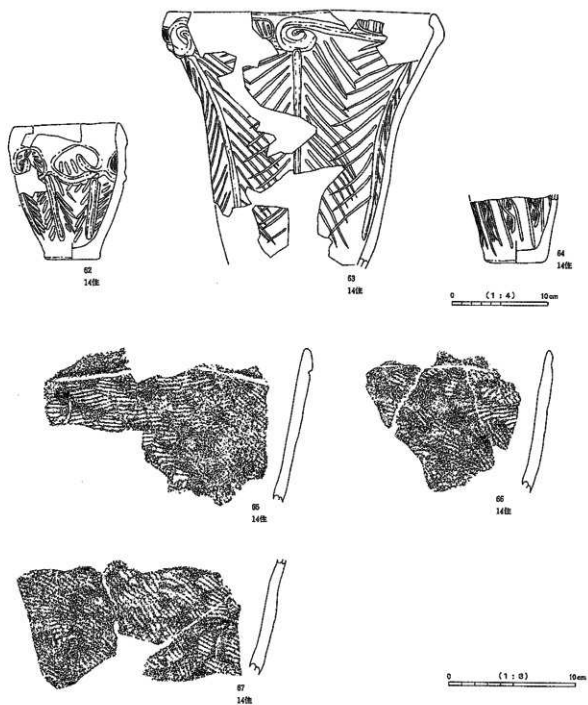

图版90 14号整穴住居跡出土土器 (62~64 1:4、他 1:3)

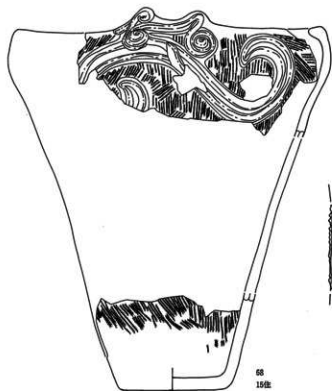

68
15枚

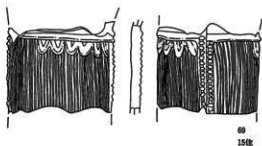

69
15枚

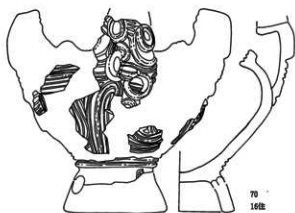

70
16枚



73
16枚



71
16枚



72
16枚



74
16枚

0 (1:4) 10mm

図版91 15号、16号竪穴住居跡出土土器 (1:4)

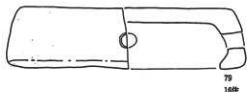
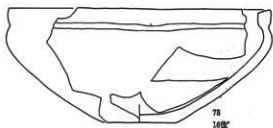
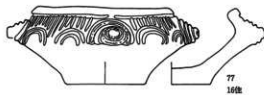
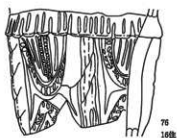
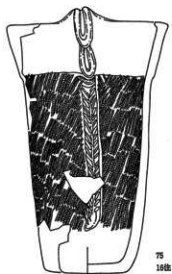

0 (1 : 4) 10cm

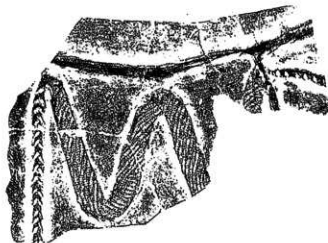

0 (1 : 8) 15mm

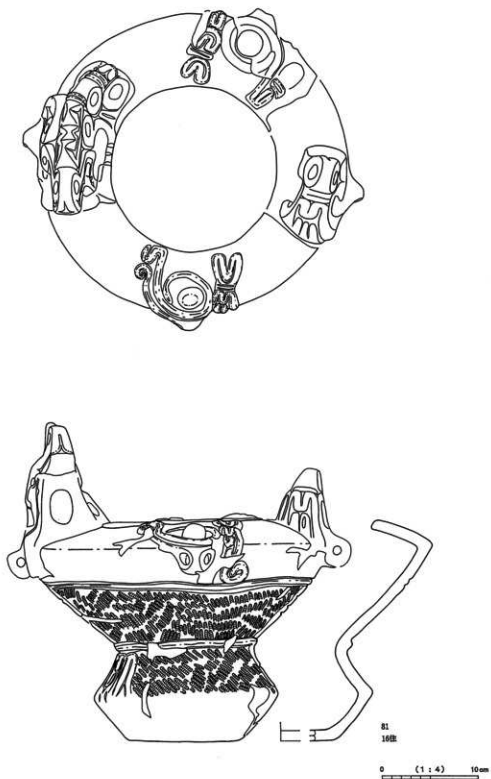

图版93 16号整穴住居跡出土土器 (1:4)

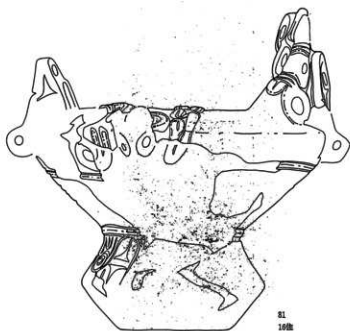
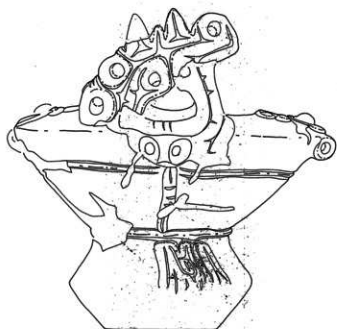

81
16世

0 (1:4) 10cm

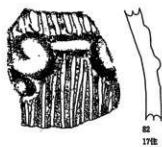

82
17世



83
17世



84
17世



85
21世



86
21世



87
21世



88
21世



89
21世



90
21世



91
22世



92
22世



93
22世



94
23世



95
23世

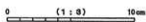
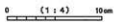

図版95 17号、21号～23号竪穴住層跡出土土器 (94 1:4、他 1:3)

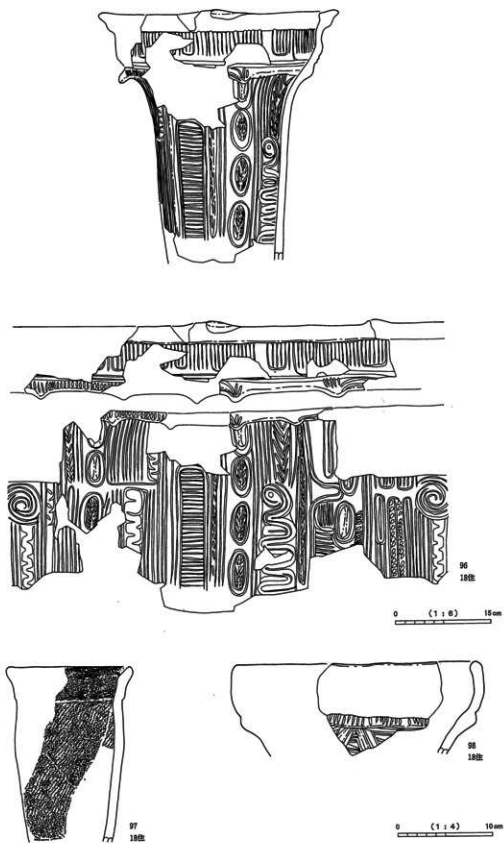

图版96 18号整穴住居跡出土土器 (96 1:6、他 1:4)

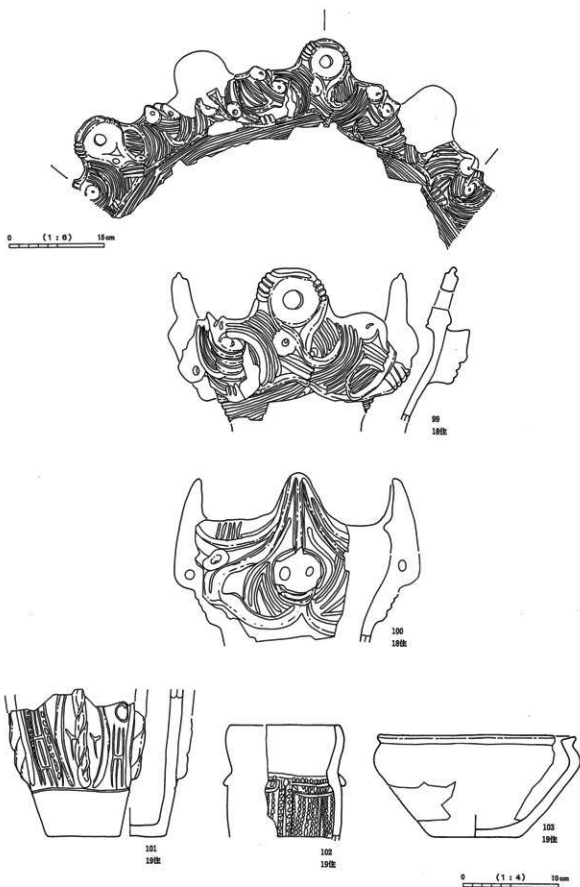

图版97 18号、19号整穴住居跡出土土器 (1:4)

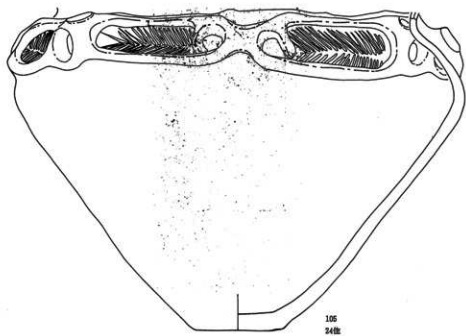
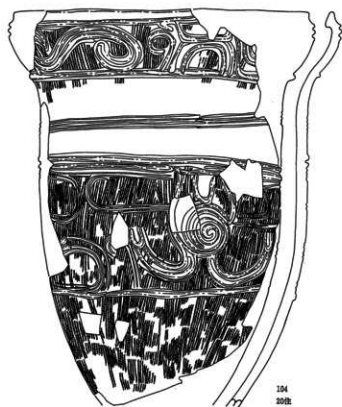

0 (1:6) 15cm

図版98 20号、24号竪穴住居跡出土土器 (1:6)

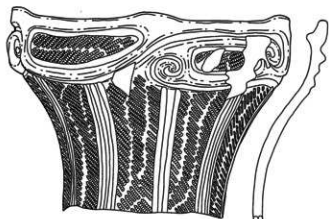

106
24世



108
24世



107
24世

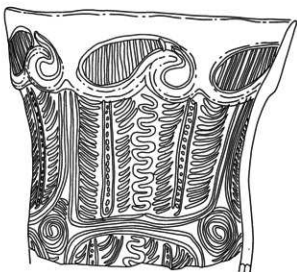

109
24世

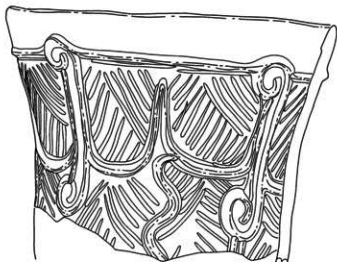

110
24世

0 (1:4) 10cm

図版99 24号竪穴住居跡出土土器 (1:4)

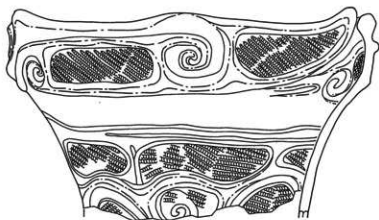

111
24位

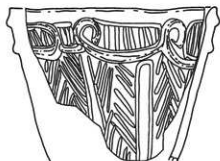

114
24位

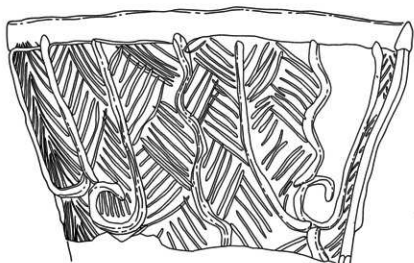

112
24位破片

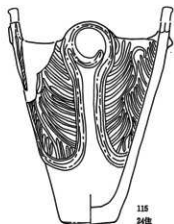

115
24位

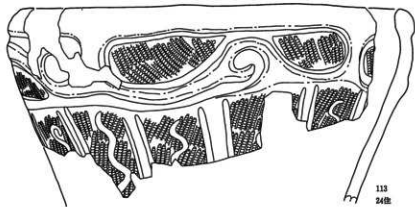

113
24位

0 (1:4) 10cm

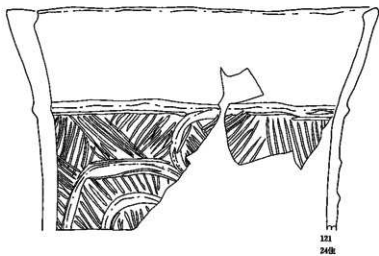
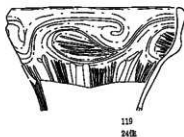
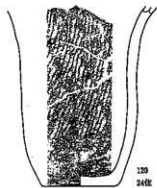
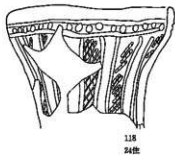
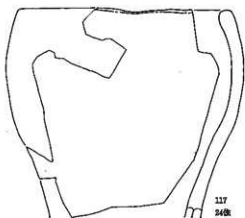
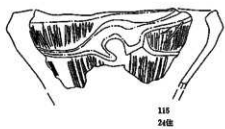

0 (1:4) 10cm

图版101 24号竖穴住居跡出土土器 (1:4)



0 (1:6) 15cm

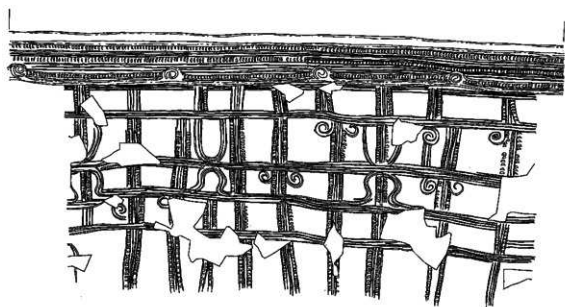

0 (1:6) 20cm

図版102 25号整穴住層跡出土土器 (1:6)

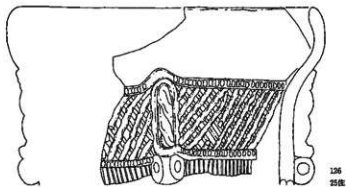
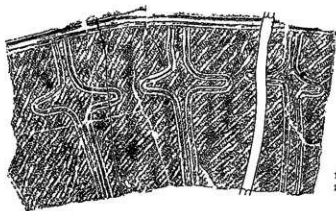

0 (1:4) 10mm

図版103 25号整穴住居跡出土土器 (1:4)

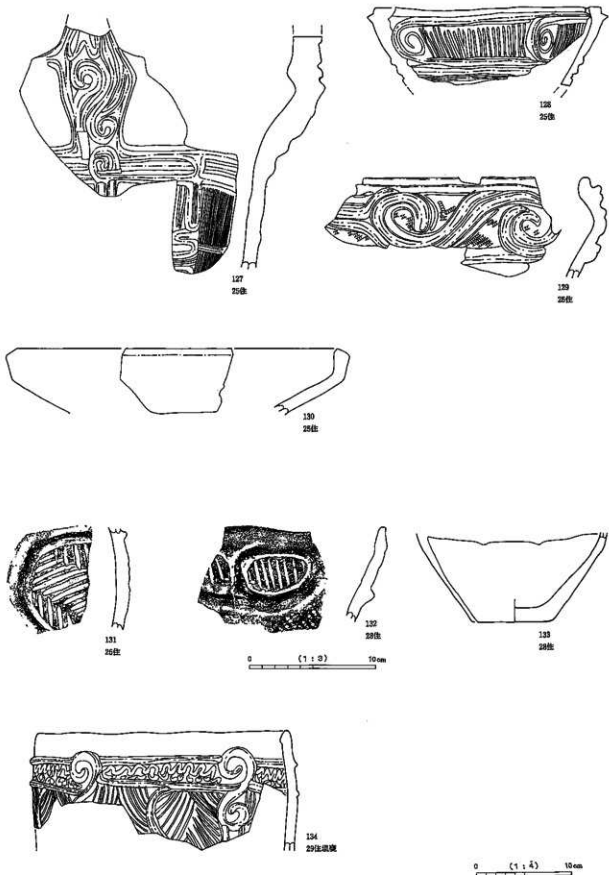

圖版104 25号、26号、28号、29号整穴住居跡出土土器 (131·132 1:3、他 1:4)

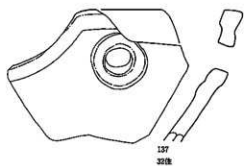
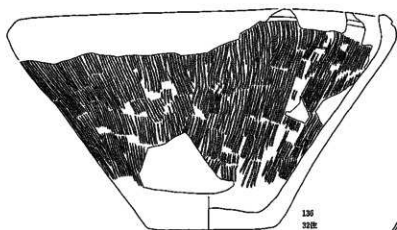
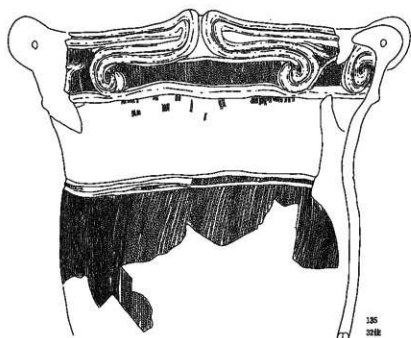

0 (1:4) 10cm

図版105 32号壘穴住居跡出土土器 (1:4)

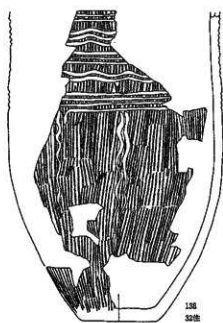

138
32E

0 (1:4) 10mm



139
32E



140
32E

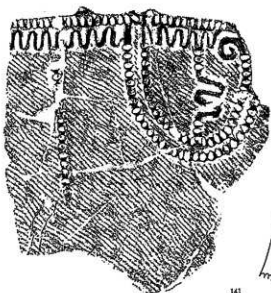

141
32E

0 (1:3) 10mm

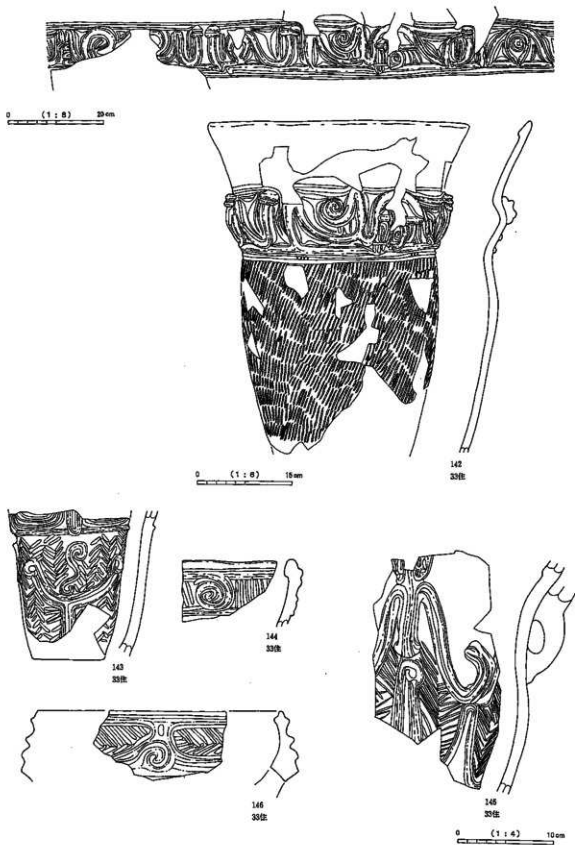

图版107 33号窑穴住居跡出土土器 (142 1:6、他 1:4)



147
37世



148
40世



149
40世



150
40世



151
40世



152
45世



153
45世



154
45世



155
45世



156
48世



157
48世



158
48世



159
50世



160
50世



161
50世



0 (1:3) 50mm

图版108 37号、40号、45号、48号、50号整穴住居跡出土土器 (1:3)

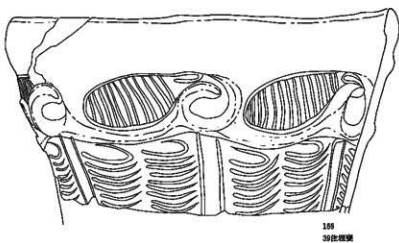
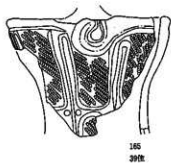
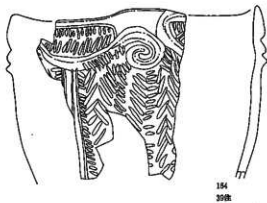
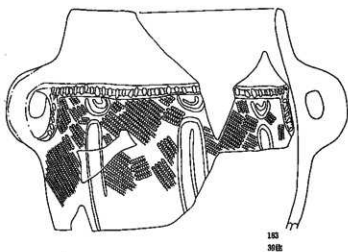
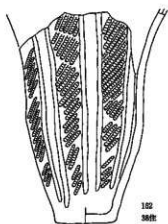

0 (1:4) 10mm

図版109 38号、39号竖穴住居跡出土土器 (1:4)

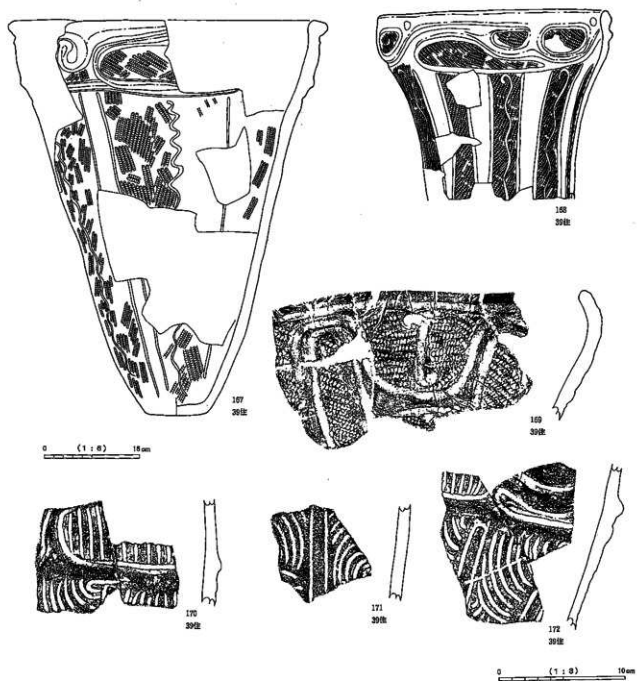

図版110 39号壺穴住居跡出土土器 (167・168 1:6、他 1:3)

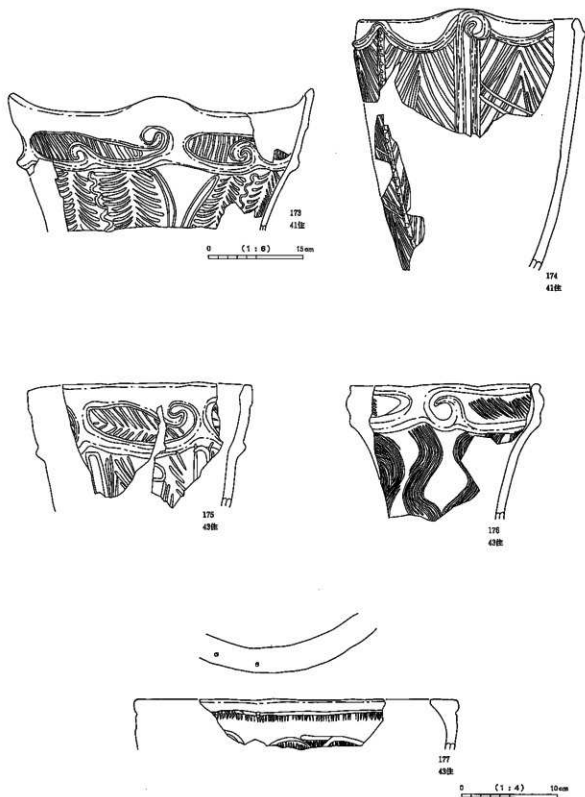

図版111 41号、43号竪穴住居跡出土土器 (173 1:6、他 1:4)

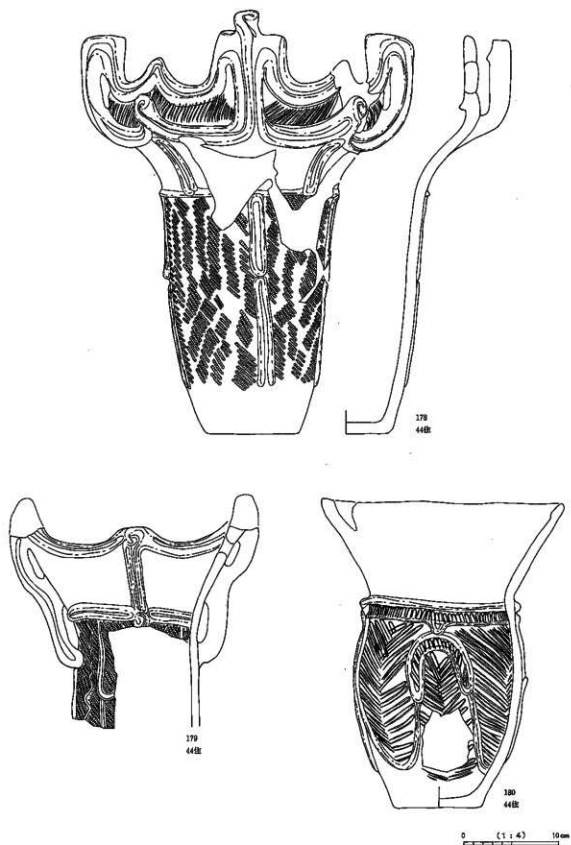

图版112 44号竖穴住居跡出土土器 (1:4)

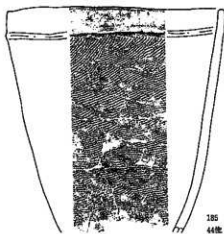
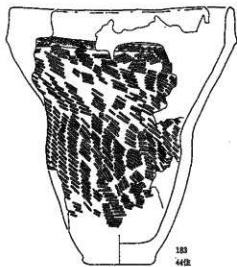
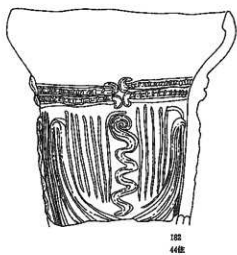
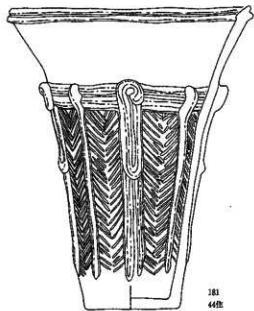

0 (1:4) 10cm

0 (1:6) 10cm

図版113 44号整大住層出土土器 (185 1:6、他 1:4)

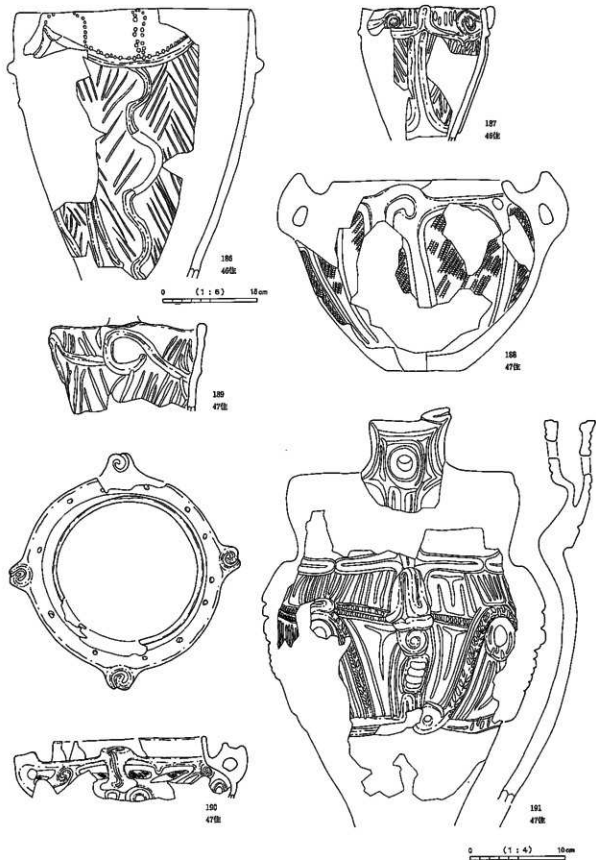

図版114 46号、47号竪穴住居跡出土土器 (186 1:6、他 1:4)

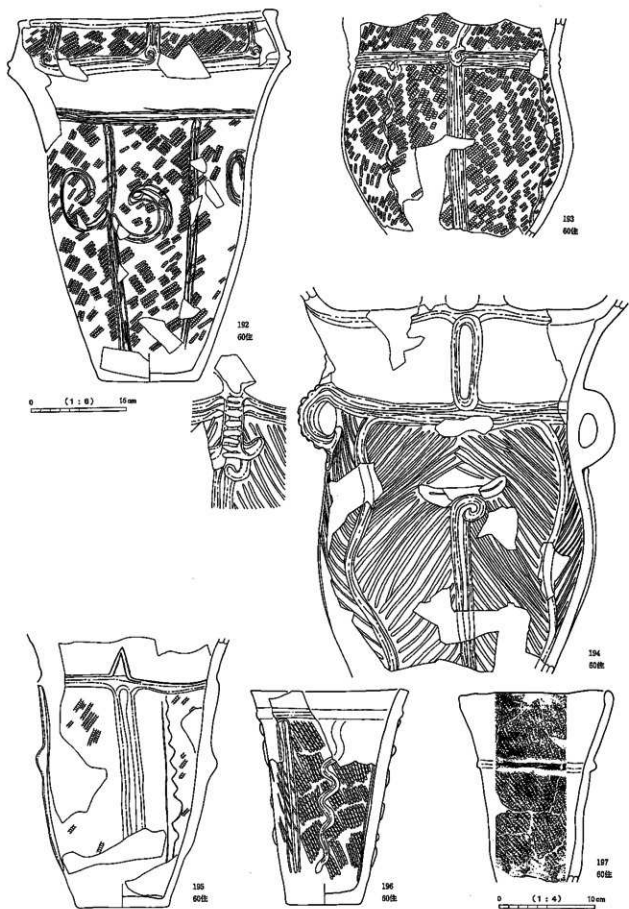

図版115 60号整穴住居跡出土土器 (192・193 1:6、他 1:4)

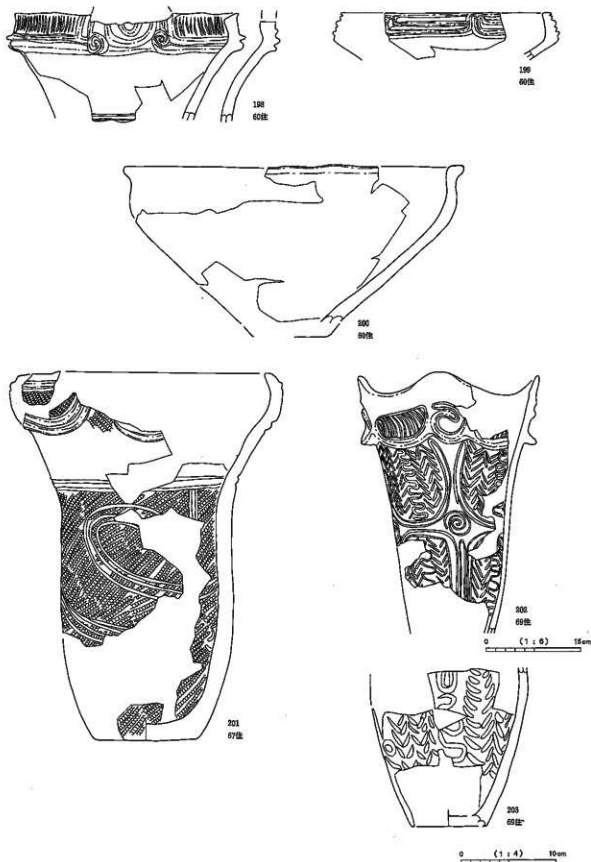

圖版116 60號、67號、69號豎穴住居跡出土土器 (202 1:6、他 1:4)

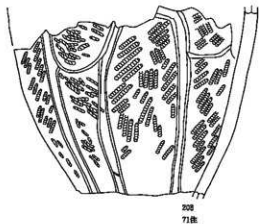
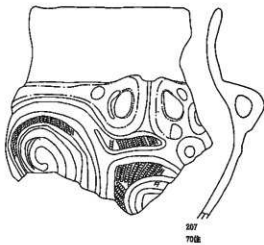
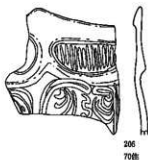
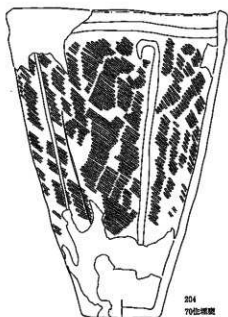

0 (1:4) 10mm

圖版117 70号、71号竖穴住居跡出土土器 (1:4)

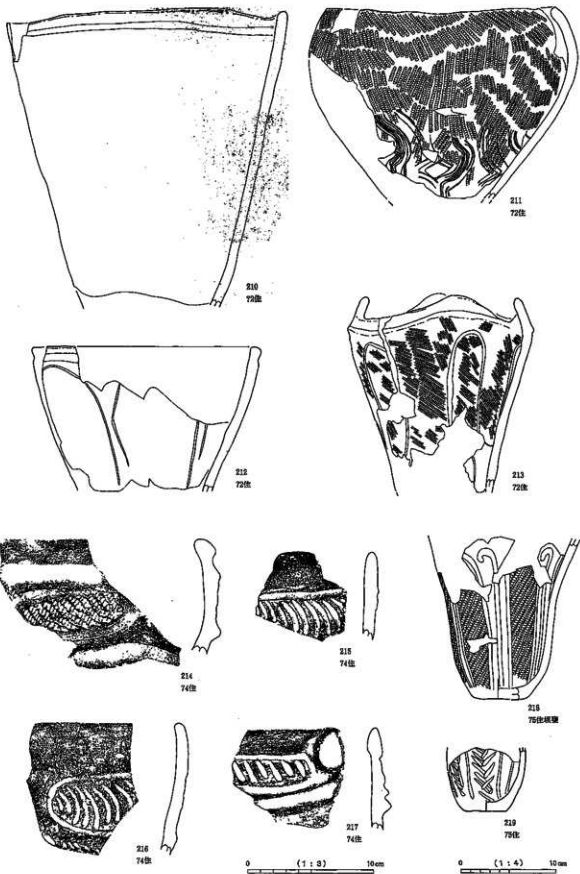

図版118 72号、74号、75号整穴住居跡出土土器 (214~217 1:3、他 1:4)

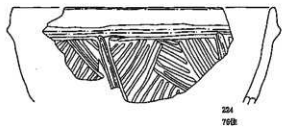
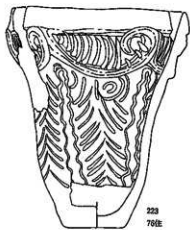
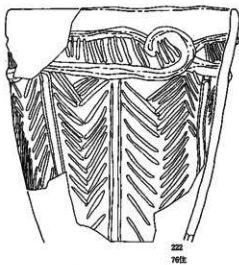

0 (1:4) 10cm

图版119 76号整穴住居跡出土土器 (1:4)

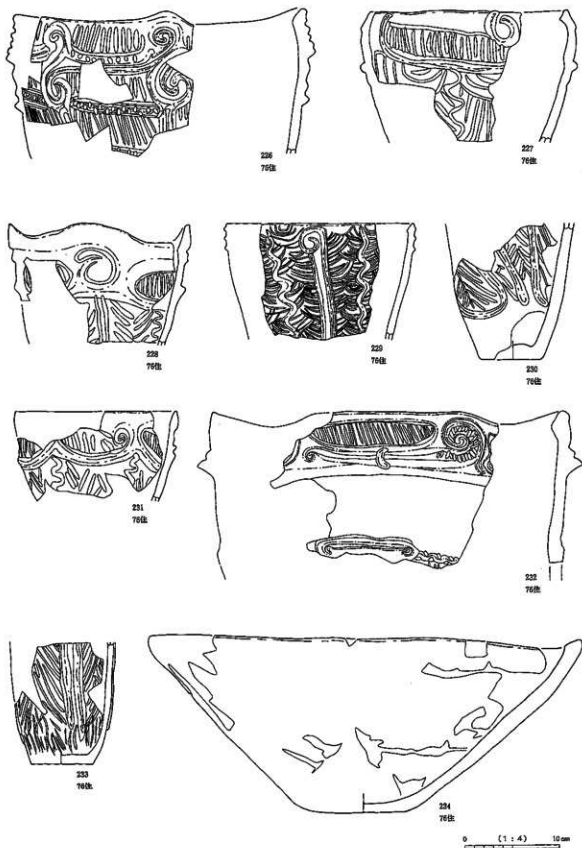

圖版120 76号整穴住居跡出土土器 (1:4)

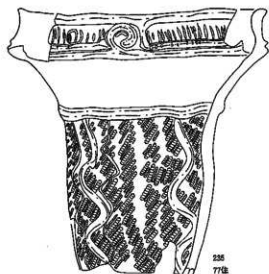

0 (1:4) 10mm

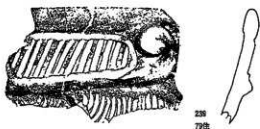
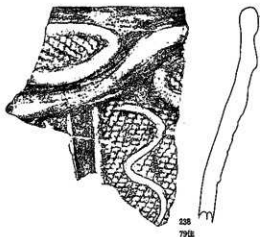

0 (1:4) 10mm

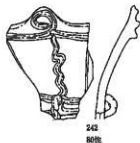
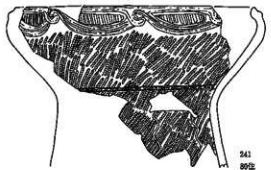

0 (1:6) 15cm

0 (1:4) 10mm

図版121 77号~80号竪穴住居跡出土土器 (235~237・242 1:4、241 1:6、他 1:3)

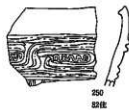
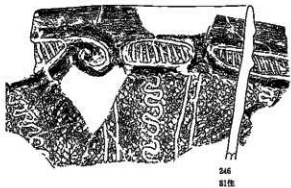
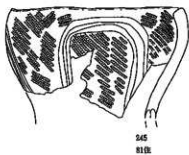
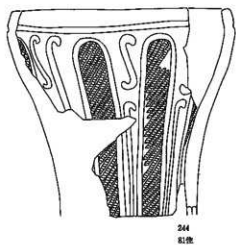
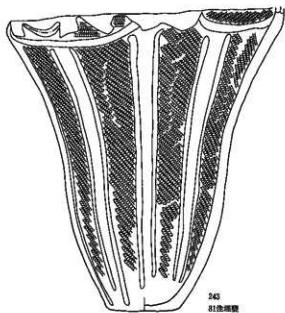

0 (1:4) 10mm

图版122 81号、82号整穴住居跡出土土器 (1:4)

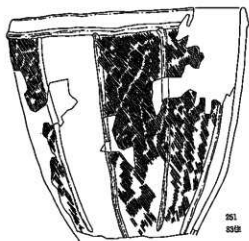

251
83號

0 (1:6) 10mm



252
83號遺蹟

0 (1:4) 10mm

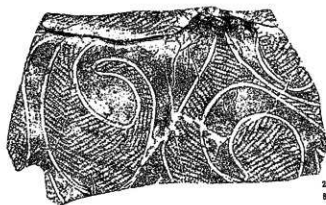

253
83號



254
83號



255
84號

0 (1:3) 10mm



256
84號



257
84號

0 (1:4) 10mm

圖版123 83號、84號竅穴住層跡出土土器 (251 1:6、252·257 1:4、他 1:3)

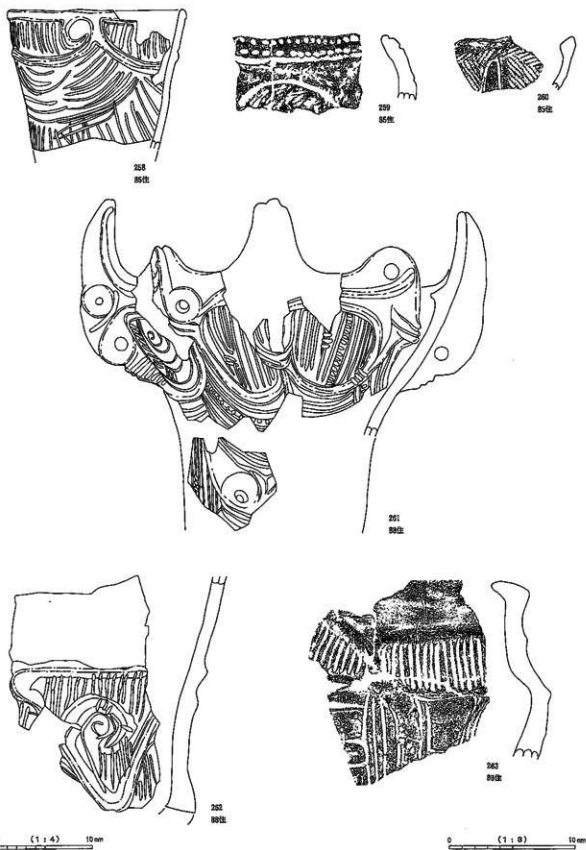

圖版124 85号、88号竪穴住居跡出土土器 (258・261・262 1:4、他 1:3)

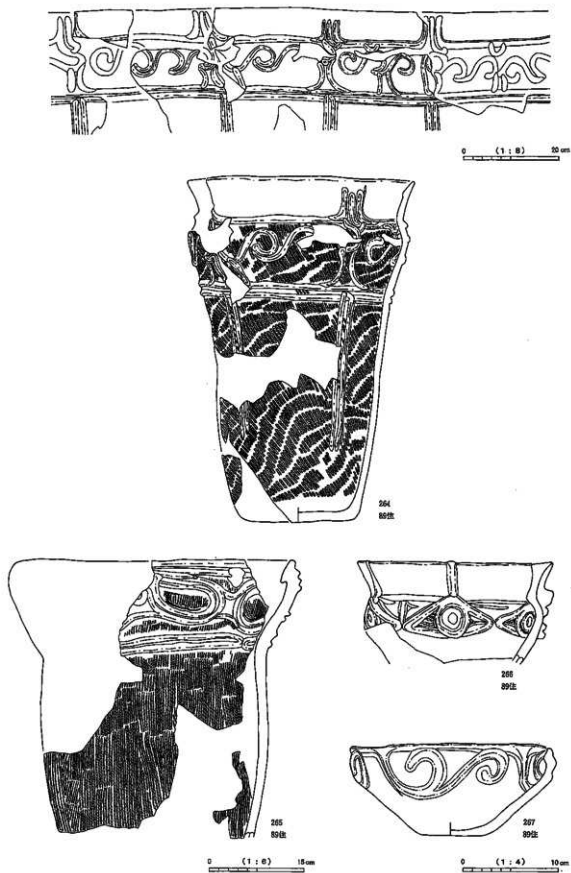

図版125 89号竪穴住居跡出土土器 (264・265 1:6、他 1:4)

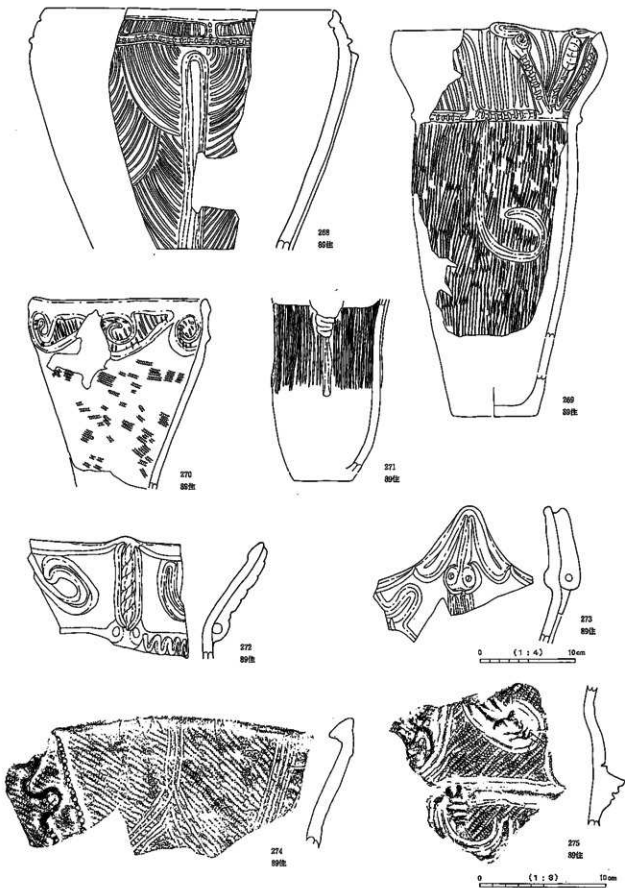

圖版126 89号整穴住居跡出土土器 (274·275 1:3、他 1:4)

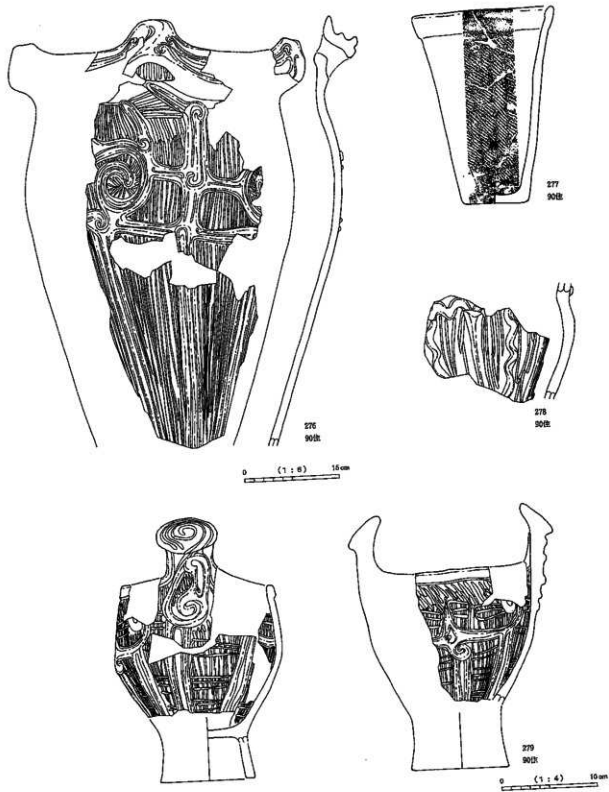

圖版127 90号豎穴住層出土土器 (276 1:6、他 1:4)

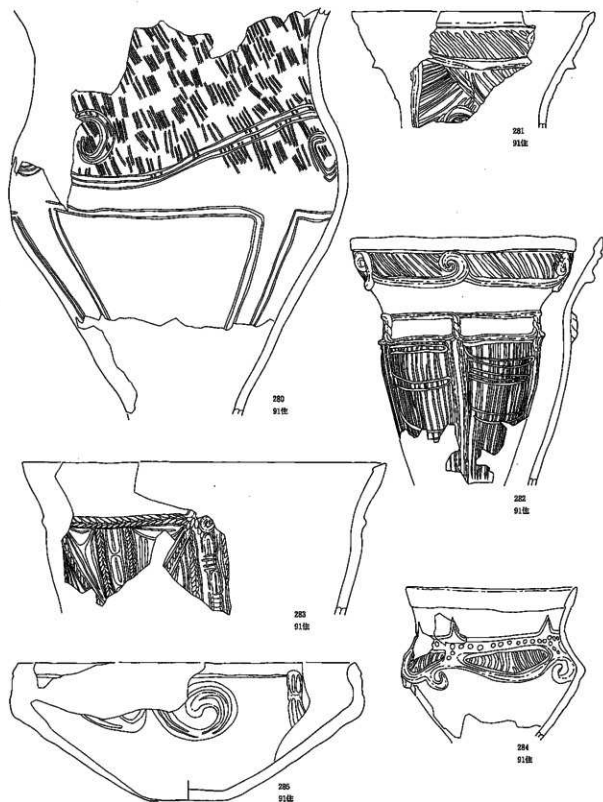

0 (1:4) 10mm

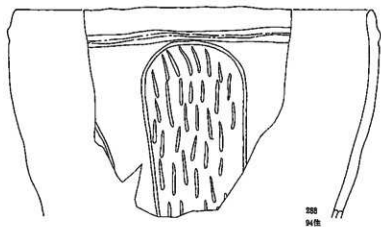
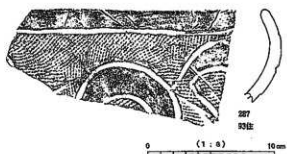

0 (1:4) 10mm

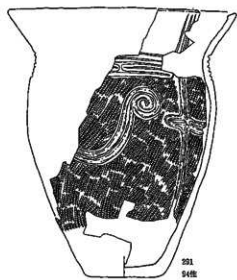

0 (1:6) 15mm

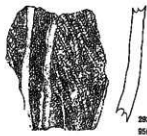
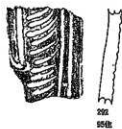

0 (1:4) 10mm

圖版129 93号~95号整穴住居跡出土土器 (288~290 1:4、291 1:6、他 1:3)

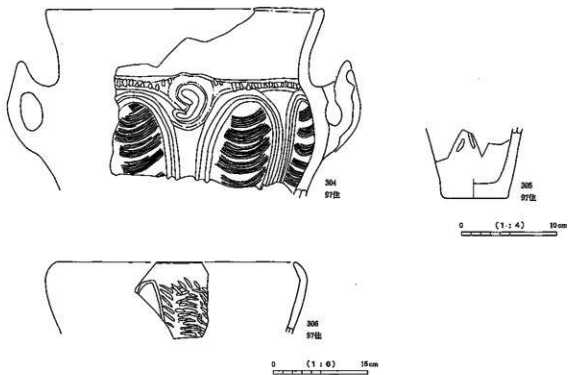
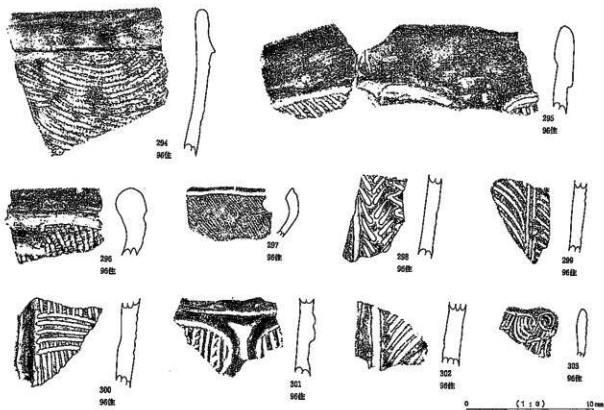

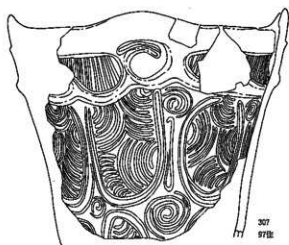

0 (1:0) 16mm

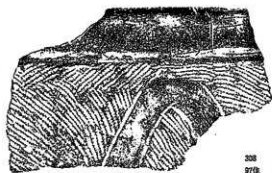

0 (1:0) 10mm

図版131 97号整穴住居跡出土土器 (307 1:6、他 1:3)

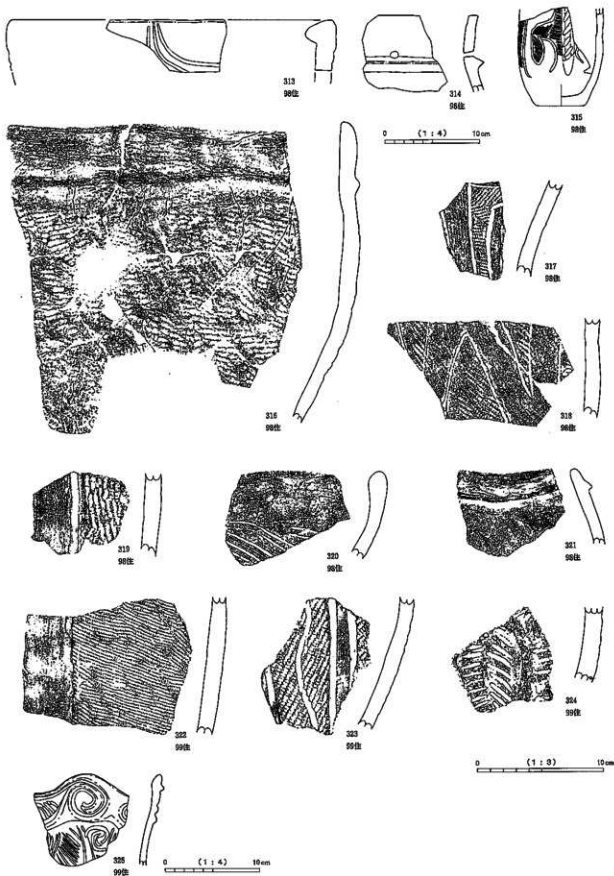

圖版132 98号、99号整穴住居跡出土土器 (313~315·325 1:4、他 1:3)

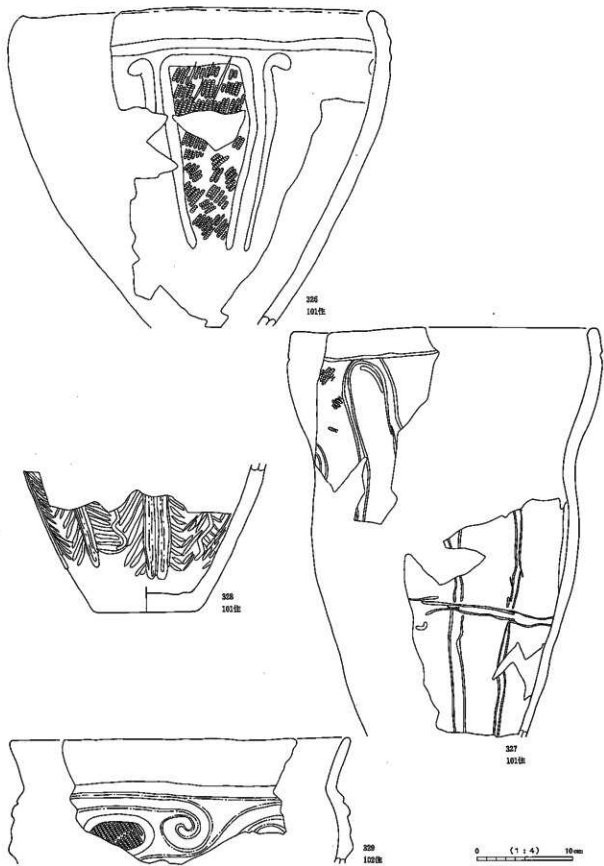

図版133 101号、102号竪穴住居跡出土土器 (1:4)

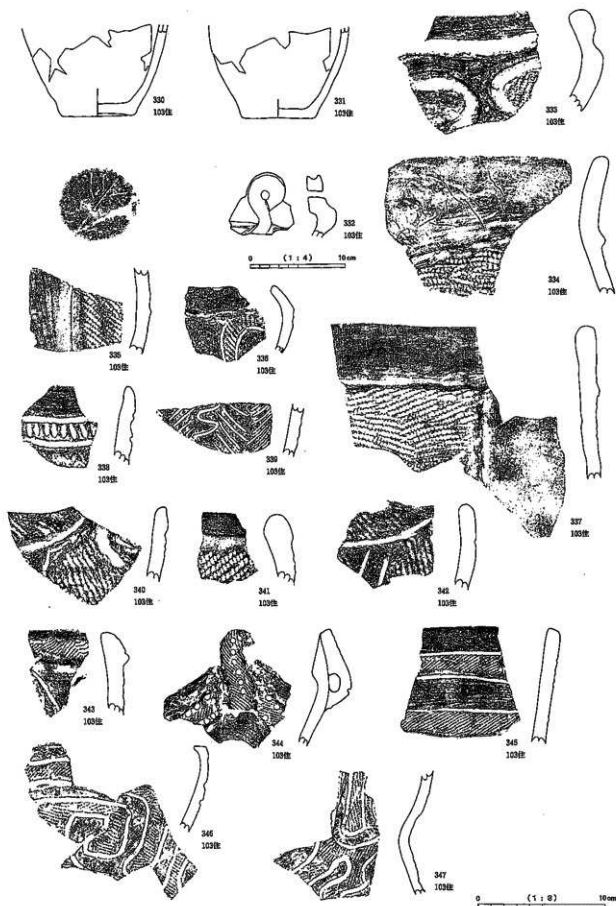

図版134 103号整穴住居跡出土土器 (330-332 1:4、他 1:3)

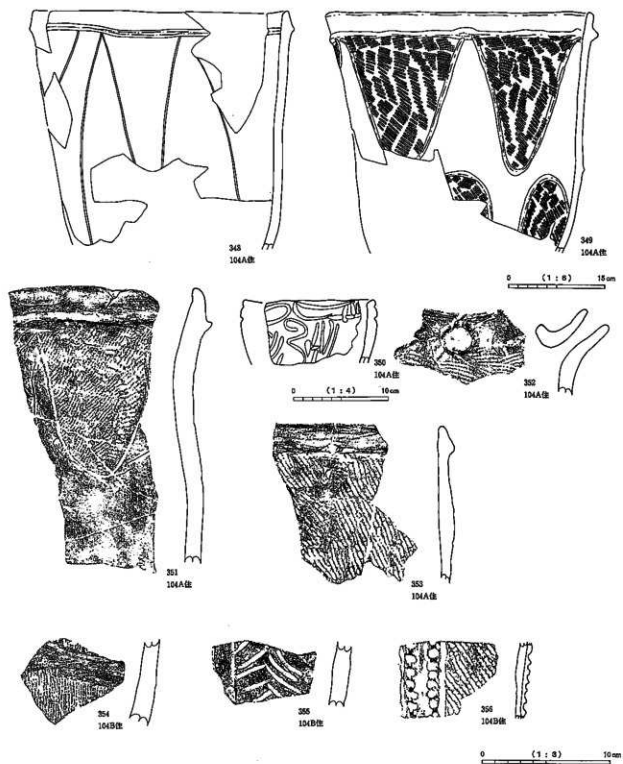

図版135 104A号、104B号整穴住居跡出土土器 (348・349 1:6、350 1:4、他 1:3)

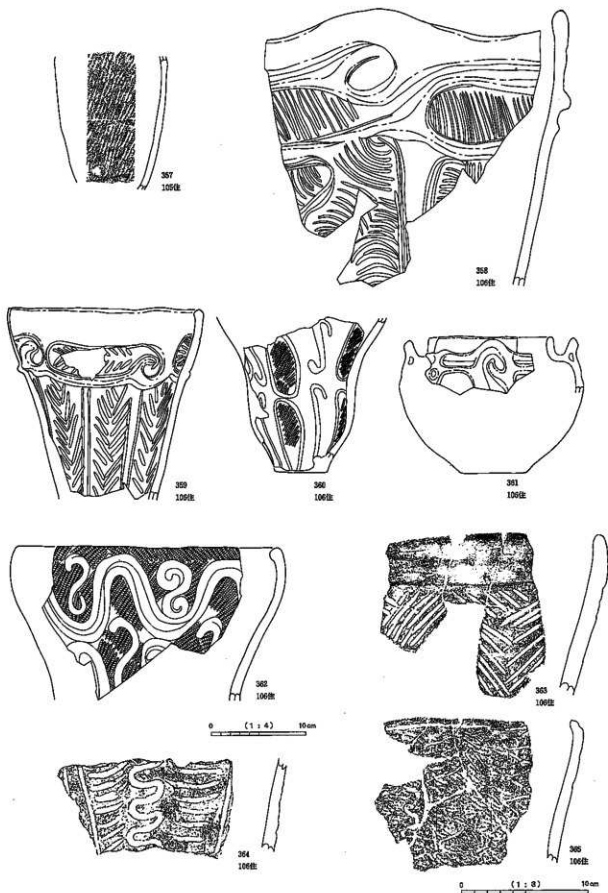

図版136 105号、106号整穴住居跡出土土器 (357~362 1:4、他 1:3)

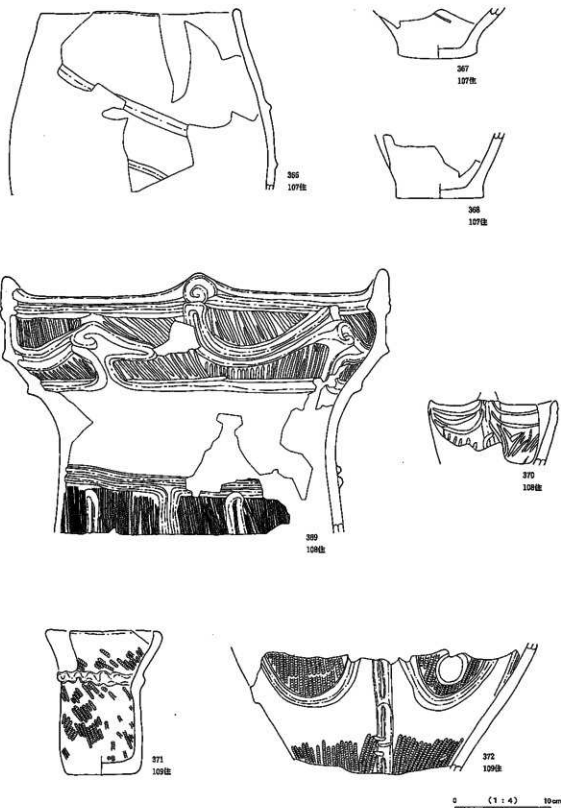

図版137 107号~109号竪穴住居跡出土土器 (1:4)

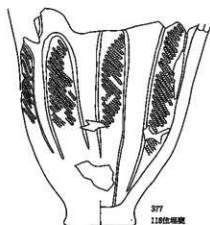
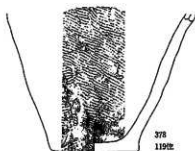
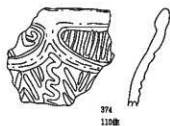
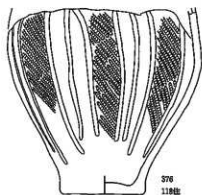
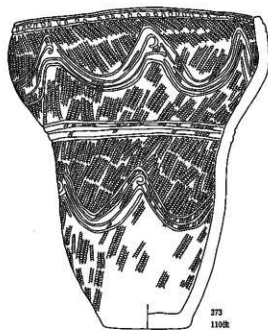

0 (1:4) 10cm

圖版138 110号、112号、118号、119号竪穴住居跡出土土器（1：4）

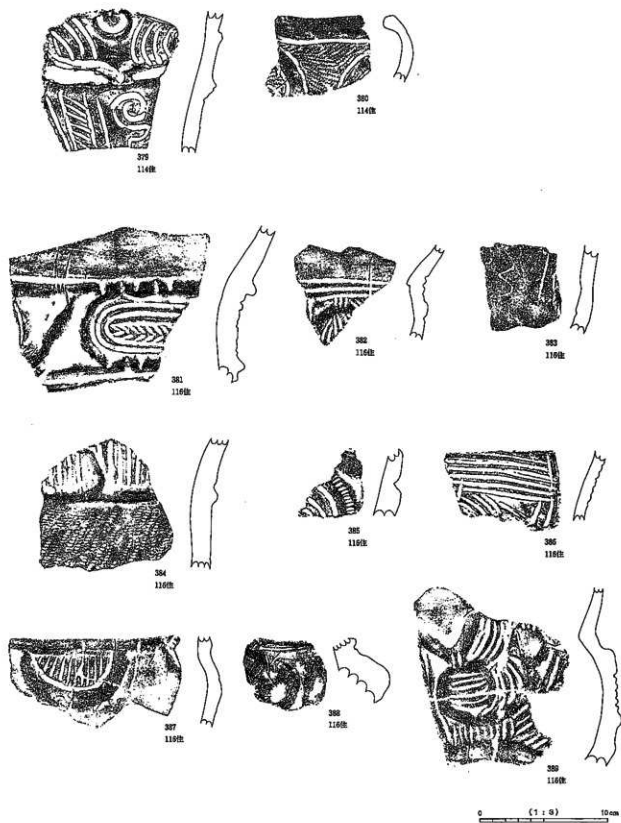

圖版139 114号、116号竪穴住居跡出土土器 (1:3)

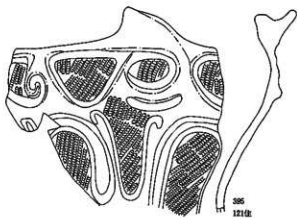
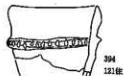
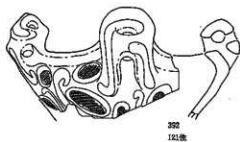
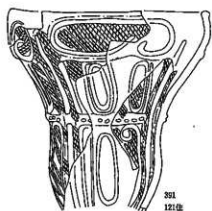
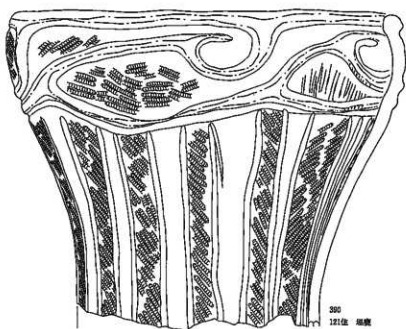

0 (1:4) 10mm

图版140 121号竪穴住居跡出土土器 (1:4)

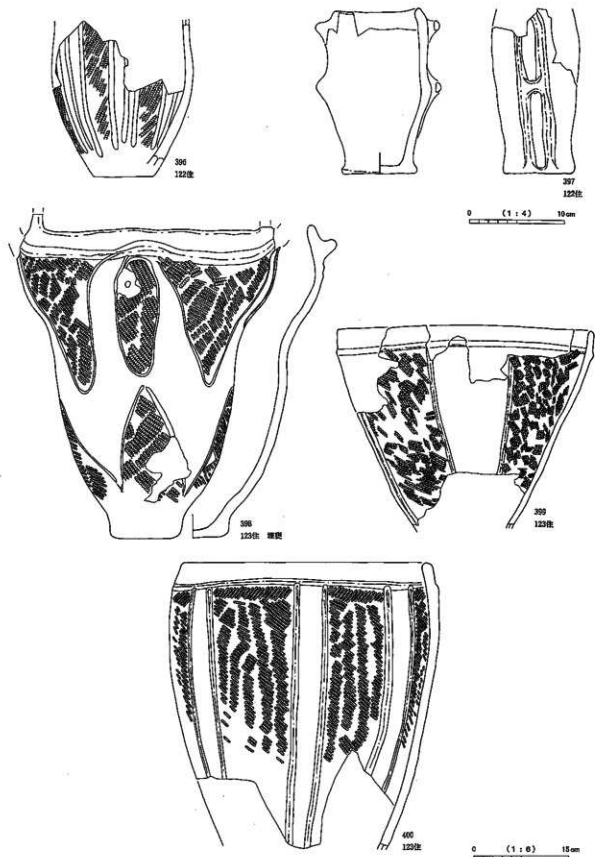

図版141 122号、123号竪穴住居跡出土土器 (396・397 1:4、398~400 1:6)

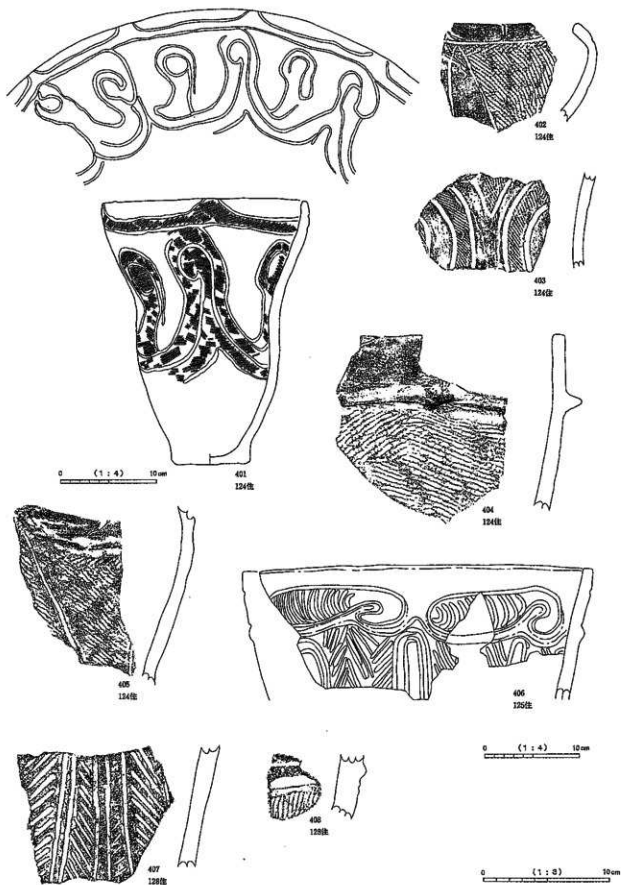

図版142 124号、125号、128号竪穴住居跡出土土器 (401・406 1:4、他 1:3)

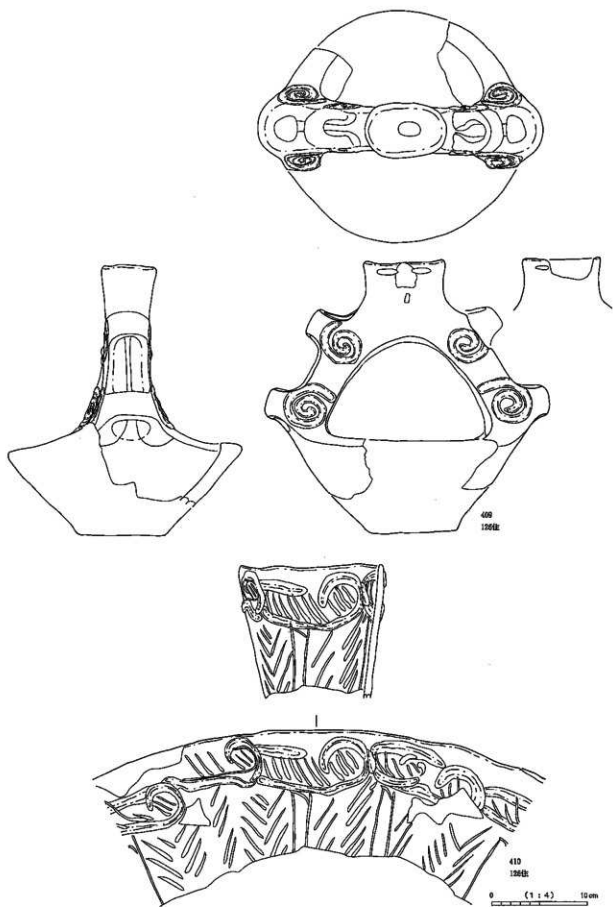

图版143 126号整穴住居出土土器 (1:4)

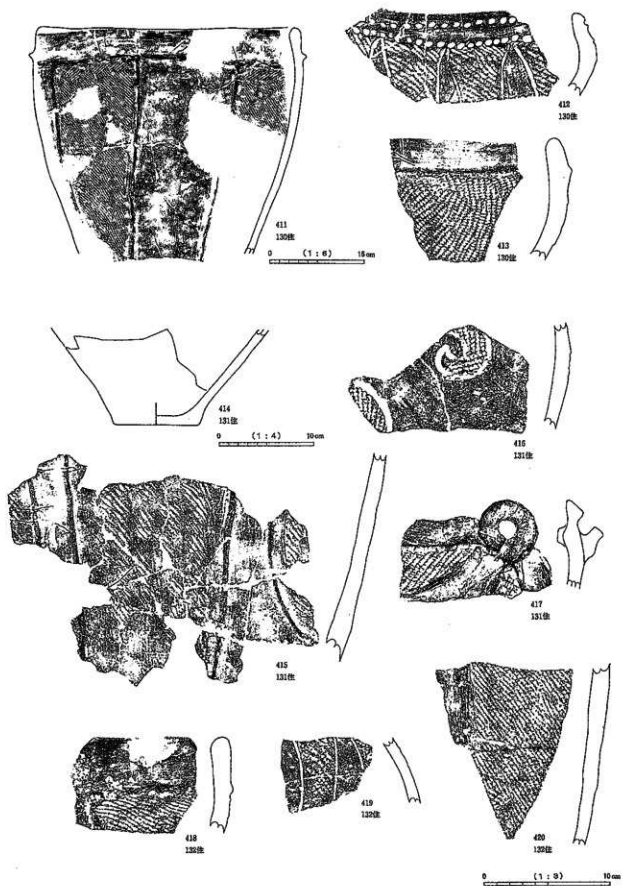

図版144 130号~132号竪穴住居跡出土土器 (411 1:6、414 1:4、他 1:3)

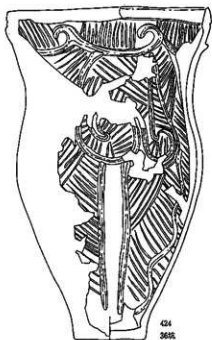
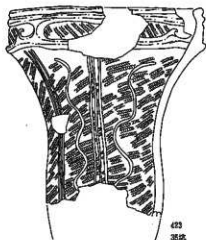
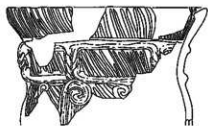
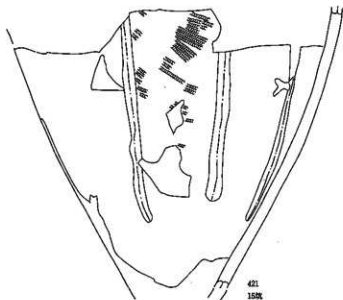

0 (1:6) 15cm



425
400%

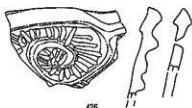

426
420%

0 (1:4) 10cm

图版145 土坑出土土器(1) (424 1:6、他 1:4)

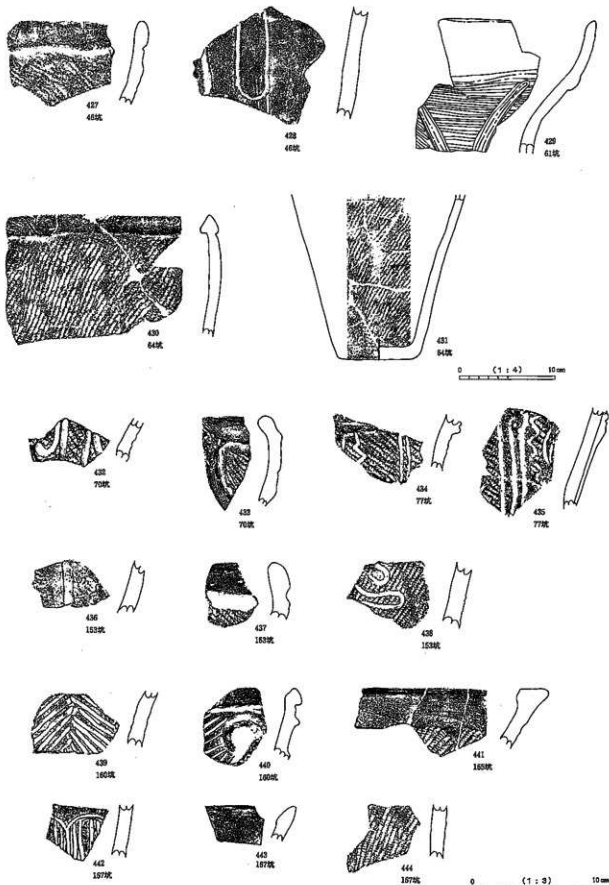

图版146 土坑出土土器(2) (429·431 1:4、他 1:3)



図版147 土坑出土土器(3) (449・450 1:4、他 1:3)

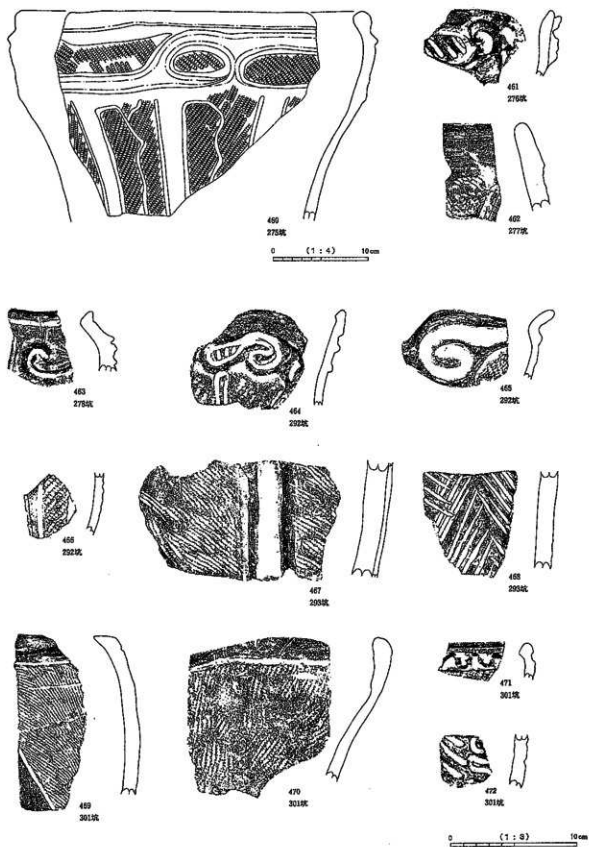

圖版148 土坑出土土器(4) (460 1:4、他 1:3)

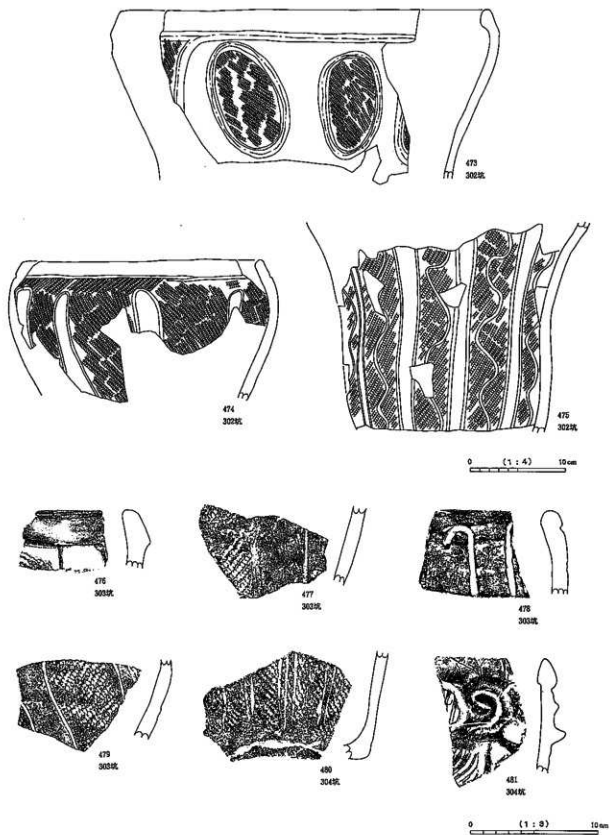

図版149 土坑出土土器(5) (473~475 1:4、他 1:3)

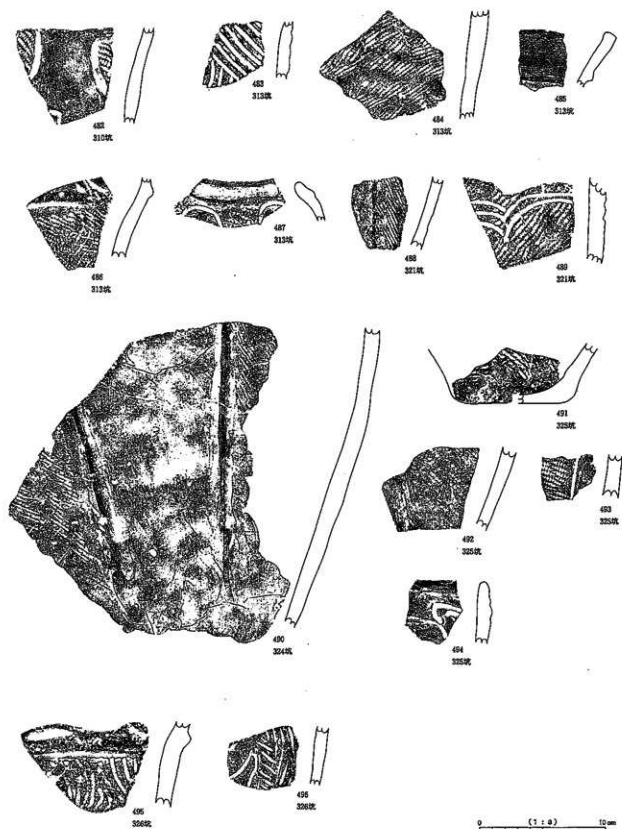

图版150 土坑出土土體(6) (1 : 3)

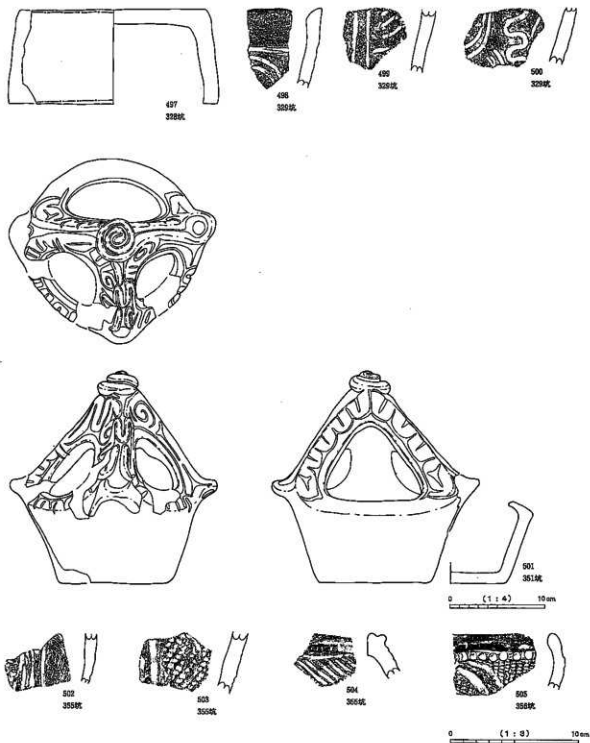

圖版151 土坑出土土器(7) (497·501 1 : 4、他 1 : 3)

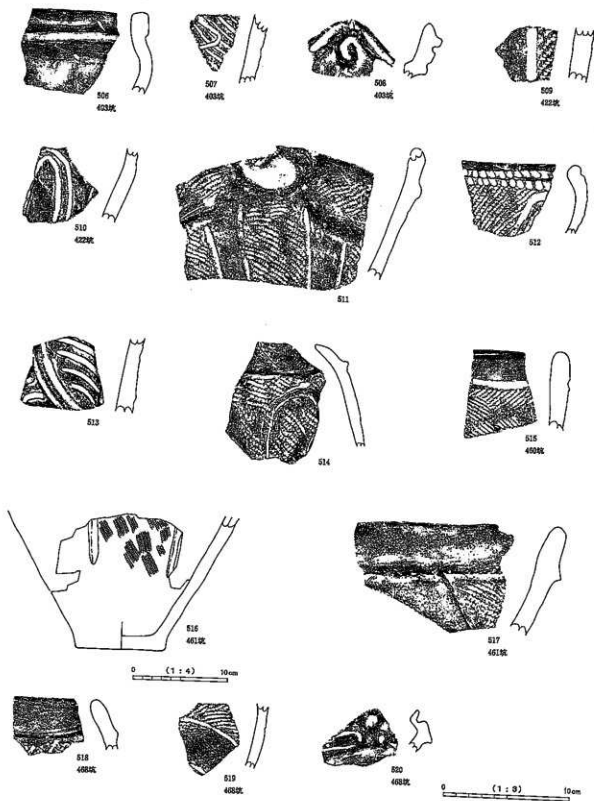

圖版152 土坑出土土器(8) (516 1:4、他 1:3)

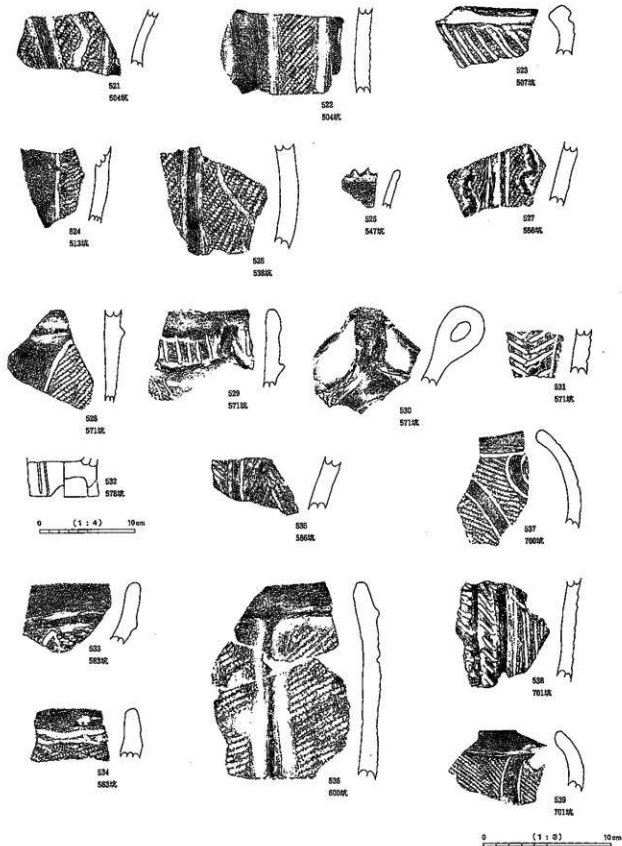

図版153 土坑出土土器(9) (532 1:4、他 1:3)

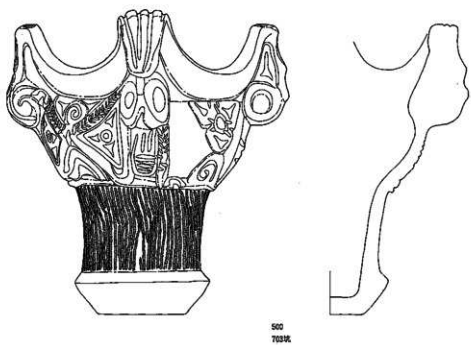
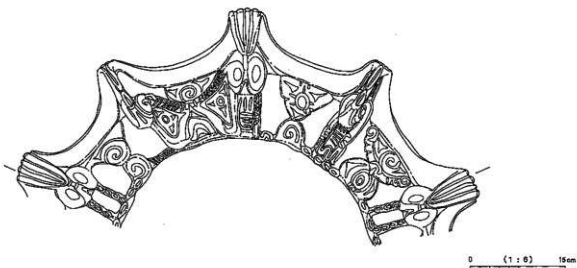

圖版154 土坑出土土器00 (1:4)

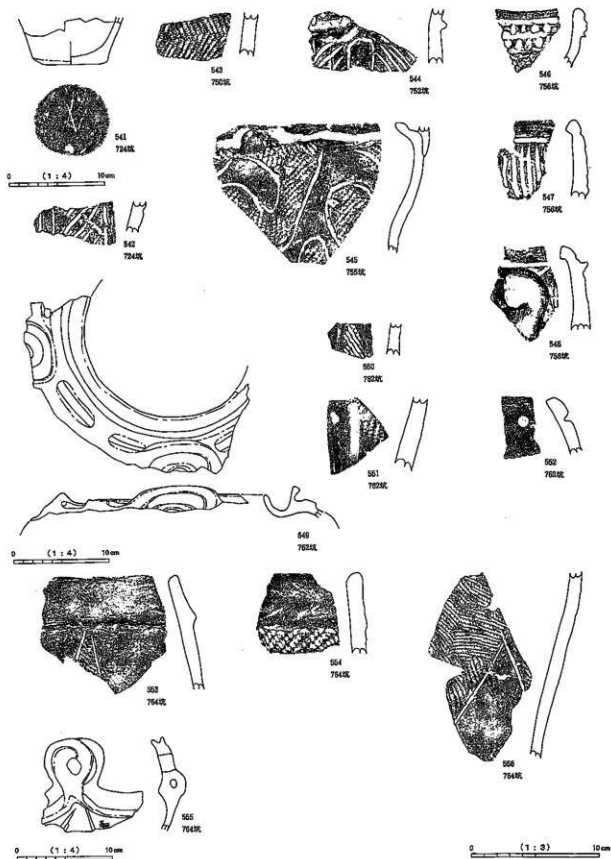

図版155 土坑出土土器01 (541・549・555 1:4、他 1:3)

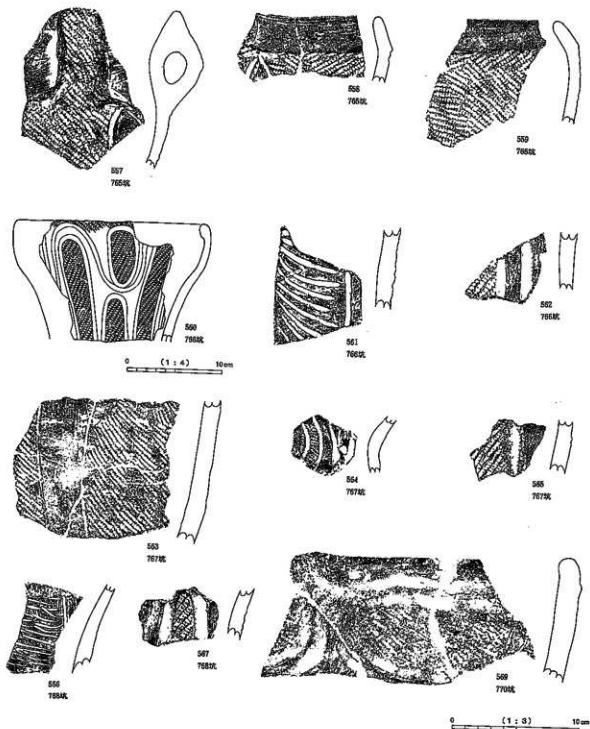

图版156 土坑出土土器(560 1:4、他 1:3)

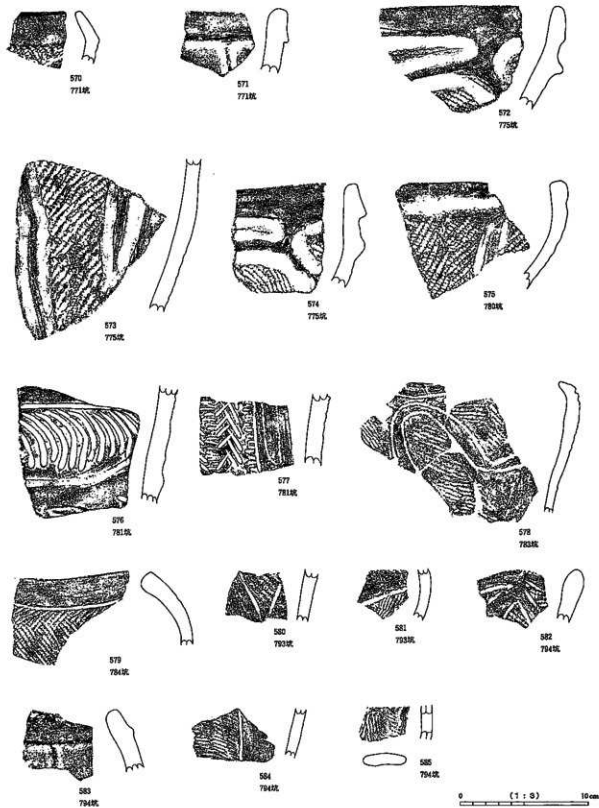

图版157 土坑出土土器03 (1:3)

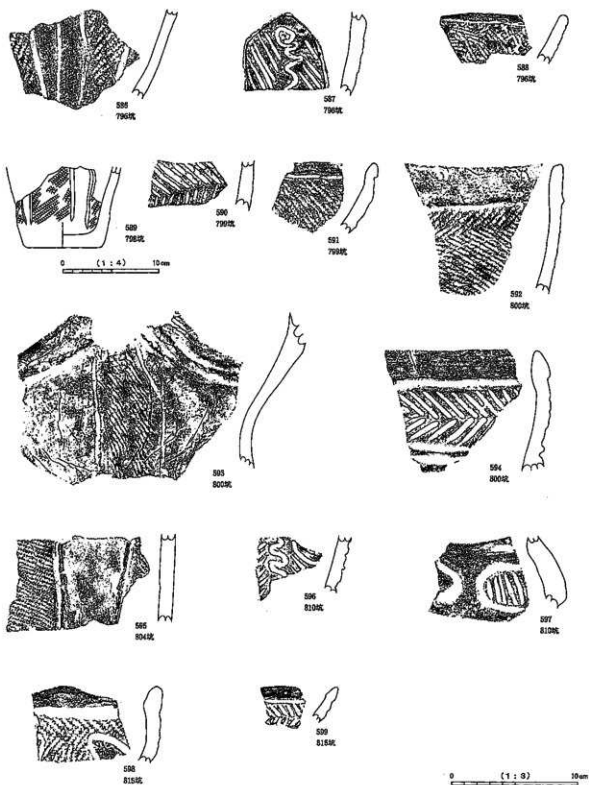

圖版158 土坑出土土器00 (589 1:4、他 1:3)



図版159 土坑出土土器09 (1:3)

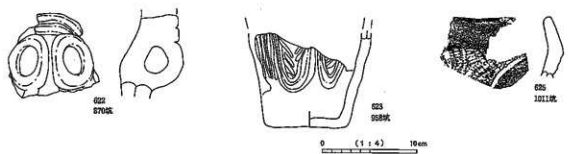
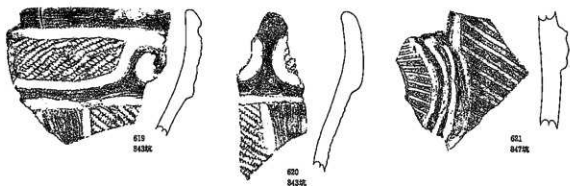
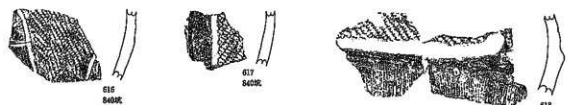

0 (1:3) 10cm

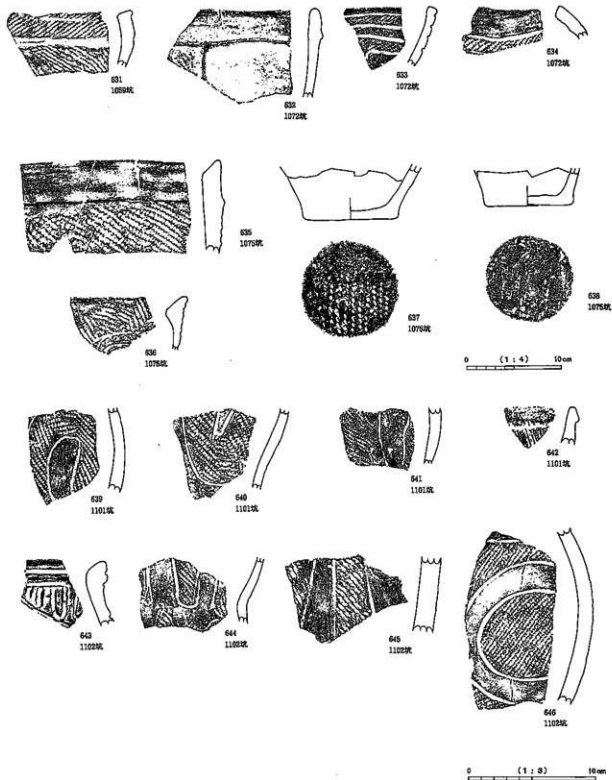

圖版161 土坑出土土器(637-638 1:4、他 1:3)

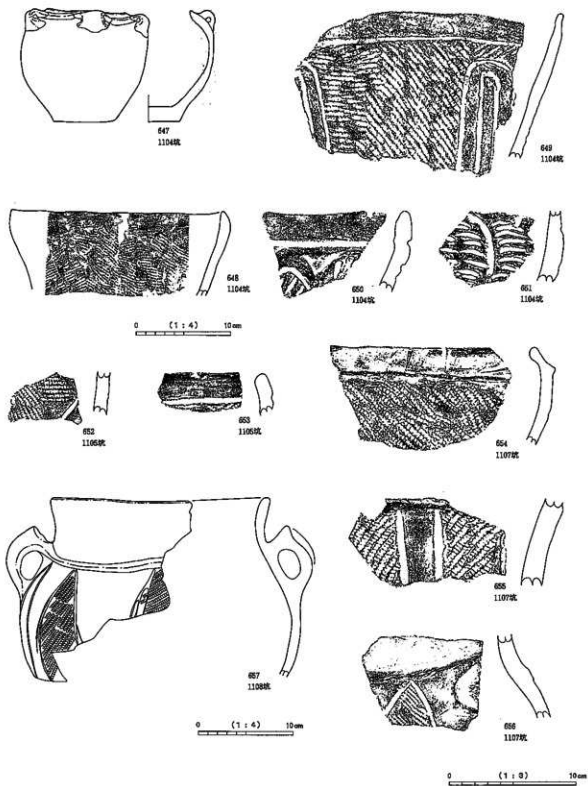

図版162 土坑出土土器08 (647・648・657 1:4、他 1:3)



0 (1:3) 10cm

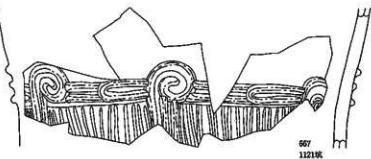
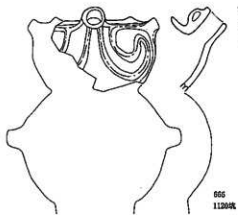

0 (1:4) 10cm

圖版163 土坑出土土器04 (666·667 1:4、他 1:3)

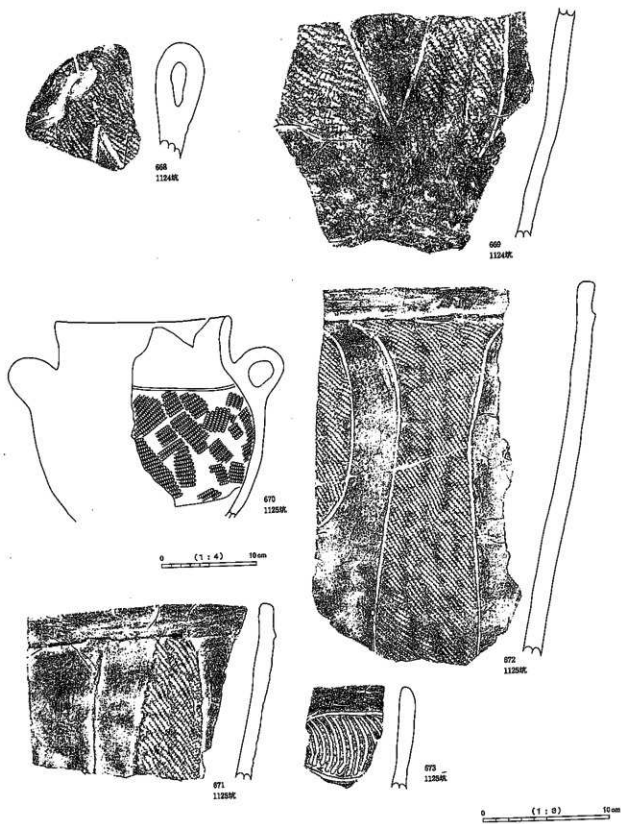

图版164 土坑出土土器片 (670 1:4、他 1:3)

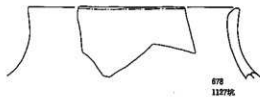
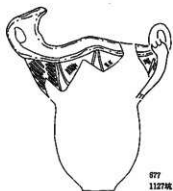
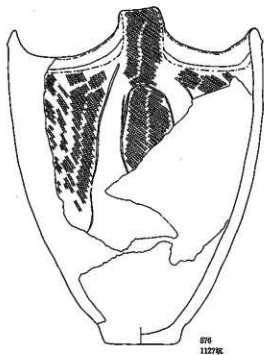
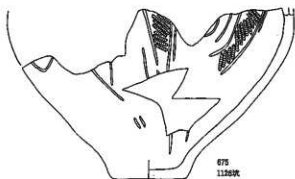
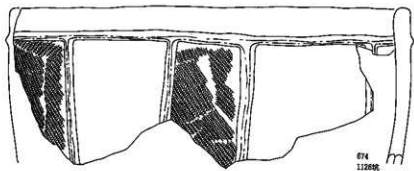

0 (1:4) 10mm

図版165 土坑出土土器(1) (1:4)

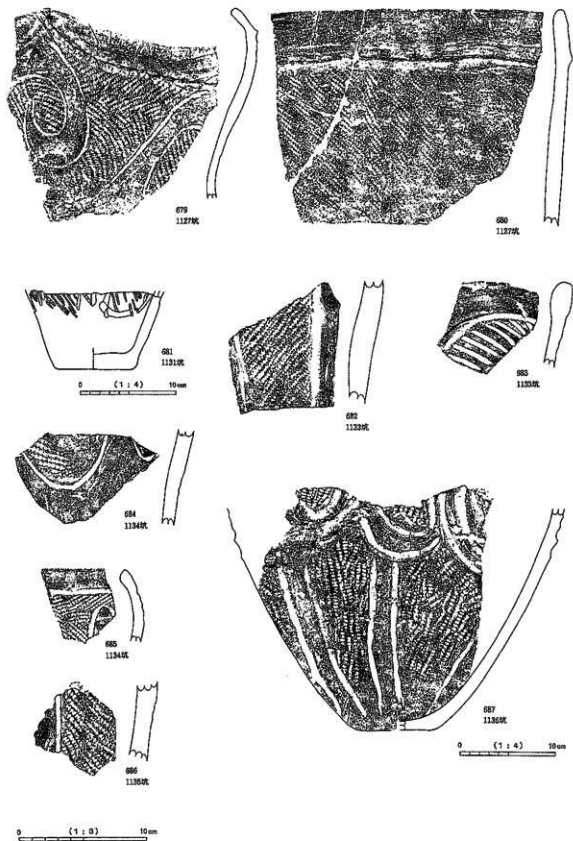

圖版166 土坑出土土器碎 (681-687 1:4、他 1:3)

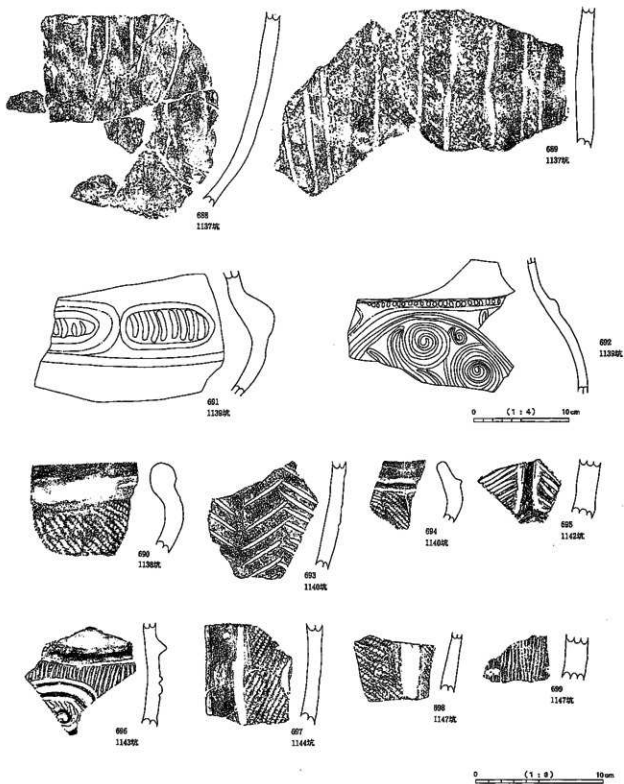

图版167 土坑出土土器碎 (691·692 1:4、他 1:3)

獅土遺跡

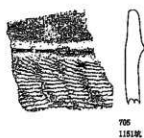
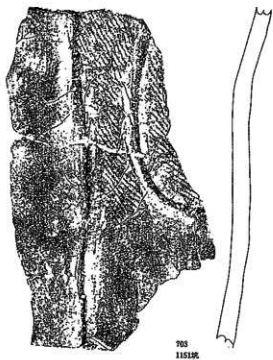
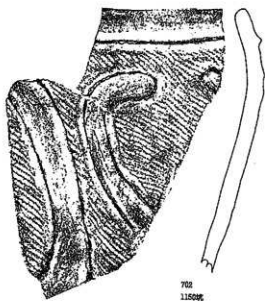
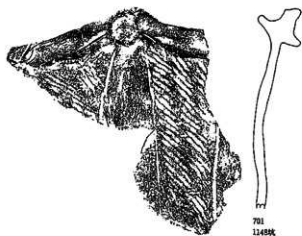

0 (1:3) 10mm

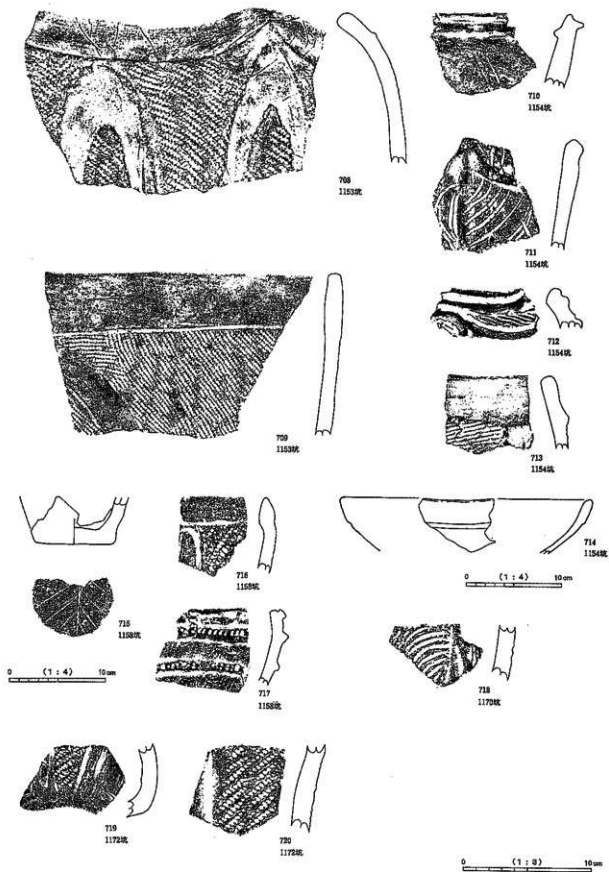

圖版169 土坑出土土器(714・715 1:4、他 1:3)

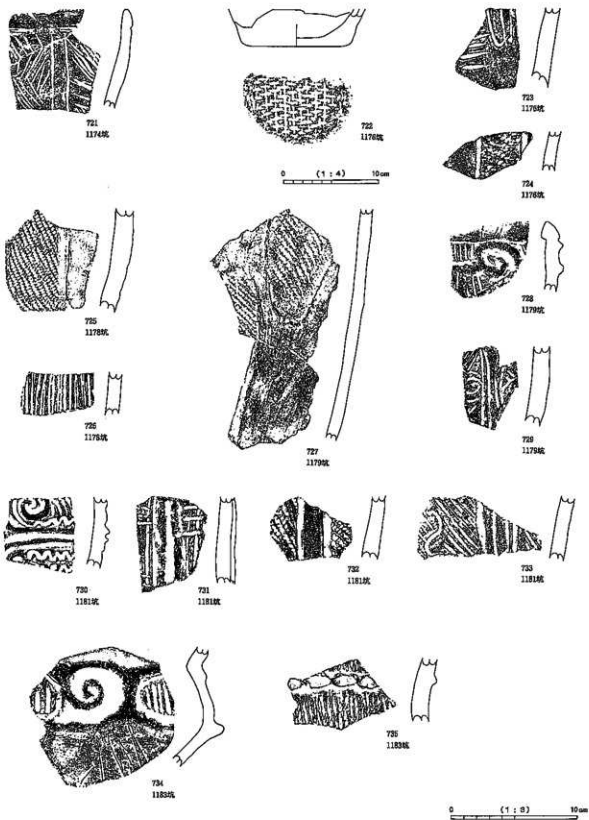

図版170 土坑出土土器の片 (722 1:4、他 1:3)

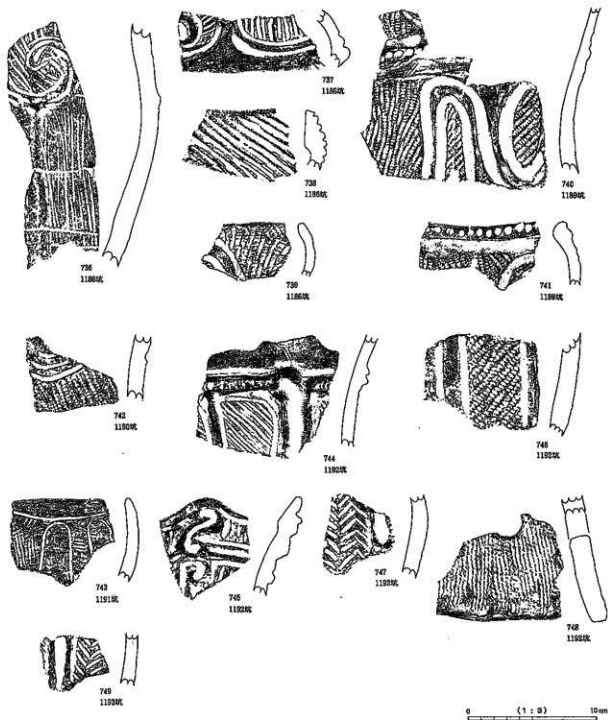

圖版171 土坑出土土器片 (1:3)

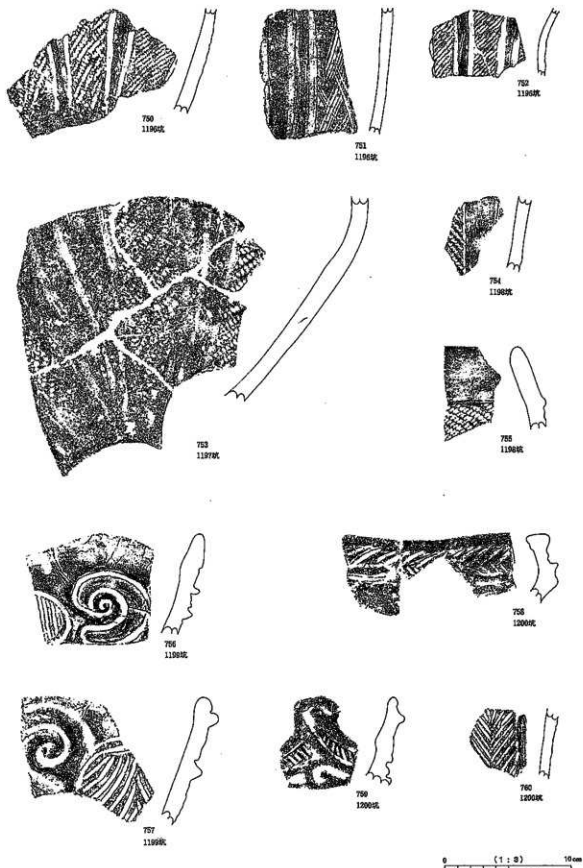

圖版172 土坑出土土器(四) (1:3)

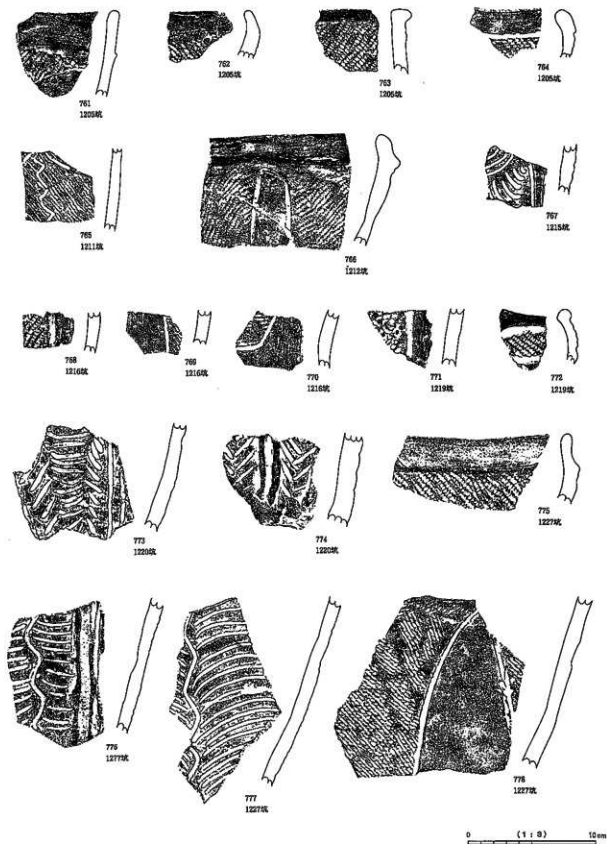

圖版173 土坑出土土器(4) (1:3)

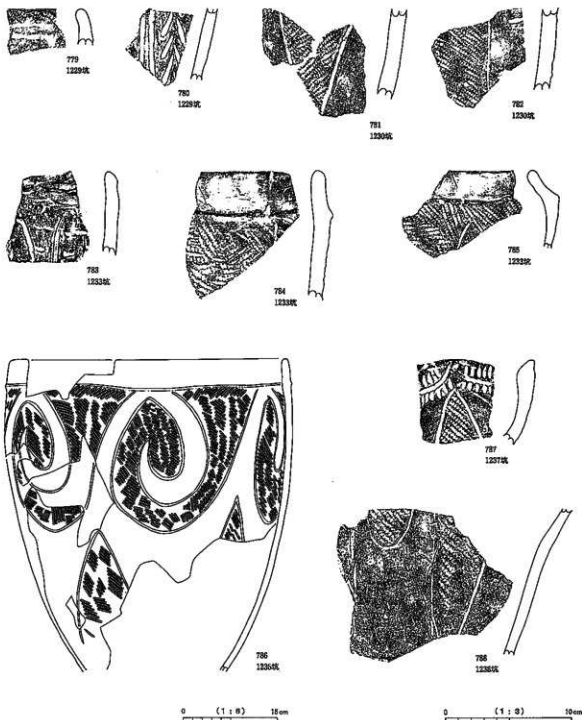

图版174 土坑出土土器(786 1:6、他 1:3)

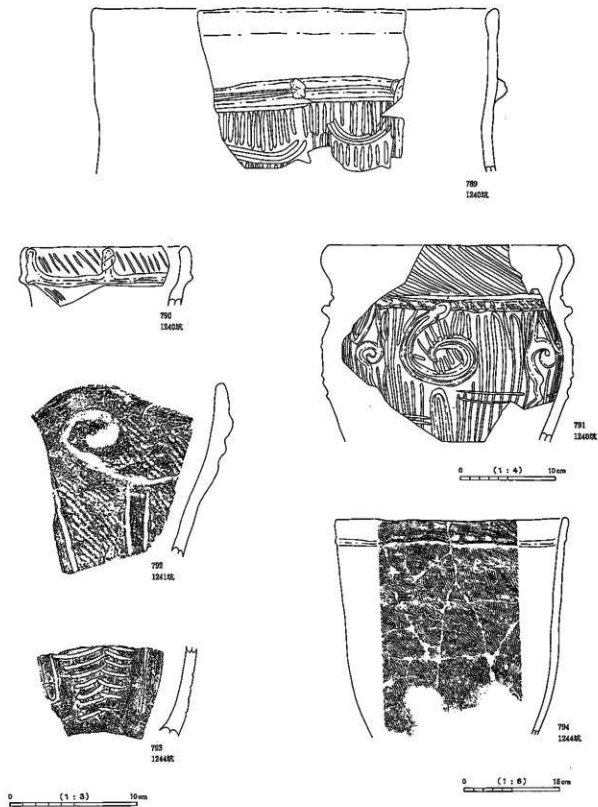

図版175 土坑出土土器90 (789~791 1:4、794 1:6、他 1:3)

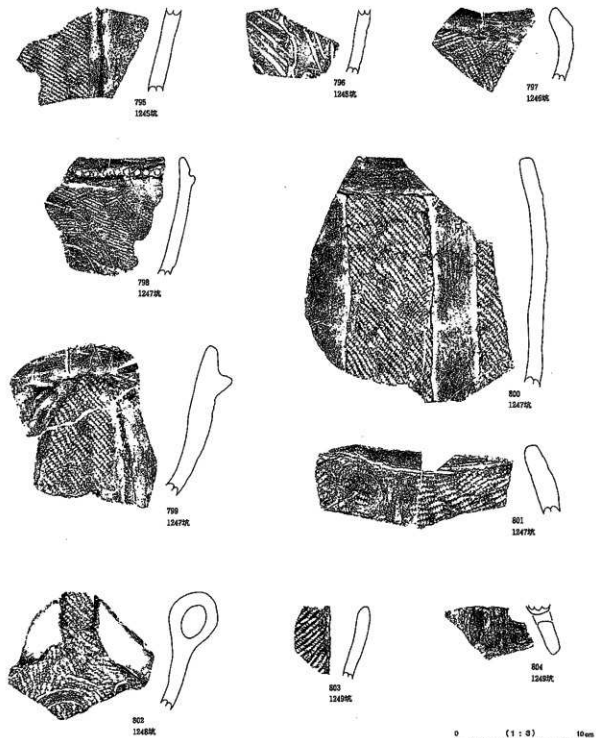

圖版176 土坑出土土器04 (1:3)

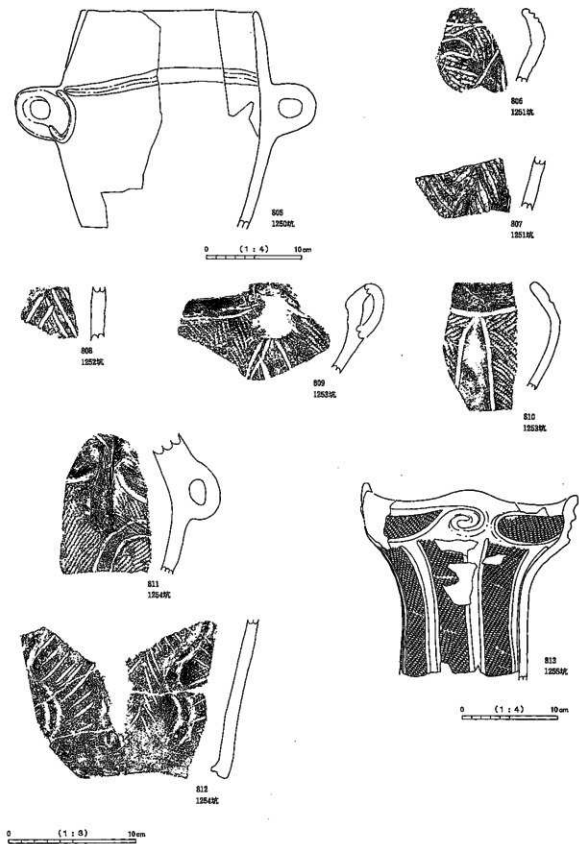

図版177 土坑出土土器類 (805、813 1:4、他 1:3)

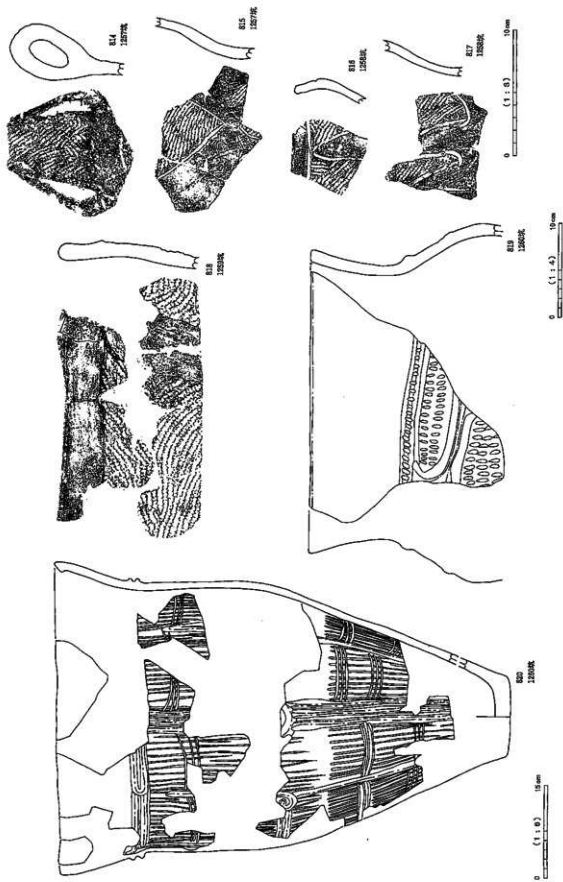

圖版178 土坑出土土器94 (819 1:4、820 1:6、他 1:3)

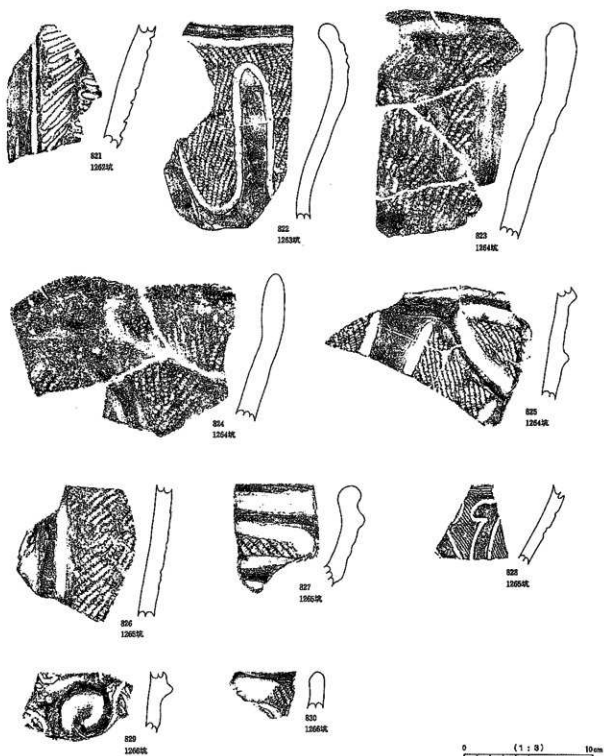

図版179 土坑出土土器(陶) (1:3)

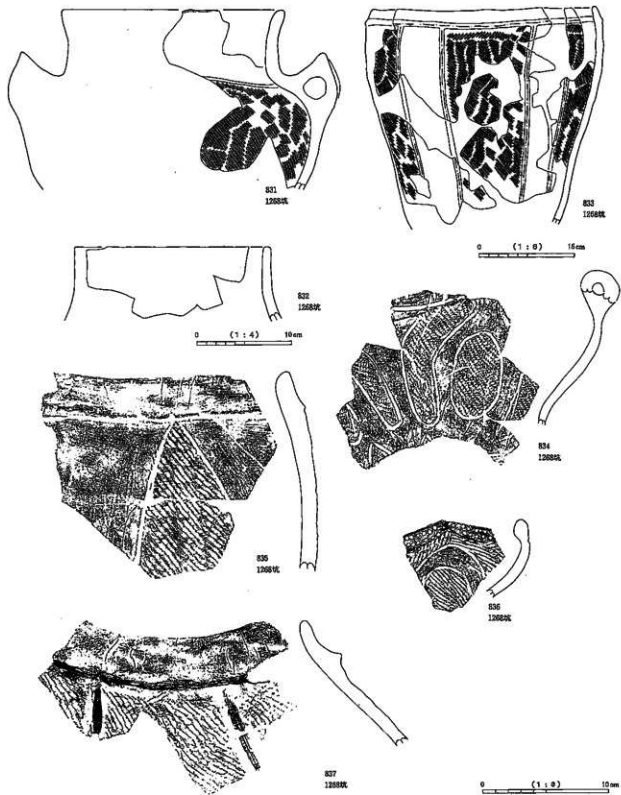

図版180 土坑出土土器06 (831・832 1:4、833 1:6、他 1:3)



838
12740L



839
12740R

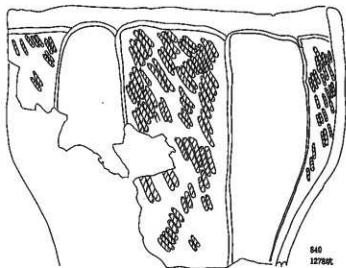

840
12780R

0 (1:4) 10cm

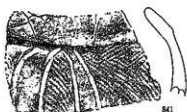

841
12790R

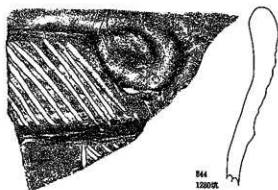

844
12800R

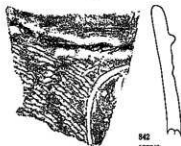

842
12792R



843
12794L

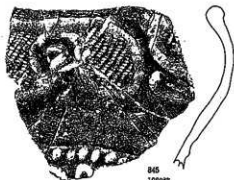

845
12802L

0 (1:3) 10cm

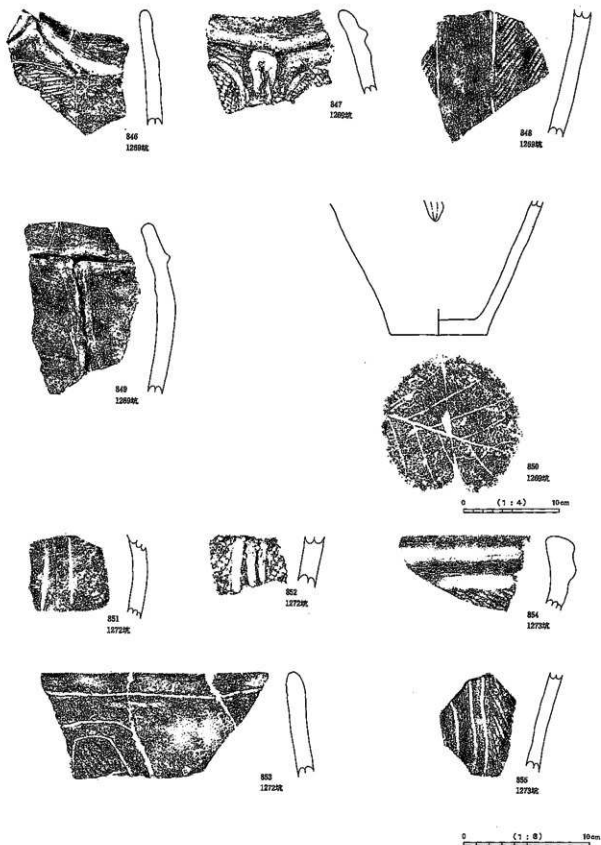

图版182 土坑出土土器碎 (850 1:4、他 1:3)

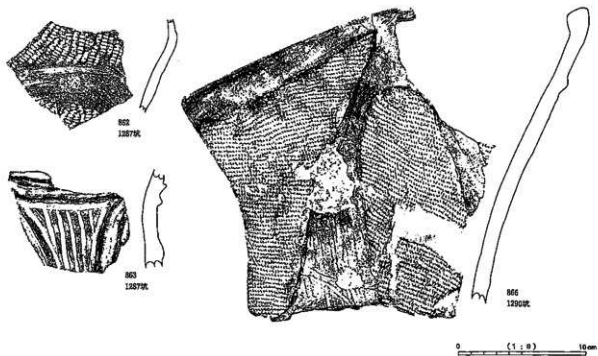
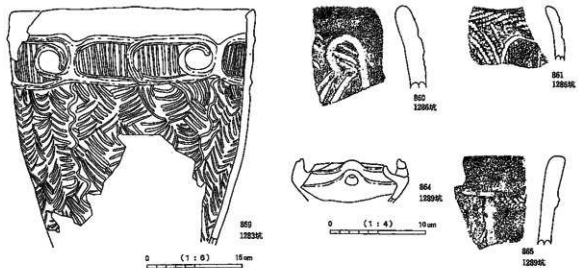
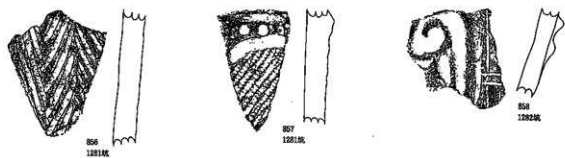

图版183 土坑出土土器碎片 (859 1:6、864 1:4、他 1:3)

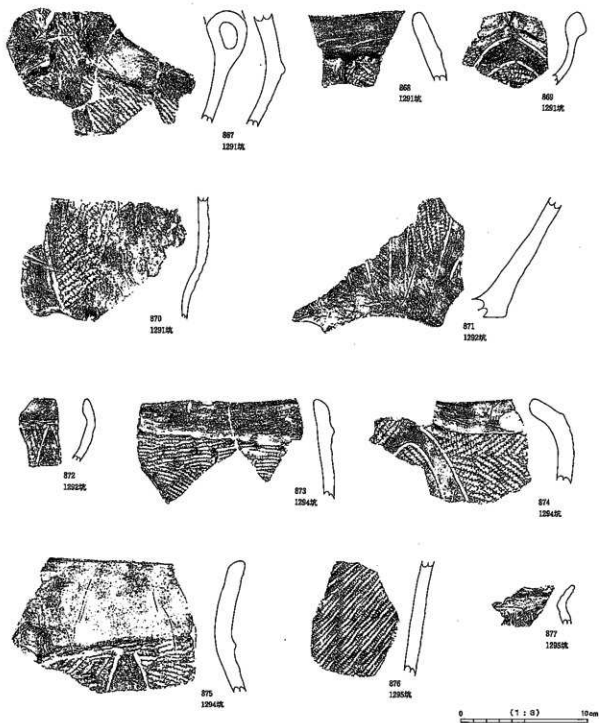

図版184 土坑出土土器④ (1:3)

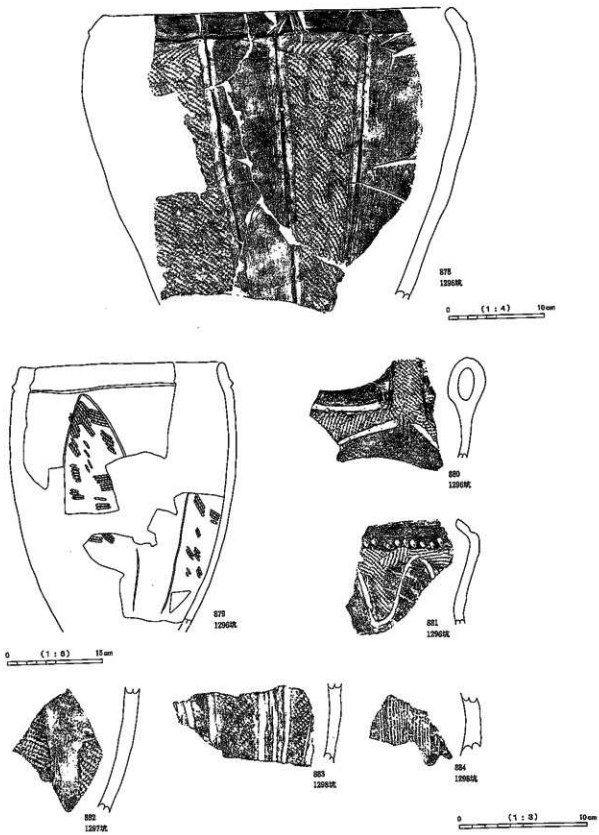

図版185 土坑出土土器(4) (878 1:4、879 1:6、他 1:3)

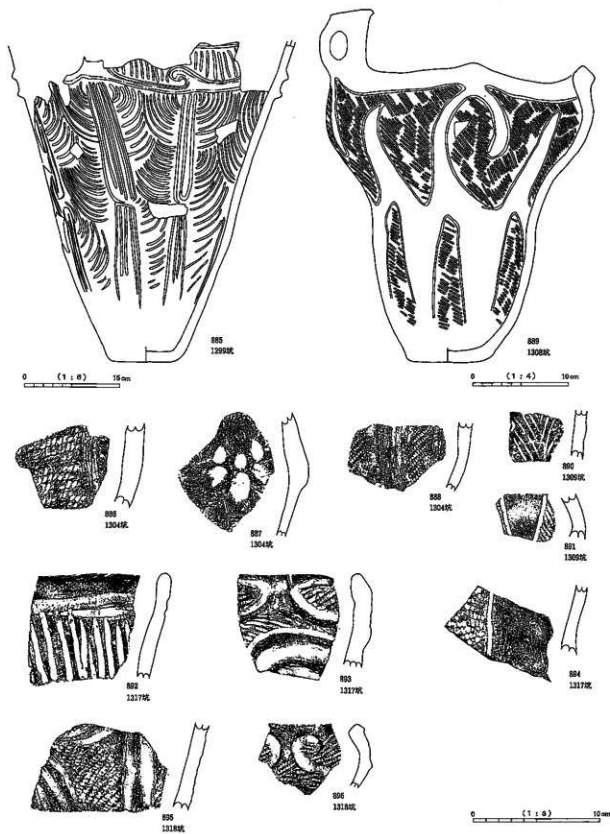

図版186 土坑出土土器40 (885 1:6、889 1:4、他 1:3)

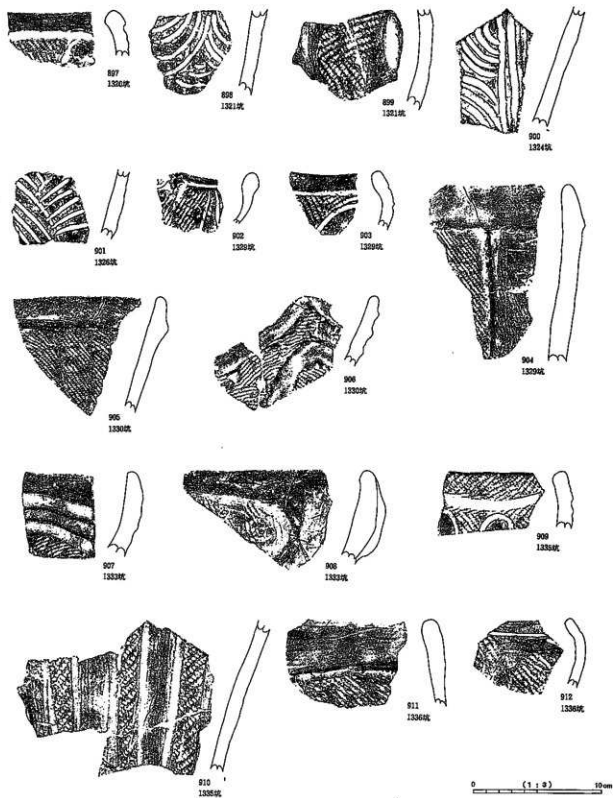

图版187 土坑出土土器(4) (1:3)

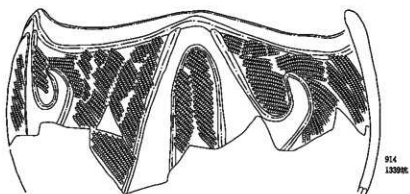
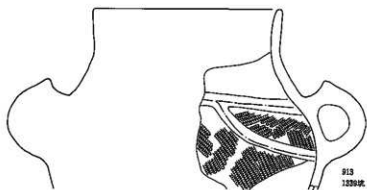

0 (1:4) 10cm

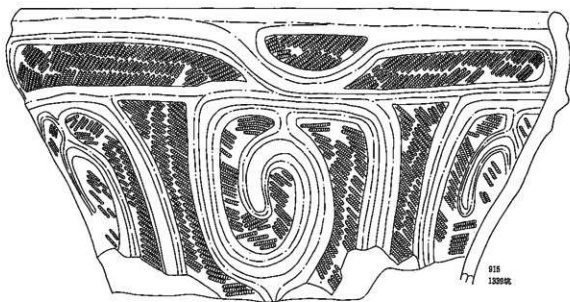

0 (1:6) 15cm

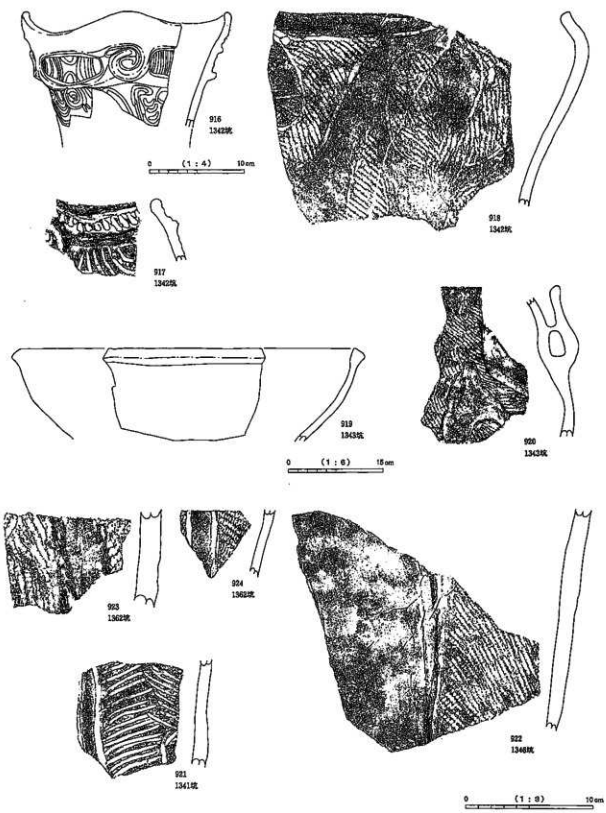

圖版189 土坑出土土器(916 1:4、919 1:6、他 1:3)

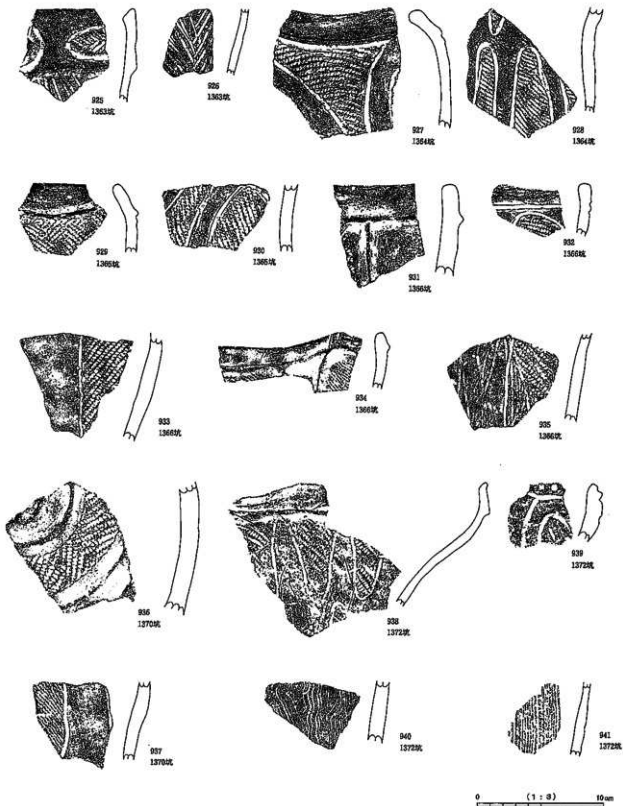

図版190 土坑出土土器49 (1:3)

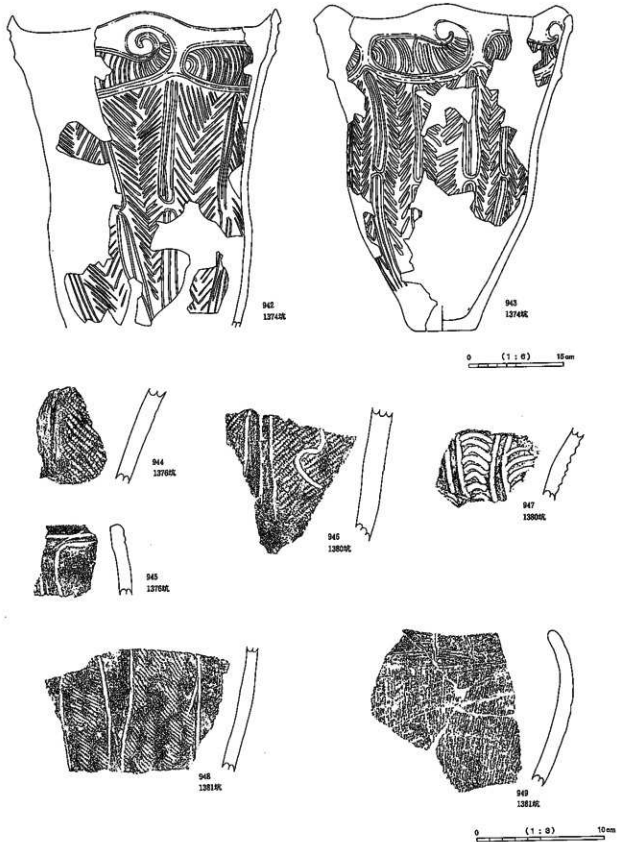

图版191 土坑出土土器(切) (942-943 1:6、他 1:3)

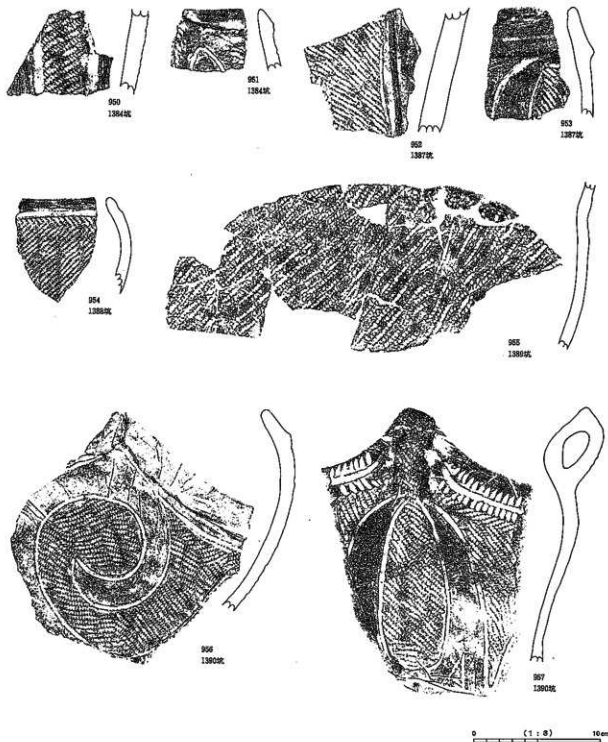

図版192 土坑出土土器(4) (1:3)

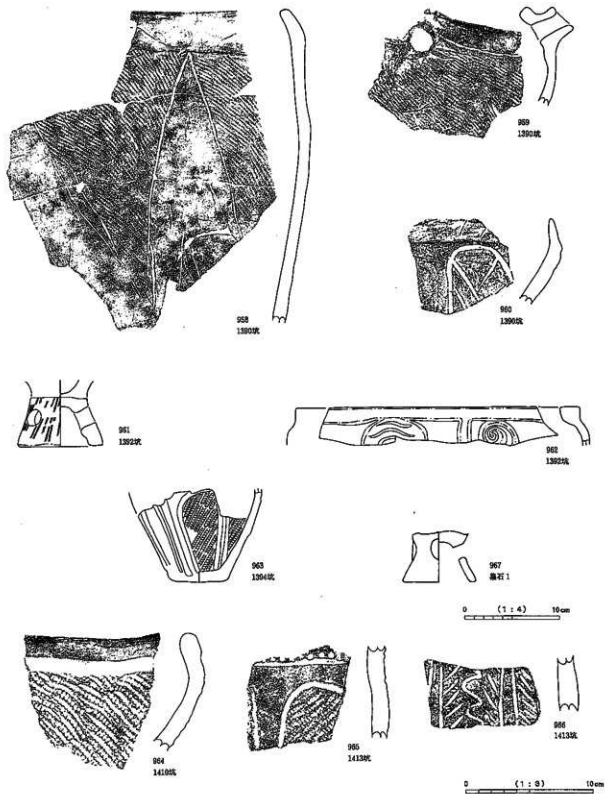

図版193 土坑出土土器69 (961~963・967 1:4、他 1:3)

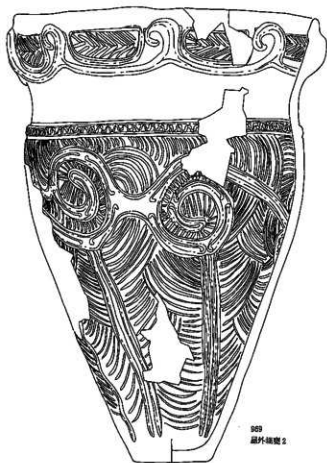
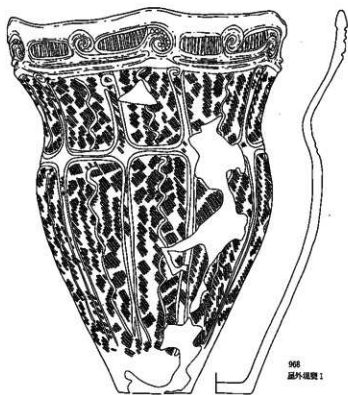

0 (1:6) 15cm

圖版194 屋外銅甕 1、2 (1:6)

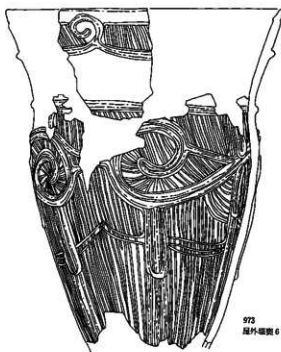
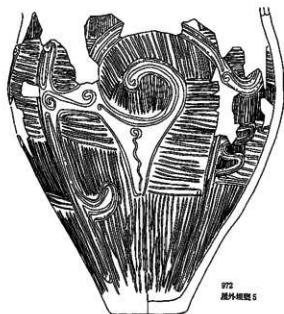
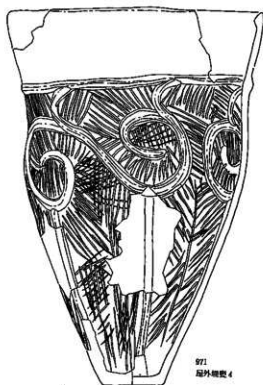
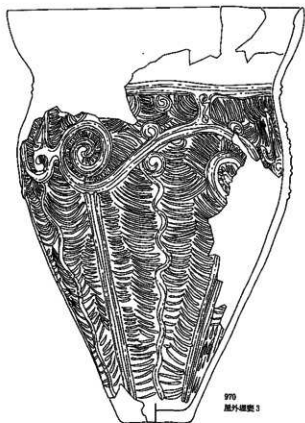

0 (1 : 6) 15cm

図版195 屋外埋藏3、4、5、6 (1 : 6)

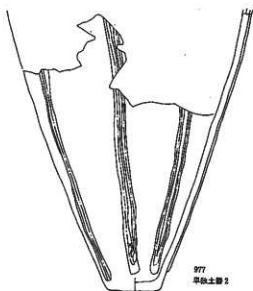
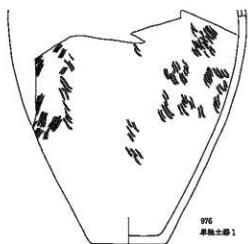
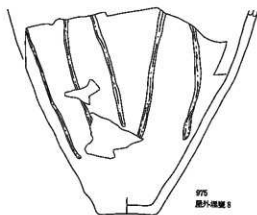
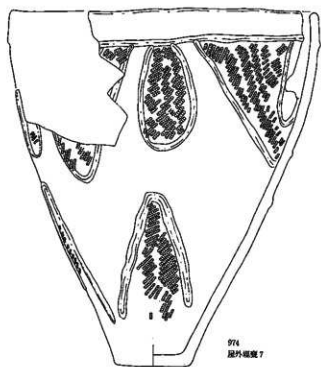

0 (1:6) 10cm

図版196 屋外埋蔵 7、8、単独土器 1、2 (1:6)

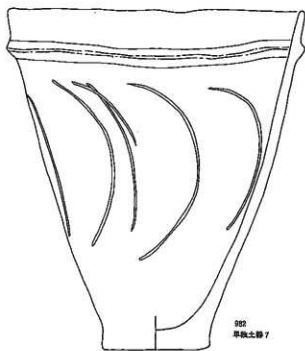
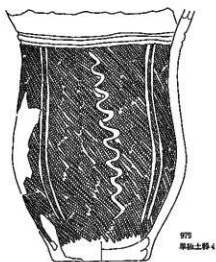
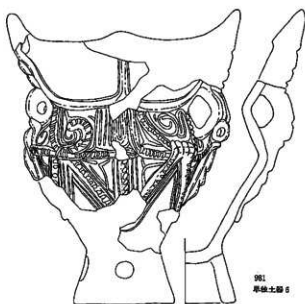

0 (1:4) 10mm

図版197 単軸土器 3、4、6、7、8 (1:4)

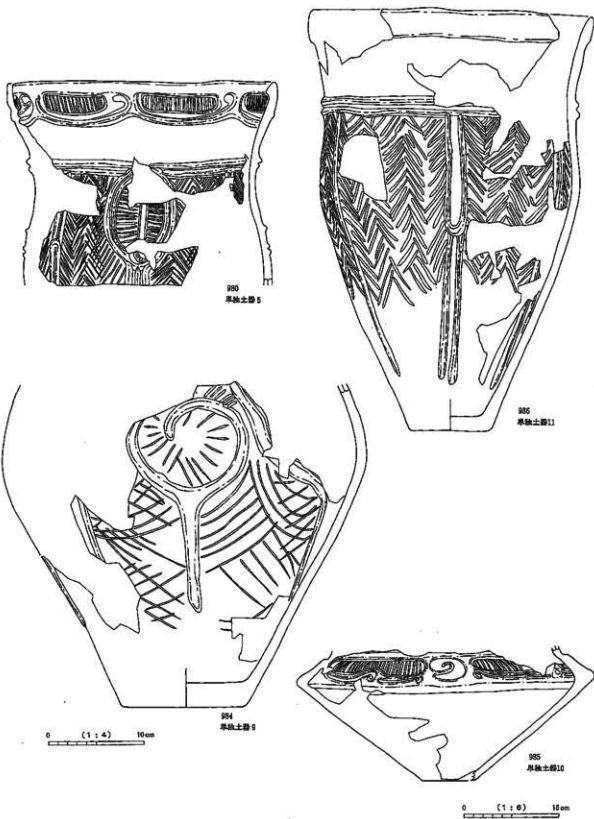

圖版198 埤土器5、9、10、11 (984 1:4、他 1:6)

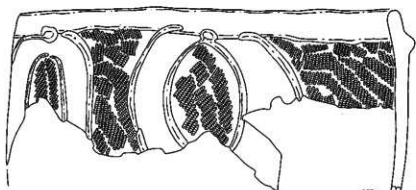

987
土器集中1

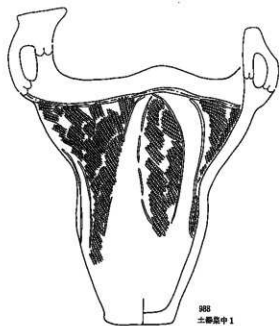

988
土器集中1

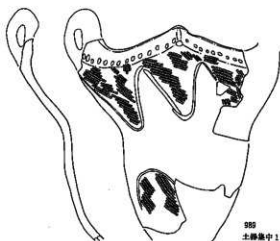

989
土器集中1

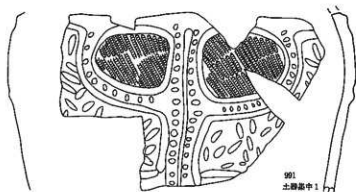

991
土器集中1



990
土器集中1



992
土器集中1

0 (1:4) 10cm

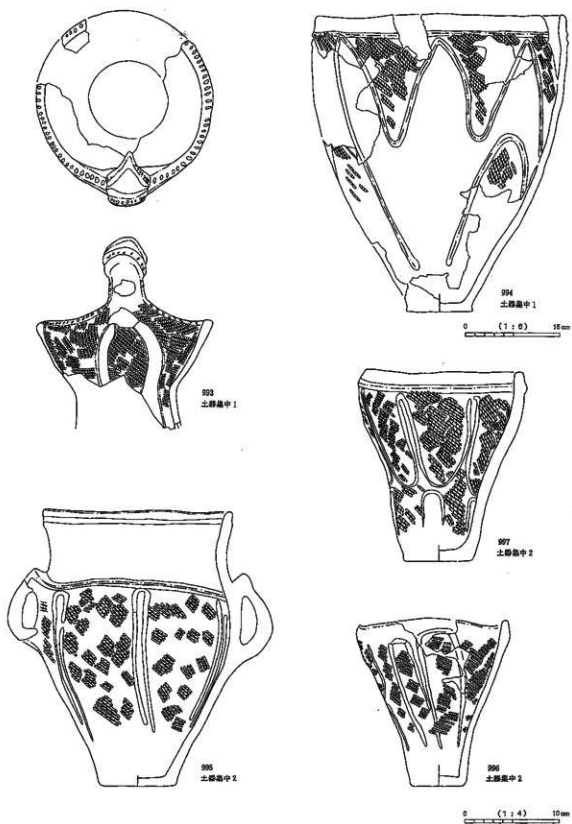

図版200 土器集中1、2出土土器 (994 1:6、他 1:4)

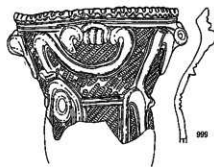
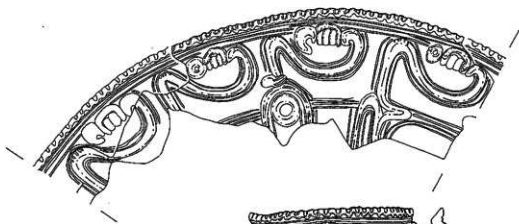
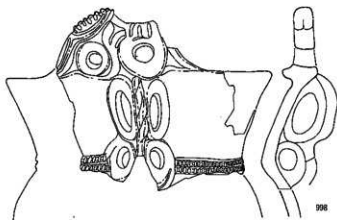
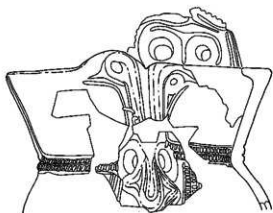

0 (1:4) 10cm

图版201 濠洲外出土土器(1) (1:4)

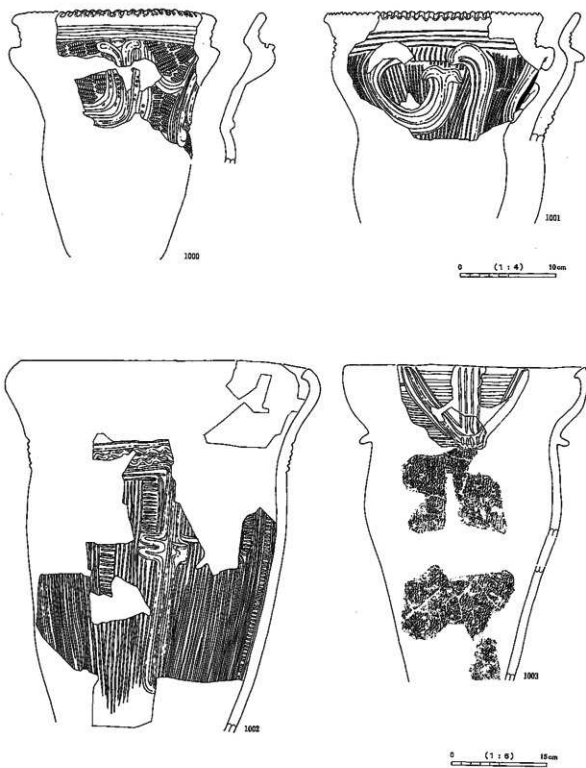

図版202 遺構外出土土器(2) (1000・1001 1:4、1002・1003 1:6)

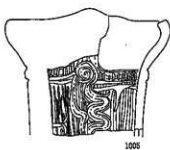
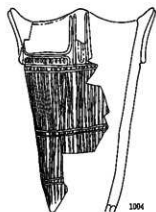

0 (1:6) 15cm

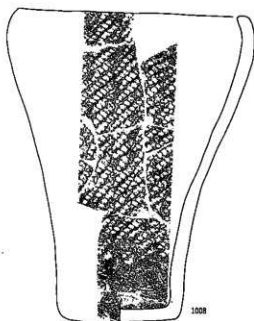

0 (1:4) 15cm

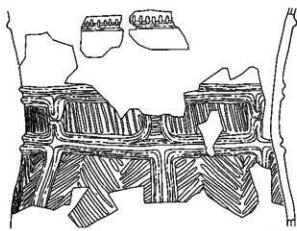

0 (1:4) 10cm

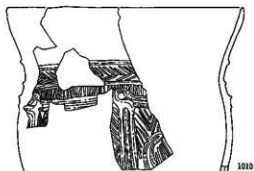

0 (1:6) 15cm

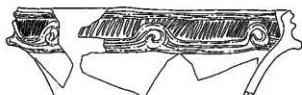
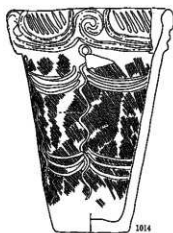
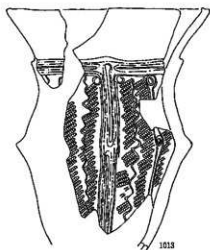
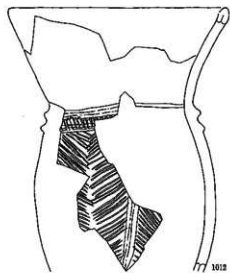
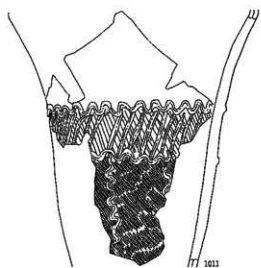

0 (1:6) 15mm

1015

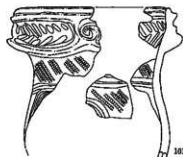

0 (1:4) 10mm

1016

図版204 遺構外出土土器(4) (1015 1:6、他 1:4)



図版205 遺構外出土土器(5) (1019~1022 1:6、他 1:4)

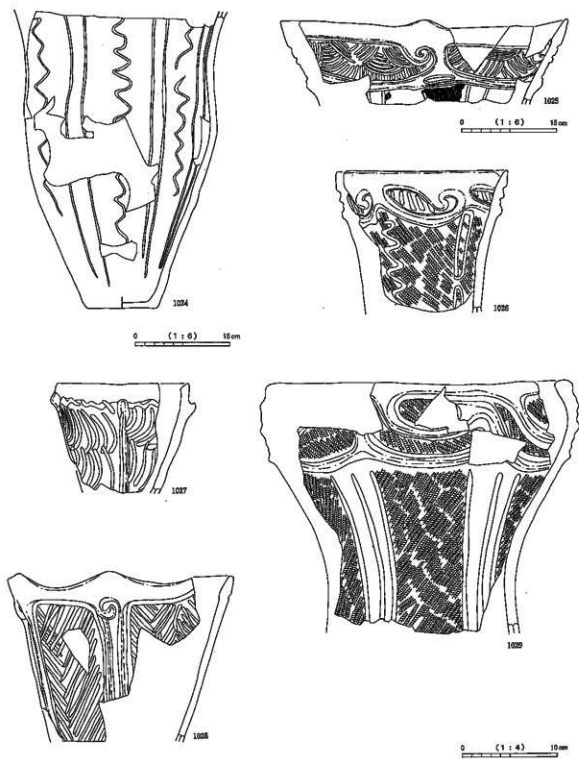

図版206 遺構外出土土器(6) (1024・1025 1:6、他 1:4)

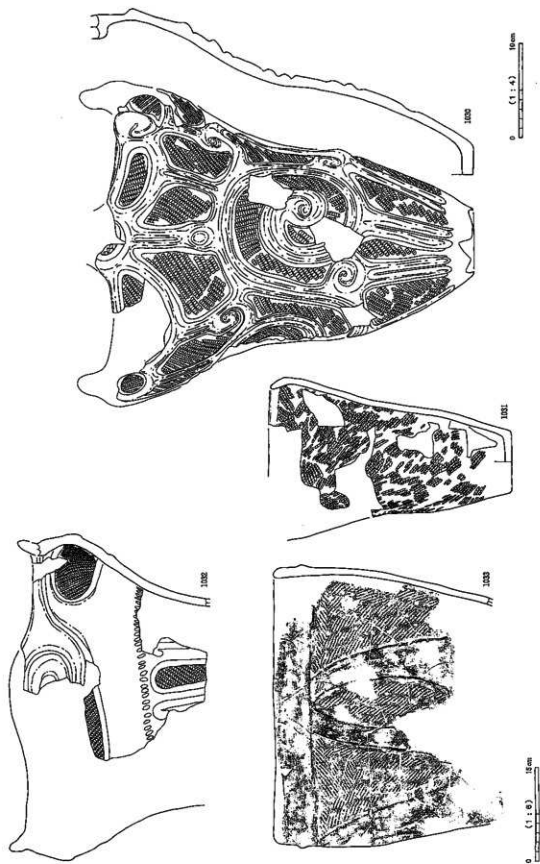

図版207 遺構外出土土器(7) (1030・1031 1:4、他 1:6)

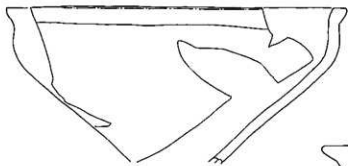

1034



1035

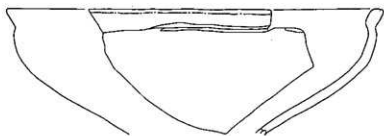

1036



1037



1038



1039

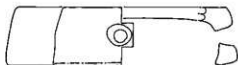

1040

0 (1:4) 10cm

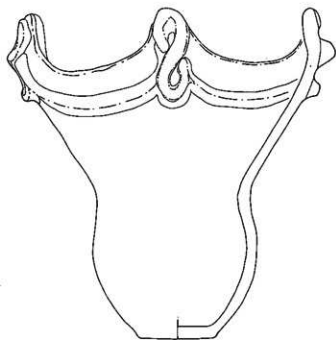

1041

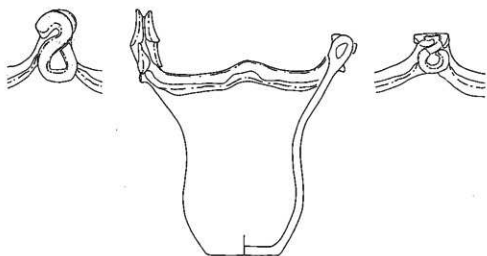

1042

0 (1:4) 10mm

図版209 遺構外出土土器(9) (1:4)

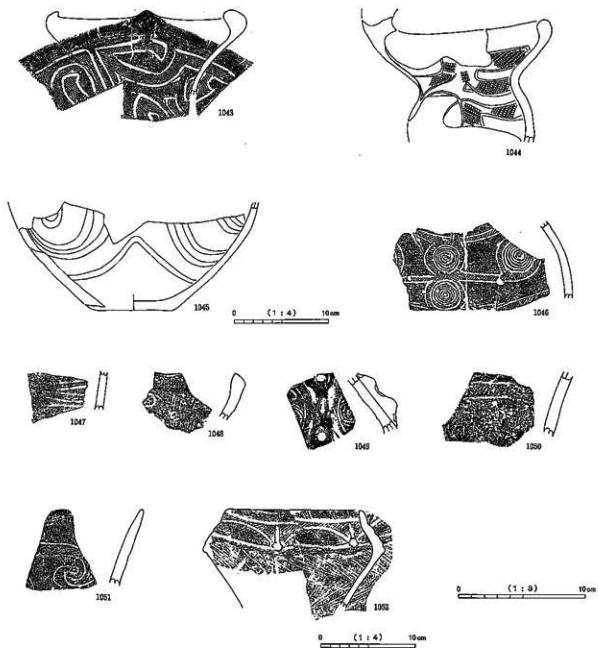

図版210 遺構外出土土器00 (1043~1045・1052 1:4、他 1:3)

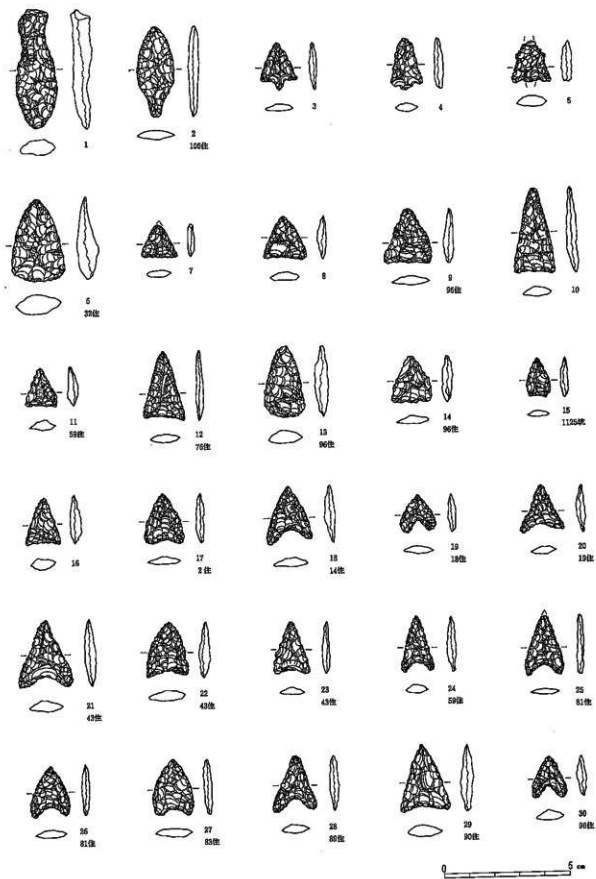

図版211 縄文時代の石器(1) 2 : 3

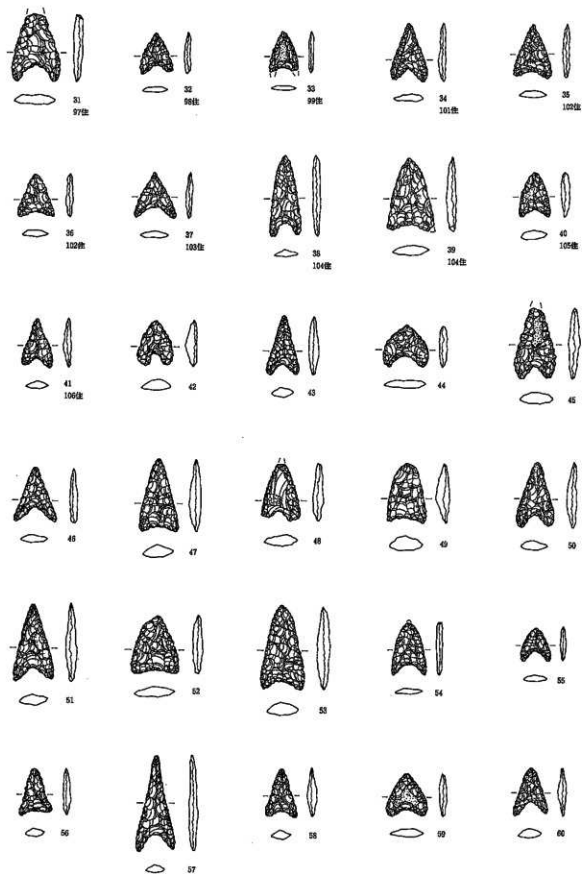

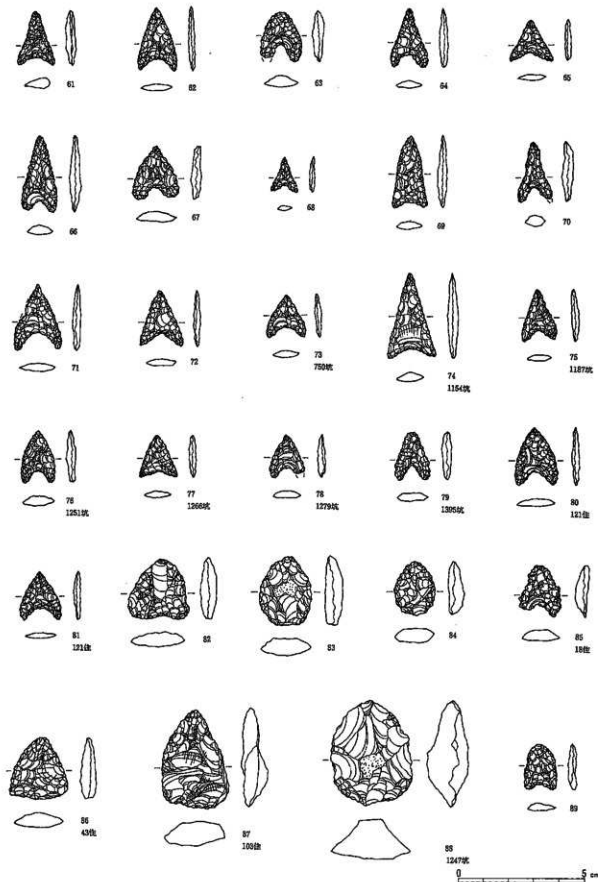

図版2.13 縄文時代の石器(3) 2 : 3

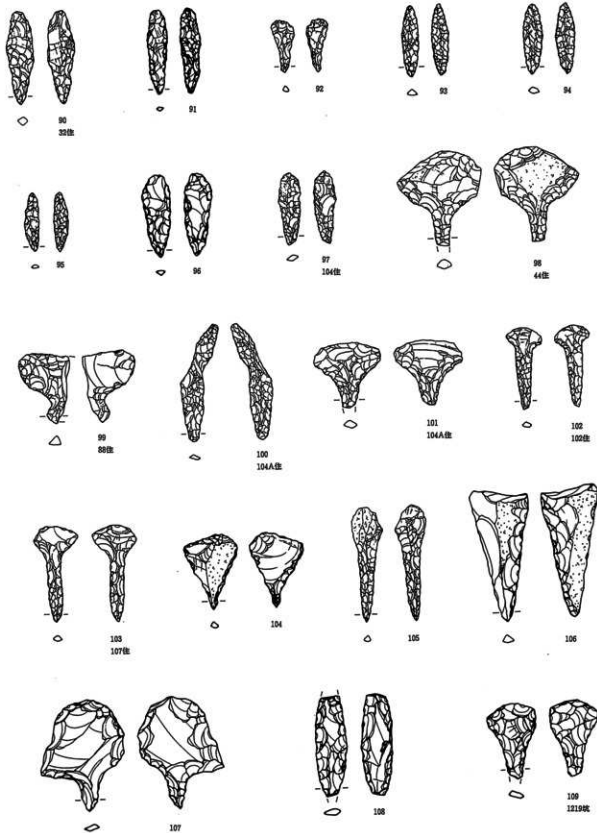

図版214 縄文時代の石器(4) 2 : 3

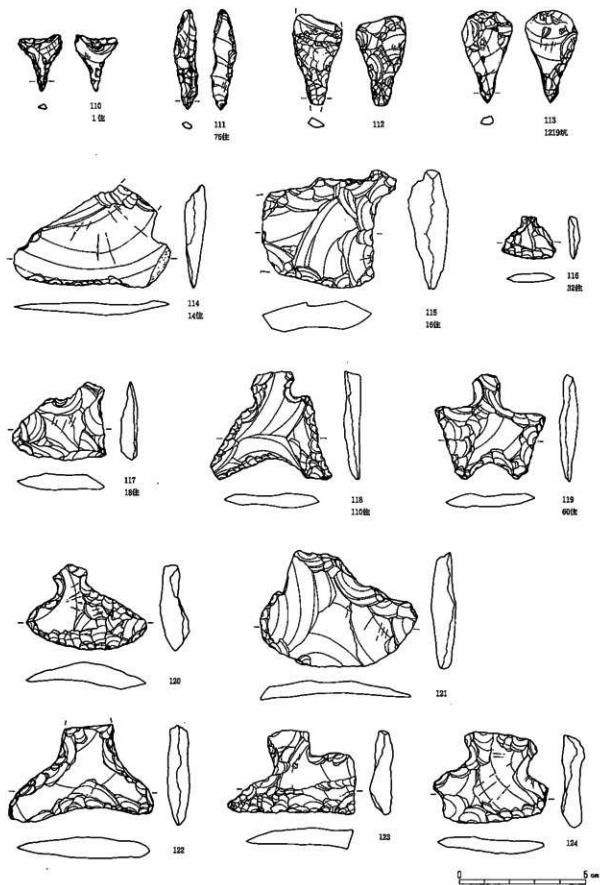

図版216 縄文時代の石器(5) 2 : 3

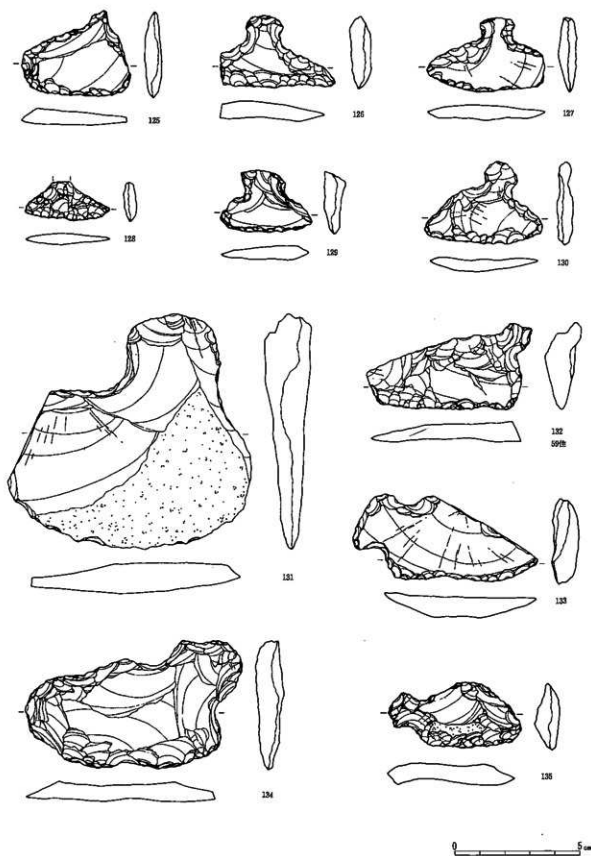

図版216 縄文時代の石器(6) 2 : 3

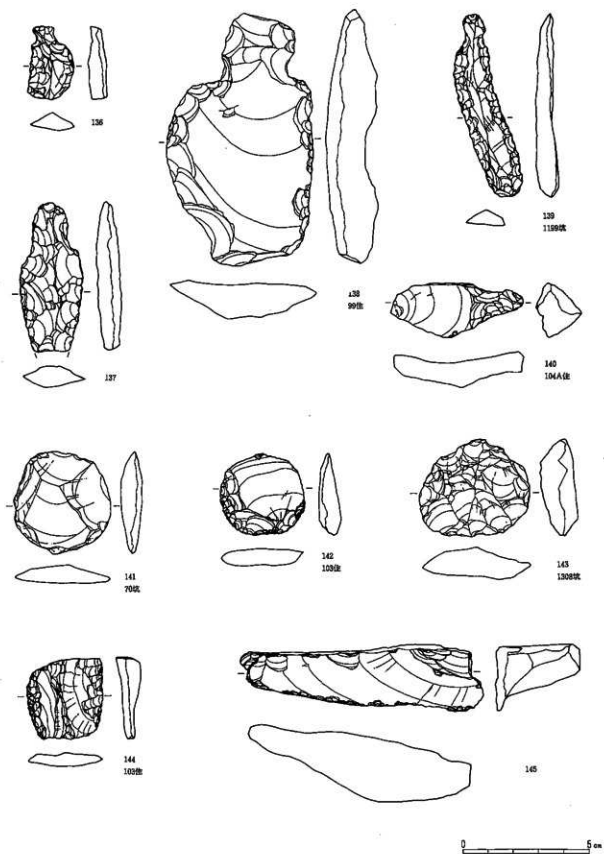

図版217 縄文時代の石器(7) 2 : 3



図版218 縄文時代の石器(8) 2 : 3

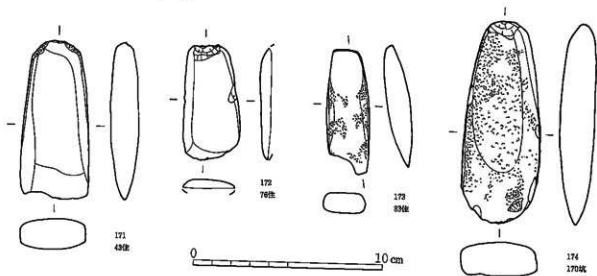
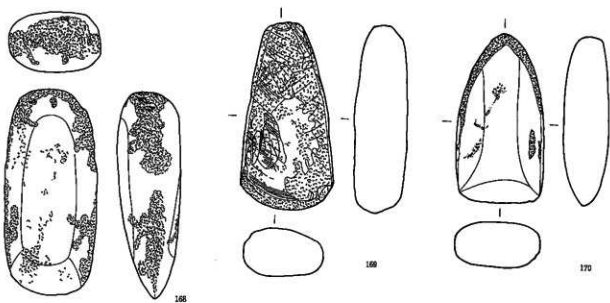
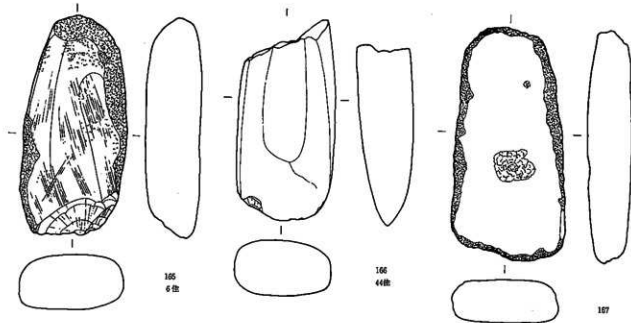

図版219 縄文時代の石器(9) 1 : 2

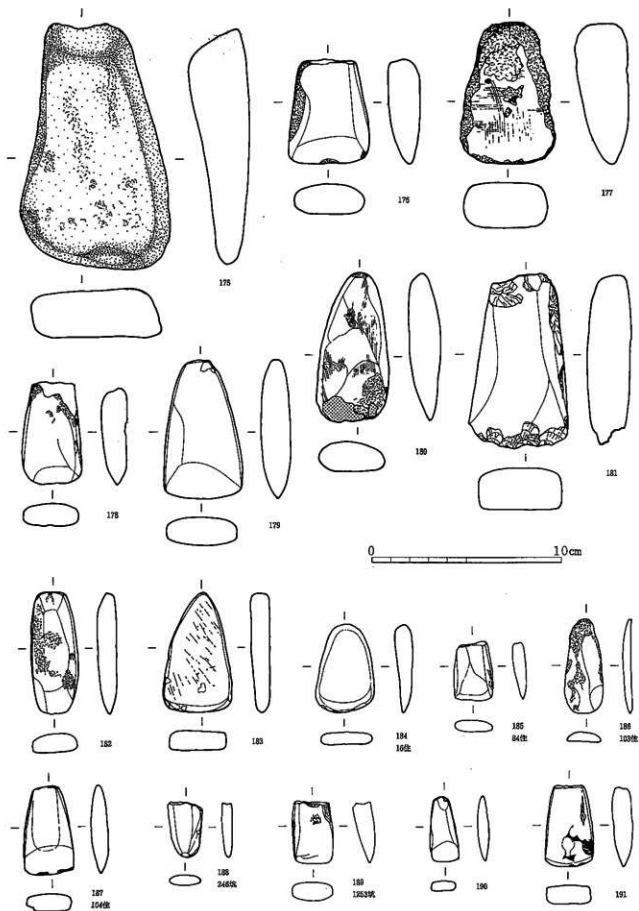

図版220 縄文時代の石器00 1:2

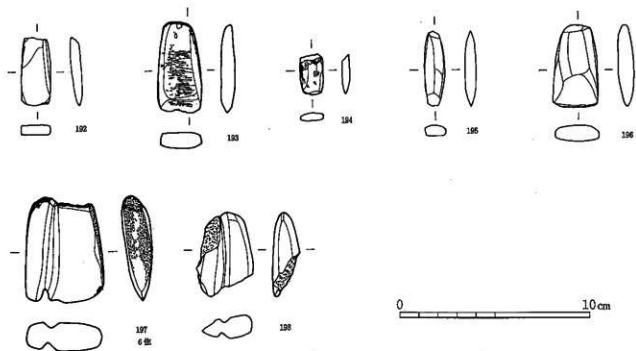

図版221 縄文時代の石器(1) 1:2

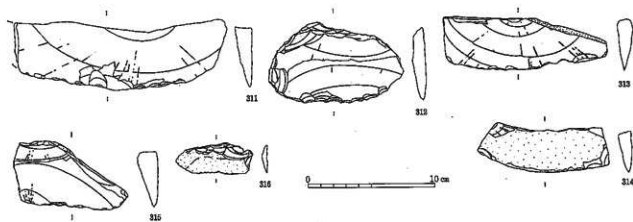

図版229 縄文時代の石器(4) 1:3

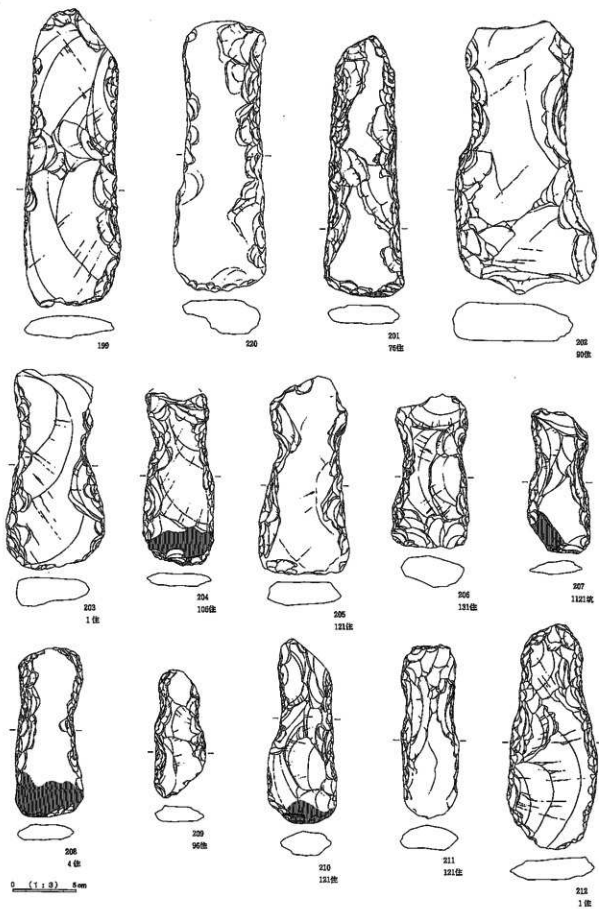

図版222 縄文時代の石器01 1 : 3

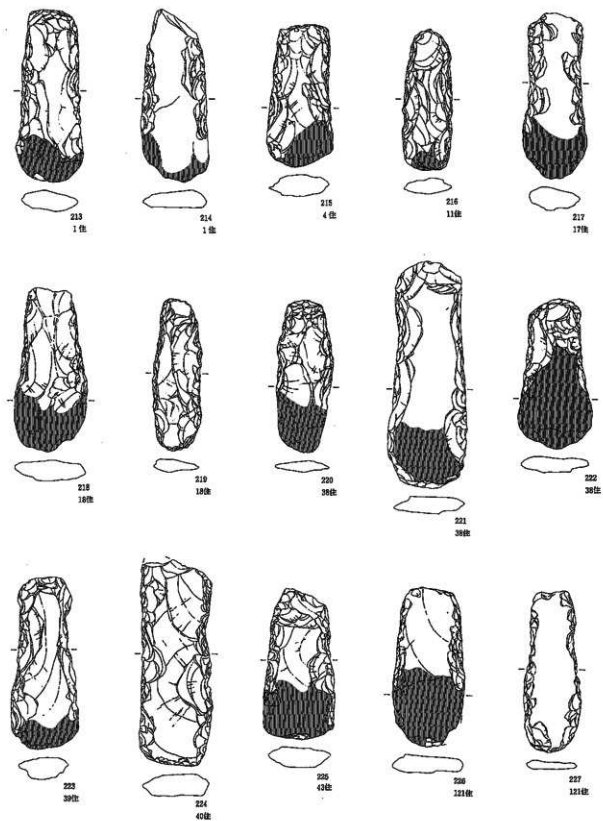

0 (1:3) 5cm

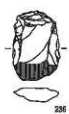

0 (1:3) 5cm

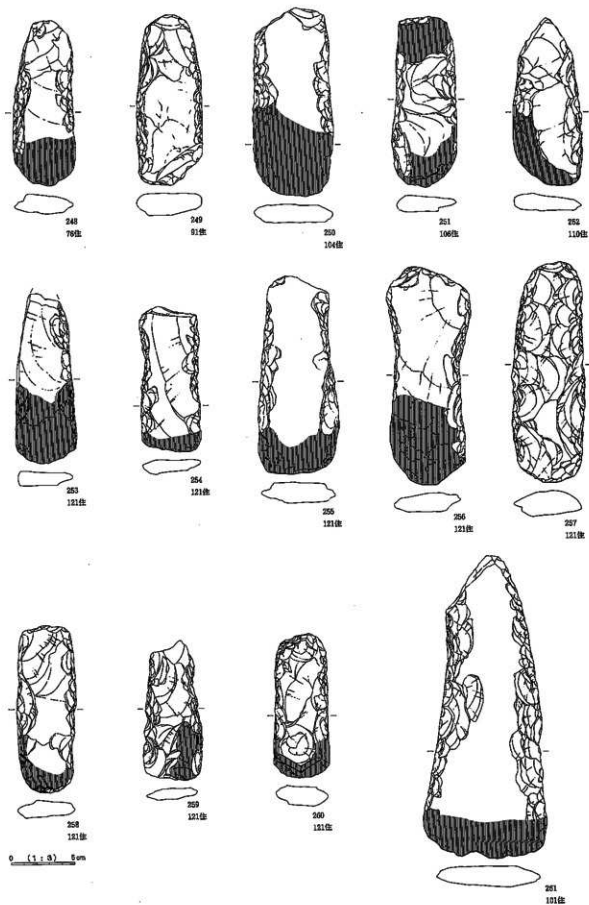

図版225 縄文時代の石器(15) 1:3

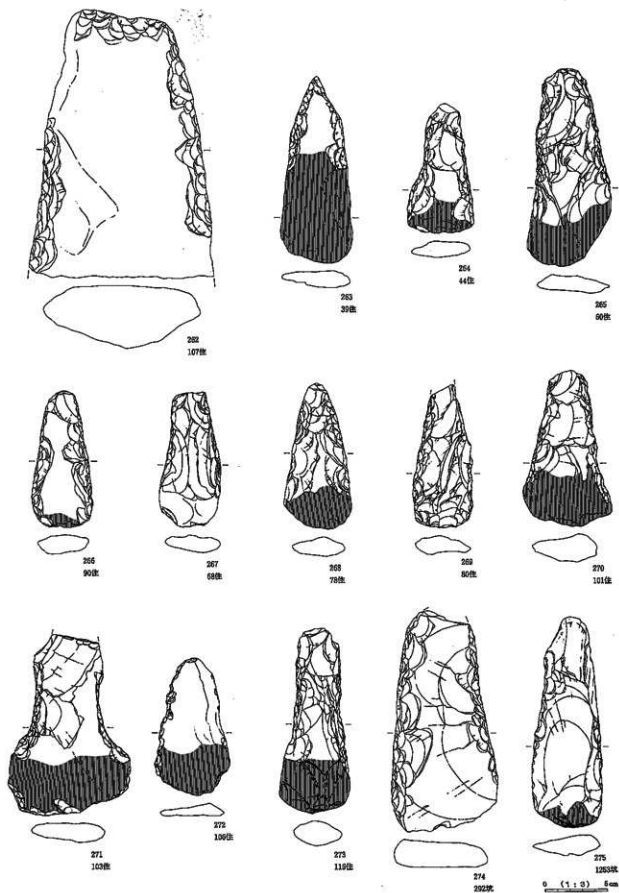

図版226 縄文時代の石器04 1 : 3

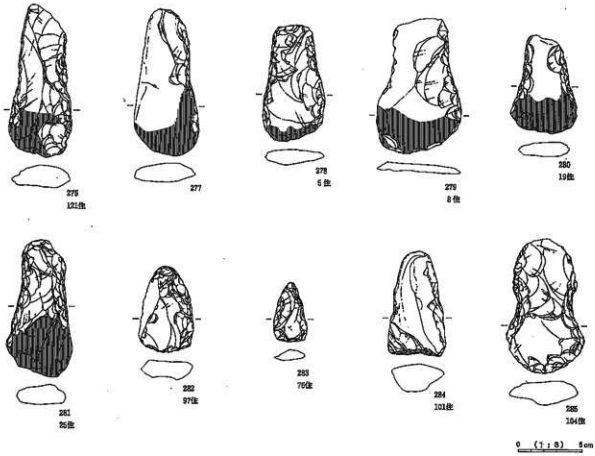

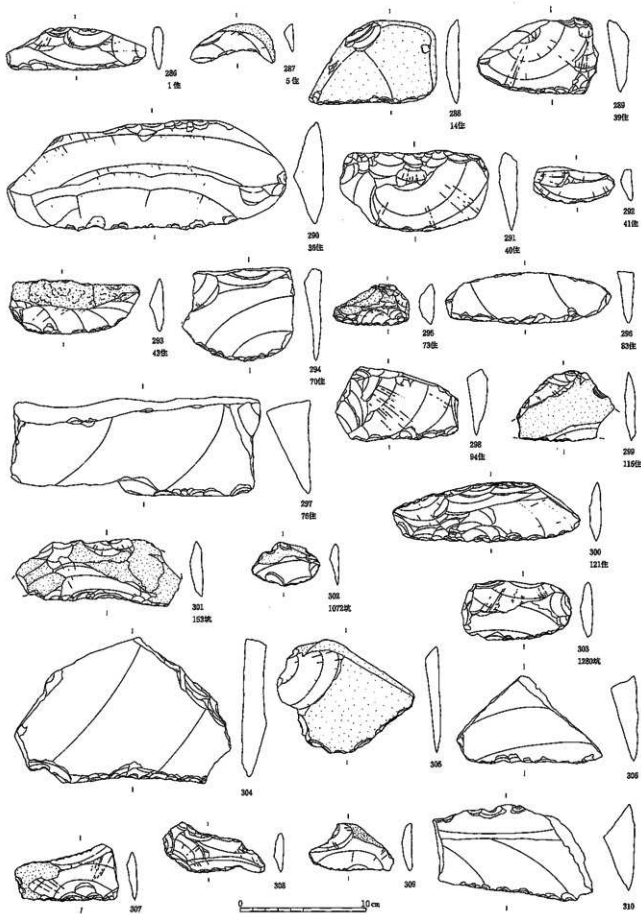

図版228 縄文時代の石器08 1 : 3

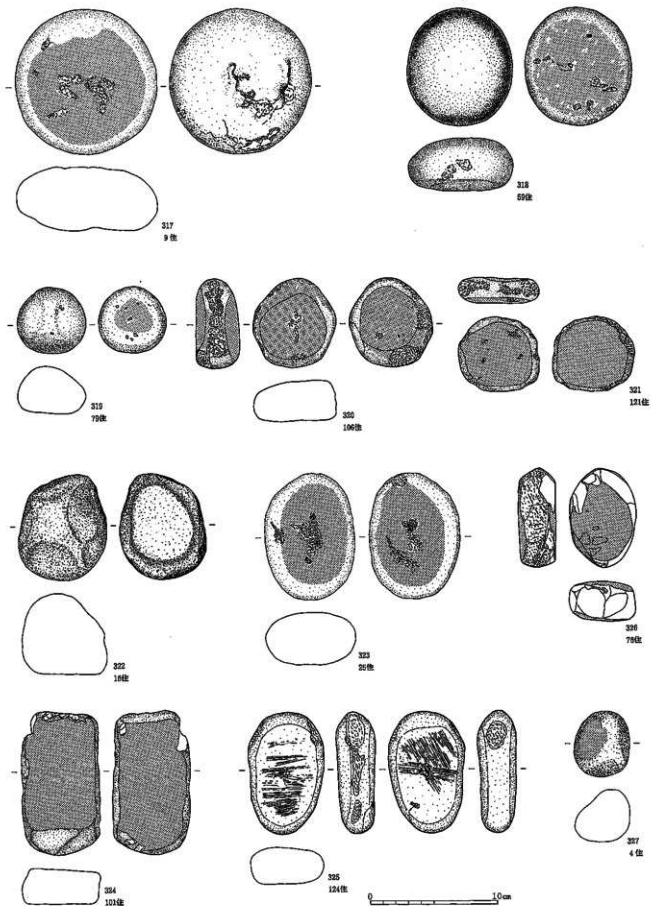

図版230 縄文時代の石器② 1 : 3

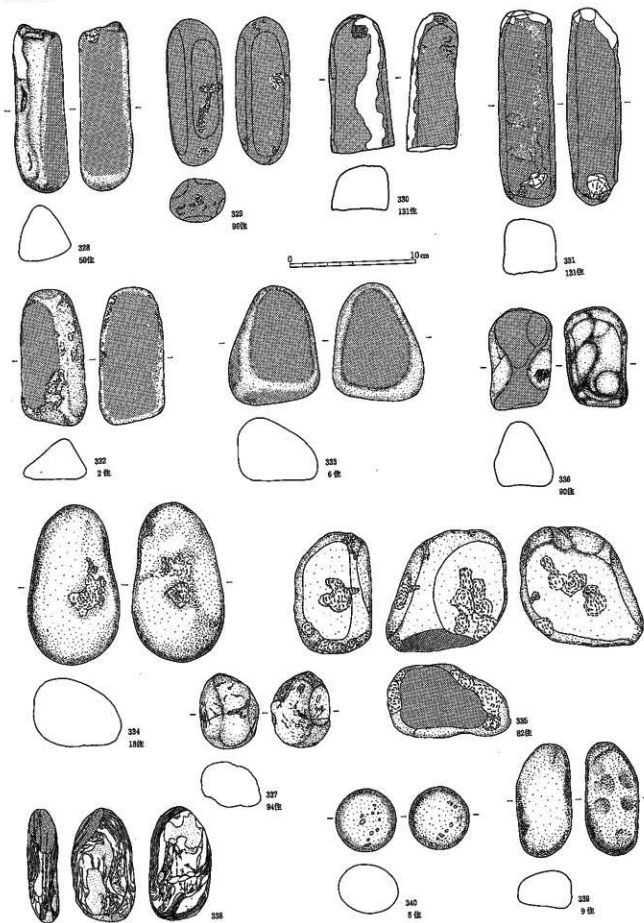

図版231 縄文時代の石器(2) 1:3



図版232 縄文時代の石器類 1 : 3

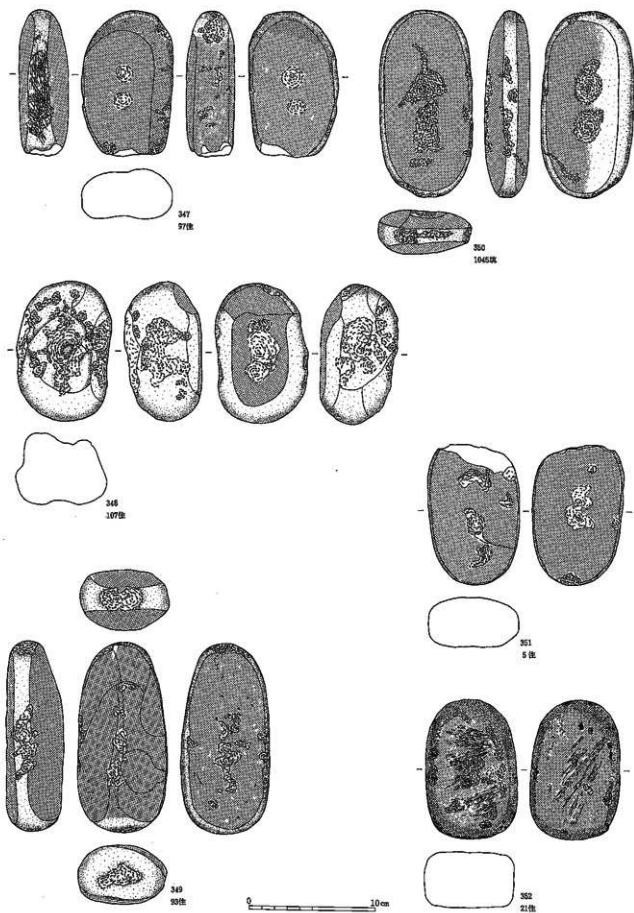

図版233 縄文時代の石器④ 1 : 3

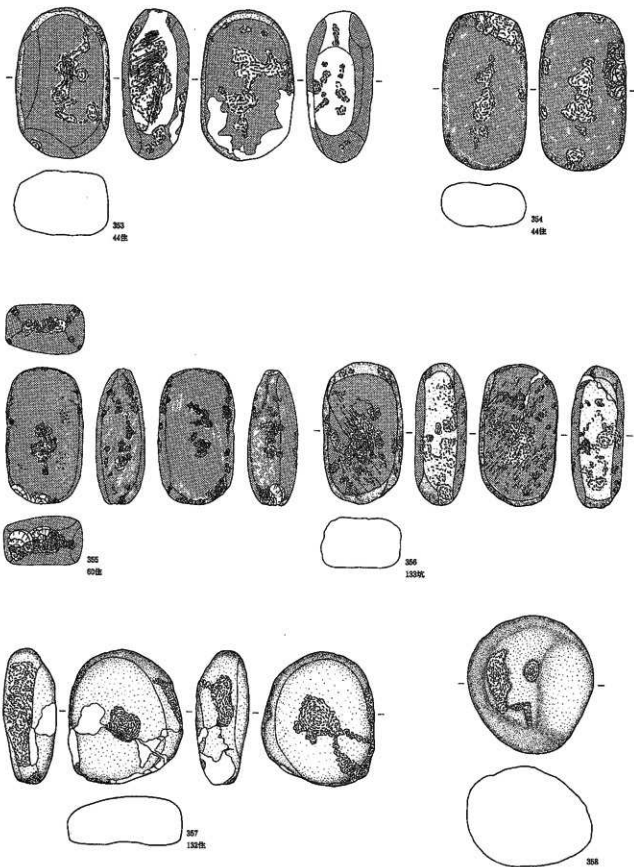

図版234 縄文時代の石器04 1 : 3

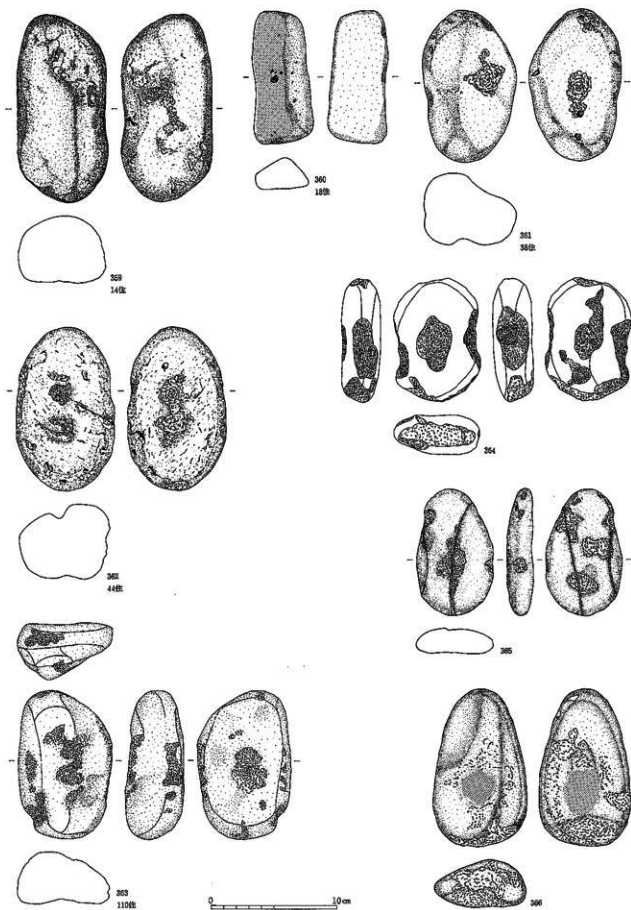

図版235 縄文時代の石器類 1 : 3

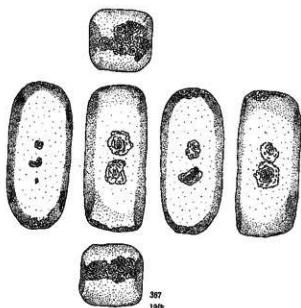

367
19位

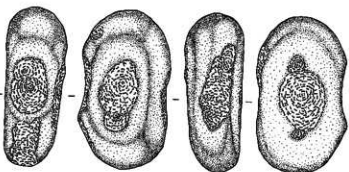

368

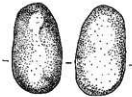

371
25位

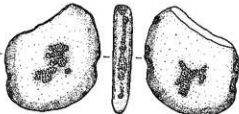

373
12位

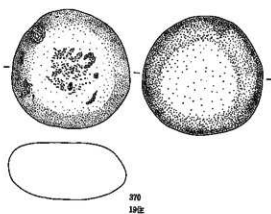

375
19位



377
70位

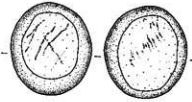

379
105位



382
12位



図版236 縄文時代の石器類 1 : 3

縄土遺跡

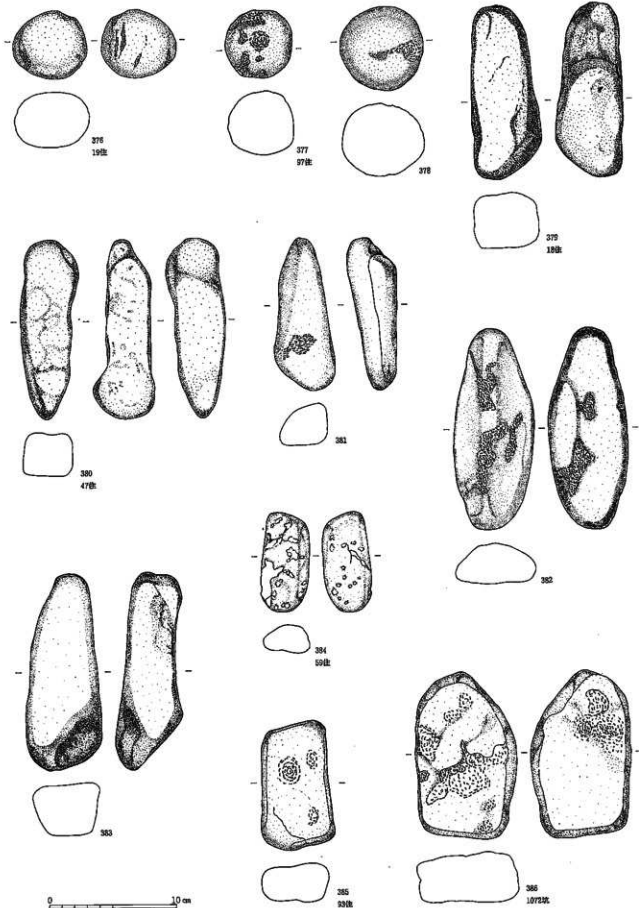

図版237 縄文時代の石器切 1 : 3

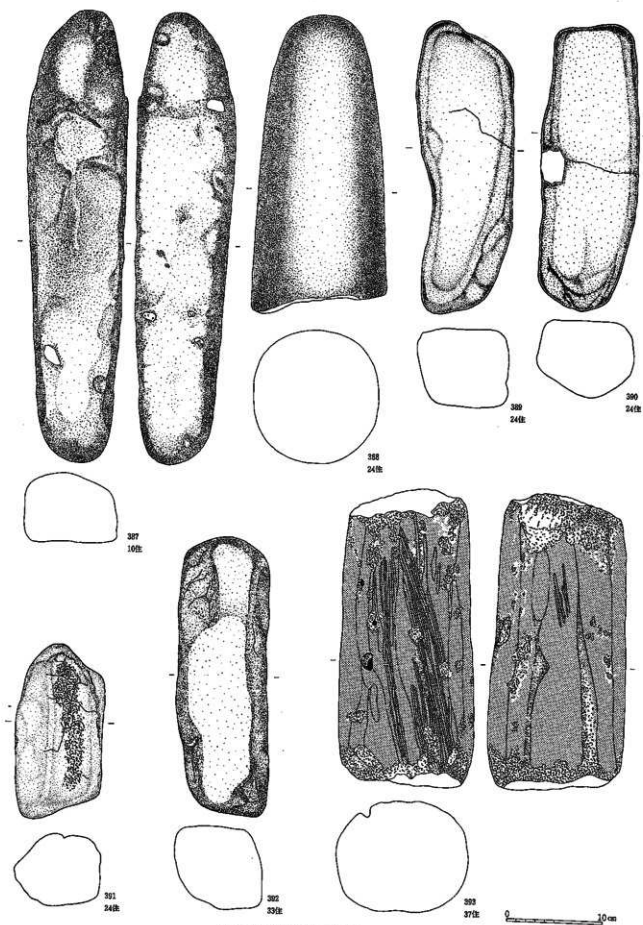

図版238 縄文時代の石器② 1 : 4

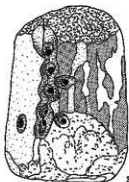
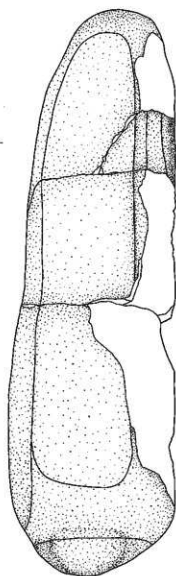
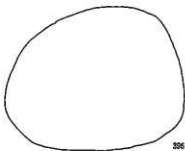
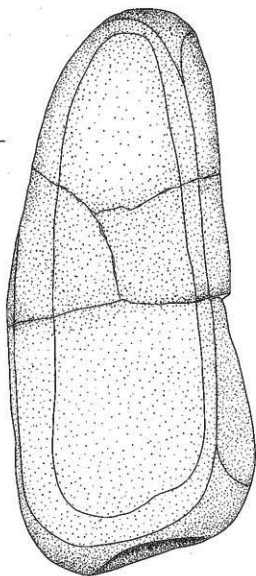
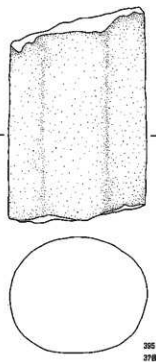
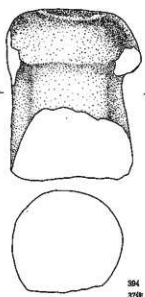

0 10cm

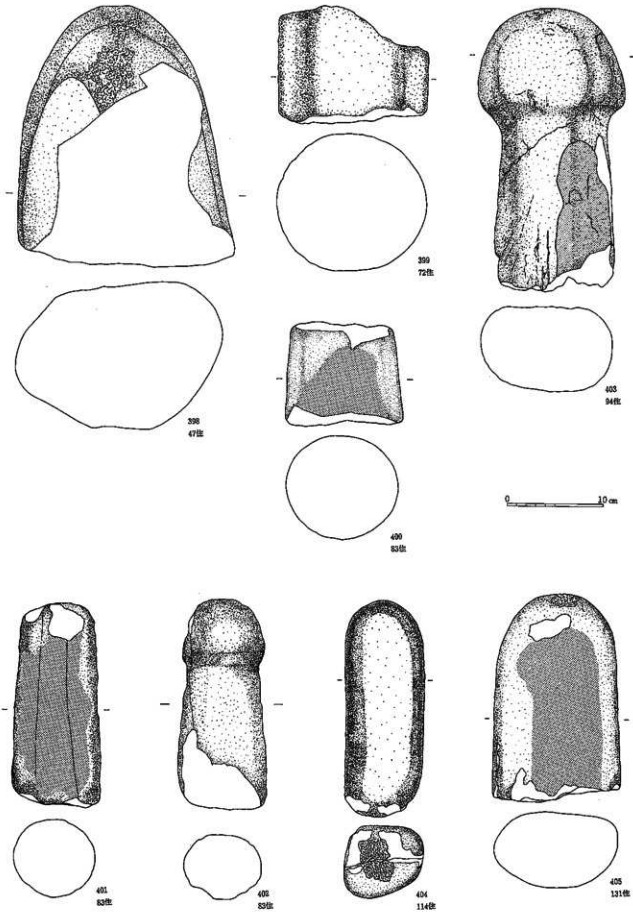

図版240 縄文時代の石器類 1 : 4

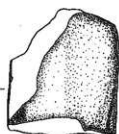

406
134枚

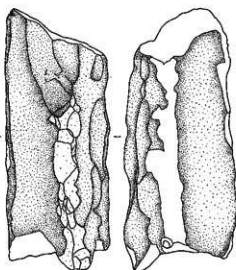

407
298枚

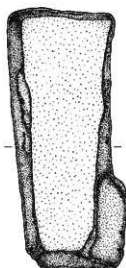

408
641枚



410
778枚

0 10cm

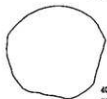
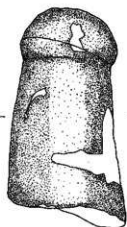

409
709枚

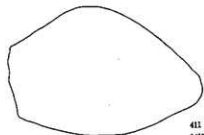
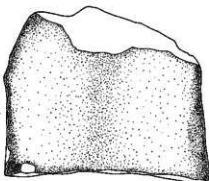

411
1417枚

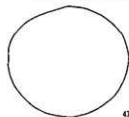
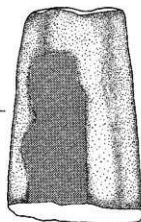

412

図版241 縄文時代の石器(4) 1 : 4

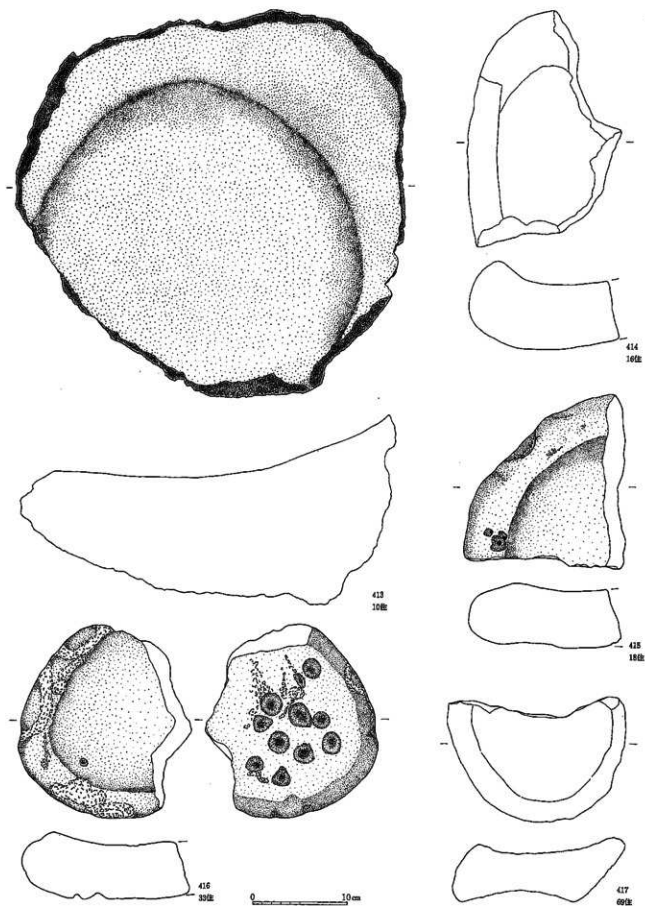

図版242 縄文時代の石器類 1 : 4

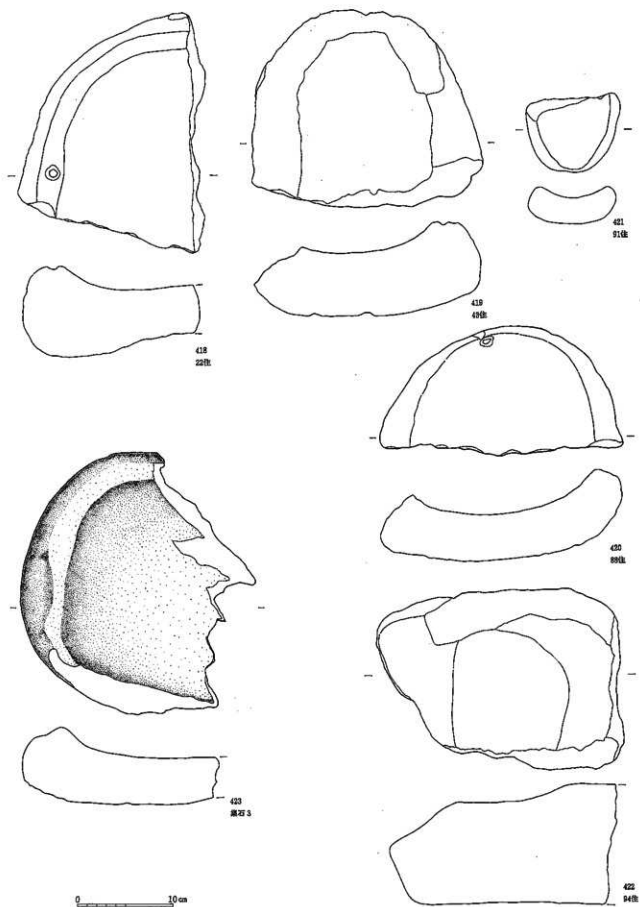

図版243 縄文時代の石器③ 1 : 4

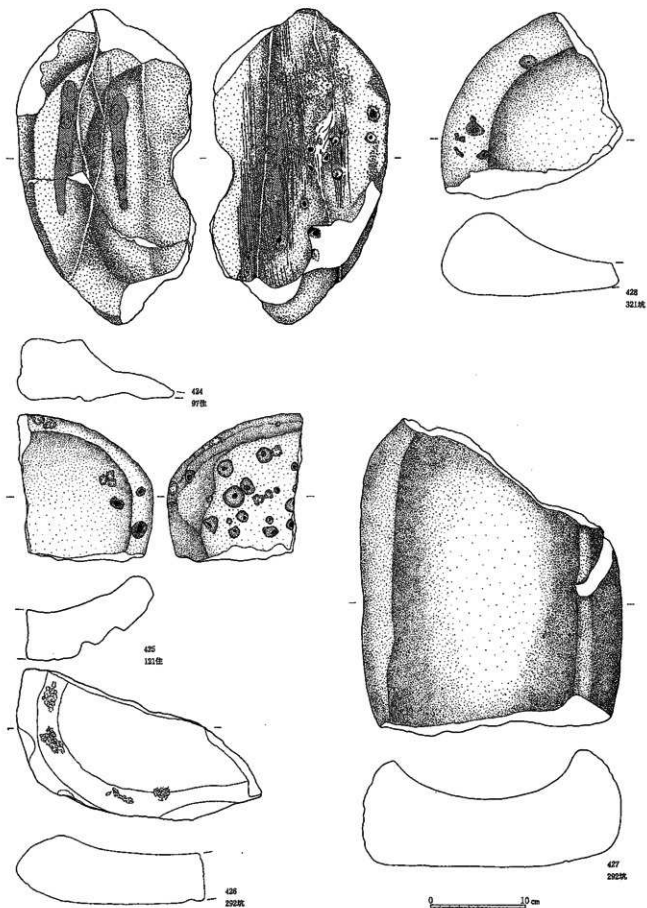

図版244 縄文時代の石器00 1 : 4

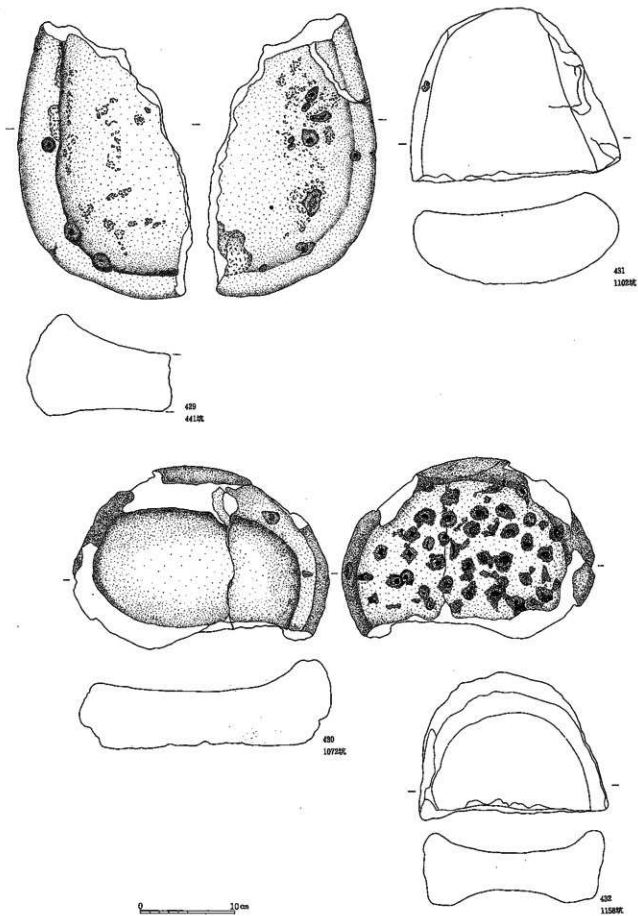

図版245 縄文時代の石器00 1 : 4

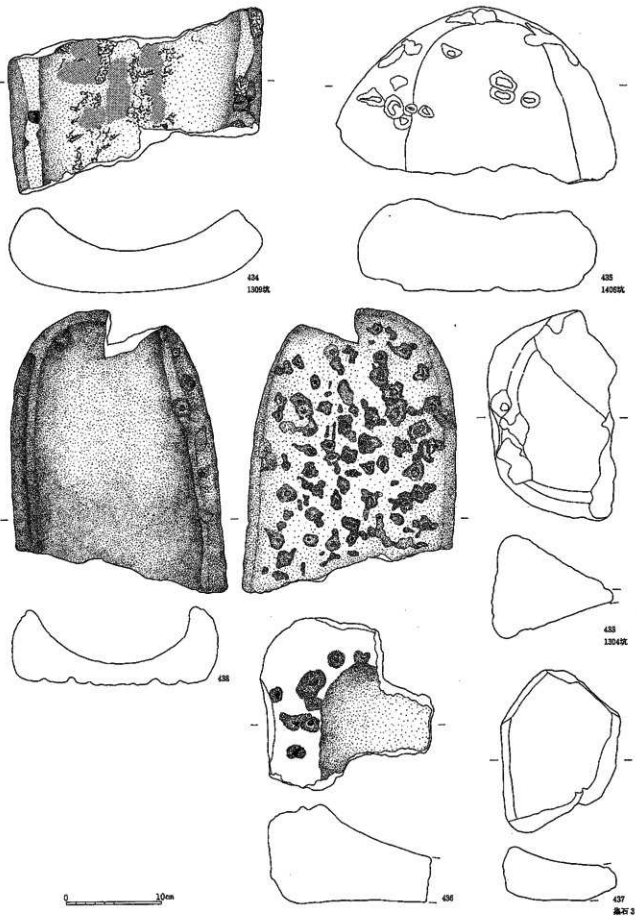

図版246 縄文時代の石器類 1:4

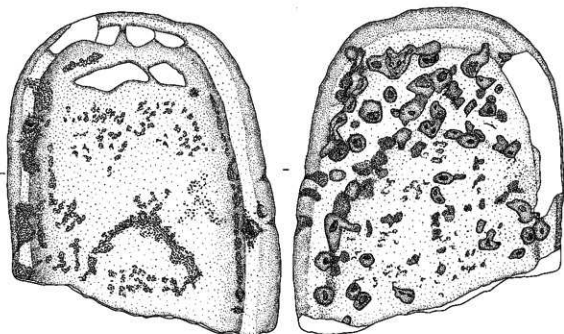

439

0 10cm

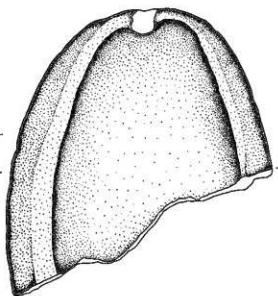
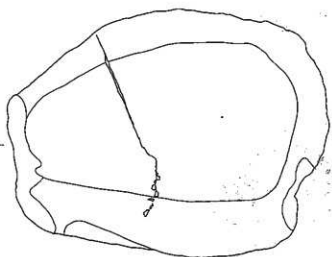

440



441

図版247 縄文時代の石器⑦ 1:4

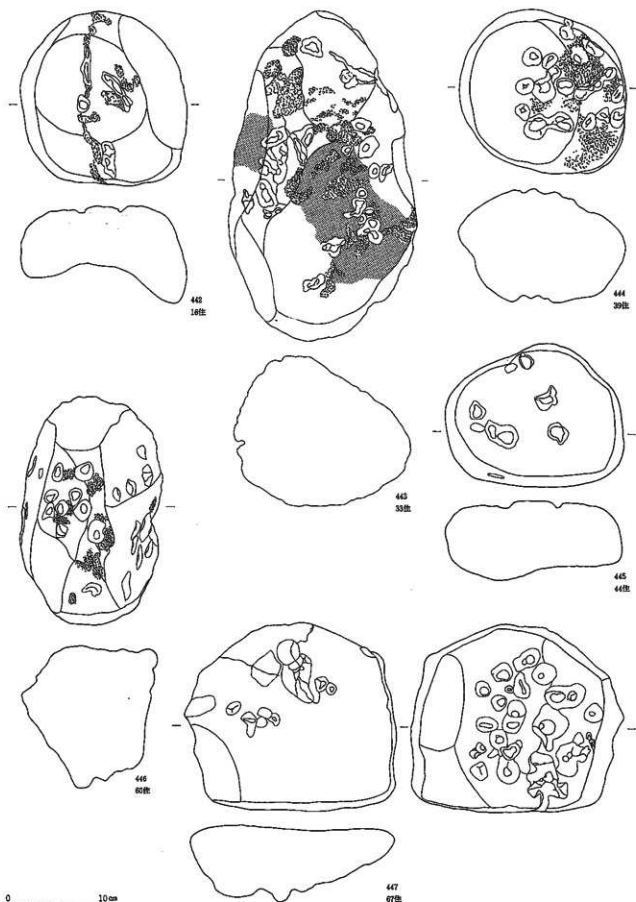

図版248 縄文時代の石器(2) 1 : 4

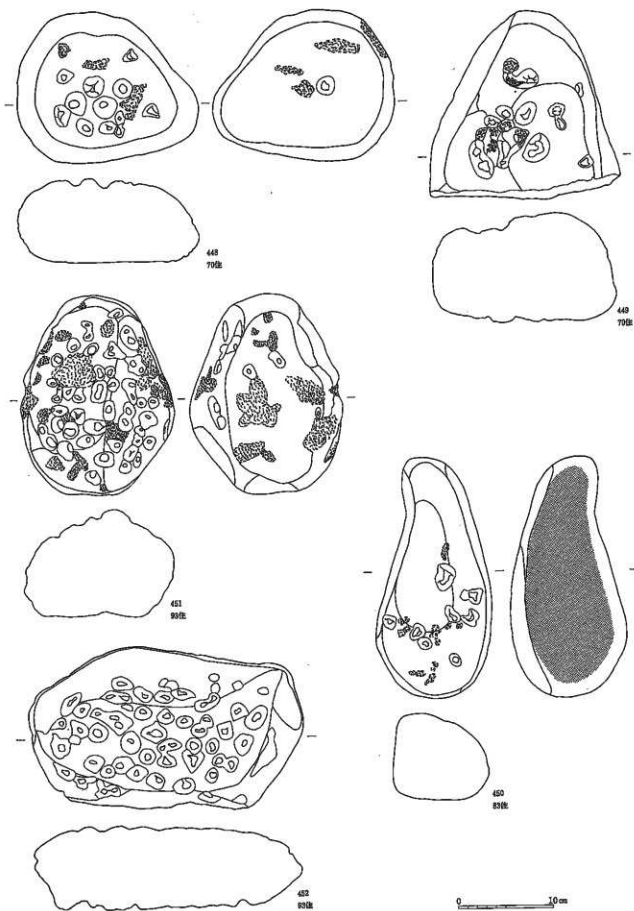

図版249 縄文時代の石器類 1:4

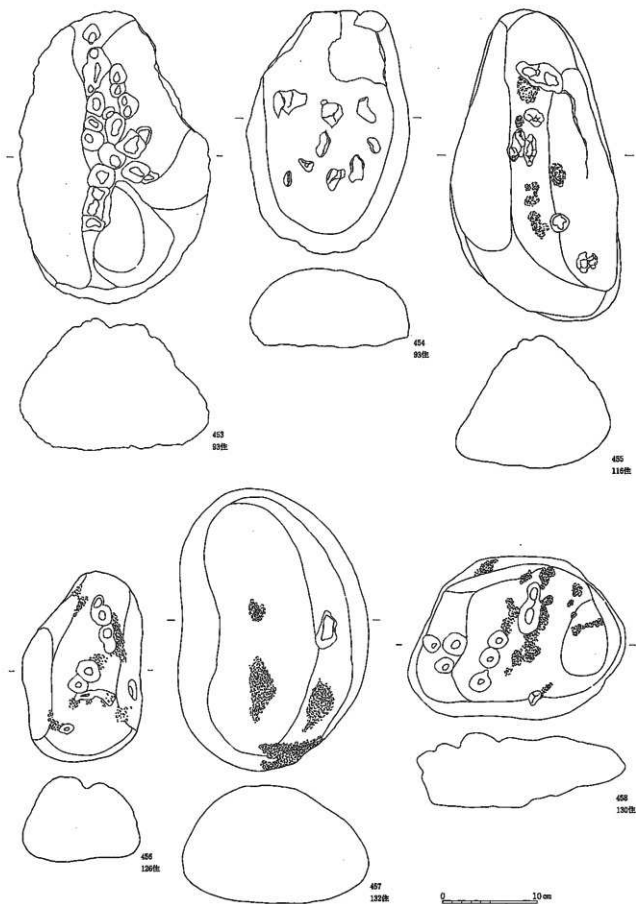

図版250 縄文時代の石器40 1 : 4

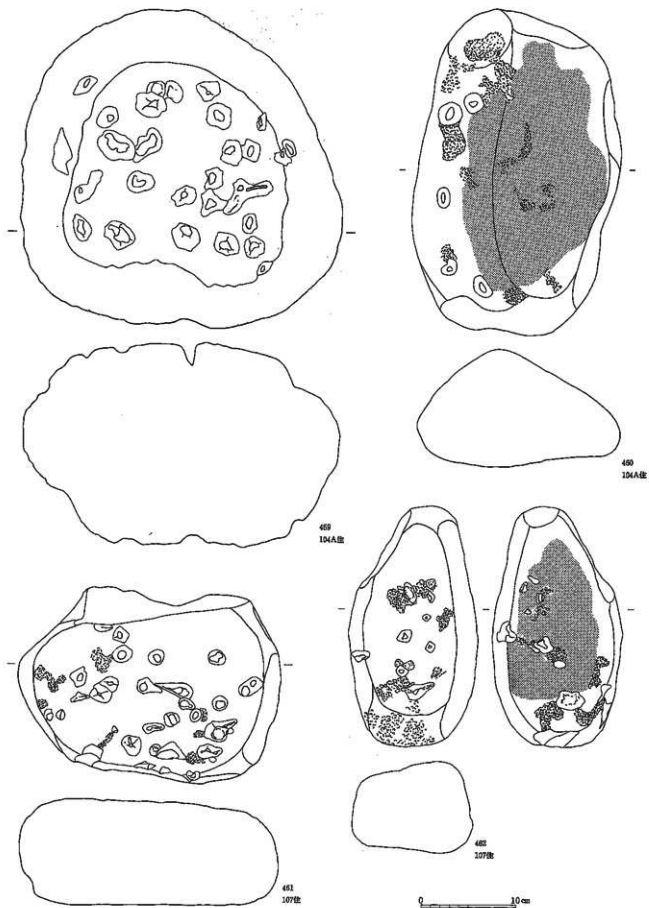

図版251 縄文時代の石器(4) 1 : 4

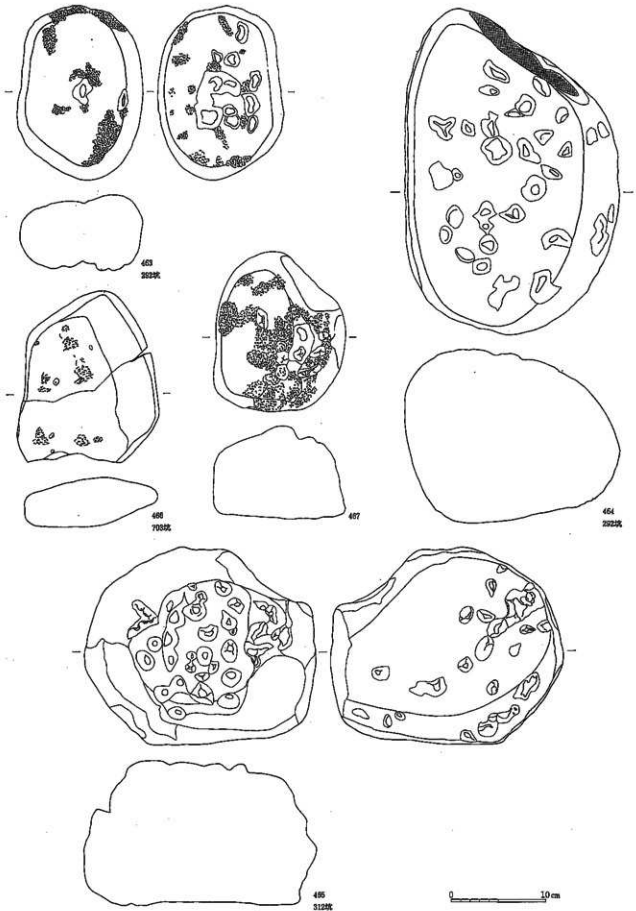

図版252 縄文時代の石器(4) 1 : 4

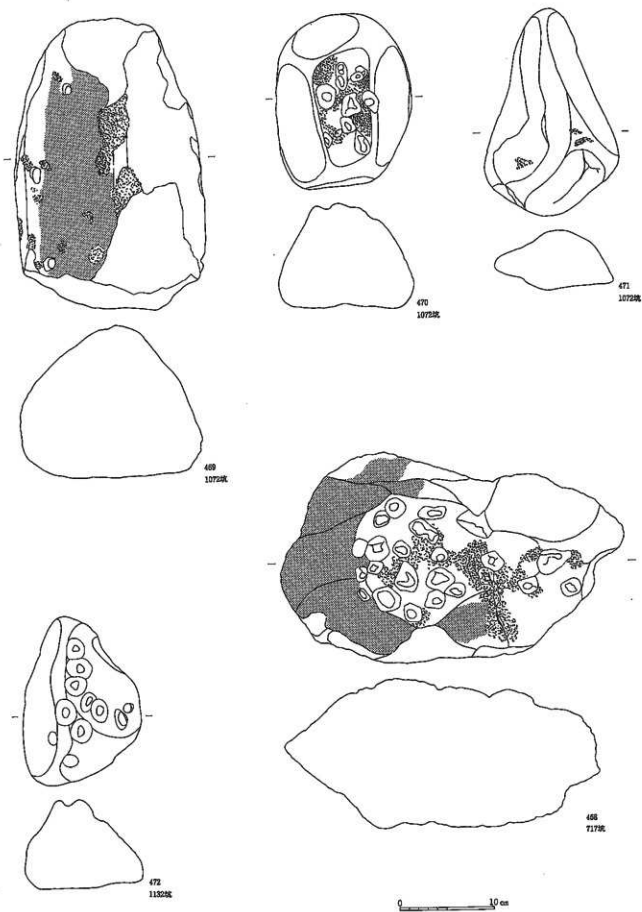

図版253 縄文時代の石器(4) 1:4

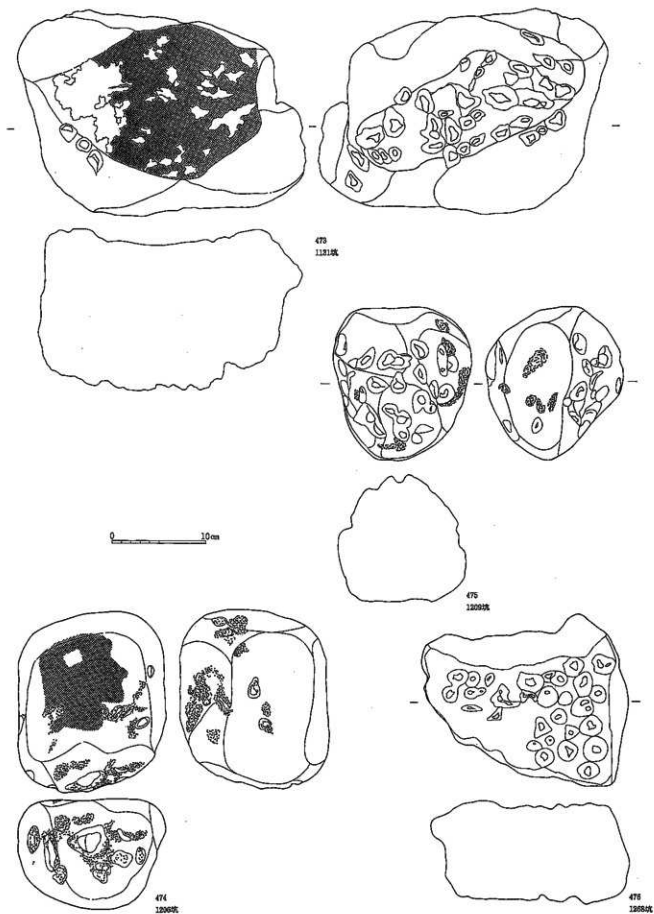

図版254 縄文時代の石器40 1:4

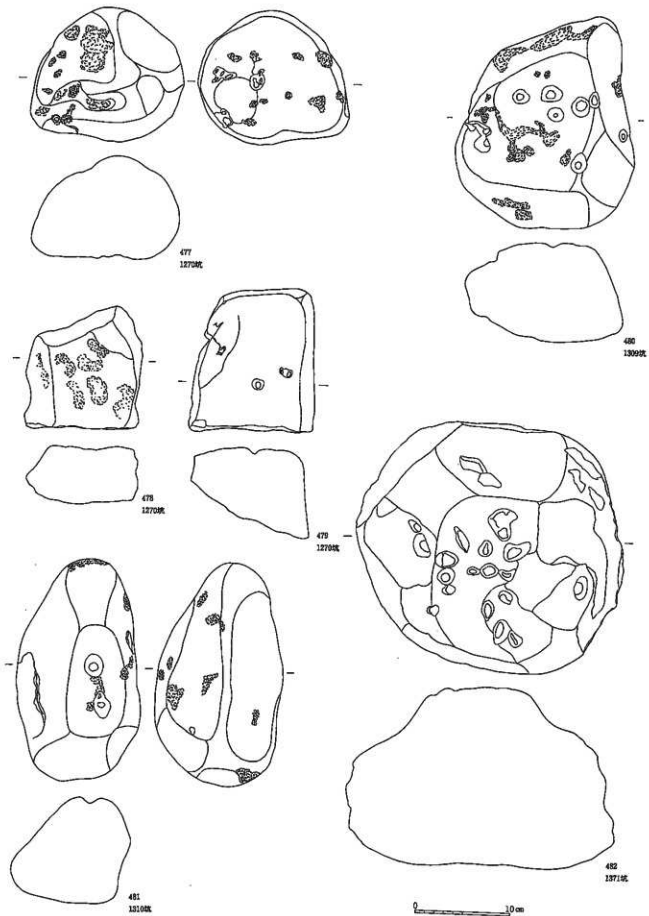

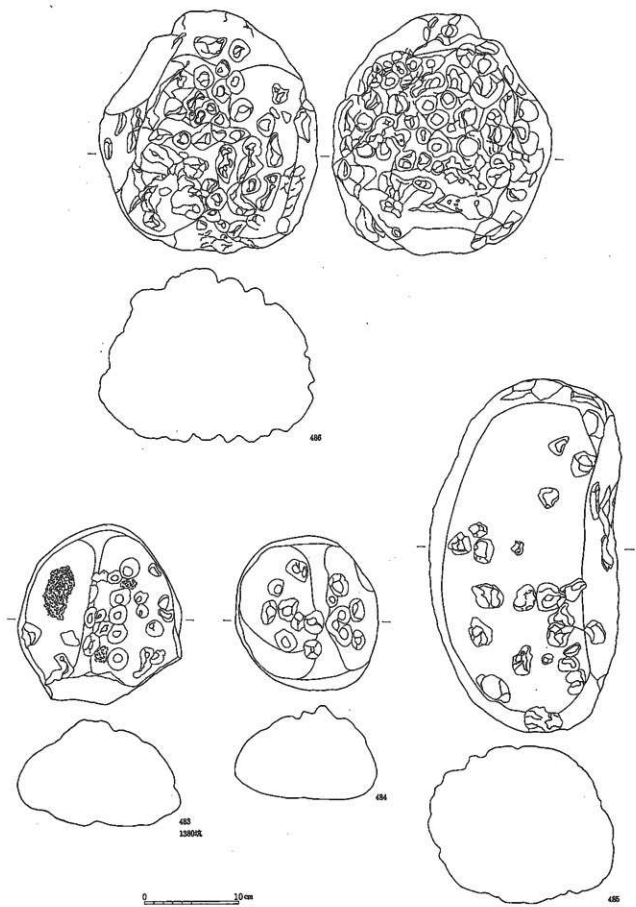

図版256 縄文時代の石器⑩ 1:4

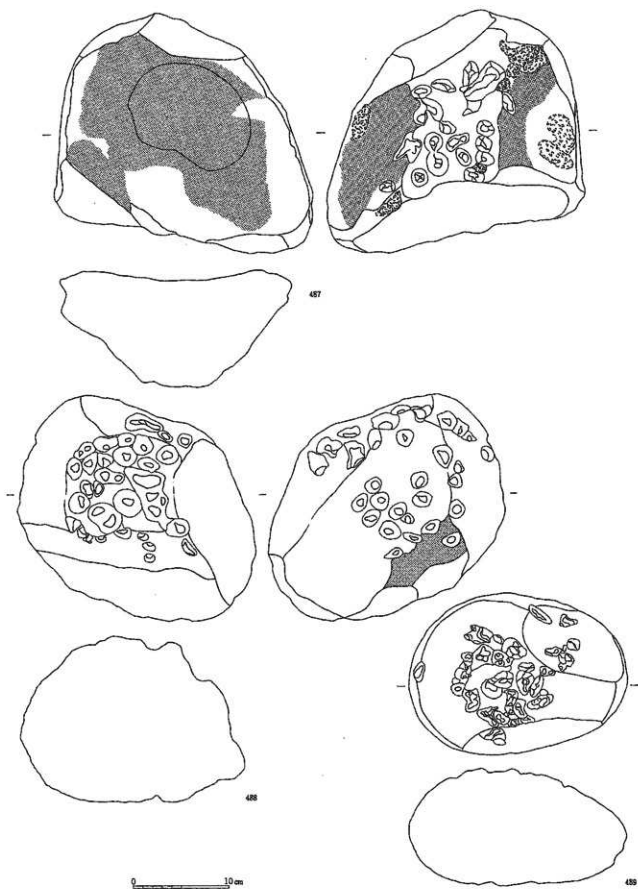

図版257 縄文時代の石器40 1 : 4

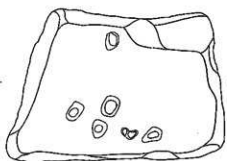
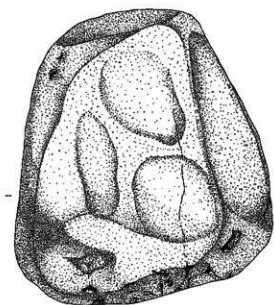

481
70世

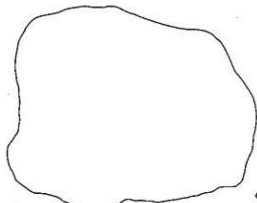

490
47世

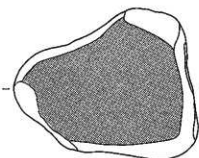

483
131世

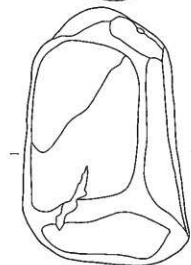

483
230世

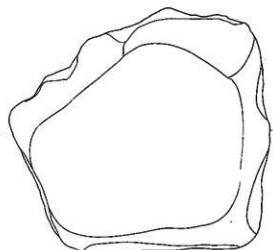

494
441世

0 10 cm

図版258 縄文時代の石器⑧ 1:4

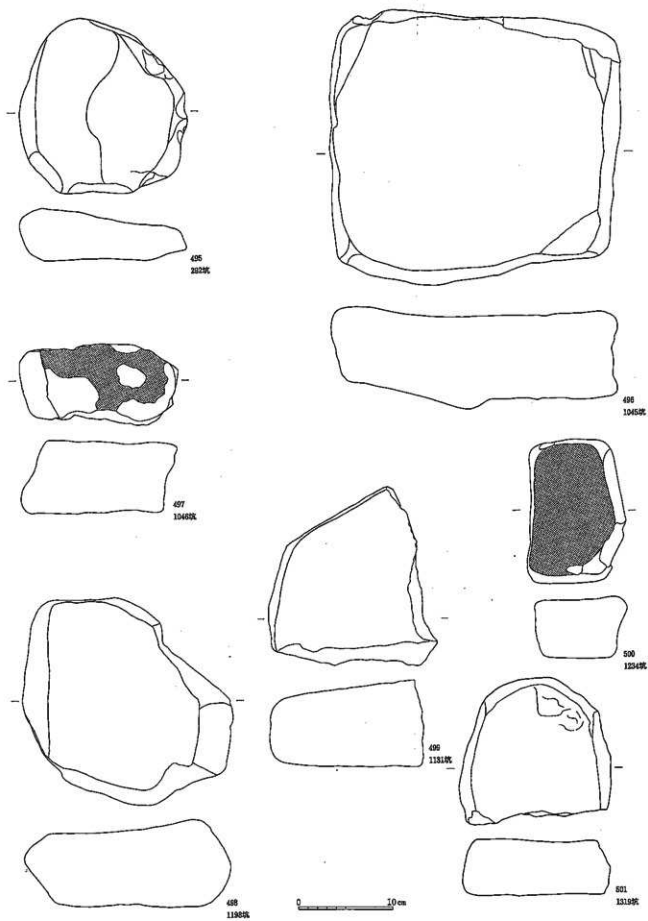

図版259 縄文時代の石器4種 1 : 4

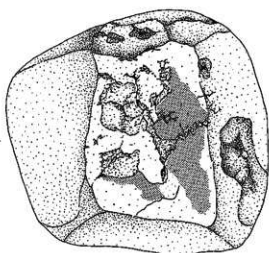
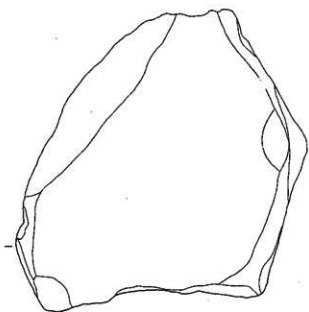

502
1209K

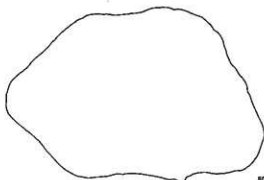

504
1273K

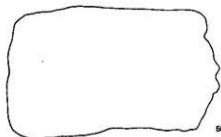
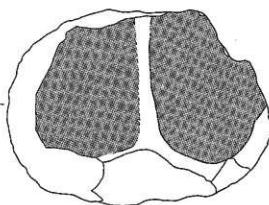
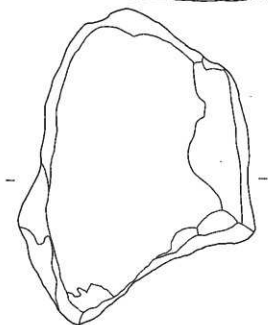

503
1270K

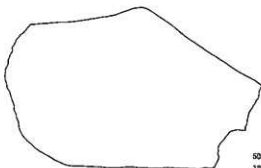

505
1224K

0 10 cm

図版260 縄文時代の石器類 1 : 4

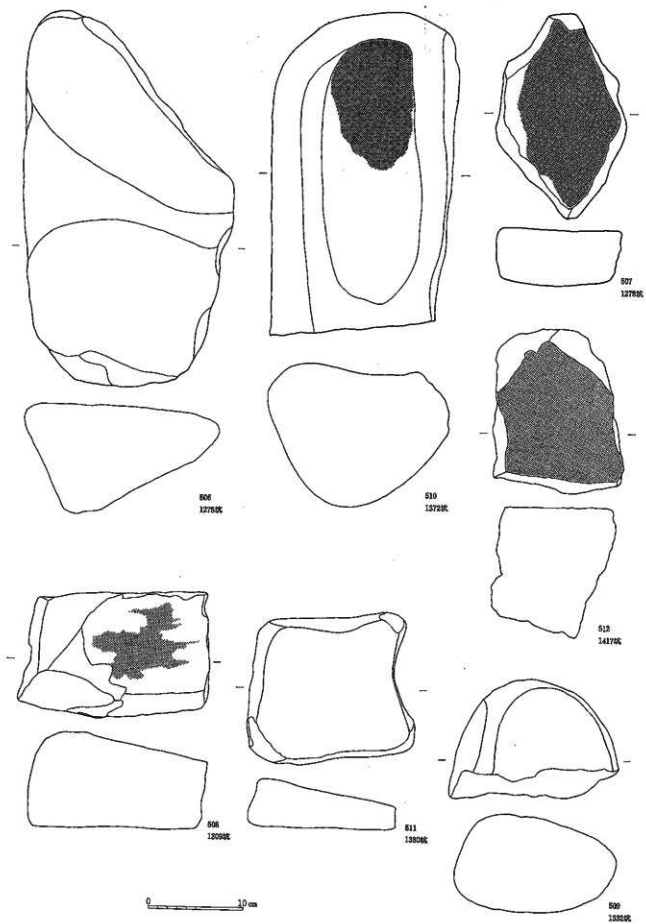

図版261 縄文時代の石器60 1 : 4

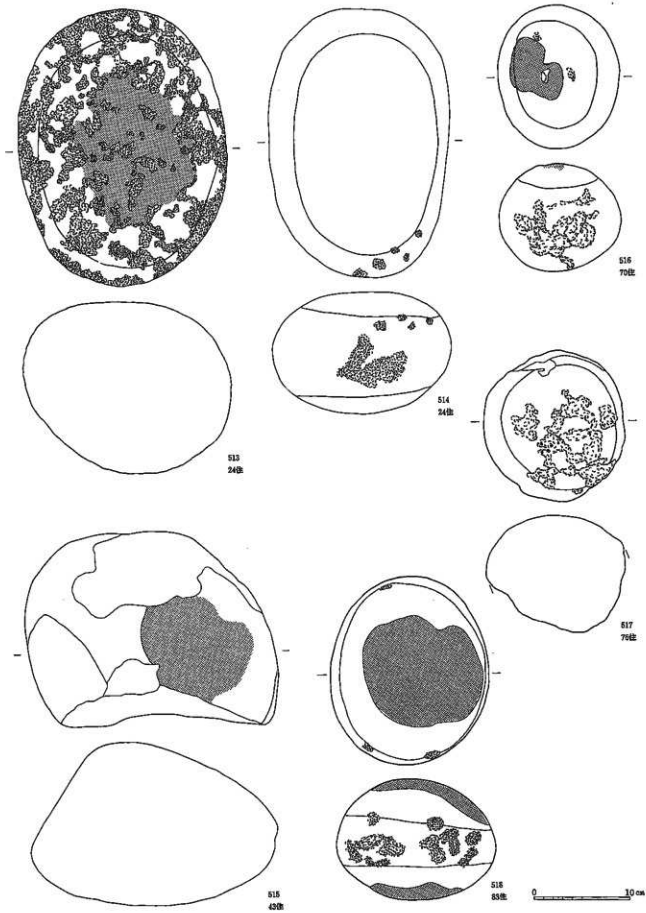

図版262 縄文時代の石器60 1 : 4

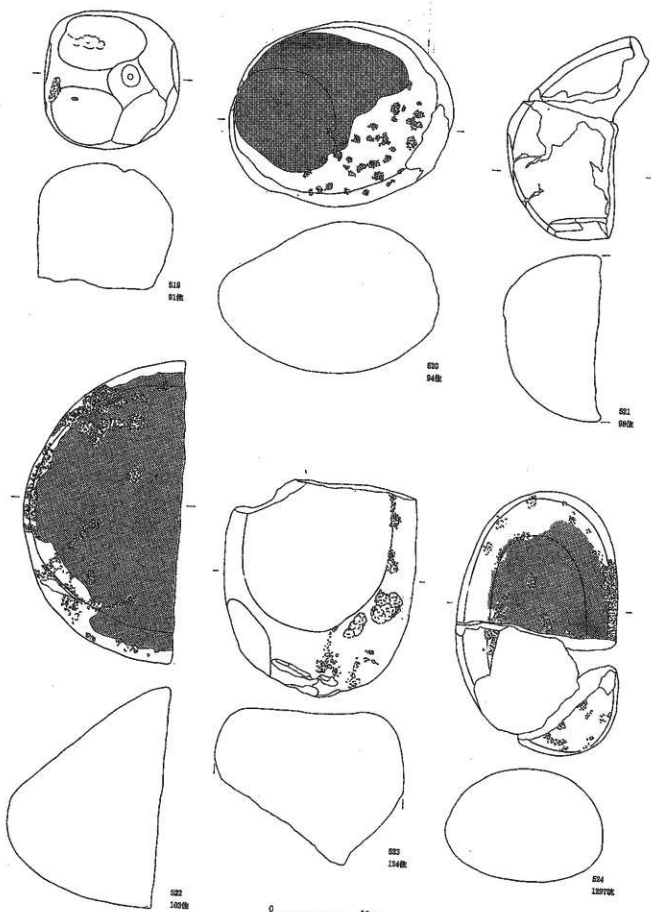

図版263 縄文時代の石器類 1 : 4

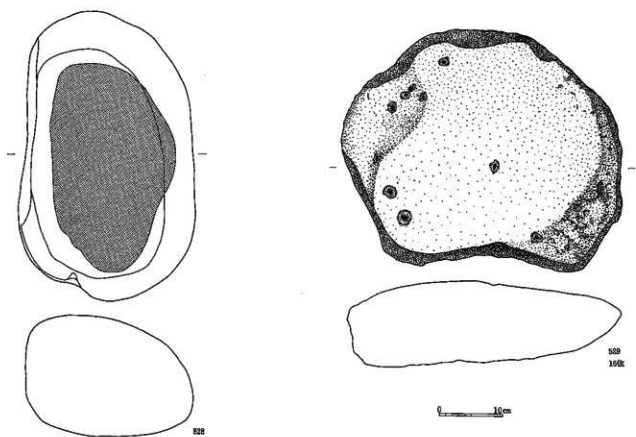
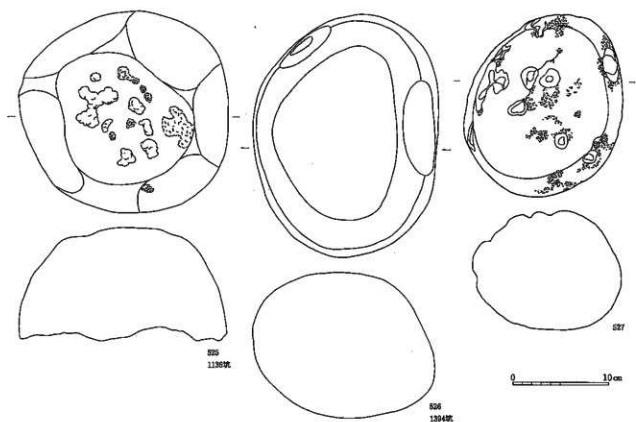

図版264 縄文時代の石器60 529・1：6、他・1：4

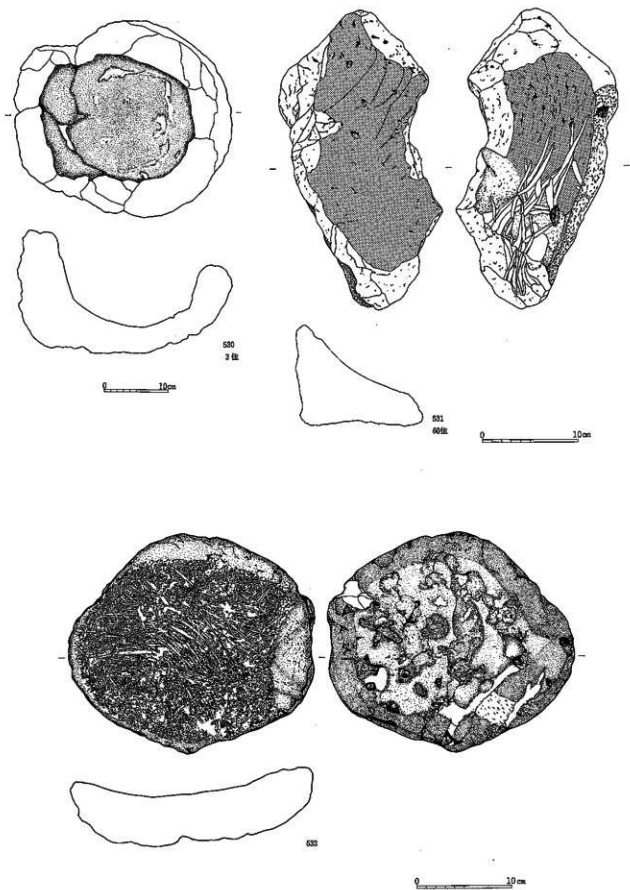

図版265 縄文時代の石器64 530・1:6、他・1:4

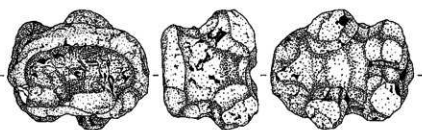

533
70枚



534

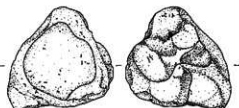

535

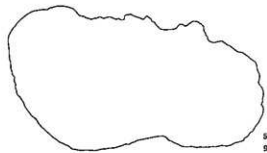

536
58枚

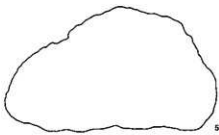
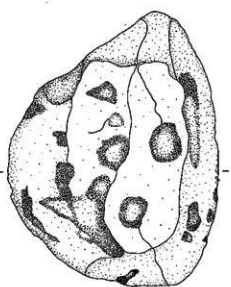

537
136枚



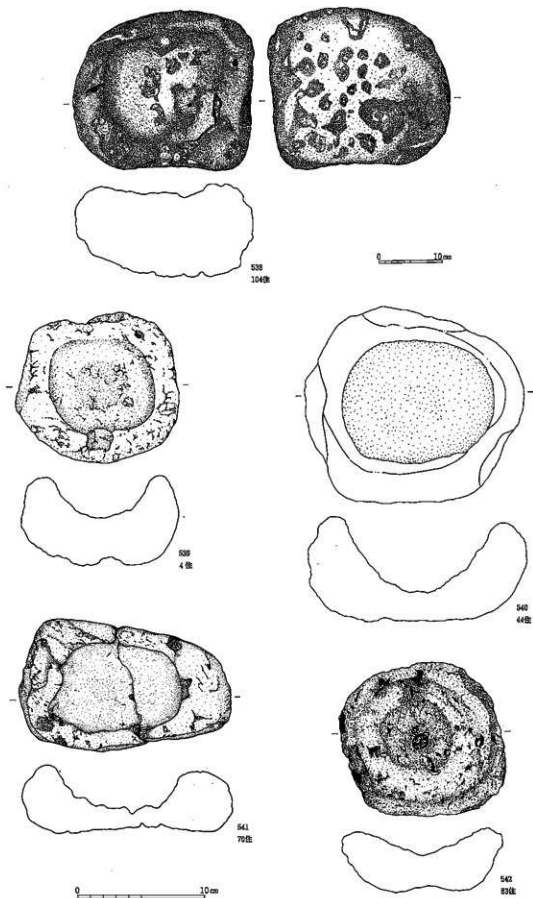

図版267 縄文時代の石器類 538・1:6、他・1:3

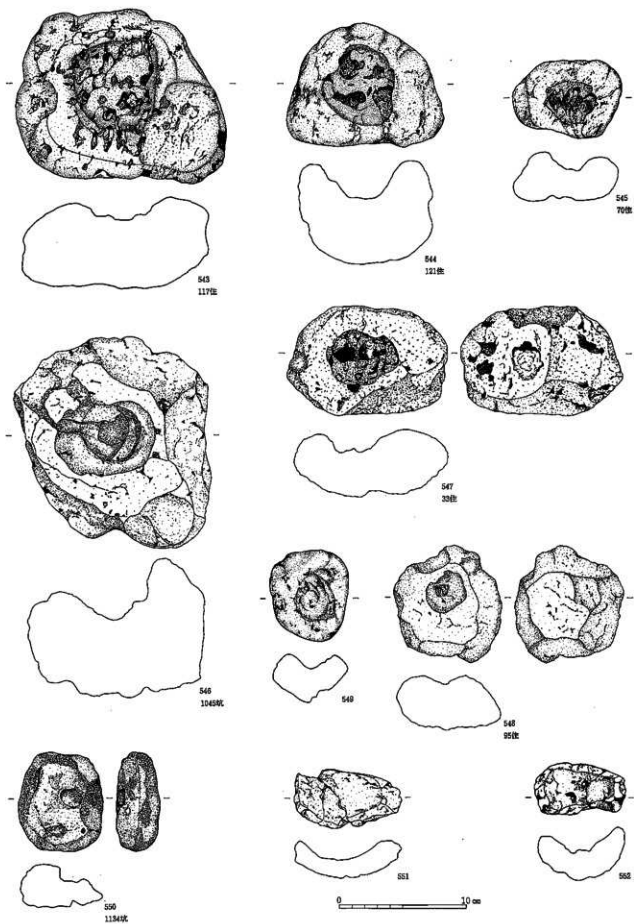

図版268 縄文時代の石器54 1 : 3

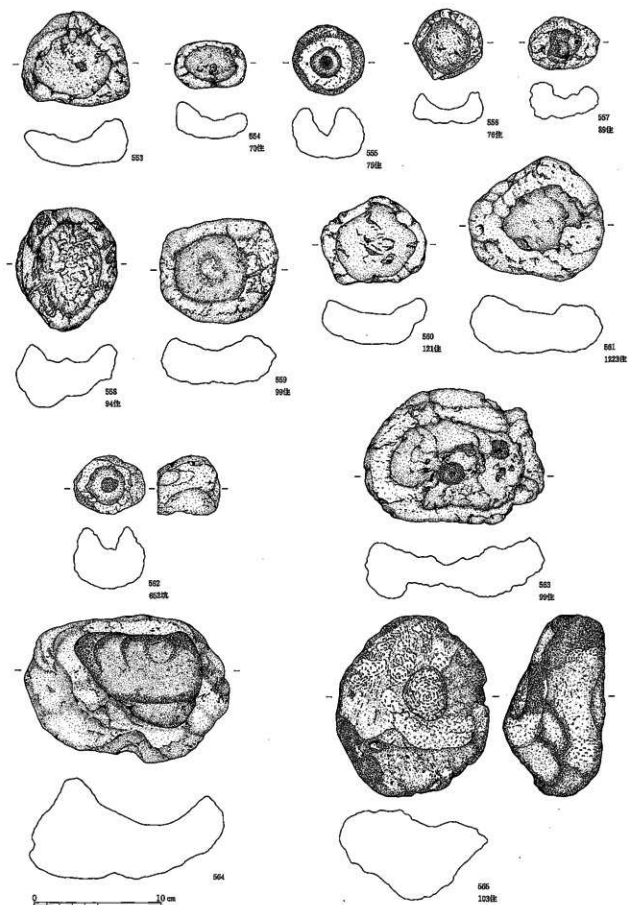

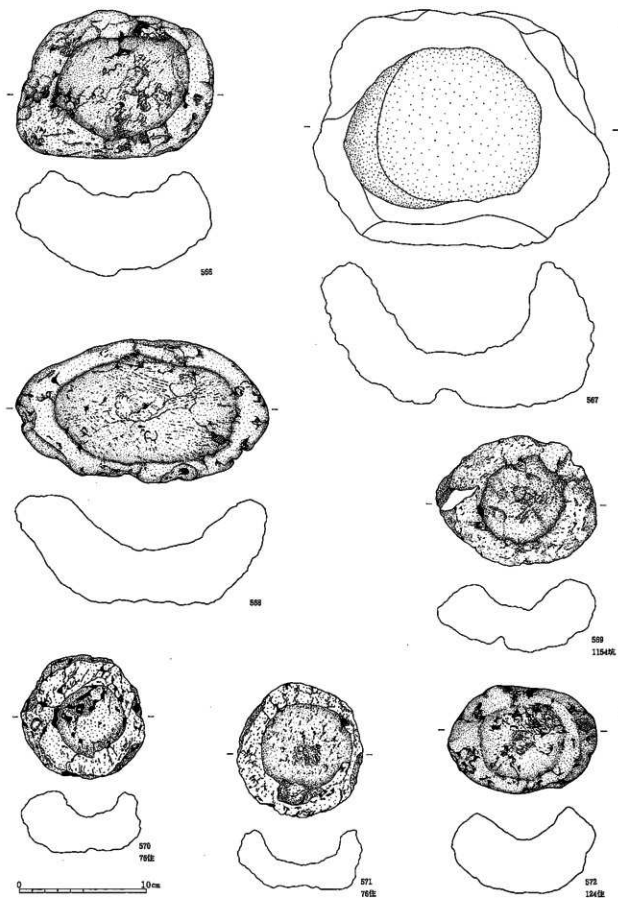

図版270 縄文時代の石器類 1 : 3

縄土遺跡

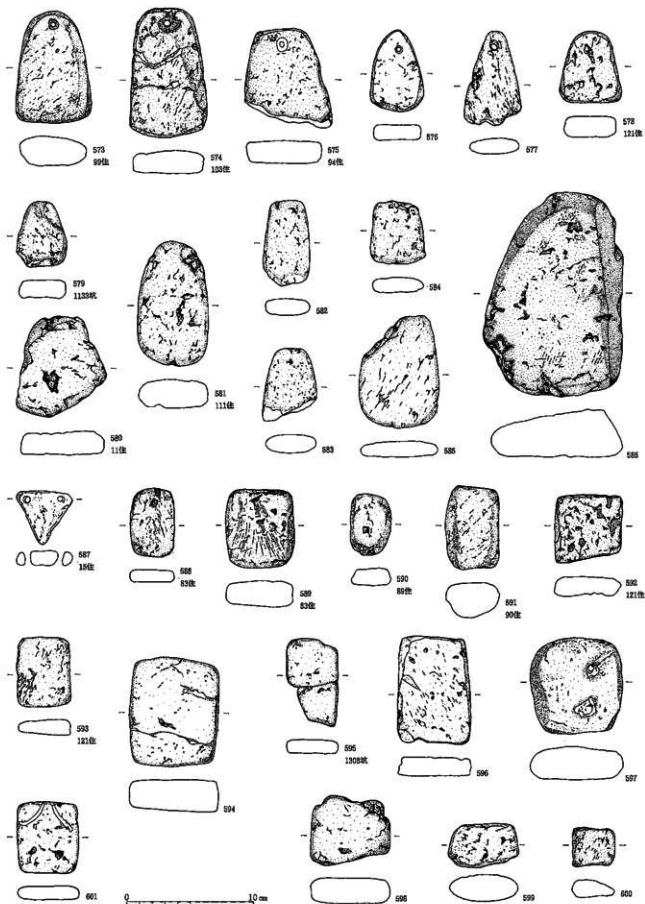

図版271 縄文時代の石器類 1 : 3

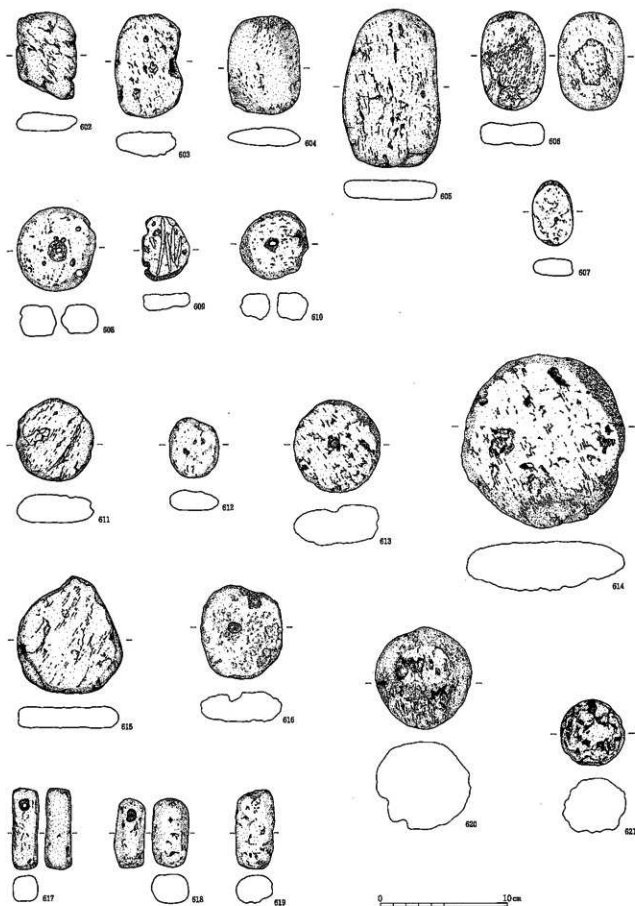

図版272 縄文時代の石器60 1 : 3

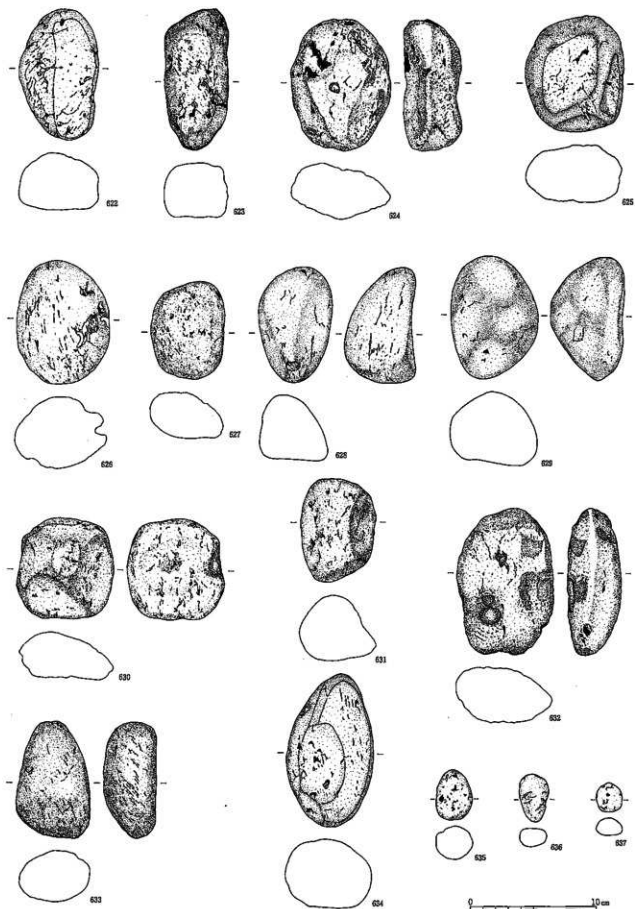

図版273 縄文時代の石器類 1 : 3

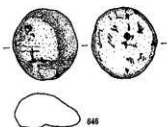
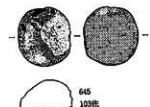
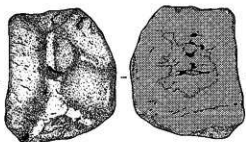
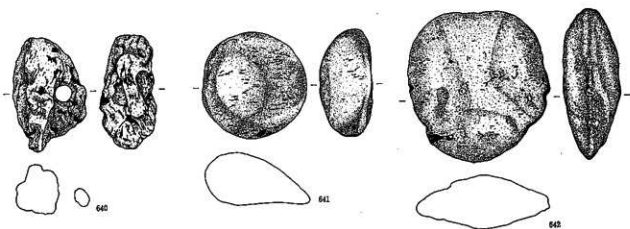
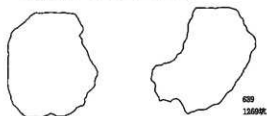
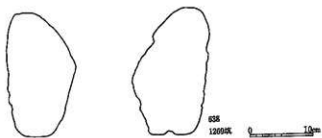
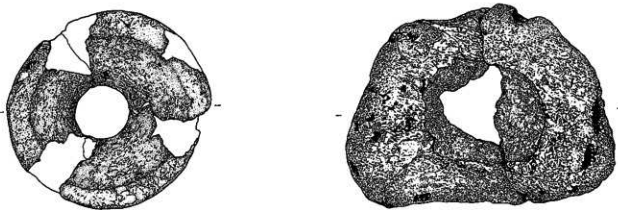

図版274 縄文時代の石器④ 638・1:6、他・1:3

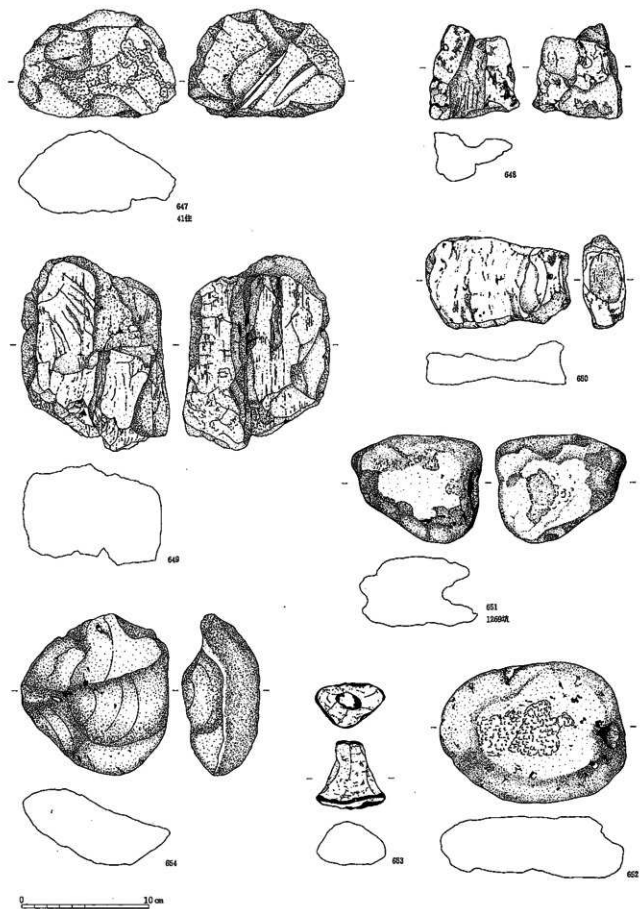

図版275 縄文時代の石器鈎 1 : 3

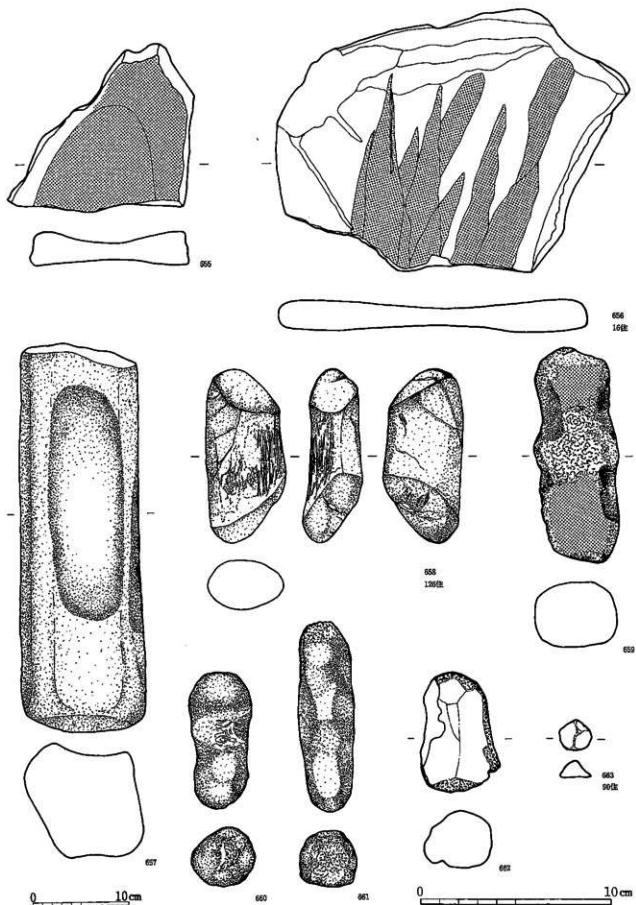

図版276 縄文時代の石器605 3・1:4、他・1:2

縄土遺跡

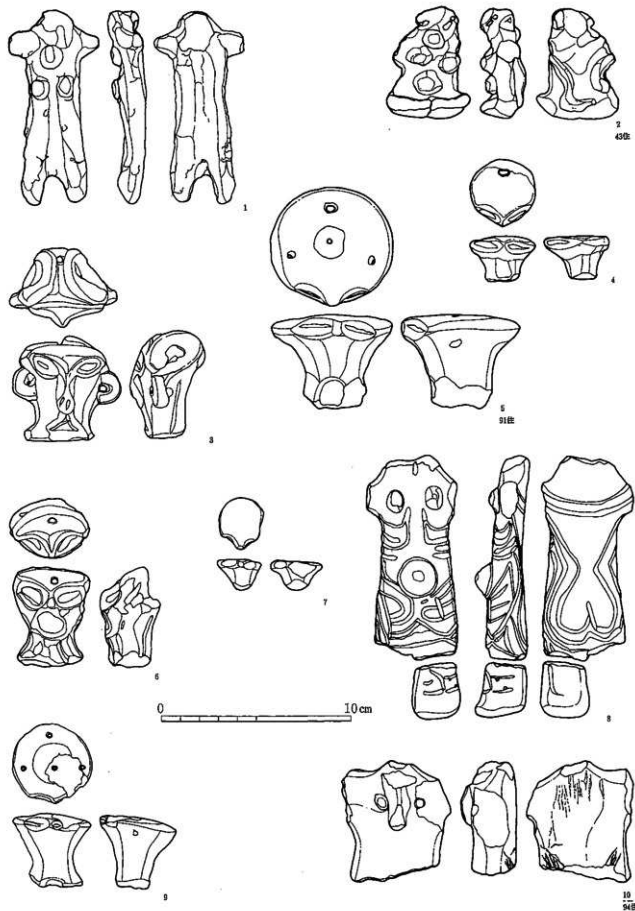

図版277 縄文時代の土製品(1) 1:2

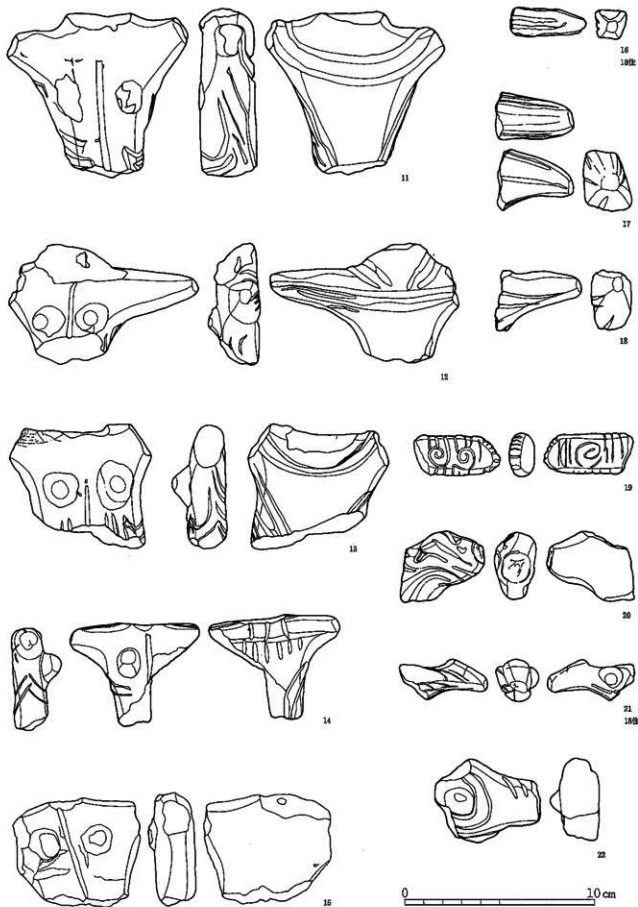

図版278 縄文時代の土製品(2) 1:2



23
40位



24
90位

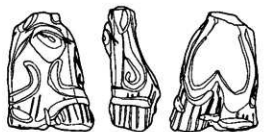

25



26



27

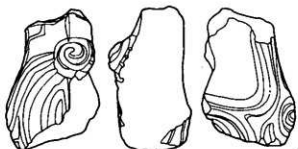

28



29

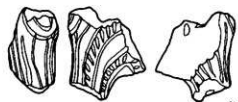

30

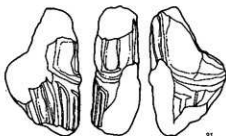

31
60位

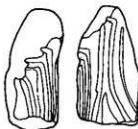

32



33

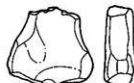

34
90位



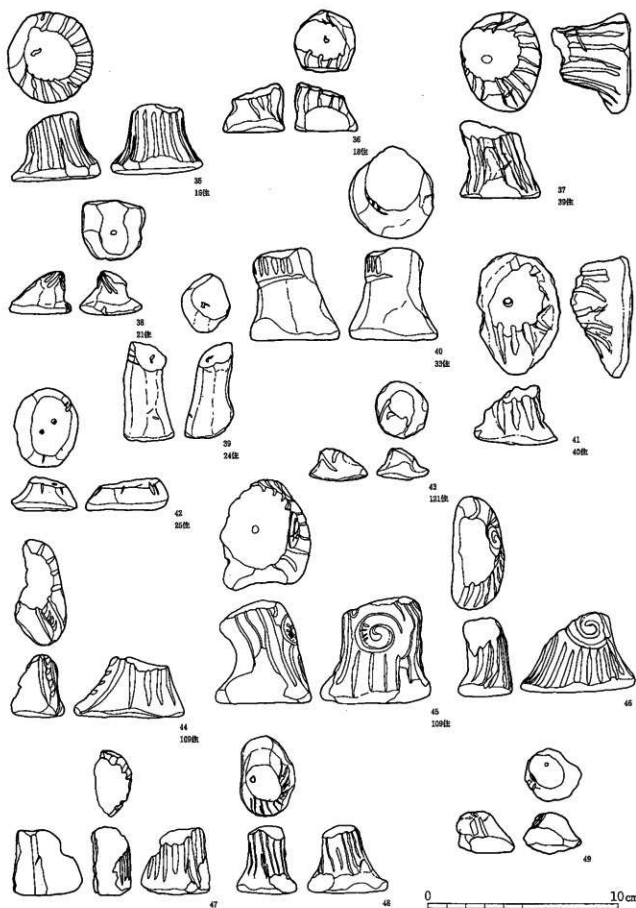

図版280 縄文時代の土製品(4) 1 : 2

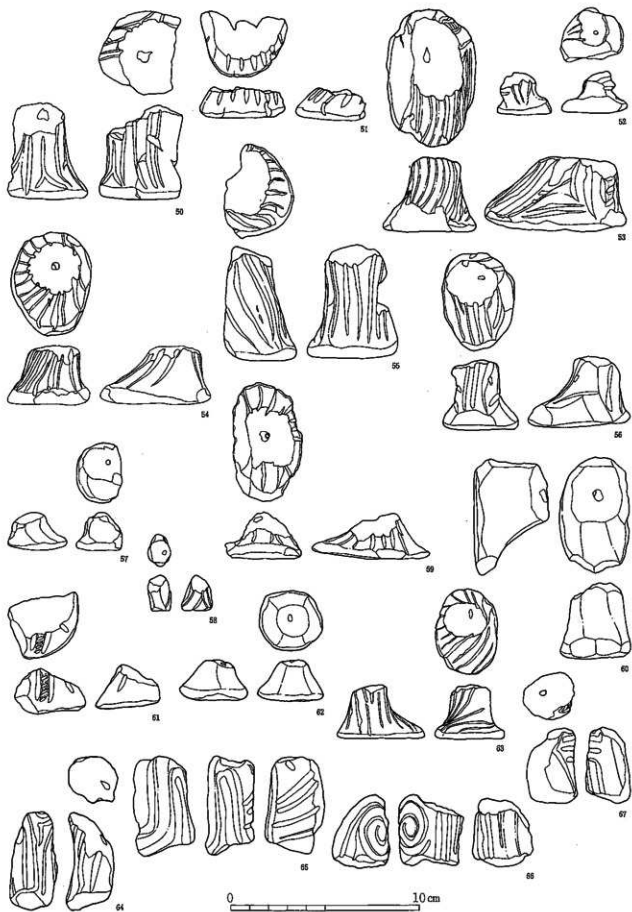

図版281 縄文時代の土製品(5) 1 : 2

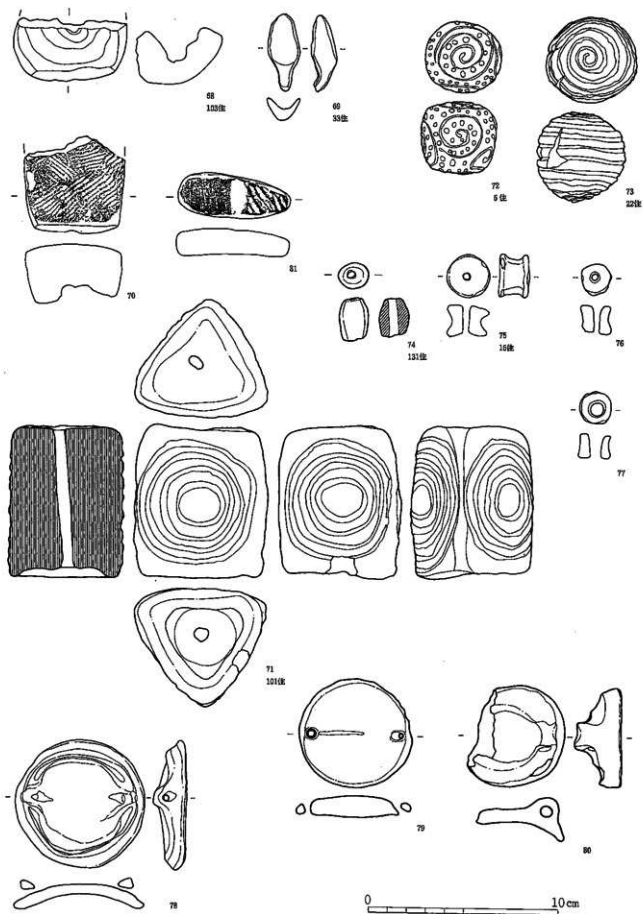

図版282 縄文時代の土製品(6) 1 : 2

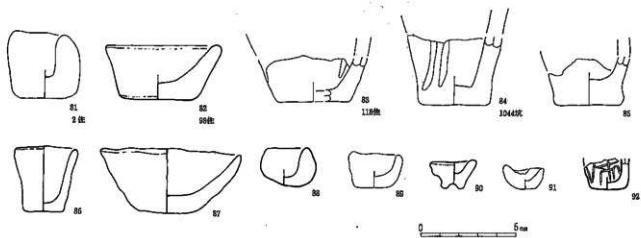

郷土遺跡 石器計測表(1)

番号	重さ(g)	石 材	番号	重さ(g)	石 材	番号	重さ(g)	石 材
1	4.9	黒曜石	46	0.6	黒曜石	91	0.9	黒曜石
2	1.8	チャート	47	1.5	チャート	92	0.7	黒曜石
3	0.5	黒曜石	48	1.1	チャート	93	0.8	黒曜石
4	0.7	黒曜石	49	1.6	玄武岩	94	1.1	チャート
5	0.7	黒曜石	50	1.0	黒曜石	95	0.4	黒曜石
6	4.6	チャート	51	1.2	黒曜石	96	2.2	玄武岩
7	0.4	黒曜石	52	1.5	黒曜石	97	0.9	黒曜石
8	0.7	黒曜石	53	2.3	黒曜石	98	10.5	チャート
9	1.0	チャート	54	0.6	チャート	99	3.1	チャート
10	1.8	安山岩	55	0.2	黒曜石	100	2.4	黒曜石
11	0.7	チャート	56	0.4	黒曜石	101	3.8	チャート
12	0.9	黒曜石	57	1.1	チャート	102	1.2	チャート
13	1.9	黒曜石	58	0.6	チャート	103	2.0	チャート
14	1.9	黒曜石	59	0.7	黒曜石	104	2.7	黒曜石
15	0.4	黒曜石	60	0.4	黒曜石	105	3.0	黒曜石
16	0.8	玄武岩	61	0.8	黒曜石	106	11.7	玄武岩
17	0.8	黒曜石	62	0.7	チャート	107	10.4	玄武岩
18	1.0	黒曜石	63	1.2	玄武岩	108	4.5	玄武岩
19	0.5	黒曜石	64	0.6	黒曜石	109	3.0	玄武岩
20	0.6	黒曜石	65	0.4	黒曜石	110	1.3	黒曜石
21	1.6	黒曜石	66	1.2	黒曜石	111	2.1	黒曜石
22	1.3	黒曜石	67	1.1	黒曜石	112	5.9	黒曜石
23	0.7	玄武岩	68	0.1	黒曜石	113	4.2	黒曜石
24	0.7	チャート	69	1.2	黒曜石	114	14.7	玄武岩
25	0.7	黒曜石	70	0.7	黒曜石	115	35.1	玄武岩
26	0.7	黒曜石	71	1.0	黒曜石	116	1.3	玄武岩
27	1.2	チャート	72	0.5	黒曜石	117	7.3	玄武岩
28	0.9	黒曜石	73	0.4	黒曜石	118	10.1	玄武岩
29	1.7	チャート	74	1.8	安山岩	119	10.4	安山岩
30	0.5	黒曜石	75	0.5	黒曜石	120	10.2	チャート
31	1.8	チャート	76	0.7	黒曜石	121	21.8	安山岩
32	0.3	黒曜石	77	0.5	黒曜石	122	18.7	玄武岩
33	0.3	黒曜石	78	0.5	黒曜石	123	13.5	チャート
34	0.6	黒曜石	79	0.7	黒曜石	124	12.6	玄武岩
35	0.6	黒曜石	80	0.9	黒曜石	125	11.5	安山岩
36	0.5	チャート	81	0.5	黒曜石	126	9.0	玄武岩
37	0.4	黒曜石	82	3.6	黒曜石	127	7.8	安山岩
38	1.0	チャート	83	4.5	たんばく石	128	2.0	黒曜石
39	1.8	玄武岩	84	2.1	黒曜石	129	5.5	玄武岩
40	0.6	黒曜石	85	1.2	黒曜石	130	7.5	安山岩
41	0.4	黒曜石	86	3.3	チャート	131	123.1	玄武岩
42	0.8	黒曜石	87	7.9	黒曜石	132	23.4	チャート
43	0.8	黒曜石	88	19.3	チャート	133	21.0	玄武岩
44	0.8	黒曜石	89	0.6	黒曜石	134	46.2	玄武岩質安山岩
45	1.8	黒曜石	90	2.4	黒曜石	135	11.2	黒曜石

舞土遺跡 石器計測表(2)

番号	重さ(g)	石 材
136	4.1	チャート
137	15.1	玄武岩
138	98.1	玄武岩
139	10.7	チャート
140	12.4	黒曜石
141	10.5	チャート
142	10.4	チャート
143	23.7	チャート
144	8.5	チャート
145	63.4	黒曜石
146	40.5	黒曜石
147	4.5	黒曜石
148	4.9	黒曜石
149	3.6	黒曜石
150	1.2	黒曜石
151	4.0	黒曜石
152	2.4	黒曜石
153	1.2	黒曜石
154	1.8	黒曜石
155	2.3	黒曜石
156	2.9	黒曜石
157	3.0	黒曜石
158	2.3	黒曜石
159	0.8	黒曜石
160	2.6	黒曜石
161	5.3	黒曜石
162	3.4	黒曜石
163	1.4	黒曜石
164	1.6	黒曜石
165	439.6	角閃輝石安山岩
166	74.4	粘板岩
167	167.0	粘板岩
168	39.1	粘板岩
169	71.7	粘板岩
170	76.6	粘板岩
171	205.5	はんれい岩
172	33.2	粘板岩
173	39.8	角閃輝石安山岩
174	17.7	粘板岩
175	8.0	粘板岩
176	8.2	チャート
177	20.1	粘板岩
178	5.7	チャート
179	15.4	粘板岩
180	5.3	粘板岩

番号	重さ(g)	石 材
181	23.5	粘板岩
182	364.3	粘板岩
183	282.5	粘板岩
184	329.1	蛇紋岩
185	313.5	粘板岩
186	224.9	砂岩
187	189.8	粘板岩
188	88.3	粘板岩
189	14.9	粘板岩
190	33.5	粘板岩
191	152.4	粘板岩
192	6.4	粘板岩
193	17.5	粘板岩
194	1.9	チャート
195	4.7	粘板岩
196	15.7	粘板岩
197	60.8	チャート
198	17.2	チャート
199	384.1	玄武岩質安山岩
200	614.8	角閃輝石安山岩
201	78.5	角閃輝石安山岩
202	96.9	安山岩
203	36.6	安山岩
204	137.0	玄武岩
205	263.2	安山岩
206	247.1	玄武岩
207	94.8	玄武岩
208	165.2	安山岩
209	60.1	玄武岩質安山岩
210	173.3	玄武岩
211	116.1	角閃輝石安山岩
212	329.4	安山岩
213	174.3	玄武岩
214	155.5	玄武岩
215	154.5	玄武岩
216	81.3	玄武岩
217	148.3	安山岩
218	162.9	玄武岩
219	78.3	玄武岩
220	72.9	玄武岩
221	240.8	玄武岩
222	165.5	角閃輝石安山岩
223	155.6	玄武岩
224	215.9	玄武岩
225	149.7	玄武岩

番号	重さ(g)	石 材
226	167.5	玄武岩
227	58.8	安山岩
228	140.2	玄武岩
229	123.3	玄武岩
230	103.4	玄武岩
231	187.3	玄武岩
232	133.8	玄武岩
233	59.0	角閃輝石安山岩
234	80.5	玄武岩
235	80.5	玄武岩
236	29.9	玄武岩
237	175.1	玄武岩
238	84.8	玄武岩
239	62.9	玄武岩
240	46.0	玄武岩
241	53.3	玄武岩
242	64.0	玄武岩
243	64.4	安山岩
244	83.3	玄武岩
245	89.7	玄武岩
246	222.2	玄武岩
247	121.4	玄武岩
248	149.4	安山岩
249	187.8	玄武岩
250	282.7	安山岩
251	142.5	玄武岩
252	140.0	玄武岩
253	122.2	玄武岩
254	93.7	玄武岩
255	233.5	安山岩
256	267.1	安山岩
257	255.7	玄武岩
258	134.1	角閃輝石安山岩
259	66.7	玄武岩
260	122.8	玄武岩
261	695.3	安山岩
262	2199	安山岩
263	158.5	安山岩
264	82.5	玄武岩
265	148.5	玄武岩
266	90.5	玄武岩
267	90.9	玄武岩
268	111.2	玄武岩
269	91.7	玄武岩
270	166.5	玄武岩

掘土遺跡 石器計測表(3)

番号	重さ(g)	石 材	番号	重さ(g)	石 材	番号	重さ(g)	石 材
271	232.1	安山岩	316	7.6	不明	361	583.1	安山岩
272	68.3	玄武岩	317	849.1	安山岩	362	777.0	安山岩
273	171.4	玄武岩	318	450.4	安山岩	363	472.1	安山岩
274	423.8	安山岩	319	142.8	安山岩	364	281.9	角閃輝石安山岩
275	191.3	玄武岩	320	237.2	安山岩	365	160.8	砂岩
276	96.7	玄武岩	321	132.9	安山岩	366	387.5	砂岩
277	116.1	角閃輝石安山岩	322	413.0	安山岩	367	457.1	安山岩
278	76.1	玄武岩	323	433.1	安山岩	368	476.5	角閃輝石安山岩
279	94.5	玄武岩	324	432.3	安山岩	369	638.2	輝石安山岩
280	58.3	玄武岩	325	299.1	安山岩	370	498.2	安山岩
281	132.4	玄武岩	326	234.0	輝緑凝灰岩	371	274.1	安山岩
282	60.4	玄武岩	327	116.3	安山岩	372	152.7	安山岩
283	11.5	玄武岩	328	334.9	安山岩	373	122.1	安山岩
284	94.0	玄武岩	329	275.4	安山岩	374	128.2	安山岩
285	132.2	玄武岩	330	347.5	玄武岩	375	503.9	砂岩
286	38.8	玄武岩	331	545.4	安山岩	376	205.9	安山岩
287	12.9	玄武岩	332	253.4	輝緑岩	377	181.8	安山岩
288	113.8	玄武岩	333	507.9	安山岩	378	281.9	角閃輝石安山岩
289	114.1	玄武岩	334	622.6	安山岩	379	525.3	安山岩
290	498.8	玄武岩	335	594.8	安山岩	380	375.4	安山岩
291	124.7	玄武岩	336	295.5	安山岩	381	240.1	輝石安山岩
292	18.0	玄武岩	337	137.0	チャー卜	382	416.9	角閃輝石安山岩
293	52.3	玄武岩	338	170.8	結晶片岩	383	648.0	角閃輝石安山岩
294	109.7	玄武岩	339	199.3	安山岩	384	100.0	流紋岩
295	24.4	玄武岩	340	128.0	安山岩	385	330.6	安山岩
296	77.3	玄武岩	341	640.0	安山岩	386	683.3	安山岩
297	659.1	玄武岩	342	687.3	安山岩	387	6400	角閃輝石安山岩
298	98.8	玄武岩	343	448.6	安山岩	388	8200	花崗岩
299	42.1	玄武岩	344	481.6	安山岩	389	4900	角閃輝石安山岩
300	86.5	玄武岩	345	442.0	安山岩	390	4500	輝石安山岩
301	74.4	玄武岩	346	331.6	安山岩	391	2200	角閃輝石安山岩
302	11.7	玄武岩	347	550.8	安山岩	392	4620	不明
303	47.8	玄武岩	348	619.7	安山岩	393	9000	不明
304	444.5	玄武岩	349	695.1	安山岩	394	4000	不明
305	84.3	玄武岩	350	584.3	安山岩	395	6200	不明
306	135.7	玄武岩	351	128.0	安山岩	396	37500	花崗岩
307	30.2	玄武岩	352	619.1	安山岩	397	4100	花崗岩
308	21.5	玄武岩	353	640.8	安山岩	398	1400	花崗岩
309	21.2	玄武岩	354	513.0	安山岩	399	3700	花崗岩
310	270.9	玄武岩	355	394.5	安山岩	400	2350	不明
311	168.3	玄武岩	356	448.0	安山岩	401	1300	不明
312	85.0	デイサイト	357	441.5	安山岩	402	120	不明
313	73.3	玄武岩	358	102.7	角閃輝石安山岩	403	6400	石墨片岩
314	55.9	玄武岩	359	769.4	安山岩	404	2380	不明
315	73.3	玄武岩	360	209.4	安山岩	405	4180	不明

郷土遺跡 石器計測表(4)

番号	重さ(g)	石 材	番号	重さ(g)	石 材	番号	重さ(g)	石 材
406	2400	不明	451	4400	不明	496	17500	輝石安山岩
407	3900	花崗斑岩	452	5000	溶岩	497	2000	輝石安山岩
408	5100	輝石安山岩	453	7000	浮石質安山岩	498	7000	輝石安山岩
409	4000	細粒花崗岩	454	5000	はんれい岩	499	4800	角閃輝石安山岩
410	750	不明	455	8400	角閃輝石安山岩	500	2200	角閃輝石安山岩
411	8000	不明	456	2800	安山岩	501	2400	安山岩
412	5800	不明	457	10600	角閃輝石安山岩	502	16500	輝石安山岩
413	17600	溶岩	458	4000	角閃輝石安山岩	503	16100	輝石安山岩
414	4000	角閃輝石安山岩	459	23600	溶岩	504	17800	輝石安山岩
415	3000	角閃輝石安山岩	460	1200	不明	505	14800	輝石安山岩
416	3200	角閃輝石安山岩	461	9000	角閃輝石安山岩	506	13900	輝石安山岩
417	2000	安山岩	462	4800	角閃輝石安山岩	507	2500	安山岩
418	5400	安山岩	463	2700	角閃輝石安山岩	508	4500	角閃輝石安山岩
419	5400	角閃輝石安山岩	464	16500	角閃輝石安山岩	509	2800	安山岩
420	2600	角閃輝石安山岩	465	9000	溶岩	510	17500	角閃輝石安山岩
421	500	安山岩	466	2000	安山岩	511	2600	角閃輝石安山岩
422	9600	角閃輝石安山岩	467	2600	角閃輝石安山岩	512	4800	輝石安山岩
423	7000	砂岩	468	11000	溶岩	513	18700	花崗岩
424	4100	角閃輝石安山岩	469	14000	角閃輝石安山岩	514	12500	角閃輝石安山岩
425	1800	安山岩	470	3800	輝石安山岩	515	14700	安山岩
426	3600	角閃輝石安山岩	471	3800	角閃輝石安山岩	516	3100	角閃輝石安山岩
427	14300	安山岩	472	2000	角閃輝石安山岩	517	3900	花崗岩
428	3500	角閃輝石安山岩	473	10400	溶岩	518	6100	輝石安山岩
429	7200	安山岩	474	4400	角閃輝石安山岩	519	4100	安山岩
430	5000	安山岩	475	3800	輝石安山岩	520	5900	花崗岩
431	4200	角閃輝石安山岩	476	3800	溶岩	521	5900	花崗岩
432	2900	細粒花崗岩	477	2600	安山岩	522	18700	花崗岩
433	3000	溶岩	478	1400	角閃輝石安山岩	523	9200	花崗岩
434	4000	安山岩	479	2500	角閃輝石安山岩	524	8100	花崗岩
435	4500	溶岩	480	4800	角閃輝石安山岩	525	8200	安山岩
436	4200	角閃輝石安山岩	481	4200	角閃輝石安山岩	526	18700	安山岩
437	1200	砂岩	482	18000	角閃輝石安山岩	527	5500	角閃輝石安山岩
438	5000	角閃輝石安山岩	483	4500	輝石安山岩	528	12500	花崗岩
439	10600	角閃輝石安山岩	484	3000	角閃輝石安山岩	529	28200	安山岩
440	15000	角閃輝石安山岩	485	16000	安山岩	530	5200	軽石
441	7200	角閃輝石安山岩	486	8900	溶岩	531	2200	軽石
442	3900	角閃輝石安山岩	487	7200	溶岩	532	2200	軽石
443	9500	溶岩	488	8000	溶岩	533	275.6	軽石
444	4400	輝緑岩	489	6000	輝石安山岩	534	48.0	軽石
445	2000	溶岩	490	26200	角閃輝石安山岩	535	188.7	軽石
446	5800	角閃輝石安山岩	491	5900	安山岩	536	1800	軽石
447	3800	角閃輝石安山岩	492	3200	不明	537	1400	軽石
448	3800	角閃輝石安山岩	493	7600	角閃輝石安山岩	538	4600	軽石
449	5400	角閃輝石安山岩	494	10300	輝石安山岩	539	388.2	軽石
450	3400	安山岩	495	2800	角閃輝石安山岩	540	734.1	軽石

写 真 图 版

遺跡群遠景 (西から)



遺跡群近景 (西から)



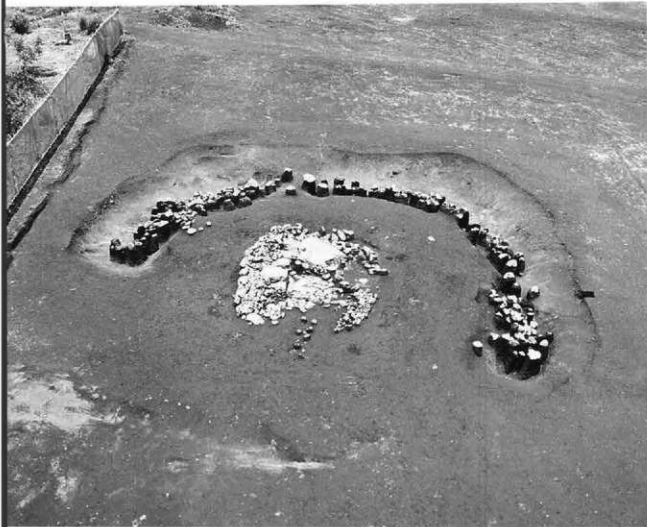

三子塚4号墳周溝礫
出土状態



左：三子塚4号古墳
周溝礫出土状態
右：三子塚4号古墳
完掘状態



左：三子塚4号古墳
石室
右：同上

左：三子塚4号古墳
掘方
右：三子塚4号古墳
支室内人骨出土
状態



左：三子塚4号古墳
羨道部遺物出土
状態
右：三子塚4号古墳
周溝内遺物出土
状態



平安時代の集落





左：1号整穴住居跡
右：同カマド



左：2号整穴住居跡
右：同カマド



左：4号整穴住居跡
右：同甕石出土状態

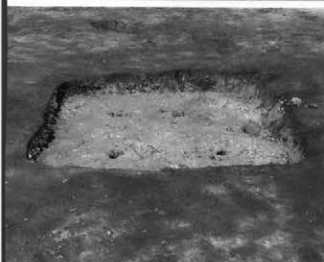

左：4号整穴住居跡
掘方
右：5号整穴住居跡

左：6号整穴住居跡

掘方



右：7号整穴住居跡

掘方



左：8号整穴住居跡

右：同カマド



左：9号整穴住居跡

右：同掘方

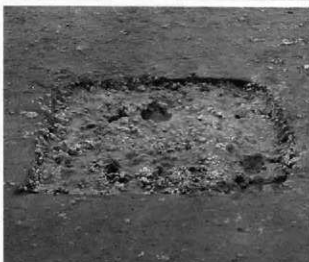
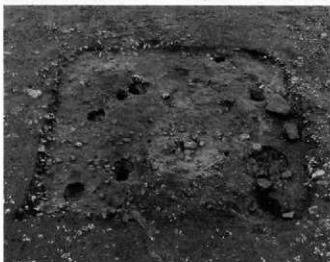

左：10号整穴住居跡

右：同カマド





左：12号竪穴住居跡
右：同跡石出土状態

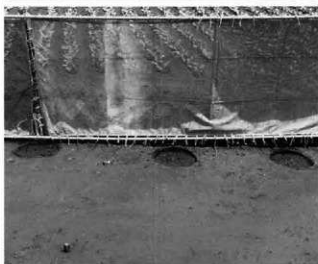
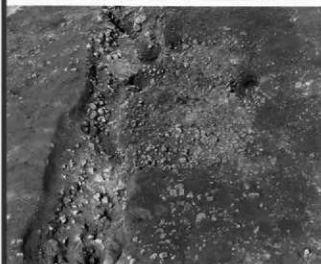

左：13号竪穴住居跡
右：1号掘立柱建物跡



左：1～5号流路跡
右：2～5号流路跡



左：畑跡
右：畑跡の畝間を覆う砂層

縄文時代から古墳時代の土器

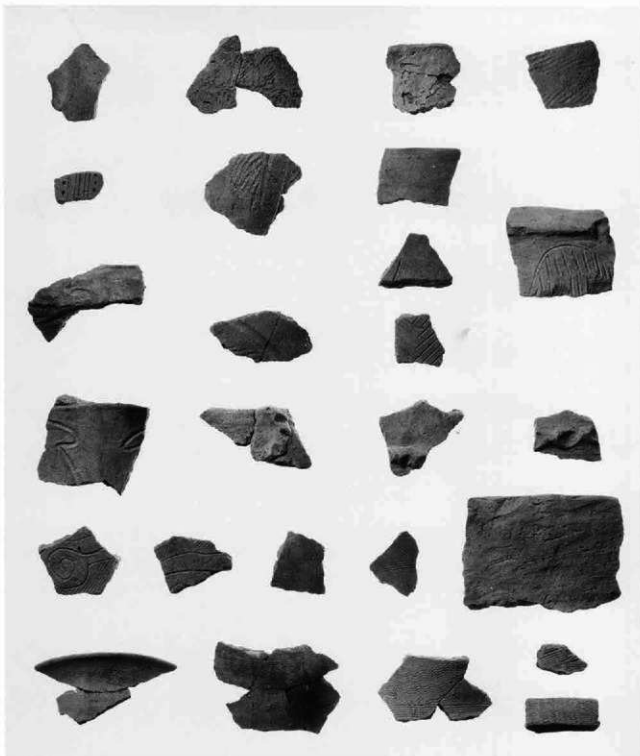

縄文時代の石鏃



縄文時代の打製石斧





1



2



3



5



6



8



12



13



14



15



16



17

左：6号竪穴住居跡

出土土器

右：9号竪穴住居跡

出土土器

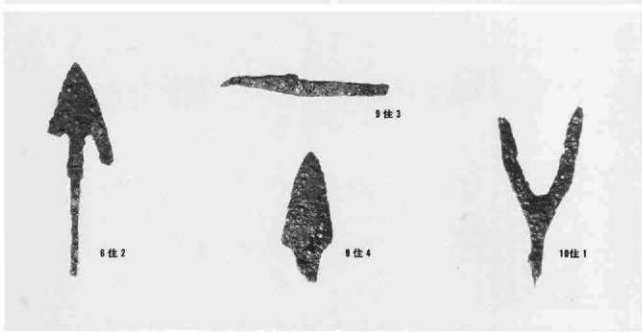
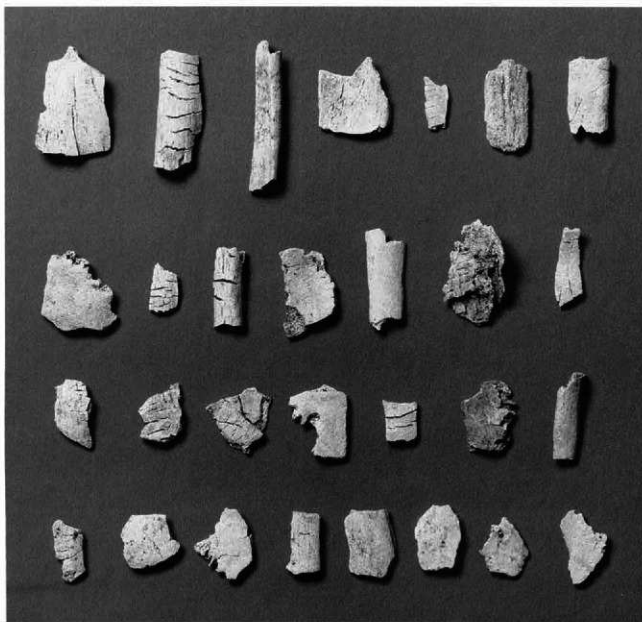

竪穴住居跡出土鉄器

三子塚4号古墳出土
人骨 (1:1)

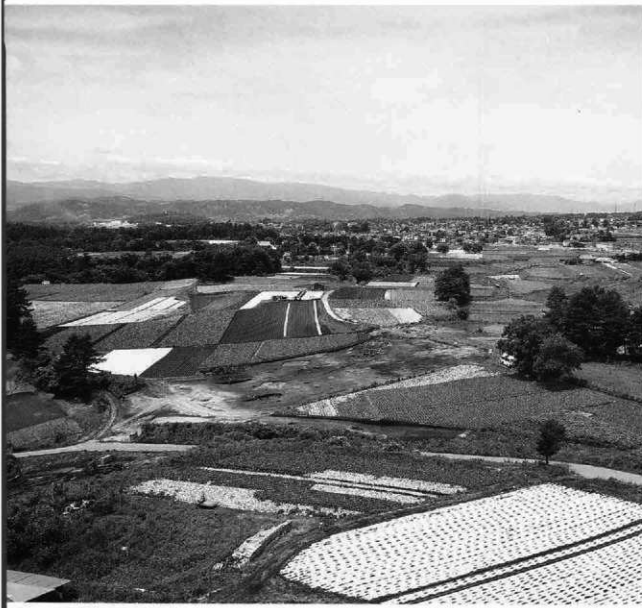

本線部分全景
(東から)



市道拡幅部分全景

環状集落北端部



1～3号竪穴住居跡
南側の掘出土状態





4号竪穴住居跡と石列

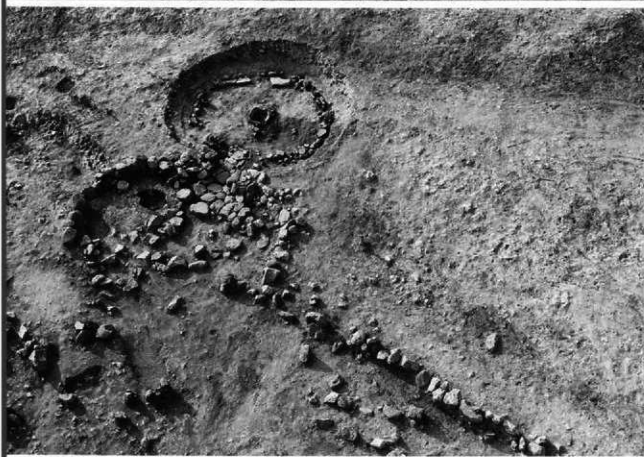

4号竪穴住居跡と石列



4号竪穴住居跡

4号竪穴住居跡

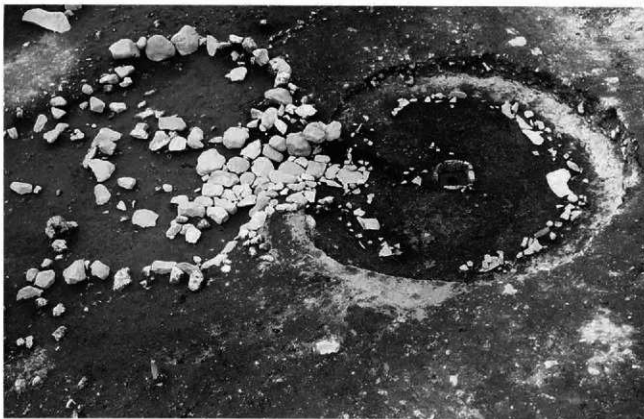
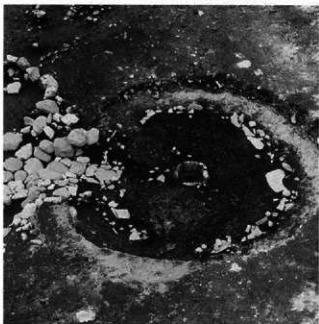
左：4号竪穴住居跡
主体部右：4号竪穴住居跡
炉4号竪穴住居跡石棒
出土状態



4号竪穴住居跡主体部煉石



左：4号竪穴住居跡主体部内煉石出土状態

右：4号竪穴住居跡張出部内煉石出土状態



7号竪穴住居跡

7号竪穴住居跡

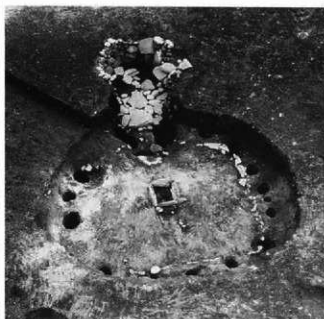

7号竪穴住居跡出土部





7号整穴住居跡主体
部縁石



7号整穴住居跡奥側
圍垣部



左：7号整穴住居跡
軽石製石鉢出土
状態

右：7号整穴住居跡
張出部掘方



左：7号整穴住居跡
張出部内軽石出
土状態

右：7号整穴住居跡
主体部内軽石出
土状態

11号竪穴住居跡



11号竪穴住居跡炉



左：11号竪穴住居跡埋築

右：11号竪穴住居跡
柱石出土状態

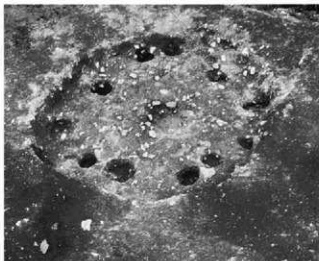

左：12号整穴住居跡
遺物出土状態
右：12号整穴住居跡
完掘状態



左：12号整穴住居跡
埋戻断面
右：13号整穴住居跡



左・右上：14号整穴
住居跡
右下：14号整穴住居跡
踏撤方



左：15号竪穴住居跡
右：17号竪穴住居跡



17号竪穴住居跡

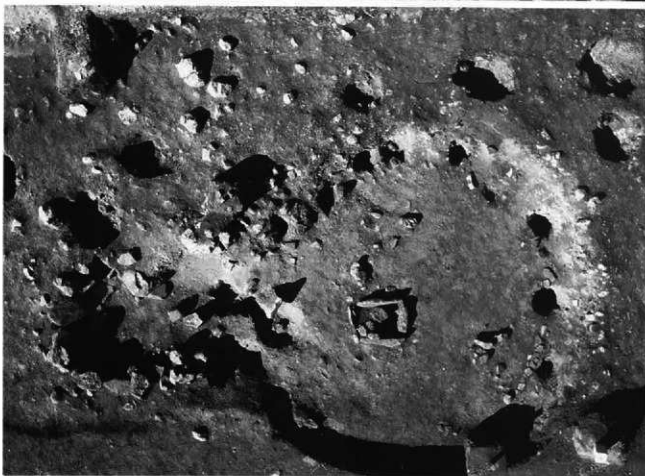

左：17号竪穴住居跡
張出部出入口部
右：17号竪穴住居跡
型





左・右上：18号竪穴
住居跡
右下：18号竪穴住居
跡張出部石積み
み状態



左・右上：18号竪穴
住居跡連
結部
右下：18号竪穴住居
跡掘方

左：19・20号竪穴住居跡
右：21号竪穴住居跡



左：22号竪穴住居跡
右：同炉



左：23号竪穴住居跡
右：24号竪穴住居跡





遺物溜まり完掘状態



左：遺物溜まり断面
右：遺物溜まり遺物
出土状態

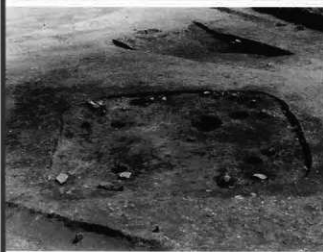

左：30号竪穴住居跡
完掘状態
右：30号竪穴住居跡
掘方



左：31号竪穴住居跡
遺物出土状態
右：31号竪穴住居跡
完掘状態

1号整穴住居跡出土
土器

1



2

左：1号整穴住居跡
出土器
右：4号整穴住居跡
出土土器

2



7

4号整穴住居跡出土
土器

1



2



3

6号整穴住居跡出土
土器(1)

3



2



1

左：6号竪穴住居跡
出土土器(2)
右：7号竪穴住居跡
出土器



6



2



5

8号竪穴住居跡出土
土器



1



1

左：9号竪穴住居跡
出土土器
右：10号竪穴住居跡
出土土器

11号竪穴住居跡出土
土器(1)







13



14



16



20



22



25

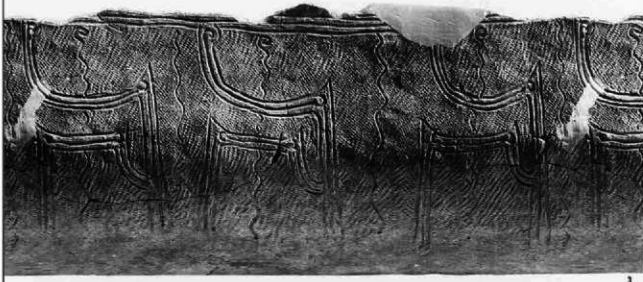

13号竪穴住居跡出土
土器

1



2

左：13号竪穴住居跡
出土土器
右：14号竪穴住居跡
出土土器

3



1

14号竪穴住居跡出土
土器

3



5

左：22号竪穴住居跡
出土土器
右：23号竪穴住居跡
出土土器

1



1

左：8号土坑出土
土器
右：23号土坑出土
土器



遺物溜まり出土土器
(1)





66



93



132



92



91



109



193



242

左：石槌
中：石鏃
右：石匙



遺外 1



遺溜 246



4 位 16



4 位 17



4 位 18



32 位 1



遺溜 247



遺溜 248



遺溜 249



遺溜 252



遺溜 254



遺溜 259



遺溜 261



遺溜 262



遺溜 265



遺溜 274



遺溜 273



遺溜 276



遺溜 280



遺溜 283

特殊磨石・凹石・磨石・敲石



遺溜 284



2 位 10



2 位 9



2 位 18



4 位 18



4 位 21



4 位 22



4 位 24



5 位 12



7 位 14



11 位 20



14 位 19



17 位 13



23 位 2



14 位 1



遺溜 281



遺溜 286



遺溜 285



遺溜 289

磨製石斧



打製石斧

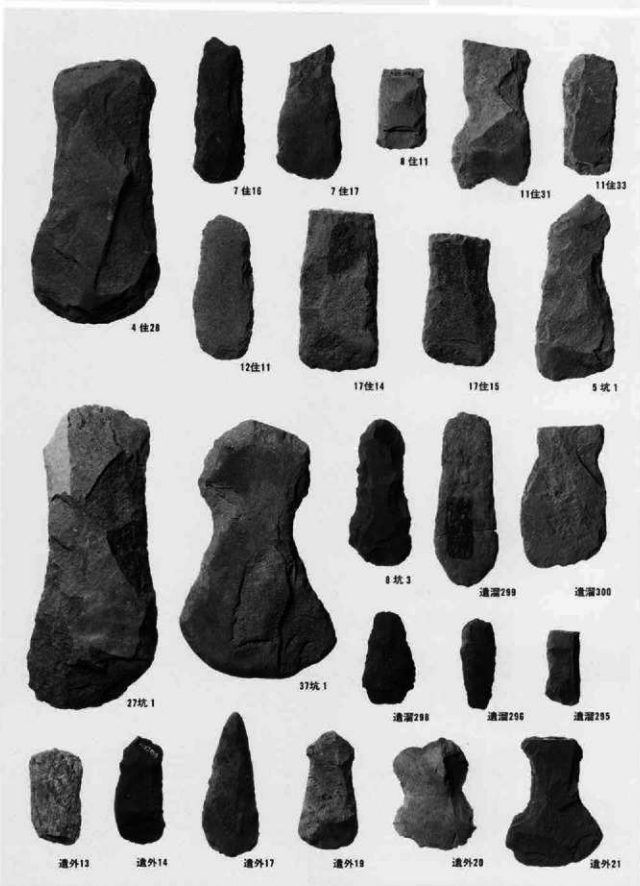

砥石



多孔石

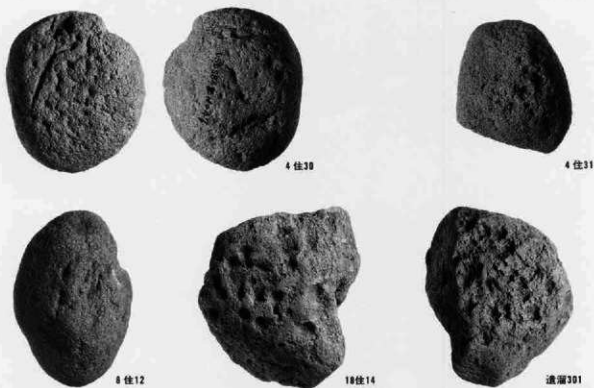

石皿

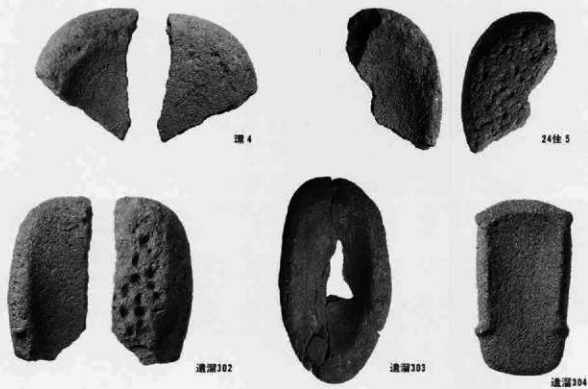

丸石

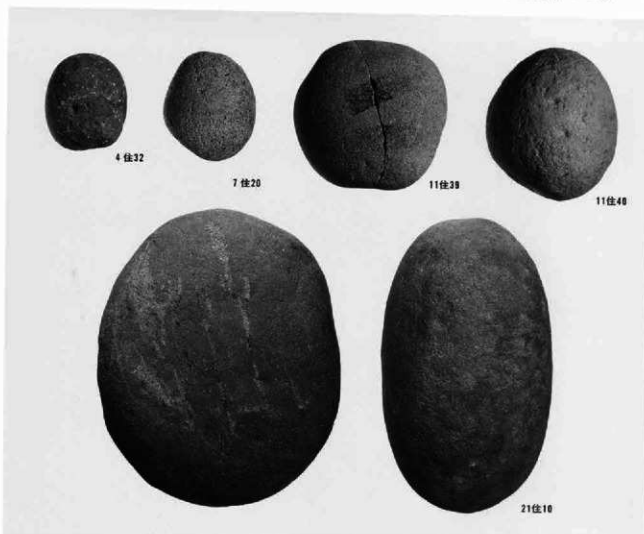

石棒及び類似品

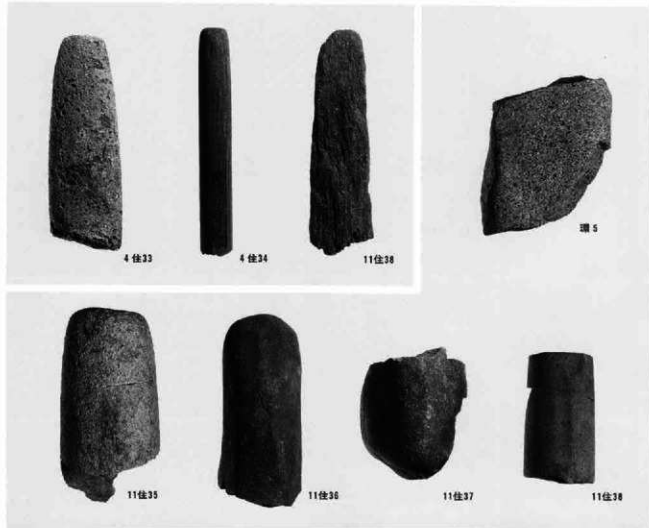



7 住22



18 住13



7 住19



11 住41



22 住13



22 住14



22 住15



遺溜308



遺溜306



遺溜307

軽石製品



現 3



2 住13



4 住36



5 住14



遺外24



遺外25

玉類



11 住42

遺跡全景 (南から)



遺跡東半部





左：2号壑穴住居跡
右：5号壑穴住居跡

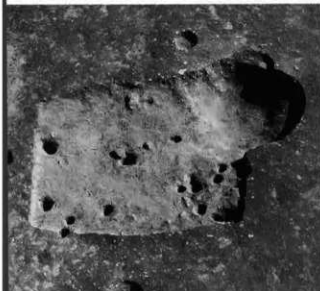

左：10号壑穴住居跡
右：12号壑穴住居跡



後期前半の環状集落
北端部





後期前半の環状集落
の石列根石出土状態



後期前半の環状集落
の南側を取り巻く土
坑群





13号整穴住居跡



13・14号整穴住居跡



15号整穴住居跡

15号整穴住居跡



16号整穴住居跡





左：18・32号整穴住居跡
右：19-22号整穴住居跡

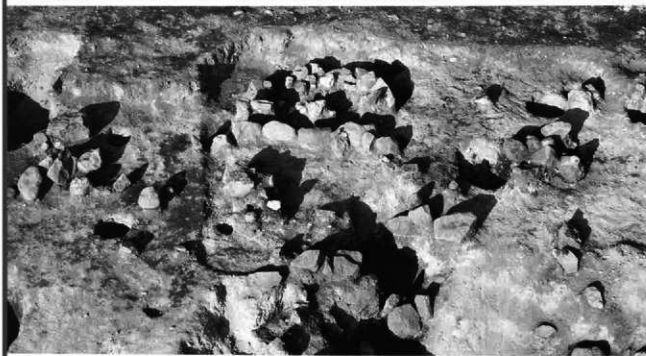

23-27号整穴住居跡



左：1号石棺檢出状態
右：1号石棺

石列を伴う28・29号
竪穴住居跡



左：28号竪穴住居跡
右：29号竪穴住居跡



左：31号竪穴住居跡
右：34～36号竪穴住居跡



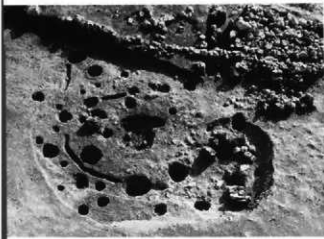

左：37～39号竪穴住居跡
居跡

右：40号竪穴住居跡

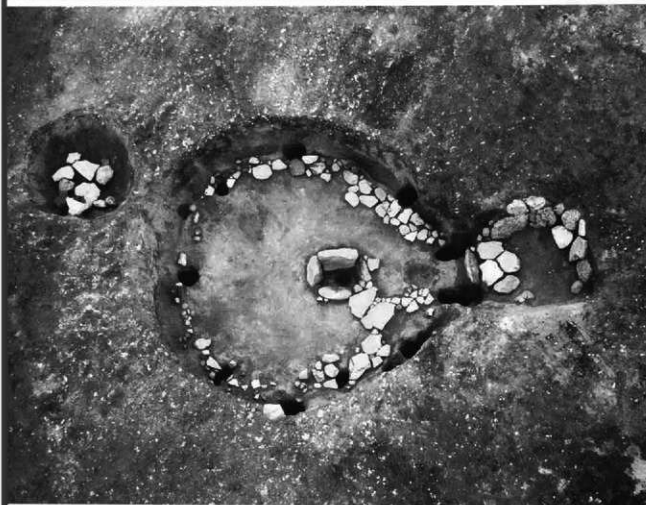

41号竪穴住居跡



左：41号竪穴住居跡
右：41号竪穴住居跡
掘出部

左：43号竪穴住居跡
右：43号竪穴住居跡
連結部



左：43号竪穴住居跡
張出部横方
右：44号竪穴住居跡

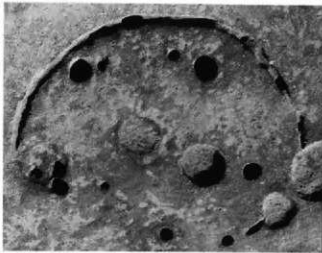

1号平地式住居跡



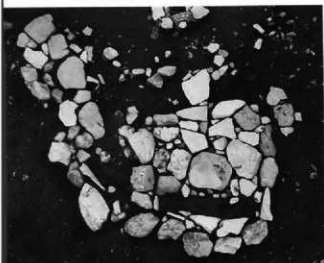

左：1号平地式住居
跡張出部
右：1号平地式住居
跡炉



左：7号土坑
右：7号土坑土層斷
面



7号土坑遺物出土狀
態

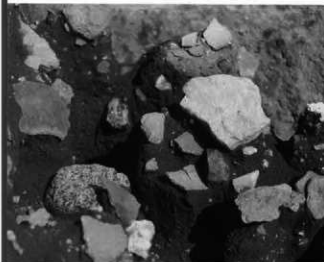

左：7号土坑遺物出
土狀態
右：7号土坑獸骨出
土狀態

左：9号土坑
右：10号土坑



左：22号土坑
右：23号土坑



左：47号土坑
右：59号土坑



左：61・62号土坑
右：61号土坑

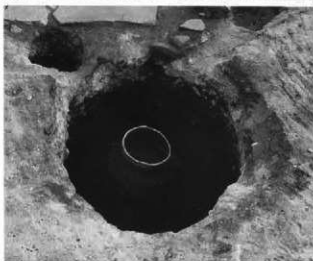



左：64号土坑
右：65号土坑



左：71号土坑
右：74号土坑



左：83号土坑
右：84号土坑



左：87号土坑
右：104号土坑

左：107号土坑
右：117号土坑



左：122号土坑
右：123号土坑



左：48号竪穴住居跡
右：48号竪穴住居跡
カマド



19号竪穴住居跡



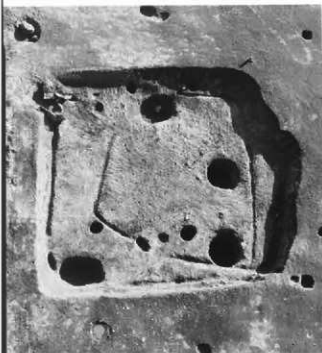

左：47・50号竪穴住居跡

右：50号竪穴住居跡遺物出土状態



50号竪穴住居跡カマド

下



左：50号竪穴住居跡カマド検出状態

右：50号竪穴住居跡内ピット

左：3号竪穴住居跡
出土土器
右：1号土坑出土土
器

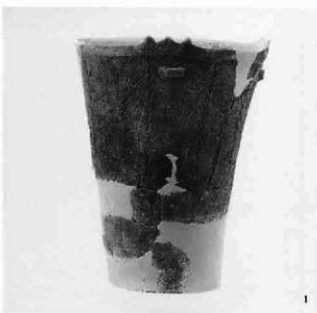

左：2号土坑出土土
器
右：13号竪穴住居跡
出土土器



13号竪穴住居跡出
土器





14号竪穴住居跡出土
土器



16号竪穴住居跡出土
土器



左：19号竪穴住居跡
出土土器
右：20号竪穴住居跡
出土土器



21号竪穴住居跡出土
土器

28号竪穴住居跡出土
土器



29号竪穴住居跡出土
土器

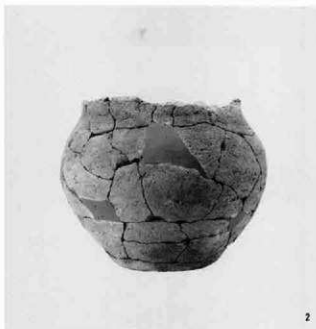

左上：34号竪穴住居
跡出土土器

左下・右：37号竪穴
住居跡出
土土器





37号壑穴住居跡出土
土器1 展開写真



40号壑穴住居跡出土
土器

2



1



2

7号土坑出土土器(1)



5



6



7

7号土坑出土土器(2)





1



1

左：22号土坑出土土器

右：23号土坑出土土器

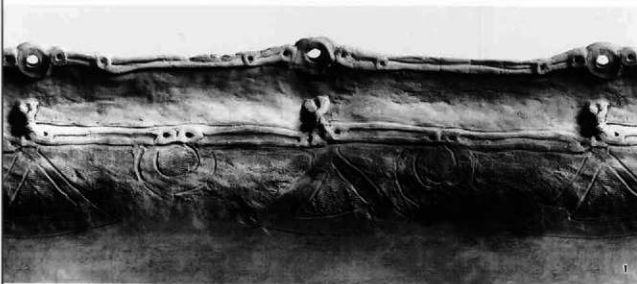

1

23号土坑出土土器1
展開写真



1

48号土坑出土土器



1



1

左：61号土坑出土土器

右：69号土坑出土土器

76号土坑出土土器



77号土坑出土土器



左：78号土坑出土土器

右：84号土坑出土土器



左：97号土坑出土土器

右：117号土坑出土土器



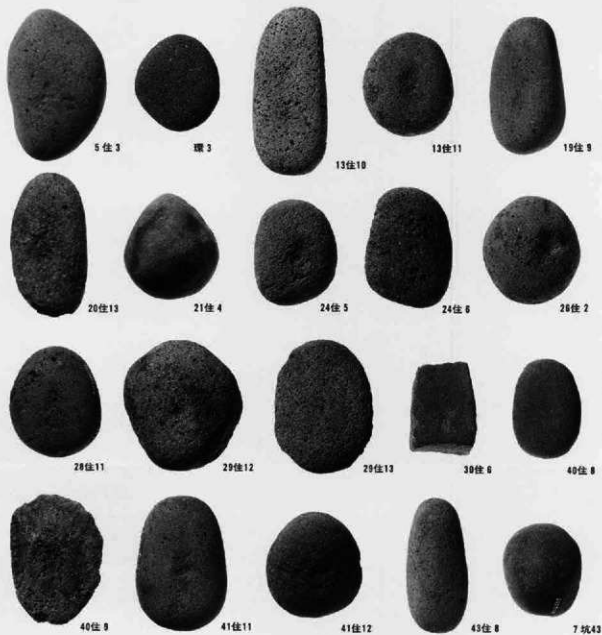

磨製石斧

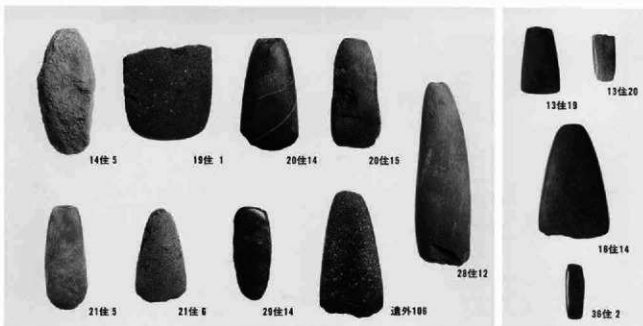

打製石斧

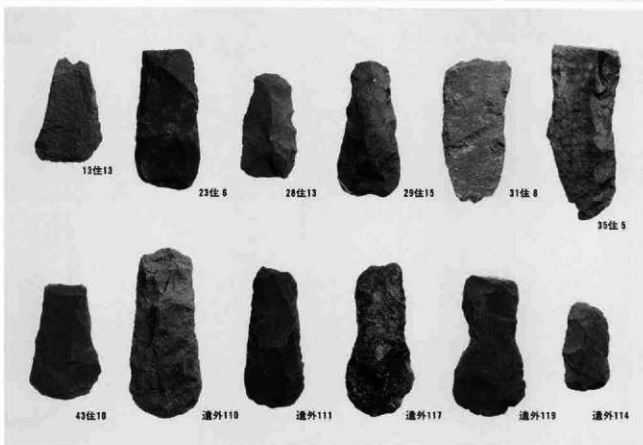

砥石

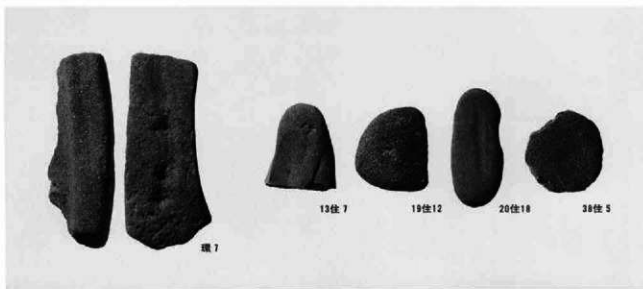



環11



環12



環14



環13



環15



環16



13位22



19位15



20位22



24位7



29位17



62坑1



104坑2



104坑3



104坑4



104坑5



110坑1



116坑1



遺外100



遺外129

石皿

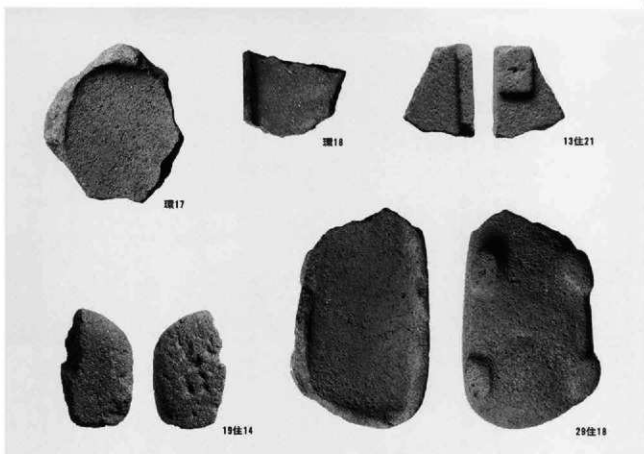

丸石

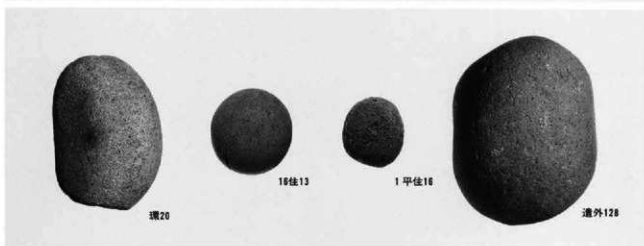

石棒

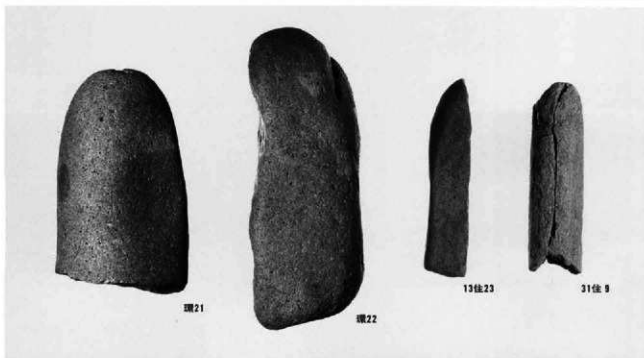

石棒

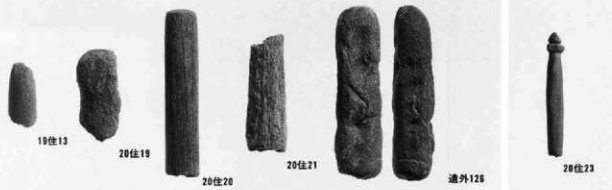

左：石錘
右：磨石？

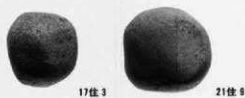

軽石製品



軽石製石鉢



玉類

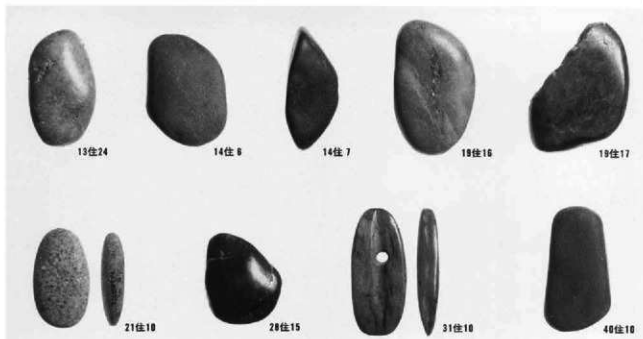

左 : 土偶
 左中 : 土製蓋
 右中 : 土製円盤
 右 : 土製品

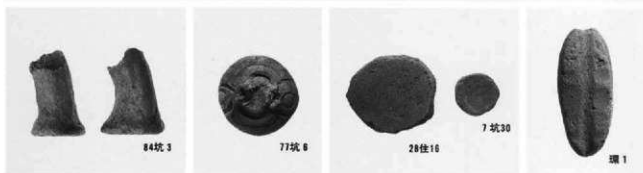

7号土坑出土獣骨
 (1 : 3)

1. シカ肩甲骨、2. シカ腕骨、3. シカ下顎左、4. シカ右下顎第三後臼歯、5. シカ頸椎、6. シカ中足骨、7. シカ脛骨、8. シカ肋骨、9. シカ中指骨、10. シカ踵骨、11. シカ末指骨、12. シカ部位不明





石神遺跡群遠景
(南から)

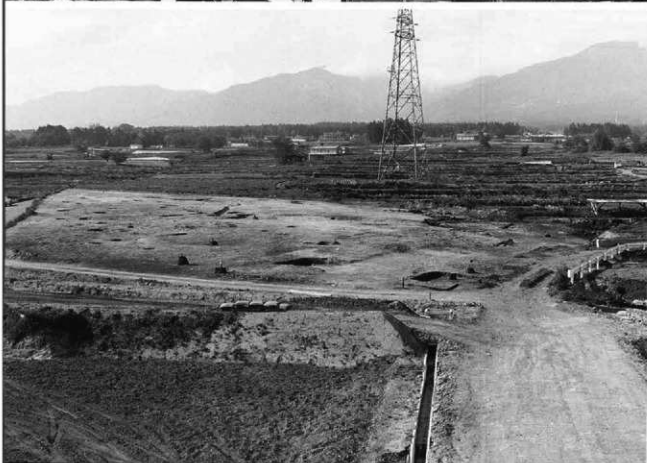

調査区全景(南から)



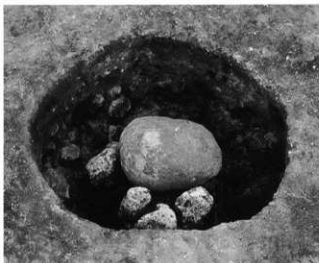

左：9号土坑
右：10号土坑



左：11号土坑
右：12号土坑



左：24号土坑
右：30号土坑



左：32号土坑
右：43号土坑

左：51号土坑
右：集石土坑



左：1号整穴住居跡
右：2号整穴住居跡

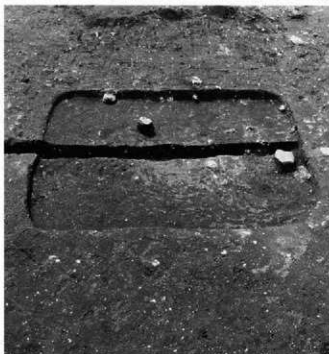

左：3号整穴住居跡
右：1号大形土坑





1



1



18

左 : 51号土坑出土
土器
右上 : 54号土坑出土
土器
右下 : 遺構外出土
土器

土坑出土土器(1)



1坑 1



2坑 1



1坑 2



2坑 2



9坑 1



12坑 1



25坑 1



41坑 1



12坑 2



25坑 2



41坑 2



43坑 1



12坑 3



25坑 3



41坑 3

土坑出土土器(2)

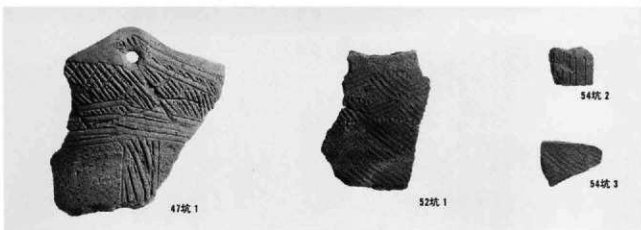

道構外出土土器

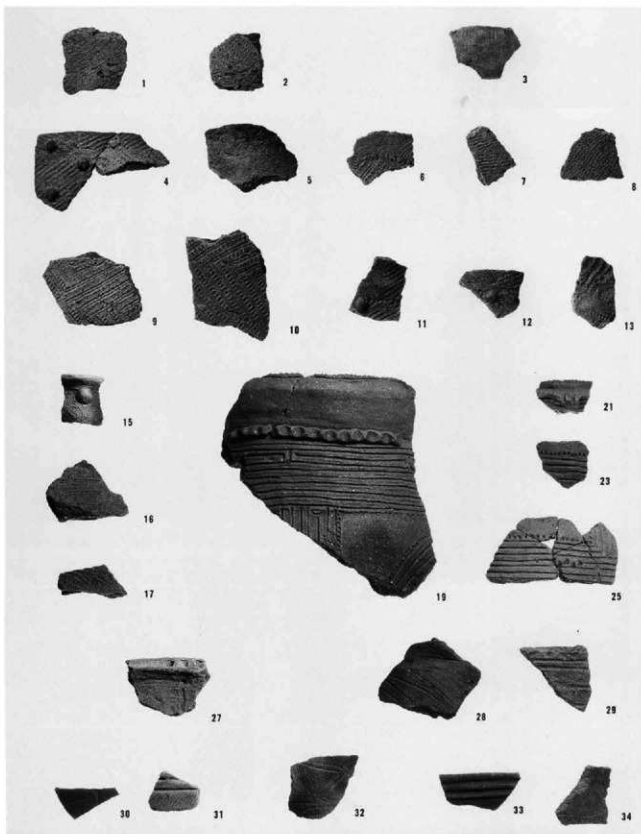

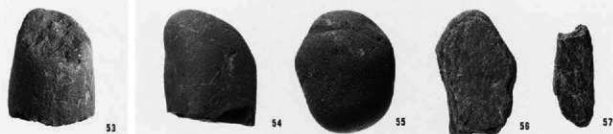
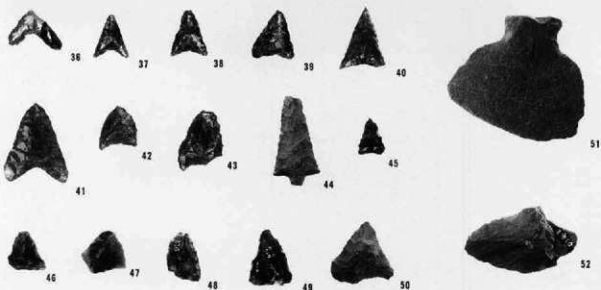

3



1



4



1



1



1

2号壑穴住居跡出土
遺物

左：1号壑穴住居跡
出土土器

中：3号壑穴住居跡
出土礫石

右：1号大形土坑出
土土器

郷土遺跡全景
(モザイク処理)



郷土遺跡から南西方向をみる
(平成5年度)



郷土遺跡から南方向をみる



平成4年度調査地区



左：平成5年度調査地区

右：平成5年度44号住居付近



平成6年度調査地区



左：平成6年度調査地区

右：平成7年度調査地区



平成5年度発掘従事者



平成6年度発掘従事者



整理作業従事者



9号住居



左 : 27号住居
右上 : 59号住居
右中 : 61号住居



左 : 36号住居
右下 : 63号住居



左 : 1号住居
右上 : 1号住居炉



左 : 2号住居
右上 : 2号住居炉
右 : 3号住居炉



左 : 3号住居





左：4号住居と17号
住居
右：4号住居伊



5号住居と6号住居



左：6号住居埋裏
右：8号住居埋裏

10号住居(左)と11号
住居(右)



左：10号住居炉
右：11号住居土器出
土状況



12号住居(右中)、15
号住居(右下)と20号
住居(左上)





左：14号住居遺物
出土状況
右上：14号住居
右下：14号住居の土
器(44、45他)



左：14号住居遺物出
土状況
右：同上



左：14号住居完掘
右上：14号住居の
覆石
右下：14号住居が休
土器



左：15号住居炉
右：16号住居炉

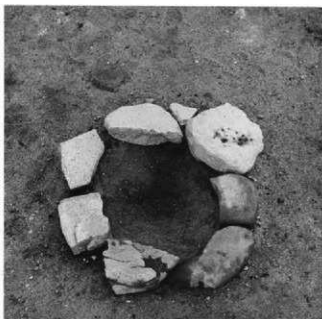

左：16号住居
右：16号住居の土器
(70)出土状況



17号住居





左：18号住居炉
右：19号住居炉



18号住居(右)、19号
住居(中)、21号住居
(左)



左：21号住居炉
右：22号住居

24号住居遺物出土状況



24号住居の遺物

左：土器109(内)
と110(外)
右：土器109(左)
と111(右)



24号住居の状況

左：平成4年度
右上：遺物出土状況
右下：埋戻



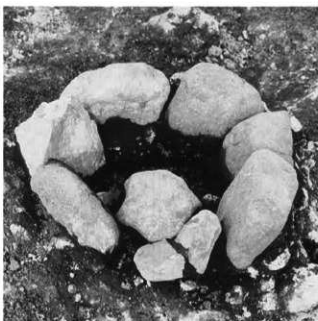

左：25号住居の土器
集中

右：25号住居炉



25号住居



左：28号住居

右：30号住居

左：32号住居
右：32号住居炉



左：33号住居
右：33号住居炉

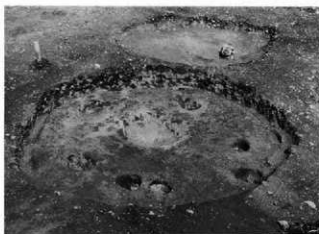

左：33号住居調査中



左：37号住居
右：37号住居炉





左：38号住居
右：38号住居炉



39号住居遺物出土状
況



左：39号住居埋壁
右：39号住居



左：40号住居
右：40号住居炉

左：41号住居(下)と
49号住居(上)
右：43号住居

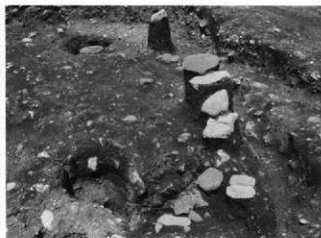

左：41号住居炉
右上：43号住居炉
右下：42号住居炉



42号住居(左)と43号
住居(右)





44号住居跡



左：44号住居
右：44号住居の土器
181



44号住居の土器180

47号住居(左上)、45
・46号住居(中右)、
49号住居(中左)、41
号住居(下左)、集石
1・集石2(下右)

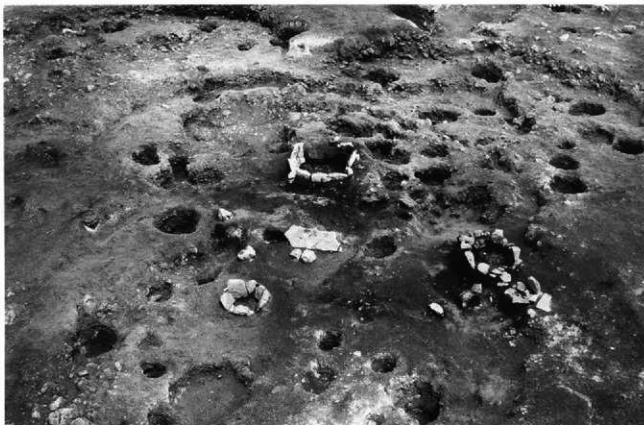

左：45号住居炉
右：49号住居炉



左：48号住居
右：49号住居



左：48号住居炉
右：50号住居

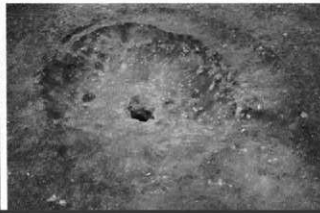



左：60号住居の検出
右：60号住居の調査



左：60号住居遺物出土状況
右：60号住居P1



左：60号住居遺物出土状況
右：60号住居P7



左：60号住居遺物出土状況
右：60号住居完掘

左：64号住居炉
右：69号住居



左：70号住居
右：69号住居炉

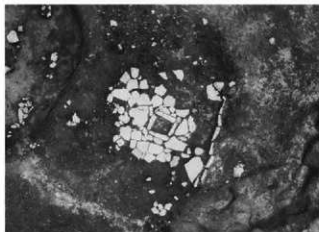

70号住居調査風景



左：70号住居炉
右：70号住居埋裏



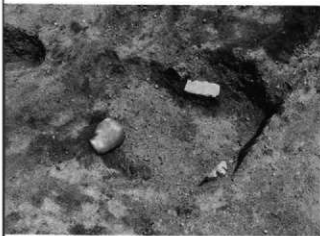

左：71号住居炉
右：71号住居埋裏

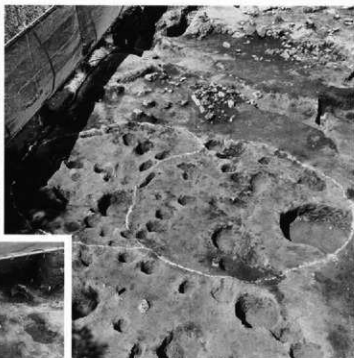

左：72号住居炉
右：71号住居(右)と
75号住居(左)

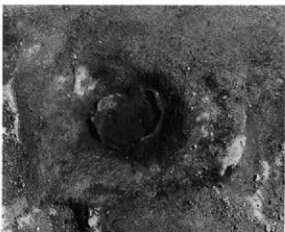

左：72号住居
右：75号住居埋裏の
検出



左：72号住居埋裏
右：75号住居埋裏

左：76号住居(上)、
77号住居(下右)
と79号住居(下
左)
右：76号住居炉

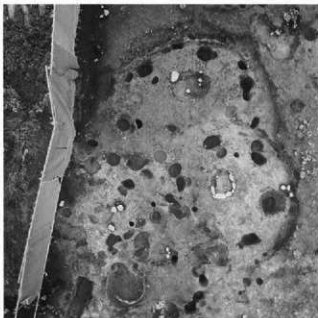

左：76号住居遺物出
土状況
右：76号住居の土器
220と221



77号住居遺物出土状
況

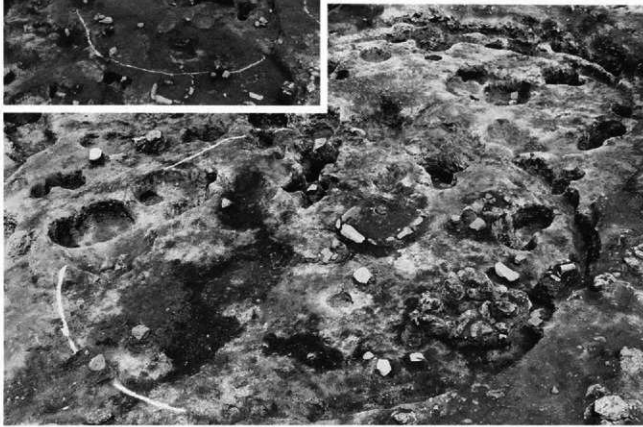

左：77号住居の土器
235
右：77号住居炉





左：80号住居炉
右：80号住居



左：81号住居軒石出土状況
右：81号住居埋篋



左：81号住居の調査
右：81号住居P2



左：81号住居完掘
右：81号住居炉

83号住居(空掘)

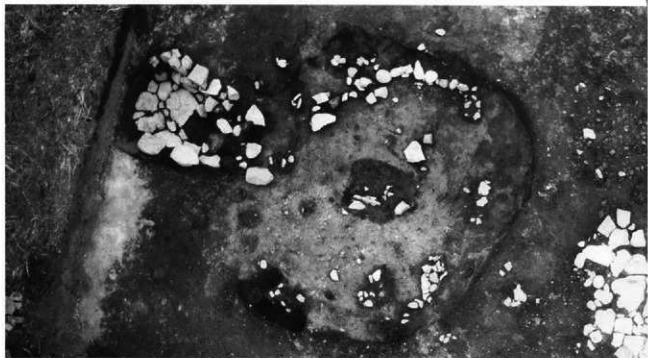

左：83号住居柱石出土状況

右：83号住居石棒(401)出土状況



左：83号住居動物骨出土状況

右：83号住居炉



左：83号住居柄部

右：83号住居





左：78号住居伊
右：84号住居伊



左：82号住居
右：82号住居埋壁



84号住居(上)、78号
住居(中)、87号住居
(下)



左：88号住居 P7取
出
右：88号住居

左：89号住居
 右：89号住居土器集中
 中（軽石で被覆）



左：89号住居
 右：89号住居炉



89号住居土器集中



左：90号住居軽石出土状況
 右：90号住居炉



91号住居(上)と92号
住居(下)の軽石



左上：91号住居の土
器282
左下：91号住居炉
右：91号住居



左下：92号住居P5
右：93号住居



左 : 94号住居石棒
(403)、石置
出土状況
右上 : 94号住居P6
右下 : 94号住居(上)、
95号住居(下)
遺物出土状況



左 : 94号住居炉



左 : 96号住居
右 : 97号住居炉(軽
石で被覆)



左 : 96号住居炉
右 : 97号住居炉





左：98号住居
右：98号住居炉



左：99号住居炉
右：102号住居炉



99号住居(上右)、
102号住居(上左)、
104号住居(下左)

101号住居

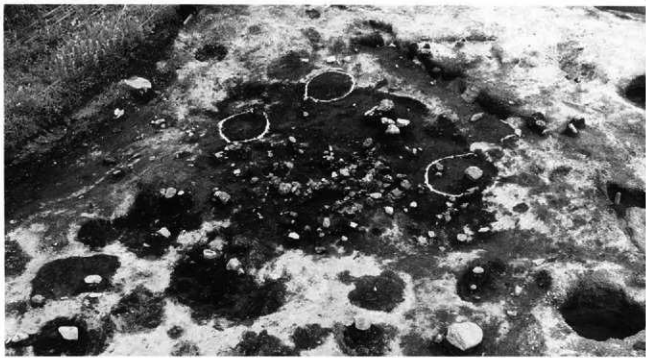

左：101号住居三角
柱状土製品出土
状況
右：101号住居炉



左：103号住居
右上：103号住居炉
右下：103号住居磨
製石斧(186)
出土状況





左：104A号住居
右：104B号住居



左：104A号住居
(上)と104B号
住居(下)の敷石
検出
右：104A号住居と
104B号住居の
炉



左：104A号住居の
土器348出土状
況
右：104B号住居P30

左：105号住居炉
右：107号住居検出



左：106号住居P1検出
右：107号住居



左：106号住居P1
右：107号住居

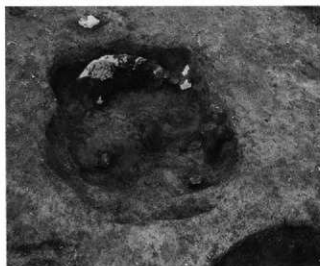

左：106号住居
右：107号住居炉

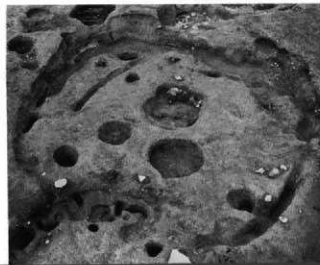



左：108号住居 P14
上面の土器369
右：108号住居と113
号住居

左：110号住居の土
器373出土状況
右：109号住居の埋
没が

左：110号住居
右：109号住居

左：110号住居が
右：109号住居の土
器371出土状況

左：111号住居炉
右：114号住居P6



左：112号住居
右上：114号住居
右下：116号住居



左：112号住居北側
敷石
右：116号住居

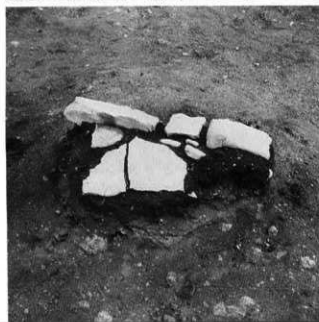

118号住居



左：118号住居跡
右：119号住居跡



左下：120号住居
右上：119号住居埋
壘
右下：120号住居跡

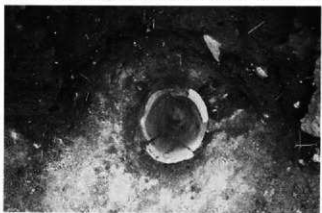

左：121号住居
右：123号住居



左：121号住居埋裏
右：123号住居土器
敷炉



左：124号住居炉
右：124号住居埋裏
炉



左：124号住居柱石
製埋裏
右：124号住居





左：129号住居(上)
127号住居(中)
126号住居(下)
右：126号住居



左：126号住居炉
右：128号住居炉



左：128号住居
右：130号住居



左：131号住居
右：132号住居P4

左：63号土坑断面
右：1162号土坑



左：63号土坑
右上：40号土坑
右下：50号土坑

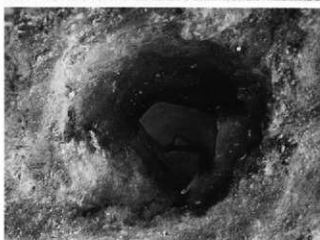

左：292号土坑
右：292号土坑完掘



293号土坑



左：321号土坑檢出
右：324号土坑(左)
355号土坑(右)



左：321号土坑
右：324号土坑



左：441号土坑
右：571号土坑断面



703号土坑



左：703号土坑
右：769号土坑横出



左：1042号土坑断面
右：769号土坑



左：1072号土坑
右：769号土坑石棒
(409)





左：1104号土坑土器
(647)出土状況
右：1104号土坑

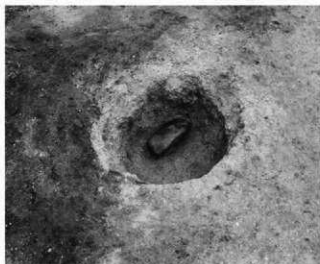

左：1116号土坑
右：1117号土坑



左：1120号土坑
右：1121号土坑



左：1125号土坑
右：1127号土坑

左：1133号土坑
右：1133号土坑断面



左：1135号土坑
(右)と1140号
土坑(左)
右上：1134号土坑
右下：1136号土坑

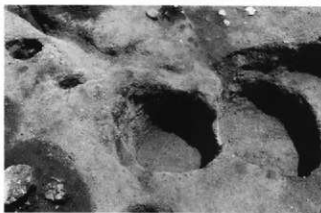

左：1137号土坑
右：1142号土坑



左：1149号土坑検出
右：1149号土坑

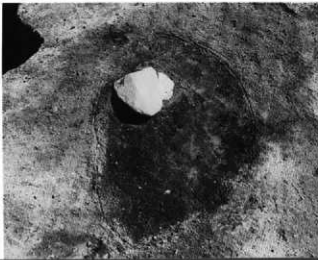



左：1150号土坑
右：1151号土坑



左：1154号土坑
右：1158号土坑

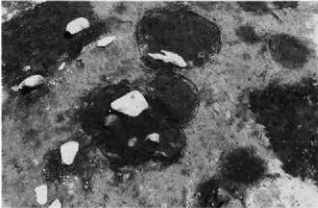

左：1170号土坑
右：1172号土坑(中上)、1173号土坑(中中)、1174号土坑(中下右)、1175号土坑(中下左)



左：1173号土坑
右：1178号土坑

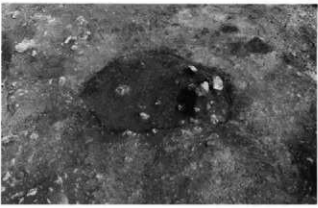

左：1179号土坑
右：1181号土坑

左：1192号土坑
右：1190号土坑

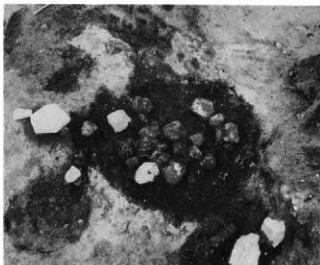

左：1204号土坑
右：1209号土坑



左：1210号土坑
右：1211号土坑



左：1212号土坑
右：1214号土坑



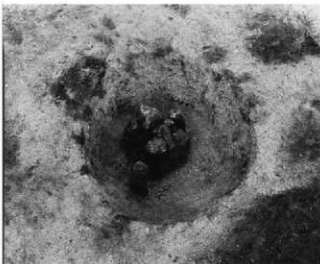

左：1216号土坑
右：1223号土坑

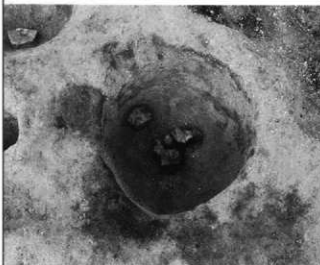

左：1227号土坑
右：1232号土坑映出



左：1233号土坑(右)
1234号土坑(左)
右：1235号土坑



左：1236号土坑
右：1238号土坑

左：1239号土坑
右：1244号土坑



左：1247号土坑
右：1248号土坑

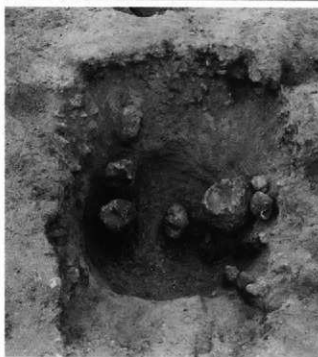

左：1249号土坑



左：1253号土坑
右：1255号土坑





左：1257号土坑
右：1258号土坑



左：1260号土坑
右：1267号土坑



左：1269号土坑調査
右：1269号土坑



左：1270号土坑
右：1271号土坑

1276号土坑(上)、
1274号土坑(中)、
1275号土坑(下)



左：1276号土坑
右：1277号土坑



左：1279号土坑
右：1283号土坑



左：1280号土坑
右：1290号土坑



左：1294号土坑横出
右：1296号土坑断面

1308号土坑断面

左：1304号土坑
右：1309号土坑(中)
1310号土坑(右)
1313号土坑(右)

左：1314号土坑
右：1333号土坑横出

1339号土坑と土器集中1の検出



左：1339号土坑
右：1344号土坑



左：1346号土坑
右：1362号土坑



左：1370号土坑検出
右：1372号土坑





左：1373号土坑検出
右：1379号土坑検出



左：1374号土坑と土器943
右：1390号土坑



左上：1389号土坑
左下：1391号土坑
右：1392号土坑



左：1394号土坑
右：1406号土坑



左：集石1(上)と集石2(下)
右：単独土器5



左：集石1
右：単独土器6



左：土器集中2



左：土器集中2(土器995)
右：単独土器11



左：土器集中1
右：0-14グリッド紙
石出土状況



左上：郷土2号墳の
確認
左下：郷土2号墳人
骨出土状況
右：郷土2号墳ト
レンチ



左：郷土2号墳
右：郷土2号墳人
骨出土状況



郷土2号墳石室



左：100号住居遺
右：1号溝断面図A



左：1号溝(平成4年度)
右：1号溝断面C

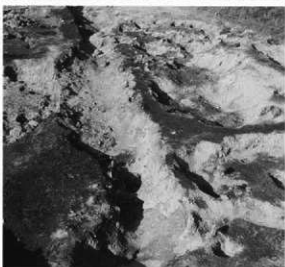

1号溝(平成6年度)





1
(9住)



2
(27住)

3
(27住)



4
(36住)



5
(36住)



6
(36住)



7
(36住)



8
(61住)



10
(61住)



9
(36住)



11
(61住)



12
(61住)



13
(61住)



15
(61住)



16
(61住)



17
(61住)



18
(61住)

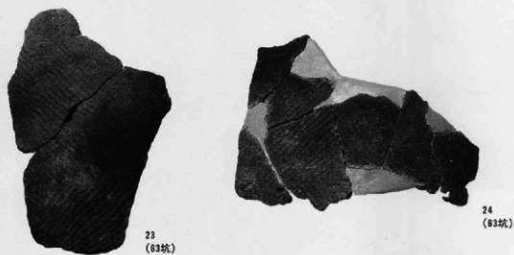

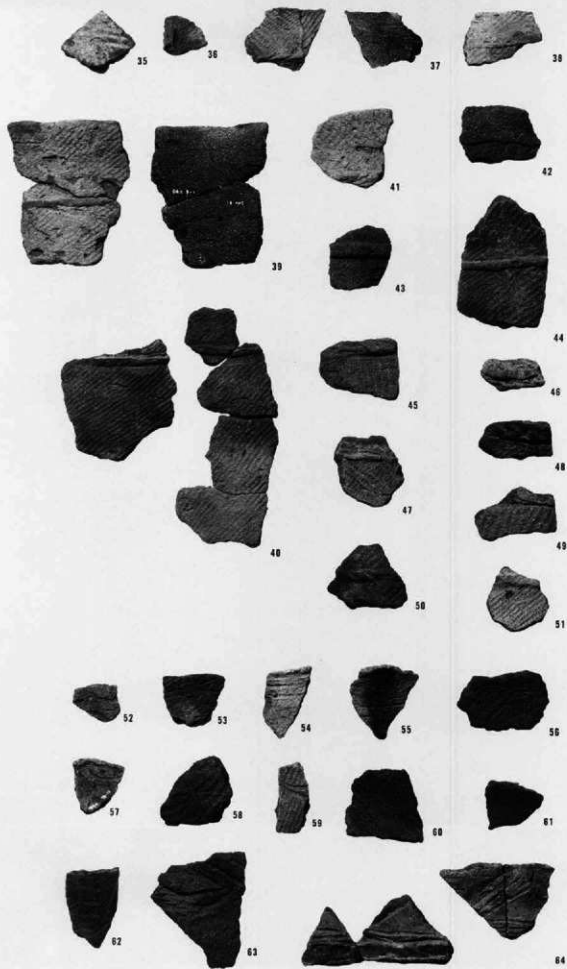

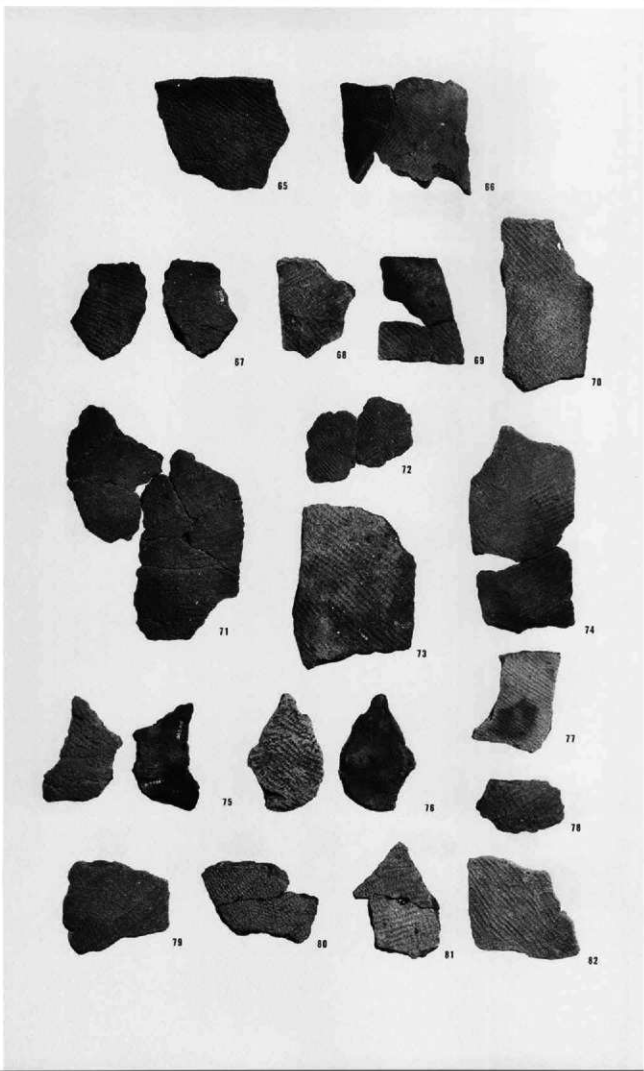

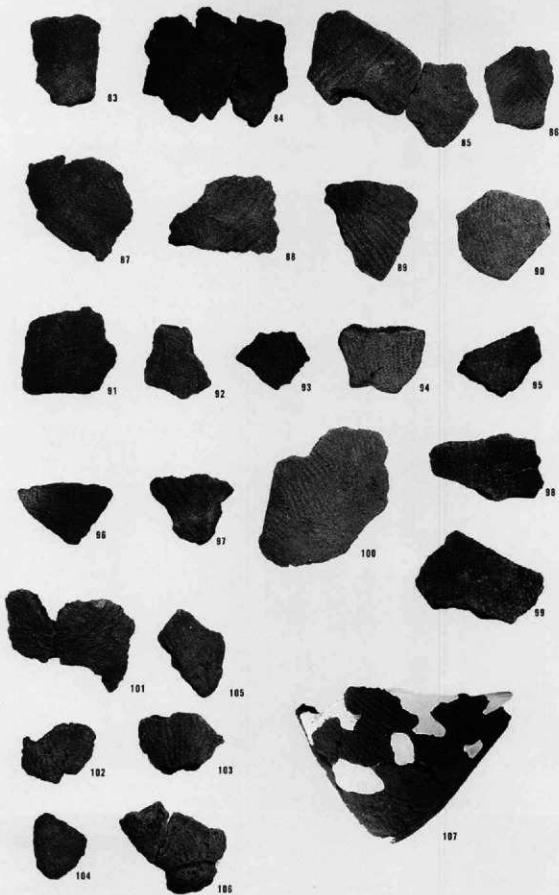

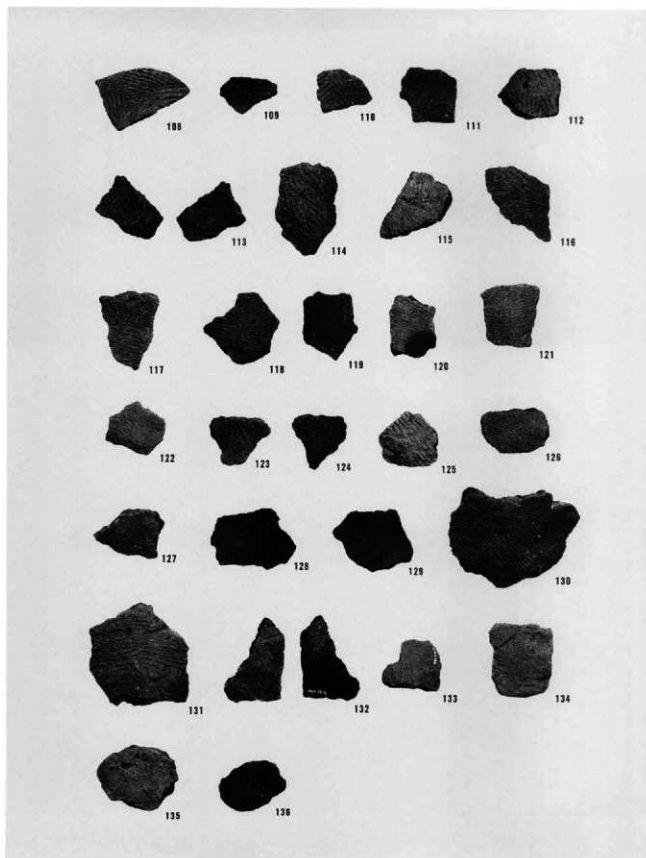

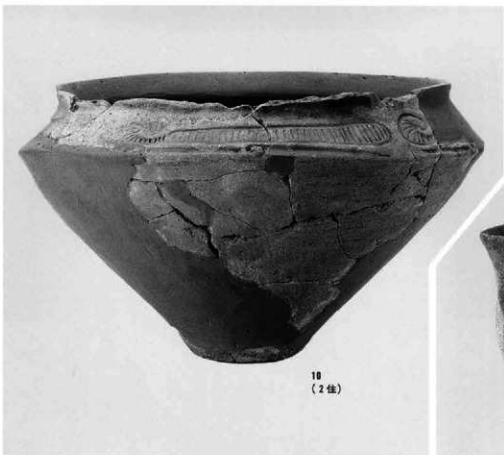

10
(2 住)11
(2 住)14
(3 住)15
(4 住)24
(6 住)25
(6 住)23
(6 住)



32
(8位)



35
(10位)



34
(10位)



33
(10位)



36
(11位)



37
(11位)

縄文中期の土器
1:4



41
(12住)



40
(12住)



38
(12住)



14住出土土器







69
(15住)



68
(15住)



75
(16住)



77
(16住)



70
(16住)



71
(16住)



78
(16住)





107
(24位)110
(24位)106
(24位)109
(24位)108
(24位)111
(24位)115
(24位)



113
(24位)



117
(24位)



118
(24位)



119
(24位)



112
(24位)



105
(24位)

縄文中期の土器
 122・123 1:6
 他 1:4



122
 (29位)



123
 (29位)



124
 (24位)



134
 (29位)



125
 (32位)



138
 (32位)



縄文中期の土器

162・163 1:4

他 1:6

165
(39位)163
(39位)166
(39位)168
(39位)167
(39位)173
(41位)



縄文中期の土器

191 1:6

他 1:4

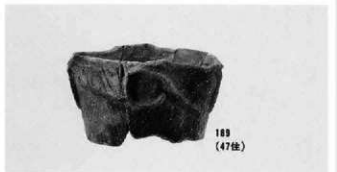
186
(46位)187
(46位)189
(47位)188
(47位)191
(47位)190
(47位)



201
(67住)202
(69住)204
(70住)205
(70住)208
(71住)209
(71住)



縄文中期の土器

234 1 : 6

他 1 : 4





縄文中期の土器

261 1:6

他 1:4

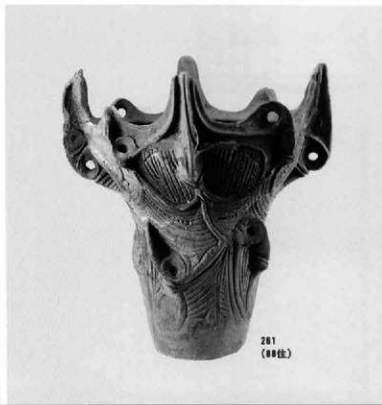

縄文中期の土器

265 1:6

他 1:4



縄文中期の土器

276 1 : 8

280 1 : 6

他 1 : 4

279
(90住)277
(80住)278
(80住)282
(91住)280
(91住)284
(91住)285
(91住)



281



288
(94位)



307
(97位)



289
(94位)



304
(97位)

縄文中期の土器

348・349 1:6

他 1:4

327
(101住)349
(104A住)348
(104A住)328
(101住)357
(105住)



359
(106住)



360
(106住)



366
(107住)



361
(106住)



370
(106住)



365
(108住)



371
(109住)



372
(109住)

縄文中期の土器

390 1 : 6

他 1 : 4

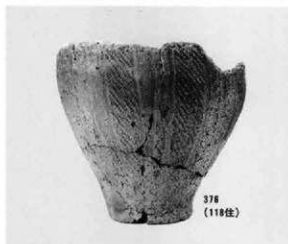
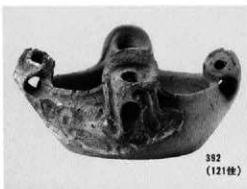
373
(110位)375
(112位)377
(118位)378
(119位)378
(119位)380
(121位)382
(121位)381
(121位)387
(122位)



399
(123枚)



398
(123枚)



400
(123枚)



401
(124枚)

406
(125住)

410

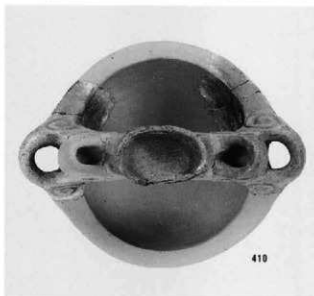
410
(126住)

410



407 (126住)

411
(130住)



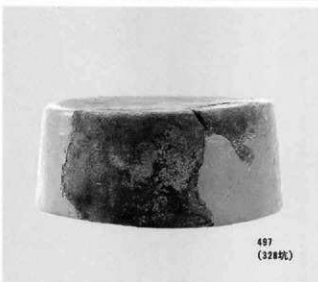



647
(1104坑)



648
(1104坑)



657
(1108坑)



666
(1120坑)



670
(1125坑)



666



670
(1127坑)

縄文中期の土器

786 1:6

他 1:4



1000

786
(1235坑)781
(1240坑)805
(1250坑)784
(1244坑)



縄文中期の土器

885 1:6

他 1:4

885
(1280坑)883
(土器集申1)879
(1286坑)889
(1308坑)813
(1339坑)

縄文中期の土器
915・943 1:6
他 1:4



915
(1338坑)



916
(1342坑)



906
(土器集中2)



907
(土器集中2)



914
(1338坑)



943
(1374坑)



905
(土器集中2)

縄文中期の土器

989 1:2

他 1:4

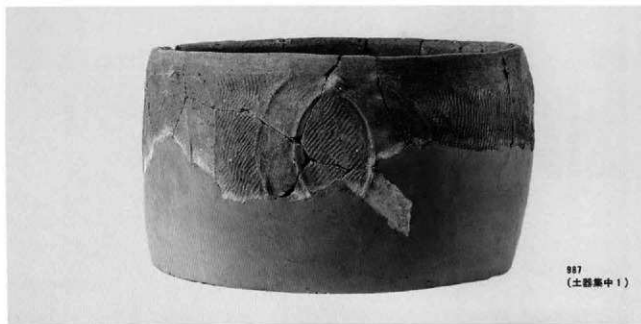
991
(土器集申1)989
(土器集申1)990
(土器集申1)987
(土器集申1)



縄文中期の土器

982 1 : 8

980・984 1 : 6

他 1 : 4

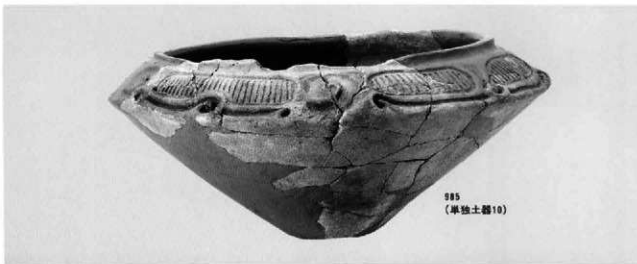

縄文中期の土器

1002 1 : 6

他 1 : 4



1002



1003



1013



1004





縄文中期の土器
1:4



968
(屋外埋壺 1)



右：屋外埋壺A群



右：屋外埋壺 2



969
(屋外埋壺 2)



970
(屋外埋壺 3)

左：屋外埋壺 3

右：屋外埋甕 5



左：屋外埋甕 4



右：屋外埋甕 6





974
(屋外埋蔵7)



右：屋外埋蔵7



右：屋外埋蔵7



左：屋外埋蔵C群
右：屋外埋蔵8



右：屋外埋蔵8



975
(屋外埋蔵8)



縄文土器展開写真
968(屋外埋蔵1)

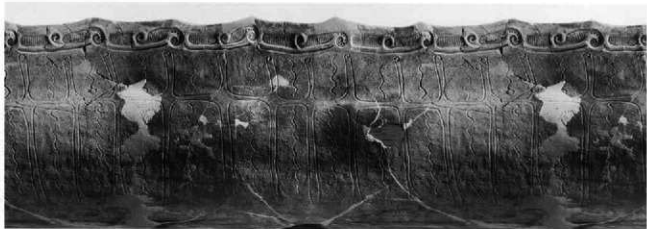

969(屋外埋蔵2)



970(屋外埋蔵3)





40 (12号住居)



41 (12号住居)



1



40



41

縄文土器展開写真
44 (14号住居)



46 (14号住居)



48 (14号住居)



49 (14号住居)



50 (14号住居)

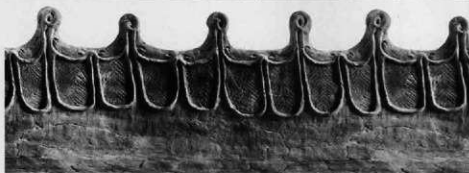

51 (14号住居)



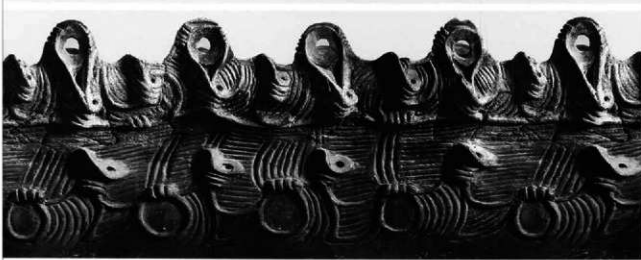

縄文土器展開写真
112 (24号住居)



112



107 (24号住居)



107



106 (24号住居)



106



110 (24号住居)



110

109

111

109 (24号住居)



111 (24号住居)





122

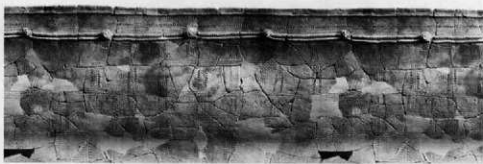

142 (24号土坑)



142



182 (44号住居)



182

180 (44号住居)



180

178 (44号住居)



178

181 (44号住居)



181

縄文土器展開写真
202 (69号住居)

202

220 (76号住居)



220

221 (76号住居)



221

264 (89号住居)



264

373 (110号住居)



373

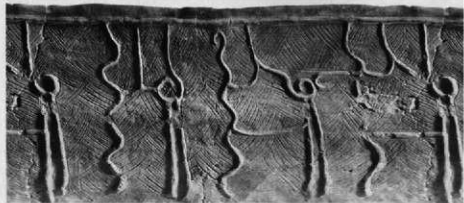

縄文土器展覧写真
401 (124号住居)



401

407 (126号住居)



407



540



786



915

540 (703号土坑)



786 (1235号土坑)



915 (1339号土坑)



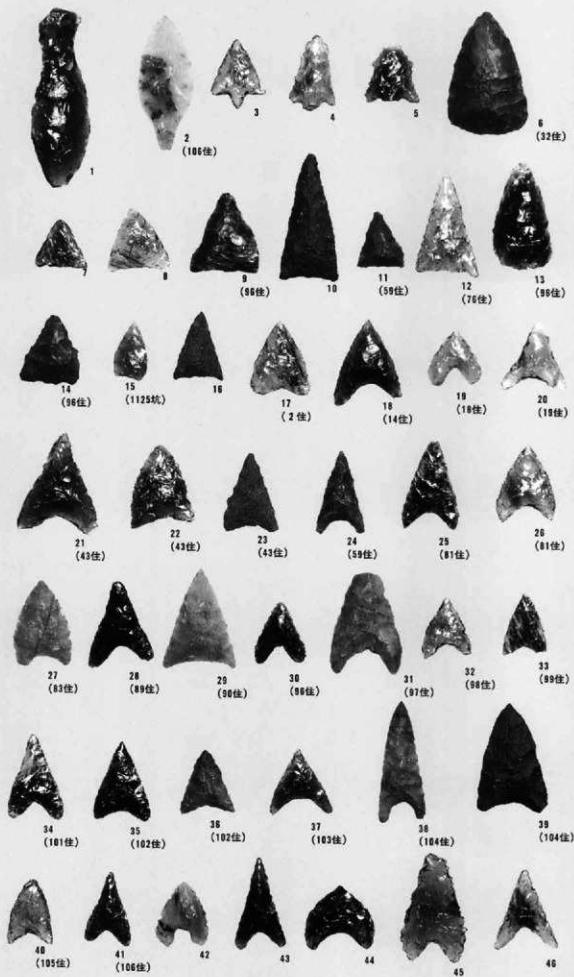

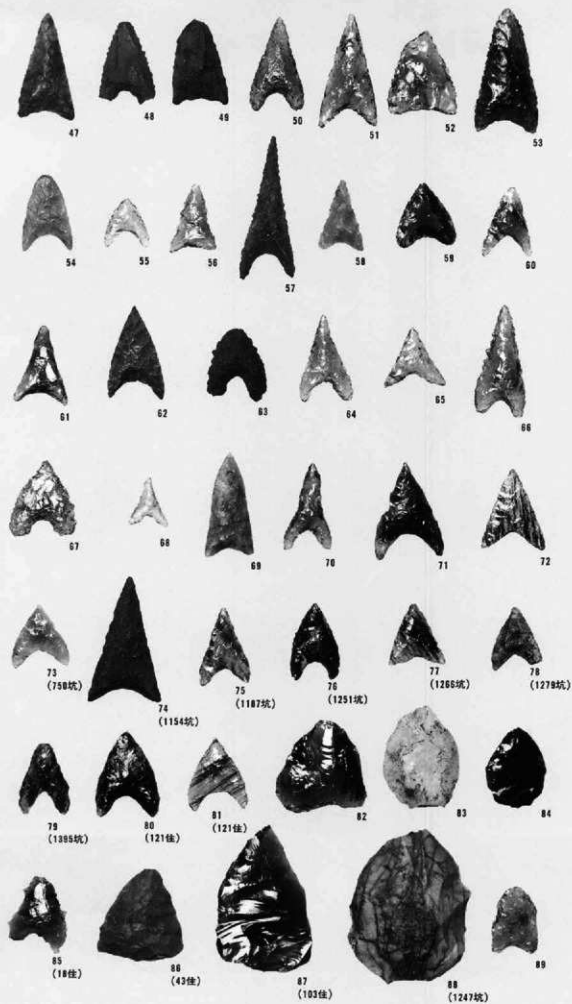

石鏃
1 : 1

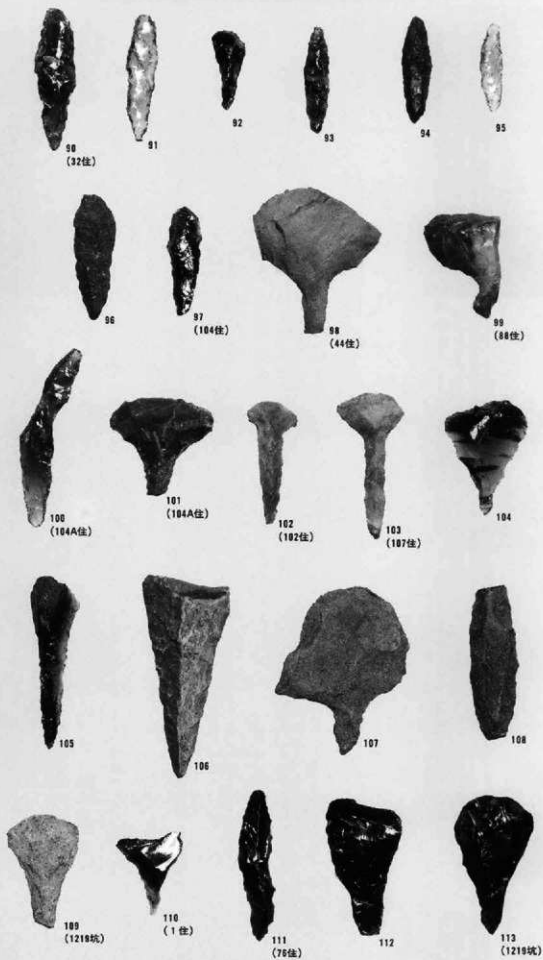



114
(14位)



115
(10位)



116
(32位)



117
(10位)



118
(110位)



119
(50位)



120



121



122



123



124



125



126



127



128



129



130



131



132
(50位)



133



134



135

石匙(2)、スクレイ

パー

2:3

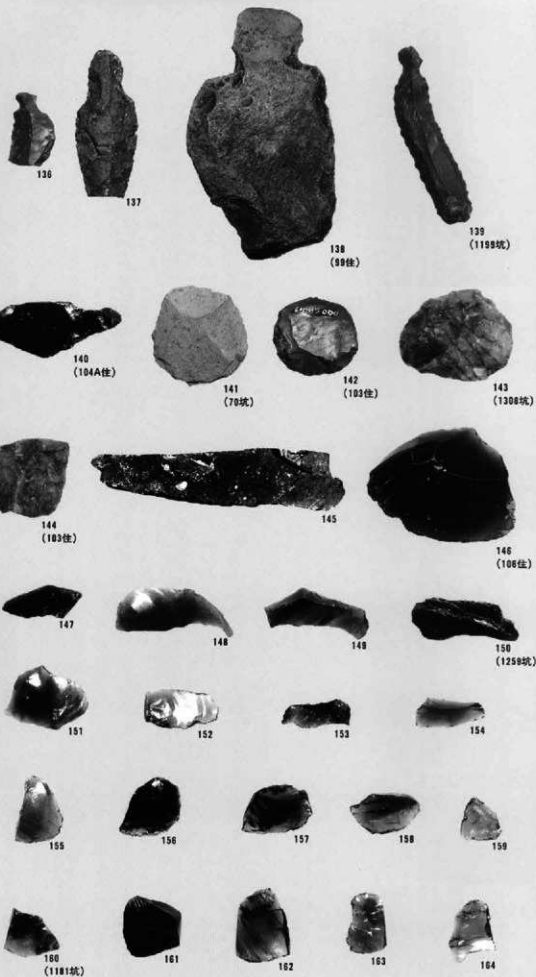
小剥離痕を有する
剥片

2:3



165
(6位)



166
(44位)



167



168



169



170



171
(43位)



172
(76位)



174
(170坑)



175



176



177



180



178



183



179
(3位)



182



184
(16位)



179



181



185
(94位)



186
(102位)



188
(246坑)

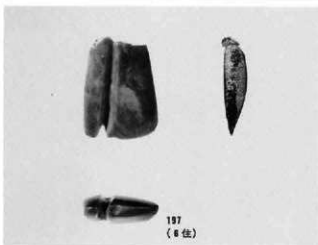
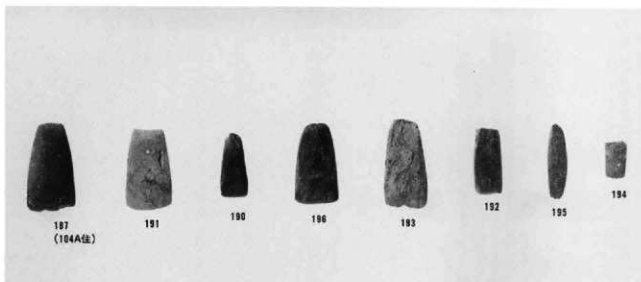

189
(1253坑)

磨製石斧 2
1 : 2

剥片 (107号住居)





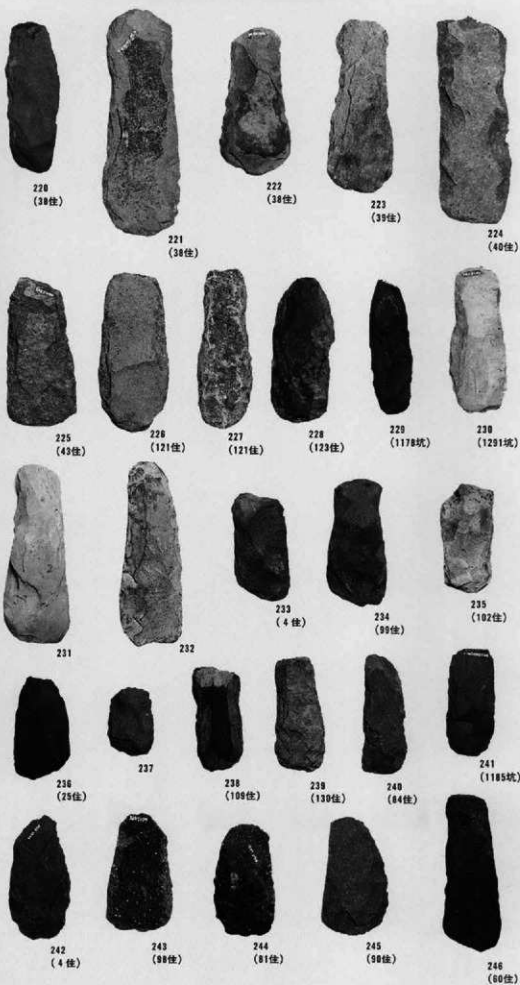



247
(92位)



248
(76位)



249
(91位)



250
(104位)



251
(106位)



252
(110位)



253
(121位)



254
(121位)



255
(121位)



256
(121位)



257
(121位)



258
(121位)



259
(121位)



260
(121位)



272
(106位)



273
(110位)



274
(292位)



275
(1259位)



276
(121位)



277



278
(9位)

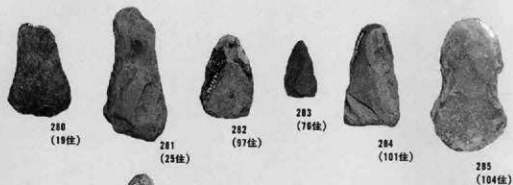

279
(9位)

打製石斧(4)
1 : 3



286
(1位)



287
(5位)



288
(14位)



289
(39位)



290
(36位)



291
(40位)



292
(41位)



293
(43位)



294
(70位)



295
(73位)



296
(83位)



297
(76位)



298
(84位)



299
(116位)

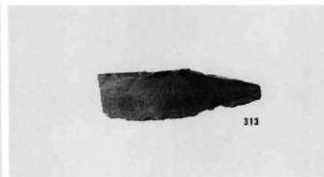
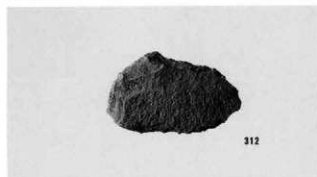
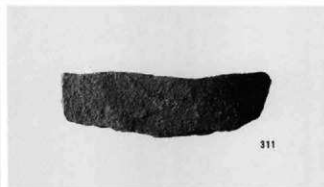
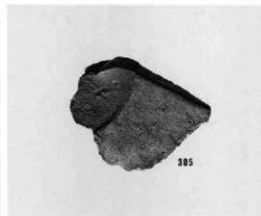

300
(121位)

剥片石器 2
1 : 3

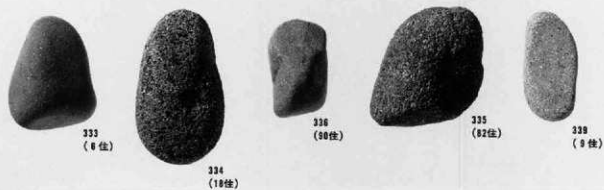
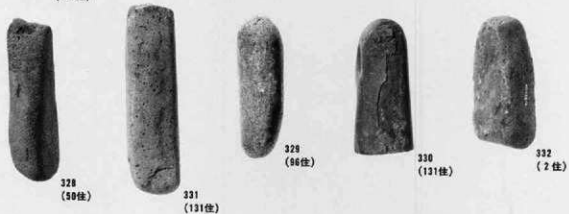
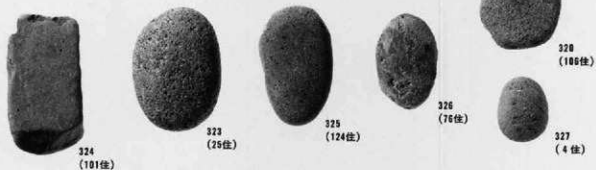
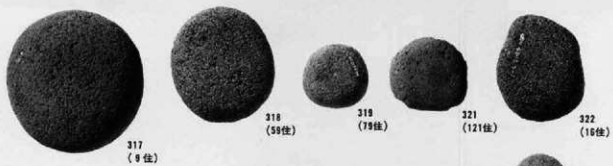

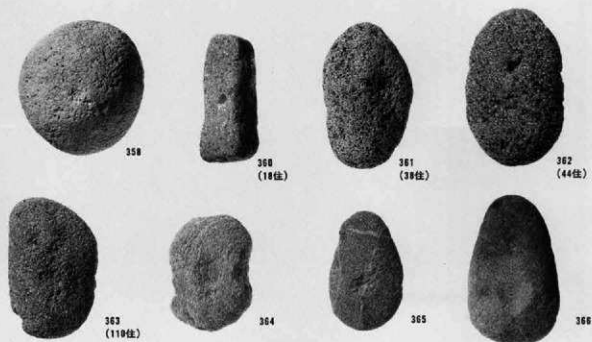
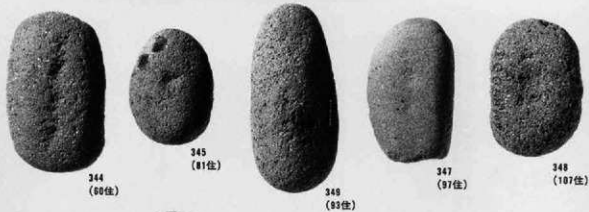



359
(14位)



355
(60位)



367
(19位)



368



370
(19位)



371
(70位)



372
(105位)



369



374



373
(29位)



375
(12位)



376
(19位)



377
(87位)



378



379
(18位)



380
(47位)



381



382



383



384
(59位)



385
(89位)



386
(1072坑)

石種類1
1:4



石棒類 2
401, 402 1 : 3
他 1 : 4



397
(39住)



394
(37住)



396
(39住)



402
(83住)



401
(83住)



403
(84住)



400
(789住)

石皿1
1:4

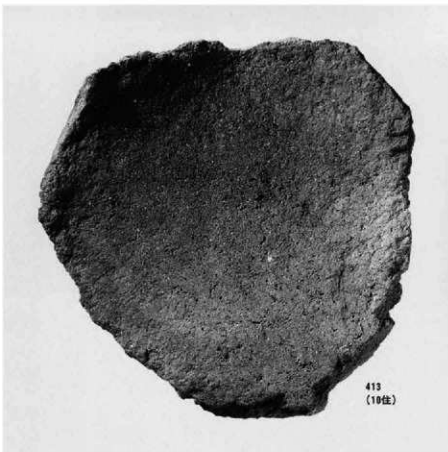

413
(10位)



433
(1304坑)



427
(282坑)

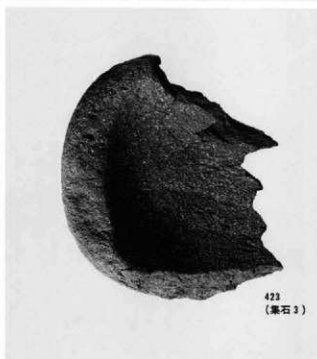

423
(集石3)



裏

430
(1072坑)

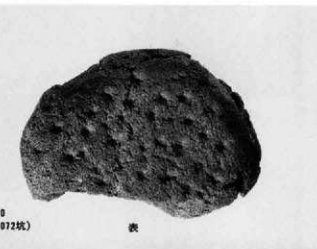

表



438表



438裏



440



441表

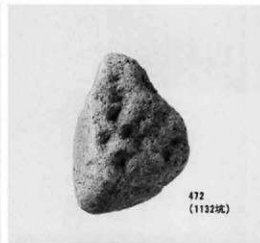
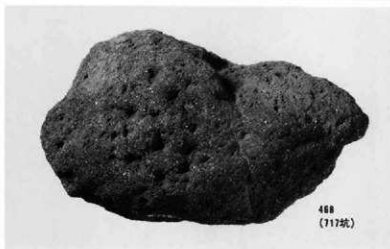
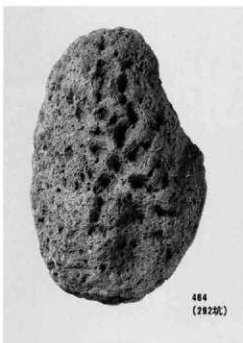
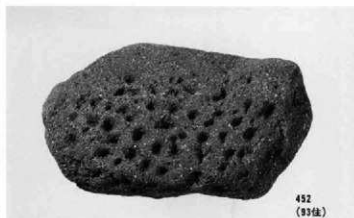

441裏

多孔石 1
1:4



475
(1209坑)



482
(1200坑)



484



485



488



490
(47坑)



491
(70坑)



492
(131坑)

合石 2
1 : 4



496
(10456g)

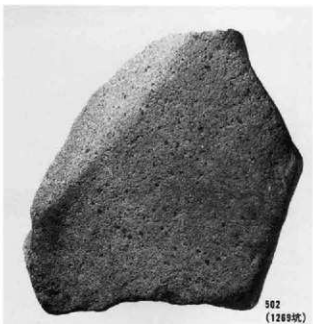

502
(12689g)



500
(12349g)

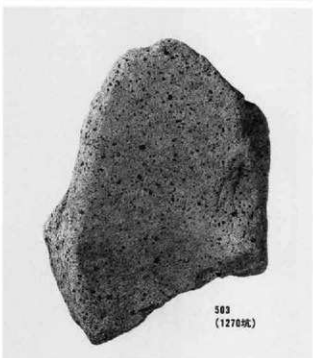

503
(12709g)

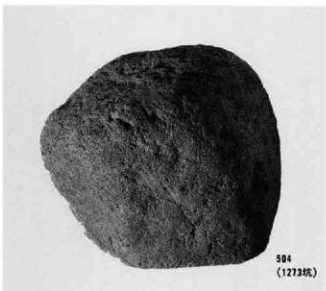

504
(12739g)



510
(13729g)

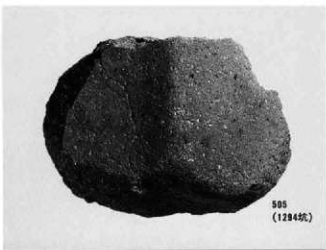

505
(12949g)



513
(24位)



514
(24位)



515
(49位)



516
(70位)



517
(76位)



518
(82位)



519
(1291位)

丸石 2

529 1 : 6

他 1 : 4

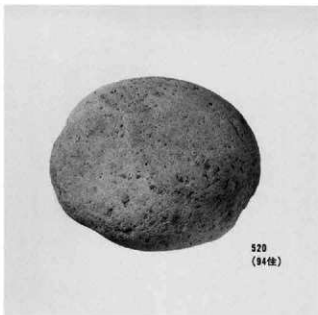

520
(94位)



525
(1138坑)

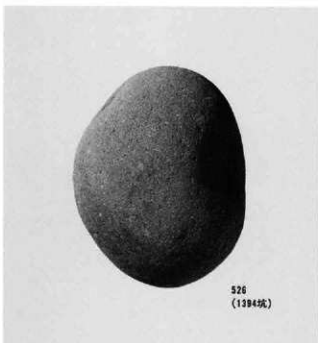

526
(1294坑)



527

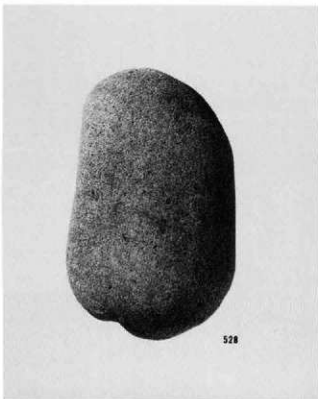

528



529
(16位)



530
(3枚)



531
(80枚)

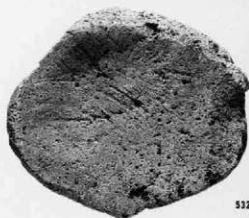

532表



532裏



533表
(70枚)

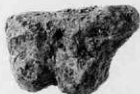

533立面



533裏



534表



534立面



534裏

軽石製品 2

538 1 : 4

他 1 : 3

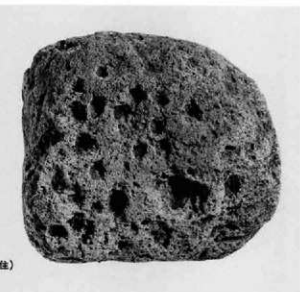
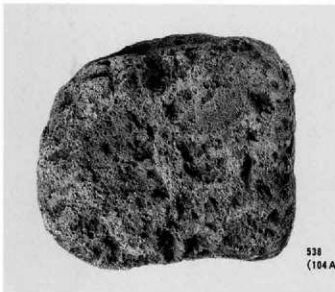
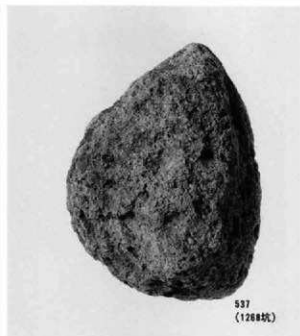
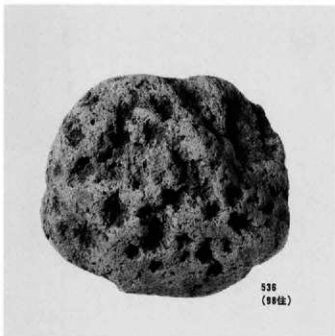



556
(70位)



557
(89位)



558
(94位)



559
(99位)



560
(121位)



561
(1223坑)



562
(852坑)



563
(99位)



564
(4位)



565
(183位)



543



544
(121位)



545
(70位)



547
(13位)



548
(99位)

軽石製品 4

539~542.

564, 567 1 : 3

他 1 : 4

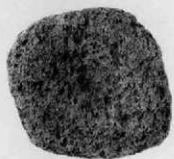
539
(4住)540
(44住)541
(70住)542
(89住)564
(4住)567
(7960住)

568

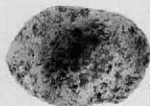
569
(11540住)570
(70住)571
(70住)572
(124住)574
(70住)575
(70住)

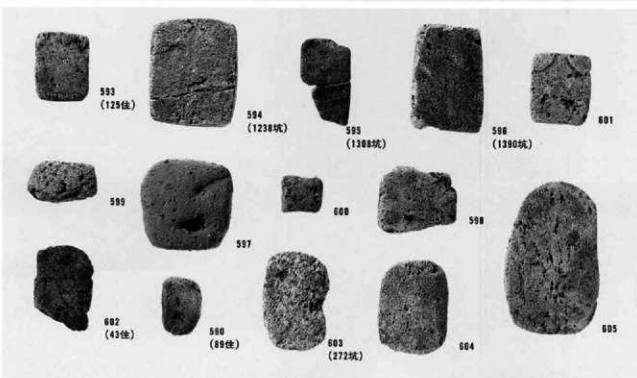
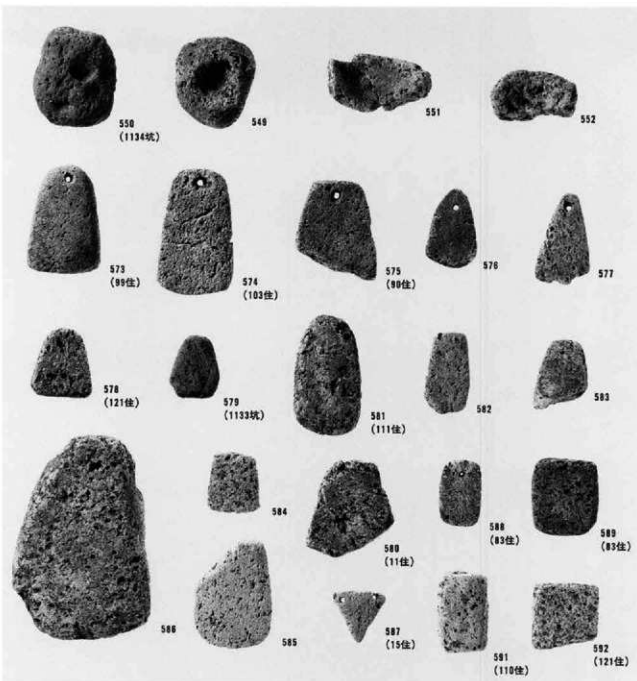

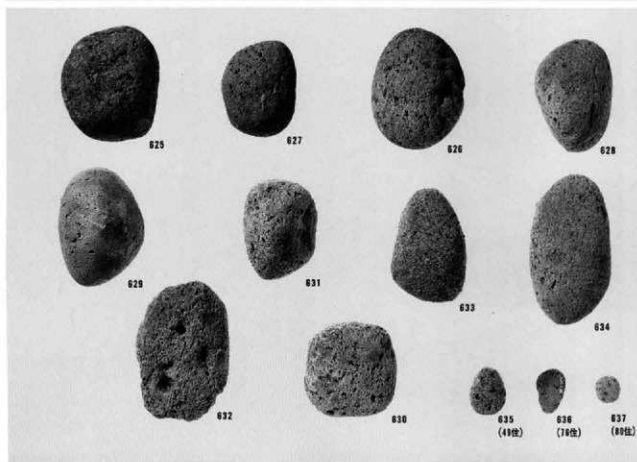
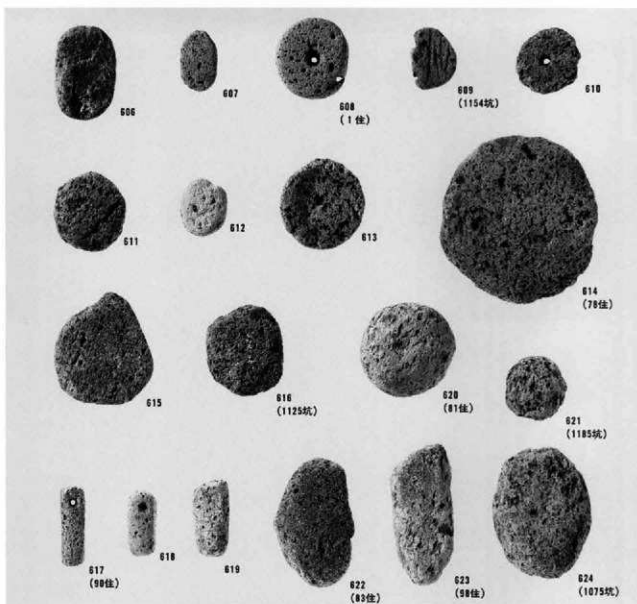



638
(126895)



640



641



639
(126896)



642

輕石製品 8

653 1 : 2

他 1 : 3

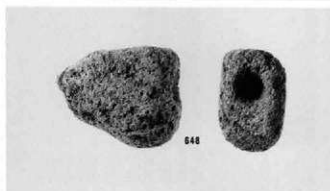
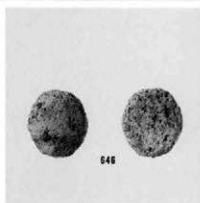
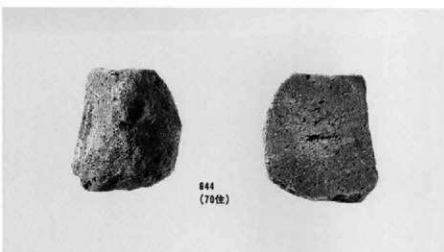

砥石 1
655、656 1 : 2
657 1 : 4



655



656
(10位)



657



658
(120位)

その他の石器など
658 1 : 2
他 1 : 3



662



663
(90位)



659



660



661

古代の砥石

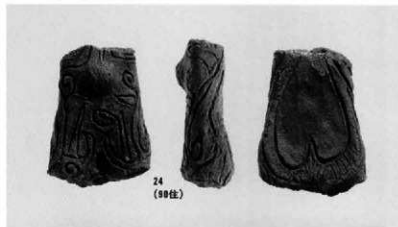

1

土偶1
1:2



25



26



33



27



11



12



13



14

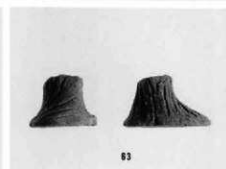
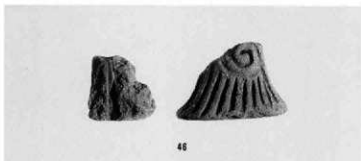

20

土偶 3
1 : 2土製品 1
1 : 2



71
 (101位)



74
 (131位)



75
 (10位)



72
 (6位)



73
 (22位)



76



77



80



78

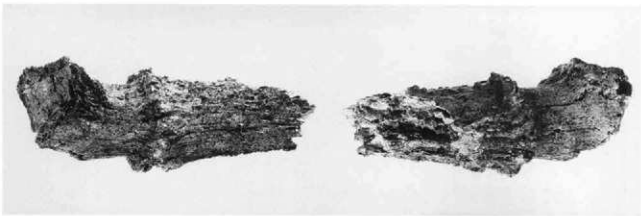

79

1125号土坑の鹿角
1 : 2

1278号土坑の骨類





1
(郷土2号墳)



11



21



4
(33坑)



3
(33坑)



10



和同開珎



1
(1溝)



2
(1溝)



16



17

遺跡近景 (南から)



遺跡近景 (東から)



1号壑穴住居跡

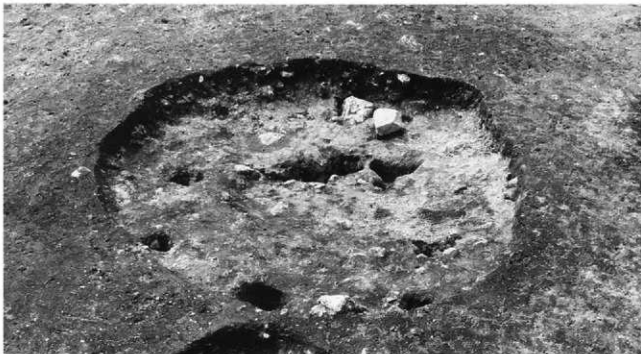

2号壑穴住居跡

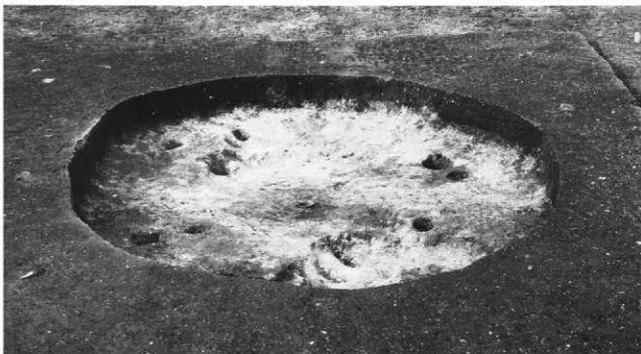

3号壑穴住居跡



土坑群



左：9・10・11・47号

土坑

右：29・31・32・35号

土坑



左：35・36号土坑

右：41号土坑



1号隔し穴



左：2号壑穴住居跡
出土土器
右：3号壑穴住居跡
出土土器

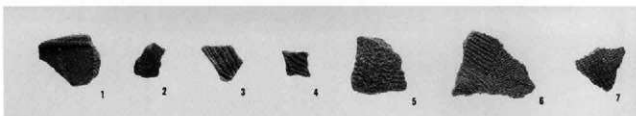
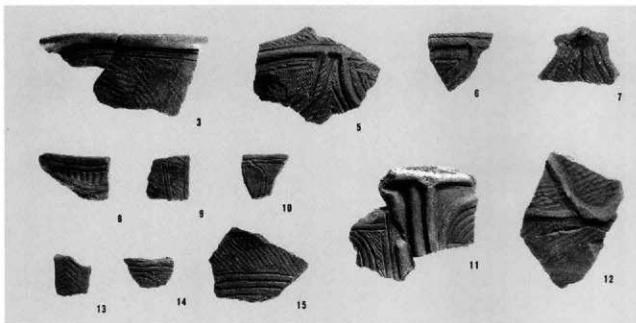

左：31号土坑出土土器
右：遺構外出土土器

1号竪穴住居跡出土
土器2号竪穴住居跡出土
土器

土坑出土土器

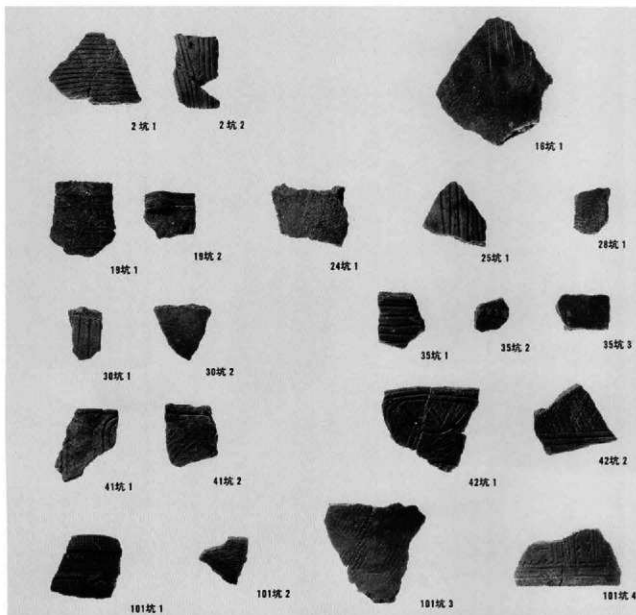

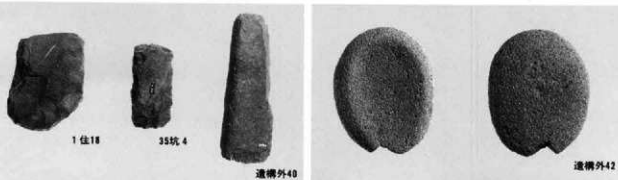
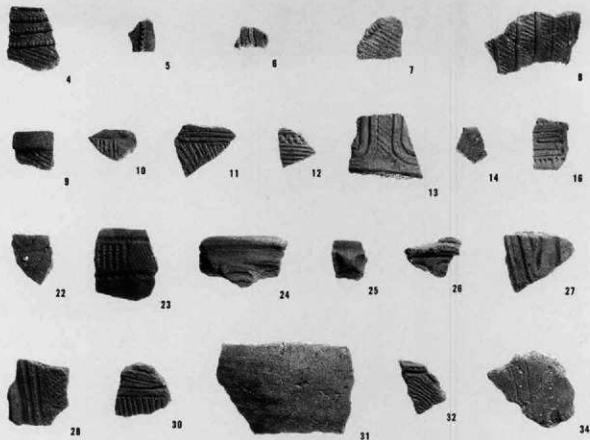

遺跡遠景（南から）



遺跡近景（西から）



左：8・9号土坑
右：13・14号土坑

左：15号土坑
右：18・25号土坑

左：22・40号土坑
右：28・29・34号土坑

左：30号土坑
右：39号土坑

左：8号土坑出土遺物
右：遺構外出土土器

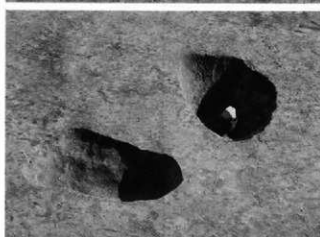
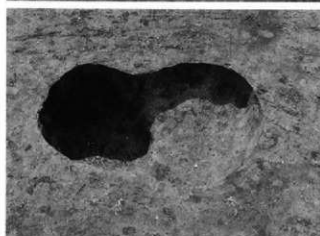

1号住居



1号溝の調査



左 1号溝断面
右 1号溝完掘





左 1号土坑
右 2号土坑



左 1号土坑
右 3号土坑

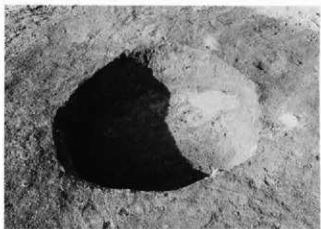

左 1号土坑
右 4号土坑

長野県埋蔵文化財センター発掘調査報告書 52

上信越自動車道埋蔵文化財発掘調査報告書 19

—小諸市内3—

三子塚遺跡群 三田原遺跡群 岩下遺跡 石神遺跡群
郷土遺跡 東丸山遺跡 西丸山遺跡 深沢遺跡群

図 版 編

発 行 平成12年3月30日

発行者 財団法人長野県文化振興事業団長野県埋蔵文化センター

〒387-0007 更埴市屋代清水260-6 電 026-274-3891

Fax 026-274-3892

印 刷 第一印刷株式会社