

佐久市

NISHICHIKATSU

# 西近津遺跡群

中部横断自動車道建設に伴う埋蔵文化財発掘調査報告書2

－佐久市内2－

第3分冊（遺物図版編）

2015.3

国土交通省関東地方整備局  
長野県埋蔵文化財センター

## 凡 例

- 1 遺物番号は、遺物種ごとに登録番号を付してある。本報告の本文・図表・写真では共通して遺物番号を用いている。遺物番号は下記のとおりである。

土器 No.00001 から始まる五桁の通し番号

土製品 No.10001 から始まる五桁の通し番号

石器・石製品 No.20001 から始まる五桁の通し番号

金属製品・鍛冶関連遺物 調査年ごとに登録番号を付けている。表記は左から調査年（西暦年）の下2桁の次に、金属の英訳 Metal の頭文字 M を冠し、通し番号を付す。

(例) 06M081 2006年調査の金属製品No 81

骨・骨製品 金属製品同様、調査年ごとに登録番号を付けている。表記は左から調査年（西暦年）の下2桁の次に、骨の英訳 Bone の頭文字 B を冠し、通し番号を付す。

(例) 08B14 2008年調査の骨No 14

- 2 本書に掲載した遺物実測図の縮尺は、原則として下記のとおりである。

土器・土器拓影・陶磁器	1 : 4	縄文土器拓影	1 : 3
大形土器	1 : 6	石鏃等小形石器・装身具・原石	2 : 3
石核・石斧・磨石・敲石など	1 : 3	台石・石皿など	1 : 6
金属製品	2 : 3 ~ 1 : 2	骨製品・骨	1 : 2

- 3 遺物の器種名については細分せず、過去の埋文センター報告書などを参考にして一般的と思われる名称を用いた。

- 4 遺構記号については第1分冊に詳細を記してあるが、主なものは下記のとおりである。

SB：堅穴住居跡・堅穴状遺構	SK：土坑・井戸跡・土坑墓
ST：掘立柱建物跡	SD：溝跡・自然流路跡
SM：古墳・周溝墓・(土坑墓)	SQ：遺物集中
SA：柵列	

- 5 実測図中の記号・トーンなどについては、原則として下記のとおりである。これ以外のものについては実測図に例示してある。



- 第1分冊 (本文編)  
第2分冊 (遺構図版編)  
**第3分冊 (遺物図版編)**  
第4分冊 (写真図版編)

### 第3分冊 (遺物図版編) 目次

#### 凡例

#### 目次

I	土器・土製品	
	縄文時代の土器・土製品	図版 1
	弥生時代中期の土器	図版 5
	弥生時代後期の土器・土製品	図版 6
	古墳時代～古代の土器	図版 58
	中世の陶磁器	図版 199
	古墳時代～古代の土製品・瓦	図版 200
II	石器・石製品・ガラス製品	図版 202
III	金属製品	図版 251
IV	鍛冶関連遺物	図版 273
V	木製品	図版 274
VI	骨角製品・未製品	図版 275

縄文時代の遺構  
SB7067

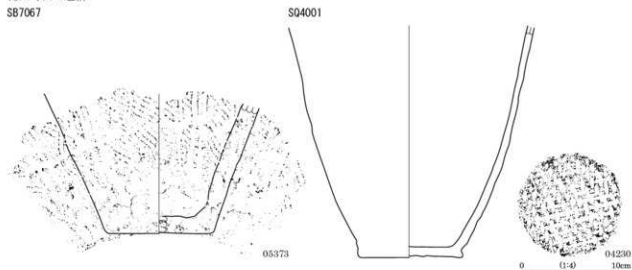

S05001

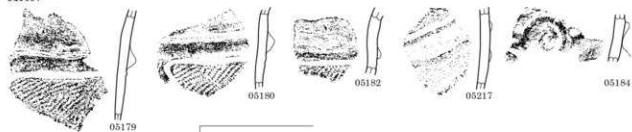

縄文時代以外の遺構、検出面

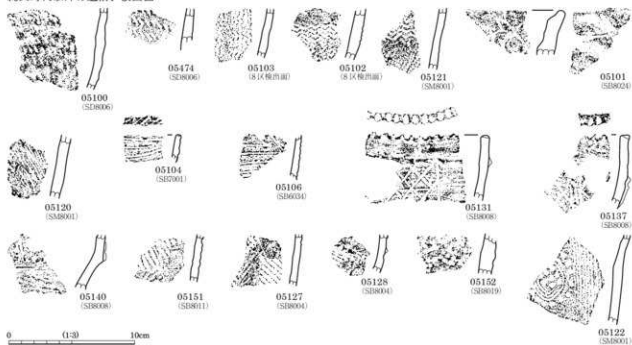



図版2 縄文時代の土器 (2)

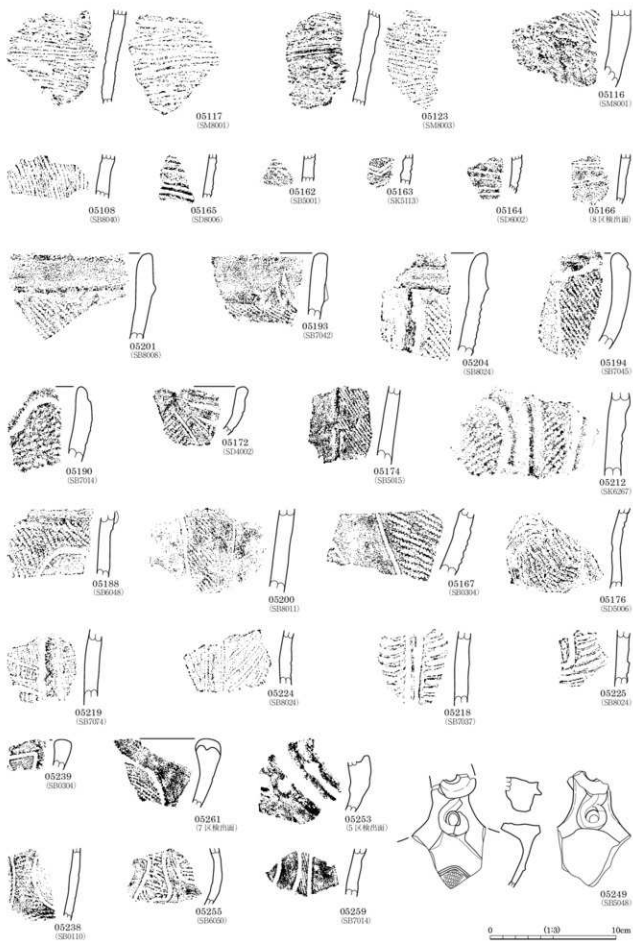

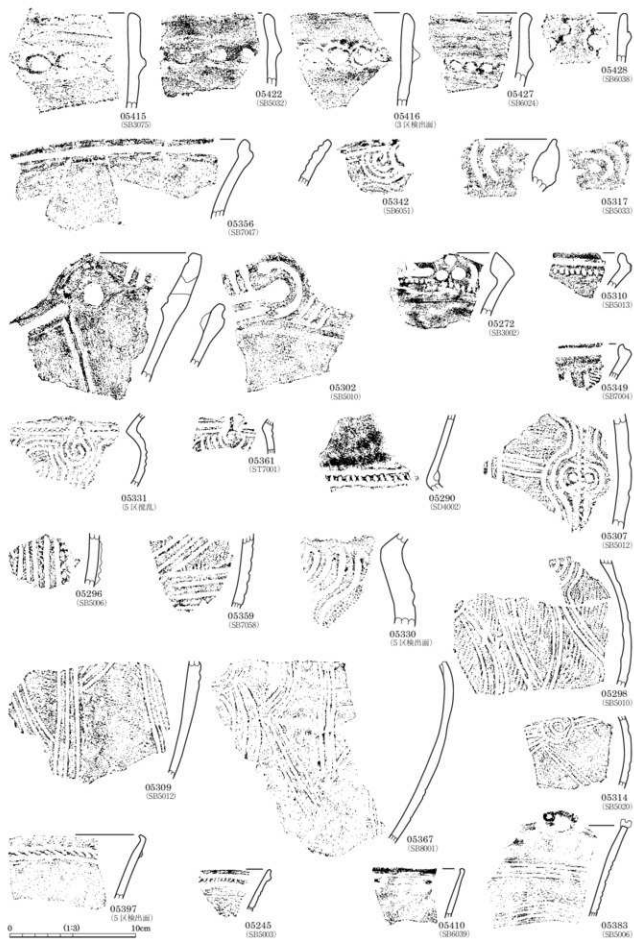

図版 4 縄文時代の土器 (4)・土製品



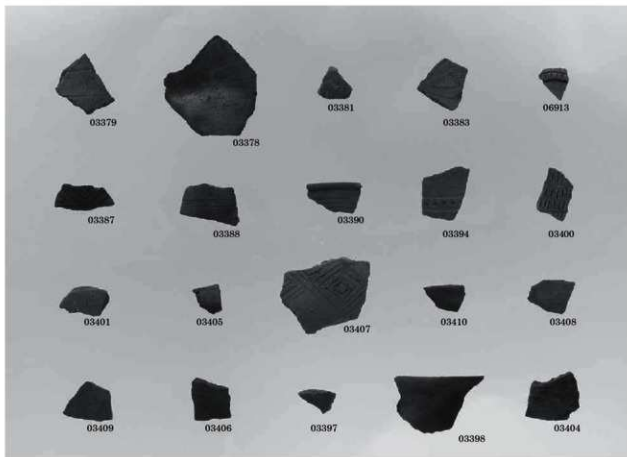
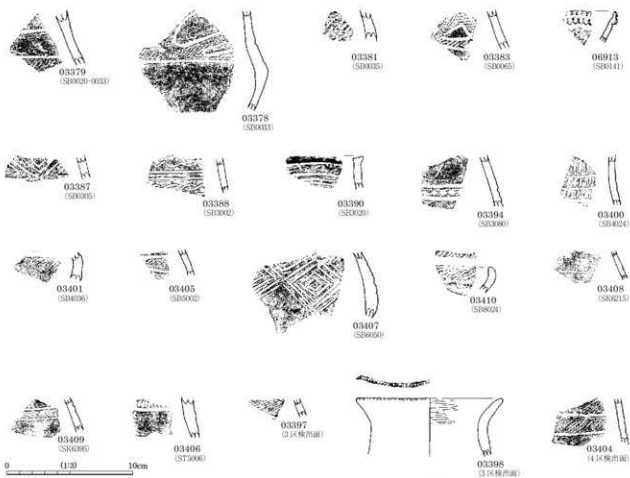

図版 6 弥生時代後期の土器 (1)

SB0002

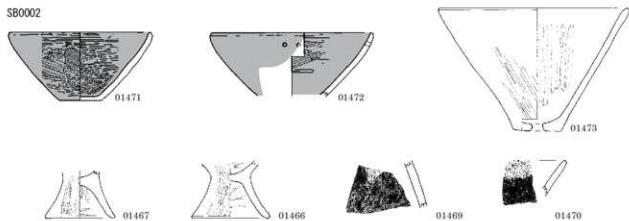

SB0004

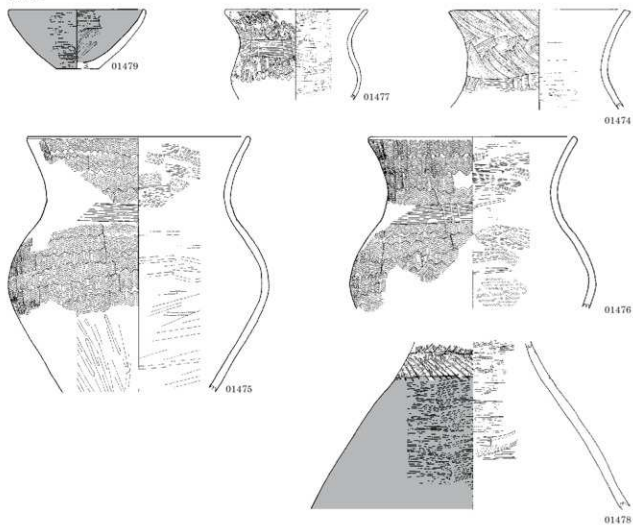

SB0007 (1)

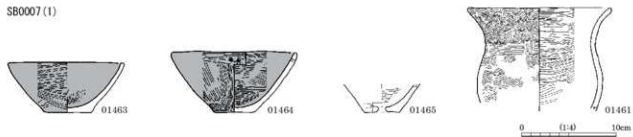

SB0007 (2)

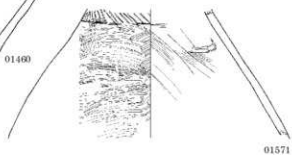
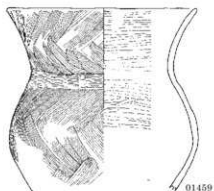
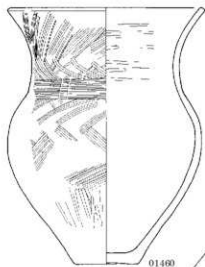
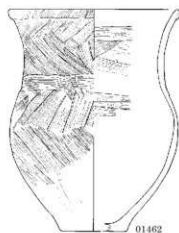

SB0011

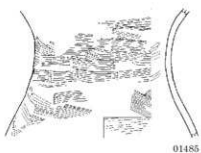
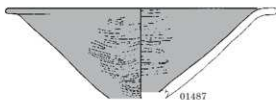

SB0015 (1)

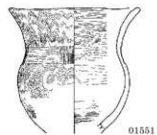
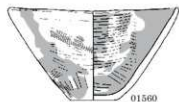
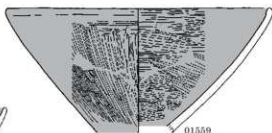

0 (1:4) 10cm

図版 8 弥生時代後期の土器 (3)

SB0015 (2)



01552

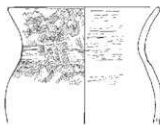

01550



01553

SB0017 (1)



01441



01442

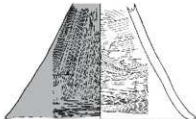

01438

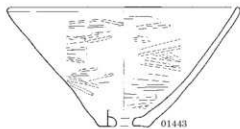

01443

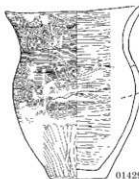

01429

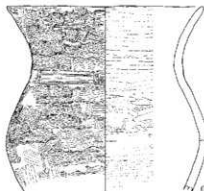

01428

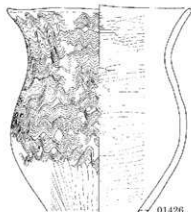

01426



01427

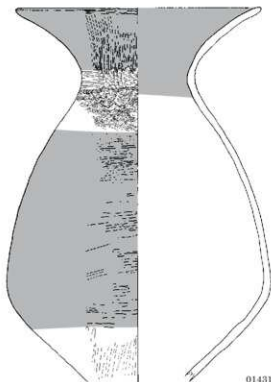

01431

0 (1:1) 10cm

SB0017 (2)

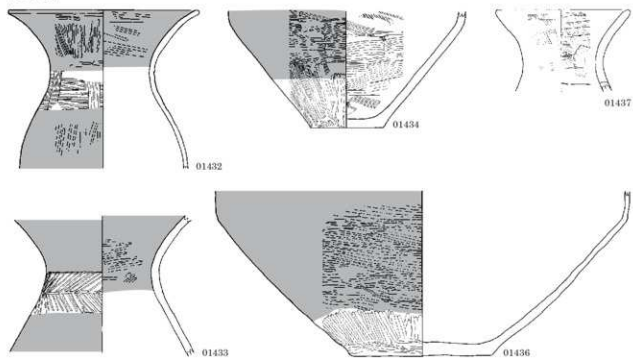

SB0019 (1)

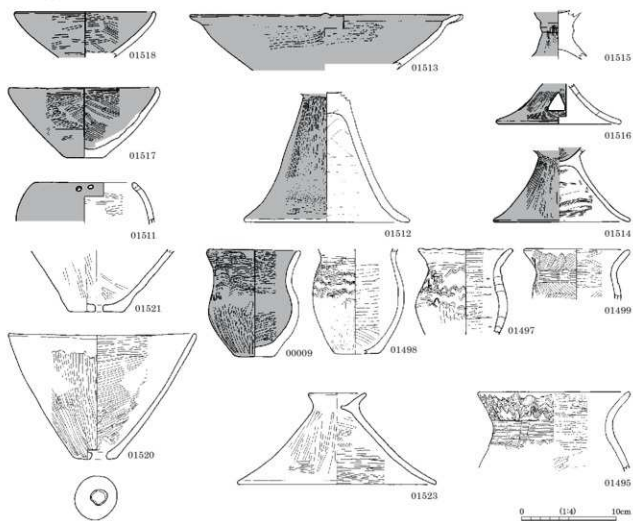



図版 10 弥生時代後期の土器 (5)

SB0019 (2)

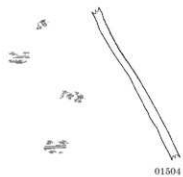
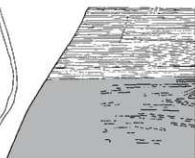
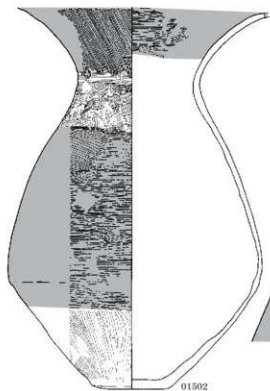
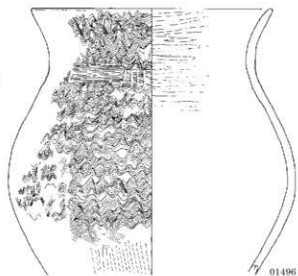
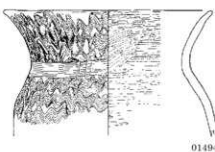
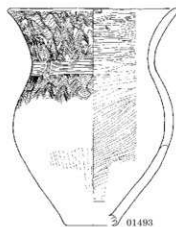
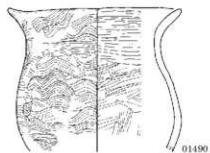
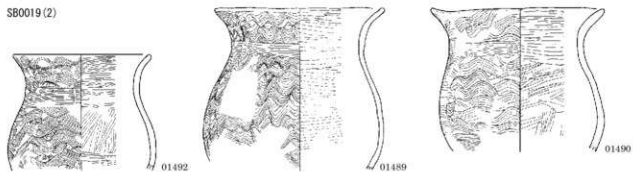

0 1:4 10cm

SB0019 (3)



01505

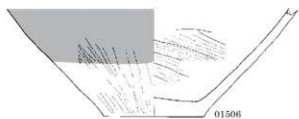

01506

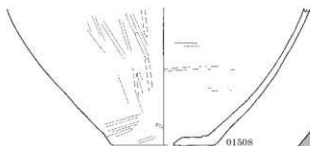

01508

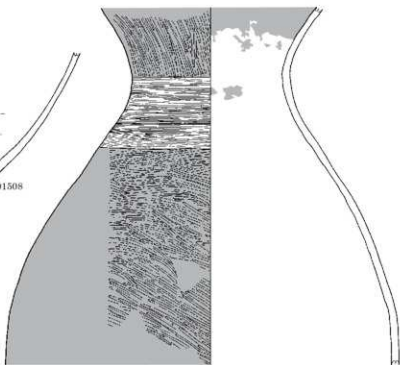
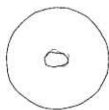

01503

SB0024



01333



01331



01330



01332

SB0025 (1)



01424



01423



01416

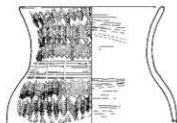

01414



01418

0 1:4 10cm

図版 12 弥生時代後期の土器 (7)

SB0025 (2)

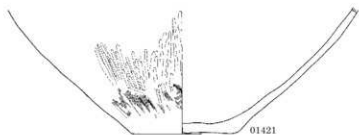
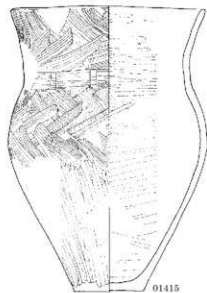

SB0026

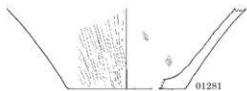
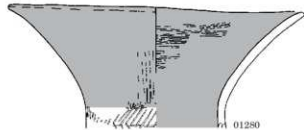

SB0027 (1)

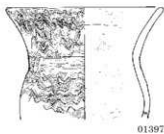
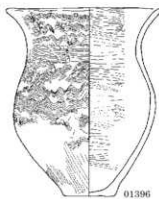
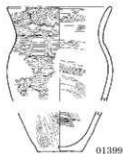
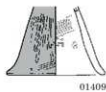

0 1:4 10cm

SB0027 (2)

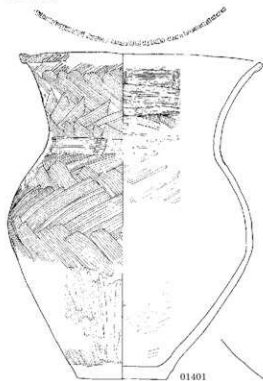

01401



01400

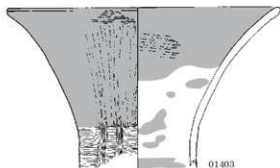

01403



01406

SB0030 (1)



01388



01390



01392



01378



01391



01389



01379



01375

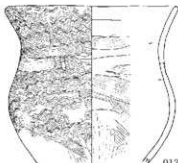

01373

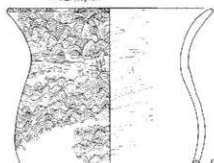

01374

0 (1:4) 10cm

図版 14 弥生時代後期の土器 (9)

SB0030 (2)

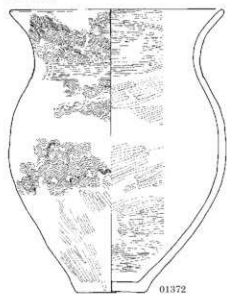

01372

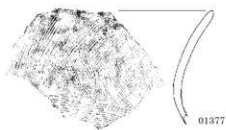

01377

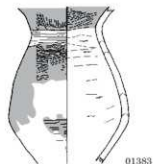

01383

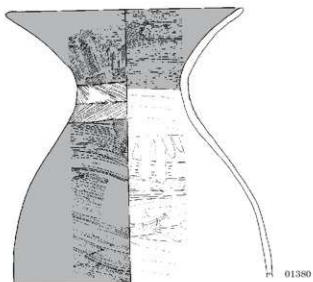

01380

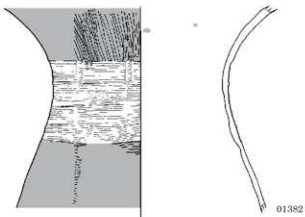

01382

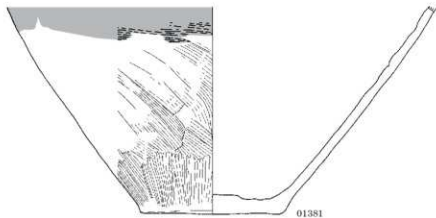

01381

0 (1:4) 10cm

SB0033

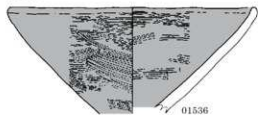

01536



01537



01532

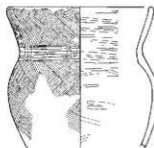

01528

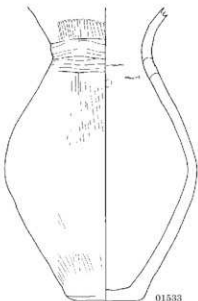

01533



01527

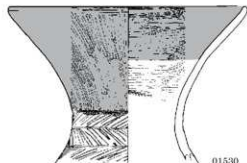

01530

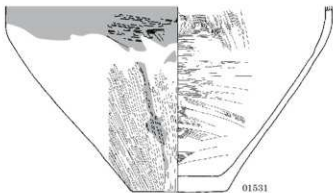

01531

SB0035 (1)



00025



01548



01547



01549

0 1:4 10cm

図版 16 弥生時代後期の土器 (11)

SB0035 (2)

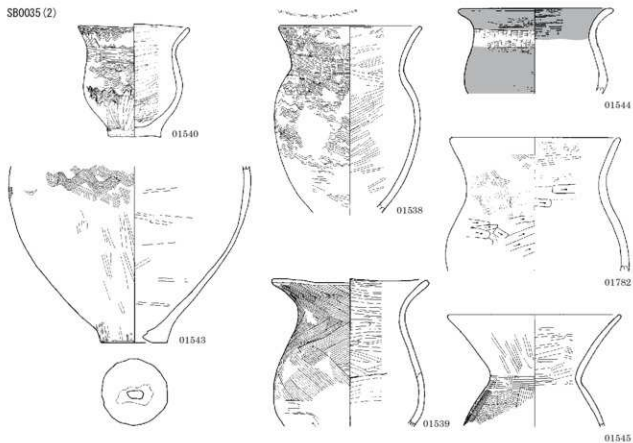

SB0036

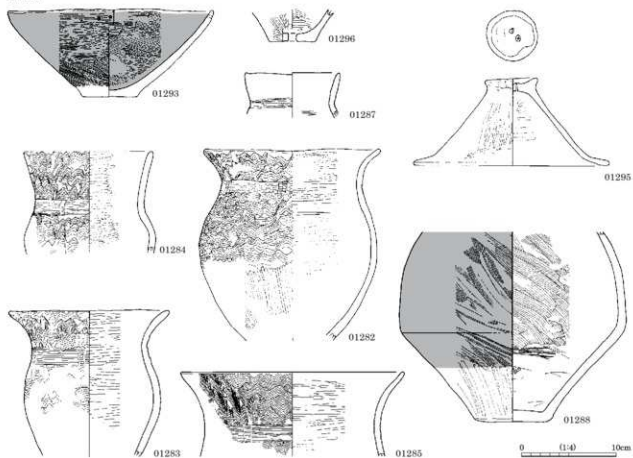

S80041

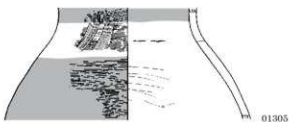
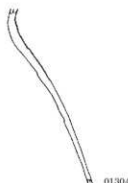
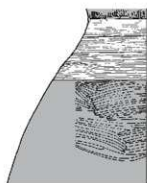
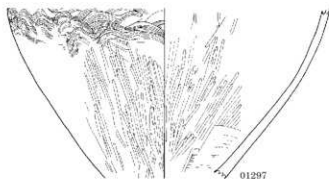
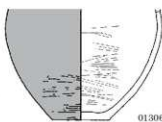
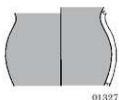
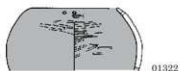
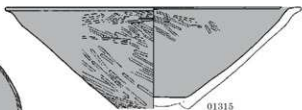
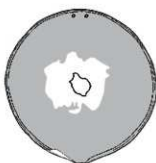

0 10cm



図版 18 弥生時代後期の土器 (13)

SB0047

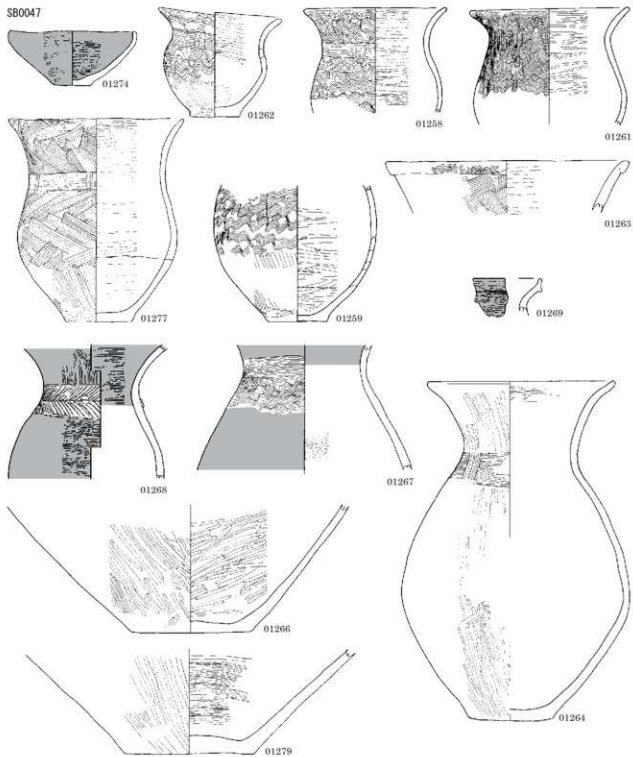

SB0048

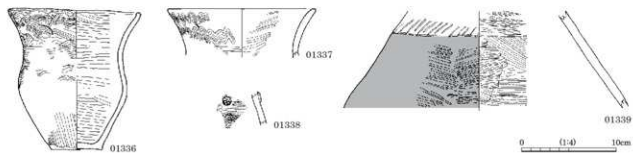

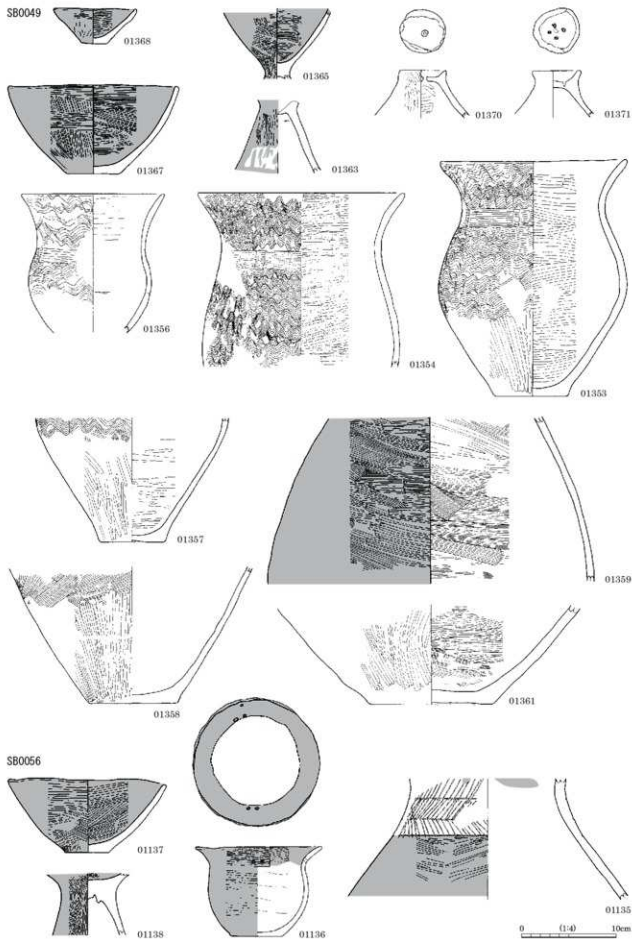

図版 20 弥生時代後期の土器 (15)

SB0057

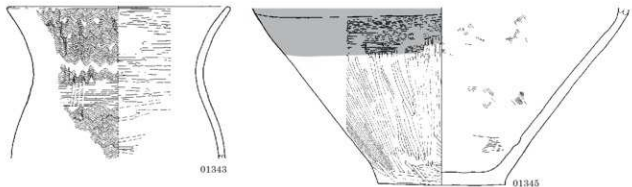
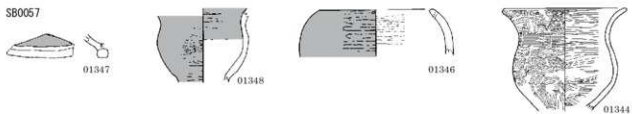

SB0061B

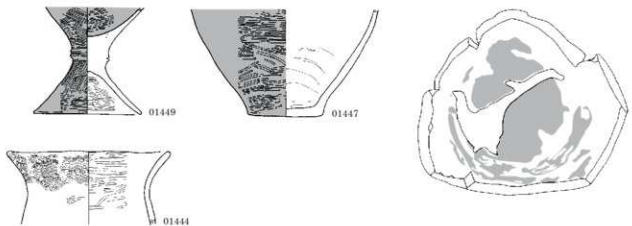

SB0062

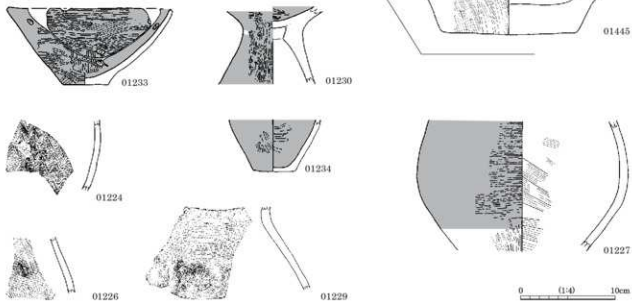

0 10 20 cm

SB0066A

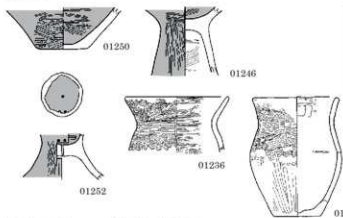

SB0066B

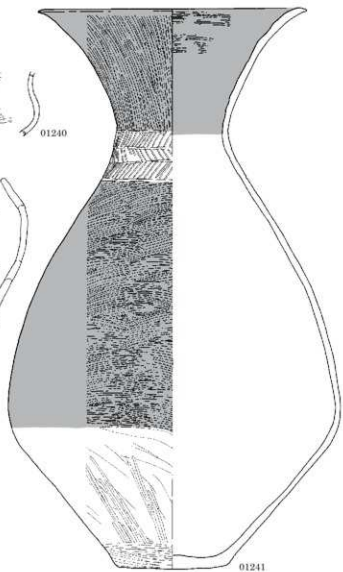
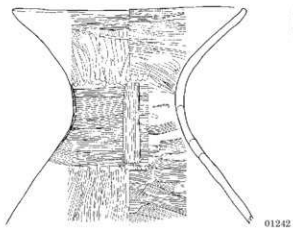
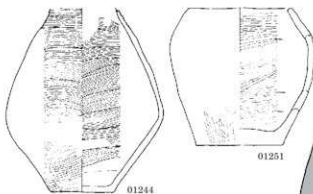
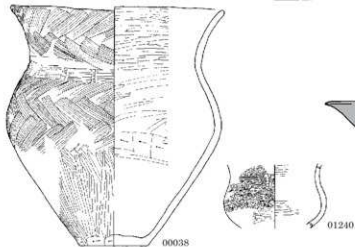
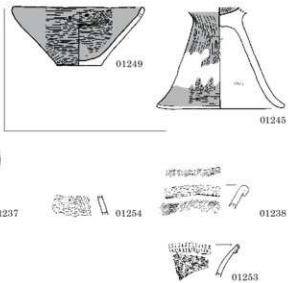

0 1:4 10cm

図版 22 弥生時代後期の土器 (17)

SB0067 (1)

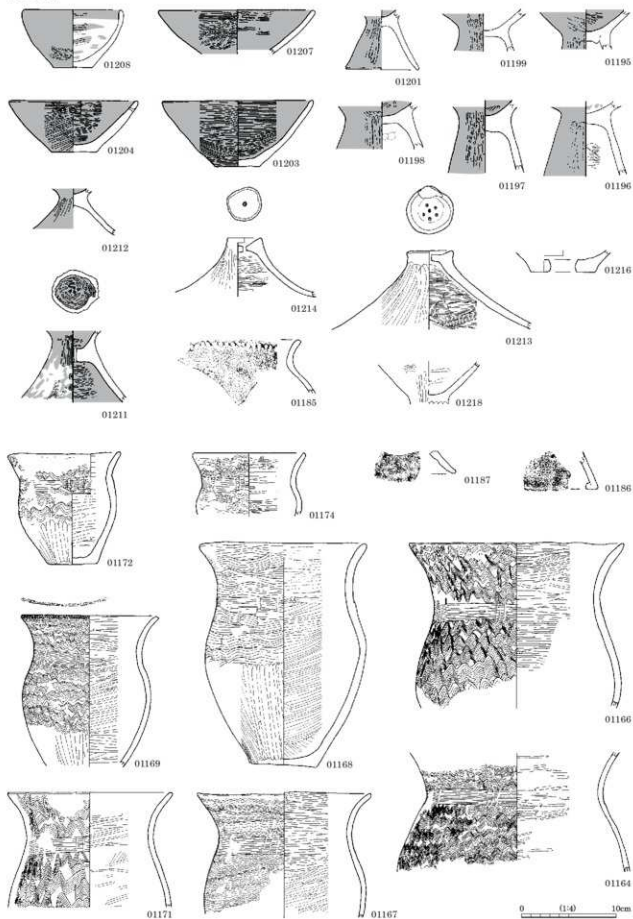

SB0067 (2)

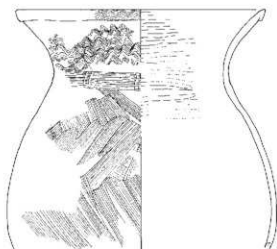

01170

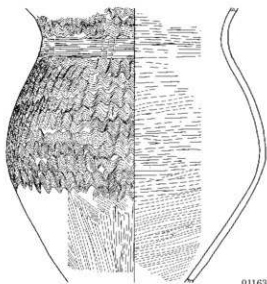

01163



01165



01192



01184



01183



01178



01179

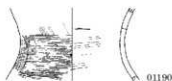

01190



01181

01217

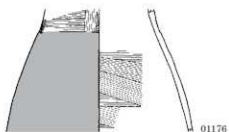

01176

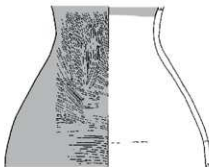

01175



01191



01182

SB0075 (1)

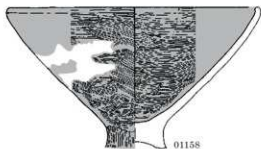

01158



01159



01162



0 1:4 10cm

図版 24 弥生時代後期の土器 (19)

SB0075 (2)

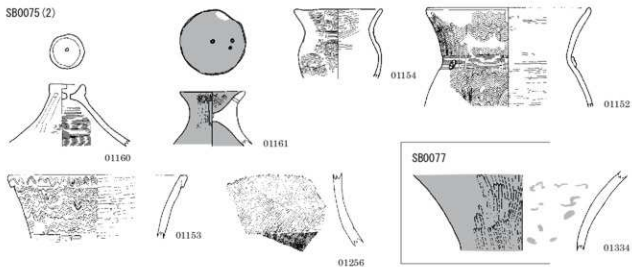

SB0102

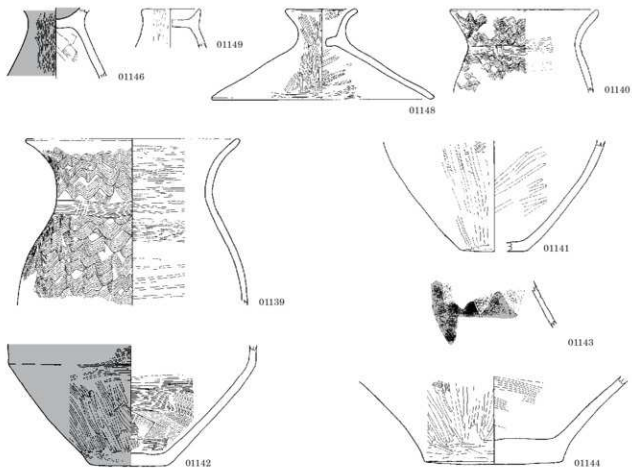

SB0105



0 1:4 10cm

SB0105 南

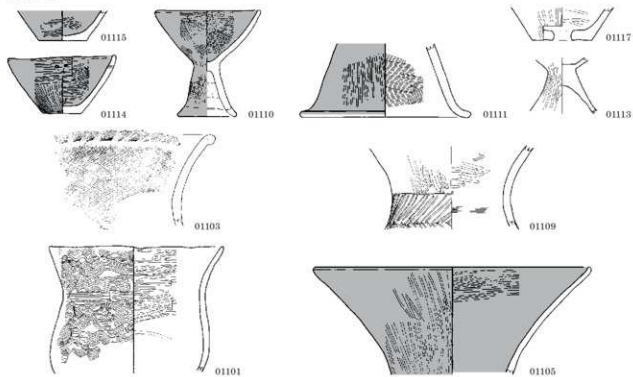

SB0105 北

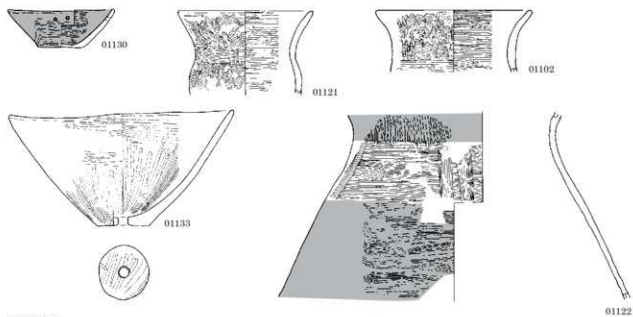

SB0106 新

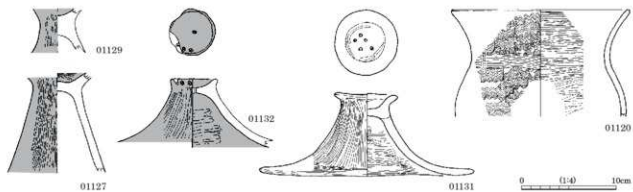



SB0110

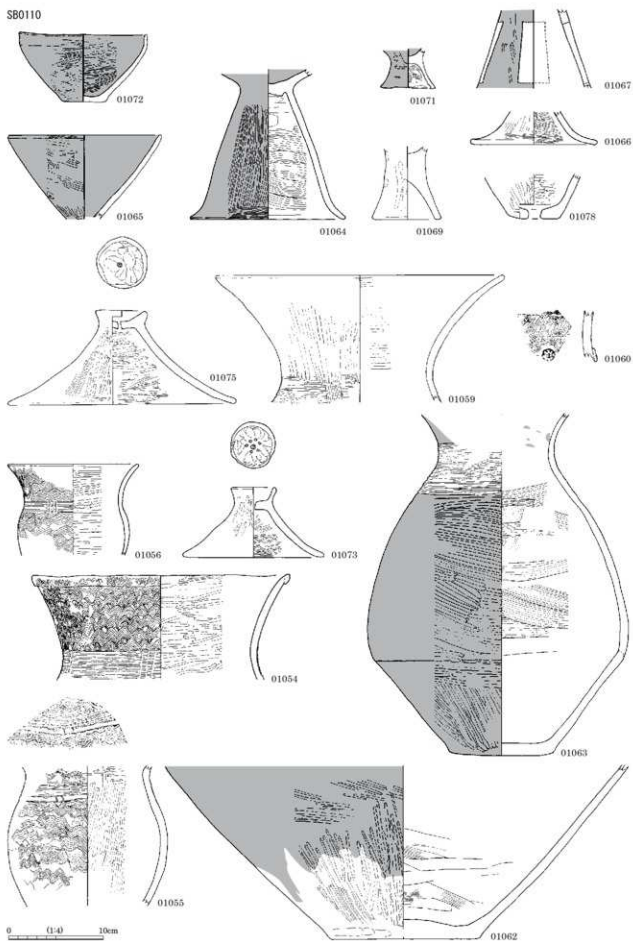

SB0111

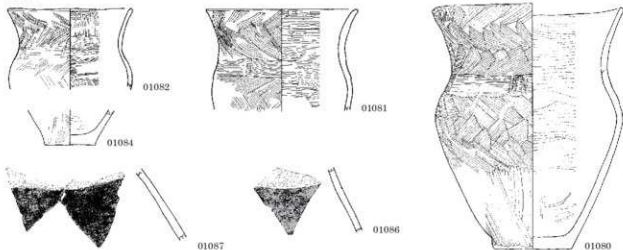

SB0117

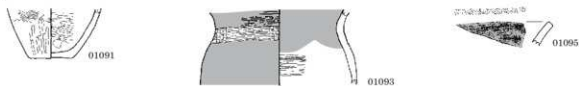

SB0128



SB0130



SB0134

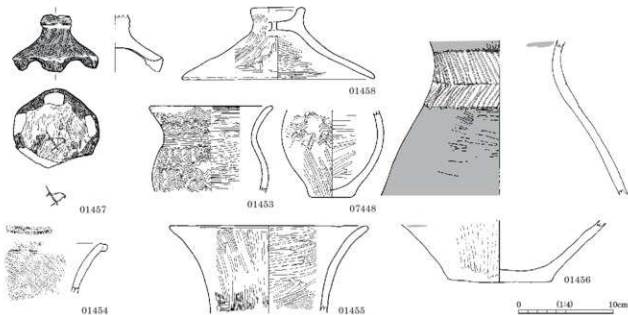

図版 28 弥生時代後期の土器 (23)

SB0149

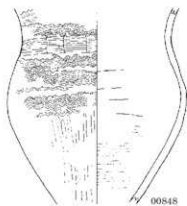

00848

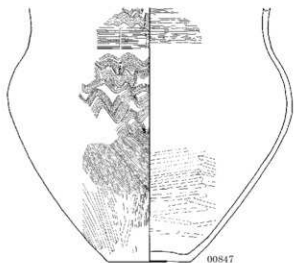

00847

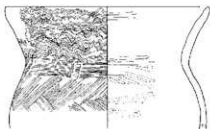

00846

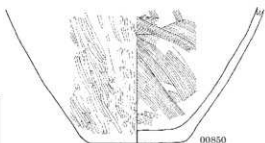

00850

SB0156



01351



01352



01349

SB0306



00998

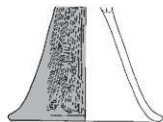

00997

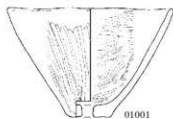

01001



01002



00996

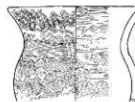

00991



00992



00993

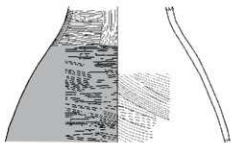

00995

0 1:4 10cm

S80307

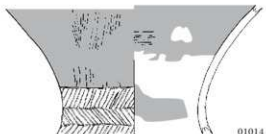
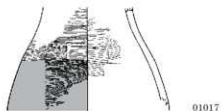
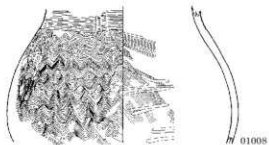
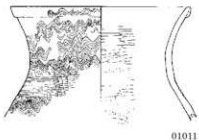
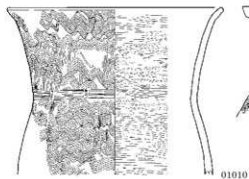
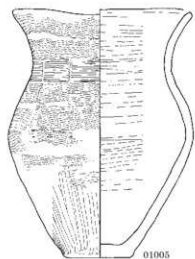
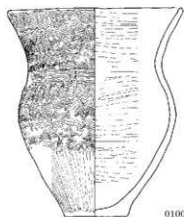
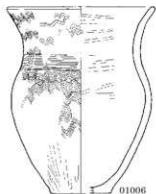
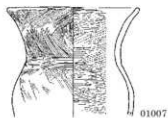
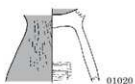
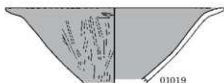

0 1:4 10cm

図版 30 弥生時代後期の土器 (25)

SB0310

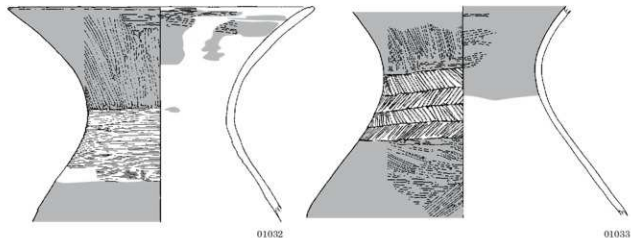
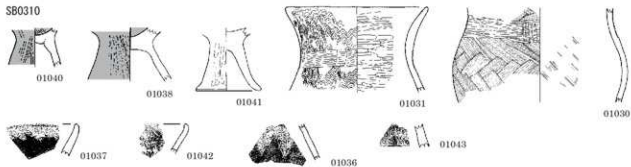

SB0315

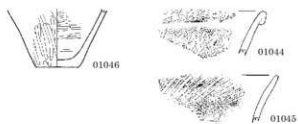

SB0316

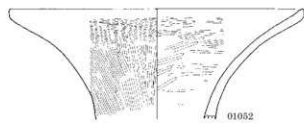

SB3029

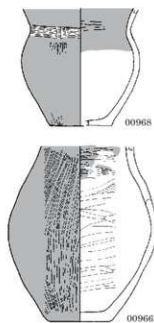

SB3036 (1)

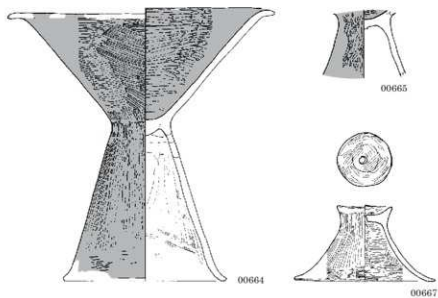

0 1:4 10cm

S83036 (2)

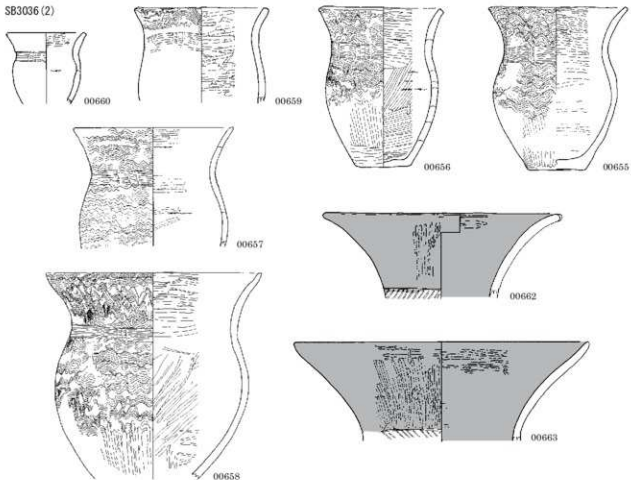

S83041 (1)

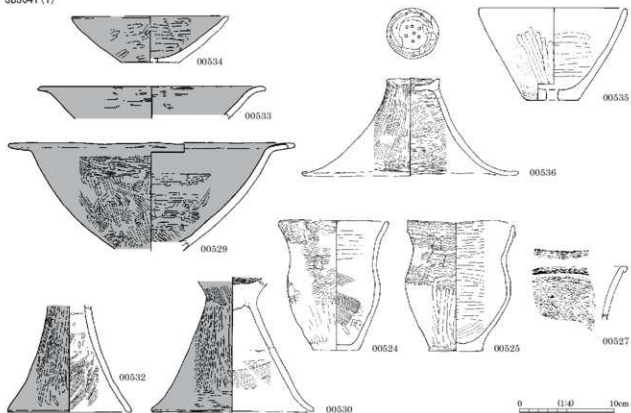

図版 32 弥生時代後期の土器 (27)

S83041 (2)

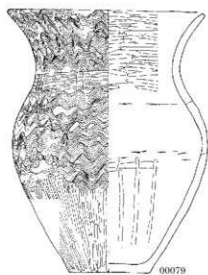
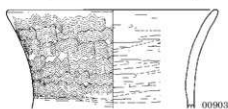
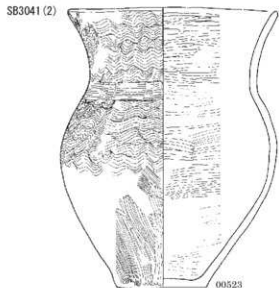

S83069

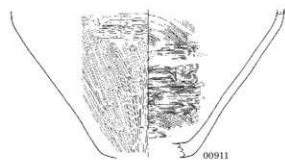
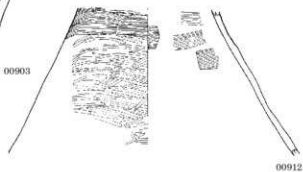
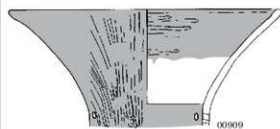
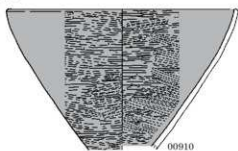

S83071



0 1:4 10cm





図版 34 弥生時代後期の土器 (29)

S83087



00892

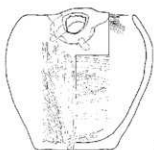

00894



00886

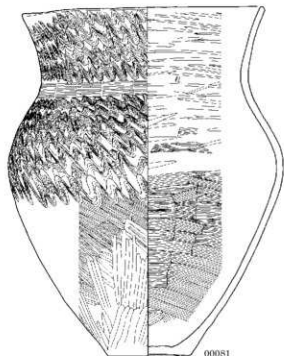

00881

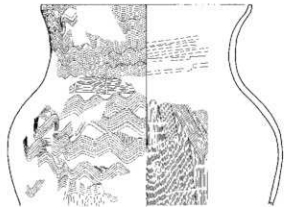

00885



00891

S83088



00934



00929

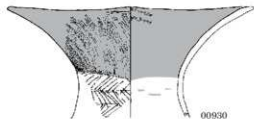

00930

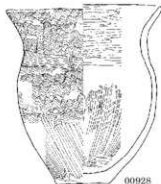

00928

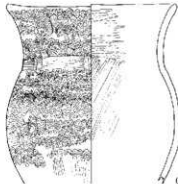

00927



00931

0 (1:4) 10cm

SB3091



00973



00972

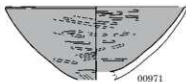

00971

SB3095



00949

SB3097



00976

SB3099

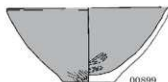

00899

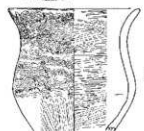

00895



00900

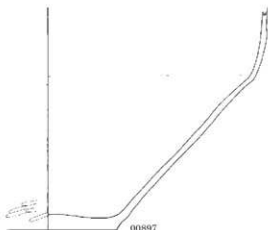

00897

SB4002 (1)



00787

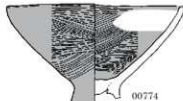

00774

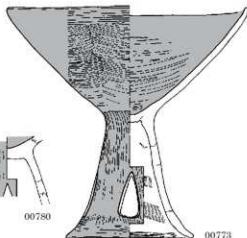

00773



00785



00786



00780



00778



00783



00779



00798



00797

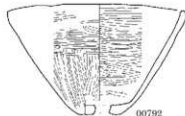

00792

0 (1:4) 10cm

図版 36 弥生時代後期の土器 (31)

SB4002 (2)

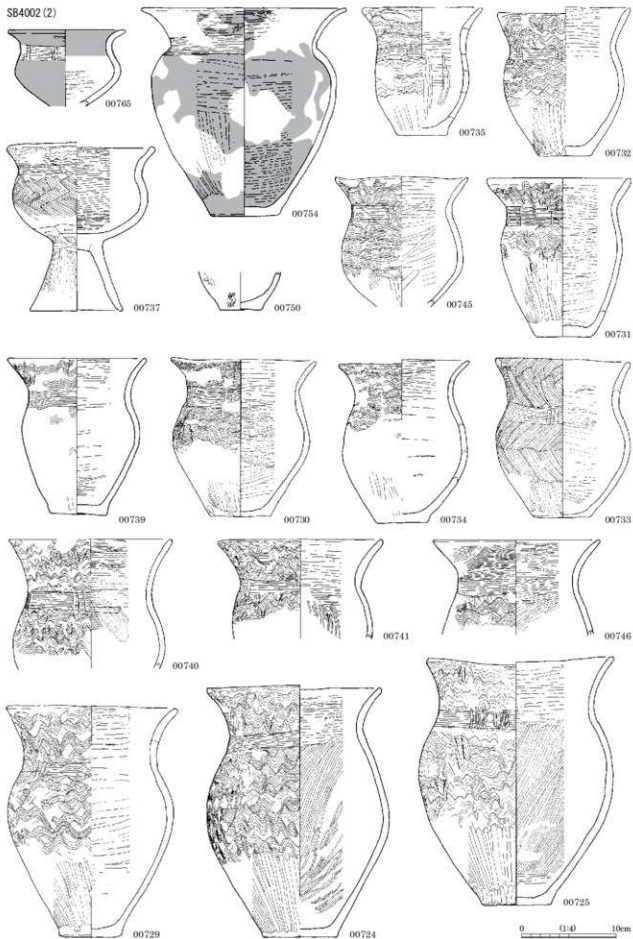

SB4002 (3)

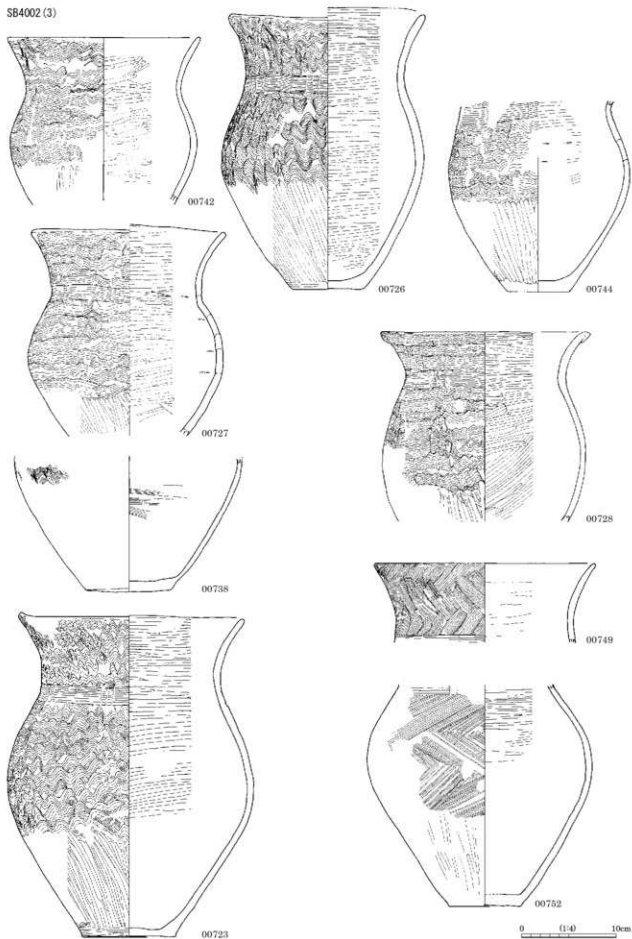

図版 38 弥生時代後期の土器 (33)

SB4002 (4)

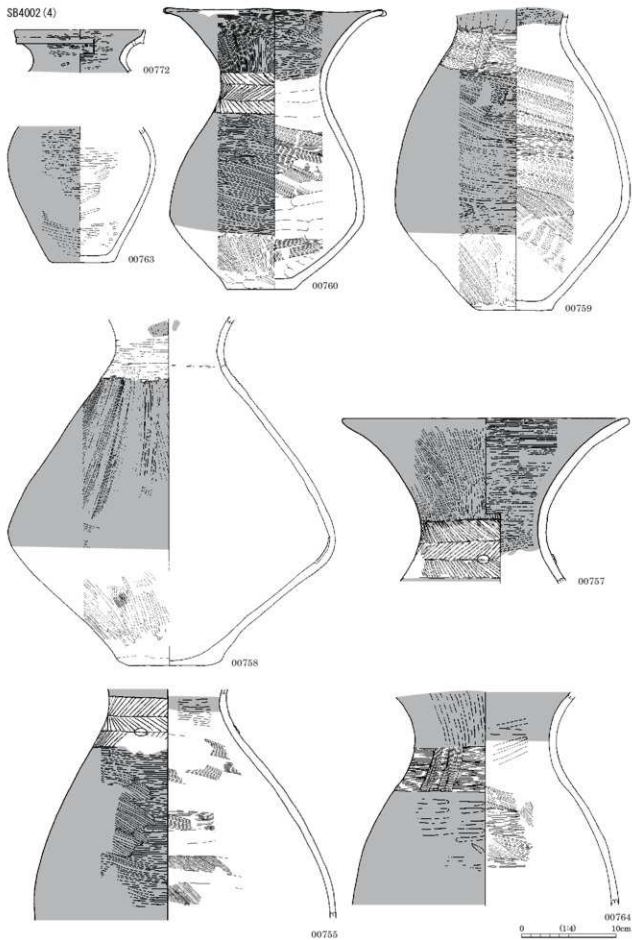

SB4002 (5)

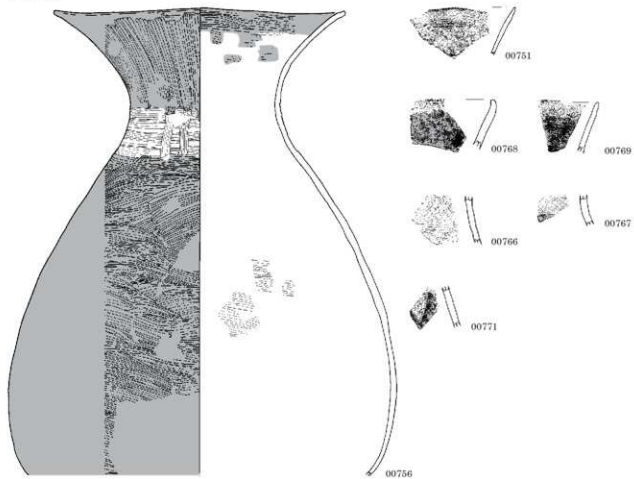

SB4003

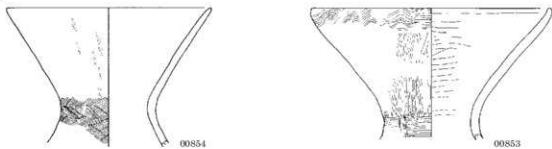

SB4008

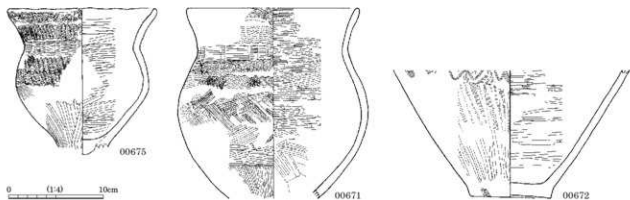

図版 40 弥生時代後期の土器 (35)

SB4016

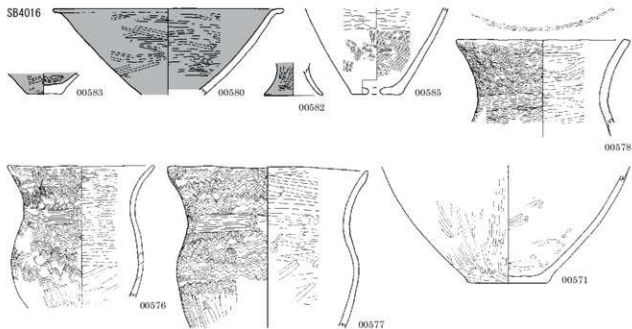

SB4029

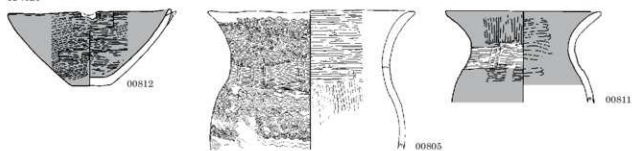

SB4030 (1)

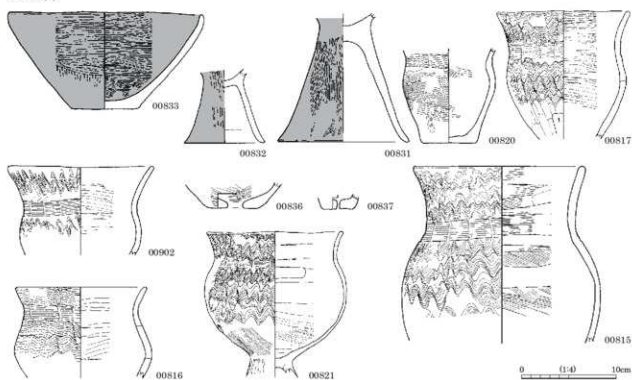

0 1:4 10cm

SB4030 (2)

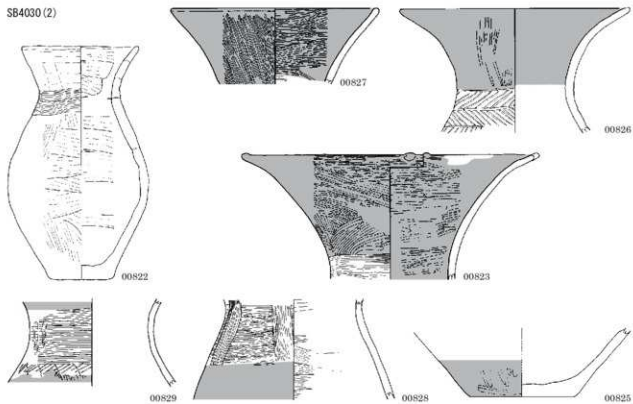

SB4032

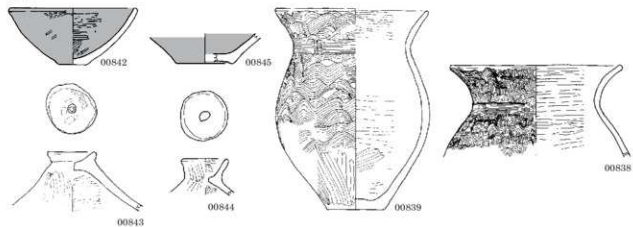

SB4035

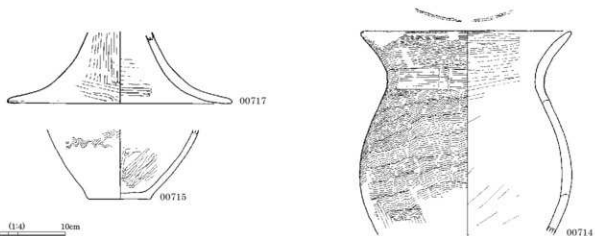



図版 42 弥生時代後期の土器 (37)

SB4038

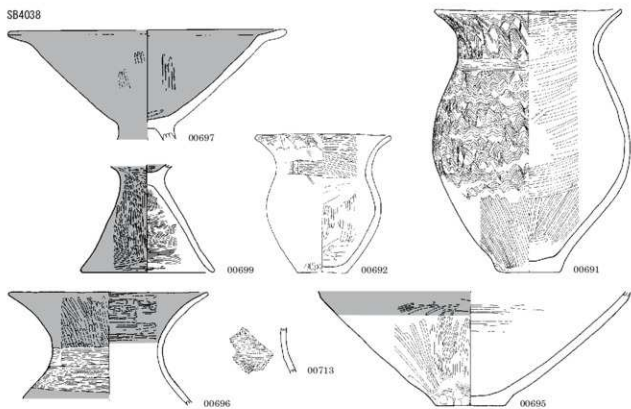

SB4056

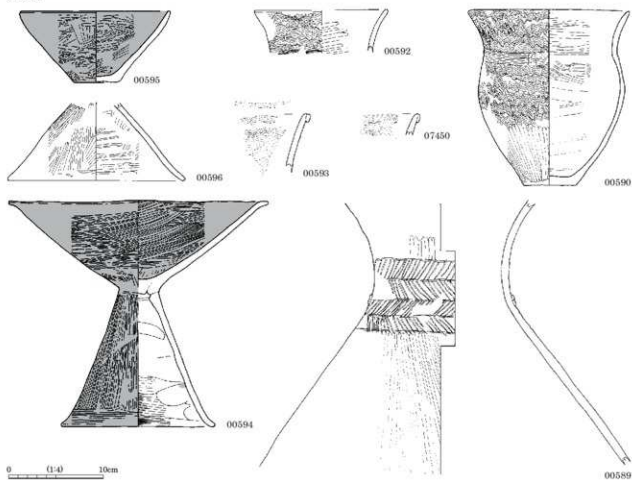

SB4066



SB4067

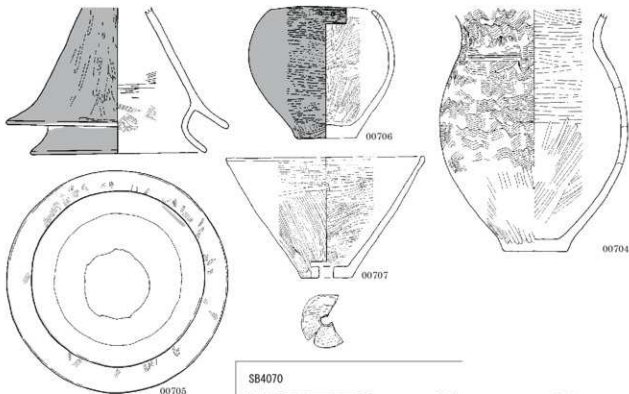

SB4070



SB5047 (1)

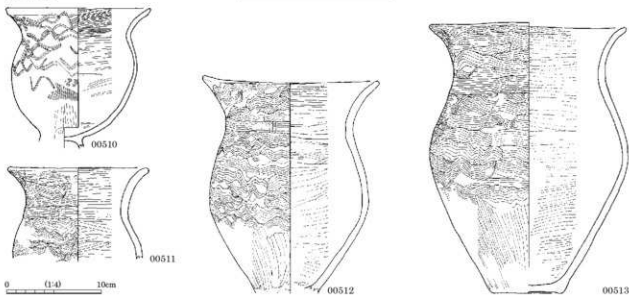

0 1:4 10cm

図版 44 弥生時代後期の土器 (39)

SB5047 (2)

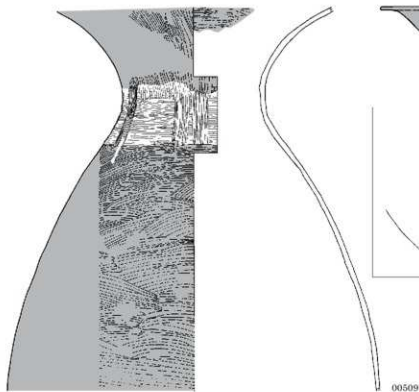

SB6012

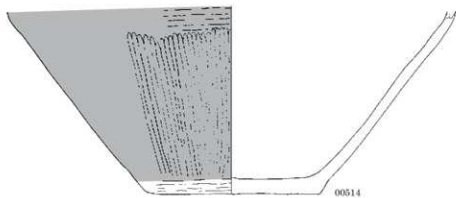
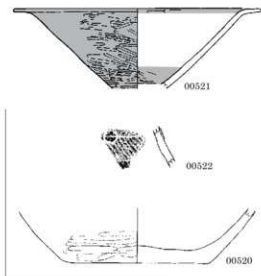

SB6025 (1)

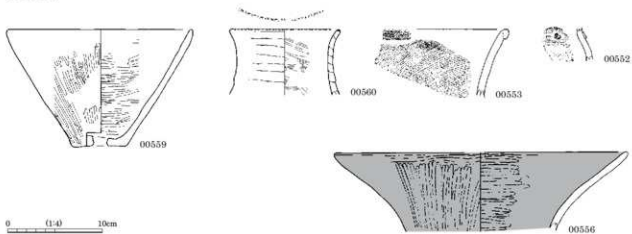

0 1:4 10cm

SB6025 (2)

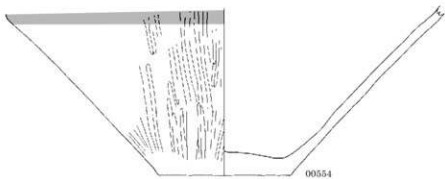

SB6028

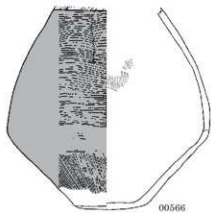
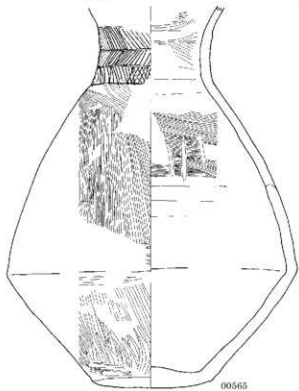
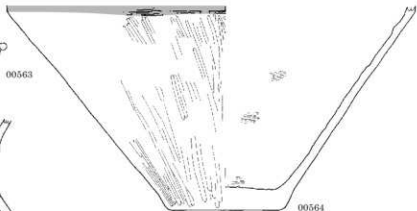
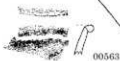
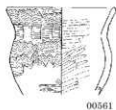

SB6044 (1)

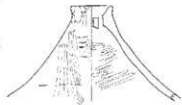

0 1:4 10cm

図版 46 弥生時代後期の土器 (41)

SB6044 (2)

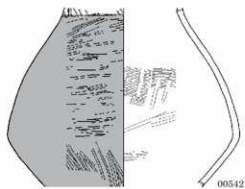
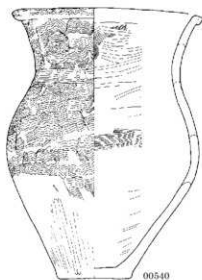
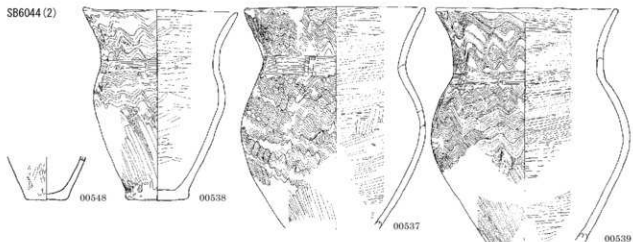

SB6067

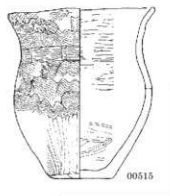

SB7047

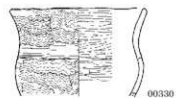
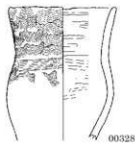
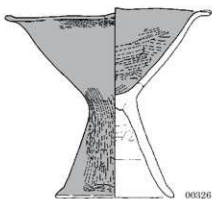

0 1:4 10cm

S88001

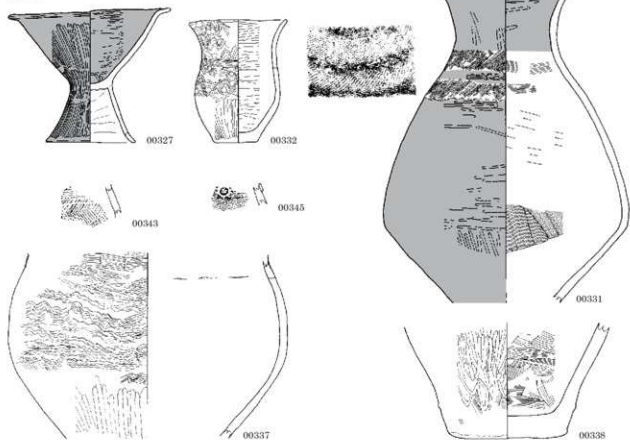

S88005

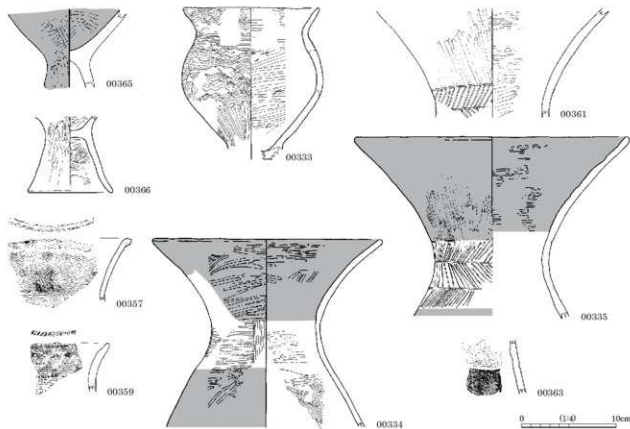

図版 48 弥生時代後期の土器 (43)

SB8006  
(SB8027)



00367



00368



00370

SB8029



00336

SB8043



00375

00376

SM3003

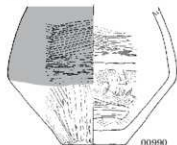

00990

SM4003



00864

SM4001



00876

00879

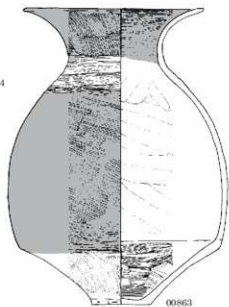

00863

S00001

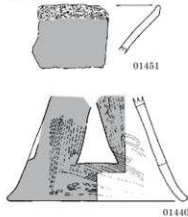

01451

01440

SK0094

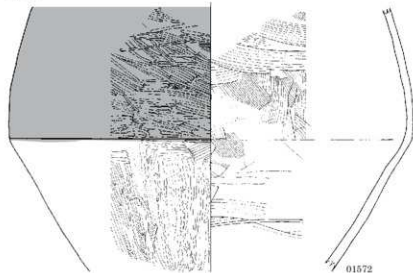

01572

S00002



01576

0 (1:4) 10cm

SK0235



SK0310

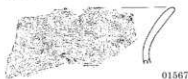

SK0315

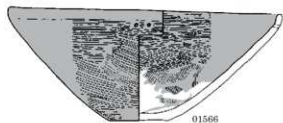

SK3018



SK3246

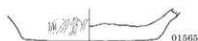

SK3284

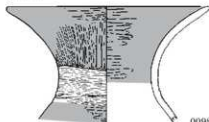

SK4145

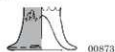

SK4259

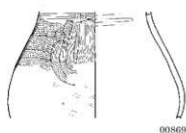
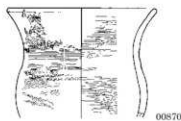

SD3006・4006 (1)  
SD3006 出土

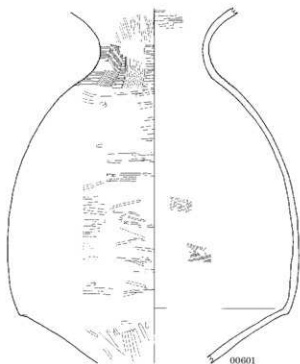

0 (1:4) 10cm



図版 50 弥生時代後期の土器 (45)

SD3006-4006 (2)  
SD4006 出土

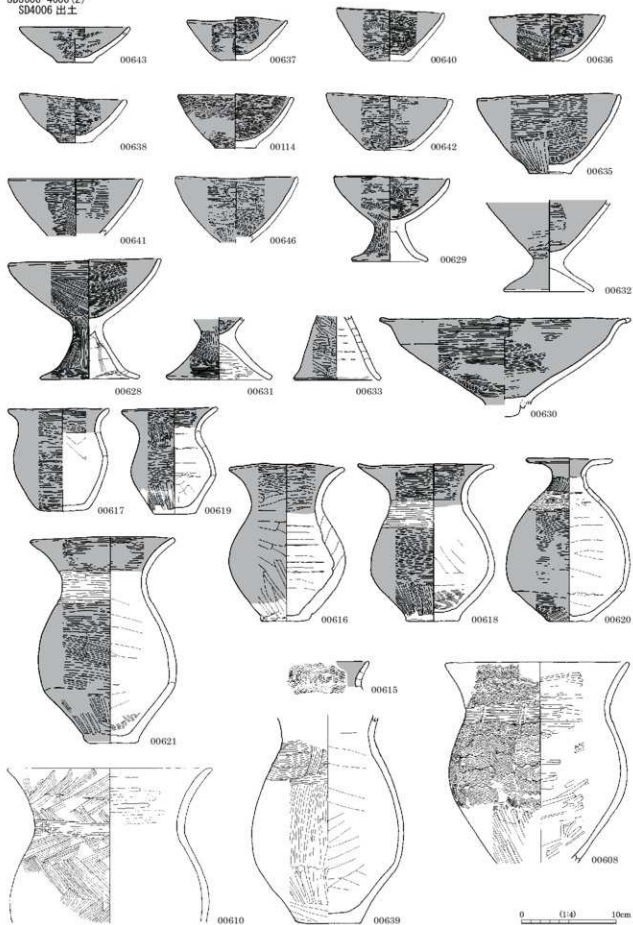

弥生時代遺構外出土

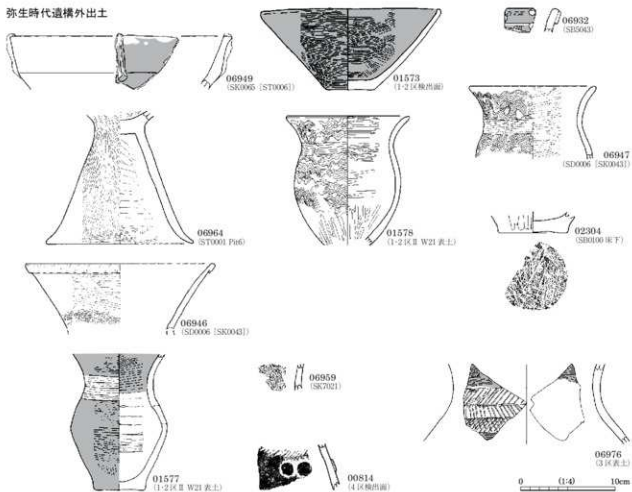

図版 52 弥生時代後期の土器 (47)

ミニチュア土器

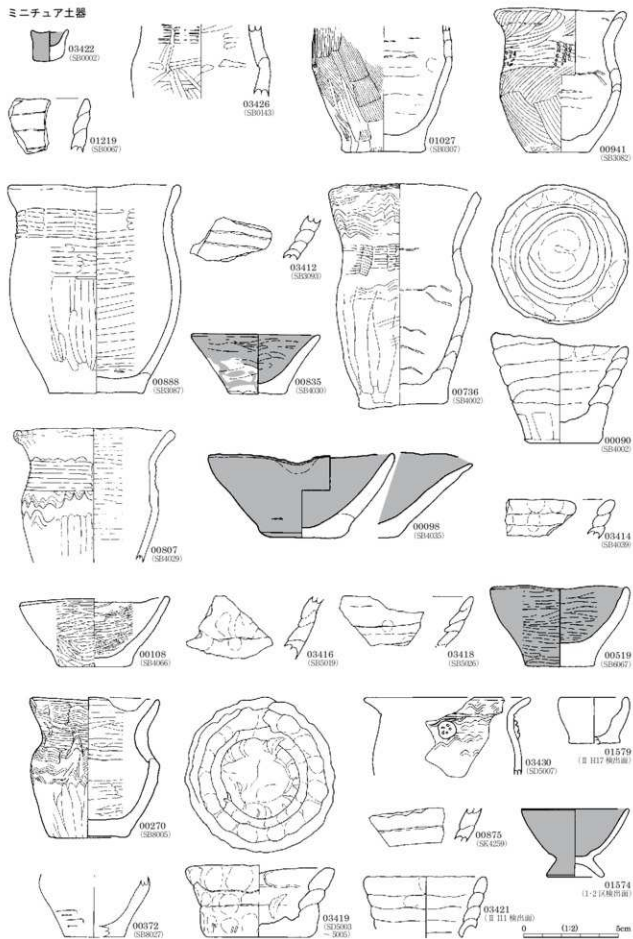

人形土器

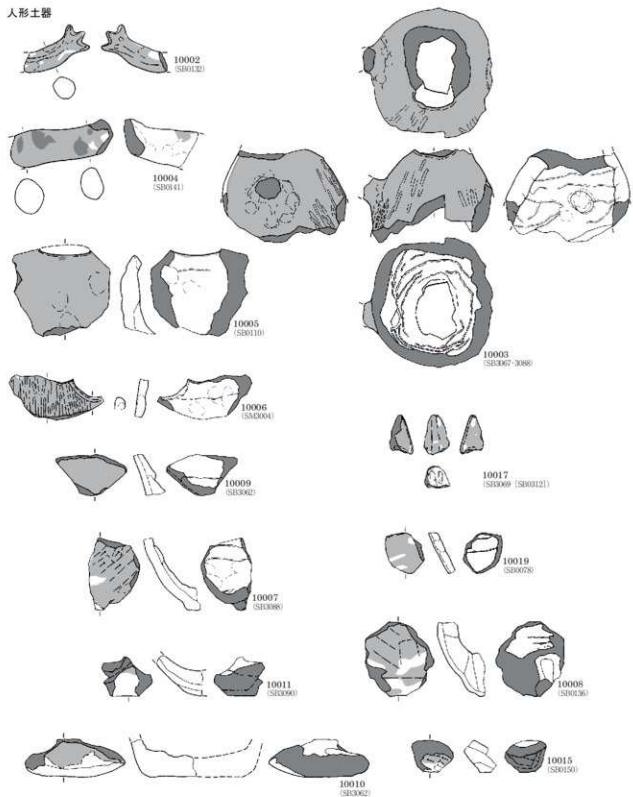

不明土製品

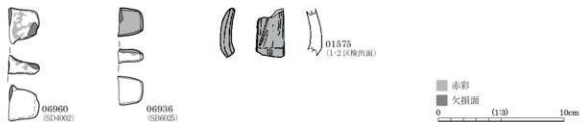

図版 54 弥生時代後期の土製品 (2)

匙形土製品

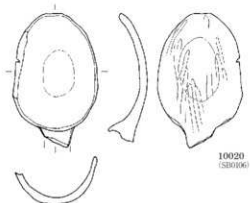

10020  
(SB0106)

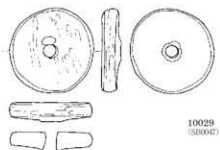

10029  
(SB0047)

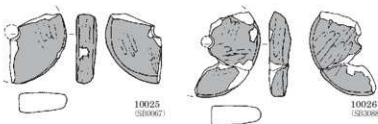

10025  
(SB0067)

10026  
(SB0088)

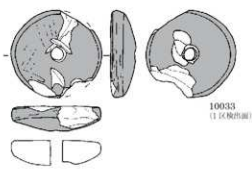

10033  
(I 区検出品)

土製玉類

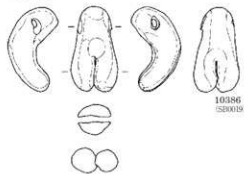

10386  
(SB0019)

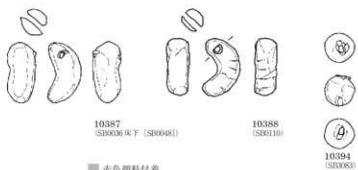

10387  
(SB0006 4/F (SB0048))

10388  
(SB0116)

10394  
(SB0083)

土製紡錘車

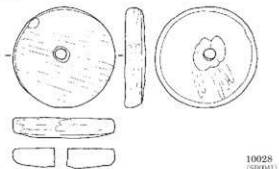

10028  
(SB0041)

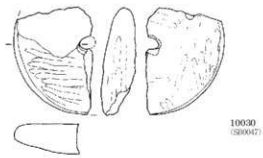

10030  
(SB0047)

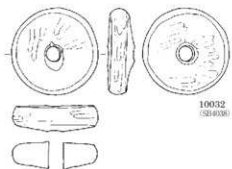

10032  
(SB0036)

■ 赤色顔料付着  
 匙形土製品・土製紡錘車 土製玉類  
 0 1cm 0 1cm

土器片加工板 (1)

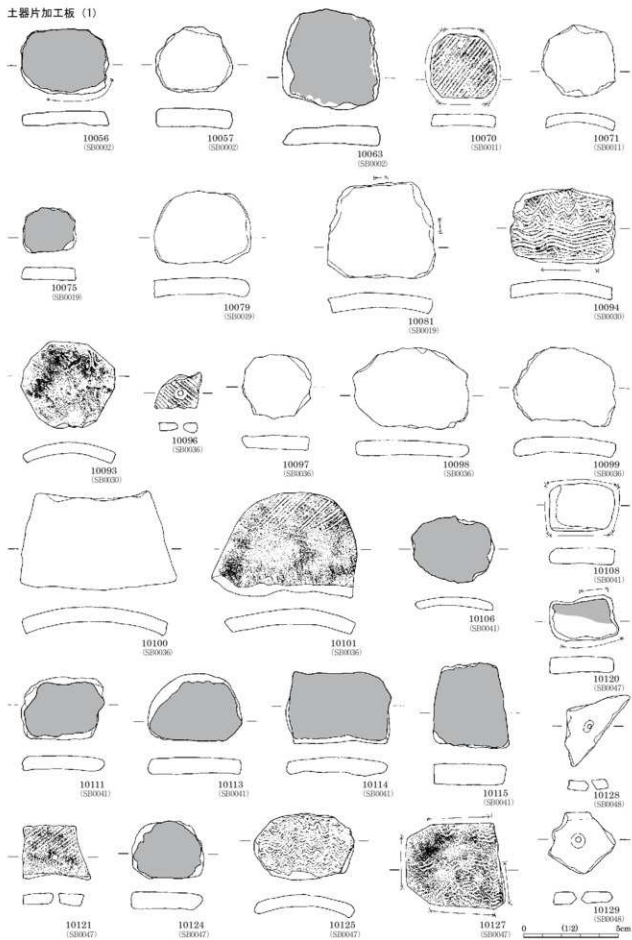

図版 56 弥生時代後期の土製品 (4)

土器片加工板 (2)

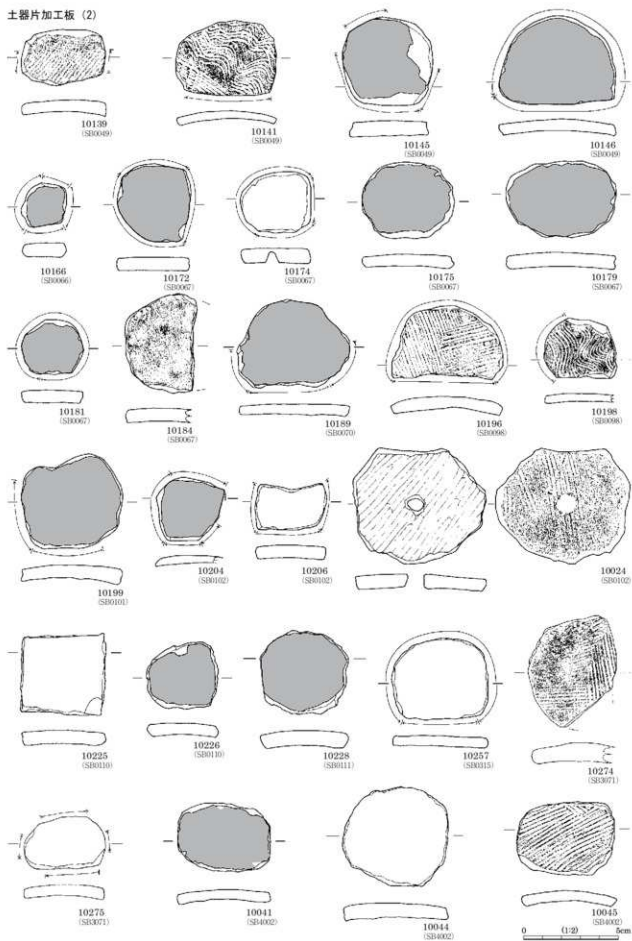

土器片加工板 (3)

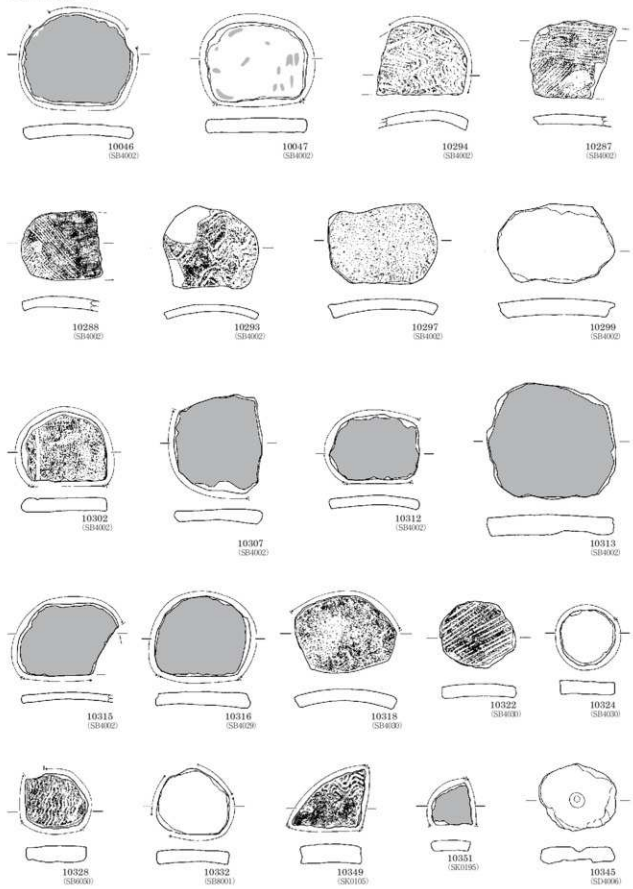



図版 58 古墳時代～古代の土器 (1)

S80001

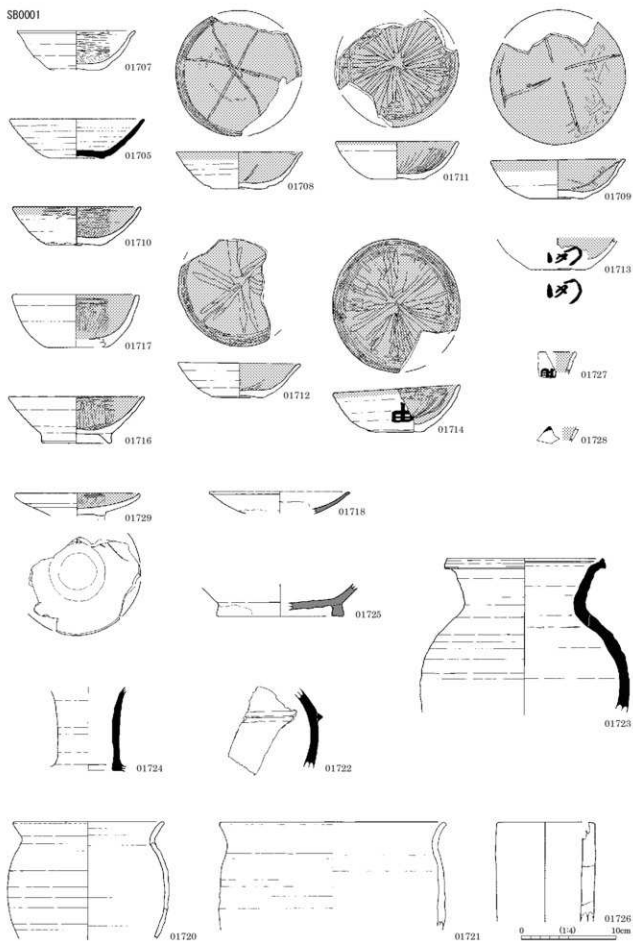

SB0003



SB0005

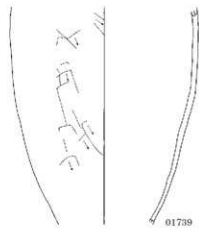
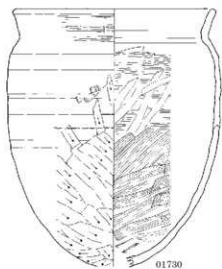
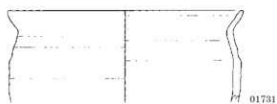
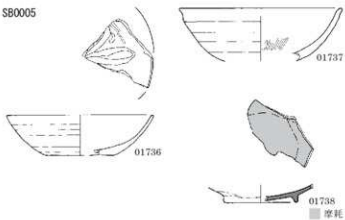

SB0009



SB0010(1)

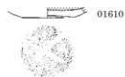
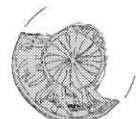
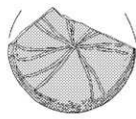
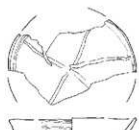
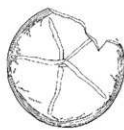

0 10cm

図版 60 古墳時代～古代の土器 (3)

SB0010 (2)

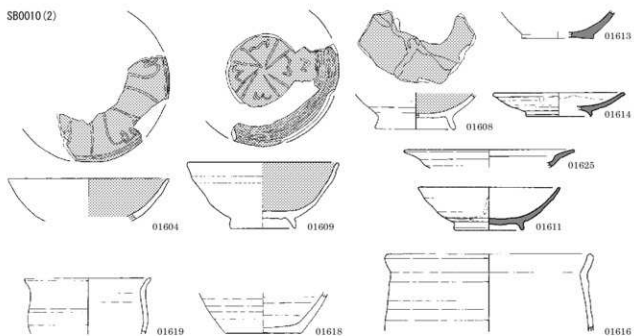

SB0013

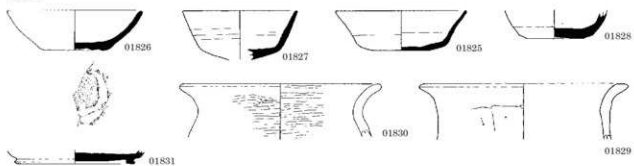

SB0014 (1)

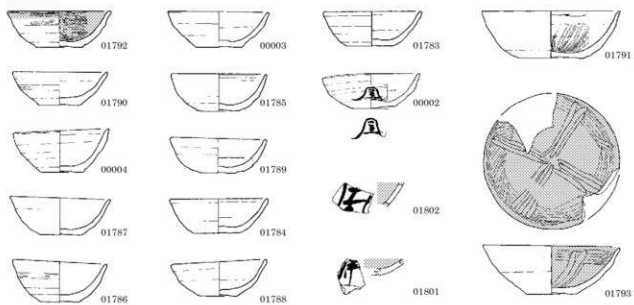

0 (1:4) 10cm

SB0014(2)

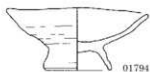

01794

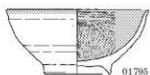

01795



01800



01799



01798

SB0016



01743



01744



01752



00005



01751



01745



01746

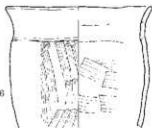

01748

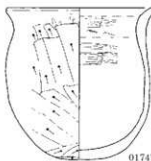

01747

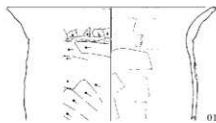

01749

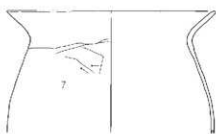

01750

SB0018(1)



01696



01704



01694

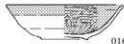

01695



01700



01701

0 1:1 10cm

図版 62 古墳時代～古代の土器 (5)

SB0018 (2)

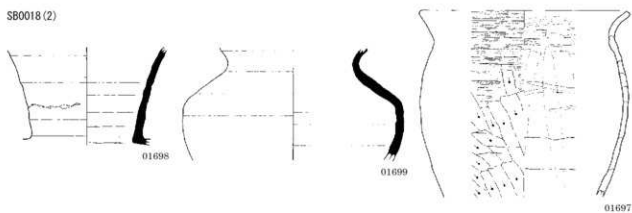

SB0020

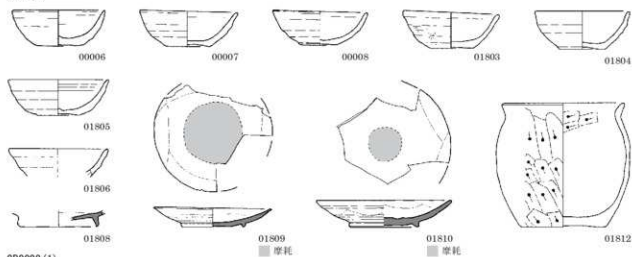

SB0022 (1)

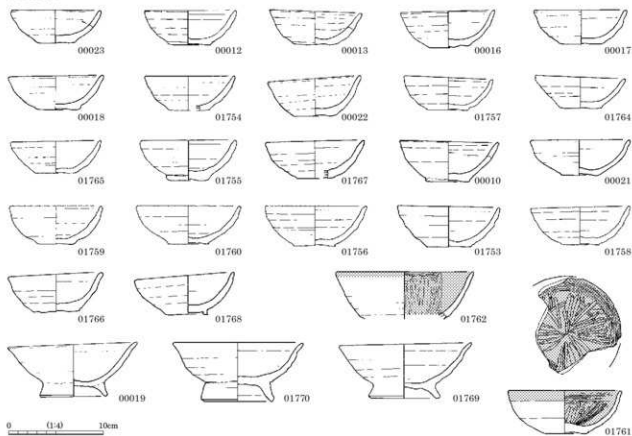

0 (1:4) 10cm

## SB0022 (2)

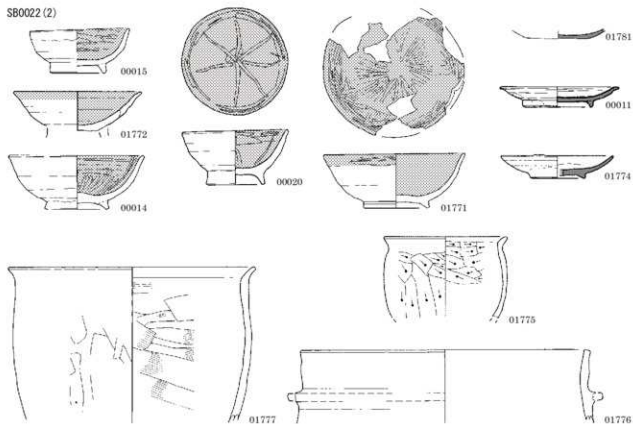

## SB0023

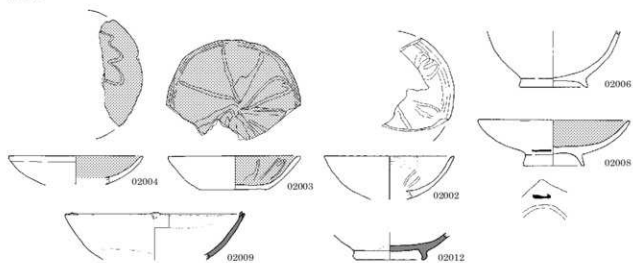

## SB0028

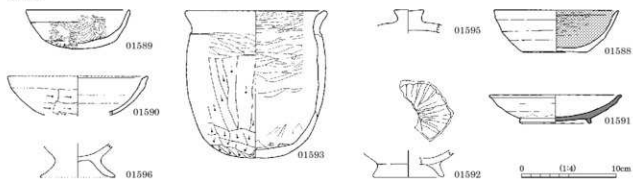

図版 64 古墳時代～古代の土器 (7)

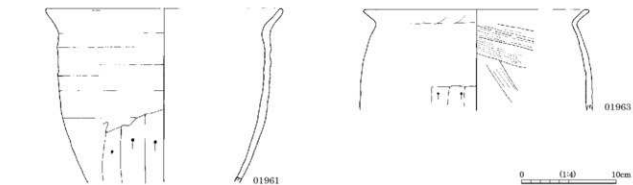
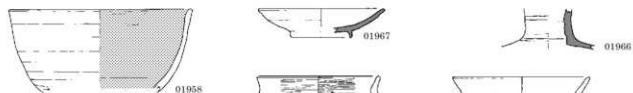
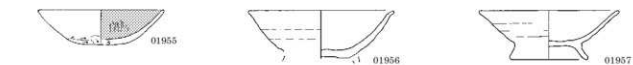
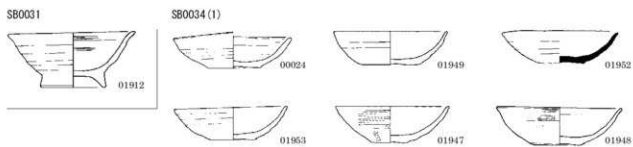
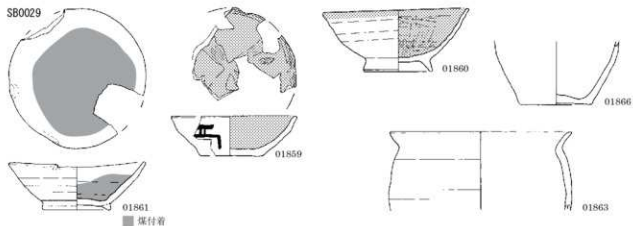

SB0034 (2)

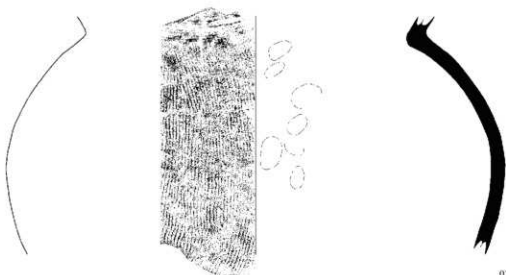

01964

SB0038

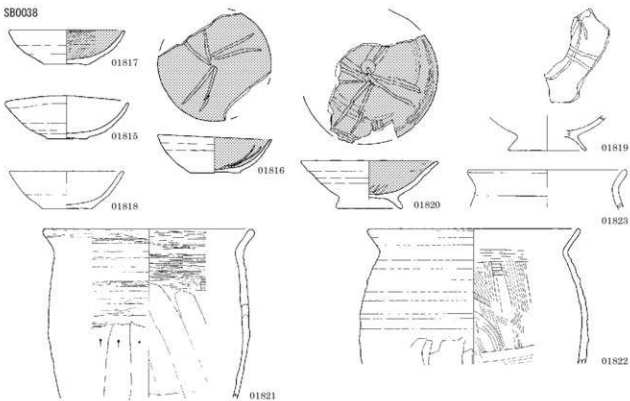

SB0039

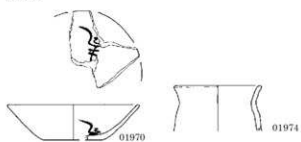

SB0040

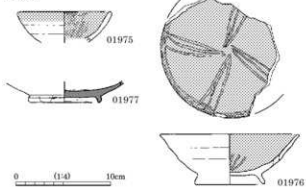



図版 66 古墳時代～古代の土器 (9)

SB0042

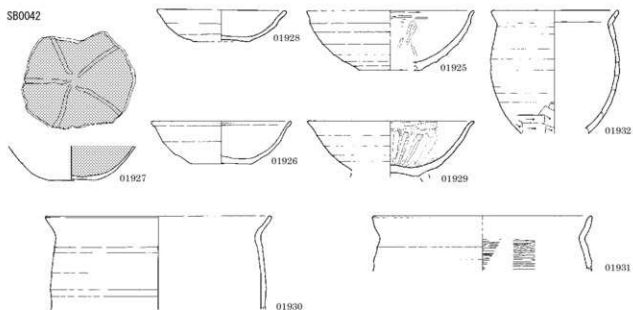

SB0043

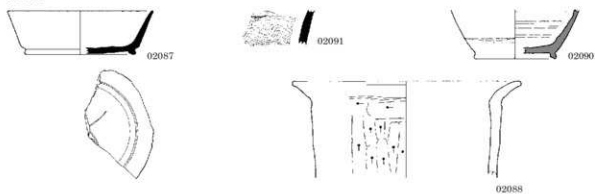

SB0050

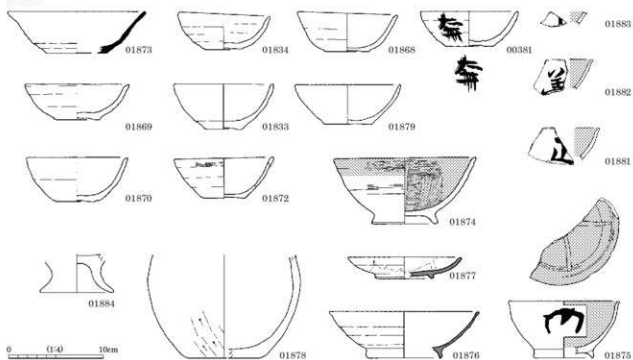

SB0051

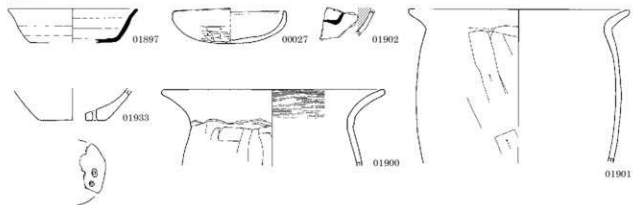

SB0053

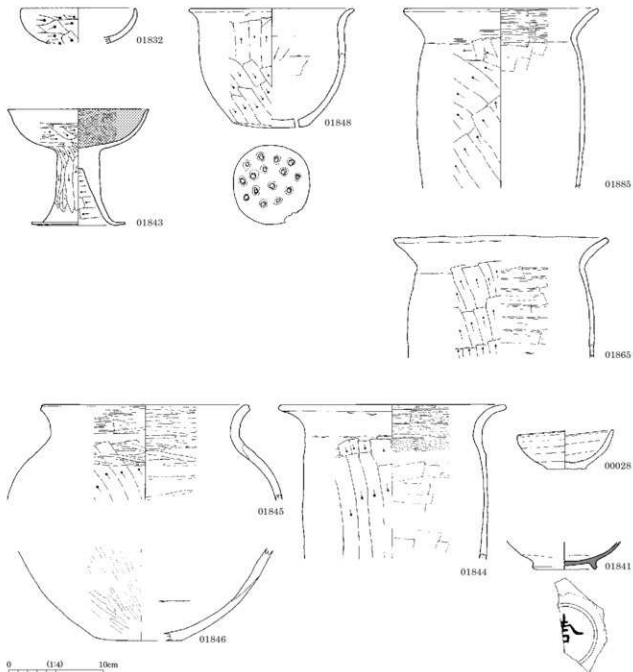

図版 68 古墳時代～古代の土器 (11)

SB0054



SB0055

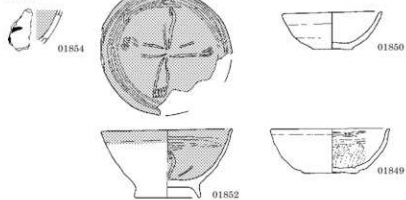

SB0058

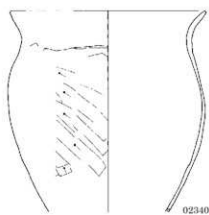
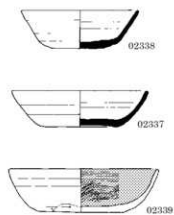

SB0063

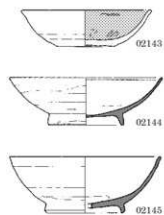

SB0060

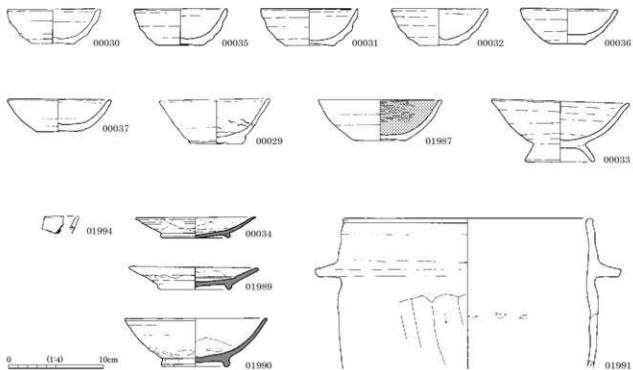

SB0065

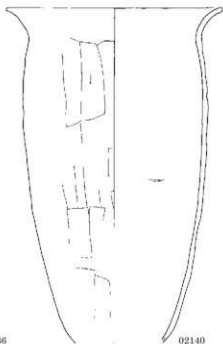
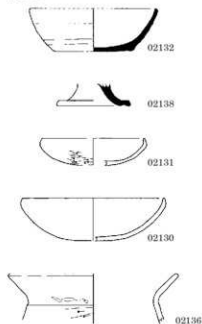

SB0065-66



SB0068

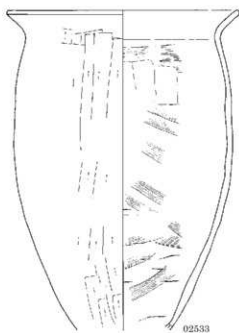
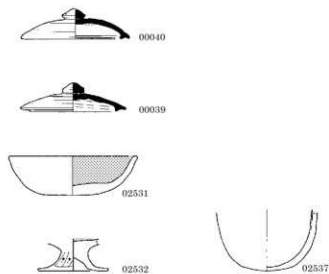

SB0070

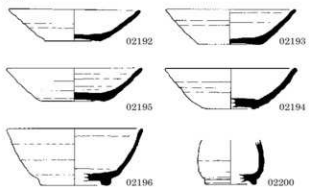

0 1:4 10cm

図版 70 古墳時代～古代の土器 (13)

S80073

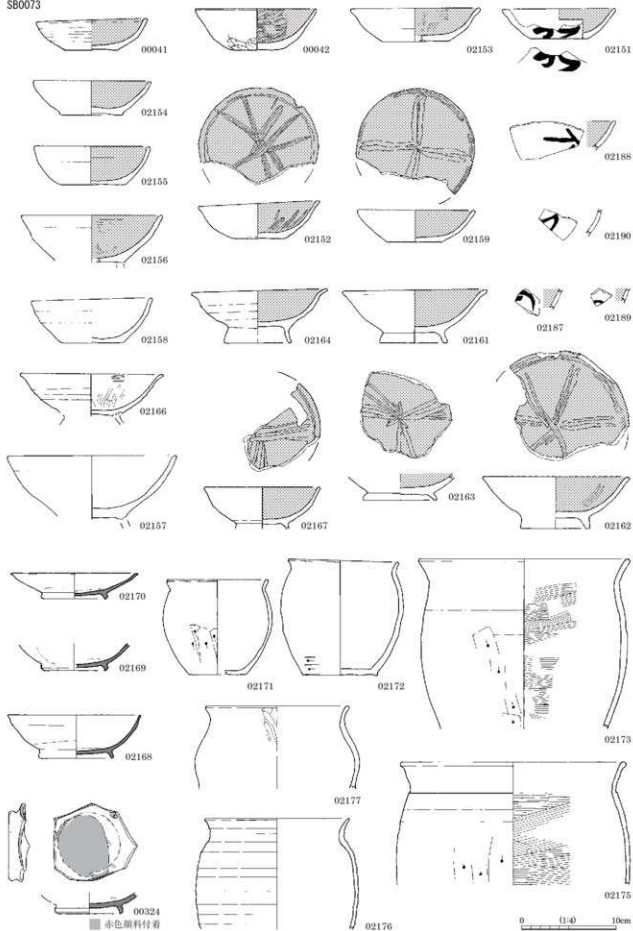

SB0074

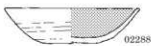
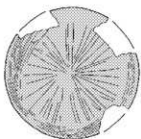
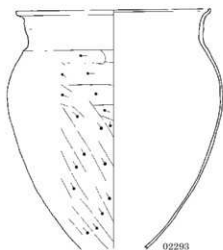
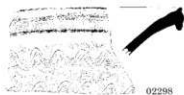

SB0076

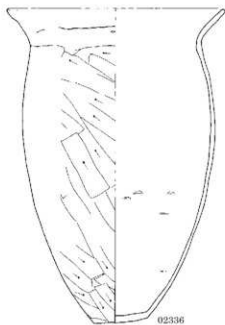

SB0078 (1)

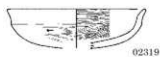
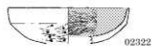

0 1:4 10cm

図版 72 古墳時代～古代の土器 (15)

SB0078 (2)

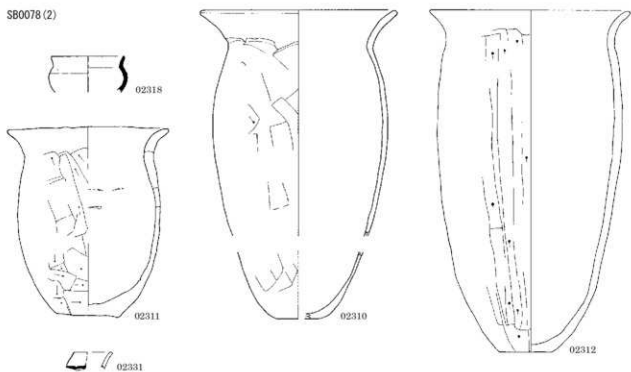

SB0079

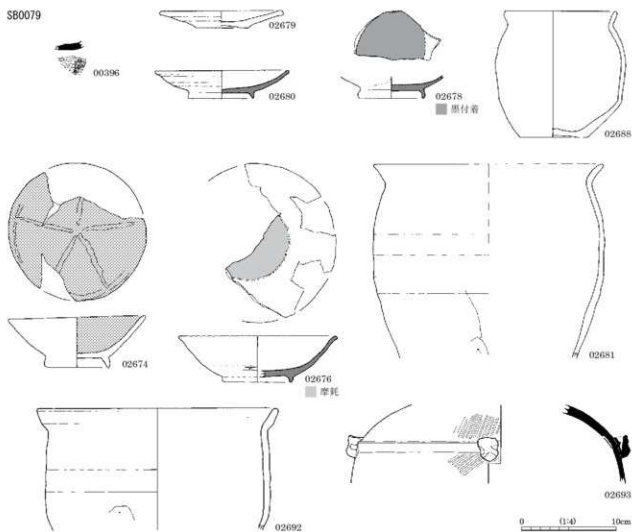

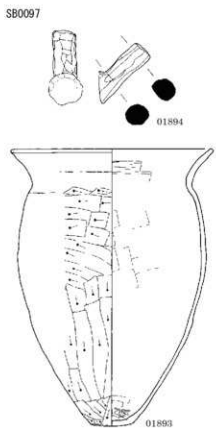
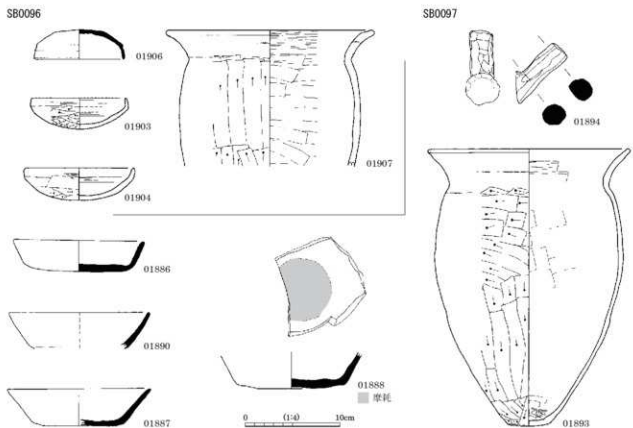
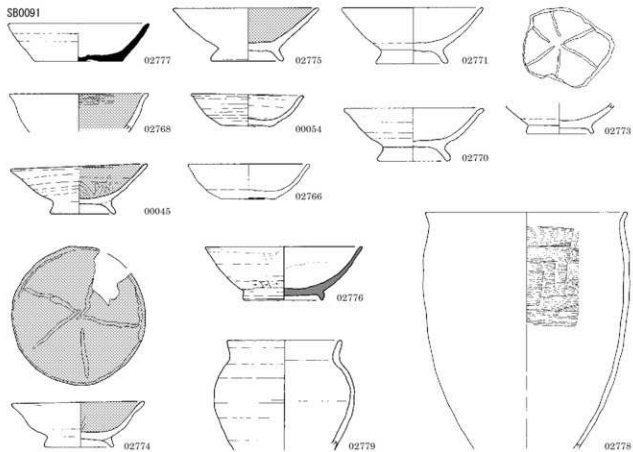



図版 74 古墳時代～古代の土器 (17)

SB0098

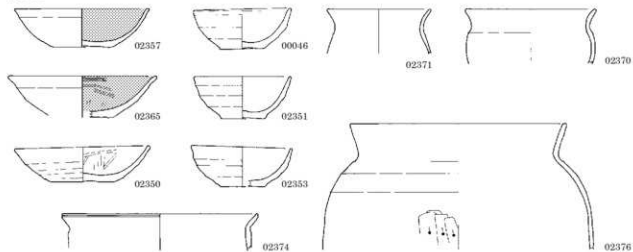

SB0101



SB0103

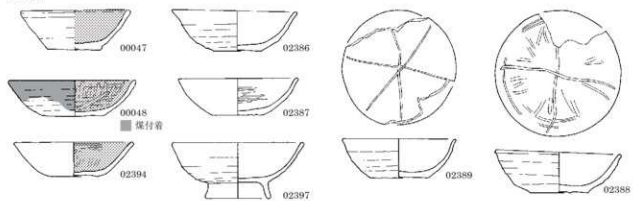

SB0104



SB0107 (1)

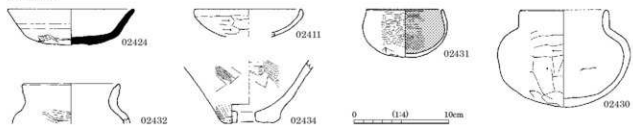

SB0107 (2)



02429

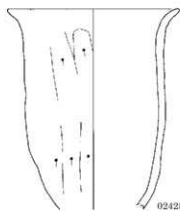

02428

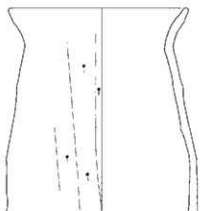

02426

SB0112



02436



00398



02437

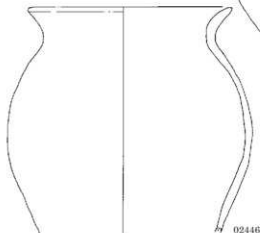
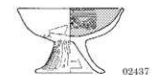

02446

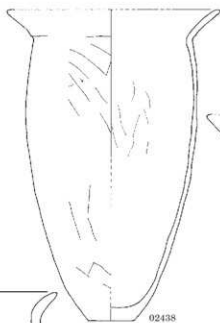

02438

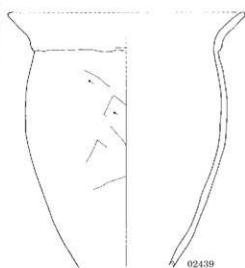

02439

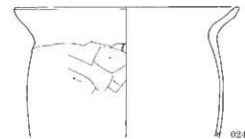

02445

SB0114



02481



02480

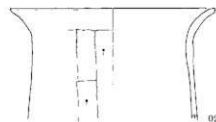

02483

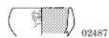

02487

0 1:4 10cm

図版 76 古墳時代～古代の土器 (19)

SB0115

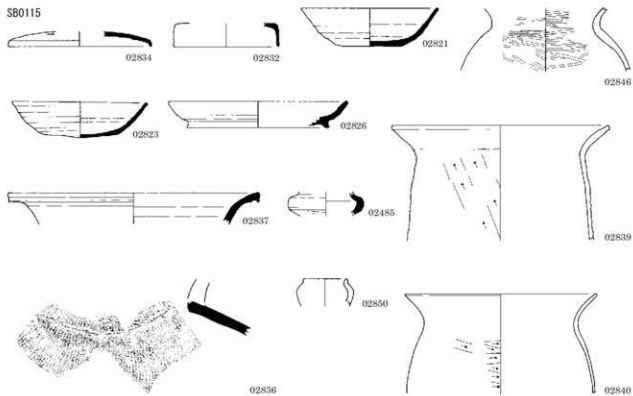

SB0116

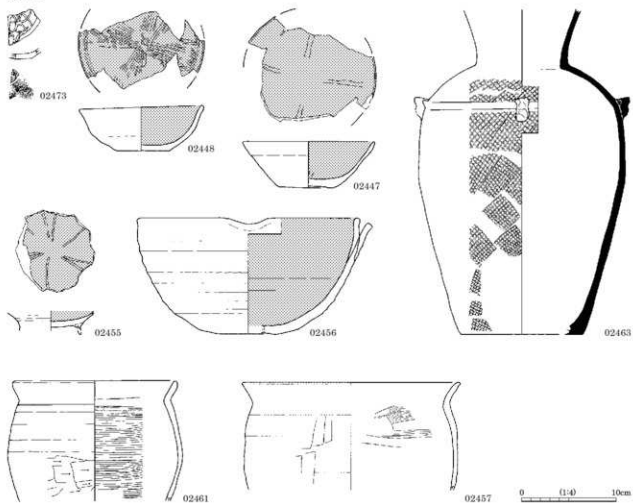

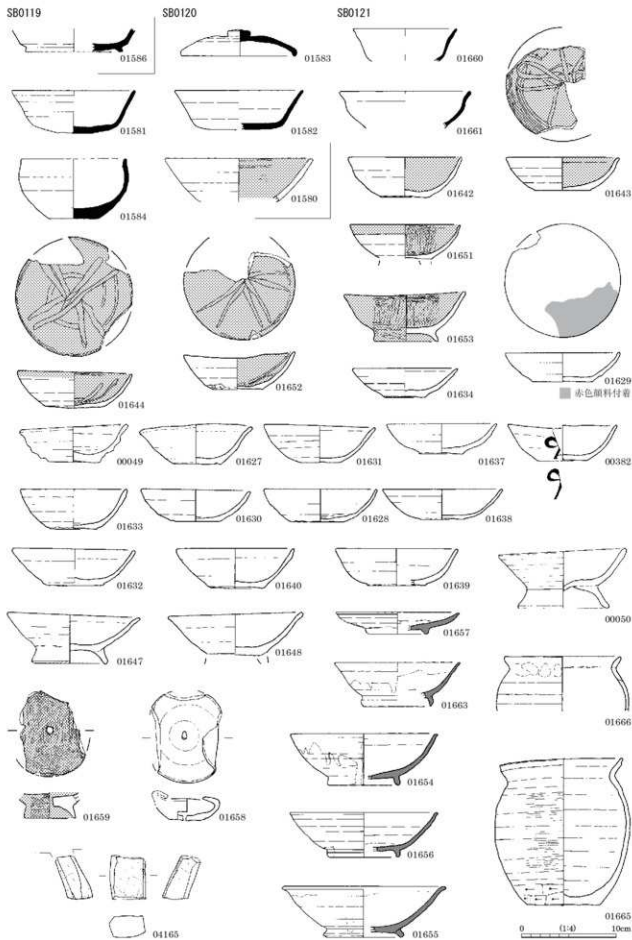

図版 78 古墳時代～古代の土器 (21)

SB0125

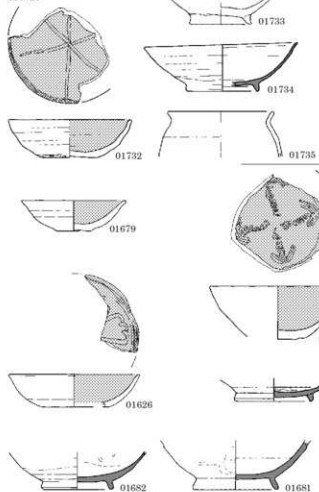

SB0126

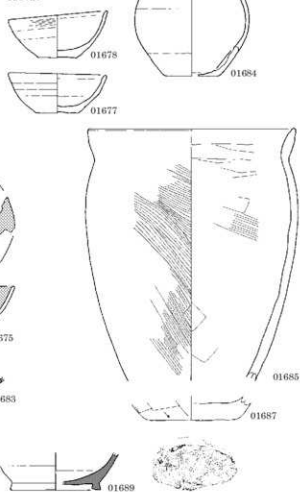

SB0132

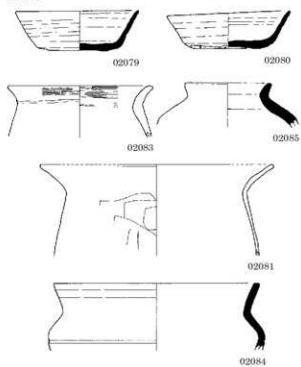

SB0133

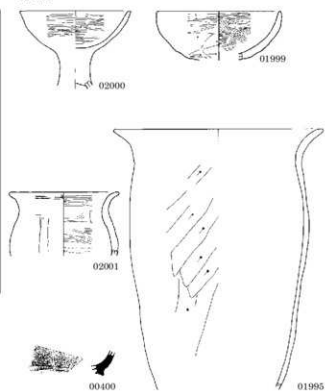

0 10cm (1:4)

SB0136

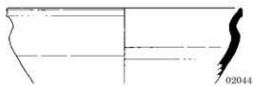
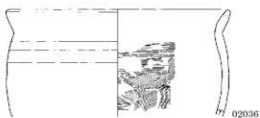
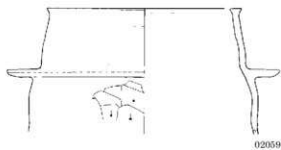
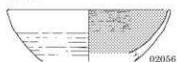

0 1(4) 10cm

SB0137

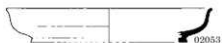
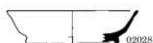
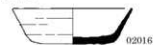

図版 80 古墳時代～古代の土器 (23)

SB0139

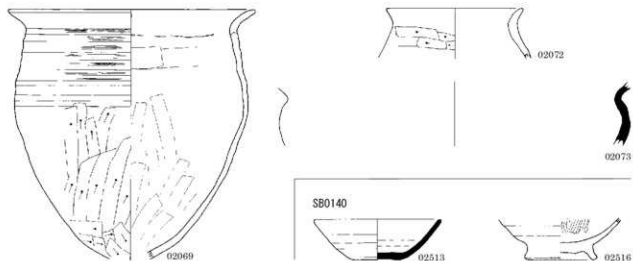
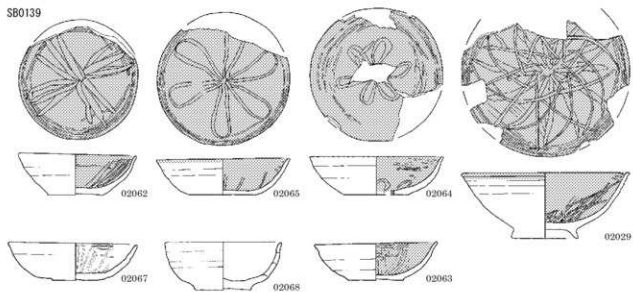

SB0141

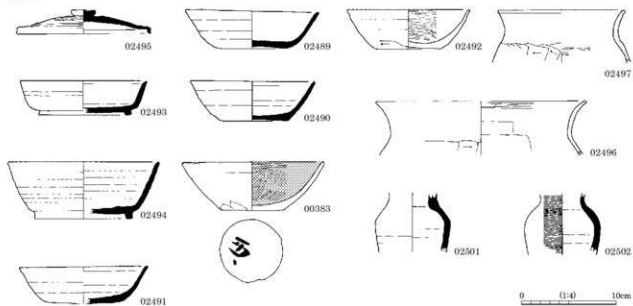

SB0143

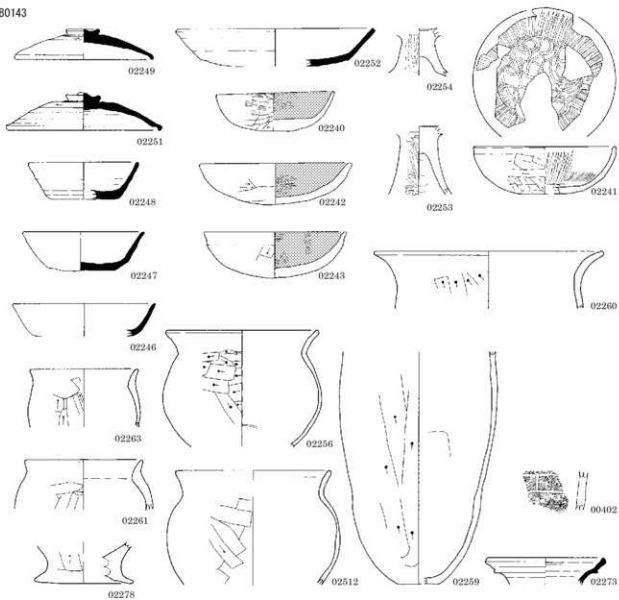

SB0144

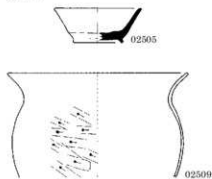

SB0145

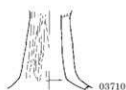

SB0148

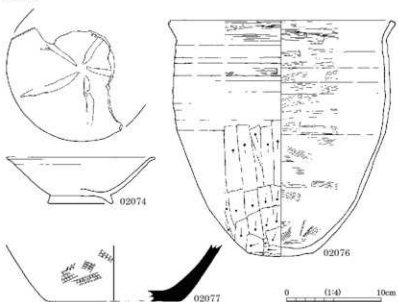



図版 82 古墳時代～古代の土器 (25)

SB0150

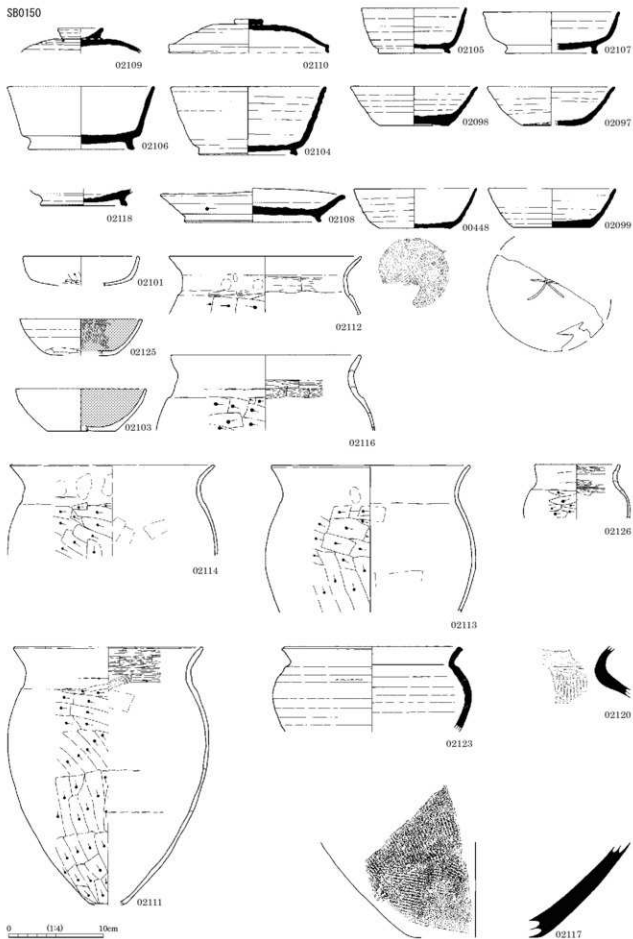

SB0152

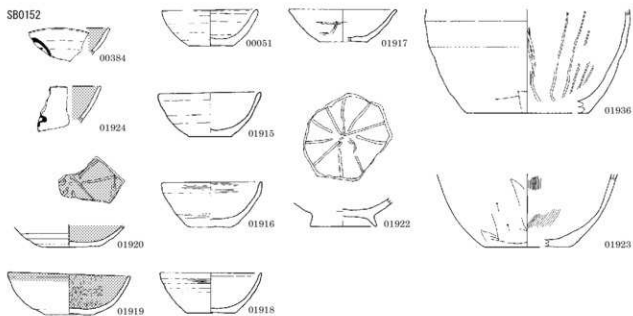

SB0157



SB0159

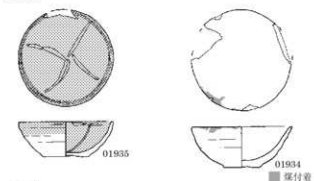

SB0161

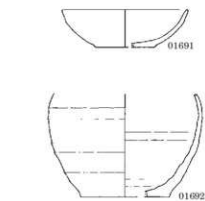

SB0164

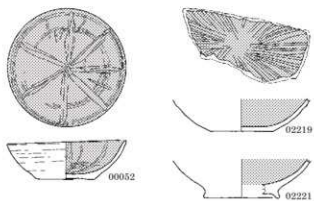

SB0165 (1)

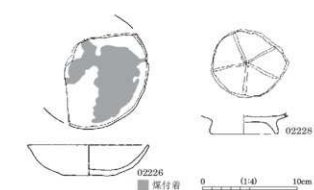
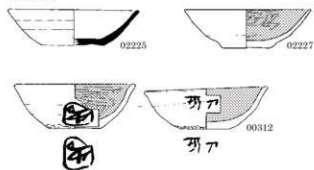

0 10cm (1:4)

図版 84 古墳時代～古代の土器 (27)

SB0165 (2)

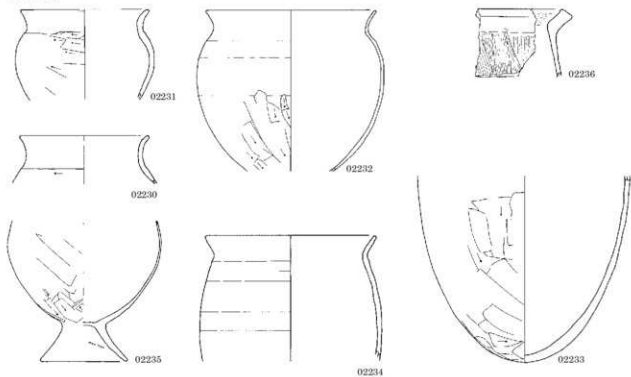

SB0167

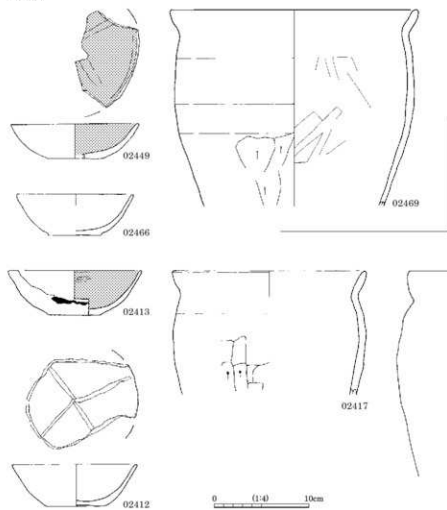

SB0170

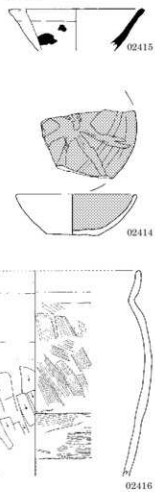

0 1:4 10cm

SB0171

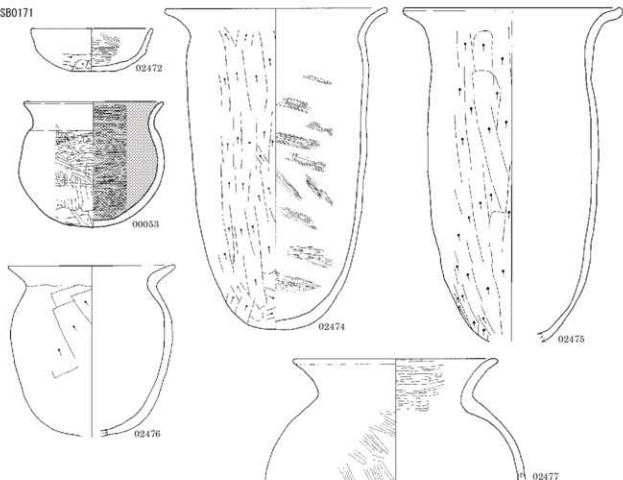

SB0172



SB0173

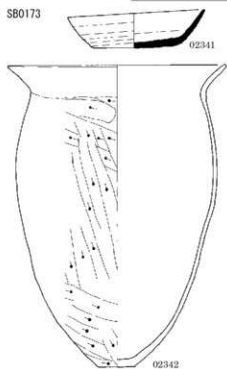

SB0174

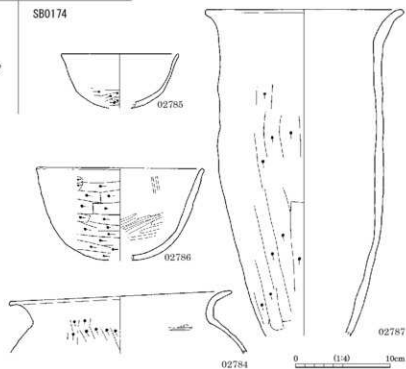

図版 86 古墳時代～古代の土器 (29)

S80301

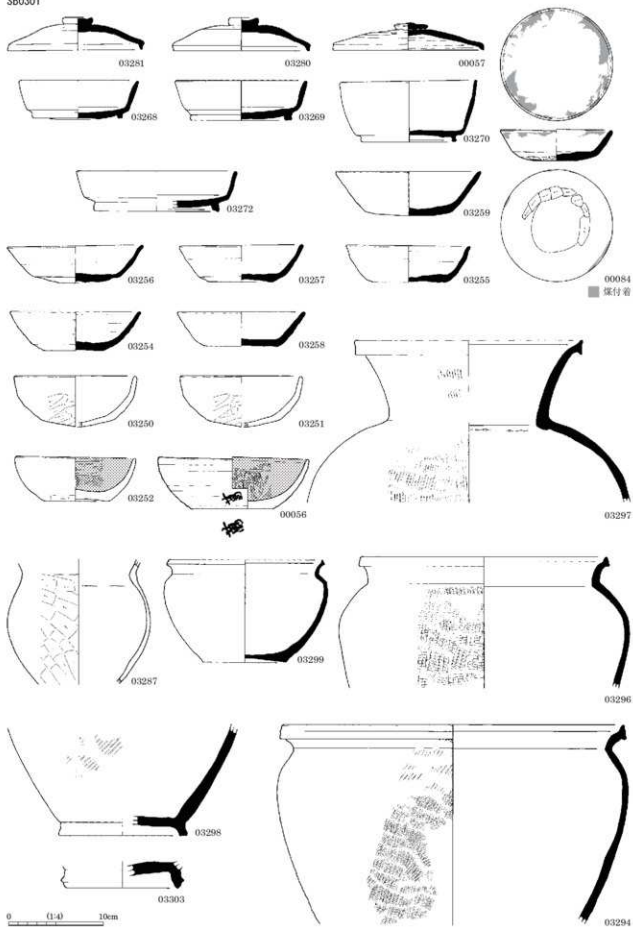

SB0303

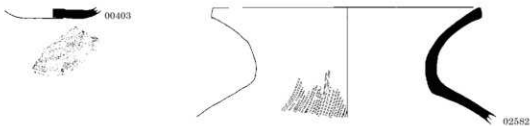

SB0304

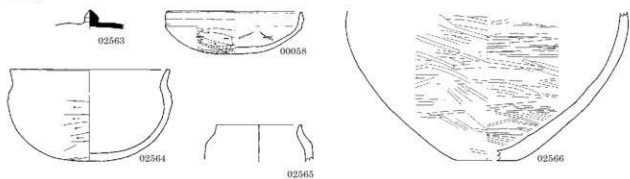

SB0305

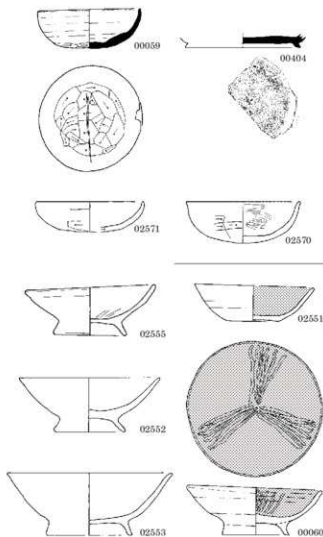

SB0309

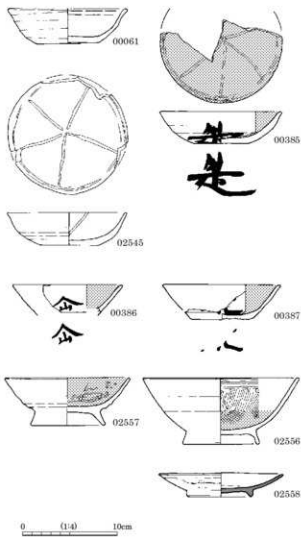

図版 88 古墳時代～古代の土器 (31)

SB0311

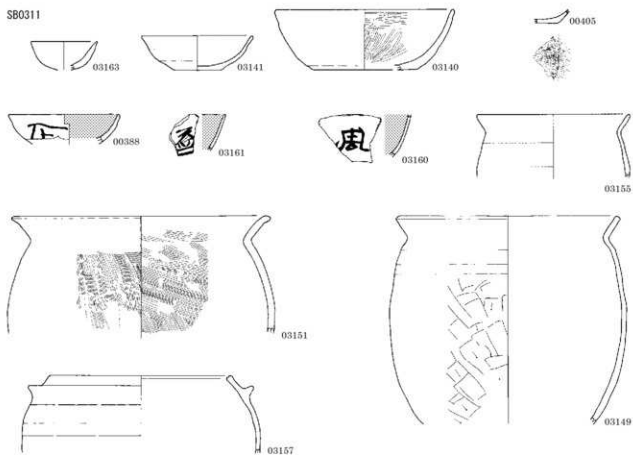

SB0313

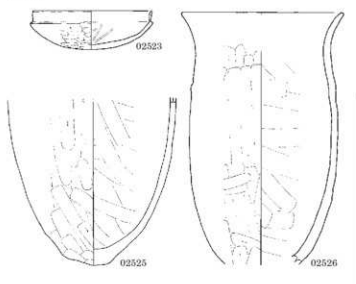

SB3002 (1)

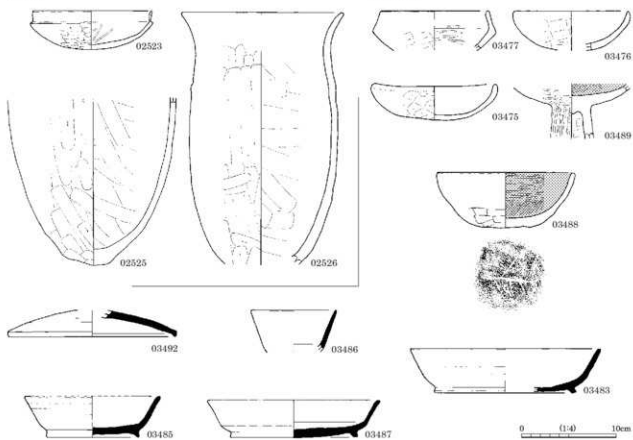

SB3002 (2)

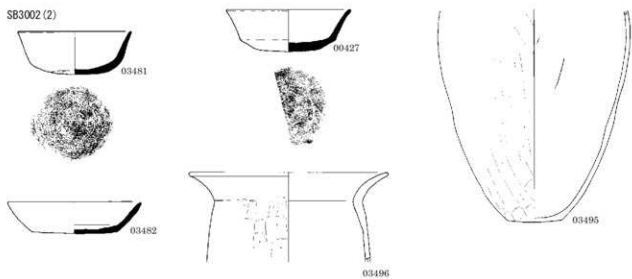

SB3008

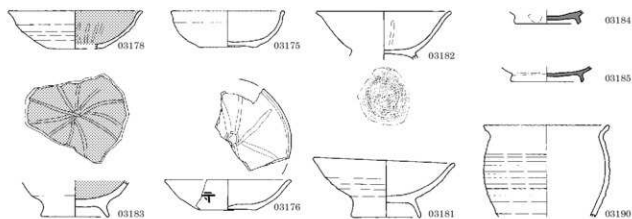

SB3020

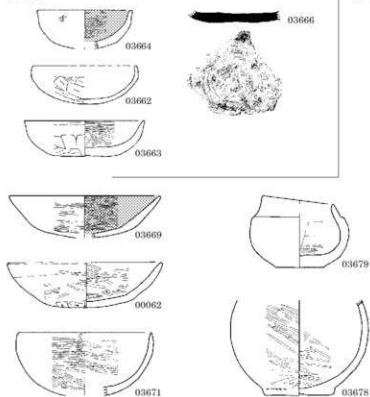

SB3022

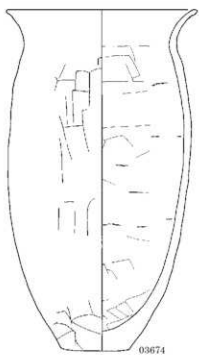

0 1:4 10cm



図版 90 古墳時代～古代の土器 (33)

SB3024

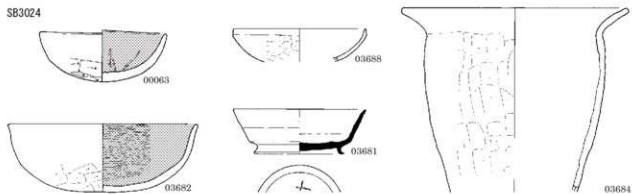

SB3025

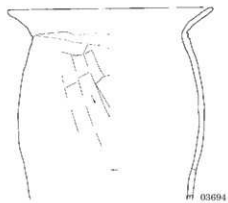
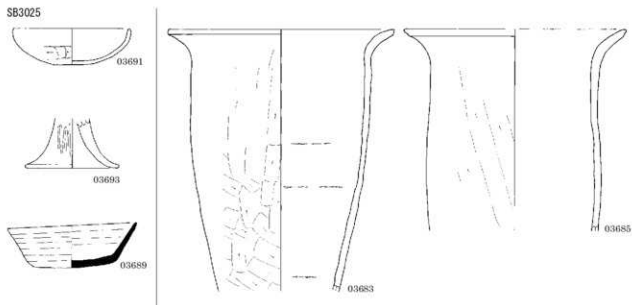

SB3026

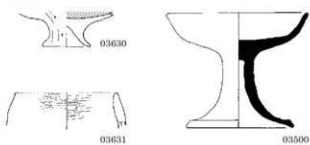

SB3027

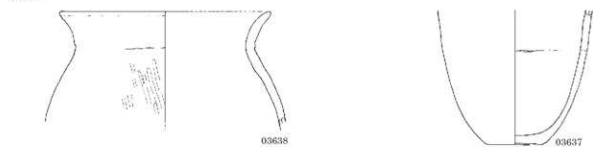

0 1:4 10cm

SB3028

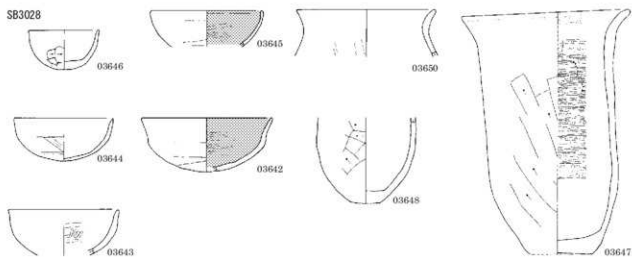

SB3030

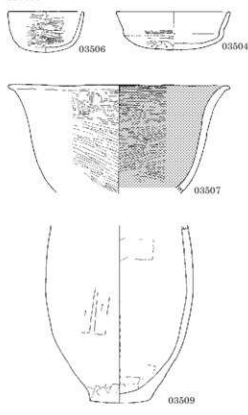

SB3031

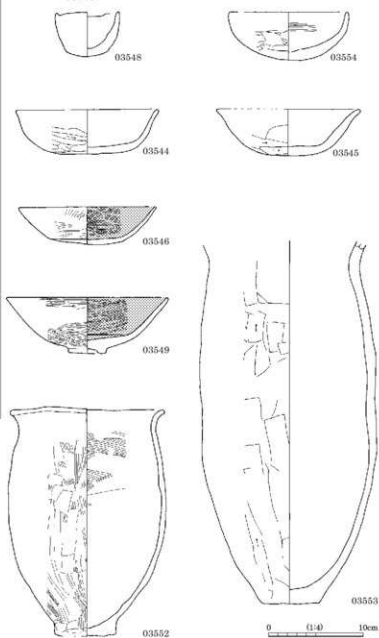

図版 92 古墳時代～古代の土器 (35)

S83032

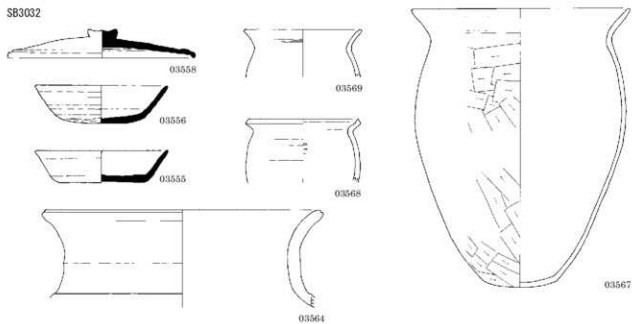

S83034

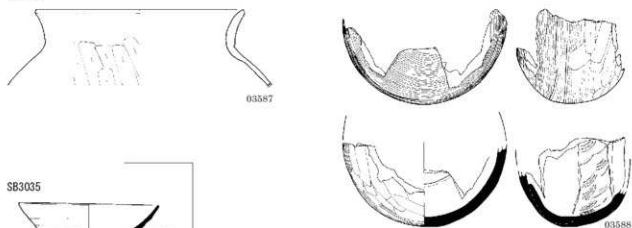

S83035

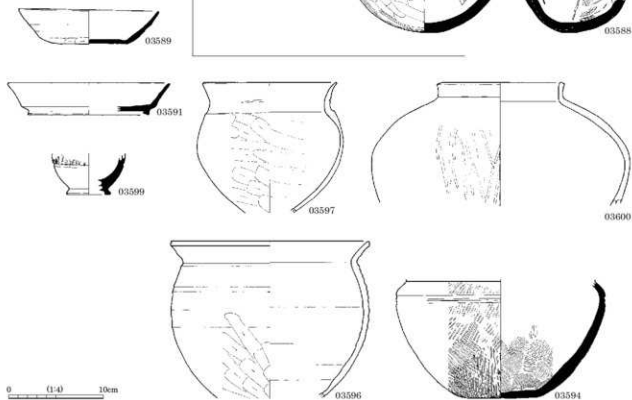

0 (1:4) 10cm

SB3038



00313

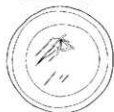

03580



03574



03577

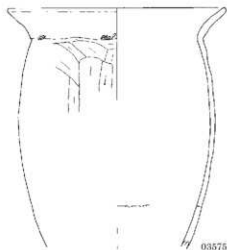

03575

SB3039

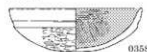

03583



03433

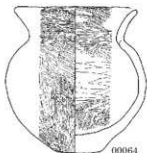

00064

SB3042



03434



03436

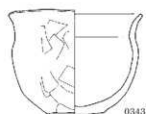

03437



03441

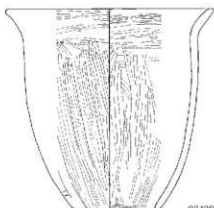

03439

SB3043



03444



03442



03443

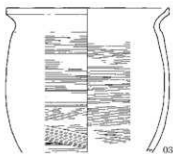

03453



03449



03445



03451

0 (1:4) 10cm



S83047 (2)

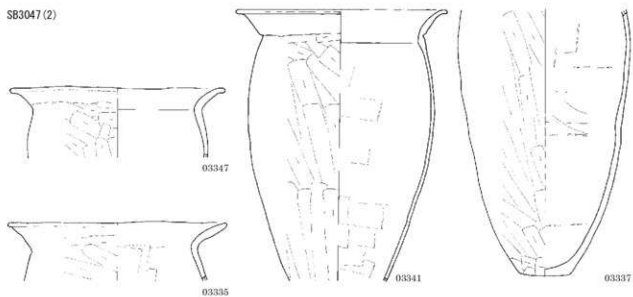

S83048

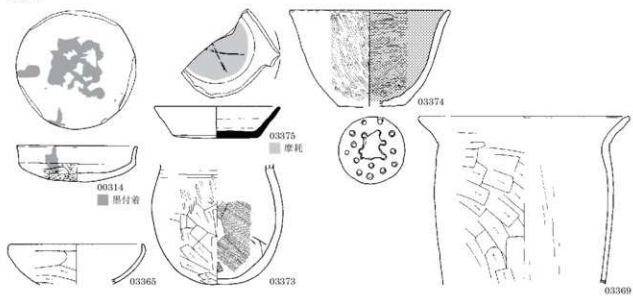

S83049

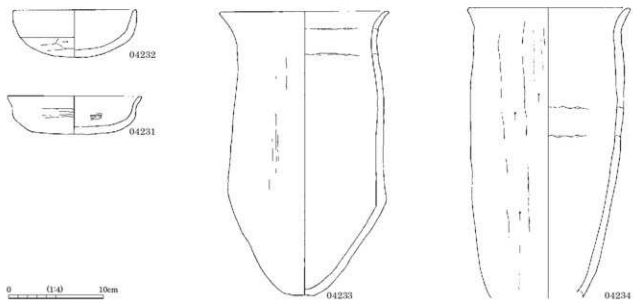

0 1:4 10cm

図版 96 古墳時代～古代の土器 (39)

SB3050

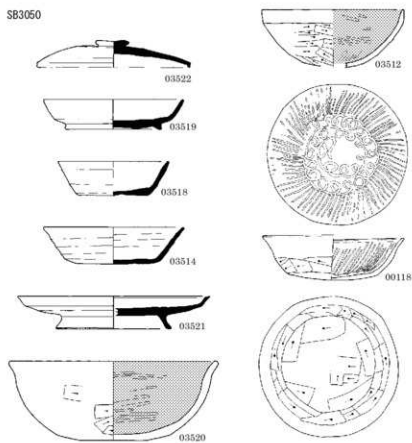

SB3051

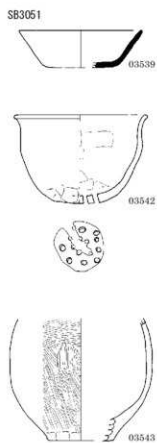

SB3052

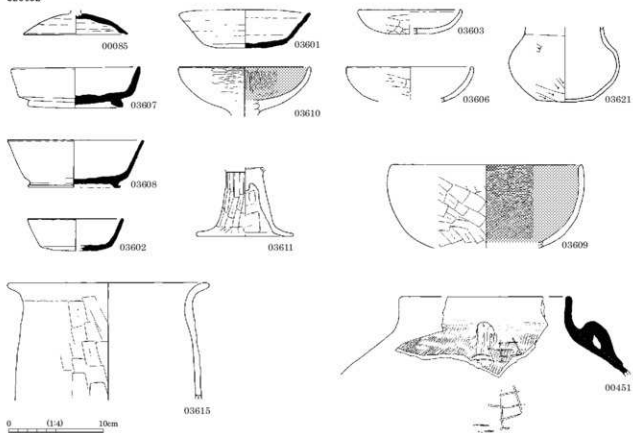

SB3055

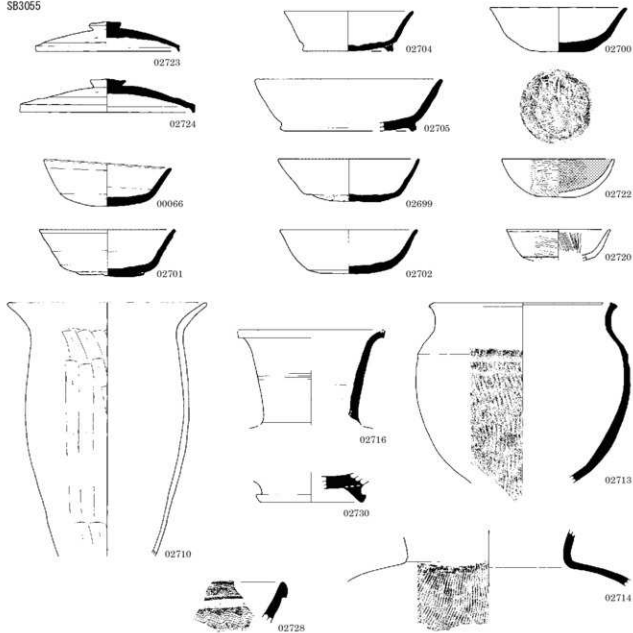

SB3056 (1)

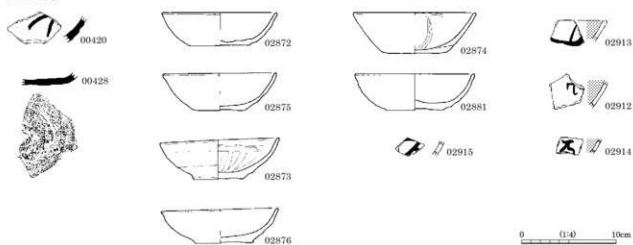



図版 98 古墳時代～古代の土器 (41)

SB3056 (2)

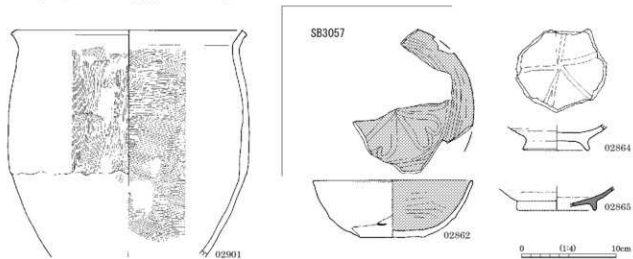
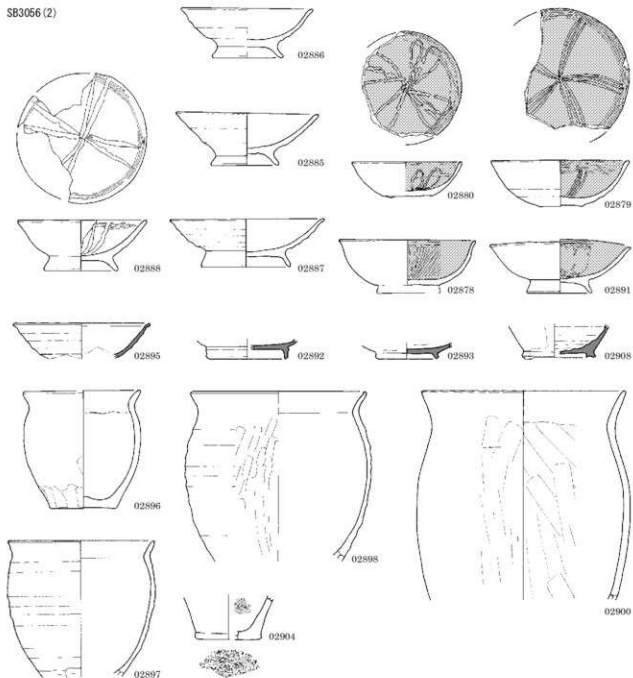

SB3058

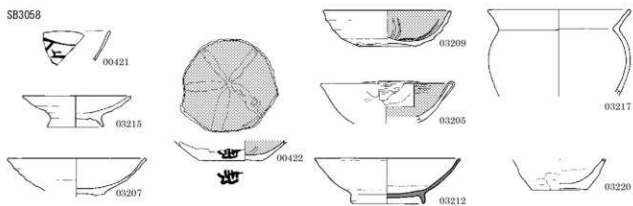

SB3059

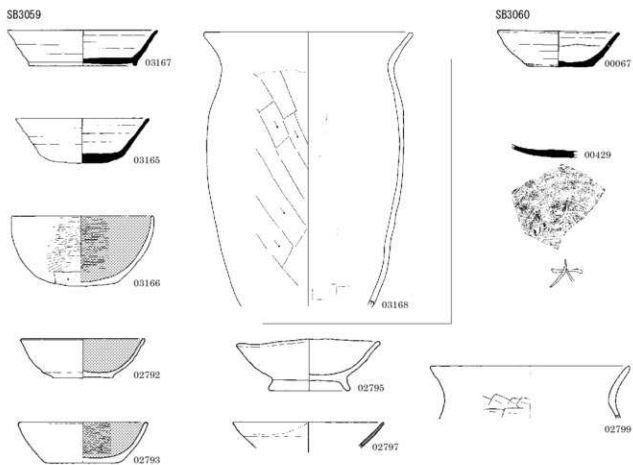

SB3060



SB3061 (1)

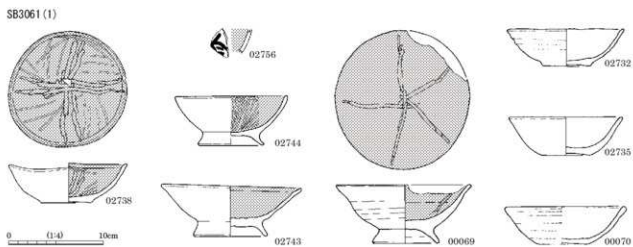

0 1:4 10cm

図版 100 古墳時代～古代の土器 (43)

SB3061 (2)

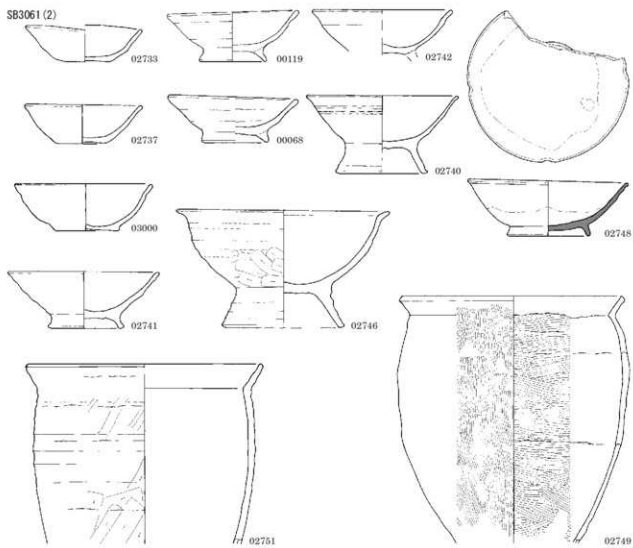

SB3062

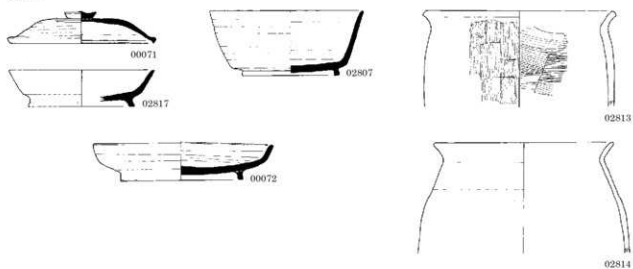

SB3064



0 1:4 10cm

SB3065

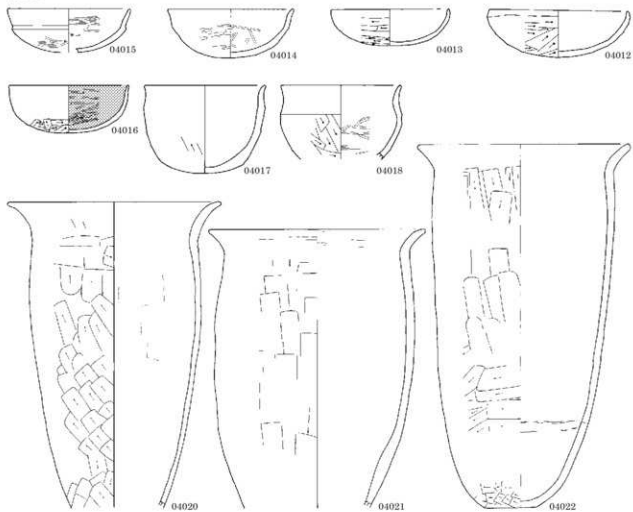

SB3066

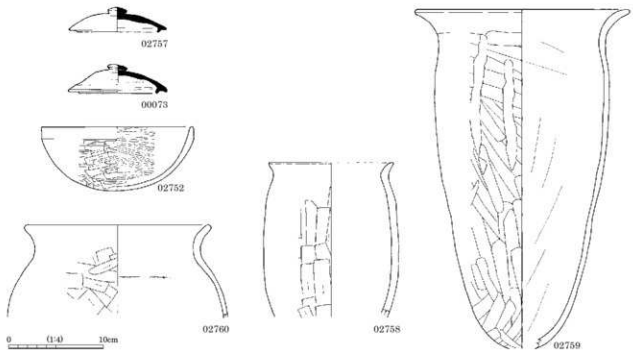

図版 102 古墳時代～古代の土器 (45)

S83067

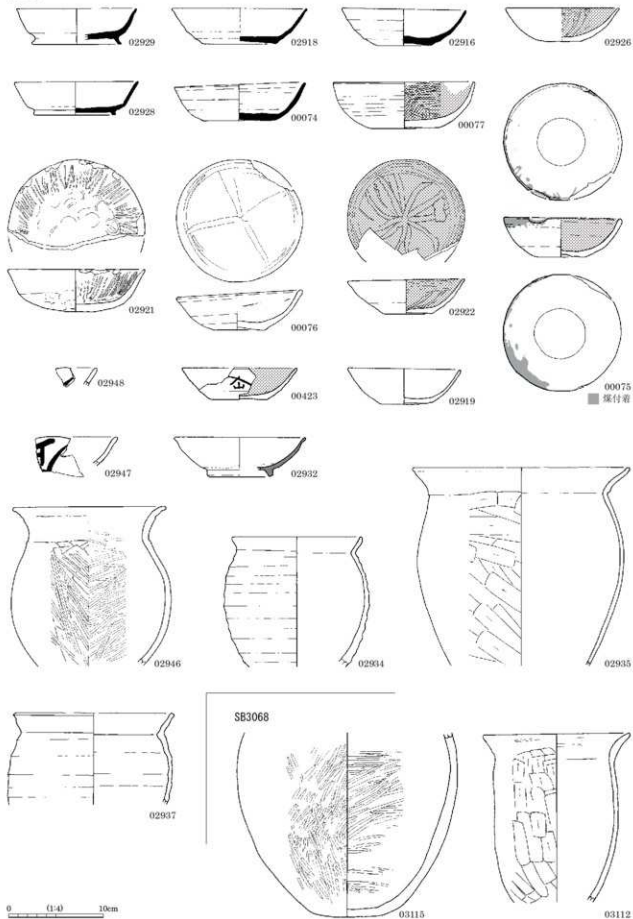

SB3070

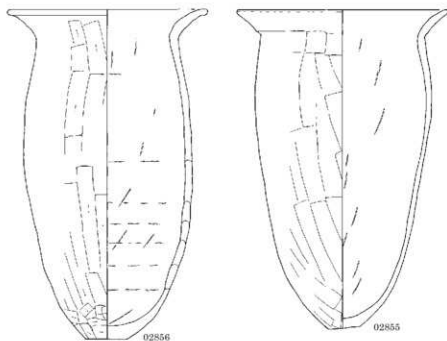
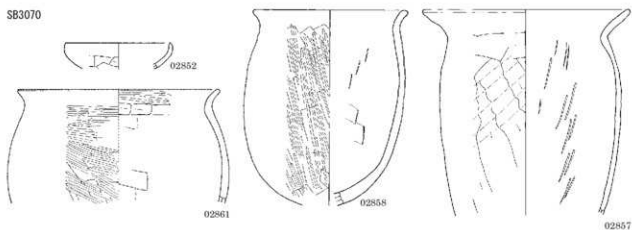

SB3071



SB3072

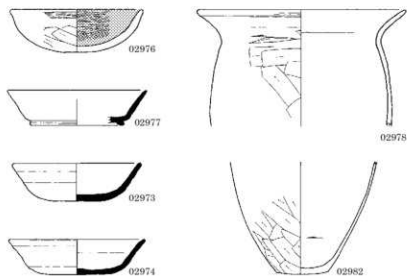

SB3077

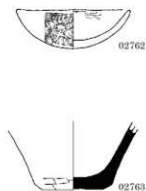

0 1:4 10cm

図版 104 古墳時代～古代の土器 (47)

S83079

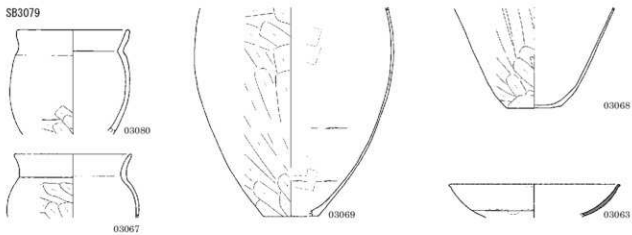

S83080

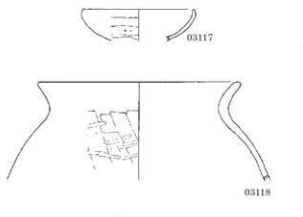

S83081

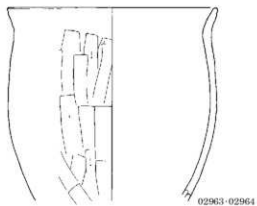
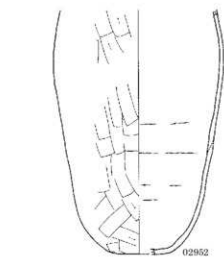
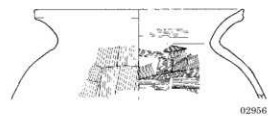
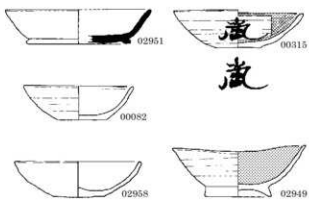

0 1:4 10cm

SB3086

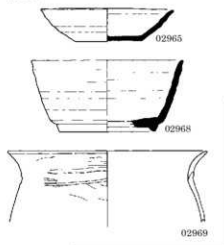

SB3089

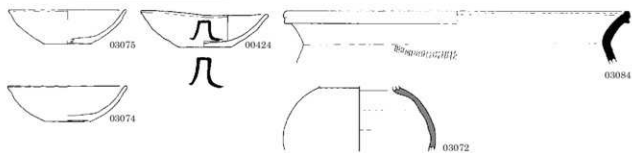
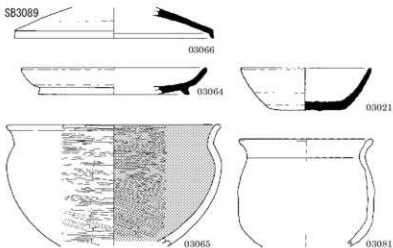

SB3090

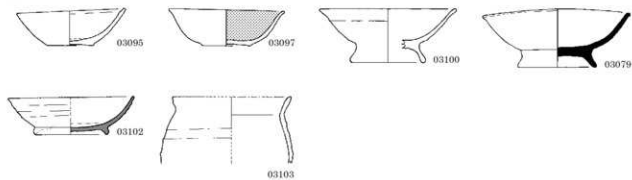

SB3093

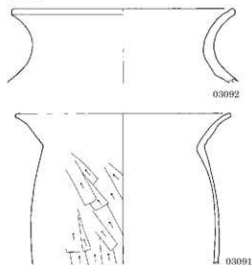

SB3094



SB3098



0 1:4 10cm



図版 106 古墳時代～古代の土器 (49)

SB4001

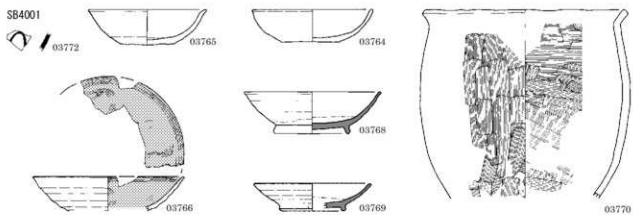

SB4004

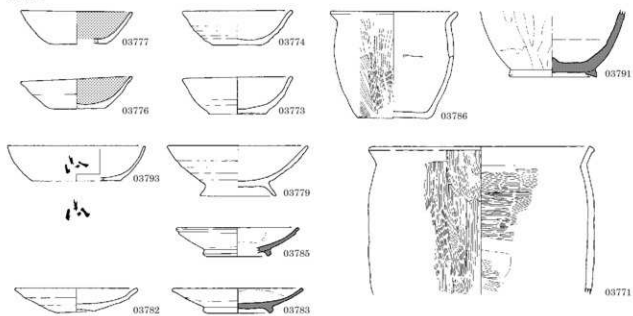

SB4005

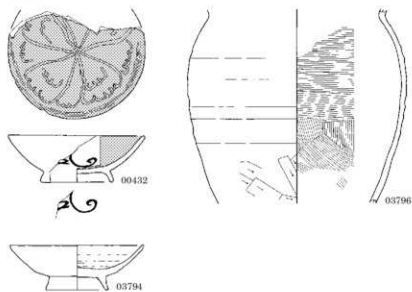

SB4006 (1)

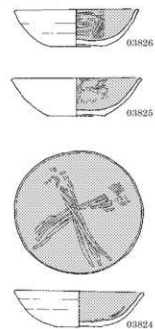

0 (1:4) 10cm

SB4006 (2)

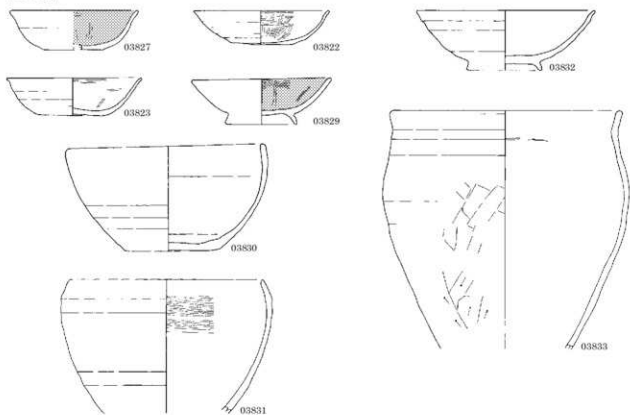

SB4007

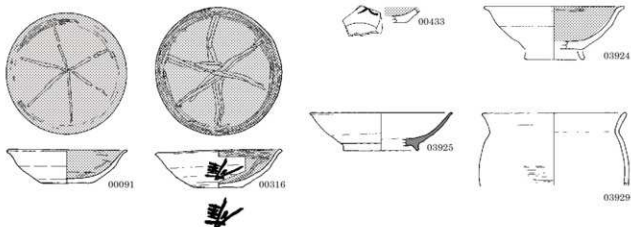

SB4009 (1)

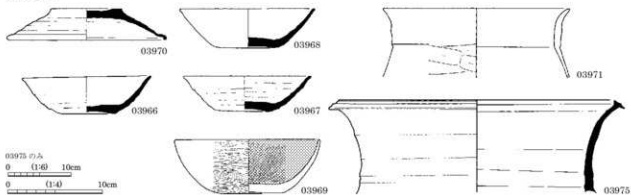

03975 の尺  
 0 (1/6) 10cm  
 0 (1/4) 10cm

図版 108 古墳時代～古代の土器 (51)

SB4009 (2)

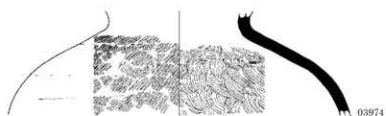

SB4010

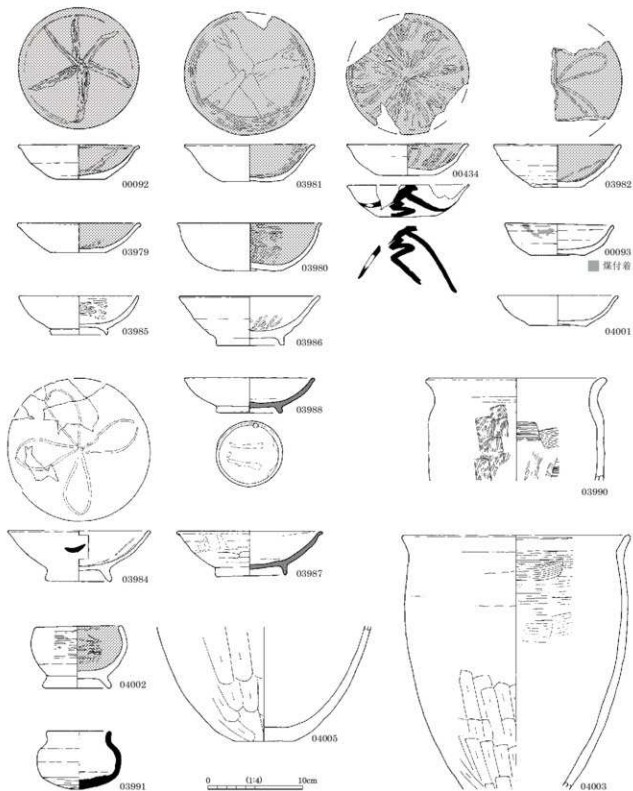

SB4011

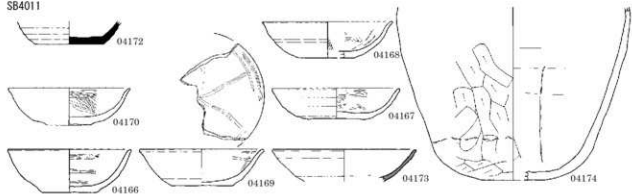

SB4012

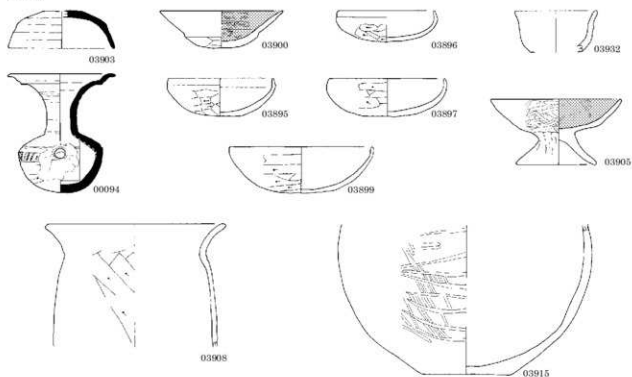

SB4014

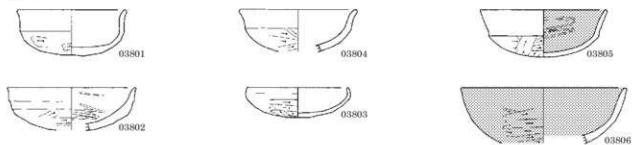

SB4015 (1)

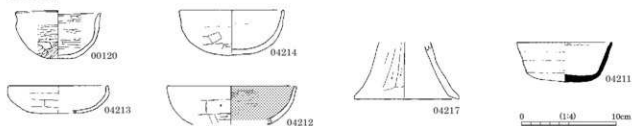

図版 110 古墳時代～古代の土器 (53)

SB4015 (2)

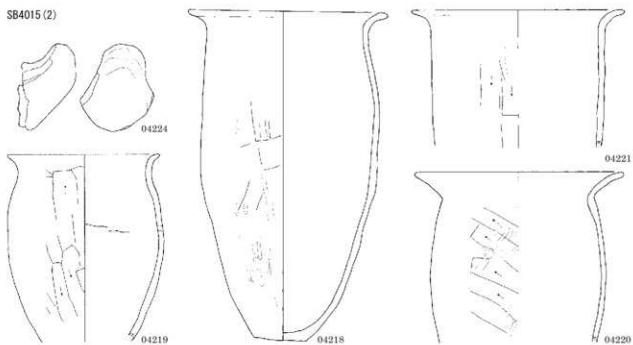

SB4019

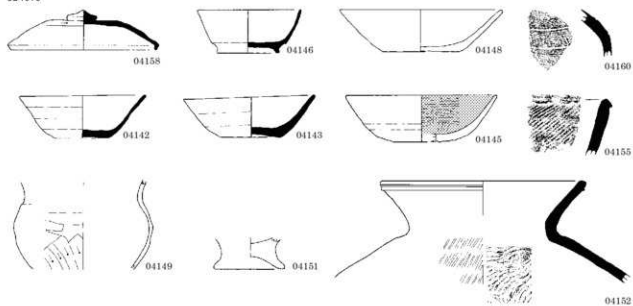

SB4020 (1)

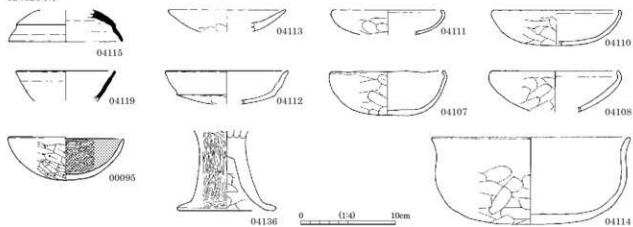

SB4020 (2)

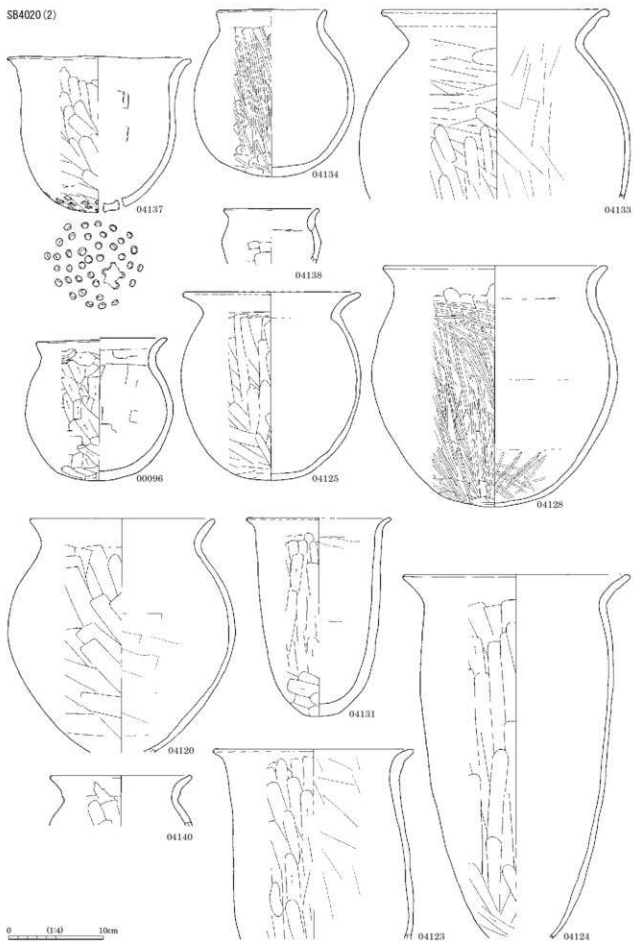

図版 112 古墳時代～古代の土器 (55)

SB4020 (3)

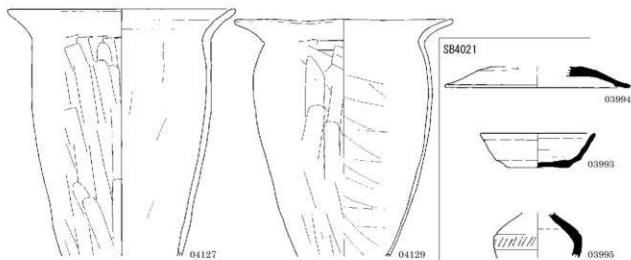
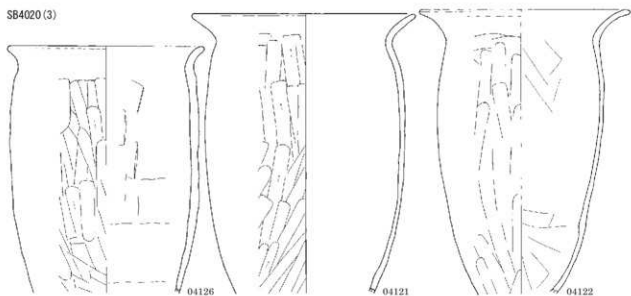

SB4022

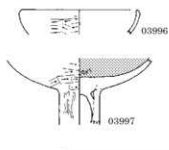

SB4024

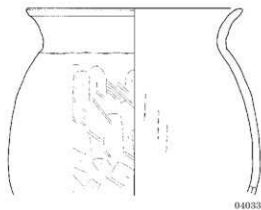
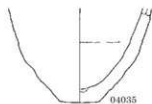
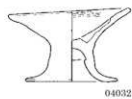
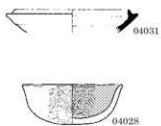

0 1:4 10cm

SB4025

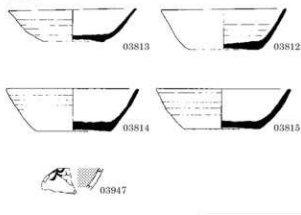

SB4026

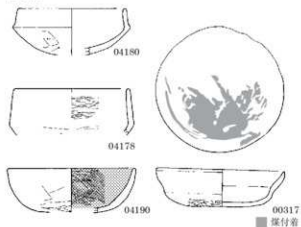

04189

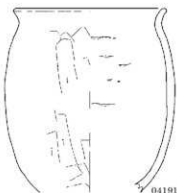

04191

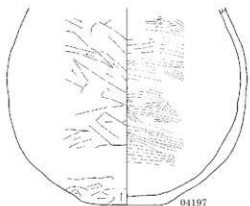

04197

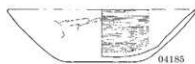

04185



04193



04199

SB4027 (1)



03949



00318



00444



03957



03950



00436



00437



00439



00440



00441



00442



03951



03959



03958



03952



00097



03960

■ 保存着

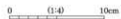



図版 114 古墳時代～古代の土器 (57)

SB4027 (2)

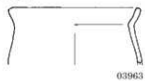

SB4034

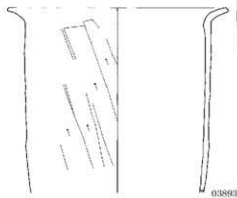
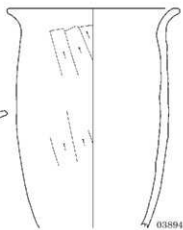

SB4028



SB4036 (1)

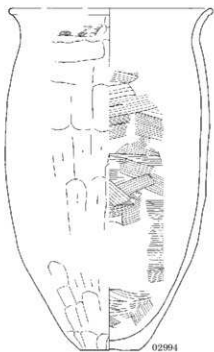
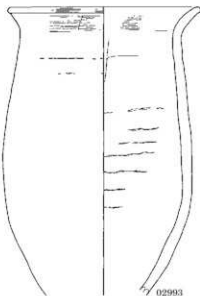
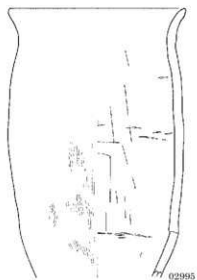
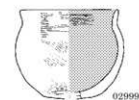
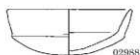
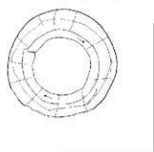
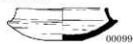

0 1:0 10cm

SB4036 (2)

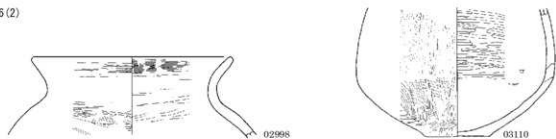

SB4037

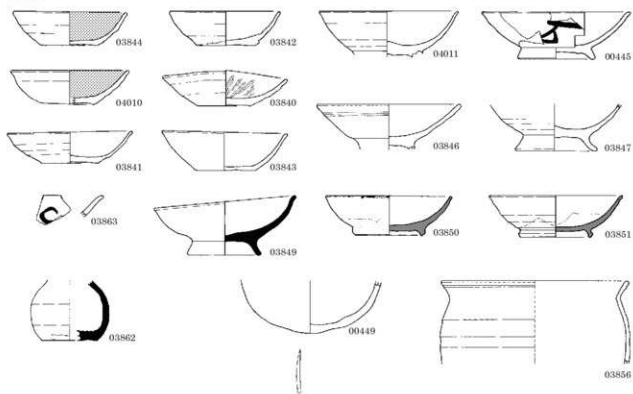

SB4039 (1)

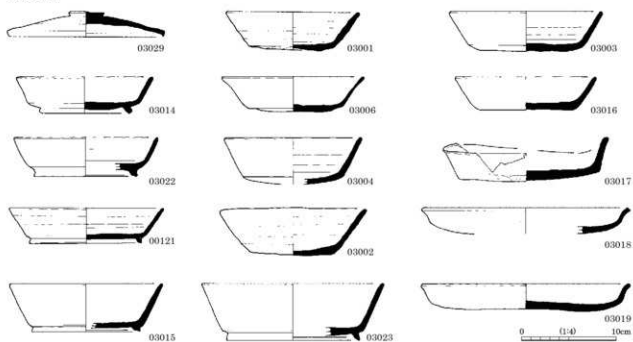

図版 116 古墳時代～古代の土器 (59)

SB4039 (2)

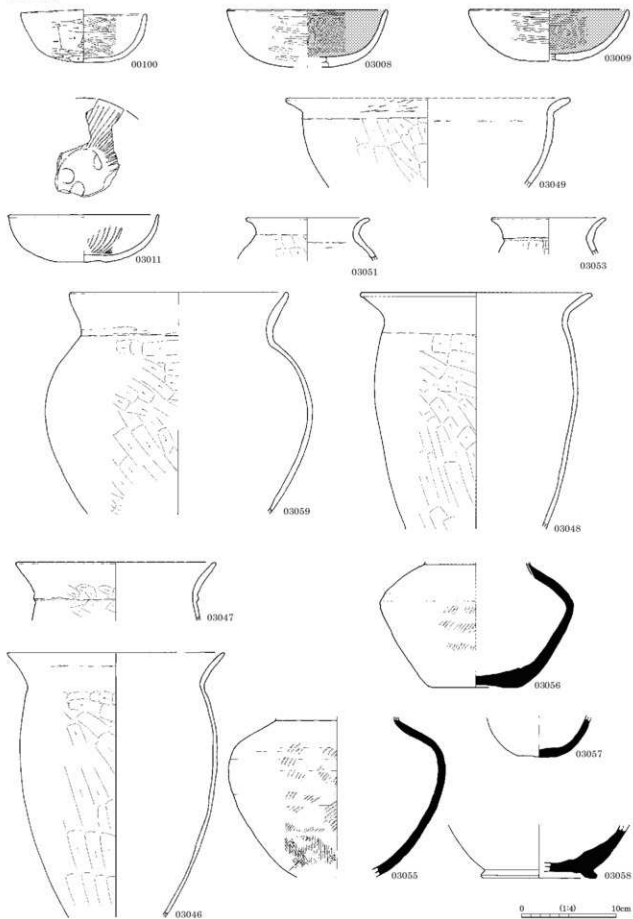

SB4039 (3)

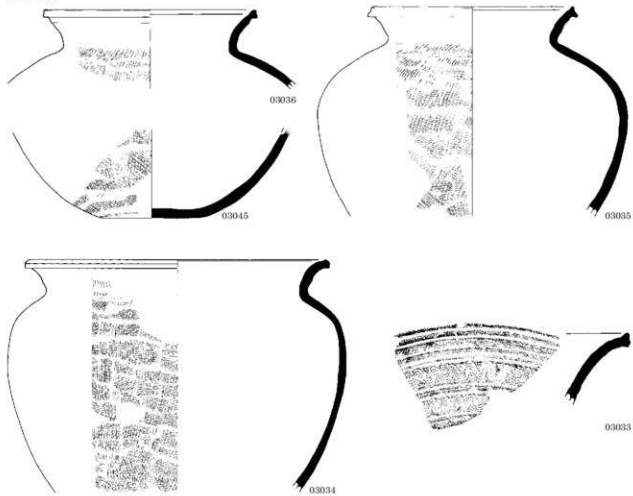

SB4040

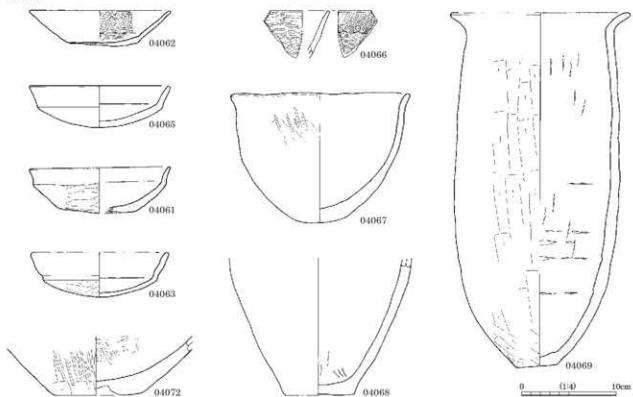

SB4041



04204

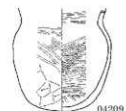

04209

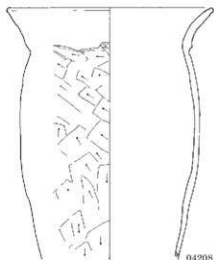

04208

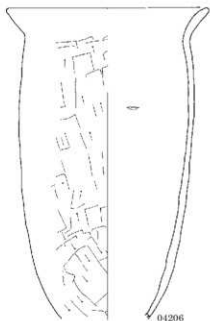

04206

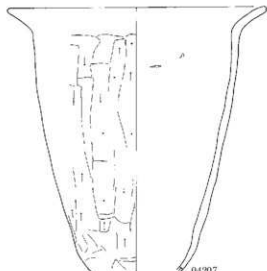

04207

SB4043



03821

SB4045



03916



00450



03917

SB4046



04042



04039



04041

SB4057



03623



03626

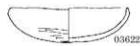

03622

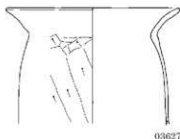

03627

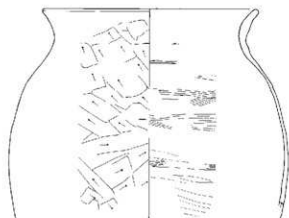

03628

0 1:4 10cm

SB4058

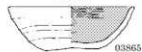

03865



03864



03869



03871



03868



03870



03872

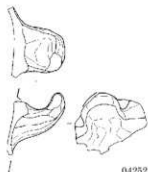

04252

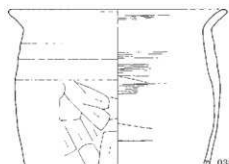

03874



03876

SB4059 (1)



00102



00103



04047



04050



00101

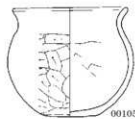

00105

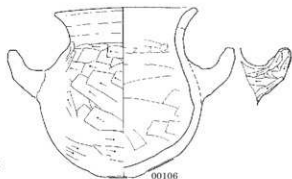

00106



04046



04058



04059

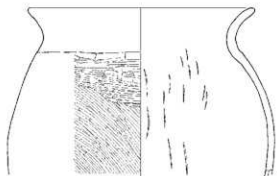

04080

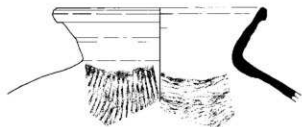

04051

0 1:4 10cm

SB4059 (2)

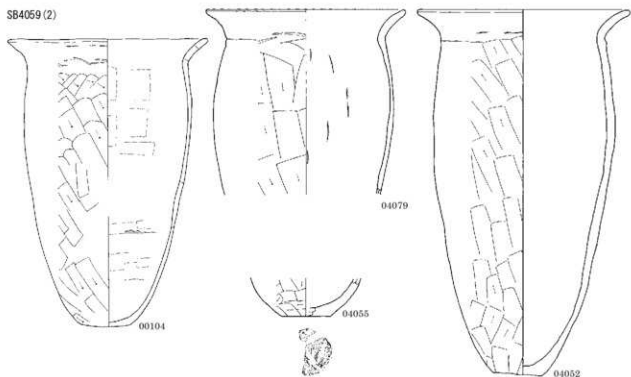

SB4061

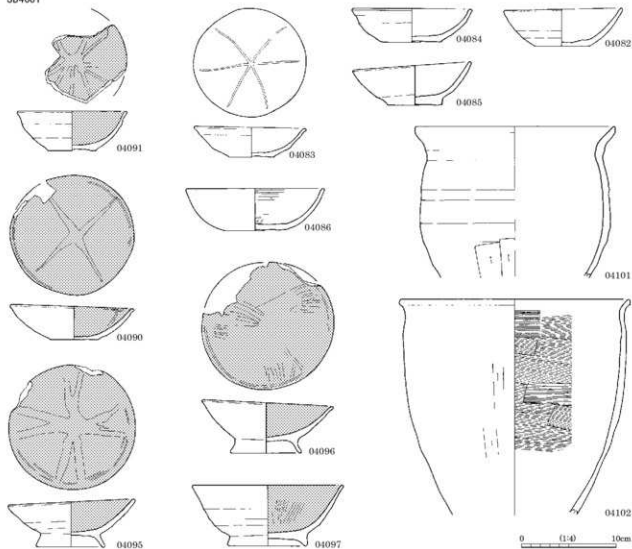

SB4062



04009

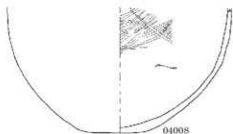

04008

SB4063



03878



03877



03879

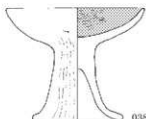

03884

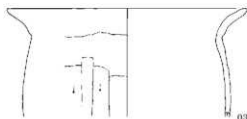

03887

SB4064



03655



03653

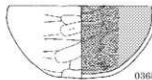

03652

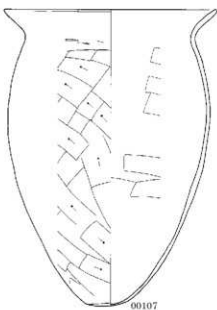

00107

SB4068



04105

0 1:4 10cm



図版 122 古墳時代～古代の土器 (65)

SB5001

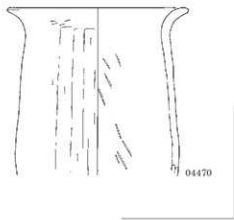

SB5002

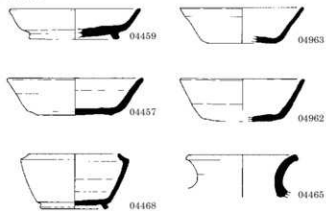

SB5003 (1)

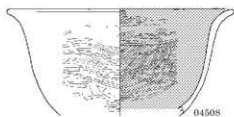
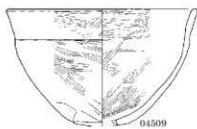
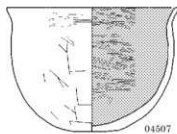
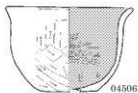
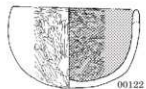
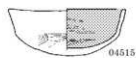

0 1:4 10cm

SB5003 (2)

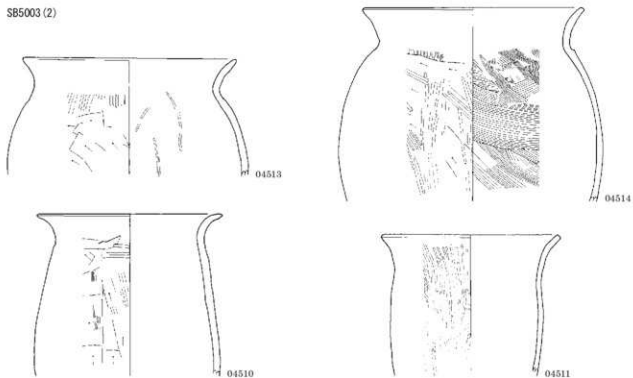

SB5005

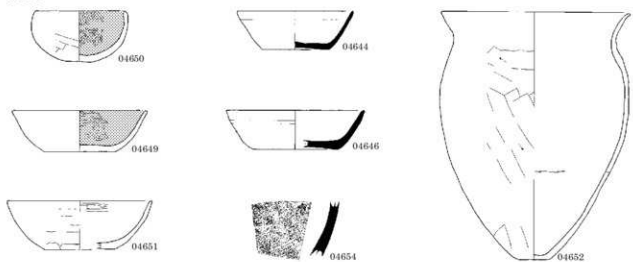

SB5006 (1)

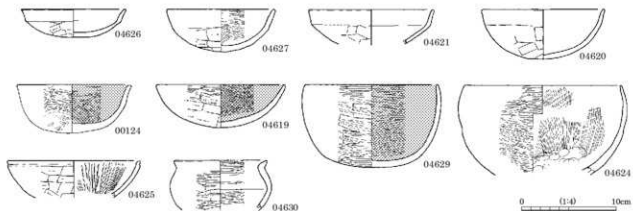

図版 124 古墳時代～古代の土器 (67)

SB5006 (2)

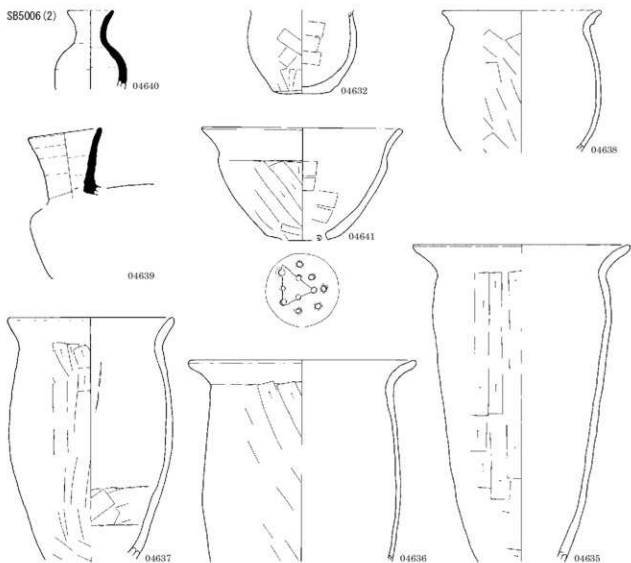

SB5007

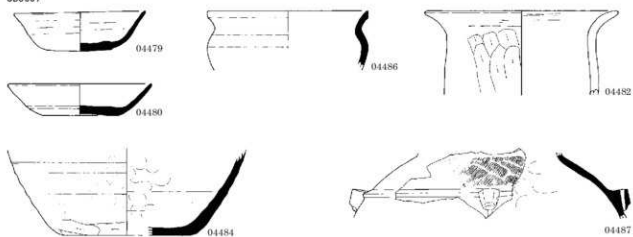

SB5008

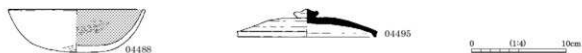

S85009



S85010

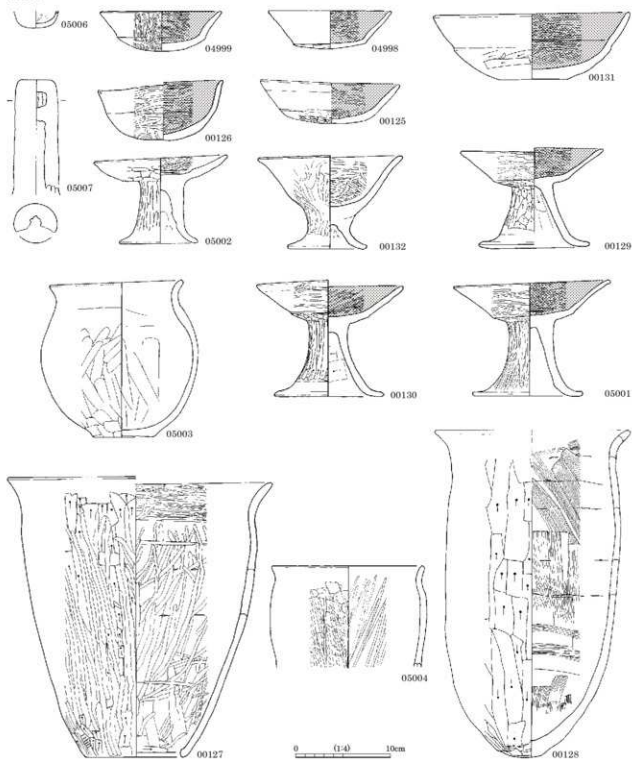

SB5011

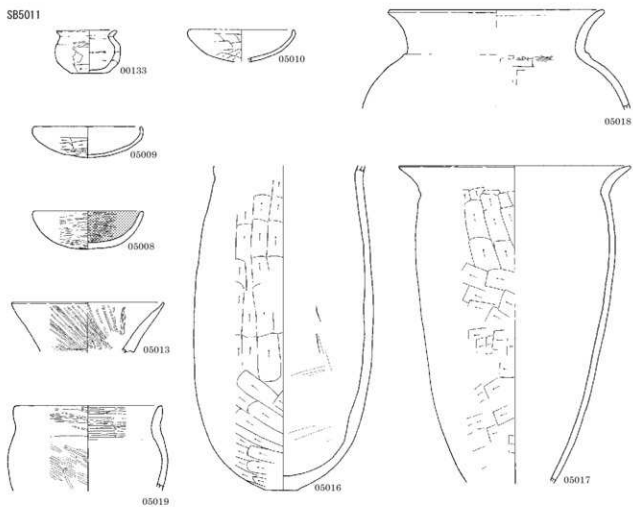

SB5012

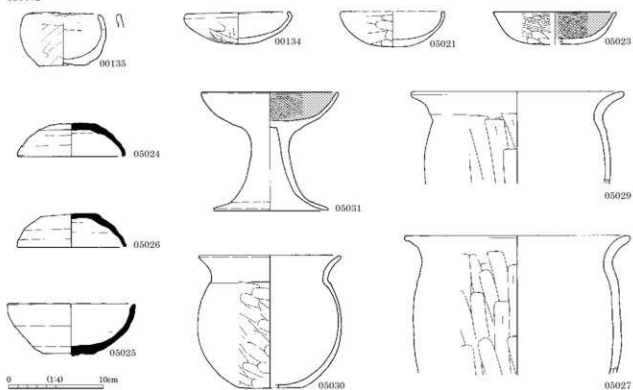



図版 128 古墳時代～古代の土器 (71)

S85015

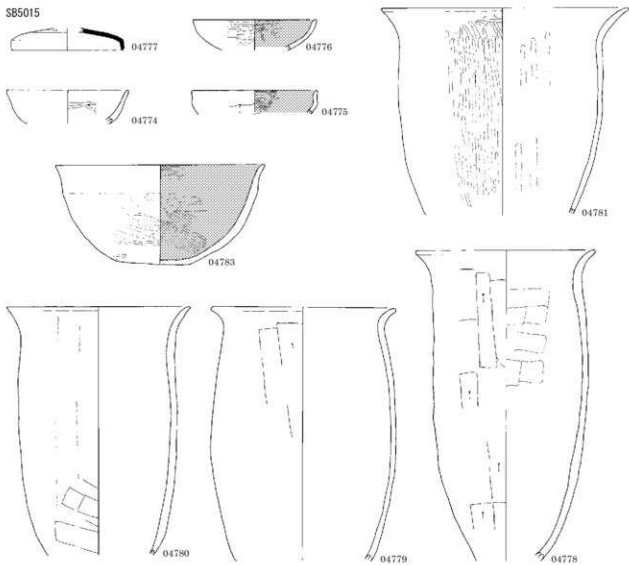

S85016

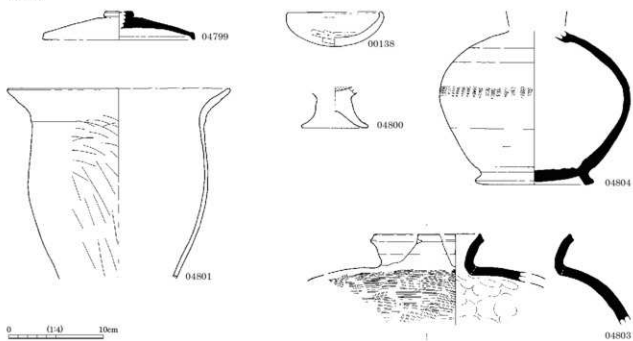

SB5017

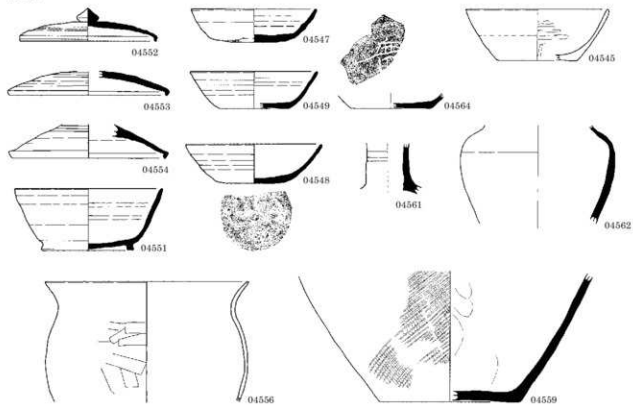

SB5018

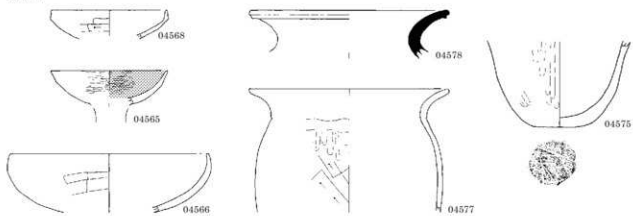

SB5019

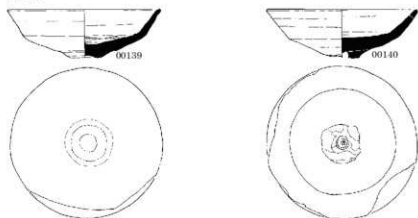

0 (1:4) 10cm



図版 130 古墳時代～古代の土器 (73)

SB5021

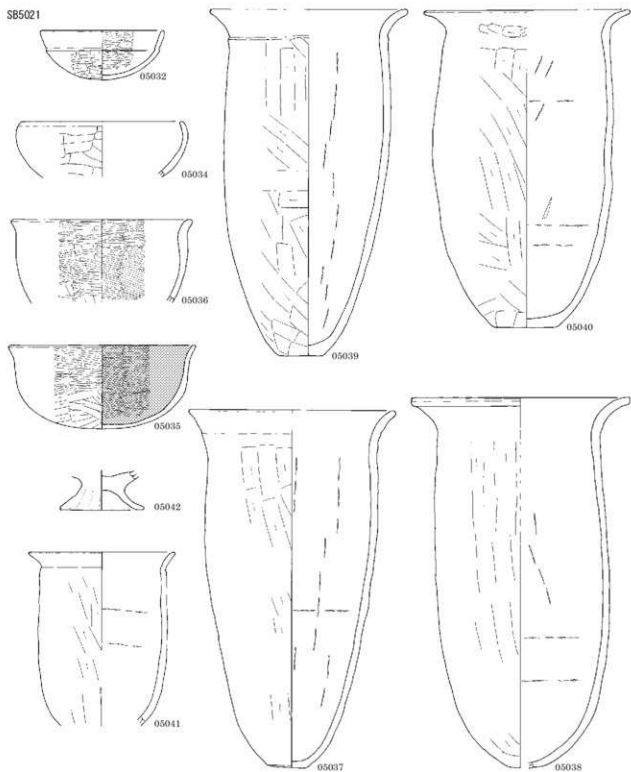

SB5022 (1)

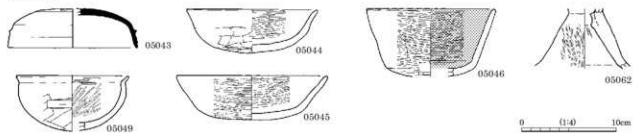

SB5022 (2)



00141

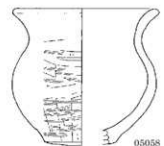
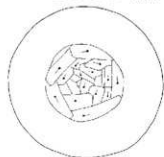

05058

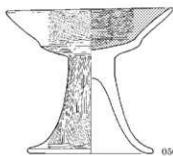

05061

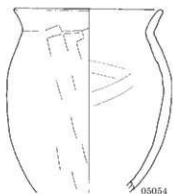

05054

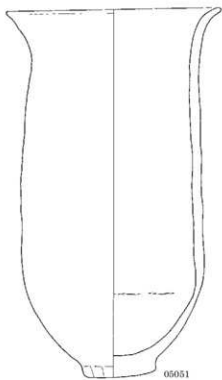

05051

SB5023



04815



00142

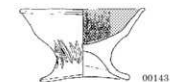

00143

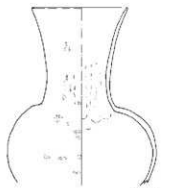

04824

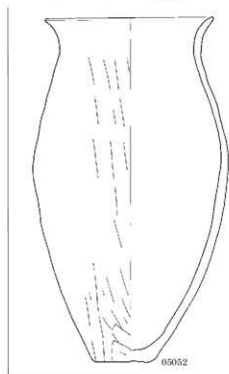

05052

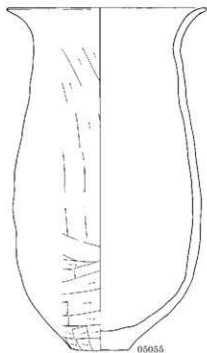

05055

0 1:4 10cm



04819



04820



04825

図版 132 古墳時代～古代の土器 (75)

S85024

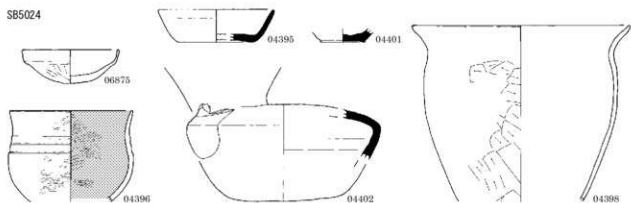

S85026

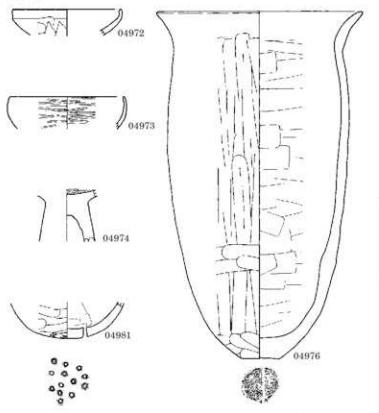

S85027

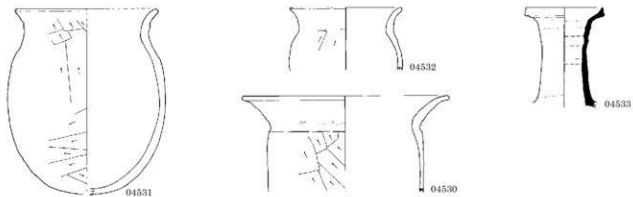
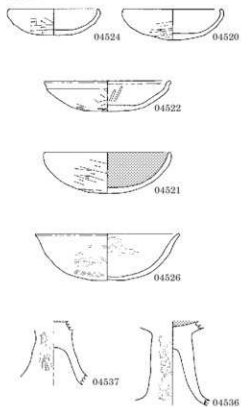

S85028



S85029

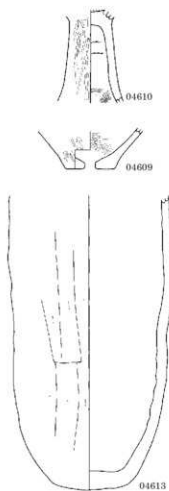

S85030

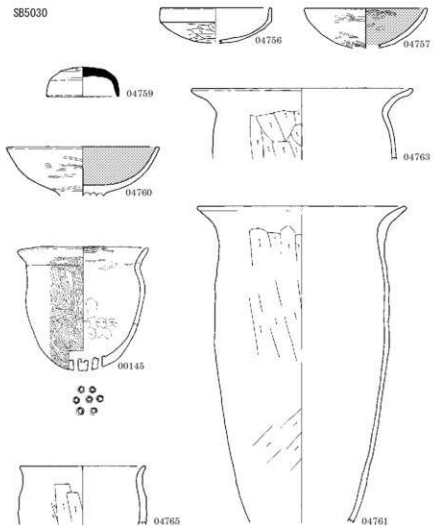

S85031

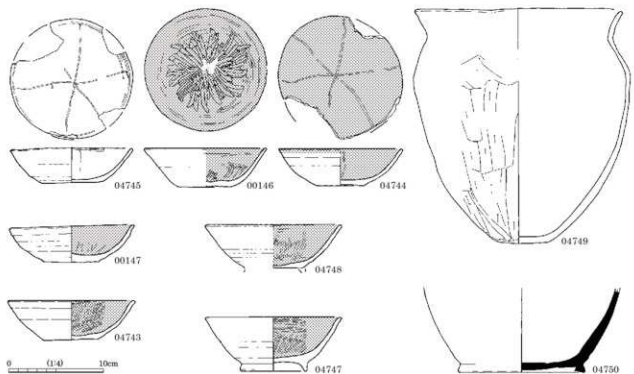

図版 134 古墳時代～古代の土器 (77)

S85034

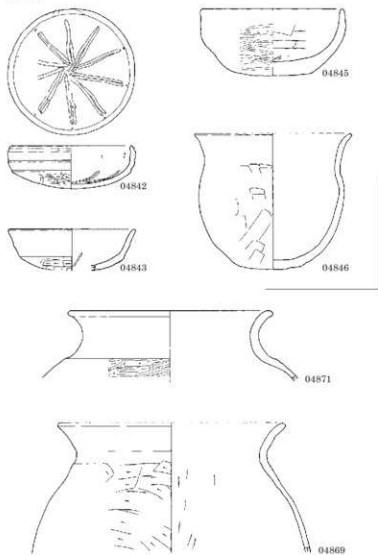

S85035

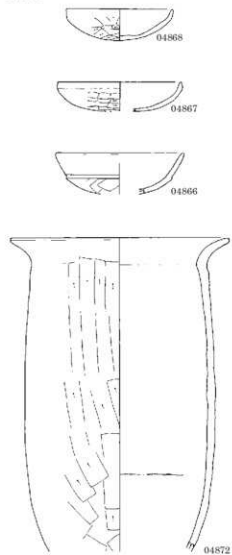

S85036

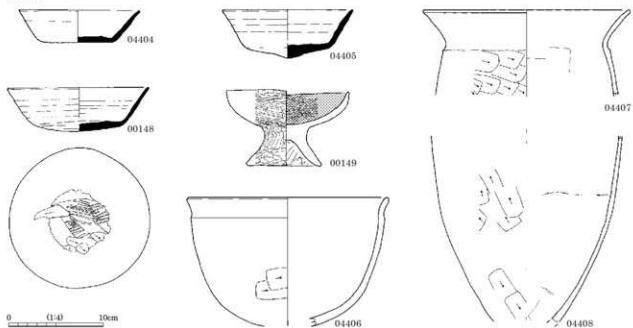

SB5037

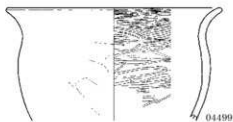
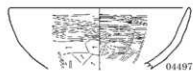

SB5039



SB5040

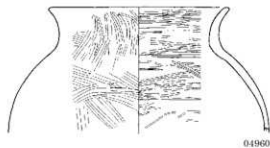

SB5043

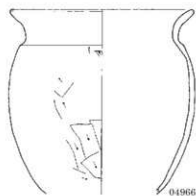

SB5045

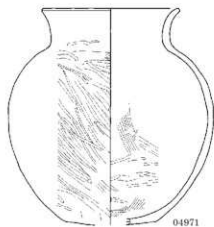
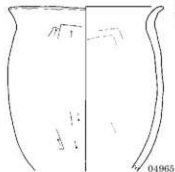

SB5048



SB5052

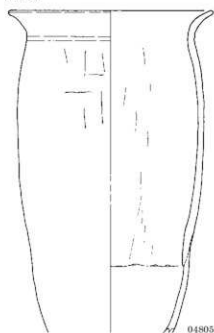

SB5053-5057



0 (1:4) 10cm

図版 136 古墳時代～古代の土器 (79)

S85064



04752



04753



04751

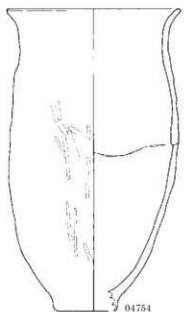

04754

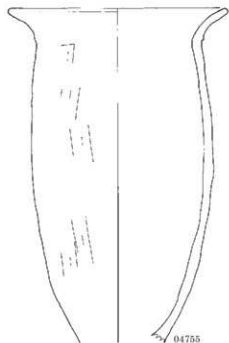

04755

S85067



04581



04588



04589

■ 赤色顔料付着

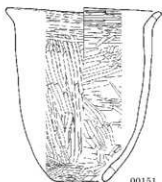

00151



04585

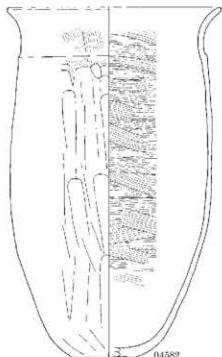

04582

0 (1:4) 10cm

SB6001



04351



04353

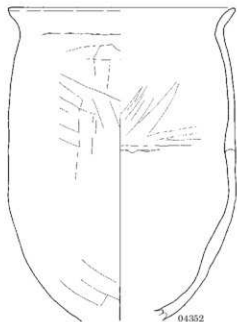

04352

SB6002

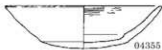

04355

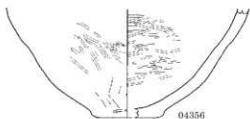

04356

SB6003



04357

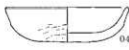

04359

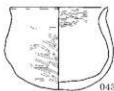

04367

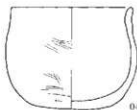

04365

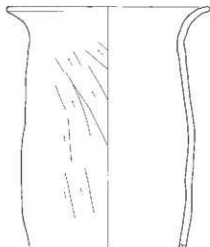

04360

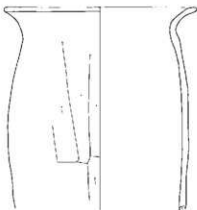

04361

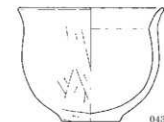

04366



04368

SB6004



04370



04372

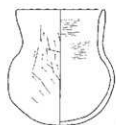

04371

0 (1:4) 10cm



図版 138 古墳時代～古代の土器 (81)

SB6005

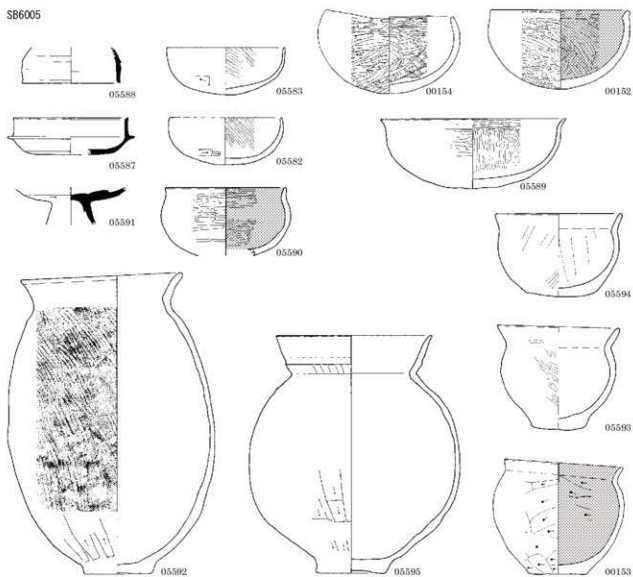

SB6006 (1)

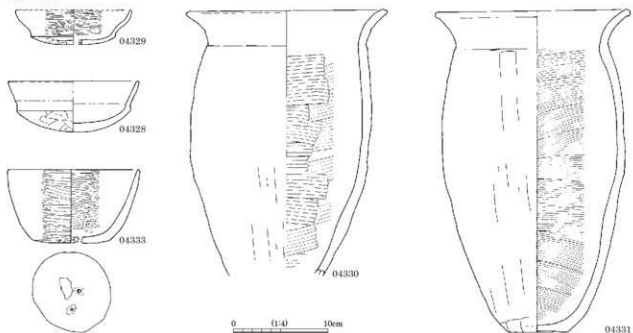

SB6006 (2)

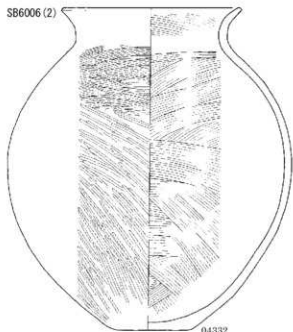

04332

SB6007

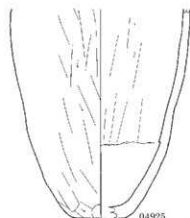

04925

SB6008



04928

SB6009 (1)



04343



00162



00163



04931



00158



04336



00159



00157

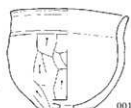

00164

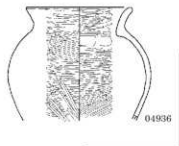

04936



04335



04334



00160



00155



00156

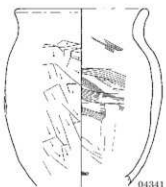

04341

0 (1:4) 10cm

図版 140 古墳時代～古代の土器 (83)

SB6009 (2)

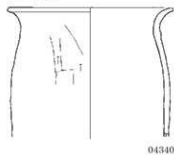

04340

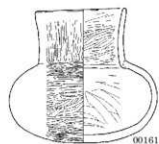

00161

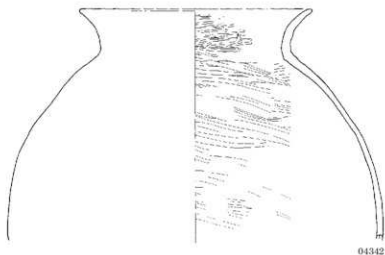

04342

SB6011



04344



04345



04349



04347

SB6013



04988



04983

SB6014



04726



04727

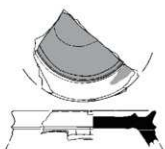

00505

■ 黒付着

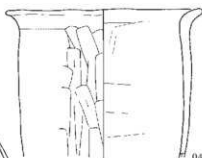

04728

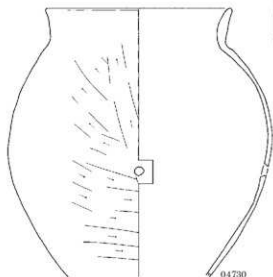

04730

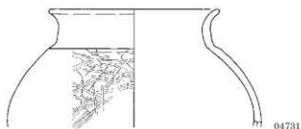

04731

0 1:4 10cm

SB6015

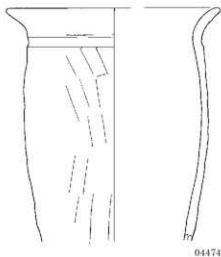

SB6016



SB6018

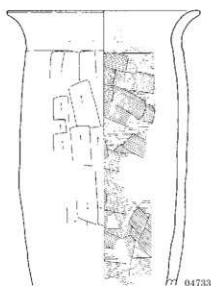

SB6019

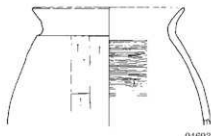
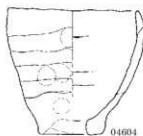

SB6020 (1)

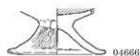
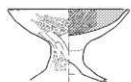
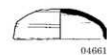

図版 142 古墳時代～古代の土器 (85)

SB6020 (2)

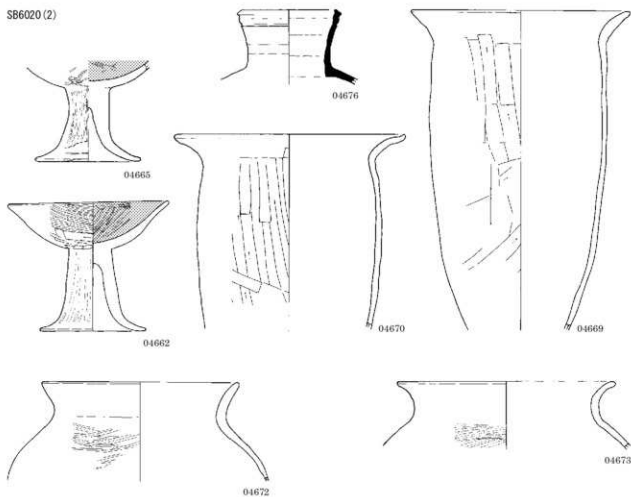

SB6021 (1)

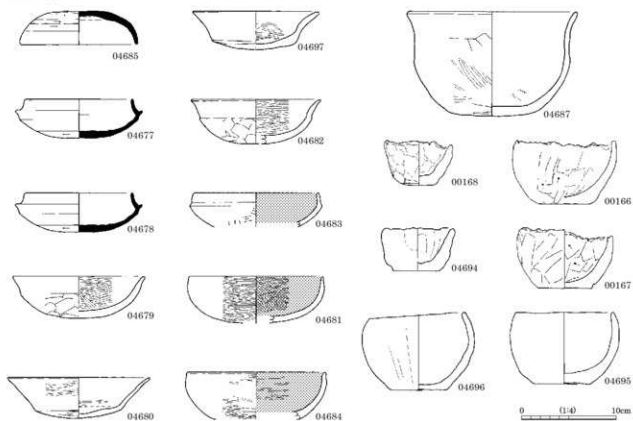

SB6021 (2)

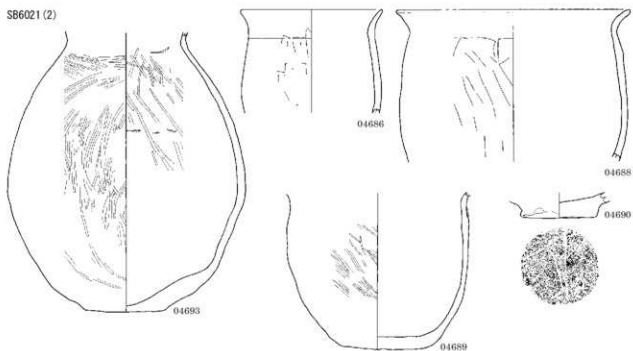

SB6022

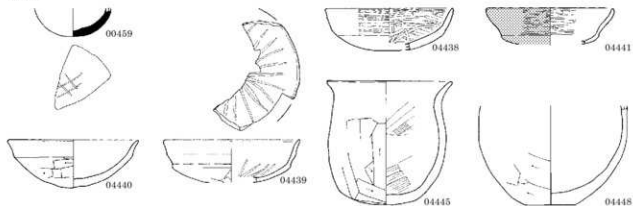

SB6023 (1)

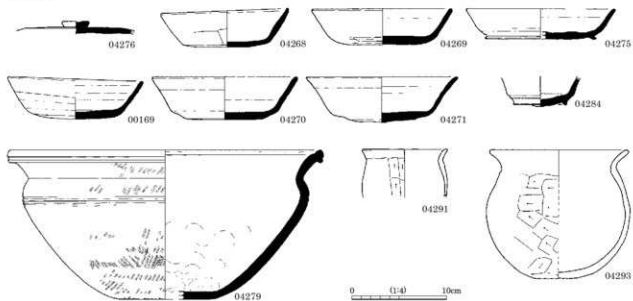

SB6023 (2)

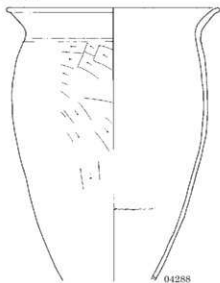

04288

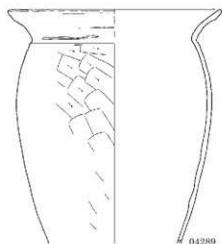

04289

SB6024



04254



00170



04253

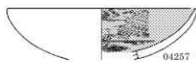

04257

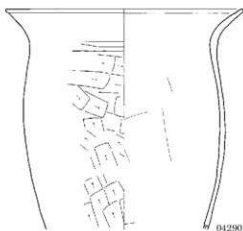

04290

SB6026 (1)



04308



04307



04310



04312

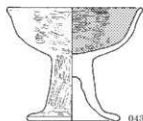

04317



04314

0 1:4 10cm

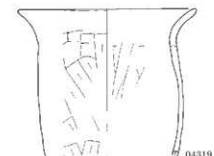

04319

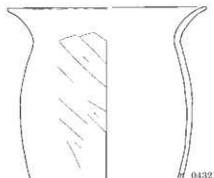

04321

SB6026 (2)

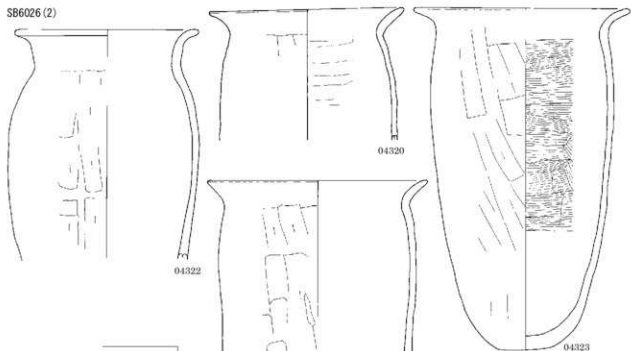

SB6027



SB6030

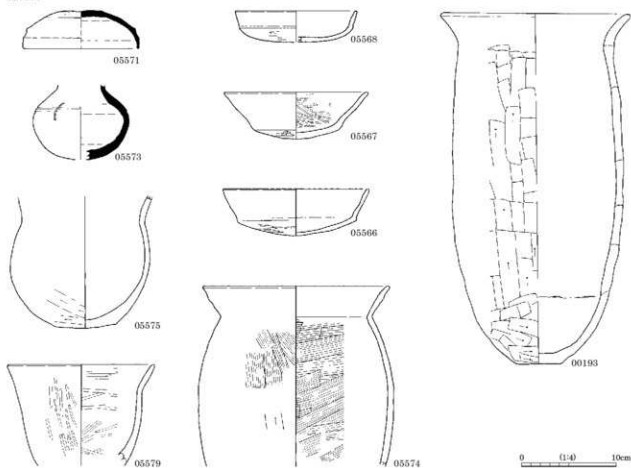

0 1:4 10cm



図版 146 古墳時代～古代の土器 (89)

S86033 (1)

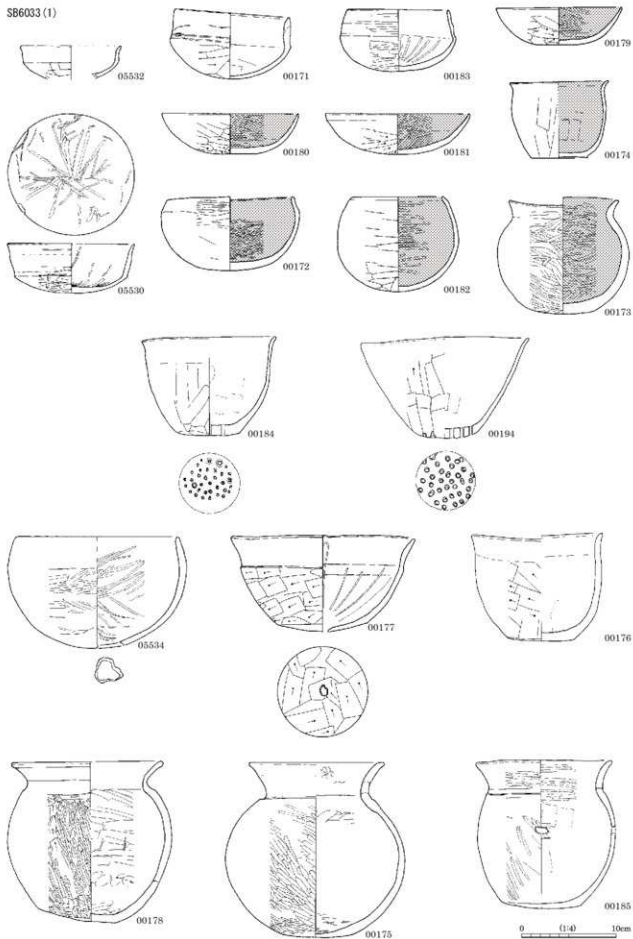

SB6033 (2)

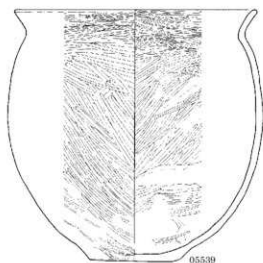

05539

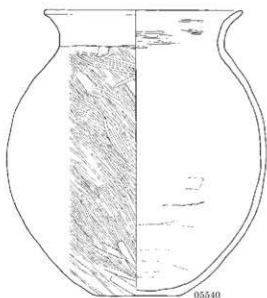

05540

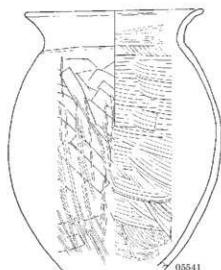

05541

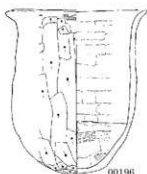

00196

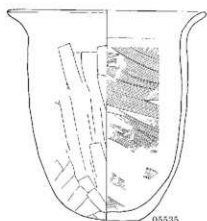

05535

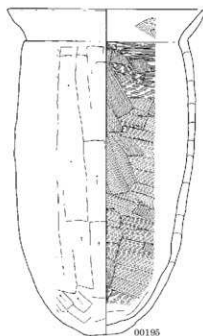

00195

SB6034

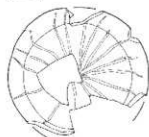

05545



05546



05549



05548

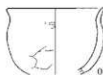

05550



05551

0 1:4 10cm

図版 148 古墳時代～古代の土器 (91)

SB6035

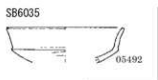

SB6036

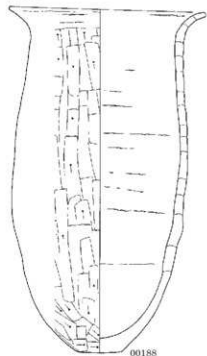

SB6037

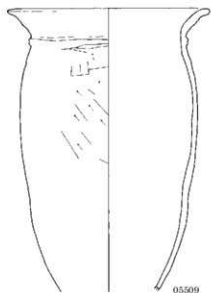

SB6038

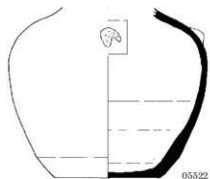
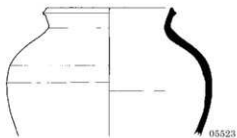

SB6039 (1)

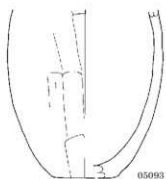
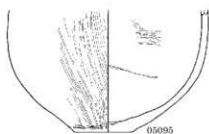
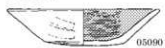

0 1:0 10cm

SB6039 (2)

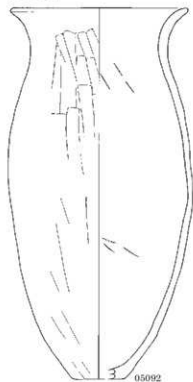

SB6041

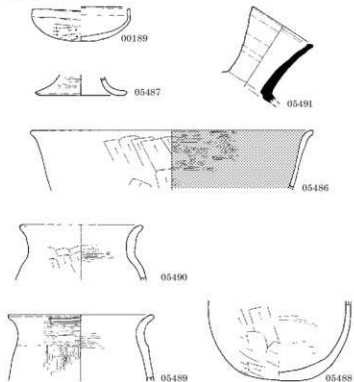

SB6042

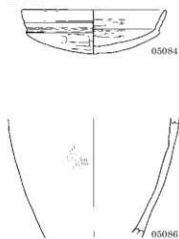

SB6045

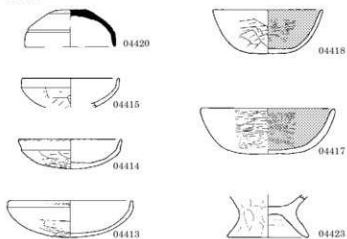

SB6046 (1)

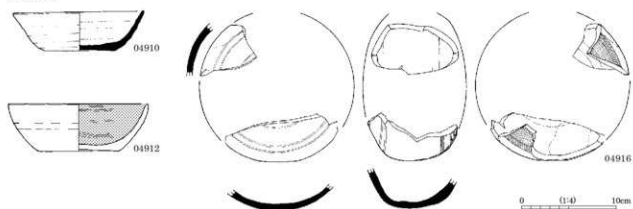

図版 150 古墳時代～古代の土器 (93)

SB6046 (2)

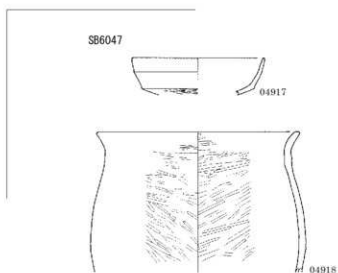
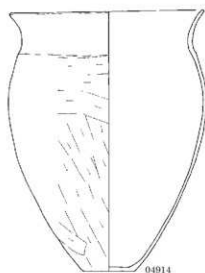
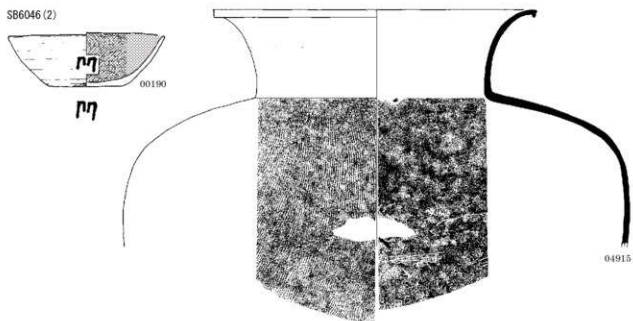

SB6048 (1)

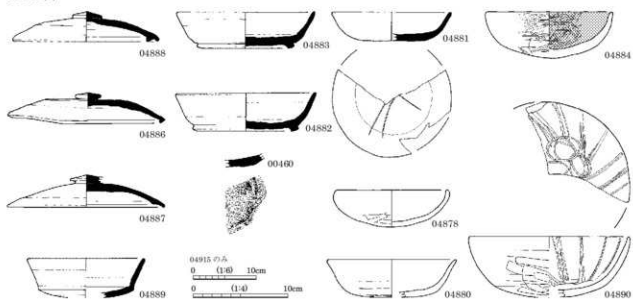

SB6048 (2)

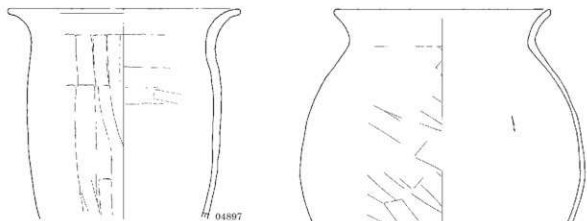
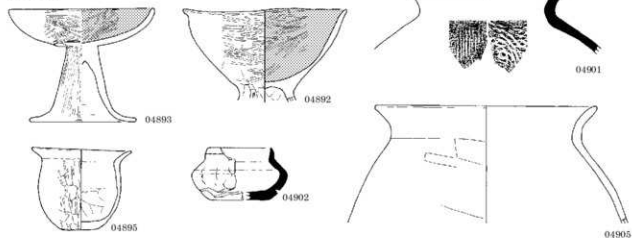

SB6049



SB6050 (1)

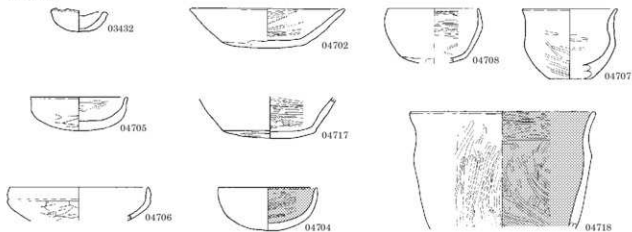

0 1:4 10cm

図版 152 古墳時代～古代の土器 (95)

SB6050 (2)

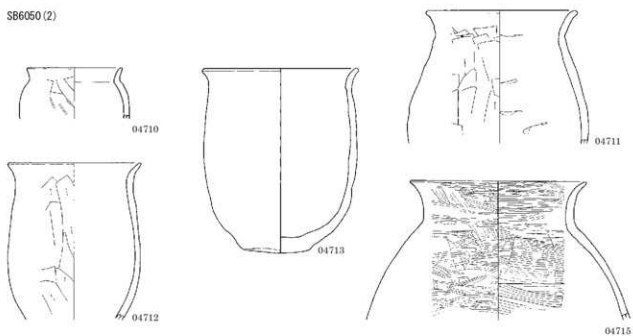

SB6051



SB6052



SB6053

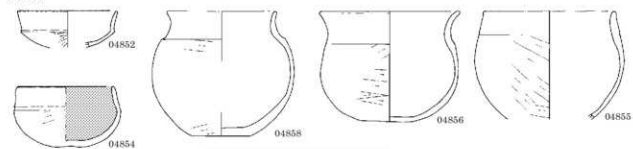

SB6054

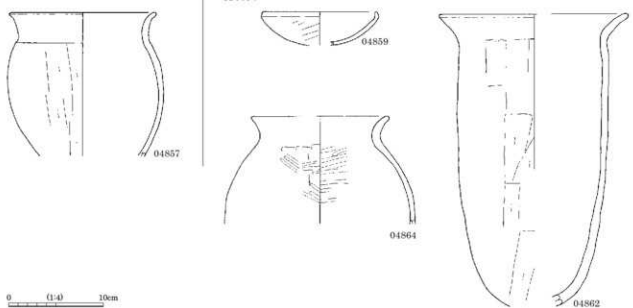

0 1:4 10cm

SB6055



04837

SB6056



04830

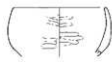

04828



04838

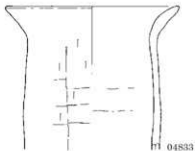

04833

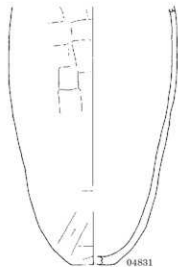

04831

SB6057



05524

SB6058



04848



04850

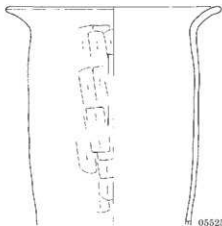

05525



04851

SB6059

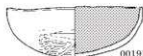

00191

SB6061 (1)



04379



04380



04383

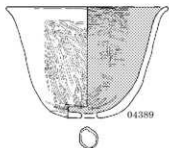

04389



04377



04381

0 1:4 10cm



図版 154 古墳時代～古代の土器 (97)

SB6061 (2)

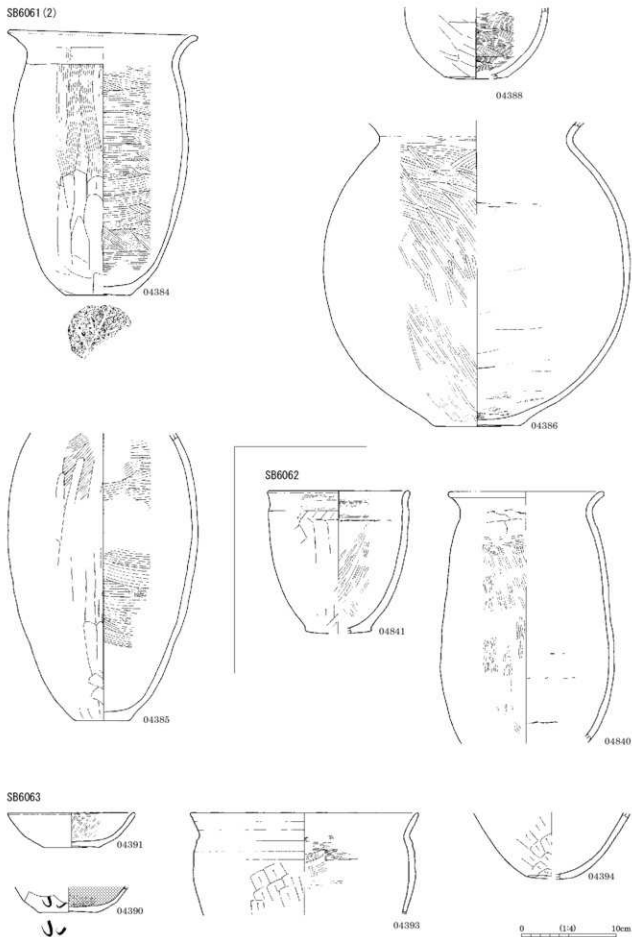

SB6065



04431



04436



04433

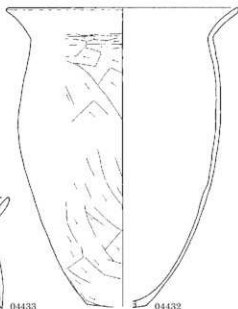

04432

SB6066



04425

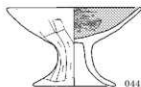

04427

SB6069



05088

SB6070

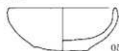

05529



05497



05496

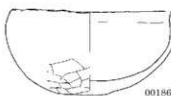

00186



00187

SB6072



05089

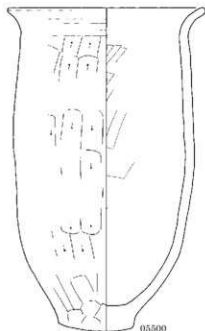

05500

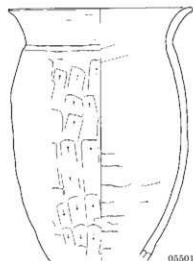

05501

0 (1:4) 10cm

図版 156 古墳時代～古代の土器 (99)

SB7001

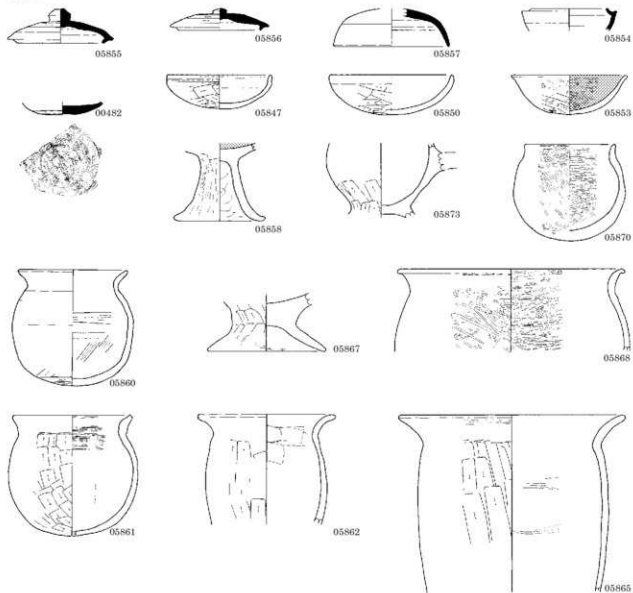

SB7002

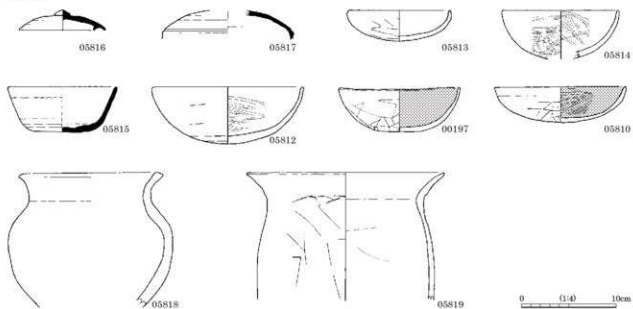

SB7003

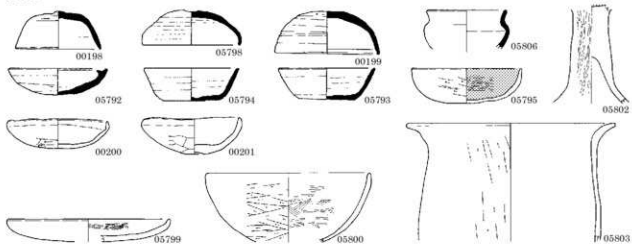

SB7004



SB7004・7005

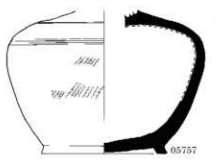

SB7005

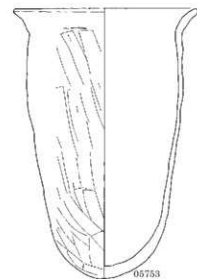
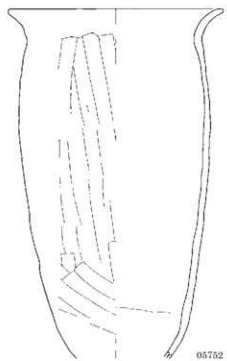
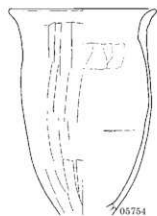
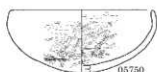

SB7006 (1)

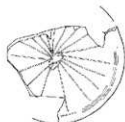

0 (1:4) 10cm

図版 158 古墳時代～古代の土器 (101)

SB7006 (2)

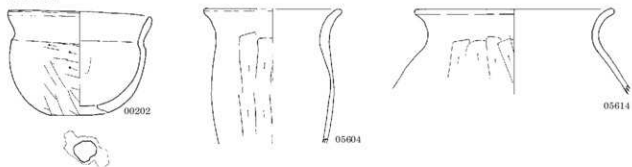

SB7007



SB7008

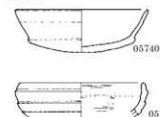

SB7009

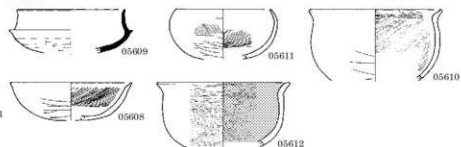

SB7011

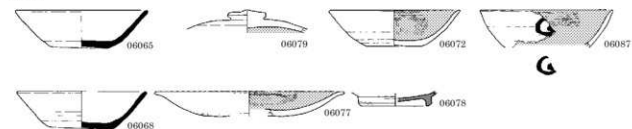

SB7012

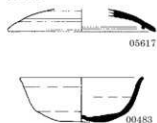

SB7013



SB7014 (1)

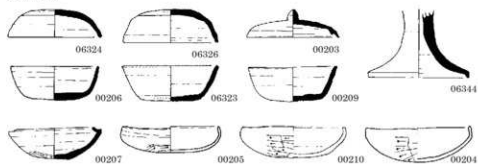

0 (1:4) 10cm

SB7014 (2)

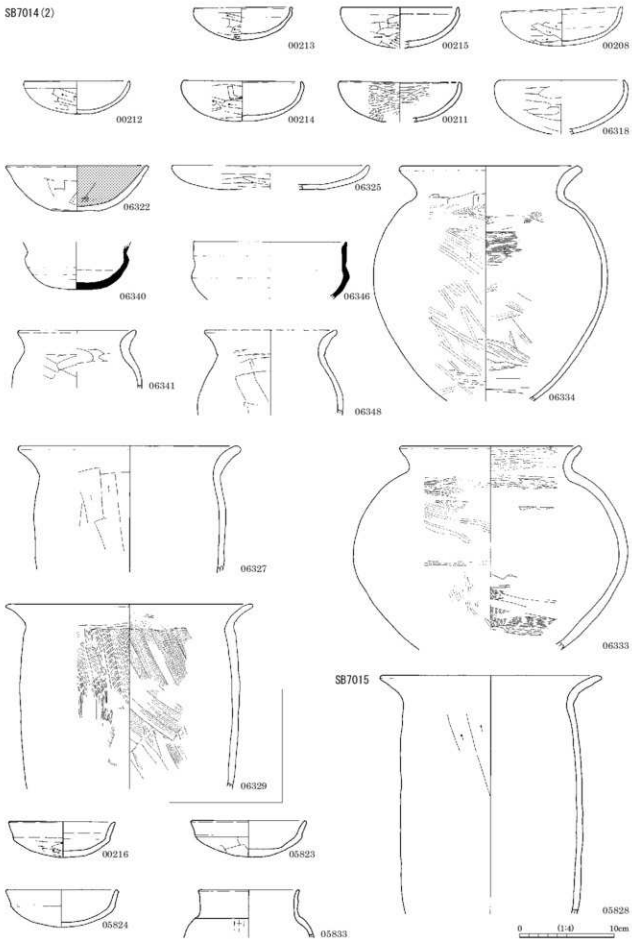

図版 160 古墳時代～古代の土器 (103)

SB7016

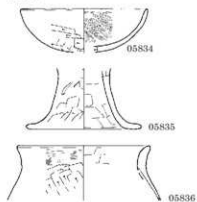

SB7017

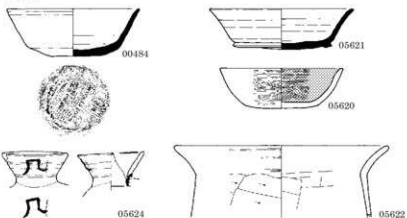

SB7018

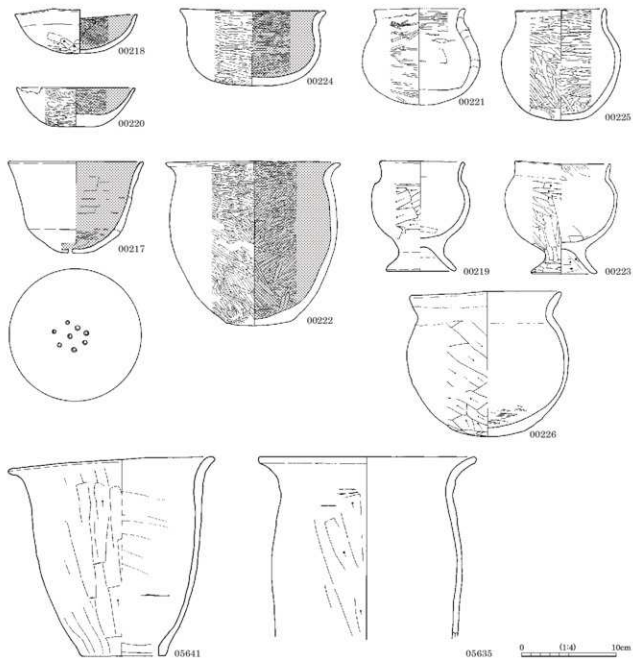

SB7019

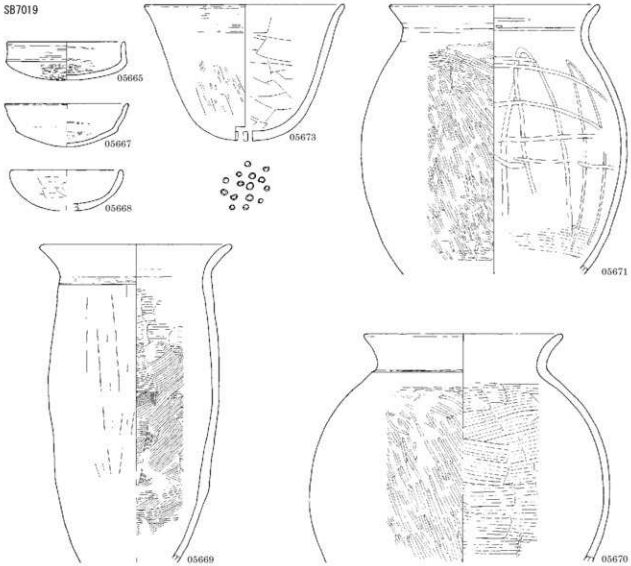

SB7020

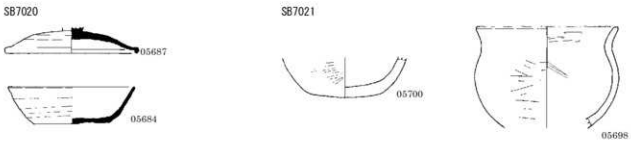

SB7021

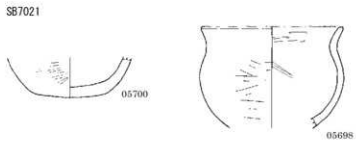

SB7022 (1)

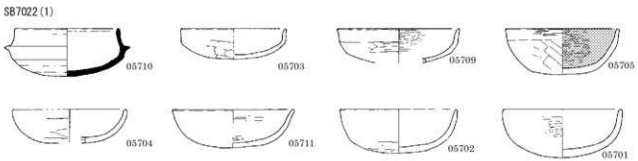

0 (1:4) 10cm



図版 162 古墳時代～古代の土器 (105)

SB7022 (2)

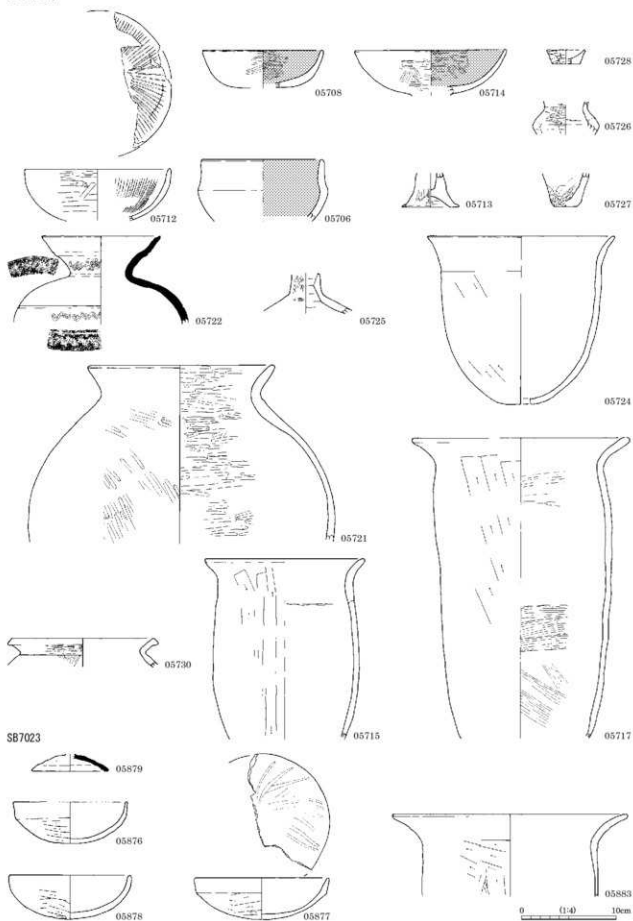

SB7024



05888

SB7025



05891

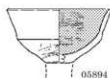

05894



05895

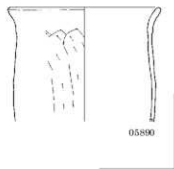

05890

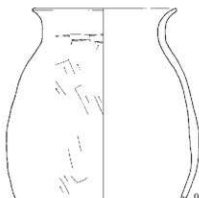

05897

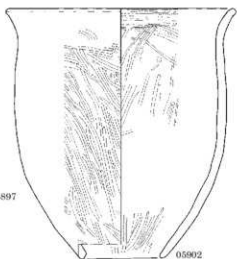

05902

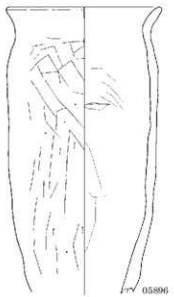

05896

SB7026



05934



05930



05927



05933



05924



05925



05932



05944

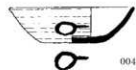

00467

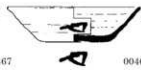

00466



00228

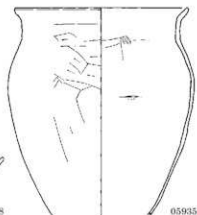

05935

SB7027



05994



05992



05993



図版 164 古墳時代～古代の土器 (107)

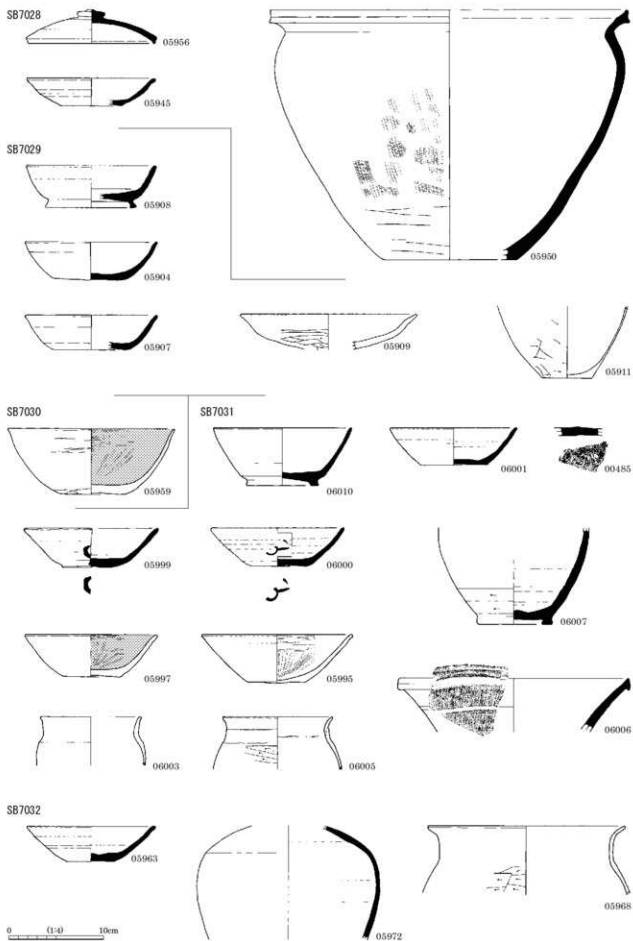

SB7033

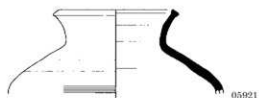
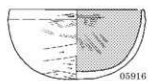

SB7034

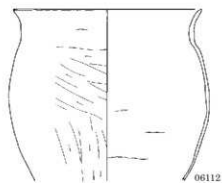
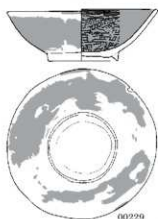
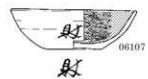
00229  
■ 底付着

SB7035 (1)

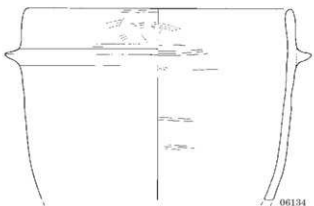

0 (1:4) 10cm

図版 166 古墳時代～古代の土器 (109)

SB7035 (2)

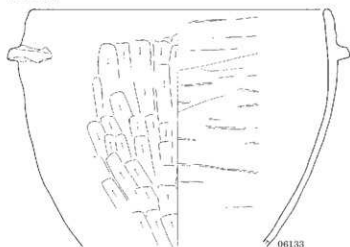

06133



06132

SB7036 (1)

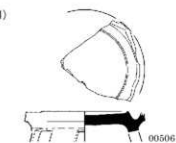

06056



06044



06032

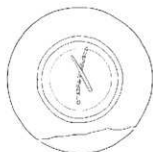

06036



06026



06033



06031

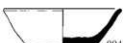

06048



06033

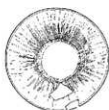

06032



06035

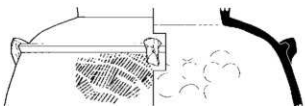

06042

0 1:4 10cm

SB7036 (2)

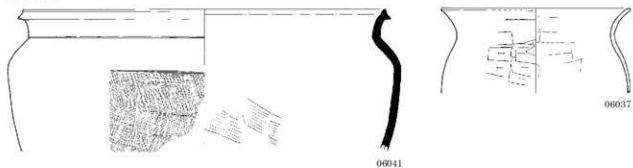

SB7037

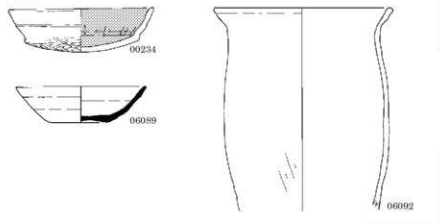

SB7039

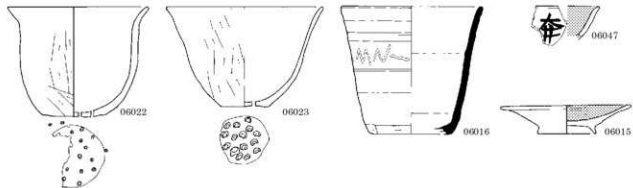
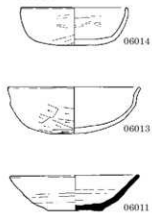

SB7040

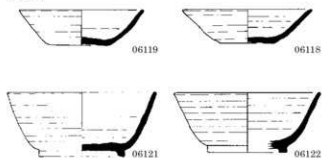

SB7041 (1)

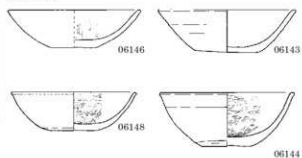

0 (1:4) 10cm

図版 168 古墳時代～古代の土器 (111)

SB7041 (2)

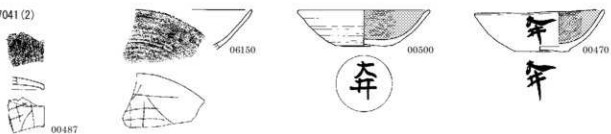

SB7042 (1)

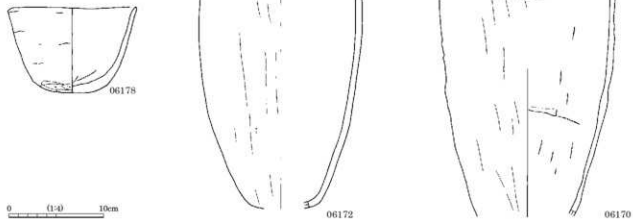
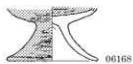
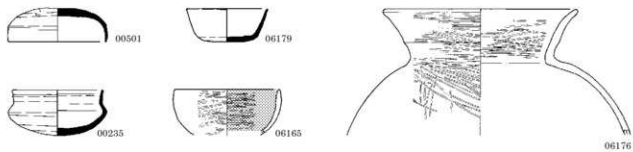

0 (1:4) 10cm

SB7042 (2)

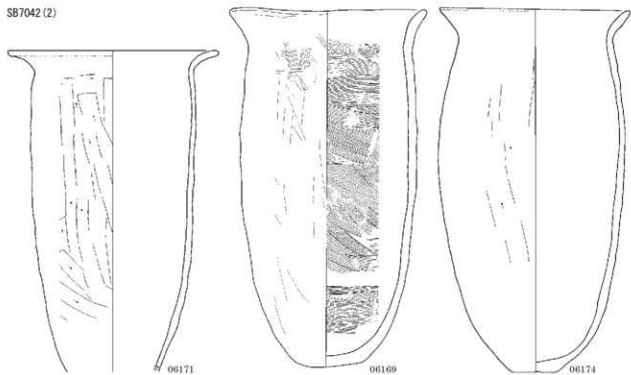

SB7043 (1)

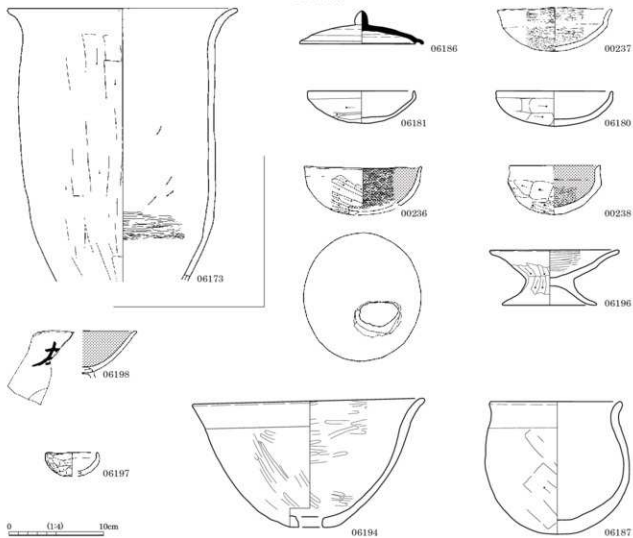

0 1:4 10cm



図版 170 古墳時代～古代の土器 (113)

SB7043 (2)

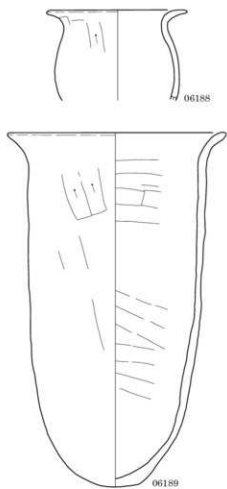

SB7044

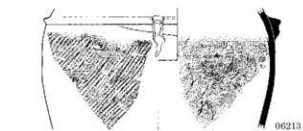
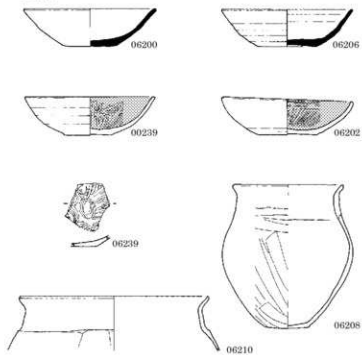

SB7045

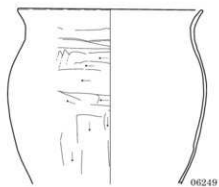
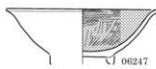
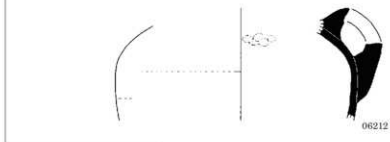
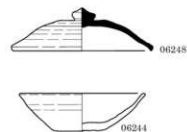

0 (1:4) 10cm

SB7046

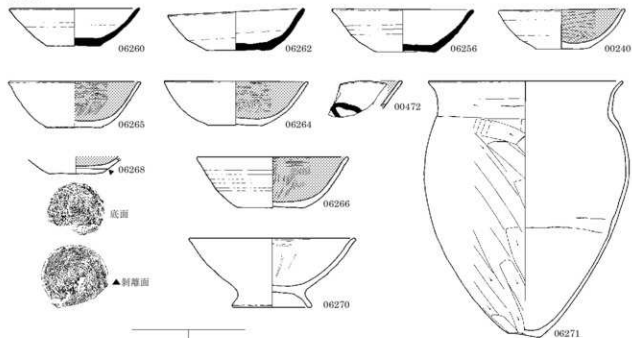

SB7048

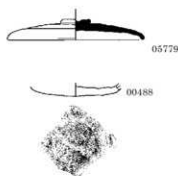

SB7050

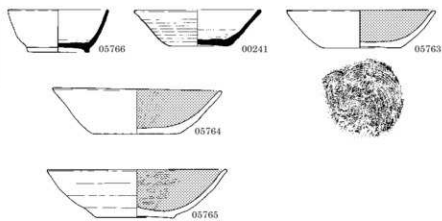

SB7049

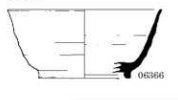

SB7052

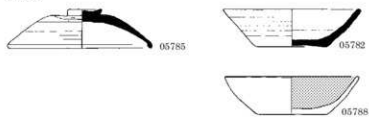

SB7055 (1)

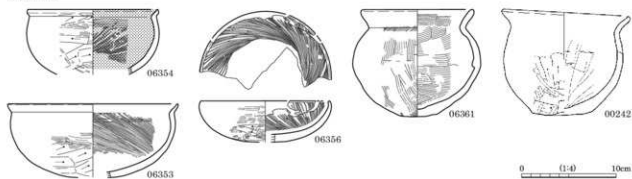

0 (1:4) 10cm

図版 172 古墳時代～古代の土器 (115)

SB7055 (2)

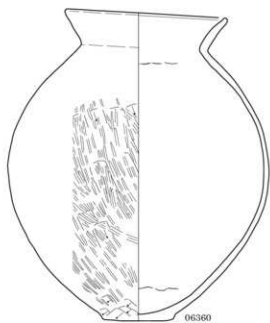
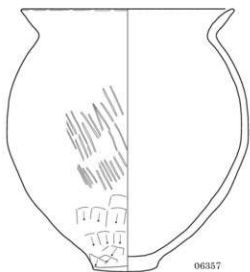
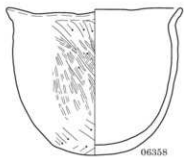
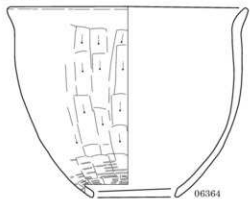

SB7057

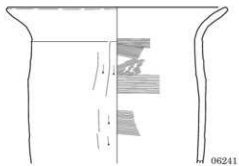
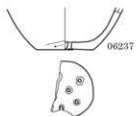
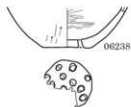
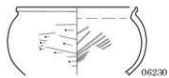

0 1:4 10cm

SB7058

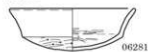

06281

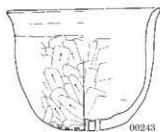

06243

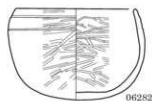

06282



06283

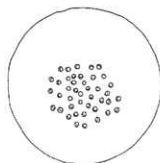

SB7060



06049



06070



06051



06050



06062



06074



06064



06063



06052

SB7061



06096



06100



06106

SB7063



06218

木



06219

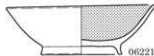

06221

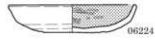

06224



06223

SB7065



06283

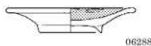

06288



06287



06295

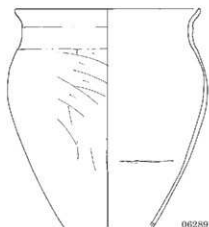

06289

0 (1:4) 10cm

図版 174 古墳時代～古代の土器 (117)

SB7068



SB7069



SB7070



SB7071

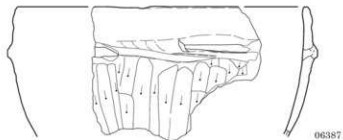
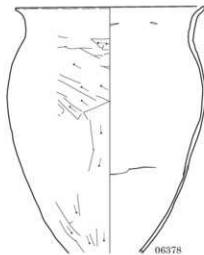
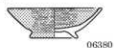

SB7072

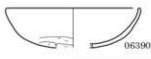

SB7073

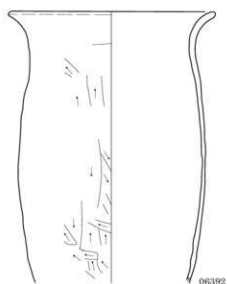
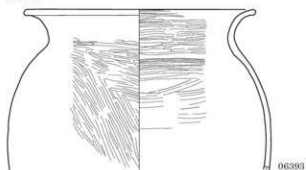

0 (1:4) 10cm

SB8003



06440



06441



06448

SB8004



06444



06455



06454

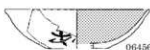

06456



06457



06459

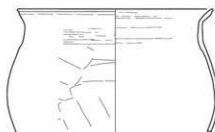

06450

SB8006



06598



06597



06599



06600

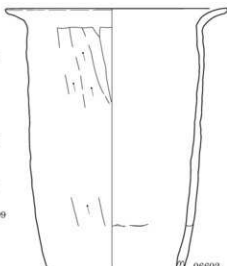

06602

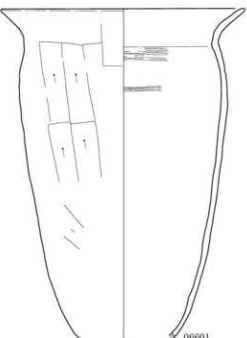

06601

SB8007



06616

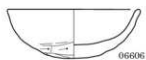

06606

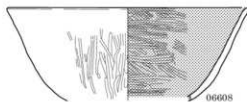

06608

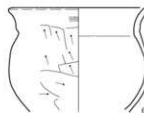

06611

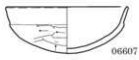

06607

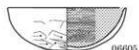

06605



06610



図版 176 古墳時代～古代の土器 (119)

S88008

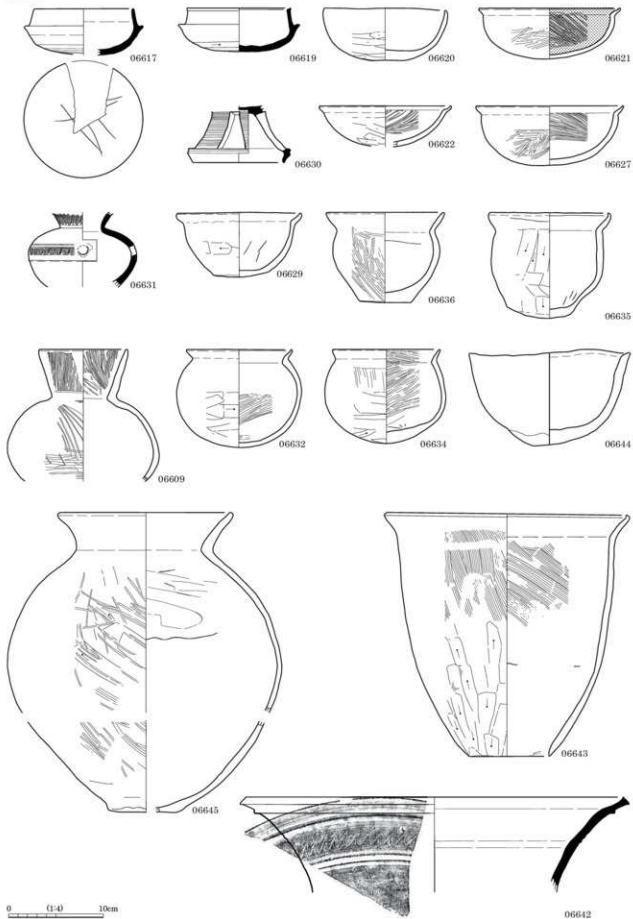

SB8009

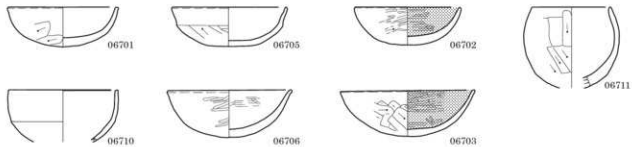

SB8010

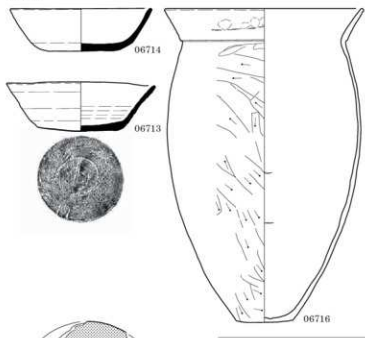

SB8011

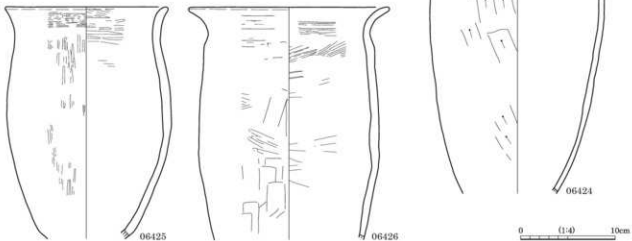
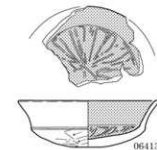
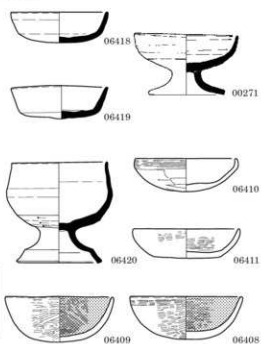

0 1:4 10cm



図版 178 古墳時代～古代の土器 (121)

S88012

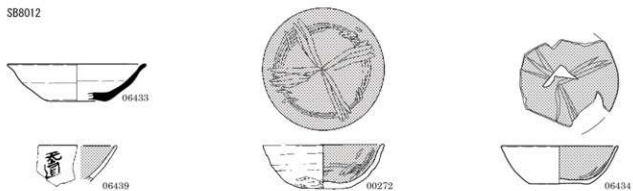

S88013

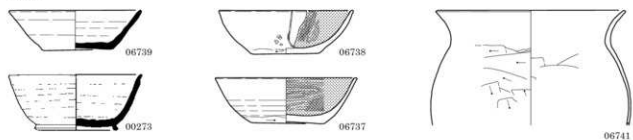

S88014

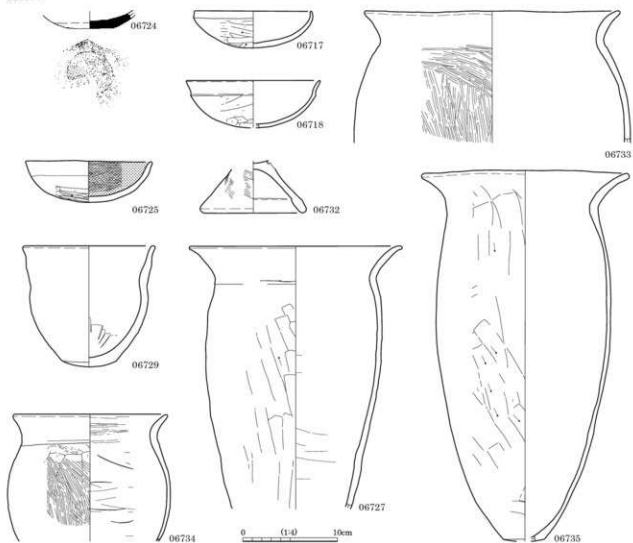

SB8015

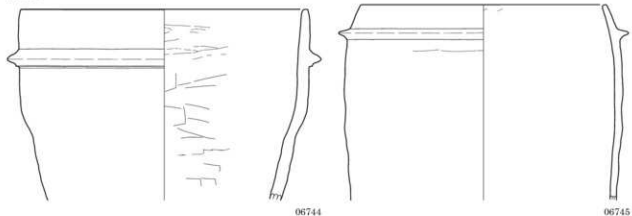

SB8016

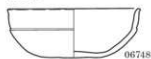

SB8017

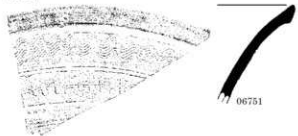

SB8018

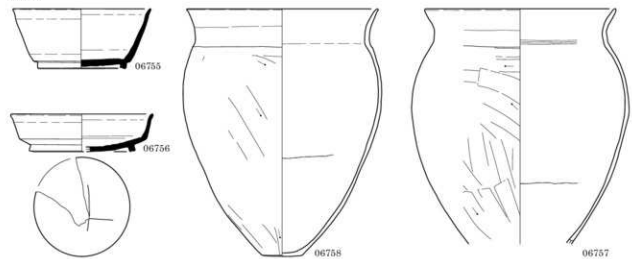

SB8019



SB8021

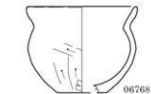

0 (1:4) 10cm

図版 180 古墳時代～古代の土器 (123)

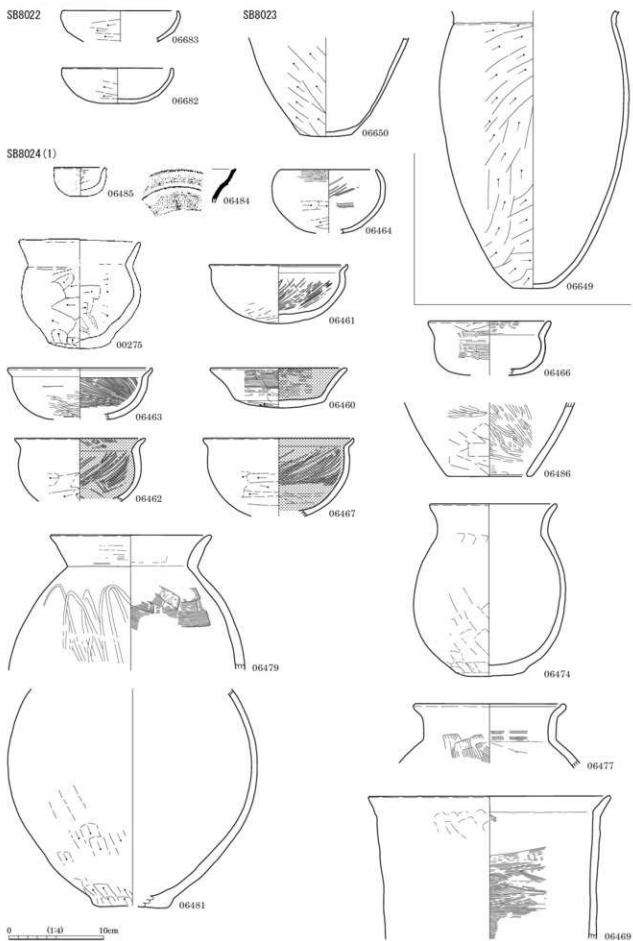

SB8024 (2)

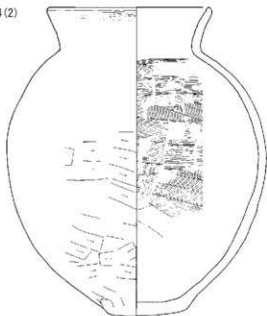

06472

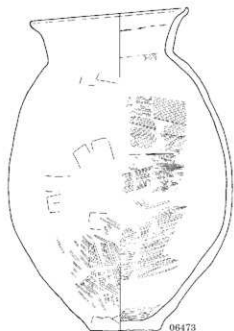

06473

SB8025 (1)



06688

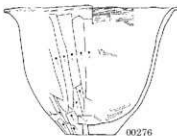

00276

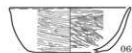

06689



06687



06692

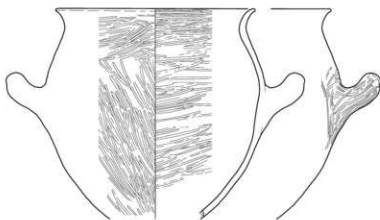

06693

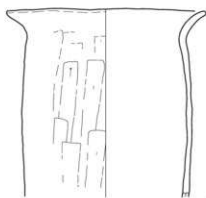

06695

0 1:4 10cm

図版 182 古墳時代～古代の土器 (125)

SB8025 (2)

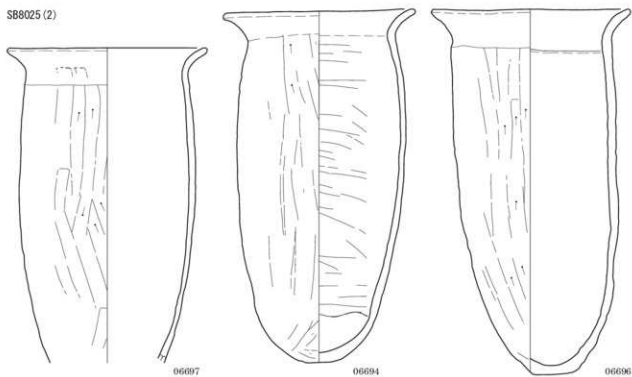

SB8026

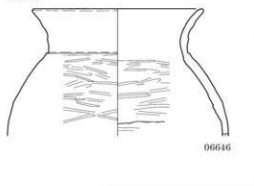

SB8028

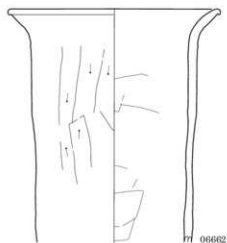
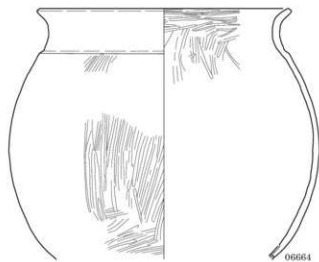
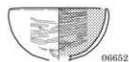
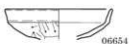

0 1:4 10cm

SB8030



06669



06671

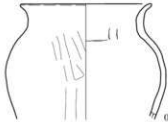

06673

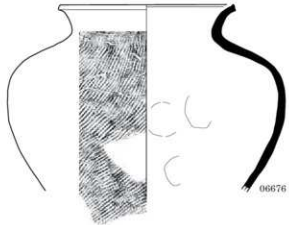

06676

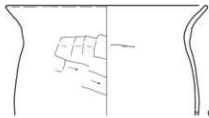

06672

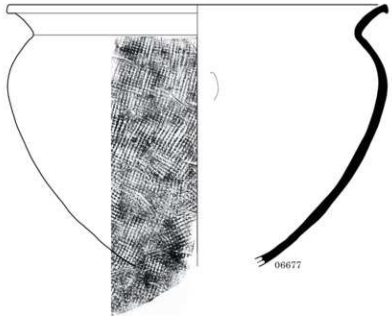

06677

SB8031



06678

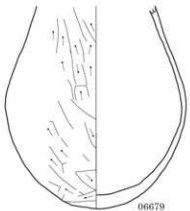

06679

SB8039

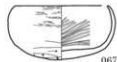

06779



06778



06780

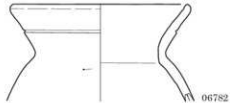

06782

SB8036



06442



06774

SB8038



06680



06781

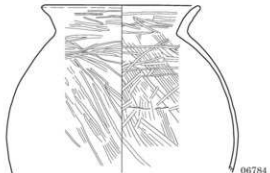

06784

0 (1:4) 10cm

図版 184 古墳時代～古代の土器 (127)

SB8040

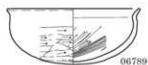
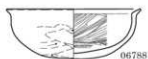

SB8041

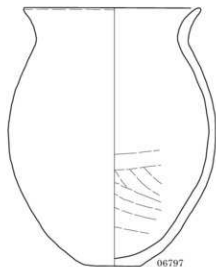
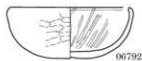
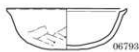

SB8042a



SB8042b

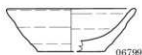

SB8042c

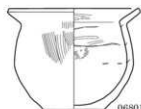
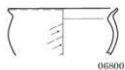

SB8044a (1)

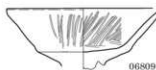
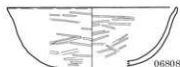
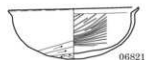
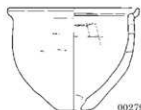

0 (1:4) 10cm

SB8044a (2)

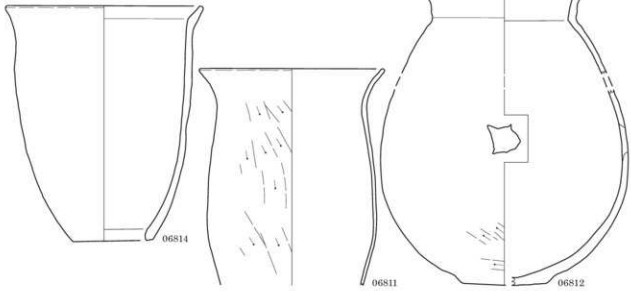

SB8044b

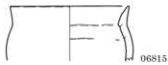

SB8045

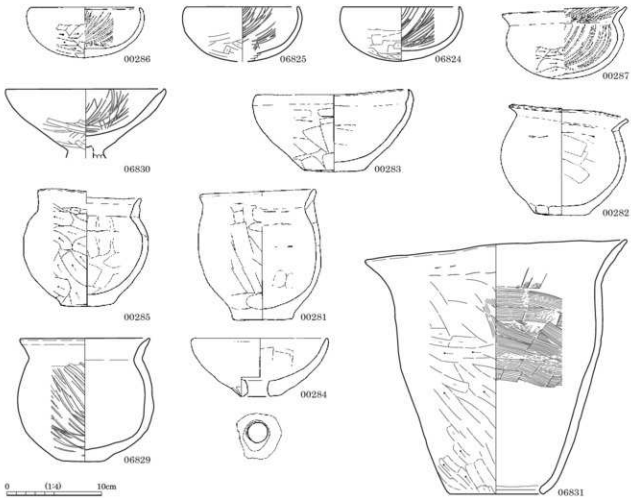



ST0002

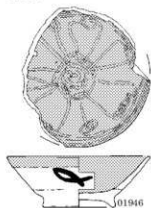

ST0005

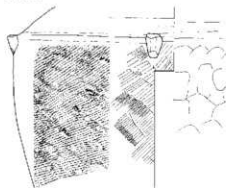

ST0007

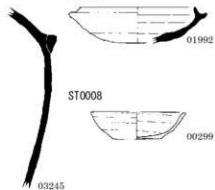

ST0008



ST0306



ST4002

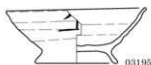

ST4004

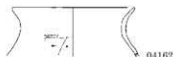

ST4009



ST5006

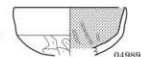
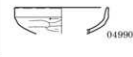

ST5007



ST6009



ST6014

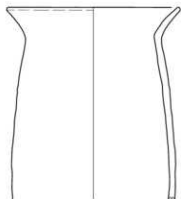

ST6028



ST6015

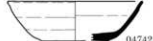

0 1/4 10cm

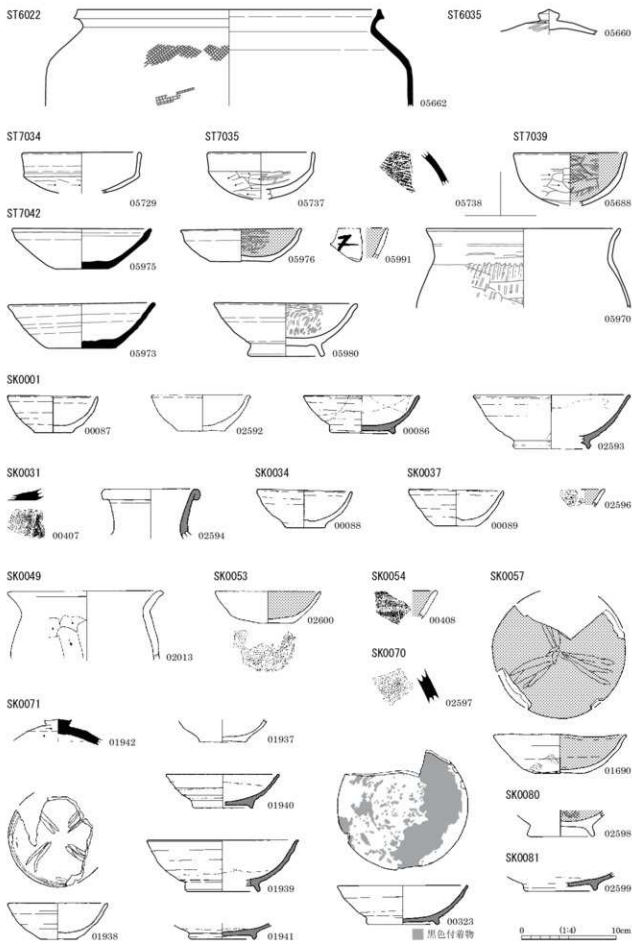

図版 188 古墳時代～古代の土器 (131)

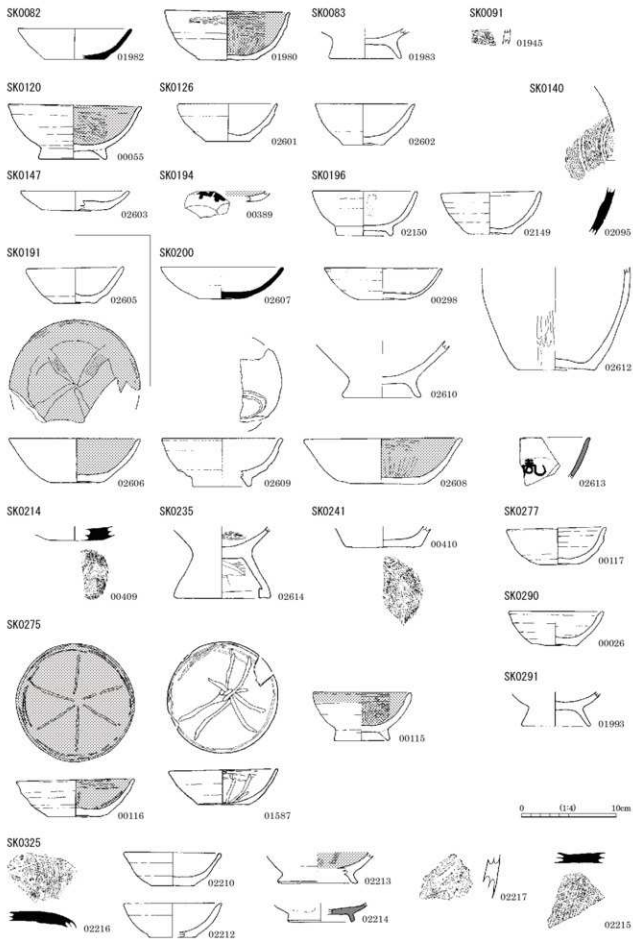

SK0331

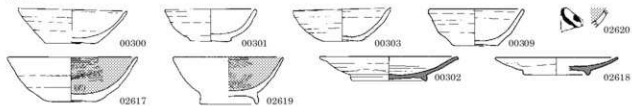

SK0347

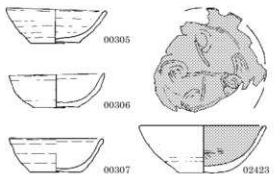

SK0349

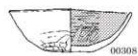

SK0363

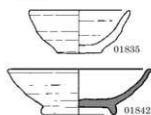

SK0350



SK3006



SK3007

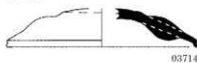

SK3016

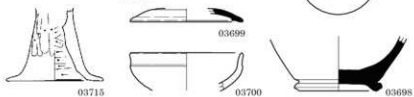

SK3029

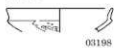

SK3080

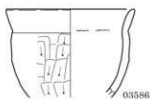
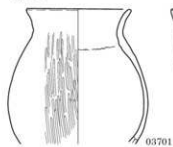

SK3100

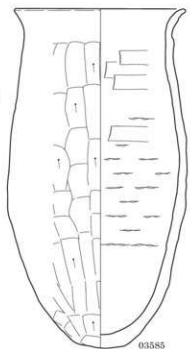
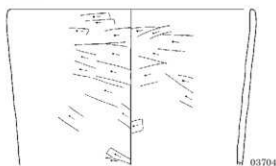

0 1:4 10cm

図版 190 古墳時代～古代の土器 (133)

SK3180

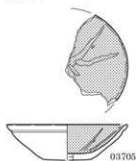

SK3220



SK3279



SK4051

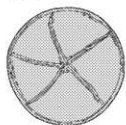

冨



00109



冨



00320

正



00321

正



00110



周



00111

SK4094



03937

SK4144



03939



03941

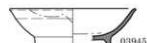

03945

SK4151



03933

SK4246



00112

冨

SK4270



00113

SK4266



03934

0 (1:4) 10cm

SK5002

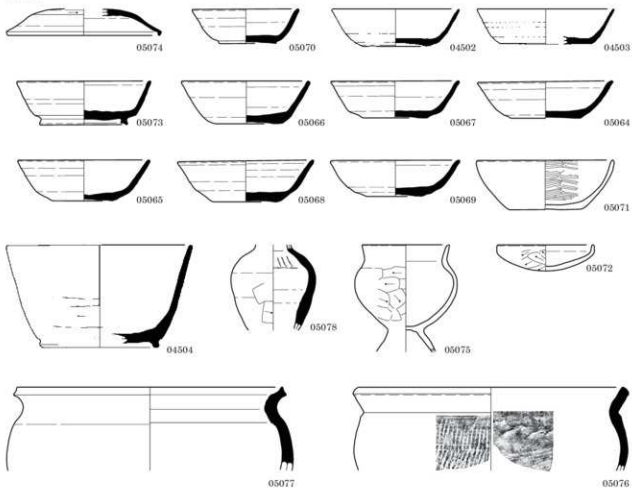

SK5075

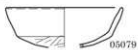

SK5143

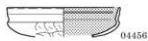

SK5168

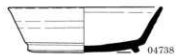

SK5298



SK6062

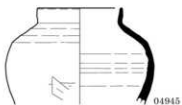
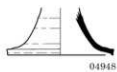
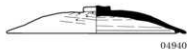

0 1:4 10cm

図版 192 古墳時代～古代の土器 (135)

SK6063

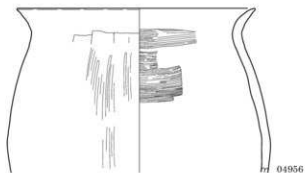
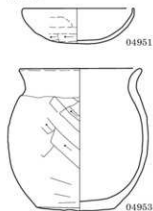

SK6183

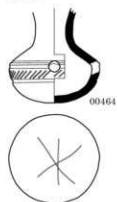

SK6182



SK6221



SK6246



SK6439

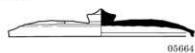

SK7021

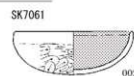
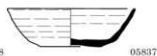
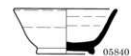

SK7210



SK7211

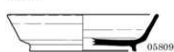

SK7243



SK7335

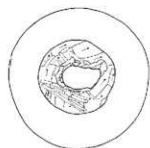

SK7697



SK7720

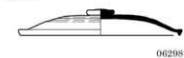

0 (1:4) 10cm

SK7782

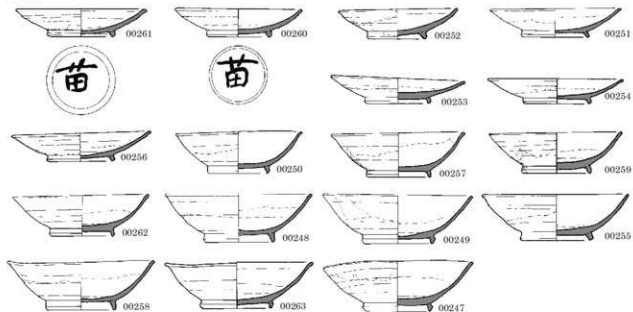

SK7847



SK7905



SK7925



SK8107



SK8149

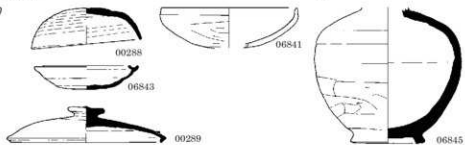

SK8204

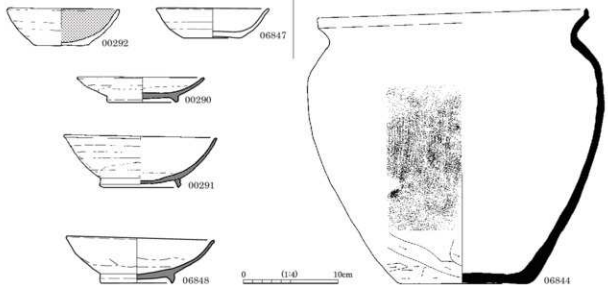



図版 194 古墳時代～古代の土器 (137)

SK8210



SM8001

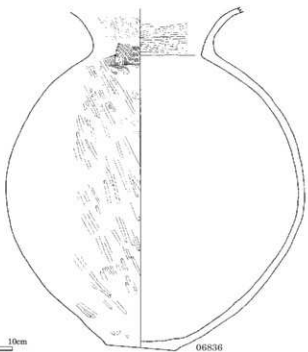
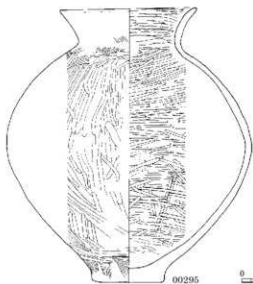
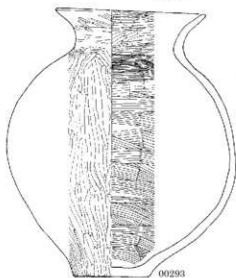
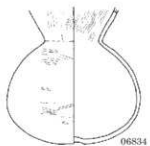
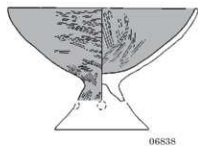
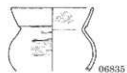

0 1:4 10cm

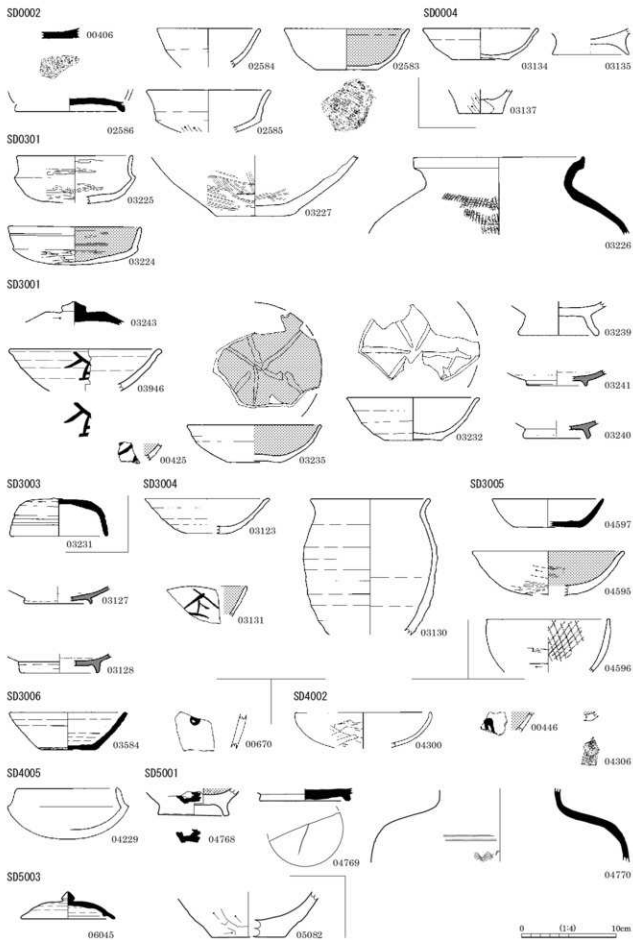

図版 196 古墳時代～古代の土器 (139)

SD5003-5004



SD5003 ~ 5005



SD5007

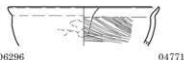

SD6001



SD6002

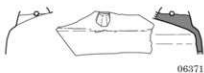
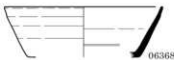

SD7002



煤付着

SD8002



SD8003

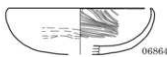

00476



06861



06862



06863



06860

SD8006 A 層



SD8006 B 層

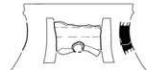

00507

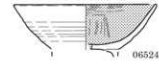
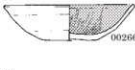

06647



06488



00264



06521



06576

0 1:4 10cm



06564



06578

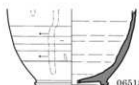

06518

SD8006 C層

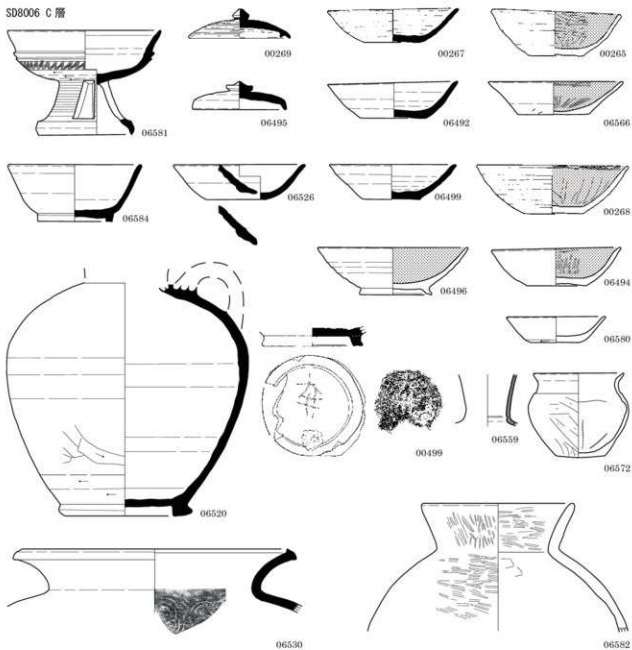

SD8006 I X10 敷石部

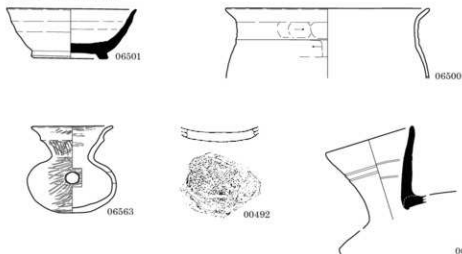

SD8006 層位不明

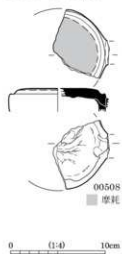

■ 草花

0 10 20 cm

1・2区 検出面

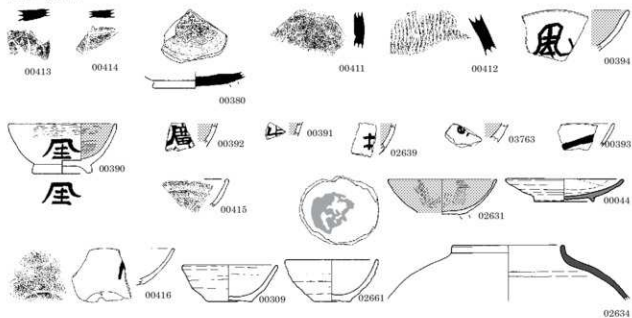

表土

攪乱ほか

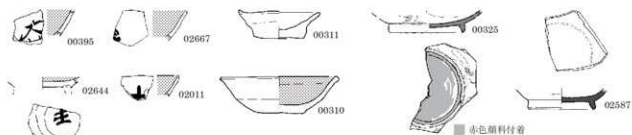

3区

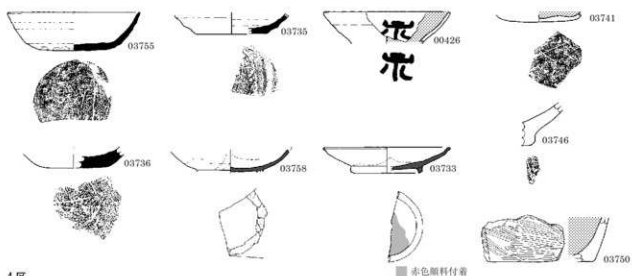

4区



5区



6区

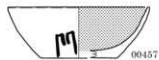
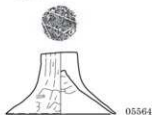

7区 I X13

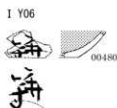
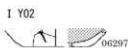
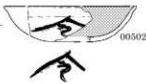

表土

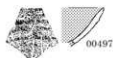

検出面



攪乱

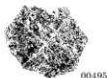

地点不明

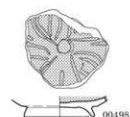

8区

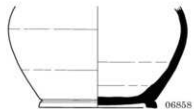

中世陶磁器

SB0006

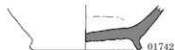

SK0181



0 (1:4) 10cm

図版 200 古墳時代～古代の土製品 (1)

土製玉類ほか



土製紡錘車

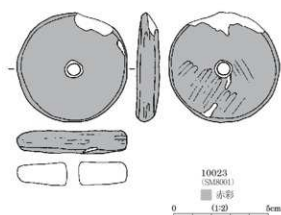
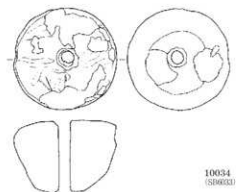
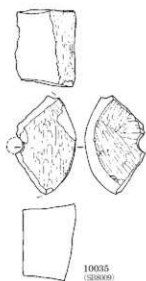

円筒形土製品

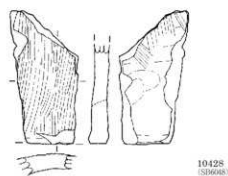

盤状土製品

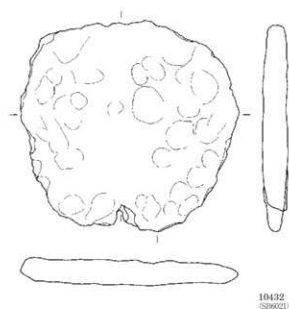

鉄斧形土製品



編羽口

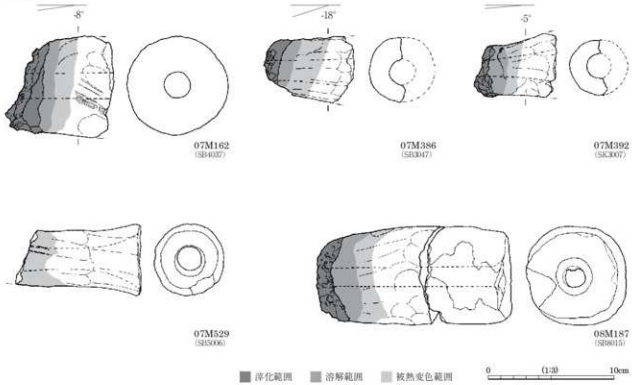

瓦

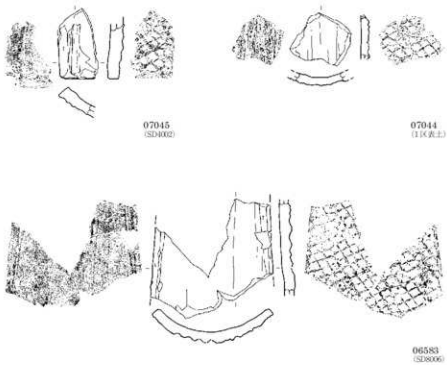



原石

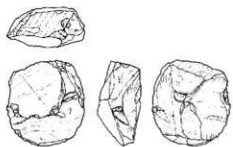

22528  
(SD4002 石塊A)

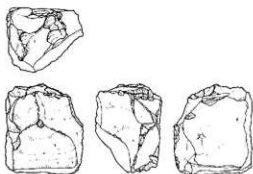

22557  
(SD7039)

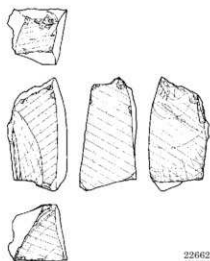

22662  
(SA8001)

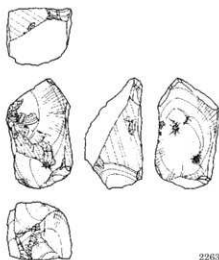

22634  
(S14801面)

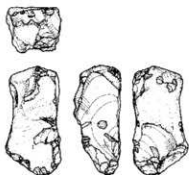

22611  
(SD8006 1 X18 DW)

石核

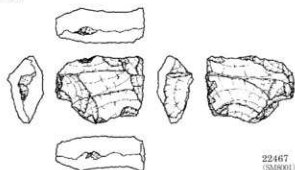

22467  
(SA8001)

0 (2:3) 5cm

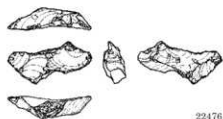

22476  
(SD8005 P430)



22484  
(SD7041 K7)



22581  
(SD8007)

0 (1:3) 10cm

模形石器

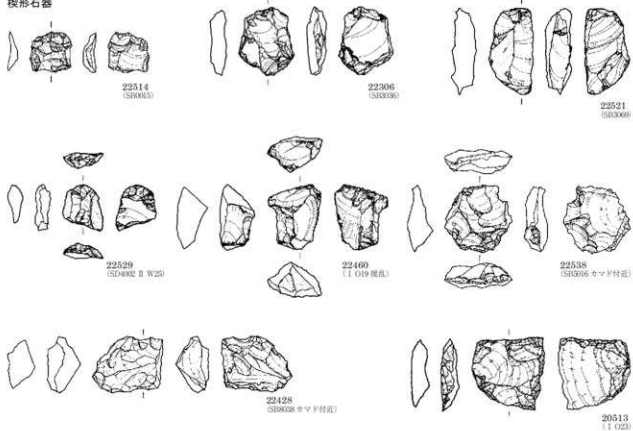

打製石器

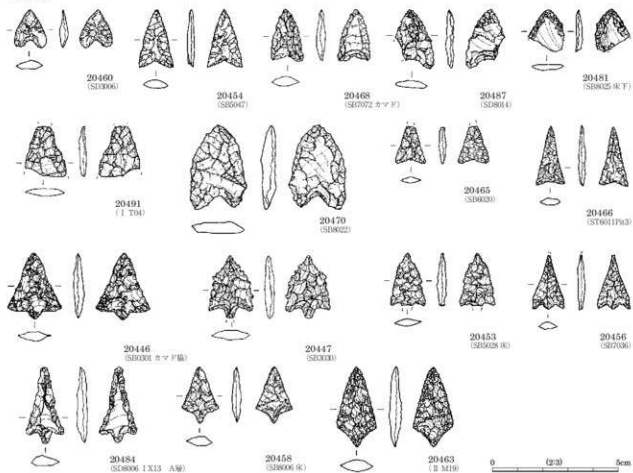

石匙

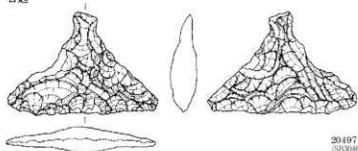

20497  
(SE3046)

20498  
(SB7011)

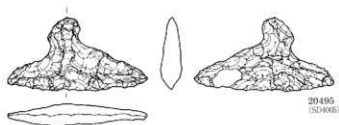

20495  
(SD4006)

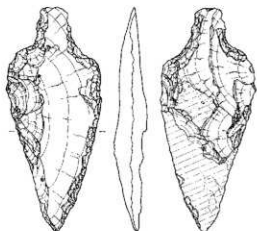

20498  
(SB7011)

小形刃器

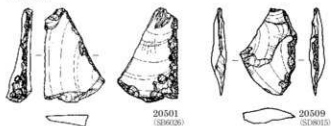

20501  
(SE9035)

20509  
(SB6015)

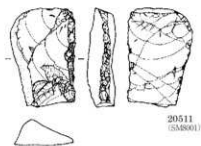

20511  
(SB48001)

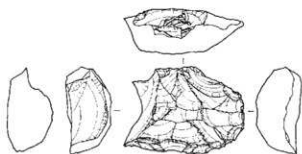

22448  
(SB6013)

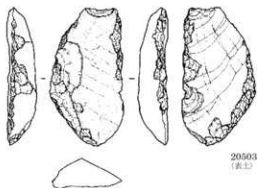

20503  
(表上)

0 (2:3) 5cm

打製石斧 (1)

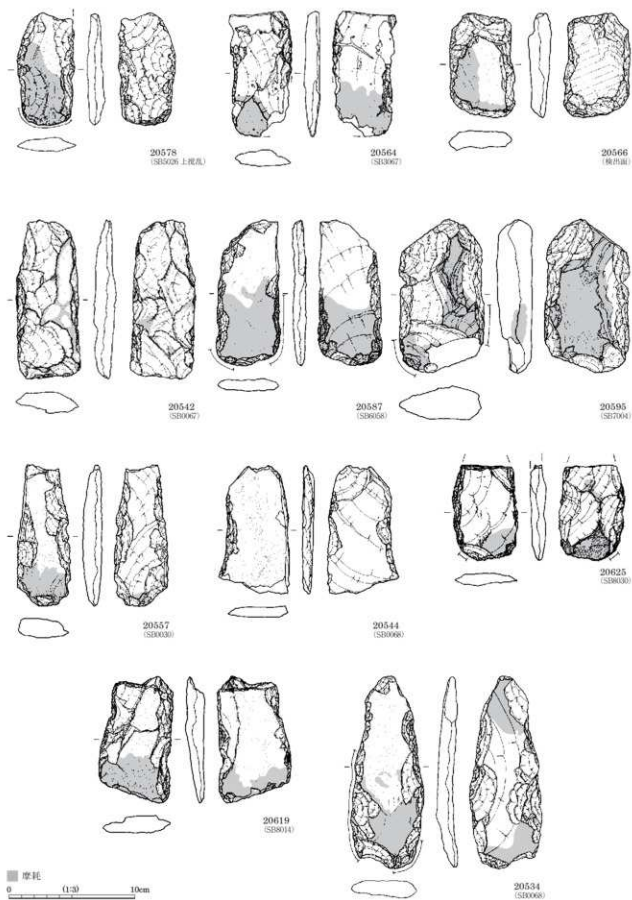

打製石斧 (2)

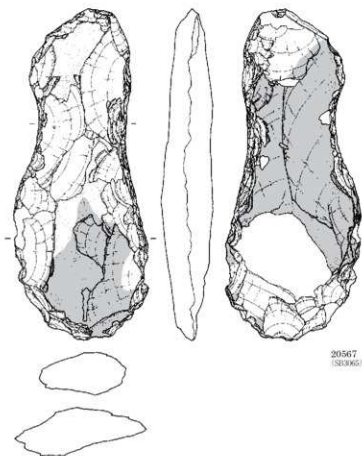
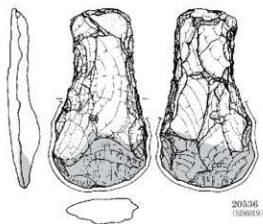
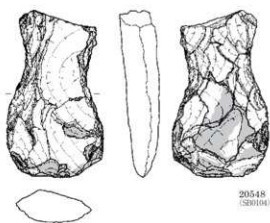
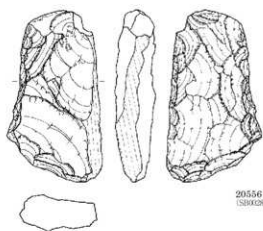

磨製石鏃



20646  
(SB0038)

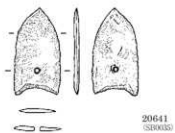

20641  
(SB0035)

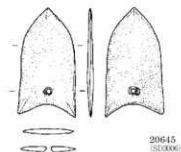

20645  
(SB0006)

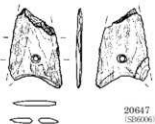

20647  
(SB0008)

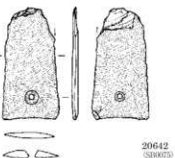

20642  
(SB0073)

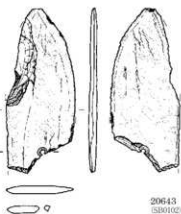

20643  
(SB0102)

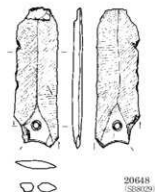

20648  
(SB0029)

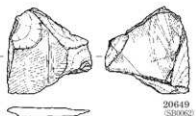

20649  
(SB0082)

0 (2:3) 5cm

磨製石斧 (I)



20658  
(SB0033)

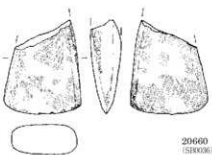

20660  
(SB0036)

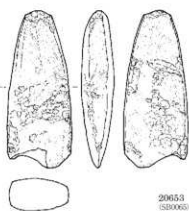

20653  
(SB0065)

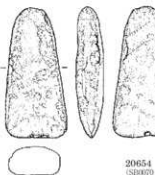

20654  
(SB0070-0072)

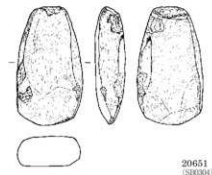

20651  
(SB0034)

0 (1:2) 5cm

磨製石斧 (2)

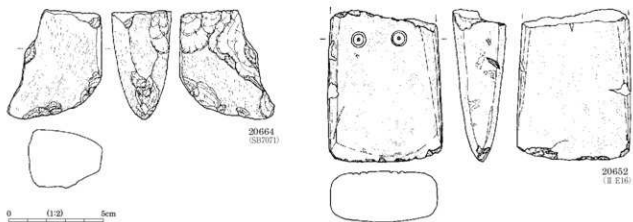
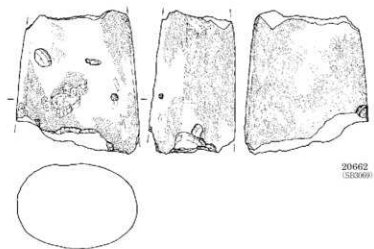
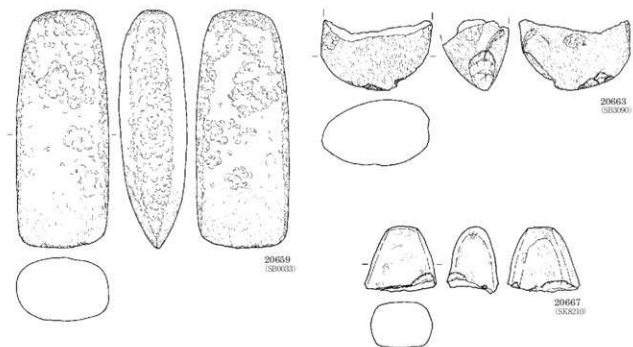

磨製石斧 (3)

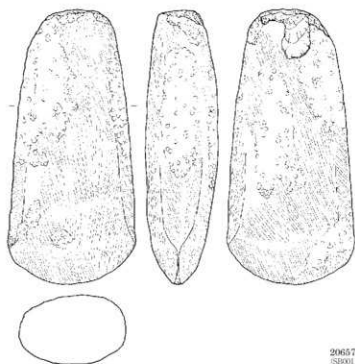

20657  
(S16001)

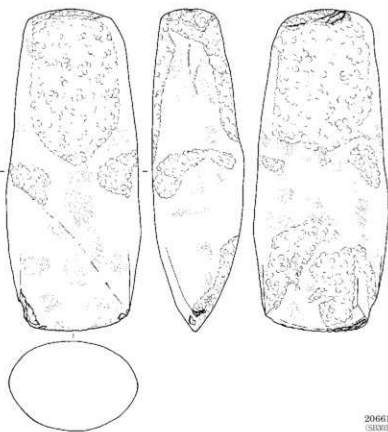

20661  
(S16036)

0 1:20 5cm



みがき石

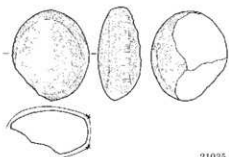

21035  
(SB0011)

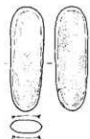

21044  
(SB0027)



21013  
(SB0005)

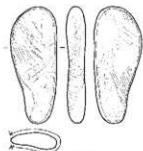

21049  
(SB0035-0046-0048)

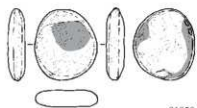

21050  
(SB0007)  
■ 赤色顔料付着

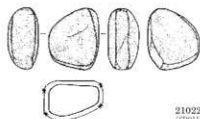

21022  
(SB0117)

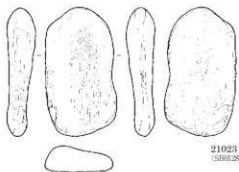

21023  
(SB0028)

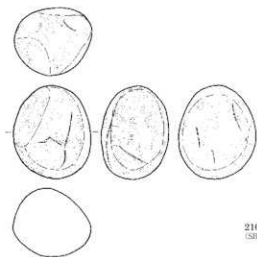

21059  
(SB0052)

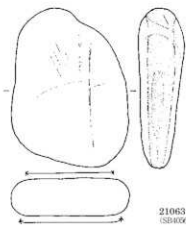

21063  
(SB0006)

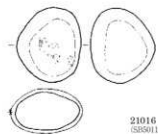

21016  
(SB0011)

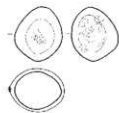

21017  
(SB0024)

石製玉類

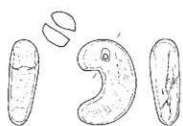

20040  
(SD4002)

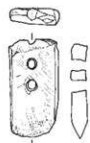

20058  
(SB4000)



20051  
(SD4002 II W25)

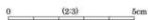

管玉



20031  
(SD0004)



20032  
(SB0019)



20033  
(SB0136)



20034  
(SB0051)



20035  
(SB0010)



20036  
(SB0024 R)



20037  
(SB0044 R)



20038  
(SB4026)



20039  
(無形面)



不明石製品

丸玉



20043  
(SD0036)



20049  
(SB0811)



20052  
(SK7321)



20050  
(ST0006P110)



20048  
(SB0066 東方)



20057  
(I Y11)



20044  
(SD1119  
R T P97)



20046  
(SB0030)



20053  
(SB7013)



20047  
(SB7007)



20055  
(SB0028)



20056  
(SK7512)



20045  
(SB4008)



20054  
(SB7022)

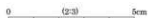

ガラス小玉



20059  
(SD0067 R)



20060  
(SB3000)



20061  
(SD7042)



20062  
(SB0019)



20063  
(SM4002)



20064  
(SM4002)



20065  
(SM4002)



20066  
(SM4002)



図版 212 石器・石製品 (11) - 古墳時代~古代 -

滑石製模造品 (1)

SB3022



20310  
(K)

SB3042



20311  
(S, Y, F)

SB4026



20312



20313

SB4040



20314



20315

SB5007・5008



20408

SB5011



20417



20317

SB5012



20318

SB5022



20319



20320  
(K)



20321  
(K)



20322  
(K)

SB5030



20323

SB5034



20324

SB5054



20325

SB6020



20326  
(S, Y, F)

SB6021



20327



20329



20330



20333



20334



20335



20336



20337



20338



20339



20340



20341



20342



20343



20344



20345



20346



20347



20348



20349



20350

SB6022



20351  
(K)



20352  
(K)

SB6024



20353



20354



20355



20356



20357



20358



20359

0 (2:3) 5cm

滑石製模造品 (2)

SB6033



20409  
(横7)



20410  
(横7)

SB6040



20360  
(横7)

SB6048



22872  
(横7)



20361



20362

SB6050



20363



20364



20365



20366



20367



20368



20369



20370



20371



20372



20373



20374



20375



20376



20377



20378



20379



20380



20381



20382



20383



20384



20385



20386



20387



20388



20389



20390



20391



20392



20411



20393

SB7008



20394

SB7019



20395



20396



20397



20412



20398



20399



20400

図版 214 石器・石製品 (13) - 古墳時代~古代 -

滑石製模造品 (3)

SB7037



20401



20402  
(R)

SB7041



20407  
(SB7041 南方北西隅 Pt)

SB8007



20403  
(R)

SB8016



20068



20069



20070



20071



20072



20073



20074



20075  
(R)



20076



20077



20080



20081

SB8019



20083

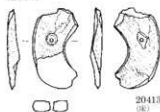

20413  
(R)



20084



20085



20086



20089



20090



20091



20092



20094



20095



20096



20098



20102



20103



20104



20105



20106



20107



20108



20109



20110



20111



20112



20113



20115



20116



20117



20118



20119



20120



20121



20123



20124



20125



20126



20129



20132



20133

0 (2:3) 5cm

滑石製模造品 (4)

SB8019

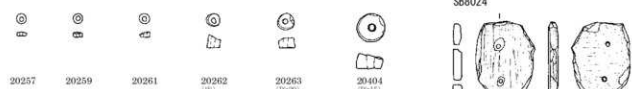

SB8024

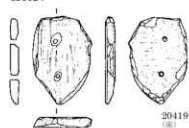

0 (2:3) 5cm

図版 216 石器・石製品 (15) - 古墳時代~古代 -

滑石製模造品 (5)

SB8024



20264

20265

SB8029



20405

SB8040



20414

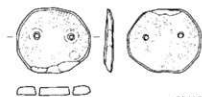

20418



20266



20267



20268



20269



20270



20271



20273



20275



20277



20278



20281



20283



20284



20287



20288



20289



20290



20292



20293



20294



20295



20296



20297

SB8044

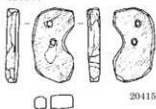

20415

SD0002

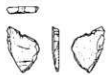

20427

SD4005



20316

SD8005



20300



20301



20302



20303



20304



20305



20306



20307



20308

SD8013

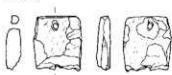

20426

SD8014



20406

ST7010



20309  
(Fig)

0 2.33 5cm

石製紡錘車 (1)

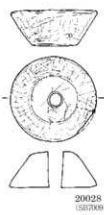
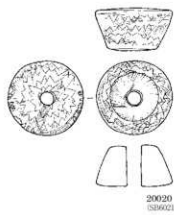
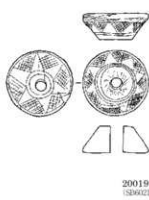
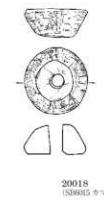
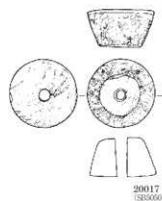
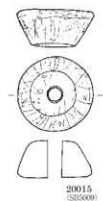
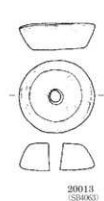
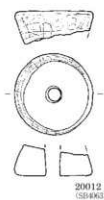
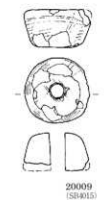
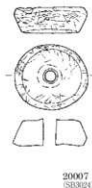



石製紡錘車 (2)

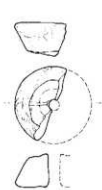

20022  
(SB7022)

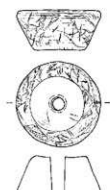

20025  
(SB7023)

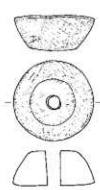

20026  
(SB7023)

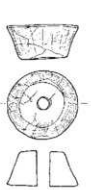

20027  
(SB7048)



20023  
(SB7025)

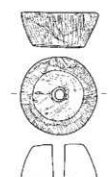

20024  
(SB7025)

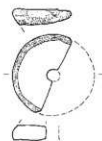

20021  
(SB7006F48)

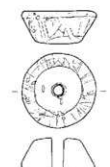

20014  
(SB7002)

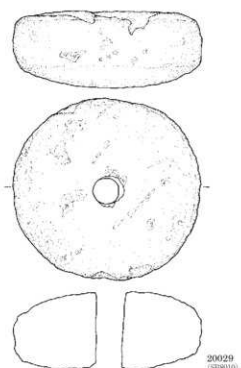

20029  
(SB8010)

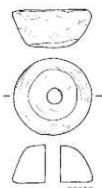

22859  
(SB7002)

石製腰帯飾具

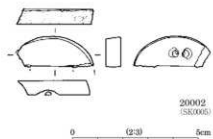
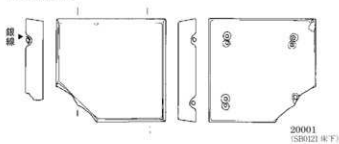

温石

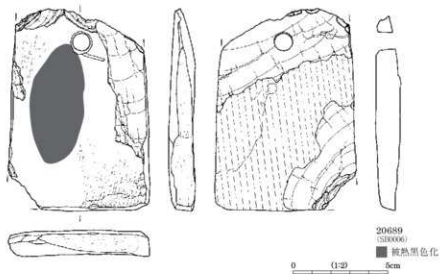

硯

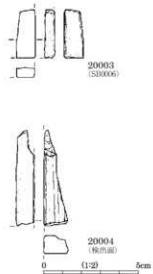

軽石製品 (1)

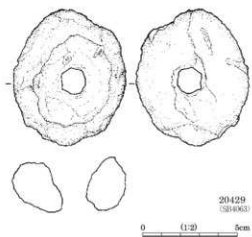
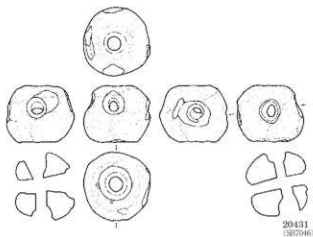
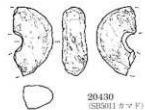
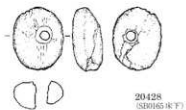
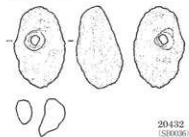

軽石製品 (2)



20436  
(SI0006)

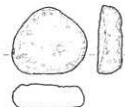

20435  
(SI0001 カマド)



20433  
(SI0014)

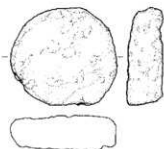

20442  
(SI0012)

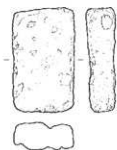

20434  
(SI0015)

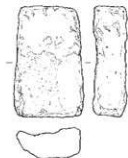

20438  
(SI0007)

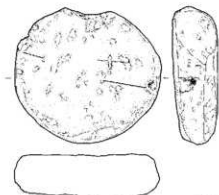

20441  
(穿孔)

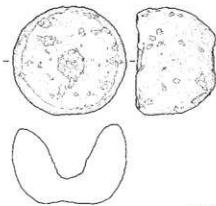

20443  
(SI0707)

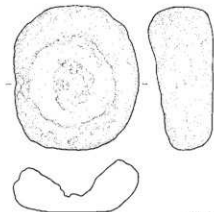

20440  
(穿孔)

小形砥石 (1)

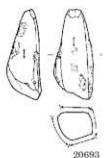

20693  
(S00089)

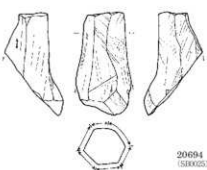

20694  
(S00085)



20695  
(S00041)



20696  
(S00047)

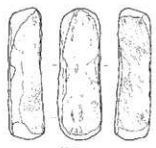

20674  
(S00067)



20673  
(S00062)



20655  
(S00134)

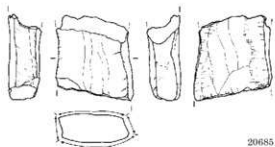

20685  
(S00310)

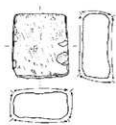

20734  
(S00088)



20705  
(S00087)

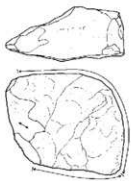

20713  
(S00002)



20710  
(S00002)

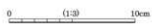

小形砥石 (2)

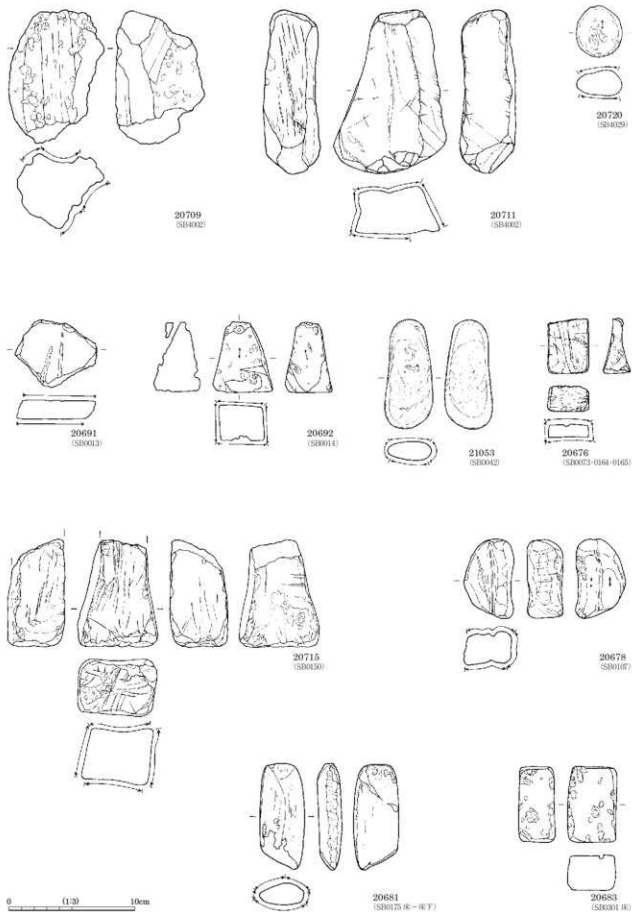

小形砥石 (3)

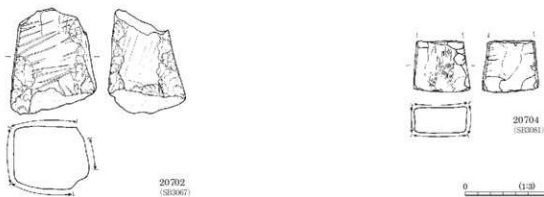
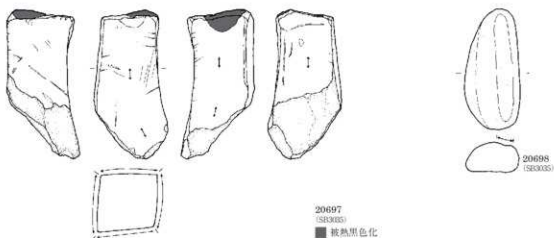
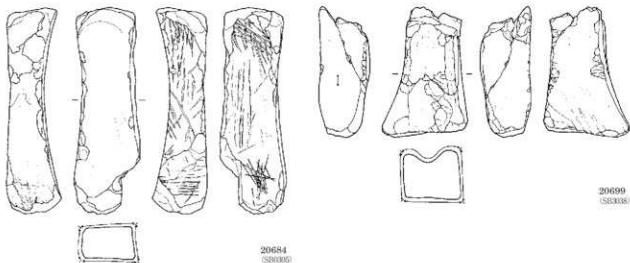

0 (1:3) 10cm

小形砥石 (4)



小形砥石 (5)

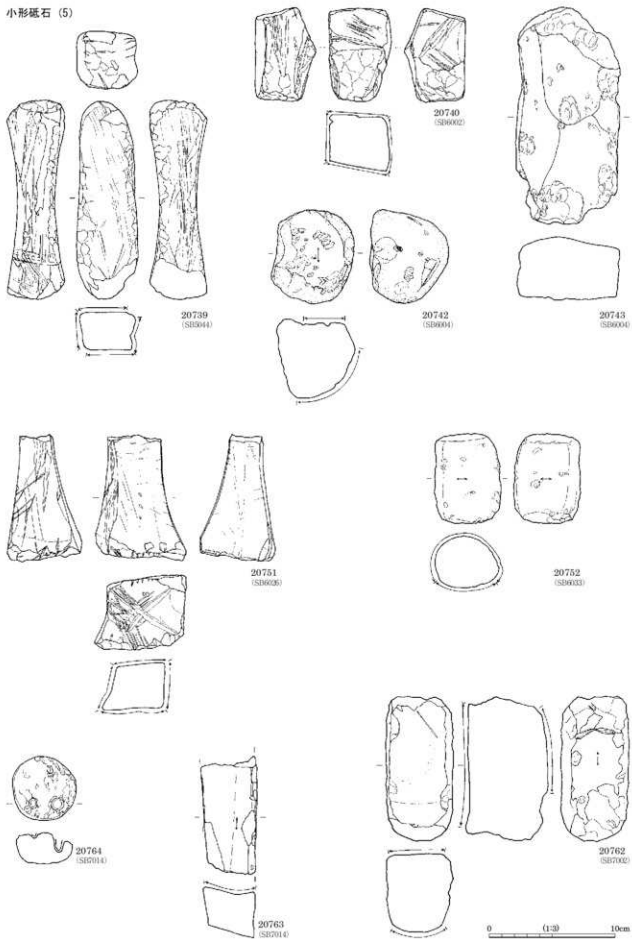



図版 226 石器・石製品 (25) - 弥生時代~中世 -

小形砥石 (6)

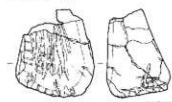

20765  
(SB7015)

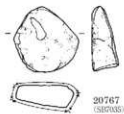

20767  
(SB7035)

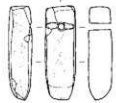

20669  
(SB7039)

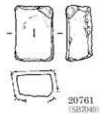

20761  
(SB7049)

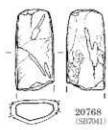

20768  
(SB7041)

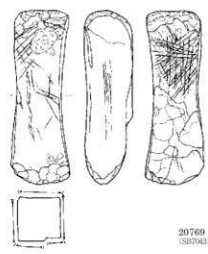

20769  
(SB7043)

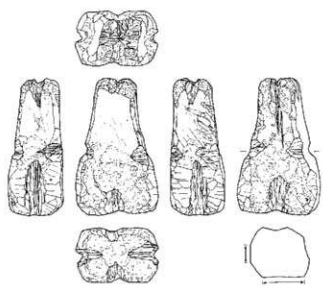

20770  
(SB7046)



20772  
(SB7048)



20672  
(SB7055)

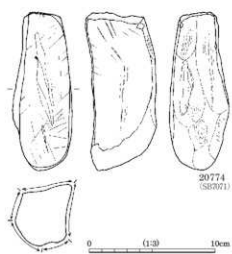

20774  
(SB7071)

0 1.0 10cm

小形砥石 (7)

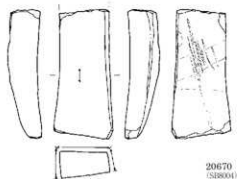

20670  
(SB8004)

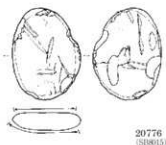

20776  
(SB8045)



20778  
(SB8021)



20780  
(SB8024)

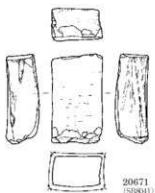

20671  
(SB8041)



20782  
(SB8044)

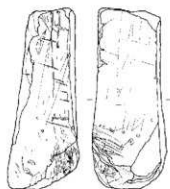

20779  
(SB8028)

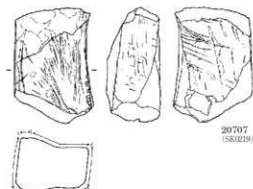

20707  
(SB0219)



20686  
(ST00079a)

0 1:30 10cm

小形砥石 (8)

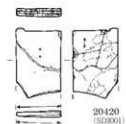

20420  
(SE0001)

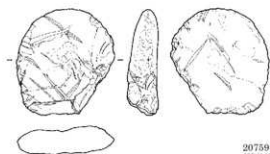

20759  
(SD0002 II D18)

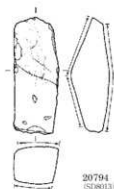

20794  
(SE0013)

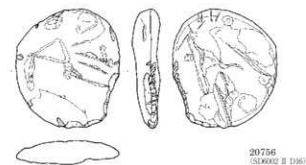

20756  
(SD0002 II D16)

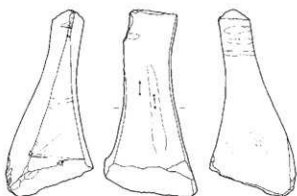

20726  
(SE0108)

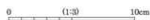

大形砥石 (1)

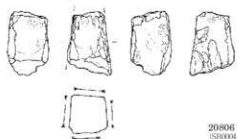

20806  
(SE0004)

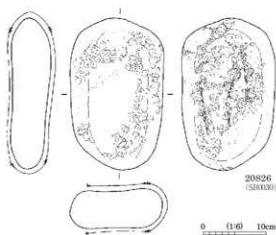

20826  
(SE0030)



大形砥石 (2)

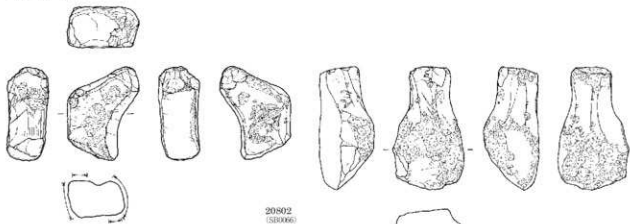

28002  
(SB0006)

28009  
(SB0077)

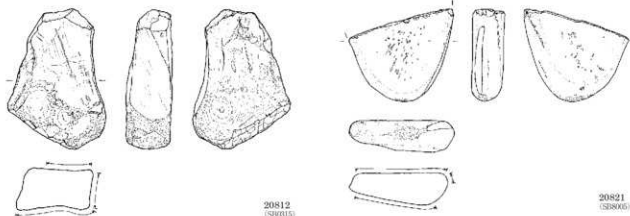

20812  
(SB0015)

20821  
(SB0075)

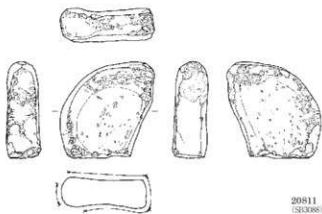

20811  
(SB0086)

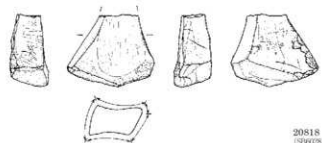

20818  
(SB0028)

0 (10) 10cm

大形砥石 (3)

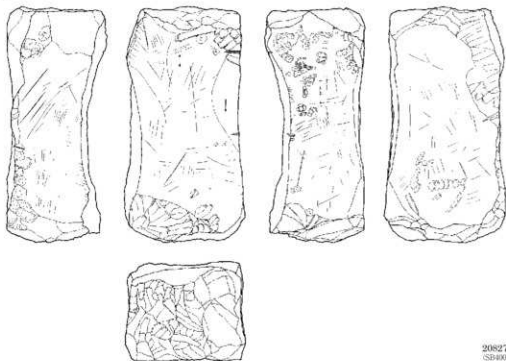

20827  
(SB4492)



20803  
(SB0079)

20804  
(SB0097)

20808  
(SB0172)

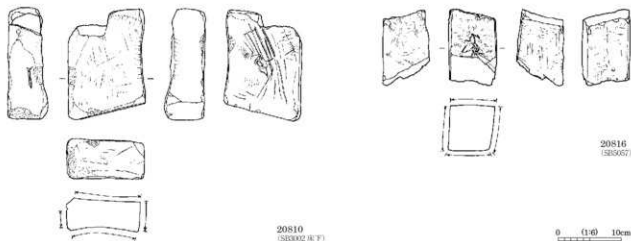

20810  
(SB3002 R T)

20816  
(SB5057)

0 (1/4) 10cm

大形砥石 (4)

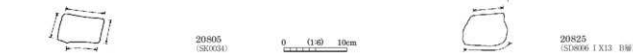
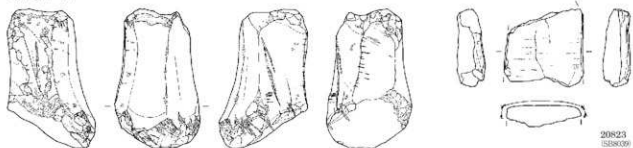

大形刃器

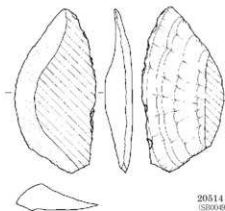

20514  
(SB0049)

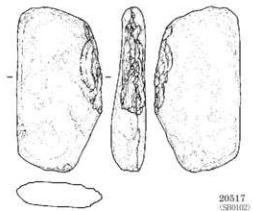

20517  
(SB0102)

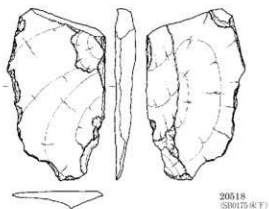

20518  
(SB0175 欠下)

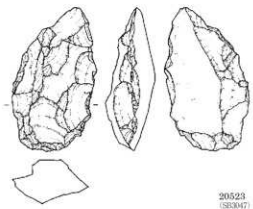

20523  
(SB0307)

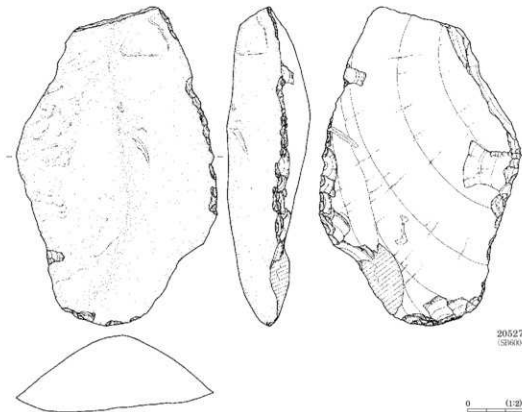

20527  
(SB0404)

磨石 (1)

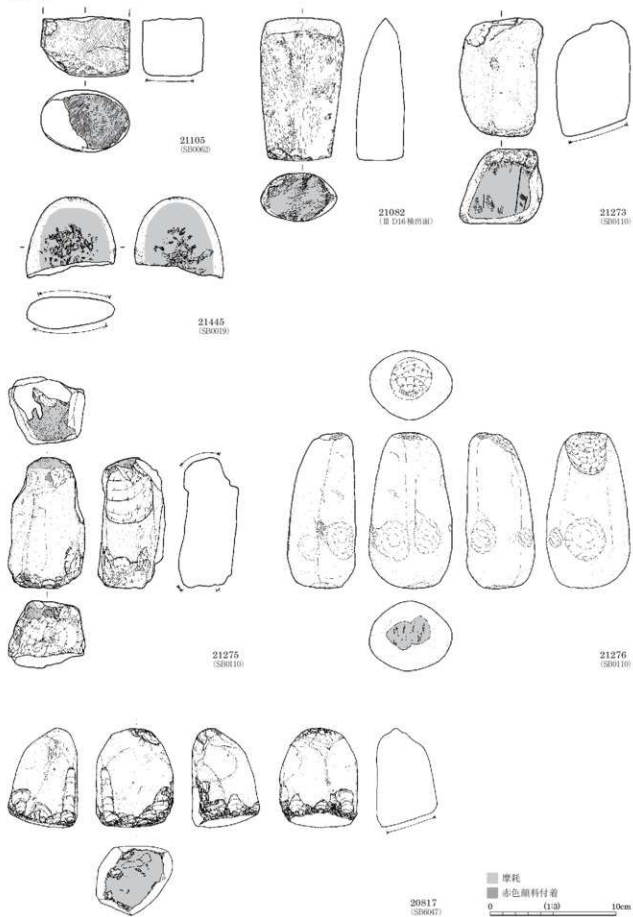



磨石 (2)

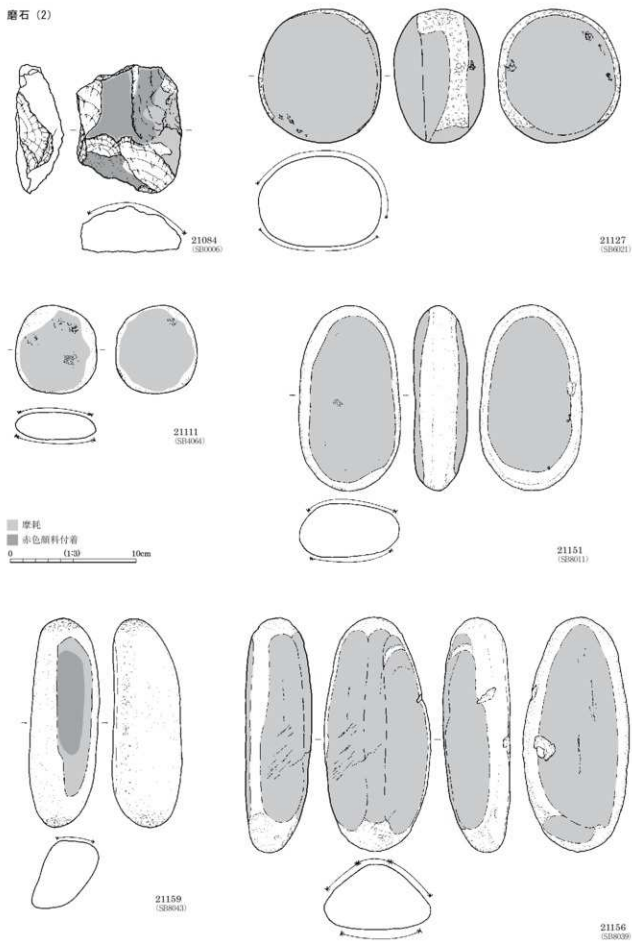

磨石 (3)

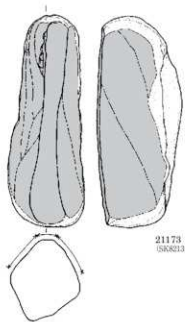

21173  
(SAB0213)

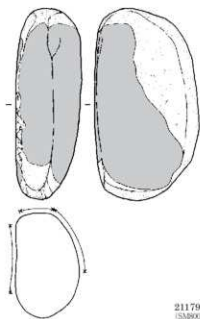

21179  
(SAB0001)

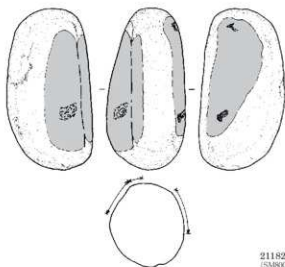

21182  
(SAB0001)



敲石 (1)

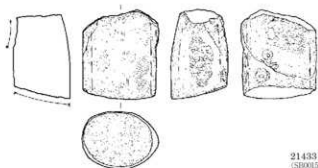

21433  
(S8003P42)

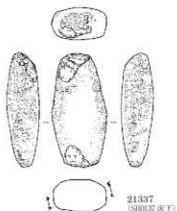

21337  
(S8007467)

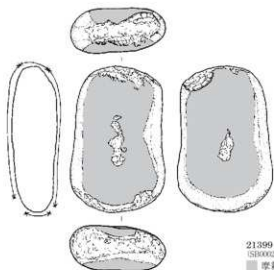

21399  
(S8000946)  
■ 摩耗

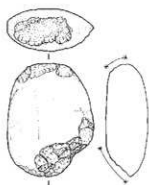

21402  
(S80004P61)

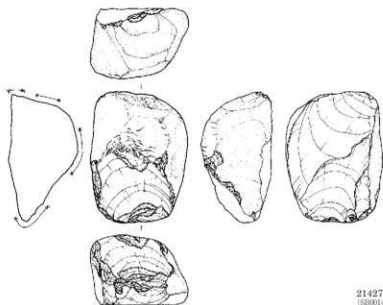

21427  
(S80014)

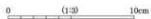

敲石 (2)

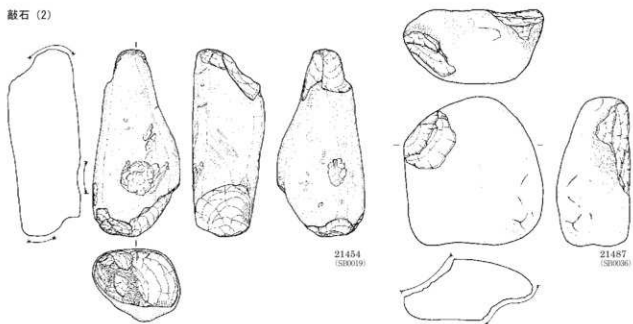

21454  
(S80019)

21487  
(S80036)

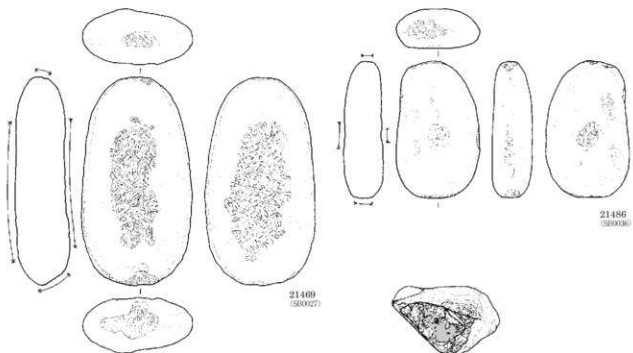

21460  
(S80027)

21486  
(S80036)

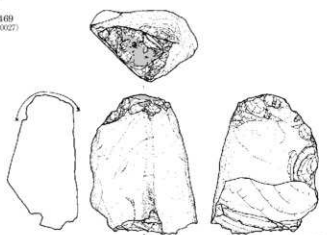

21490  
(S80036)

0 (1:30) 10cm

■ 摩耗

敲石 (3)

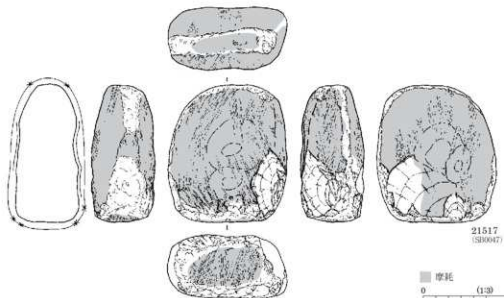
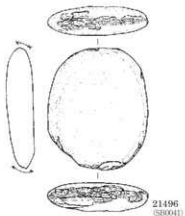
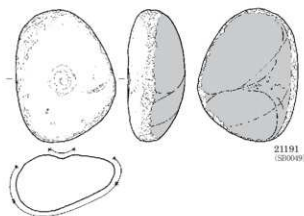
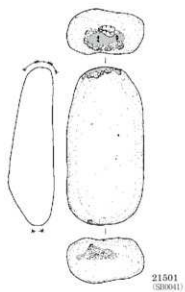
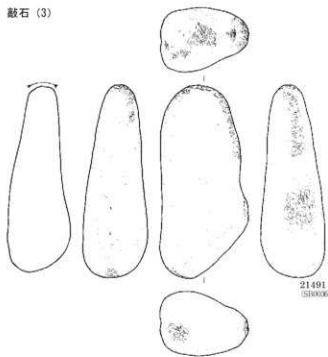

■ 摩耗  
0 (1:3) 10cm

敲石 (4)

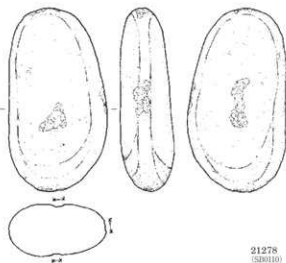
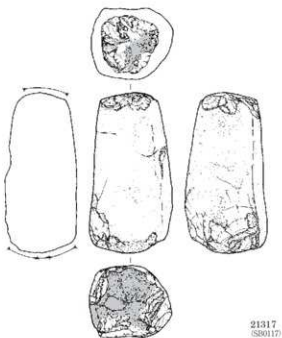
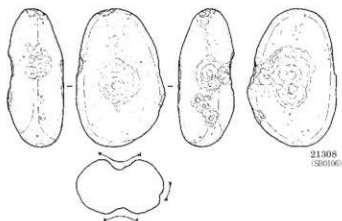
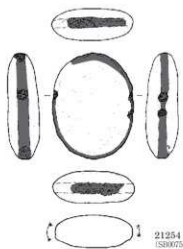
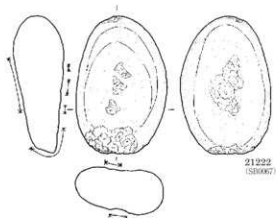
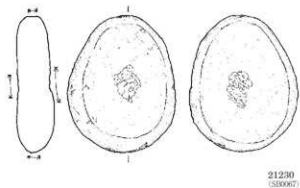
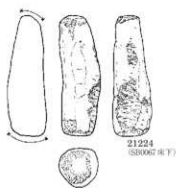

■ 厚托  
■ 赤色顔料付着  
0 (1:3) 10cm

敲石 (5)

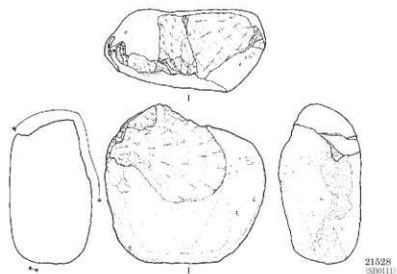

21528  
(SB0111)

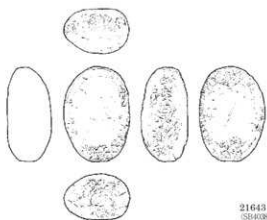

21643  
(SB4038)

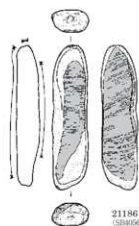

21186  
(SB4056)

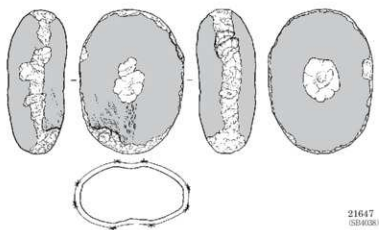

21647  
(SB4038)

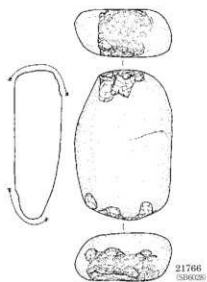

21766  
(SB6005)



敲石 (6)

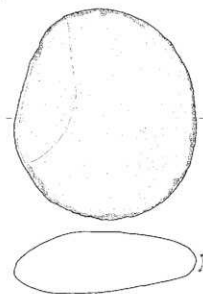

21281  
(SB0052)

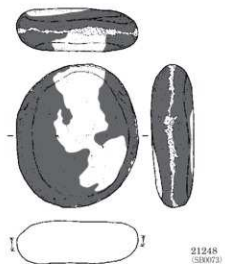

21248  
(SB0072)

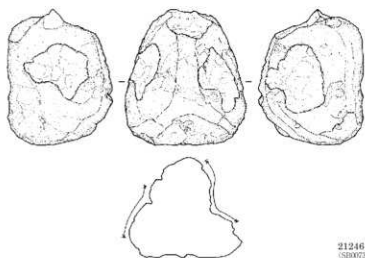

21246  
(SB0073)

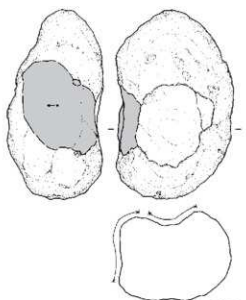

21289  
(SB0074)

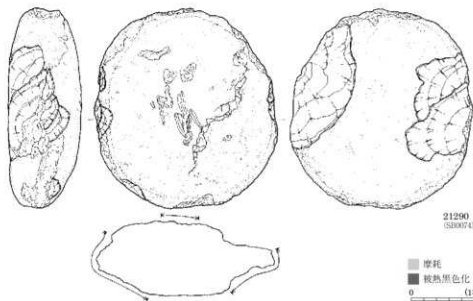

21290  
(SB0074)

■ 厚托  
■ 被熱黒色化

0 (1:3) 10cm



敲石 (7)

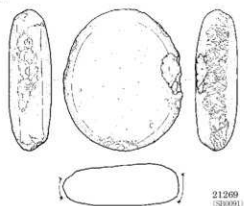

21269  
(SR0091)

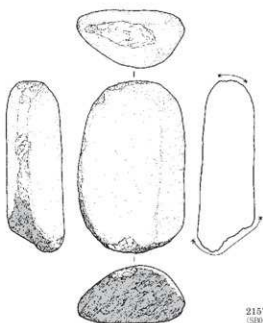

21575  
(SR0114)

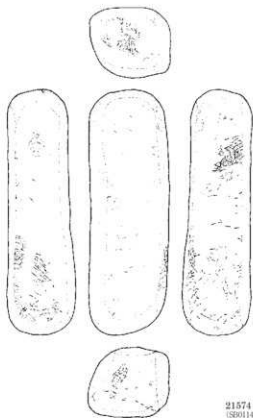

21574  
(SR0114)

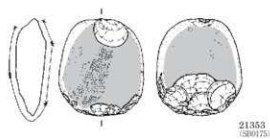

21353  
(SR0175)

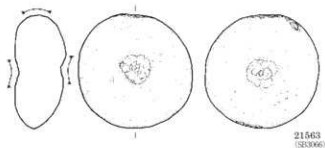

21563  
(SR3066)

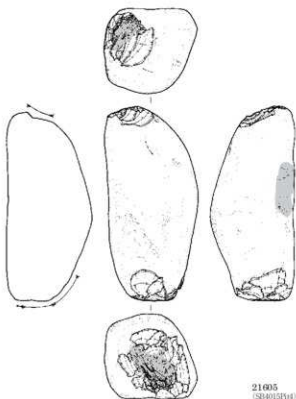

21605  
(SR403514)

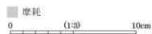

敲石 (8)

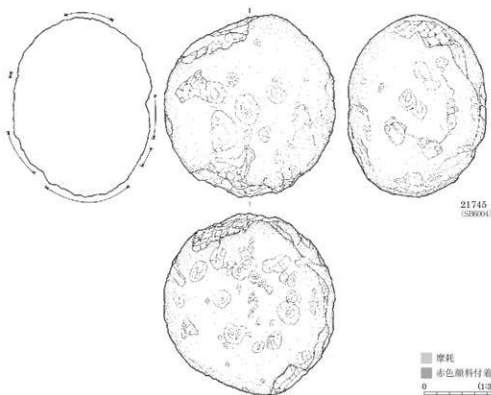
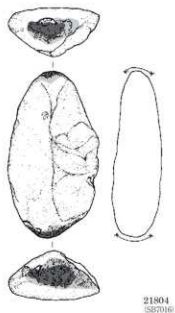
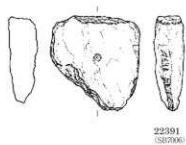
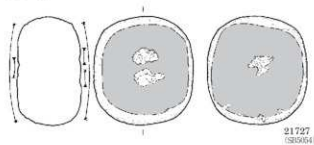

台石 (1)

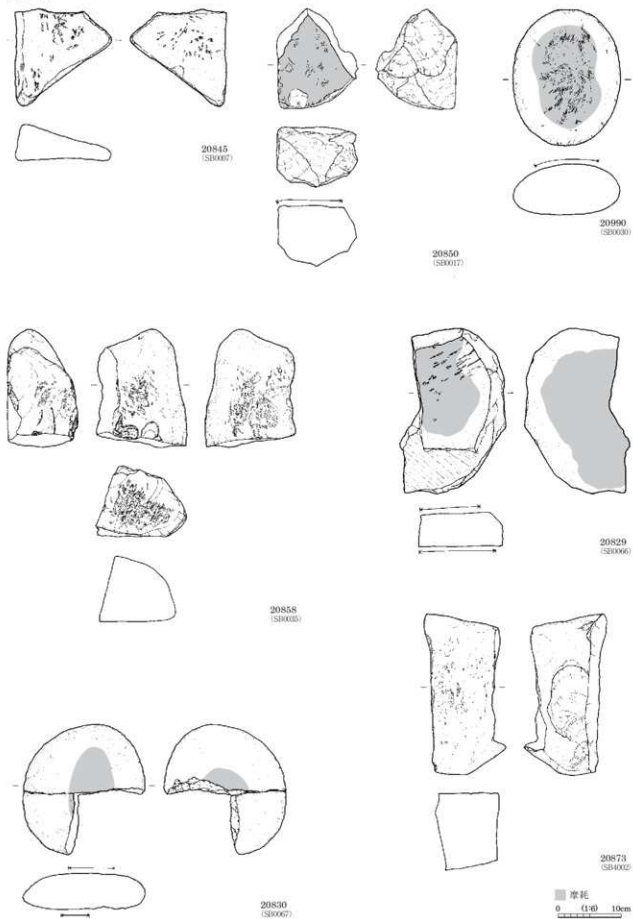

台石 (2)



20876  
(SB400)

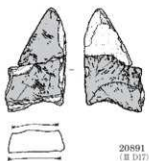

20891  
(II D17)



20977  
(SB8043)

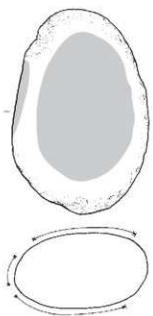

20979  
(SB8043)

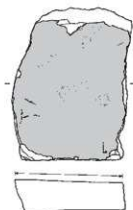

20864  
(SB306)



20878  
(SB404)

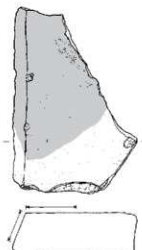

20882  
(SB404)



20903  
(SB604)

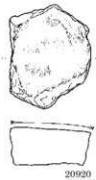

20920  
(SB604)



20948  
(SB702)

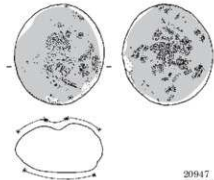

20947  
(SB703)

■ 摩耗  
0 100 10cm

台石 (3)

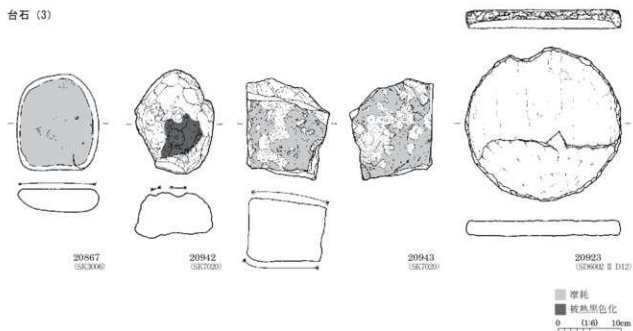

石皿 (1)

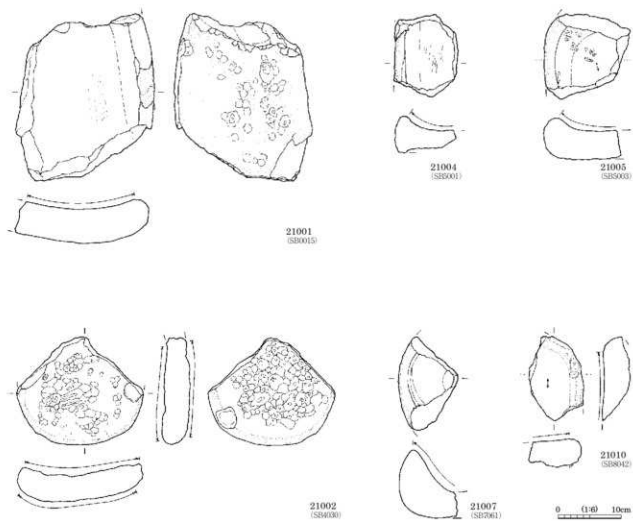

石皿 (2)

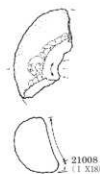
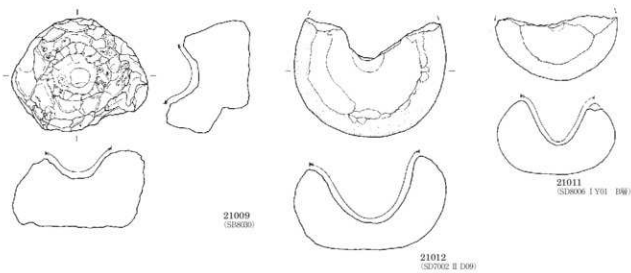
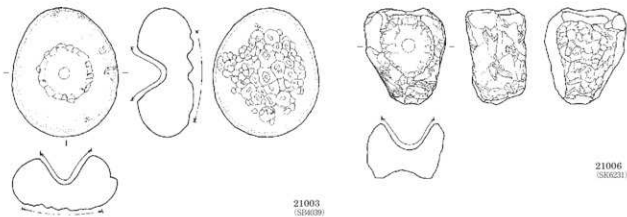

0 (1:6) 10cm

石錘

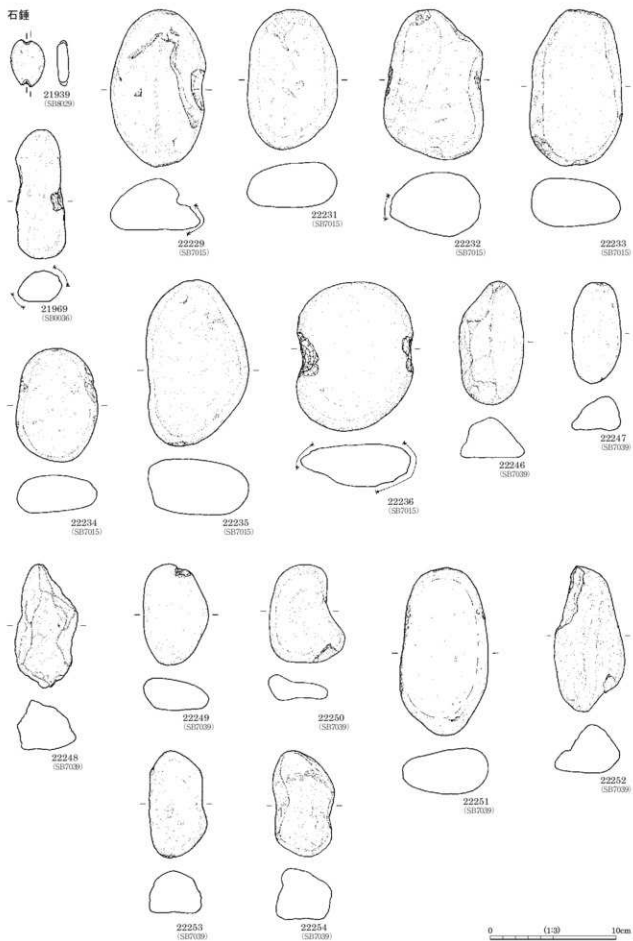

カマド材 (1)  
支脚石



22745  
(SH4047)



22752  
(SH5007)



22754  
(SH5017)



22760  
(SH5067)

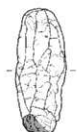

22761  
(SH5054)



22785  
(SH6006)



22786  
(SH6014)



22789  
(SH6023)



22790  
(SH6024)



22794  
(SH6045)



22823  
(SH7044)



22824  
(SH7046)



22828  
(SH7070)

■ 粘土付着範囲  
■ 被熱変色範囲  
0 100 10cm



図版 250 石器・石製品 (49) -古墳時代~古代-

カマド材 (2)  
袖石

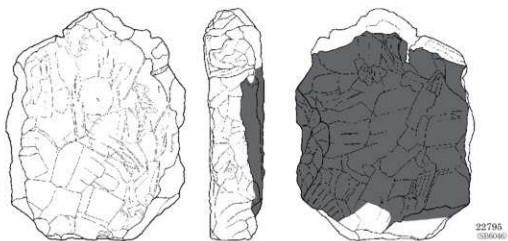
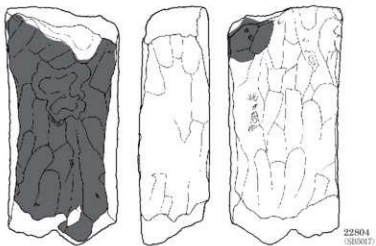

■ 被熱変色範囲  
0 (1:4) 10cm

銅劍

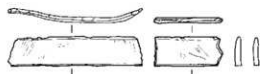

06M013  
(SB0013)



06M015  
(SB0015)

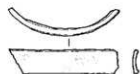

06M064  
(SB0067・64 F)



06M031  
(SB0027)

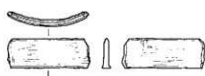

06M099  
(SB0451)

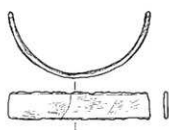

06M100  
(SB0156)

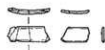

06M135  
(SB0067)

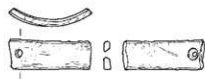

06M186  
(SB0027)



07M056  
(SB0049)

銅鏃



06M117  
(SB0019)

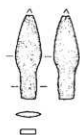

07M297  
(SB0016)

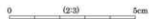

耳環

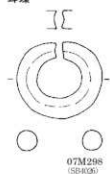

馬具 (帯先金具)

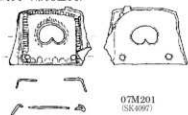

帯金具

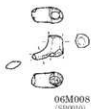

腰帯飾具

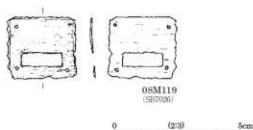

銅印

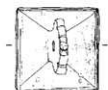

■ 赤色顔料付着

07M376  
(SB0001)

0 (2:3) 5cm

鎖



銅製管状品



銅製円板

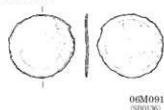

銭貨



06M132 開元通寶  
(SI0006)

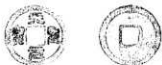

06M133 天聖元寶  
(SI0006)



06M014  
(SI0015)



06M140 太平通寶  
(SI0031)



07M377 建永通寶  
(SI0086)



07M300 建永通寶  
(SI0409)



08M120 建永通寶  
(SI0705)

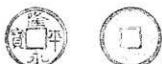

07M305 隆平永寶  
(SI0210)



07M307 永樂通寶  
(SI0218)



07M306 元豐通寶  
(SI0218)



07M290 治平通寶  
(SI0218)



07M291-1 天聖元寶  
(SI0218)



07M291-2 皇宋元寶  
(SI0218)



07M292 至道元寶  
(SI0218)



07M267 至道元寶  
(SI0002)



08M022 神功開寶  
(SI0006 | Y01)



06M134 聖元元寶  
(I | 既見)



07M200 建永通寶?  
(I | 既見)

鉄器 (1)

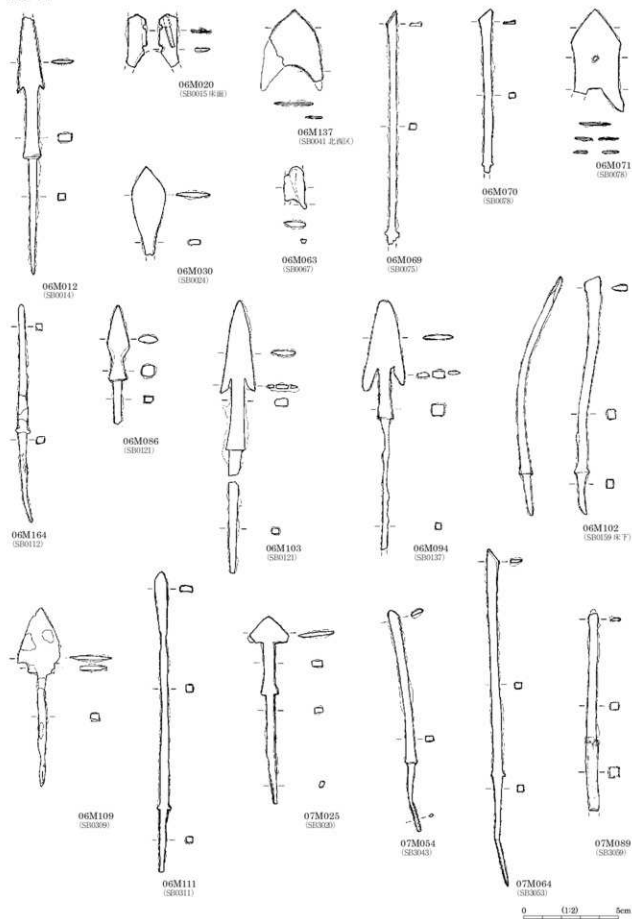

鉄器 (2)

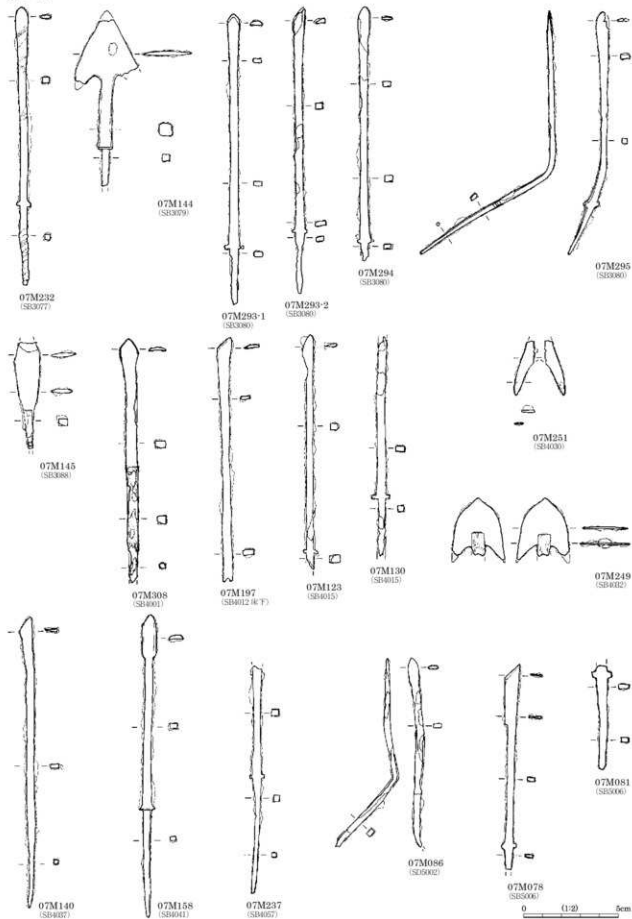

鉄器 (3)

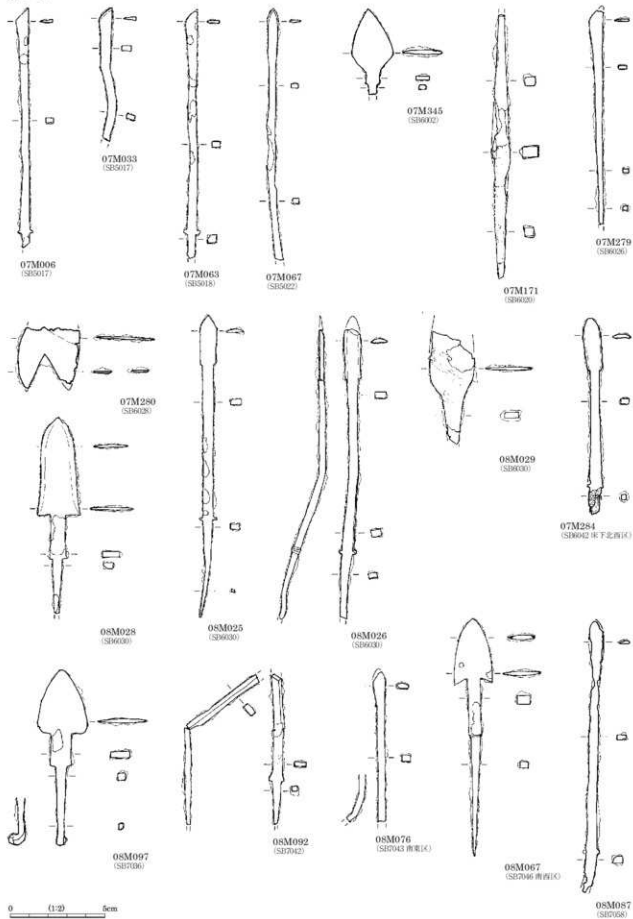

鉄器 (4)

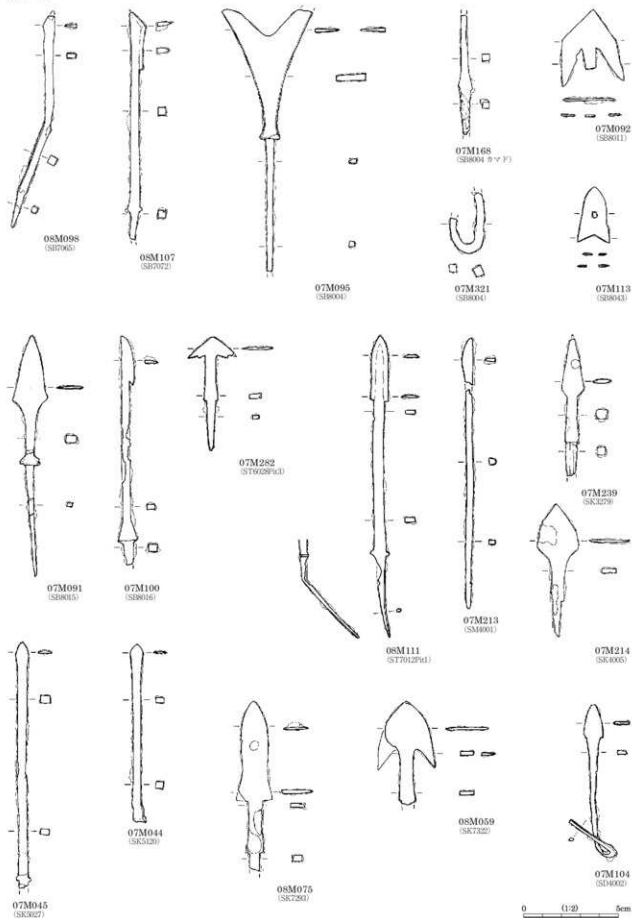



図版 258 金属製品 (8) - 弥生時代~中近世の鉄製品 -

鉄鏝 (5)

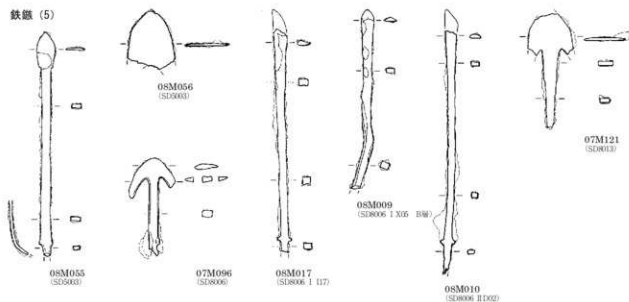

鉄剣

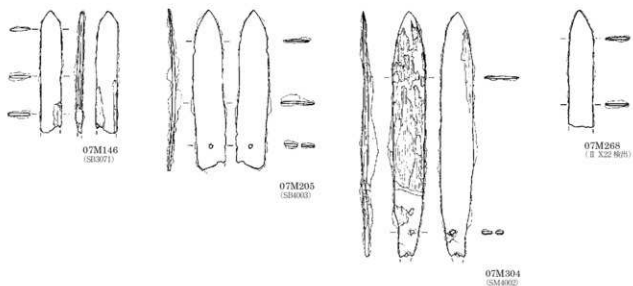

刀子 (1)

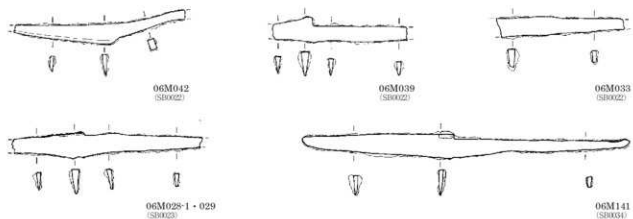

0 1:20 5cm

刀子 (2)

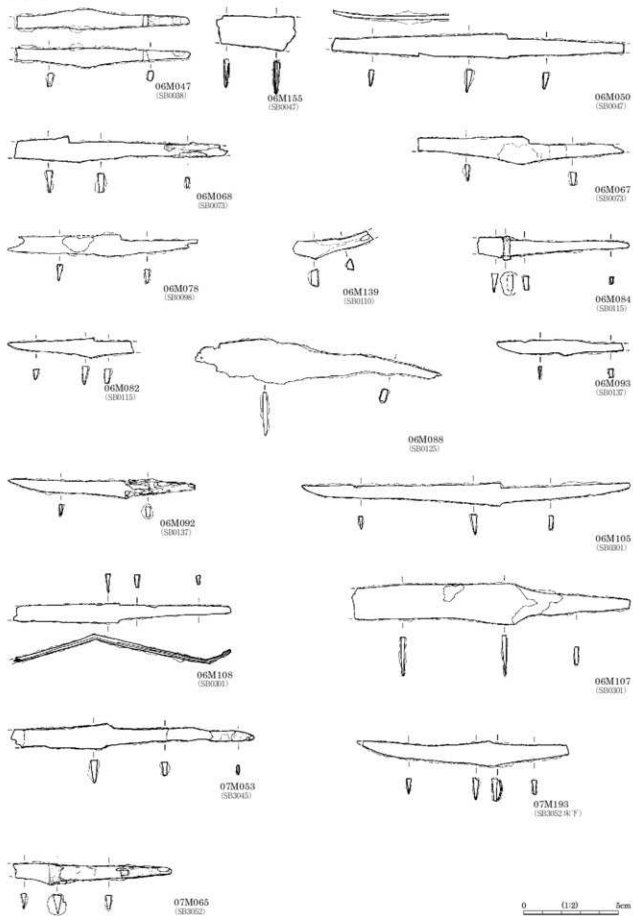

刀子 (3)

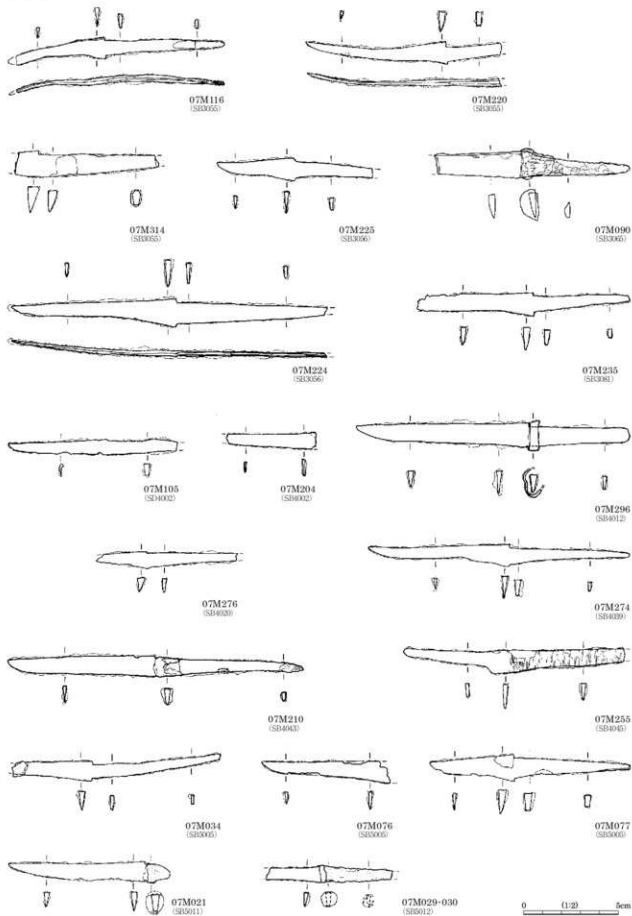

刀子 (4)



07M035  
(SR5914)



07M074  
(SR6008)

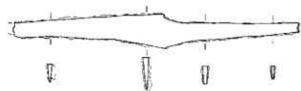

07M062  
(SR5947)

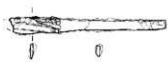

07M150-1  
(SR6023)

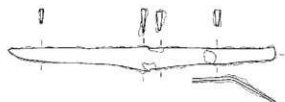

07M278  
(SR6026)



07M246  
(SR6048 (K Y))

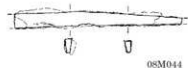

08M044  
(SR7011)



08M045  
(SR7011)



08M049  
(SR7011)



08M109  
(SR7014 北西那中層)



08M127  
(SR7029 カマ Y)



08M060  
(SR7032)



08M066  
(SR7046 南那C)



08M037  
(SR7036)



08M082  
(SR7040)



08M089  
(SR7042)



08M080  
(SR7046)

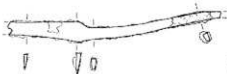

08M106  
(SR7070)

刀子 (5)

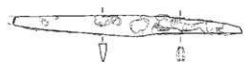

07M107  
(SB8003)

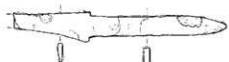

07M088  
(SB8006)

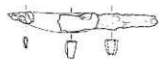

07M289  
(SB8022)



08M101  
(SB7904)



08M016  
(SD8006 | T17 CW)



08M035  
(SD8006 | Y01 CW)

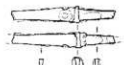

07M060  
(3区 高野地出産)

剃刀

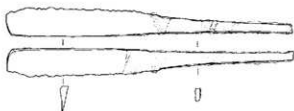

07M059  
(SB3001)

金具 (黄金具か)

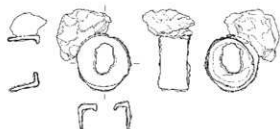

06M076-1  
(SB0097)

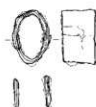

07M195  
(SB5025 16面)



08M014  
(SB8006 | T22 B面)

鉄剣

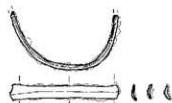

07M250  
(SB4032)

鉄鐙



07M169  
(SB6021)



08M027  
(SB6030)

鉄鐙舌

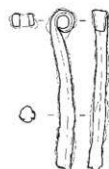

07M170  
(SB6021)

0 (1:2) 5cm

弓金具



経軸端金具か

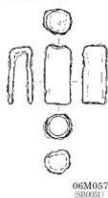

蛇尾

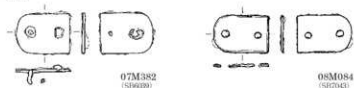

鉄製金具など

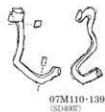
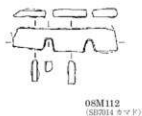
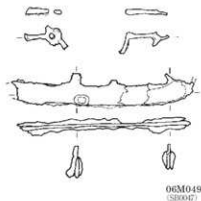
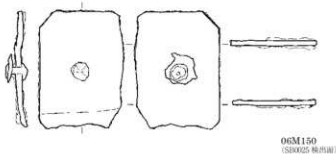
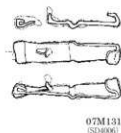
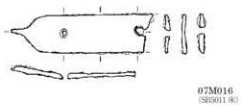
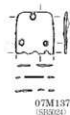
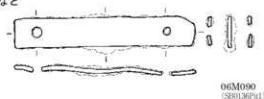

0 1:20 5cm

馬具など

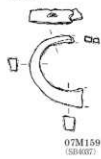

07M159  
(SB0407)

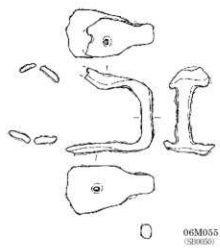

06M055  
(SB0050)

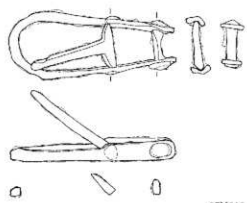

07M019  
(SB0320)

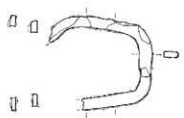

07M156  
(SB0158)

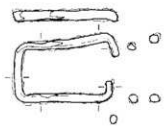

08M091  
(SB7042)

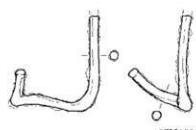

07M166  
(SB0491)

不明板状製品



07M150-2  
(SB0623)

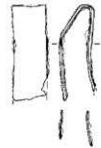

08M116  
(SB7031)

鑷子

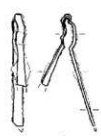

07M194  
(SB4036)

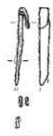

07M050  
(SB0306)



07M051  
(SB0306)



08M051  
(SB7041)



08M041  
(SB7013)

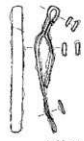

08M126  
(SB7017)



08M020  
(SB0006)

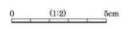

鉄



07M256・257  
(SD4039)



07M119  
(SD0011)

針



08M072  
(SD7041)

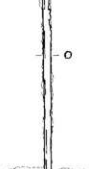

07M301  
(SD4039)

紡錘車



07M341  
(SD8034)

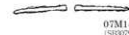
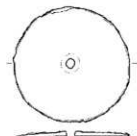

07M141  
(SD0079)

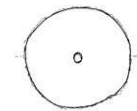

07M142  
(SD0079)

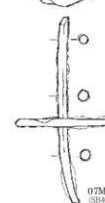

07M157  
(SD4060)



07M149  
(SD6023)

0 1:20 5cm



焼印

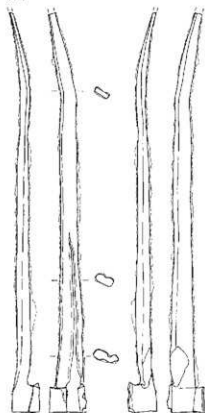

07M218  
(SB4025)

鉄鉗

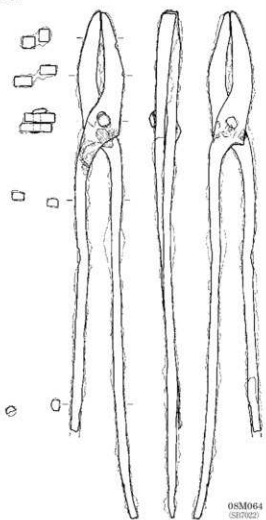

08M064  
(SB7022)

槍鉋



06M025  
(SD0020)

鋸

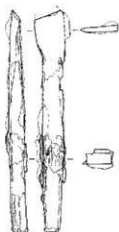

07M198  
(SM4006)

鋸

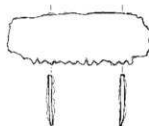

06M076-2  
(SB0097)

楔



07M261  
(SB4027)

0 1 2 5cm

工具など

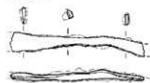

06M016  
(SD0005)



06M009-2  
(SD0011)



06M018  
(SD0015)



06M138  
(SD0006)



07M207  
(SD0004)



08M019  
(SD0006 1 X 18)

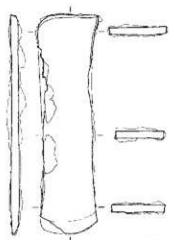

06M129  
(1 10)

鉄斧



07M196  
(SD0005 8 F)



07M072  
(SD0005 9&11)



08M128  
(SD0005)

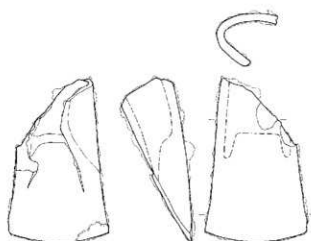

07M042  
(SD0002 1&12)

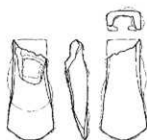

06M183  
(SD0000)

草引具

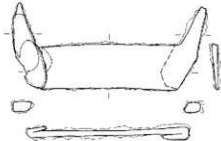

06M041  
(SR0022)



07M129  
(SR0415)

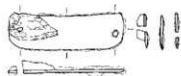

08M030  
(SR0030)

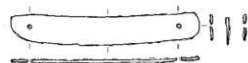

07M040  
(SR0008)



07M285  
(SR0059)

鎌 (1)

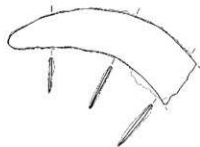

06M037  
(SR0029)

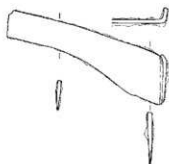

06M060  
(SR0065 非直上)

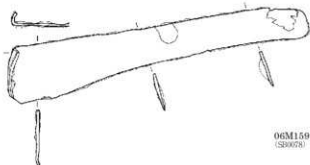

06M159  
(SR0078)

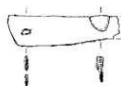

06M073  
(SR0059)

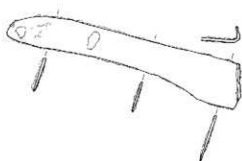

07M047  
(SR0006)

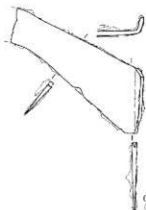

07M233  
(SR0077)

0 (1:2) 5cm

鎌 (2)

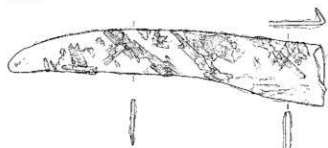

07M009  
(SR0013)

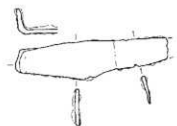

07M005  
(SR0017)

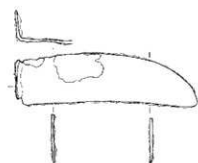

07M046  
(SR0027)

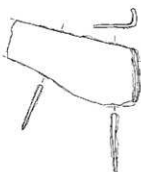

07M120  
(SR0011)

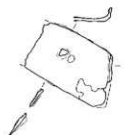

07M288  
(SR0063)

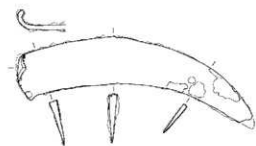

08M065  
(SR0036)

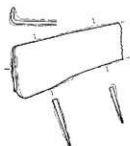

08M113  
(SR0040)

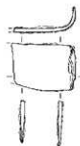

08M103  
(SR0067)

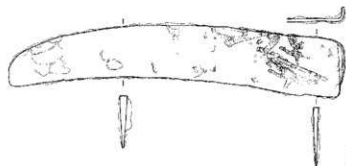

07M087  
(SR0006 表面上)



07M018  
(SR0060)

0 1:20 5cm

鎌 (3)

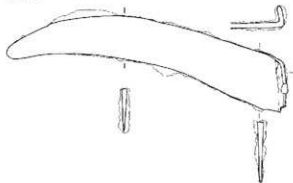

07M133  
(S18049)

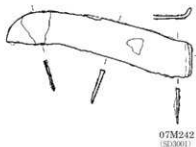

07M242  
(S19001)

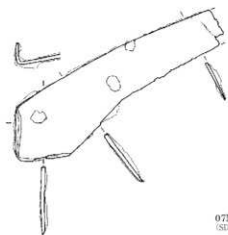

07M324  
(S18003)

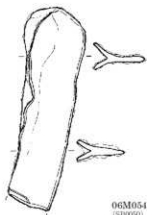

06M054  
(S19050)

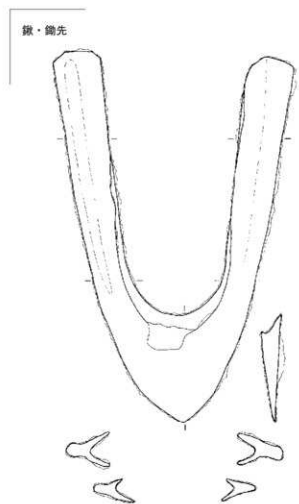

鎌・鎌先

06M056  
(S19050)

0 1:20 5cm

棒状品



07M254  
(SD4080)

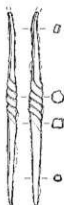

08M096  
(SD7036)

T字形製品



06M101  
(SB0159)

鉤



07M015  
(SB5007)

釘



06M001  
(SD0001)

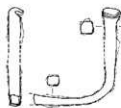

06M002-038  
(SD0006-0022)

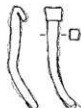

06M042-4  
(SD0022)



06M044  
(SD0034)



06M173  
(SB0131)



07M098  
(SB4015)



07M160  
(SB4037)

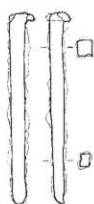

07M212  
(SD4063)



07M013  
(SR6017)



08M061  
(SD7022)

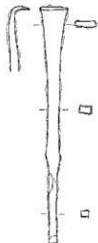

08M071  
(SD7045 北東1C)



07M215  
(SK4051 中層)

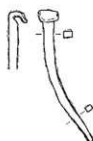

08M062  
(SB7045)



06M116  
(SK0008)



07M216  
(SK4051 中層)



07M217  
(SK4051 北東1)



08M052  
(SK7020 II D19-20)



08M018  
(SK4006 I X16)

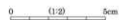

長方形板状鉄製品

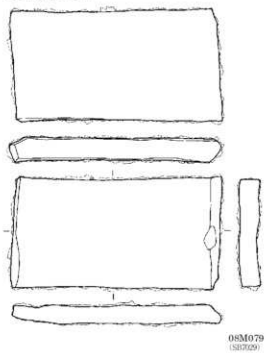

鉄製容器

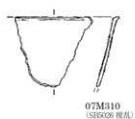

集合鉄片

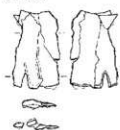

鉄片

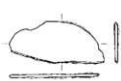
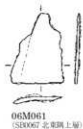
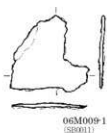

06M062  
(S28067 北九州中層)

07M315  
(S28033)

07M245  
(S28402)

07M319-1  
(S28004)

0 1(2) 5cm

鉄器片

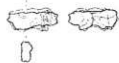

07M270-2  
(SD4037)

鉄塊系遺物



07M332  
(SD4037 背面)



07M252-1  
(SD4037 9F 1)



07M326  
(SD4037 北面)



07M355  
(SD4037 南東隅北面)

鉄滓 (1)



06M048  
(SD0017)



06M158-1  
(SD0070)



07M378  
(SD0046)

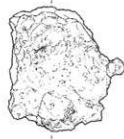

06M162  
(SD0091)

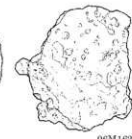

07M372-1  
(SD4037)



07M188  
(SD4037)

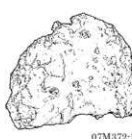

07M270-1  
(SD4037)



07M186-1  
(SD4037)



■ 溶解範囲

0 (1:3) 10cm



図版 274 鍛冶関連遺物 (2)・木製品

鉄滓 (2)



07M191  
(SB4037)



07M183-1  
(SB4037 表面上)

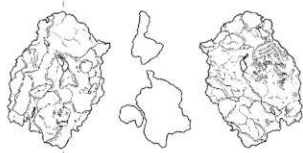

07M161  
(SB4037)

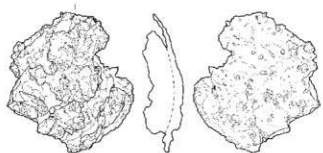

07M302  
(SB5010)

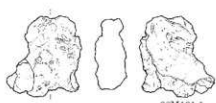

08M131-1  
(SB7026 表面IC)

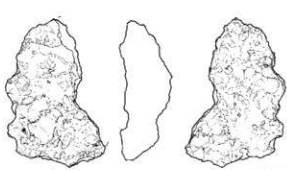

08M133  
(SB7026)

0 1:30 10cm

木製品

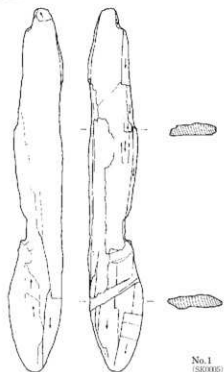

No.1  
(SB0005)

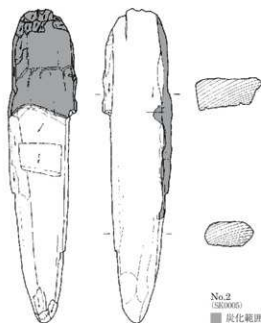

No.2  
(SB0005)  
■ 炭化範囲

0 1:30 10cm

S80036 出土

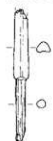

06B120-3  
(種不明、中手骨または中足骨か)

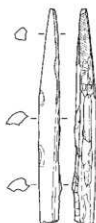

06B121  
(シカ、中足骨)



06B85-1-2  
(シカ、角)



06B120-1-4  
(シカ、角)



06B120-1-2  
(シカ、角)



06B120-1-1  
(シカ、角)

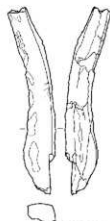

06B120-1-3  
(シカ、角)



06B120-1-5  
(シカ、角)

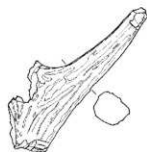

06B85-1-1  
(シカ、角)

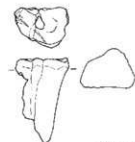

06B85-1-3  
(シカ、中手骨近位部)

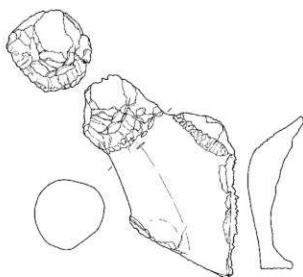

06B81-1  
(シカ、角)

0 (1:20) 5cm

平成 27 (2015) 年 3 月 27 日 発行

長野県埋蔵文化財センター発掘調査報告書 104

### 西近津遺跡群

中部横断自動車道建設に伴う埋蔵文化財発掘調査報告書 2

－佐久市内 2－

#### 第 3 分冊 (遺物図版編)

発行者 国土交通省 関東地方整備局  
(一財) 長野県文化振興事業団  
長野県埋蔵文化財センター  
〒 388-8007 長野県長野市篠ノ井布施高田 963-4  
Tel 026-293-5926 Fax 026-293-8157  
E-Mail info@naganomaibun.or.jp

印刷者 信毎書籍印刷株式会社  
〒 381-0037 長野県長野市西和田 1-303  
Tel 026-243-2105 Fax 026-243-3494