



2区 第1遺構面完掘状況  
(北から撮影)



2区西壁③ 土層堆積状況



2区 SA1004EP2遺物出土  
状況 (南から撮影)

図版 4



2区 SD1004完掘状況  
(北東から撮影)



2区 SD1004集石遺構  
(東から撮影)



2区 SK1006遺物出土状況  
(南から撮影)

2区 SK1015遺物出土状況①  
(東から撮影)



2区 SK1015遺物出土状況②  
(北から撮影)



2区 SP1096遺物出土状況  
(北から撮影)



図版6



3区 第1遺構面完掘状況  
(南から撮影)



3区西壁④ 土層堆積状況



3区 SD1008土層堆積状況

3区 SD1008・SD1009  
遺物出土状況(北東から撮影)



3区 SK1025遺物出土状況  
(東から撮影)



3区 SX1002遺物出土状況  
(南東から撮影)





4区 第1遺構面完掘状況  
(南東から撮影)



4区北壁⑦ 土層堆積状況

4区 SD1017土層堆積状況



4区 SE1001検出状況  
(北から撮影)



4区 SE1001石組み完掘状況  
(北西から撮影)

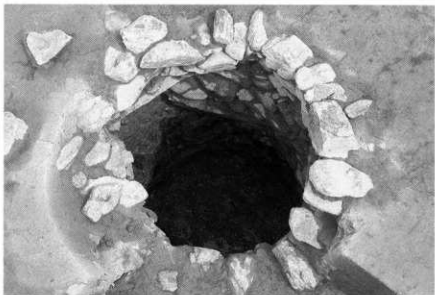

図版10



5区 第1遺構面完掘状況  
(南から撮影)

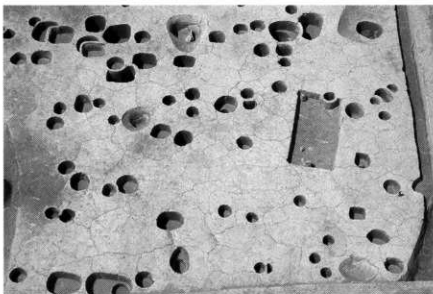

5区 SA1016完掘状況  
(南から撮影)



5区 SA1017完掘状況  
(西から撮影)



5区 SD1023・SD1024  
遺物出土状況(南から撮影)



5区 SM1001完掘状況  
(北から撮影)



5区 SM1001遺物出土状況  
(南西から撮影)





6区 第1遺構面遺構検出  
状況 (南から撮影)



6区 第1遺構面完掘状況  
(北から撮影)

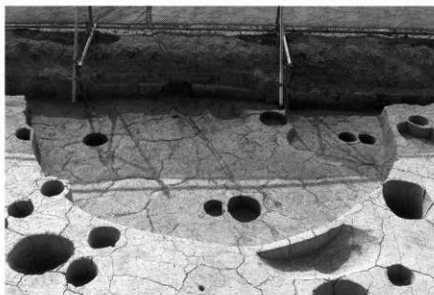

6区 SB1001完掘状況  
(東から撮影)

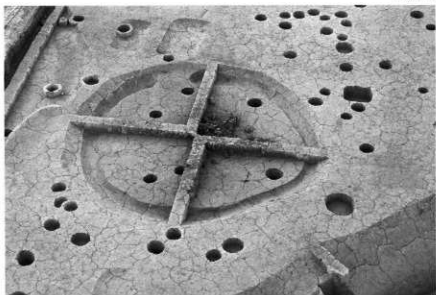

6区 SB1004遺物出土状況  
(北から撮影)

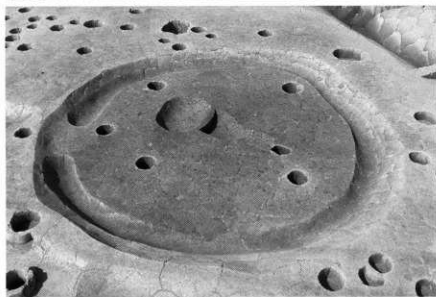

6区 SB1004完掘状況  
(東から撮影)



6区 SB1004遺物出土状況  
(南西から撮影)

図版 14



6区 SM1002検出状況  
(南から撮影)



6区 SM1002完掘状況  
(南から撮影)



6区 SM1002土層堆積状況・  
遺物出土状況 (南西から撮影)



7区 第1遺構面完掘状況  
(南から撮影)



7区 SM1003・SM1004  
完掘状況 (南から撮影)



7区 SM1004遺物出土状況  
(南東から撮影)

図版16



7区 SM1003ED1  
土層堆積状況



現地説明会



調査完了



SA1004出土 1



SA1010出土 2

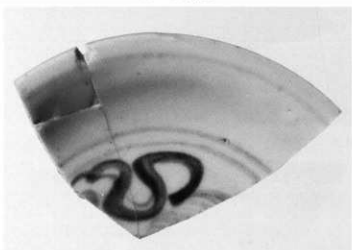

SA1017出土 8



SA1015出土 6



SA1017出土 10



SA1035出土 39

出土遺物(1)

図版 18



SA1033出土

37



43 SA1040出土



51



54

SA1051出土

出土遺物(2)



SA1039出土

42



49



50



52





57



58



59



62



60



64



72

SB1001出土

出土遺物(3)

図版 20



71



77



73



78



79

SB1001出土



80



81



82

SB1004出土

出土遺物(4)



84



87



88



101

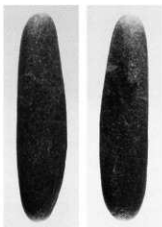

98



108



105



110

SB1004出土

出土遺物(5)



111



113



114



119



116



120



128

SB1004出土

出土遺物(6)



126



136



134



137



139



140



141

SB1004出土  
出土遺物(7)



135

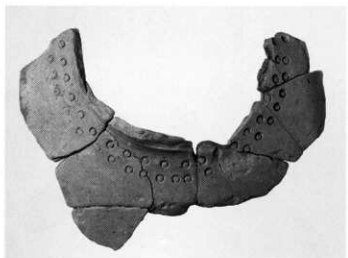

138

SB1004出土

出土遺物(8)



142



144



150



156



158



159



161



162



160



167

SB1004出土

出土遺物(9)



170



176



172



173



177

SB1004出土



178

出土遺物10





183



184



185



186



188

SB1004出土

出土遺物11)

図版28



190



193

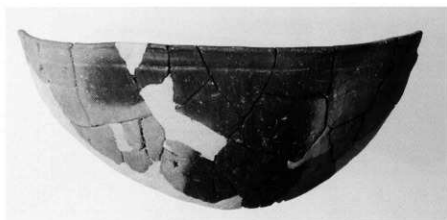

192



194

SB1007出土



197

SD1001出土

出土遺物(2)



198



199



SD1002出土



200



201  
SD1003出土

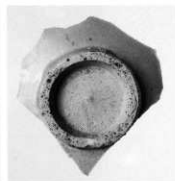
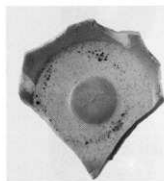

SD1006出土

207



SD1004出土

206

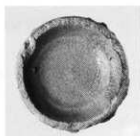
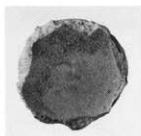

211

SD1008出土



213

出土遺物(13)

图版 30



216



218



220



222



223

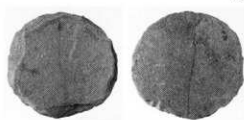

224



225

SD1008出土



226



228



229



230

SD1009出土

出土遺物(14)



231



233



232



235

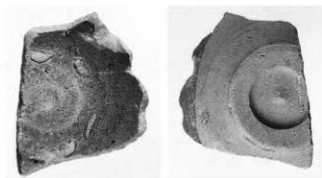

234



240



237



239

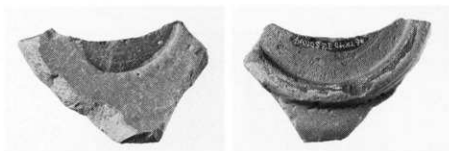

241

SD1009出土

出土遺物(15)

図版 32



242



244



243



245



246

SD1009出土



248



250



251

SD1010出土

出土遺物16



252



259



262



261

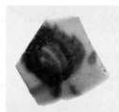

260

SD1014出土



263



266

SD1015出土

出土遺物(17)



270



273



275



274

SD1017出土



278



279



280



281

SD1018出土

出土遺物(18)





283



286



287

SD1020出土



292



300



301



303



304

SD1023出土

出土遺物(19)

図版 36



307



311



316

SD1023出土



319



330



320



333



321



337

SD1024出土

出土遺物20



334



338



339



340



SD1024出土



342



SD1026出土



343

出土遺物(2)



347



348

SD1030 出土



340



351



355



365



367



370

SD1037 出土

出土遺物22



372



375

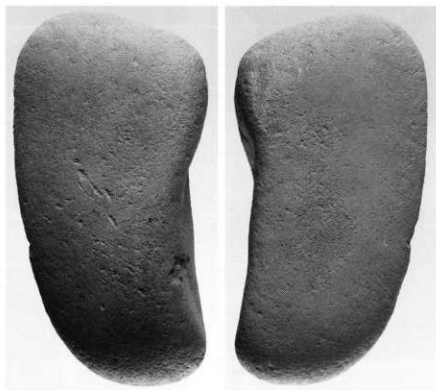

374

SD1037出土



377

SD1041出土

出土遺物



381



382



SD1044出土

384



SD1046出土

385



386



SE1001出土

388

出土遺物24



389



394



396



398

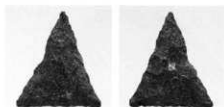

400

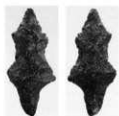

401



405



409



417

SE1002 出土

出土遺物 29



SK1006出土

421



423



424

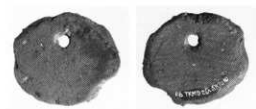

428



426

SK1015出土

出土遺物29





SK1021出土

429

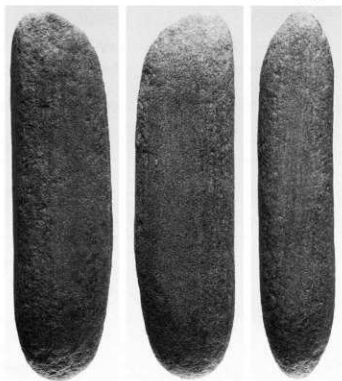

SK1073出土

438



430  
SK1025出土

出土遺物27



431

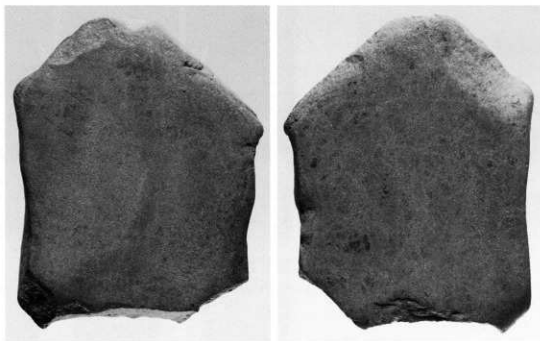

SK1110出土

449



SM1001出土

450

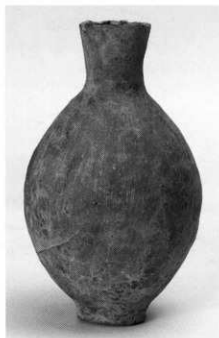

SM1002出土

451



452

出土遺物28



455



456



459

SM1003出土

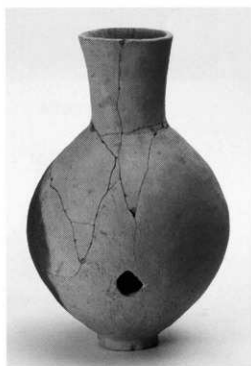

460



462

SM1004出土

出土遺物29



SP1016出土

465



SP1096出土

468

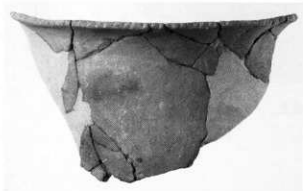

SP1097出土

469



SP1120出土

470



SP1196出土

473



SP1210出土

475

出土遺物30



476



478

SP1336・1337出土



477

SP1262出土



479

SP1341出土



482

SP1423 出土



486



485

SP1554出土

出土遺物(3)



488



図版 48

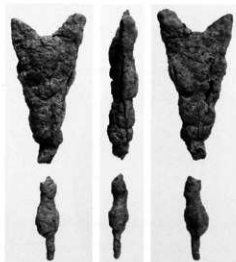

SP1580出土

494



SP1587出土

495



SP1594出土

497



SP1628出土

500



SP1637出土

503



SP1663出土

507



509



SP1711出土

514



SP1672出土

510



SP1738出土

516



SP1740出土

518

出土遺物



535

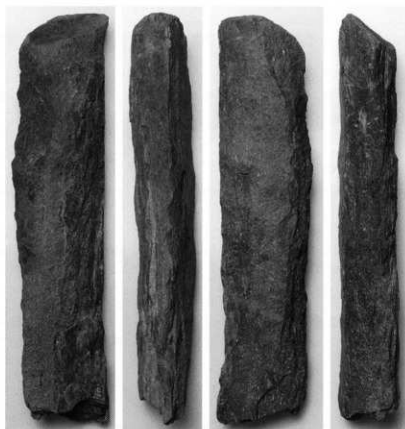

536

SX1002出土

出土遺物33



532



534



533



SX1003出土

540



539

SX1002出土



544



549



548



545



550

1区 包含層出土

出土遺物34





551



552



554



553

2区 包含層出土



556



557



560



561



3区 包含層出土



567



569



568

4区 包含層出土

出土遺物⑤

图版 52



577  
5区 包含層出土



580



582



583



592

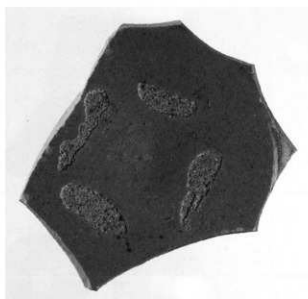

578  
5区 包含層出土

578



7区 包含層出土

590

出土遺物③



593



604

605

SX2001出土

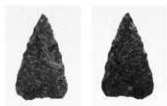

594

SD2001出土



595

SD2002出土



600

SD2003出土

出土遺物(3)



#### IV 南庄遺跡

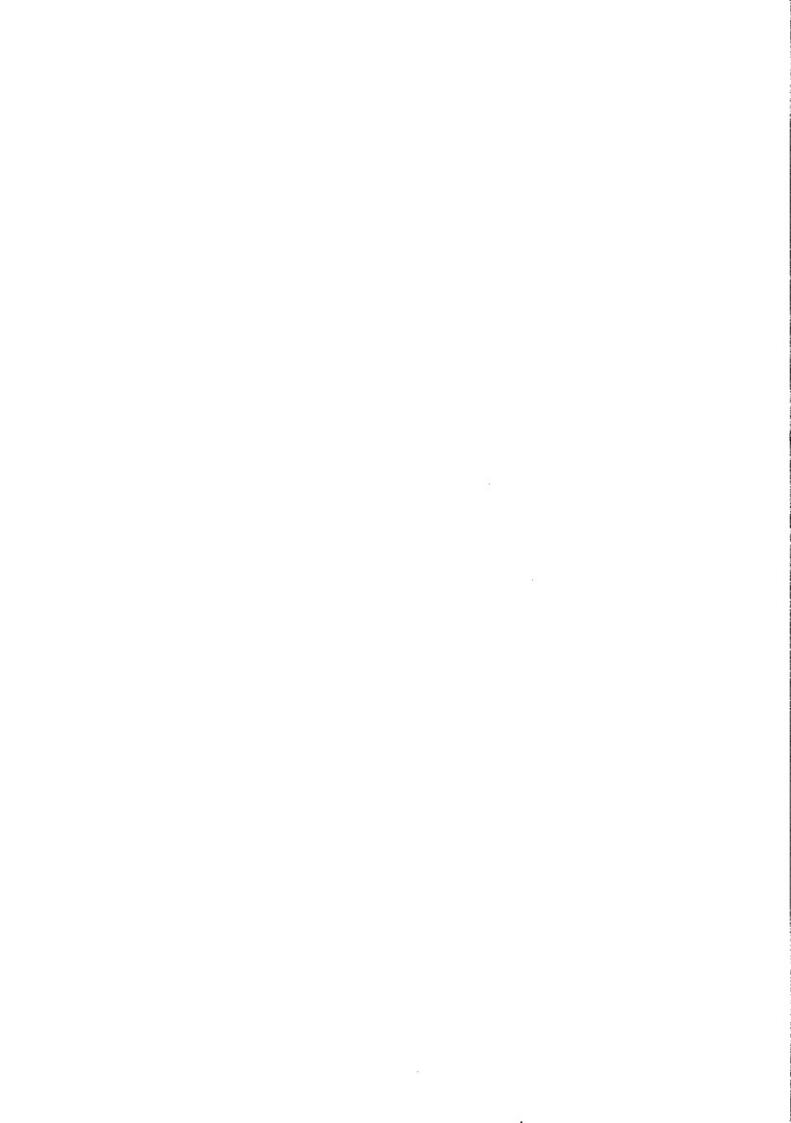

# 1 調査成果

## (1) 調査区の配置と基本層序 (付図21・22 第406図)

南庄遺跡は名東遺跡の北側に隣接する。調査区は南半を1区、北半を2区、北東部を3区として区分した。調査地は、かつて旧日本陸軍の射撃場跡地であり、現在は徳島県立森林林業研究所として利用されている。現地表下には研究所造成時の客土、造成前の水田土壌、さらに下層に射撃場造成土が堆積し、包含層と遺構面の大部分が削平されていた。整地層は南から北へ向かって緩やかに下りの傾斜が見られる。調査区の南北両端の距離約135mでの比高差は、約80cmであった。

包含層は黒褐色のシルト層、遺構検出面はオリーブ褐色または黄褐色(2.5Y5/4)のシルト層である。各調査区で検出された遺構数は、第9表の通りである。

遺構の種類	1区	2区	3区	合計
掘立柱建物 (SA)	0	2	2	4
竪穴住居 (SB)	1	0	0	1
溝状遺構 (SD)	16	8	1	25
構列 (SG)	0	6	0	6
土坑 (SK)	12	16	8	36
柱穴 (SP)	13	43	9	65
自然流路 (SR)	3	1	0	4
土墳墓 (ST)	1	0	0	1
性格不明遺構 (SX)	1	1	0	2

第9表 南庄遺跡 遺構数一覧表

## (2) 遺構と遺物

南庄遺跡の調査時においては、戦前の整地層が全面にわたって検出され、その下層から遺構面が確認された。遺跡全体の遺構数は、掘立柱建物4棟、竪穴住居1軒、溝状遺構25条、構列6基、土坑36基、柱穴65基、自然流路4条、土墳墓1基、性格不明遺構2基である。なお溝状遺構など、複数の調査区にまたがった遺構は、主となる調査区のみを集計した。

### ①遺構の概要 (付図23・24 第9表)

1区は南庄遺跡の南半分にあたり、南端は名東遺跡と接する。竪穴住居1棟、溝状遺構16条、土坑12基、柱穴13基、自然流路3条、土墳墓1基、性格不明遺構1基を検出した。

2区は遺跡の北半部分にあたる。掘立柱建物2棟、溝状遺構8条、構列6列、土坑16基、柱穴43基、自然流路1条、性格不明遺構1基である。

3区は1区の北東部にあたる。掘立柱建物2棟、溝状遺構1条、土坑8基、柱穴9基である。

南側の1区では、溝状遺構が多く、北側の2、3区では掘立柱建物を含む柱穴や土坑が多い傾向が見られる。

### ②掘立柱建物

掘立柱建物 (SA1001) (第407・408図)

検出場所 2区 ε-IV・R-18、19およびS-18、19グリッド

形態・規模 梁間1間(2.55m)×桁行3間(6.8m)、床面積17.34㎡の側柱建物である。建物の主軸方向はN11°Wである。南西隅の柱は溝状遺構(SD1020)によって切られている。

土層 各柱穴の堆積は暗灰黄色、オリーブ褐色などのシルトで、粘質土を含む。3～6層に細分した。

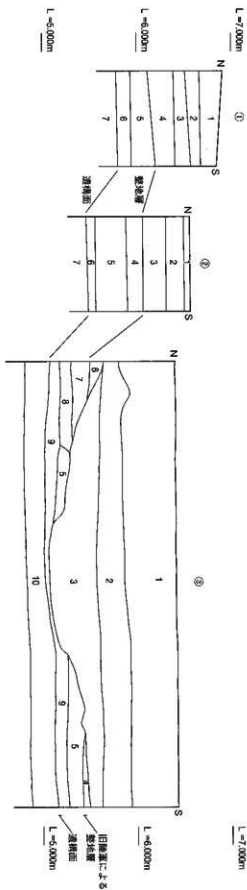

- ① アスファルト等
- 1 瓦土 (7SV4/1) 現代の木田土層
  - 2 灰・粘土層
  - 3 田設置による整地層
  - 4 灰オリーゾ色 (2SV3/3) シルト (包含層)
  - 5 黒褐色 (2SV5/3) シルト (遺構面)
  - 6 オリーゾ色 (2SV3/2) シルト (包含層)
  - 7 灰褐色 (2SV4/4) シルト (遺構面)

- ②
- 1 遺土
  - 2 瓦土 (水田土層)
  - 3 灰・粘土層
  - 4 整地層
  - 5 灰オリーゾ色 (7SV4/2) 水田土層
  - 6 黒褐色 (2SV3/2) シルト (包含層)
  - 7 オリーゾ色 (2SV4/4) シルト (遺構面)

- ③ アスファルト等
- 1 瓦土
  - 2 灰土から現代の層
  - 3 灰・粘土層
  - 4 整地層
  - 5 灰オリーゾ色 (7SV5/3) 水田土層
  - 6 灰オリーゾ色 (7SV6/3) 水田土層
  - 7 オリーゾ色 (7SV6/2) 水田土層
  - 8 黒褐色 (2SV3/2) シルト (包含層)
  - 9 灰褐色 (2SV5/3) シルト (遺構面)
  - 10 灰褐色 (2SV5/3) シルト (遺構面)

第406図 南田遺跡 基本土層図



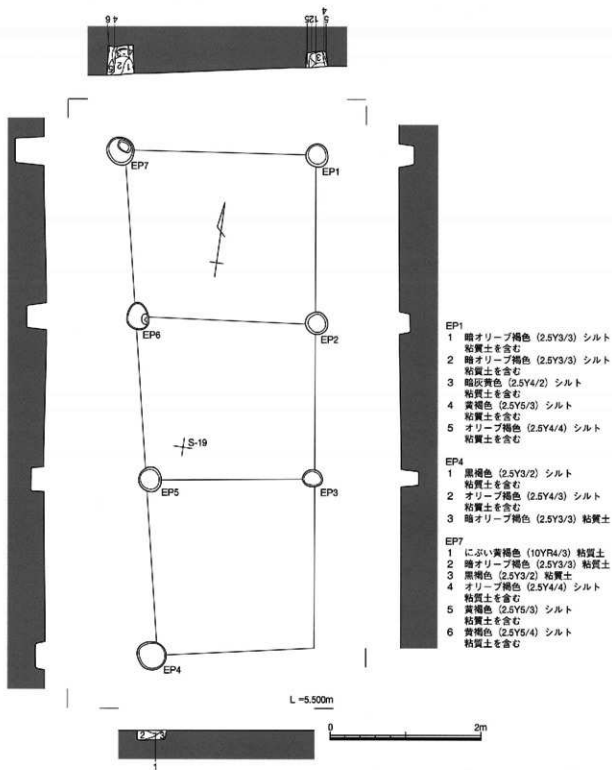

第407図 SA1001 平・断面図



第408図 SA1001EP7 出土遺物

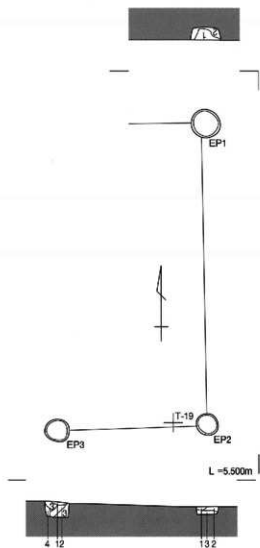

第409図 SA1002 平・断面図

遺物出土状況 出土状況を図化できたものはない。

出土遺物 1は黒色土器A類の碗である。

時期 9世紀後半と考えられる。

掘立柱建物 (SA1002) (第409・410図)

検出場所 2区 ε-IV・T-18、19グリッド

形態・規模 梁間1間(1.98m)×桁行1間(3.98m)、床面積7.88㎡の掘立柱建物である。建物の主軸方向は正方位の南北方向である。

土層 各柱穴の堆積は黄褐色、にぶい黄色などのシルトで、粘質土を含む。2～4層に細分した。

遺物出土状況 出土状況を図化できたものはない。

出土遺物 2は黒色土器B類の碗の底部破片である。

時期 10世紀と考えられる。

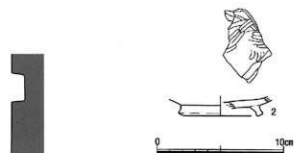

第410図 SA1002EP3 出土遺物

EP1  
1 黄褐色 (2.5Y5/3) シルト 粘質土を含む  
2 黄褐色 (2.5Y5/4) シルト 粘質土を含む

EP2  
1 にぶい黄色 (2.5Y6/3) シルト 粘質土を含む  
2 黄褐色 (2.5Y5/4) シルト 粘質土を含む  
3 黄褐色 (2.5Y5/3) シルト 粘質土を含む

EP3  
1 灰黄褐色 (10YR4/2) シルト 粘質土を含む  
2 暗灰黄色 (2.5Y4/2) シルト 粘質土を含む  
3 オリーブ褐色 (2.5Y4/3) シルト 粘質土を含む  
4 黄褐色 (2.5Y5/3) シルト 粘質土を含む



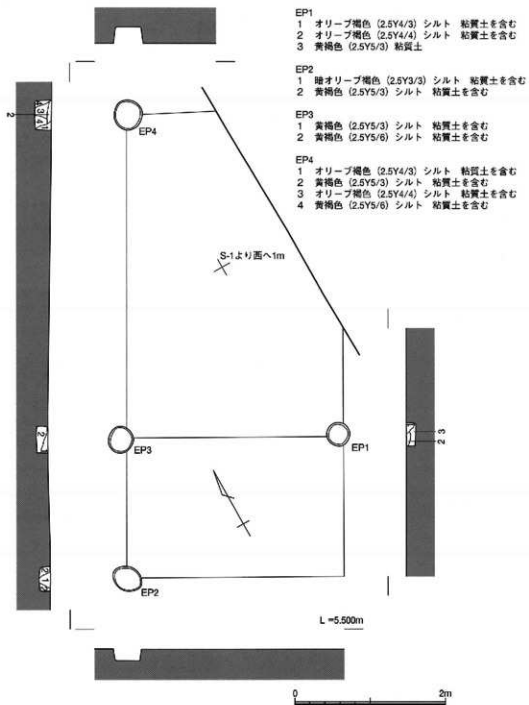

第411図 SA1003 平・断面図

掘立柱建物 (SA1003) (第411図)

検出場所 3区 ε-IV・R、S-20グリッド

形態・規模 梁間1間 (2.89m) × 桁行2間 (6.14m)、床面積17.74㎡の側柱建物である。建物の主軸方向はN30°Eである。建物の東半は調査区外に位置する。

土層 各柱穴の堆積は暗オリーブ褐色、暗灰黄色などのシルトで、粘質土を含む。2～4層に細分した。

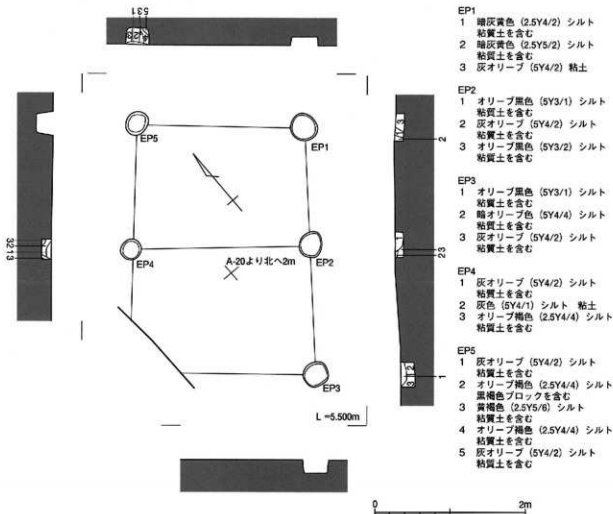

第412図 SA1004 平・断面図

遺物出土状況 出土状況を図化できたものはない。

出土遺物 図化できる遺物は出土していない。

時期 同一遺構面の遺構の時期を考慮すると、古代と推測される。

#### 掘立柱建物 (SA1004) (第412図)

検出場所 3区 a-IV・A-19、20グリッド

形態・規模 梁間1間 (2.40m) × 桁行2間 (3.29m)、床面積7.90㎡の圓柱建物である。建物の主軸方向はN38°Eである。西側の角の柱は調査区外に位置する。

土層 各柱穴の堆積はオリブ褐色、黄褐色などのシルトで、粘質土を含む。3～5層に細分した。

遺物出土状況 出土状況を図化できたものはない。

出土遺物 図化できる遺物は出土していない。

時期 同一遺構面の遺構の時期を考慮すると、古代と推測される。

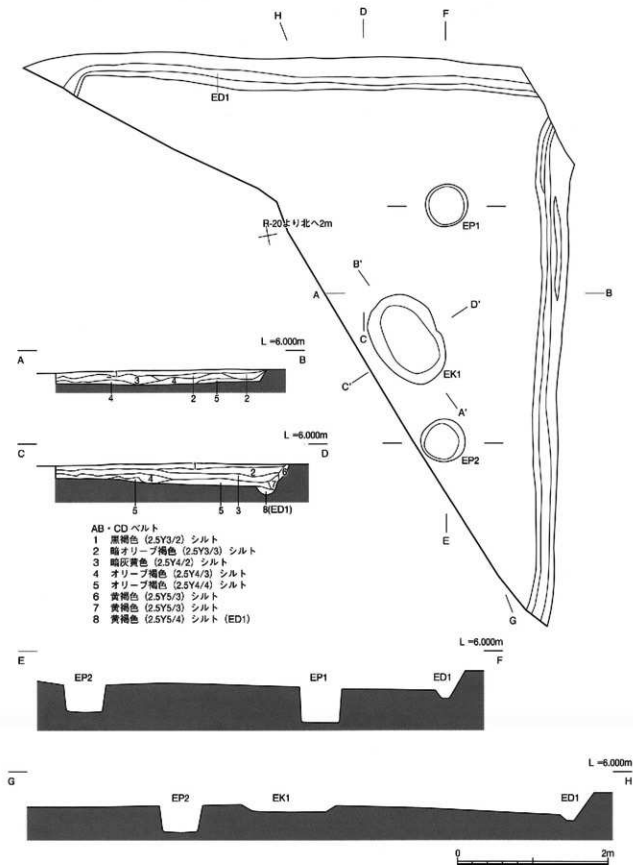

第413図 SB1001 平・断面図