

53① SA 4

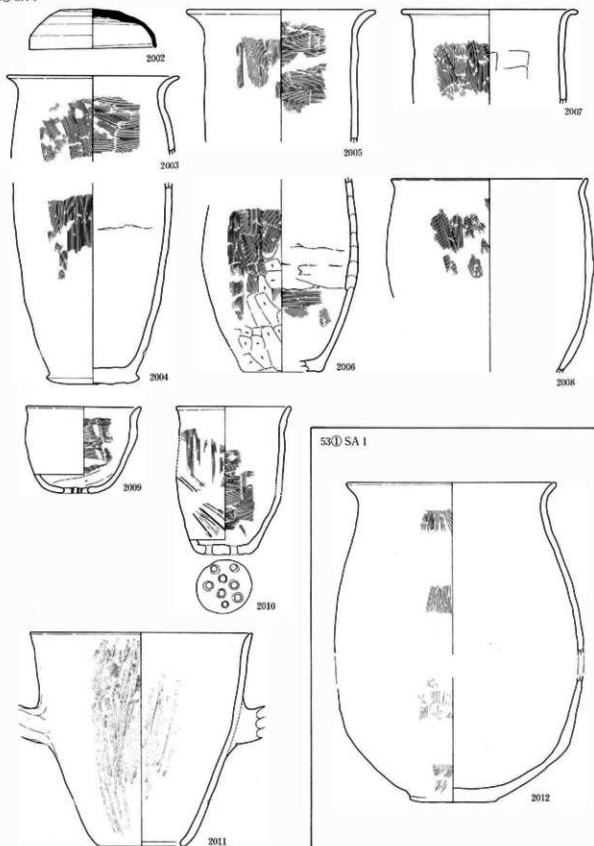

53① SA 1

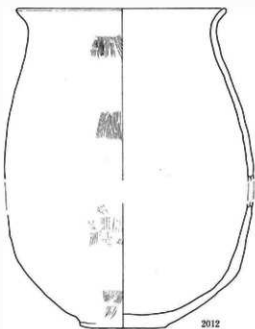

0 (1:4) 10cm

図版 210 古墳時代後期の遺物 (7)

53① SA 3

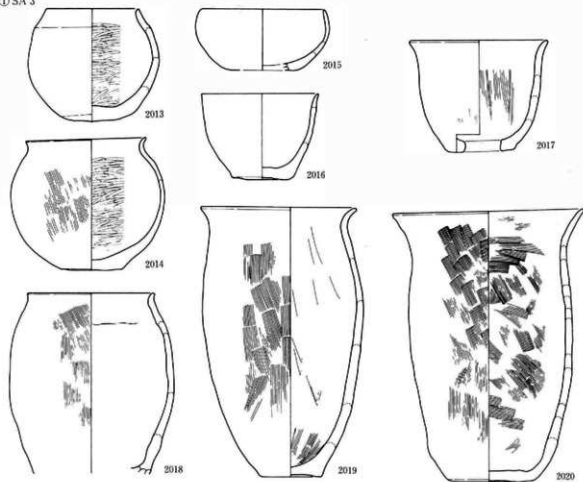

53① SA 5

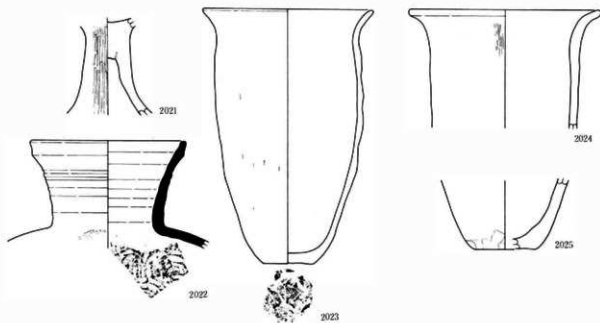

0 (1:4) 10cm

図版 211 古墳時代後期の遺物 (8)

53① SA 4

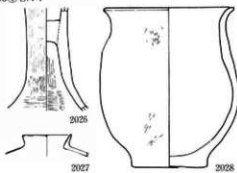

53① SA11

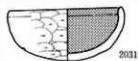

53① SA 9

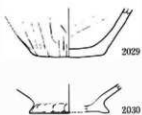

53② SA 6

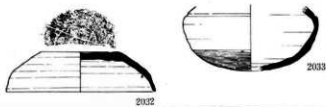

53① SA10

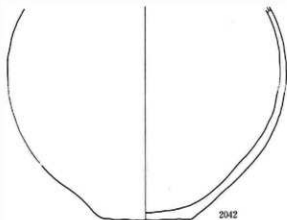
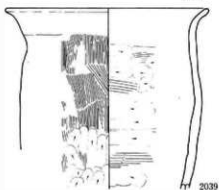
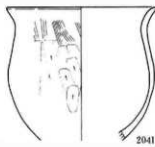
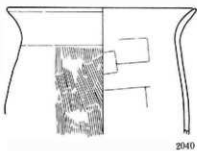
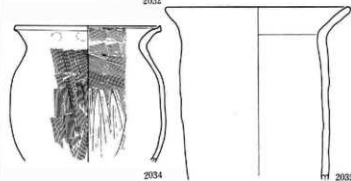

0 (1:4) 10cm

54① SA 2

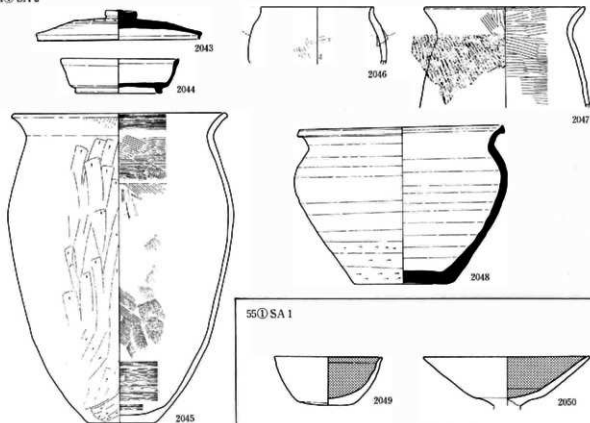

55① SA 1

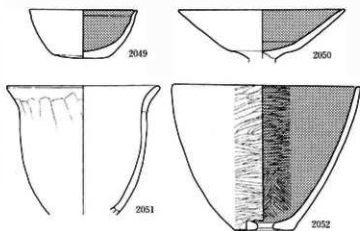

55① SA 5

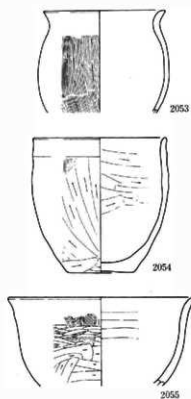

56① SA 1

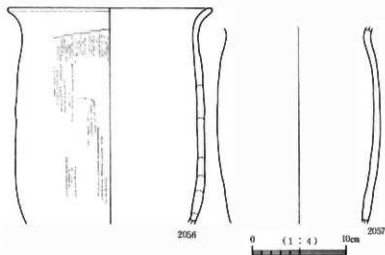

図版 213 古墳時代後期の遺物 (10)

56① SA 4

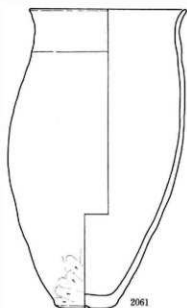
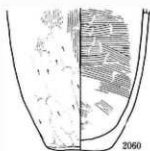
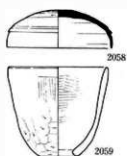

57① SA 1

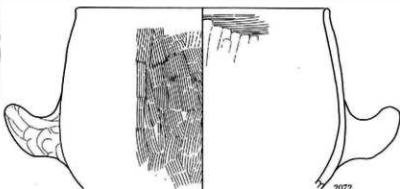
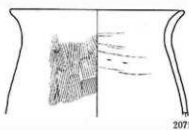
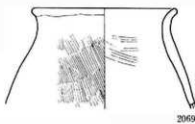
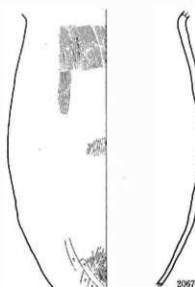
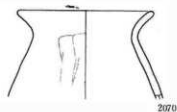
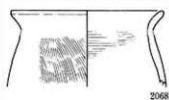
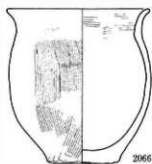
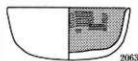
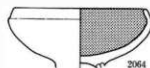
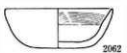

0 (1 : 4) 10cm

図版 214 古墳時代後期の遺物 (11)

57㊦ SA 2

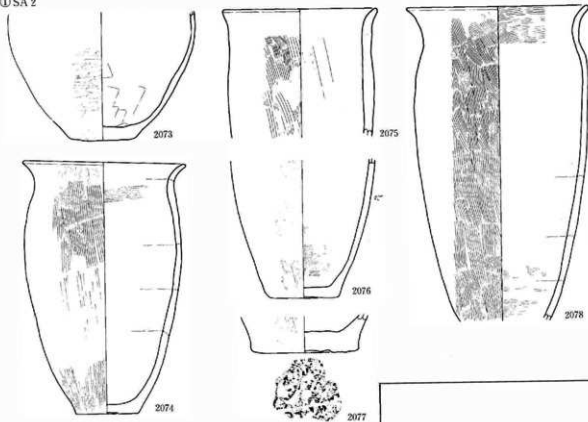

60㊦ SA 1

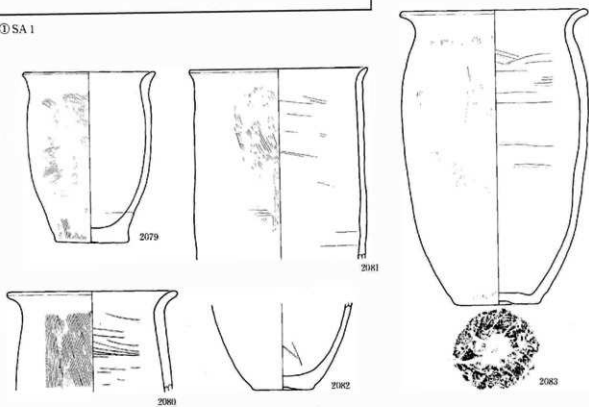

0 (1:4) 10cm

図版 215 古墳時代後期の遺物 (12)

61①SA 1

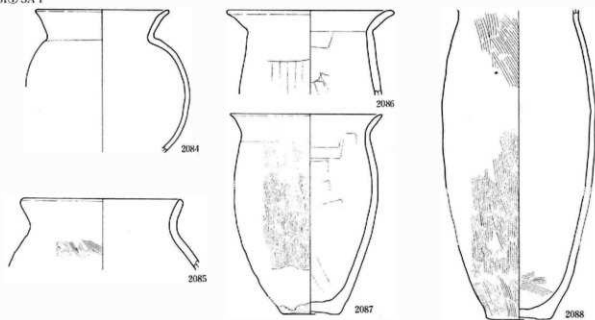

61①SA 2

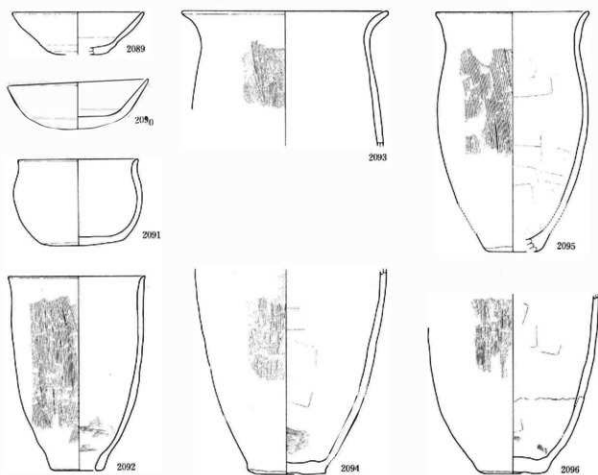

0 (1:4) 10cm

図版 216 古墳時代後期の遺物 (13)

61① SA 3

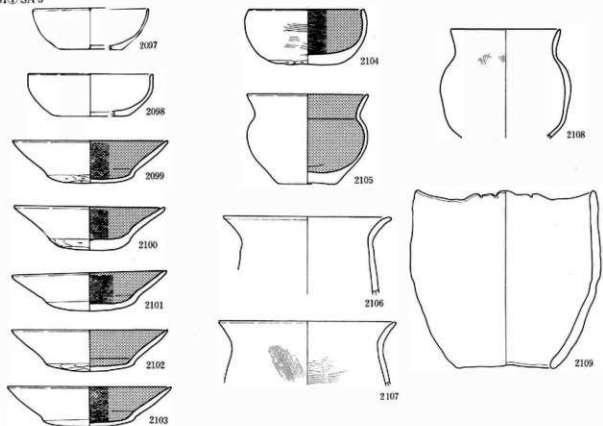

61① SA 5

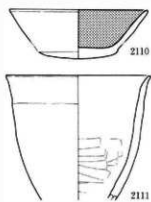

78① SA 3

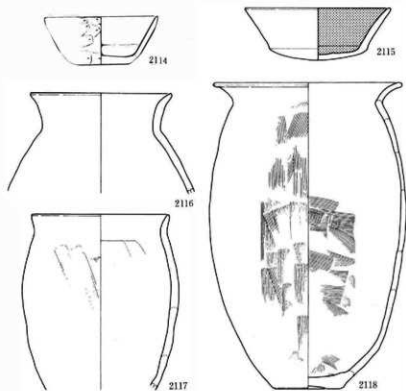

78① SA 1

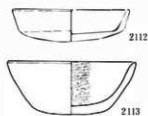

0 (1 : 4) 10cm



図版 217 古墳時代後期の遺物 (14)

79㉔ SA 4

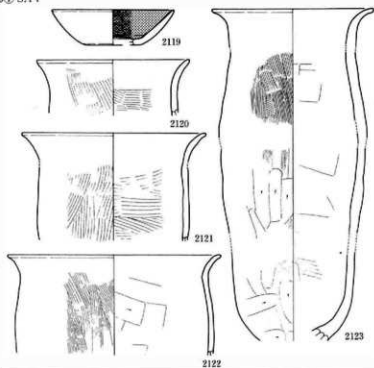

79㉔ SA 9

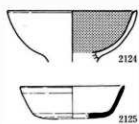

79㉔ SA 6

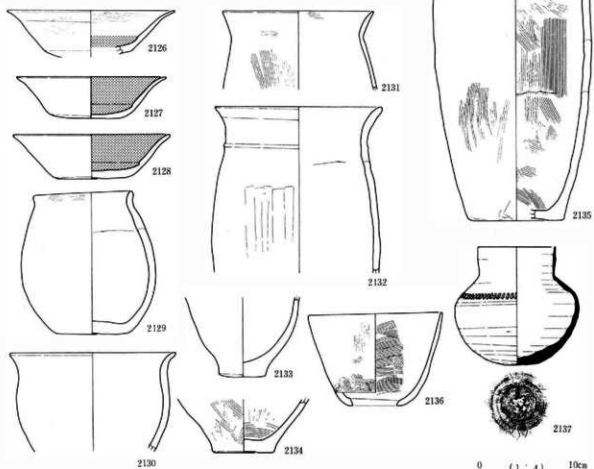

0 ( 1 : 4 ) 10cm

図版 218 古墳時代後期の遺物 (15)

B①SA 2



B①SA 4

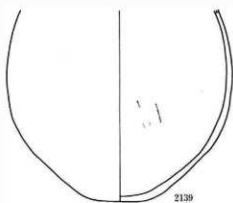

B①SA 3

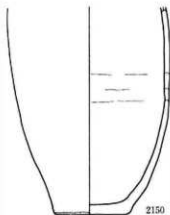
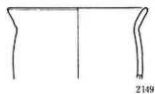
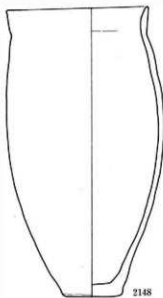
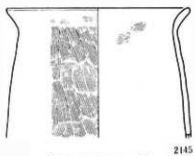
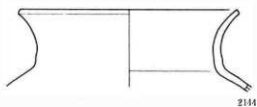
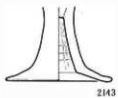
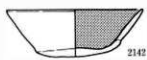
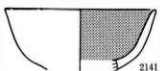
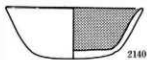

図版 219 古墳時代後期の遺物 (16)

B④SA 5



2151

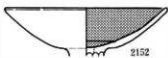

2152

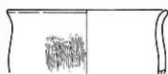

2156

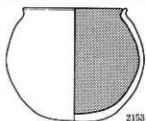

2153



2154

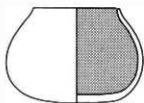

2155

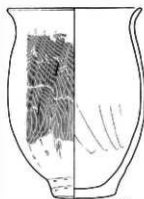

2157

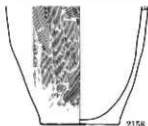

2158

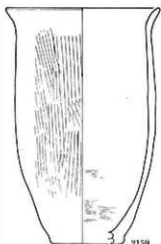

2159

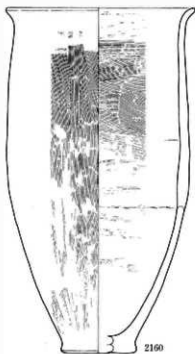

2160

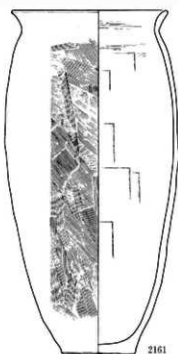

2161

0 (1:4) 10cm

図版 220 古墳時代後期の遺物 (17)

B①SA 6

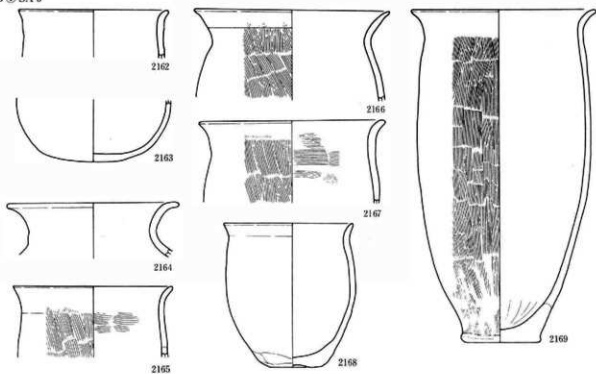

B①SA 7

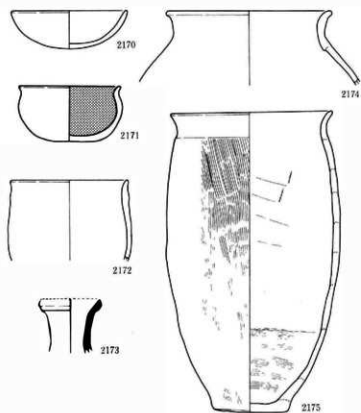

B①SA 8

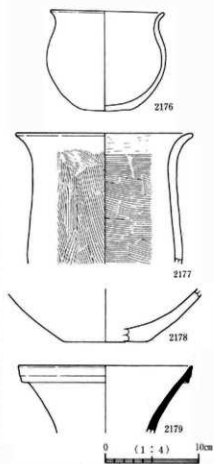

図版 221 古墳時代後期の遺物 (18)

B①SA 9

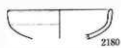

2180

B①SA11

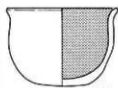

2181

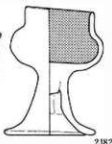

2182

B①SA12

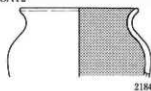

2184

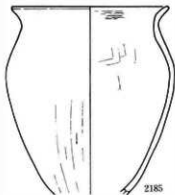

2185

B①SA14



2183

B①SA13

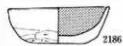

2186



2187

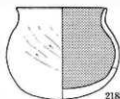

2188



2190



2191



2189

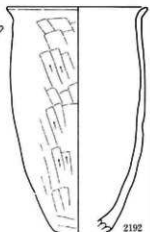

2192

B①SA16 (1)

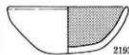

2193



2196



2199



2200



2201



2194

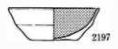

2197



2195

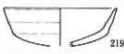

2198

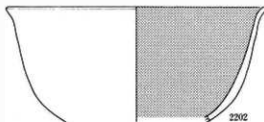

2202



B①SA16 (2)

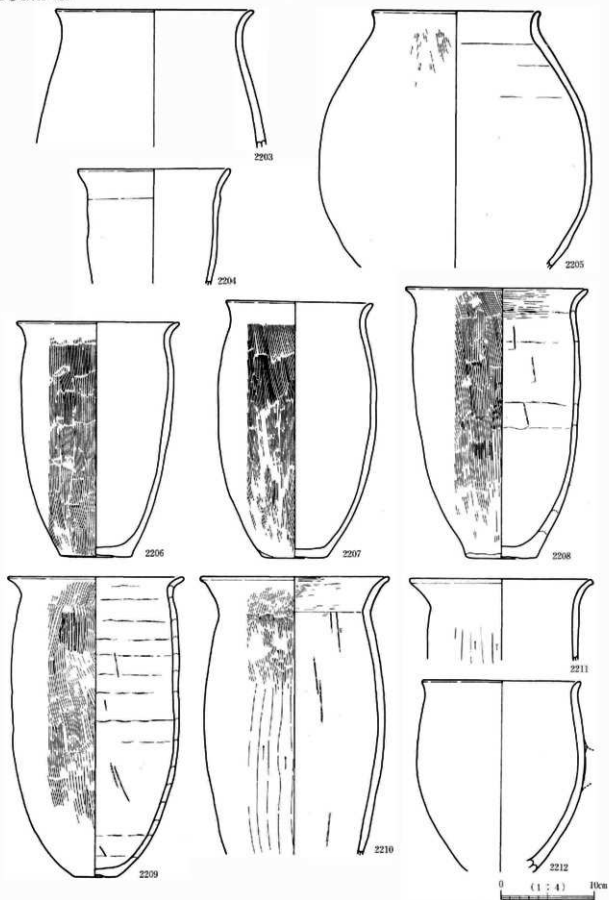

図版 223 古墳時代後期の遺物 (20)

C①SA 2

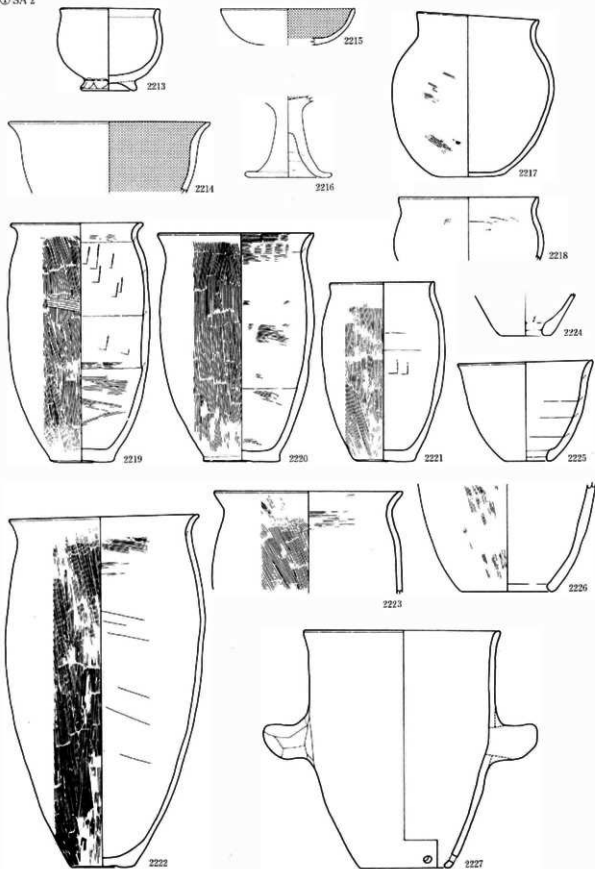

0 (1:4) 10cm

図版 224 古墳時代後期の遺物 (21)

C①SA 3

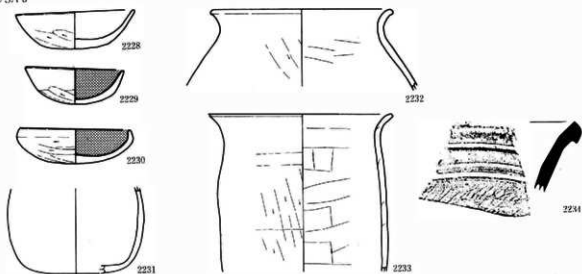

C①SA 4

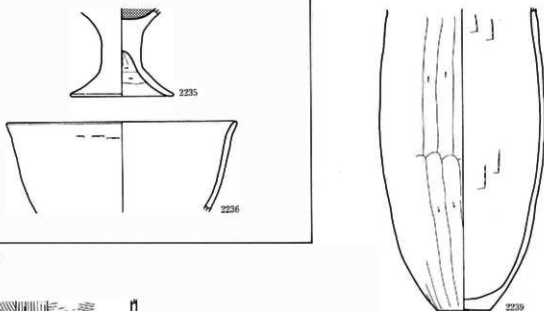

C①SA 6

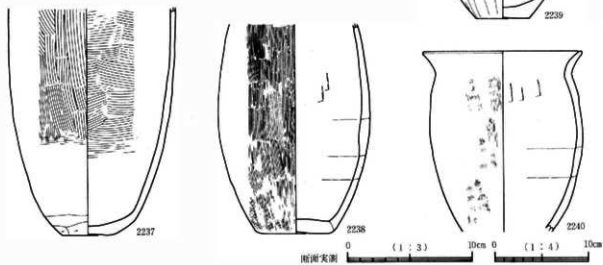



図版 225 古墳時代後期の遺物 (22)

C①SA 5

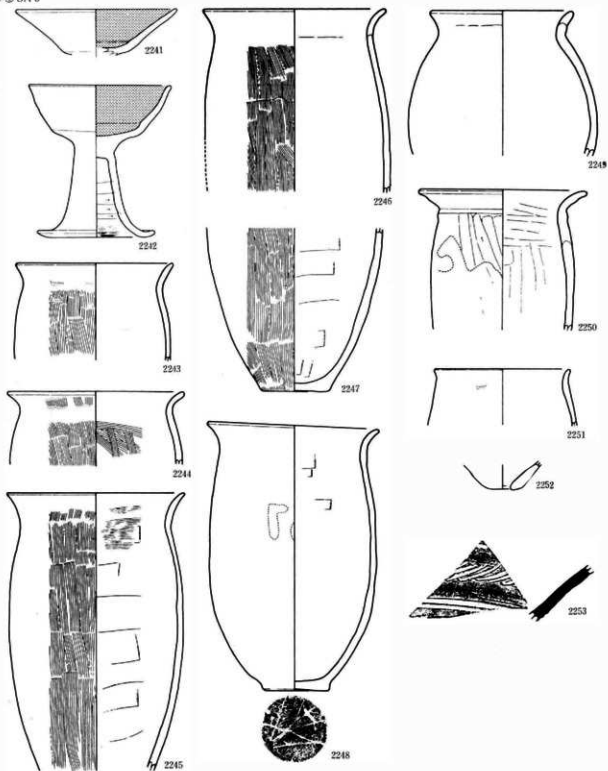

0 (1:3) 10cm 0 (1:4) 10cm  
断面実測

図版 226 古墳時代後期の遺物 (23)

C①SA 7

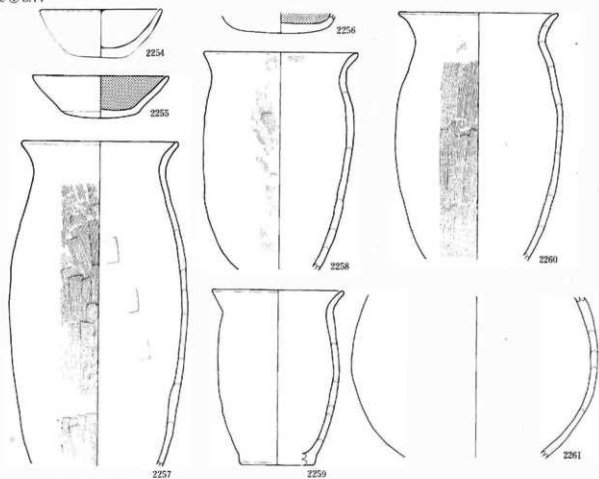

C①SA 8 (1)

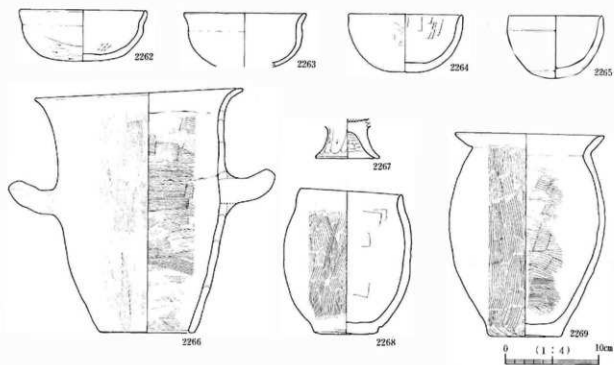

図版 227 古墳時代後期の遺物 (24)

C①SA 8 (2)

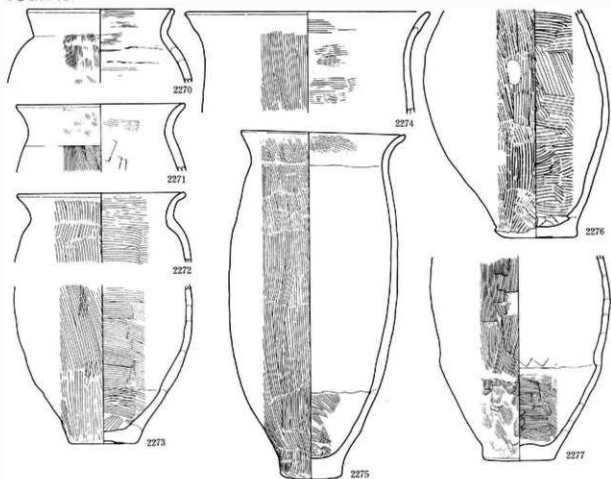

C①SA 9 (1)

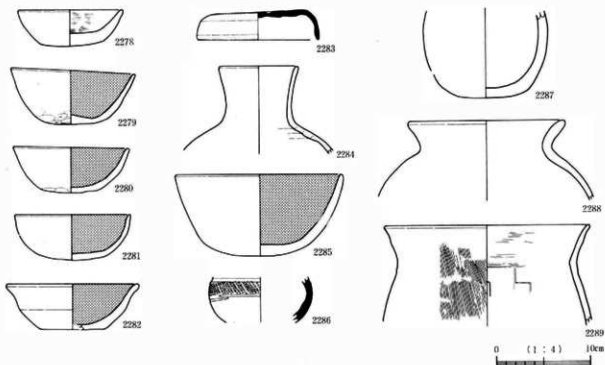

C① SA 9 (2)

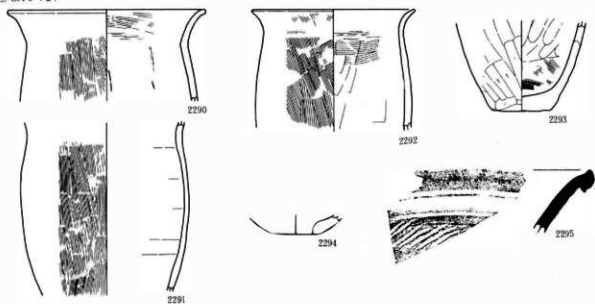

C① SA10

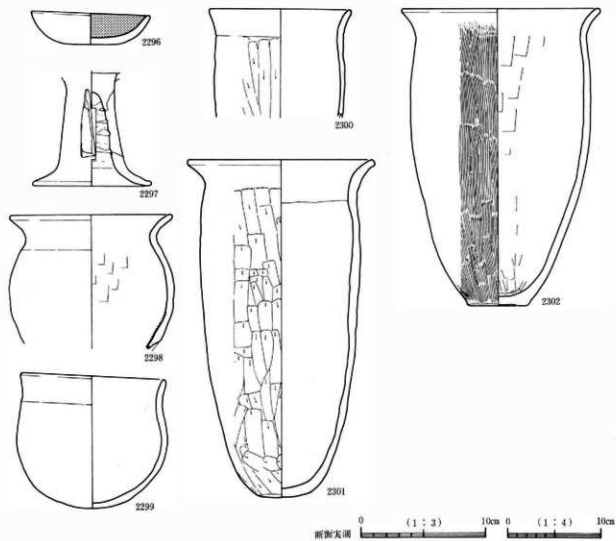

C④SA11(1)

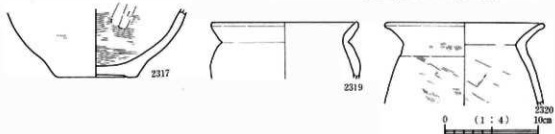
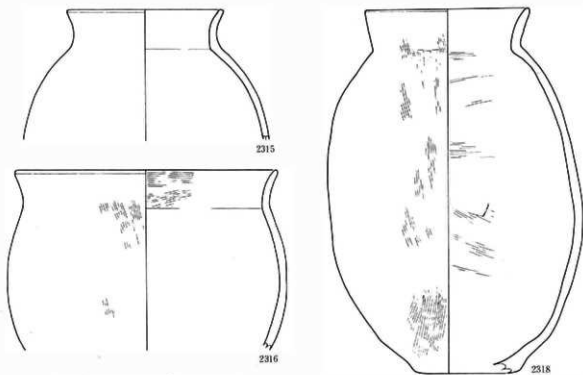
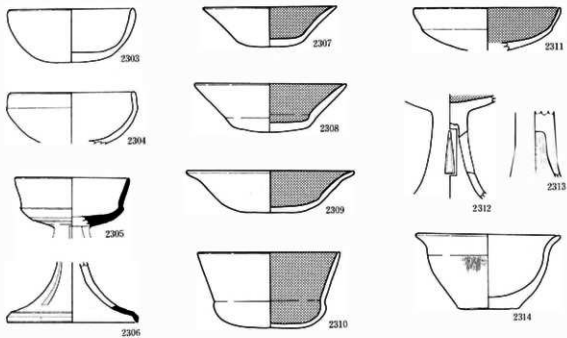

C①SA11(2)

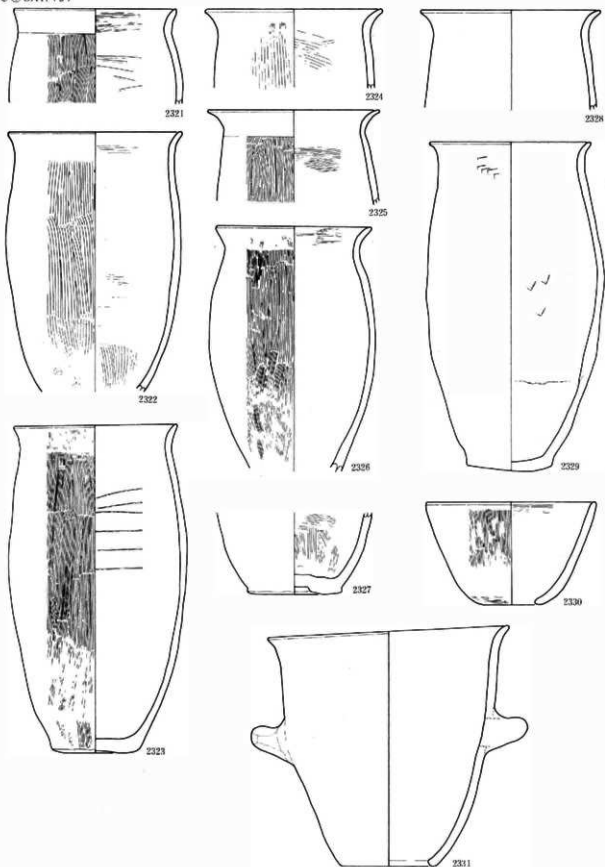

図版 231 古墳時代後期の遺物 (28)

C①SA13

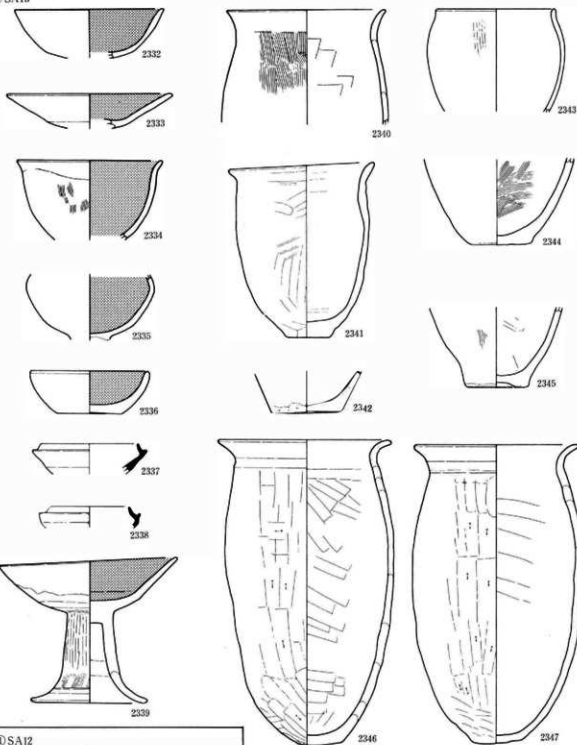

C①SA12

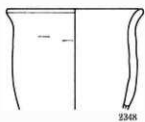

C①SA14

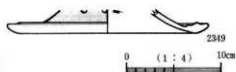

図版 232 古墳時代後期の遺物 (29)

C①SA15

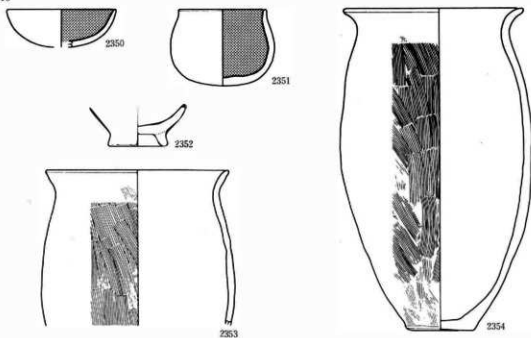

C①SA16 (1)

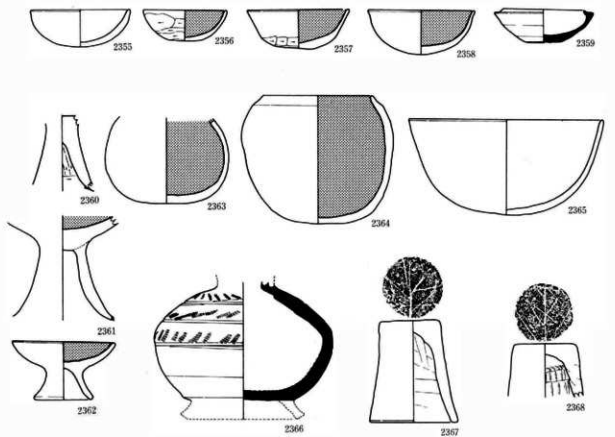

0 (1 : 4) 10cm



C①SA16(2)

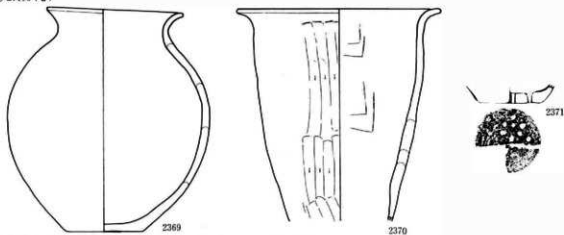

C①SA17

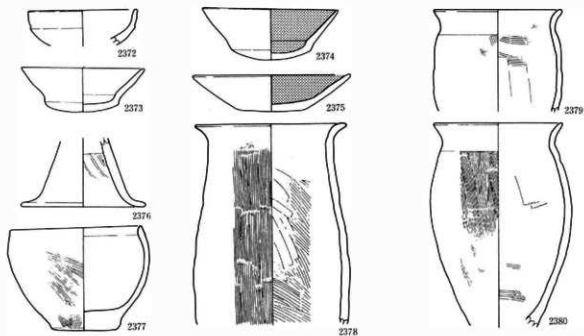

C①SA18(1)

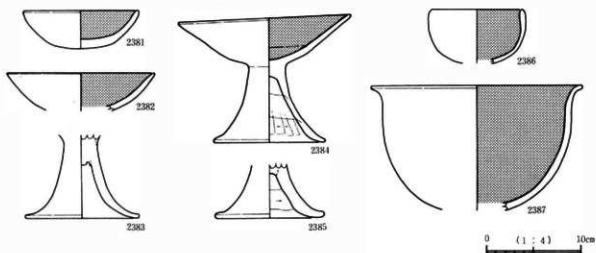

図版 234 古墳時代後期の遺物 (31)

C①SA18(2)

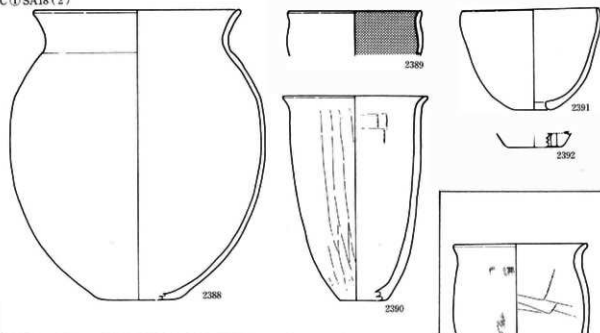

C①SA19

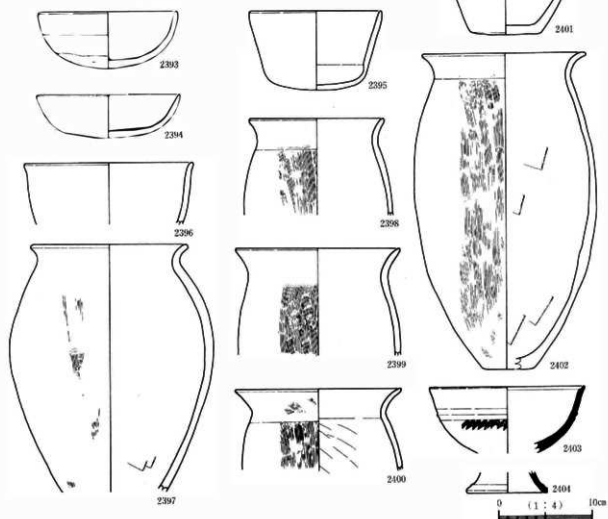

図版 235 古墳時代後期の遺物 (32)

C ① SA21

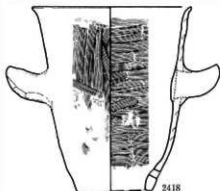
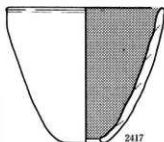
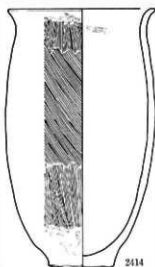
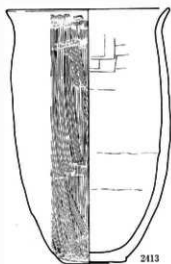
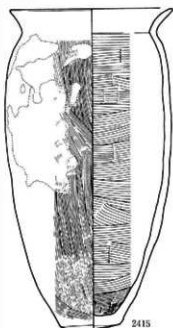
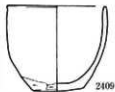
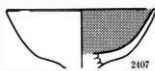
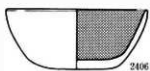

断面実測 0 (1:3) 10cm 0 (1:4) 10cm

図版 236 古墳時代後期の遺物 (33)

C ① SA20

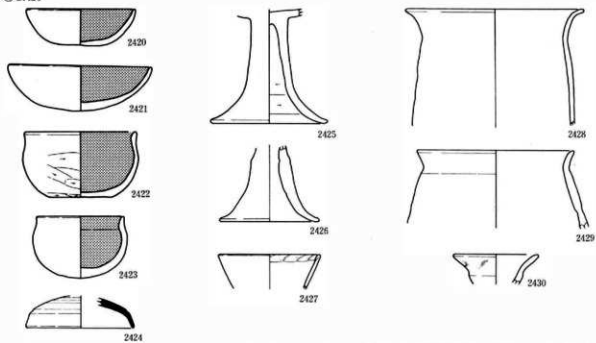

C ① SA22

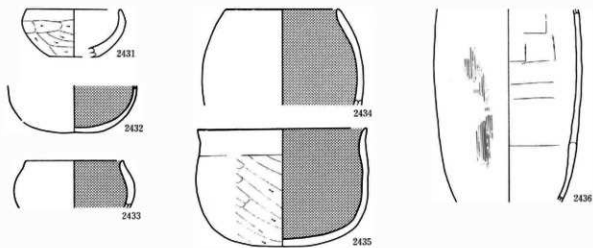

C ① SA23



0 (1:4) 10cm

図版 237 古墳時代後期の遺物 (34)

C①SA24

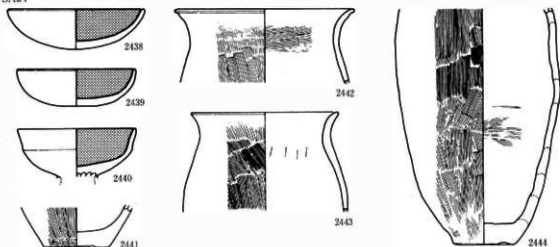

C①SA25

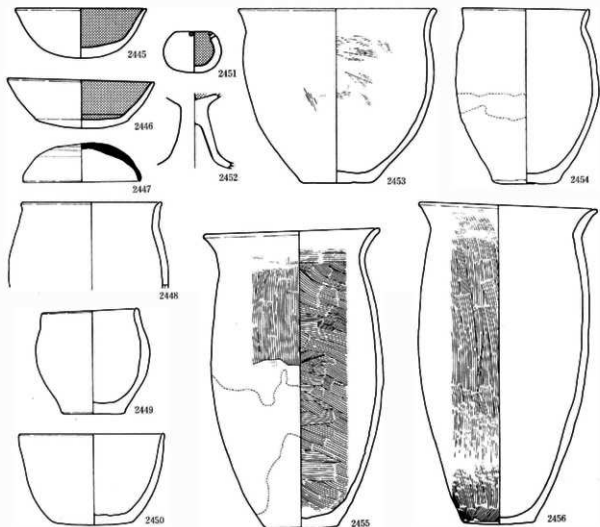

0 (1:4) 10cm

図版 238 古墳時代後期の遺物 (35)

C ① SA26

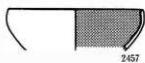

C ① SA27

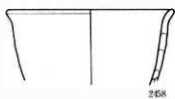

C ① SA28

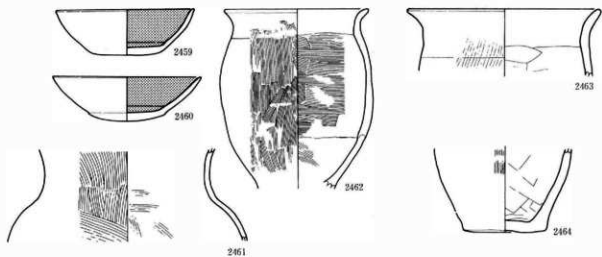

C ① SA29

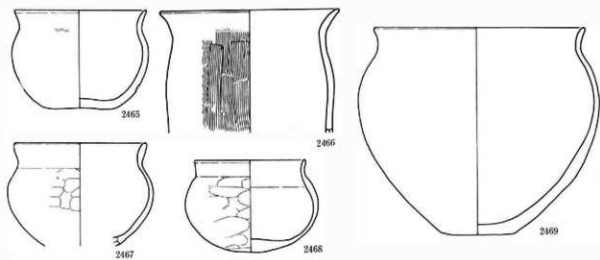

図版 239 古墳時代後期の遺物 (36)

55① SB 1



56① SK 5



C ① SK 76

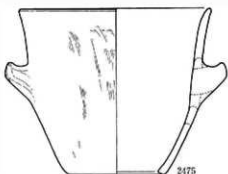
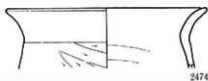
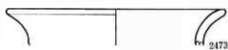

23① SD 1

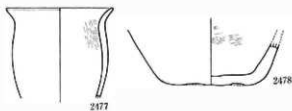

23① SD 2

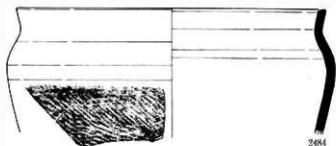
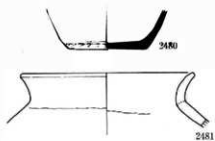
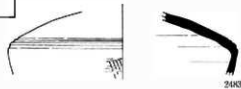

断面実測 0 (1:3) 10cm 0 (1:4) 10cm

図版 240 古墳時代後期の遺物 (37)

34①SD 1

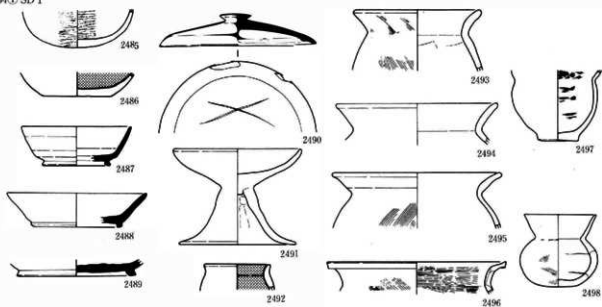

34①SD 2

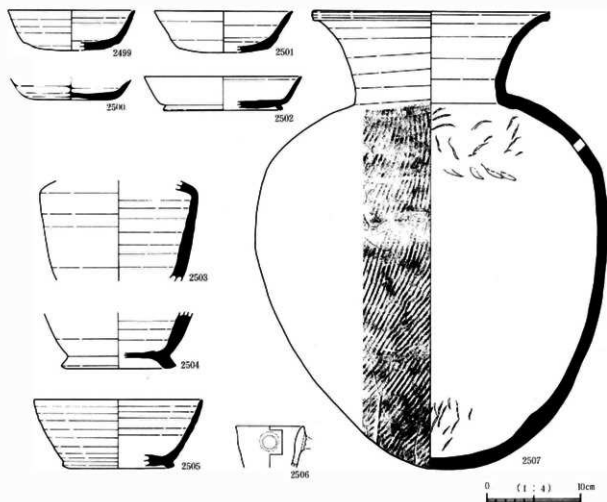



図版 241 古墳時代後期の遺物 (38)

49① SD 1

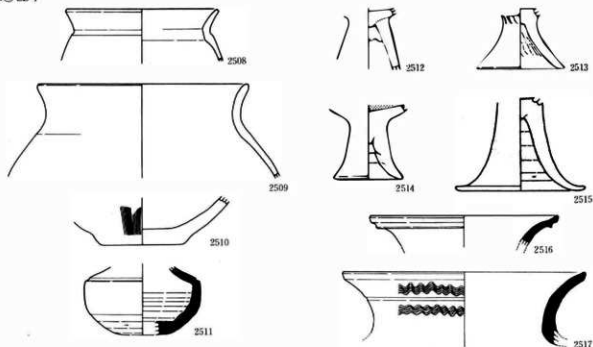

52② SD 1

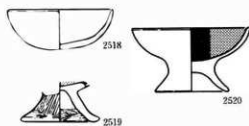

55① SD 2



55① SD 3

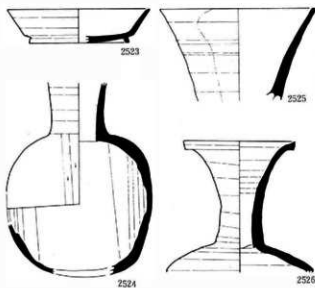

71① SD 2

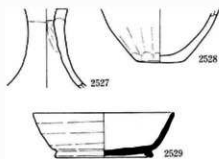

C ① SD 8



D① SD 1

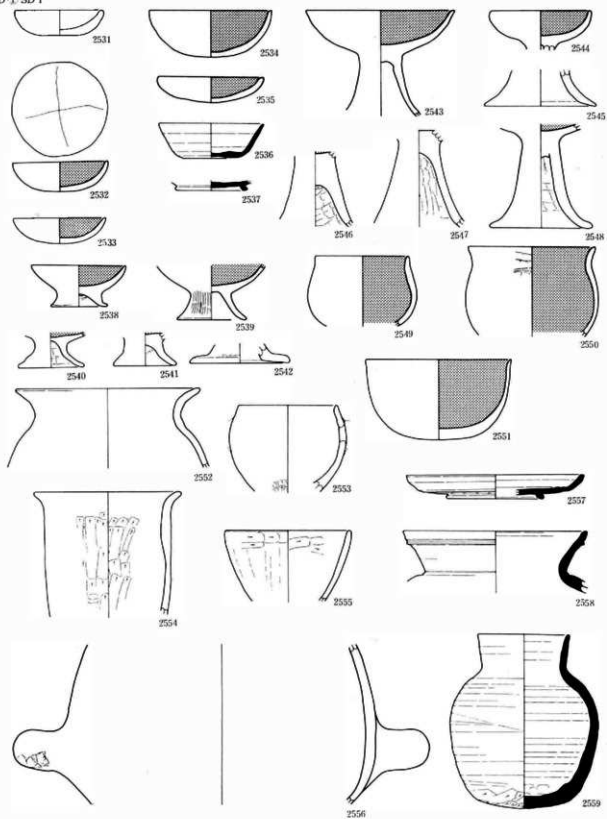

0 (1:4) 10cm

図版 243 古墳時代後期の遺物 (40)

E① SD17 (1)

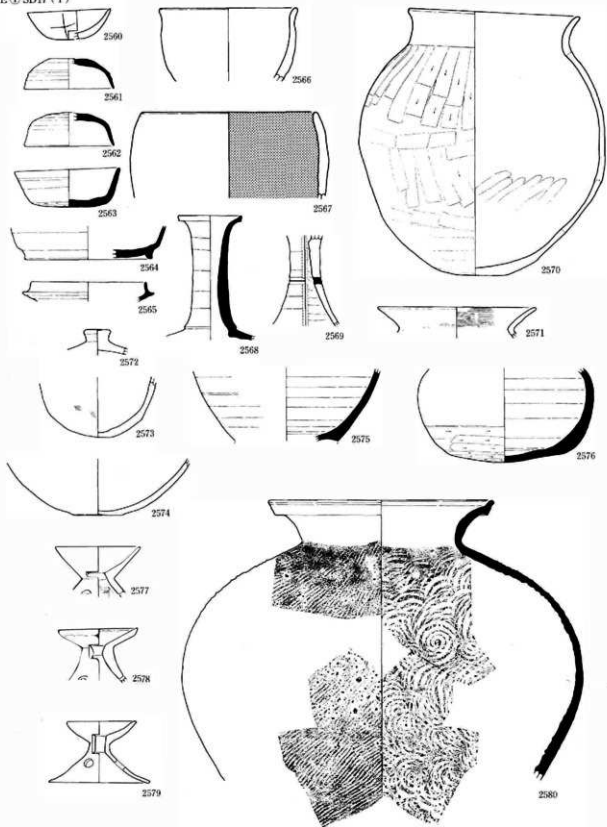

0 (1:4) 10cm

図版 244 古墳時代後期の遺物 (41)

E ①SD17 (2)

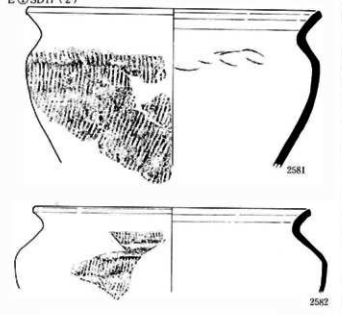

62② SU 2

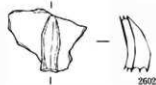
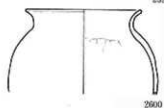
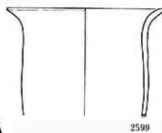
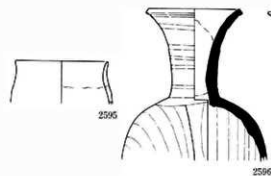
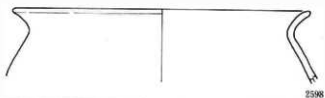
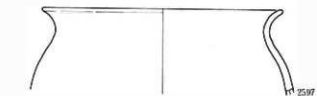
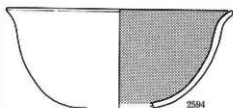
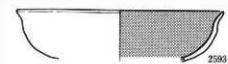
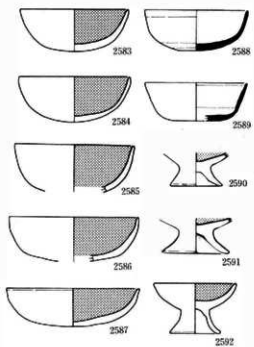

62① SX 3



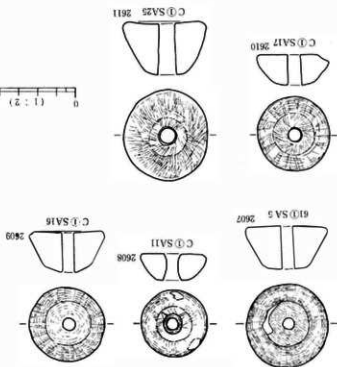
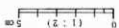
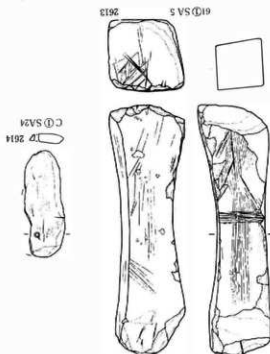
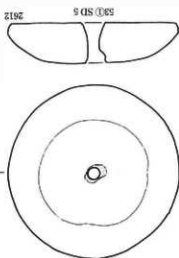
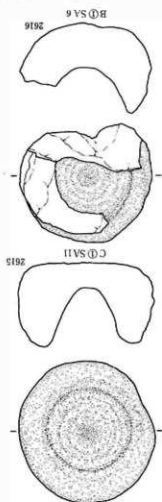

石製品

図版 245 古墳時代後期の遺物 (42)

土製品

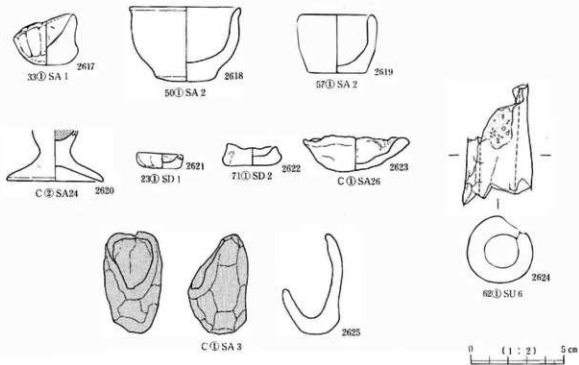

装身具

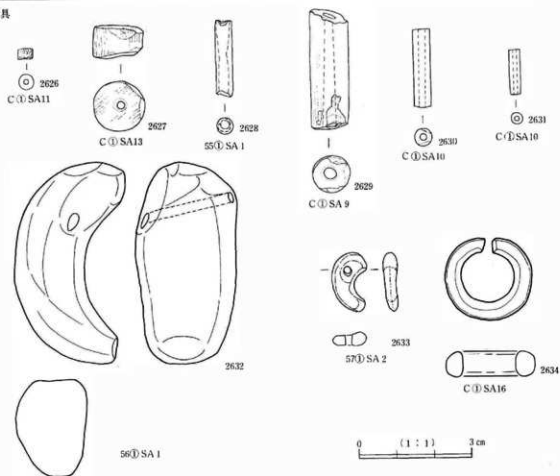

図版 247 平安時代～中世の遺物

53①SK 1



C①SD 1



C①SD 2



16①SD 1



C①SU 3

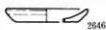

断面実測 0 (1:3) 10cm 0 (1:4) 10cm

石製品

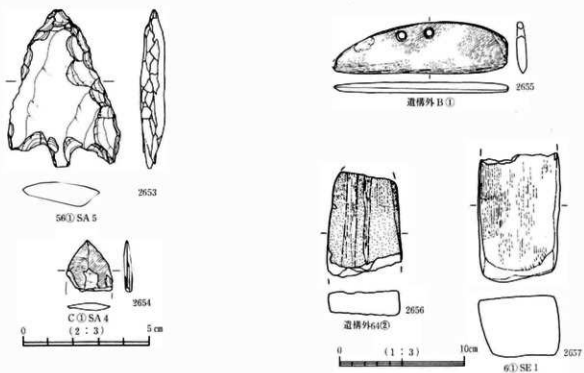

土製品

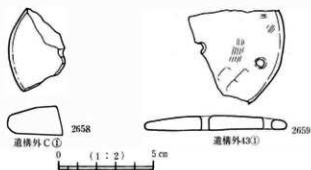

装身具

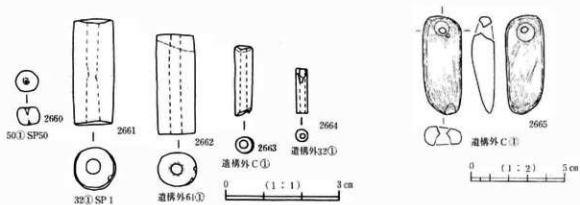





45㉔S A1



45㉔S A2



45㉔S A3



45㉔S A4



45㉔S A5/6

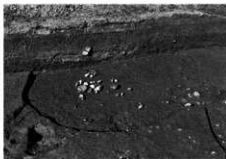

45㉔S A7

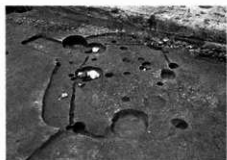

63㉔S A1



63㉔S A1土偶出土状況



63㉔S A1土器出土状況



63㉔S A2



63㉔S A2土器出土状況



63㉔S A3



E㉔S A1



E㉔S A2遺物出土状況

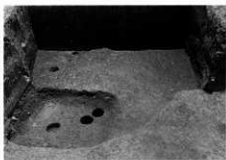

E㉔S A2完掘



E②S A3遺物出土状況(1)



E②S A3遺物出土状況(2)



E②S A3土器出土状況(1)



E②S A3土器出土状況(2)



E②S A3完掘



E②S A4上層遺物出土状況



E②S A4中層遺物出土状況(1)



E②S A4中層遺物出土状況(2)



E②S A4中層石棒出土状況



E②S A4石器出土状況



E②S A4完掘



E②S A5遺物出土状況



E②S A5ピット内遺物出土状況



E②S A5完掘

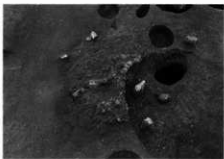

E②S A5跡

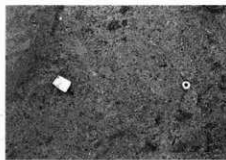

E②SA6上層遺物出土状況



E②SA6遺物出土状況

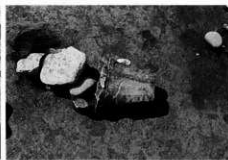

E②SA6土器出土状況



E②SA6完掘



E②SA7



E②SA7炉



E②SA8



E②SA8炉



E②SK8



E②SK9遺物出土状況

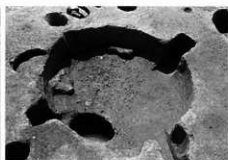

E②SK9完掘



E②SX1



E②SJ1



E②SJ2



E②SJ3



E②S J4



48②S R1



69②S R1



E②S R1



E②S R2



E②SN1検出状況



E②SN1発掘



3①S A1



3①S A2



4①S A1



10①S A1

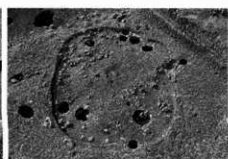

18①S A1



25①S A1



29①S A2



30①S A1



32㊦S A1



34㊦S A4



37㊦S A1



43㊦S A2



50㊦S A10



51㊦S A2

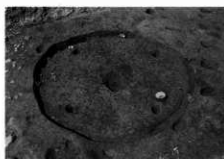

52㊦S A1

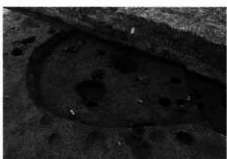

52㊦S A3



53㊦S A3



53㊦S A7



53㊦S A11遺物出土状況 (1)



53㊦S A11遺物出土状況 (2)



53㊦S A11完掘



55㊦S A2



55㊦S A4



64①S A1 (外) / 2 (内)



65①S A1



69①S A1



74①S A1 (左) / 2 (右)

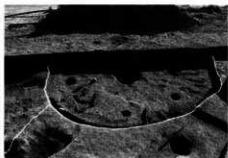

75①S A1



B②S A4



B②S A5



B②S A6



C②S A13 (外) / 14 (内) (1)



C②S A13 (外) / 14 (内) (2)



C②S A19

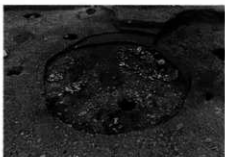

C②S A20遺物出土状況 (1)



C②S A20遺物出土状況 (2)



C②S A20完掘



E①S A1遺物出土状況

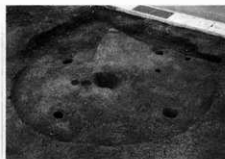

E①S A1完掘



18①S K 4



26①S K 10



29①S K 2



60①S K 3



64①S K 1



C②S K 111



48①S J 5



61区S J 群



61区S J 群掘り方



61区S J 群埋葬時復元状況



61②S J 1



61②S J 1掘り方



61②S J 2



61②S J 2掘り方

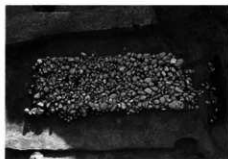

61㉔S J3 (1)



61㉔S J3 (2)



61㉔S J3掘り方



61㉔S J4



61㉔S J4掘り方



61㉔S J5

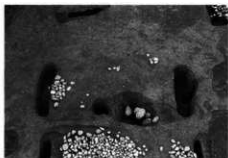

61㉔S J6

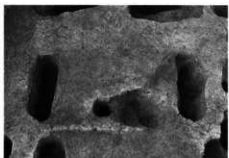

61㉔S J6掘り方

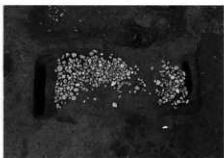

61㉔S J7

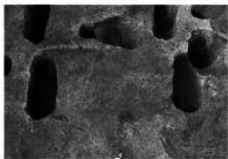

61㉔S J7掘り方



61㉔S J8

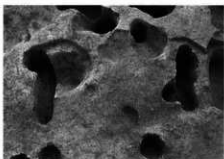

61㉔S J8掘り方

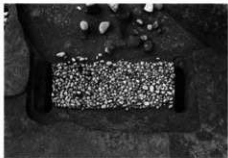

61㉔S J9



61㉔S J9掘り方



61㉔S D3





27① S D1



73① S U2



3① S X1



43① S X1

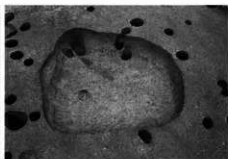

55① S X1



33① S A2



46① S A1



46① S A2



46① S A3



50① S A7



50② S A1



50② S A2 (1)



50② S A2 (2)



50② S A3炭化材出土状況



50② S A3完掘

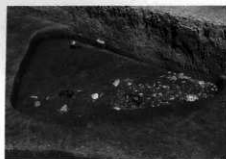

50② S A4



50② S A6



50② S A7炭化材・遺物出土状況



50② S A7完掘



50② S A8



51① S A1



51② S A1



51② S A2



51② S A3



52① S A5



52① S A7



52② S A2

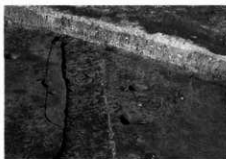

53② S A1



53② S A4/5



55① S A3



55㊦ S A1

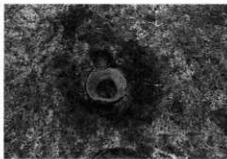

55㊦ S A 1甲



55㊦ S A1 甲平截



56㊦ S A1 炭化材・遺物出土状況



56㊦ S A3



57㊦ S A1



57㊦ S A5



60㊦ S A2



60㊦ S A4 炭出土状況



60㊦ S A4 炭掘



61㊦ S A4



61㊦ S A6



61㊦ S A8



62㊦ S A1



70㊦ S A1



78①S A2



78①S A6



79①S A2



79①S A10



B②S A2



B②S A2遺物出土状況



B②S A3炭化材出土状況



B②S A3石釘出土状況



B②S A3完掘



B②S A7覆土集石出土状況



B②S A7完掘



B②S A8覆土集石出土状況



B②S A8完掘



B②S A9炭化材・遺物出土状況 (1)



B②S A9炭化材・遺物出土状況 (2)



B②S A9 定測



B②S A10 覆土集石出土状況

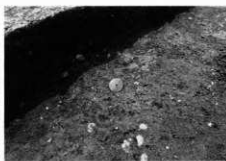

B②S A10 紡錘車出土状況



B②S A10 土器出土状況



B②S A10 完掘



B②S A11 遺物出土状況



B②S A11 定測



B②S A12 土層断面



B②S A12 完掘



B②S A14



B②S A15

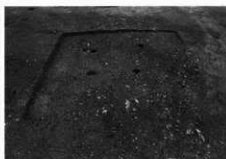

B②S A16



B②S A17



B②S A18



C②S A1



C②S A2炭出土状況



C②S A2完掘



C②S A2壁面炭化状況



C②S A4勾玉出土状況



C②S A4石割拵出土状況



C②S A4完掘



C②S A4石



C②S A6



C②S A7



C②S A7土器出土状況



C②S A8 (1)



C②S A8 (2)



C②S A9

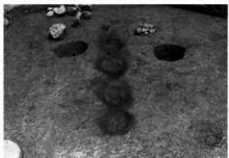

C②S A9石



C②S A10



C2SA10遺物出土状況



C2SA11



C2SA11遺物出土状況



C2SA12 (1)



C2SA12 (2)



C2SA15



C2SA17



C2SA18

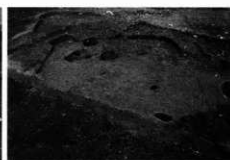

C2SA21

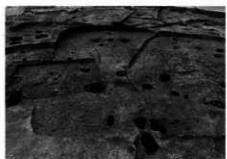

C2SA22



C2SA23



C2SA25



502SK4

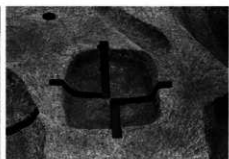

481SJ3



481SJ7



64㉔S J 1出土状況

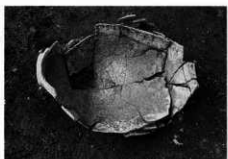

64㉔S J 1棺内遺物出土状況



64㉔S J 1棺支え出土状況



4㉔S C 2 (手前) / S D Z 1 (奥)



4㉔S D Z 1遺物出土状況



4㉔S D 2 / S D Z 1土層断面



19㉔S D Z 1



37㉔S D Z 1



48㉔S J / S D Z 群 (東から)



48㉔S J / S D Z 群 (西から)

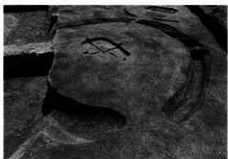

48㉔S D Z 1



48㉔S D Z 1主体部



48㉔S D Z 1主体部遺物出土状況 (1)

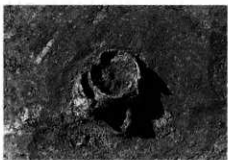

48㉔S D Z 1主体部遺物出土状況 (2)



48㉔S D Z 1主体部遺物出土状況 (3)





48①SD Z2



48①SD Z2主体部



48①SD Z2主体部遺物出土状況



48①SD Z4



48①SD Z4主体部



48①SD Z6

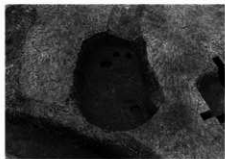

48①SD Z8主体部



4①SD 2



26①SD 7



48①SD 1



B②SD 6土層断面

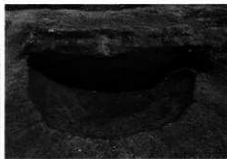

B②SU 2



62①S X4



6①S A1



6①S A1遺物出土状況

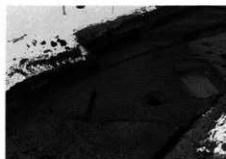

34① S A3



48① S A1



48② S A2



48③ S A3

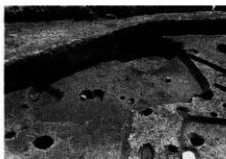

50① S A8



50② S A5



54① S A1



57① S A3



60② S A3



61① S A9



61② S A10



62① S A2



62② S A3



63① S A1



79① S A5



79①S A 8



B②S A 13 出土状況



B②S A 13 完掘



C①S A 30



C①S A 30 遺物出土状況



C②S A 16

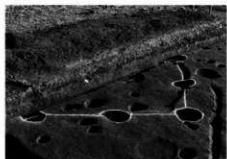

34①S B 1



48①S K 3



65①S D Z 1 (65区西から)



65①S D Z 1 (65区東から)

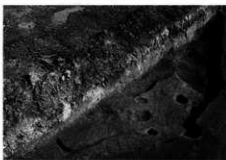

65①S D Z 1 (75区検出)



65①S D Z 1 土層断面 (74区検出)



75①S D Z 1



75①S D Z 4



75①S D Z 4 土層断面



60 S D1



13 S D1



23 S D5



33 S D7



34 S D7



34 S D7土層断面

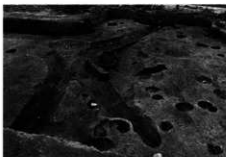

50 S D3/4



52 S D1



52 S D4



63 S D1/2



46 S X1



75 S X1



75 S X1遺物出土状況 (1)



75 S X1遺物出土状況 (2)



C S X1



23①S A1炭化材出土状況



23①S A1カマド出土状況



23①S A1完掘



33①S A1



33①S A1カマド



33①S A4 (奥) / 5 (手前)



34①S A1炭化材出土状況



34①S A1完掘

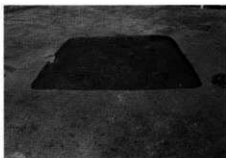

48①S A4



50①S A1



50①S A2

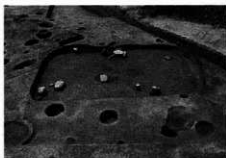

50①S A3



50①S A4

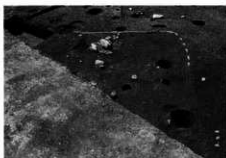

50①S A6



50①S A9



52㊦S A1



52㊦S A2



52㊦S A3



52㊦S A6

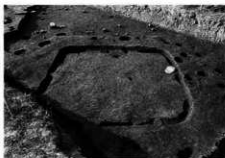

53㊦S A1

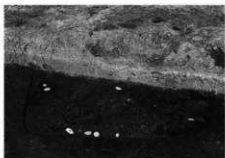

53㊦S A2



53㊦S A3カマド出土状況

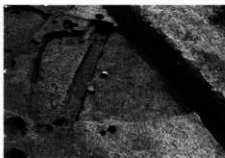

53㊦S A3



53㊦S A4



53㊦S A5カマド出土状況



53㊦S A5



53㊦S A9



53㊦S A10カマド出土状況



53㊦S A10



53㊦S A11



53㊦ S A6



54㊦ S A2 (奥) / 3 (手前)



55㊦ S A1



55㊦ S A5 カマド出土状況



55㊦ S A5

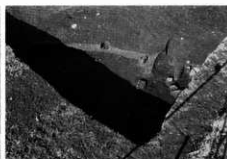

56㊦ S A1



56㊦ S A4



57㊦ S A1



57㊦ S A2



60㊦ S A1



61㊦ S A1 カマド出土状況



61㊦ S A1

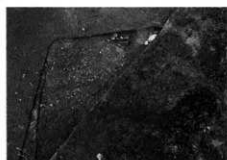

61㊦ S A2



61㊦ S A3



78㊦ S A1



78①S A3



78①S A4



78①S A5



79①S A4



79①S A6



79①S A7



79①S A9



B①S A1

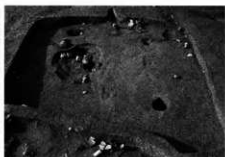

B①S A3遺物出土状況



B①S A3完掘



B①S A4カマフ出土状況



B①S A4



B①S A5カマフ出土状況

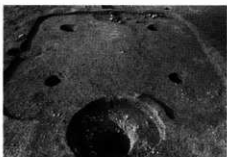

B①S A5



B①S A6カマフ出土状況





B1SA6



B1SA6 凹石出土状況



B1SA7 カマド出土状況



B1SA7



B1SA8



B1SA9



B1SA11

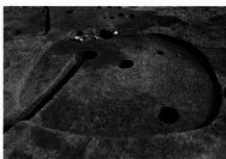

B1SA12



B1SA13 カマド出土状況



B1SA13



B1SA14



B1SA16 カマド出土状況



B1SA16 遺物出土状況



B1SA17



C1SA2 カマド出土状況



C1S A2



C1S A3



C1S A4



C1S A4カマド



C1S A5カマド1出土状況

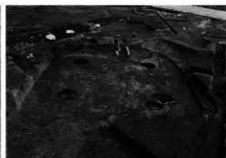

C1S A5完備 (カマド1)

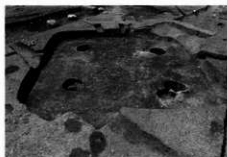

C1S A5完備 (カマド2)



C1S A5カマド2/3



C1S A6カマド出土状況

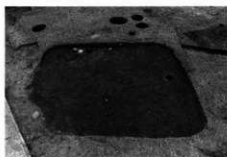

C1S A6



C1S A7



C1S A8カマド出土状況

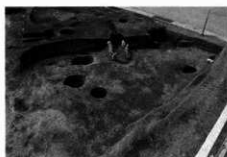

C1S A8



C1S A9カマド出土状況 (1)



C1S A9カマド出土状況 (2)



C1S A9遺物出土状況



C1S A9完掘



C1S A10カマドF1出土状況

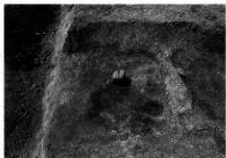

C1S A10カマド2



C1S A10 (左) / 14 (右)



C1S A11遺物出土状況 (1)



C1S A11遺物出土状況 (2)



C1S A11カマド出土状況



C1S A11



C1S A12



C1S A13カマド出土状況



C1S A13カマド完掘



C1S A13 (1)



C1S A13 (2)



C1S A15

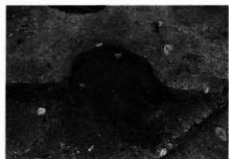

C①S A15カマドF1



C①S A15カマドF2



C①S A16カマド出土状況



C①S A16



C①S A16カマドF1土製支脚出土状況

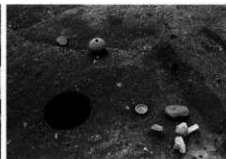

C①S A16遺物出土状況



C①S A17



C①S A18カマド出土状況



C①S A18



C①S A19カマド出土状況



C①S A19

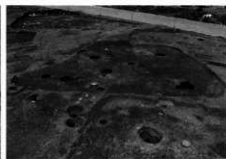

C①S A20



C①S A21カマド出土状況



C①S A21



C①S A22

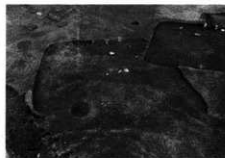

C1S A23



C1S A24カマド出土状況



C1S A24 (外) / 27 (内)



C1S A25カマド出土状況



C1S A25



C1S A26



C1S A28カマド内土器出土状況



C1S A28



C1S A28カマド



C1S A29



55S B1

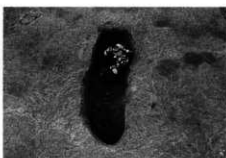

C1S K76



12S D2



23S D1 (右) / 2 (左)



34S D2



46①S D2



49①S D1



52②S D1



55①S D2 (手前) / 3 (奥)



D①S D1



D①S D2



E①S D17



62①S X3



26①S B2



39①S B1 / S H1



54①S B1



C①S B1



33①S H1



52①S H1 / 2



53①S K1



53①S J1



16①S D1



53①S D1 (右) / 2 (左)



4①S E1/2

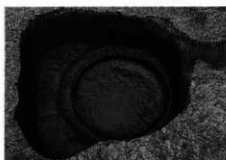

14①S E1



52①S E1



70①S E1

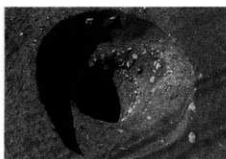

B①S E1



B①S E2

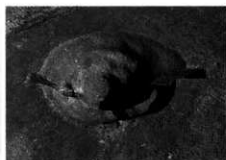

B①S E4

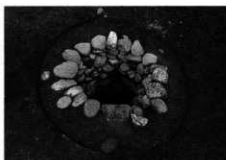

B①S E5



B①S E6



C①S U3石組み検出状況



C①S U3石組み完備



C①S U3断面