

図版 105 縄文時代中期の遺物 (17)

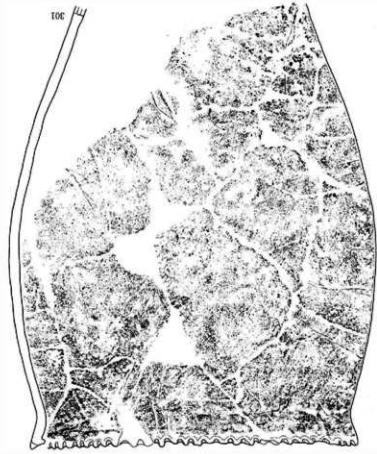

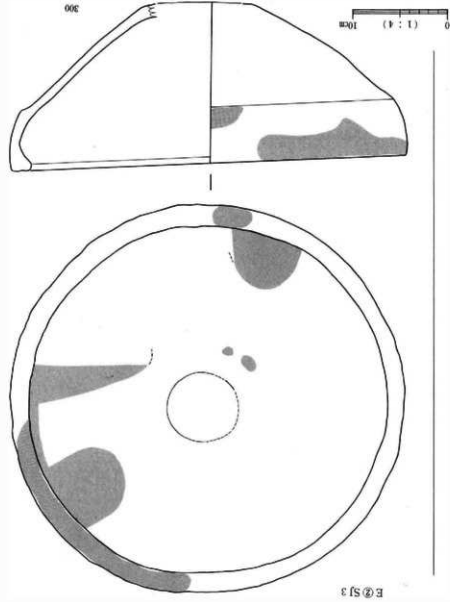
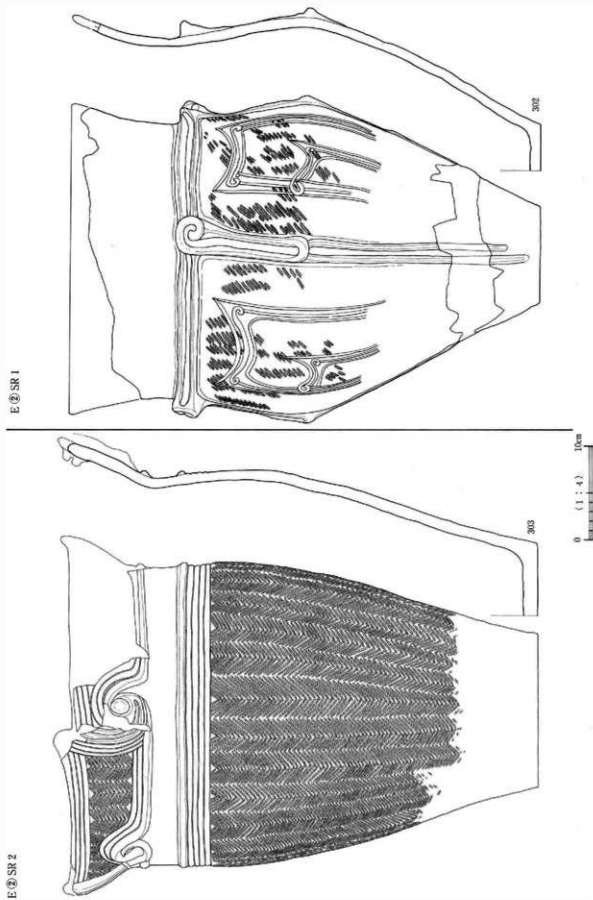

図版 107 縄文時代中期の遺物 (19)

E②SN I

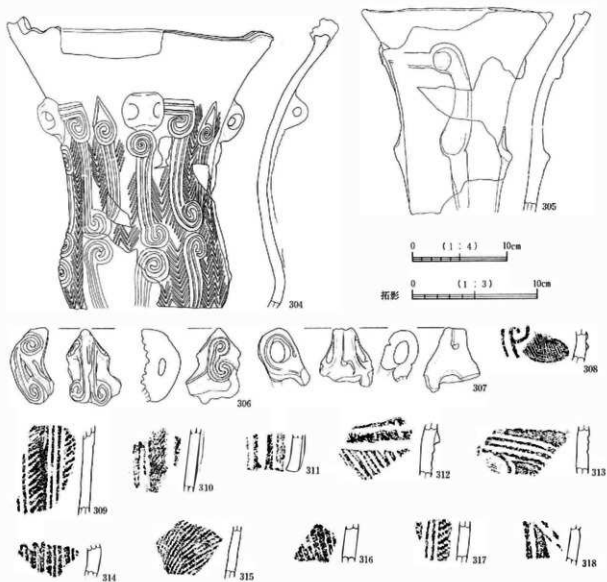

道橋外 (3)

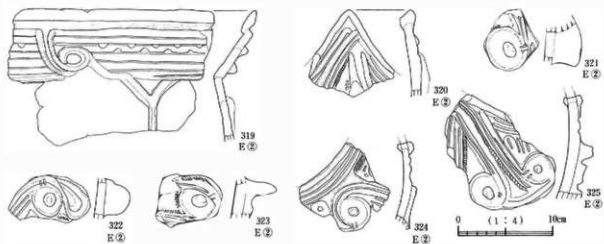

遺物外 (4)

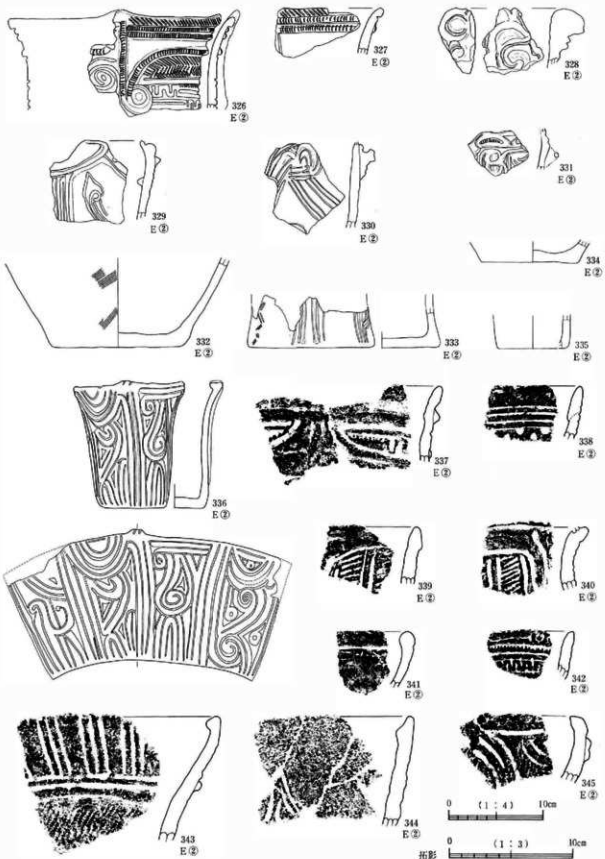

遺構外 (5)

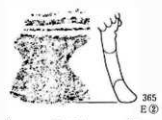
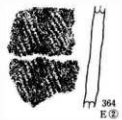
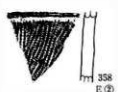
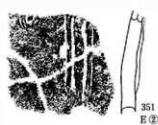

0 (1:3) 10cm
拓影

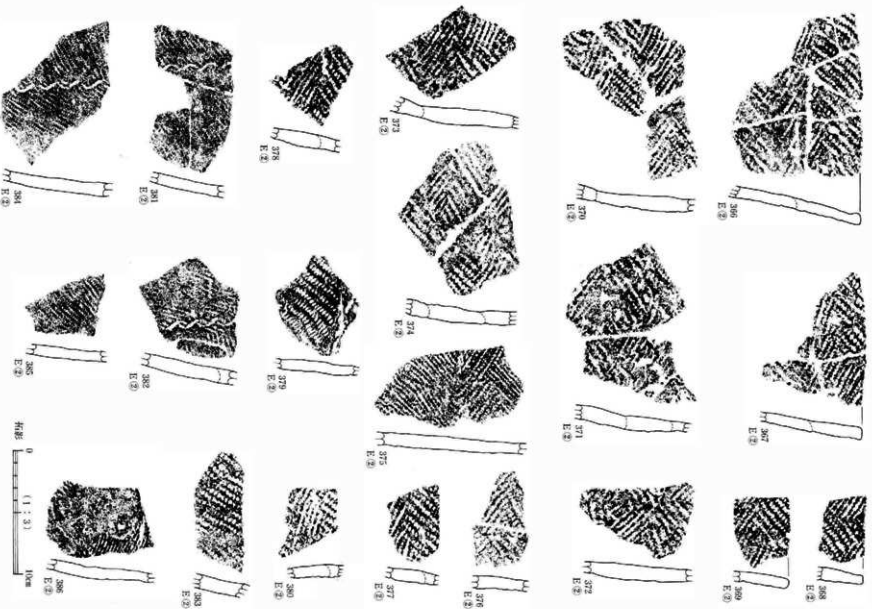

遺情外 (7)

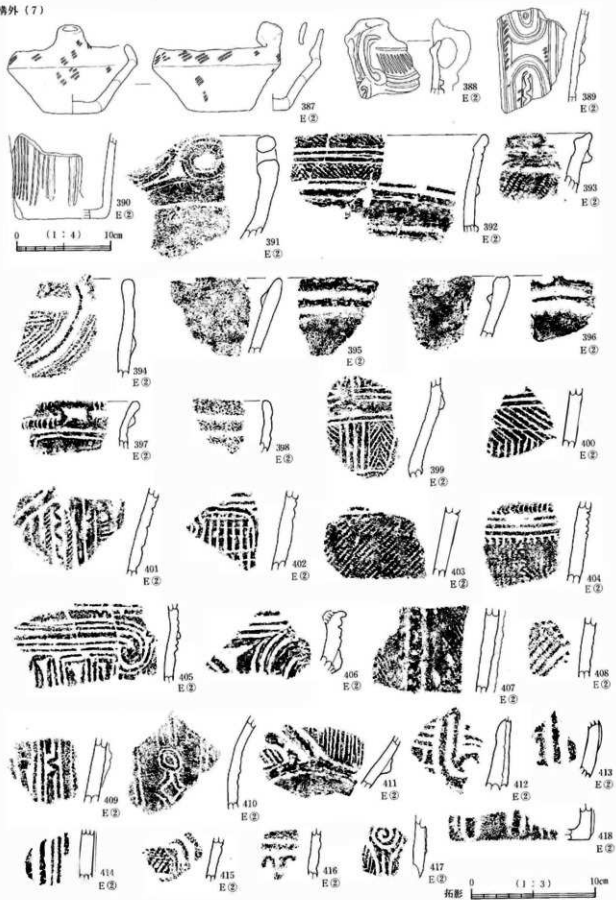

遺物外 (8)

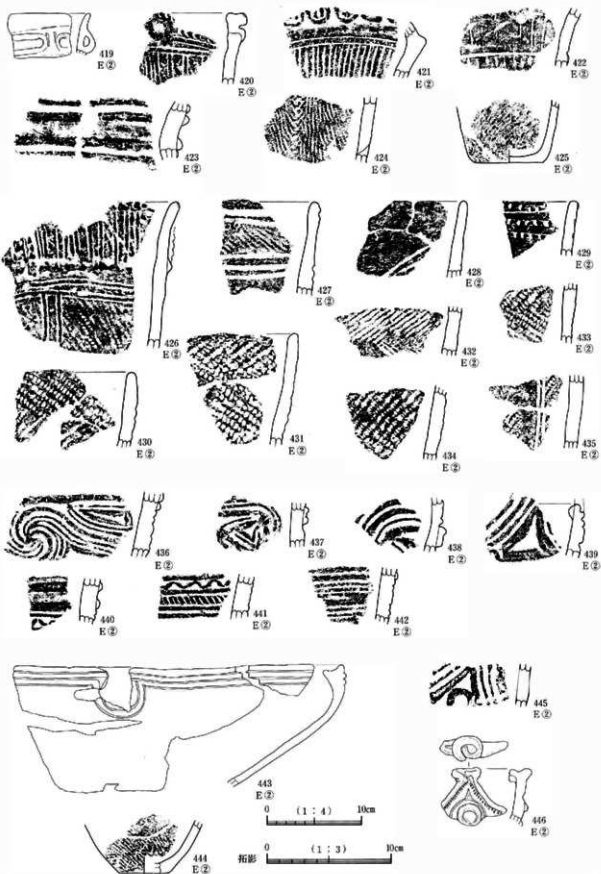

図版 113 縄文時代中期の遺物 (25)

石製品 (1)

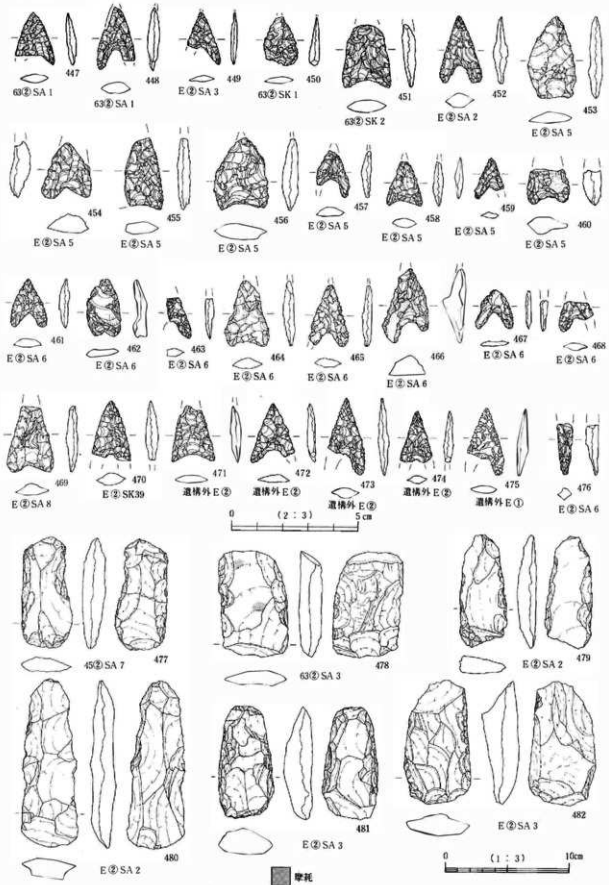

石製品 (2)

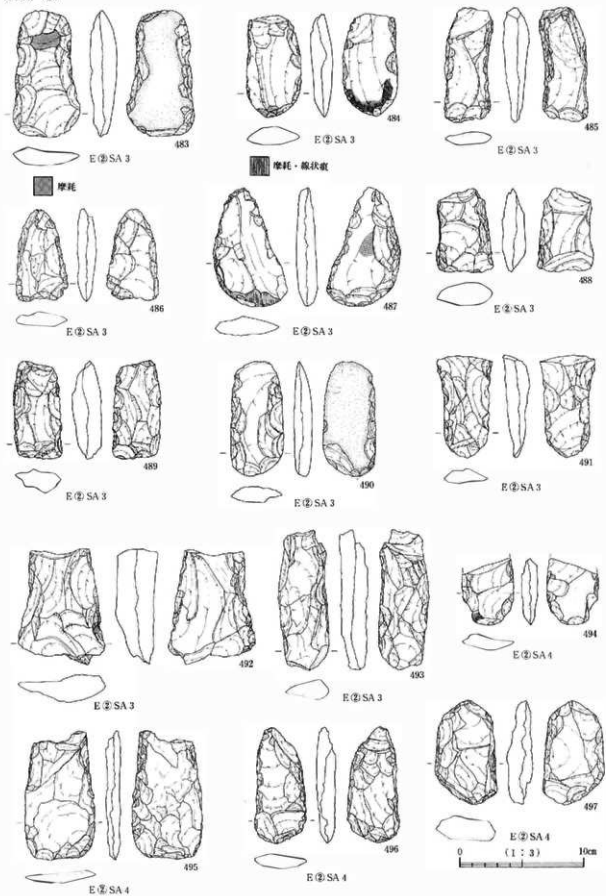

図版 115 縄文時代中期の遺物 (27)

石製品 (3)

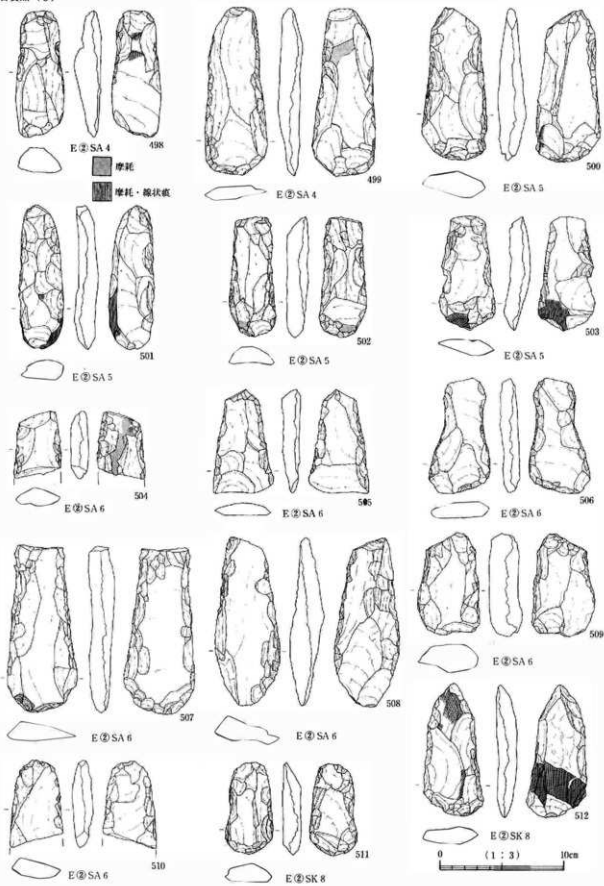

石製品 (4)

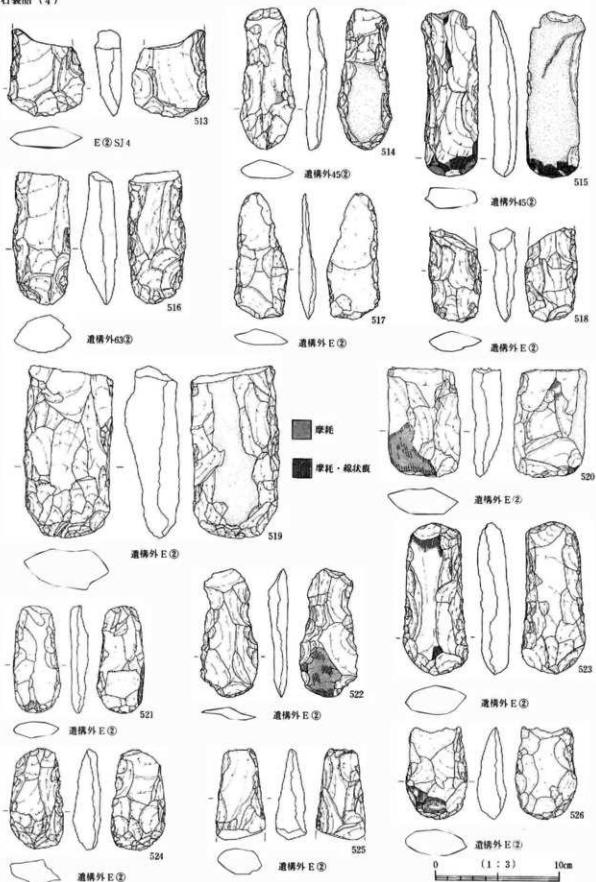

石製品 (5)

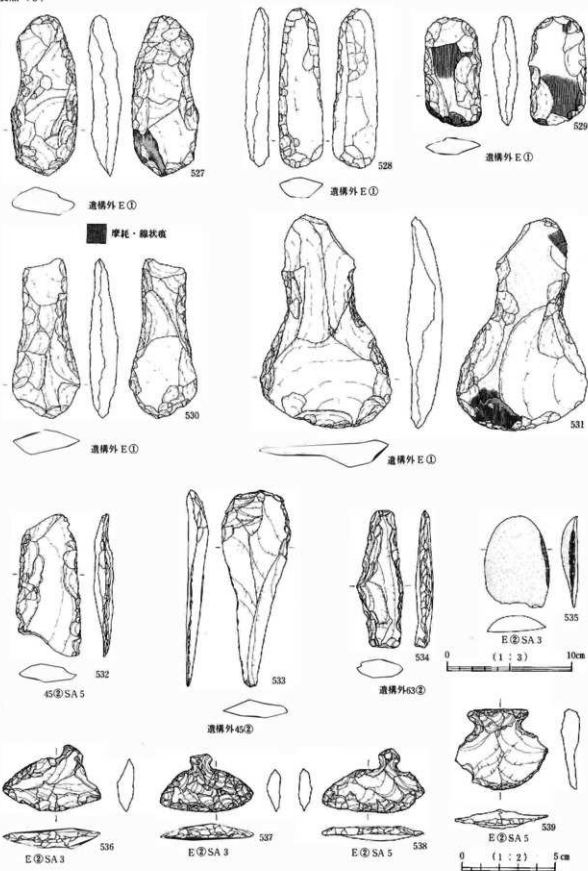

石製品 (6)

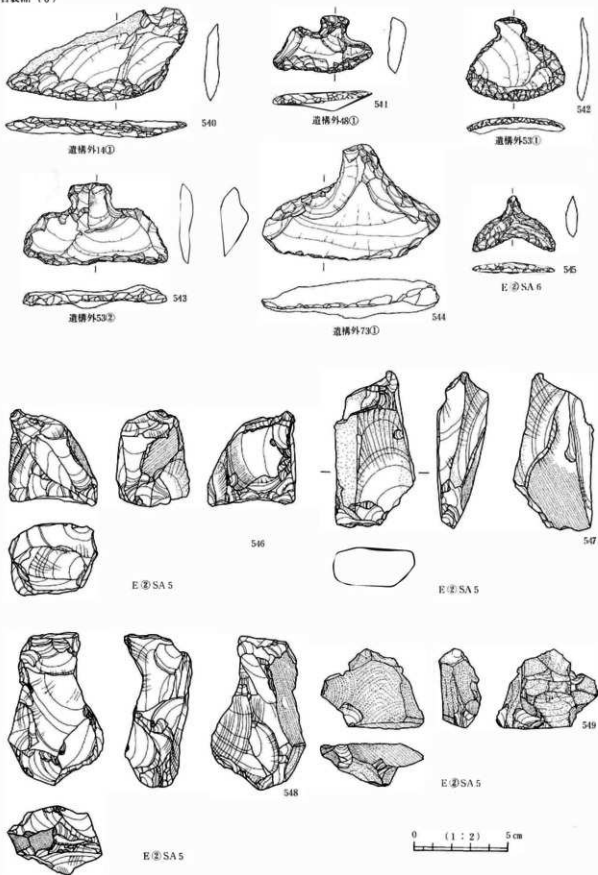

石製品 (7)

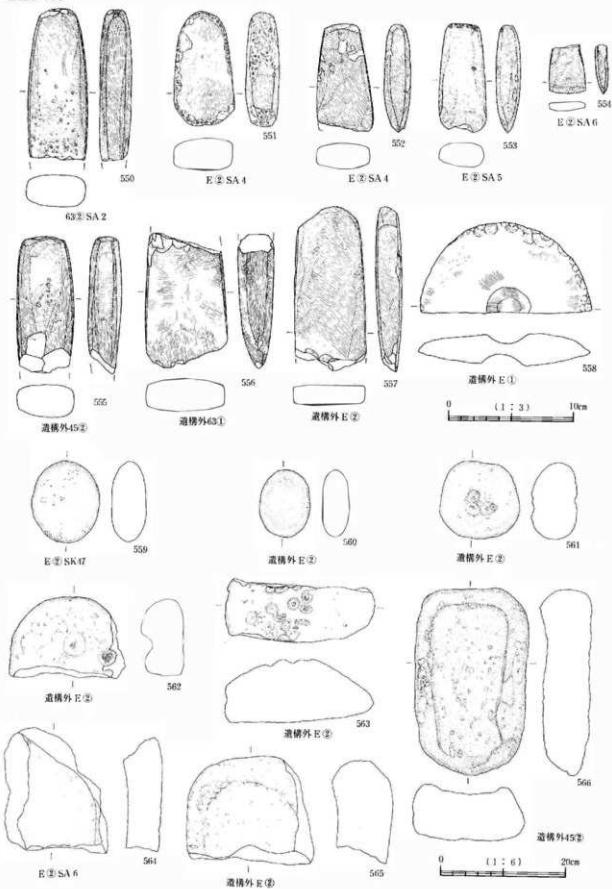

石製品 (8)

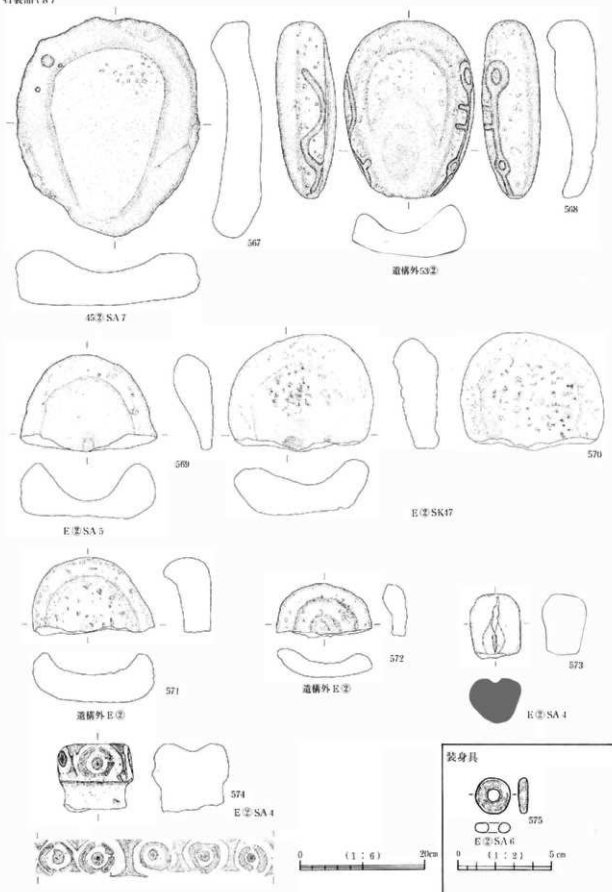

土製品

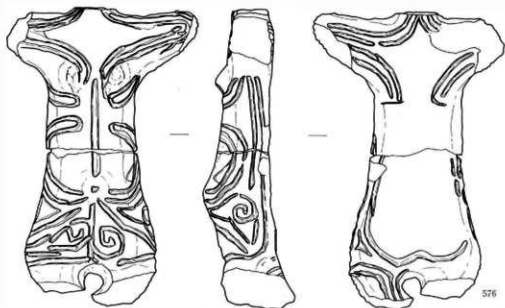

60 SA 1

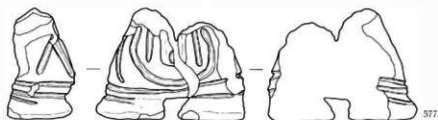

F SA 4



E SA 3

遺構外 E ②



E SA 6

遺構外 E ②

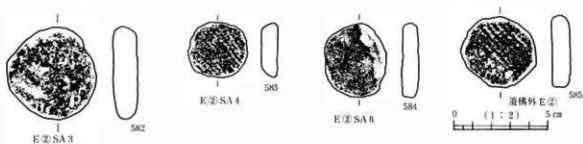

E SA 3

E SA 4

E SA 6

遺構外 E ②

0 (1:2) 5 cm

1① SA 1

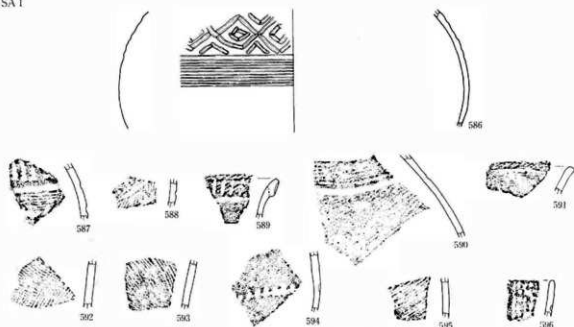

1① SA 2

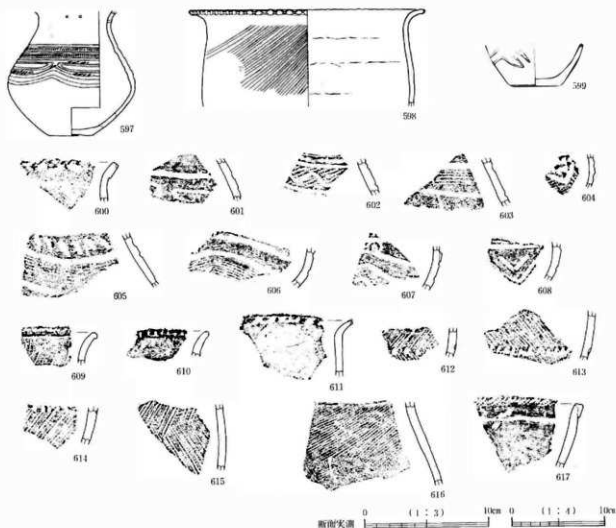

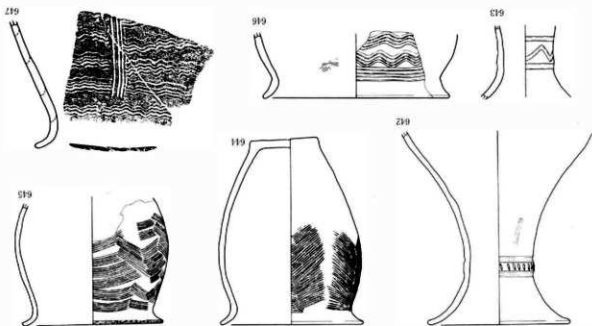

101 SA 1

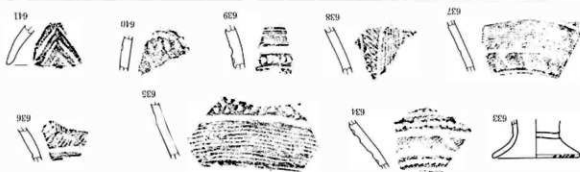

101 SA 2

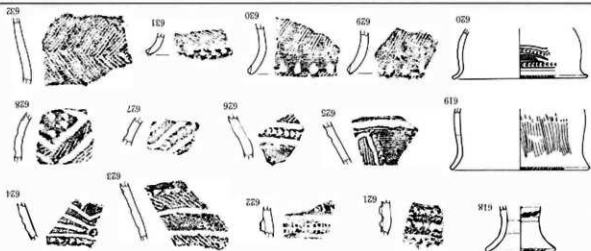

101 SA 1

図版 124 弥生時代中期の遺物 (3)

18① SA 1

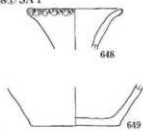

29① SA 1

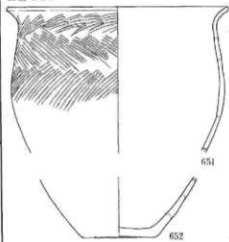

29① SA 2

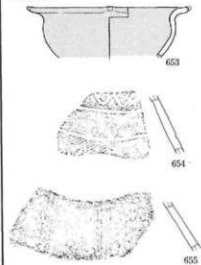

25① SA 1



30① SA 1

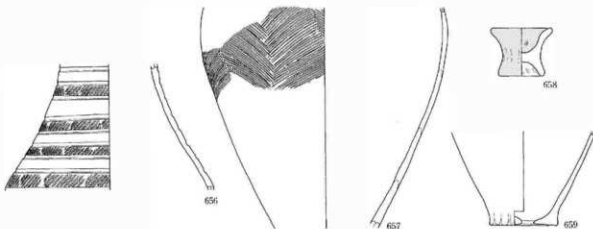

32① SA 1 (1)

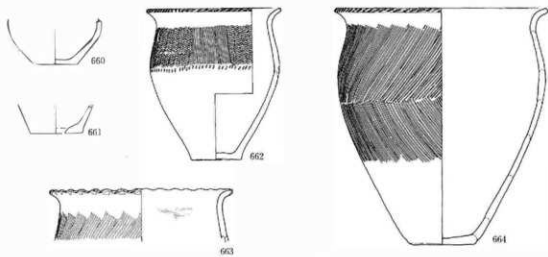

図版 125 弥生時代中期の遺物 (4)

320 SA 1 (2)

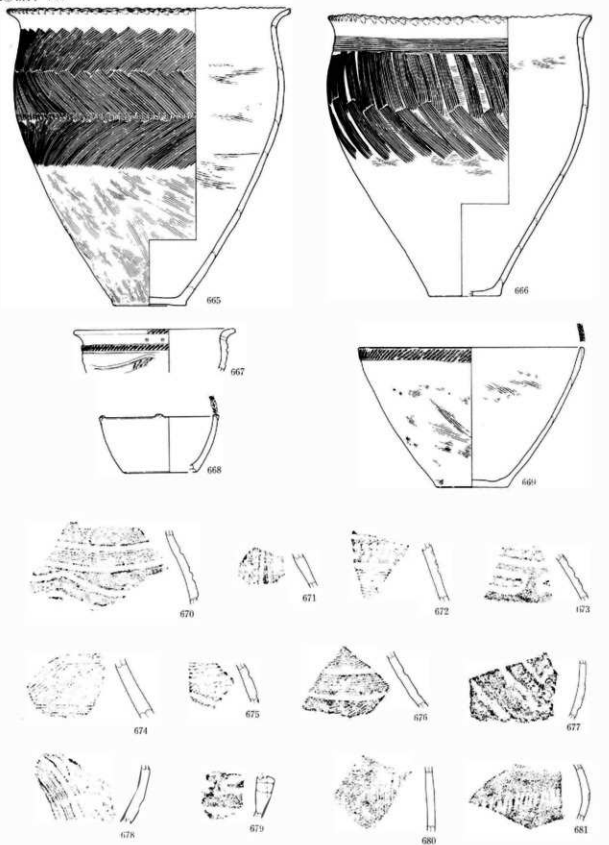

0 (1:3) 10cm 0 (1:4) 10cm
 前面実測

図版 126 弥生時代中期の遺物 (5)

34① SA 4



43① SA 2

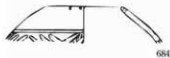

50① SA 10



51① SA 2



52② SA 1

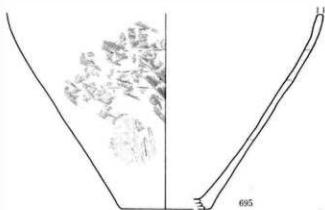
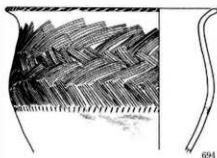

0 (1:3) 10cm 0 (1:1) 10cm

図版 127 弥生時代中期の遺物 (6)

532 SA 3

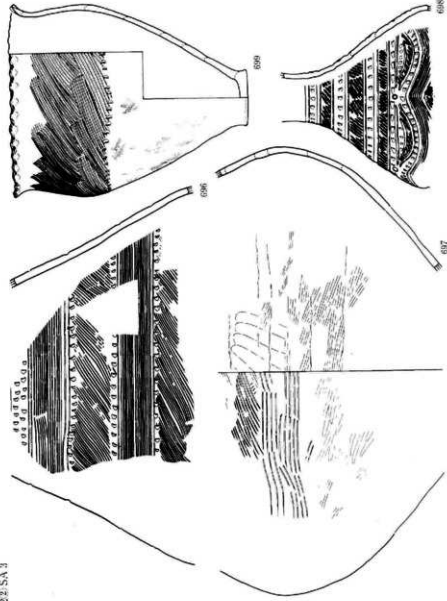

532 SA 3



532 SA 7

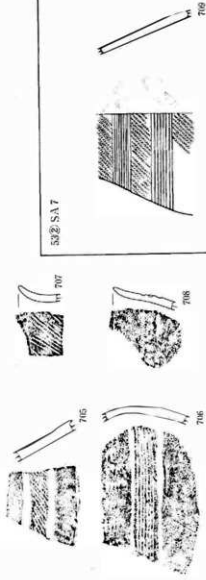

532 SA11 (1)

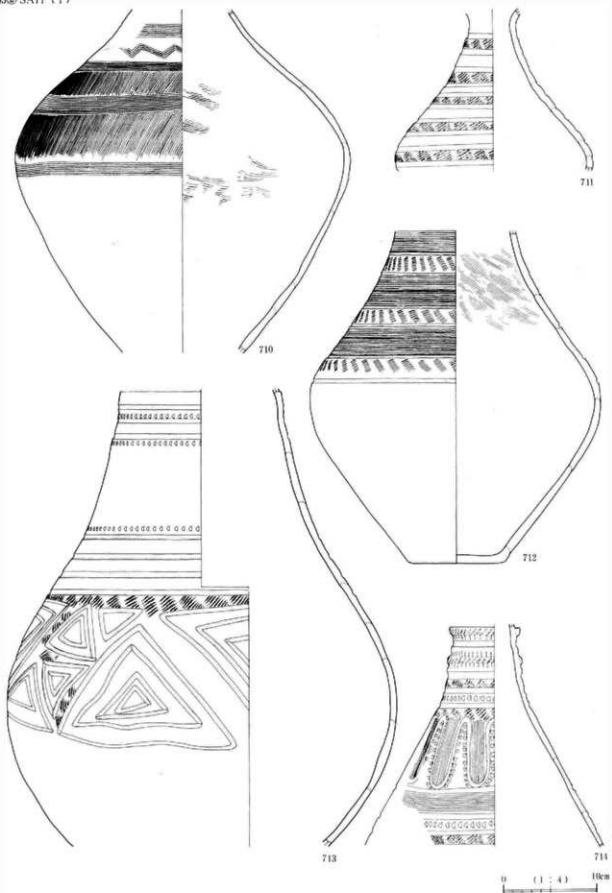

図版 129 弥生時代中期の遺物 (8)

337 SA11 (2)

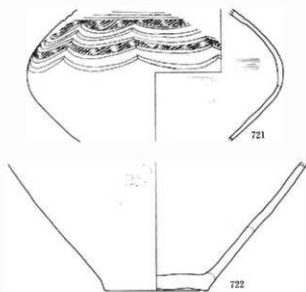
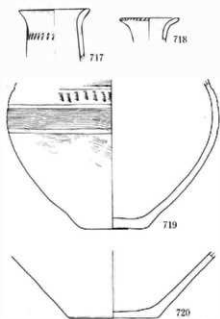
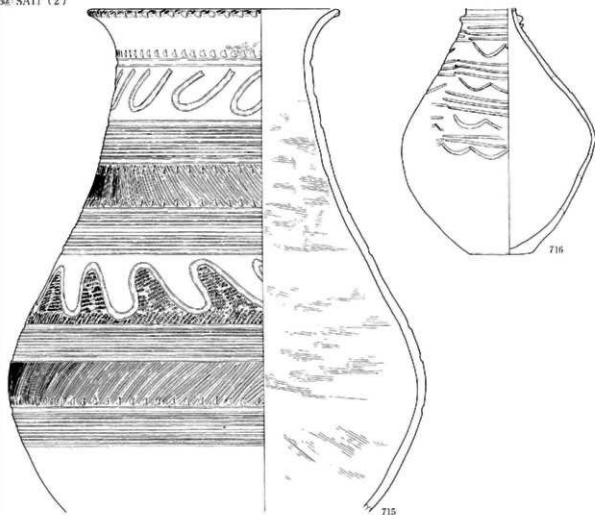

0 (1:4) 10cm

図版 130 弥生時代中期の遺物 (9)

53② SA11 (3)

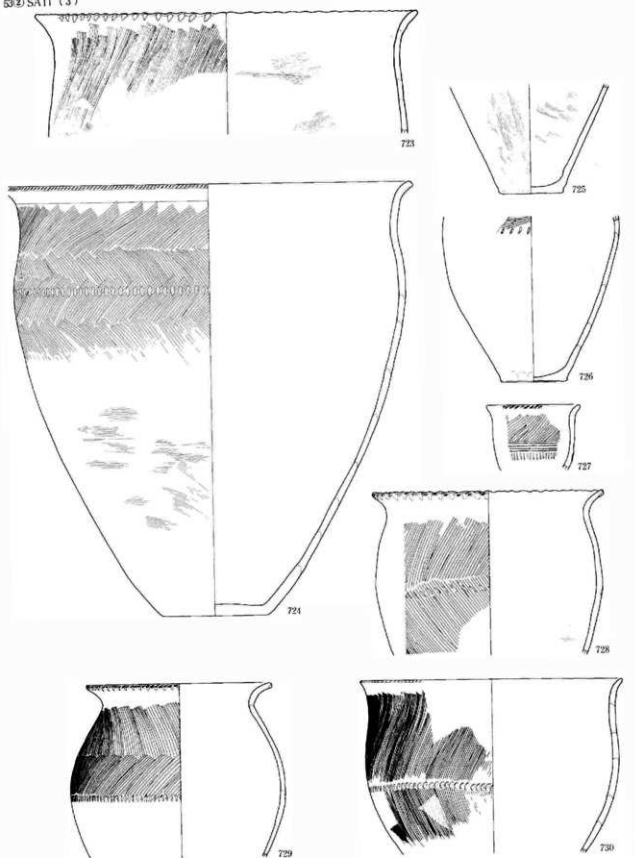

0 5 10c

382) SAI1 (4)

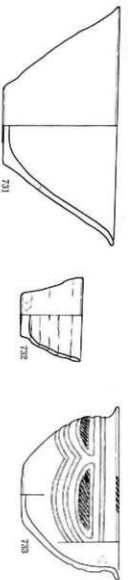

694) SAI 1

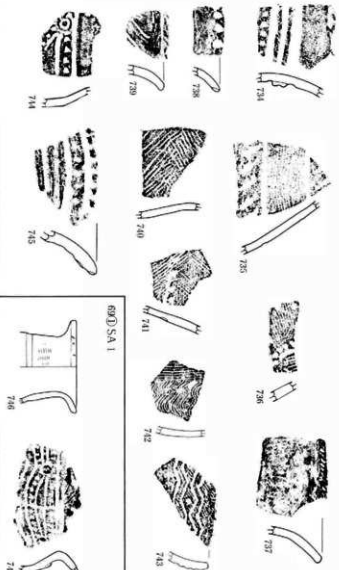

740) SAI 1

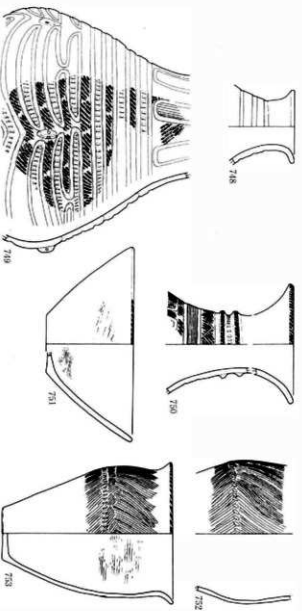

図版 132 弥生時代中期の遺物 (11)

74Q SA 2

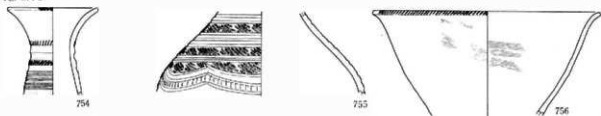

75Q SA 1

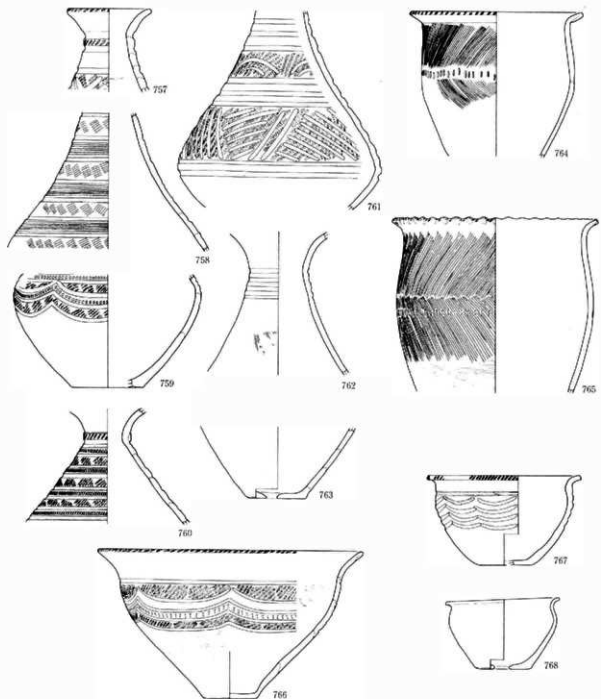

0 (1 : 4) 10cm

図版 133 弥生時代中期の遺物 (12)

B ② SA 5

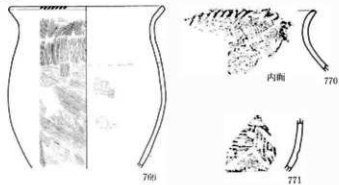

B ② SA 6

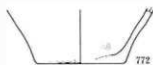

C ② SA13

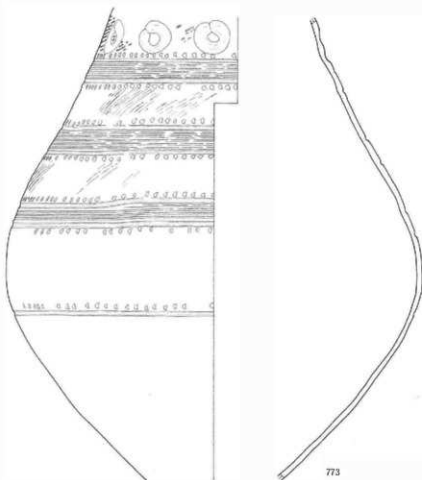

断面実測 0 (1:3) 10cm 0 (1:4) 10cm

図版 134 弥生時代中期の遺物 (13)

C@SAIH

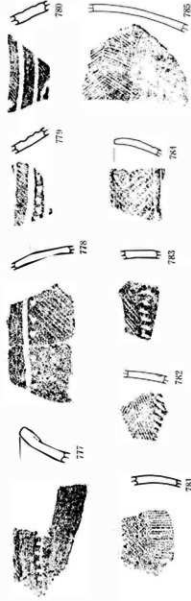

C@SAI19

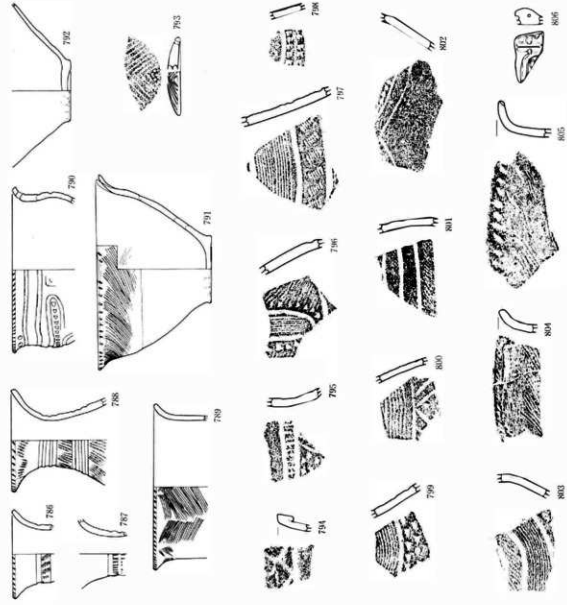

0 10cm (1:3) 0 10cm (1:4)

図版 135 弥生時代中期の遺物 (14)

C ② SA20 (1)

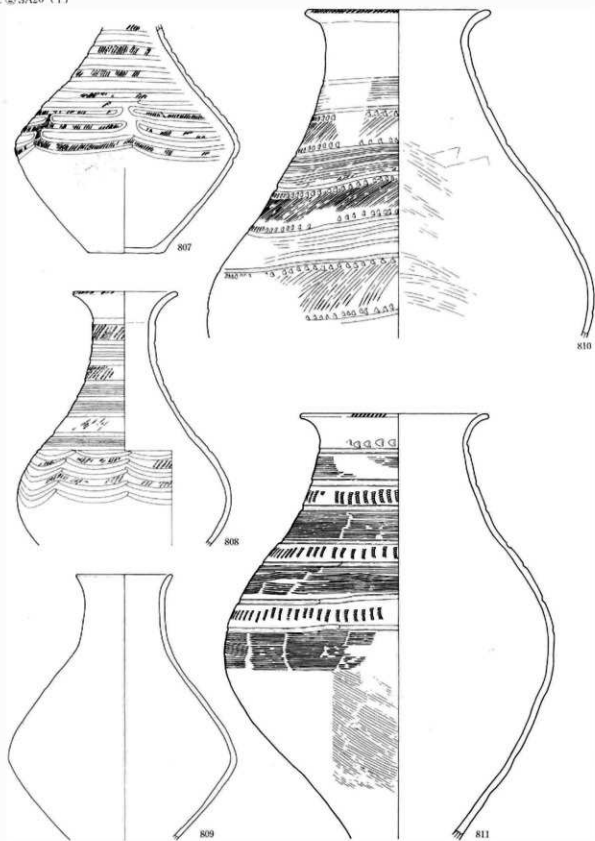

0 (1:4) 10cm

図版 136 弥生時代中期の遺物 (15)

C② SA20 (2)

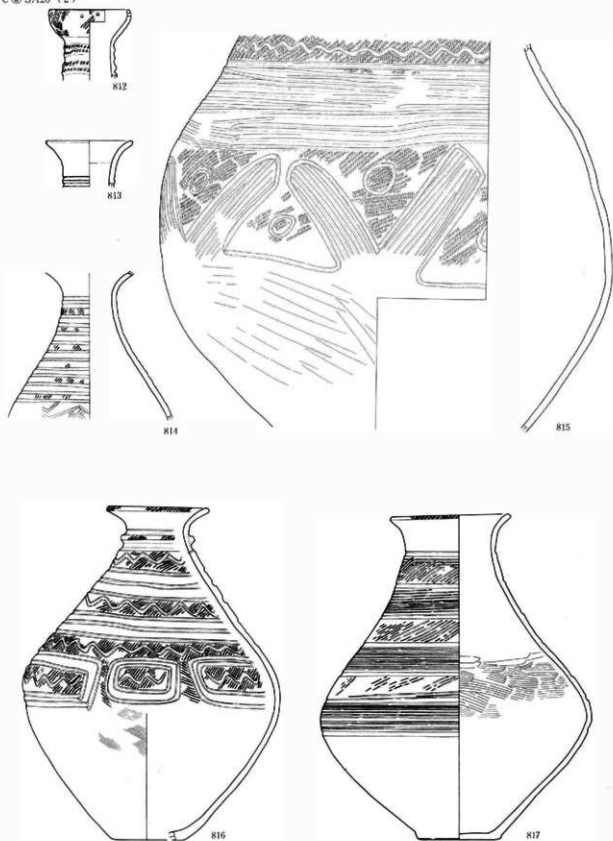

図版 137 弥生時代中期の遺物 (16)

C② SA20 (13)

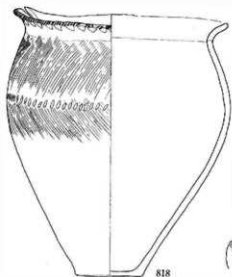

818

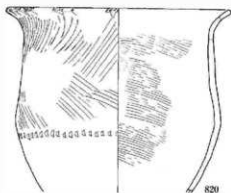

820



821



822

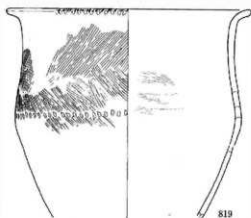

819

C② SA27

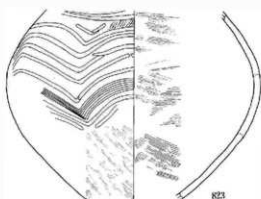

823

E① SA 1

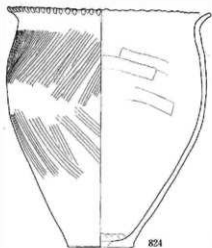

824



825



827

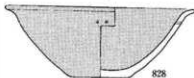

828

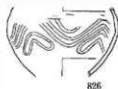

826

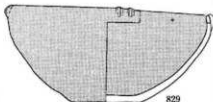

829

0 (1:4) 10cm

図版 138 弥生時代中期の遺物 (17)

18① SK 4

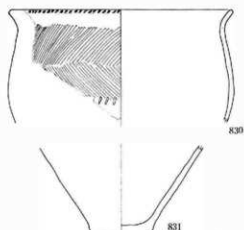

60① SK 3

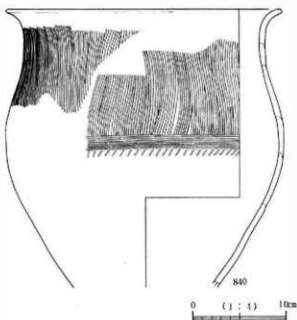
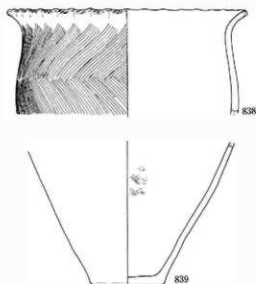
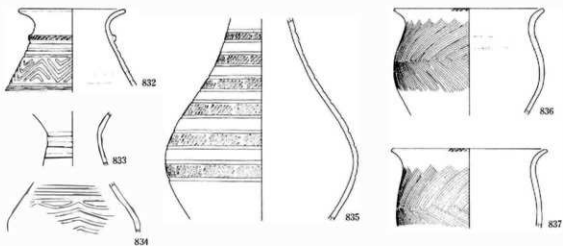

図版 139 弥生時代中期の遺物 (18)

29㉔ SK 10

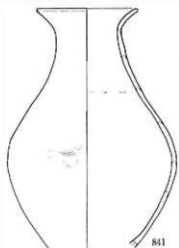

29㉕ SK 2

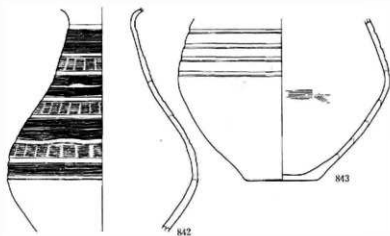

64㉔ SK 1

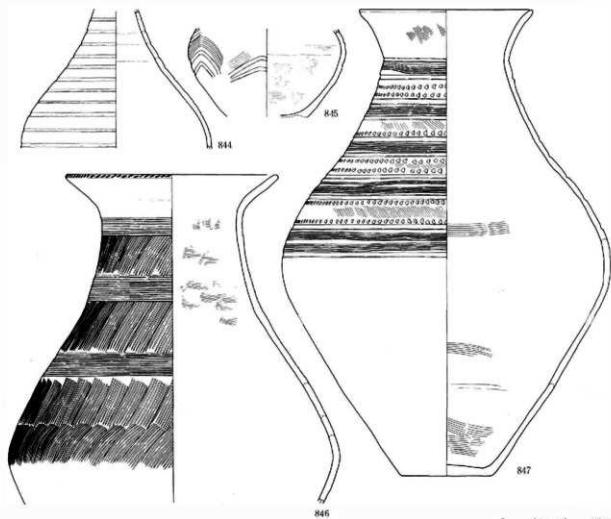

0 (1:4) 10cm

図版 140 弥生時代中期の遺物 (19)

C② SK I ⑨

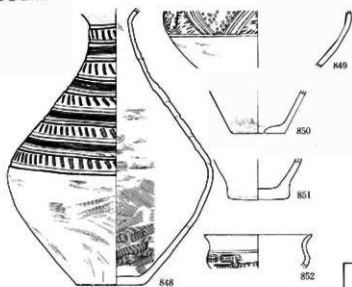

C② SK III

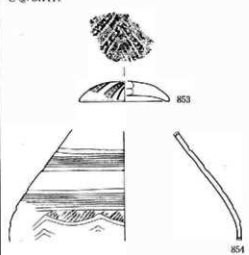

27① SD 1

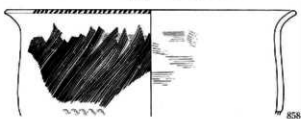
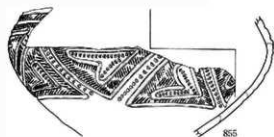

3① SX 1



25① SX 1



断面実測 0 (1:3) 10cm 0 (1:4) 10cm

図版 141 弥生時代中期の遺物 (20)

石製品 (1)

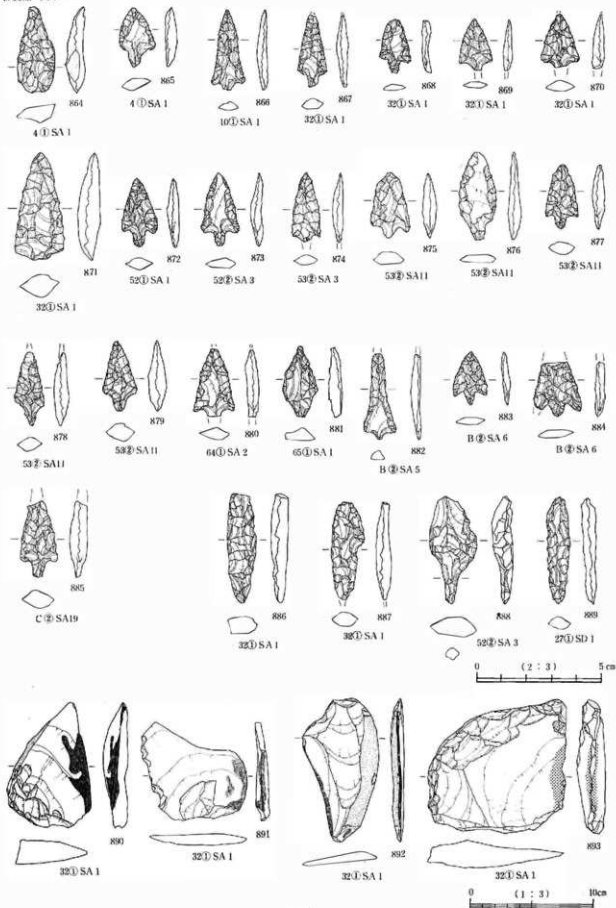

図版 142 弥生時代中期の遺物 (21)

石製品 (2)

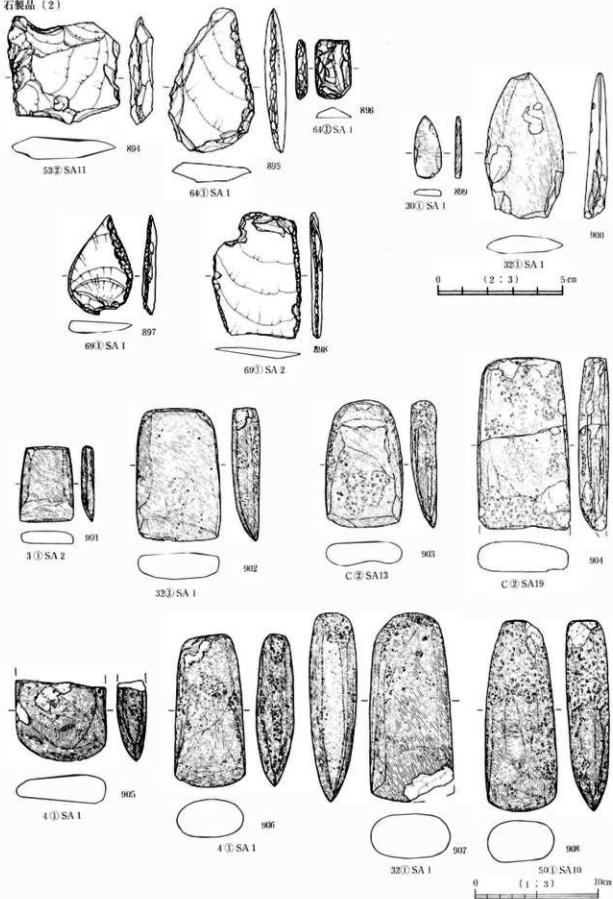

図版 143 弥生時代中期の遺物 (22)

石製品 (3)

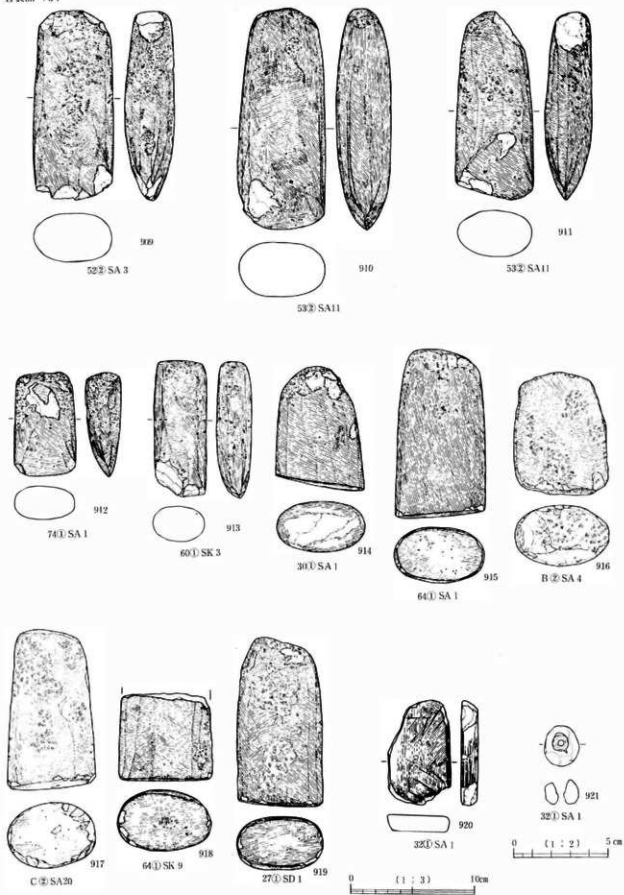

図版 144 弥生時代中期の遺物 (23)

土製品

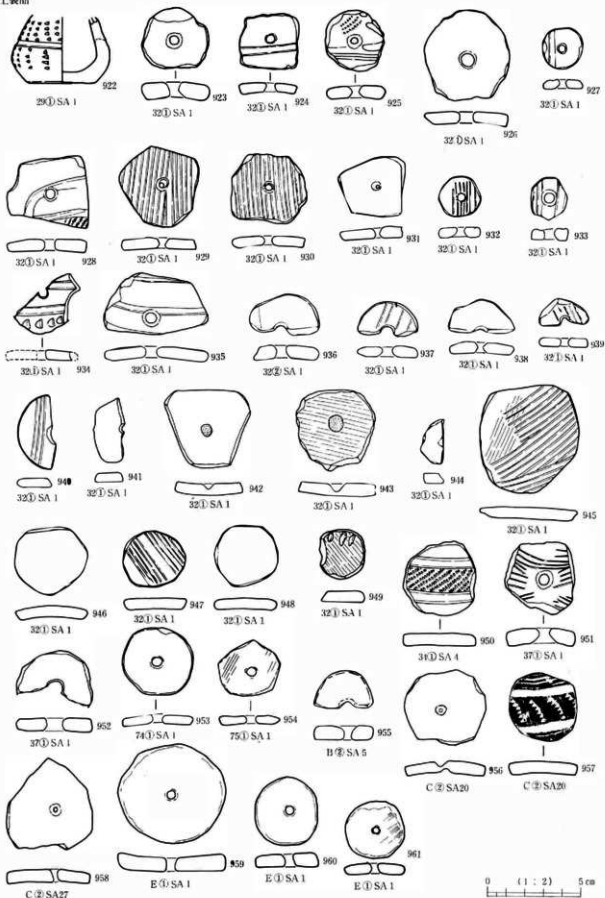

図版 145 弥生時代中期の遺物 (24)

装身具

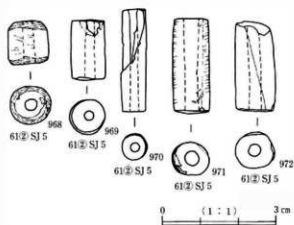
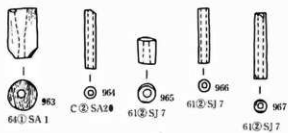
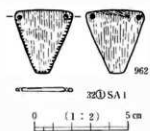

図版 146 弥生時代後期の遺物 (1)

33㉔ SA 2

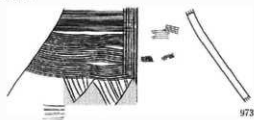

46㉔ SA 2

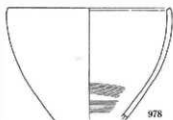

46㉔ SA 3



50㉔ SA 1

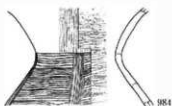

46㉔ SA 1

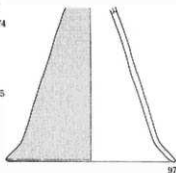

50㉔ SA 7

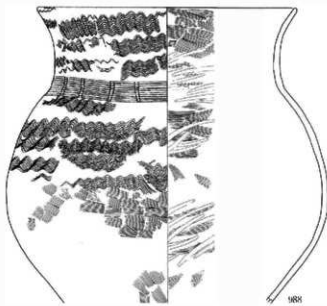
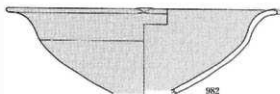
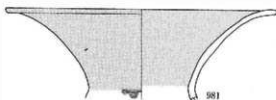

0 (1:4) 10cm

図版 147 弥生時代後期の遺物 (2)

50㉔SA 2

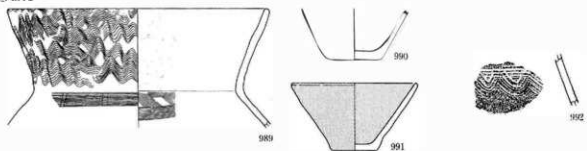

50㉔SA 3

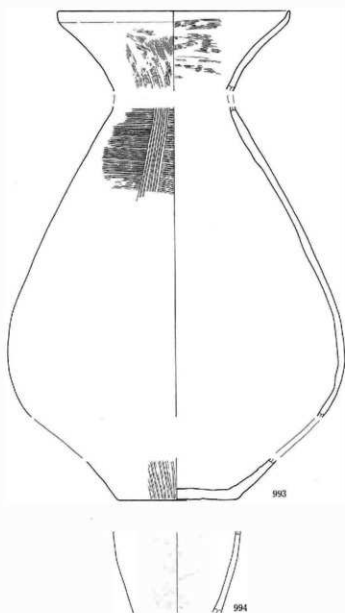

0 (1:3) 10cm 0 (1:4) 10cm
 断面実測

50㉔ SA 4

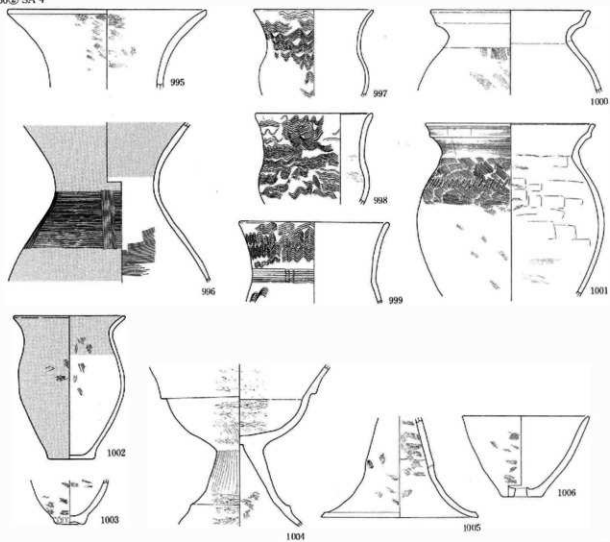

50㉔ SA 6

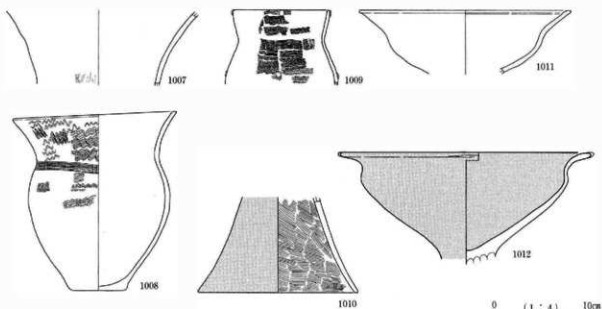

0 (1 : 4) 10cm

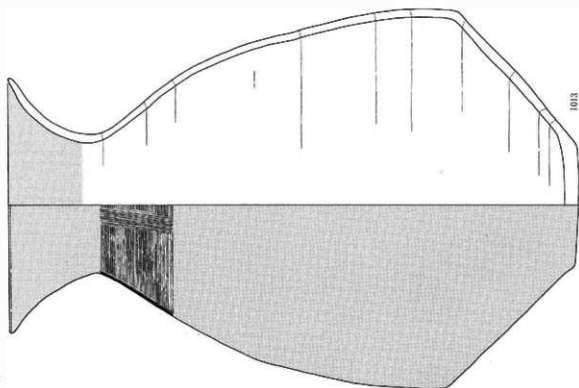
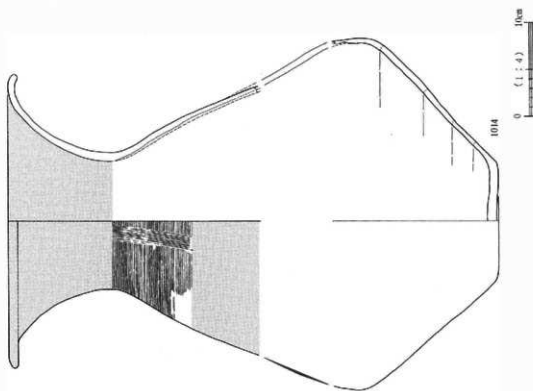

50 SA 7 (1)

図版150 弥生時代後期の遺物 (5)

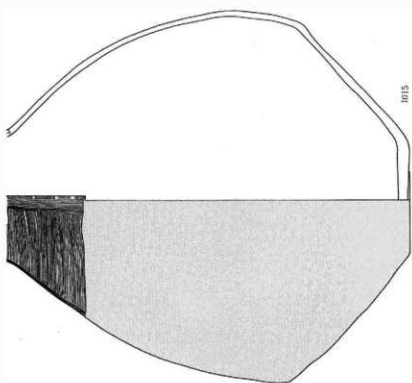
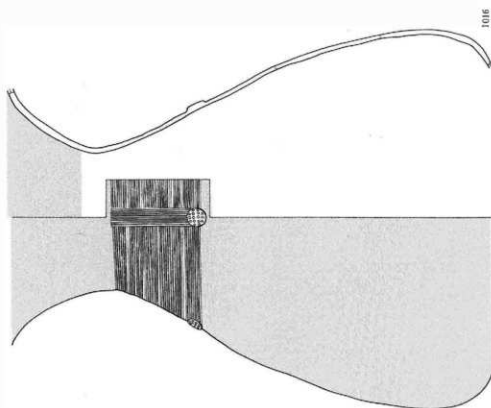

302 SA 7 (2)

50㉔SA7(3)

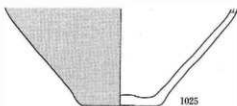
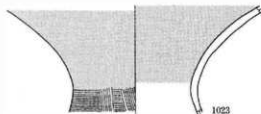
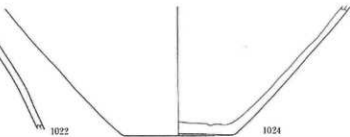
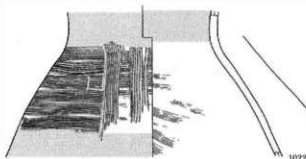
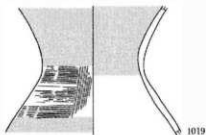
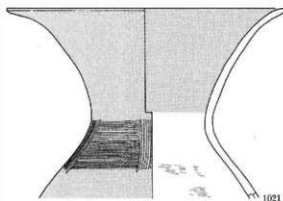
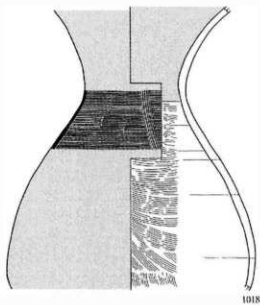
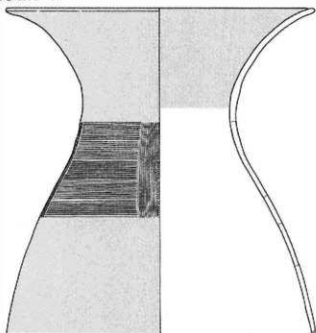

0 (1:4) 10cm

図版 152 弥生時代後期の遺物 (7)

50② SA 7 (4)

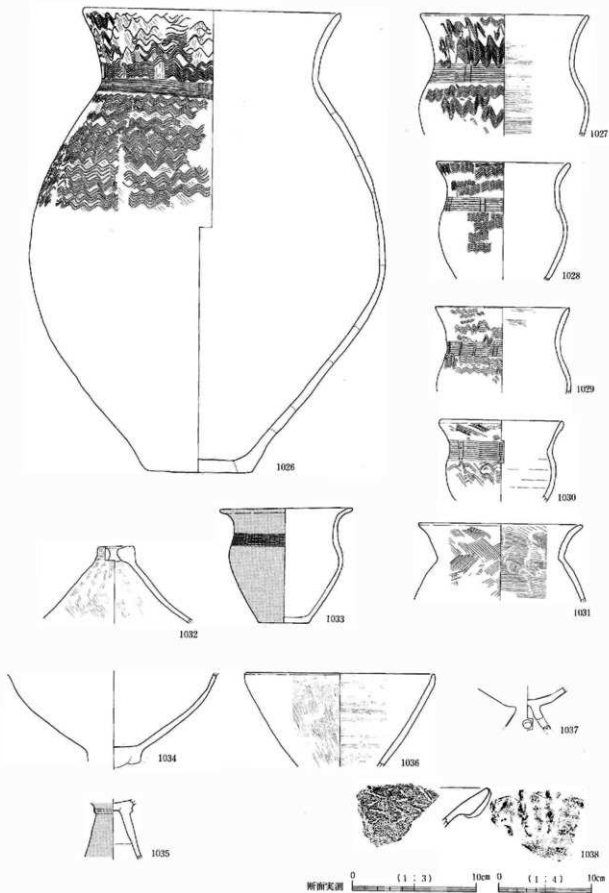

図版 153 弥生時代後期の遺物 (8)

50㉔ SA 8

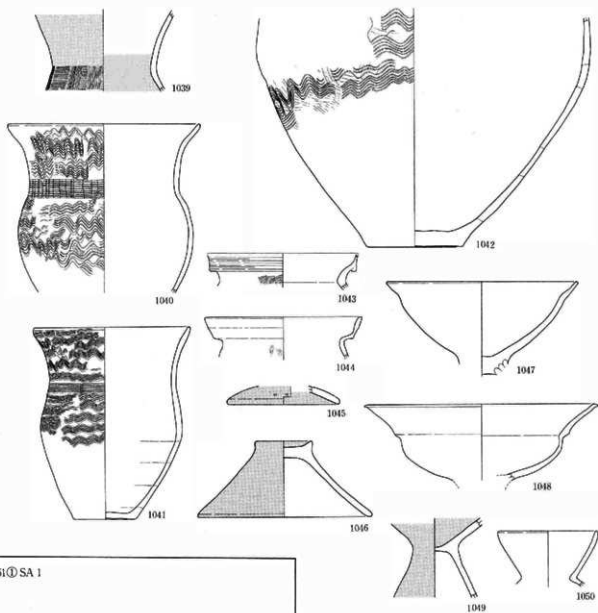

51㉑ SA 1

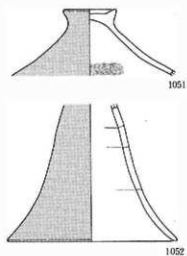

51㉒ SA 1

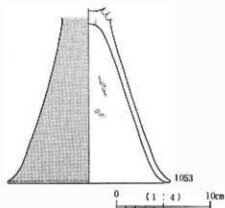

図版 154 弥生時代後期の遺物 (9)

51② SA 2

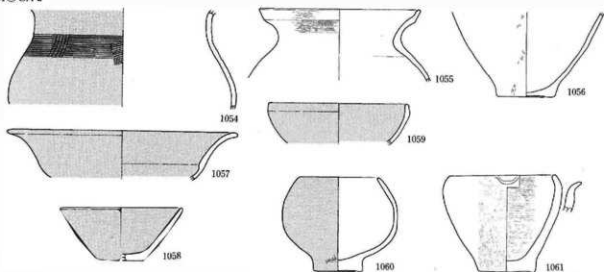

52① SA 5

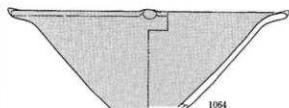
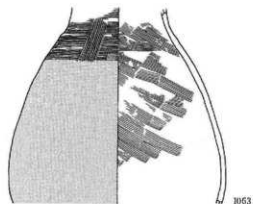
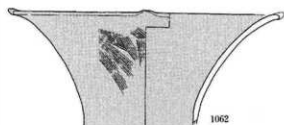

52① SA 7



52② SA 2

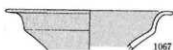

53② SA 1

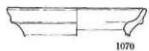
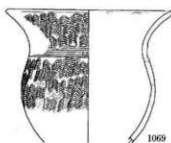
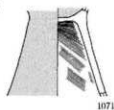
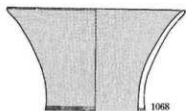

図版 155 弥生時代後期の遺物 (10)

53㉔ SA 5

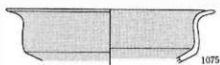

55㉔ SA 3

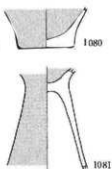
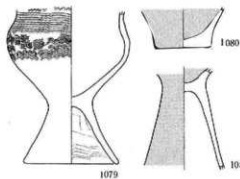
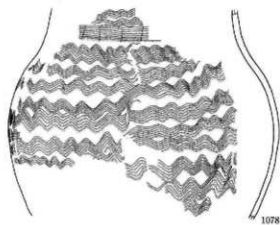
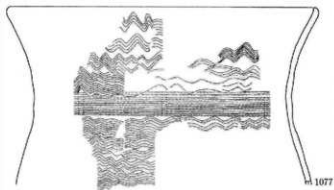

55㉔ SA 1 (1)

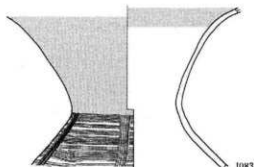
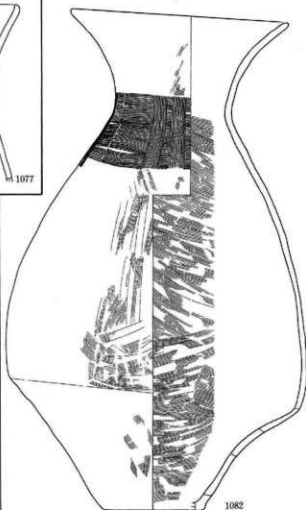

0 (1 : 4) 10cm

図版 156 弥生時代後期の遺物 (11)

55② SA 1 (2)

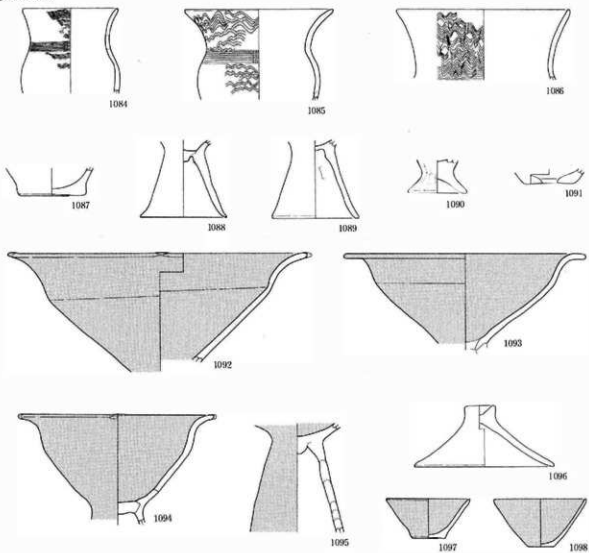

56② SA 1

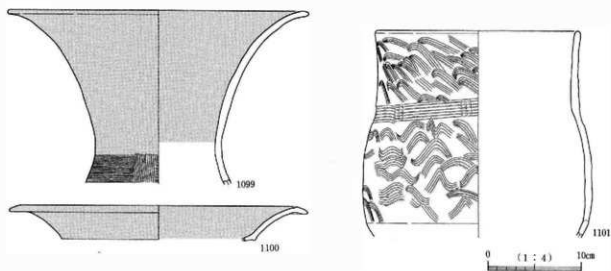

図版 157 弥生時代後期の遺物 (12)

56㉔ SA 3

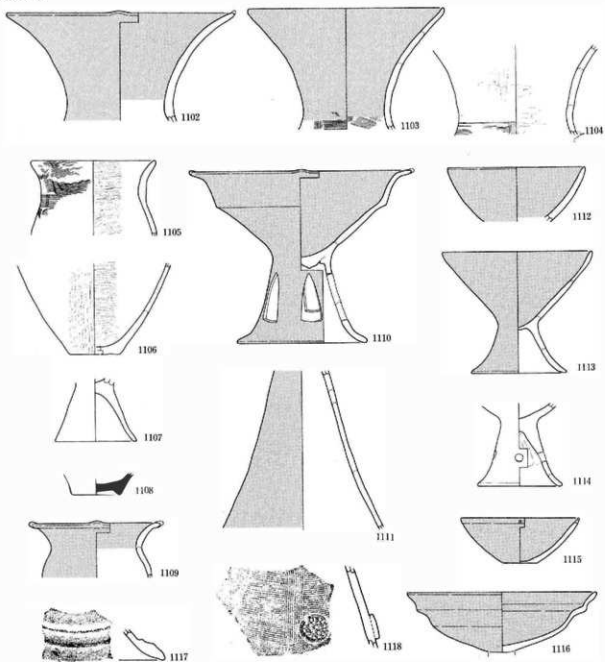

57㉔ SA 1

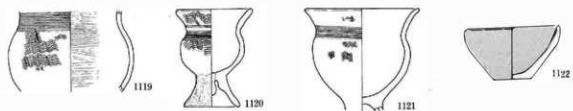

断面実測 0 (1:3) 10cm 0 (1:4) 10cm

57㉔ SA 5 (1)

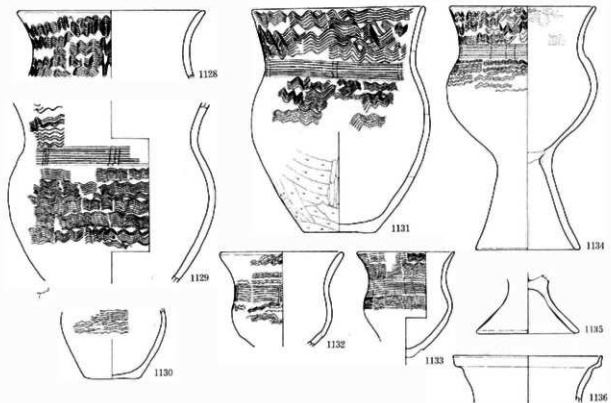
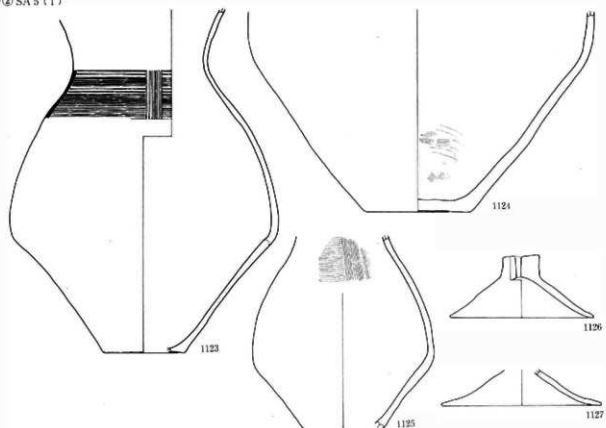

0 (1:4) 10cm

図版 159 弥生時代後期の遺物 (14)

57㉔ SA 5 (2)

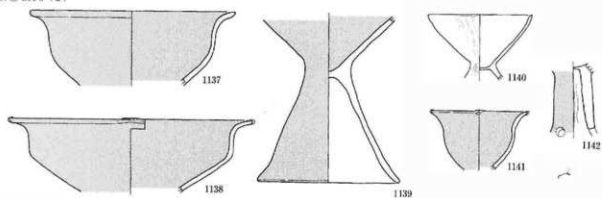

60㉔ SA 2

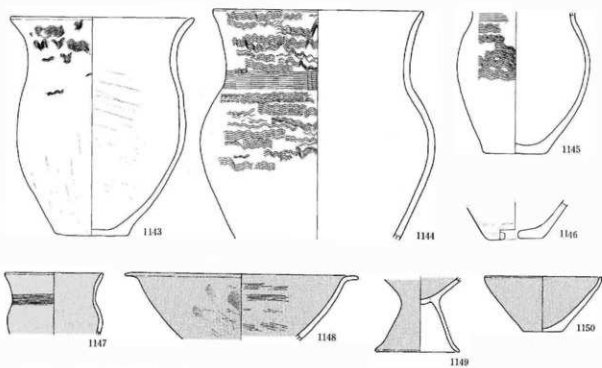

61㉔ SA 6

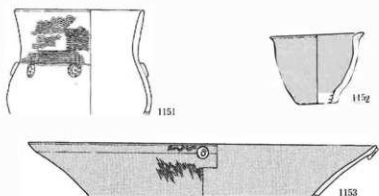

図版 160 弥生時代後期の遺物 (15)

60㉔ SA 4

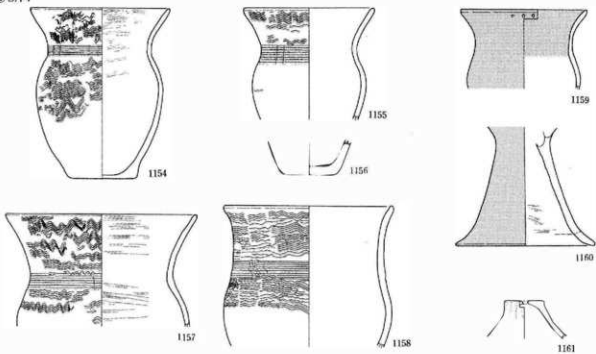

62㉔ SA 1

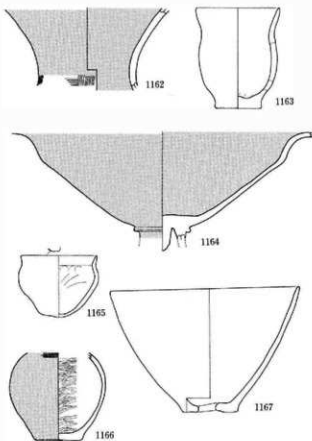

70㉔ SA 1

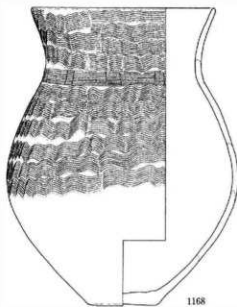

0 (1:4) 10cm

図版 161 弥生時代後期の遺物 (16)

78D SA 2

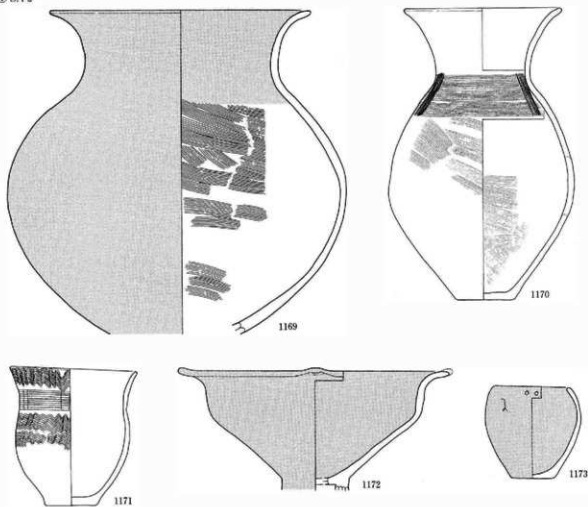

78D SA 6

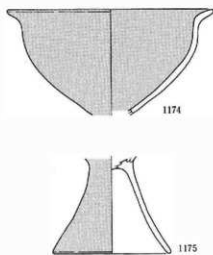

0 (1:4) 10cm

図版 162 弥生時代後期の遺物 (17)

79① SA 2

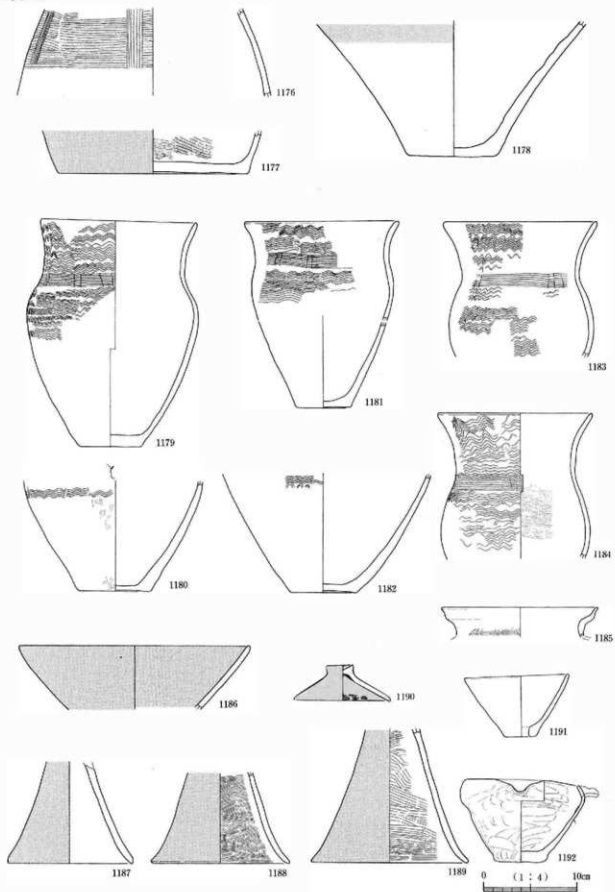

B②SA2(1)

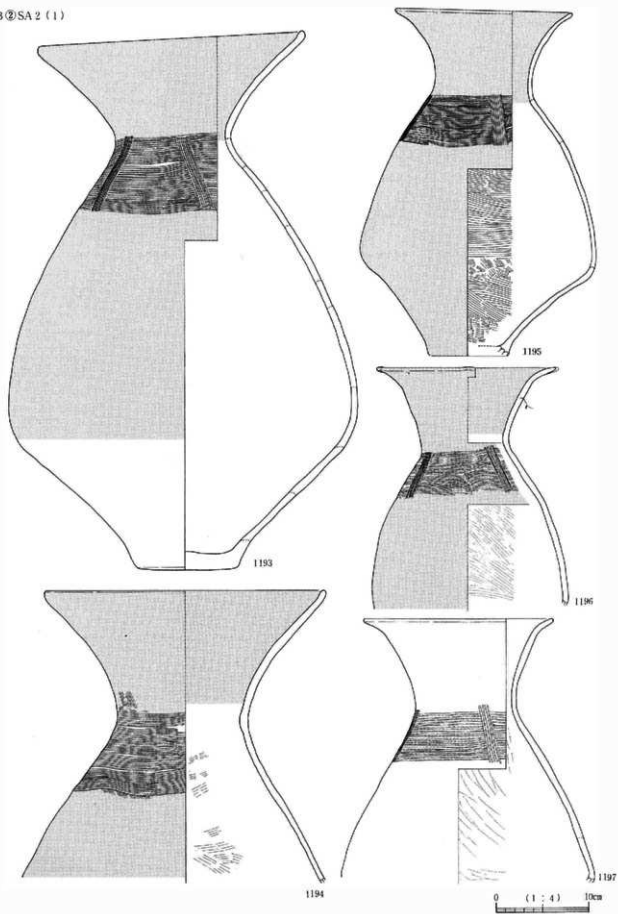

図版 164 弥生時代後期の遺物 (19)

B②SA 2 (2)

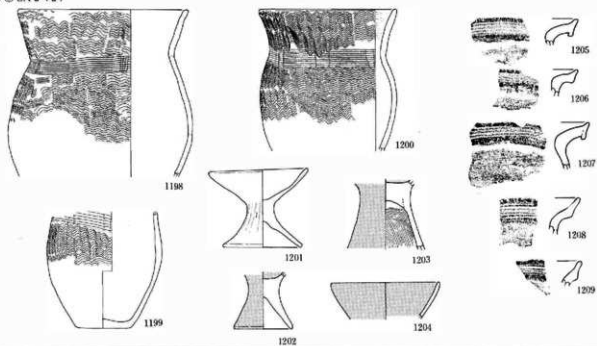

B②SA 3 (1)

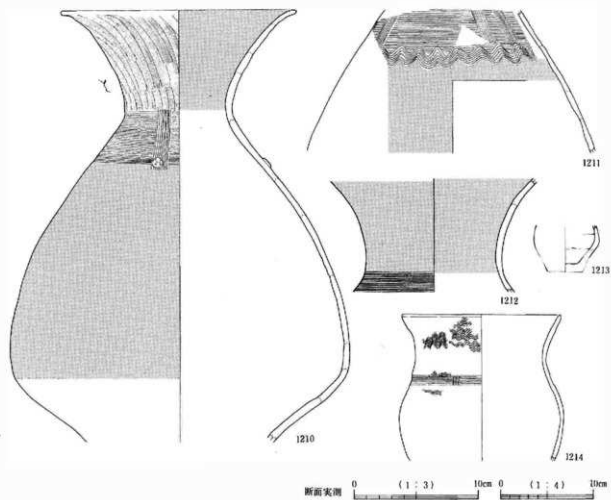

B②SA3 (2)

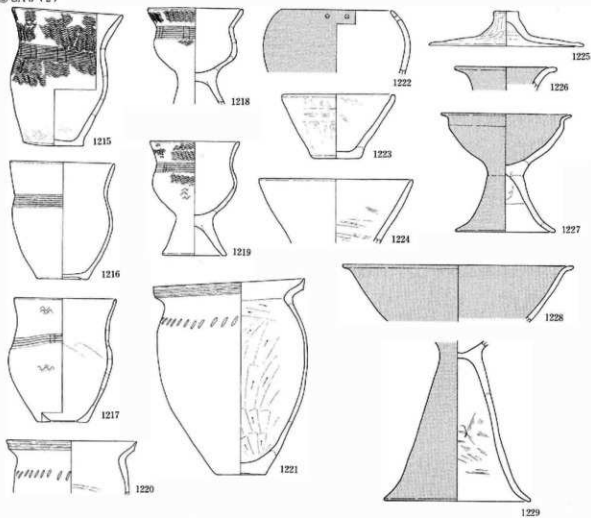

B②SA7 (1)

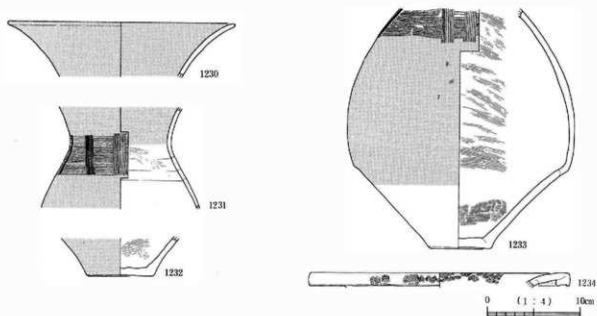

B②SA7(2)

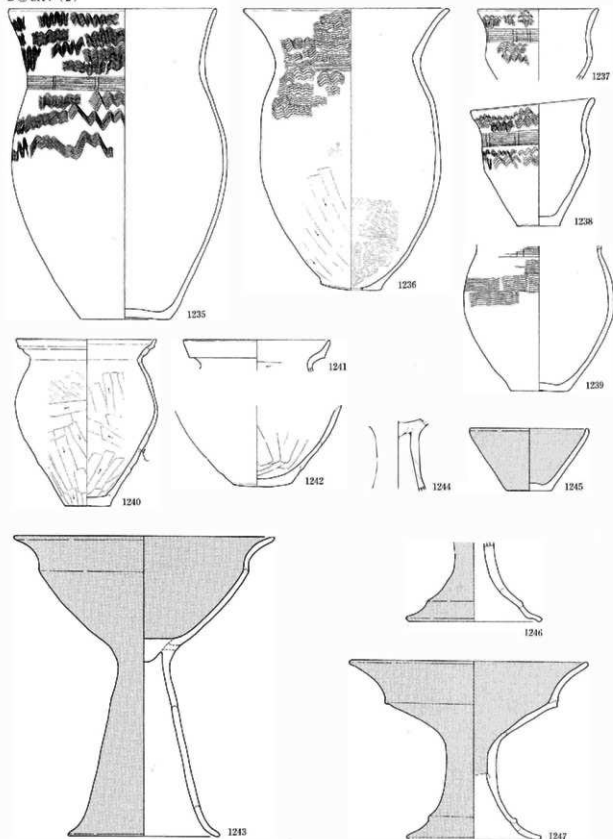

0 (1:4) 10cm

図版 167 弥生時代後期の遺物 (22)

B ② SA 8

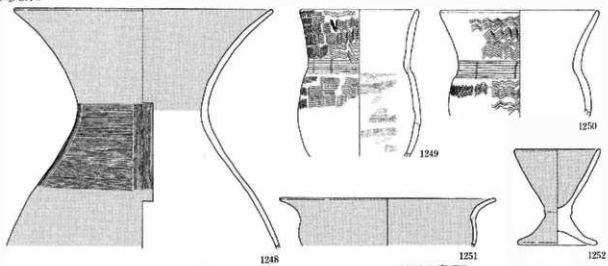

B ② SA 9 (1)

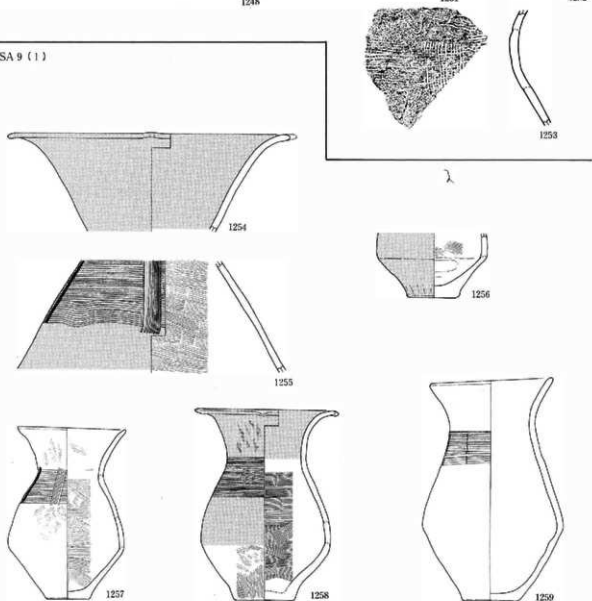

断面実測 0 (1:3) 10cm 0 (1:4) 10cm

B②SA9 (2)

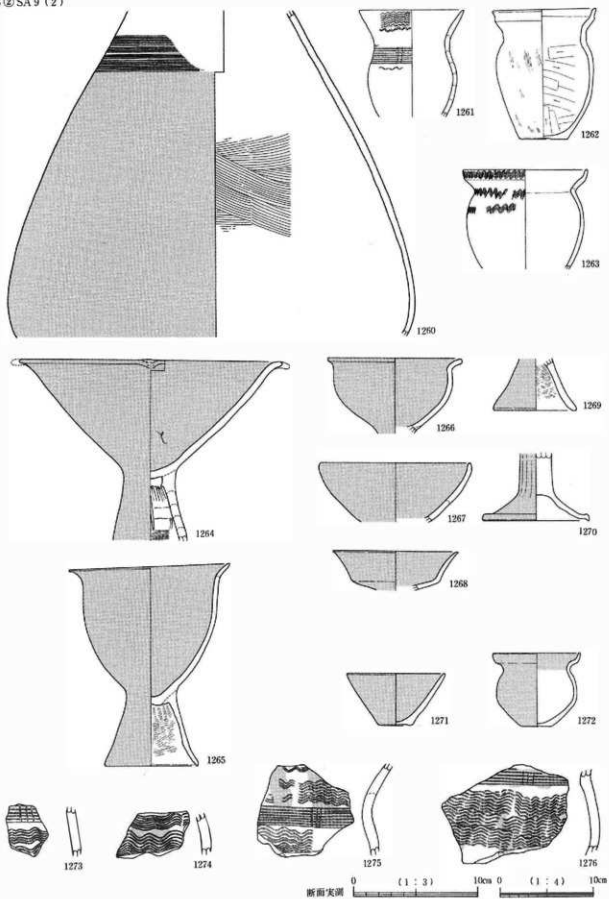

図版 169 弥生時代後期の遺物 (24)

B ② SA10

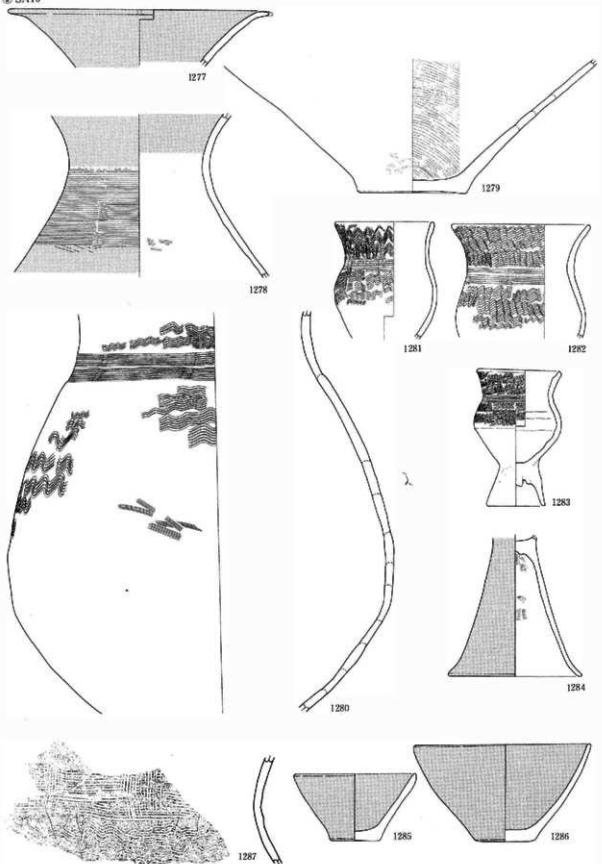

断面実測 0 (1:3) 10cm 0 (1:4) 10cm

図版 170 弥生時代前期の遺物 (25)

B②SA11

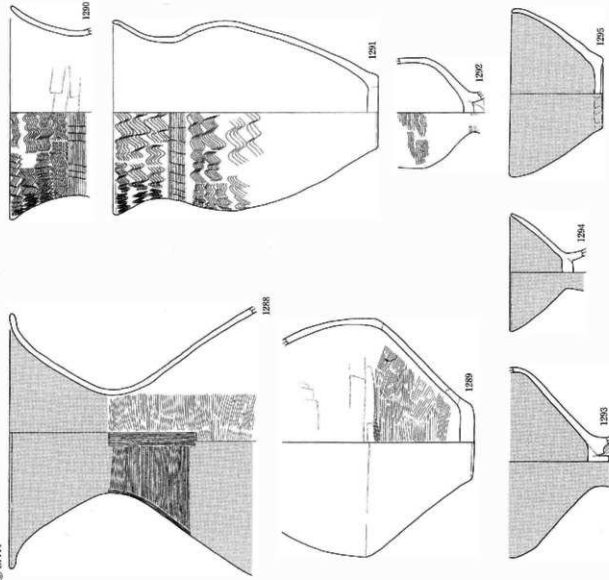

B②SA12

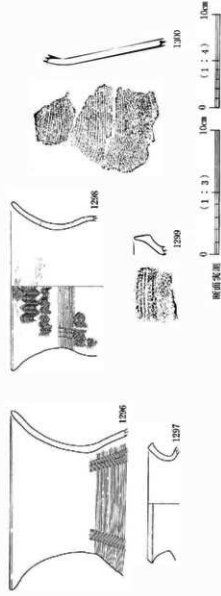

断面実寸 0 (1:3) 10cm 0 (1:4) 10cm

図版 171 弥生時代後期の遺物 (26)

B ㊦ SA14

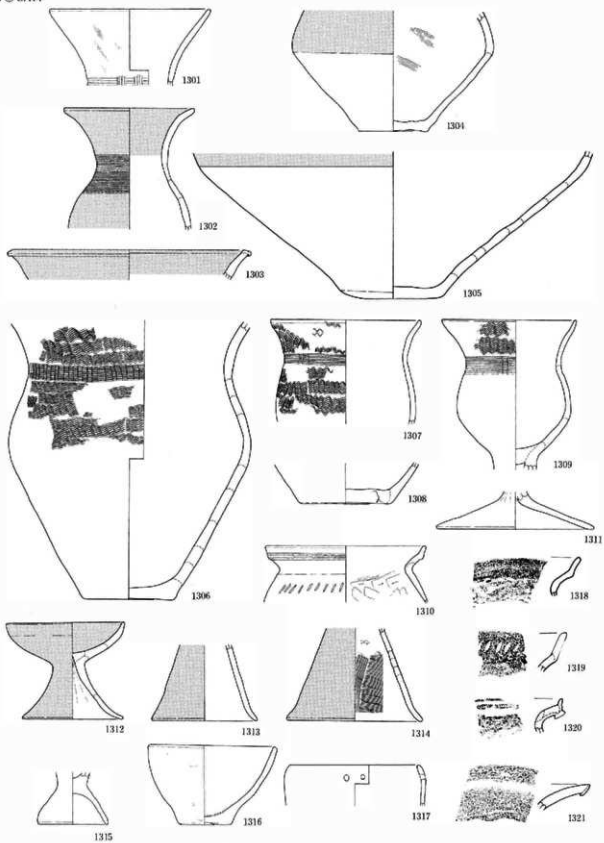

断面実測 0 (1:3) 10cm 0 (1:4) 10cm

図版 172 弥生時代後期の遺物 (27)

B ② SA15

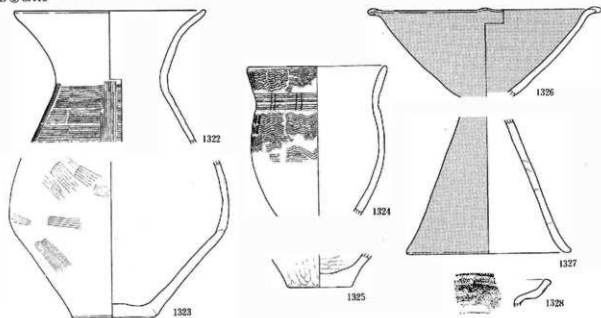

B ② SA16

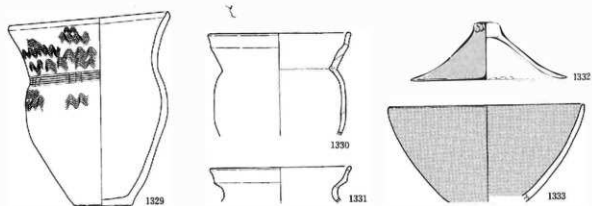

B ② SA18

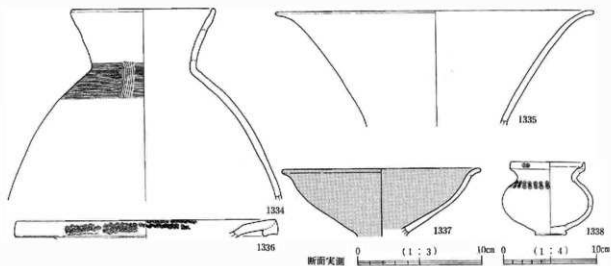

C②SA 1



1339



1340

C②SA 2

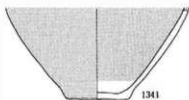

1341

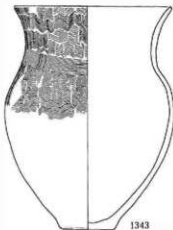

1343

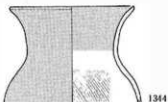

1344



1342

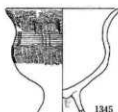

1345



1346

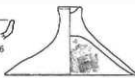

1347

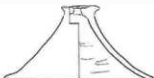

1348



1351

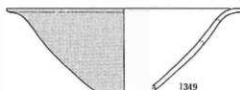

1349

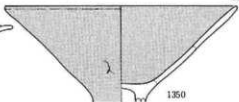

1350



1352



1353

C②SA 4

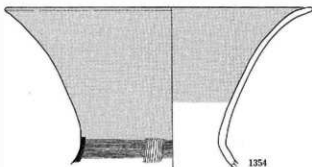

1354



1355



1357



1356



1358



1359



1360



1361



1362



C②SA 6

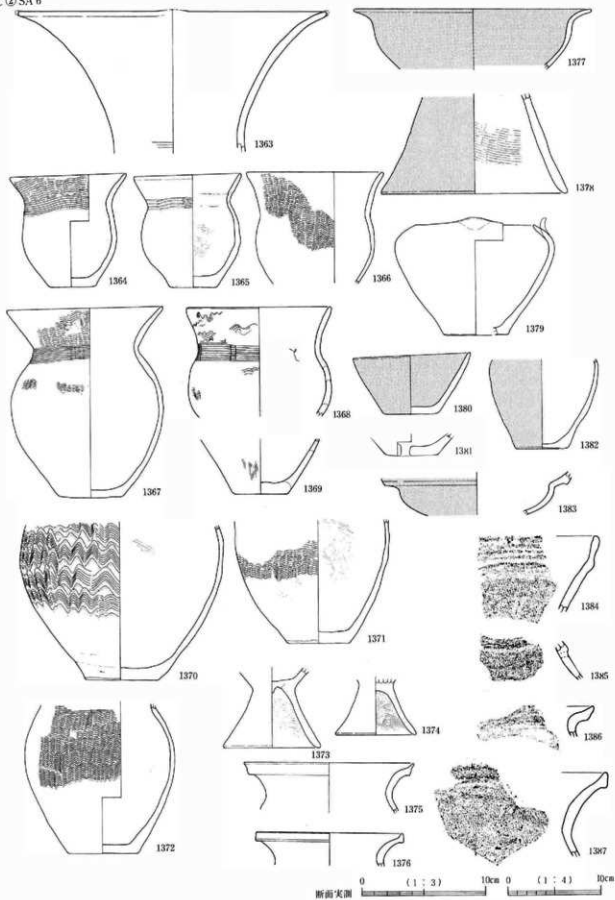

図版 175 弥生時代後期の遺物 (30)

C② SA 7

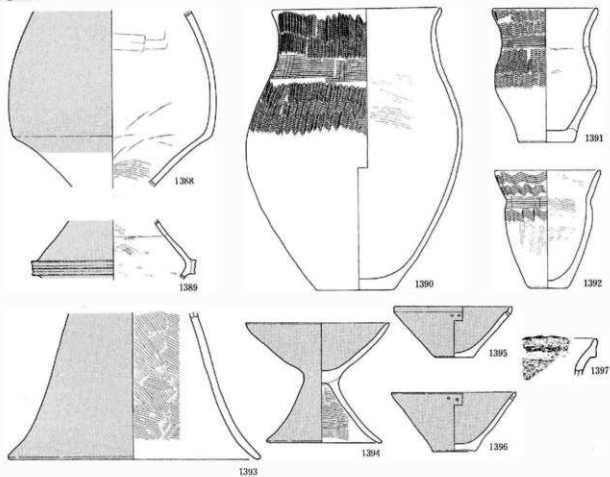

C② SA 8 (1)

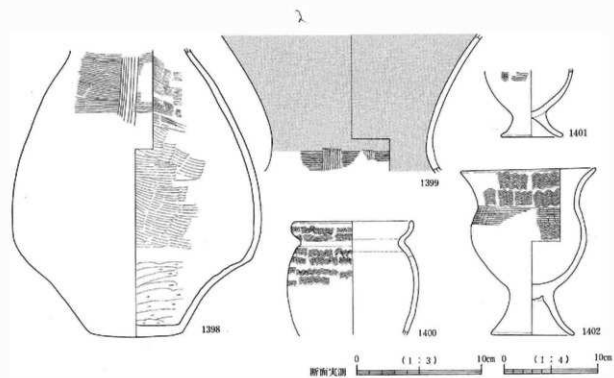

C② SA 8 (2)

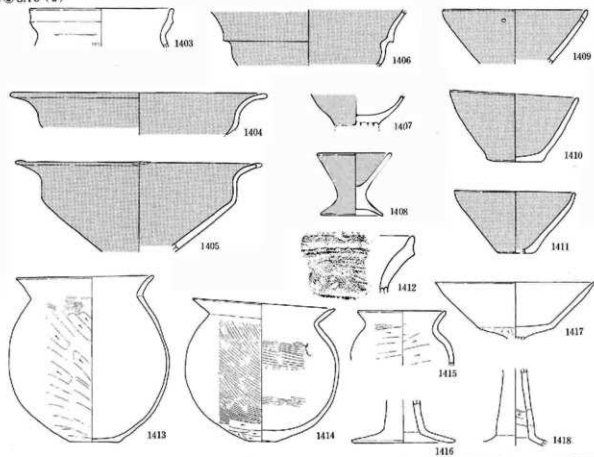

C② SA 9

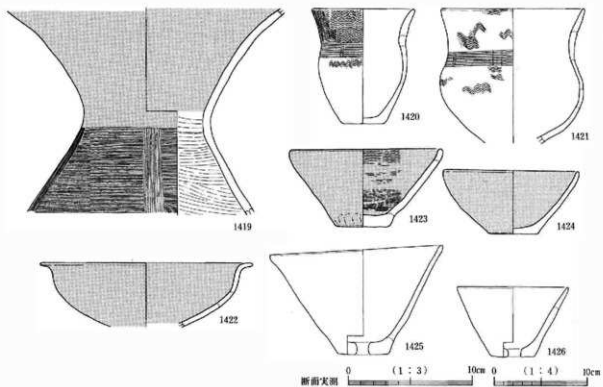

C②SA18(1)

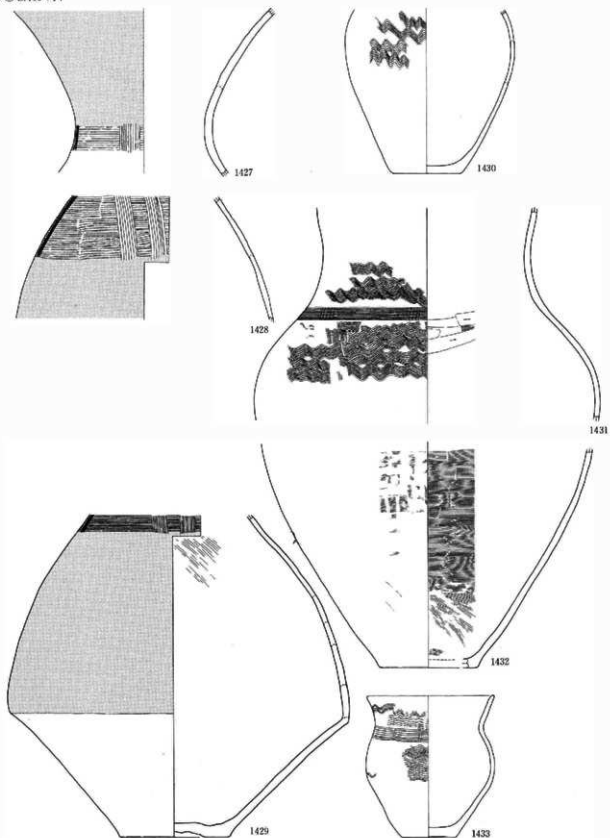

0 (1:4) 10cm

C② SA10 (2)

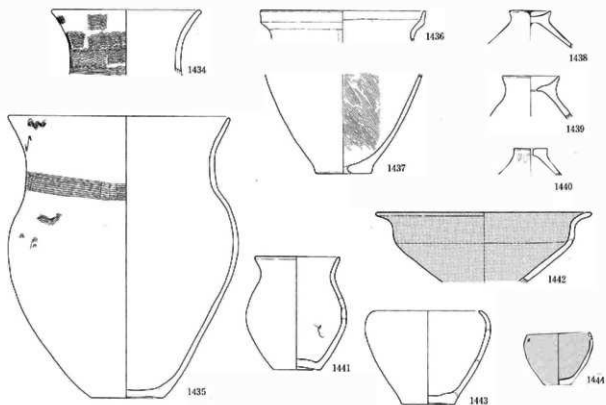

C② SA11

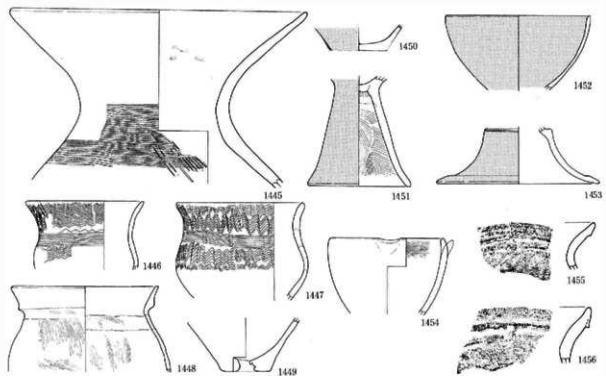

断面実測 0 (1:3) 10cm 0 (1:4) 10cm

C ② SA12

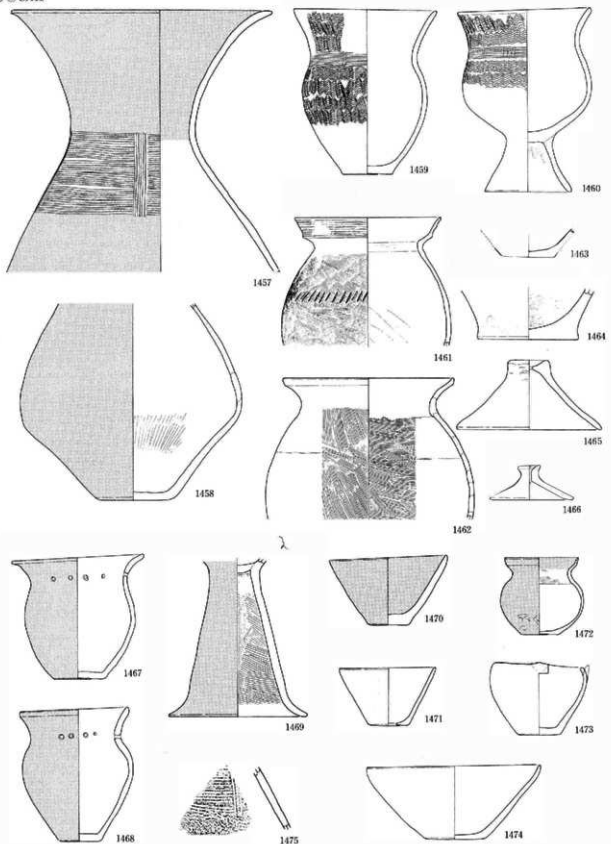

断面実測 0 (1:3) 10cm 0 (1:4) 10cm

C③SA1S

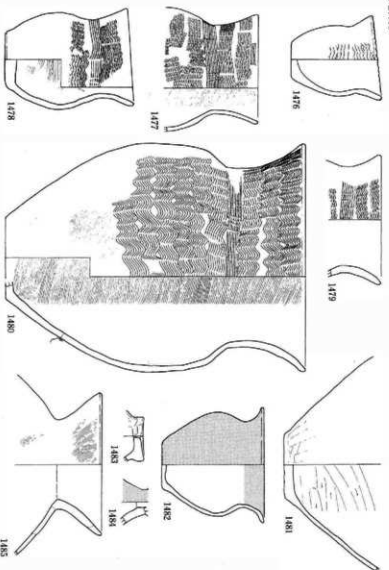

C③SA1T



C③SA1R

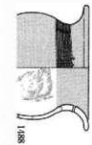

C③SA2I

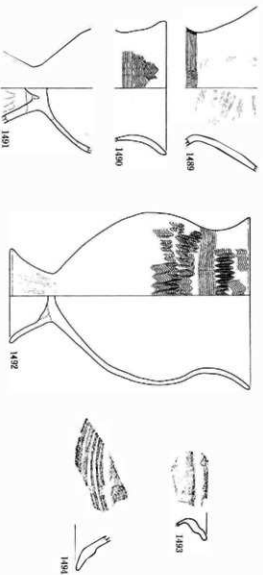

C ㊦ SA22

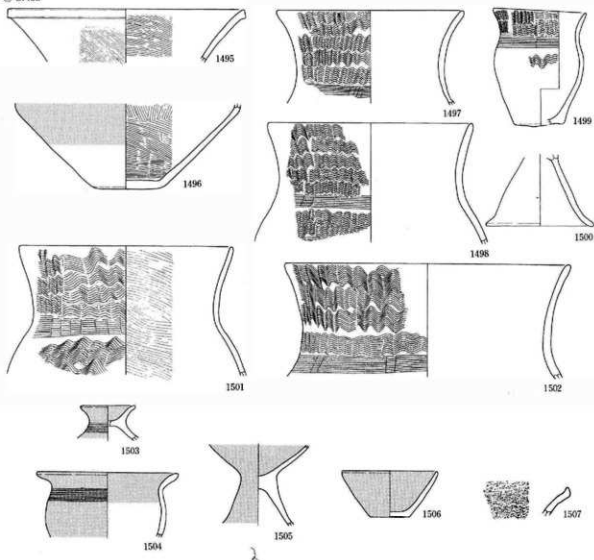

C ㊦ SA25

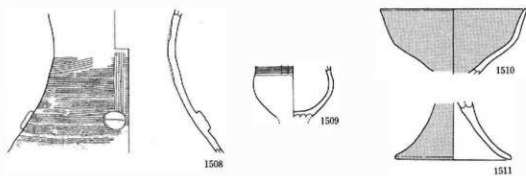

断面実測 0 (1:3) 10cm 0 (1:4) 10cm

48D SJ 7

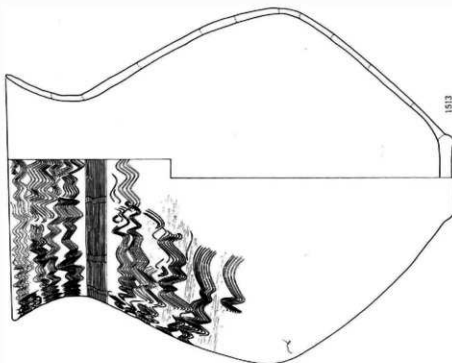

1513



25D SJ 1

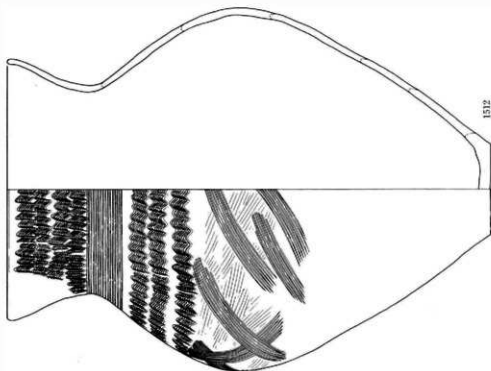

1512

64①SJ1

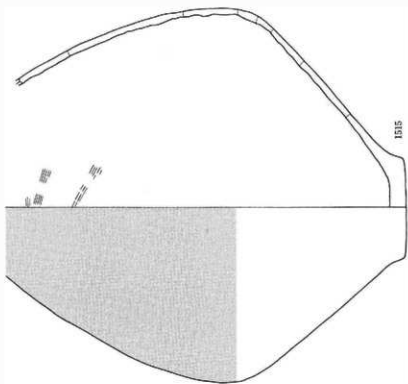
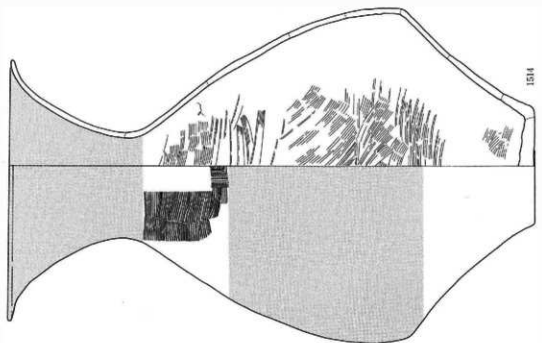

50㉔ SK 4

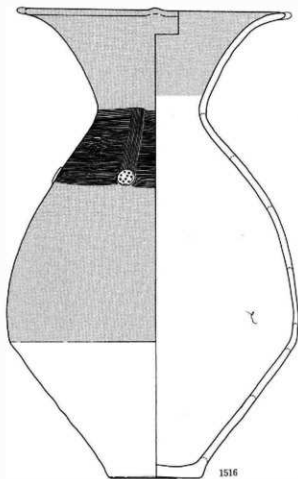

4㉔ SDZ 1

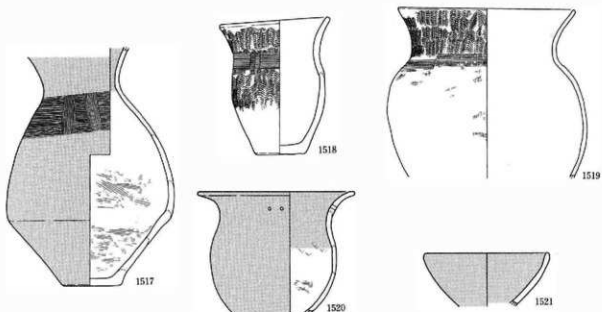

0 (1:4) 10cm

19① SDZ 1

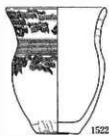

1522

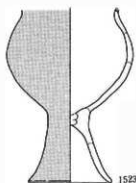

1523



1524

48① SDZ 5

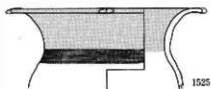

1525

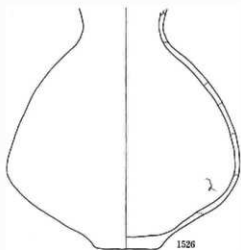

1526

48① SDZ 6

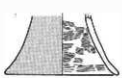

1527

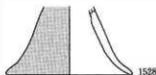

1528

48① SD 1

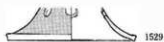

1529

B ② SD 2

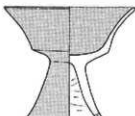

1530

B ② SD 8

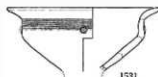

1531

B ② SD 6

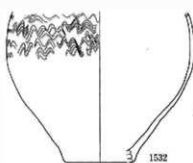

1532



1533

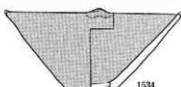

1534

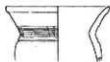

1535



1536



1537

1538

0 1537 (1 : 4) 10cm

62① SX 4

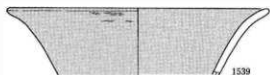

1539

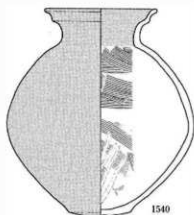

1540

遺構外

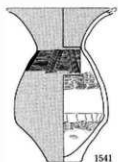

1541
5①

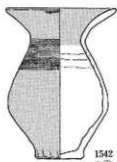

1542
5①



1547
73①



1548
B①

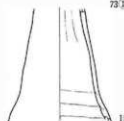

1552
B①

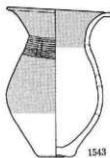

1543
14①

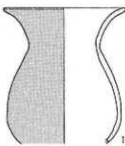

1544
48①



1549
B①



1553
C①

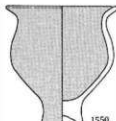

1550
48①



1554
C①

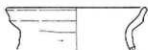

1545
C①



1555
C①



1546
C①

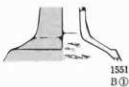

1551
B①

0 (1:4) 10cm

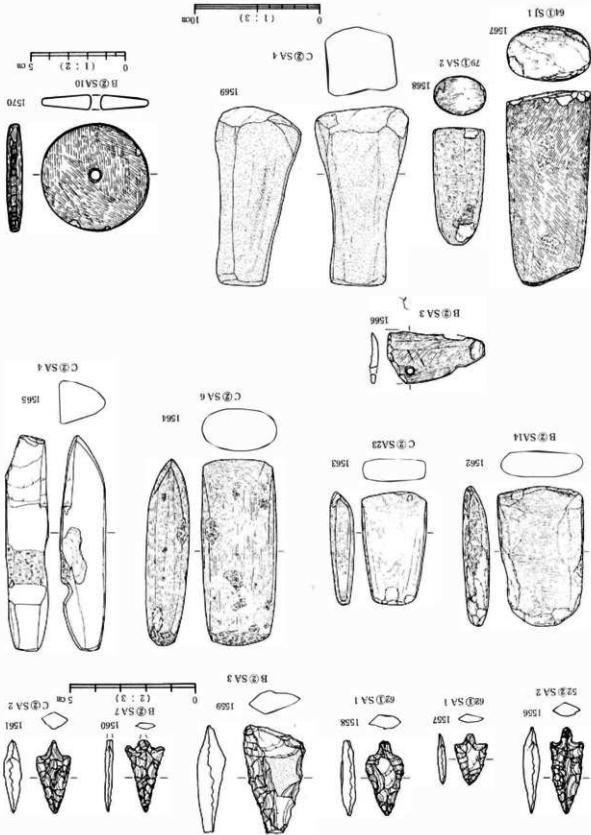

土製品

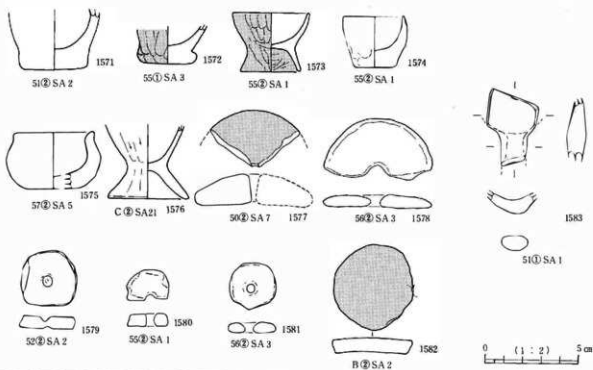

装身具 (1)

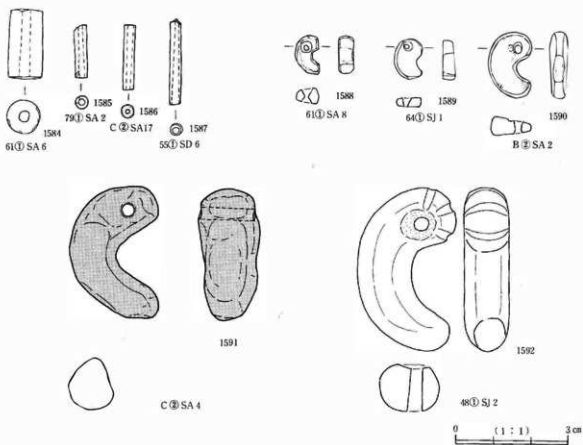

装身具 (2)

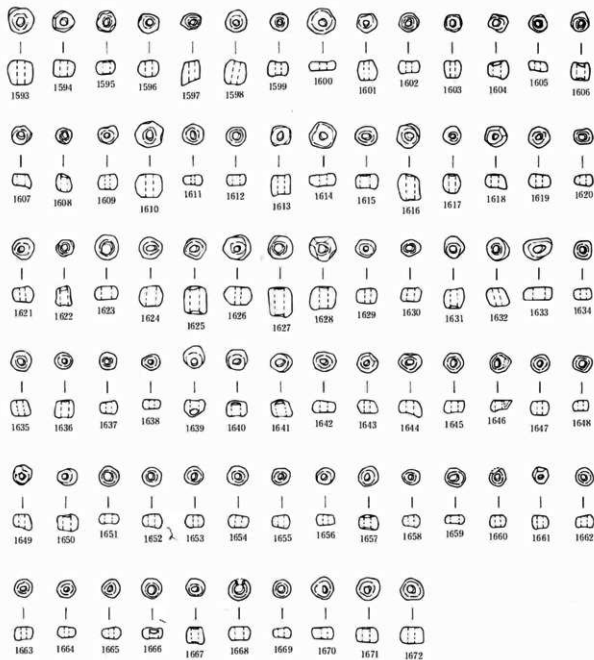

1593~1670
48(S) SJ 1

1671~1672
48(S) SJ 2



装身具 (3)

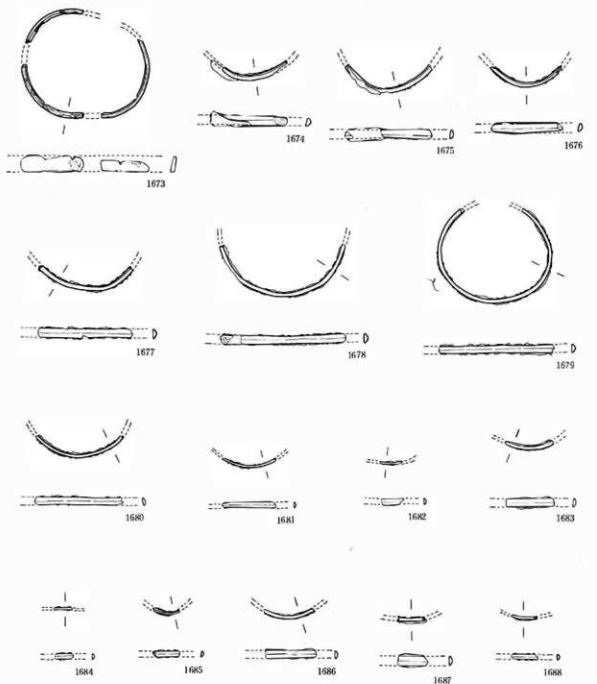

すべて48D SJ 1

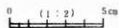

図版 191 古墳時代前期～中期の遺物 (1)

6① SA 1

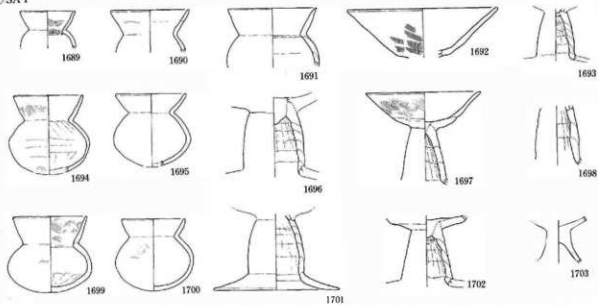

31① SA 3

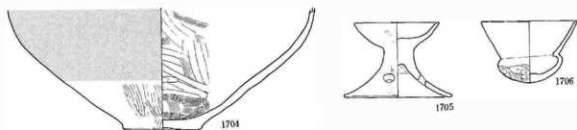

48① SA 1

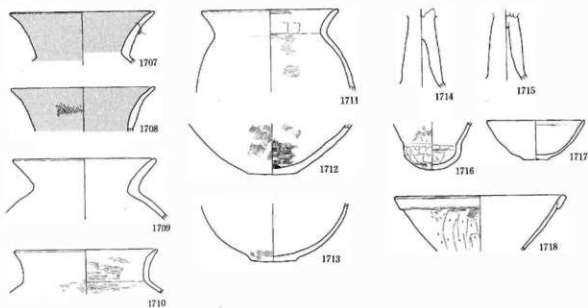

0 (1:4) 10cm

図版 192 古墳時代前期～中期の遺物 (2)

48㊦ SA 2

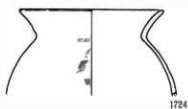
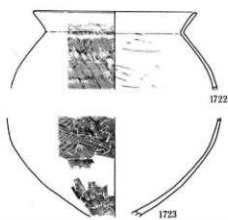
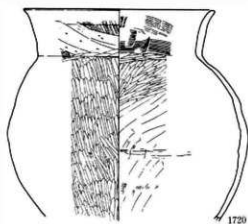
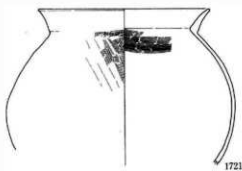
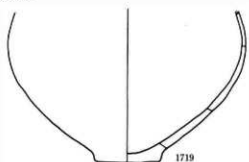

48㊦ SA 3



50㊦ SA 5

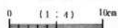
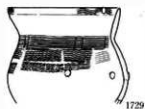
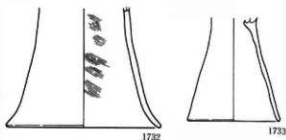

図版 193 古墳時代前期～中期の遺物 (3)

54㊦ SA 1

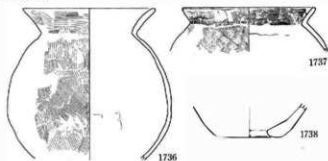

57㊦ SA 3

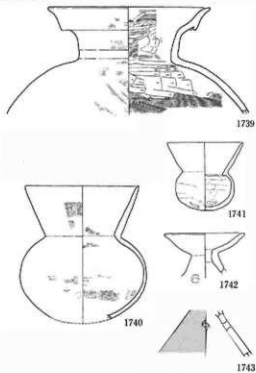

61㊦ SA 9

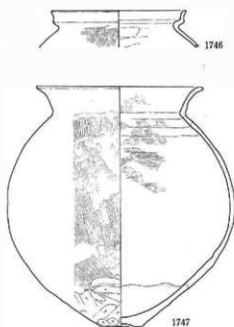

60㊦ SA 3

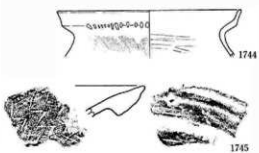

63㊦ SA 1 (1)

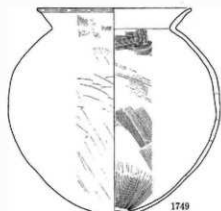
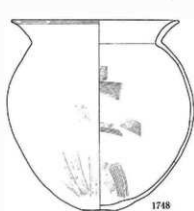

断面丈規 0 (1:3) 10cm 0 (1:4) 10cm

図版 194 古墳時代前期～中期の遺物 (4)

63㊦ SA1 (2)

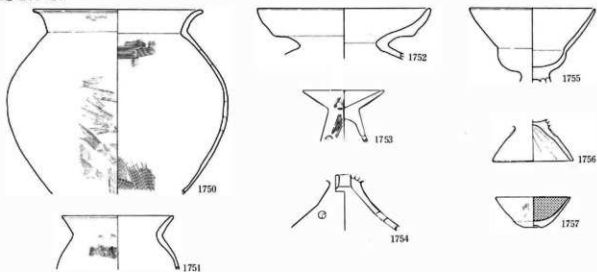

79㊦ SA5



B㊦ SA13

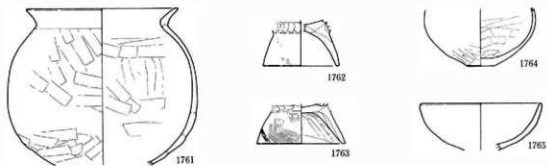

C㊦ SA30 (1)

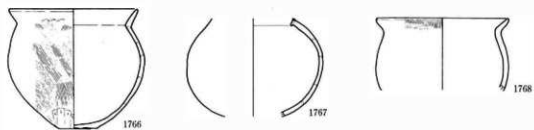

0 (1:4) 10cm

図版 195 古墳時代前期～中期の遺物 (5)

C ① SA30 (2)

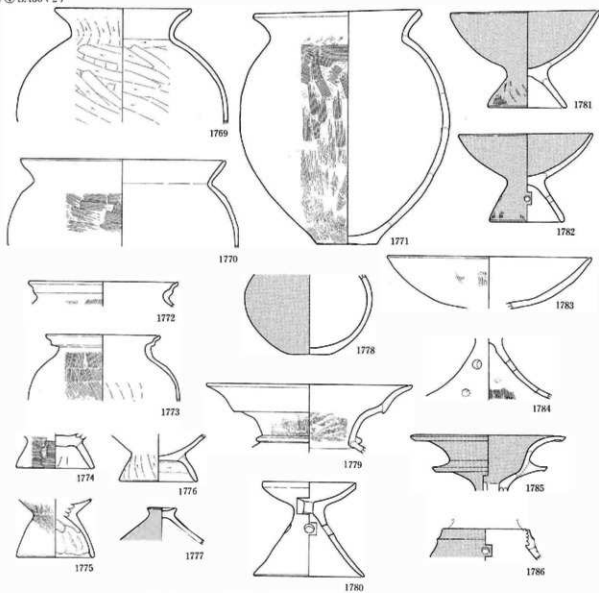

C ② SA16

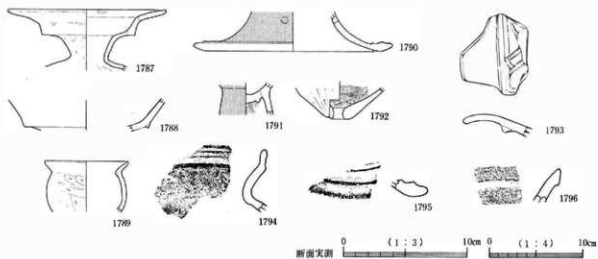

図版 196 古墳時代前期～中期の遺物 (6)

34①SB 1

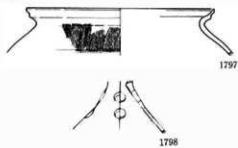

48①SK 3

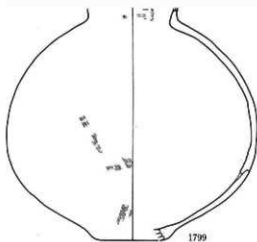

65①SDZ 1

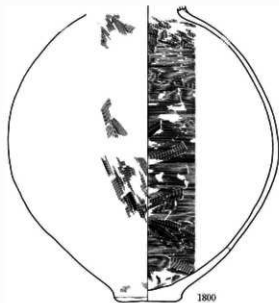

75①SDZ 4

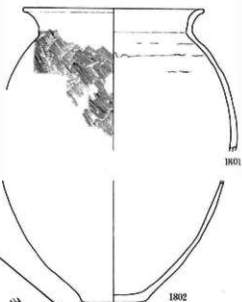

6①SD 1 (1)

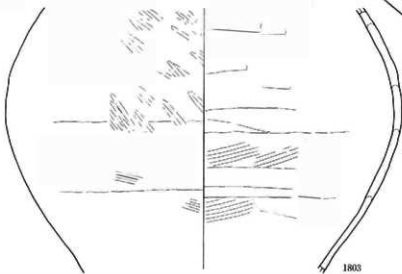

0 (1:4) 10cm

6①SD1 (2)

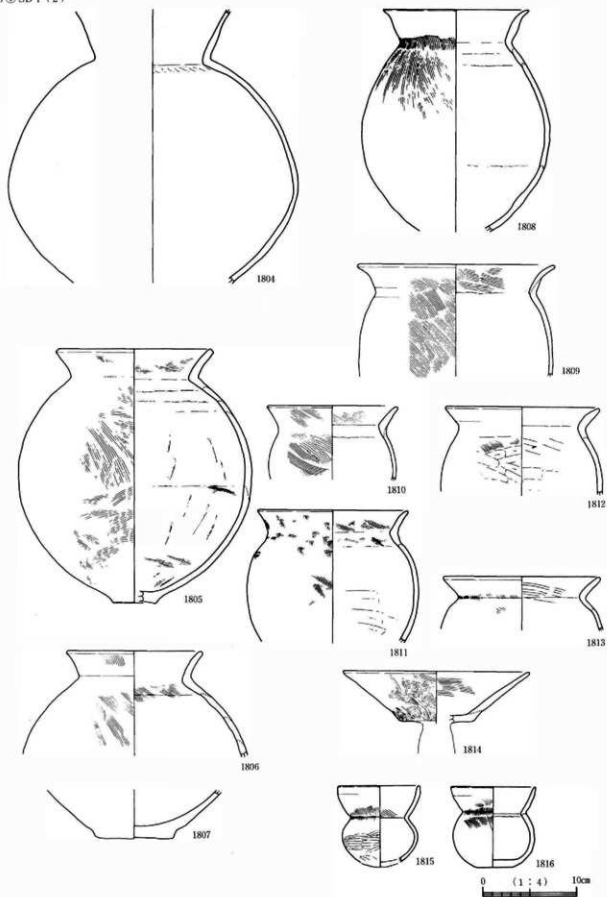

23① SD 5

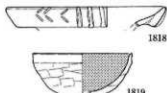
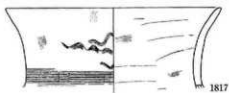

50① SD 2



33① SD 7

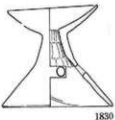
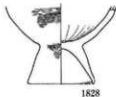
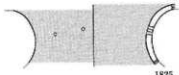
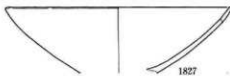
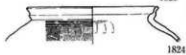
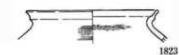
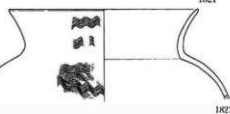
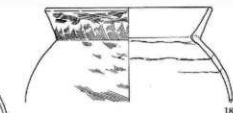
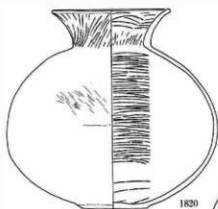

50② SD 3

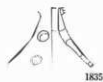
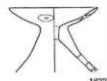
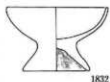

52① SD 1

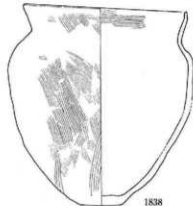

52① SD 4



0 (1 : 4) 10cm

図版 199 古墳時代前期～中期の遺物 (9)

34①SD7

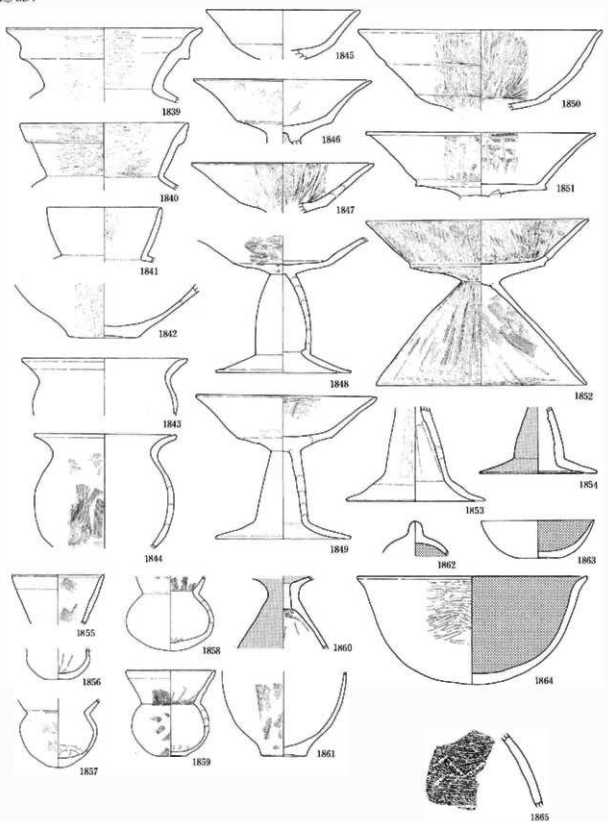

断面実測 0 (1:3) 10cm 0 (1:4) 10cm

62①SD 2

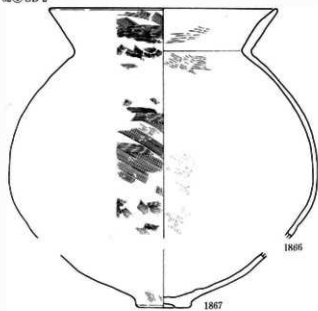

63①SD 2

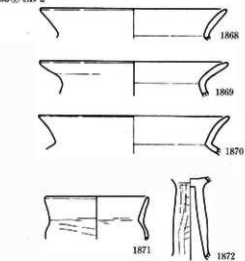

63①SD 6

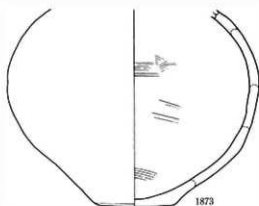
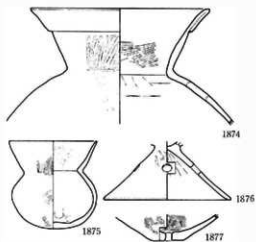

46①SX 1

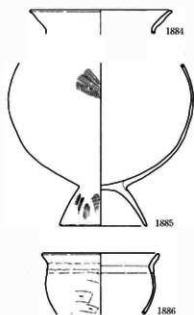

63①SD12

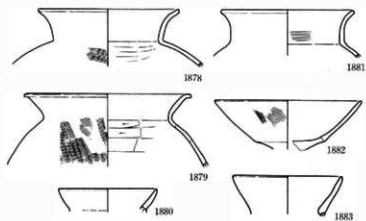

0 (1:4) 10cm

75① SX 1

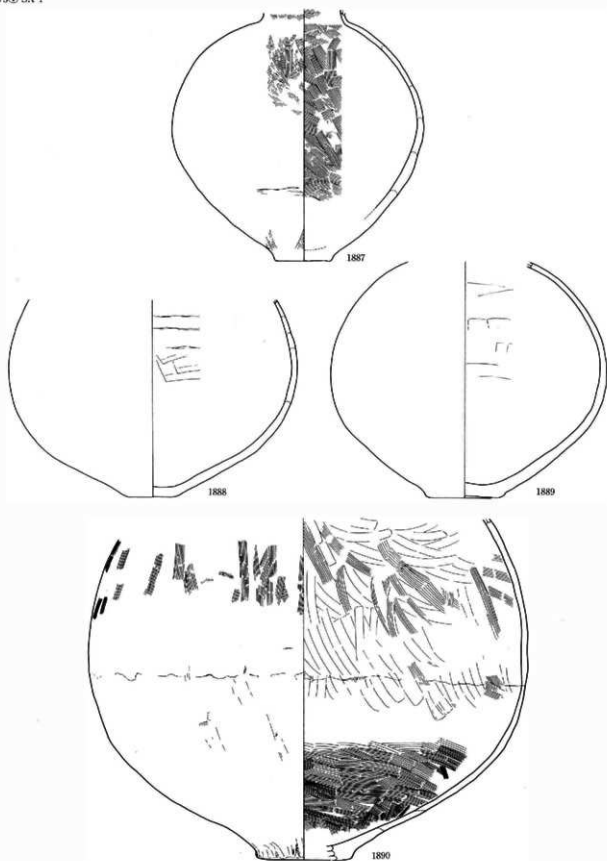

(1:4) 10cm

C①SX.1

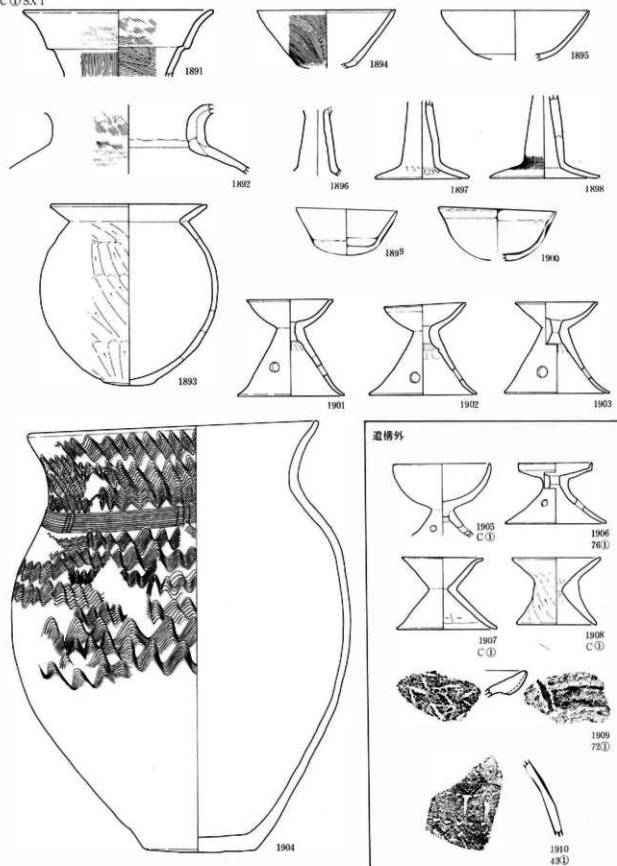

断面実測 0 (1:3) 10cm 0 (1:4) 10cm

図版 203 古墳時代前期～中期の遺物 (13)

土製品

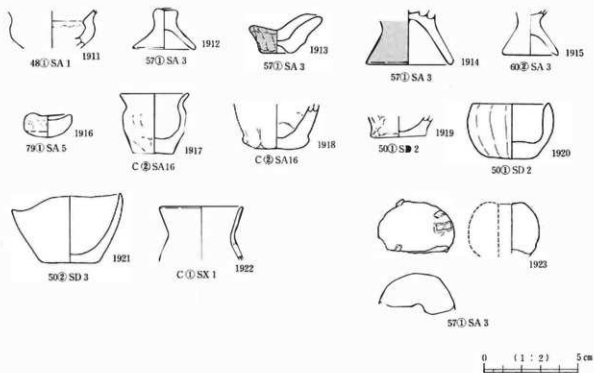

装身具

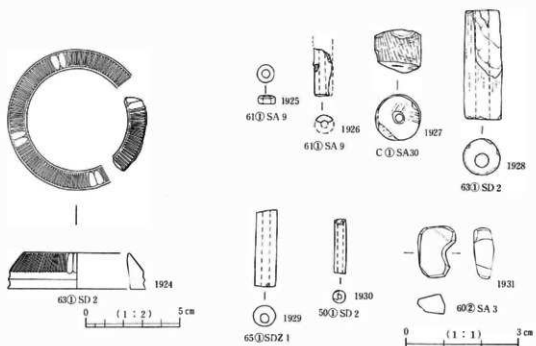

23① SA 1

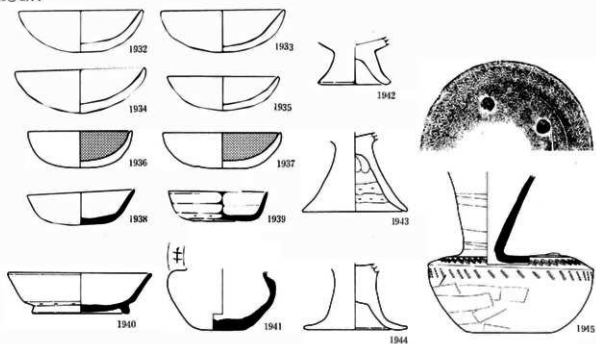

33① SA 5

33① SA 1

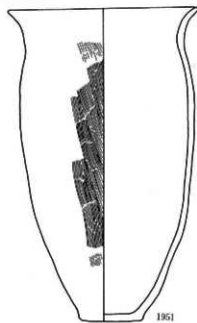
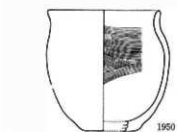
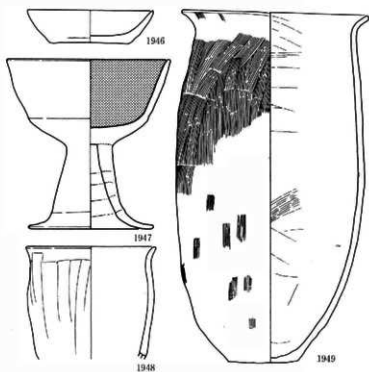

0 (1:4) 10cm

33① SA 4

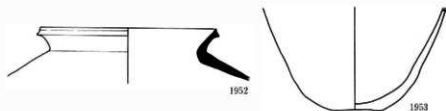

34① SA 1

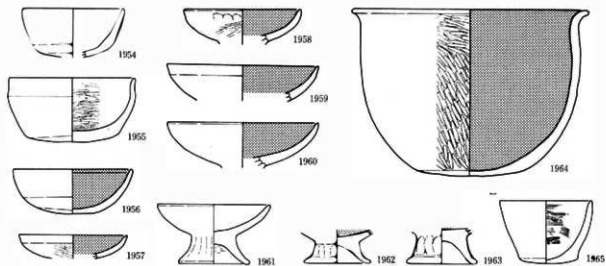

50① SA 1

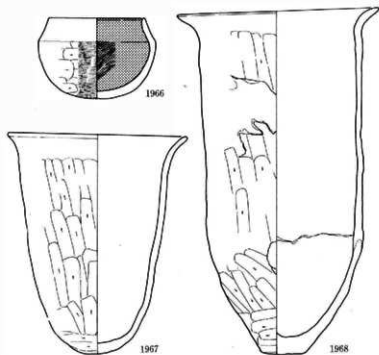

50① SA 4

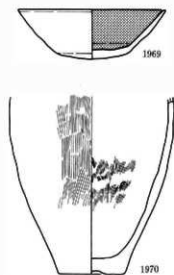

0 (1 : 4) 10cm

図版 206 古墳時代後期の遺物 (3)

48①SA4

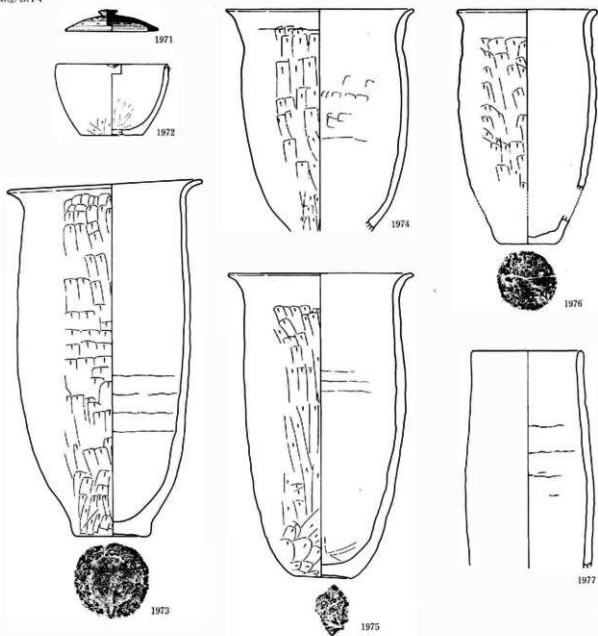

図版 207 古墳時代後期の遺物 (4)

●① SA 2

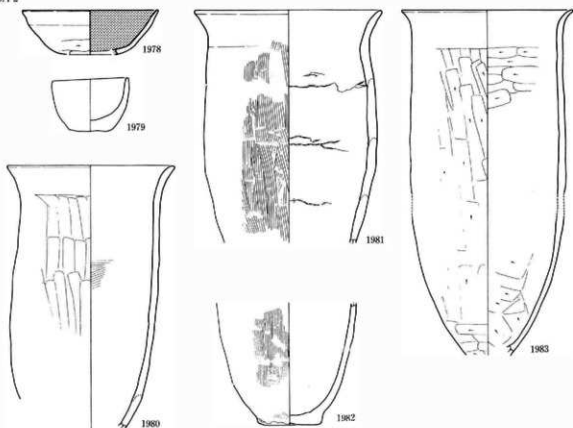

●① SA 3

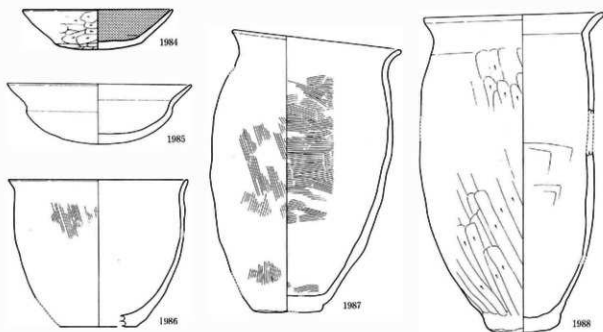

0 (1:4) 10cm

54① SA 6

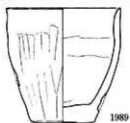

1989

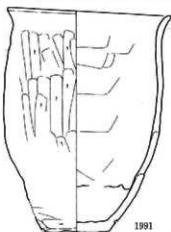

1991

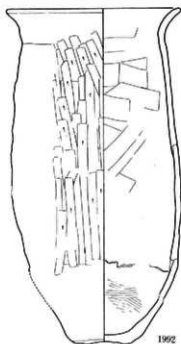

1992

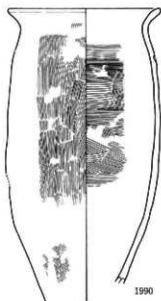

1990

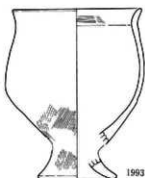

1993

52① SA 6



1994



1995

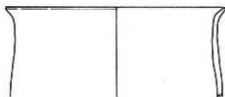

1996

52① SA 2

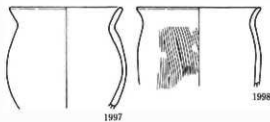

1997

1998



1999



2000

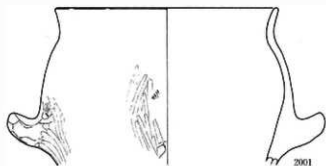

2001

0 (1:4) 10cm