

图 94 十二ノ后遺跡20号住居址出土土器拓影



图 95 十二、后遗址 21、23 号伴层出土土器拓影



图 96 十二ノ所遺跡24・25・26・27号住居址出土土器拓影

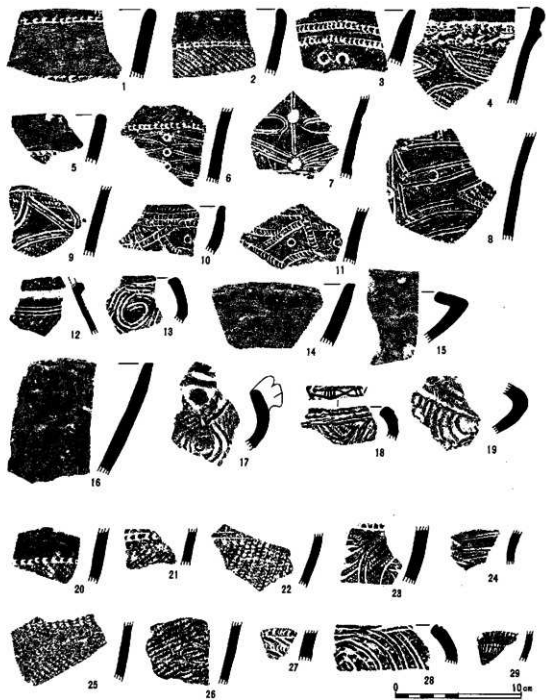
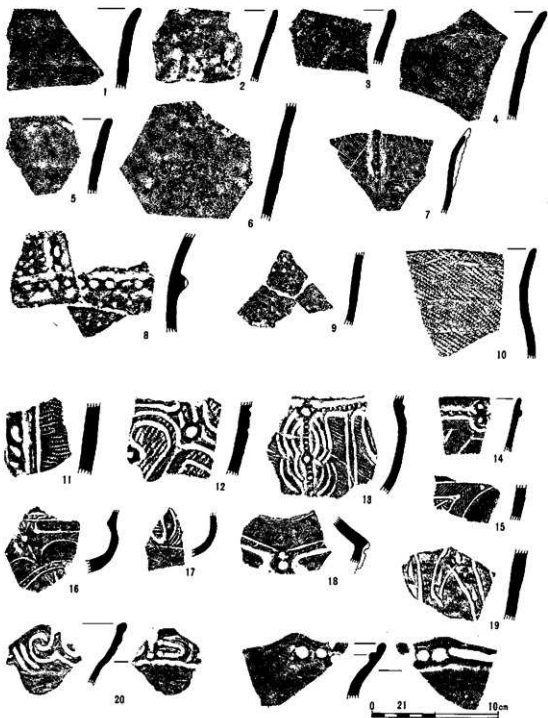

区97 十二ノ后遺跡37号住居址, 38号住居址(その1)出土土器拓影



図98 十二ノ所遺跡38号住居址(その2)出土土器拓影



图99 十二ノ后凉跡38号住居址(その3)出土土器拓影



図100 十二ノ后遺跡38号住居址(その4)出土土器折形

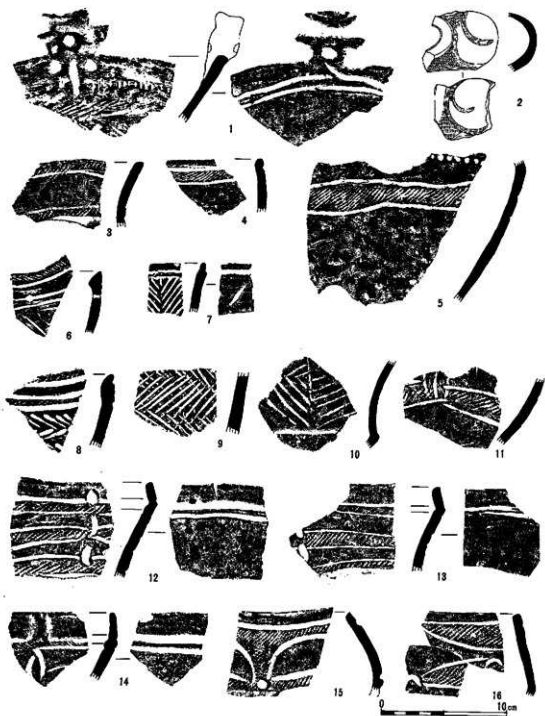

图101 十二/后筑跡39号住居址出土器拓影

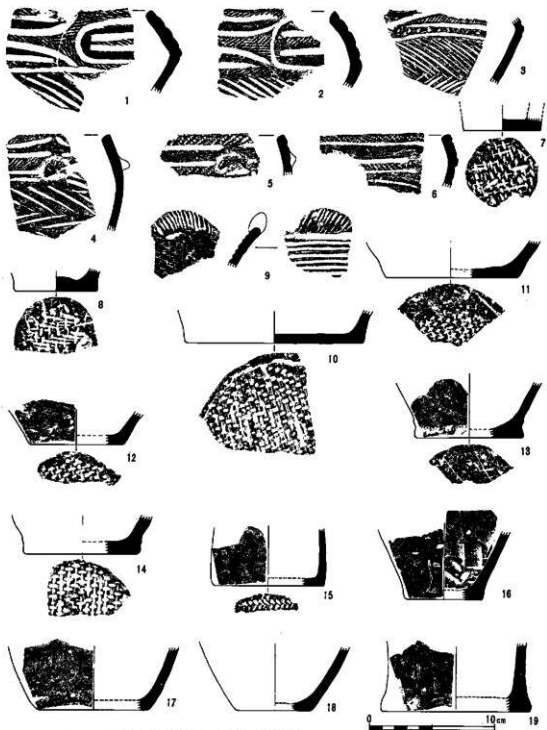

图102 十二ノ后遺跡46号住居社(その1)出土土器拓影

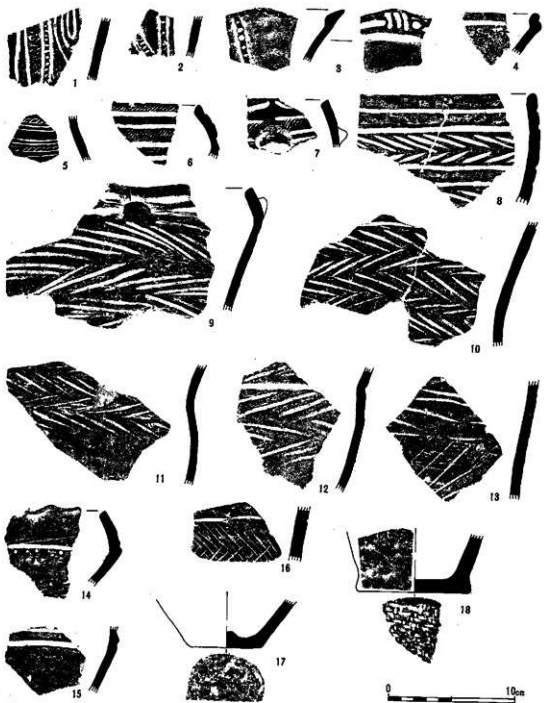

図103 十二ノ后遺跡46号住居址(その2)出土七器拓影



图104 十二ノ后遺跡47号住居址(その1)出土十種拓影

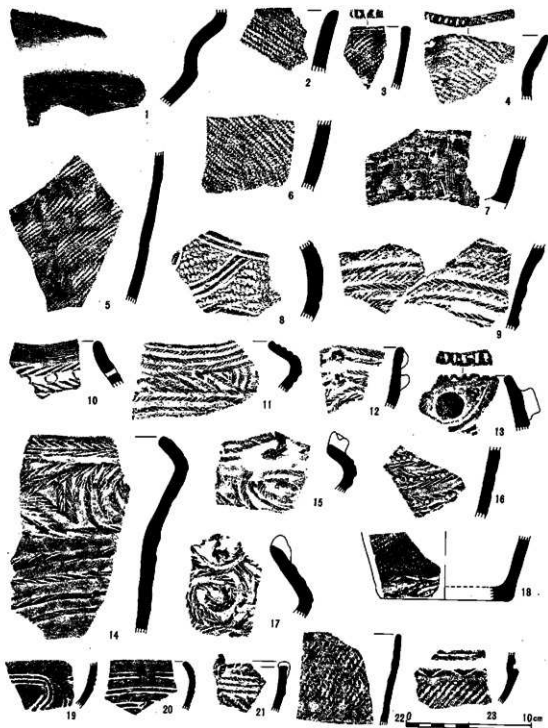

図105 十二ノ后遺跡47号生居址(その2)出土土器片



図106 十二ノ浜遺跡47号伴塚址(その3)出土土器拓影



图107 十二ノ后遺跡50号住居址，52号住居址(その1)出土土器拓影

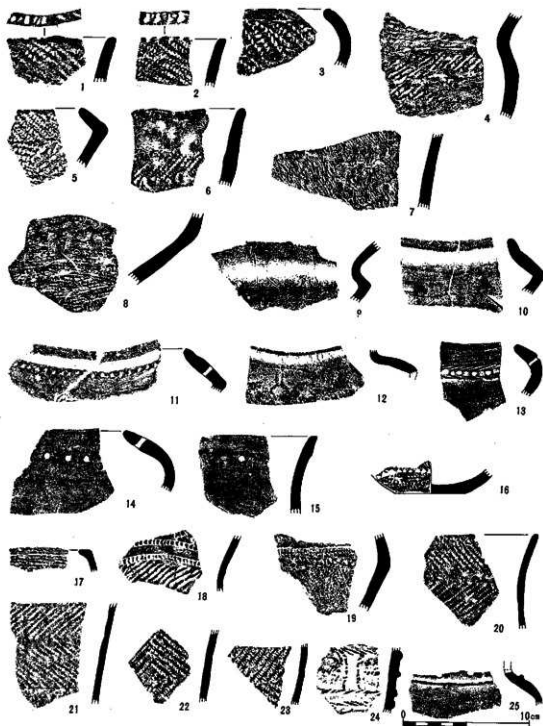

图108 十二ノ后遺跡52号住居址(その2), 56号住居址(その1)出土十器拓影

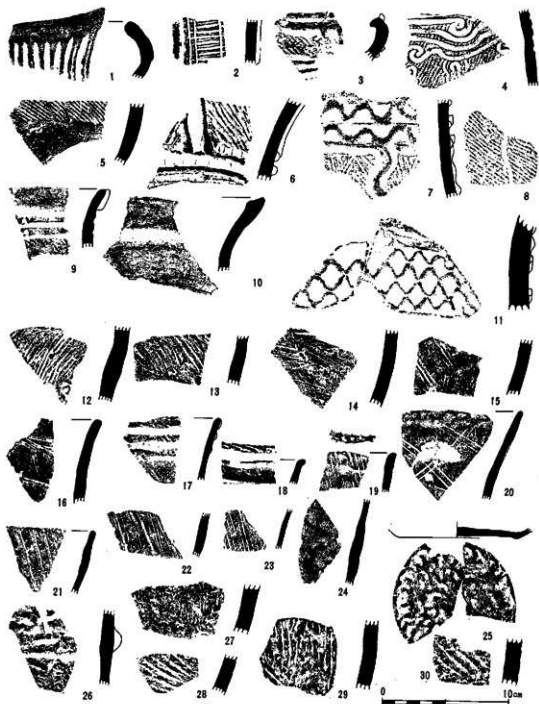

图109 十二ノ后遺跡56号住居址(その2), 58号住居址, 59号住居址(その1)出土土器拓影

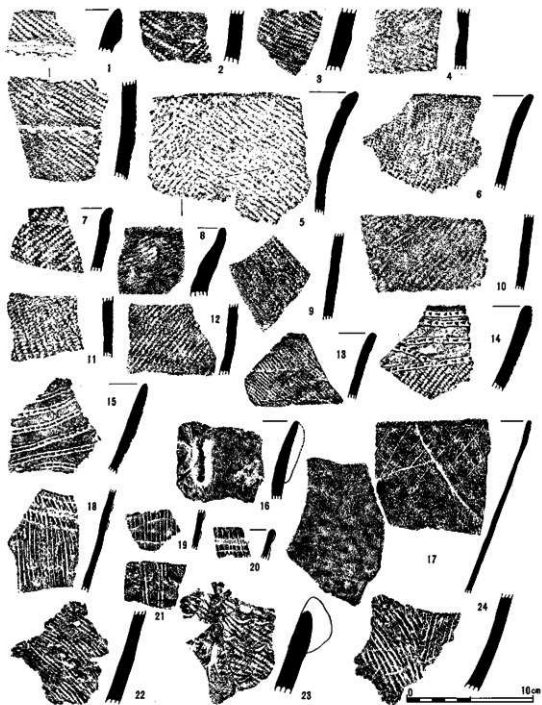

図110 十二ノ后遺跡59号住居址(その2), 61号住居址出土土器示影

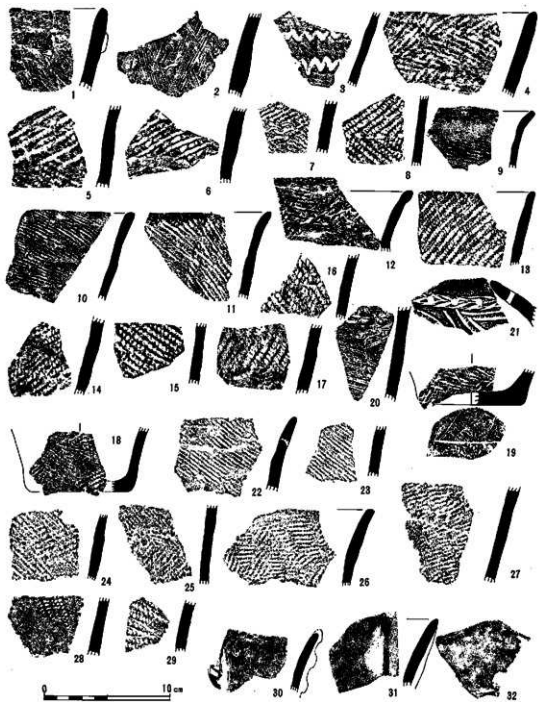

图111 十二ノ后道跡64号住層址(その1)出土土器拓影



図112 十二ノ后遺跡64号住居址(その2), 65号住居址, 66号住居址(その1)出土土器拓影

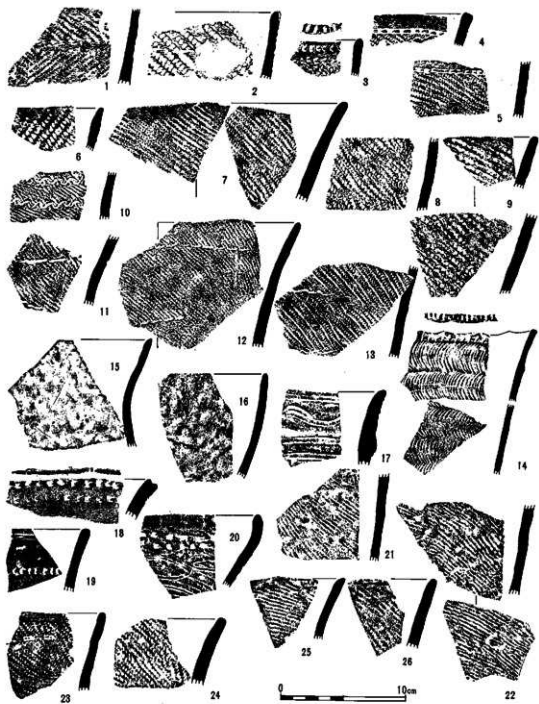

图113 十二ノ后遺跡66号住居址(その2), 68号住居址, 69号住居址(その1)出土土器拓影

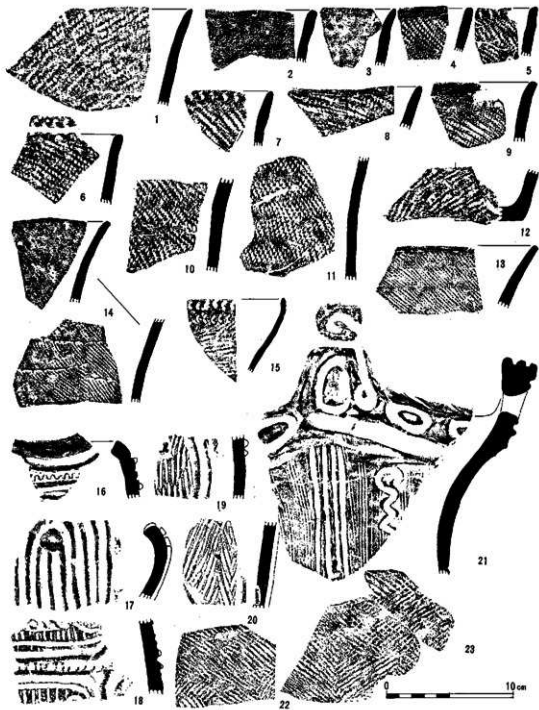

图114 十二ノ后遺跡69号住居址(その2), 73号住居址出土土器拓形

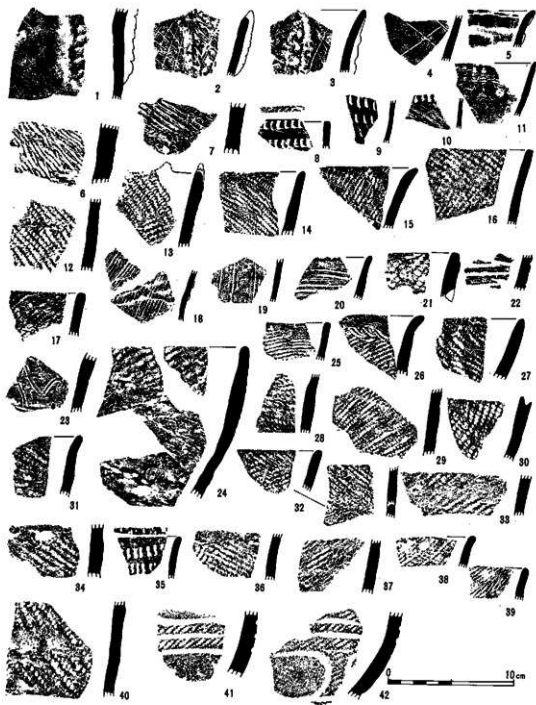

图115 1一ノ后遺跡74号住居址、75号住居址(その1)出土土器拓影

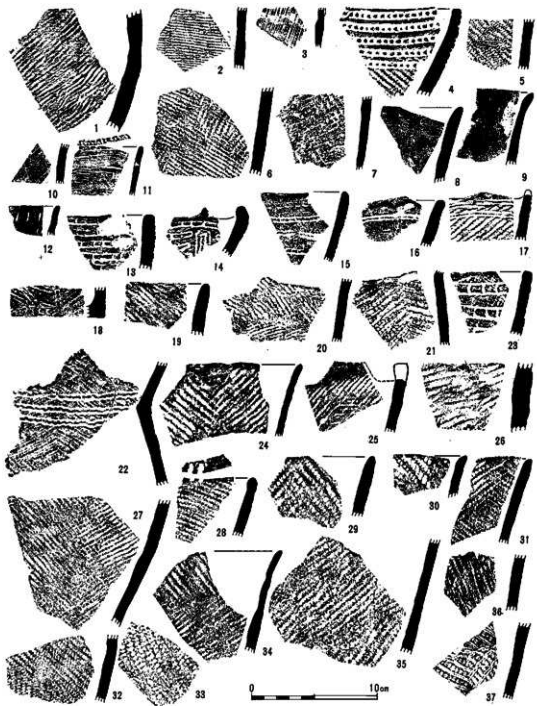

図116 十二ノ后遺跡75号住居址(その2)用上上器拓影



图117 二ノ后遺跡80号住居址出土土器拓影



图118 十二ノ后遺跡81号住居址出土上器拓影



図119 〔二ノ后遺跡86号住居址(その1)出土土器拓影

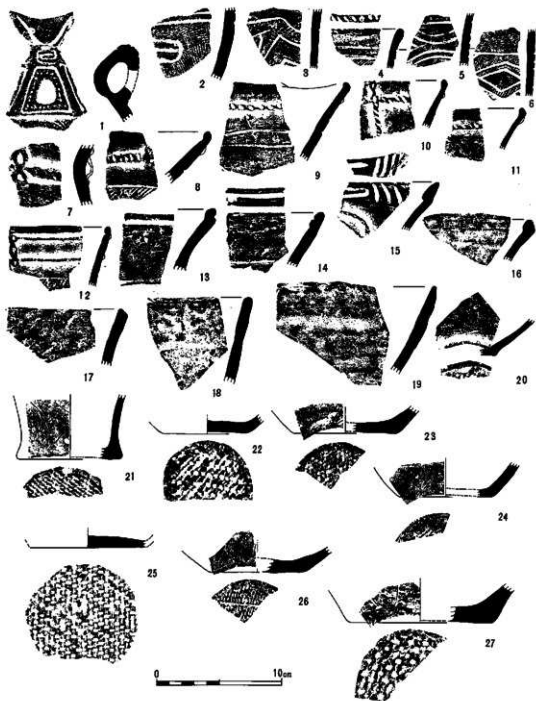

図120 十二ノ洞遺跡86号住居址(その2), 88号住居址(その1)出土土器拓影

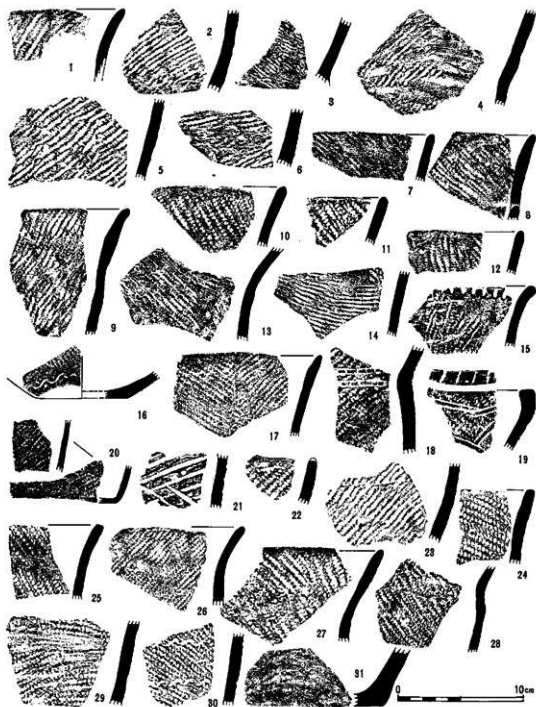

図121 十二ノ后遺跡88号住居址(その2)、90号住居址、92号作居址、93号住居址(その1)出土土器拓影



图122 十二ノ后遺跡93号住居址(その2)、95号住居址(その1)出土土器拓影

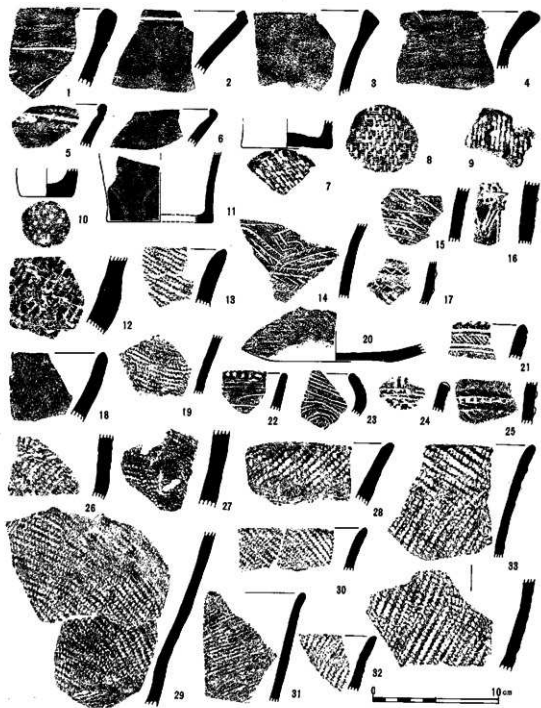

図123 十二ノ所遺跡95号住居址(その2), 96号住居址(その1)出土土器拓影

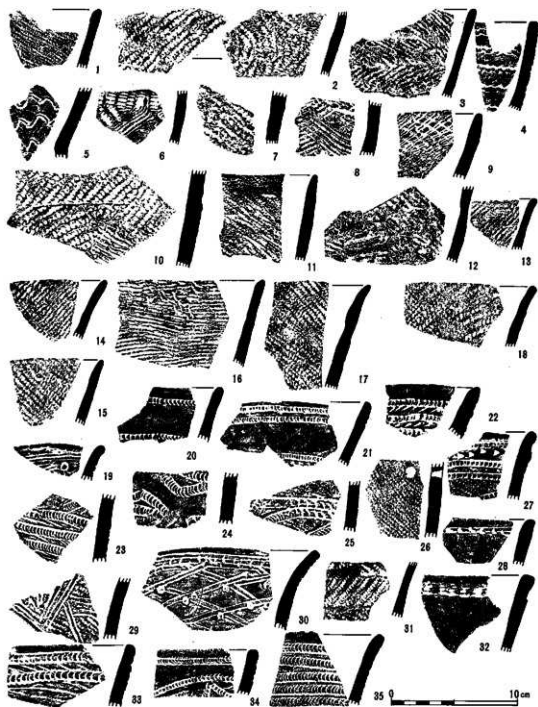

图124 十二ノ活遺跡96号住居址(その2), 98号住居址, 99号住居址出土土器拓影

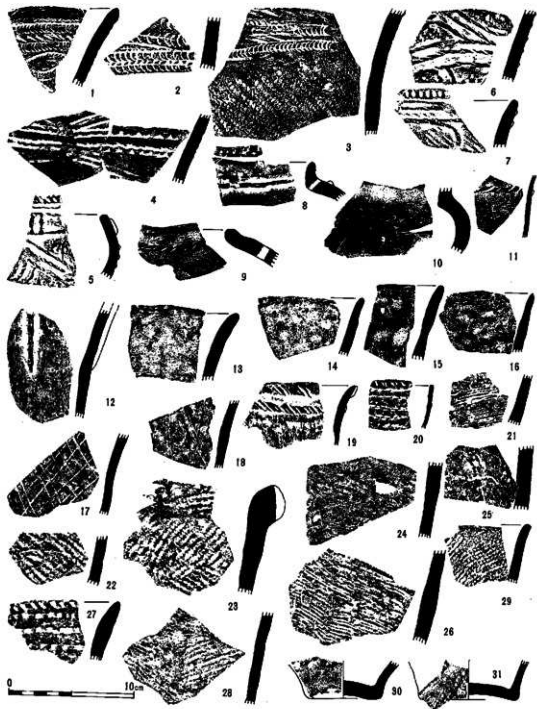

图125 十二ノ府遺跡100・102号住居址出土土器拓影

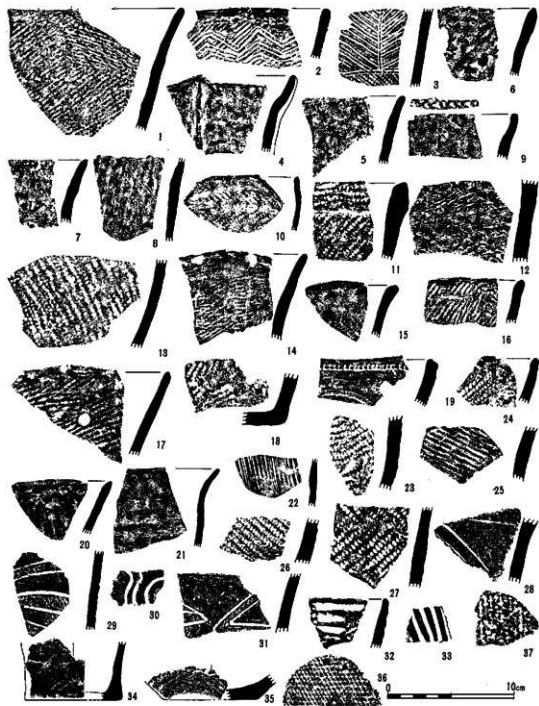

図126 十二ノ后遺跡104号住居址、106号住居址(その1)出土土器拓影

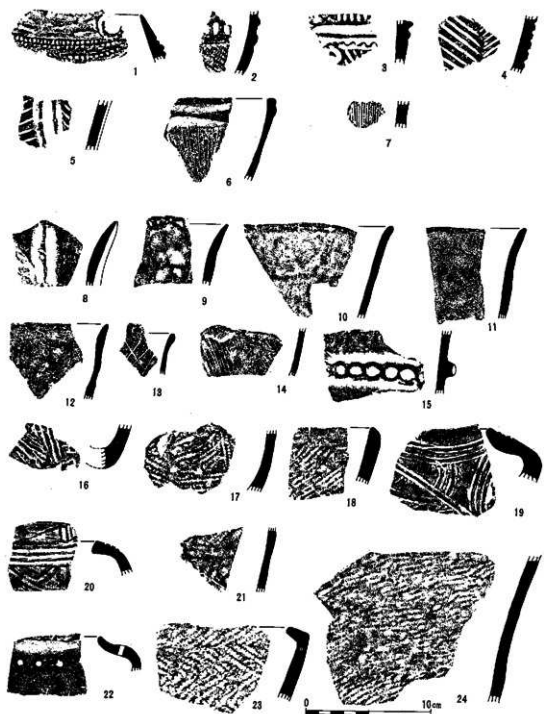

図127 十二ノ后遺跡106号住層址(その2)出上土器拓影

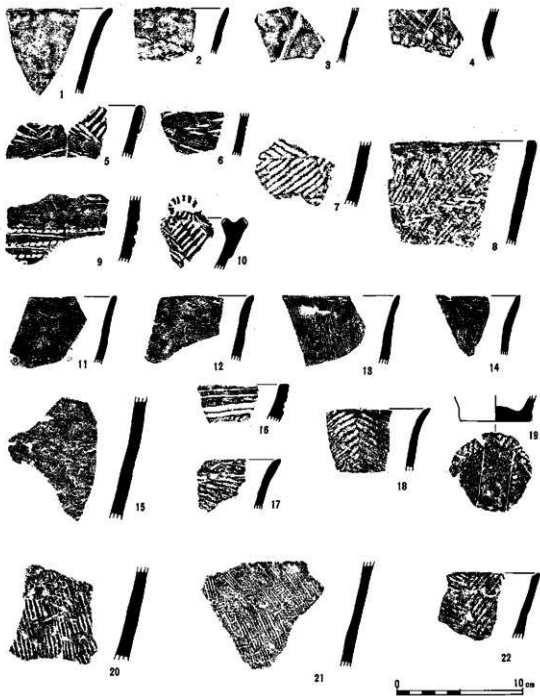

図128 十二ノ后遺跡108号住居址(その1)出土土器拓影

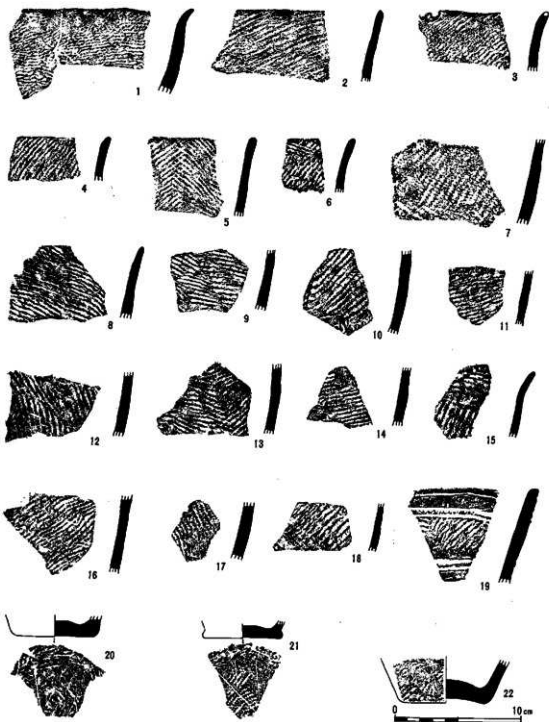

図129 十二ノ所遺跡108号住居址(その2), 110号住居址出土土器拓影

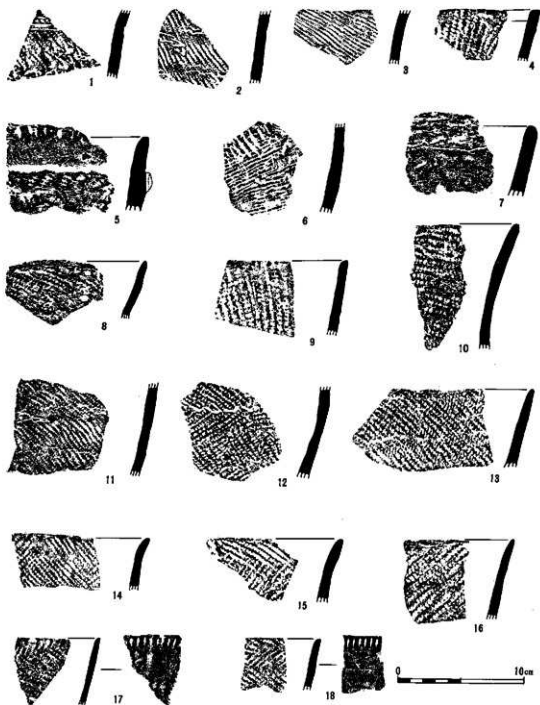

图130 十二ノ后遺跡111号伴出址出土十番拓影

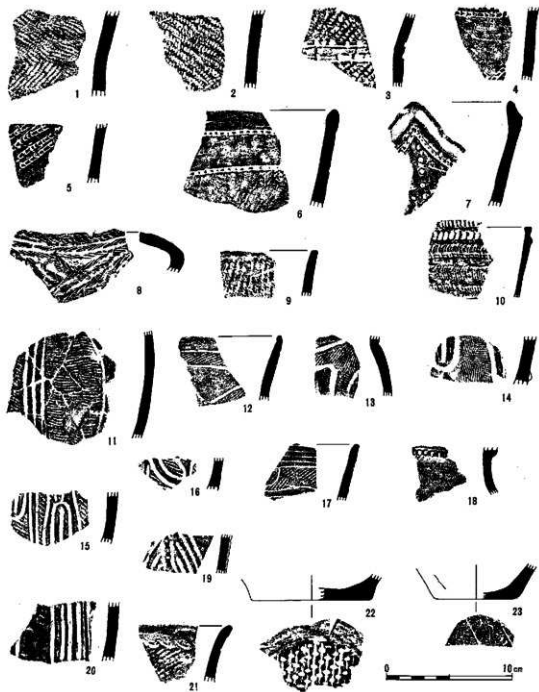

図131 十二ノ后遺跡112号住居址(その1)出土土器拓影

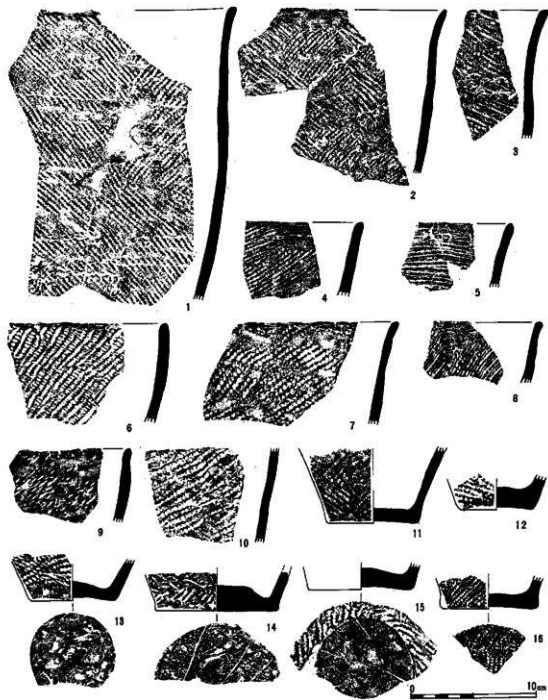

图132 十一ノ后遺跡112号住居址(その2)出土上器拓影

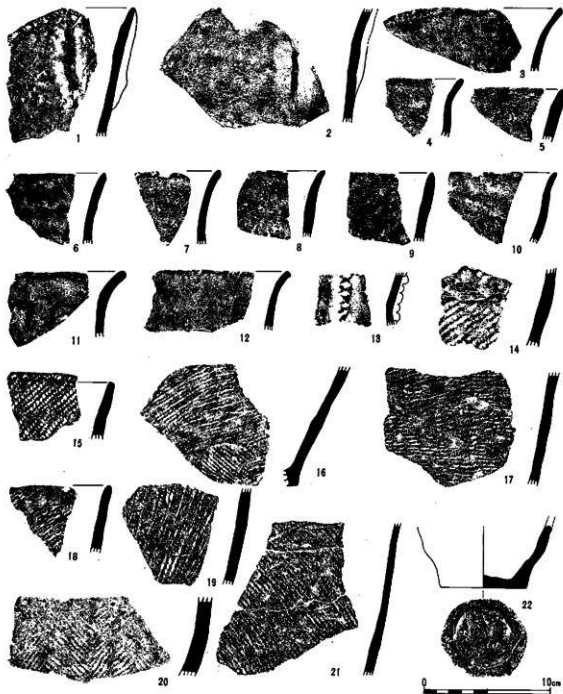

图133 十二/后道陈113号生厝址出土土器拓影

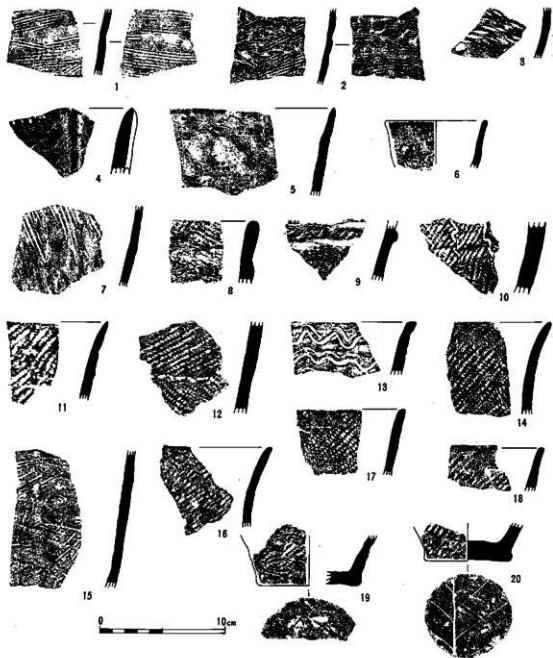

图134 十二ノ后遺跡118号在岡辻山出土器拓形

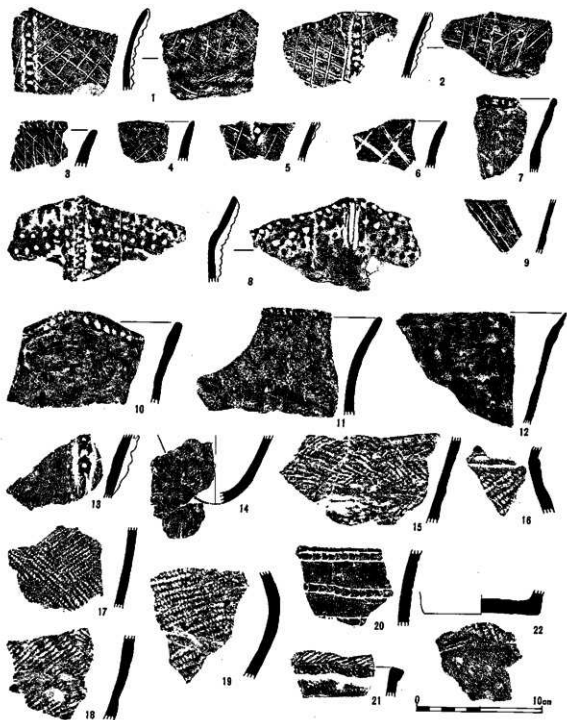

图135 十二/后遗址119号伴出出土石器拓影

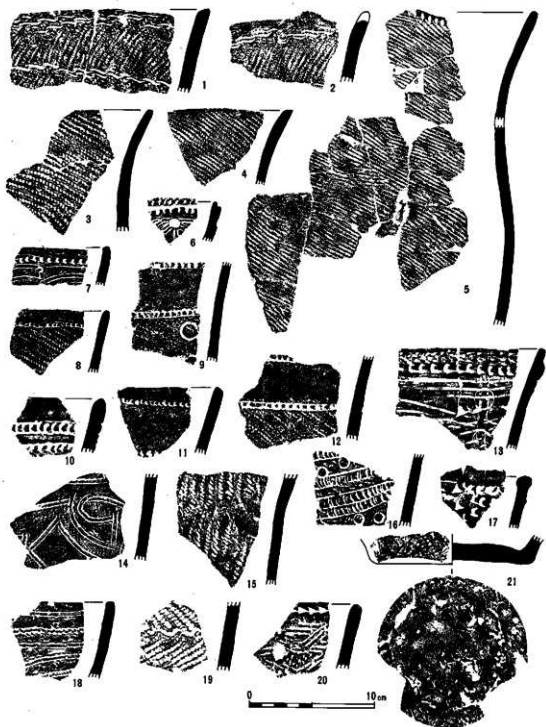

圖136 十二ノ厩遺跡 122 号住居址出土土器拓影

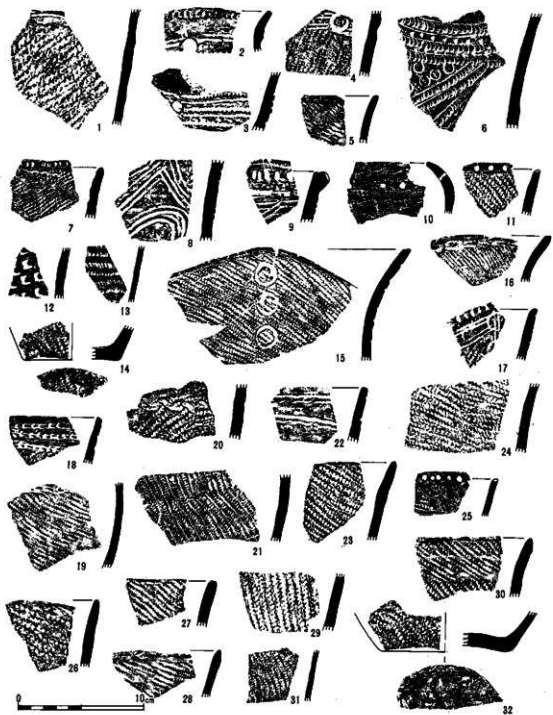

圖137 十二ノ后遺跡125・127号住居址出土土器拓影



图138 十二ノ后遺跡 131号住居址出土土器拓影

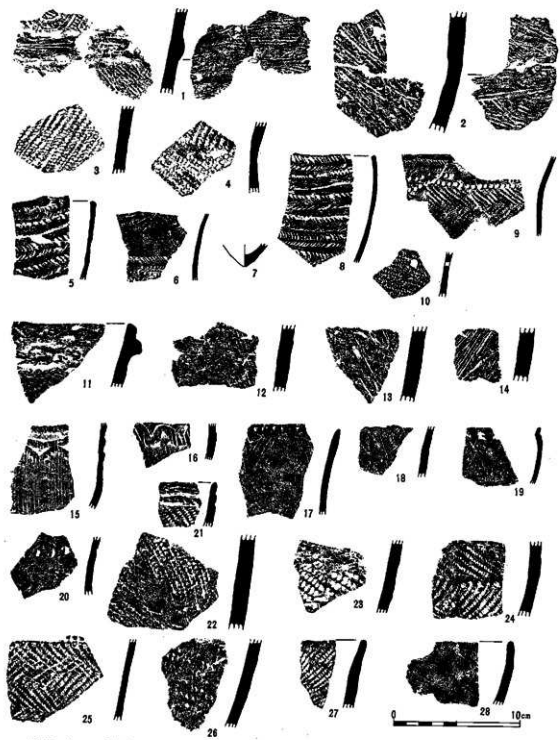

图139 十二ノ后沢跡132号住居址(その1)出土土器拓影

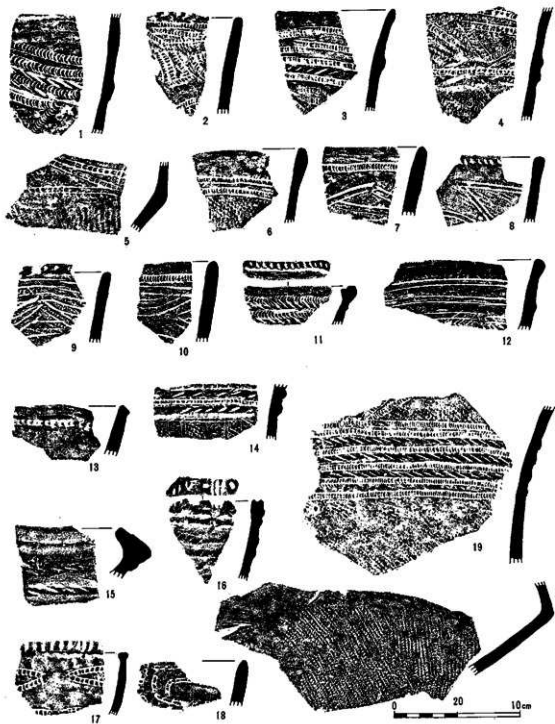

图140 十二ノ后遺跡 132号住居址(その2)出土土器拓影

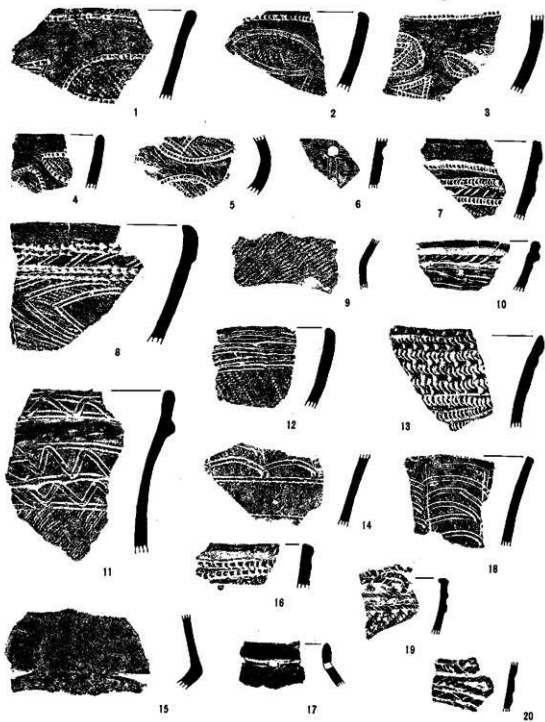

图141 十二ノ后遺跡135・137号住居址出土土器拓影

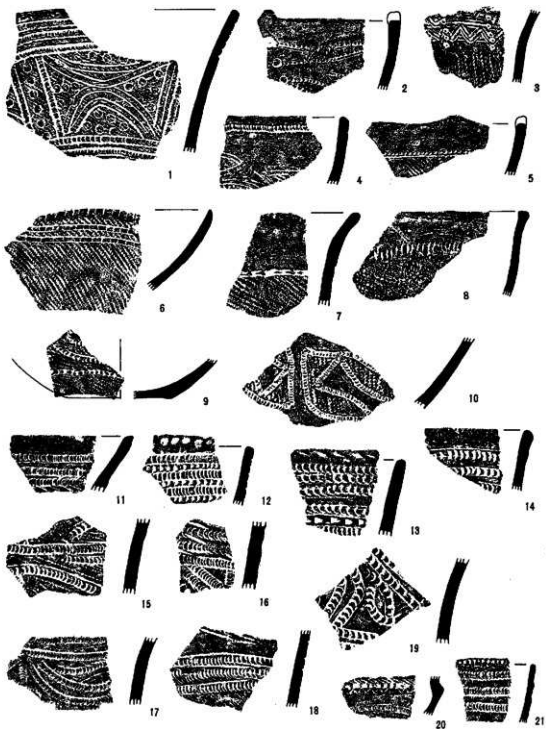

图142 十二ノ后遺跡 139号住居址出土土器拓影

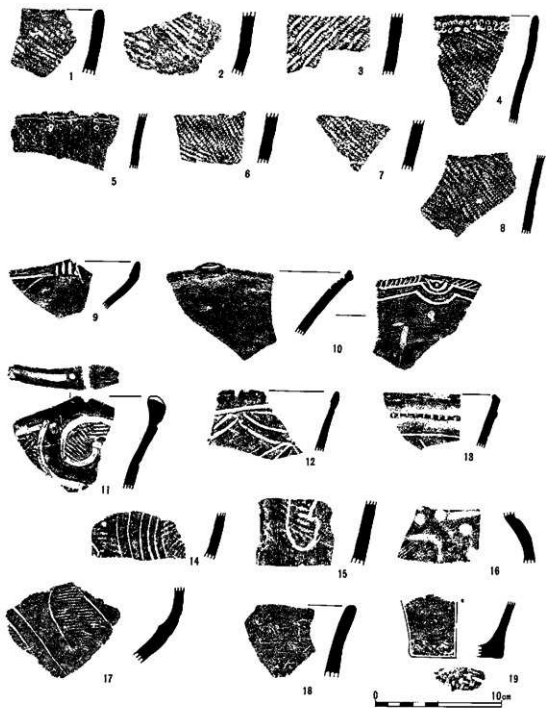

图143 十二ノ后遺跡140・141号住居址出土土器拓影

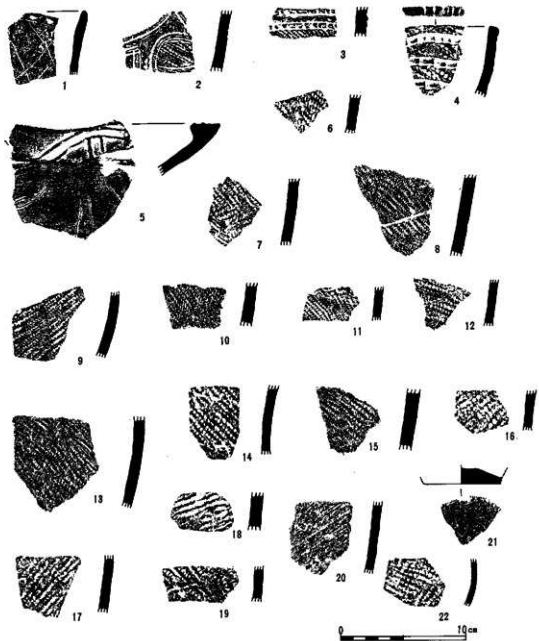

图144 十二ノ后遺跡塚穴1，築石伊1，築石1出土土器拓影

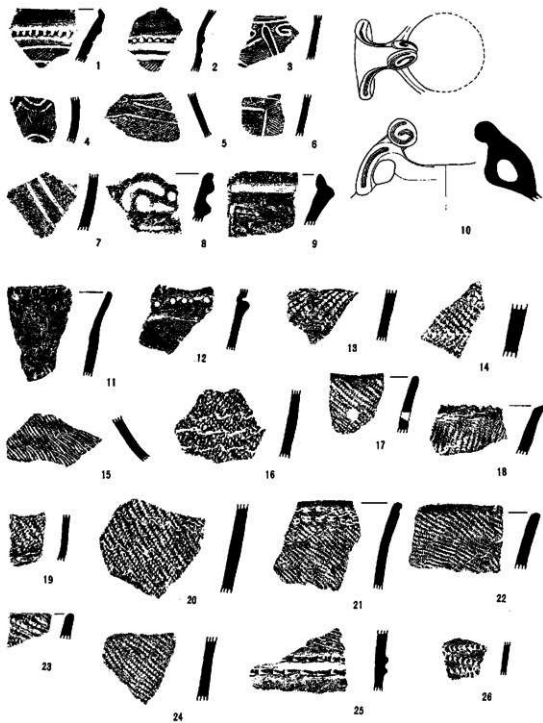

图145 十二ノ后遺跡集行2，溝状纹様，土器1～7出土土器拓影

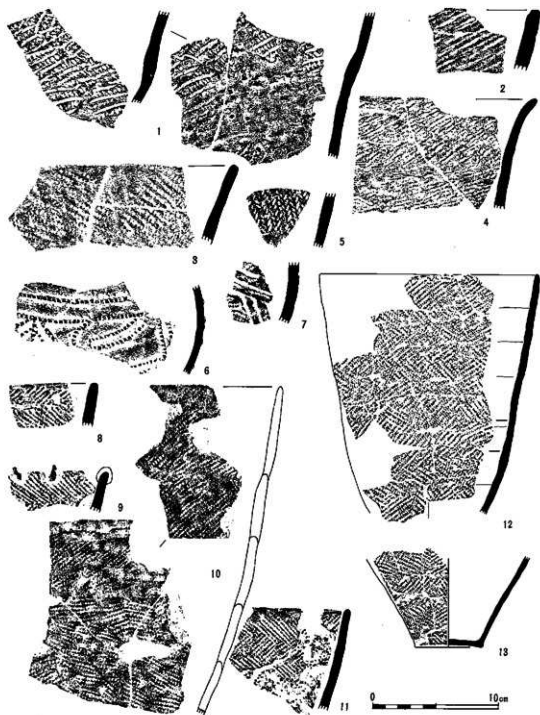

図146 十二ノ后遺跡土城9~13・15~19, 35~38出土土器拓影



图147 十二ノ后遺跡土城39~45山土器拓影



图148 十二后道船上墓22~26, 30·33·34·44·104·107出土器拓影

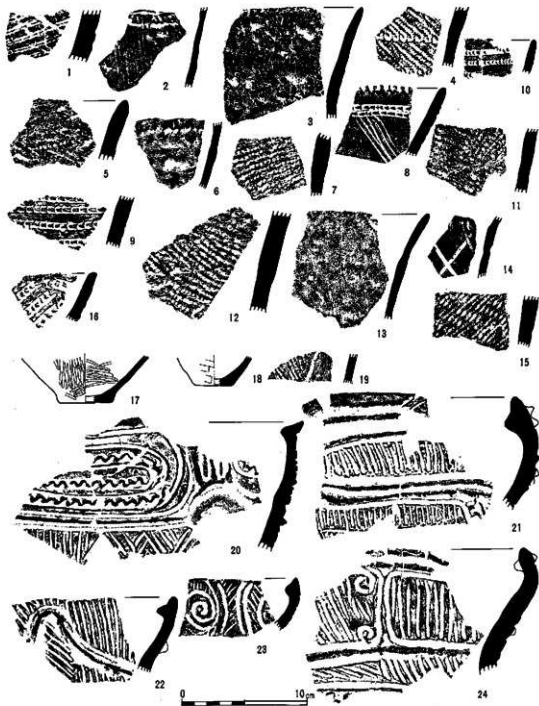

图149 十二/后溪陈十坛45·49·53·57·101·105·106出土陶器拓影

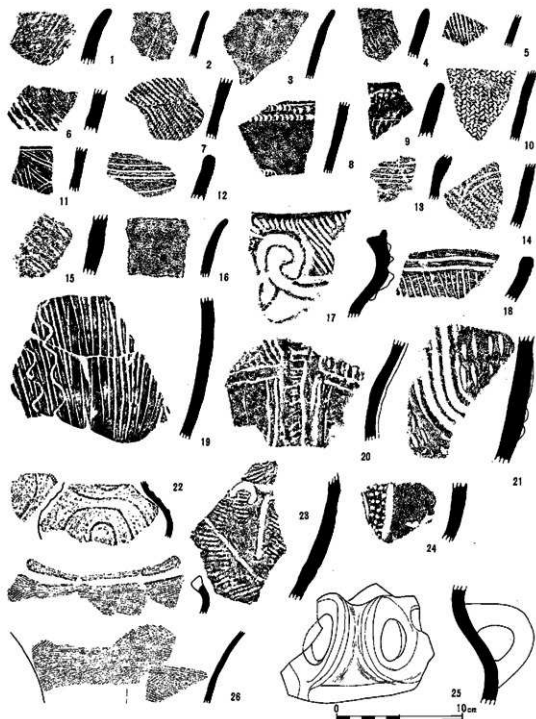

图150 十二ノ后遺跡土城107~114・119・120・121出土土器拓影

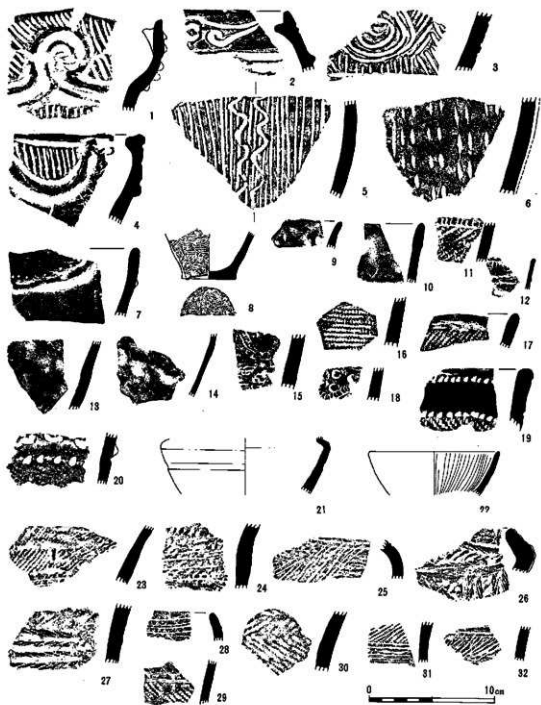

图151 十二ノ后遺跡土灰122~125・127~129出土上器拓影

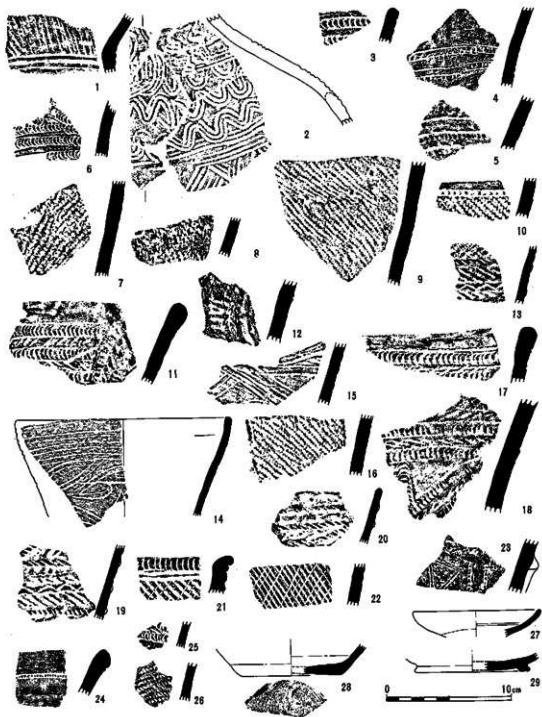

图152 十二ノ后道跡上原131・134・136・140・142・143・146・155・159・160出土土器拓影



图153 十二ノ后遺跡上址160・164・166~172・174出土土器拓影

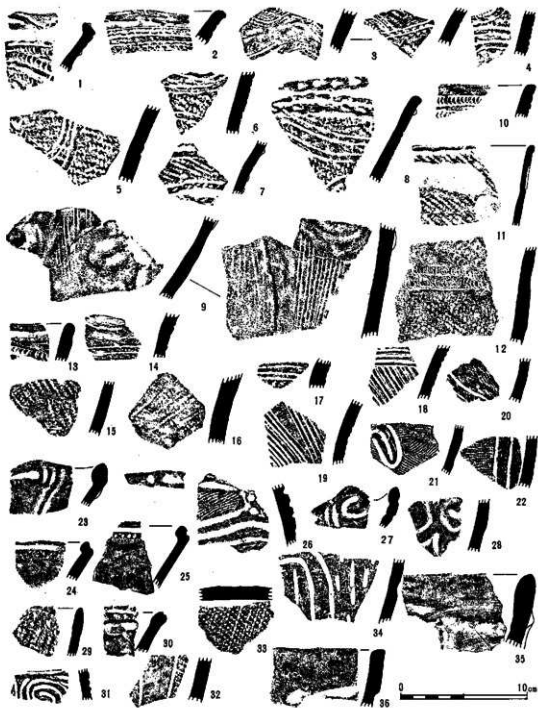

图154 十二ノ后渡跡土城174・176・180~187・191州上土器拓影

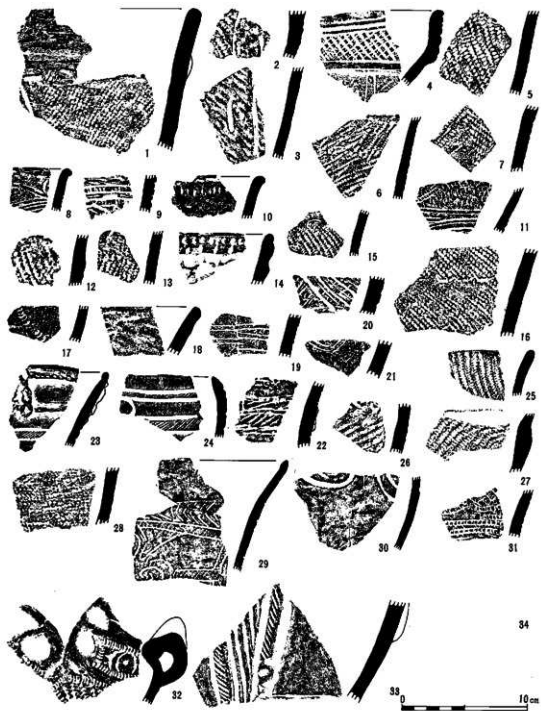

图155 十二ノ后遺跡土城128・130・132・137~140・148~150・153・176・178出土土器拓影



図156 十二ノ后遺跡遺構外(その1)出土石器(1群1類)拓影

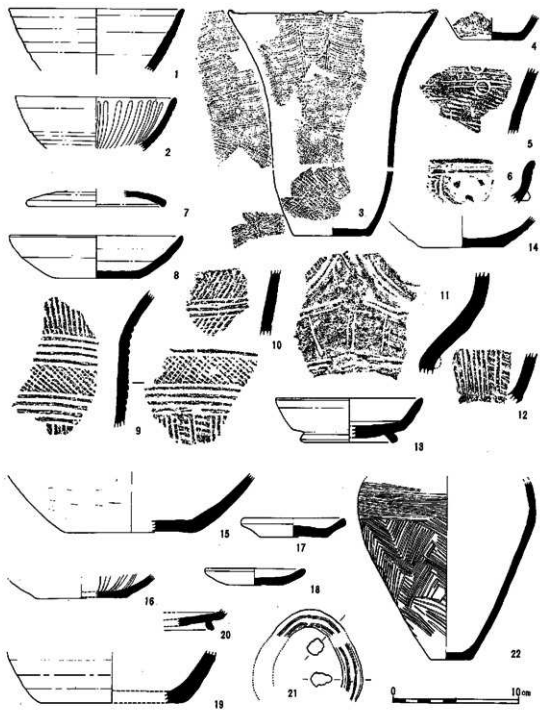

図157 十二ノ后遺跡遺構外(その2)出土土器(I群2類)拓影

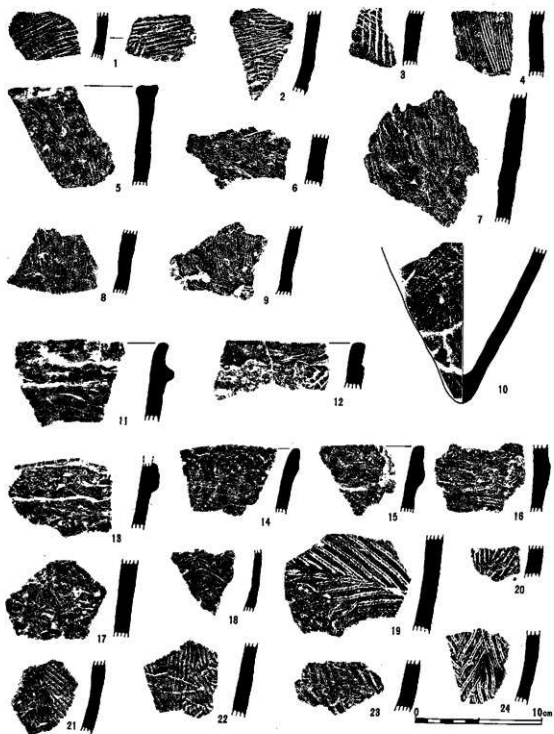

図158 十二ノ后遺跡遺構外(その3)出土土器(I群3類)拓影

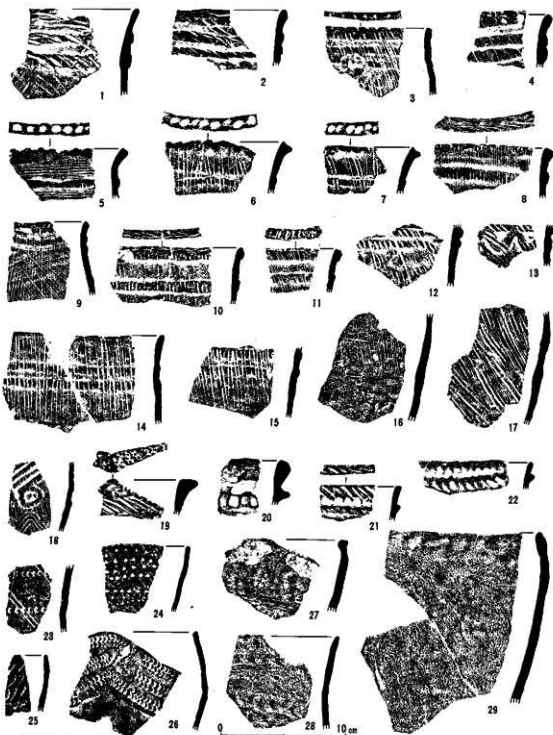

四159 十二ノ后遺跡遺構外(その4)出土土器(T群4類)拓影

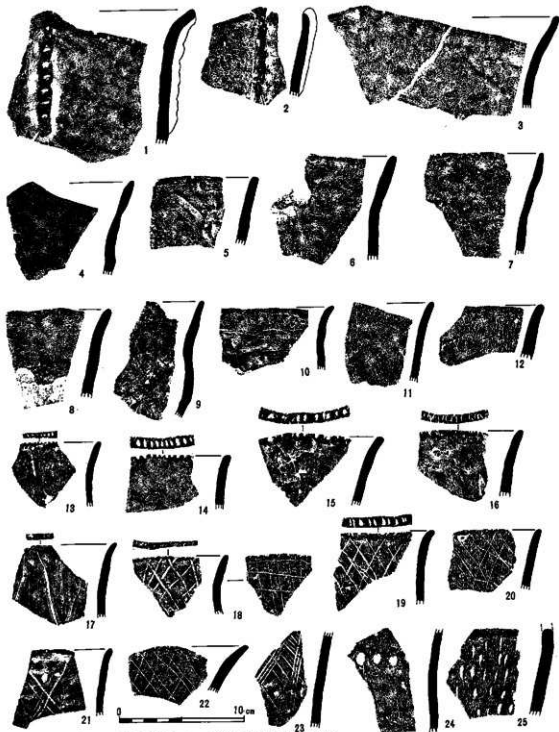
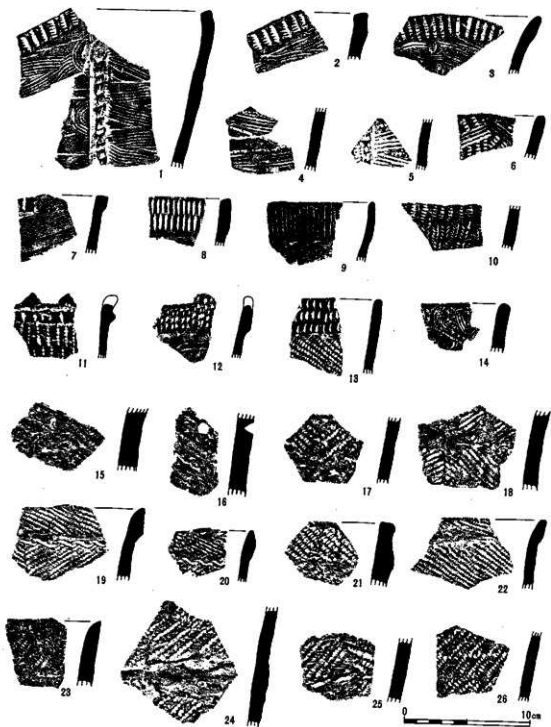

図160 十二ノ后遺跡遺構外(その5)出土土器(I群4・5類)拓影



図161 上二ノ后遺跡遺物外(その6)出土土器(J群5類)坯影

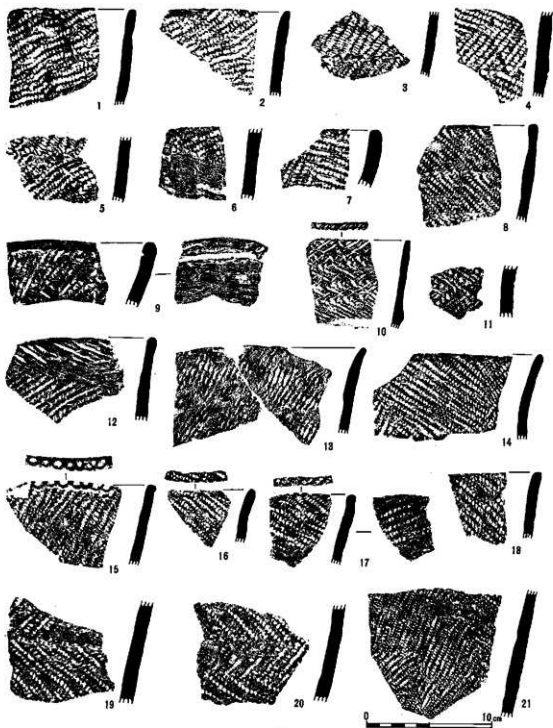

図162 十二ノ后遺跡遺構外(その7)出土土器(Ⅱ群1・2類)拓影

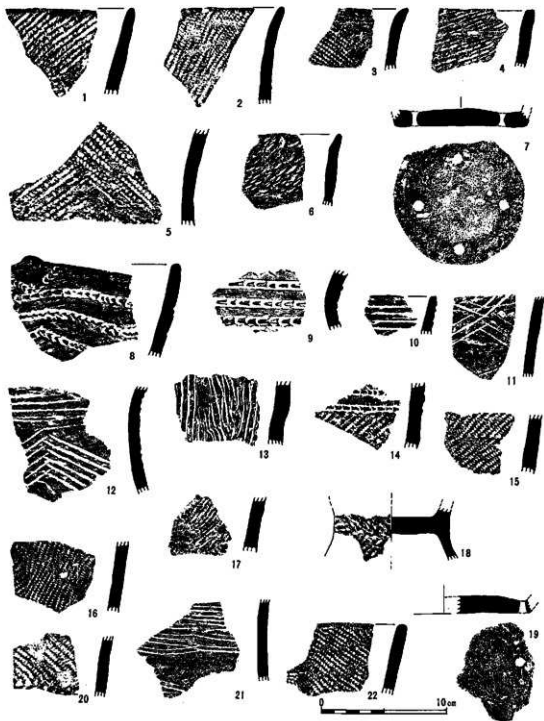

図163 十二ノ所遺跡遺物外(その8)出土土器(Ⅱ群2類)拓形

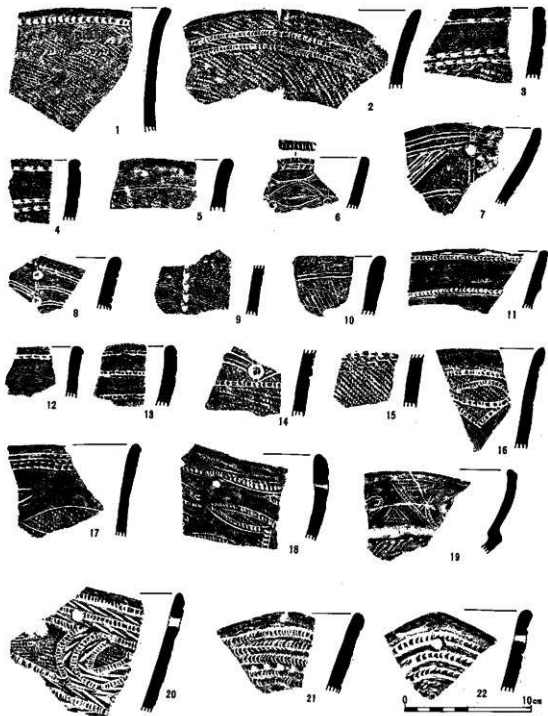

図164 十二ノ后遺跡遺構外(その9)山土土器(Ⅱ群3類, Ⅰ群6類, Ⅱ群4類, Ⅲ群2・3類)拓影



図165 十二ノ后遺跡遺構外(その10)山土土器(百肆1・2類)拓影



図166 十ノ后遺跡遺構外(その11)出土土器(IV群2類)拓影



図167 十二ノ后遺跡遺構外(その12)出土土器(IV群2類)拓影



図168 十二ノ后遺跡遺構外(その13)出上土器(IV群2・3類)拓影



図169 十二ノ后遺跡遺構外(その14)出土土器(百群3類)拓影

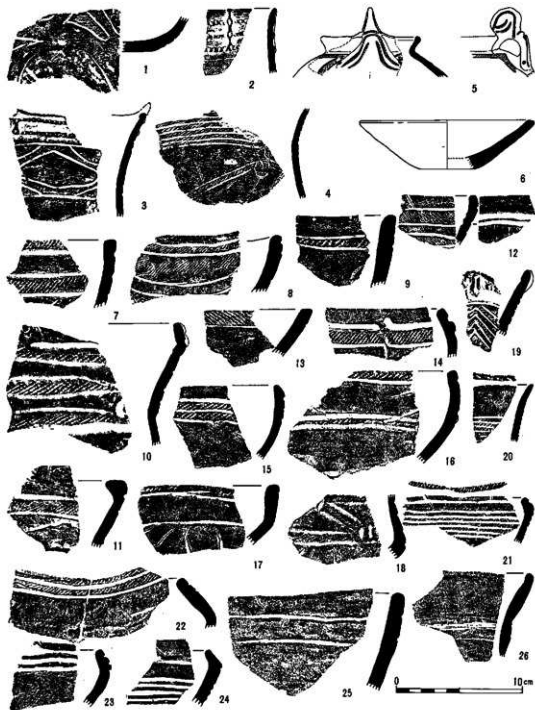

図170 十二ノ后遺跡遺構外(その15)出土土器(N群3・2類)撮影

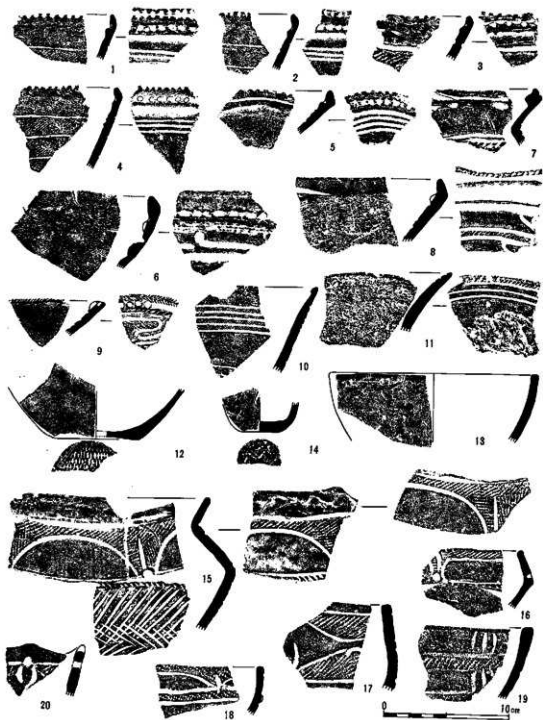

图171 十二ノ后遺跡遺構外(その16)出土土器(IV群2類, IV群, V群1類A)拓影

包含物

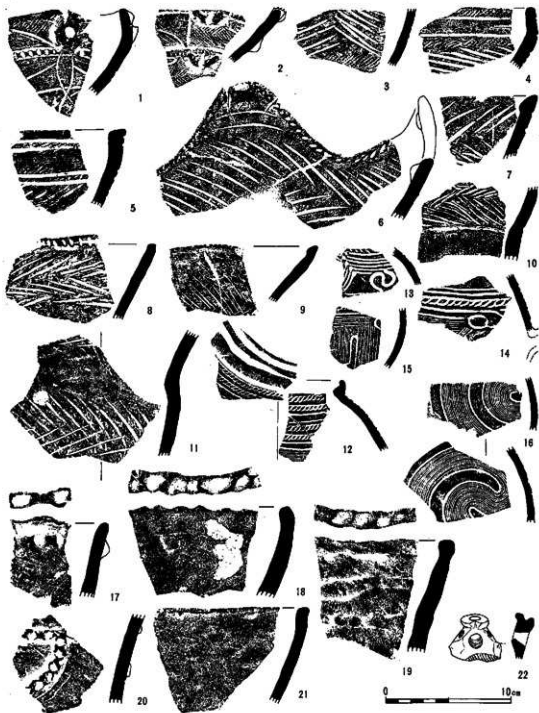

図172 十二ノ所遺跡出土弥生土器(その1)実測図・拓影

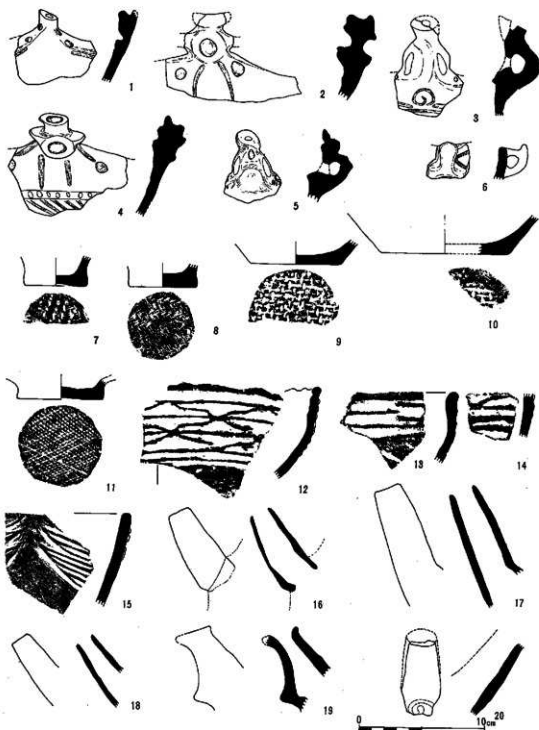

第48号住居址

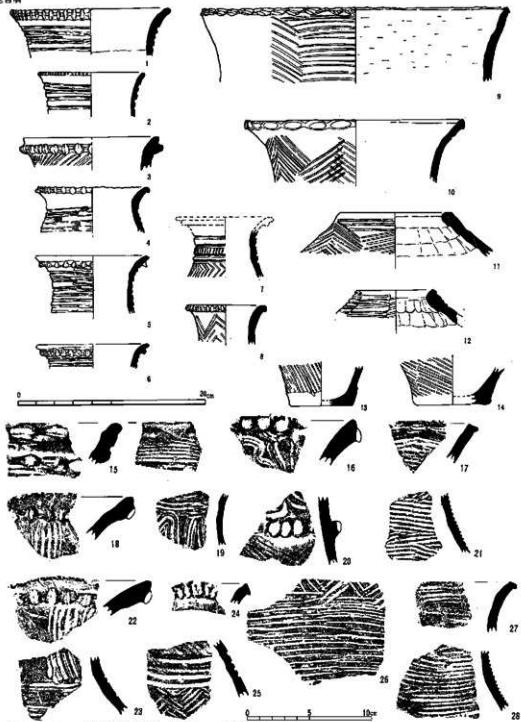
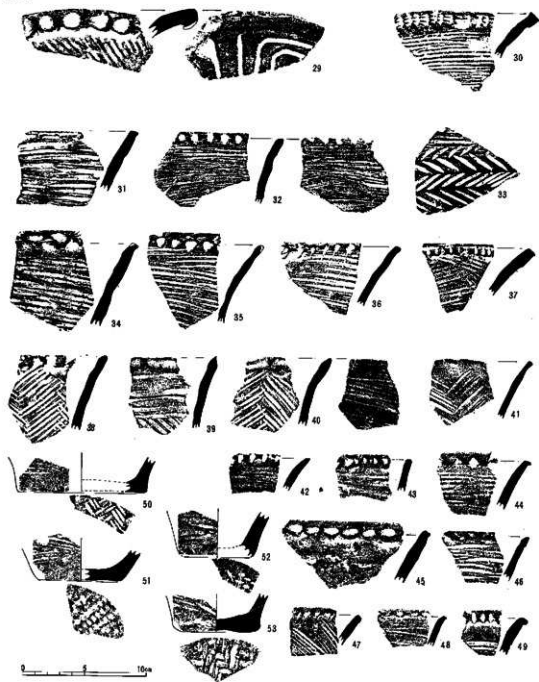
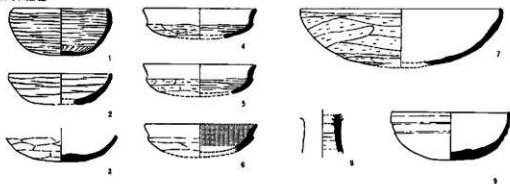

第116号住居址

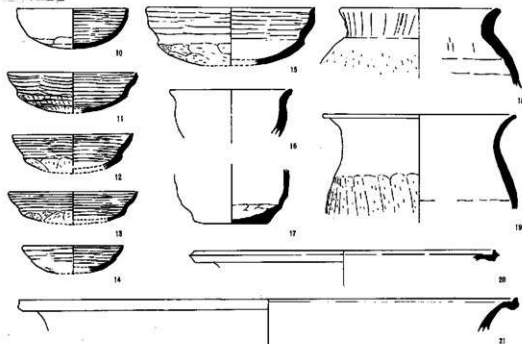

包含層



图174 十二ノ后遺跡第48・116号住居址包含層出土土器実測圖

第82号住居址

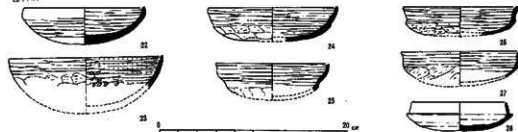

图175 十二ノ后遺跡第82号住居址出土土器実測图

第128号住居址



第85号住居址

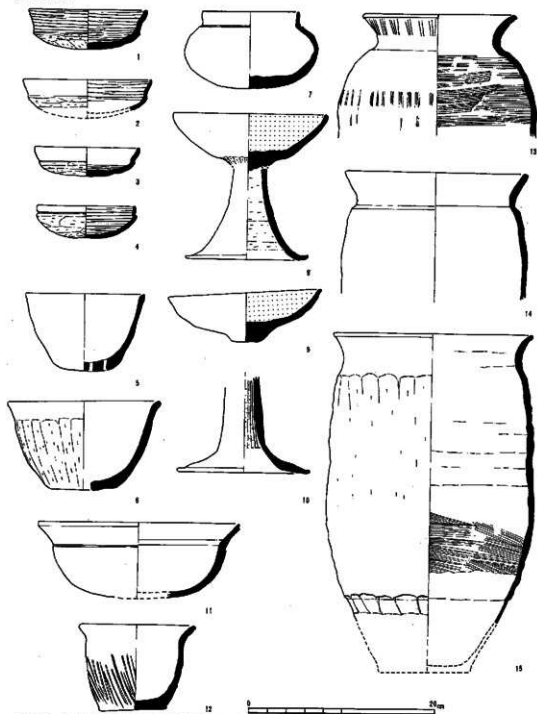
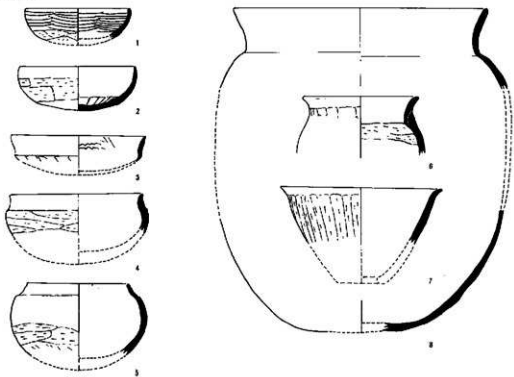

图176 十二ノ后遺跡第128・85号住居址包含層出土土器実測圖

第7号住居址



第14号住居址

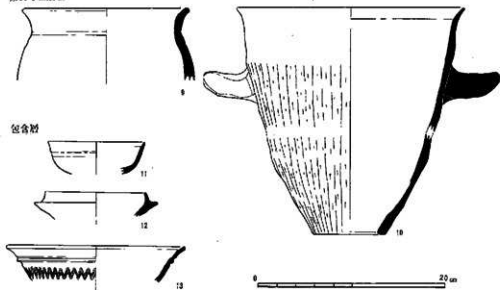
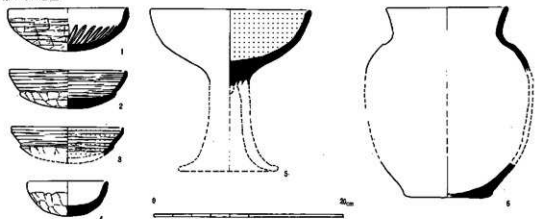

図177 十二ノ后遺跡第7・14号住居址出土土器実測図

第9号住居址



第13号住居址

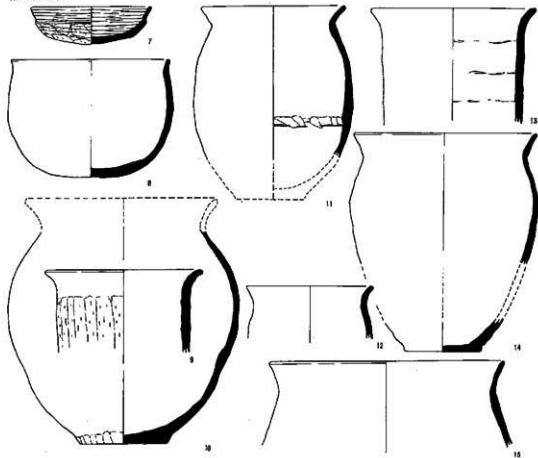
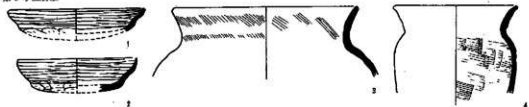

图178 十二ノ后遺跡第9・13号住居址出土土器実測图

第31·32号住居址



第44号住居址

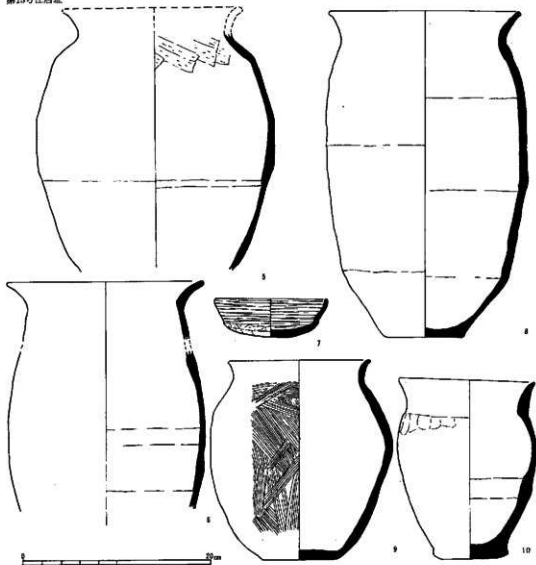
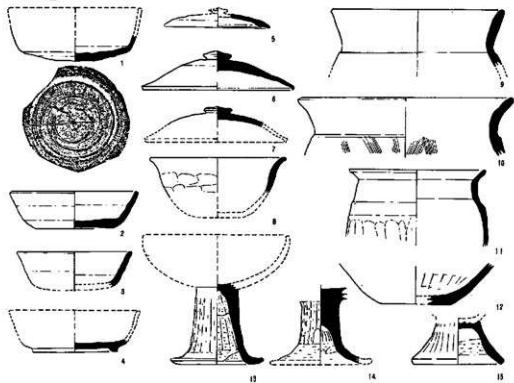

16



17

包含層



18

第77号住居址

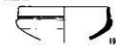

19



20

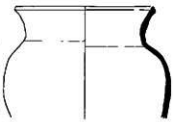

21



22



23



图179 十二ノ后遺跡第31·32·44·77号住居址，包含層出土器実物圖

第114号住居址

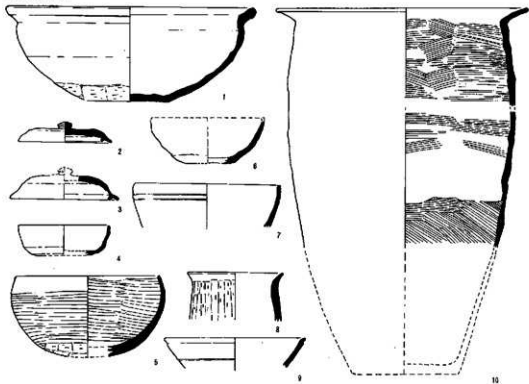

第133号住居址



图180 十二ノ所遺跡第114・133号住居址出土土器実况图

第142号住居址

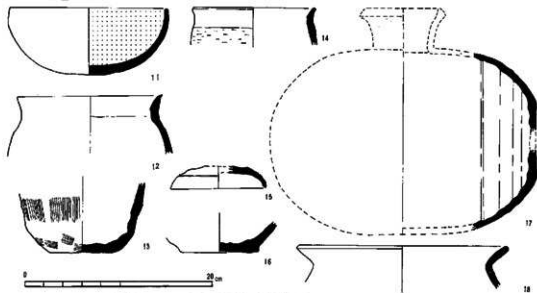

图181 十二ノ后遺跡 142号住居址。包含層出土土器実測図

第4号住居址

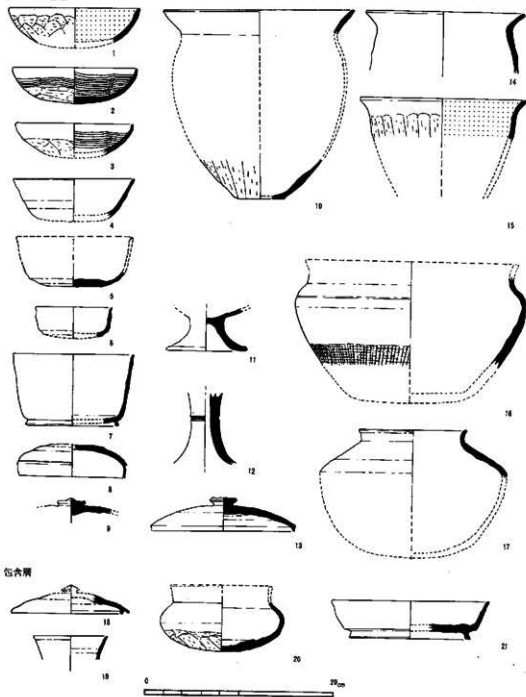

图182 十二ノ后遺跡4号住居址出土土器実測図

第91号住居址



第117号住居址

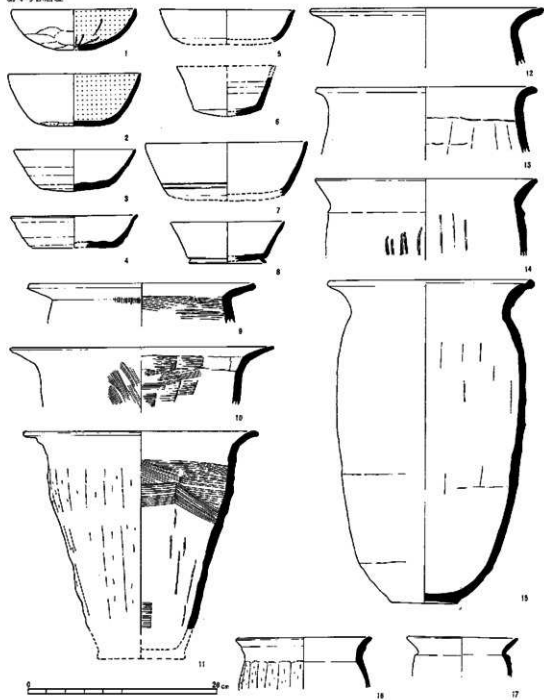
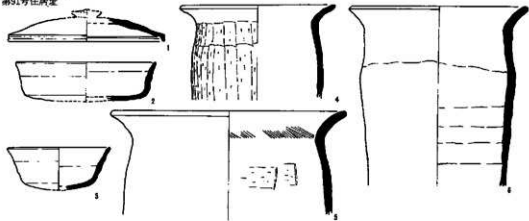
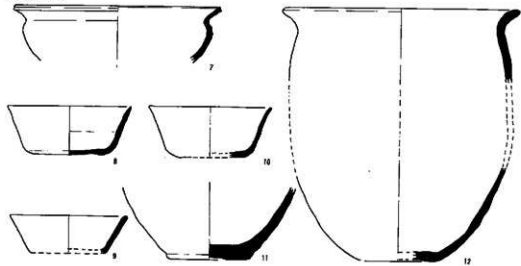

第126号住居址

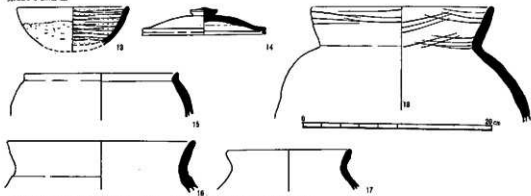

第30号住居址



图184 十二ノ后遺跡30号住居址出土土器実測図

第35号住居址



第57号住居址

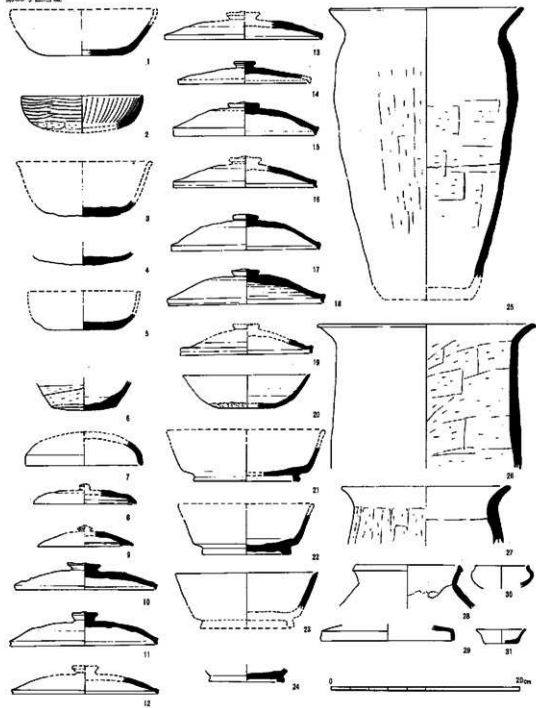
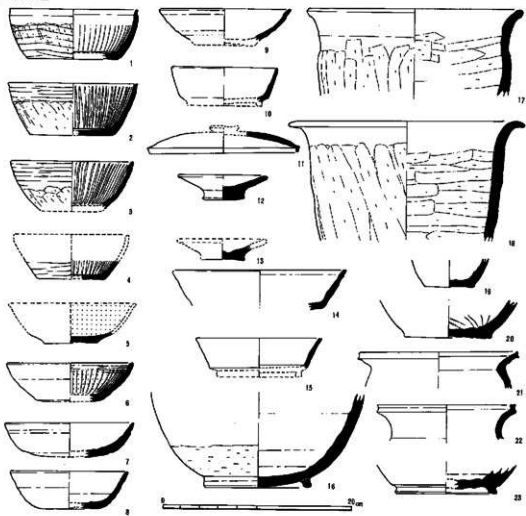

図185 十三ノ后遺跡35・57号住居址出土土器実測図

第123号住居址



第76号住居址

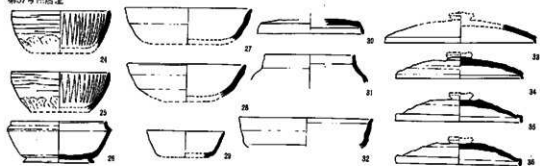
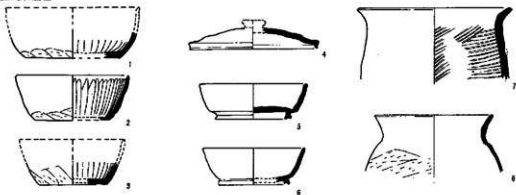

图186 十二ノ后遺跡123・76号住居址出土土器実態圖

第78号住居址



第84号住居址

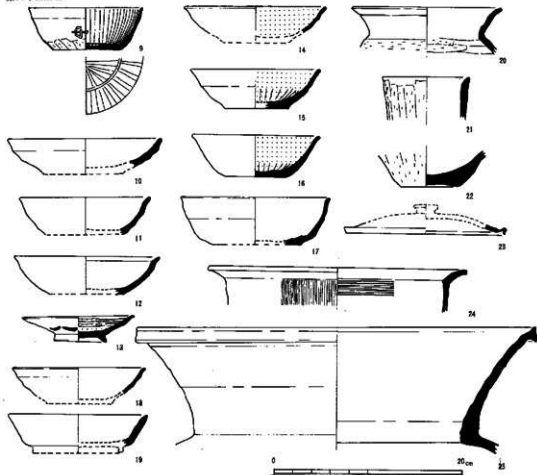
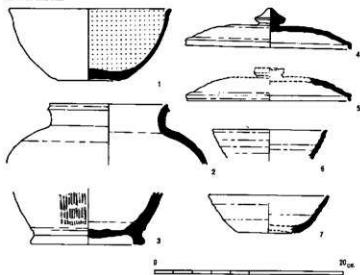
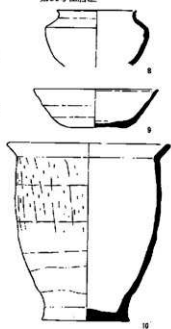

第105号住居址



图187 十二ノ后遺跡78・84・105号住居址出土土器実測図

第55号住居址



第94号住居址

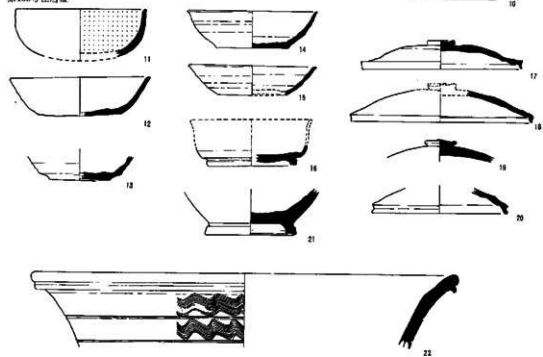
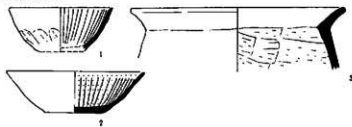

第79号住居址

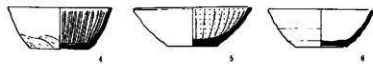

第51号住居址

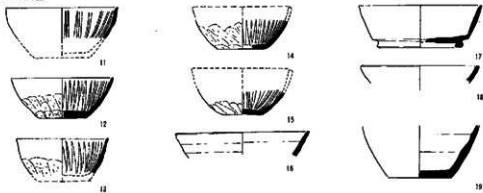

第103号住居址

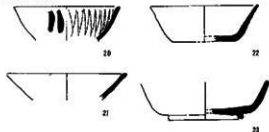

第130号住居址



图188 十二ノ后遺跡55・79・94・51・103・130号住居址出土土器尖刺区

第40号位图址

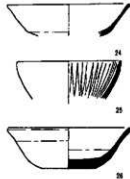

图189 十二ノ后遺跡40号位所出土土器実面图

第60号住居址



第67号住居址

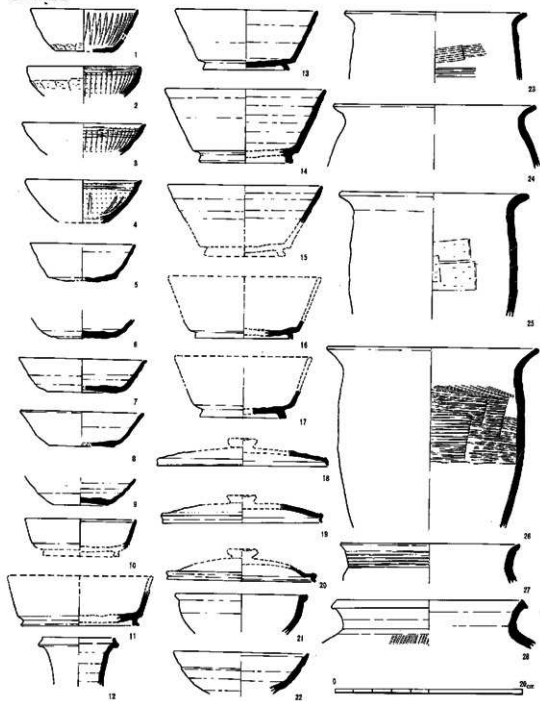
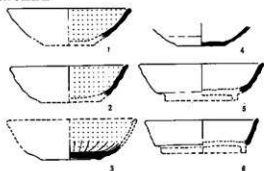
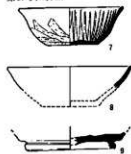

第97号住居址



图190 十二ノ后遺跡60・67・97号住居址出土土器実測图

第83号住居址

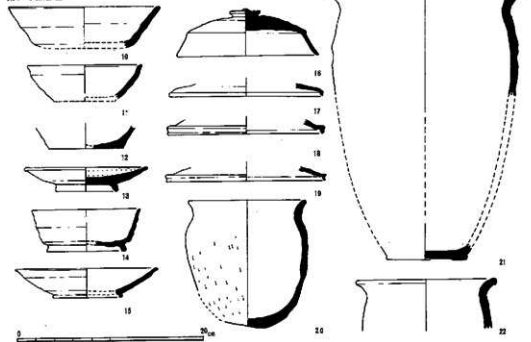

图191 十二ノ后遺跡83号住居址出土土器実測图

第62号住居址



第89号住居址

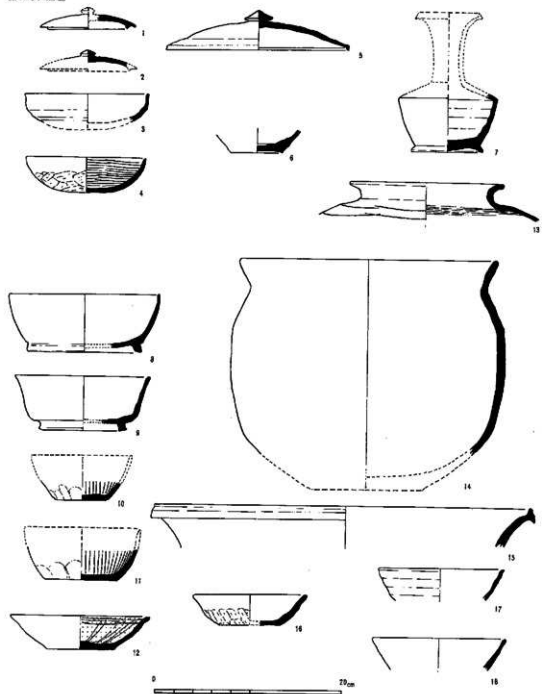
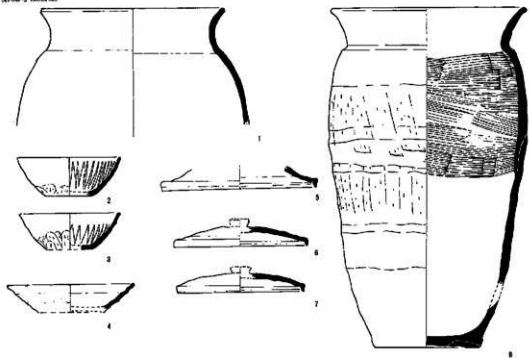
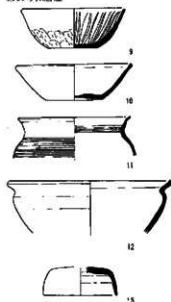

第101号住居址

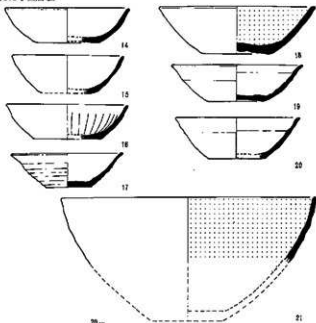

0 20cm

图192 十二ノ府遺跡62・89・101号住居址出土土器実測图

第101号住居址

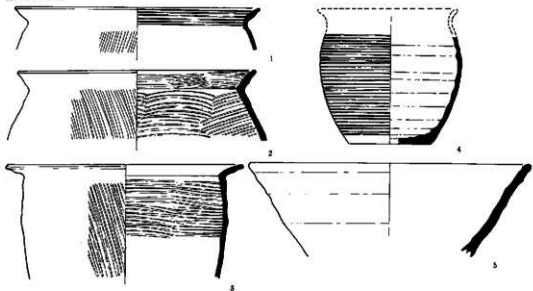

第87号住居址



图193 十二ノ后遺跡 101・87号住居址出土上器実測图

第2号住居址

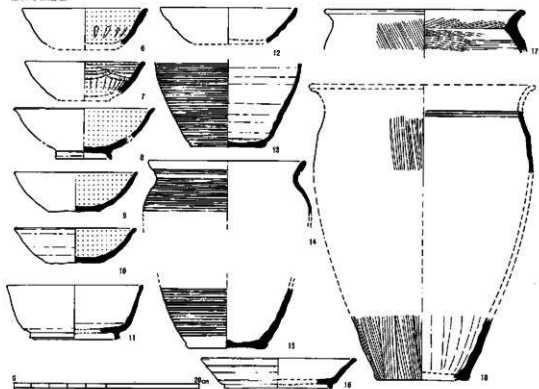

图194 十二ノ后遺跡2号住居址出土土器実測圖

第5号住居址



第45号住居址

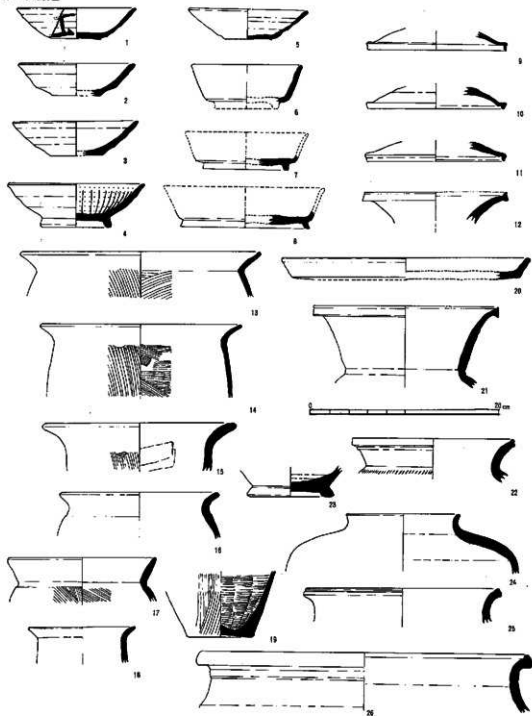
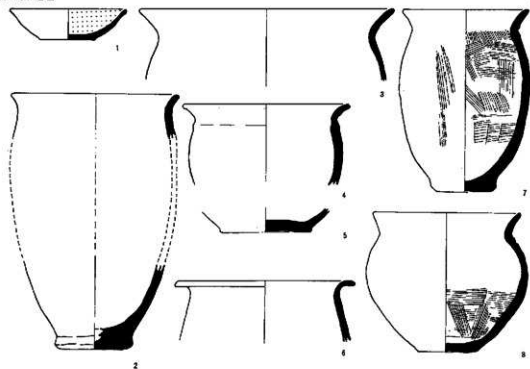

图195 十二ノ后遺跡5・45号住居址出土土器実測図

第53号住居址

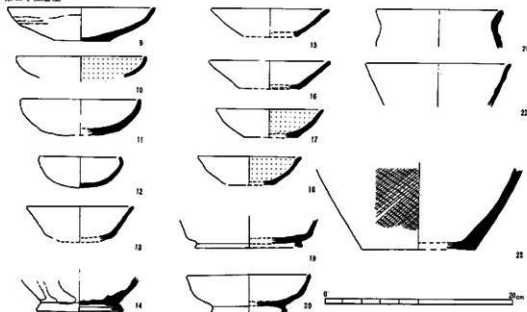

図196 十二ノ后遺跡53号住居址(その1)出土土器実面図

第53号住居址

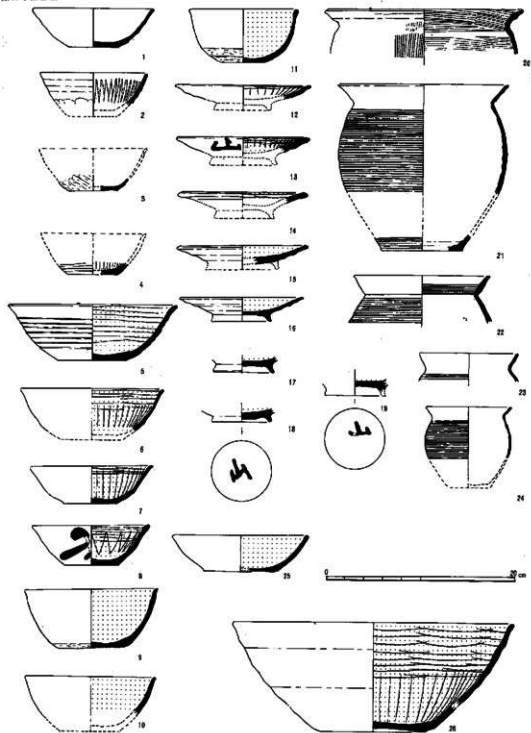

図197 十二ノ所遺跡53号住居址(その2)出土土器実測図

第115号伴塚址

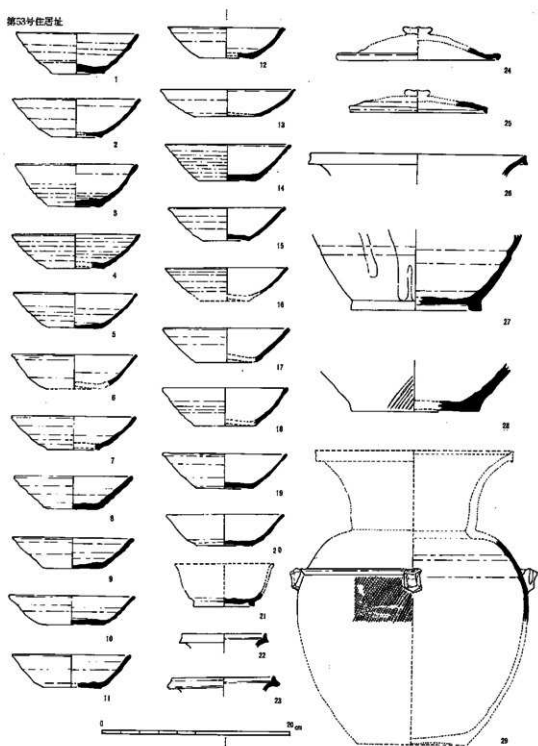

图198 十二ノ后遺跡115住居址出土土器実物图

第63号住居址



第36号住居址

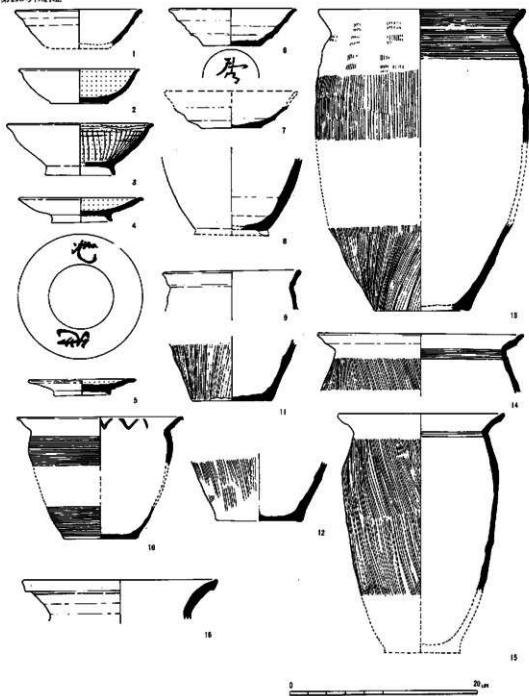
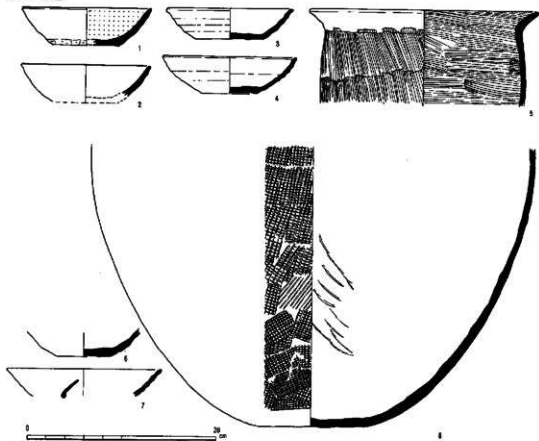

图199 十二ノ后遺跡63・36号住居址出土土器実例圖

第43号住居址

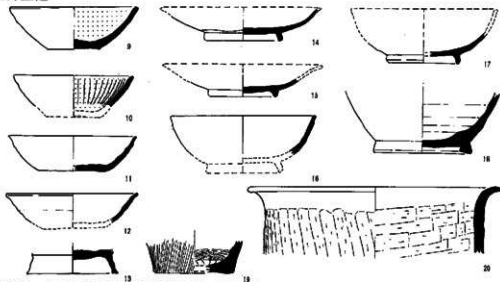

图200 十二ノ后遺跡43号住居址出土土器実図

第71号生居址



第124号住居址

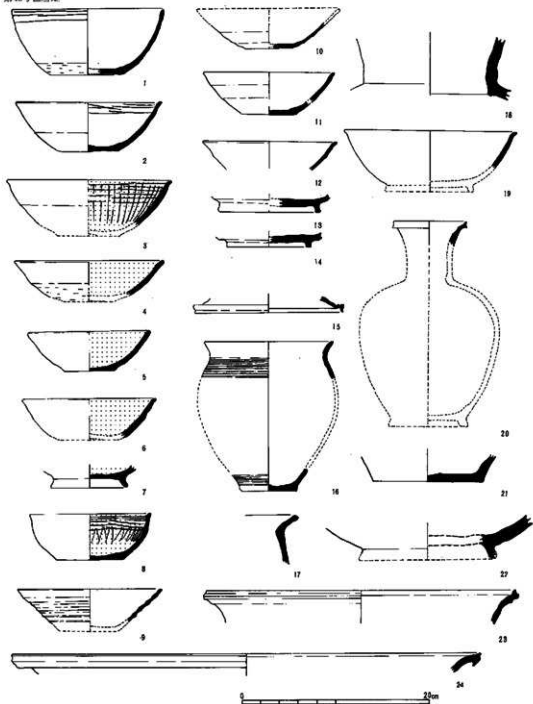
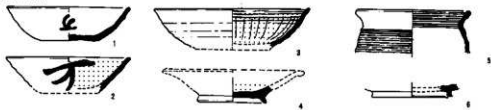

图201 十二ノ后遺跡71・124号住居址山土器実測图

第120号住居址



第129号住居址

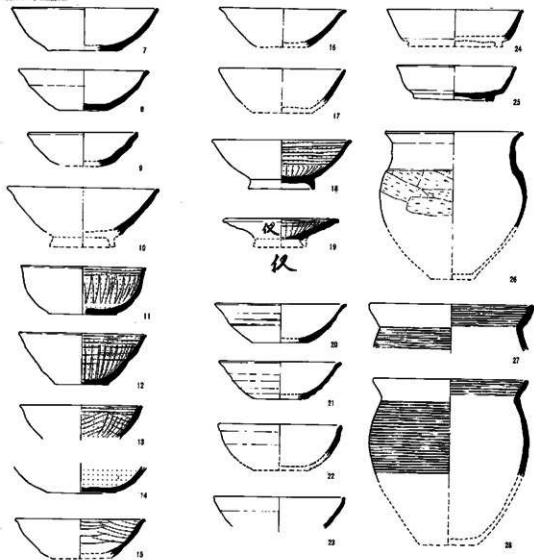
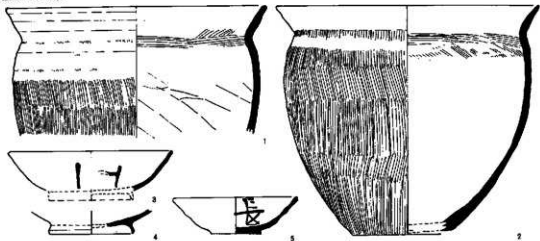
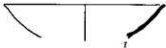

第134号住居址



第54号住居址



第70号住居址



第72号住居址



图202 十二ノ后遺跡120・129・134・70・54・72号住居址出土器実測图

第3号住居址

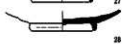
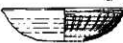
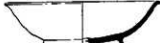
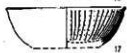

图203 十二ノ后遺跡3号住居址出土土器実測図

第41号住居址

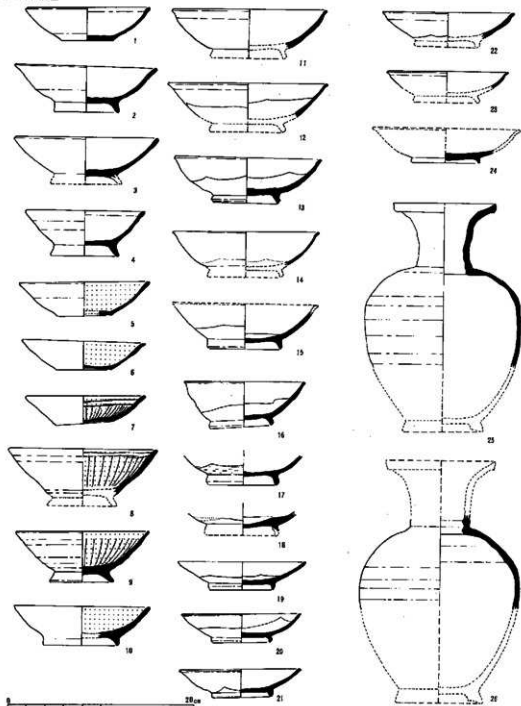

图204 十二ノ后遺跡41号住居址出土土器実測图

第18号住居址



第29号住居址

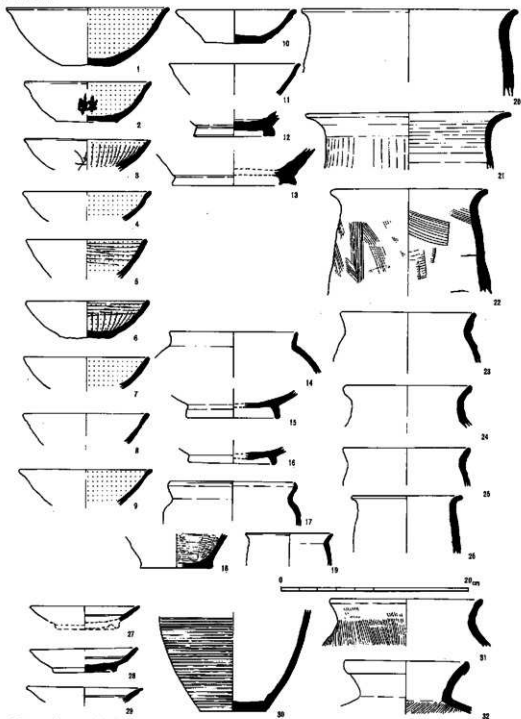
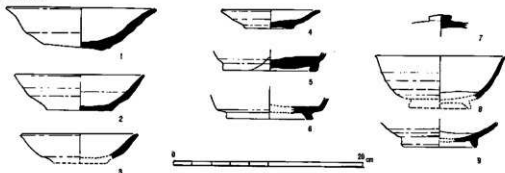
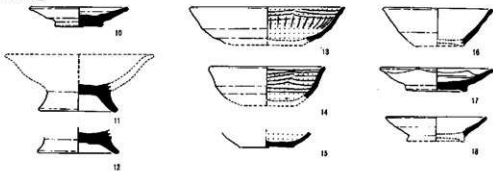

第33号住居址



图205 十二ノ后遺跡18・29・33号住居址出土土器尖側面图

第34号住居址



第121号住居址

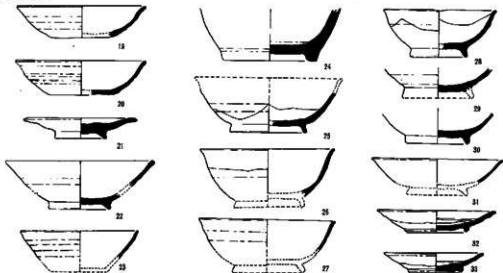
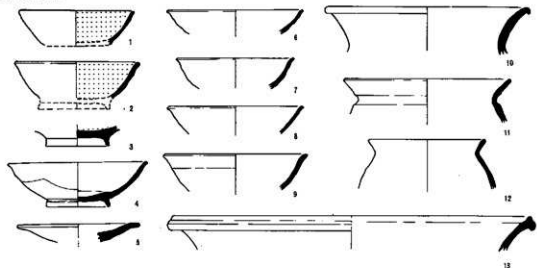

图206 十二ノ后遺跡 34・121号住居址出土土器実測図

フンド3

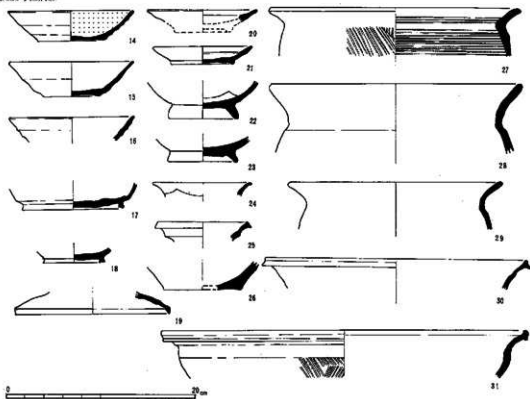

図207 十二ノ后遺跡3号フンド出土土器実高図

フンド3



フンド2

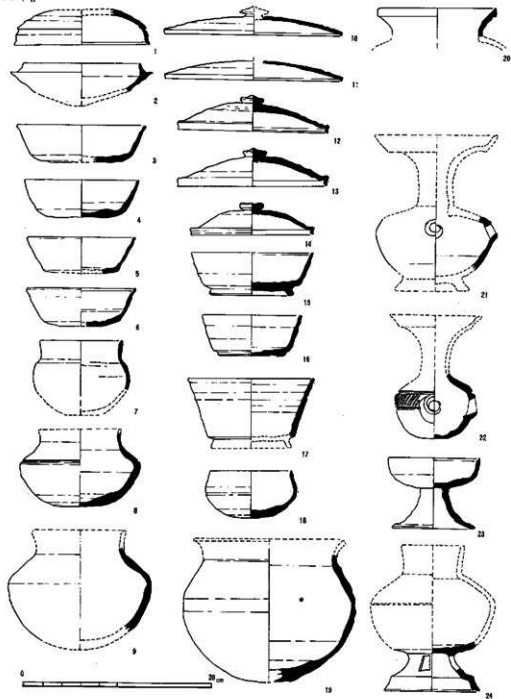
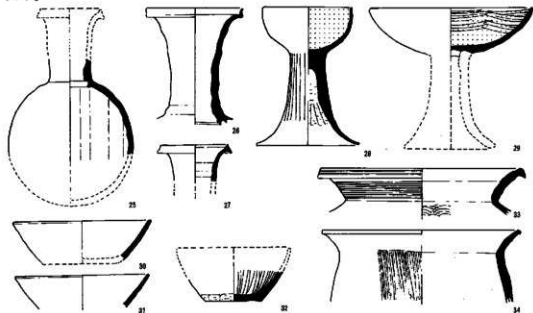
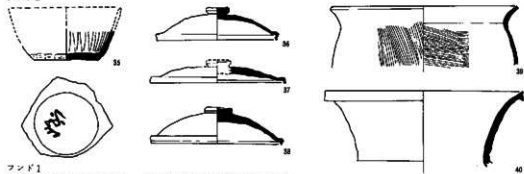

フンド1

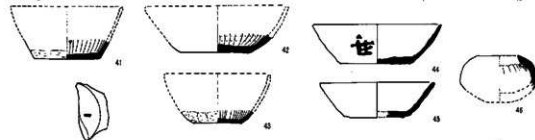

フンド1

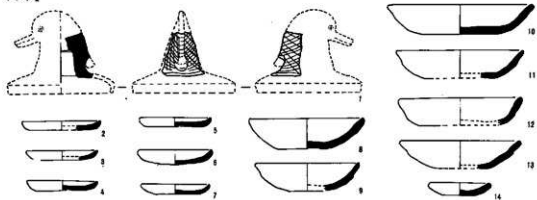

フンド4

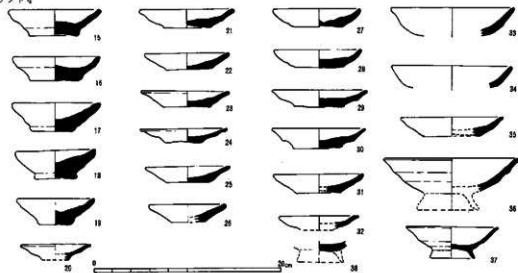

集列石



図209 十二ノ后遺跡1・4号フンド，集列石出土土器尖測図

包含層・フンド4



フンドI

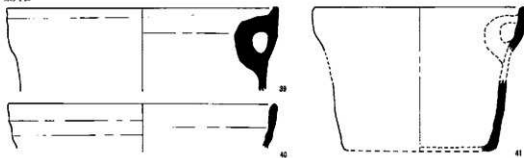
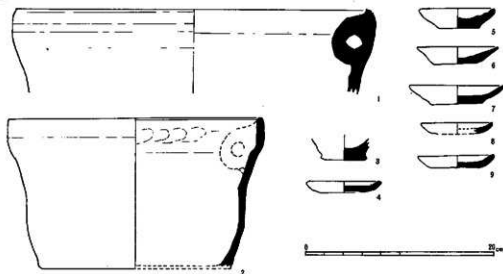
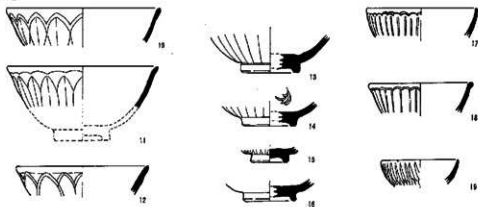

第6号墳墓



図210 十二ノ后遺跡4・1号フンド，包含層，1号墳墓出土土器実測図

包含層



图211 十二ノ后遺跡包含層出土土器実測図

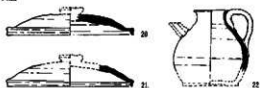

図212 十二ノ厩遺跡1号住居址(その1)出土石器実面図

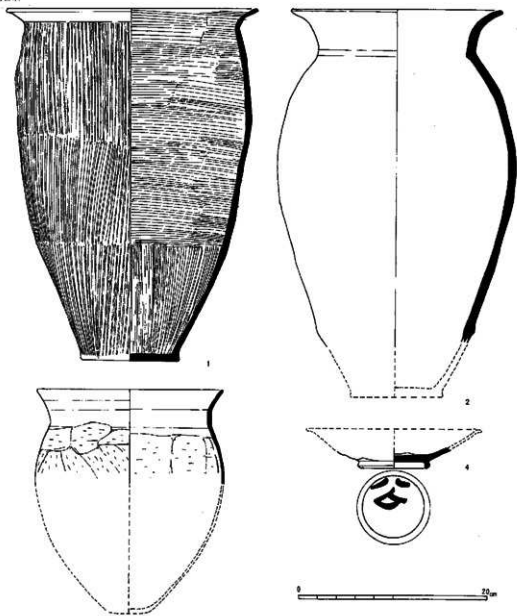

图213 十二ノ后遺跡1号住居址(その2)、6号住居址、8号住居址(その1)出土石器実測図

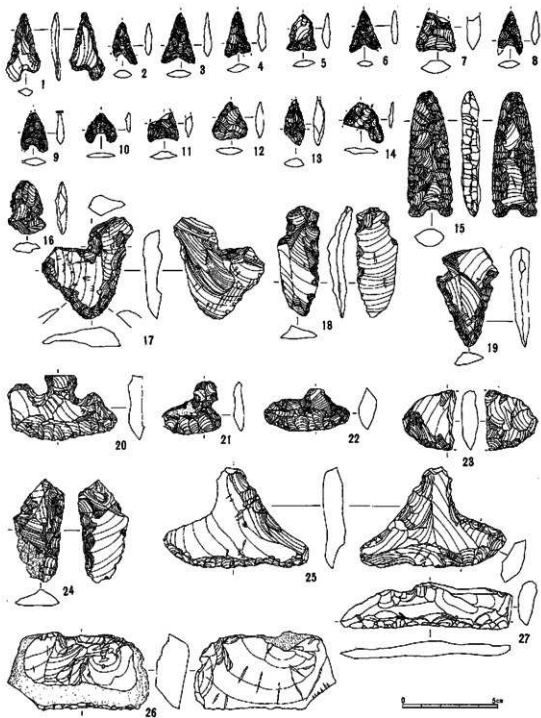

図214 十二ノ后遺跡8号住居址(その2)出土石器実測図

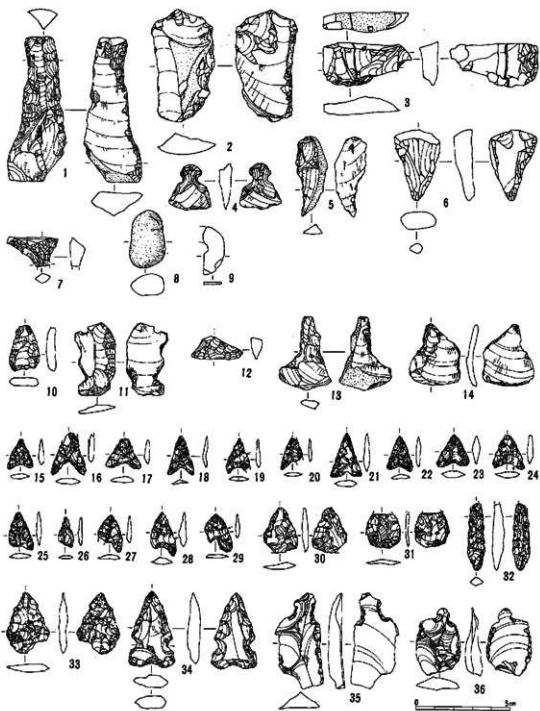

图215 十二ノ后遺跡10・11号住居址，12号住居址(その1)出土石器実例图

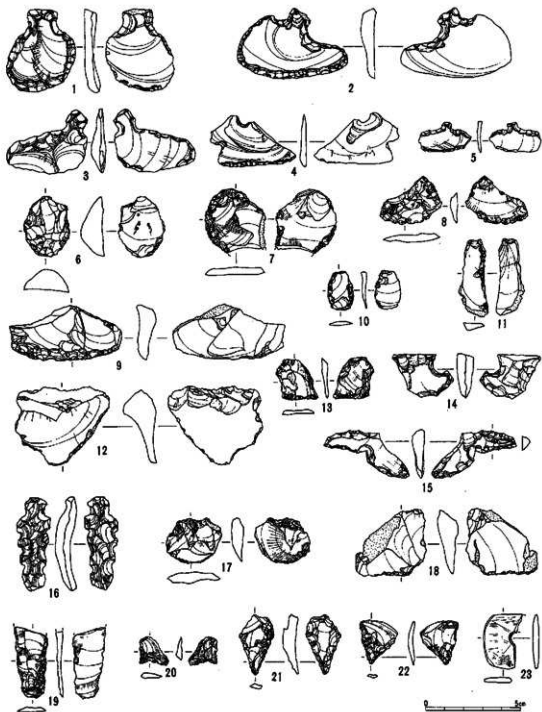

图216 十二ノ后遺跡12号住居址(その2)出土石器実測図

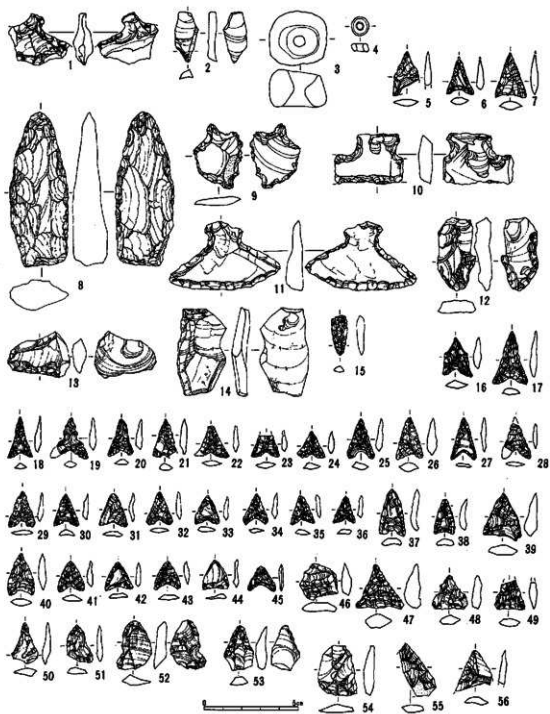

图217 1二ノ后遺跡12号住居址(その3)出土石器実測図

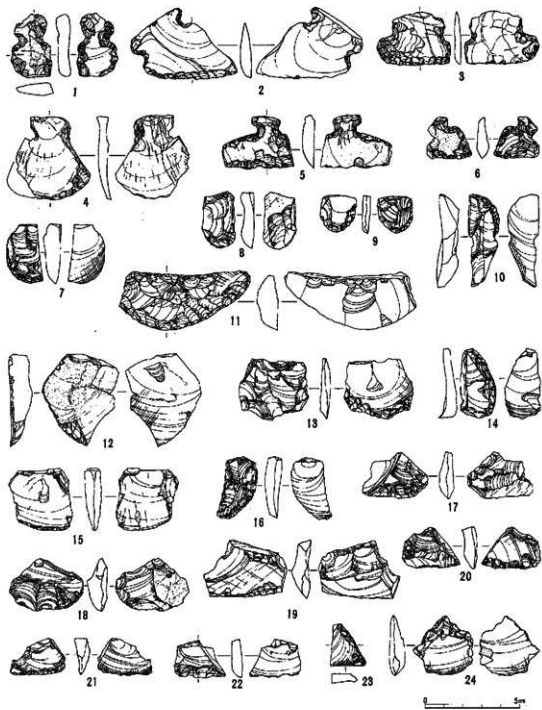

图218 十二ノ后遺跡15号住居址出土石器実測图



図219 十二ノ后遺跡16号住居址(その1)出土石器実測図

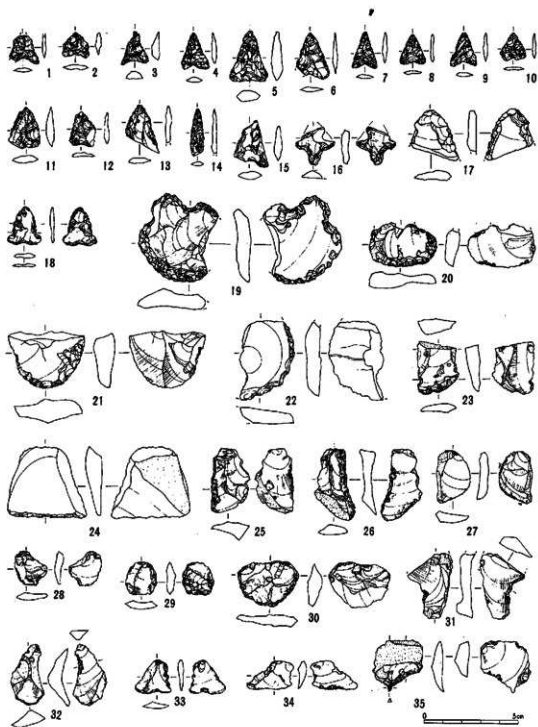

220 十二ノ后遺跡16号住居址(その2)出土石器実測図

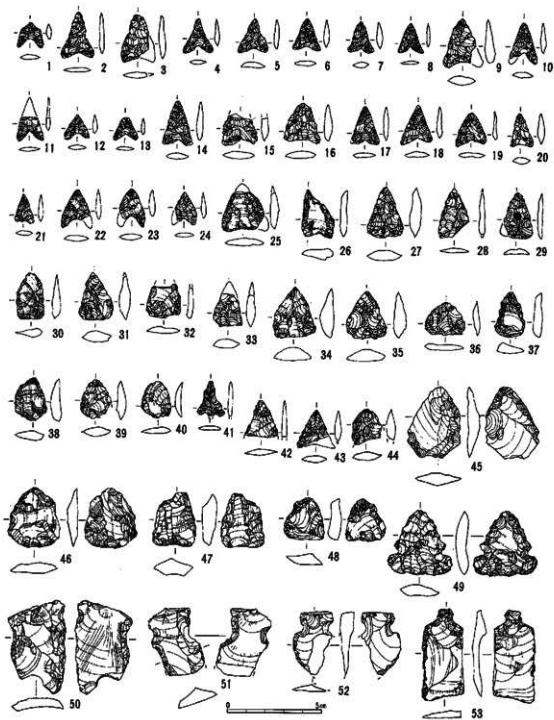
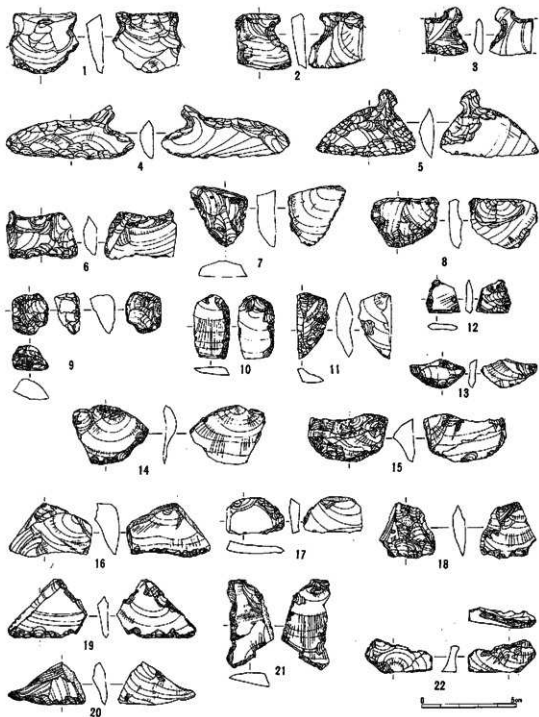

图221 十二ノ后遺跡16号住層正(その3)出土石器実測図



图222 十二ノ后遺跡16号住居址(その4)出土石器実測图

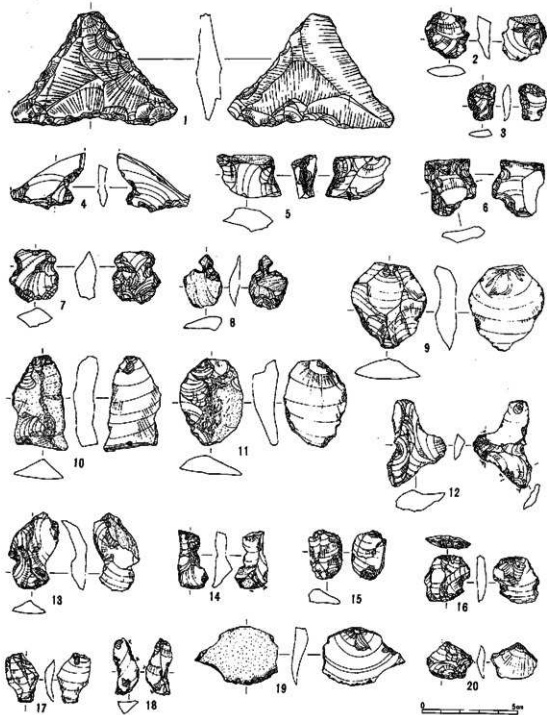

図223 十二ノ后遺跡16号住居址(その5)出土石器実測図

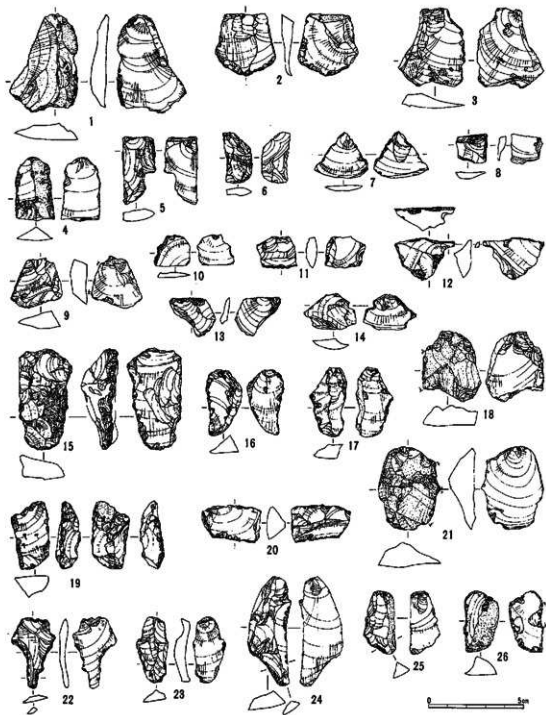

区224 十二ノ后遺跡16号住居址(その6), 17・19・20号住居址出土石器実測図

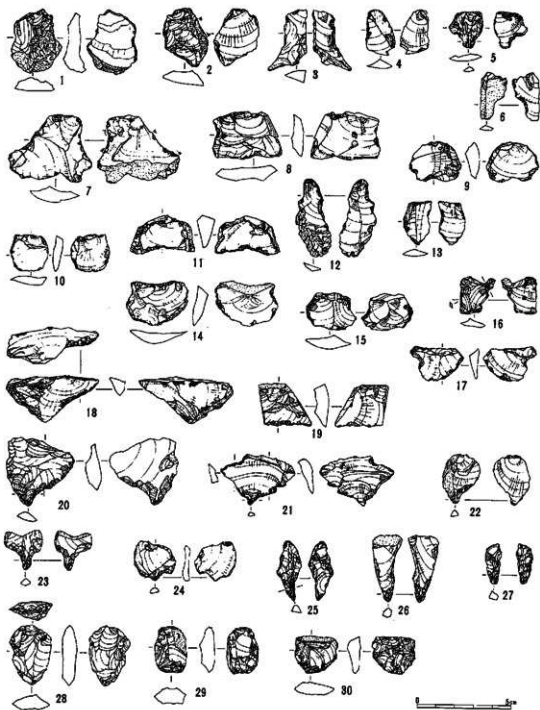
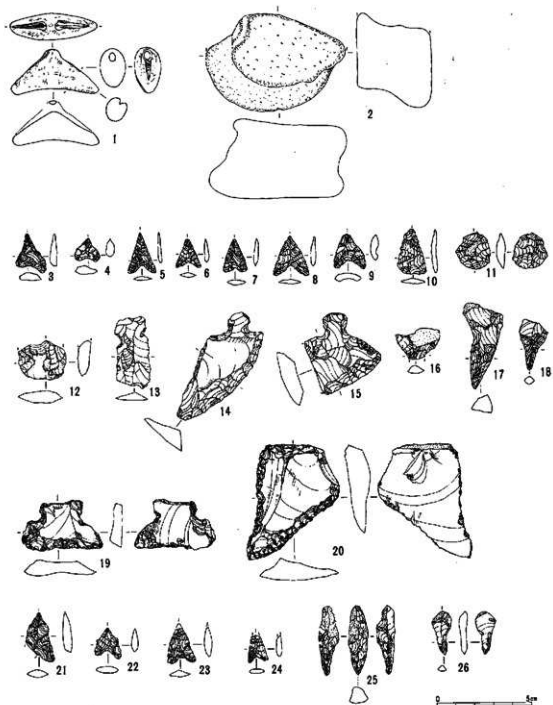

图225 十二ノ后遺跡21号件层址(その1)出土石器実測図



図226 十二ノ后遺跡21号住居址(その2), 22・23・24・25号住居址, 26号住居址(その1)出土石器実測図

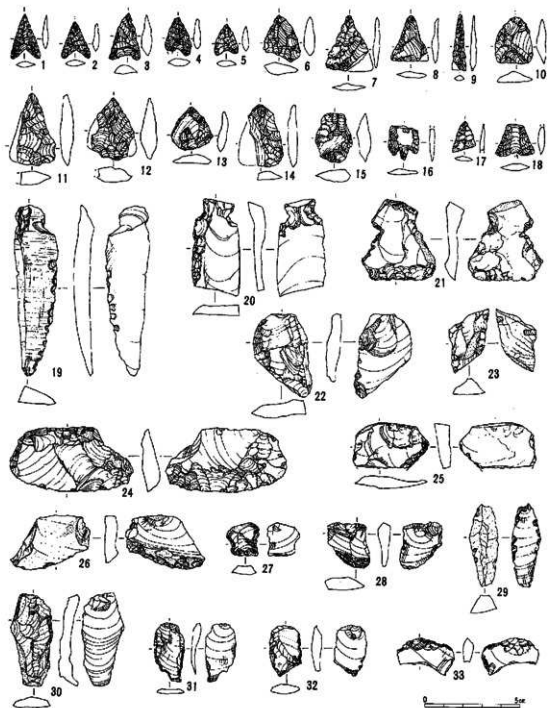

図227 十二ノ后遺跡26号住居址(その2), 27・28号住居址, 37号住居址(その1)出土石器実測図

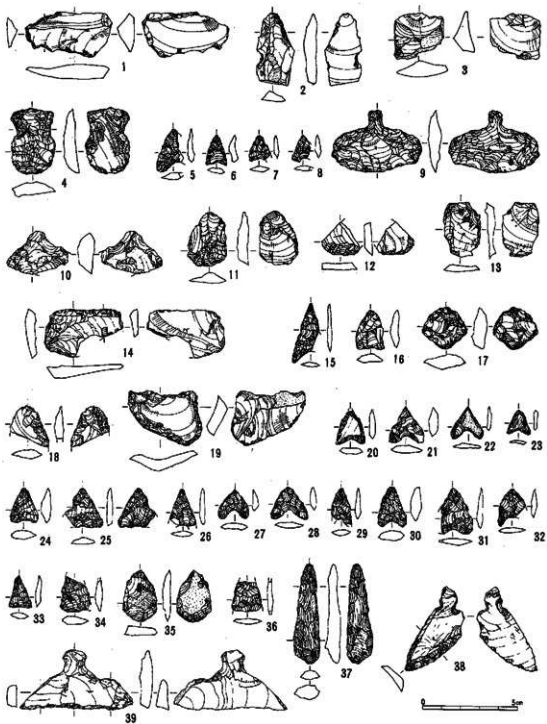

図228 十二ノ后遺跡37号住居址(その2)出土石器実測図



图229 十二ノ所遺跡38号住隅址出土石器実測図

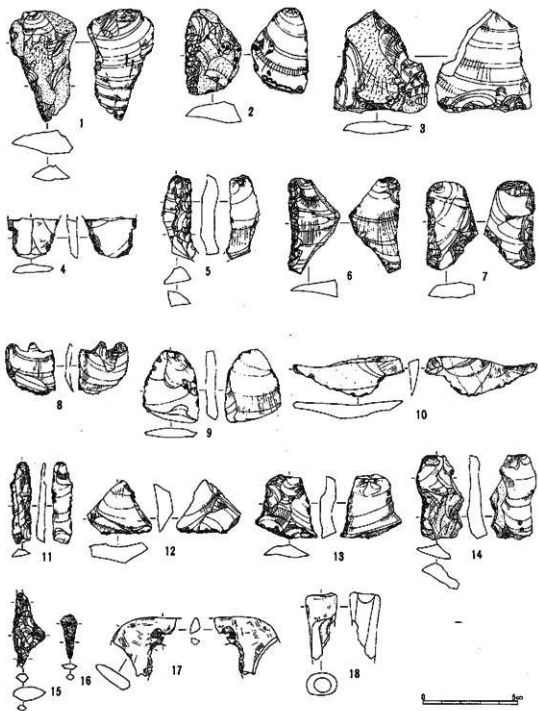

图230 十二ノ后遺跡39号住居址，46号住居址（その1）出土石器実測図

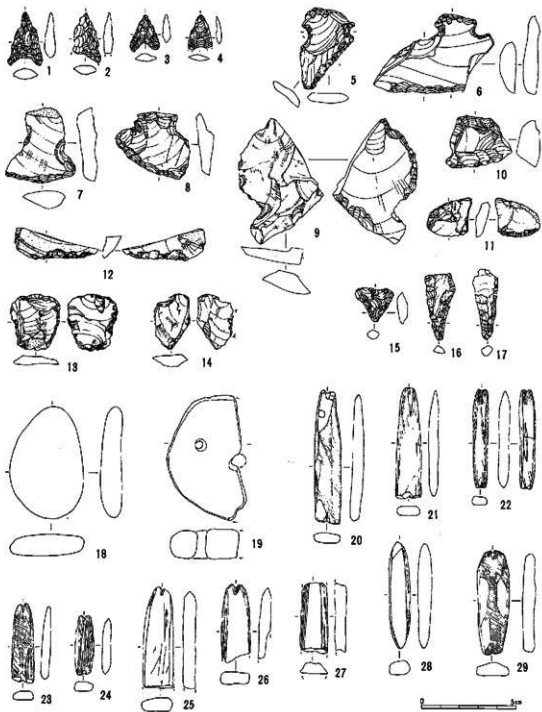

図231 十二ノ后遺跡46号住居址(その2), 47・49・50号住居址出土石器実測圖

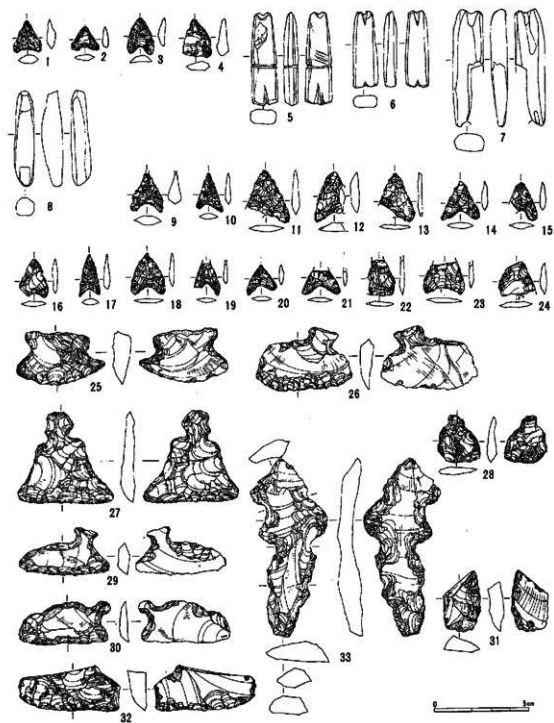

图232 十二、后溪路52·56·58·61号住居址出土石器类图

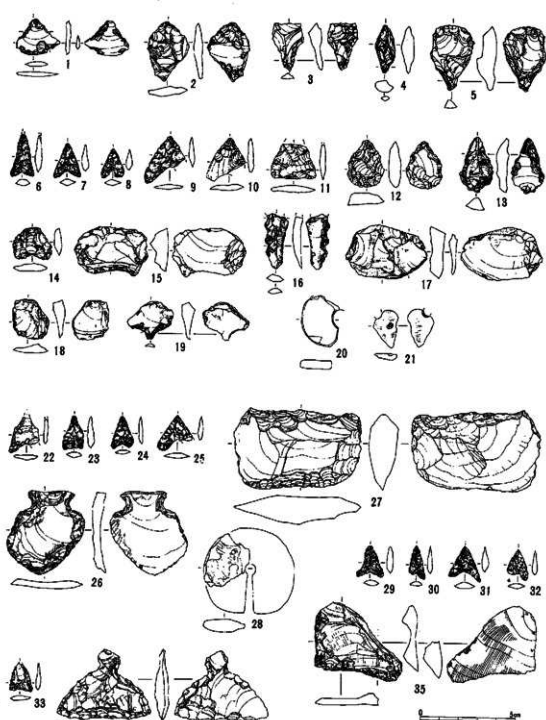

图233 十二ノ后遺跡64・65号住居址，66号住居址(その1)山十石器実測区



图234 十二ノ后遺跡66号住居址(その2), 68・69・73号住居址出土石器実測図



图235 十二ノ后遺跡74・75号住居址出土石器実測图



図236 十二ノ后遺跡81・86・90・92号住居址，93号住居址（その1）出土石器実態図

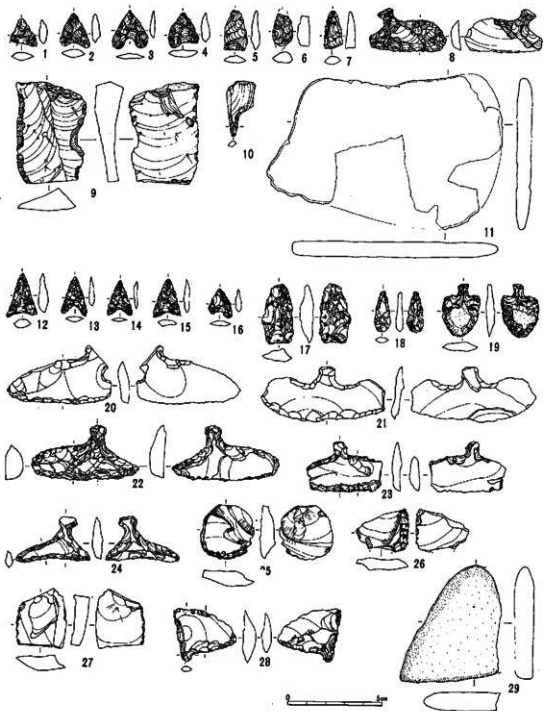

图237 十二ノ后遺跡93号住居址(その2), 95・96号住居址出土石製尖頭四

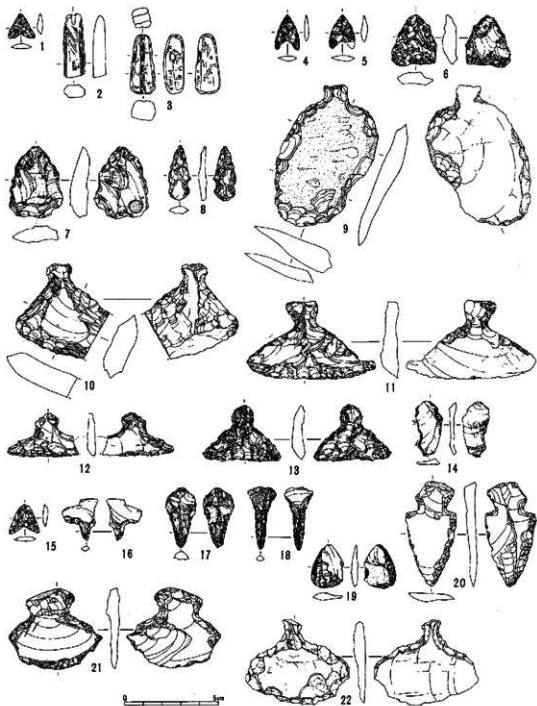

图238 十二ノ后遺跡98・99・100・102・104号住居址出土石器実測图

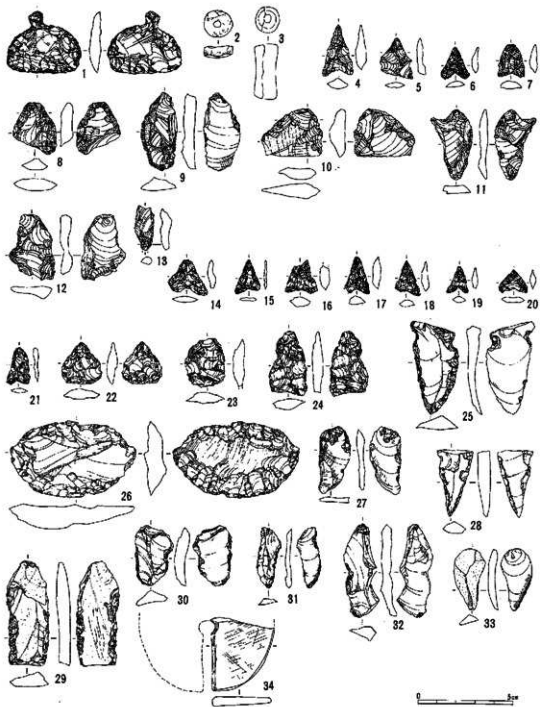

图239 十二ノ后遺跡106・108号住居址出土石器実測図

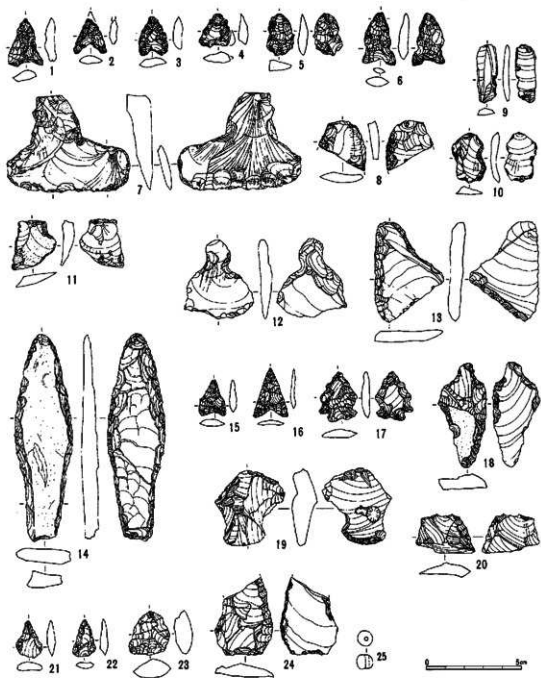

图240 十二ノ后遺跡 111号住居址出土石器実測図

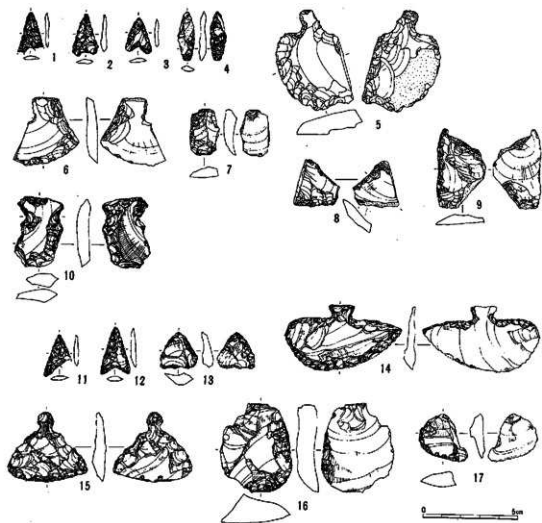

图241 十二ノ后遺跡 112 号住居址出土石器実測图



图242 十二ノ后遺跡 113号住居址出土石器実測図

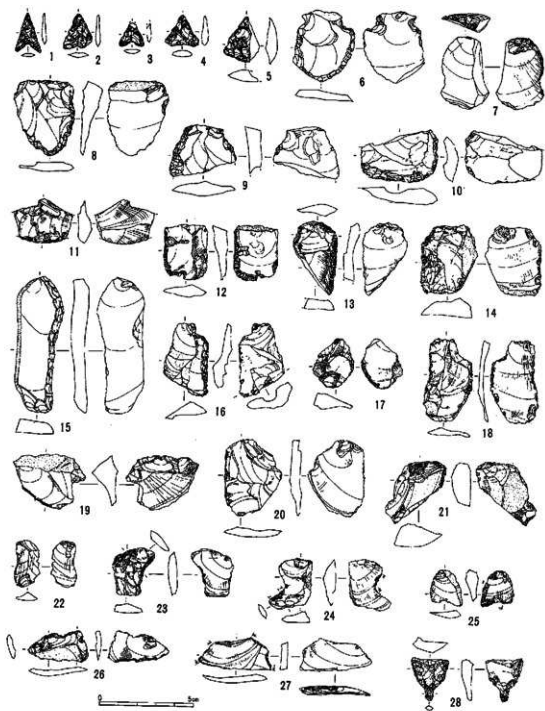

図243 十二ノ后遺跡 118・119・122・125号住居址，127号住居址(その1)出土石器実測図

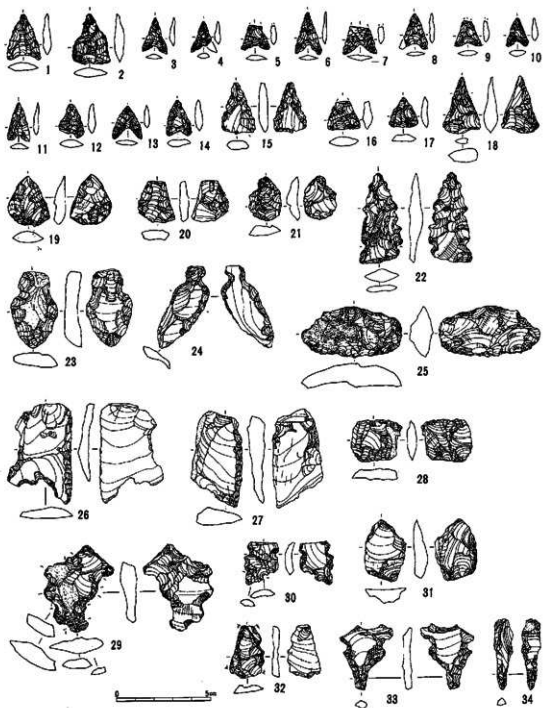

图244 1-1-1后遺跡127号住居址(その2), 131号住居址出土石器実測圖



图245 十二ノ后遺跡132・135・137・139号住居址出土石器実測图

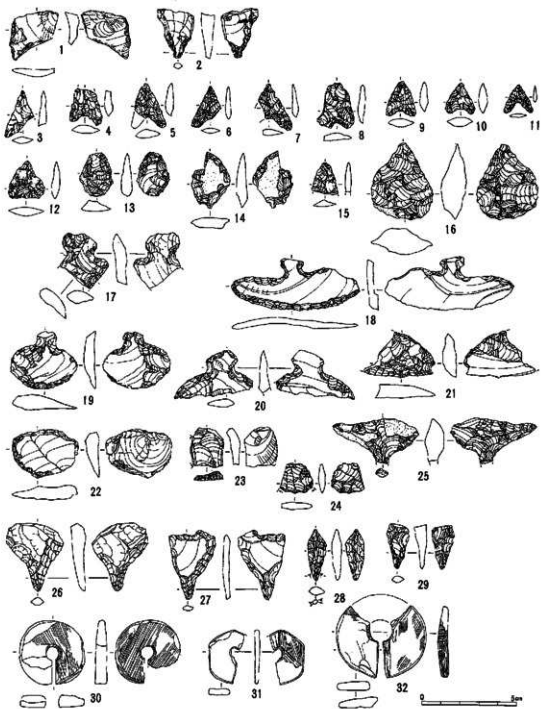

图246 十二ノ后遺跡 141号住居址、塚穴1・2、集石1出土石器実測図

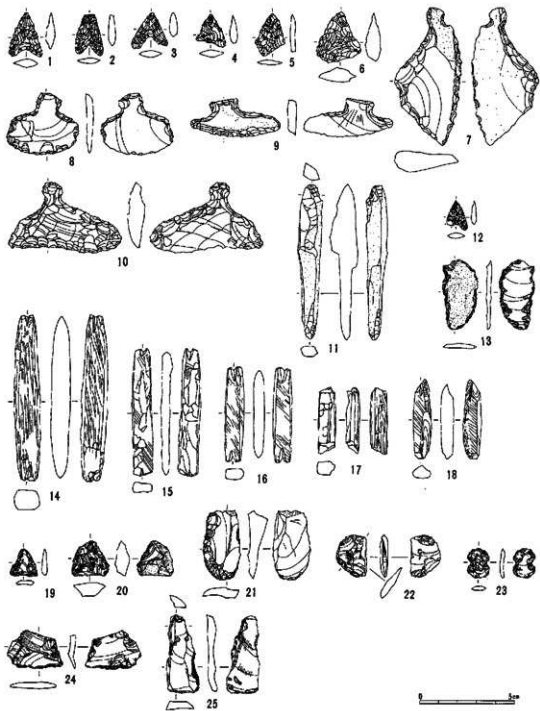

図247 十二ノ后遺跡遺構外(その1)出土石器実測図

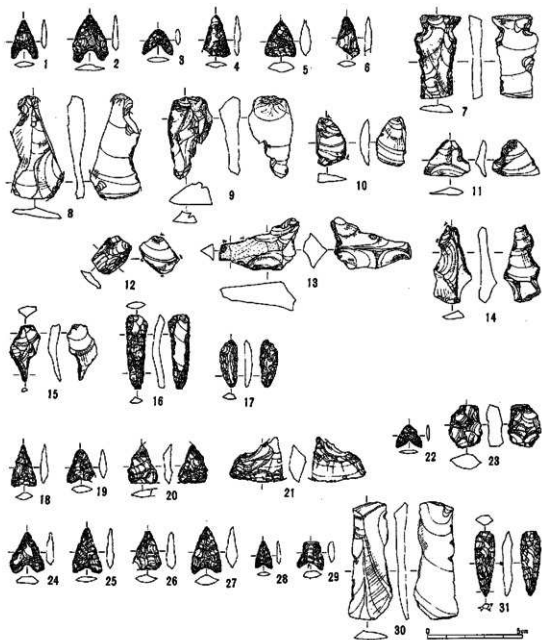

図248 十二ノ活痕跡遺構外(その2)出土石器実測図

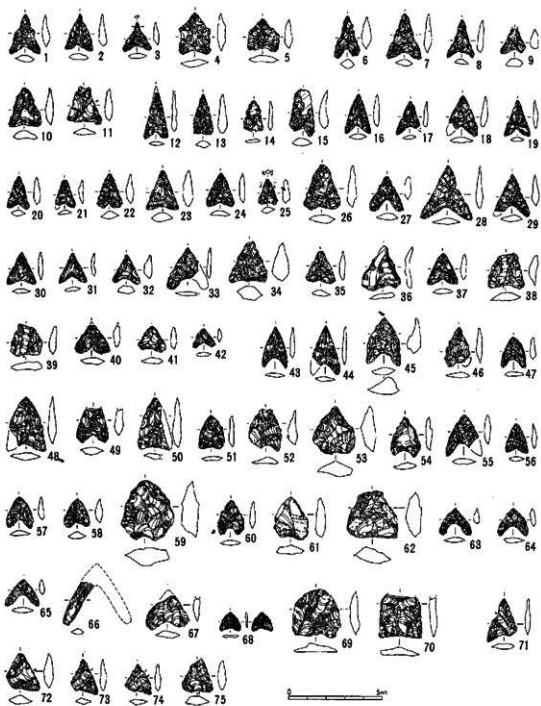

図249 トニノ后辺跡遺構外(その3)出土石器実測図

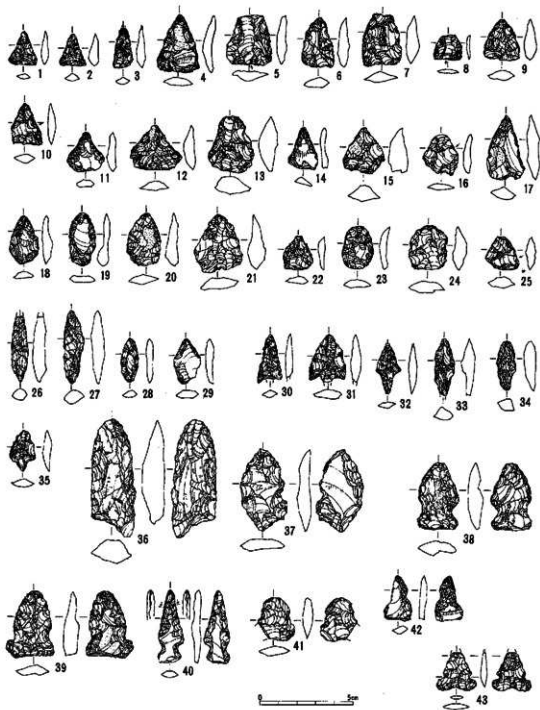

図250 十二ノ后遺跡遺構外(その4)出土石器実測図



图251 十二ノ后遺跡遺構外(その5)出土石器実測図



図252 一ノ后遺跡遺構外(その6)出土石器奥面図

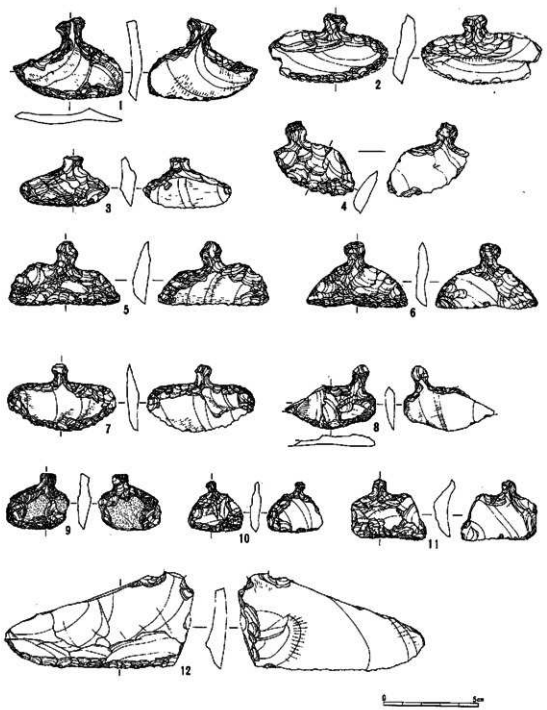

図253 十二ノ后遺跡遺構外(その7)出土石器実測図

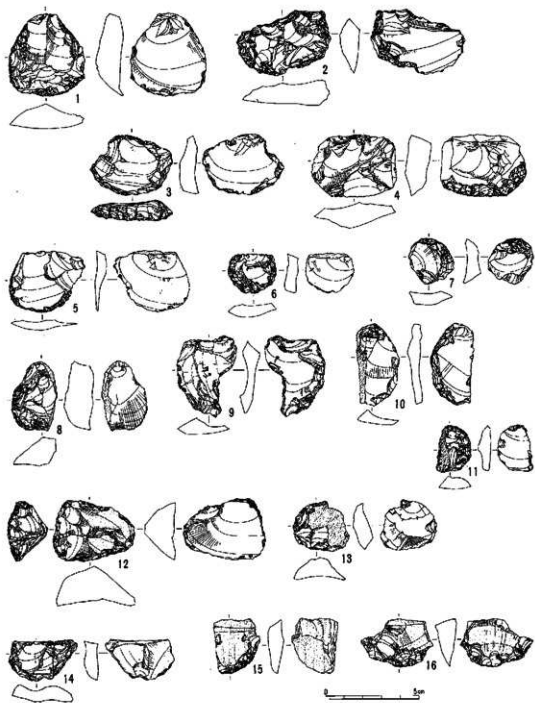

図254 十二ノ后遺跡遺構外(その8)出土石器実測図



図255 十二ノ后遺跡遺構外(その9)出土石器実測図

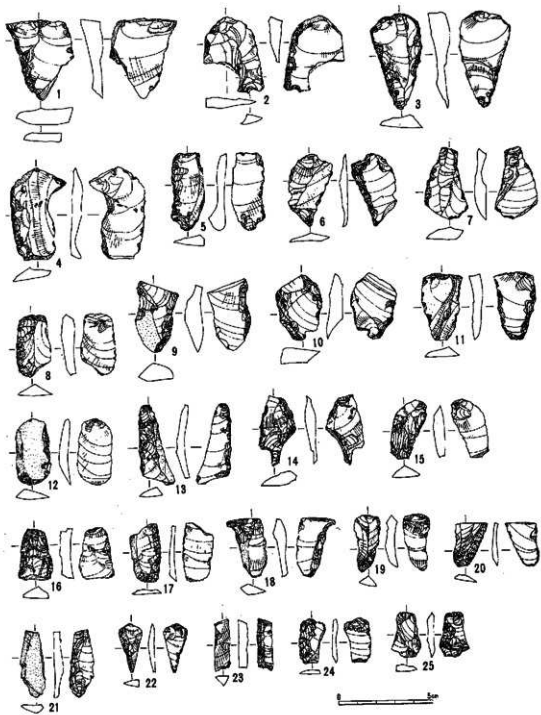

図256 十二ノ后沢跡遺構外(その10)出土石器実測図

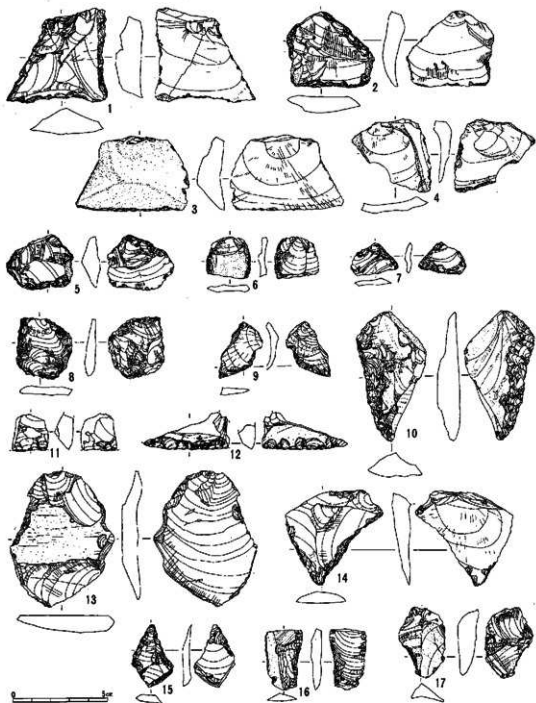

図257 十二ノ后遺跡遺構外(その11)出土石物実測図

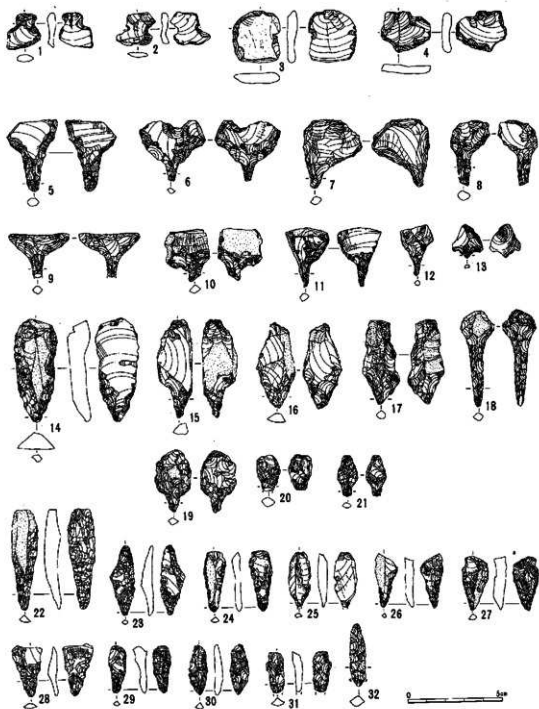

図258 十二ノ后遺跡遺構外(その12)出土石器実測図

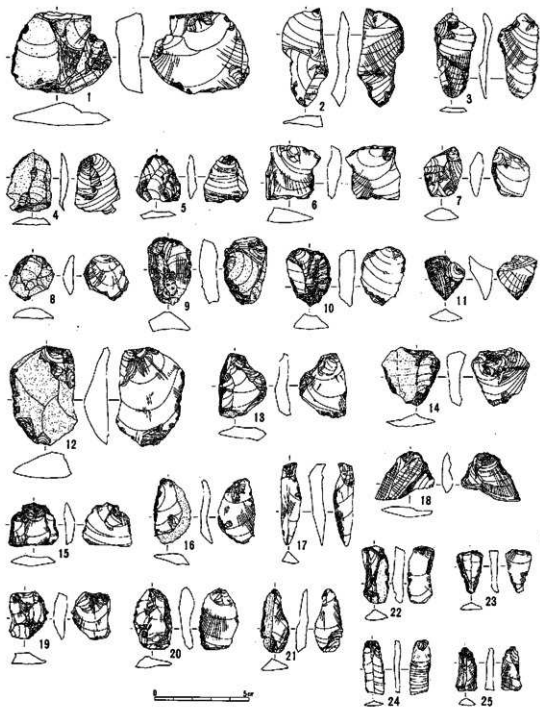

図259 十二ノ后遺跡遺構外(その13)出土石器実測図

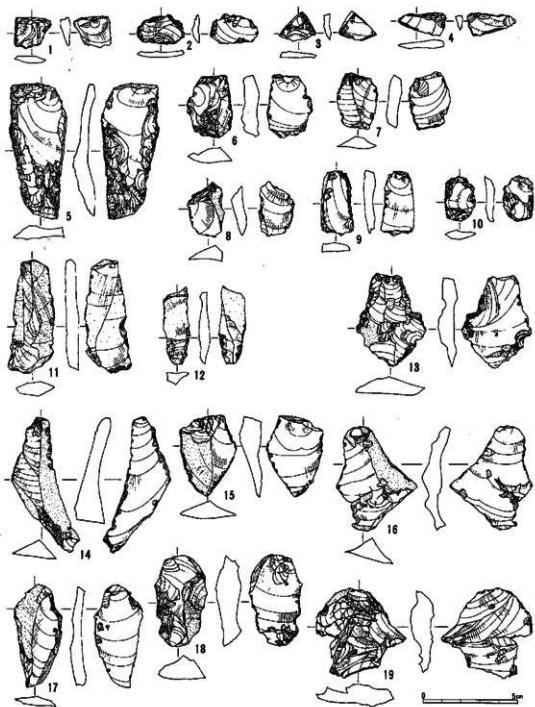

图260 十二ノ后遺跡遺構外(その14)出土石器実測図



図261 十一ノ所遺跡遺構外(その15)出土石器実測図



図262 十二ノ后遺跡遺構外(その16)出土石器実測図

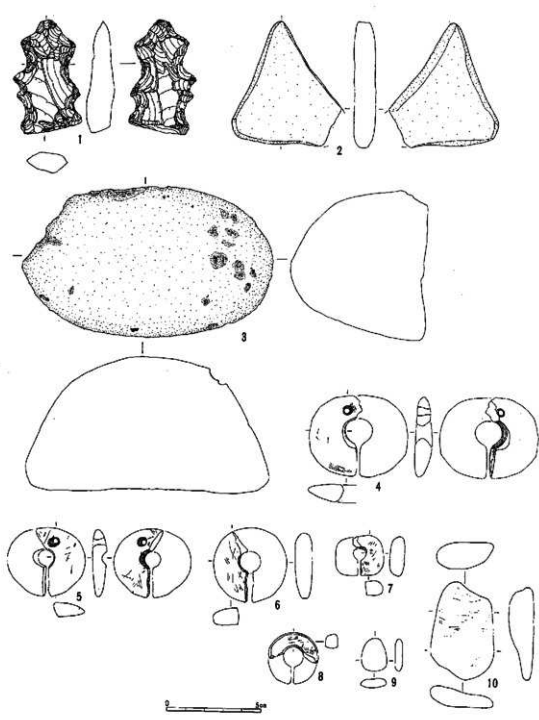

図263 十二ノ后造跡遺構外(その17)出土石器, 古墳時代, 平安時代以降, 77・34・4・55・94号住居址, マンド1・3出土石器実測図

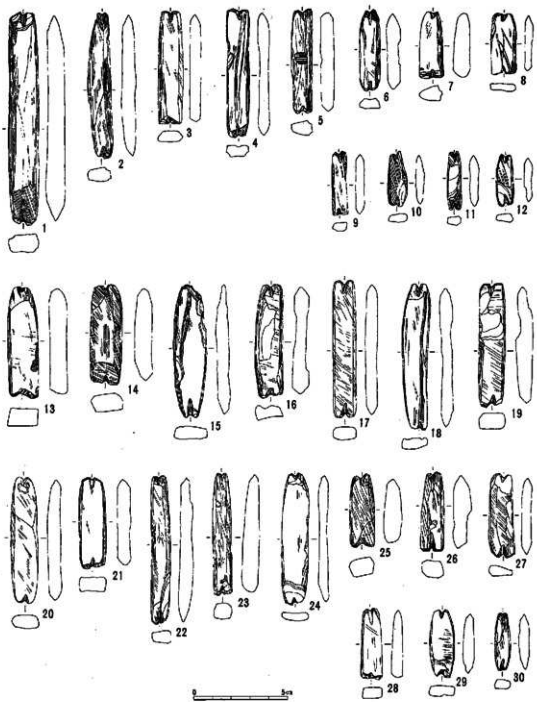

图264 三门峡上村 2·3·5·7·9·12·15·17·25·26·34·35·40·42出土石器

实例图

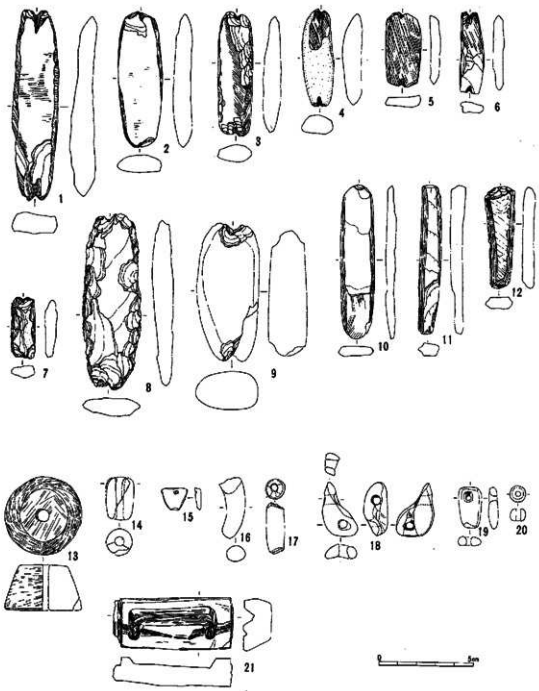

图265 十二ノ后遺跡土坑44・45・59・66・77・78・83・84・101・107・123・130・142・146・

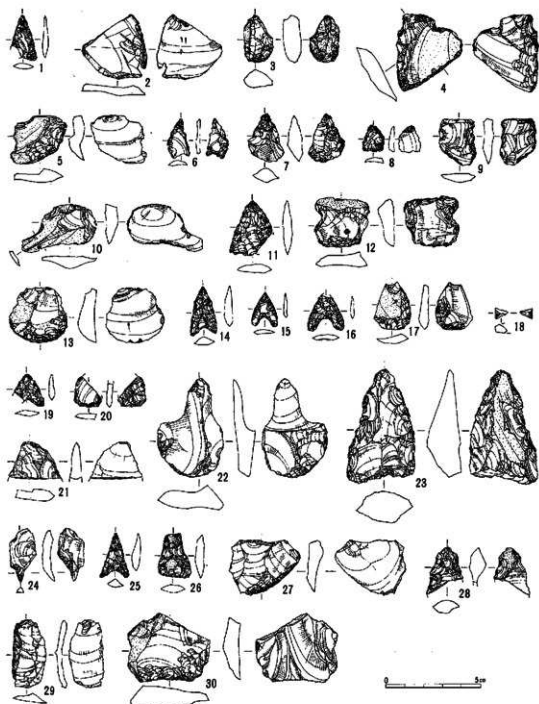
164・177・179 出土石器実面図



図266 十二ノ后遺跡出土打製石斧(その1)実測図

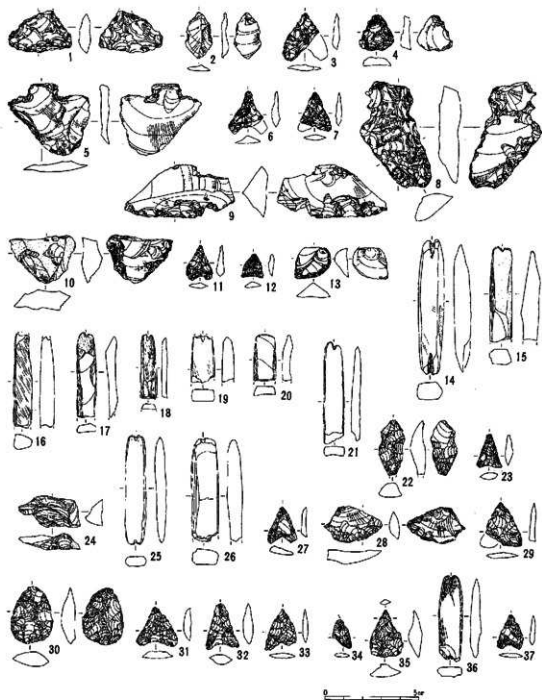

図267 十二ノ后遺跡出土打製石斧(その2)実測図

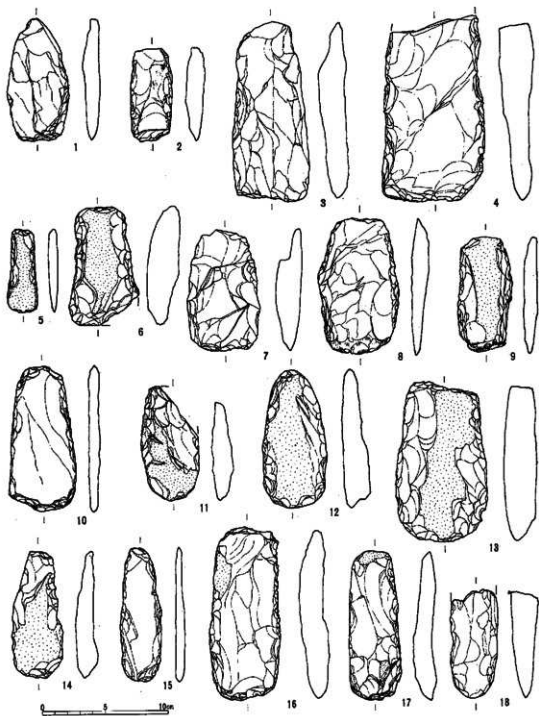

図268 十二ノ后遺跡出土磨製石斧(その1-小形)実測図

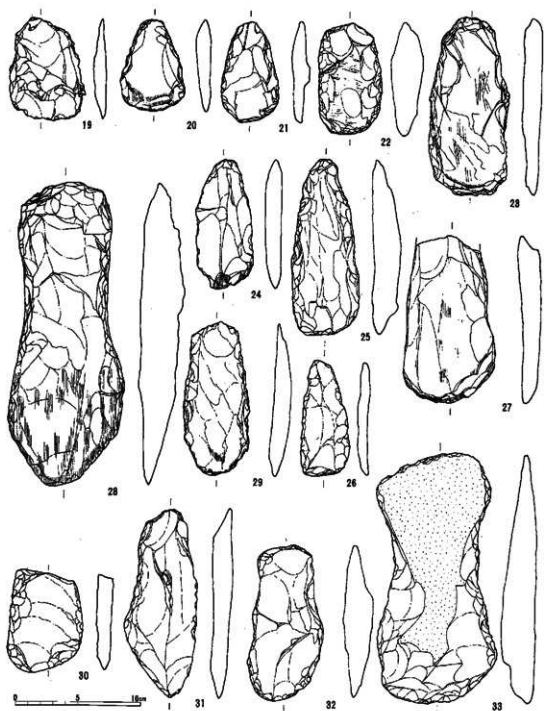

図269 十二ノ后遺跡出土磨製石斧(その2一定角・乳棒状)実測図



图270 十二ノ后遺跡出土磨製石斧(その3-乳棒状)実測図

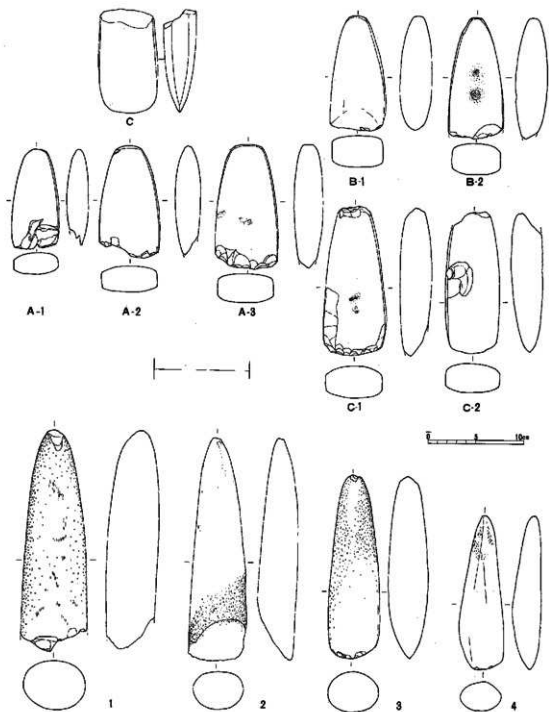

图271 十二/后滩跡出土打製石器類，石髓実面図

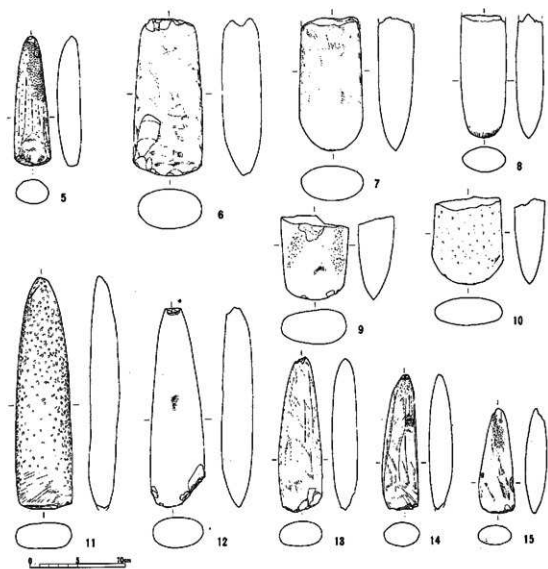

图272 十二个后通轴出土壳打粉类实例图

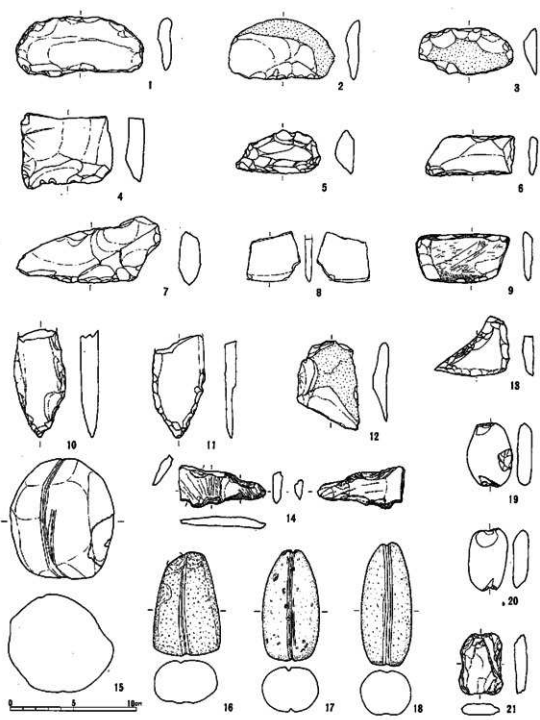

図273 十二ノ所遺跡出土磨石実状圖

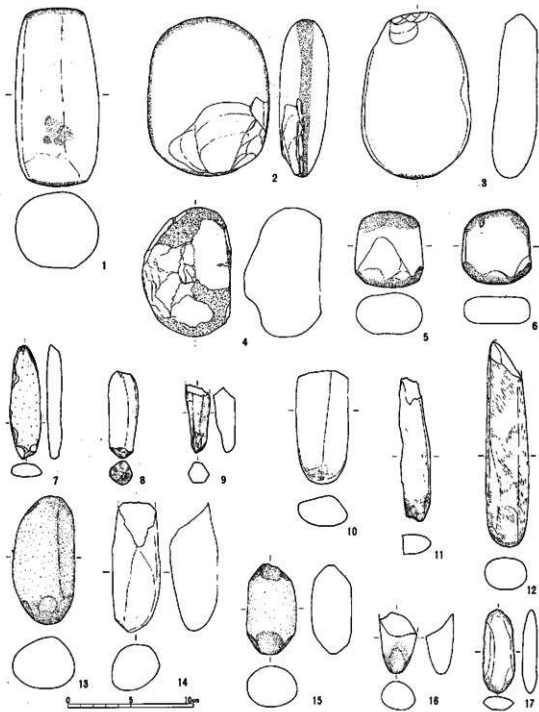

图274 十二/后遗址出土特殊磨石，凹石类复原

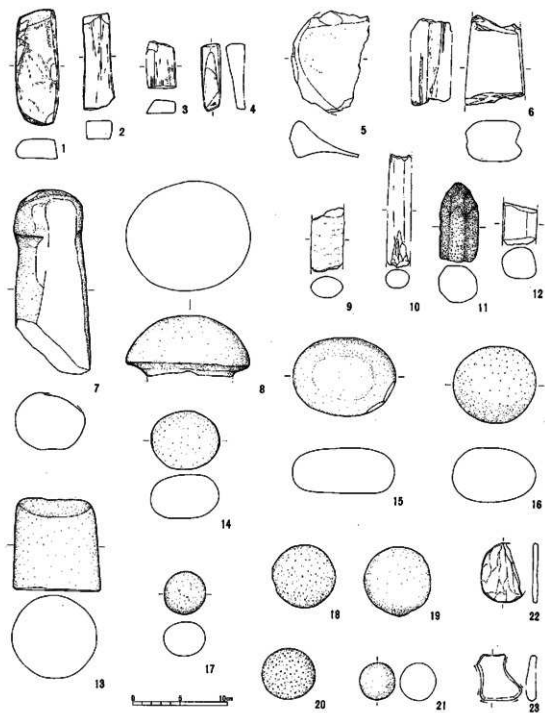

図275 十二ノ后濃跡出土凹石(その1)実測図

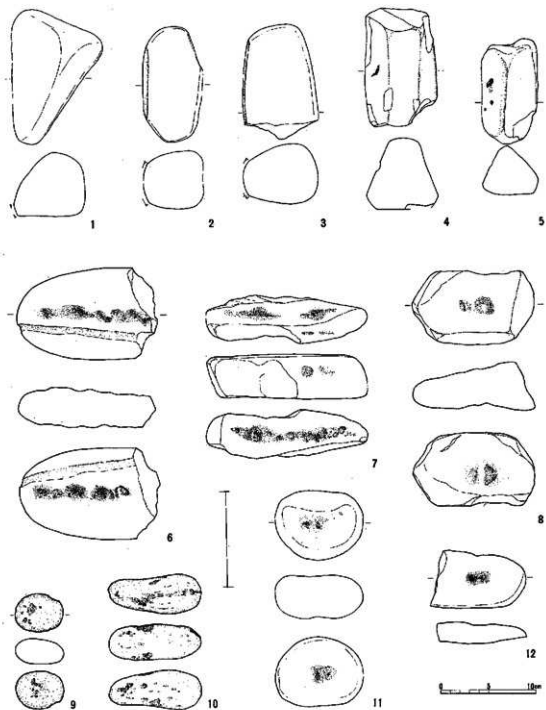

图276 十二ノ后遺跡出土石(その2)実測図

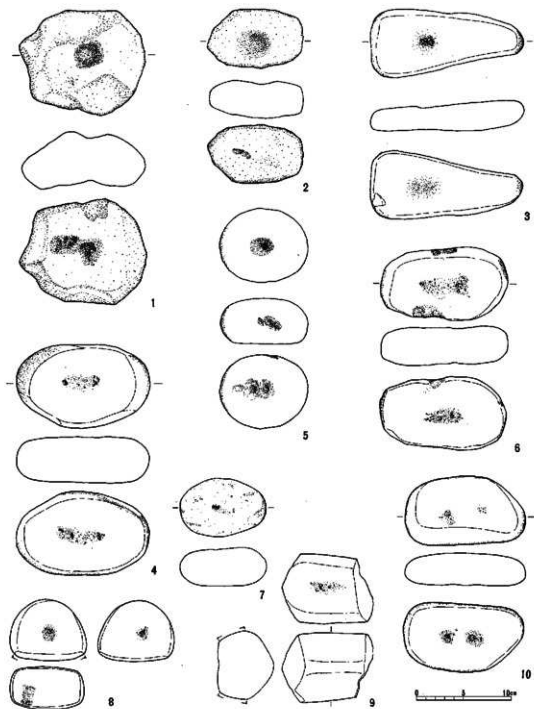

図277 1二ノ后遺跡出土凹石(その3)実測図

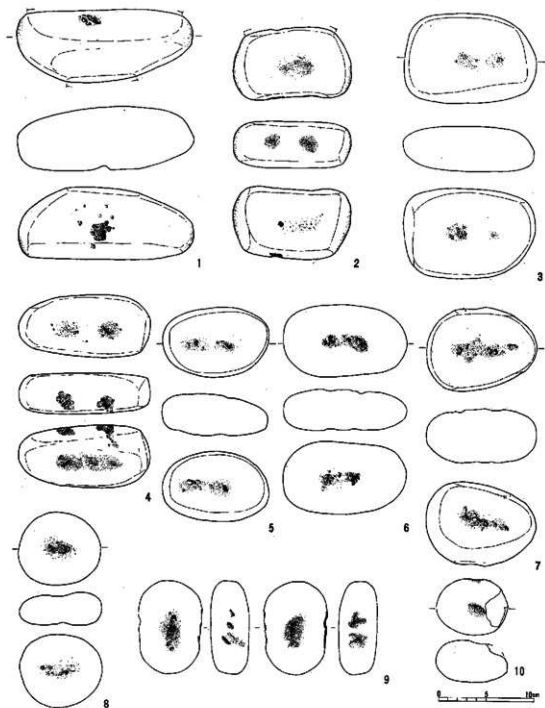

図278 十二ノ后遺跡出土凹石(その4)実測図

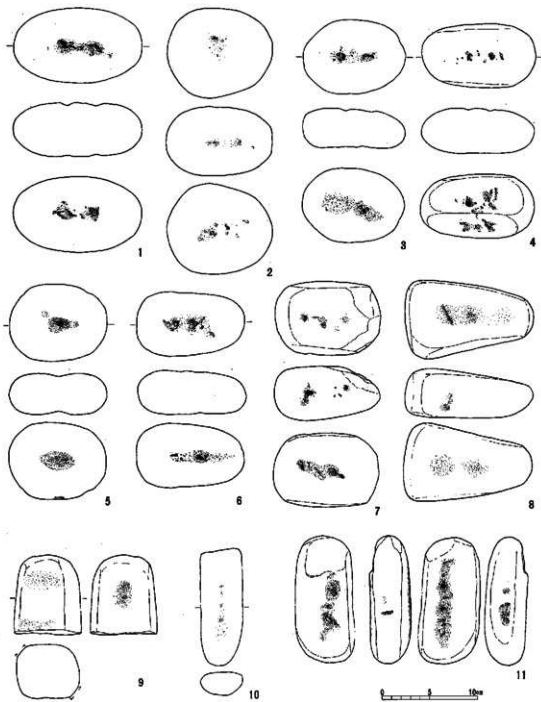

图279 十二ノ后遺跡 出上四石(その5)実測図

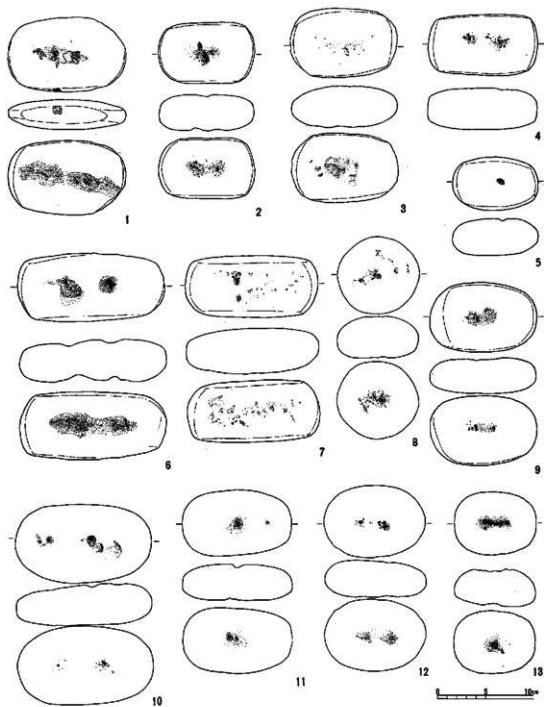

图280 十二ノ后遺跡出土石皿実測図

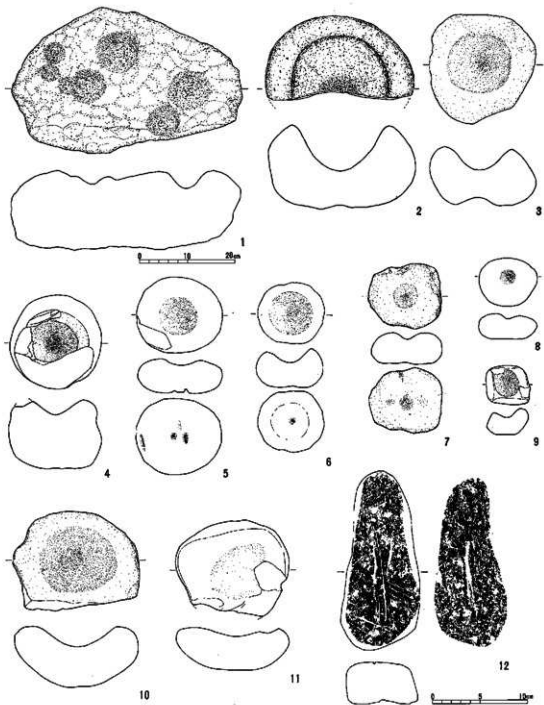

図281 十二ノ后遺跡出土縄文時代土製品(その1)土偶他実測図

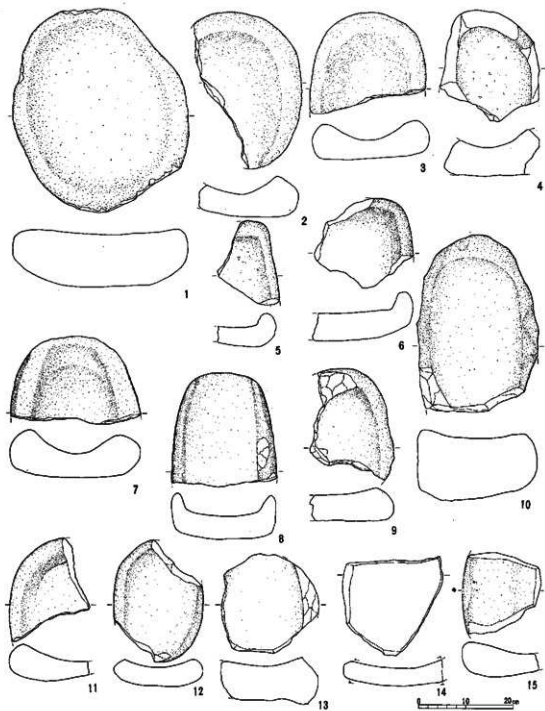

図282 十二ノ后遺跡出土縄文時代土製品(その2)十器(土器片)実測図

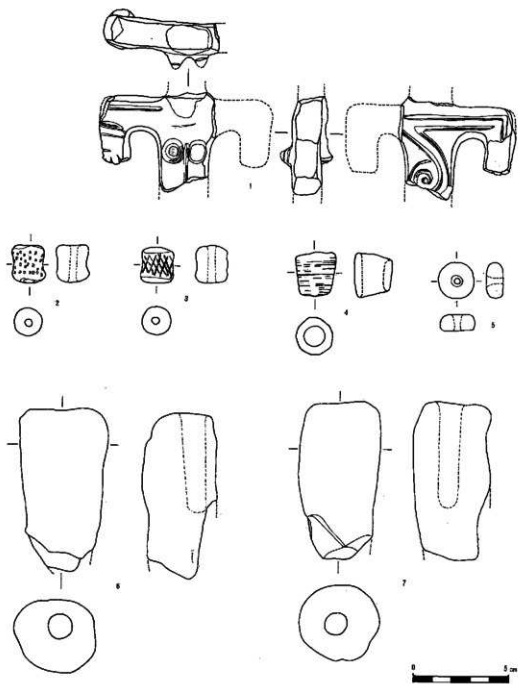

图283 十ノ后瓦跡出土 縄文時代土製品(その3)土器(土器片)実例区

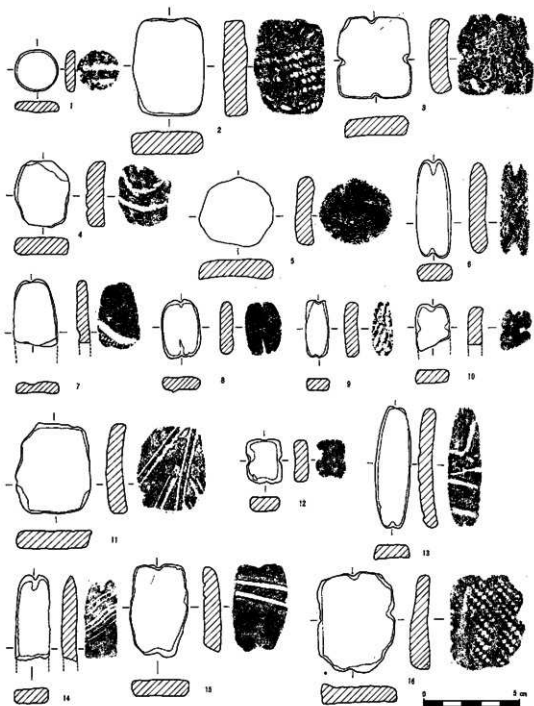

図284 十二ノ后遺跡出土縄文時代土製品(その4)上鉄(三聯片)奥西區

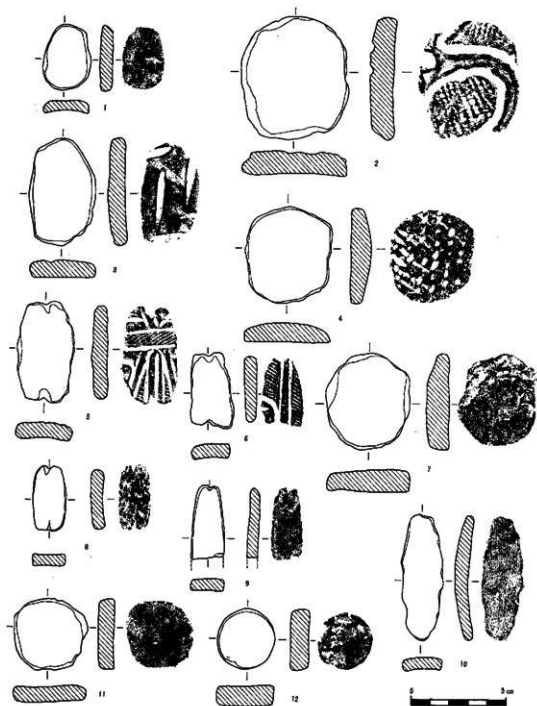

図285 十二ノ后遺跡住居址出土鉄製品(その1)実測図

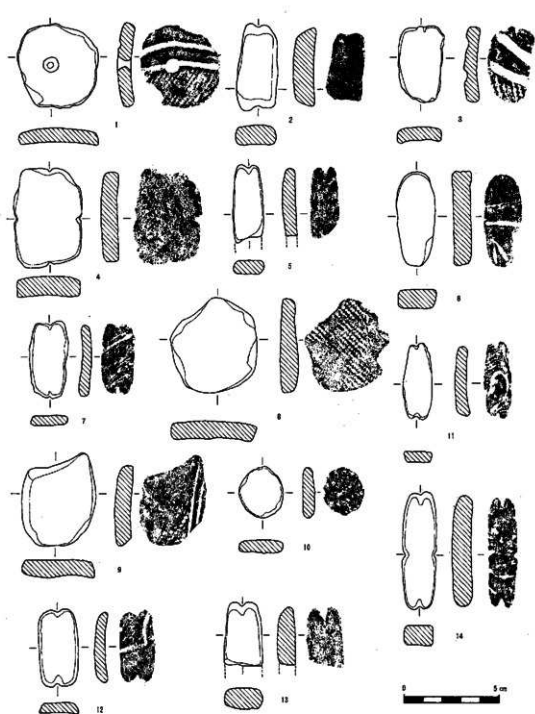

図286 十二ノ后遺跡住居址出土鉄製品(その2)実測図

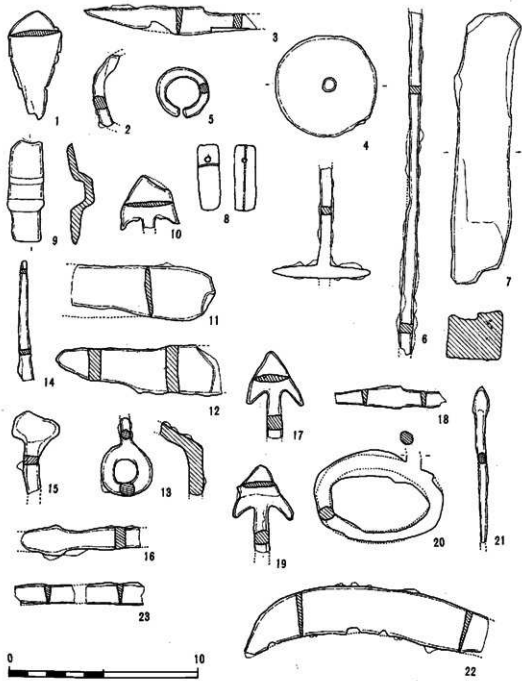

図287 十二ノ后遺跡31・32号住居址、フンド1・2・3、基杭1、グリット(その1)出土鉄製品実測図

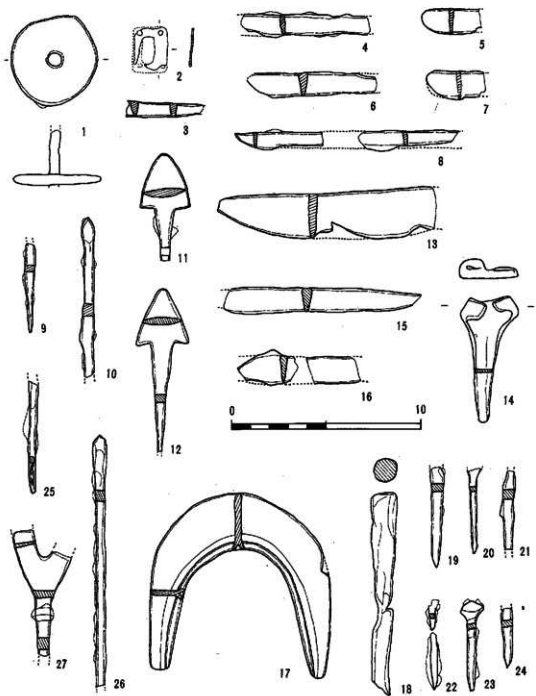

図288 十二ノ后遺跡グリット(その2)出土鉄製品実測図

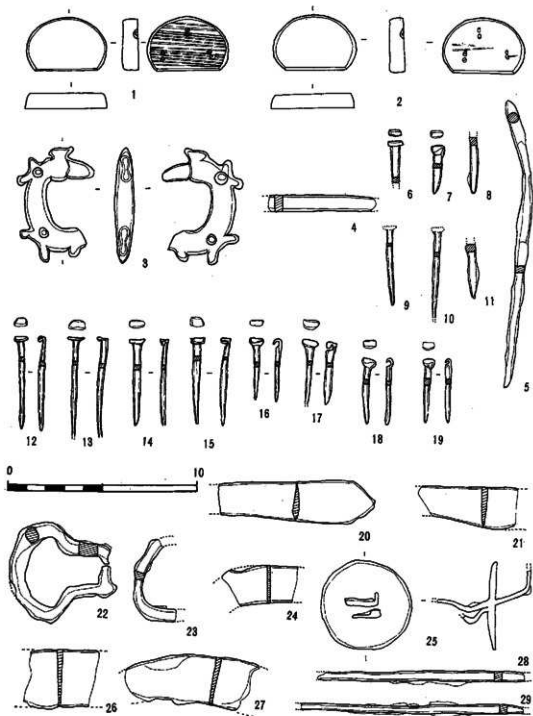

図289 十二ノ后遺跡グリット出土古銭実況38

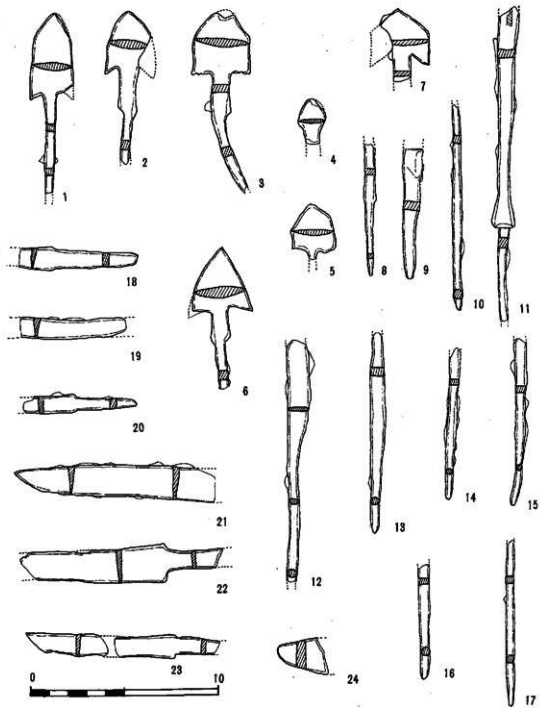

図290 十二ノ后遺跡出土土鏡(その1)実測図

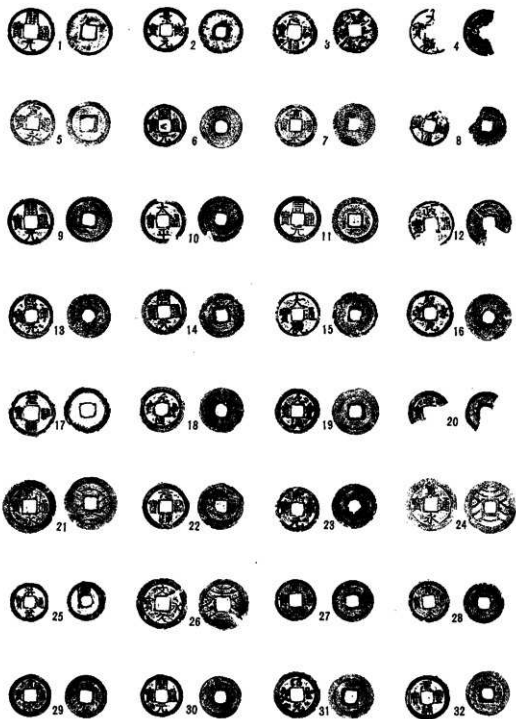

図291 十二ノ后遺跡出土土器(その2)実測図

全景

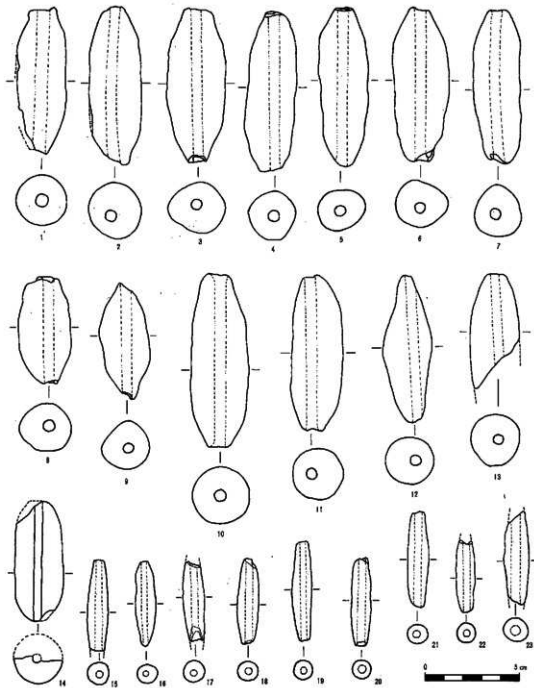

1・2号住居址，溝1

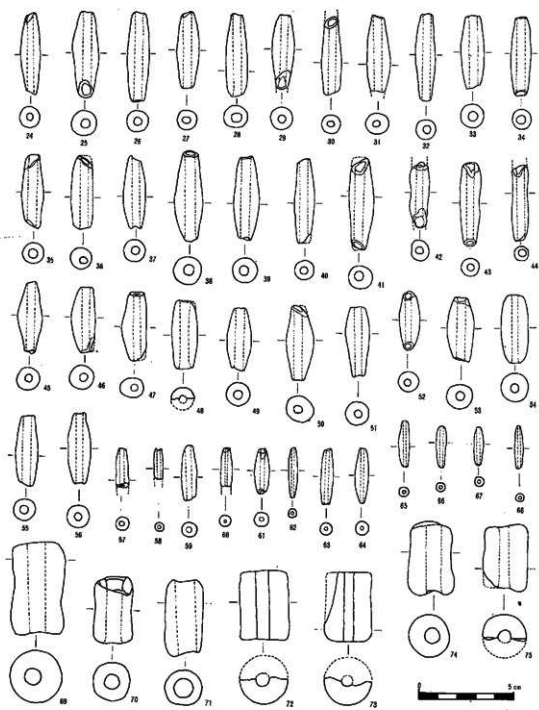

3・4号住





5～10号住居址



11・12号住居址



12号址カマド

14・15号住居址



14号住居址埋甕炉



16号住居址





18号住居址集石



18号住居址



18号住居址カマド

19号住居址



20号住居址



20号住居址





21号住居址



21号住居址カマド
遺物出土状況



22号住居址

22号住居址集石



22号住居址カマド



23号住居址





24号住居址



25号住居址



25号住居址カマド

26号住居址



26号集石



26号住居址カマド



図版10 金崎場遺跡27号住居址



27号住居址



27号集石



27号住居址カマド

28号住居址



29号住居址



30号住居址 (弥生)

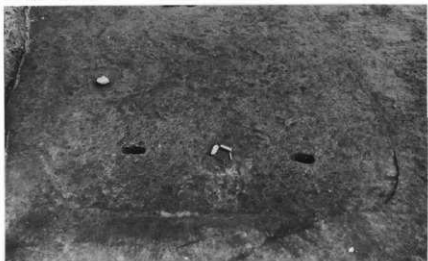



30号住居址埋藏炉 (弥生)



31号住居址



31号住居址集石

33号住居址



34号住居址



34号住居址集石





34号住居址カマド



36号住居址



37号住居址

38号住居址



39号住居址



39号住居址遺物出土状況





1号古墳



土坑列集石

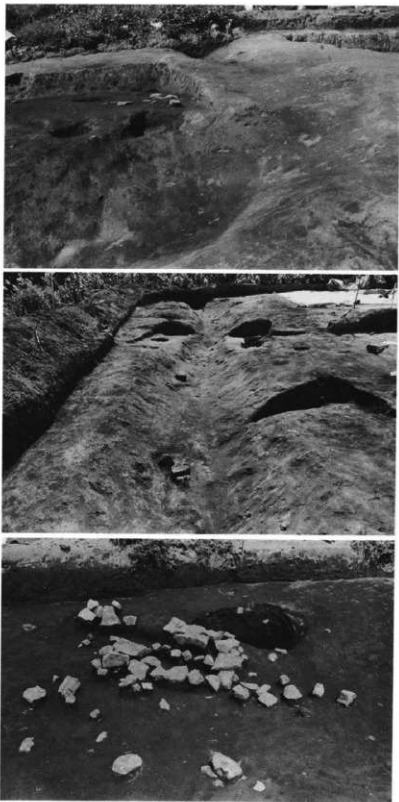

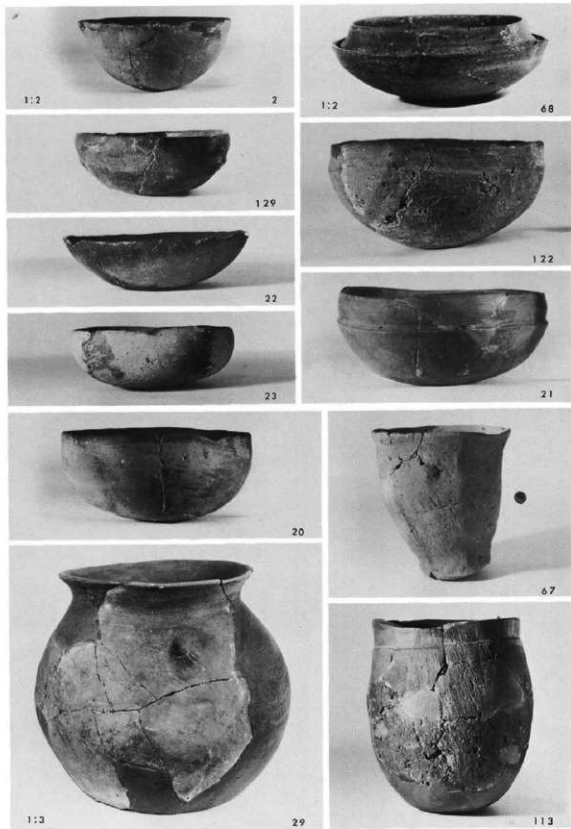

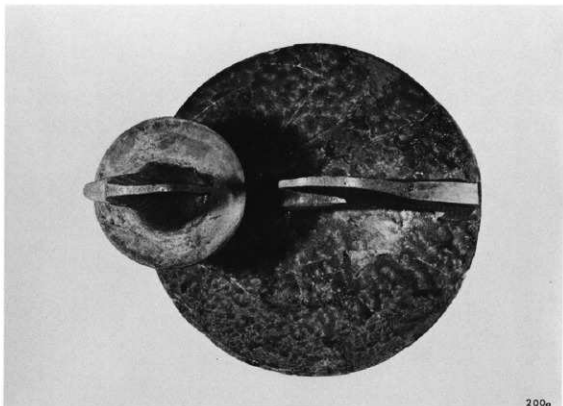

200a



1:3

200b

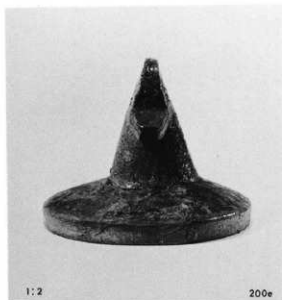

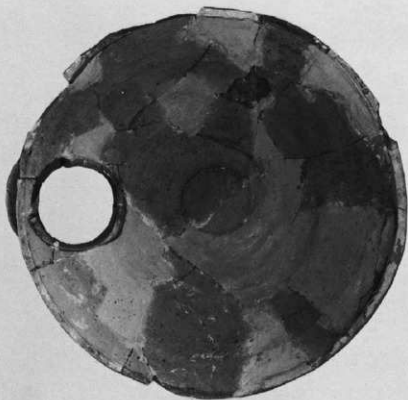

1:3

200j

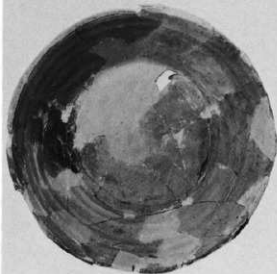

1:4

200k



200L







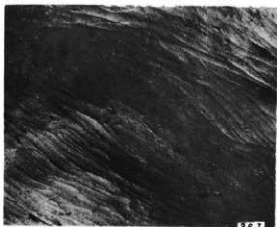
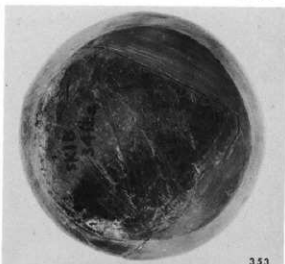
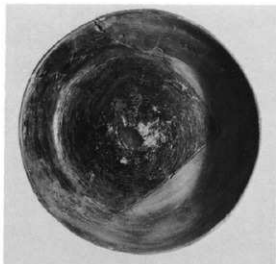







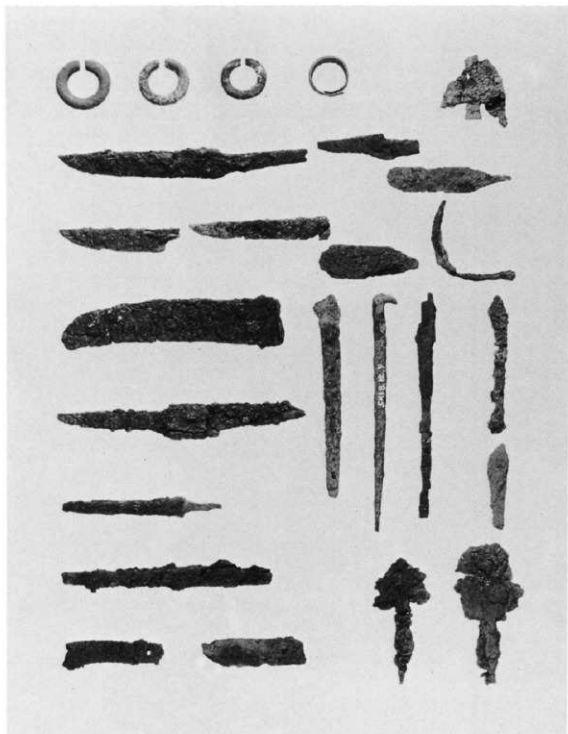

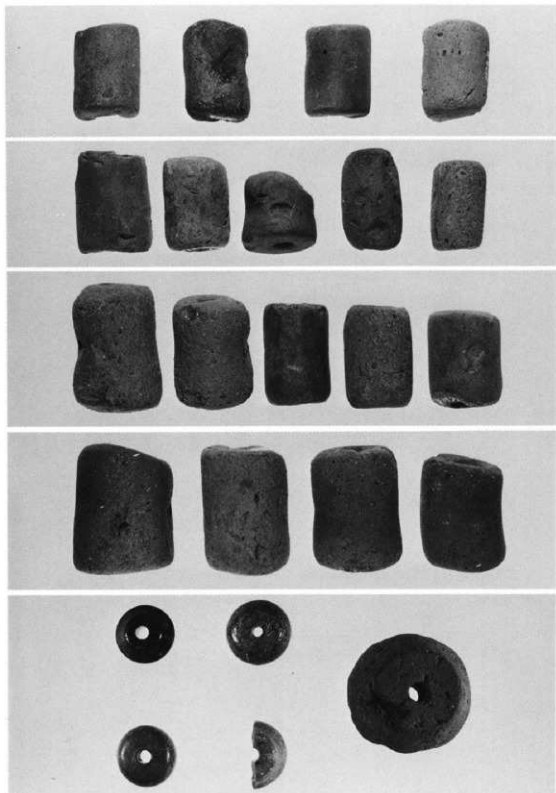

遠景



近景



近景 (千鹿頭社)





住居址群(1)



同(2)



同(3)

1・10・42号住居址



2・3・5号住居址



6~8・13・16・20・
22・24・28号住居址



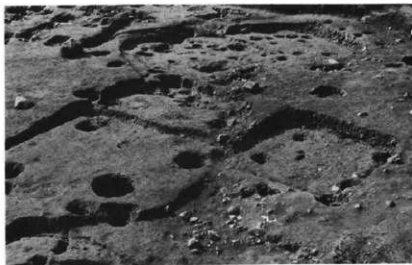

11・12・14号住居址



13号住居址



13号住居址 (遺物出土)

15・27号住居址



18・21・138号住居址



9・20・23号住居址





20・23号住居址



26号住居址



26号住居址埋甕