

中央自動車道長野線
埋蔵文化財発掘調査報告書7

—松本市内 その4—

南 栗 遺 跡

図 版 編

1 9 9 0

日本道路公団名古屋建設局
長野県教育委員会
(財)長野県埋蔵文化財センター

中央自動車道長野線
埋蔵文化財発掘調査報告書7

—松本市内 その4—

南 栗 遺 跡

図 版 編

1 9 9 0

日本道路公団名古屋建設局
長野県教育委員会
(財)長野県埋蔵文化財センター

凡 例

1 本書に掲載した実測図の縮尺は、特に断りのある場合を除いて下記のように統一してある。

(1) 遺構実測図

本文挿図 竪穴住居址・竪立柱建物址 1:60 住居址内施設・墓址・土坑 1:40

図 版 遺構図 1:120

(2) 遺物実測図等

土器・陶磁器 1:4 文字関係資料 1:3 墨書文字 1:2 土器拓影 1:3

金属製品 1:2 石器・石製品 1:4~2:3 銭貨拓影 2:3

(3) 遺物写真

土器・陶磁器 2:5 内耳鉢・常滑系甕 1:4 中世土器・陶磁器破片 1:2

鉄製品 1:2 銅製品・銭貨 1:1 石器・石製品 1:4~2:3

2 遺物実測図の番号は、遺跡ごとに次のように付けてある。

- | | |
|-----------------------------|-----------------------|
| (1) 縄文・弥生土器、石器……1から通し番号 | (4) 文字関係資料……1から通し番号 |
| (2) 古代土器……各遺構毎の通し番号 | (5) 金属製品……1から通し番号 |
| (3) 中・近世土器・陶磁器……それぞれ1から通し番号 | (6) 古代以降の石製品……1から通し番号 |

3 実測図中のスクリーン等には以下の事項を表わしている。

(1) 遺構

ア 竪穴住居址

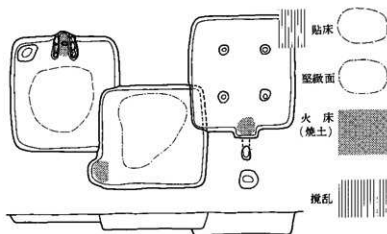

イ 竪立柱建物址

本文中の竪立柱建物址模式図は、

約1:200で以下の事項を表わしている。

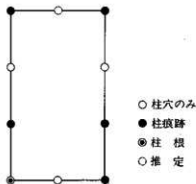

(2) 遺物

ア 古代土器

① 実測図の断面は、黒色土器・赤彩土器を含む土器一白抜き、須恵器・施釉陶磁器一黒塗り、輸入陶磁器一スクリーンによって区別した。黒色処理・赤彩を施したものはその処理された器面の範囲に、漆・炭化物の付着については以下のスクリーンにより表現してある。



② 施釉陶磁器の施釉範囲は一点鎖線で示した。

イ 中・近世土器・陶磁器

① 実測図の断面は、土器一白抜き、陶器一黒塗り、輸入陶磁器一スクリーンにより区別してある。

② 国産陶磁器の釉の種類は以下の網目により区別してある。但し、灰釉は白抜きにした。





③ 施釉陶磁器の施釉範囲は一点鎖線で示した。

ウ 金属製品

- ① 金属製品の形状はX線等の観察にもとづいており、錆・付着物によるふくらはみは線の太さをとって表現してある。
- ② 断面図は、平面形状観察にさしきわりのない範囲で平面図に組み入れてある。
- ③ 鉄製品、銅製品の断面図と、漆・炭化物の付着及び木質部を以下のスクリーン・トーンで表現してある。



エ 石器・石製品

- ① 打製石斧・磨製石斧等の磨耗範囲は  で示し、砥石の使用面は、断面図に「」で示した。

オ 土製品

- ① 羽口のゲール付着・ガラス状発泡範囲を  、被熱により変色した範囲を  で示した。

図 版 目 次

- | | |
|--|--|
| <p>図版1 南架遺跡周辺の遺跡</p> <p>図版2 南架遺跡周辺の地形と発掘範囲図</p> <p>図版3 南架遺跡古代全体図 (1:1000)</p> <p>図版4 南架遺跡中・近世全体図 (1:1000)</p> <p>図版5 遺構実測図I (1:400)</p> <p>図版6 遺構実測図II (#)</p> <p>図版7 遺構実測図III (#)</p> <p>図版8 遺構実測図IV (#)</p> <p>図版9 遺構実測図V (#)</p> <p>図版10 遺構実測図VI (#)</p> <p>図版11 遺構実測図VII (#)</p> <p>図版12 遺構実測図割付図</p> <p>図版13 遺構実測図1</p> <p>図版14 遺構実測図2</p> <p>図版15 遺構実測図3</p> <p>図版16 遺構実測図4</p> <p>図版17 遺構実測図5</p> <p>図版18 遺構実測図6</p> <p>図版19 遺構実測図7</p> <p>図版20 遺構実測図8</p> <p>図版21 遺構実測図9</p> <p>図版22 遺構実測図10</p> <p>図版23 遺構実測図11</p> <p>図版24 遺構実測図12</p> <p>図版25 遺構実測図13</p> <p>図版26 遺構実測図14</p> <p>図版27 遺構実測図15</p> <p>図版28 遺構実測図16</p> <p>図版29 遺構実測図17</p> <p>図版30 遺構実測図18</p> <p>図版31 遺構実測図19</p> <p>図版32 遺構実測図20</p> <p>図版33 遺構実測図21</p> <p>図版34 遺構実測図22</p> <p>図版35 遺構実測図23</p> <p>図版36 遺構実測図24</p> <p>図版37 遺構実測図25</p> <p>図版38 遺構実測図26</p> <p>図版39 遺構実測図27</p> <p>図版40 遺構実測図28</p> <p>図版41 遺構実測図29</p> <p>図版42 遺構実測図30</p> <p>図版43 遺構実測図31</p> <p>図版44 遺構実測図32</p> <p>図版45 遺構実測図33</p> <p>図版46 遺構実測図34</p> <p>図版47 遺構実測図35</p> | <p>図版48 遺構実測図36</p> <p>図版49 遺構実測図37</p> <p>図版50 遺構実測図38</p> <p>図版51 遺構実測図39</p> <p>図版52 遺構実測図40</p> <p>図版53 遺構実測図41</p> <p>図版54 遺構実測図42</p> <p>図版55 遺構実測図43</p> <p>図版56 遺構実測図44</p> <p>図版57 遺構実測図45</p> <p>図版58 遺構実測図46</p> <p>図版59 遺構実測図47</p> <p>図版60 遺構実測図48</p> <p>図版61 遺構実測図49</p> <p>図版62 遺構実測図50</p> <p>図版63 遺構実測図51</p> <p>図版64 遺構実測図52</p> <p>図版65 遺構実測図53</p> <p>図版66 遺構実測図54</p> <p>図版67 遺構実測図55</p> <p>図版68 遺構実測図56</p> <p>図版69 遺構実測図57</p> <p>図版70 遺構実測図58</p> <p>図版71 遺構実測図59</p> <p>図版72 遺構実測図60</p> <p>図版73 遺構実測図61</p> <p>図版74 遺構実測図62</p> <p>図版75 縄文・弥生時代遺物実測図</p> <p>図版76 古代土器実測図 (SB1・2)</p> <p>図版77 古代土器実測図 (SB2・5)</p> <p>図版78 古代土器実測図 (SB6・8)</p> <p>図版79 古代土器実測図 (SB10・12)</p> <p>図版80 古代土器実測図 (SB13・16・18)</p> <p>図版81 古代土器実測図 (SB20・23・25)</p> <p>図版82 古代土器実測図 (SB26・28, 31・32)</p> <p>図版83 古代土器実測図 (SB33・36)</p> <p>図版84 古代土器実測図 (SB37)</p> <p>図版85 古代土器実測図 (SB37・40, 43・44)</p> <p>図版86 古代土器実測図 (SB45・49)</p> <p>図版87 古代土器実測図 (SB50・55)</p> <p>図版88 古代土器実測図 (SB55・57)</p> <p>図版89 古代土器実測図 (SB57・58・60・61)</p> <p>図版90 古代土器実測図 (SB62・66)</p> <p>図版91 古代土器実測図 (SB67・68)</p> <p>図版92 古代土器実測図 (SB69・71・72)</p> <p>図版93 古代土器実測図 (SB73・74)</p> <p>図版94 古代土器実測図 (SB75, 77・80)</p> |
|--|--|

- 圖版95 古代土器実測圖 (SB80・82・84)
 圖版96 古代土器実測圖 (SB84-92)
 圖版97 古代土器実測圖 (SB90, 92-95, 97)
 圖版98 古代土器実測圖 (SB98-100)
 圖版99 古代土器実測圖 (SB101-104, 109)
 圖版100 古代土器実測圖 (SB110, 113-115)
 圖版101 古代土器実測圖 (SB114・116)
 圖版102 古代土器実測圖 (SB117, 119-125)
 圖版103 古代土器実測圖 (SB126-129)
 圖版104 古代土器実測圖 (SB129)
 圖版105 古代土器実測圖 (SB130-133)
 圖版106 古代土器実測圖 (SB134-137)
 圖版107 古代土器実測圖 (SB138・141・142)
 圖版108 古代土器実測圖 (SB142・143)
 圖版109 古代土器実測圖 (SB144-146)
 圖版110 古代土器実測圖 (SB147-150)
 圖版111 古代土器実測圖 (SB151・153・155)
 圖版112 古代土器実測圖 (SB155・156)
 圖版113 古代土器実測圖 (SB157, 159-162)
 圖版114 古代土器実測圖 (SB163・164)
 圖版115 古代土器実測圖 (SB164-168)
 圖版116 古代土器実測圖 (SB169-172)
 圖版117 古代土器実測圖 (SB173-175)
 圖版118 古代土器実測圖 (SB175・176)
 圖版119 古代土器実測圖 (SB176, 177-178, 183)
 圖版120 古代土器実測圖 (SB183・184)
 圖版121 古代土器実測圖 (SB185-188, 191)
 圖版122 古代土器実測圖 (SB192-194)
 圖版123 古代土器実測圖 (SB195-199)
 圖版124 古代土器実測圖 (SB199・200・202・205)
 圖版125 古代土器実測圖 (SB201, 206-208)
 圖版126 古代土器実測圖 (SB208-211)
 圖版127 古代土器実測圖 (SB213-216, 218・219)
 圖版128 古代土器実測圖 (SB220-224)
 圖版129 古代土器実測圖 (SB224・501・503)
 圖版130 古代土器実測圖 (SB504-508)
 圖版131 古代土器実測圖 (SB509・521)
 圖版132 古代土器実測圖 (SB522・523)
 圖版133 古代土器実測圖 (SB524, 526-528)
 圖版134 古代土器実測圖 (SB528・529)
 圖版135 古代土器実測圖 (SB530・534・536・537)
 圖版136 古代土器実測圖 (SB537・540)
 圖版137 古代土器実測圖 (SB541・542)
 圖版138 古代土器実測圖 (SB544・545)
 圖版139 古代土器実測圖 (SB546・547)
 圖版140 古代土器実測圖 (SB547-550)
 圖版141 古代土器実測圖 (SB550)
 圖版142 古代土器実測圖 (S551・553B)
 圖版143 古代土器実測圖 (SB555)
 圖版144 古代土器実測圖 (SB554・565, 567-569, 571)
 圖版145 古代土器実測圖 (SB557・558)
 圖版146 古代土器実測圖 (SB558・559)
 圖版147 古代土器実測圖 (SB560・564)
 圖版148 古代土器実測圖 (SB564・565, 567-569, 571)
 圖版149 古代土器実測圖 (SB572・573・575)
 圖版150 古代土器実測圖 (SB574・576-579)
 圖版151 古代土器実測圖 (SB580-582)
 圖版152 古代土器実測圖 (SB583・586・587)
 圖版153 古代土器実測圖 (SB588・589)
 圖版154 古代土器実測圖 (SB589-592)
 圖版155 古代土器実測圖 (SB595-598)
 圖版156 古代土器実測圖 (SB598-606)
 圖版157 古代土器実測圖 (SB601・602・605・606)
 圖版158 古代土器実測圖 (SB607・609・610・611・612・615)
 圖版159 古代土器実測圖 (SB614・616・617)
 圖版160 古代土器実測圖 (SB618-621)
 圖版161 古代土器実測圖 (SB623-625)
 圖版162 古代土器実測圖 (SB625・626)
 圖版163 古代土器実測圖 (SB626・627)
 圖版164 古代土器実測圖 (SB627-629)
 圖版165 古代土器実測圖 (SB633-637)
 圖版166 古代土器実測圖 (SB637-60, ST 3・11-12-16-34-36)
 圖版167 古代土器実測圖 (各ST出土)
 圖版168 古代土器実測圖 (各SD, SK出土)
 圖版169 古代土器実測圖 (各SK出土)
 圖版170 古代土器実測圖 (各SK, NR出土)
 圖版171 古代土器実測圖 (SD524)
 圖版172 古代土器実測圖 (SD524)
 圖版173 文字關係資料実測圖
 圖版174 文字關係資料実測圖
 圖版175 文字關係資料実測圖
 圖版176 文字關係資料実測圖
 圖版177 文字關係資料実測圖
 圖版178 古代金屬製品実測圖
 圖版179 古代金屬製品実測圖
 圖版180 古代金屬製品実測圖
 圖版181 古代金屬製品実測圖
 圖版182 古代石製品実測圖
 圖版183 古代石製品実測圖
 圖版184 古代石製品実測圖
 圖版185 古代土製品実測圖
 圖版186 中世土器・陶磁器実測圖
 圖版187 中世土器・陶磁器実測圖
 圖版188 中・近世金屬製品・錢貨・石製品実測圖

写真図版 (PL) 目次

- P L 1 調査遺跡周辺の地形と遺跡分布
 P L 2 遺跡南都遺景、北部近景
 P L 3 調査区遺構分布
 P L 4 調査区遺構分布
 P L 5 調査区遺構分布
 P L 6 調査区遺構分布
 P L 7 調査区遺構分布
 P L 8 SB1・2完掘、4・12カマド
 P L 9 SB37・55・58完掘
 P L 10 SB68・71完掘、68・72・80カマド
 P L 11 SB73・91完掘、91・93・95カマド
 P L 12 SB97・100・113完掘、114・128カマド
 P L 13 SB129・136・完掘、136・141カマド
 P L 14 SB147・153完掘、153カマド
 P L 15 SB155・160・172完掘
 P L 16 SB175・176完掘、176カマド
 P L 17 SB179・183カマド、185・187完掘
 P L 18 SB192・196・201完掘
 P L 19 SB201カマド・施設、210・214完掘
 213・219・222カマド
 P L 20 SB522・526・528完掘 P L 21 SB536・537・
 540完掘、537カマド
 P L 22 SB541・545・547完掘
 P L 23 SB549・550・551完掘
 P L 24 SB553・555完掘、555・556・564カマド
 P L 25 SB558・573・577完掘
 P L 26 SB582・593完掘、582・589・597カマド
 P L 27 SB598・600・609完掘、598カマド
 P L 28 SB623・625・626完掘、626カマド、627施設
 P L 29 SB627・637・640完掘
 P L 30 カマド (1～8期)
 P L 31 カマド (11～15期)
 P L 32 ST1・3・11・13完掘
 P L 33 ST19・20・21・26完掘
 P L 34 ST29・32・35完掘
 P L 35 ST42・43・46完掘
 P L 36 ST48・50・51完掘
 P L 37 ST521・524・526・527完掘
 P L 38 ST528・529・530・535・SA501完掘
 P L 39 ST538・539・548・549完掘
 P L 40 ST555・558・560完掘
 P L 41 ST561・562・566完掘、530・548断面
 P L 42 SK176完掘、同出土遺物
 P L 43 SK183・193・200完掘、同出土遺物
 P L 44 SK349・514完掘、同出土遺物
 P L 45 SK1069完掘、同出土遺物
 P L 46 SK11・55・64・348完掘
 P L 47 SK421・522・548完掘
 P L 48 SK518・1071・SA3・502・503・SD25完掘
 P L 49 SB630・631・632・639完掘
 P L 50 ST33・56・SA4・SK174・175・192完掘
 P L 51 SK486完掘、SK51・52検出、完掘
 P L 52 SK53・171完掘、同断面、308完掘
 P L 53 SK330・331・371・372完掘
 P L 54 SK390・392・460・482～484・492完掘
 P L 55 SK629・652・552・553・636完掘
 P L 56 SK347・599・559・SD16など完掘
 P L 57 SD5・13・524・533・534完掘
 P L 58 縄文・弥生時代遺物
 P L 59 SB1・2出土土器
 P L 60 SB2出土土器
 P L 61 SB2・37出土土器
 P L 62 SB37・55出土土器
 P L 63 SB68・79・96出土土器
 P L 64 SB96・116出土土器
 P L 65 SB116・129出土土器
 P L 66 SB129・131出土土器
 P L 67 SB136・142出土土器
 P L 68 SB142・155出土土器
 P L 69 SB155・156・164出土土器
 P L 70 SB164・175出土土器
 P L 71 SB175・176出土土器
 P L 72 SB176・184出土土器
 P L 73 SB184・192出土土器
 P L 74 SB192出土土器
 P L 75 SB199出土土器
 P L 76 SB209出土土器
 P L 77 SB220・523・529出土土器
 P L 78 SB529・537出土土器
 P L 79 SB537・540
 P L 80 SB550出土土器
 P L 81 SB550・555出土土器
 P L 82 SB555出土土器
 P L 83 SB555・559・530・556出土土器
 P L 84 SB591・598出土土器
 P L 85 SB598・606出土土器
 P L 86 SB626出土土器
 P L 87 SB637・617・NR4出土土器
 P L 88 須恵器・緑釉陶器
 P L 89 須恵器・越州窯系青磁
 P L 90 墨書・刺書土器
 P L 91 古代の鉄製品
 P L 92 古代の鉄製品
 P L 93 古代の銅製品・石製品
 P L 94 古代の石製品
 P L 95 古代の土製品
 P L 96 中世土器・陶磁器
 P L 97 中世金属・石製品・自然遺体
 P L 98 中世の石製品

圖 版

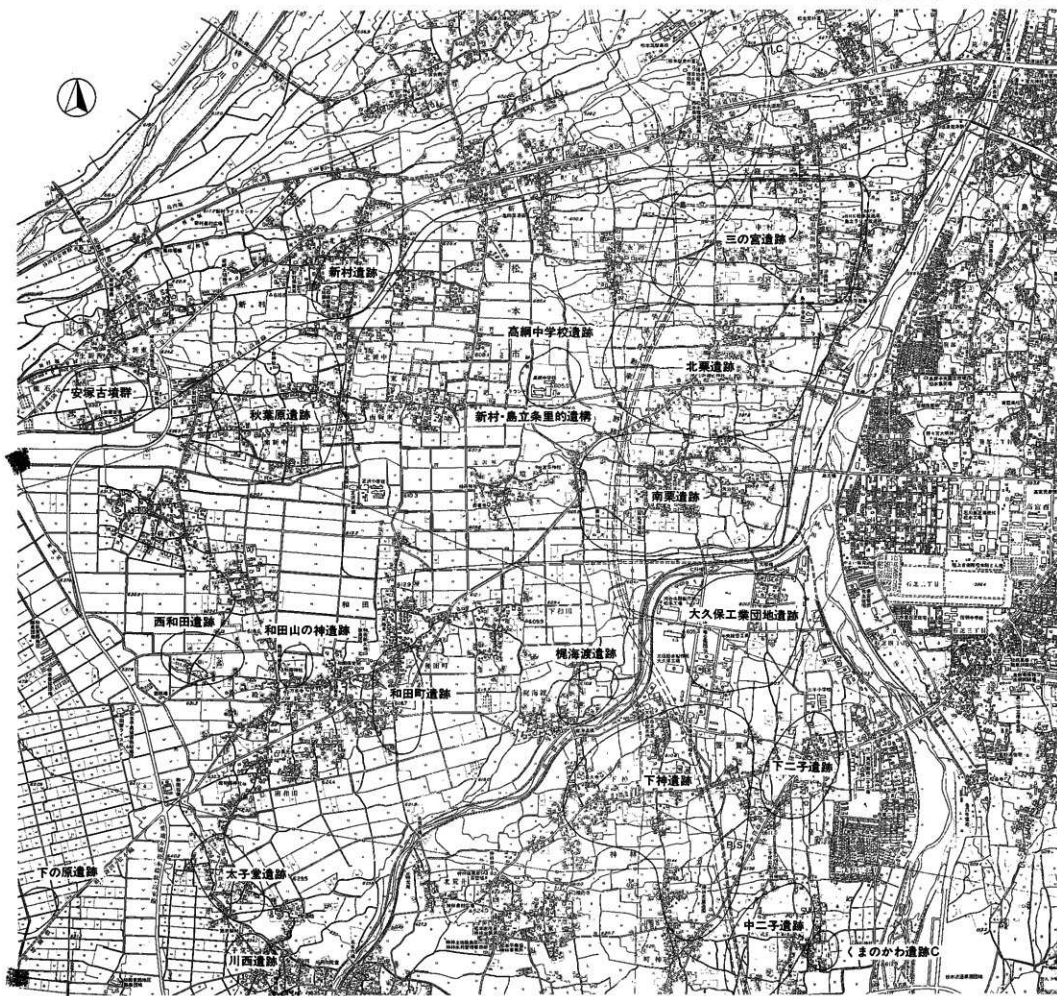



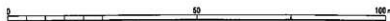
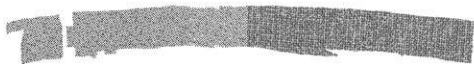
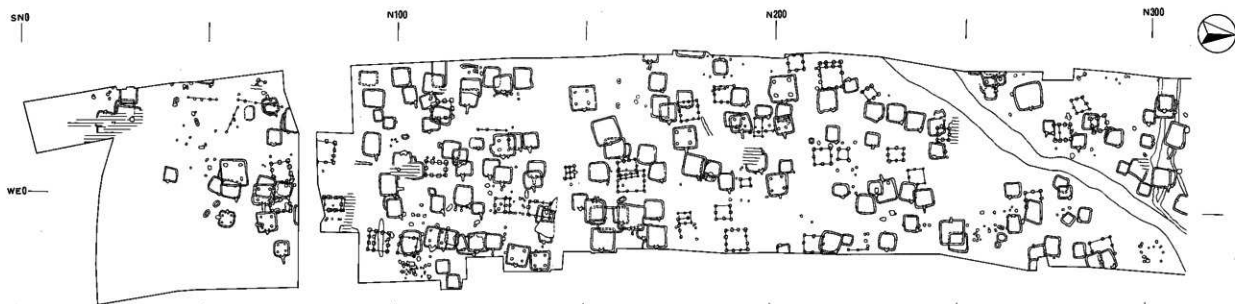

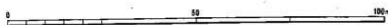
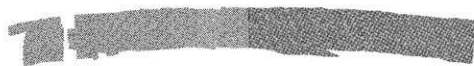
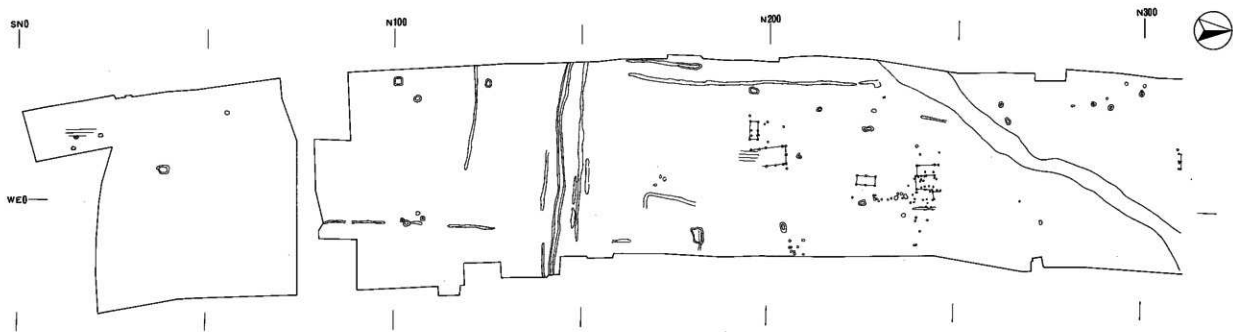
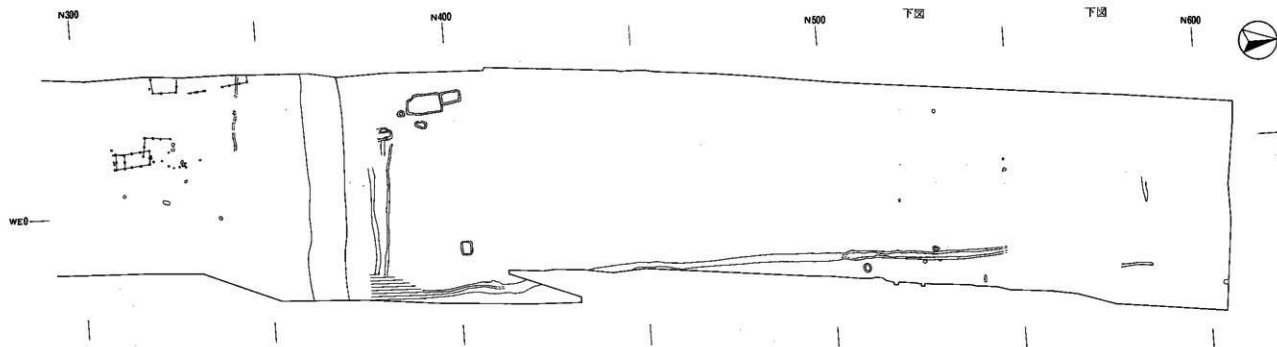

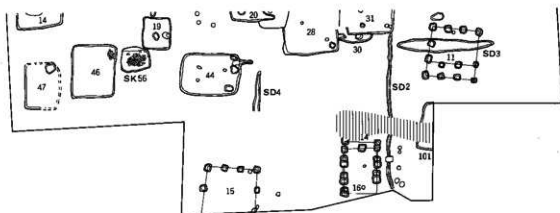

図版 6 遺構実測図Ⅱ

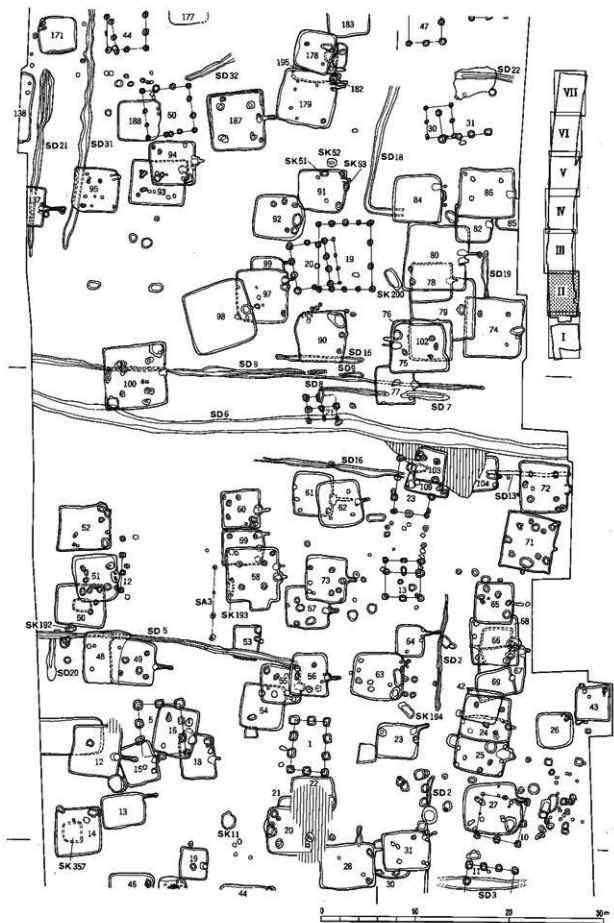

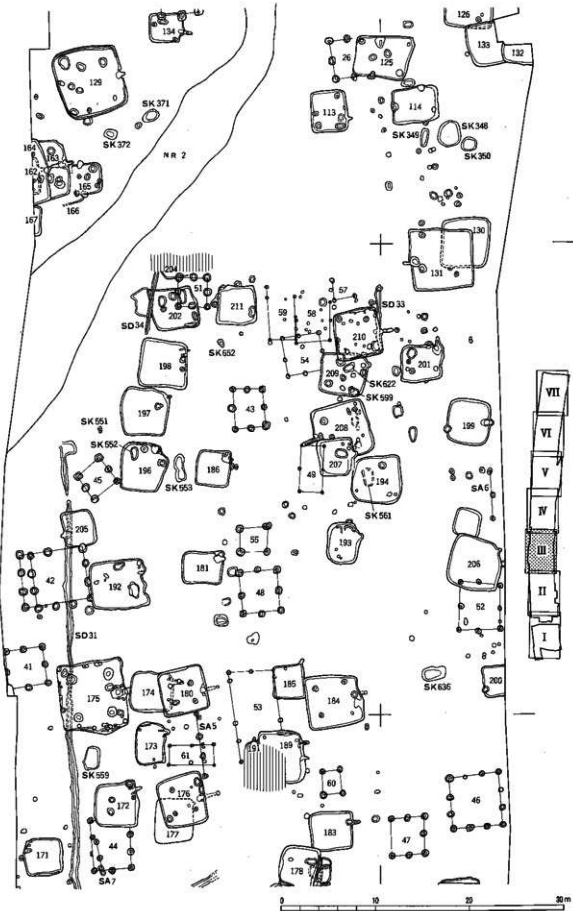

图版 8 遺構実測図Ⅳ

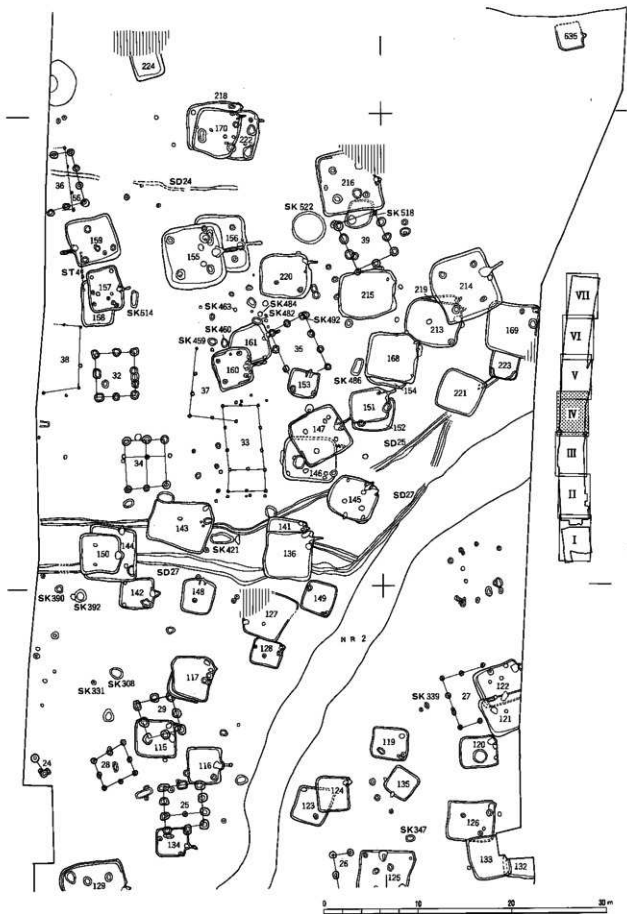

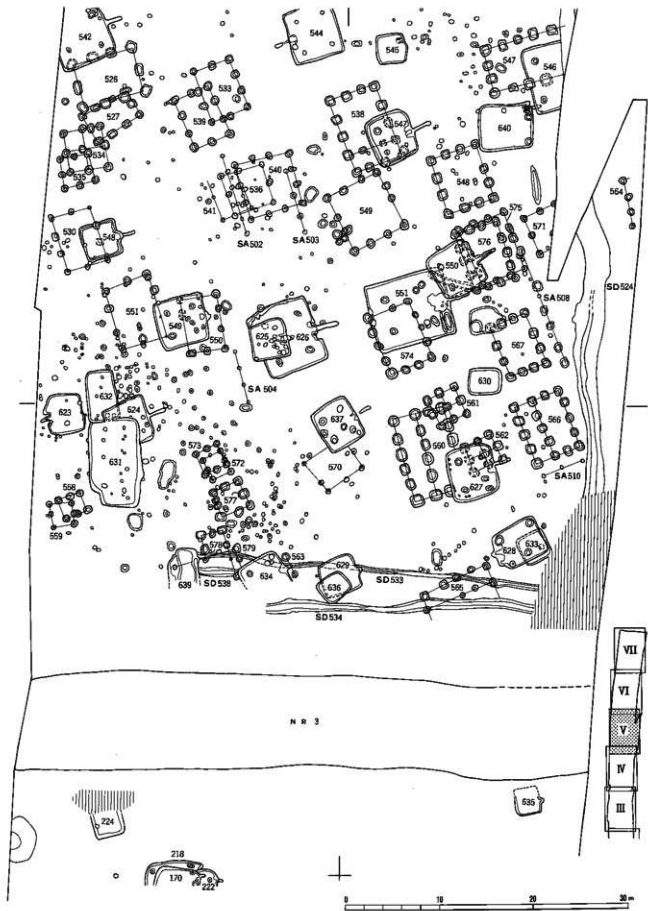

図版10 遺構実測図Ⅵ

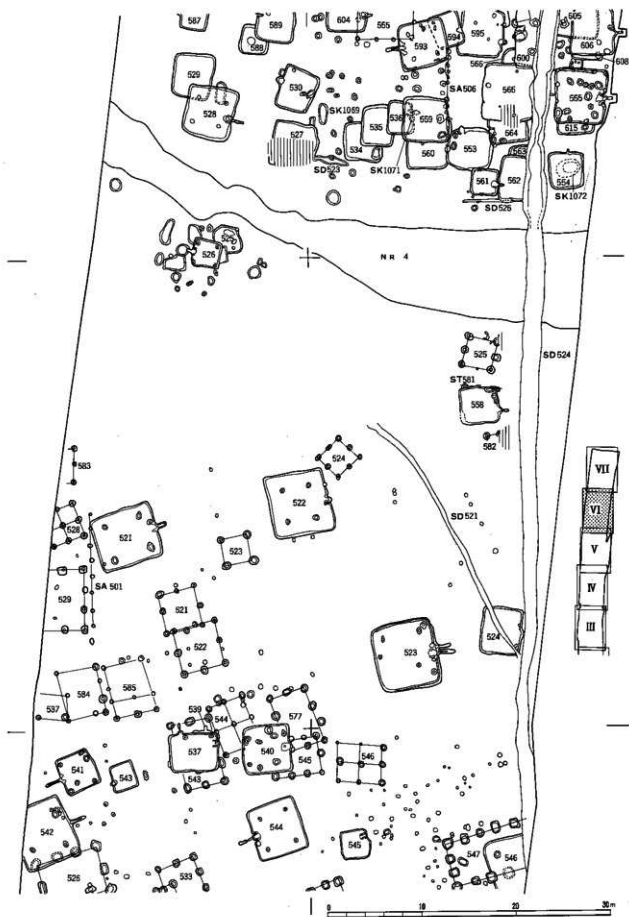

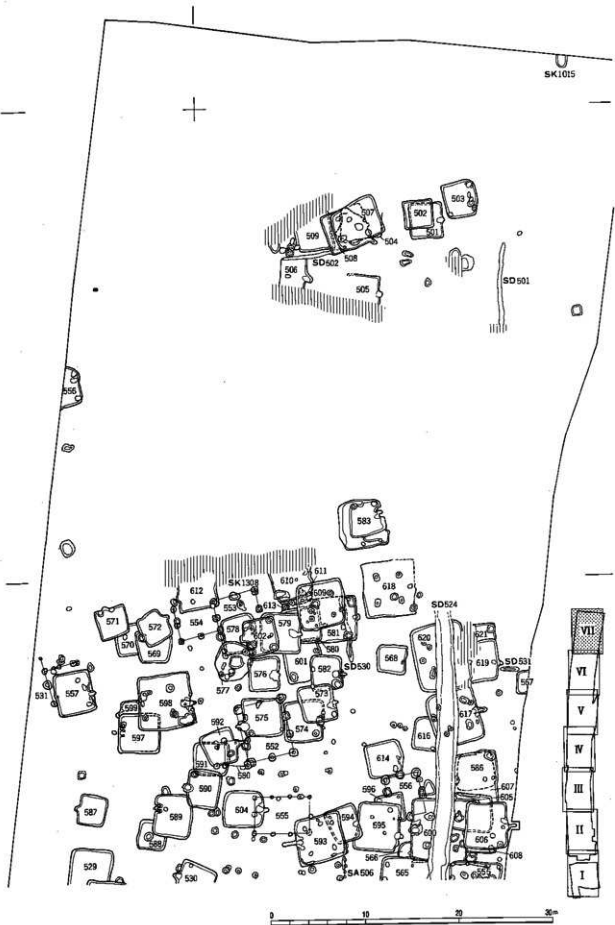

図版12 遺構実測図割付図

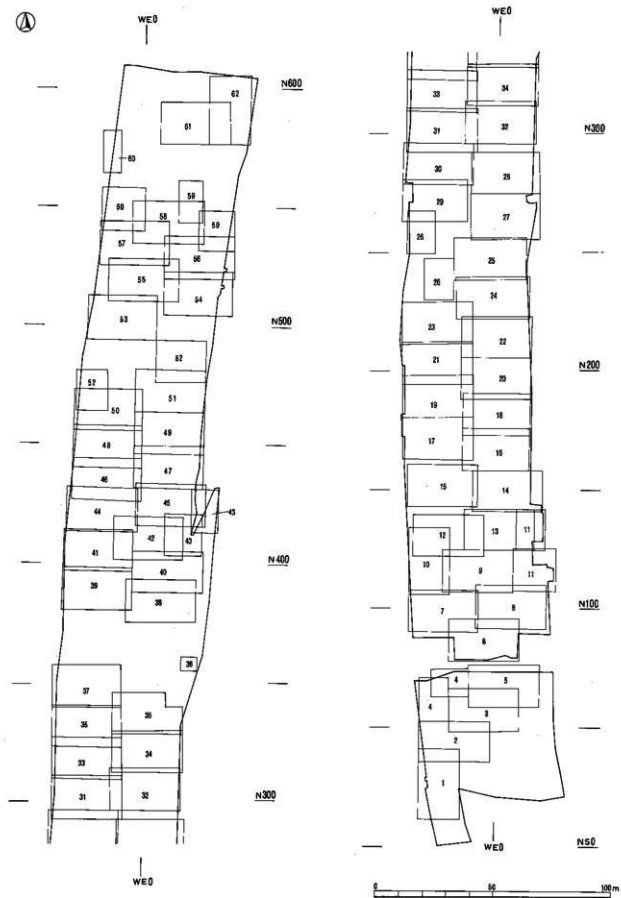

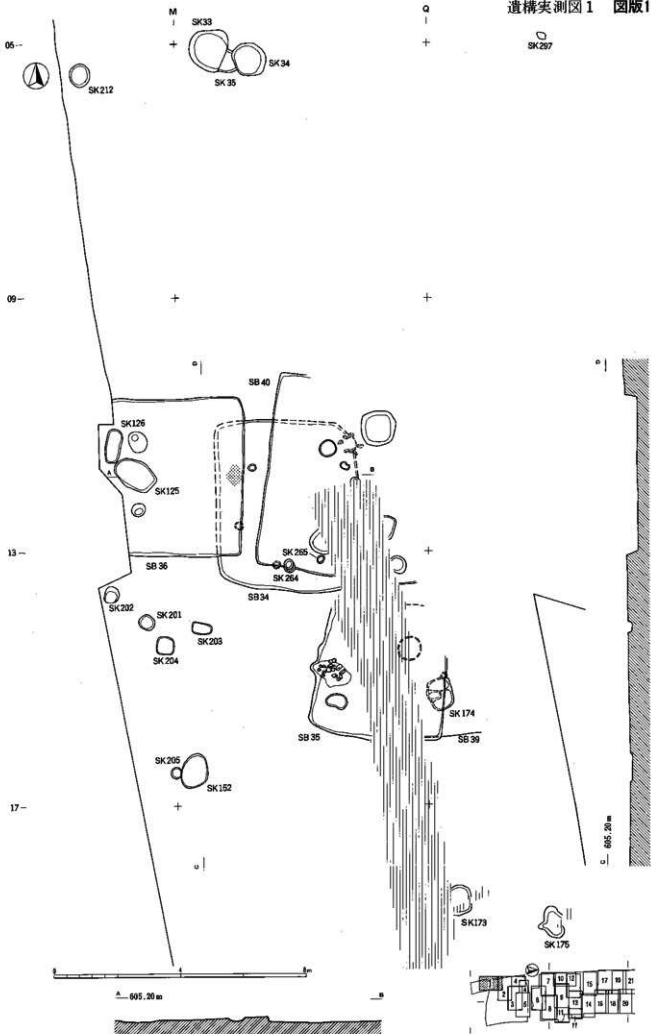

図版14 遺構実測図2

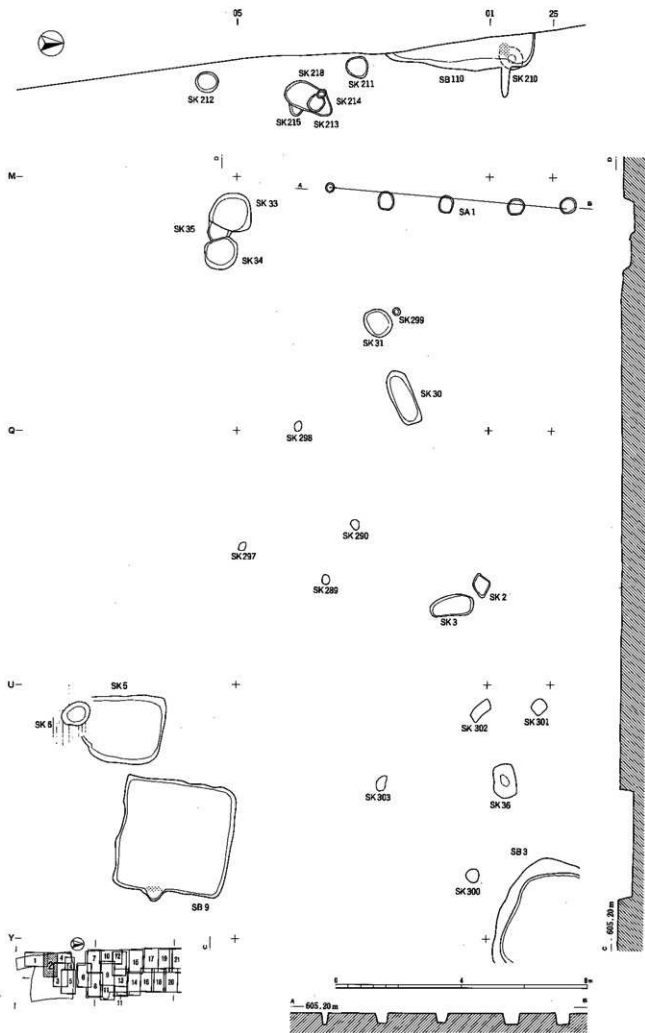

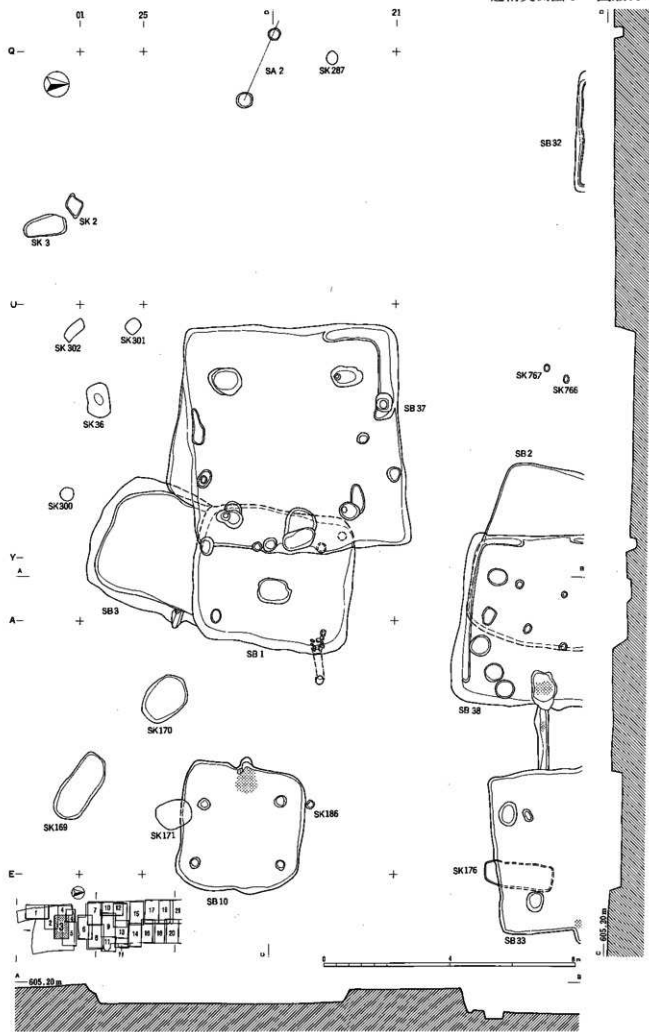

図版16 遺構実測図 6

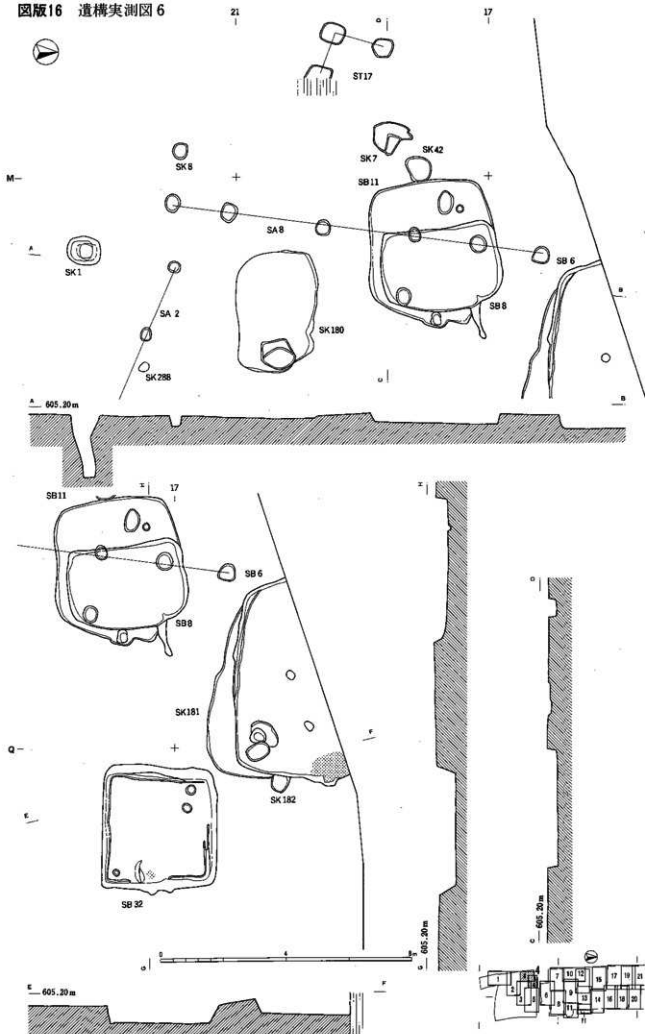

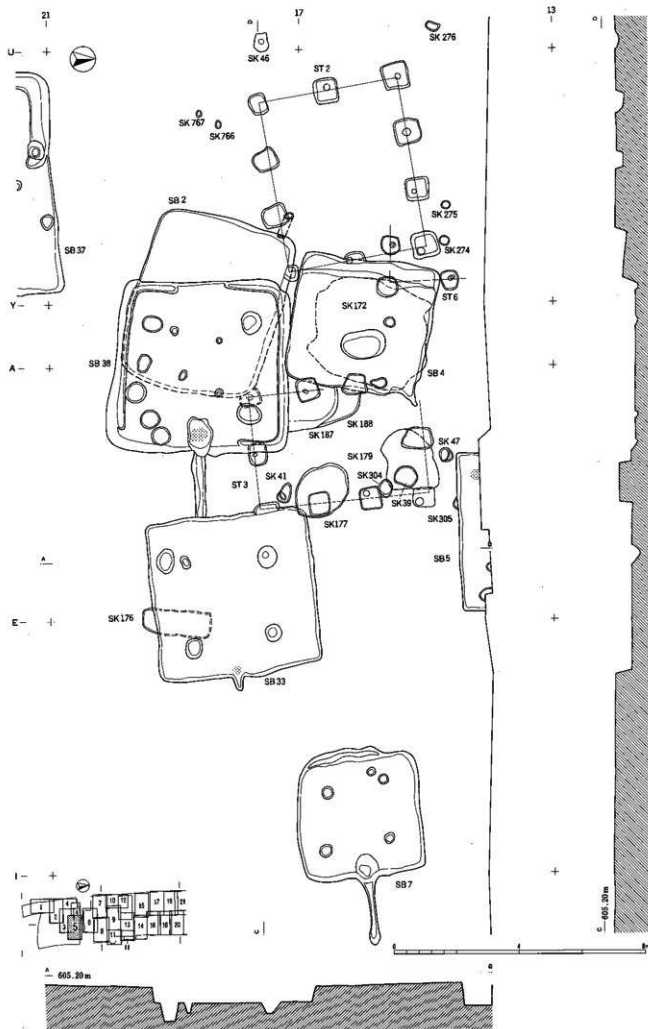

図版18 遺構実測図6

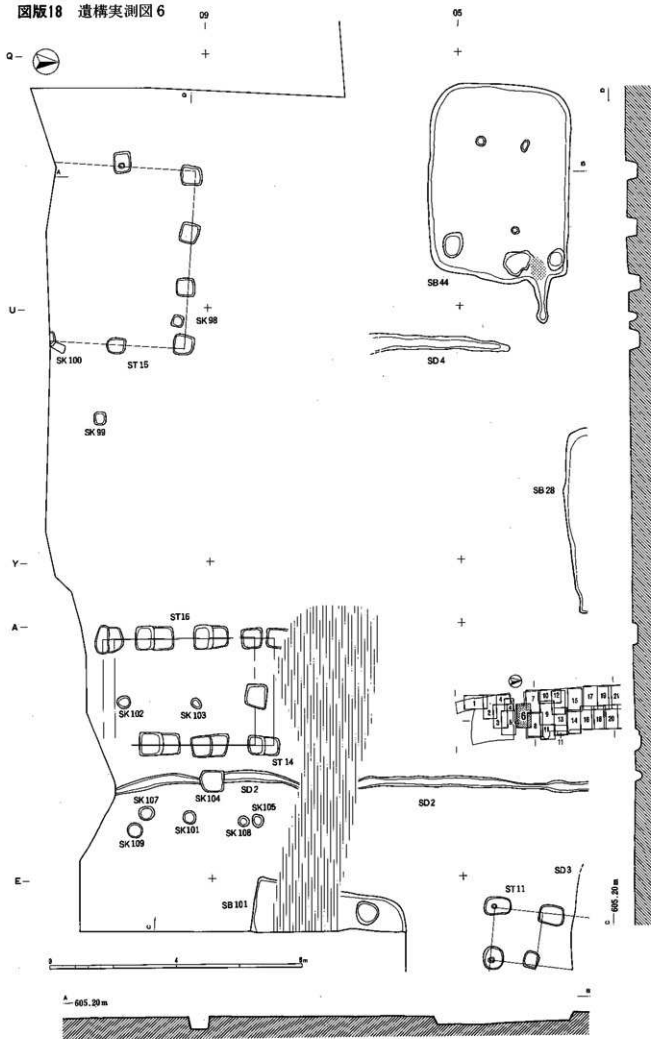

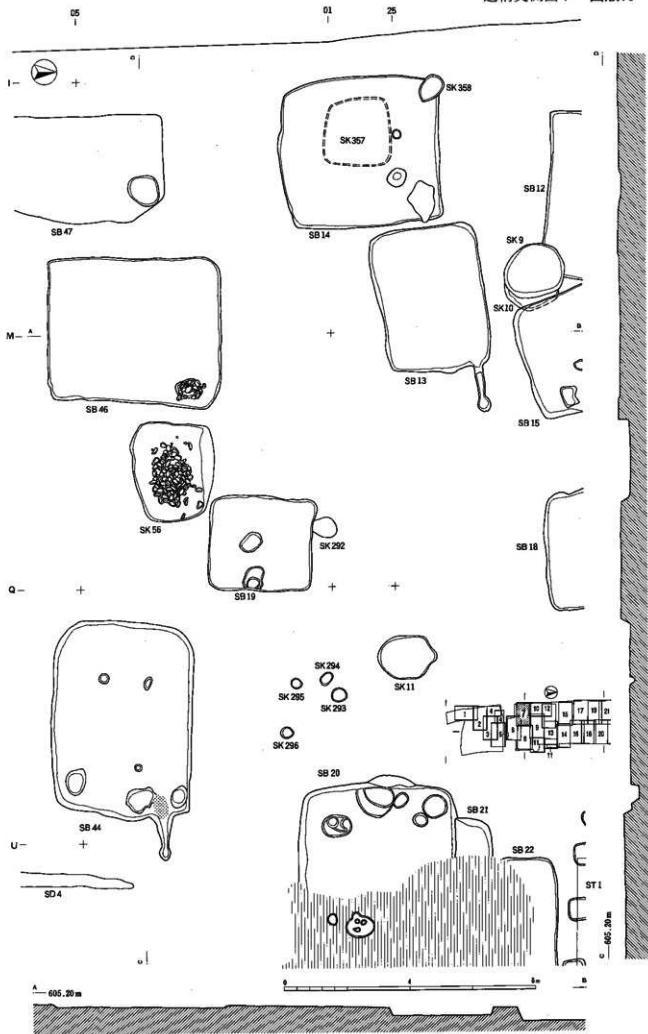

图版20 遺構実測図 8

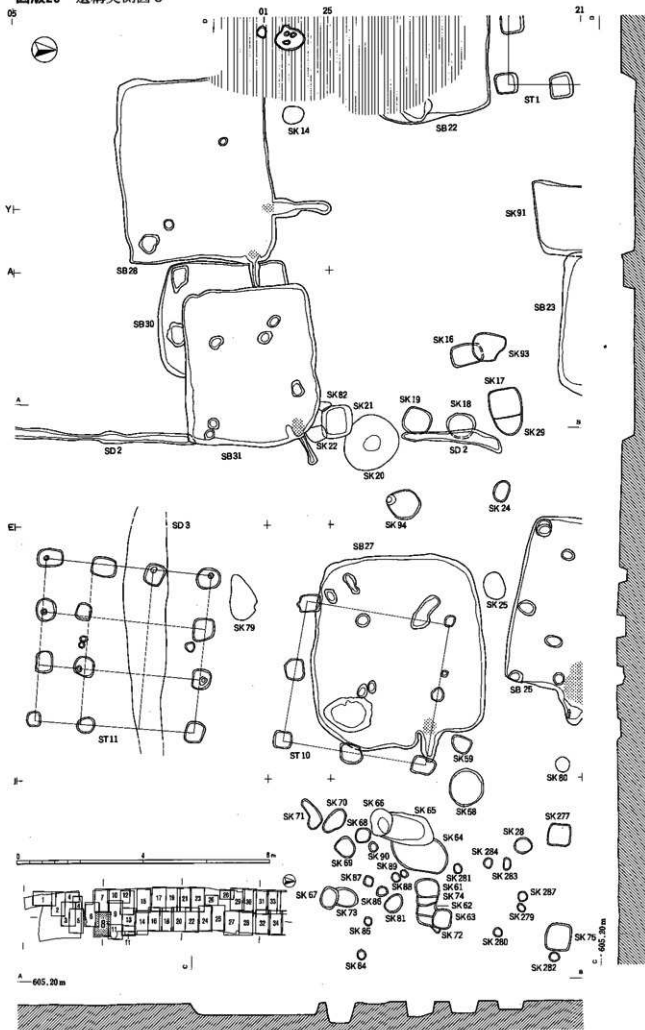

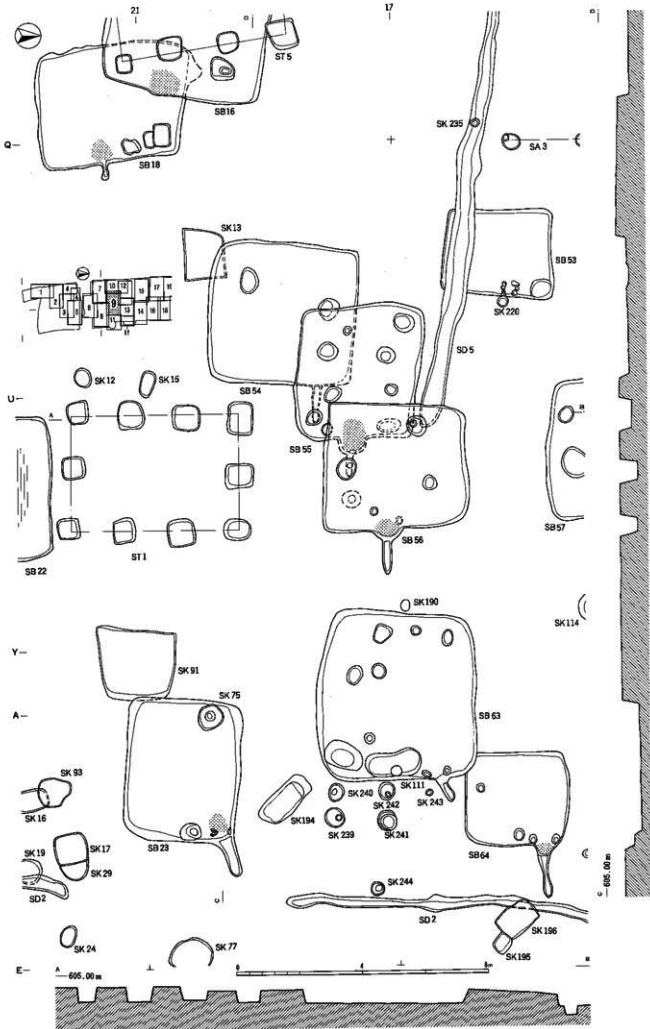

図版22 遺構実測図10

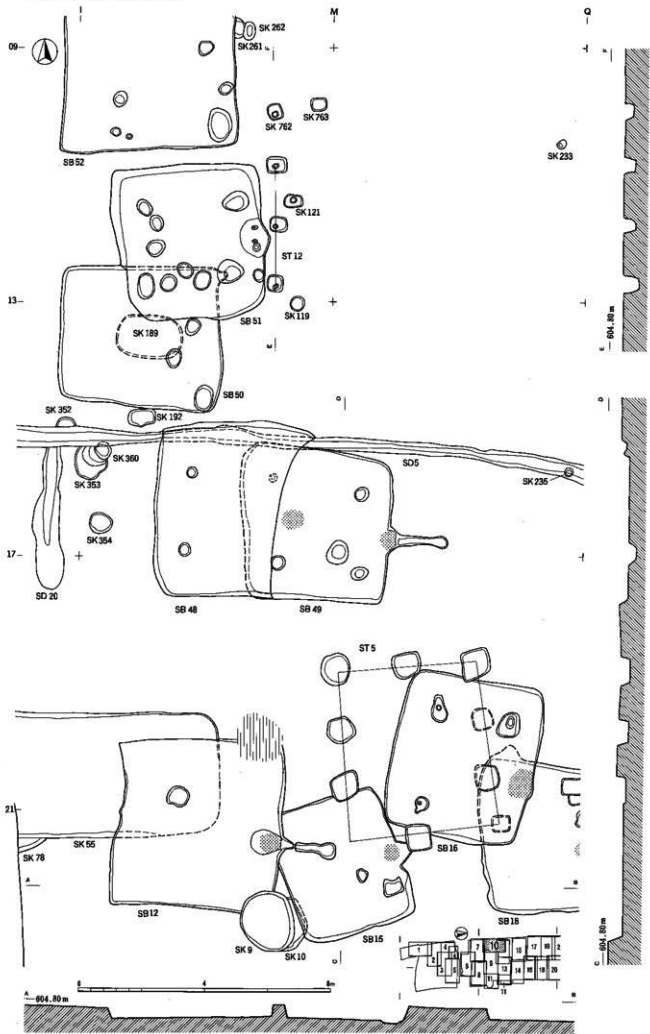

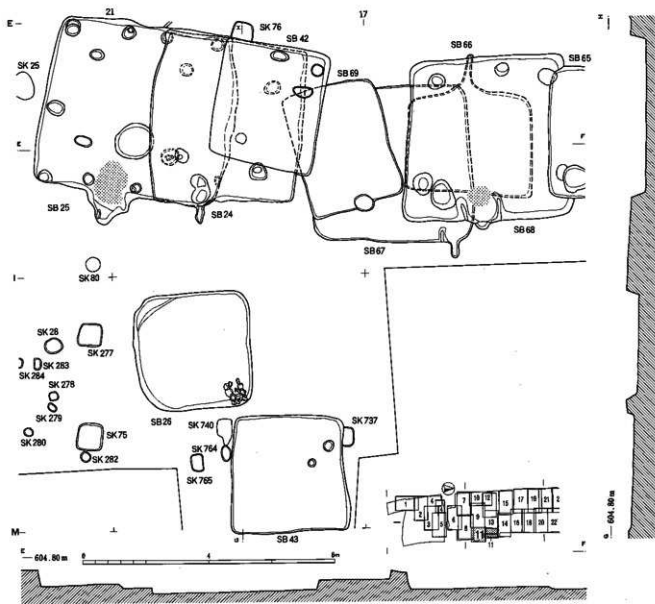
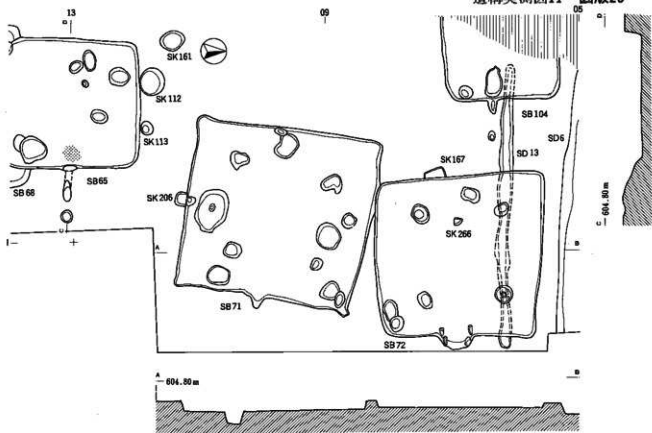

図版24 遺構実測図12

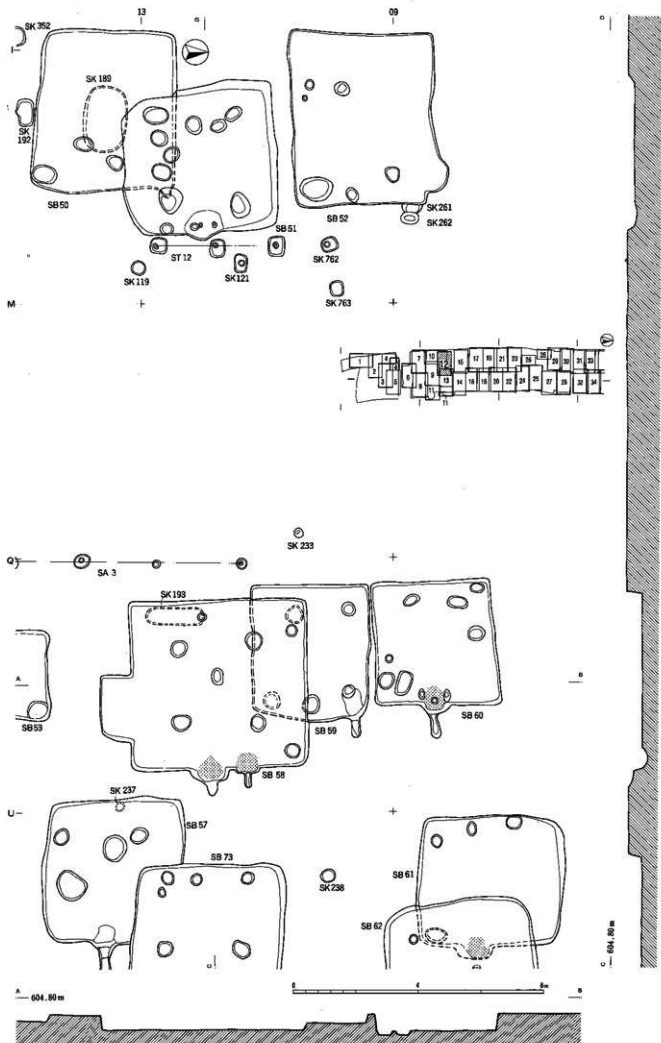

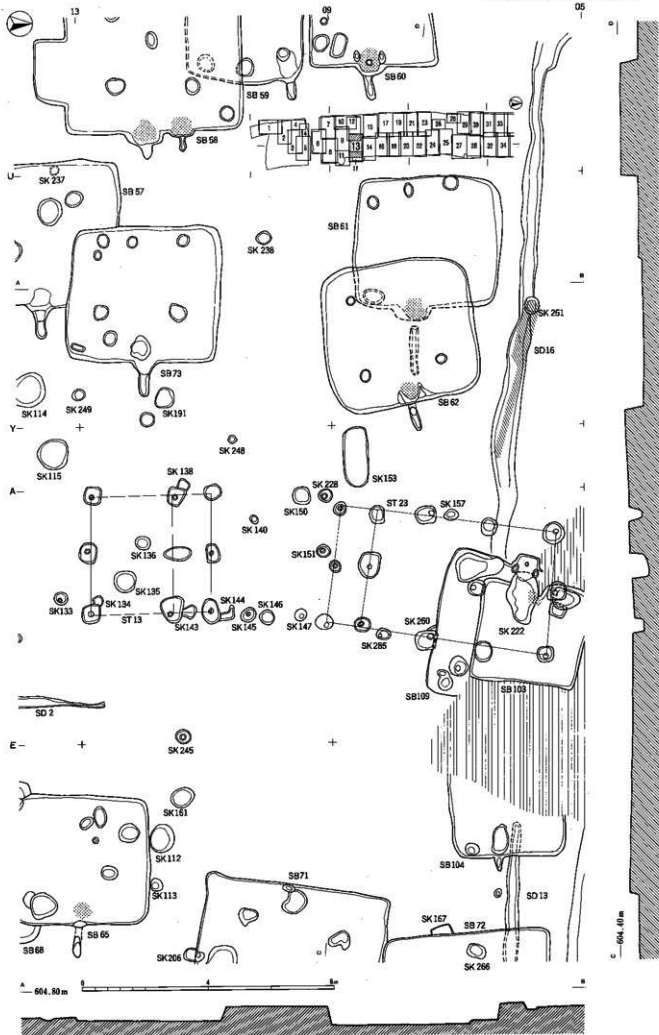

图版26 遺構実測図14

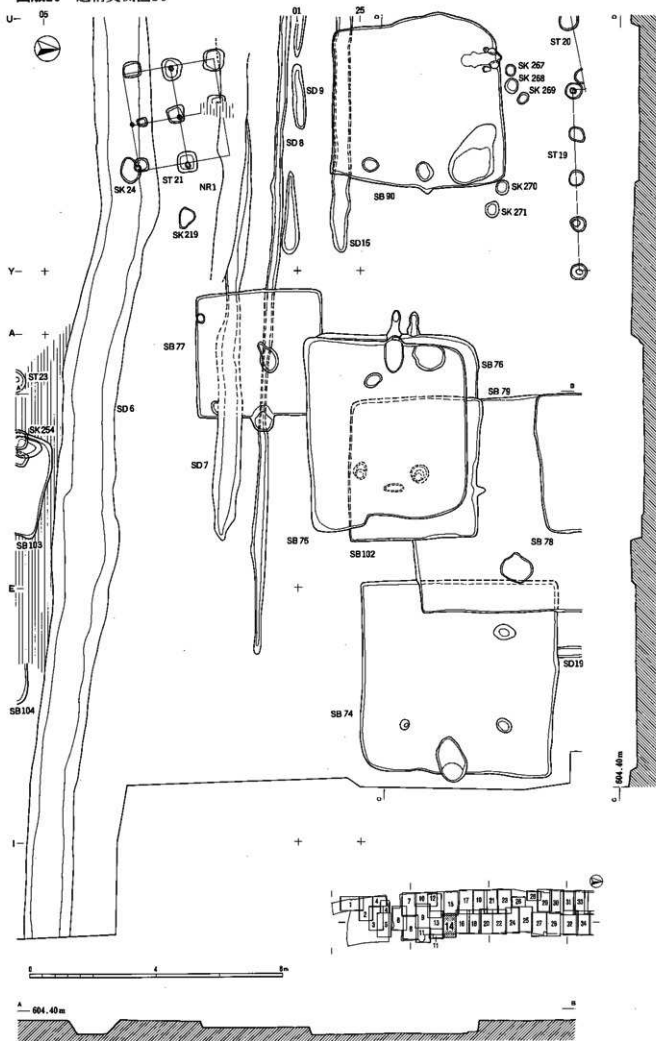

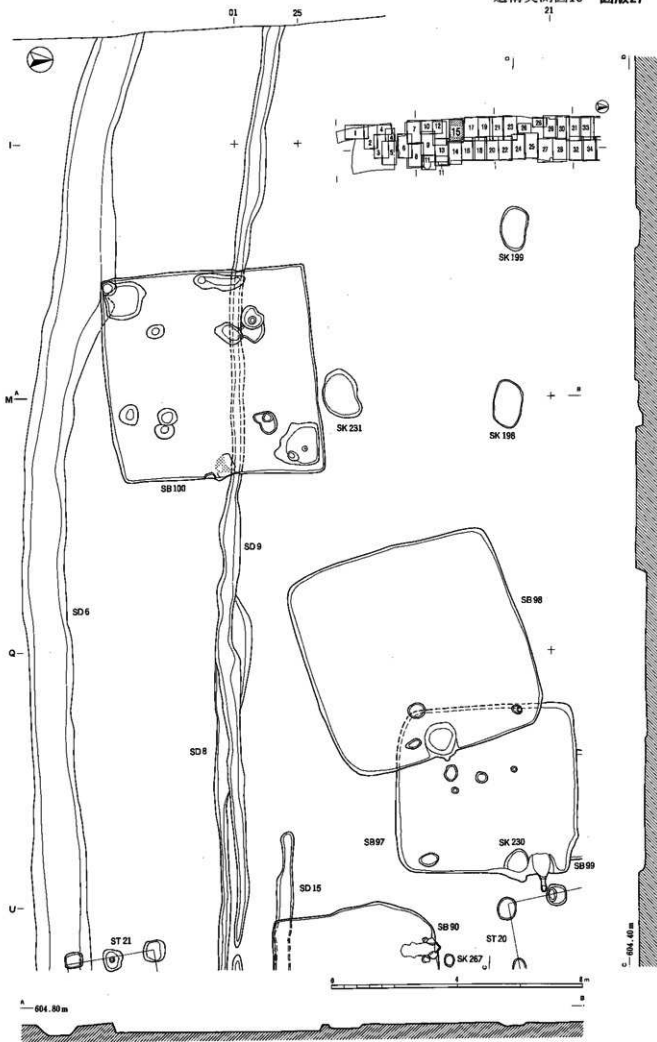

图版28 遗构实测图16

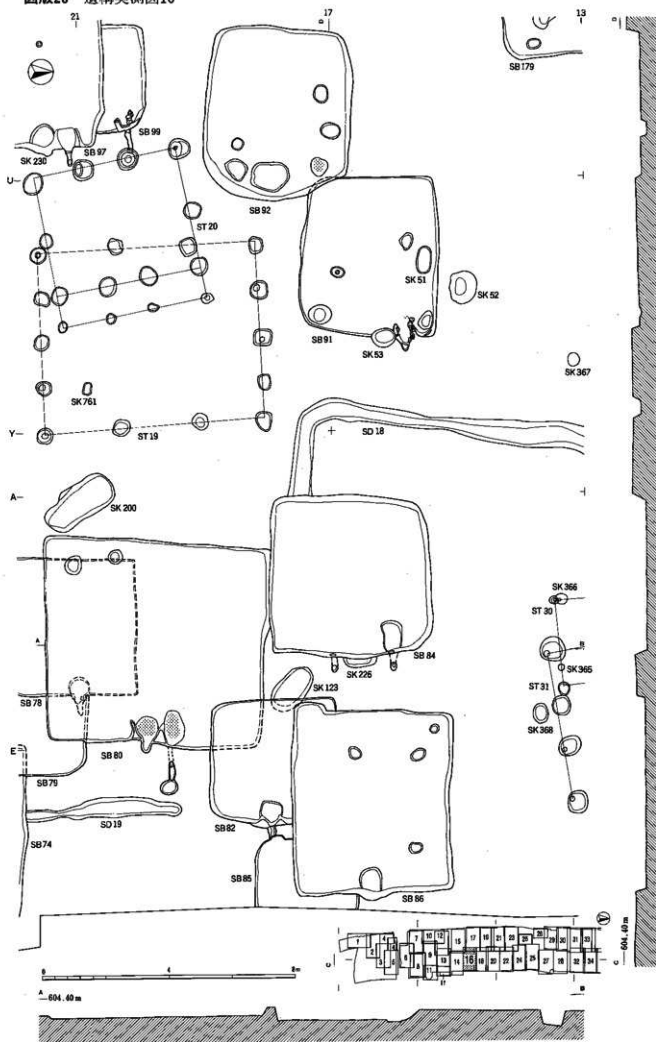

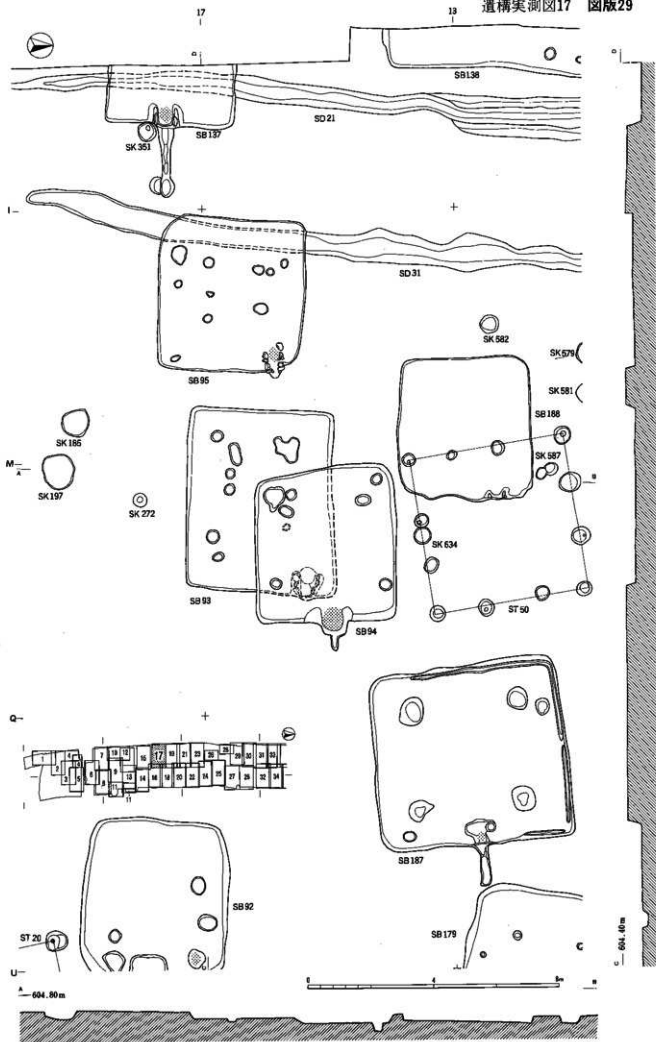

图版30 遗构实测图18

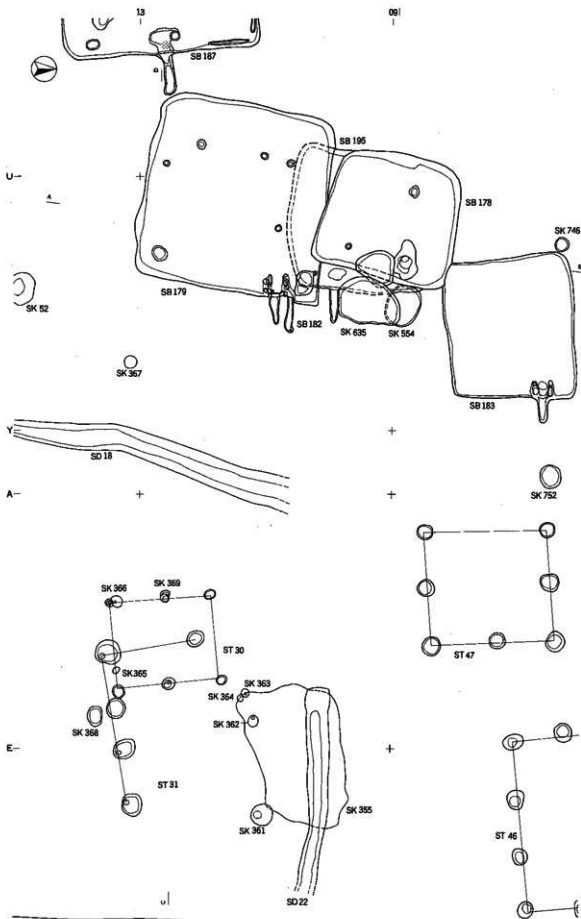

C—604.40 m



A—604.40 m

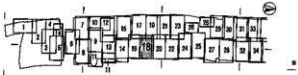

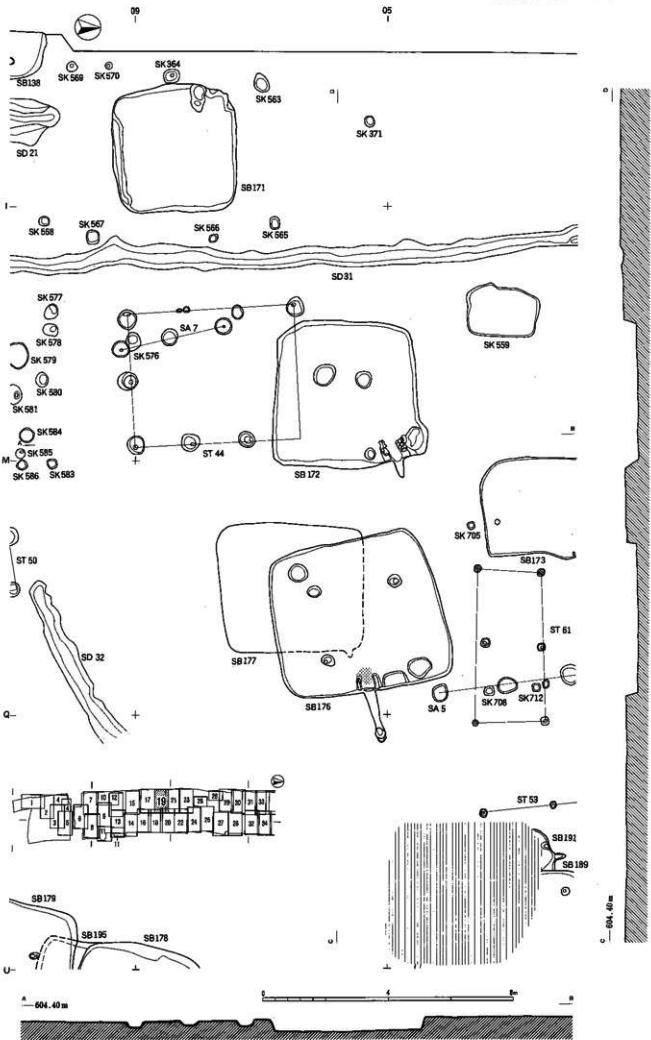

図版32 遺構実測図20

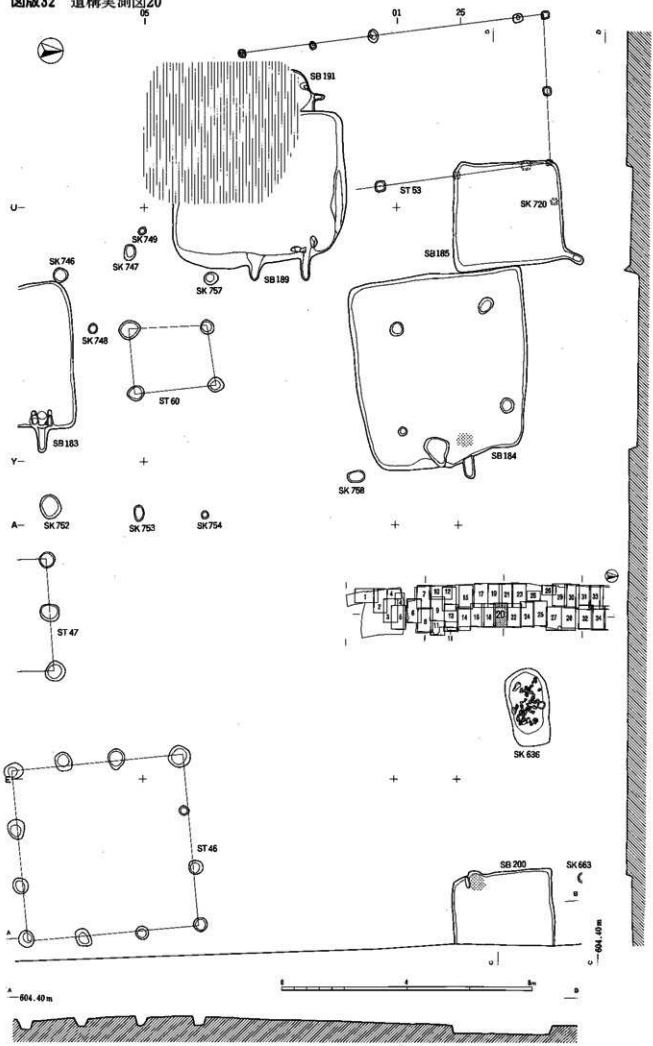

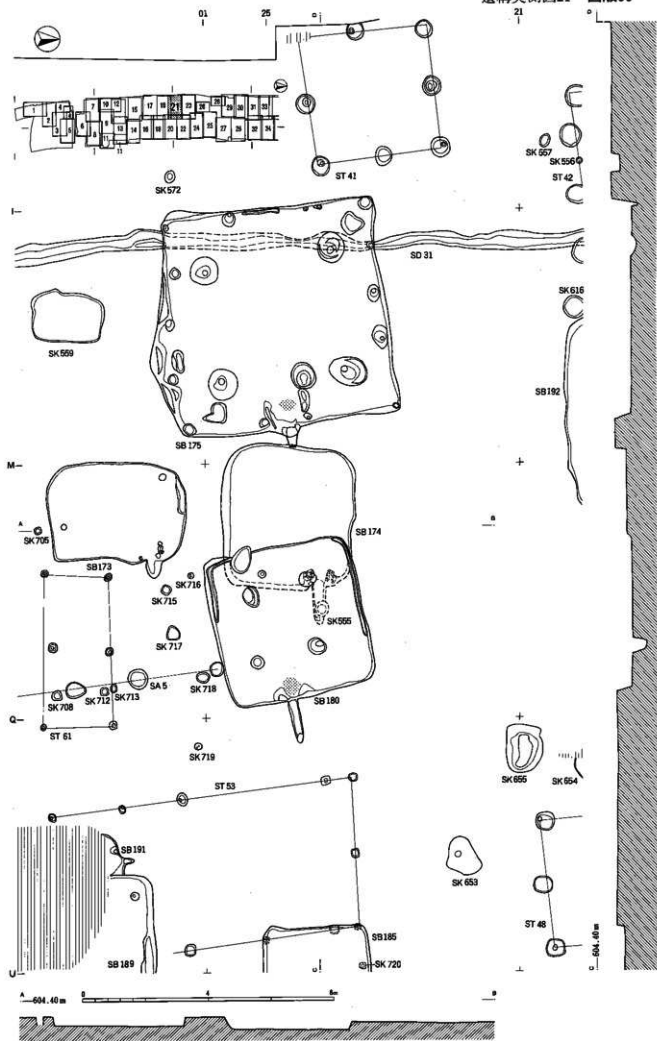

図版34 遺構実測図22

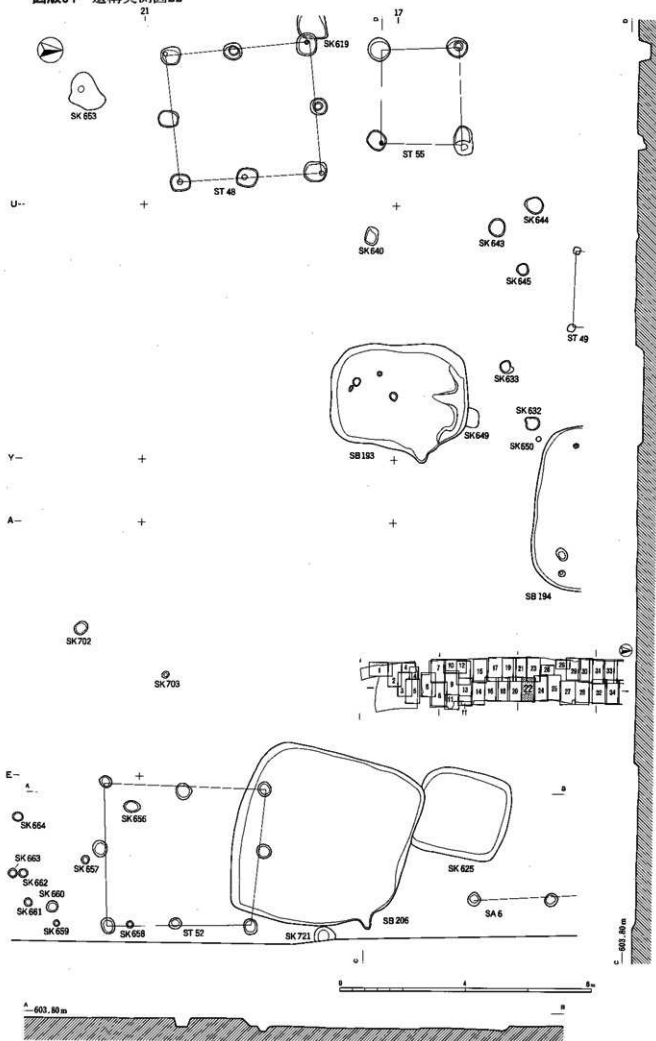

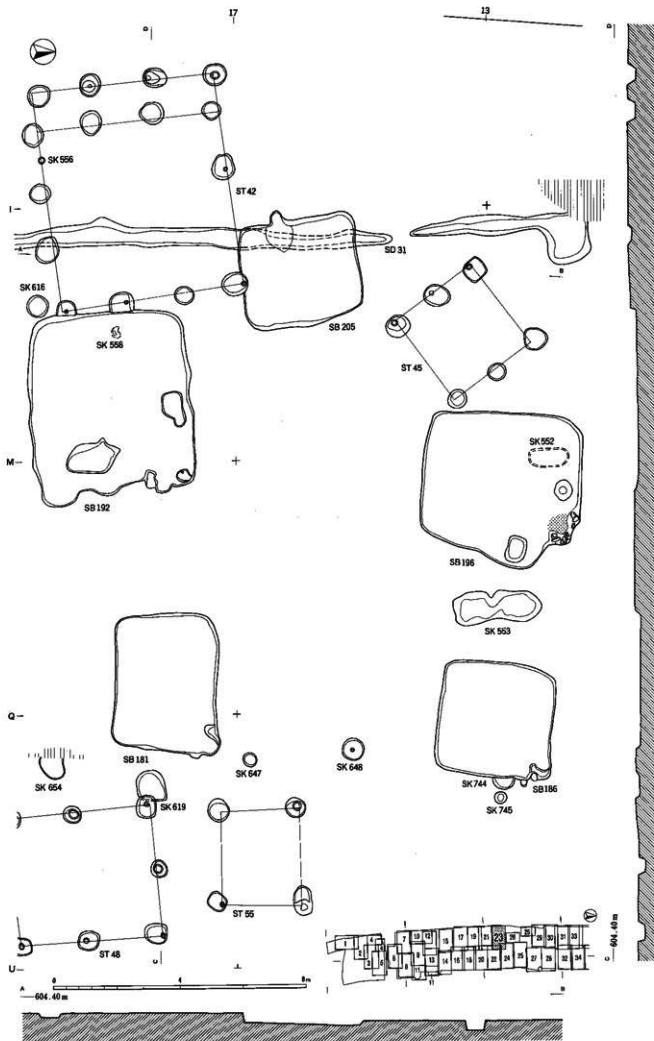

図版36 遺構実測図24

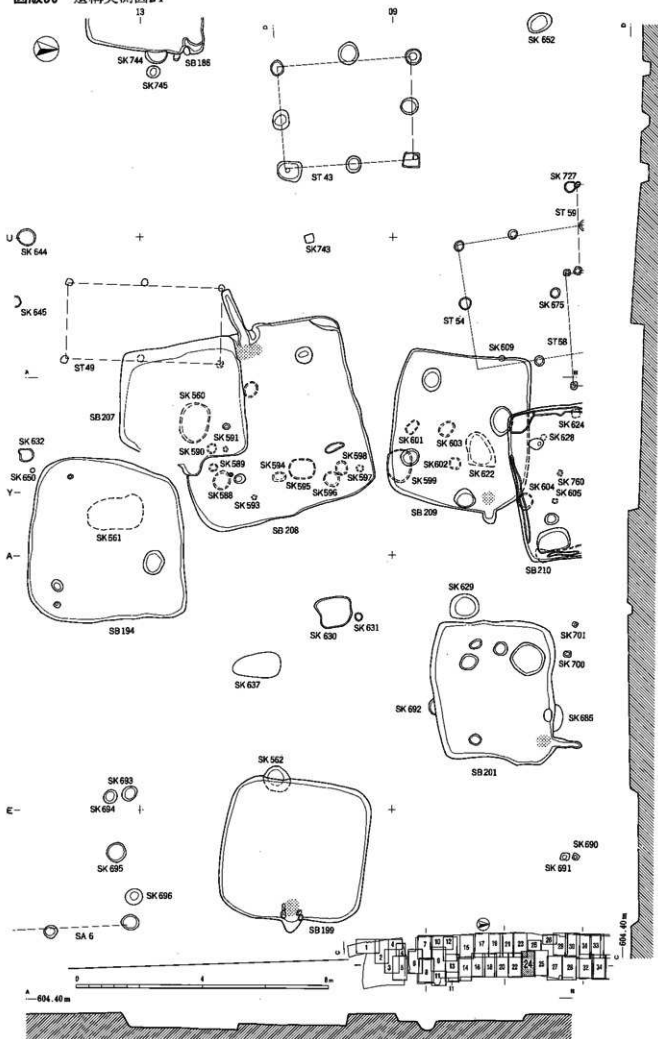

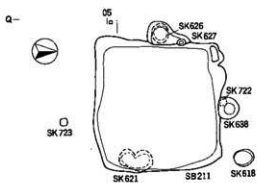

01 | 25

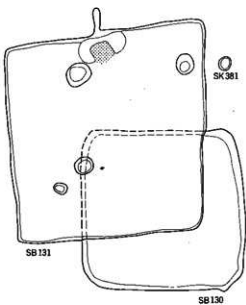
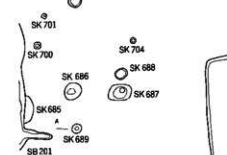
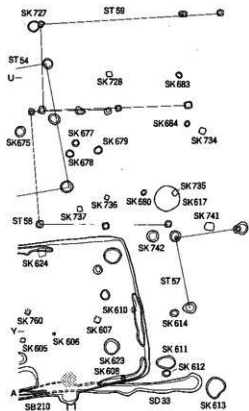

A 603.50m

C 603.50m



図版38 遺構実測図26

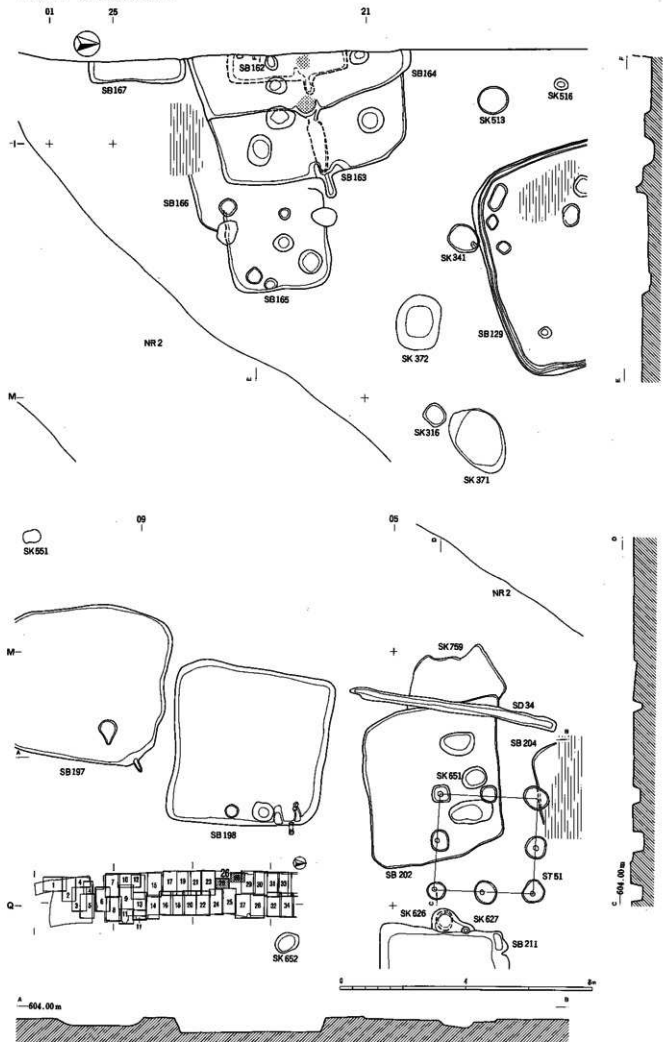

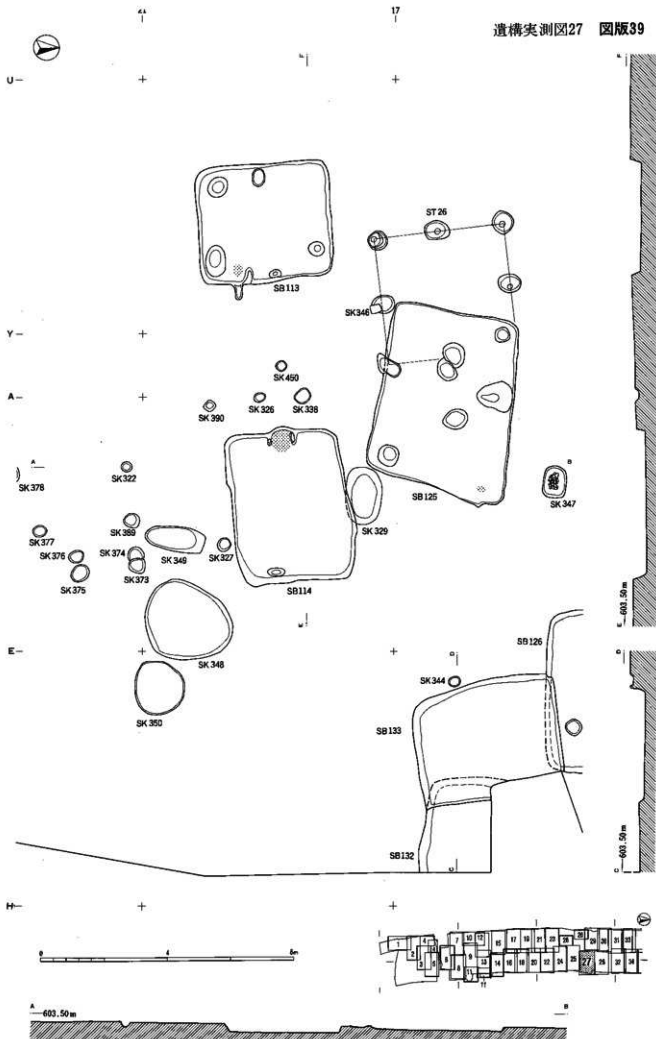

图版40 遗构实测图28

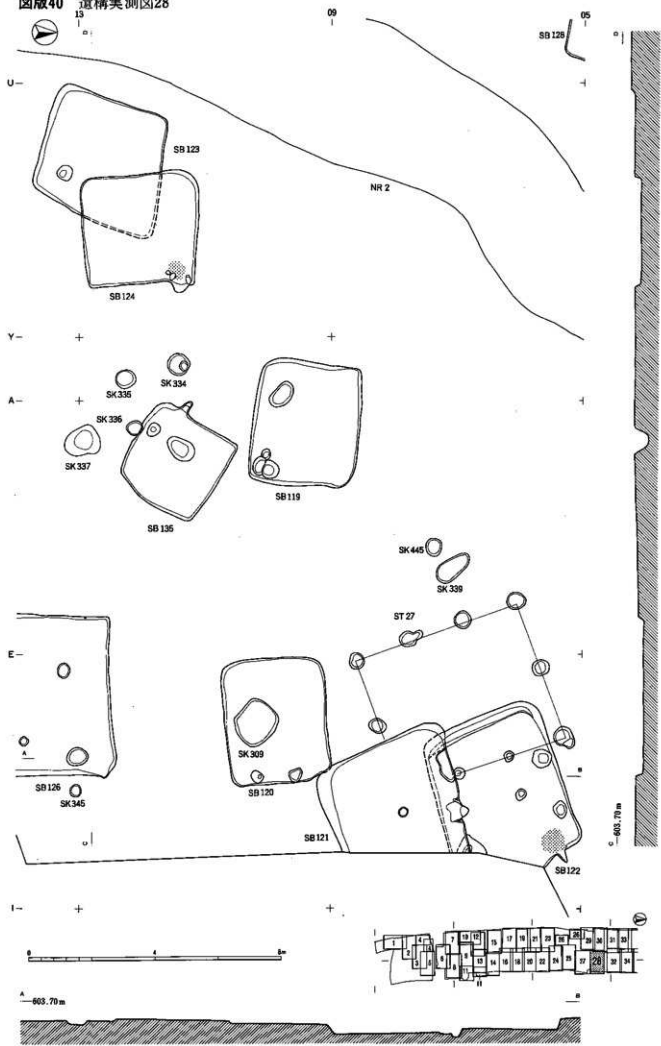

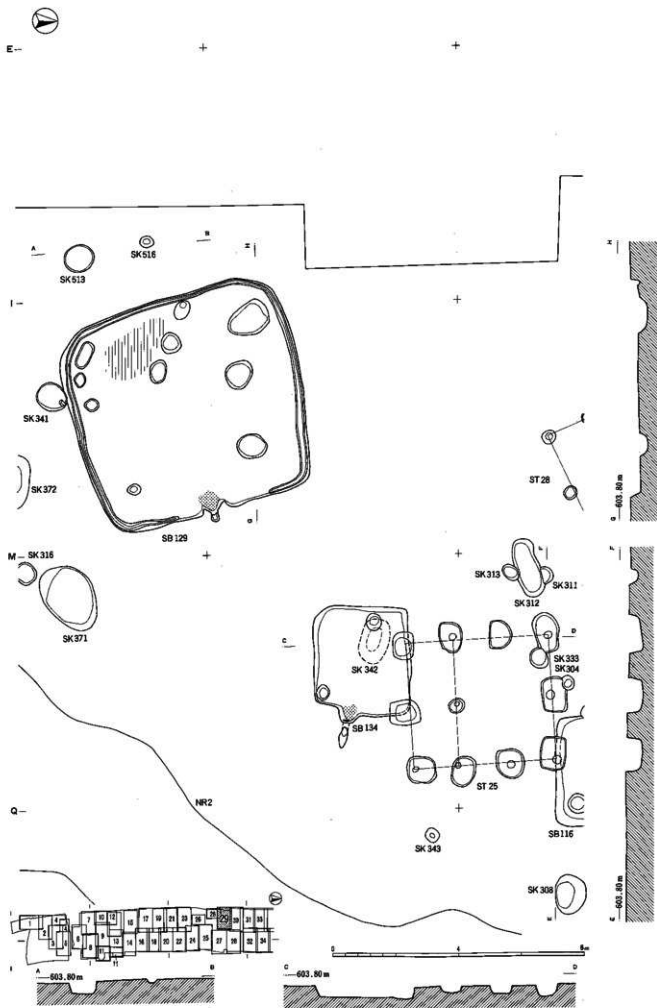

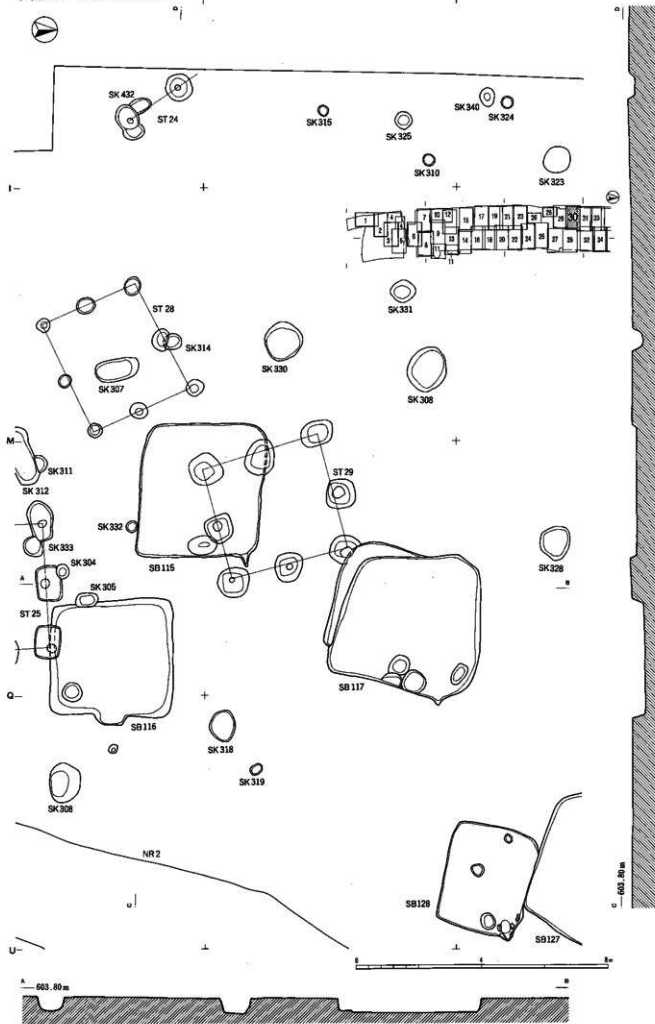

05 01 25 21

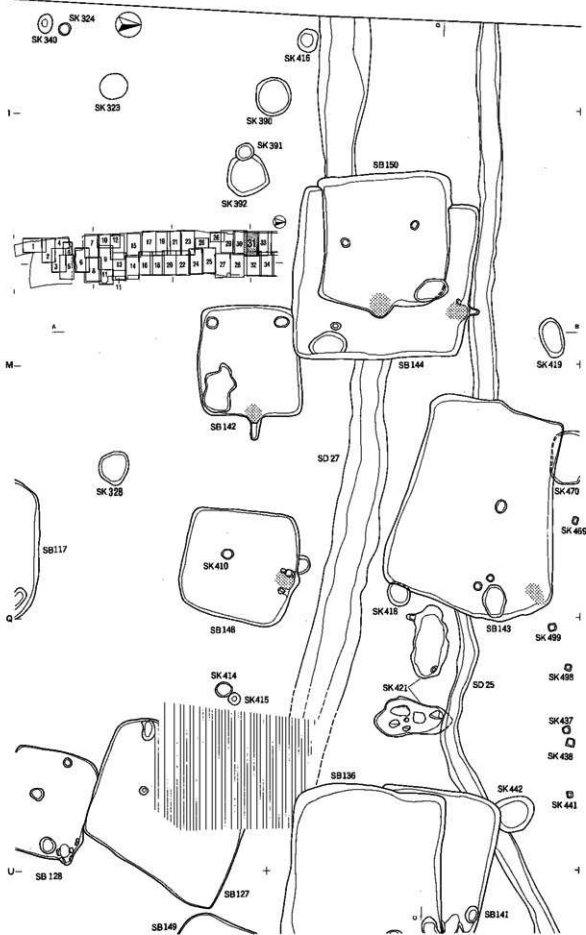

603.70m

603.70m

図版44 遺構実測図32

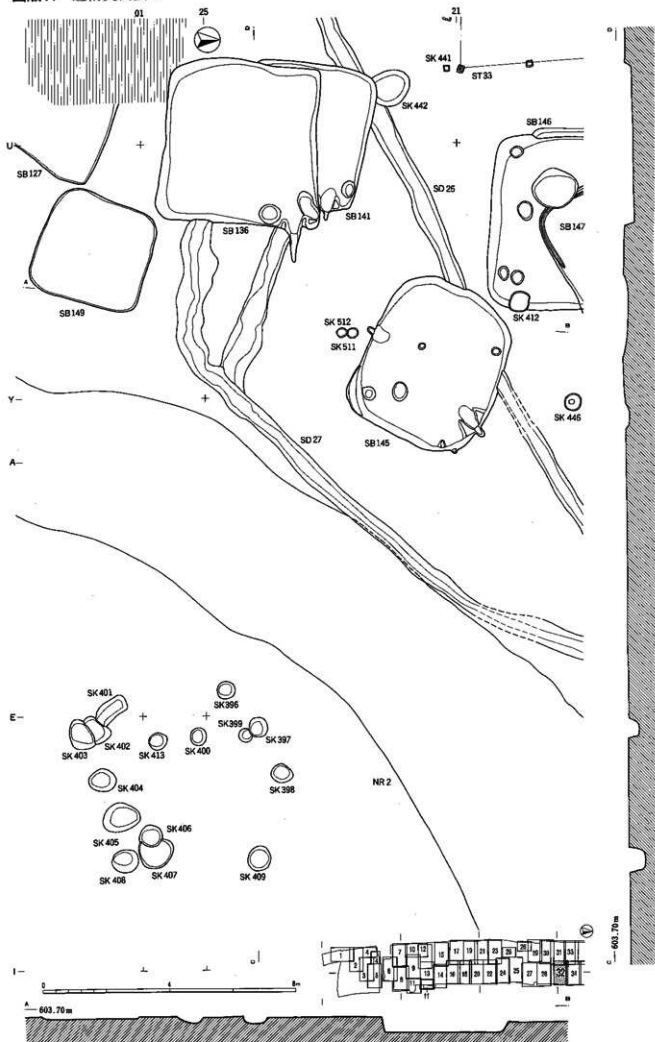

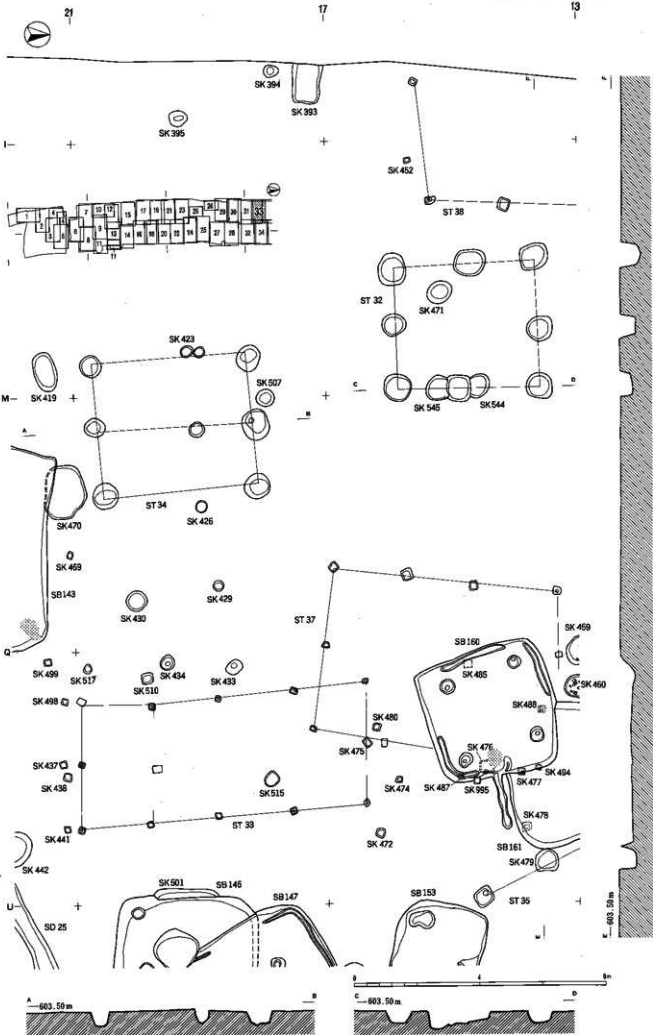

図版46 遺構実測図34

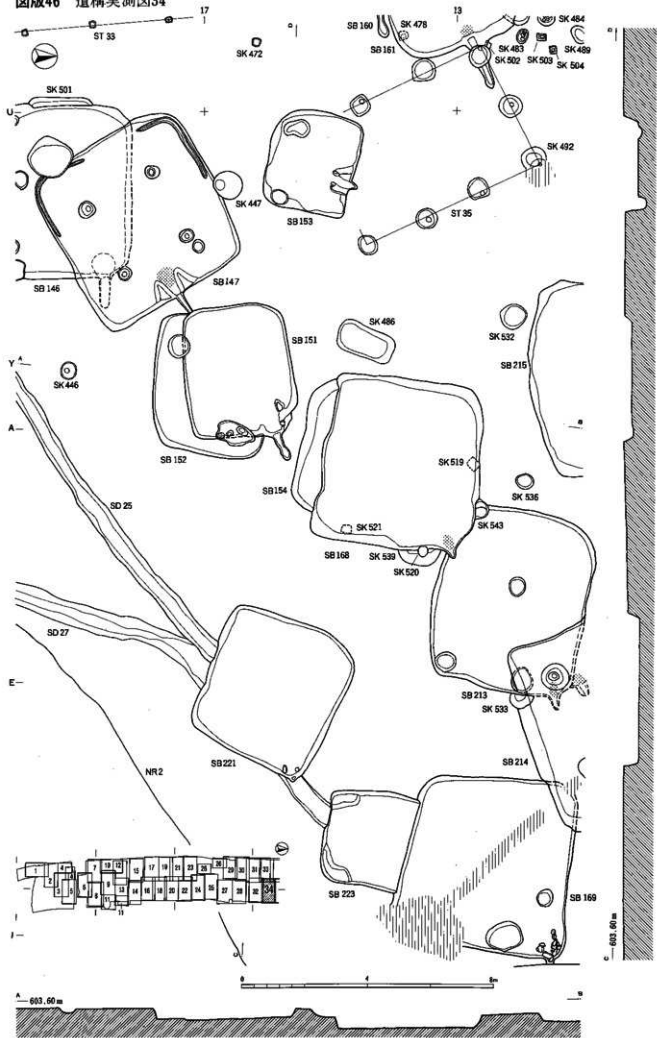

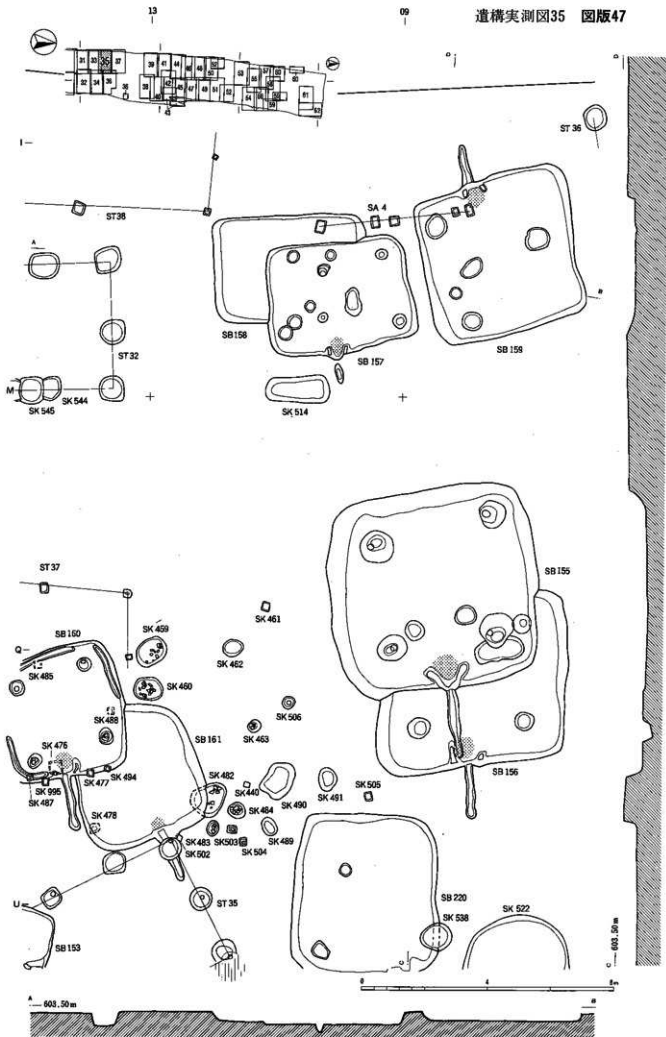

図版48 遺構実測図36

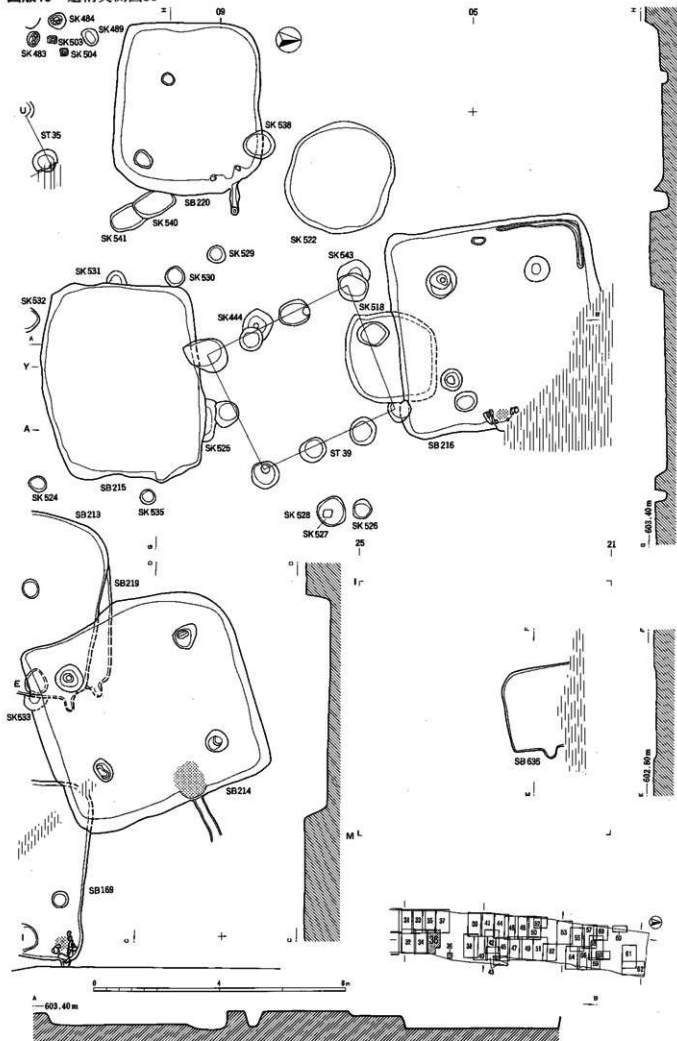

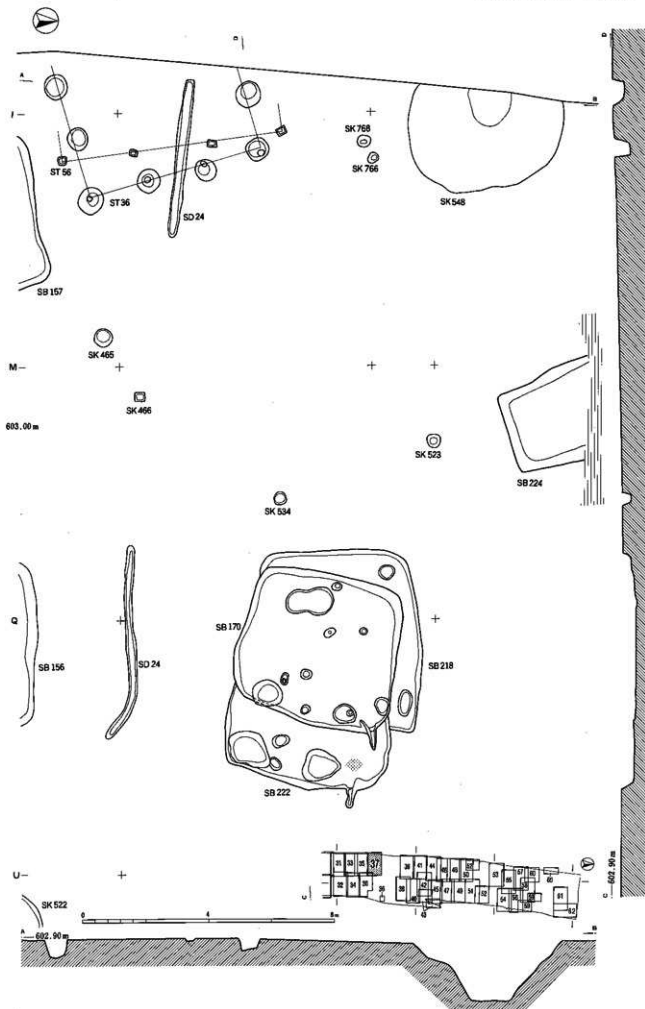

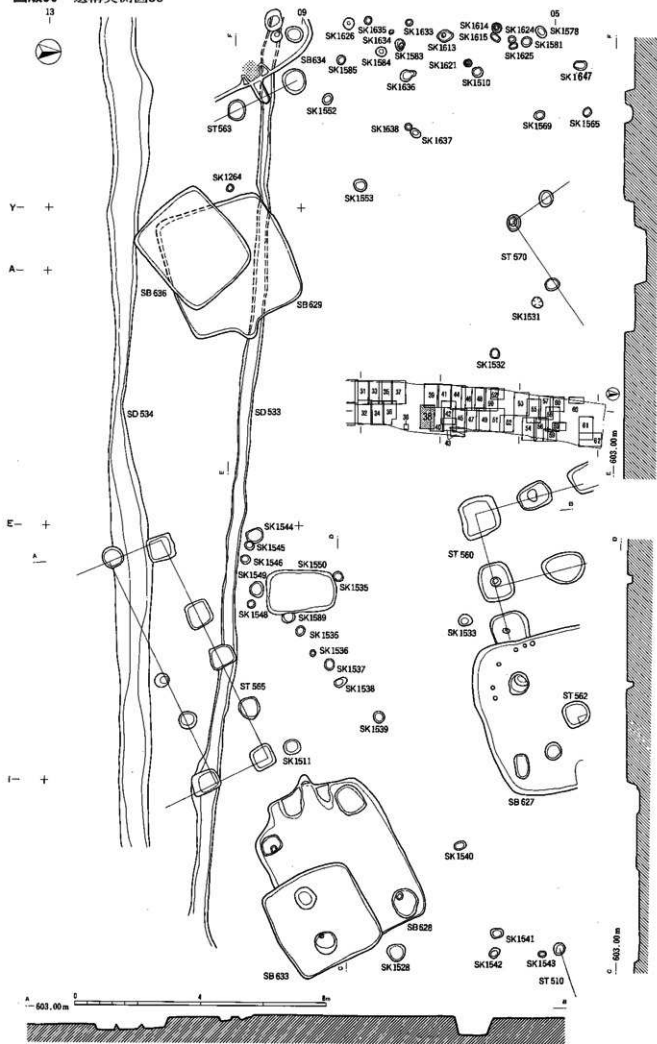

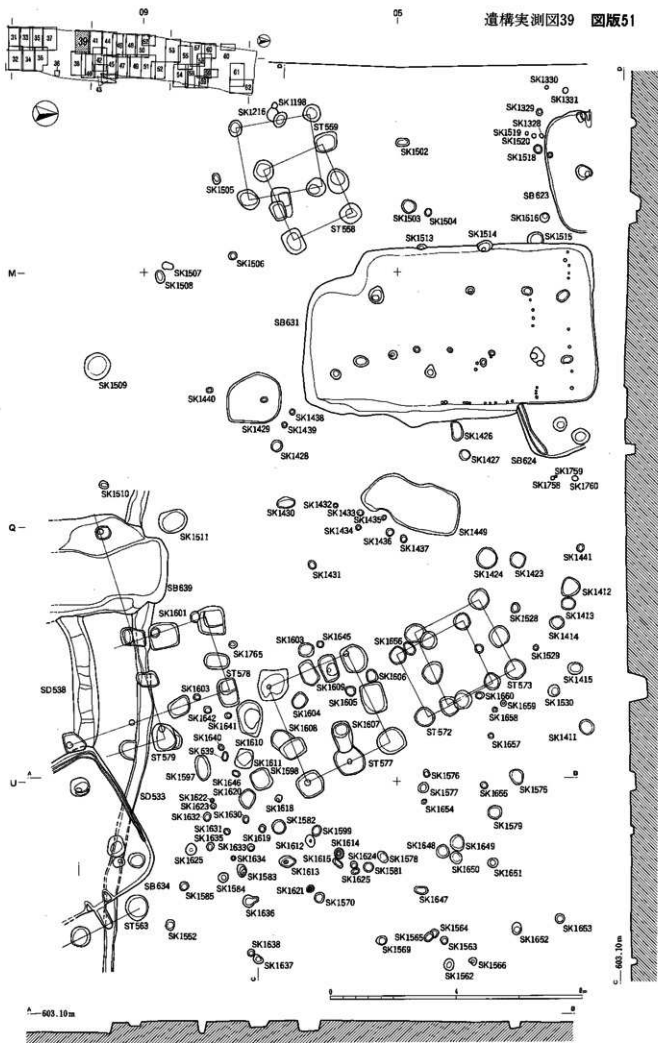

図版52 遺構実測図40

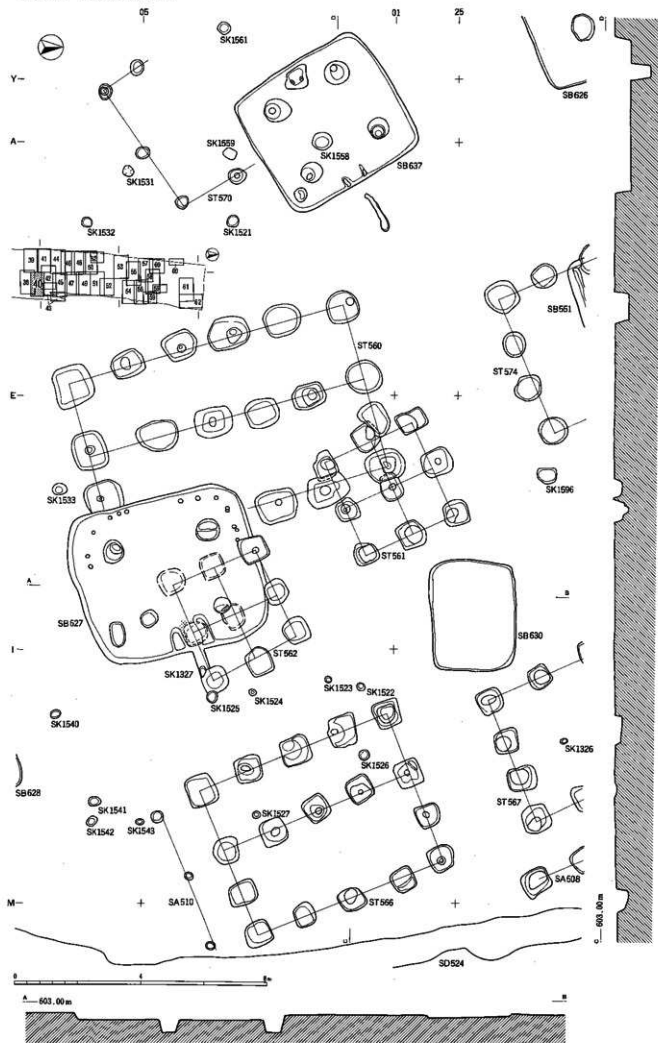

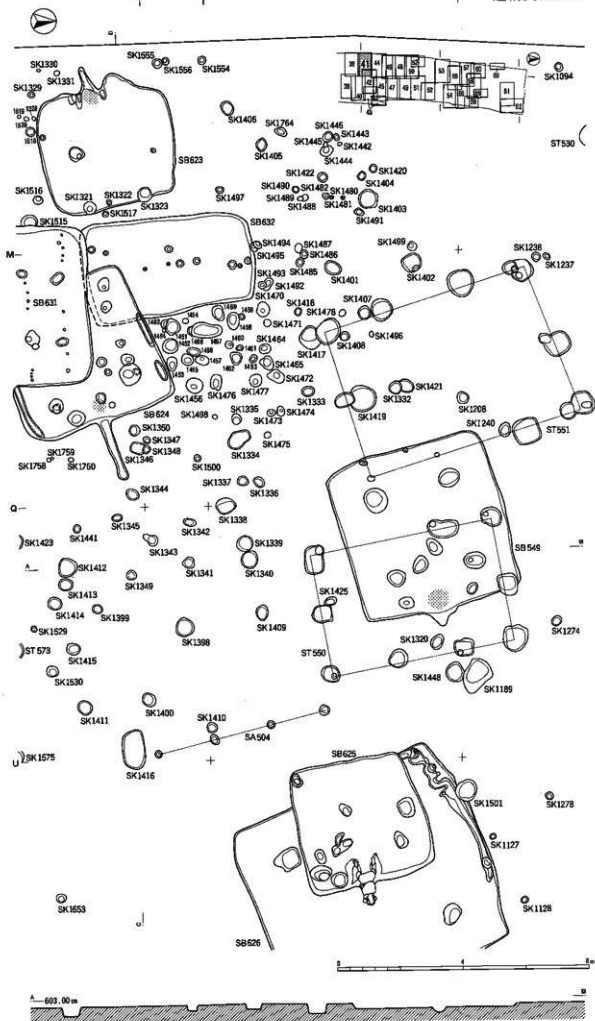

图版54 遺構実測図42

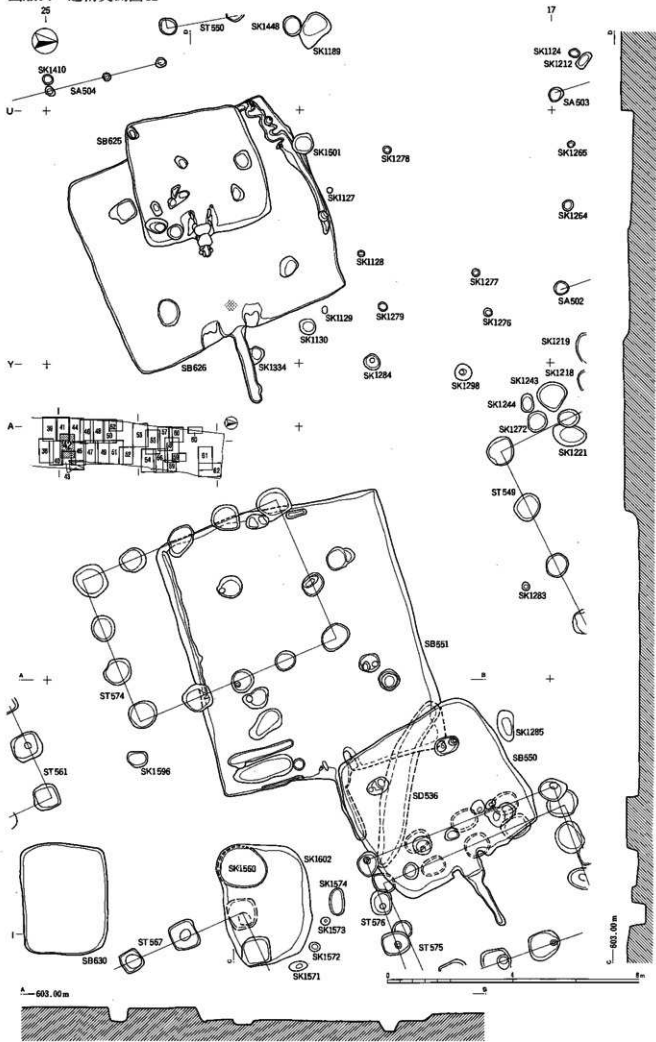

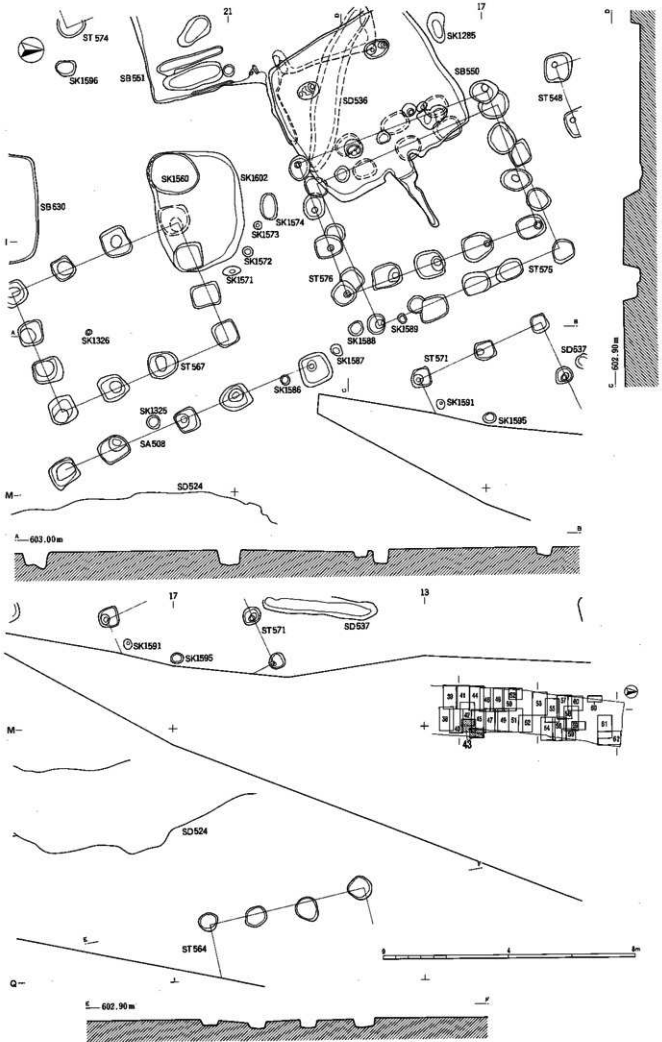

図版56 遺構実測図44

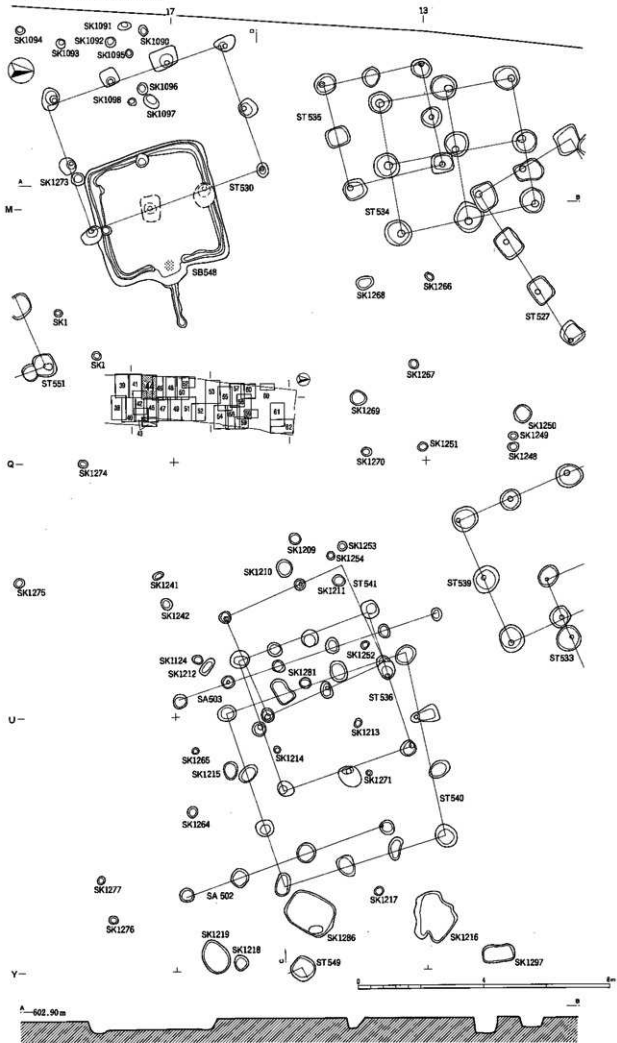

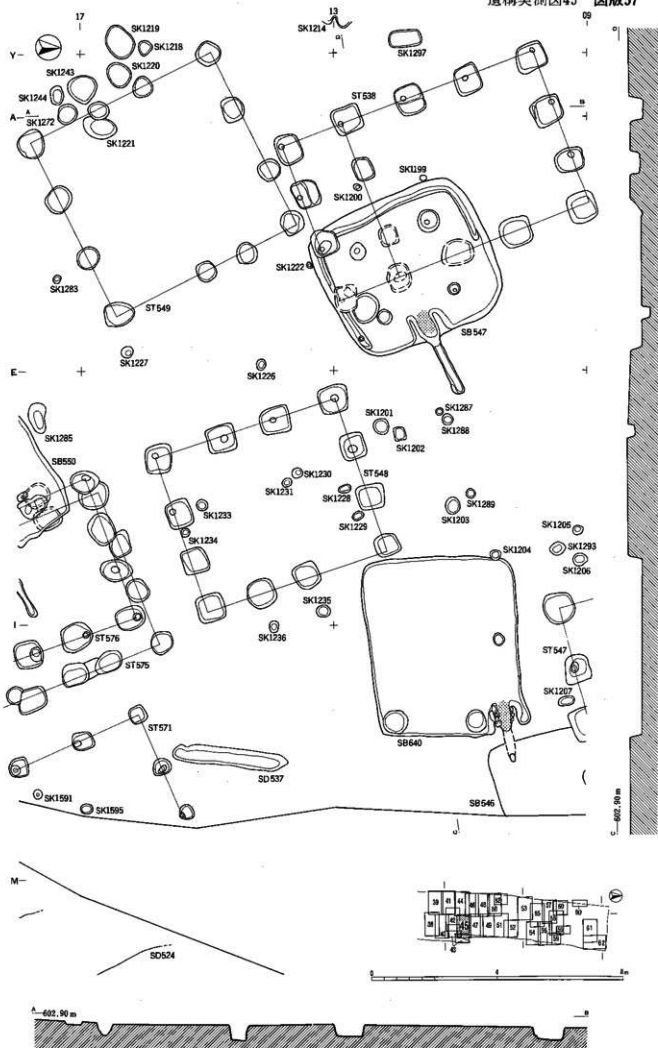

図版58 遺構実測図46

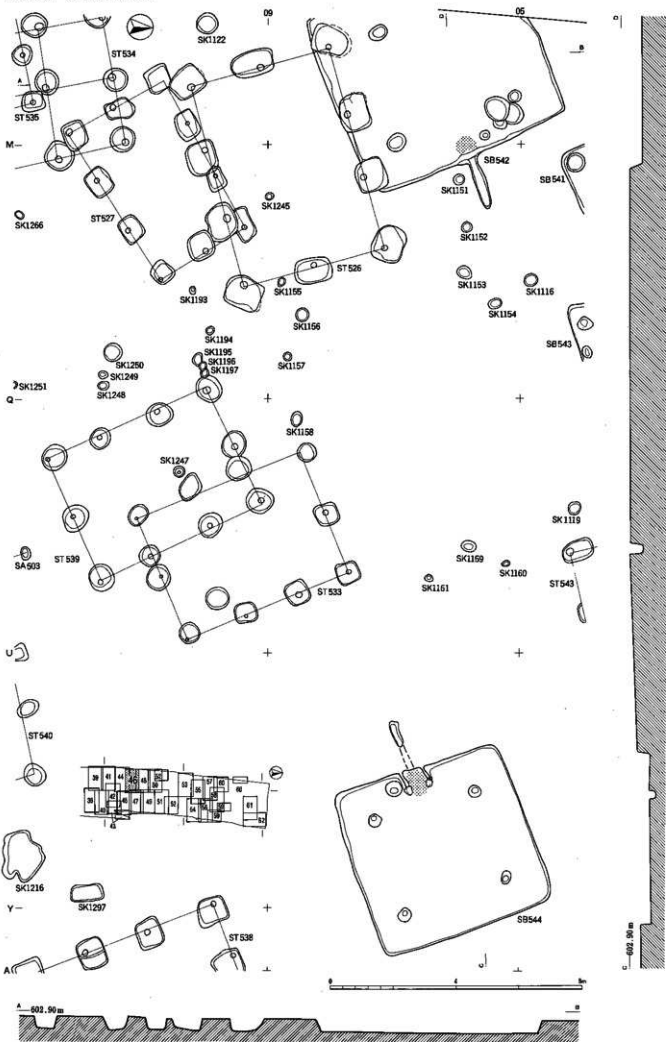

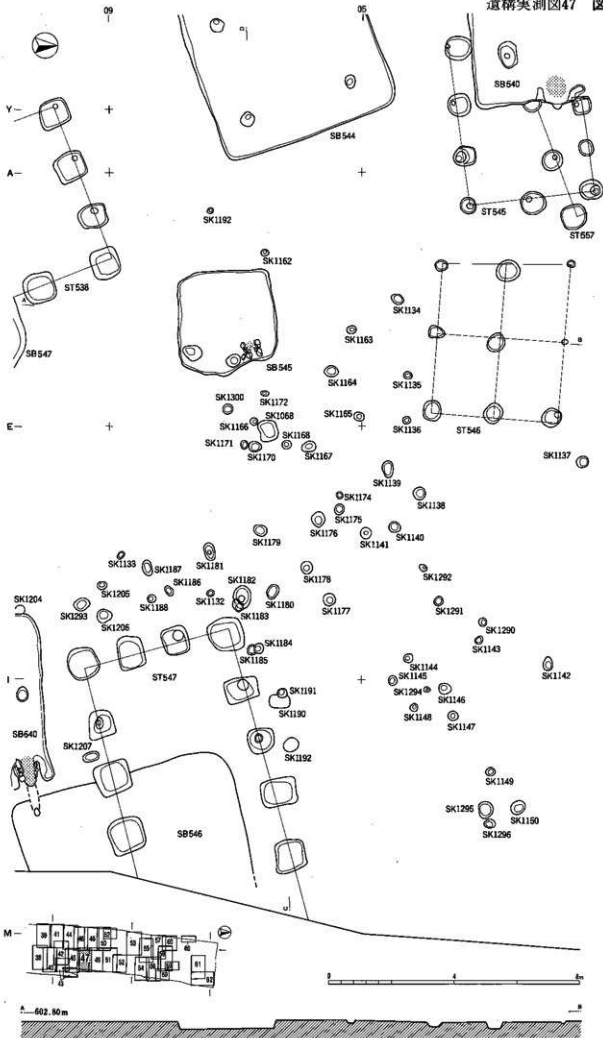

0-60.0m

图版60 遗构实测图48

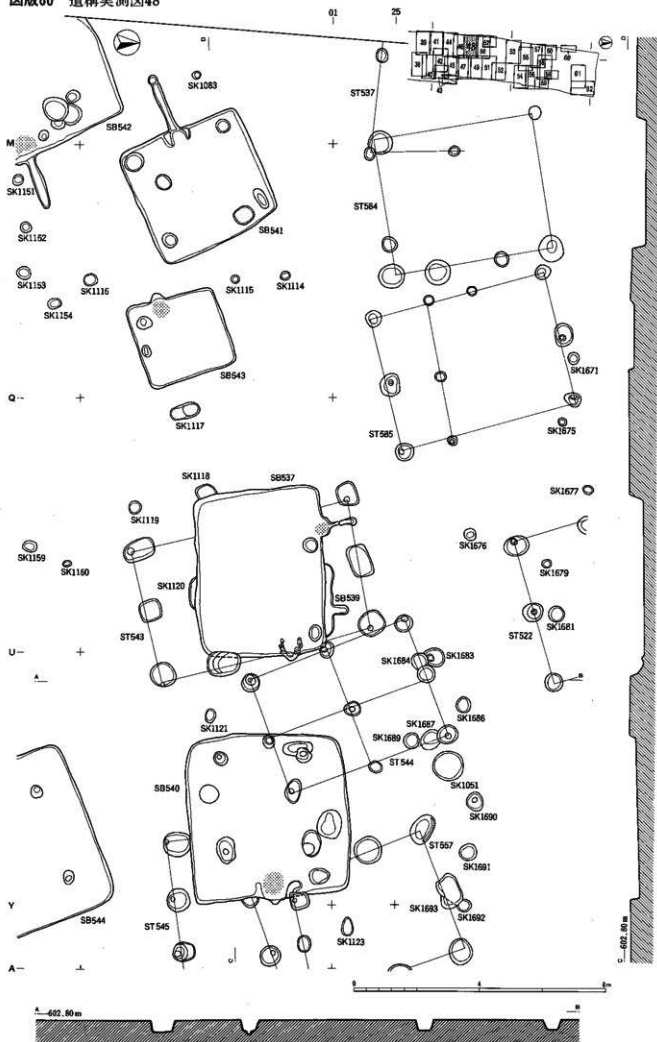

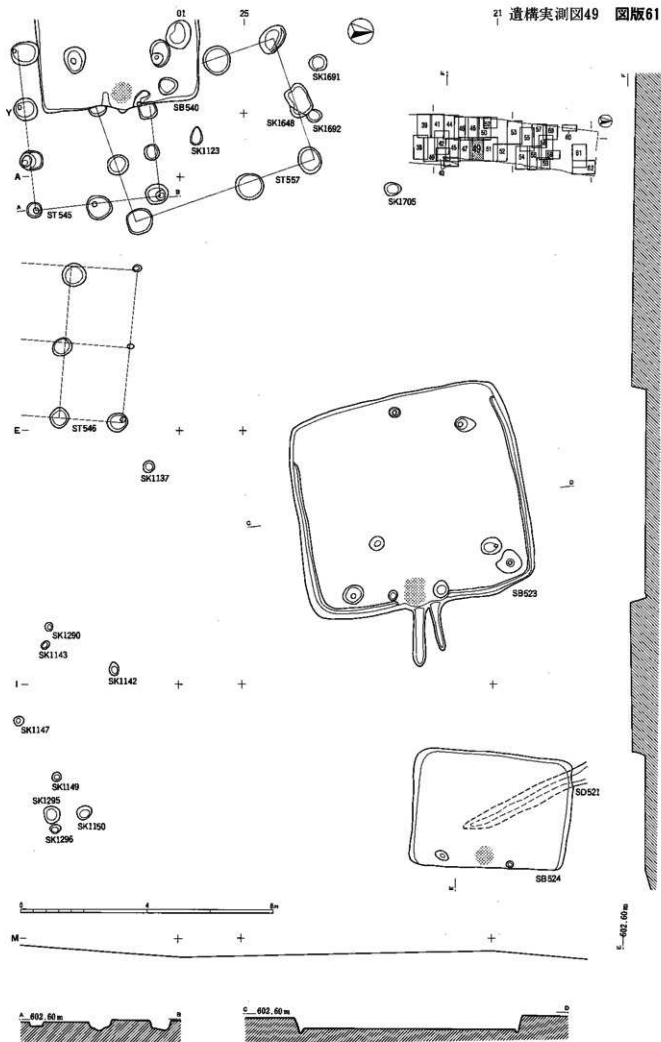

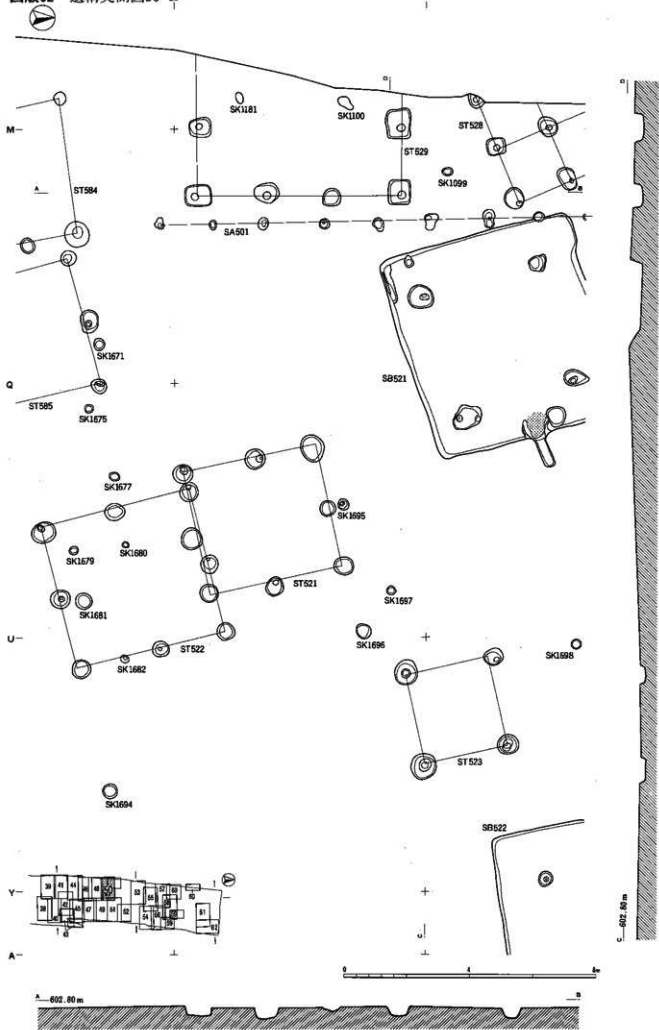

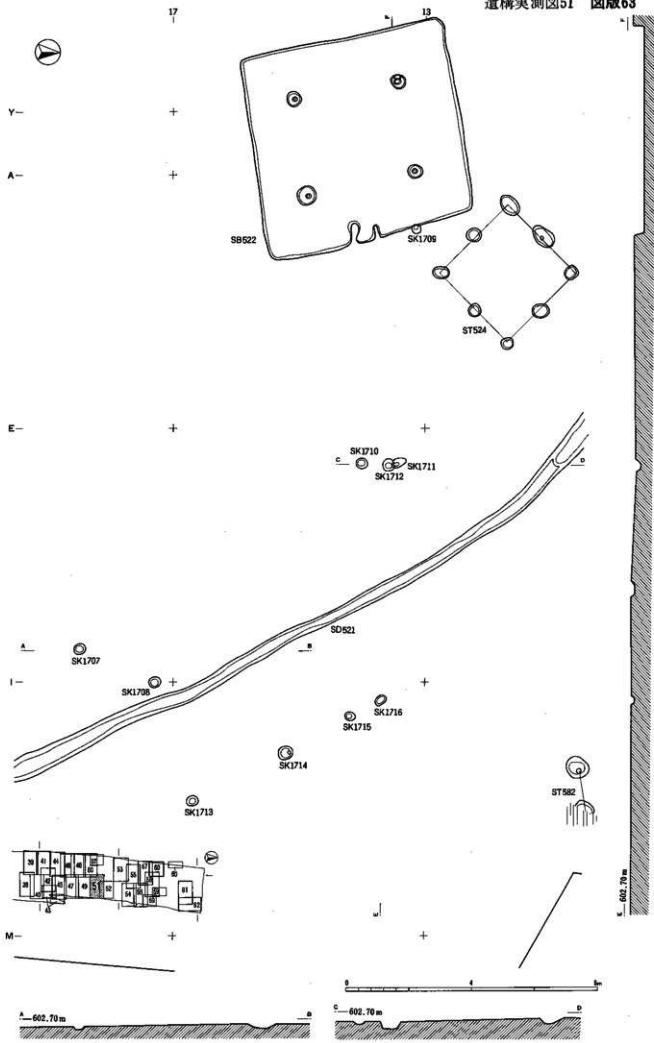

図版64 遺構実測図52

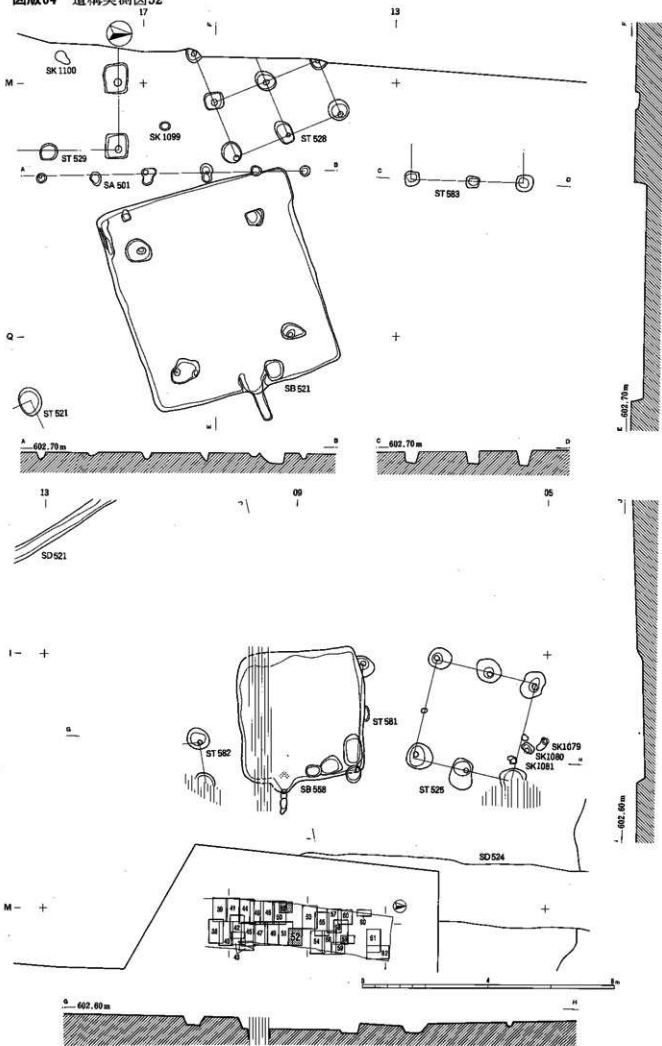

01 25

21

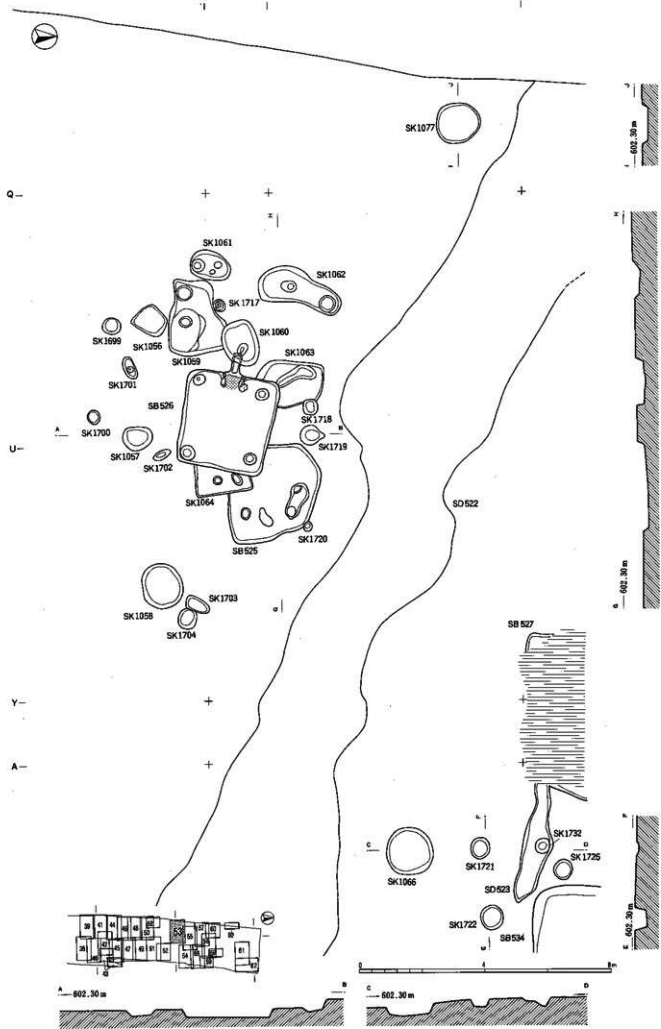

図版66 遺構実測図54

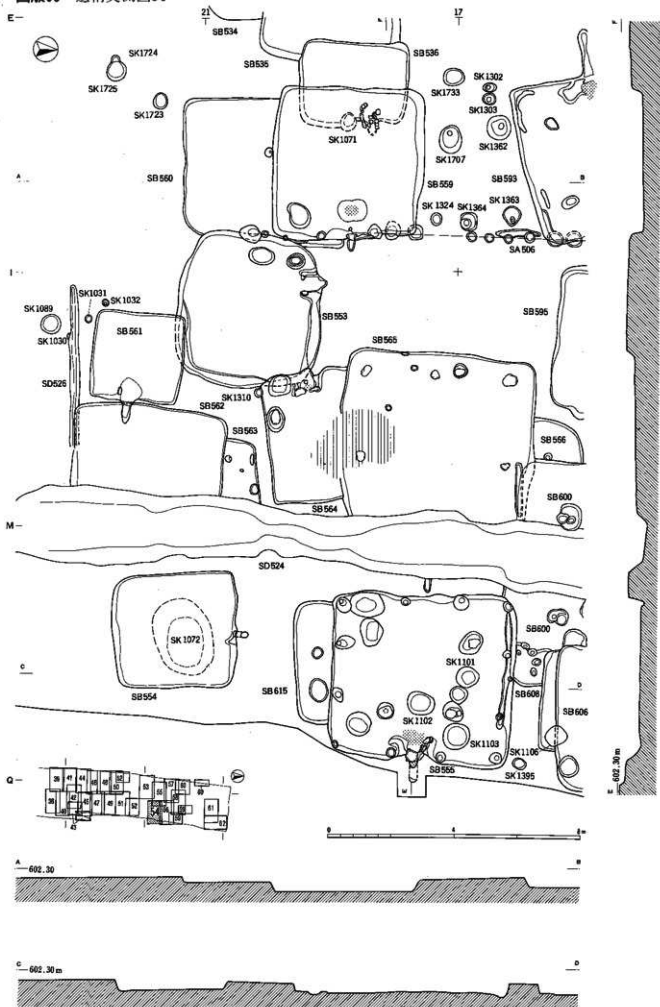

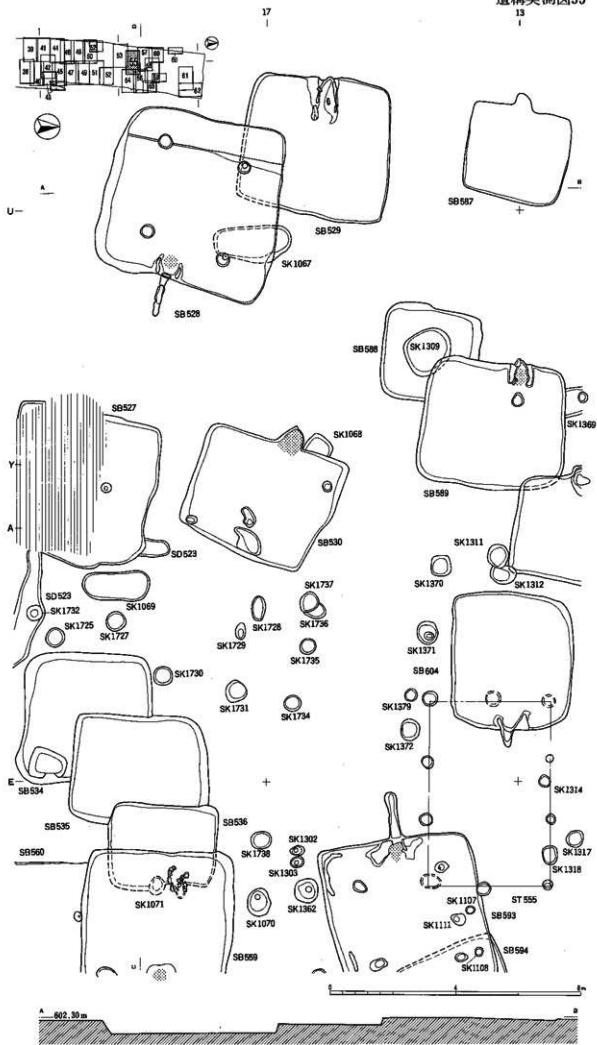

0-600.30m

0-60.23m

図版68 遺構実測図56

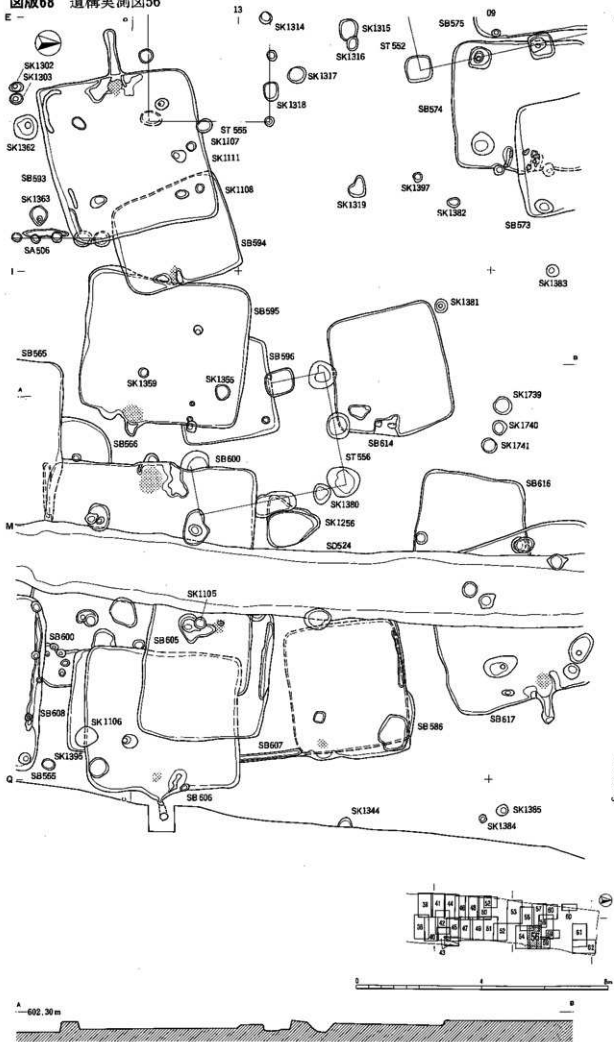

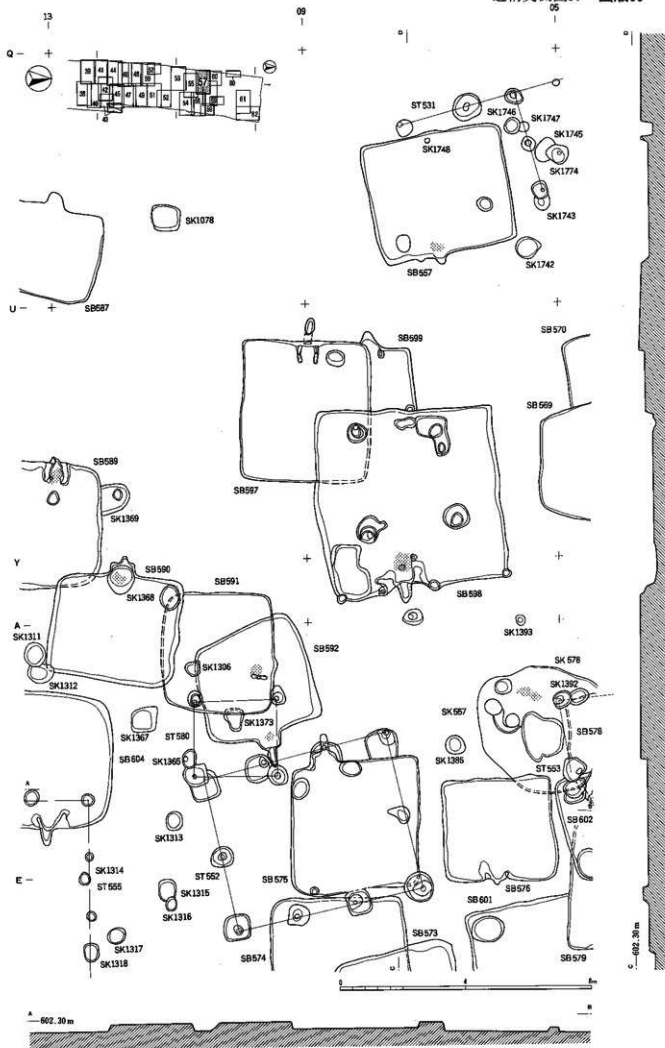

图版70 遺構実測図58

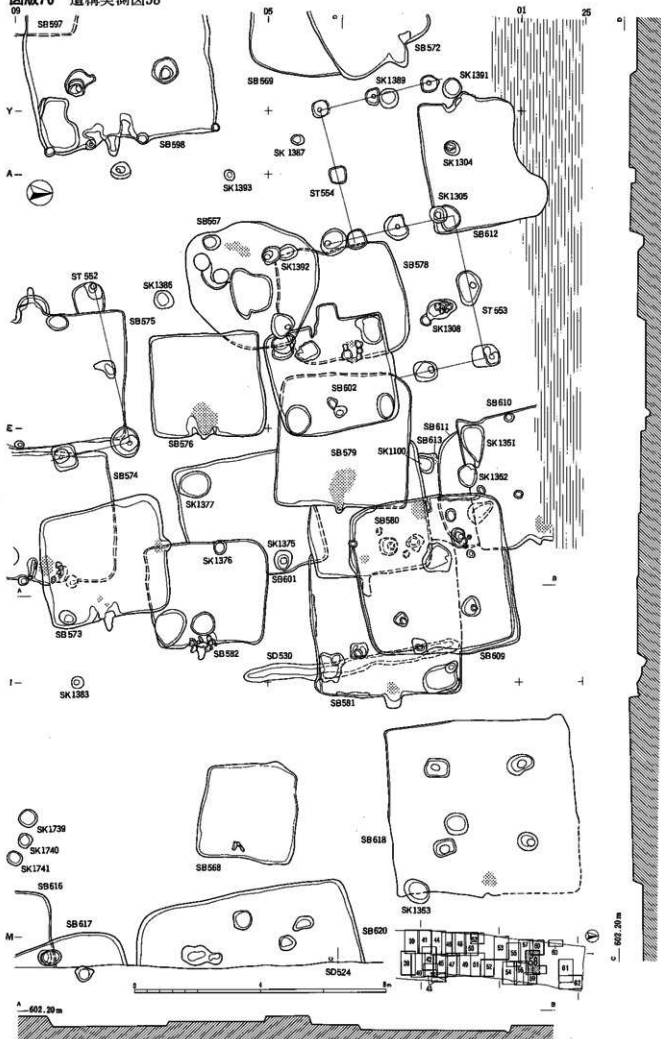

21
1

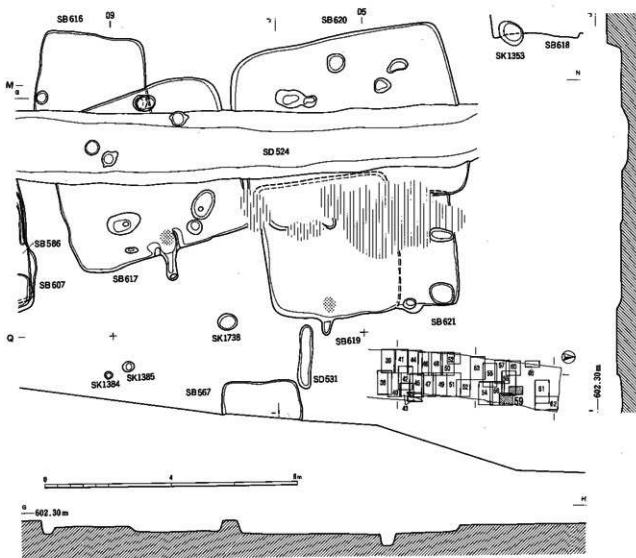
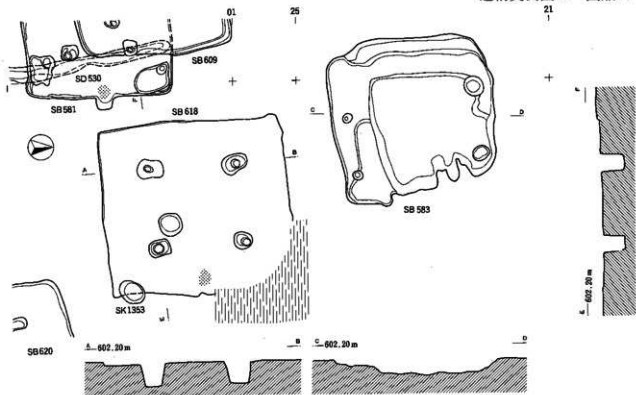

図版72 遺構実測図60

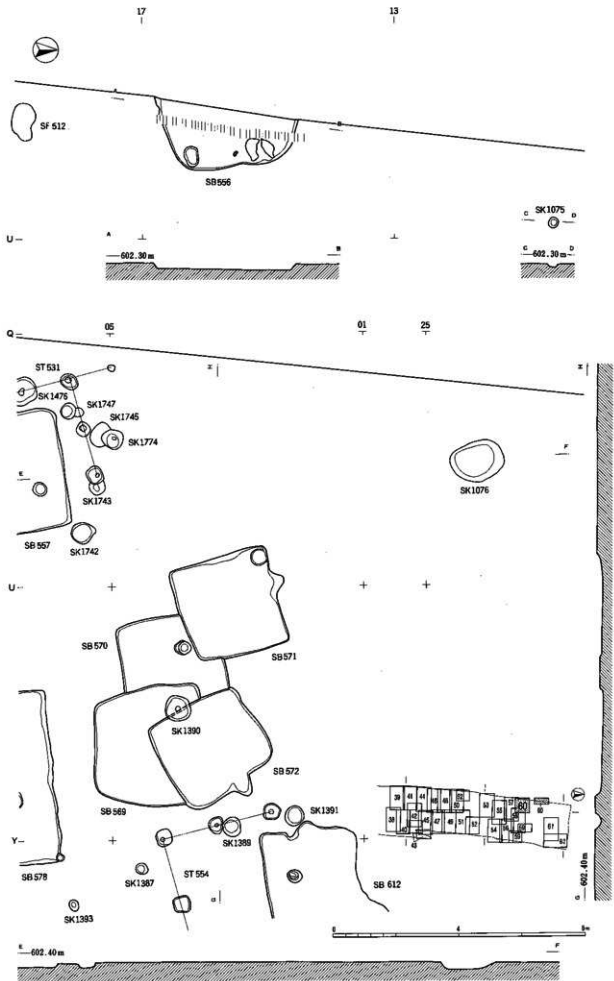

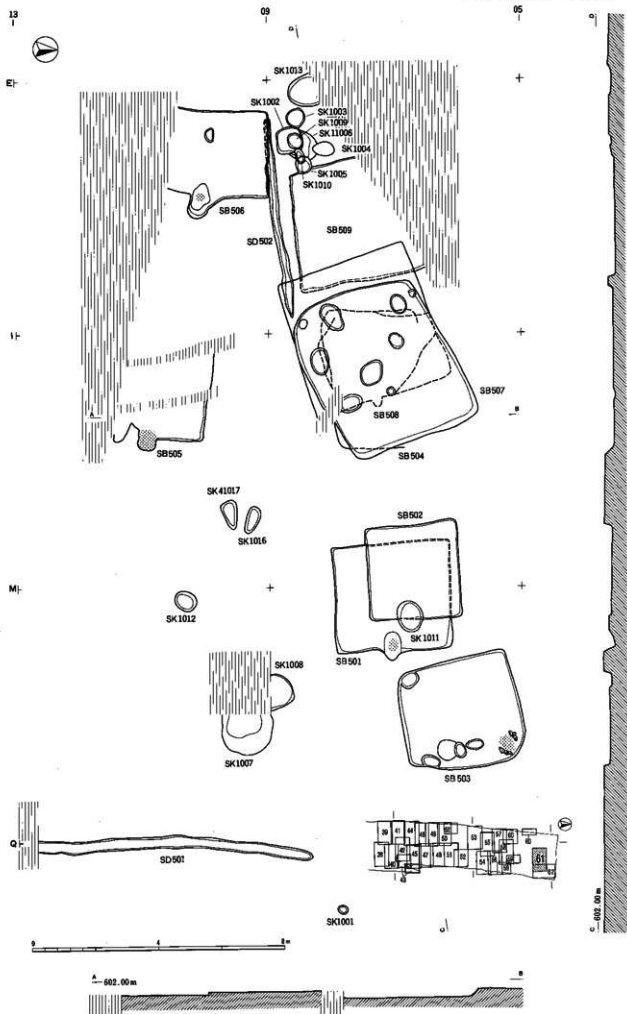

图版74 遗构实测图62

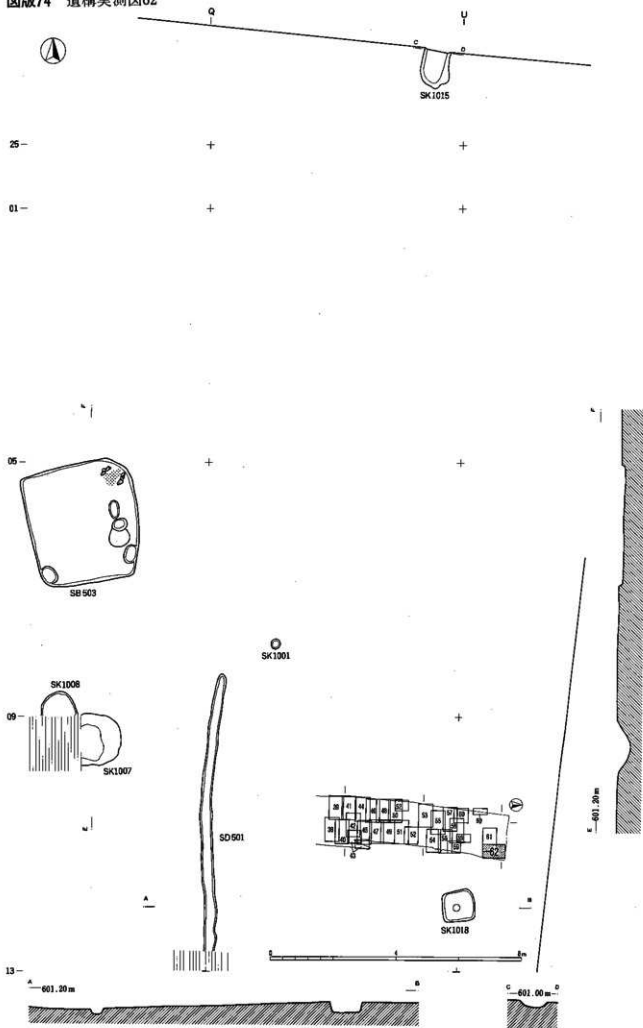

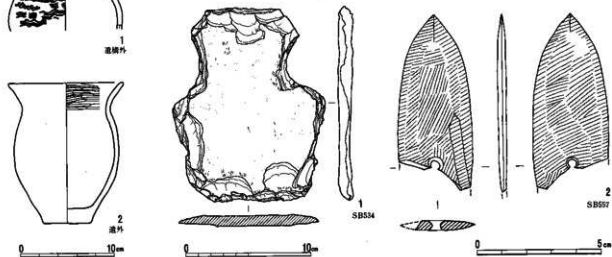
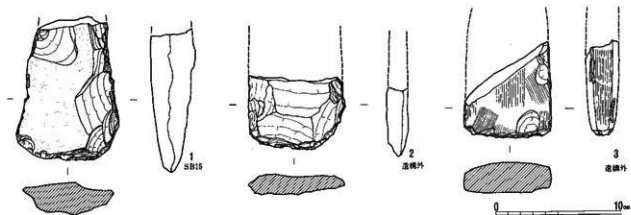
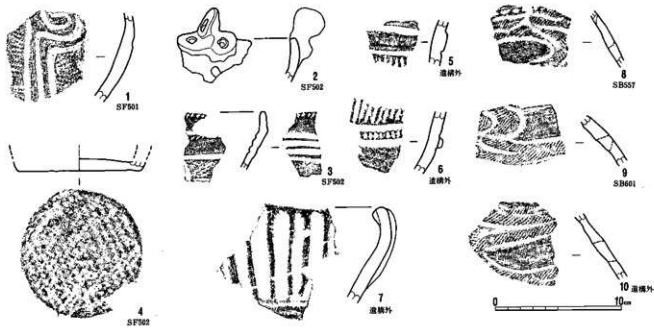

SB 1

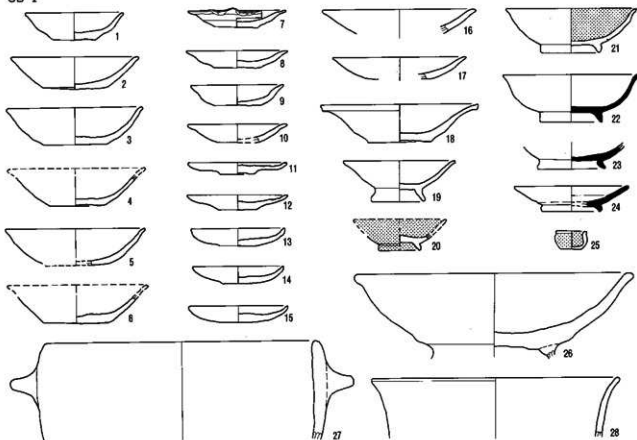

SB 2

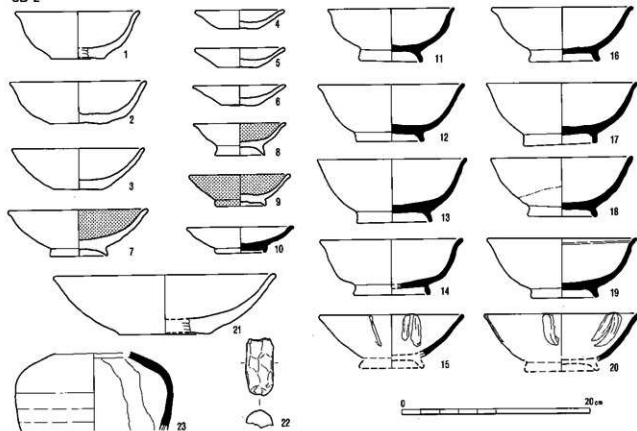

0 20cm

SB 2

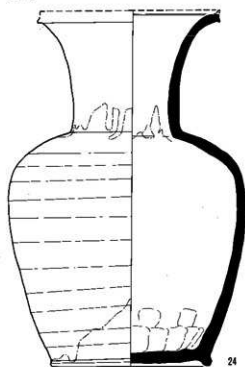

SB 3

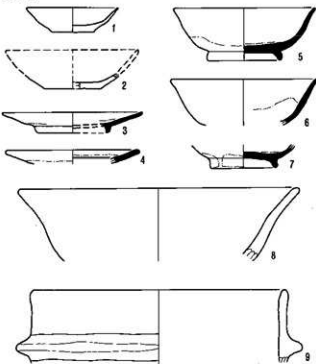

SB 4

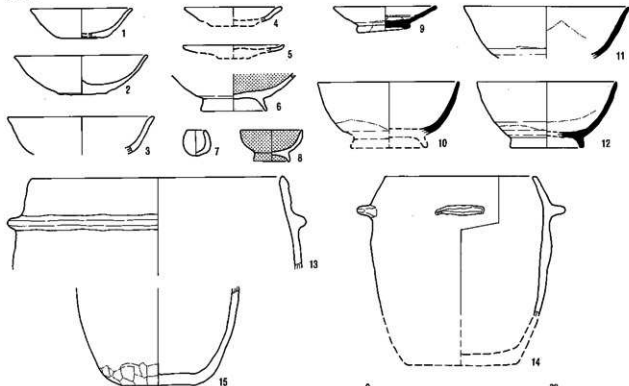

SB 5



图版78 古代土器实侧图

SB 6

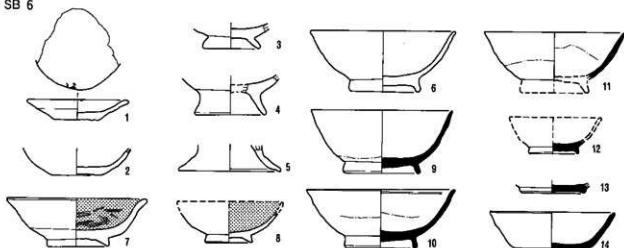

SB 7

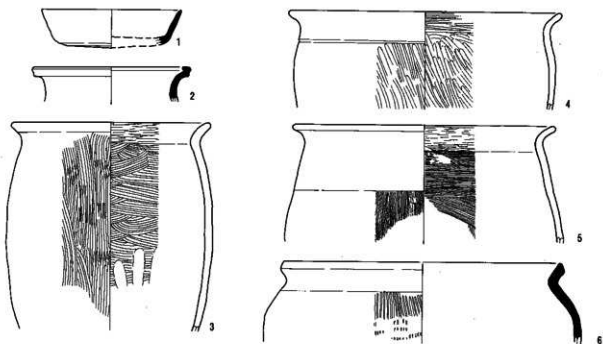

SB 8

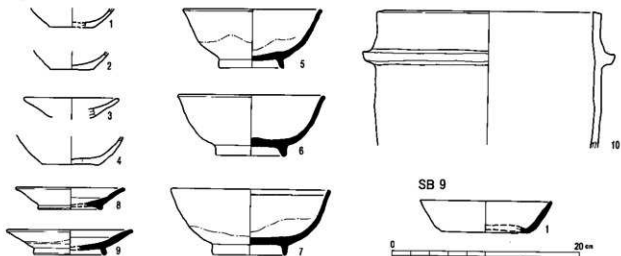

SB 9

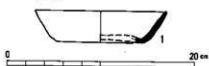

SB 10

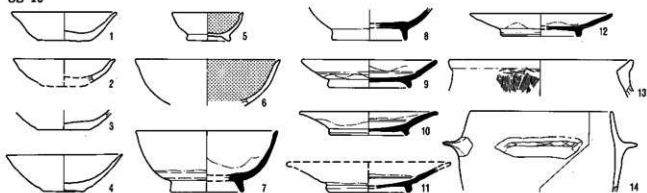

SB 11

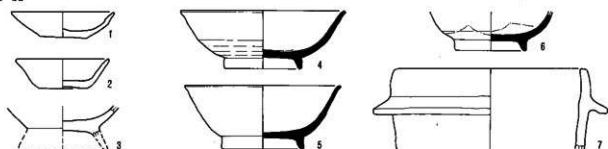

SB 12

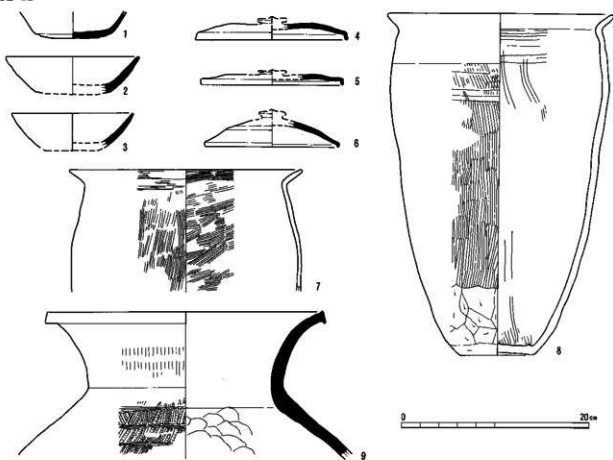

SB 13

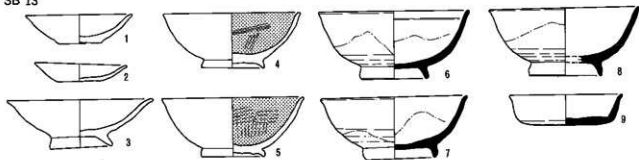

SB 14

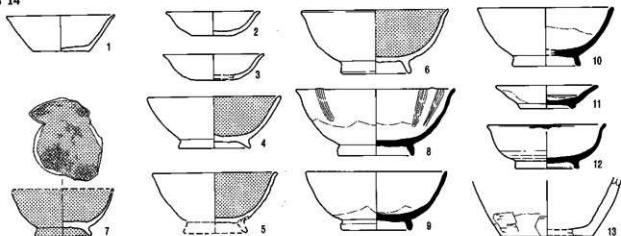

SB 15



SB 18

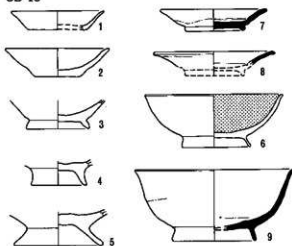

SB 16

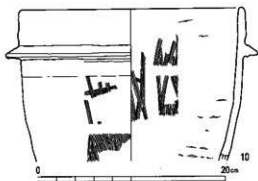
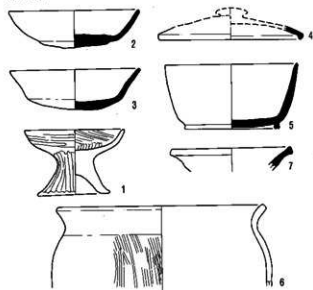

SB 20

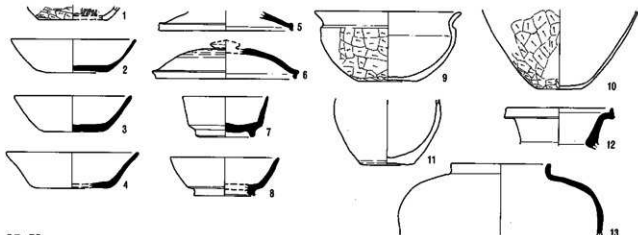

SB 23

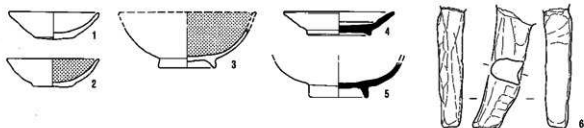

SB 24



SB 25

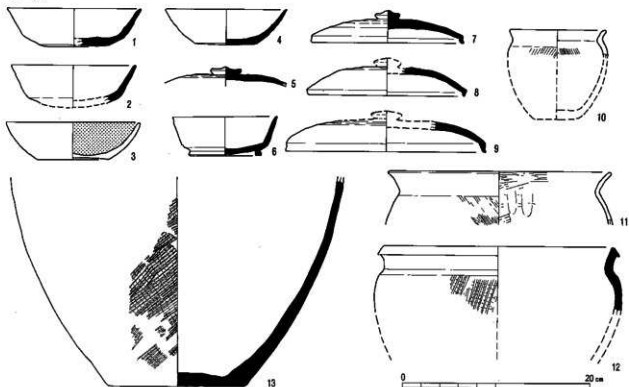

SB 26

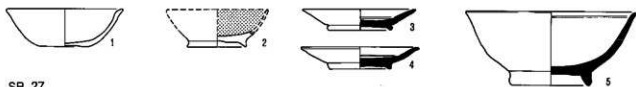

SB 27

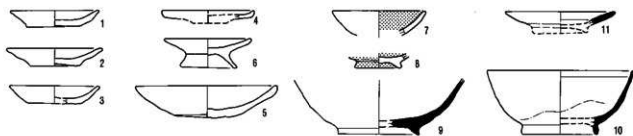

SB 28

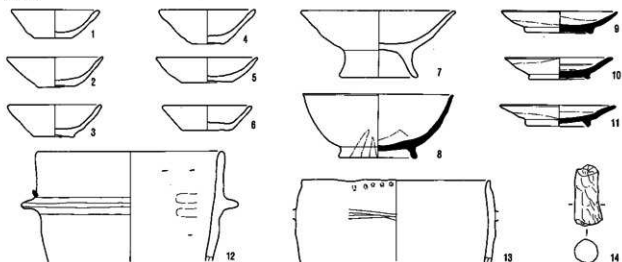

SB 31

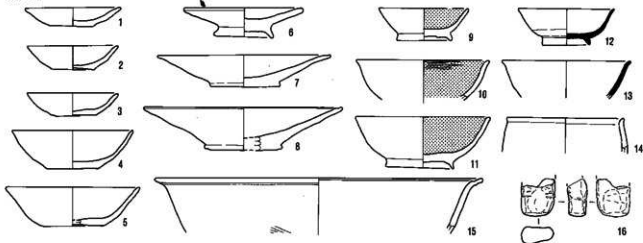

SB 32



SB 33

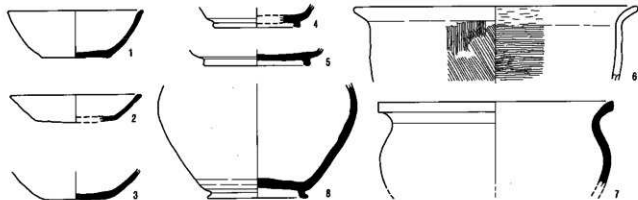

SB 34

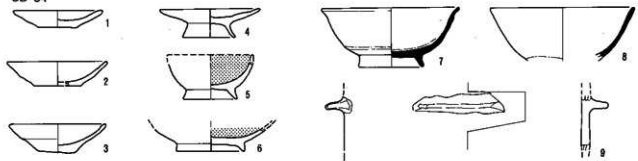

SB 35

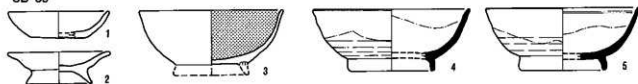

SB 36

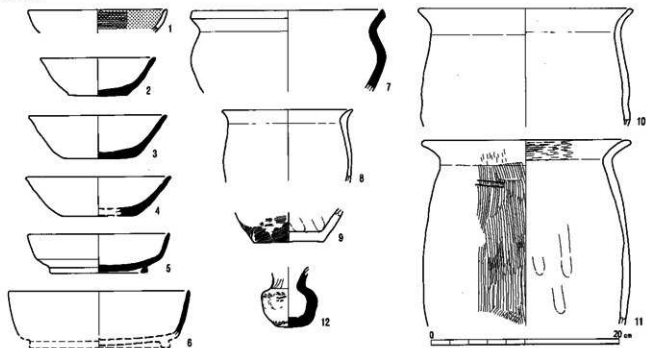

SB 37

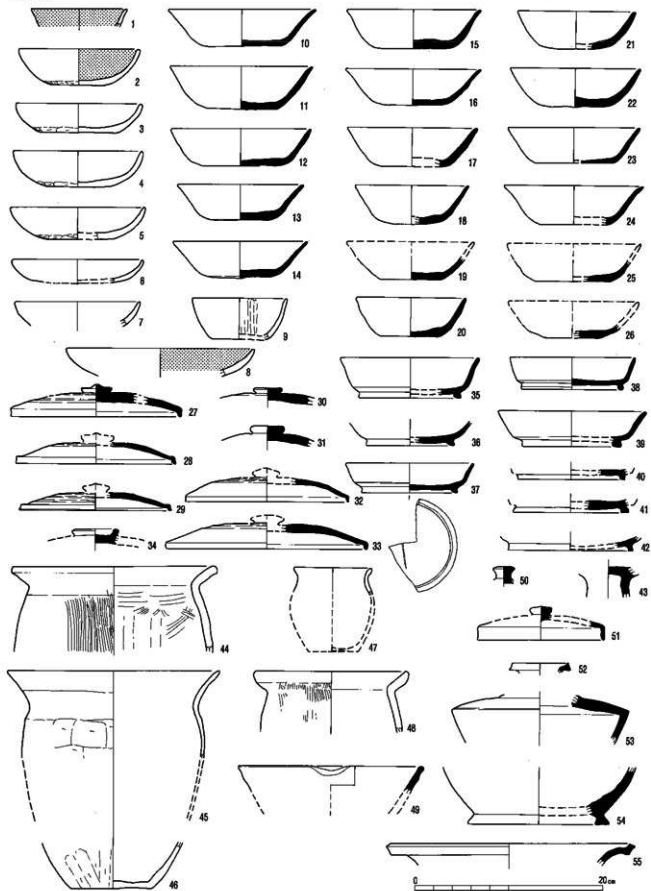

SB 37

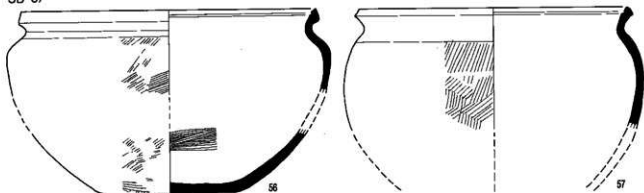

SB 38

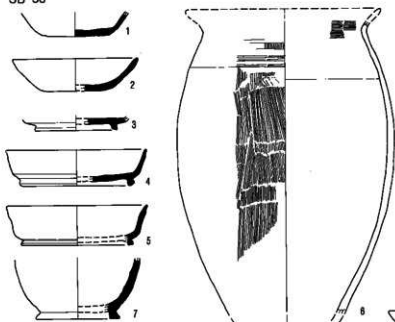

SB 39

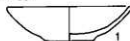

SB 44



SB 40

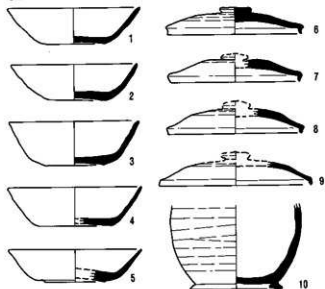

SB 43

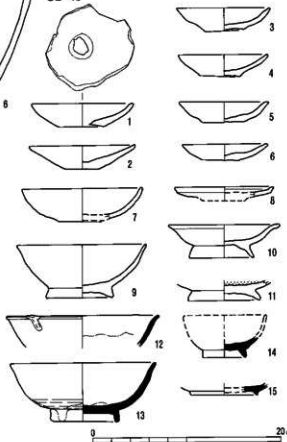

SB 46

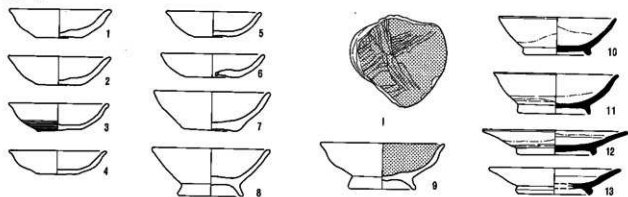

SB 48

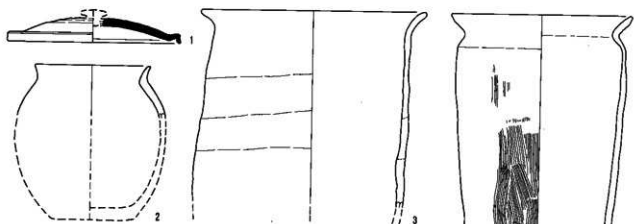

SB 47

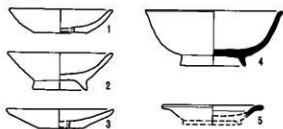

SB 49

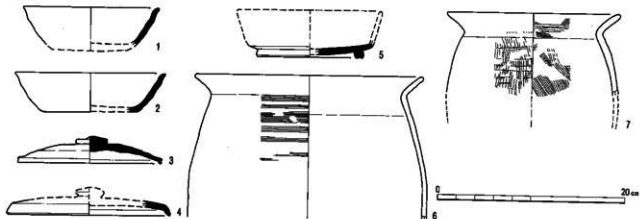

SB 50

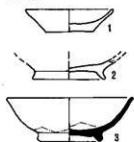

SB 53

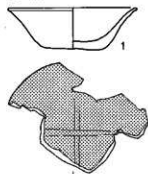

SB 52

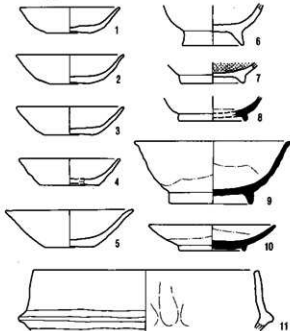

SB 51

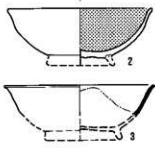
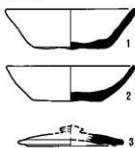

SB 54

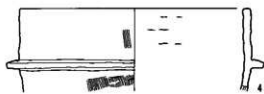
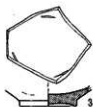

SB 55

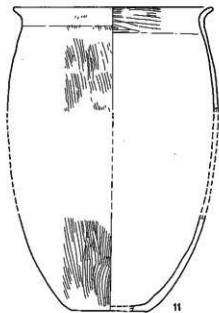
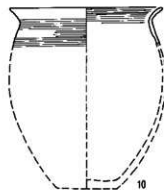
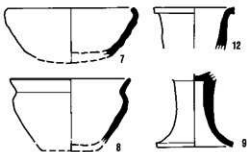
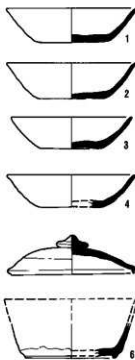

SB 55

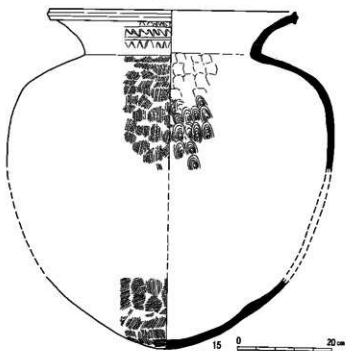
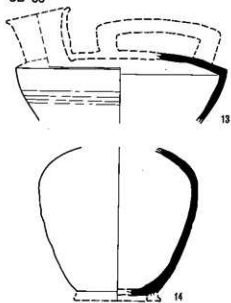

SB 56

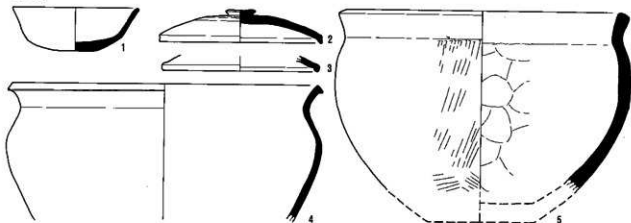

SB 57

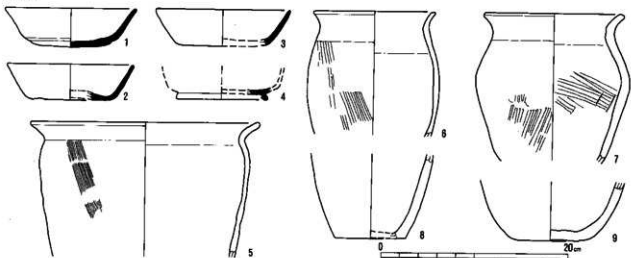

SB 57

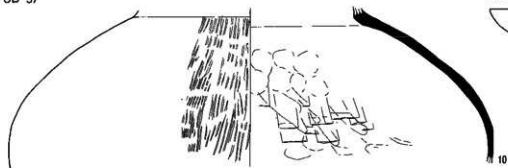

SB 59



SB 58

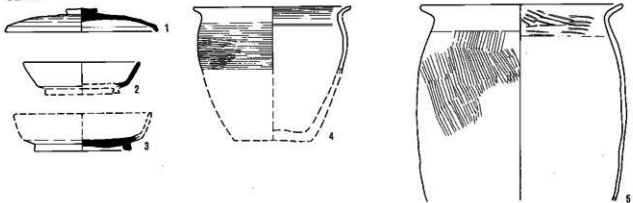

SB 60

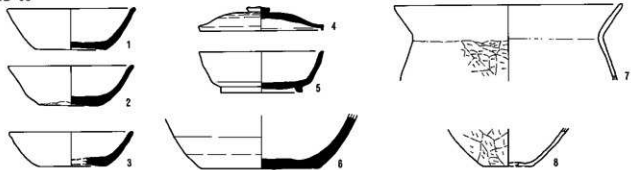

SB 61

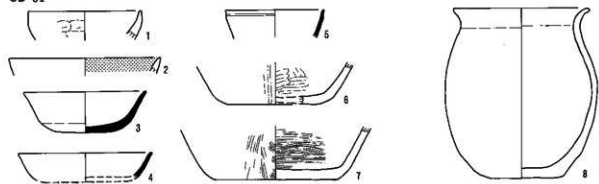

0 20cm

SB 62

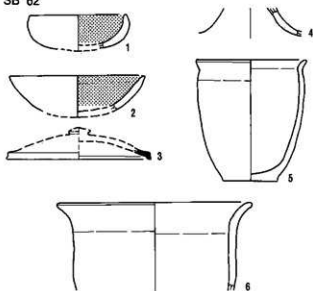

SB 63

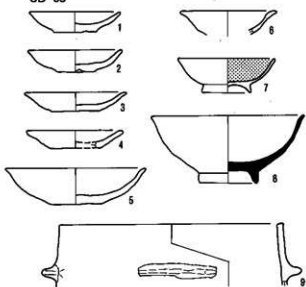

SB 65

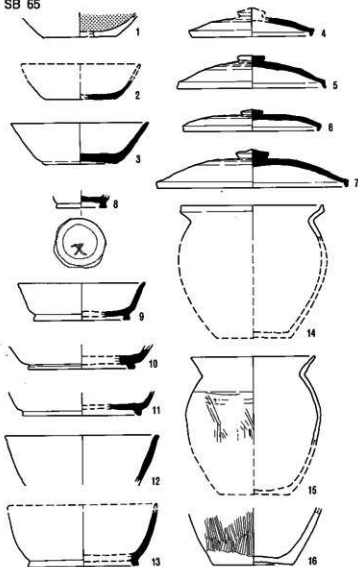

SB 64

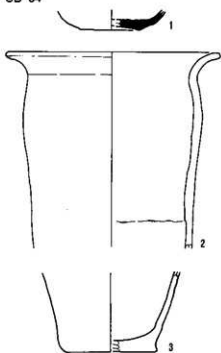

SB 66

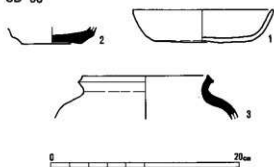

SB 67

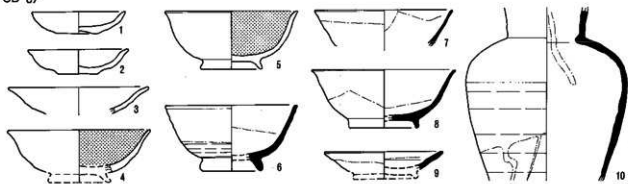

SB 68

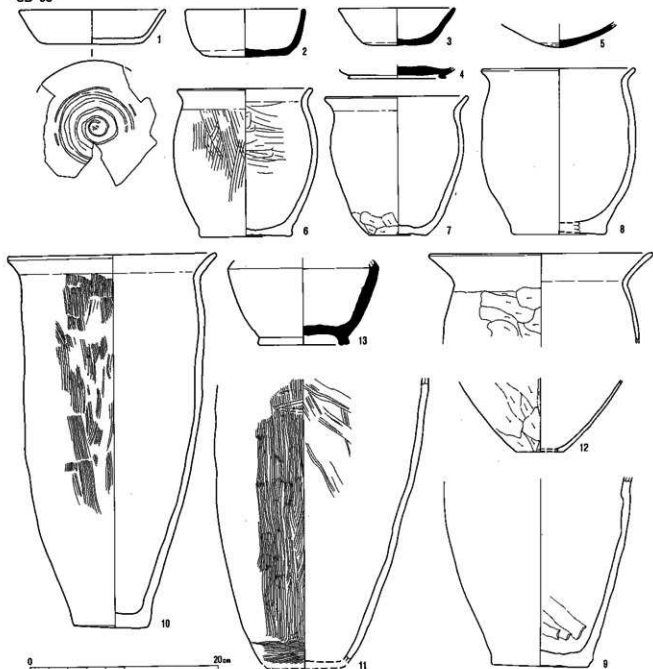

SB 71

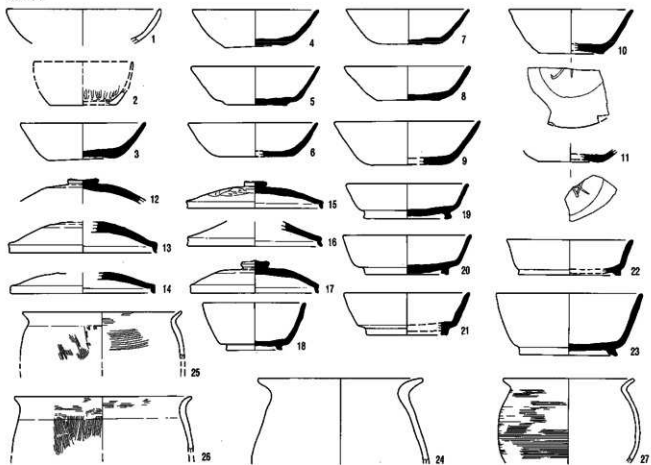

SB 72

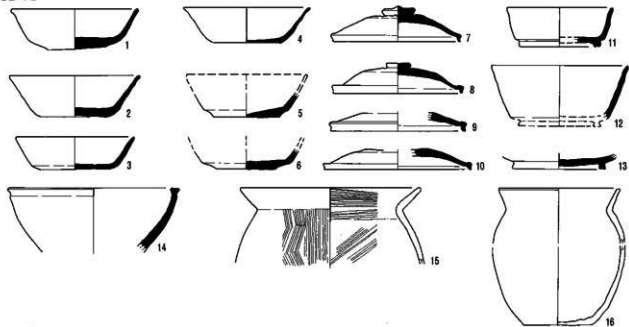

SB 69



SB 73

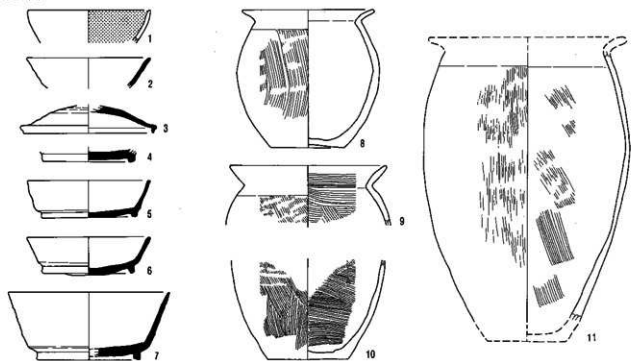

SB 74

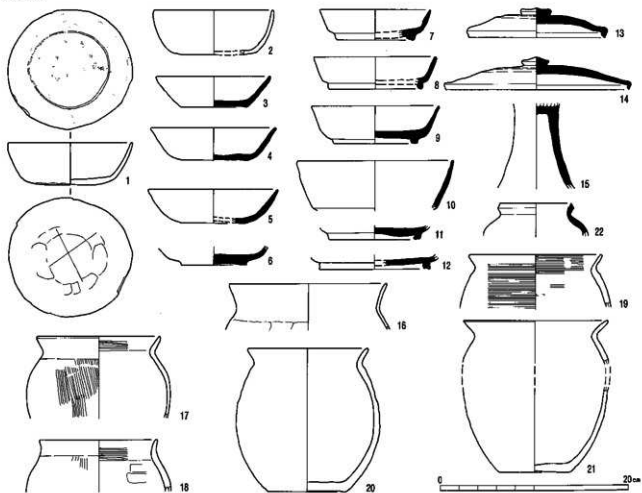

SB 75

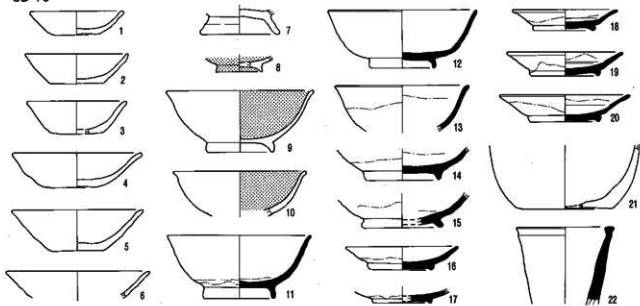

SB 77

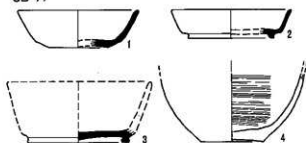

SB 79

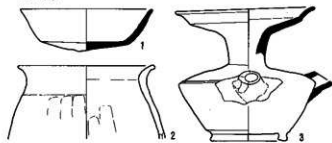

SB 78

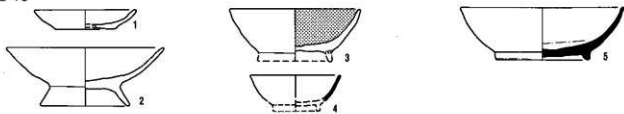

SB 80

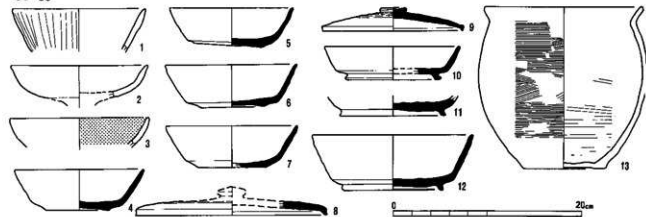

SB 80

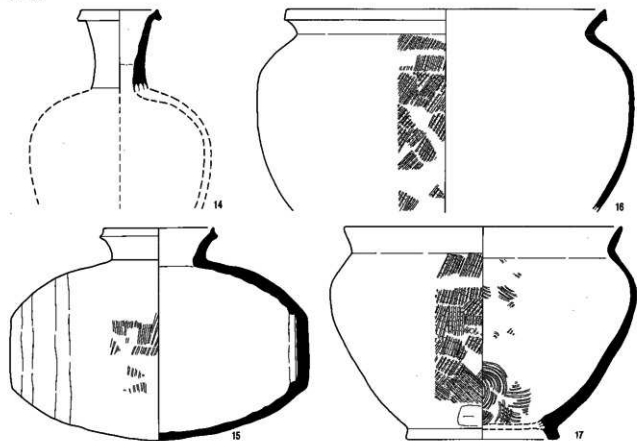

SB 82

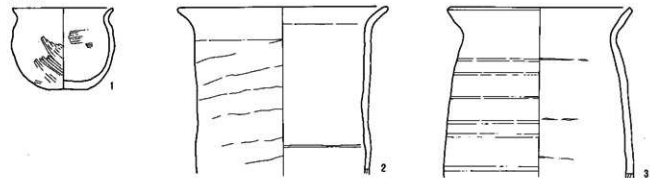

SB 84

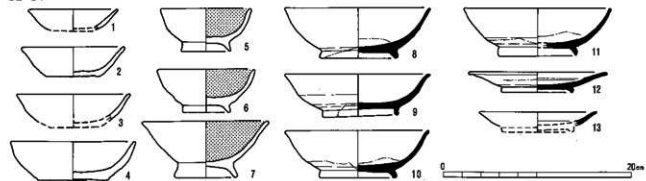

SB 84

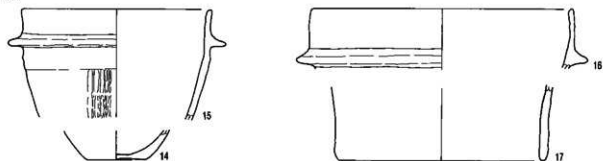

SB 86

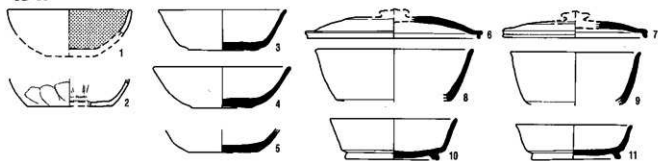

SB 91

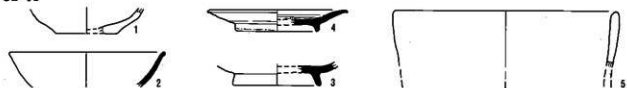

SB 92

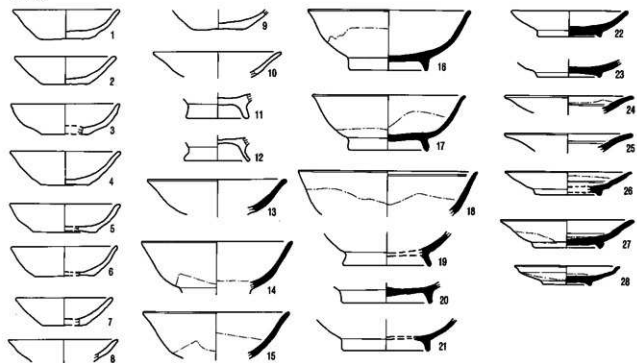

0 20 cm

SB 92

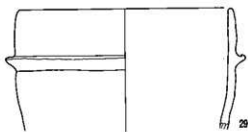

SB 95

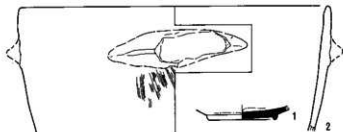

SB 97

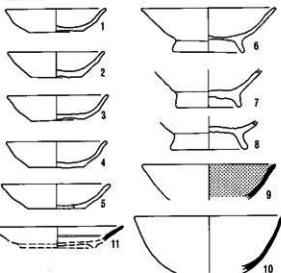

SB 93

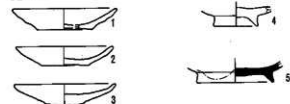

SB 94

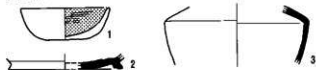

SB 90

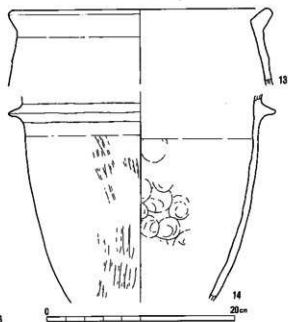
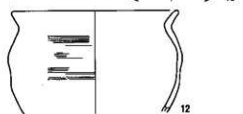
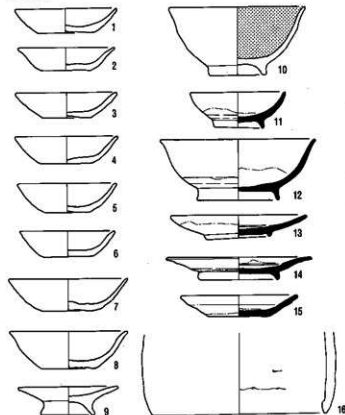

(上册)

SB 98

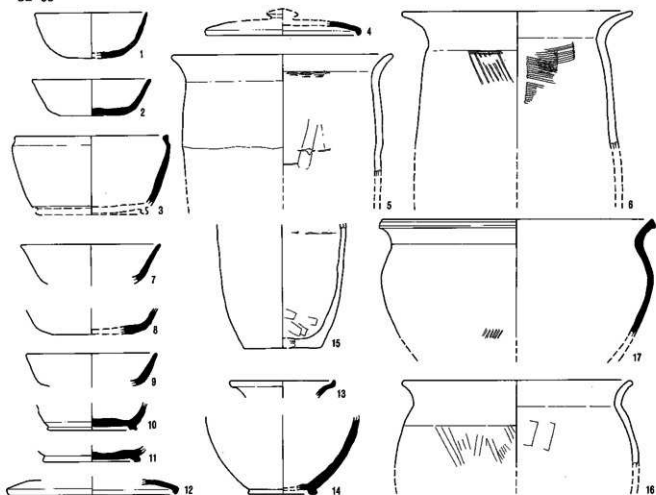

SB 100

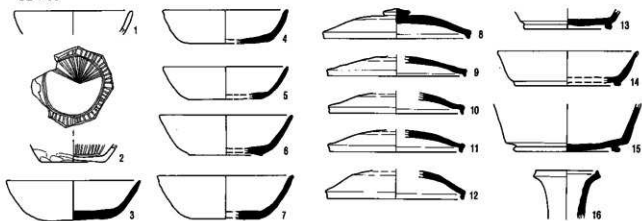

SB 99

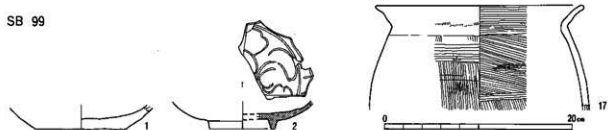

SB 101

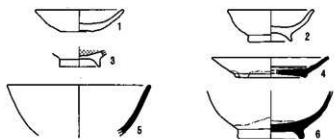

SB 102

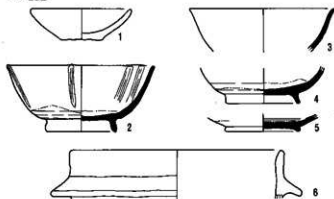

SB 104



SB 109

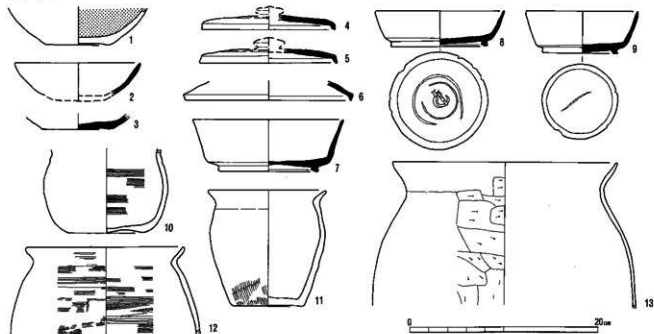

SB 103

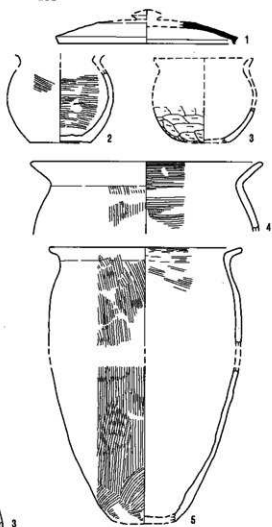

SB 110

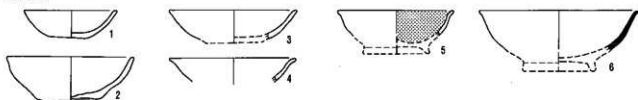

SB 113

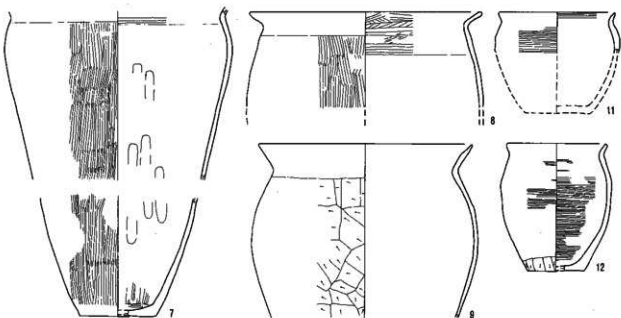
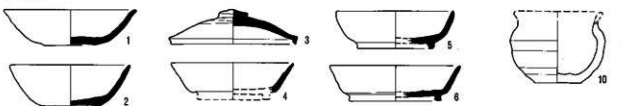

SB 115

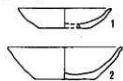

SB 114

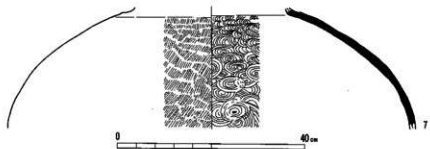
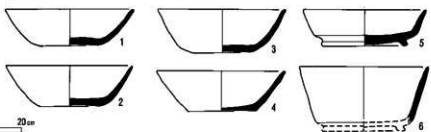

SB 114

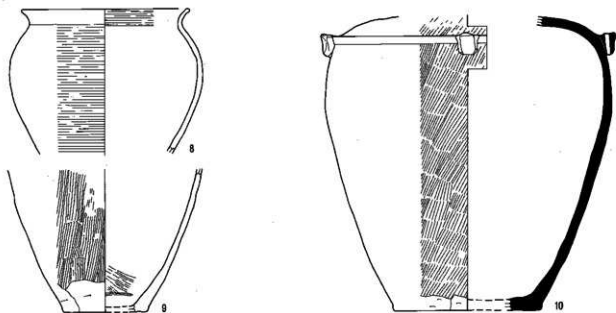

SB 116

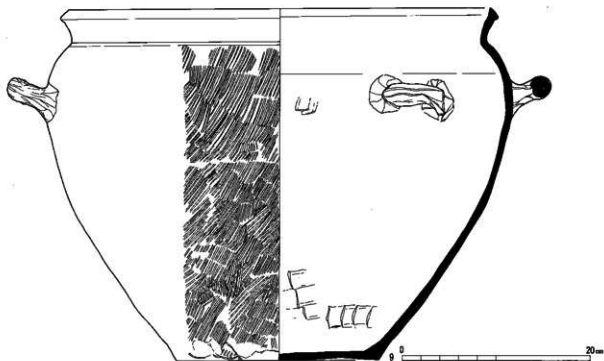
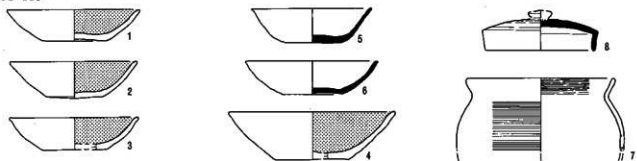

SB 117

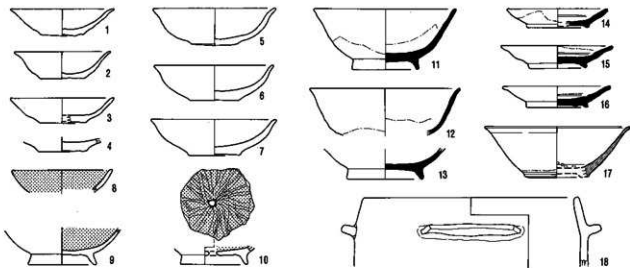

SB 119

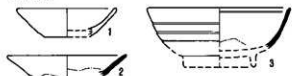

SB 120

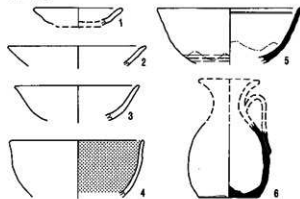

SB 121

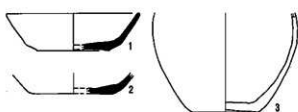

SB 123

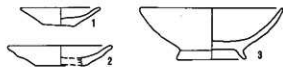

SB 124

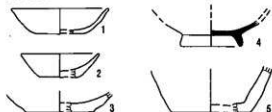

SB 122

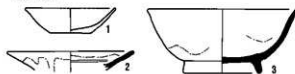

SB 125

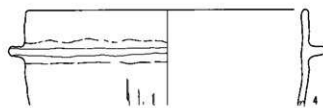
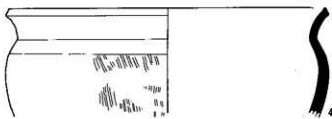
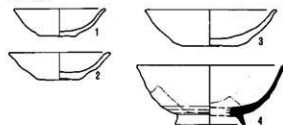

0 20cm

SB 126

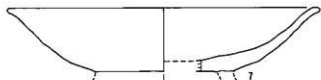
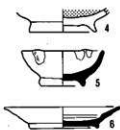
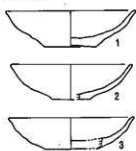

SB 127

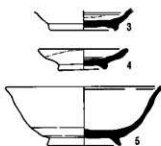
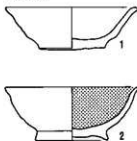

SB 128

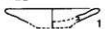

SB 129

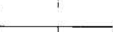
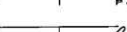
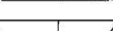
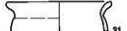
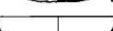
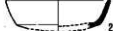
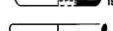
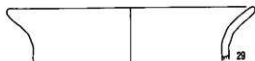
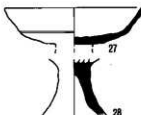
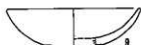
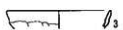
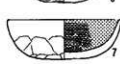
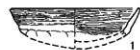

SB 129

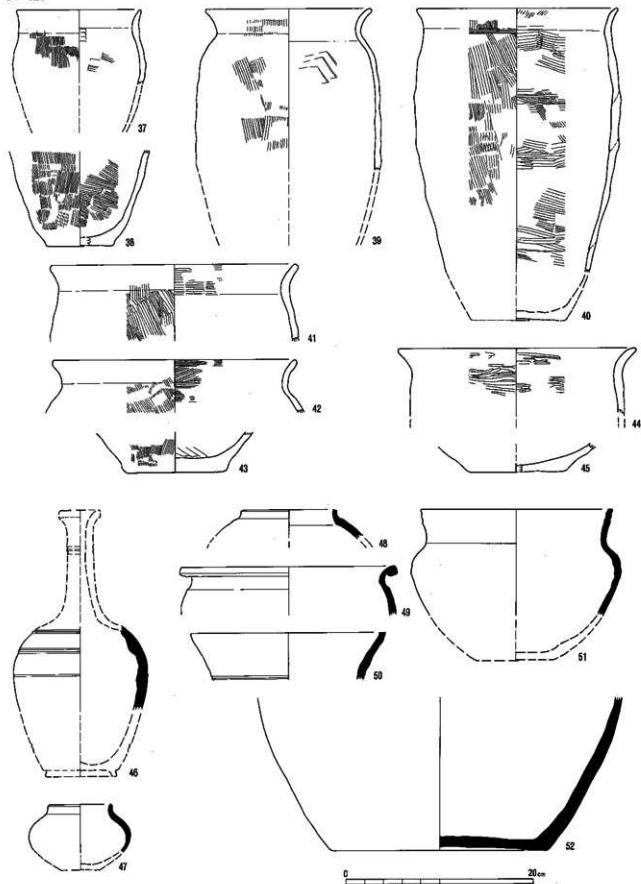

SB 130

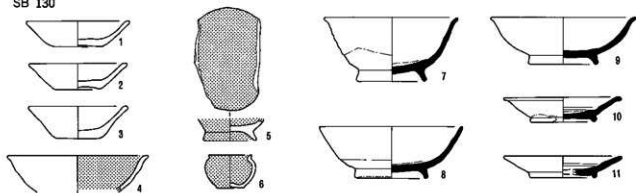

SB 131

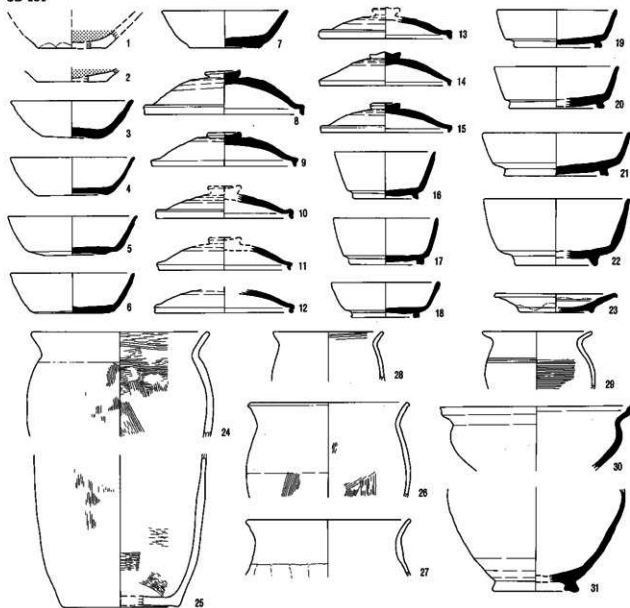

SB 133



SB 132



SB 134

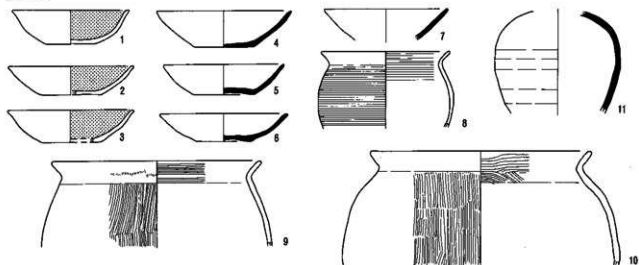

SB 136

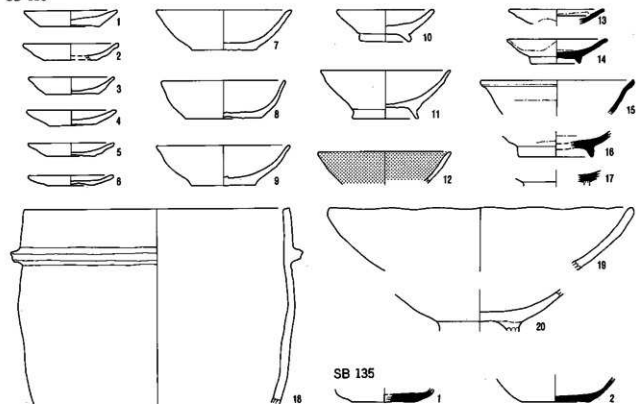

SB 135



SB 137

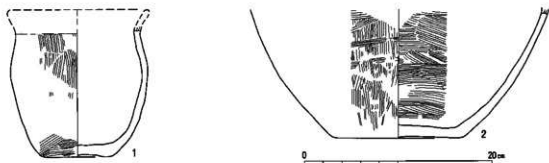

SB 138

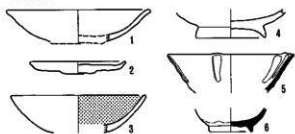

SB 141

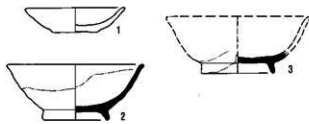

SB 142

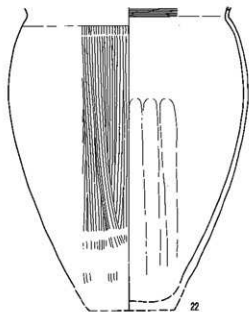
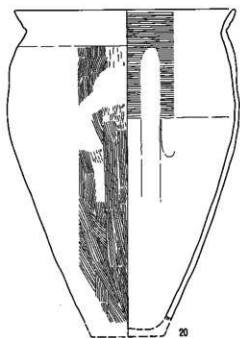
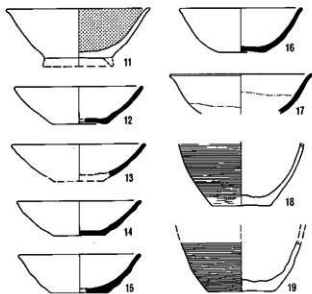
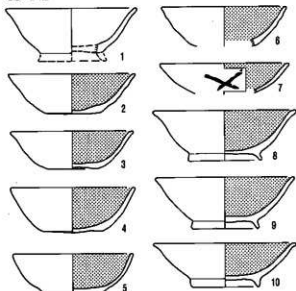

SB 142

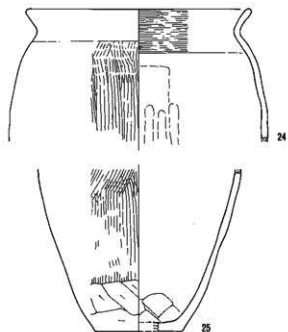
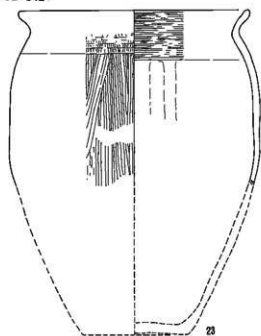

SB 143

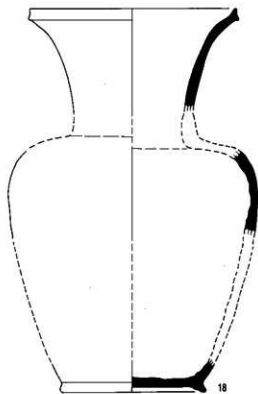
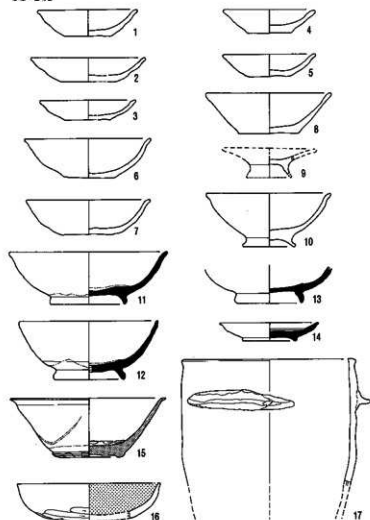

SB 144

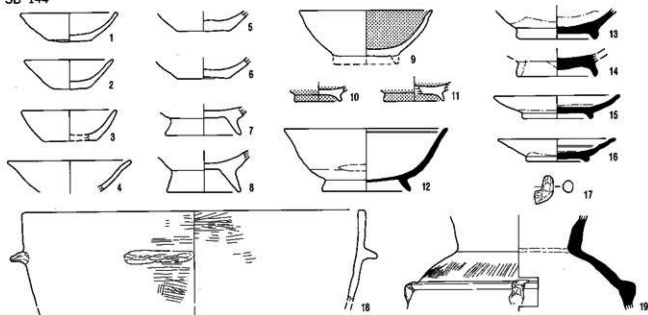

SB 145

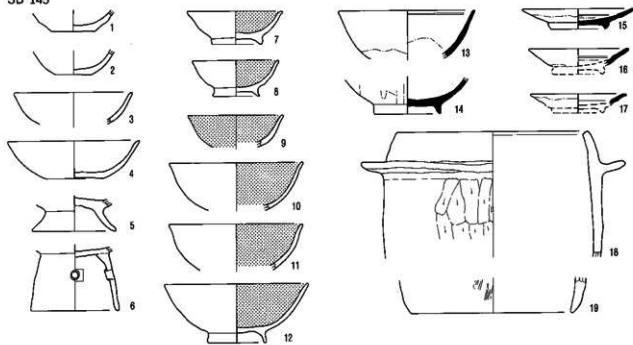

SB 146

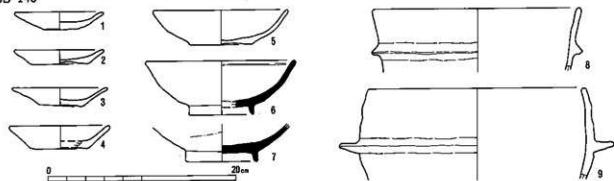

SB 147

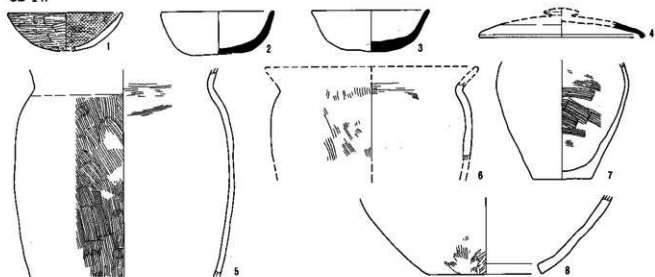

SB 148

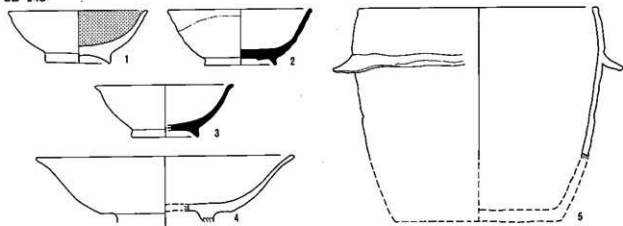

SB 149

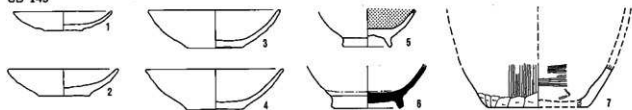

SB 150

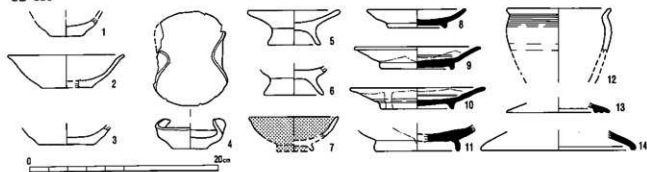

SB 151

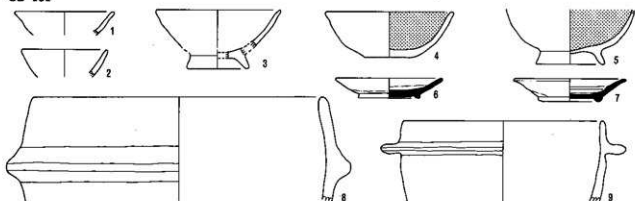

SB 153

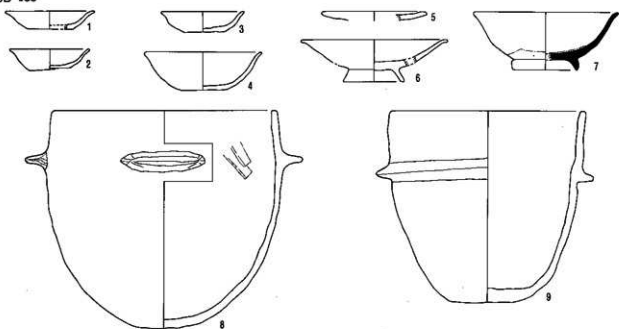

SB 155

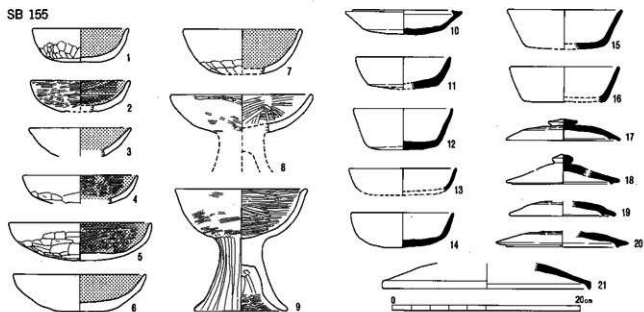

SB 155

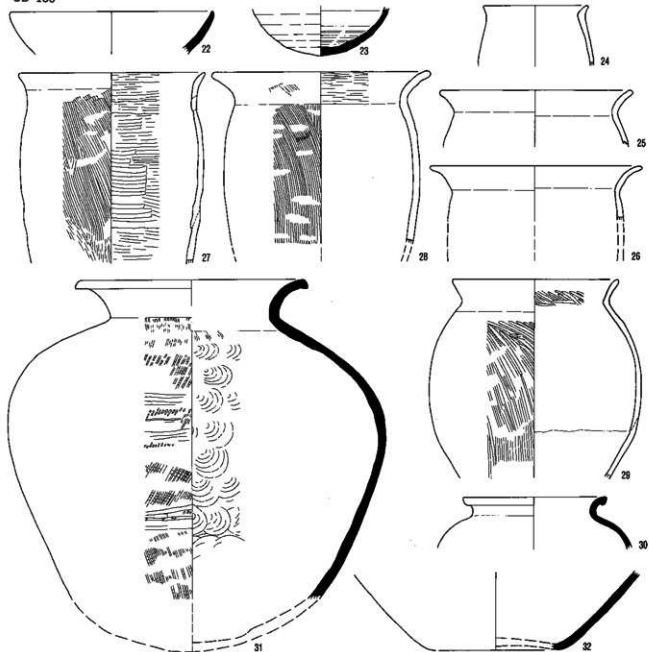

SB 156

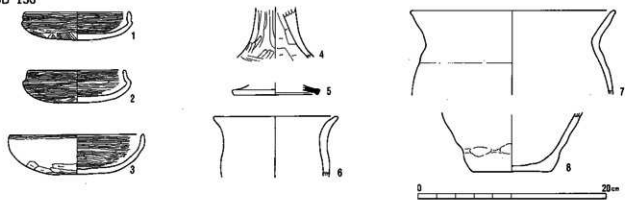

SB 157

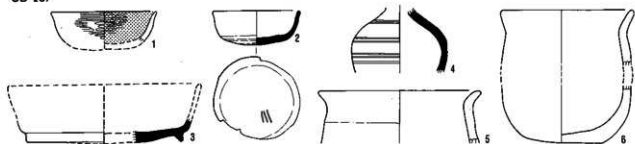

SB 159

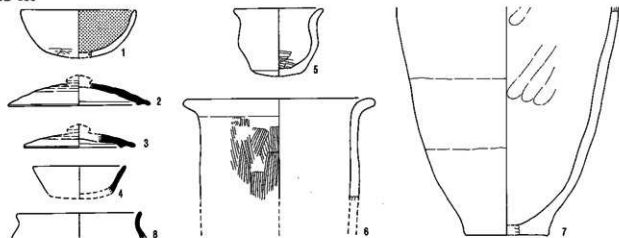

SB 160

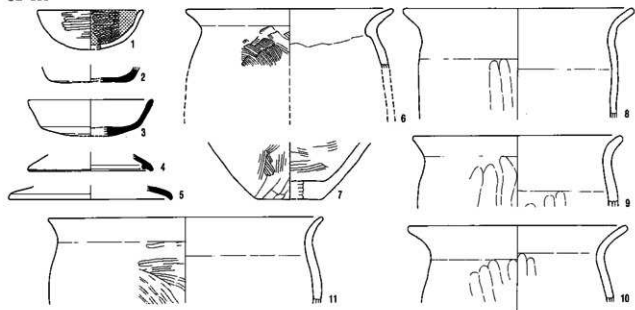

SB 161



SB 162

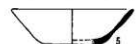

SB 163

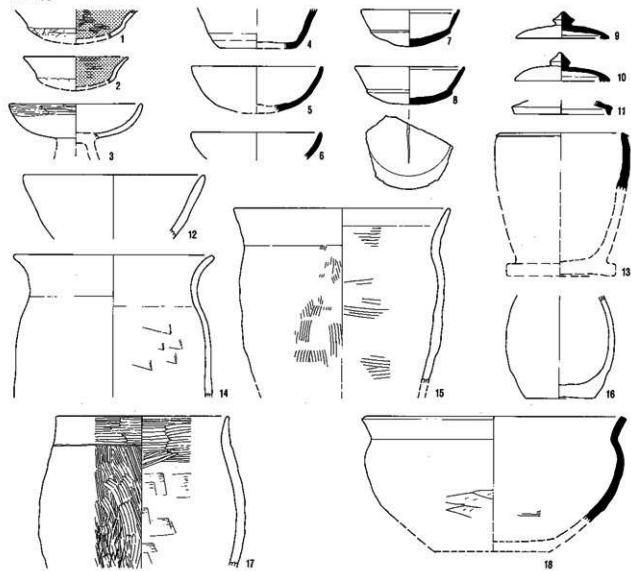

SB 164

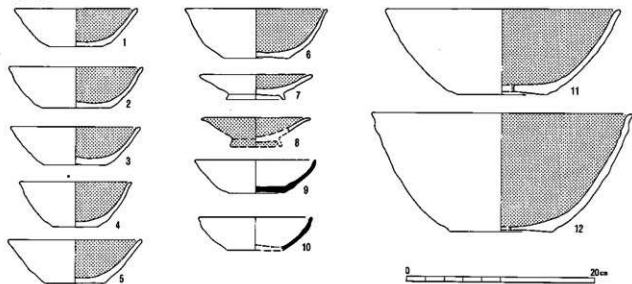

SB 164

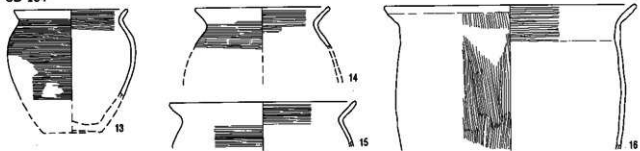

SB 165

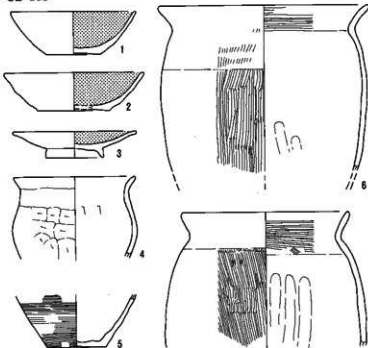

SB 166



SB 167

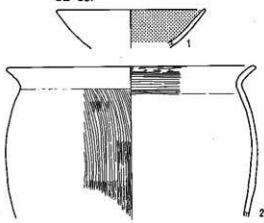

SB 168

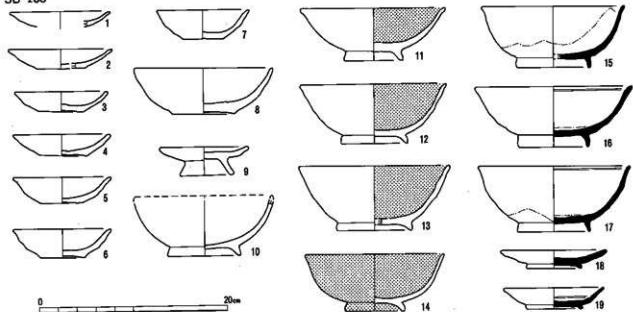

SB 169

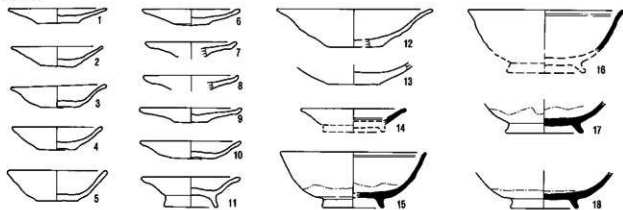

SB 170

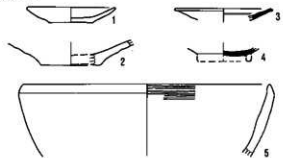

SB 172

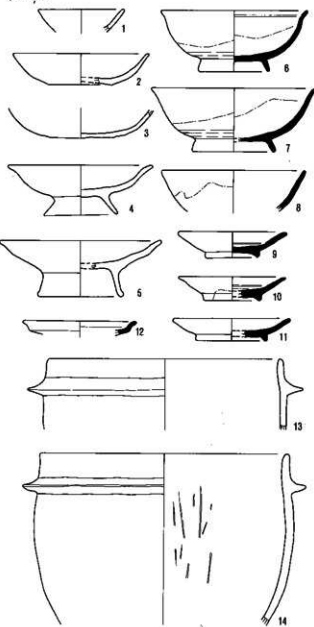

SB 171

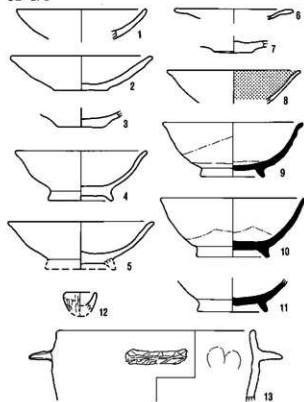

SB 173

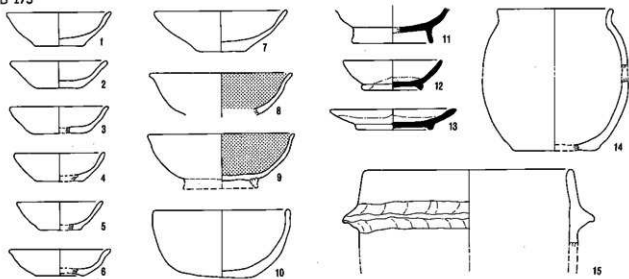

SB 174

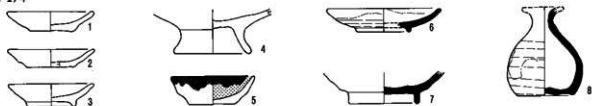

SB 175

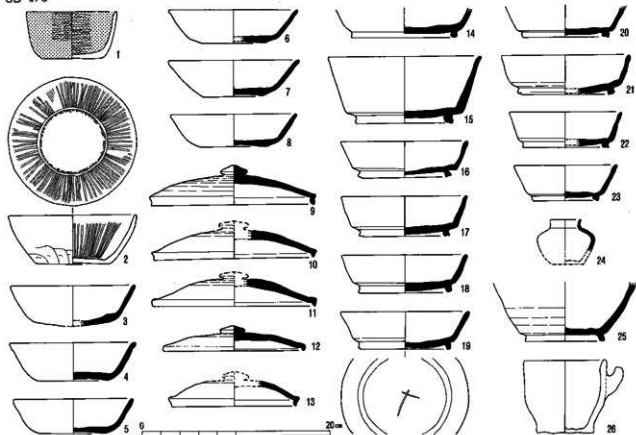

SB 175

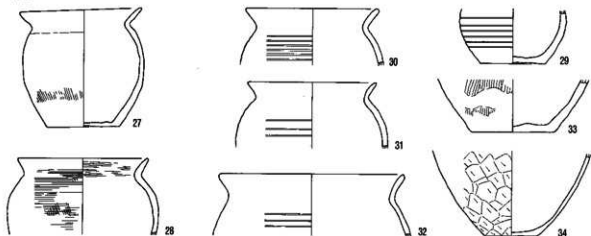

SB 176

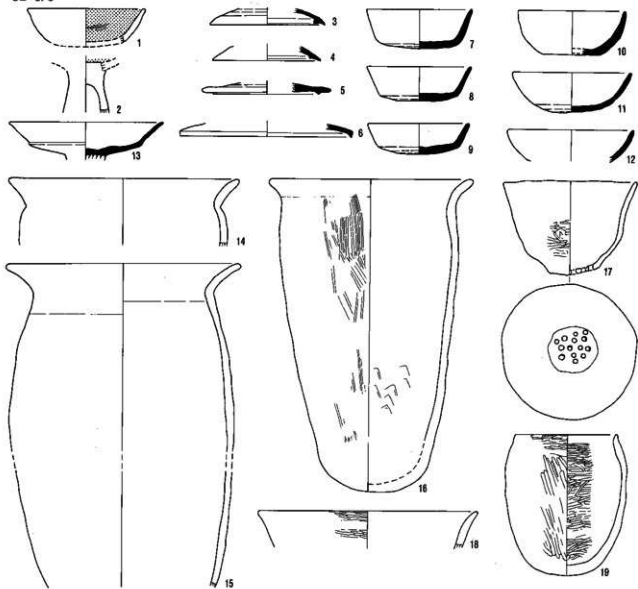

0 20 cm

SB 176

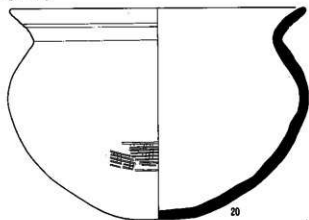

SB 181

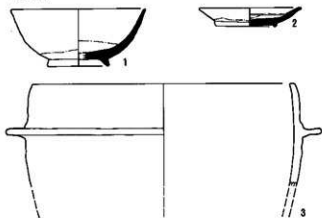

SB 177

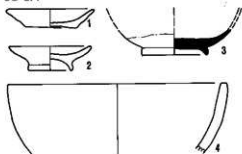

SB 178

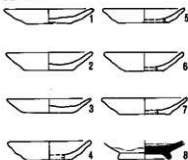

SB 179

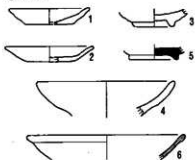

SB 180

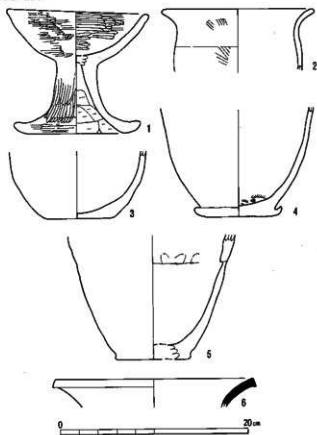

SB 183

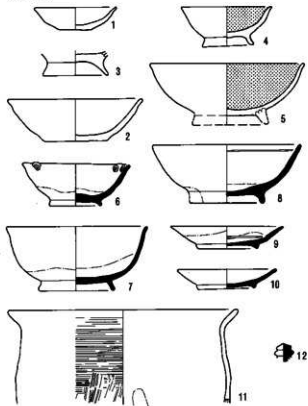

SB 183

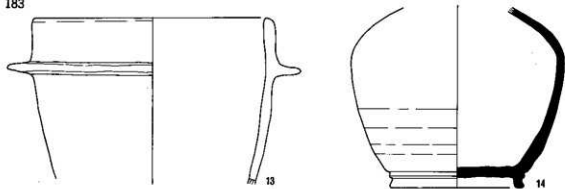

SB 184

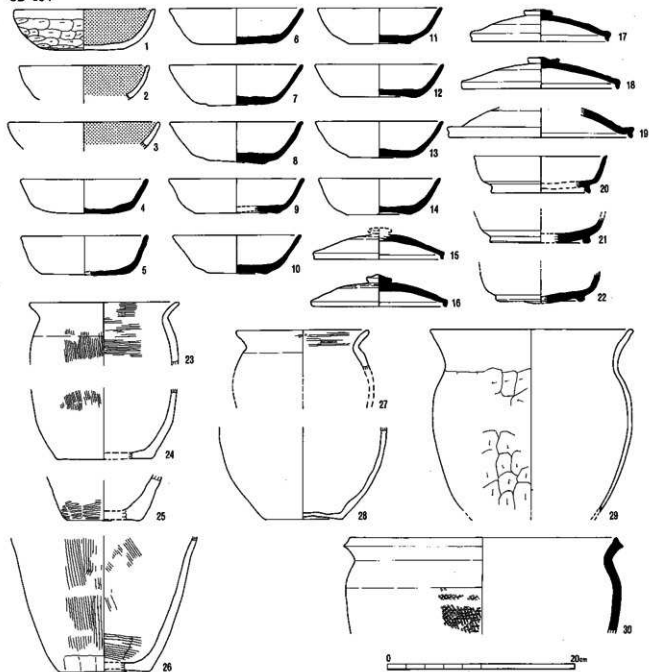

SB 185

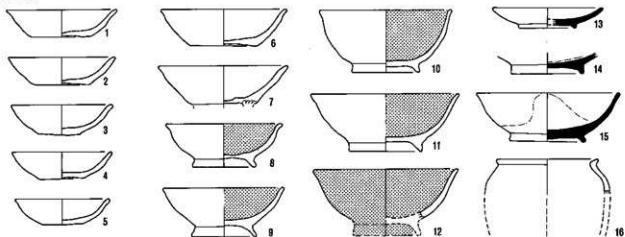

SB 186

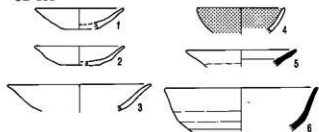

SB 188

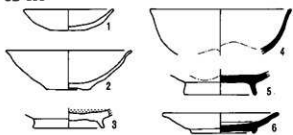

SB 189

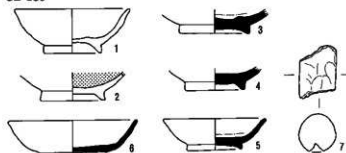

SB 191

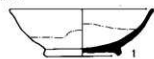

SB 187

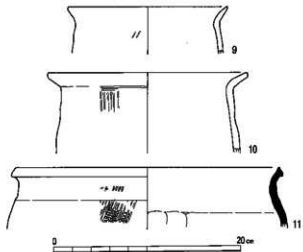
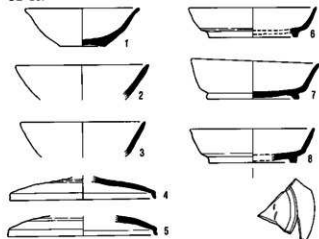

SB 192

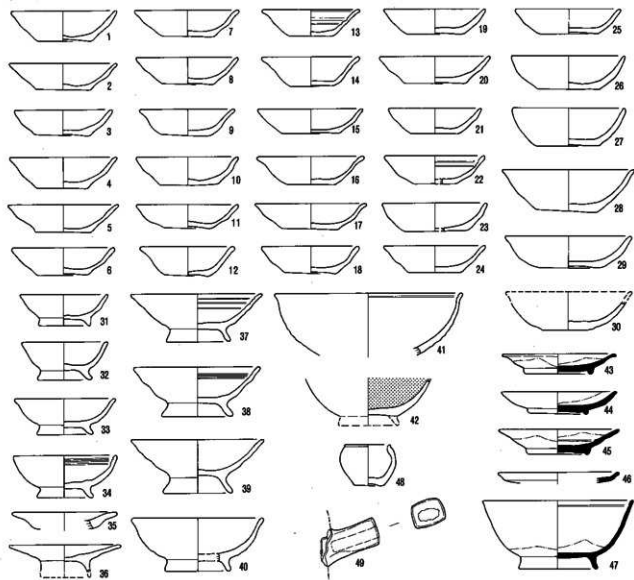

SB 193

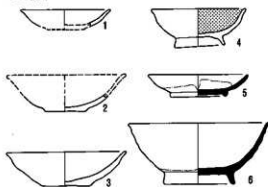

SB 194

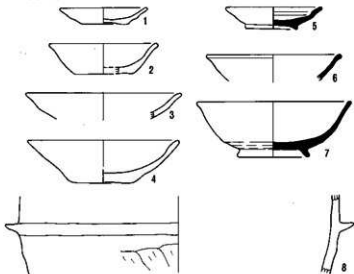

SB 195

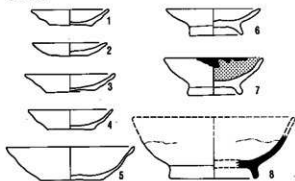

SB 196

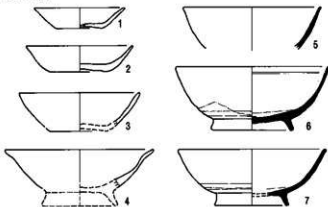

SB 197

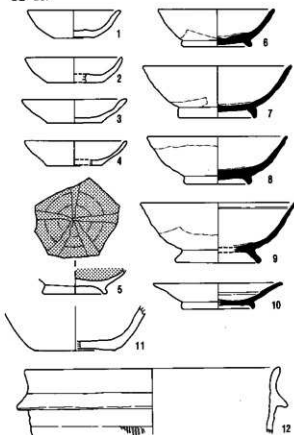

SB 198

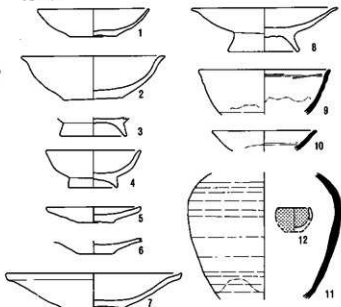

SB 199

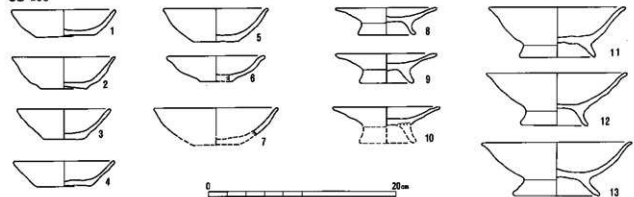

SB 199

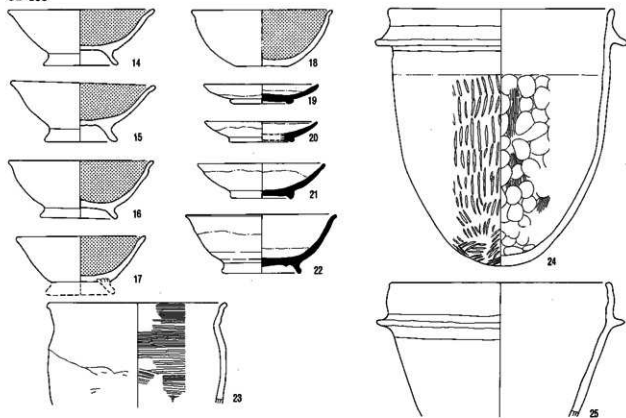

SB 200

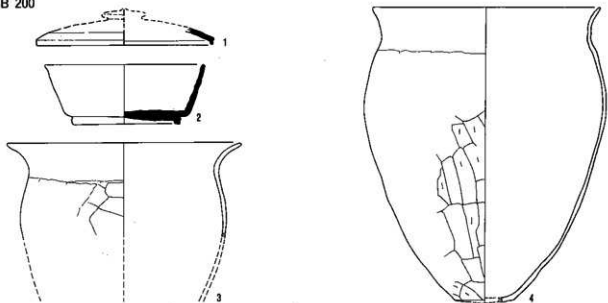

SB 202



SB 205

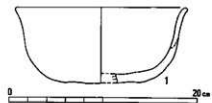

SB 201

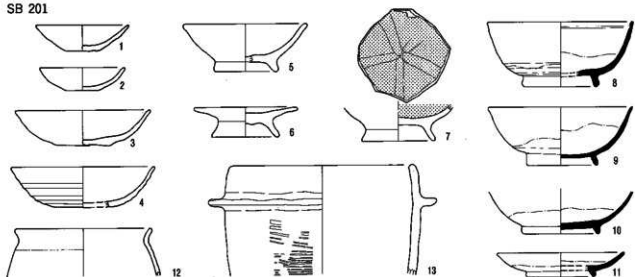

SB 206

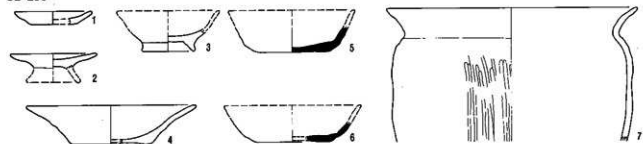

SB 207

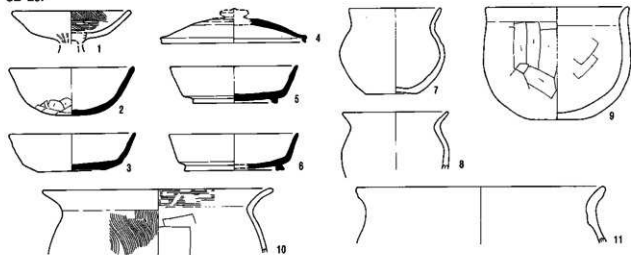

SB 208

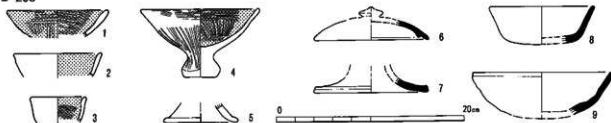

SB 208

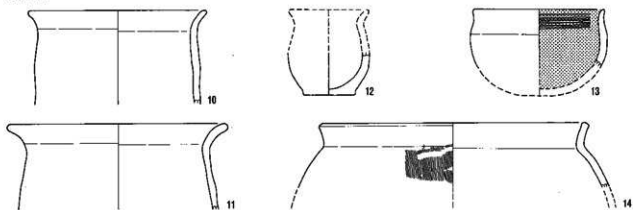

SB 209

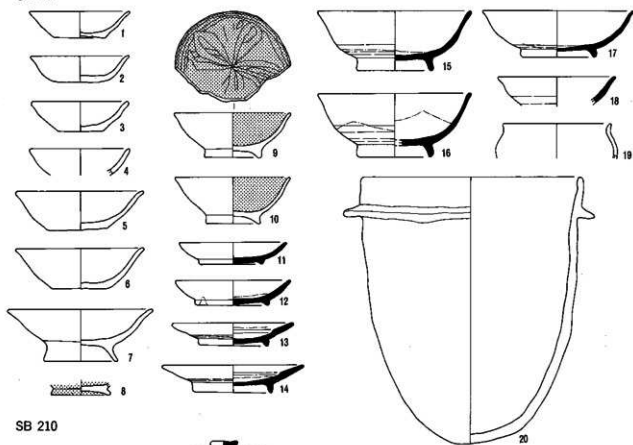

SB 210

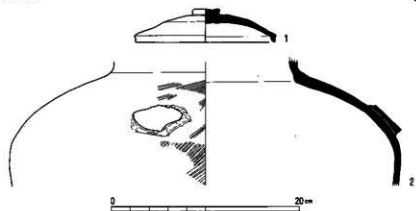

SB 211

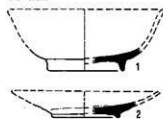

SB 213

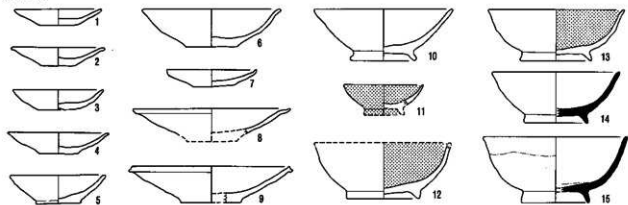

SB 214

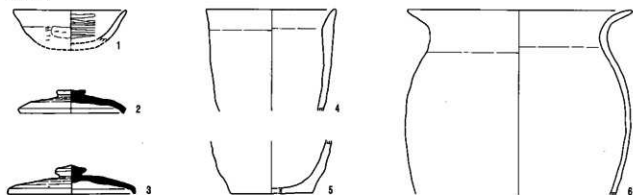

SB 215

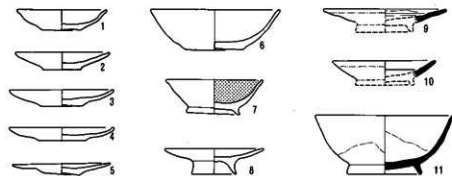

SB 218

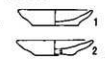

SB 219

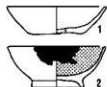

SB 216

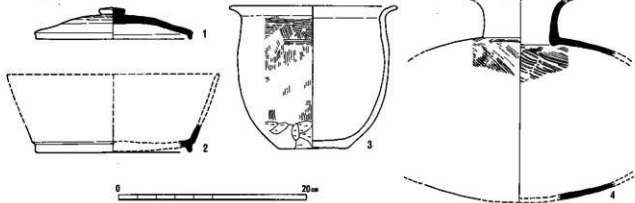

SB 220

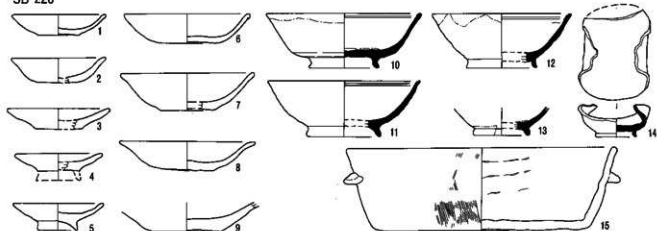

SB 221

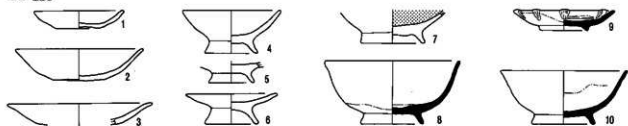

SB 222

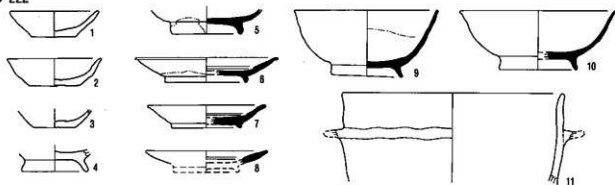

SB 223

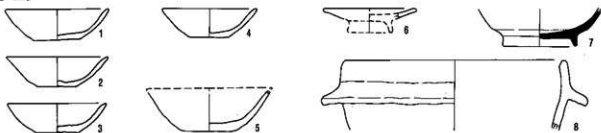

SB 224

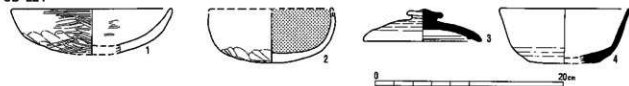

SB 224

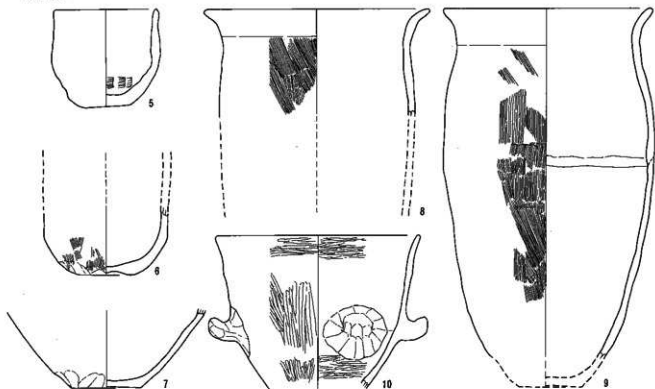

SB 501

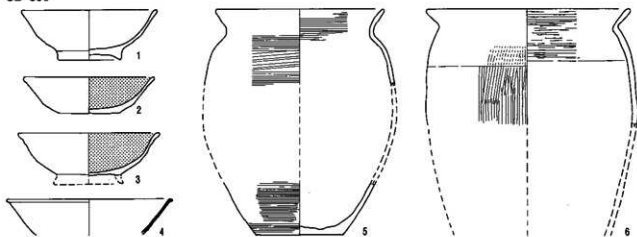

SB 503

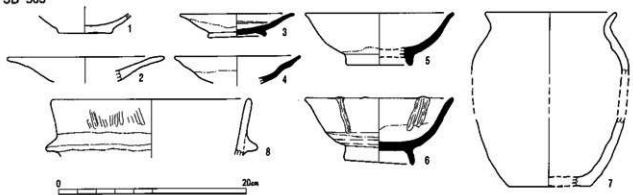

SB 504

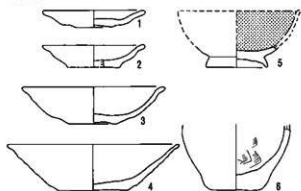

SB 505

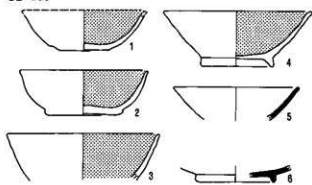

SB 506

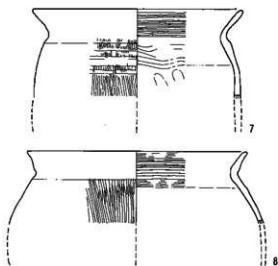
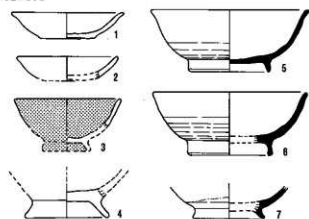

SB 507

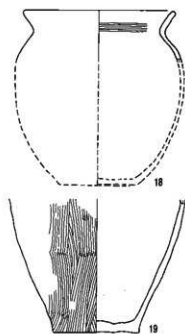
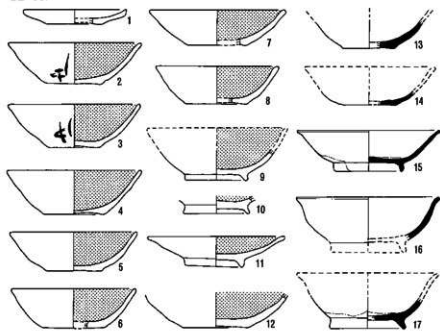

SB 508



SB 509

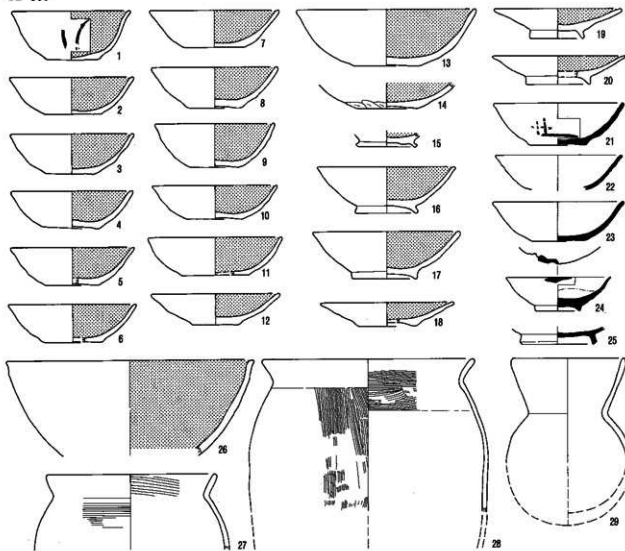

SB 521

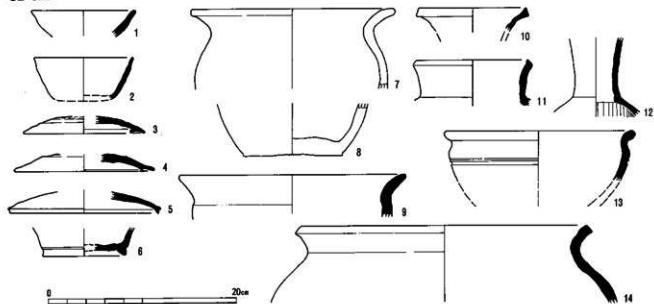

SB 522

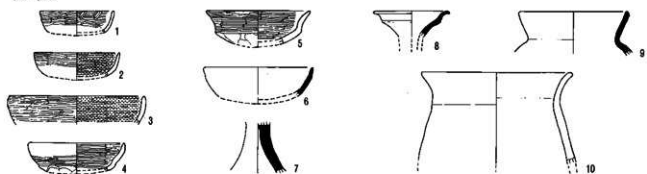

SB 523

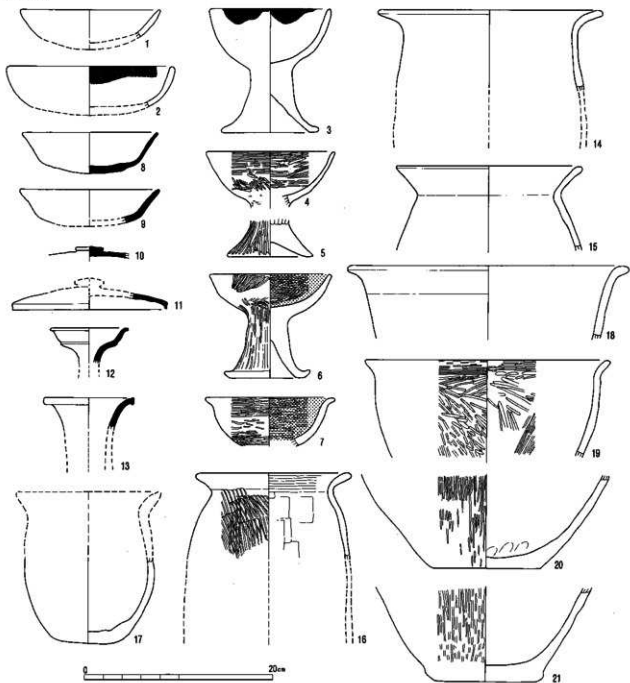

SB 524

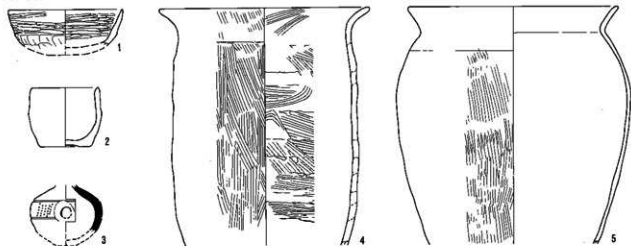

SB 526

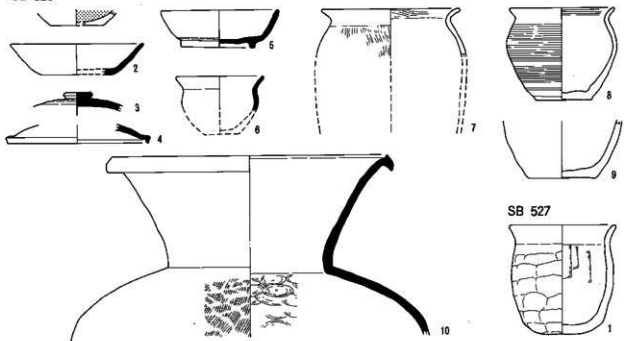

SB 527

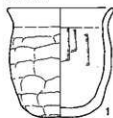

SB 528

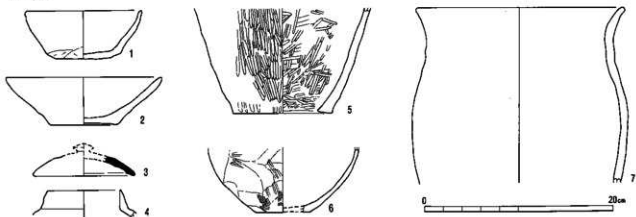

(上層)

SB 528

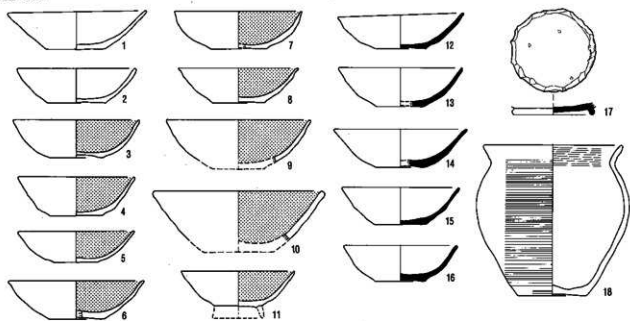

SB 529

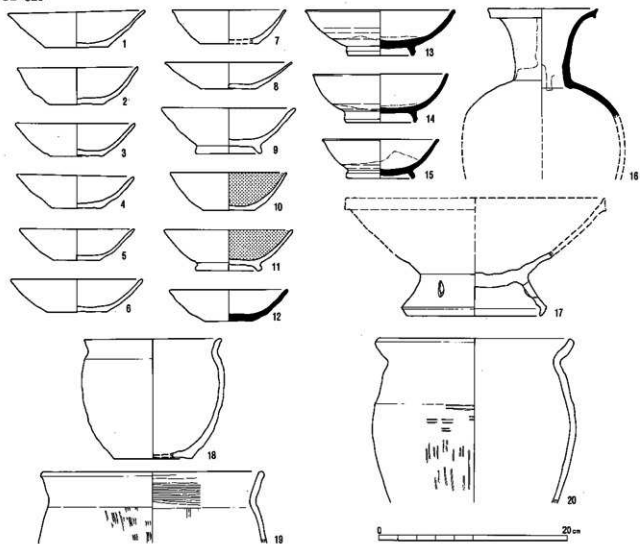

SB 530

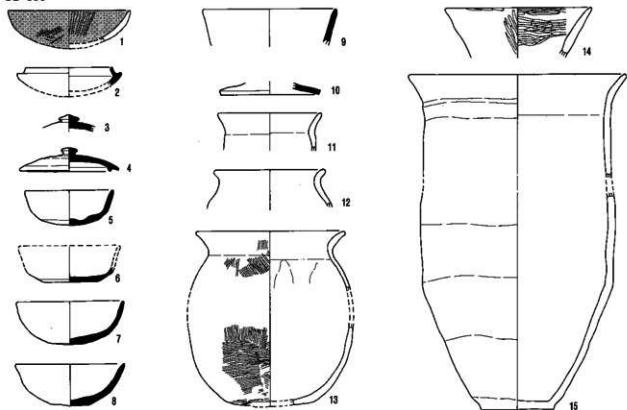

SB 534

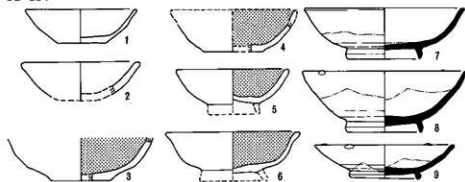

SB 536

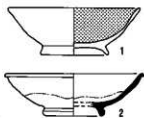

SB 537

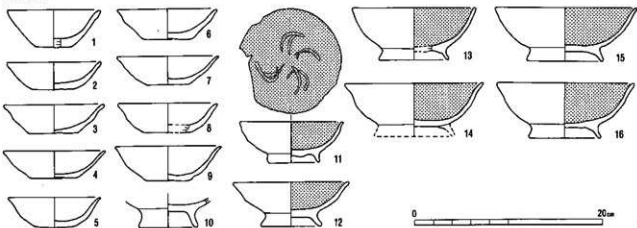

SB 537

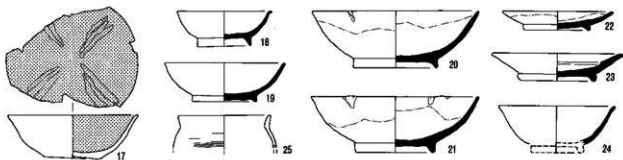

SB 540

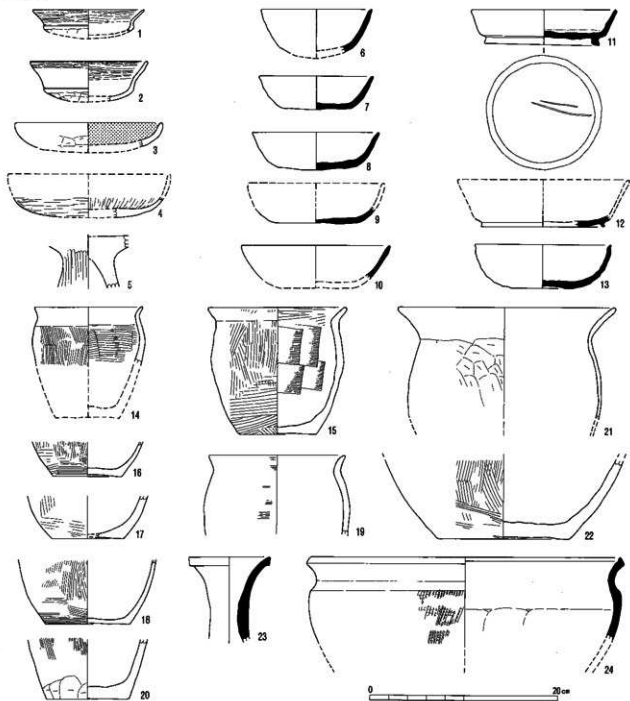

SB 541

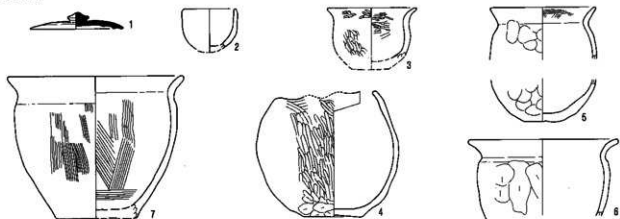

SB 542

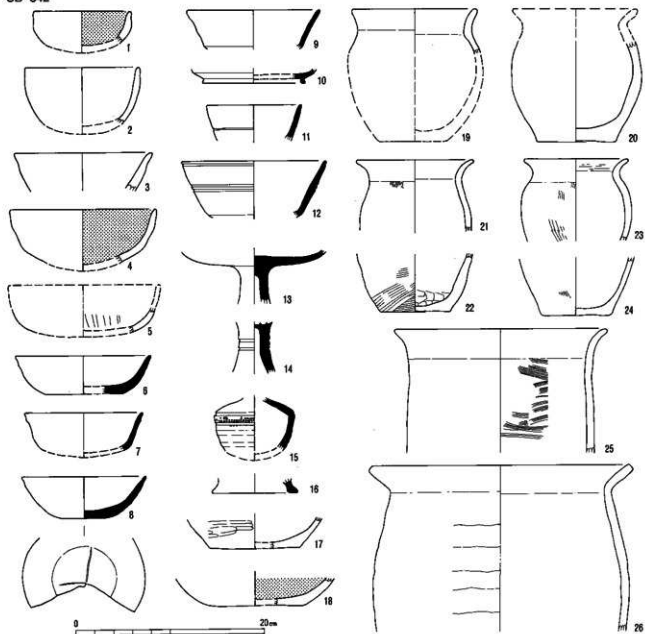

SB 544

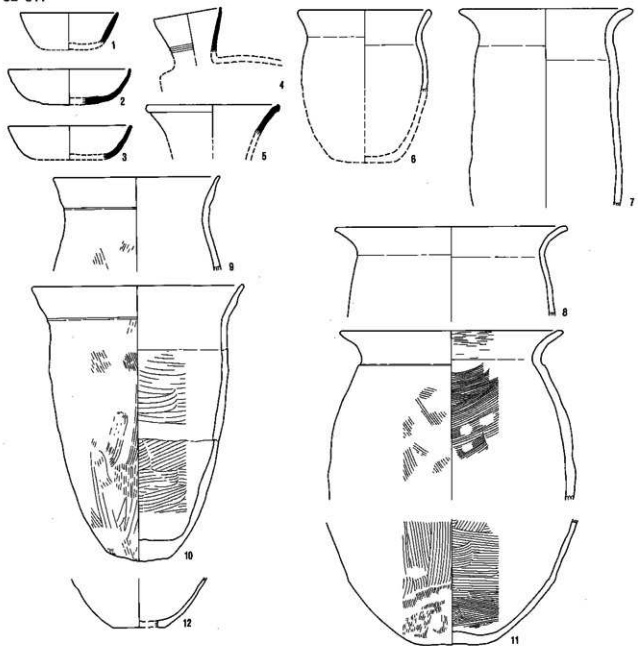

SB 545

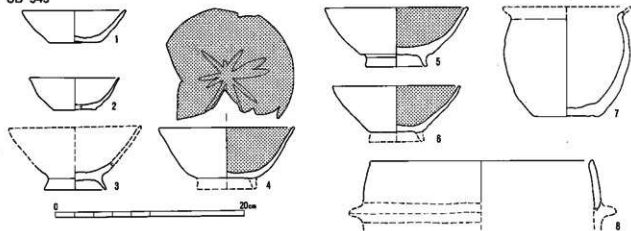

SB 546

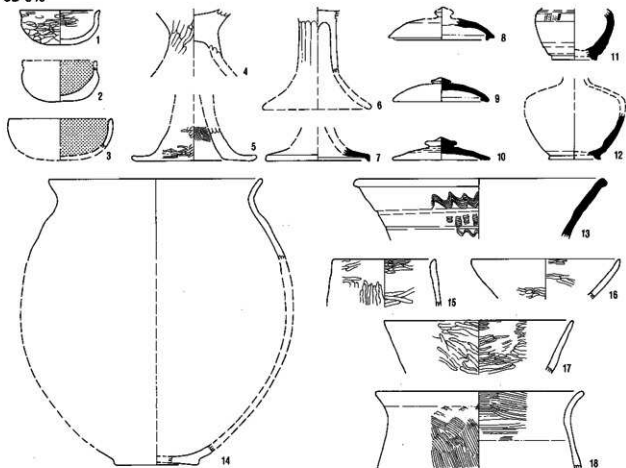

SB 547

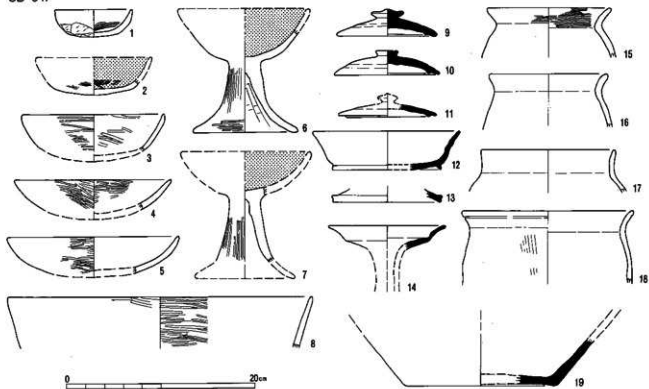

SB 547

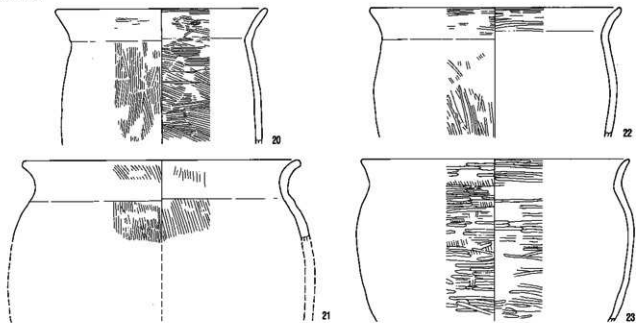

SB 549

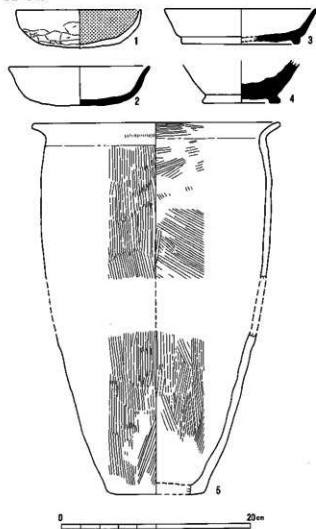

SB 548

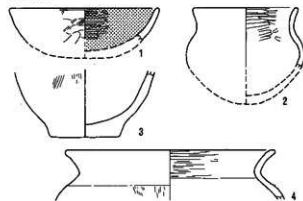

SB 550

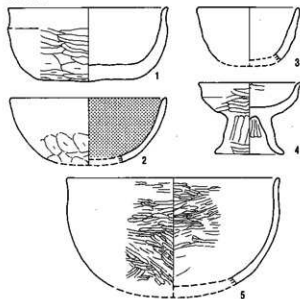

SB 550

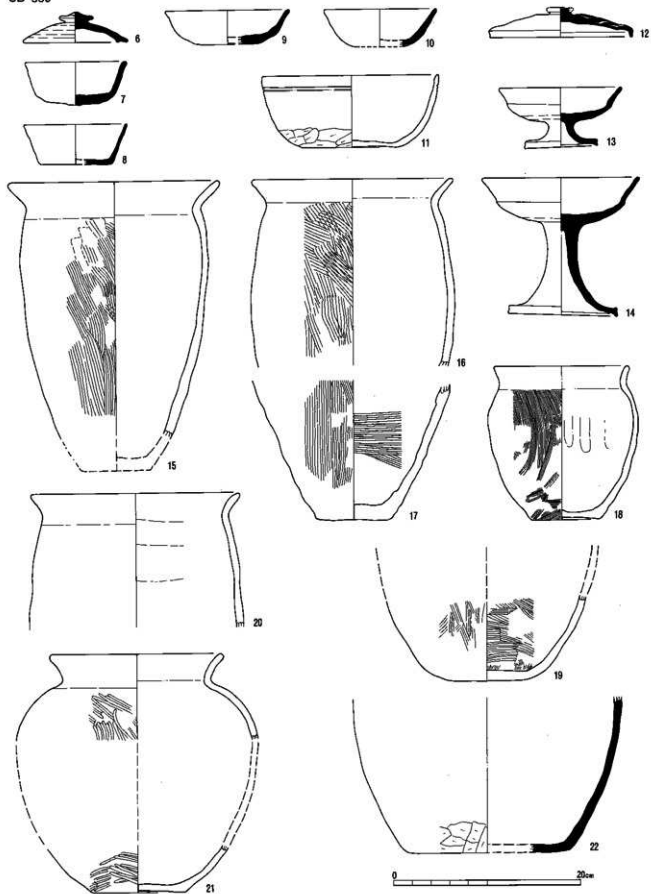

SB 551

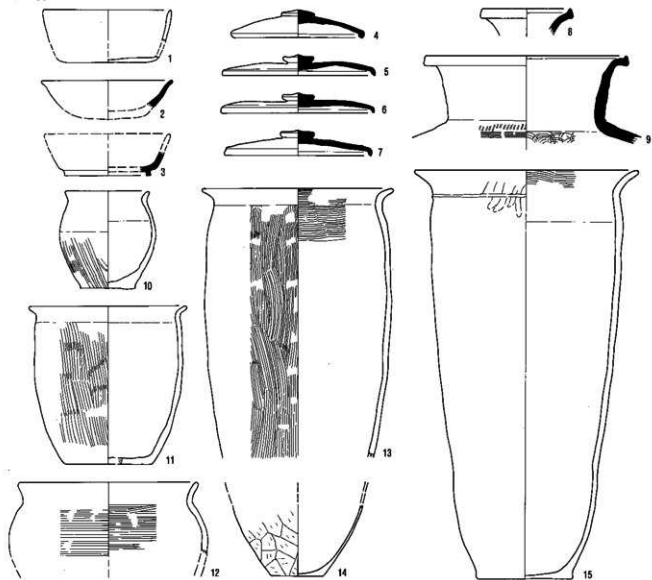

SB 553

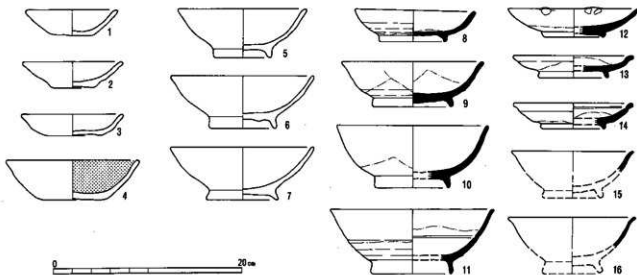

SB 555

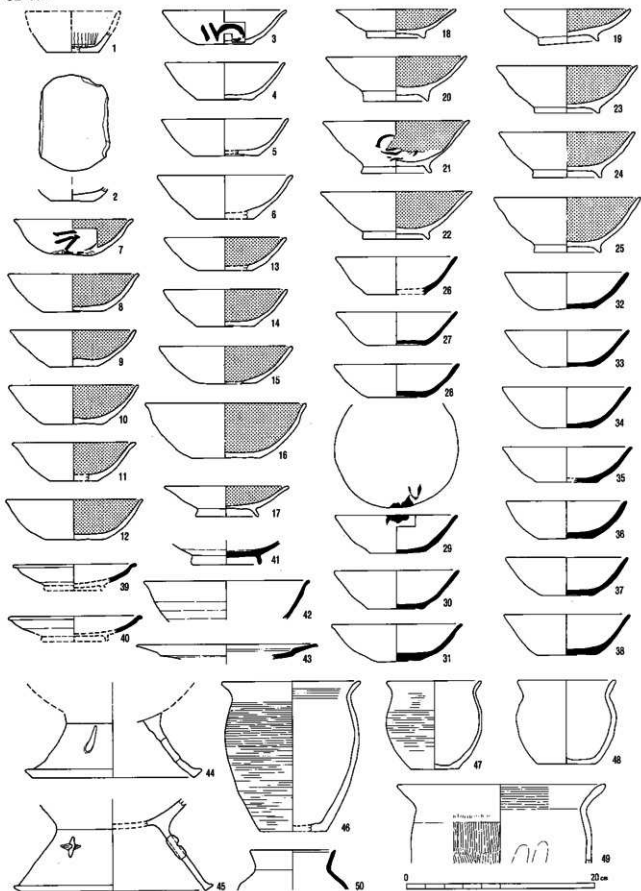

SB 554

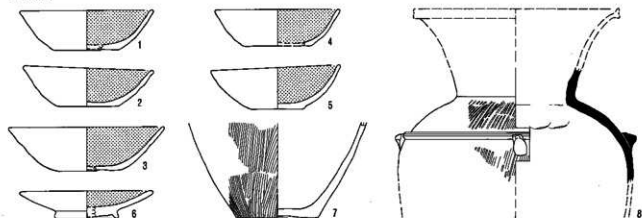

SB 556

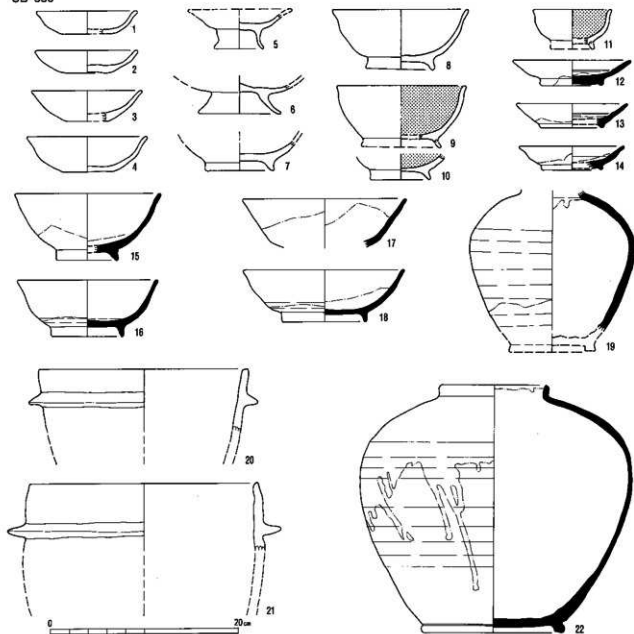

SB 557

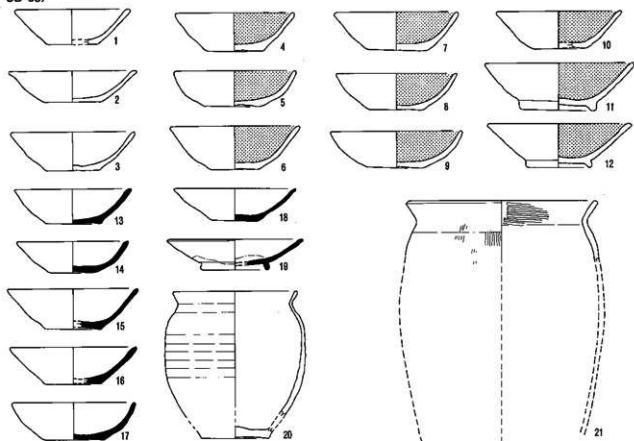

SB 558

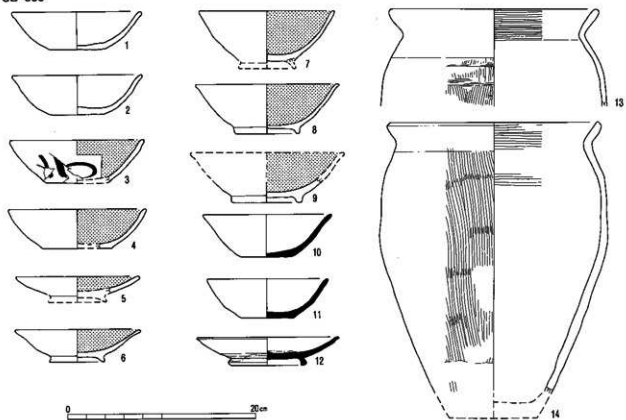

SB 558

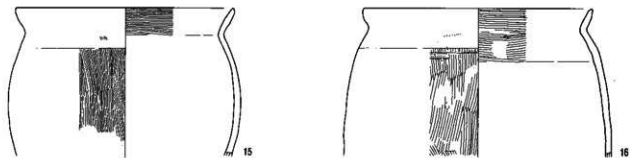

SB 559

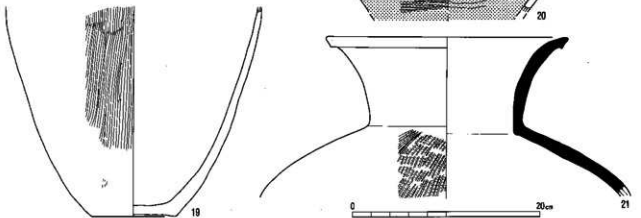
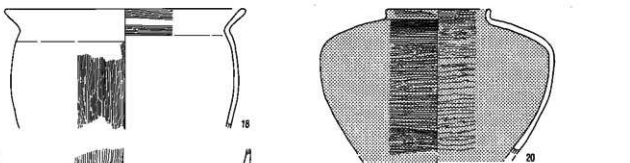
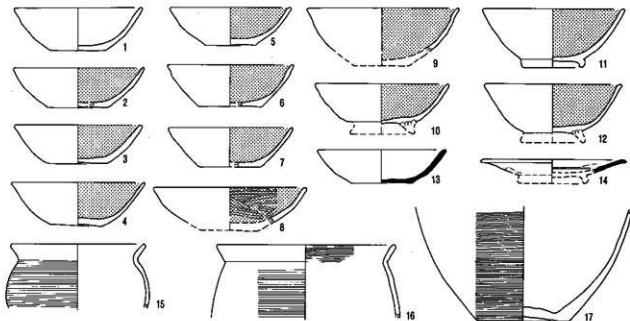

SB 560

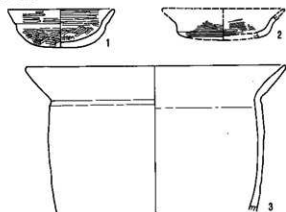

SB 562

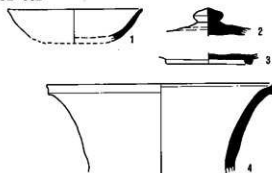

SB 564

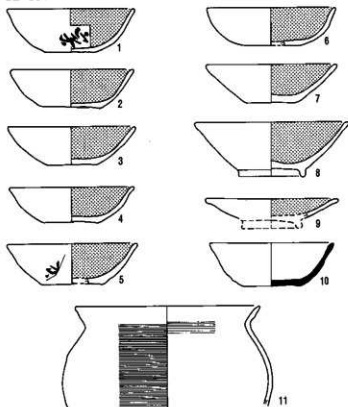

SB 561

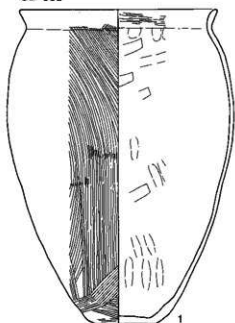

SB 563

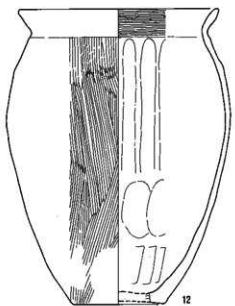
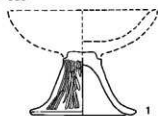

SB 564

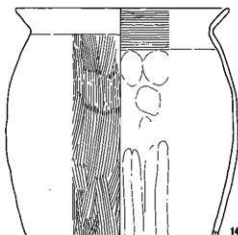
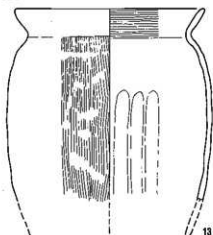

SB 565

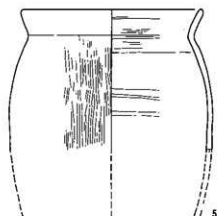
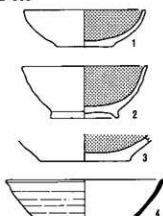

SB 567

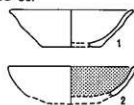

SB 568

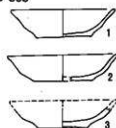

SB 571

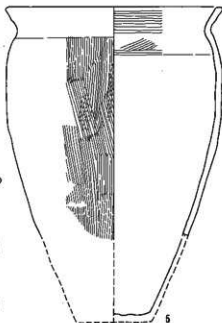
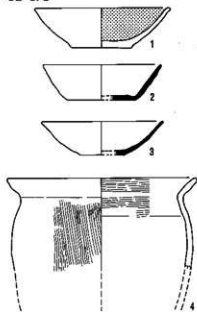

SB 569

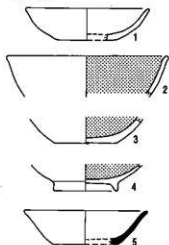

SB 573

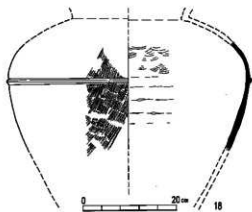
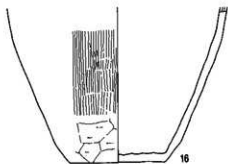
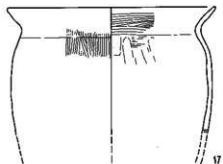
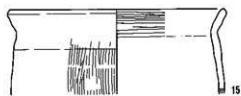
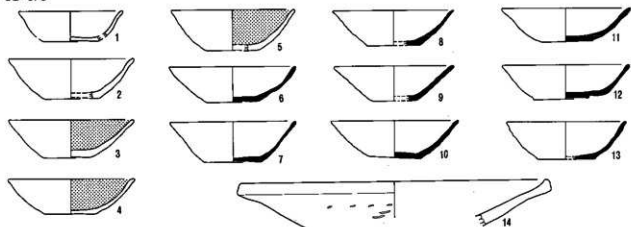

SB 572



SB 575

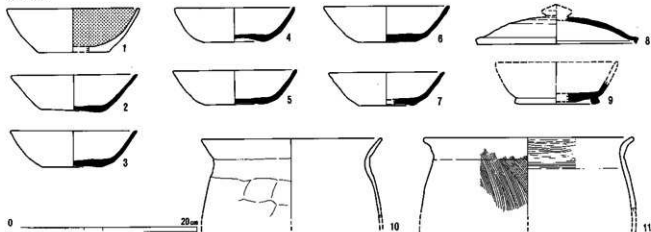

SB 574

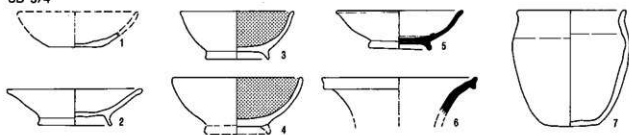

SB 576

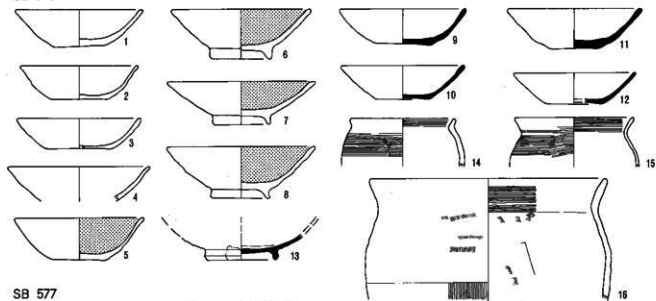

SB 577

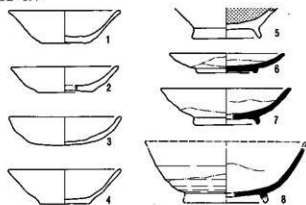

SB 578

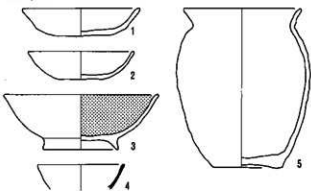

SB 579

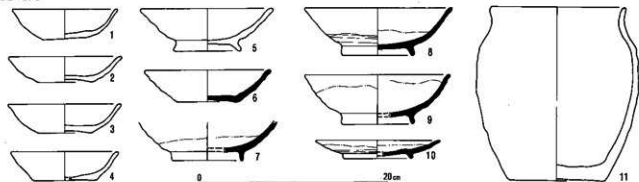

SB 580

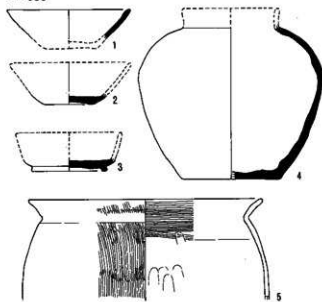

SB 581

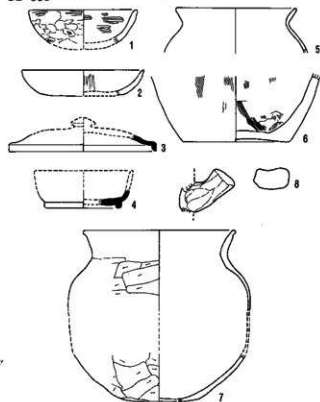

SB 582

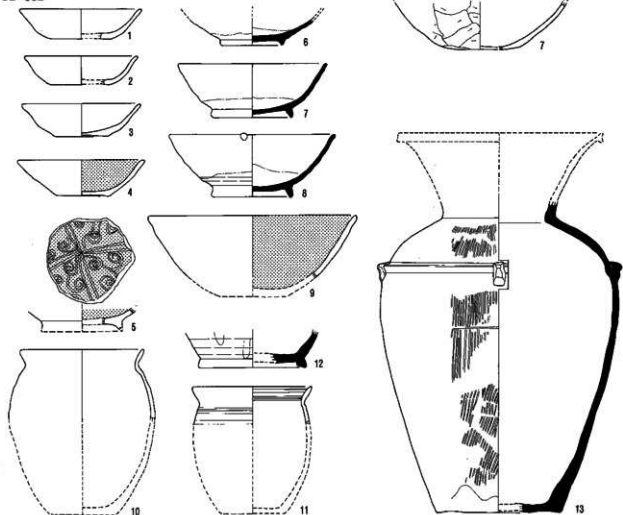

SB 583

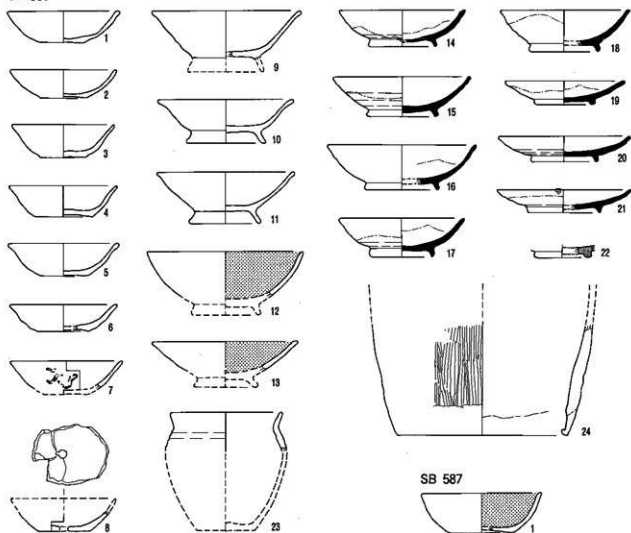

SB 587



SB 586

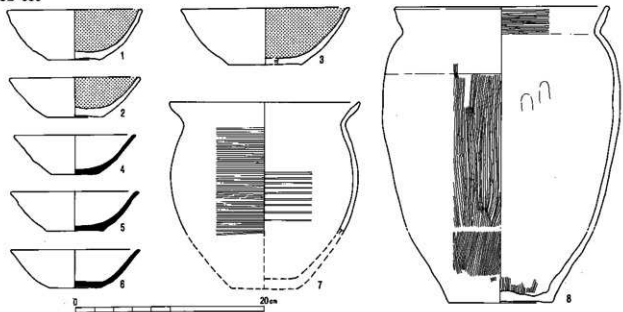

SB 588

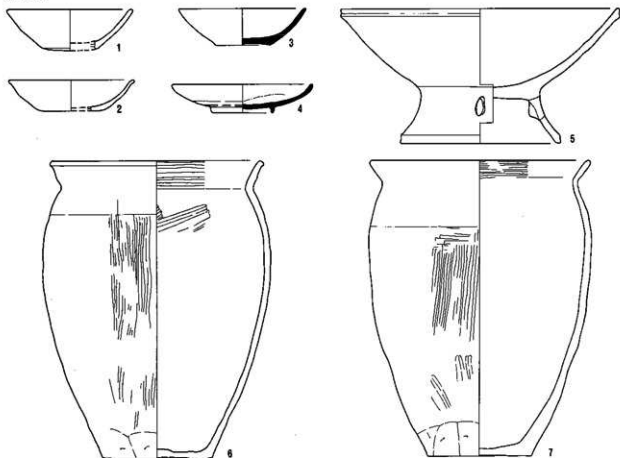

SB 589

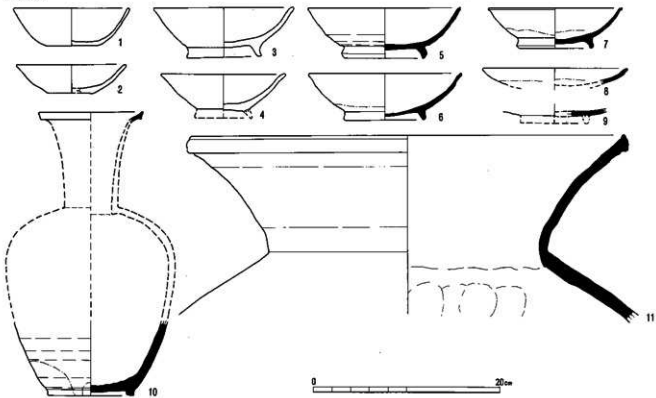

SB 589



SB 591

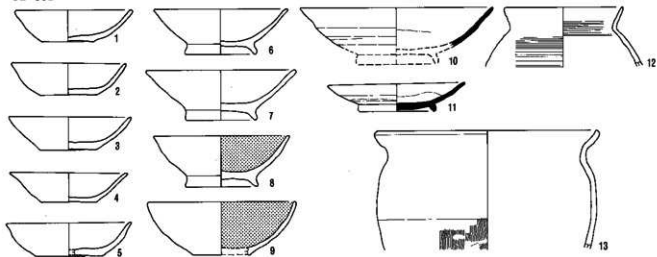

SB 592

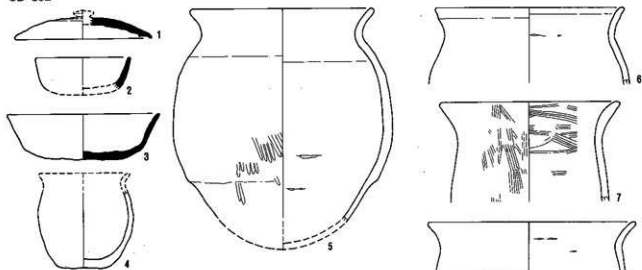

SB 590

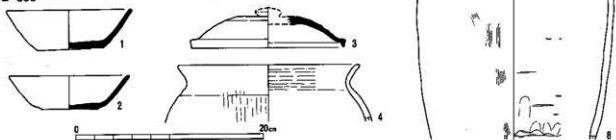

SB 595

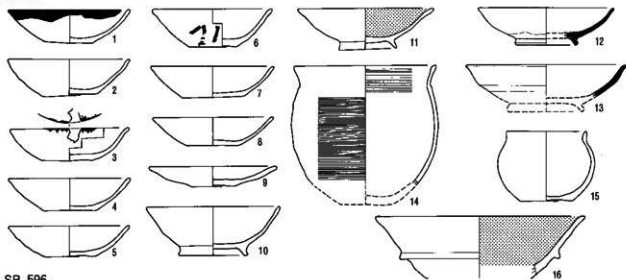

SB 596



SB 597

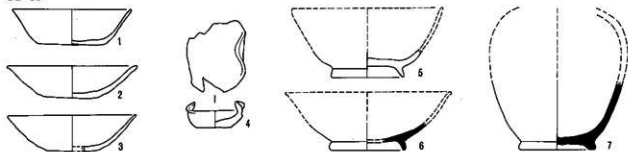

SB 598

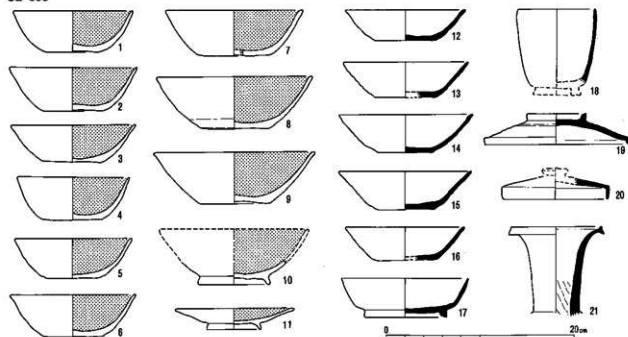

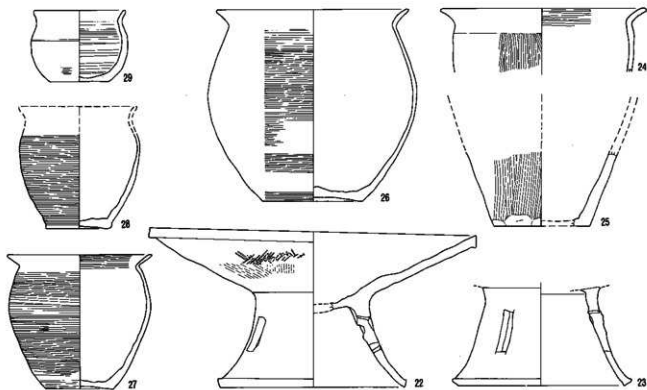

SB 599

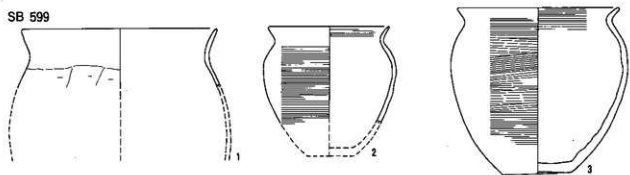

SB 600

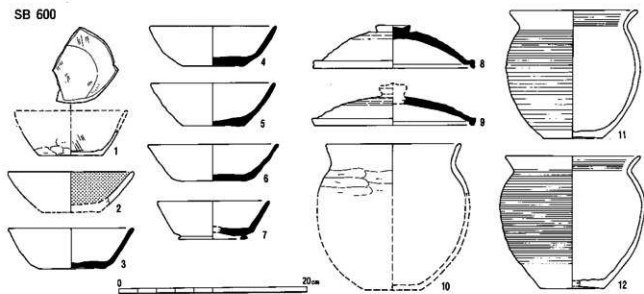

SB 601

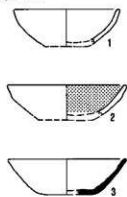

SB 602

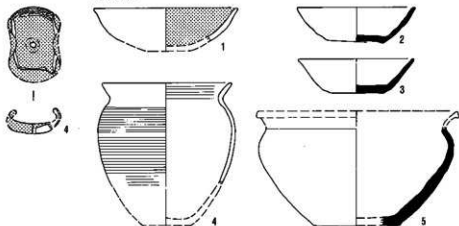

SB 605

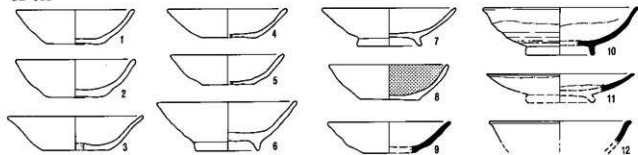

SB 606

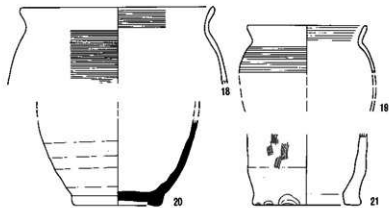
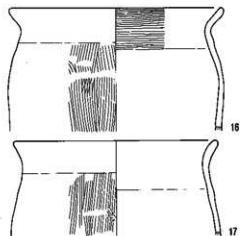
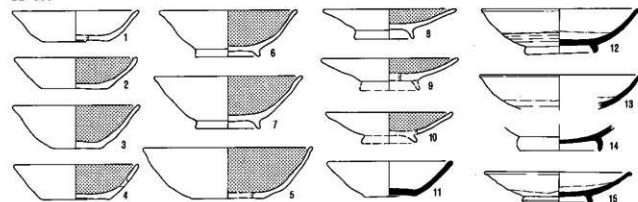

SB 607

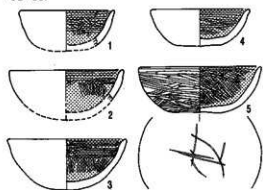

SB 609

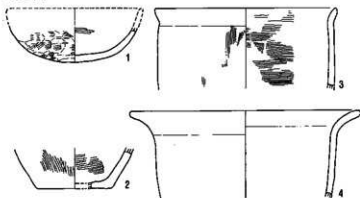

SB 610

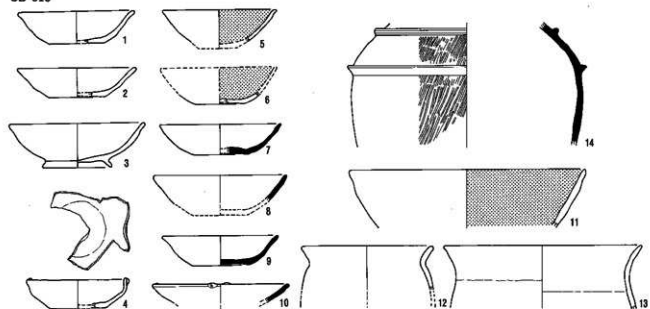

SB 611

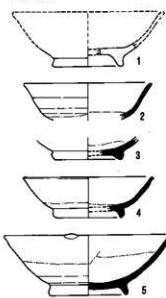

SB 612

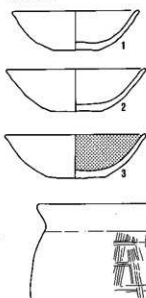

SB 615

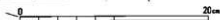
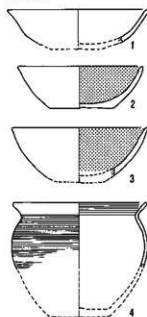

SB 614

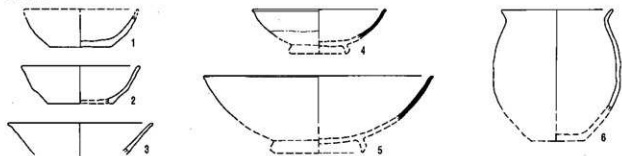

SB 616

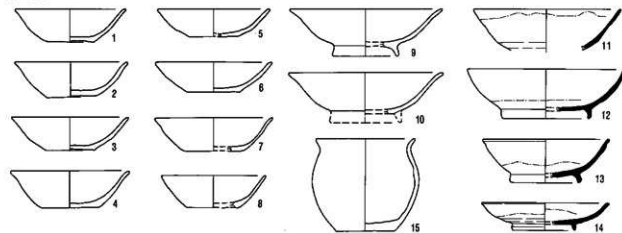

SB 617

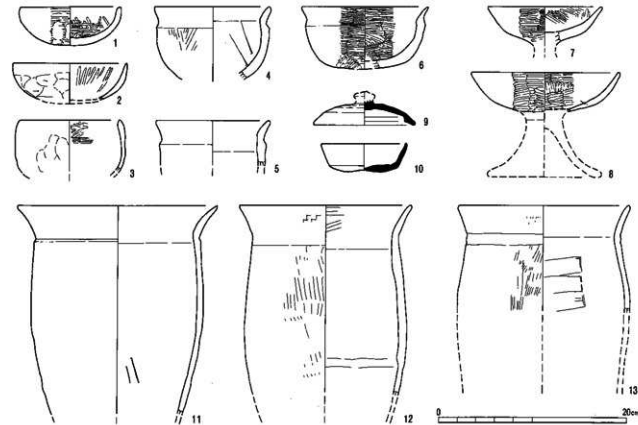

SB 618

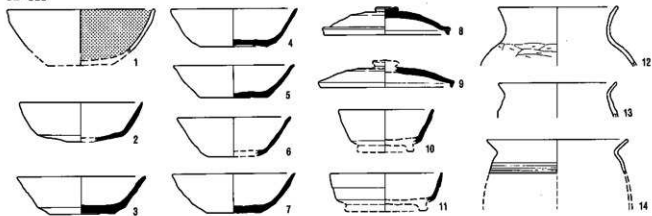

SB 619

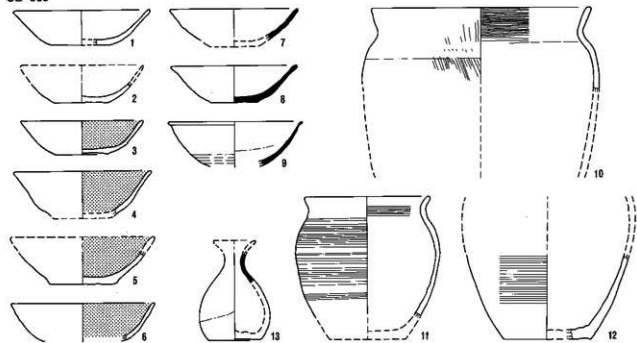

SB 620

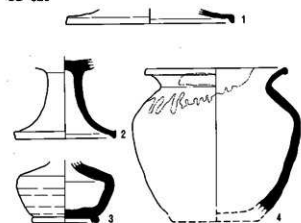

SB 621

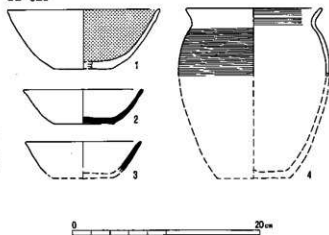

SB 623

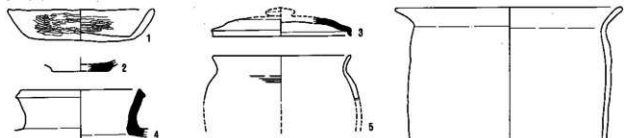

SB 624

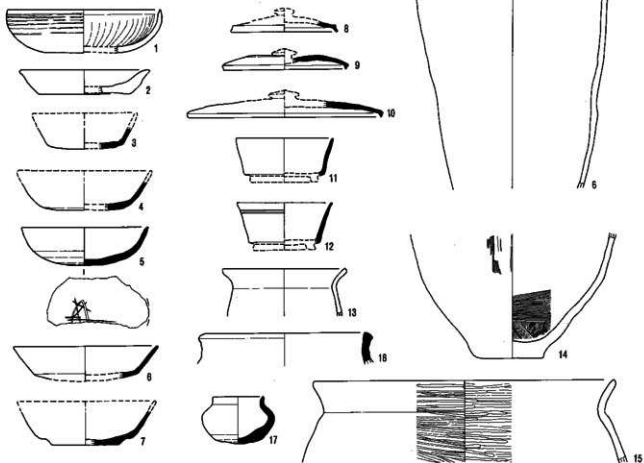

SB 625

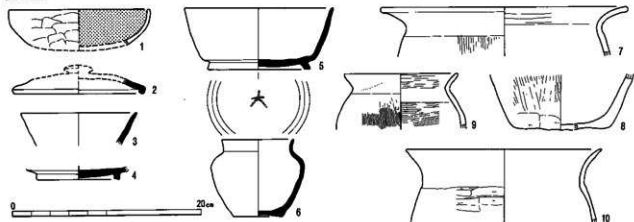

SB 625

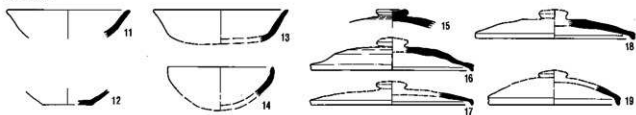

SB 626

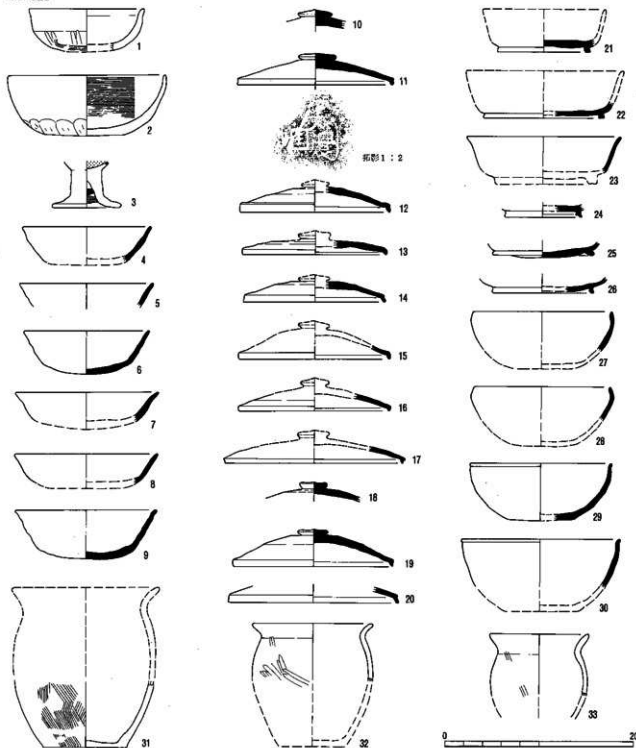

SB 626

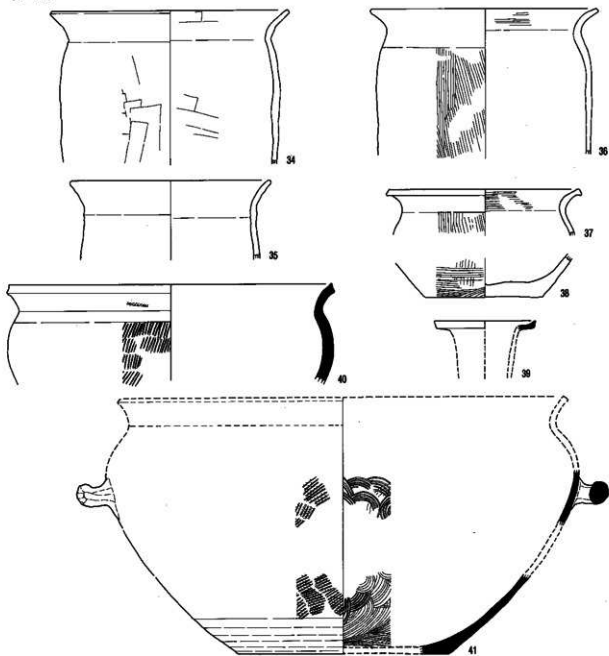

SB 627

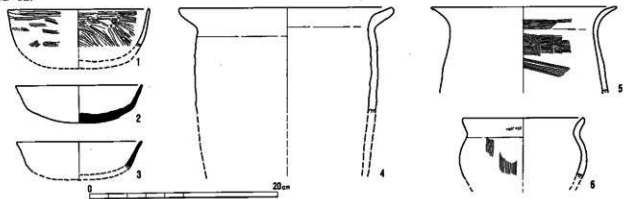

SB 627

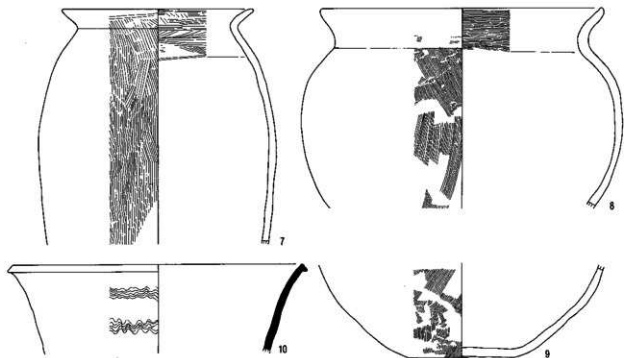

SB 628

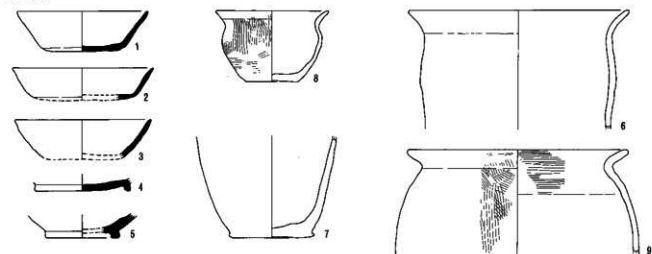

SB 629

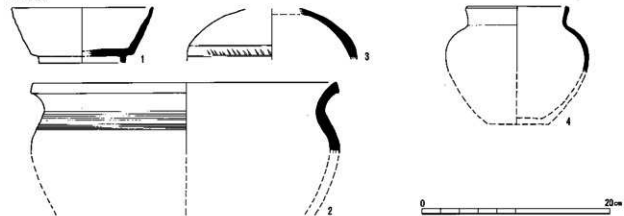

SB 633

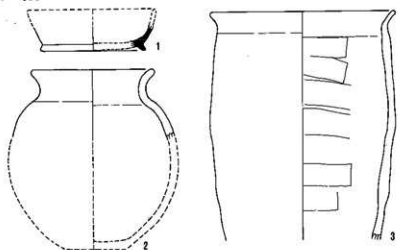

SB 635



SB 634



SB 636

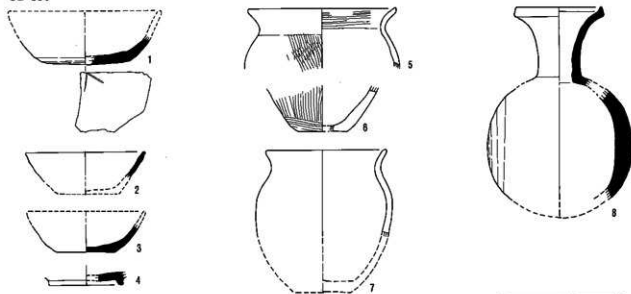

SB 637

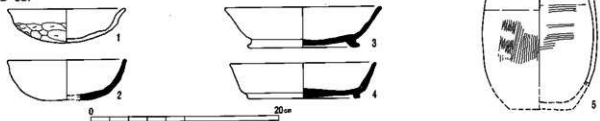

SB 637

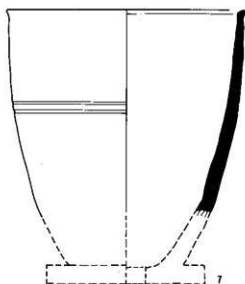
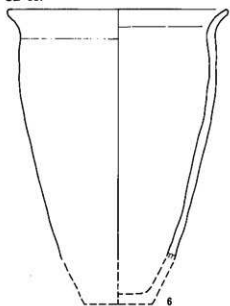

SB 640

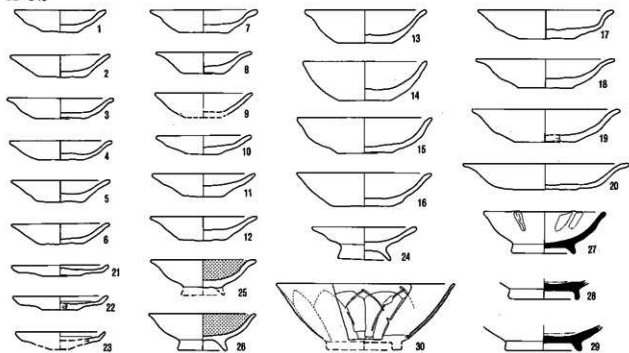

ST 3



ST 16



ST 50



ST 12



ST 11



ST 34

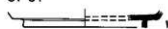

0 20 cm

ST 25



ST 539

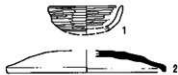

ST 543



ST 27



ST 538

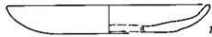

ST 549

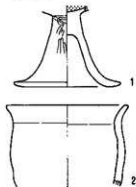

ST 547

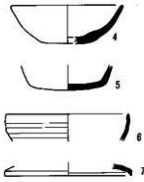
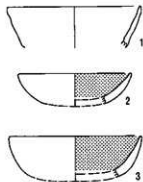

ST 550

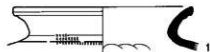

ST 548

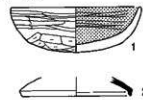

ST 552

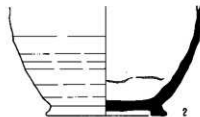
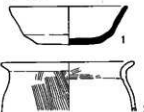

ST 553



ST 551

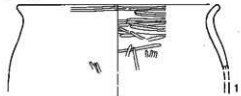

ST 566

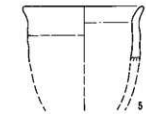
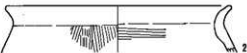
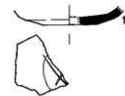

ST 572



ST 576

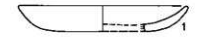

SD 27

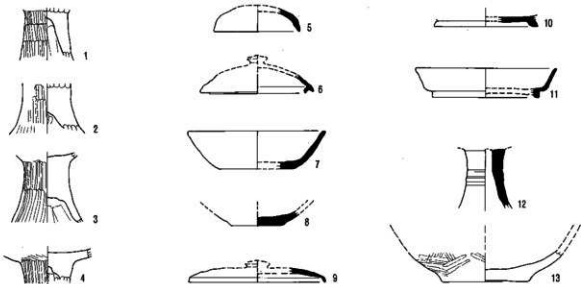

SD 18

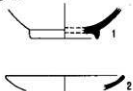

SD 521

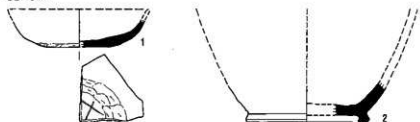

SK 176

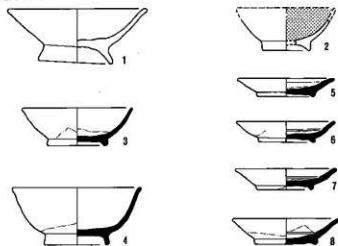

SK 193



SK 514

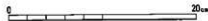
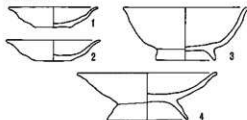

SK 1069

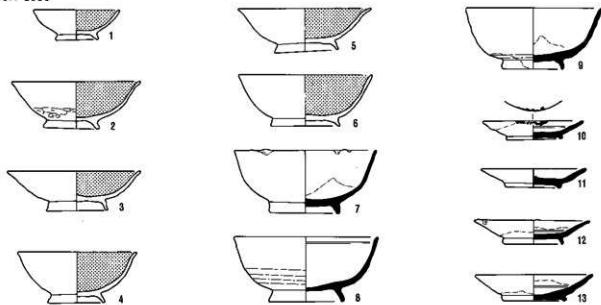

SK 349

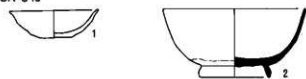

SK 11

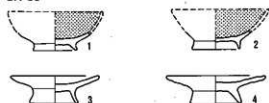

SK 114



SK 348

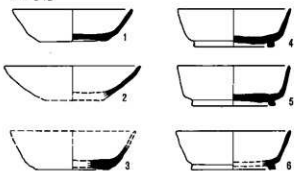

SK 339

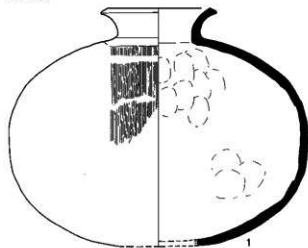

SK 350

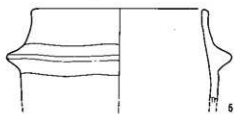

SK 548

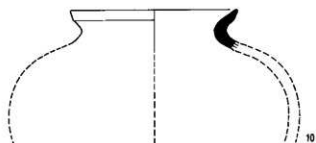
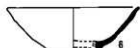
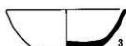

SK 522



SK 1071

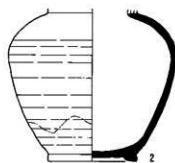

NR 4

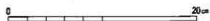
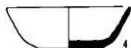

SD 524

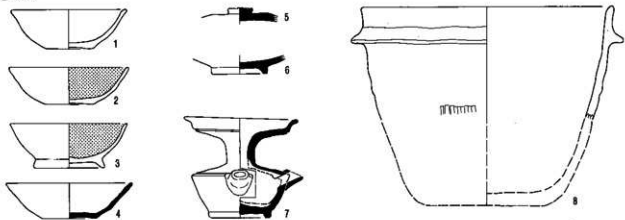

南部A・B区

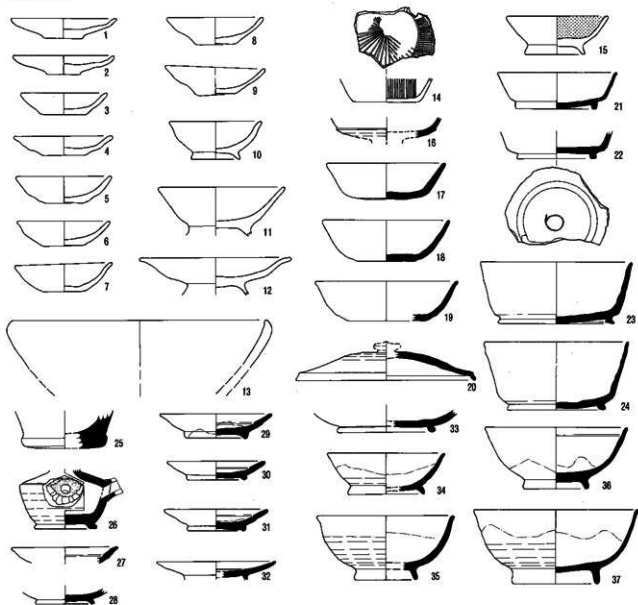

0 20cm

南部A·B区

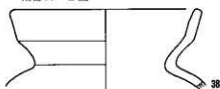

南部C区



北部D区

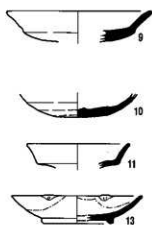
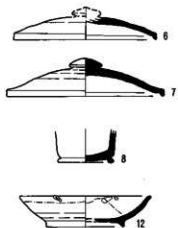
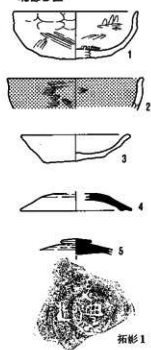

北部E区

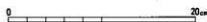
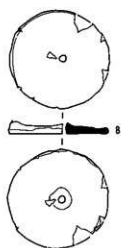
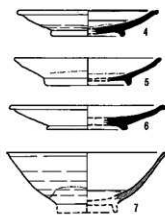
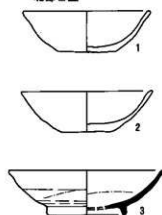

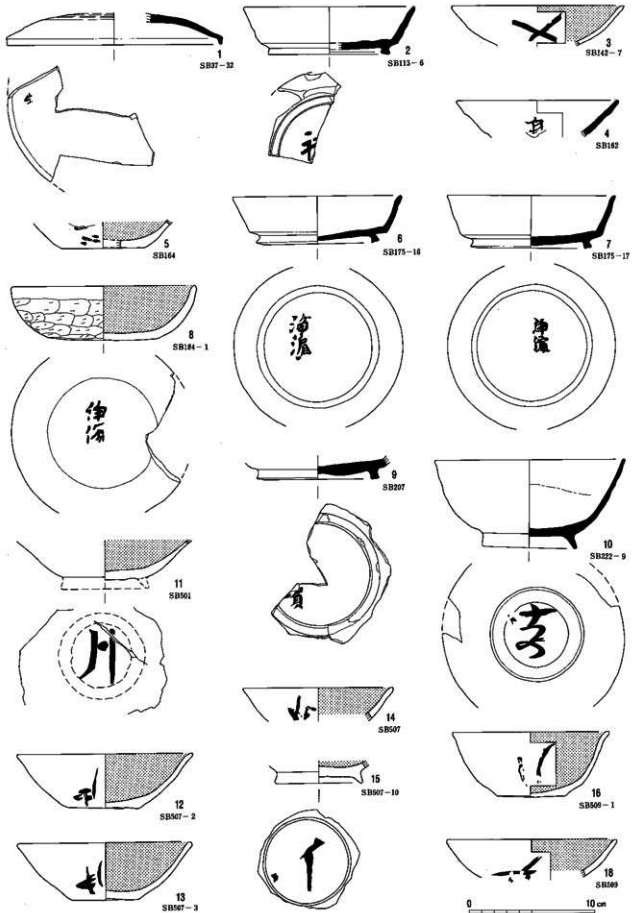

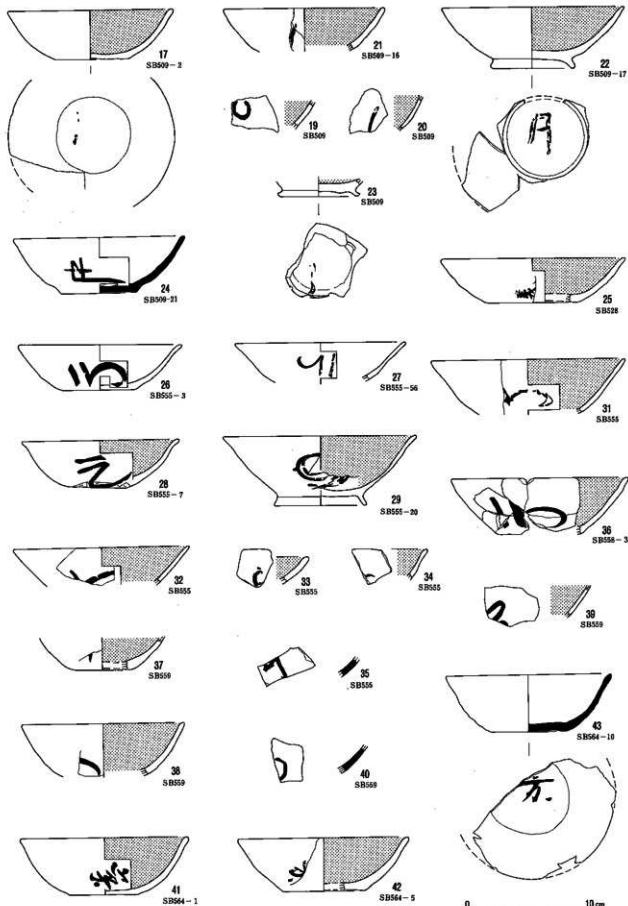

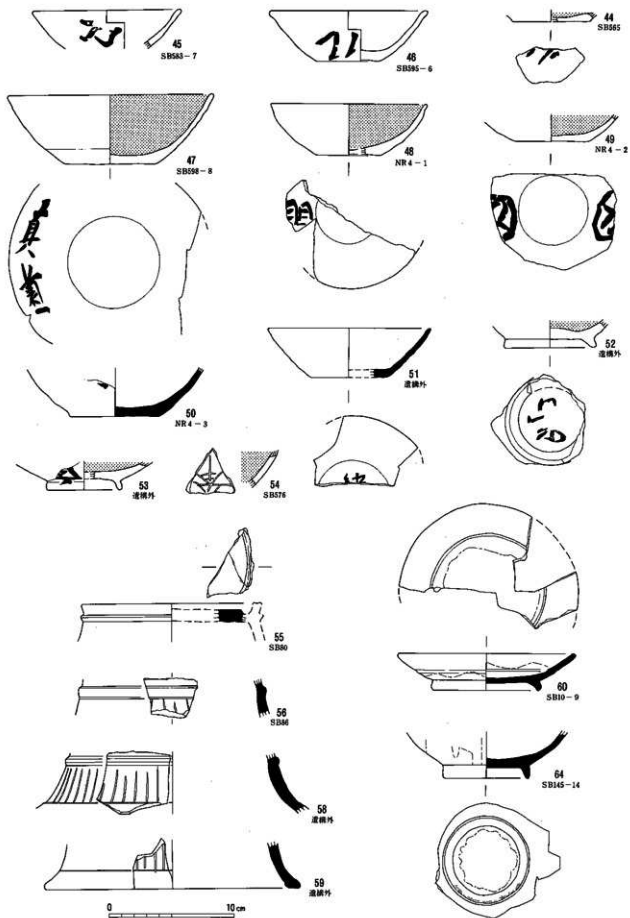

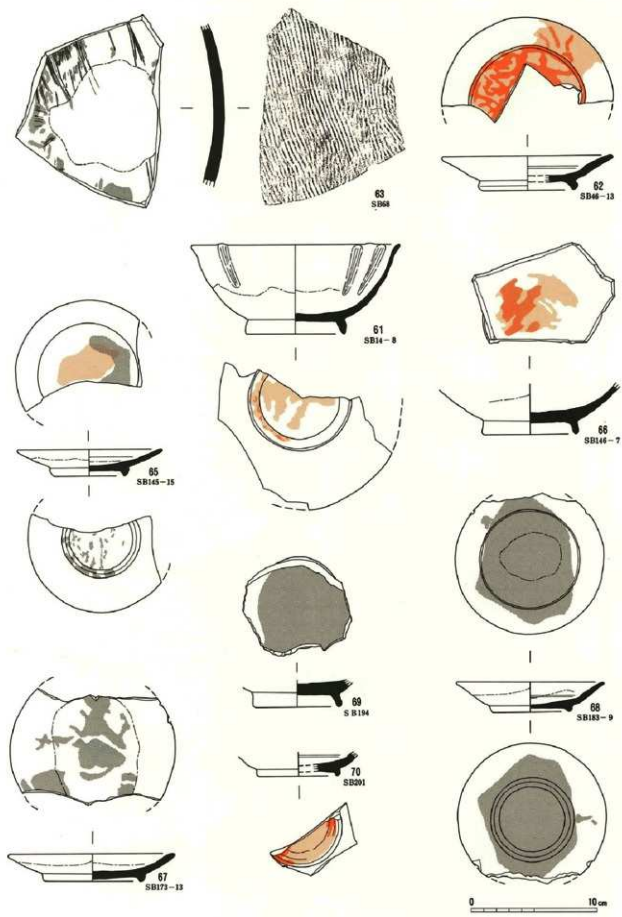

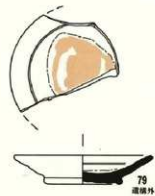
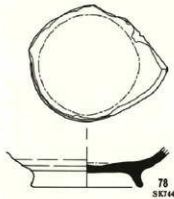
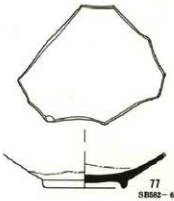
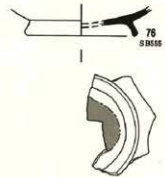
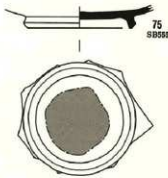
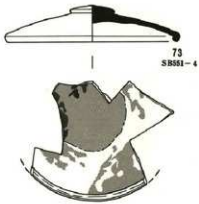
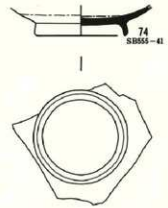
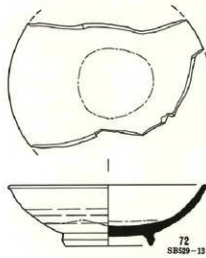
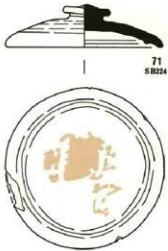

0 10 cm

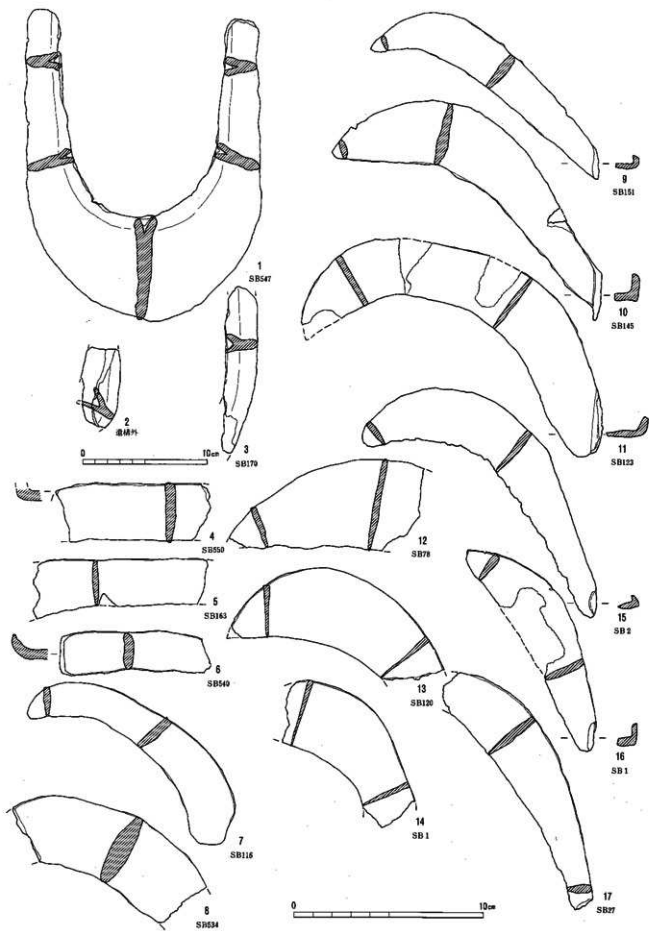

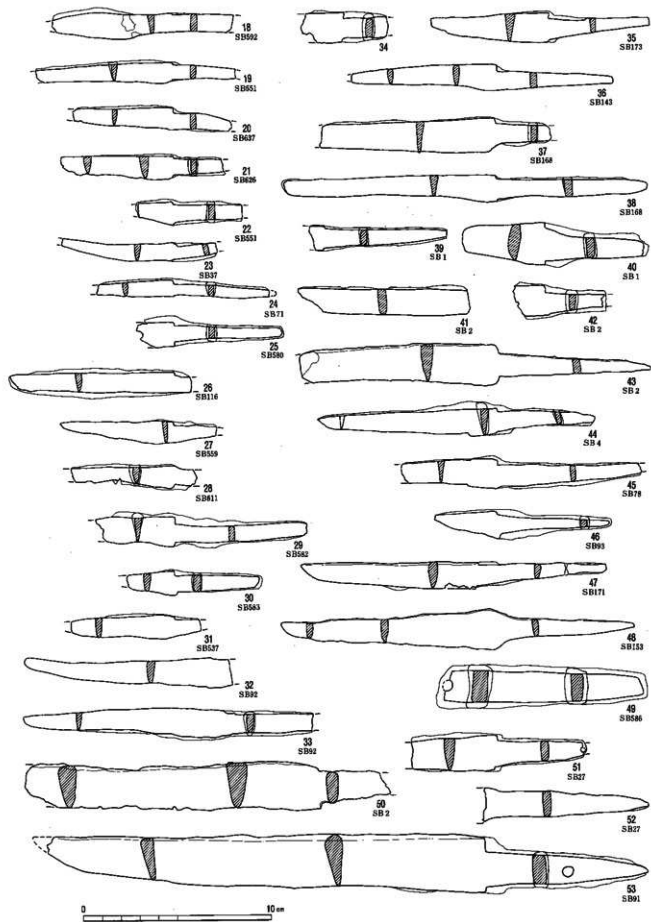

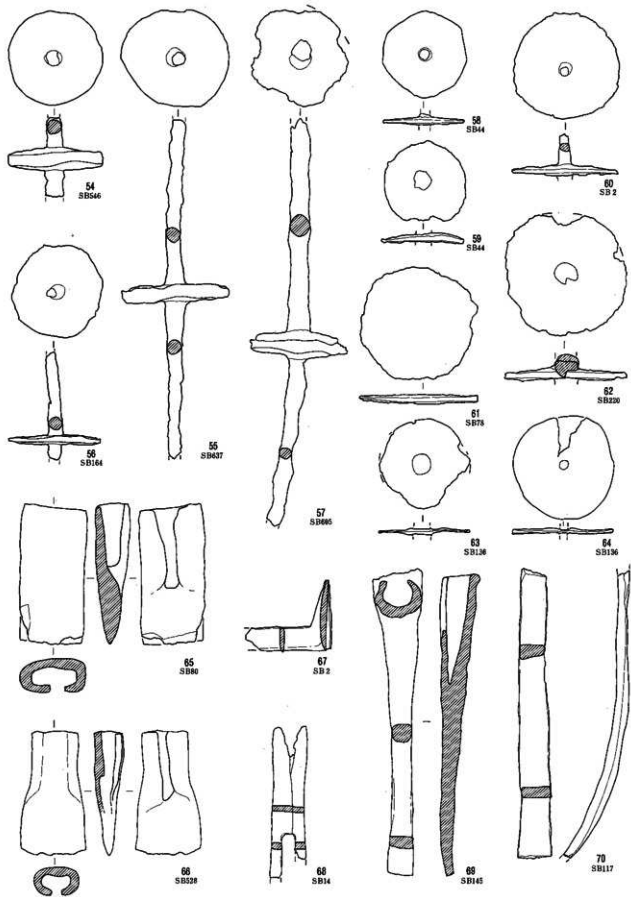

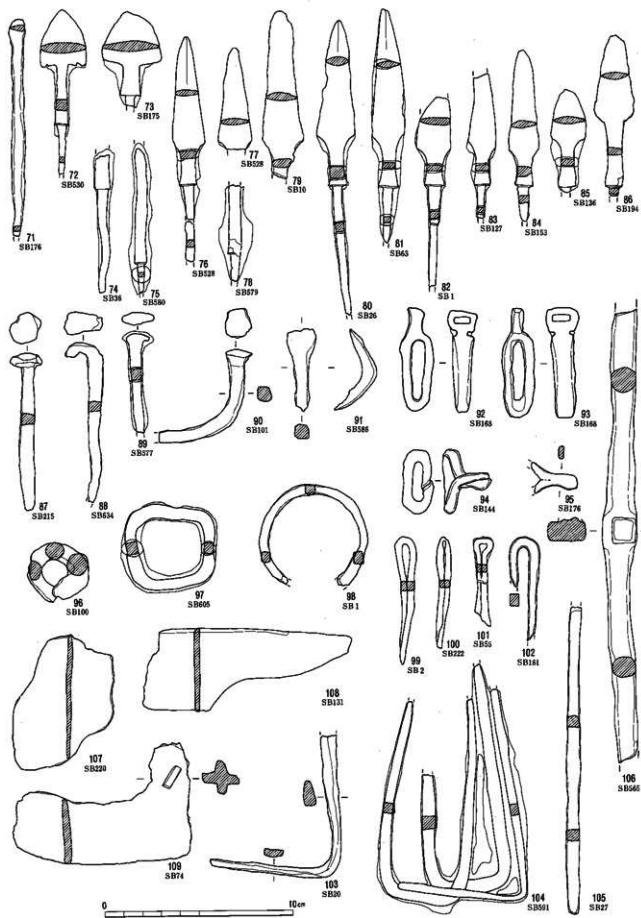

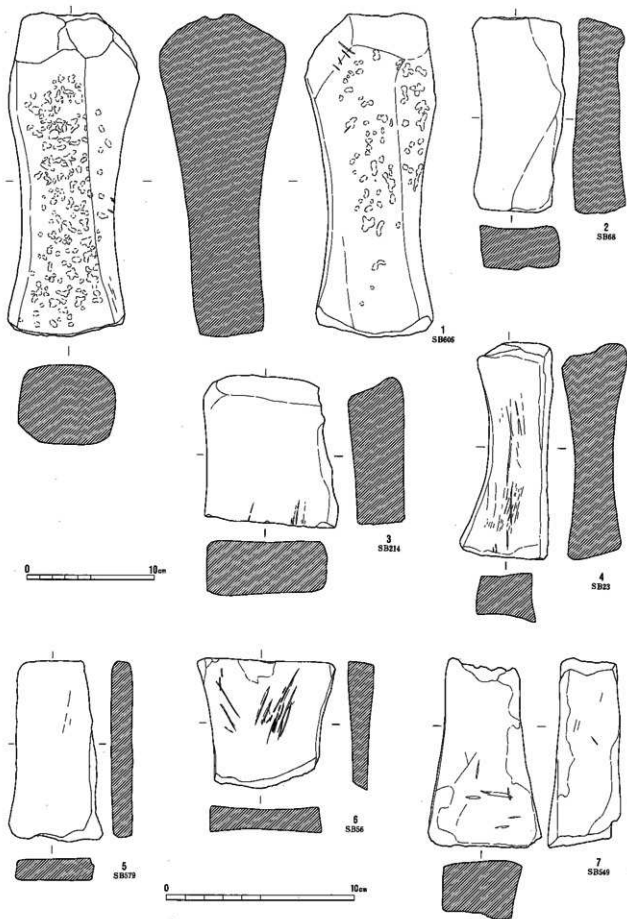

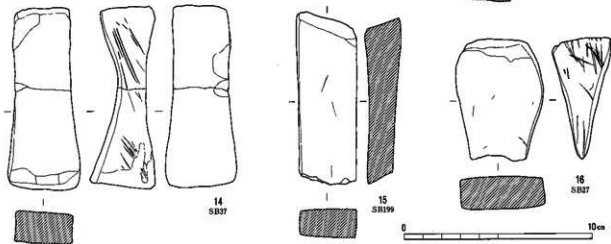
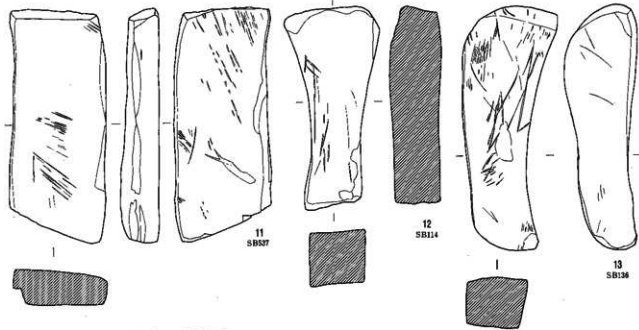
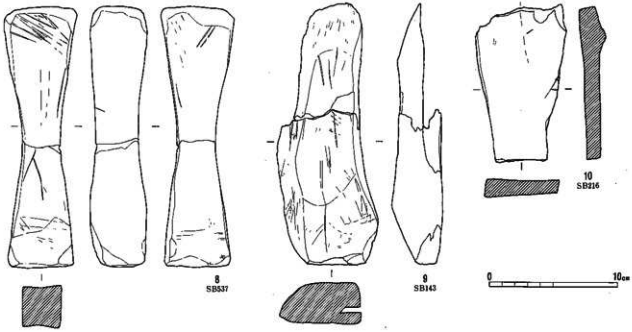

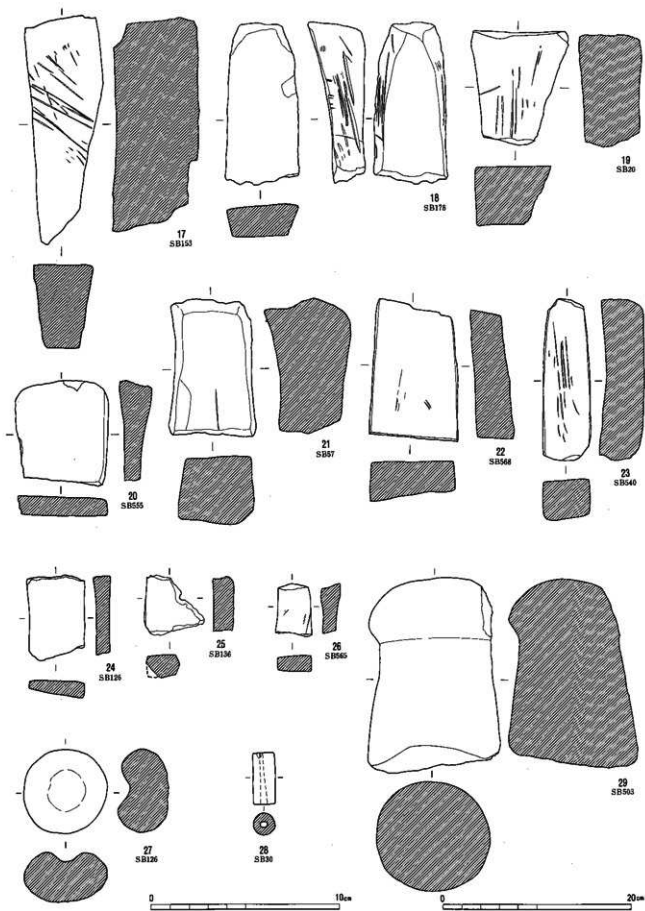

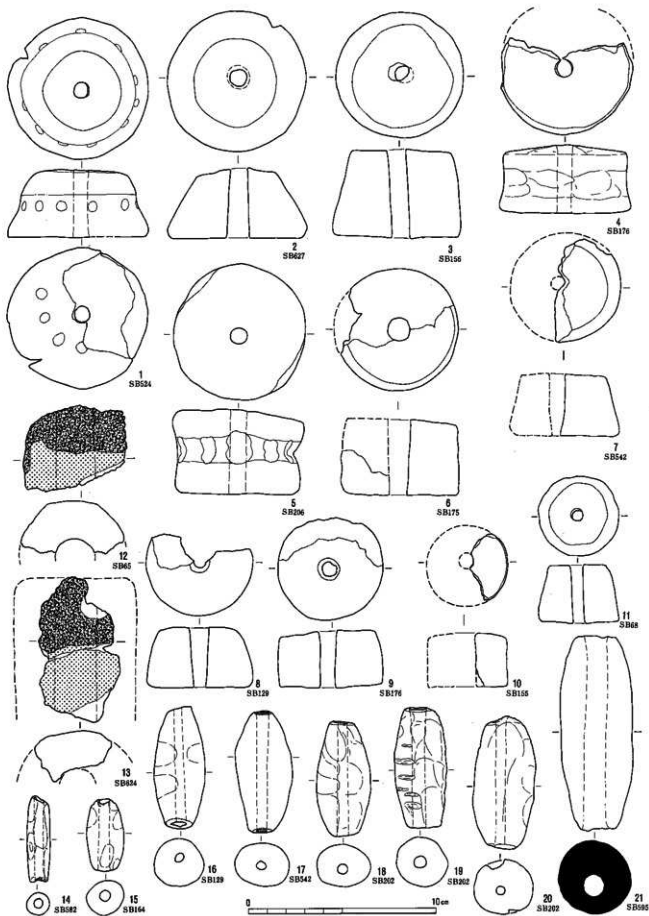

SB 631

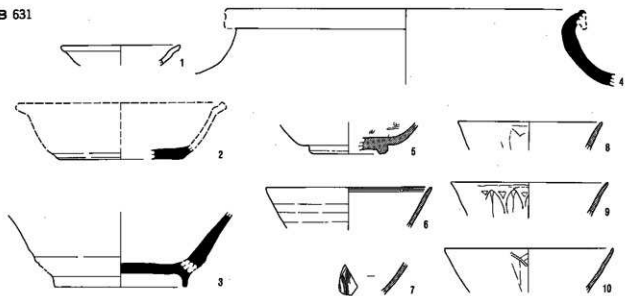

その他

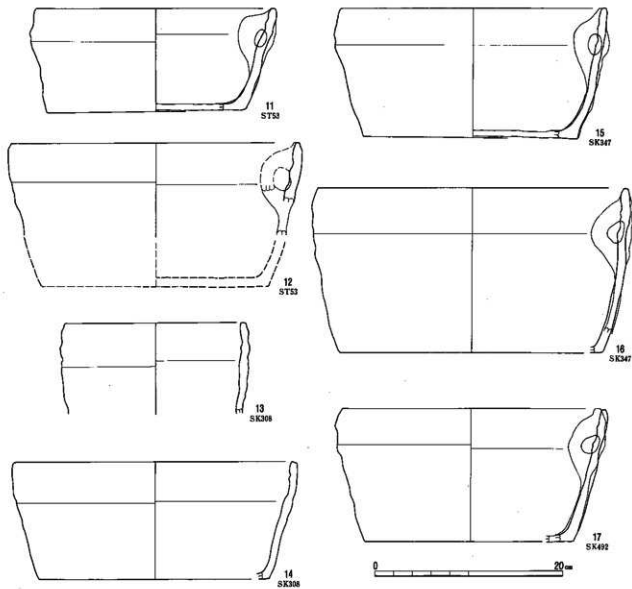

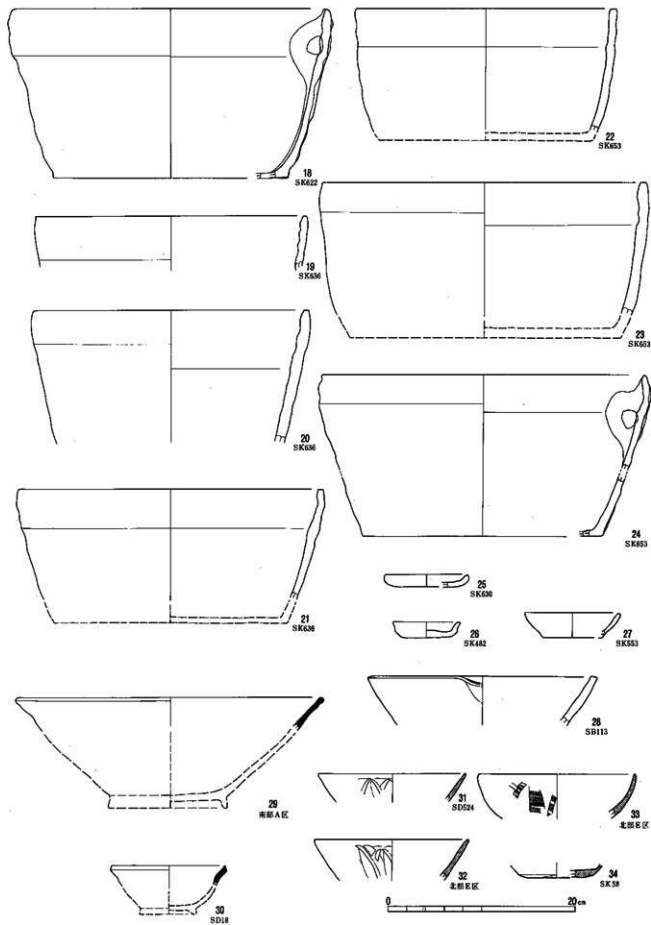

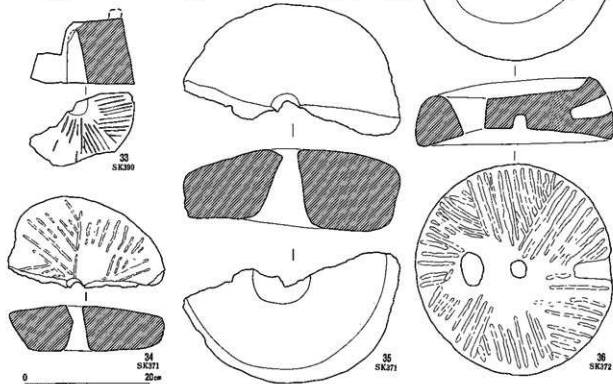
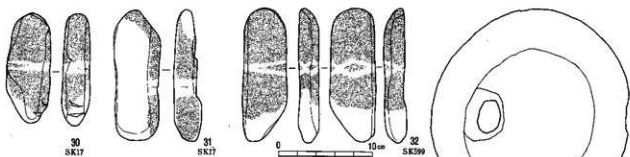
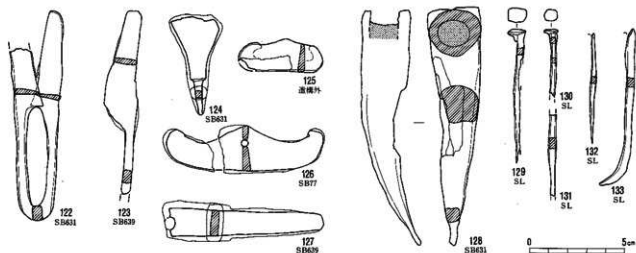

写 真 图 版
(P L)



1. 南栗遺跡
2. 北栗遺跡
3. 三の宮遺跡
4. 下神遺跡
5. 中二子遺跡
6. 下二子遺跡
7. くまのかわ遺跡
8. 南荒井遺跡
9. 大久保工業団地遺跡
10. 概海渡遺跡
11. 和田町遺跡
12. 和田山の神遺跡
13. 太子堂遺跡
14. 川西遺跡
15. 秋葉原遺跡
16. 高岡中学校遺跡
17. 新村遺跡
18. 高松遺跡
19. 南中遺跡



南部調査区遠景
(南から)



南部調査区遠景
(北から)



北部調査区近景
(北から)

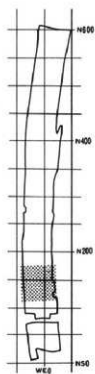

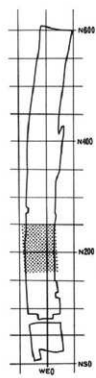

南部調査区遺構分布



北部調査区遺構分布

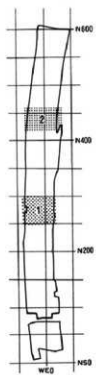

調査区遺構分布
(中央付近)

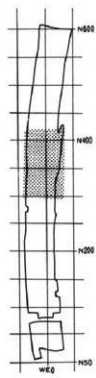

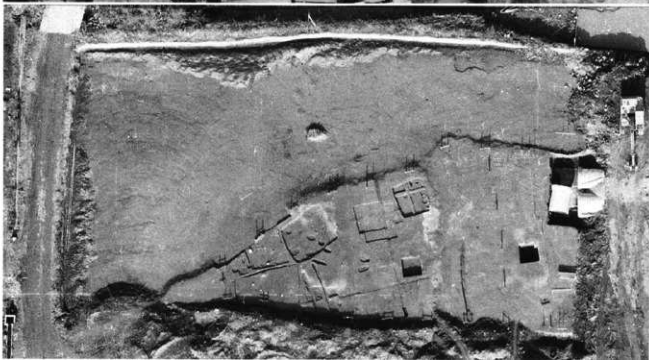
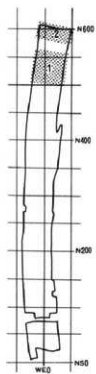

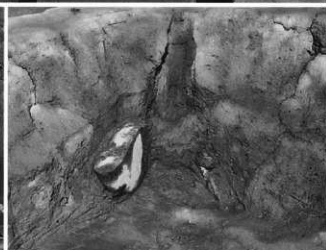
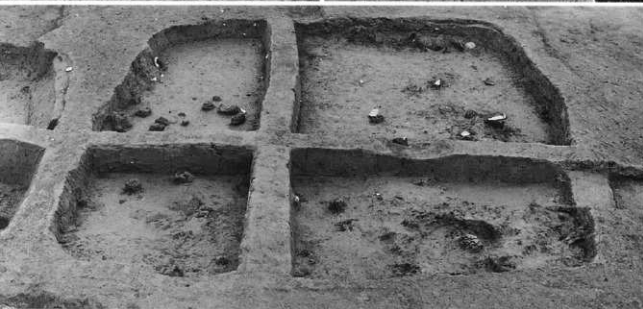

SB1 (西から)

左, SB1 カマド遺物
出土状況 (西から)右, SB4 カマド
(西から)左, SB12カマド
右, SB12煙道壁出し
遺物出土状況

SB2 (西から)



SB37 (西から)



SB55遺物出土状況
(西から)

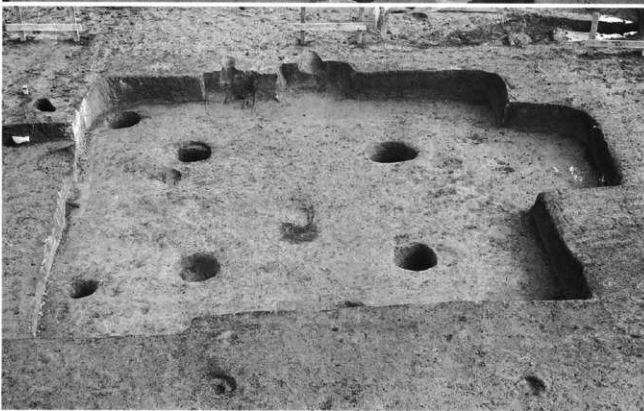

SB58 (西から)



SB68 (西から)

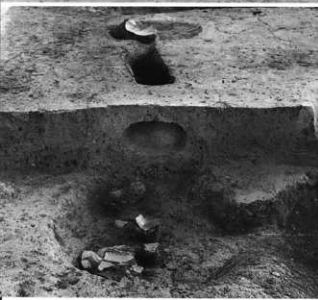

SB71 (西から)

左, SB68北カマド
(西から)右, SB72南カマド
(西から)左, SB80カマド
(西から)右, 同カマド
(西から)

古代の遺構



左, SB73 (西から)
右, SB73埋出し遺物
出土状況(北から)

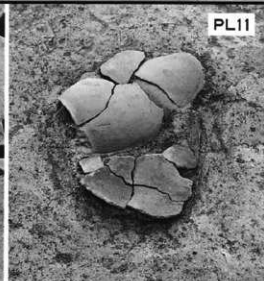

SB91 (西から)



左, SB91刀子
出土状況(南から)



右, SB91カマド
(西から)



左, SB93カマド
(西から)

右, SB95カマド
(西から)





SB97 (西から)



SB100 (西から)

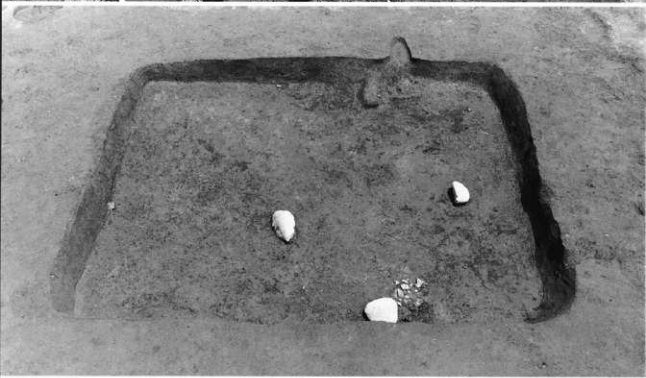

SB113 (西から)

左. SB114カマド
(西から)右. SB128カマド
(西から)



SB129 (西から)



SB136 (西から)



左, SB136カマド
(西から)



右, SB141カマド
(西から)