

上信越自動車道
埋蔵文化財発掘調査報告書 6

—長野市内 その4—

松原遺跡

古代・中世

図版編

2000

日本道路公団
長野県教育委員会
長野県埋蔵文化財センター

上信越自動車道
埋蔵文化財発掘調査報告書 6

——長野市内 その4——

松 原 遺 跡

古代・中世

図 版 編

2 0 0 0

日 本 道 路 公 団
長 野 県 教 育 委 員 会
長 野 県 埋 蔵 文 化 財 セ ン タ ー

例 言

1. 本書は長野県長野市松代町東寺尾字北堀他に所在する松原遺跡の発掘調査報告書のうち、古代・中世についての調査結果を取録したものである。
2. 本書は『上信越自動車道埋蔵文化財発掘調査報告書6 長野市内 その4 松原遺跡—古代・中世—』全2分冊のうち、第2分冊 図版編である。
3. 調査は上信越自動車道建設工事に伴う事前の記録保存のための調査として、長野県教育委員会の委託を受け、県教育委員会の指導のもとに、財団法人長野県埋蔵文化財センター及び財団法人長野県文化振興事業団長野県埋蔵文化財センターが実施したものである。
4. 調査にあたっては以下の関係機関のご協力を得た。
長野県教育委員会文化財生涯学習課 日本道路公団名古屋建設局 日本道路公団東京第二建設局
長野市教育委員会 JAグリーン長野農協
5. 発掘調査から本書の刊行に至るまで多くの方々のご指導を賜り、ご協力を得た。第1分冊 本文編にお名前を掲げさせていただくが、厚く感謝申し上げたい。
6. 本遺跡の概要については、すでに当センター発行の『長野県埋蔵文化財センター年報』6～15で報告している。それらと本書での記述に若干の相違があるが、古代・中世に関してのものは、本書をもって最終的な報告とする。
7. 調査記録、出土遺物は報告書刊行後、長野県立歴史館に移管し保管する。
8. 編集は上田典男が行い、百瀬長秀が全体を校閲した。

凡 例

1. 本書に掲載した実測図等の縮尺は、特に断りのある場合を除いて下記のように統一してある。

(1) 遺構実測図

全体図	1 : 3000	遺構配置図	1 : 400
遺構実測図	1 : 120	住居址重複関係図	1 : 120

(2) 遺物実測図

土器・焼物・円筒形土製品	1 : 4	台石・凹石	1 : 4
土錘・用途不明土製品・文字関係資料	1 : 3	砥石・軽石製品	1 : 3
上製紡錘車・ミニチュア土器	1 : 2	石帯・石製紡錘車	1 : 2
金属製品・鋳造関係資料	1 : 3	石臼	1 : 6
銭貨拓影図	2 : 3	石塔類	1 : 8
鍛冶関係資料	1 : 4	骨角牙製品	1 : 2

(3) 遺構写真

縮尺不統一

(4) 遺物写真

土器（食膳具・小形甕）	1 : 3	土製品	1 : 3	石塔類	1 : 6
土器（上記以外の煮炊具・貯蔵具）	1 : 4	金属製品	1 : 2	文字関係資料	1 : 1

上記以外は実測図の縮尺に対応している。

2. 実測図中のスクリーントーンは、特に断りのある場合を除いて以下の事項を表している。

(1) 遺構実測図

- ①=被熱痕跡及び焼土堆積 ②=焼土・炭化物の分布範囲 ③=炭化物の分布範囲
 ④=灰の分布範囲 ⑤=柱痕跡 ⑥=近世以降の暗渠
 ⑦=近代以降の暗渠 ⑧=攪乱・トレンチ・後世の遺構などに破壊されている部分



(2) 遺物実測図

古代土器

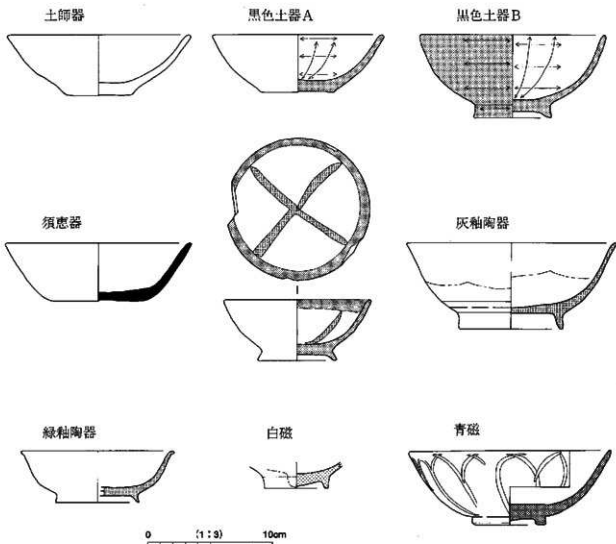

文字関係資料

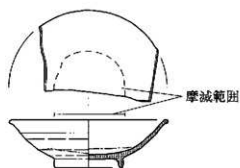

中世焼物

実測図の断面を、土師質＝白抜き、須恵質＝黒塗りで表す他、瓦質、陶器、磁器は以下のスクリーントーンで表した。また、国産陶磁器の釉薬の種類については以下のスクリーントーンで表した。ただし、灰釉については白抜きにした。なお、白磁・青磁については古代と同様に表した。



下記の遺物についてはそれぞれ以下のスクリーントーンで当該事項を表現している。

石器・石製品



金属製品



骨角牙製品



木製品



*各遺物の欠損及び剥落部、すずの付着範囲については、木製品を除いて共通のスクリーントーンで表した。



图 版 目 次

图版 1	遺跡全体図 (1:3000)	图版39	遺構実測図24
图版 2	遺構配置図割付図	图版40	遺構実測図25
图版 3	遺構配置図 1 (1:400)	图版41	遺構実測図26
图版 4	遺構配置図 2 (1:400)	图版42	遺構実測図27
图版 5	遺構配置図 3 (1:400)	图版43	遺構実測図28
图版 6	遺構配置図 4 (1:400)	图版44	遺構実測図29
图版 7	遺構配置図 5 (1:400)	图版45	遺構実測図30
图版 8	遺構配置図 6 (1:400)	图版46	遺構実測図31
图版 9	遺構配置図 7 (1:400)	图版47	遺構実測図32
图版10	遺構配置図 8 (1:400)	图版48	遺構実測図33
图版11	遺構配置図 9 (1:400)	图版49	遺構実測図34
图版12	遺構配置図10 (1:400)	图版50	遺構実測図35
图版13	遺構配置図11 (1:400)	图版51	遺構実測図36
图版14	遺構配置図12 (1:400)	图版52	遺構実測図37
图版15	1:120遺構実測図割付図	图版53	遺構実測図38
图版16	遺構実測図 1	图版54	遺構実測図39
图版17	遺構実測図 2	图版55	遺構実測図40
图版18	遺構実測図 3	图版56	遺構実測図41
图版19	遺構実測図 4	图版57	遺構実測図42
图版20	遺構実測図 5	图版58	遺構実測図43
图版21	遺構実測図 6	图版59	遺構実測図44
图版22	遺構実測図 7	图版60	遺構実測図45
图版23	遺構実測図 8	图版61	遺構実測図46
图版24	遺構実測図 9	图版62	遺構実測図47
图版25	遺構実測図10	图版63	遺構実測図48
图版26	遺構実測図11	图版64	遺構実測図49
图版27	遺構実測図12	图版65	遺構実測図50
图版28	遺構実測図13	图版66	遺構実測図51
图版29	遺構実測図14	图版67	遺構実測図52
图版30	遺構実測図15	图版68	遺構実測図53
图版31	遺構実測図16	图版69	遺構実測図54
图版32	遺構実測図17	图版70	遺構実測図55
图版33	遺構実測図18	图版71	遺構実測図56
图版34	遺構実測図19	图版72	遺構実測図57
图版35	遺構実測図20	图版73	遺構実測図58
图版36	遺構実測図21	图版74	遺構実測図59
图版37	遺構実測図22	图版75	遺構実測図60
图版38	遺構実測図23	图版76	遺構実測図61

- 圖版77 遺構實測圖62
- 圖版78 遺構實測圖63
- 圖版79 遺構實測圖64
- 圖版80 遺構實測圖65
- 圖版81 遺構實測圖66
- 圖版82 遺構實測圖67
- 圖版83 遺構實測圖68
- 圖版84 遺構實測圖69
- 圖版85 遺構實測圖70
- 圖版86 遺構實測圖71
- 圖版87 遺構實測圖72
- 圖版88 遺構實測圖73
- 圖版89 遺構實測圖74
- 圖版90 遺構實測圖75
- 圖版91 遺構實測圖76
- 圖版92 遺構實測圖77
- 圖版93 遺構實測圖78
- 圖版94 遺構實測圖79
- 圖版95 遺構實測圖80
- 圖版96 遺構實測圖81
- 圖版97 遺構實測圖82
- 圖版98 遺構實測圖83
- 圖版99 遺構實測圖84
- 圖版100 遺構實測圖85
- 圖版101 遺構實測圖86
- 圖版102 遺構實測圖87
- 圖版103 遺構實測圖88
- 圖版104 遺構實測圖89
- 圖版105 遺構實測圖90
- 圖版106 遺構實測圖91
- 圖版107 遺構實測圖92
- 圖版108 竪穴住居址重複關係圖 1
- 圖版109 竪穴住居址重複關係圖 2
- 圖版110 竪穴住居址重複關係圖 3
- 圖版111 竪穴住居址重複關係圖 4
- 圖版112 竪穴住居址重複關係圖 5
- 圖版113 竪穴住居址重複關係圖 6
- 圖版114 竪穴住居址重複關係圖 7
- 圖版115 竪穴住居址重複關係圖 8
- 圖版116 竪穴住居址重複關係圖 9
- 圖版117 竪穴住居址重複關係圖10
- 圖版118 古代土器實測圖 1
- 圖版119 古代土器實測圖 2
- 圖版120 古代土器實測圖 3
- 圖版121 古代土器實測圖 4
- 圖版122 古代土器實測圖 5
- 圖版123 古代土器實測圖 6
- 圖版124 古代土器實測圖 7
- 圖版125 古代土器實測圖 8
- 圖版126 古代土器實測圖 9
- 圖版127 古代土器實測圖10
- 圖版128 古代土器實測圖11
- 圖版129 古代土器實測圖12
- 圖版130 古代土器實測圖13
- 圖版131 古代土器實測圖14
- 圖版132 古代土器實測圖15
- 圖版133 古代土器實測圖16
- 圖版134 古代土器實測圖17
- 圖版135 古代土器實測圖18
- 圖版136 古代土器實測圖19
- 圖版137 古代土器實測圖20
- 圖版138 古代土器實測圖21
- 圖版139 古代土器實測圖22
- 圖版140 古代土器實測圖23
- 圖版141 古代土器實測圖24
- 圖版142 古代土器實測圖25
- 圖版143 古代土器實測圖26
- 圖版144 古代土器實測圖27
- 圖版145 古代土器實測圖28
- 圖版146 古代土器實測圖29
- 圖版147 古代土器實測圖30
- 圖版148 古代土器實測圖31
- 圖版149 古代土器實測圖32
- 圖版150 古代土器實測圖33
- 圖版151 古代土器實測圖34
- 圖版152 古代土器實測圖35
- 圖版153 古代土器實測圖36
- 圖版154 古代土器實測圖37
- 圖版155 古代土器實測圖38
- 圖版156 古代土器實測圖39

- | | | | |
|-------|-----------|-------|------------|
| 图版157 | 古代土器实测图40 | 图版197 | 古代土器实测图80 |
| 图版158 | 古代土器实测图41 | 图版198 | 古代土器实测图81 |
| 图版159 | 古代土器实测图42 | 图版199 | 古代土器实测图82 |
| 图版160 | 古代土器实测图43 | 图版200 | 古代土器实测图83 |
| 图版161 | 古代土器实测图44 | 图版201 | 古代土器实测图84 |
| 图版162 | 古代土器实测图45 | 图版202 | 古代土器实测图85 |
| 图版163 | 古代土器实测图46 | 图版203 | 古代土器实测图86 |
| 图版164 | 古代土器实测图47 | 图版204 | 古代土器实测图87 |
| 图版165 | 古代土器实测图48 | 图版205 | 古代土器实测图88 |
| 图版166 | 古代土器实测图49 | 图版206 | 古代土器实测图89 |
| 图版167 | 古代土器实测图50 | 图版207 | 古代土器实测图90 |
| 图版168 | 古代土器实测图51 | 图版208 | 古代土器实测图91 |
| 图版169 | 古代土器实测图52 | 图版209 | 古代土器实测图92 |
| 图版170 | 古代土器实测图53 | 图版210 | 古代土器实测图93 |
| 图版171 | 古代土器实测图54 | 图版211 | 古代土器实测图94 |
| 图版172 | 古代土器实测图55 | 图版212 | 古代土器实测图95 |
| 图版173 | 古代土器实测图56 | 图版213 | 古代土器实测图96 |
| 图版174 | 古代土器实测图57 | 图版214 | 古代土器实测图97 |
| 图版175 | 古代土器实测图58 | 图版215 | 古代土器实测图98 |
| 图版176 | 古代土器实测图59 | 图版216 | 古代土器实测图99 |
| 图版177 | 古代土器实测图60 | 图版217 | 古代土器实测图100 |
| 图版178 | 古代土器实测图61 | 图版218 | 古代土器实测图101 |
| 图版179 | 古代土器实测图62 | 图版219 | 古代土器实测图102 |
| 图版180 | 古代土器实测图63 | 图版220 | 古代土器实测图103 |
| 图版181 | 古代土器实测图64 | 图版221 | 古代土器实测图104 |
| 图版182 | 古代土器实测图65 | 图版222 | 古代土器实测图105 |
| 图版183 | 古代土器实测图66 | 图版223 | 古代土器实测图106 |
| 图版184 | 古代土器实测图67 | 图版224 | 古代土器实测图107 |
| 图版185 | 古代土器实测图68 | 图版225 | 古代土器实测图108 |
| 图版186 | 古代土器实测图69 | 图版226 | 古代土器实测图109 |
| 图版187 | 古代土器实测图70 | 图版227 | 古代土器实测图110 |
| 图版188 | 古代土器实测图71 | 图版228 | 古代土器实测图111 |
| 图版189 | 古代土器实测图72 | 图版229 | 古代土器实测图112 |
| 图版190 | 古代土器实测图73 | 图版230 | 古代土器实测图113 |
| 图版191 | 古代土器实测图74 | 图版231 | 古代土器实测图114 |
| 图版192 | 古代土器实测图75 | 图版232 | 古代土器实测图115 |
| 图版193 | 古代土器实测图76 | 图版233 | 古代土器实测图116 |
| 图版194 | 古代土器实测图77 | 图版234 | 古代土器实测图117 |
| 图版195 | 古代土器实测图78 | 图版235 | 古代土器实测图118 |
| 图版196 | 古代土器实测图79 | 图版236 | 古代土器实测图119 |

- 圖版237 古代土器実測圖120
- 圖版238 古代土器実測圖121
- 圖版239 古代土器実測圖122
- 圖版240 古代土器実測圖123
- 圖版241 古代土器実測圖124
- 圖版242 古代土器実測圖125
- 圖版243 古代土器実測圖126
- 圖版244 古代土器実測圖127
- 圖版245 古代土器実測圖128
- 圖版246 古代土製品実測圖1
- 圖版247 古代土製品実測圖2
- 圖版248 古代土製品実測圖3
- 圖版249 古代土製品実測圖4
- 圖版250 古代土製品実測圖5
- 圖版251 古代石器・石製品実測圖1
- 圖版252 古代石器・石製品実測圖2
- 圖版253 古代石器・石製品実測圖3
- 圖版254 古代石器・石製品実測圖4
- 圖版255 古代石器・石製品実測圖5
- 圖版256 古代石器・石製品実測圖6
- 圖版257 古代石器・石製品実測圖7
- 圖版258 古代石器・石製品実測圖8
- 圖版259 古代石器・石製品実測圖9
- 圖版260 古代石器・石製品実測圖10
- 圖版261 古代石器・石製品実測圖11
- 圖版262 古代金屬製品実測圖1
- 圖版263 古代金屬製品実測圖2
- 圖版264 古代金屬製品実測圖3
- 圖版265 古代金屬製品実測圖4
- 圖版266 古代金屬製品実測圖5
- 圖版267 古代金屬製品実測圖6
- 圖版268 古代金屬製品実測圖7
- 圖版269 古代金屬製品実測圖8
- 圖版270 古代骨角牙製品実測圖1
- 圖版271 古代骨角牙製品実測圖2
- 圖版272 古代骨角牙製品実測圖3
- 圖版273 古代骨角牙製品実測圖4
- 圖版274 古代骨角牙製品実測圖5
- 圖版275 古代木製品実測圖1
- 圖版276 古代木製品実測圖2
- 圖版277 古代木製品実測圖3
- 圖版278 古代木製品実測圖4
- 圖版279 古代木製品実測圖5
- 圖版280 古代木製品実測圖6
- 圖版281 古代木製品実測圖7
- 圖版282 古代木製品実測圖8
- 圖版283 古代木製品実測圖9
- 圖版284 古代木製品実測圖10
- 圖版285 古代木製品実測圖11
- 圖版286 古代木製品実測圖12
- 圖版287 古代木製品実測圖13
- 圖版288 古代木製品実測圖14
- 圖版289 古代木製品実測圖15
- 圖版290 古代木製品実測圖16
- 圖版291 古代木製品実測圖17
- 圖版292 古代鍛冶・鑄造關係資料1
- 圖版293 古代鍛冶・鑄造關係資料2
- 圖版294 古代鍛冶・鑄造關係資料3
- 圖版295 古代鍛冶・鑄造關係資料4
- 圖版296 古代鍛冶・鑄造關係資料5
- 圖版297 古代鍛冶・鑄造關係資料6
- 圖版298 古代鍛冶・鑄造關係資料7
- 圖版299 古代文字關係資料1
- 圖版300 古代文字關係資料2
- 圖版301 古代文字關係資料3
- 圖版302 古代文字關係資料4
- 圖版303 古代文字關係資料5
- 圖版304 古代文字關係資料6
- 圖版305 古代文字關係資料7
- 圖版306 古代文字關係資料8
- 圖版307 古代文字關係資料9
- 圖版308 古代文字關係資料10
- 圖版309 古代文字關係資料11
- 圖版310 古代文字關係資料12
- 圖版311 古代文字關係資料13
- 圖版312 古代文字關係資料14
- 圖版313 古代文字關係資料15
- 圖版314 古代文字關係資料16
- 圖版315 古代文字關係資料17
- 圖版316 中世雜物実測圖1

图版317	中世烧物实测图 2	图版328	中世石塔類实测图 3
图版318	中世烧物实测图 3	图版329	中世石塔類实测图 4
图版319	中世烧物实测图 4	图版330	中世石塔類实测图 5
图版320	中世烧物实测图 5	图版331	中世金屬製品实测图 1
图版321	中世烧物实测图 6	图版332	中世金屬製品实测图 2
图版322	中世石器・石製品实测图 1	图版333	中世金屬製品实测图 3
图版323	中世石器・石製品实测图 2	图版334	中世木製品实测图 1
图版324	中世石器・石製品实测图 3	图版335	中世木製品实测图 2
图版325	中世石器・石製品实测图 4	图版336	中世木製品实测图 3
图版326	中世石塔類实测图 1	图版337	中世木製品实测图 4
图版327	中世石塔類实测图 2		

写真图版目次

PL 1	遺跡上空空中写真	PL 25	古代土器 2
PL 2	遺跡遠景・基本階序	PL 26	古代土器 3
PL 3	松原 1 号墳 (全景・石室内)	PL 27	古代土器 4
PL 4	松原 1 号墳 (墳丘)	PL 28	古代土器 5
PL 5	松原 1 号墳 (墳丘・遺物出土状況)	PL 29	古代土器 6
PL 6	松原 2・3 号墳	PL 30	古代土器 7
PL 7	松原 1 号墳出土土器 1	PL 31	古代土器 8
PL 8	松原 1 号墳山土土器 2	PL 32	古代土器 9
PL 9	松原 1 号墳出土金屬製品 1	PL 33	古代土器 10
PL 10	松原 1 号墳出土金屬製品 2	PL 34	古代土器 11
PL 11	松原 1 号墳出土金屬製品 3	PL 35	古代土器 12
PL 12	松原 1 号墳出土玉類・2 号墳出土金屬製品	PL 36	古代土器 13
PL 13	古代竪穴住居址 1	PL 37	古代土器 14
PL 14	古代竪穴住居址 2	PL 38	古代土器 15
PL 15	古代竪穴住居址 3	PL 39	古代土器 16
PL 16	古代竪穴住居址 4	PL 40	古代土器 17
PL 17	古代竪穴住居址 5	PL 41	古代土器 18
PL 18	古代竪穴住居址 6・掘立柱建物址	PL 42	古代土器 19
PL 19	古代道路址・溝址	PL 43	古代土器 20
PL 20	古代墓址	PL 44	古代土器 21
PL 21	古代井戸址・土坑	PL 45	古代土器 22
PL 22	古代土坑・河川址・築状遺構	PL 46	古代土器 23
PL 23	古代築状遺構	PL 47	古代土器 24
PL 24	古代土器 1	PL 48	古代土器 25
		PL 49	古代土器 26

PL50	古代土器27	PL90	古代土器67
PL51	古代土器28	PL91	古代土器68
PL52	古代土器29	PL92	古代土器69
PL53	古代土器30	PL93	古代土製品 1
PL54	古代土器31	PL94	古代土製品 2
PL55	古代土器32	PL95	古代土製品 3
PL56	古代土器33	PL96	古代土製品 4
PL57	古代土器34	PL97	古代土製品 5
PL58	古代土器35	PL98	古代石器・石製品 1
PL59	古代土器36	PL99	古代石器・石製品 2
PL60	古代土器37	PL100	古代石器・石製品 3
PL61	古代土器38	PL101	古代石器・石製品 4
PL62	古代土器39	PL102	古代石器・石製品 5
PL63	古代土器40	PL103	古代金屬製品 1
PL64	古代土器41	PL104	古代金屬製品 2
PL65	古代土器42	PL105	古代金屬製品 3
PL66	古代土器43	PL106	古代金屬製品 4
PL67	古代土器44	PL107	古代金屬製品 5
PL68	古代土器45	PL108	古代金屬製品 6
PL69	古代土器46	PL109	古代金屬製品 7
PL70	古代土器47	PL110	古代骨角牙製品 1
PL71	古代土器48	PL111	古代骨角牙製品 2
PL72	古代土器49	PL112	古代木製品 1
PL73	古代土器50	PL113	古代木製品 2
PL74	古代土器51	PL114	古代木製品 3
PL75	古代土器52	PL115	古代木製品 4
PL76	古代土器53	PL116	古代木製品 5
PL77	古代土器54	PL117	古代木製品 6
PL78	古代土器55	PL118	古代木製品 7
PL79	古代土器56	PL119	古代木製品 8
PL80	古代土器57	PL120	古代木製品 9
PL81	古代土器58	PL121	古代木製品10
PL82	古代土器59	PL122	古代木製品11
PL83	古代土器60	PL123	古代木製品12
PL84	古代土器61	PL124	古代木製品13
PL85	古代土器62	PL125	古代木製品14
PL86	古代土器63	PL126	古代木製品15
PL87	古代土器64	PL127	古代木製品16
PL88	古代土器65	PL128	古代木製品17
PL89	古代土器66	PL129	古代鍛冶・鑄造関係資料 1

- PL130 古代鍛冶・鑄造關係資料 2
- PL131 古代文字關係資料 1
- PL132 古代文字關係資料 2
- PL133 古代文字關係資料 3
- PL134 古代文字關係資料 4
- PL135 古代文字關係資料 5
- PL136 古代文字關係資料 6
- PL137 古代文字關係資料 7
- PL138 古代文字關係資料 8
- PL139 古代文字關係資料 9
- PL140 中世溝址・墓址 1
- PL141 中世墓址 2
- PL142 中世墓址 3・井戸址 1
- PL143 中世井戸址 2・土坑
- PL144 斜面部中世墓址群 1
- PL145 斜面部中世墓址群 2
- PL146 斜面部中世墓址群 3
- PL147 中世燒物 1
- PL148 中世燒物 2
- PL149 中世燒物 3
- PL150 中世燒物 4
- PL151 中世燒物 5
- PL152 中世石器・石製品 1
- PL153 中世石器・石製品 2
- PL154 中世石塔類 1
- PL155 中世石塔類 2
- PL156 中世石塔類 3
- PL157 中世石塔類 4
- PL158 中世石塔類 5
- PL159 中世石塔類 6
- PL160 中世石塔類 7
- PL161 中世石塔類 8
- PL162 中世石塔類 9
- PL163 中世石塔類 10
- PL164 中世石塔類 11
- PL165 中世石塔類 12
- PL166 中世金屬製品 1
- PL167 中世金屬製品 2
- PL168 中世金屬製品 3
- PL169 中世木製品 1
- PL170 中世木製品 2
- PL171 中世木製品 3
- PL172 中世木製品 4
- PL173 中世木製品 5

実測図版

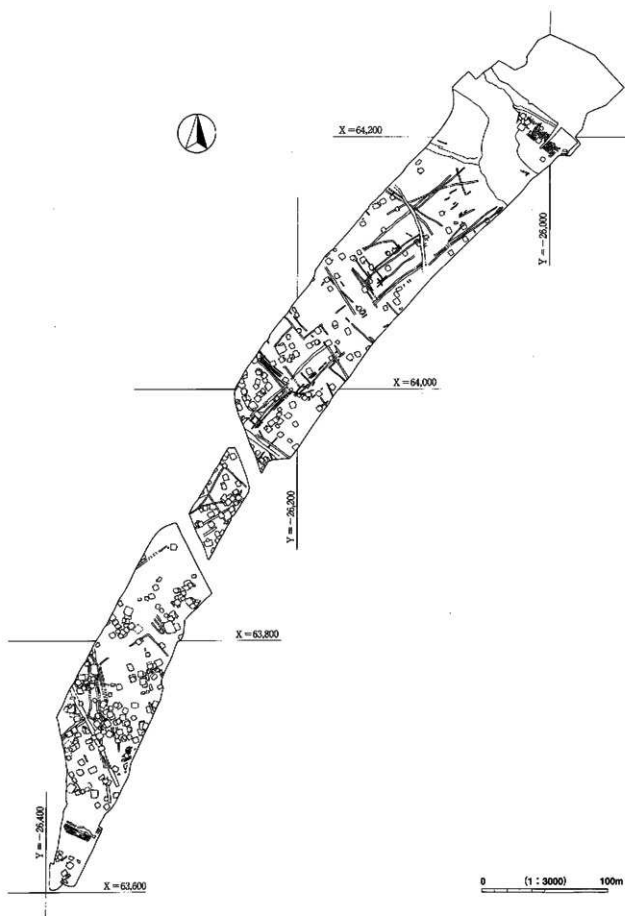

図版 2 遺構配置図割付図

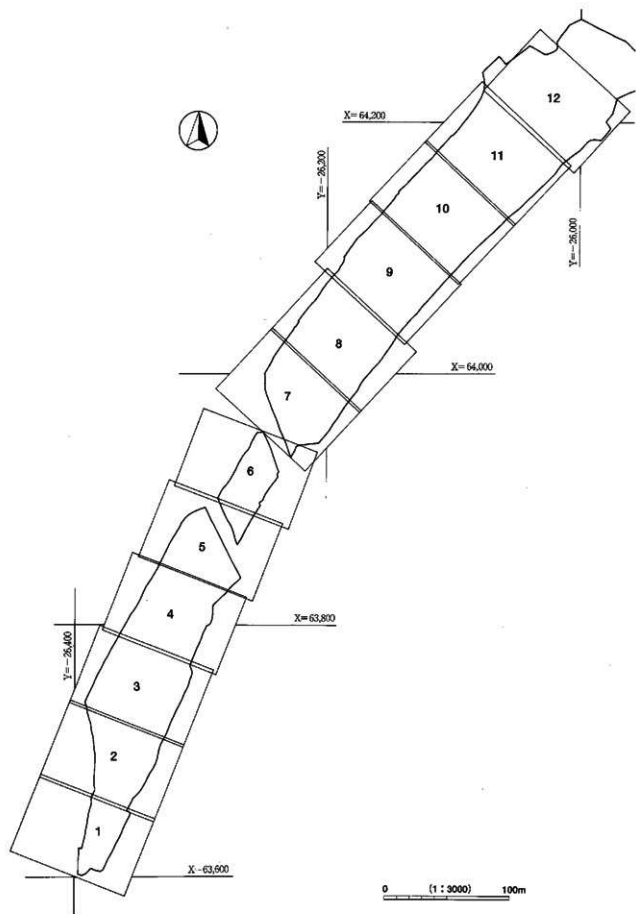

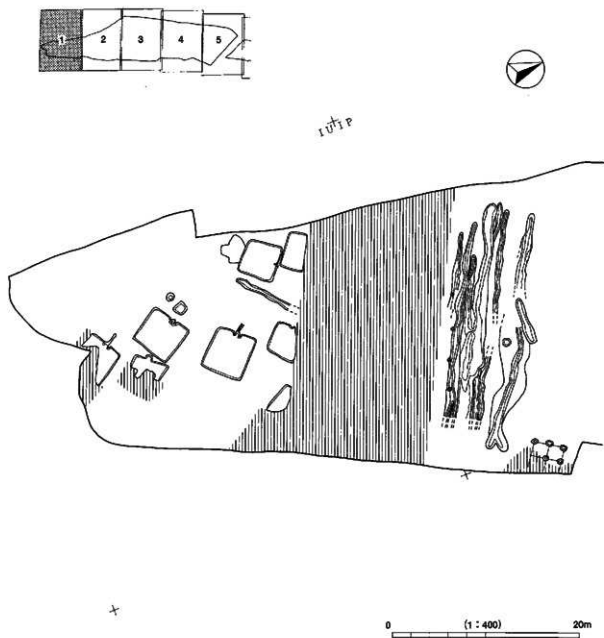

图版4 遗构配置图2 (1:400)

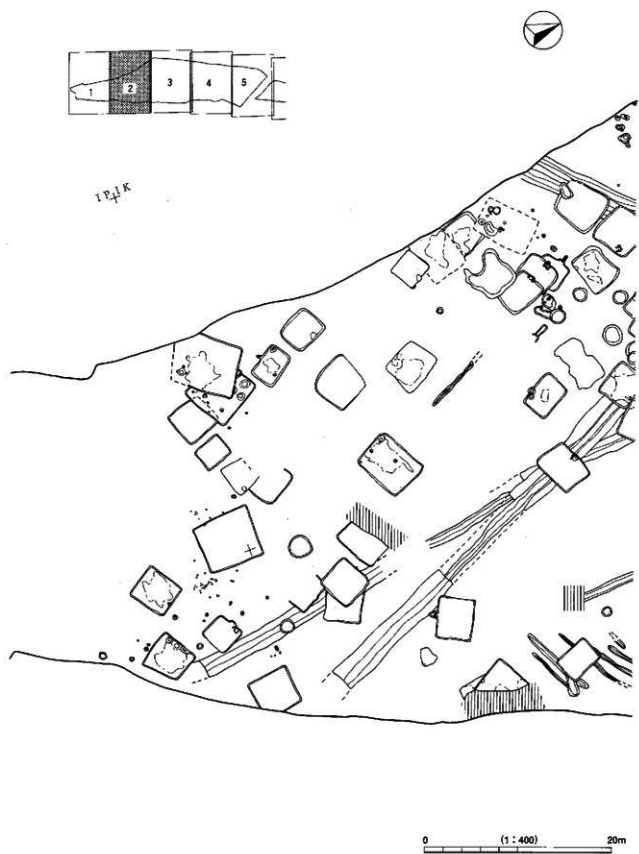

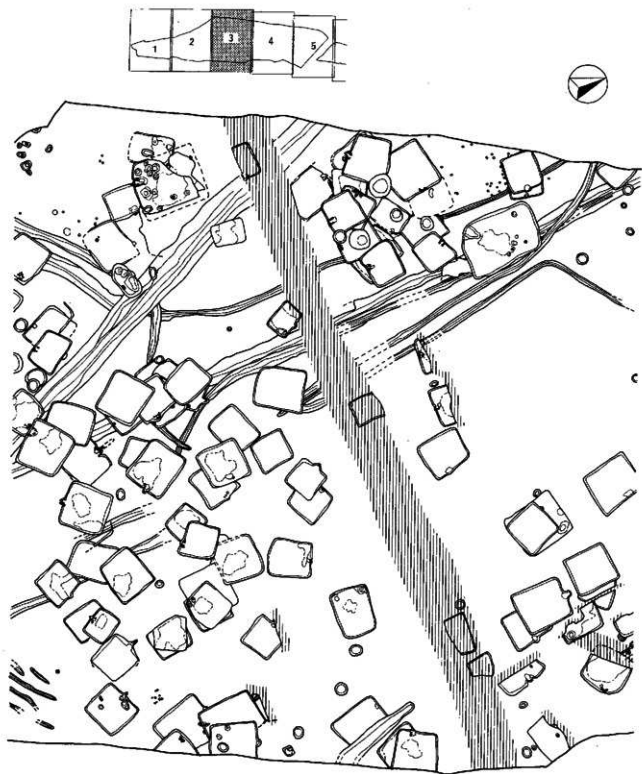

141
118

0 (1:400) 20m

図版 6 遺構配置図 4 (1:400)

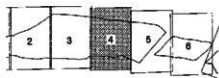
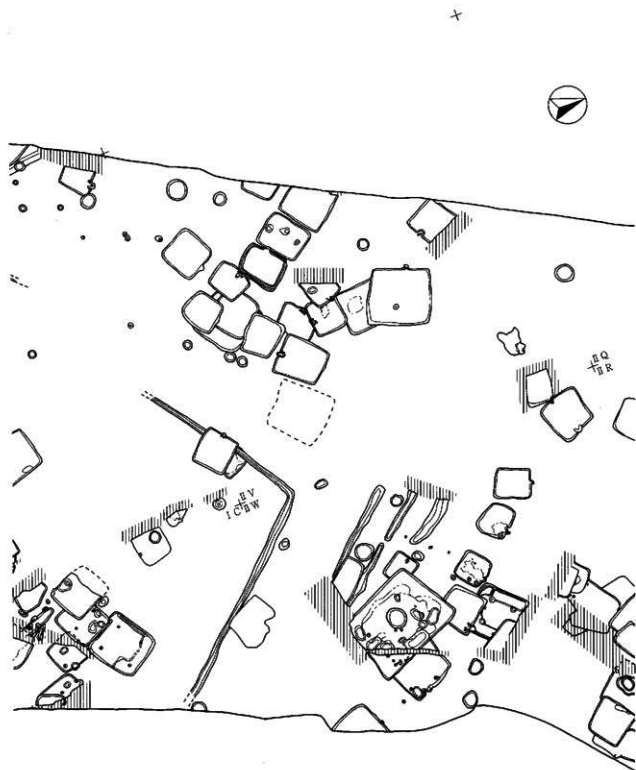

0 (1:400) 20m

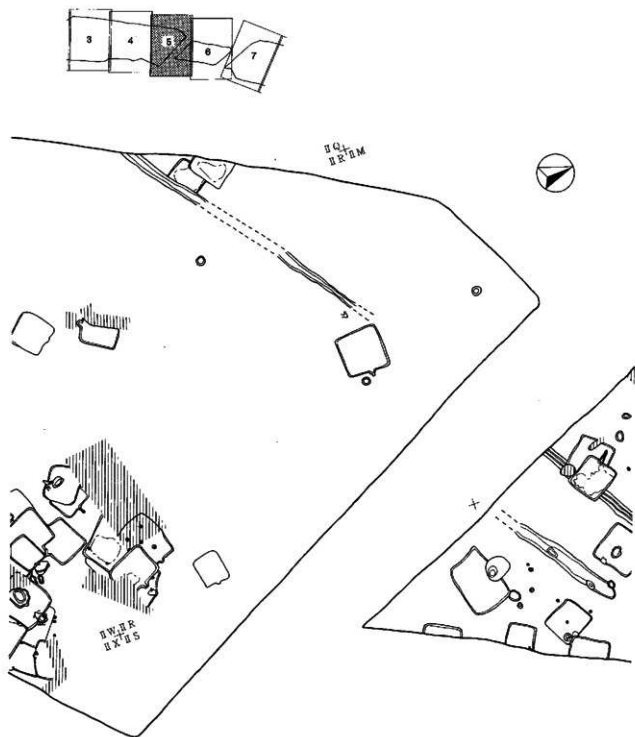

図版 8 遺構配置図 6 (1:400)

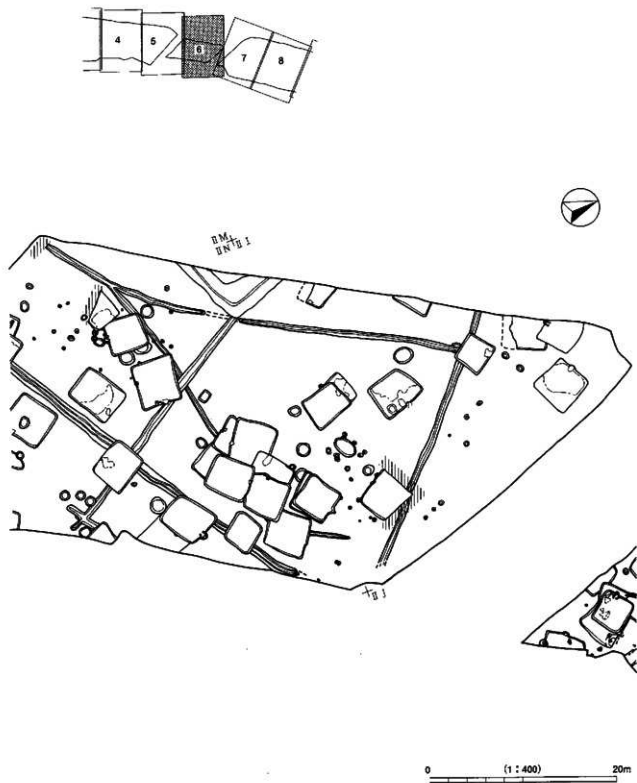

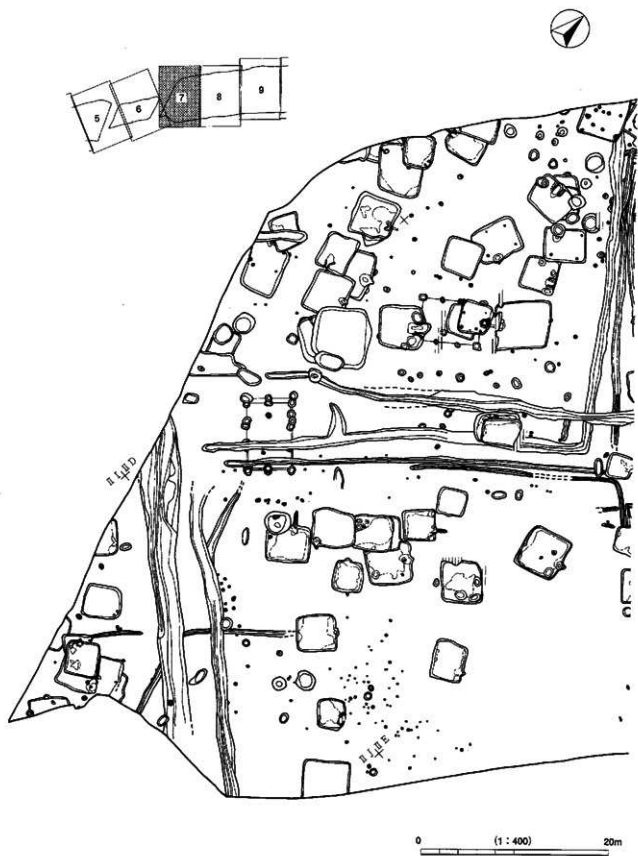

图版10 遗物配置图 8 (1:400)

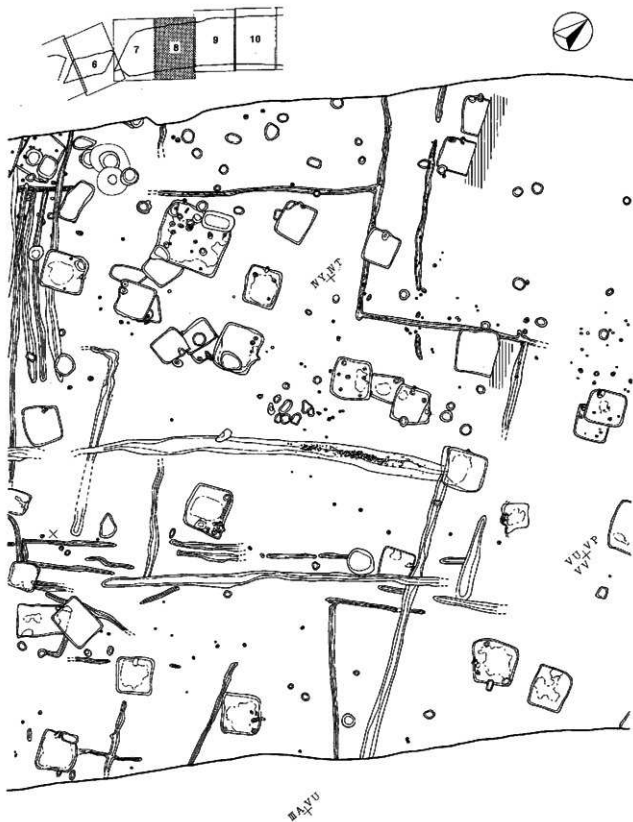

0 (1:400) 20m



图版12 遺構配置図10 (1:400)

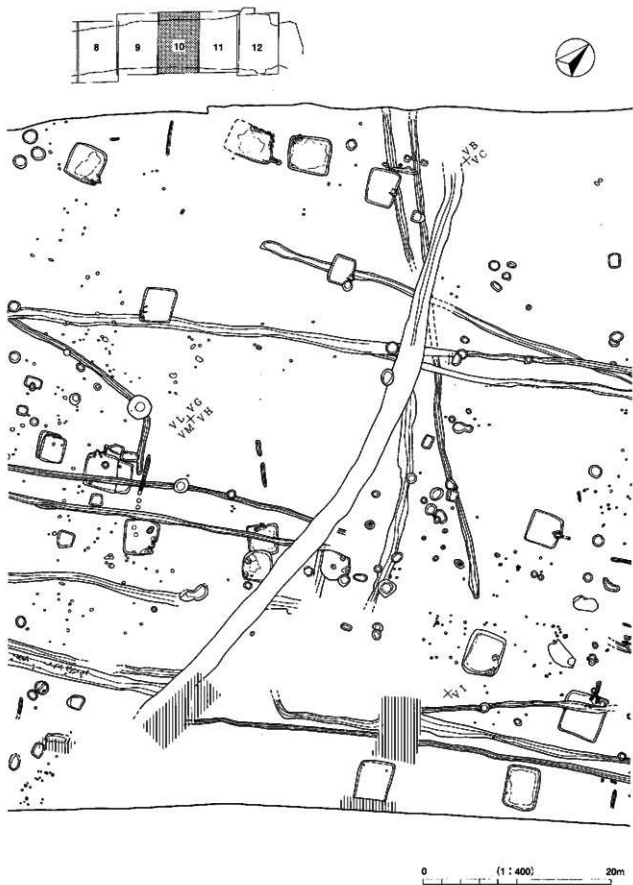



図版14 遺構配置図12 (1:400)

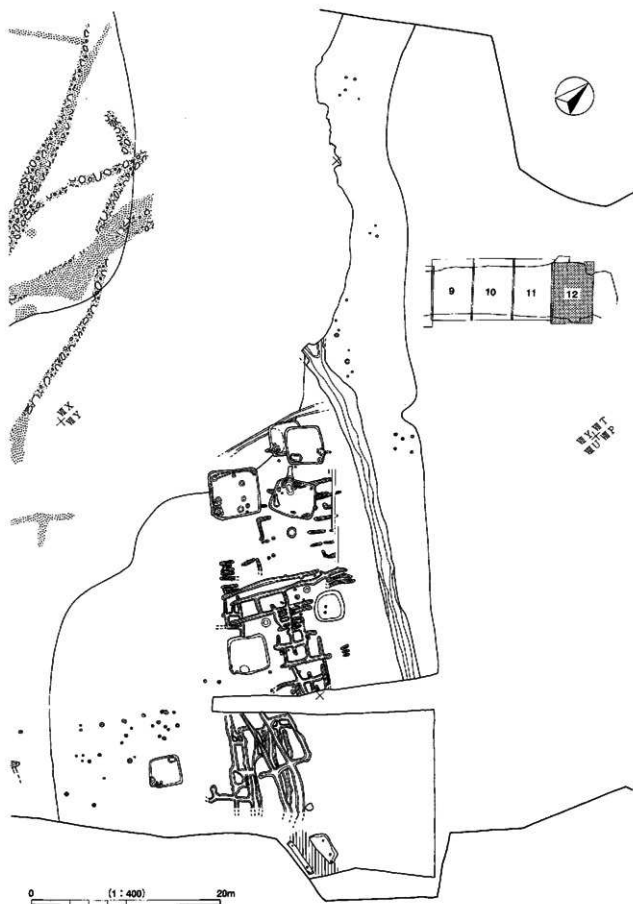

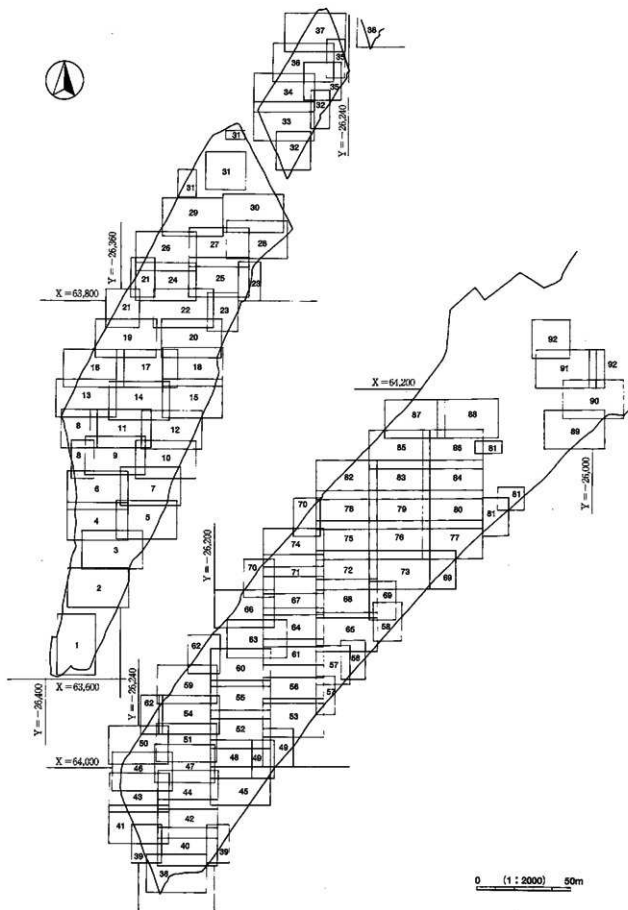

图版16 遺構実測図1

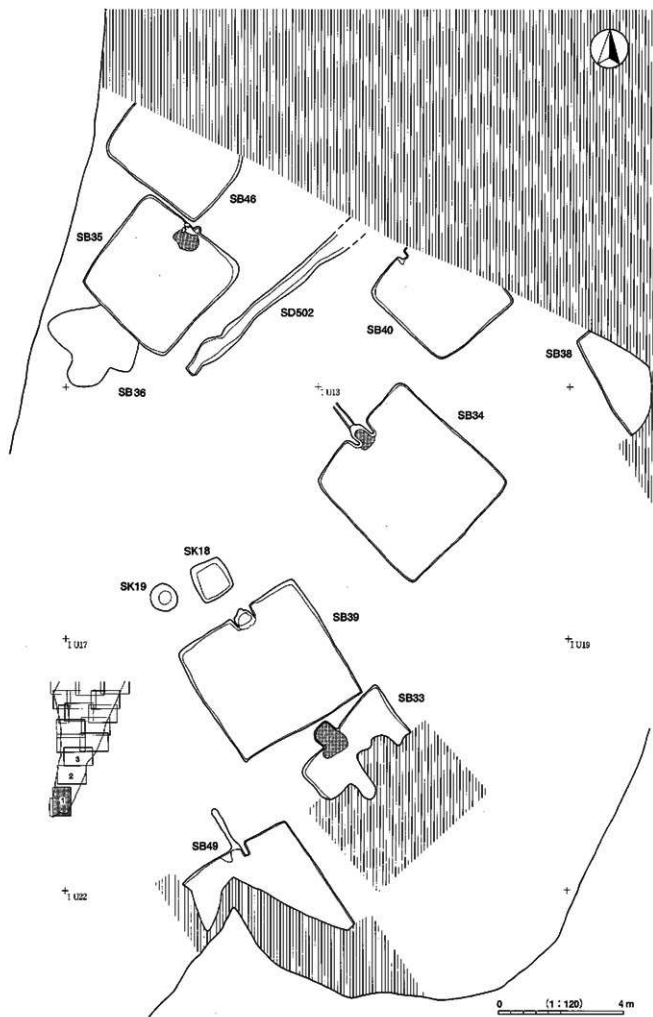

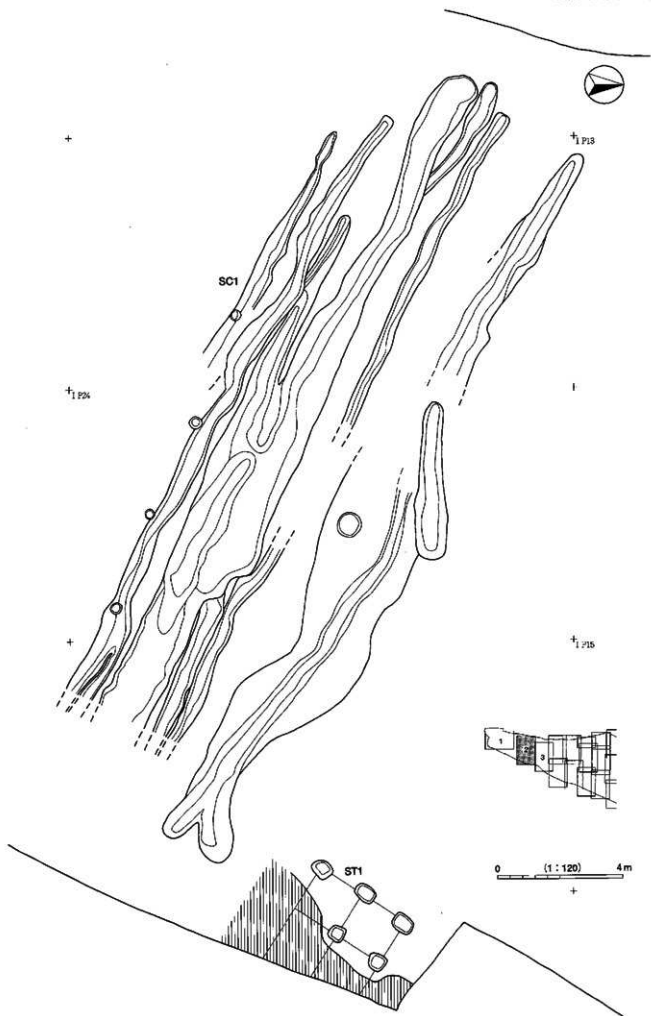

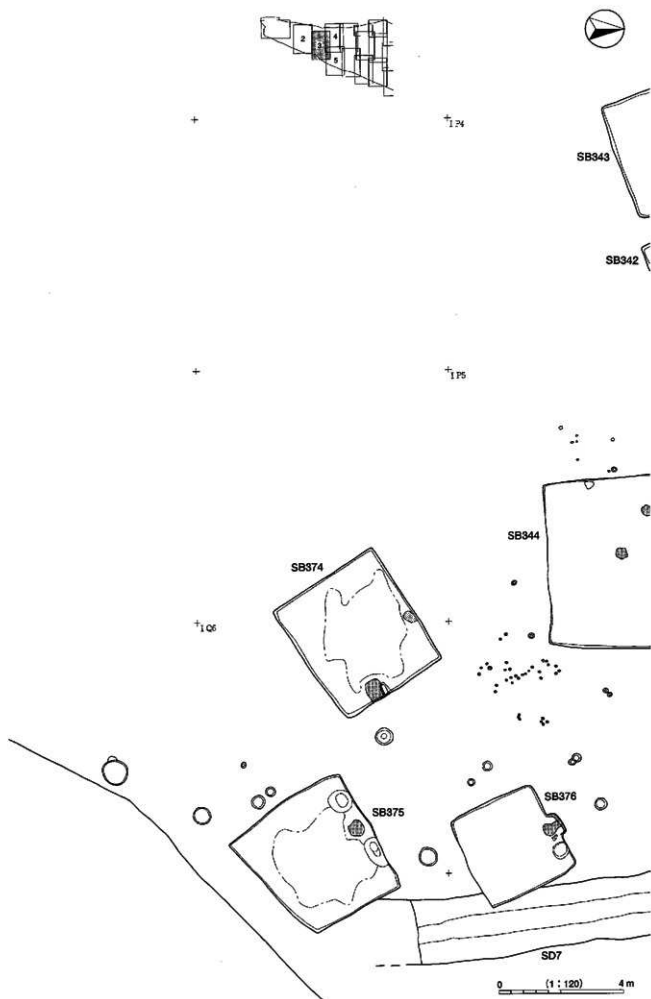

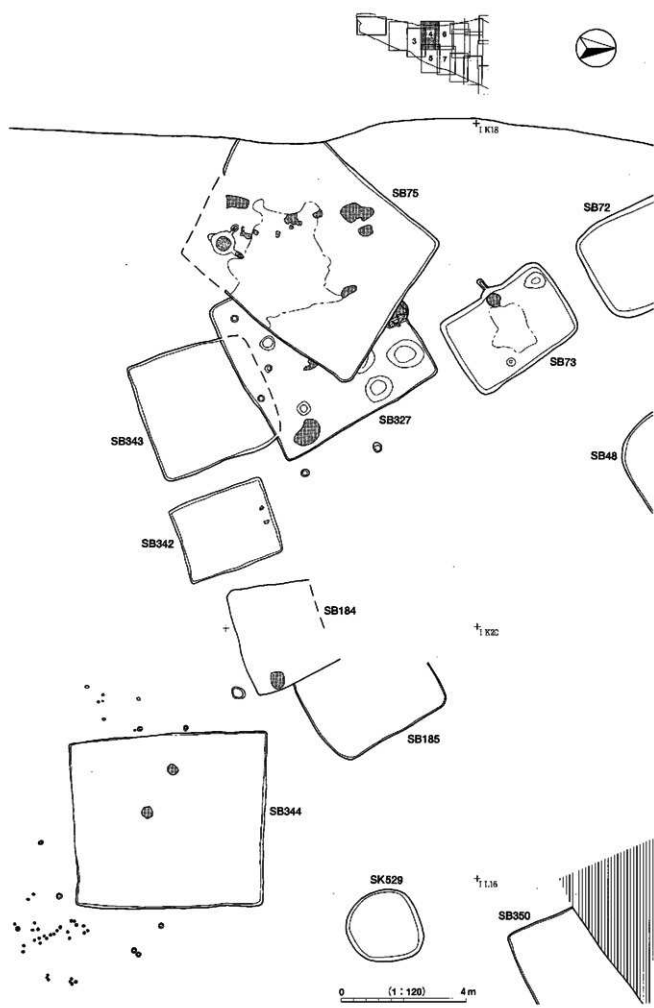

図版20 遺構実測図 5

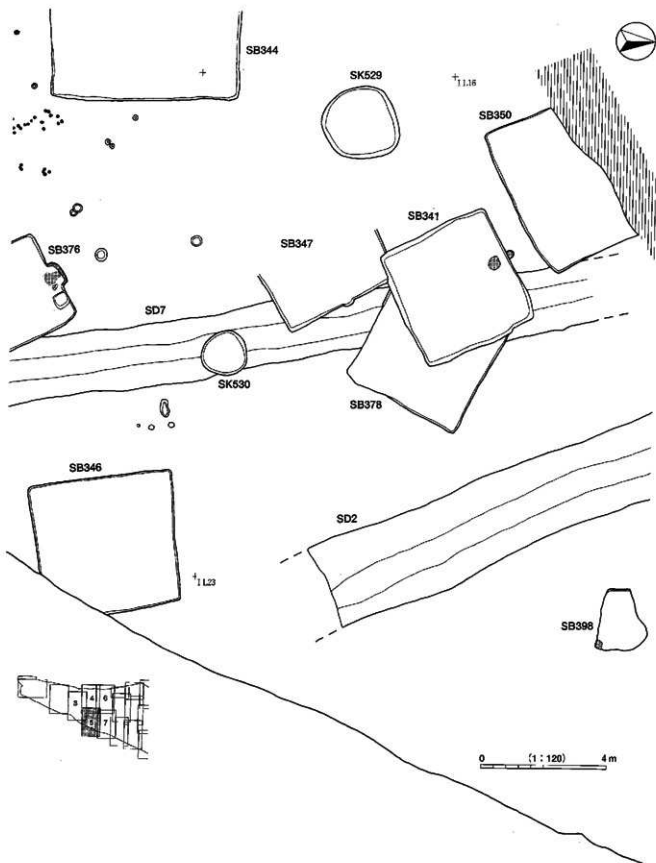

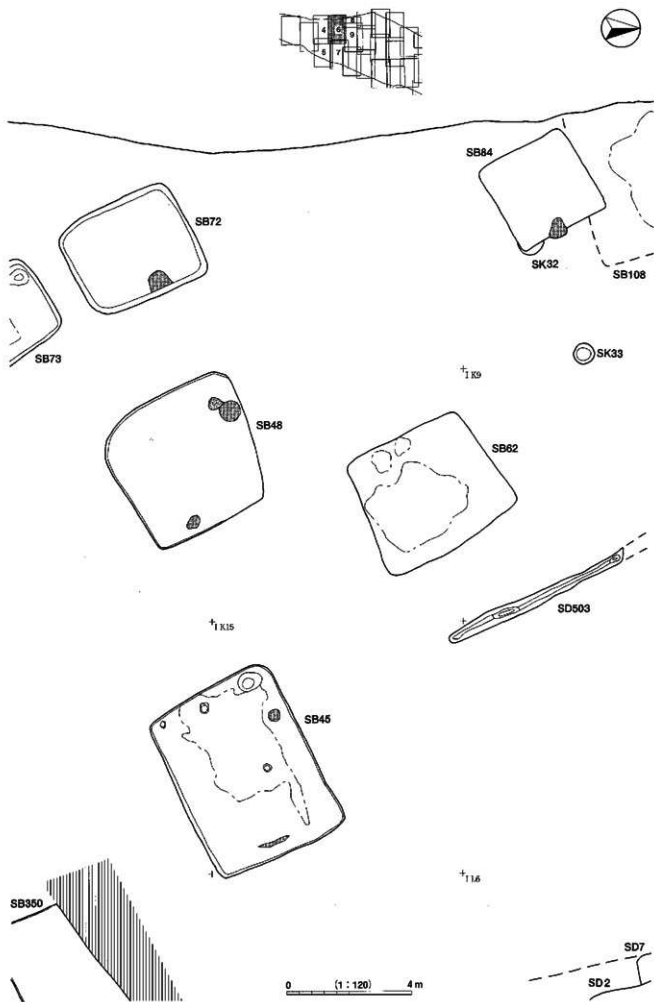

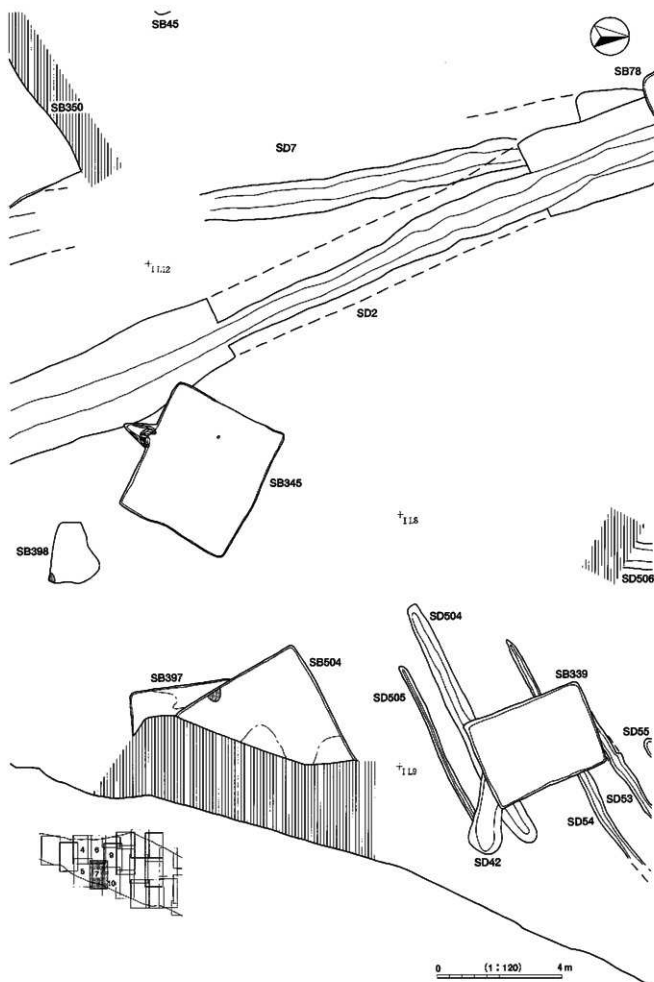

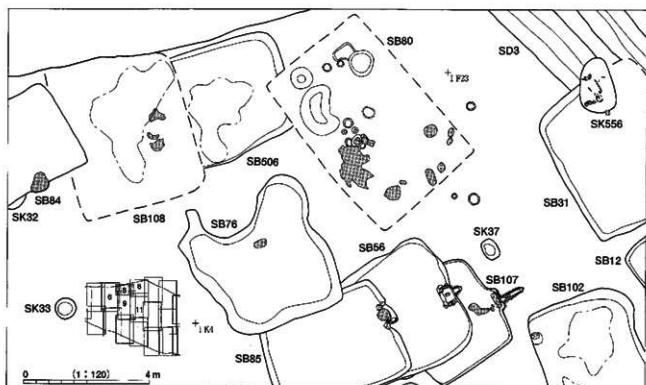
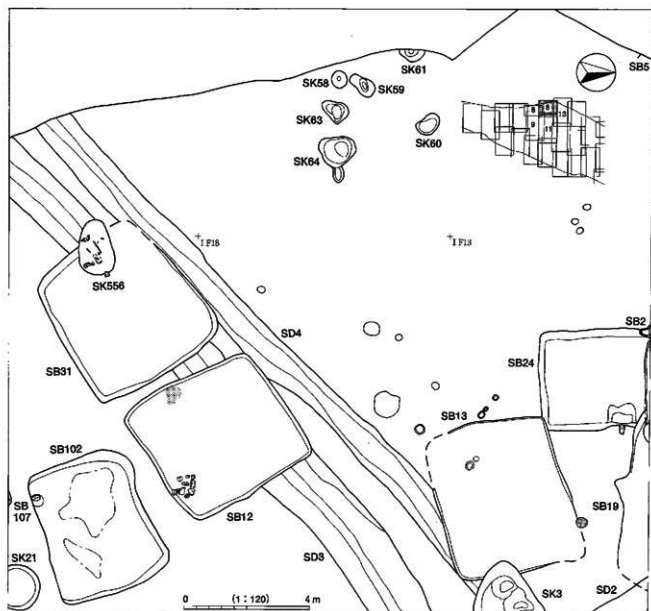

图版24 遺構実測図 9

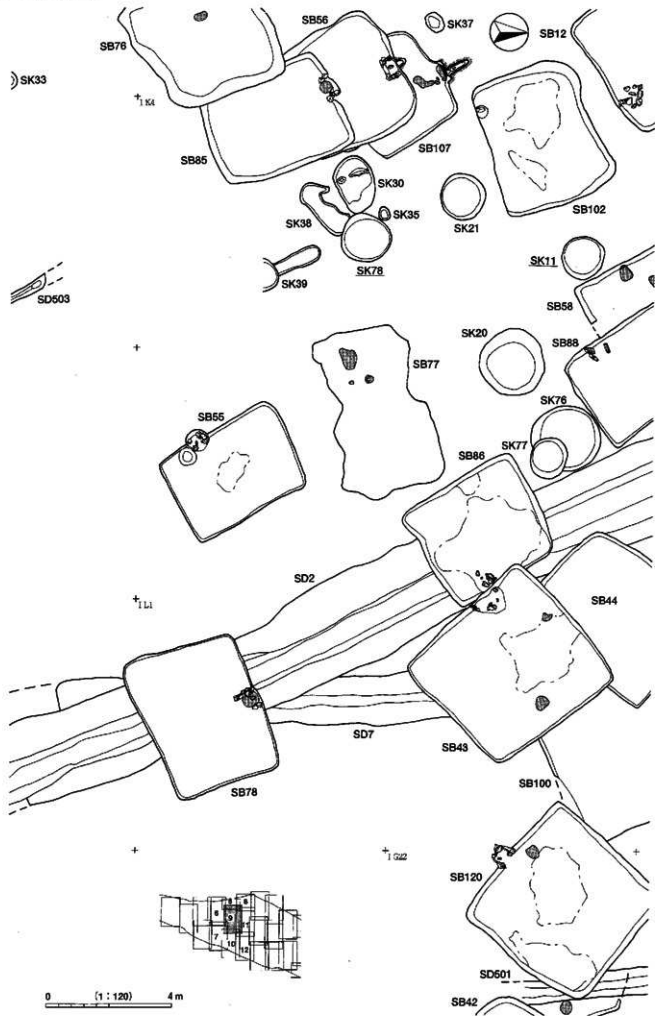

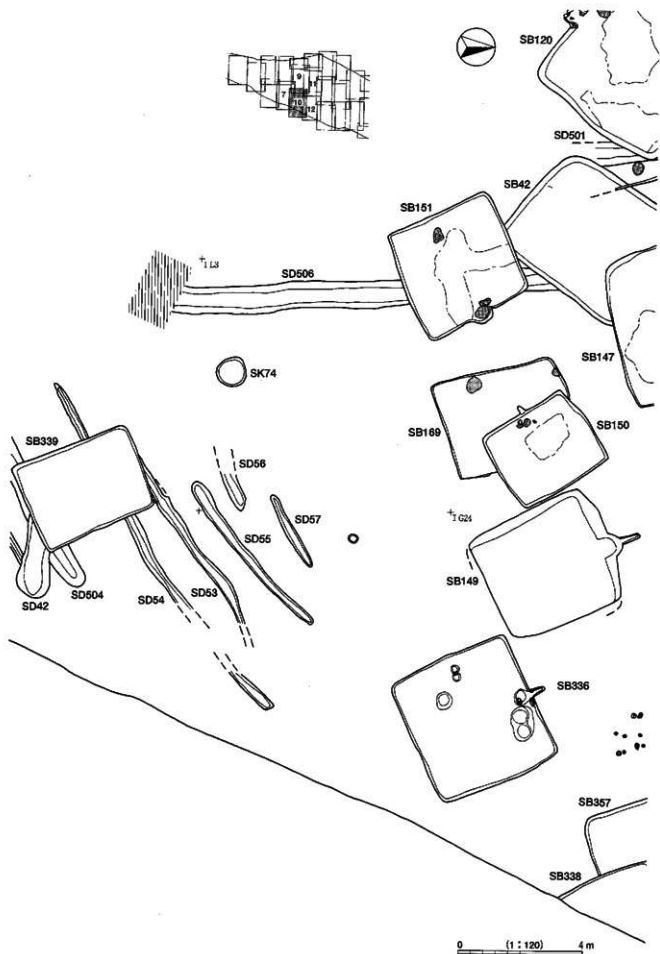

図版26 遺構実測図11

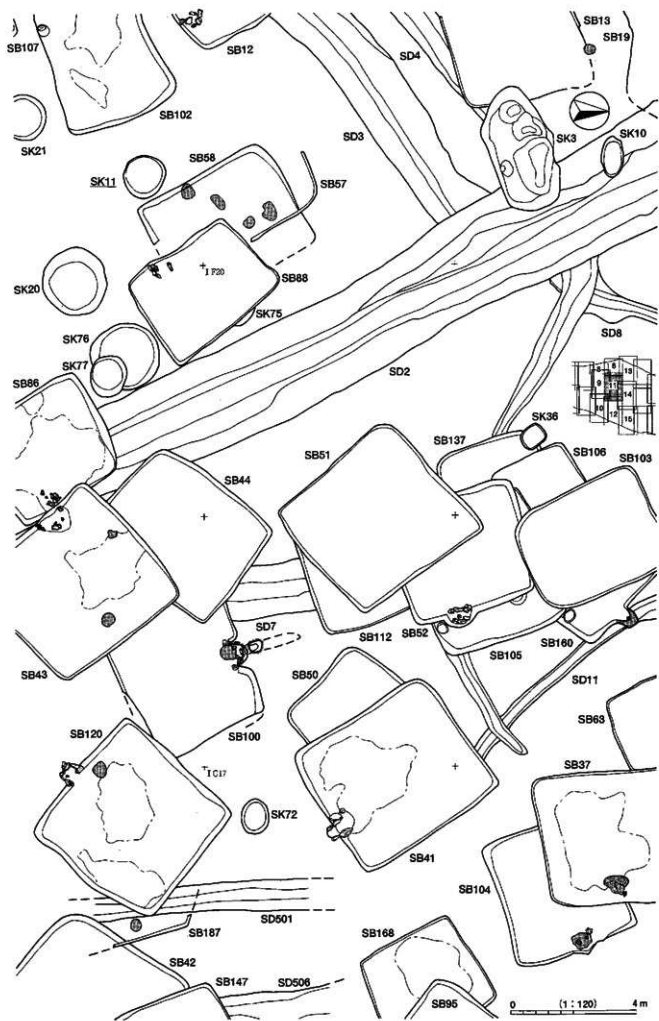

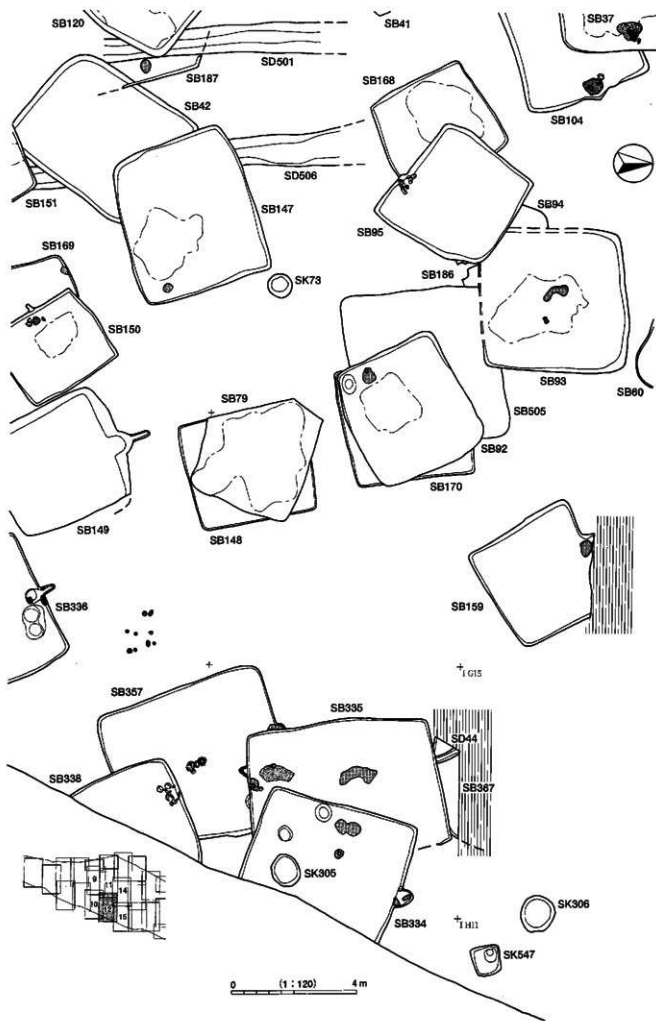

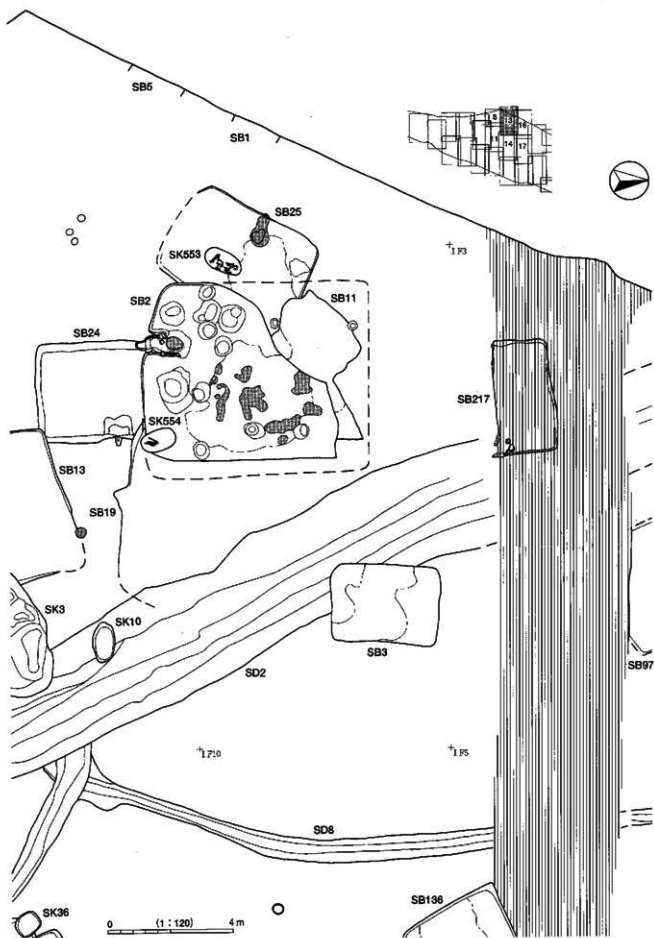

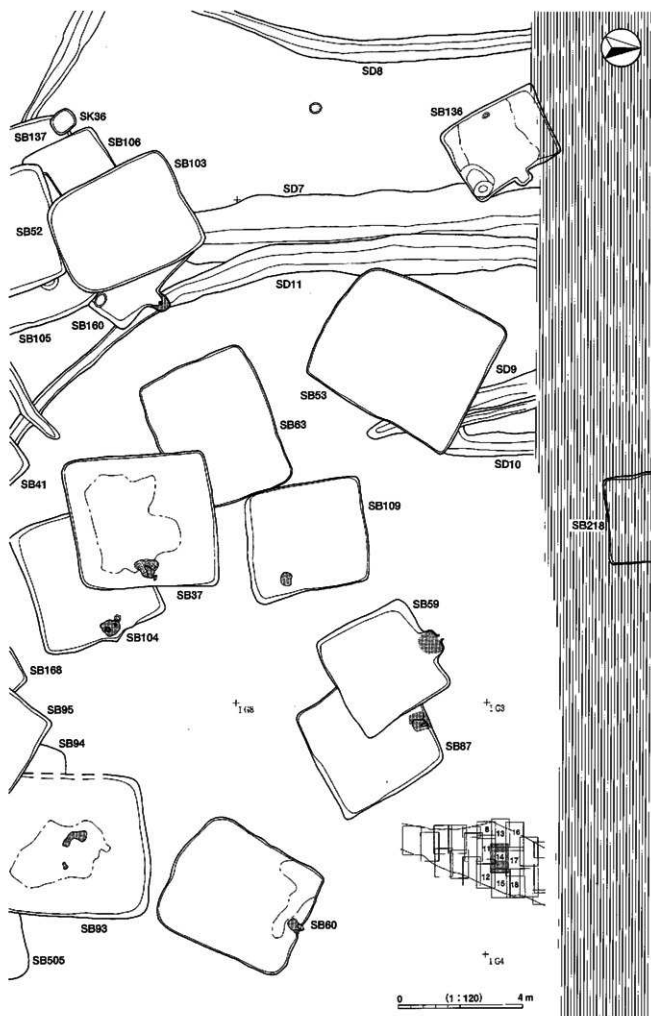

图版30 遺構実測図15

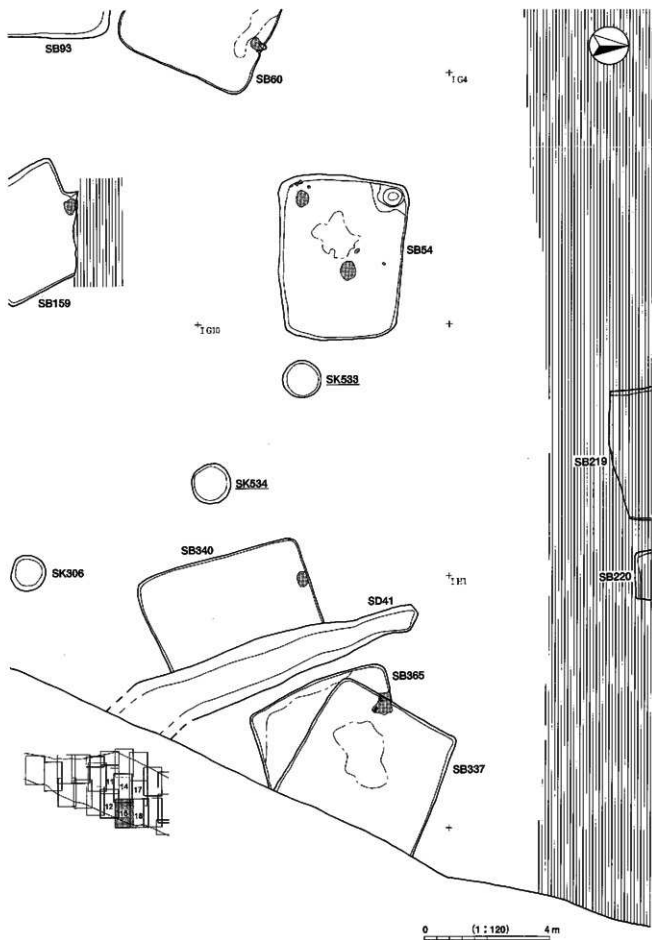

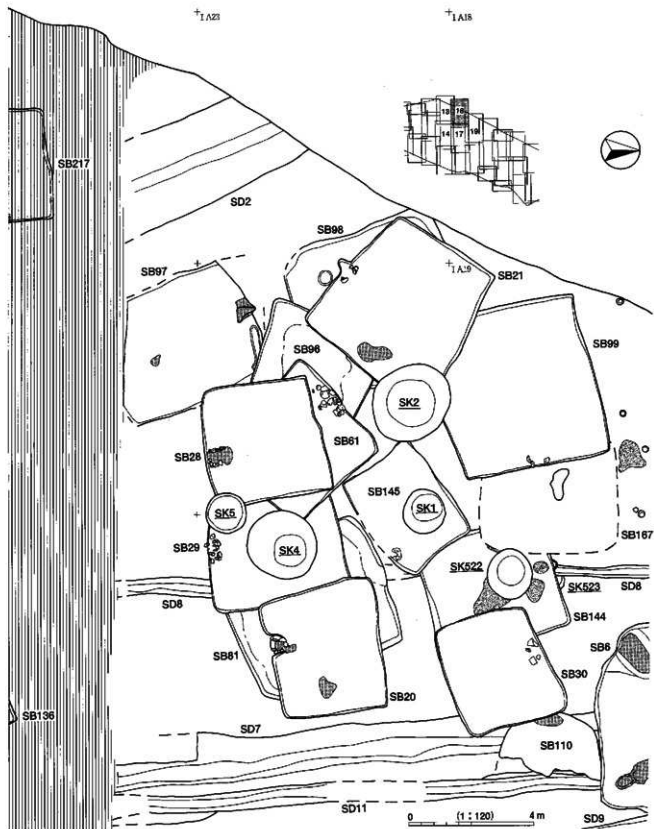

図版32 遺構実測図17

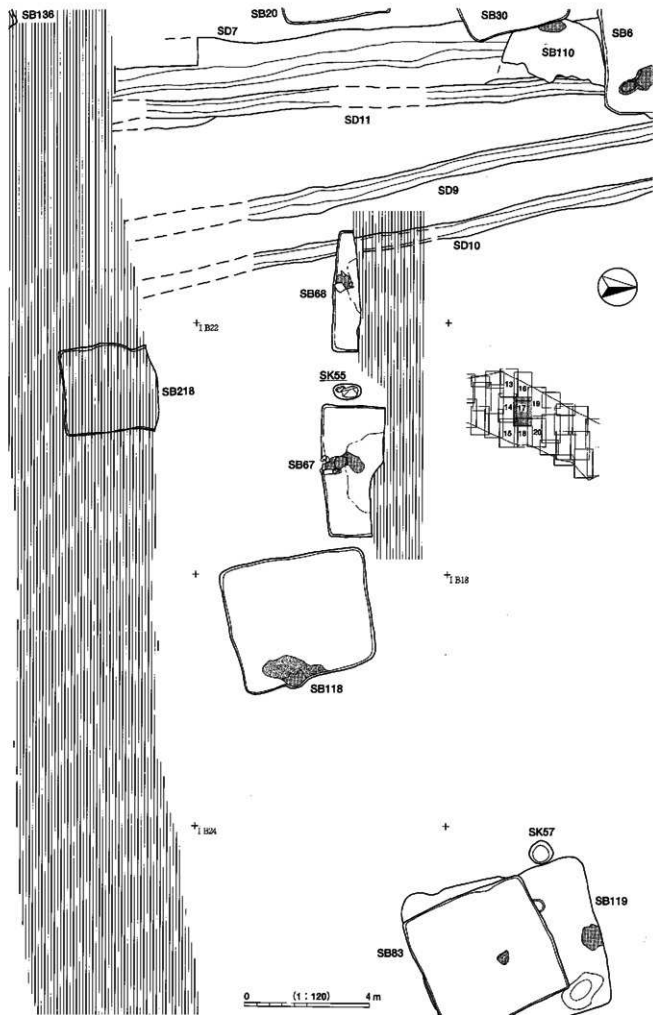

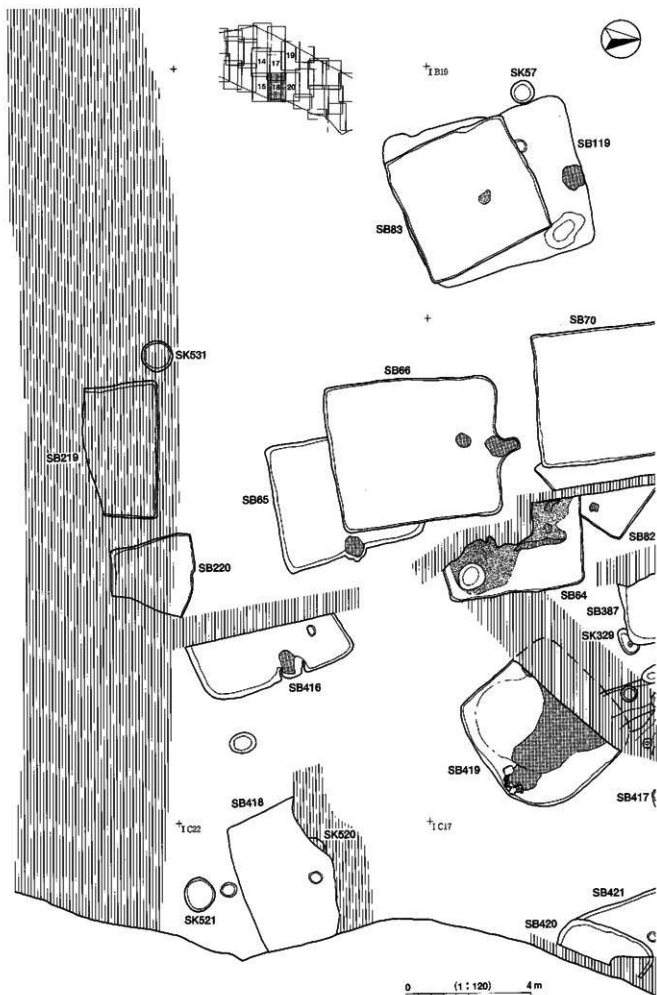

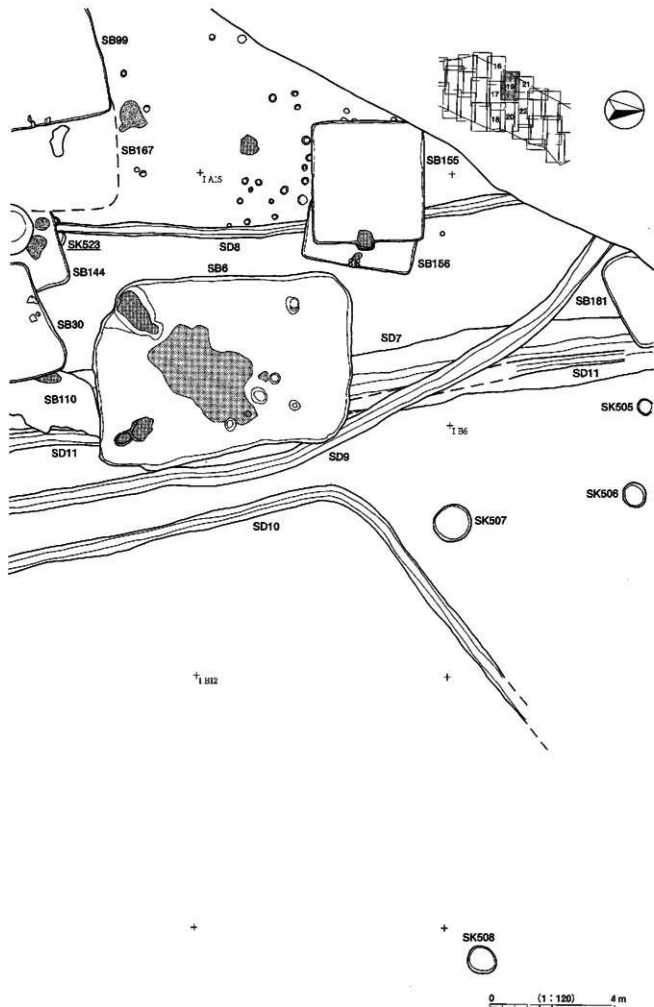

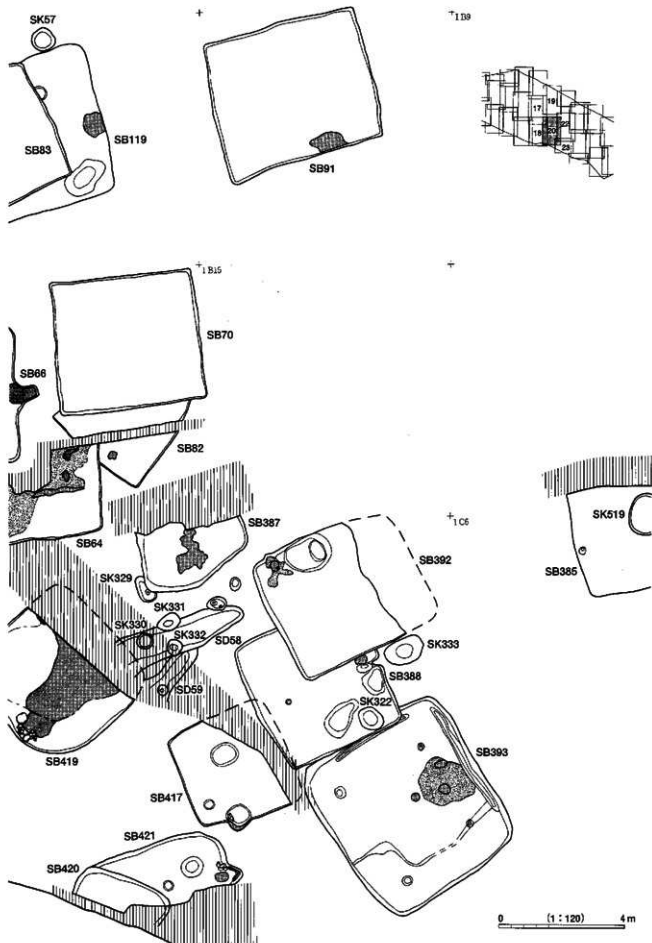

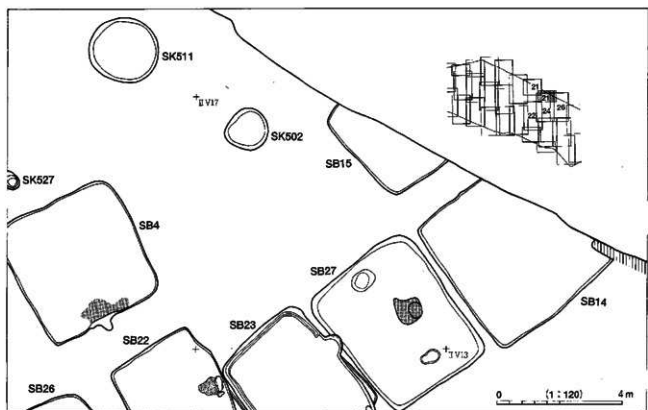
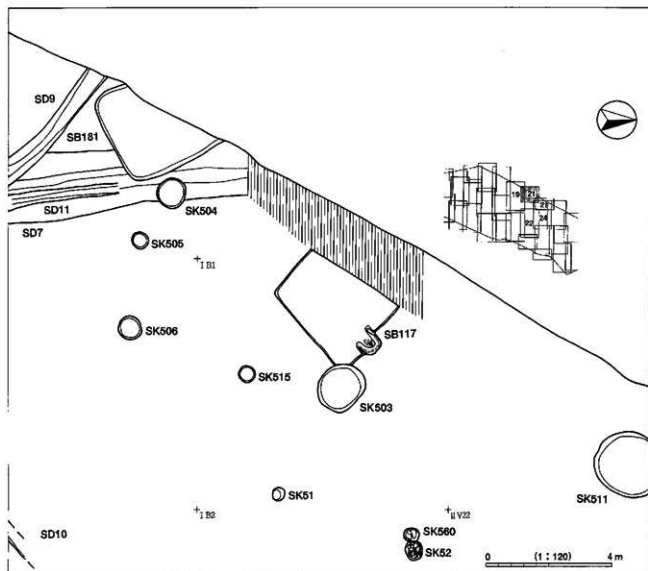

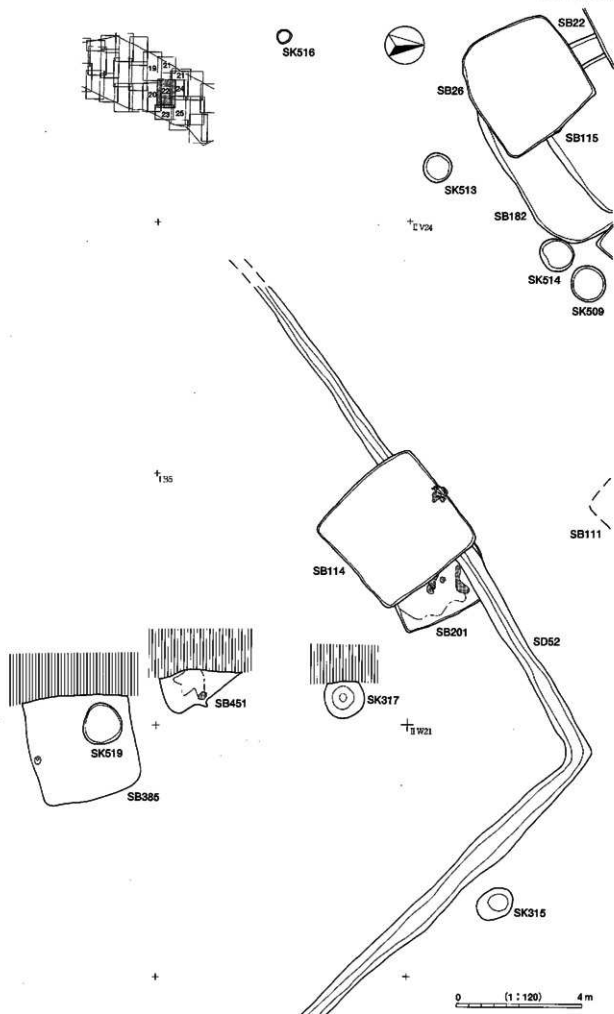

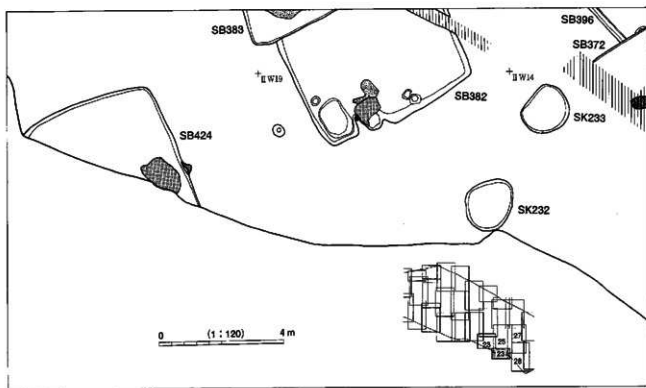
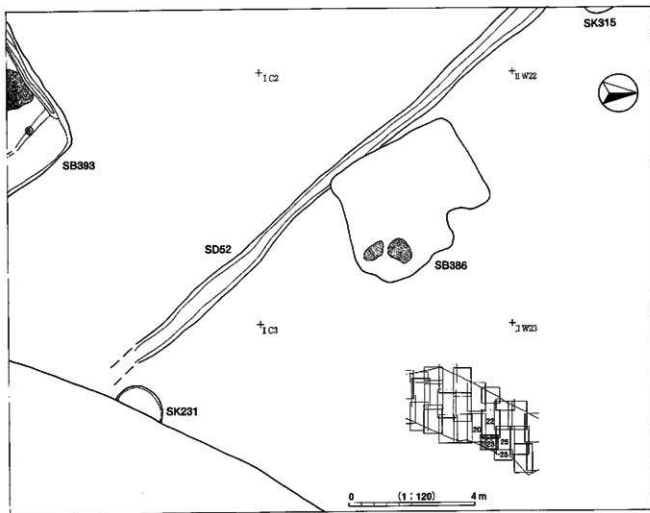

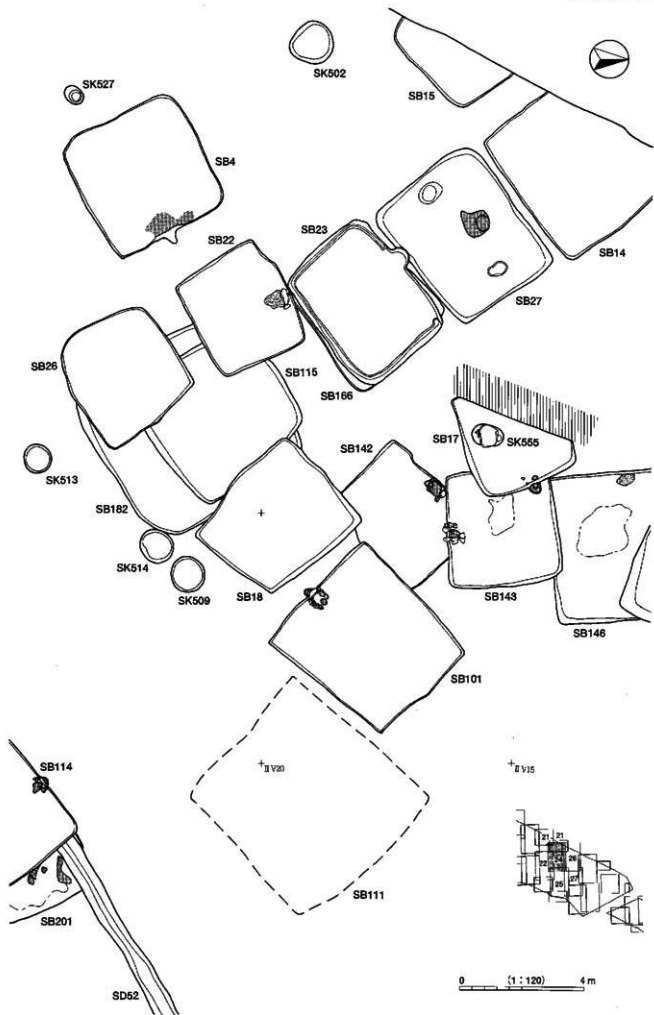

図版40 遺構実測図25

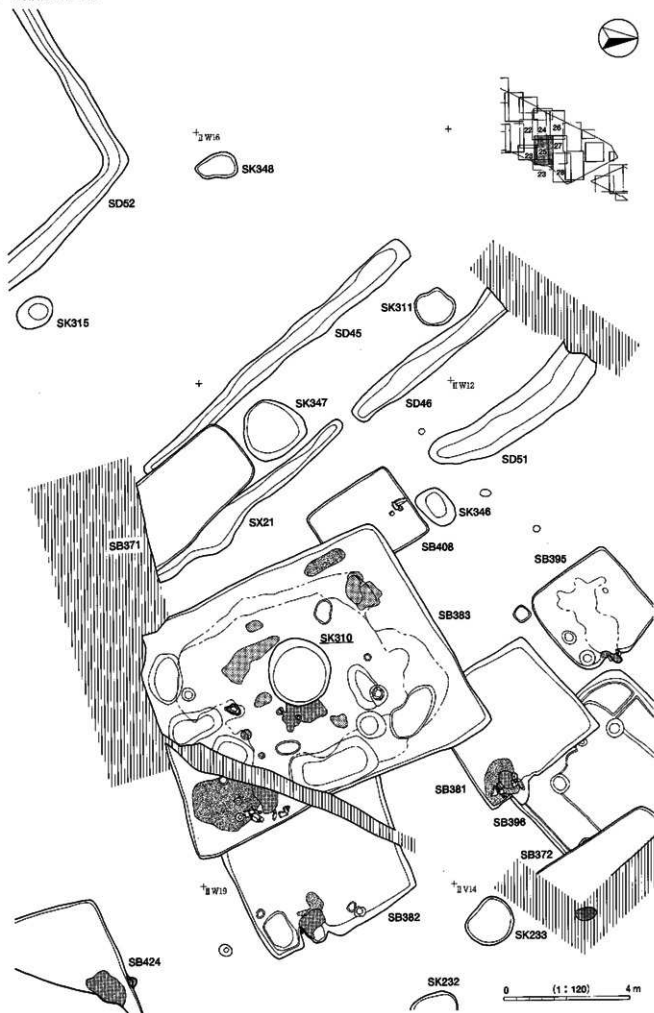

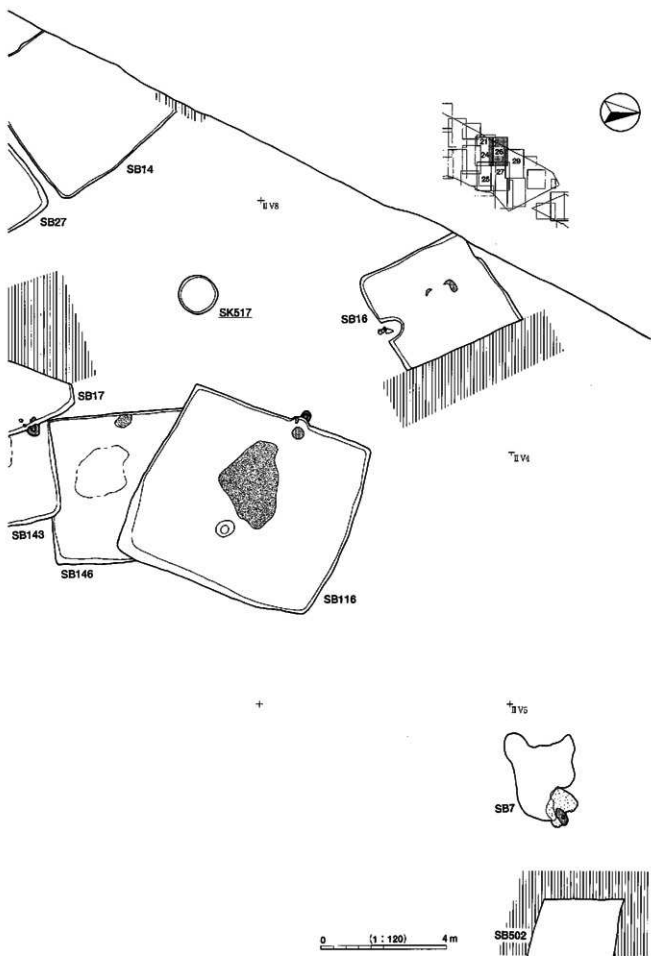

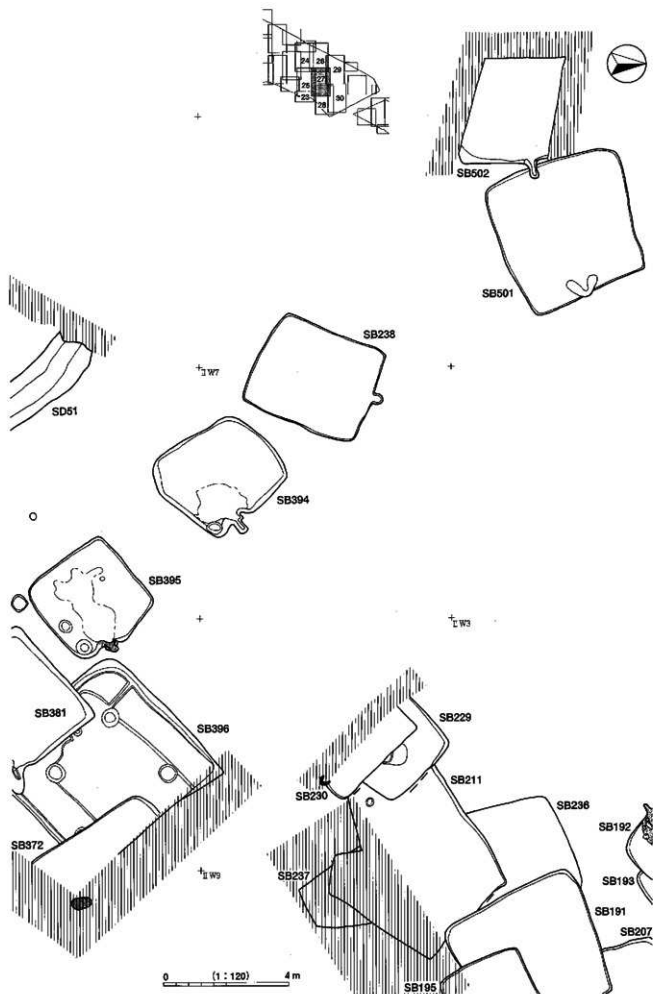

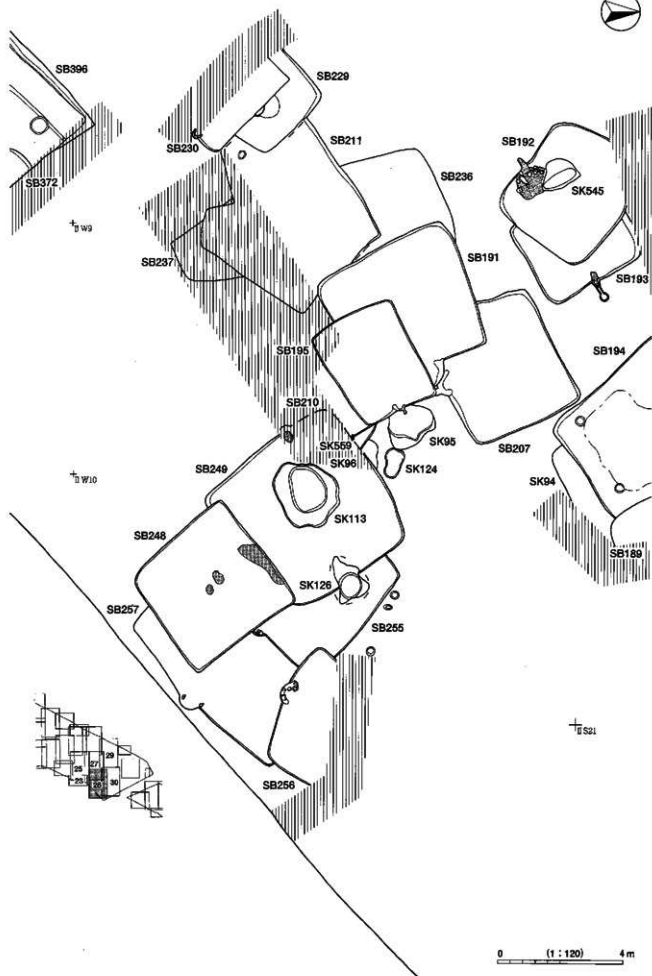

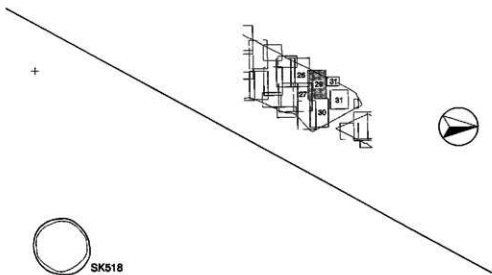

+
T 525

+

)
)
)

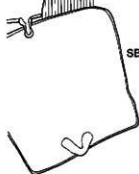

+
T 521

+
T 216

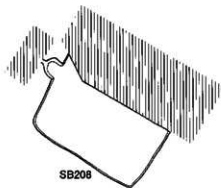
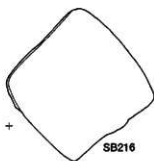

0 (1:120) 4 m

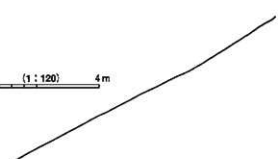
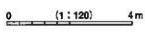
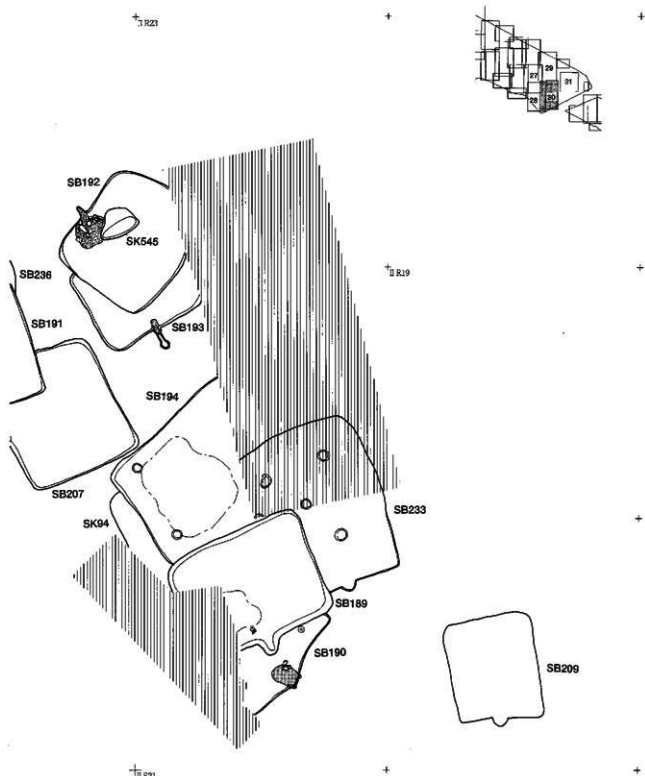

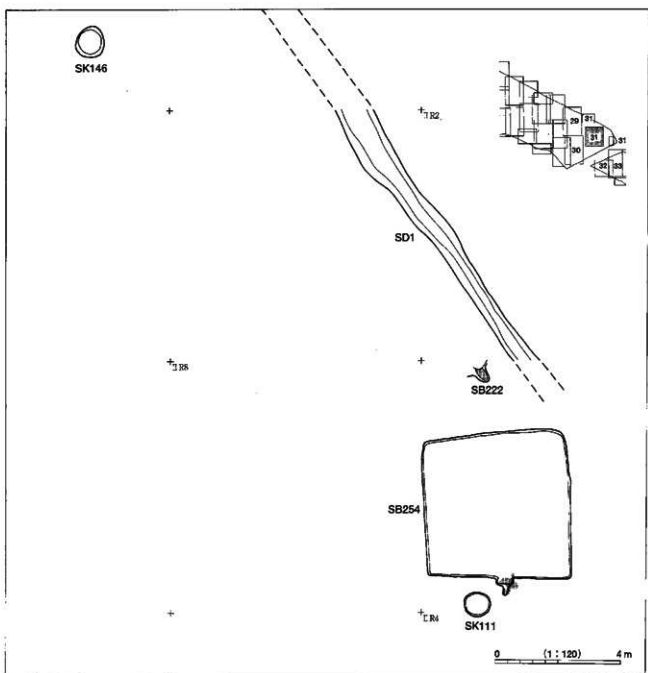
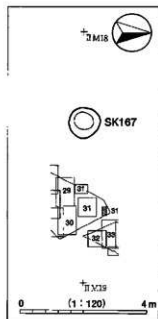
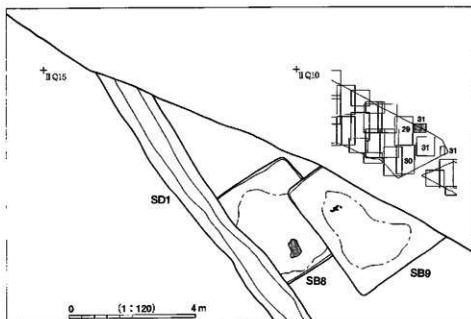

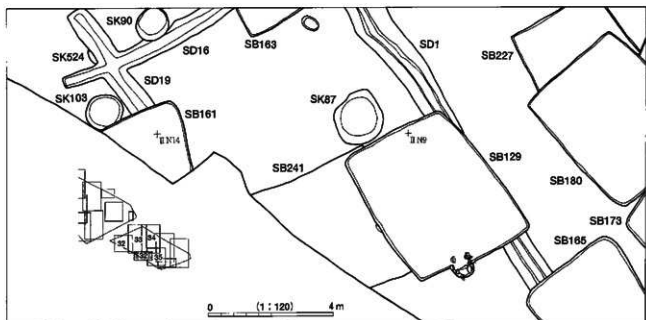
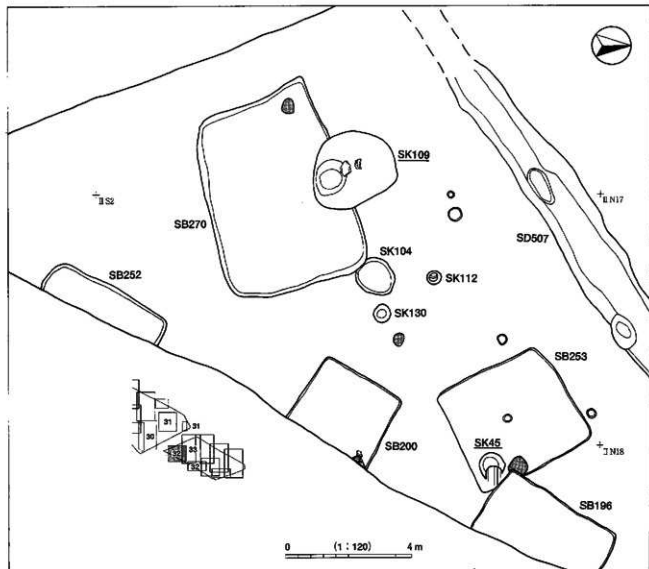

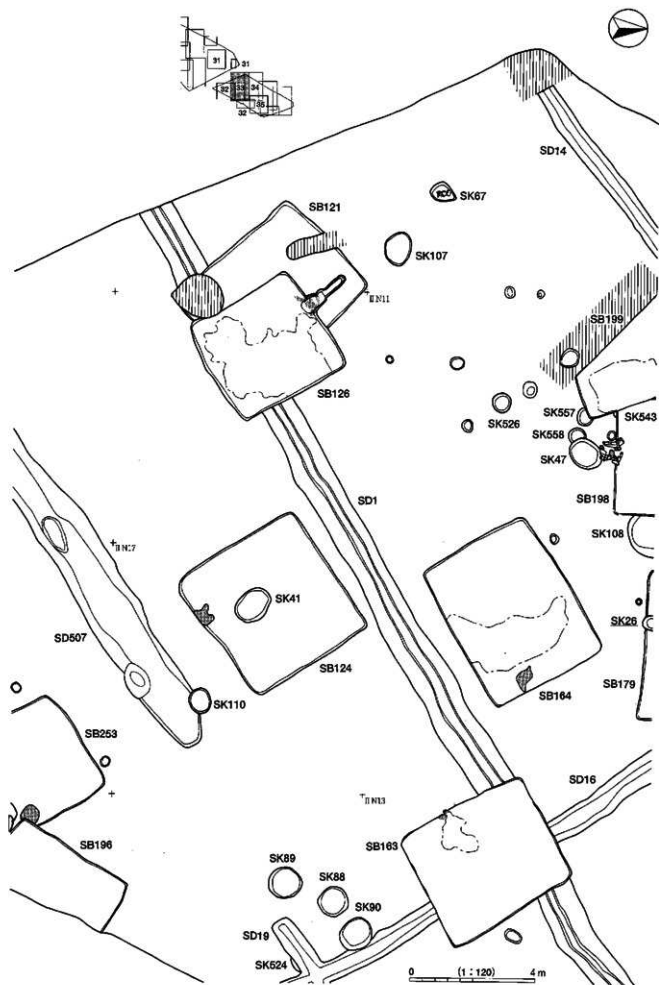

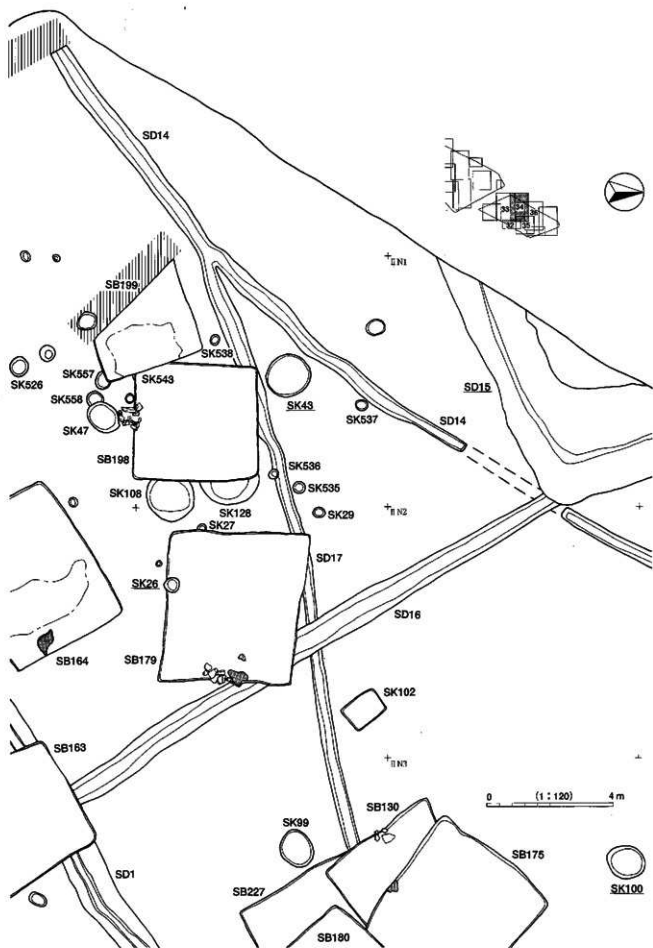

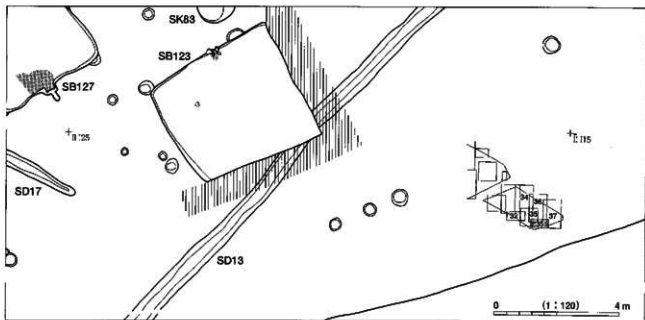
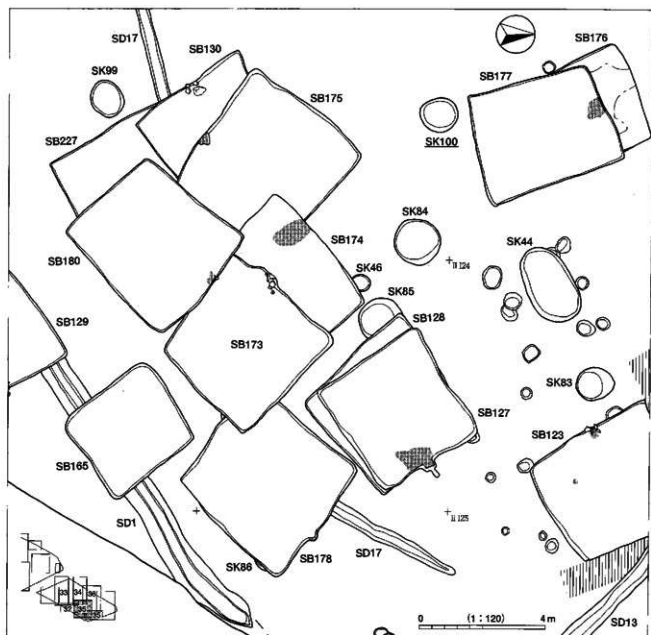

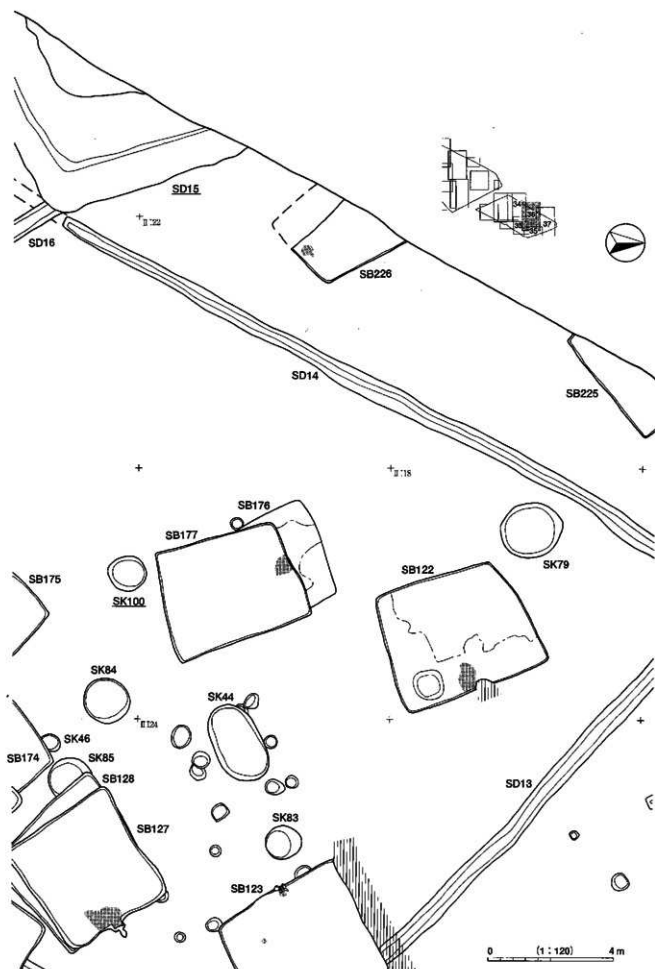

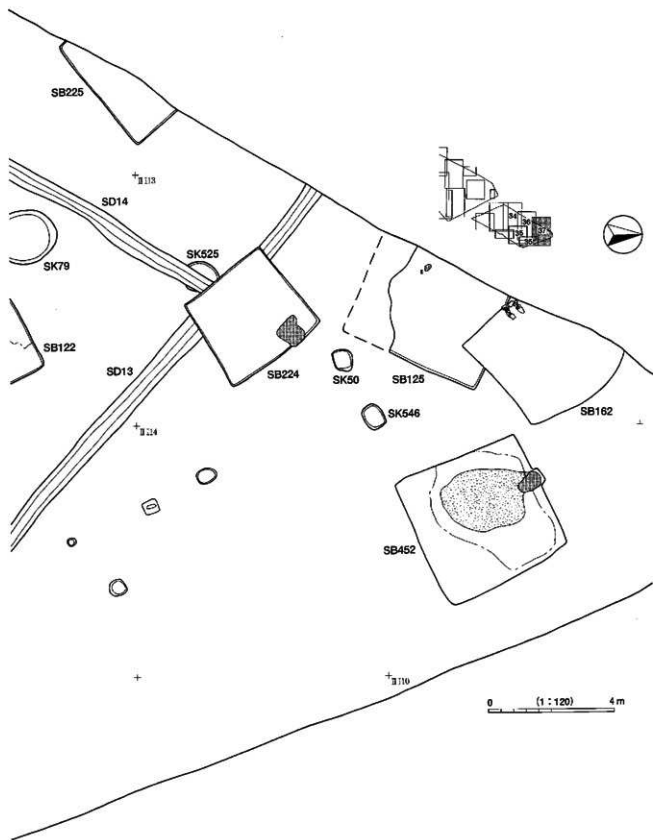

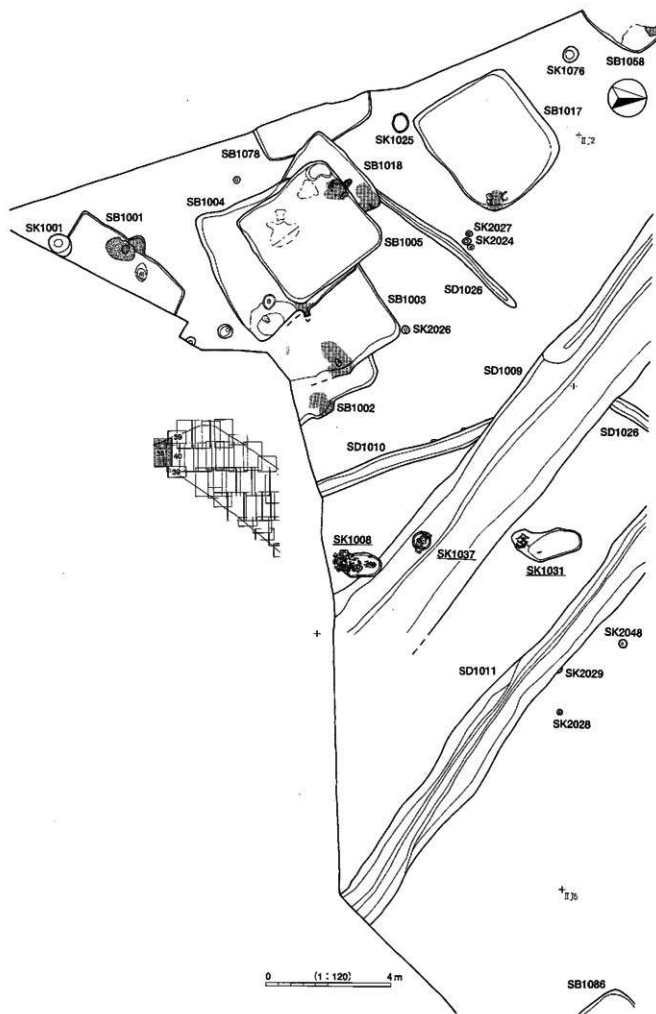

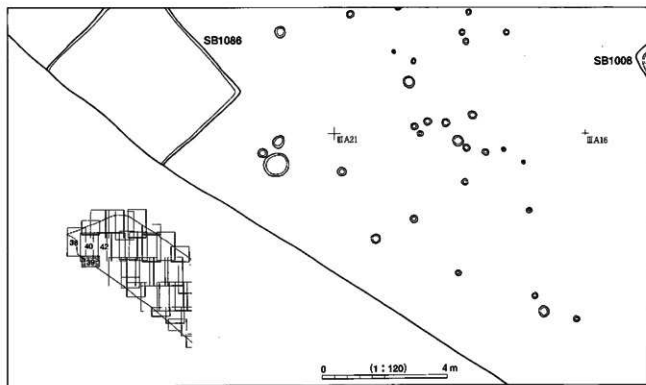
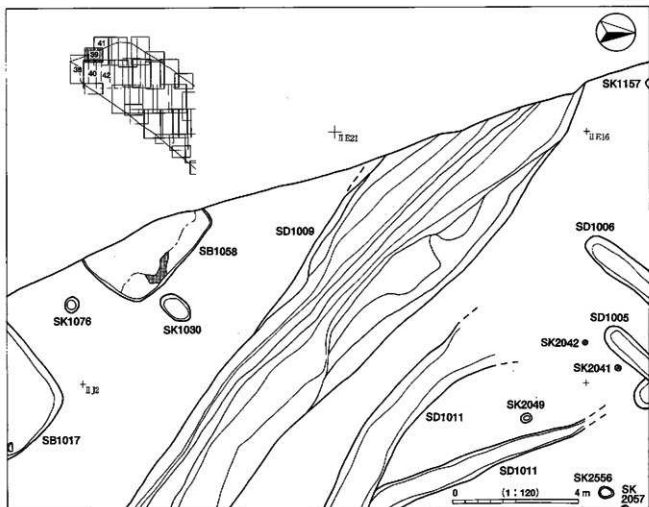

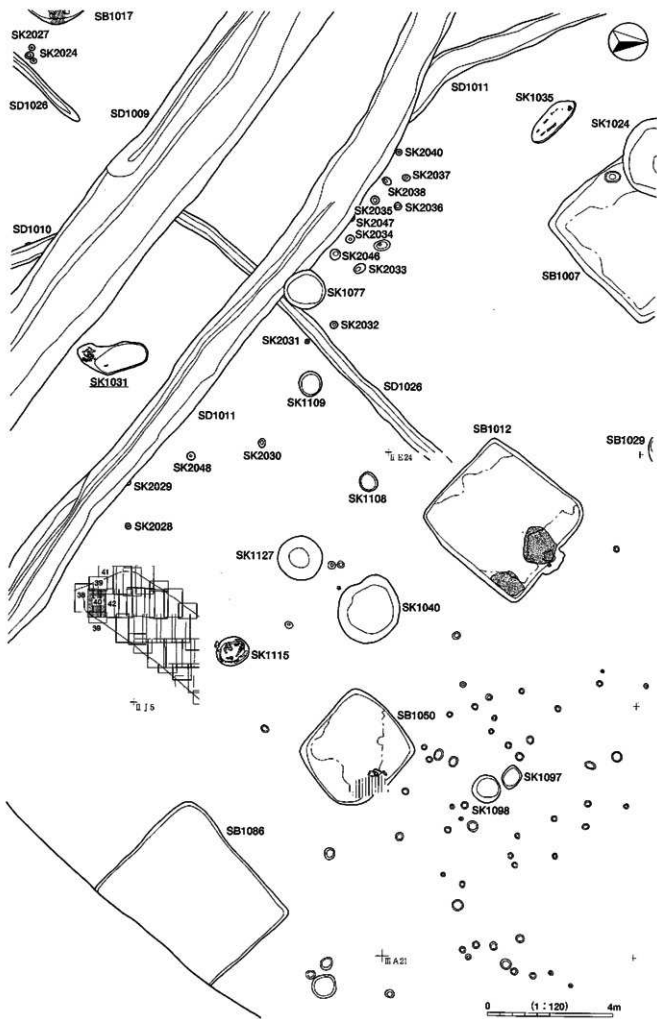

图版56 遺構実測図41

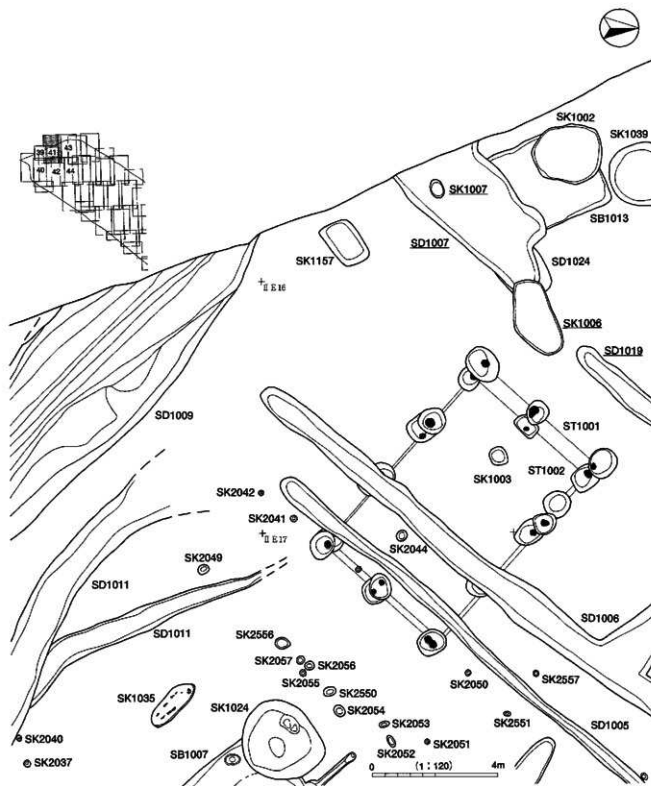

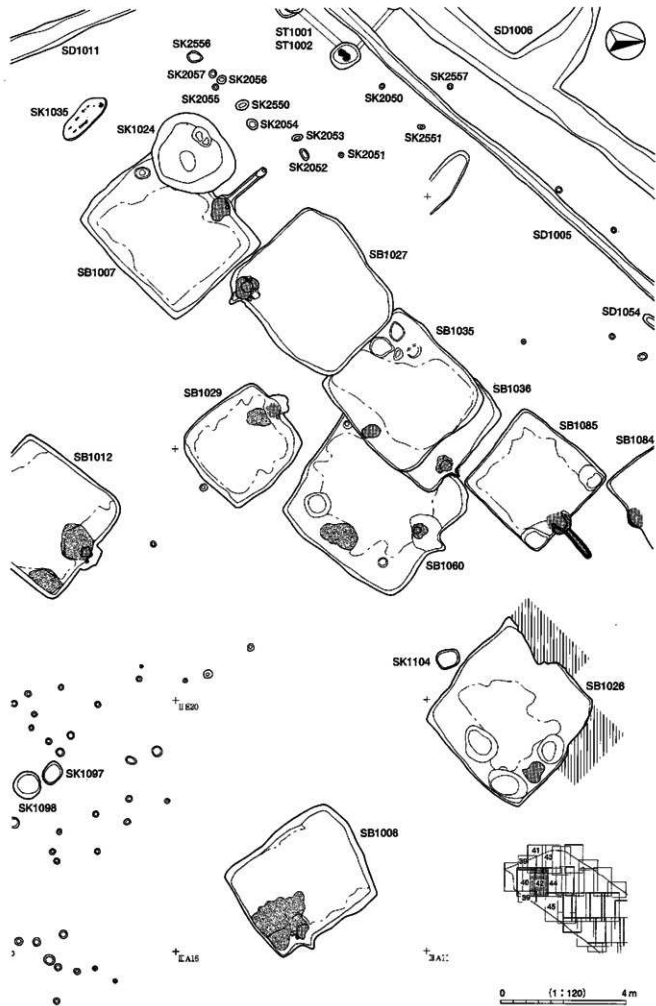

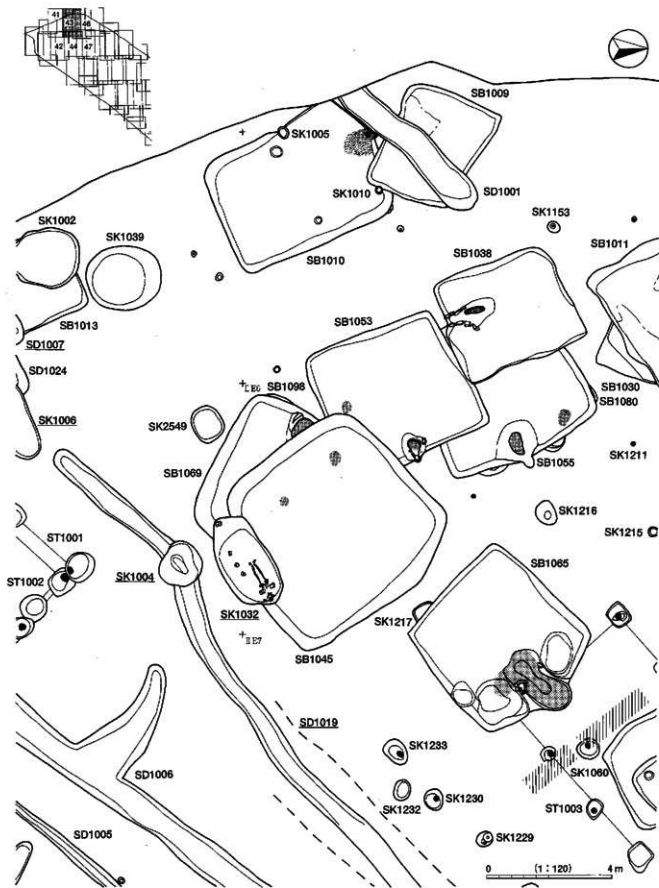

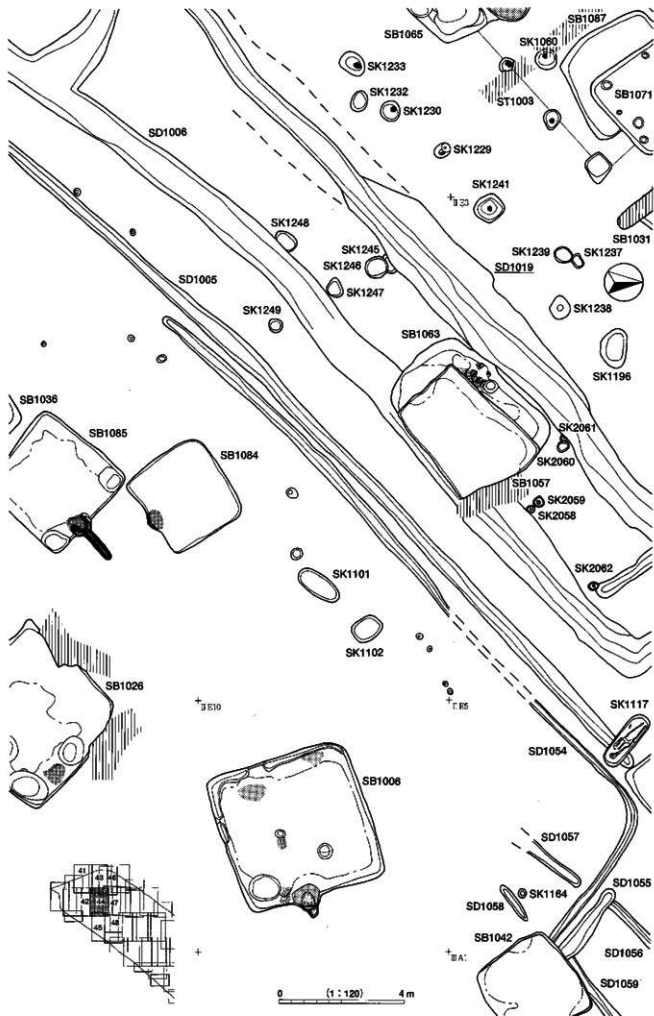

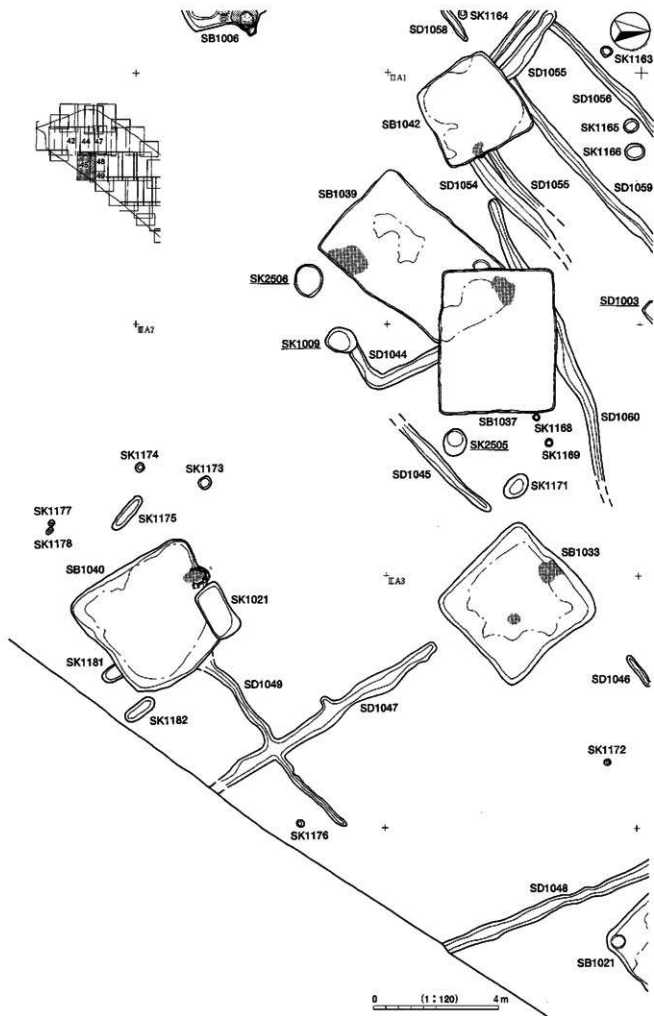

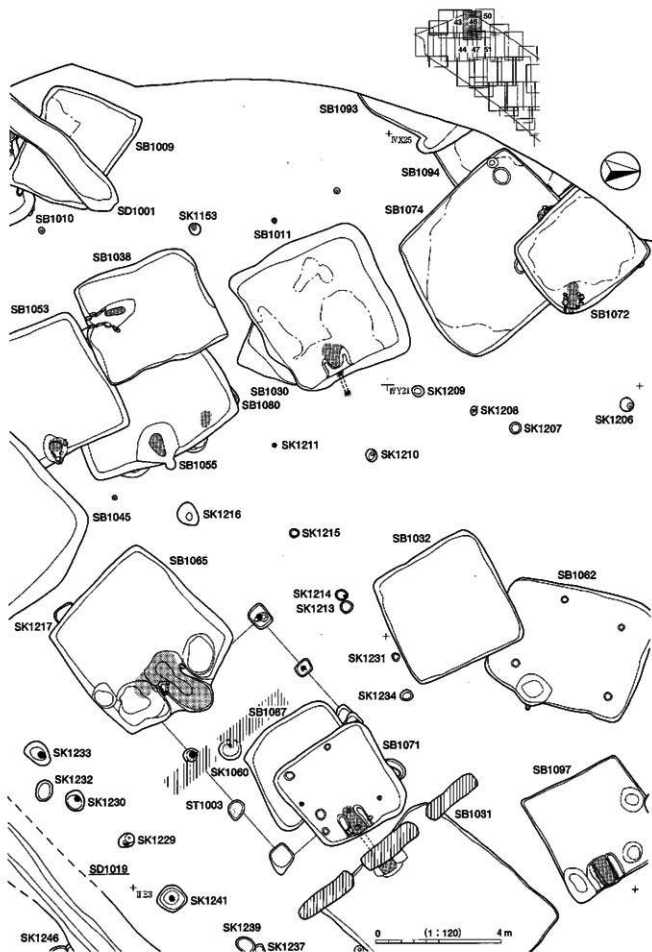

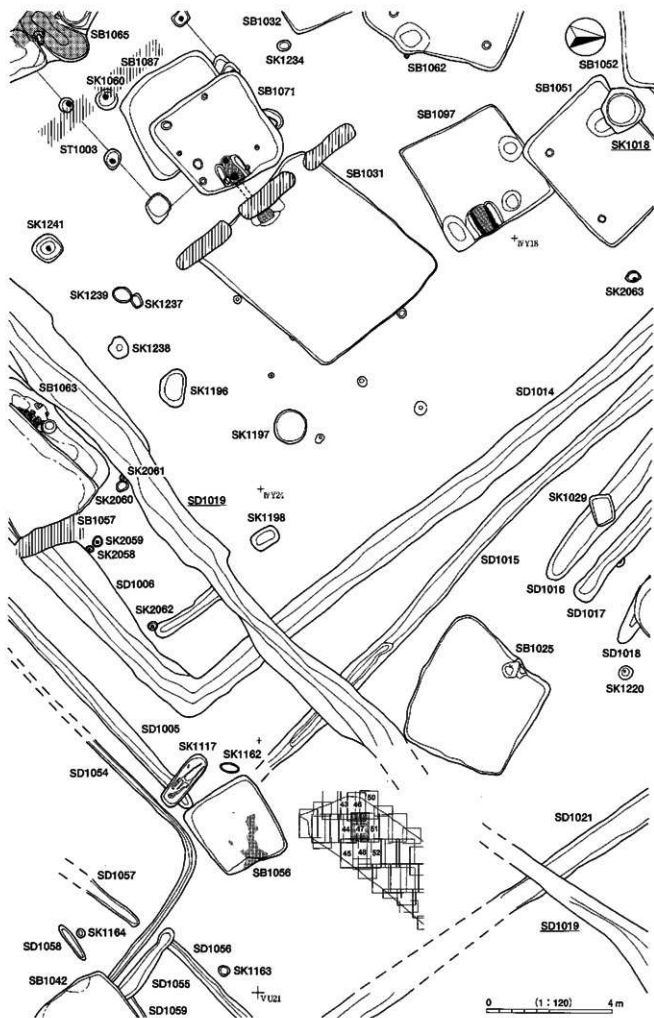

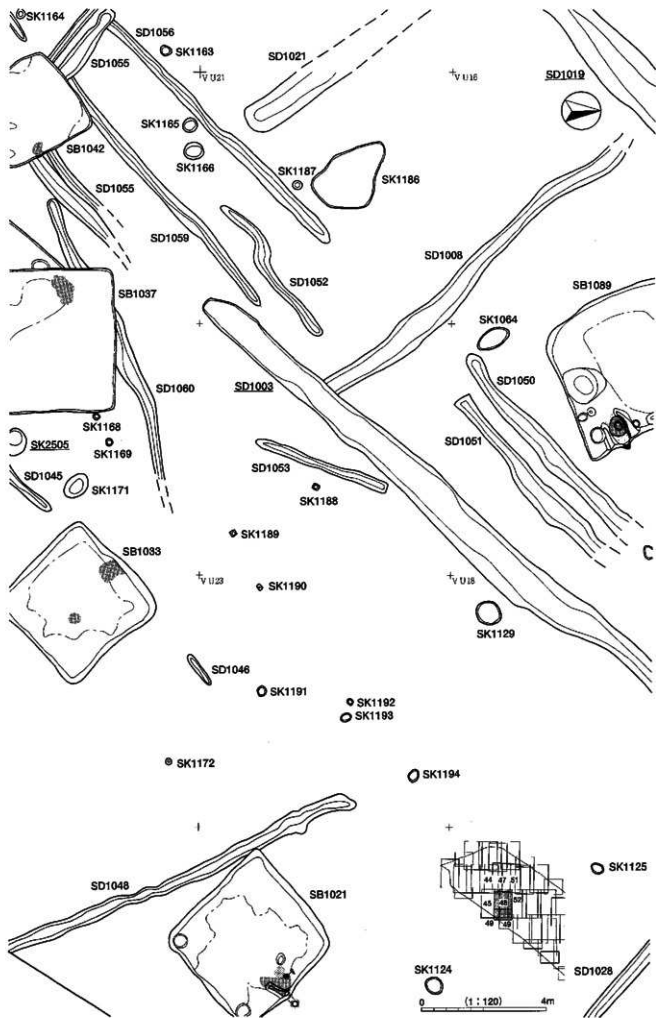

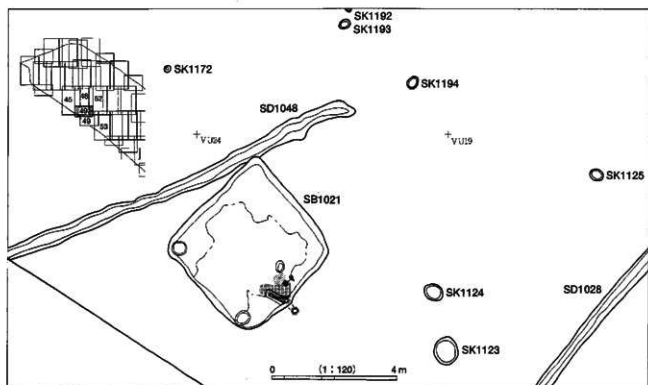
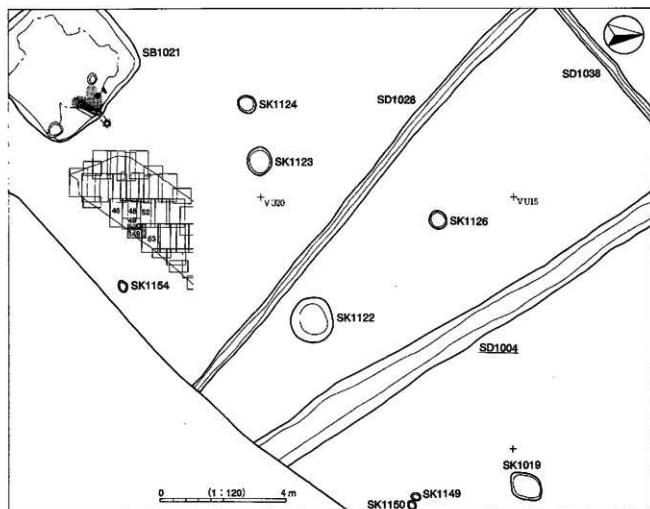

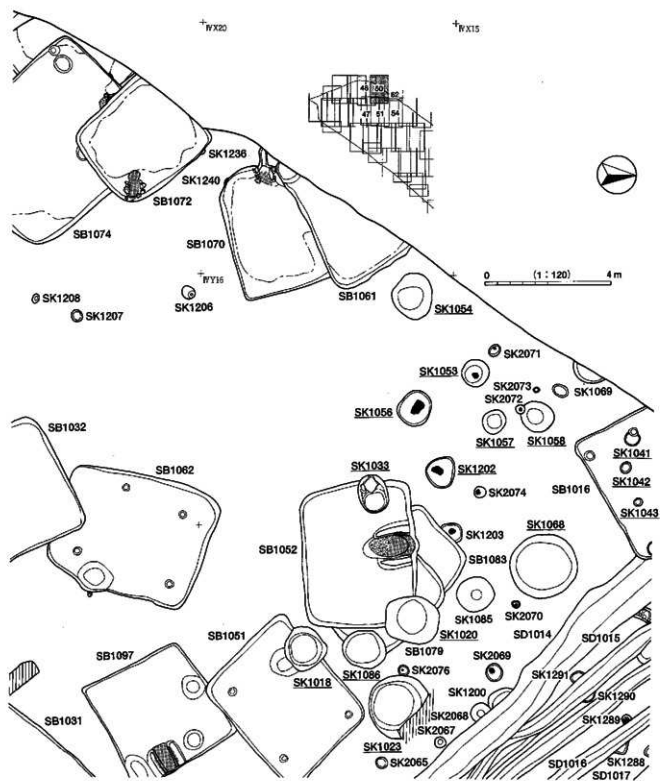

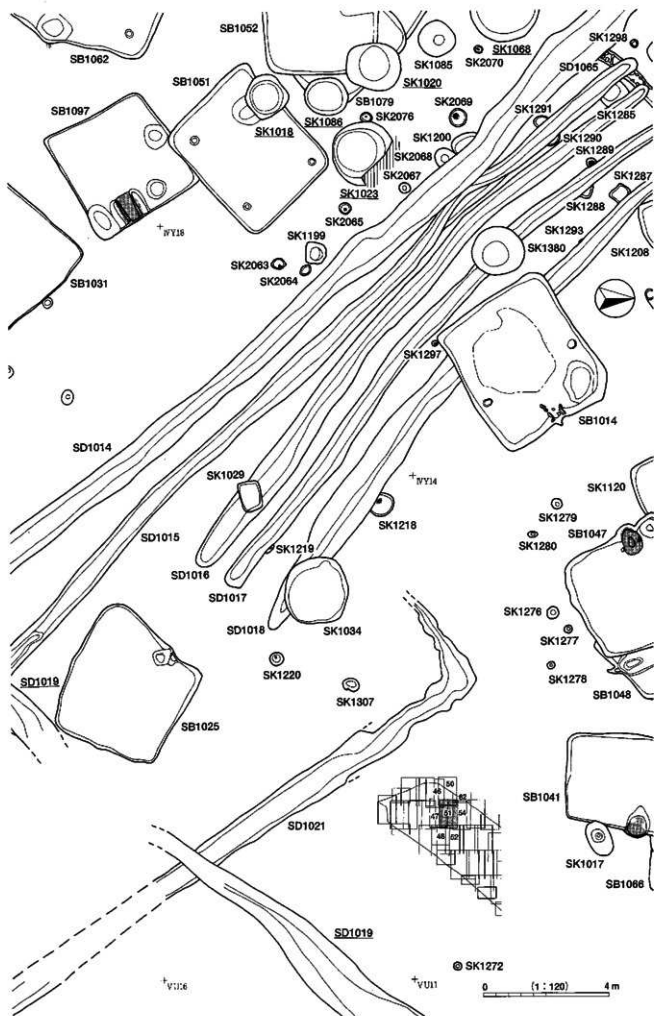

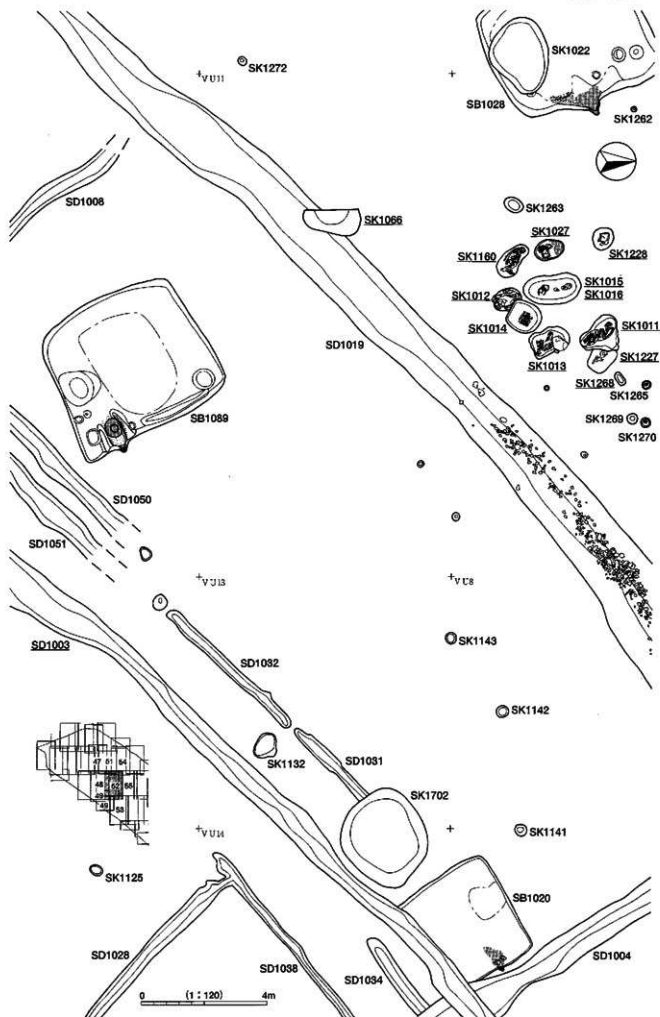

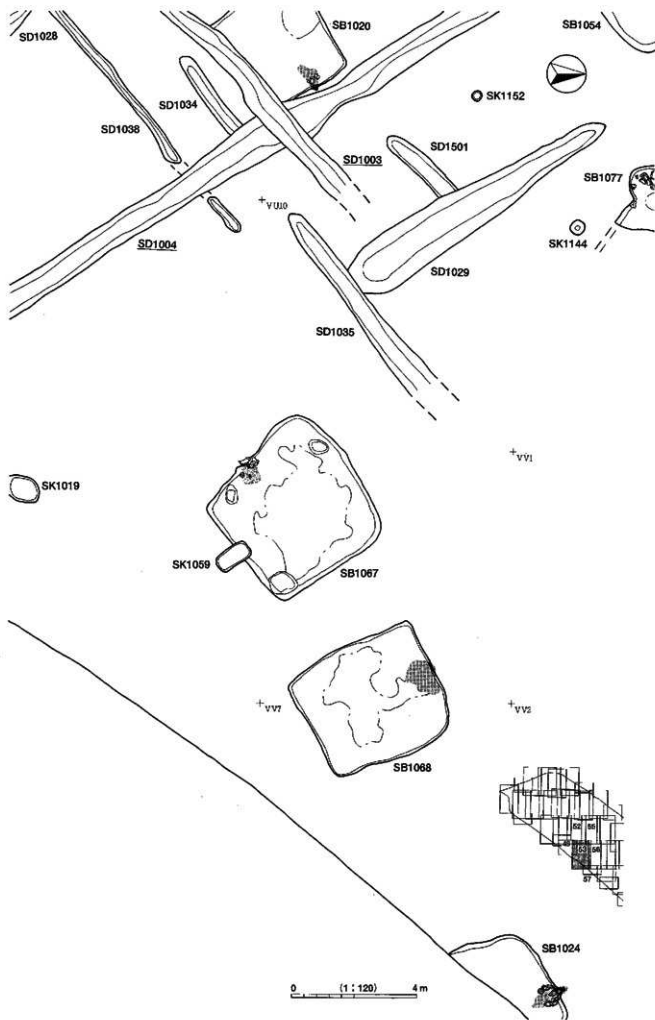

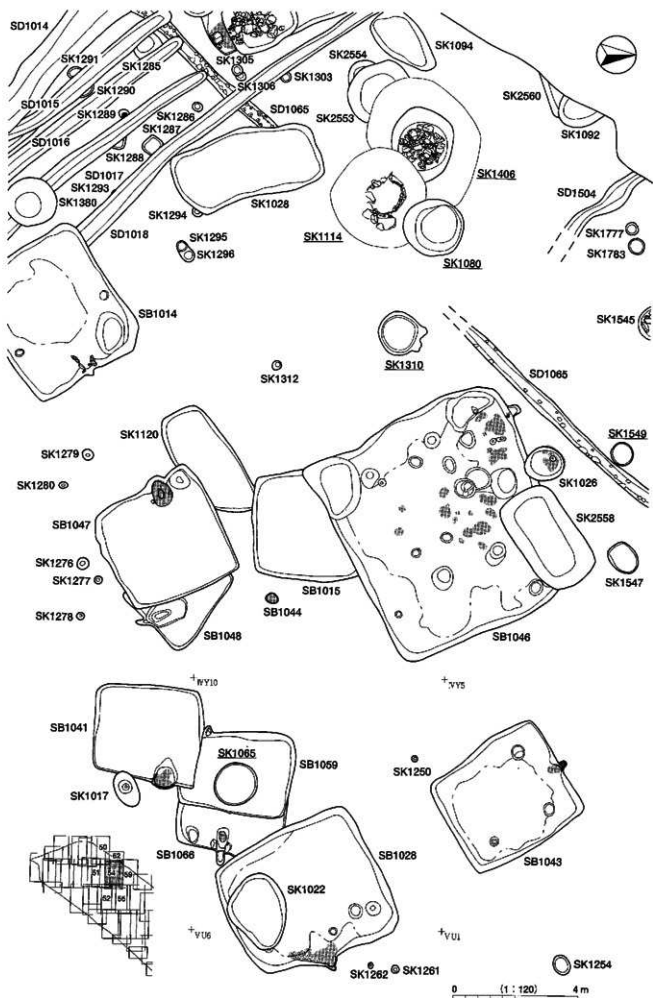

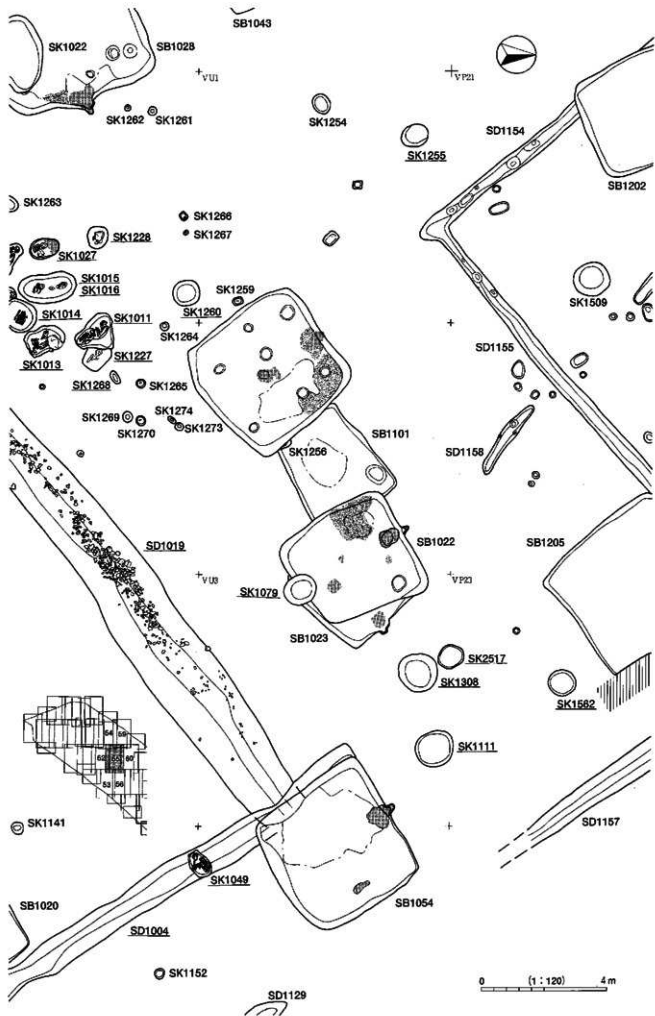

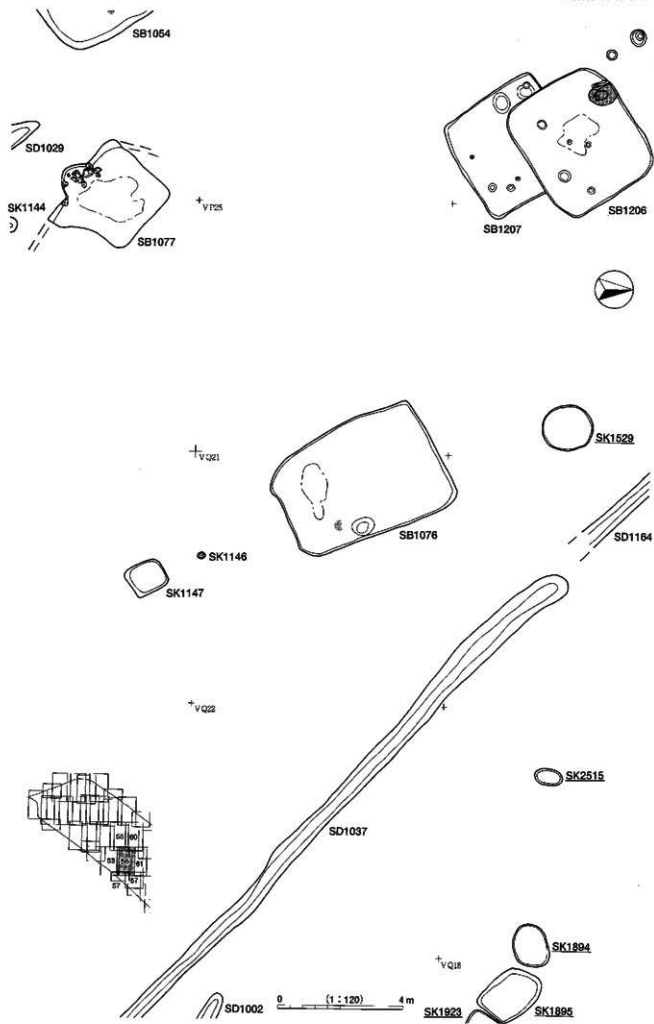

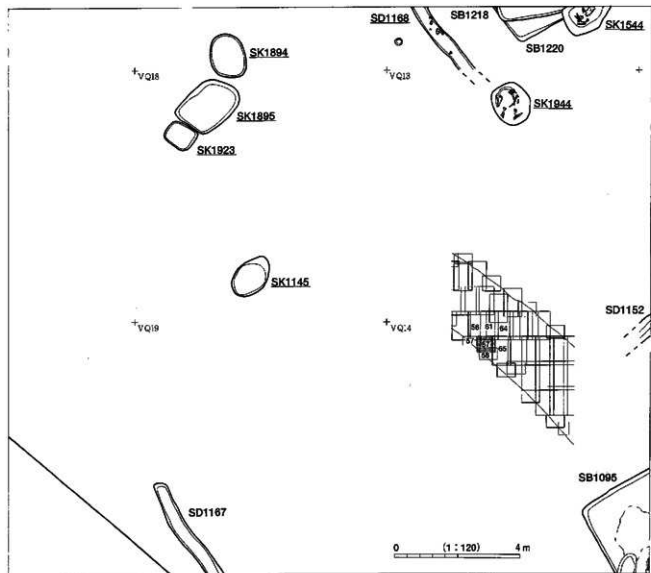
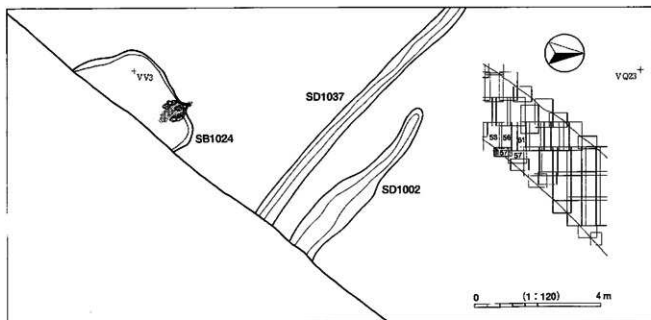

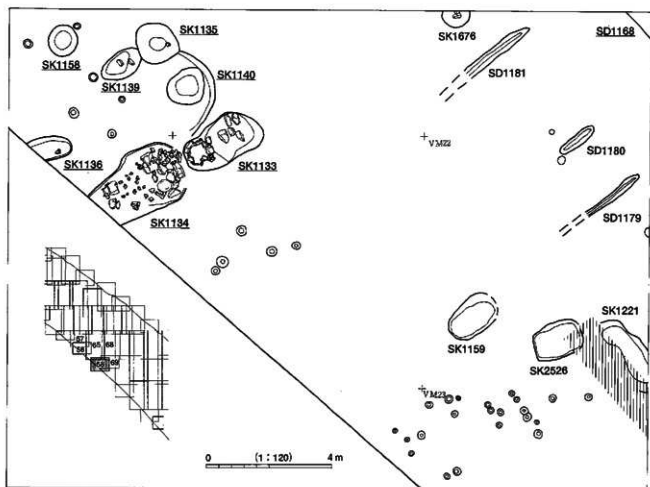
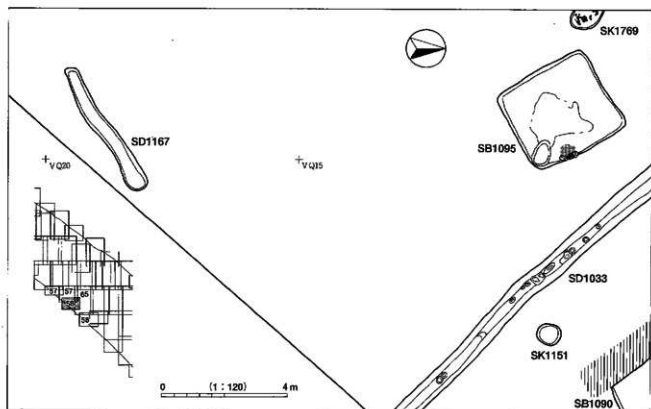

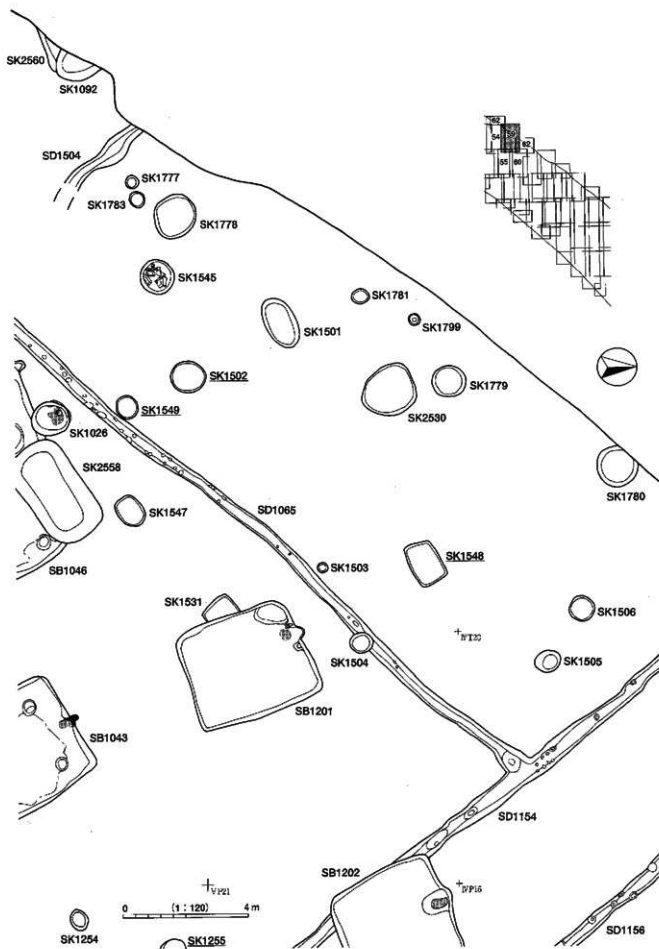

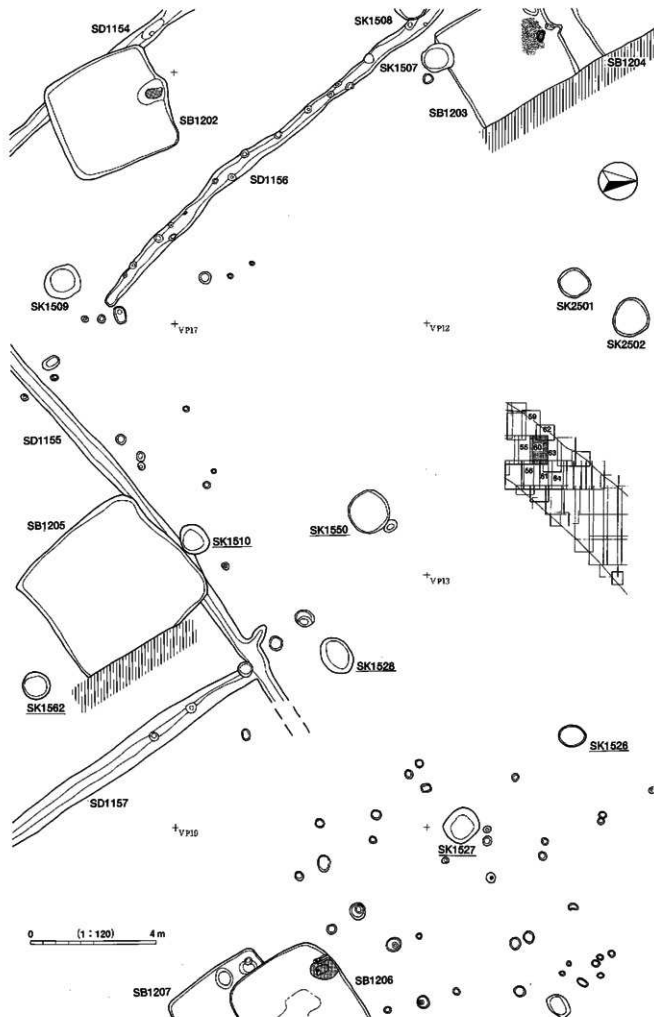

图版76 结构素描图61

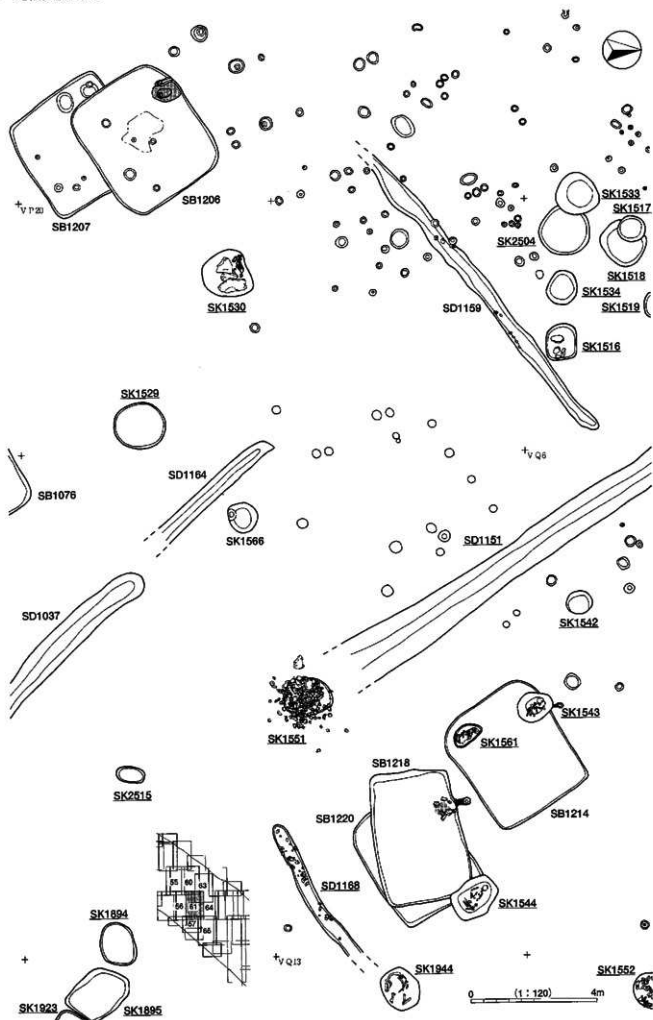

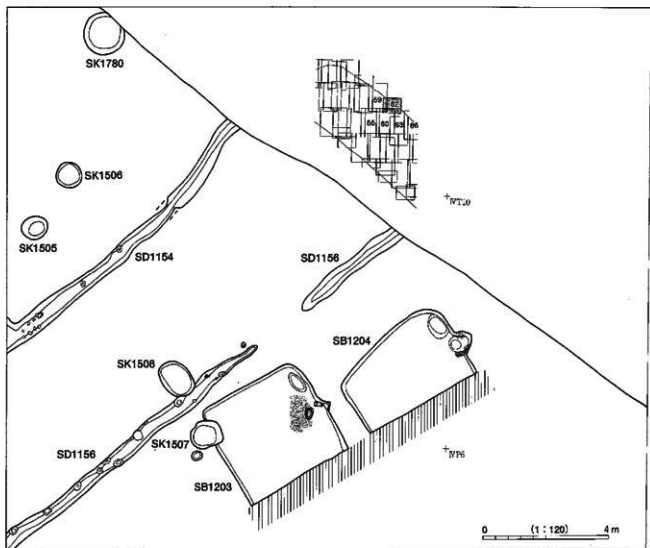
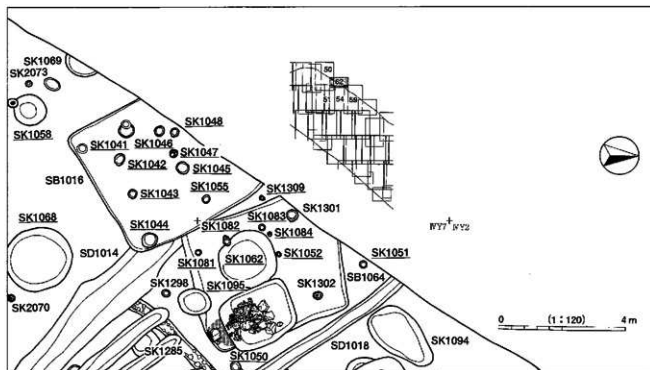

図版78 遺構実測図63

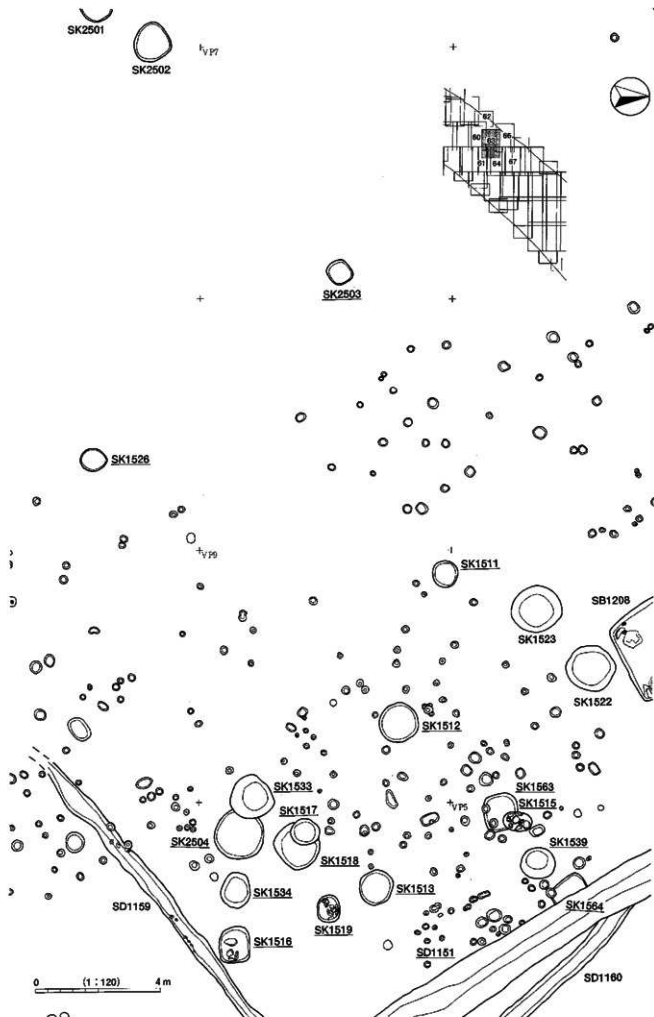

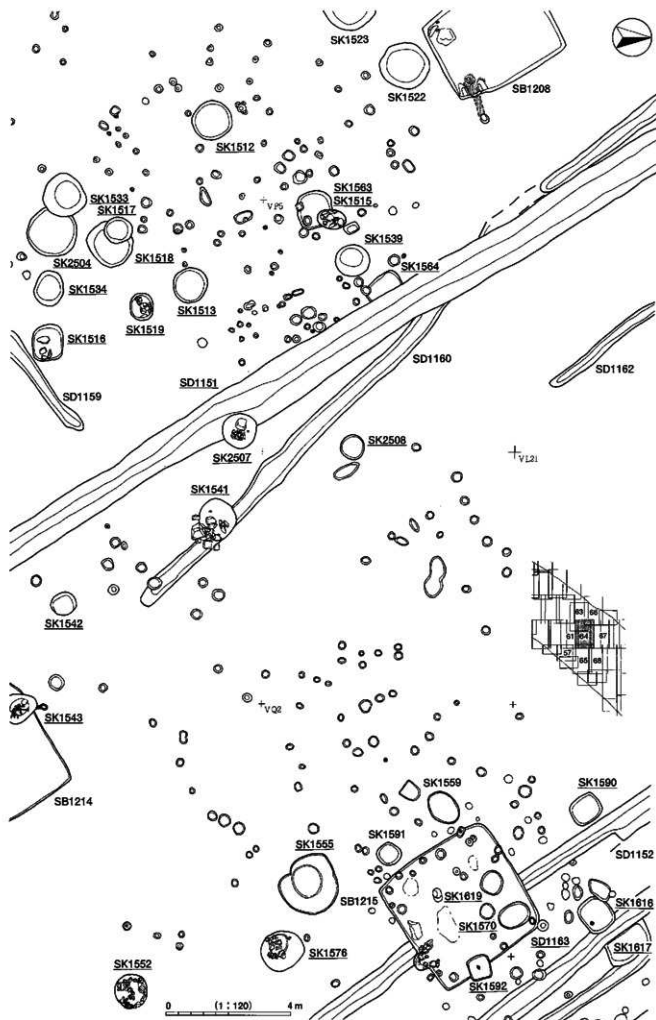

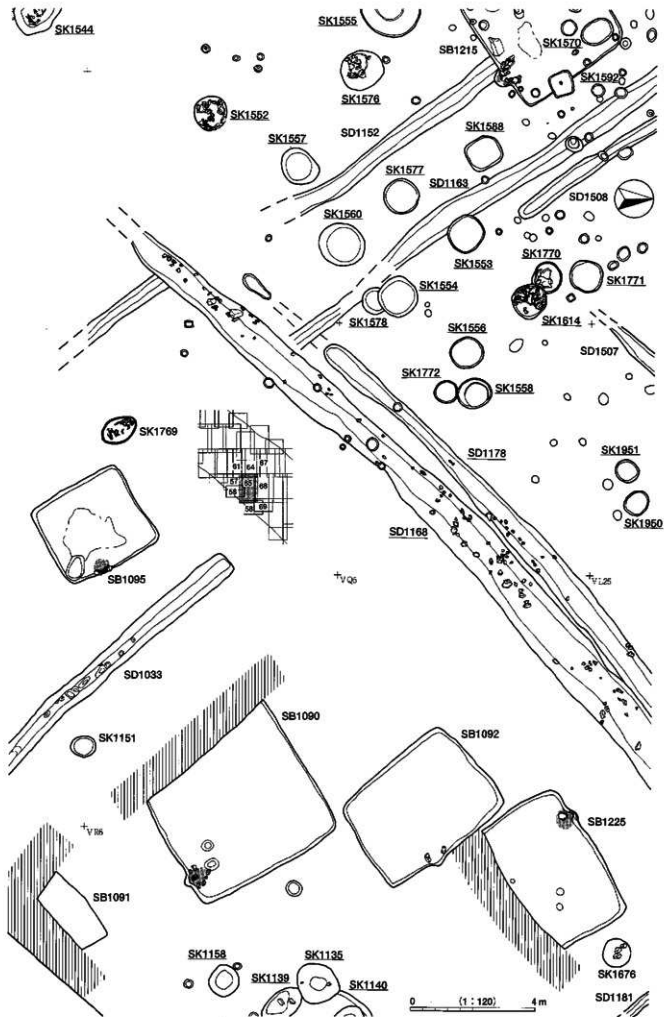

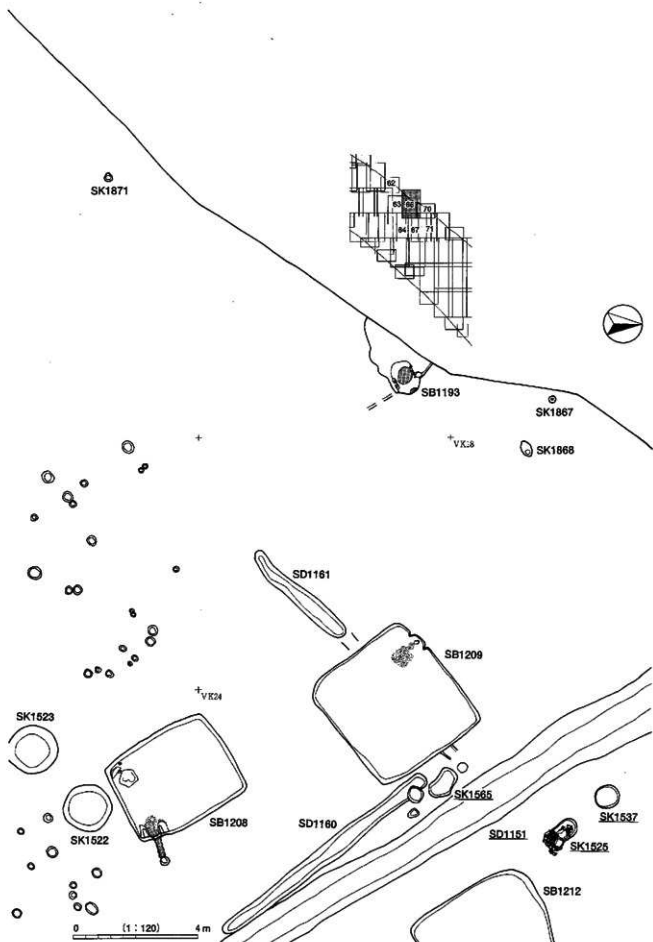

图版 82 遺構実測図67

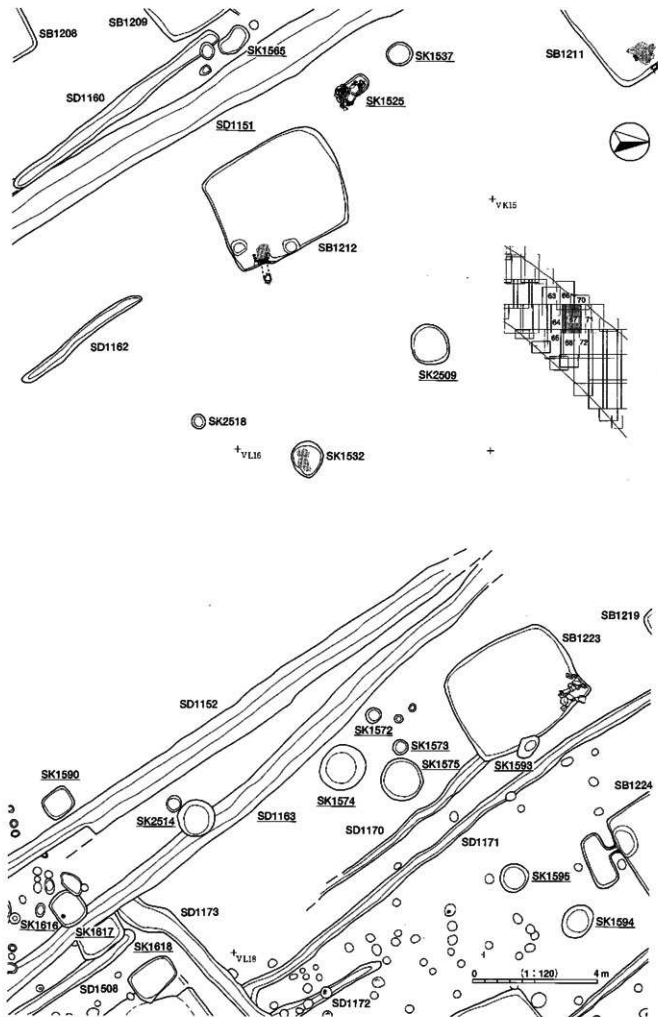

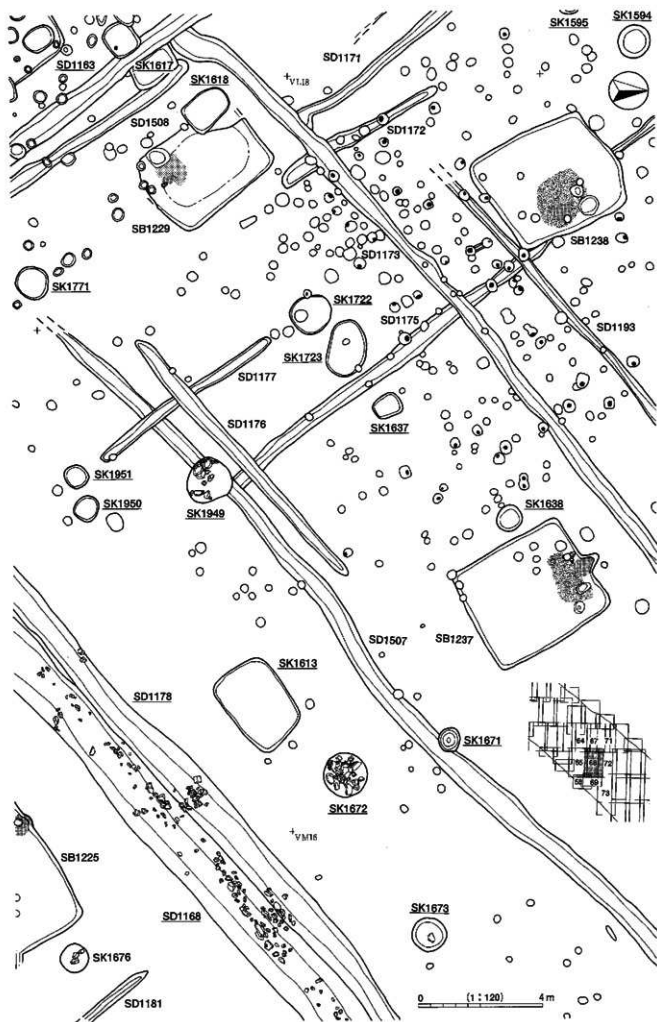

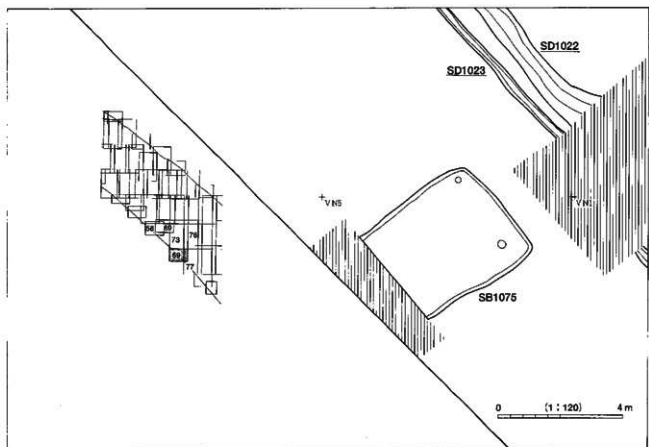
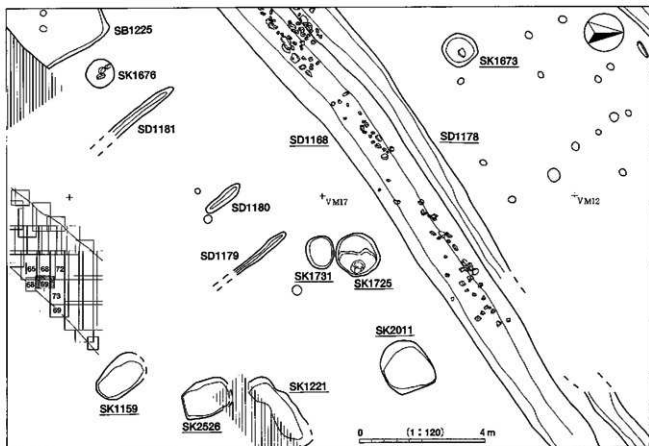

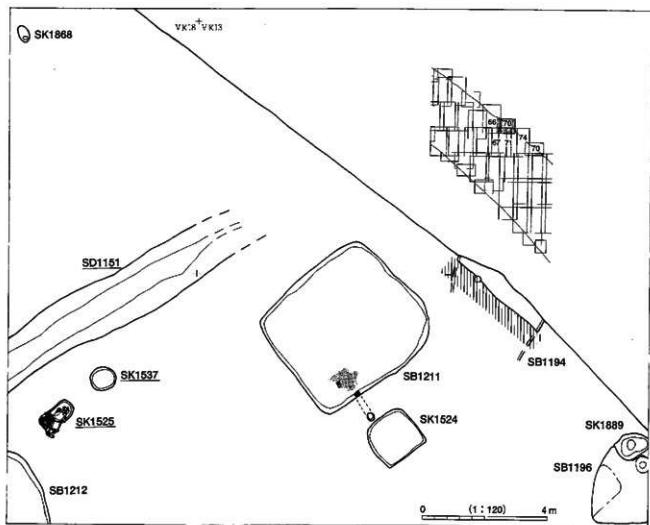
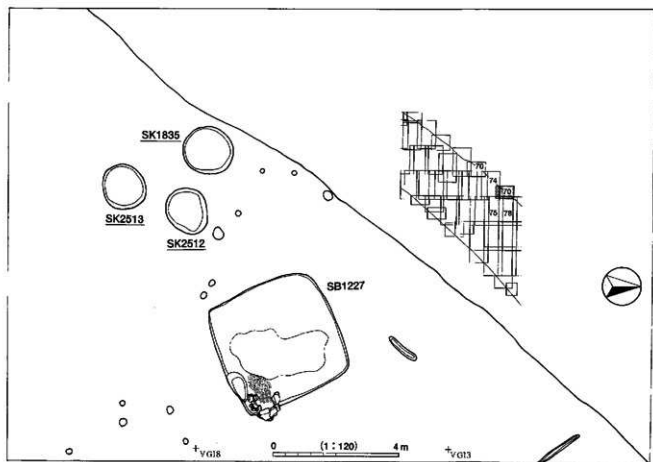

図版86 遺構実測図71

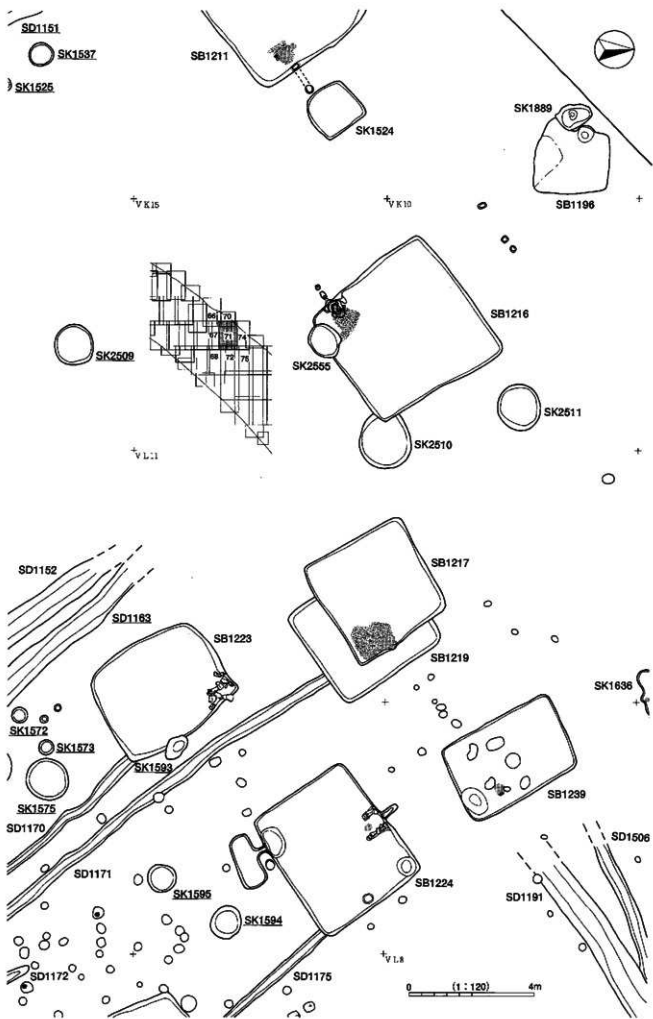

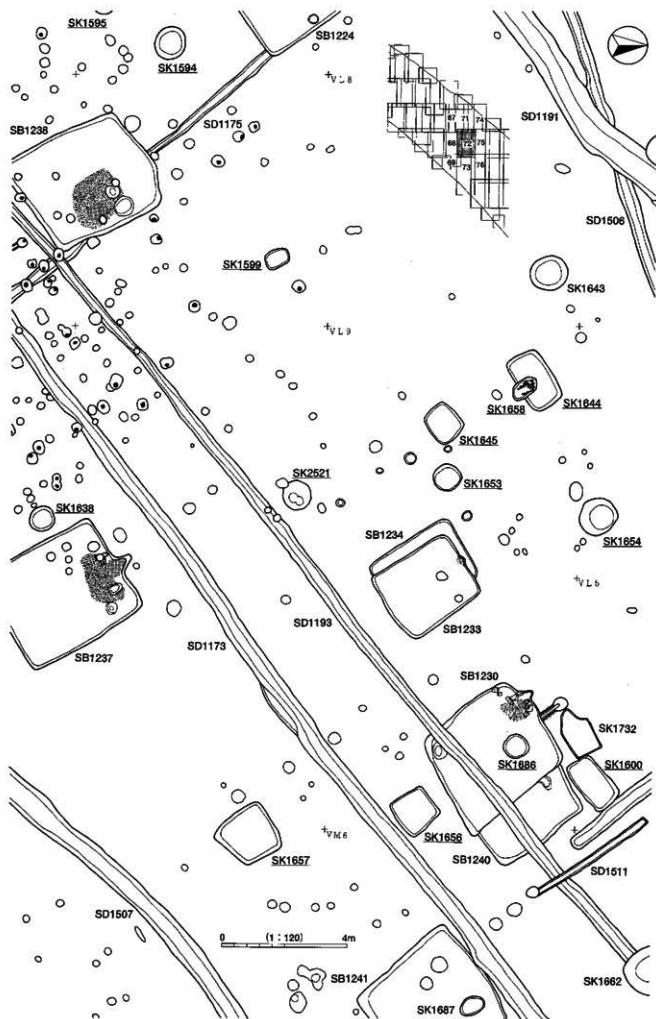

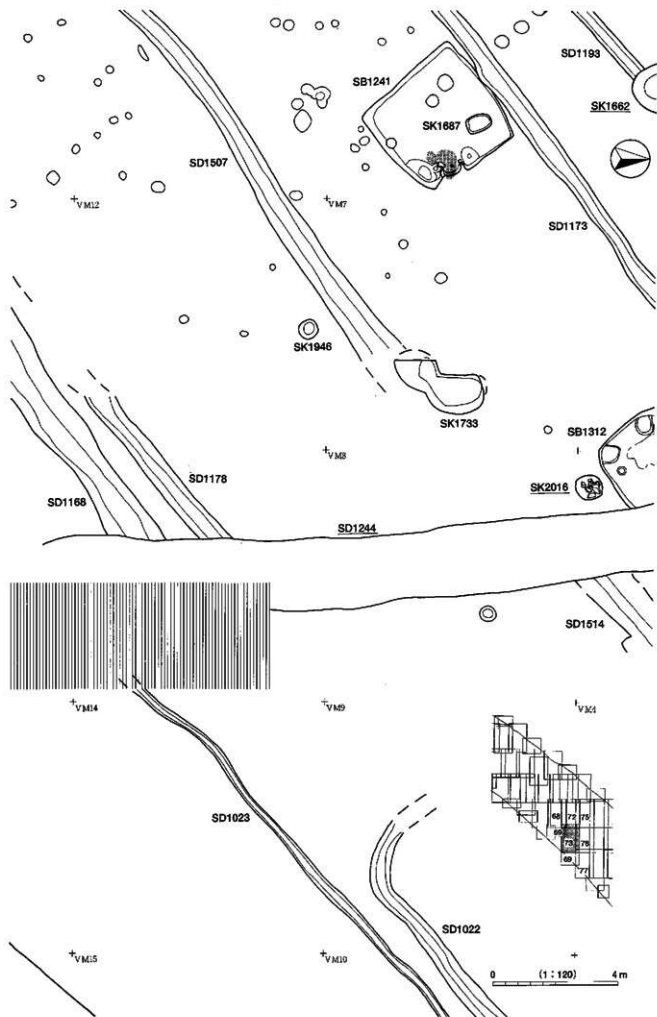

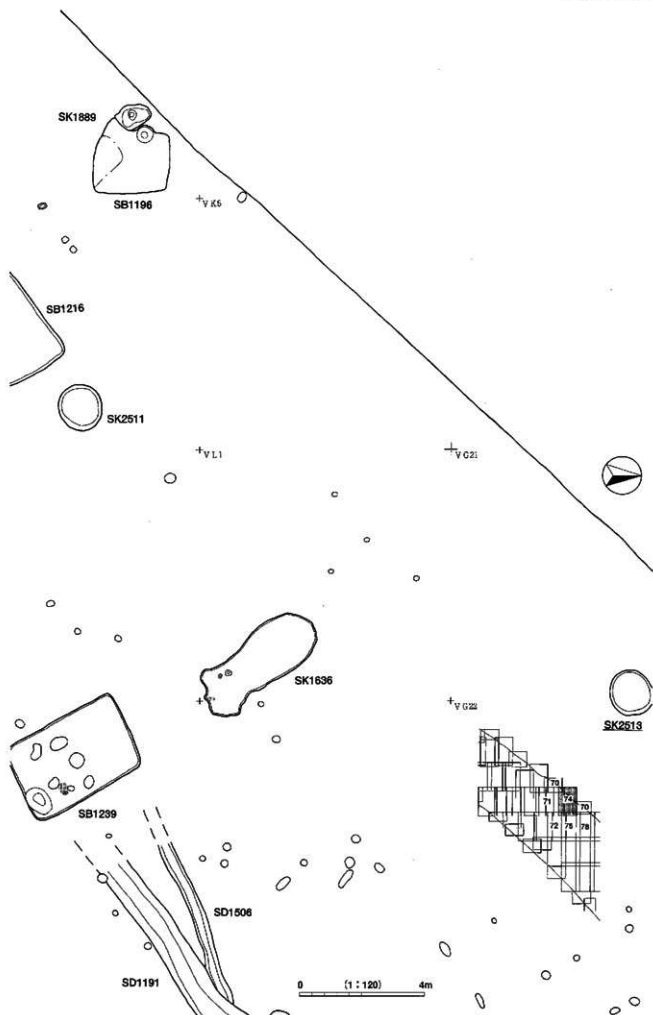

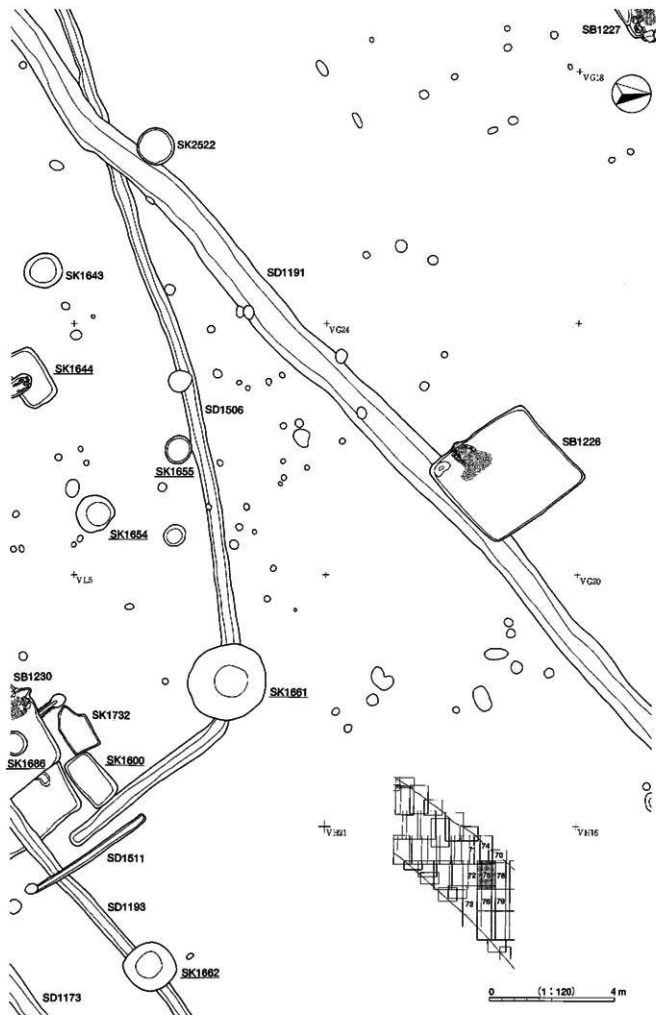

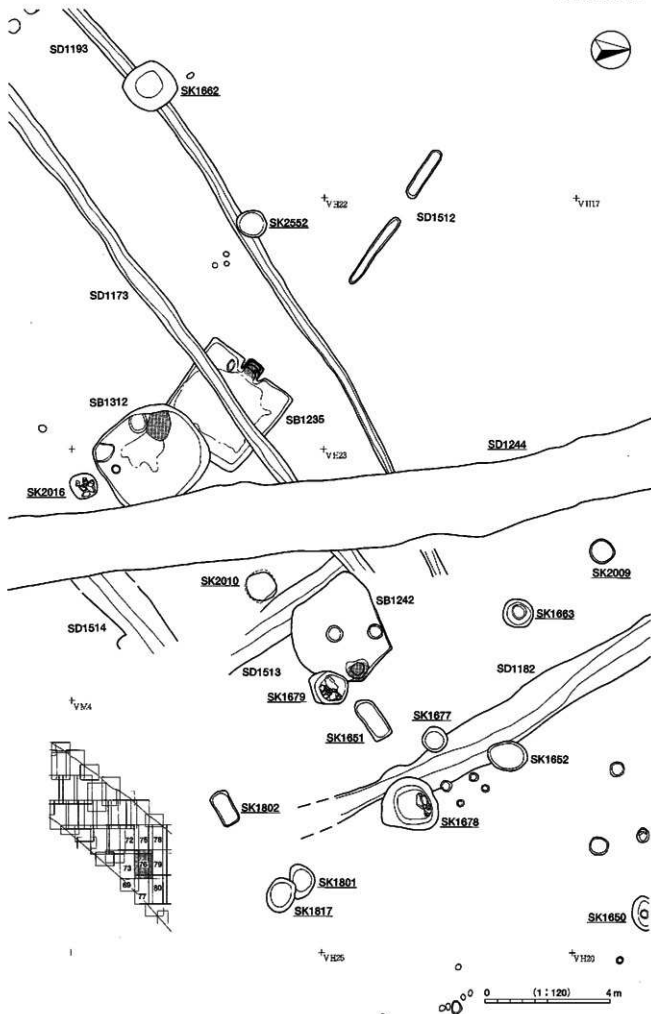

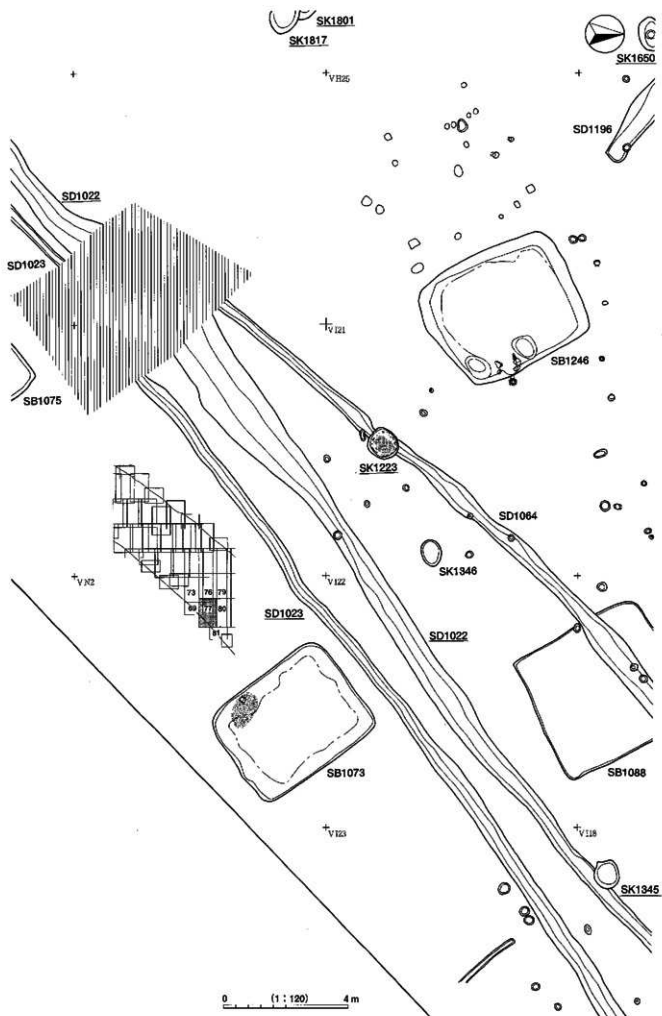

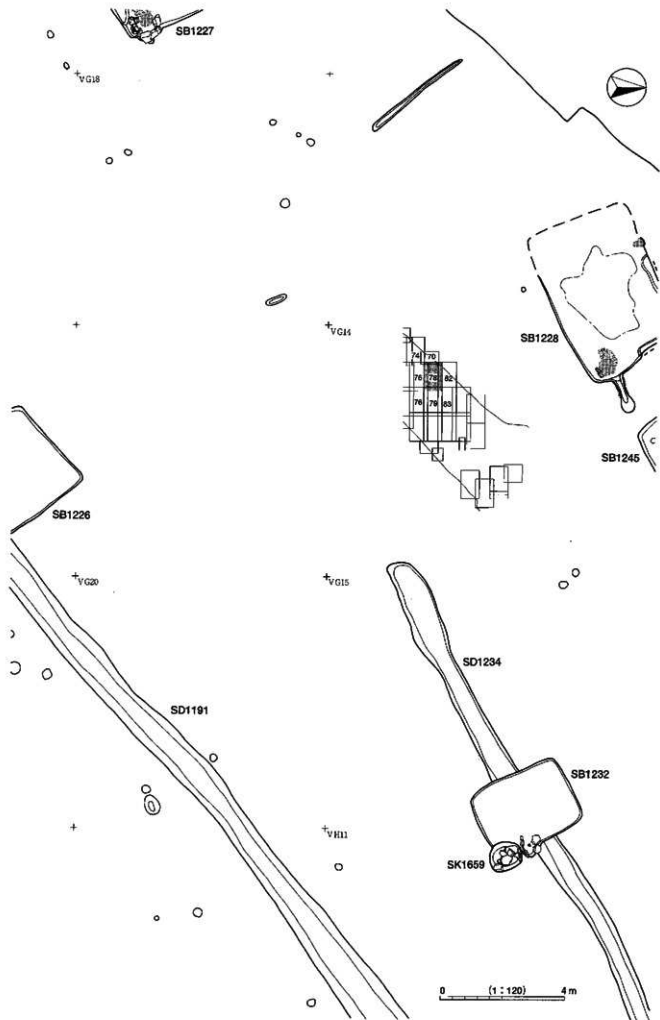

図版94 遺構実測図79

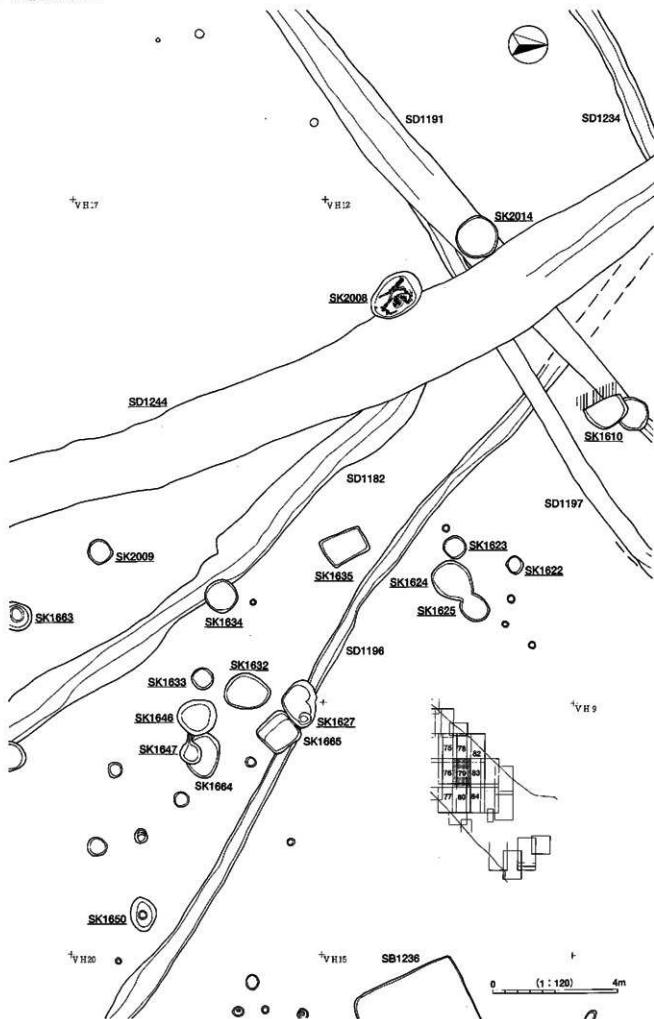

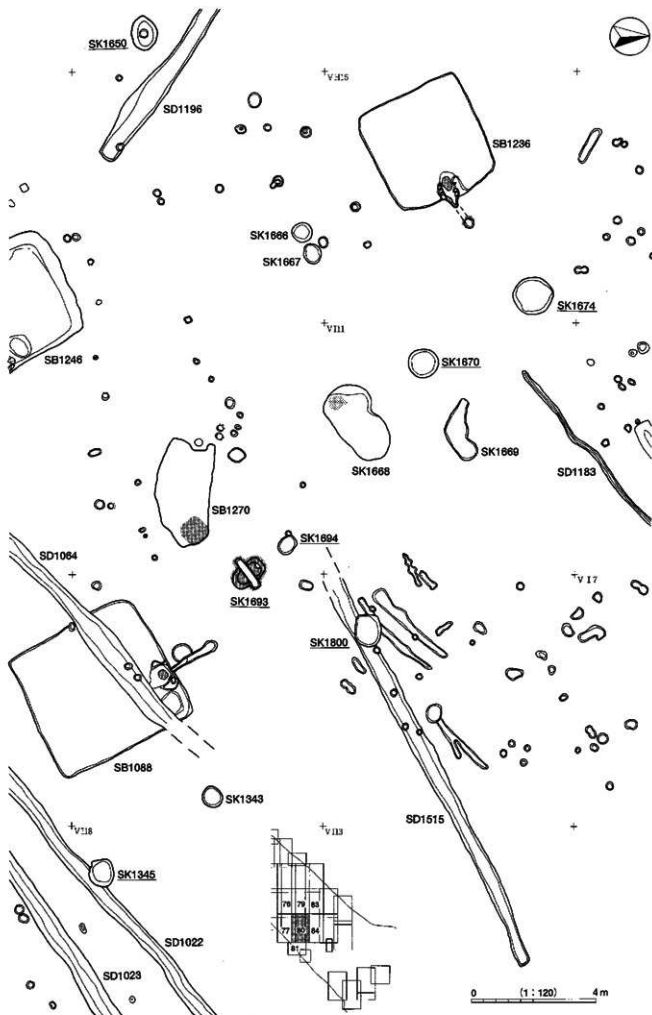

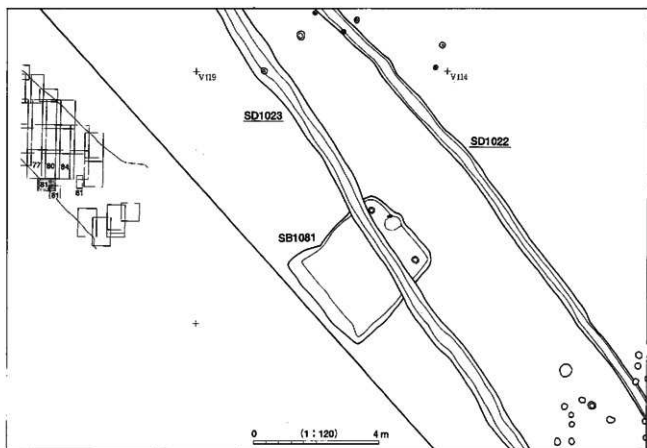
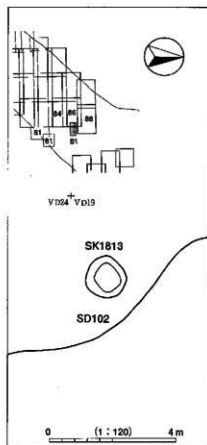
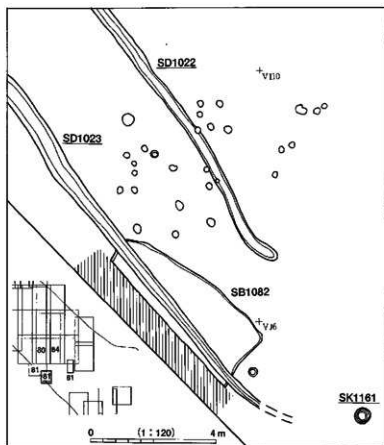

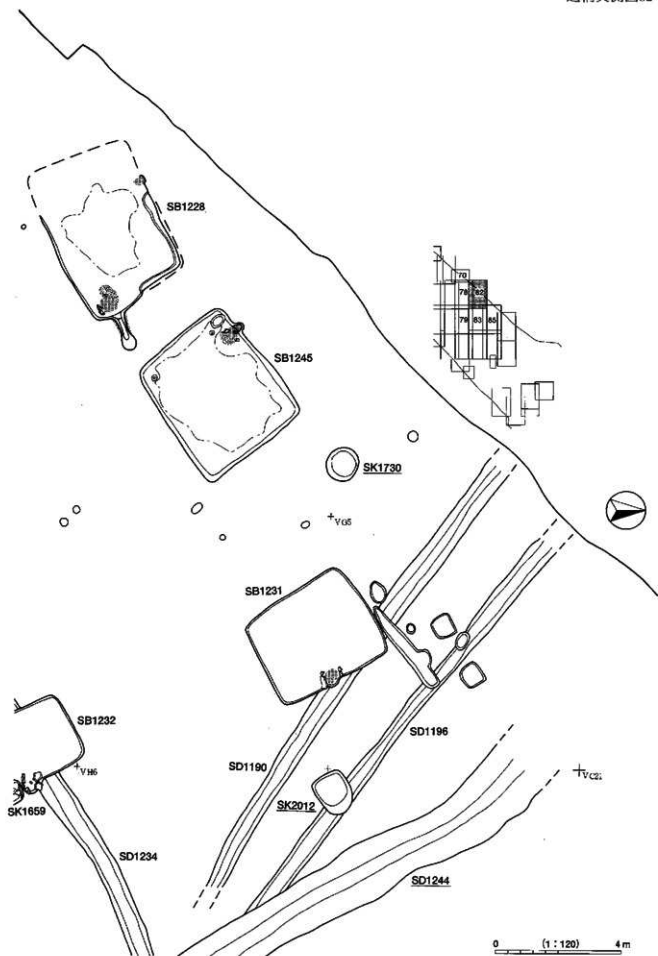

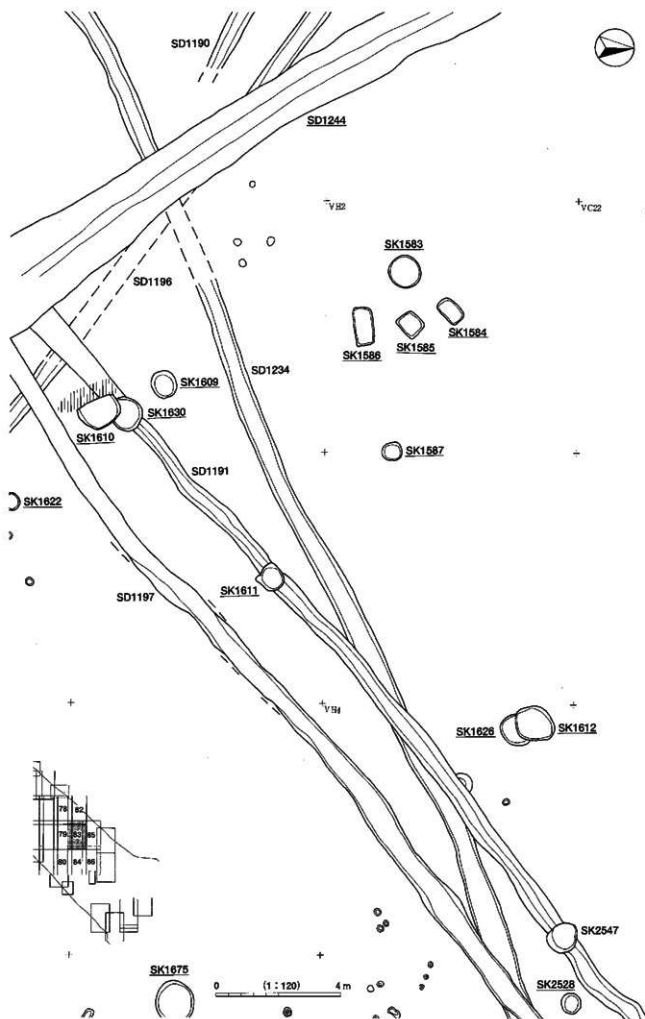



0 (1:120) 4m

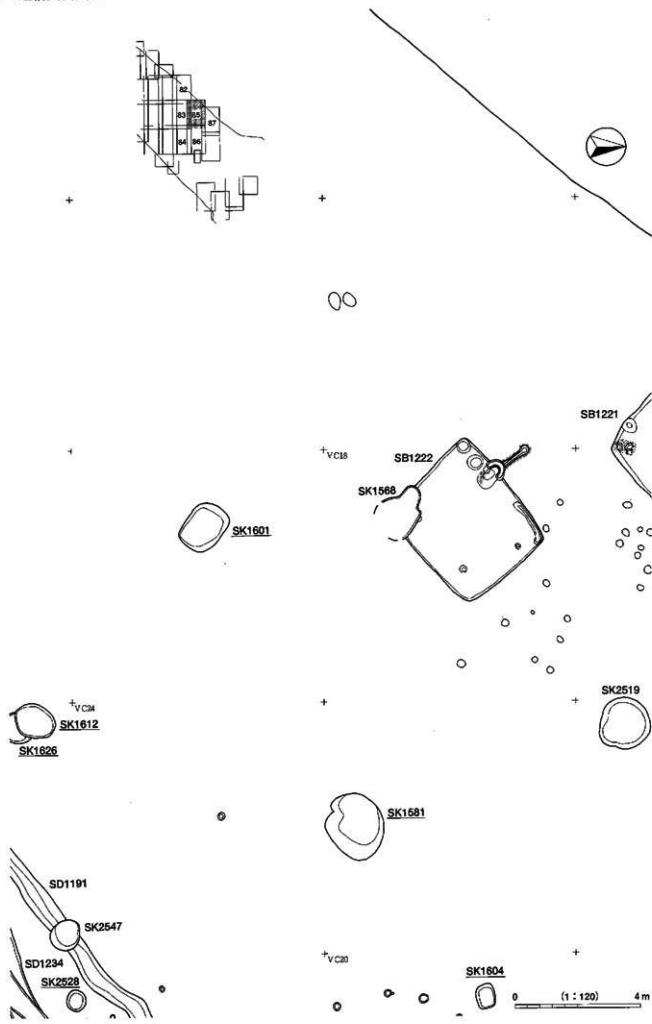

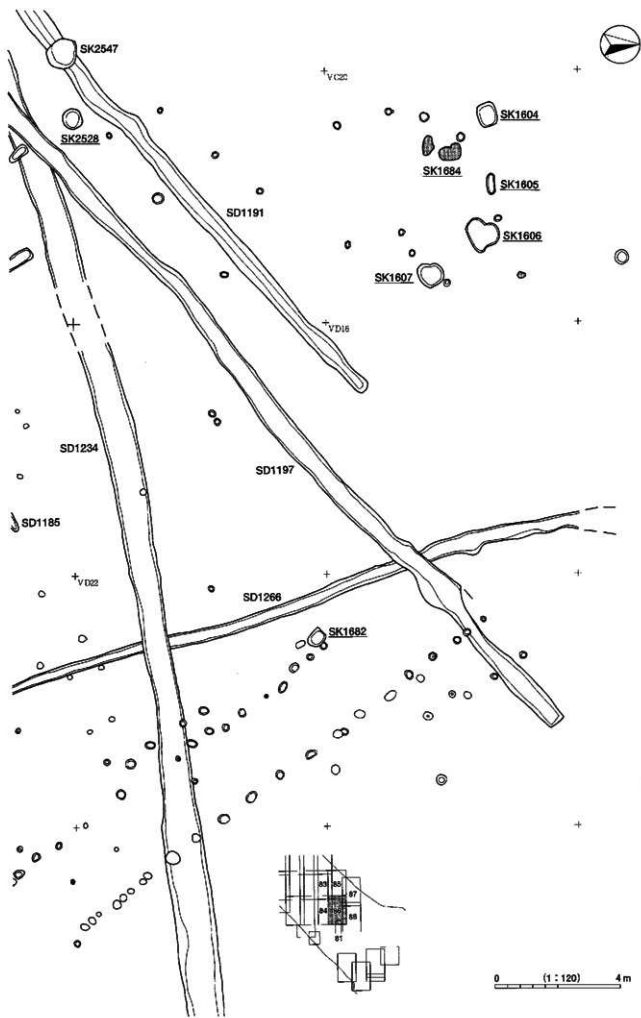

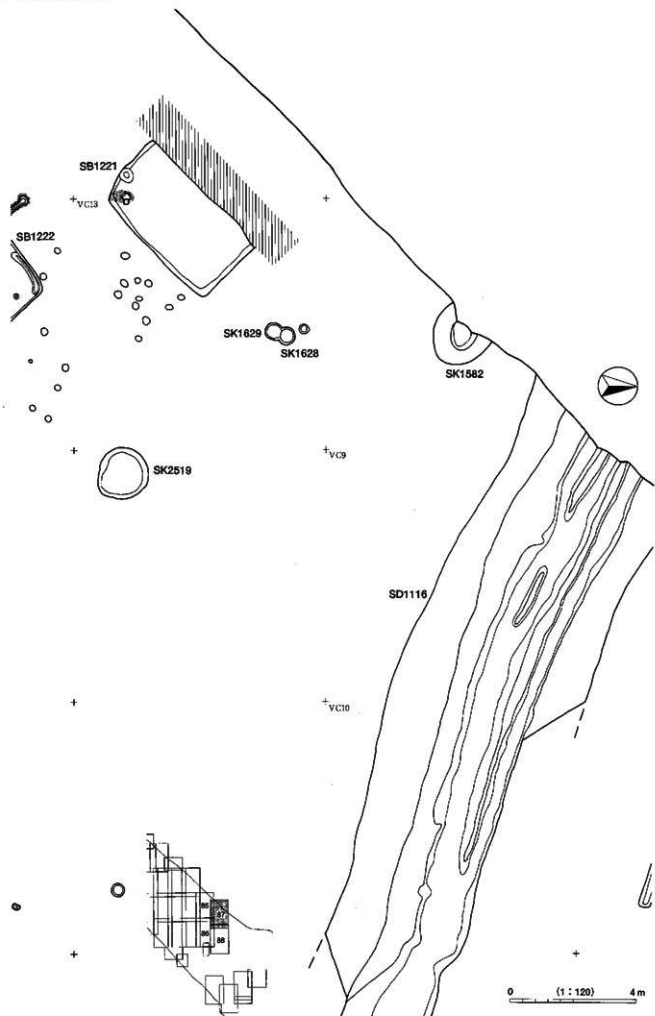

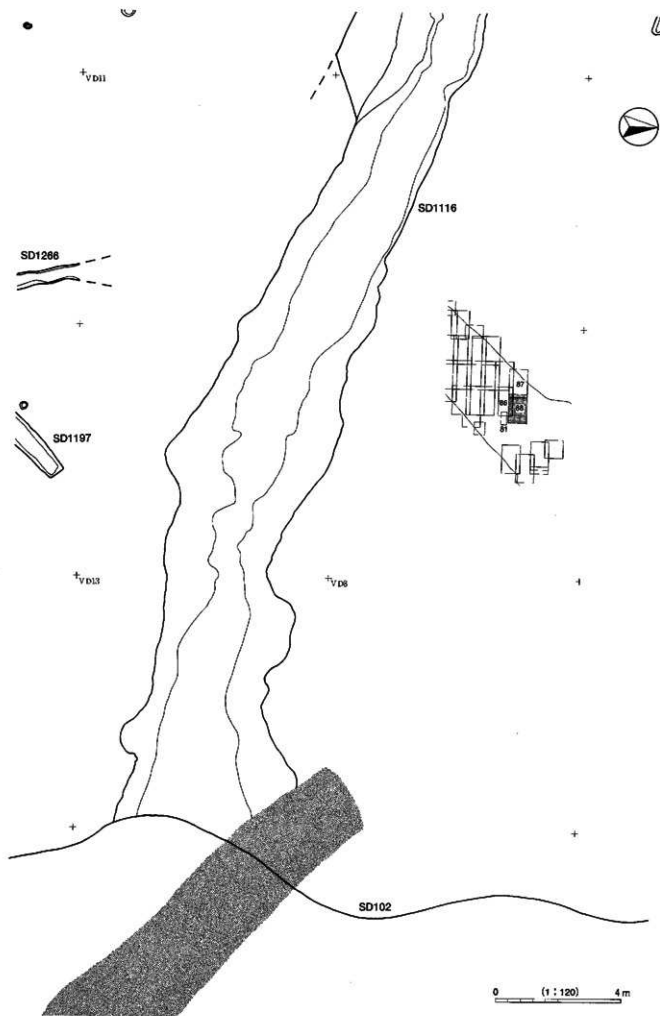

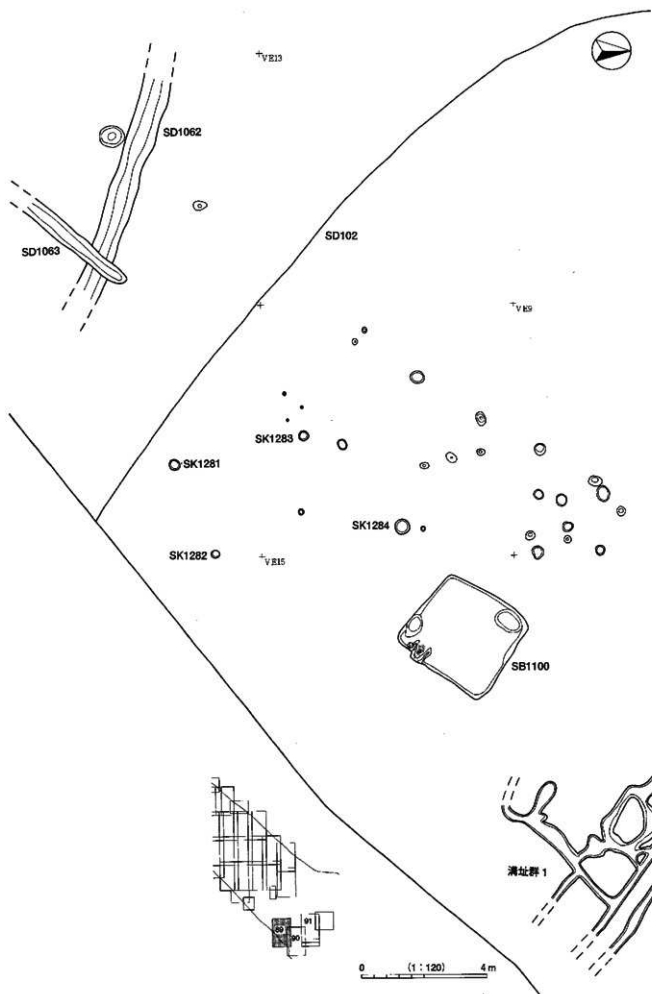

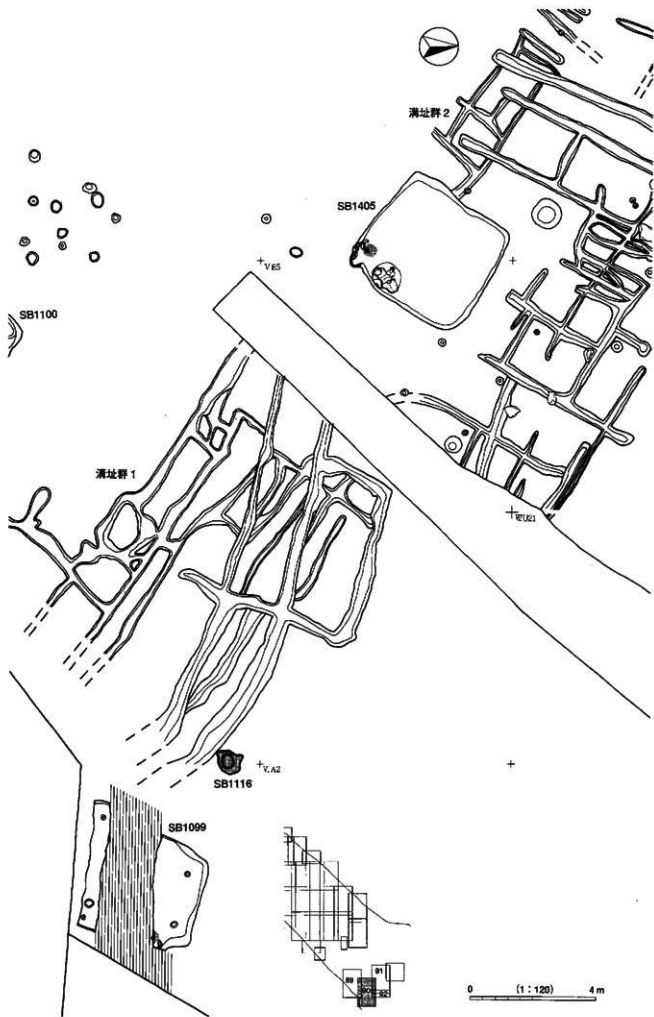

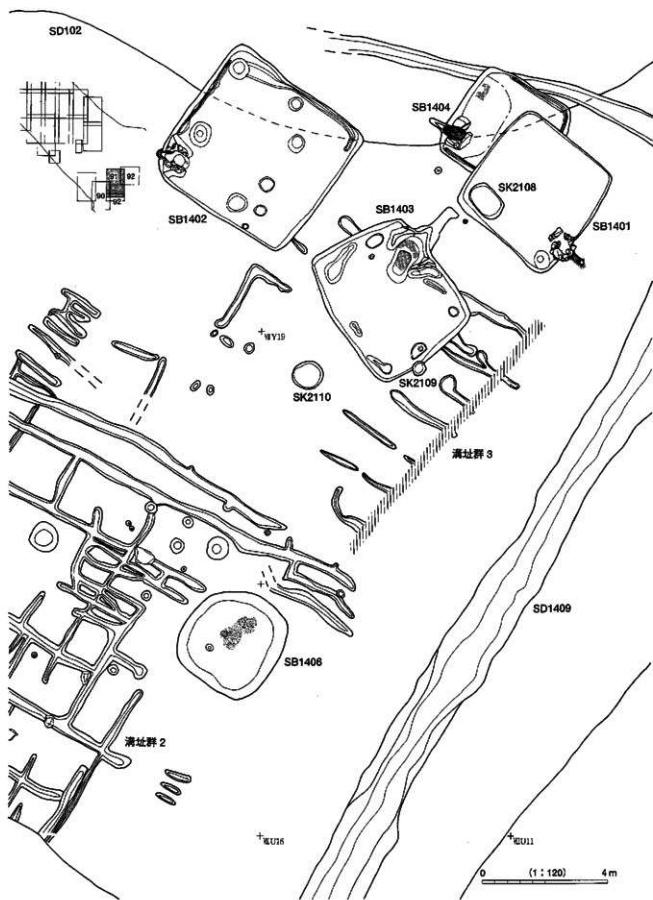

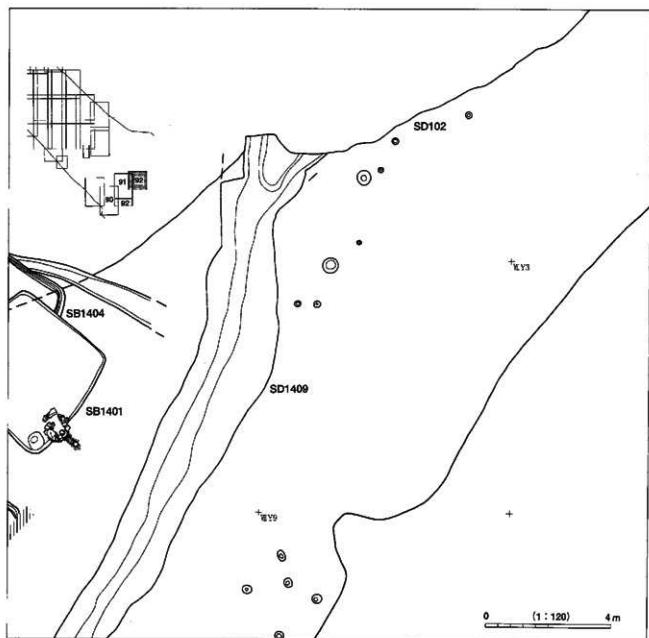
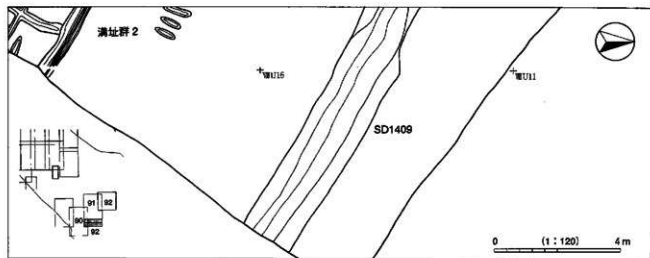

図版108 竪穴住居址重複関係図1

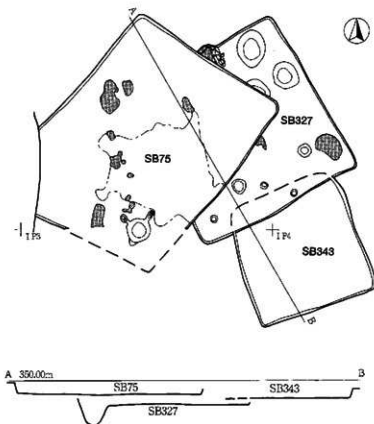
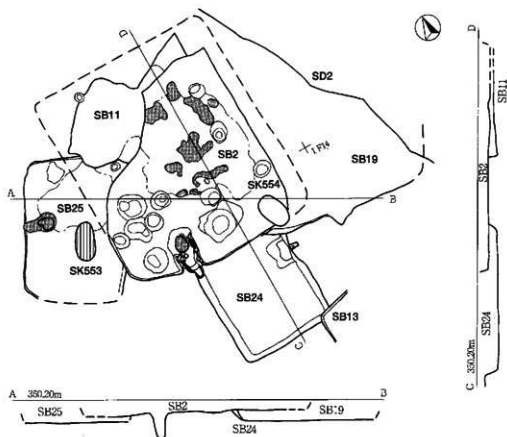

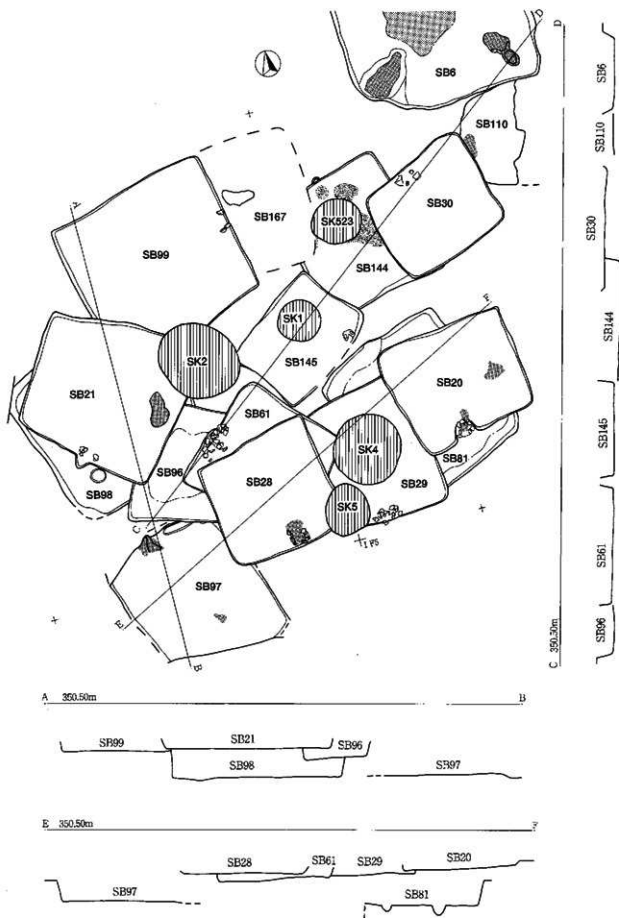

図版110 竪穴住居址重複関係図 3

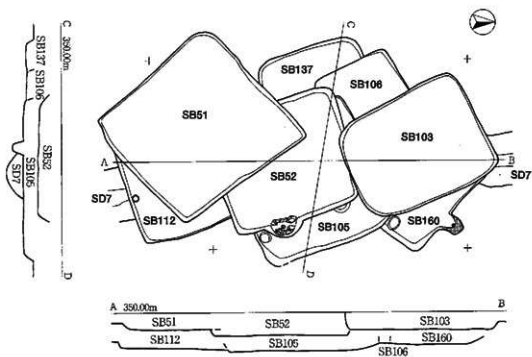
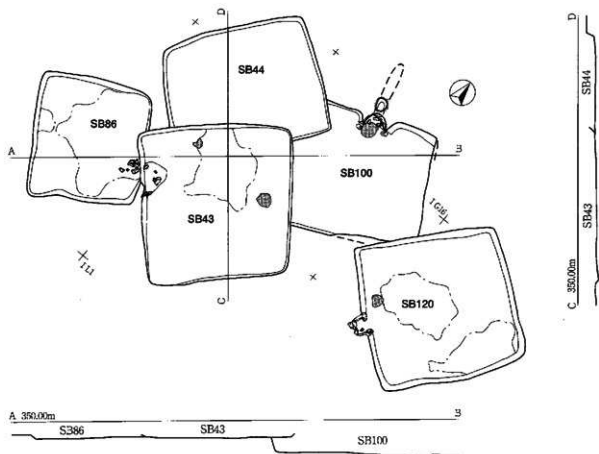

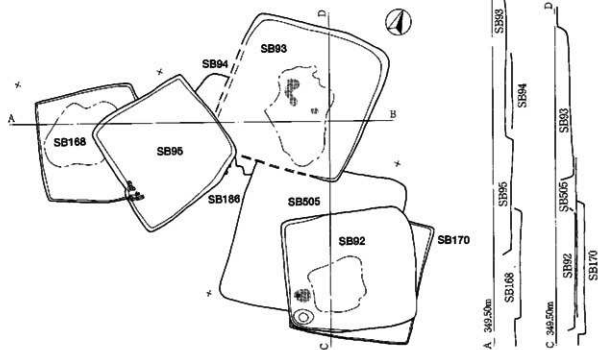
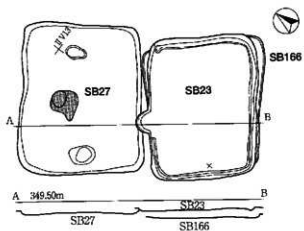
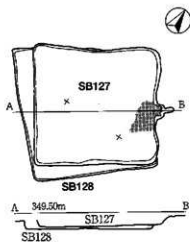
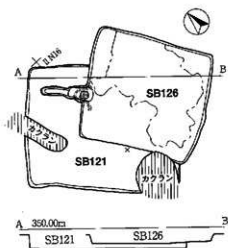

図版112 竪穴住居址重複関係図 5

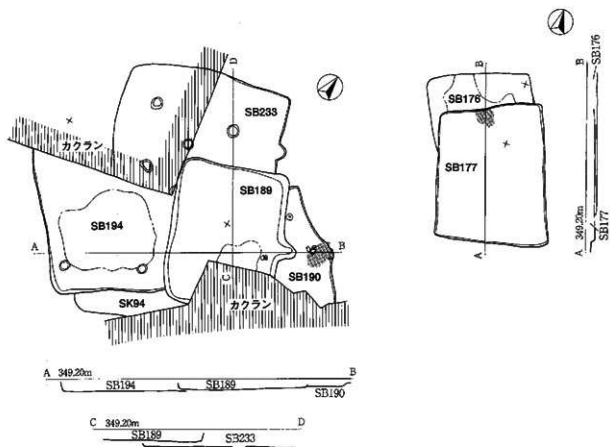
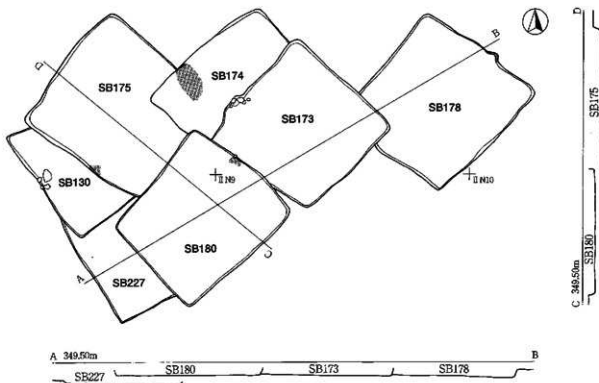

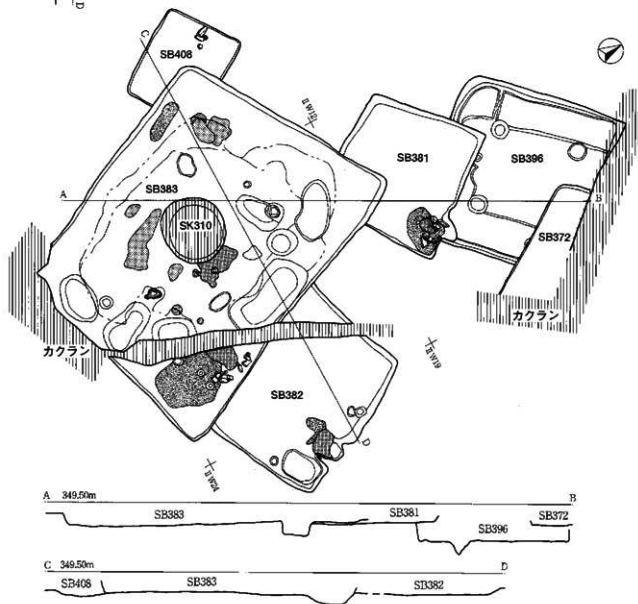
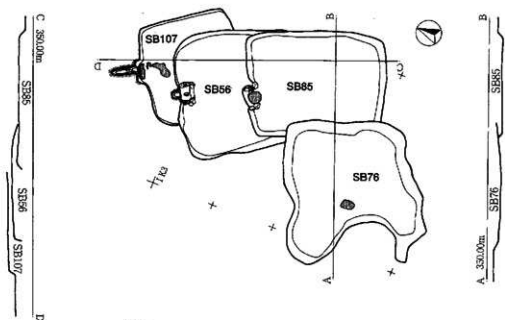

図版114 竪穴住居址重複関係図7

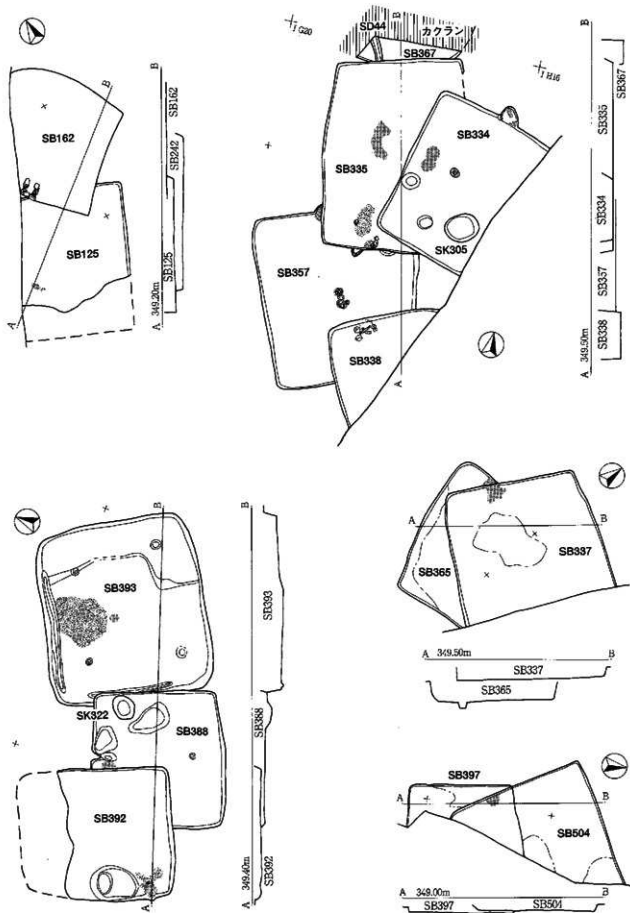

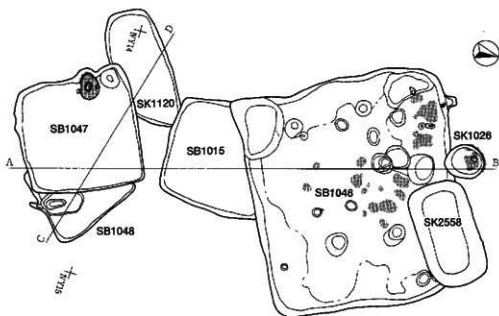
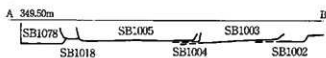
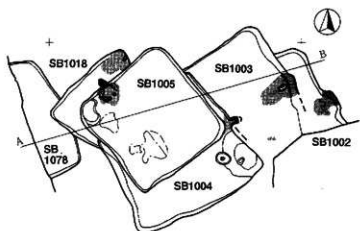
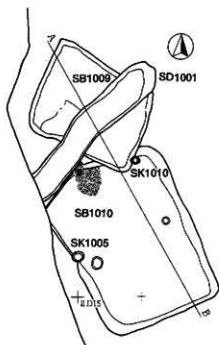

圖版116 竪穴住居址重複關係圖 9

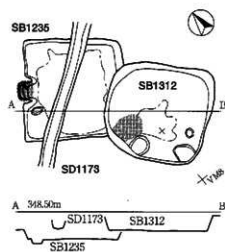
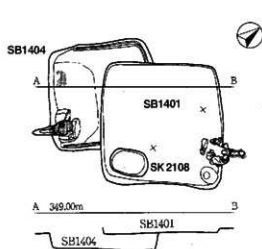
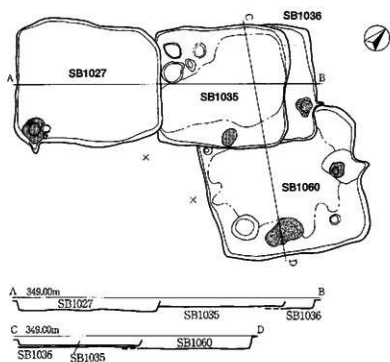
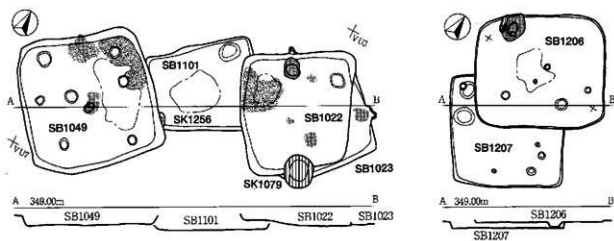

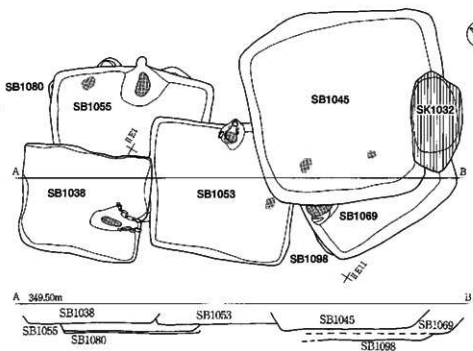
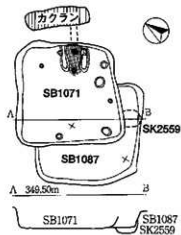
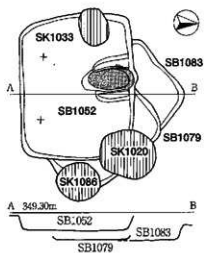
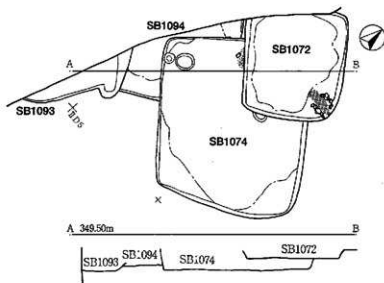
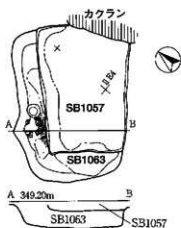

SB2 (1-8)

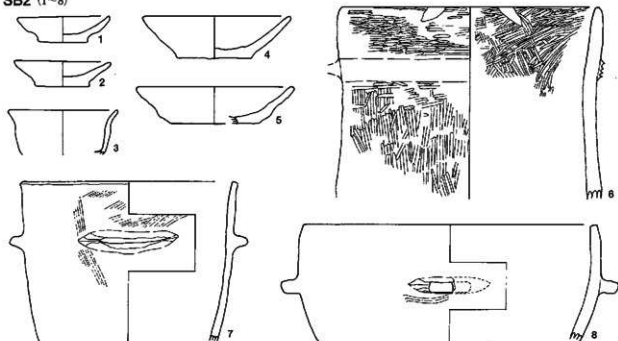

SB6 (1-23)

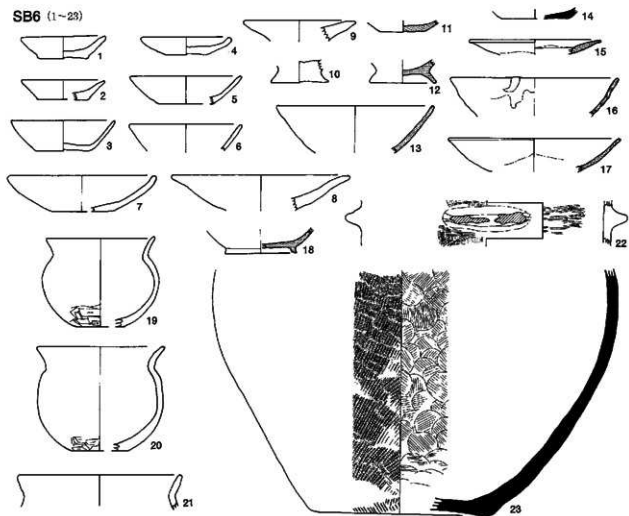

SB7 (1~29)

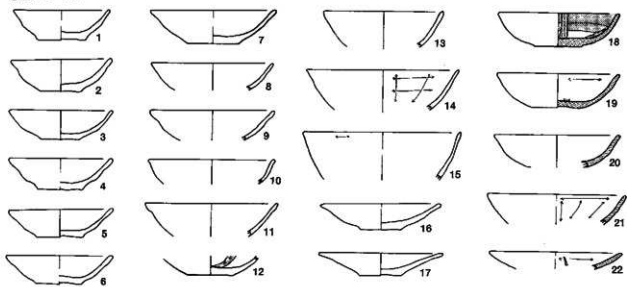

SB12

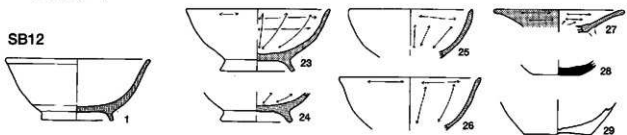

SB16 (1~24)

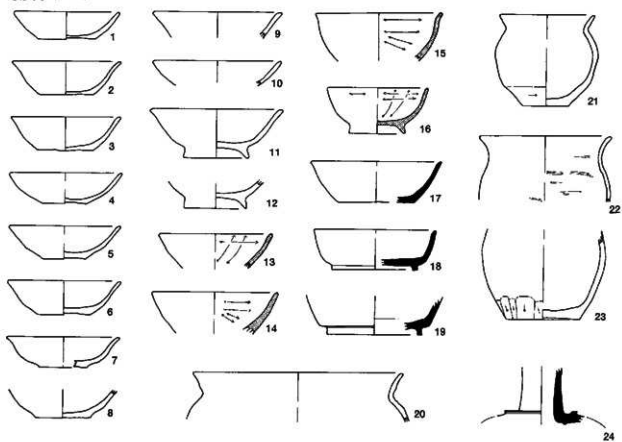

SB18 (1~22)

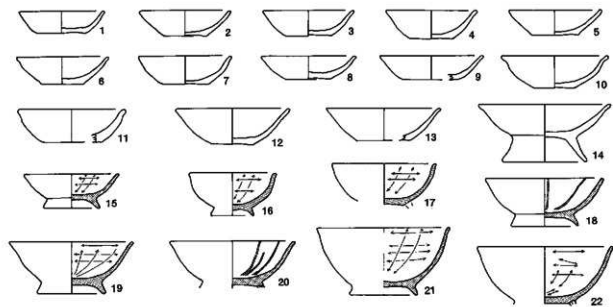

SB22 (1~14)

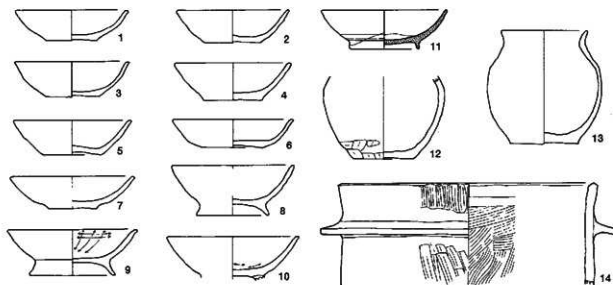

SB25 (1~9)

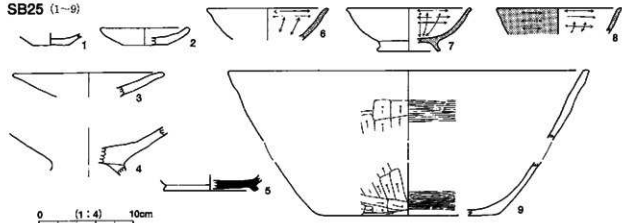

SB29 (1~20)

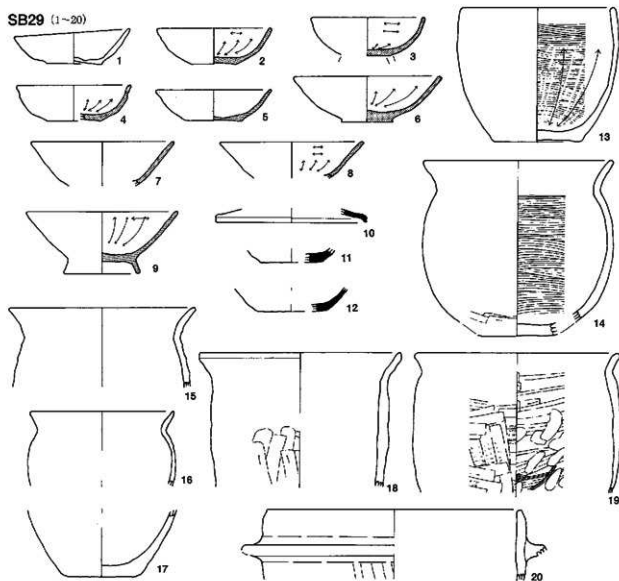

SB31 (1~23)

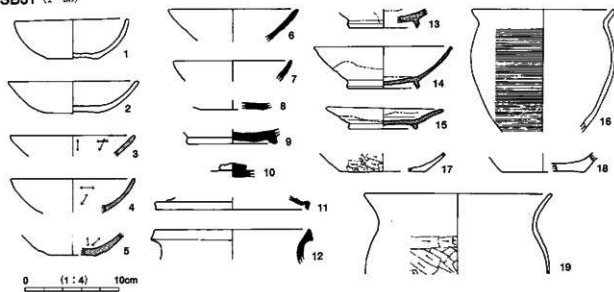

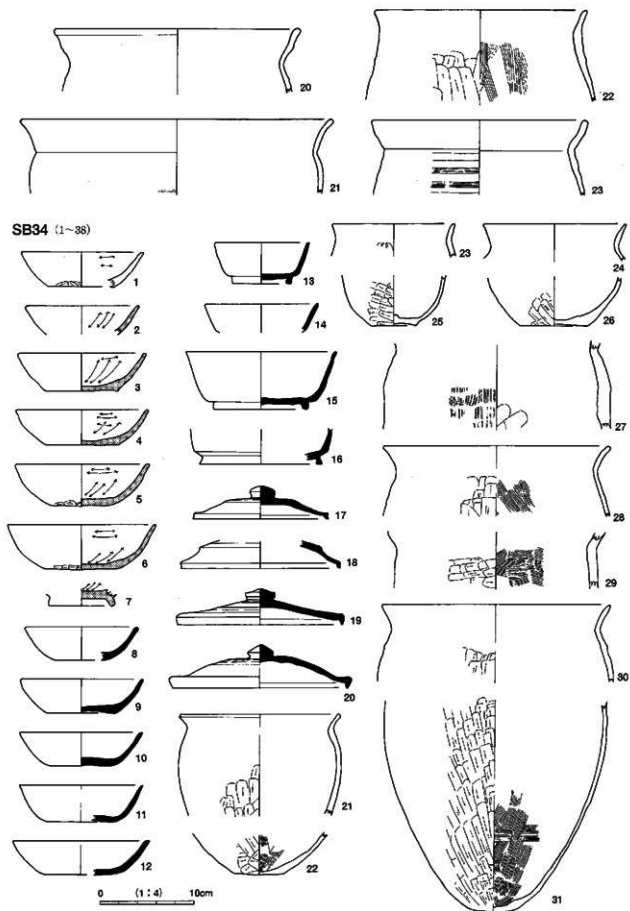

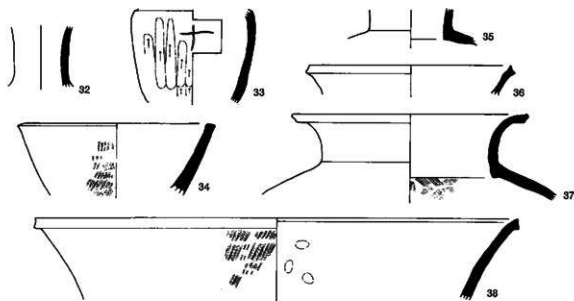

SB35 (1~29)

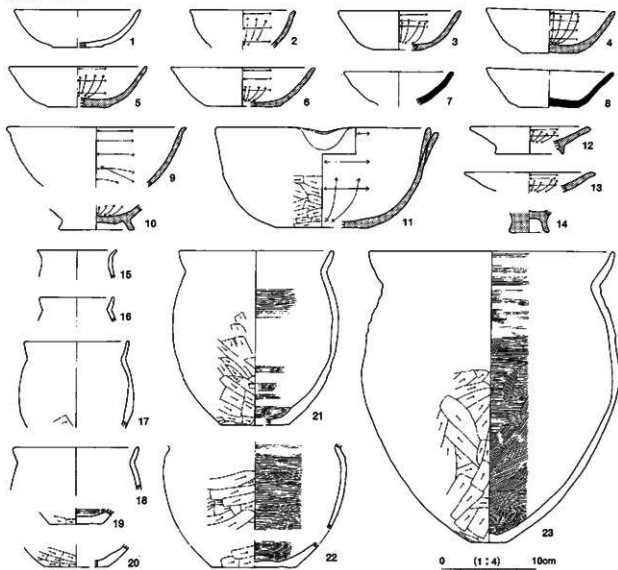

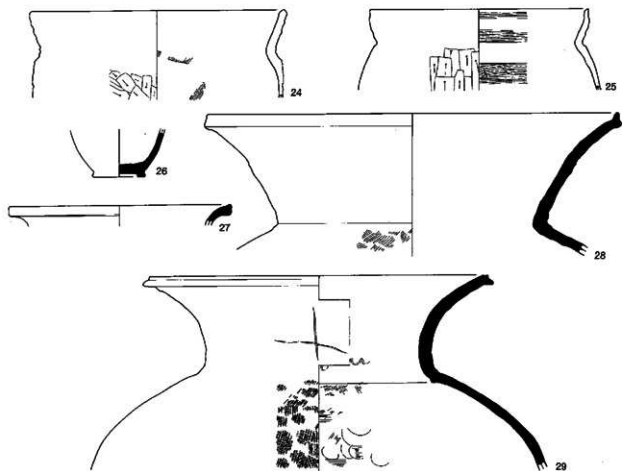

SB37

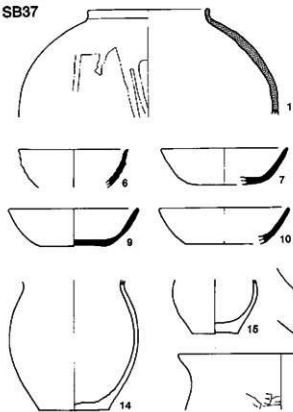

SB38 (1~19)

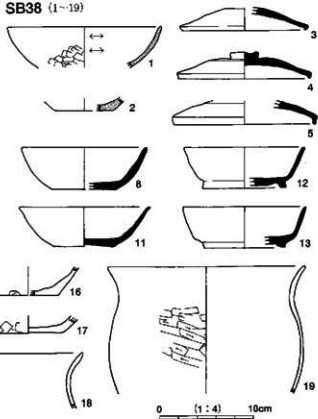

SB39 (1~6)

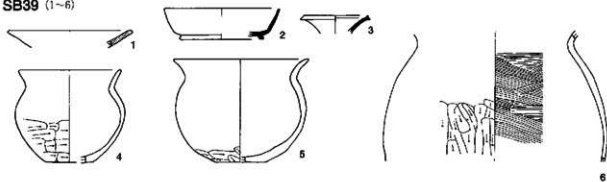

SB40 (1~19)

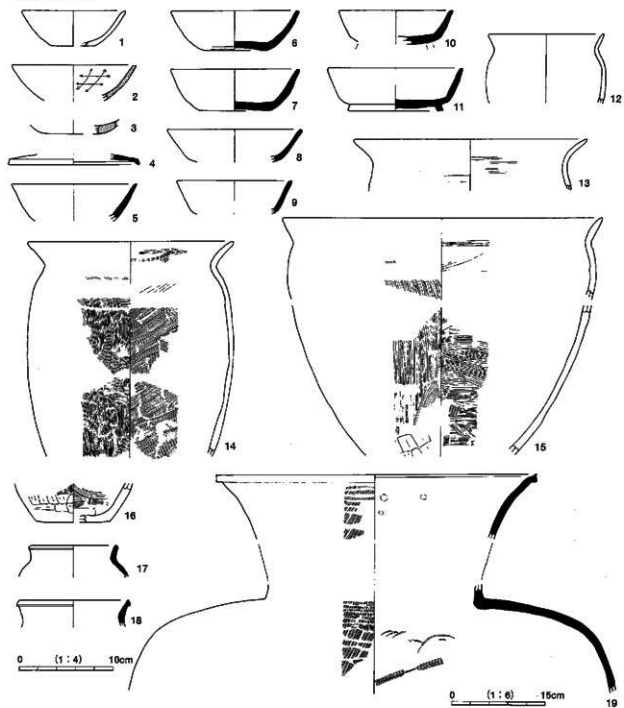

SB41 (1~5)

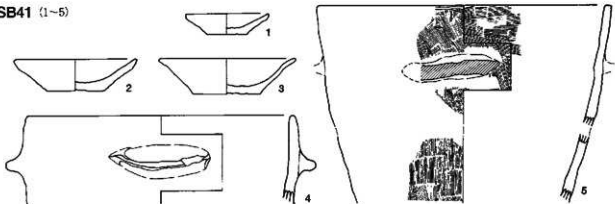

SB43 (1~10)

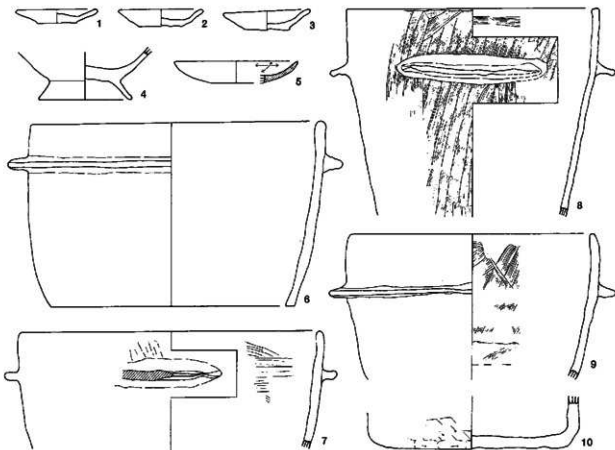

SB45 (1~3)

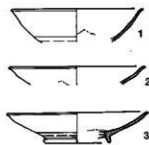

SB48 (1~22)

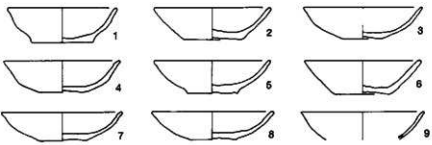

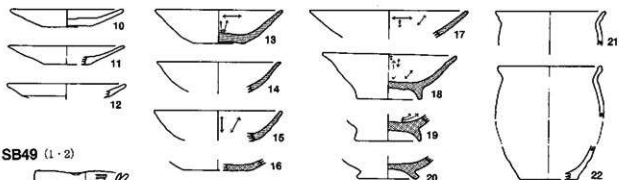

SB49 (1-2)

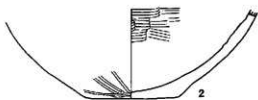

SB54 (1-4)

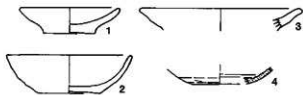

SB56 (1-21)

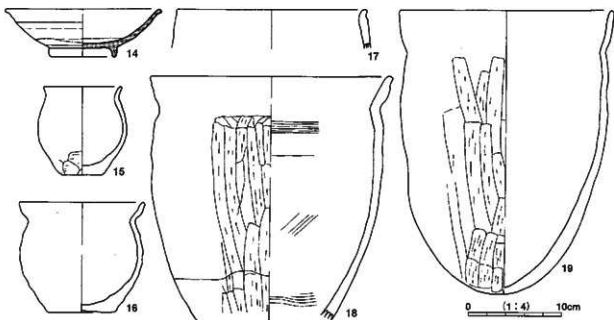
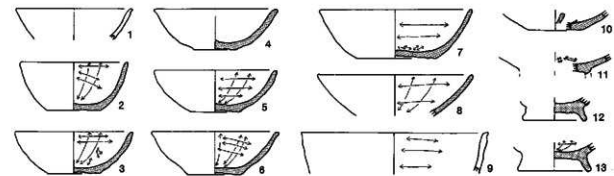

0 (1:4) 10cm

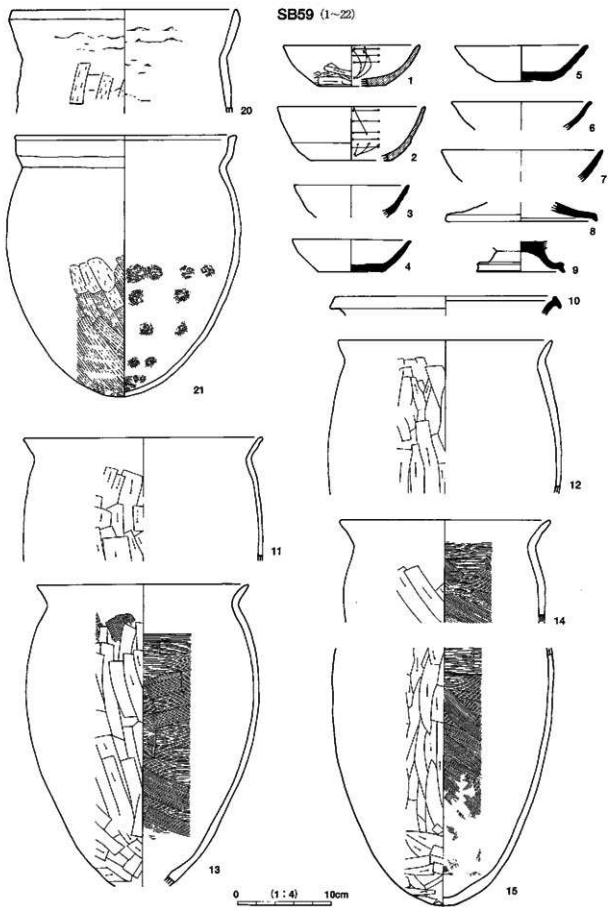

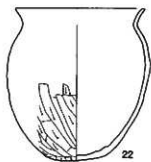
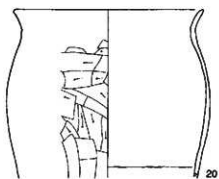
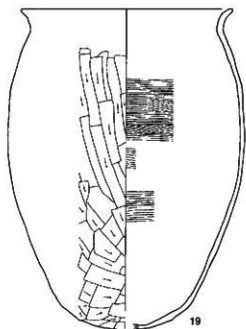
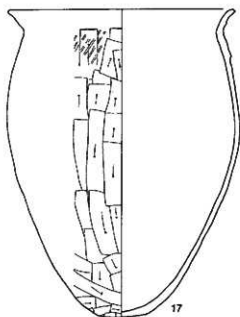
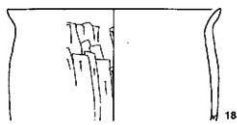
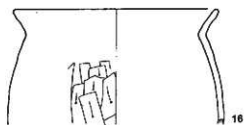

SB60 (1~3)

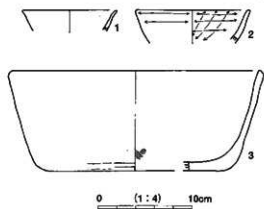

SB64

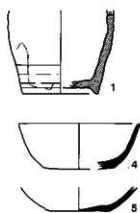

SB65 (1~14)

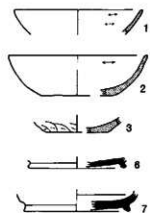

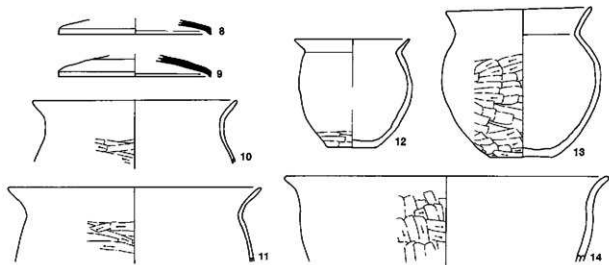

SB70 (1~13)

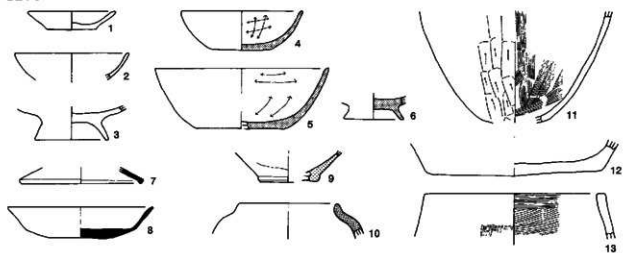

SB76 (1~12)

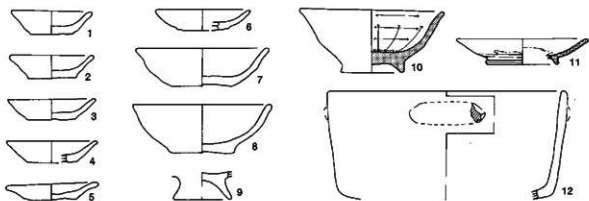

SB72 (1~3)



SB77 (1~6)



SB78 (1~11)

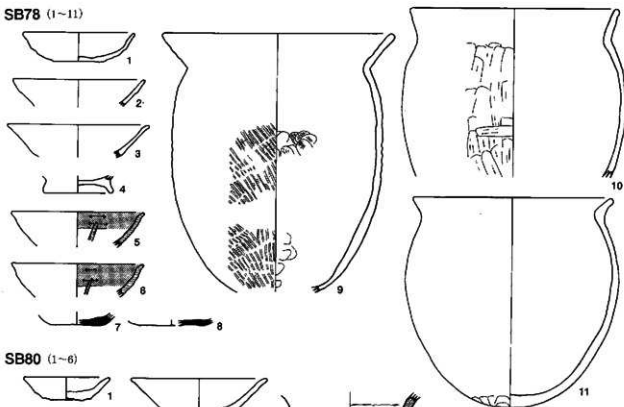

SB80 (1~6)

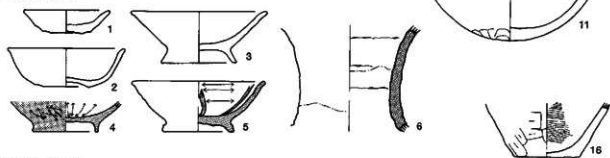

SB81 (1~19)

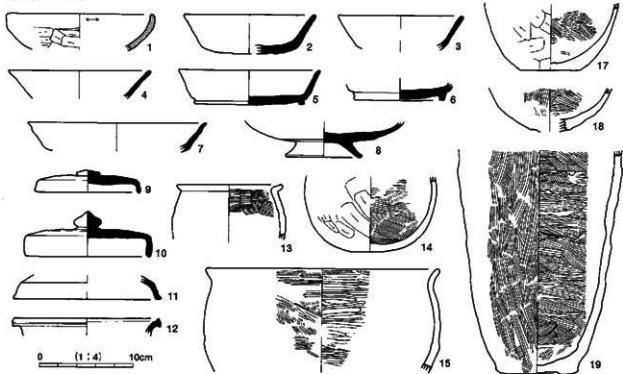

SB83 (1~4)

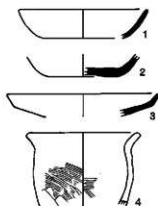

SB85 (1~2)

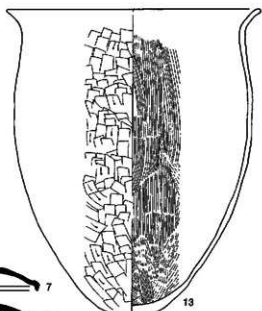
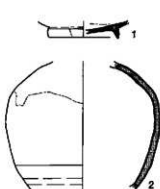

SB87 (1~15)

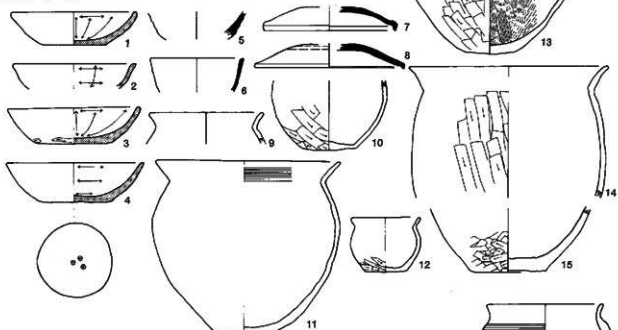

SB88 (1~12)

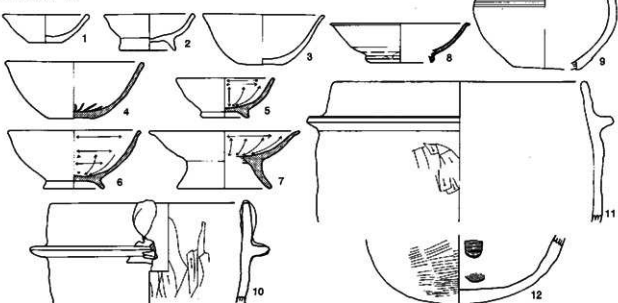

SB91 (1-5)

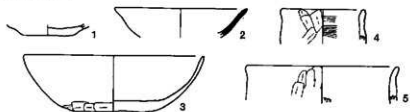

SB93



SB95



SB92 (1-36)

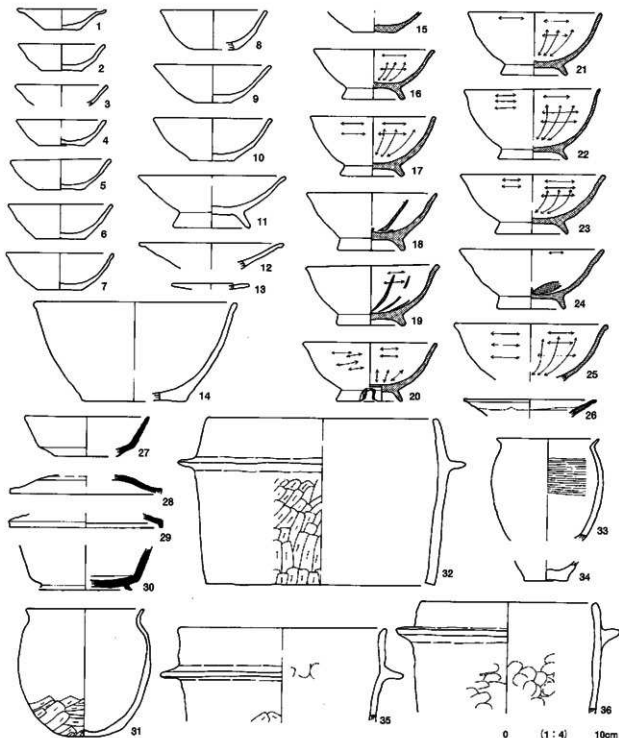

0 (1:4) 10cm

SB97 (1~16)

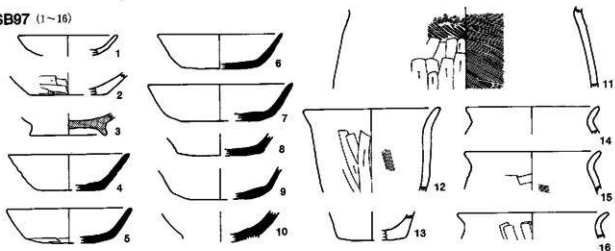

SB98 (1~22)

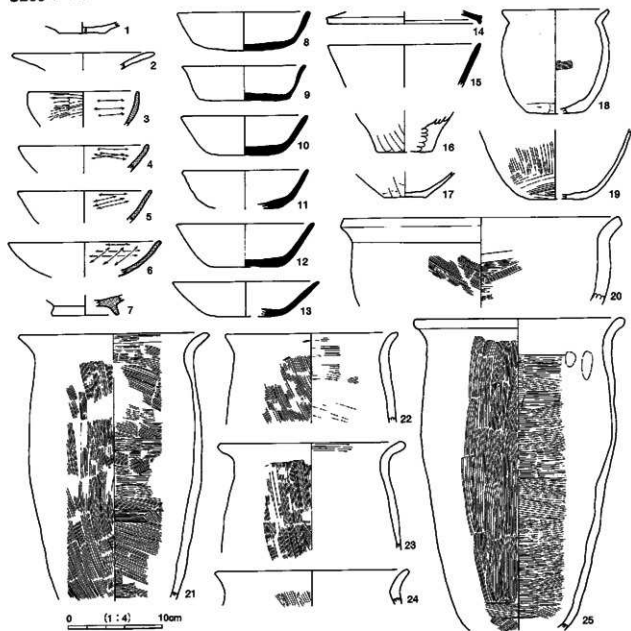

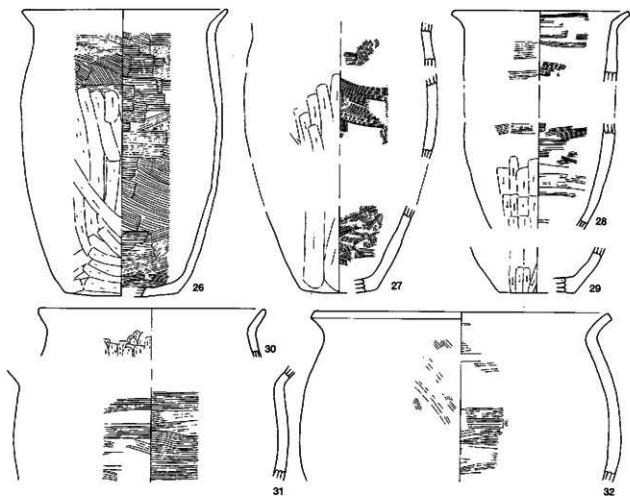

SB99 (1~19)

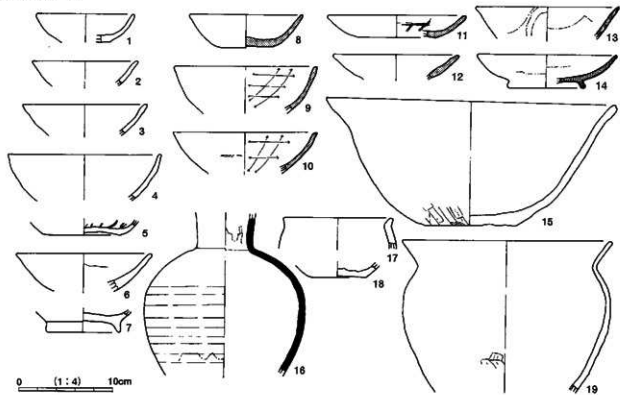

SB100 (1~24)

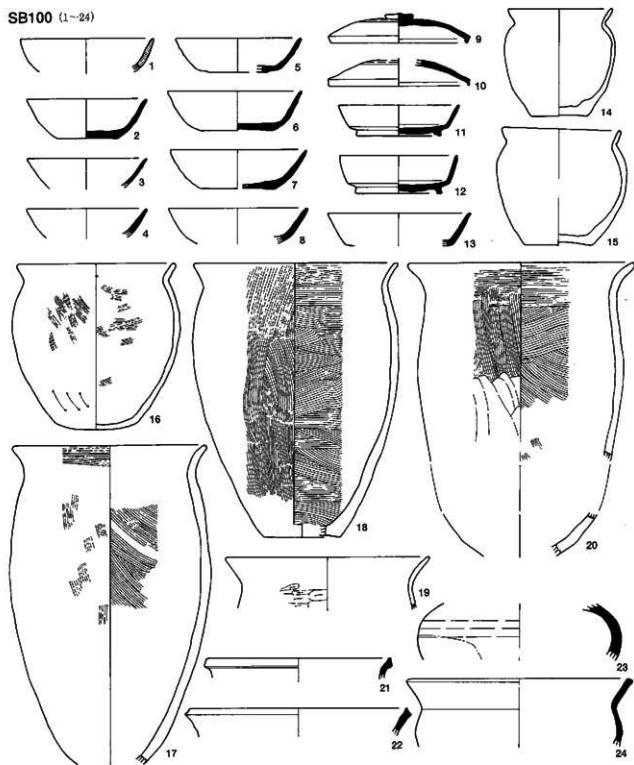

SB101 (1~51)

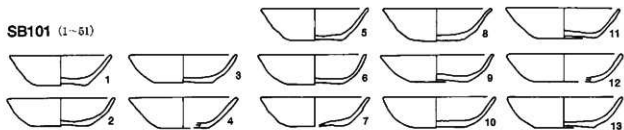

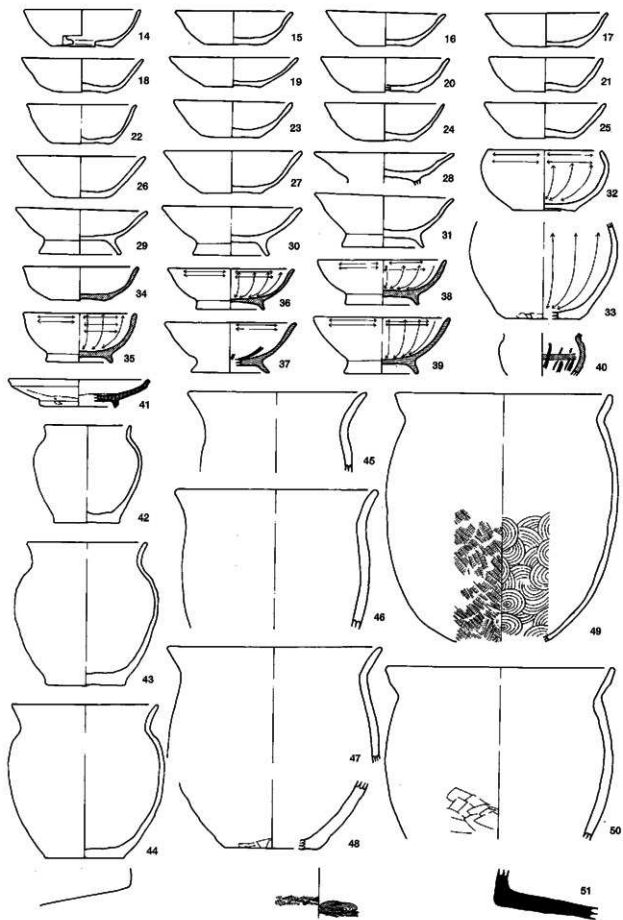

SB102 (1~6)

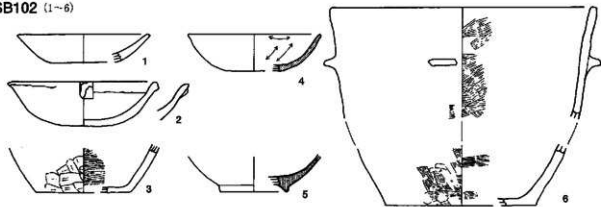

SB104 (1~14)

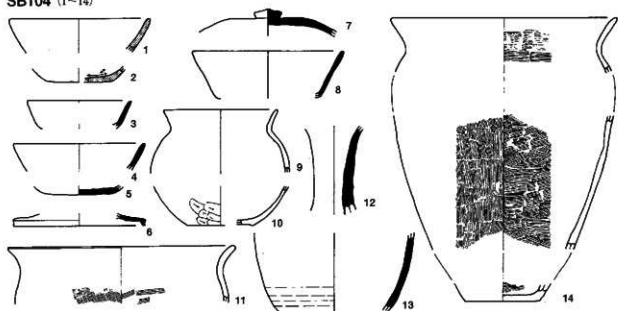

SB105 (1~33)

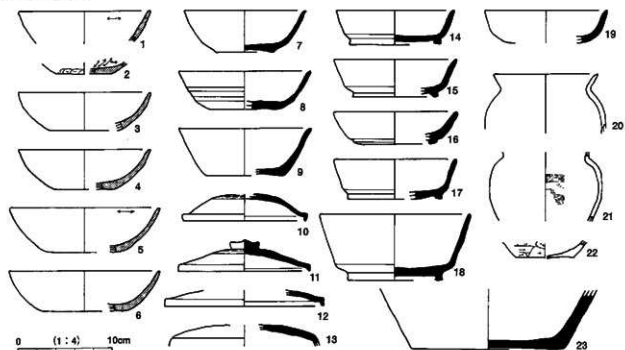

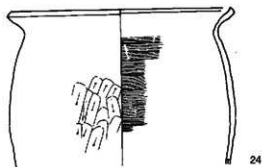

24



25



26



27

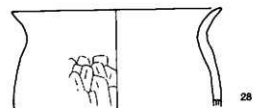

28



29



30

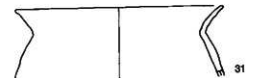

31

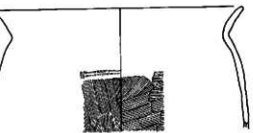

32



33

SB108



1

SB111 (1~20)

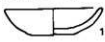

1



6



7



8



2

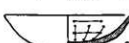

9



10



11

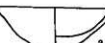

3

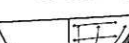

12

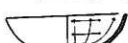

13



14

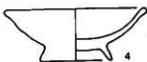

4

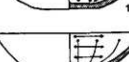

15



16



17



5

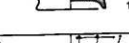

18

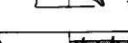

19



20

0 (1:4) 10cm

SB114 (1~42)

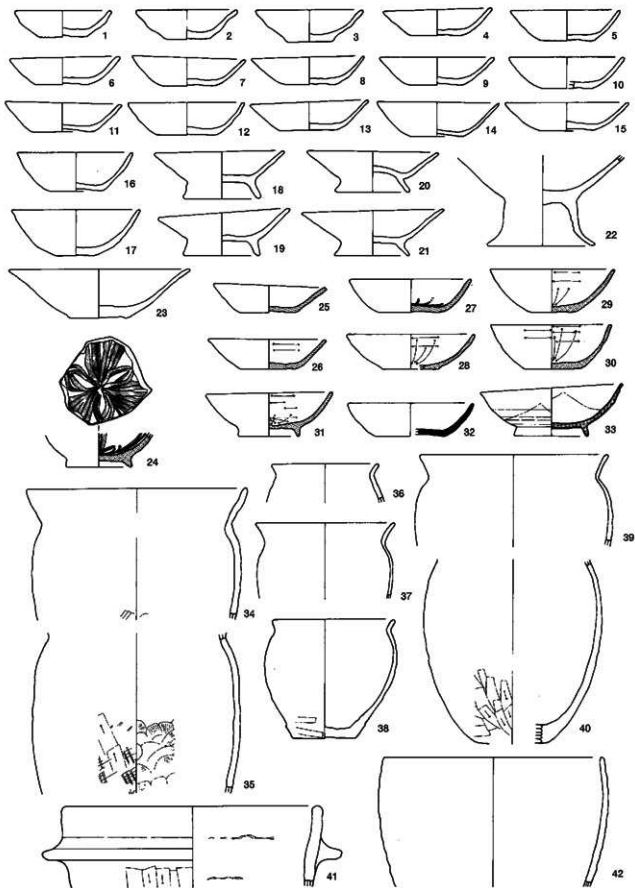

SB116 (1~87)

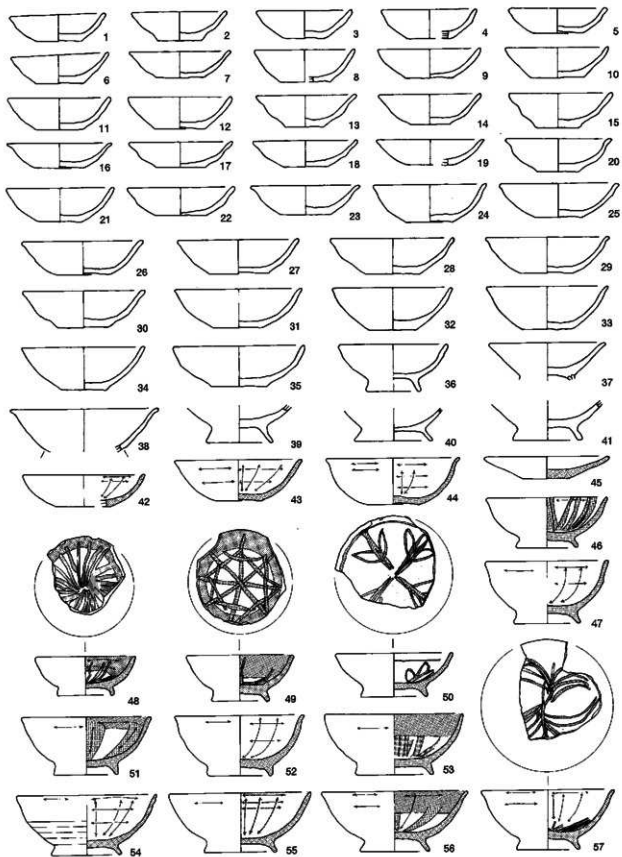

0 (1:4) 10cm

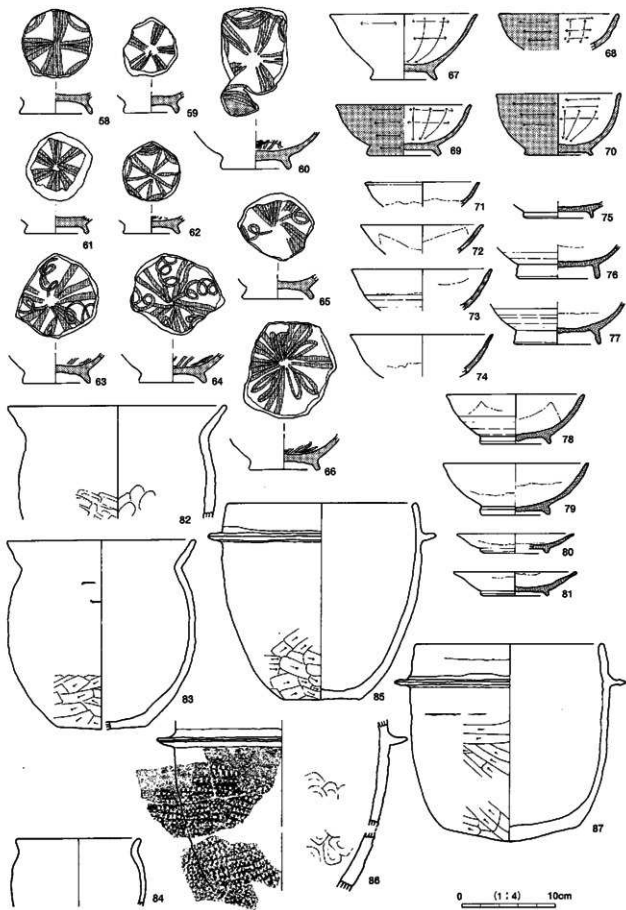

SB117 (1・2)



SB121 (1~16)

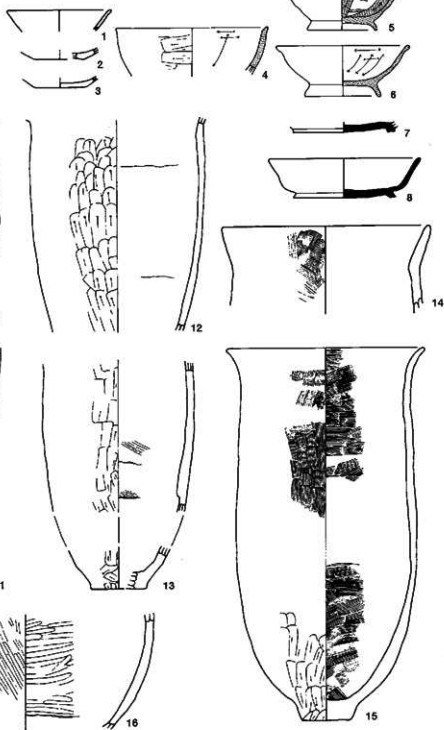

SB122 (1~47)

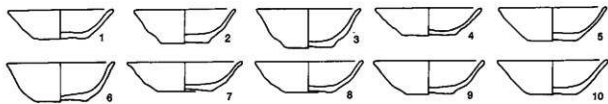

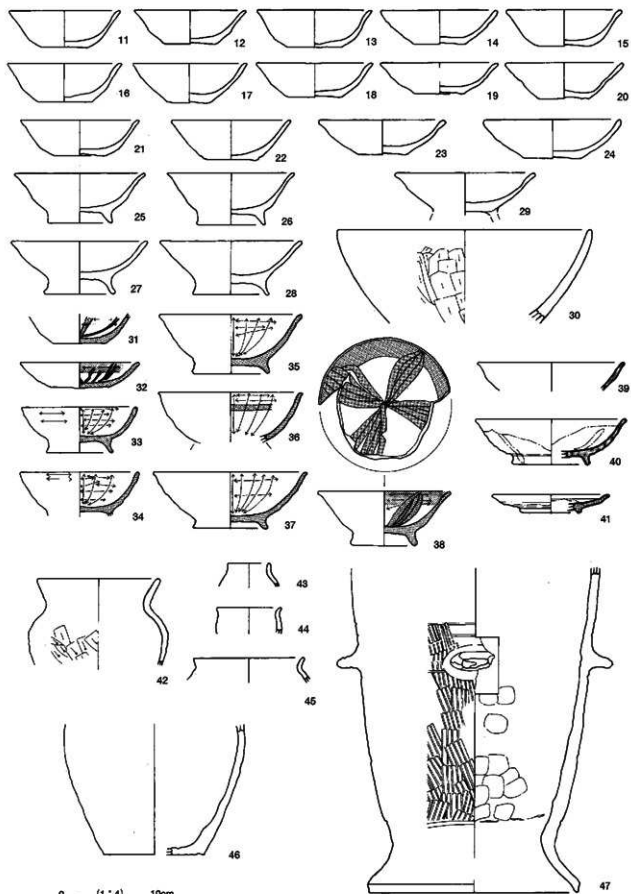

SB123 (1~36)

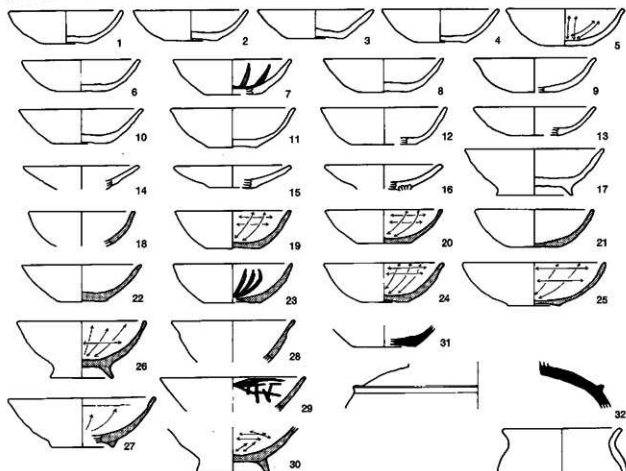

SB124 (1-2)



SB125 (1~28)

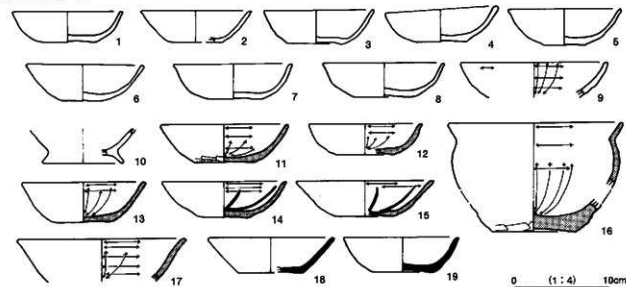

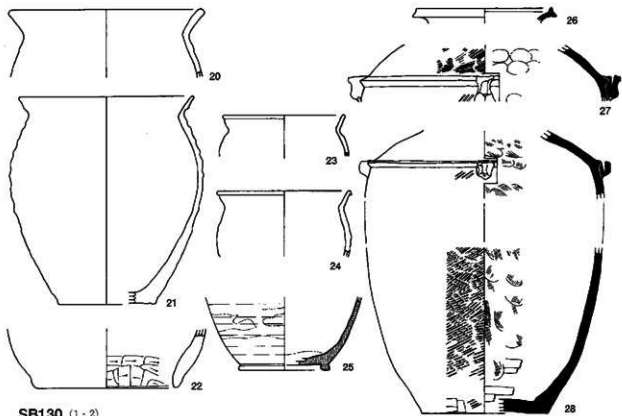

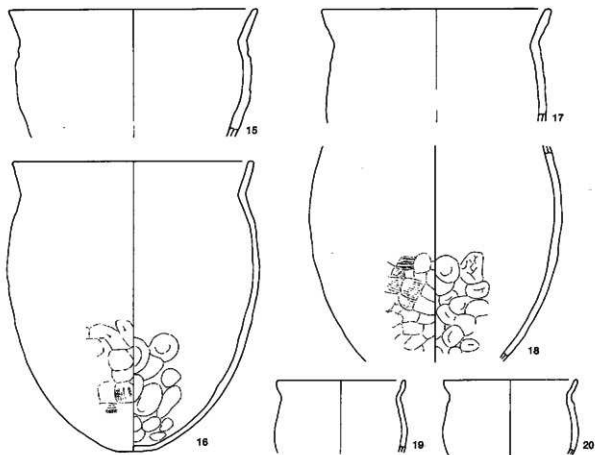

SB145 (1・2)

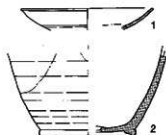

SB146 (1~3)

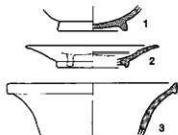

SB147

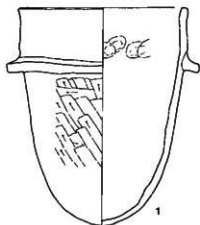

SB149 (1~6)

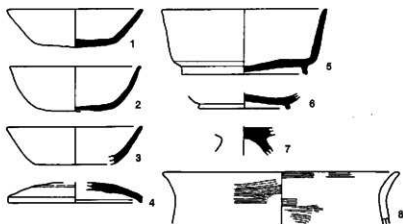

SB148



0 (1:4) 10cm

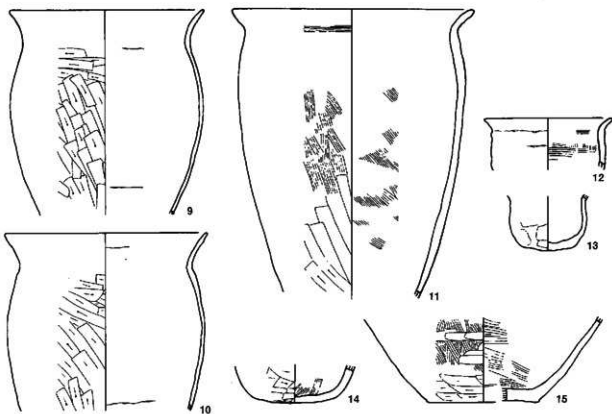

SB160 (1・2)

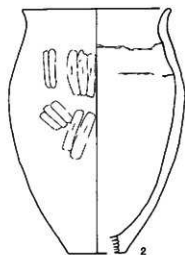

SB163 (1~14)

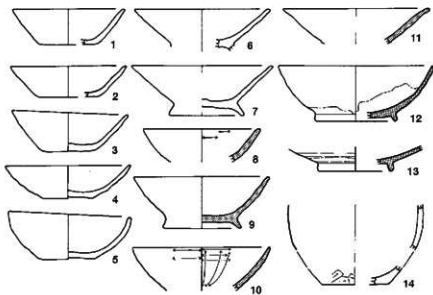

0 (1:4) 10cm

SB165 (1・2)

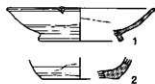

SB168 (1~14)

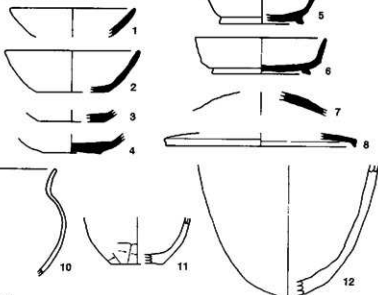

SB167

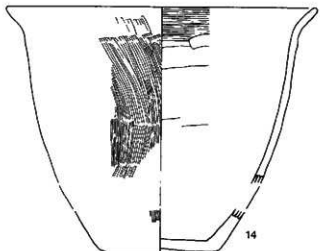
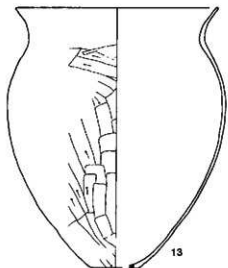
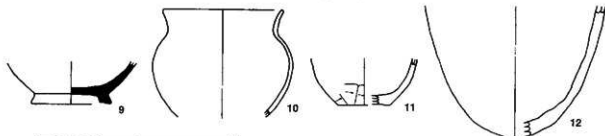

SB183 (1~5)

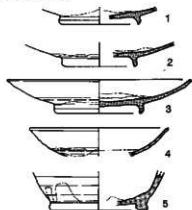

SB185 (1~6)

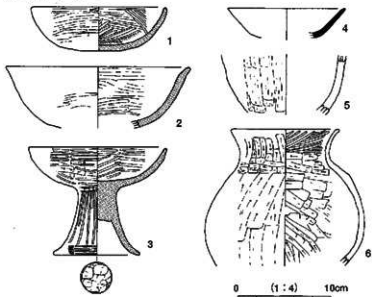

SB187



0 (1:4) 10cm

SB189 (1~58)

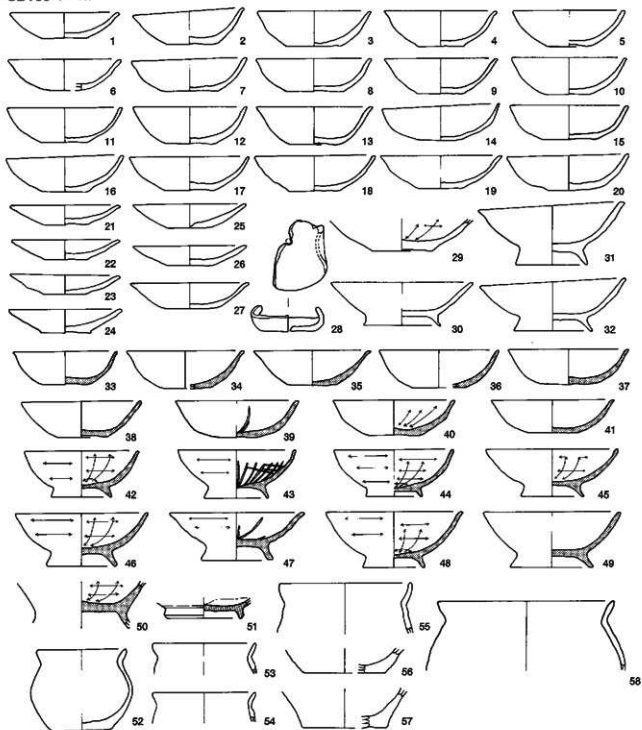

SB191 (1~26)

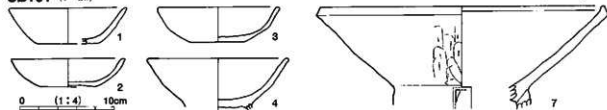

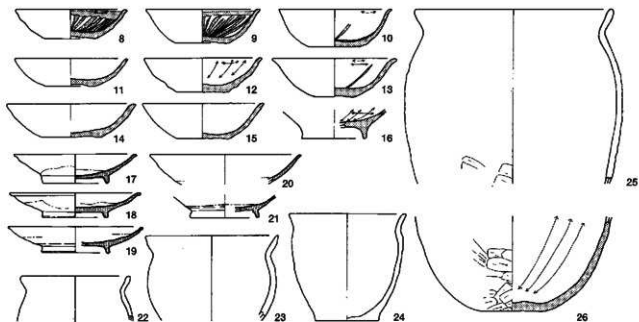

SB192 (1~21)

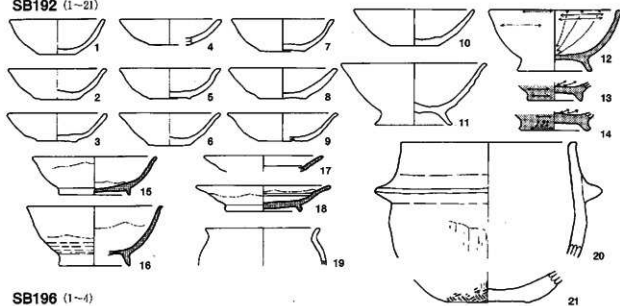

SB196 (1~4)

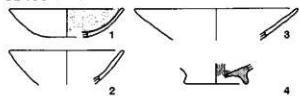

SB198 (1~11)

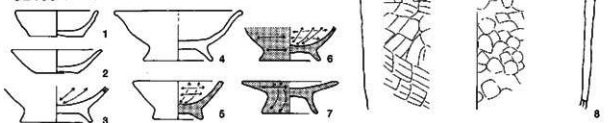

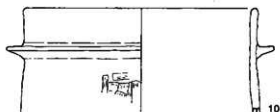
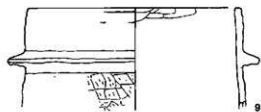

SB200 (1・2)



SB210 (1~41)

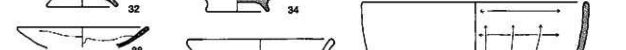
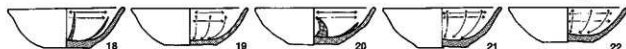
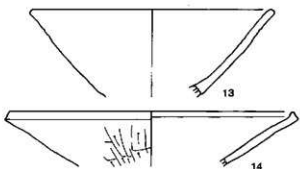
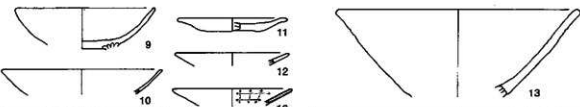
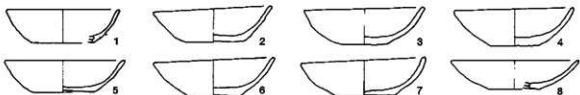

0 (1 : 4) 10cm

41

SB216 (1~23)

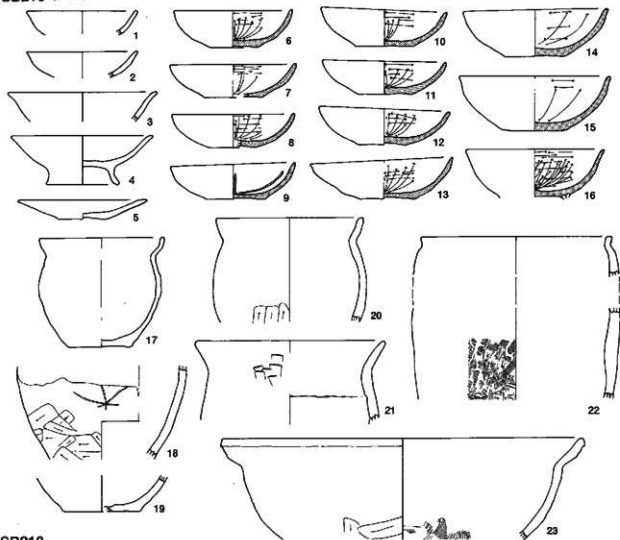

SB218



SB219 (1~10)

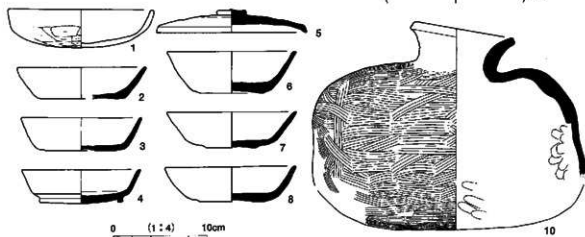

0 (1:4) 10cm

SB224

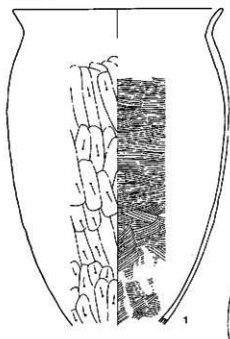

SB227 (1~10)

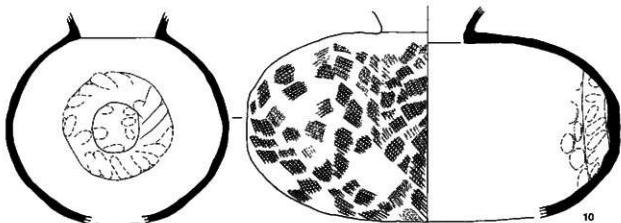
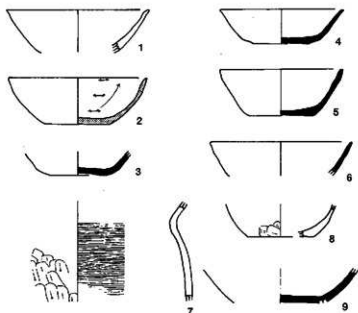

SB242 (1~8)

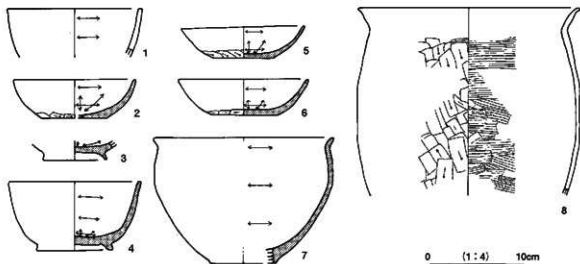

SB249



SB255 (1~34)

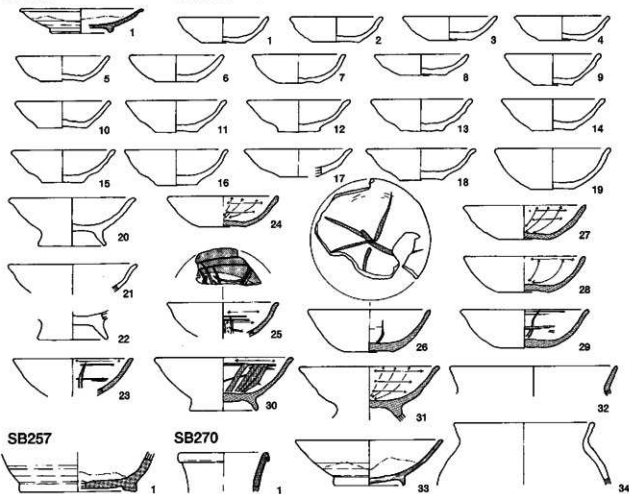

SB257



SB270



SB327 (1~44)

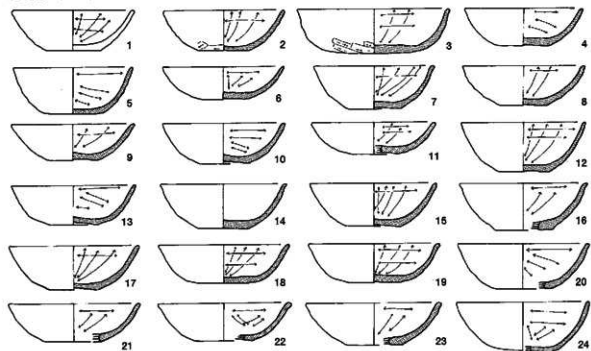

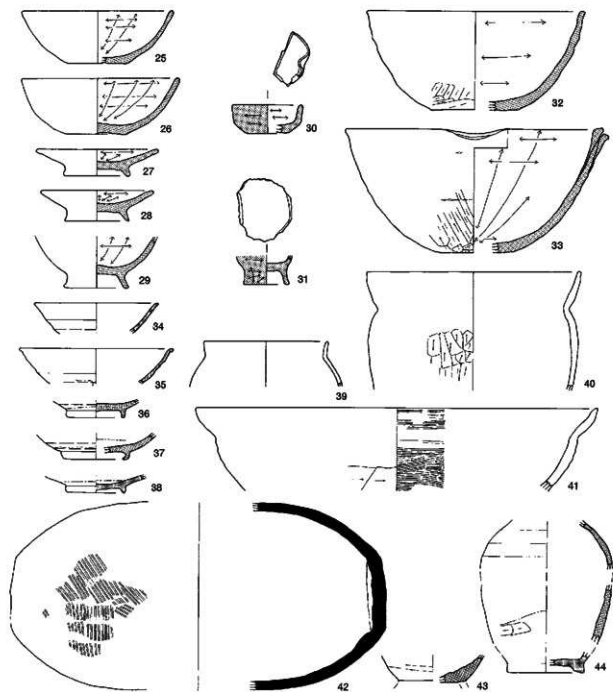

SB336 (1~18)

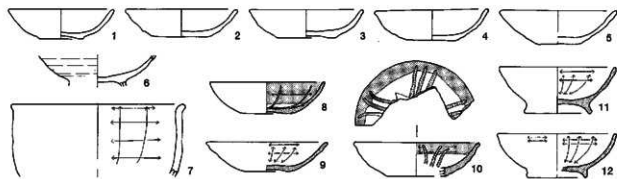

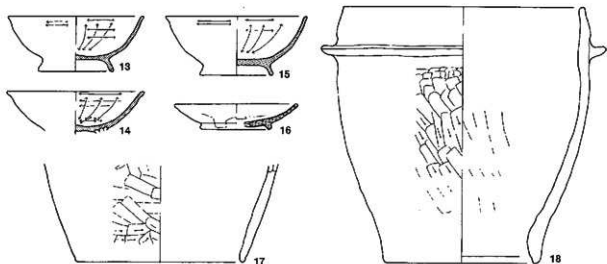

SB338 (1-44)

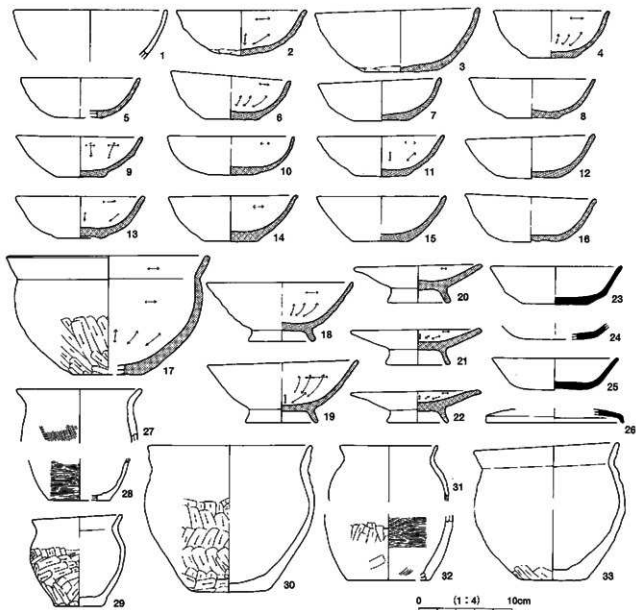

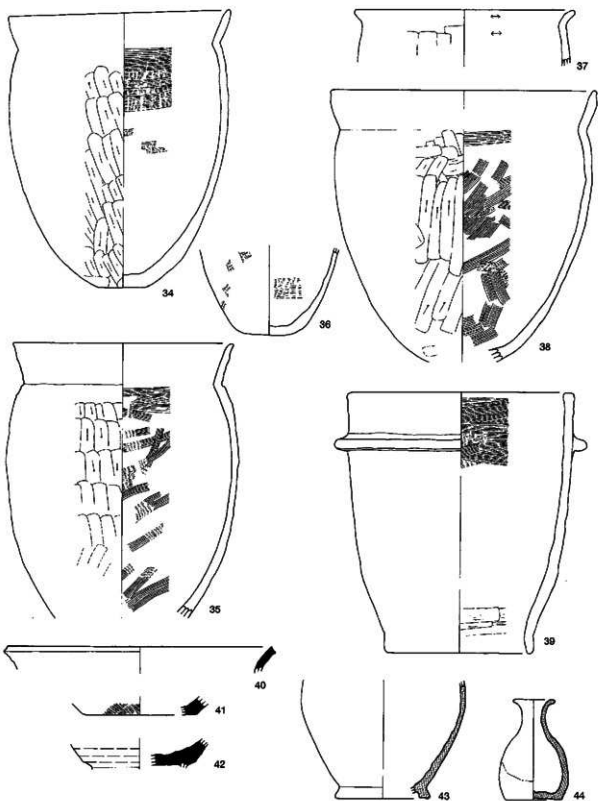

SB343 (1·2)

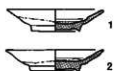

SB345

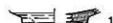

0 (1:4) 10cm

SB357 (1~6)

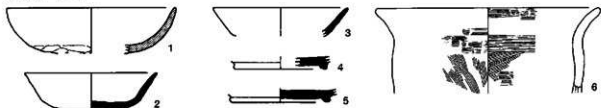

SB374 (1~10)

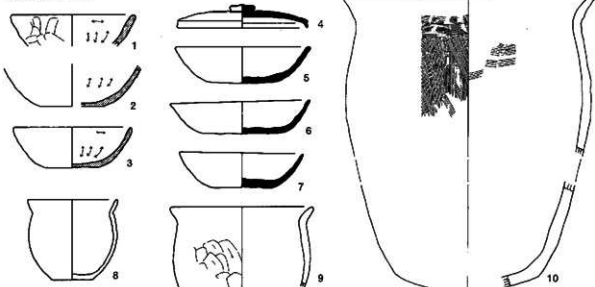

SB375 (1~8)

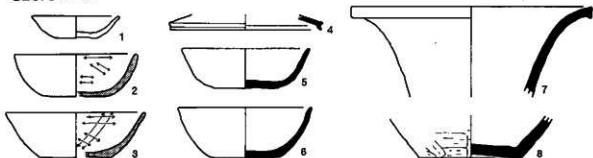

SB378

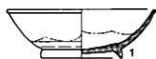

SB382 (1~56)

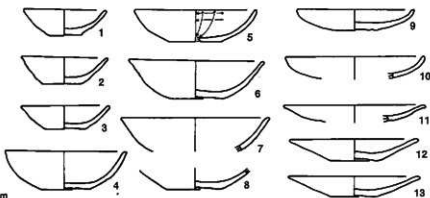

SB381 (1~2)



0 (1:4) 10cm

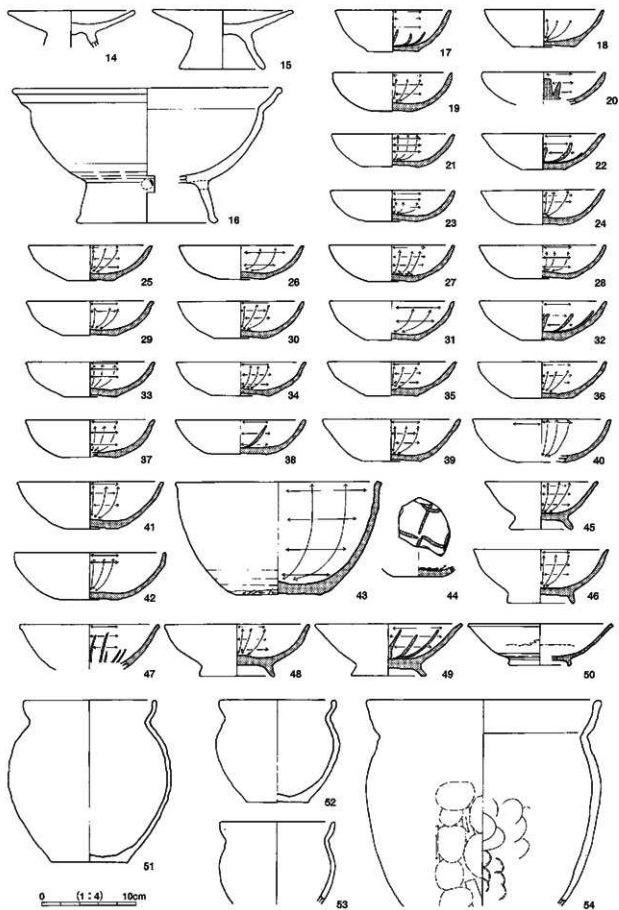

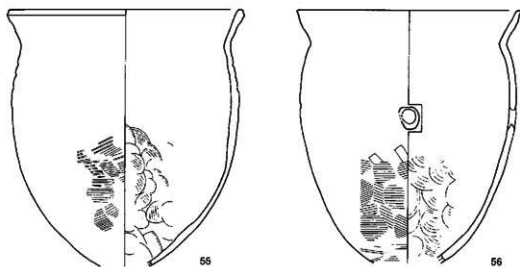

SB383 (1~211)

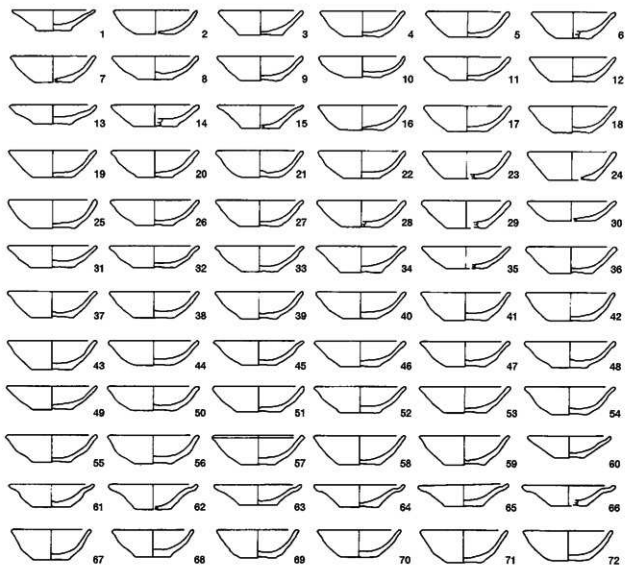

0 (1:4) 10cm

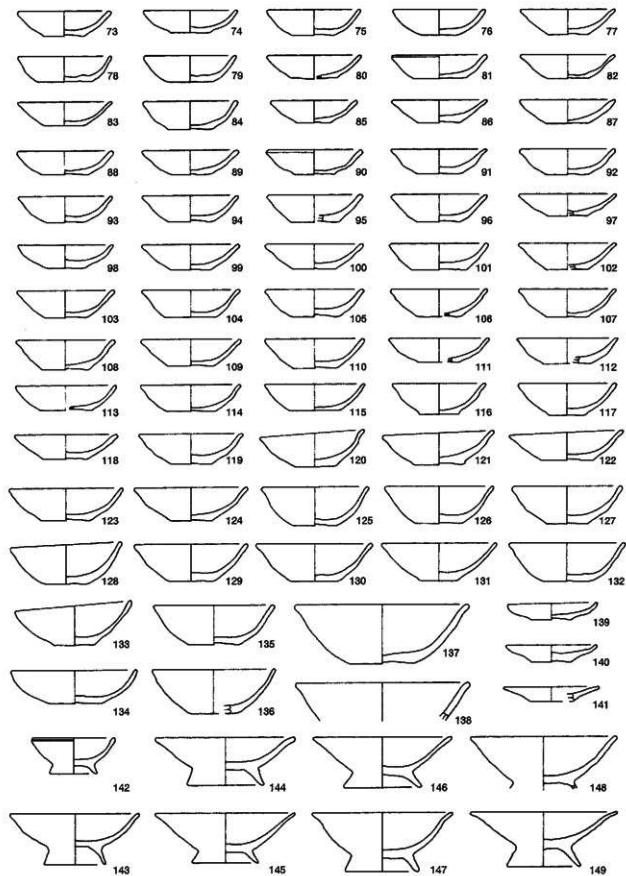

0 (1:4) 10cm

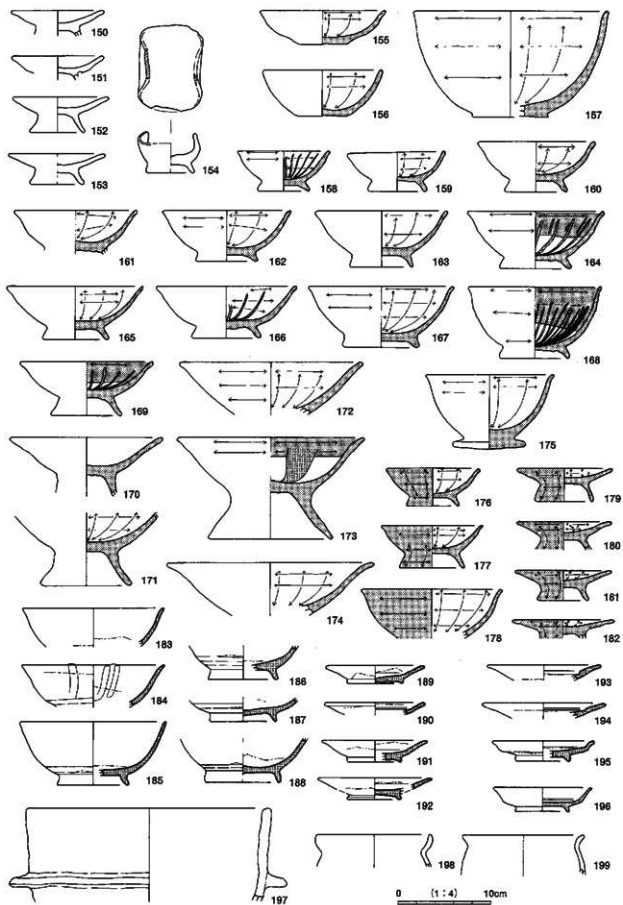

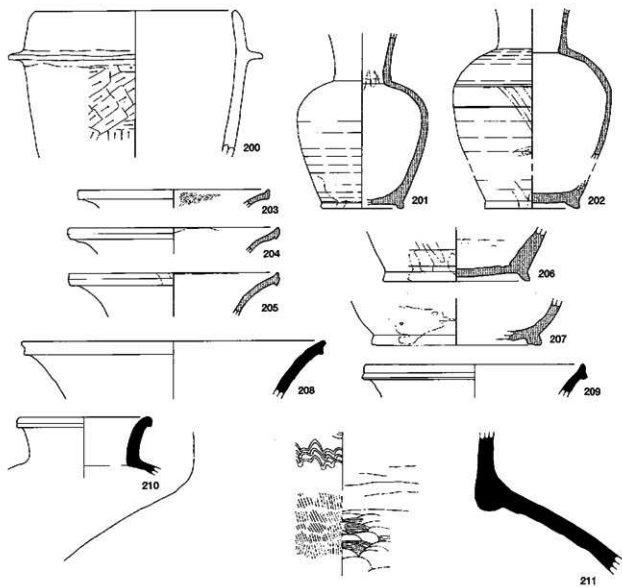

SB388 (1~20)

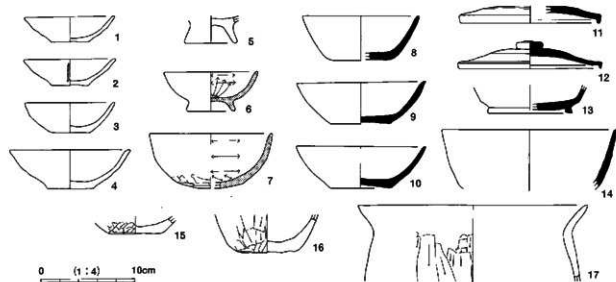

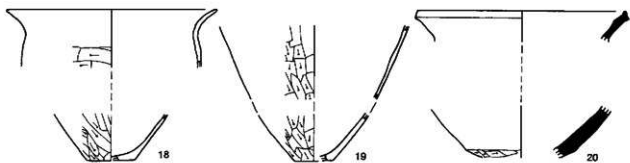

SB395 (1~15)

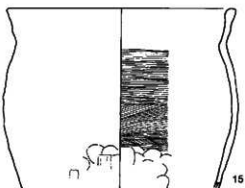
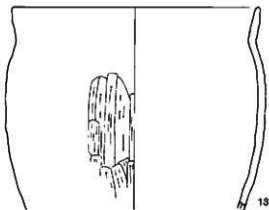
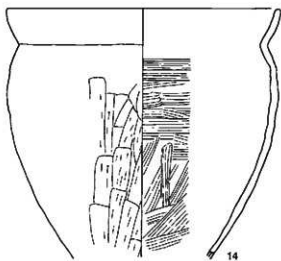
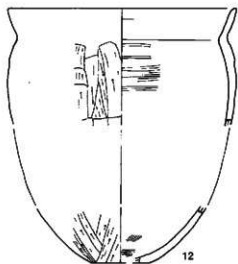
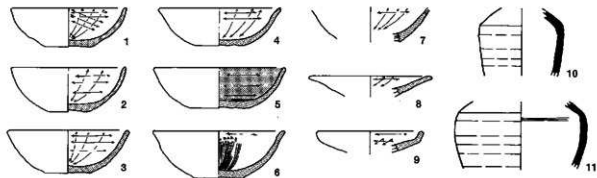

0 (1:4) 10cm

SB416 (1~10)

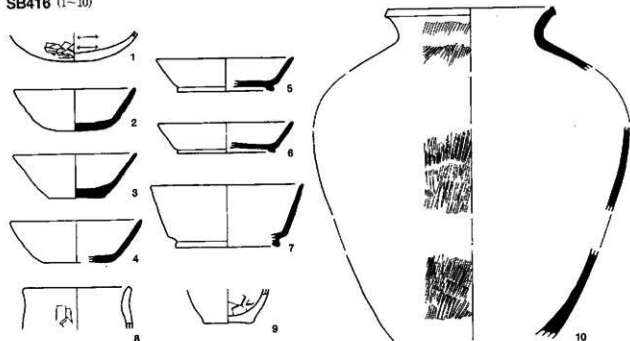

SB421 (1~59)

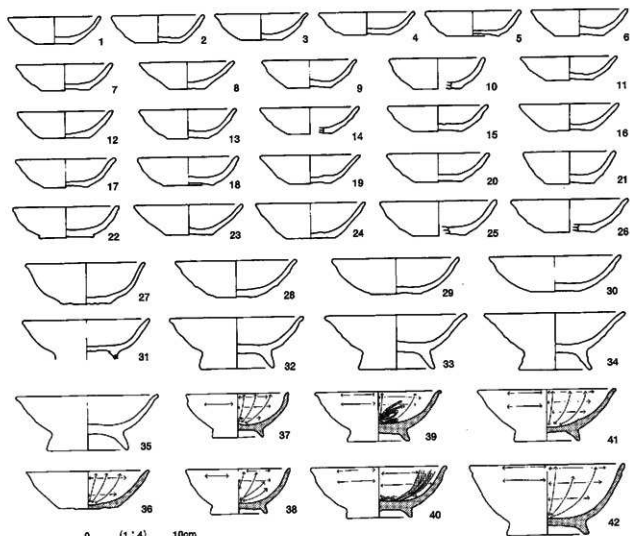

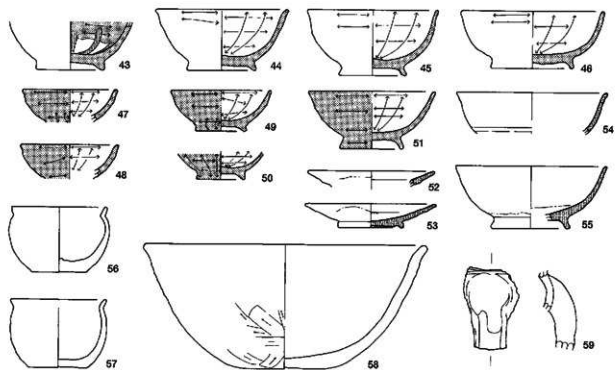

SB504 (1・2)

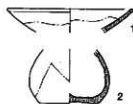

SB1002 (1~23)

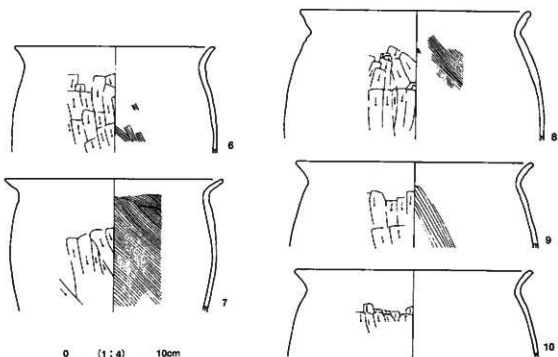
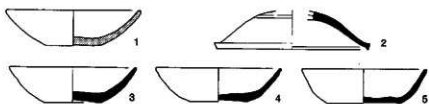

0 (1:4) 10cm

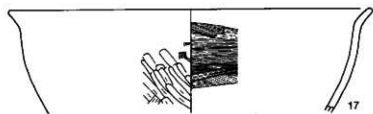
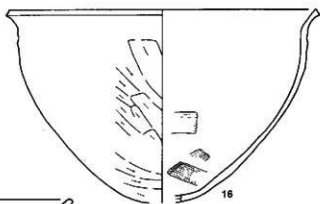
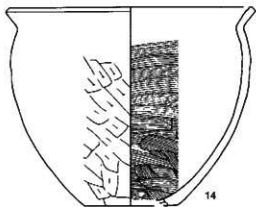
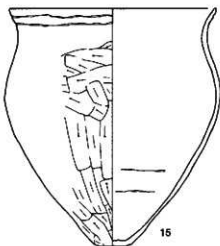
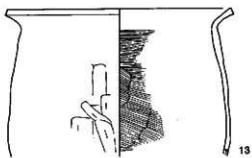
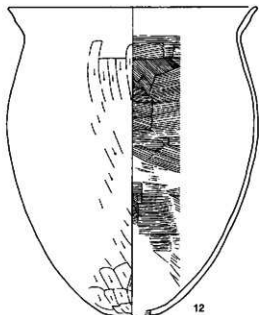
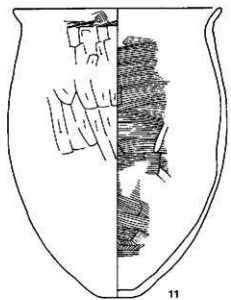

0 (1:4) 10cm

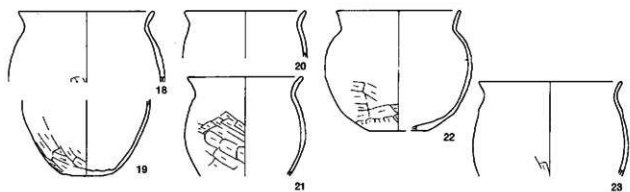

SB1005 (1~56)

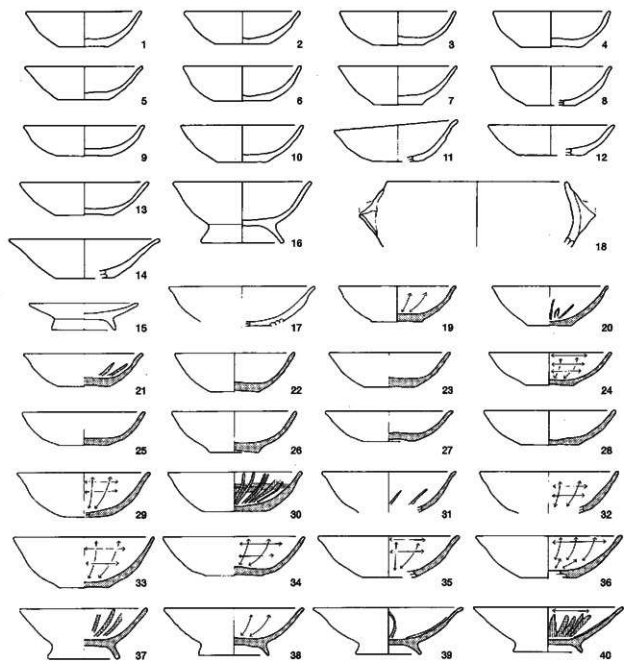

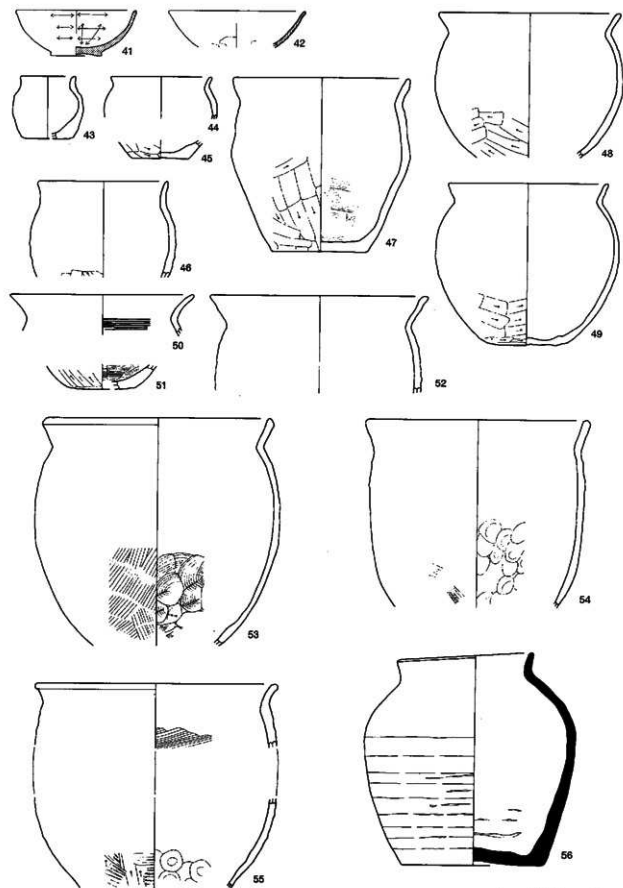

SB1006 (1~14)

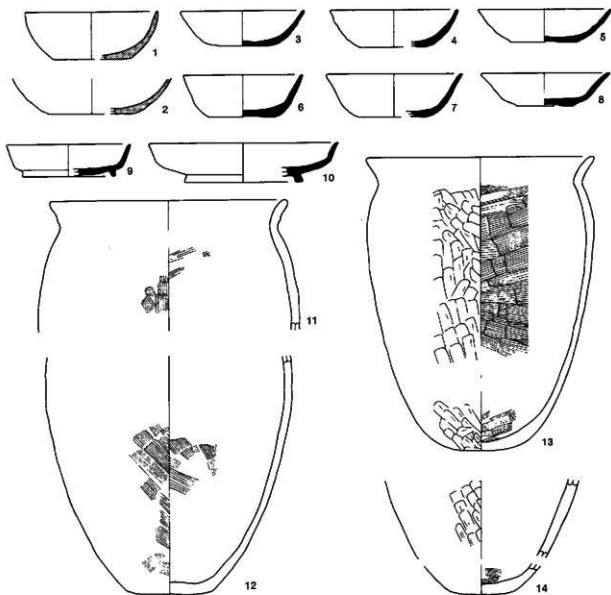

SB1008 (1~38)

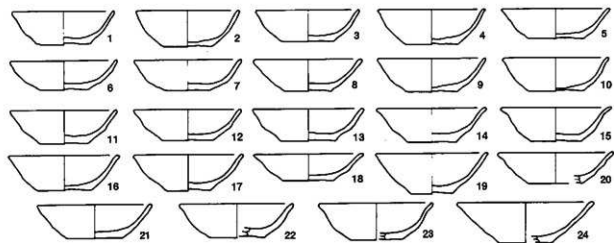

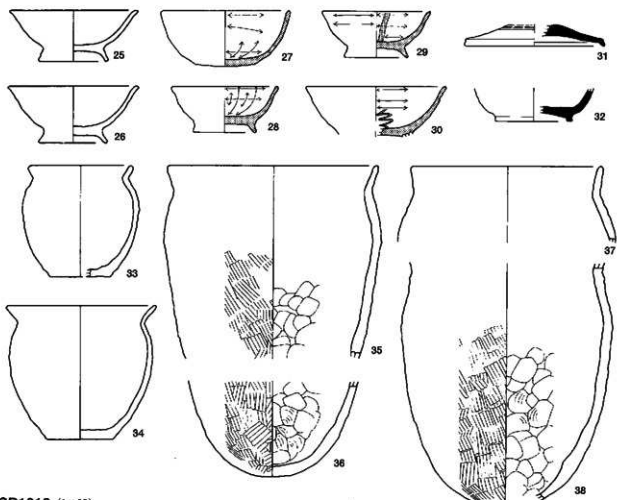

SB1010 (1~38)

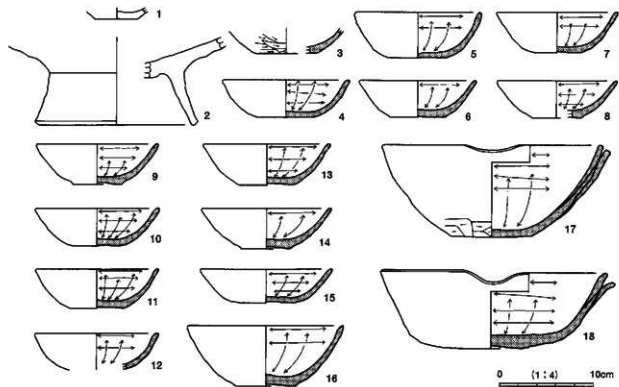

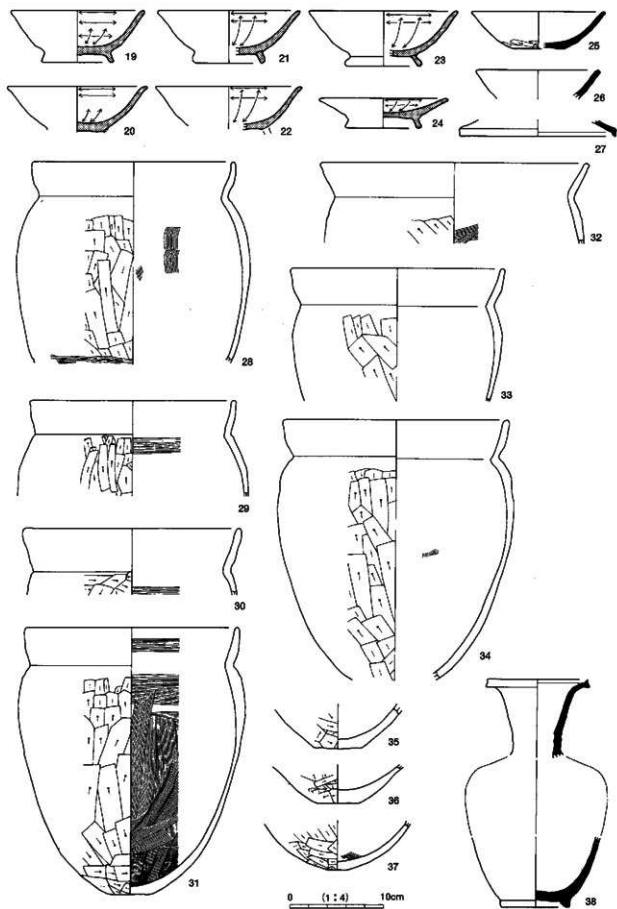

SB1011 (1~73)

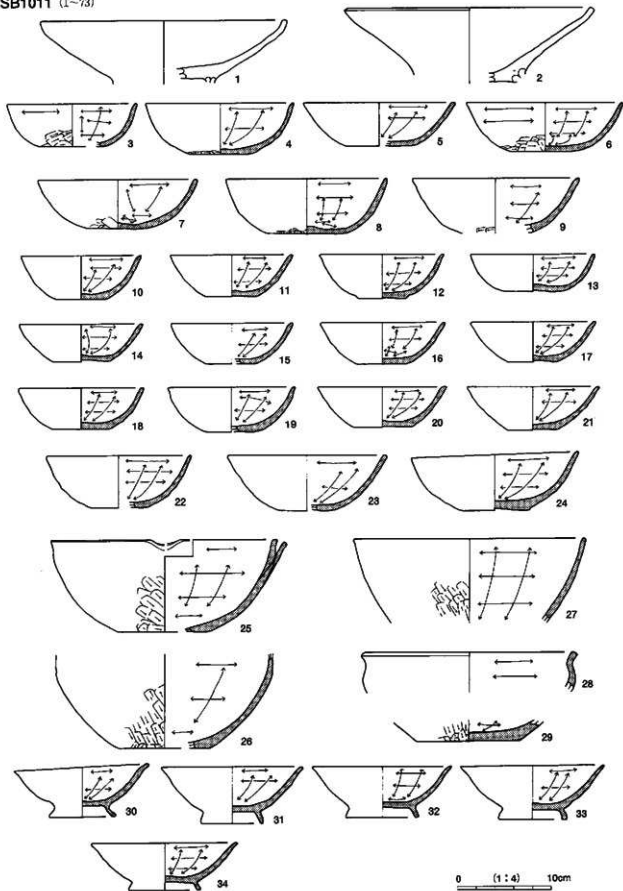

0 (1:4) 10cm

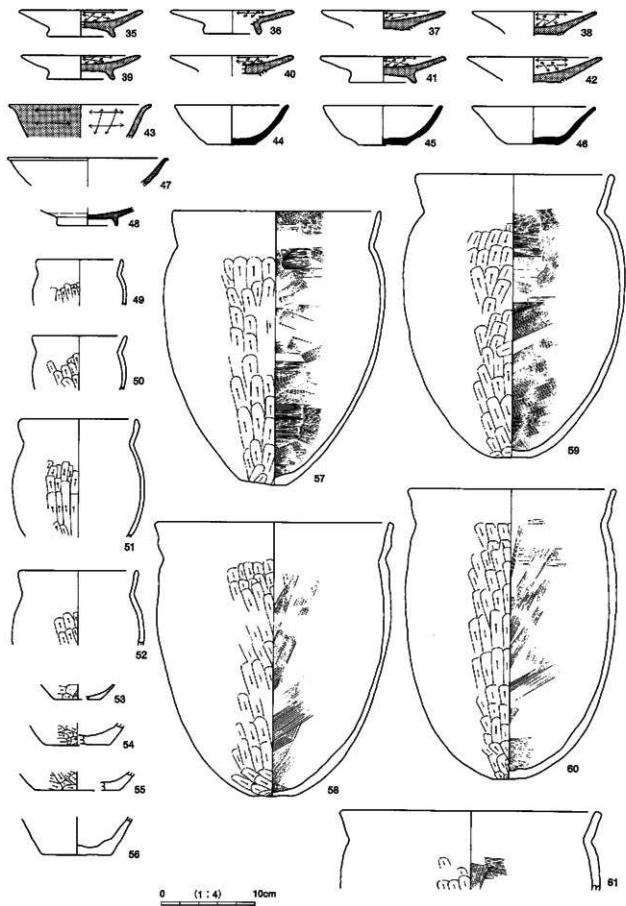

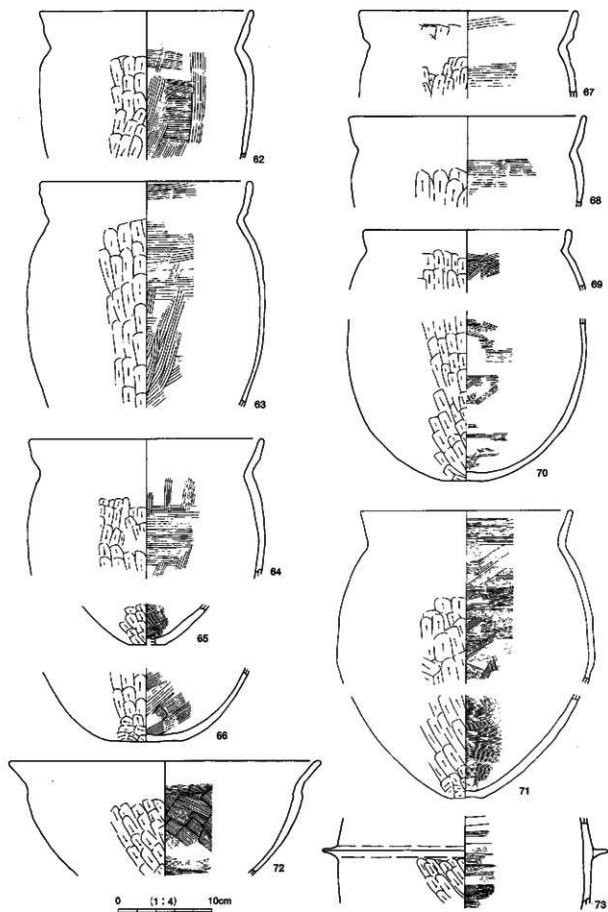

SB1014

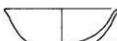
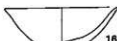
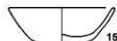
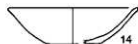
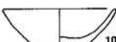
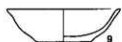
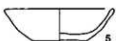
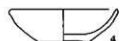

SB1017 (1~31)

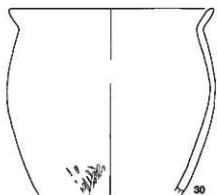
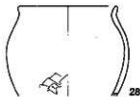
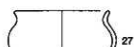
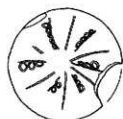
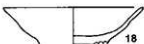
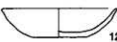
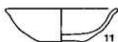
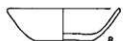
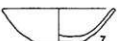
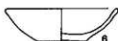
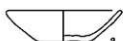
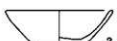
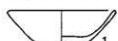

SB1020 (1~14)

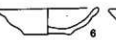
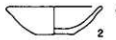
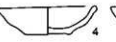

0 (1:4) 10cm



13

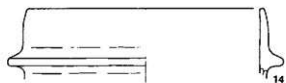

SB1022



SB1024 (1~17)

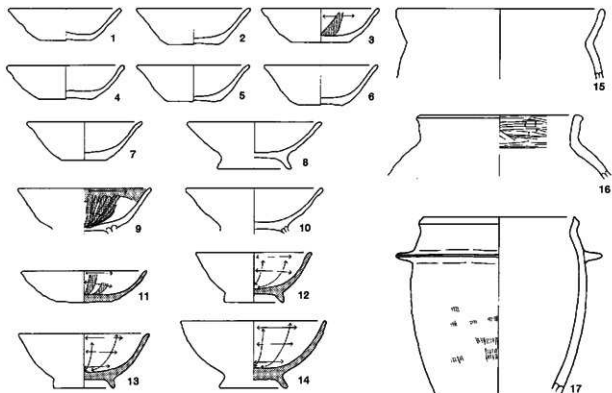

SB1026 (1~25)

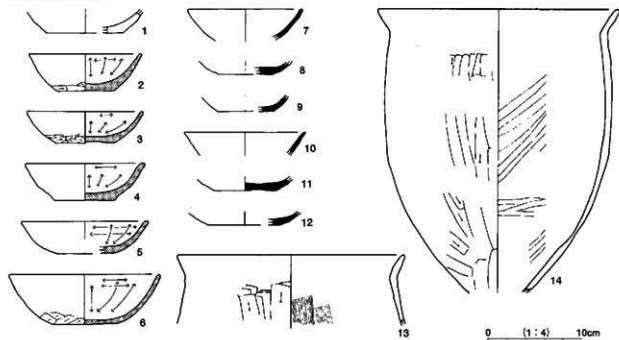

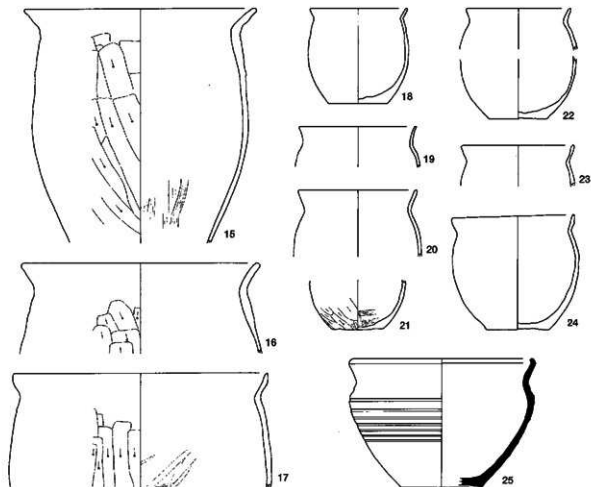

SB1029 (1~5)

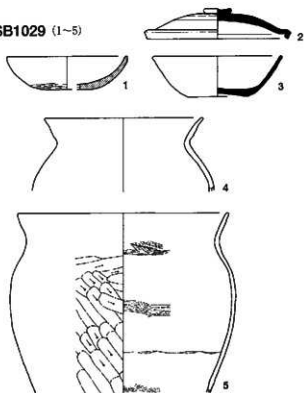

SB1030 (1~20)

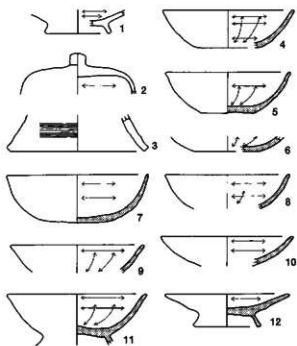

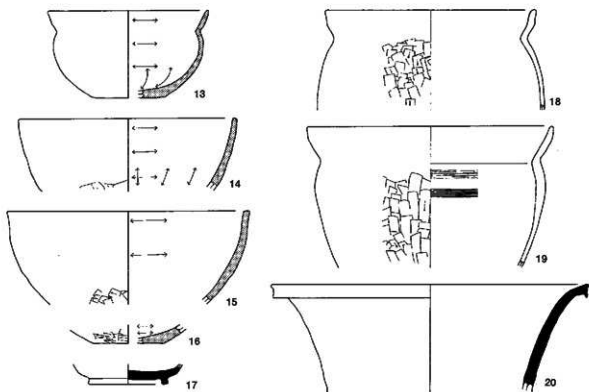

SB1033 (1・2)

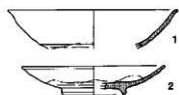

SB1038 (1~4)

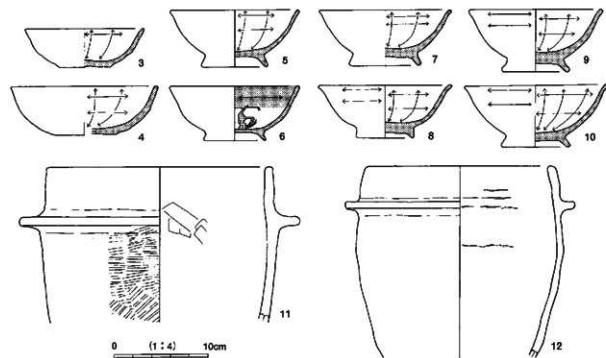

0 (1:4) 10cm

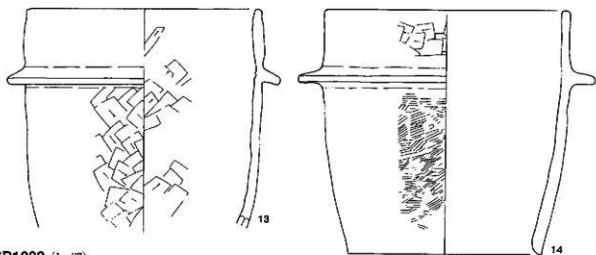

SB1039 (1~27)

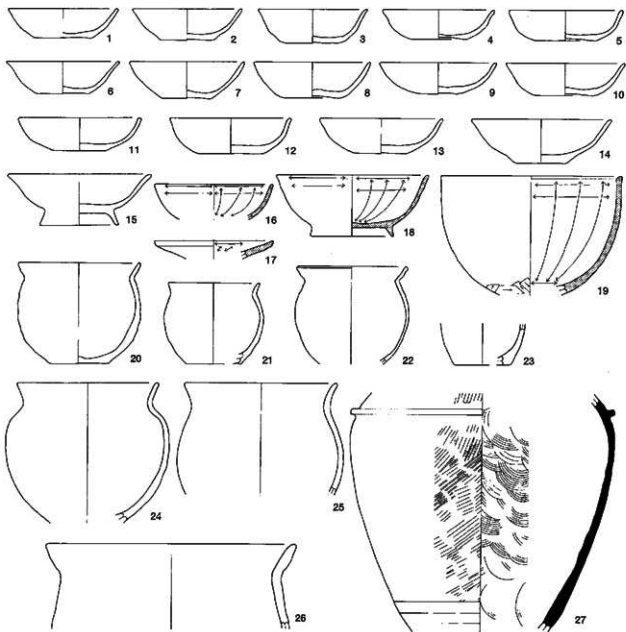

SB1041



SB1045 (1·2)



SB1046 (1~157)

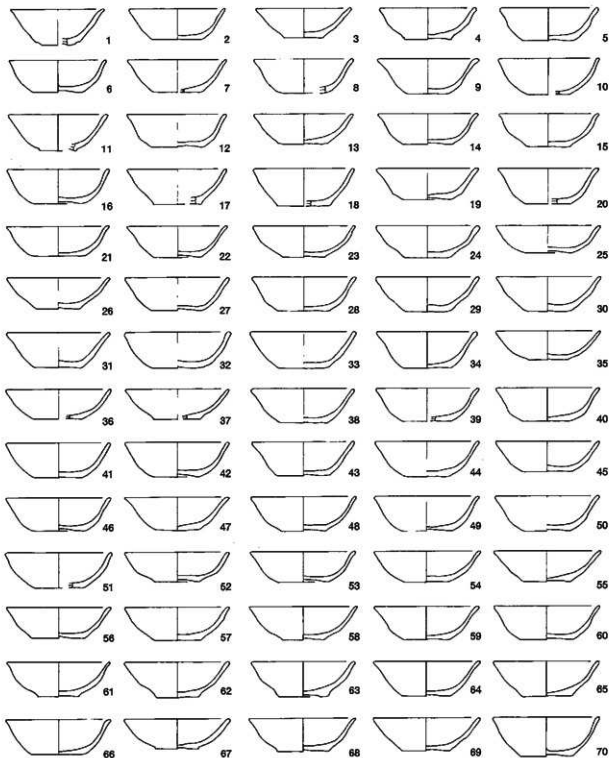

0 (1:4) 10cm

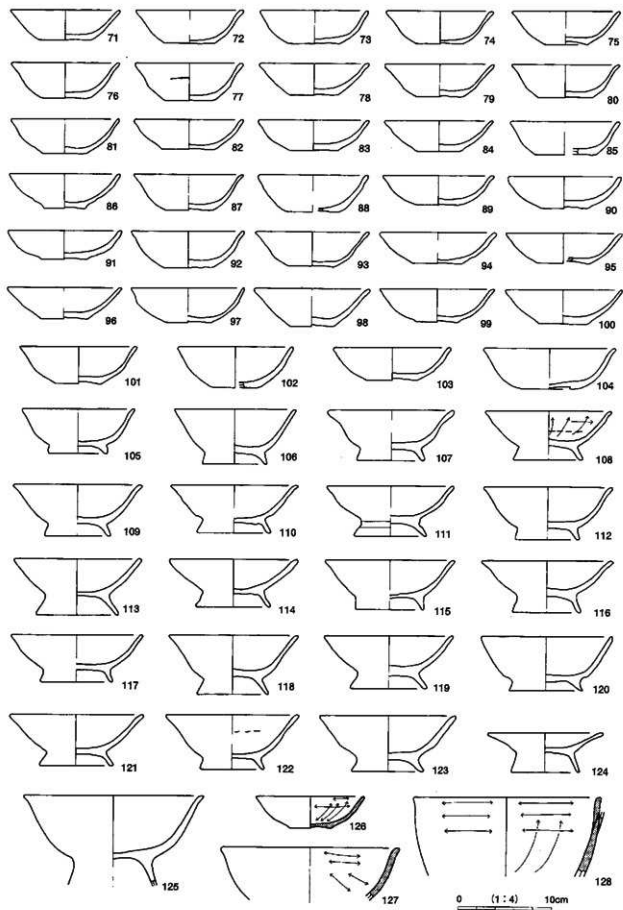

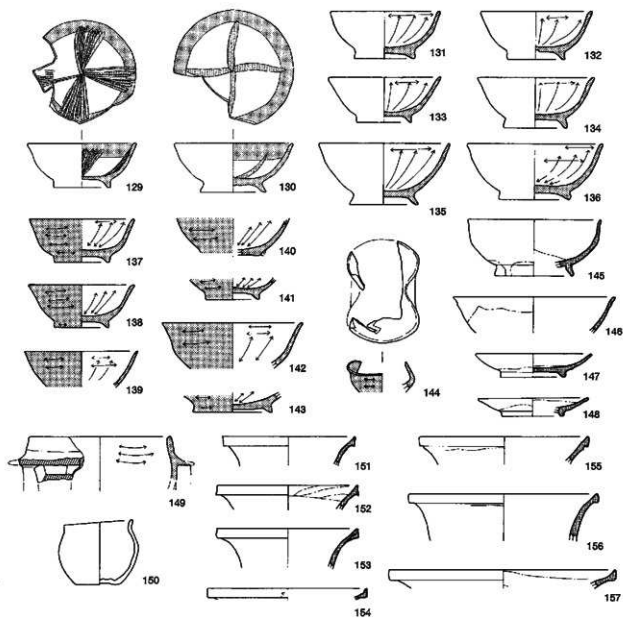

SB1047

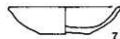

0 (1:4) 10cm

SB1051 (1~28)

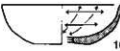
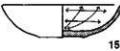
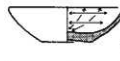
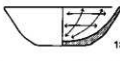
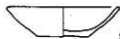
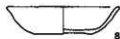
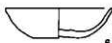

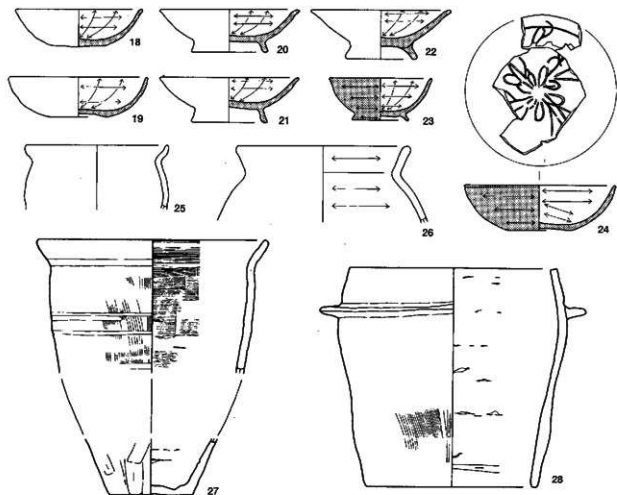

SB1052 (1~22)

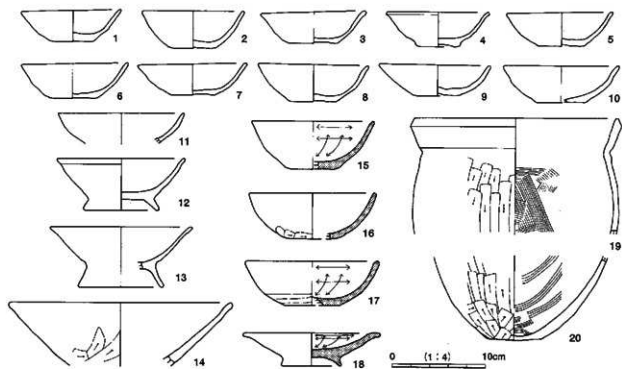

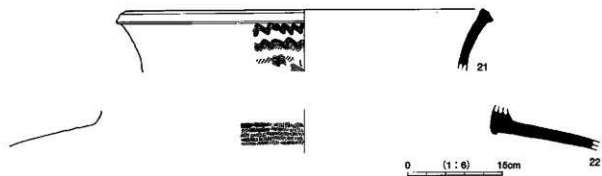

SB1059 (1~4)

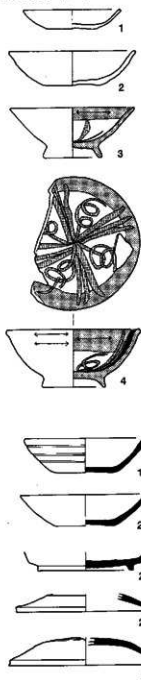

SB1060 (1~48)

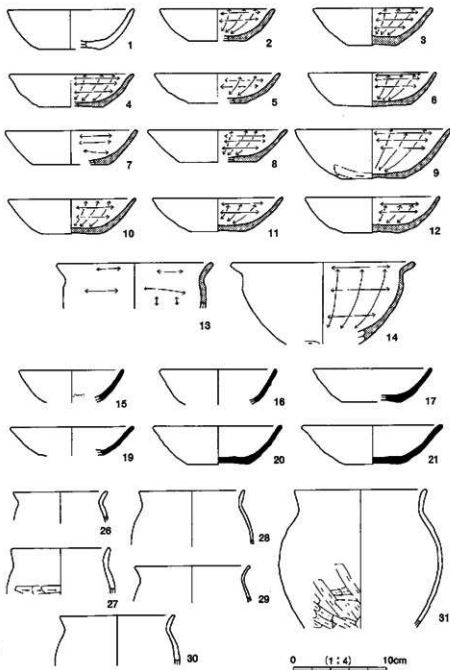

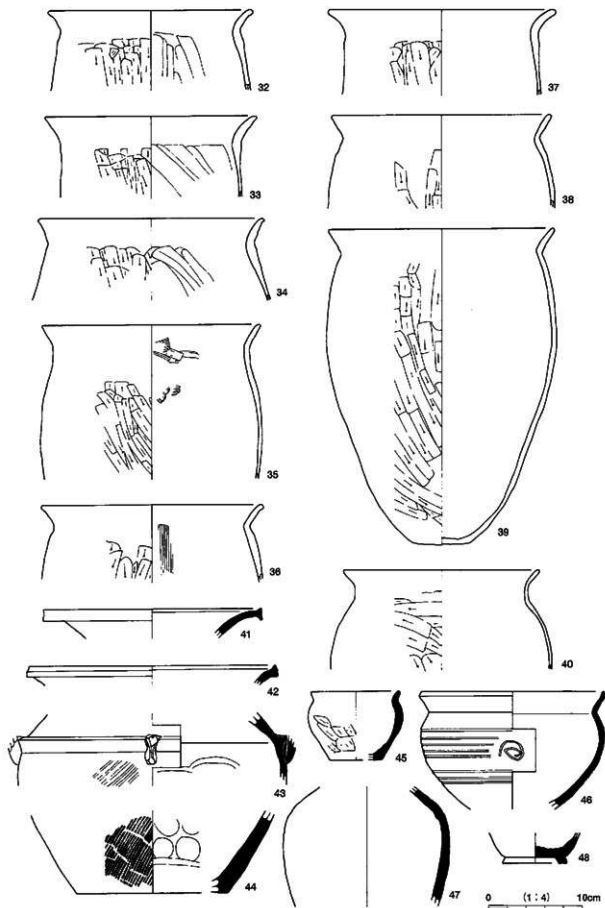

SB1063 (1~19)

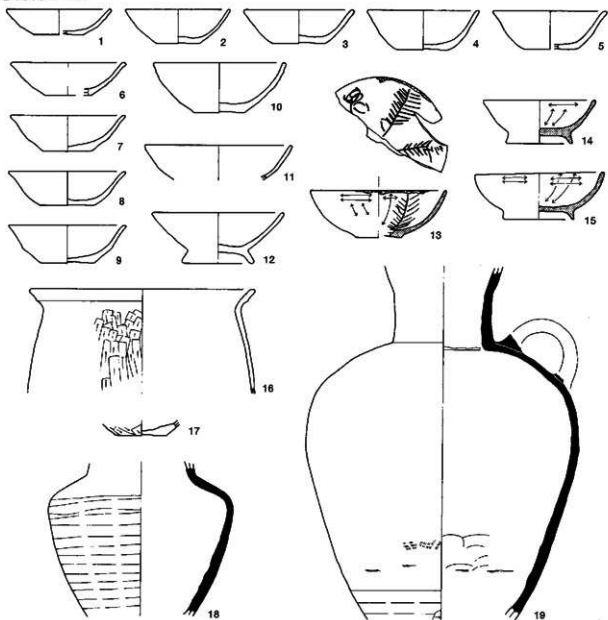

SB1065 (1~72)

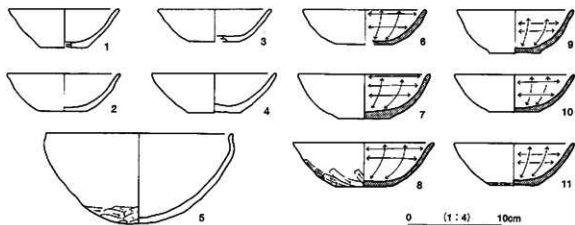

0 (1:4) 10cm

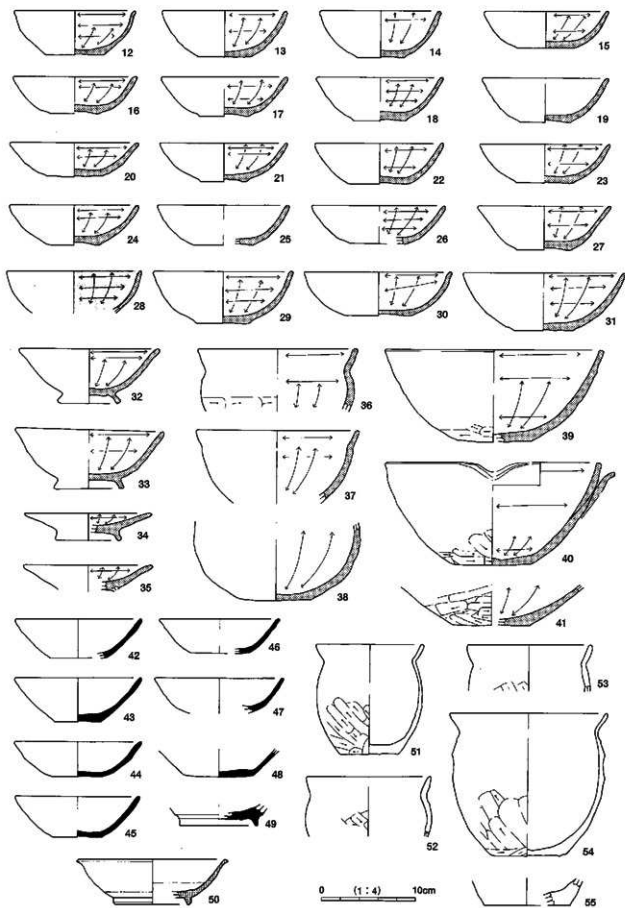

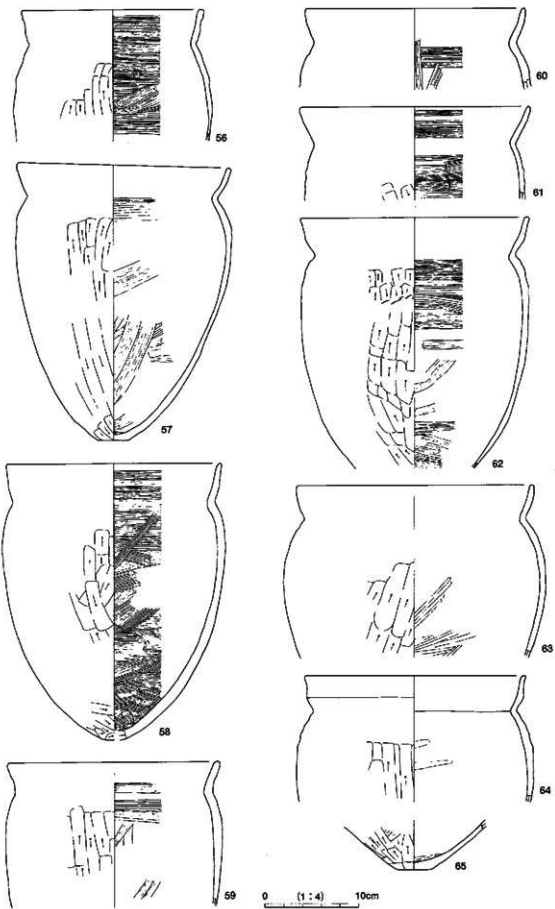

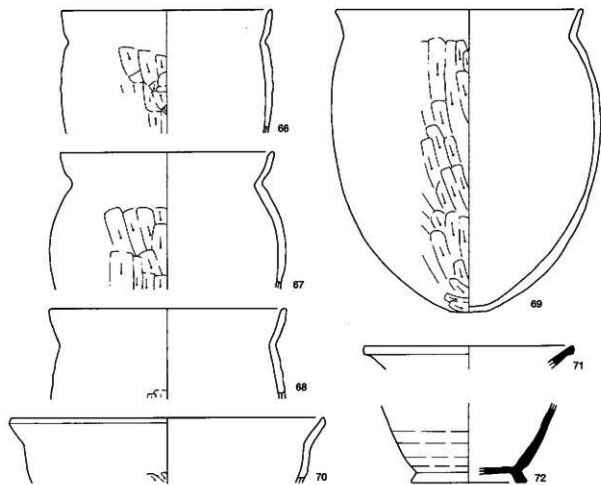

SB1067 (1~47)

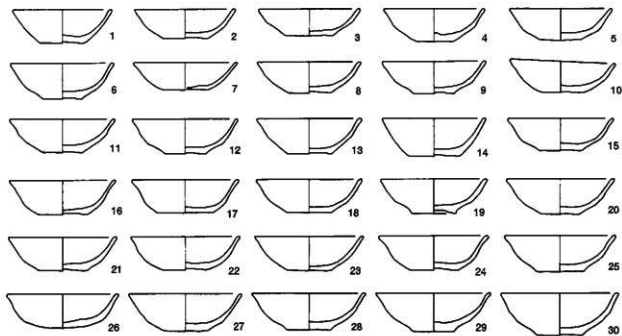

0 (1:4) 10cm

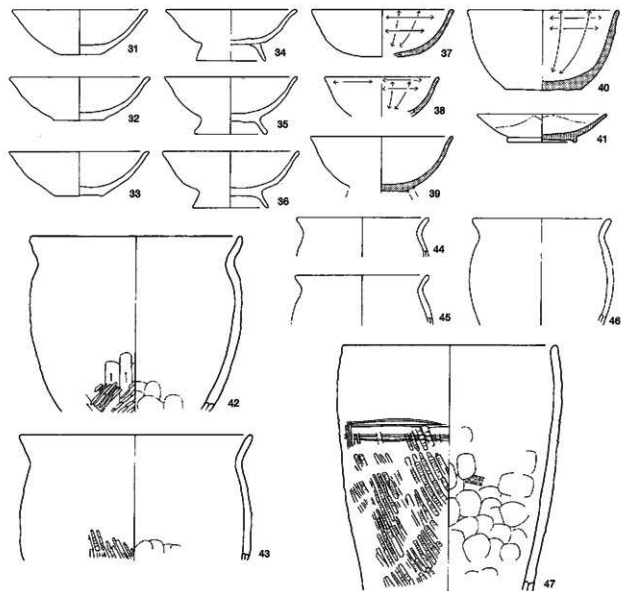

SB1070 (1-19)

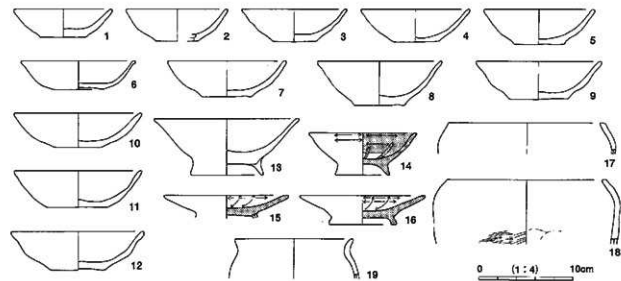

SB1071 (1~18)

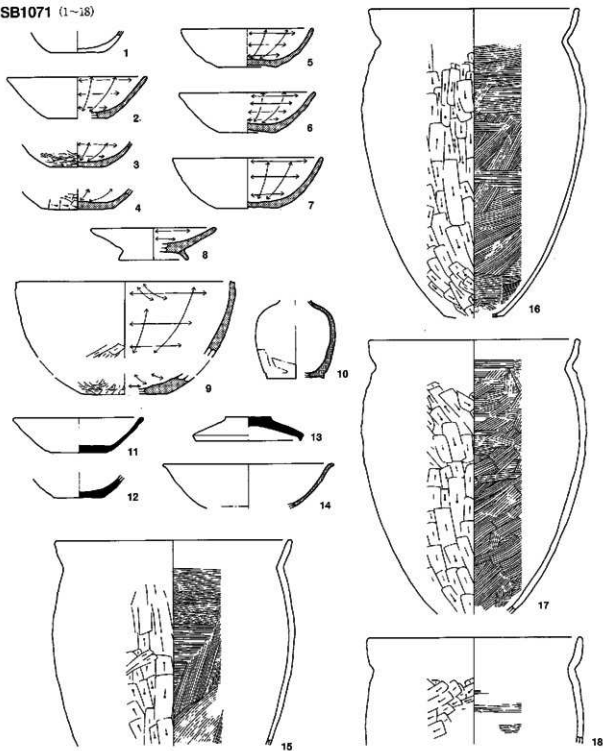

SB1074 (1~73)

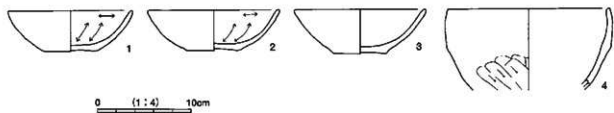

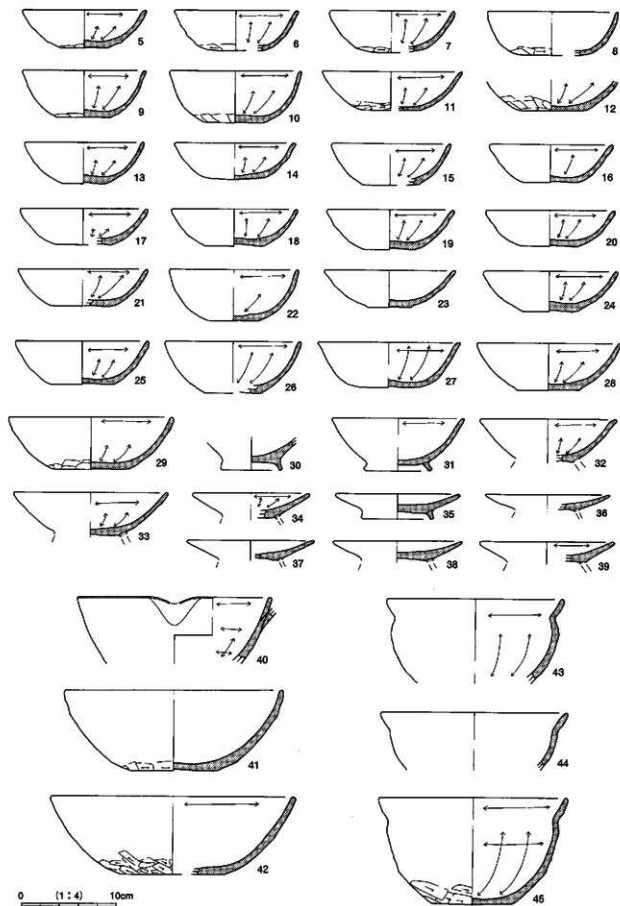

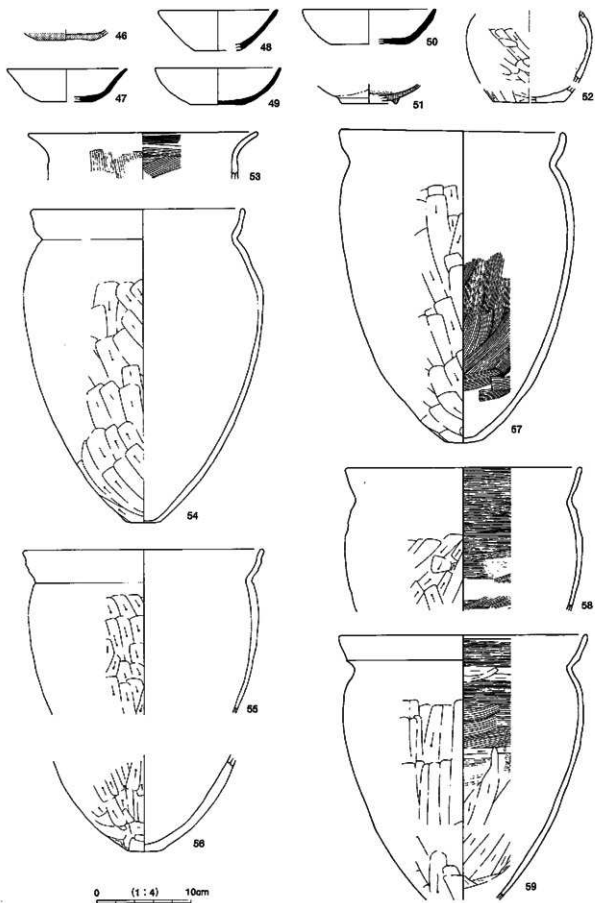

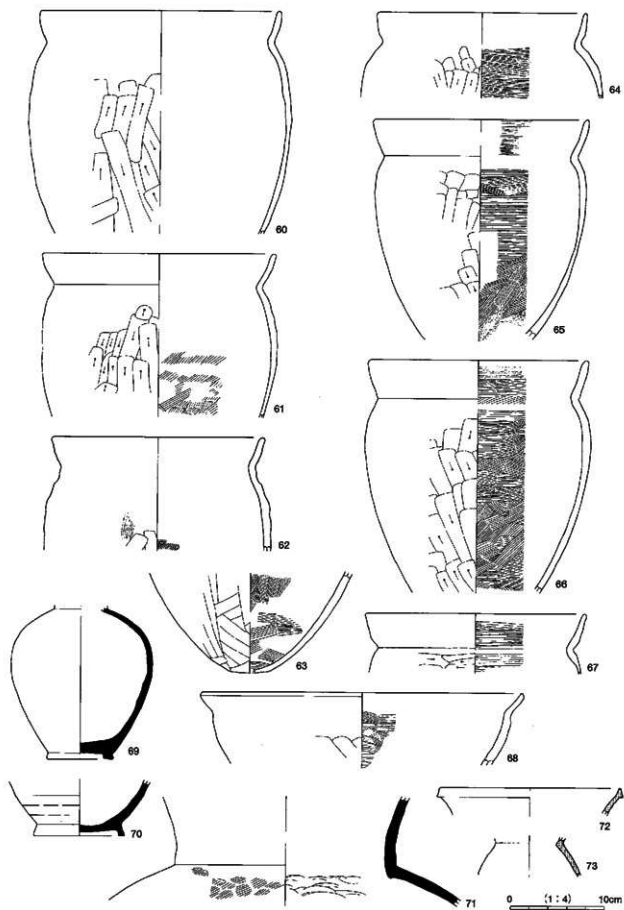

SB1076 (1~26)

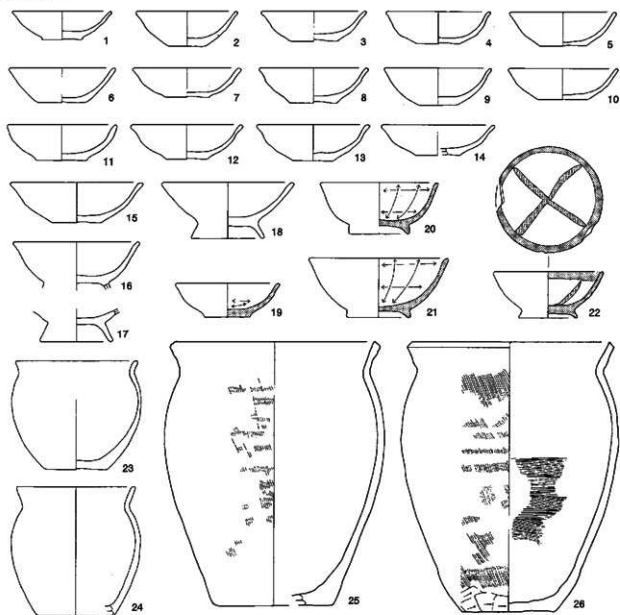

SB1080 (1~47)

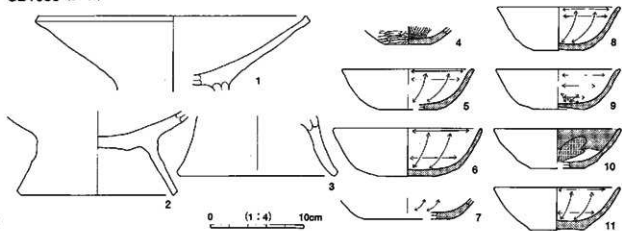

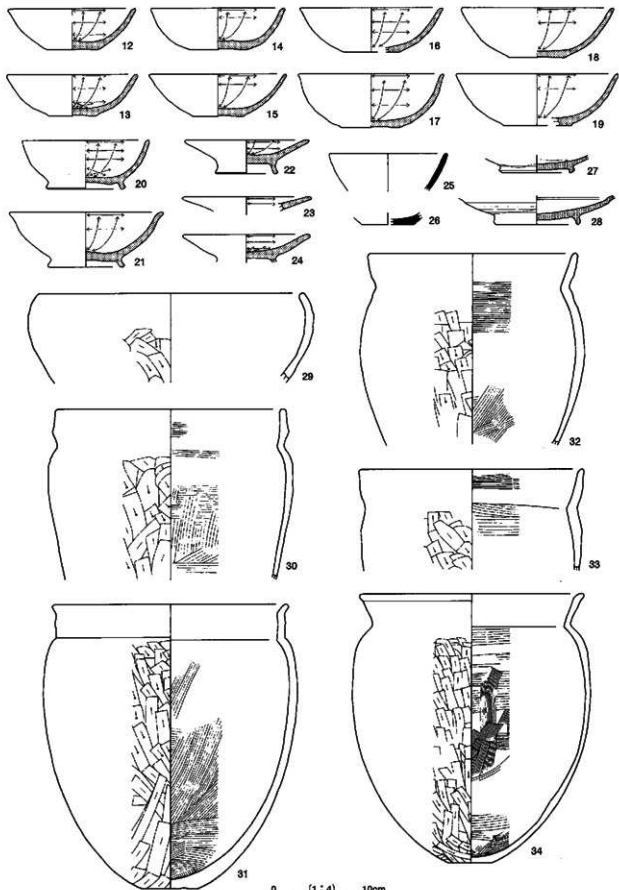

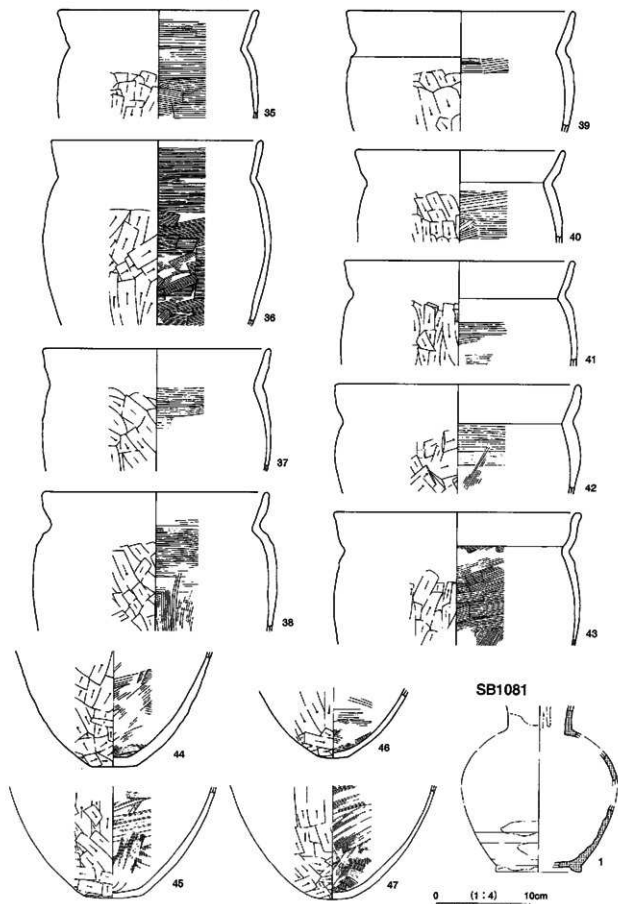

SB1084 (1-6)

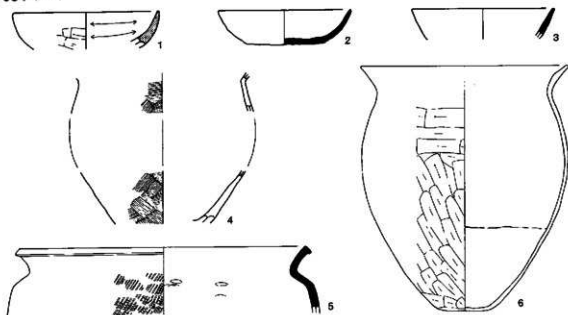

SB1085 (1-7)

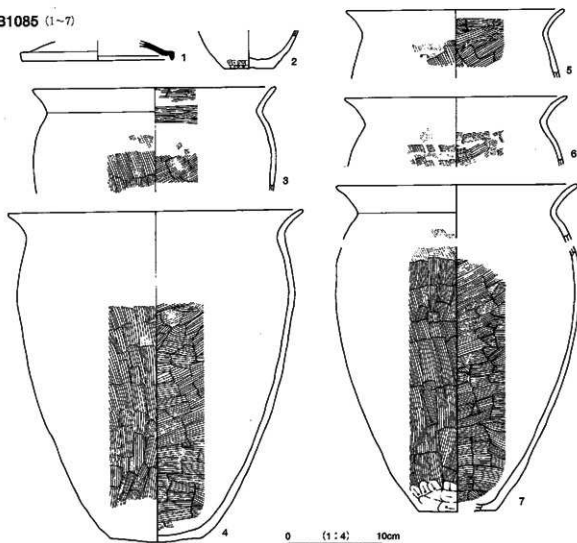

0 (1:4) 10cm

SB1086 (1~22)

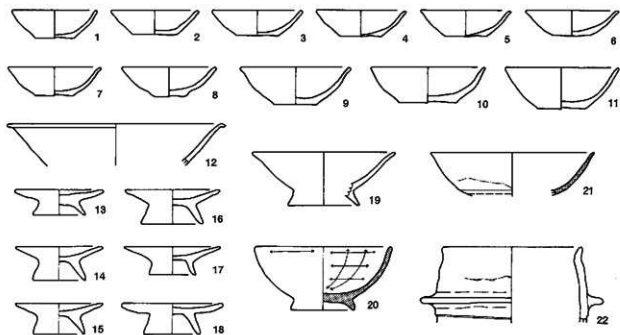

SB1088 (1~9)

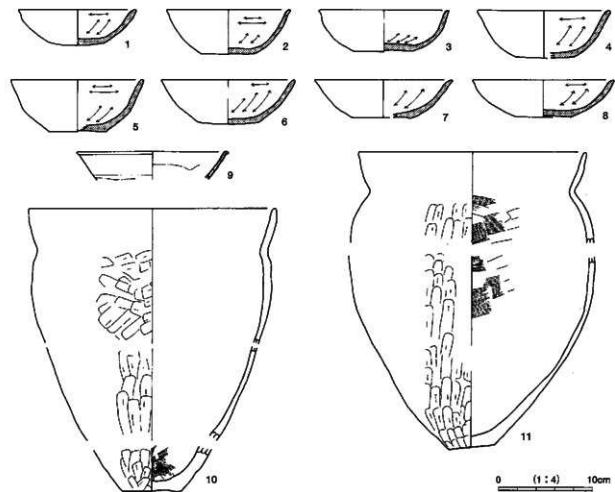

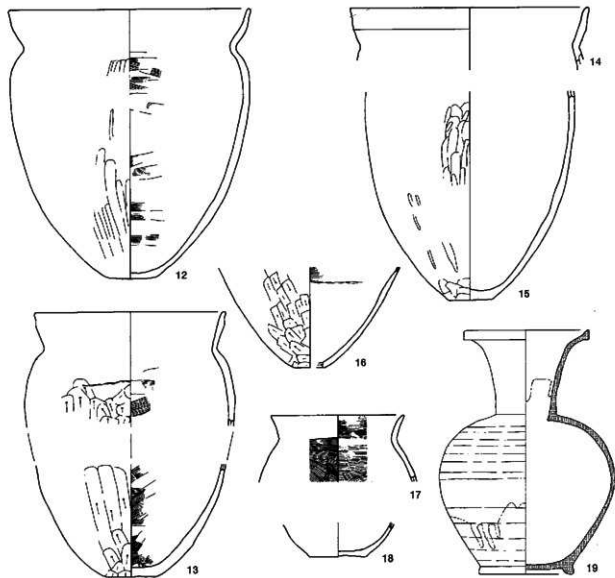

SB1089 (1~15)

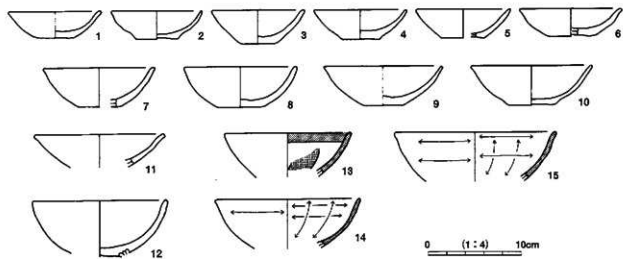

SB1090 (1~26)

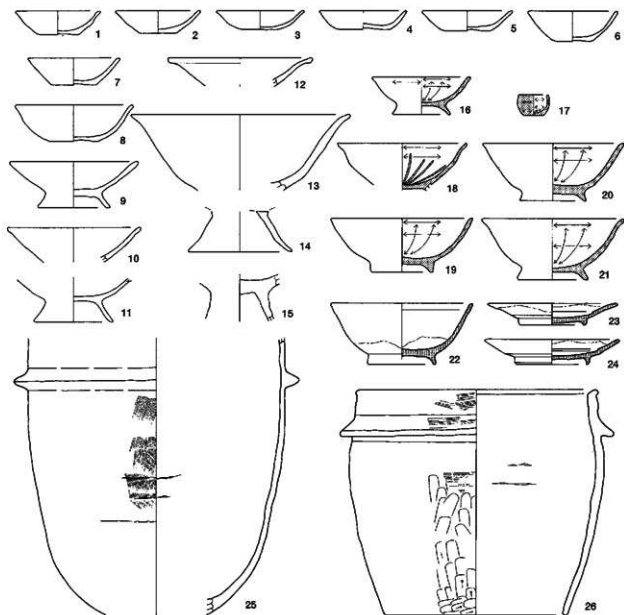

SB1092 (1~12)

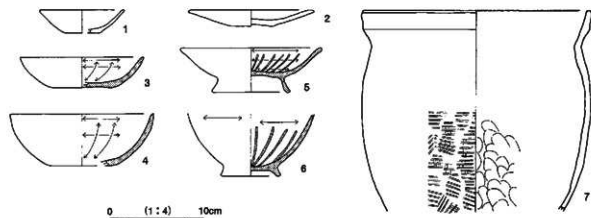

0 (1:4) 10cm

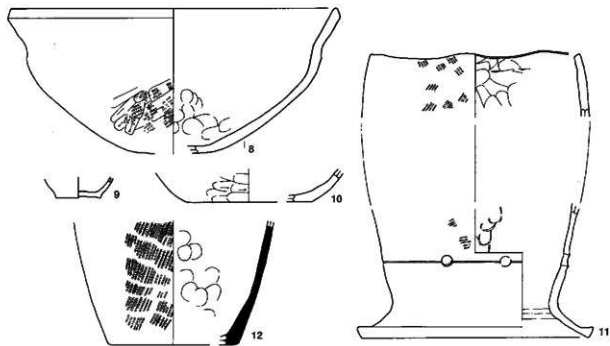

SB1093 (1~10)

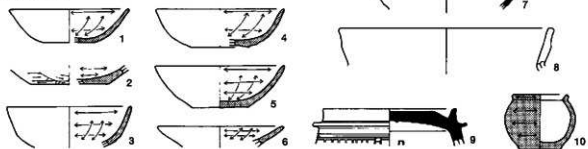

SB1095 (1~27)

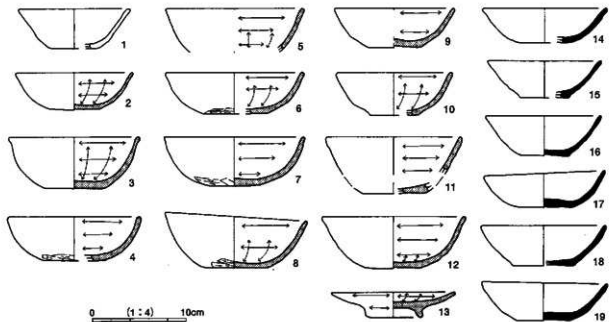

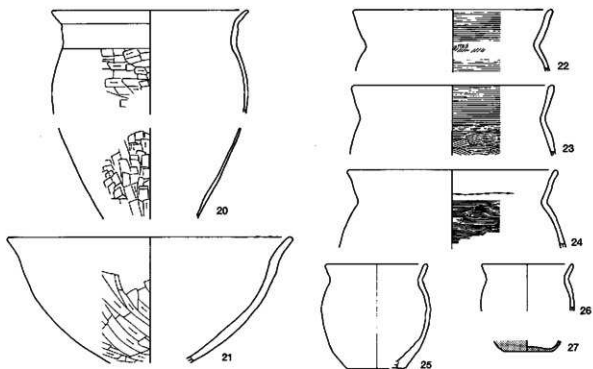

SB1098 (1~15)

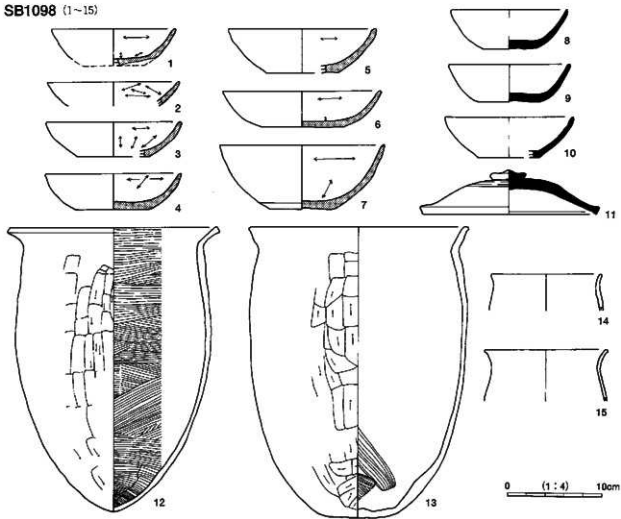

SB1100 (1・2)

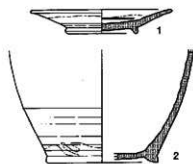

SB1101 (1~11)

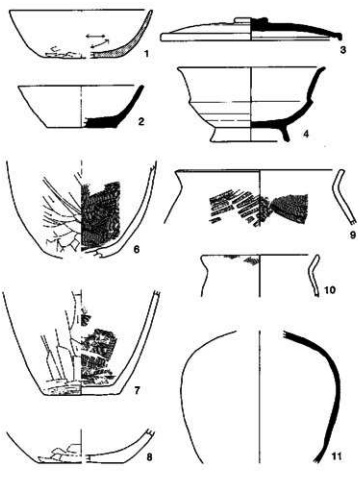

SB1194 (1~15)

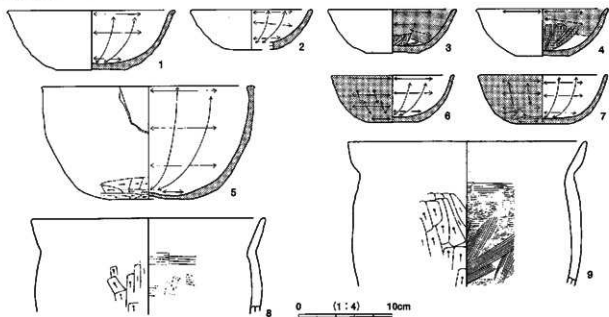

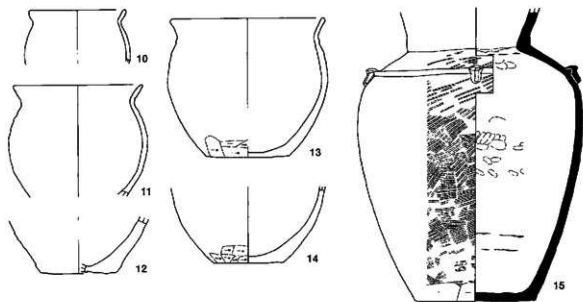

SB1201 (1~29)

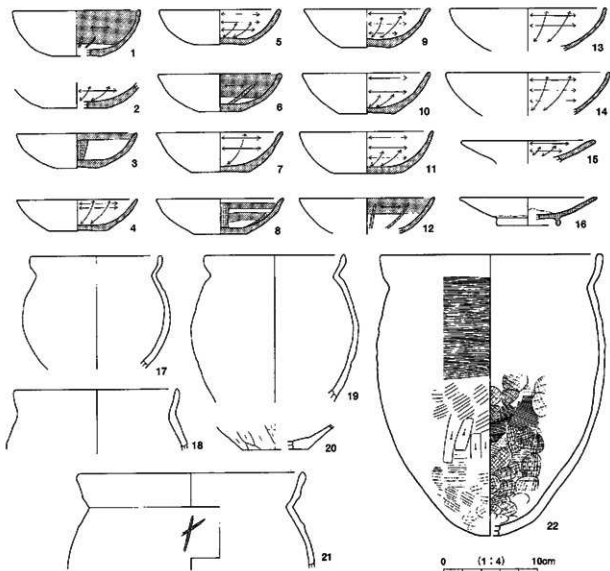

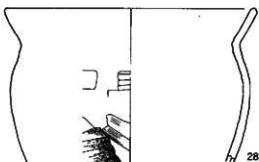
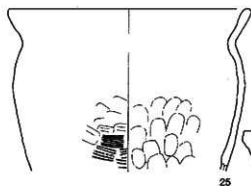
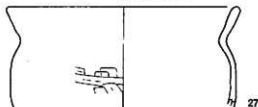
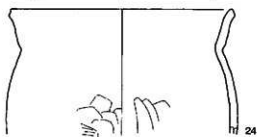
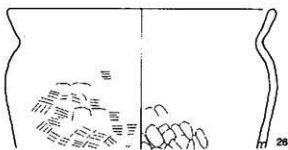
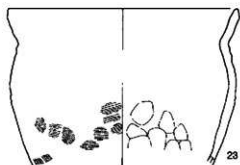

SB1204



SB1205 (1・2)

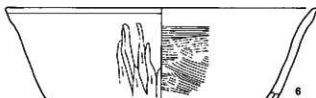
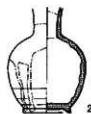

SB1207 (1~9)

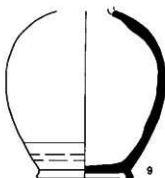
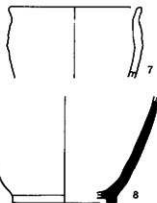
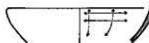
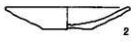
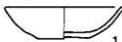

0 (1:4) 10cm

SB1208 (1~9)

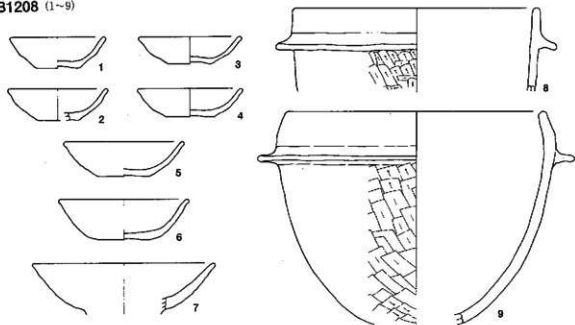

SB1209 (1~20)

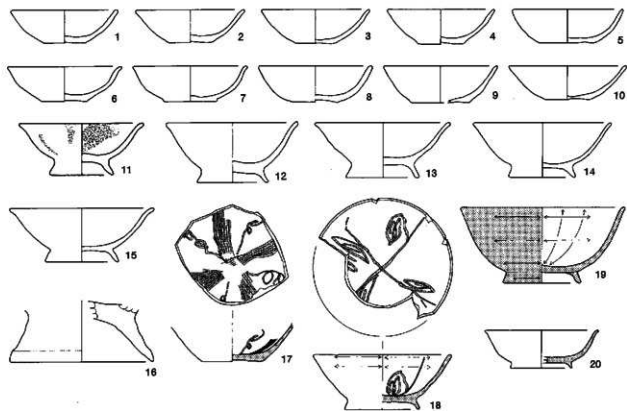

SB1211



SB1213



0 (1:4) 10cm

SB1212 (1-8)

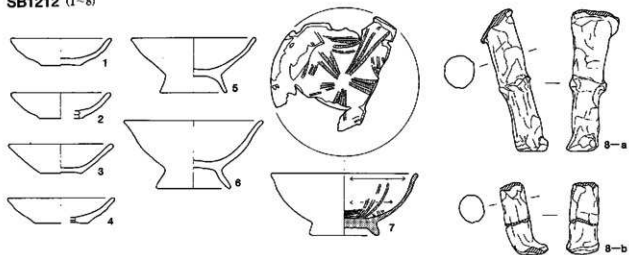

SB1216 (1-13)

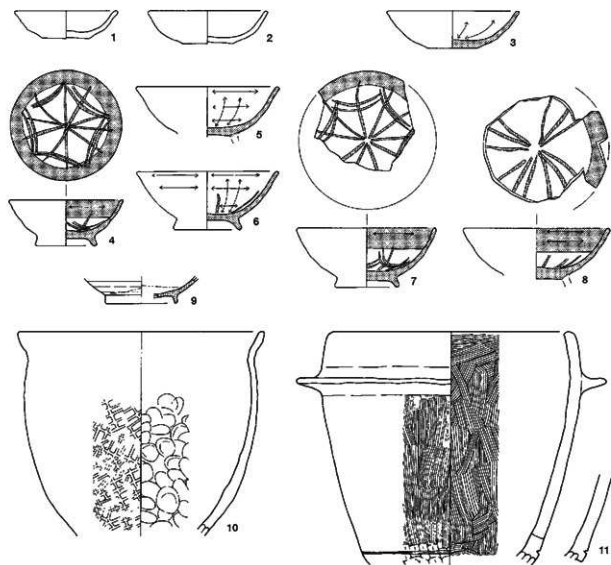

0 (1:4) 10cm

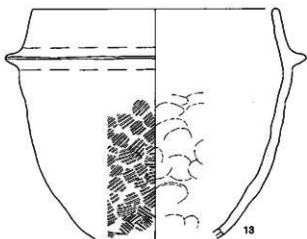
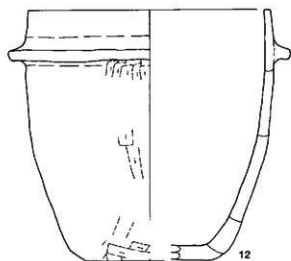

SB1217 (1~16)

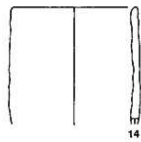
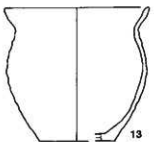
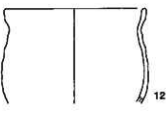
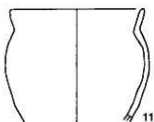
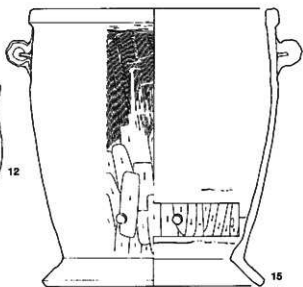
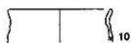
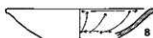
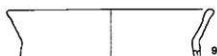
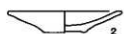

0 (1:4) 10cm



SB1218 (1~14)

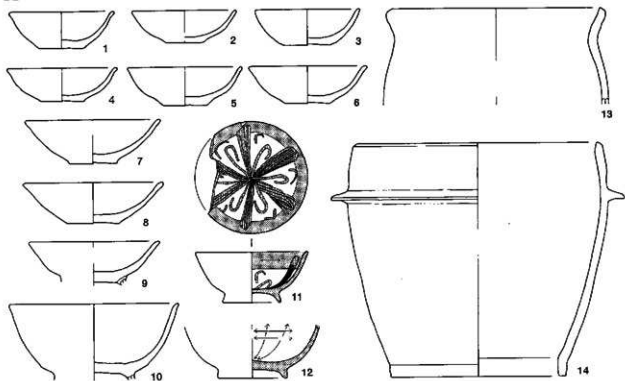

SB1219 (1~9)

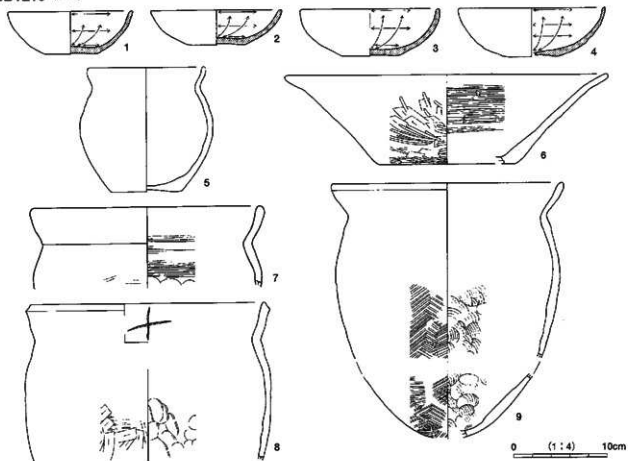

0 (1:4) 10cm

SB1222 (1~28)

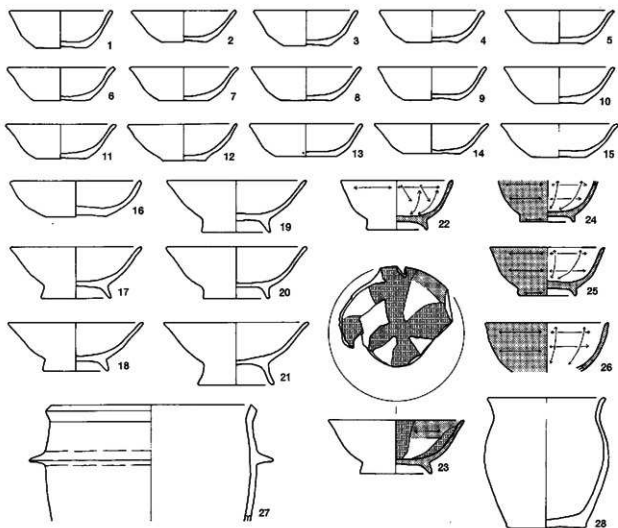

SB1224 (1~44)

SB1223

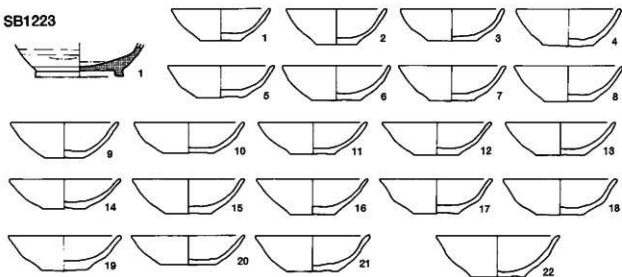

0 (1:4) 10cm

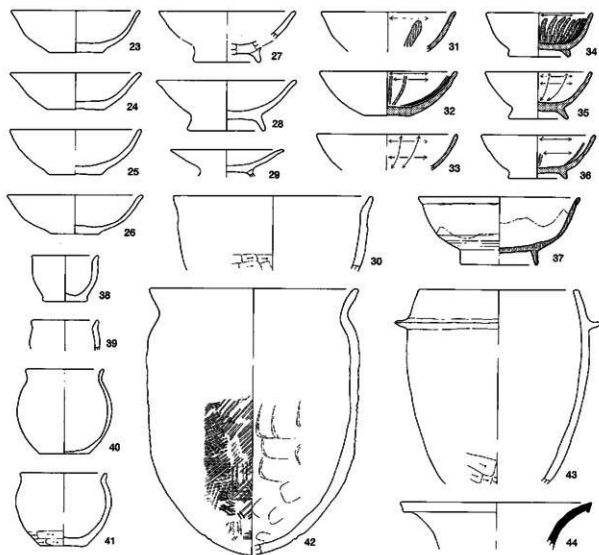

SB1225

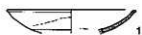

SB1228



SB1226 (1~29)

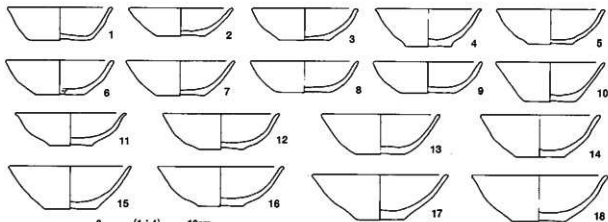

0 (1:4) 10cm

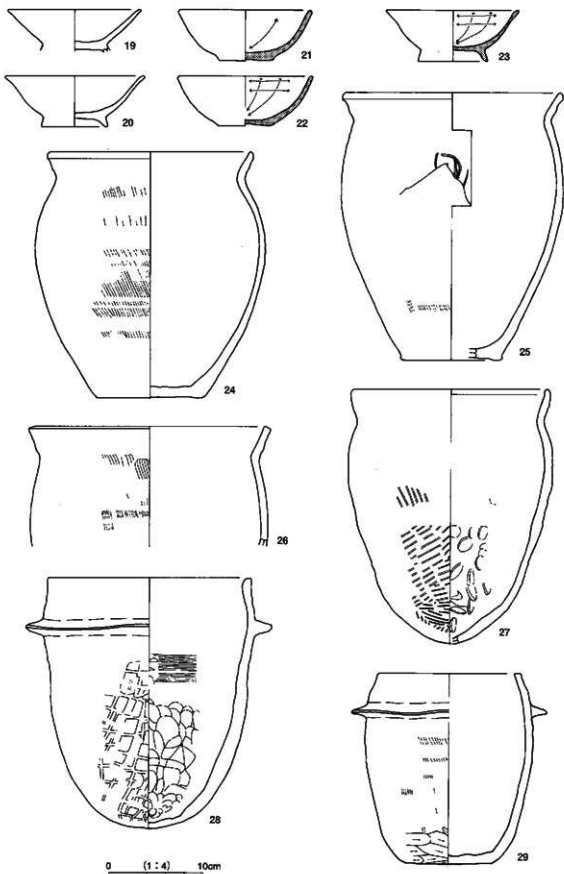

SB1230 (1-4)

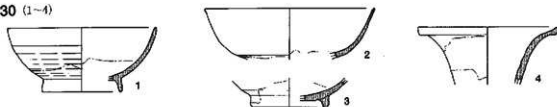

SB1231 (1-21)

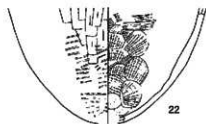
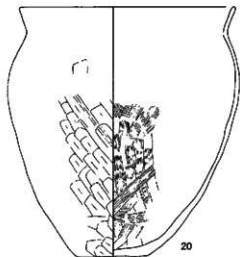
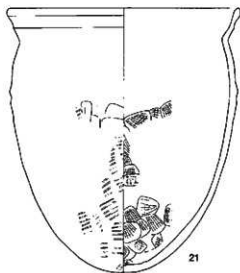
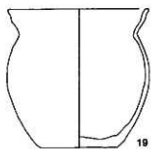
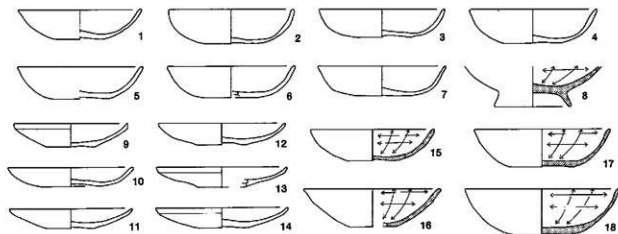

0 (1:4) 10cm

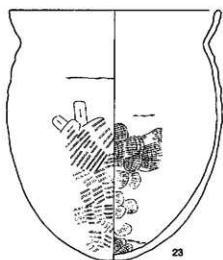

23

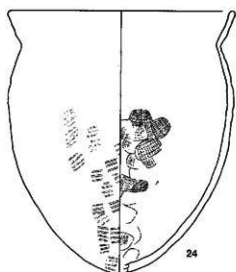

24

SB1235 (1~4)

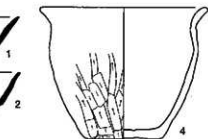
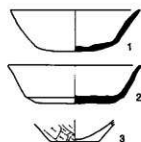

SB1236 (1~13)

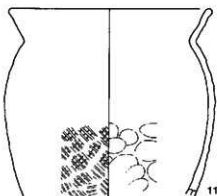
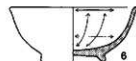
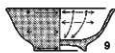
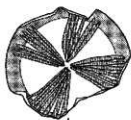
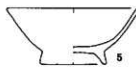
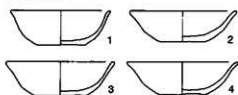

11

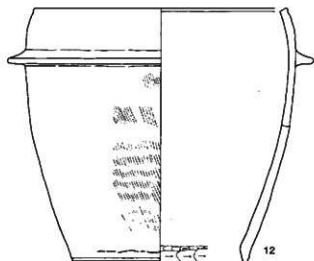

12

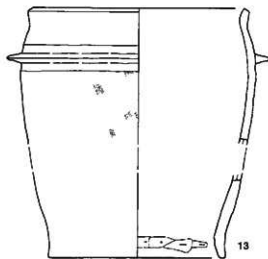

13

0 (1:4) 10cm

SB1237 (1~23)

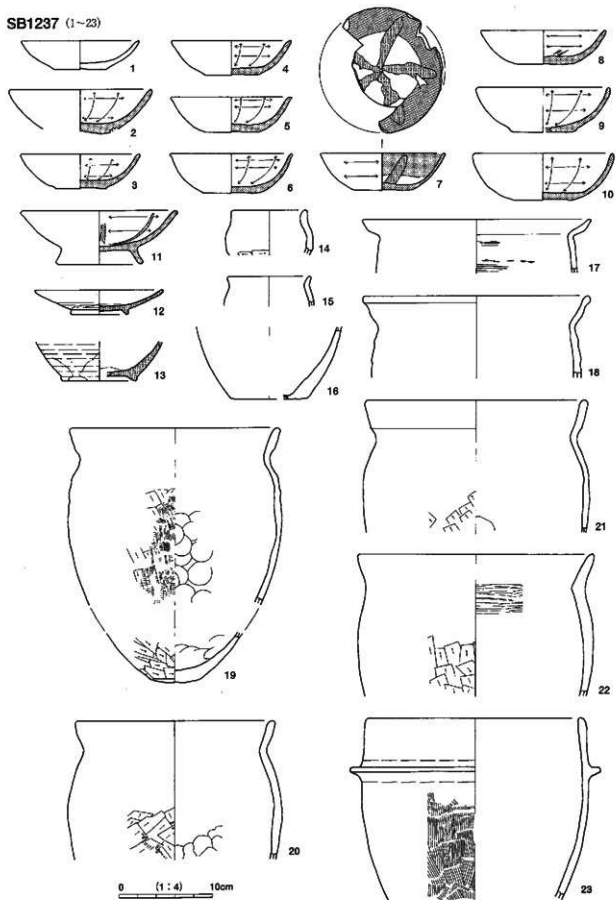

SB1238 (1・2)

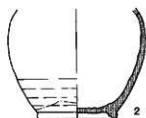

SB1241



SB1246 (1~27)

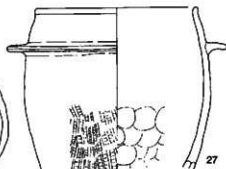
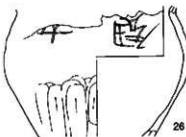
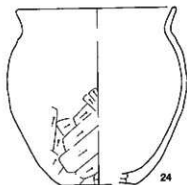
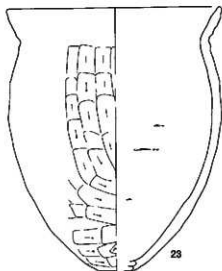
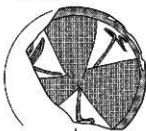
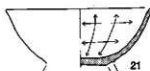
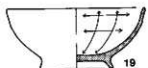
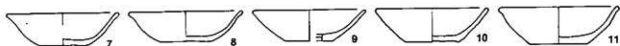
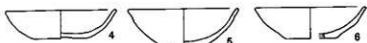
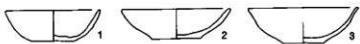

0 (1:4) 10cm

SB1312 (1~27)

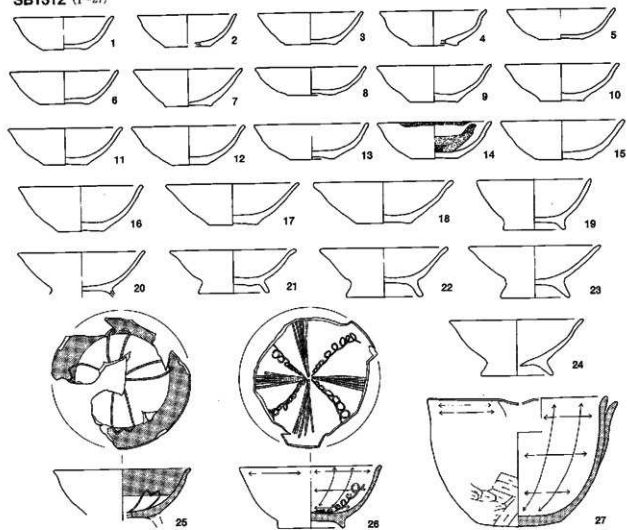

SB1401 (1~29)

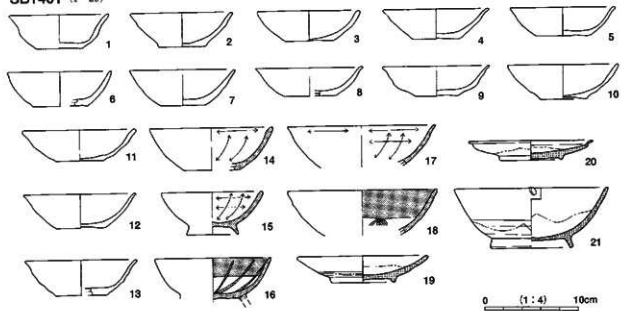

0 (1:4) 10cm

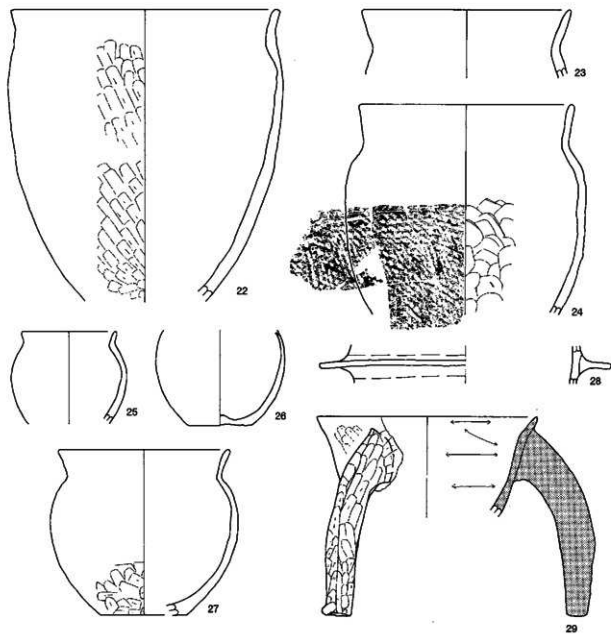

SB1402 (1~6)

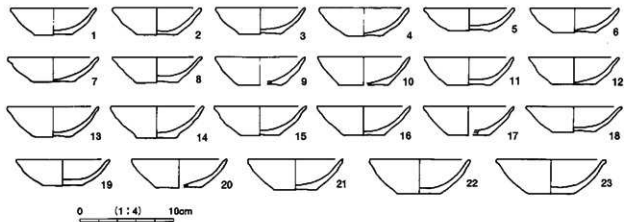

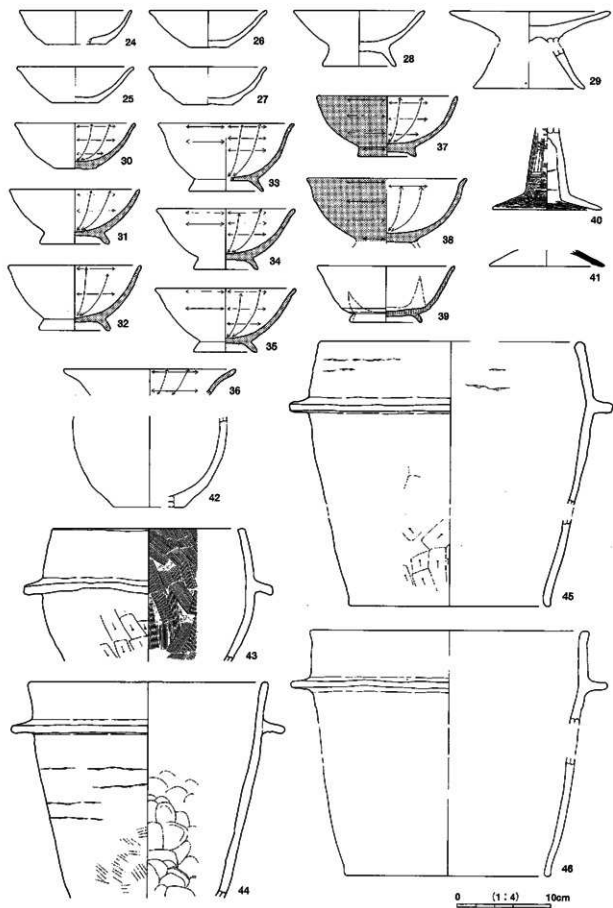

SB1403 (1~3)

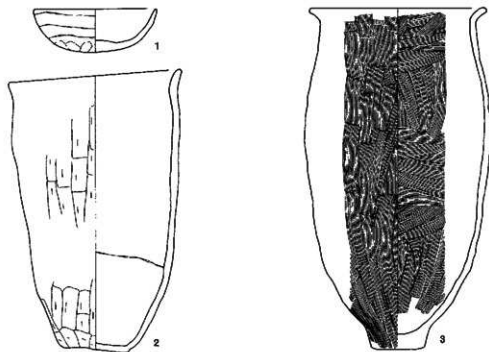

SB1404 (1~4)

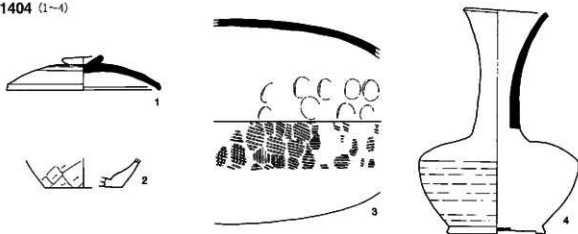

SB1405 (1~26)

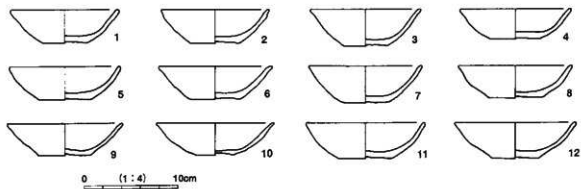

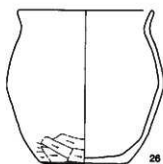
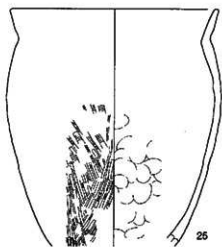
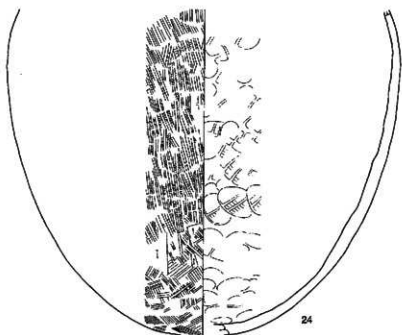
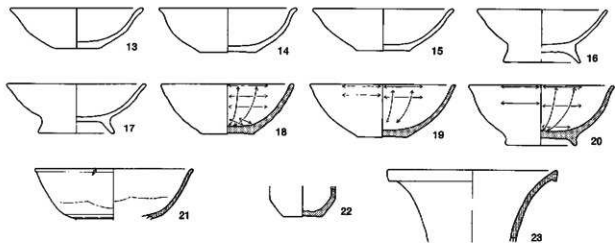

0 (1:4) 10cm

SD1 (1~4)



SD2 (1~54)

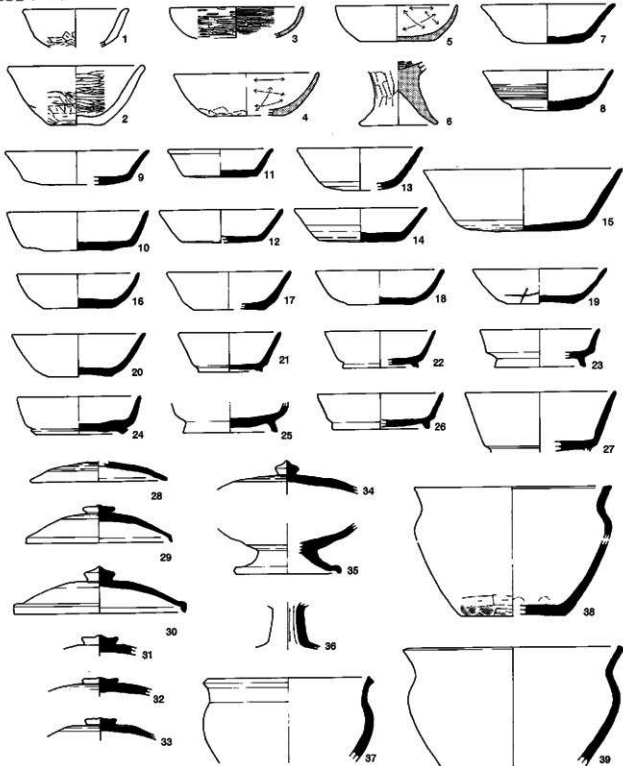

0 (1:4) 10cm

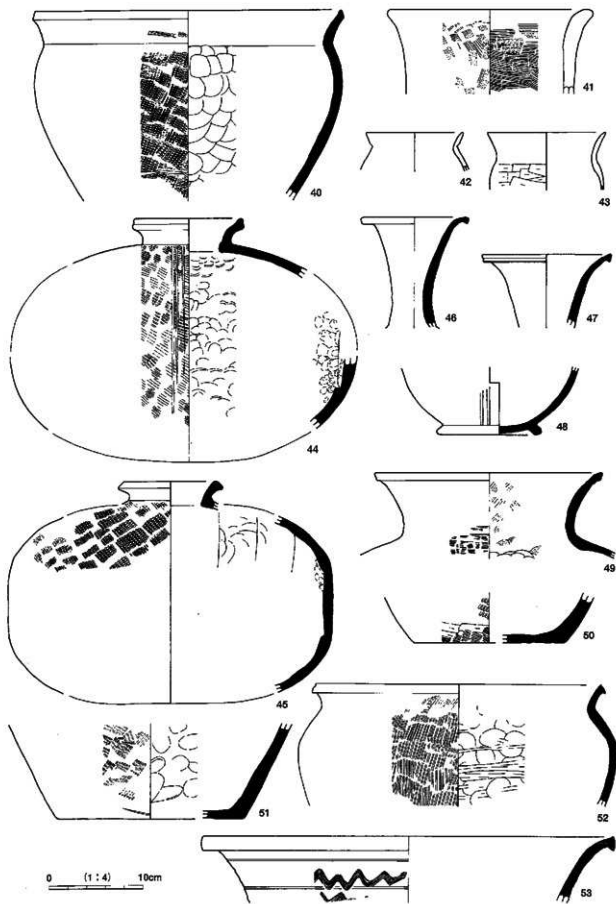

SD3 (1~17)

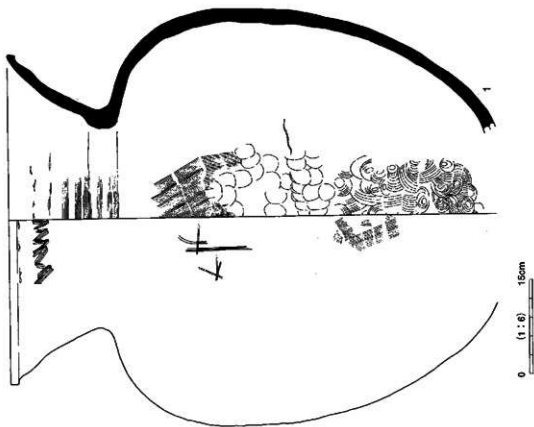

SD2

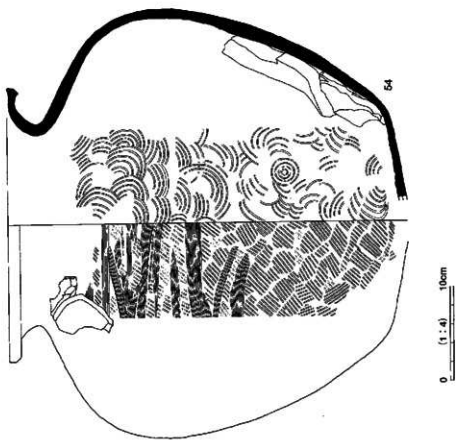

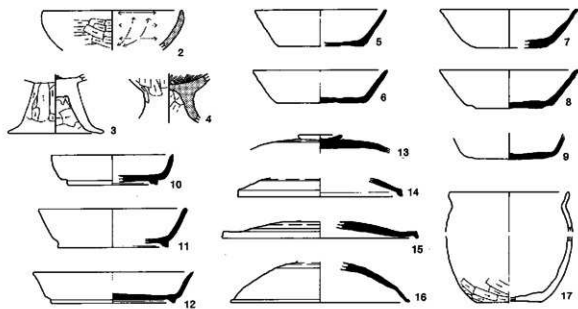

SD9



SD10 (1~3)



SD18 (1~2)

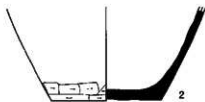

SD45 (1~7)

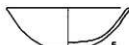
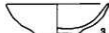

SD24

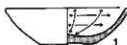

SD46 (1~6)

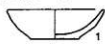

0 (1:4) 10cm

SD51

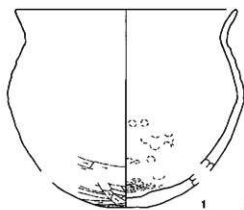

SD58 (1~6)

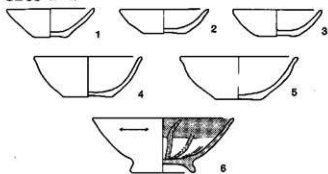

SD53



SD1001 (1~13)

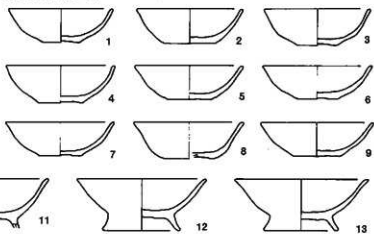

SD1009 1層 (1~14)

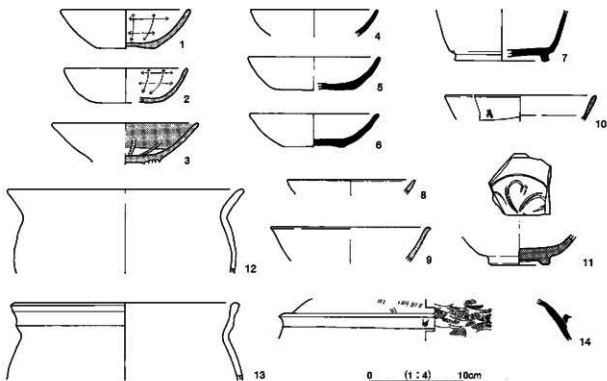

SD1009 2層 (15~38)

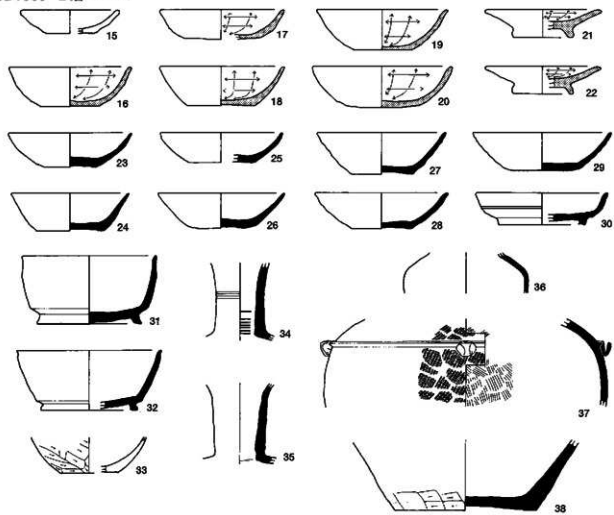

SD1009 3層 (39~40)



SD1009 覆土一括 (41~46)

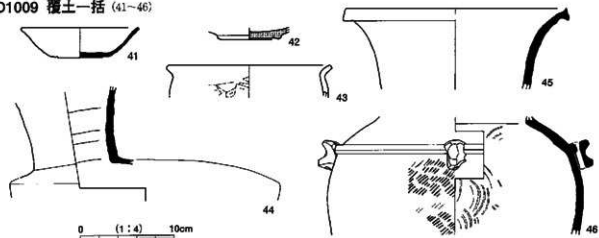

SD1014



SD1015 (1・2)

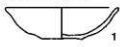

SD1018 (1・2)

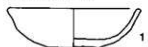

SD1152 (1・2)

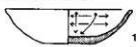

SD1016

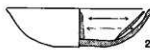

SD1021 (1~8)

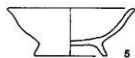
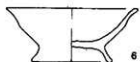
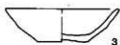
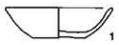

SD1173 (1~3)

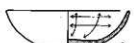

SD1191

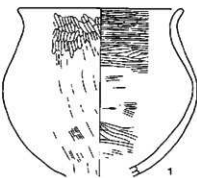

SD1409 (1・2)

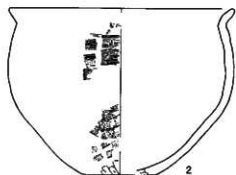
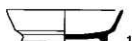

SC1 (1~20)

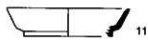
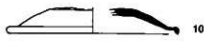
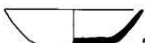

0 (1:4) 10cm

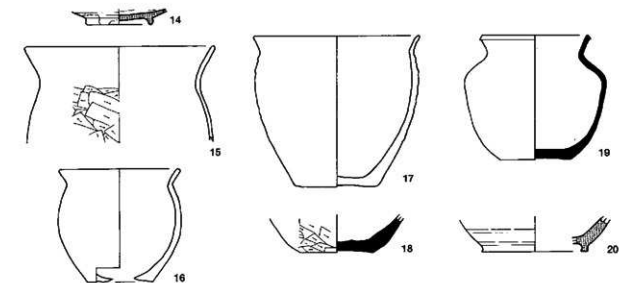

SK556 (1~3)

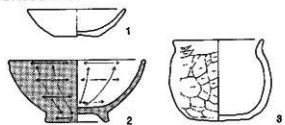

SK1035



SK1094



SK1117

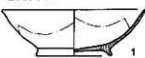

SK1226 (1~5)



SK76 (1~2)

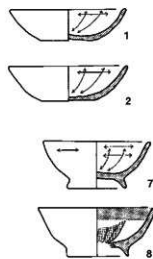

SK84 (1~17)

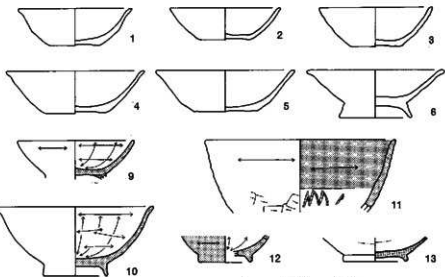

0 (1:4) 10cm

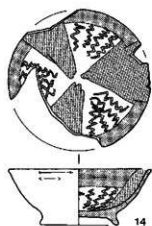

14

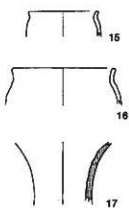

15

16

17

SK111 (1-2)

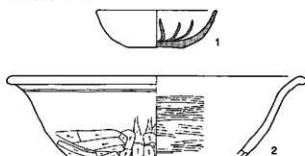

1

2

SK128 (1-2)



1

2

SK146

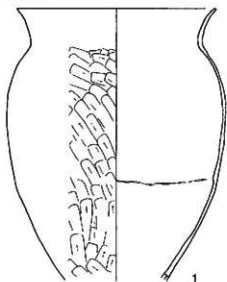

1

SK502 (1~22)

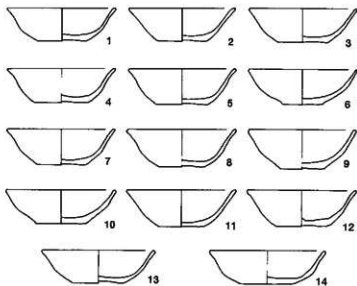

1

2

3

4

5

6

7

8

9

10

11

12

13

14



15

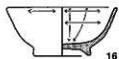

16

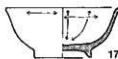

17



18



19



20



21

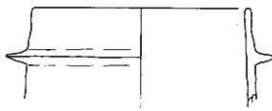

22

0 (1:4) 10cm

SK504 (1·2)

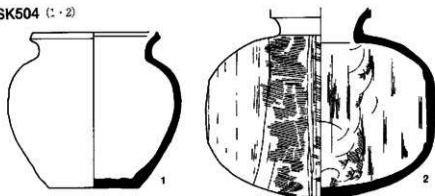

SK509 (1·2)

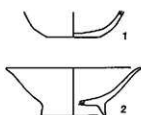

SK505 (1~3)

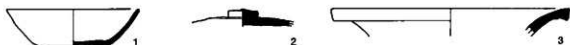

SK515

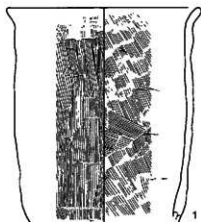

SK522 (1~6)

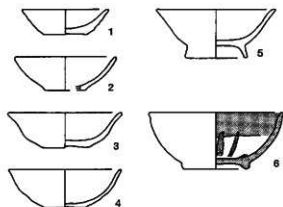

SK1034 (1~36)

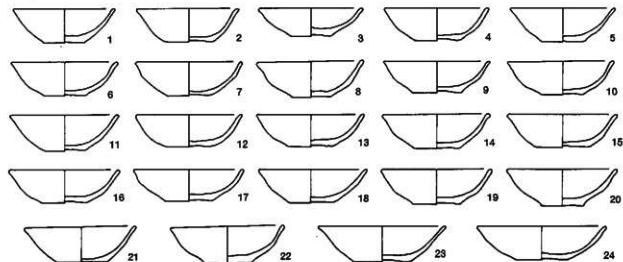

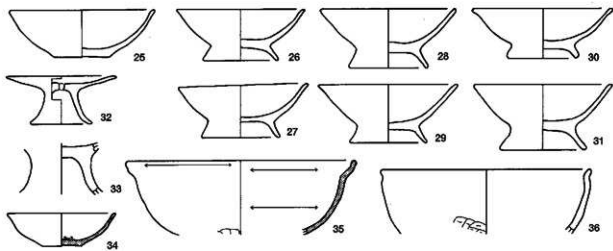

SK1127 (1・2)



SK1676



SK2511 (1~3)



SK3 (1~7)

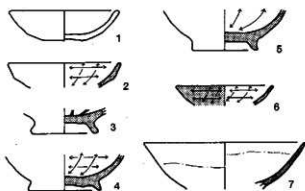

SK26



SK19 (1~3)

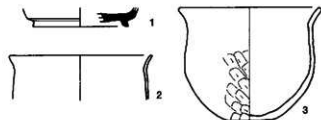

SK30 (1~3)

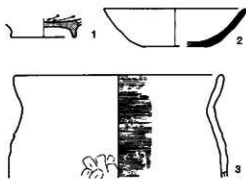

0 (1:4) 10cm

SK32 (1·2)

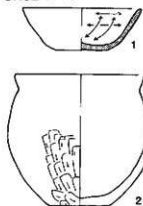

SK33 (1-4)

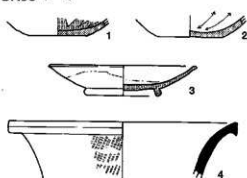

SK36 (1·2)

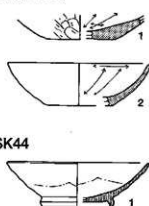

SK44

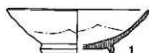

SK47 (1-11)

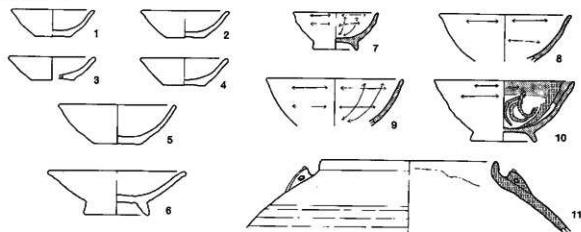

SK51 (1-12)

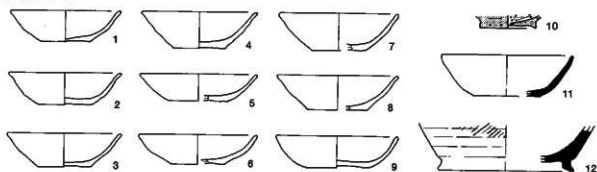

SK52 (1-4)

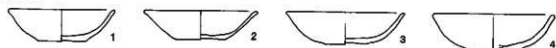

SK532

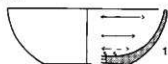

SK94 (1-17)



0 (1:4) 10cm

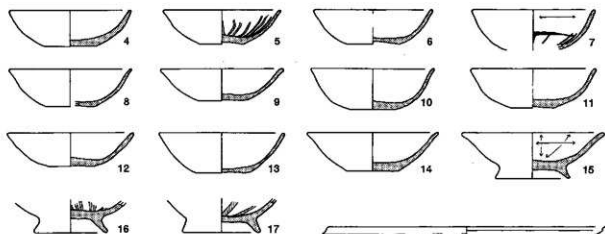

SK95 (1~9)

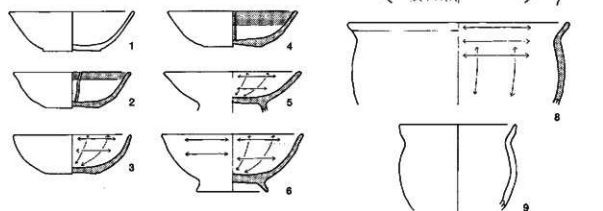

SK113 (1~13)

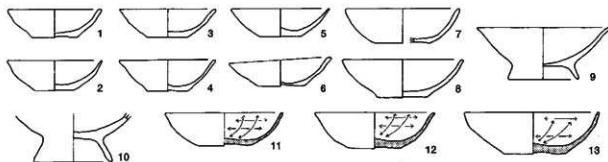

SK124 (1~3)

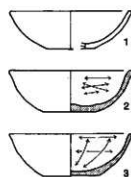

SK126 (1~5)

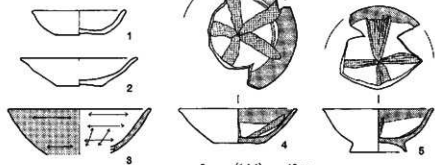

0 (1:4) 10cm

SK123 (1~52)

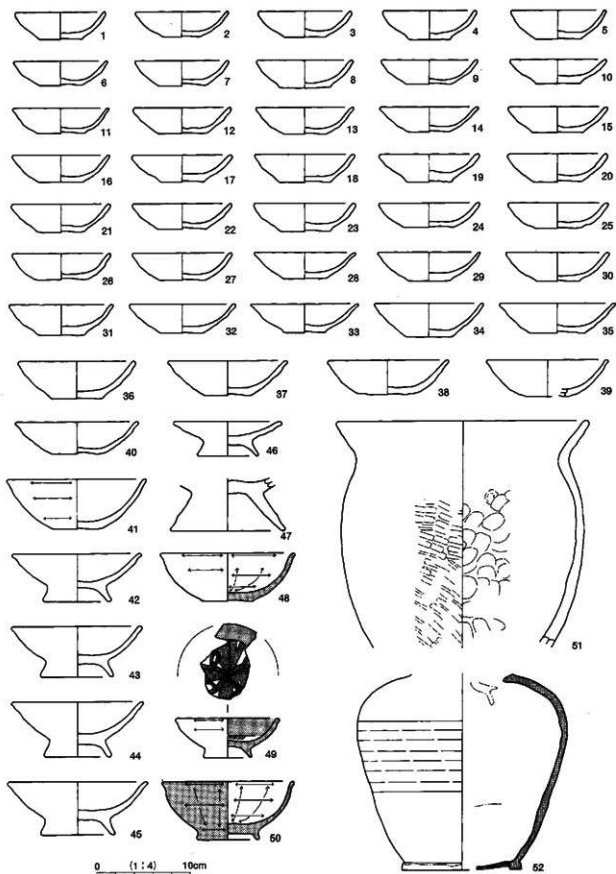

0 (1:4) 10cm

SK130 (1~7)

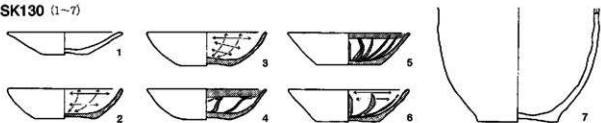

SK231 (1~27)

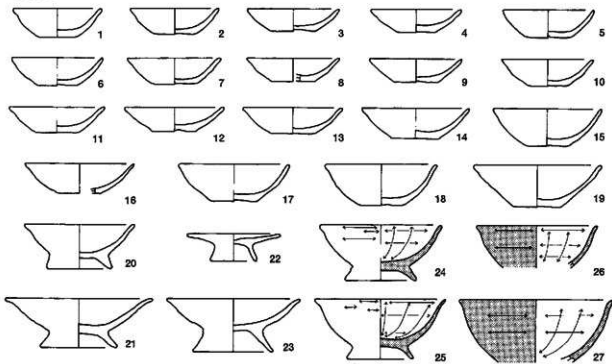

SK232



SK347 (1~6)

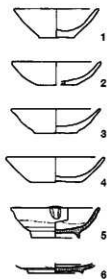

SK349 (1~7)

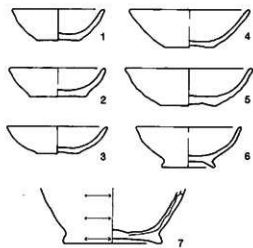

SK233

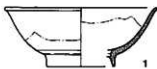

SK348



0 (1:4) 10cm

SK1001

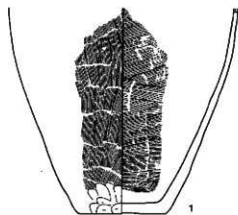

SK1021 (1~4)

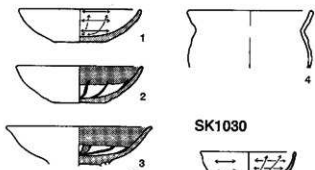

SK1030



SK1028 (1~15)

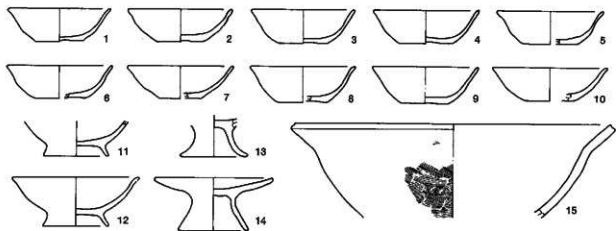

SK1040 (1~7)

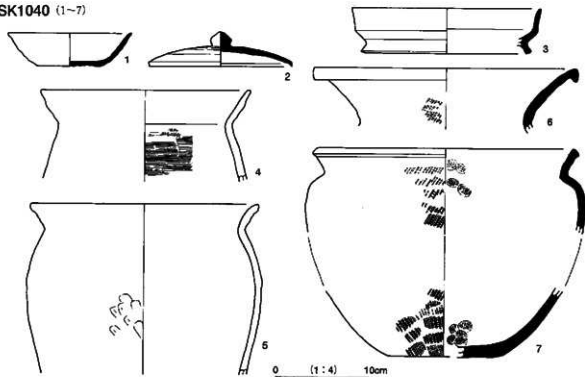

0 (1:4) 10cm

SK1064

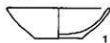

SK1120 (1-2)

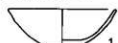

SK1636 (1-5)



SK1092 (1-2)

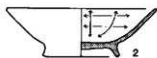
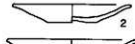

SK1501

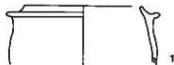

SK1524

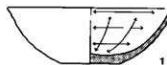

SK1659 (1-3)

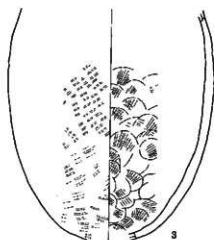
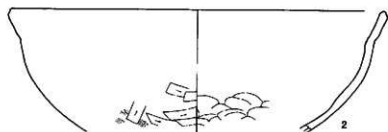

SK1733 (1-10)

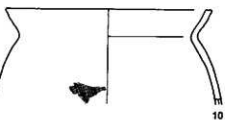
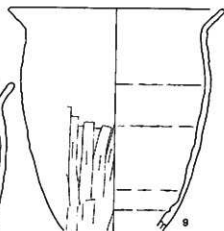
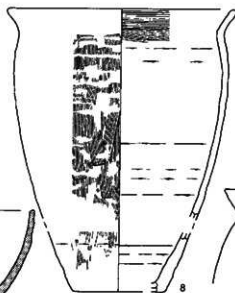
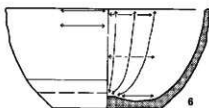
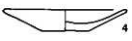
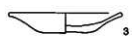
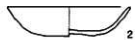

0 (1:4) 10cm

SK1889 (1・2)

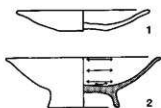

SK2108 (1~5)

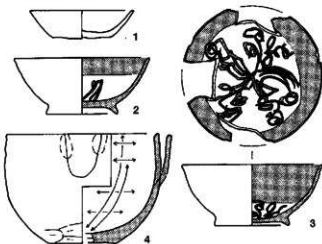

SK2558 (1~4)

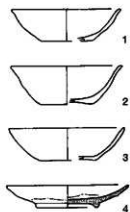

SD102 VD区 (1~36)

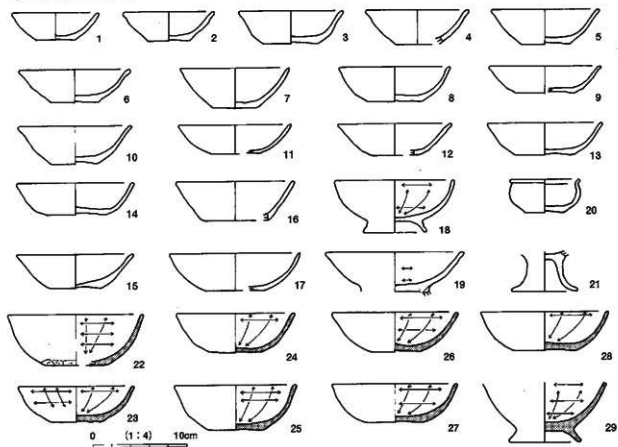

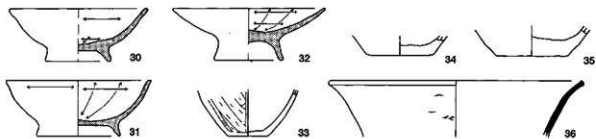

SD102 VE区 (37~61)

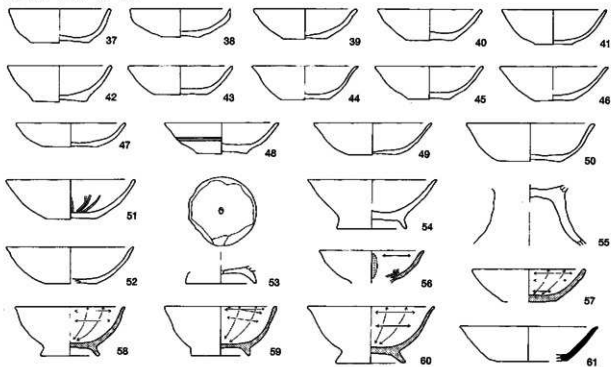

SD102 VJ区 (62~69)

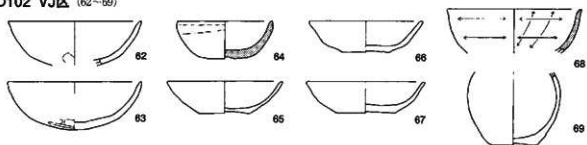

SD102 VIX区 (70~90)

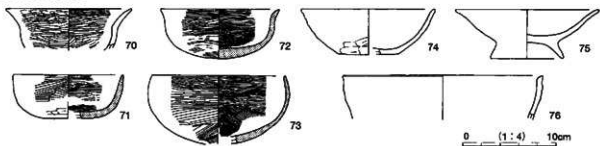

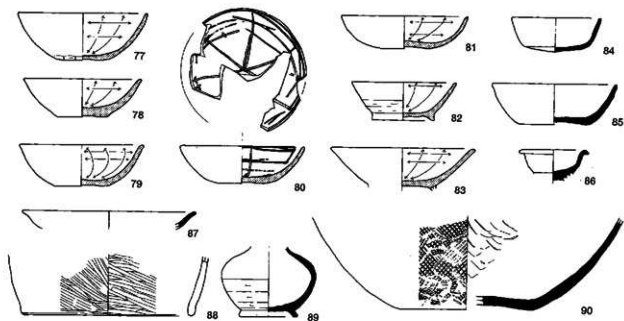

SD102 VII区 (91~103)

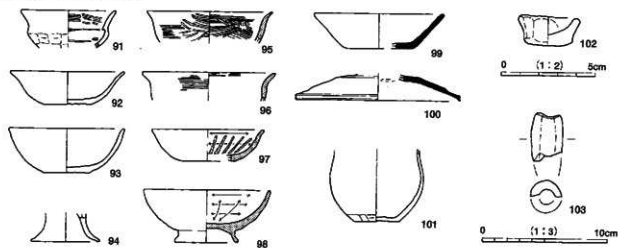

SD102 覆土一括 (104~112)

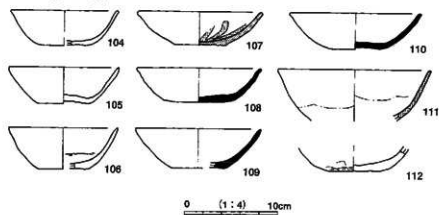

SD102 ヤナ (113~115)

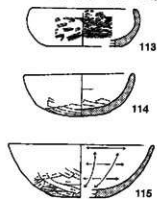

遺構外 (1~32)

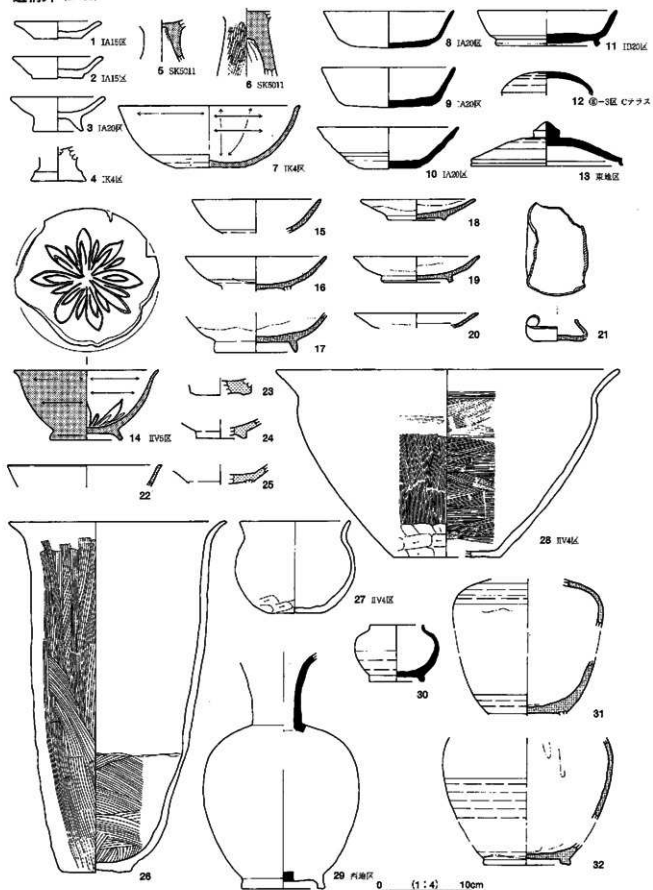

円筒形土製品 (1~15)

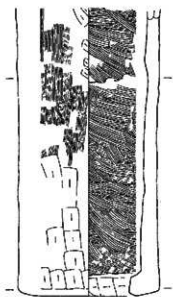
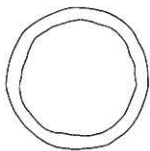
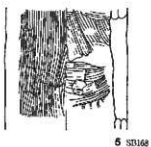
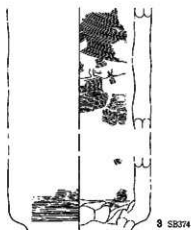
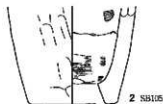

6 SB100

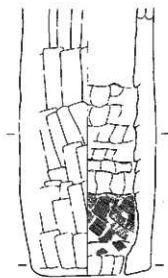
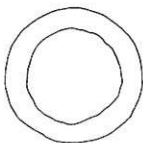

7 SB160

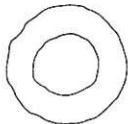
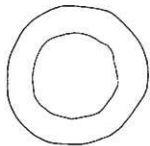

0 [1:4] 10cm



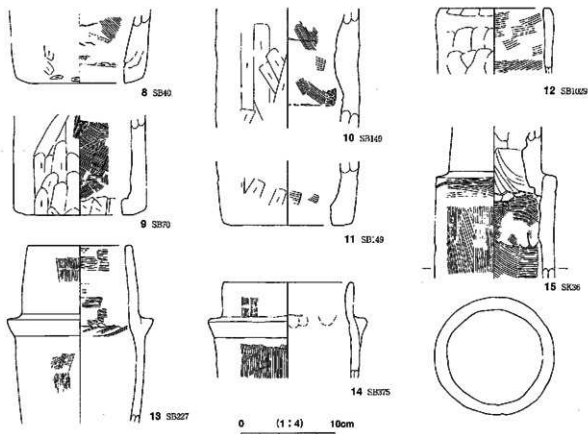

土錘 (1~40)

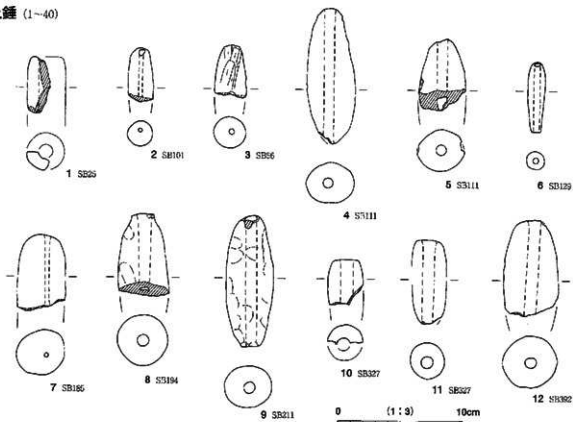

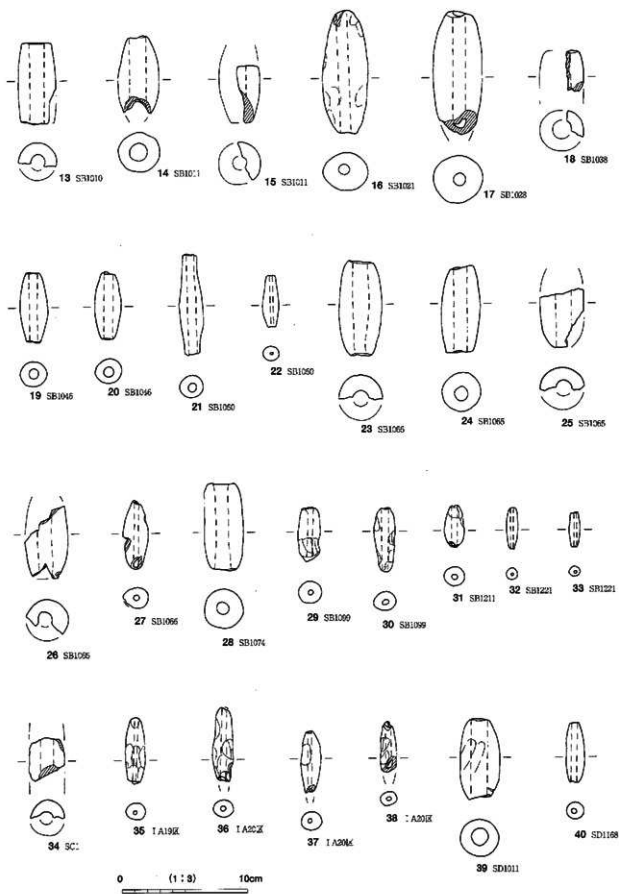

土製紡錘車・有孔土製円板 (1~3)

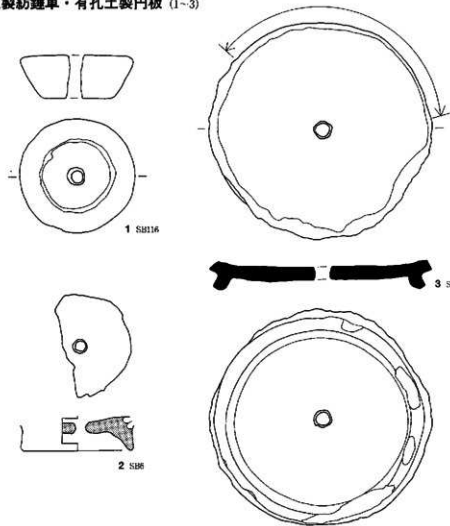

0 (1:2) 5cm

球状土製品 (1・2)

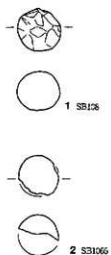

円柱状土製品 (1・2)



用途不明土製品 (1~7)

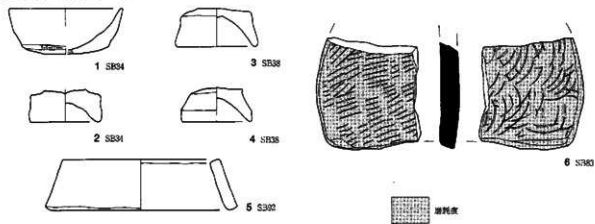

0 (1:3) 10cm

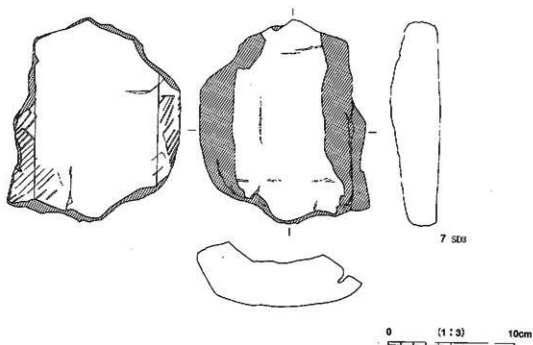

ミニチュア土器 (1~12)

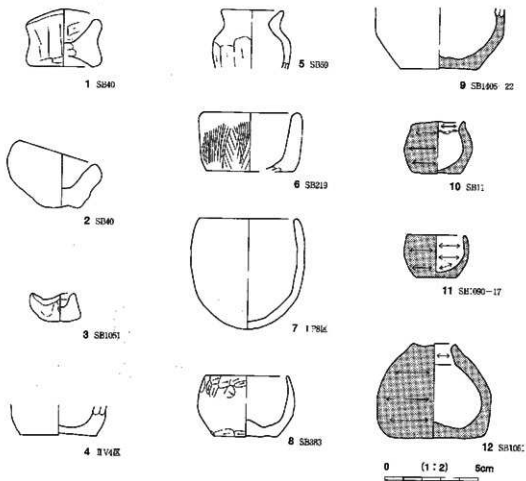

石帯 (1・2)

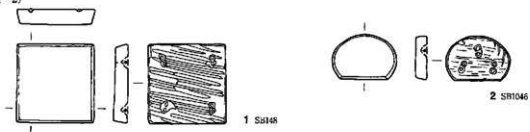

碁石状石製品 (1~10)

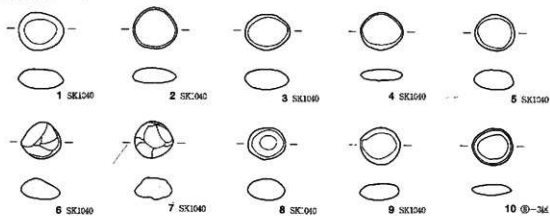

紡錘車

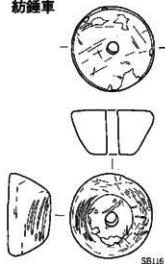

用途不明石製品 (1~4)

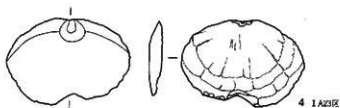
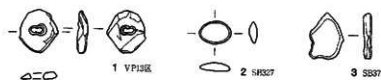

0 (1:2) 5cm

編物石 (1~6)

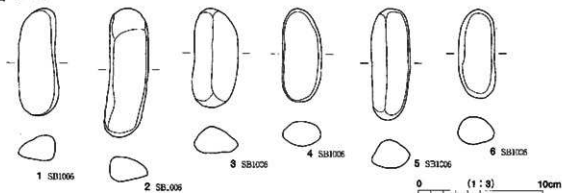

砥石 (1~56)

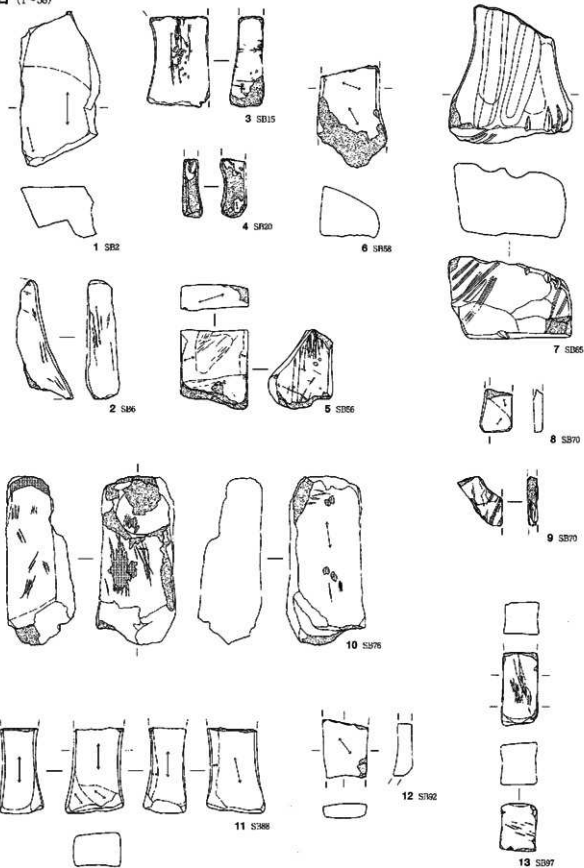

0 (1:3) 10cm

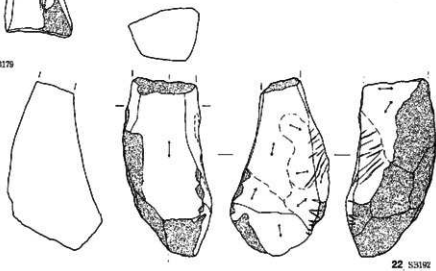
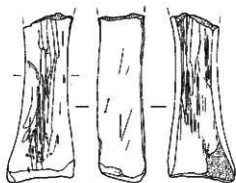
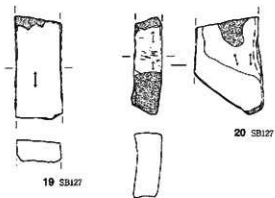
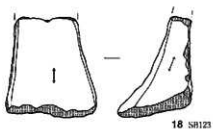
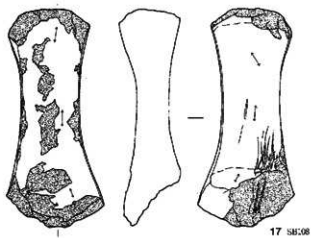
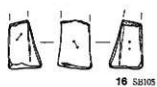
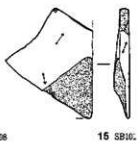
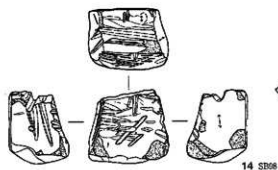

0 (1:3) 10cm

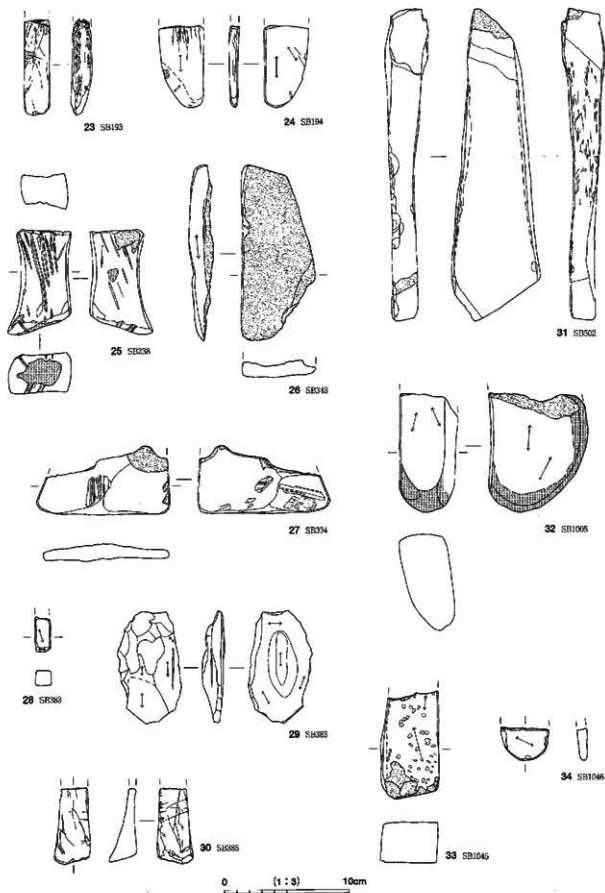

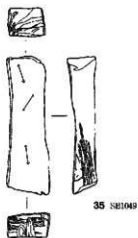

35 SB1049

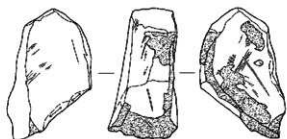

36 SB1067

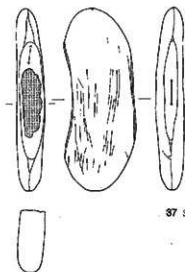

37 SB1202

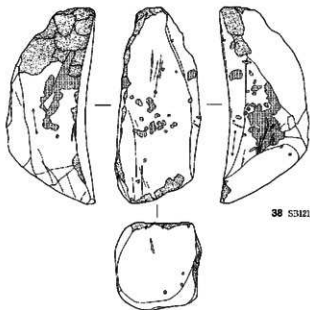

38 SB1217

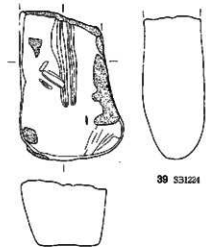

39 SB1224

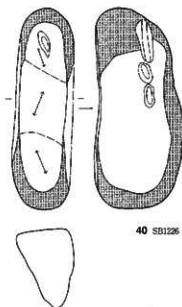

40 SB1226

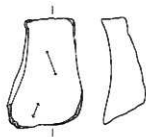

41 SB1226

0 (1:3) 10cm

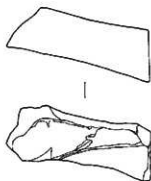
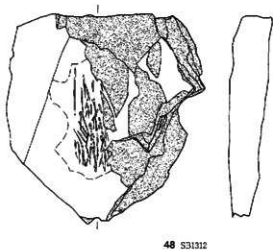
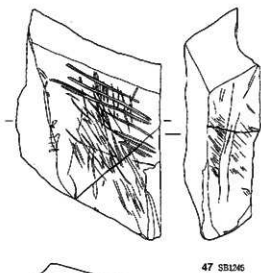
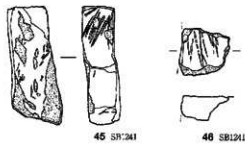
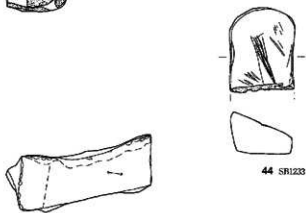
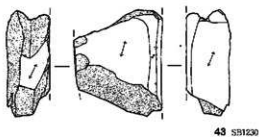
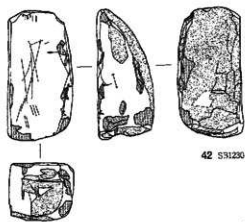

0 (1:3) 10cm

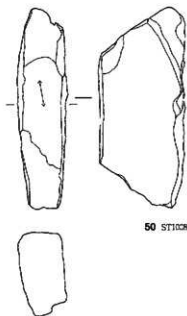

50 SK1008

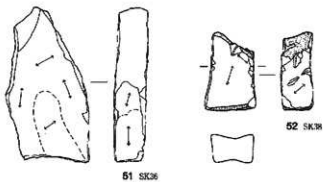

51 SK36



52 SK39

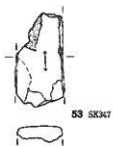

53 SK347

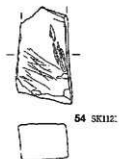

54 SK112

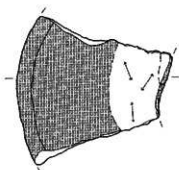

55 I1702

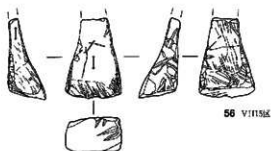

56 V1156

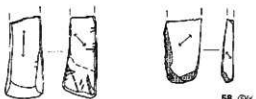

57 V365



58 O94

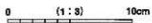

台石・凹石 (1~11)

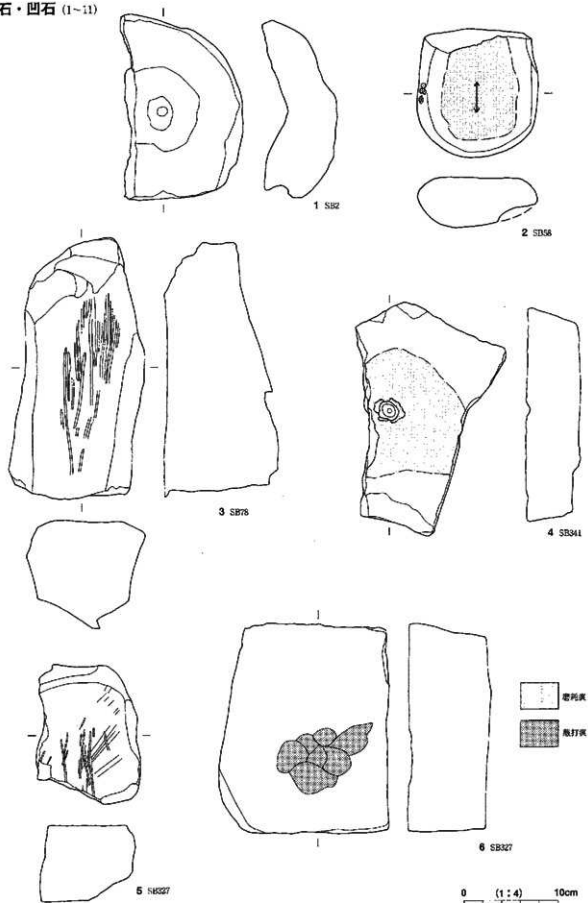

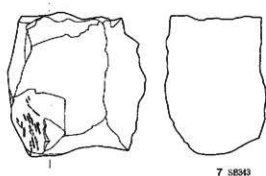

7 SB043

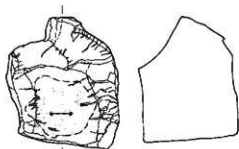

8 SR943

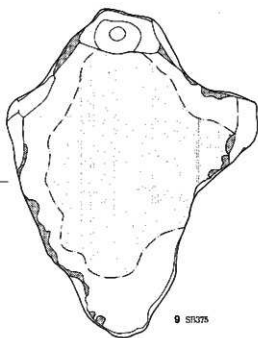
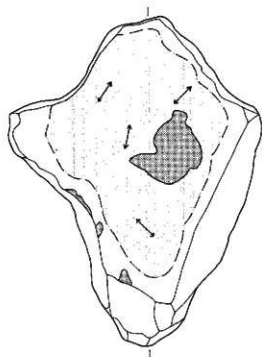

9 ST0375

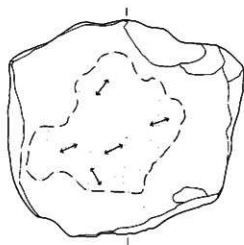

10 ST1026



0 (1:4) 10cm

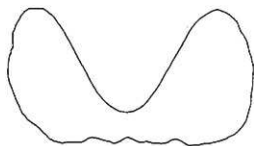
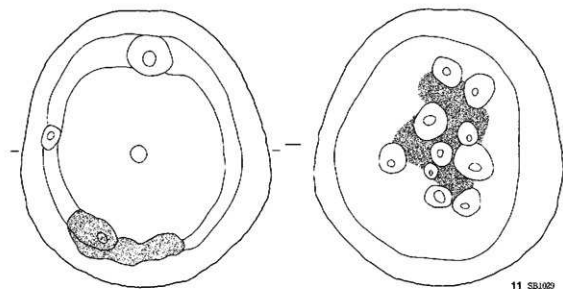

軽石製品 (1~26)

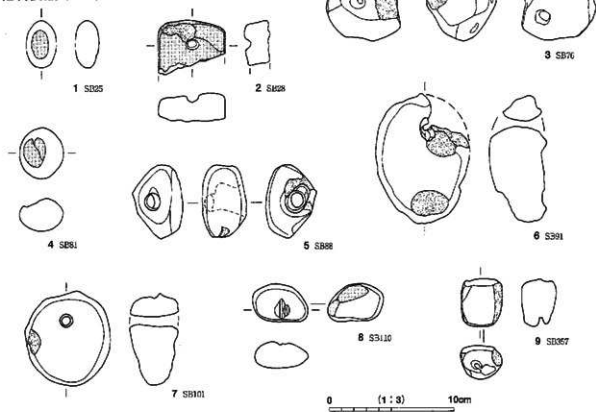

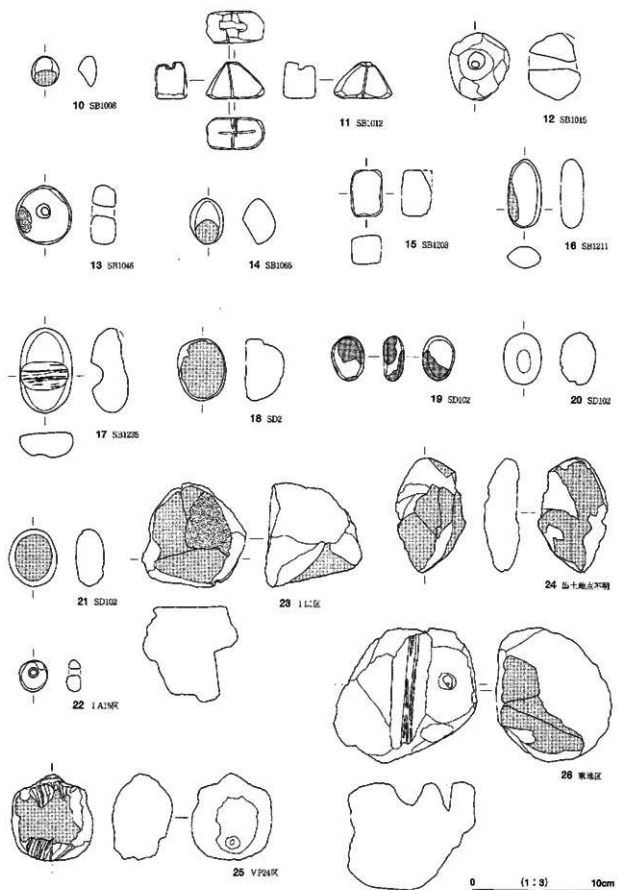

鉄製品 (1~239)

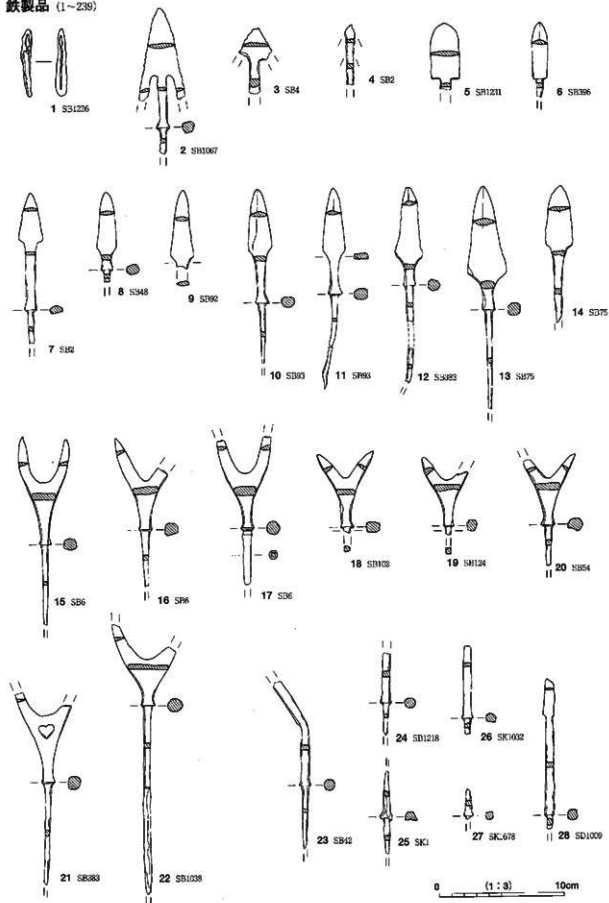

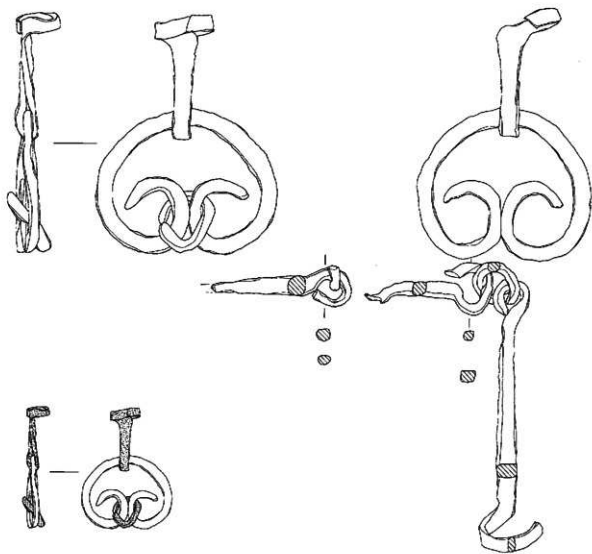

※ スクリントーンの遺いは
鍍鉄の遺い・組み合わせを示す。

29 SK29

0 (1:2) 5cm



30

30 SB883

0 (1:3) 10cm

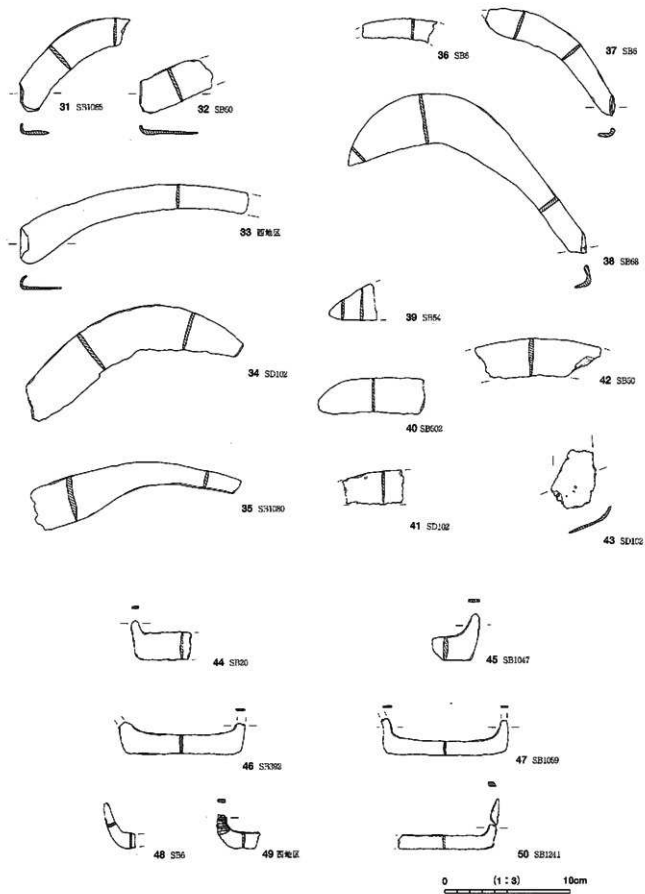

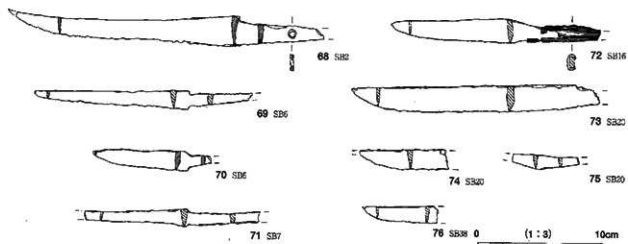
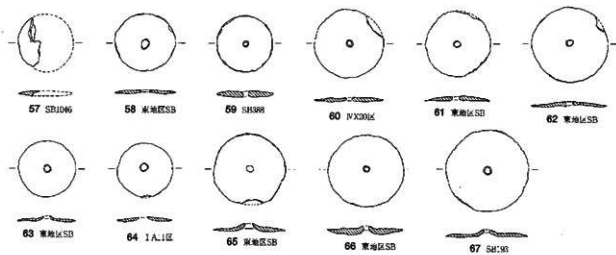
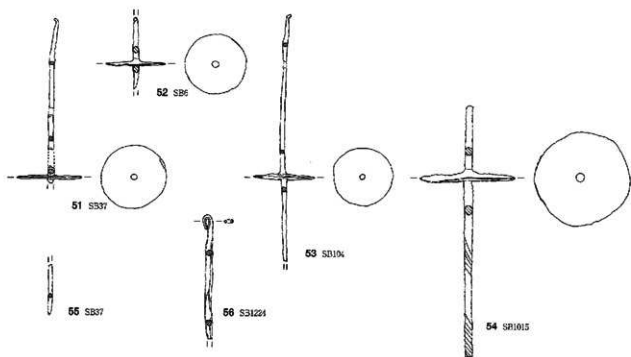

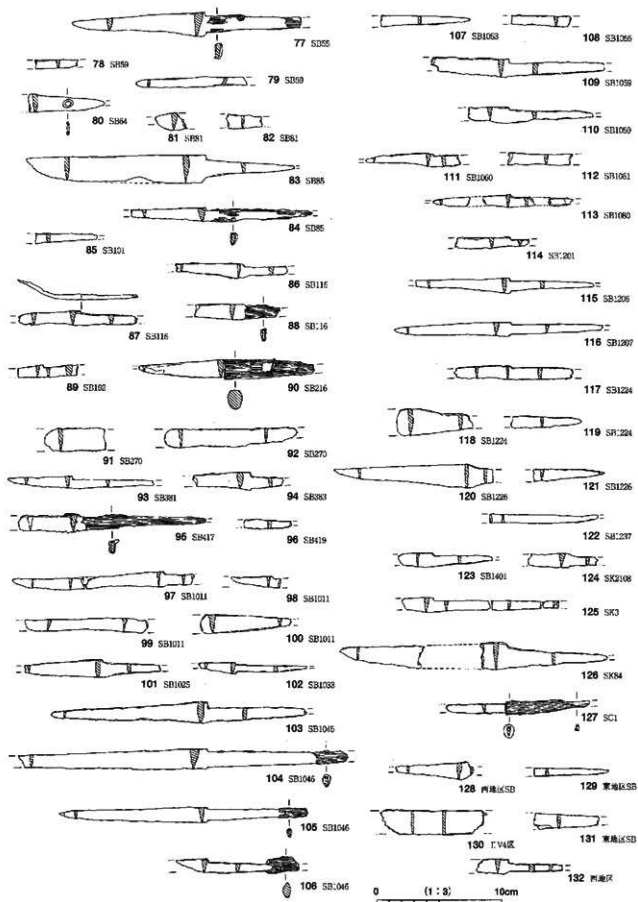

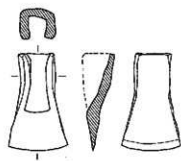

133 SR80

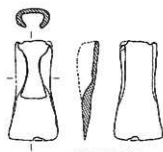

134 SD102VJ1K

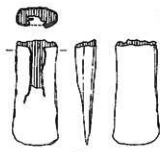

135 SD102W4R



136 出土地点不明



137 SB:3



141 SD47



143 SB371



145 SB383



146 SB383



138 SR29



142 SB149



144 SB371



147 SB383



139 SR35



140 SR86



148 SB383



149 SB1094



151 SB:207



153 SB1207



155 SB1207



157 SB1207



148 SB383



150 SB:092



152 SB1207



154 SB1207



156 SB1207



159 SB1207



160 SB:225



162 東地区



163 SB6



164 SB:065



161 SB:225



165 SB1207

0 (1:3) 10cm

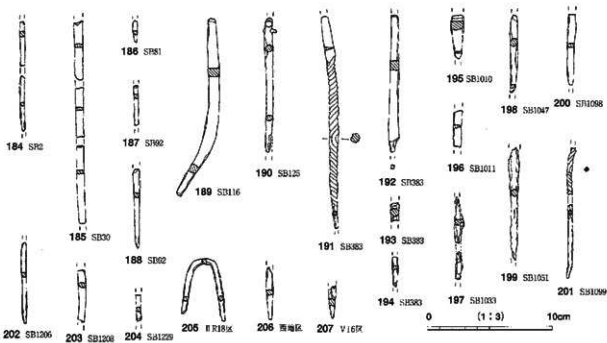
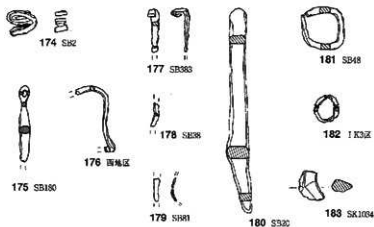

銅製品 (1~6)

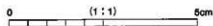
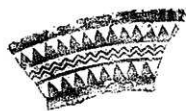
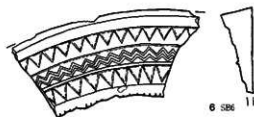
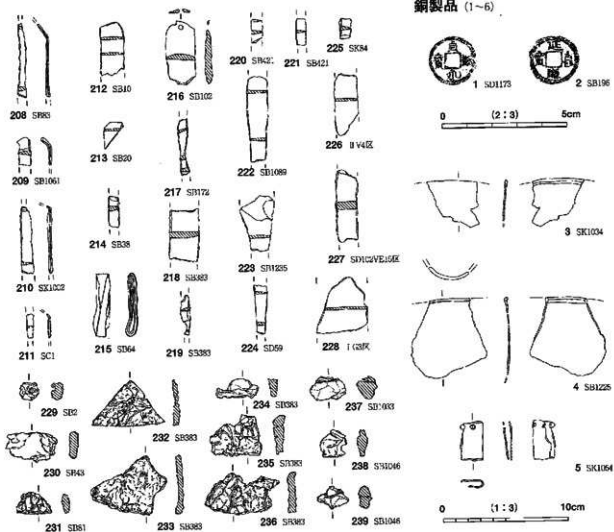

弭

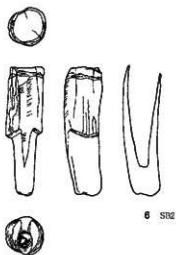
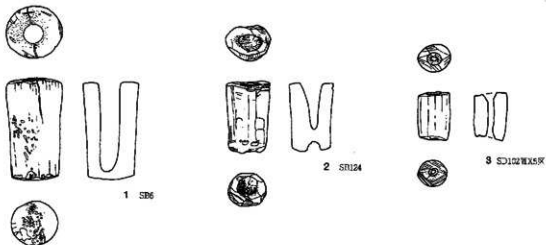

刀子柄

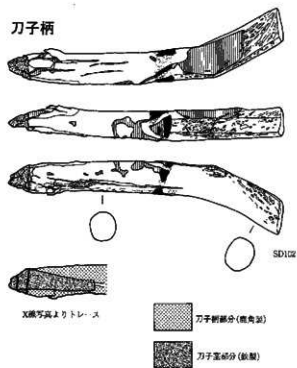

刺突具

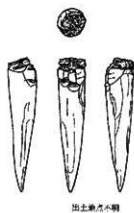

0 (1:2) 5cm

裝飾品 (1-5)

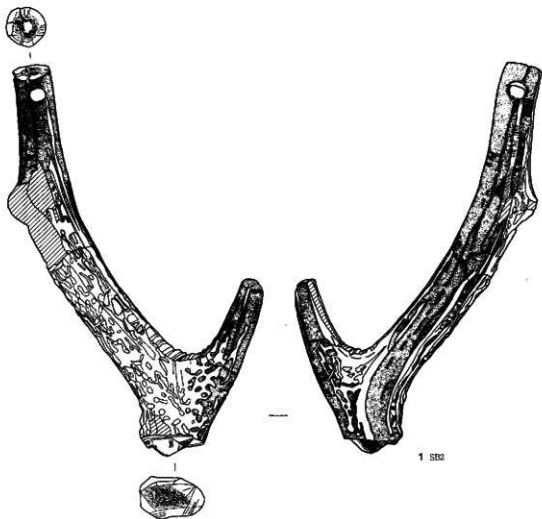

0 (1:2) 5cm

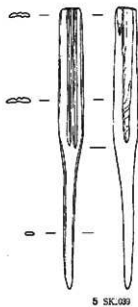
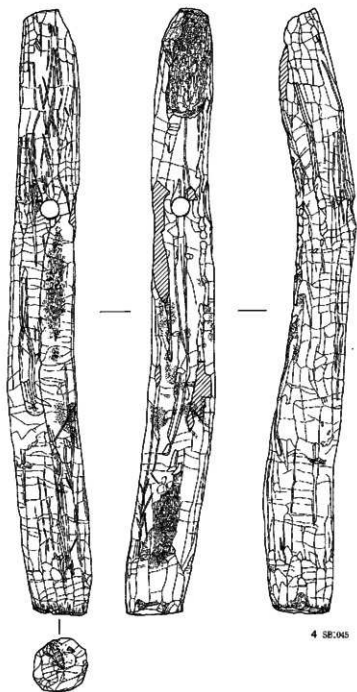

0 (1:2) 5cm

サイコロ

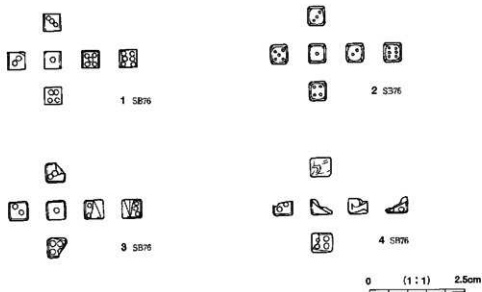

卜骨



製品素材 (1~15)

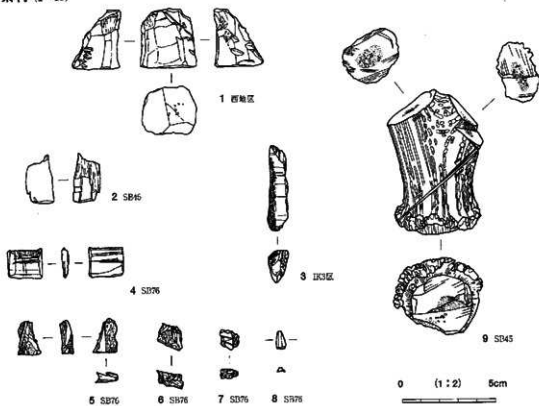

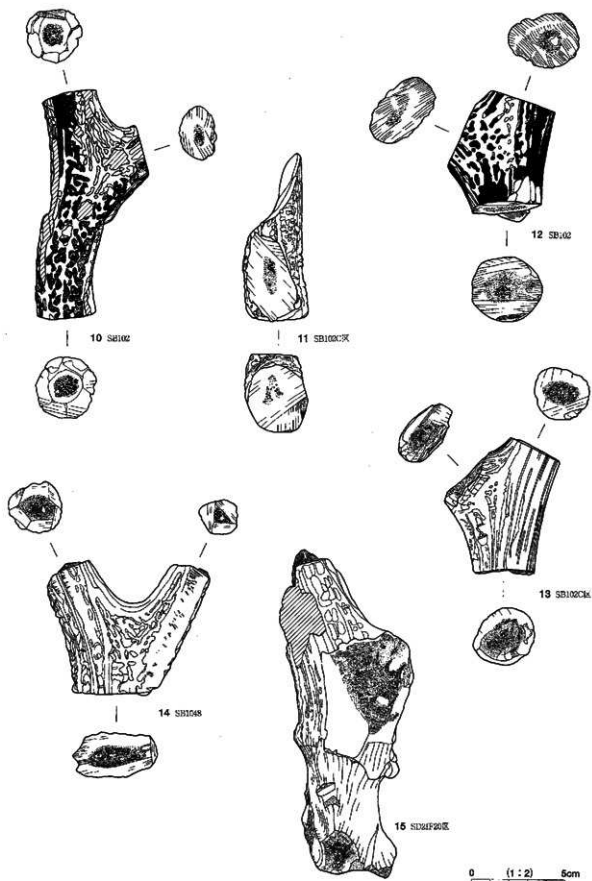

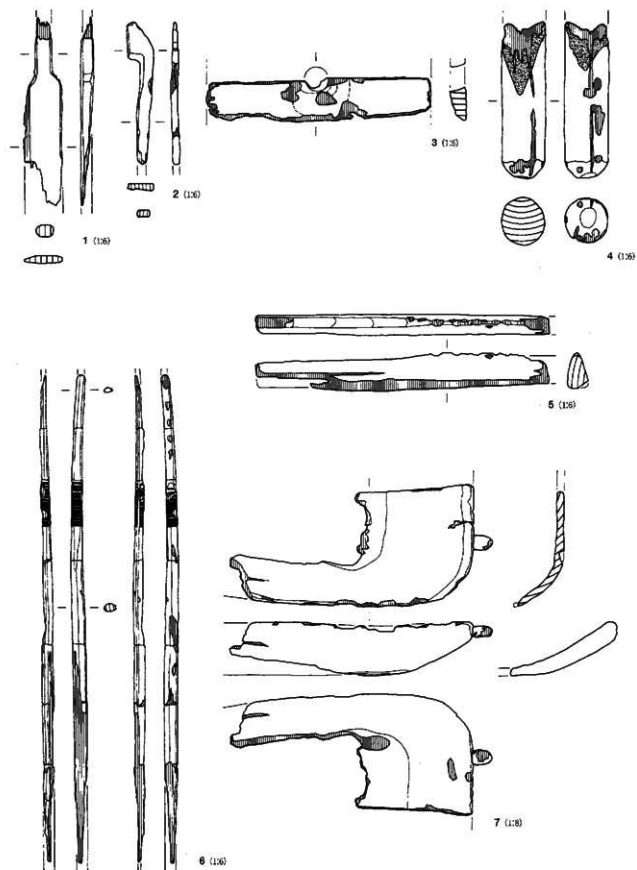

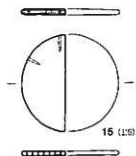
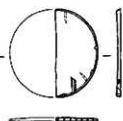
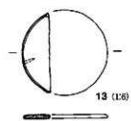
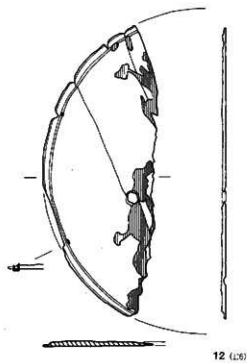
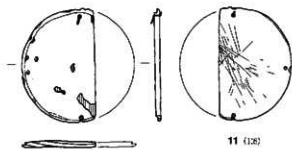
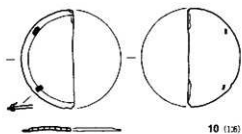
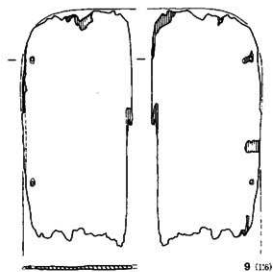
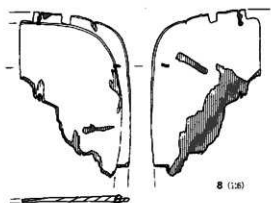

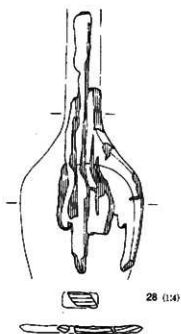
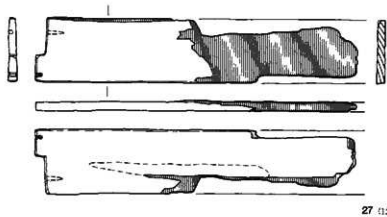
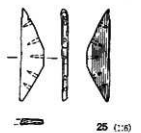
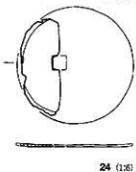
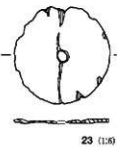
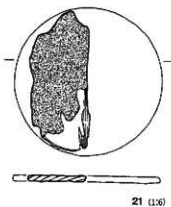
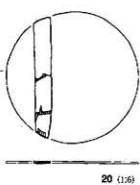
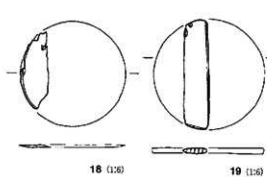
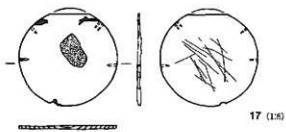
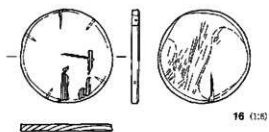



29 (2/3)



30 (2/3)

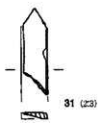

31 (2/3)

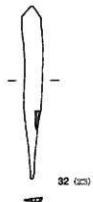

32 (2/3)



33 (2/3)

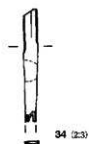

34 (2/3)

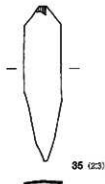

35 (2/3)

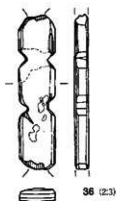

36 (2/3)



37 (2/3)

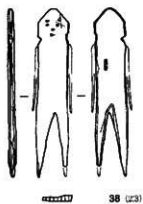

38 (2/3)

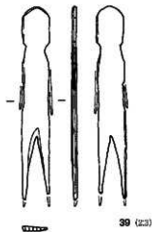

39 (2/3)

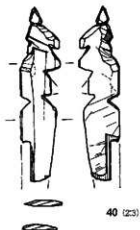

40 (2/3)

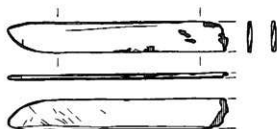

41 (2/3)

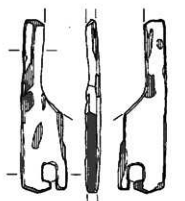

42 (1:4)

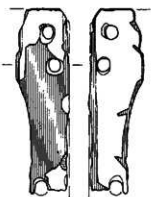

43 (1:4)

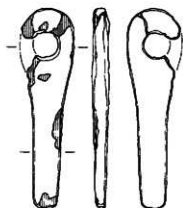

44 (1:6)

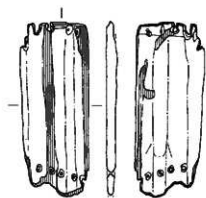

45 (1:4)



46 (1:4)

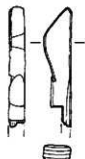

47 (1:4)

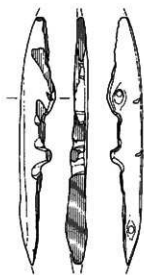

48 (1:4)

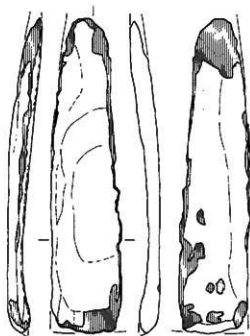

49 (1:6)



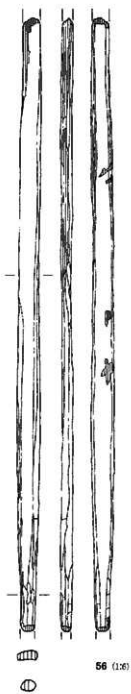
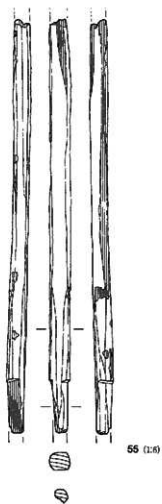
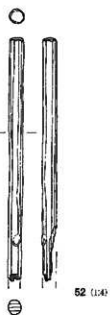
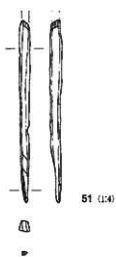

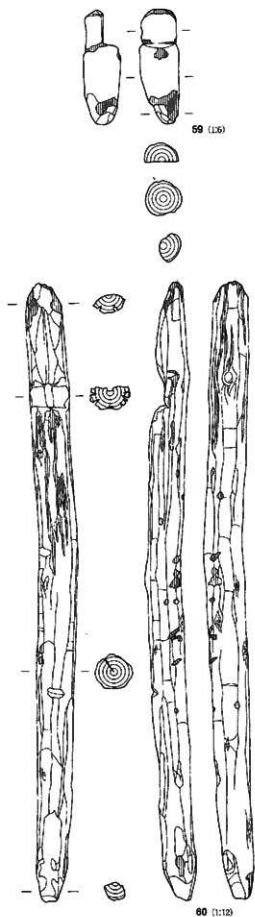
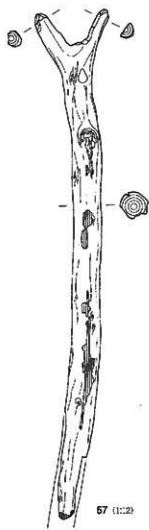



61 (1:16)

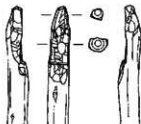

62 (1:10)



63 (1:12)



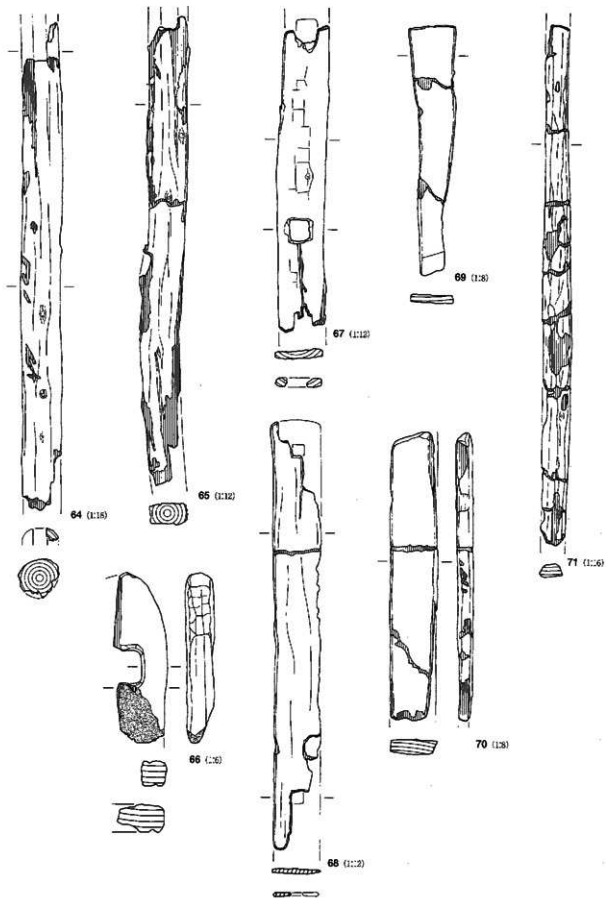

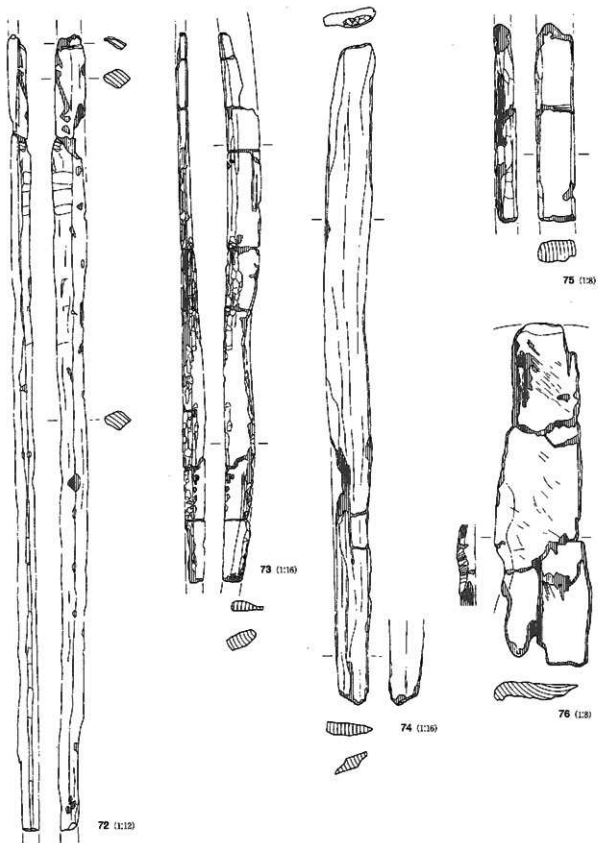

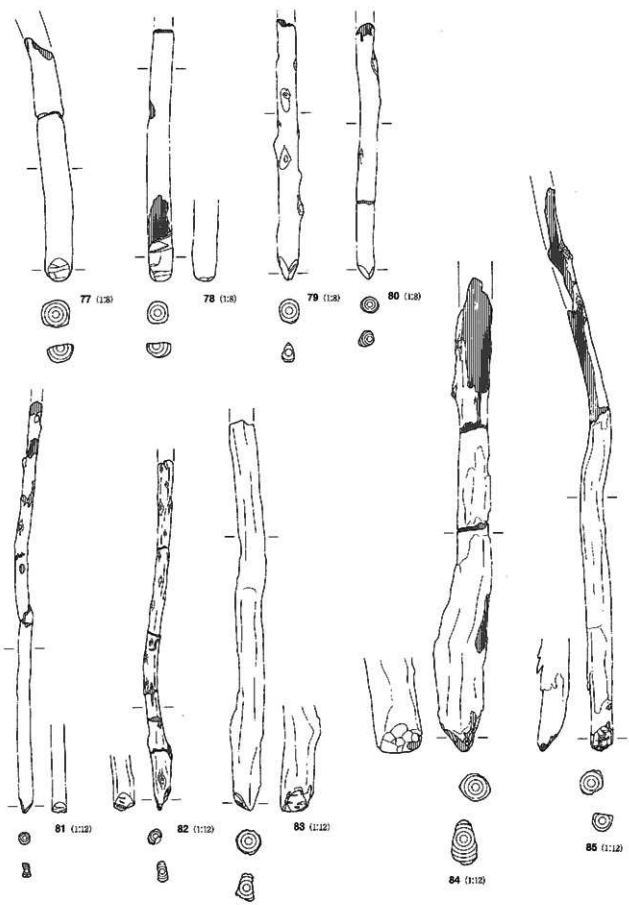

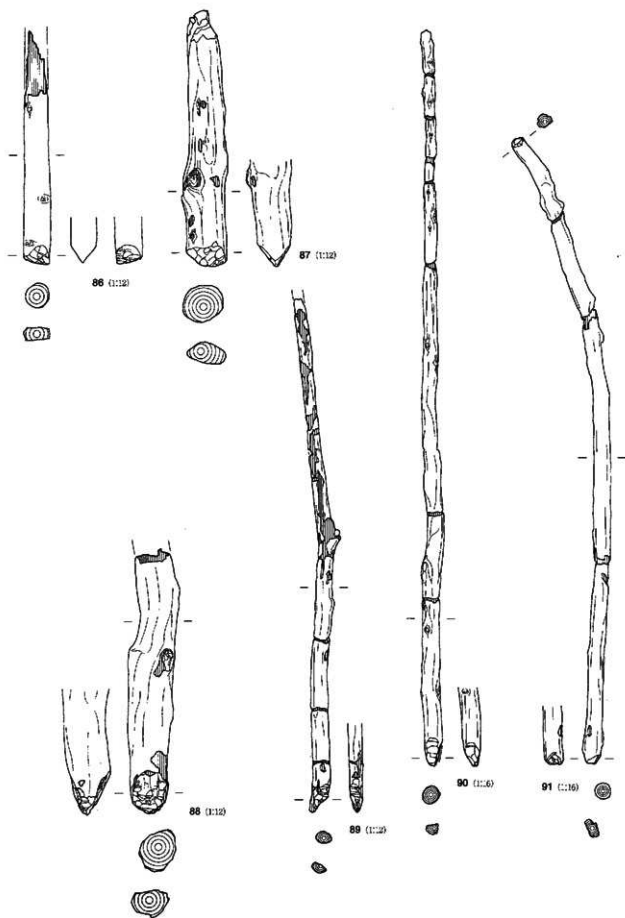

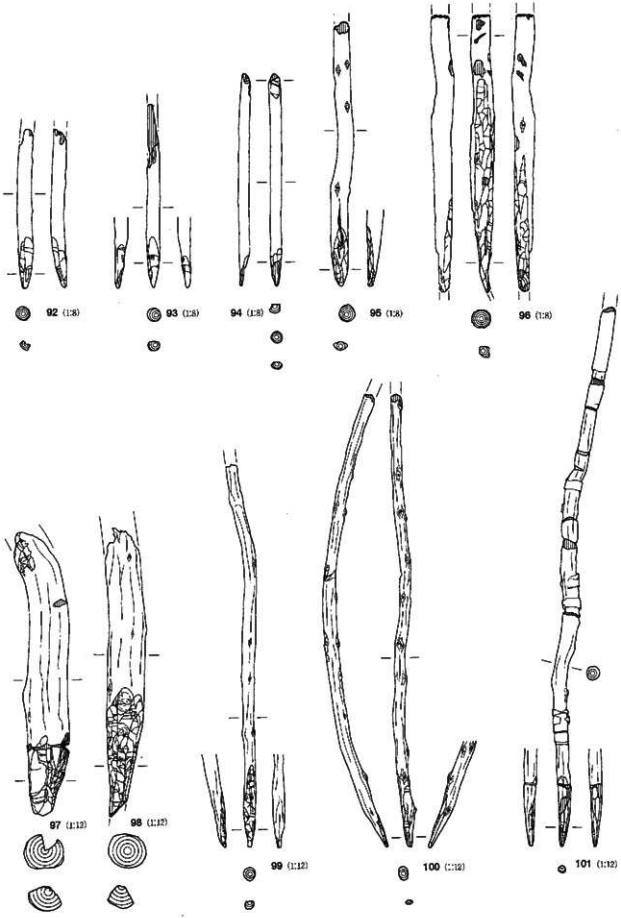

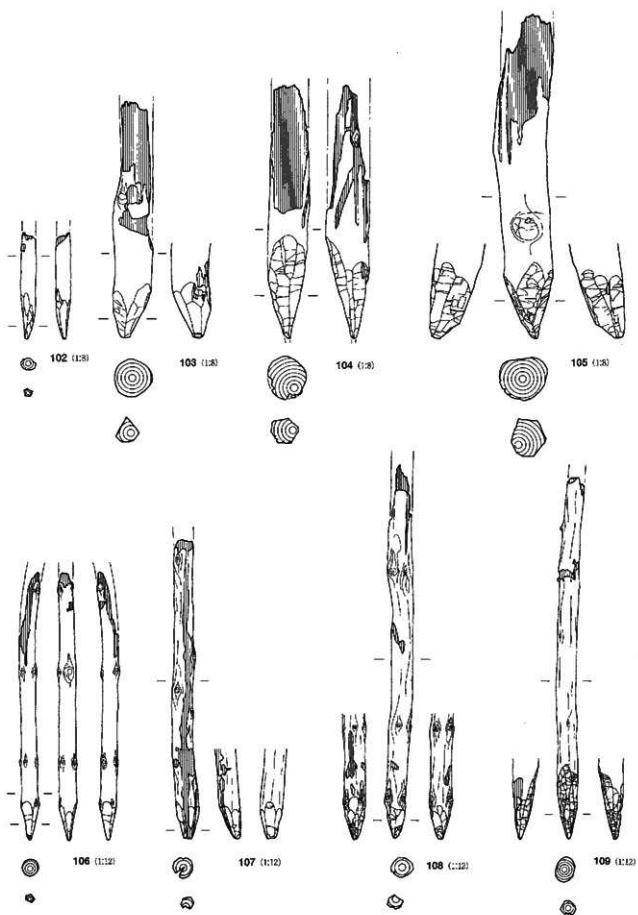

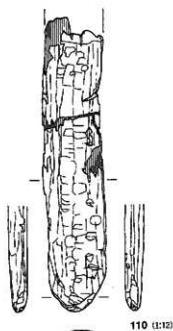

110 (1:12)



111 (1:12)



112 (1:12)

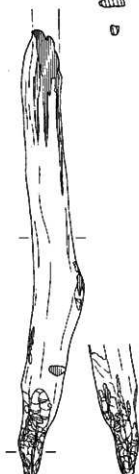

113 (1:12)

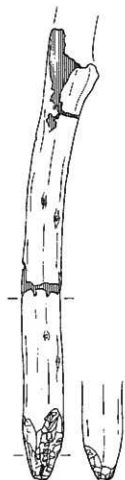

114 (1:12)

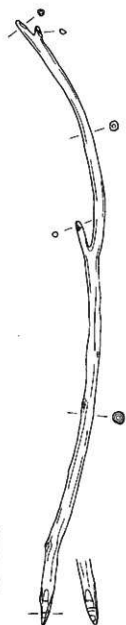

115 (1:12)



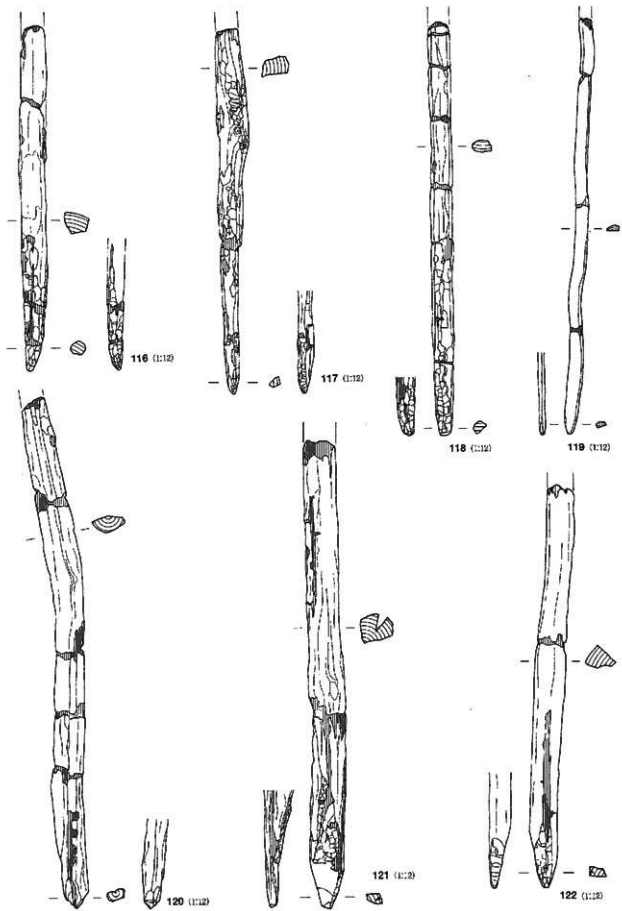

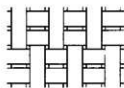
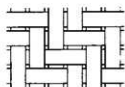
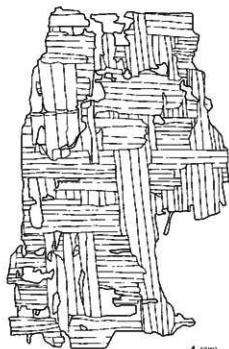
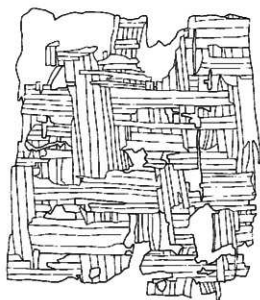
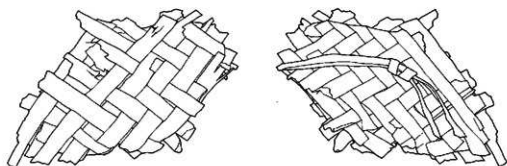
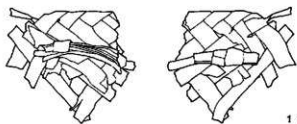

鉄塊 (1~4)

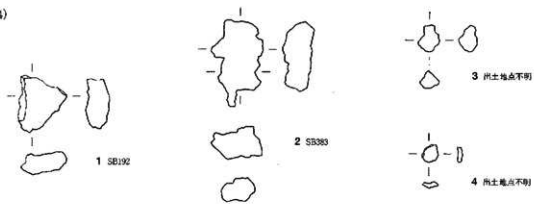

流動滓 (1~5)

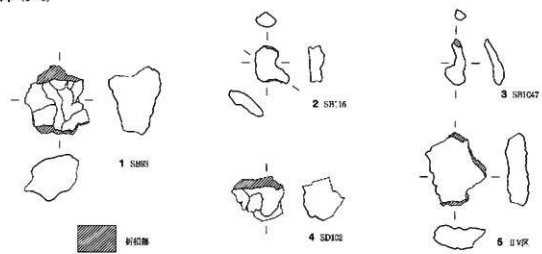

椀形滓 (1~45)

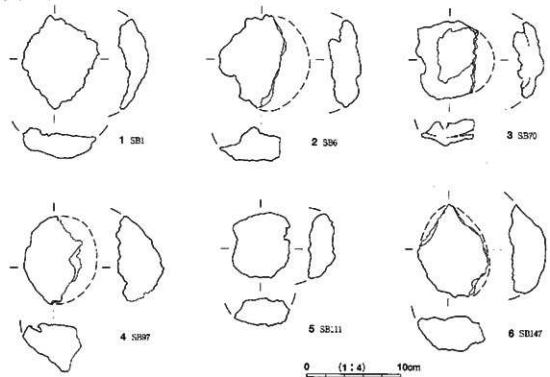

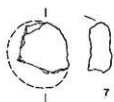

7 SB173



8 SR178

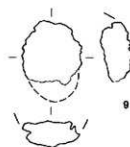

9 SB191

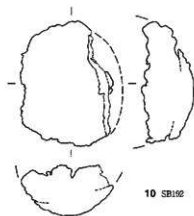

10 SB192

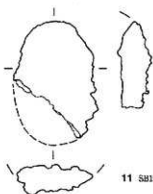

11 SB192

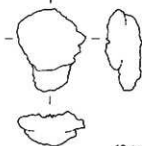

12 SH210

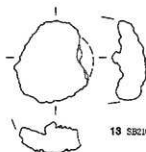

13 SB210

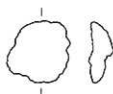

14 SB408

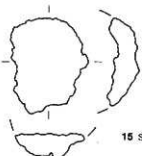

15 SD1014

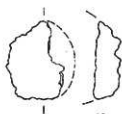

16 SB1028



17 SR1047

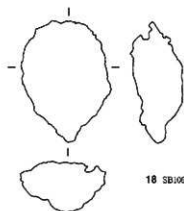

18 SB1067

0 (1:4) 10cm



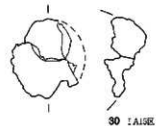
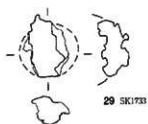
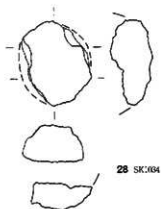
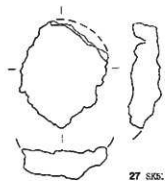
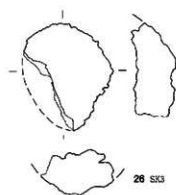
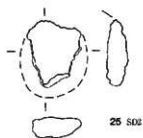
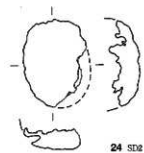
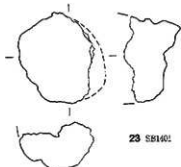
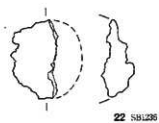
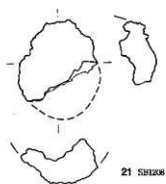
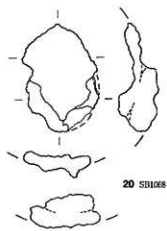
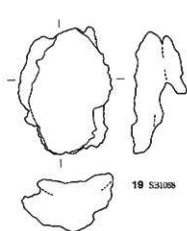

0 (1:4) 10cm

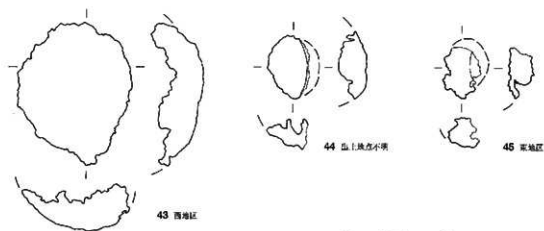
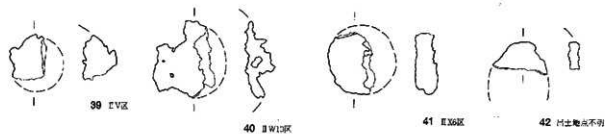
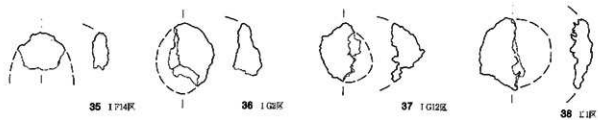
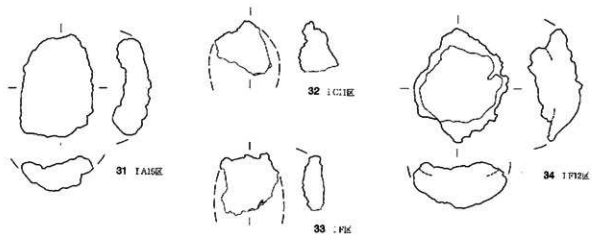

0 (1:4) 10cm

羽口 (1~10)

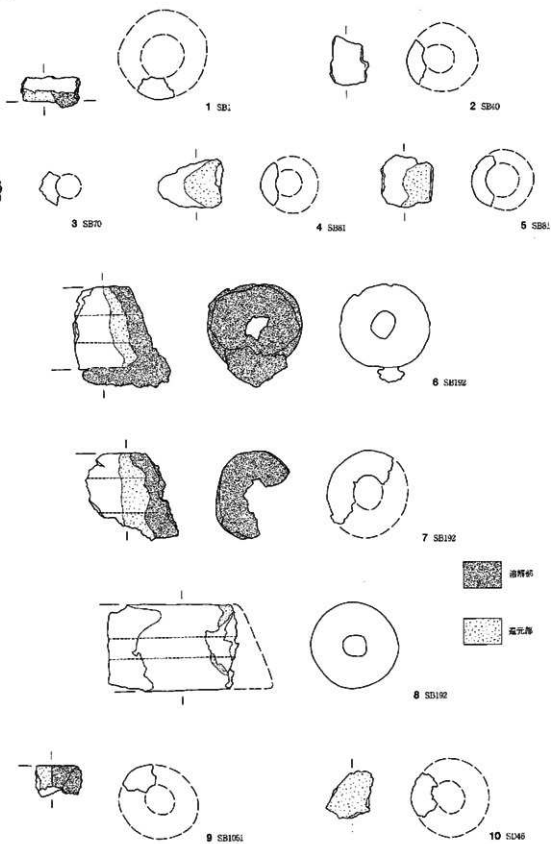

炉壁 (1~3)

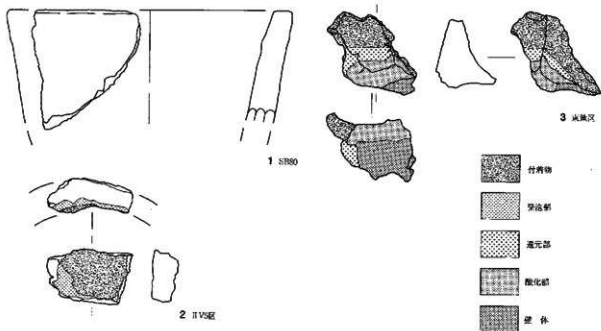

壁体 (1~3)

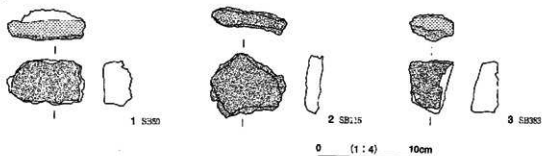

鑄型 (1~5)

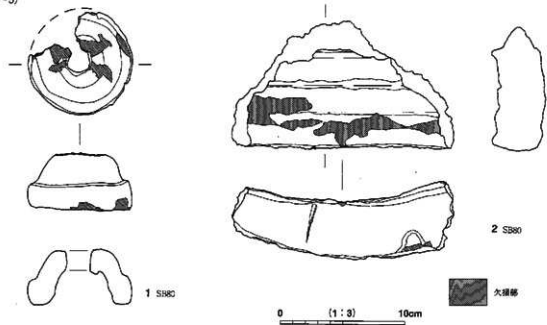

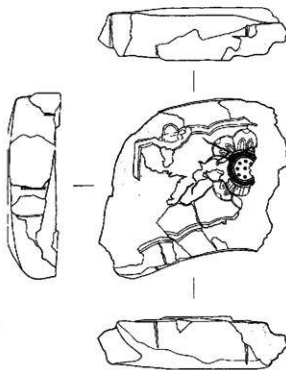

3 SB60

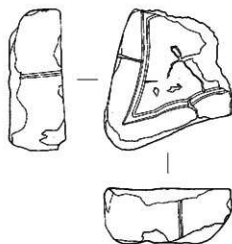

4 SB60



0 (1:3) 10cm

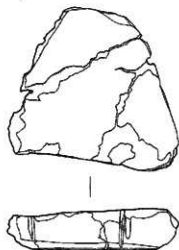
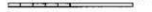

5 SB60

墨書土器 (1~142)

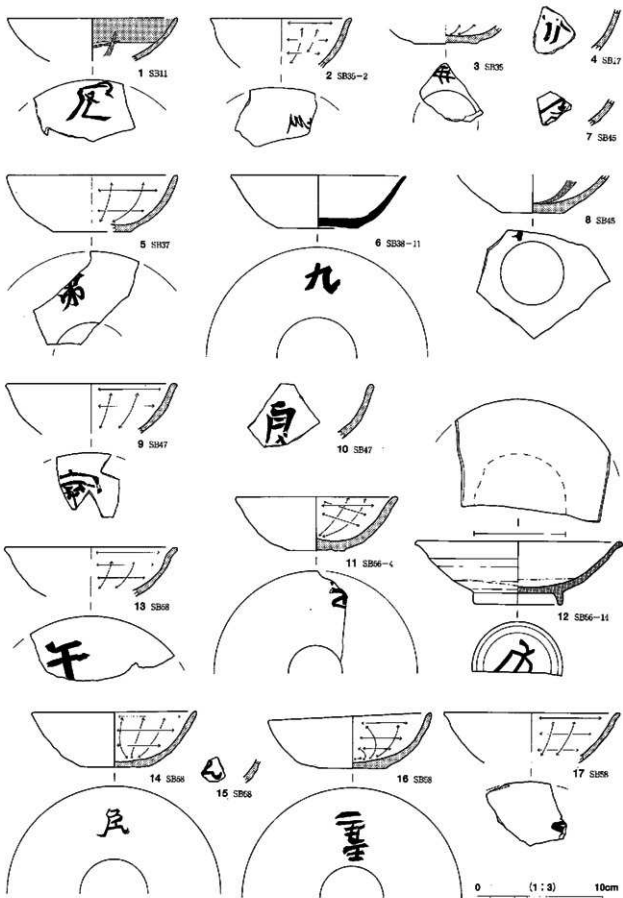

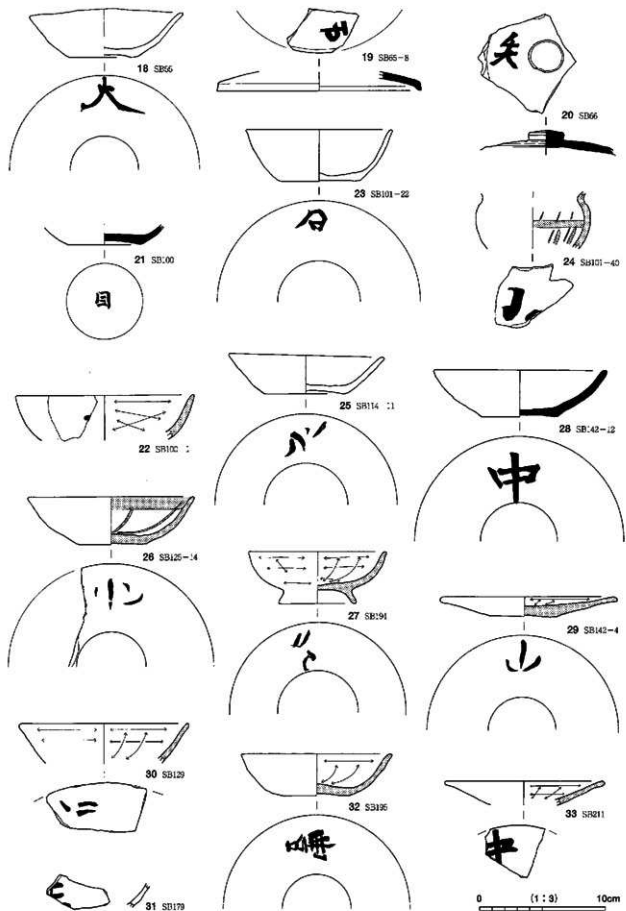

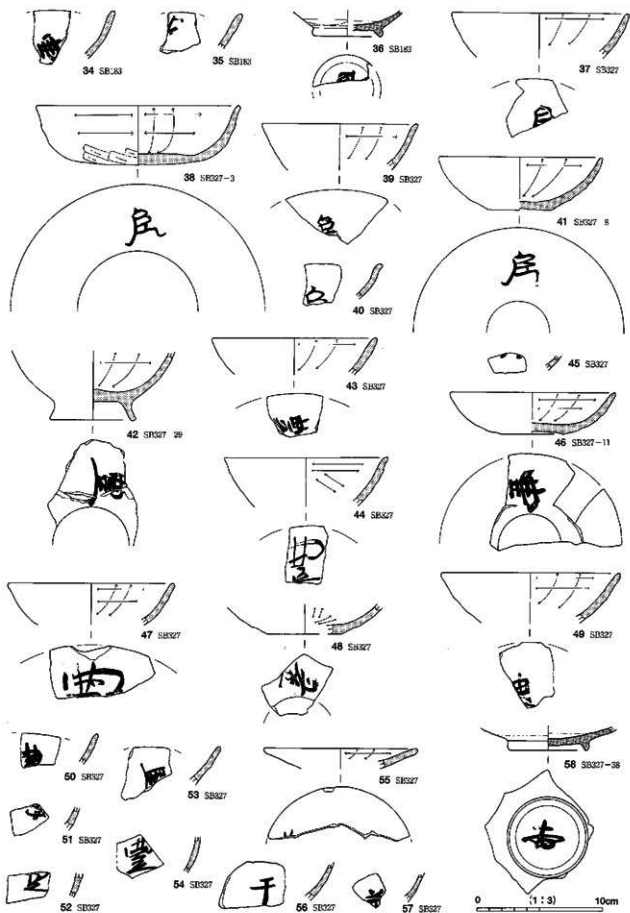

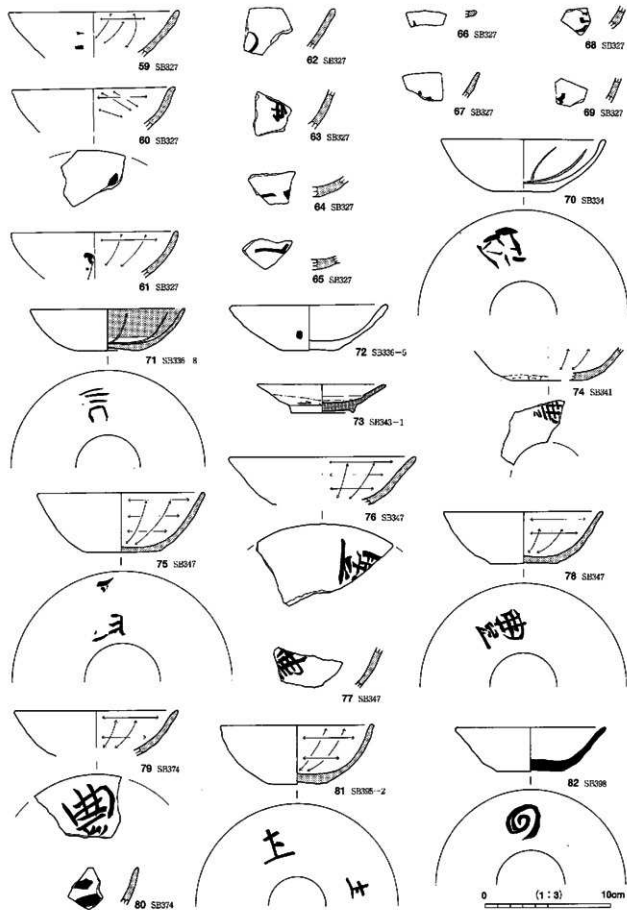

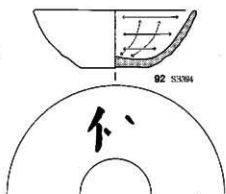
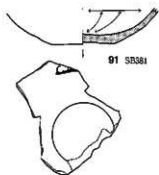
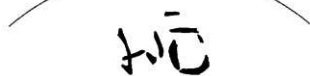
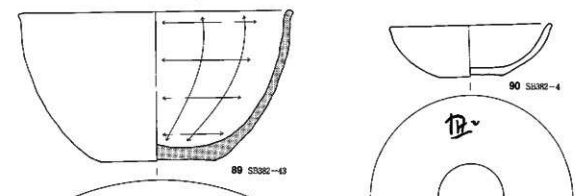
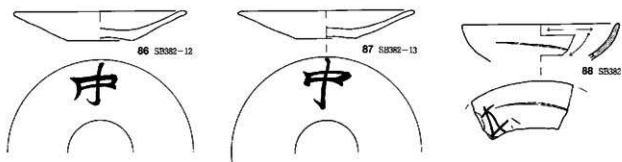
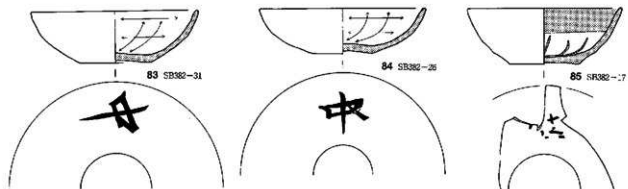

0 (1 : 3) 10cm

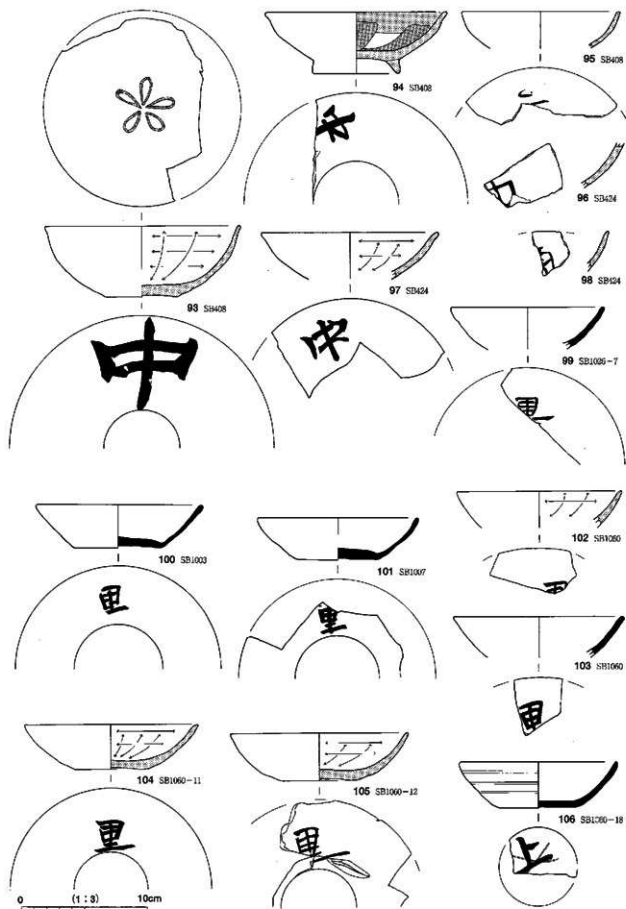

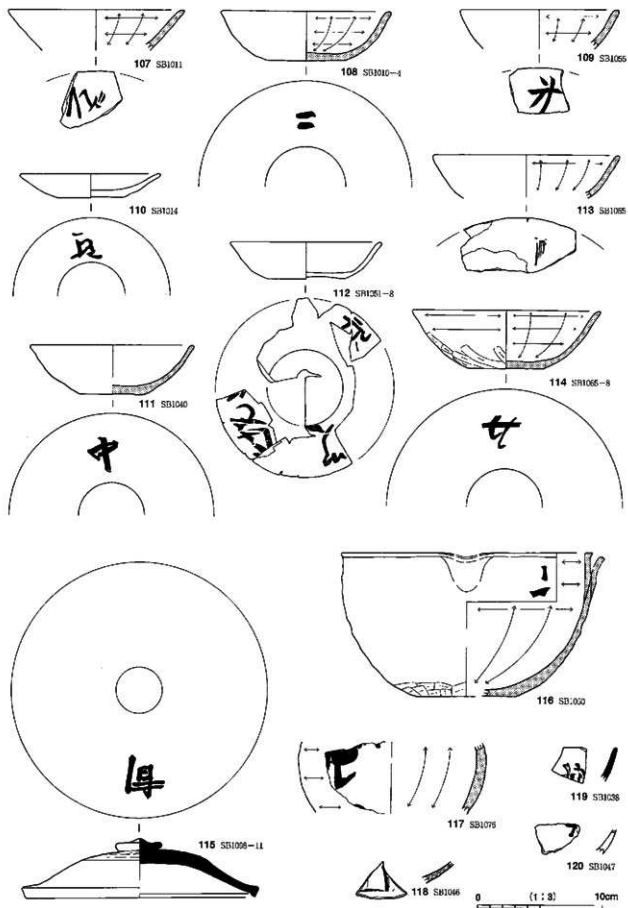

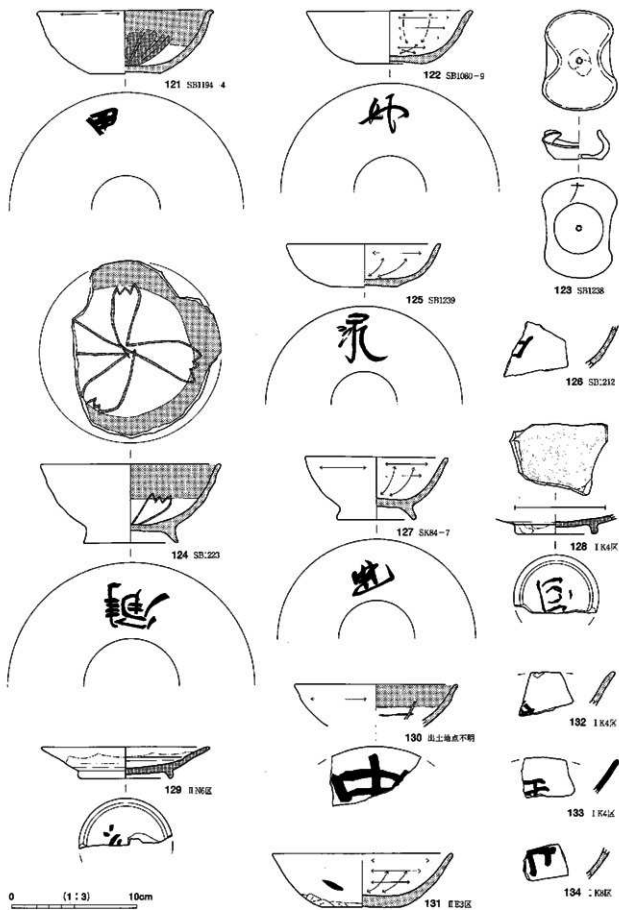

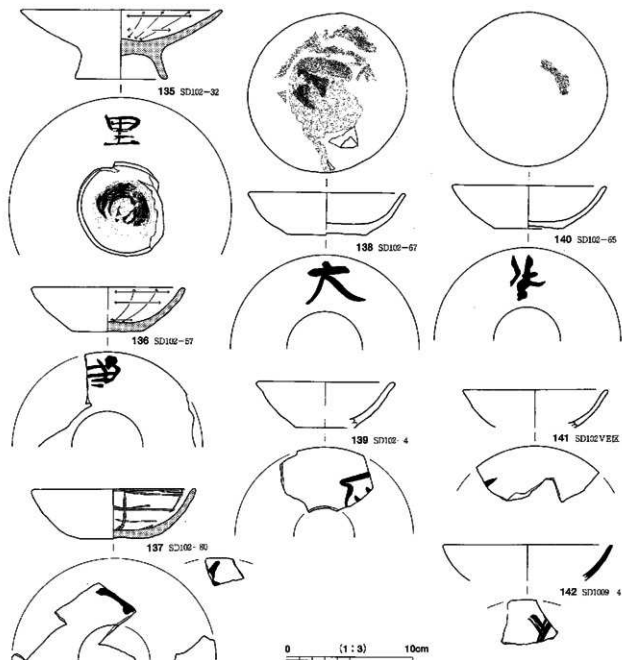

銘書・刻印・刻書土器 (143~167)

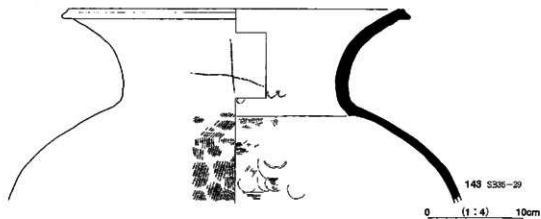

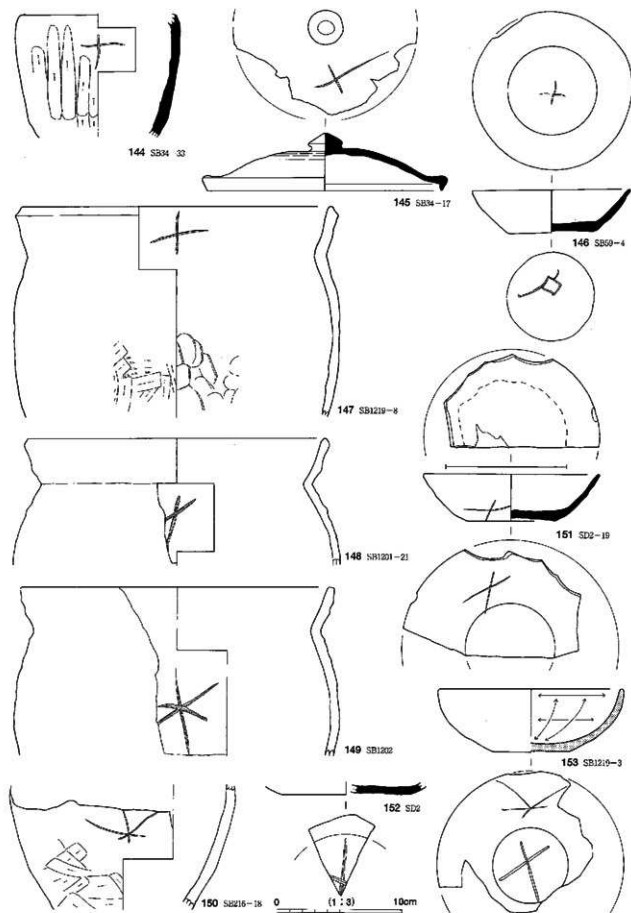

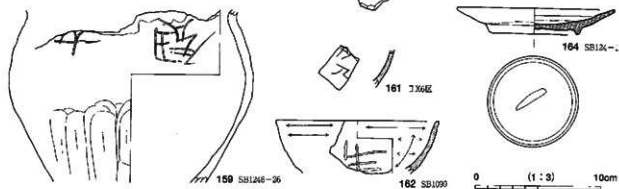
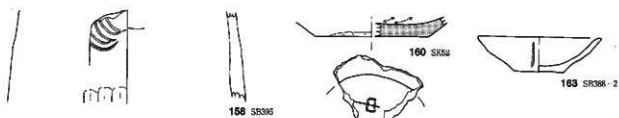
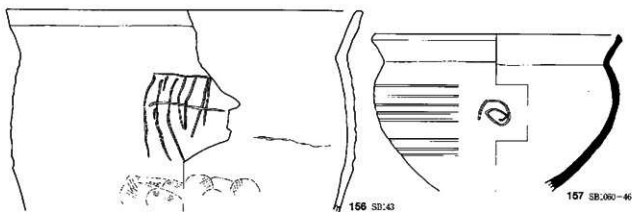
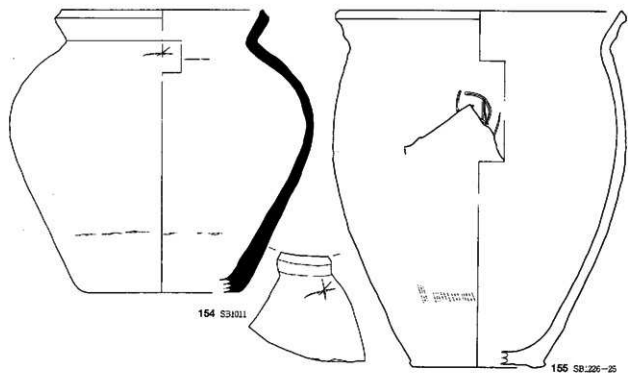

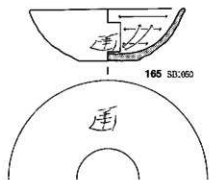

165 SD:060



166 SK26

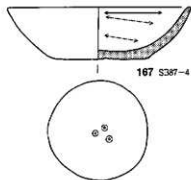

167 S387-4

陶硯・転用硯 (168~231)

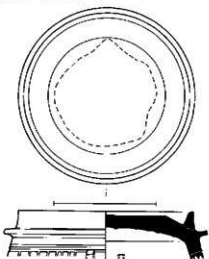

168 S3103-9

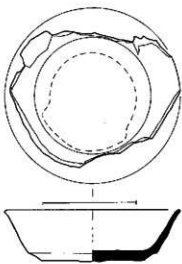

169 SB1225-2

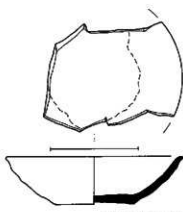

170 SD1009 2硯-28

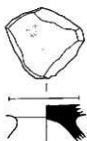

171 SB119-7



172 SK26-1

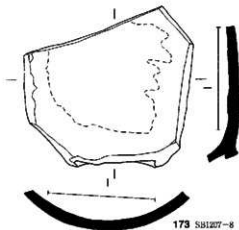
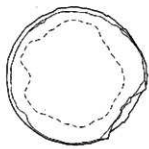

173 SB1207-8



174 S5380



175 SB:21-7

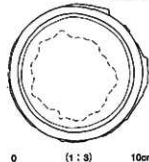
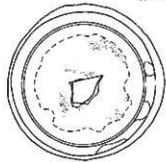

0 (1:3) 10cm

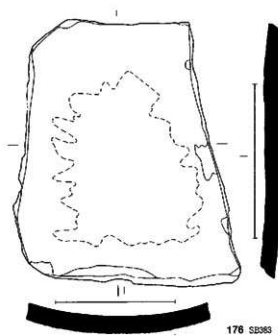

176 SB083

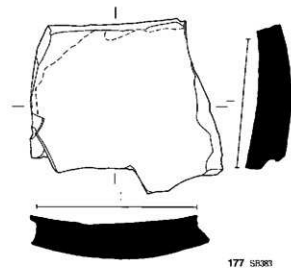

177 SR081

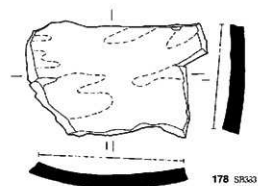

178 SR330

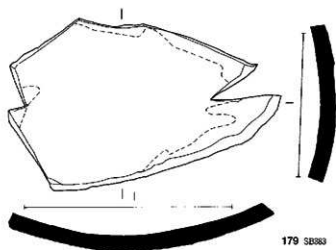

179 SB863

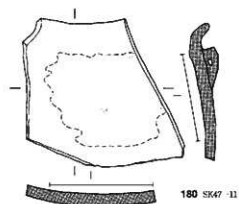

180 SK47-II

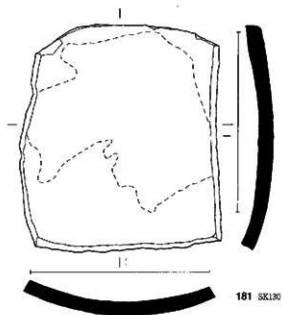

181 SK130

0 (1:3) 10cm

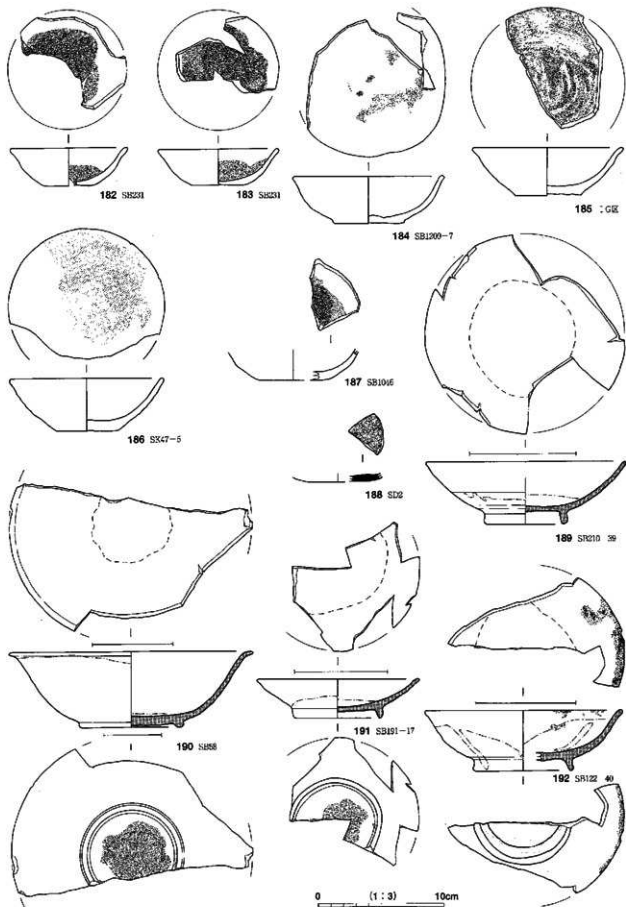

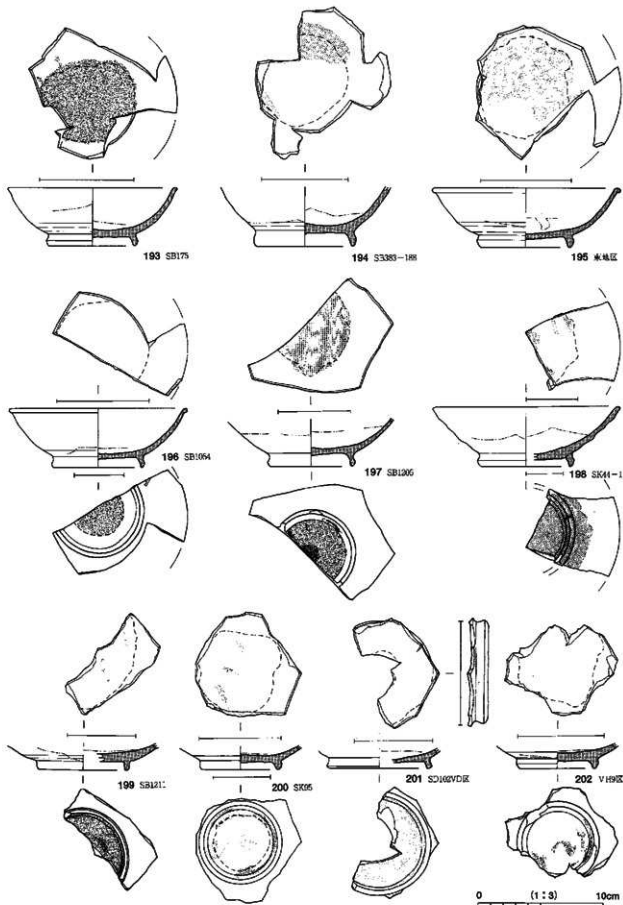

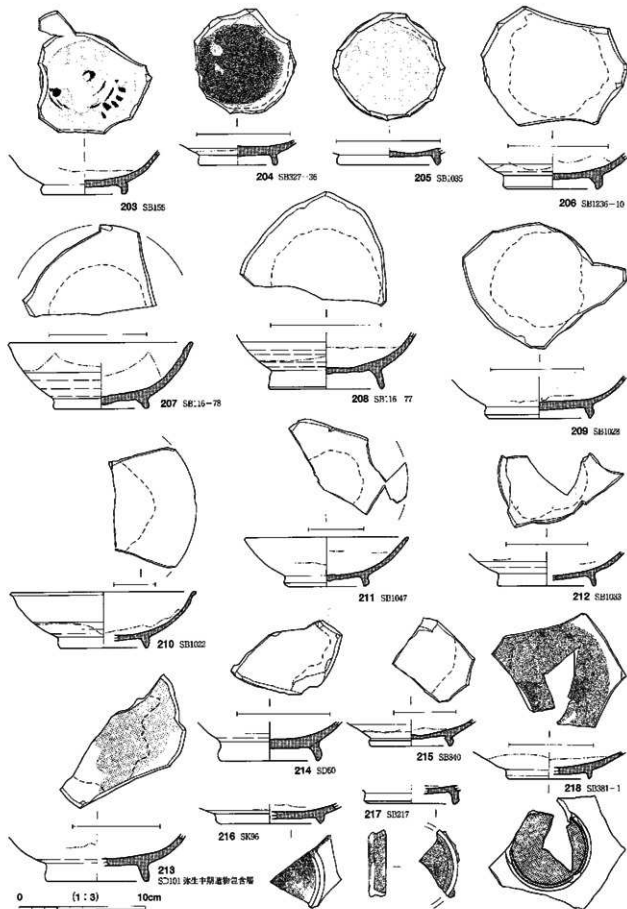

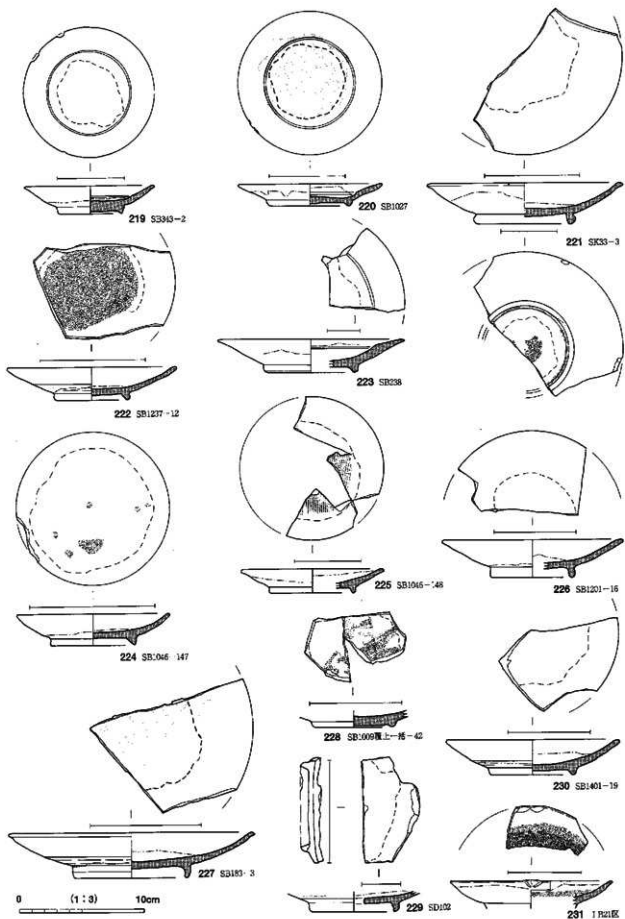

SD15 (1~4)

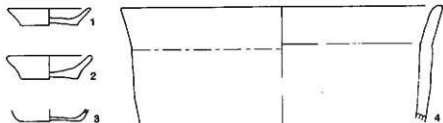

SD1003

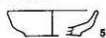

SD1004

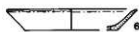

SD1151

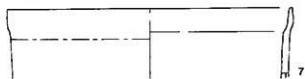

SD1178 (8-9)

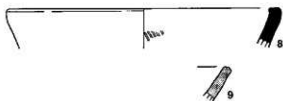

SD1187



SD1244 (11-12)



SD1019 · SX1001 (13-21)

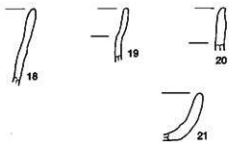
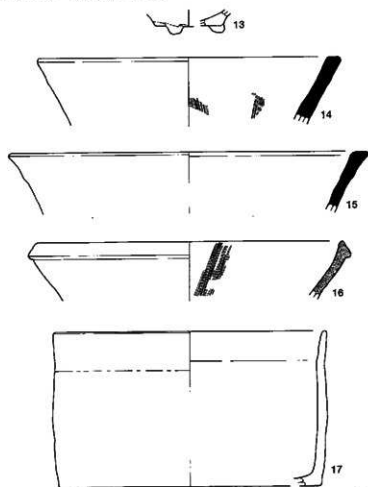

SD1168 (22-25)

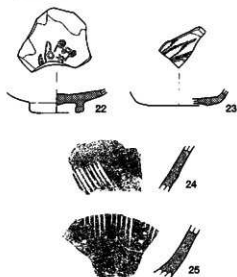

0 (1:4) 10cm

平坦部中世墓址
SK1014



斜面部中世墓址群周辺出土 (27~36)

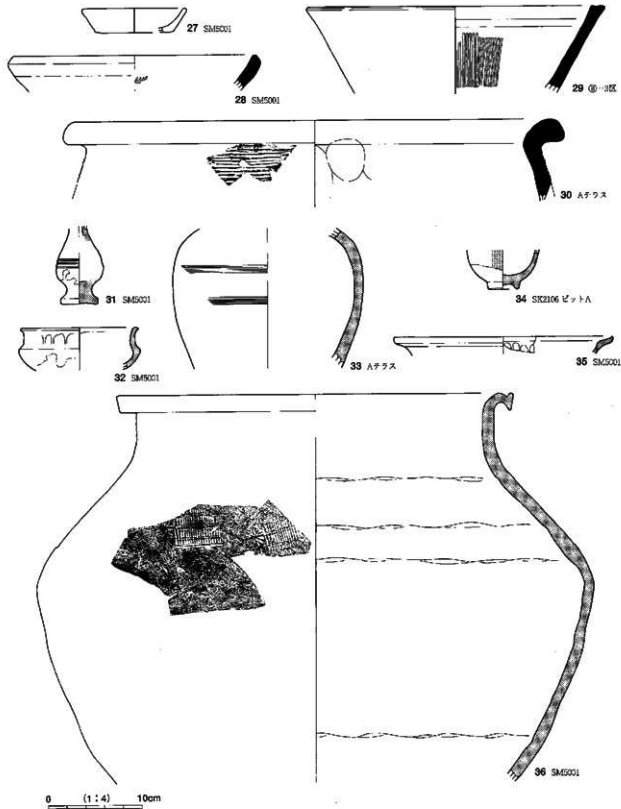

0 (1:4) 10cm

SK523



SK1255



SK2



SK1541 (53 - 54)



SK533

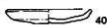

SK1655



SK1562



SK1560

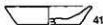

SK1574

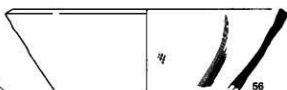

SK1550 (43~51)



SK2513



SK1033



SK1080



SK45

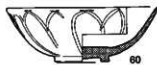

SK1053



SK1533



SK1004



SK1133



SK1221



0 (1 : 4) 10cm

SK1581



SK1607



SK1644 (70-71)



SK1646

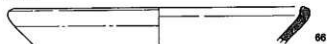

SK1613

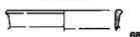

SK1637

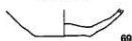

SK1650

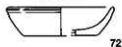

遺構外出土焼物 (古代遺構出土焼物も含む)

カワラケ (73-77)

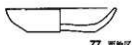
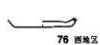
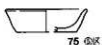

内耳鍋 (78-84)

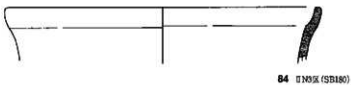
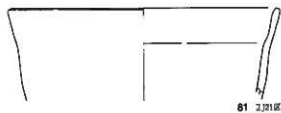
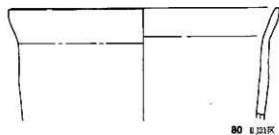
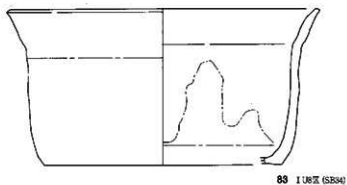
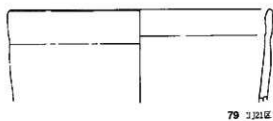
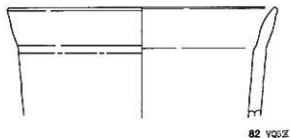
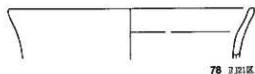

0 (1:4) 10cm

在地産攪鉢 (85~92)

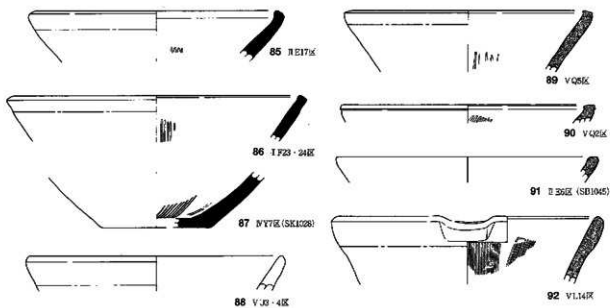

珠洲攪鉢 (93~102)

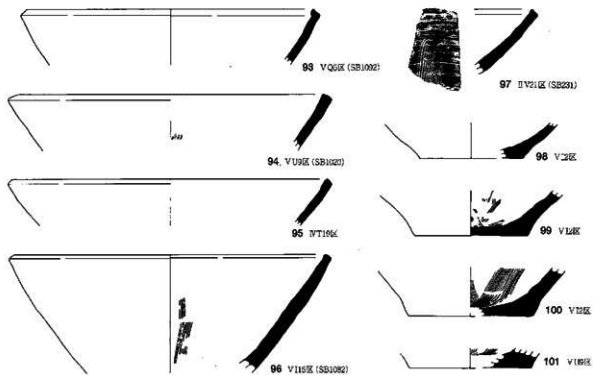

古瀬戸 (102~106)

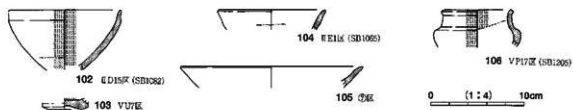

山茶碗系コネ鉢

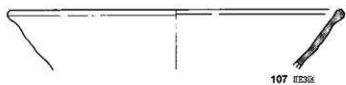

107 107B

常滑コネ鉢 (108・109)

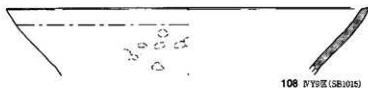

108 108B (SB1015)

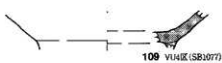

109 109B (SB1077)

越中瀬戸 (117~119)

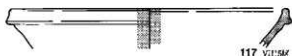

117 117B



118 118B



119 119B (SB1069)

中国陶磁器 (110~116)



110 110B

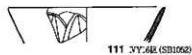

111 111B (SD1062)



112 112B



113 出土地点不明



114 出土地点不明



115 115B (SD1050)

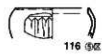

116 116B

信楽



120 120B

0 (1:4) 10cm

土製品 (1~5)

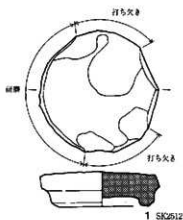

1 1B

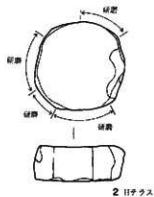

2 2B

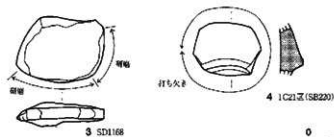

3 3B

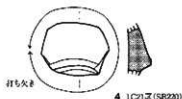

4 4B (SB220)

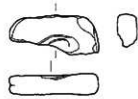

5 5B

0 (1:2) 5cm

礧石 (1~6)

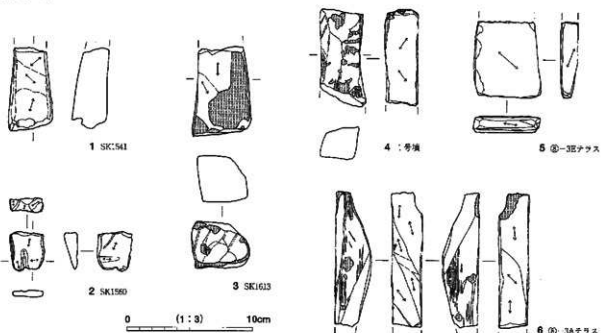

台石・凹石 (1~6)

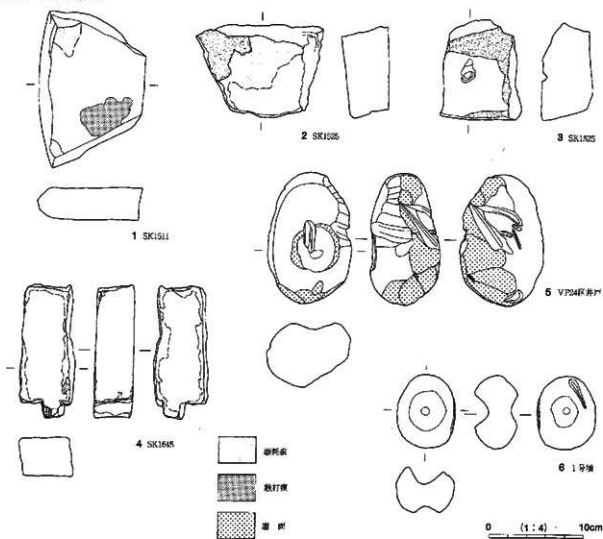

軽石製品 (1~5)

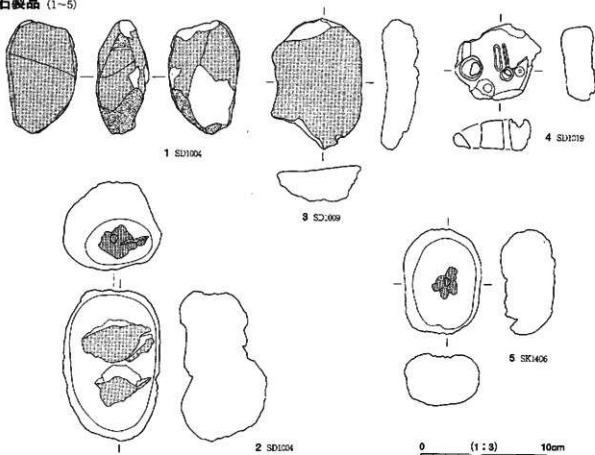

石臼・茶臼 (1~10)

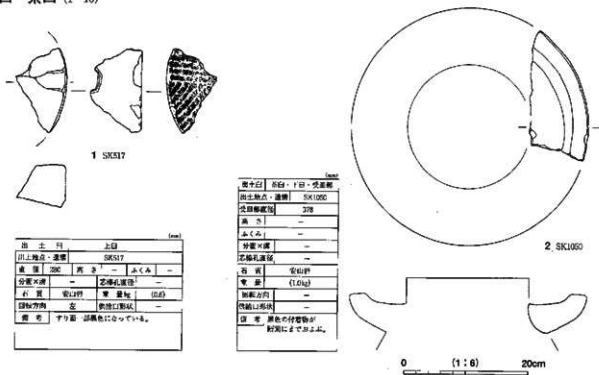

出土品	石臼
出土地点・遺跡	SK517
数量	2個
長さ	10.5cm
幅	7.5cm
厚さ	1.5cm
重量	1.0kg
材質	凝灰岩
用途	すり臼

SK1060	
出土品	石臼・茶臼・炊飯器
出土地点・遺跡	SK1060
数量	3個
長さ	—
幅	—
厚さ	—
重量	—
材質	凝灰岩
用途	すり臼

すり臼 凝灰岩にできています。

石臼 凝灰岩の付着物が
経年によりおぼろげ

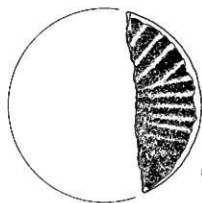
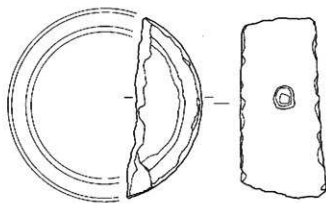

3 SK154

出土口	注目
出土地点・遺跡	SK154:
年代	3000 縄文 24-25 土くみ
分類学番号	8×8 芯棒孔流石 -
材質	安山岩 重量 (4.2)
観察方向	左 側面(断面)
備考	

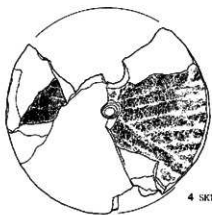
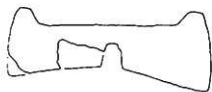
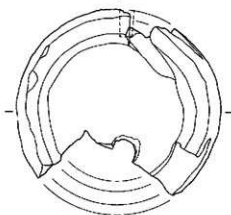

4 SK151

出土口	注目
出土地点・遺跡	SK151:
年代	3000 縄文 25-26 土くみ 35
分類学番号	8×8 芯棒孔流石 (27)
材質	安山岩 重量 (10.6)
観察方向	左 表側(断面) 鏡面(断面)
備考	K分厚は交わった角より別した。

0 (1:6) 20cm

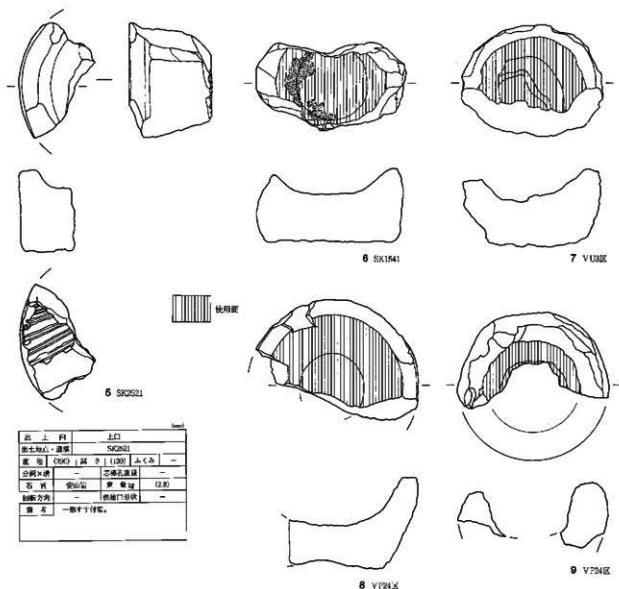

品上号	上口
出土地点・遺跡	SK21
重 量	70K3 縦 寸 (130) 横 寸 寸
分類名称	— 芯部孔遺跡 —
石 質	安山岩 黄 色 (2.8)
断面方向	— 斜行線状 —
備 考	— 破片 1 片あり。

研究番号	出土地点・遺跡	石 質	縦径 mm	横寸 mm	厚さ mm	重量 g
6	SK1641	安山岩	123	110	140	73.7
備 考	内面打痕あり。背面打痕あり。 内面に黄色塗あり。					

研究番号	出土地点・遺跡	石 質	縦径 mm	横寸 mm	厚さ mm	重量 g
7	V133	安山岩	124	122	52	14.6
備 考	内面2段階で線打痕あり。 外縁・底面全て線打痕あり。					

研究番号	出土地点・遺跡	石 質	縦径 mm	横寸 mm	厚さ mm	重量 g
8	V124	安山岩	126	140	77	15.4
備 考	内面打痕あり。底部不明。 背縁線による破片1片。					

研究番号	出土地点・遺跡	石 質	縦径 mm	横寸 mm	厚さ mm	重量 g
9	V24	安山岩	240	100	81	12.3
備 考	内面にノミ痕あり。					

研究番号	出土地点・遺跡	石 質	縦径 mm	横寸 mm	厚さ mm	重量 g
10	①-36	安山岩	—	124	66	16.9
備 考	内面にノミ痕あり。背縁の破片のみ。					

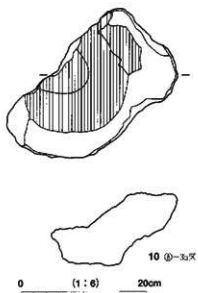

五輪塔 空風輪

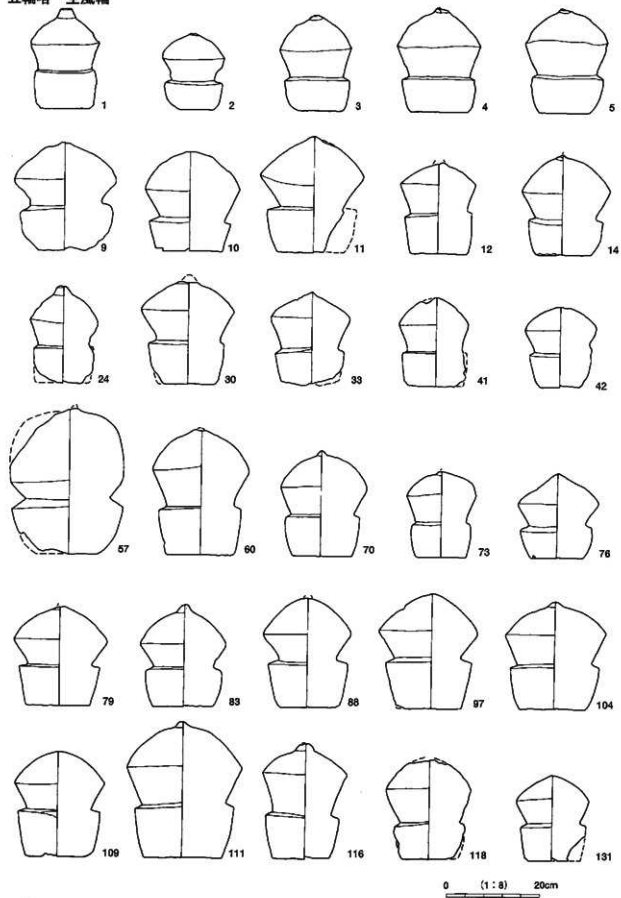

五輪塔 火輪

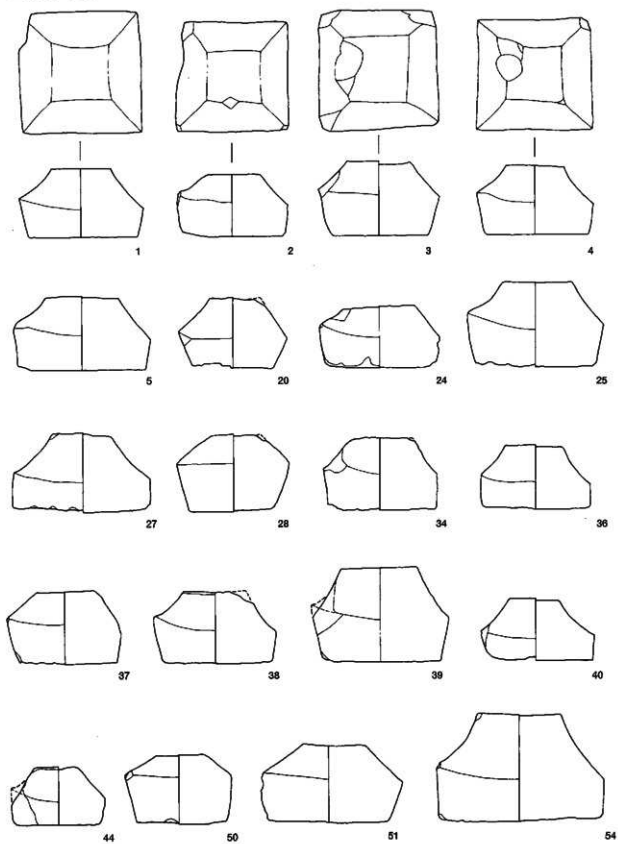

0 (1:6) 20cm

五輪塔 水輪

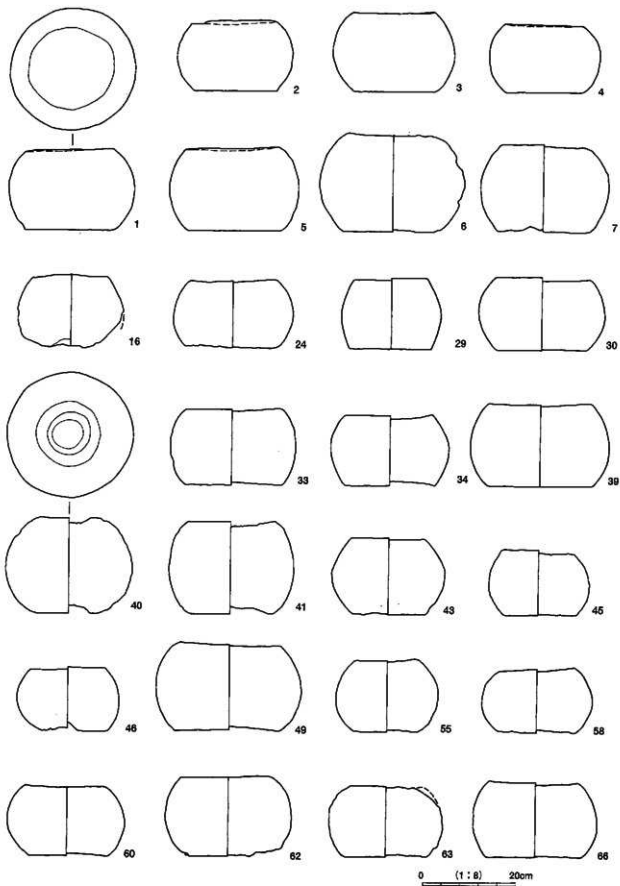

五輪塔 地輪

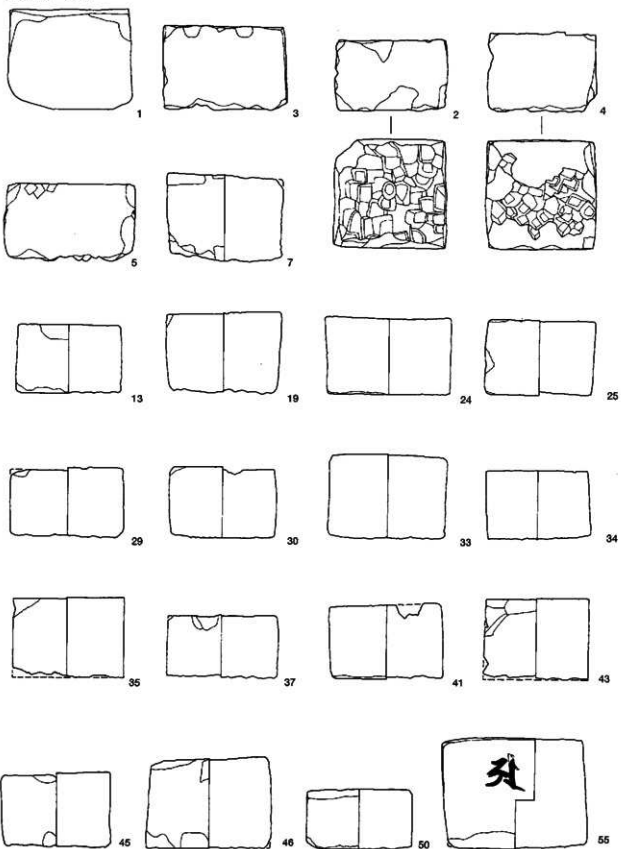

0 (1:8) 20cm

その他の石塔類 (1~18)

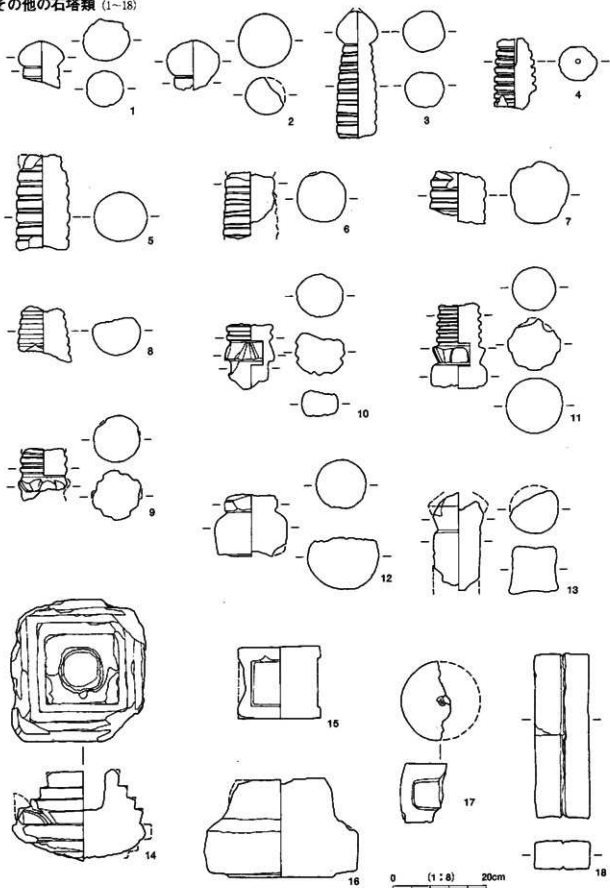

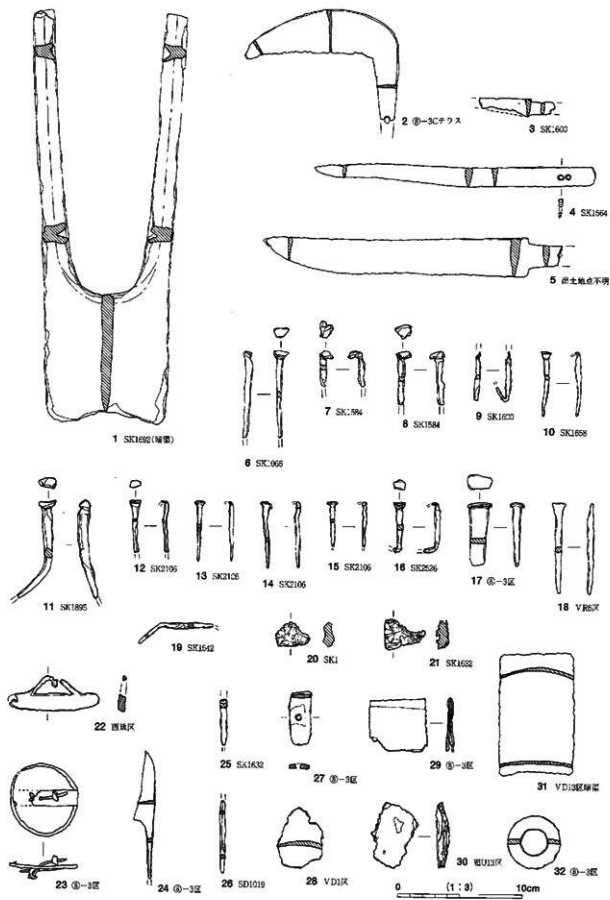

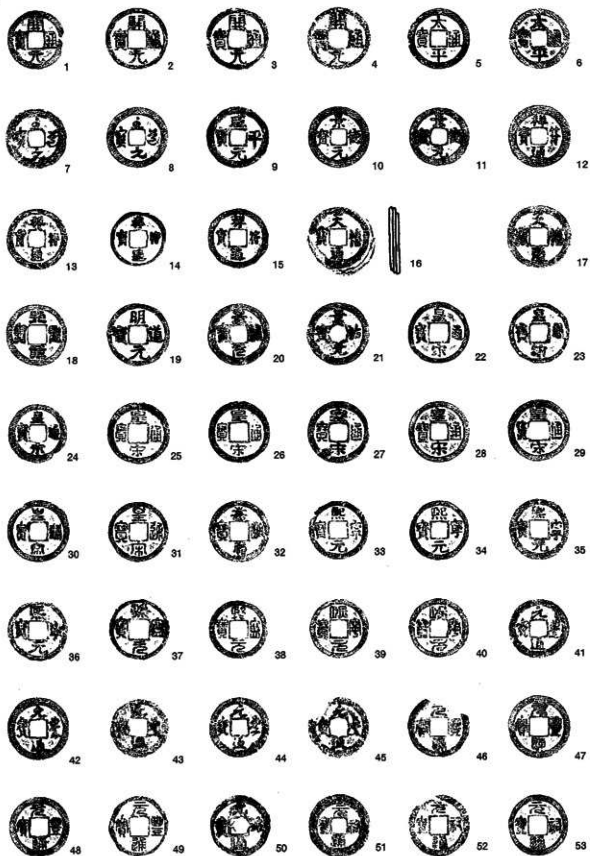

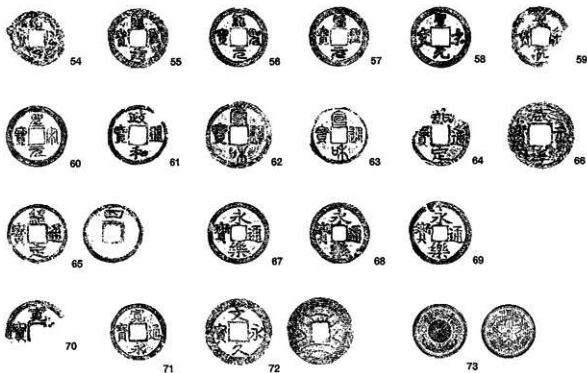

0 (2:3) 5cm

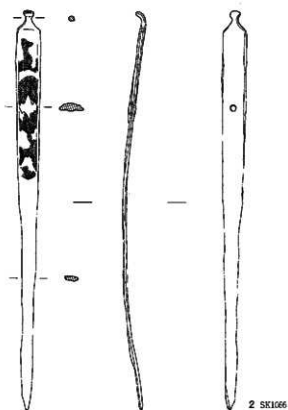
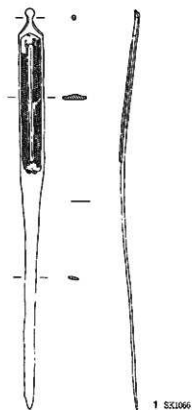

0 (1:2) 5cm

图版334 中世木製品実測图 1

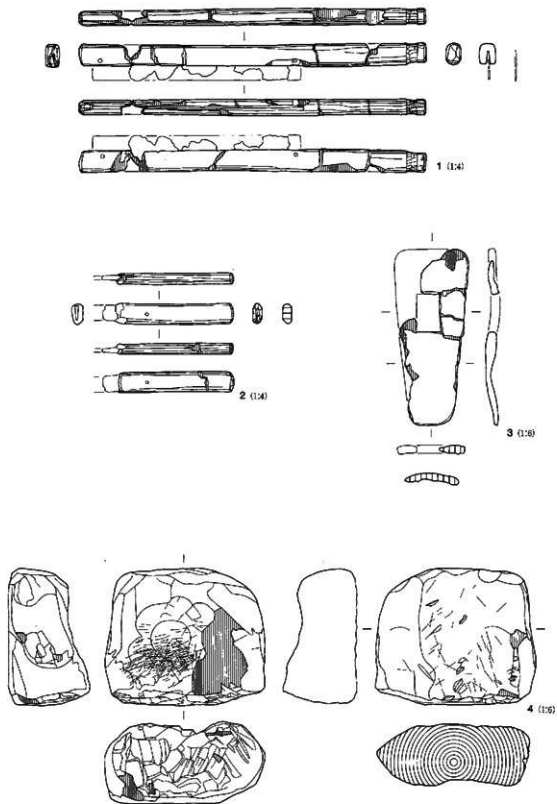

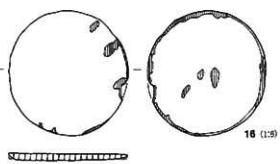
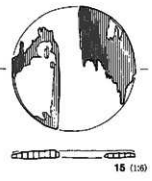
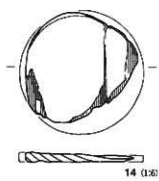
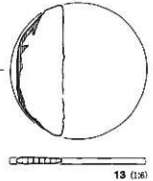
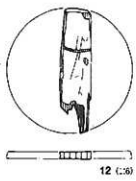
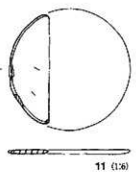
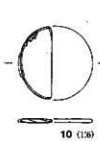
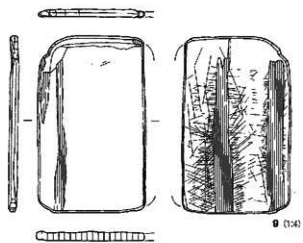
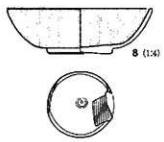
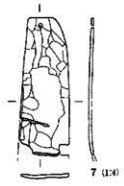
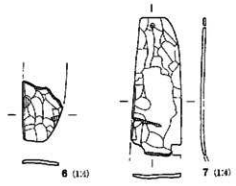
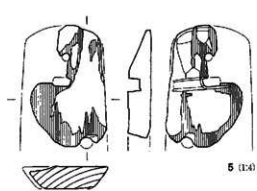

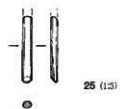
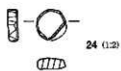
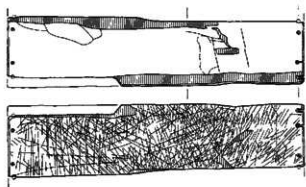
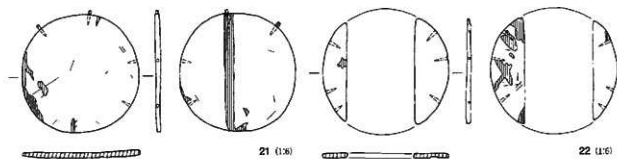
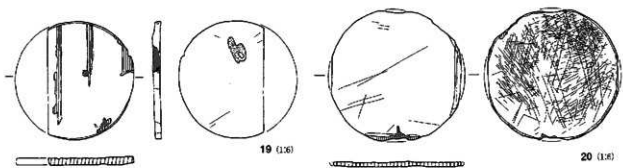
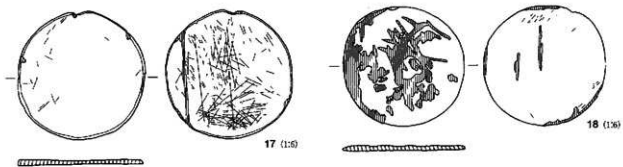

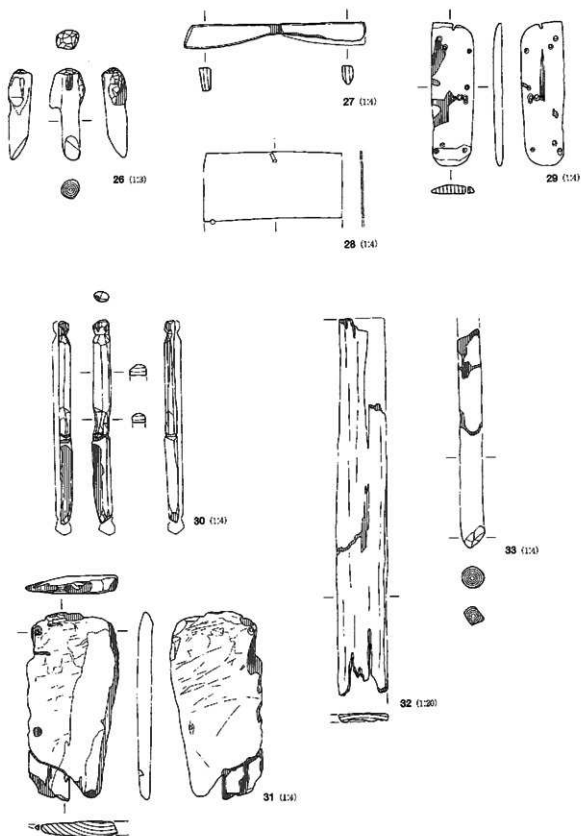

写 真 图 版

遺跡上空空中写真
(昭和40年撮影)





遺跡遠景
(地藏峠上空より)

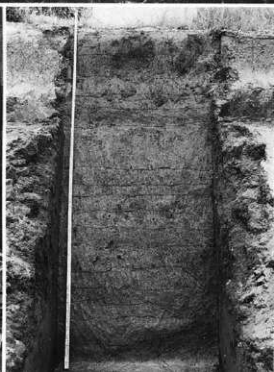

左：遺跡遠景
(長野IC上空より)
右：㊶区基本層序

完形状況
(斜面下方より)



玄室内床面

- 2: 床面の小角礫
 礫敷き状況
- 3: 床面下の大角礫
 礫・礫敷き状況
 と排水施設天井
 部(奥壁側より)



排水施設

- 4: 椀石と誤道部
- 5: 床面下礫敷き除
 去後





6: 玄室左側壁
7: 奥壁左コーナーとその裏込め



8: 玄室右側壁
9: 奥壁右コーナーとその裏込め



10: 玄室奥壁
11: 玄室及びその裏込め状況



石室構築掘り方
12: 石室及びその裏込め状況
13: 裏込め除去後の石室と掘り方



石室構築掘り方
石室除去後

玄室に直交する墳丘断面

15:左側壁側

16:右側壁側



外護列石及び内回りの列石

17:右側面より

18:左側面より



外護列石及び内回りの列石

(墳丘背面より)

19:左側

20:右側



21:石室裏込めと内回りの列石

22:高杯出土状況



須恵器大甕出土状況

23:口縁部出土状況

24:口縁部除去後





松原2号墳
排水施設残存状況



松原3号墳 玄室
奥壁残存状況



松原3号墳 玄室
奥壁及び側壁
29：左コーナー
30：右コーナー



松原3号墳
31：石室構築掘り方
32：玄室内床面鉄刀
出土状況

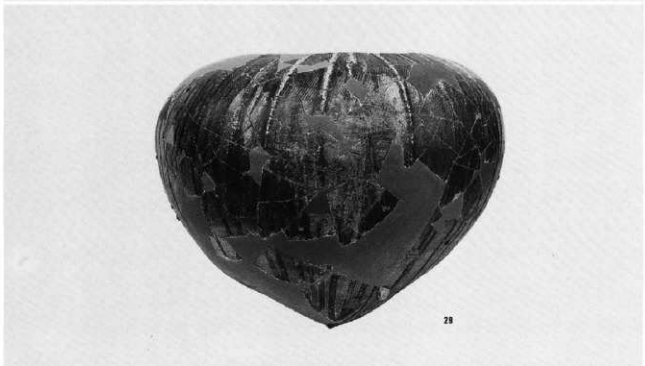
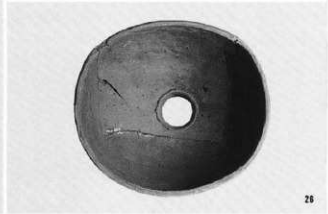



左：直刀
 右上：刀装具
 右中：鉄鎌
 右下：両環金具

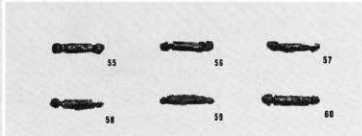
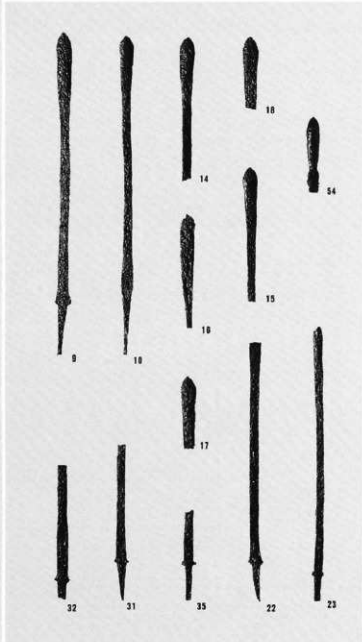
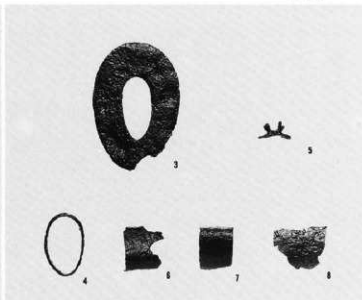
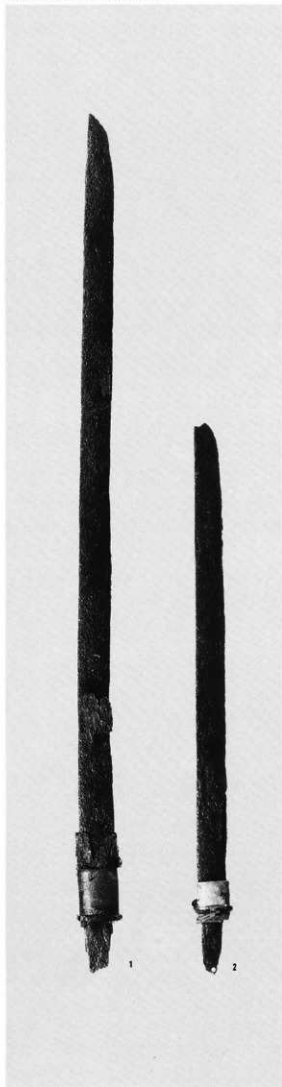

素環鍍板付巻

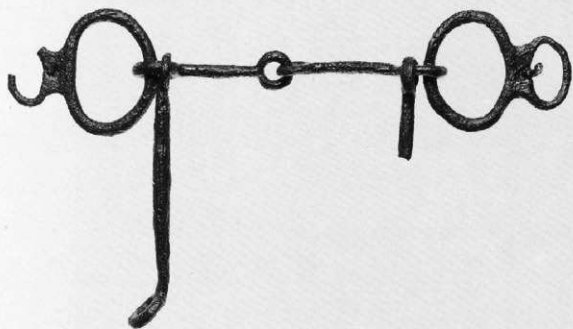

81

素環鍍板付巻

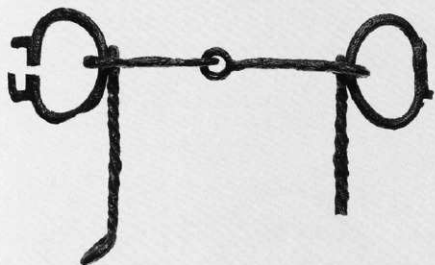

82

金銅製板金具



84



85

金銅製飾金具

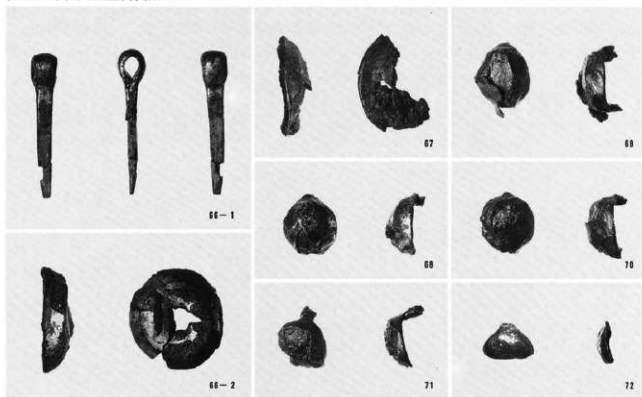

釘等鉄製品

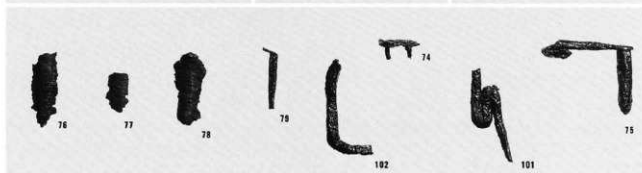

鉄簡



耳環

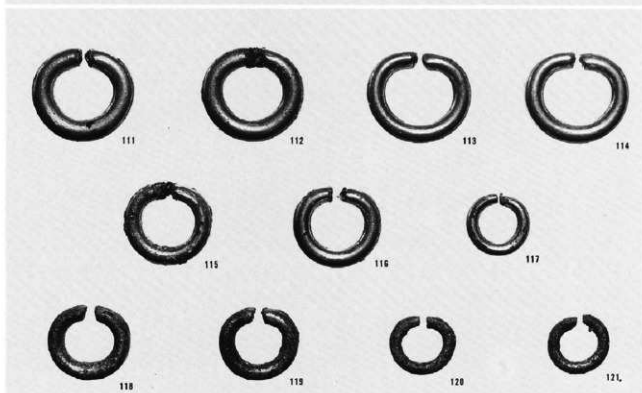

勾玉・平玉・管玉

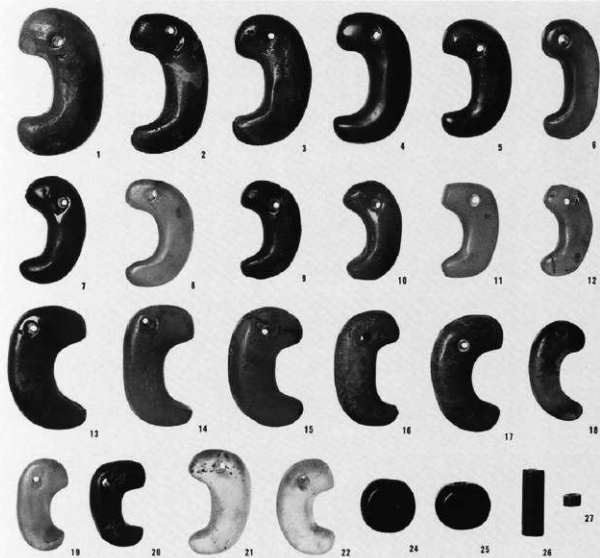

石製丸玉とガラス玉類

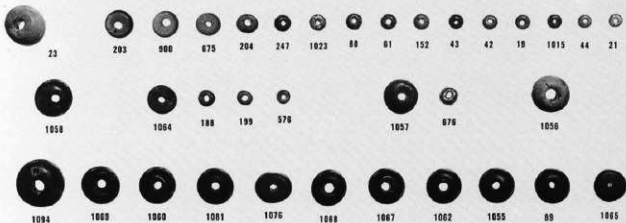

2・3号墳出土金属製品



SB6

左：完掘
右：竈冶炉



SB41

左：完掘
右：カマド

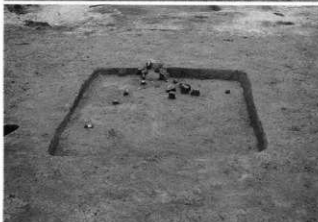

SB52カマド

左：石組み
右：天井石除去後



SB56カマド

左：燃焼部より
右：煙道部より



左：SB56カマド脇
遺物出土状況

右：SB58
遺物出土状況





左：SB59・87
遺物出土状況
右：SB76
遺物出土状況



SB80
左：全景
右：P5・6 鋳型等
出土状況



左：P7～9 検出状況
右：P7～9 断面



左：P7～9 完掘
右：P1 検出状況



SB81
左：完掘
右：床面中央鋳冶炉

左：SB92
遺物出土状況
右：SB98完掘



SB100カマド
左：遺物出土状況
右：完掘



左：SB101カマド
遺物出土状況
右：SB104紡織車
出土状況

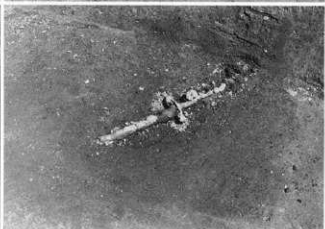

左：SB105・106等
住居址重複状
況
右：SB109
遺物出土状況



左：SB114カマド
遺物出土状況
右：SB150完掘





左：SB192カマド
右：SB198カマドと
SK47

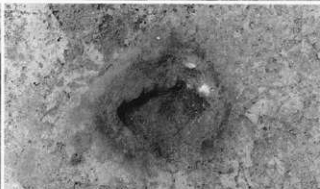

左：SB327カマド
右：SB335内殿治伊



左：SB345カマド
右：SB1006完備



SB1017
左：完備
右：カマド遺物出土
状況



SB1024カマド
左：燃焼部側より
右：左側より

左：SB1038
遺物出土状況
右：SB1043完掘

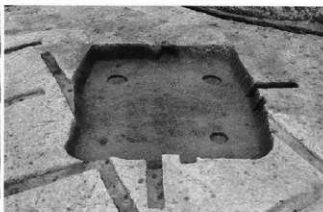

SB1046
左：完掘
右：石帯出土状況



SB1046
左：カマド跡遺物
出土状況
右：東壁跡遺物出
土状況

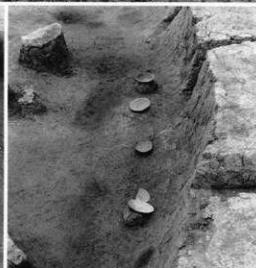

左：SB1066
カマド
右：SB1072
獣骨出土状況



左：SB1085
完掘
右：SB1097
完掘



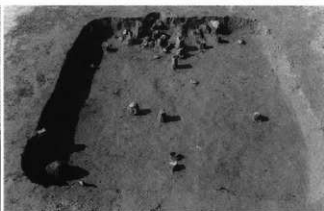

左：SB1100
遺物出土状況
右：SB1201
遺物出土状況



SB1207
左：炭化物等出土状況
右：鉄釘出土状況



左：SB1208カマド
右：SB1222カマド



左：SB1223カマド
右：SB1226カマド
遺物出土状況



掘立柱建物址
左：ST1001・1002
右：ST1003