

(財)長野県埋蔵文化財センター発掘調査報告書 6

# 中央自動車道長野線 埋蔵文化財発掘調査報告書 6

— 松本市内 その3 —

## 下 神 遺 跡

図 版 編

1 9 9 0

日本道路公団名古屋建設局  
長野県教育委員会  
(財)長野県埋蔵文化財センター

# 中央自動車道長野線 埋蔵文化財発掘調査報告書 6

— 松本市内 その3 —

下 神 遺 跡

図 版 編

1 9 9 0

日本道路公団名古屋建設局  
長野県教育委員会  
(財)長野県埋蔵文化財センター

# 凡 例

1 本書に掲載した実測図の縮尺は、特に断りのある場合を除いて下記のように統一してある。

(1) 遺構実測図

本文挿図 竪穴住居址・掘立柱建物址 1：60 住居址内施設・墓址・土坑 1：40

図 版 遺構図 1：120

(2) 遺物実測図等

土器・陶磁器 1：4 (大型品 1：4～1：8) 文字関係資料 1：3 墨書文字 1：2

土器拓影 1：3 金属製品 1：2 石器・石製品 1：6～2：3 銭貨拓影 2：3

(3) 遺物写真

土器・陶磁器 2：5 内耳鍋・常滑系甕 1：4 中世土器・陶磁器破片 1：2

鉄製品 1：2 銅製品・銭貨 1：1 石器・石製品 1：6～2：3

2 遺物実測図の番号は、遺跡ごとに次のように付けてある。

- |                          |                        |
|--------------------------|------------------------|
| (1) 縄文・弥生土器、石器…… 1から通し番号 | (4) 文字関係資料…… 1から通し番号   |
| (2) 古代土器…… 各遺構毎の通し番号     | (5) 金属製品…… 1から通し番号     |
| (3) 中・近世土器・陶磁器…… 1から通し番号 | (6) 古代以降の石製品…… 1から通し番号 |

3 実測図中のスクリントーン等は以下の事項を表わしている。

(1) 遺構

ア 竪穴住居址

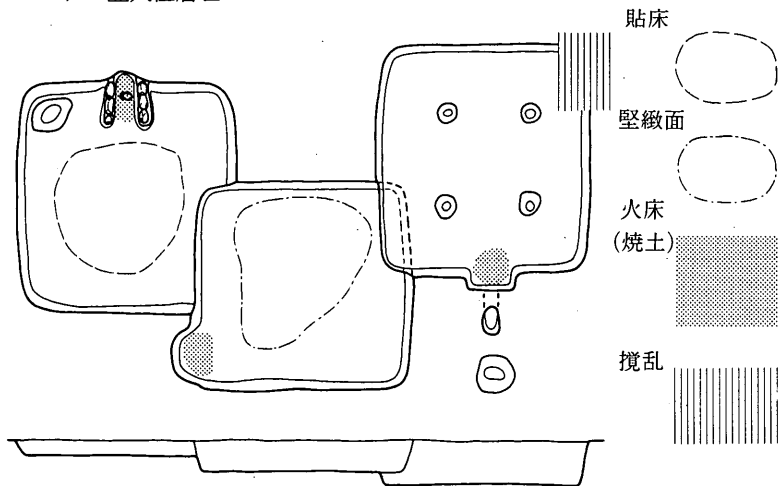

イ 掘立柱建物址

本文中の模式図は、約1：200で以下の事項を表わしている。

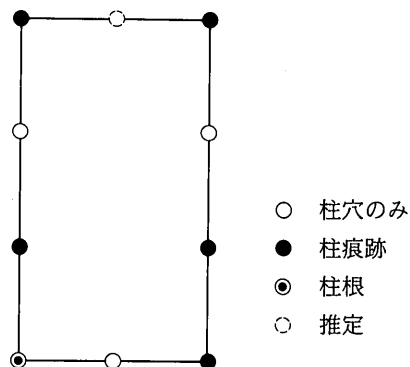

(2) 遺物

ア 古代土器

① 実測図の断面は、黒色土器・赤彩土器を含む土師器—白抜き、須恵器・施釉陶器—黒塗り、輸入陶磁器—スクリントーンによって区別した。黒色処理・赤彩を施したものはその処理された器面の範囲に、漆・炭化物の付着については以下のスクリントーンにより表現してある。



② 施釉陶磁器の施釉範囲は一点鎖線で示した。

イ 中・近世土器・陶磁器

① 実測図の断面は、土器—白抜き、陶器—黒塗り、輸入陶磁器—スクリントーンにより区別してある。

② 国産陶磁器の釉の種類は以下のスクリントーンにより区別してある。但し、灰釉は白抜きにした。

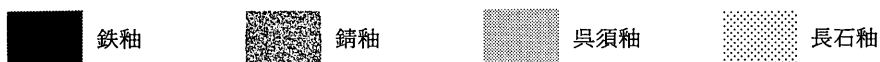

③ 施釉陶磁器の施釉範囲は一点鎖線で示した。

ウ 金属製品

- ① 金属製品の形状はX線等の観察にもとづいており、錆・付着物によるふくらみは線の太さを落して表現してある。
- ② 断面図は、平面形状観察にさしさわりのない範囲で平面図に組み入れてある。
- ③ 鉄製品、銅製品の断面図と、漆・炭化物の付着および木質部を以下のスクリーンで表現してある。



鉄製品



銅製品



漆



炭化物・木質部

エ 石器・石製品

- ① 打製石斧・磨石等の磨耗範囲は で示し、砥石の使用面は、断面図に |← →| で示した。

オ 土製品

- ① 羽口のタール付着・ガラス状発泡範囲を 、被熱により変色した範囲を で示した。

## 図版目次

- |       |         |       |                      |
|-------|---------|-------|----------------------|
| 図版 1  | 周辺遺跡分布図 | 図版 44 | 古代遺構実測図              |
| 図版 2  | 遺跡周辺地形図 | 図版 45 | 古代遺構実測図              |
| 図版 3  | 遺構分布図   | 図版 46 | 古代遺構実測図              |
| 図版 4  | 遺構分布図   | 図版 47 | 古代遺構実測図              |
| 図版 5  | 遺構割り付図  | 図版 48 | 古代遺構実測図              |
| 図版 6  | 古代遺構実測図 | 図版 49 | 古代遺構実測図              |
| 図版 7  | 古代遺構実測図 | 図版 50 | 古代遺構実測図              |
| 図版 8  | 古代遺構実測図 | 図版 51 | 古代遺構実測図              |
| 図版 9  | 古代遺構実測図 | 図版 52 | 古代遺構実測図              |
| 図版 10 | 古代遺構実測図 | 図版 53 | 古代遺構実測図              |
| 図版 11 | 古代遺構実測図 | 図版 54 | 古代遺構実測図              |
| 図版 12 | 古代遺構実測図 | 図版 55 | 古代遺構実測図              |
| 図版 13 | 古代遺構割付図 | 図版 56 | 古代遺構実測図              |
| 図版 14 | 古代遺構実測図 | 図版 57 | 古代遺構実測図              |
| 図版 15 | 古代遺構実測図 | 図版 58 | 古代遺構実測図              |
| 図版 16 | 古代遺構実測図 | 図版 59 | 古代遺構実測図              |
| 図版 17 | 古代遺構実測図 | 図版 60 | 古代遺構実測図              |
| 図版 18 | 古代遺構実測図 | 図版 61 | 古代遺構実測図              |
| 図版 19 | 古代遺構実測図 | 図版 62 | 古代遺構実測図              |
| 図版 20 | 古代遺構実測図 | 図版 63 | 古代遺構実測図              |
| 図版 21 | 古代遺構実測図 | 図版 64 | 古代遺構実測図              |
| 図版 22 | 古代遺構実測図 | 図版 65 | 古代遺構実測図              |
| 図版 23 | 古代遺構実測図 | 図版 66 | 古代遺構実測図              |
| 図版 24 | 古代遺構実測図 | 図版 67 | 古代遺構実測図              |
| 図版 25 | 古代遺構実測図 | 図版 68 | 古代遺構実測図              |
| 図版 26 | 古代遺構実測図 | 図版 69 | 古代遺構実測図              |
| 図版 27 | 古代遺構実測図 | 図版 70 | 古代遺構実測図              |
| 図版 28 | 古代遺構実測図 | 図版 71 | 古代遺構実測図              |
| 図版 29 | 古代遺構実測図 | 図版 72 | 古代遺構実測図              |
| 図版 30 | 古代遺構実測図 | 図版 73 | 古代遺構実測図              |
| 図版 31 | 古代遺構実測図 | 図版 74 | 古代遺構実測図              |
| 図版 32 | 古代遺構実測図 | 図版 75 | 古代遺構実測図              |
| 図版 33 | 古代遺構実測図 | 図版 76 | 古代遺構実測図              |
| 図版 34 | 古代遺構実測図 | 図版 77 | 古代遺構実測図              |
| 図版 35 | 古代遺構実測図 | 図版 78 | 古代遺構実測図              |
| 図版 36 | 古代遺構実測図 | 図版 79 | 古代遺構実測図              |
| 図版 37 | 古代遺構実測図 | 図版 80 | 古代遺構実測図              |
| 図版 38 | 古代遺構実測図 | 図版 81 | 縄文時代遺物実測図            |
| 図版 39 | 古代遺構実測図 | 図版 82 | 古代土器実測図 SB1・2・3・4    |
| 図版 40 | 古代遺構実測図 | 図版 83 | 古代土器実測図 SB4・5・6      |
| 図版 41 | 古代遺構実測図 | 図版 84 | 古代土器実測図 SB7・8・9      |
| 図版 42 | 古代遺構実測図 | 図版 85 | 古代土器実測図 SB9・10・11・12 |
| 図版 43 | 古代遺構実測図 | 図版 86 | 古代土器実測図 SB13・14      |

図版 87	古代土器実測図	SB15·17·18·19	図版132	古代土器実測図	SB139·140·141·142
図版 88	古代土器実測図	SB20·21	図版133	古代土器実測図	SB143
図版 89	古代土器実測図	SB22·23	図版134	古代土器実測図	SB143·144·145
図版 90	古代土器実測図	SB24·25·26	図版135	古代土器実測図	SB146·147·148·149
図版 91	古代土器実測図	SB26	図版136	古代土器実測図	SB150·151·152·153
図版 92	古代土器実測図	SB27·29	図版137	古代土器実測図	ST3·6·7·8·9·12·17·30· 101·102·105·108·111
図版 93	古代土器実測図	SB29·31·32·33	図版138	古代土器実測図	ST111
図版 94	古代土器実測図	SB34·36·37·38·39	図版139	古代土器実測図	ST113·123·区画溝 I
図版 95	古代土器実測図	SB39·40·42	図版140	古代土器実測図	区画溝 I
図版 96	古代土器実測図	SB43·44	図版141	古代土器実測図	区画溝 I
図版 97	古代土器実測図	SB44·45·46·47·48	図版142	古代土器実測図	区画溝 I·II·III
図版 98	古代土器実測図	SB48·49·50·51	図版143	古代土器実測図	区画溝 III·SD1·7·18·52·100· 104·105
図版 99	古代土器実測図	SB52·53·54	図版144	古代土器実測図	SD108
図版100	古代土器実測図	SB55·56·57·58	図版145	古代土器実測図	SD108
図版101	古代土器実測図	SB59·60·61·62·63	図版146	古代土器実測図	SD108
図版102	古代土器実測図	SB64·65	図版147	古代土器実測図	SD108
図版103	古代土器実測図	SB66·67·68·69·70·71	図版148	古代土器実測図	SD108
図版104	古代土器実測図	SB72·73·74	図版149	古代土器実測図	SD108
図版105	古代土器実測図	SB76·77	図版150	古代土器実測図	SD108
図版106	古代土器実測図	SB77·78·82·83	図版151	古代土器実測図	SD108
図版107	古代土器実測図	SB84	図版152	古代土器実測図	SD108·106·109·110
図版108	古代土器実測図	SB85·87·88	図版153	古代土器実測図	SD117·118·12·119
図版109	古代土器実測図	SB89·90	図版154	古代土器実測図	SD130·132·135·137
図版110	古代土器実測図	SB91·92	図版155	古代土器実測図	SD137·139·147·151·163· 173·176·181
図版111	古代土器実測図	SB92	図版156	古代土器実測図	SD170·171·溝址群 III
図版112	古代土器実測図	SB92·93·95	図版157	古代土器実測図	SK110·435·170·436·466· 491·533·540·530·534·554
図版113	古代土器実測図	SB96	図版158	古代土器実測図	SK579·551·555·599·565· 566
図版114	古代土器実測図	SB97(上·下層)	図版159	古代土器実測図	SK574·580·609·610·624· 628·684
図版115	古代土器実測図	SB97(下層)	図版160	古代土器実測図	SK632·643·652·833·834· 835·910·937·975·1008· 1069·1276·1338
図版116	古代土器実測図	SB97·99	図版161	古代土器実測図	SK1208·1281·1285·1286· 1410·1527·SX30
図版117	古代土器実測図	SB100·101	図版162	古代土器実測図	SX30
図版118	古代土器実測図	SB101·102·103	図版163	古代土器実測図	SX30
図版119	古代土器実測図	SB104·105·106	図版164	古代土器実測図	SX30
図版120	古代土器実測図	SB107·108·109·110	図版165	古代土器実測図	SX30·遺構外
図版121	古代土器実測図	SB110·111	図版166	文字関係資料	墨書土器
図版122	古代土器実測図	SB112·114·115	図版167	文字関係資料	墨書土器
図版123	古代土器実測図	SB115·116			
図版124	古代土器実測図	SB117·118·119·120			
図版125	古代土器実測図	SB121·122·123			
図版126	古代土器実測図	SB124·125·127			
図版127	古代土器実測図	SB126			
図版128	古代土器実測図	SB126·128·129			
図版129	古代土器実測図	SB130·131·132			
図版130	古代土器実測図	SB133·134·135			
図版131	古代土器実測図	SB136·138			

図版168 文字関係資料 墨書土器  
 図版169 文字関係資料 墨書土器  
 図版170 文字関係資料 墨書土器  
 図版171 文字関係資料 墨書土器  
 図版172 文字関係資料 墨書土器  
 図版173 文字関係資料 墨書土器  
 図版174 文字関係資料 墨書土器  
 図版175 文字関係資料 墨書土器  
 図版176 文字関係資料 墨書土器  
 図版177 文字関係資料 墨書土器  
 図版178 文字関係資料 墨書土器  
 図版179 文字関係資料 墨書土器  
 図版180 文字関係資料 墨書土器  
 図版181 文字関係資料 墨書土器

図版182 文字関係資料 墨書土器  
 図版183 文字関係資料 墨書土器  
 図版184 文字関係資料 墨書土器  
 図版185 文字関係資料 墨書土器  
 図版186 文字関係資料 墨書土器  
 図版187 文字関係資料 墨書土器  
 図版188 文字関係資料 刻書土器・硯類  
 図版189 金属製品 鉄製品  
 図版190 金属製品 鉄製品  
 図版191 金属製品 銅製品  
 図版192 石製品  
 図版193 石製品  
 図版194 石製品・土製品

## 写真図版目次

P L 1 調査遺跡周辺  
 P L 2 下神遺跡遠景・同近景  
 P L 3 南部Ⅲ地区航空写真  
 P L 4 南部Ⅰ地区遺構写真  
 P L 5 南部Ⅱ地区遺構写真  
 P L 6 南部Ⅲ地区遺構写真  
 P L 7 北部Ⅰ・Ⅱ地区遺構写真  
 P L 8 北部Ⅰ・Ⅱ・Ⅲ地区遺構写真  
 P L 9 北部Ⅲ地区遺構写真  
 P L 10 SB7・9  
 P L 11 SB12・14  
 P L 12 SB19・20・24  
 P L 13 SB26・27・29  
 P L 14 SB38・39  
 P L 15 SB52・53  
 P L 16 SB64・65  
 P L 17 SB68・72  
 P L 18 SB74・76・77・78・83  
 P L 19 SB84・85  
 P L 20 SB88・89  
 P L 21 SB92  
 P L 22 SB96・97  
 P L 23 SB97  
 P L 24 SB97  
 P L 25 SB101・108・109  
 P L 26 SB111  
 P L 27 SB119・120・121

P L 28 SB126127  
 P L 29 SB130・138・139・140・142  
 P L 30 SB143・144・147  
 P L 31 SB148・152  
 P L 32 石組カマド SB96・100・101・112・115・136・  
 145・148  
 P L 33 函形カマド SB12・82・108・123・130・140・  
 142・149  
 P L 34 ST2・3・4  
 P L 35 ST6・8・9  
 P L 36 ST7・8・9  
 P L 37 ST15・16  
 P L 38 ST21・22・23  
 P L 39 ST101・102・106  
 P L 40 ST102・103・105  
 P L 41 ST108・111  
 P L 42 ST113・114・115・120  
 P L 43 区画溝Ⅰ・Ⅱ・Ⅲ  
 P L 44 SD108  
 P L 45 SD108  
 P L 46 SD7・18・106・109  
 P L 47 SA1・2・101  
 P L 48 SK460・580・703・705・835  
 P L 49 SX30・SN1  
 P L 50 古代土器 SB4  
 P L 51 古代土器 SB6・14  
 P L 52 古代土器 SB14・21・72

PL 53	古代土器	SB72·76	PL 73	古代土器	区画溝 I
PL 54	古代土器	SB76·84	PL 74	古代土器	区画溝 II·III
PL 55	古代土器	SB84·85	PL 75	古代土器	SD108 1区
PL 56	古代土器	SB89	PL 76	古代土器	SD108 3区
PL 57	古代土器	SB92	PL 77	古代土器	SD108 3区
PL 58	古代土器	SB92	PL 78	古代土器	SK580
PL 59	古代土器	SB96	PL 79	古代土器	ST111·SX30
PL 60	古代土器	SB97	PL 80	古代土器	SX30
PL 61	古代土器	SB97·99	PL 81	古代土器	緑釉陶器
PL 62	古代土器	SB99·100	PL 82	墨書土器	
PL 63	古代土器	SB100·101	PL 83	墨書土器	
PL 64	古代土器	SB111	PL 84	墨書土器	
PL 65	古代土器	SB111·121·124	PL 85	墨書土器	
PL 66	古代土器	SB124·126	PL 86	陶硯	
PL 67	古代土器	SB126·130	PL 87	鉄製品	
PL 68	古代土器	SB136	PL 88	鉄製品	
PL 69	古代土器	SB143	PL 89	銅製品・銭貨	
PL 70	古代土器	SB143	PL 90	石製品	
PL 71	古代土器	SB148·152	PL 91	石製品・土製品	
PL 72	古代土器	区画溝 I	PL 92	漆紙文書	



図

版

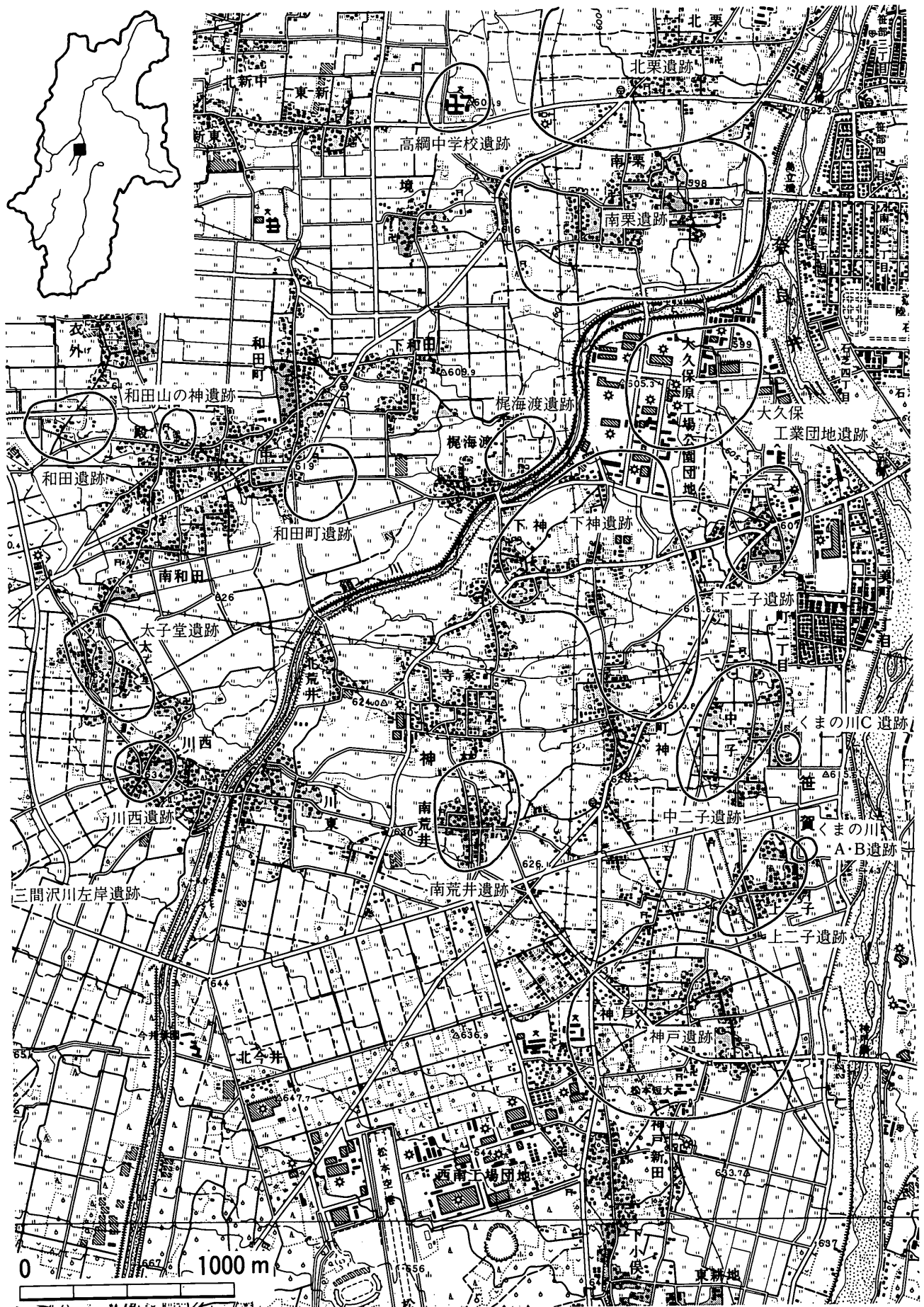

図版2 遺跡周辺地形図

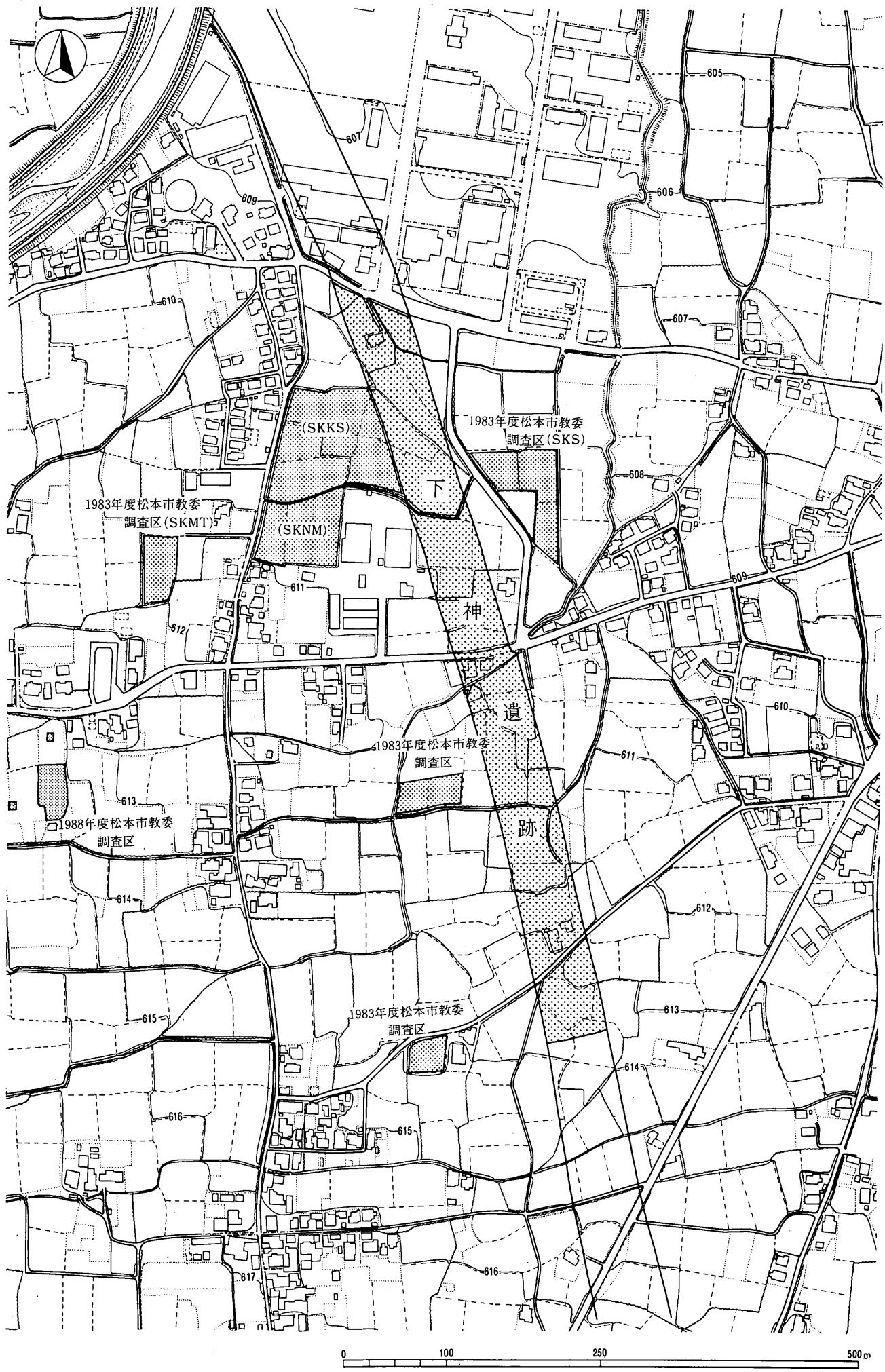

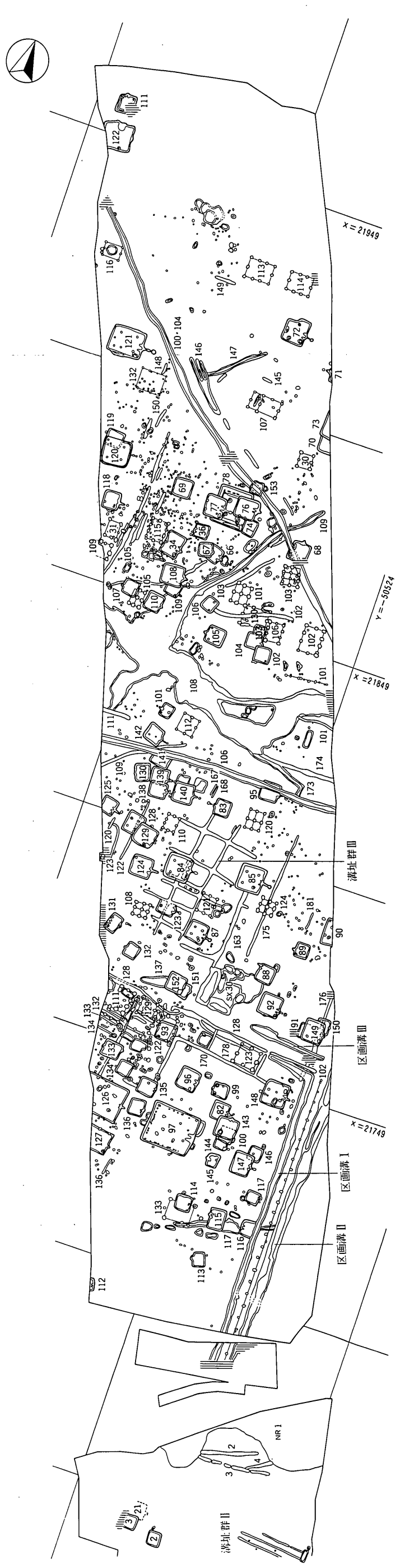
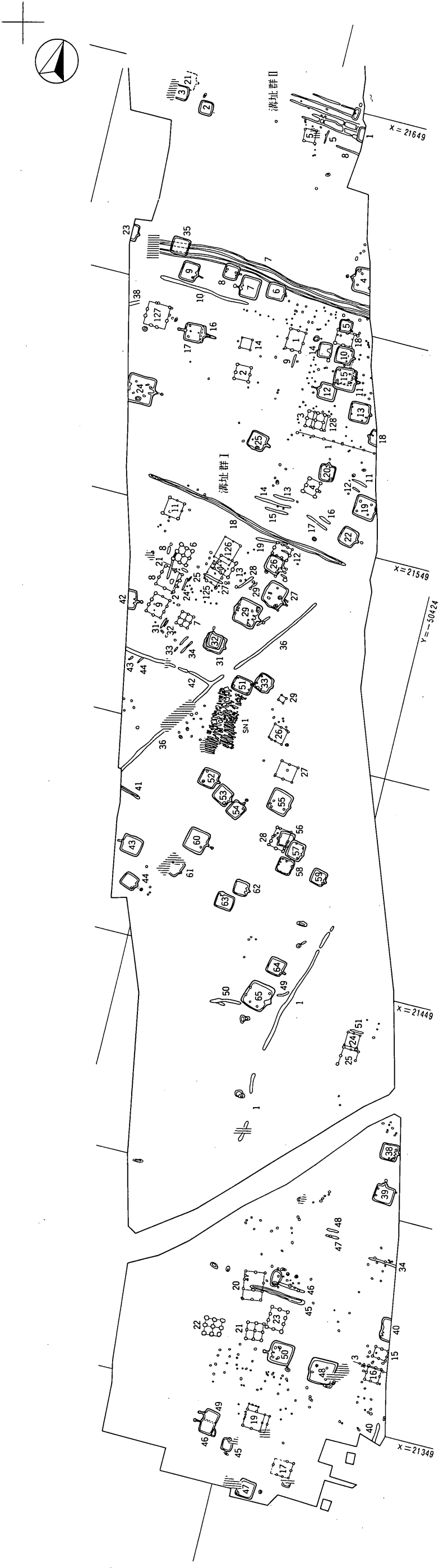

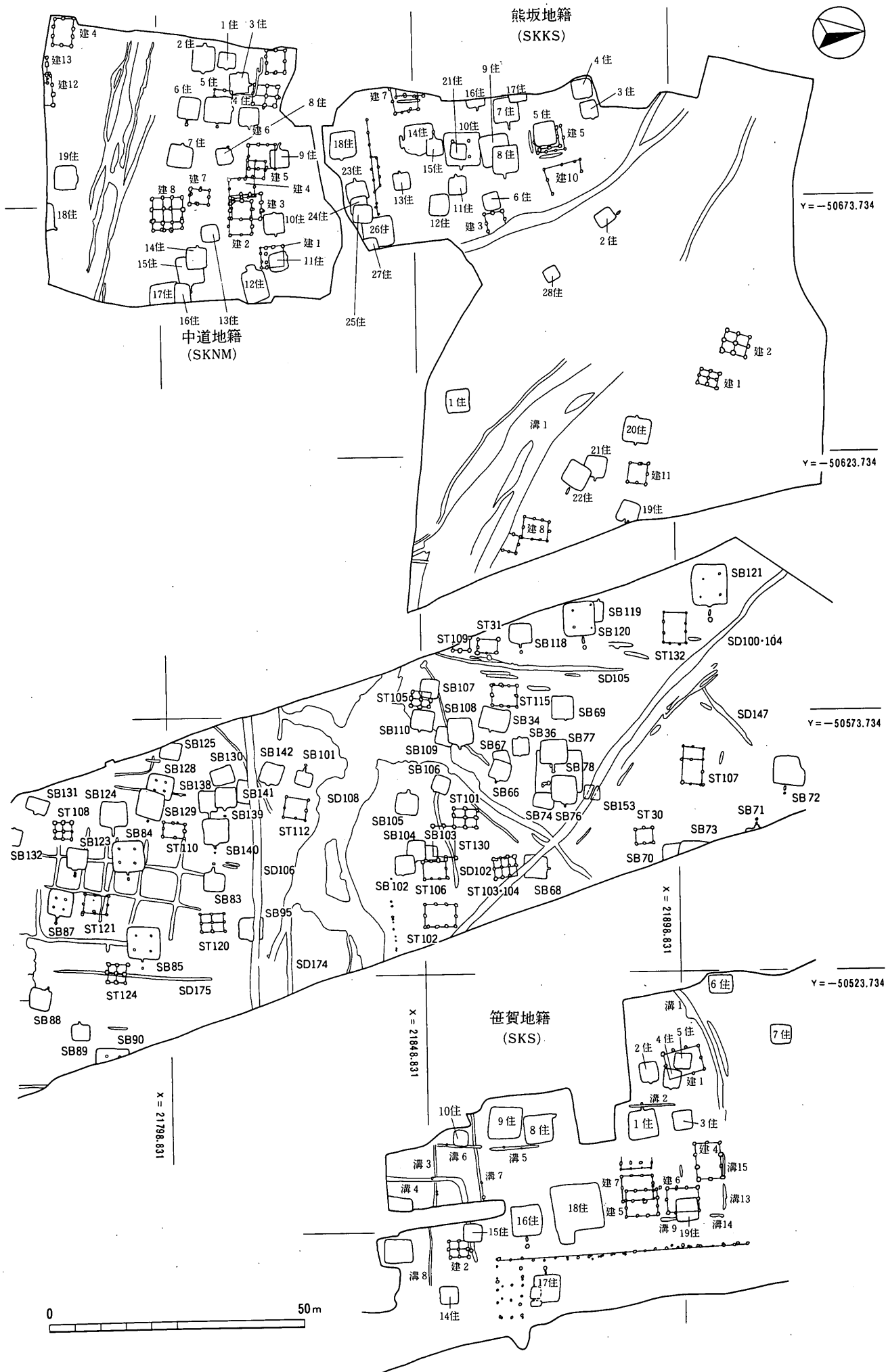

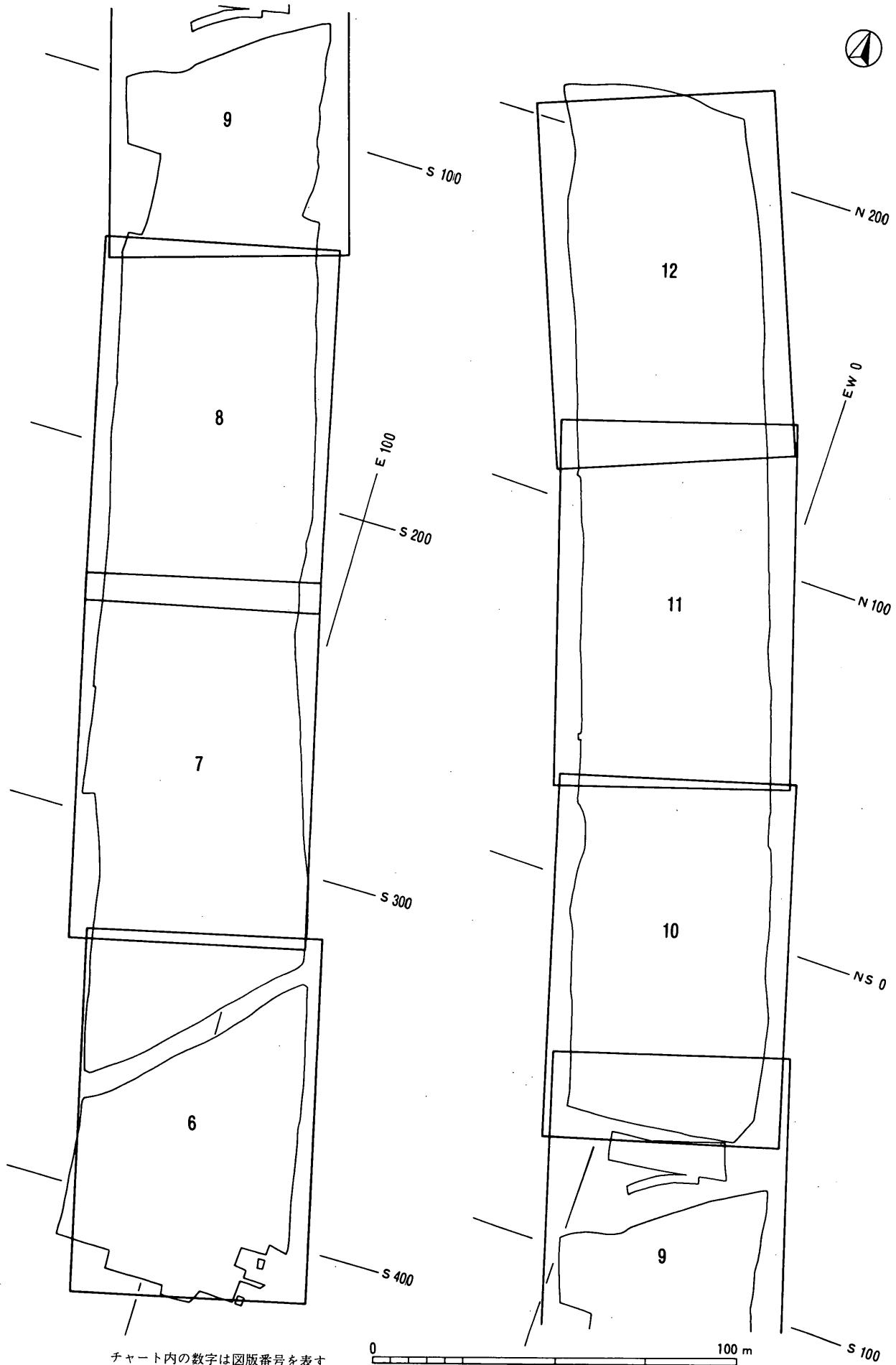

チャート内の数字は図版番号を表す

0 100 m

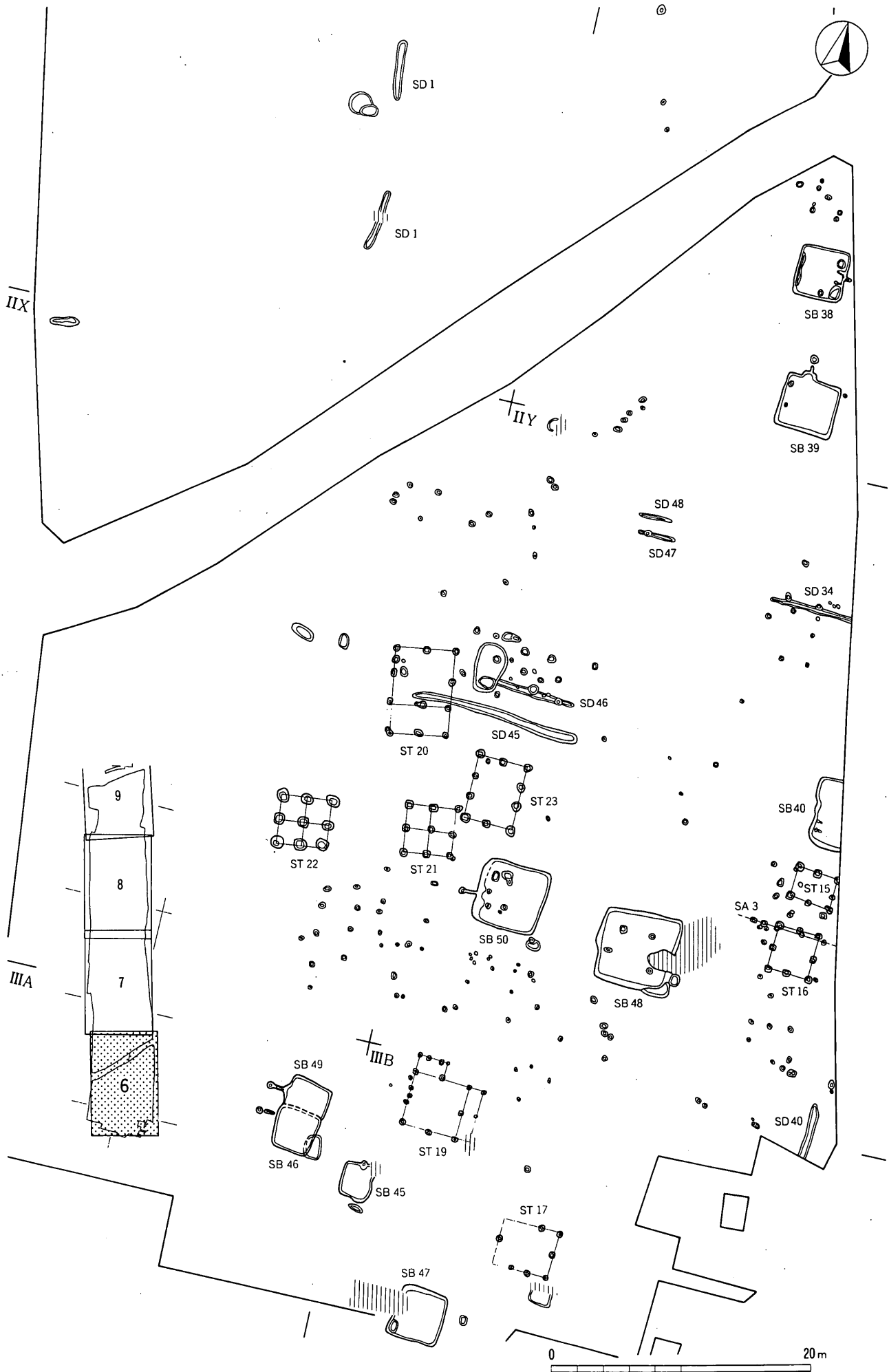

图版 7 古代遺構実測図

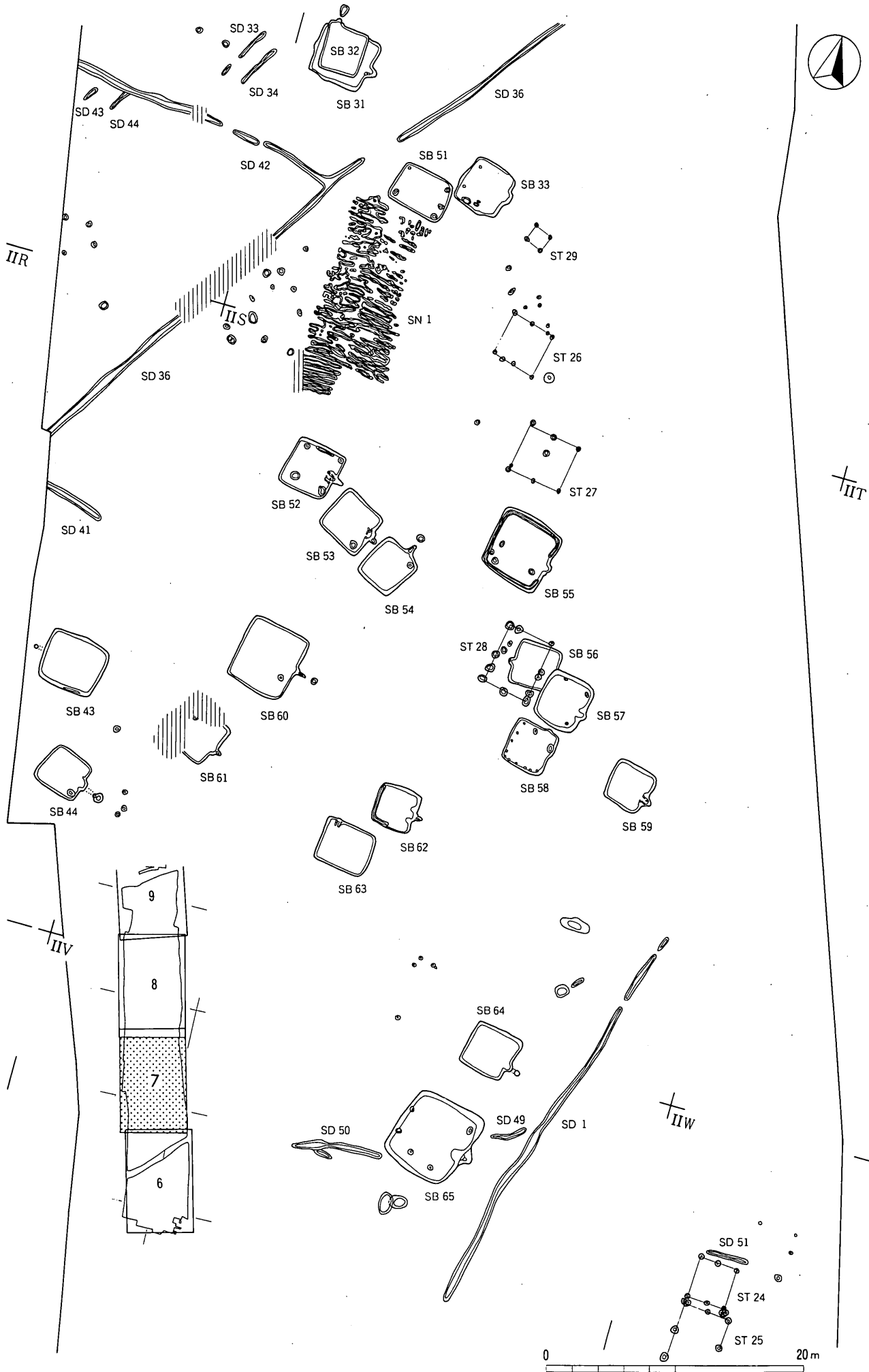





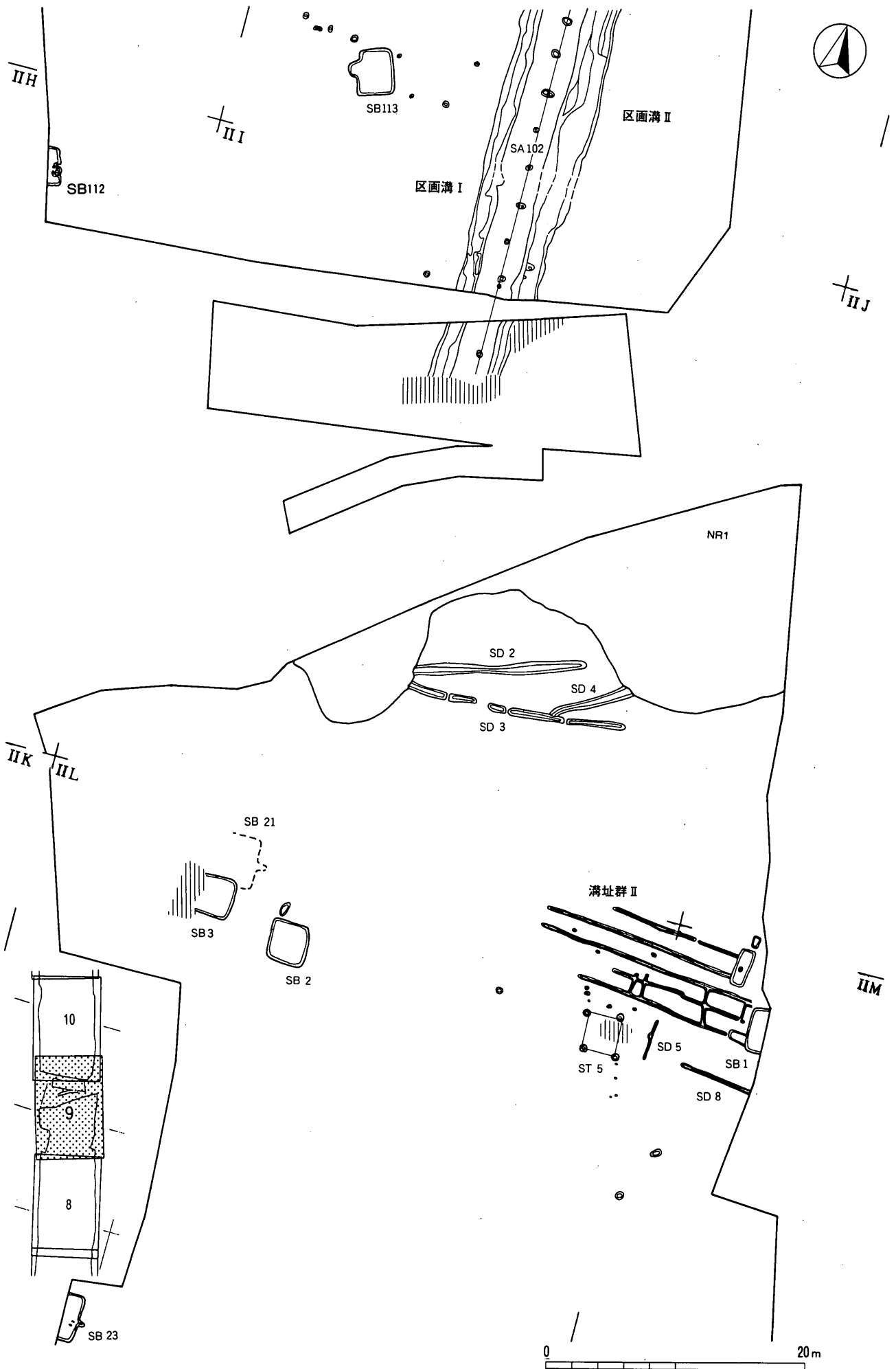

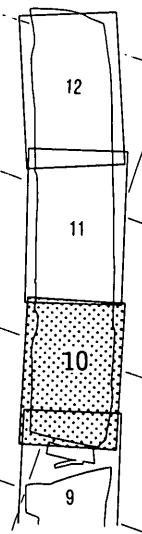
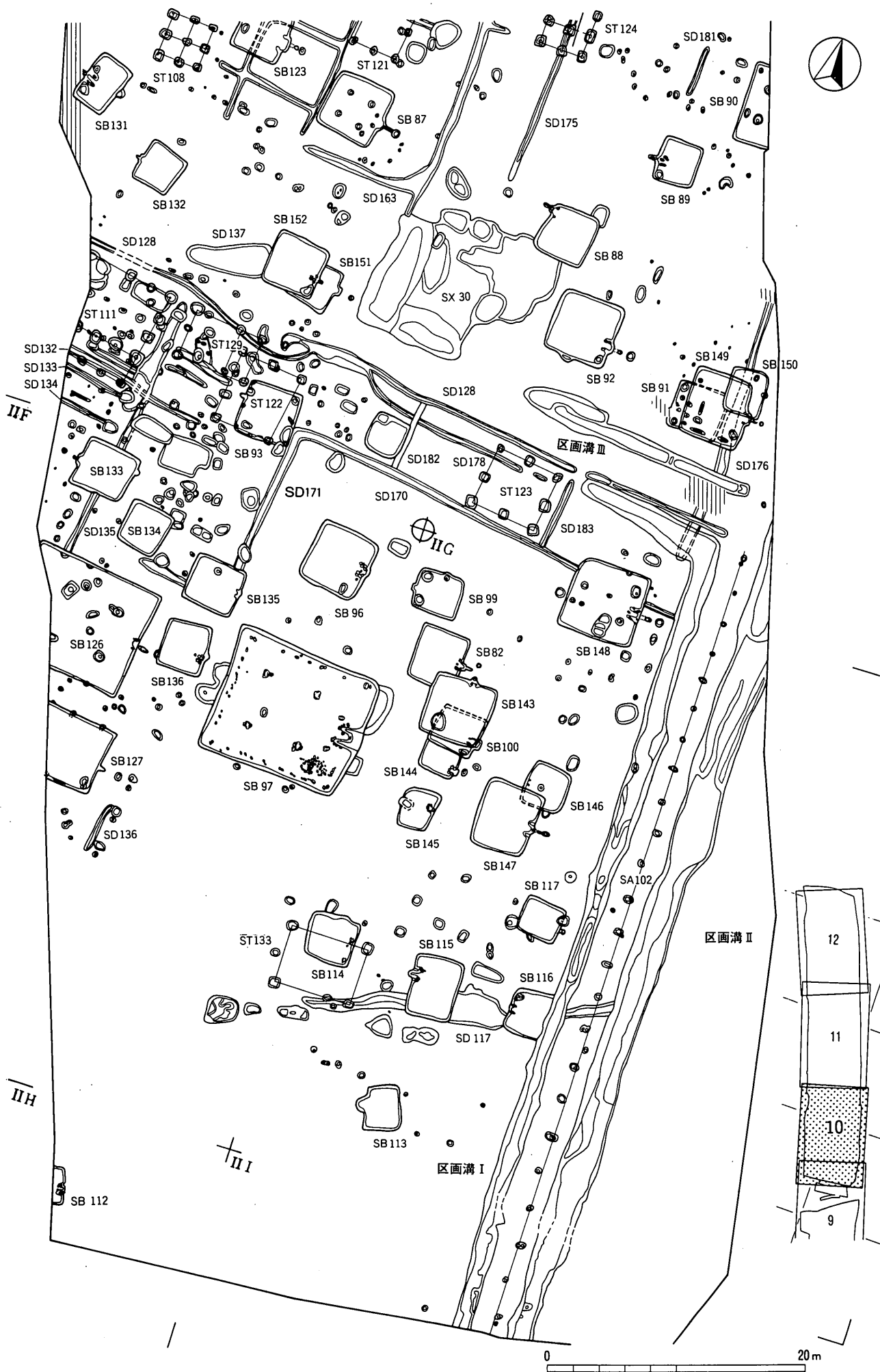

0 20 m

図版11 古代遺構実測図

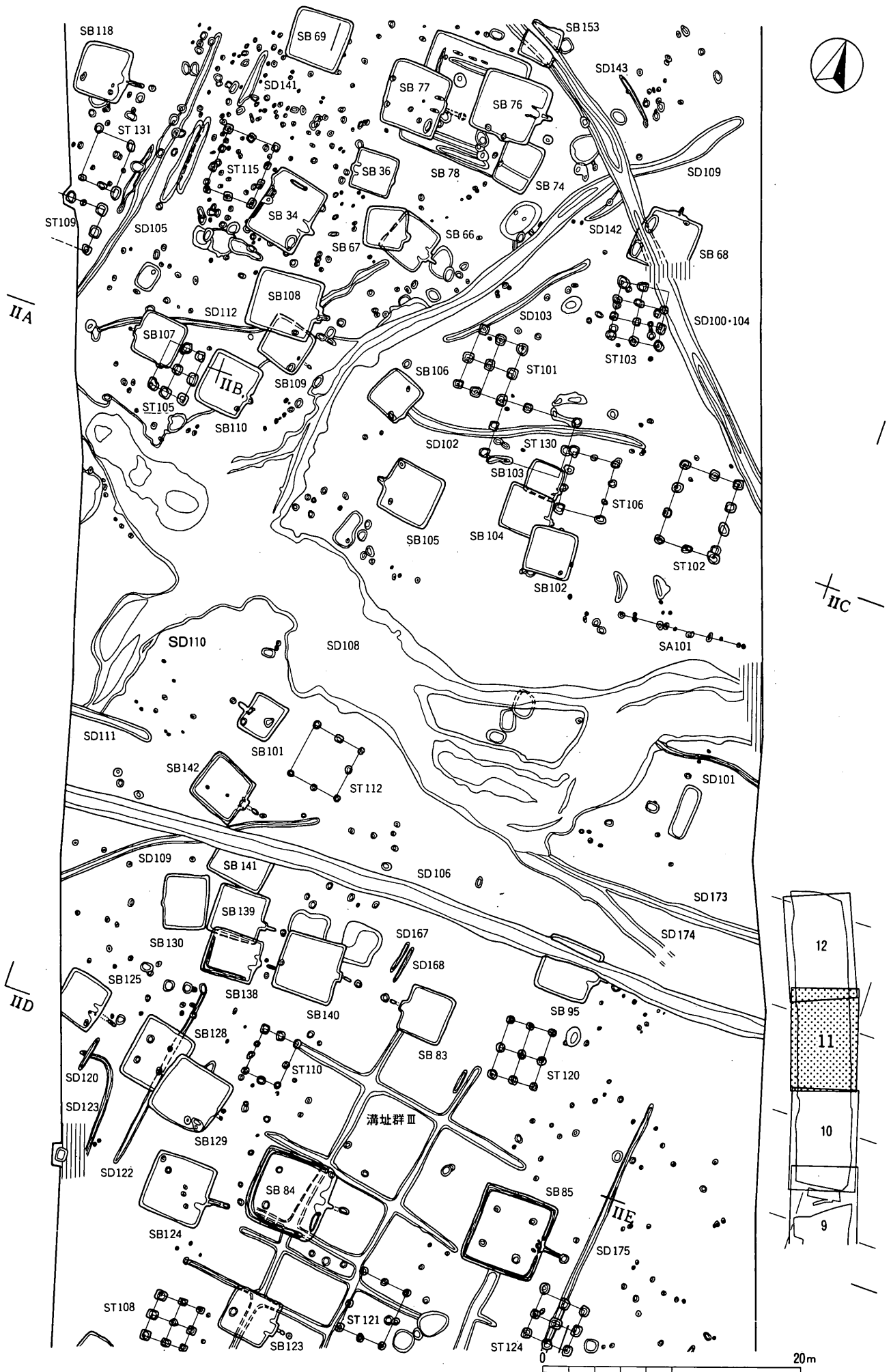



図版13 古代遺構割付図

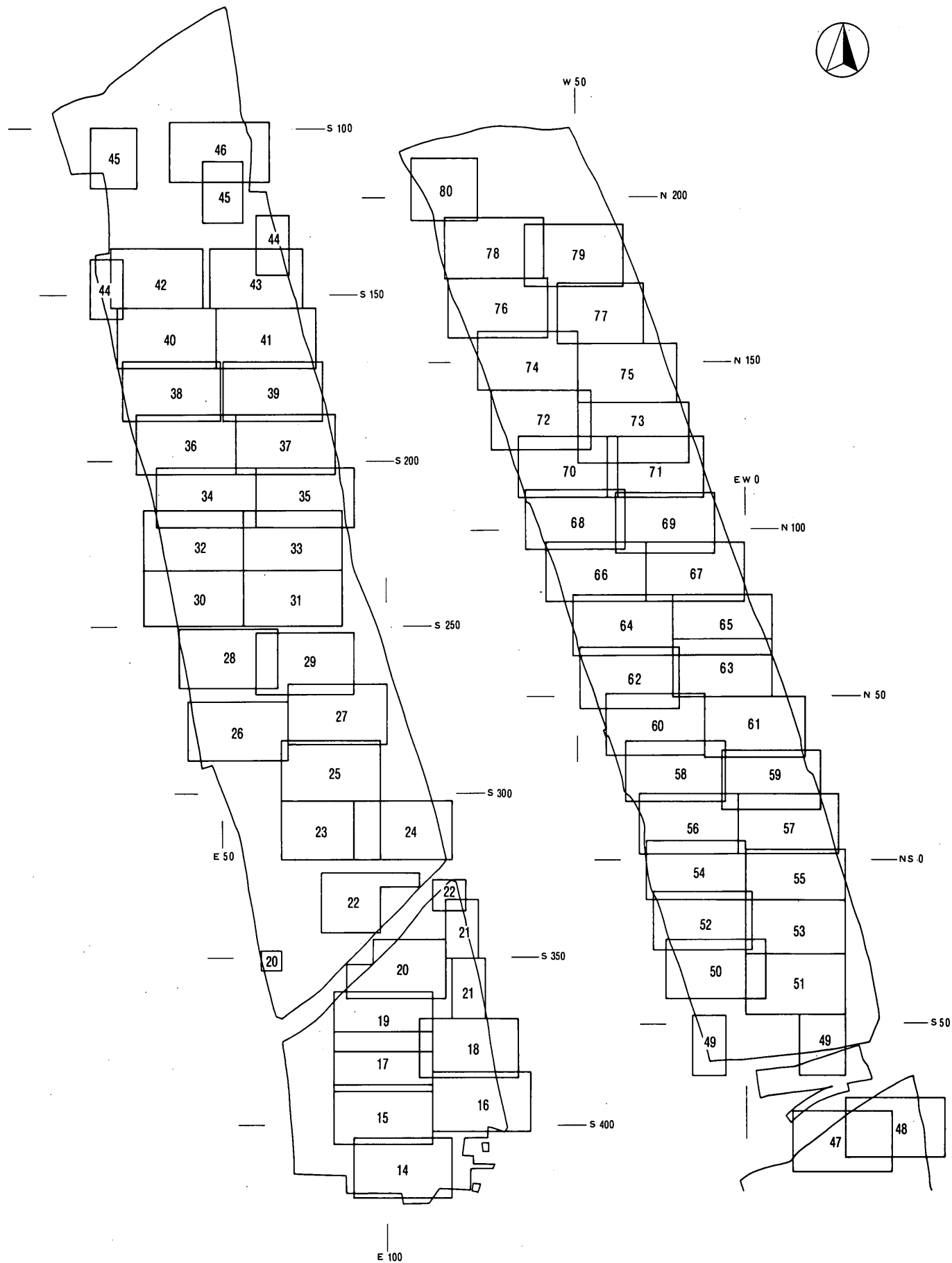

チャート内の数字は図版番号を表す

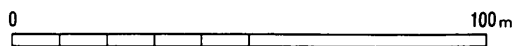

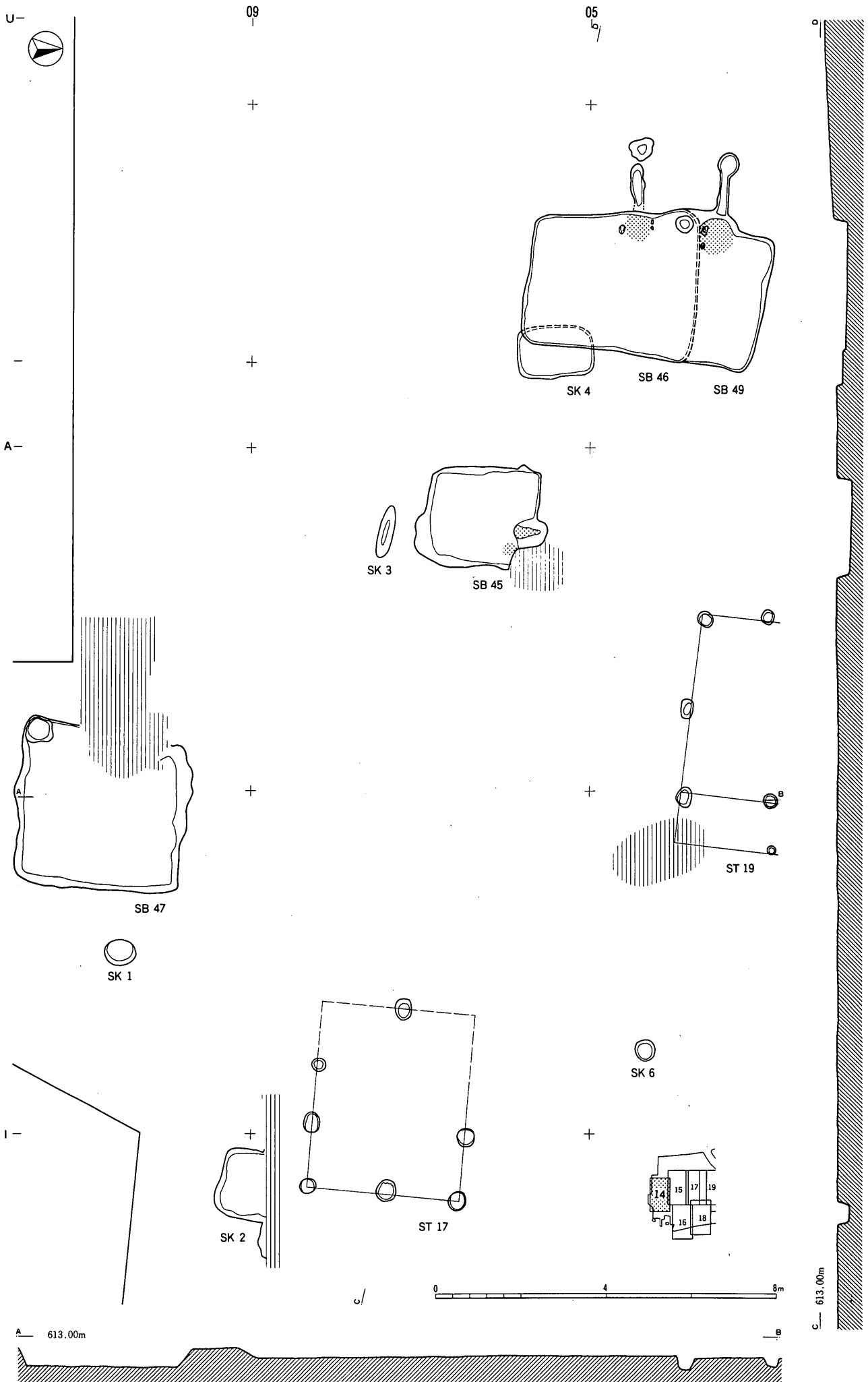

図版15 古代遺構実測図

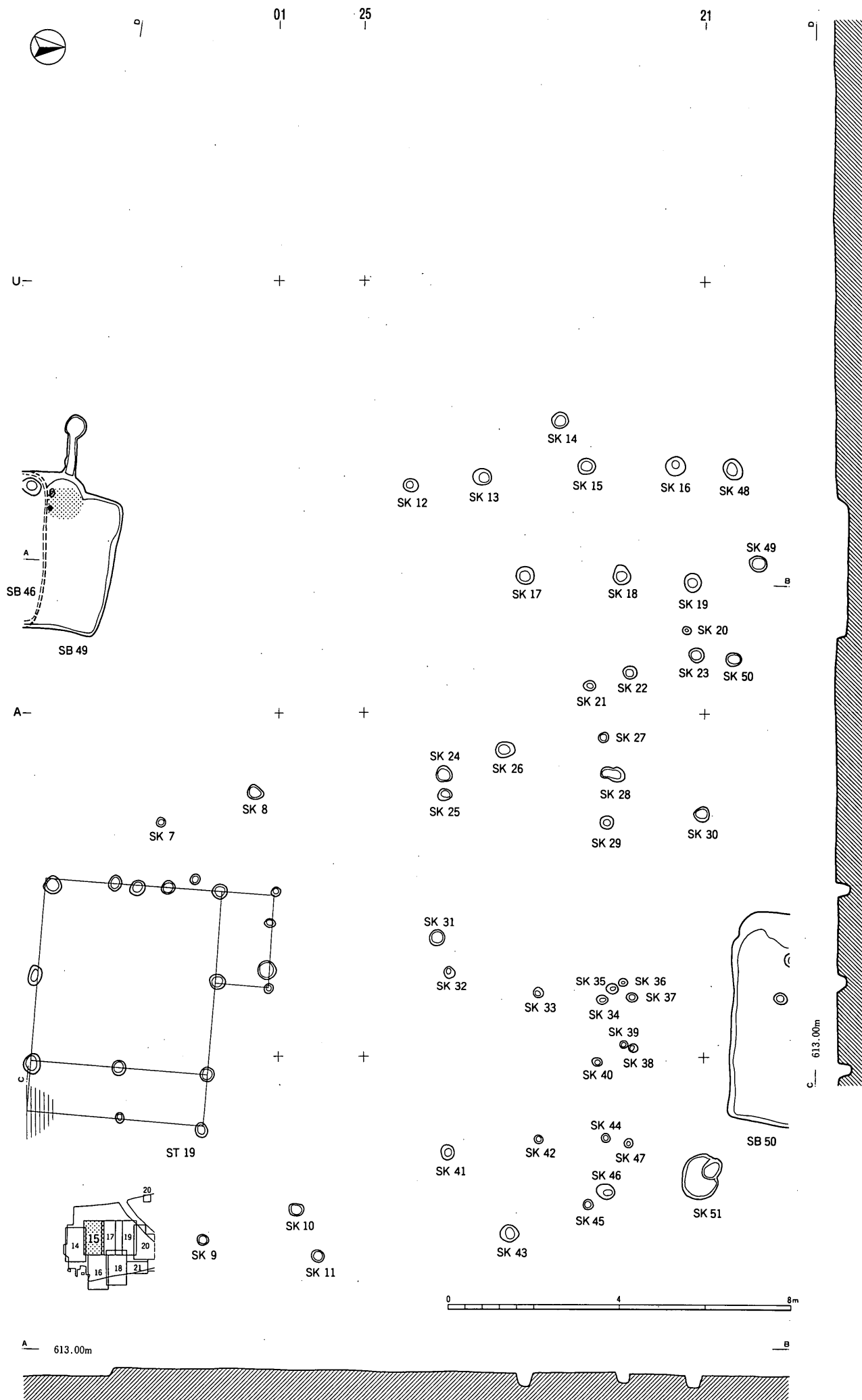



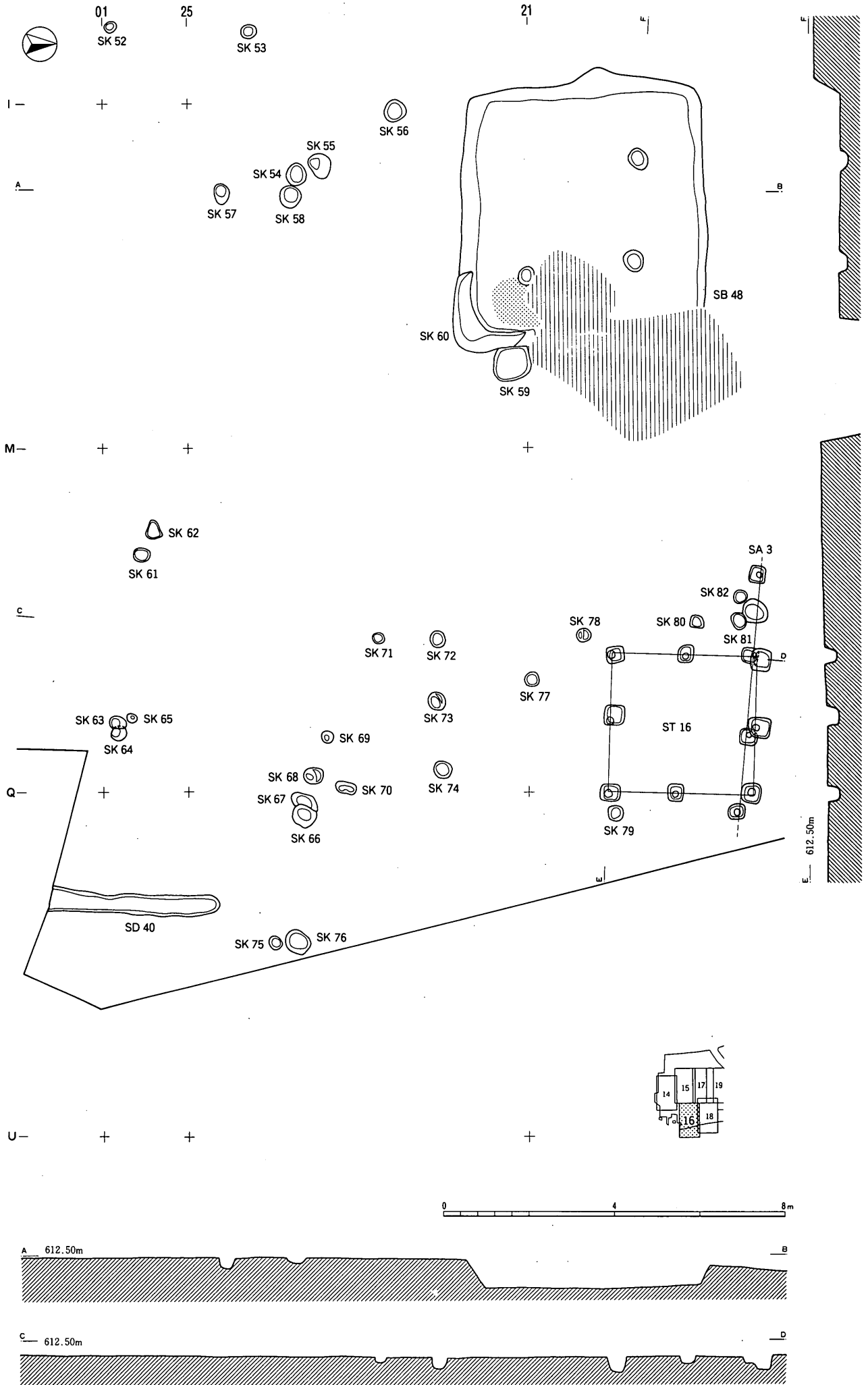

图版17 古代遺構実測図

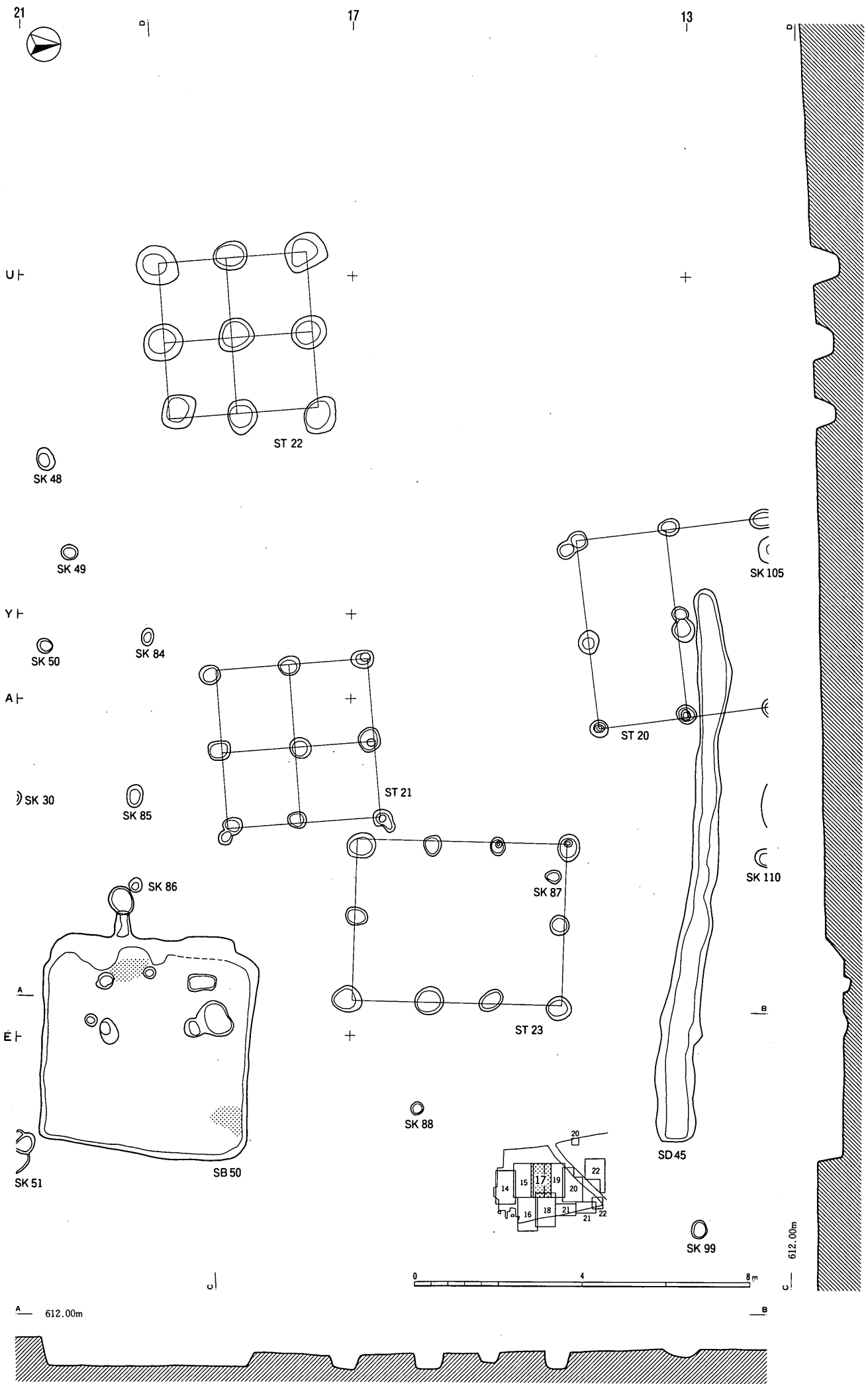

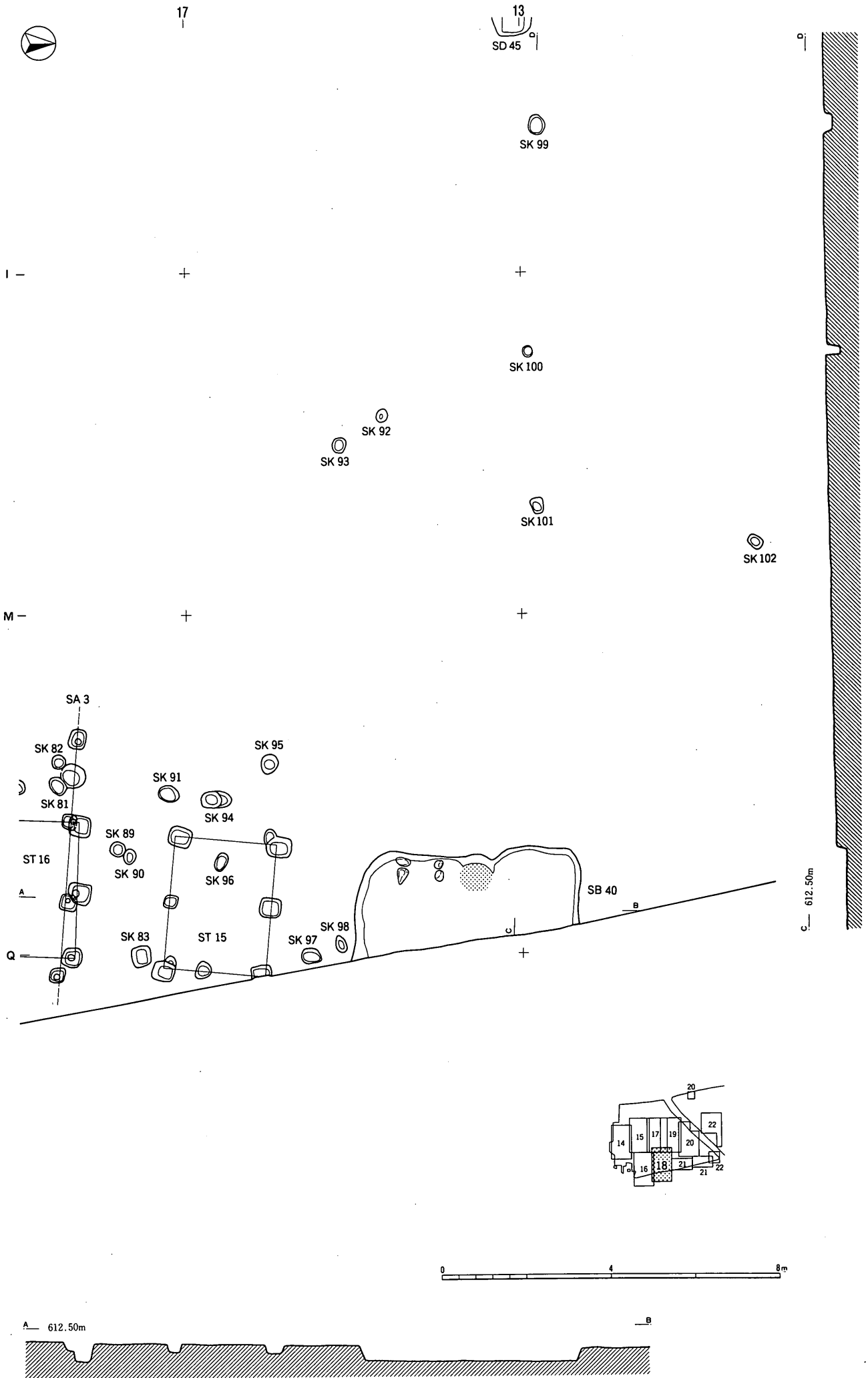

A 612.50m

B

c 612.50m

0 4 8m

図版19 古代遺構実測図

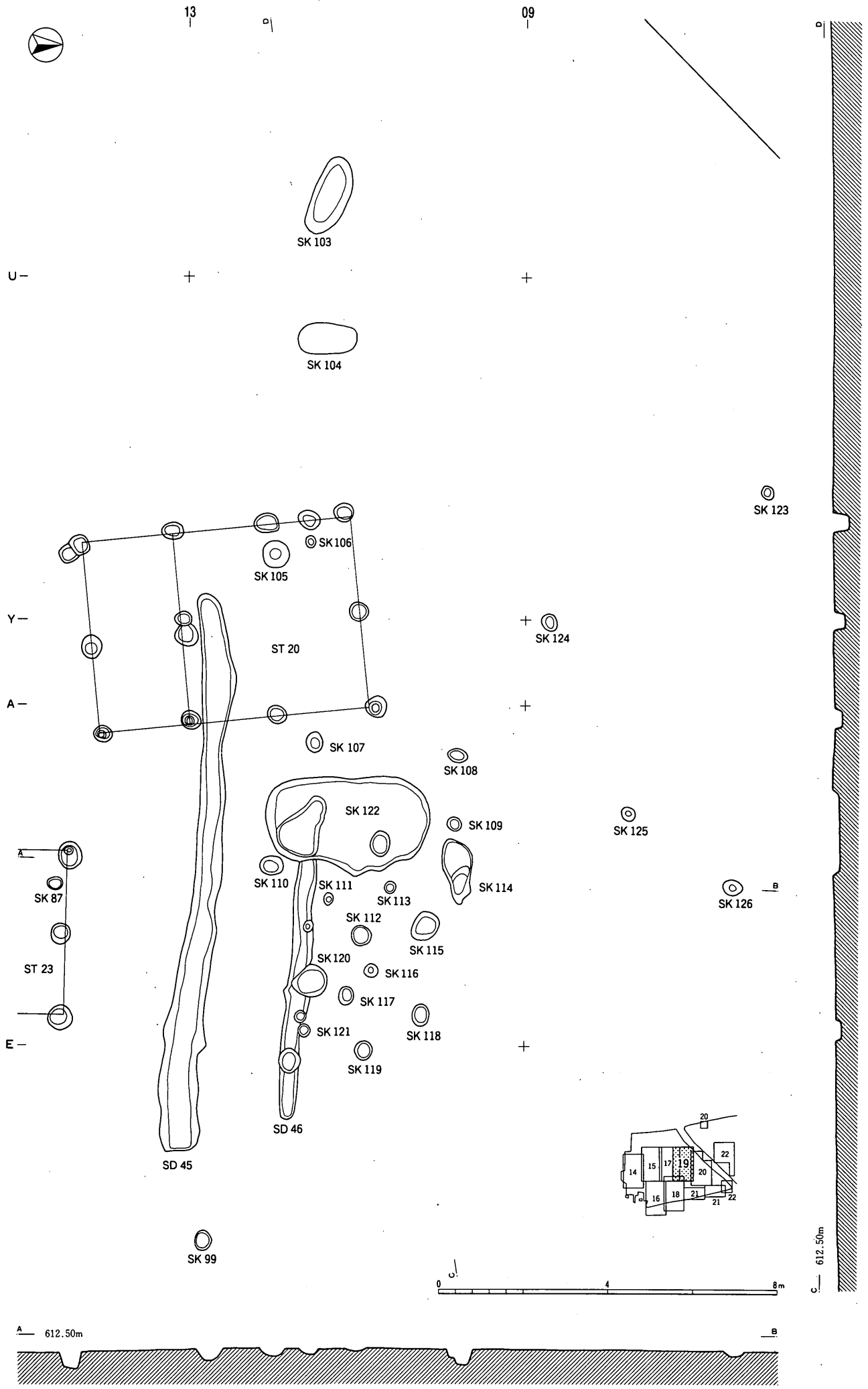

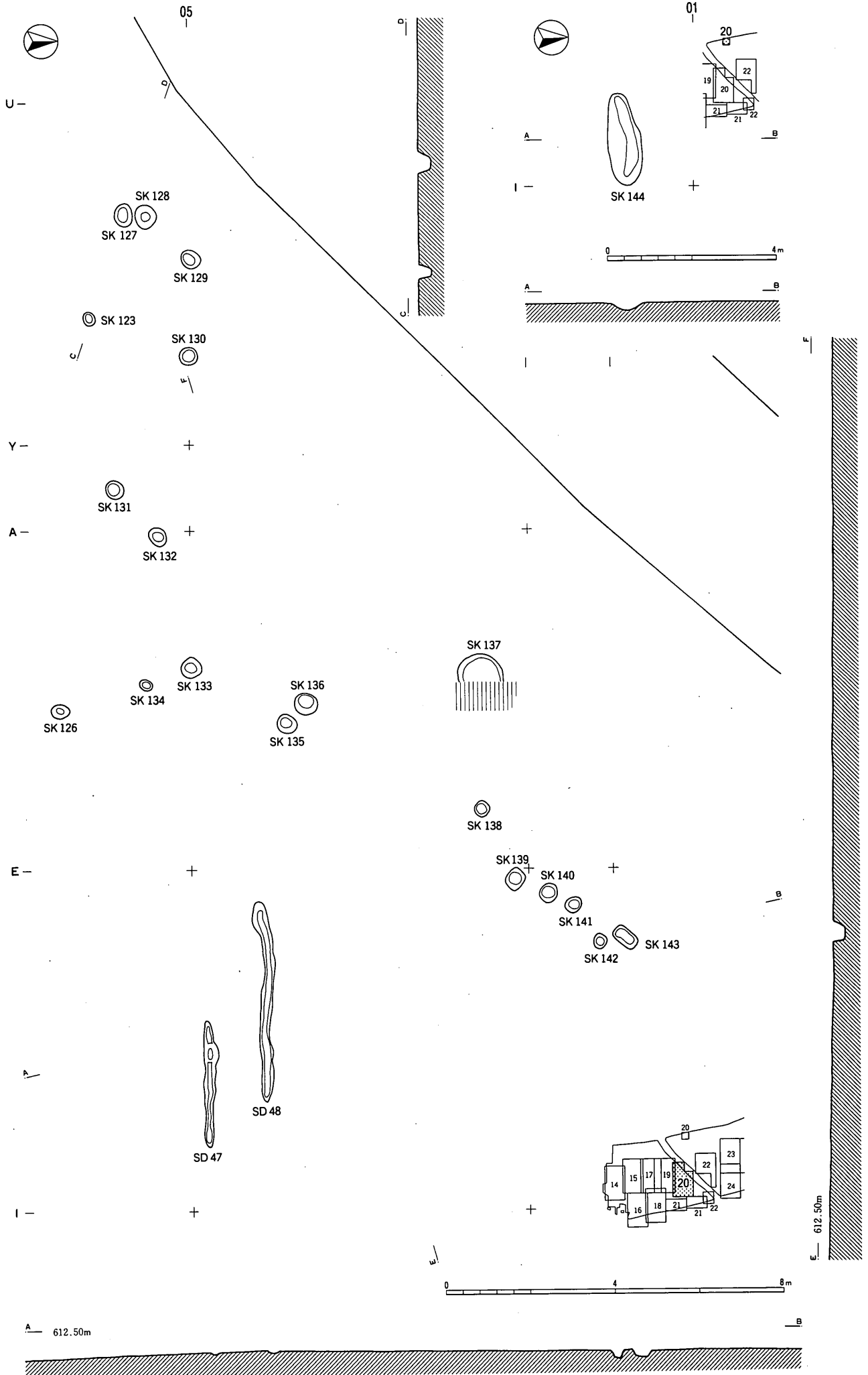

図版21 古代遺構実測図

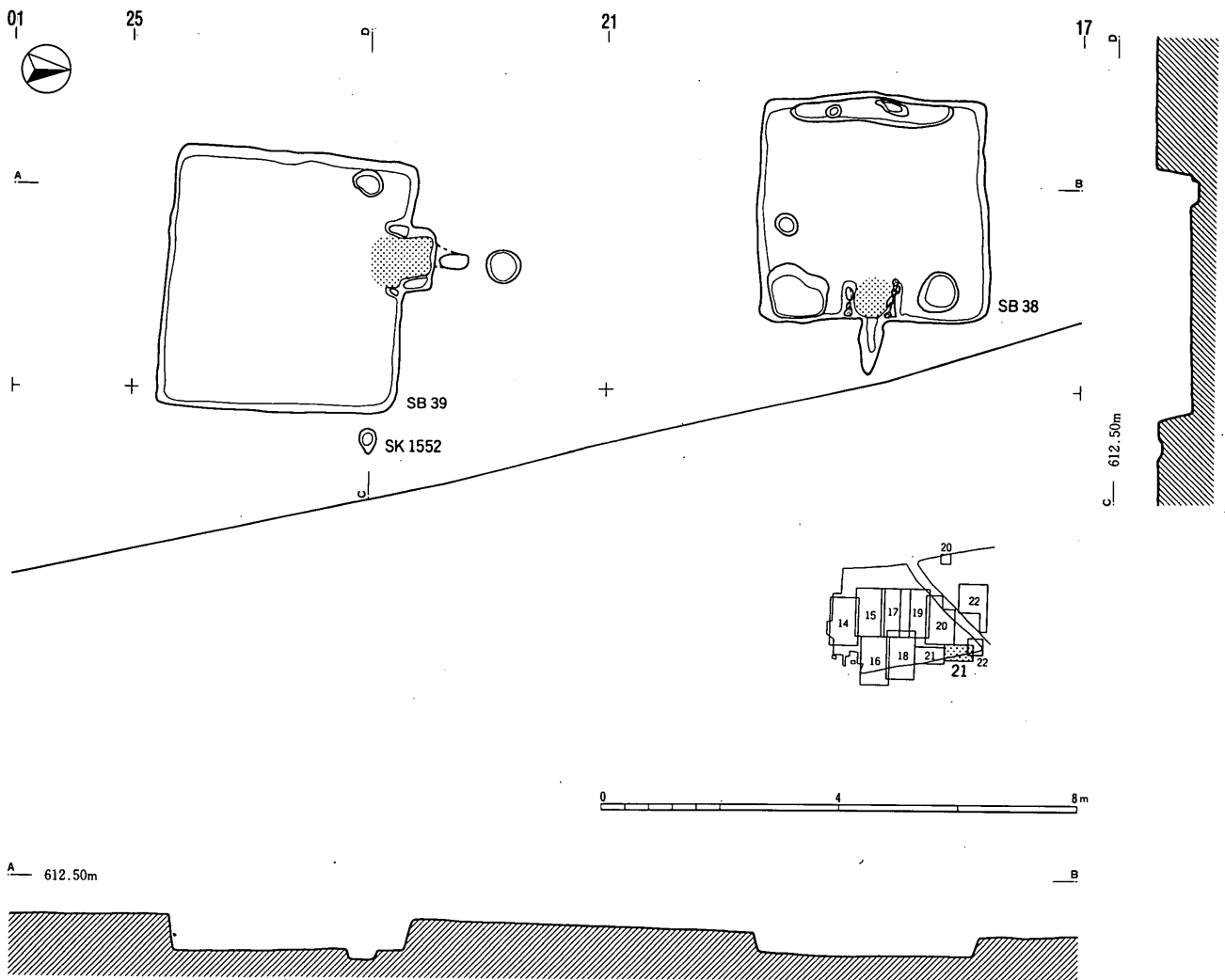
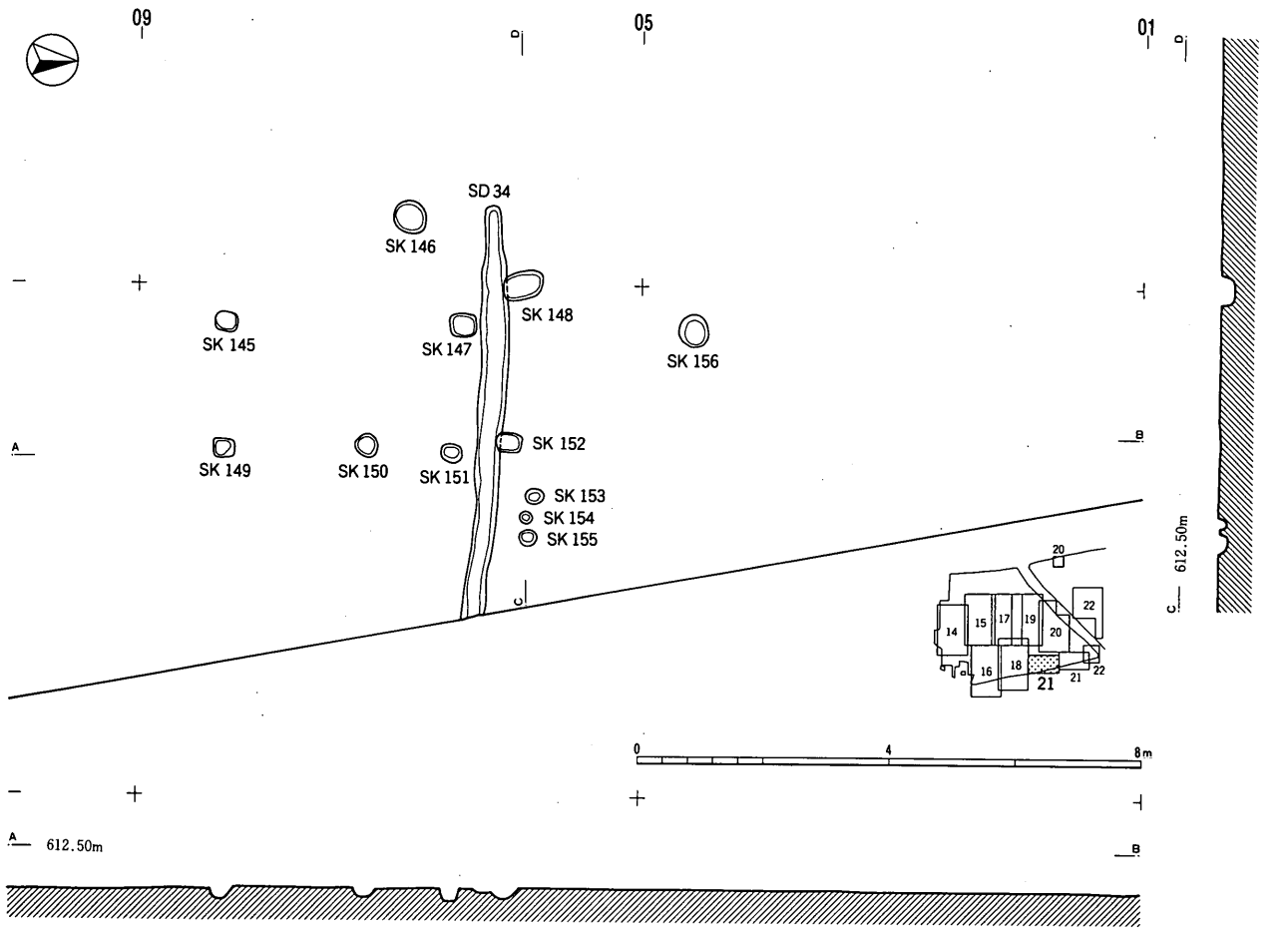

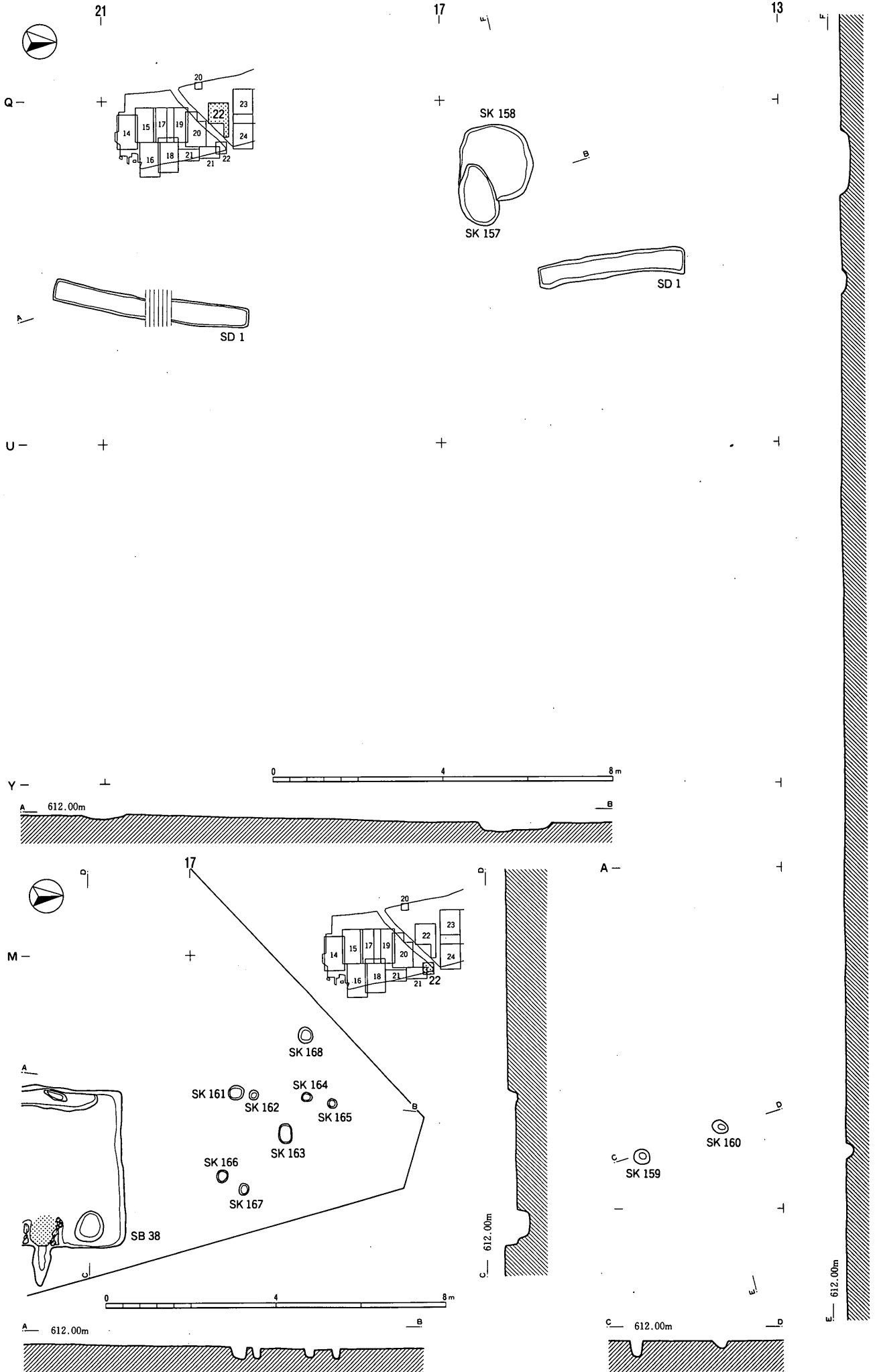

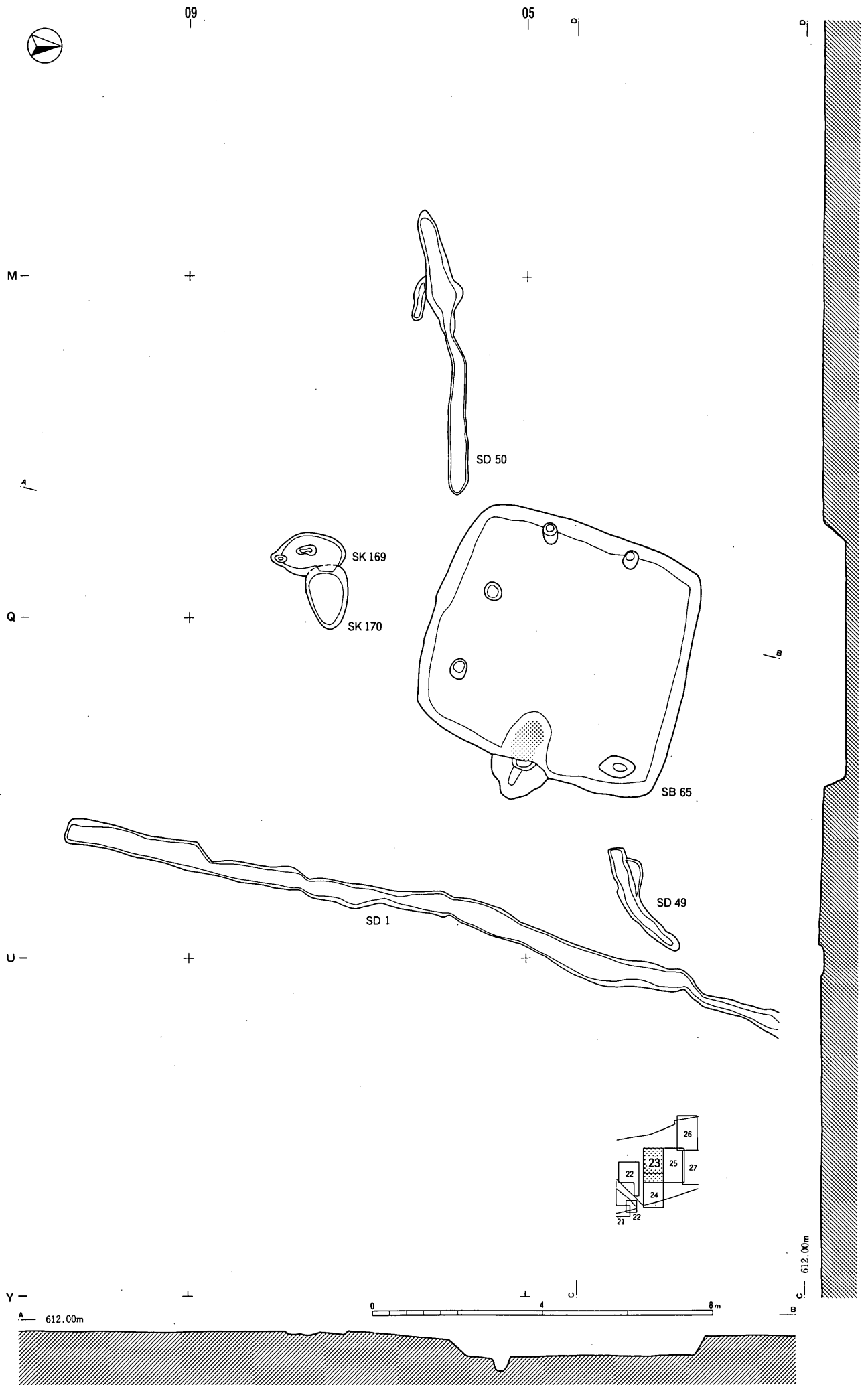



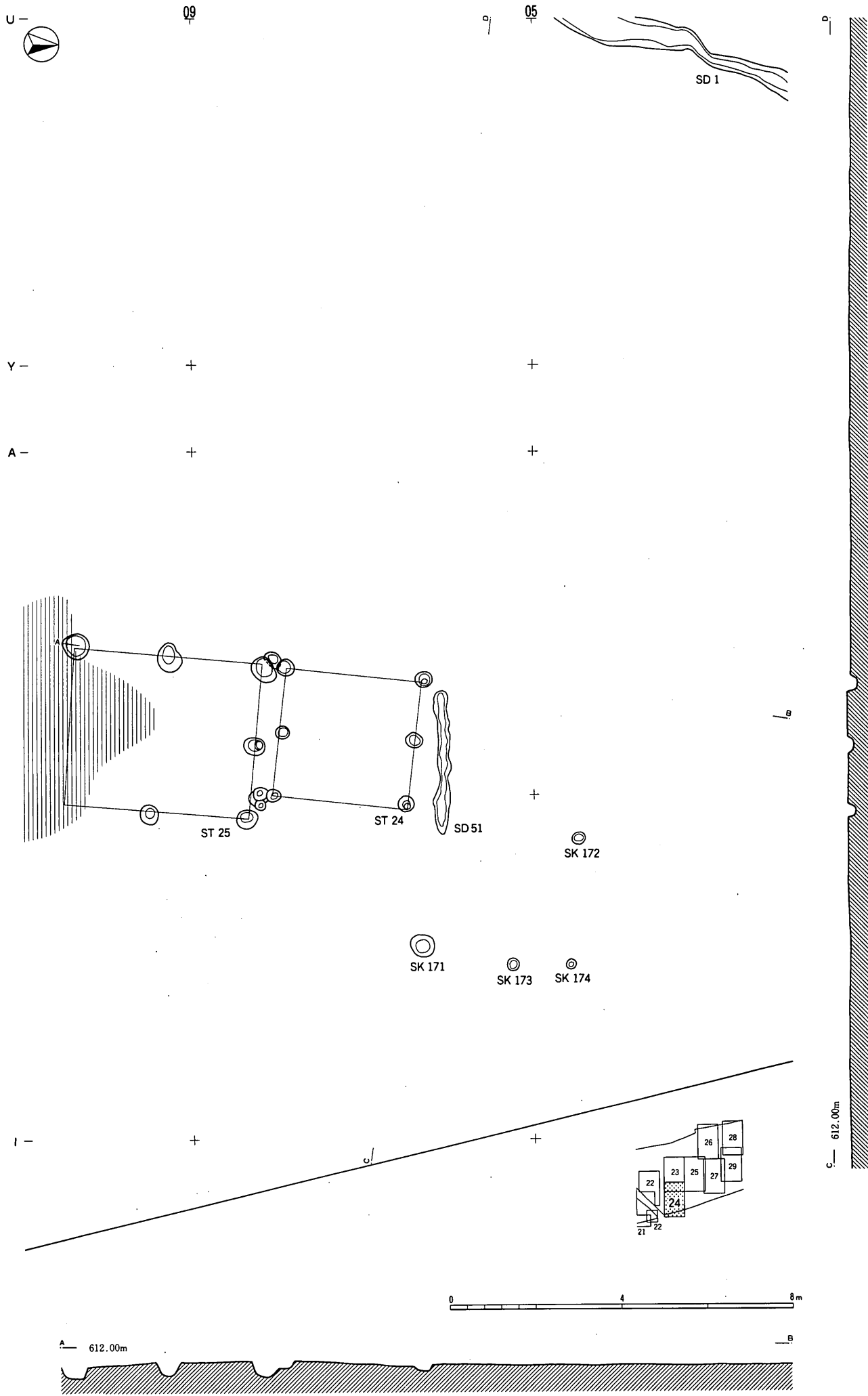

図版25 古代遺構実測図

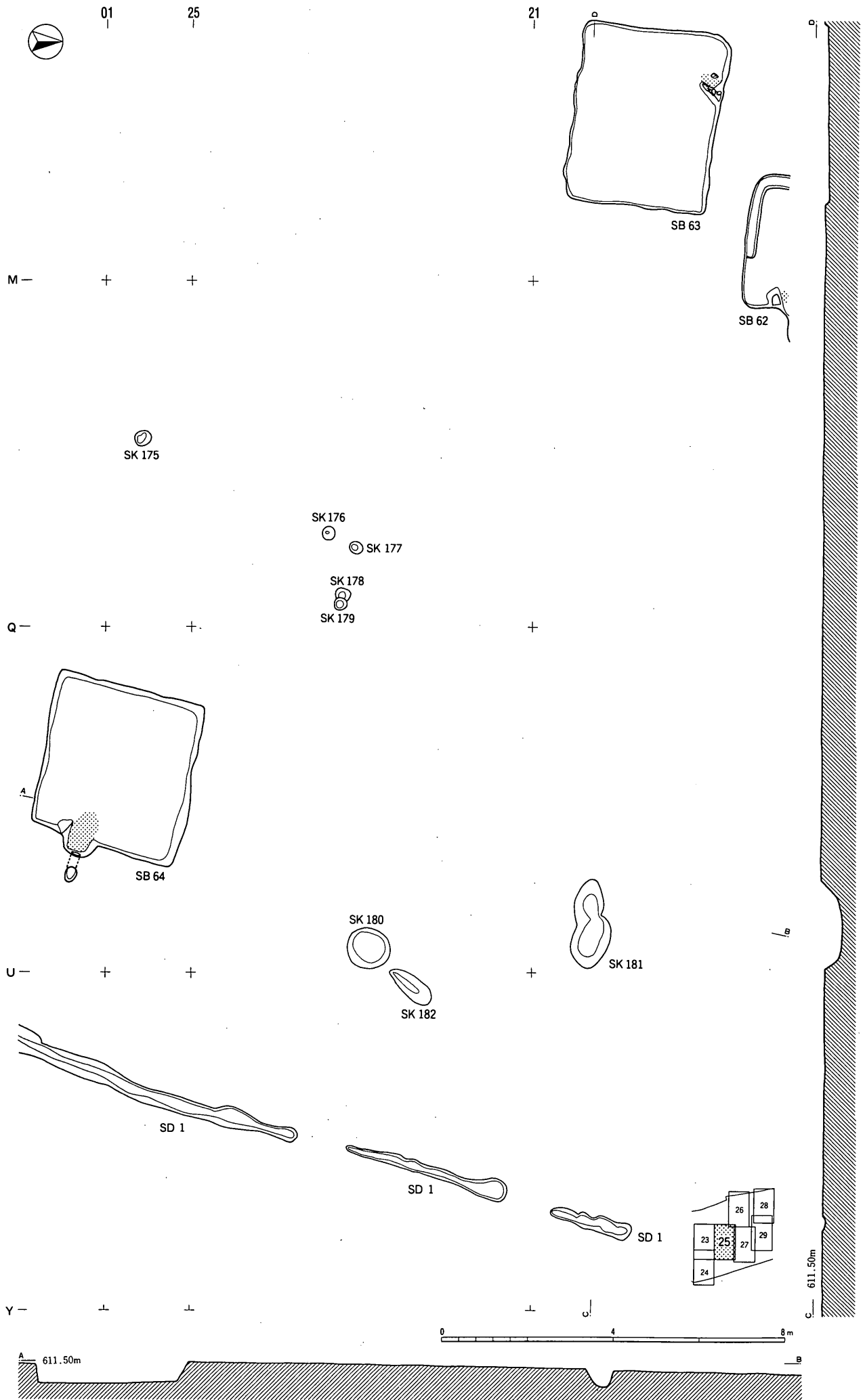

U<sup>21</sup>

17

13

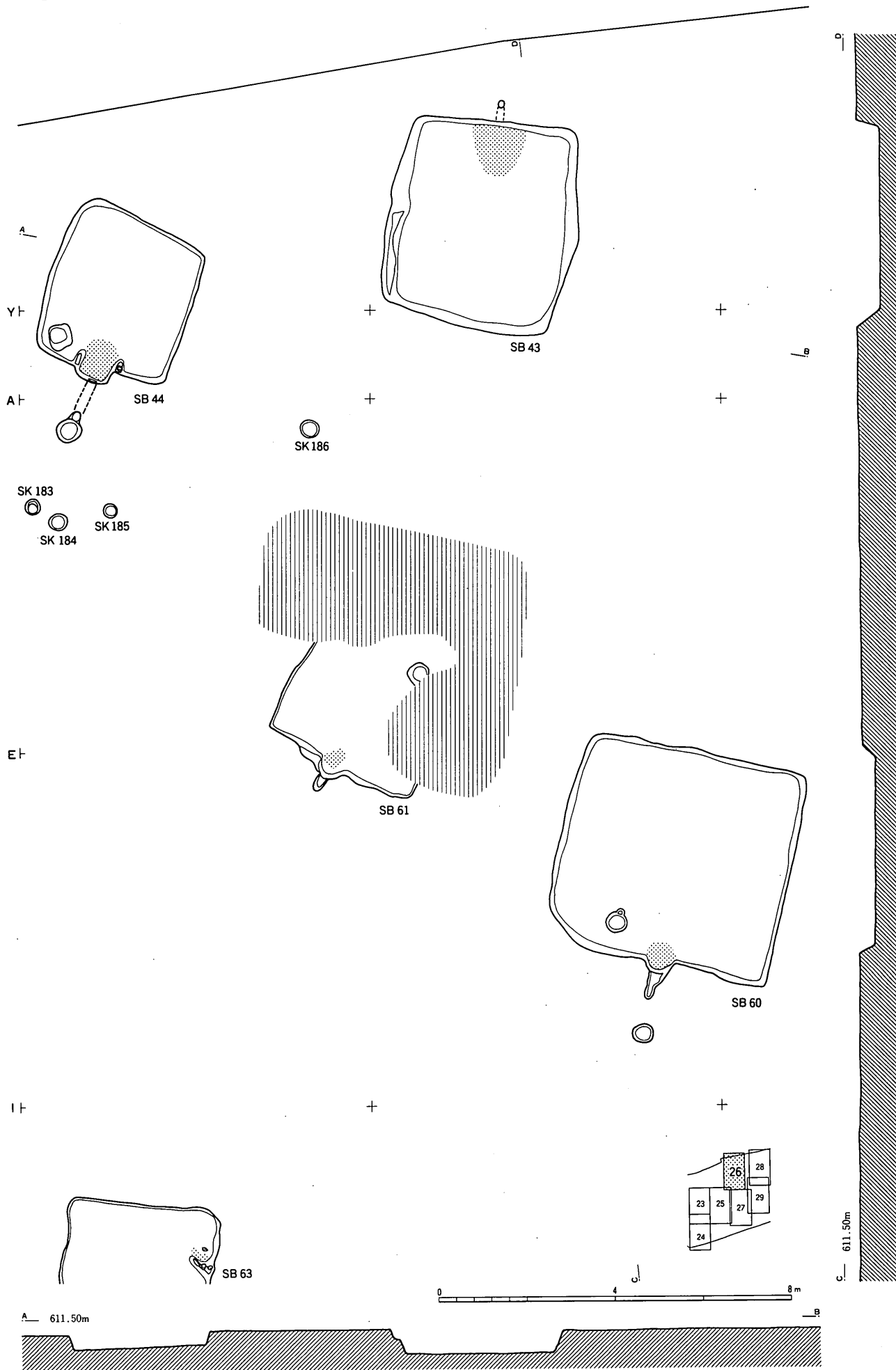

C 611.50m

A 611.50m

0 4 8 m

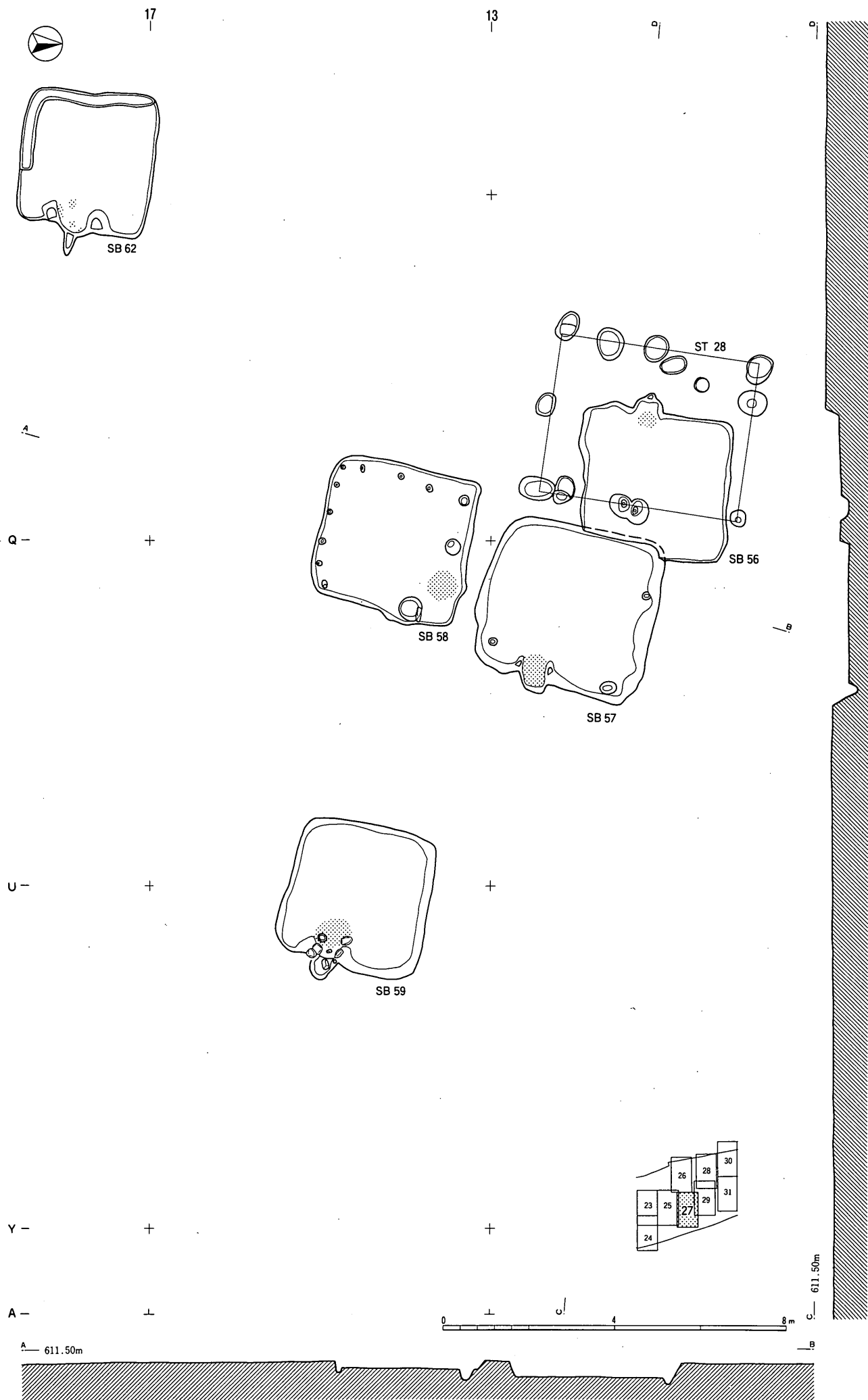

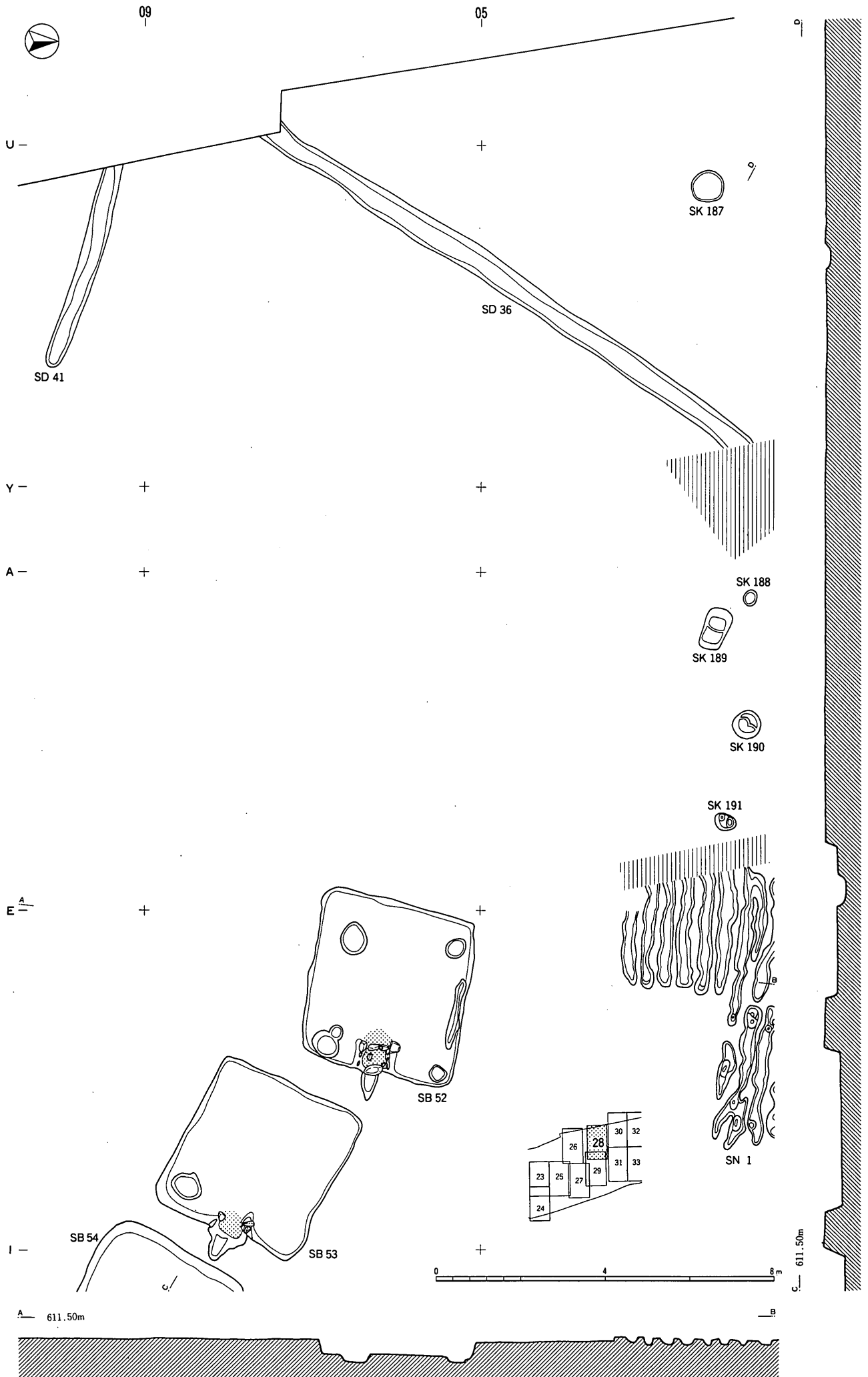

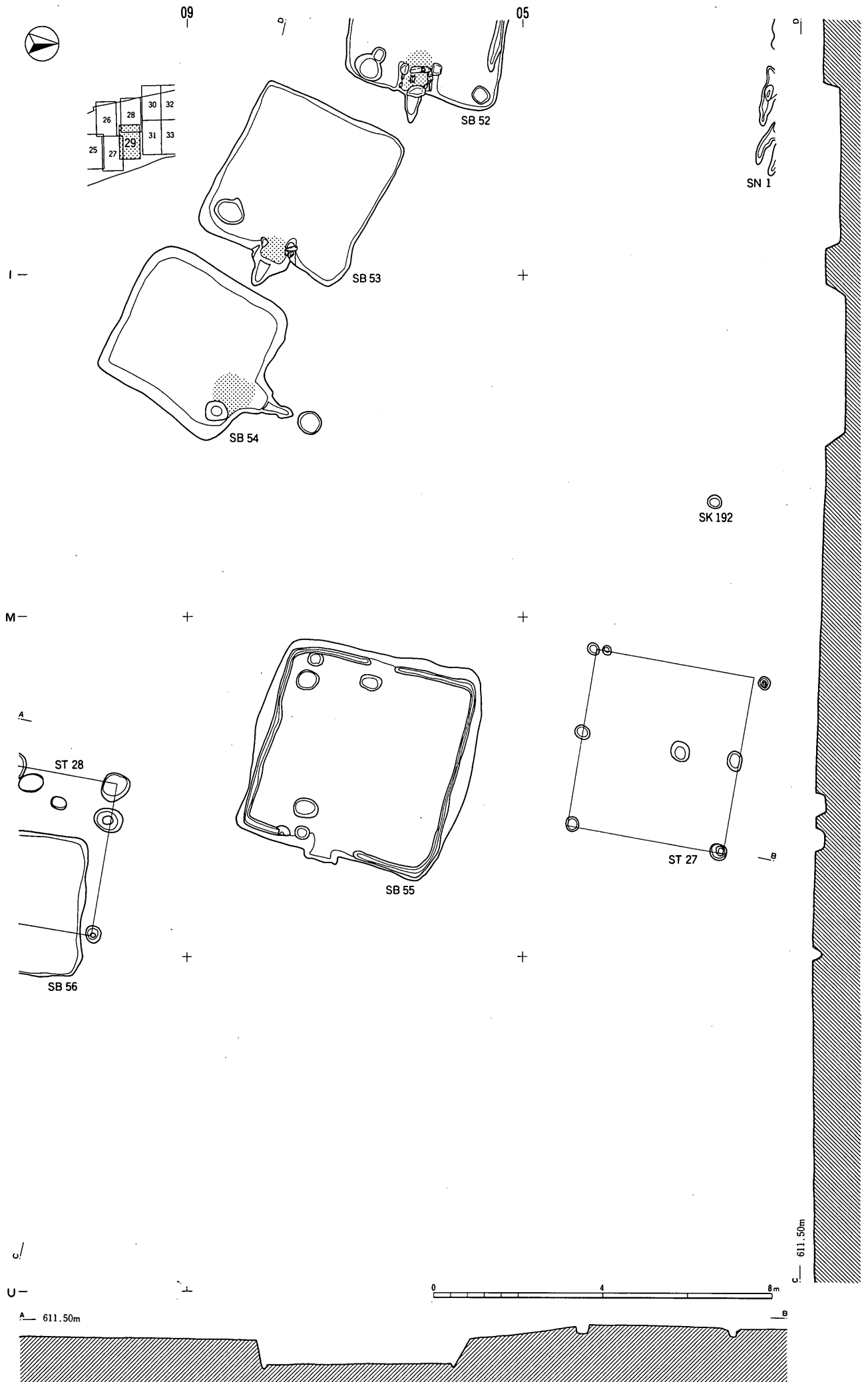

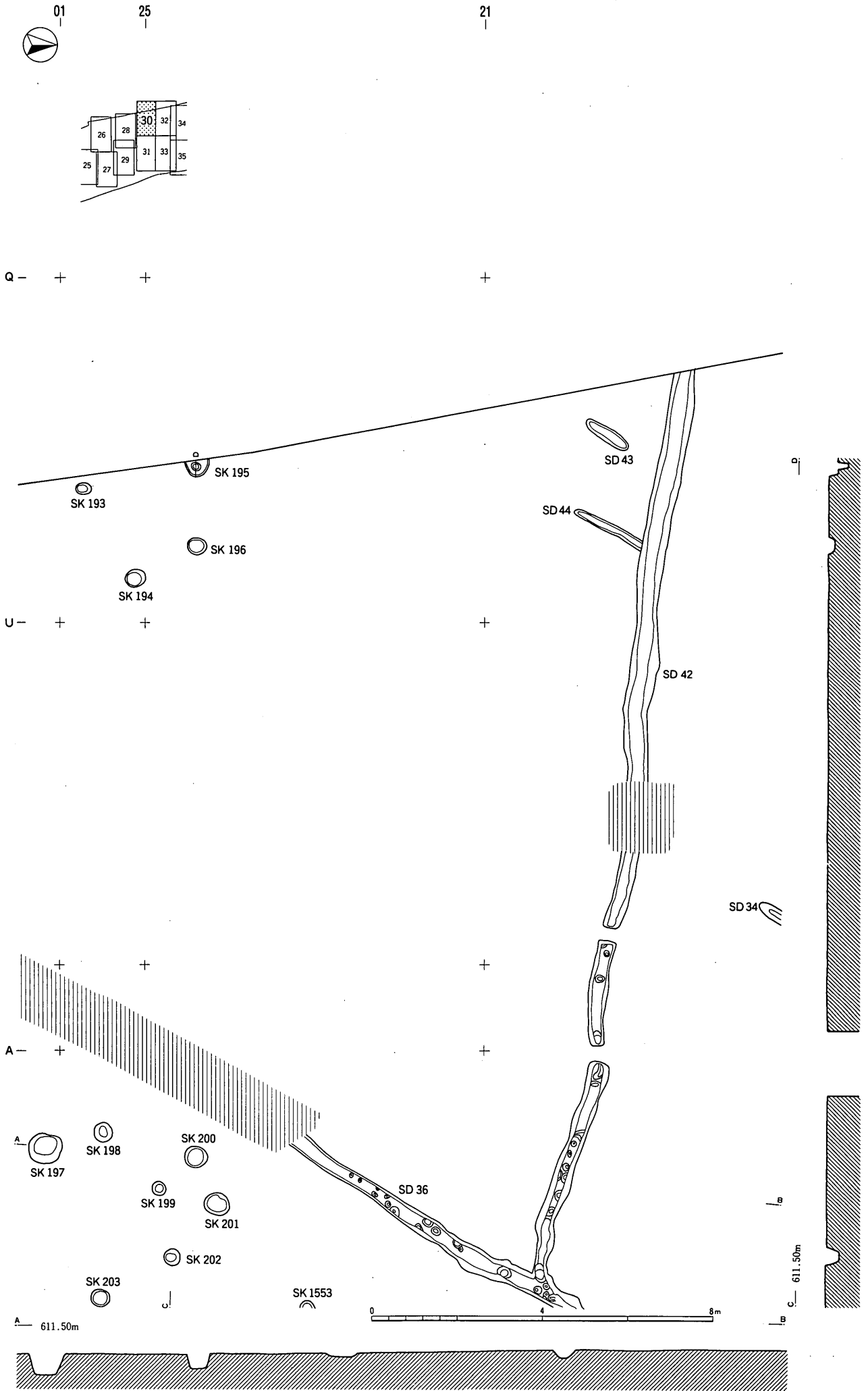

図版31 古代遺構実測図

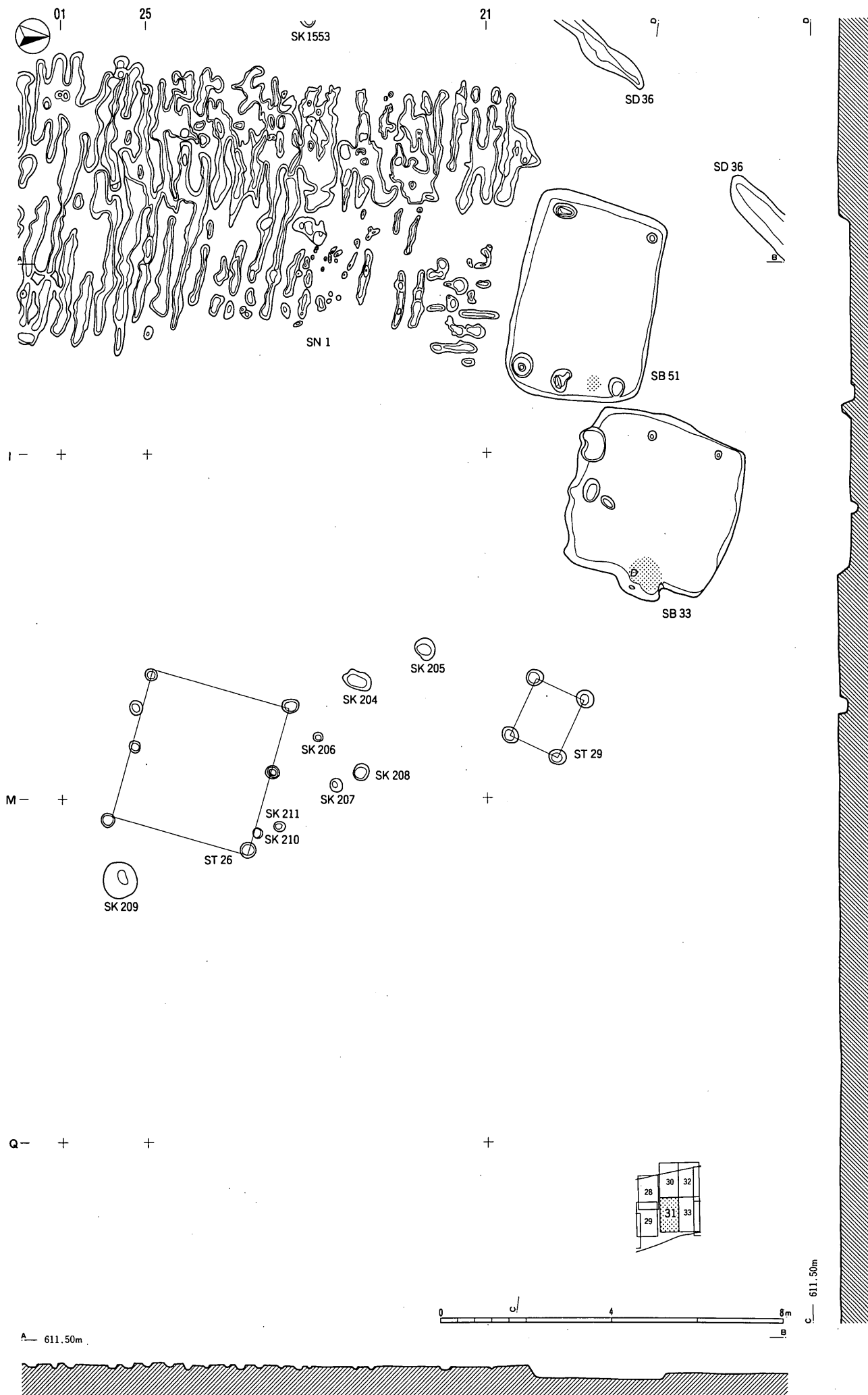



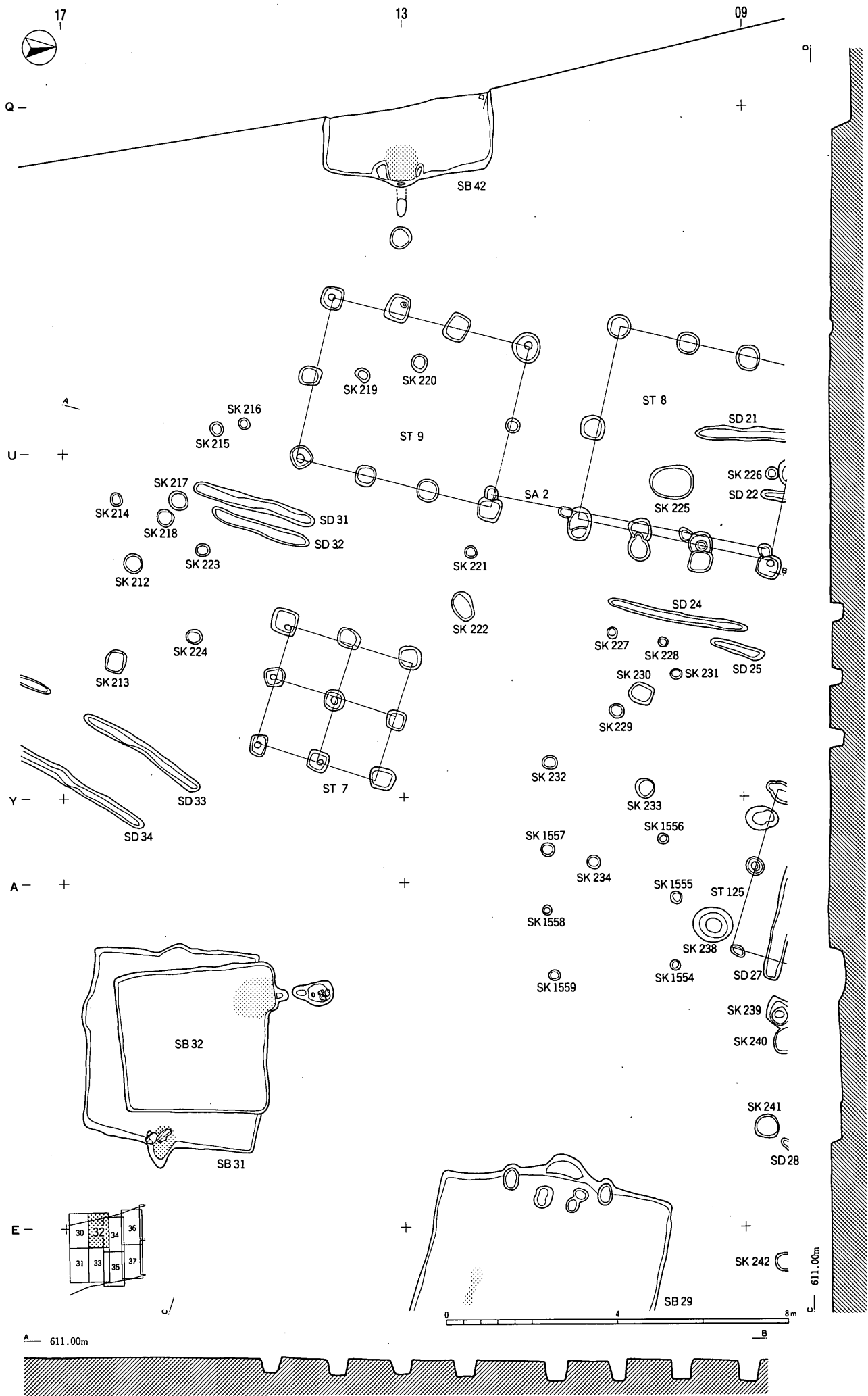

图版33 古代遺構実測図

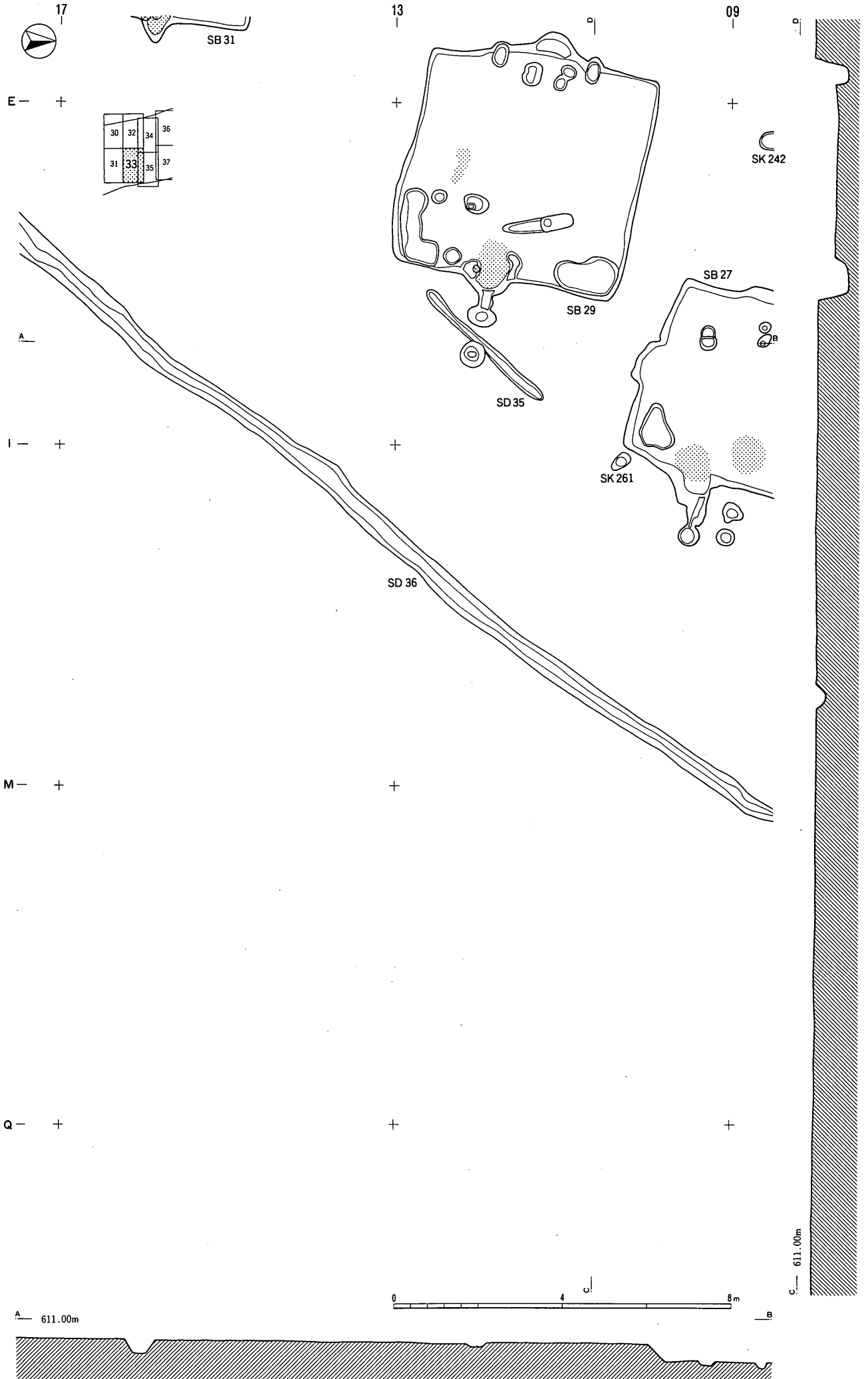



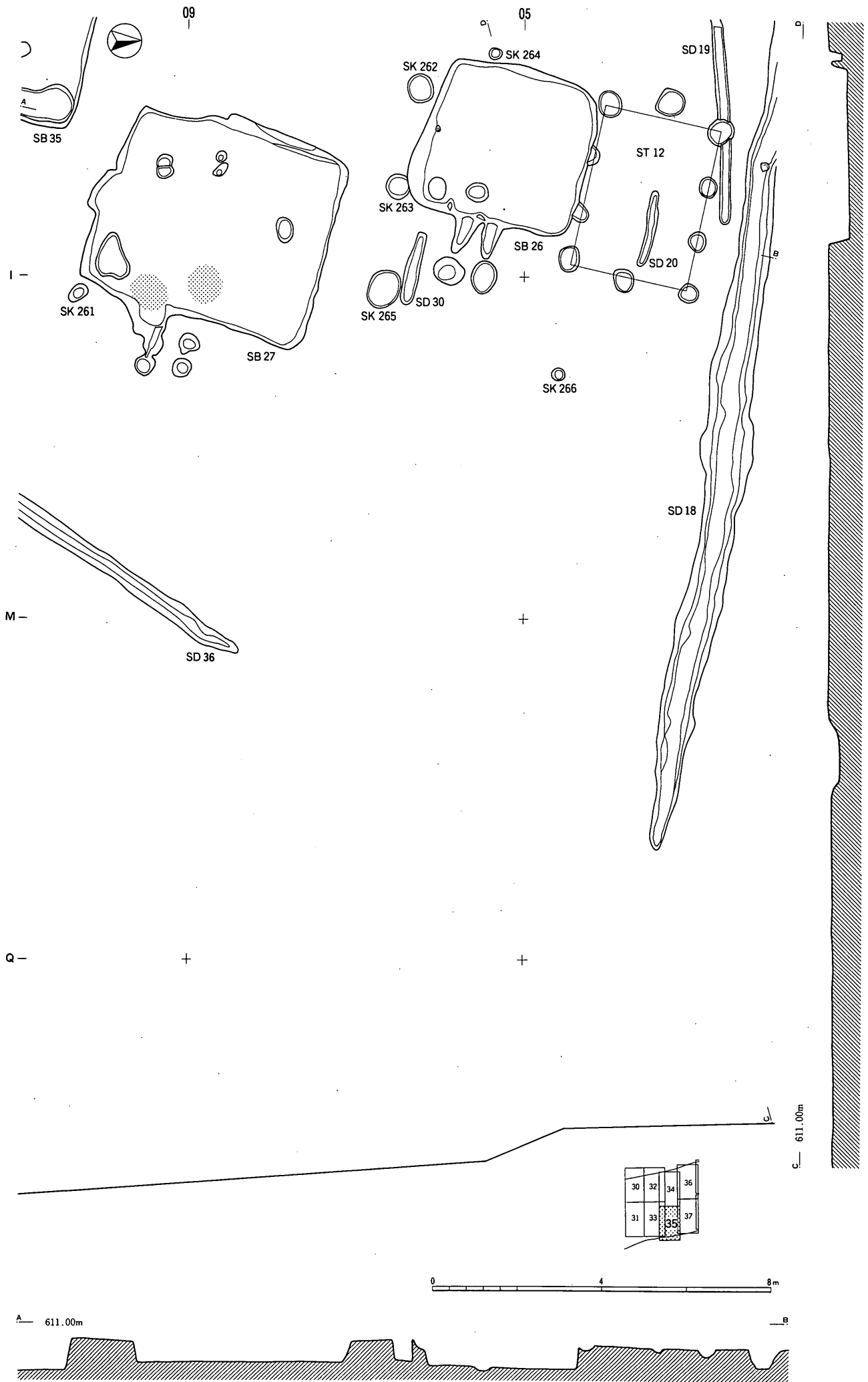

01

25

21

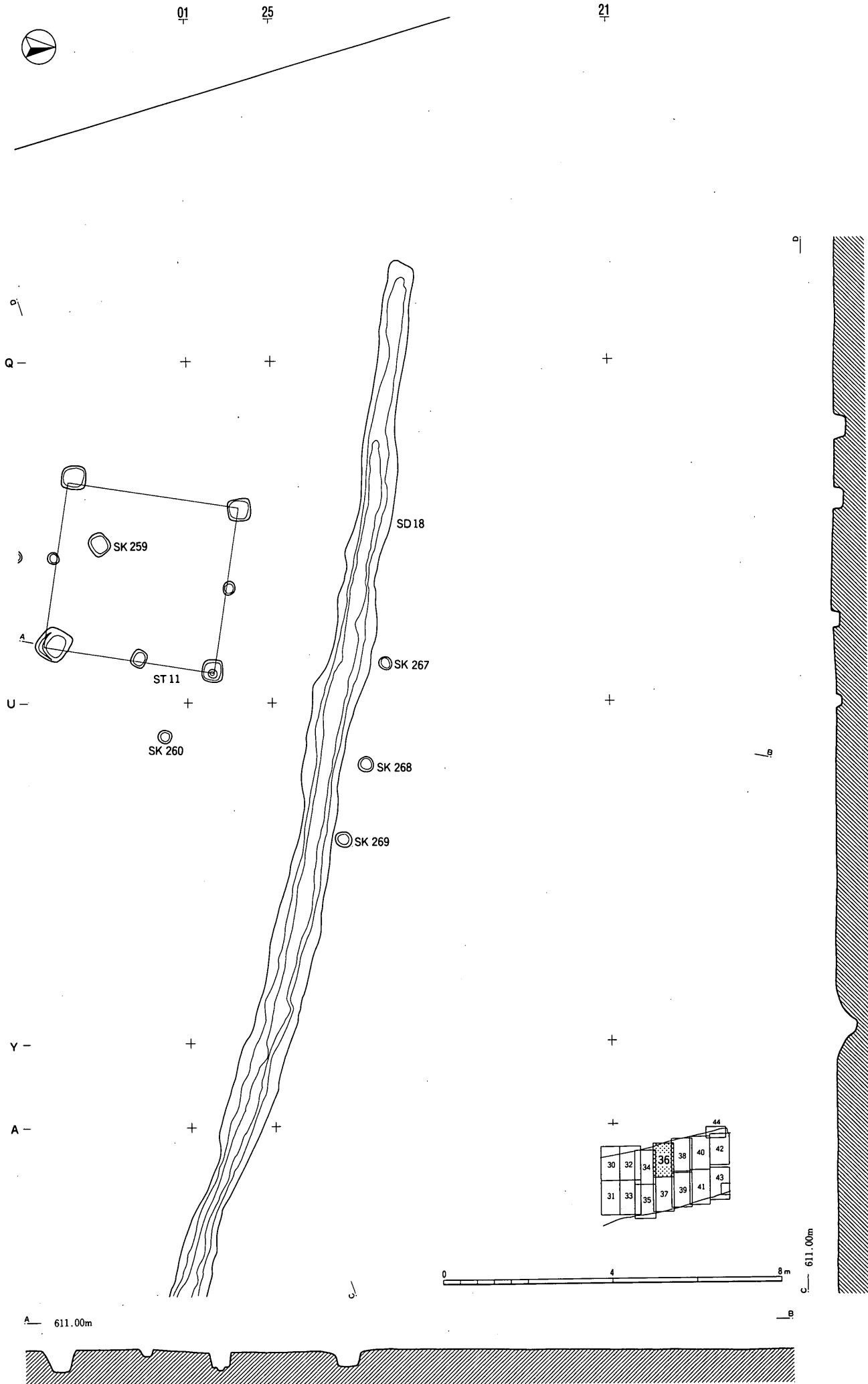

9

Q-

)

A

U-

Y-

A-

SD 18

SK 267

SK 268

SK 269

SK 259

ST 11

SK 260

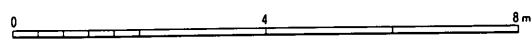
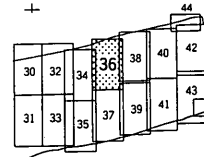

611.00m

611.00m

611.00m

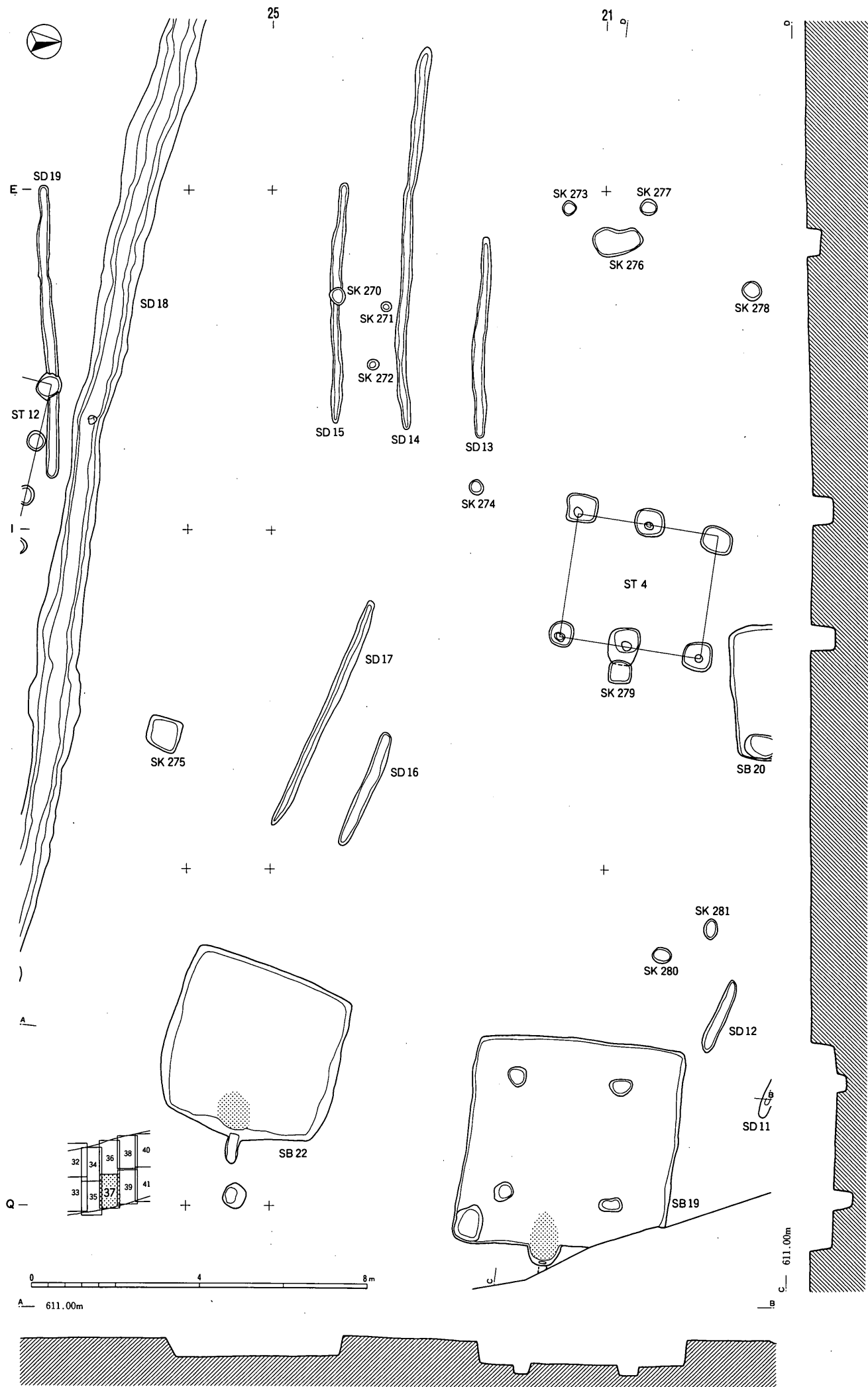

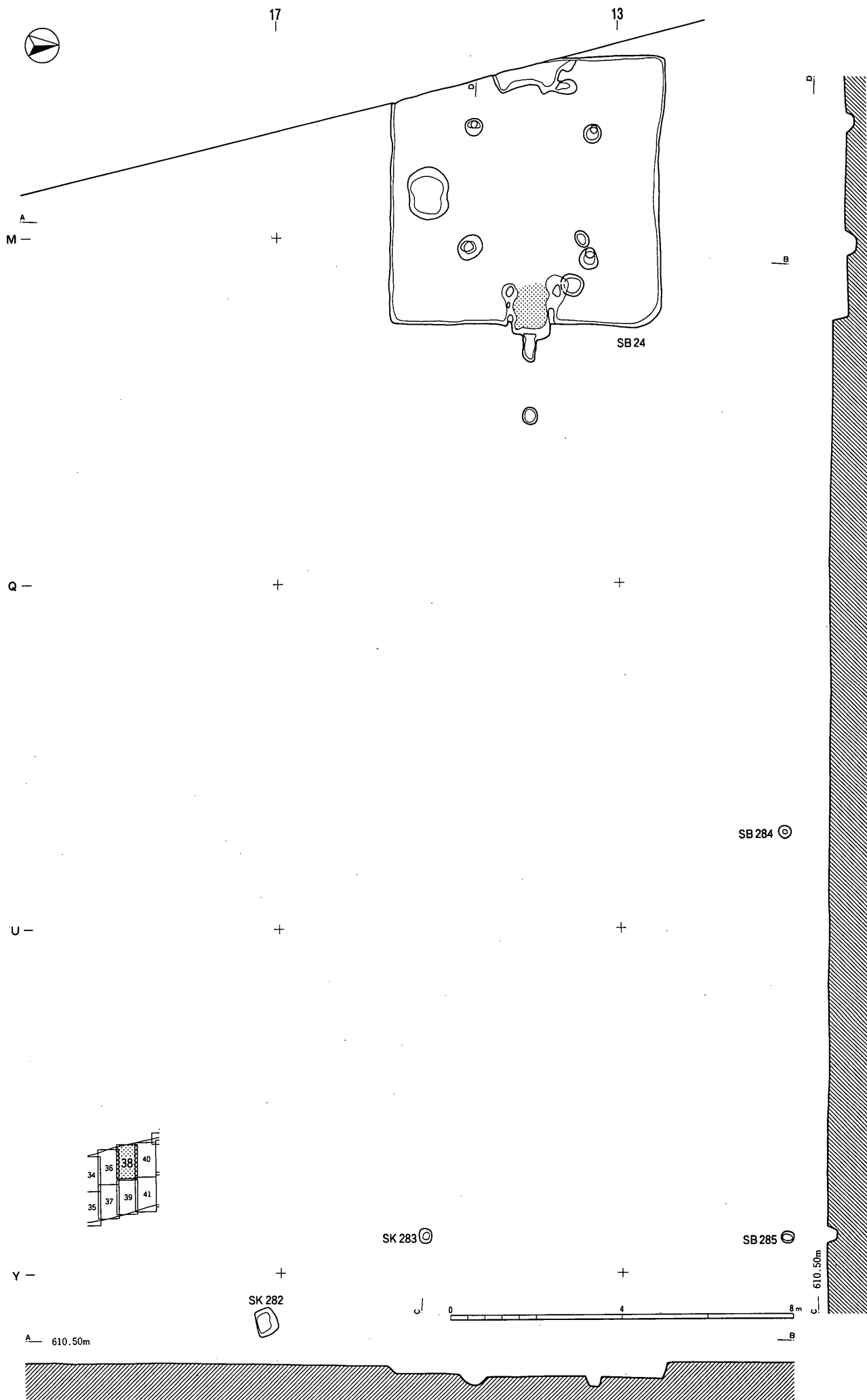

17

13

A  
M -

+

B

SB 24

Q -

+

+

SB 284 ⊙

U -

+

+

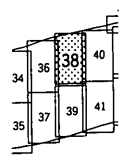

SK 283 ⊙

SB 285 ⊙

Y -

+

+

SK 282

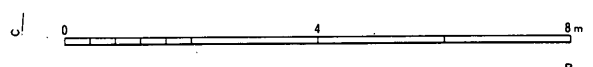

610.50m

A 610.50m

B



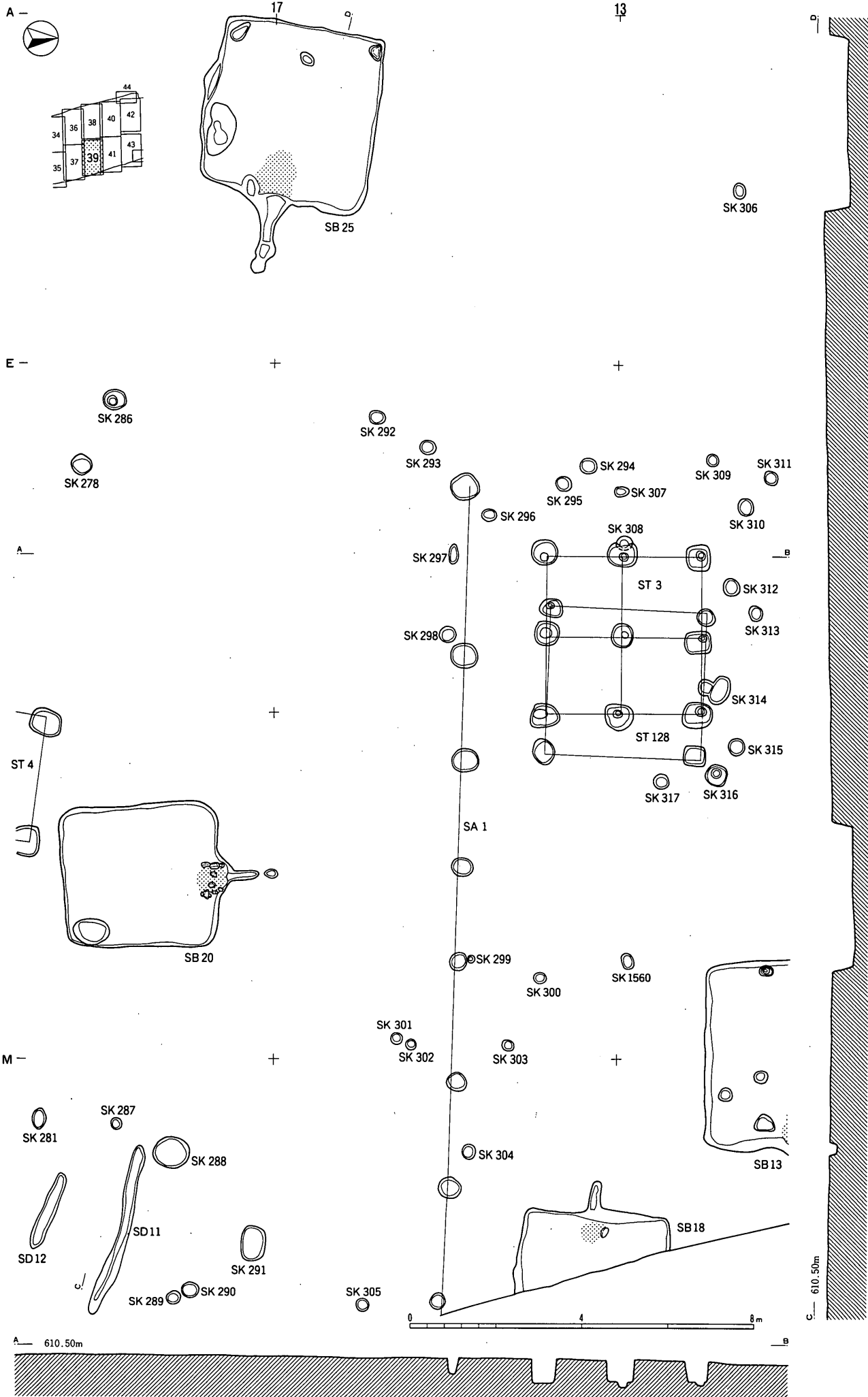





09

05

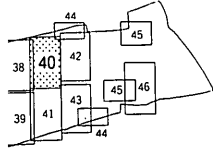

M -

+

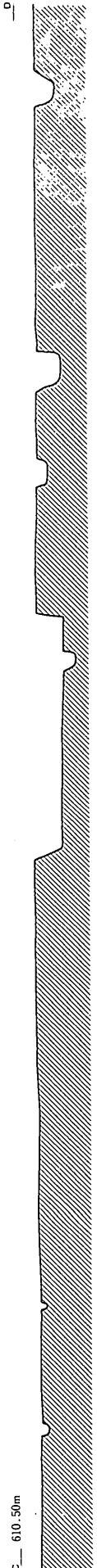
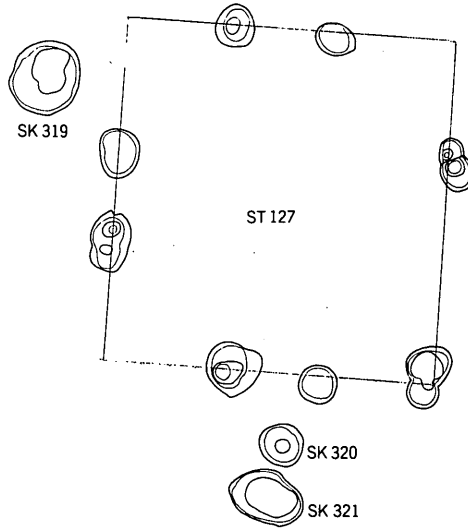

Q -

+

◎ SK 318

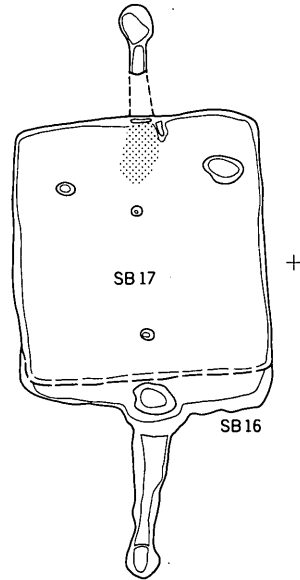

◎ SK 284

U -

+

+

A -

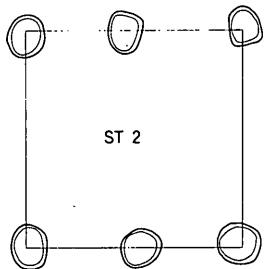

◎ SK 285

◎ SK 322

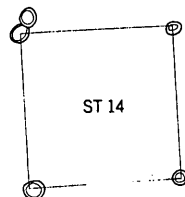

B -

C 610.50m

Y -

+

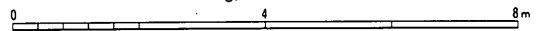

A 610.50m

B -



図版41 古代遺構実測図

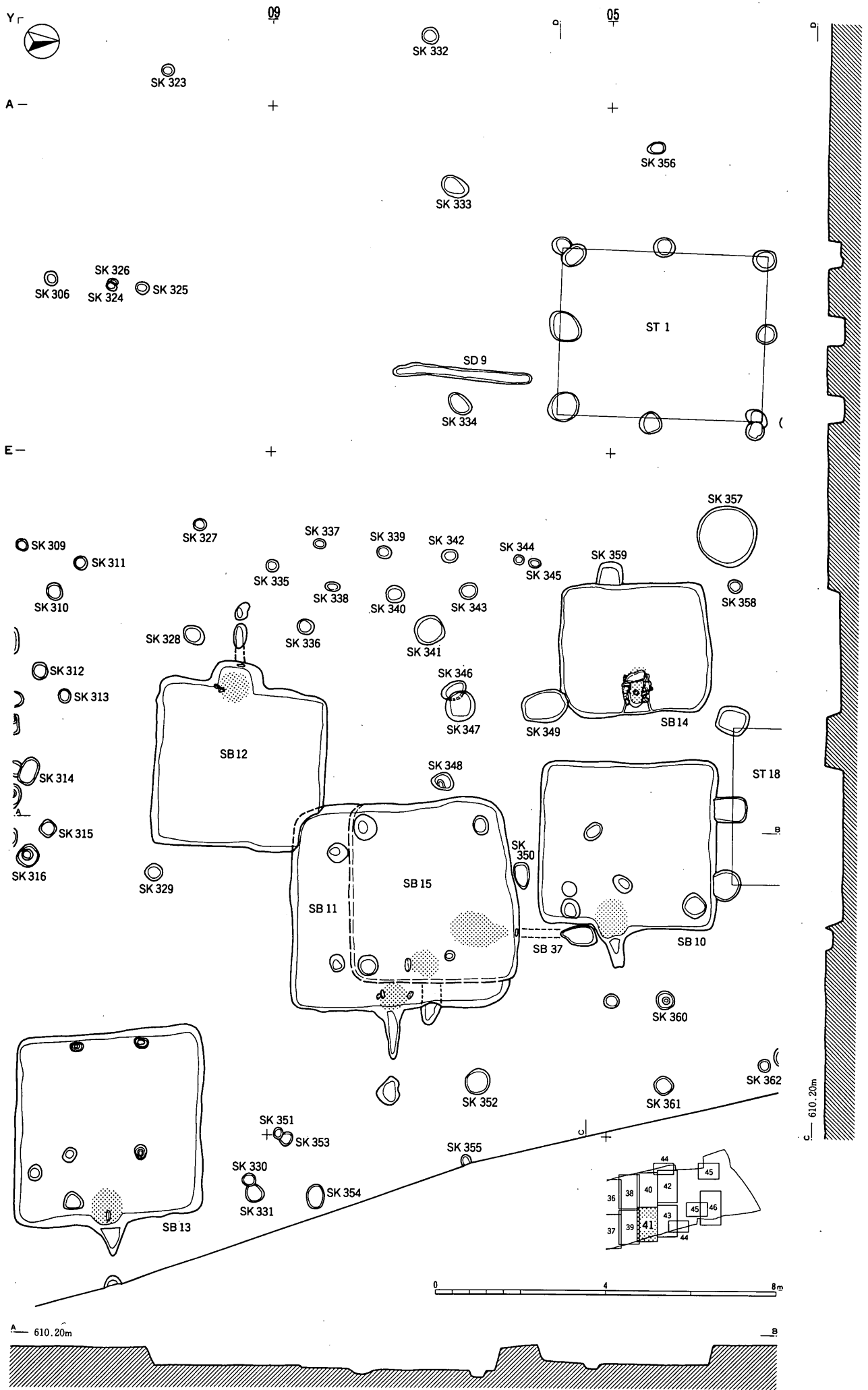

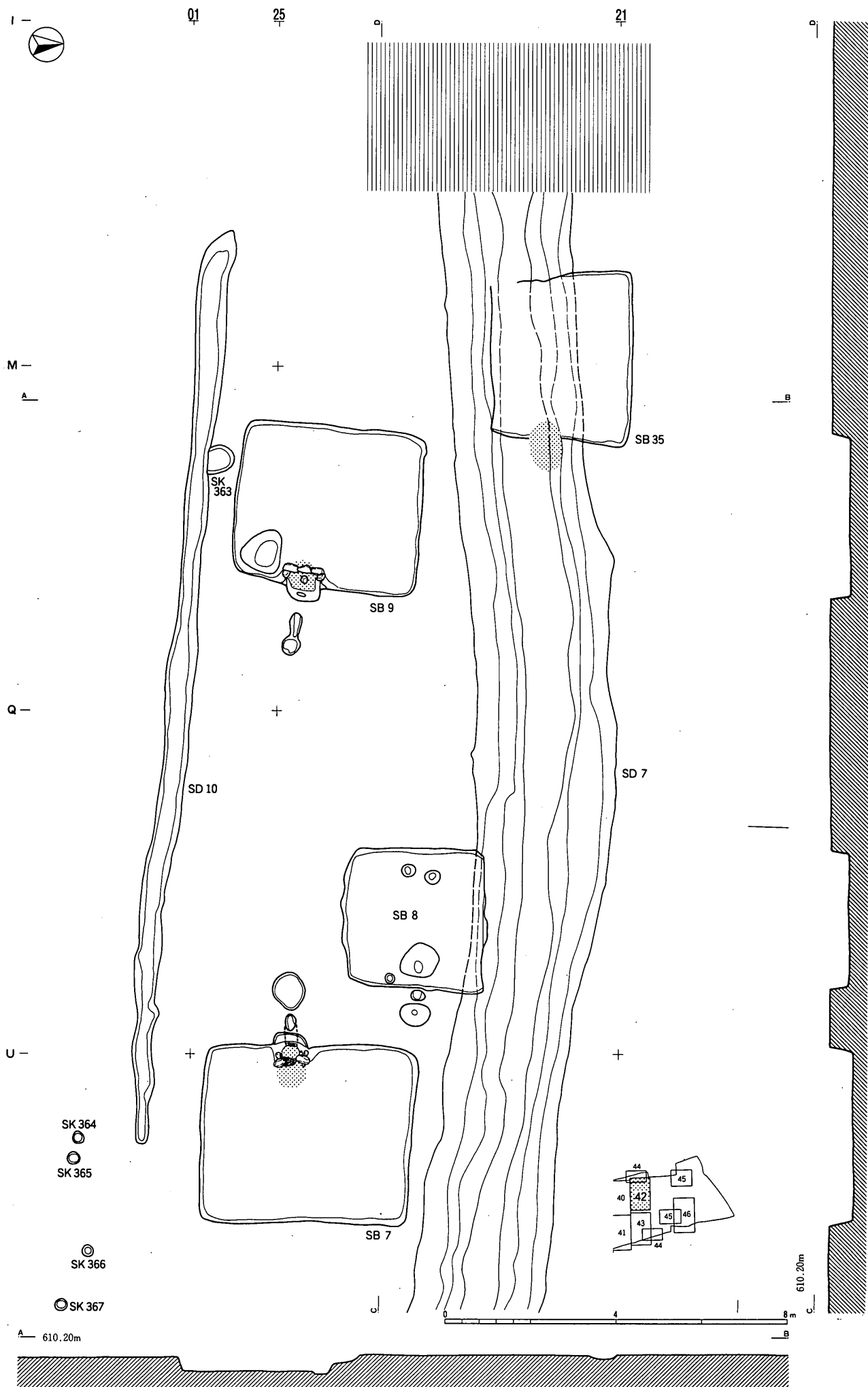

図版43 古代遺構実測図

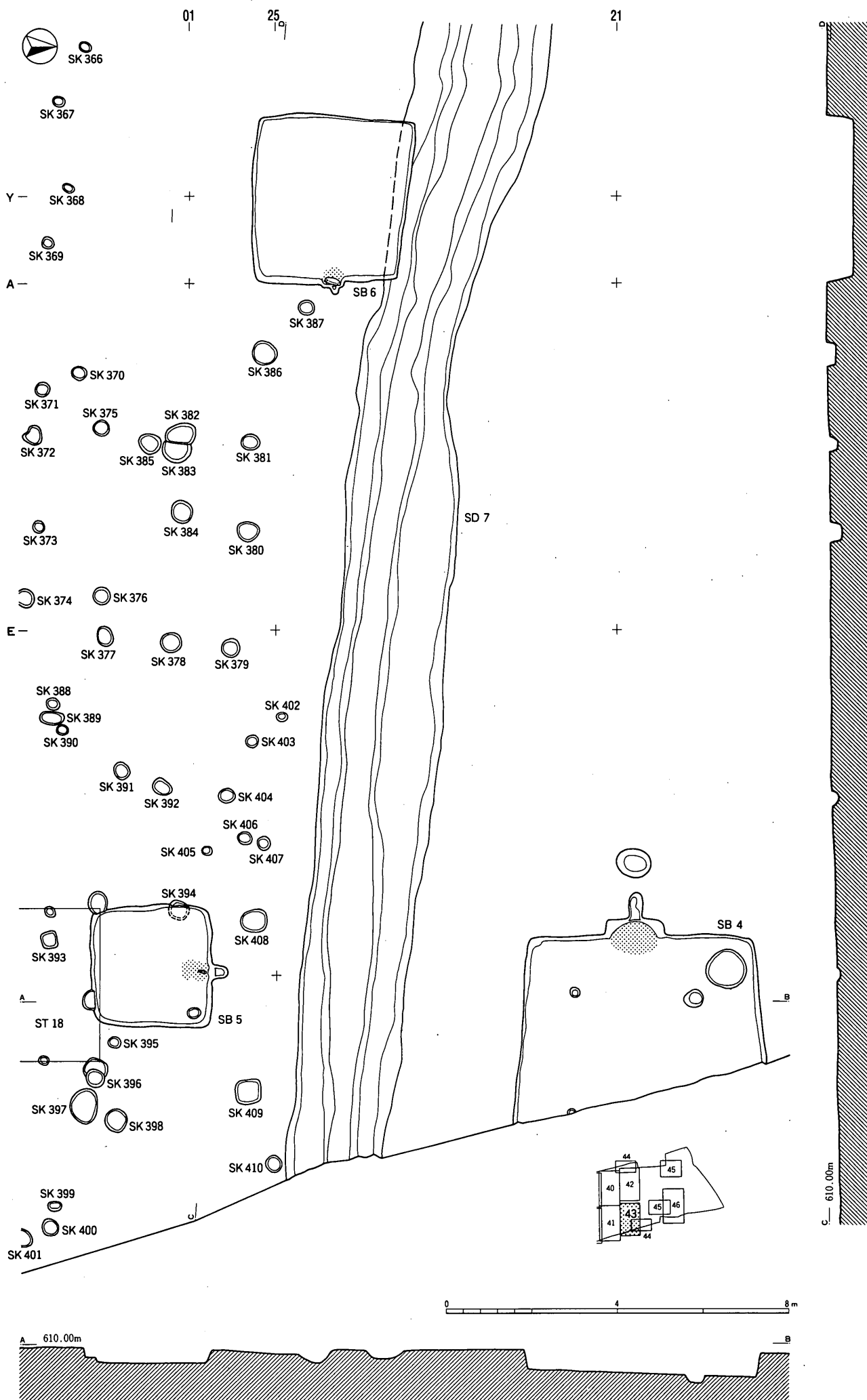

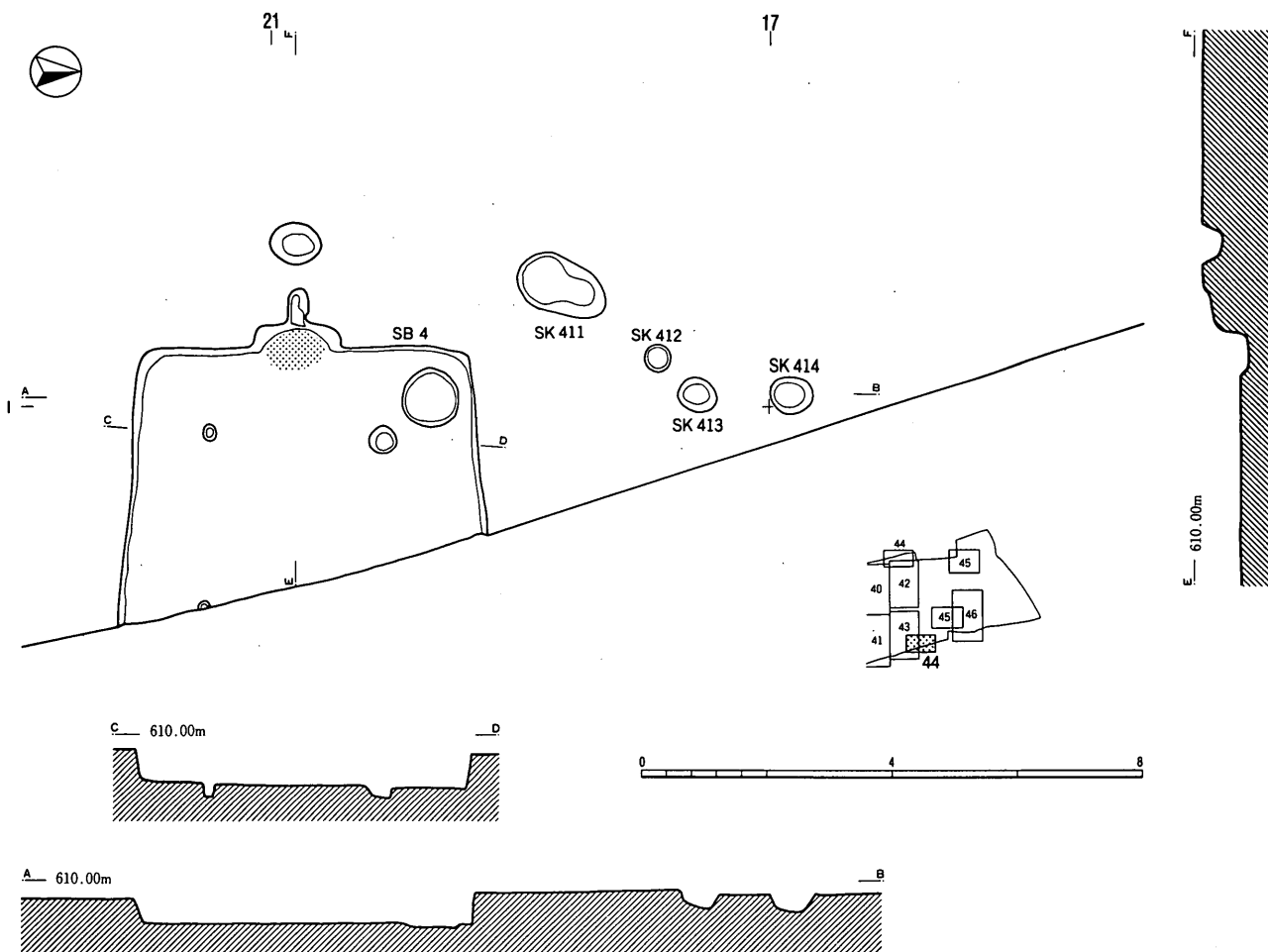
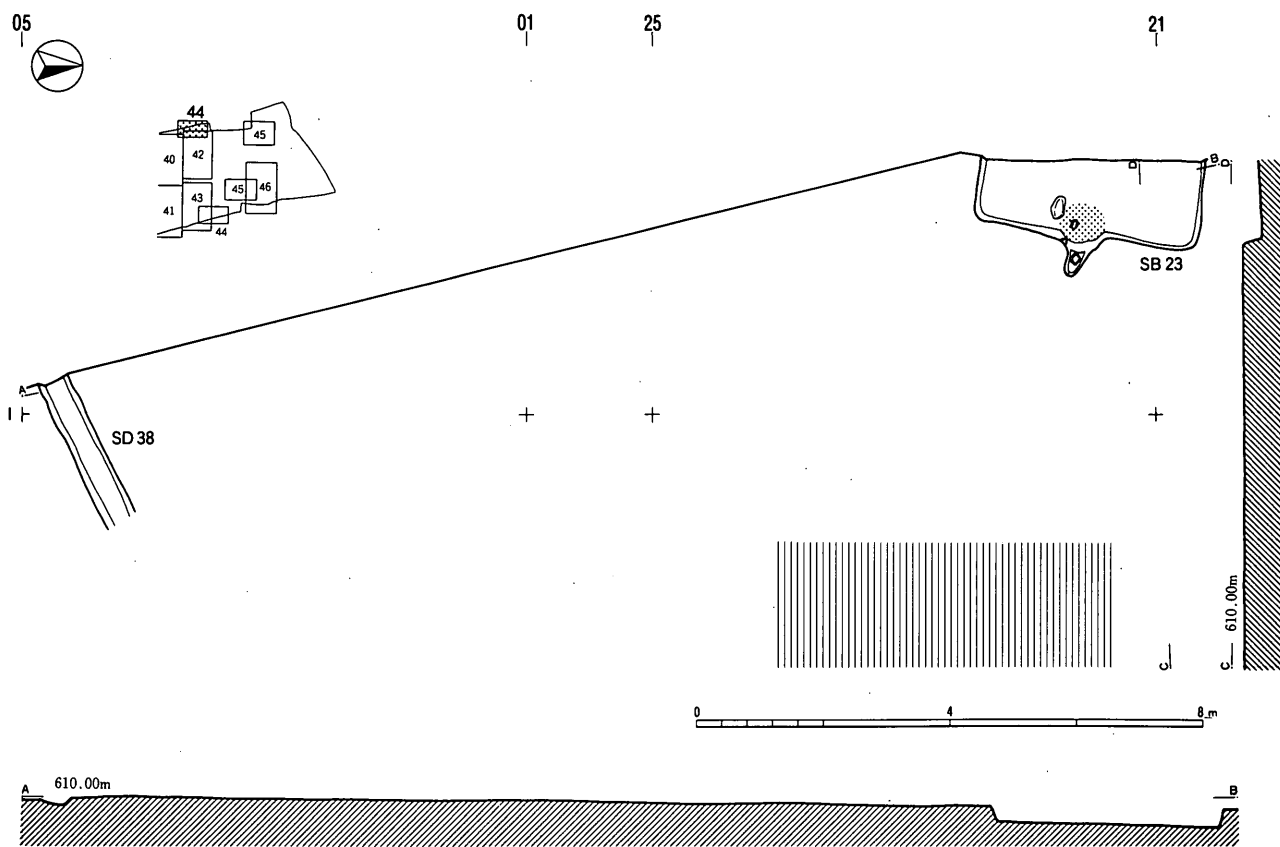

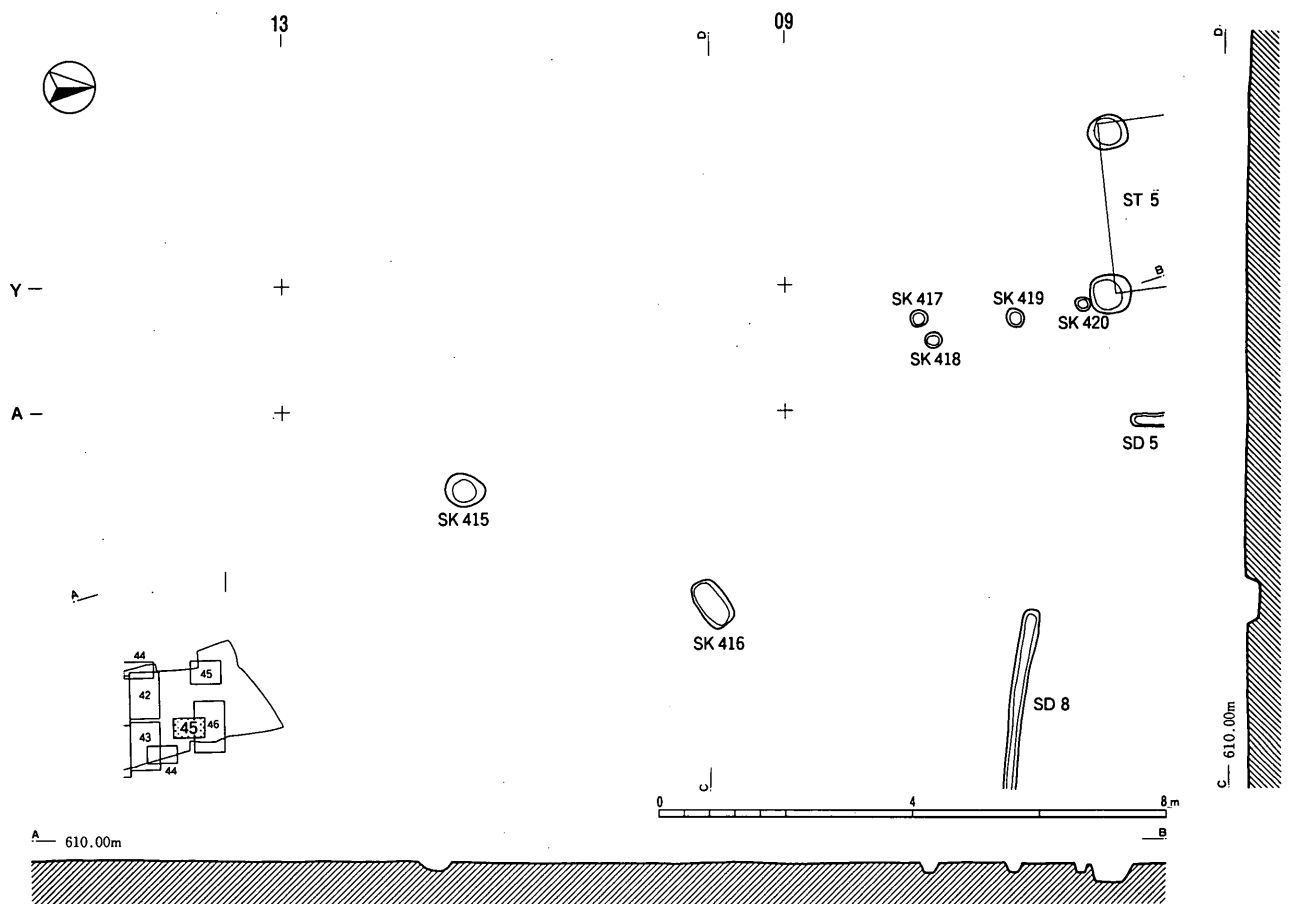
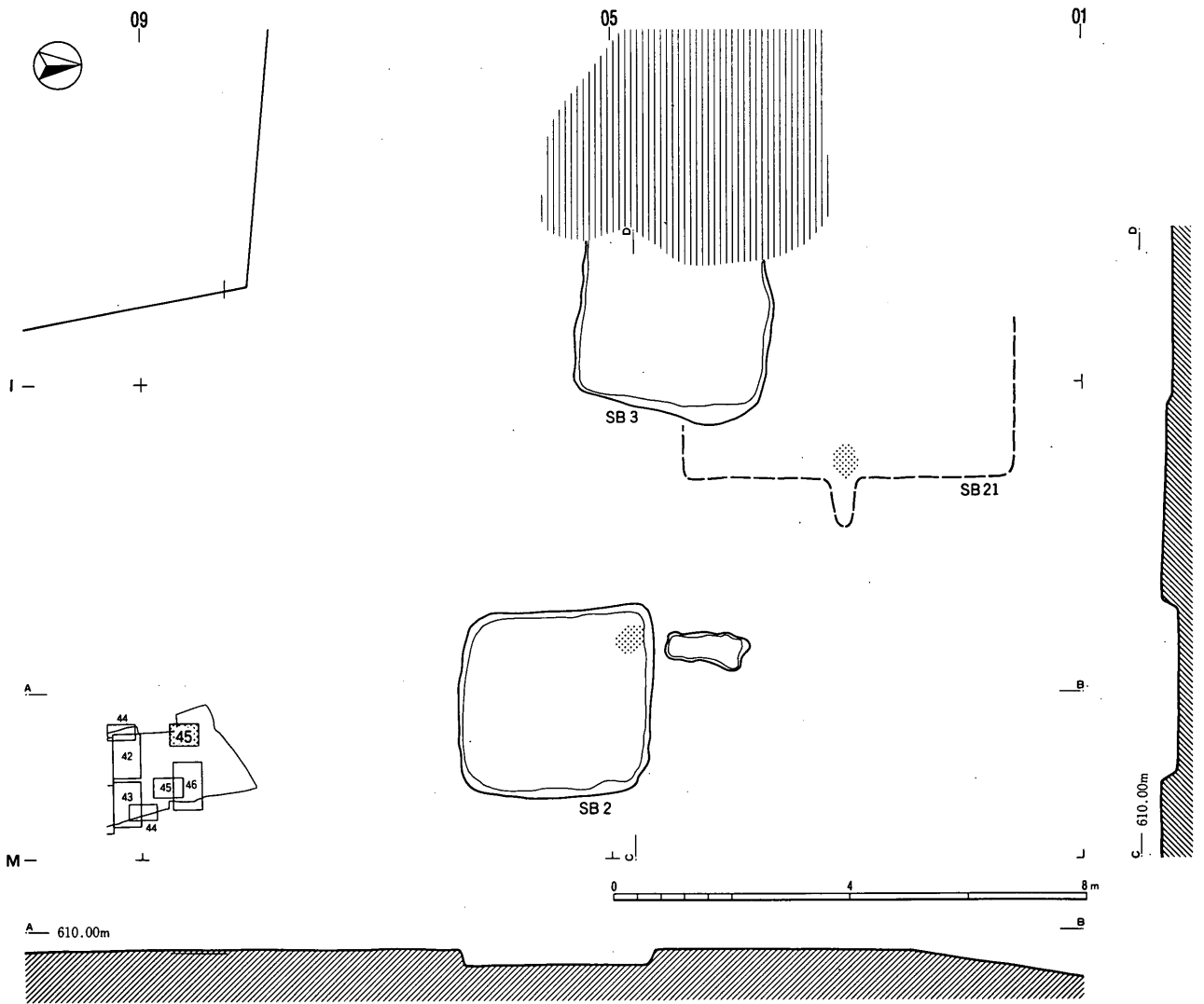

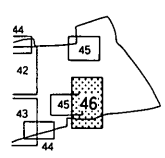
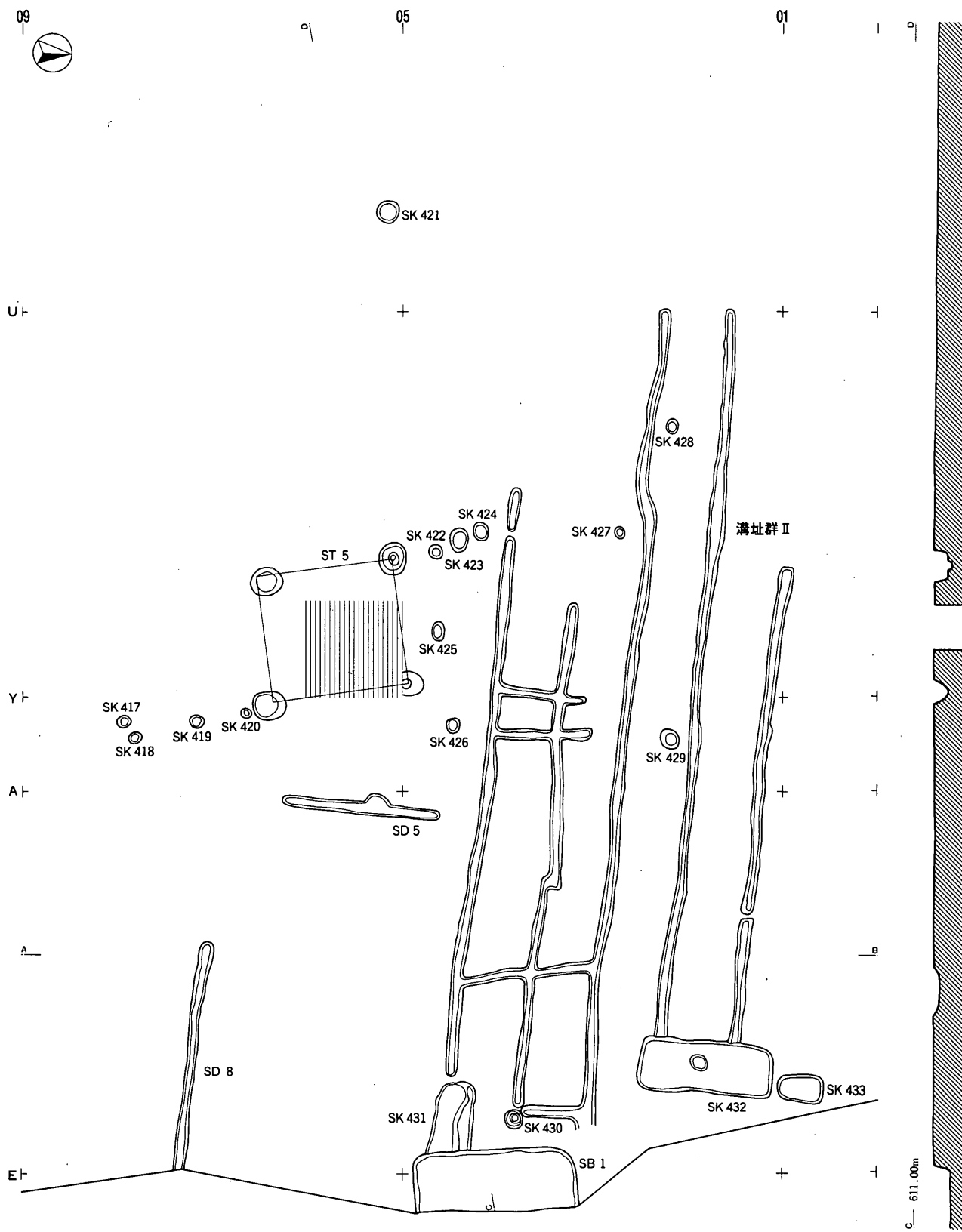

図版47 古代遺構実測図

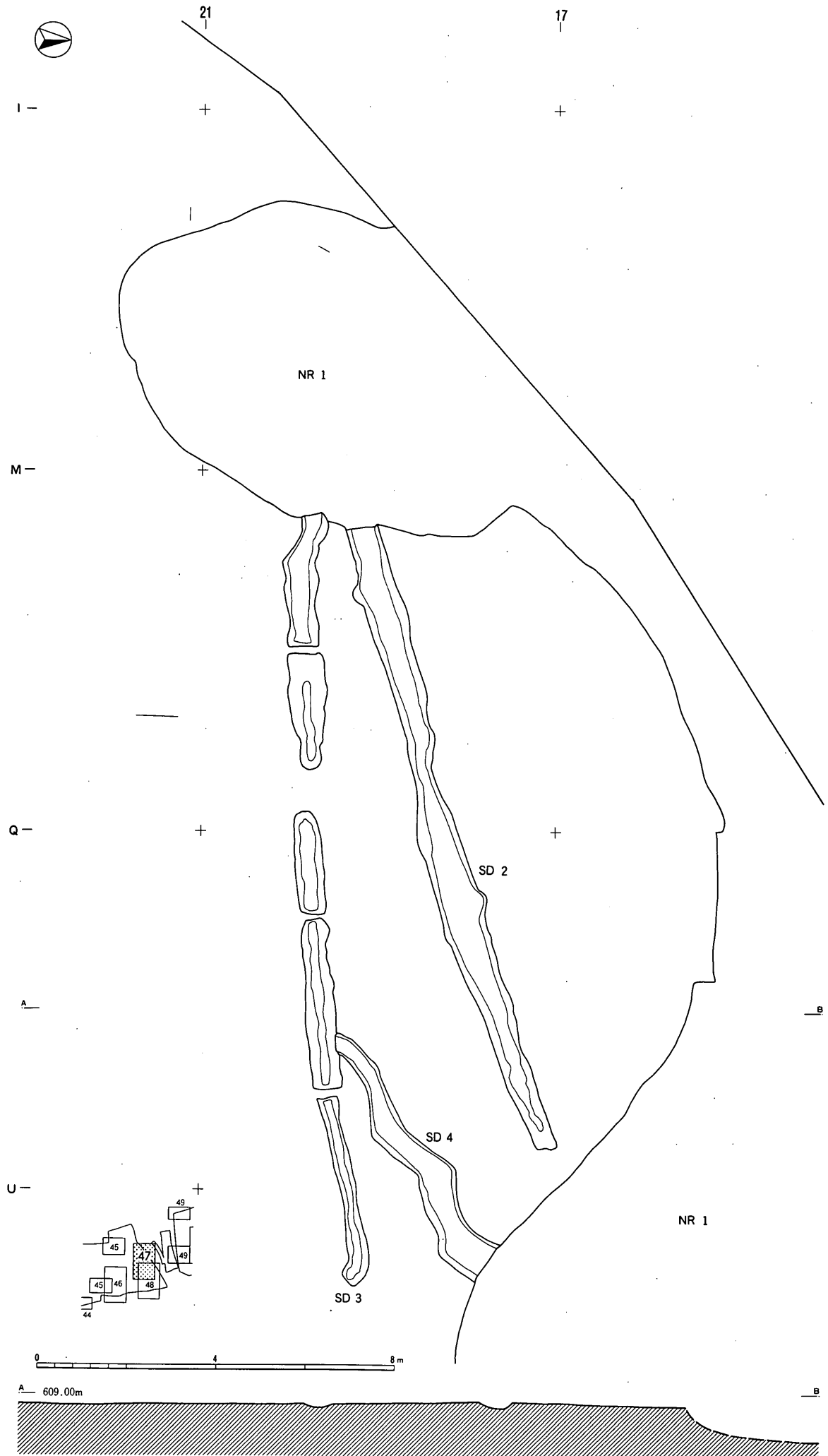



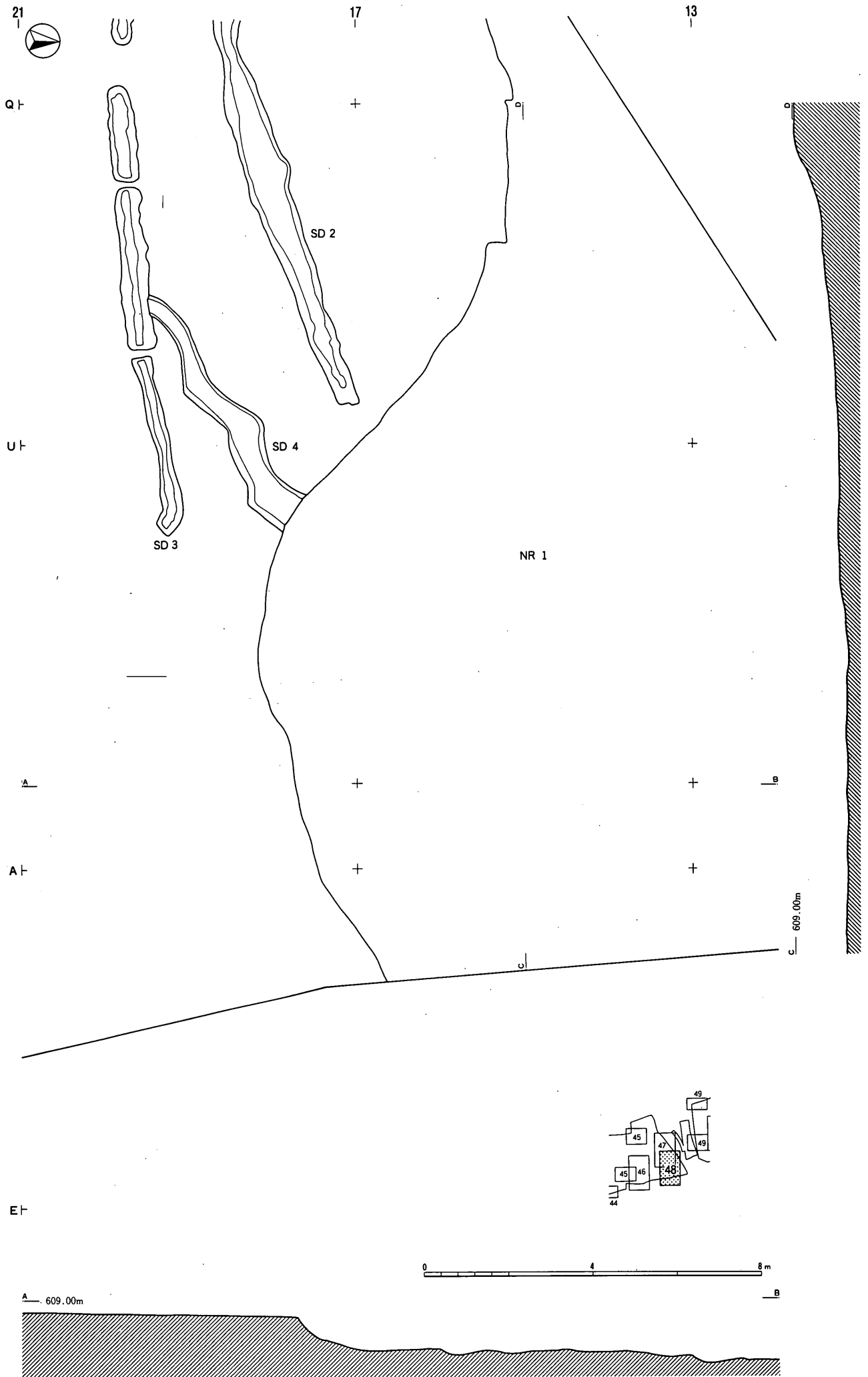

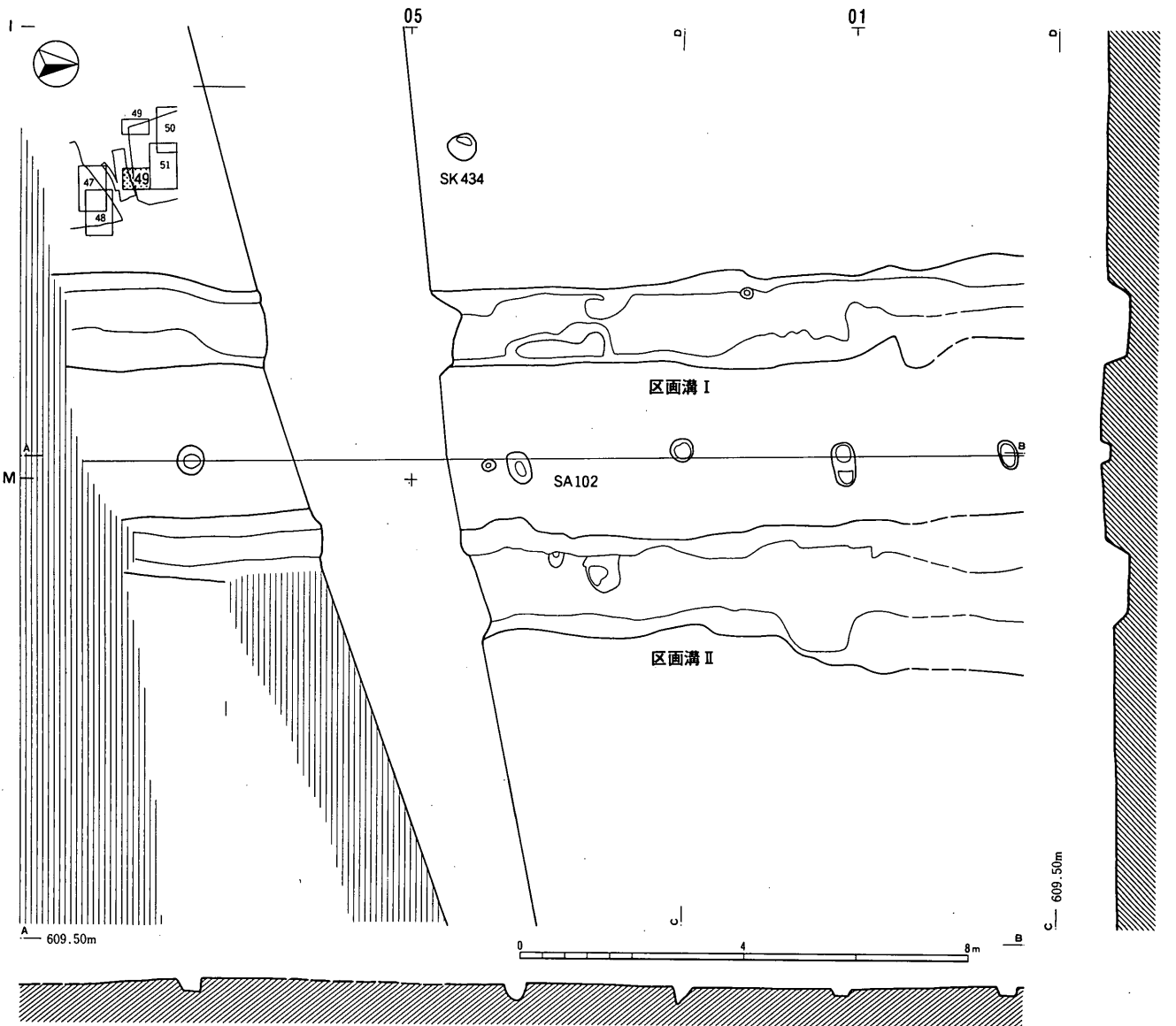
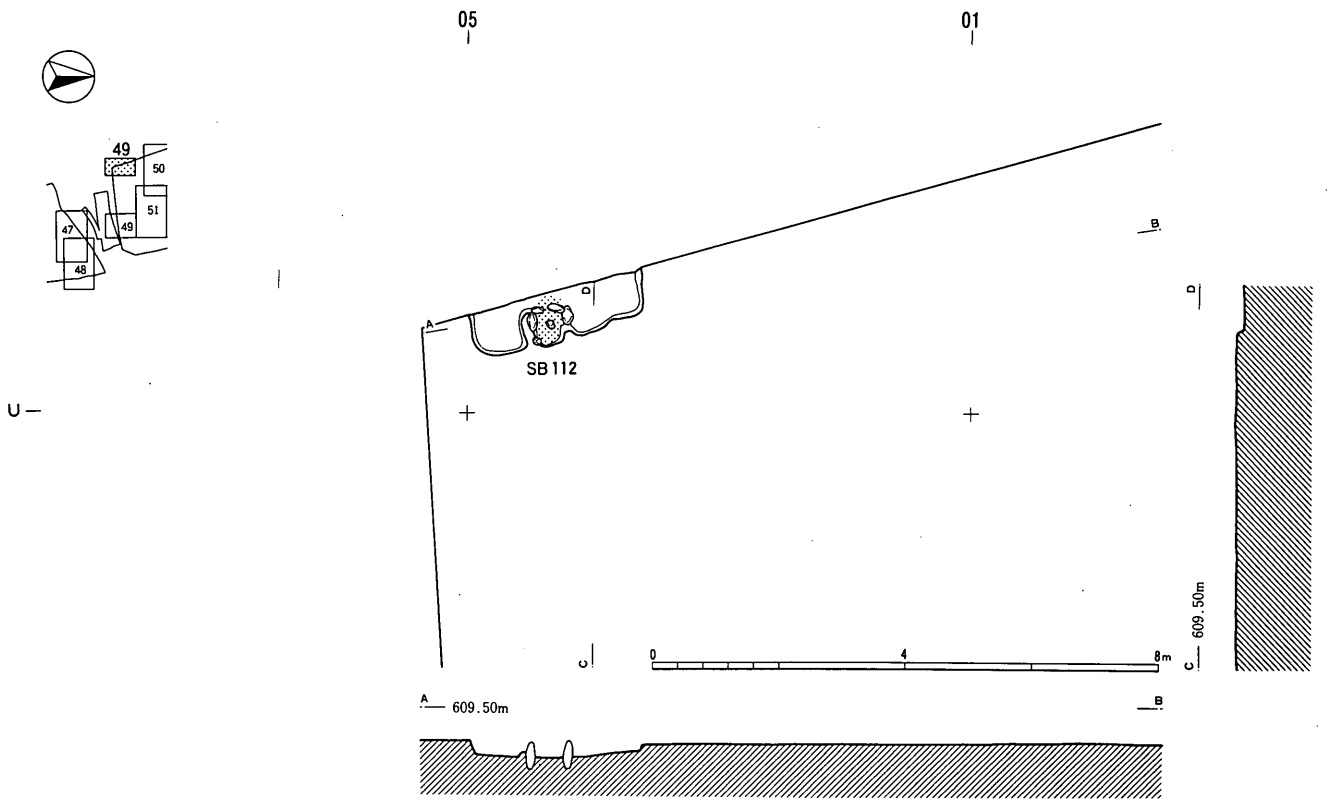

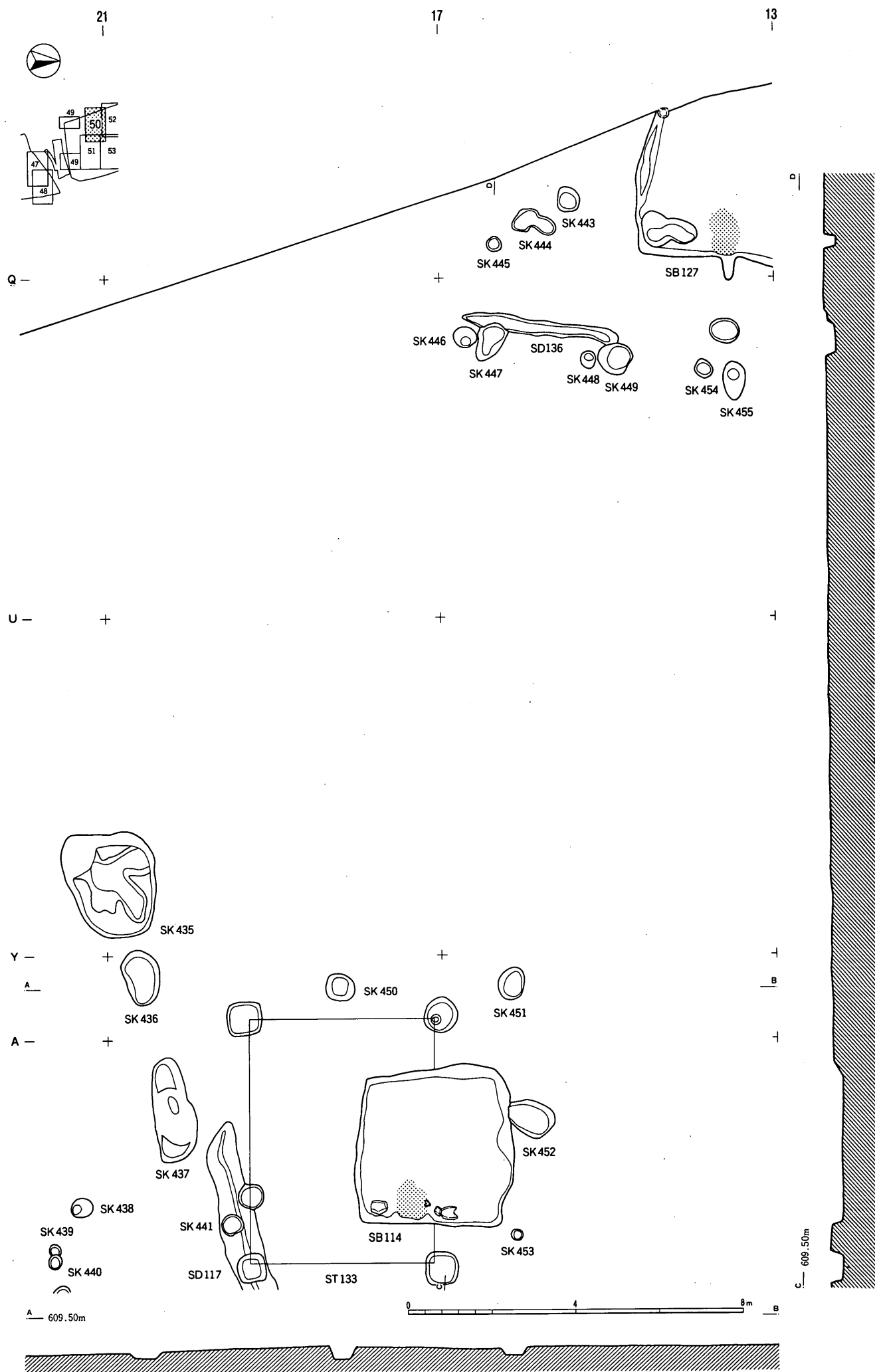

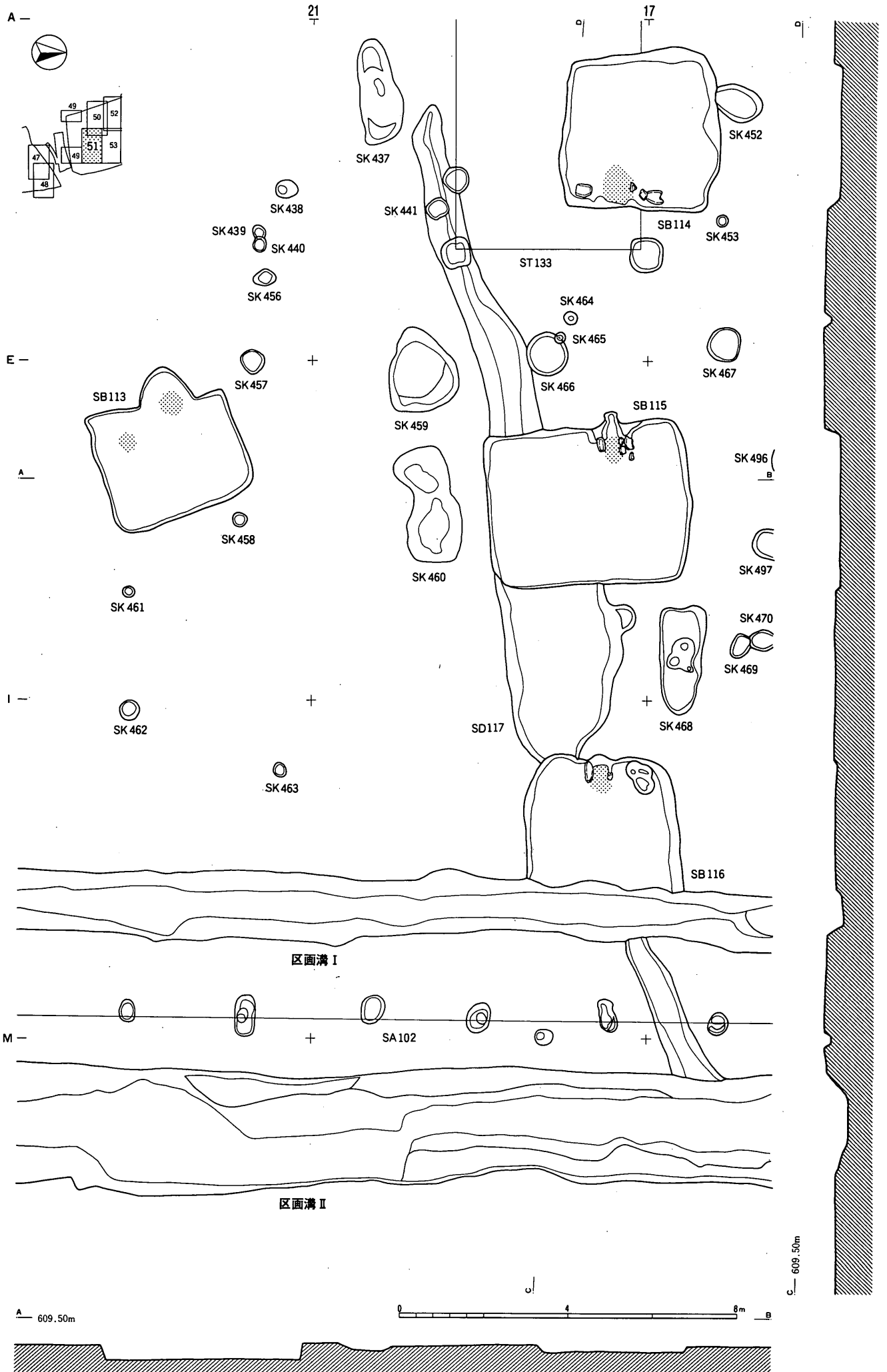

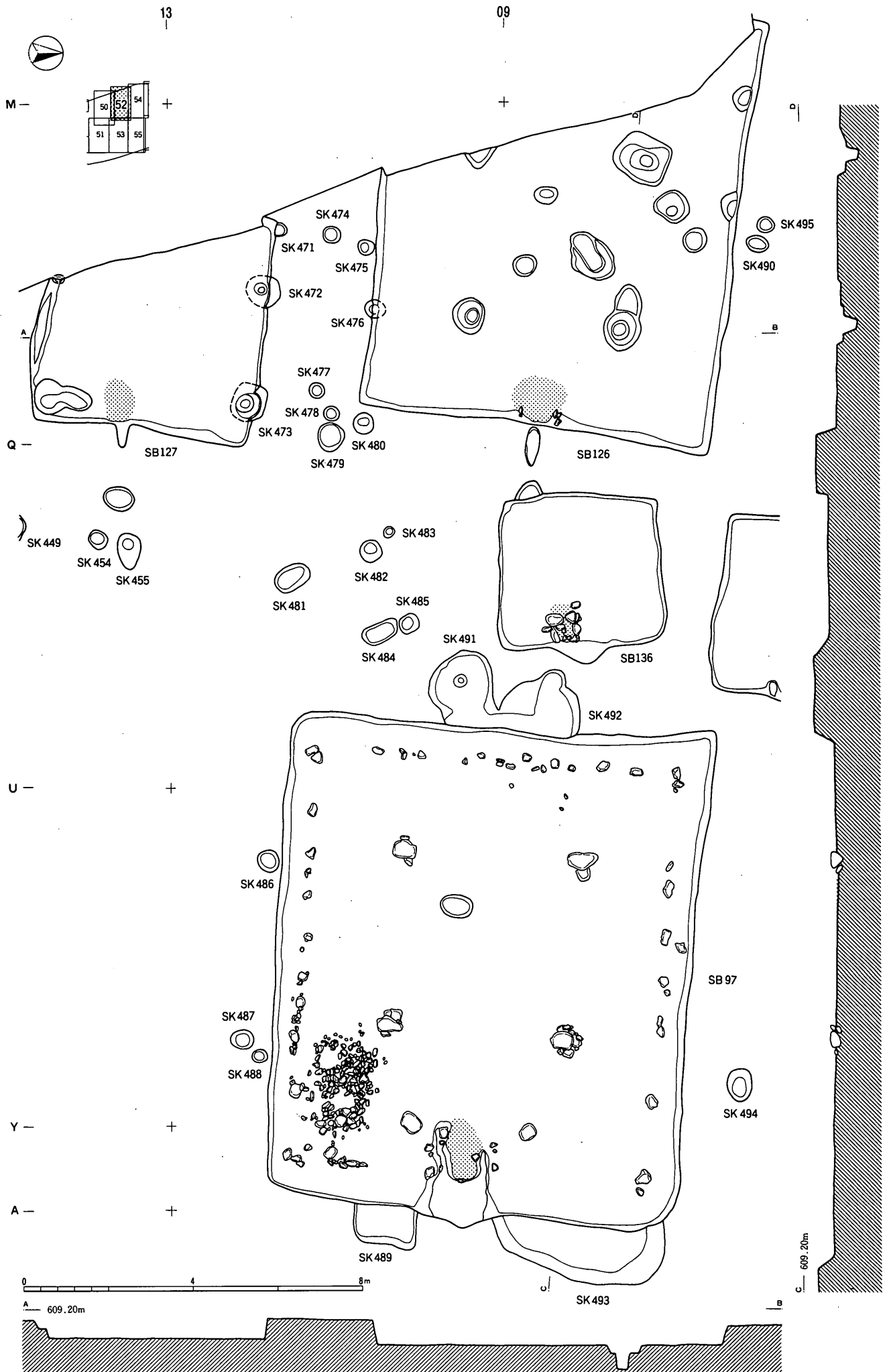

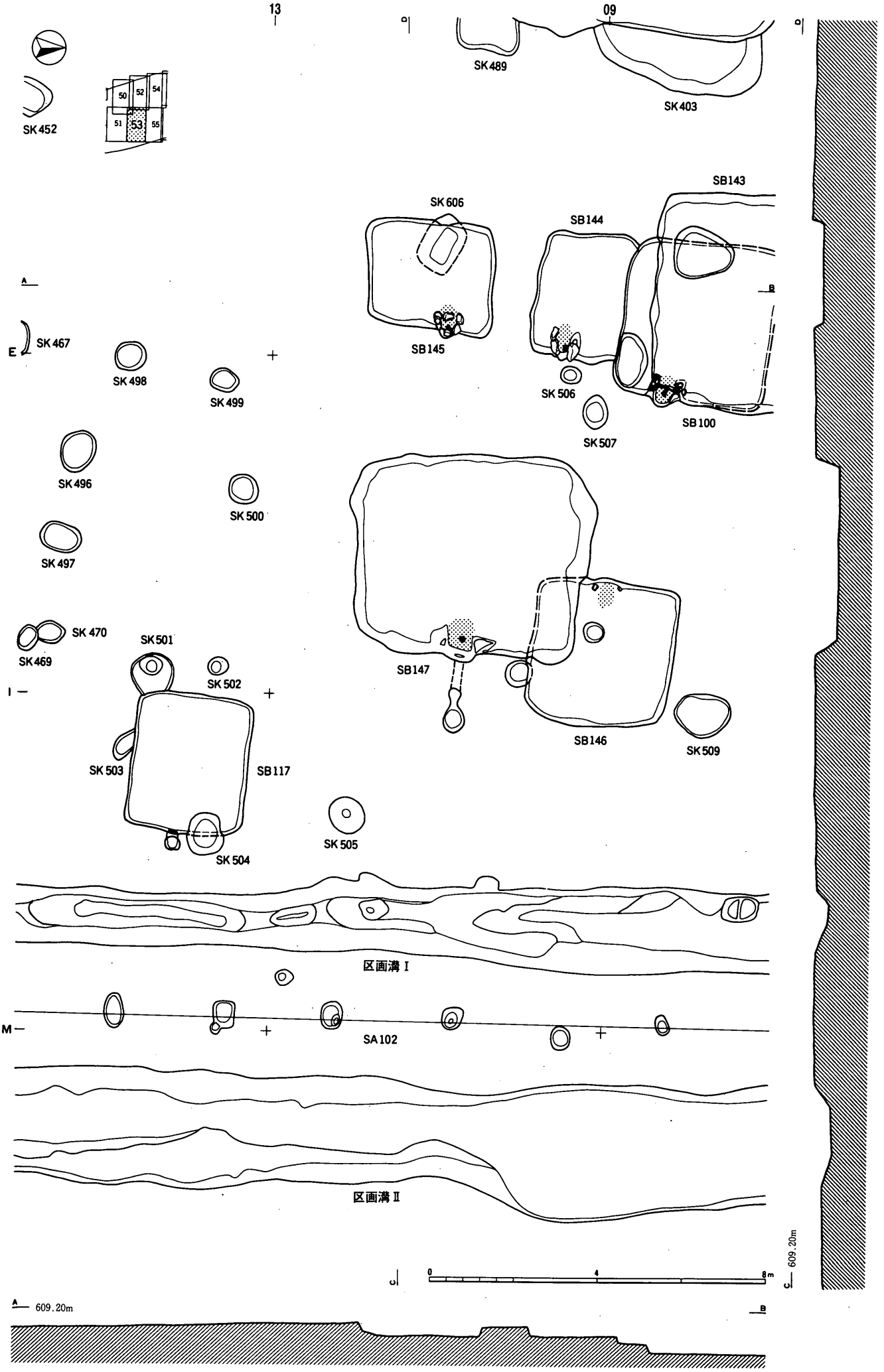



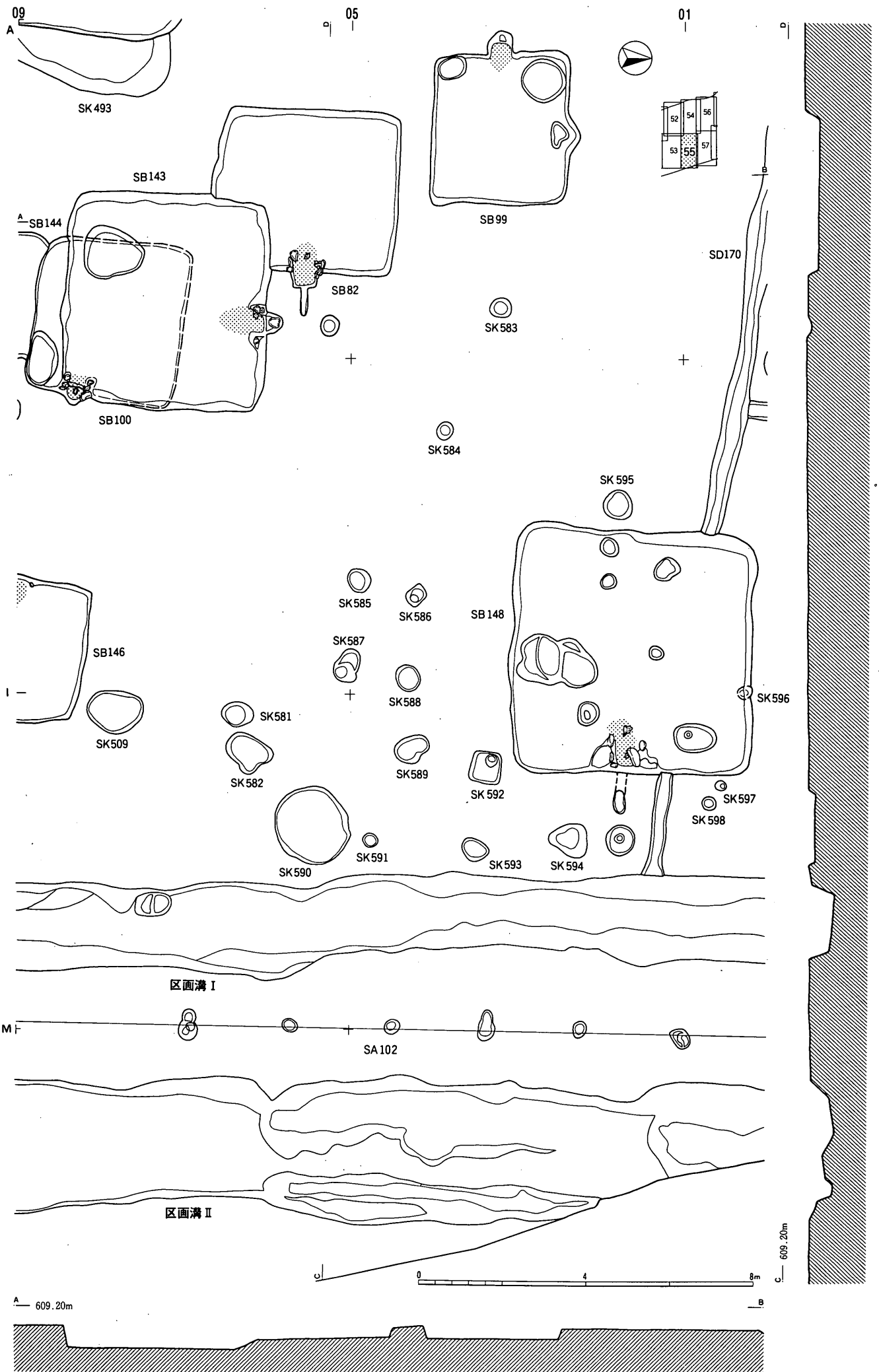



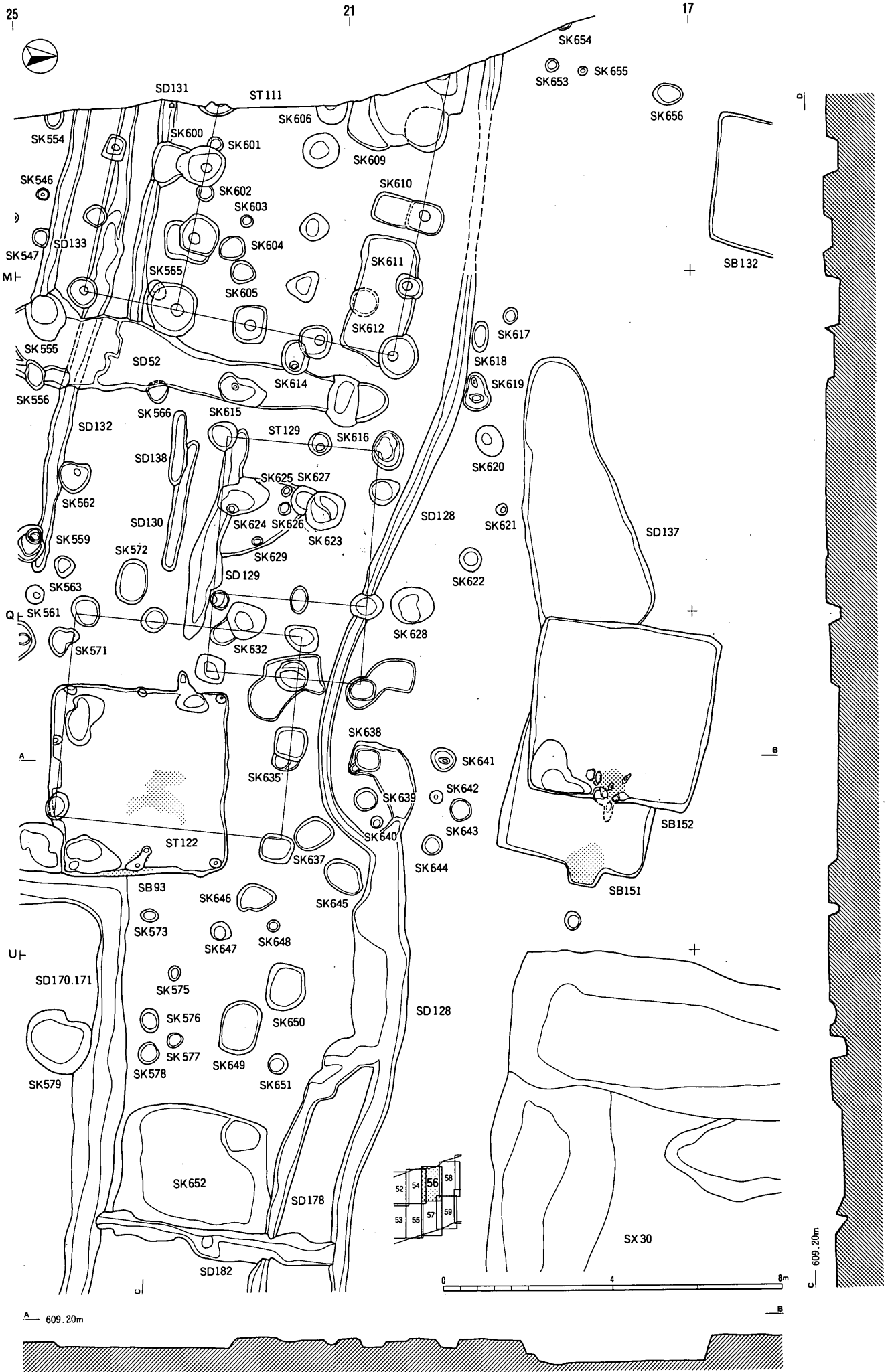

A 609.20m

C 609.20m

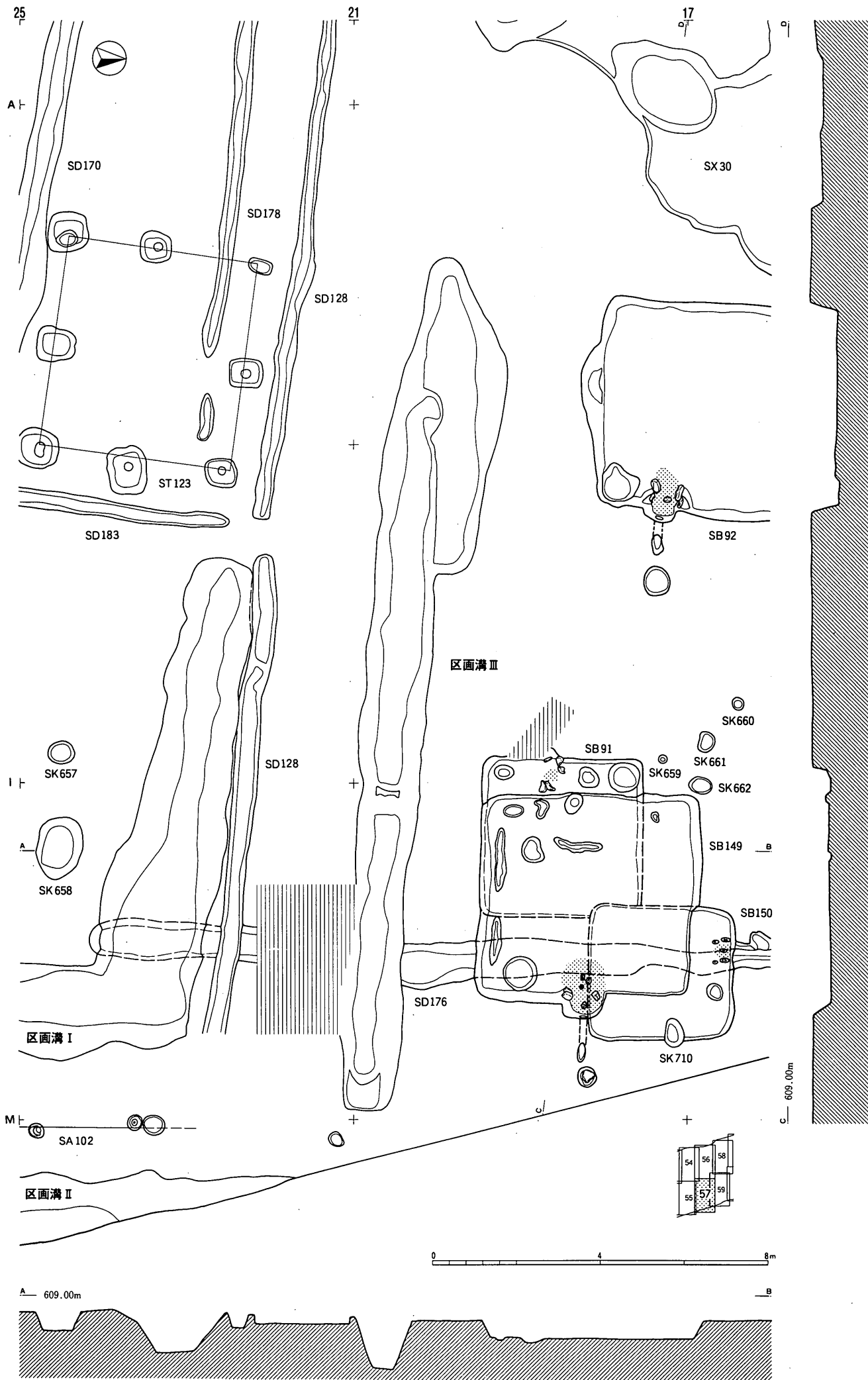

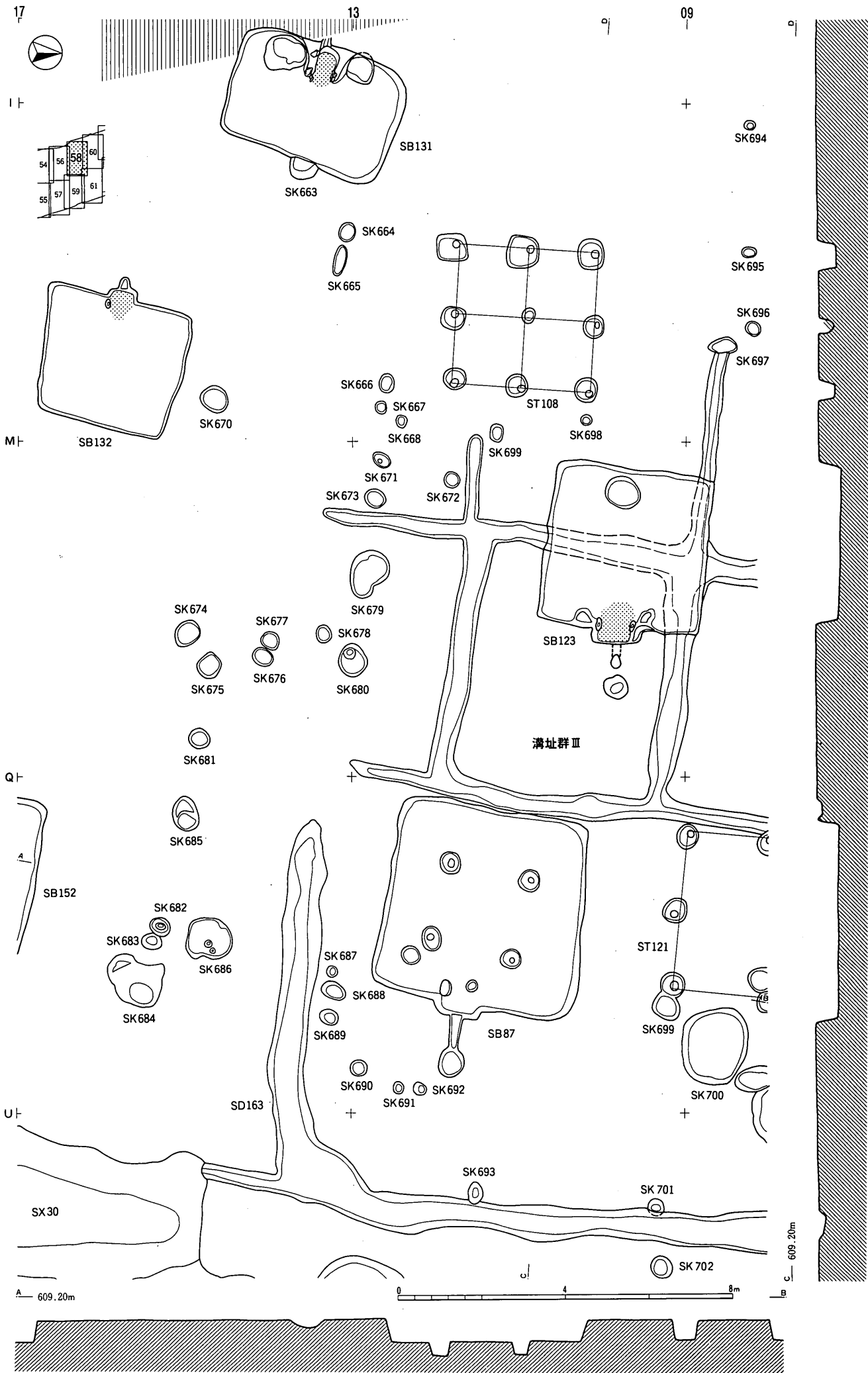

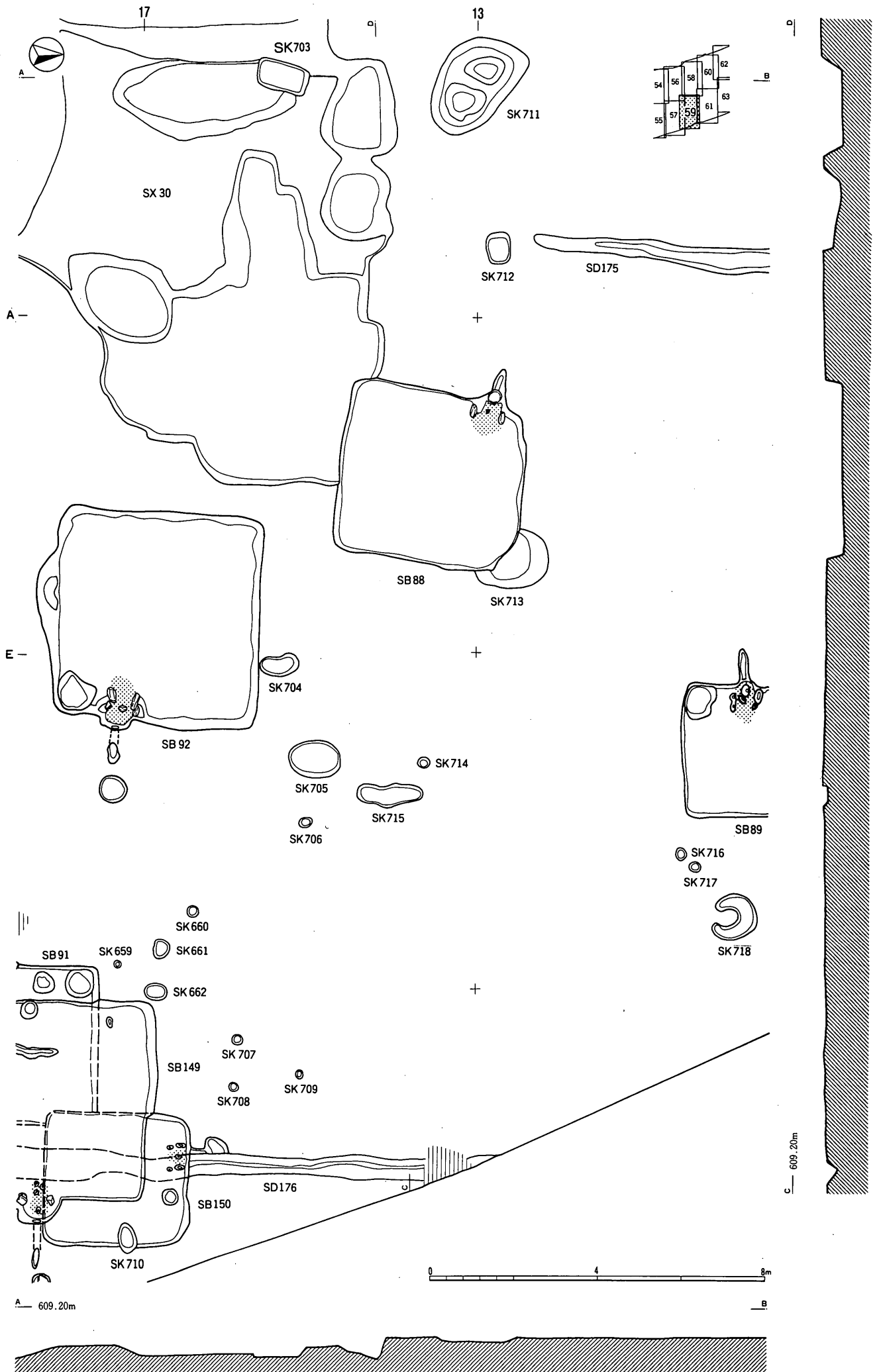

A 609.20m

C 609.20m

0 4 8m

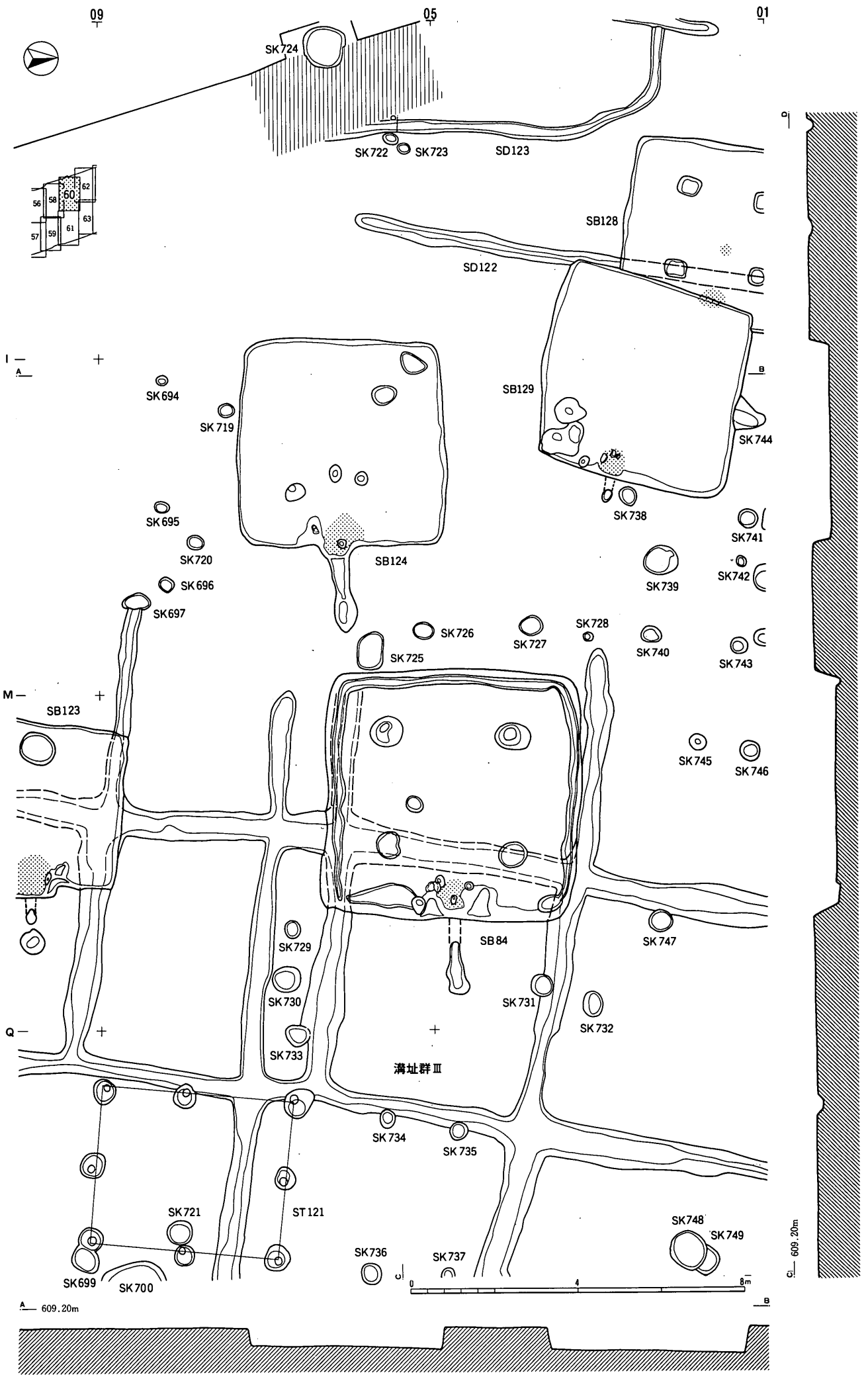

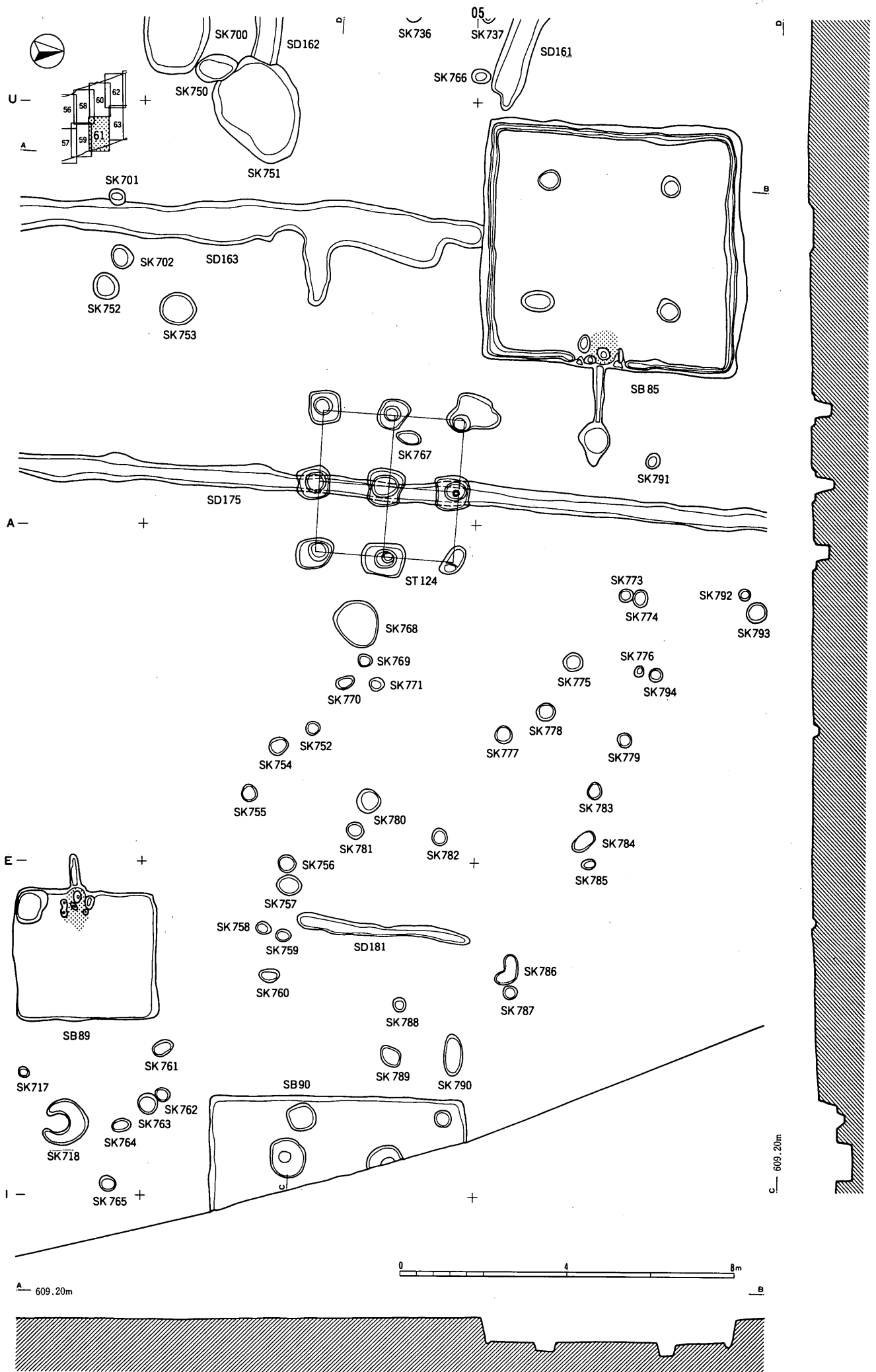



図版63 古代遺構実測図

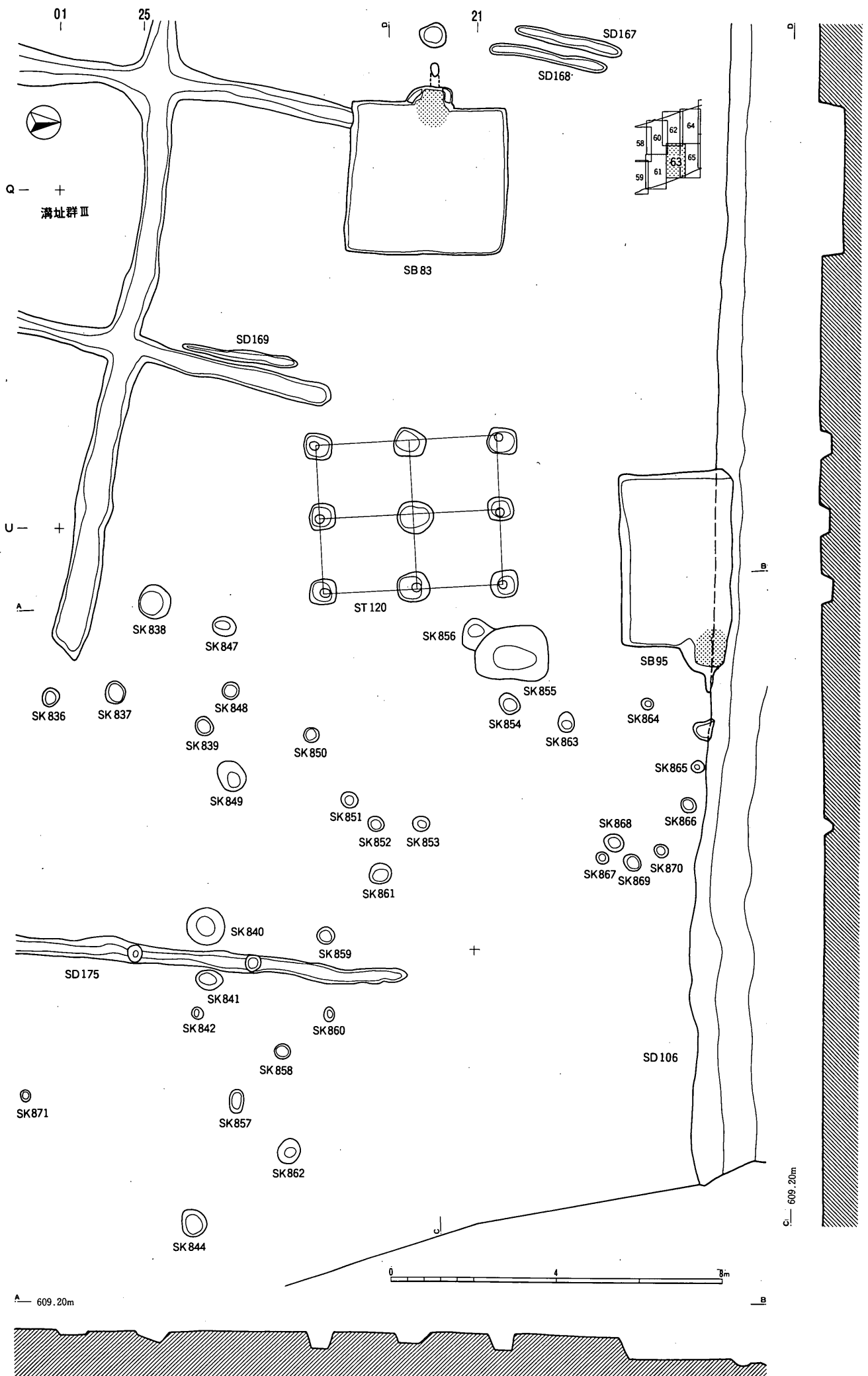

A — 609.20m

C — 609.20m



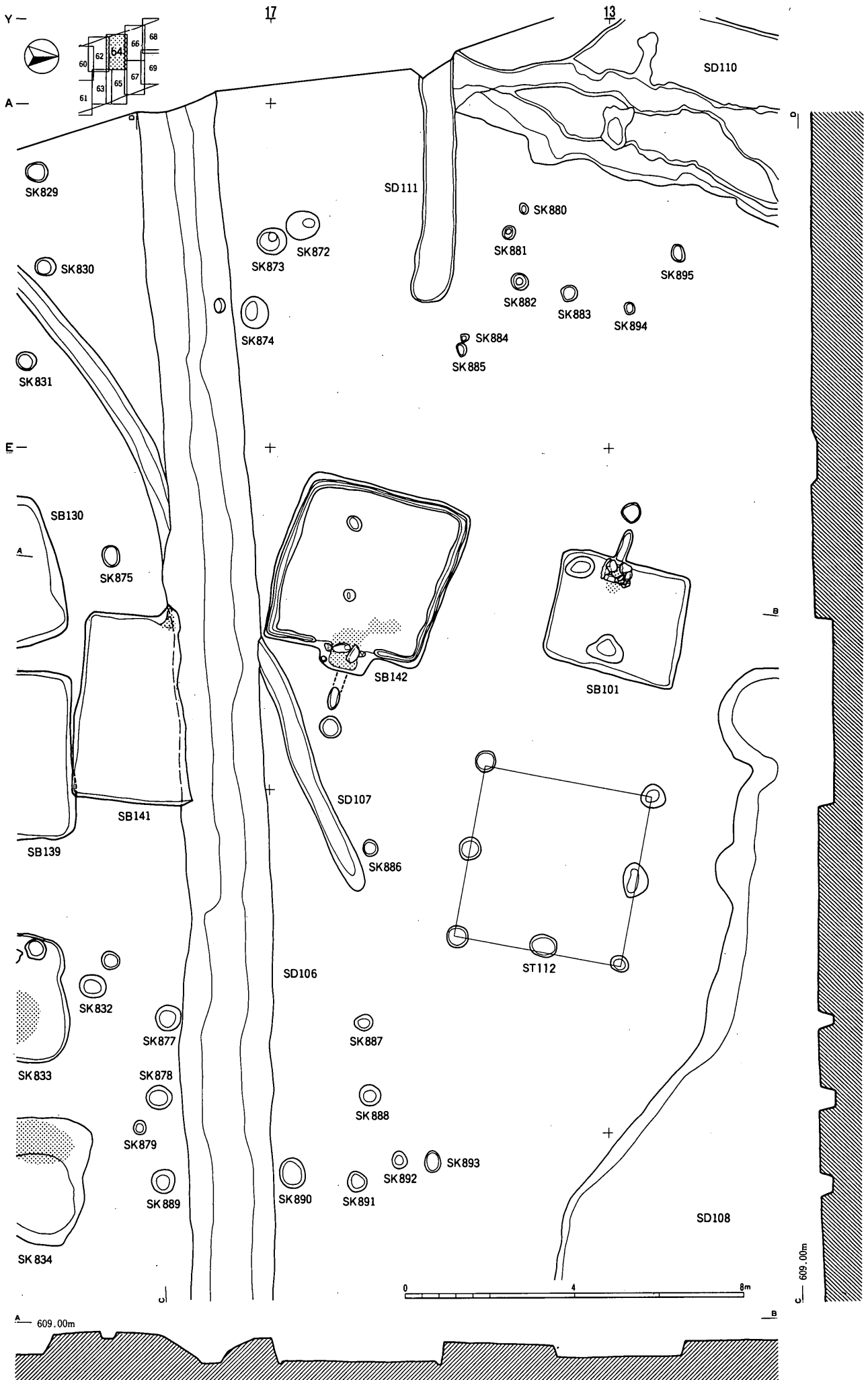

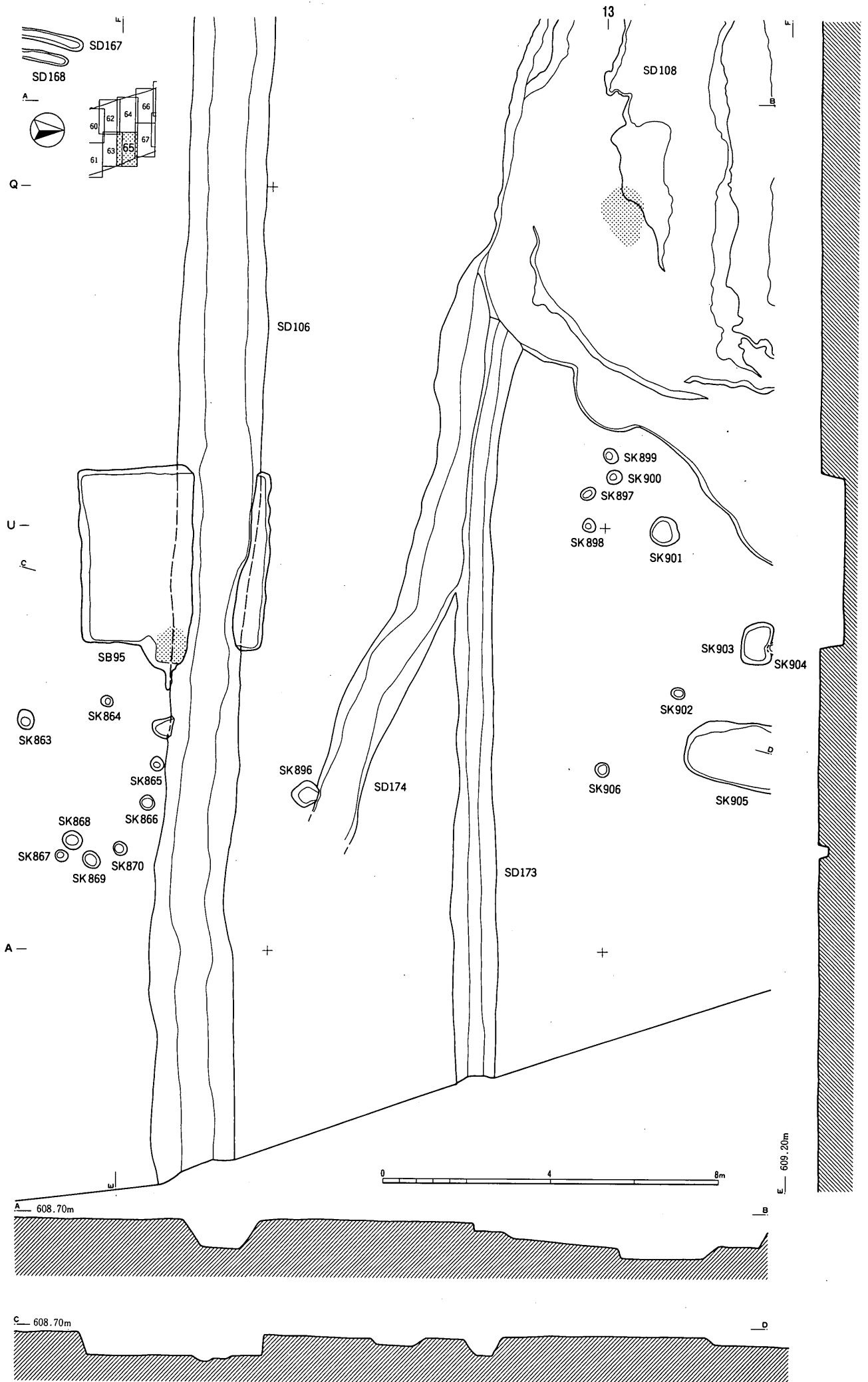



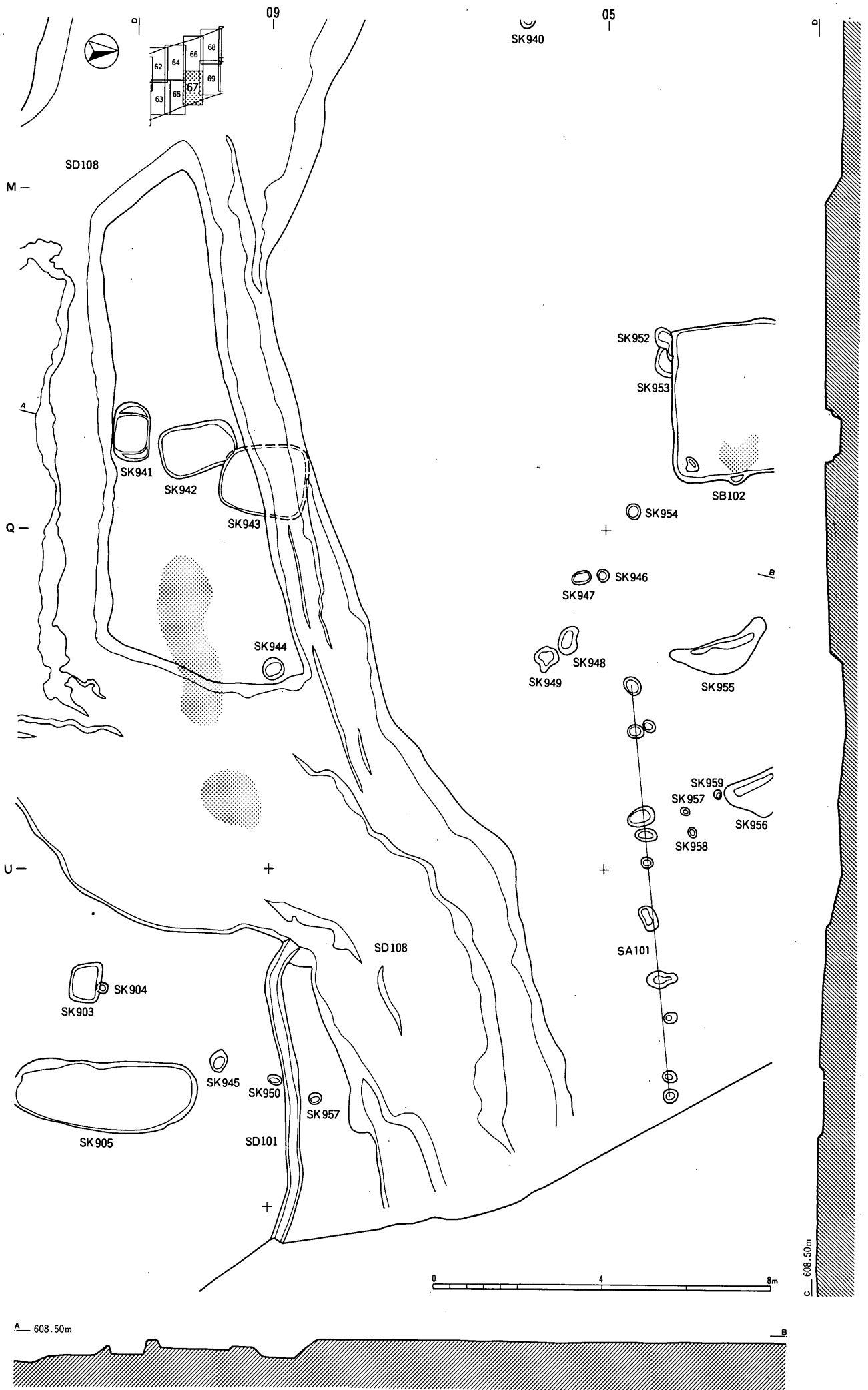

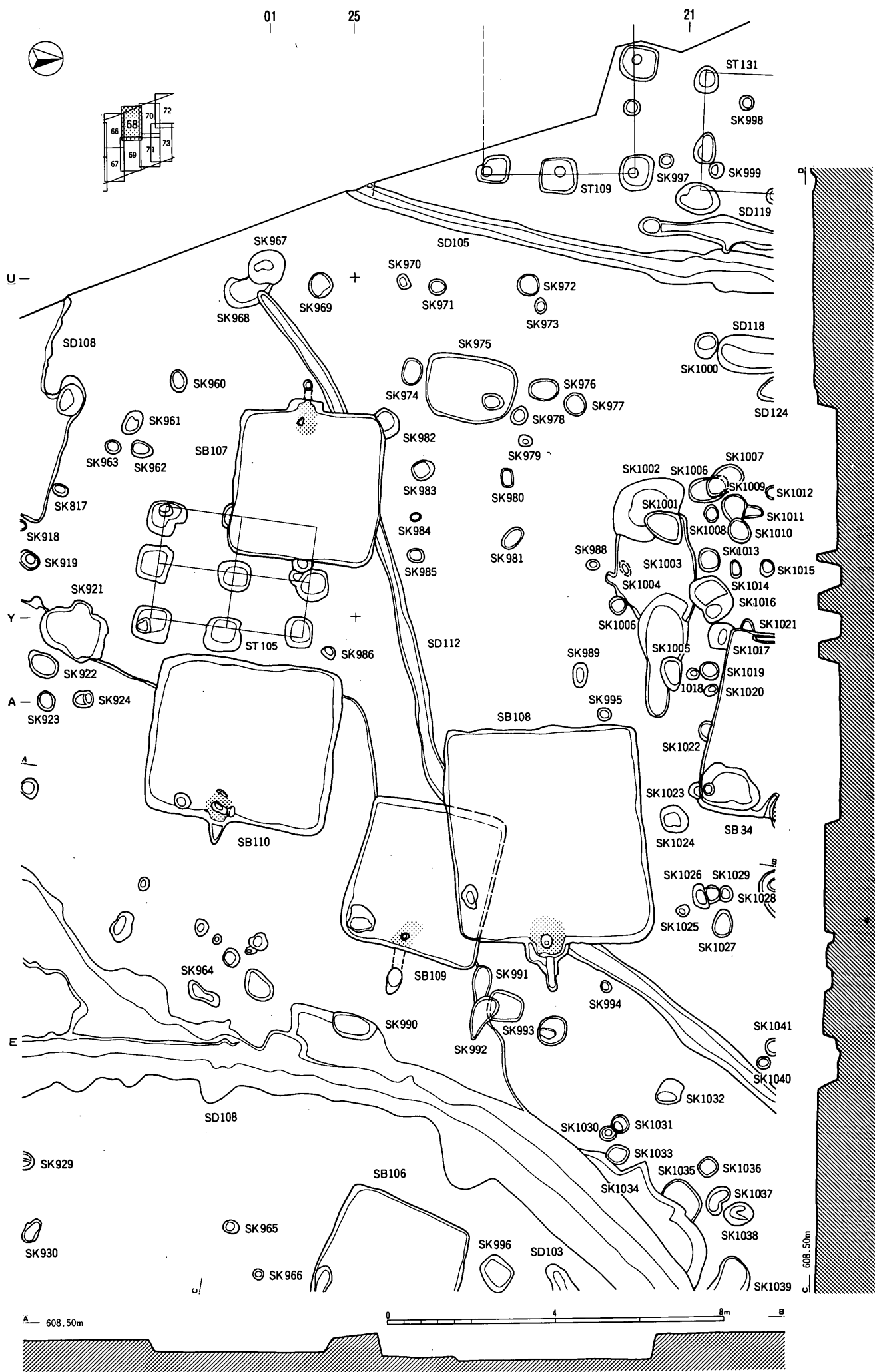

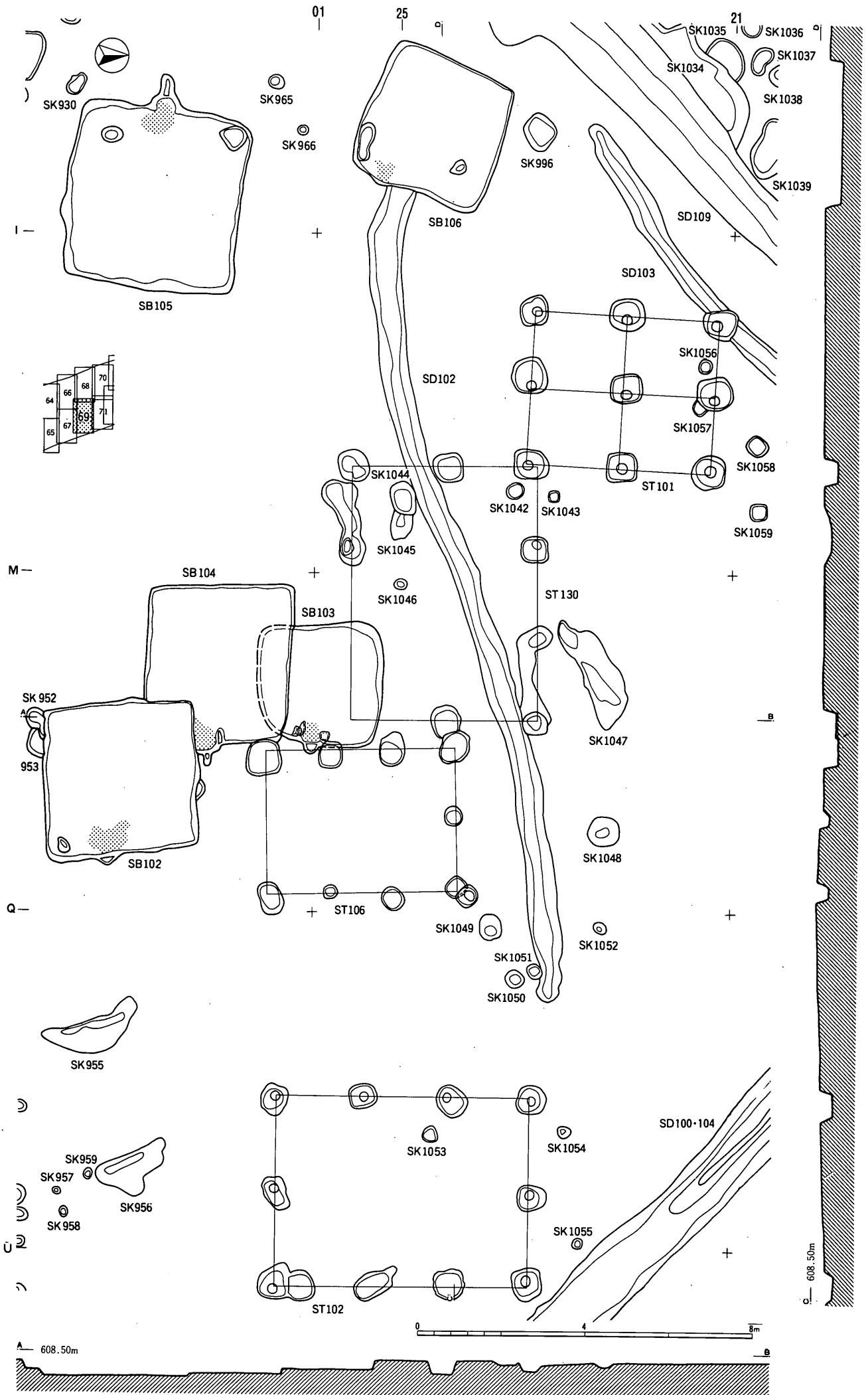

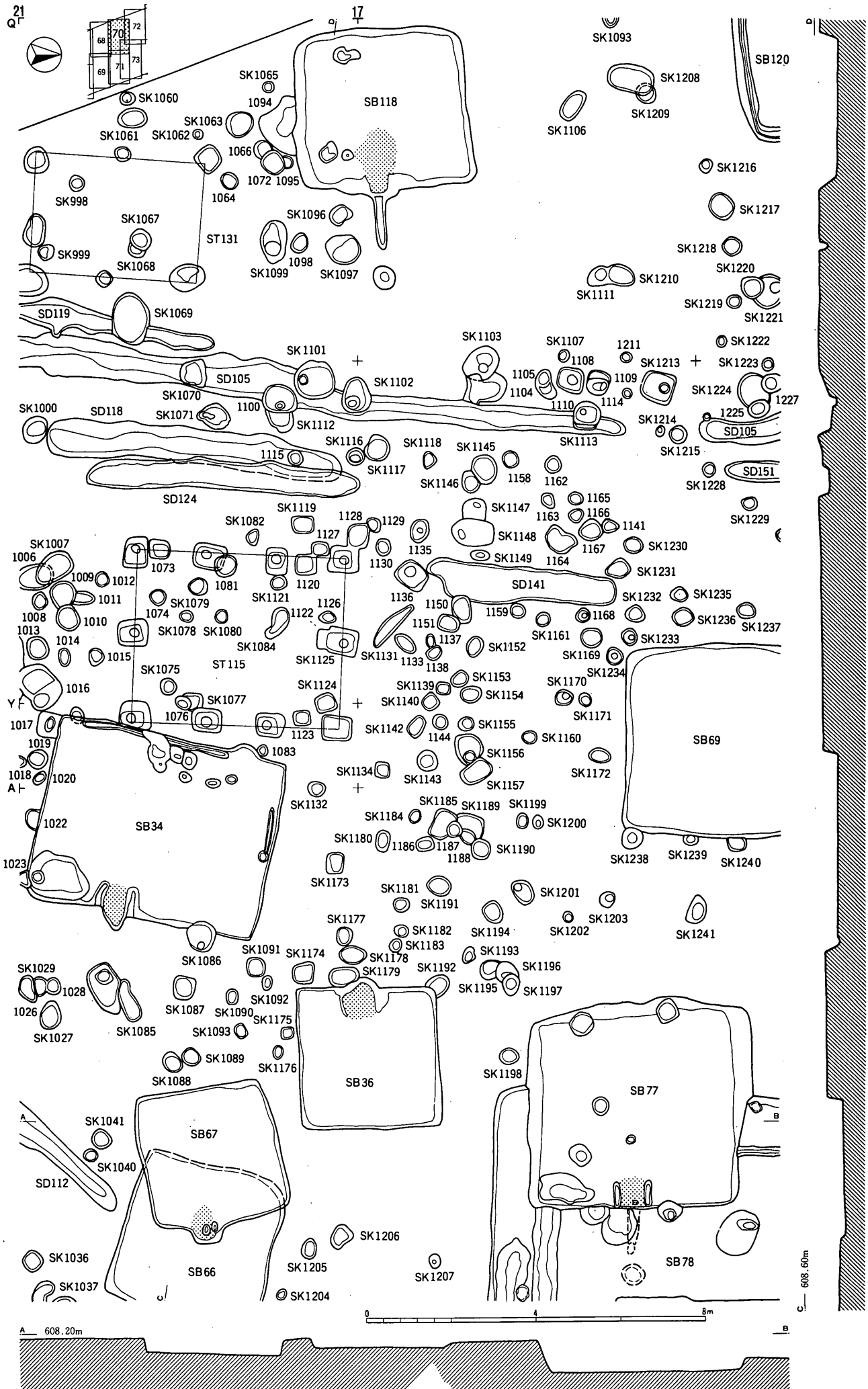

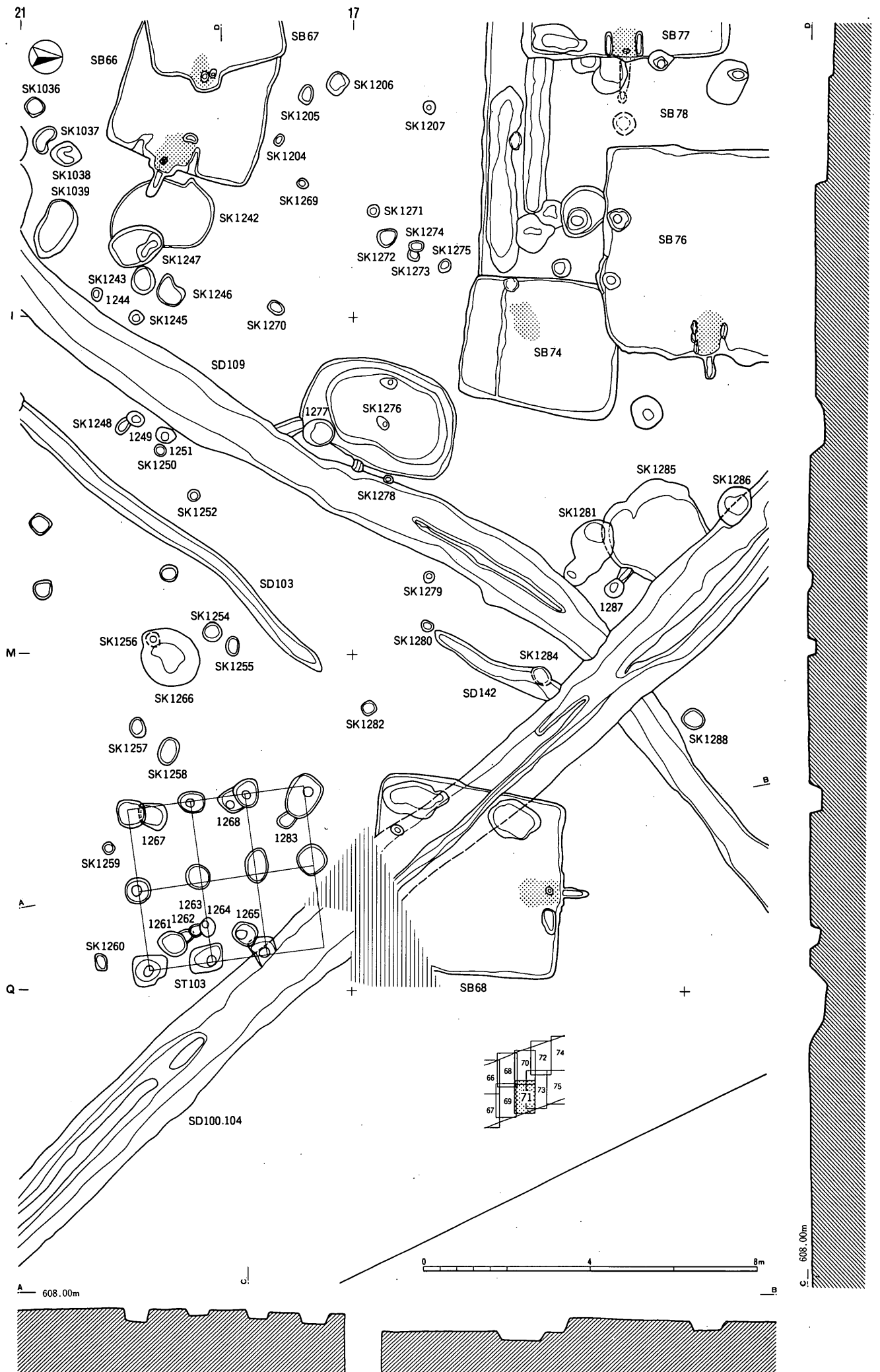



M- 13

09

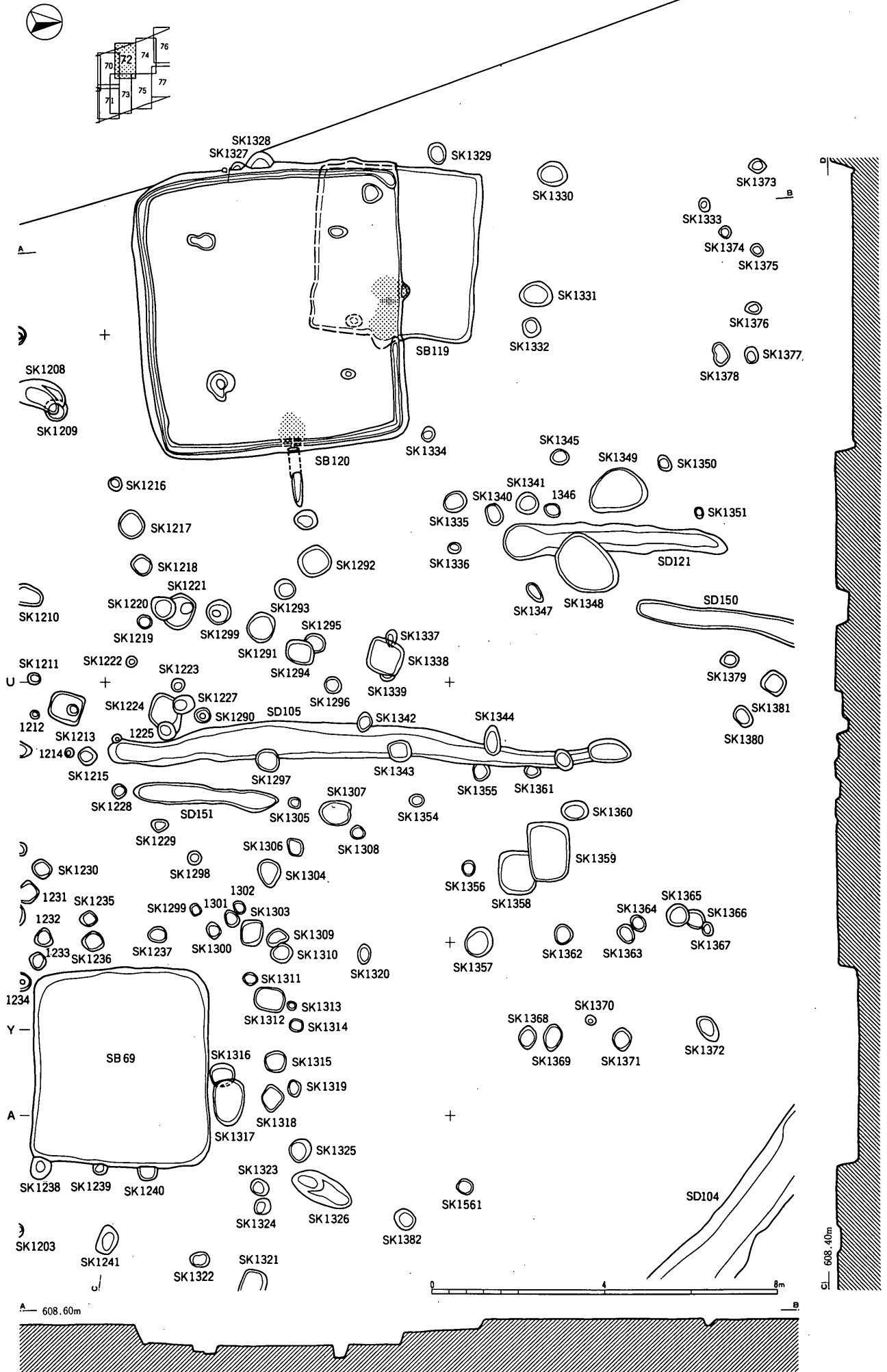

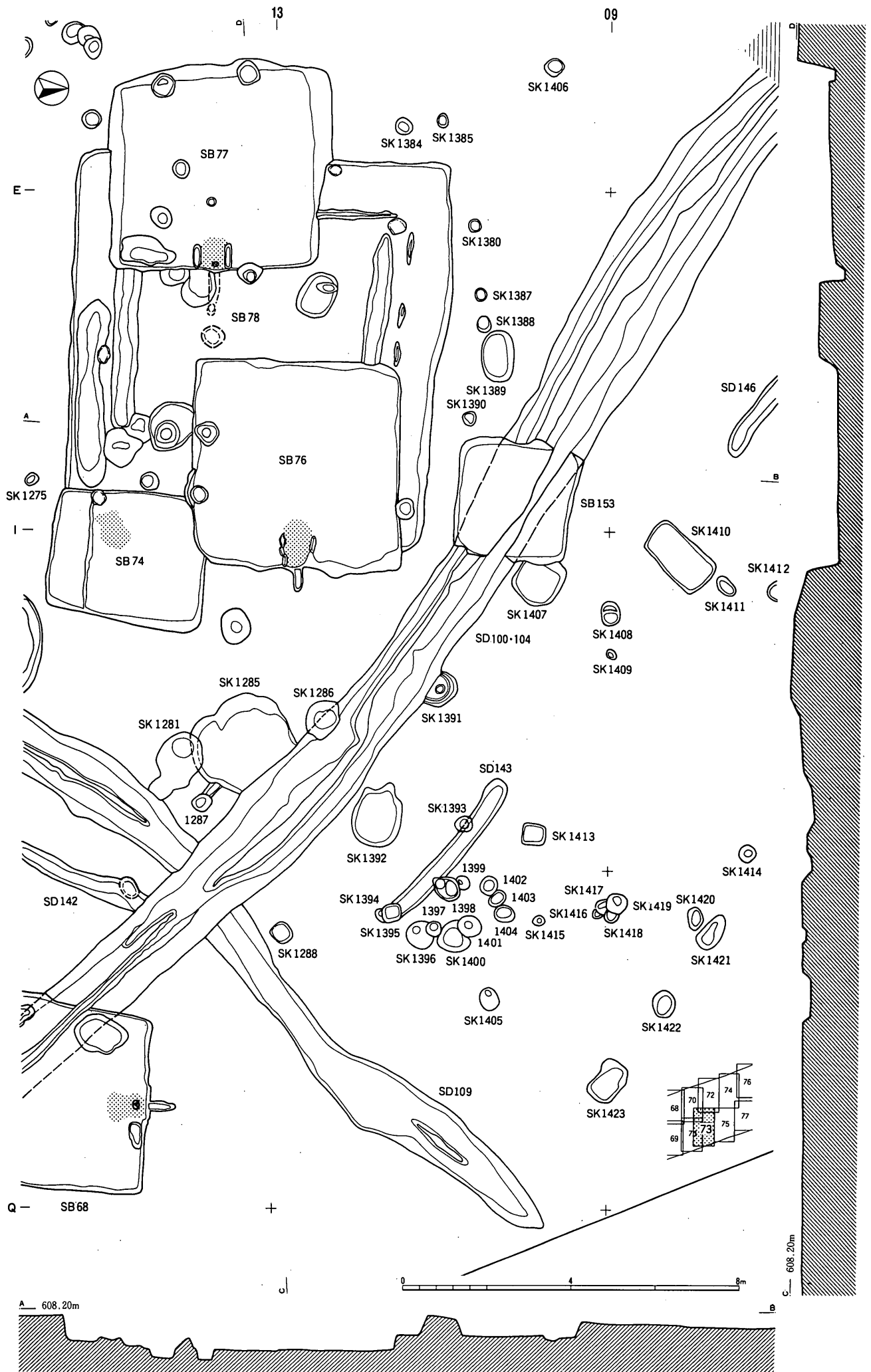

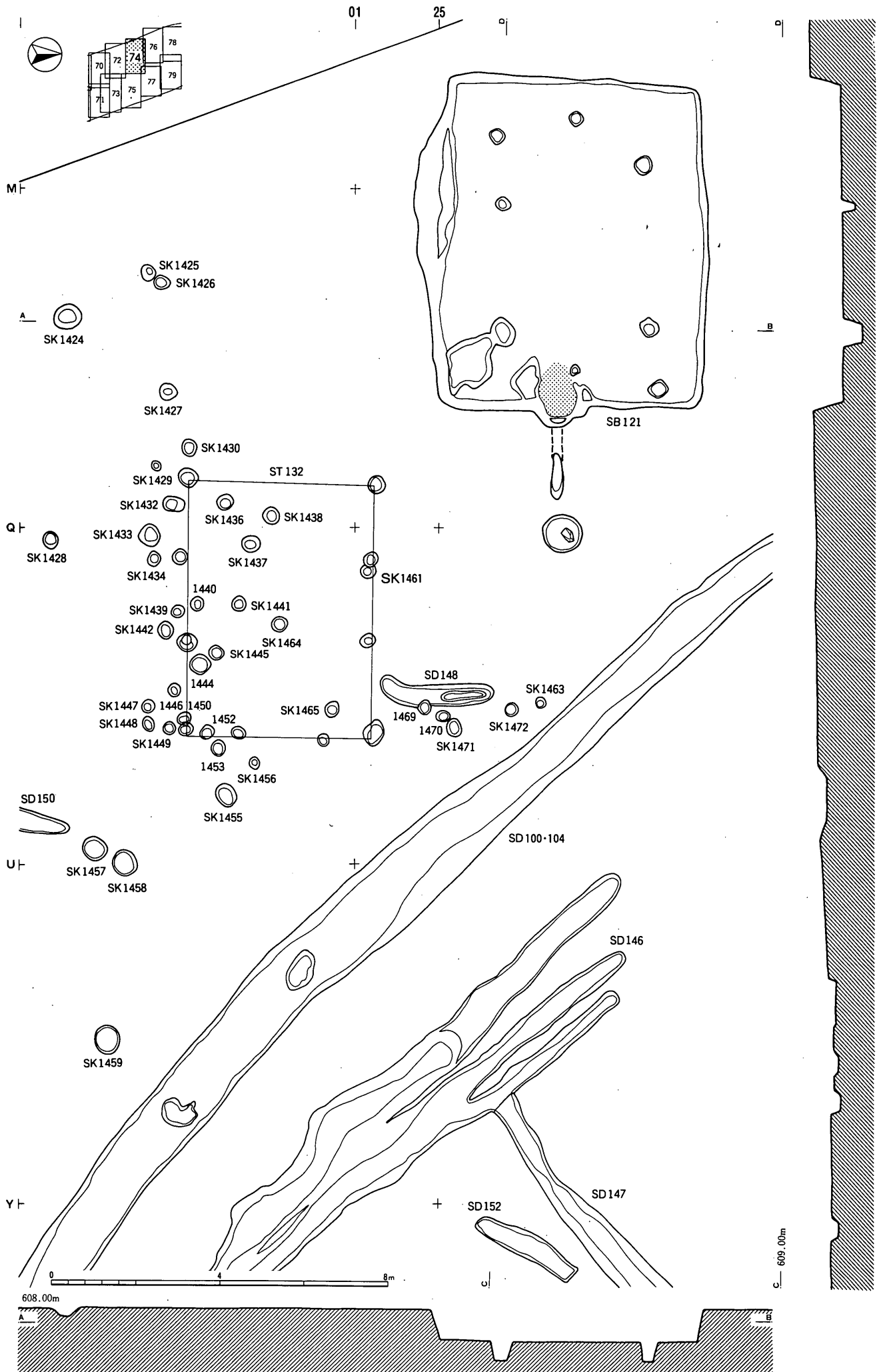

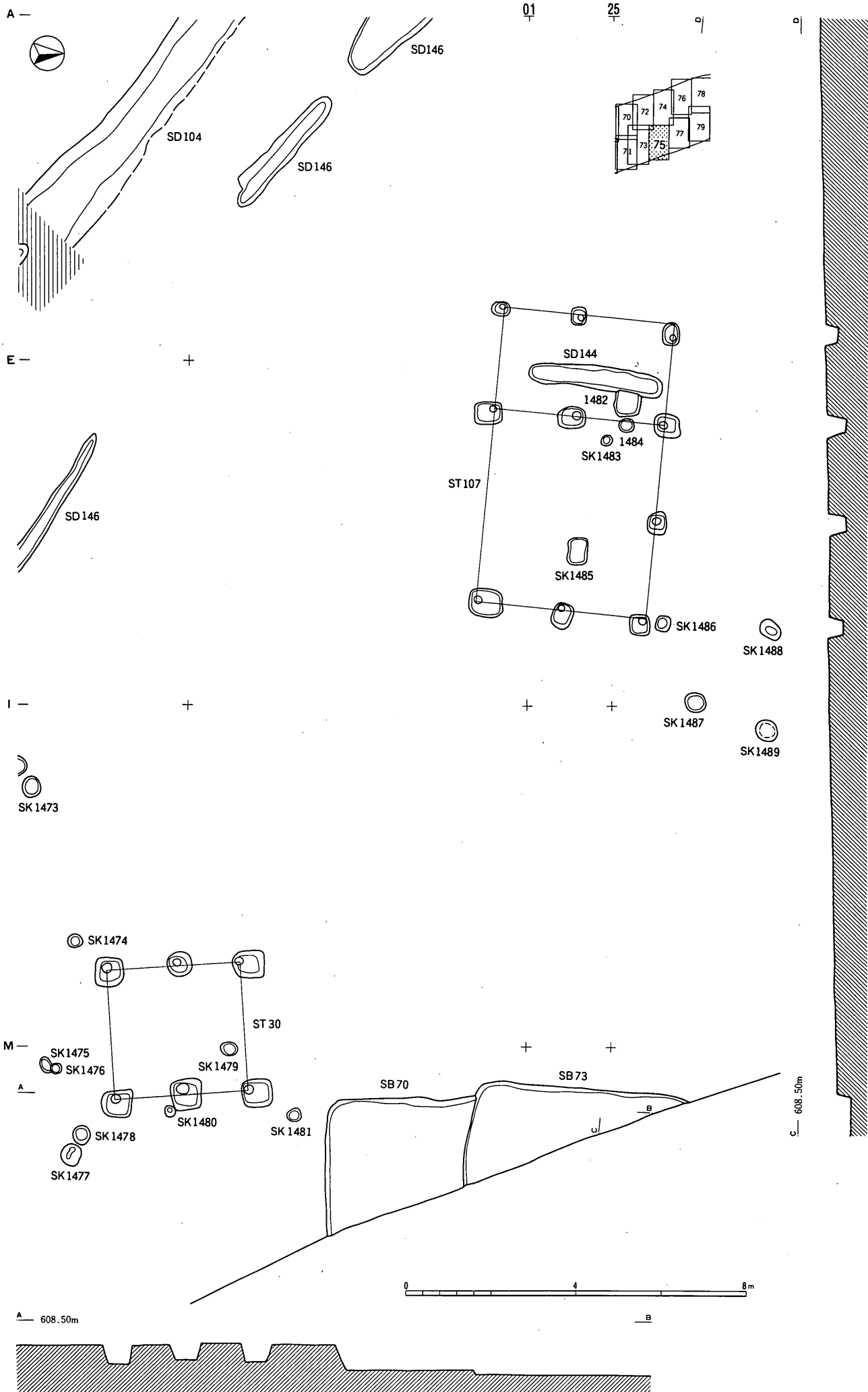

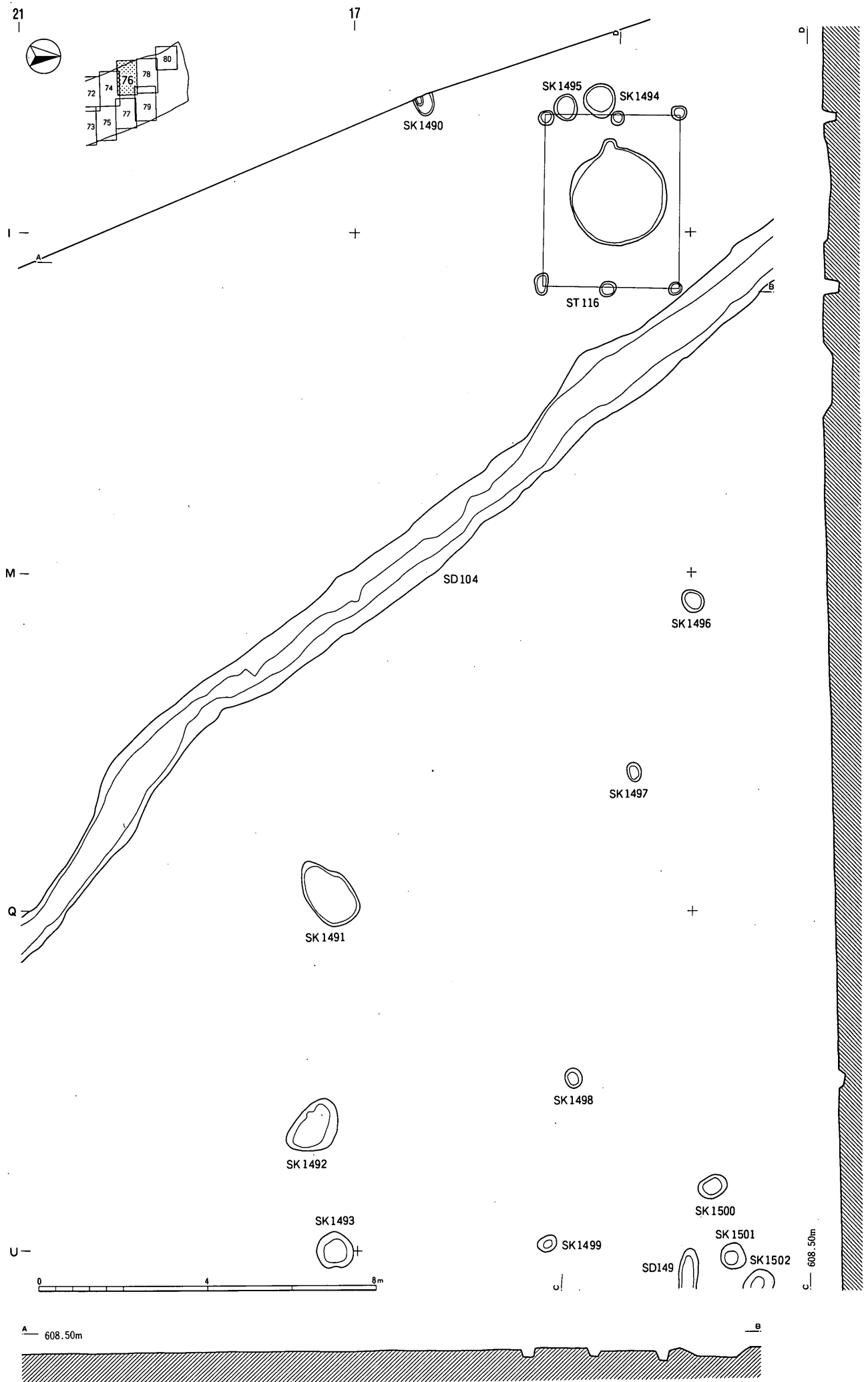

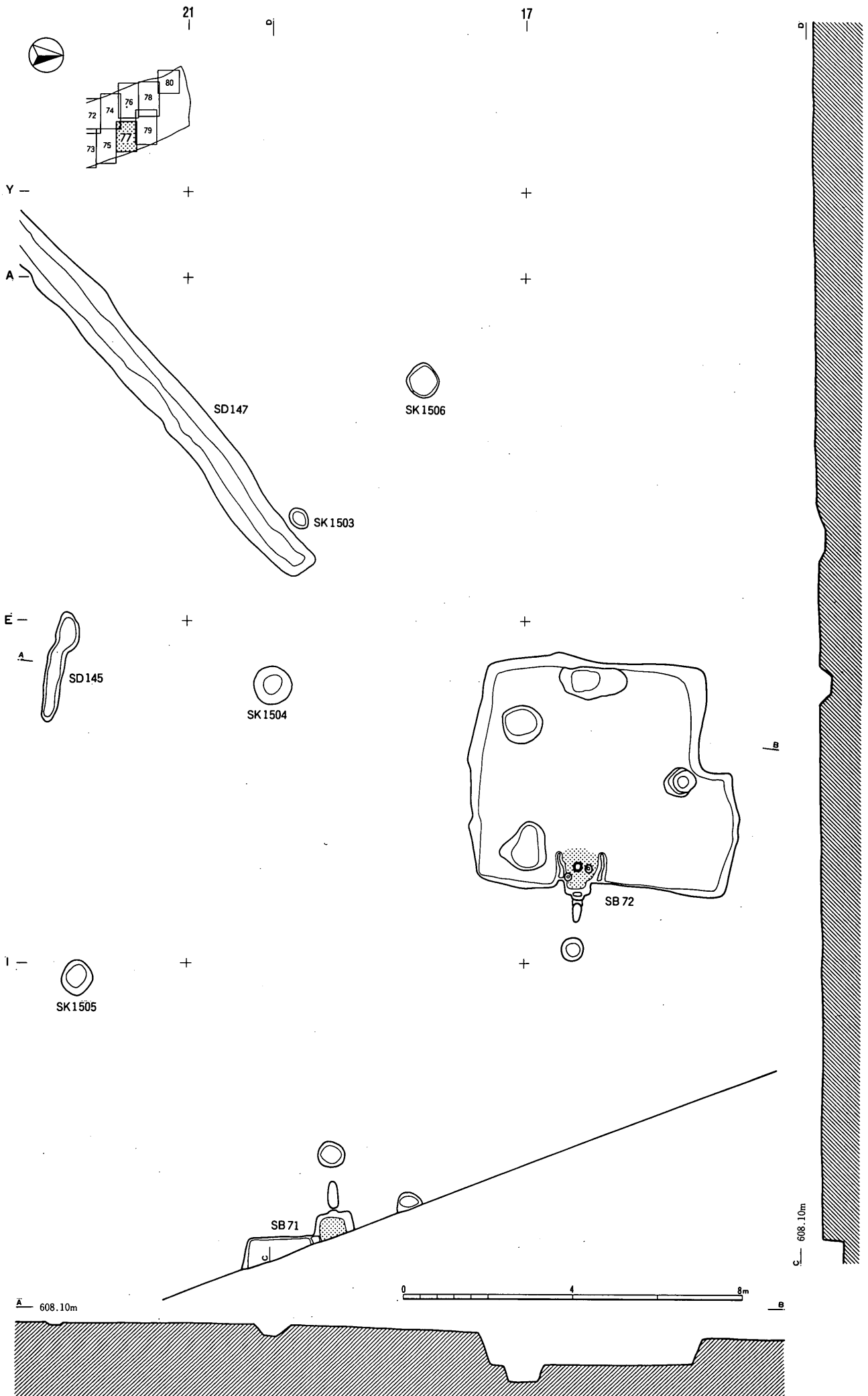

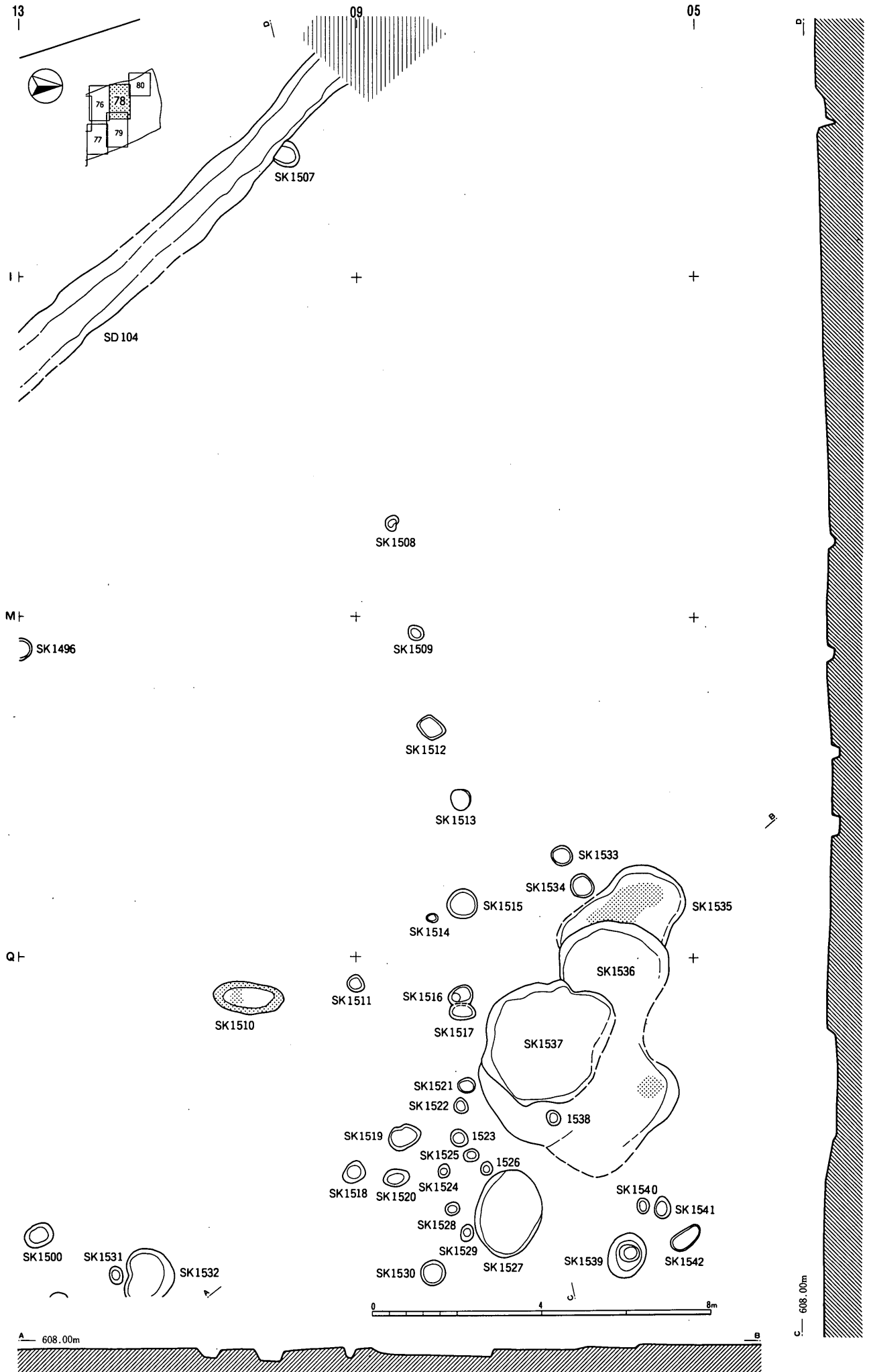

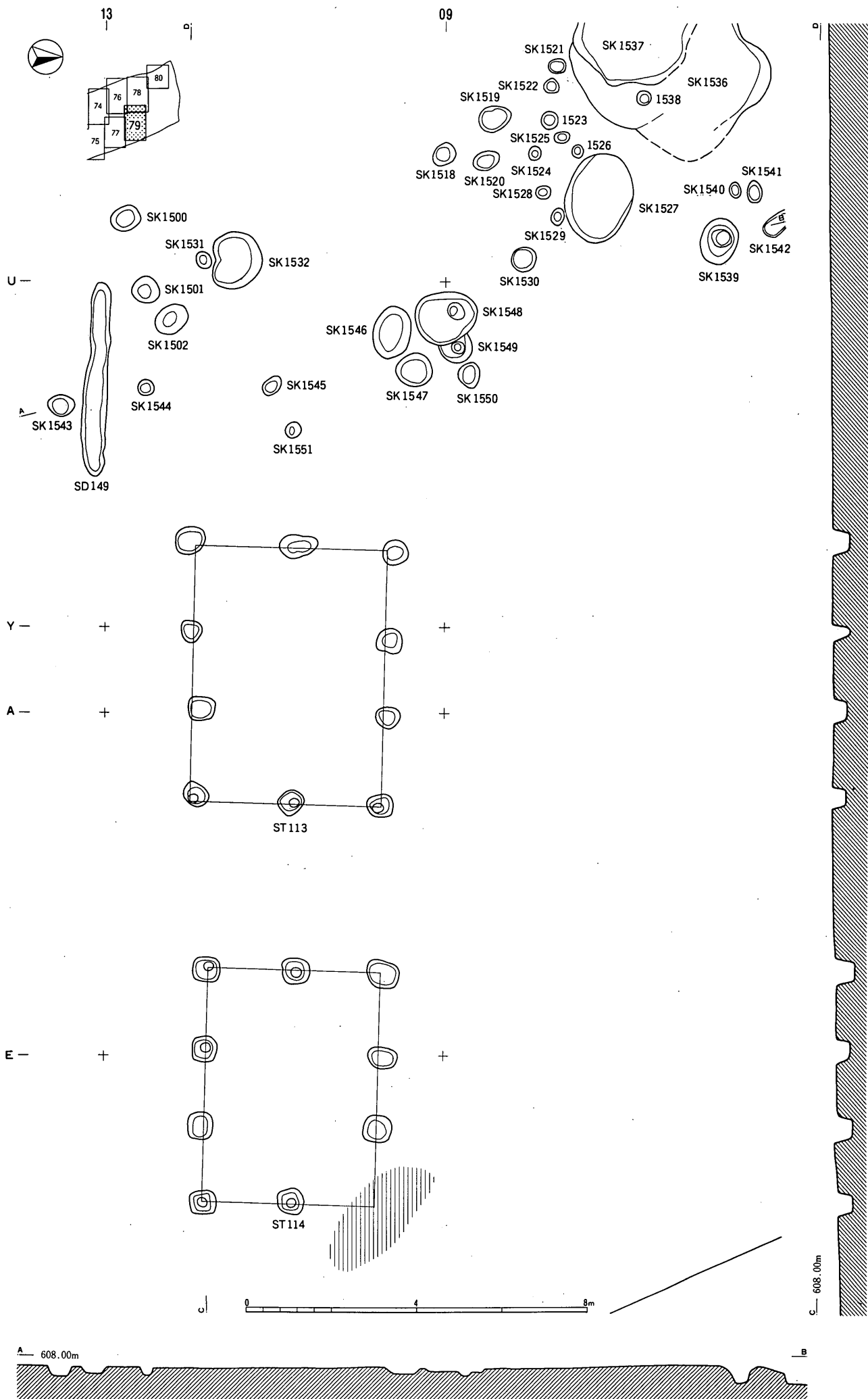



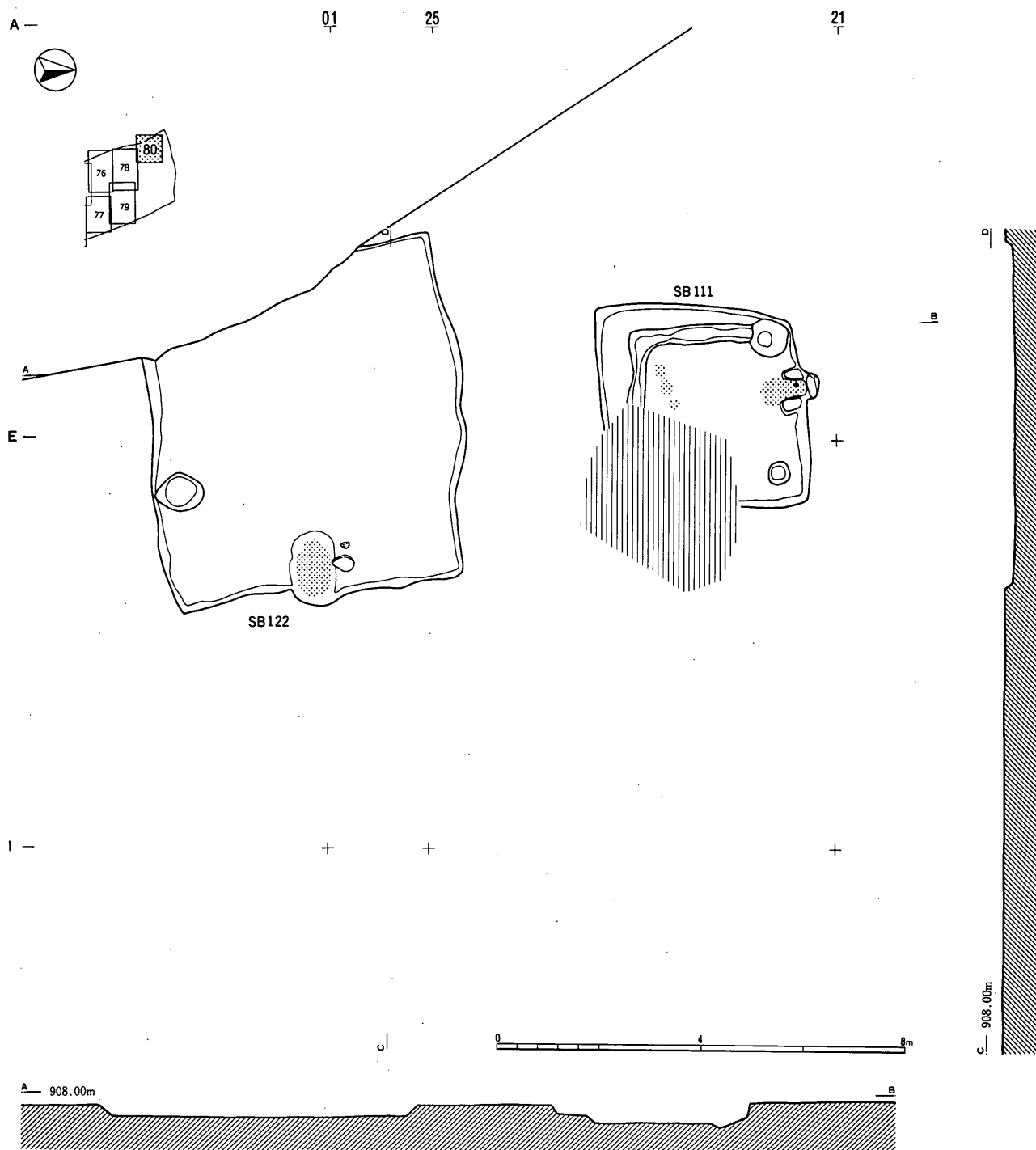

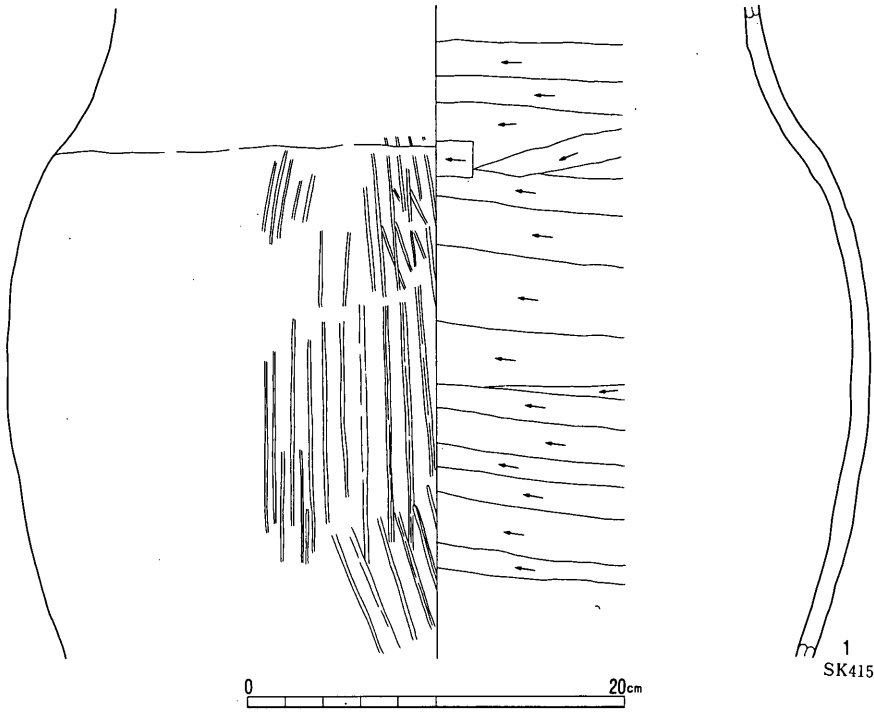

1  
SK415

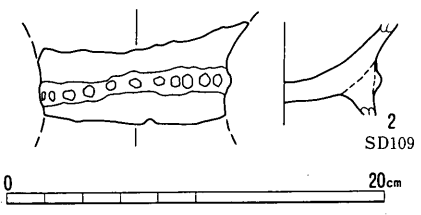

2  
SD109

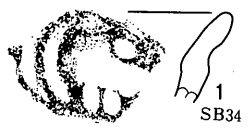

1  
SB34

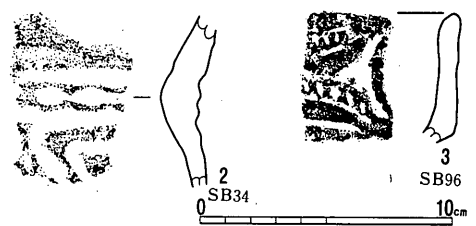

2  
SB34

3  
SB96

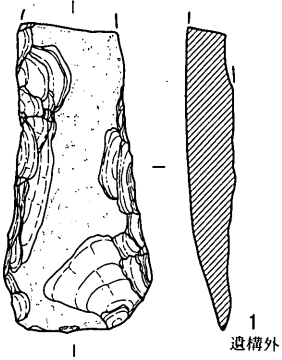

1  
遺構外

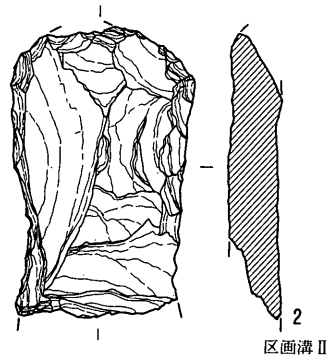

2  
区画溝Ⅱ

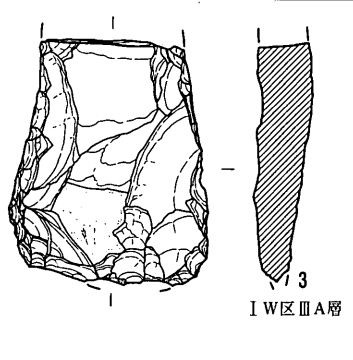

3  
I区ⅢA層

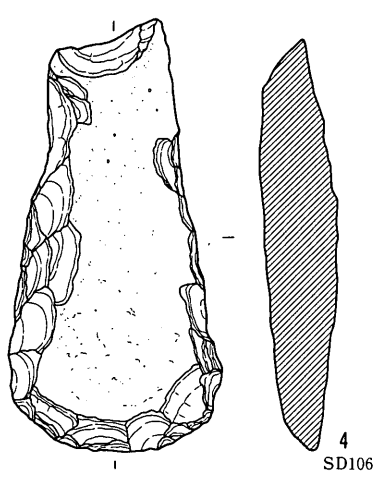

4  
SD106

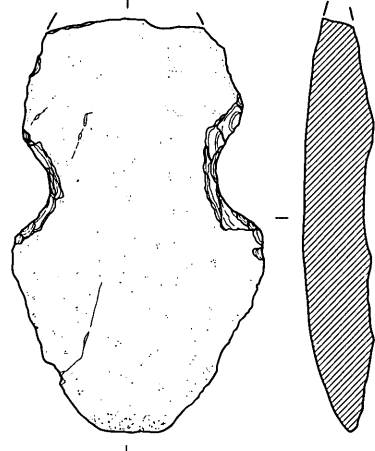

5  
SB129

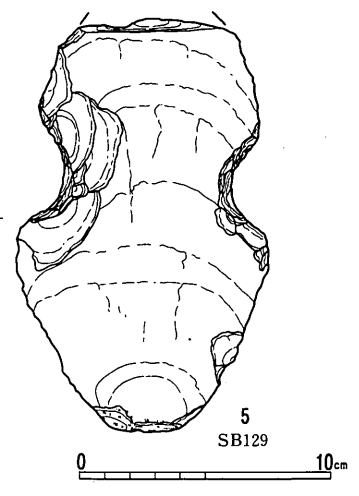

SB 1

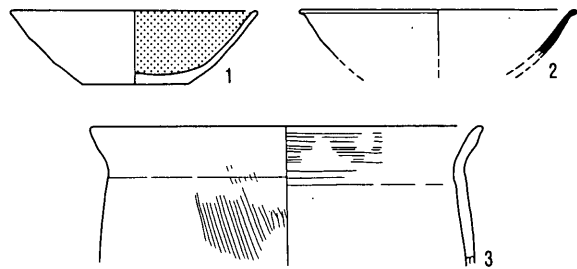

SB 2

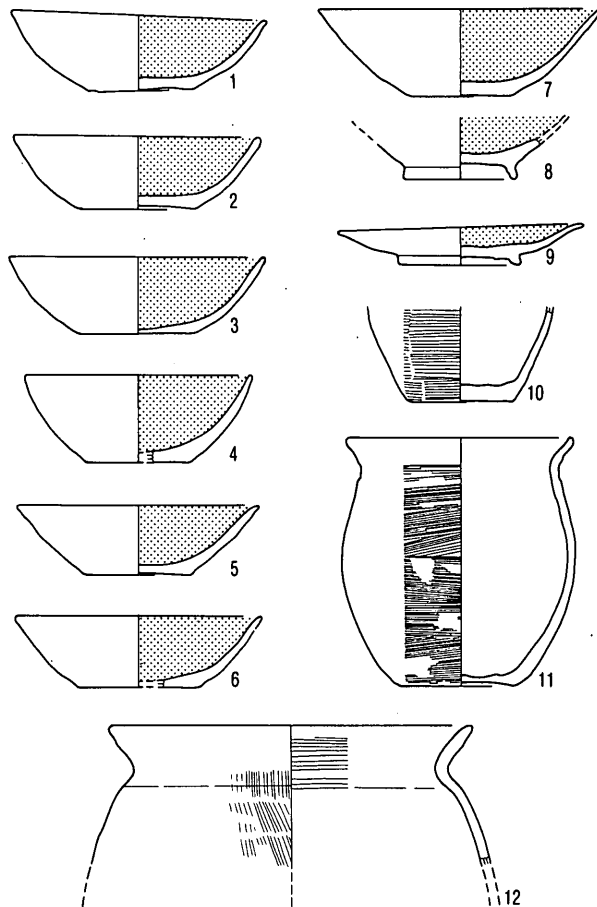

SB 3

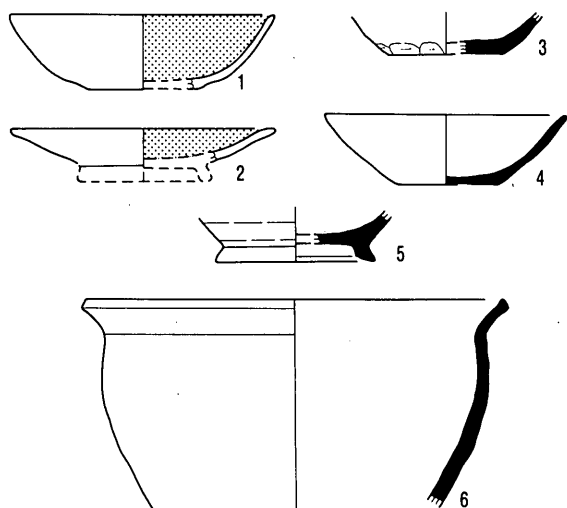

SB 4

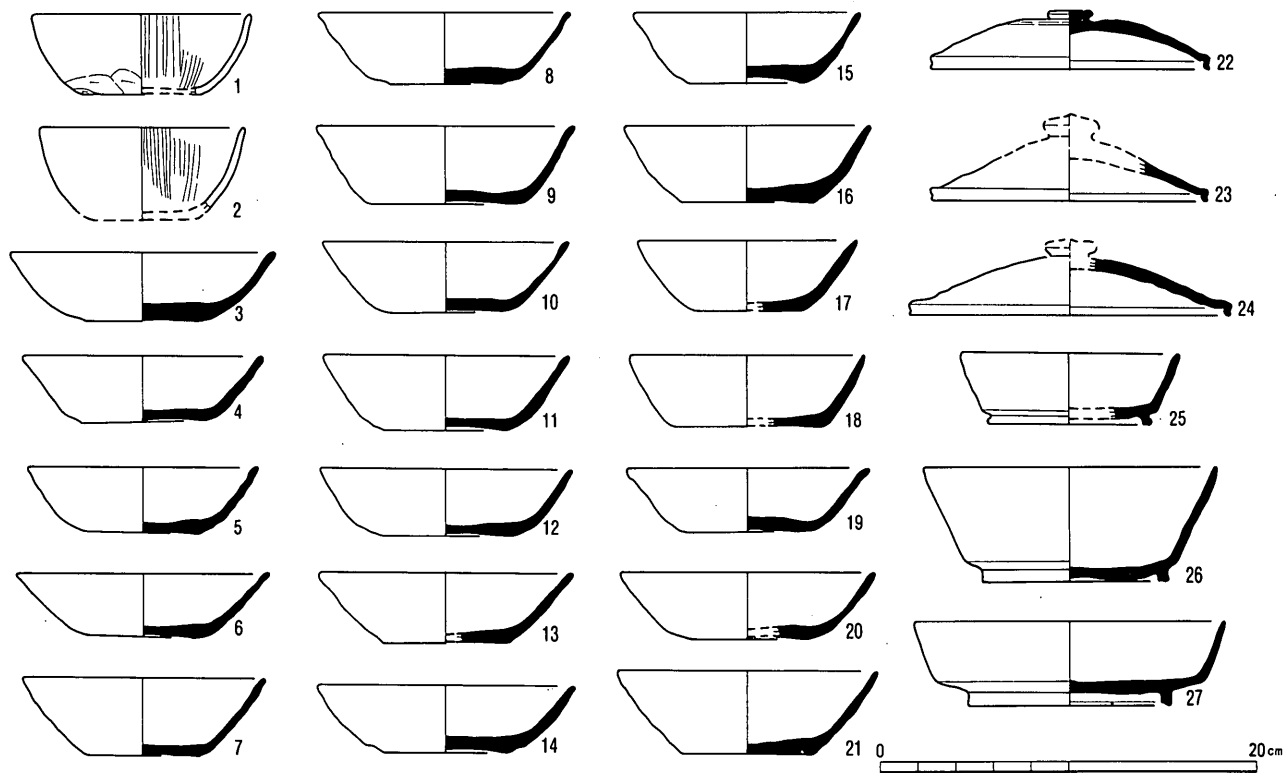

SB 4

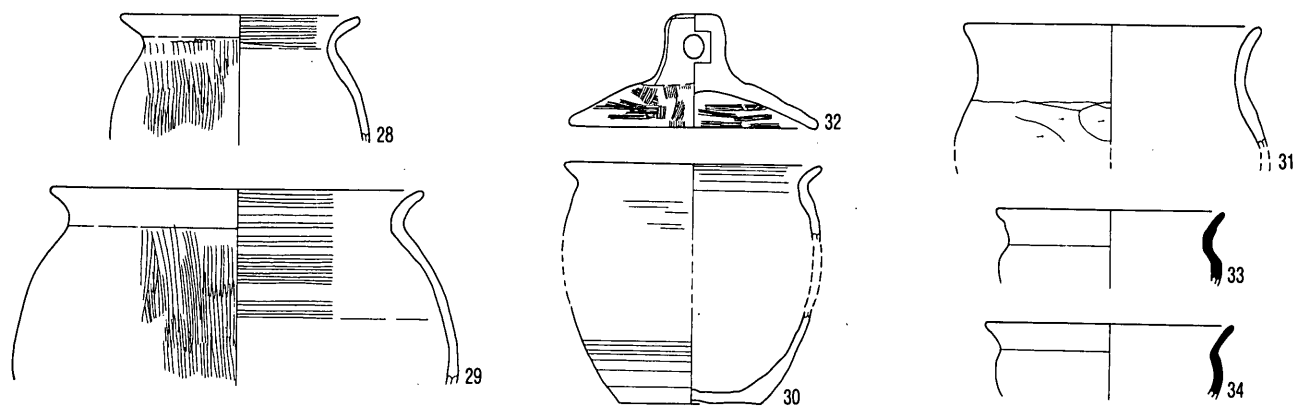

SB 5

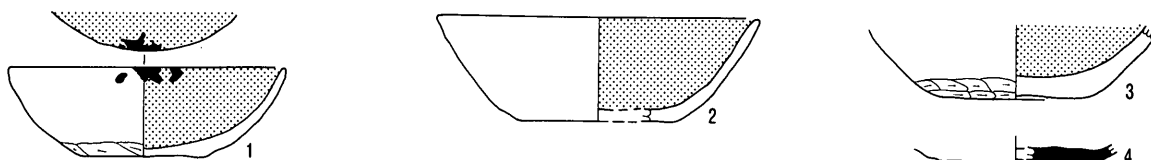

SB 6

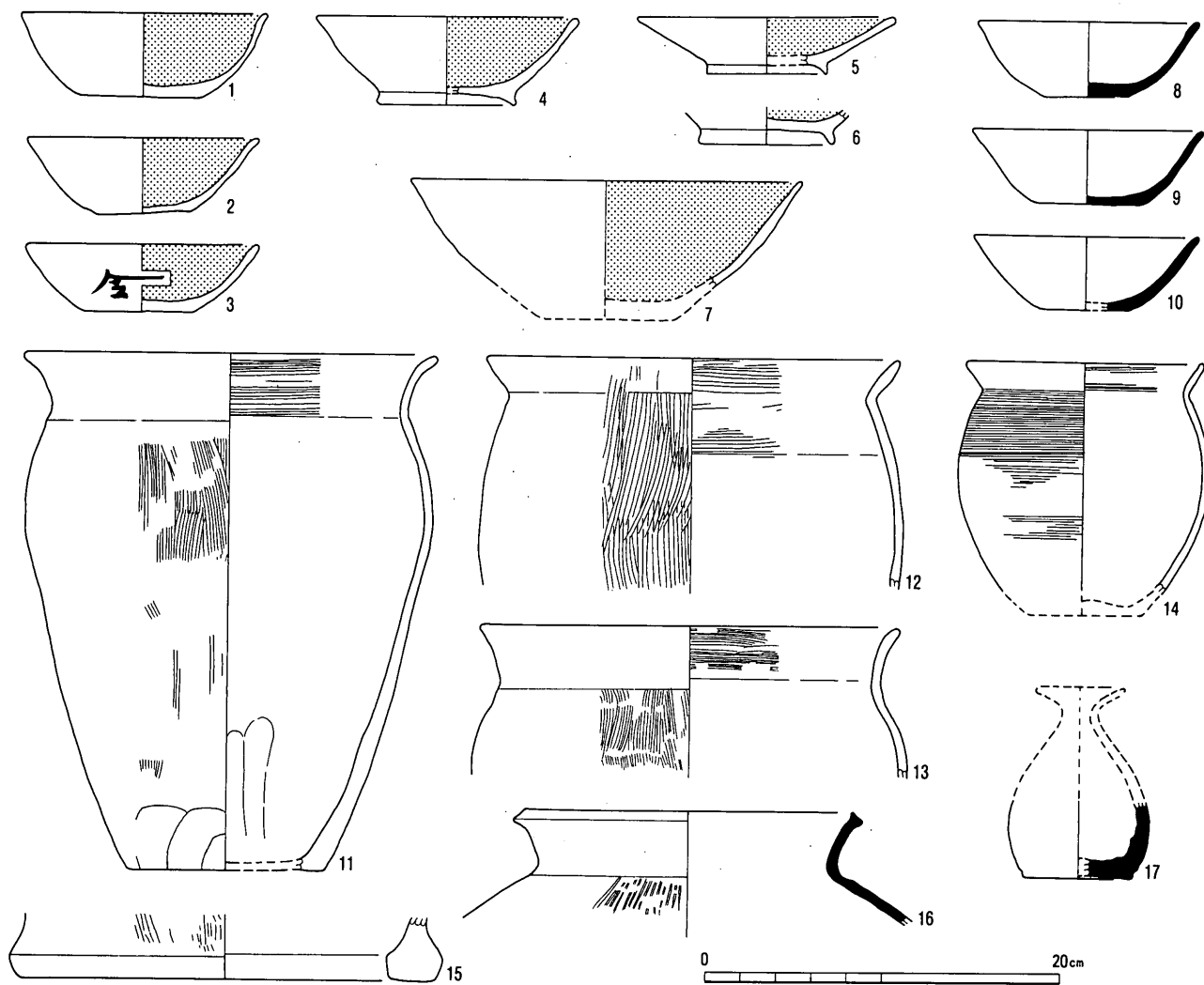

SB 7

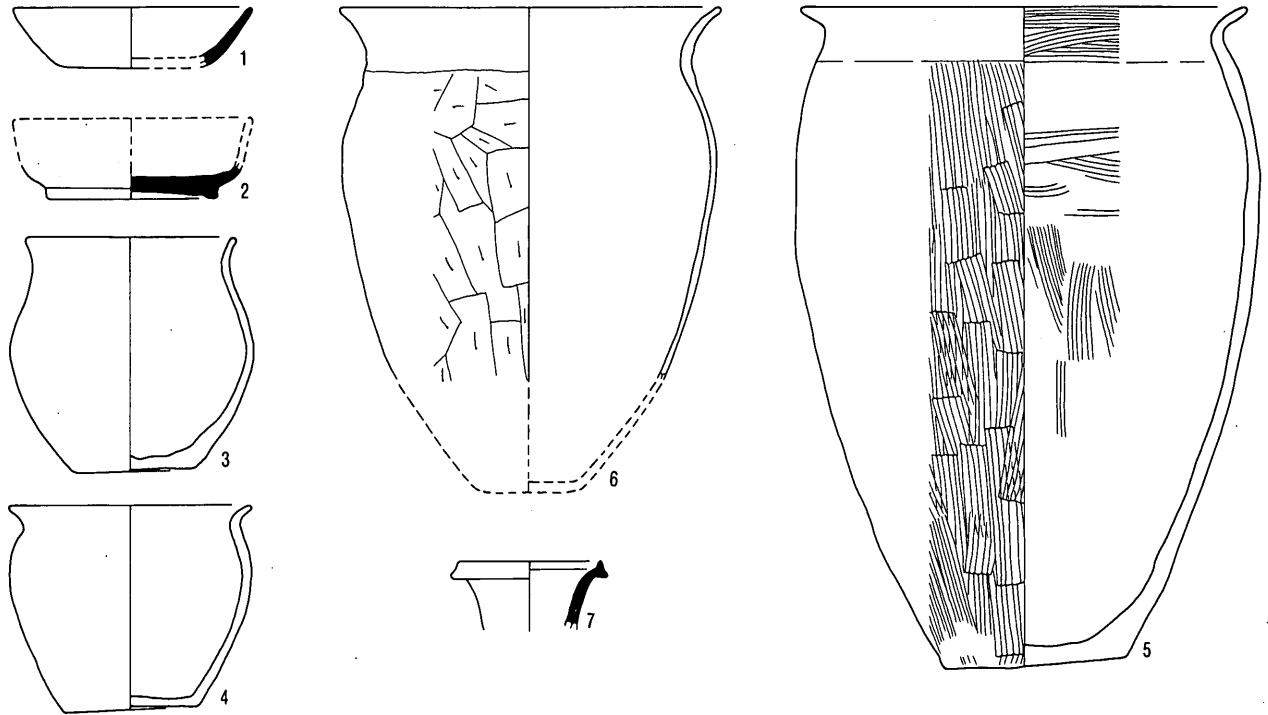

SB 8

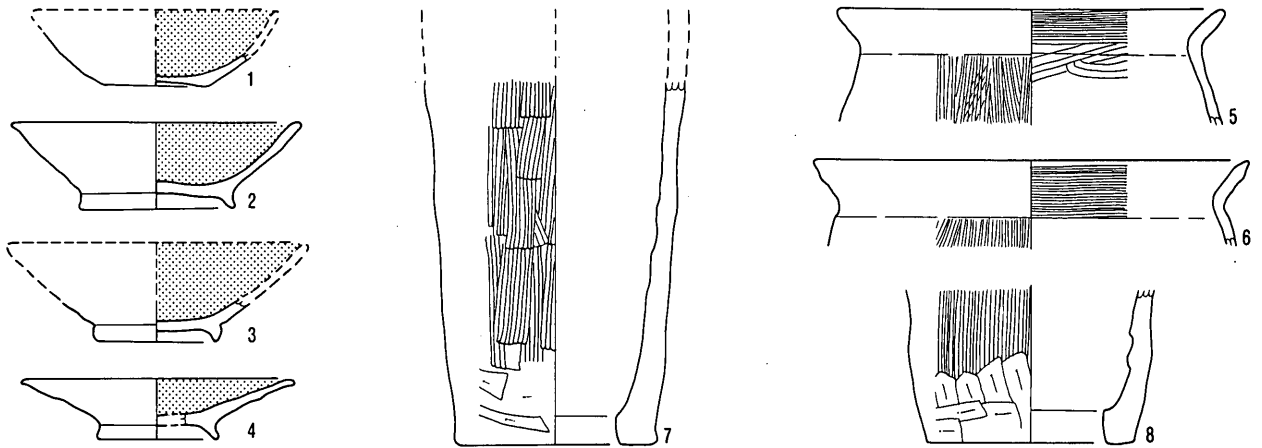

SB 9

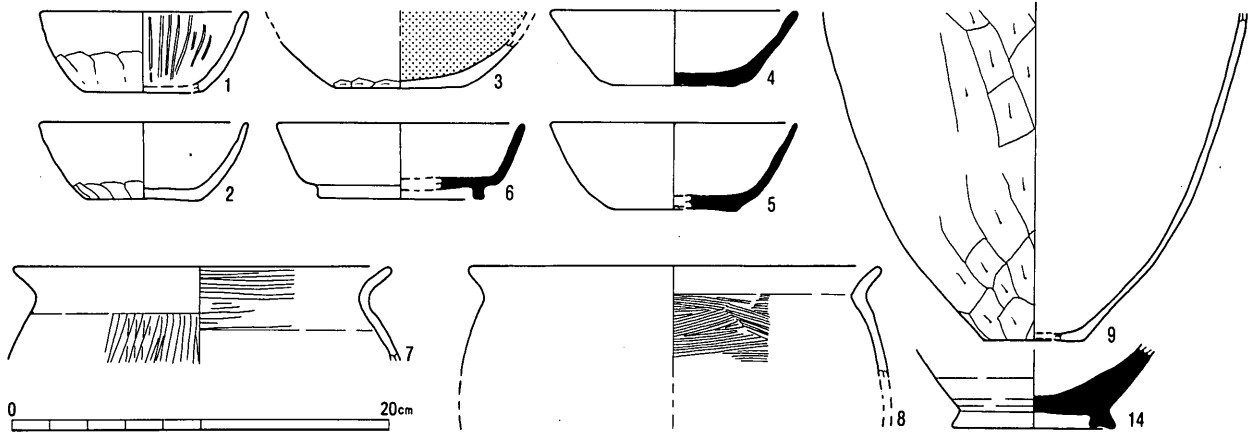

SB 9

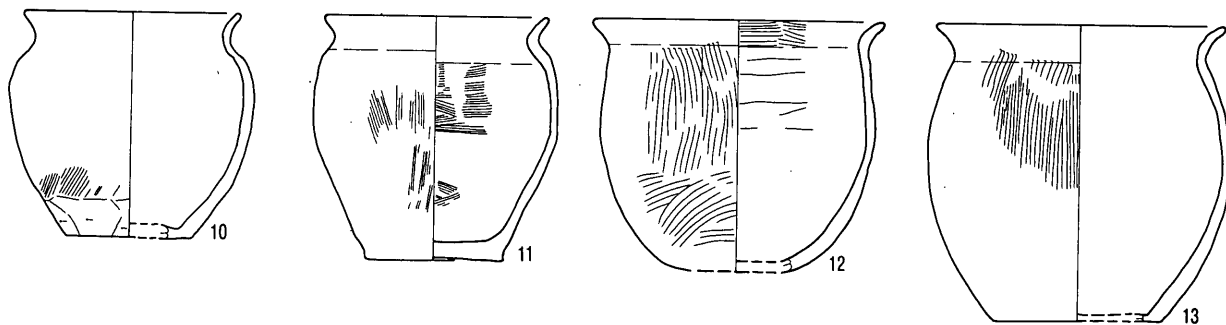

SB 10

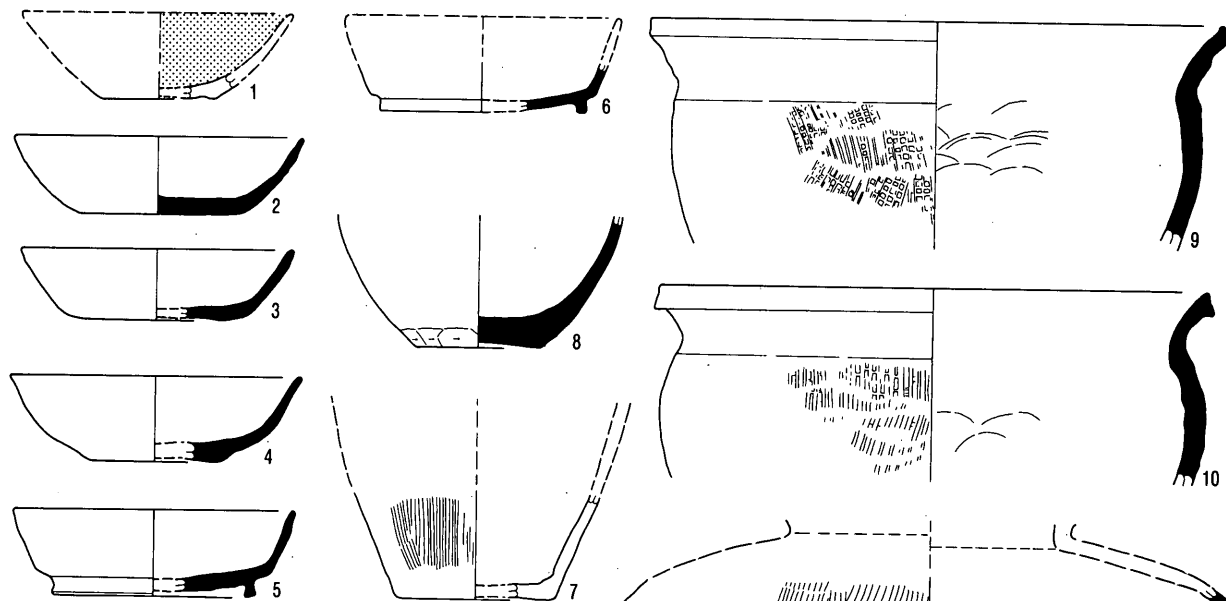

SB 11



SB 12

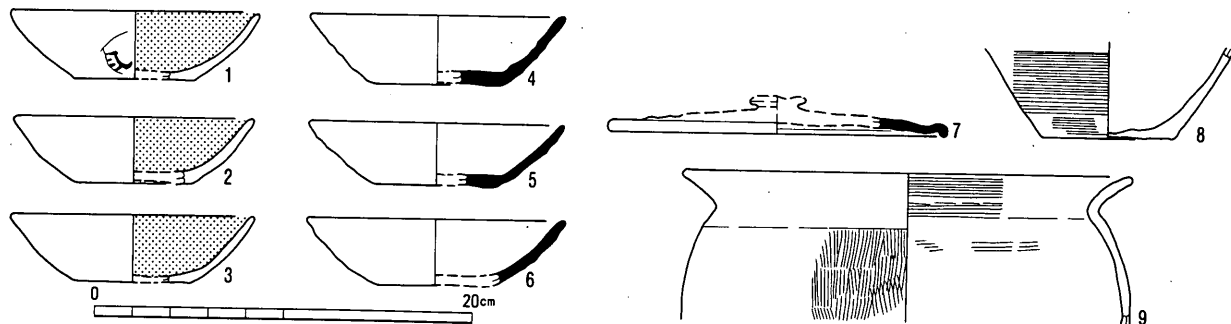

SB 13

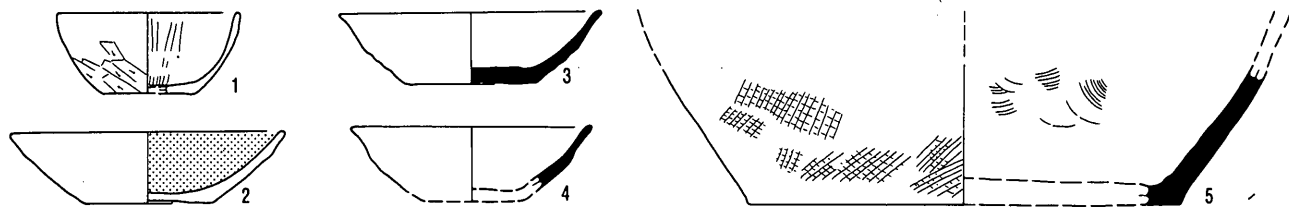

SB 14

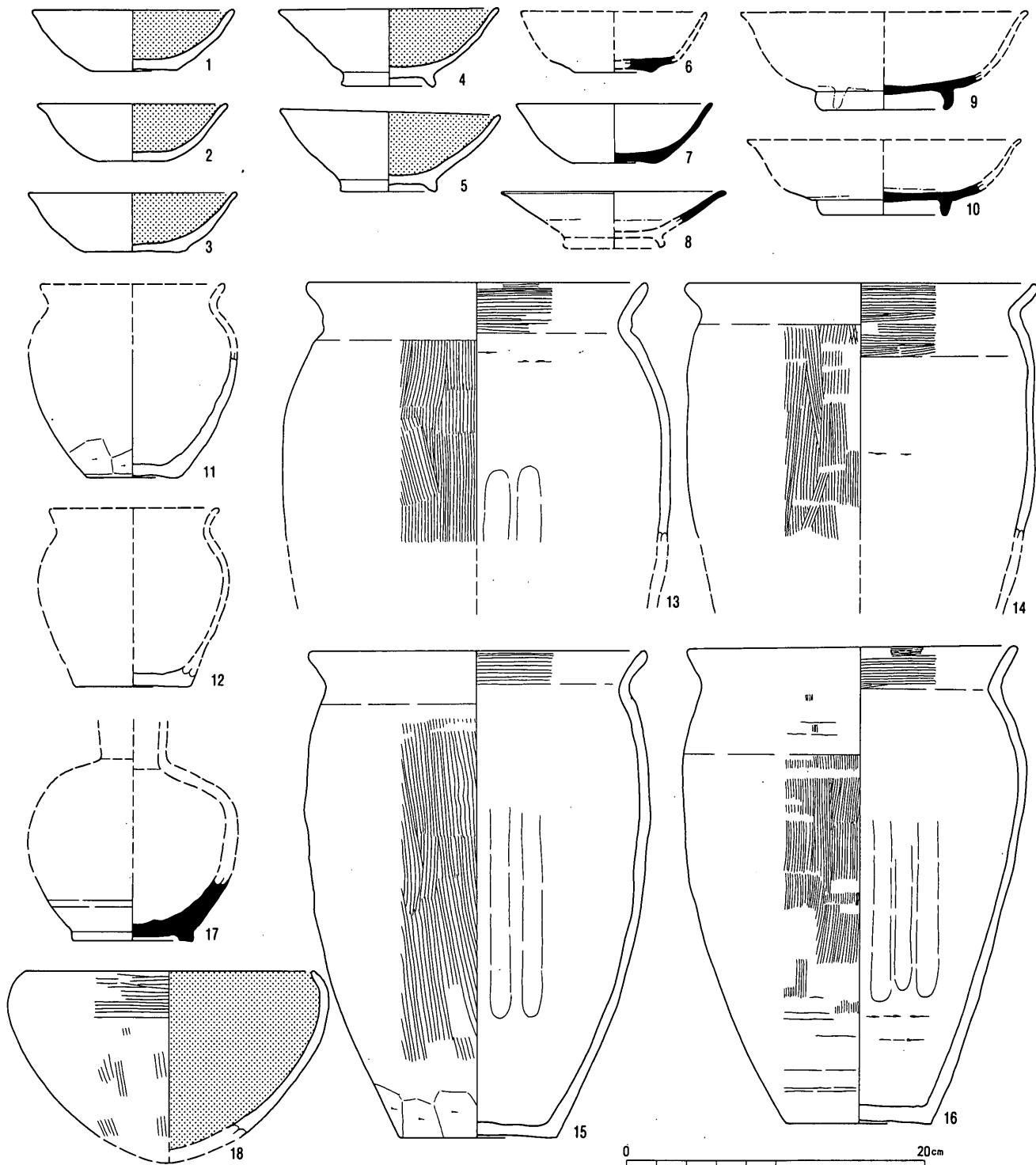

SB 15

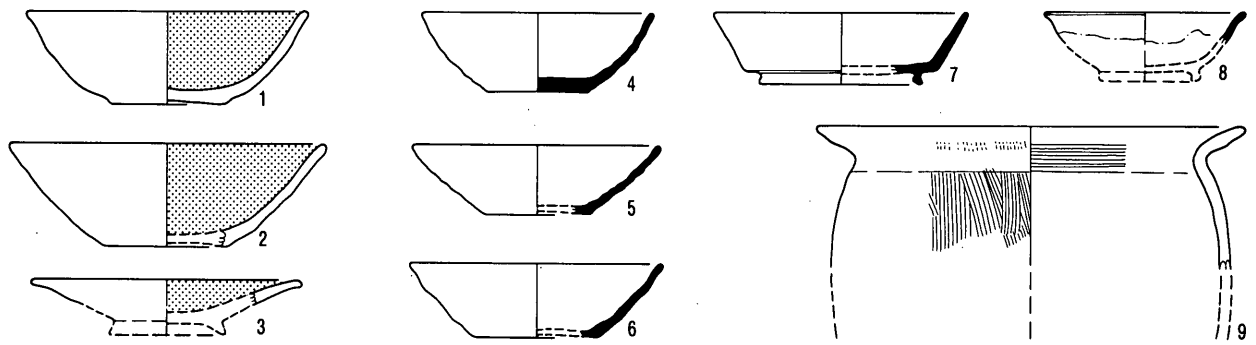

SB 17

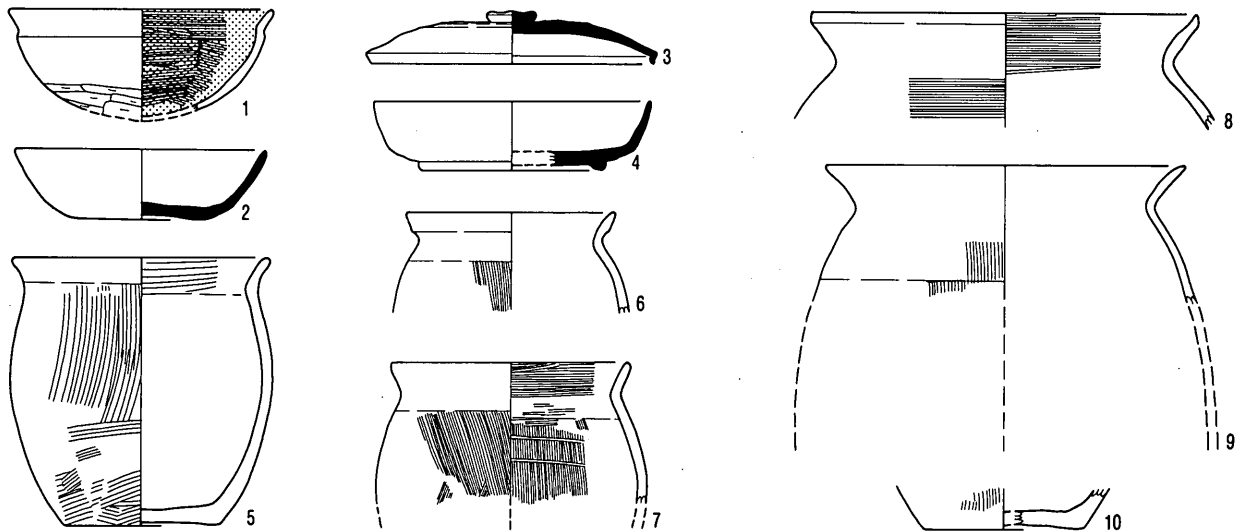

SB 18

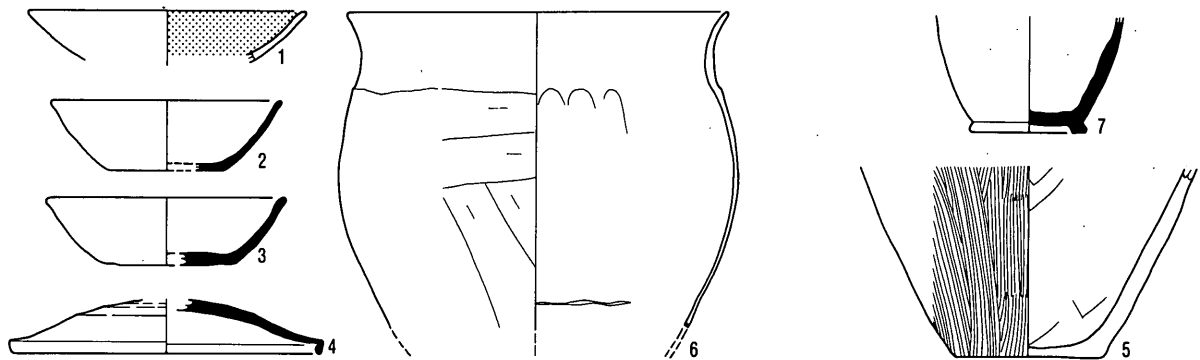

SB 19

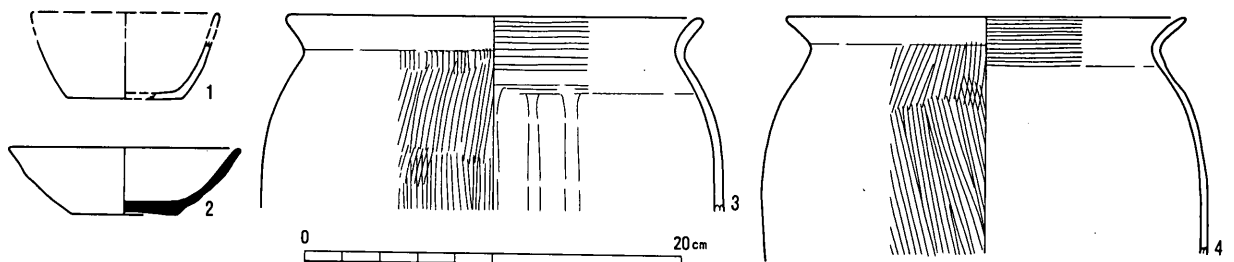



SB 20

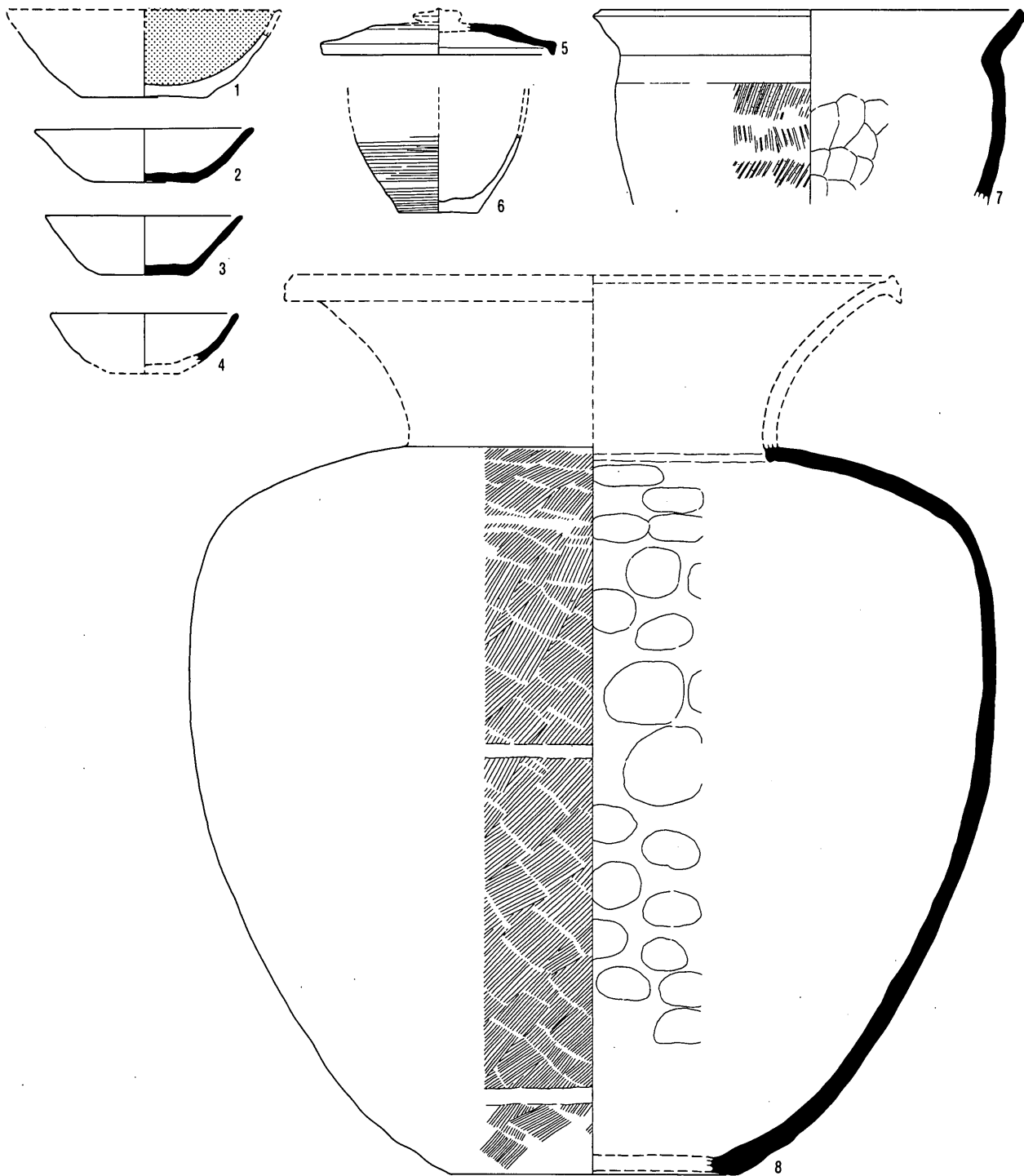

SB 21

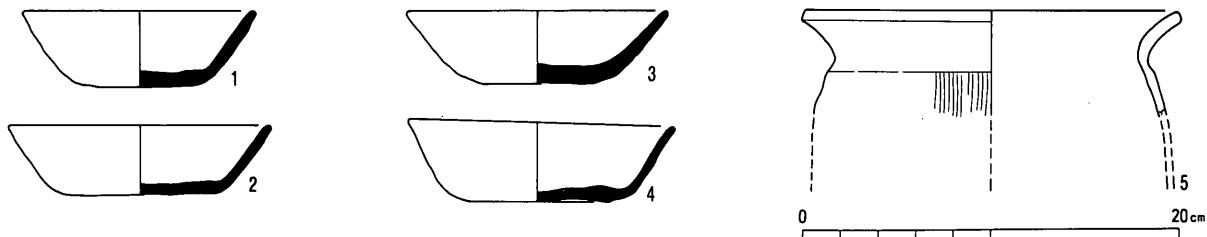

SB 22

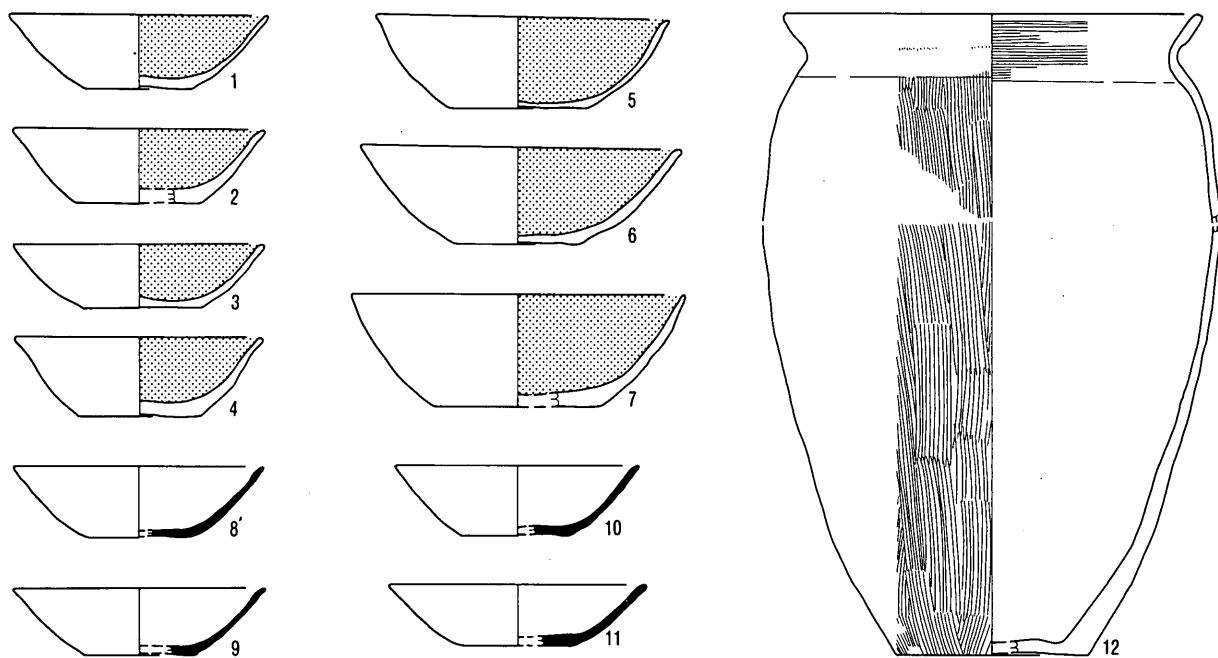

SB 23

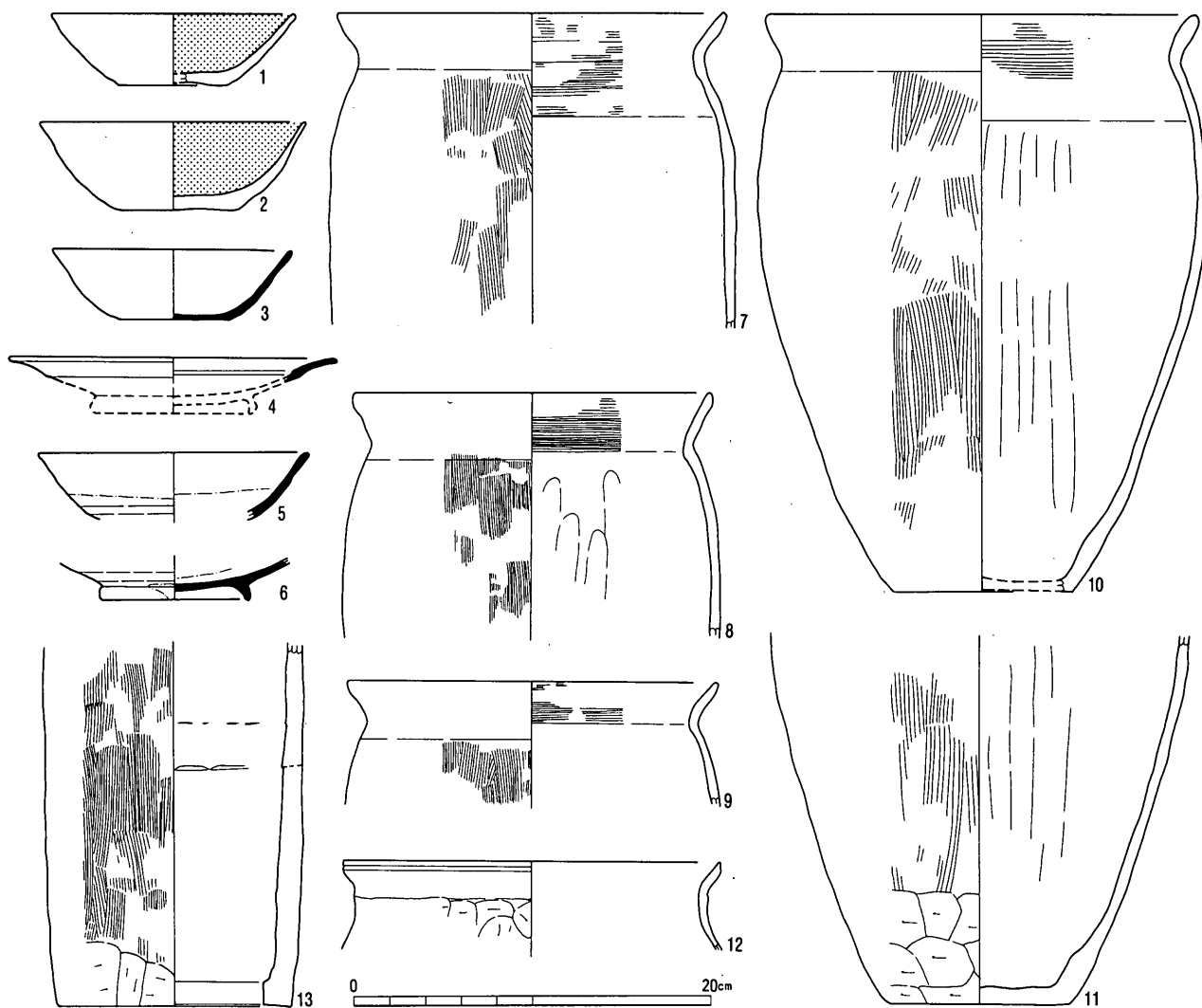

SB 24

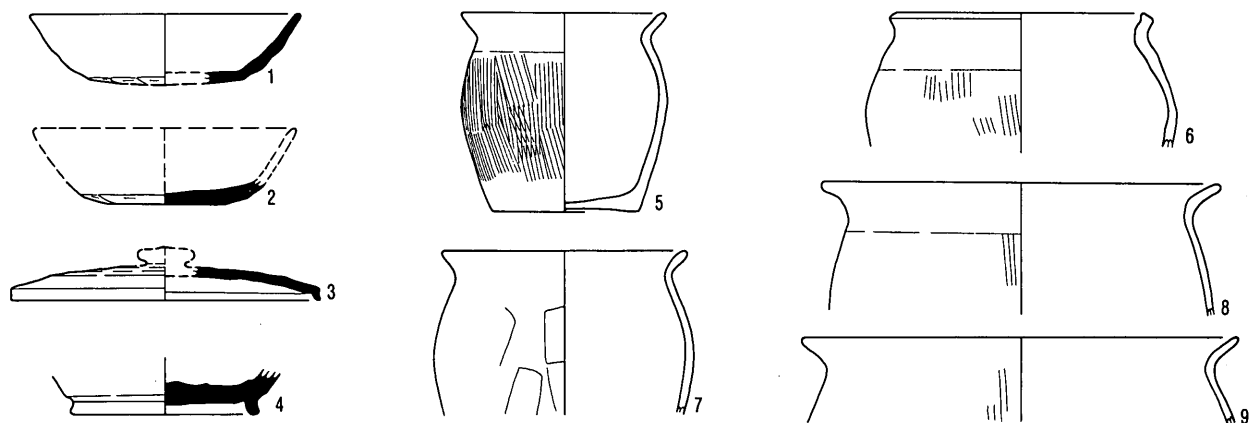

SB 25

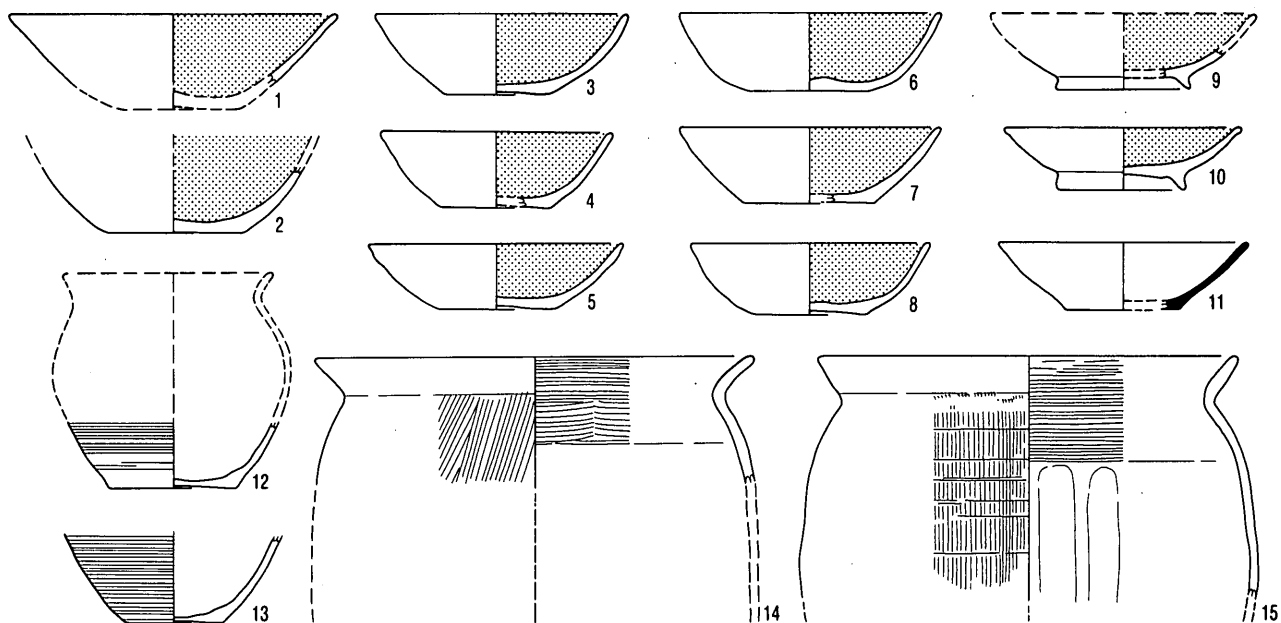

SB 26

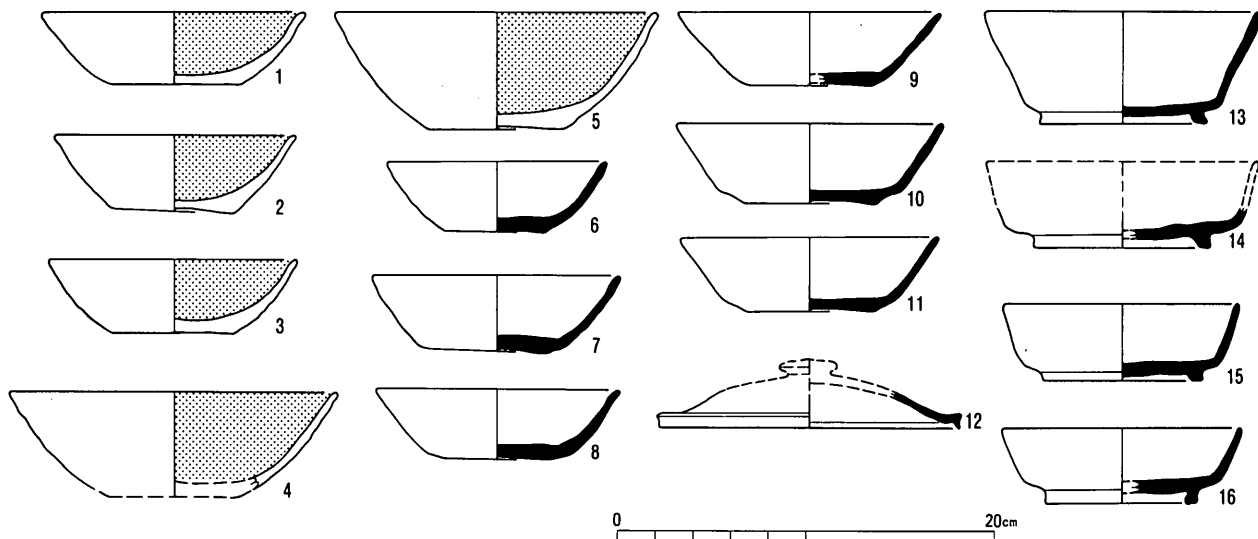

SB 26

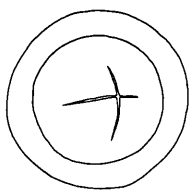
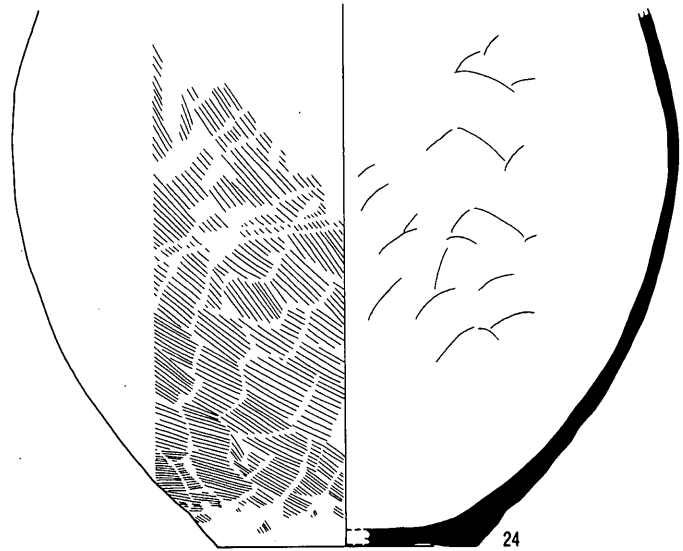
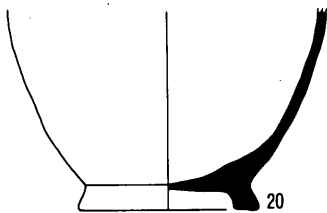
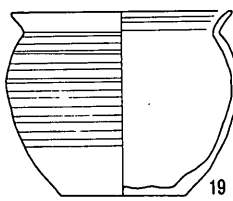
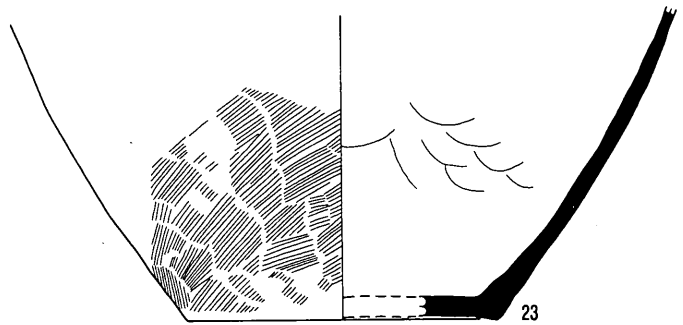
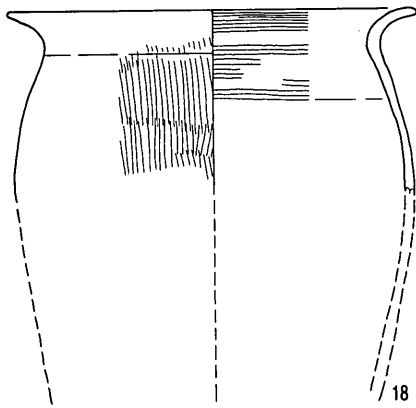
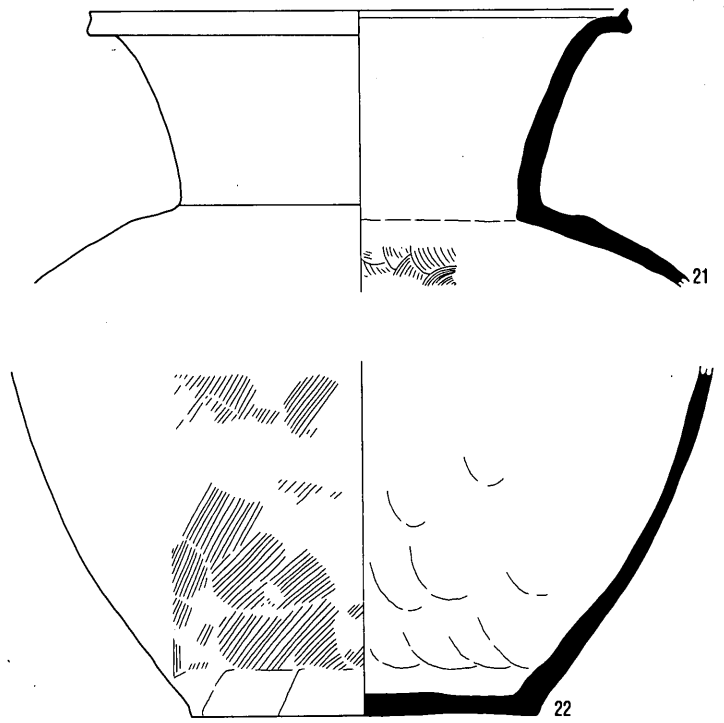
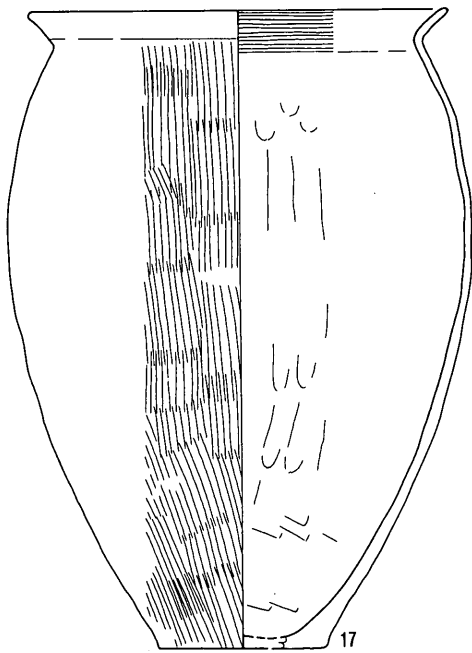

0 20cm

SB26

SB 27

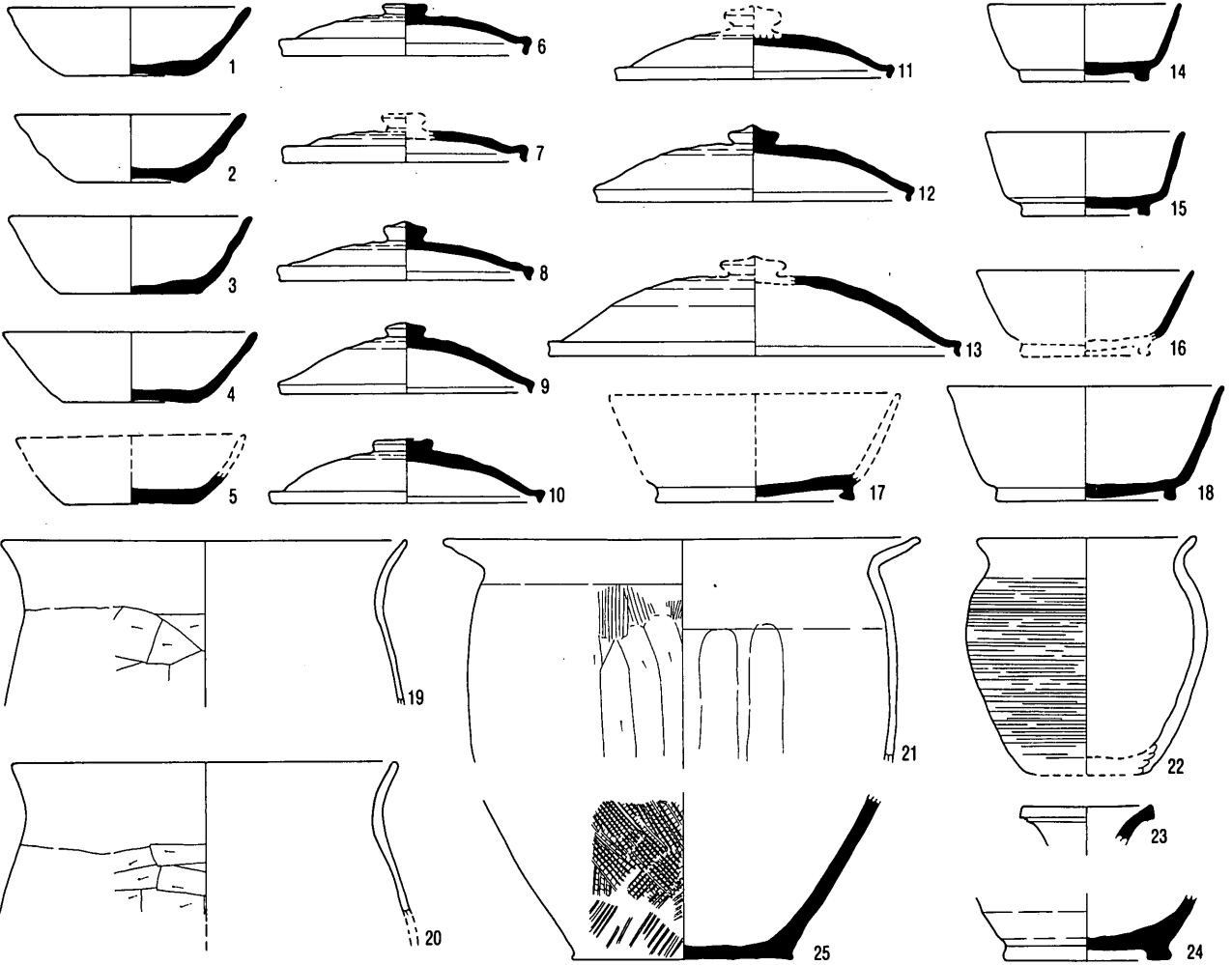

SB 29

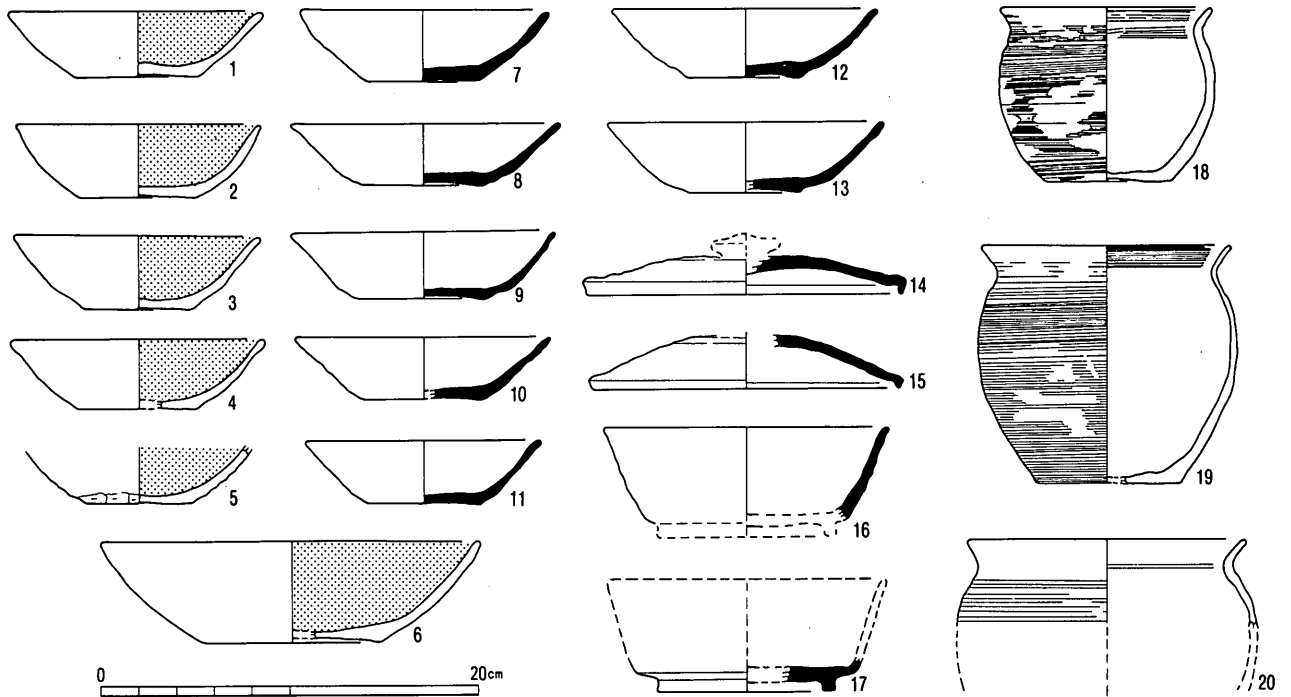

SB 29

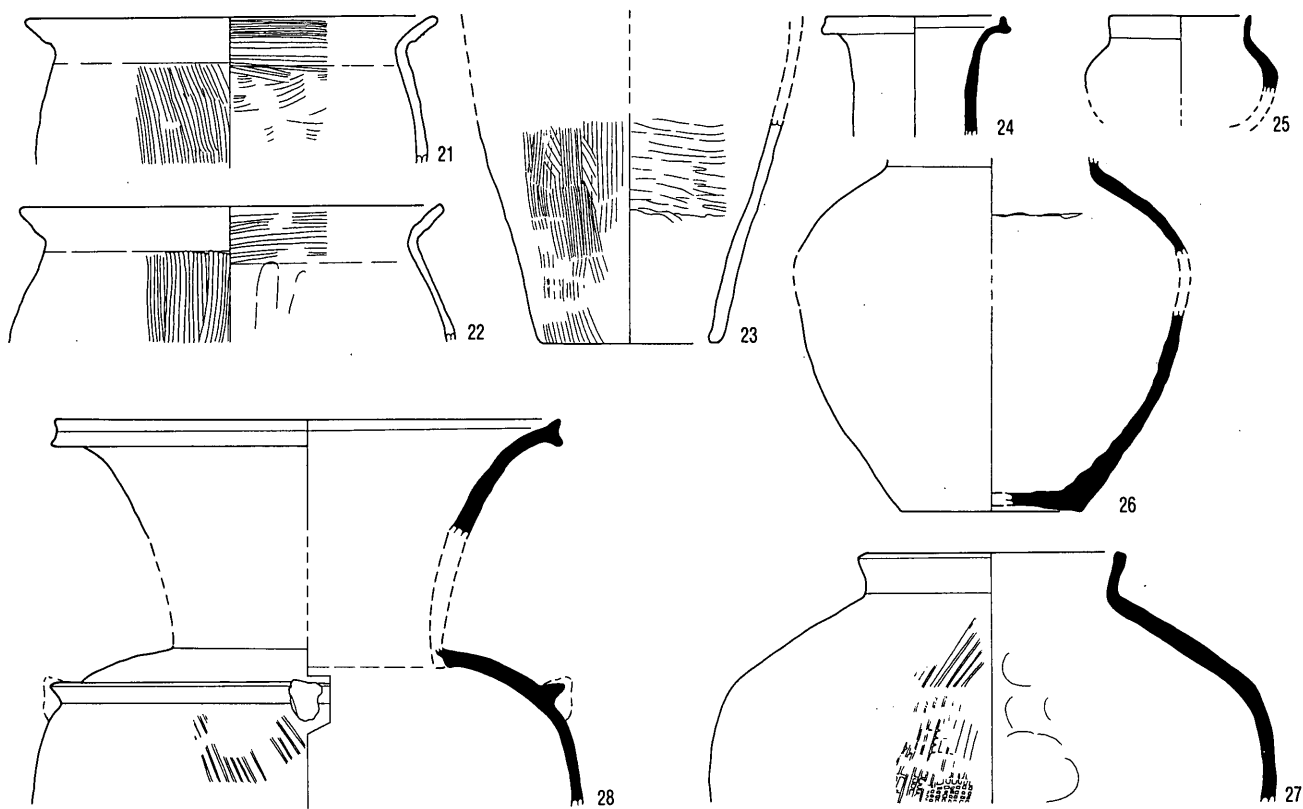

SB 31

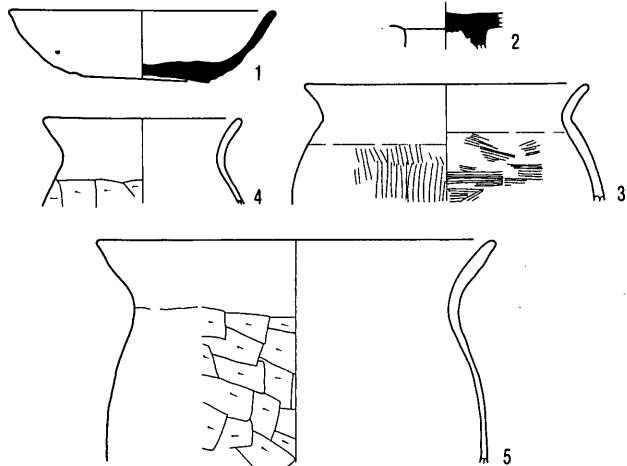

SB 32

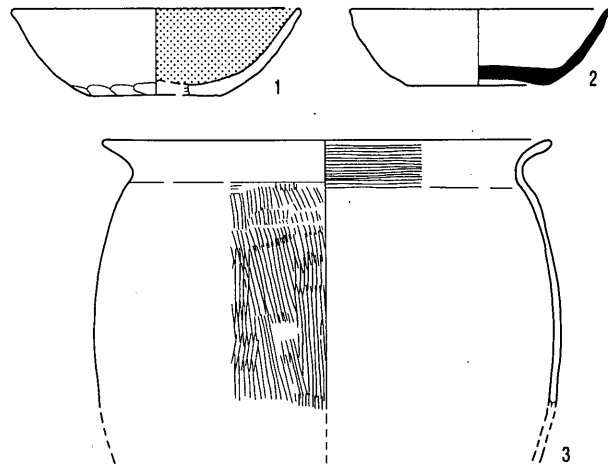

SB 33

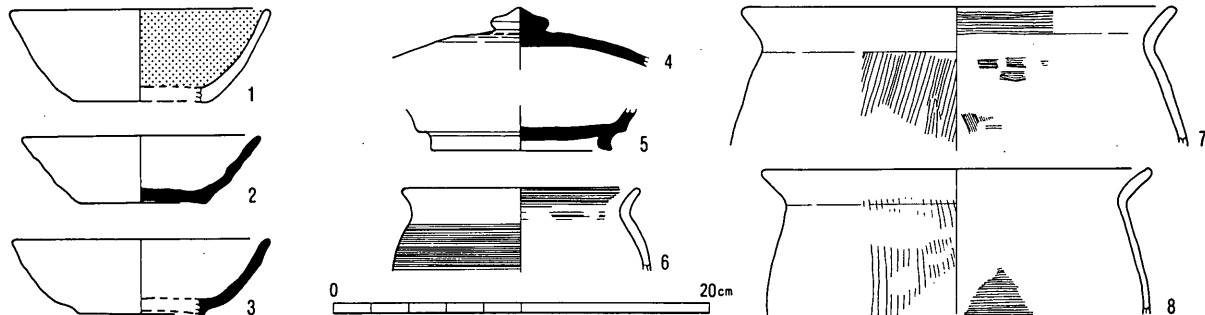

SB 34

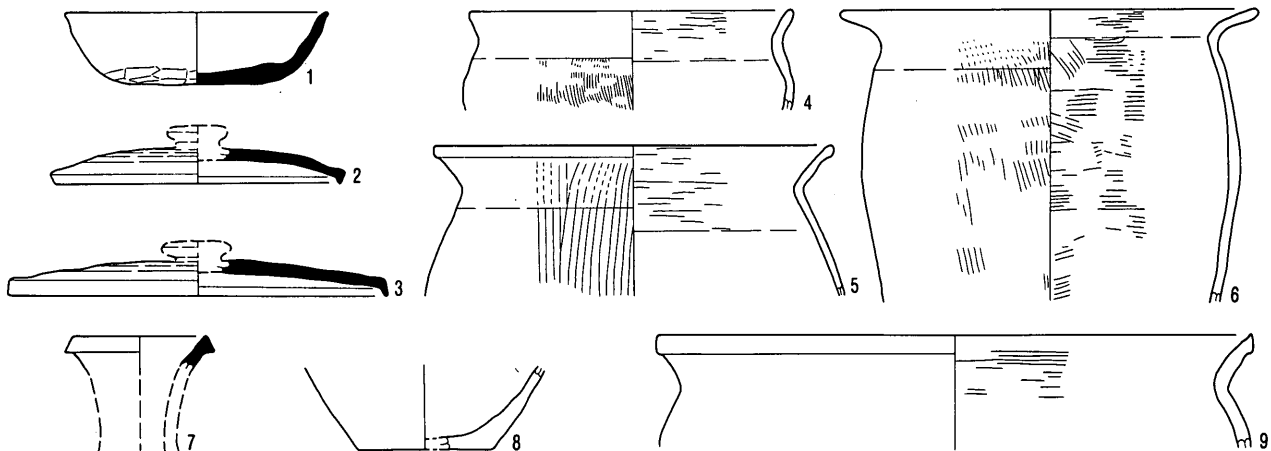

SB 36

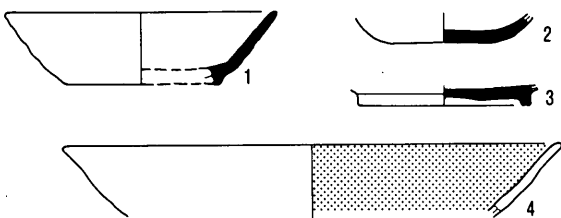

SB37

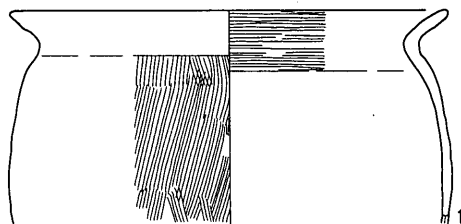

SB 38

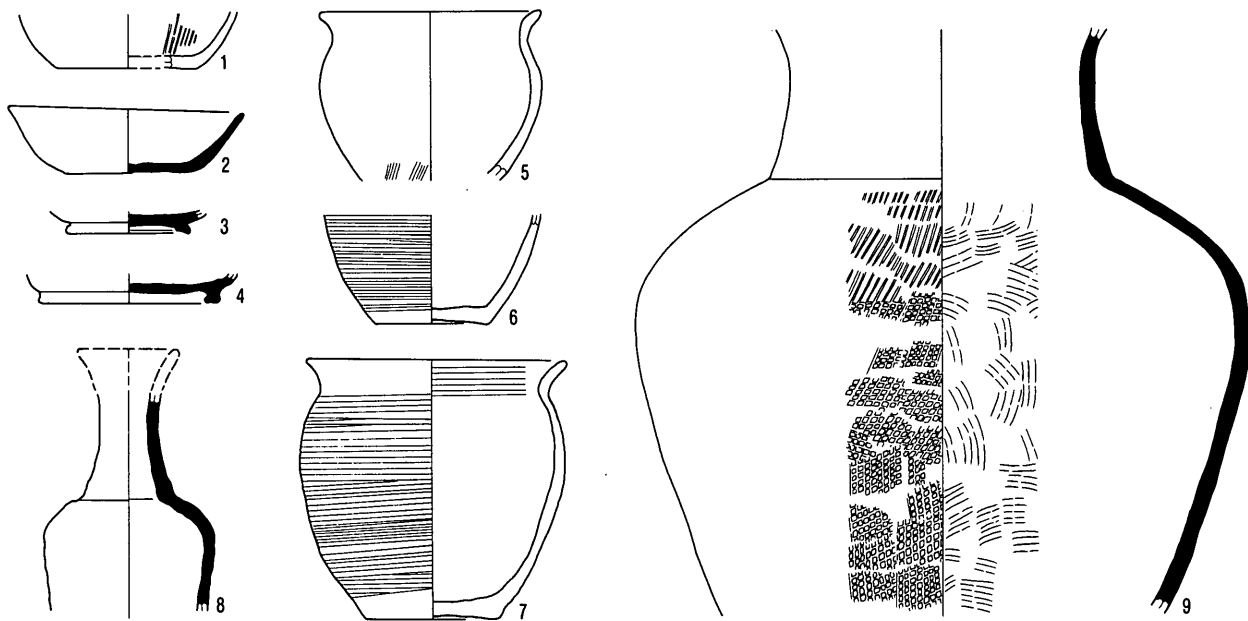

SB 39

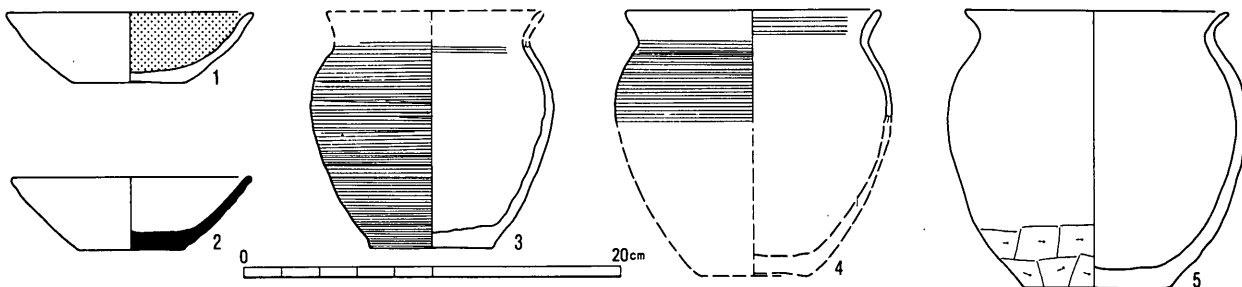

SB 39

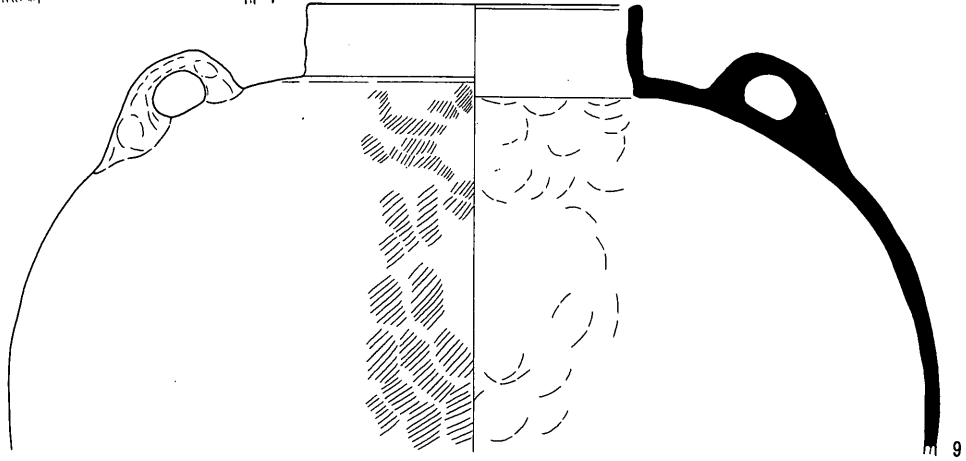
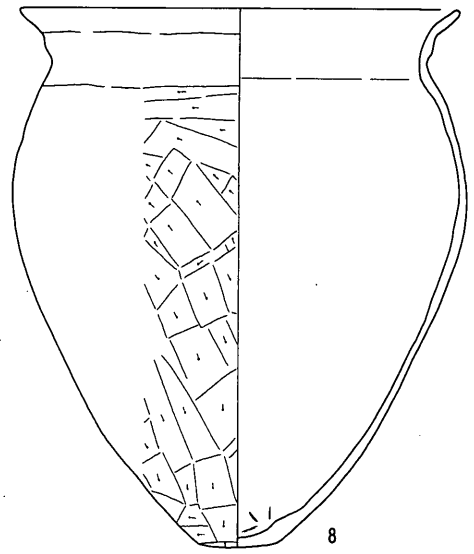
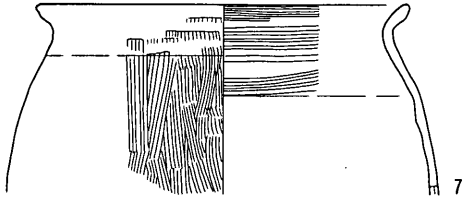
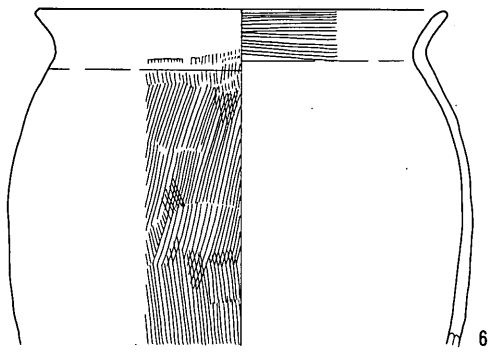

SB 40

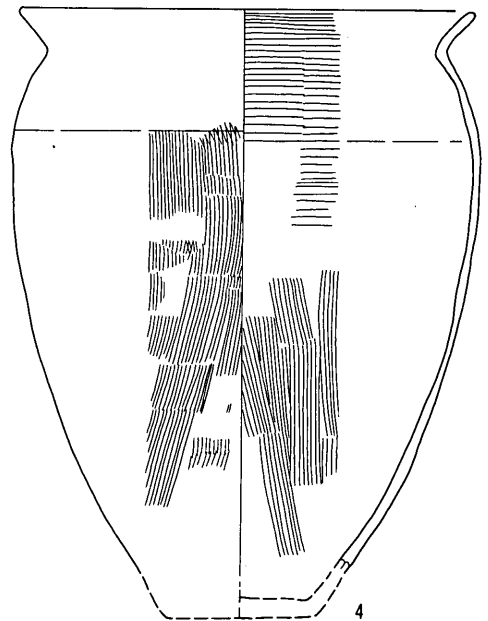
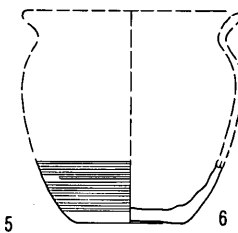
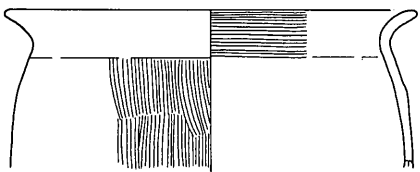
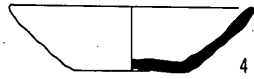
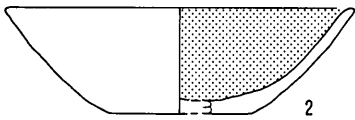
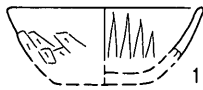

SB 42

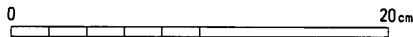
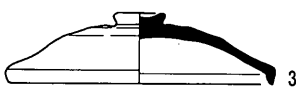

SB39·40·42



SB 43

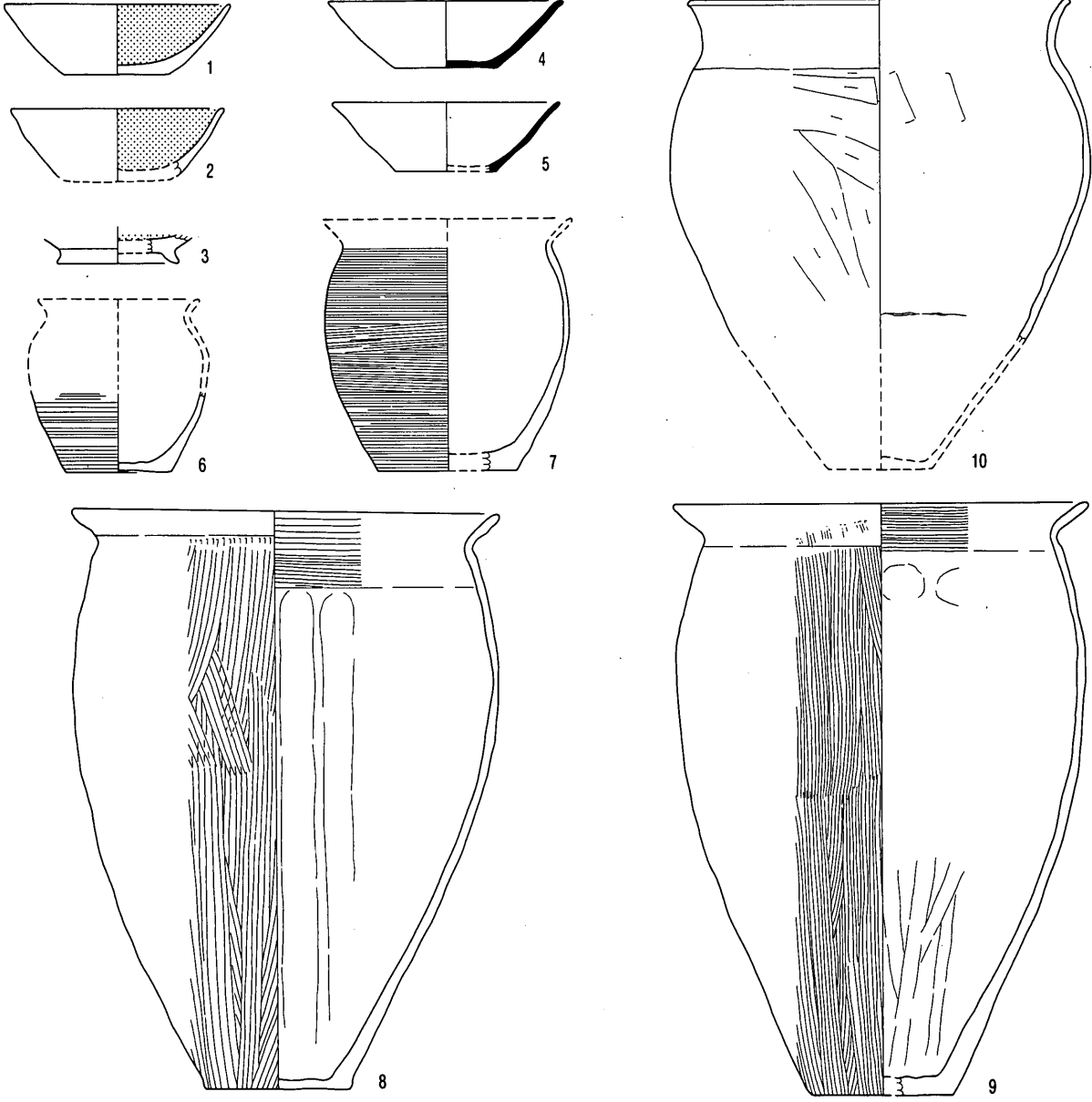

SB 44

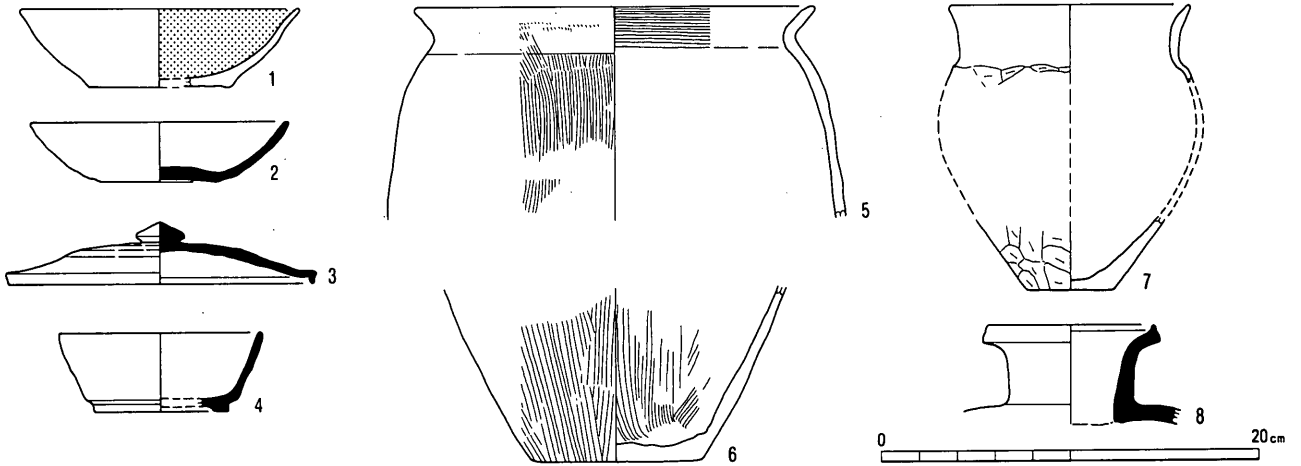

SB 44

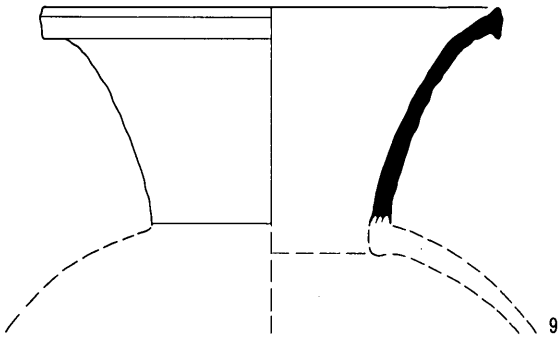

SB 45

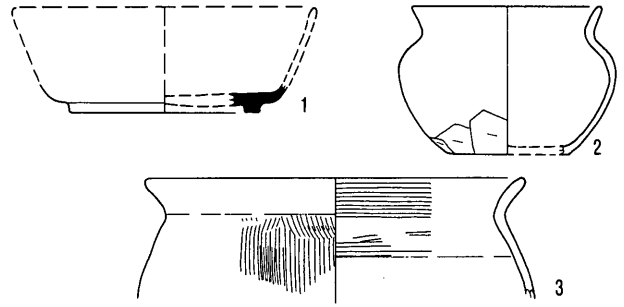

SB 46

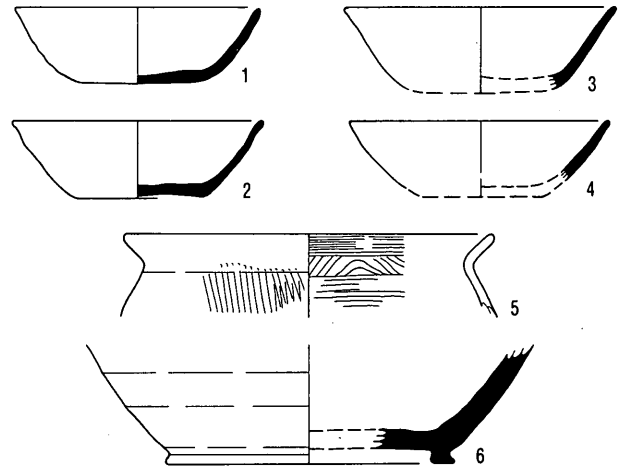

SB 47

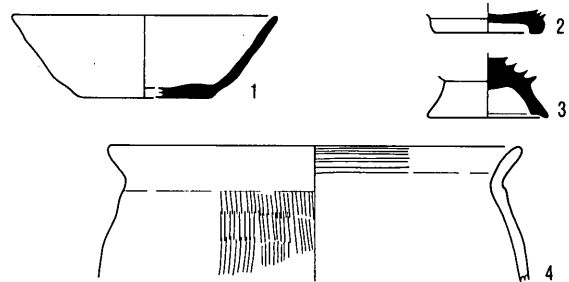

SB 48

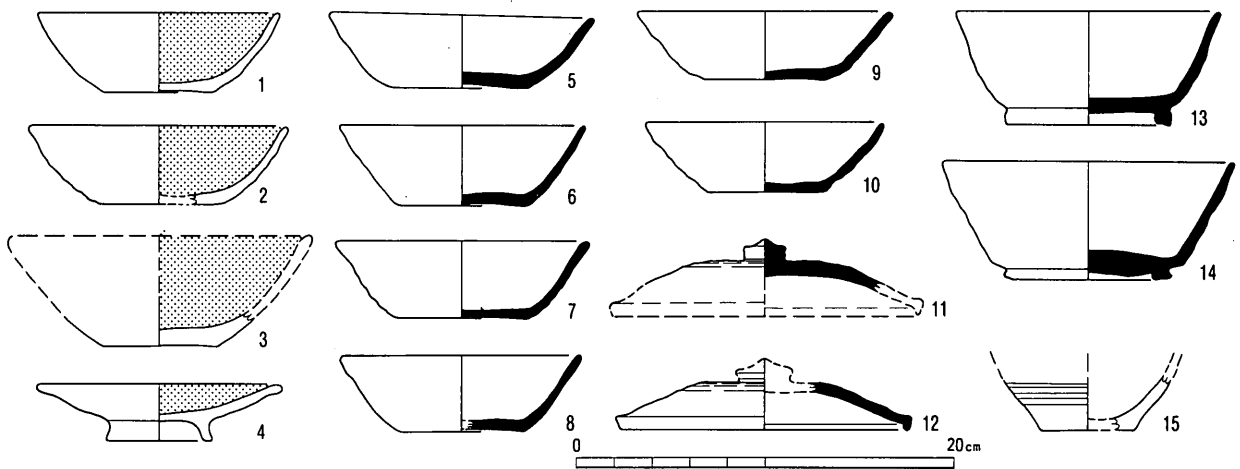

SB 48

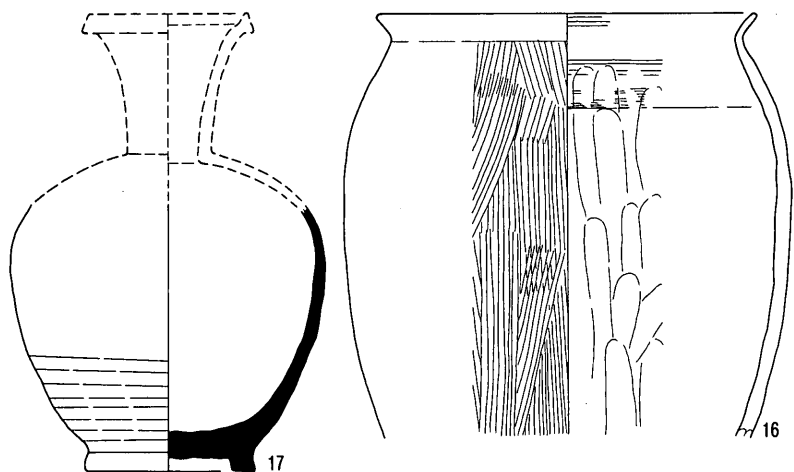

SB 49

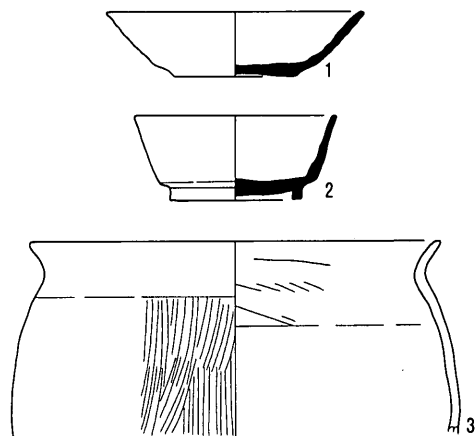

SB 50

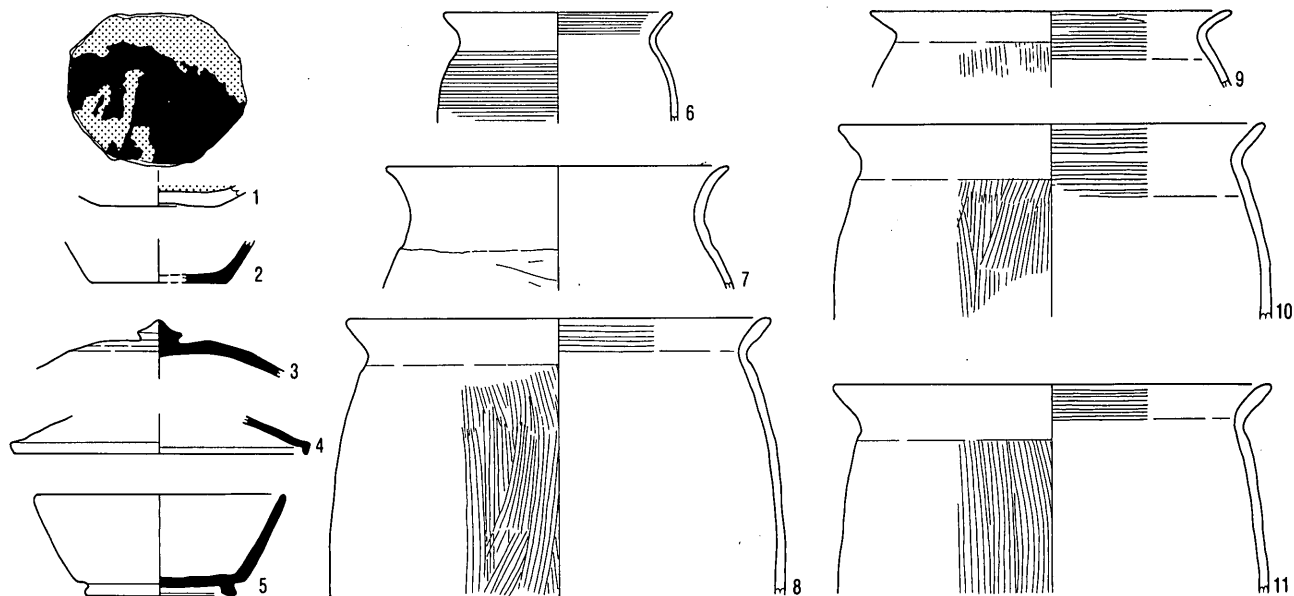

SB 51

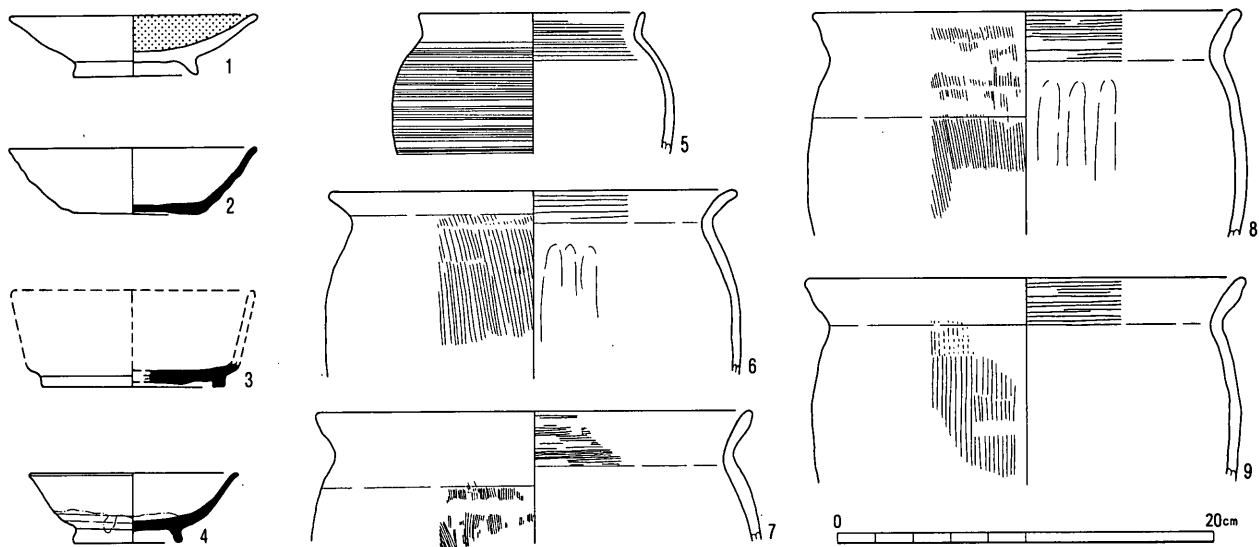

SB 52

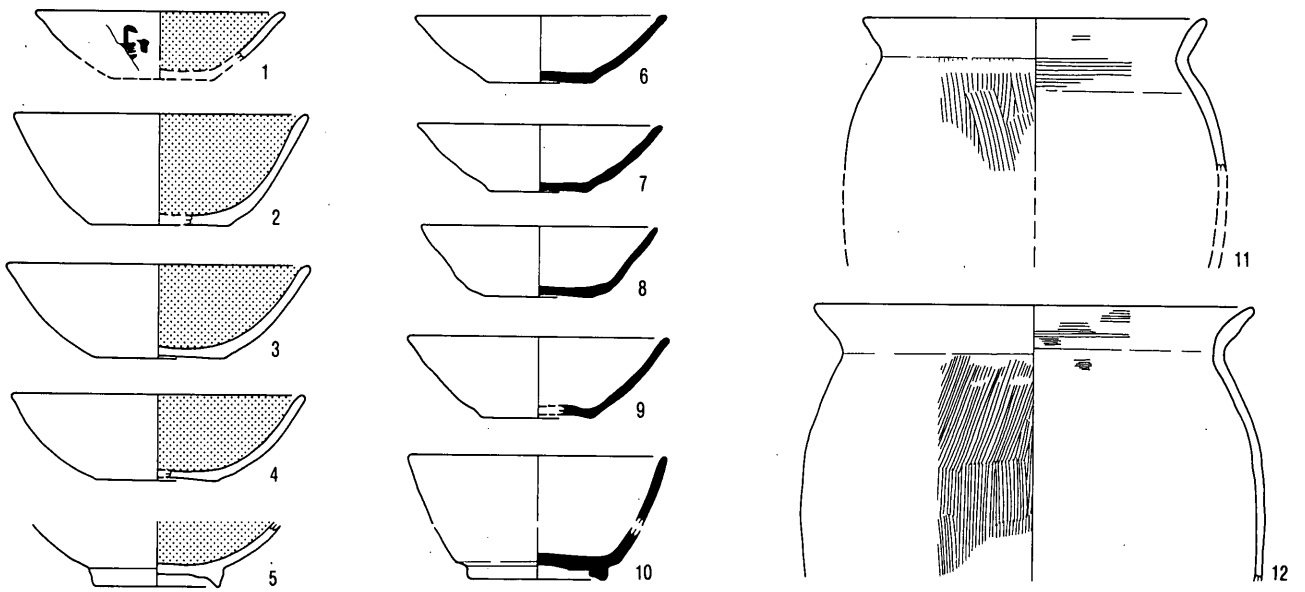

SB 53

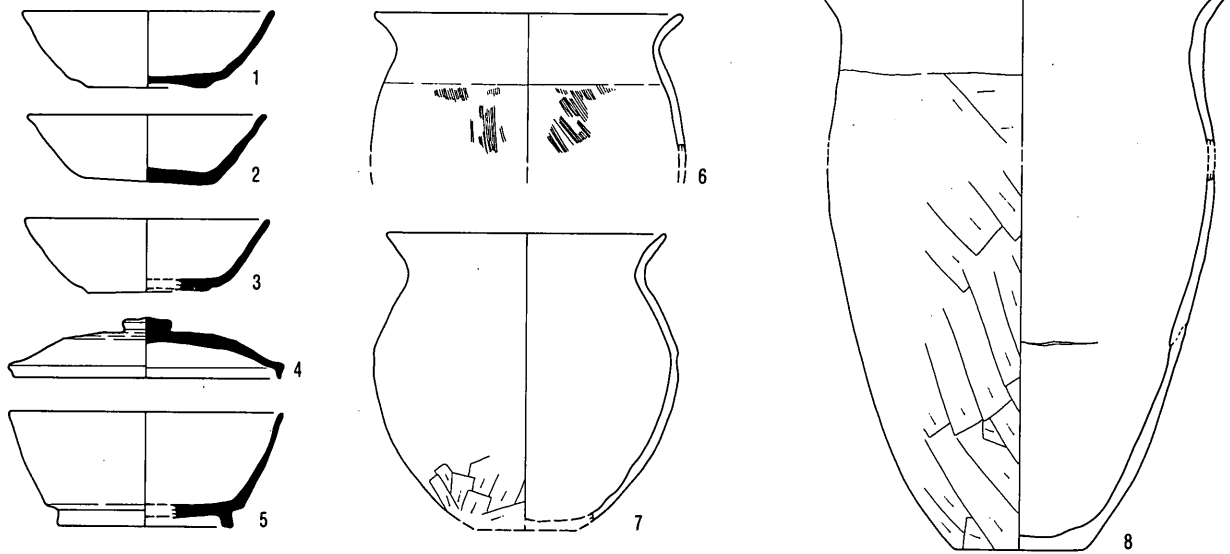

SB 54

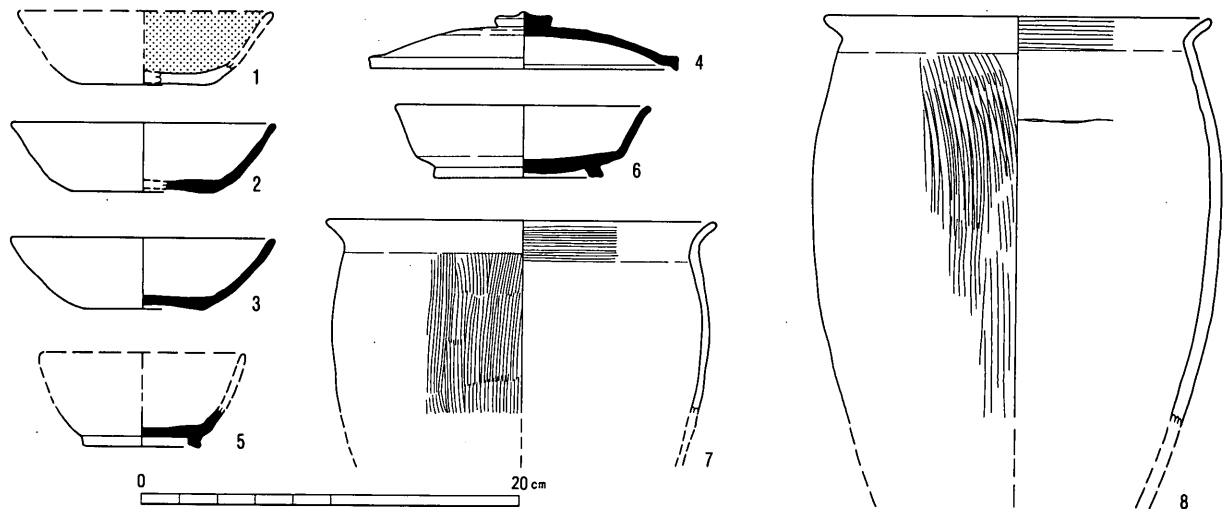

SB 55

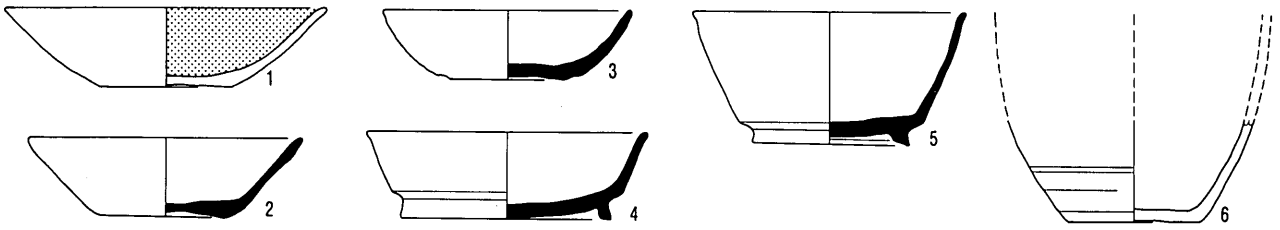

SB 56

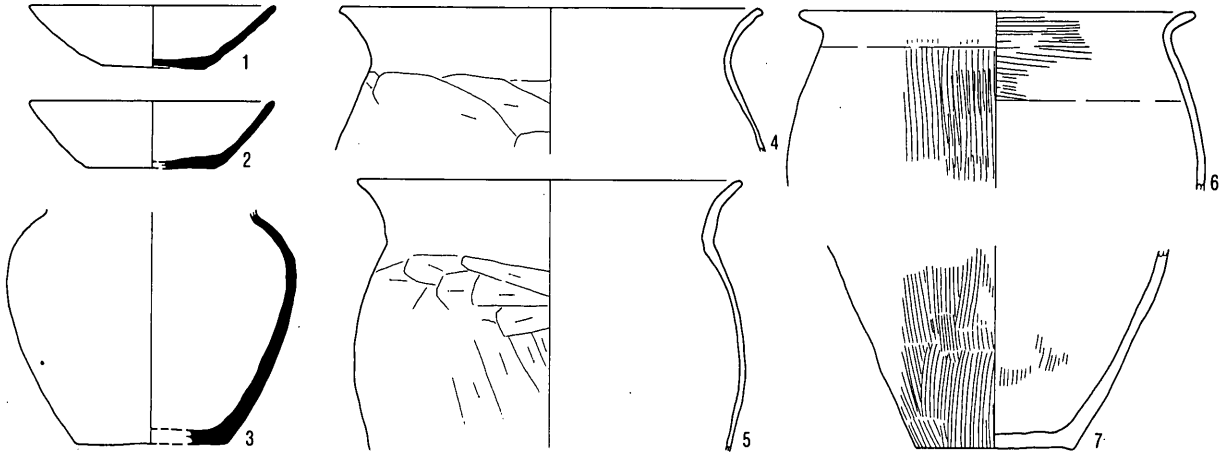

SB 57

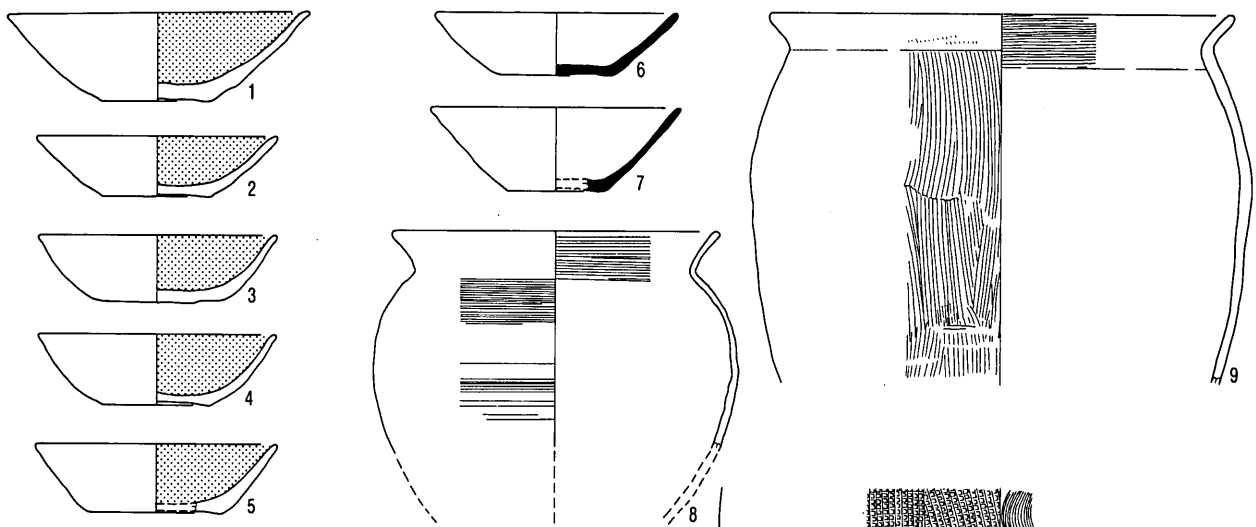

SB 58

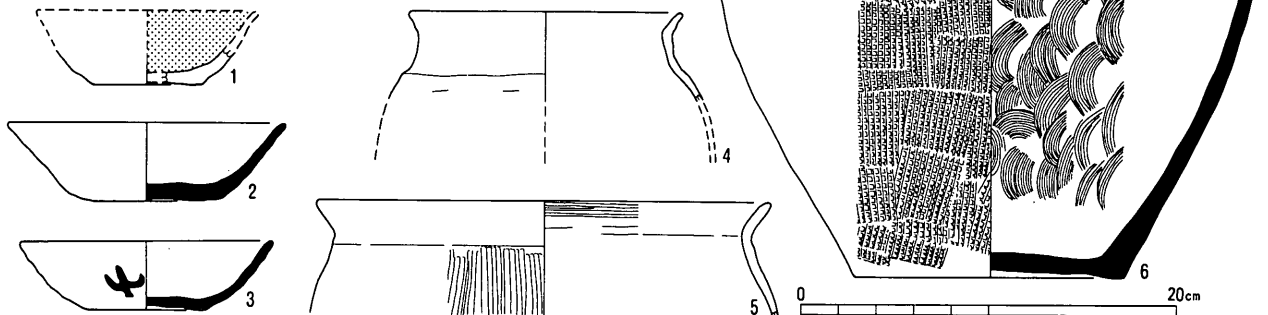

SB 59

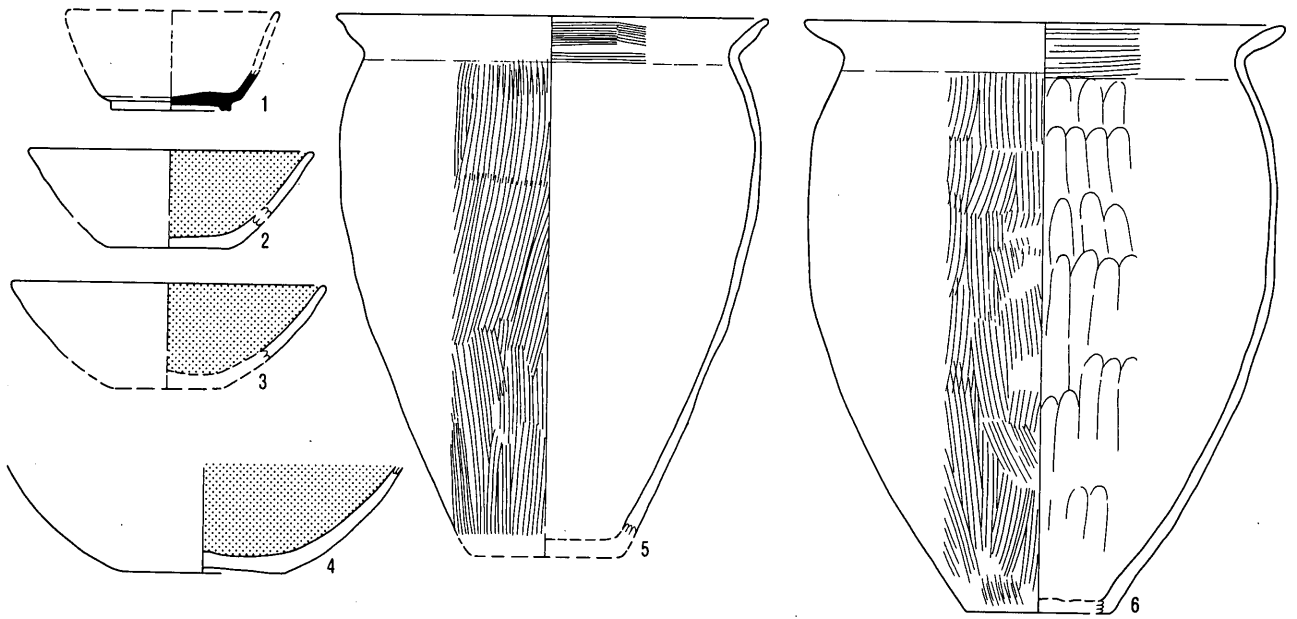

SB 60

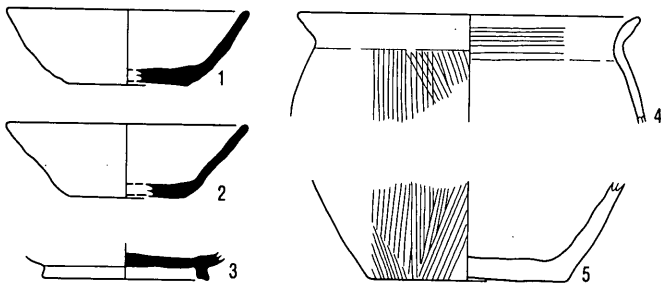

SB 61

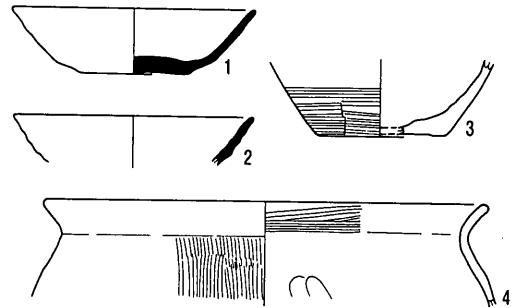

SB 62

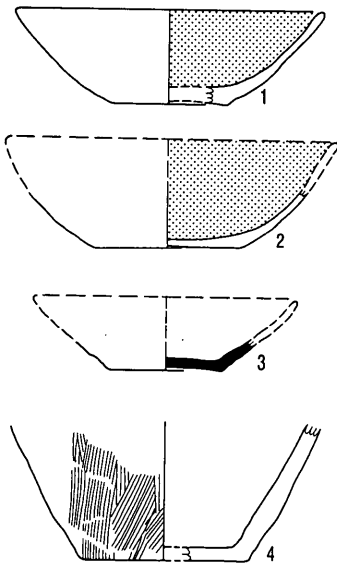

SB 63

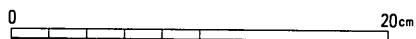
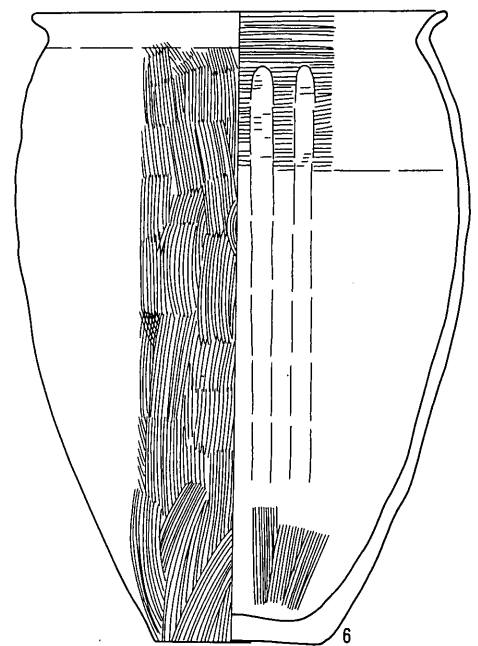
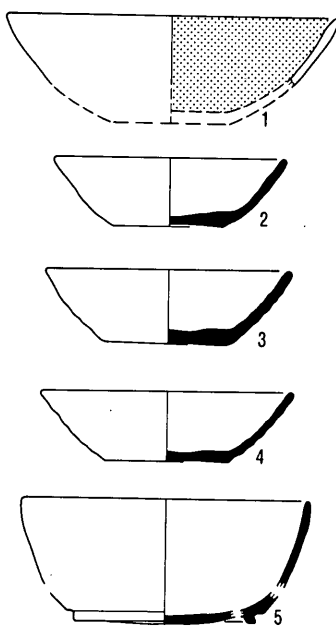

SB 64

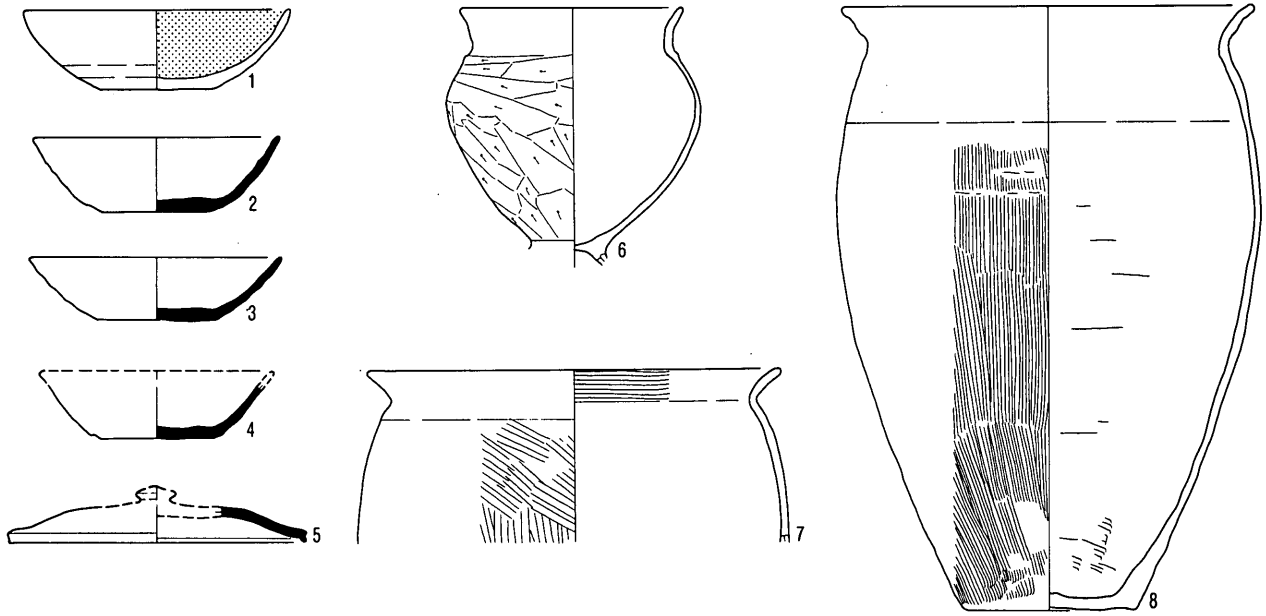

SB 65

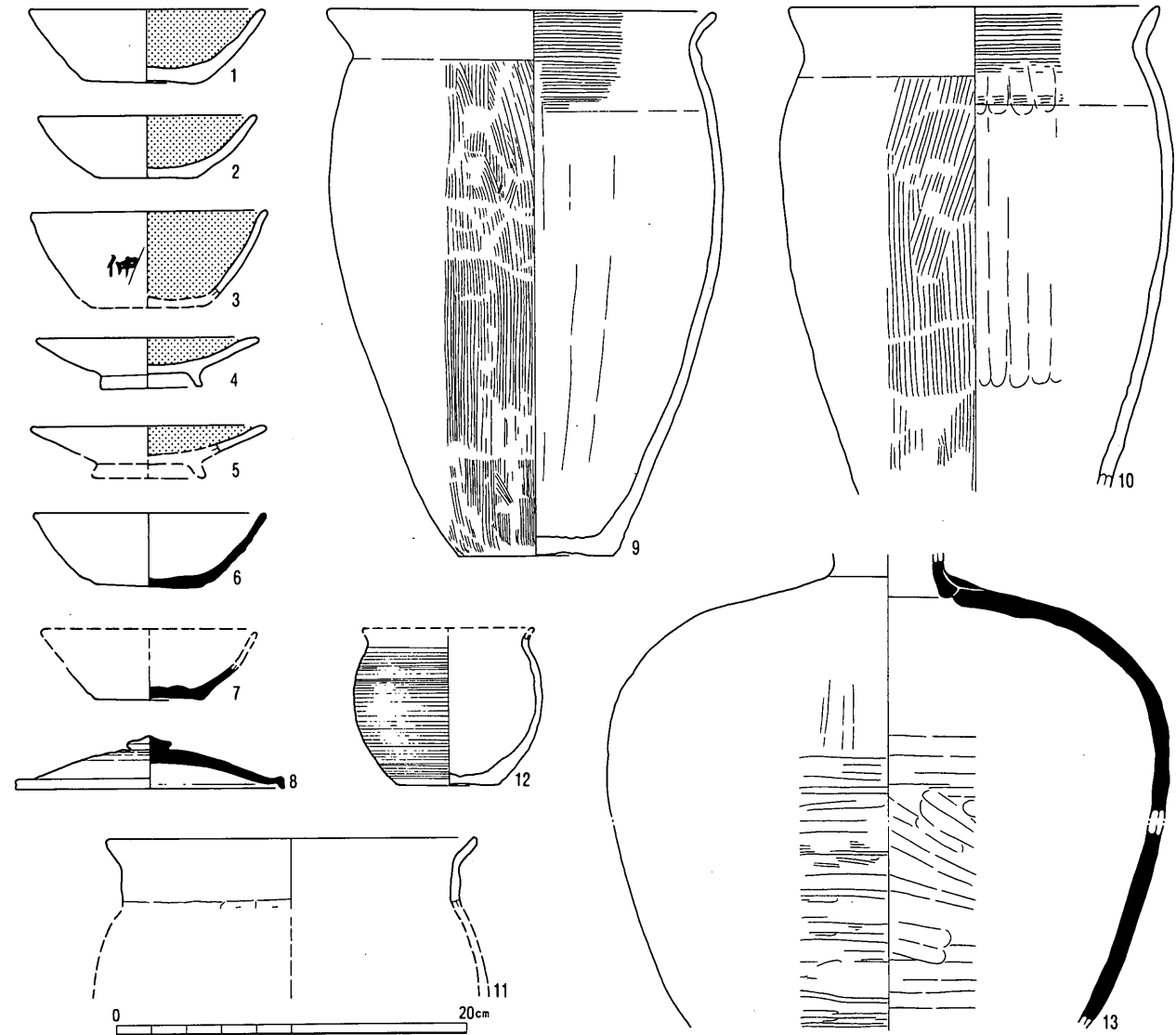

SB64・65

SB 66

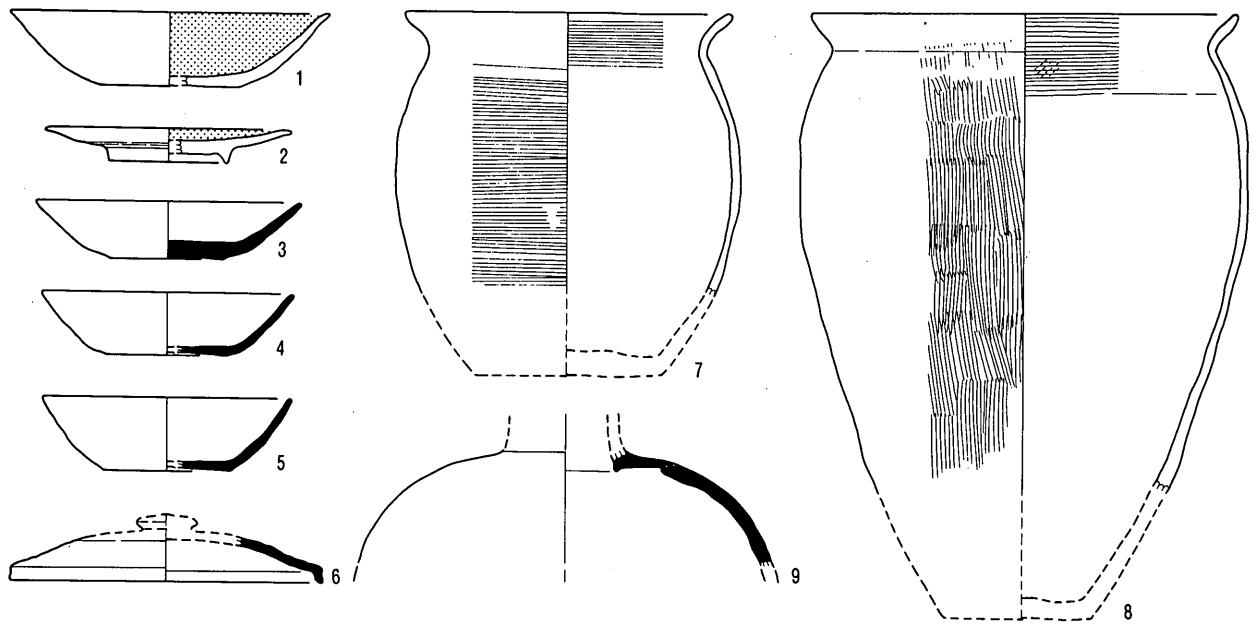

SB 67

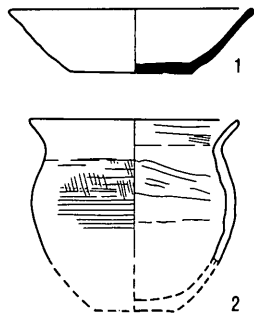

SB 70

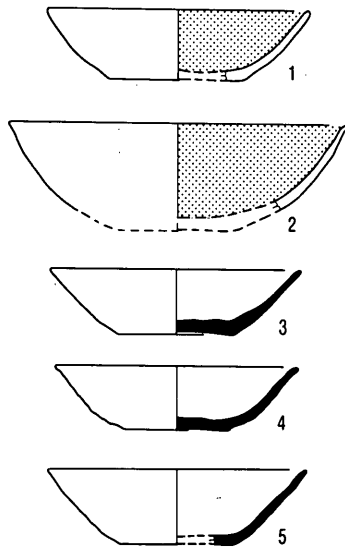

SB 71

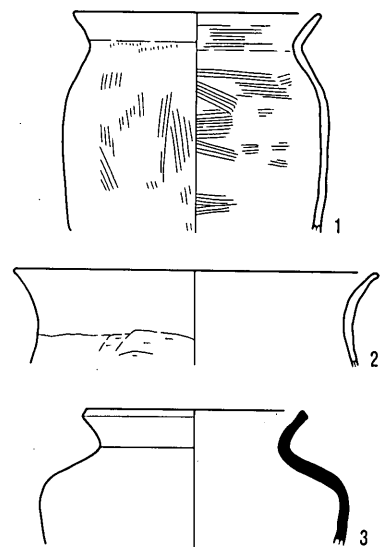

SB 69

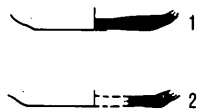

SB 68

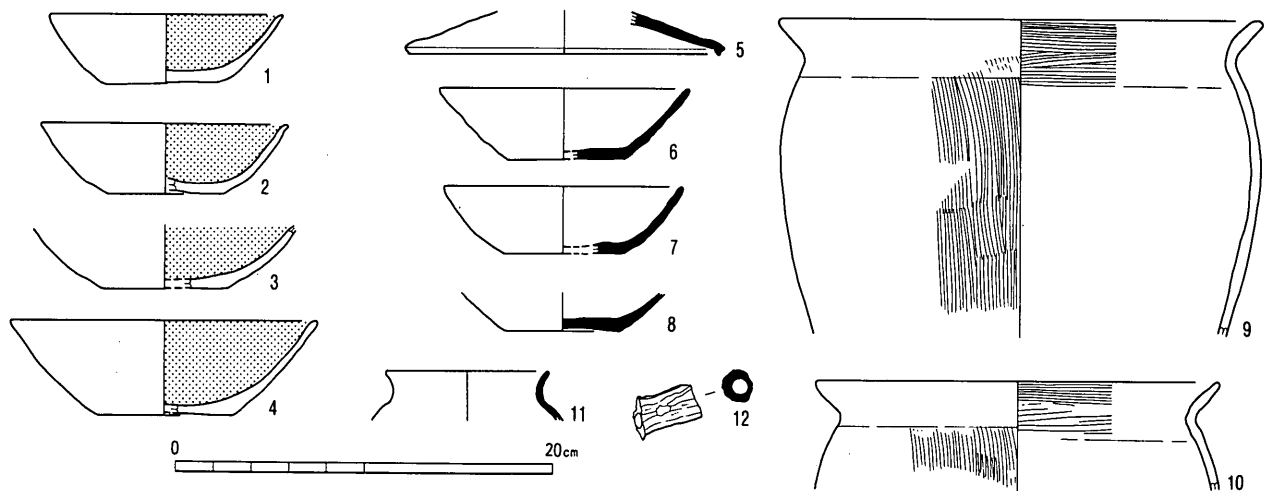



SB 72

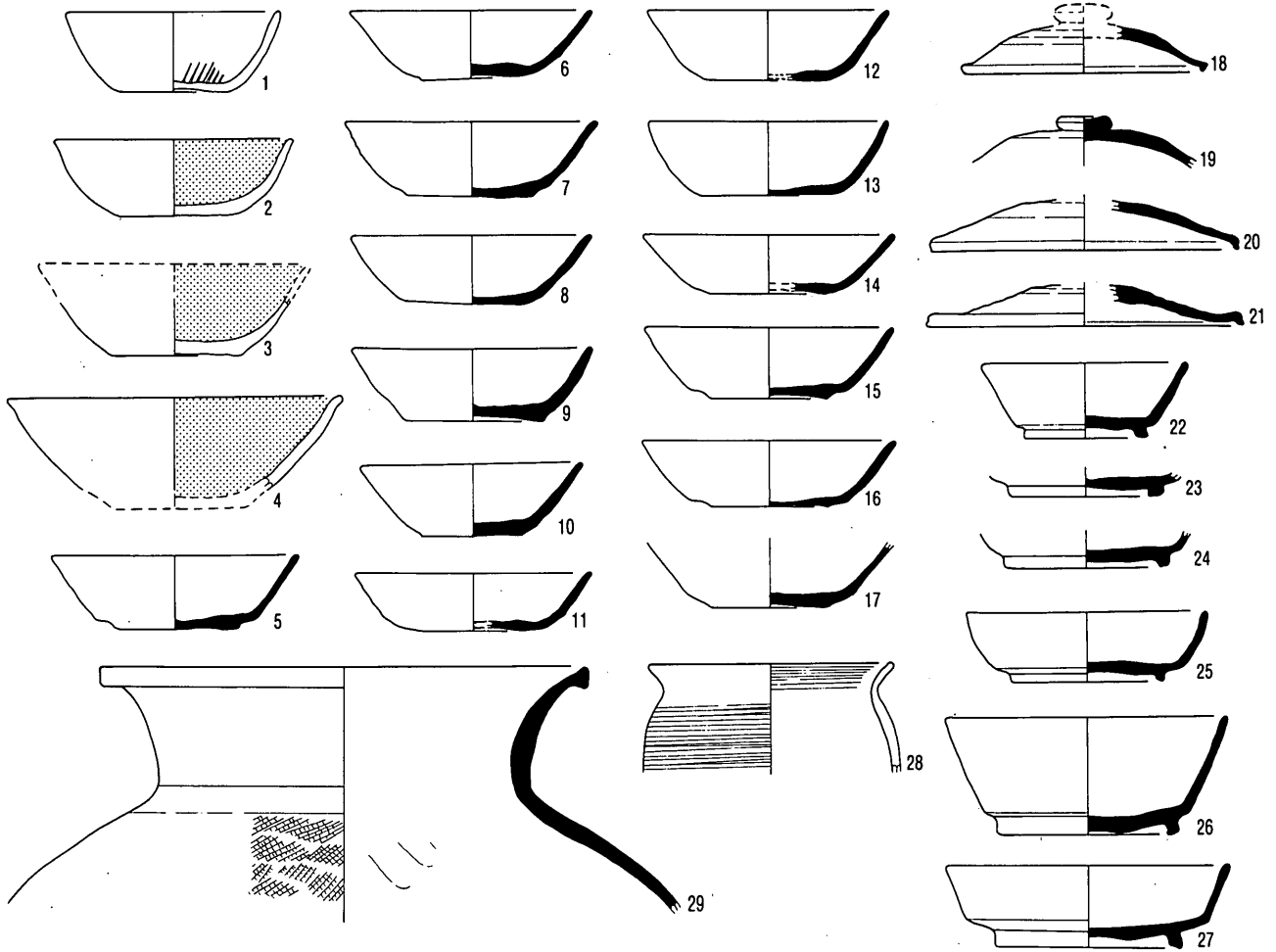

SB 73

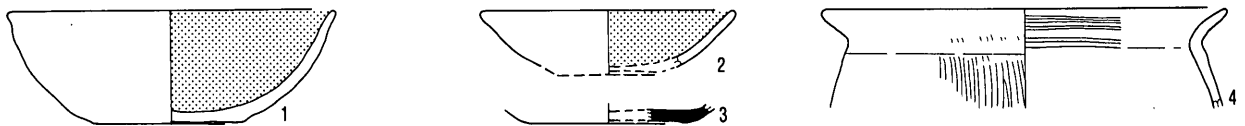

SB 74

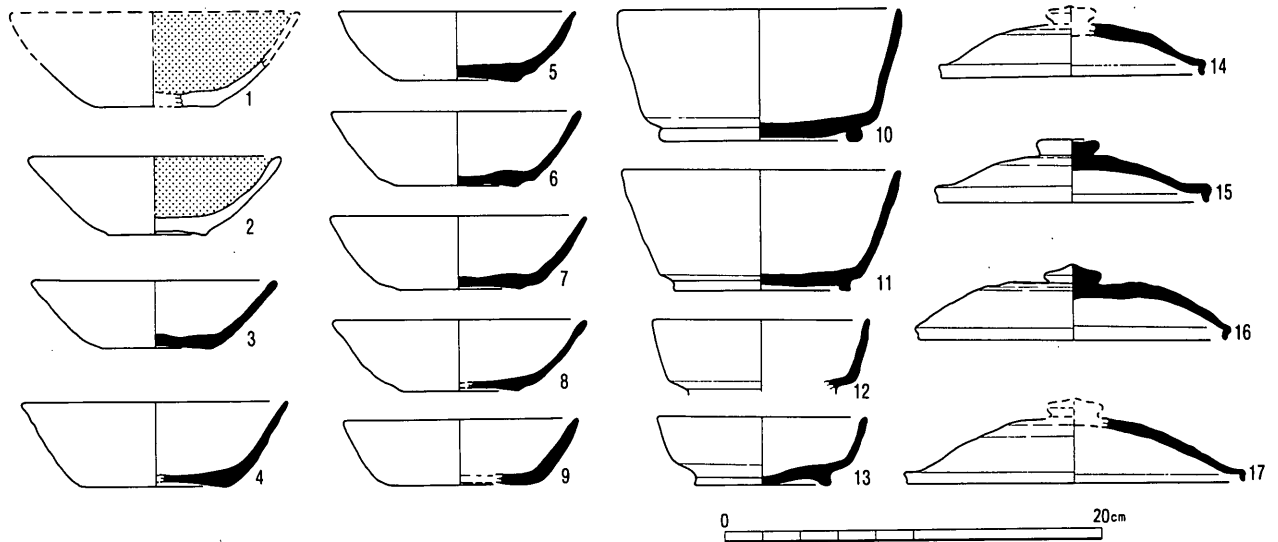

SB 76

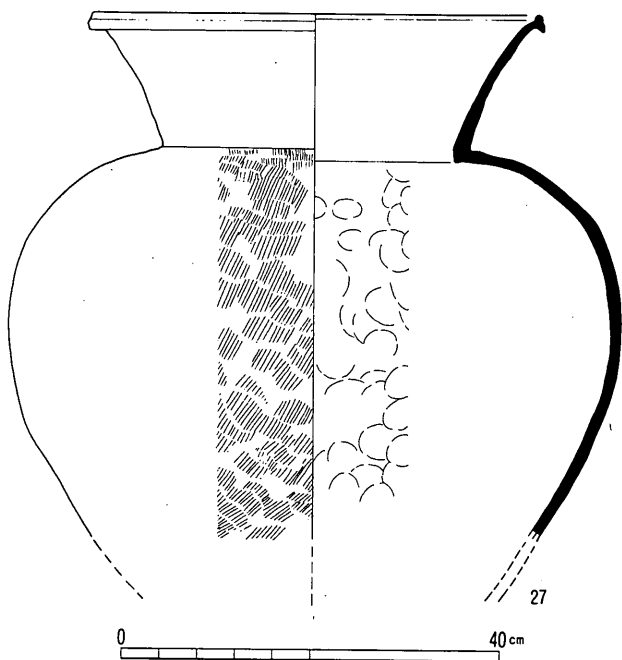
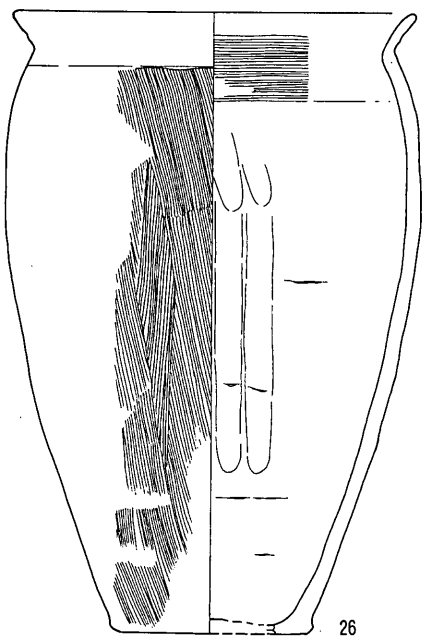
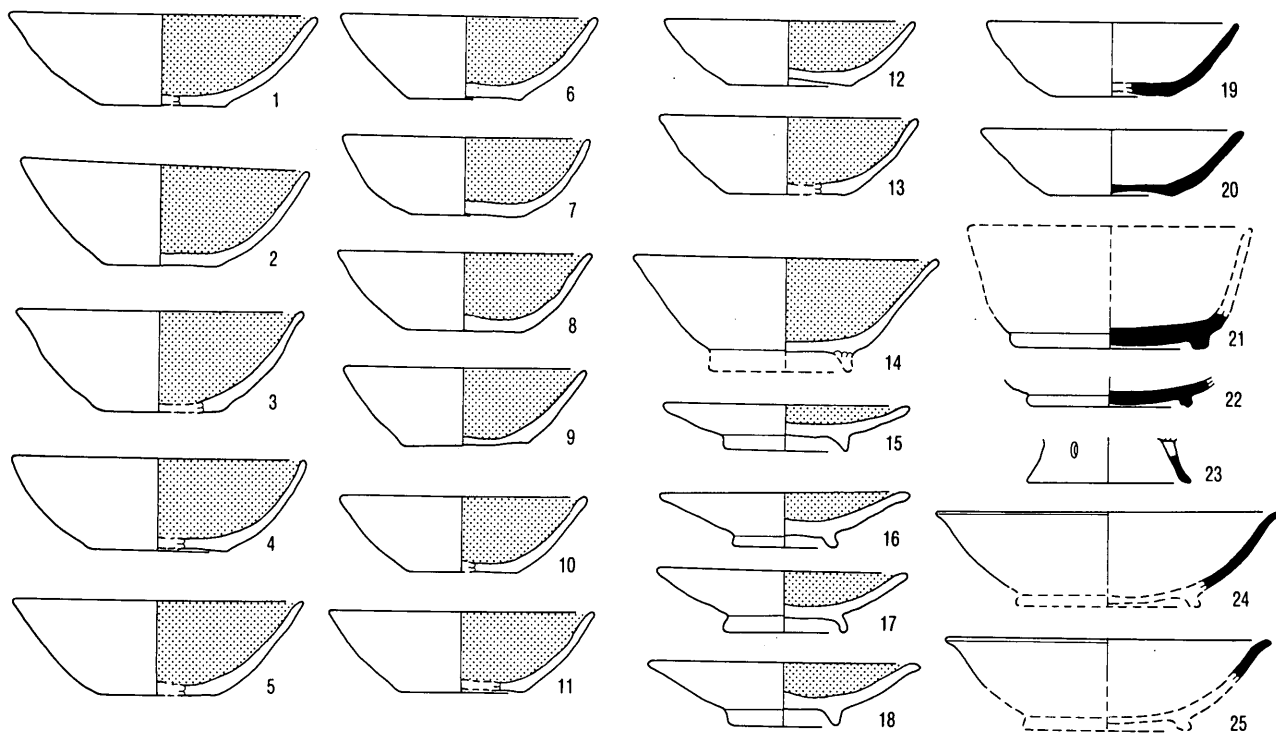

SB 77

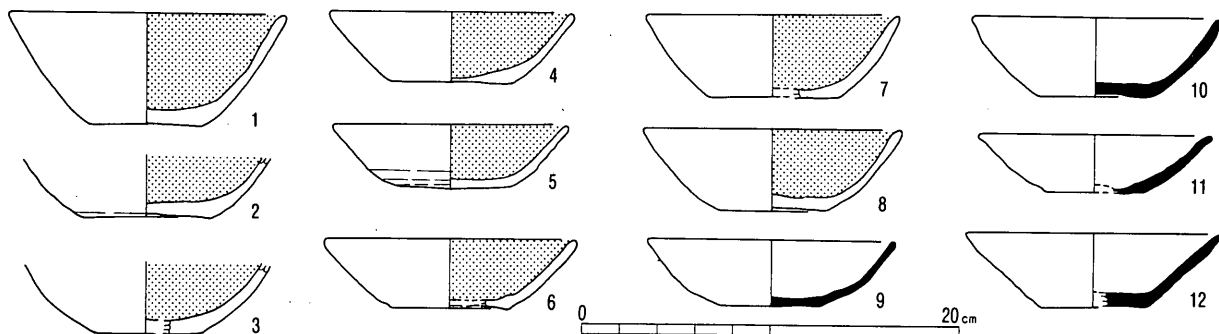

SB 77

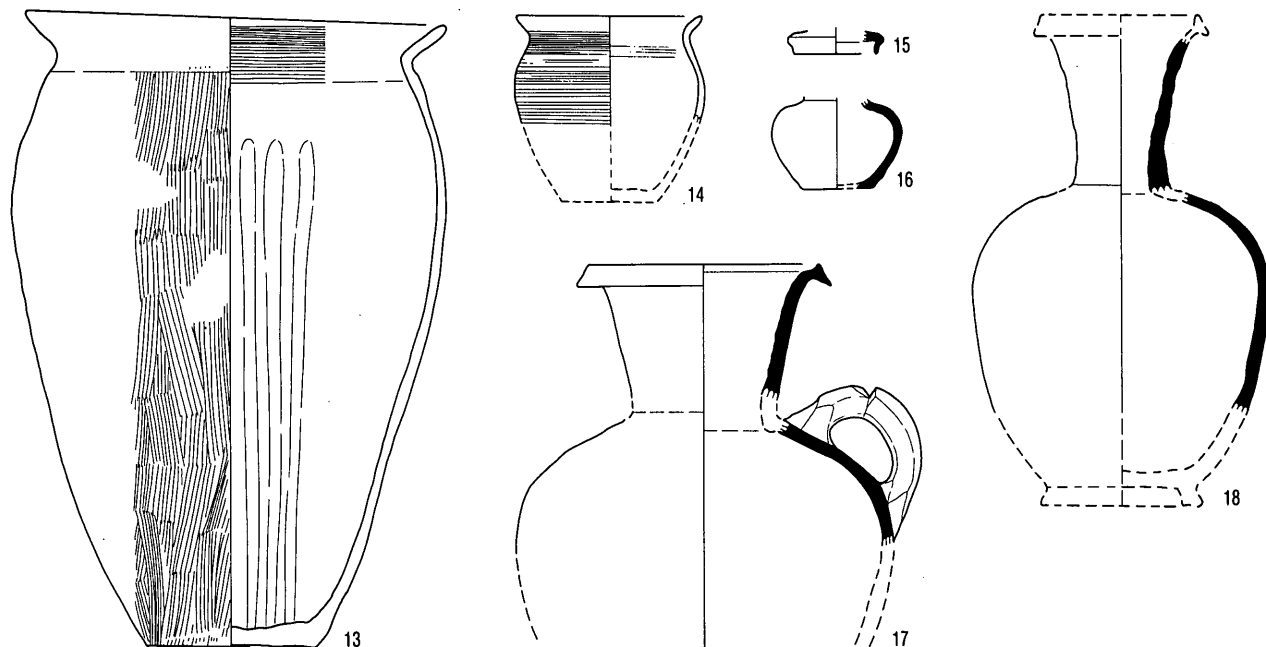

SB 78

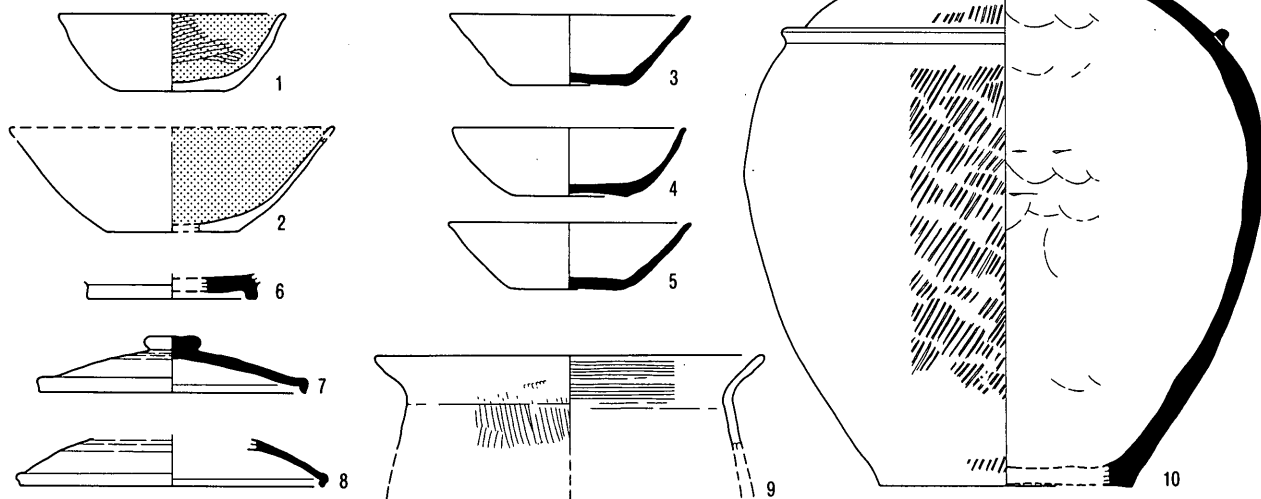

SB 82

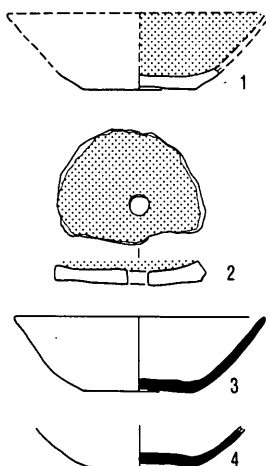

SB 83

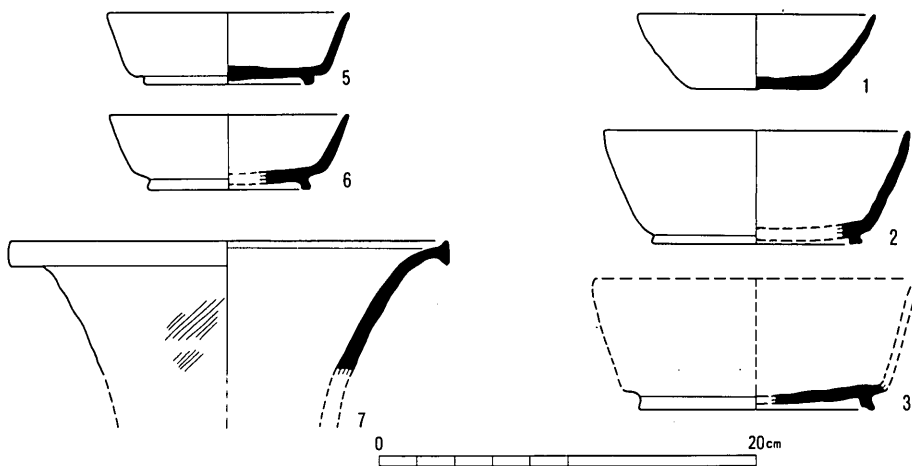

SB 84

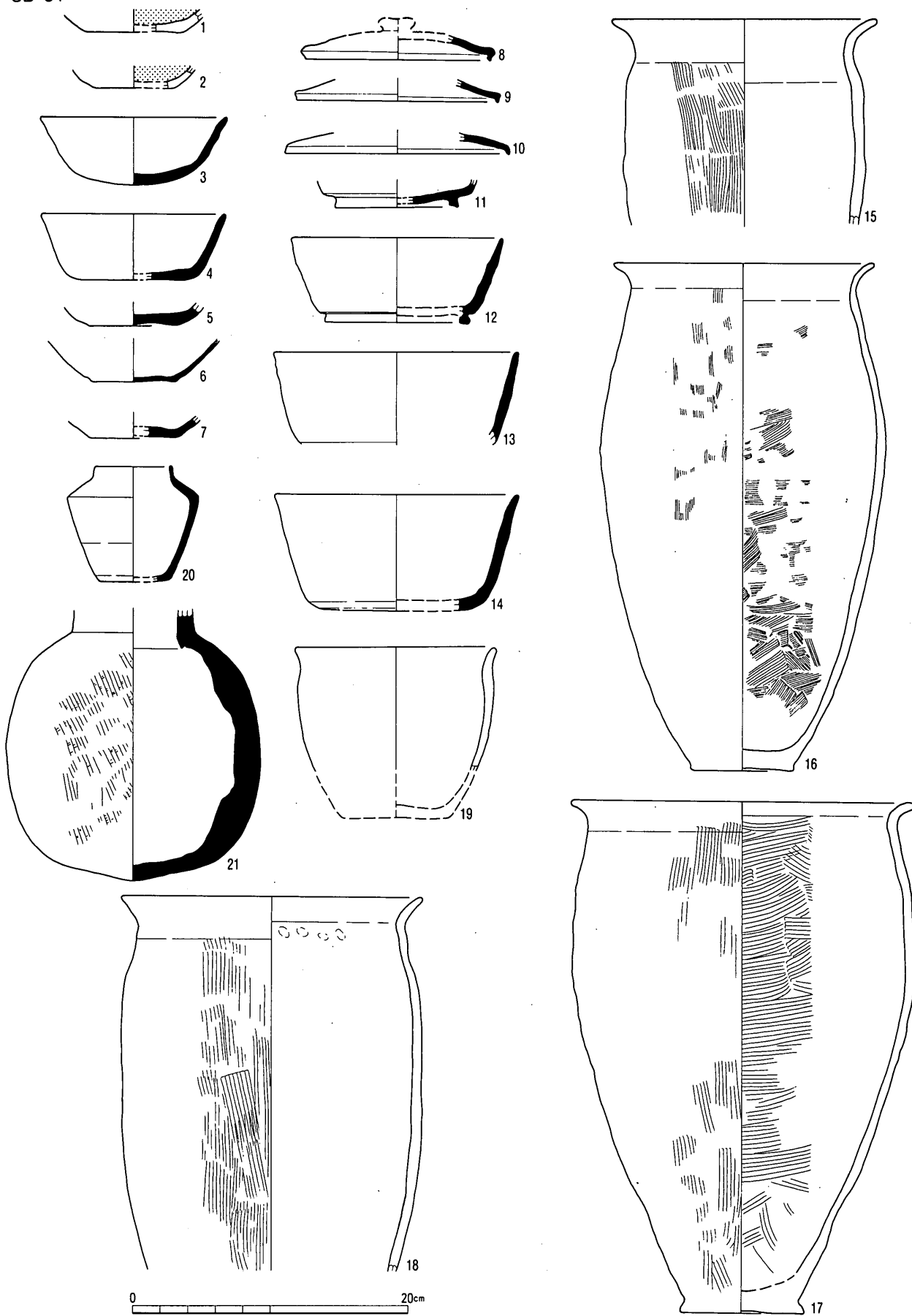

SB 85

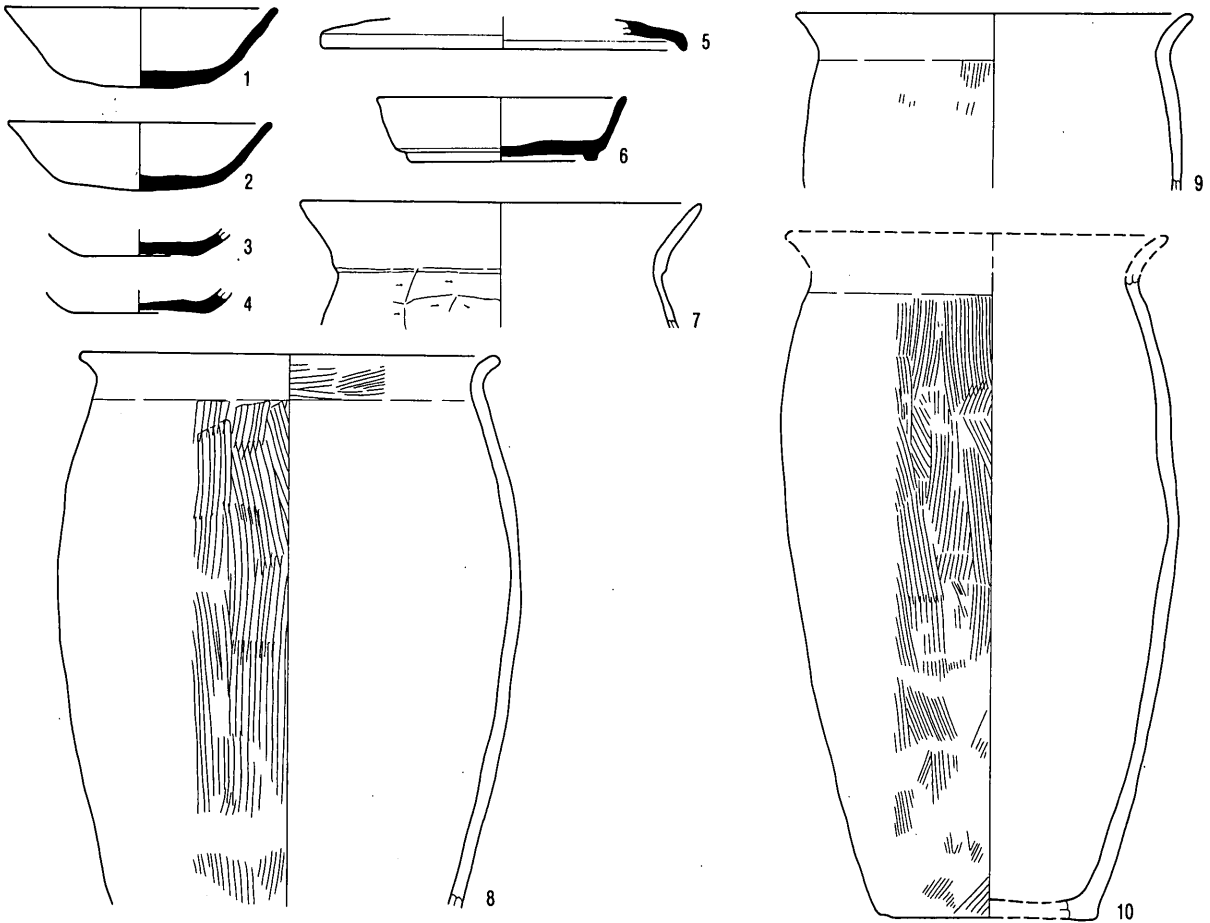

SB 87

SB 88

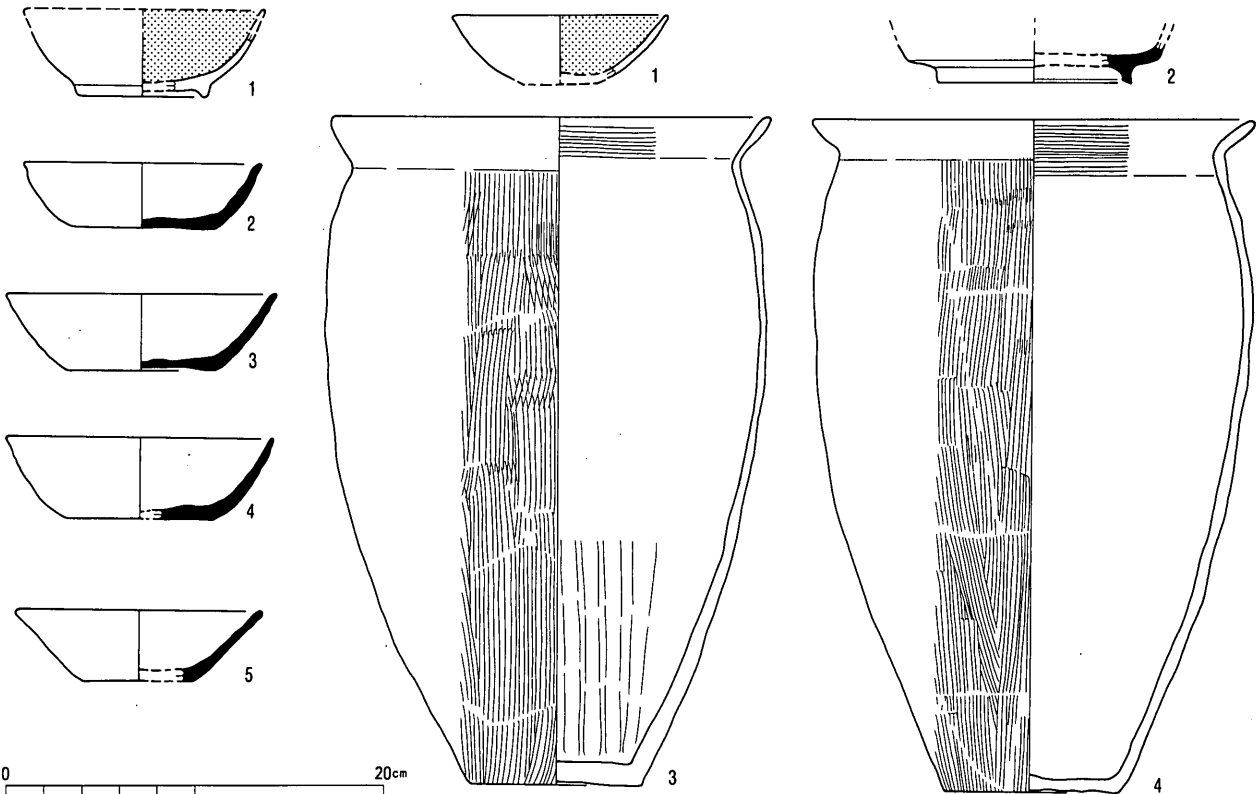

SB85・87・88

SB 89

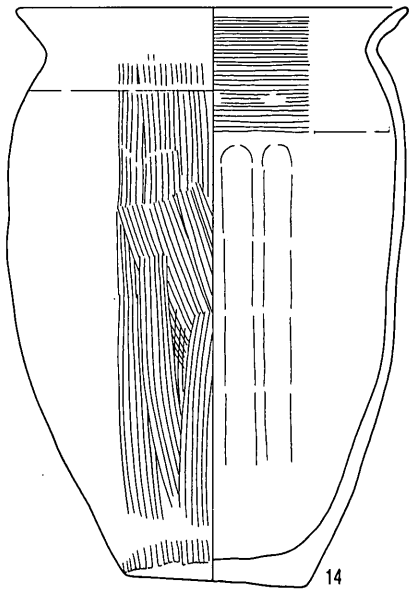
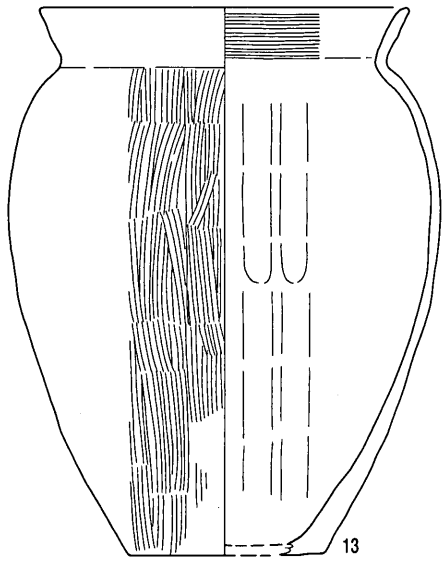
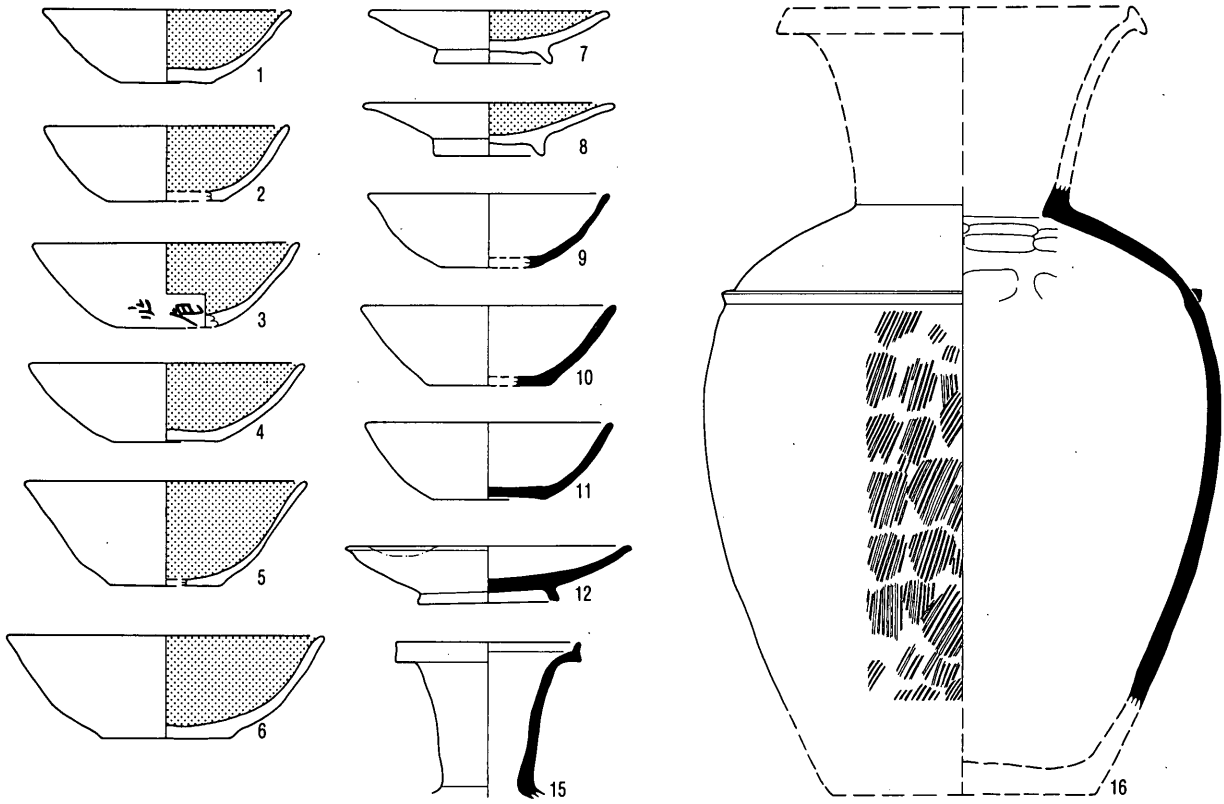

SB 90

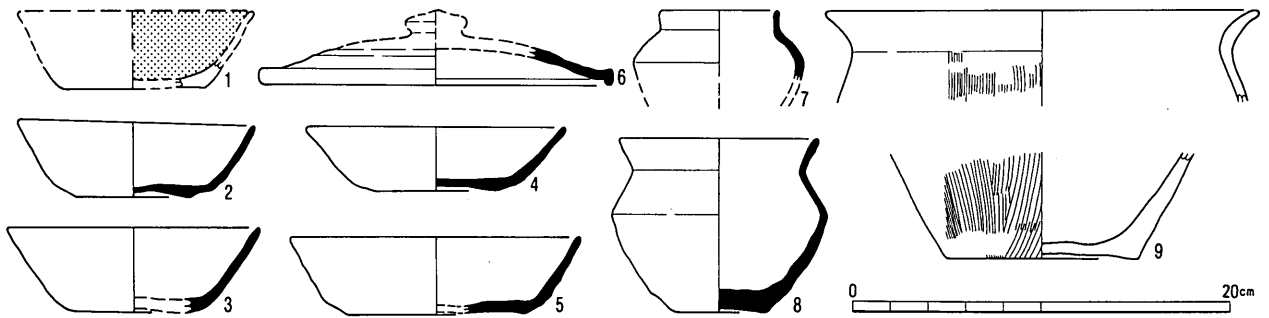

SB 91

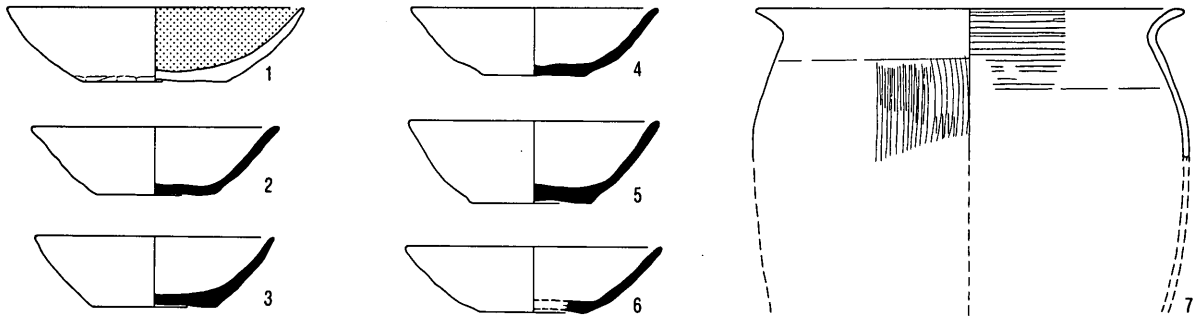

SB 92

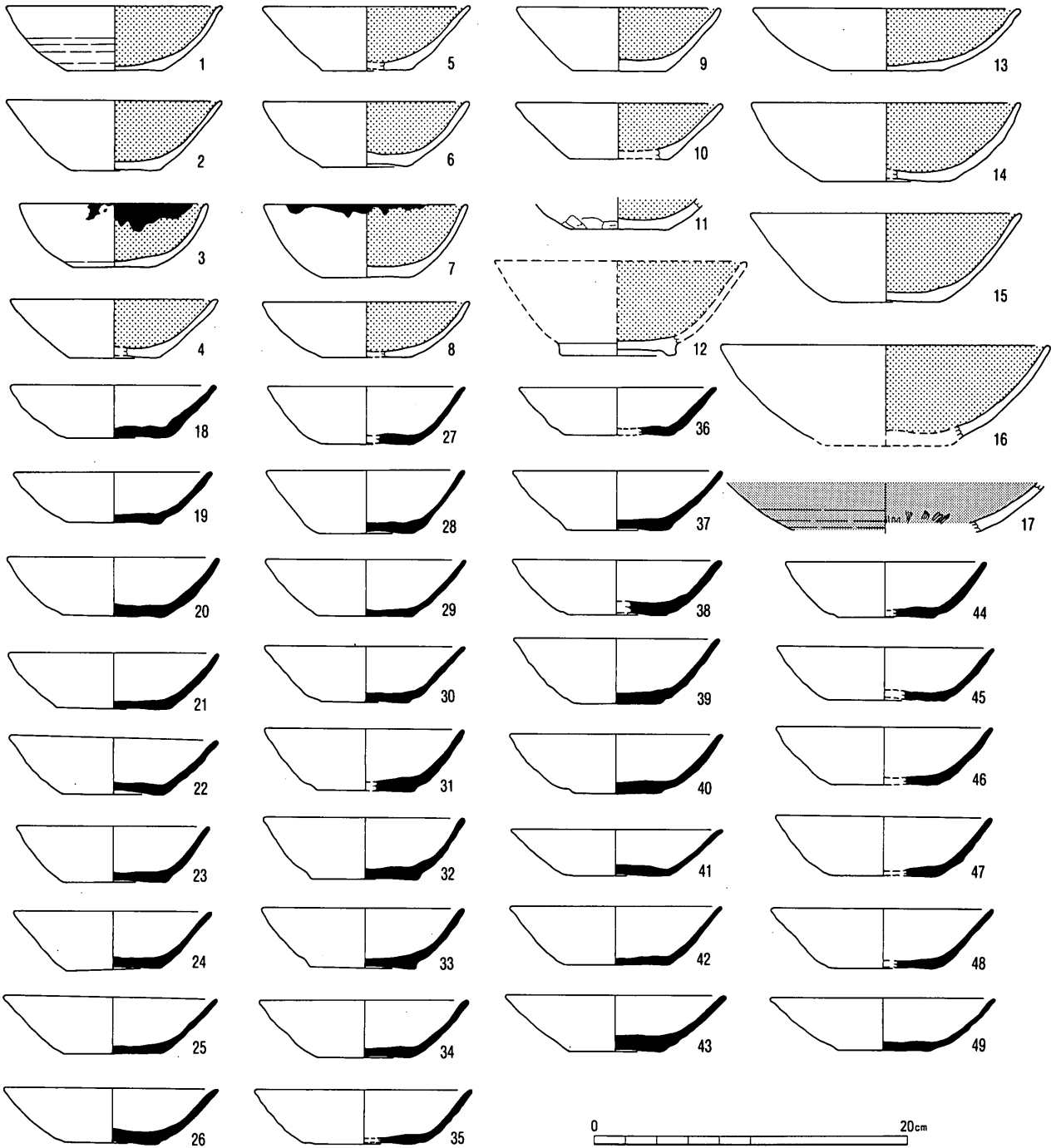

SB 92

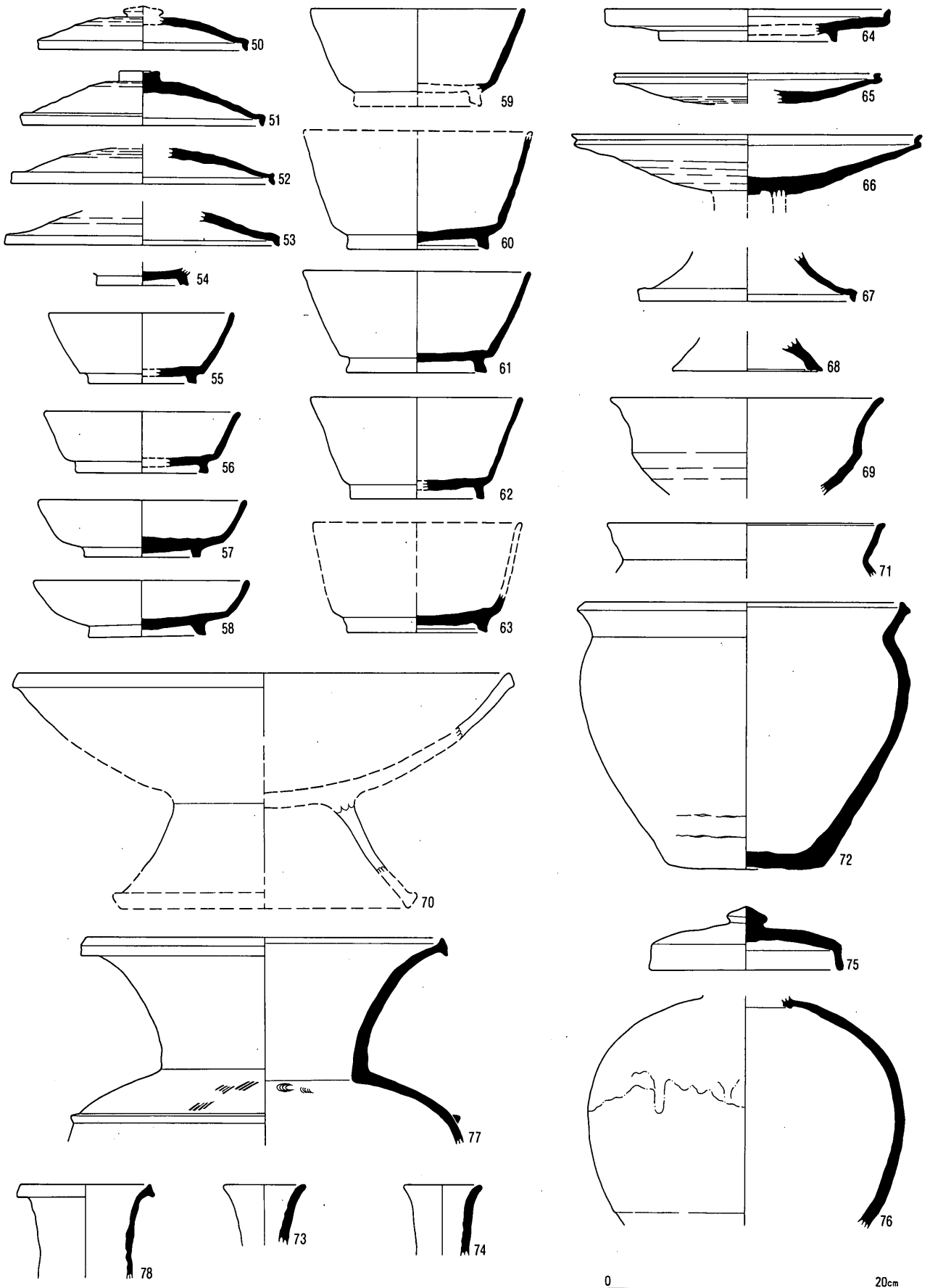

SB92



SB 92

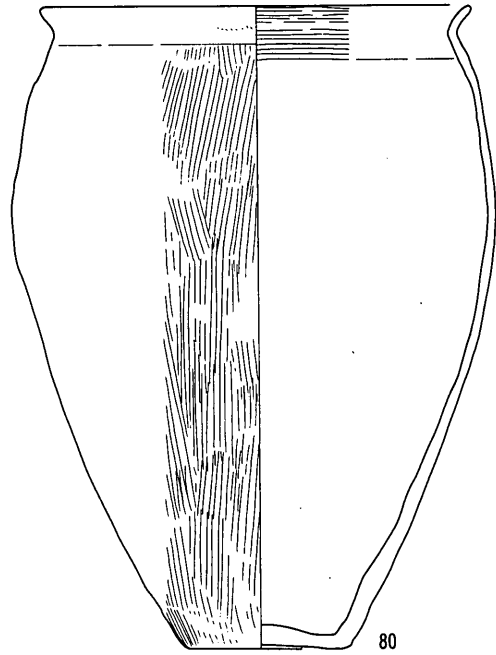
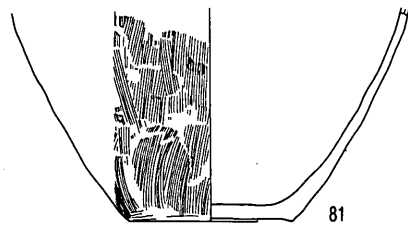
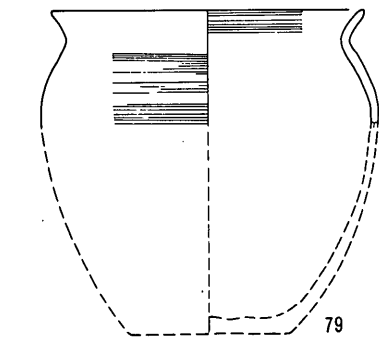

SB 93

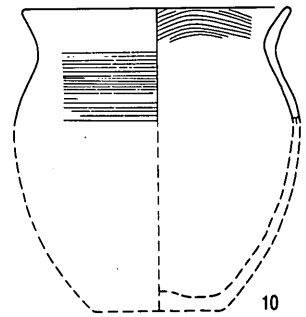
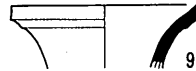
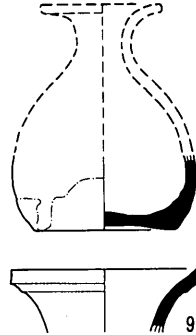
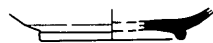
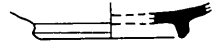
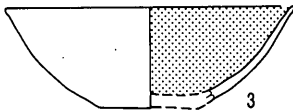
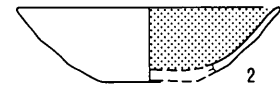
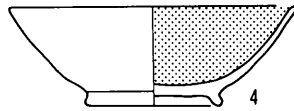
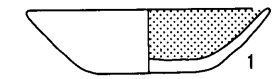

SB 95

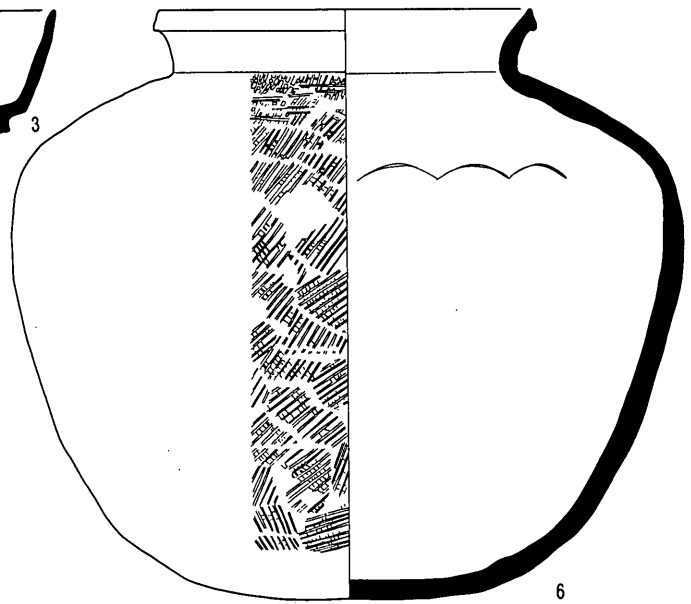
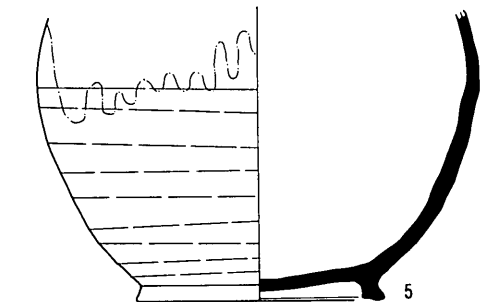
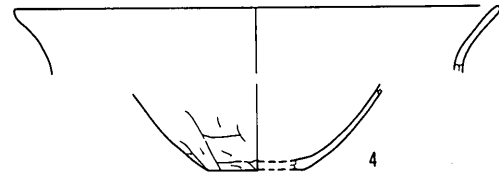
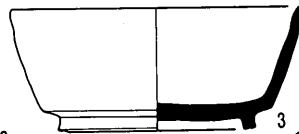
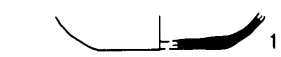

SB 96

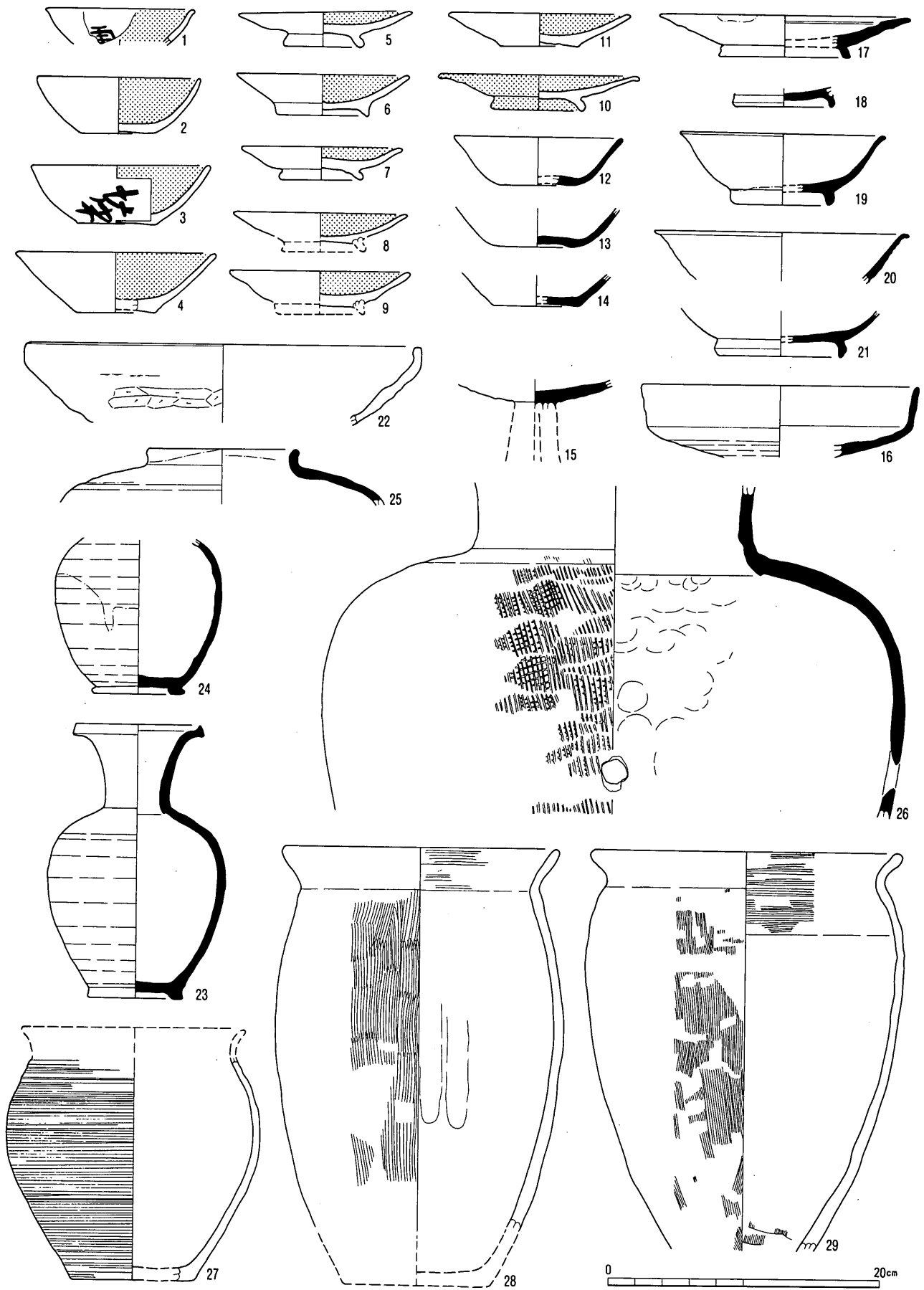

SB96

SB 97 上層

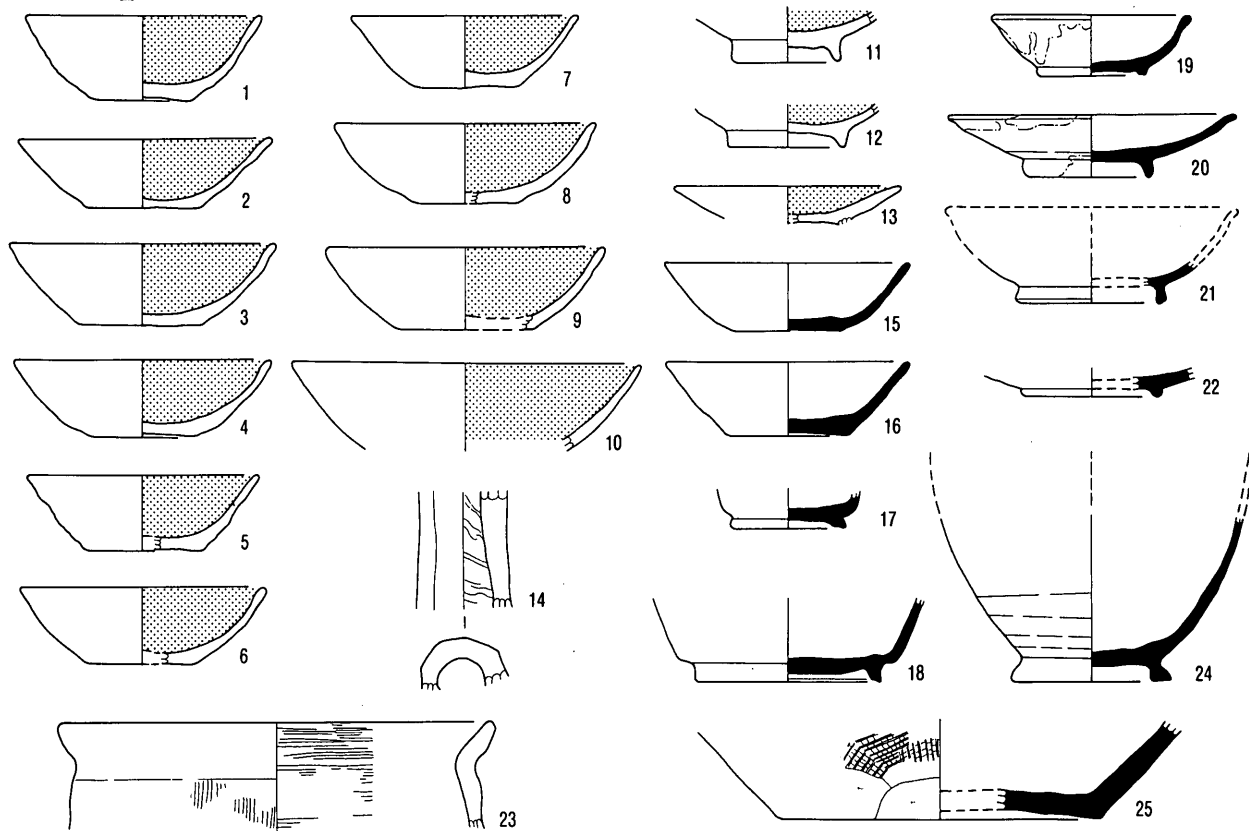

SB 97 下層

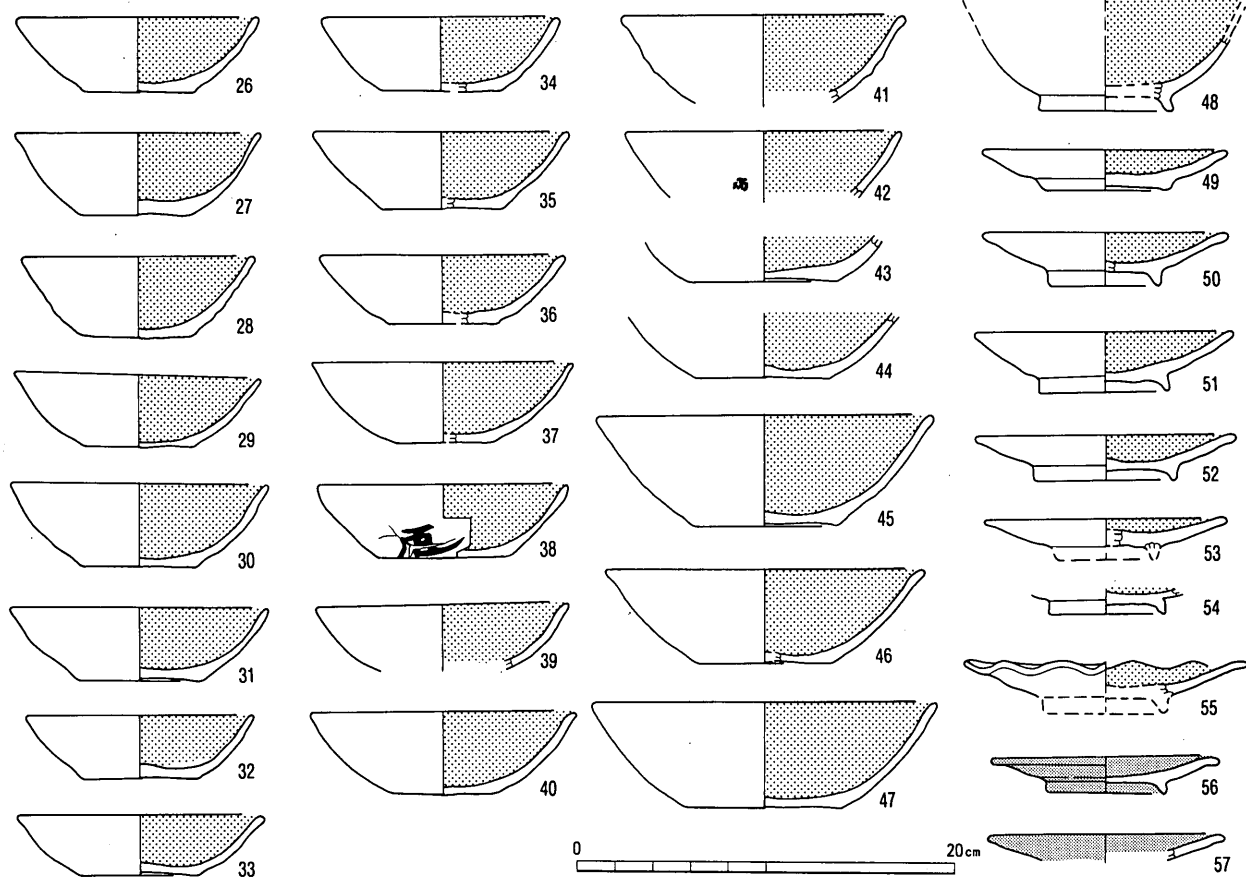

SB97上層・下層

SB 97 下層

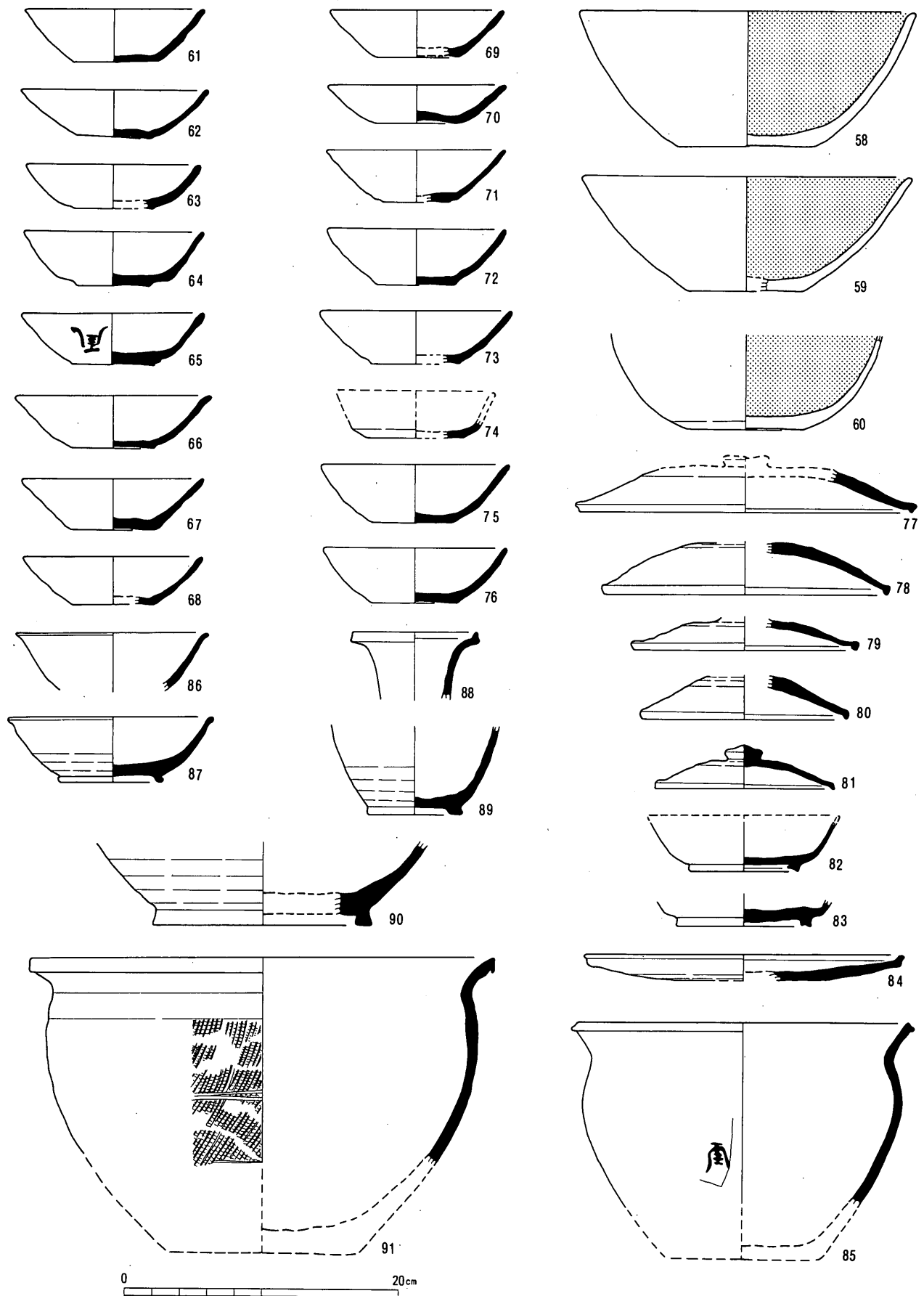

SB 97 下層

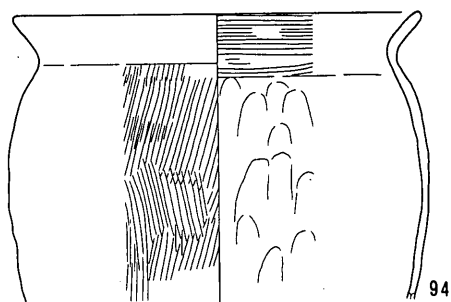
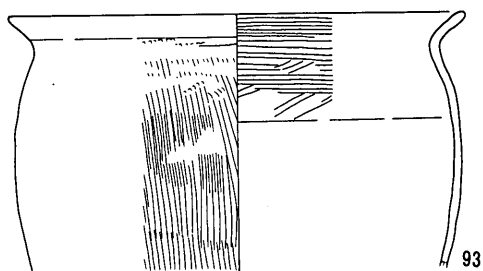
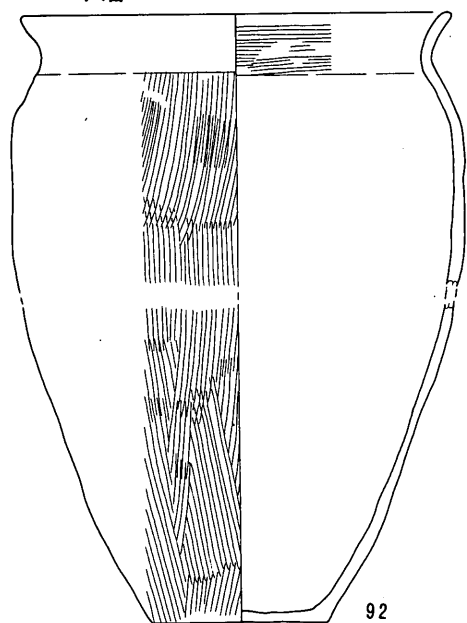

SB 99

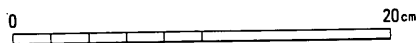
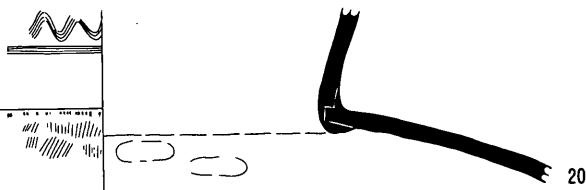
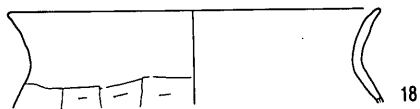
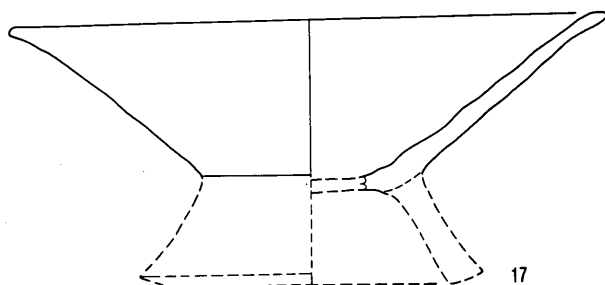
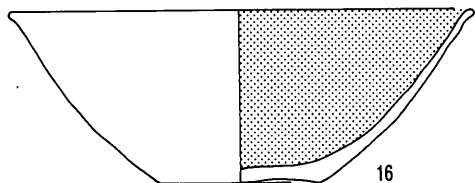
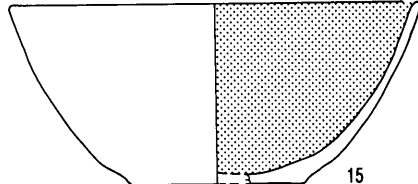
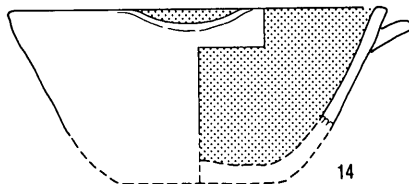
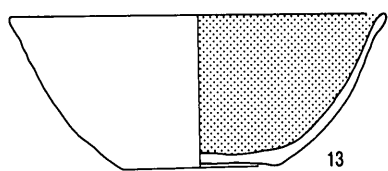
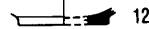
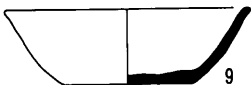
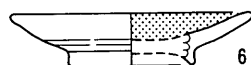
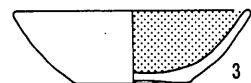
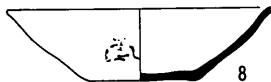
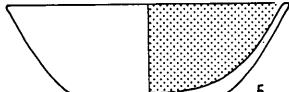
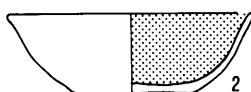
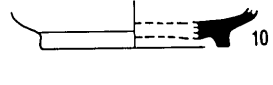
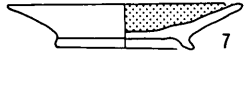
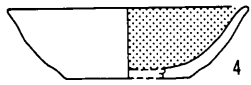
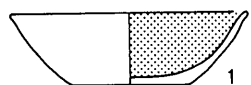

SB 100

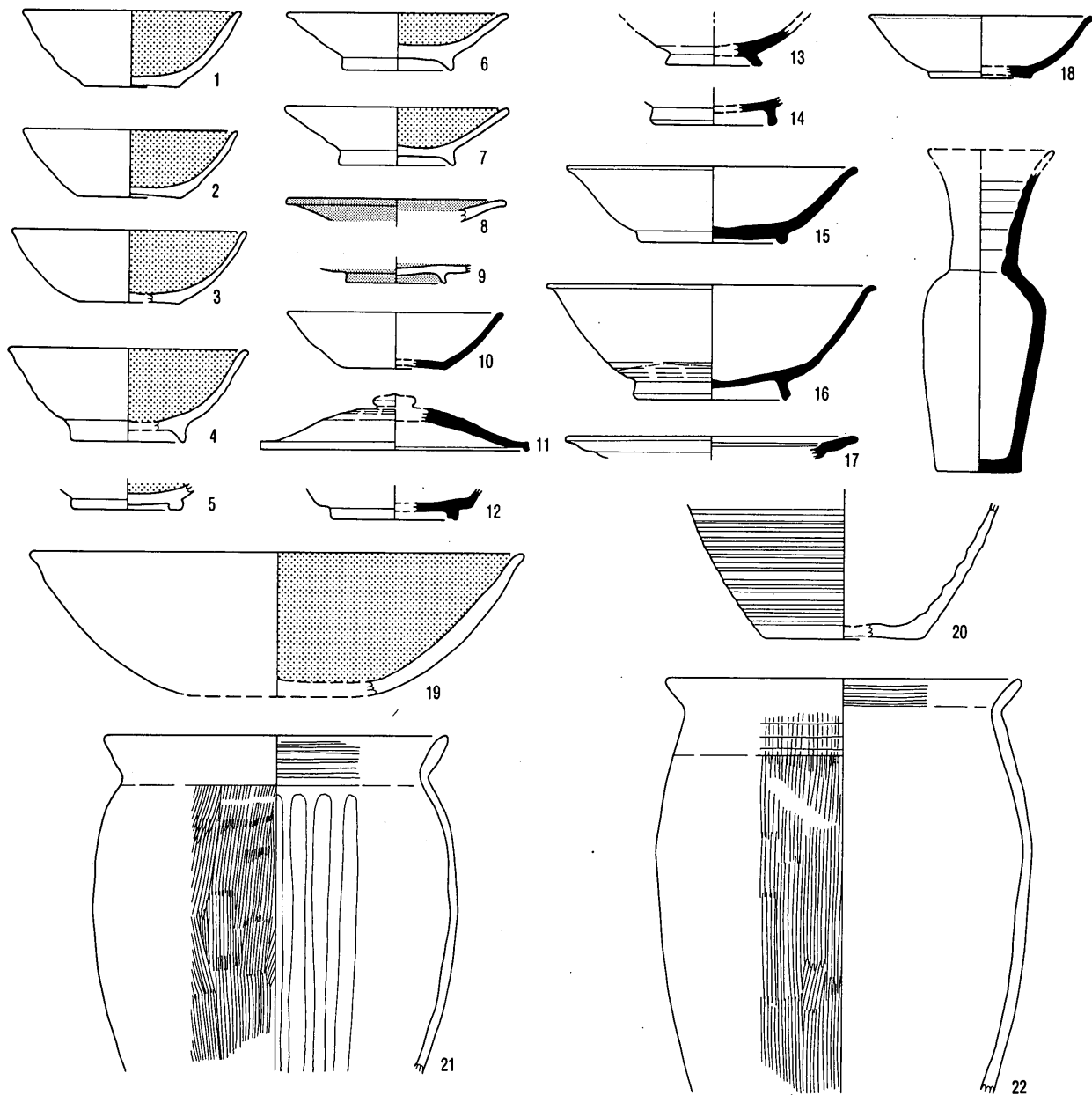

SB 101

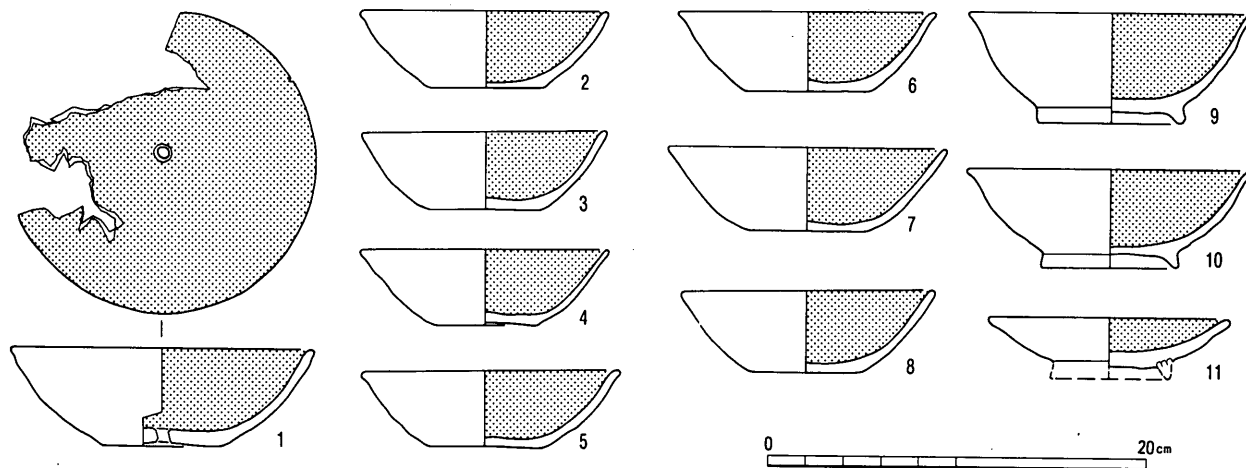



SB 104

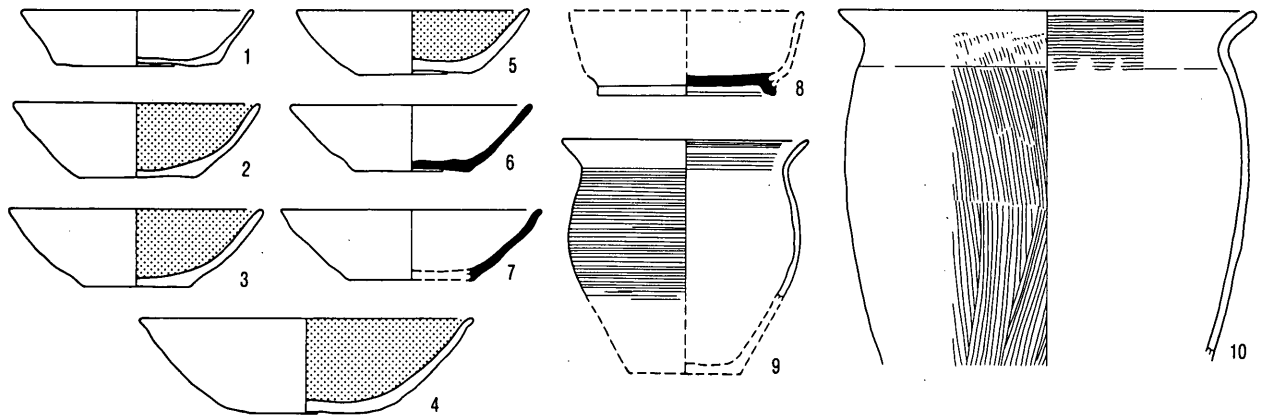

SB 105

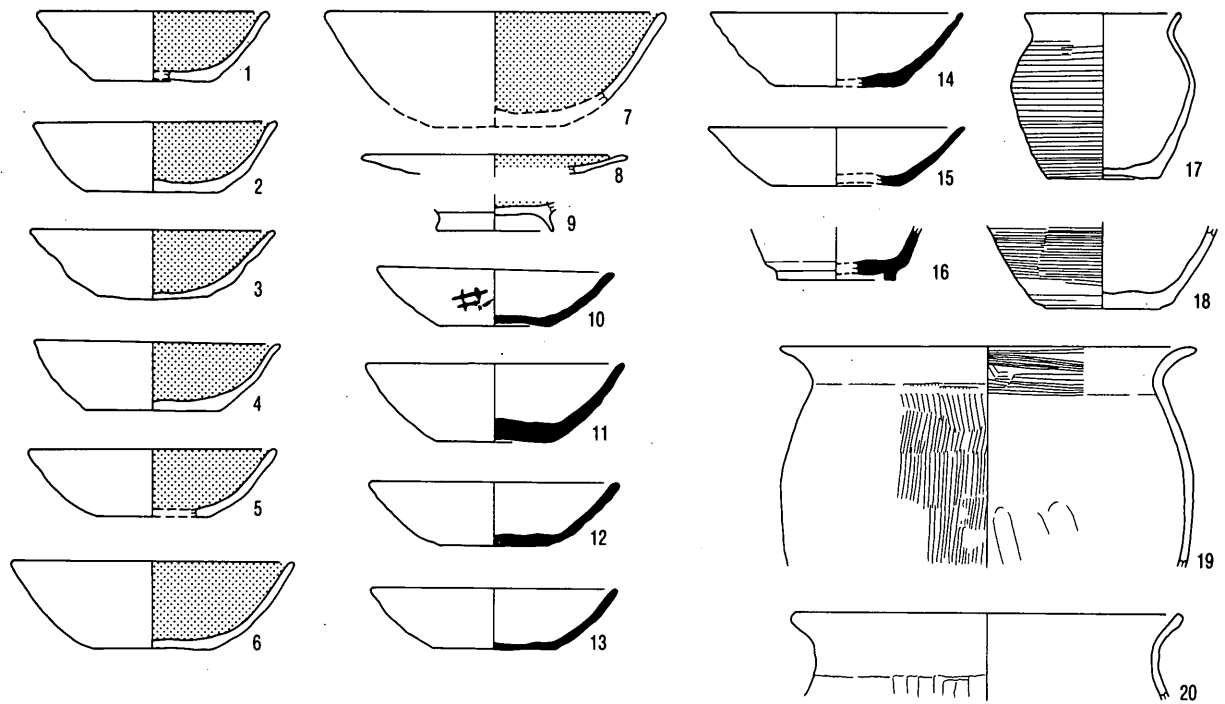

SB 106

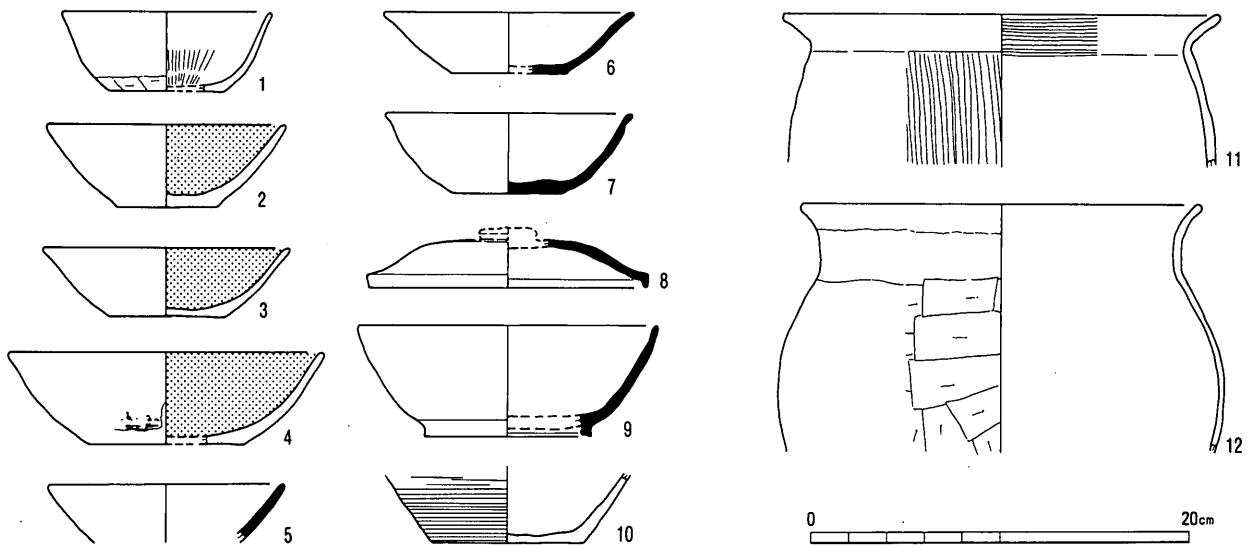



SB 107

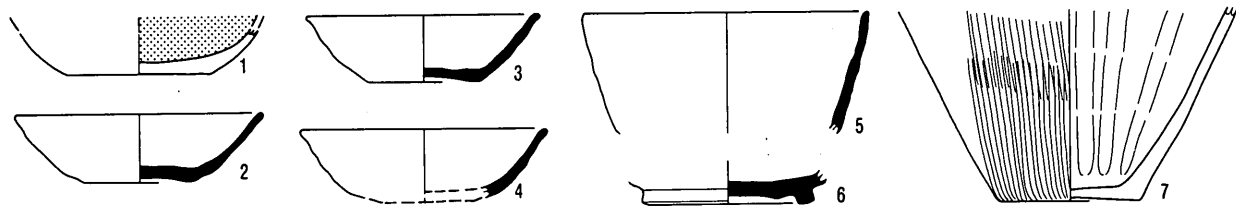

SB 108

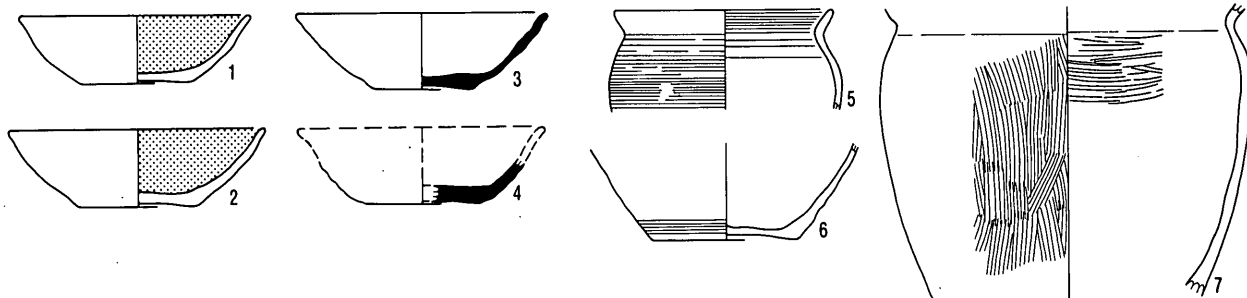

SB 109

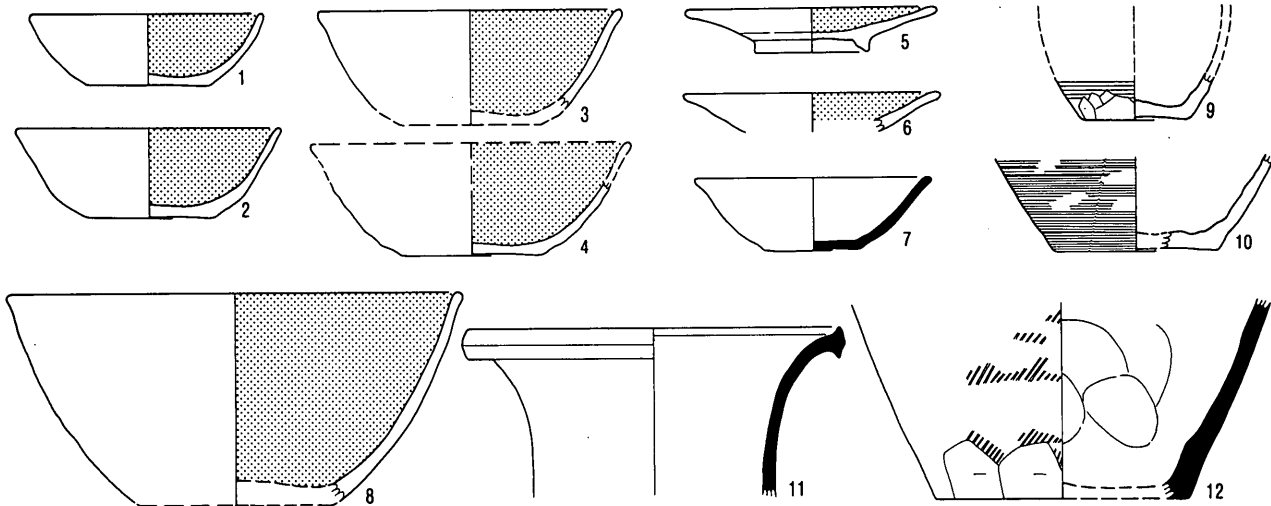

SB 110

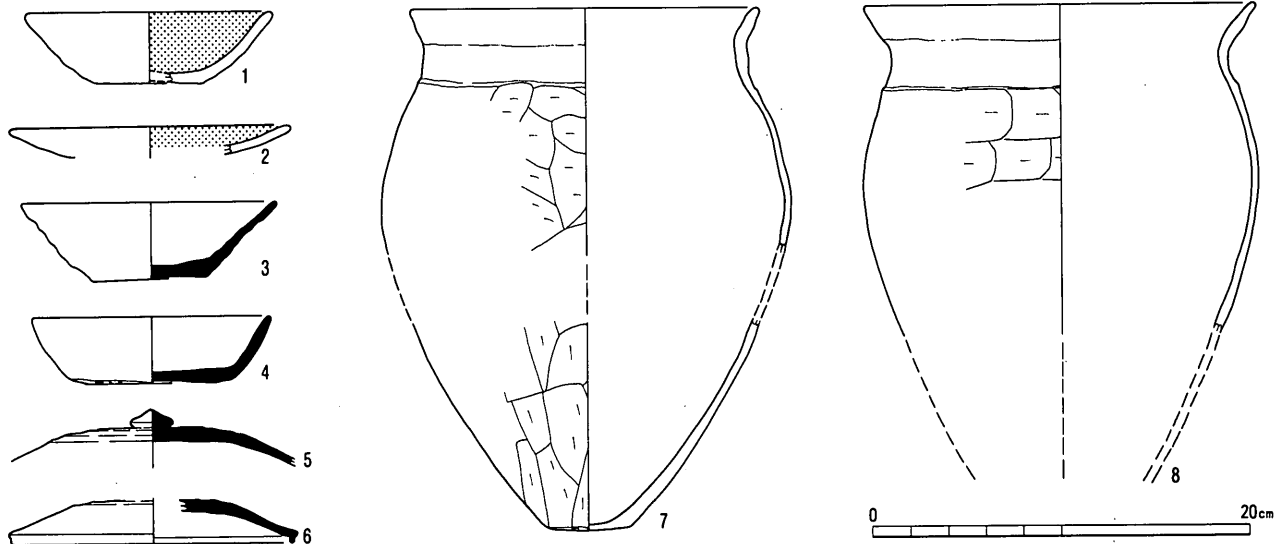

SB 110

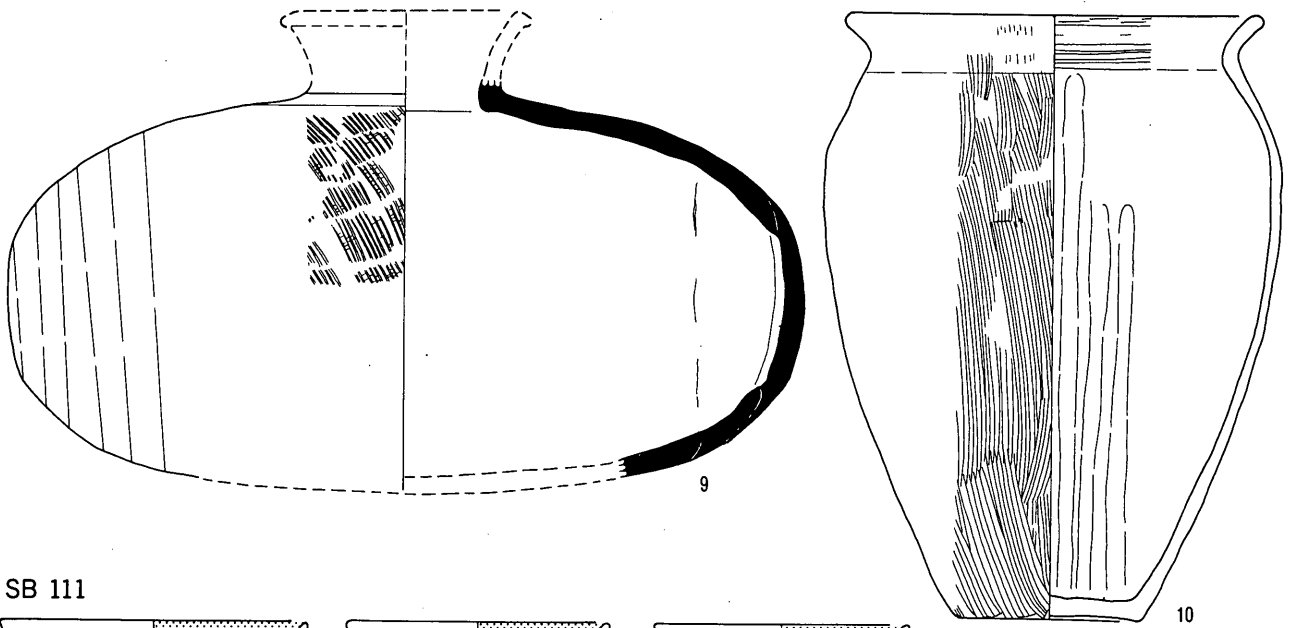

SB 111

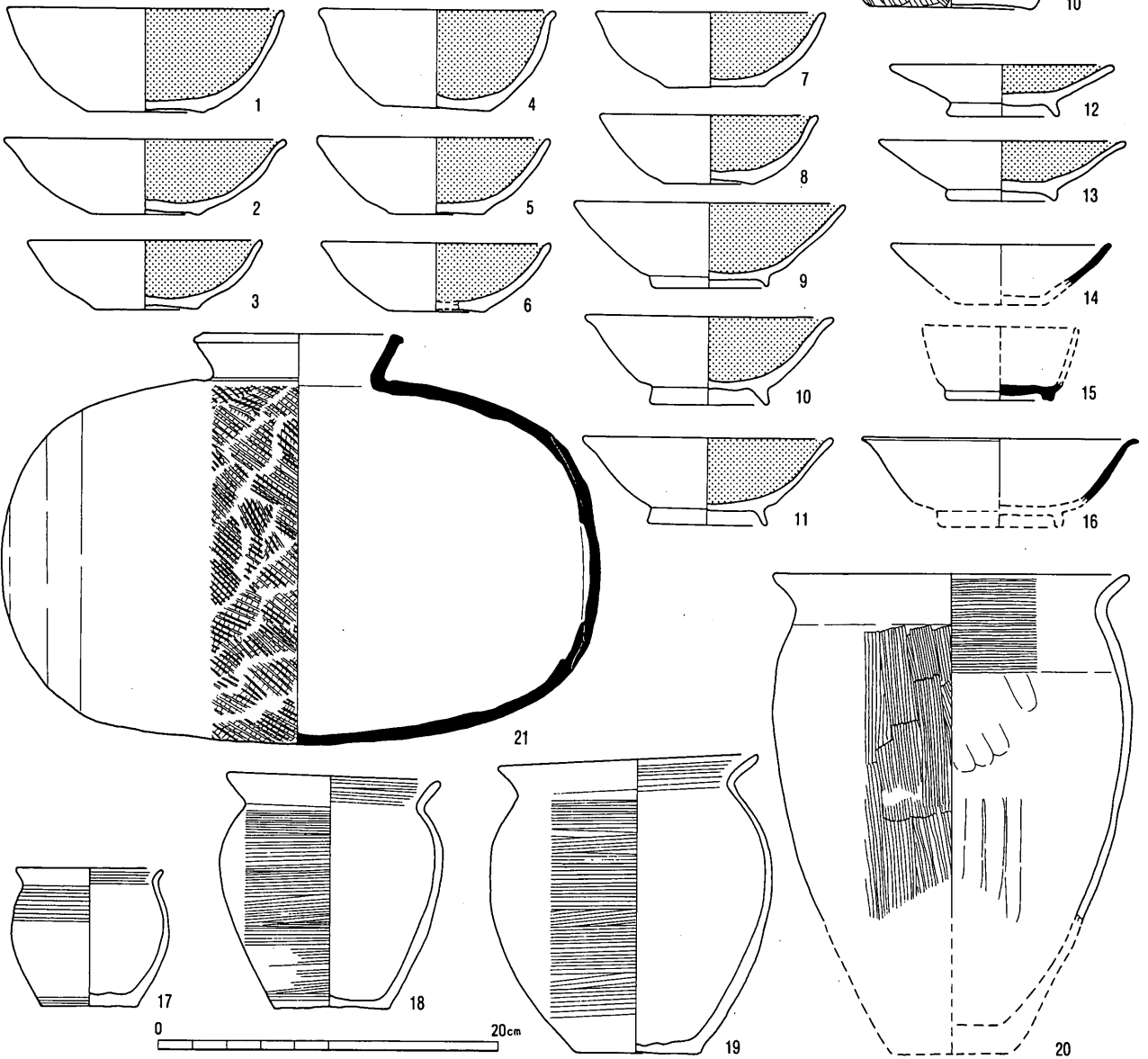

SB110·111

SB 112

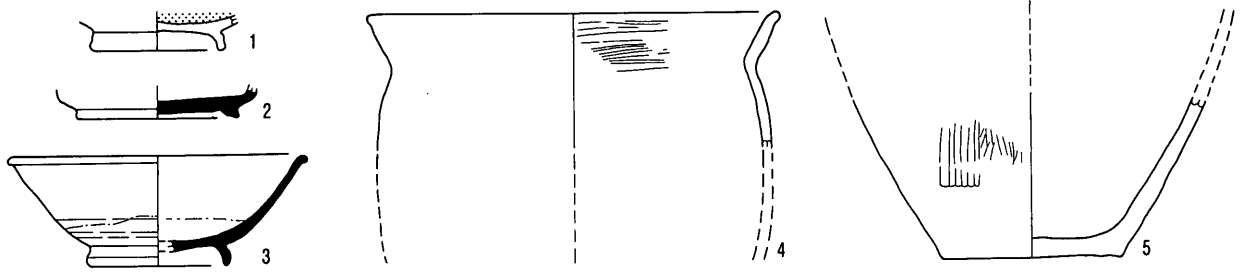

SB 114

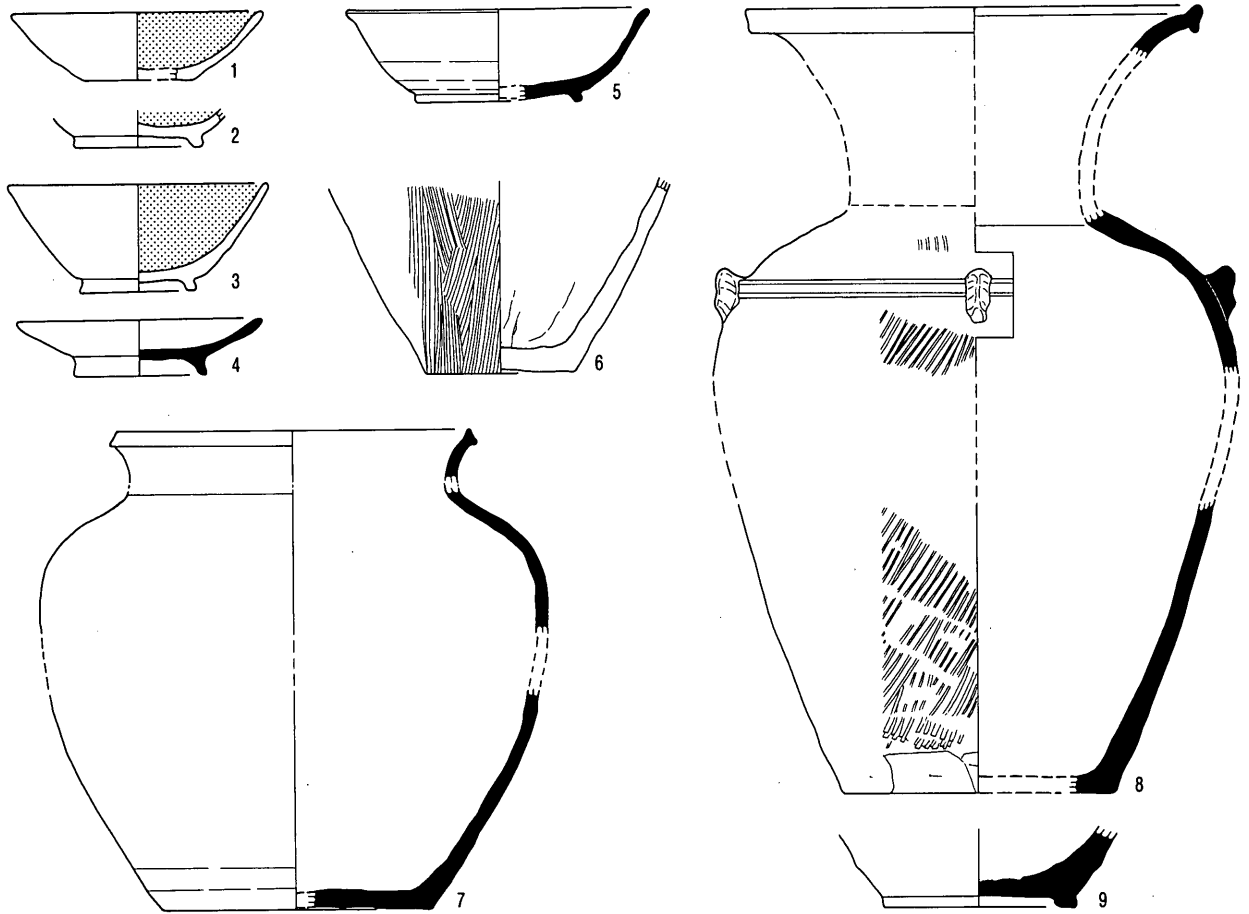

SB 115

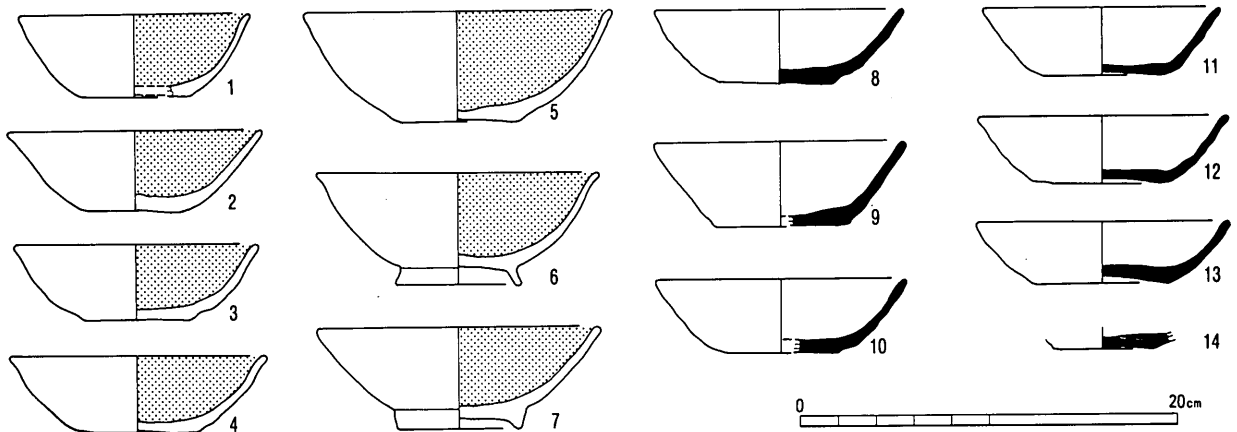

SB 115

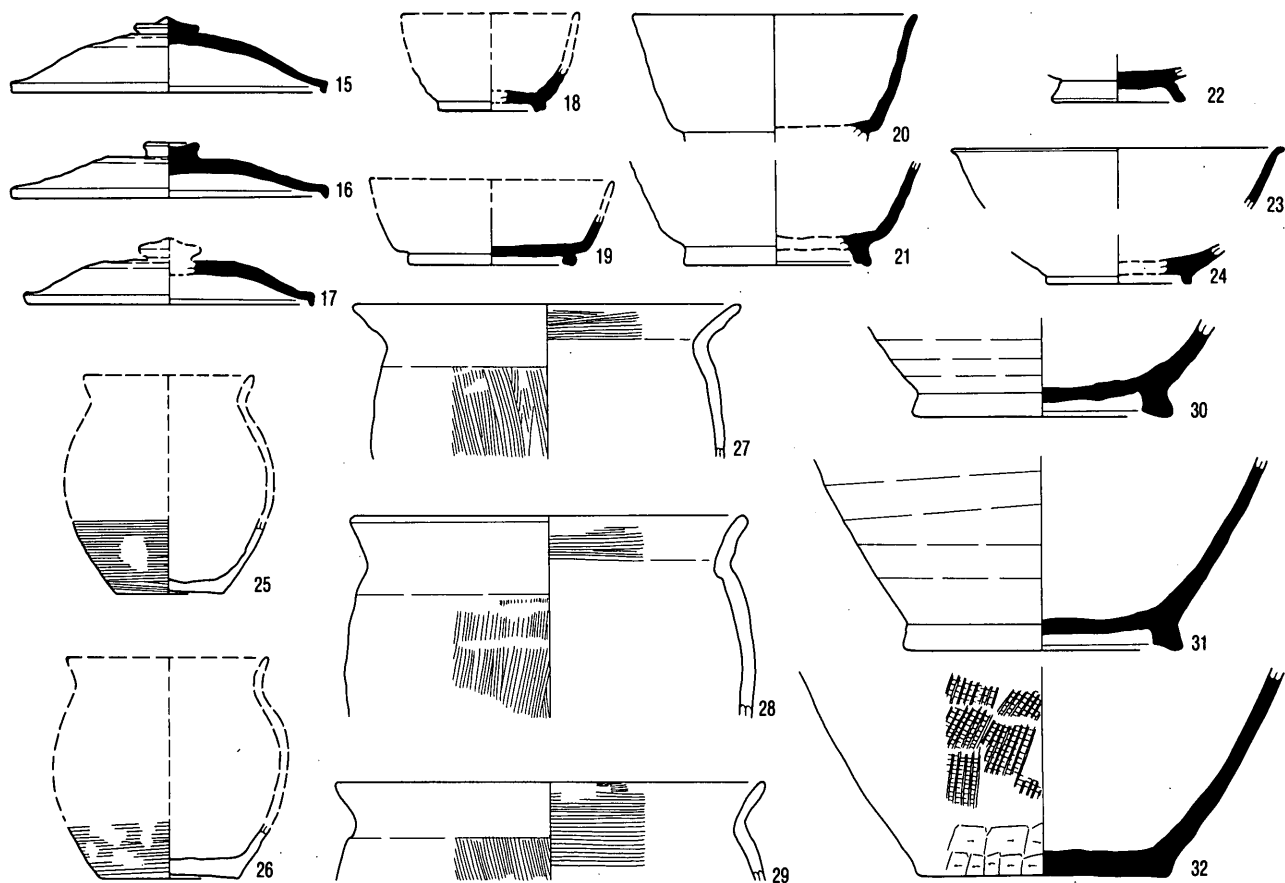

SB 116

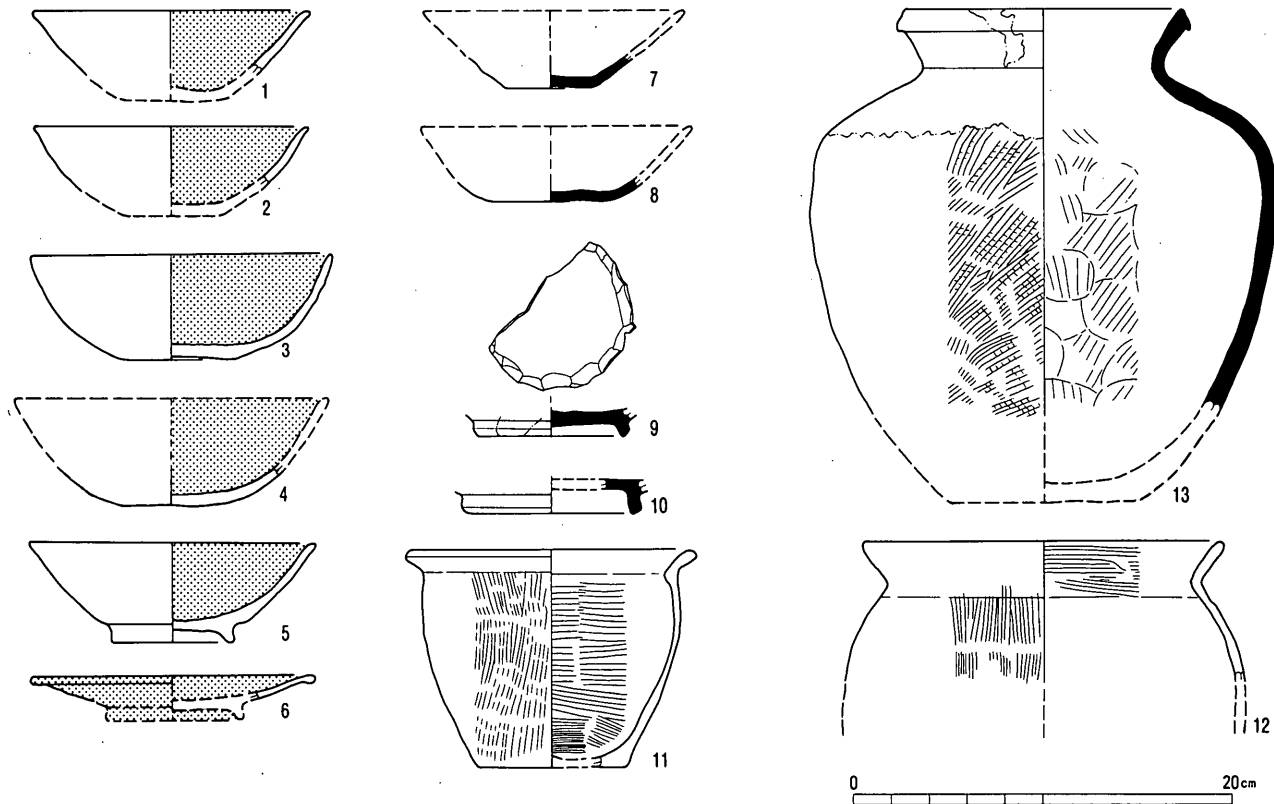

SB 117

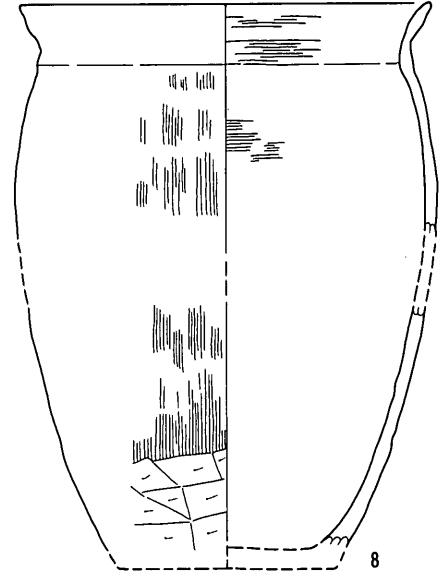
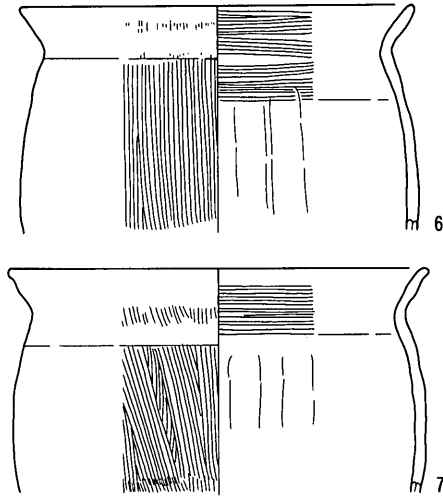
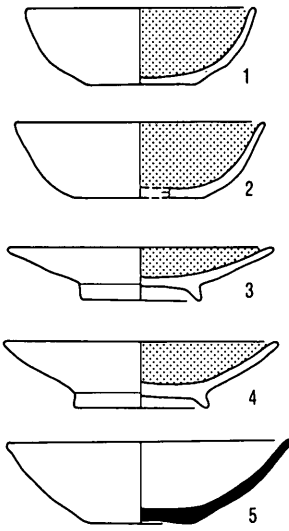

SB 118

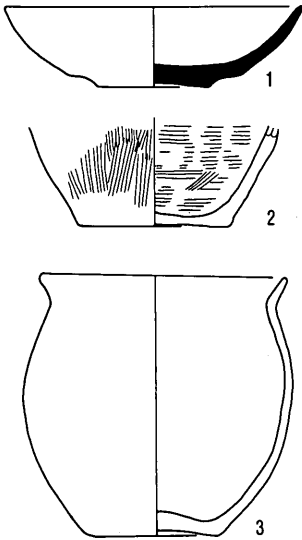

SB 119

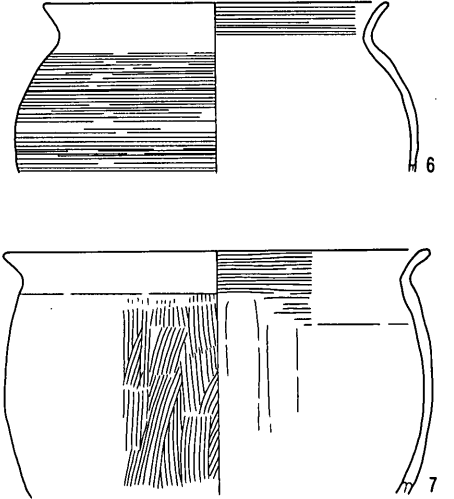
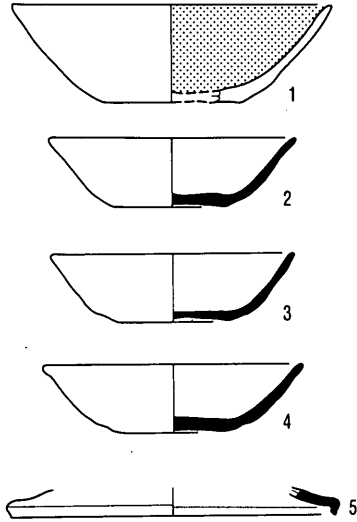

SB 120

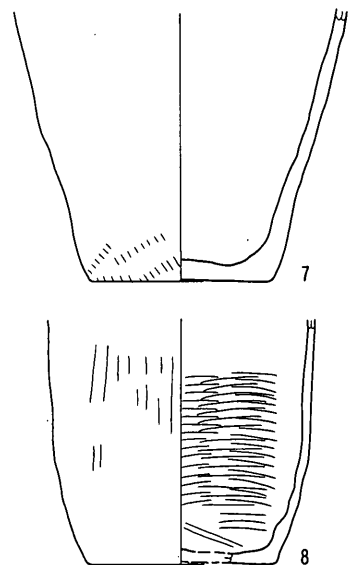
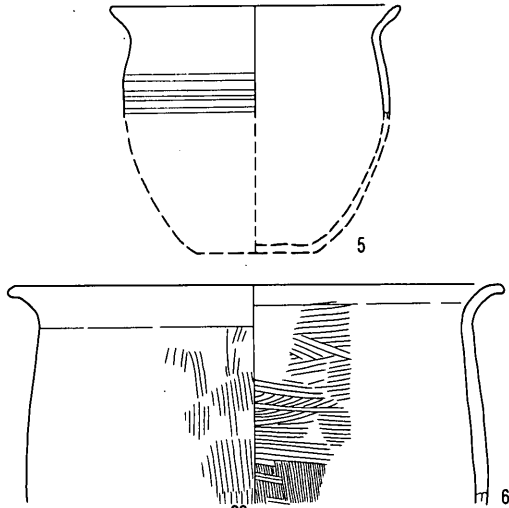
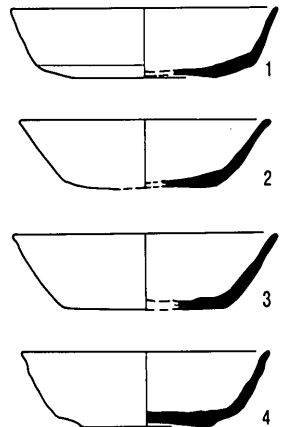

SB 121

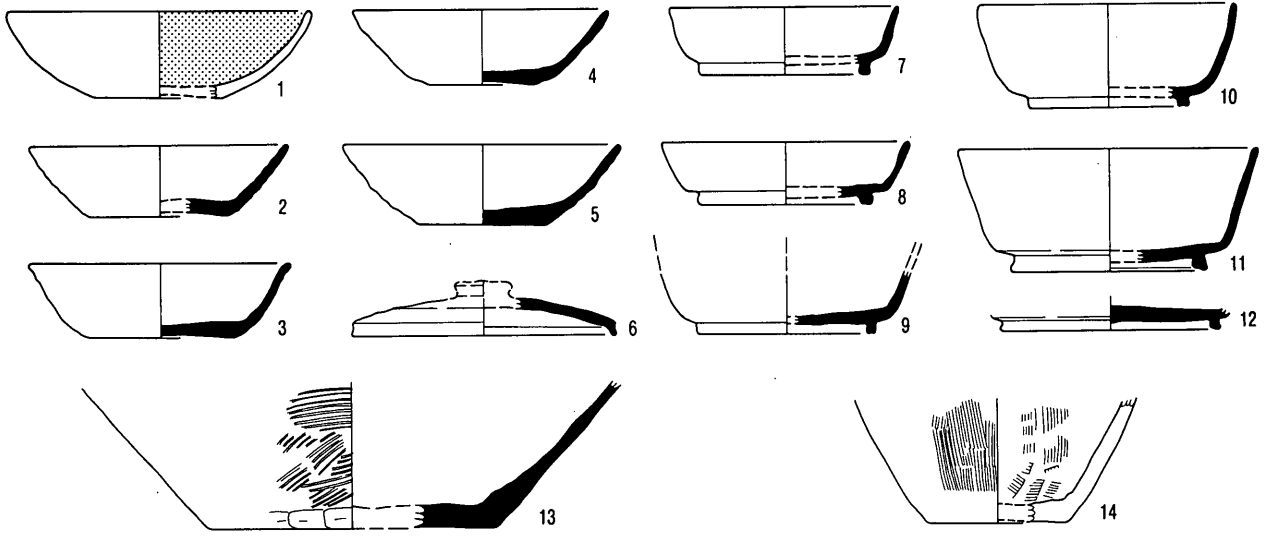

SB 122

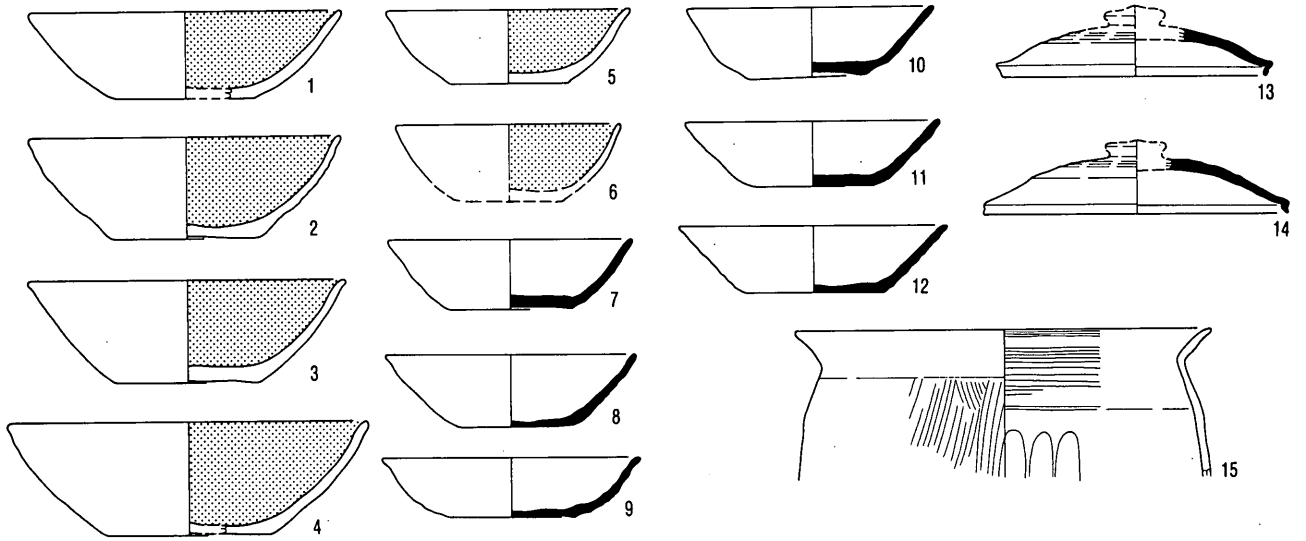

SB 123

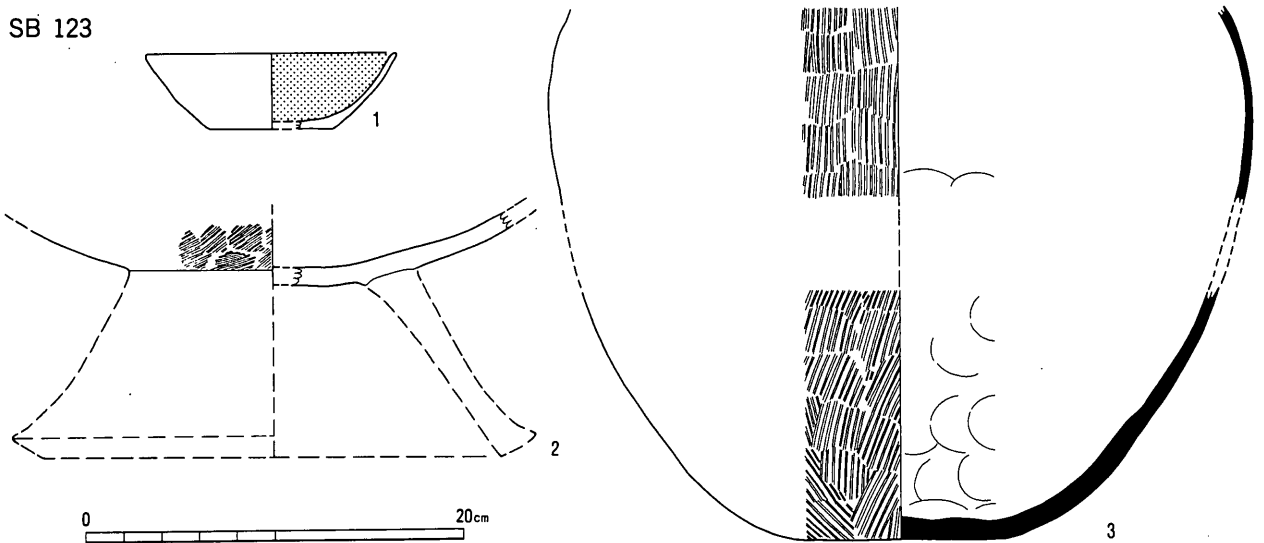

SB 124

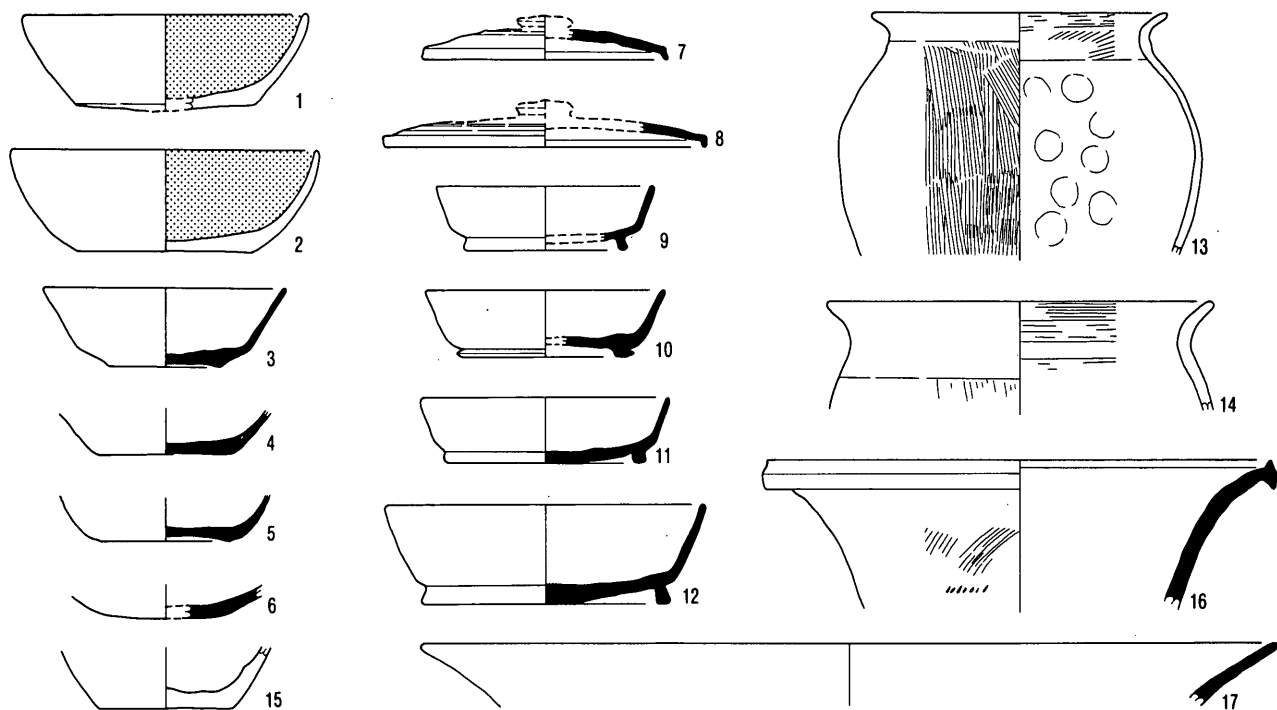

SB 125

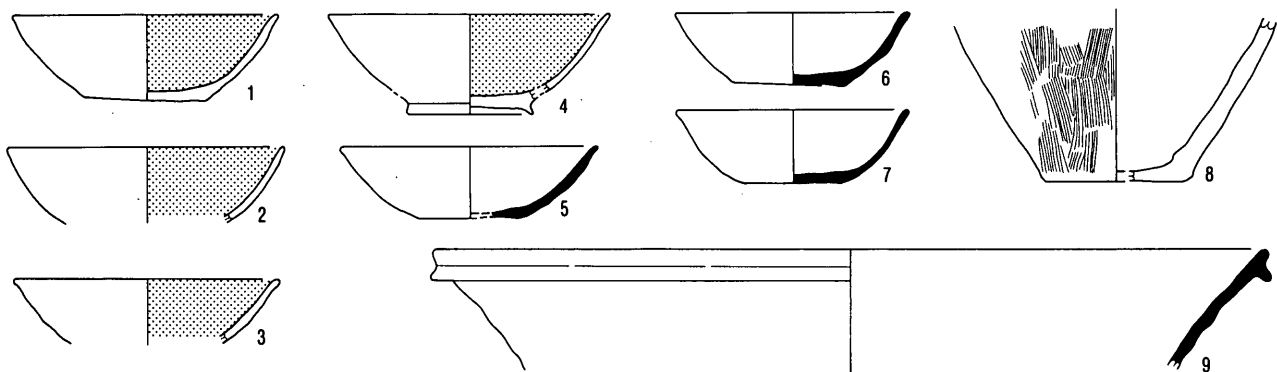

SB 127

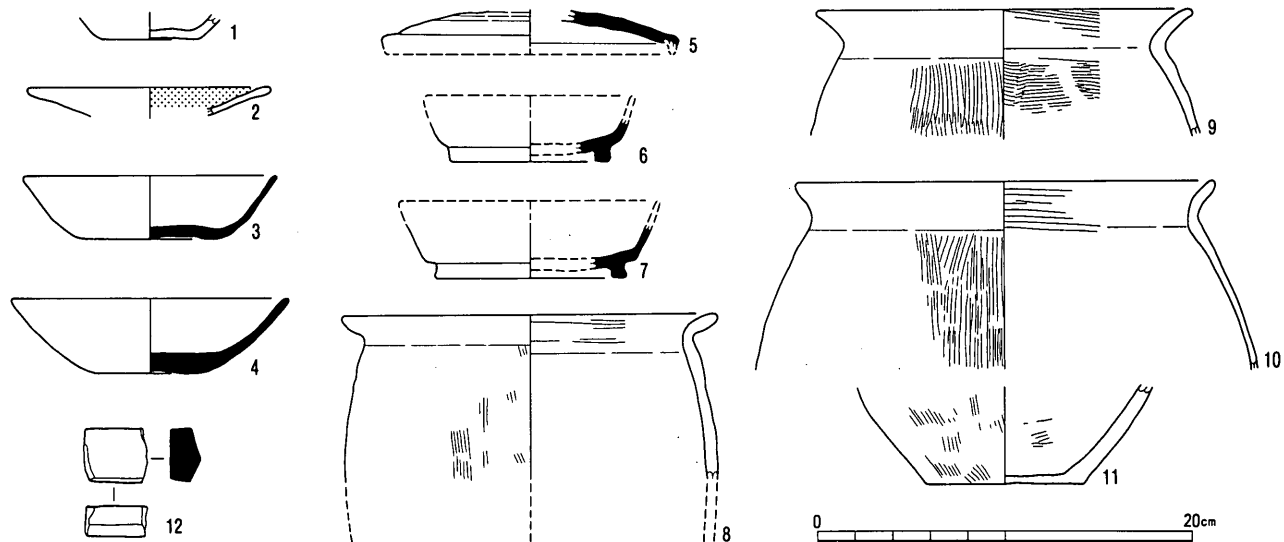

SB 126

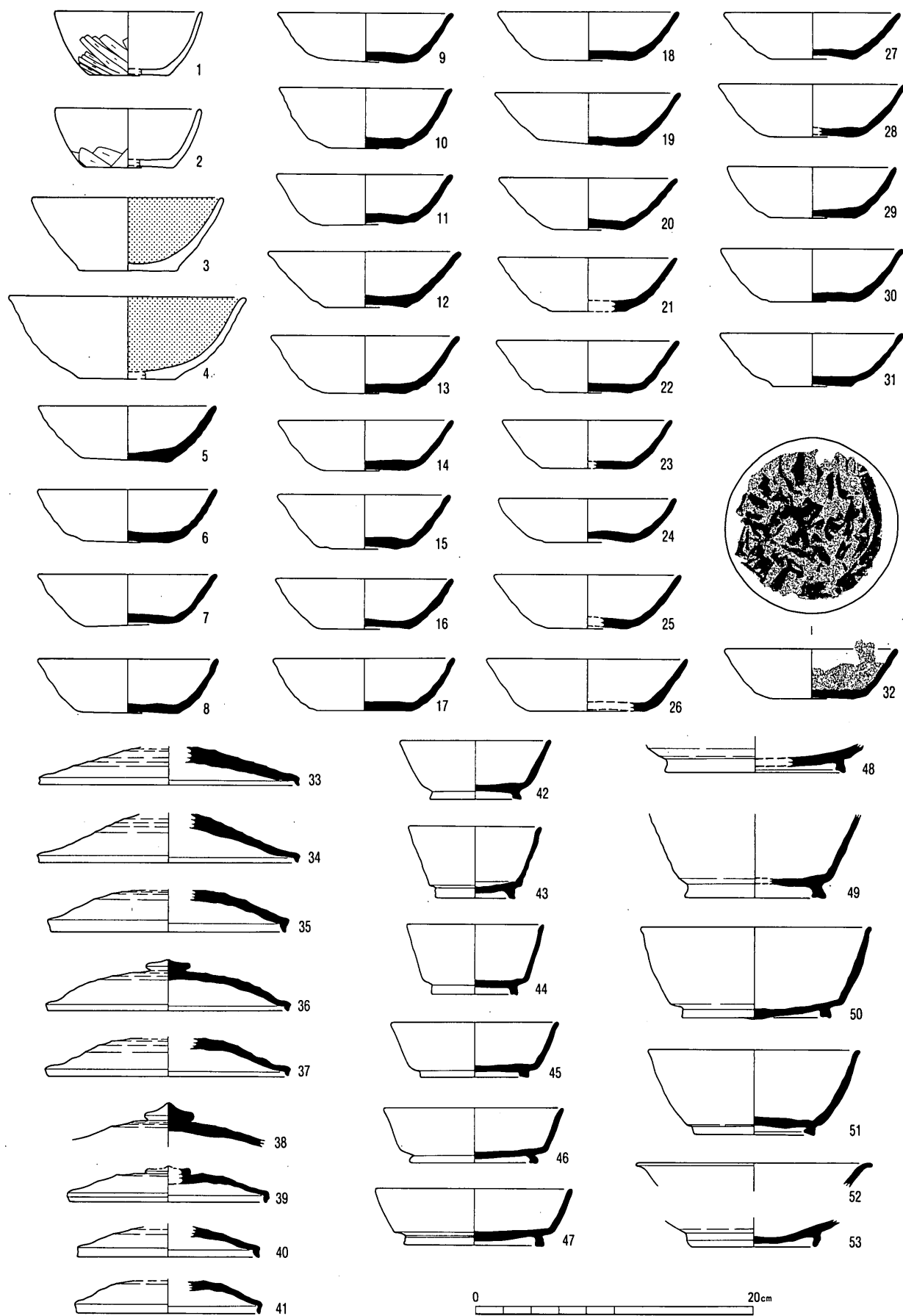

SB126



SB 126

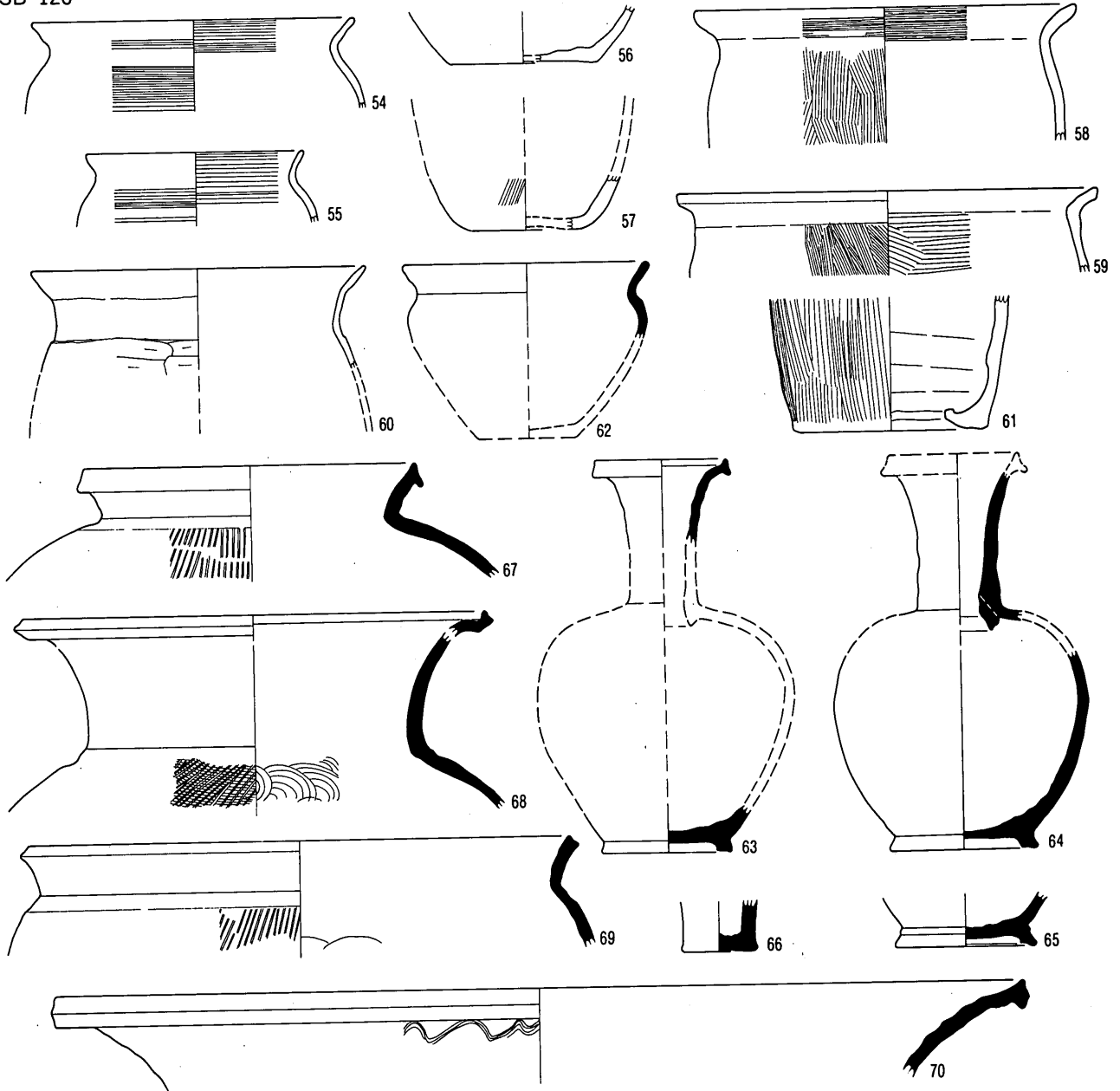

SB 128

SB 129

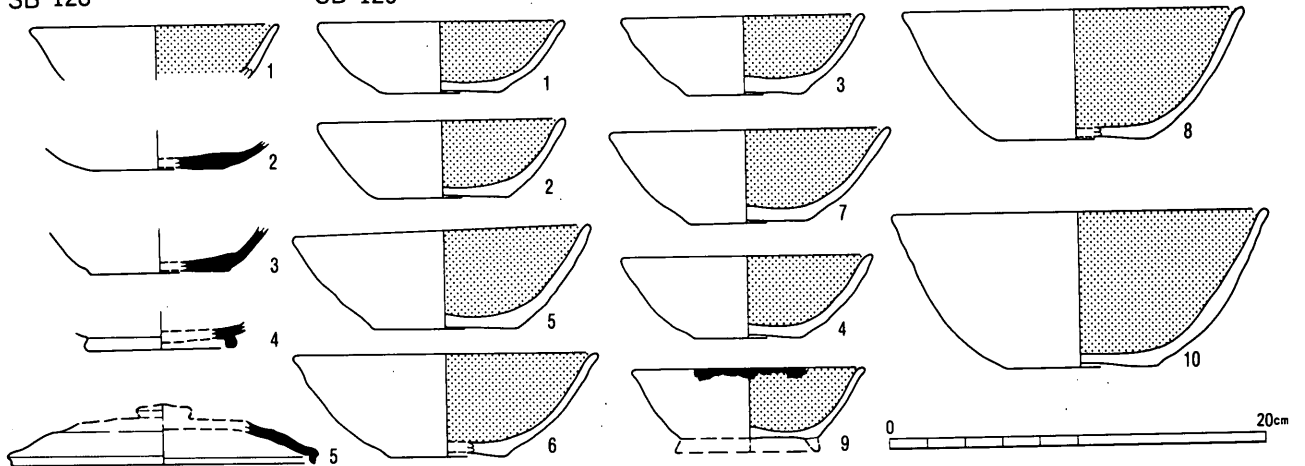

SB 130

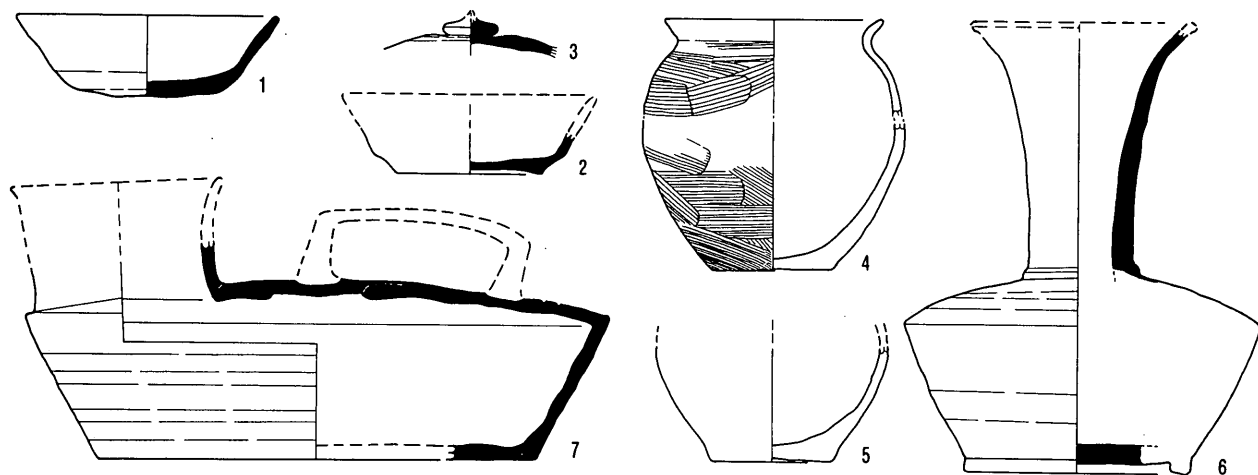

SB 131

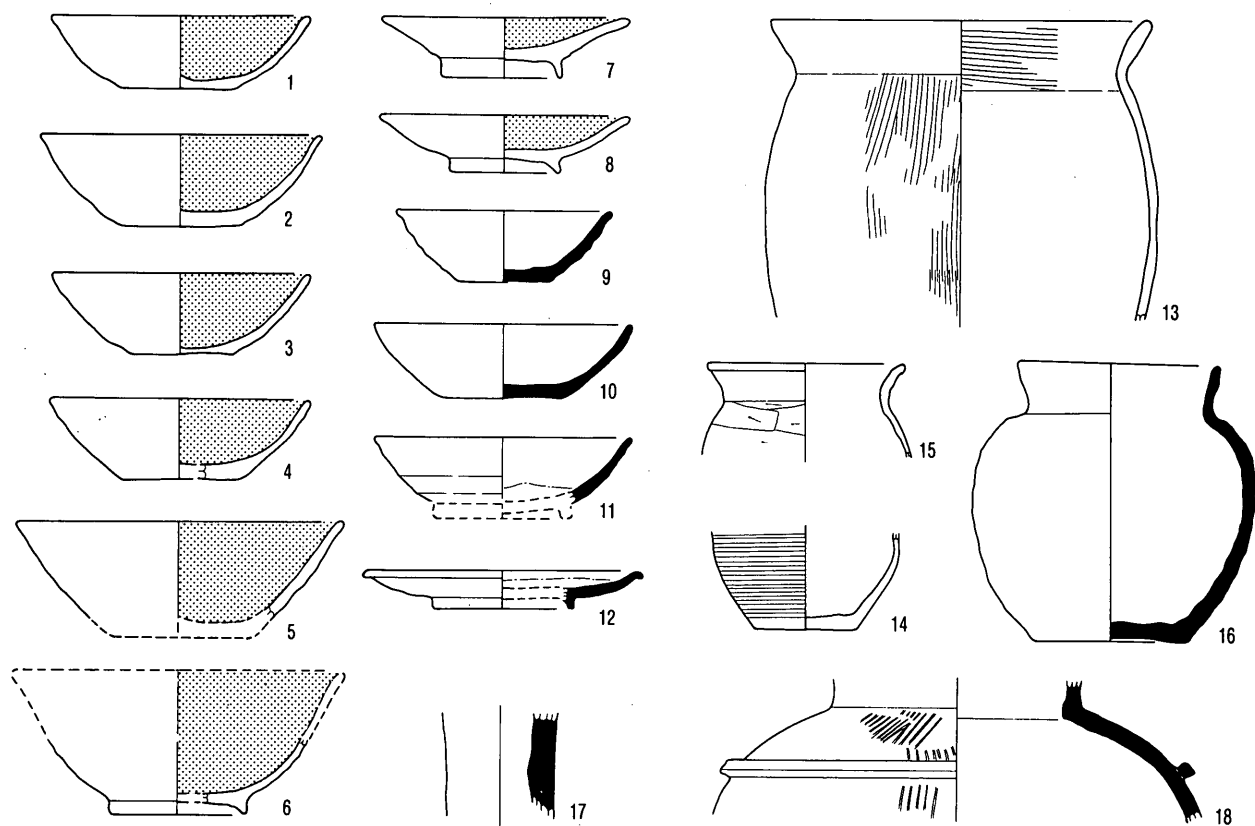

SB 132

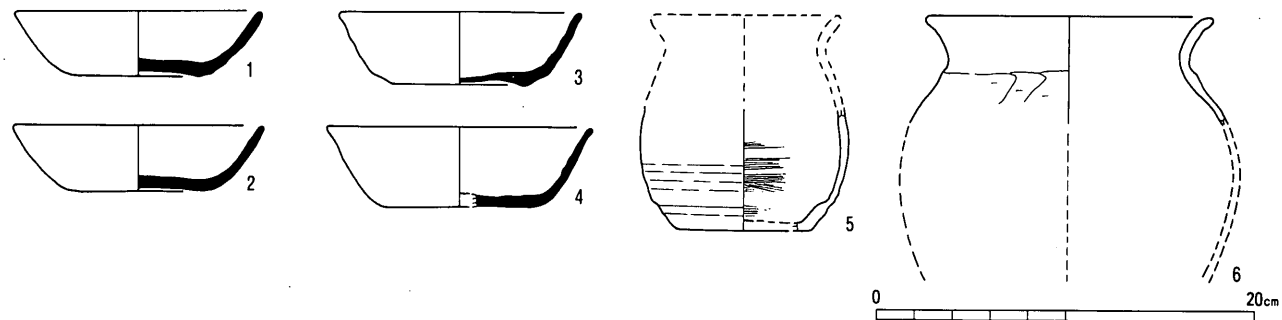

SB 133

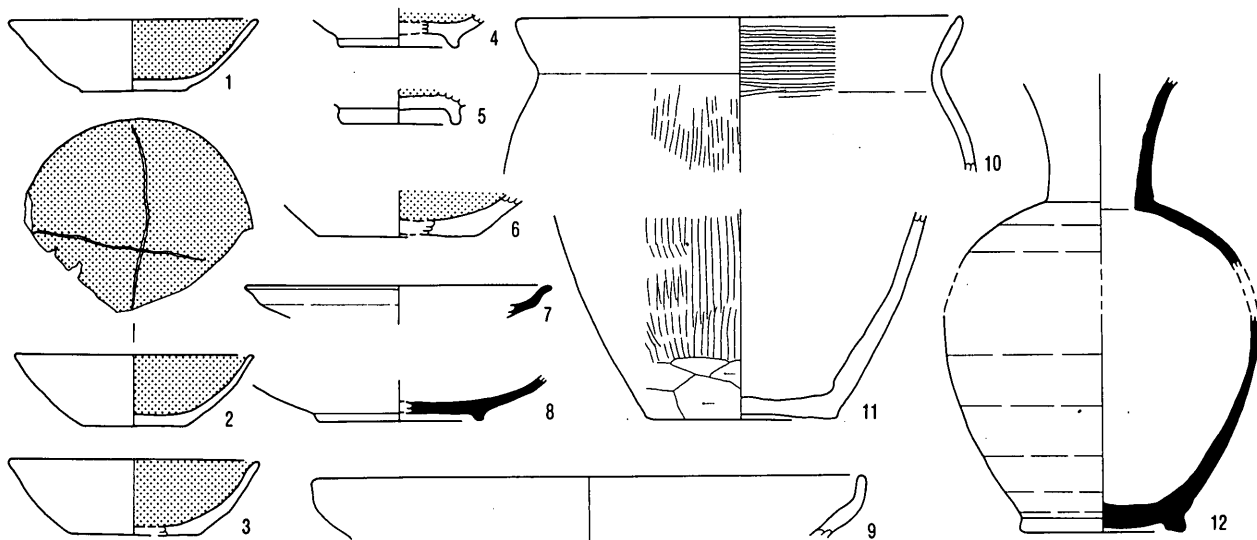

SB 134

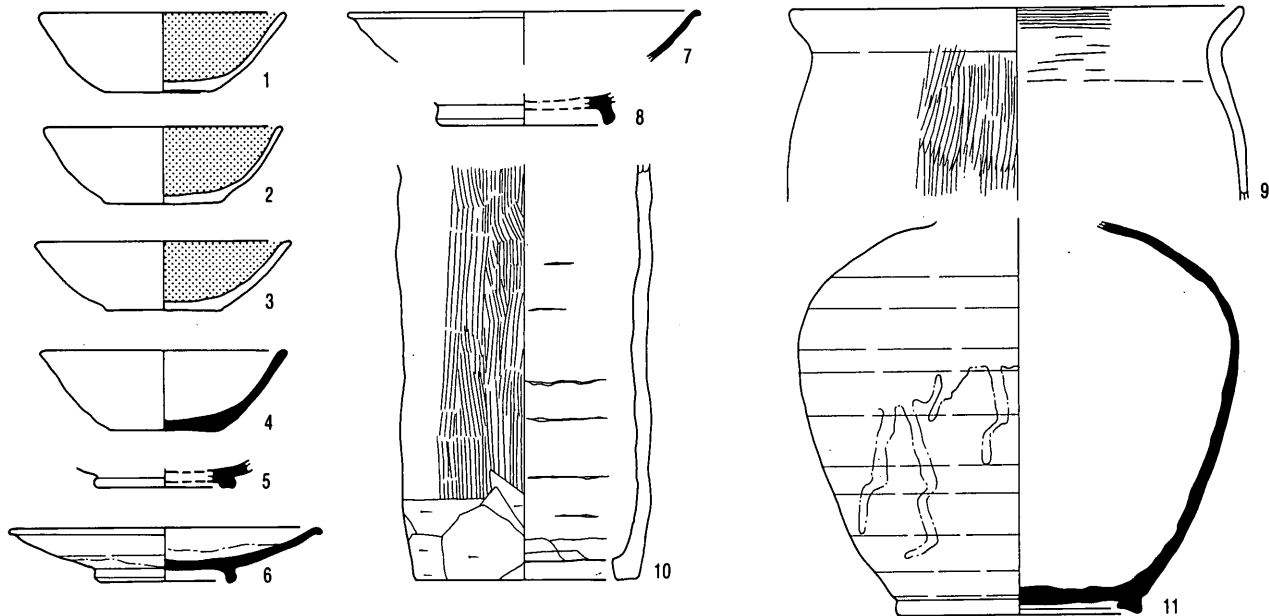

SB 135

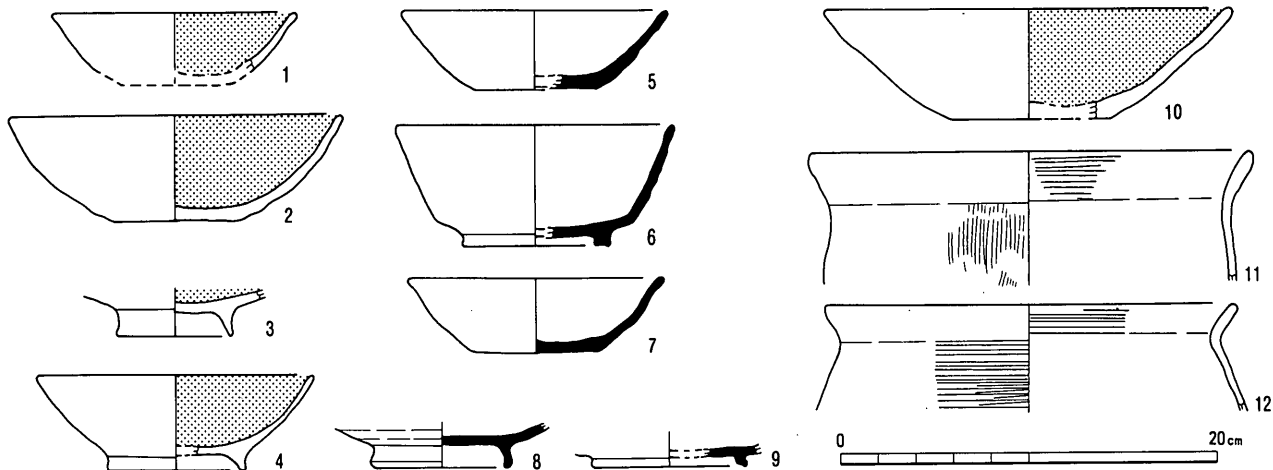

SB 136

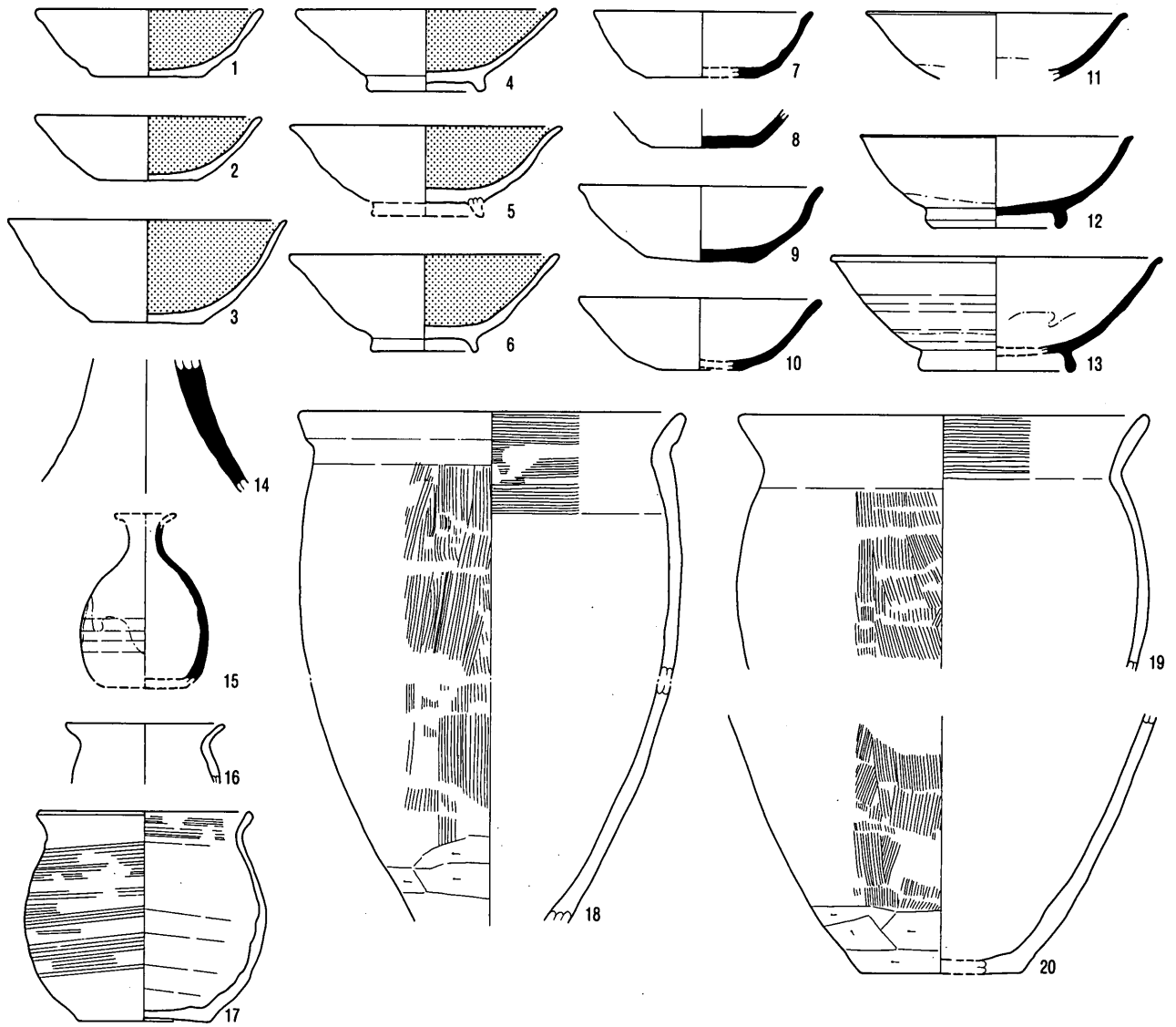

SB 138

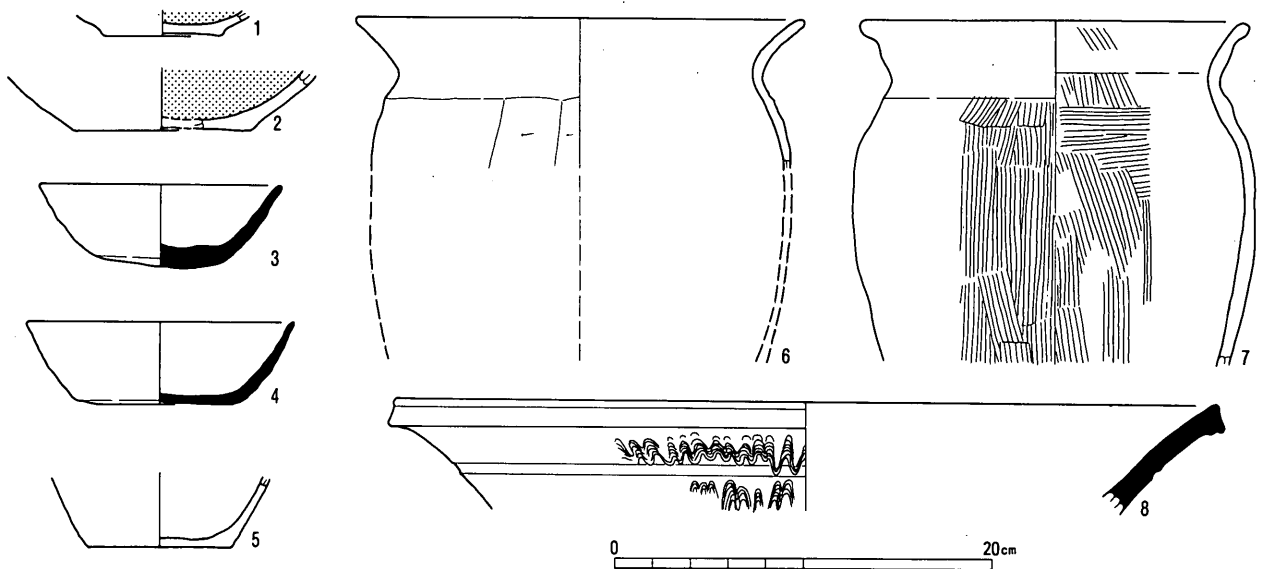

SB 139

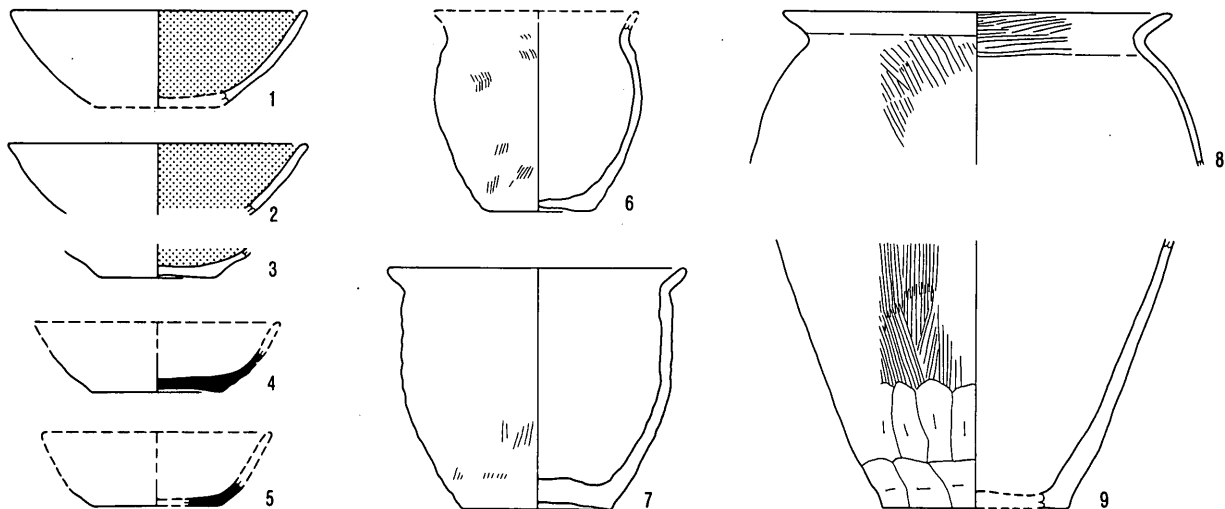

SB 140

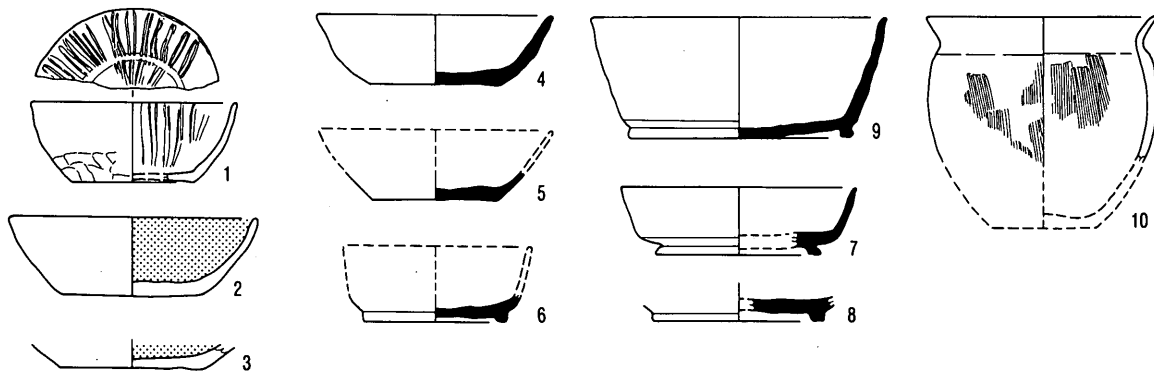

SB 141

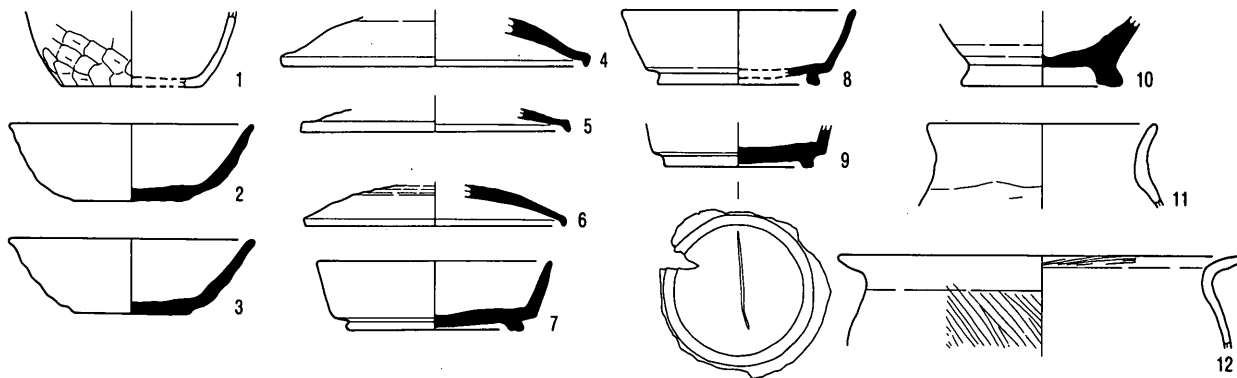

SB 142

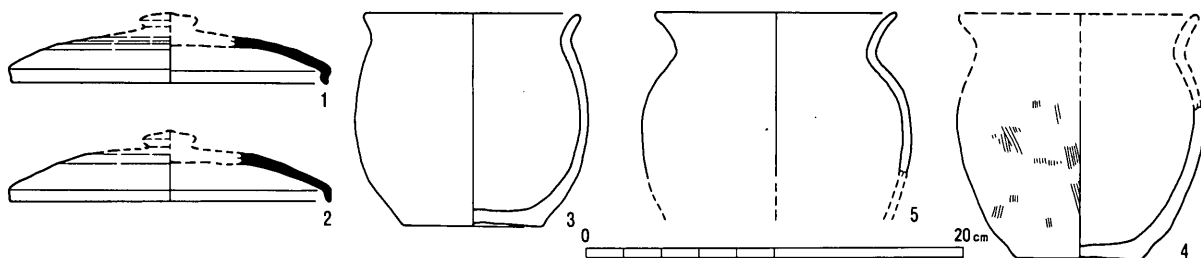

SB 143

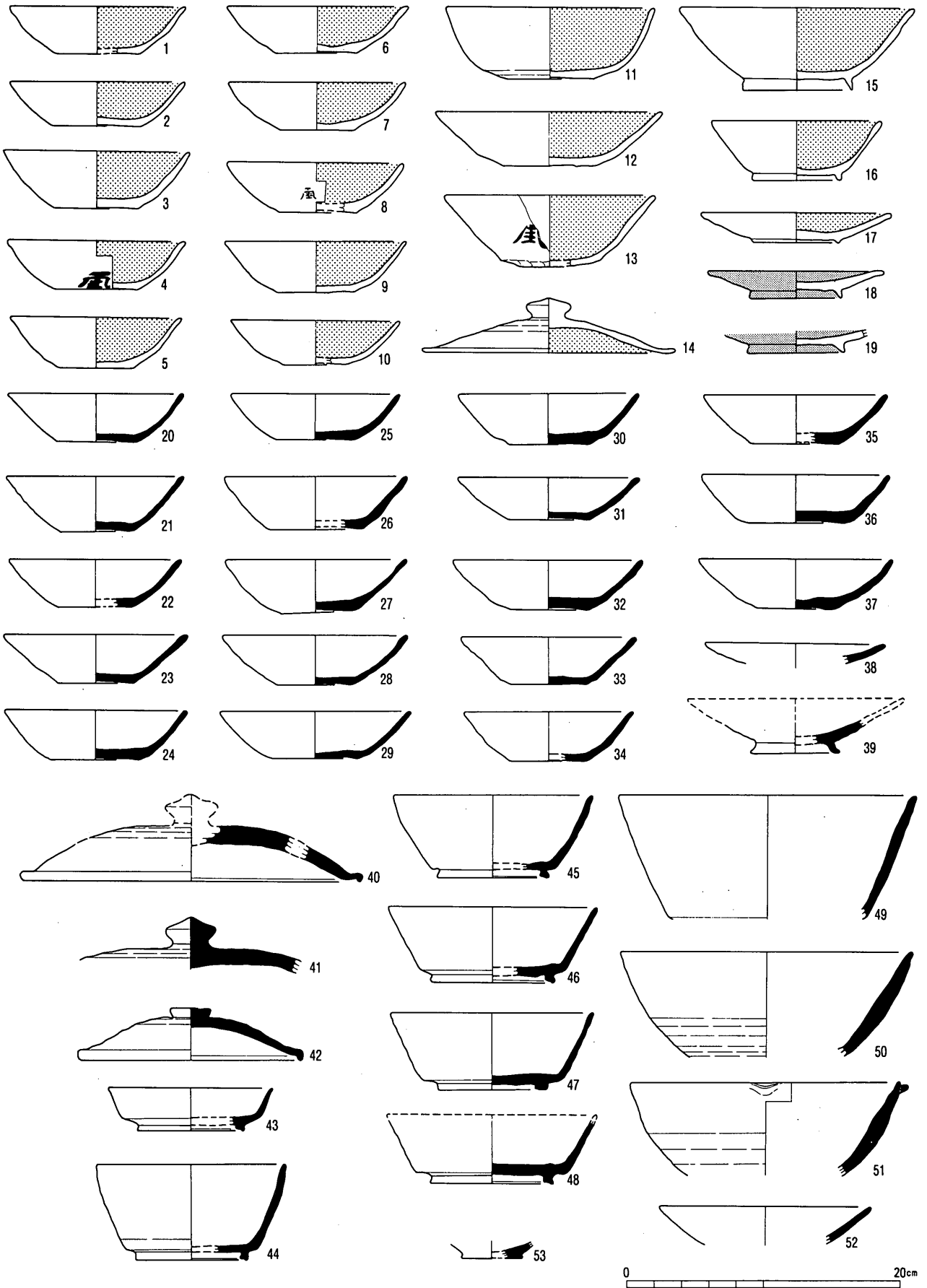

SB143

SB 143

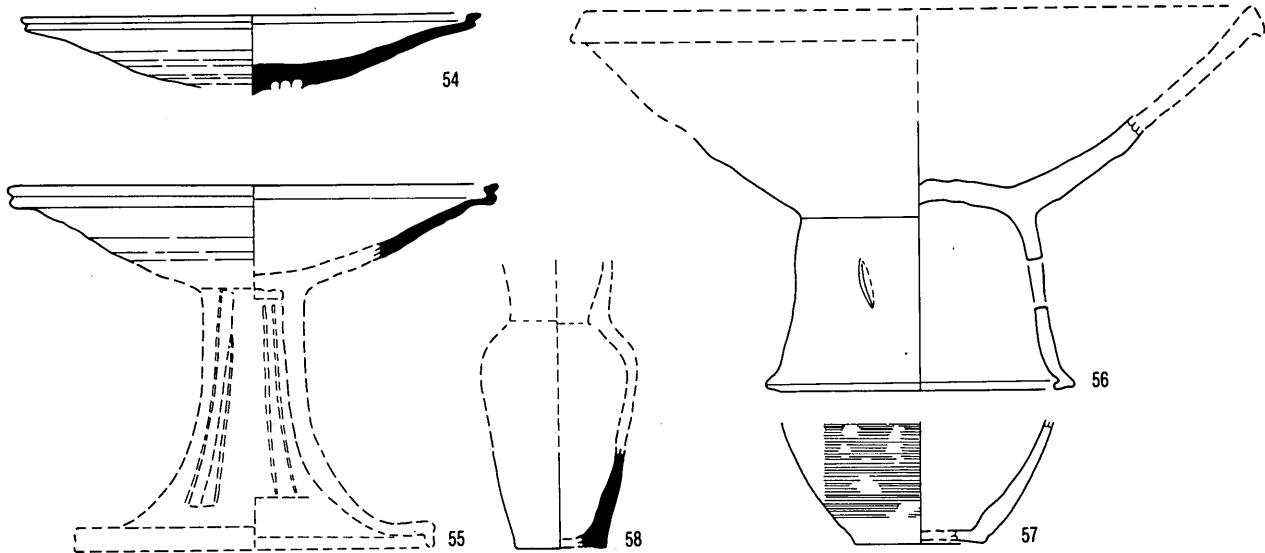

SB 144

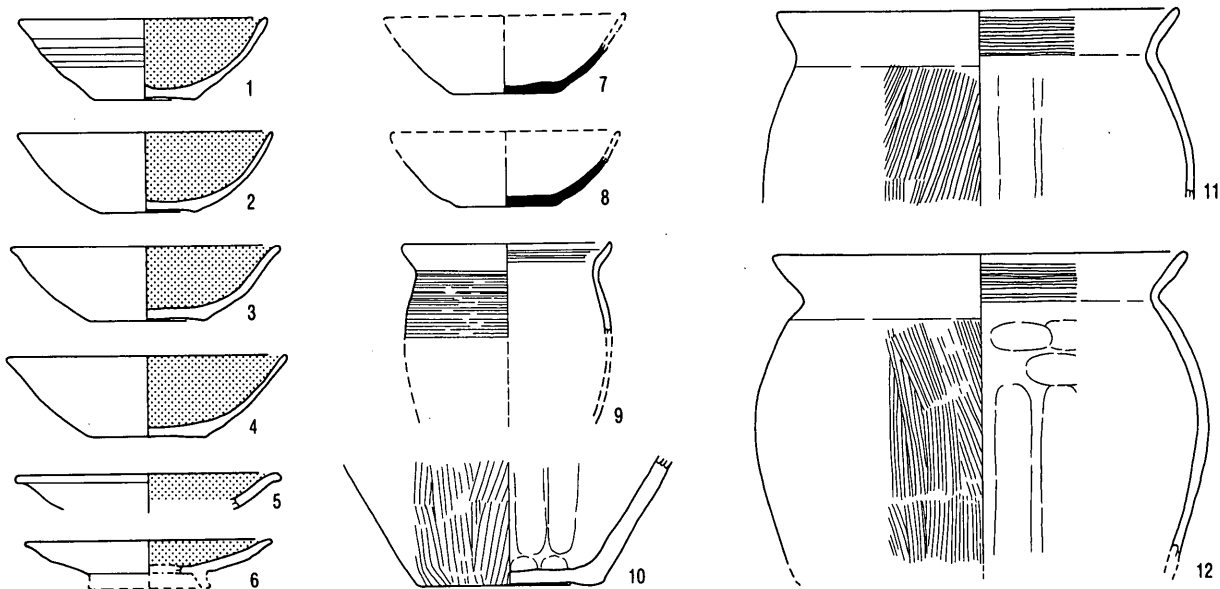

SB 145

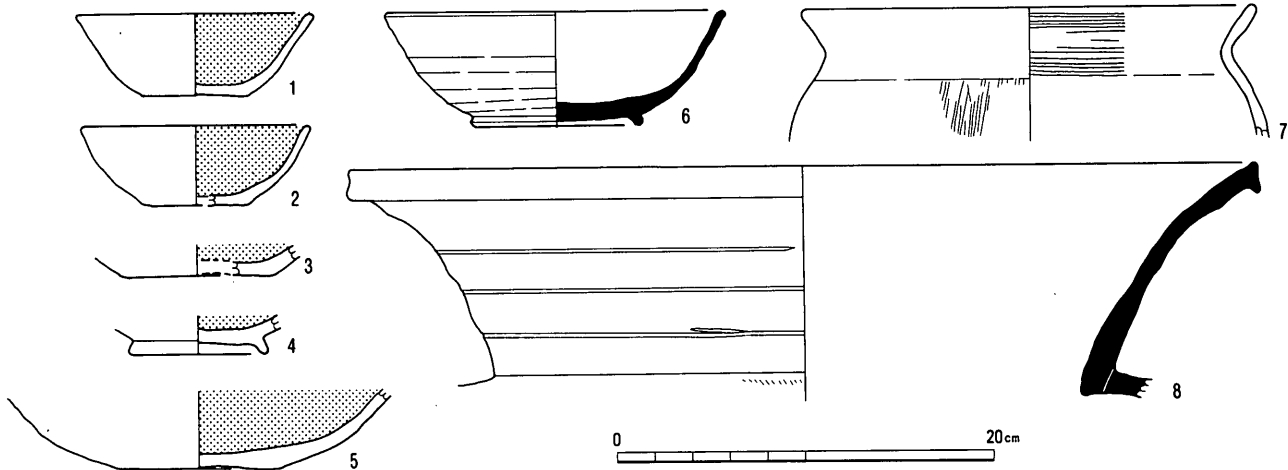

SB 146

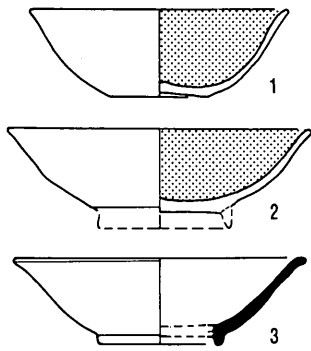

SB 147

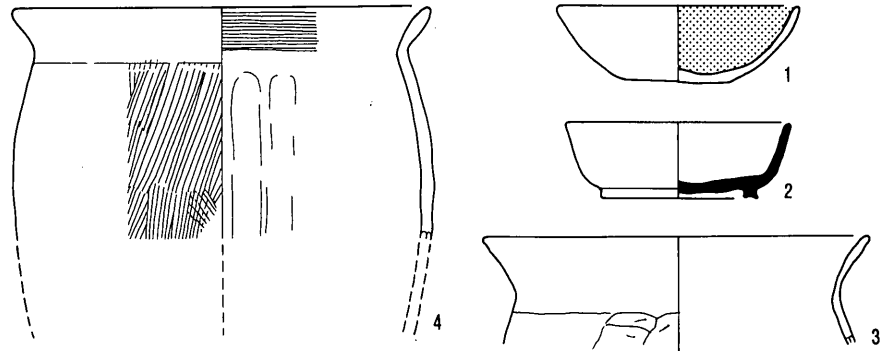

SB 148

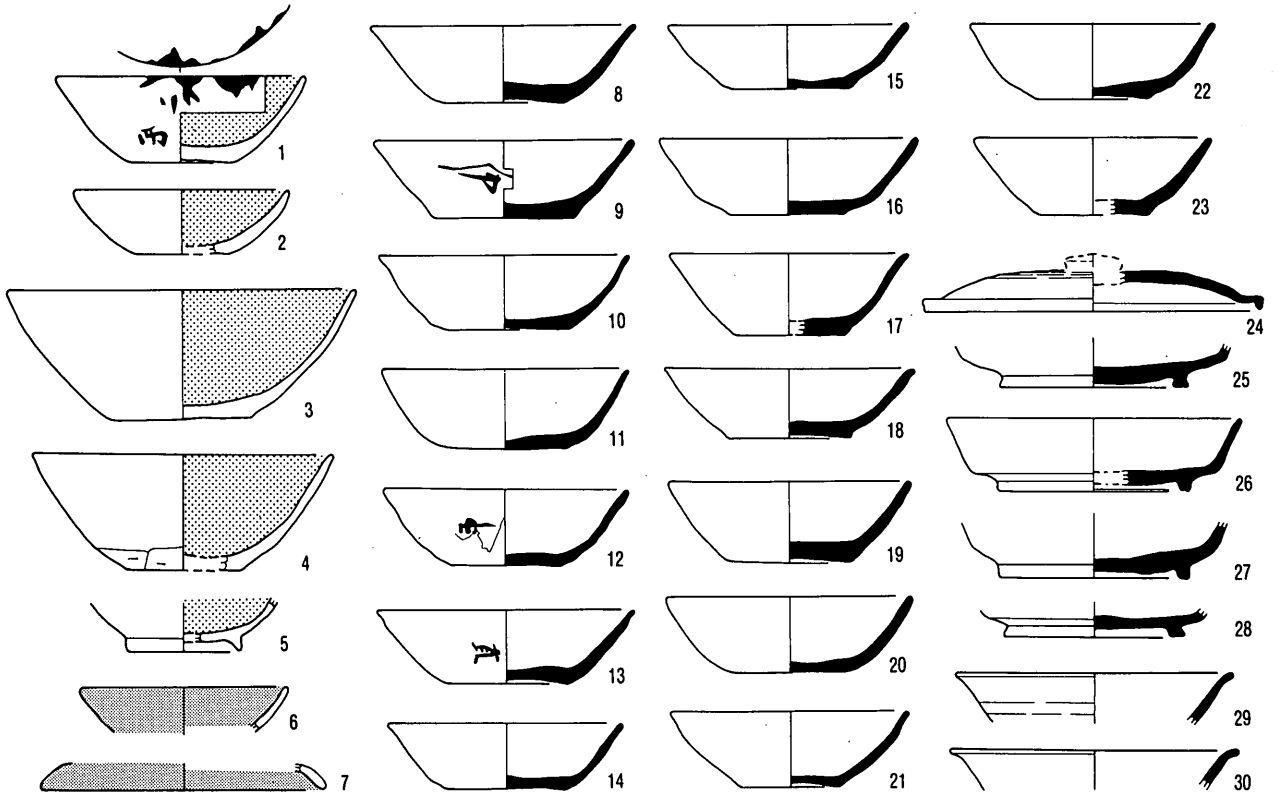

SB 149

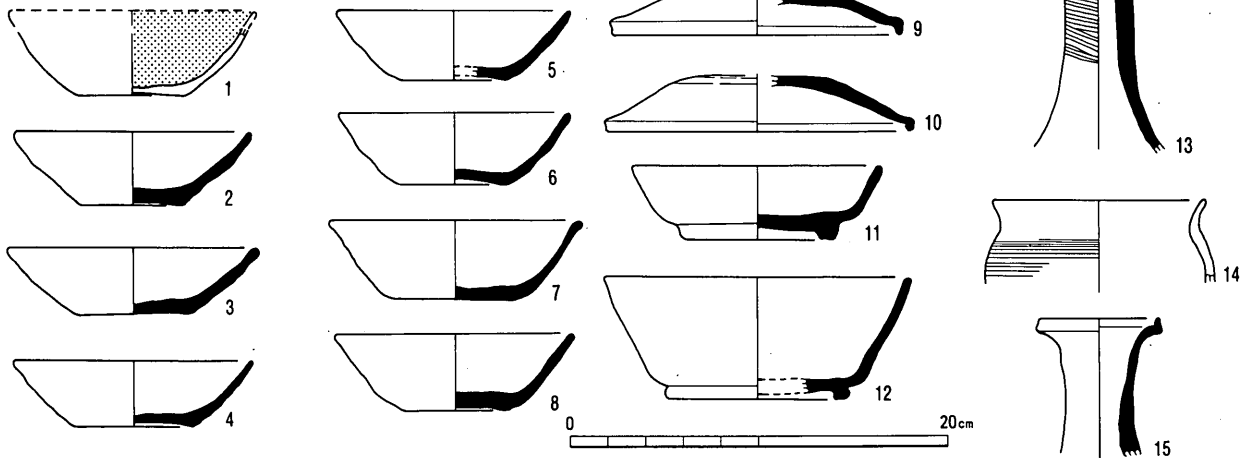



SB 150

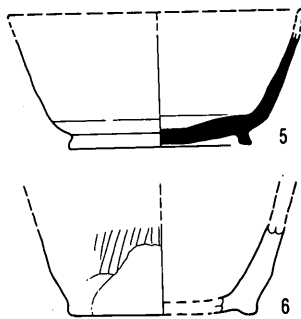
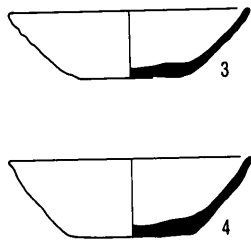
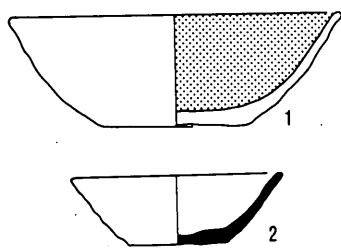

SB 151

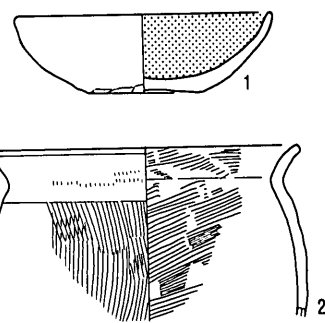

SB 152

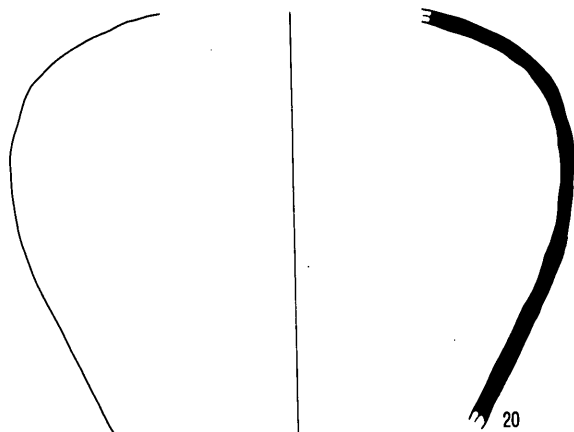
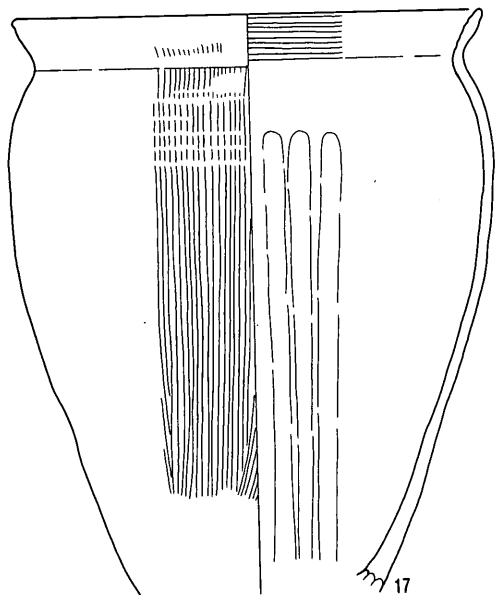
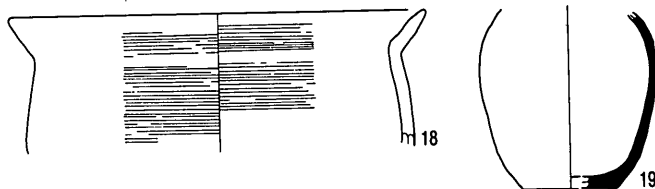
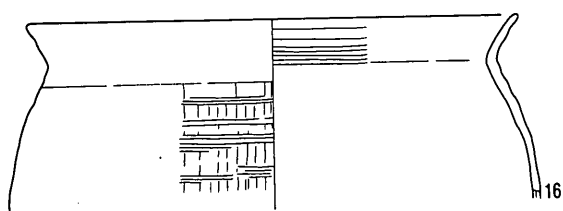
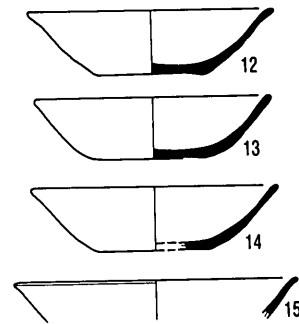
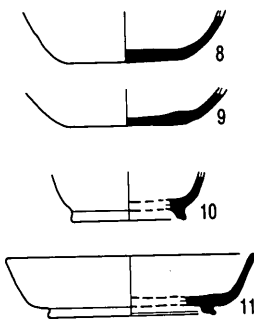
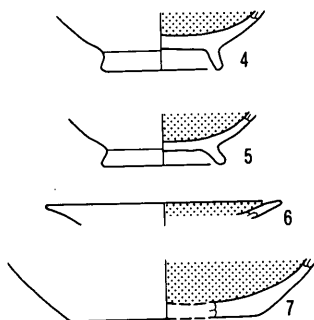
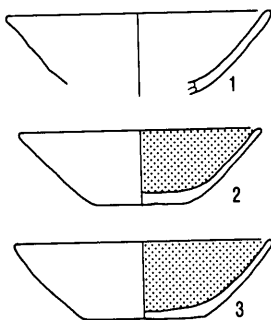

SB 153

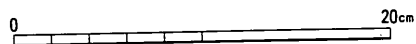
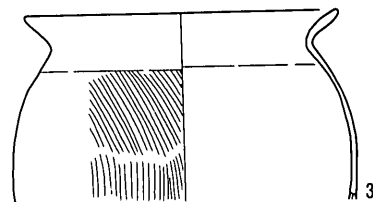
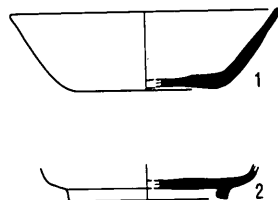

ST 3

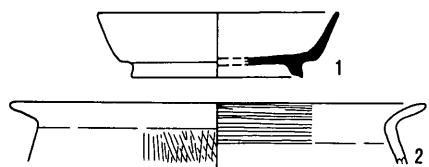

ST 7

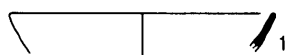

ST 101



ST 8

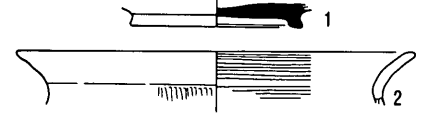

ST 9



ST 102

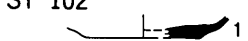

ST 6

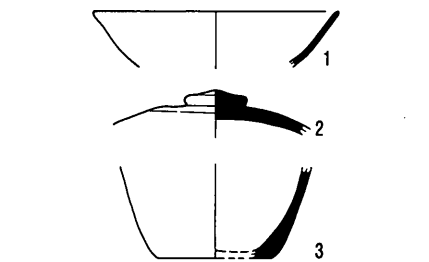

ST 12

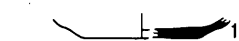

ST 105



ST 17



ST 105

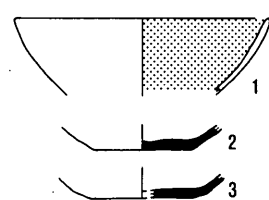

ST 21

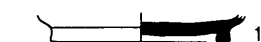

ST 30

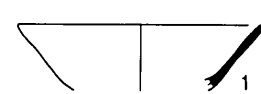

ST 108

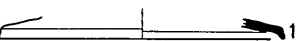

ST 111

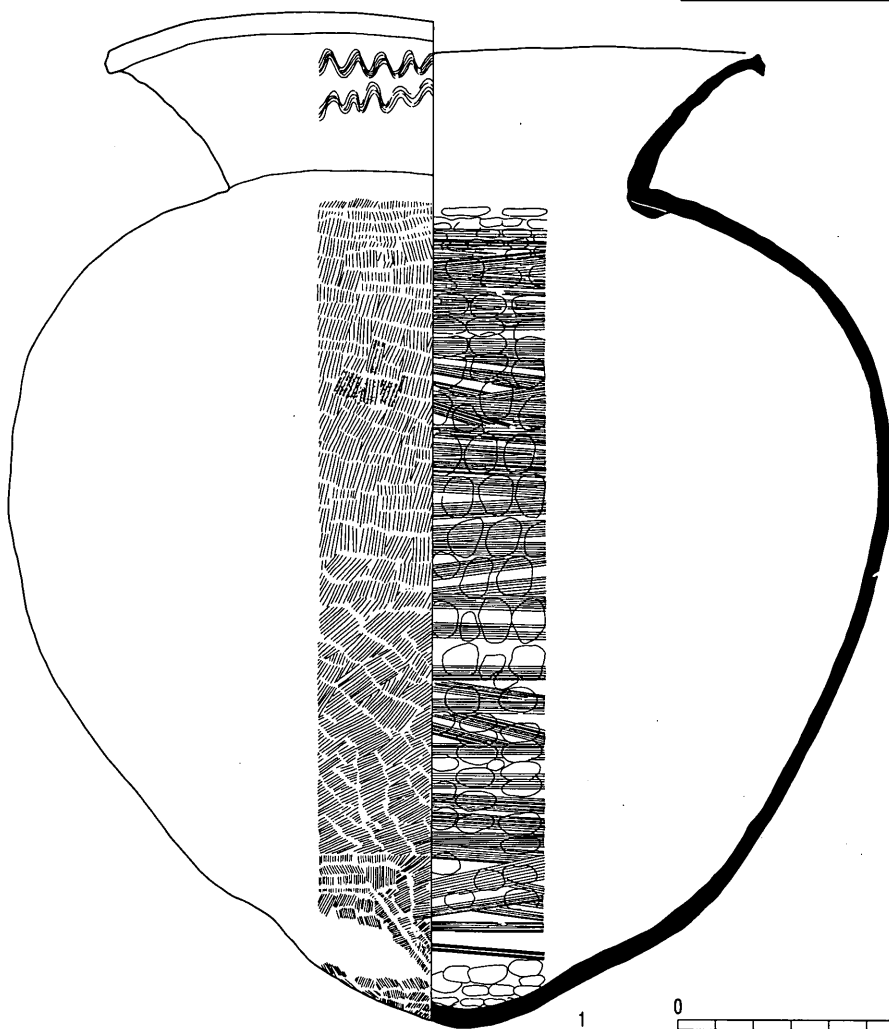

0 20cm

0 40cm

ST 111

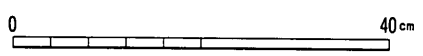
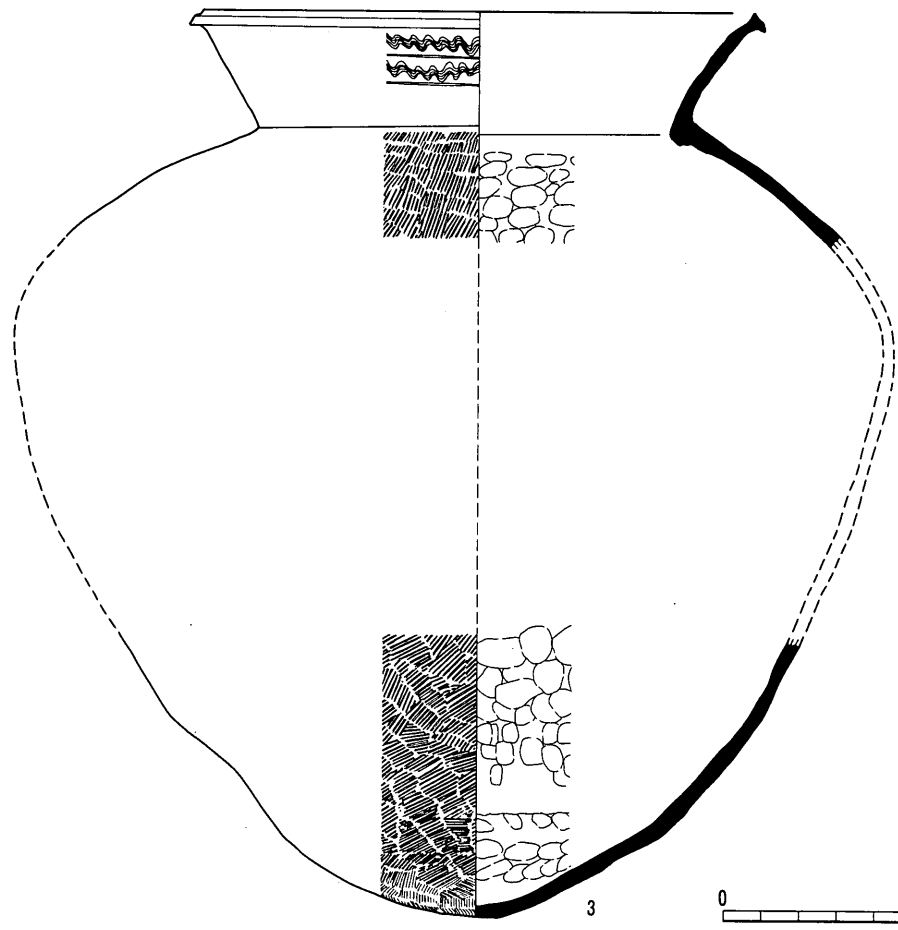
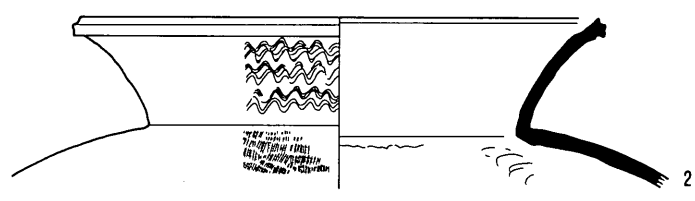
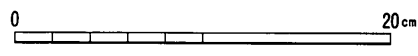
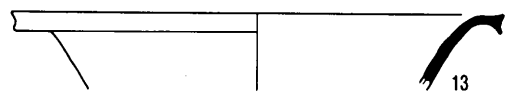
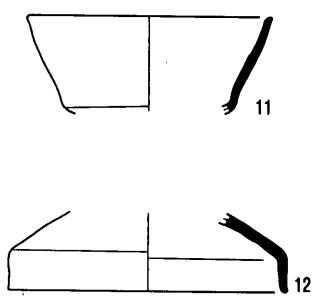
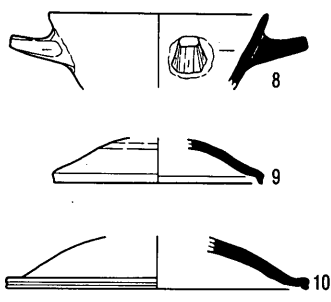
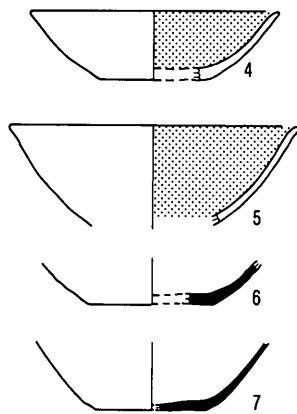

ST111

ST 113

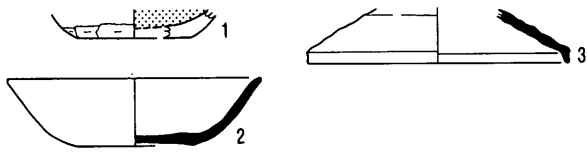

ST 123

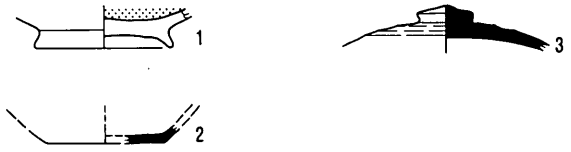

区画溝 I (南北溝 1層)

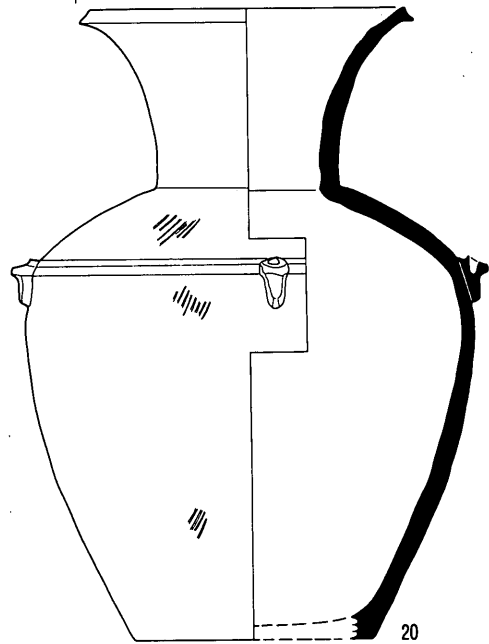
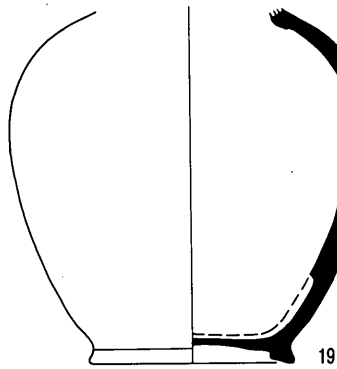
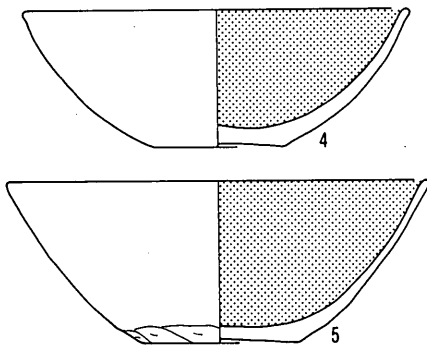
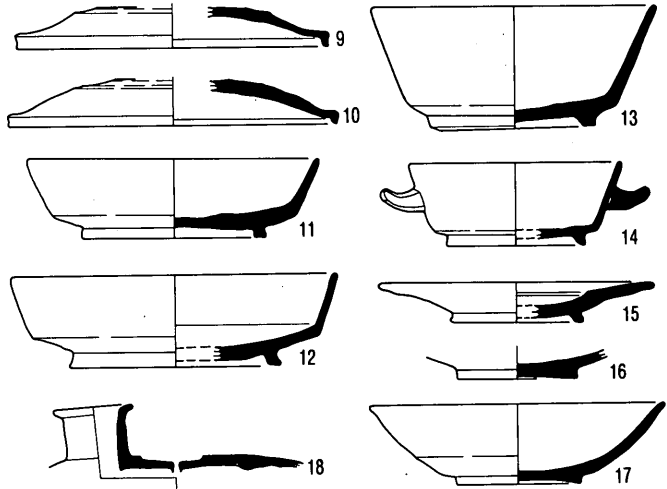
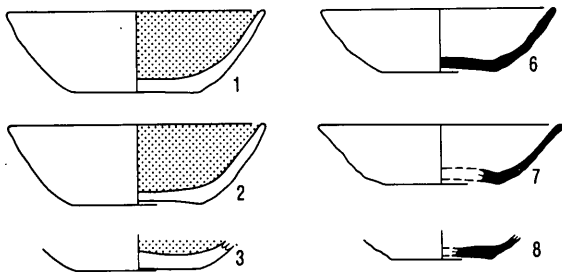

区画溝 I (南北溝 2層)

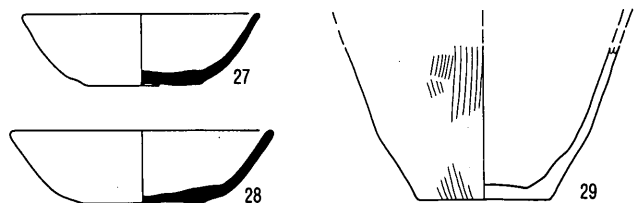
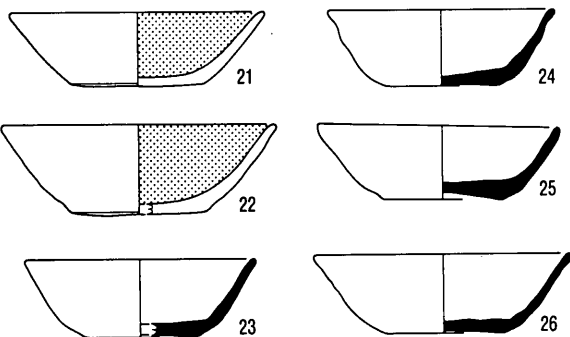

区画溝 I (南北溝 3層)

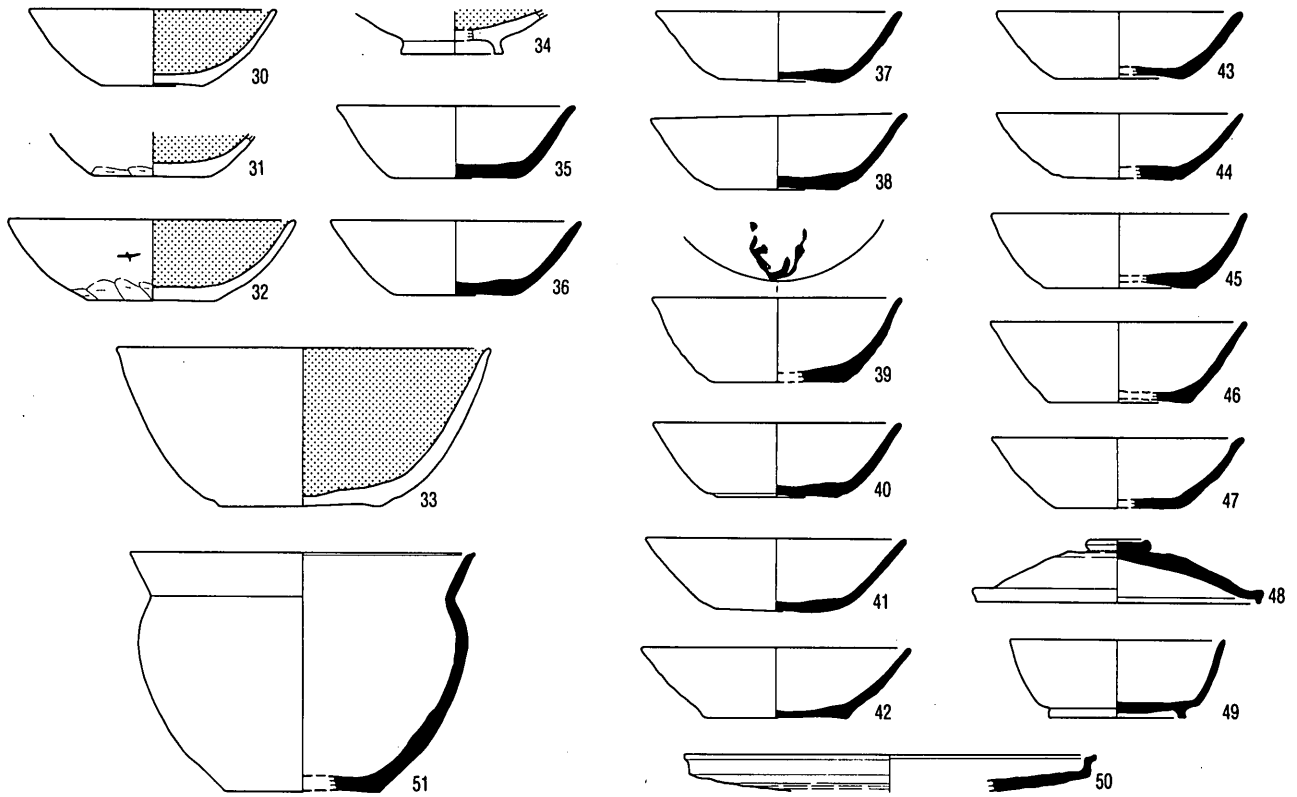

区画溝 I (南北溝 7層)

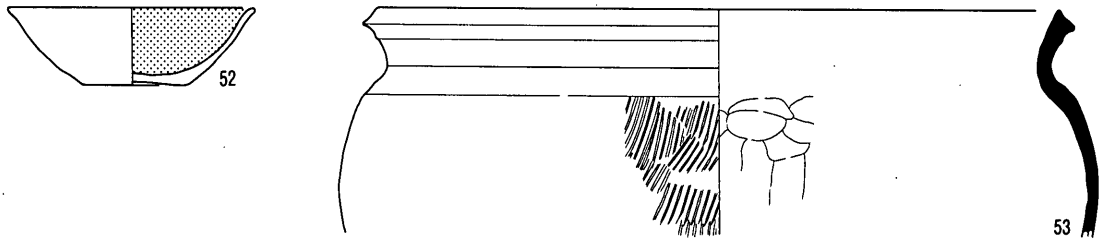

区画溝 I (南北溝 その他)

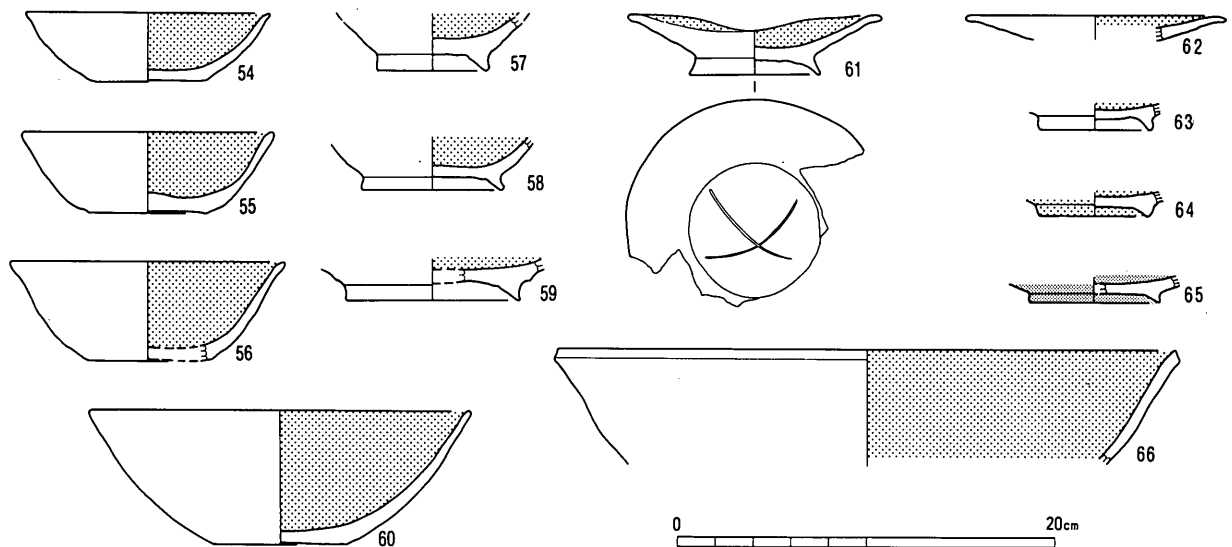

区画溝 I (南北溝その他)

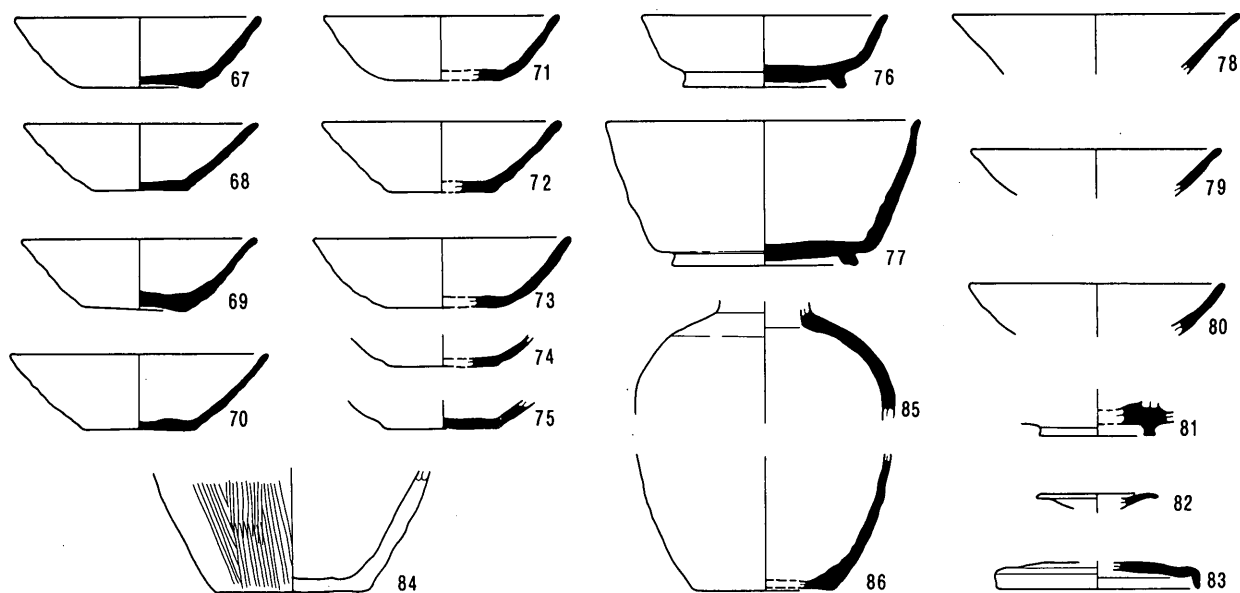

区画溝 I (東西溝1層)

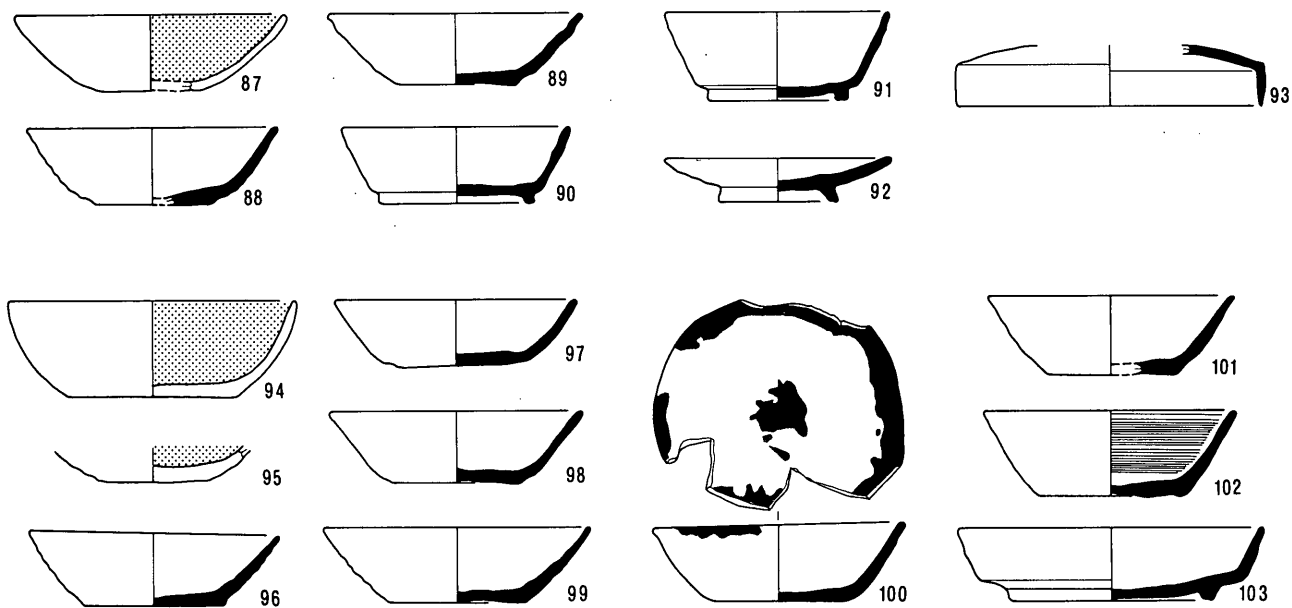

区画溝 I (東西溝3層)

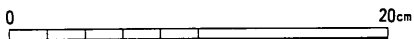
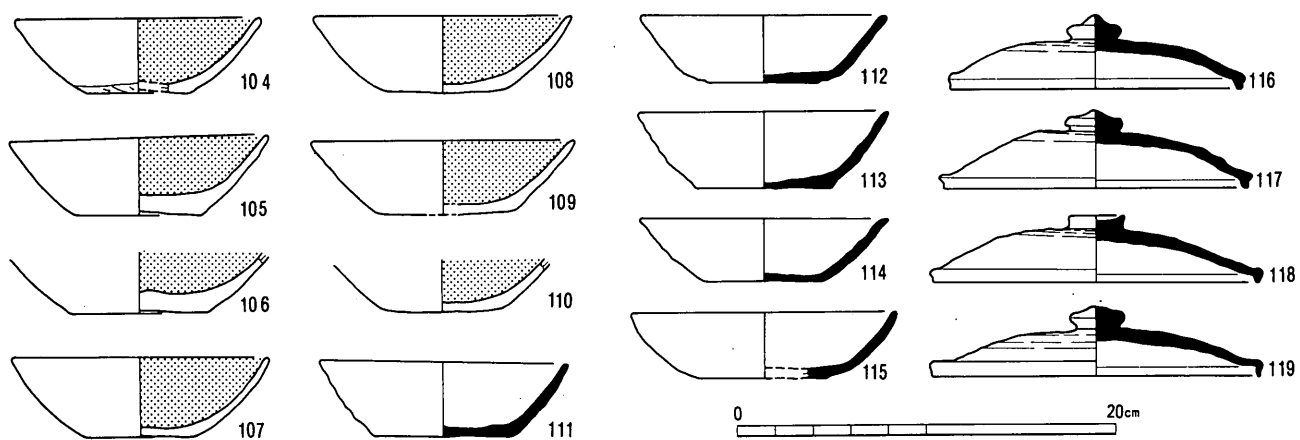

区画溝 I (東西溝 3層)

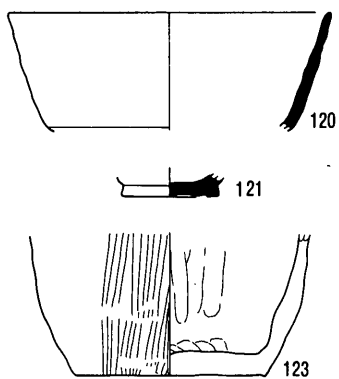

区画溝 I (東西溝 4層)

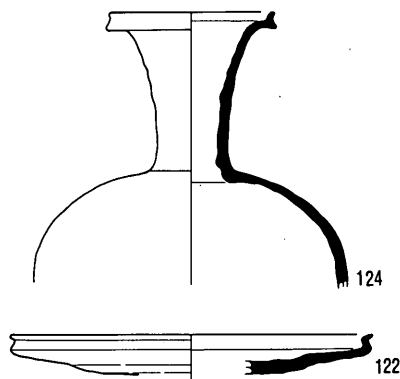
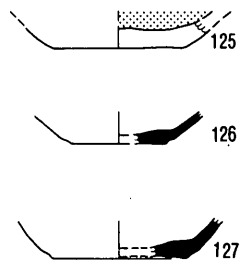

区画溝 II (南北溝)

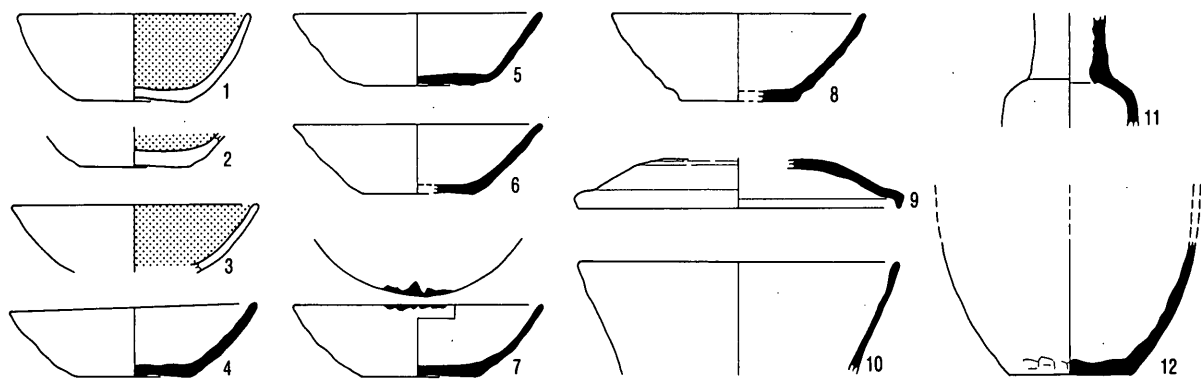

区画溝 III (東西溝 1層)

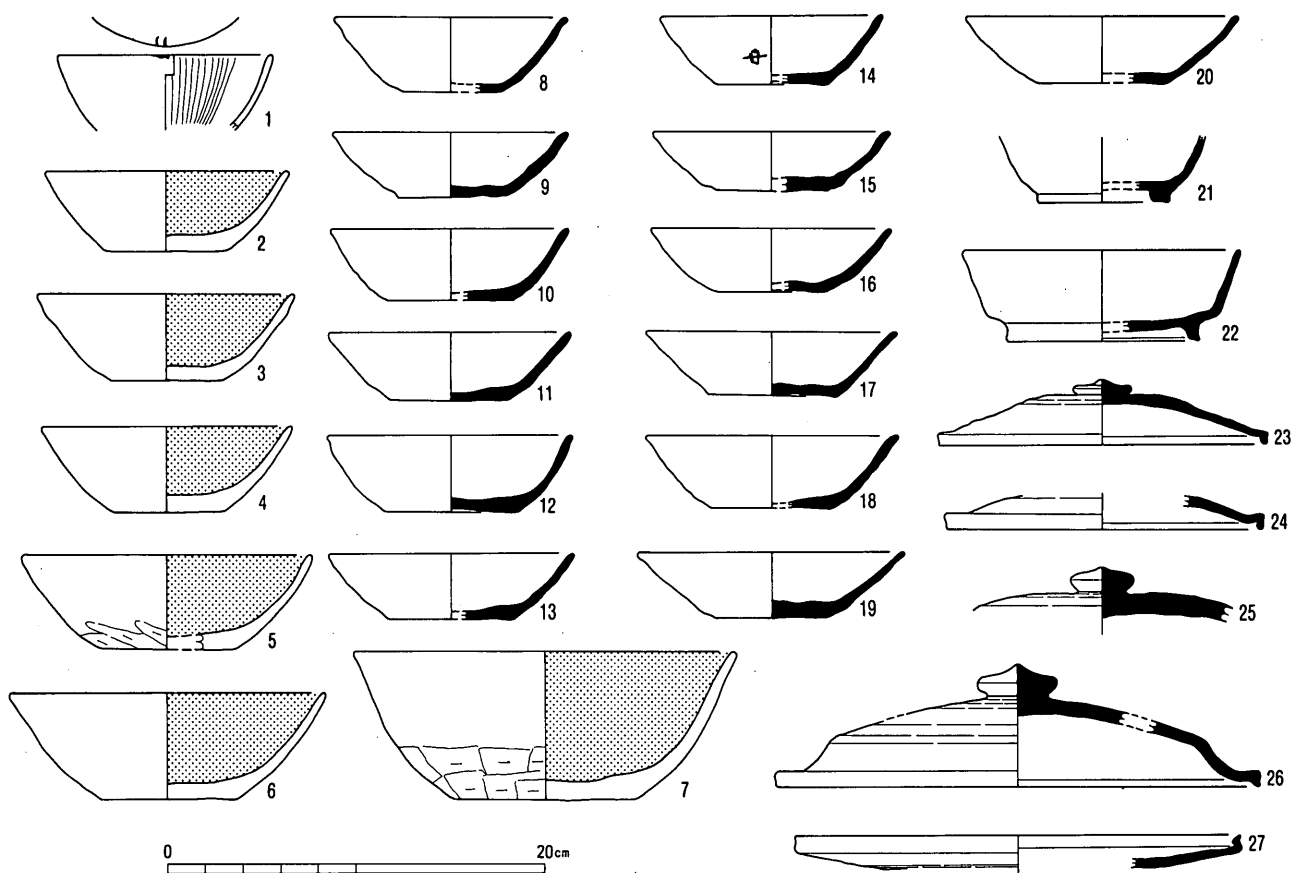

区画溝 I (東西溝 3・4層)・II (南北溝)・III (東西溝 1層)

区画溝Ⅲ (東西溝その他)

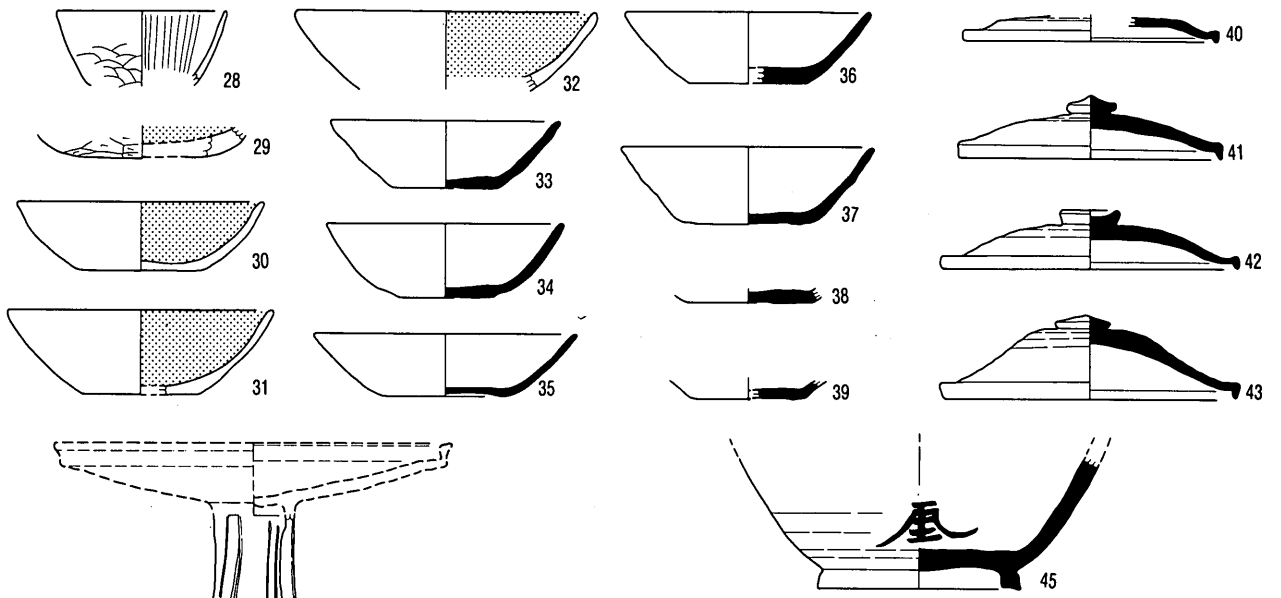

SD 1

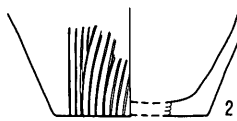
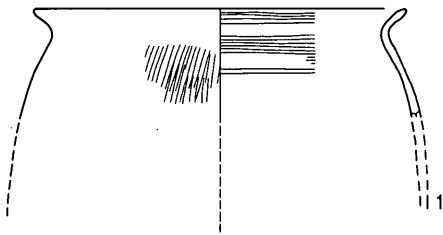

SD 18

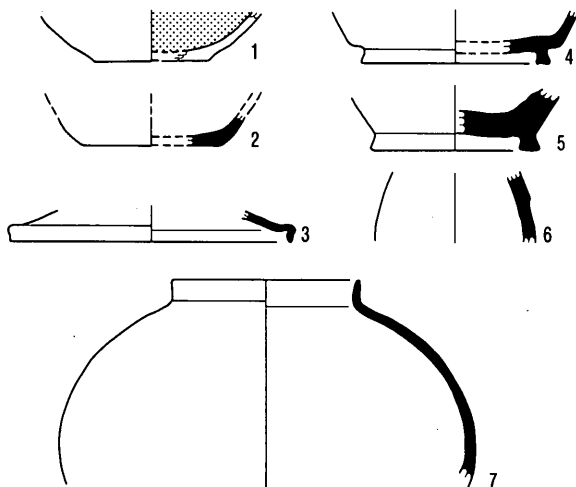

SD 7

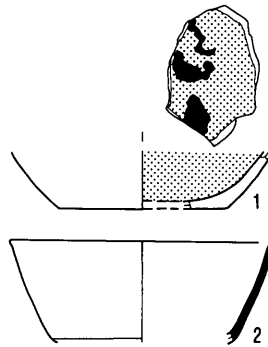

SD 105

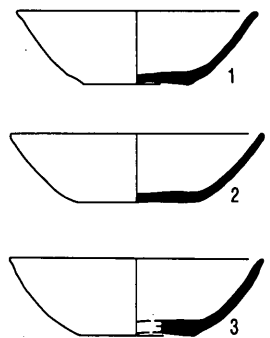

SD 52

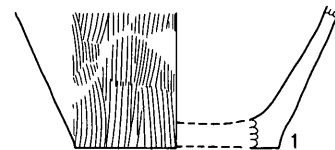

SD 100-104

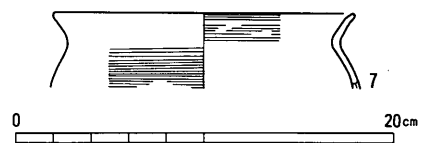
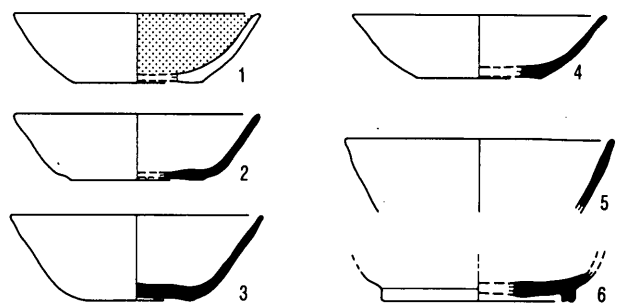



SD 108 (1区2層)

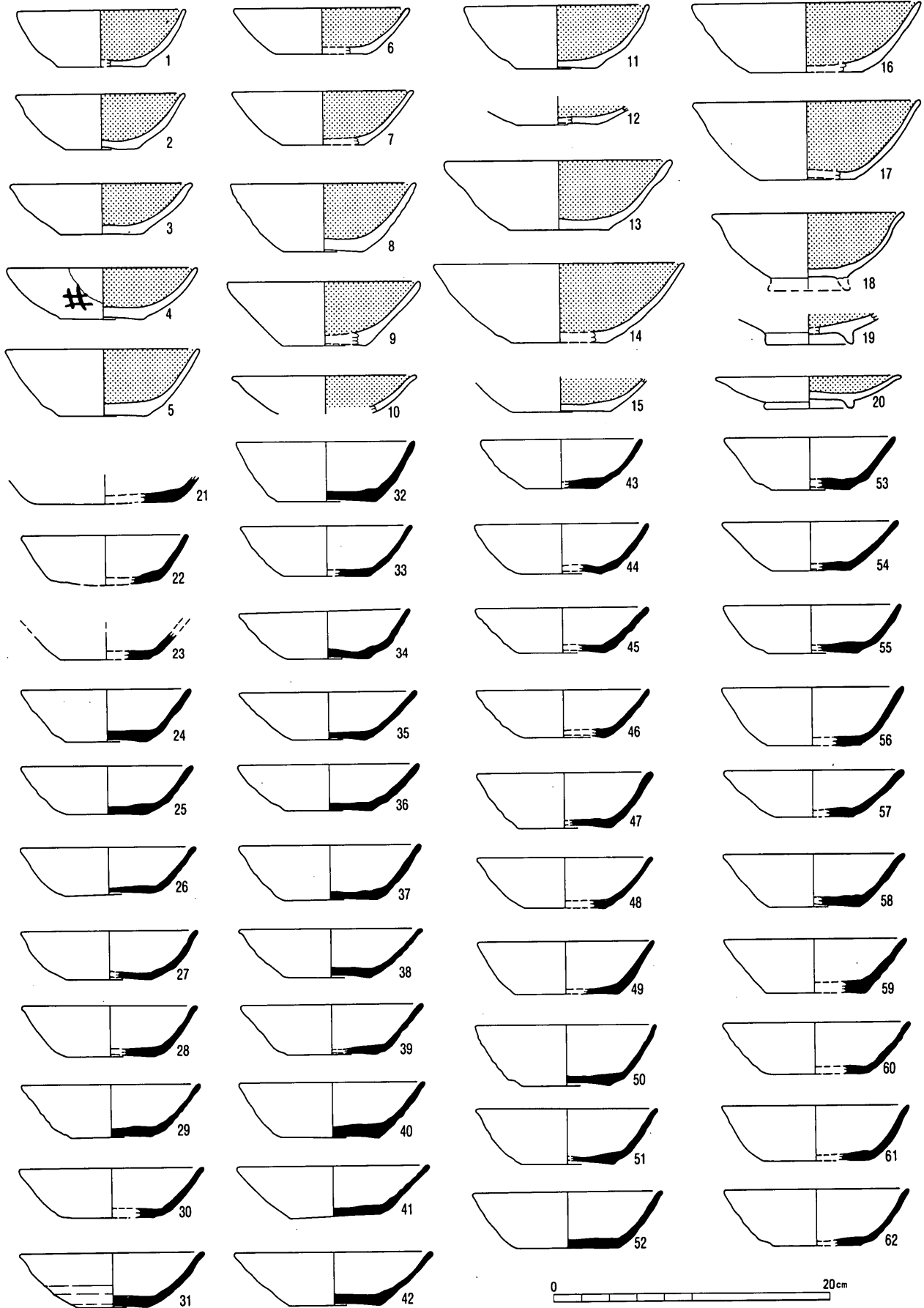

SD108 (1区2層)

SD 108 (1区2層)

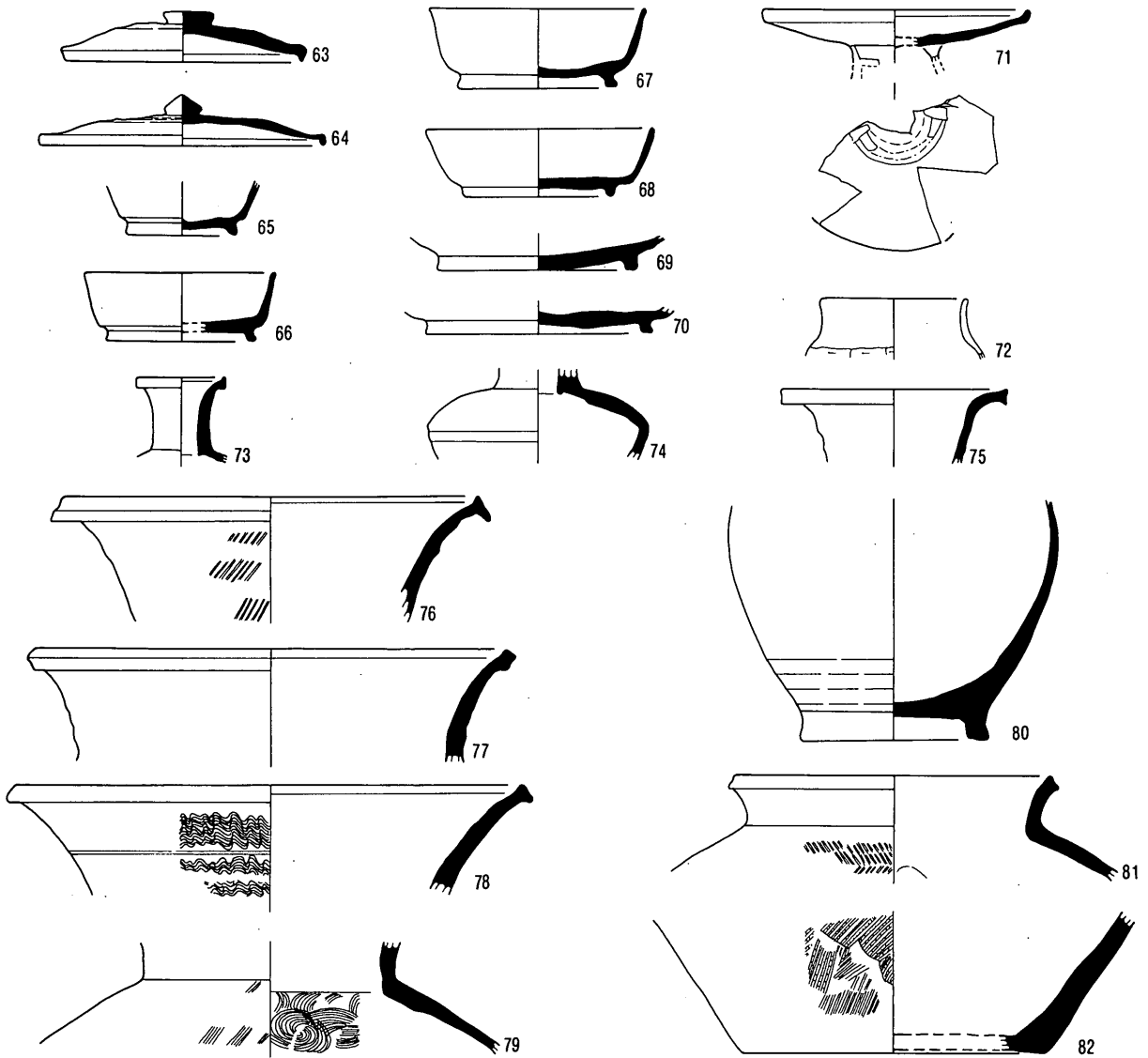

SD 108 (1区3層)

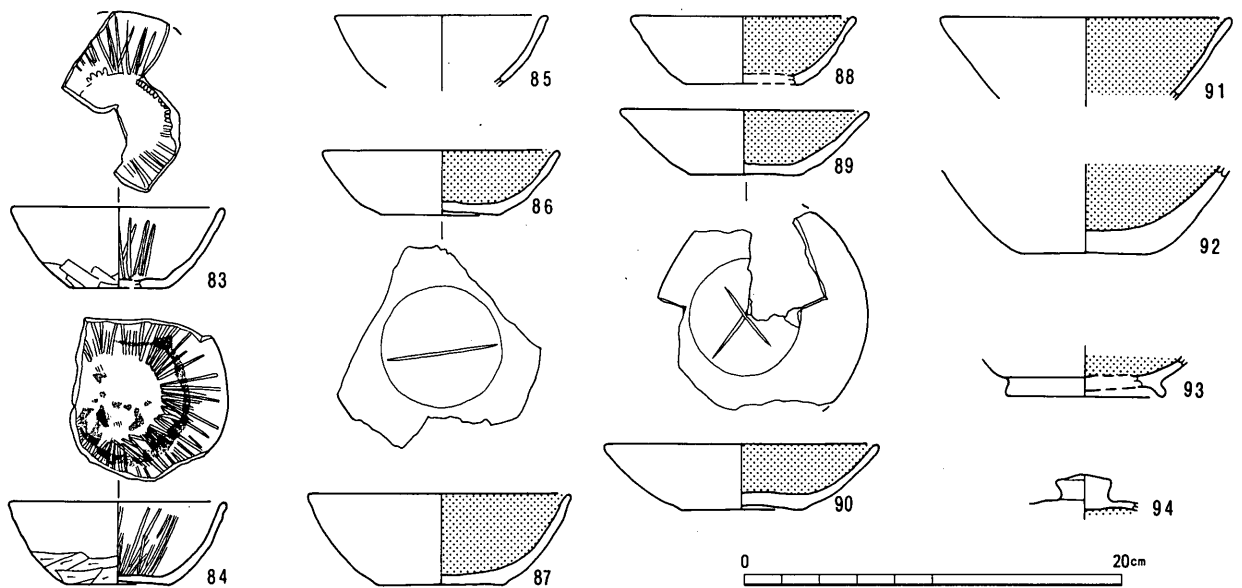

SD 108 (1区3層)

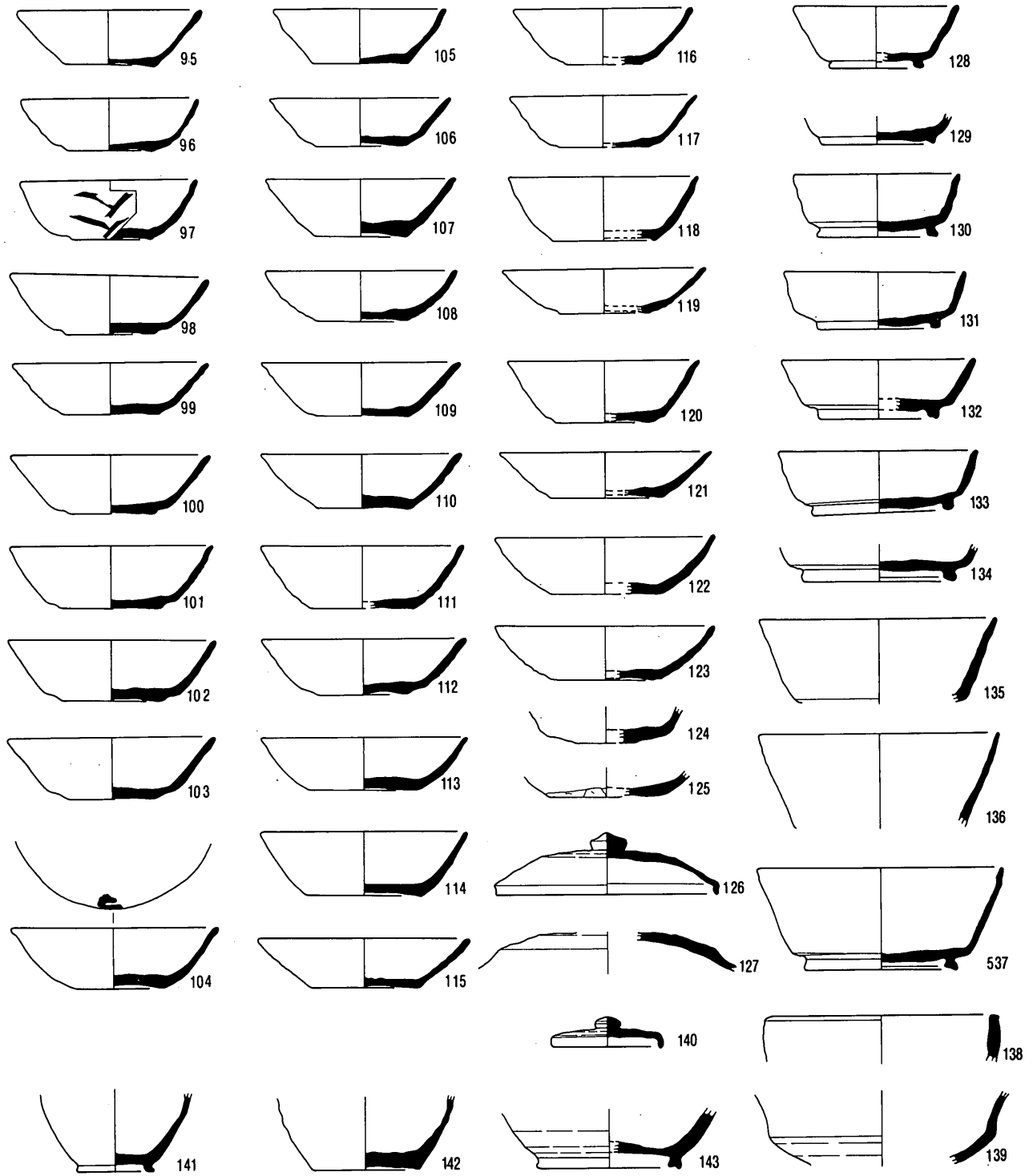

SD 108 (2区1層)

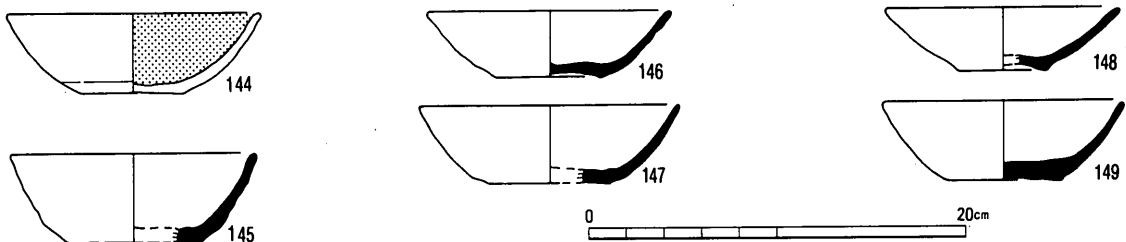

SD108 (1区3層・2区1層)

SD 108 (2区2層)

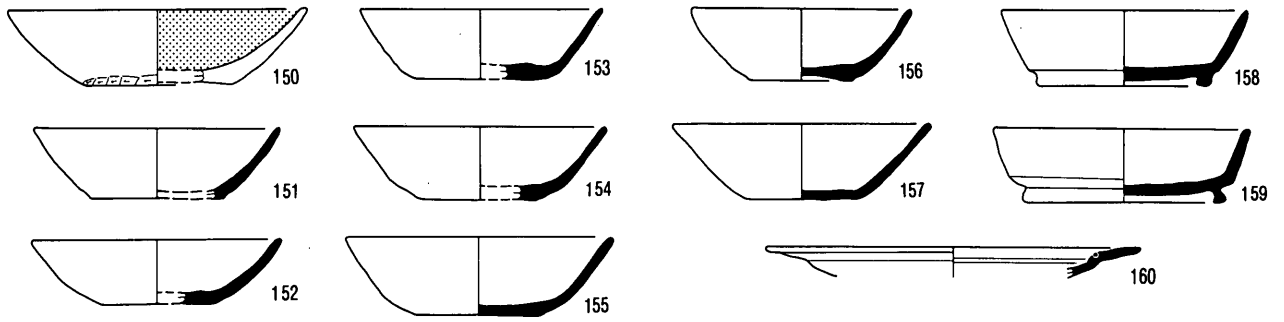

SD 108 (3区2層一括土器)

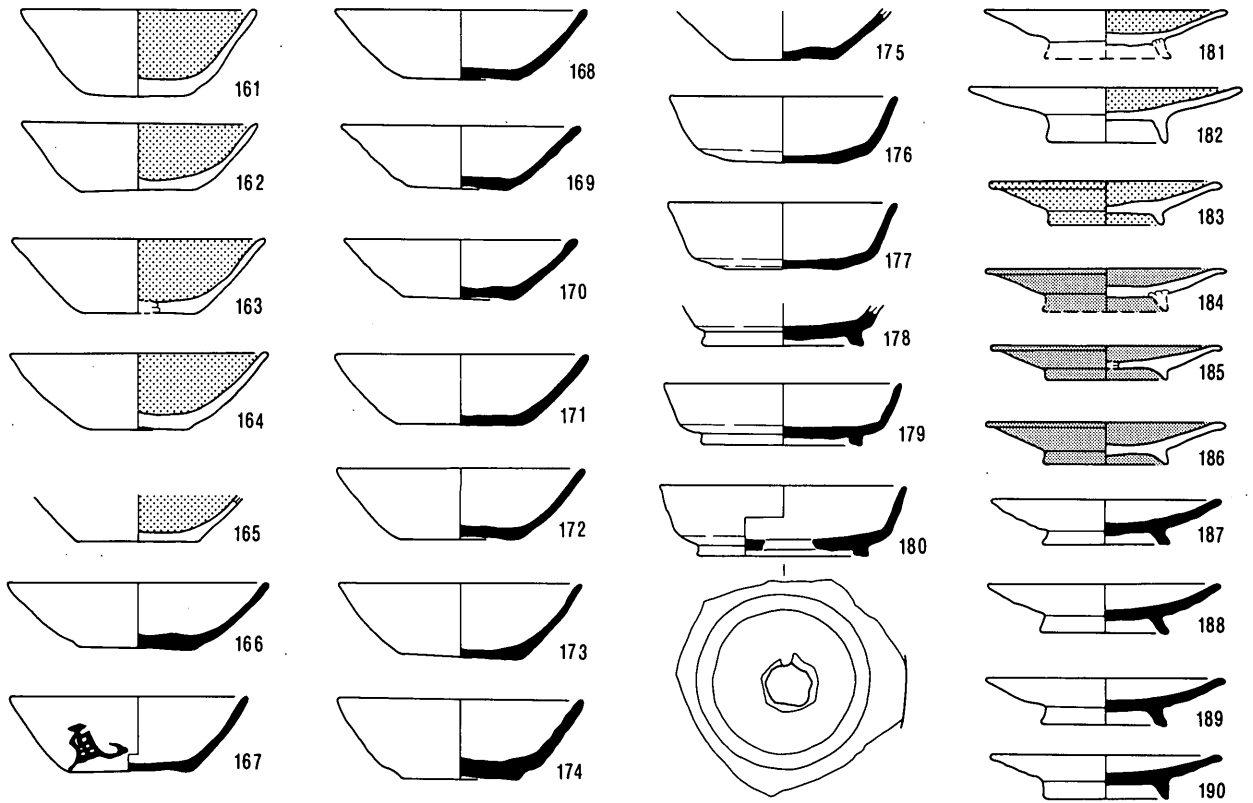

SD 108 (3区2層)

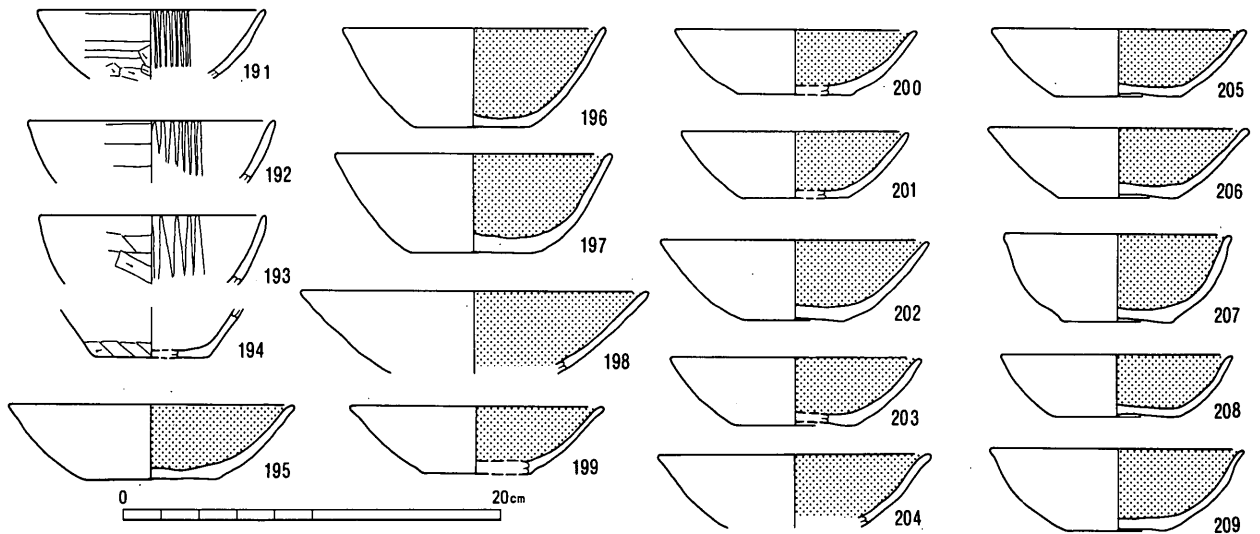

SD 108 (3区2層)

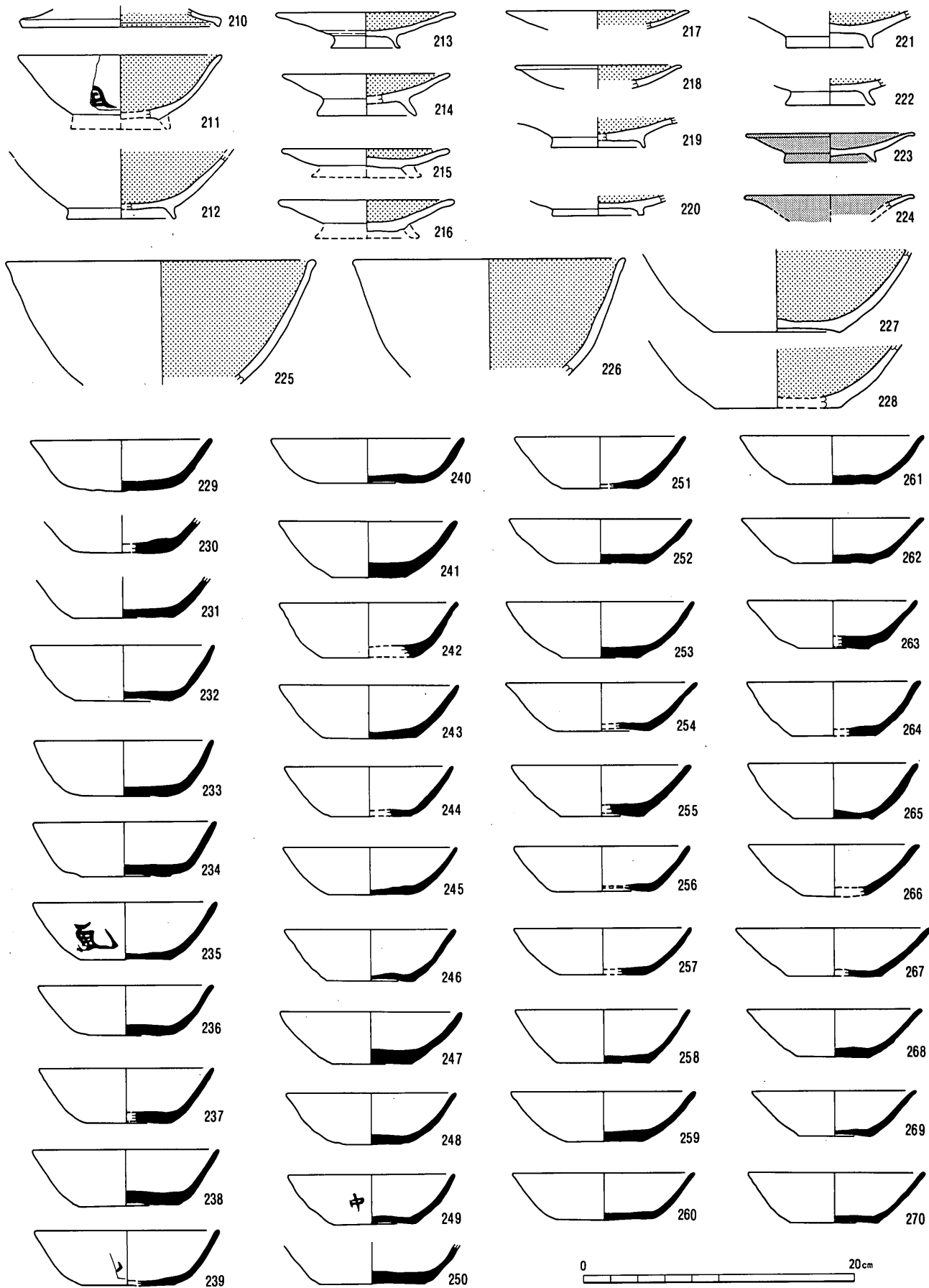

SD 108 (3区2層)

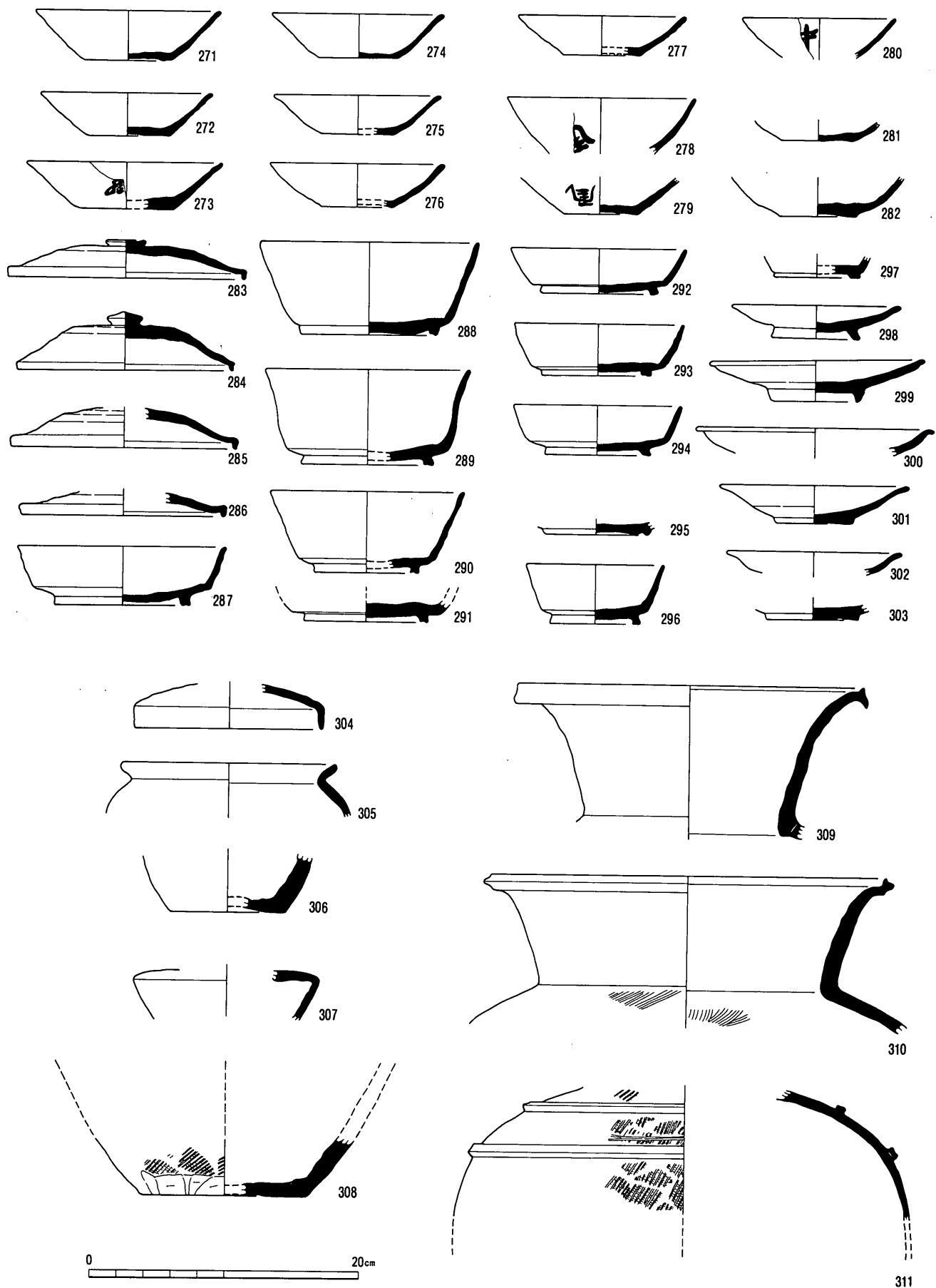

SD108 (3区2層)

SD 108 (3区2層)

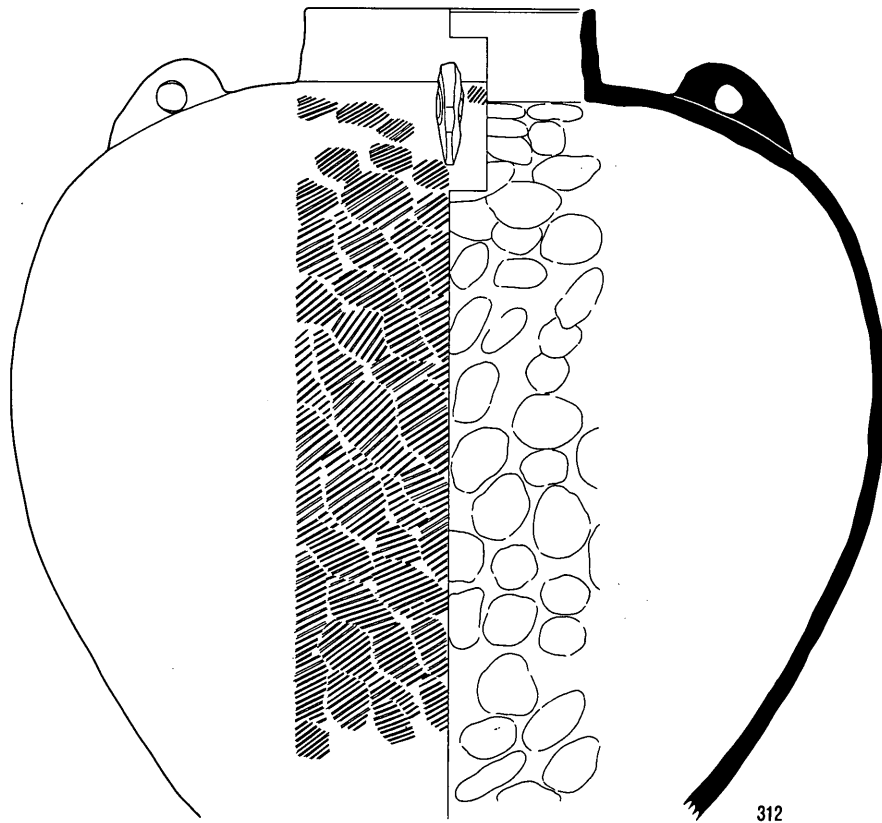

SD 108 (3区枝溝1層)

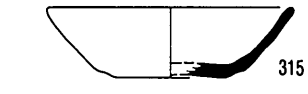
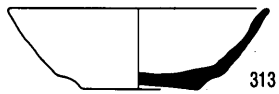

SD 108 (4区1層)

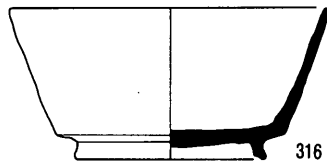

SD 108

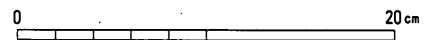
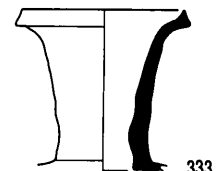
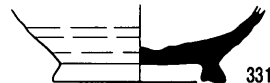
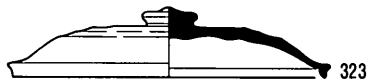
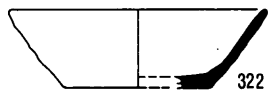
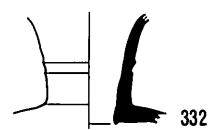
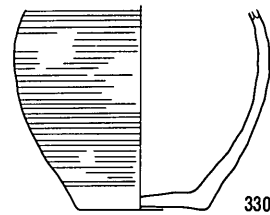
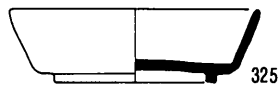
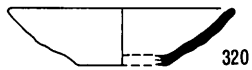

SD108 (3区2層・枝溝1層・4区1層)

SD 108 (4区2層)

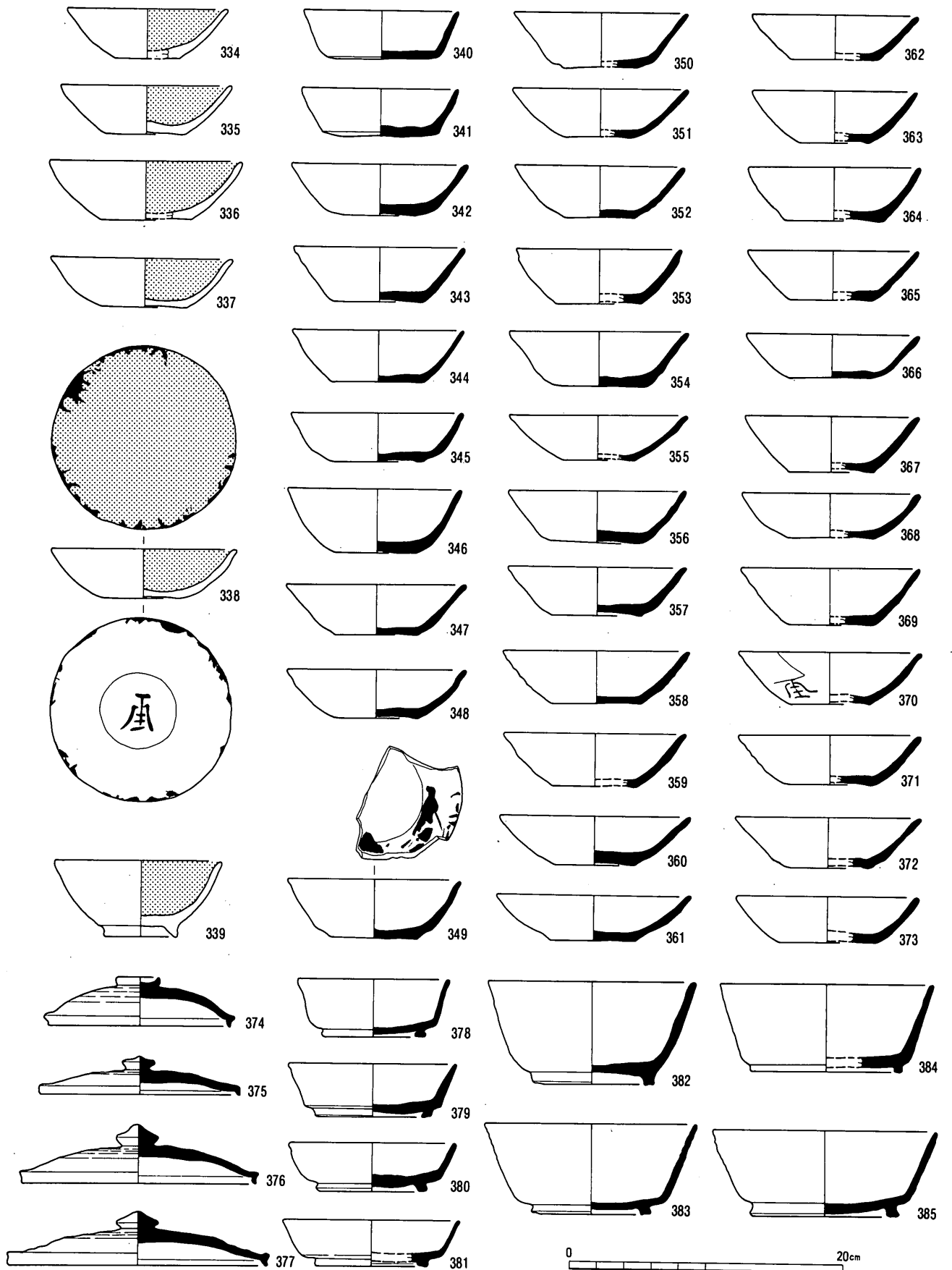



SD 108 (4区)

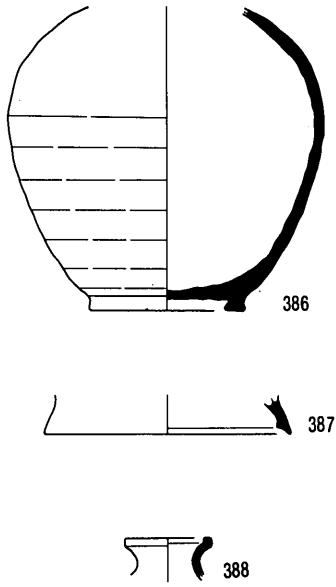

SD 106

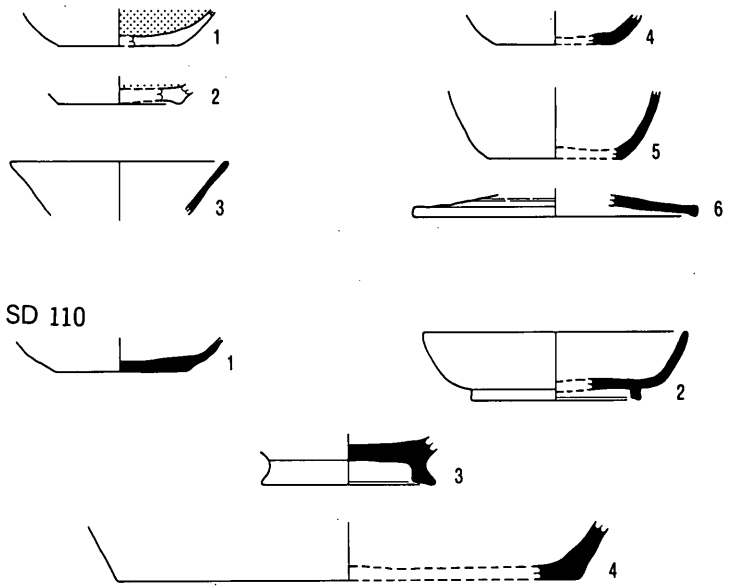

SD 110

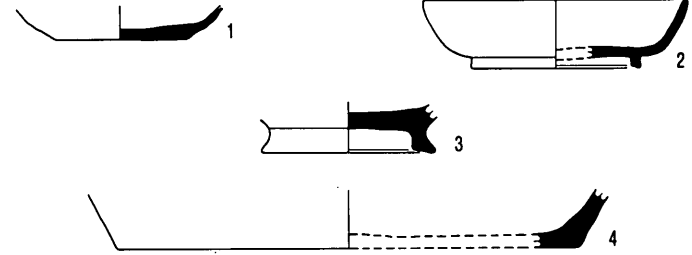

SD 109

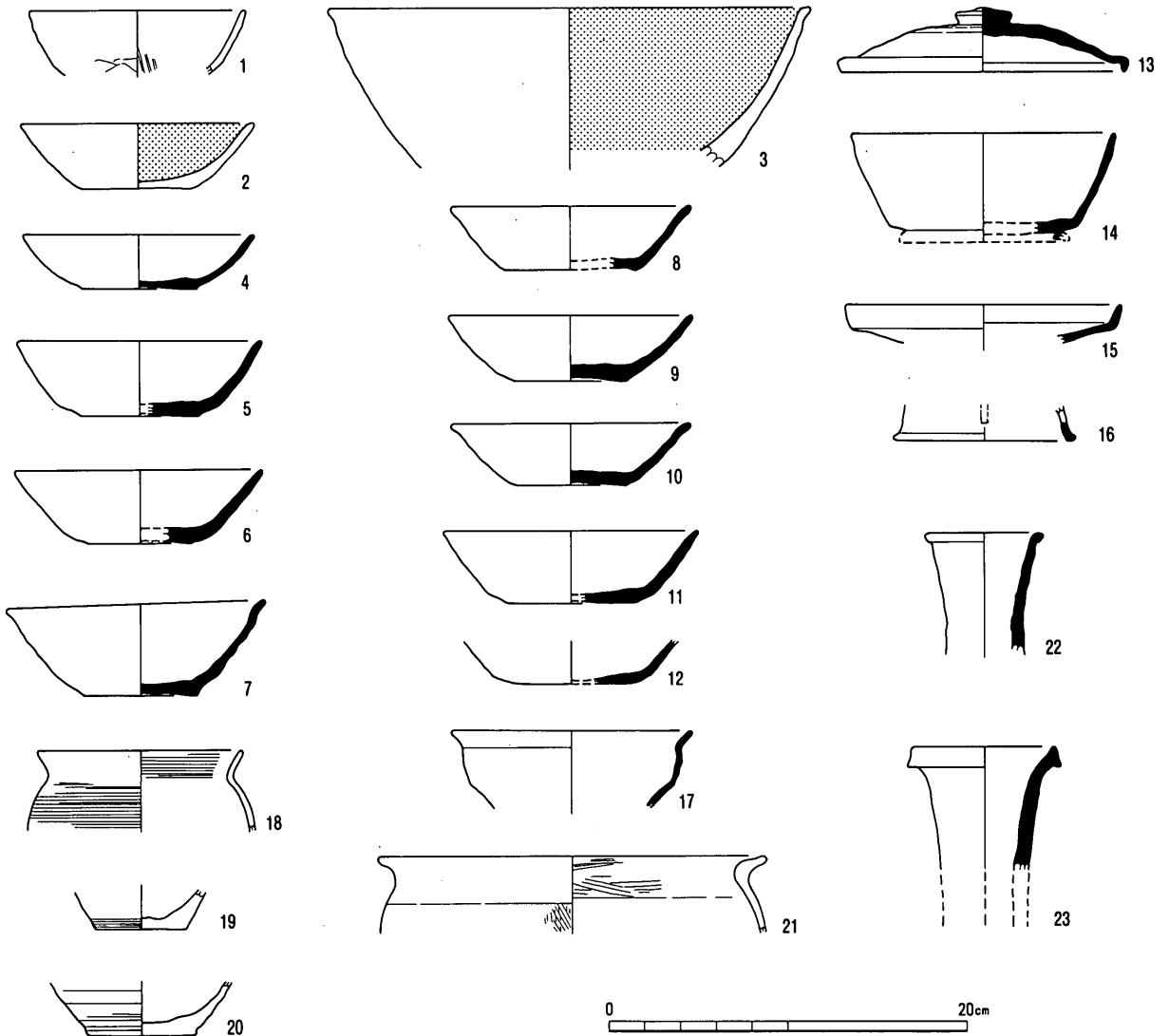

0 20cm

SD 117

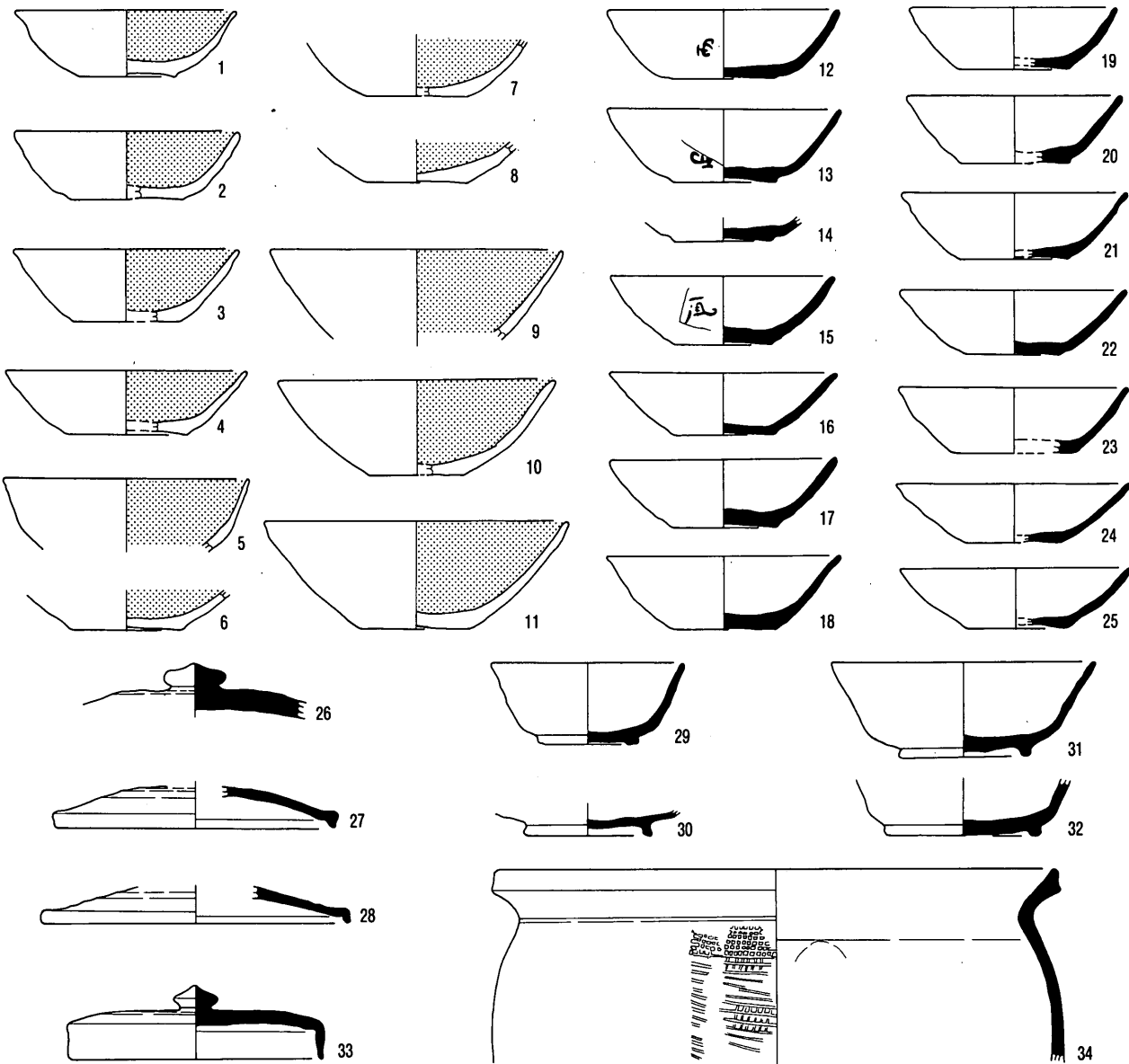

SD 118

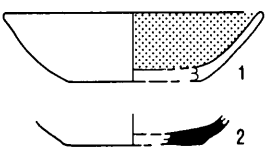

SD 128

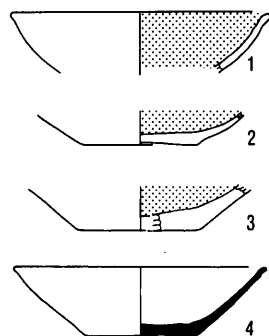

SD 119

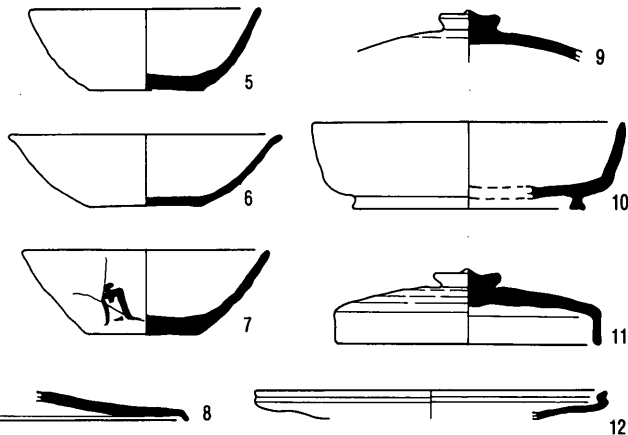
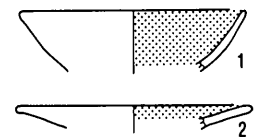

SD 124

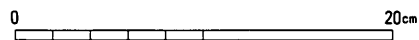

SD 130

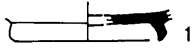

SD 135

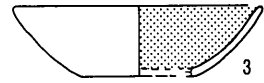
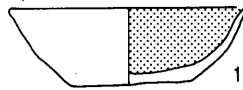

SD 132

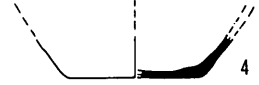
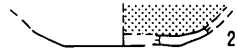
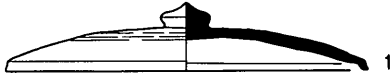

SD 137

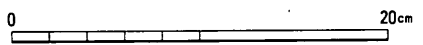
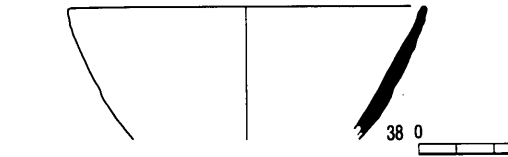
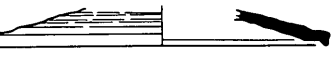
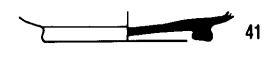
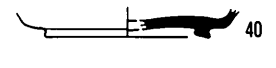
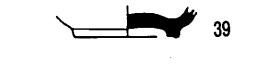
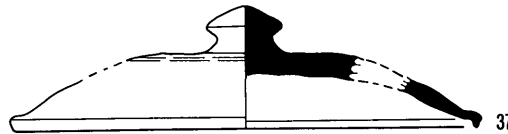
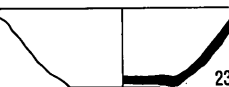
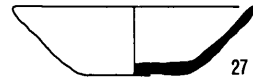
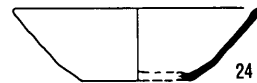
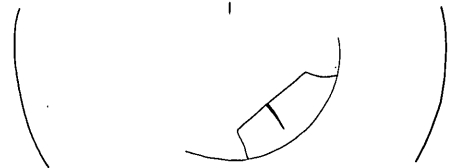
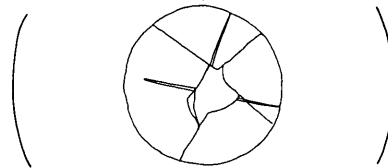
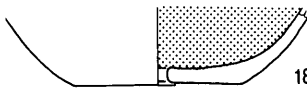
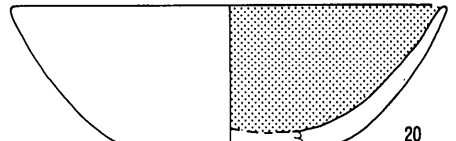
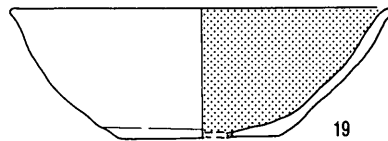
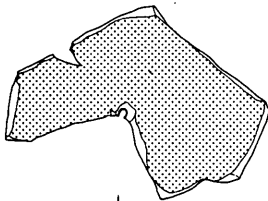
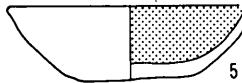
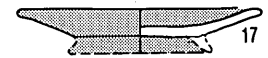
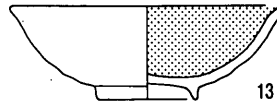
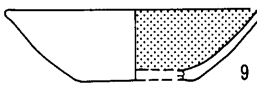
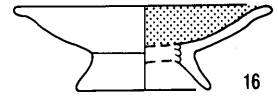
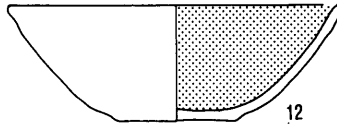
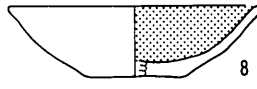
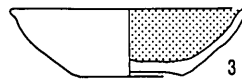
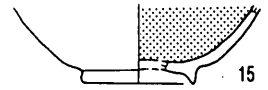
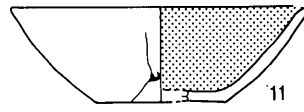
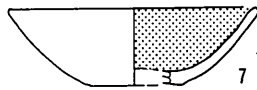
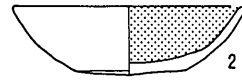
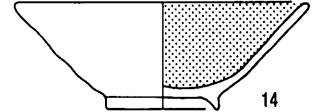
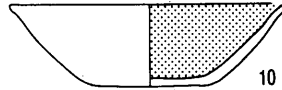
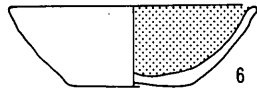
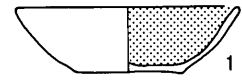

SD 137

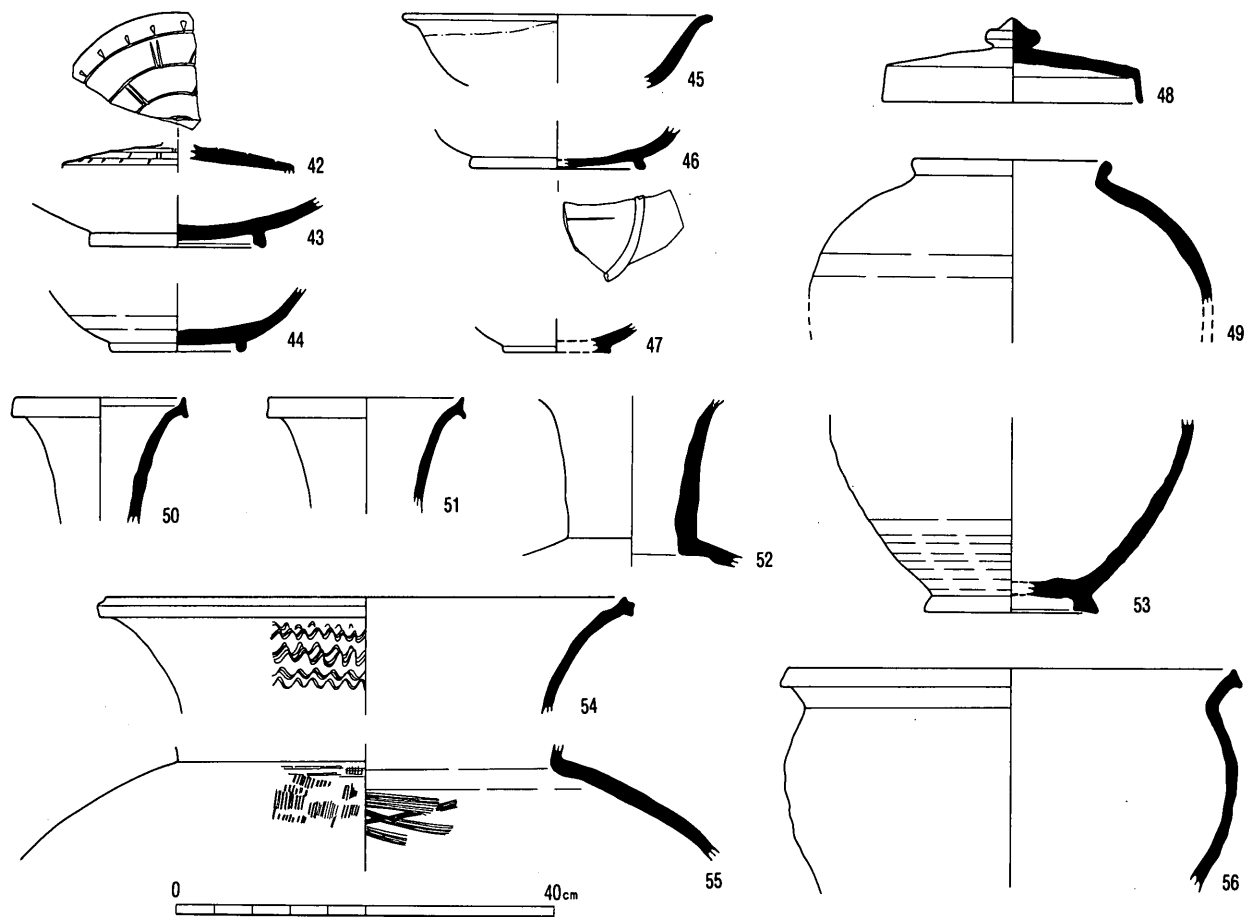

SD 139

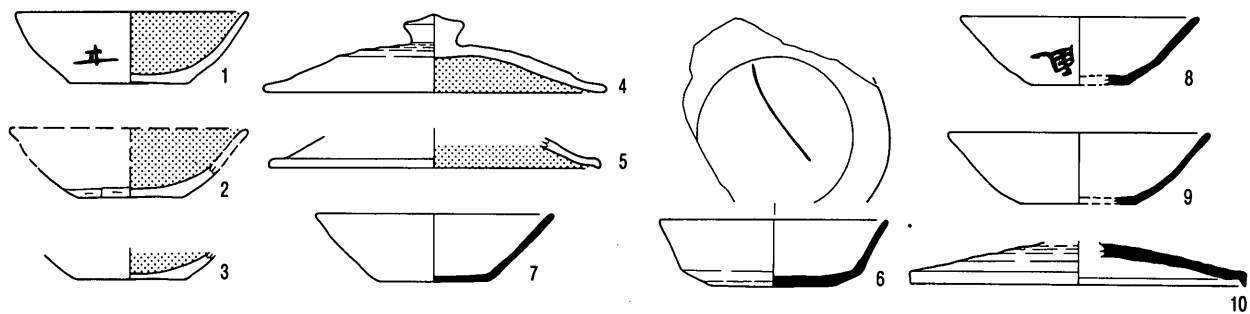

SD 147



SD 163



SD 151

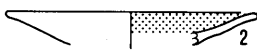
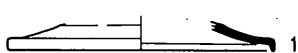

SD 173

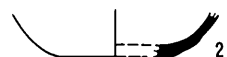
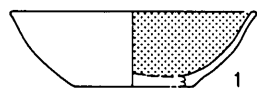

SD 176



SD 181

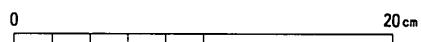

SD 170

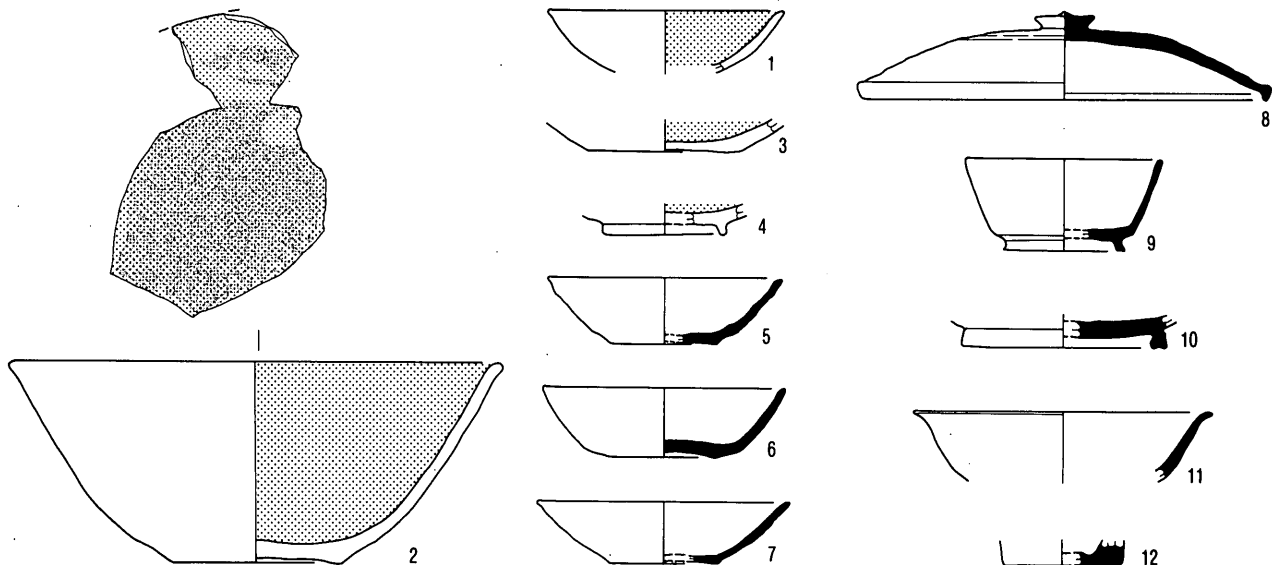

SD 171

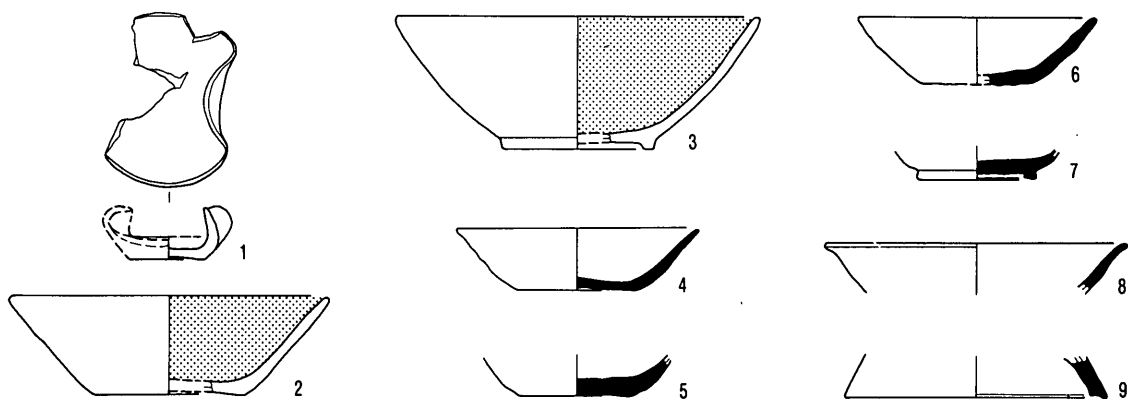

溝址群Ⅲ

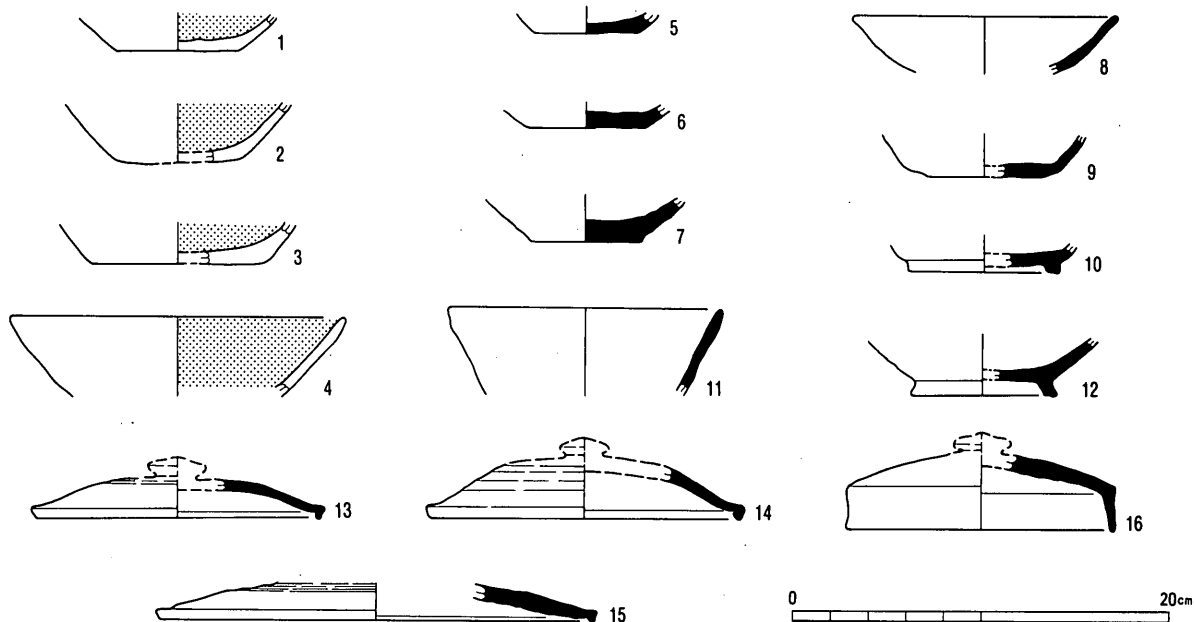

SK 110

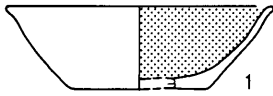

SK 435

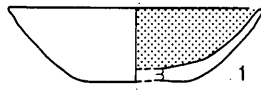

SK 170

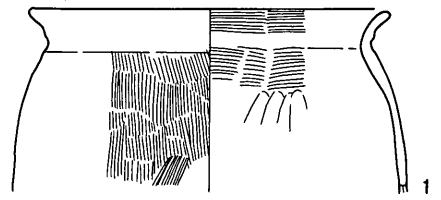

SK 398



SK 436

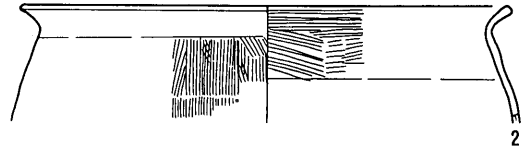

SK 460



SK 533



SK 491

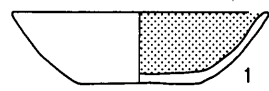

SK 466



SK 540

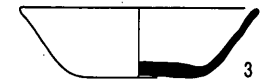
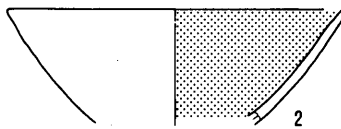
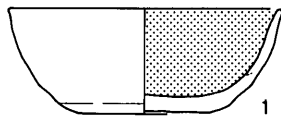

SK 530

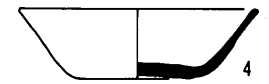

SK 534

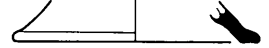
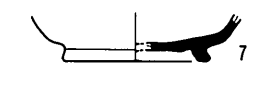
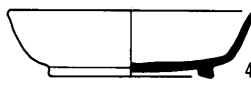
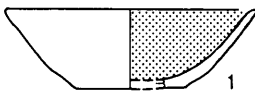

SK 554

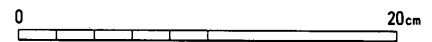
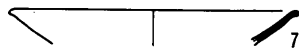
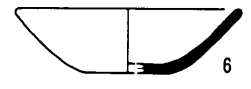
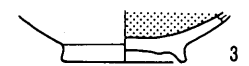
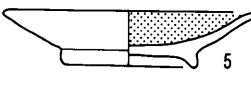
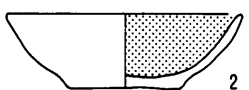
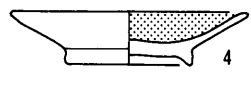
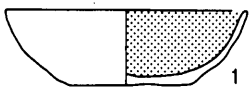

SK 579

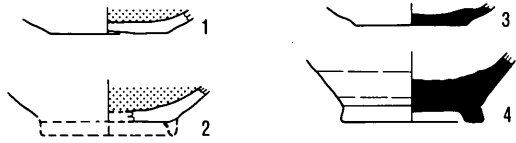

SK 599

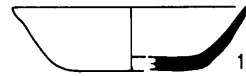

SK 551

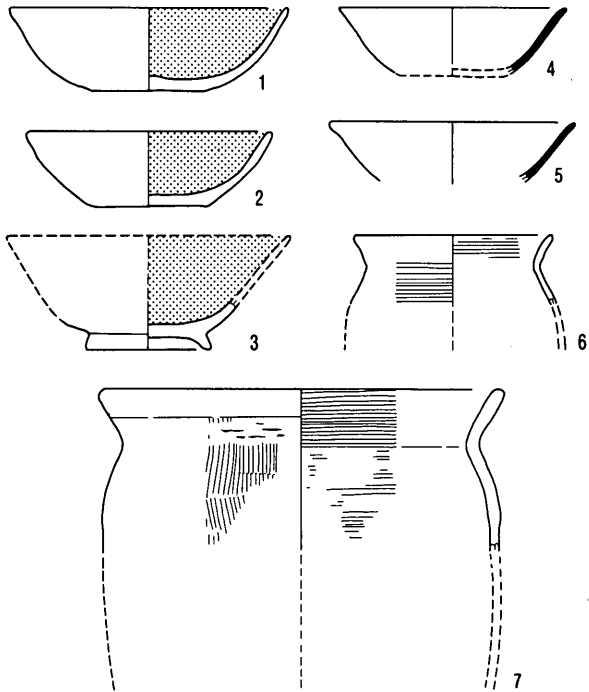

SK 555

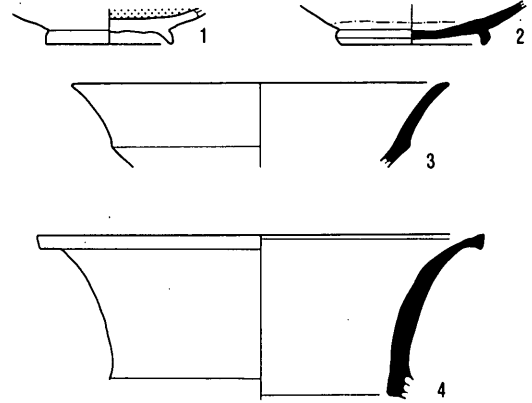

SK 566

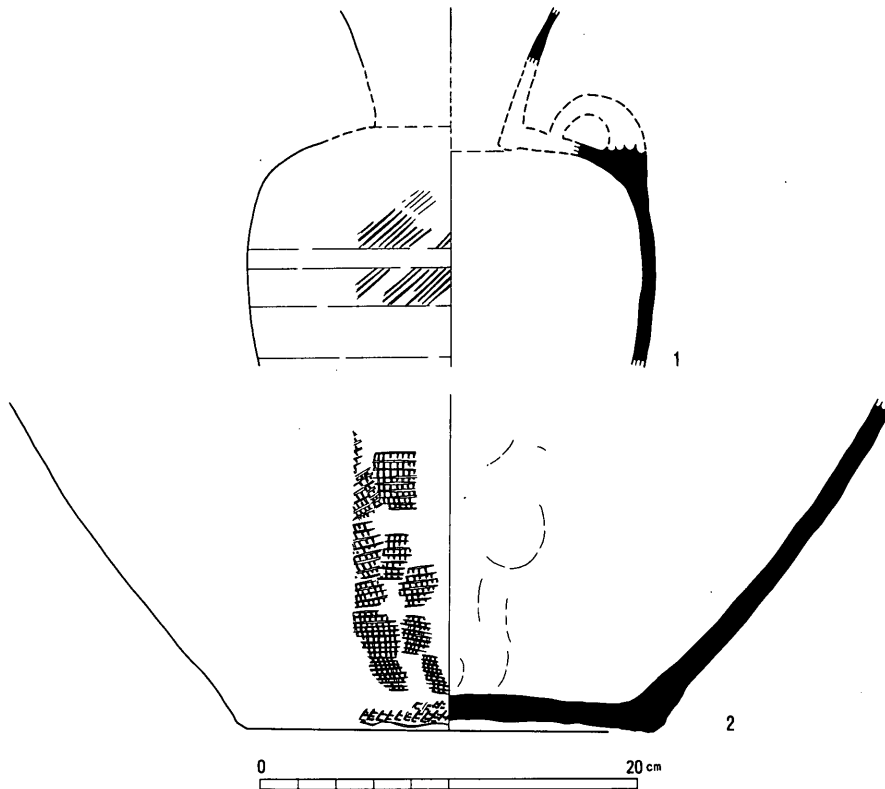

SK 574

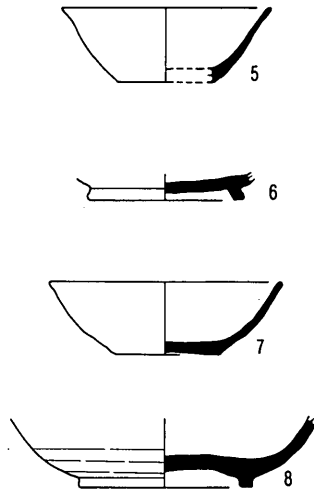
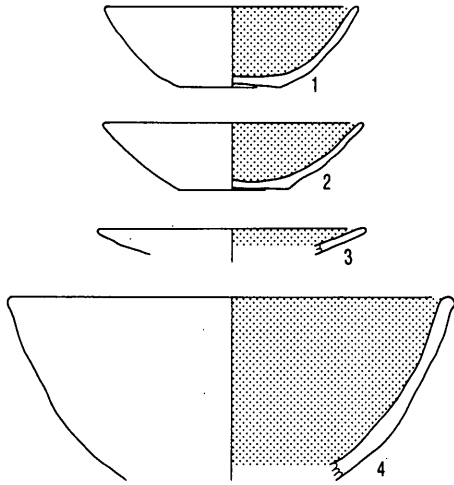

SK 610



SK 624

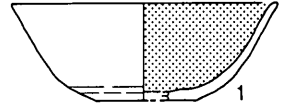

SK 628



SK 580

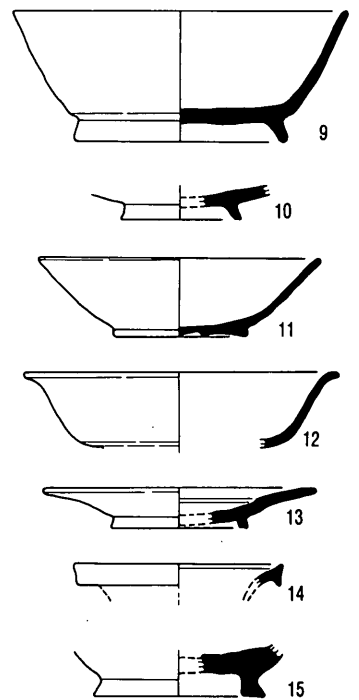
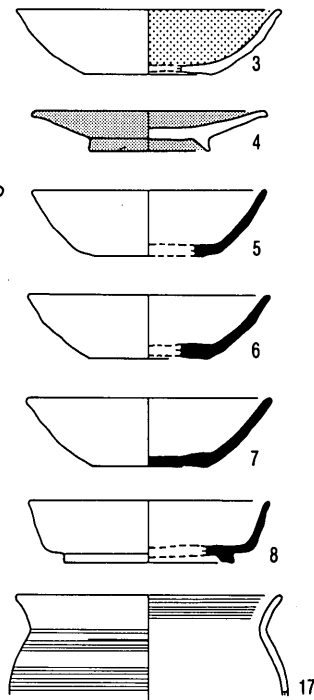
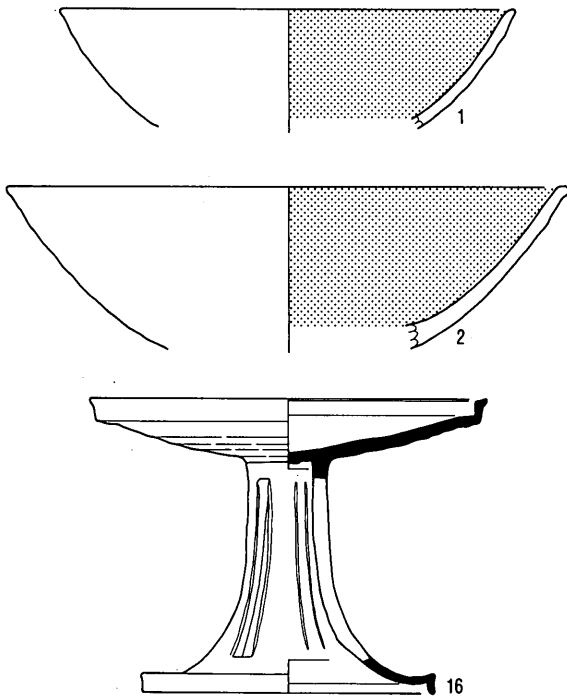

SK 609

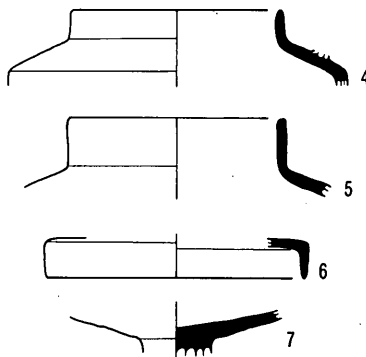
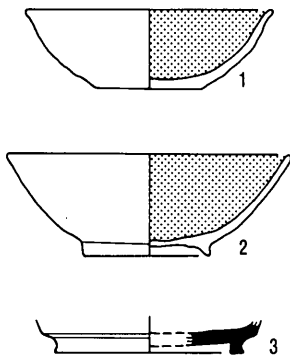

SK 684

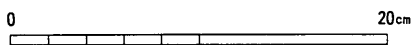
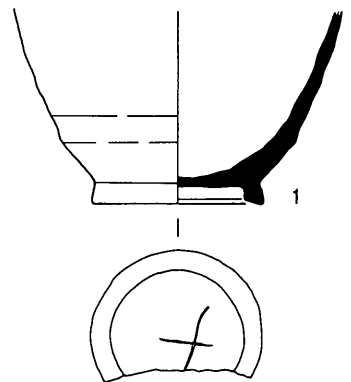



SK 632

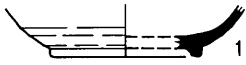

SK 643

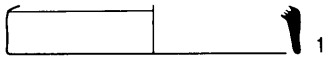

SK 833

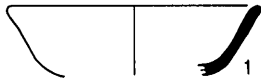

SK 1008

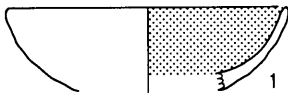

SK 652

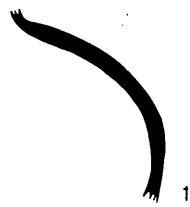
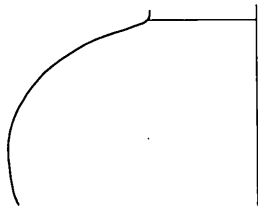

SK 1069

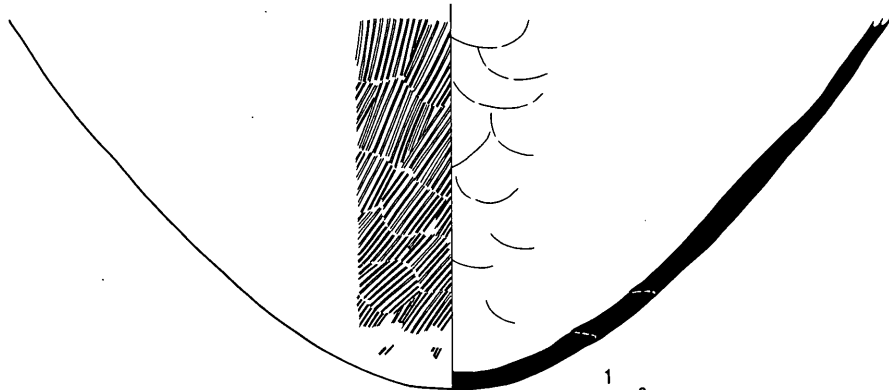

SK 834

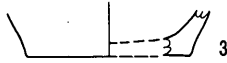
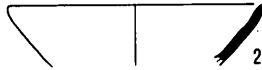
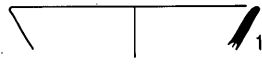

SK 910

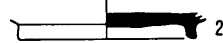
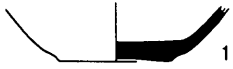

SK 1276

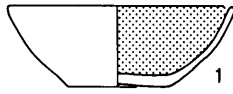

SK 937

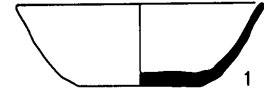

SK 975

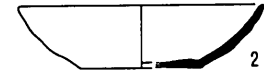
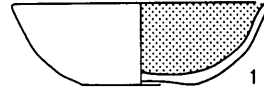

SK 1338



SK 835

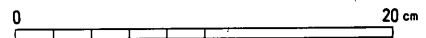
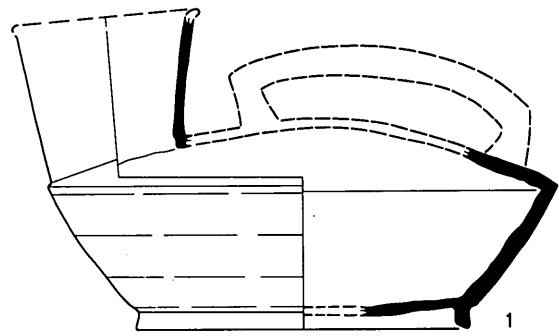

SK 1281

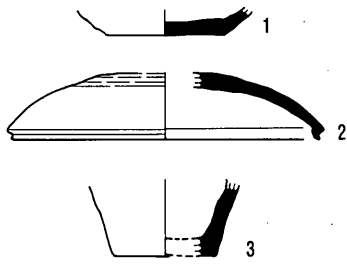

SK 1285

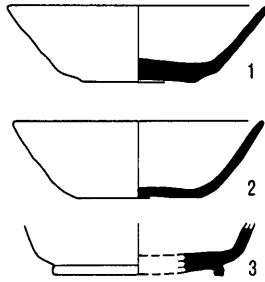

SK 1208

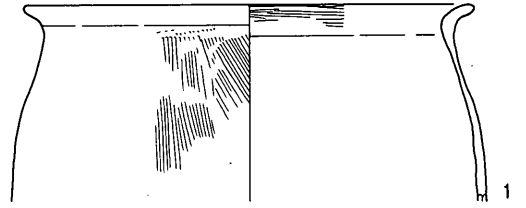

SK 1286



SK 1527

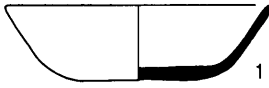

SK 1410

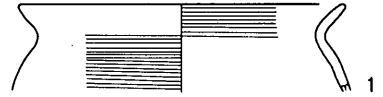

SX 30 (1区)

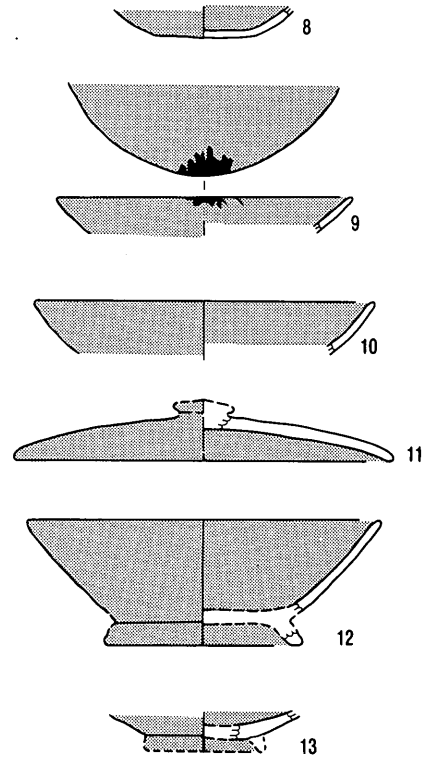
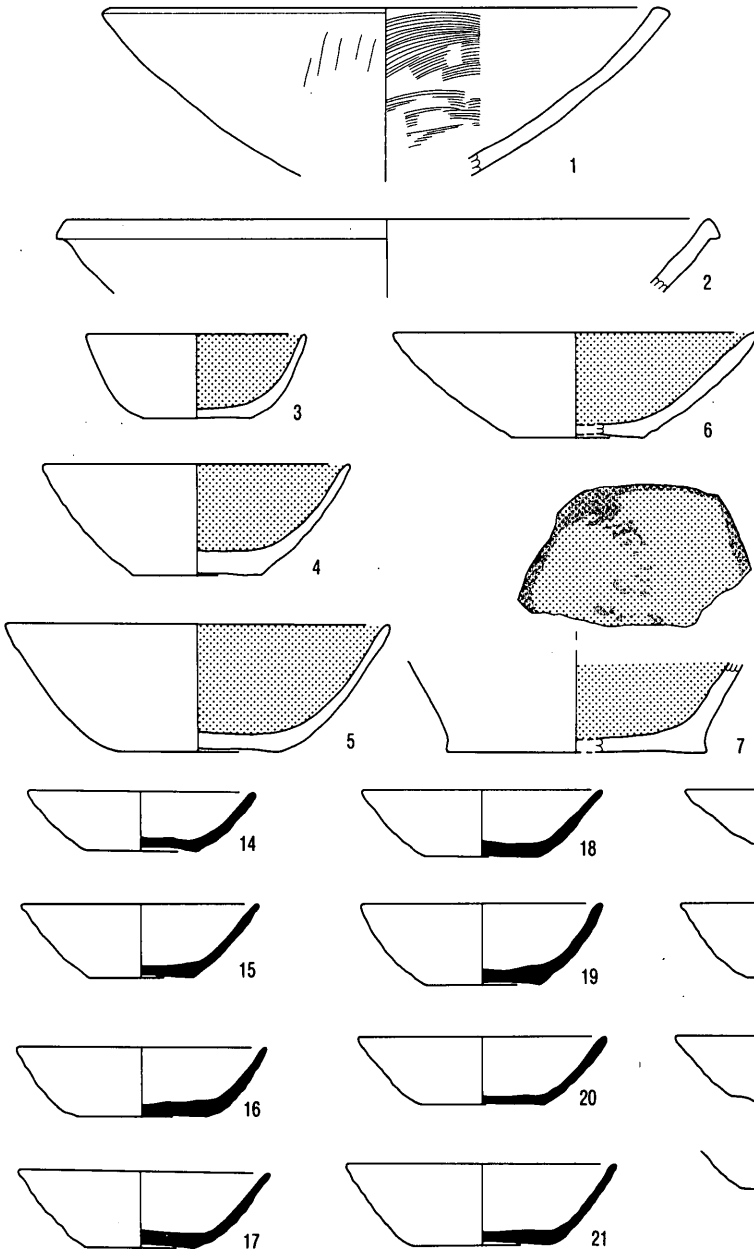

SX 30 (1区)

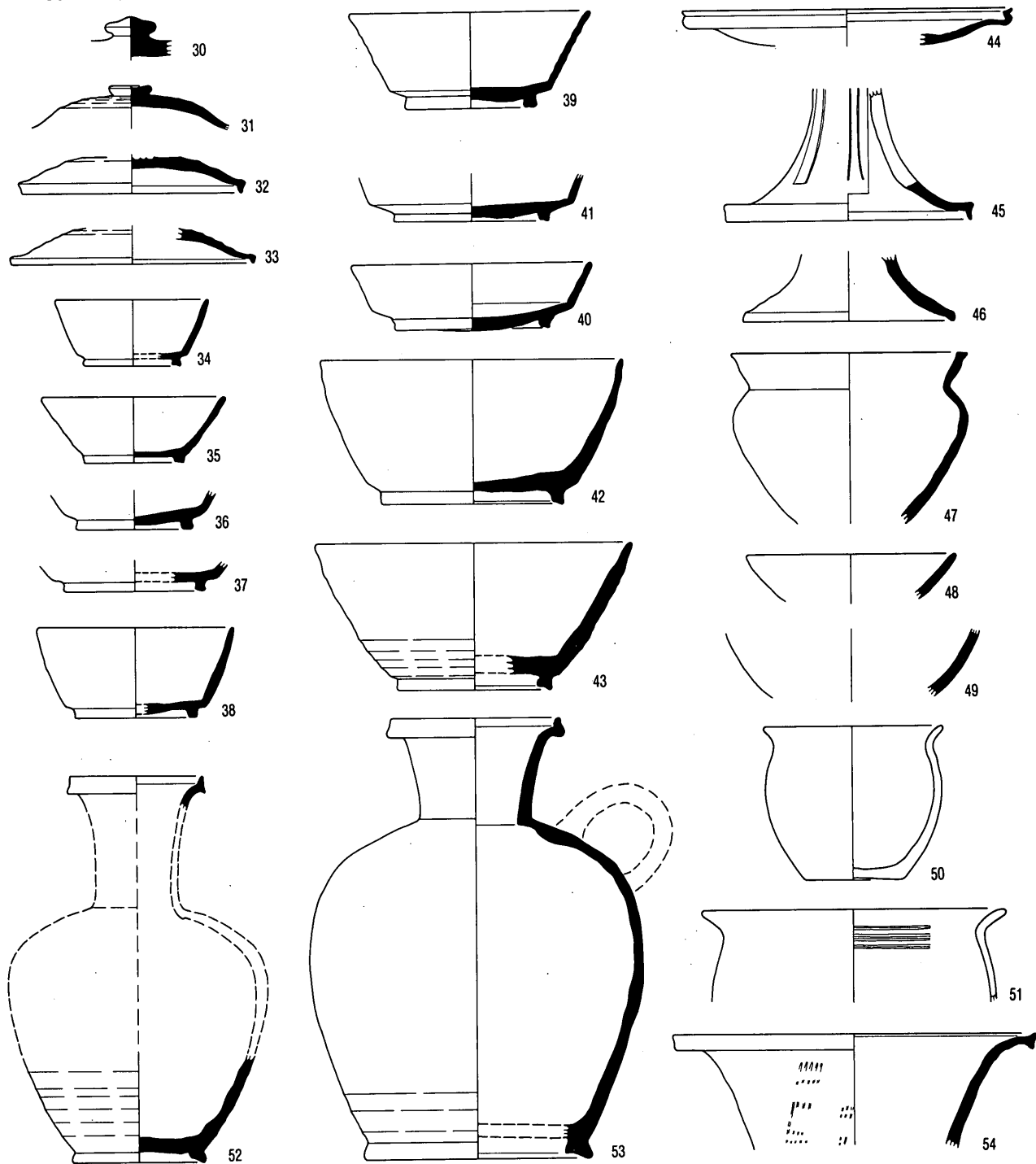

SX 30 (2区)

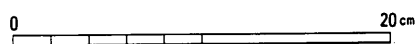
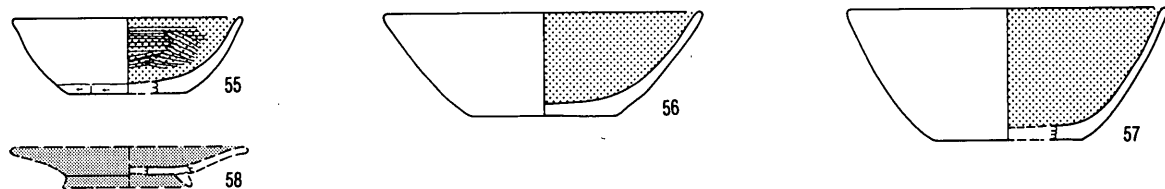

SX 30 (2区)

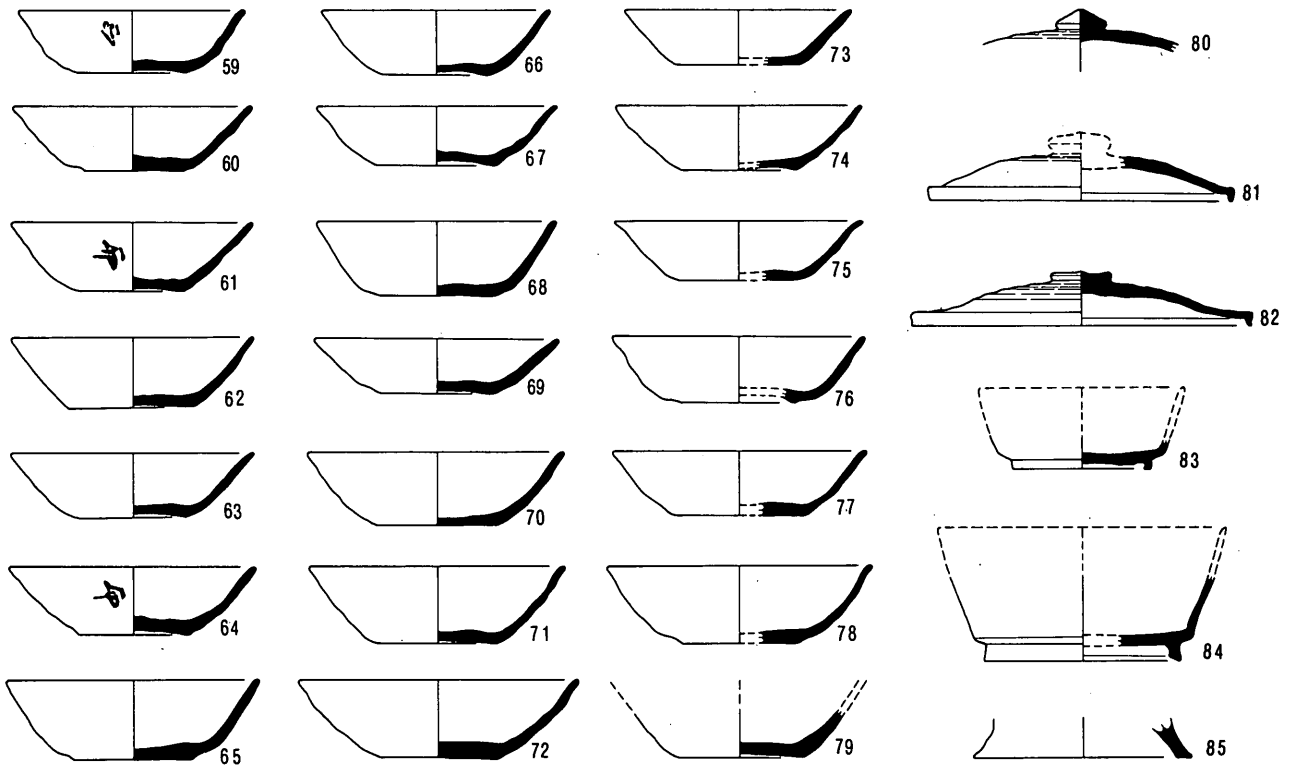

SX 30 (3区)

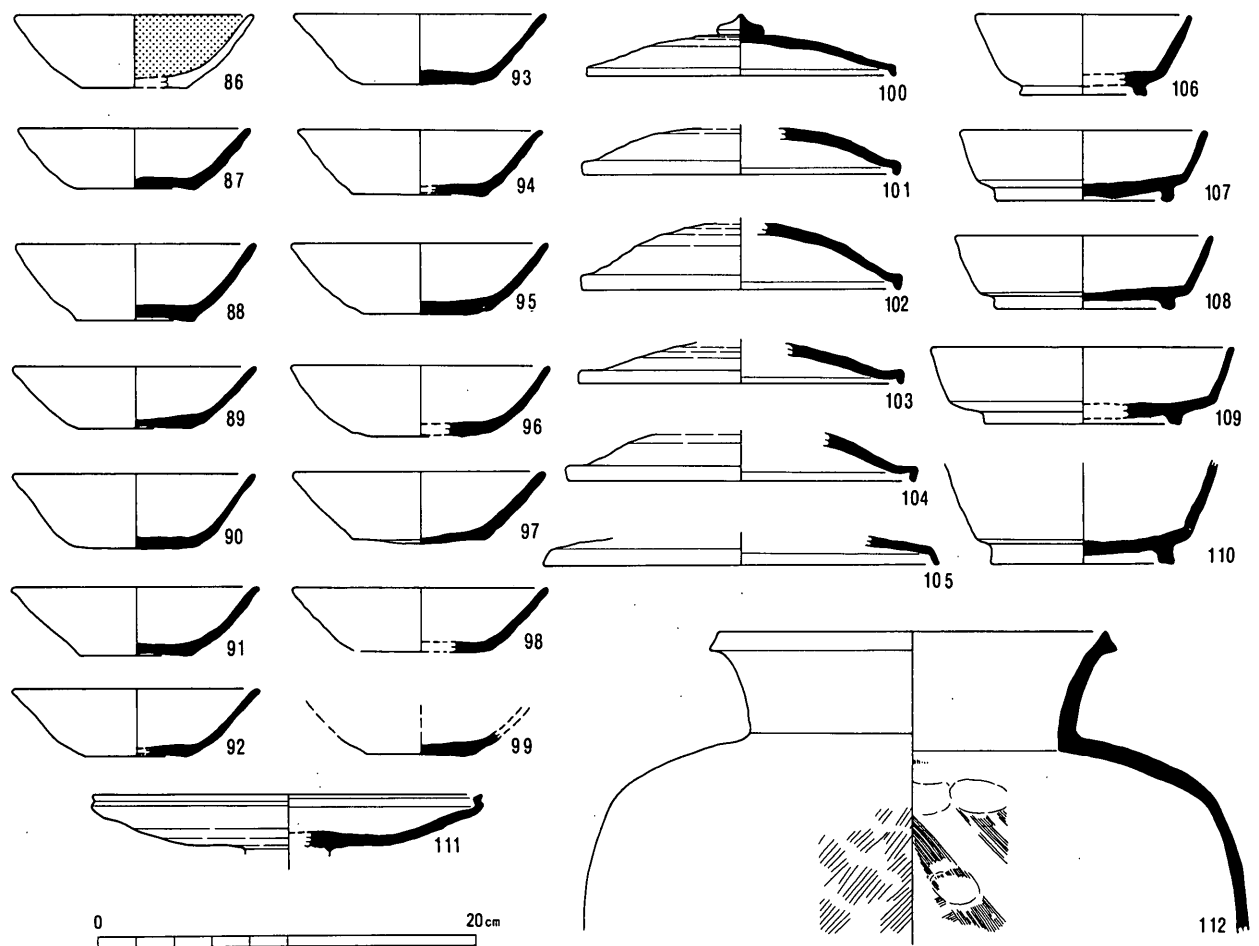

SX 30 (3区)

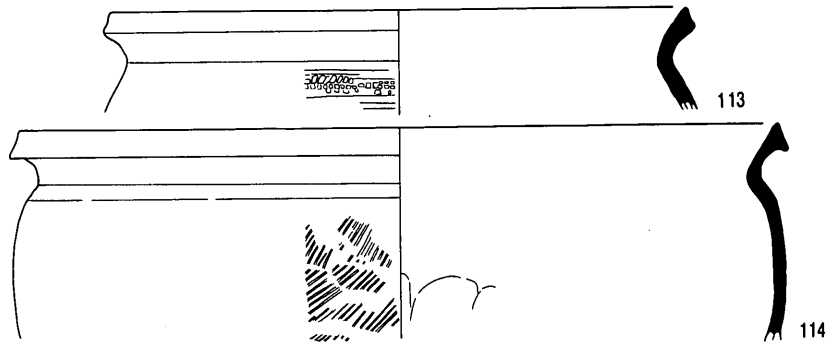
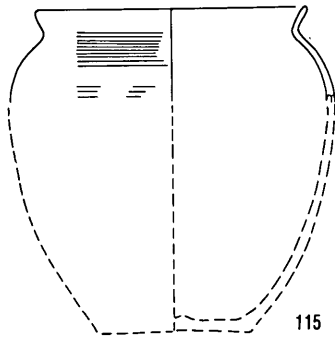

SX 30 (5区)

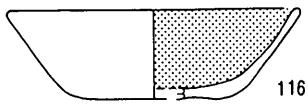

SX 30 (6区)

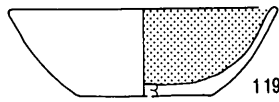

SX 30 (7区)

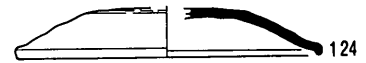
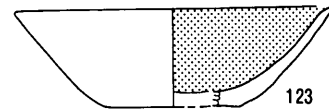
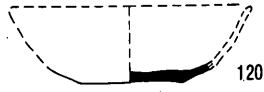
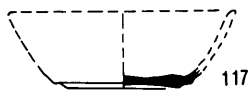
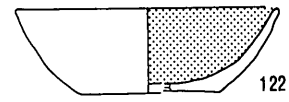

SX 30 (その他)

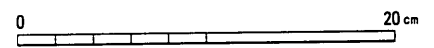
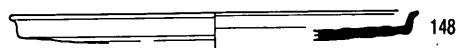
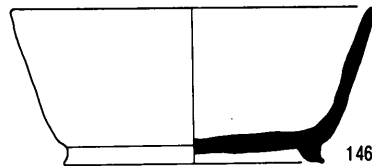
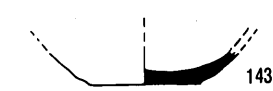
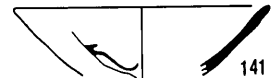
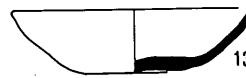
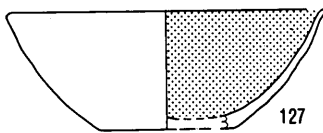
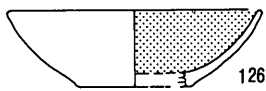
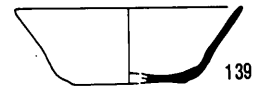
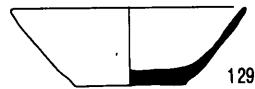
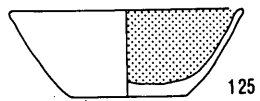

SX30 (3・5・6・7区・その他)

遺構外

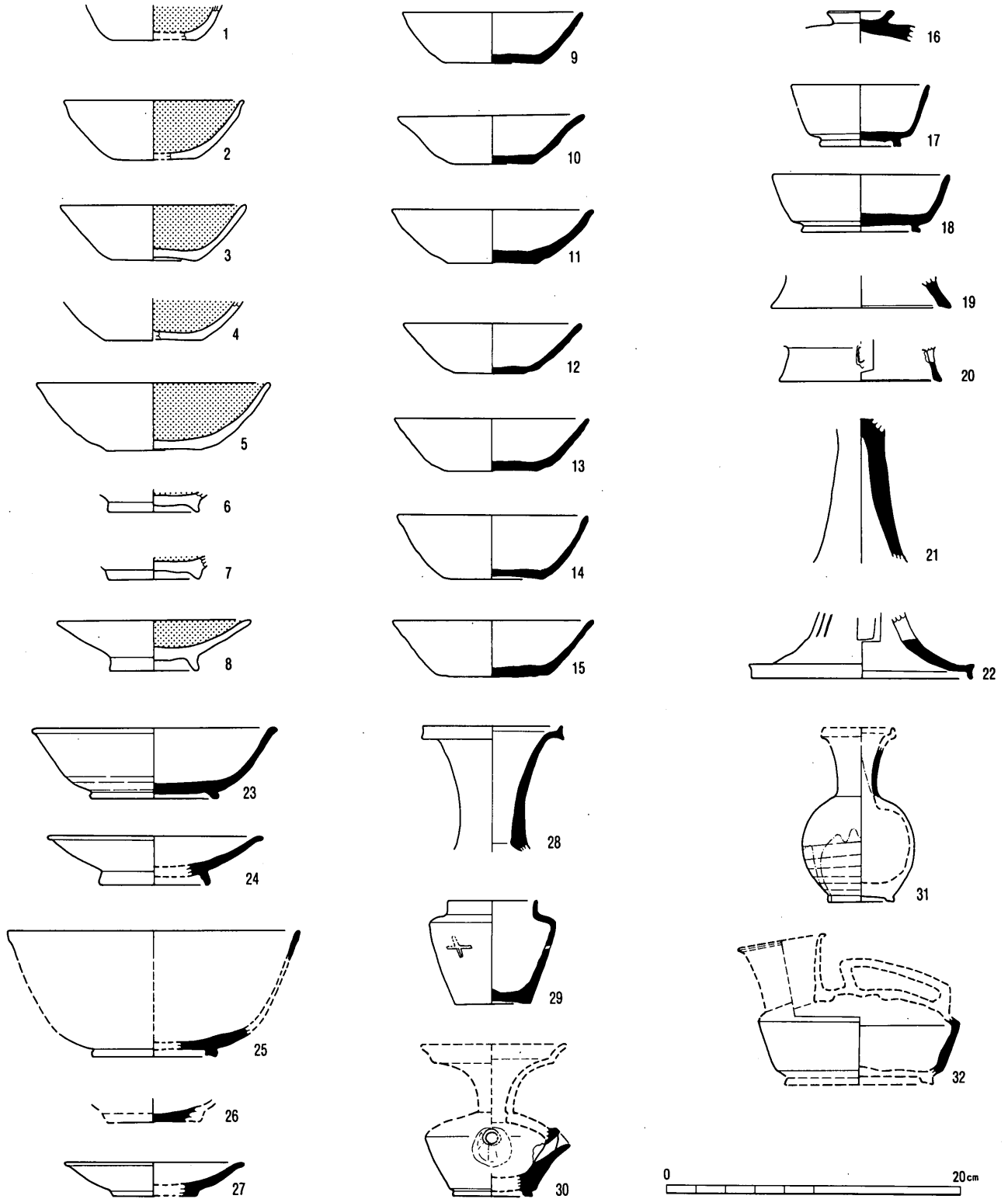

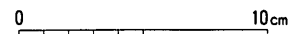
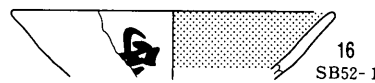
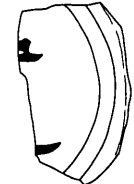
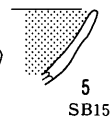
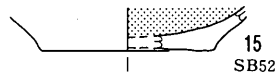
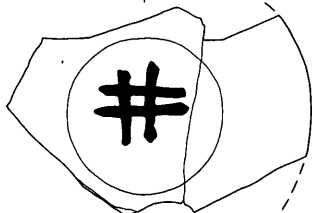
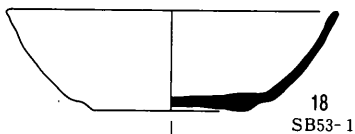
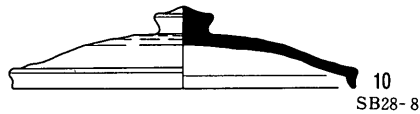
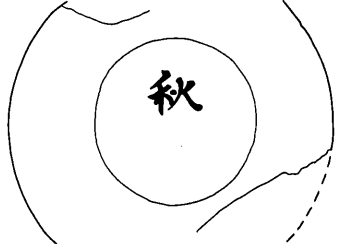
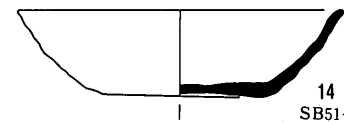
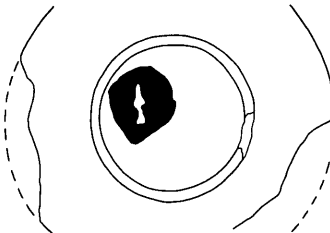
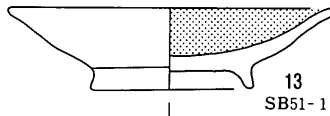
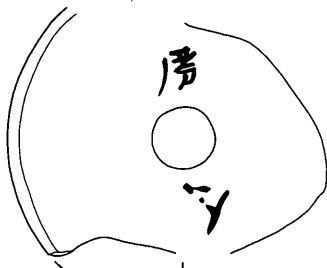
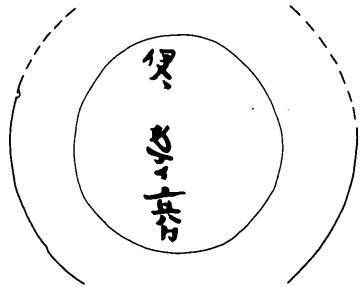
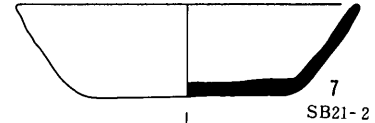
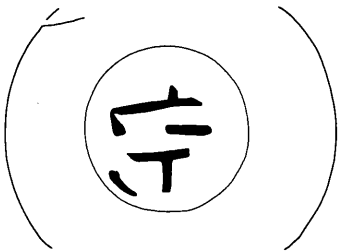
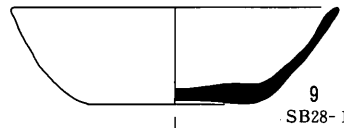
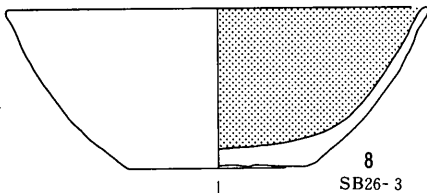
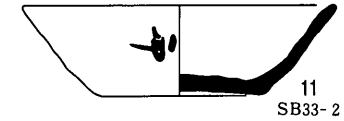
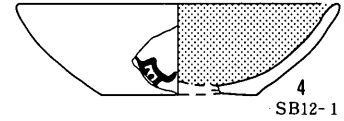
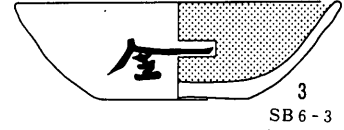
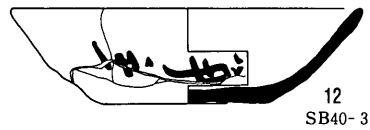
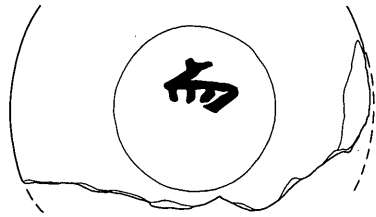
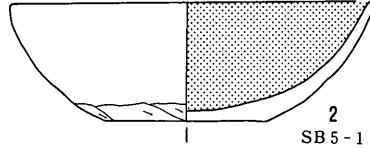
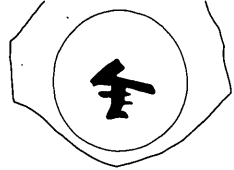

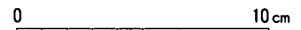
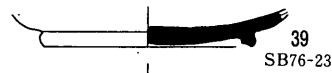
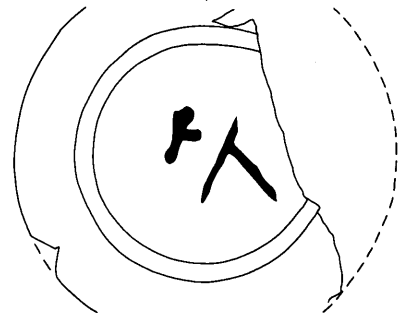
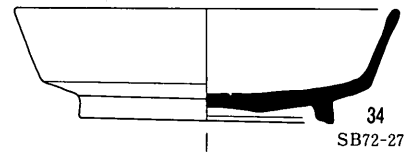
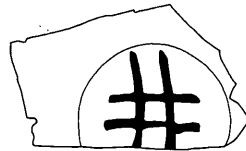
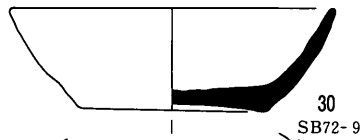
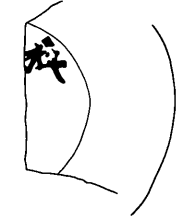
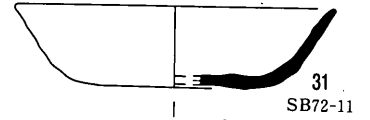
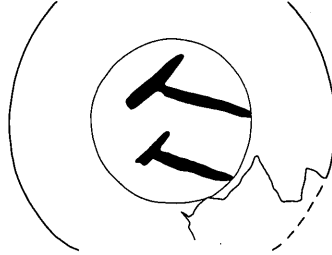
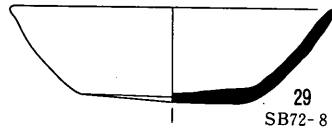
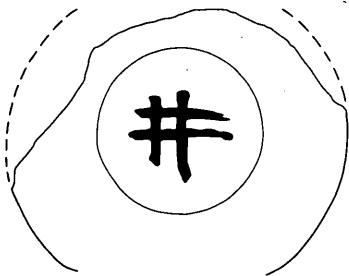
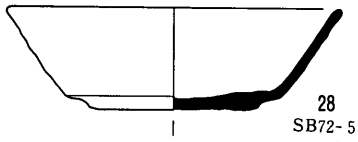
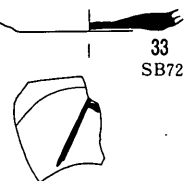
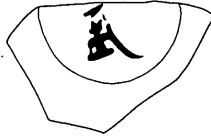
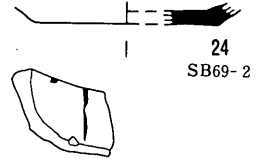
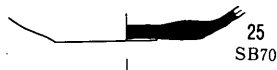
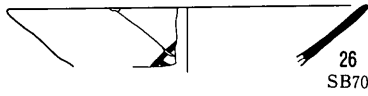
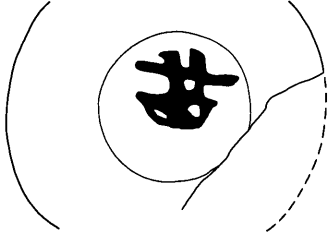
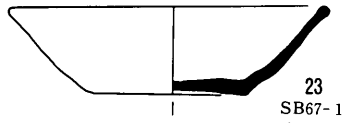
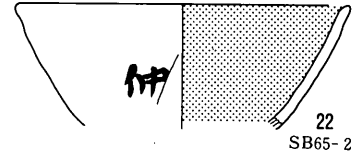
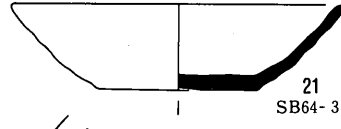
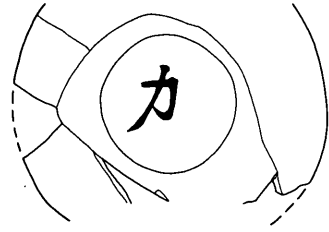
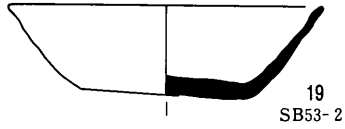



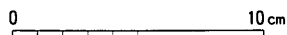
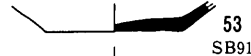
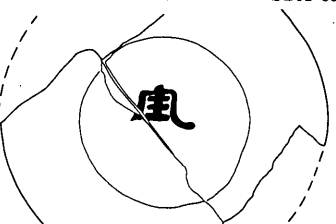
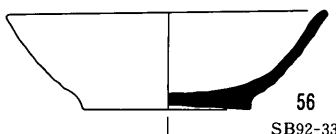
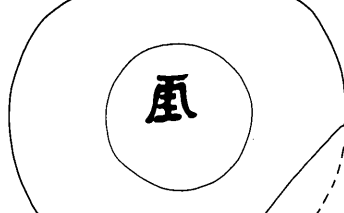
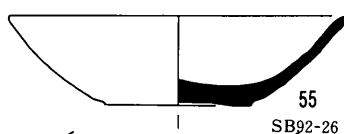
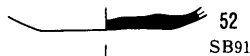
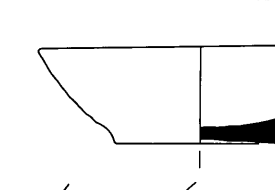
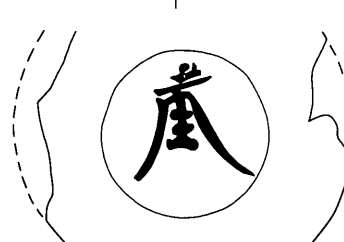
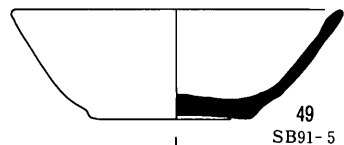
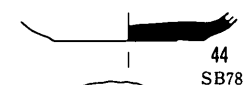
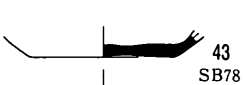
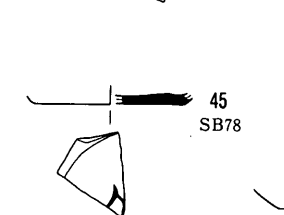
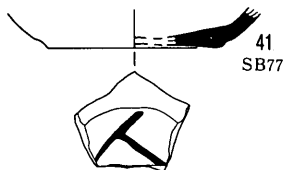
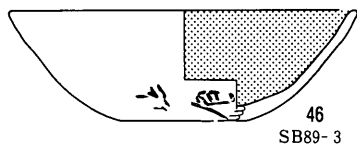
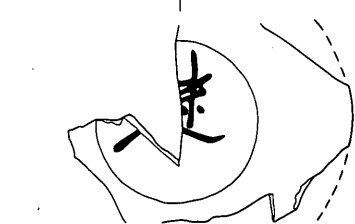
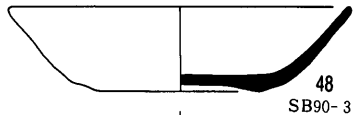
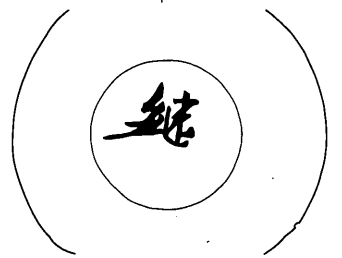
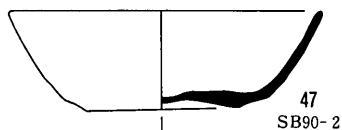
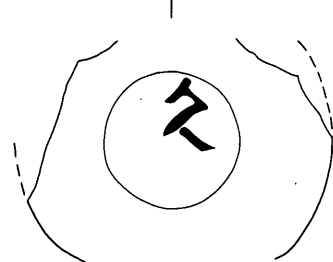
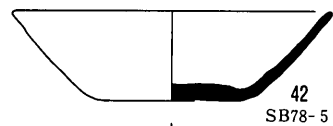
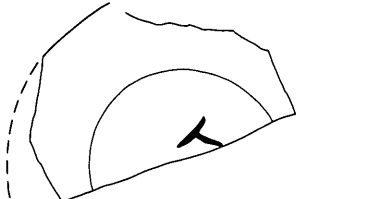
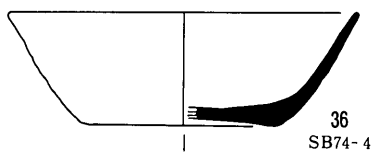
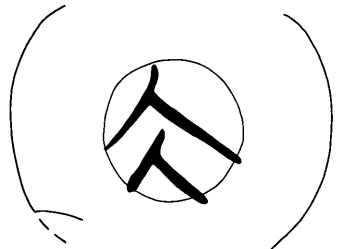
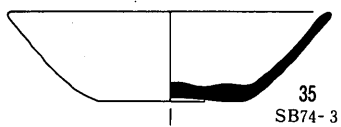

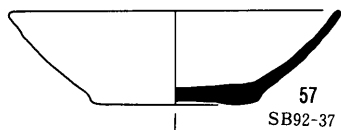

57  
SB92-37

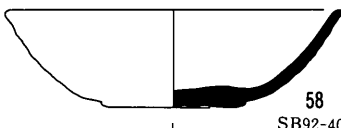
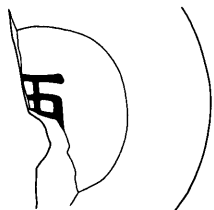

58  
SB92-40

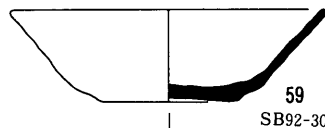
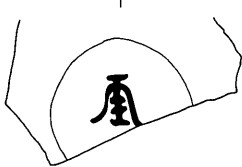

59  
SB92-30

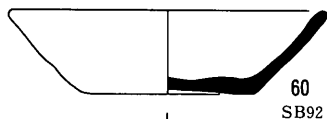
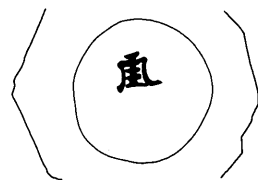

60  
SB92

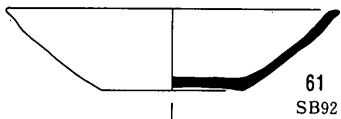
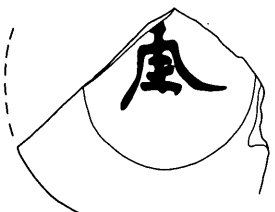

61  
SB92

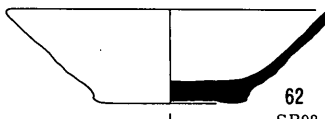

62  
SB92

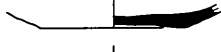
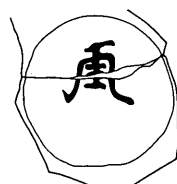

63  
SB92

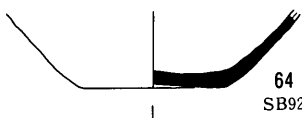

64  
SB92



65  
SB92



66  
SB92



67  
SB92



68  
SB92

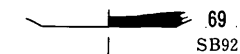

69  
SB92



70  
SB92

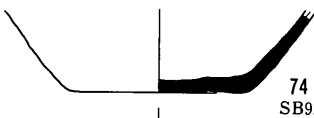

74  
SB92

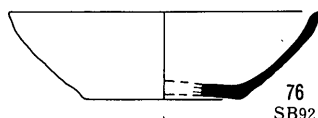

76  
SB92

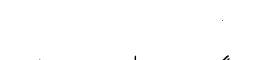

72  
SB92



73  
SB92



75  
SB92

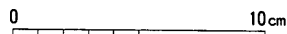

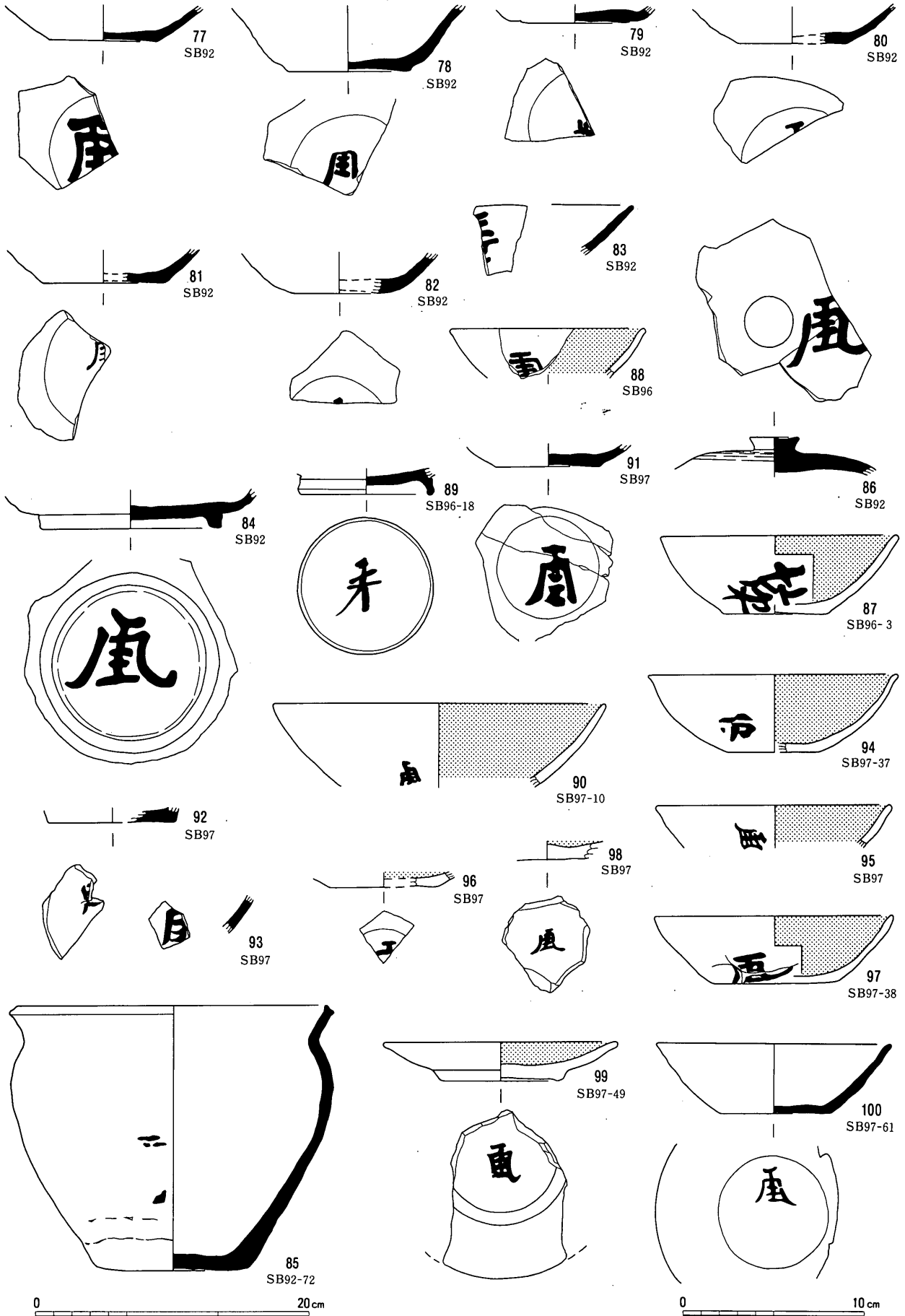

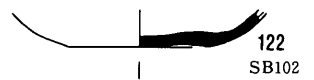
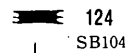
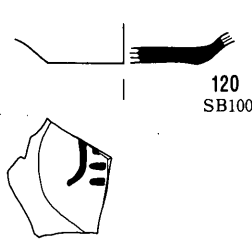
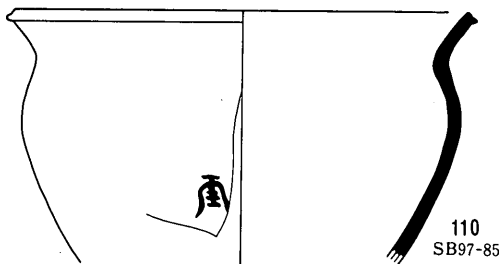
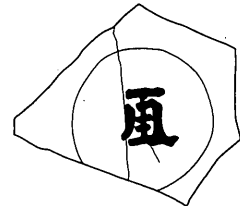
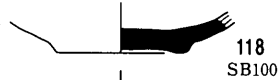
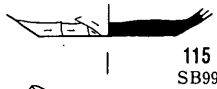
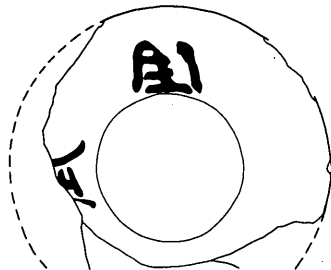
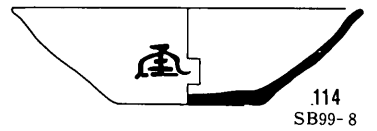
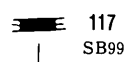
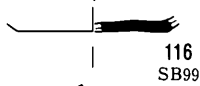
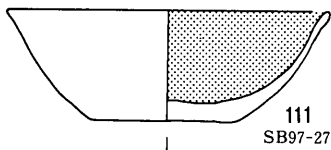
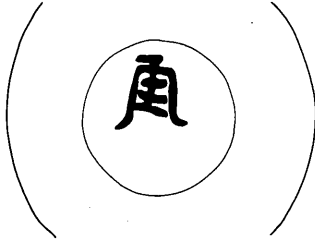
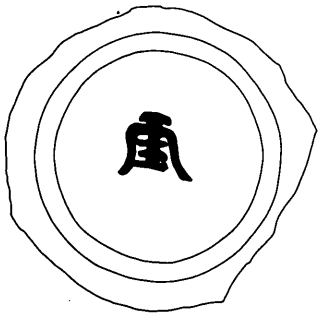
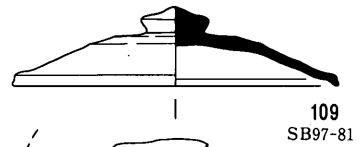
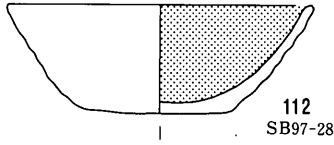
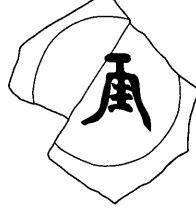
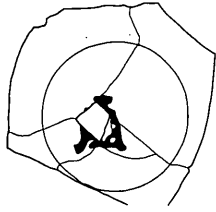
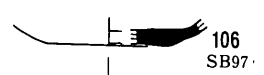
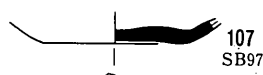
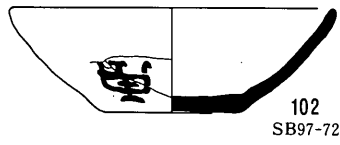
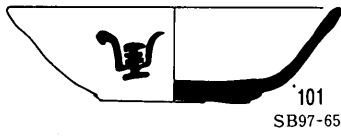

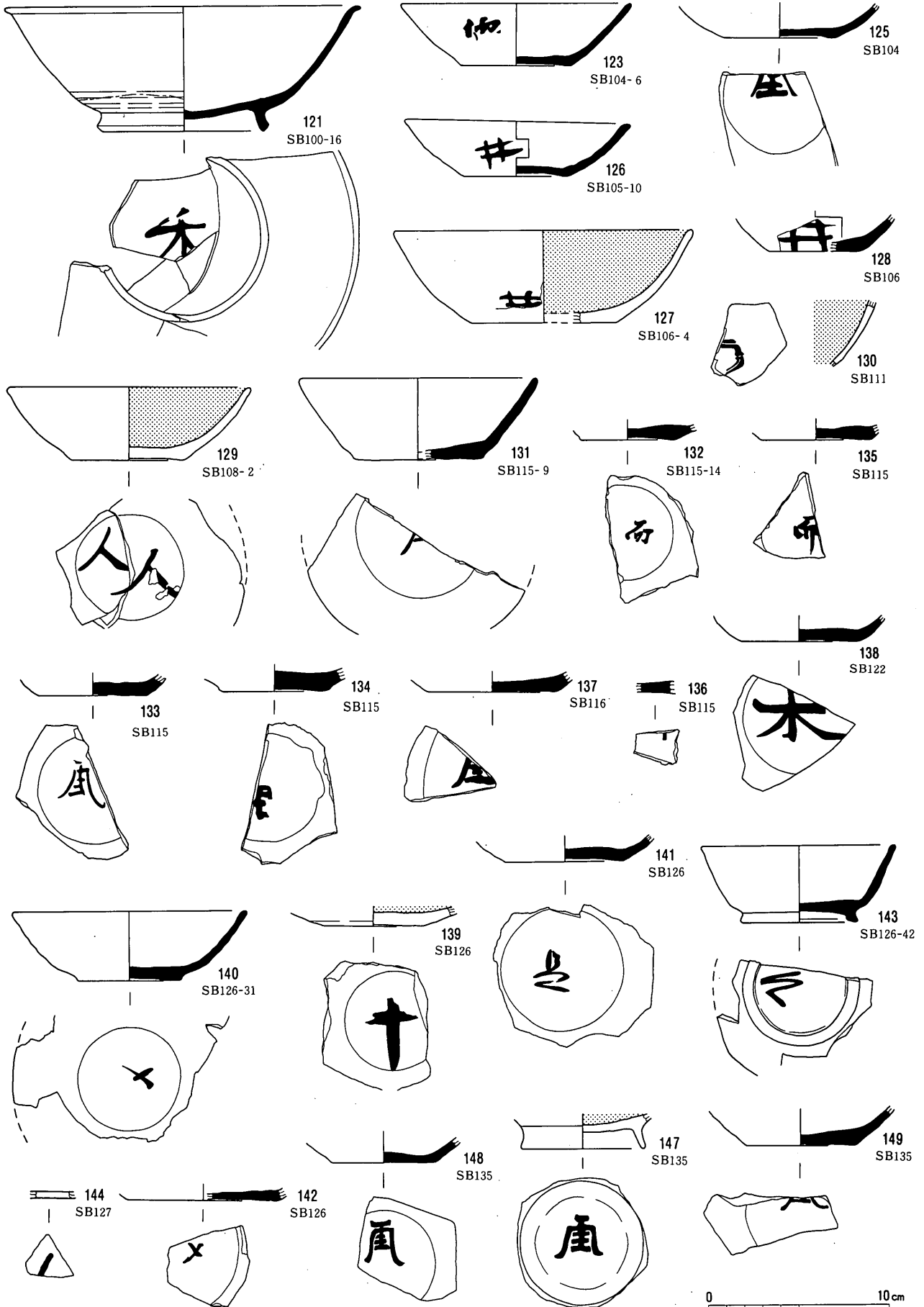

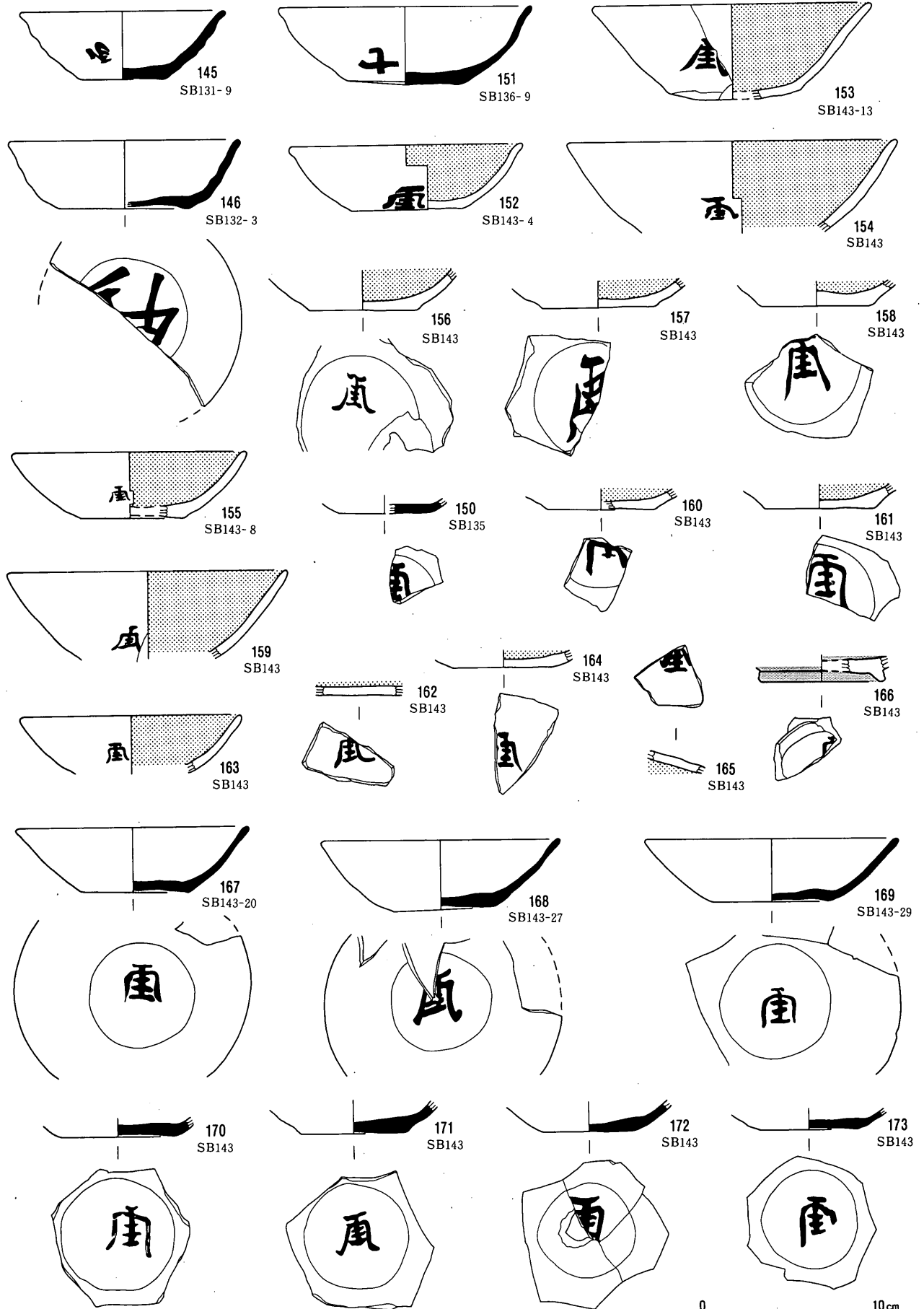

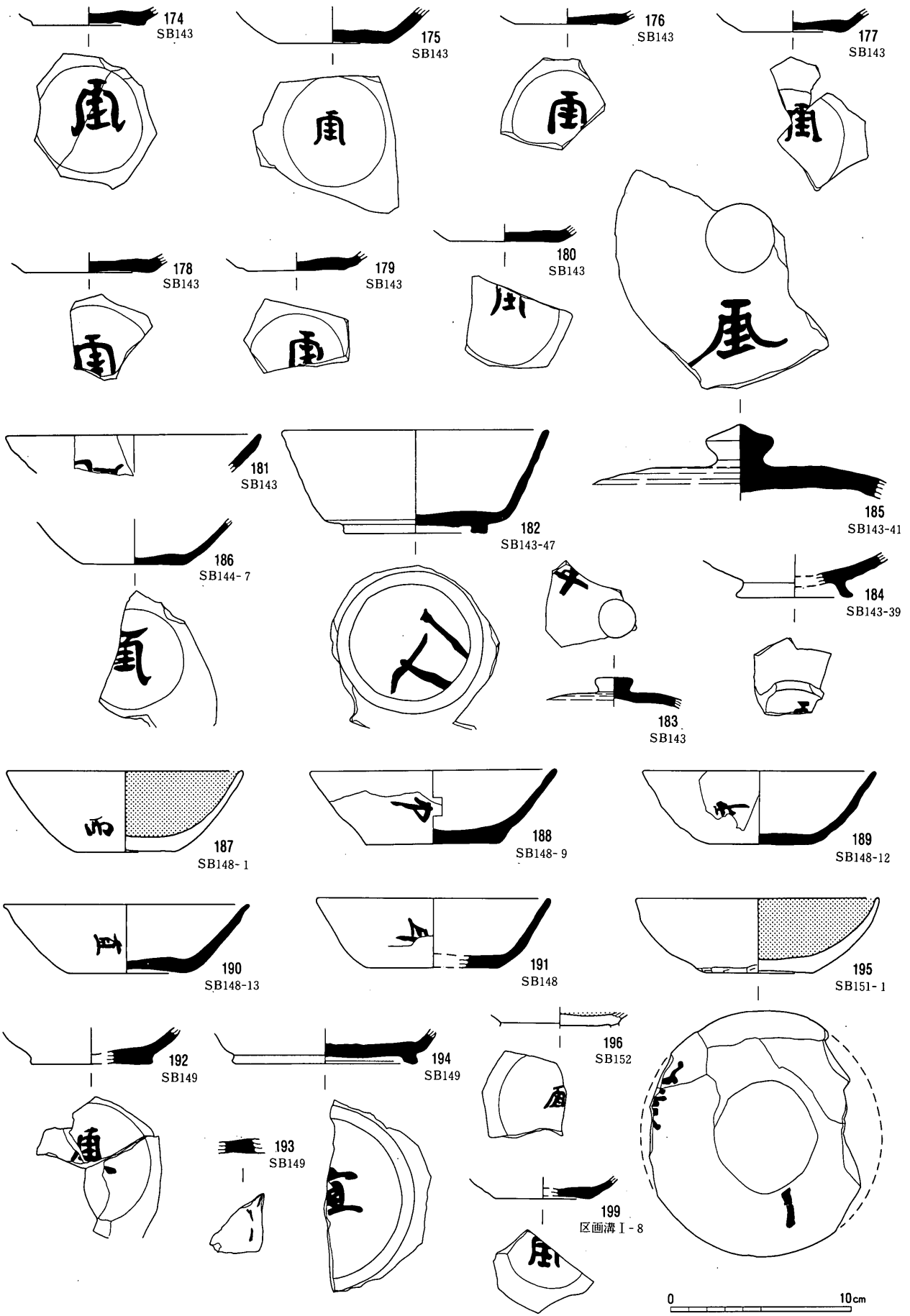

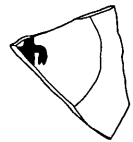
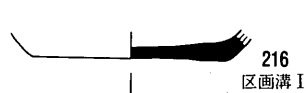
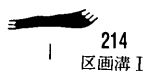
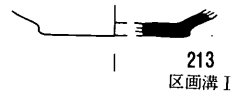
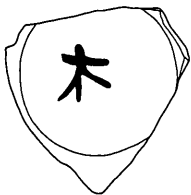
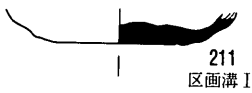
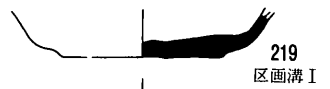
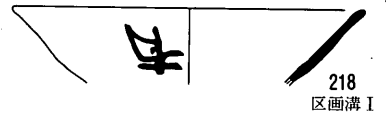
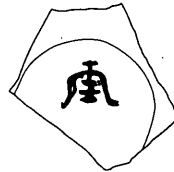
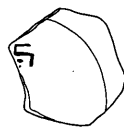
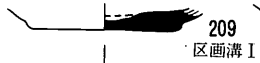
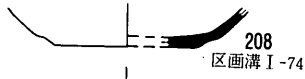
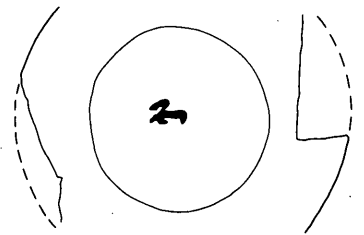
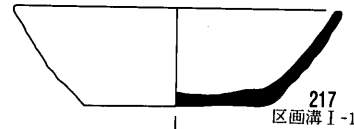
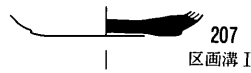
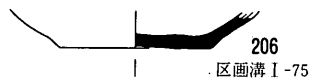
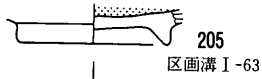
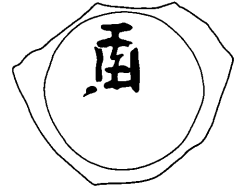
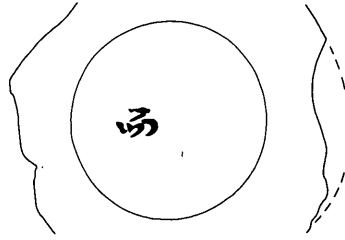
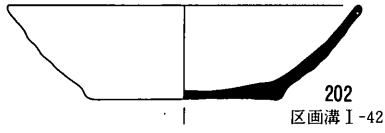
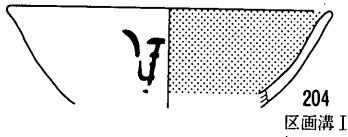
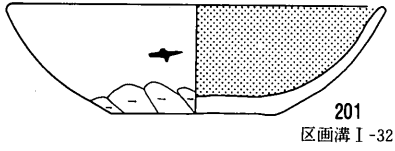
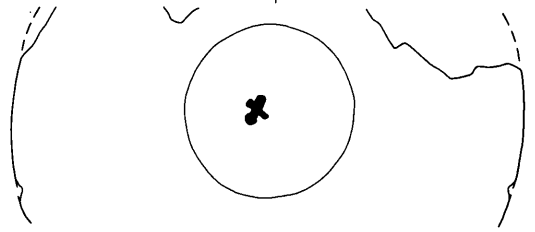
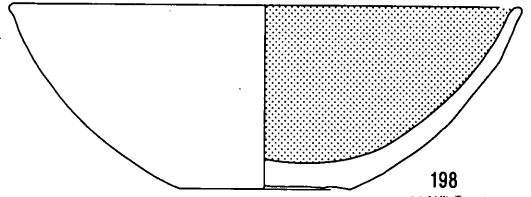
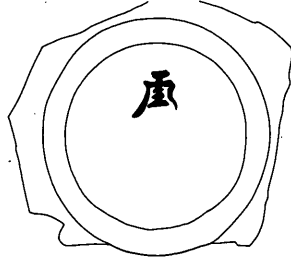
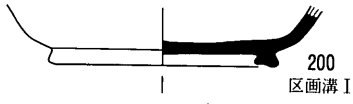
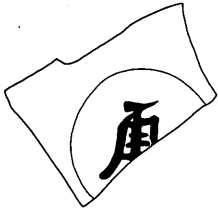
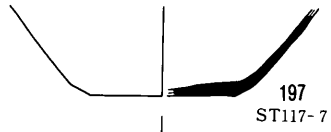





221  
区画溝 I

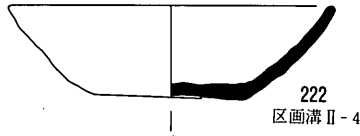

222  
区画溝 II - 4

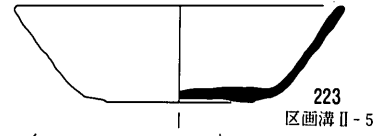

223  
区画溝 II - 5

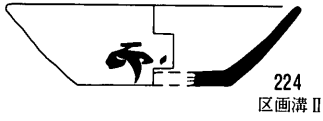

224  
区画溝 II

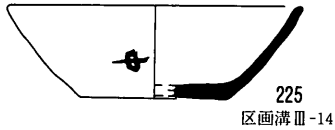
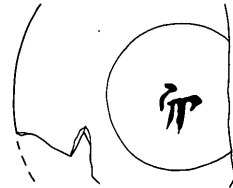
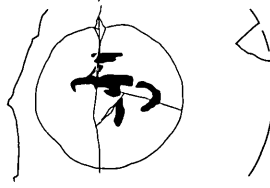

225  
区画溝 III - 14

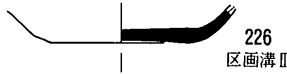

226  
区画溝 III

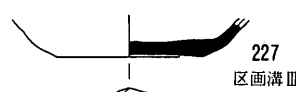

227  
区画溝 III

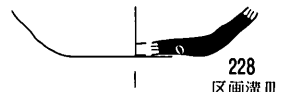

228  
区画溝 III

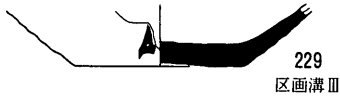

229  
区画溝 III

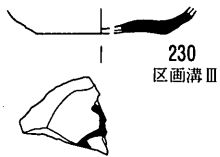

230  
区画溝 III

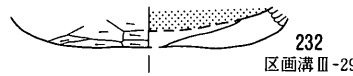

232  
区画溝 III - 29

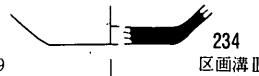

234  
区画溝 III



233  
区画溝 III

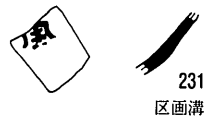

231  
区画溝 III

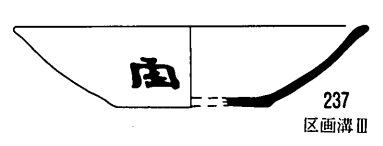
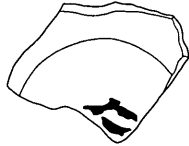

237  
区画溝 III



239  
区画溝 III



240  
区画溝 III

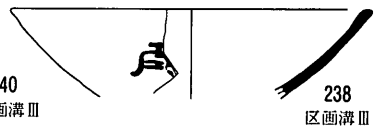

238  
区画溝 III

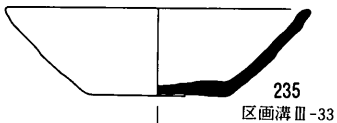

235  
区画溝 III - 33

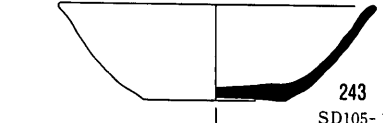
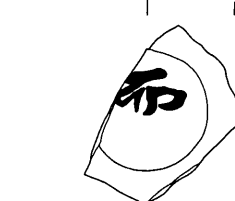

243  
SD105-1

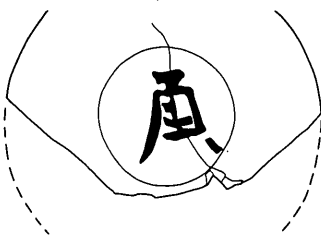

236  
区画溝 III - 34

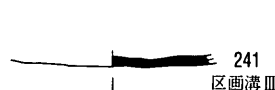

241  
区画溝 III

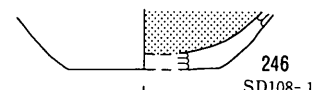

246  
SD108-1

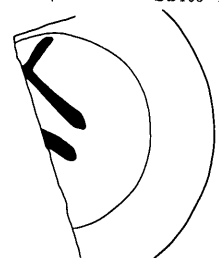

236  
区画溝 III - 34

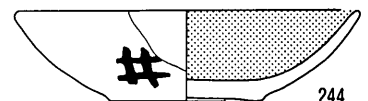

244  
SD108-1-4

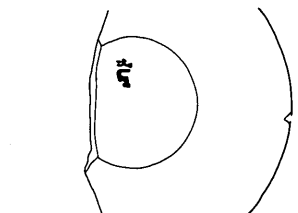

236  
区画溝 III - 34



242  
区画溝 III - 45



247  
SD108-1

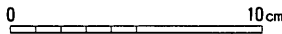

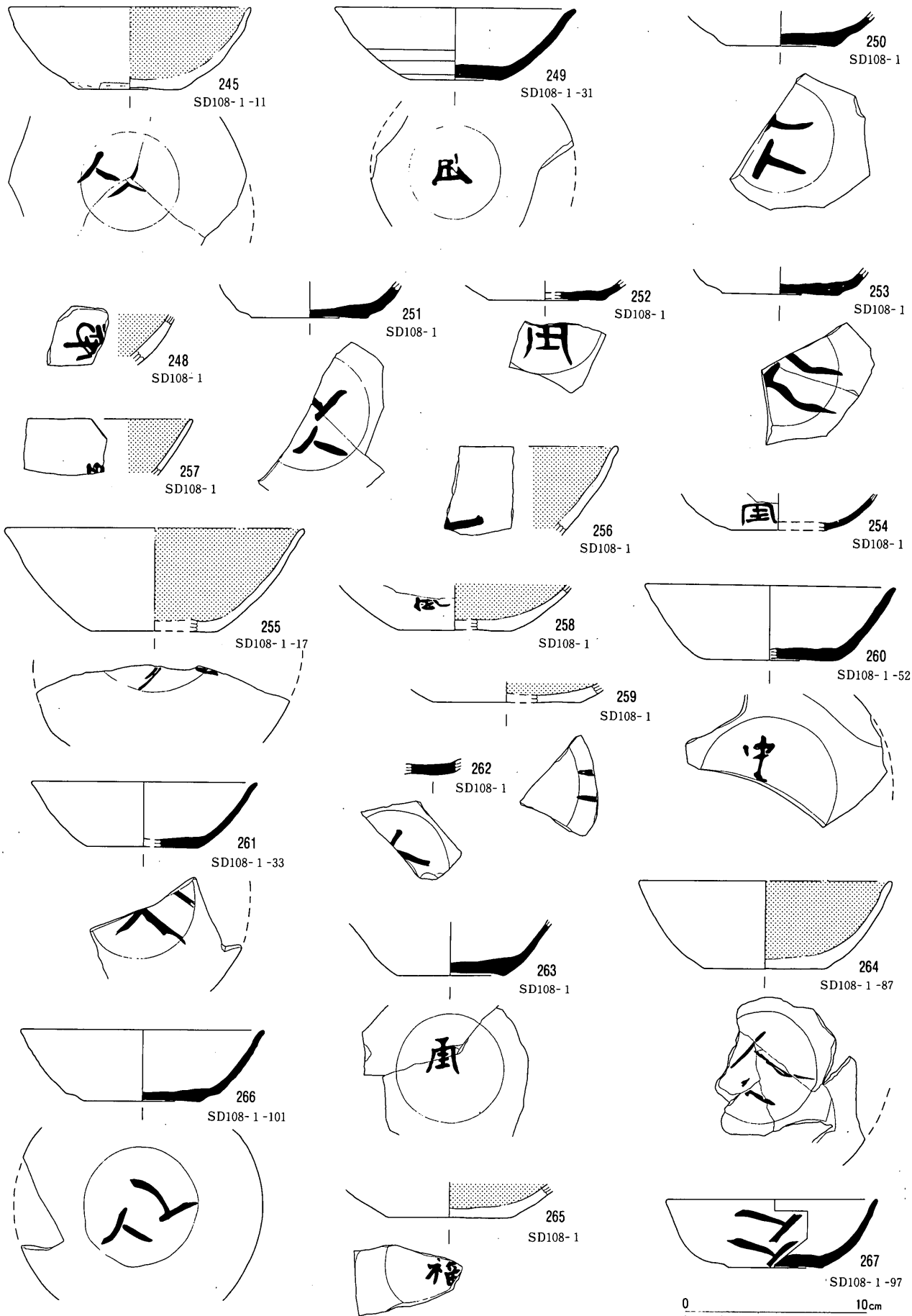

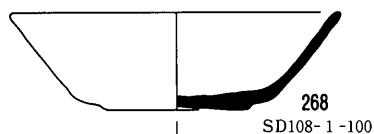

268  
SD108-1-100

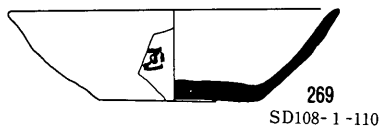

269  
SD108-1-110



270  
SD108-1

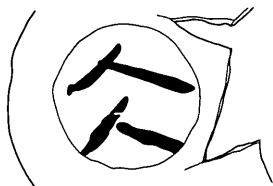

271  
SD108-1



272  
SD108-2



273  
SD108-2



274  
SD108-2-152

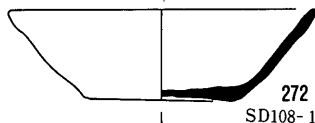

275  
SD108-1-95



276  
SD108-3

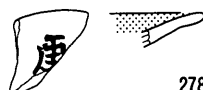

277  
SD108-3-221



278  
SD108-3-280

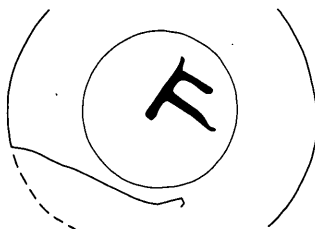

279  
SD108-3



281  
SD108-3



282  
SD108-3-273

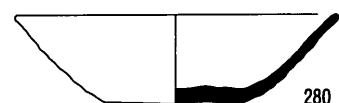

283  
SD108-3-268

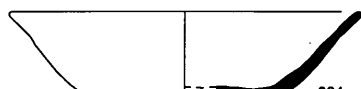

284  
SD108-3-154

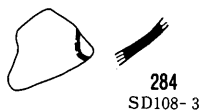

285  
SD108-3

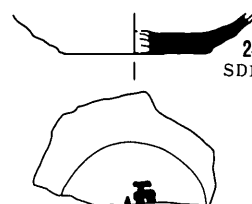

286  
SD108-3



287  
SD108-3-282

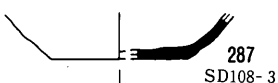

288  
SD108-3

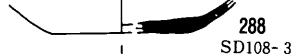

289  
SD108-3



290  
SD108-3-281



291  
SD108-3-282



292  
SD108-3



293  
SD108-3



294  
SD108-3-298

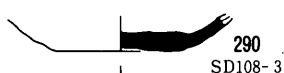

295  
SD108-3



296  
SD108-3

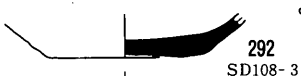

297  
SD108-3



298  
SD108-3-298



299  
SD108-3



300  
SD108-3



301  
SD108-3

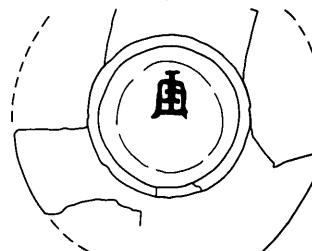

302  
SD108-3-298

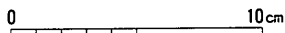

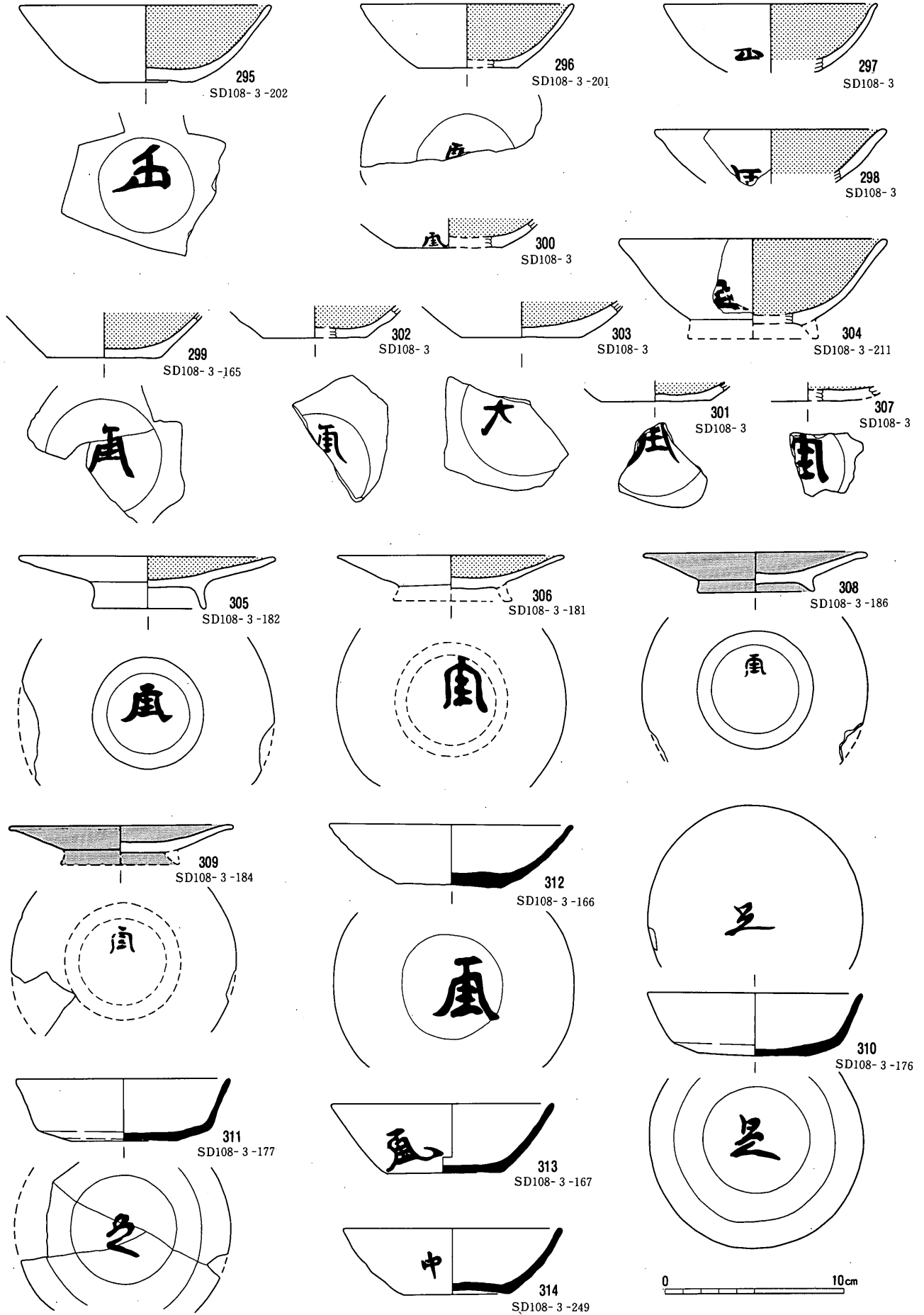

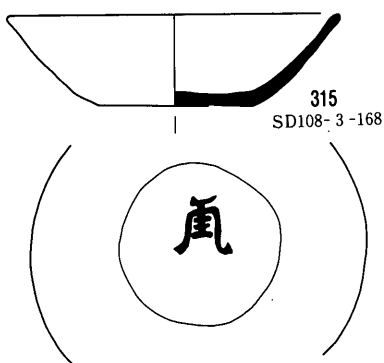

315  
SD108-3-168

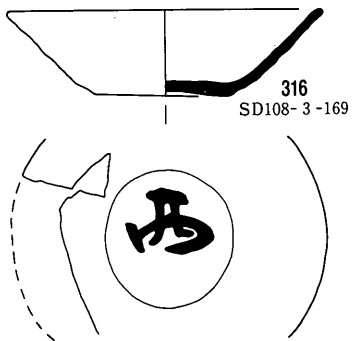

316  
SD108-3-169

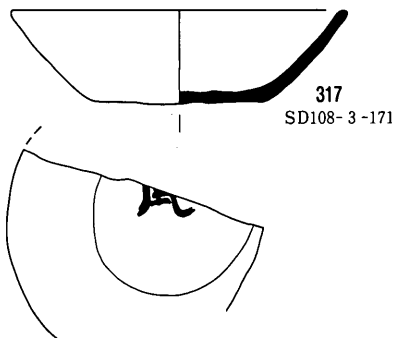

317  
SD108-3-171

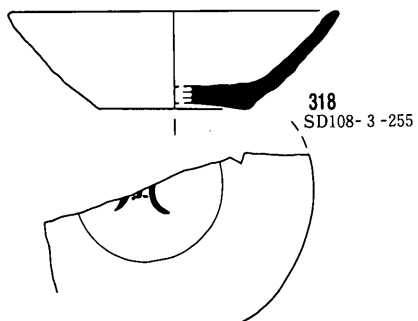

318  
SD108-3-255

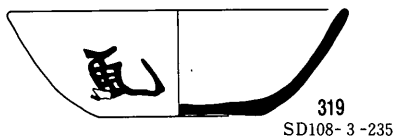

319  
SD108-3-235

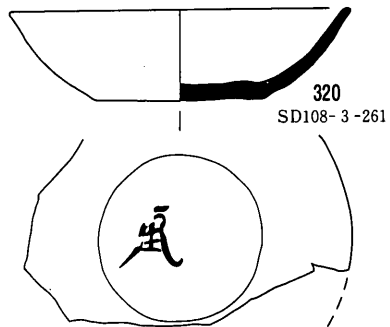

320  
SD108-3-261

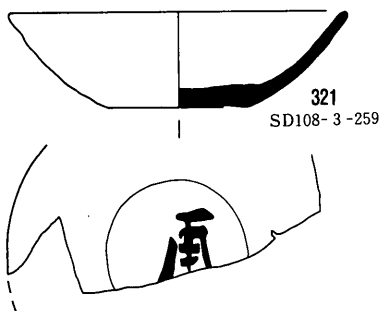

321  
SD108-3-259

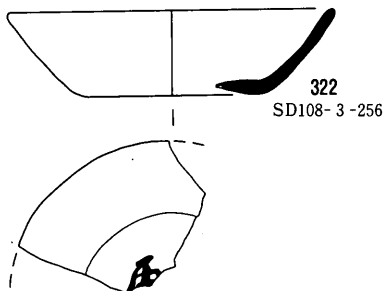

322  
SD108-3-256

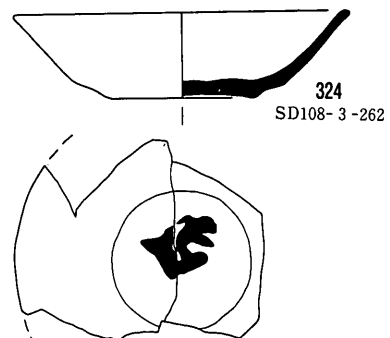

324  
SD108-3-262

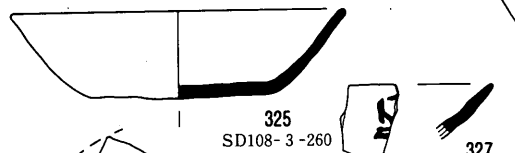

325  
SD108-3-260

327  
SD108-3

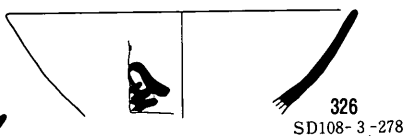

326  
SD108-3-278



329  
SD108-3



330  
SD108-3

331  
SD108-3



328  
SD108-3-279



333  
SD108-3-291

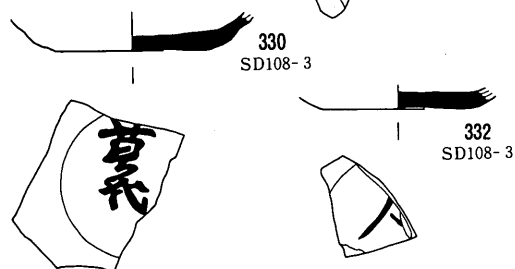

332  
SD108-3

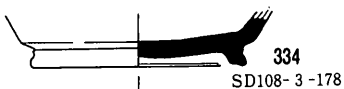
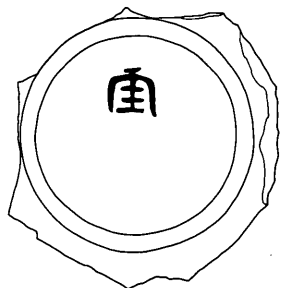

334  
SD108-3-178



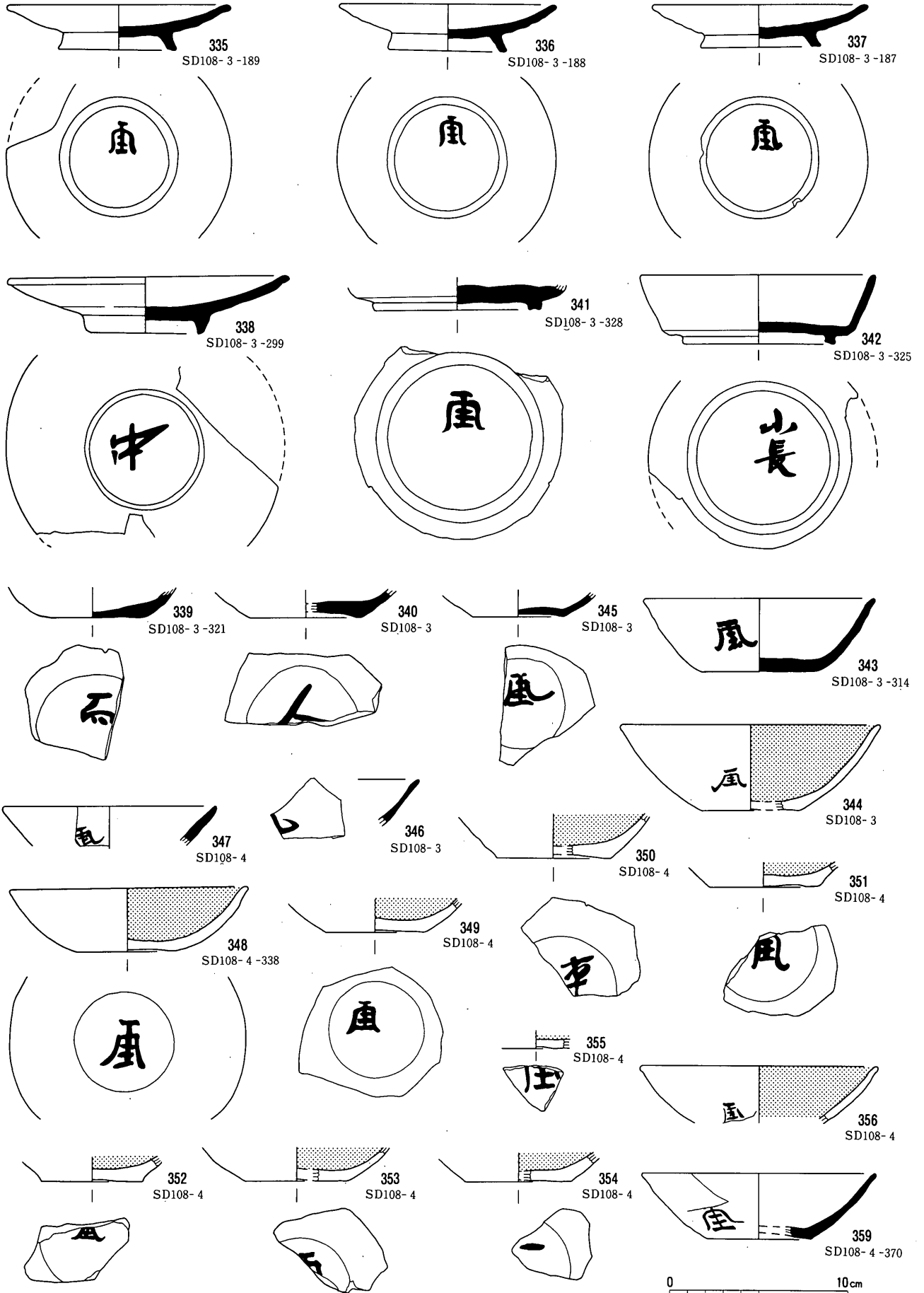

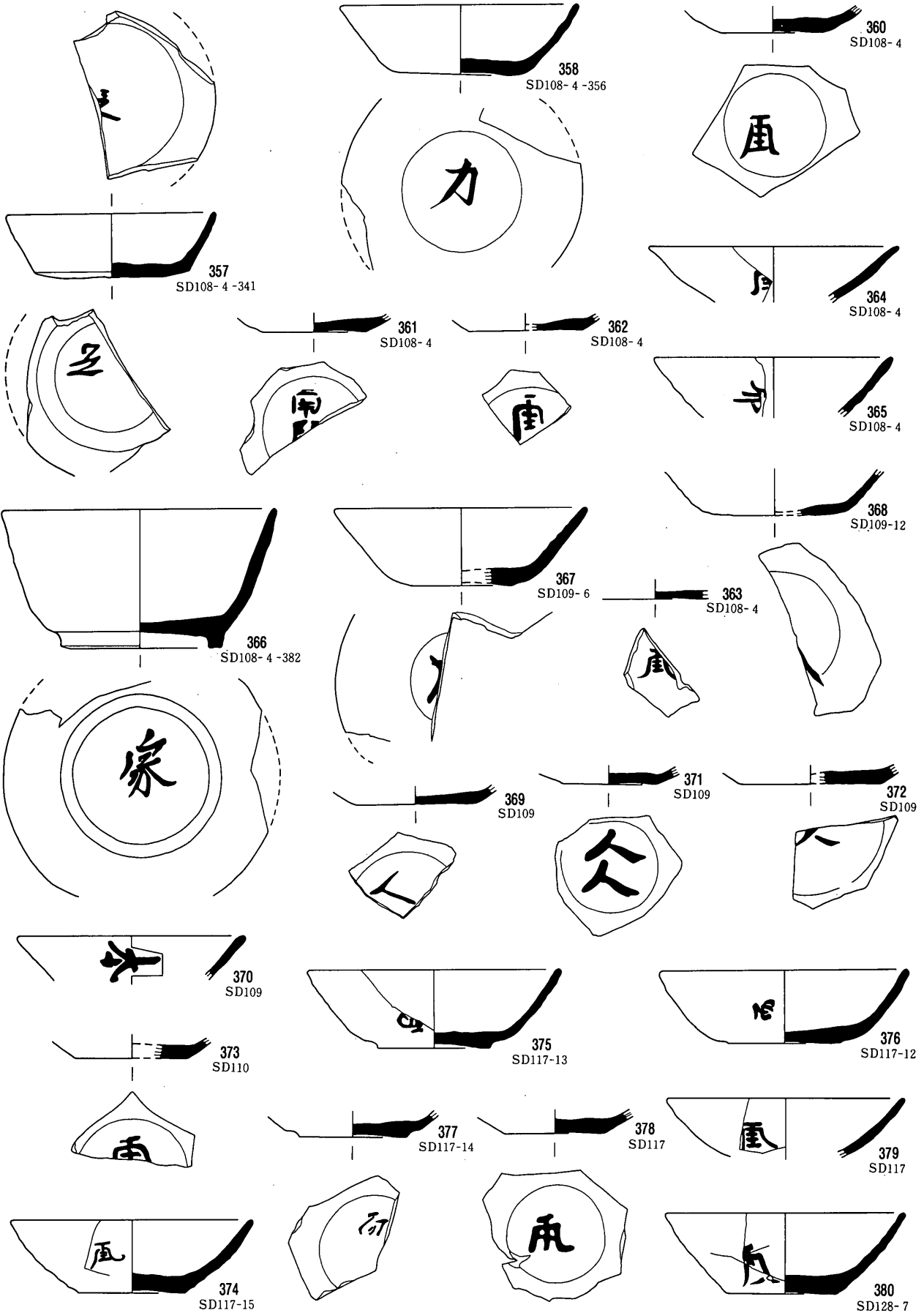

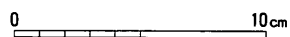
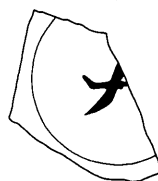
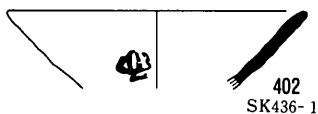
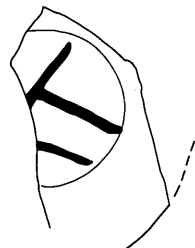
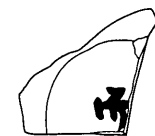
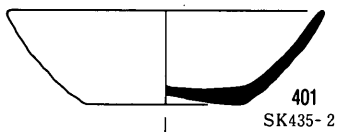
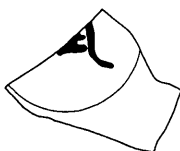
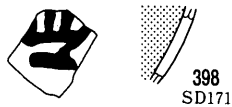
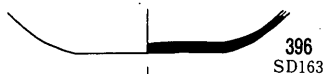
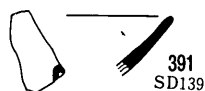
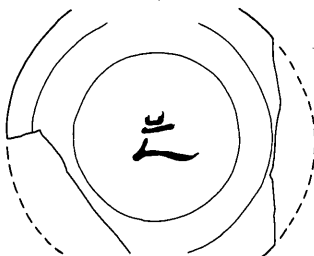
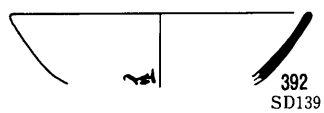
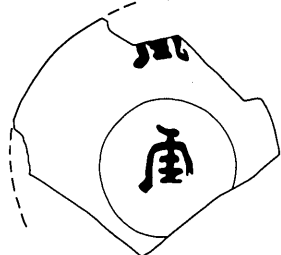
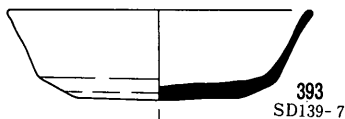
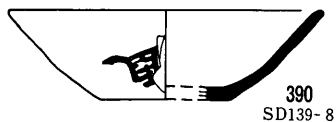
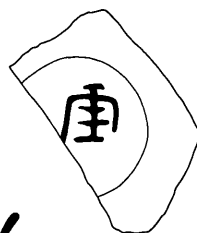
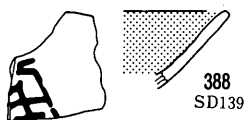
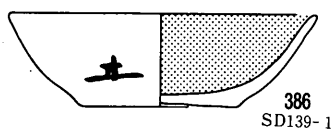
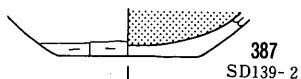
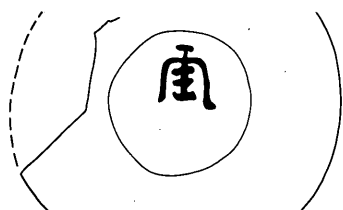
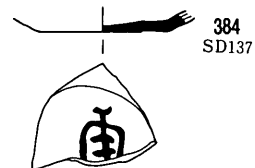
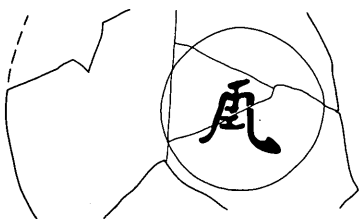
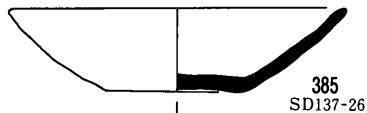
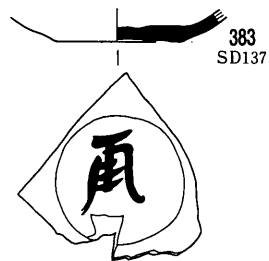
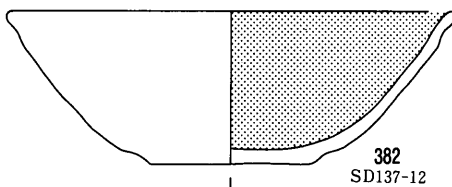
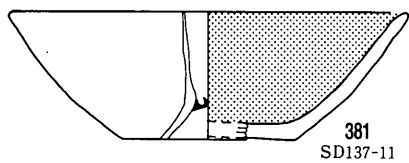



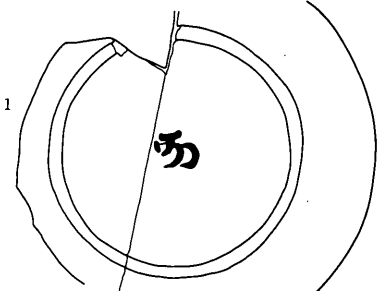
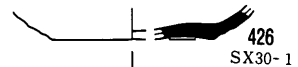
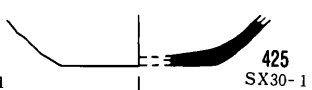
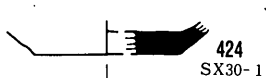
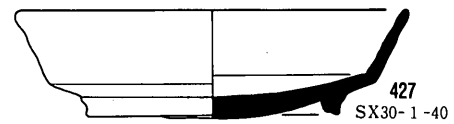
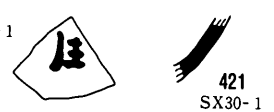
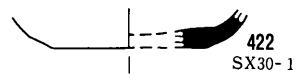
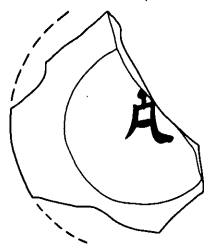
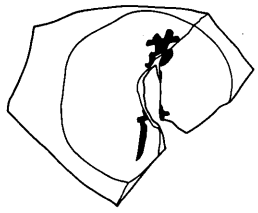
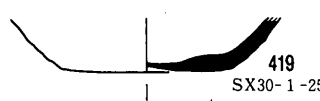
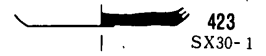
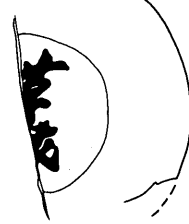
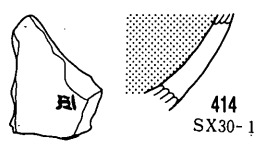
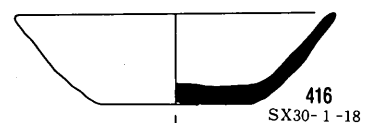
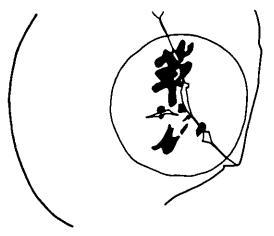
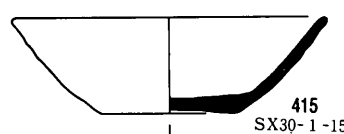
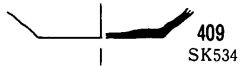
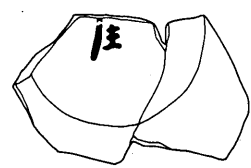
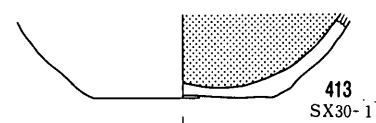
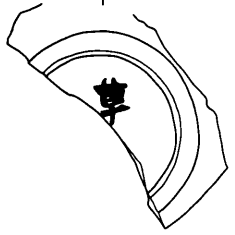
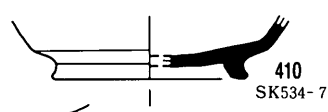
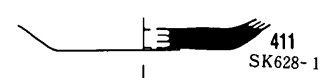
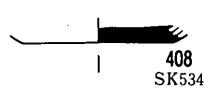
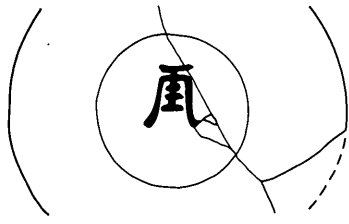
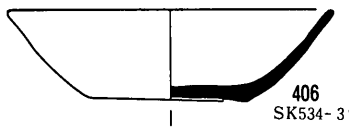

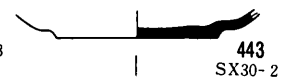
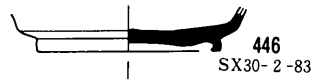
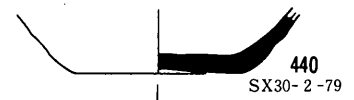
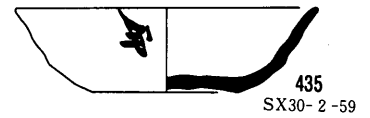
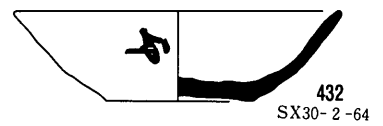
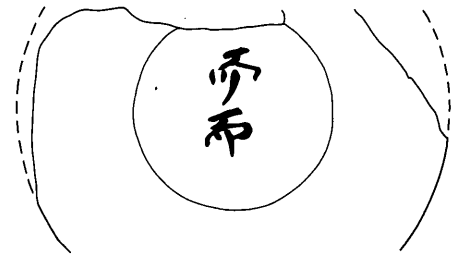
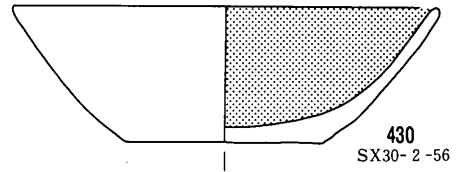
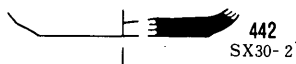
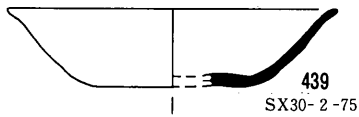
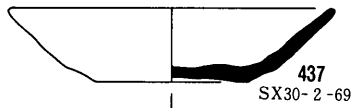
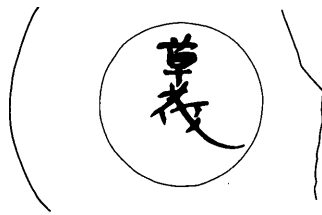
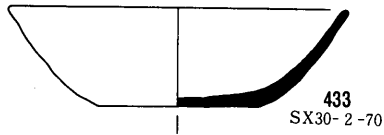
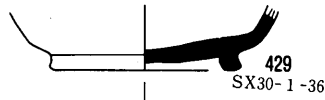
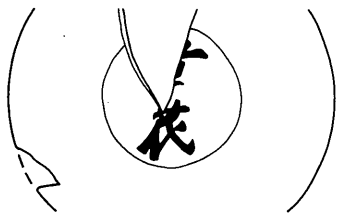
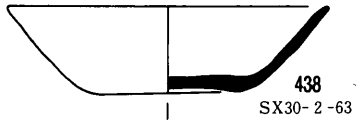
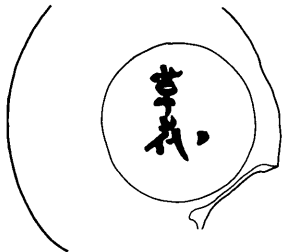
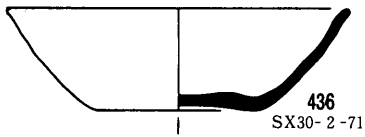
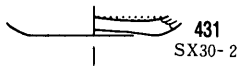
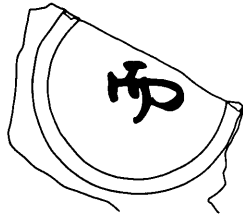
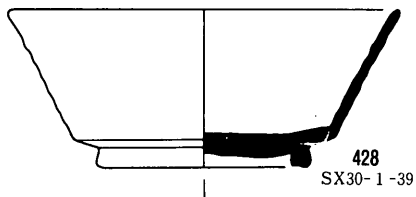

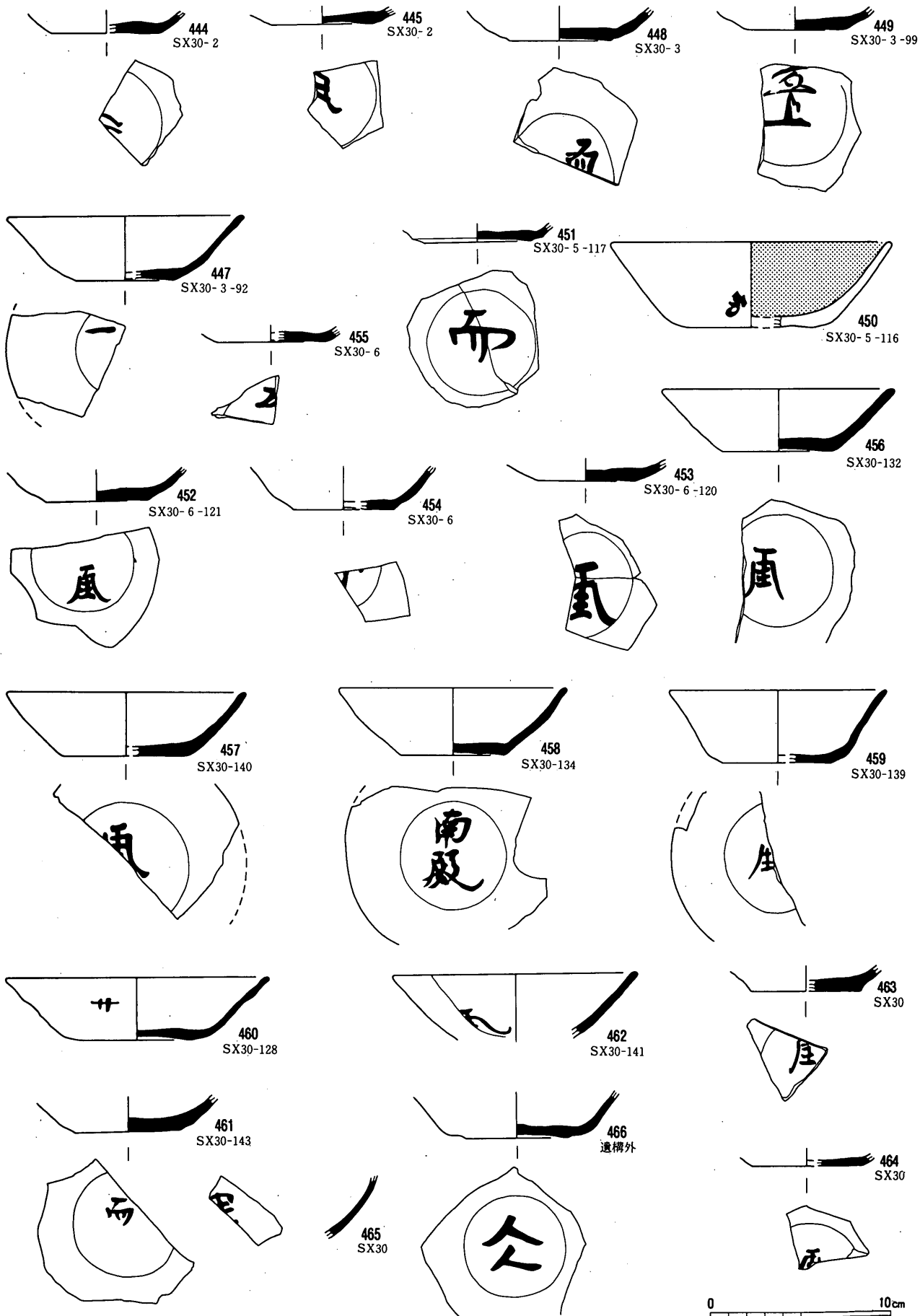

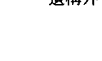
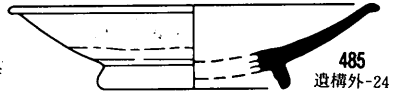
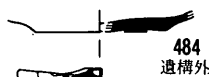
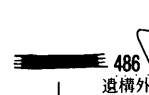
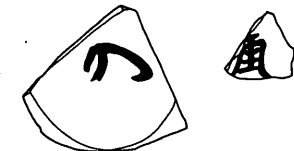
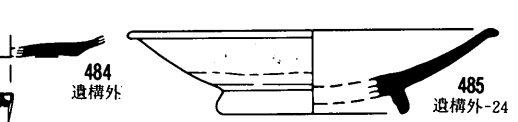
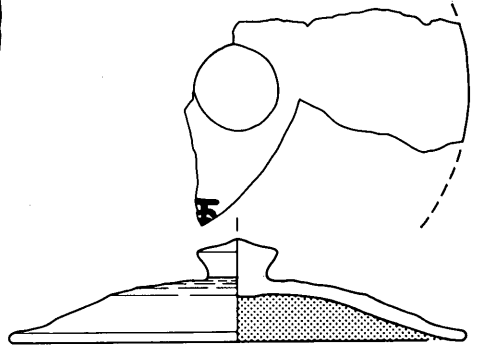
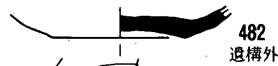
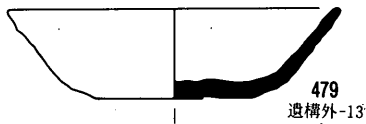
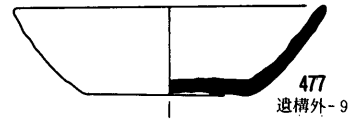
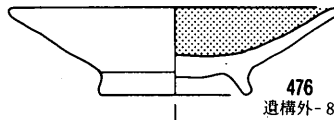
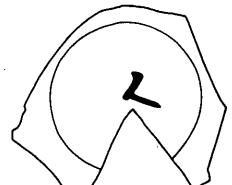
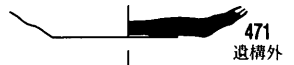
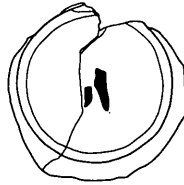
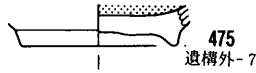
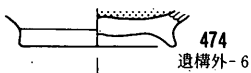
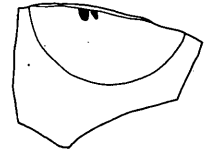
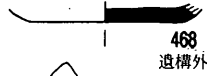
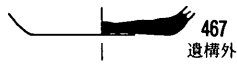
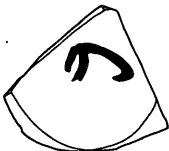
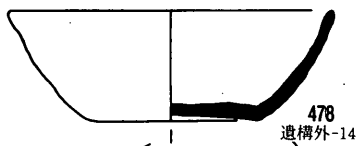
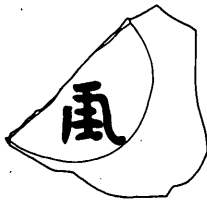
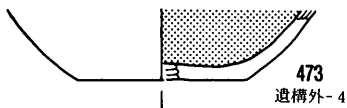
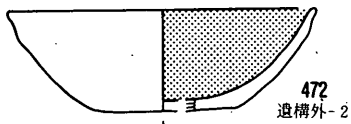
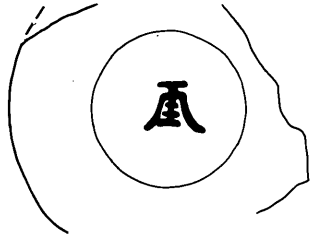
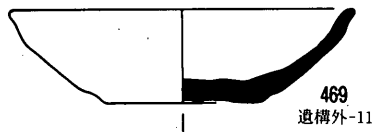

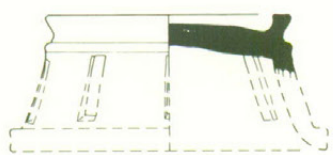

493  
SB127



498  
遺構外



495  
区画溝Ⅲ

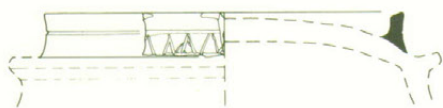

497  
溝址群Ⅲ

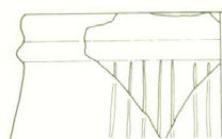

496  
区画溝Ⅲ

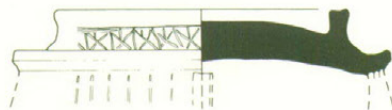

494  
区画溝Ⅰ



499  
SB23-6



500  
SB92

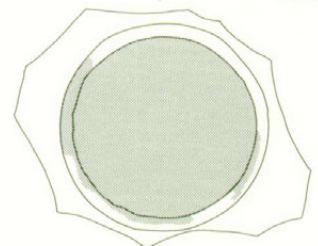
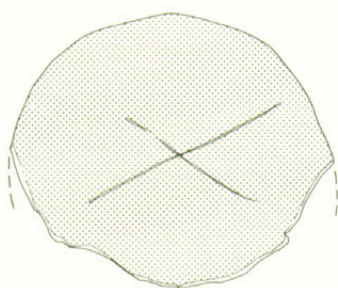

491  
SK551-2

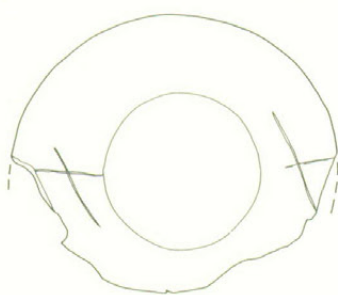
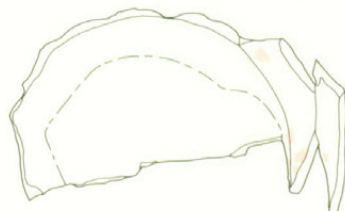

504  
SD117-25



501  
SB92-60

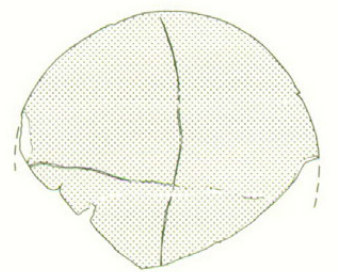

502  
SB123

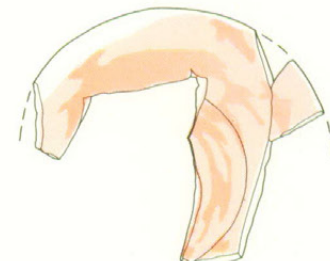

492  
SB133-2



503  
SB126-11



505  
SX30-3-98



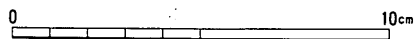
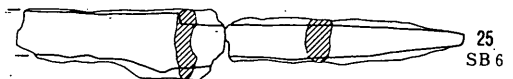
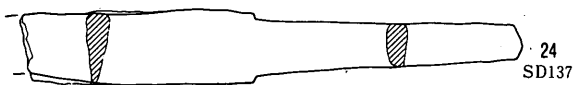
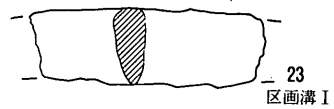
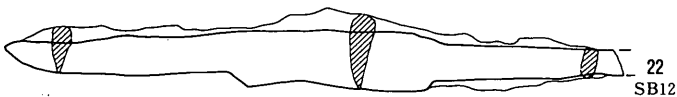
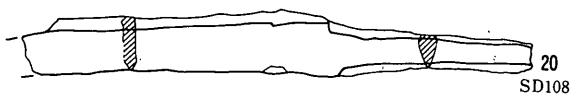
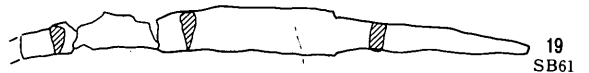
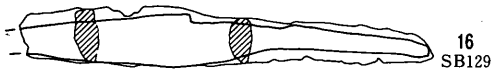
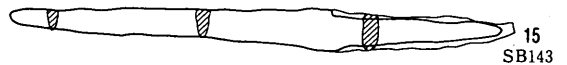
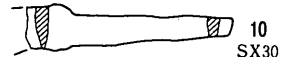
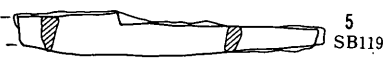
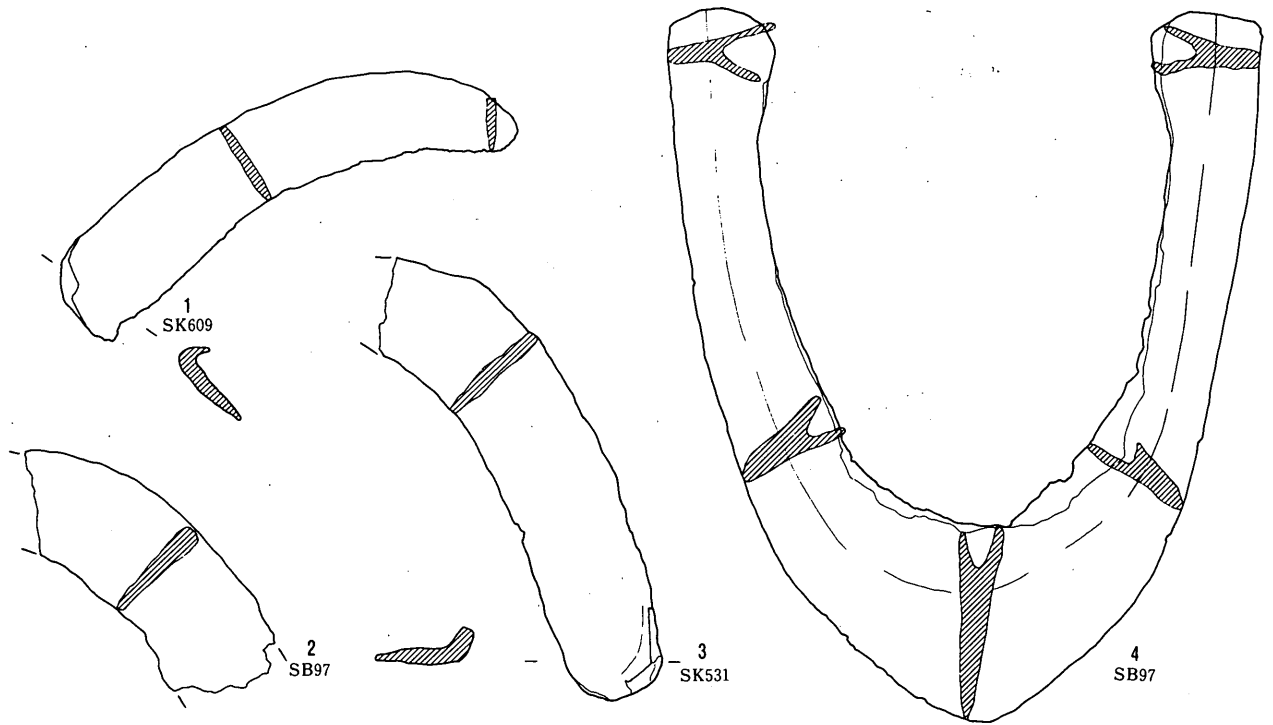

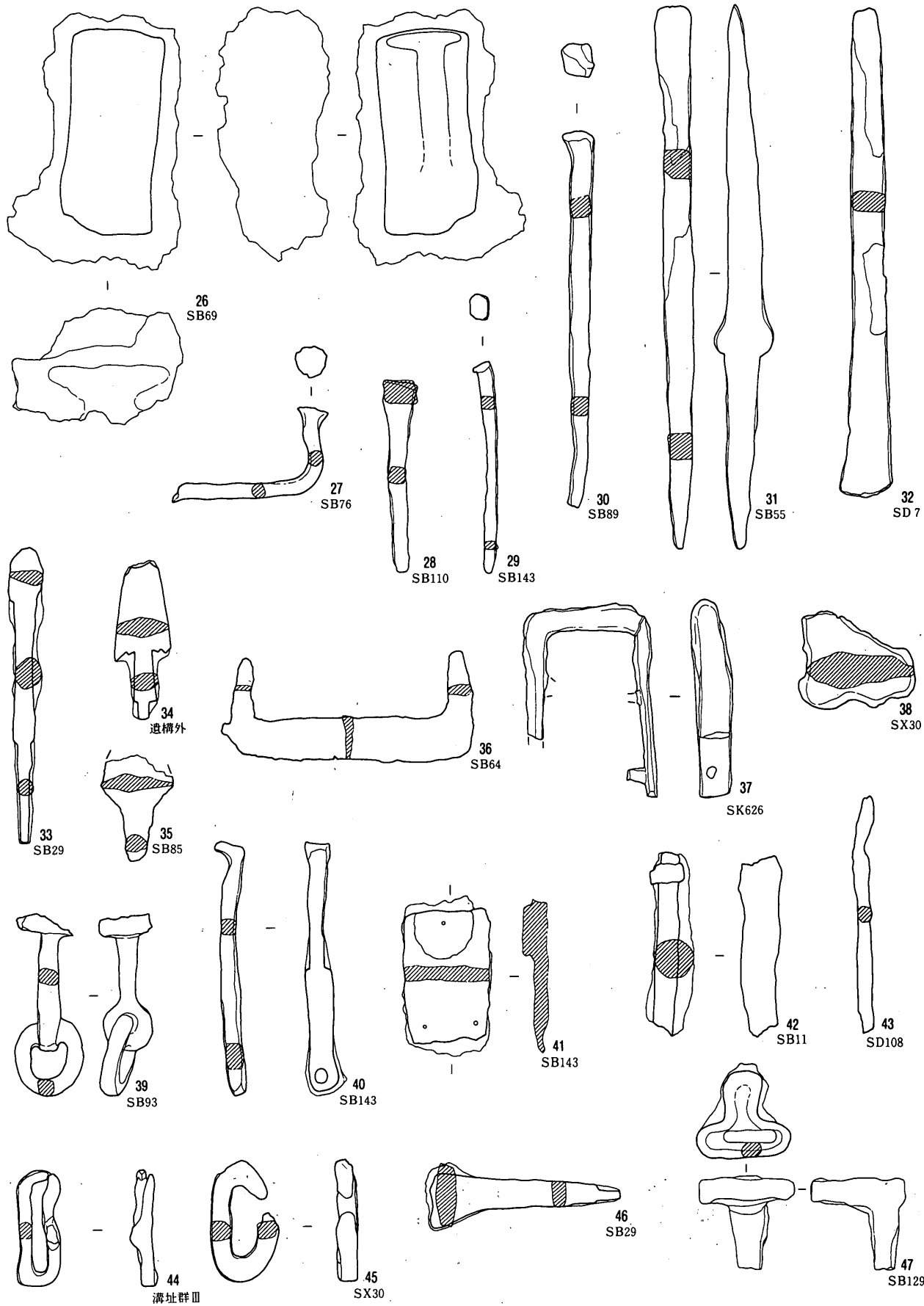

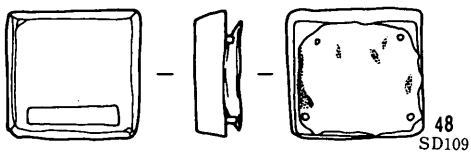

48  
SD109

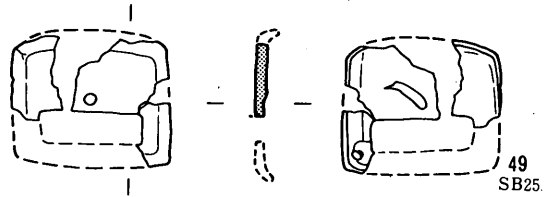

49  
SB25

鍍金部分

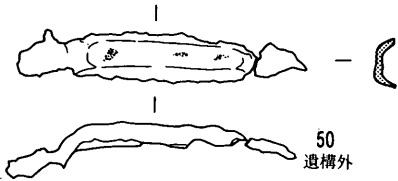

50  
遺構外

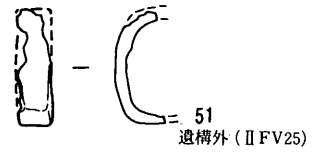

51  
遺構外 (II FV25)

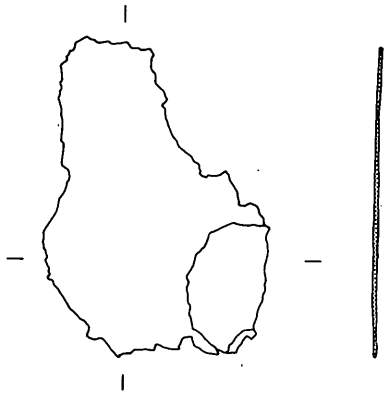

52  
区画溝 I

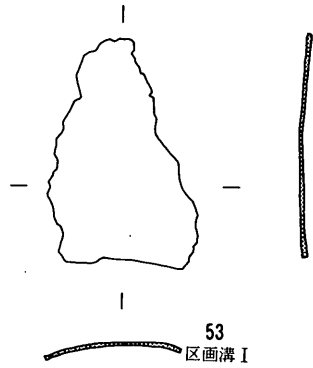

53  
区画溝 I

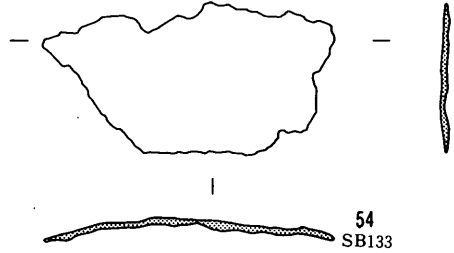

54  
SB133

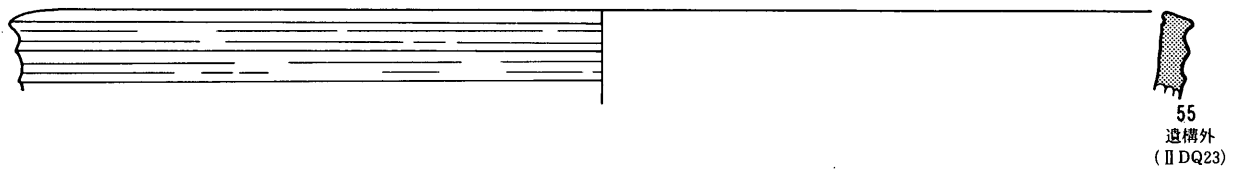

55  
遺構外  
(II DQ23)

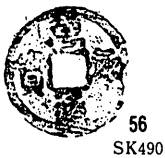

56  
SK490

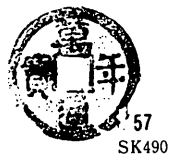

57  
SK490



58  
SK490

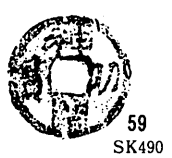

59  
SK490



60  
SK554

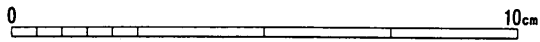



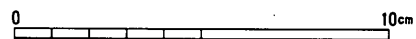
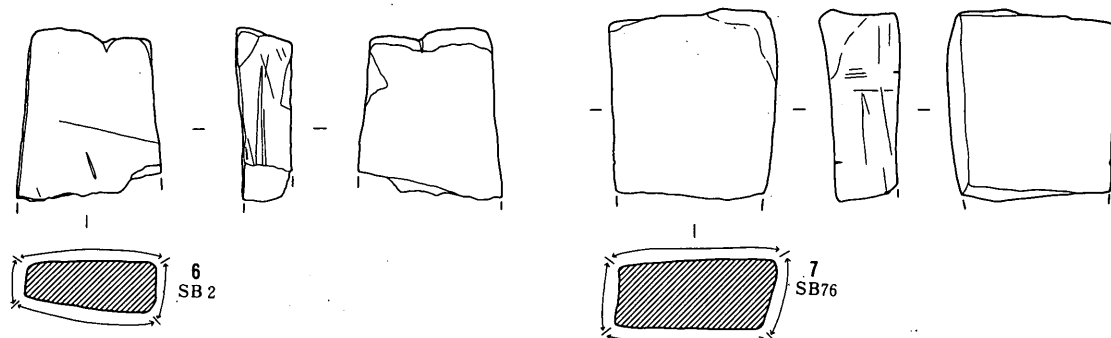
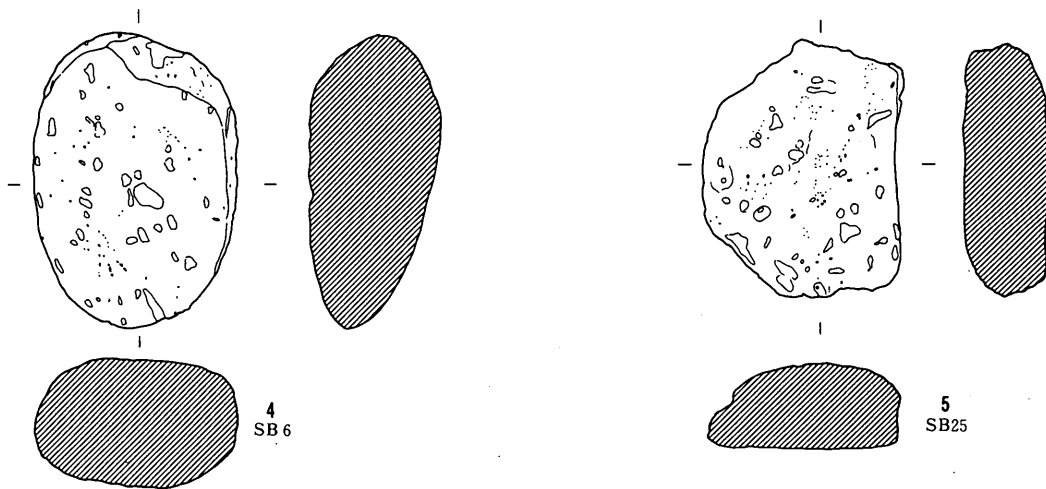
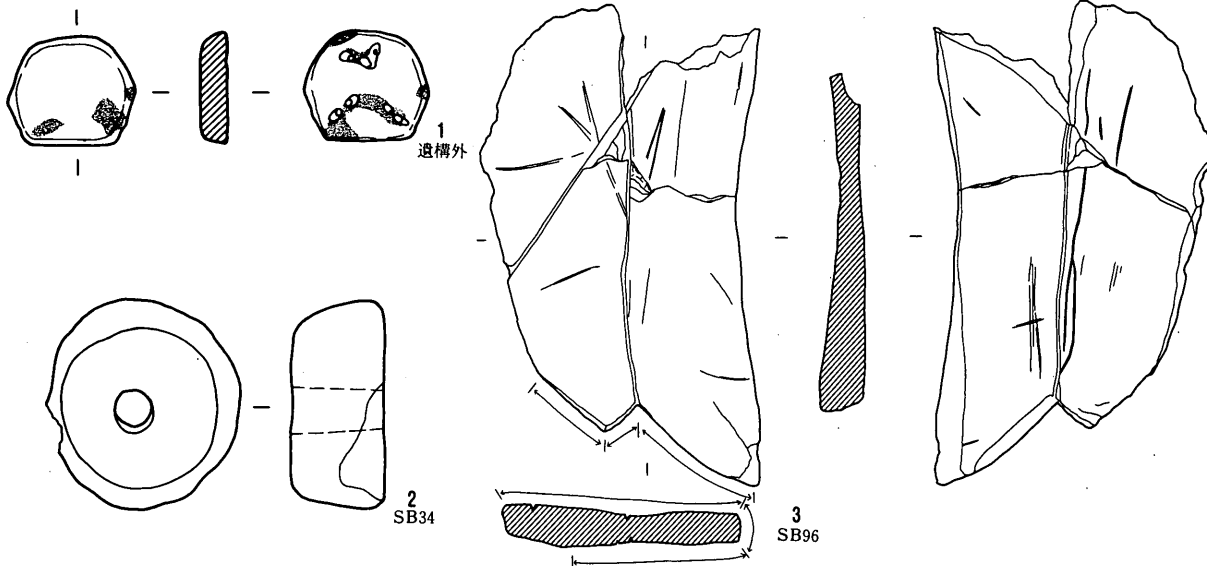

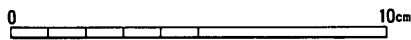
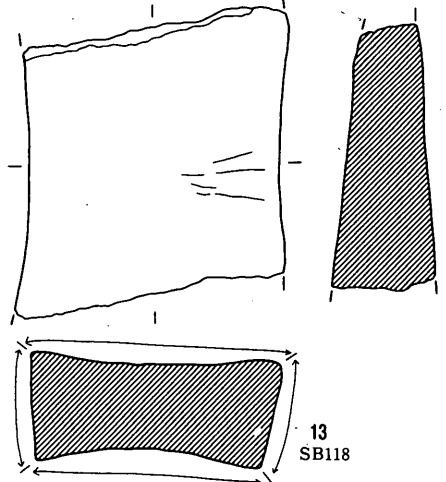
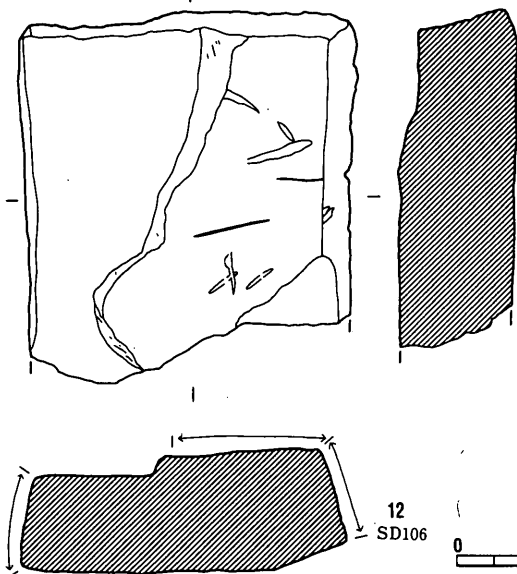
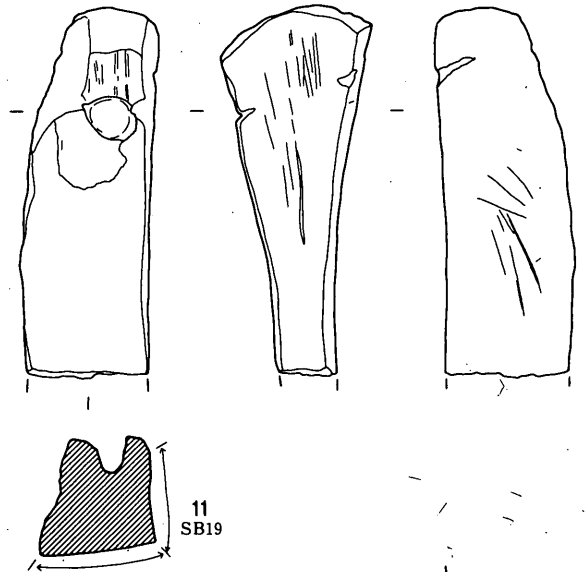
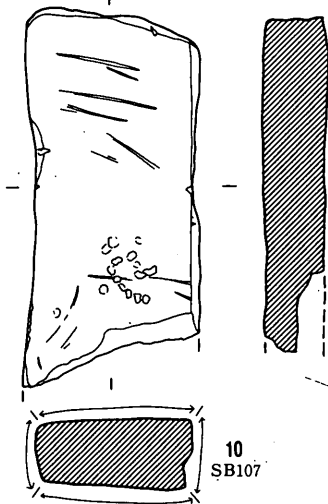
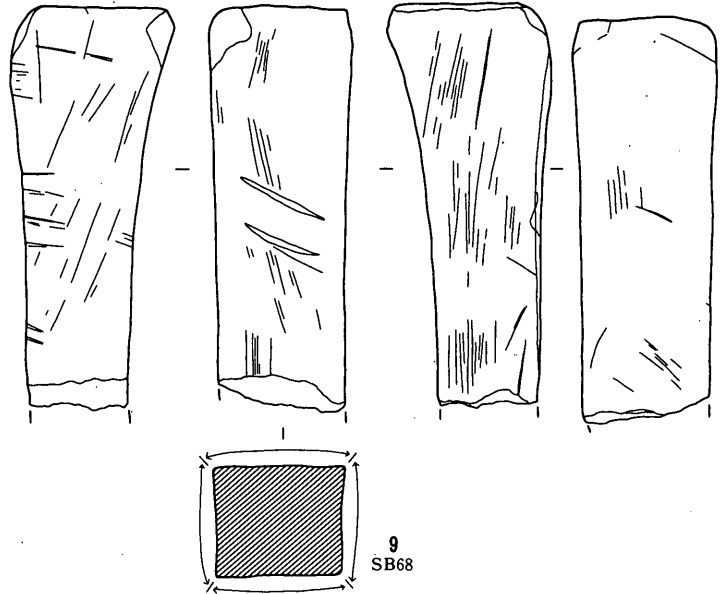
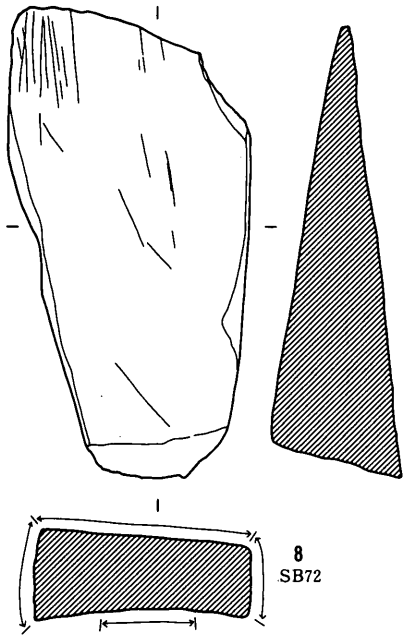

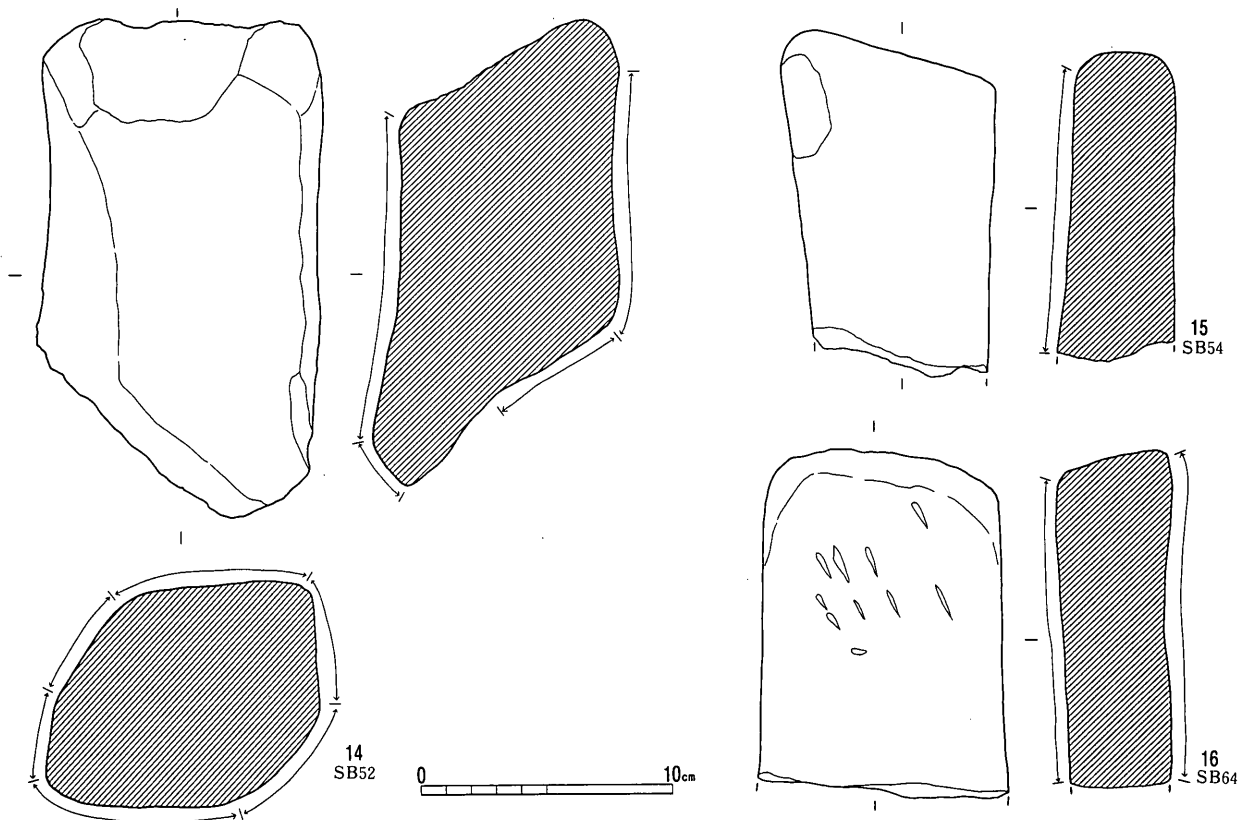

土製品

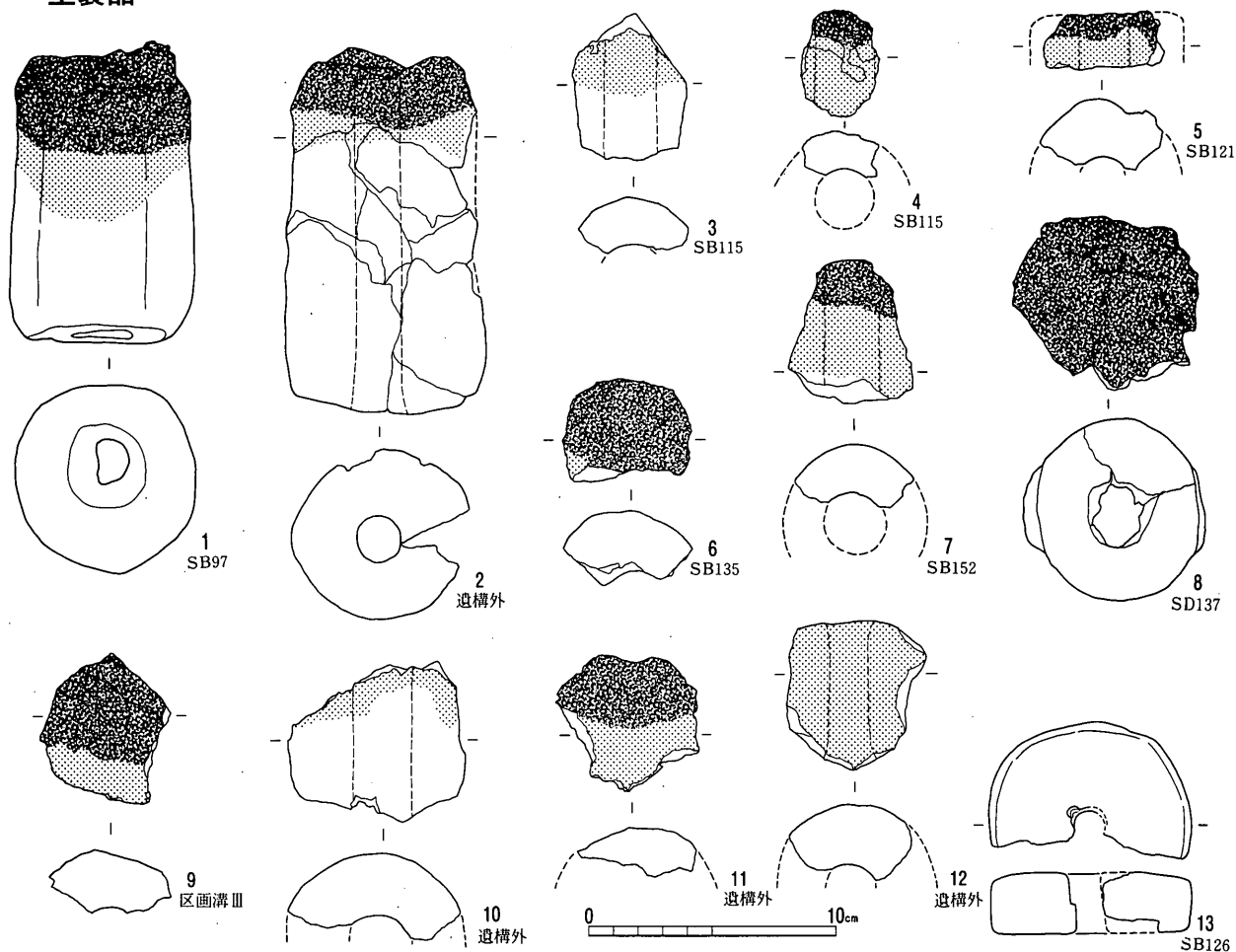

写 真 图 版

(P L)



1. 下神遺跡
2. 神戸遺跡
3. 上二子遺跡
4. 中二子遺跡
5. 南栗遺跡
6. 北栗遺跡
7. 三の宮遺跡
8. 下二子遺跡
9. 大久保工業団地遺跡
10. 南荒井遺跡
11. 川西遺跡
12. 三間沢川左岸遺跡
13. 太子堂遺跡
14. 和田遺跡
15. 和田山の神遺跡
16. 和田町遺跡
17. 梶海渡遺跡
18. 高綱中学校遺跡



遺跡遠景  
(北西上空から)



遺跡近景  
(北東から)



南部Ⅲ地区  
航空写真  
(北上空から)



南部Ⅰ地区  
SB45・46・47・49  
(東から)



左 南部Ⅰ地区  
SB40・ST15・16(南から)  
右 南部Ⅰ地区  
SB38・39・40(北から)



南部Ⅰ地区  
建物址群(ST20・21・22・23)  
(東から)



古代遺構

PL5

南部Ⅱ地区  
SB33・51～60  
(北から)



南部Ⅱ地区  
SB60・61  
(西から)



南部Ⅱ地区  
SB52～69  
(西から)



PL6



古代遺構

南部Ⅲ地区

ST 6・8  
SB26~29  
(西から)



南部Ⅲ地区

SB29・27・26  
(南から)



南部Ⅲ地区

SB 9~6  
(西から)

古代遺構

PL7

北部Ⅰ地区  
(北上空から)



北部Ⅰ・Ⅱ地区  
(東上空から)

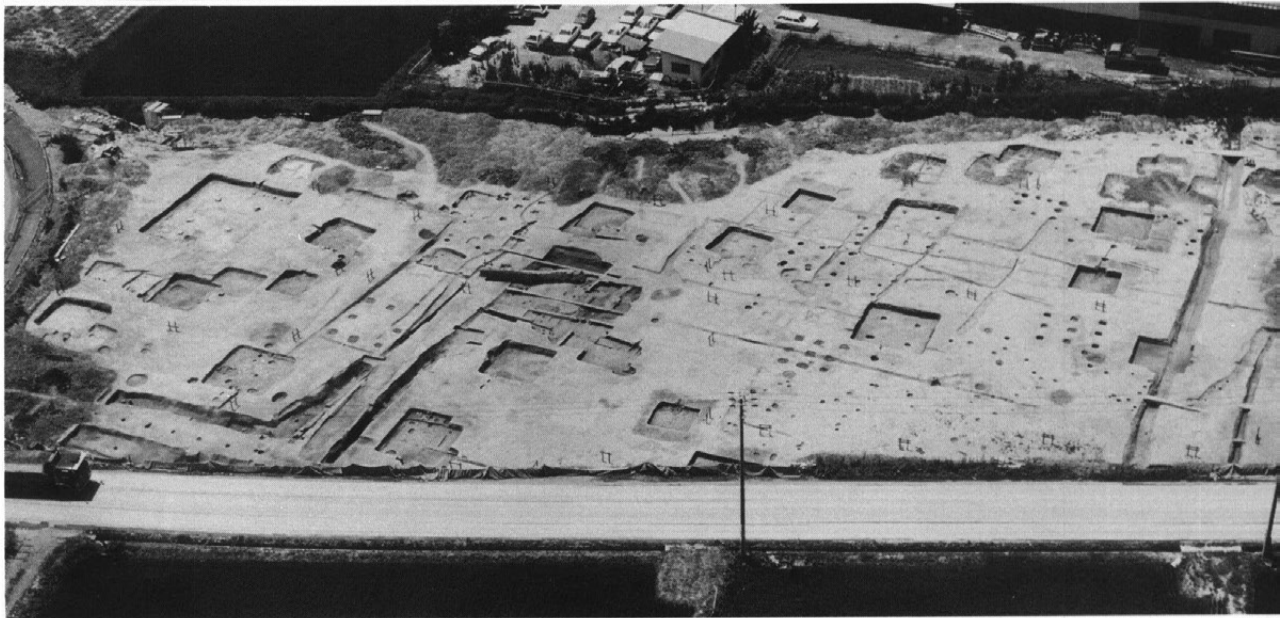

北部Ⅰ地区  
(南から)



PL8



古代遺構

北部Ⅰ地区

区画溝Ⅰ・Ⅱ  
(南上空から)



北部Ⅱ地区

(西から)



北部Ⅲ地区

(北東上空から)

古代遺構

PL9

北部Ⅲ地区

SD108  
SB102~106  
(西から)



北部Ⅲ地区

SB118~121  
(南から)



北部Ⅲ地区

ST115  
SB34・69  
(南から)



PL10



古代遺構

SB7 完掘  
(東から)

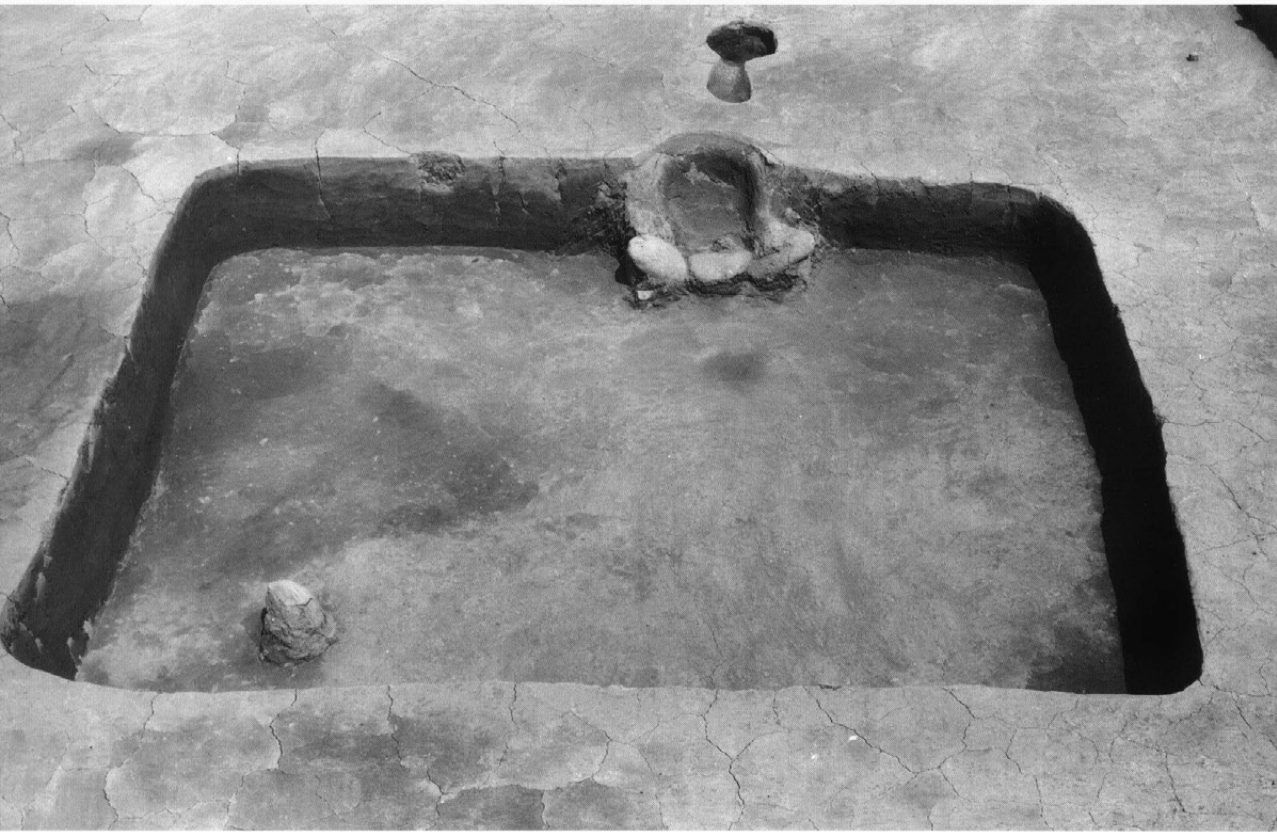

SB9 完掘  
(西から)



左 SB7 カマド  
右 SB9 カマド

古代遺構

PL11

SB12完掘  
(東から)



SB14完掘  
(西から)



左 SB14カマド  
右 同遺物出土状況  
(南から)



PL12



古代遺構

SB19完掘  
(西から)



SB20完掘  
(南から)



SB24完掘  
(北から)



SB29・27・26完掘  
(南から)



SB29完掘  
(西から)



左 SB29カマド  
遺物出土状況  
(西から)



右 SB27煙道先ピット  
遺物出土状況  
(東から)

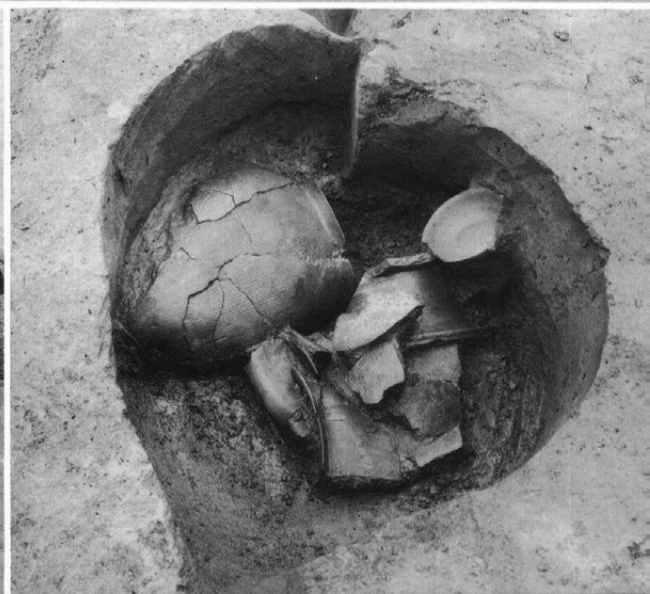

PL14

古代遺構



SB38完掘  
(西から)

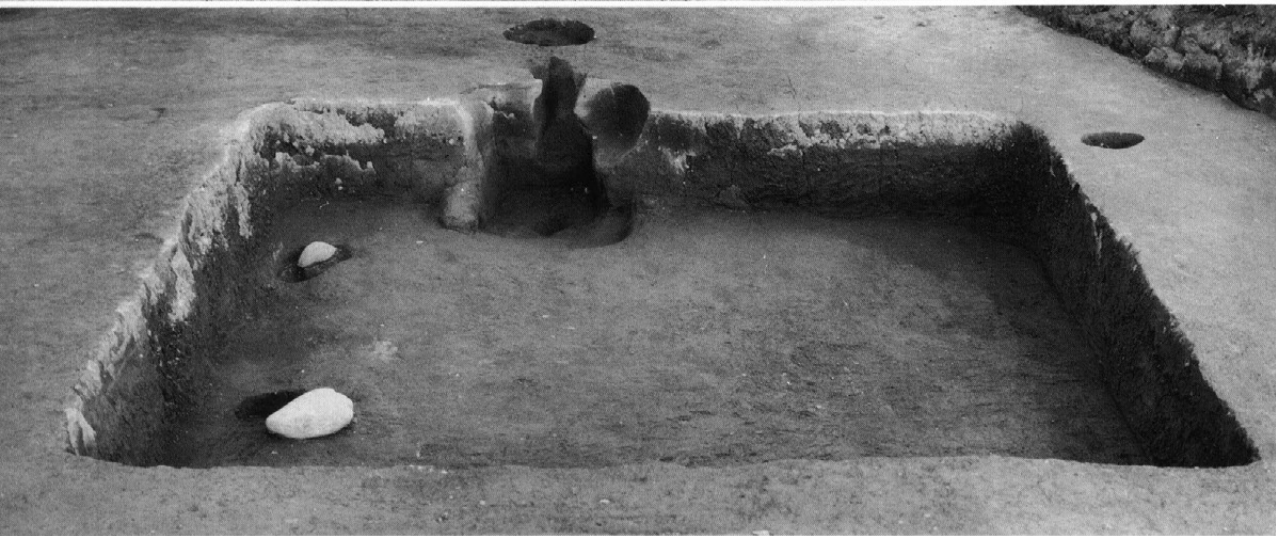

SB39完掘  
(南より)



左 SB38カマド  
右 SB39カマド

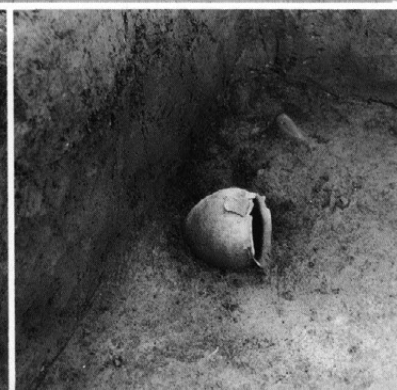

左 SB38ピット  
(カマド左)  
中 SB38ピット  
(カマド右)  
右 SB39  
小型甕出土状況

SB52完掘  
(西から)



左 SB52カマド  
右 同カマド  
遺物出土状況

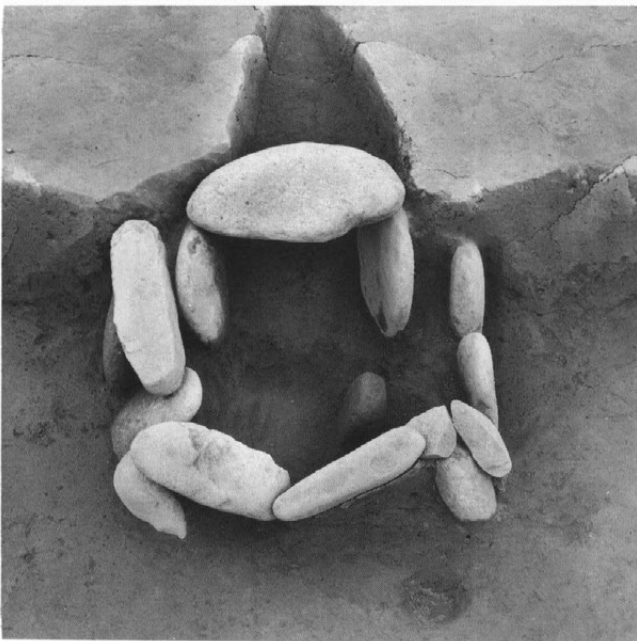

SB53完掘  
(西から)



PL16

古代遺構

SB64完掘  
(西から)



左 SB64カマド遺物  
右 SB65土師器甕B  
出土状況



SB65遺物出土状況



SB68完掘  
(南から)



SB72完掘  
(西から)



SB72完掘  
(南から)



左 SB72カマド  
右 SB72 砥石出土状況

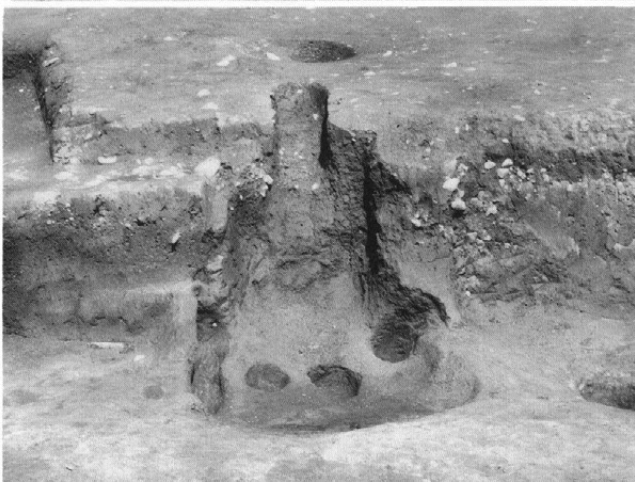

PL18



古代遺構

SB74・76・77・78完掘

(西から)



左 SB76カマド

右 SB77カマド

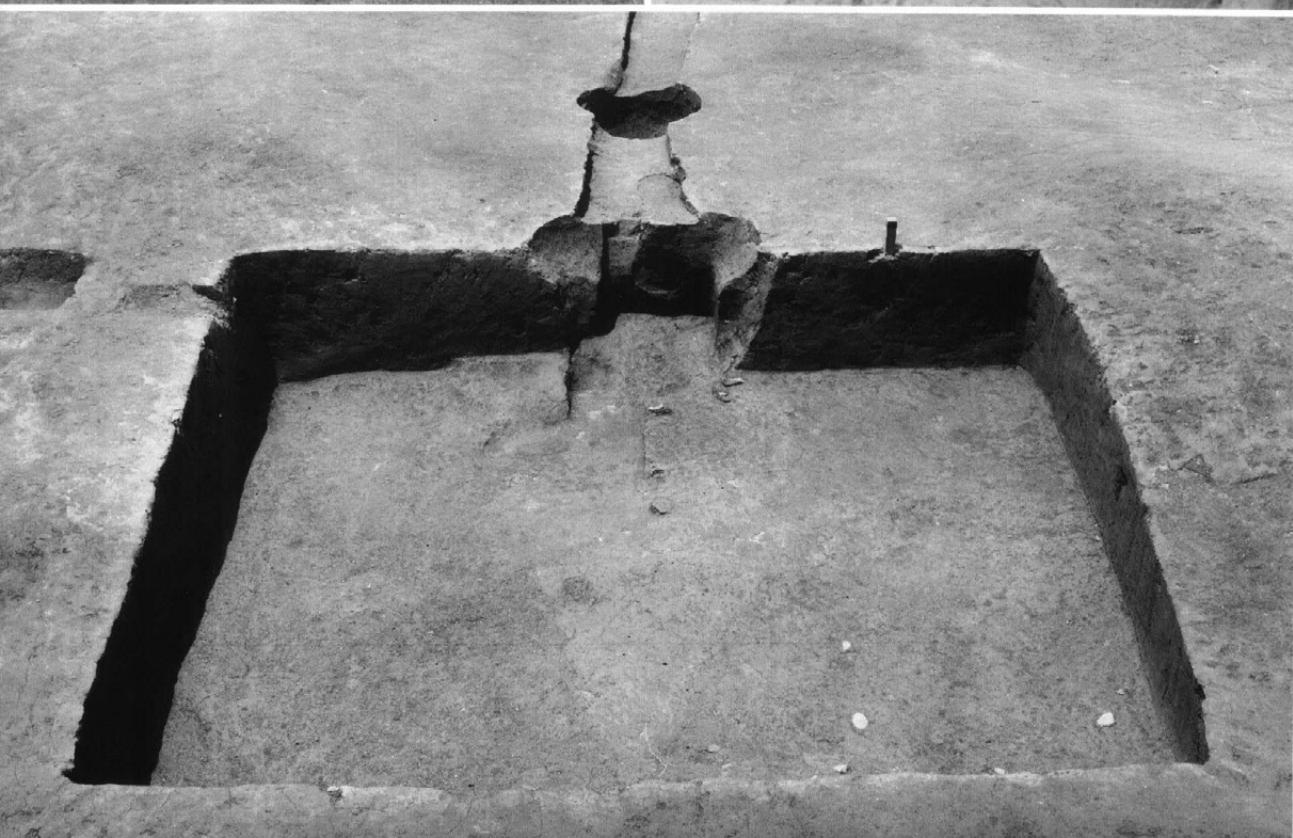

SB83完掘

(東から)

古代遺構

PL19

SB84完掘  
(西から)



左 同遺物出土状況

右 同カマド遺物出土状況



SB85完掘  
(西から)



同完掘  
(南から)



SB88完掘

(西から)



左 SB88カマド完掘  
右 同遺物出土状況

SB89完掘

(東から)





SB92完掘  
(西から)



SB92床面遺物  
(西から)



左 同カマド遺物  
右 同カマド完掘

