

図版215 古墳時代前期割付図48 (SK以外)

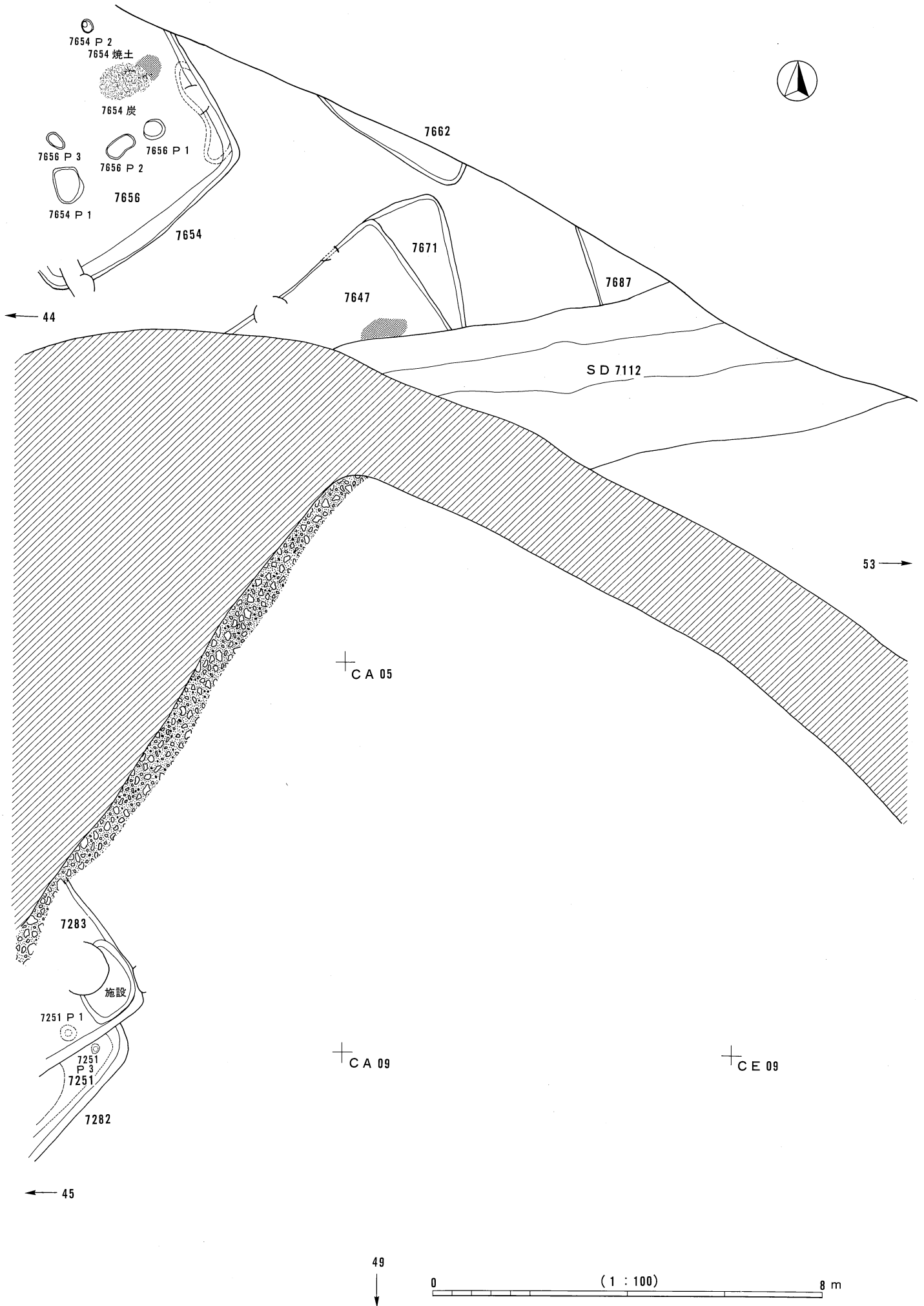

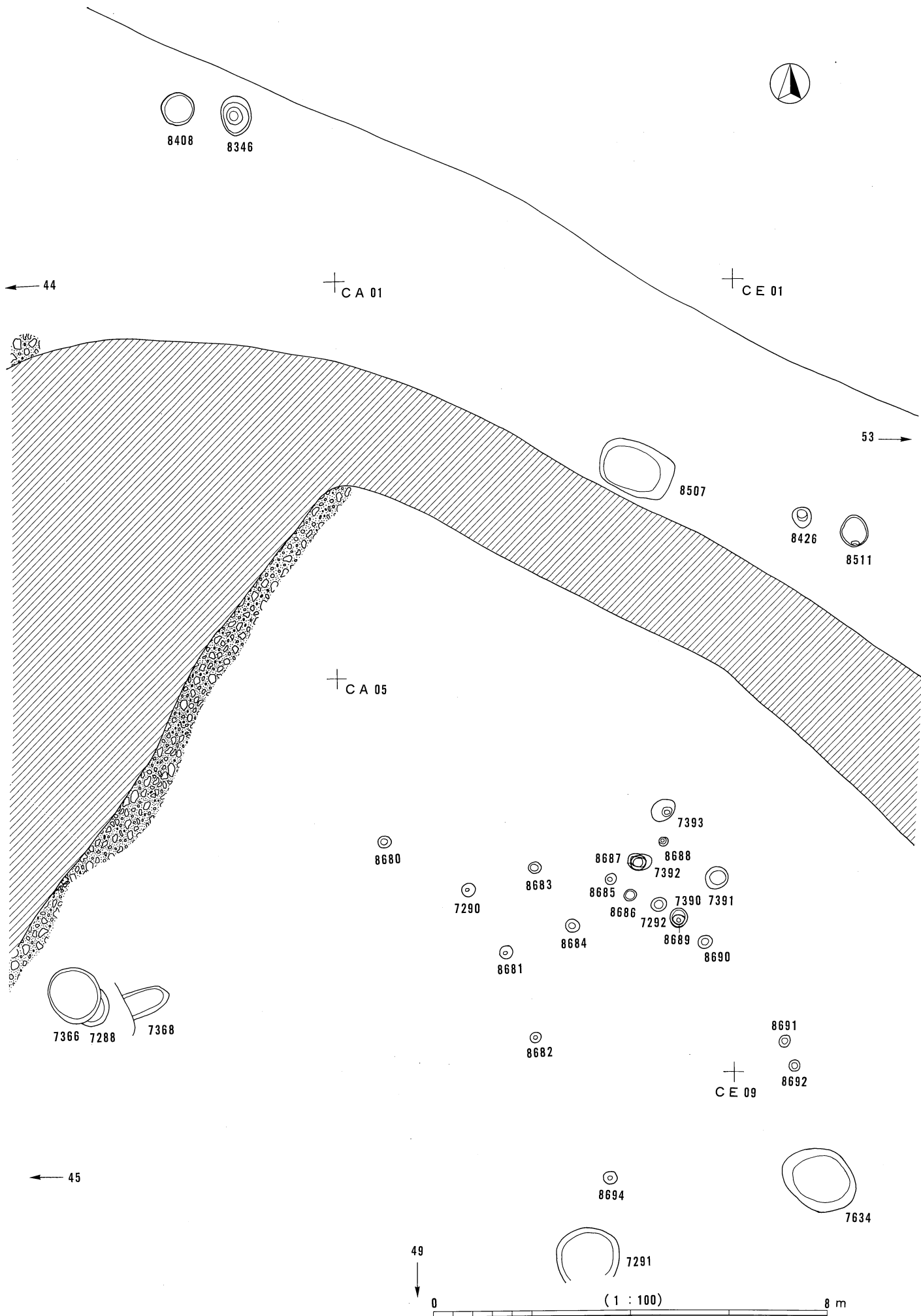

図版217 古墳時代前期割付図49 (SK以外)

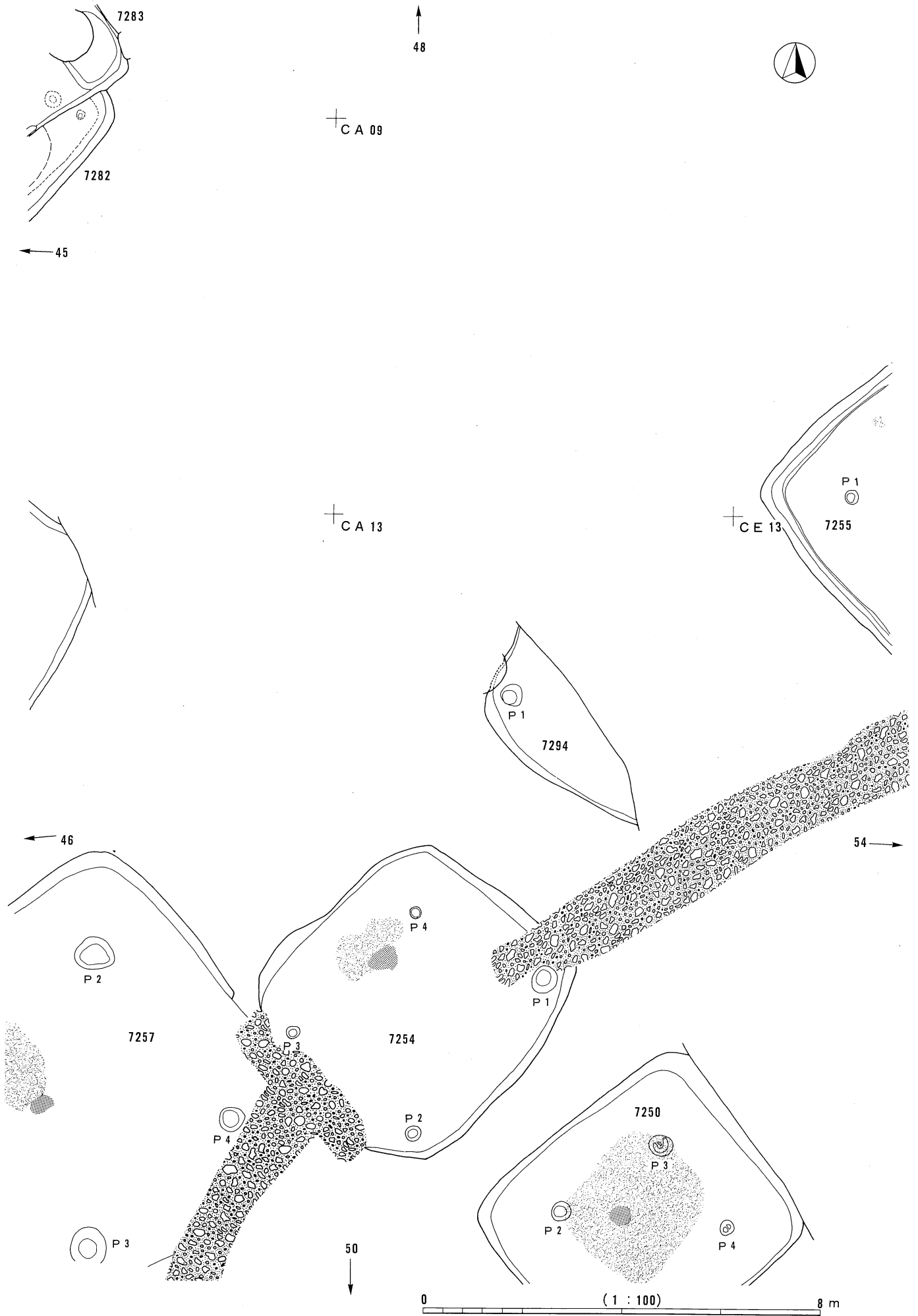

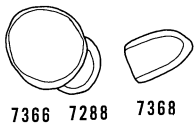

48 ↑

8682



8691
8692

8694

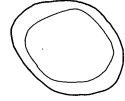

7364

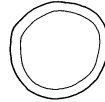

7291

8700

8696
8697
8699

8695

8698



8663

+ CA 13

+ CE 13

← 45

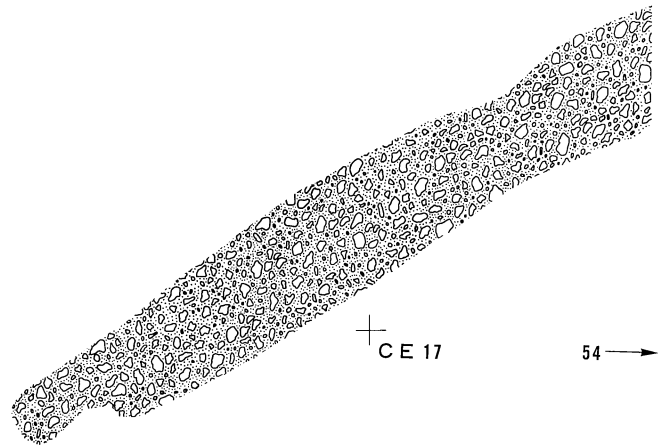

+ CE 17

54 →

← 46

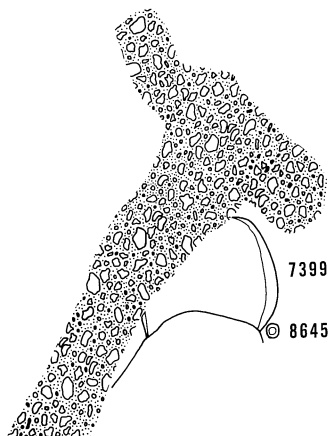

7399

8645

50 ↓

0

(1 : 100)

8 m

図版219 古墳時代前期割付図53 (SK以外)

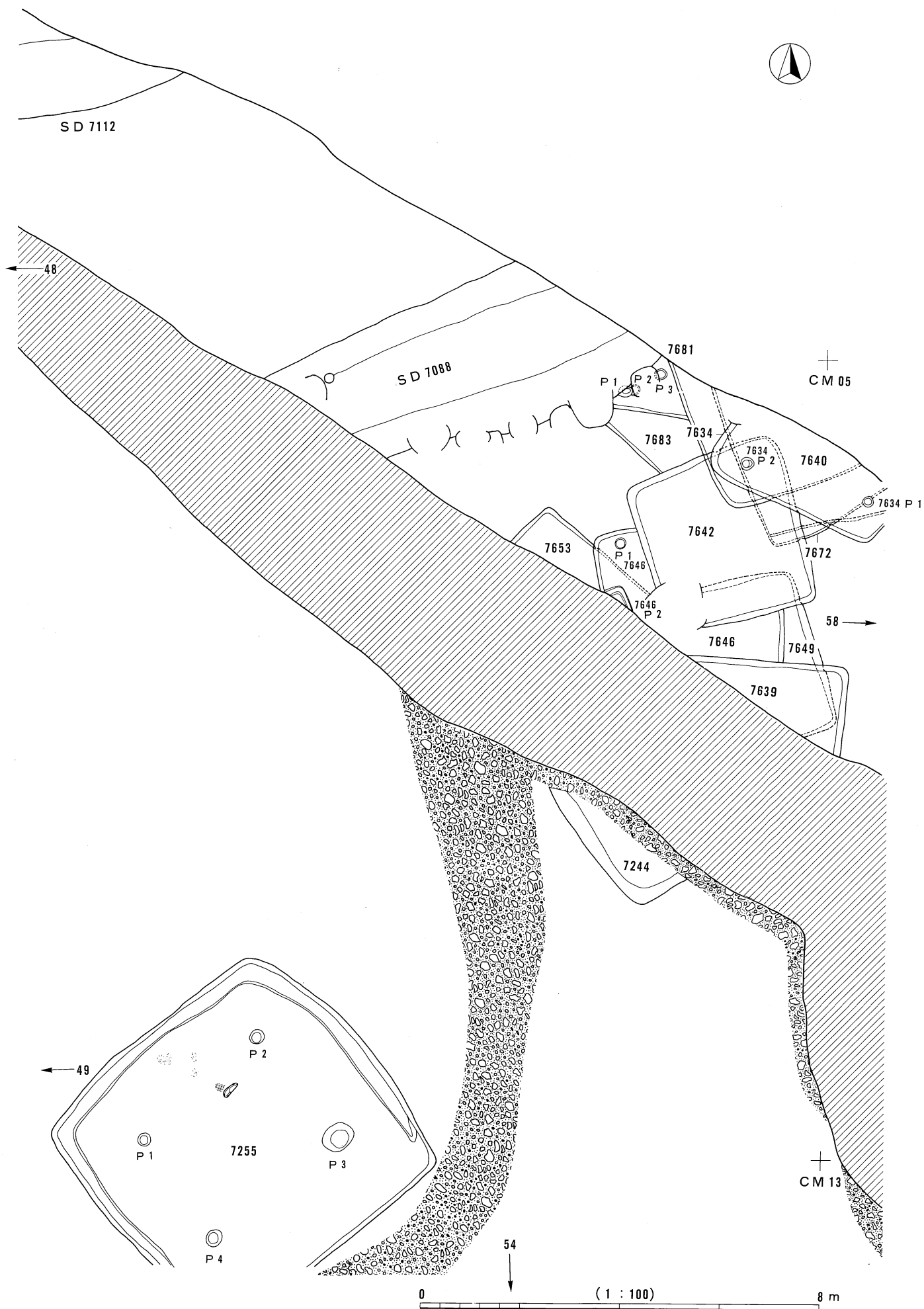

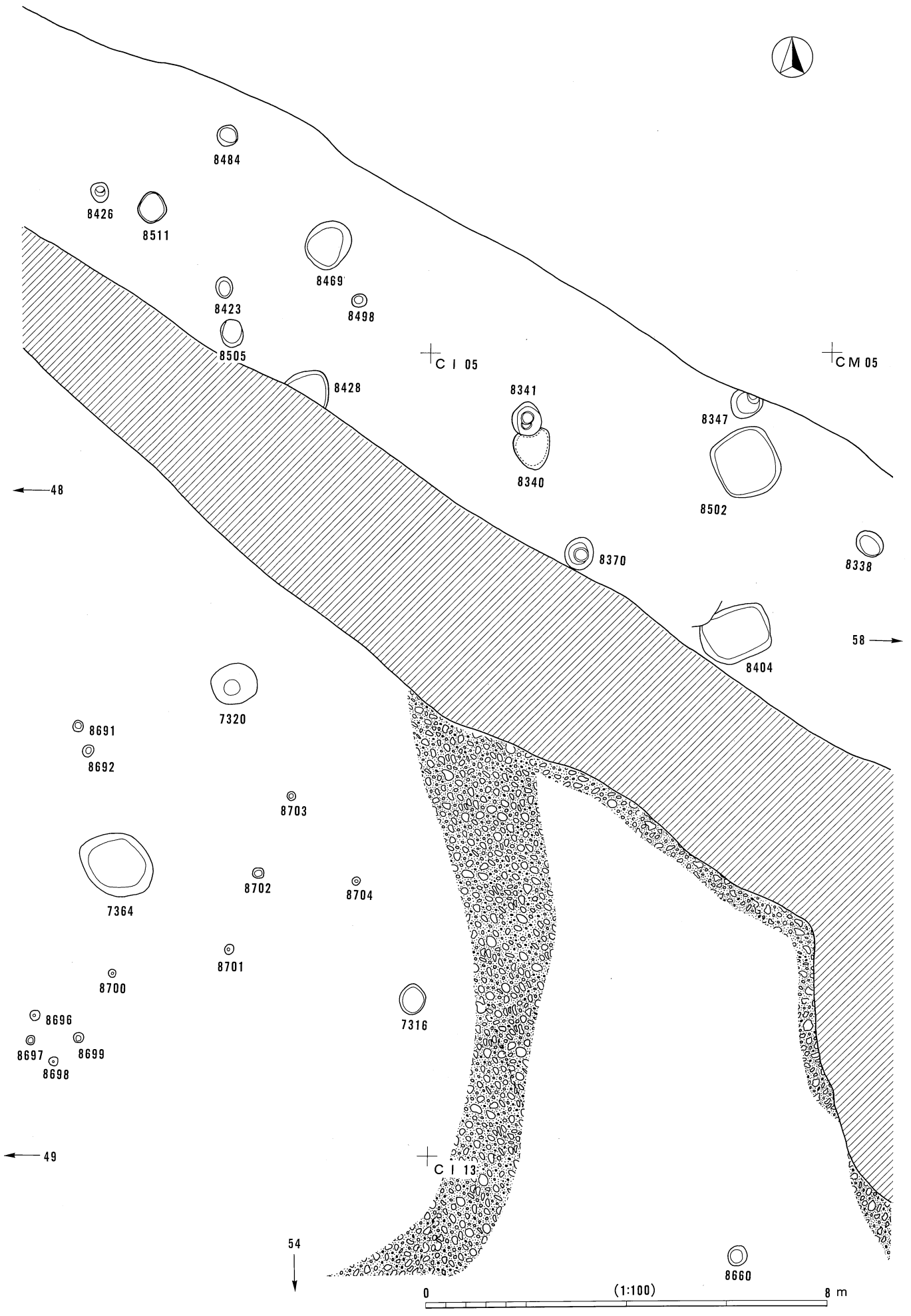

図版221 古墳時代前期割付図58 (SK以外)

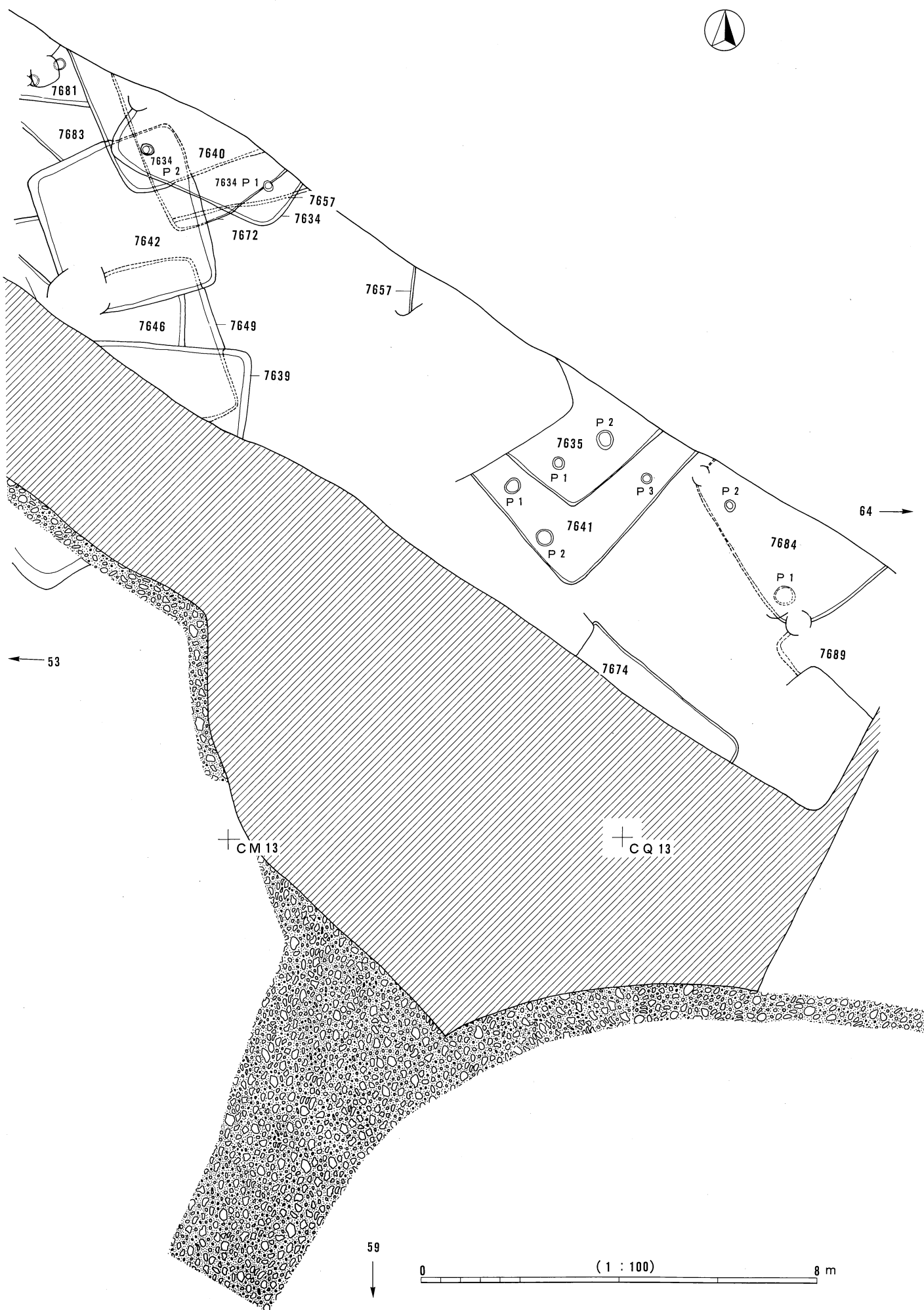

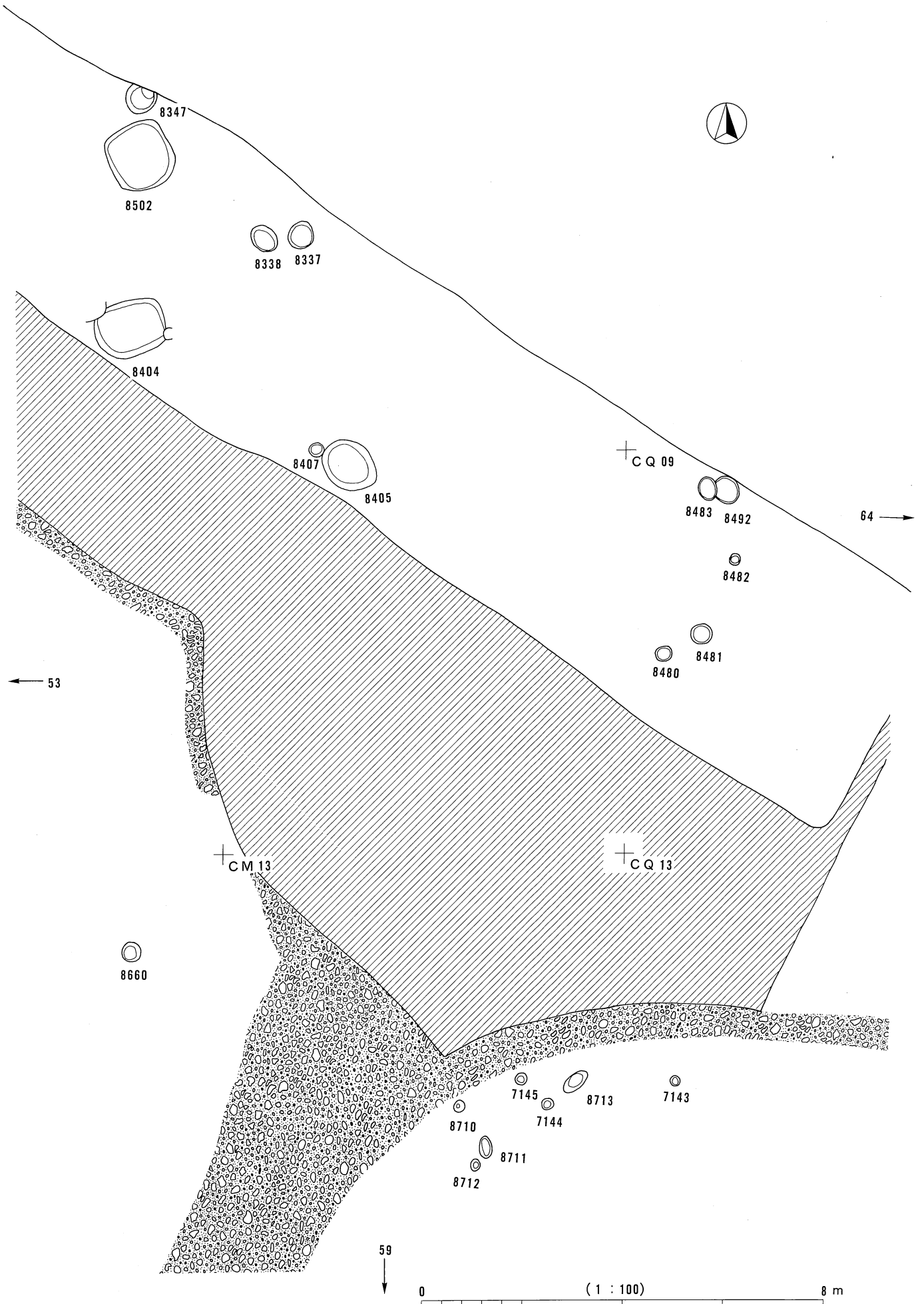

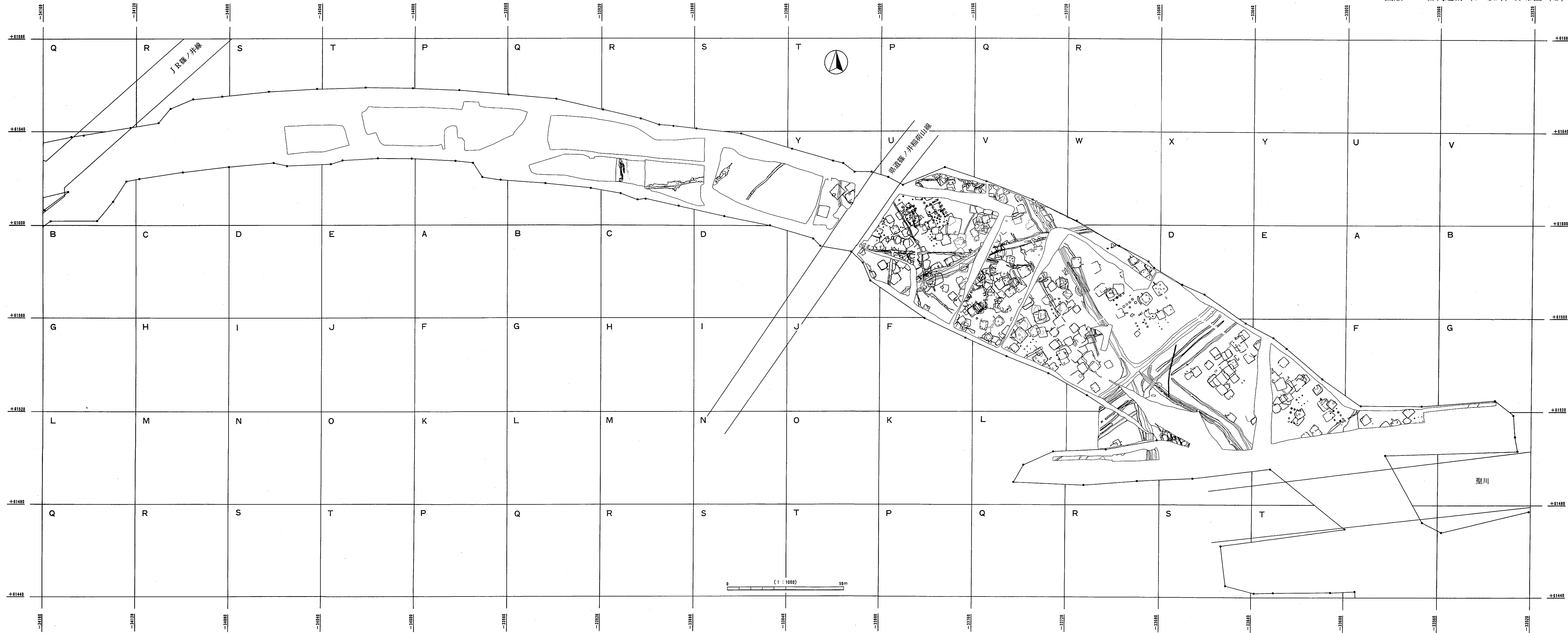

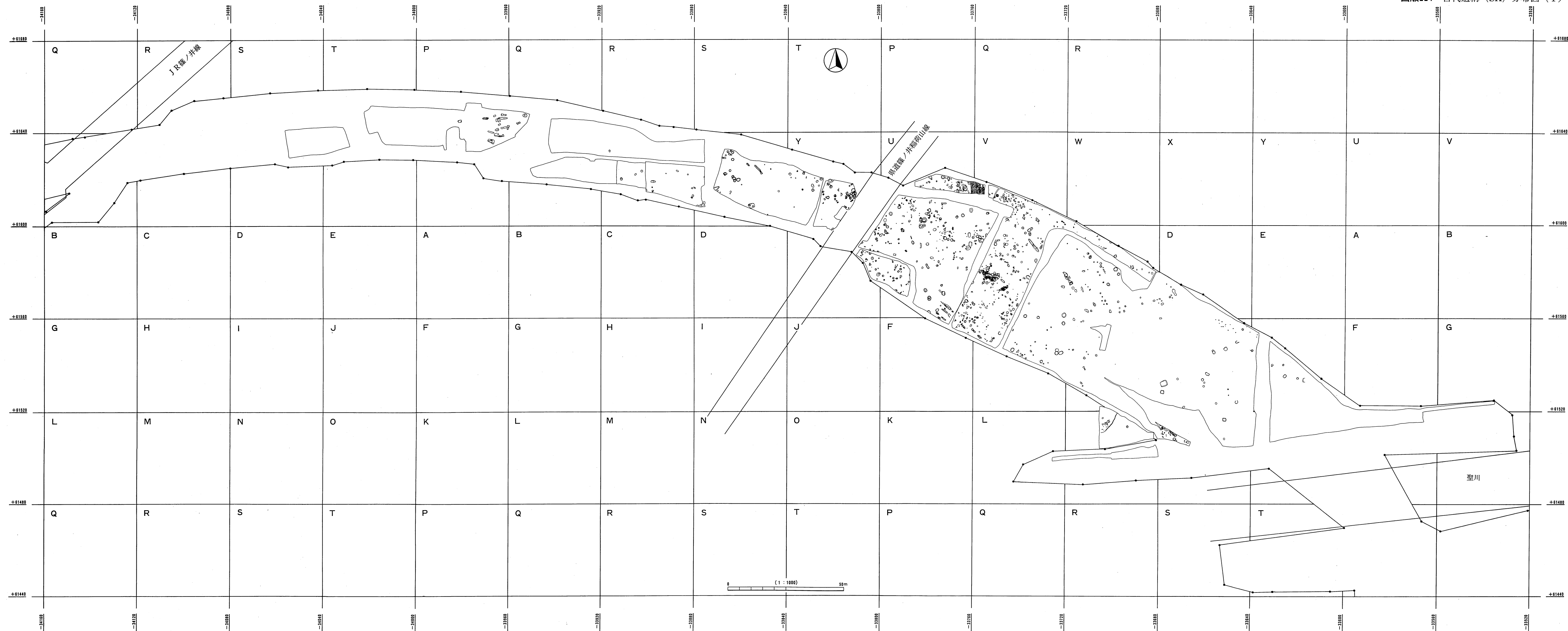

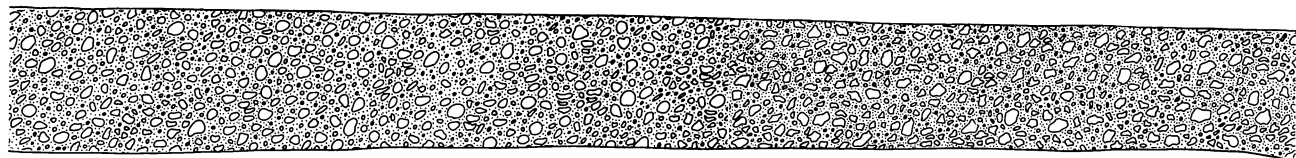

+ PA 17

5 →

SA 6002

+ UA 01

+ UE 01

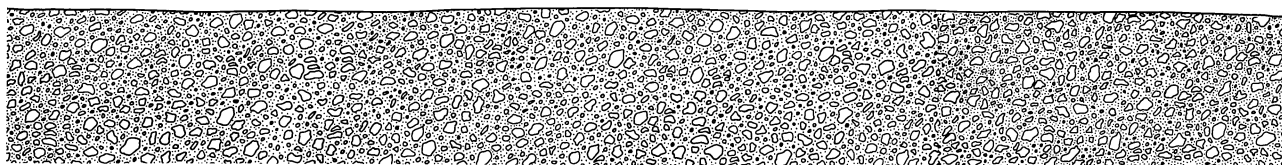

0 (1 : 100) 8 m

图版226 古代割付图5 (一括)

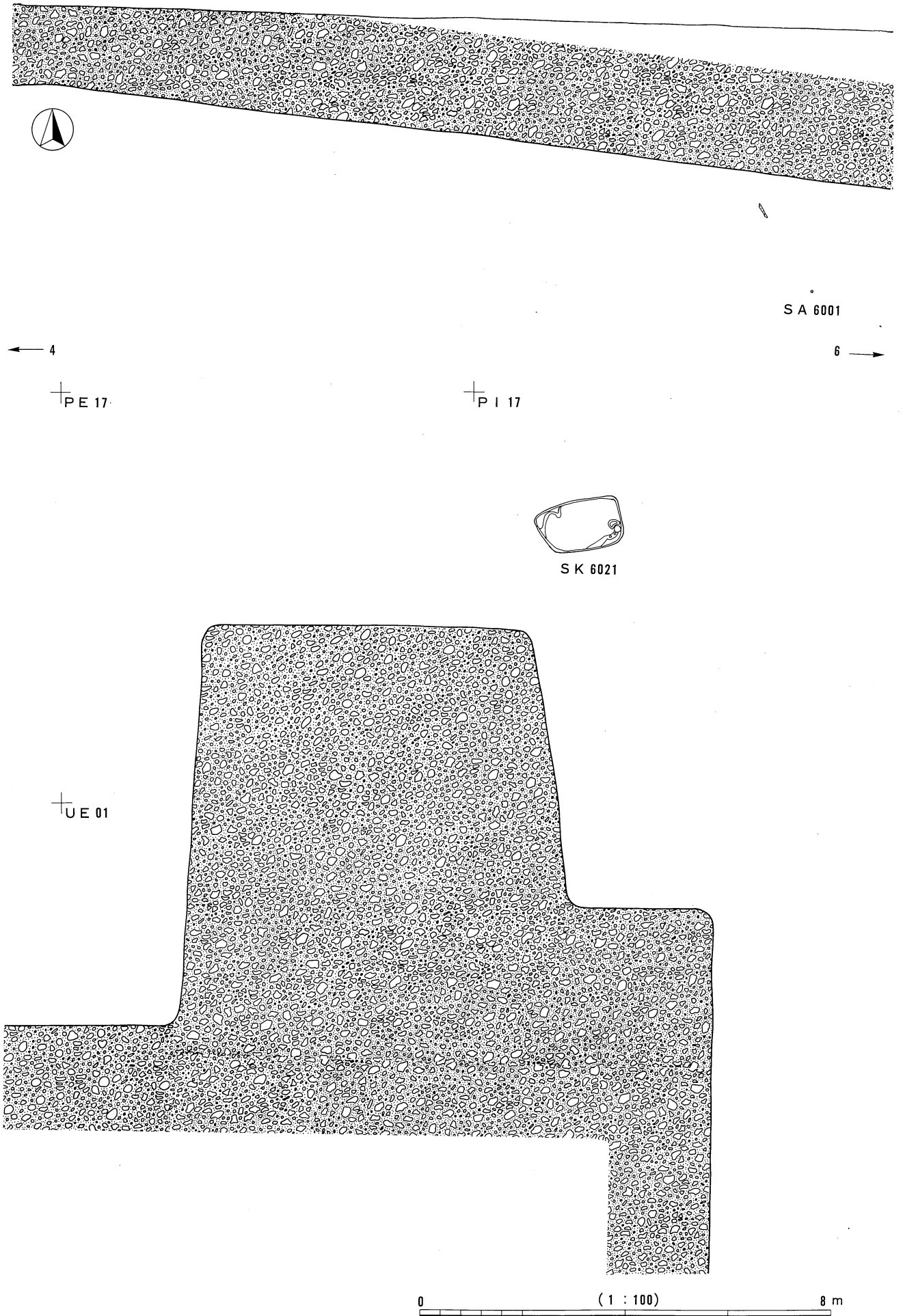

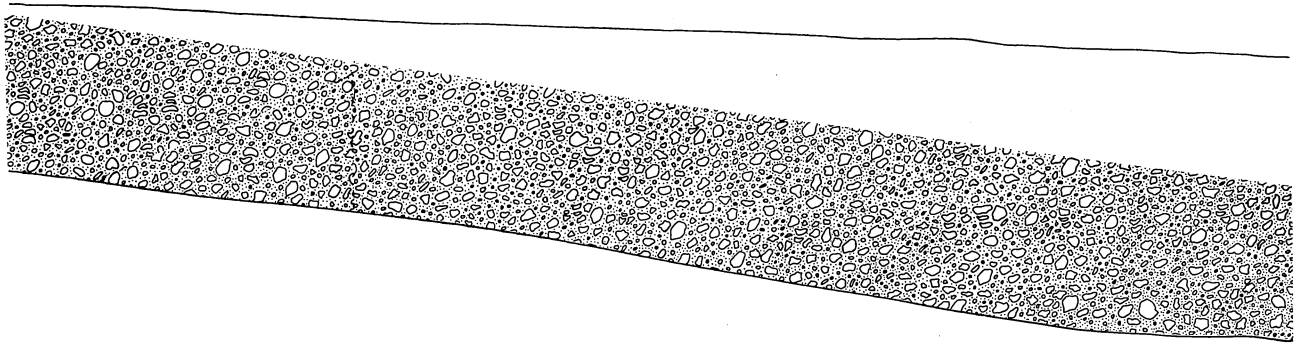

← 5



S K 6021

+PM 17



S K 6015

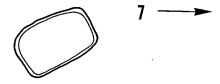

S K 6019



S K 6004

+UM 01

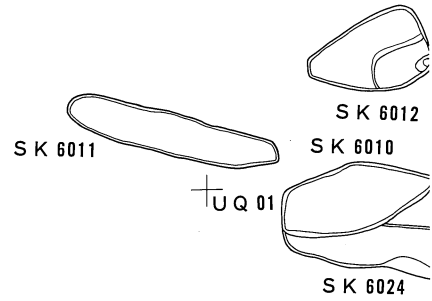

S K 6011

S K 6012

S K 6010

S K 6024

+UQ 01

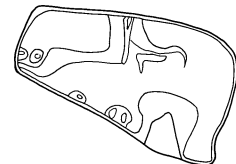

S K 6009

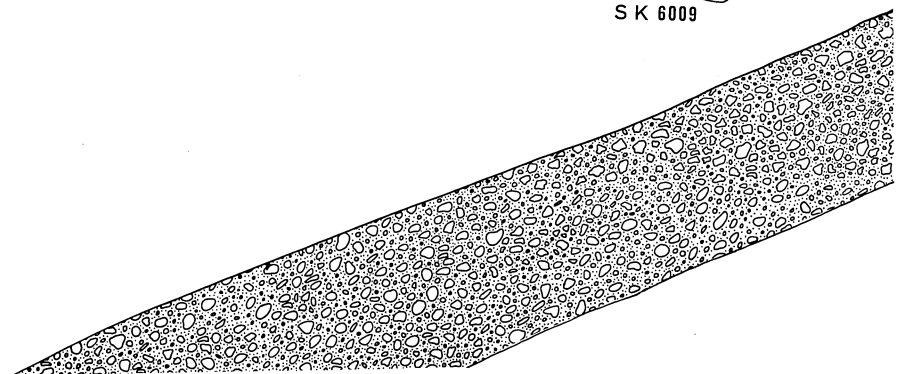
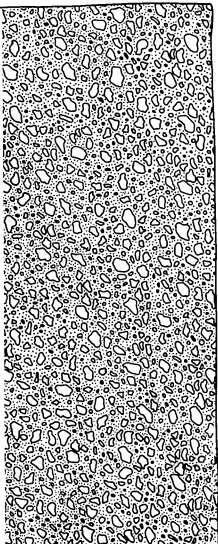

0 (1 : 100) 8 m

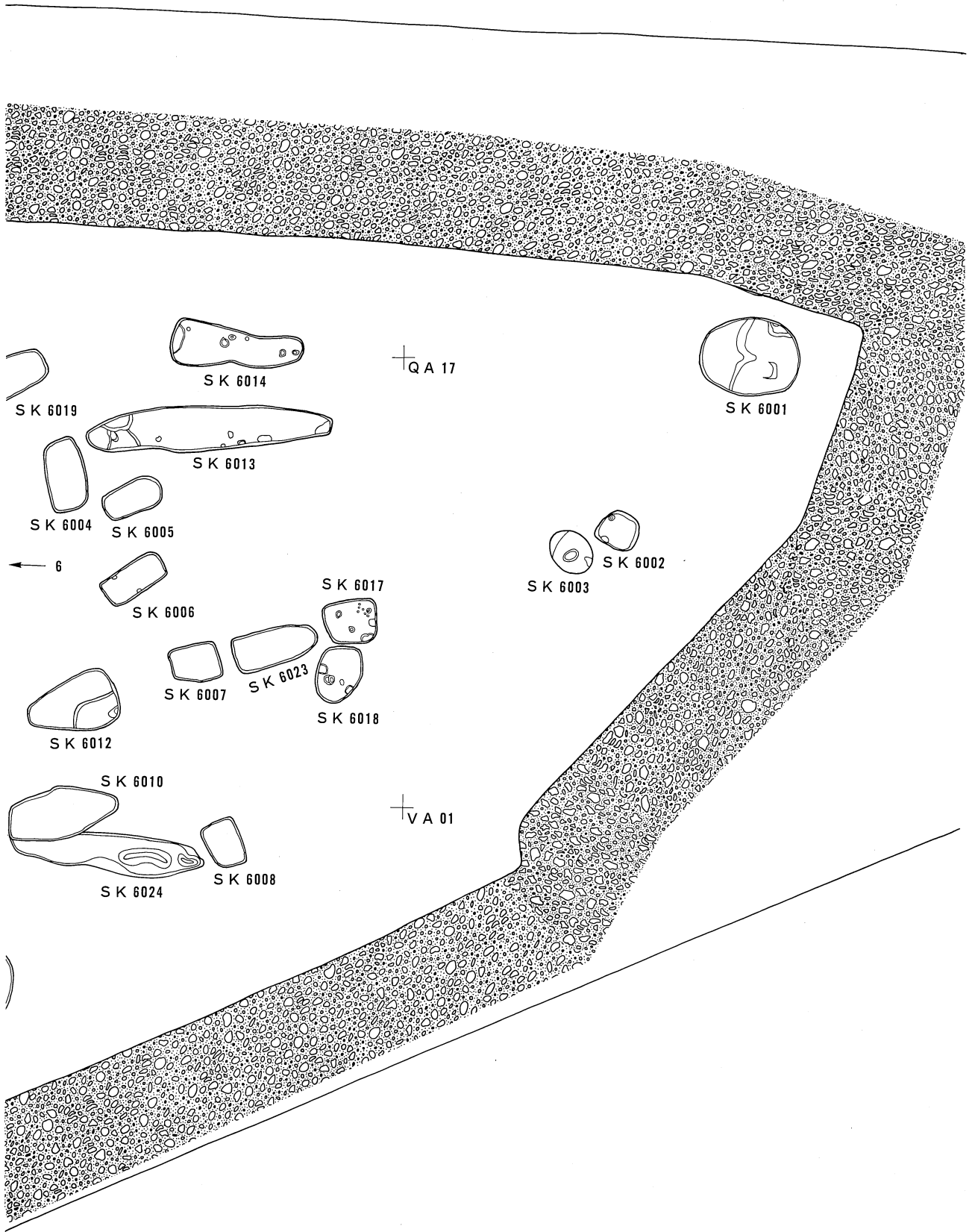

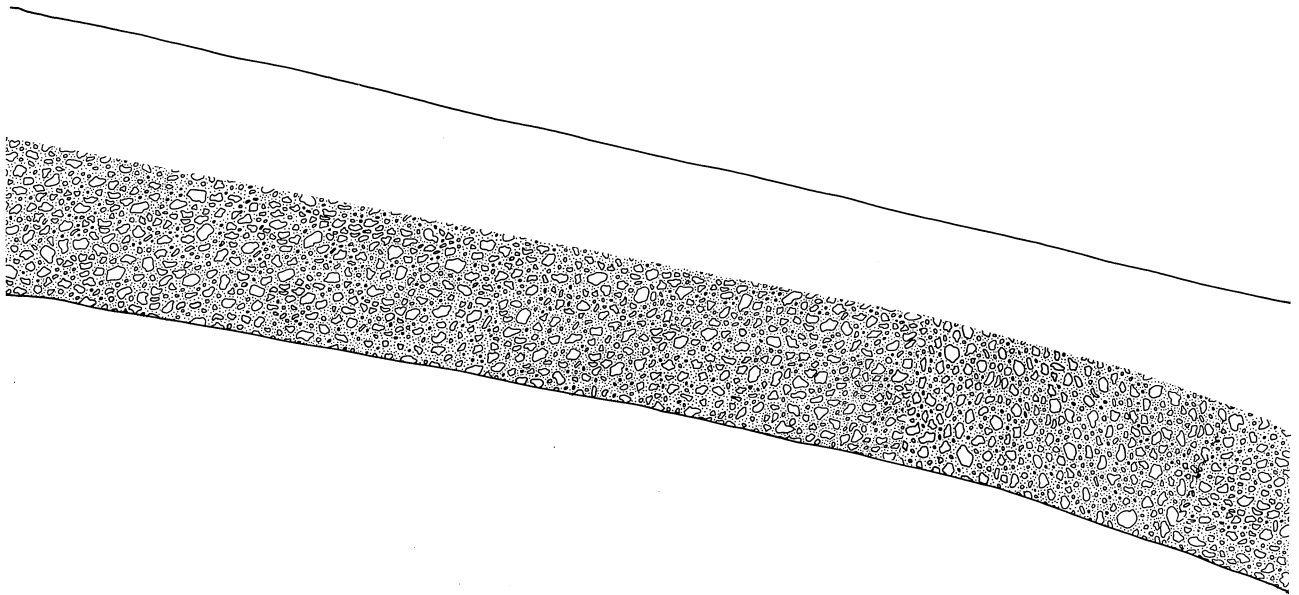

WA 01

WE 01

WA 05



SK 6101

16 →

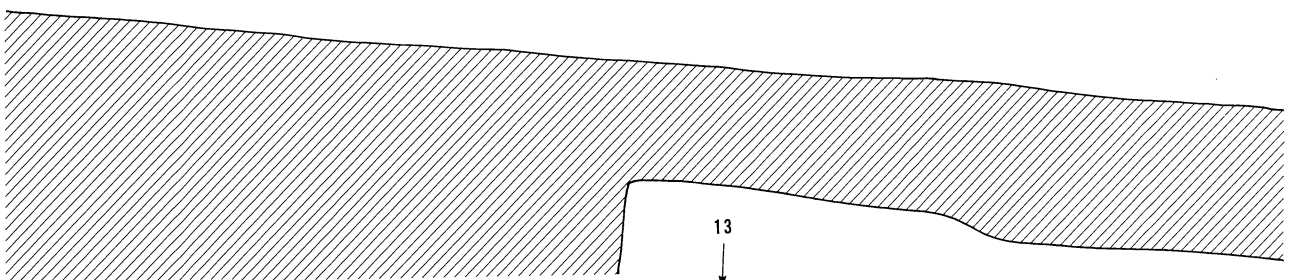

0 (1 : 100) 8 m

↑
12



+ WA 05



SK 6101

+ WE 05

16 →

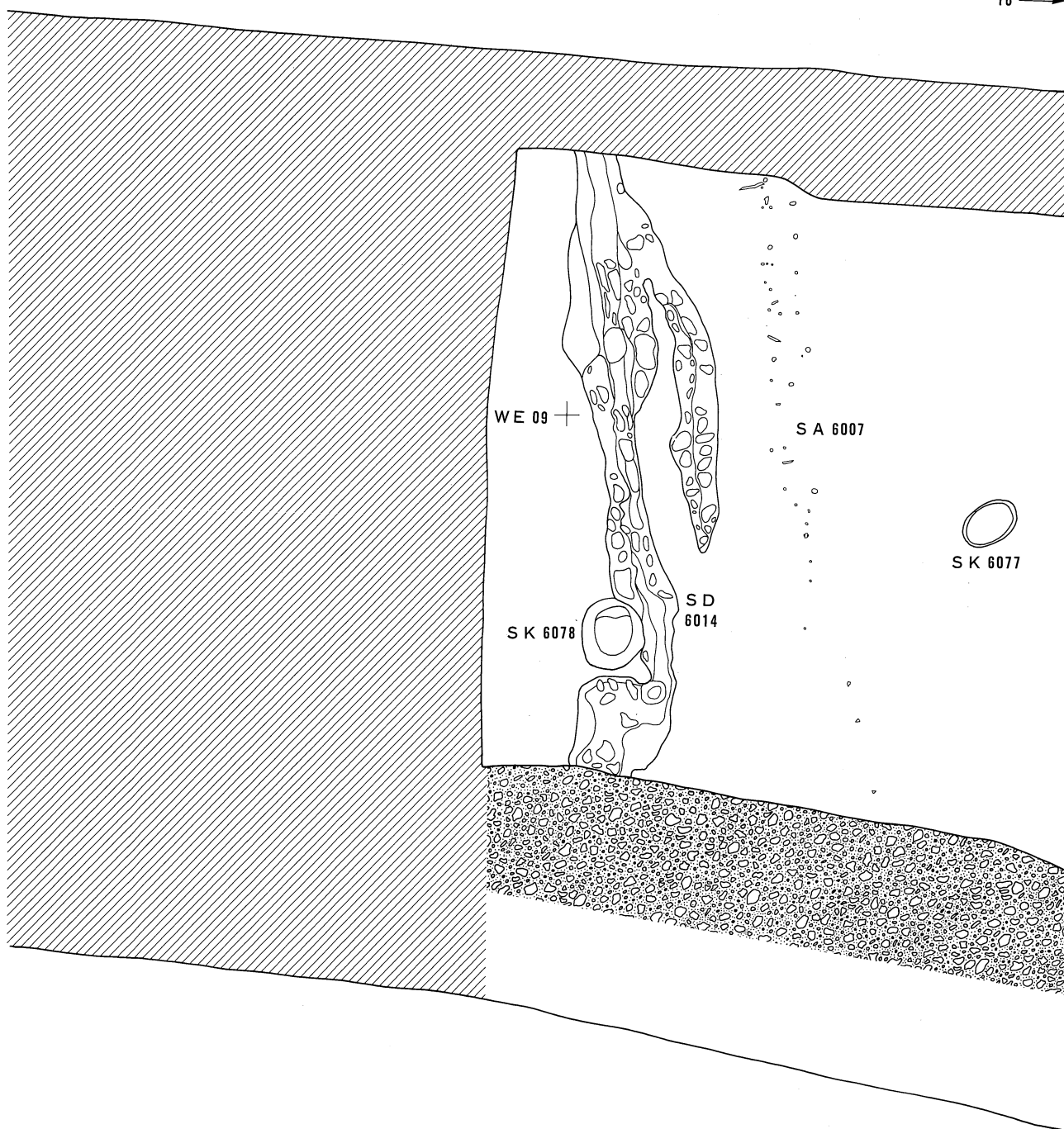

0 (1 : 100) 8 m



+ WQ 05 17 →

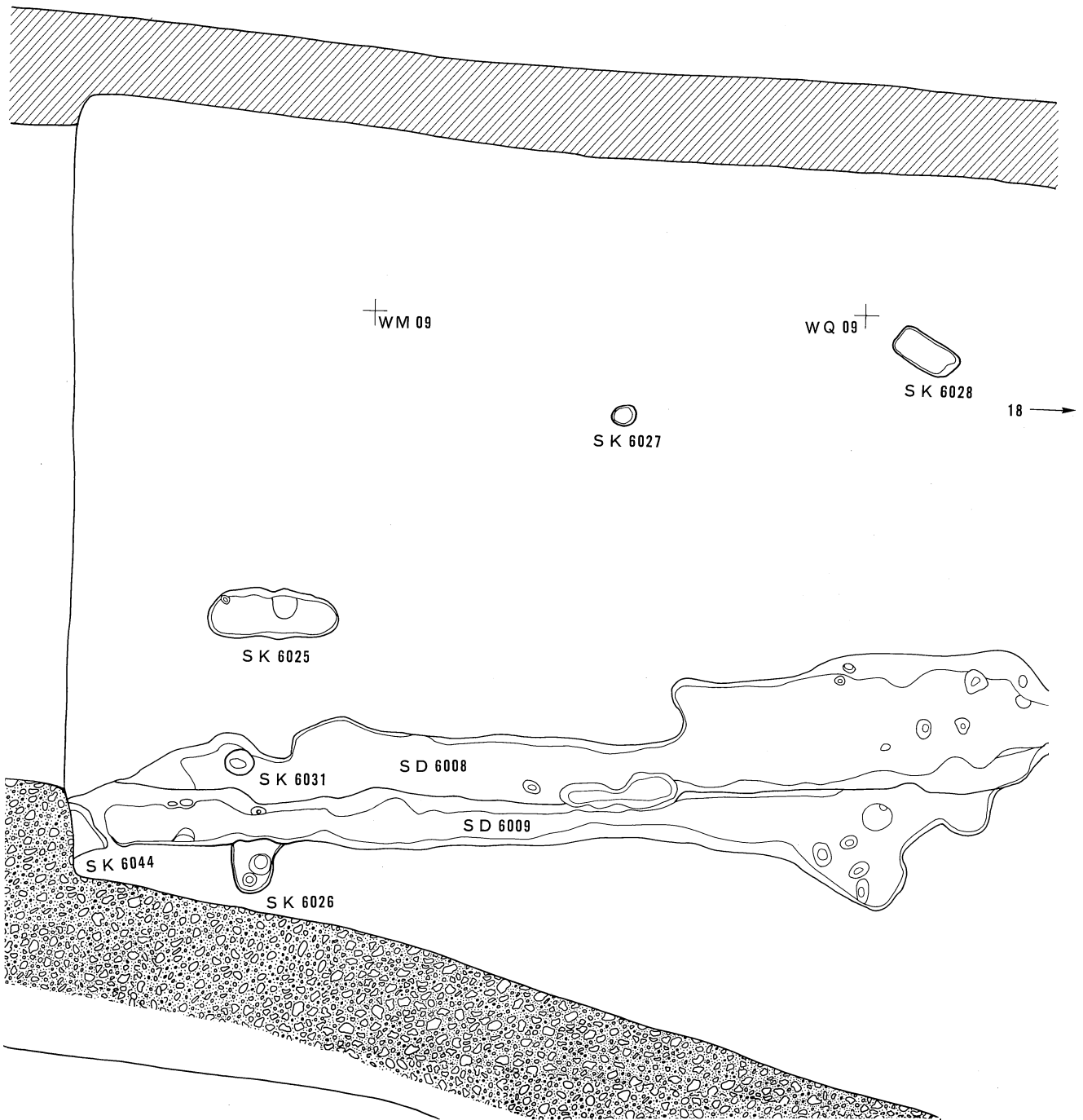

0 (1 : 100) 8 m



← 12

17 →

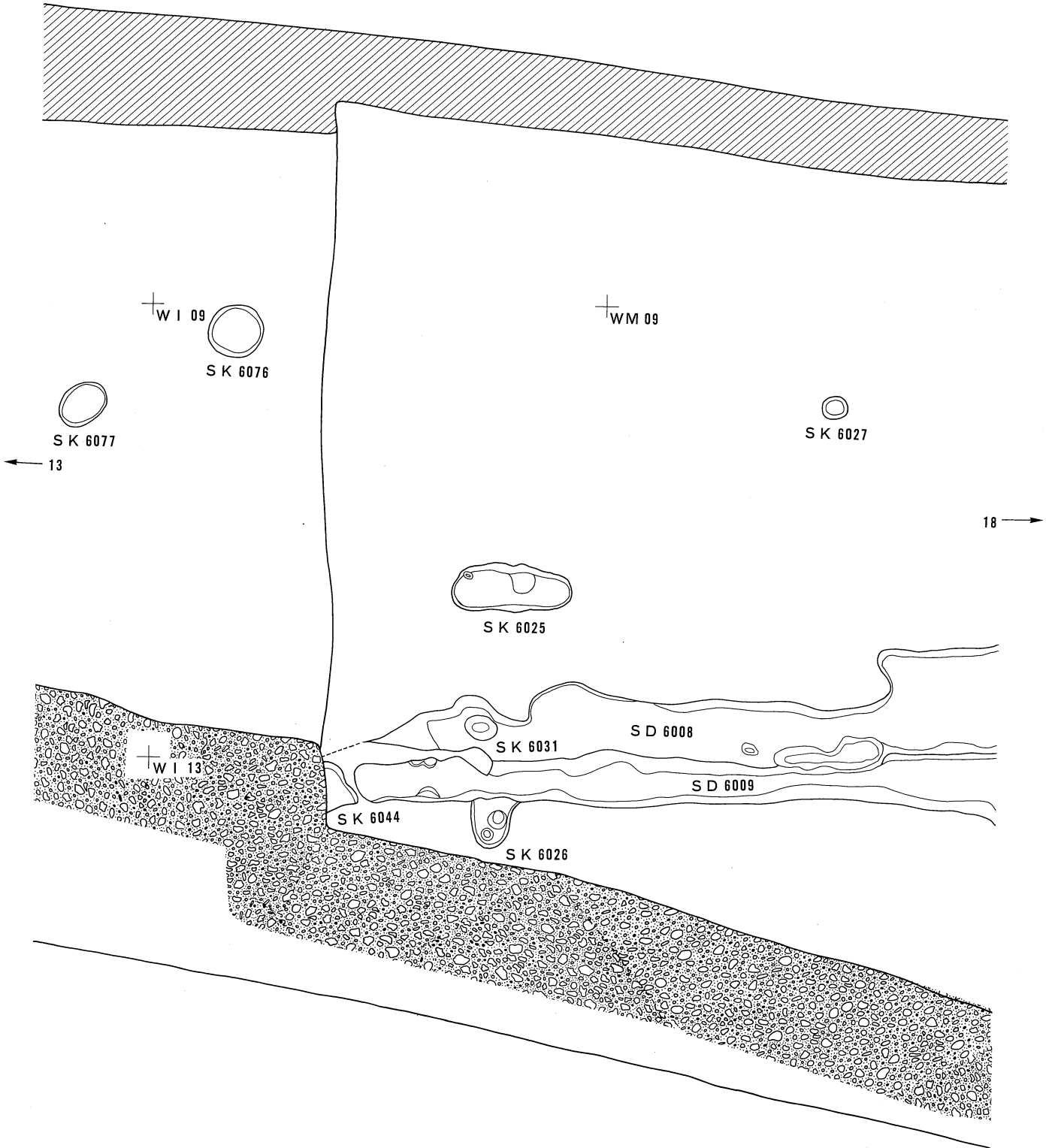

0 (1 : 100) 8 m

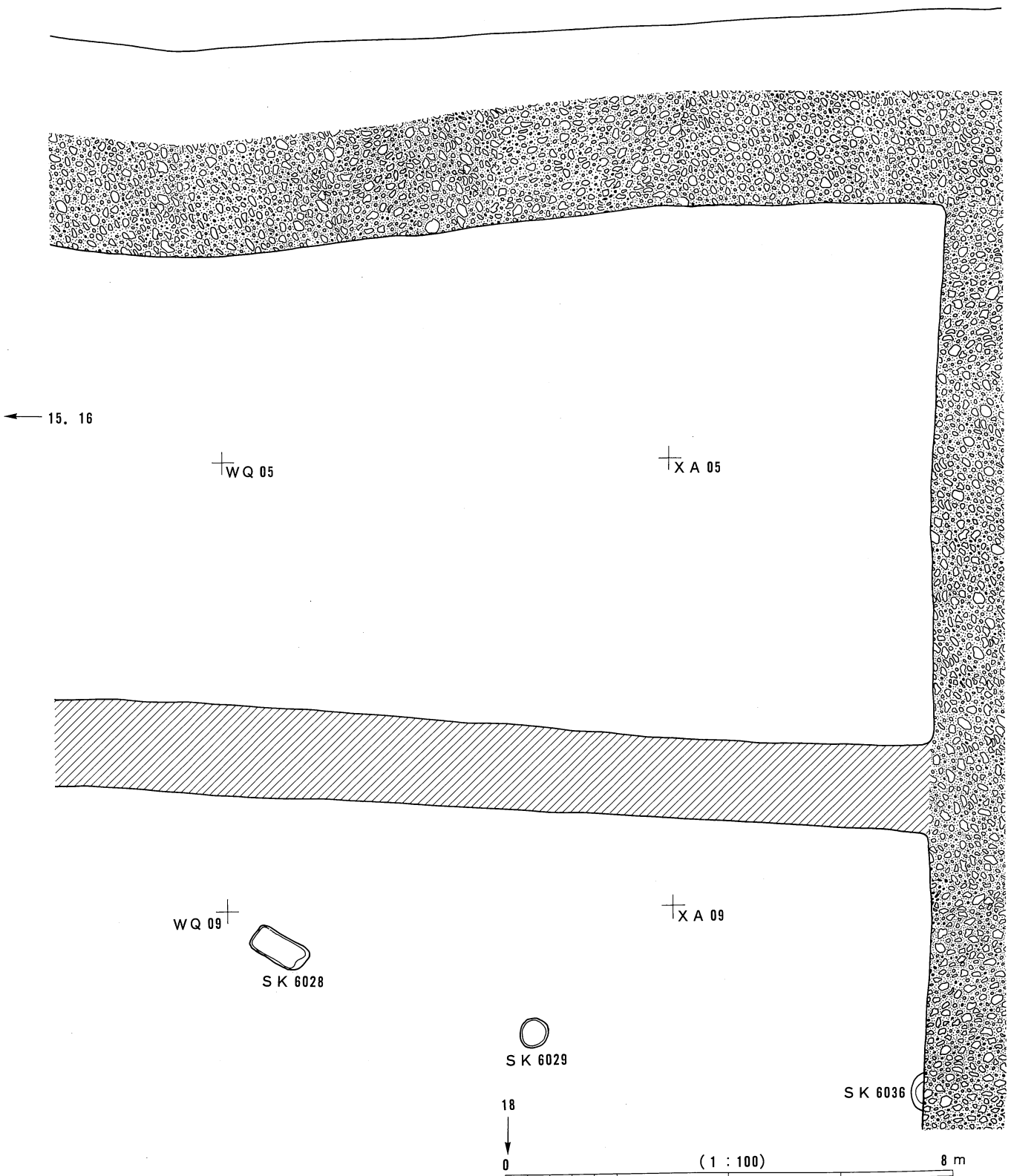

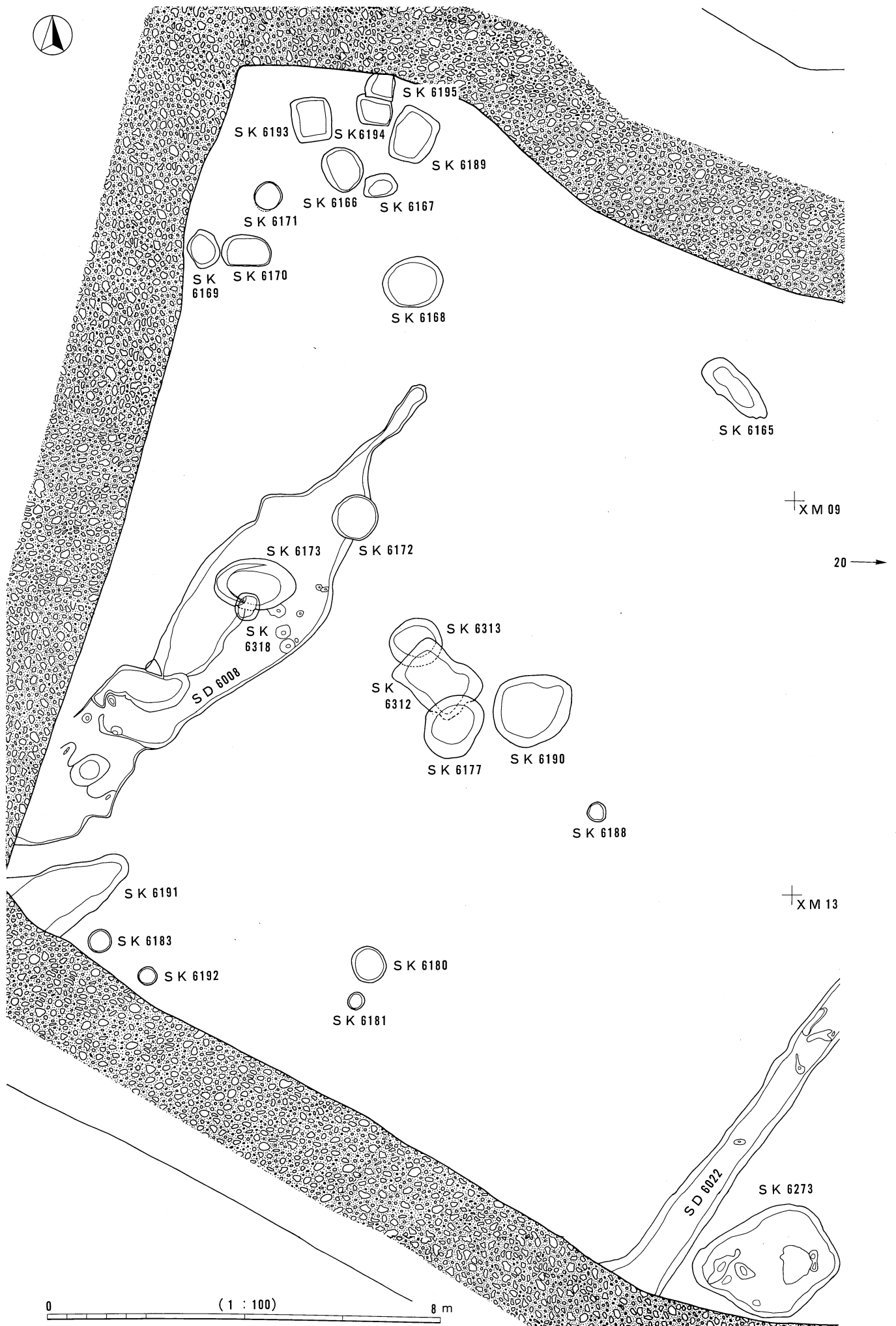

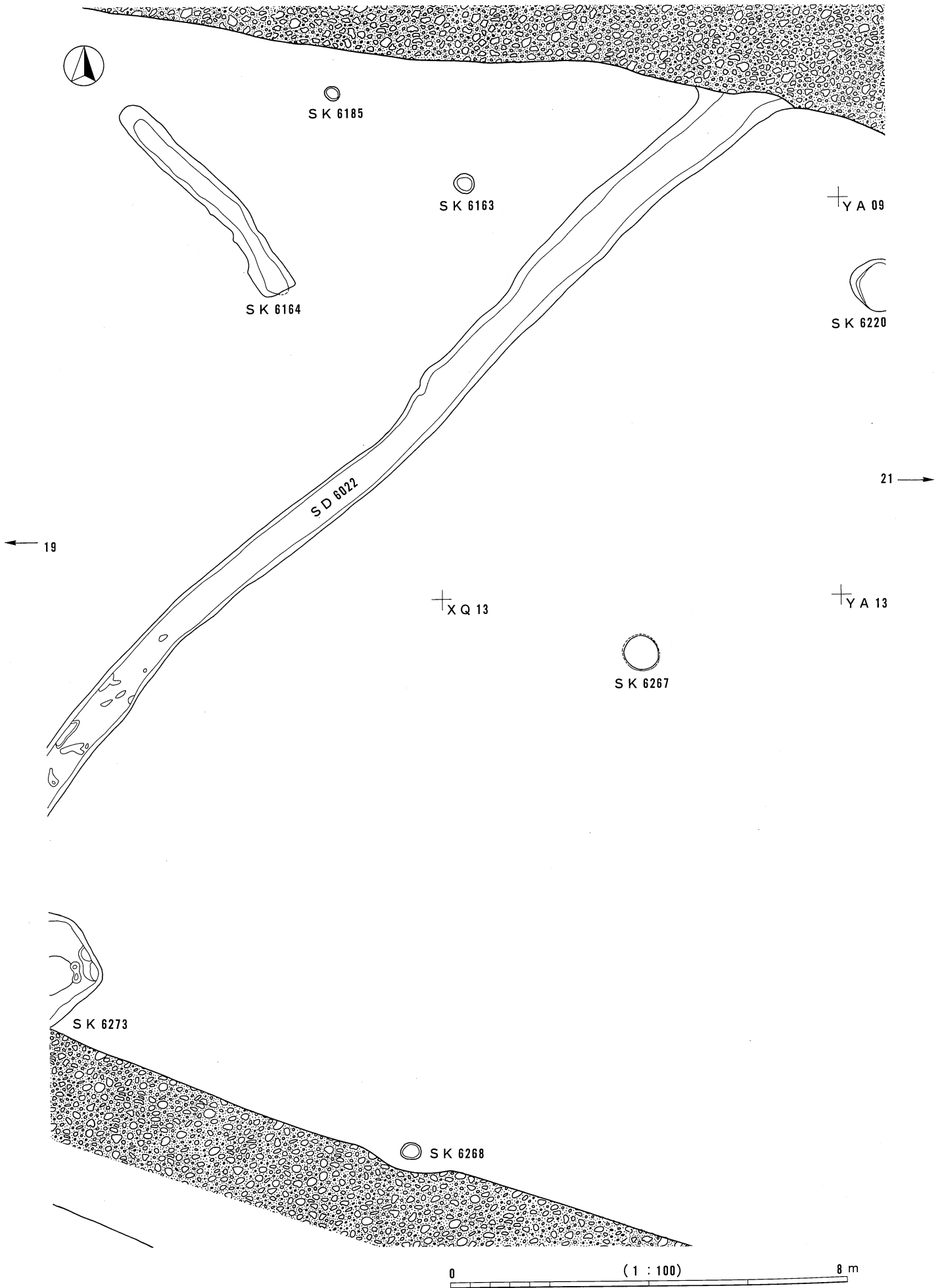

図版236 古代割付図21 (一括)

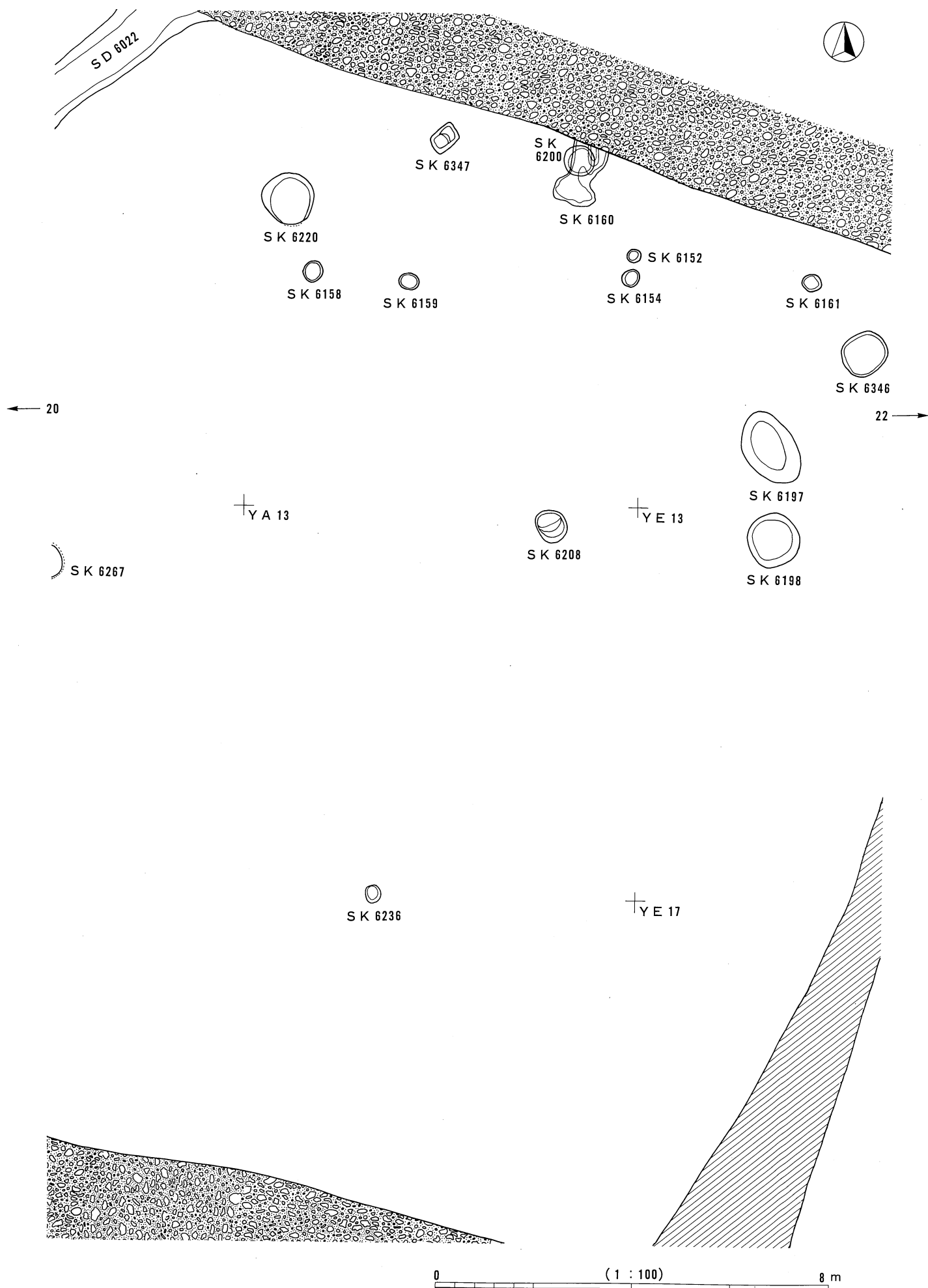



57 →

+ MA 09

+ ME 09

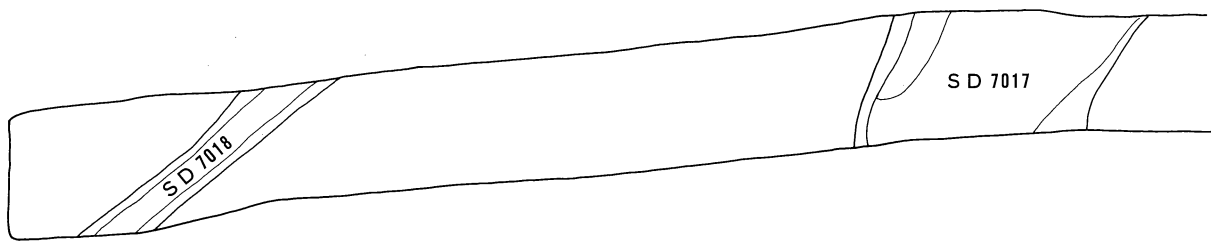

+ MA 13

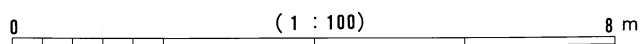

図版238 古代割付図60 (一括)

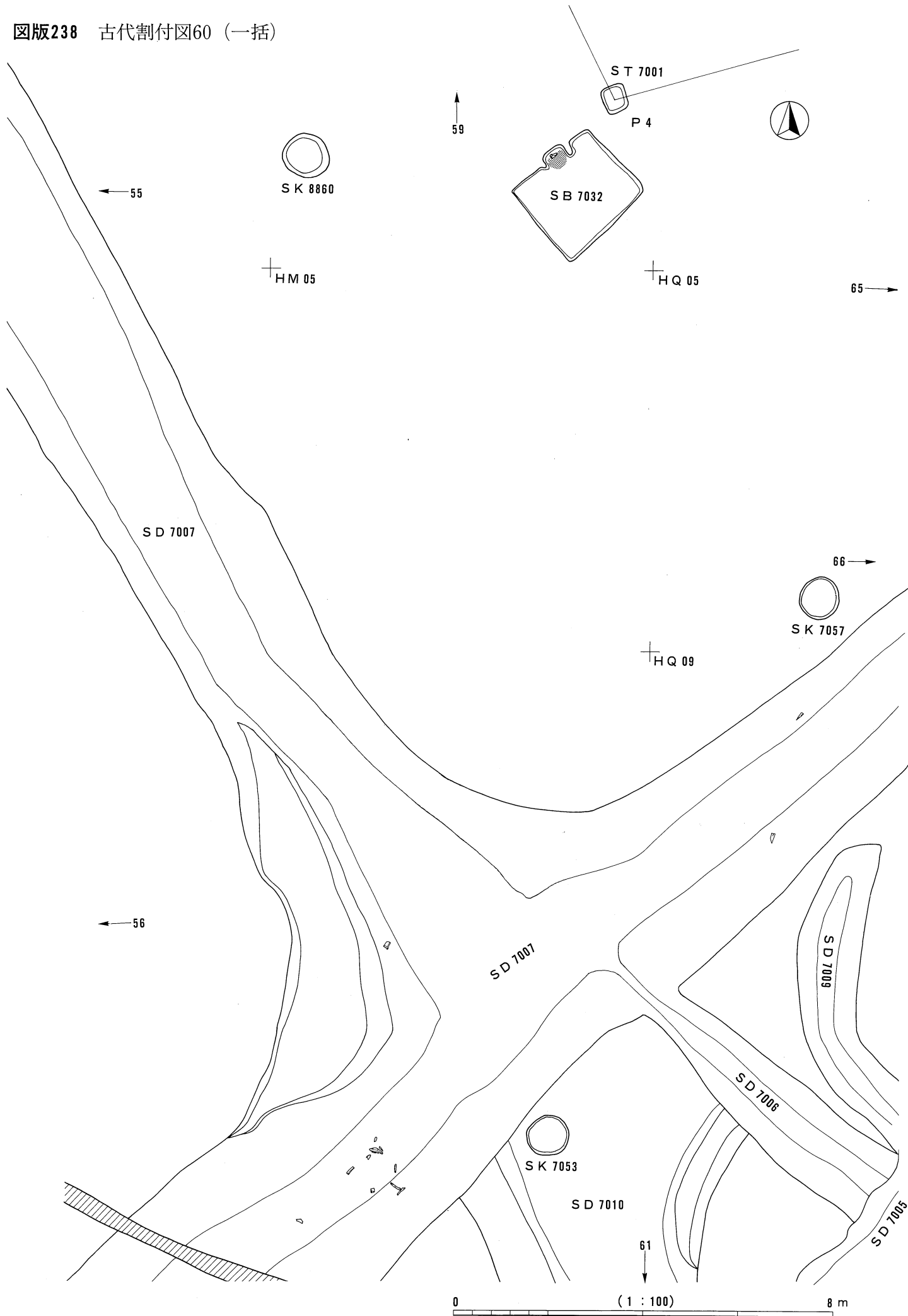

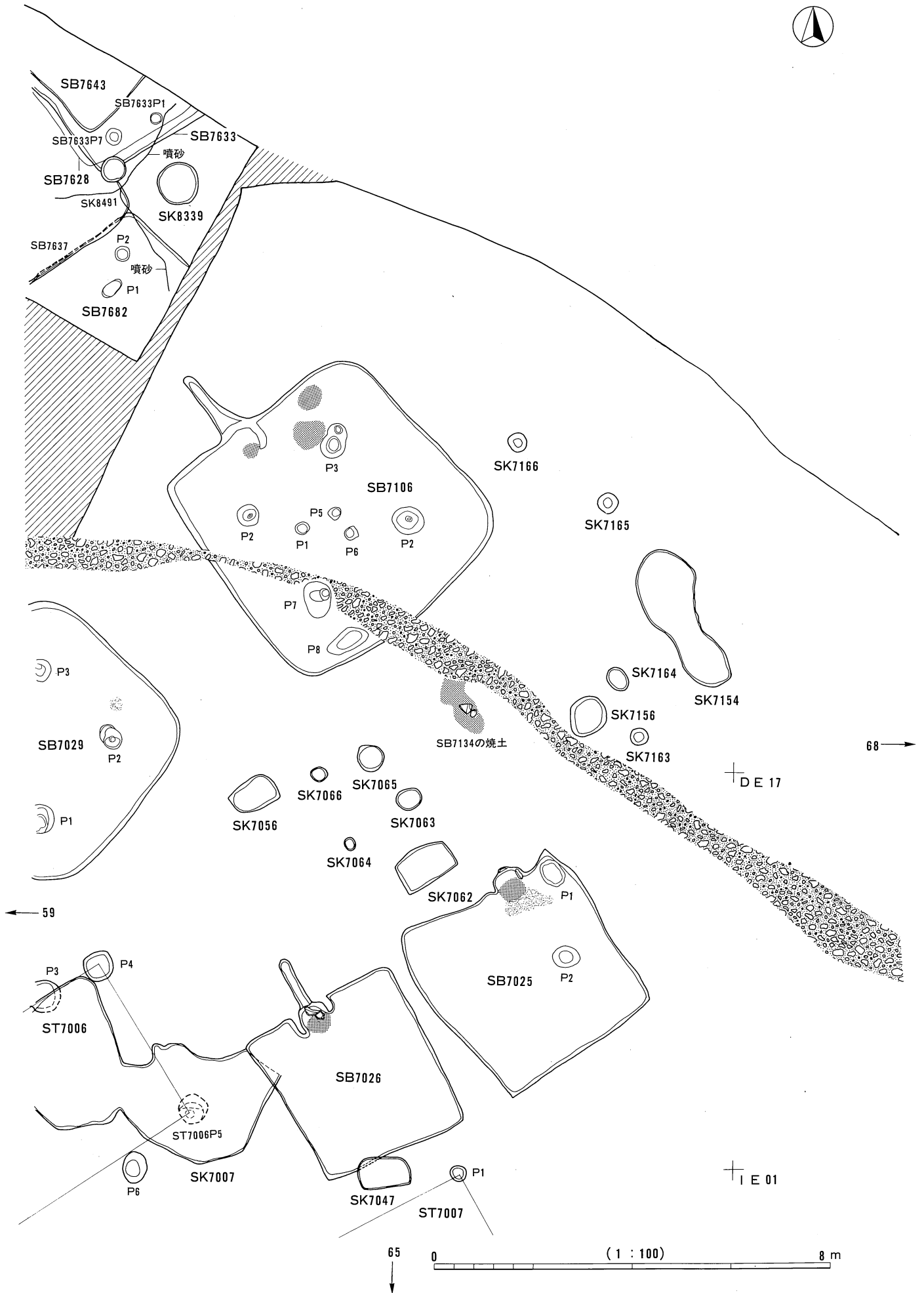

図版240 古代割付図65 (一括)

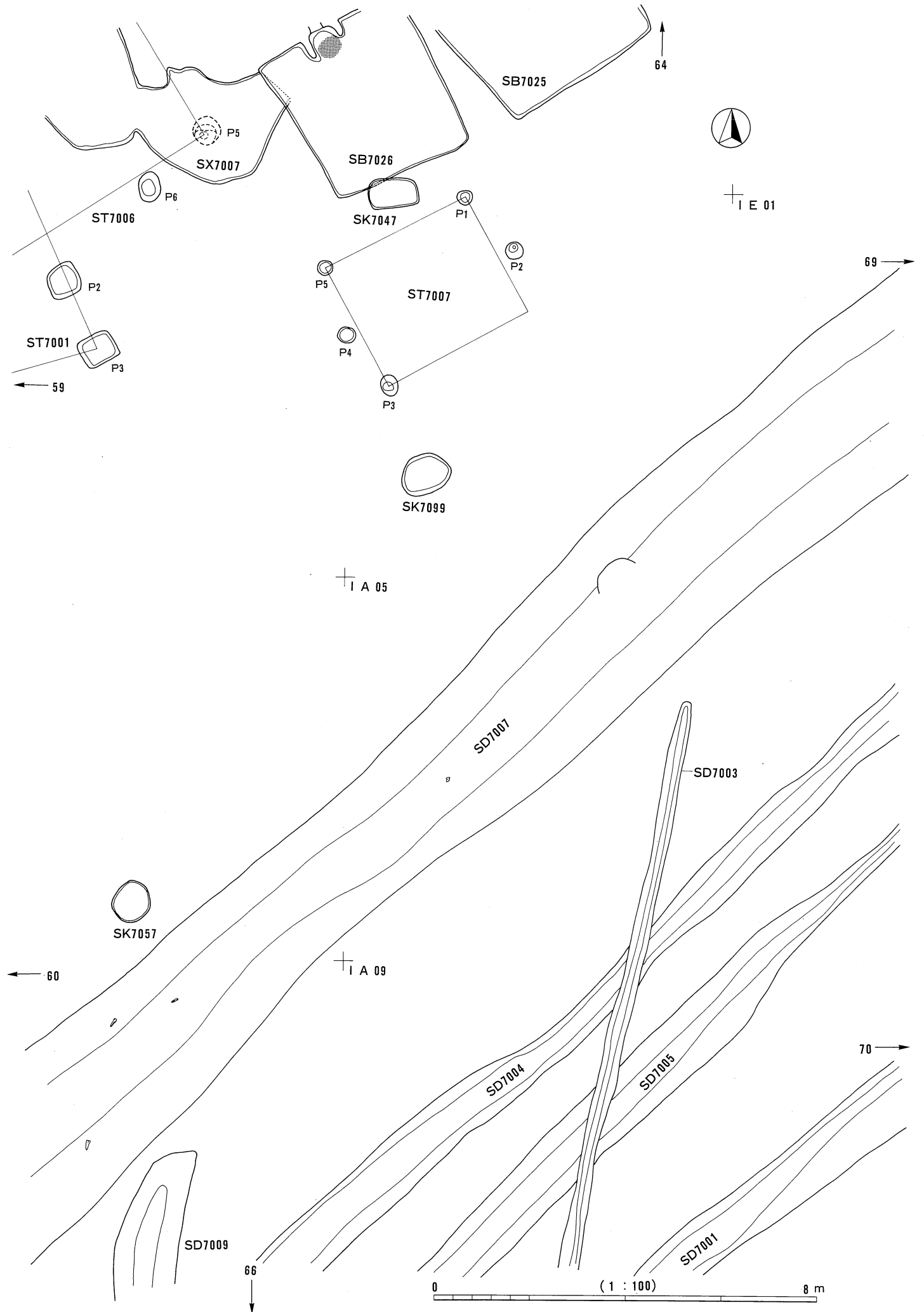

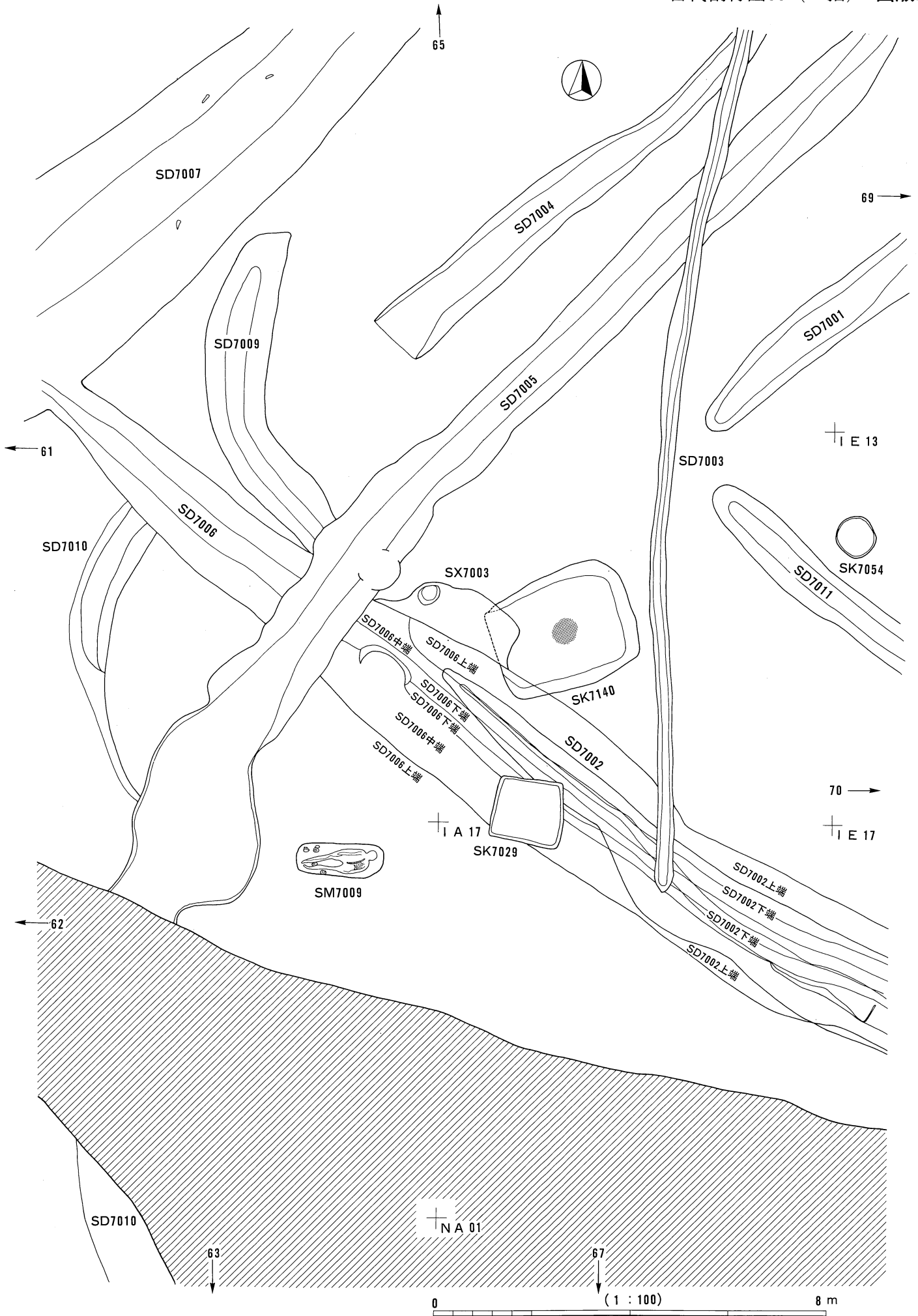

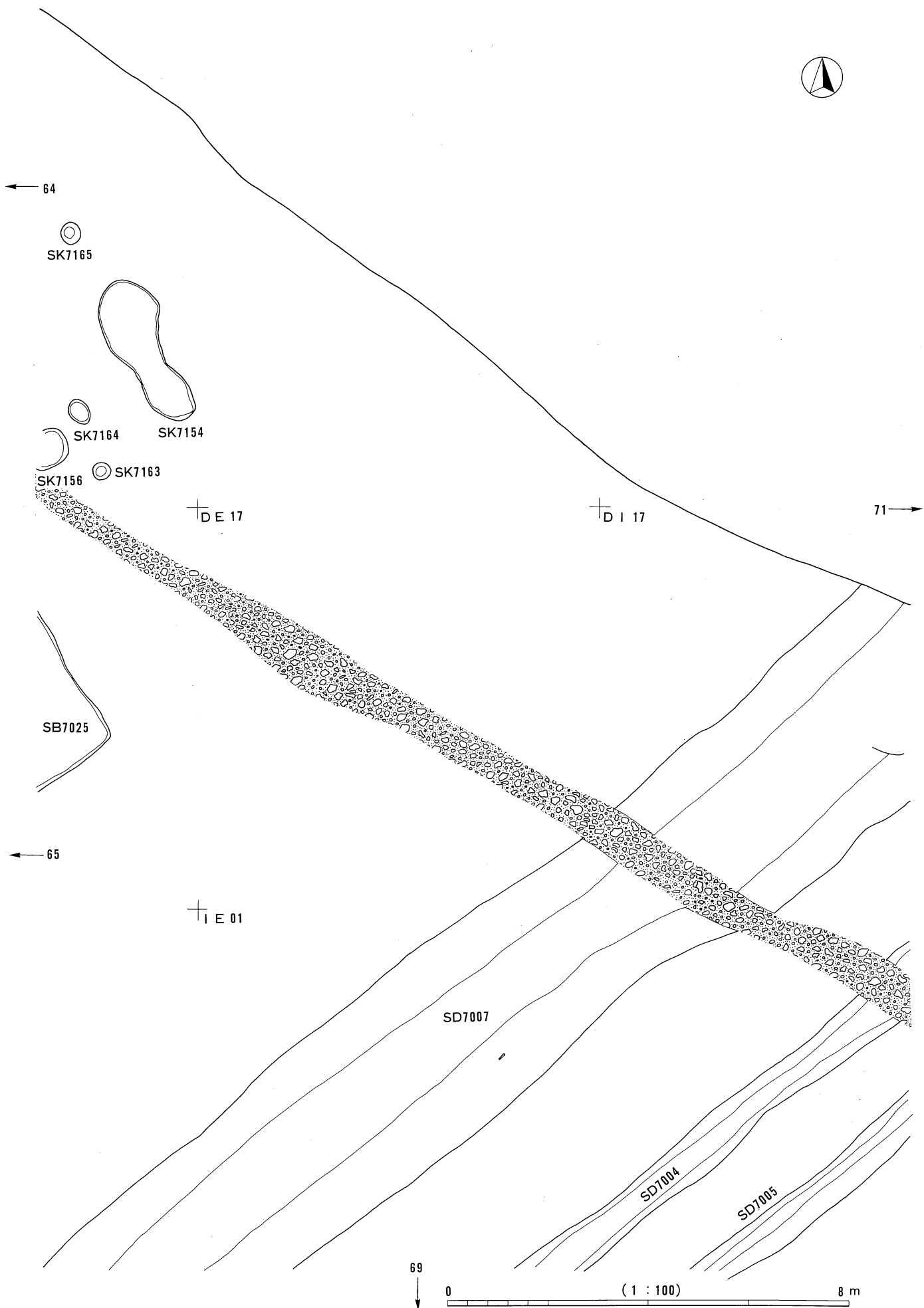

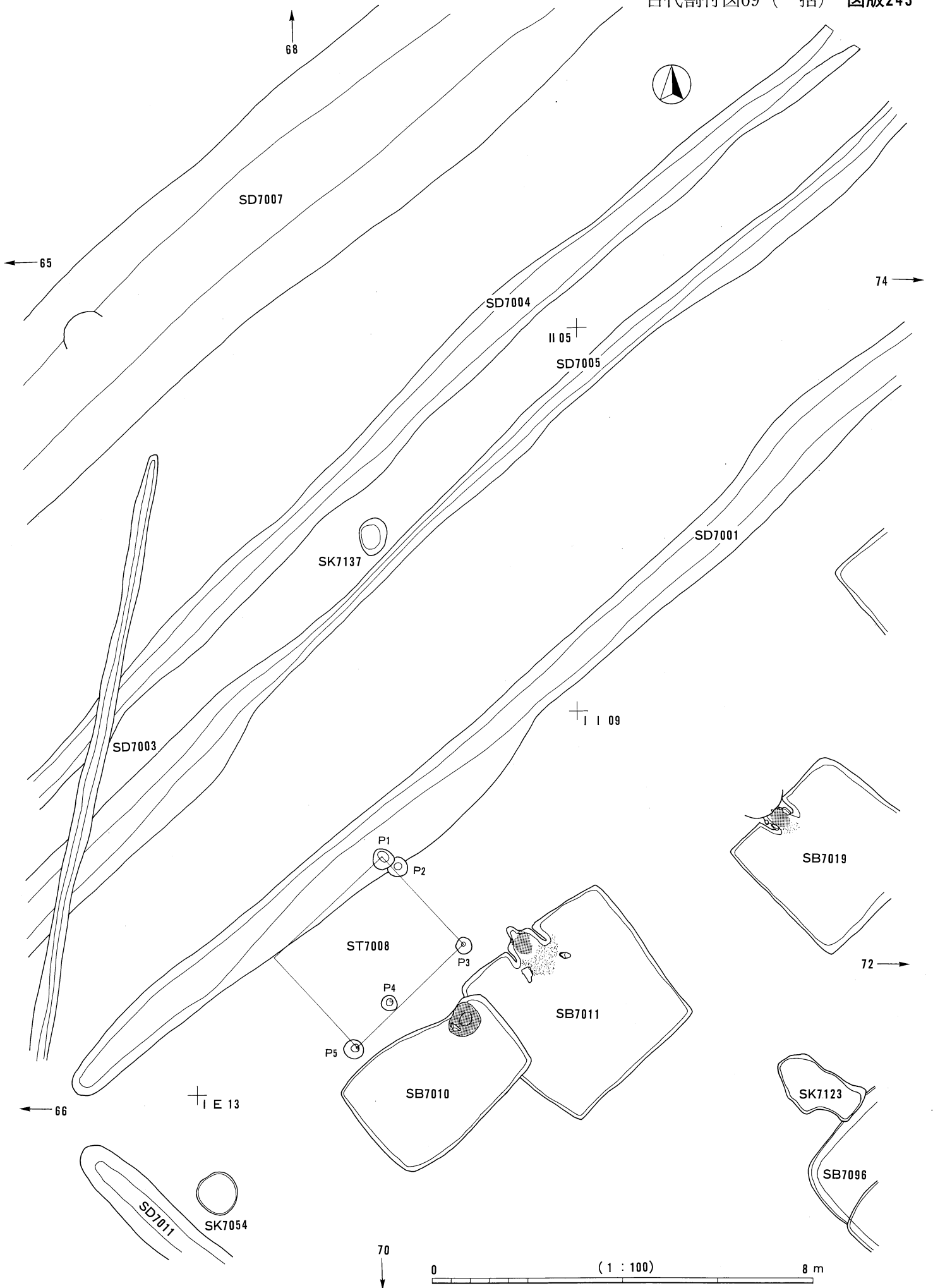

図版244 古代割付図70 (一括)

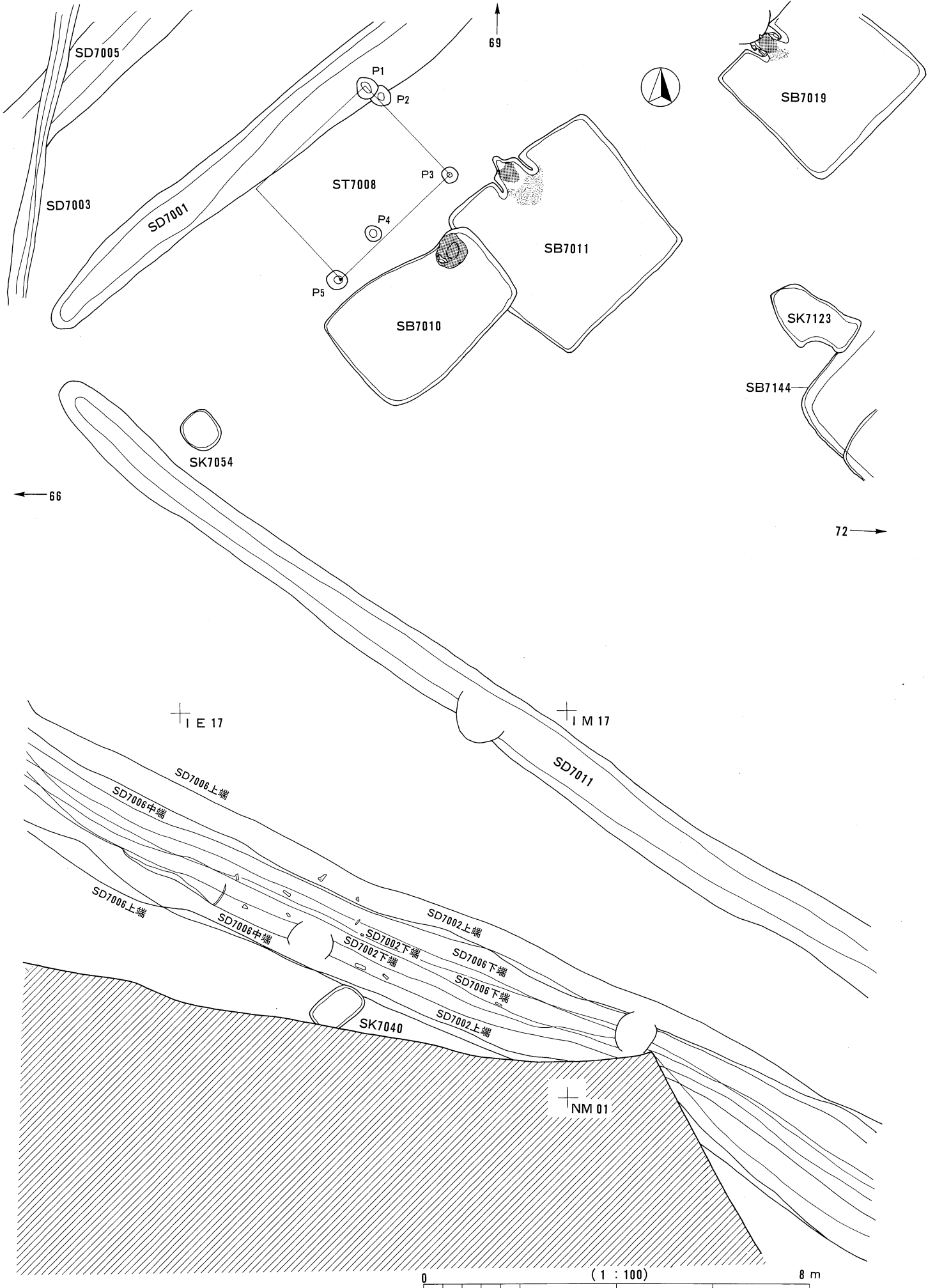

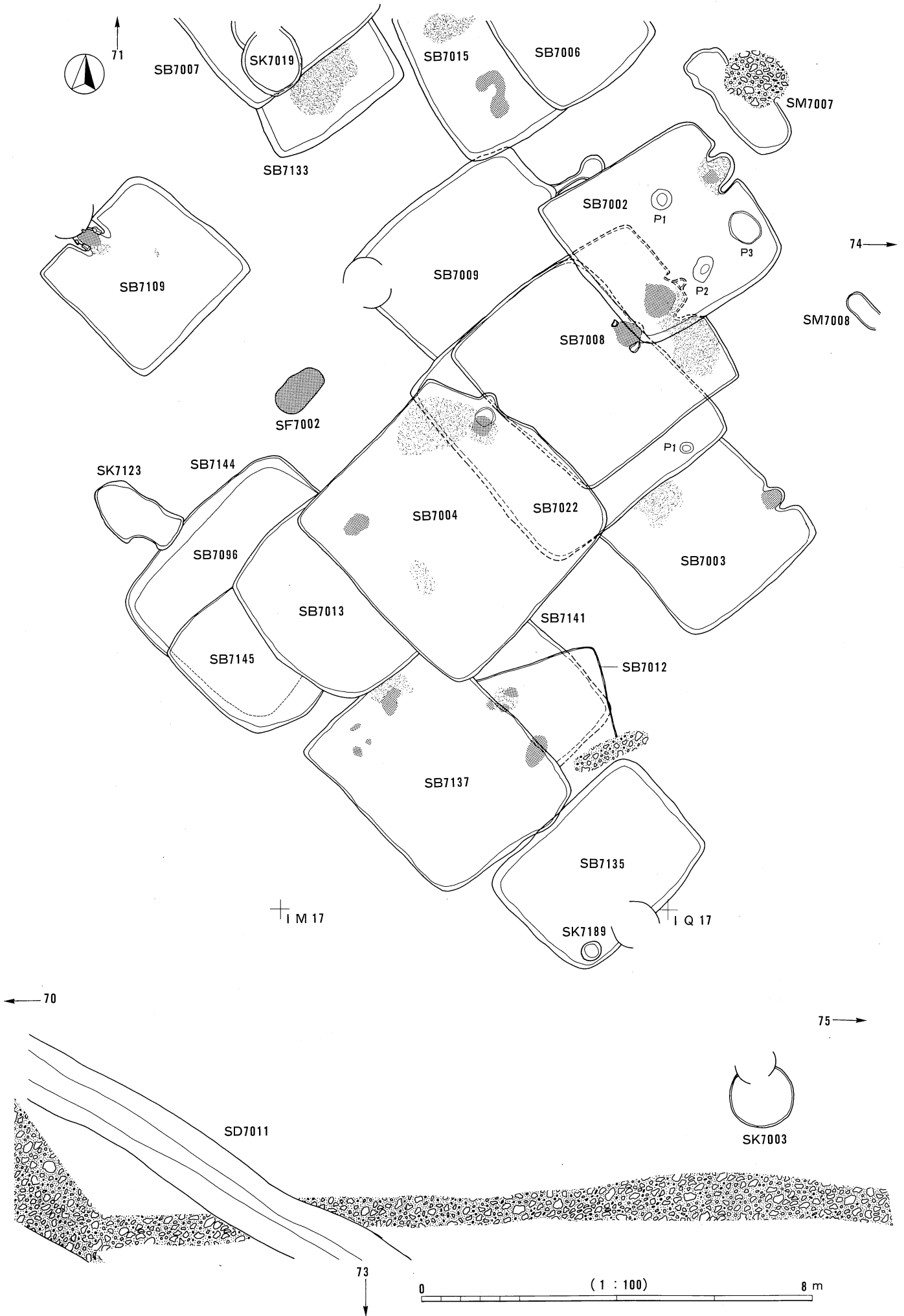

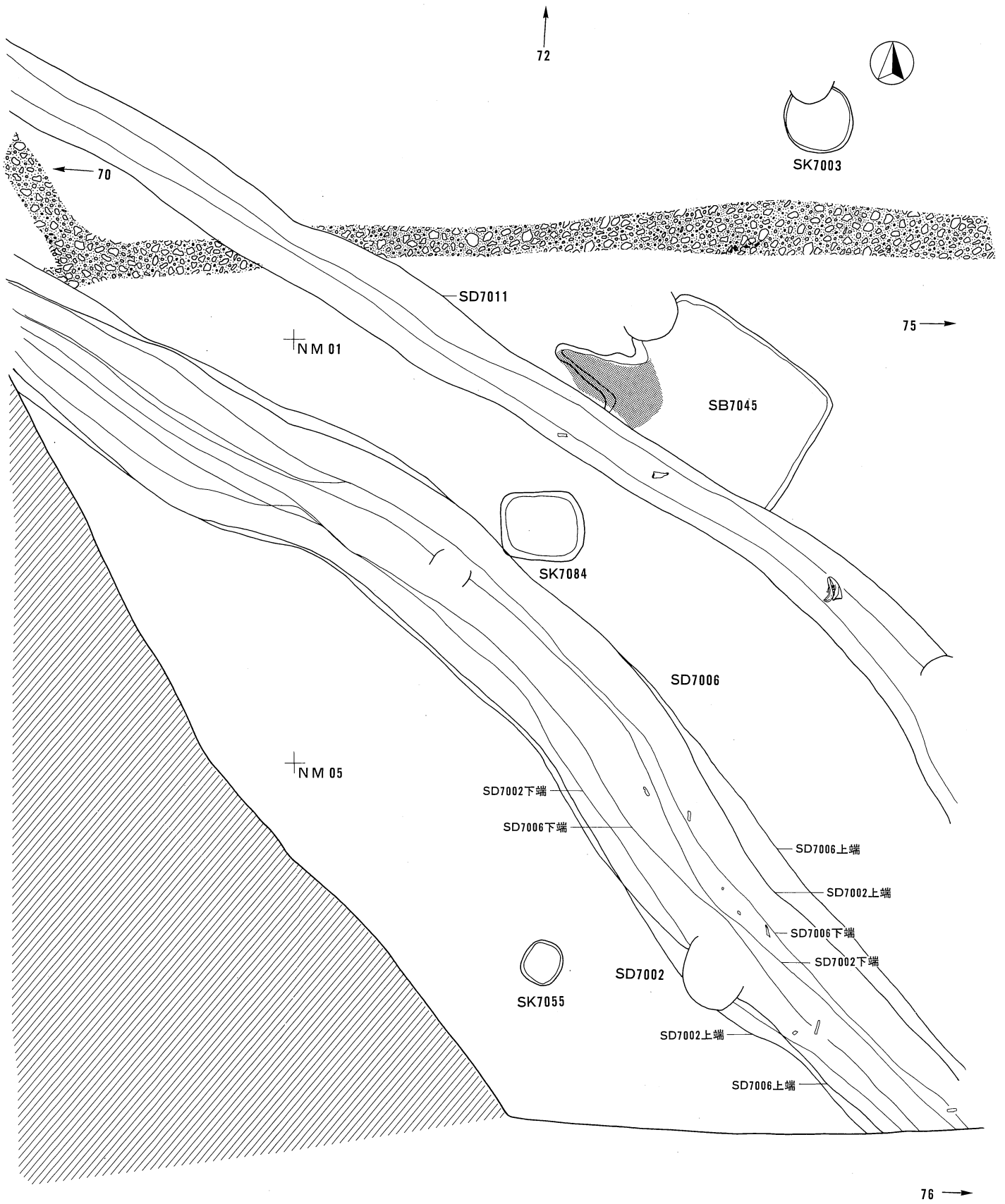

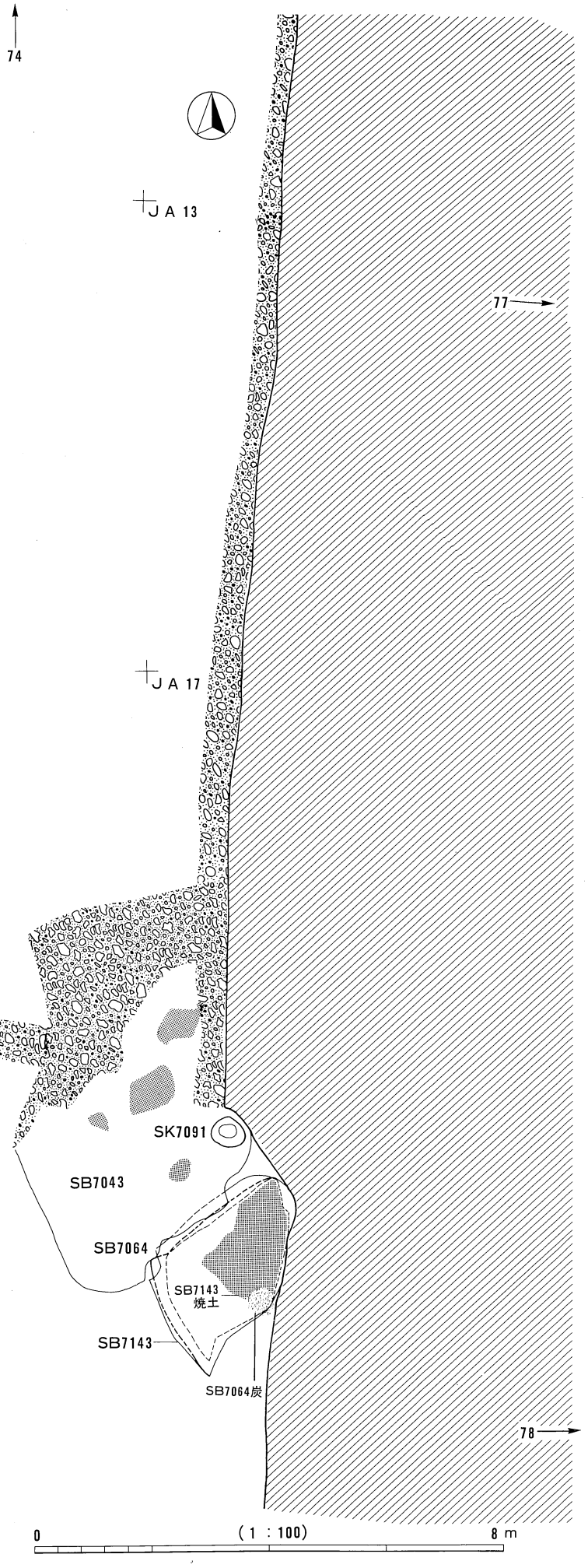
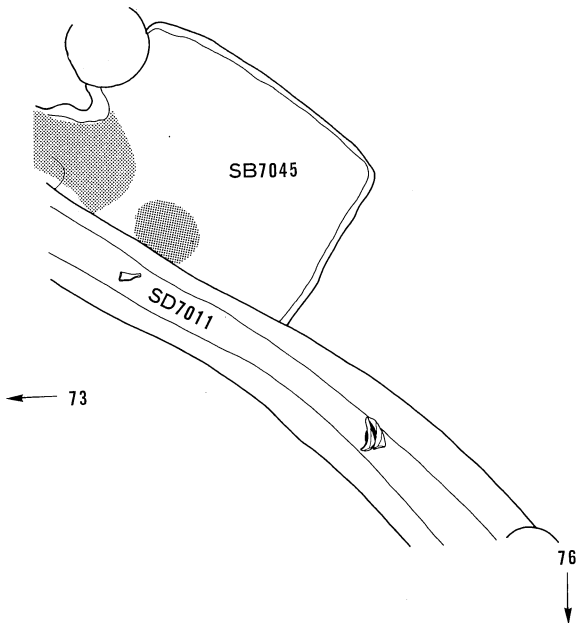
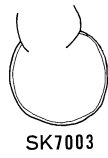
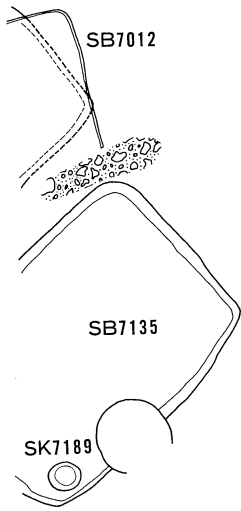
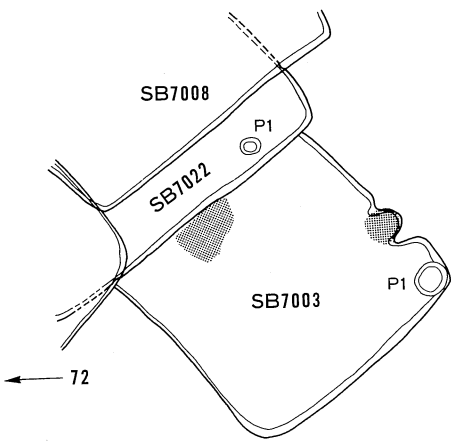

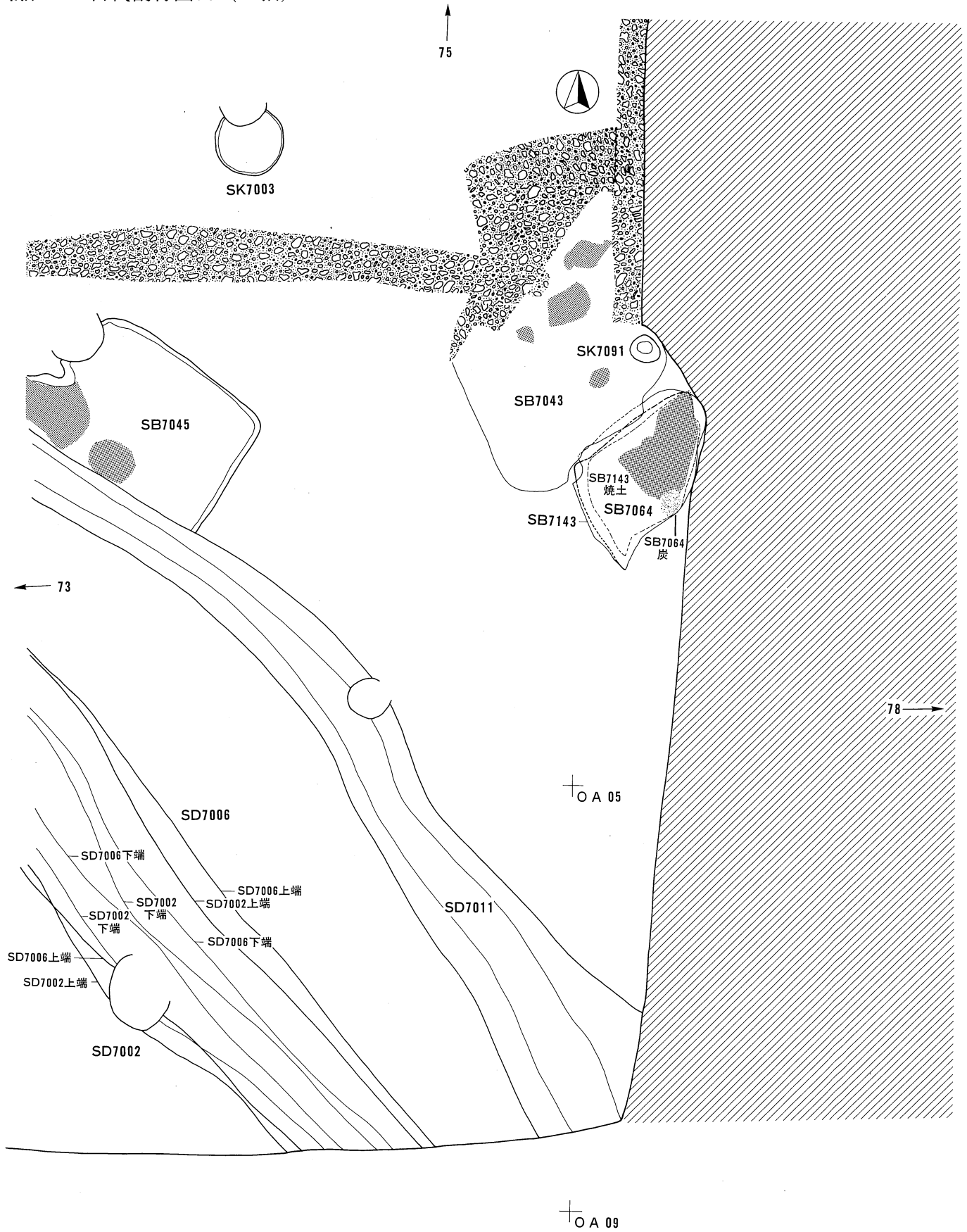

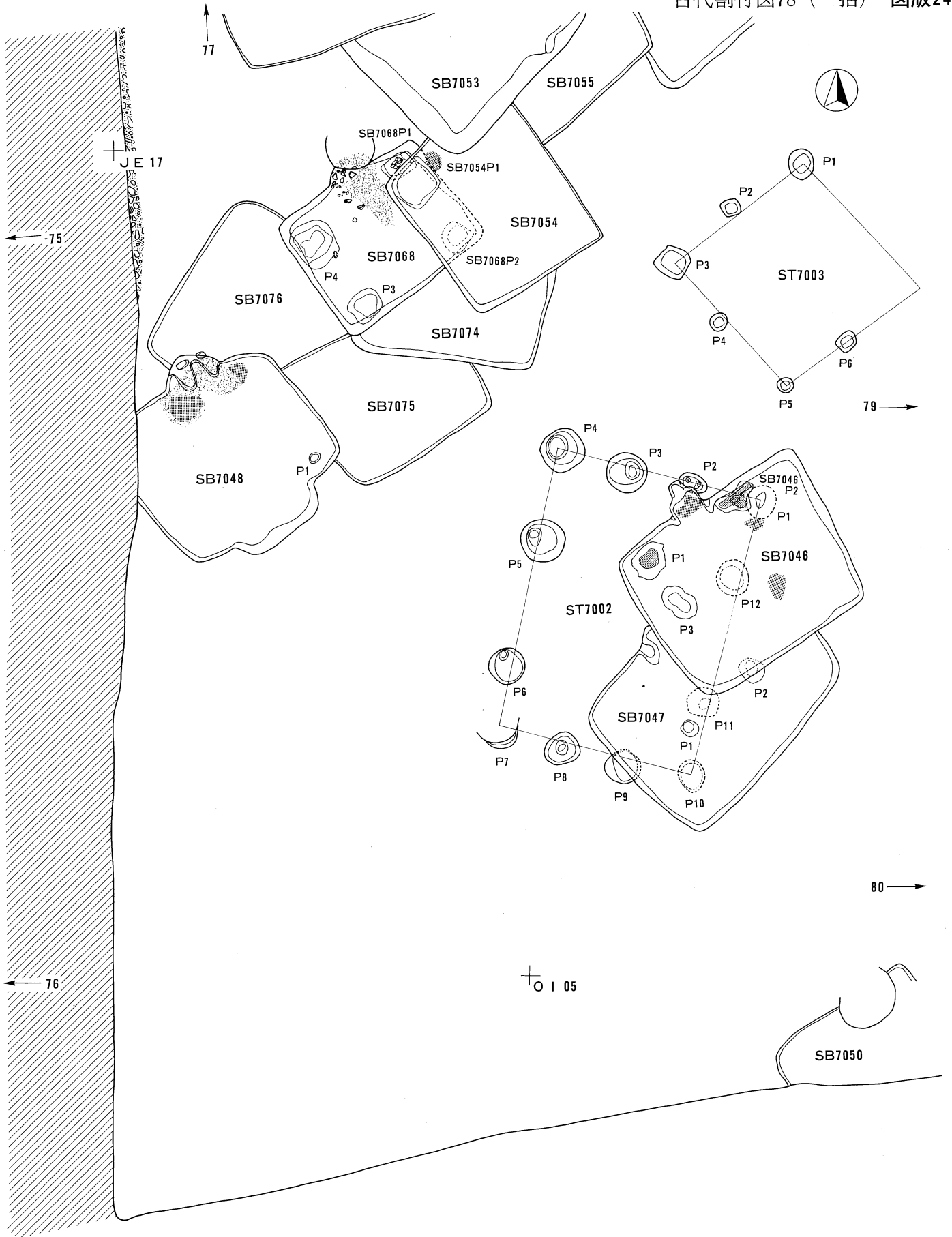

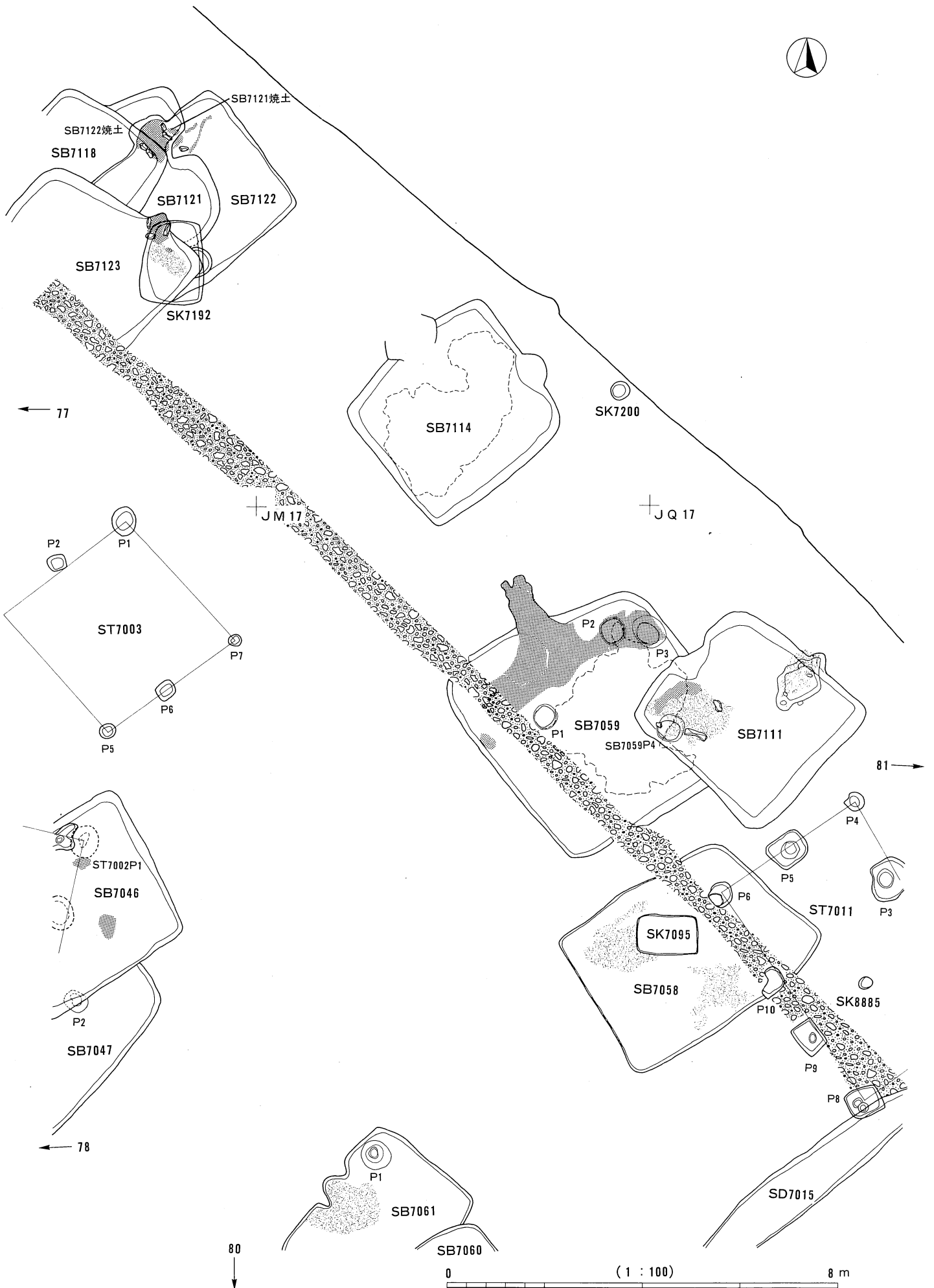

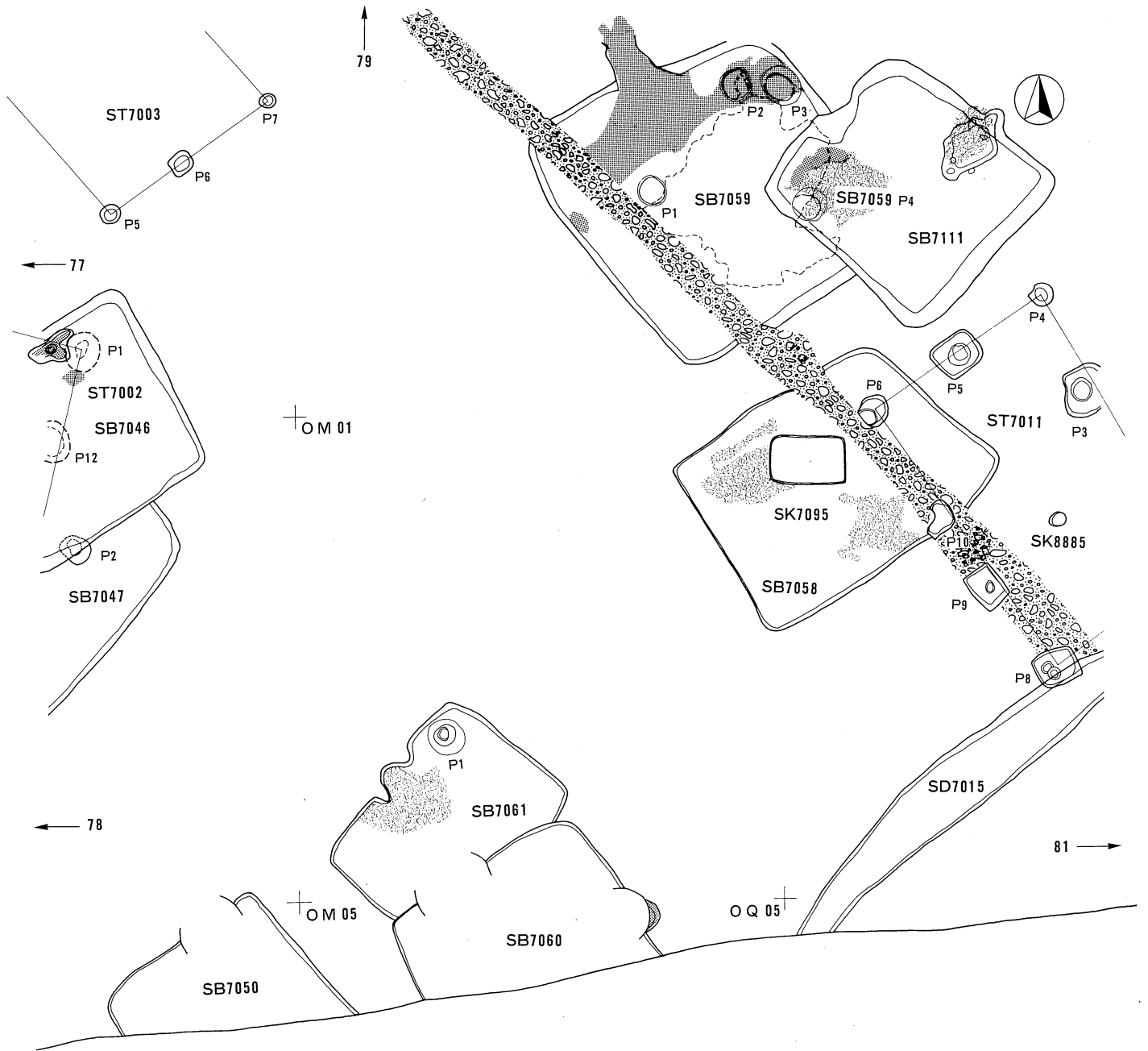

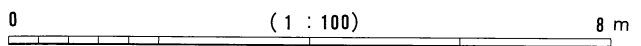
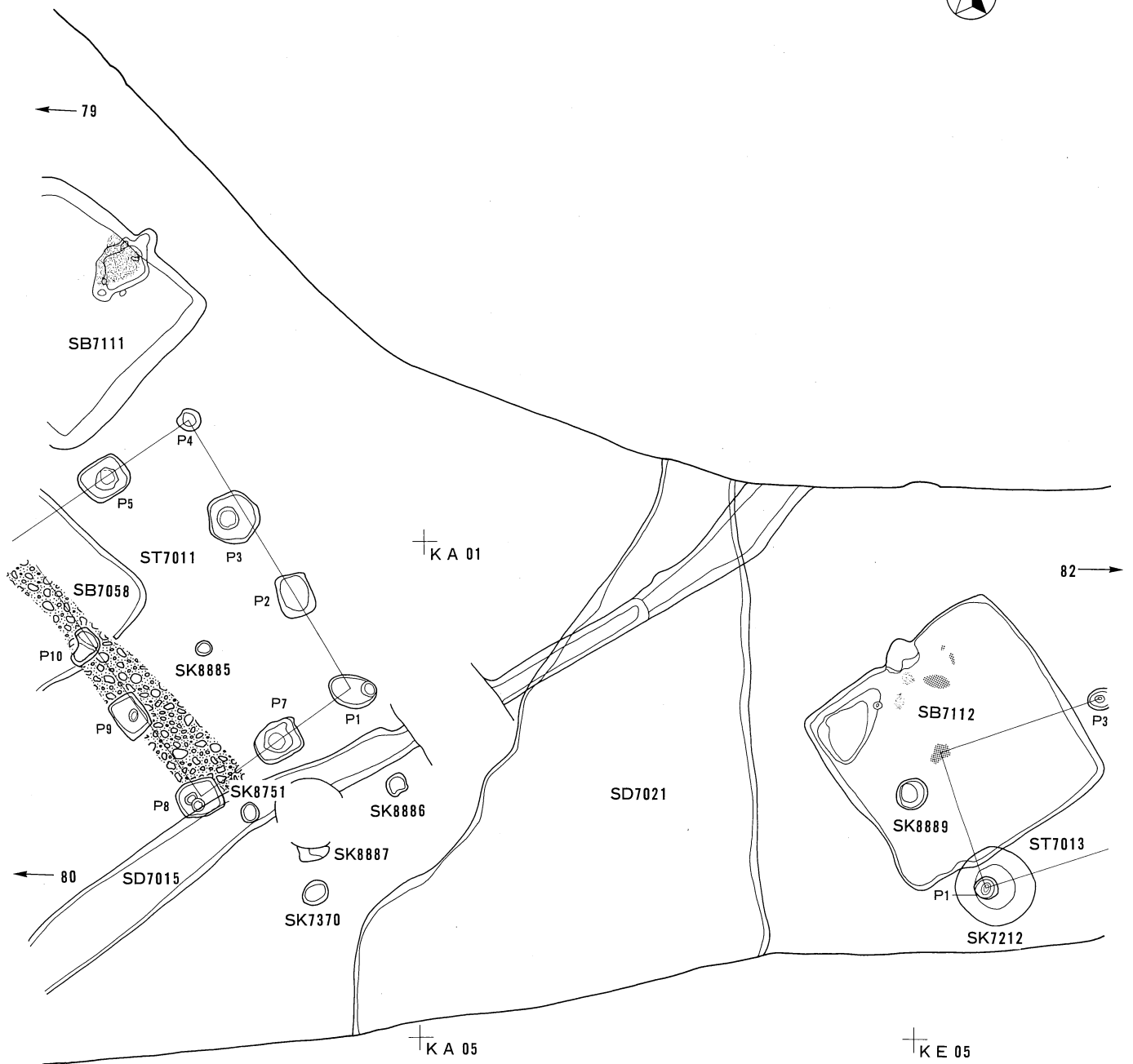

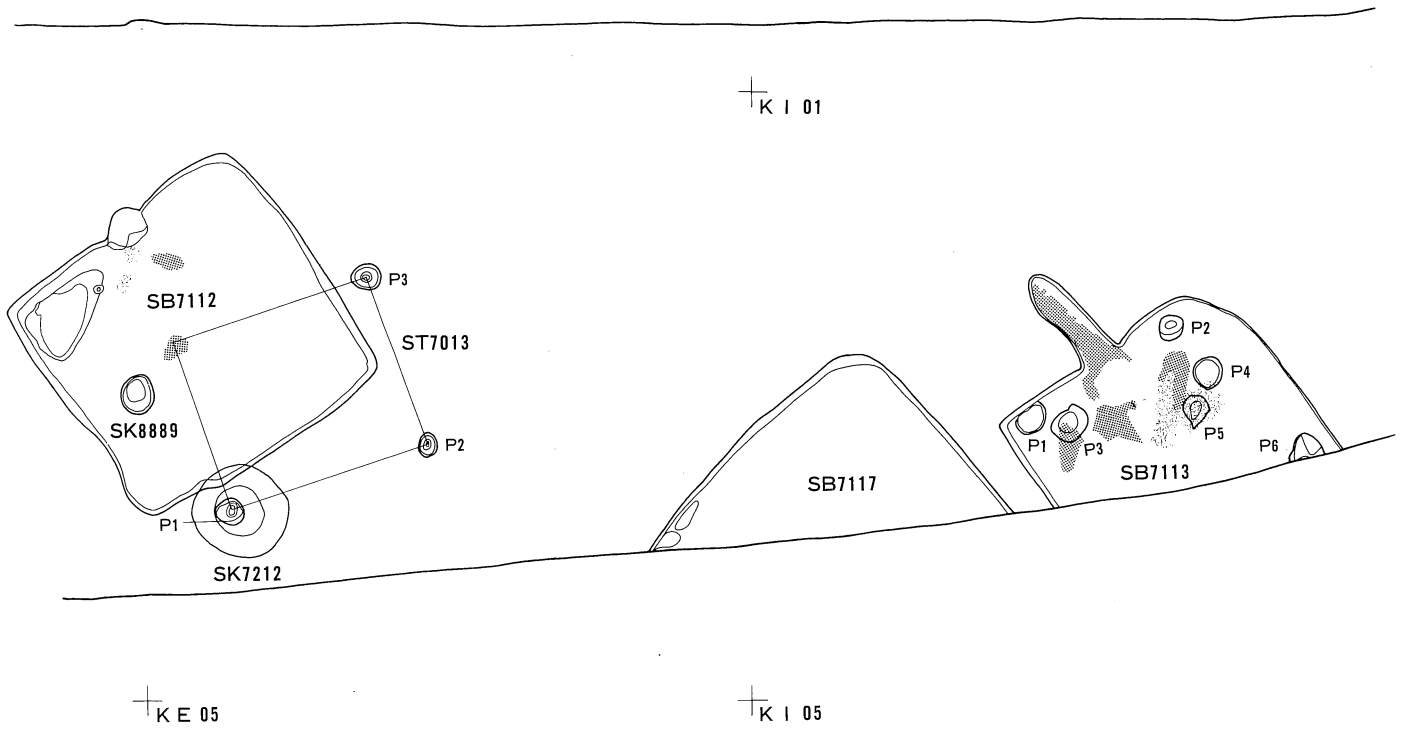

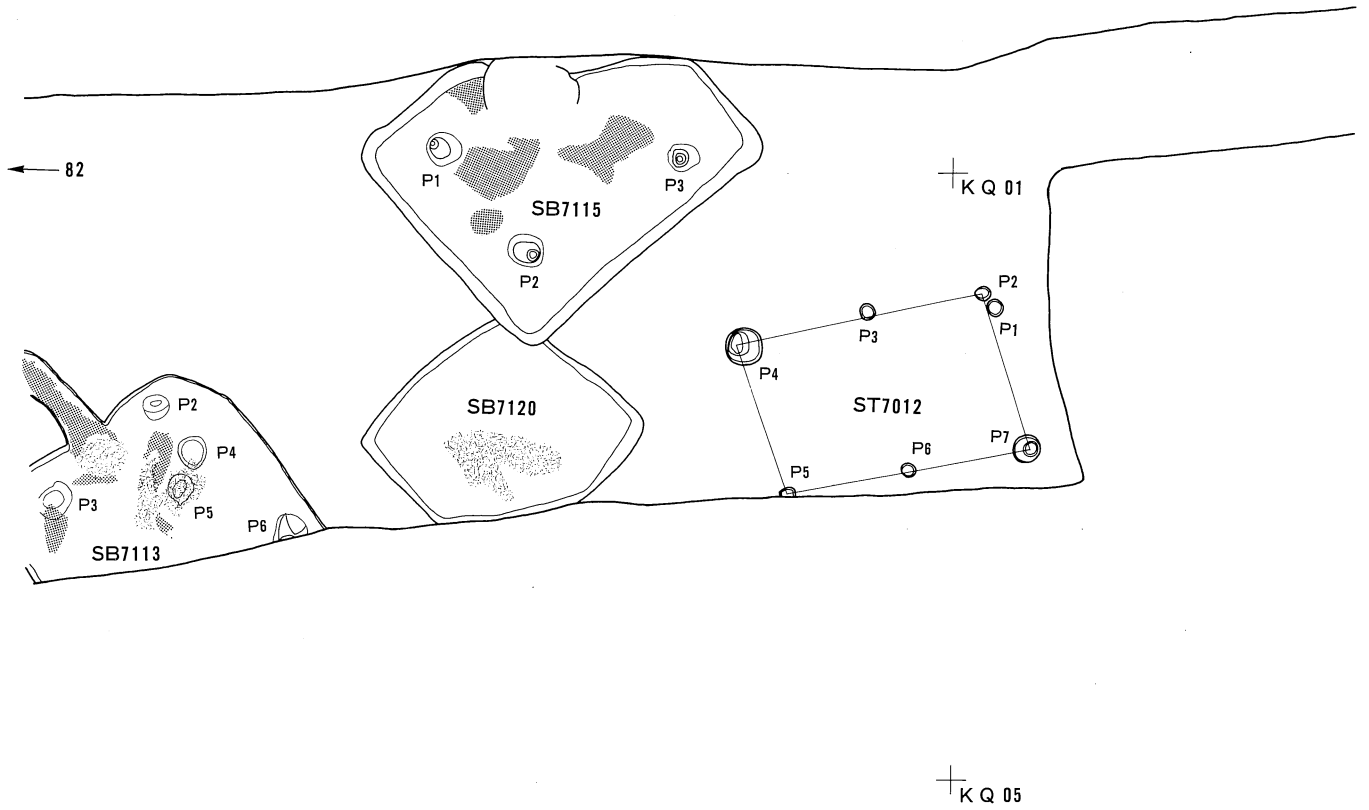

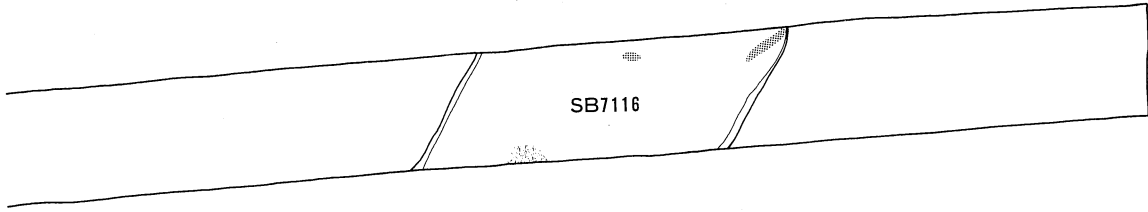

+LE 01

+LI 01

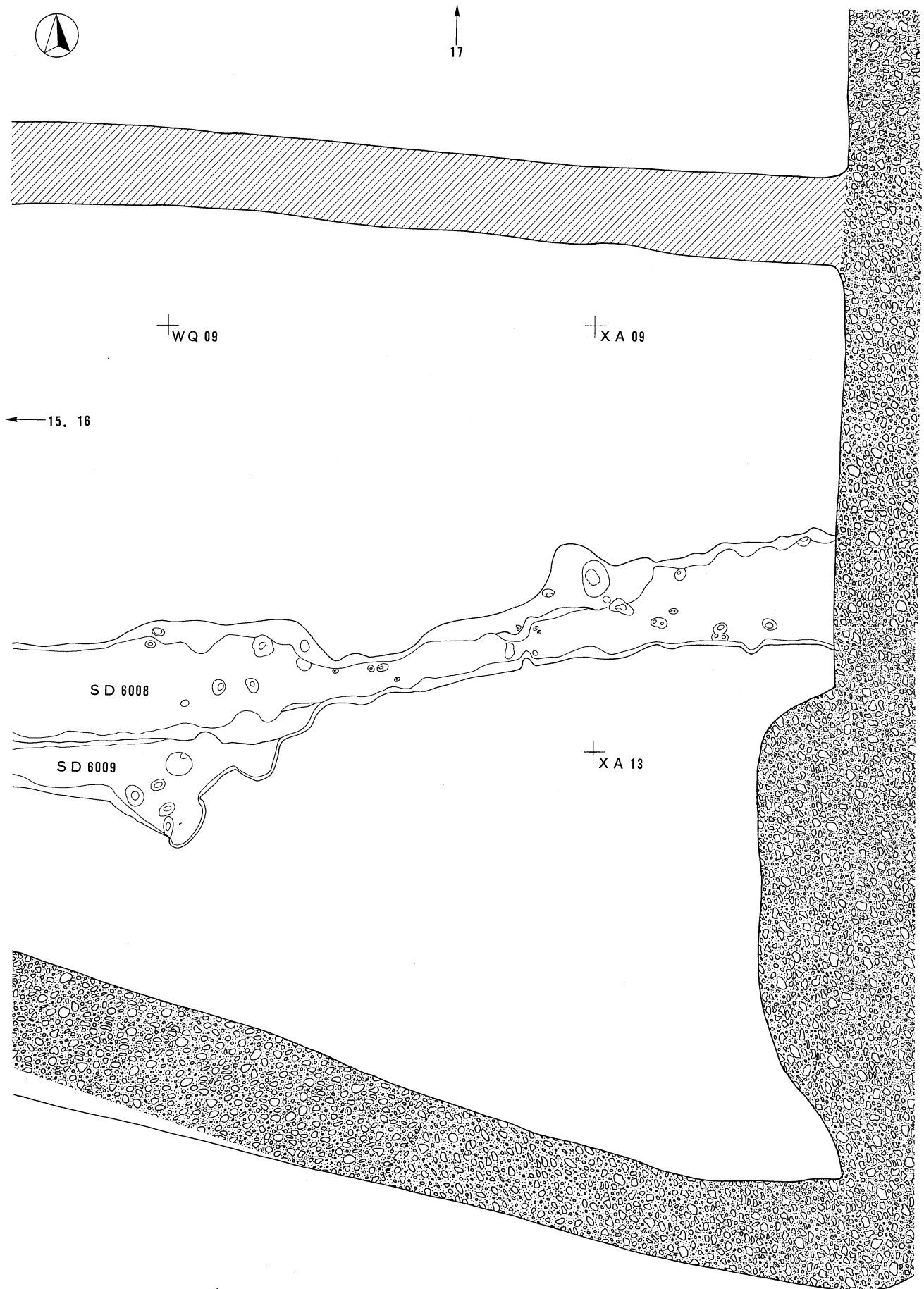

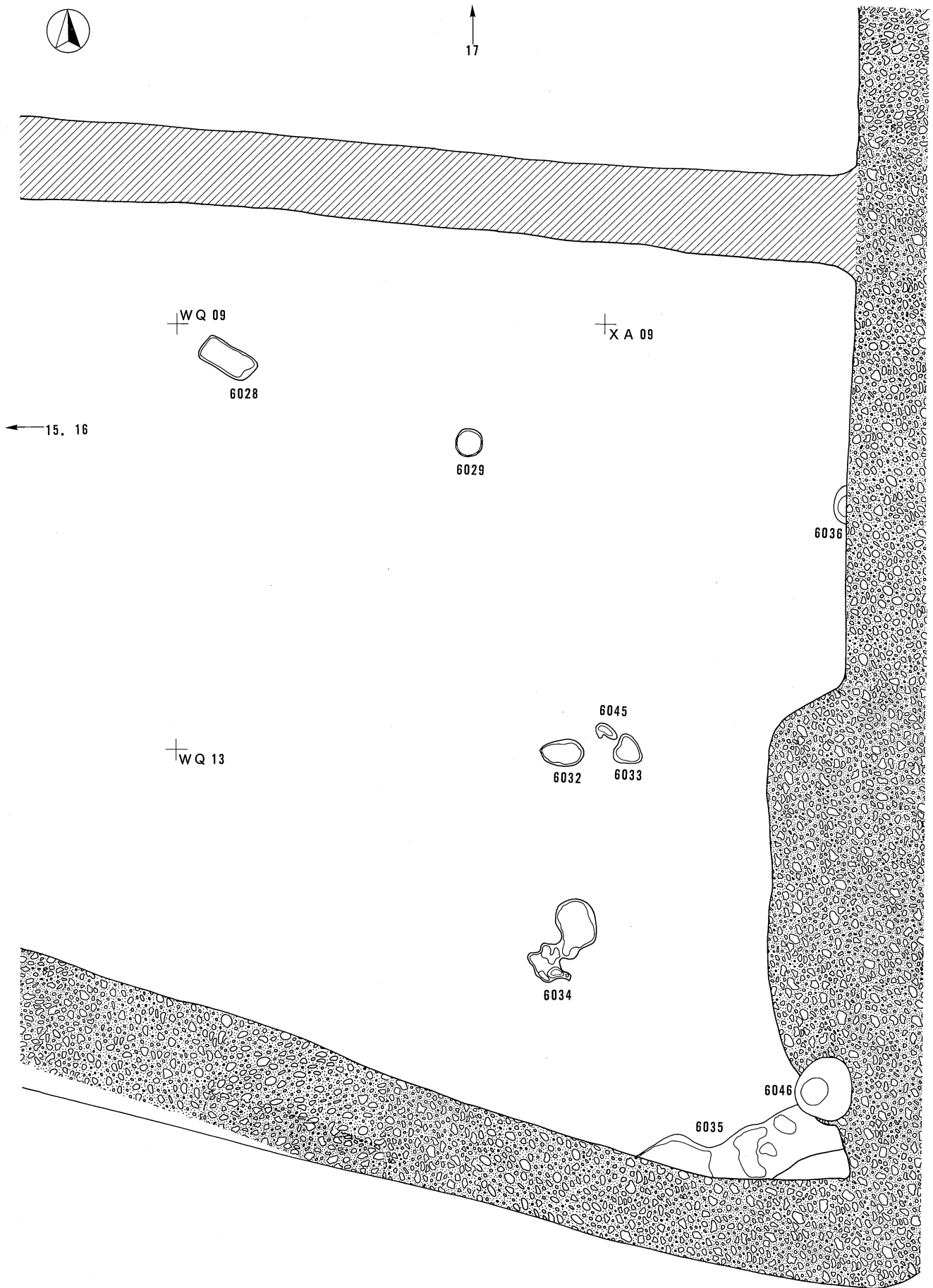

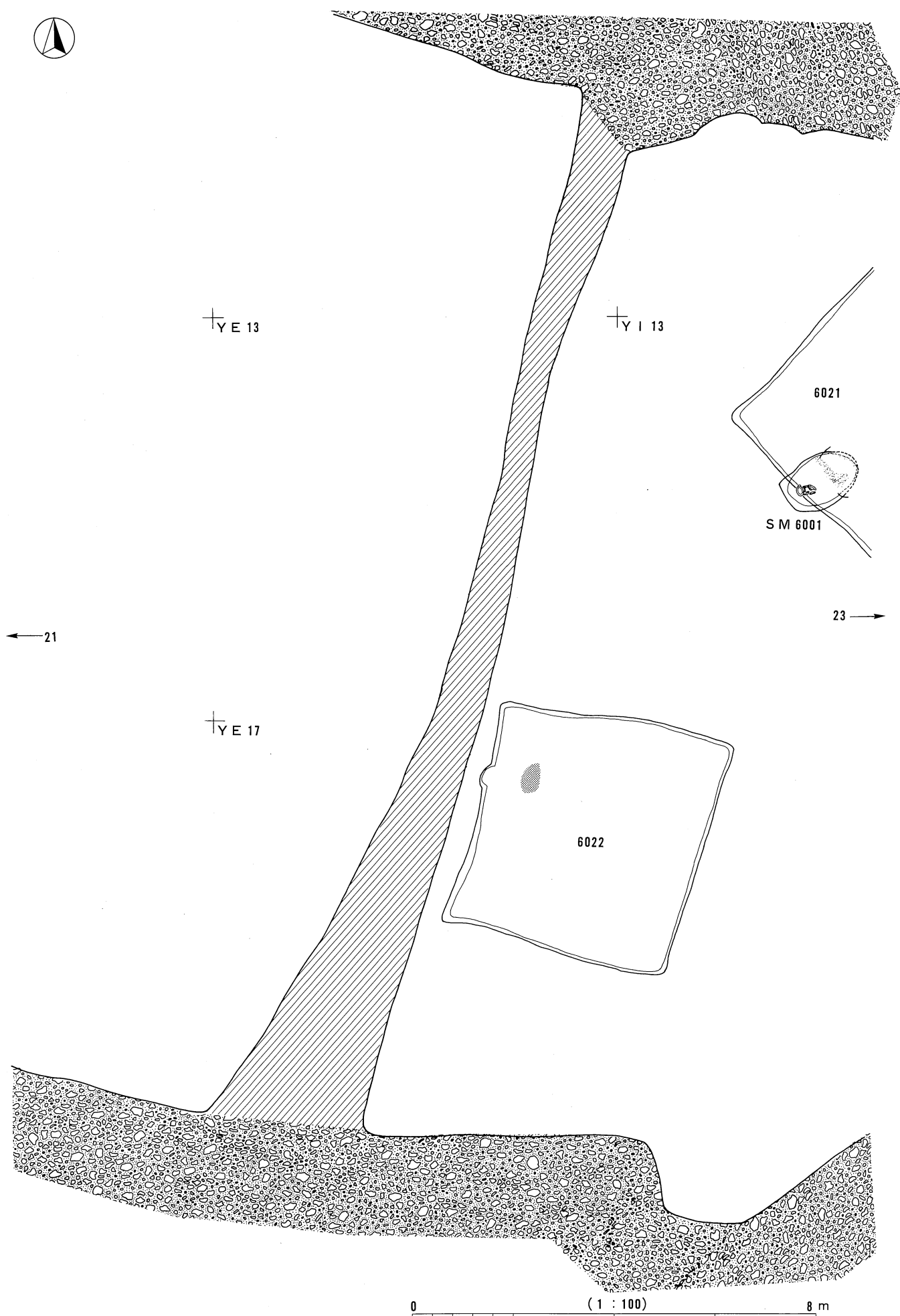

0 (1 : 100) 8 m

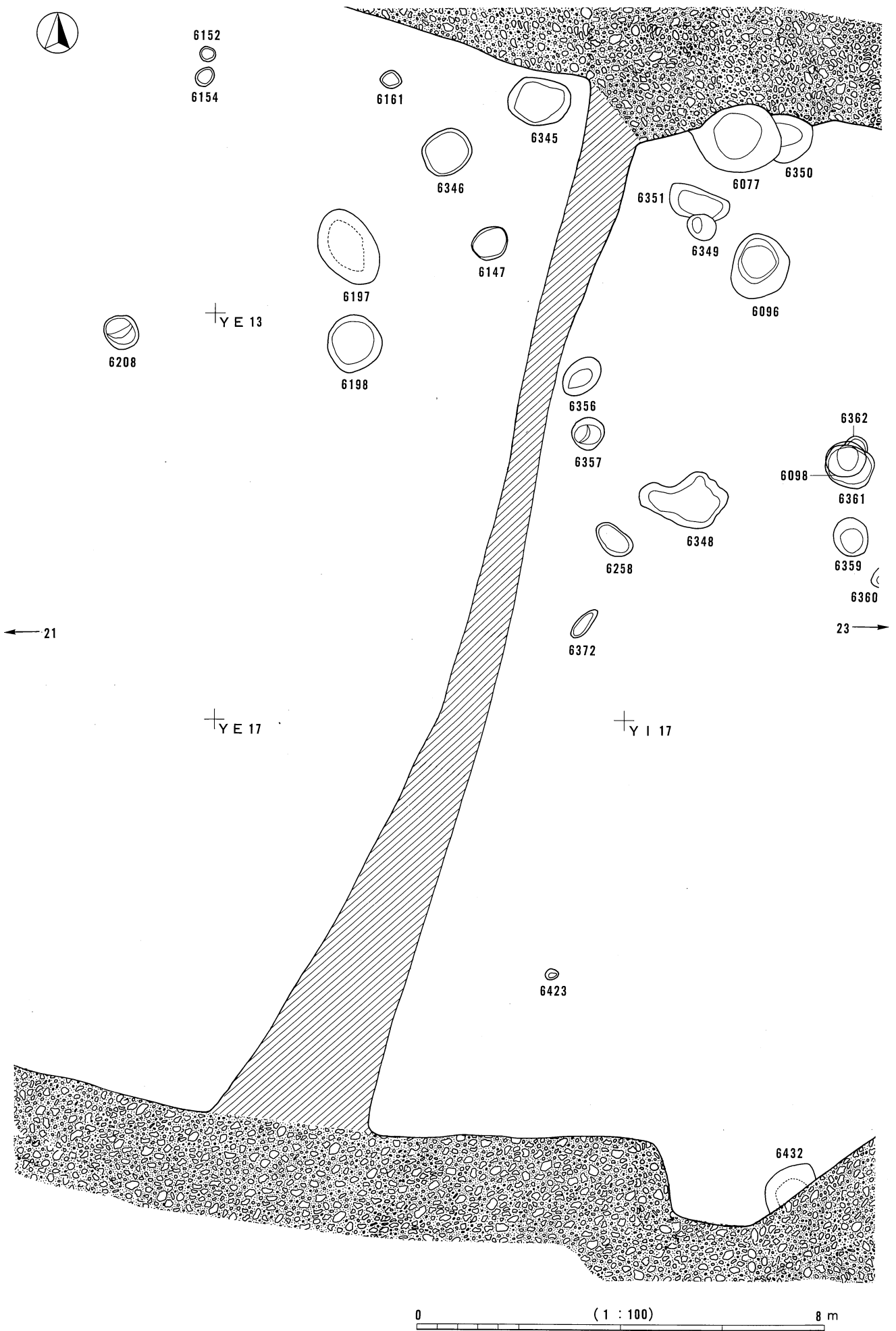

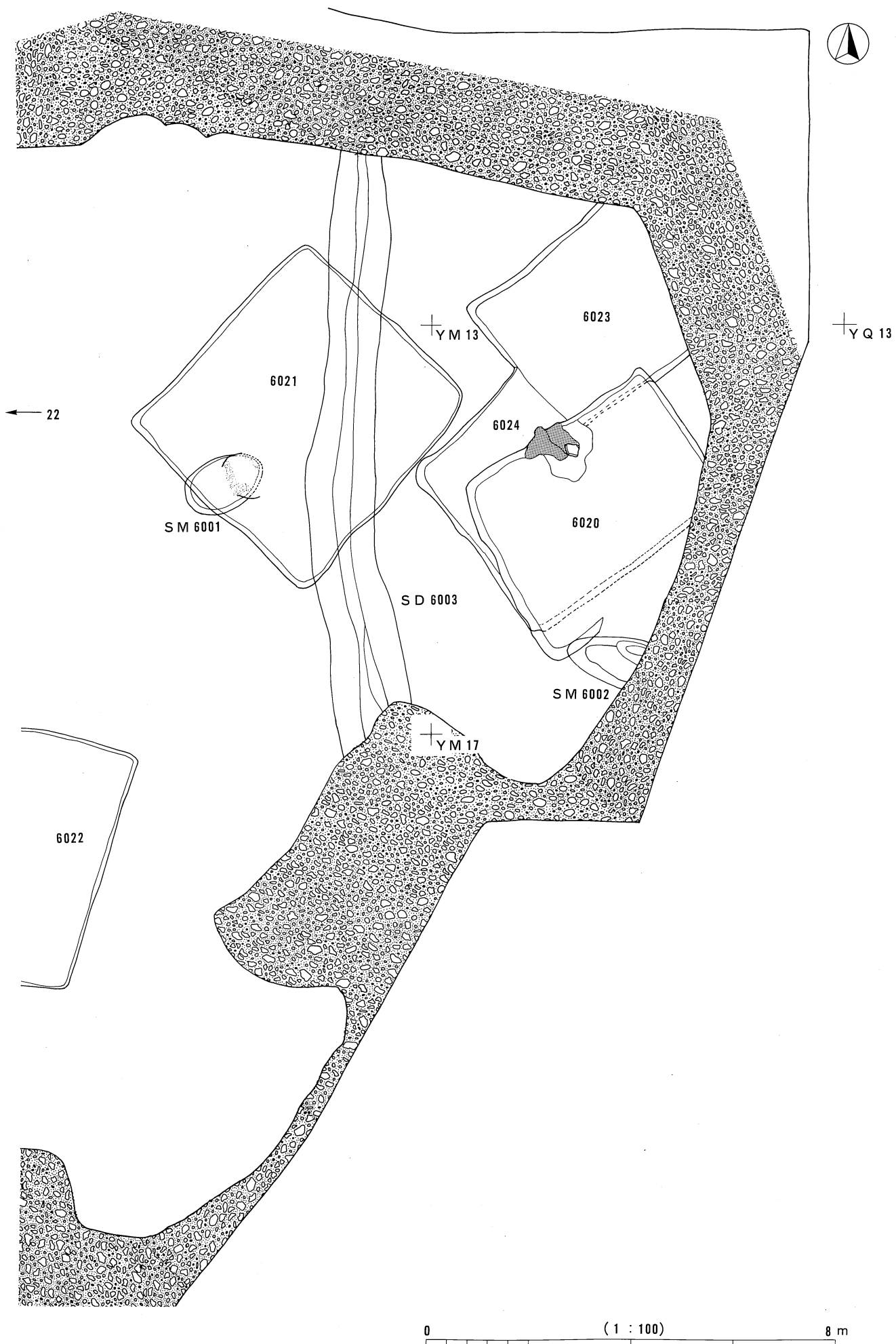

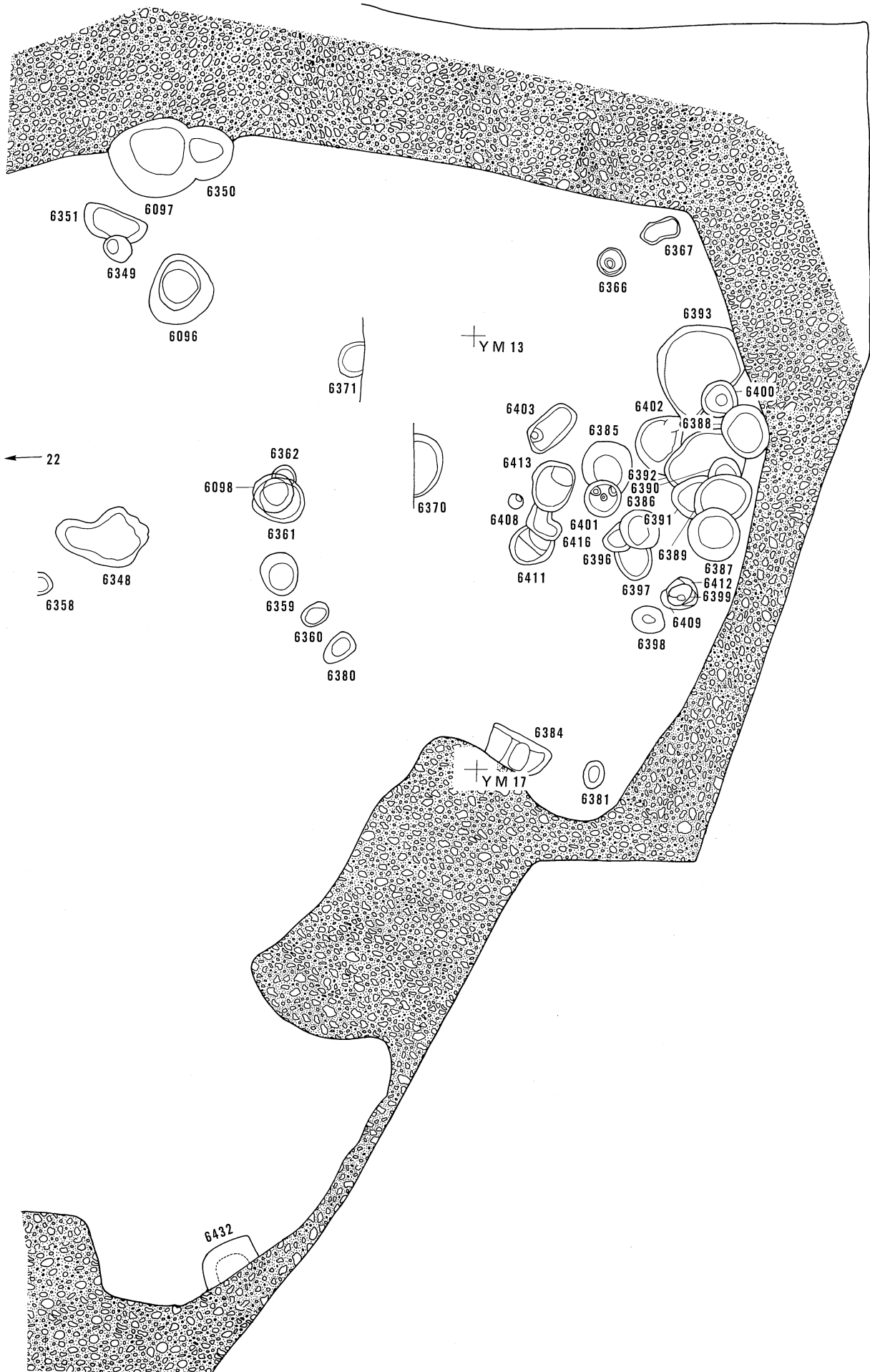

← 22

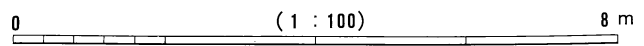

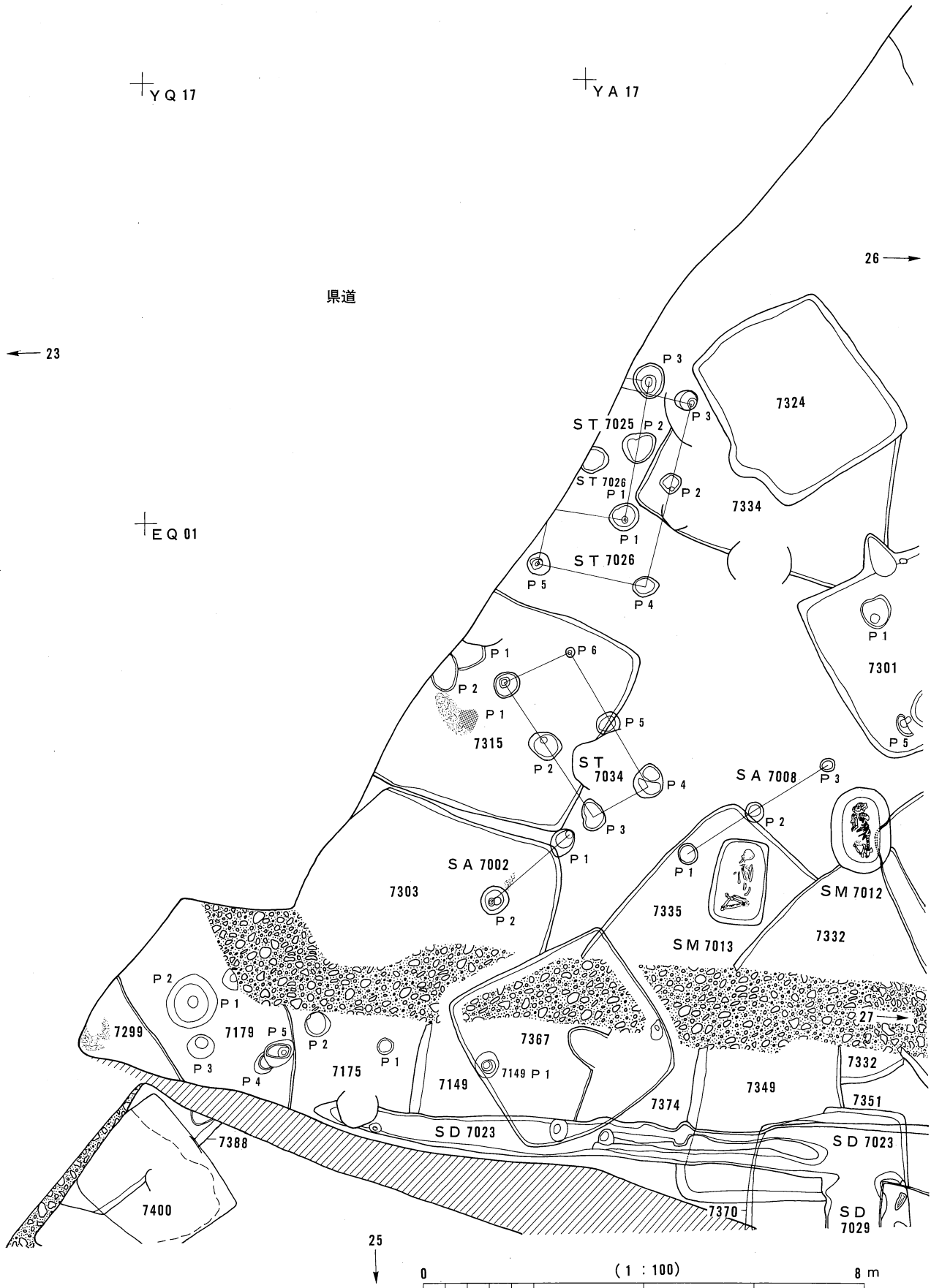

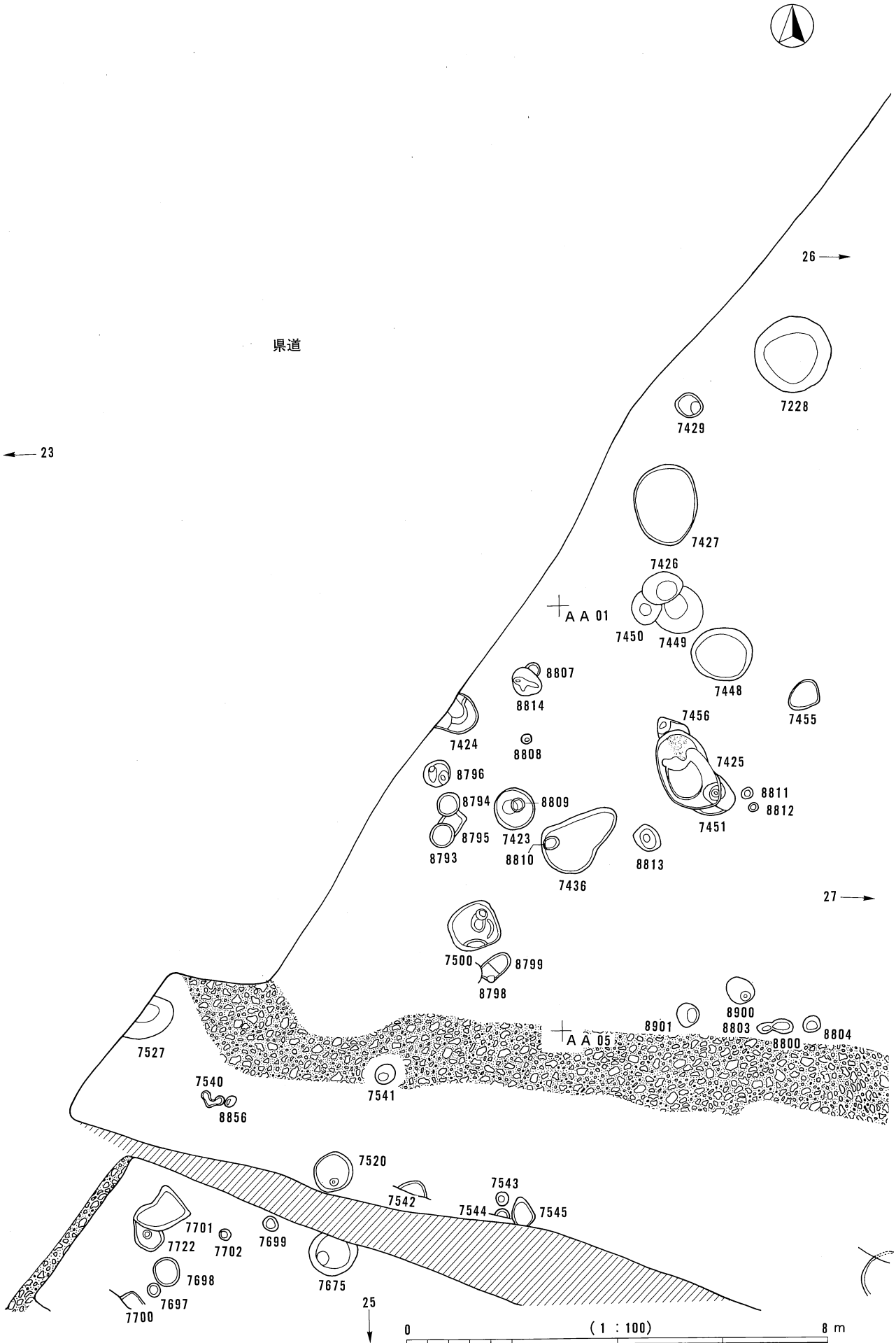

图版264 古代割付图25 (SK以外)

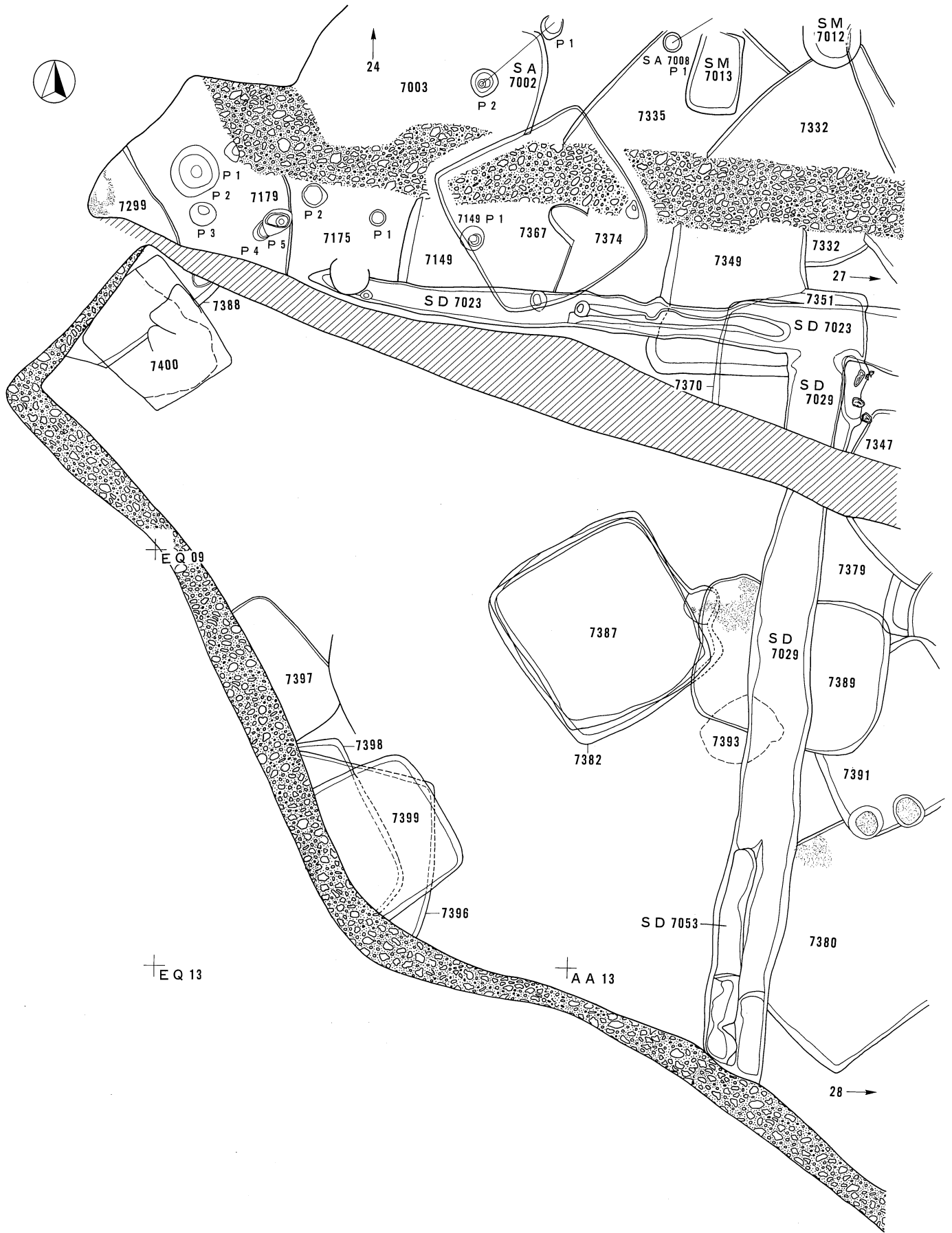

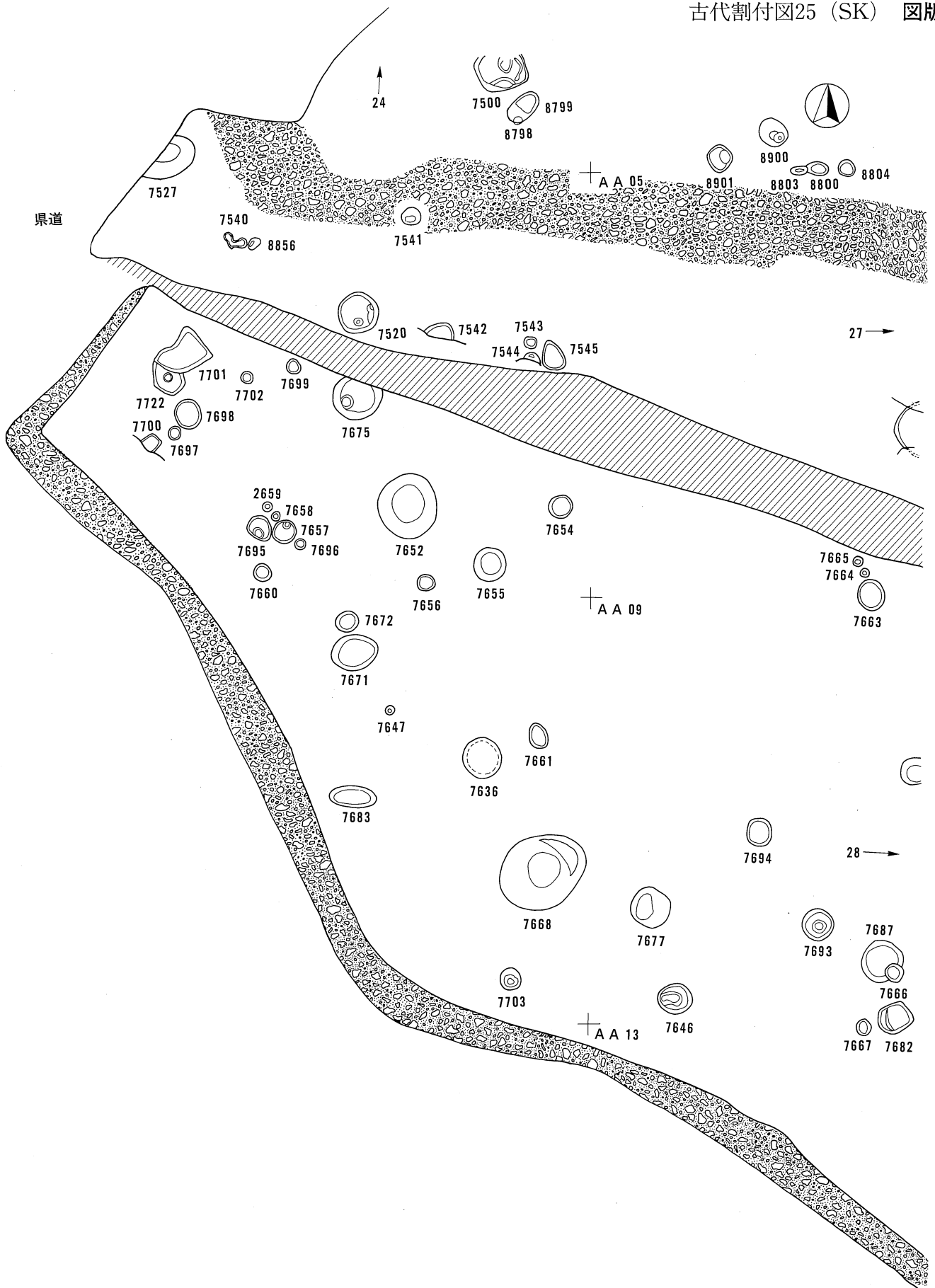

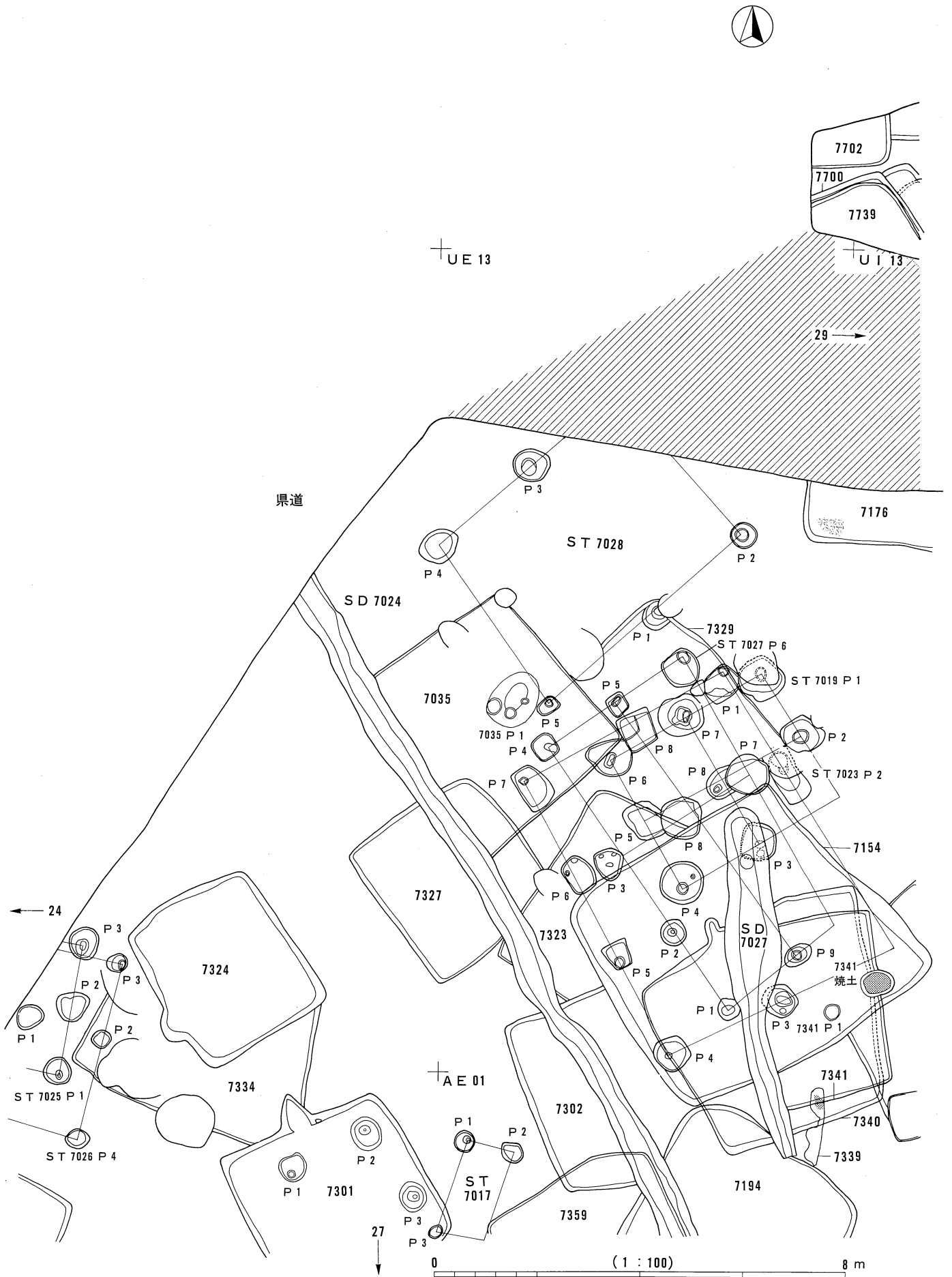

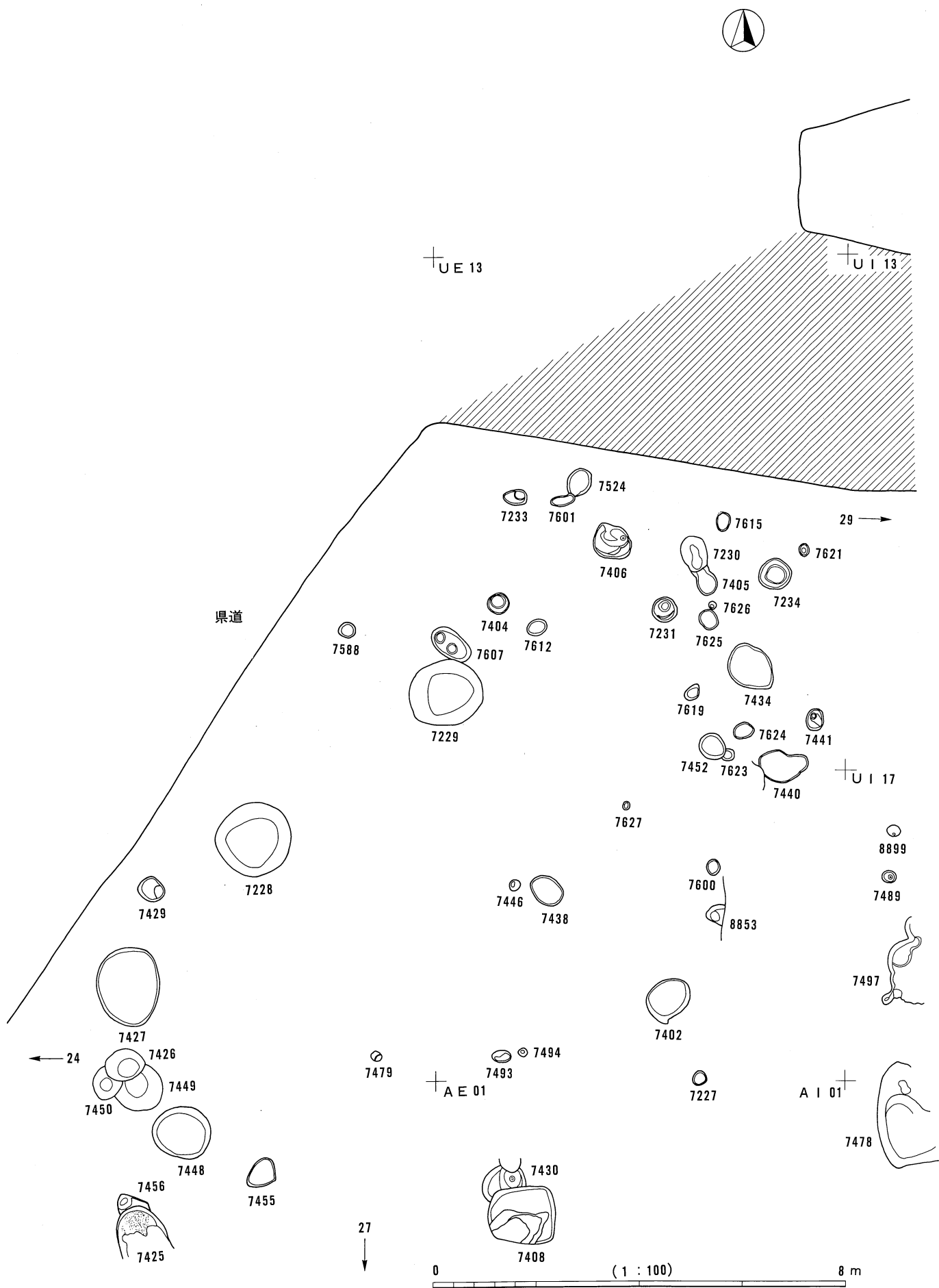

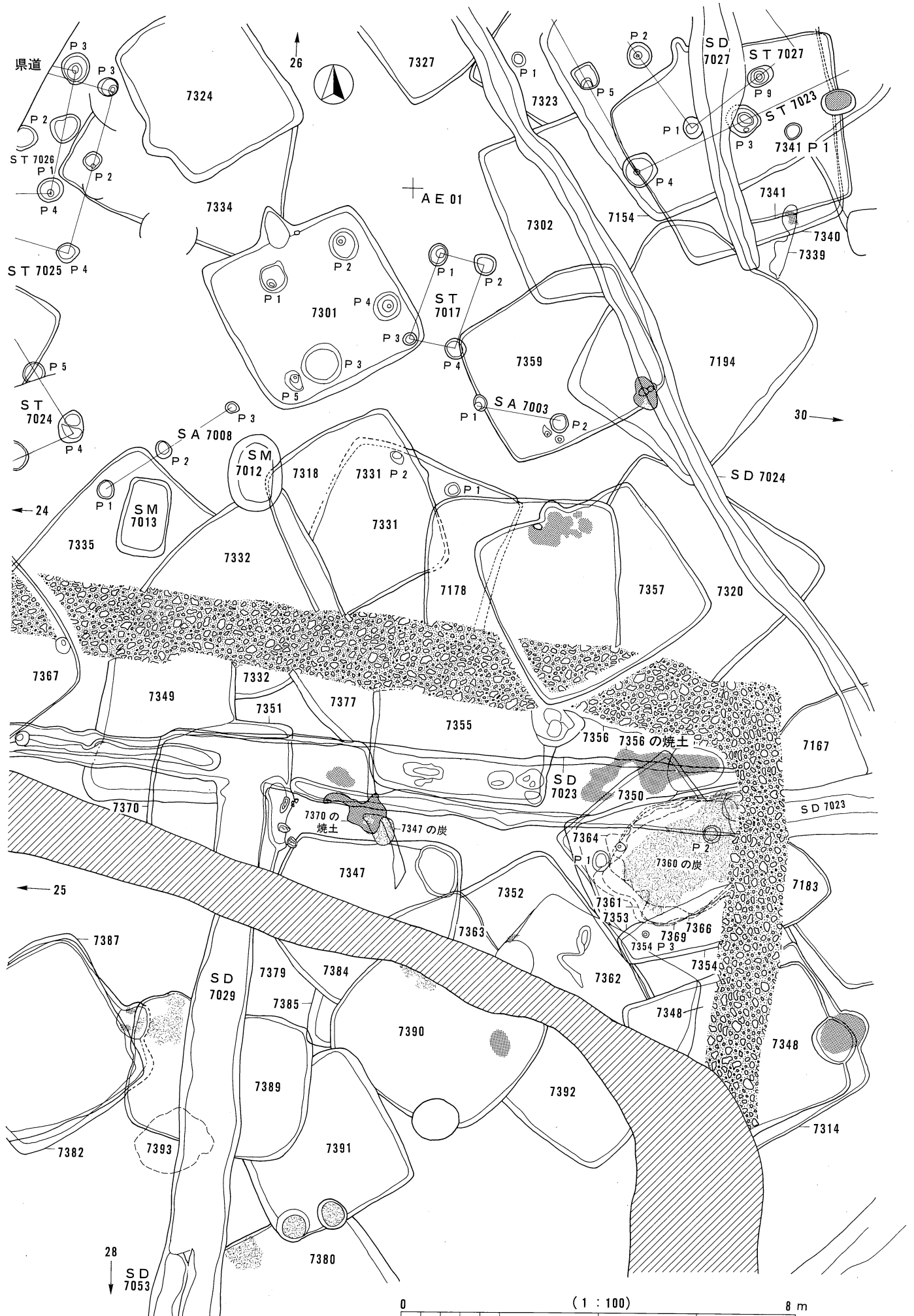

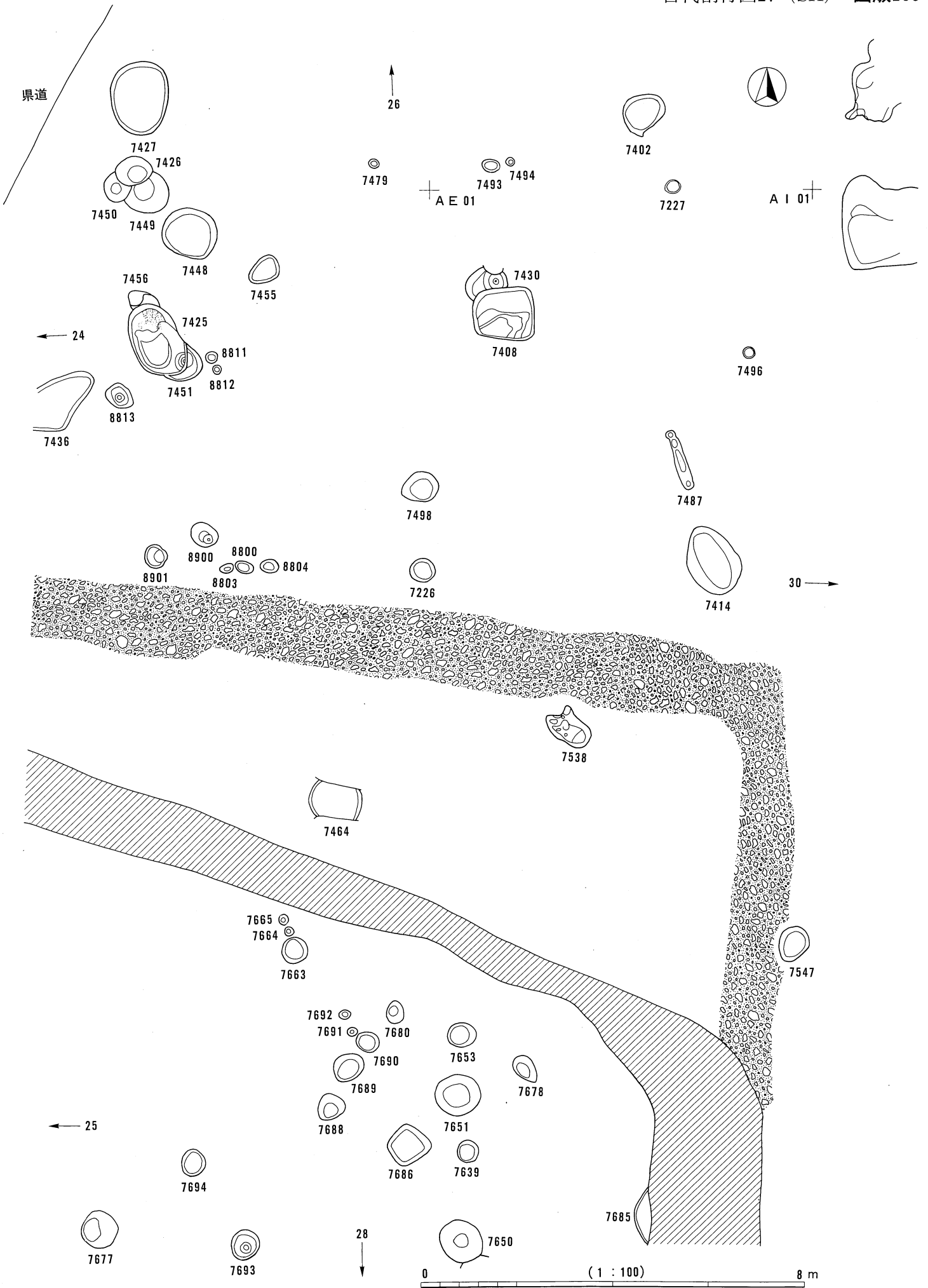

図版270 古代割付図28 (SK以外)

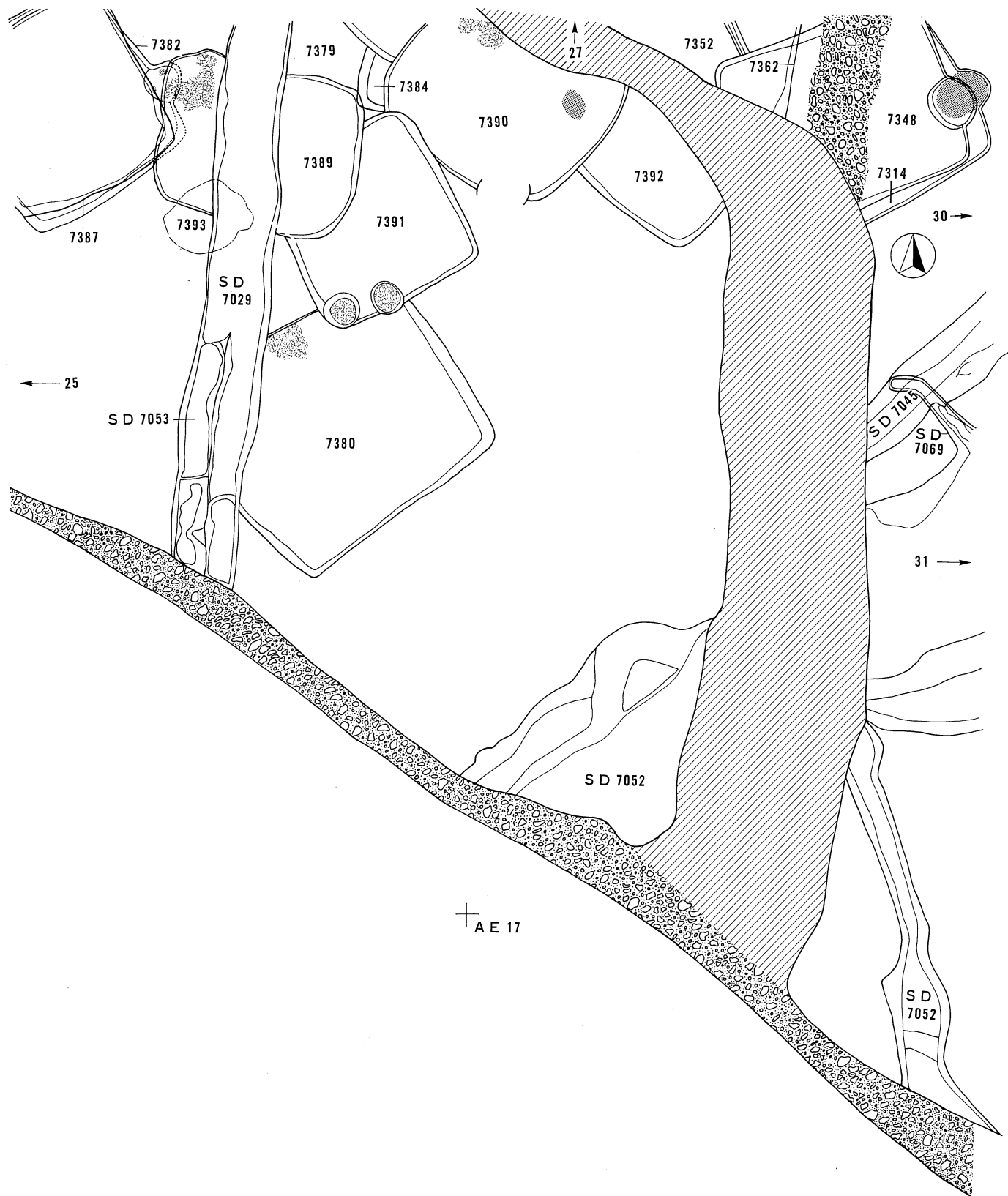

+ AE 17

+ FE 01

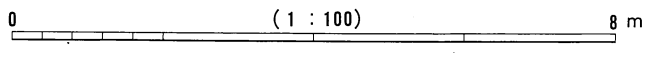

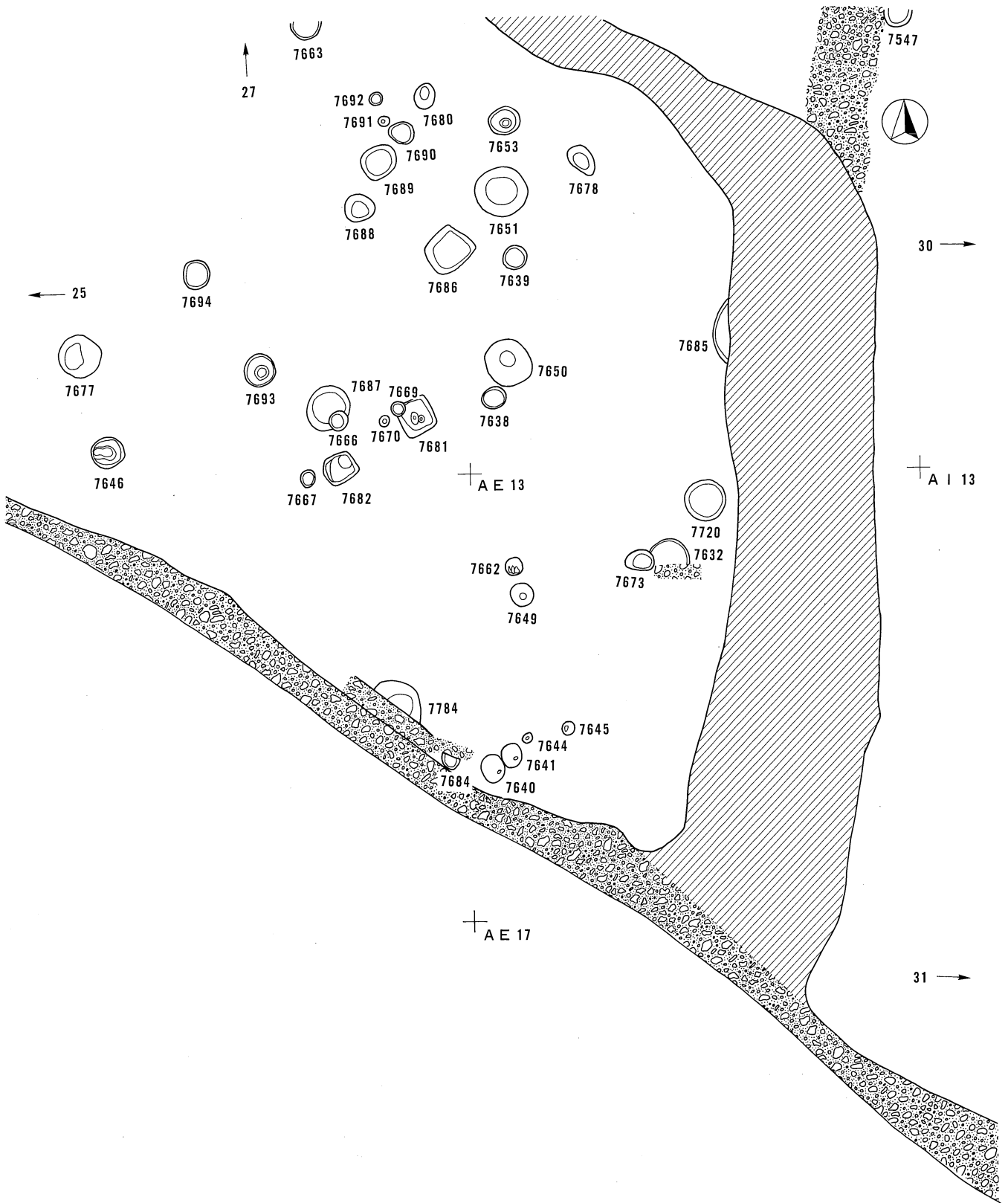

图版272 古代割付图29 (SK以外)

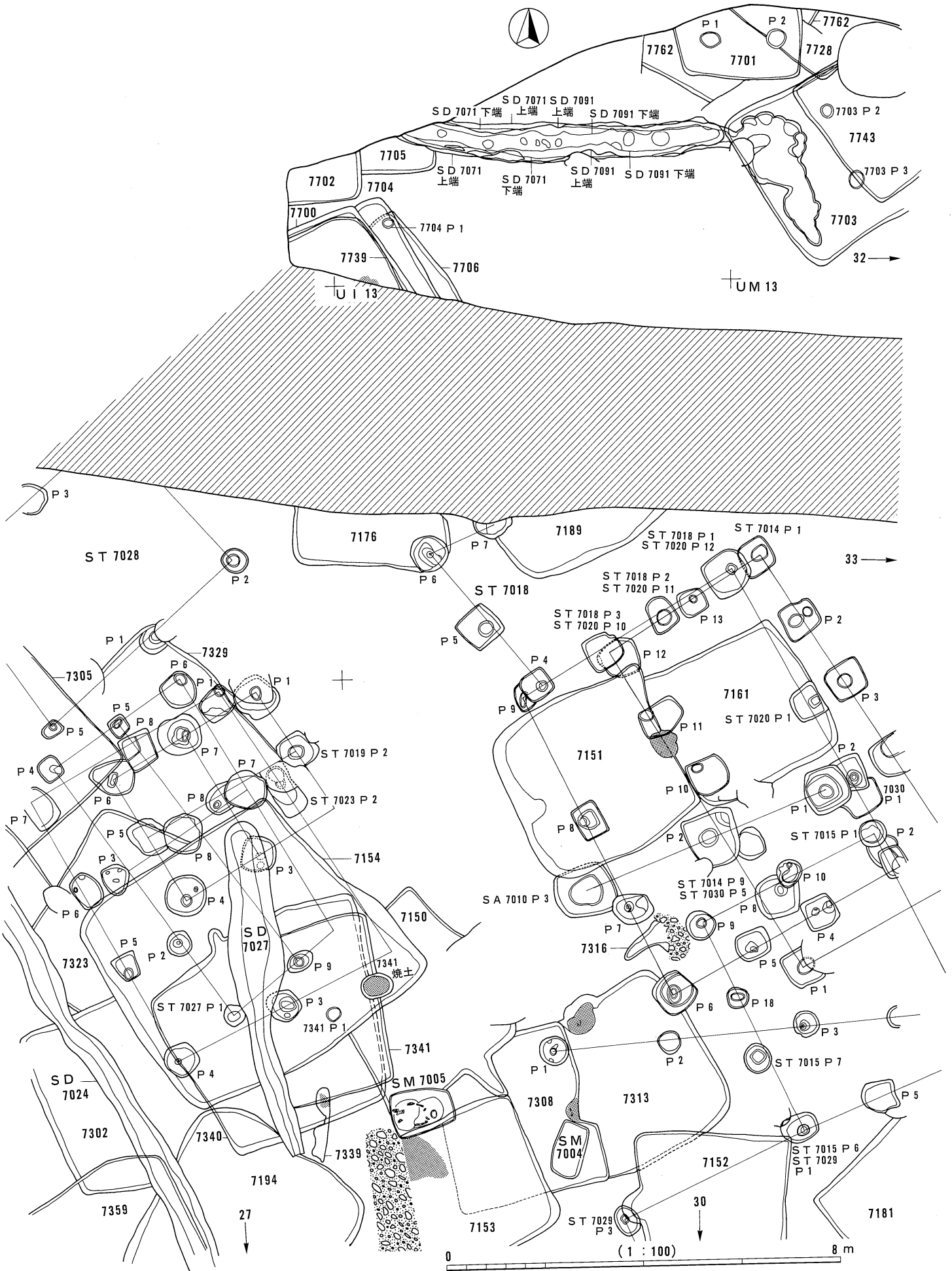

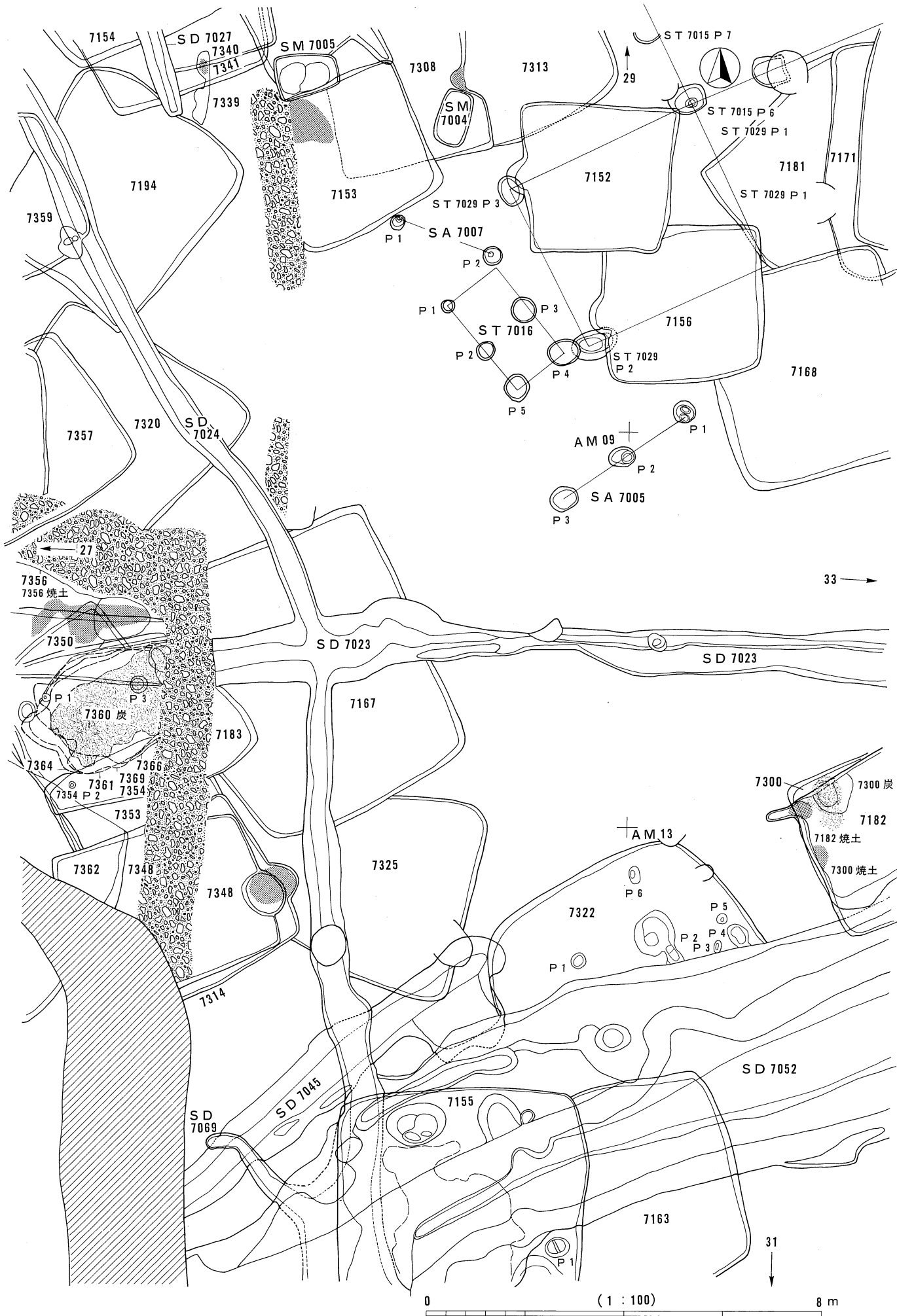

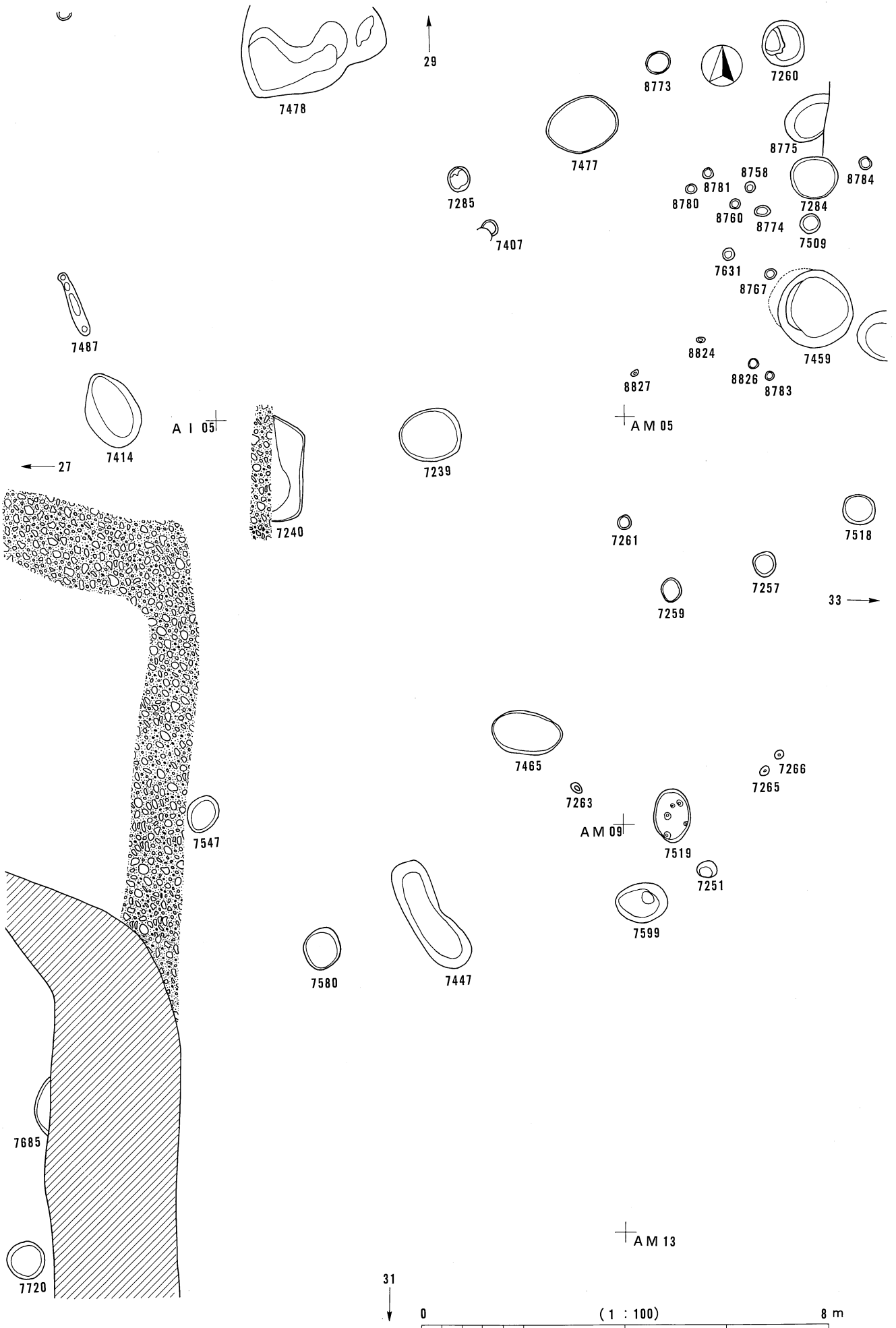

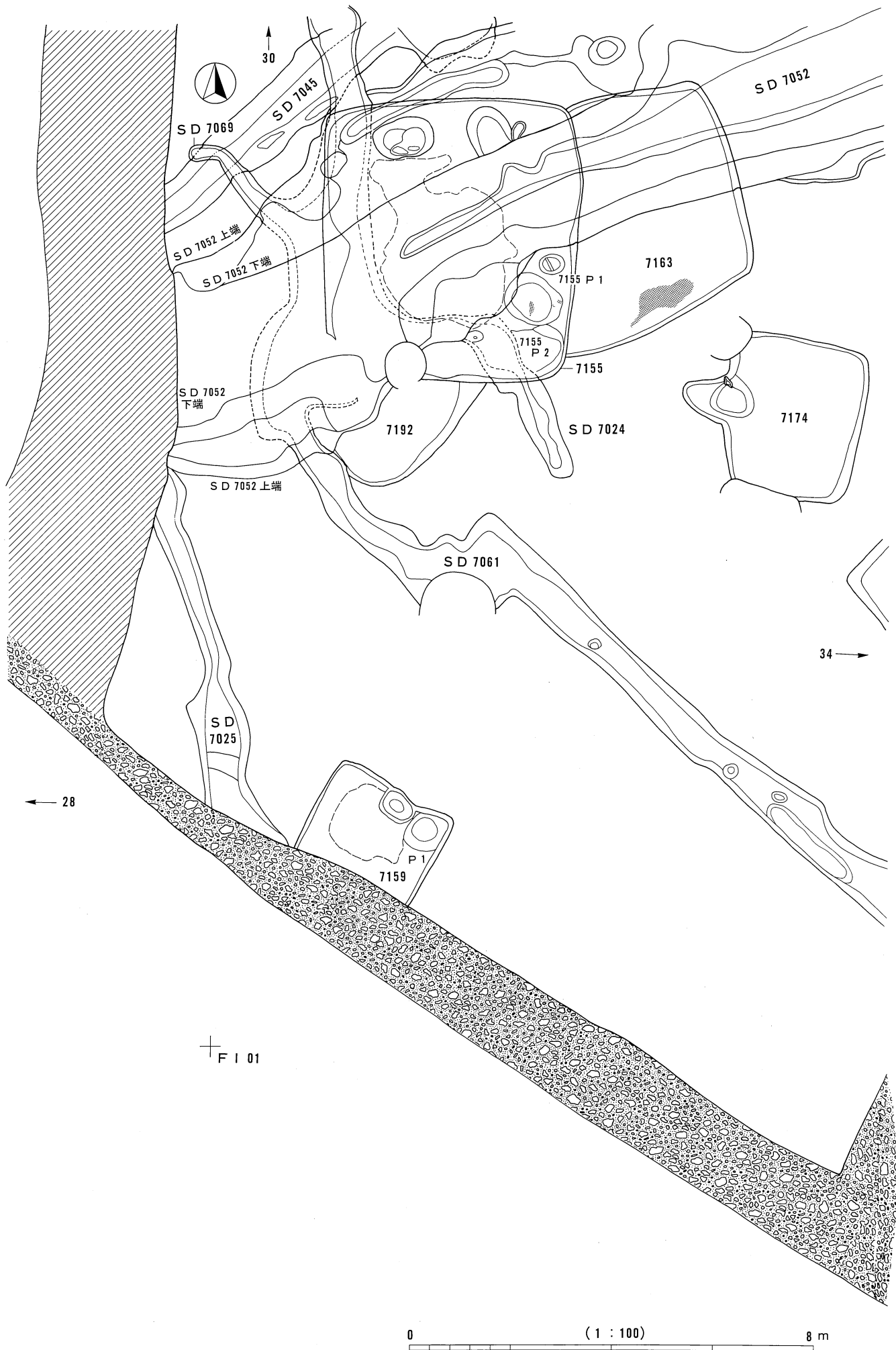

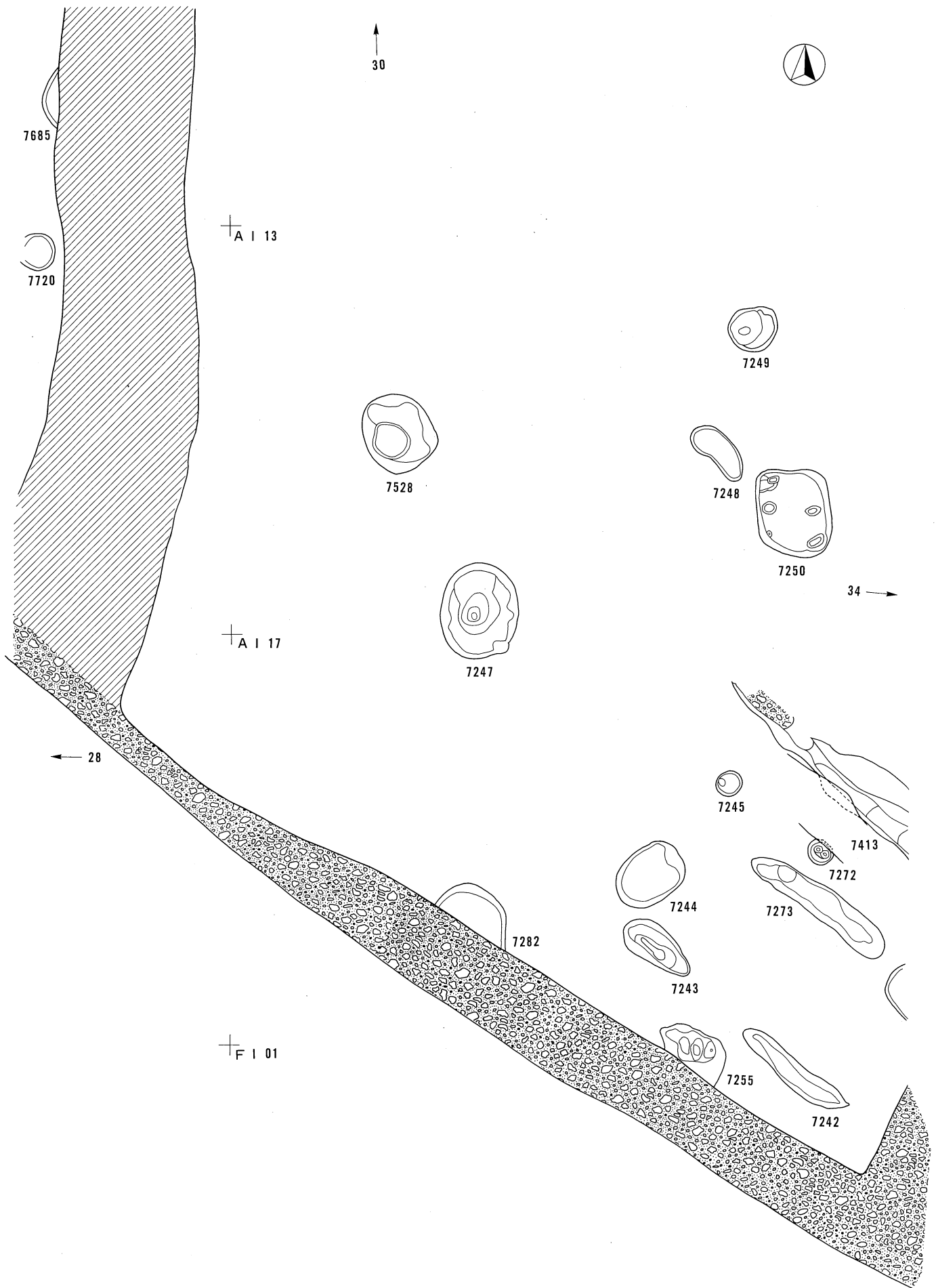

図版278 古代割付図32 (SK以外)

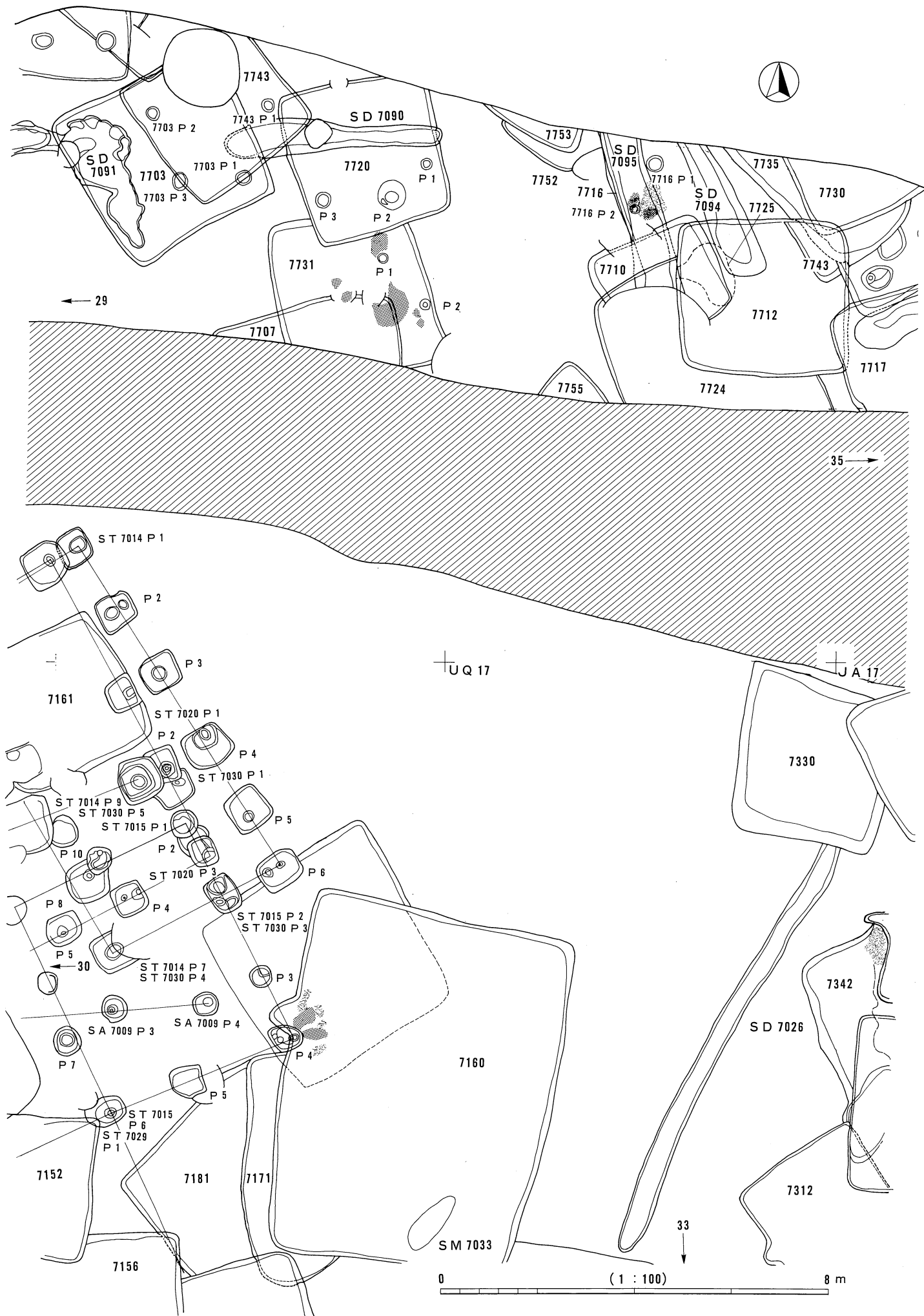

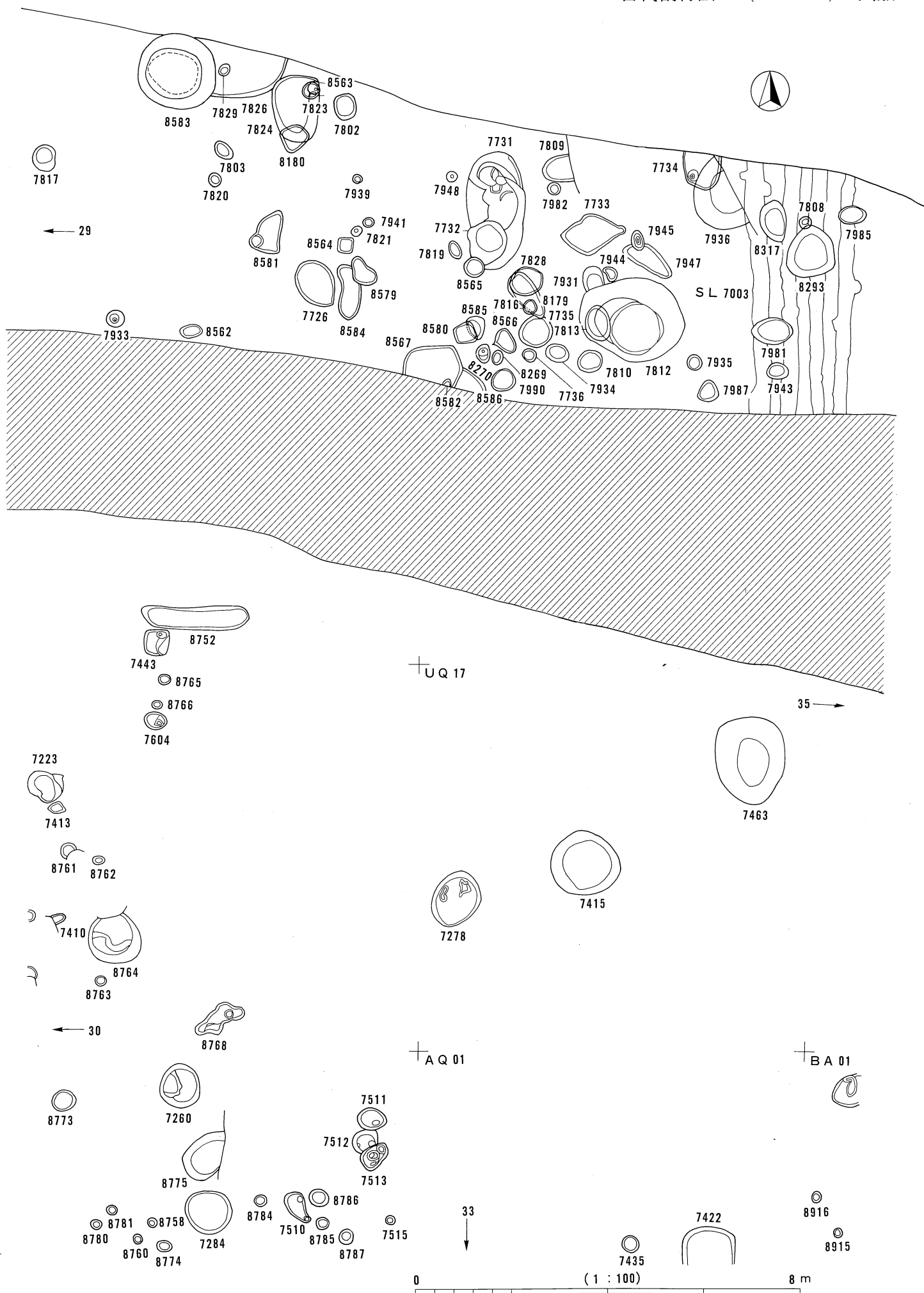

図版280 古代割付図33 (SK以外)

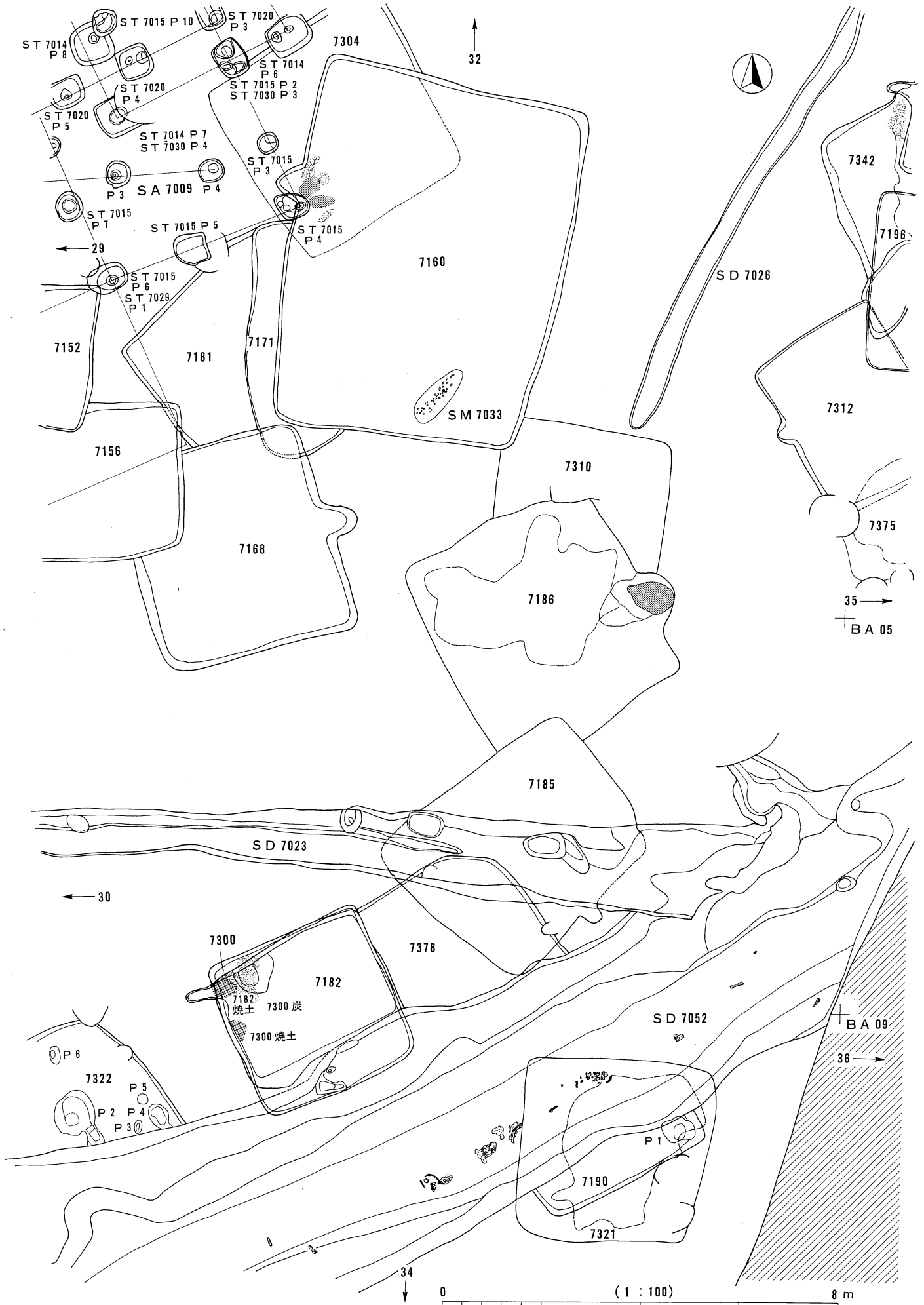

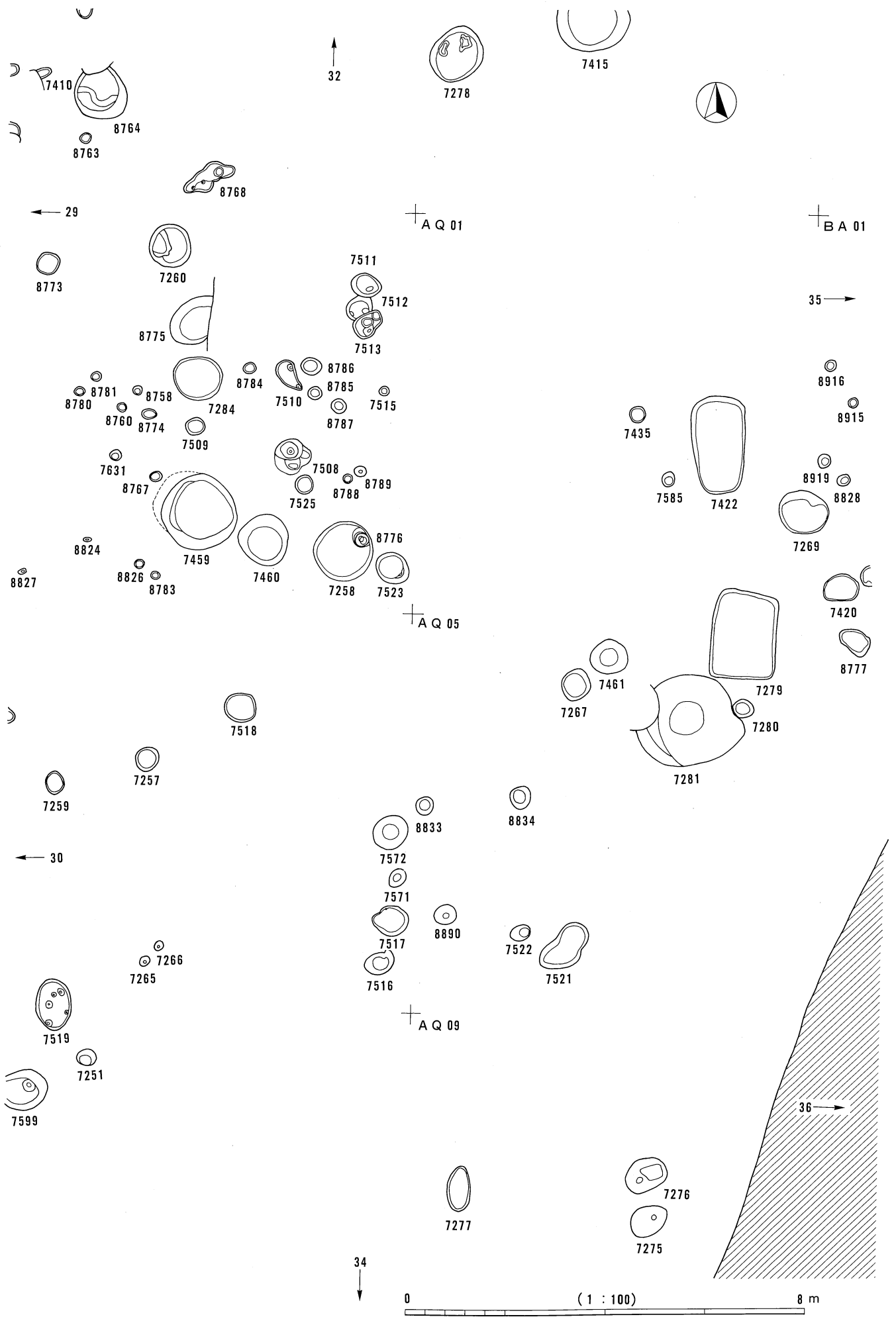

図版282 古代割付図34 (SK以外)

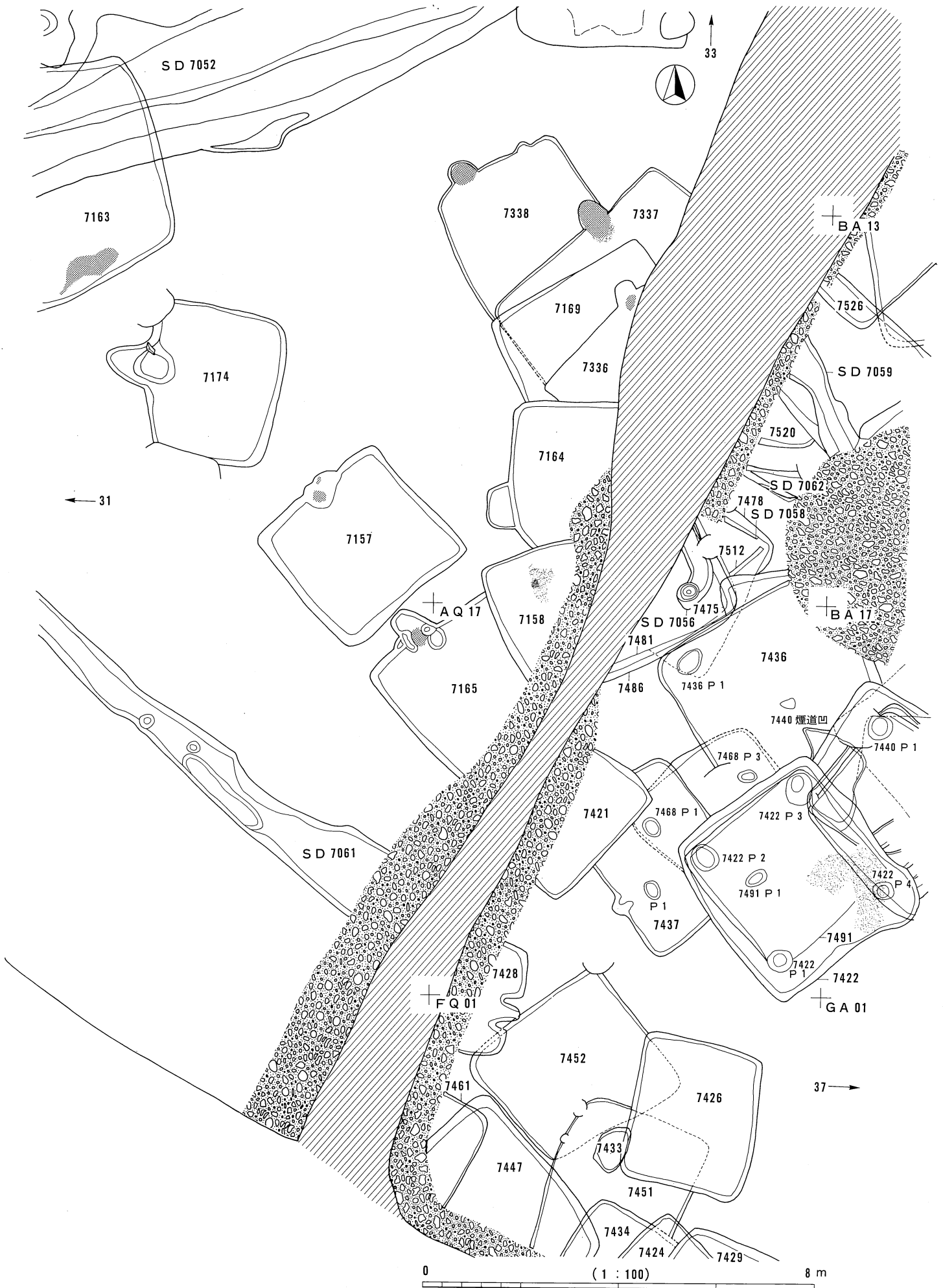

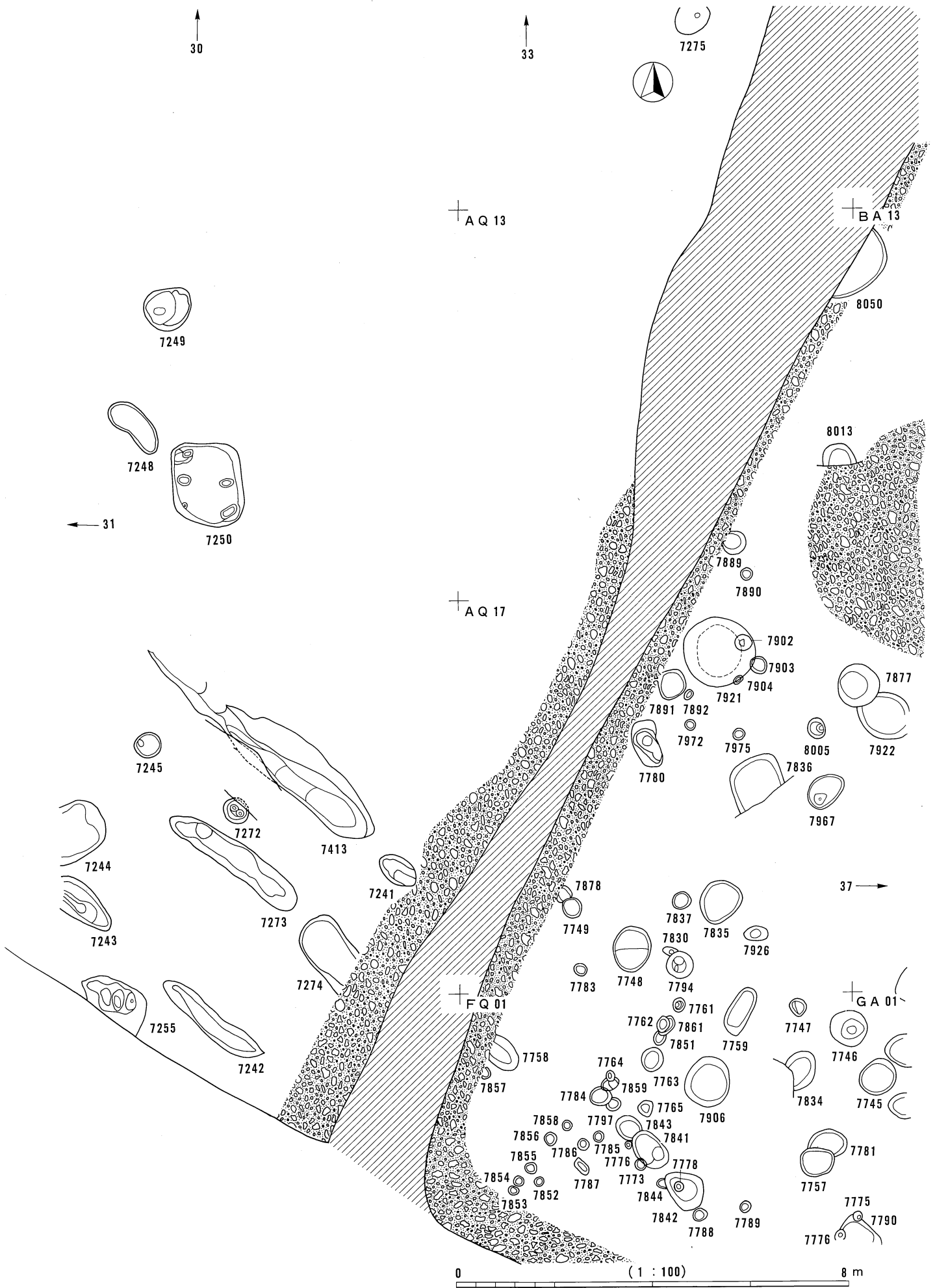

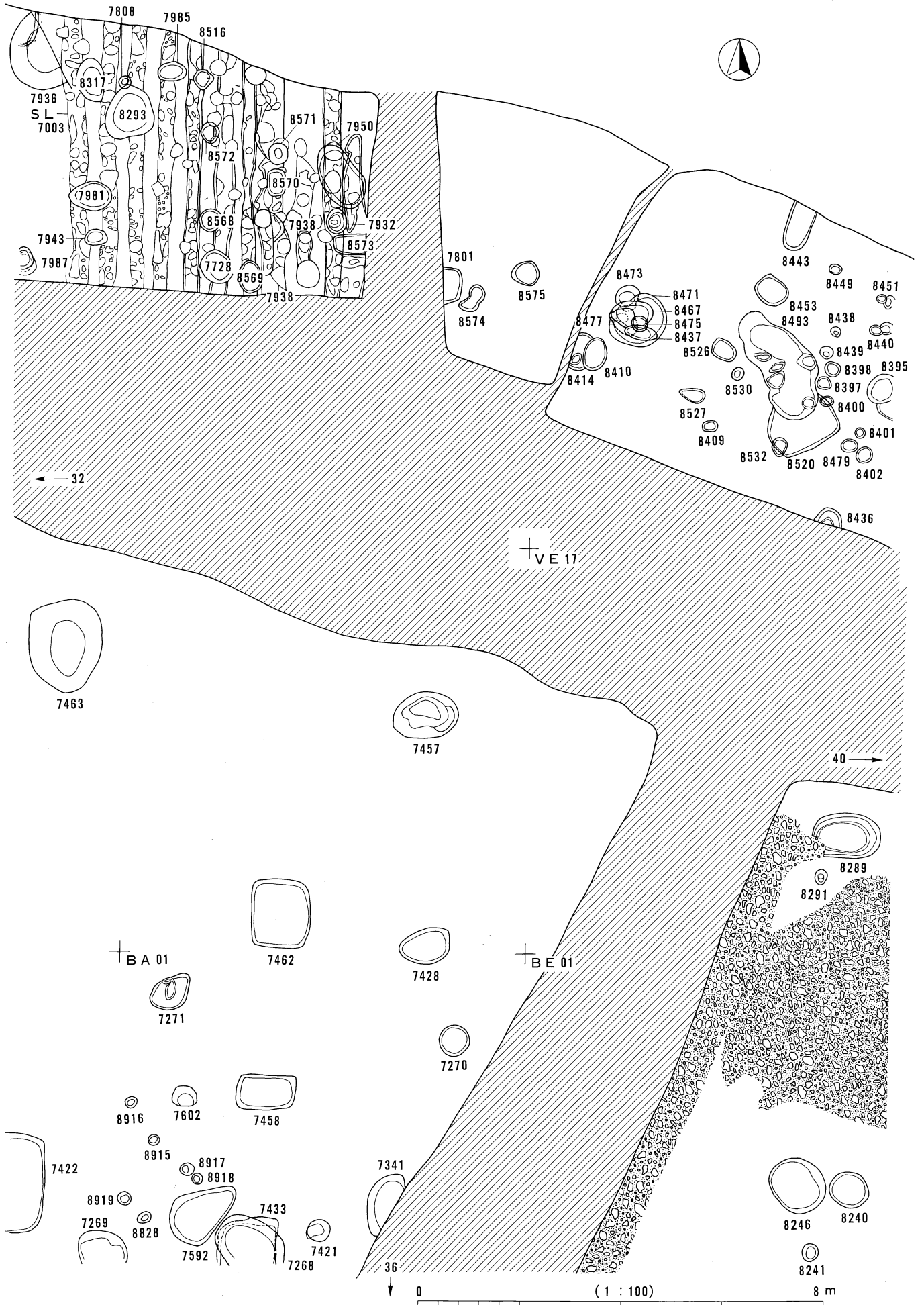

図版286 古代割付図36 (SK以外)

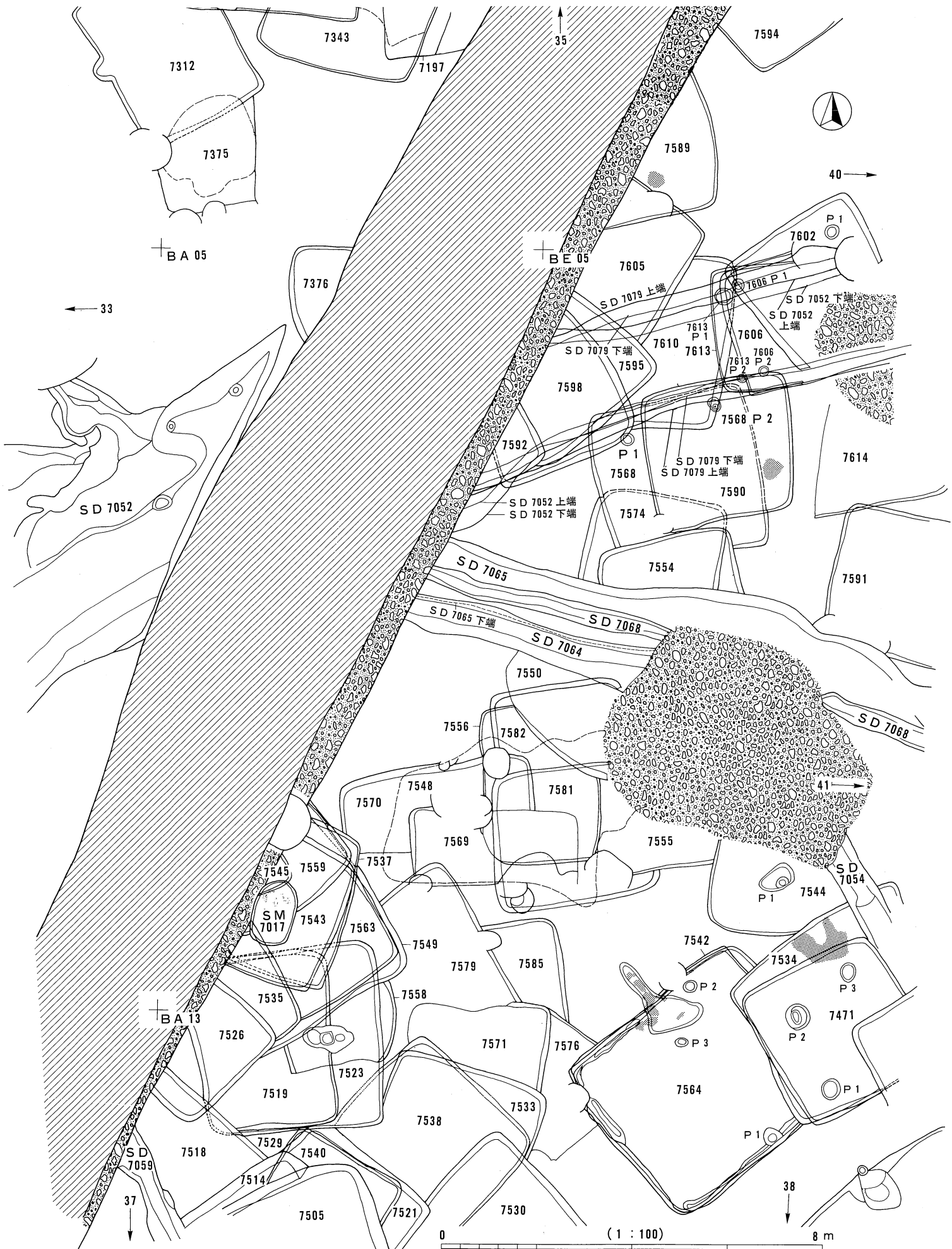

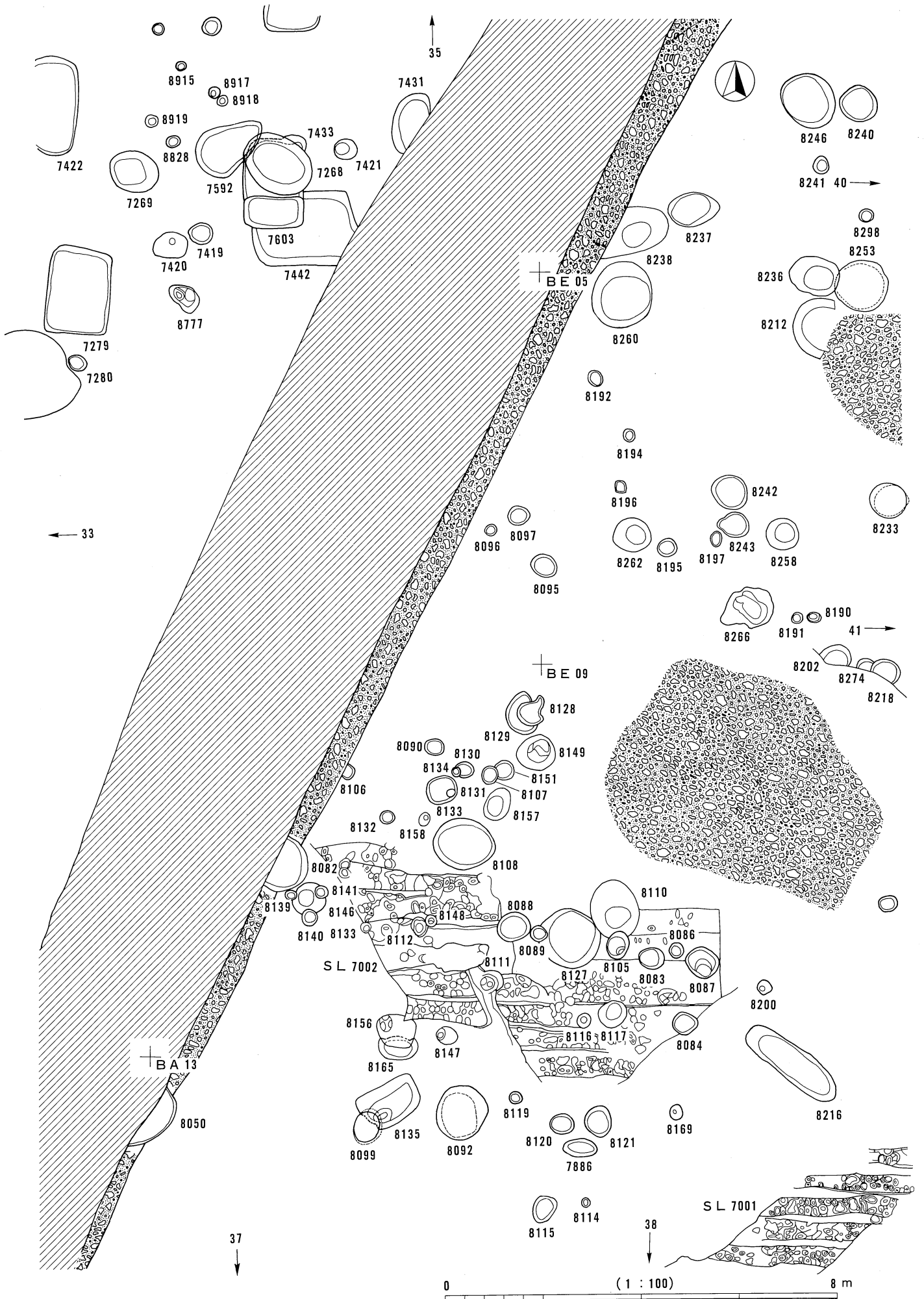

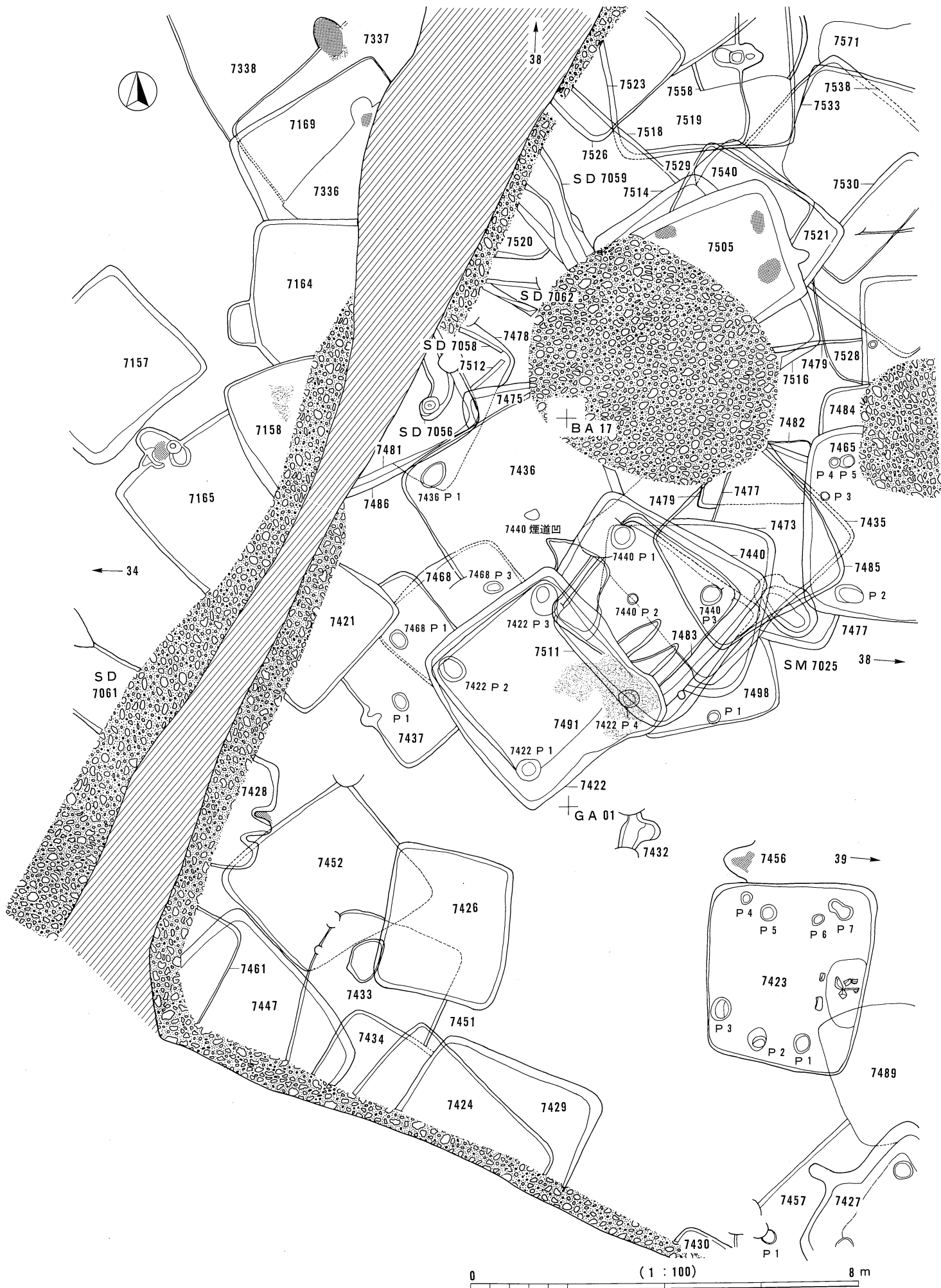



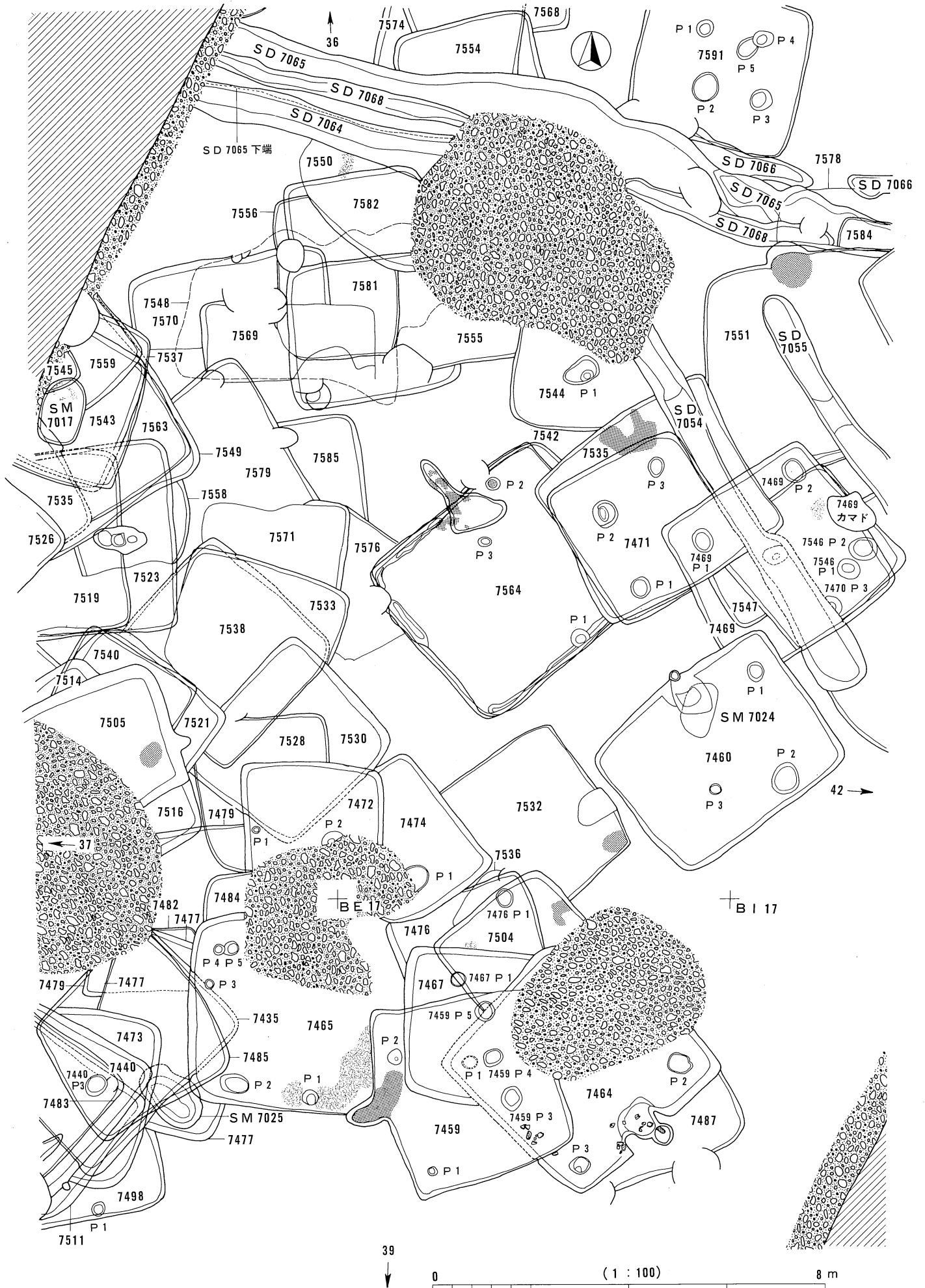

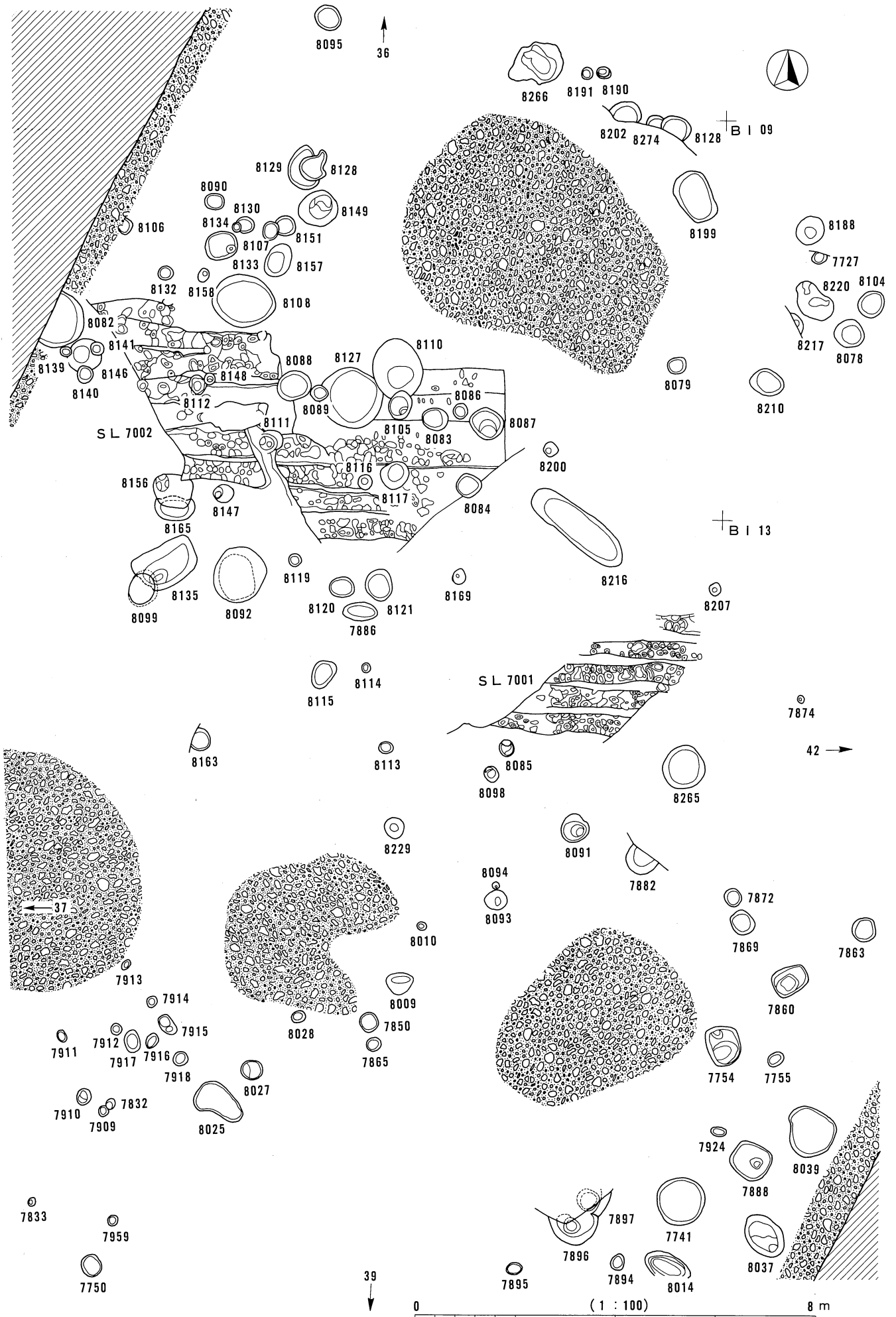

図版292 古代割付図39 (SK以外)

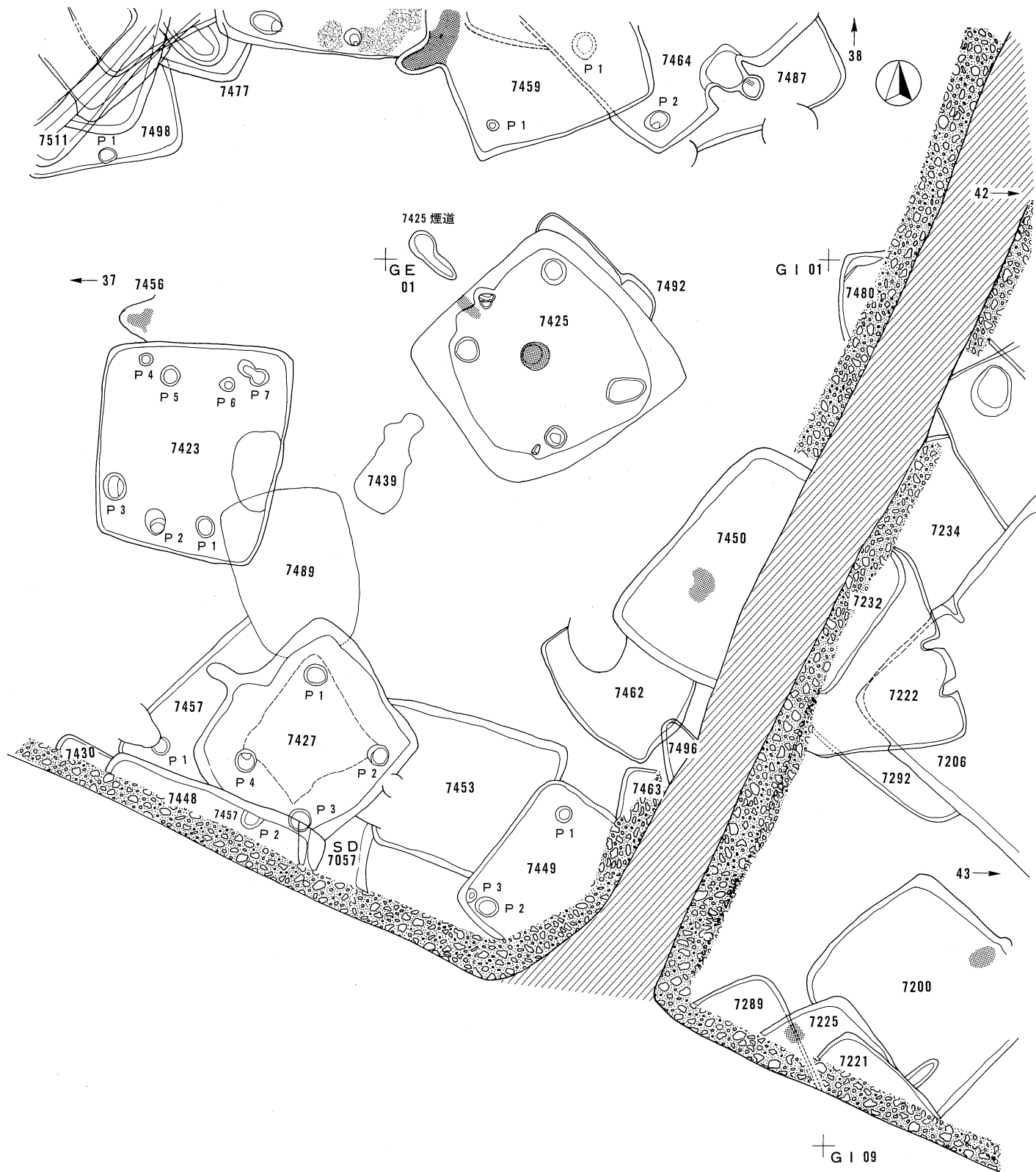

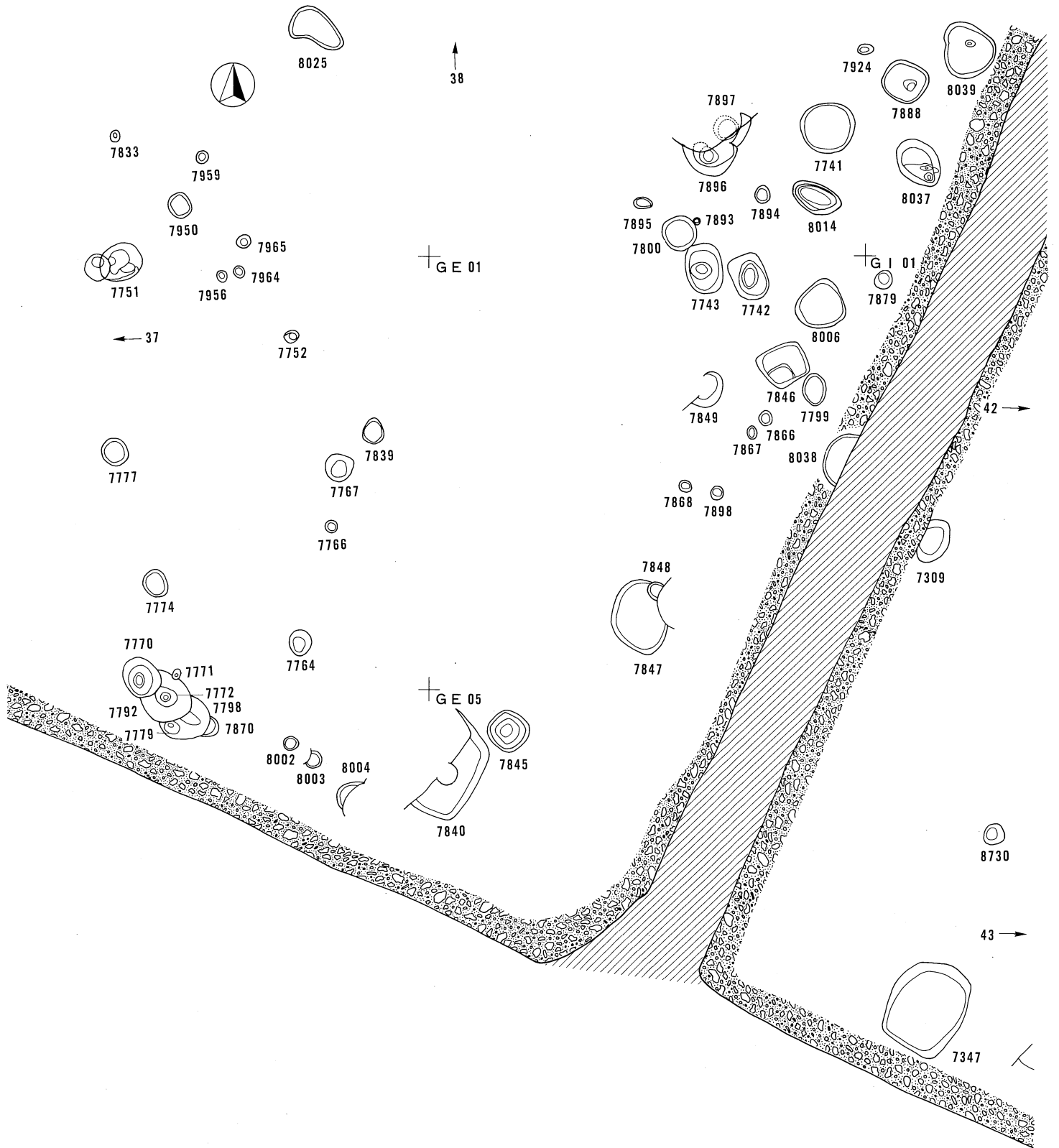

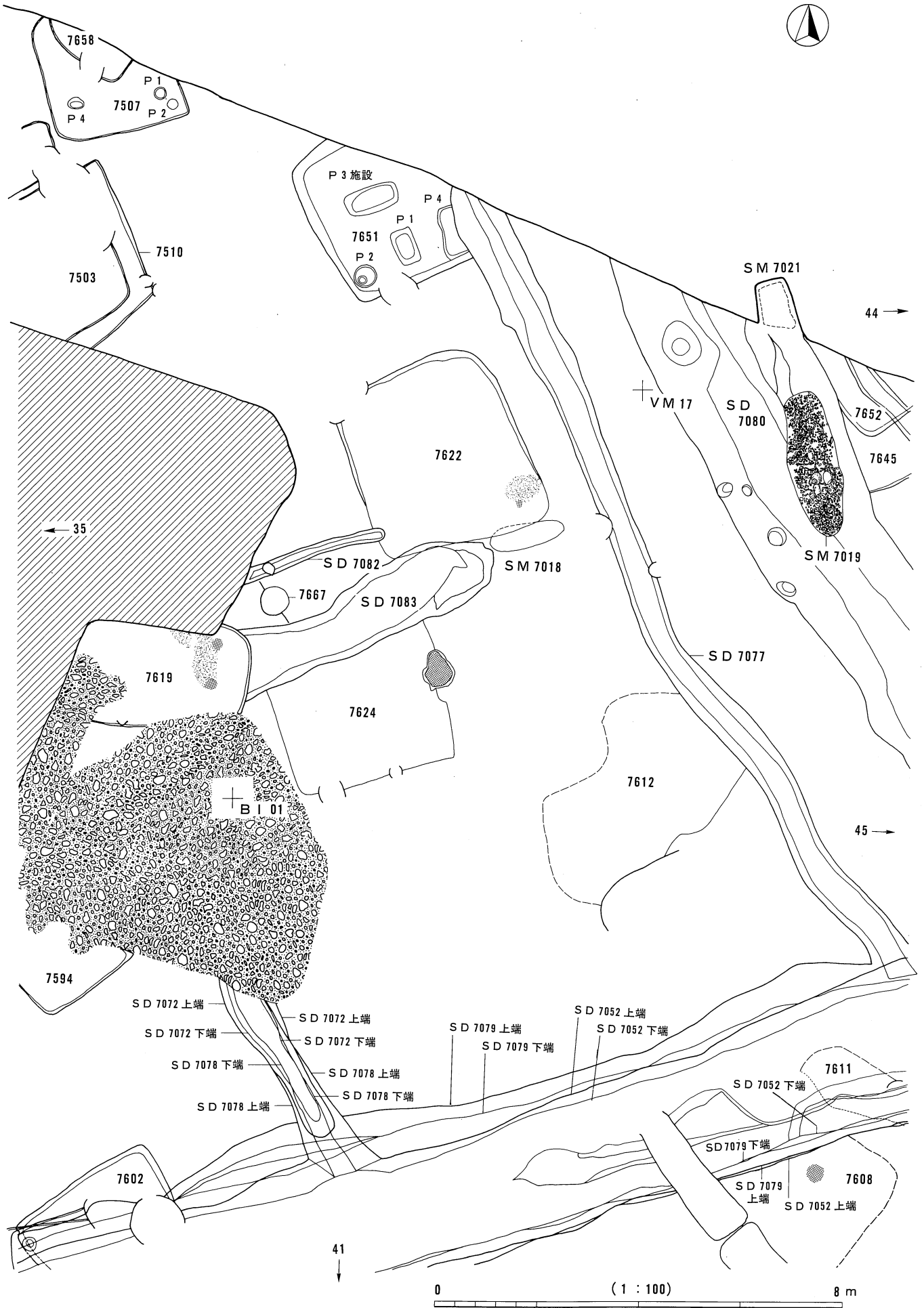

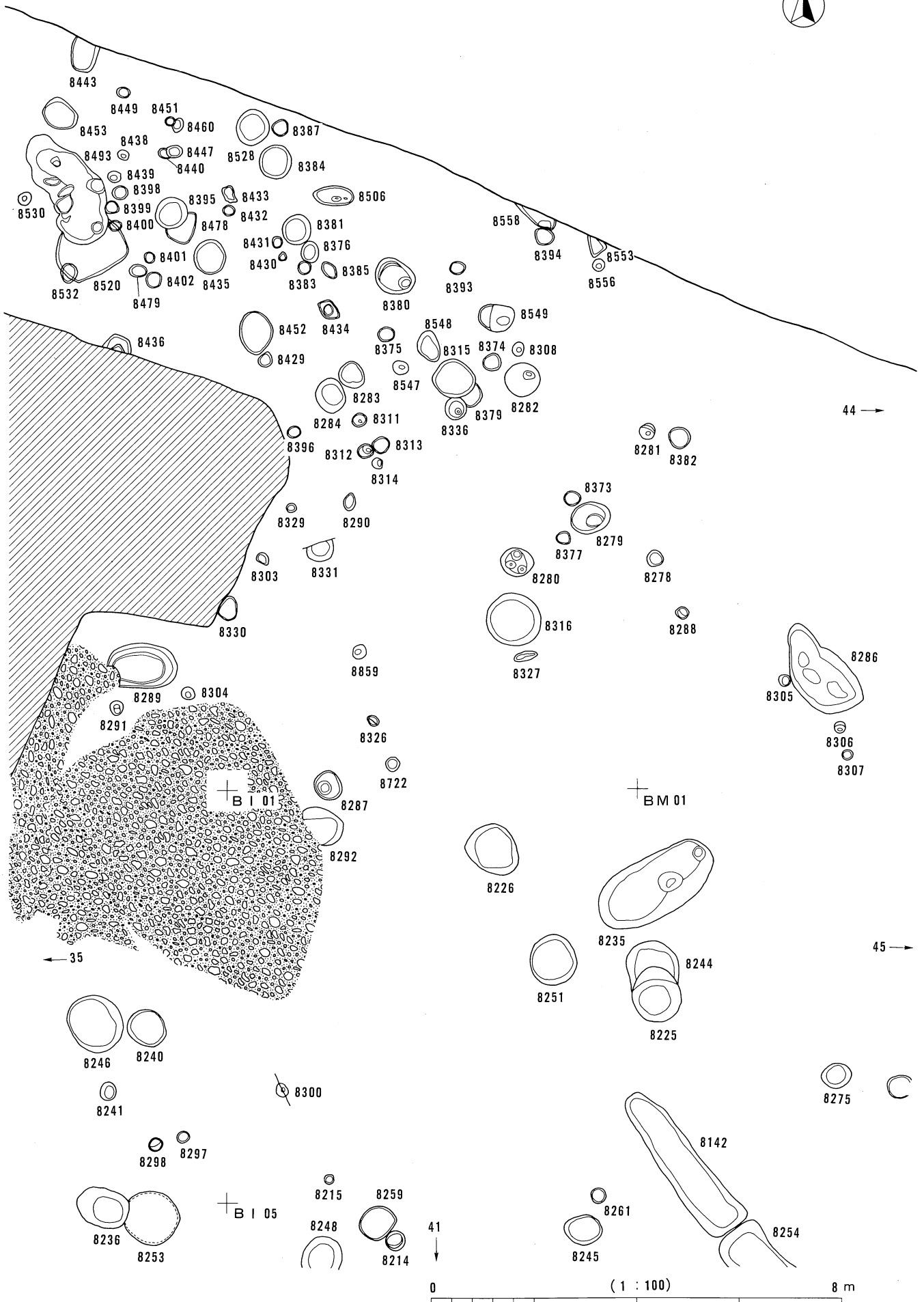

図版296 古代割付図41 (SK以外)

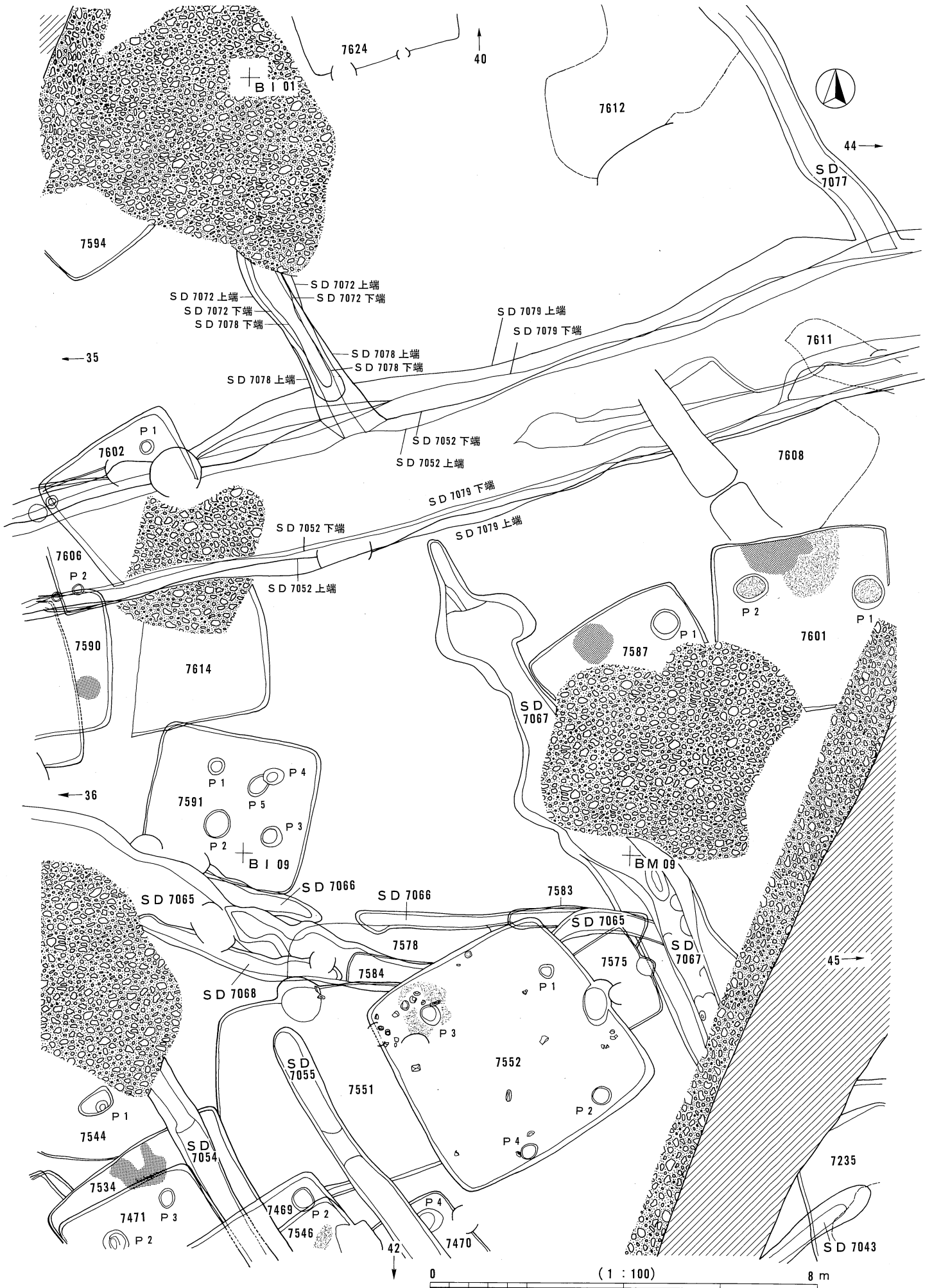

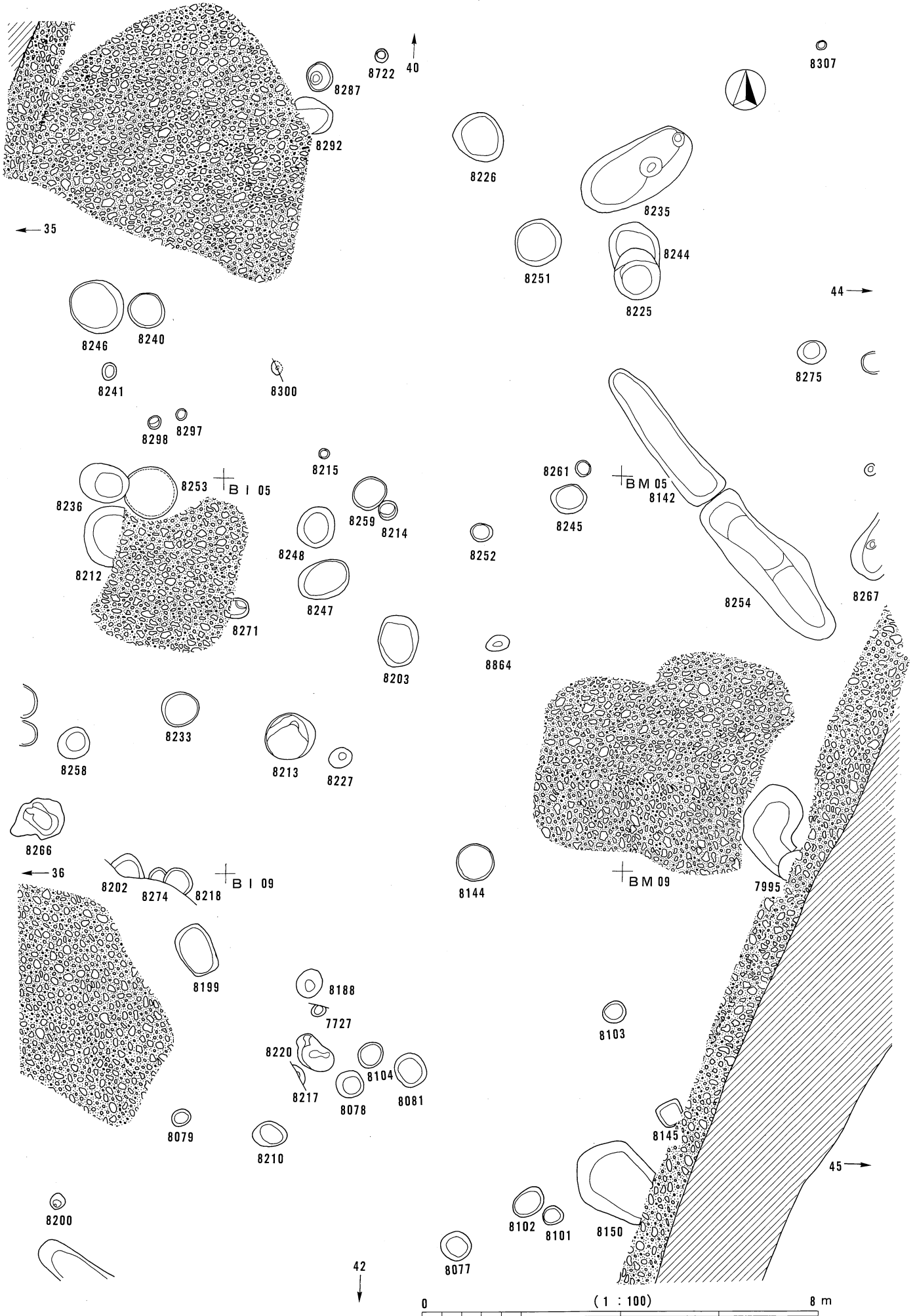

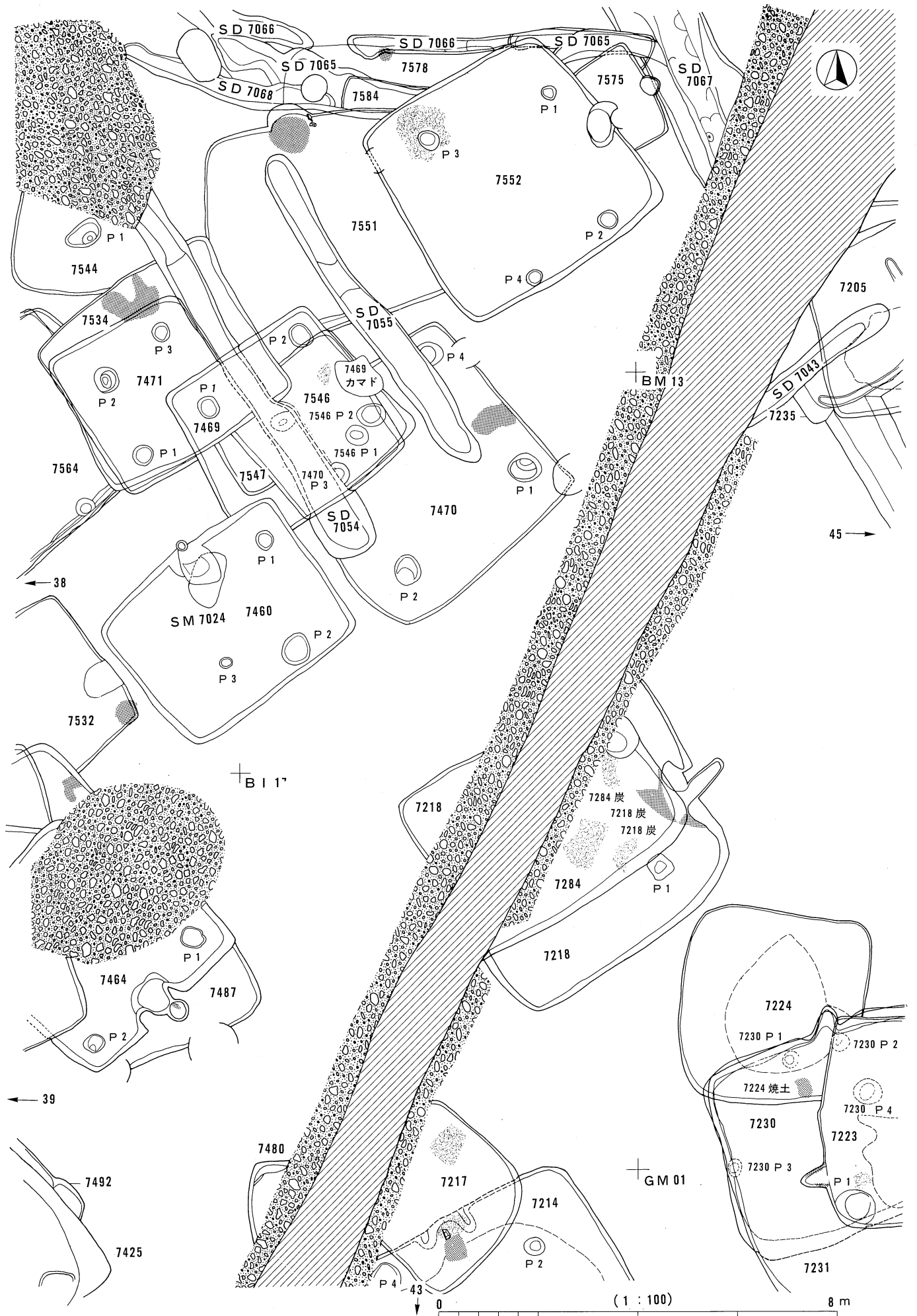

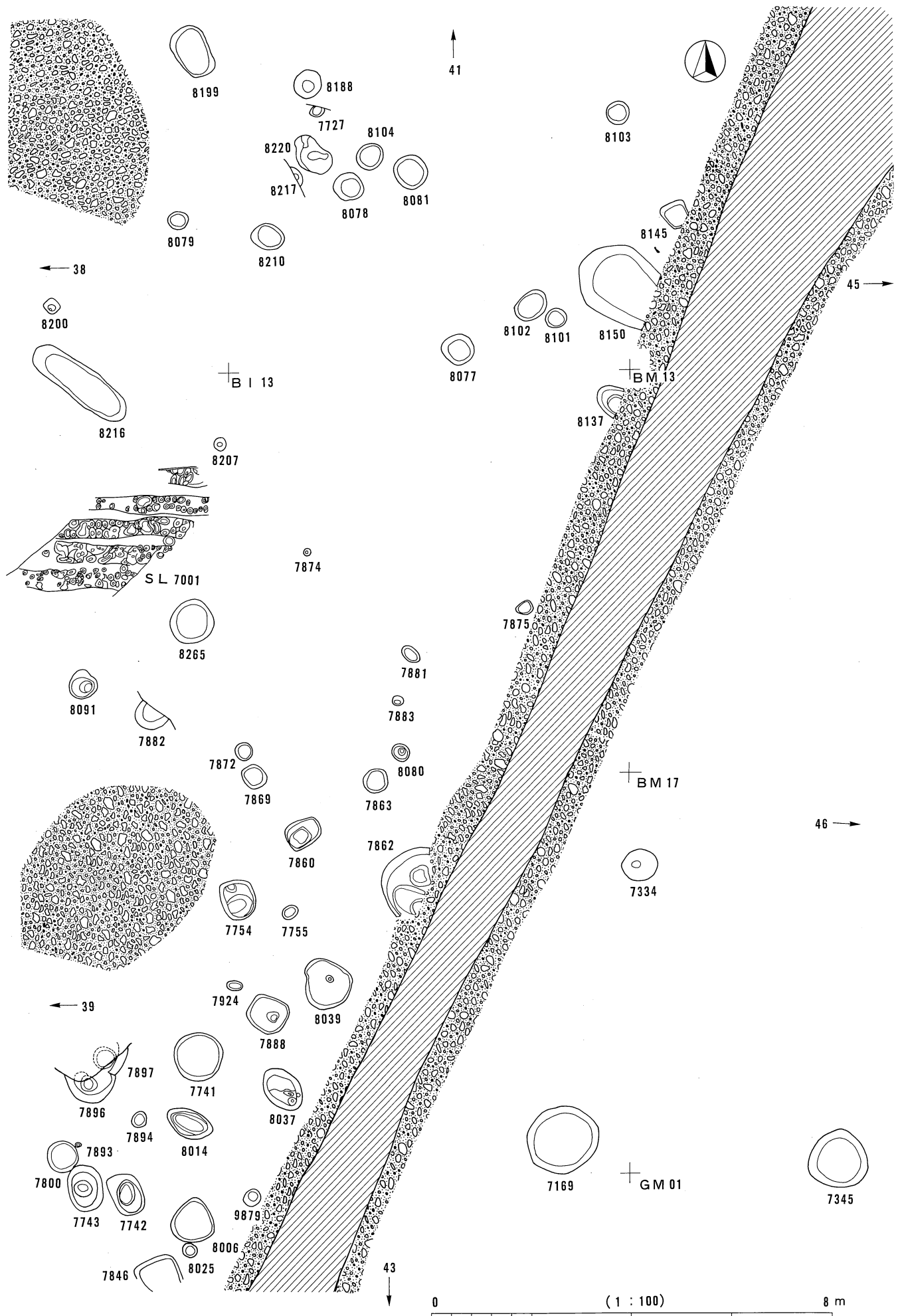

図版300 古代割付図43 (SK以外)

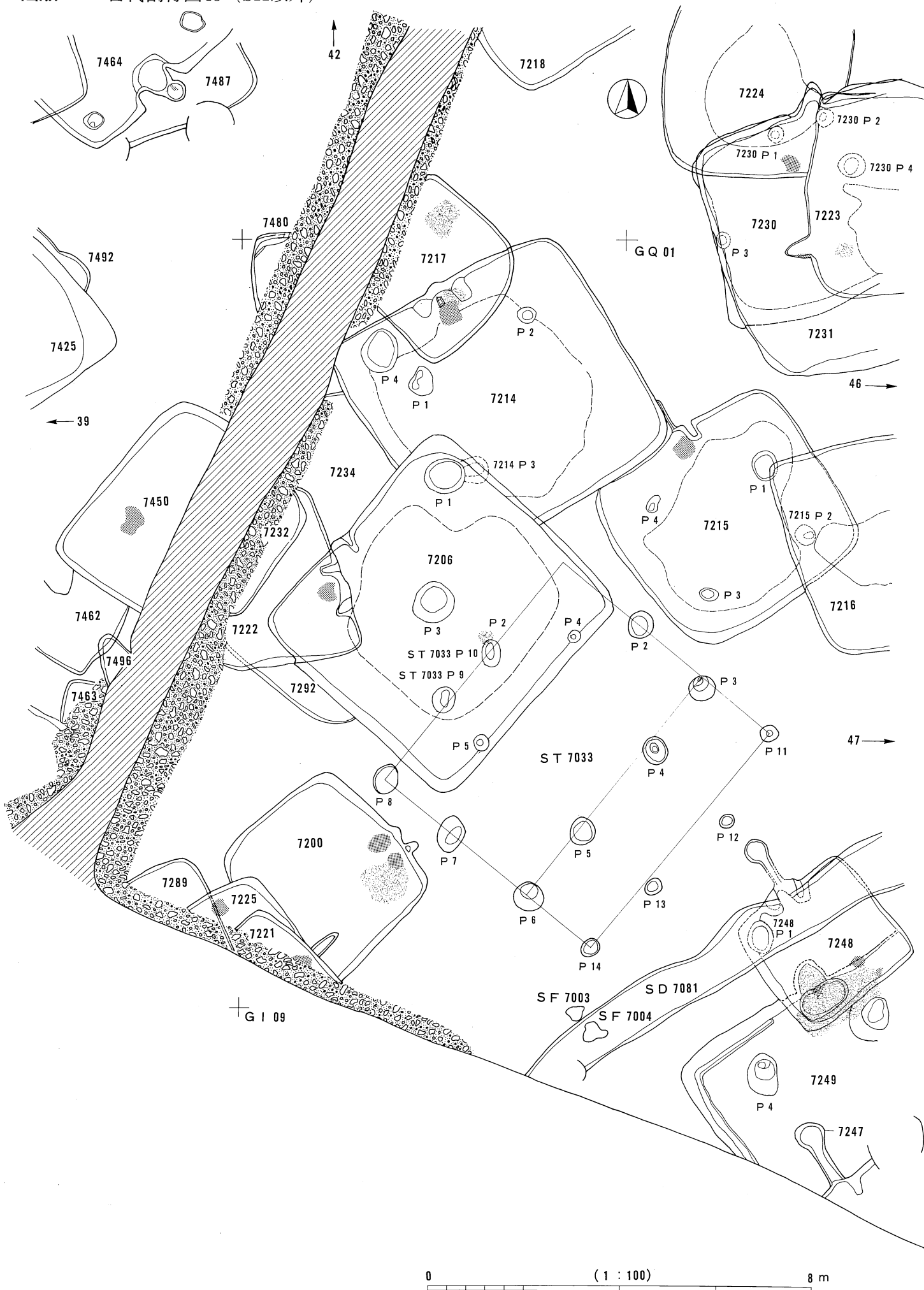

0 (1 : 100) 8 m

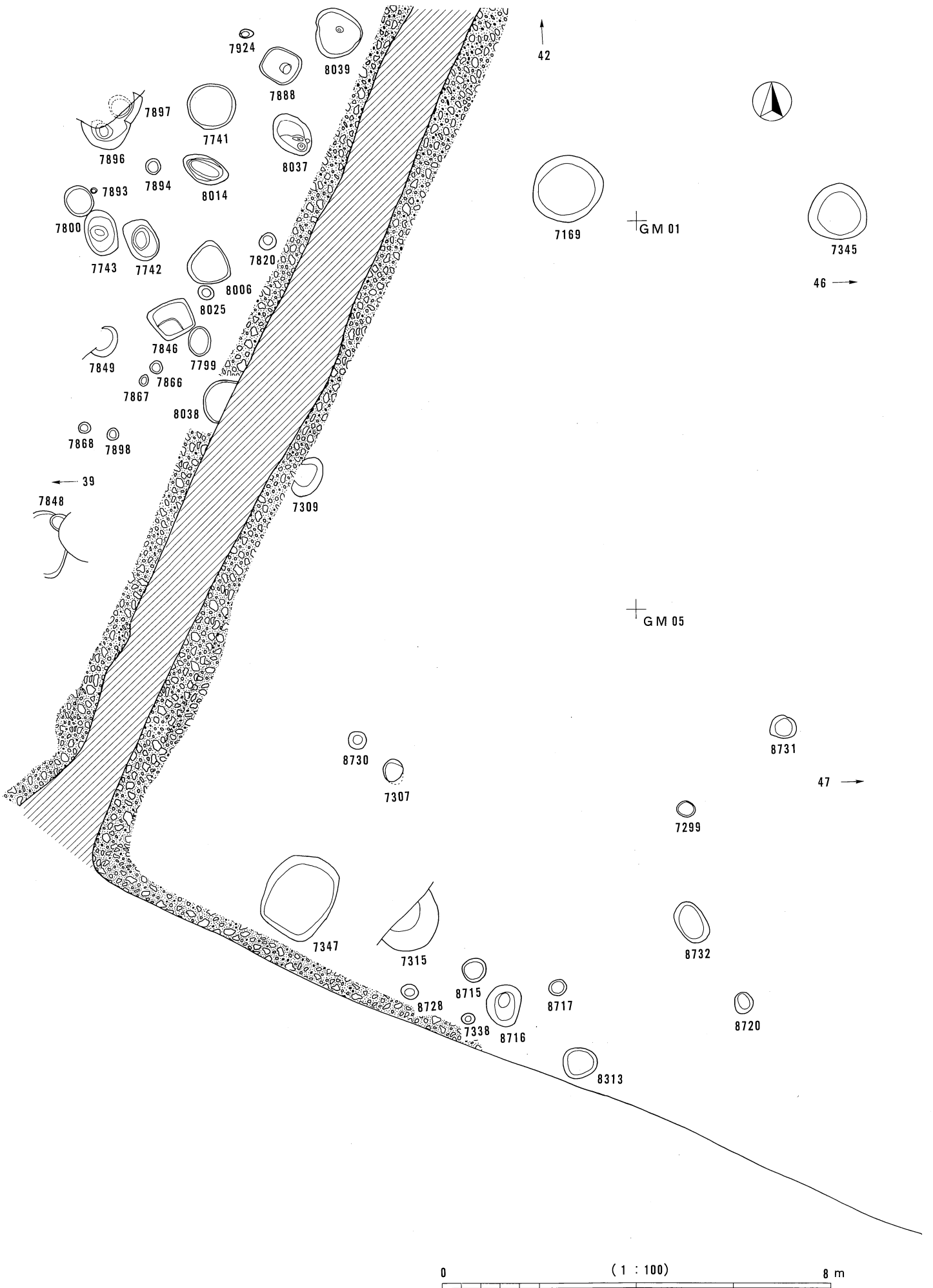

図版302 古代割付図44 (SK以外)

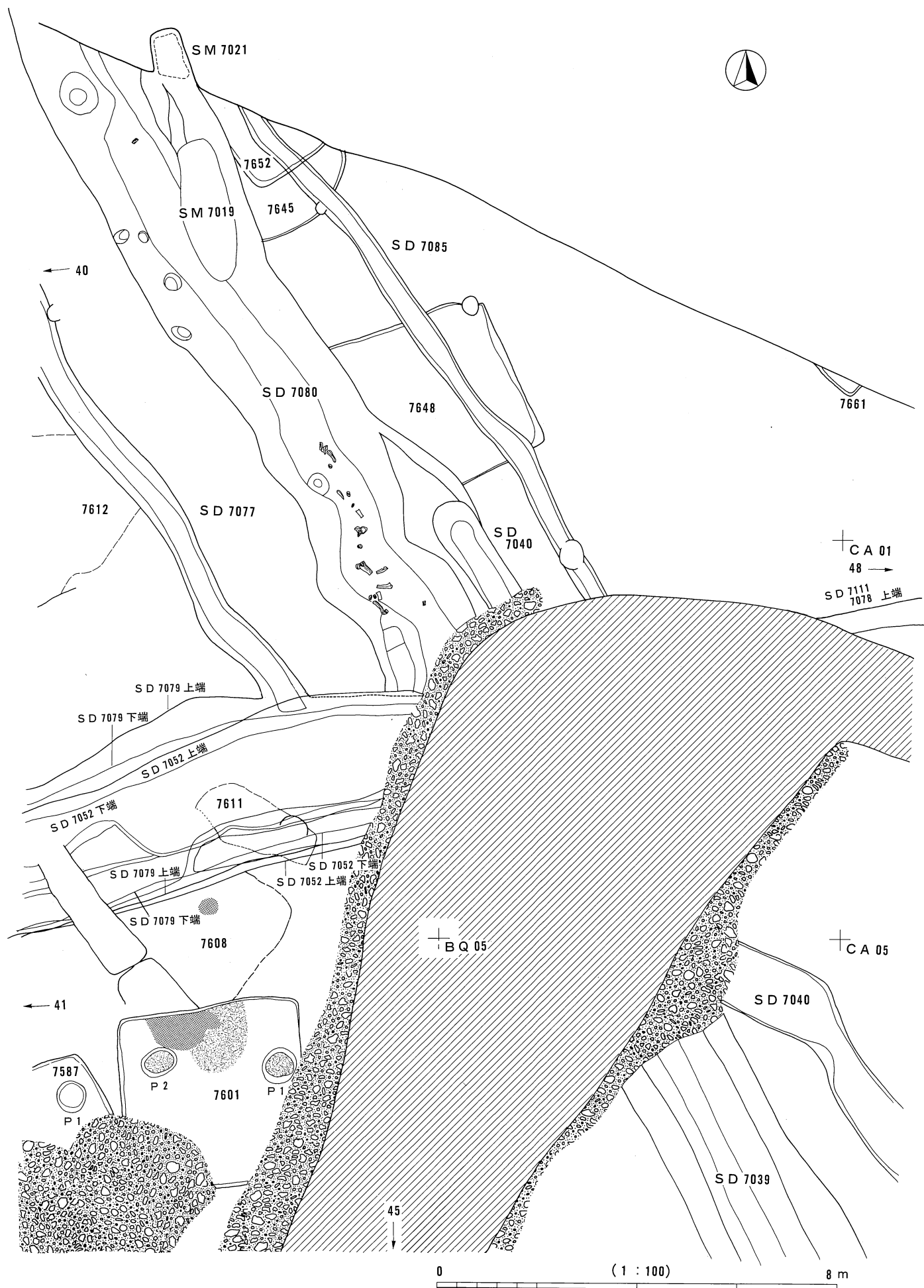

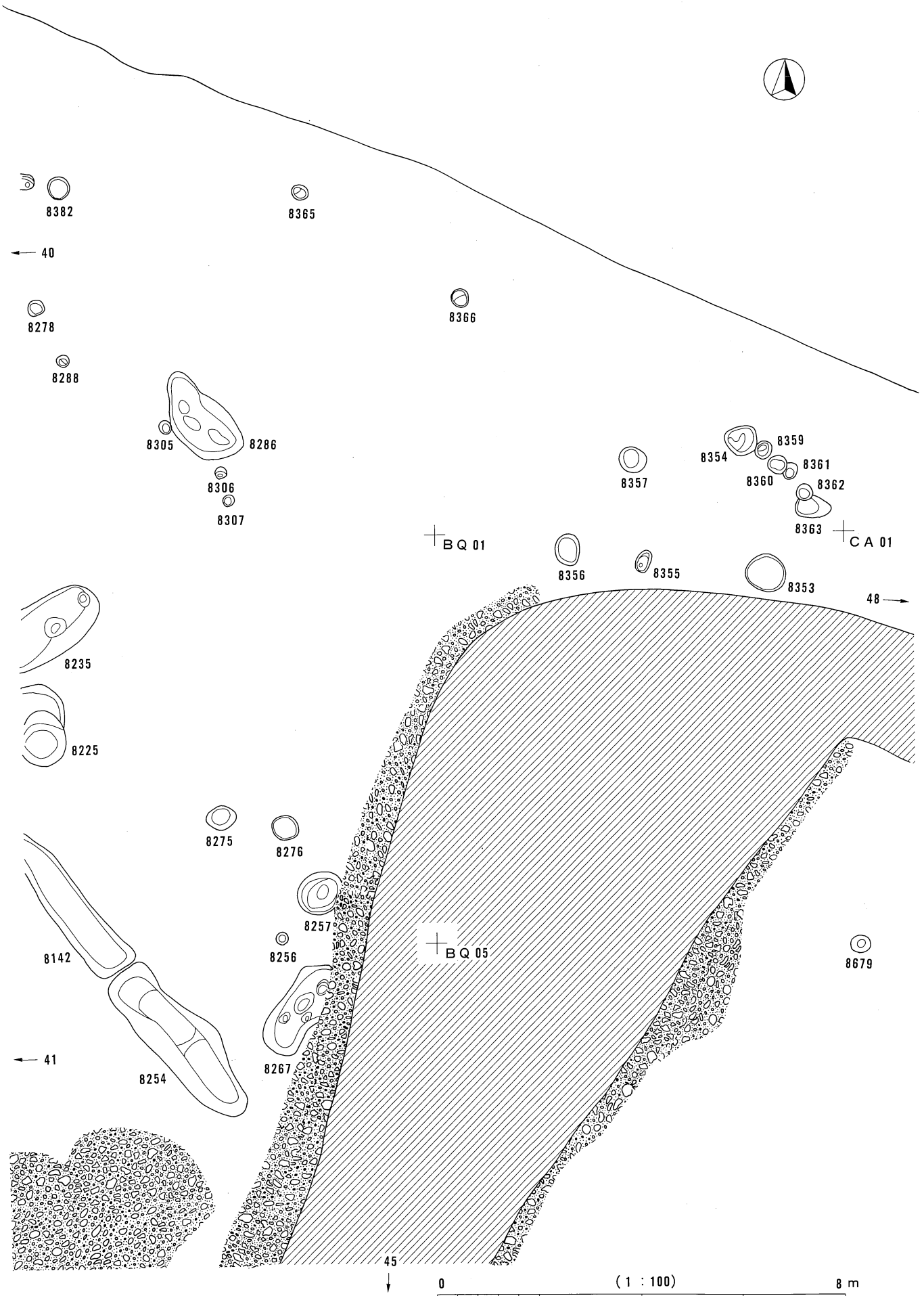

图版304 古代割付图45 (SK以外)

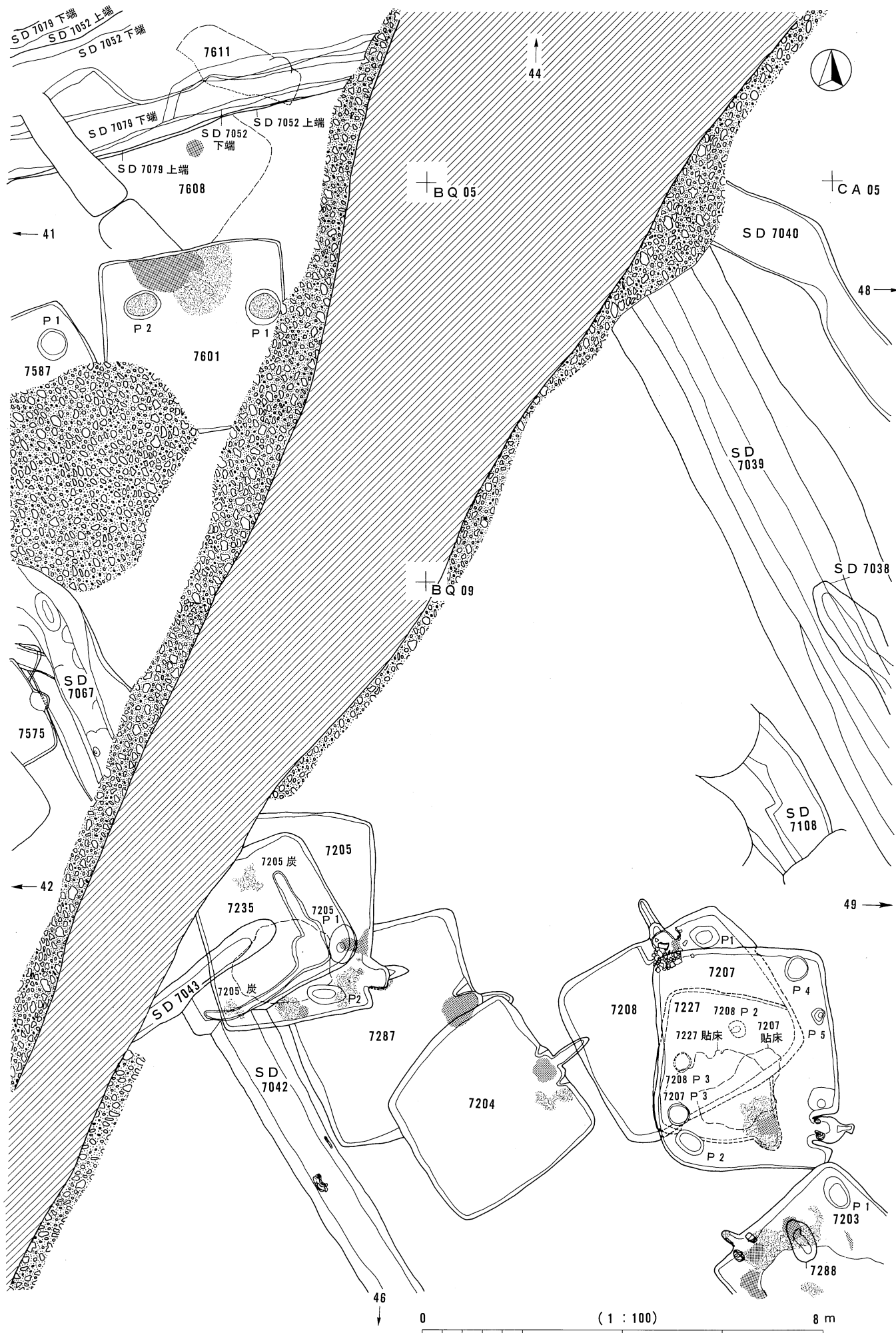

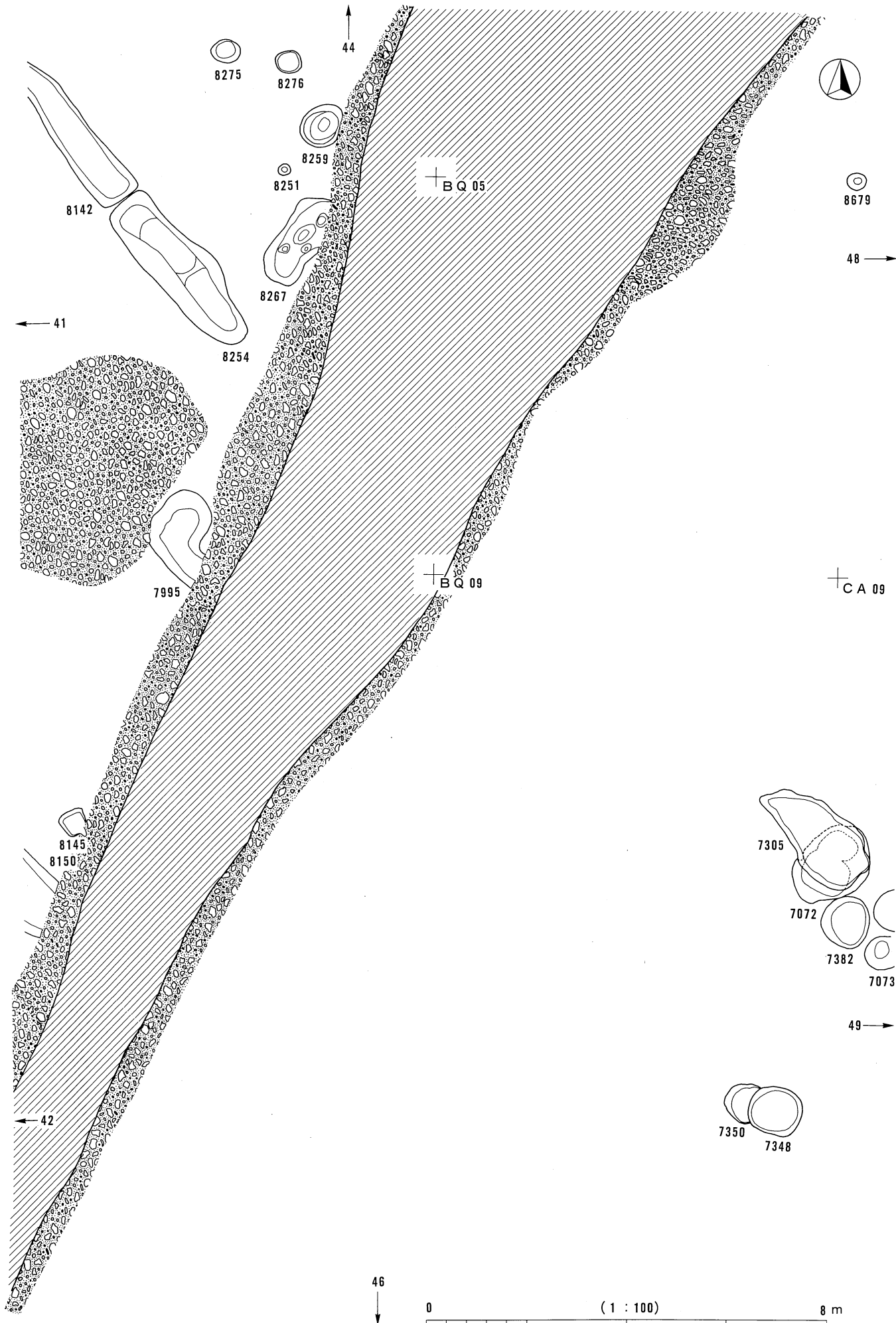

図版306 古代割付図46 (SK以外)

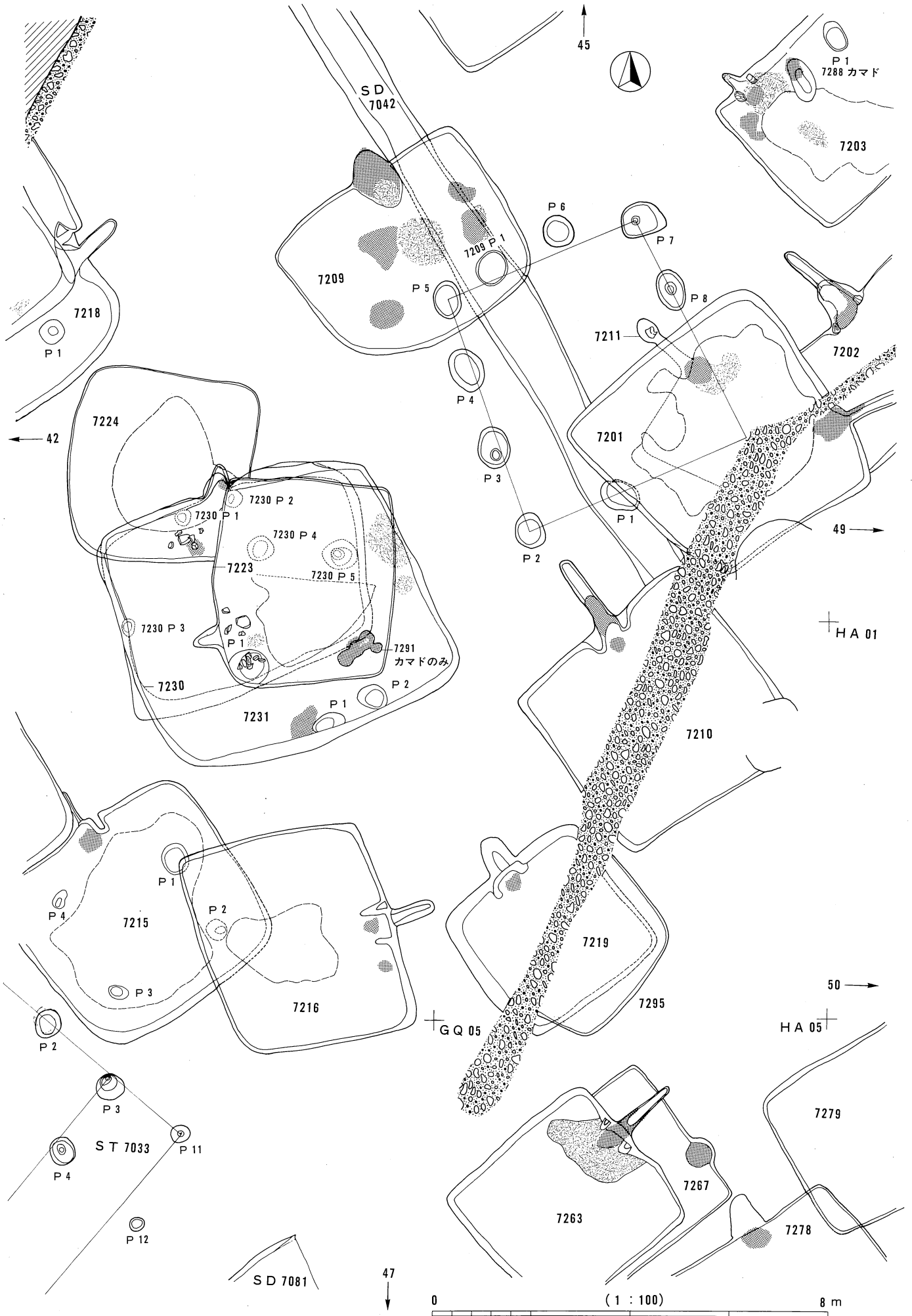

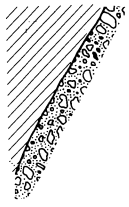

↑
45



+ B Q 17



7334

← 42

→ 49

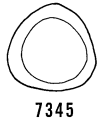

7345

+ G Q 01

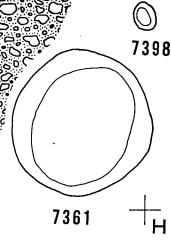

7361



7398

+ H A 01

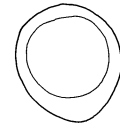

7358

8726



8714



7363

8727

← 43

→ 50

+ G Q 05



8713

↓
47

0 (1 : 100) 8 m



図版308 古代割付図47 (SK以外)

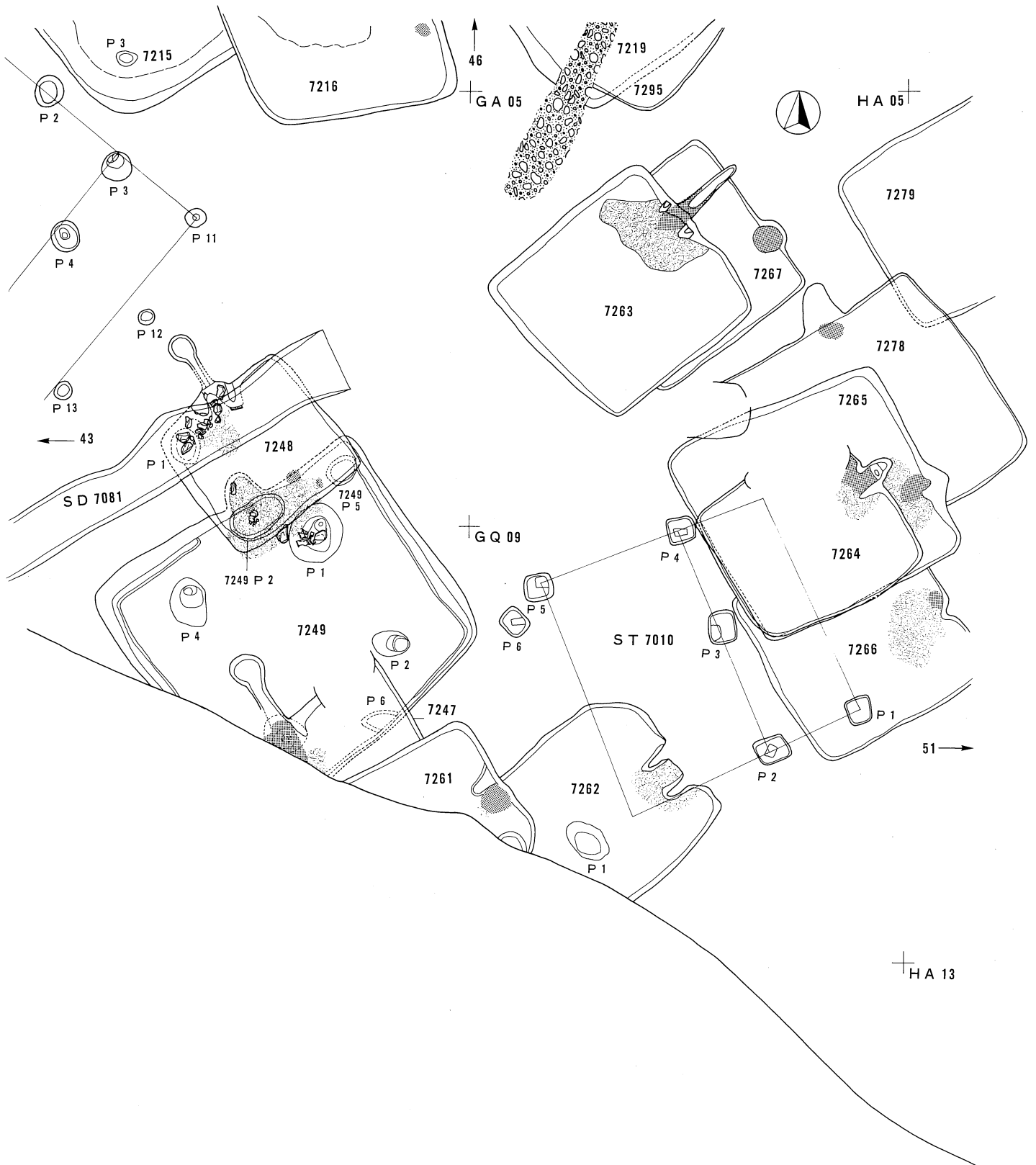

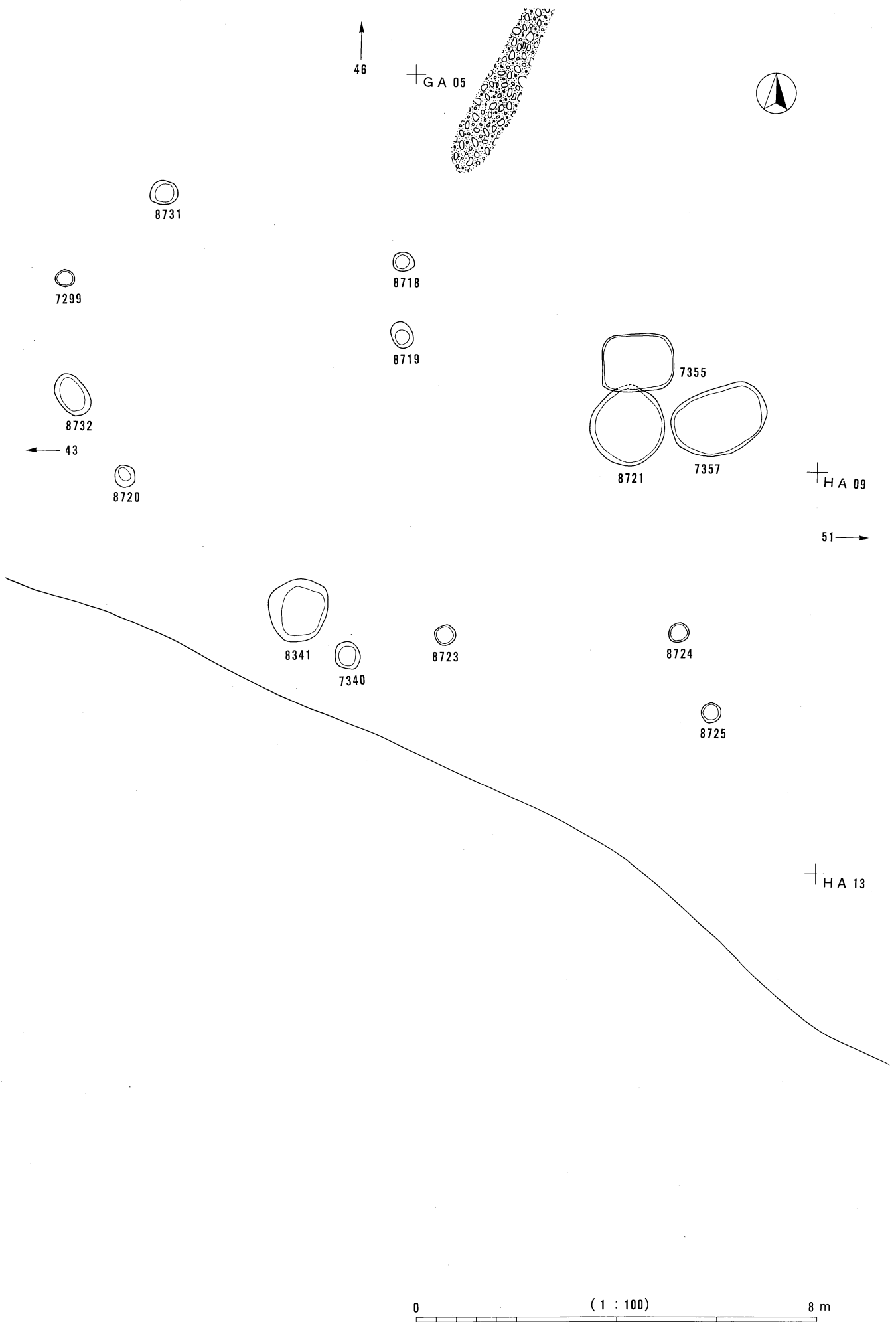

図版310 古代割付図48 (SK以外)

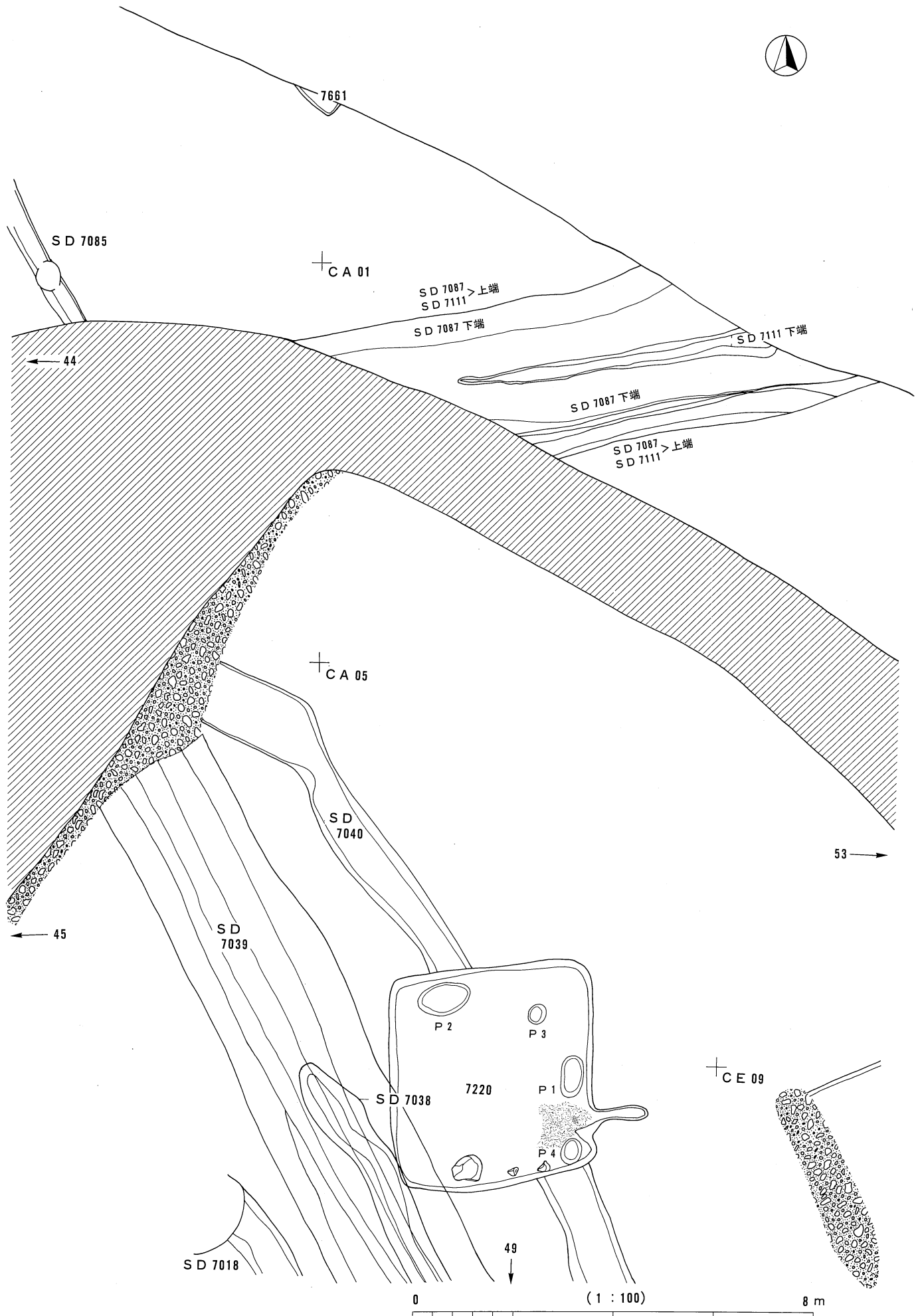

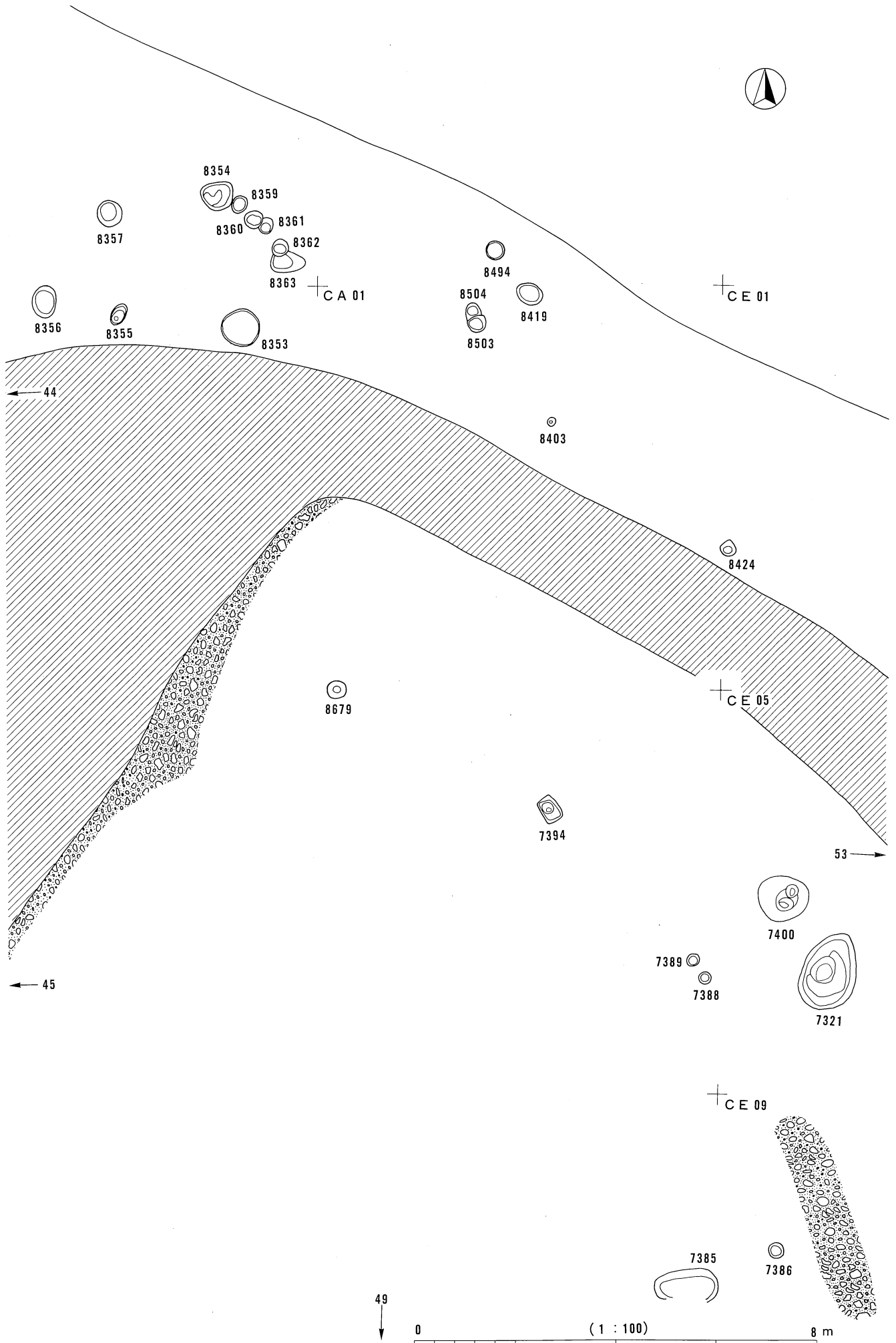

図版312 古代割付図49 (SK以外)

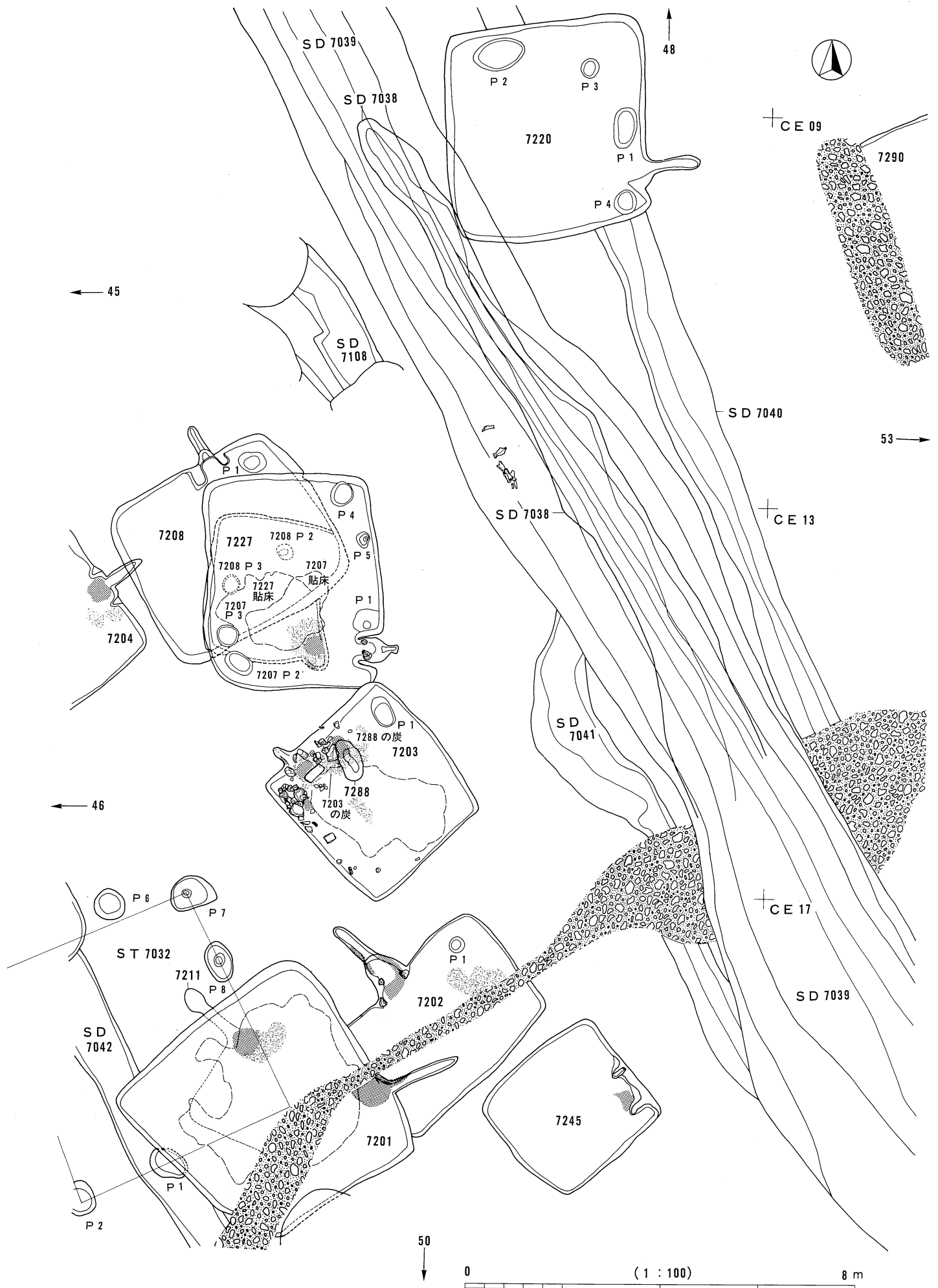

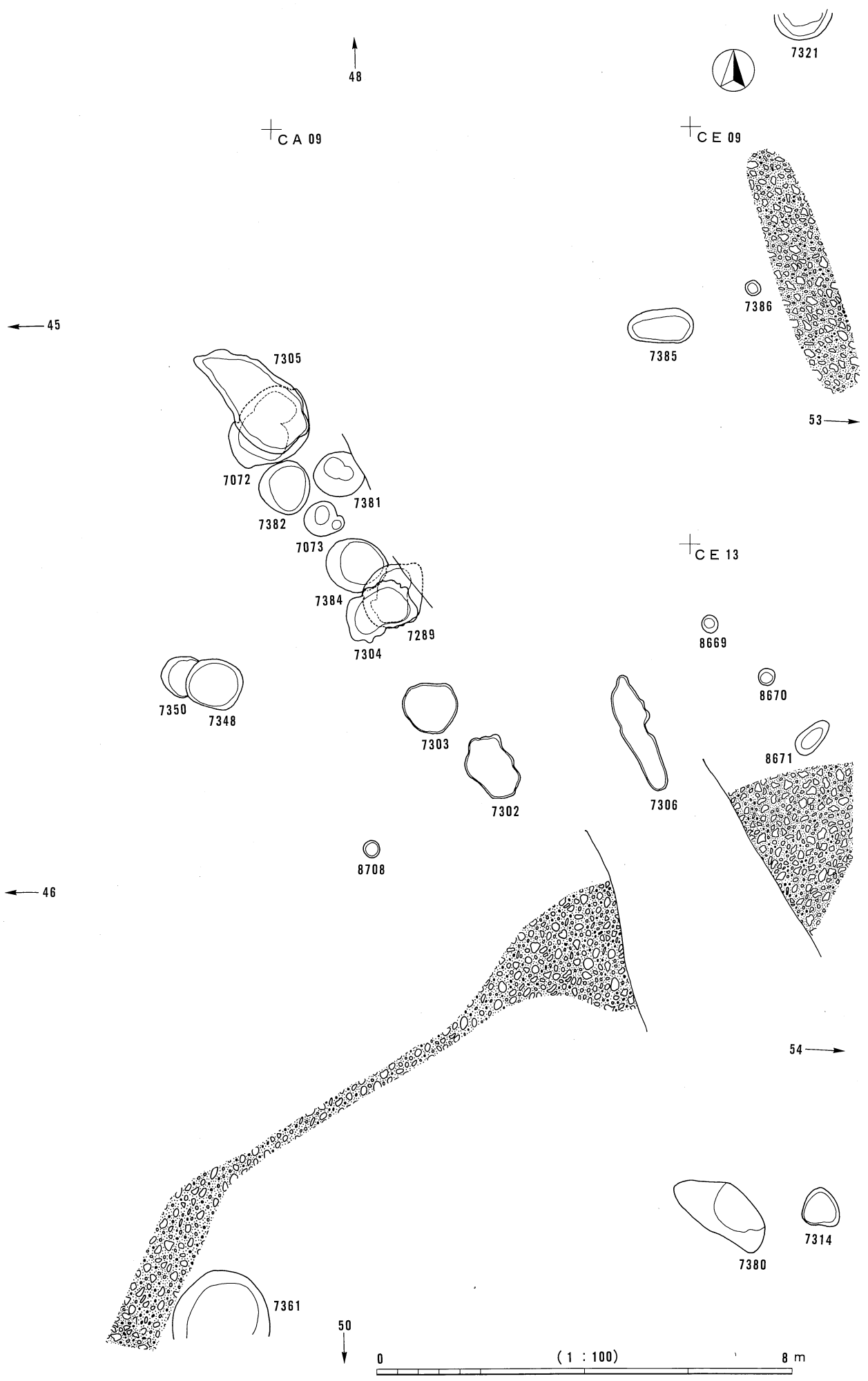

图版314 古代割付图50 (SK以外)

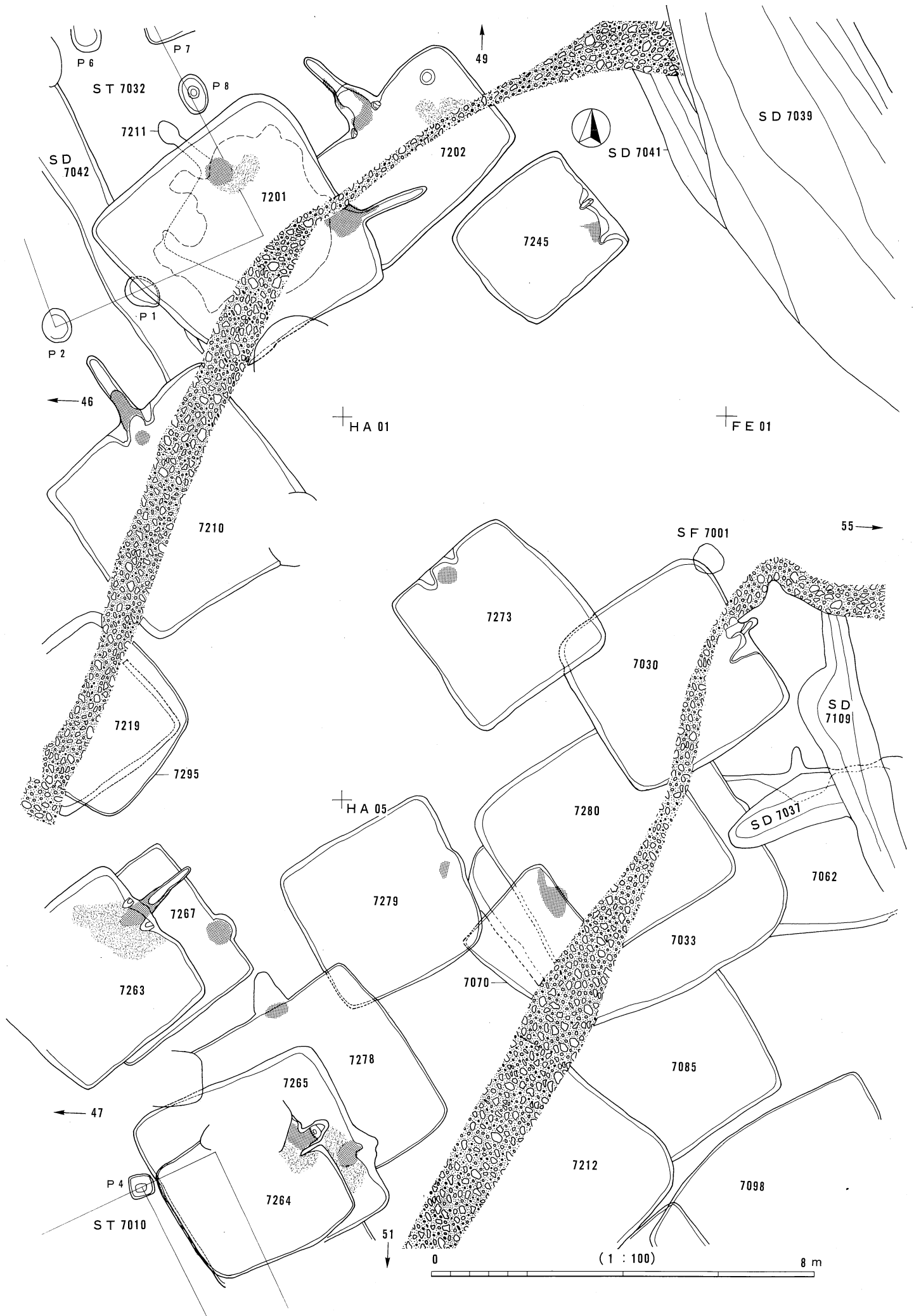

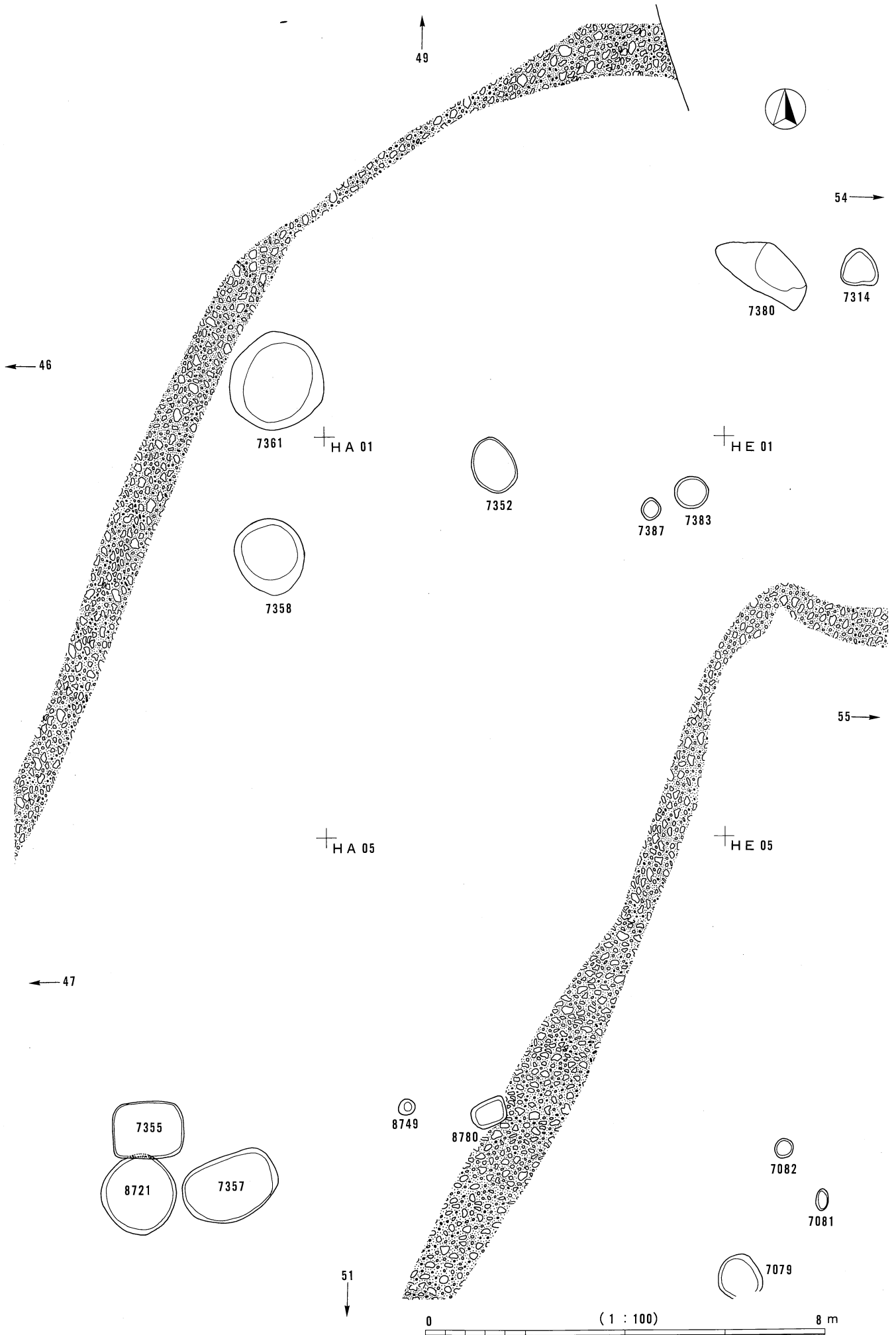

図版316 古代割付図51 (SK以外)

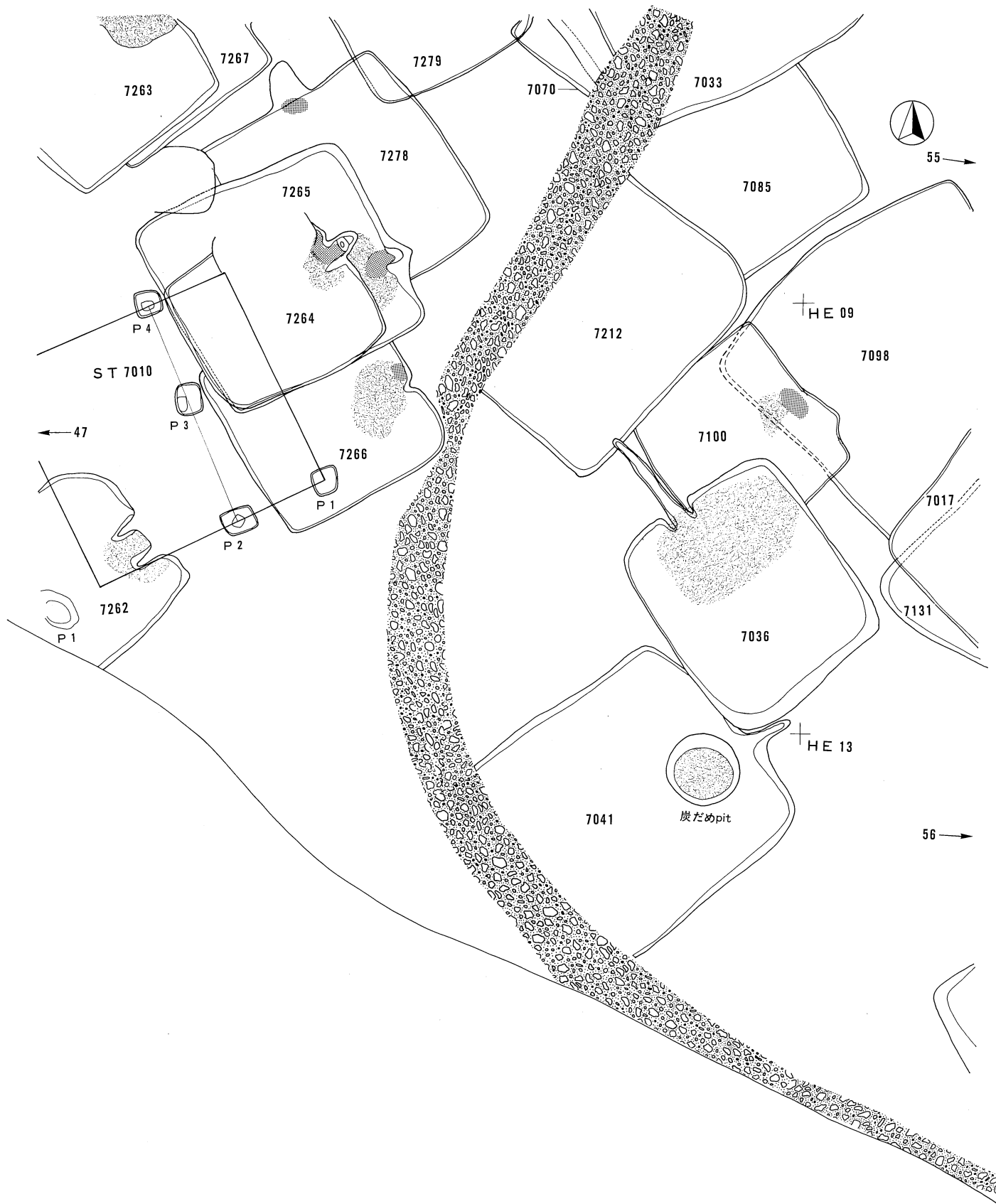

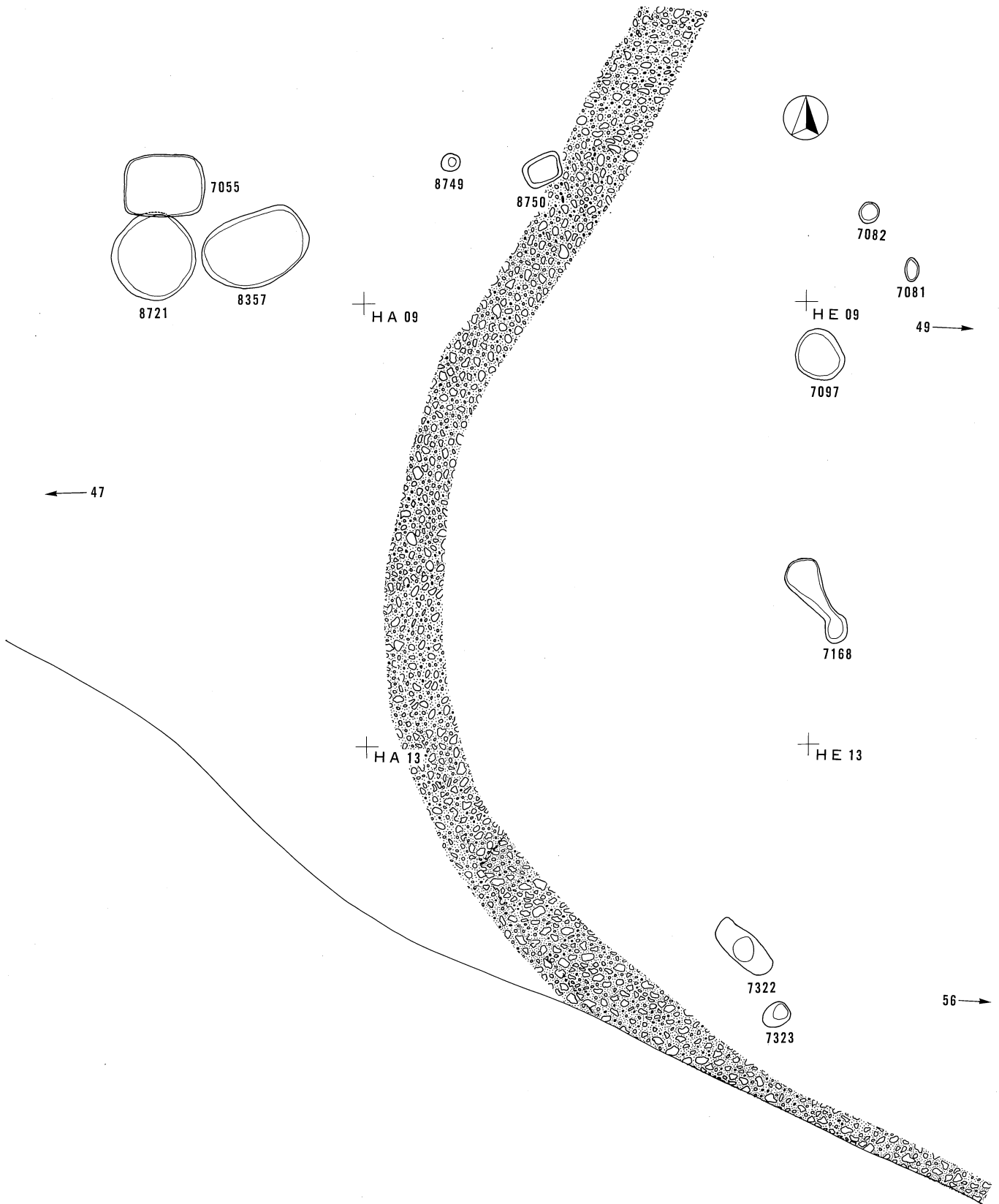

図版318 古代割付図53 (SK以外)

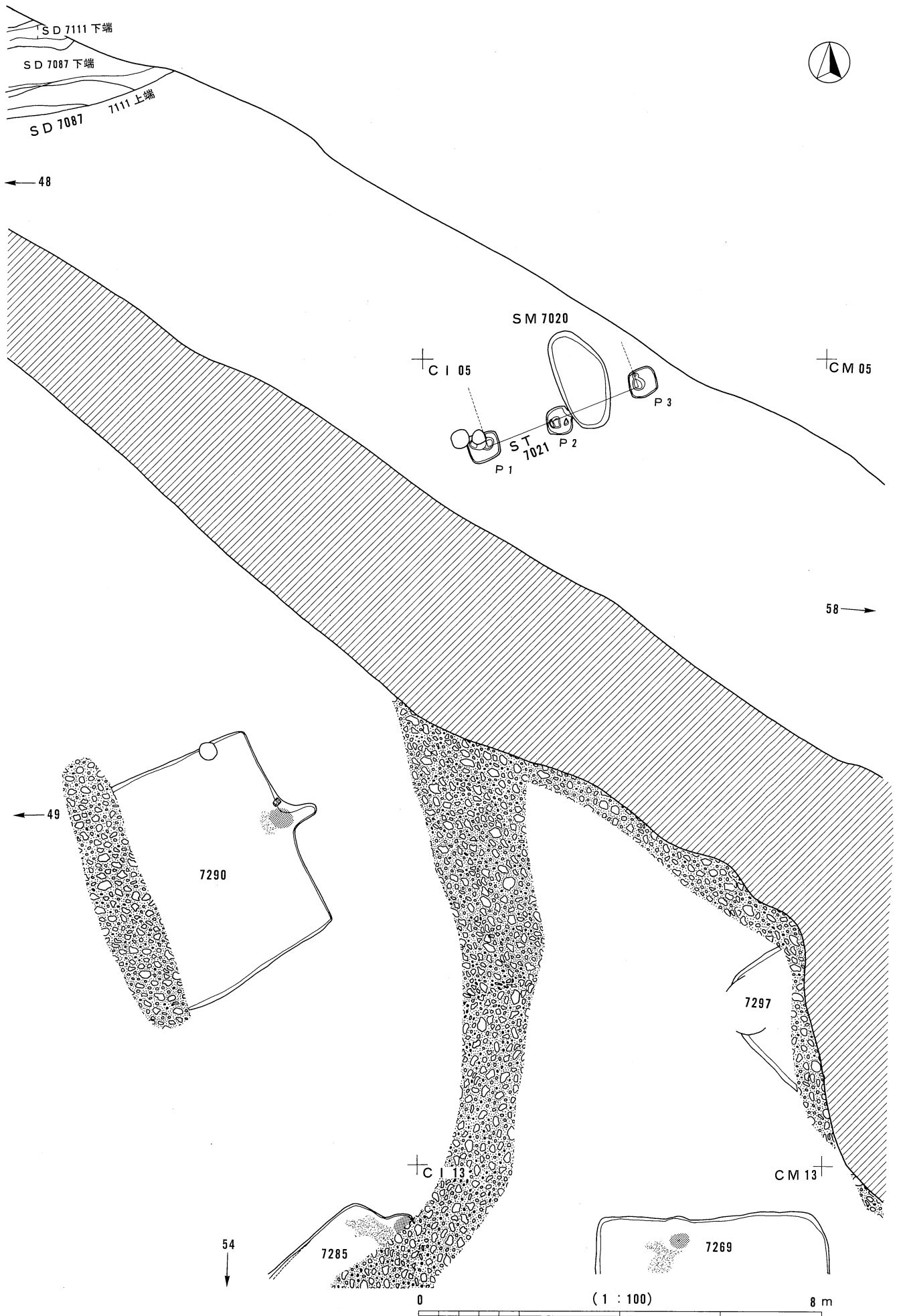

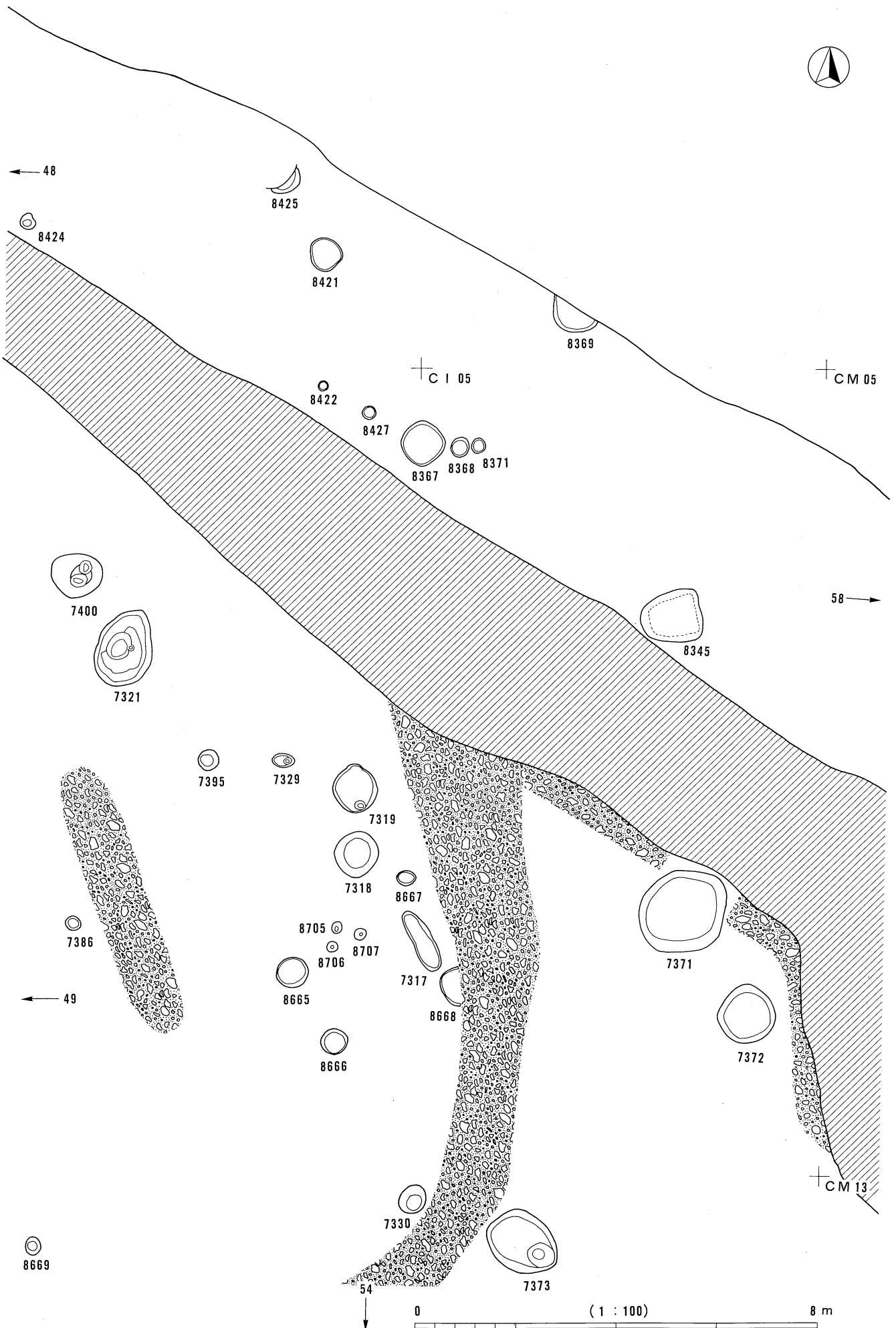

图版320 古代割付图54 (SK以外)

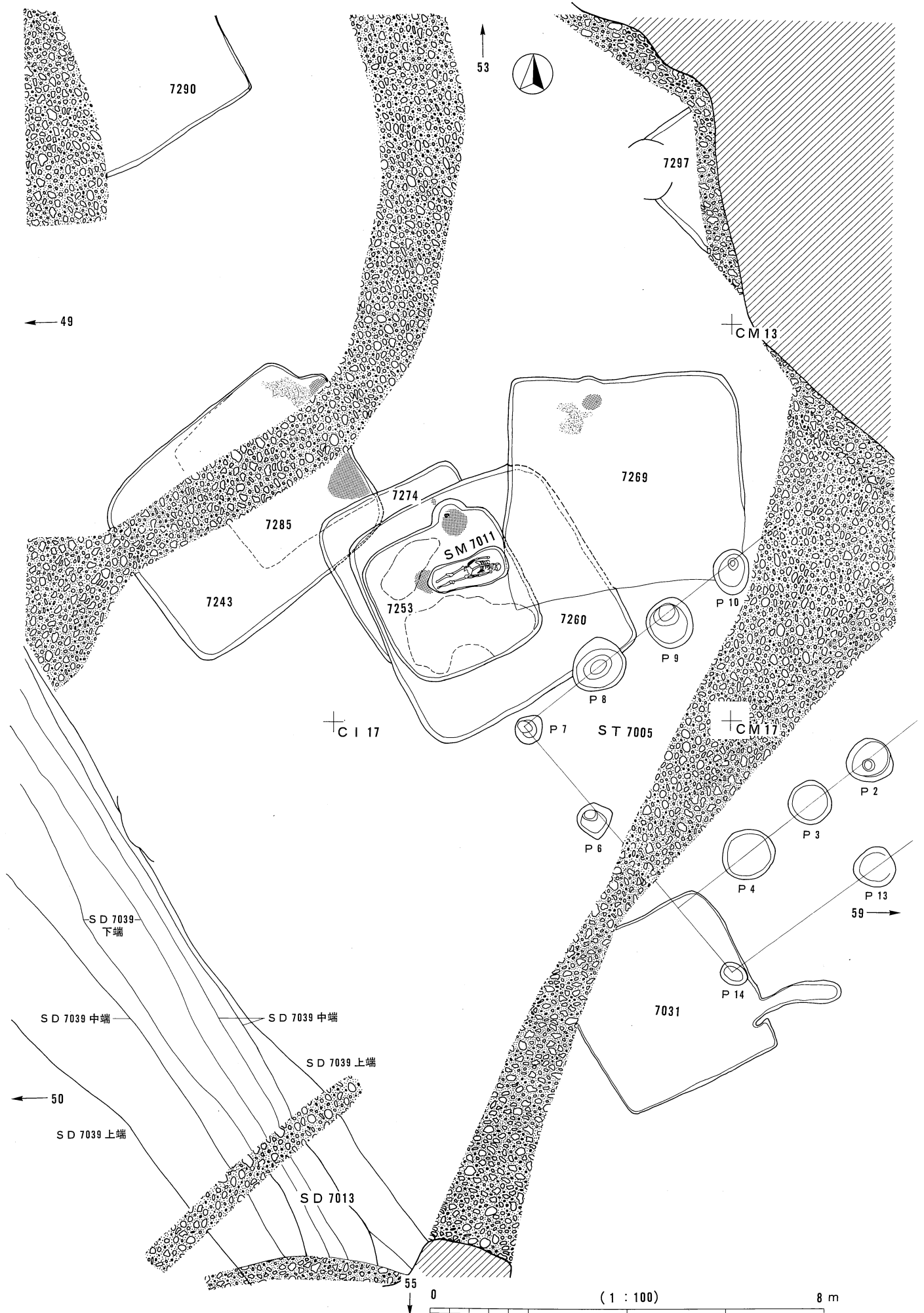

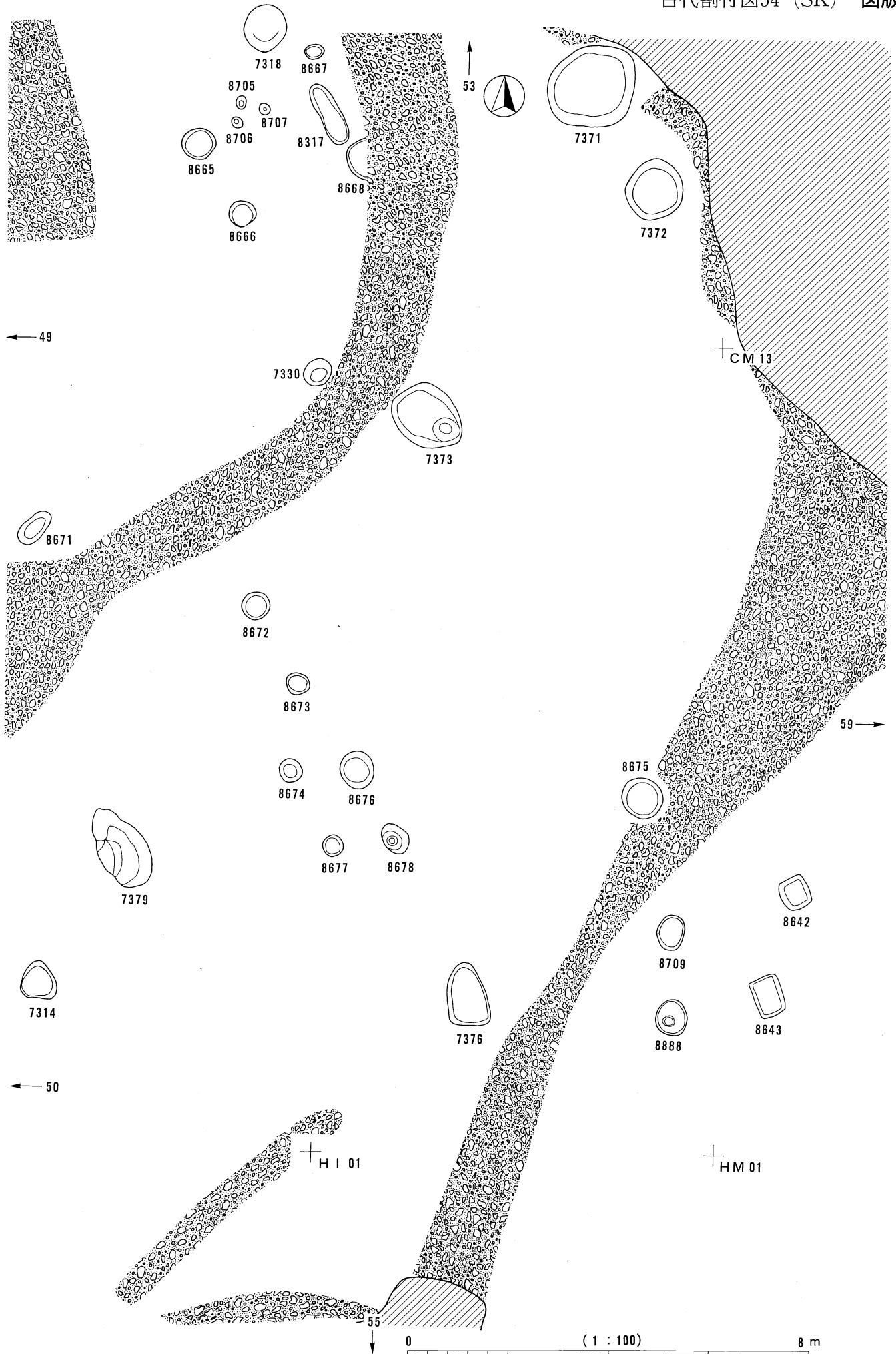

図版322 古代割付図55 (SK以外)

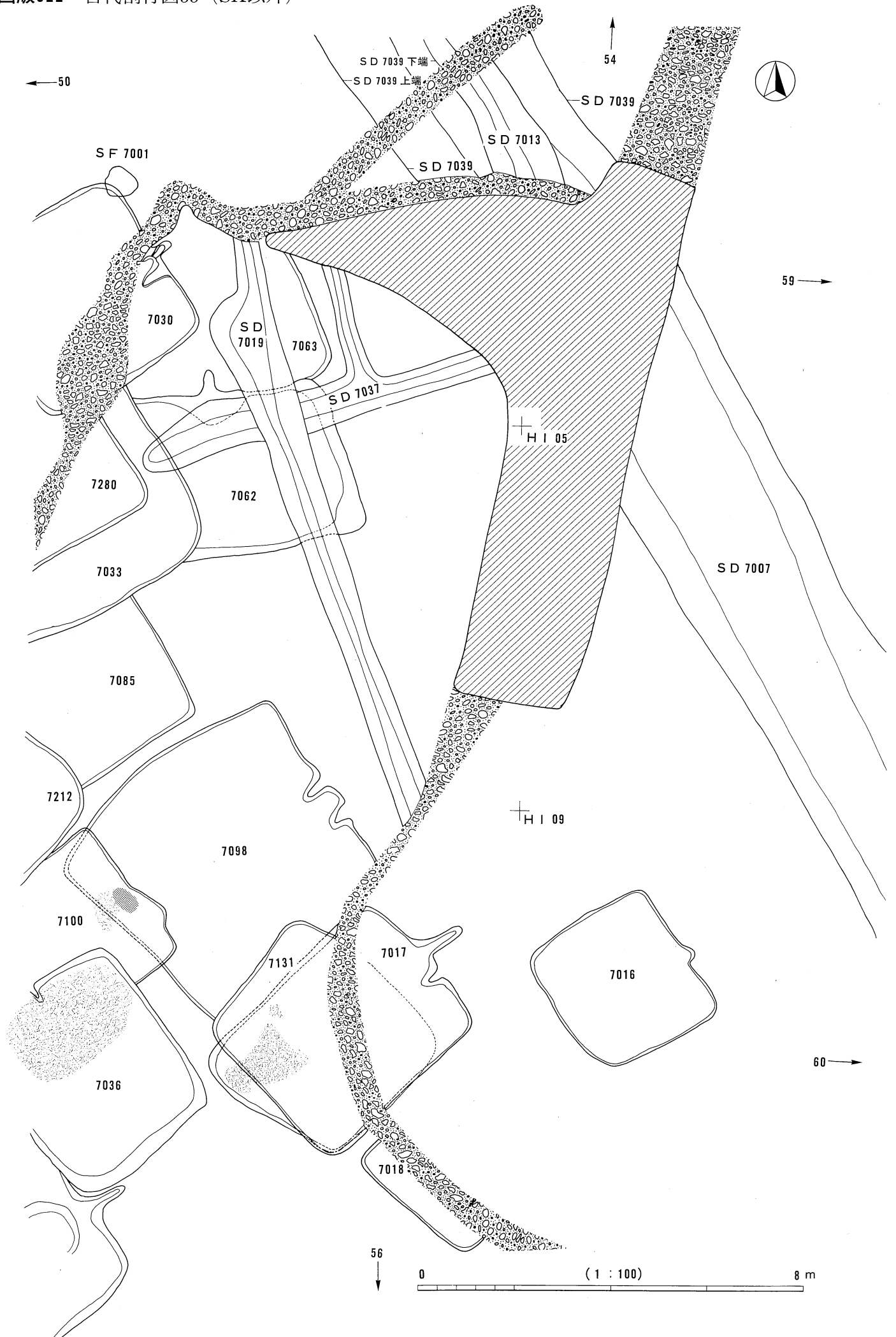

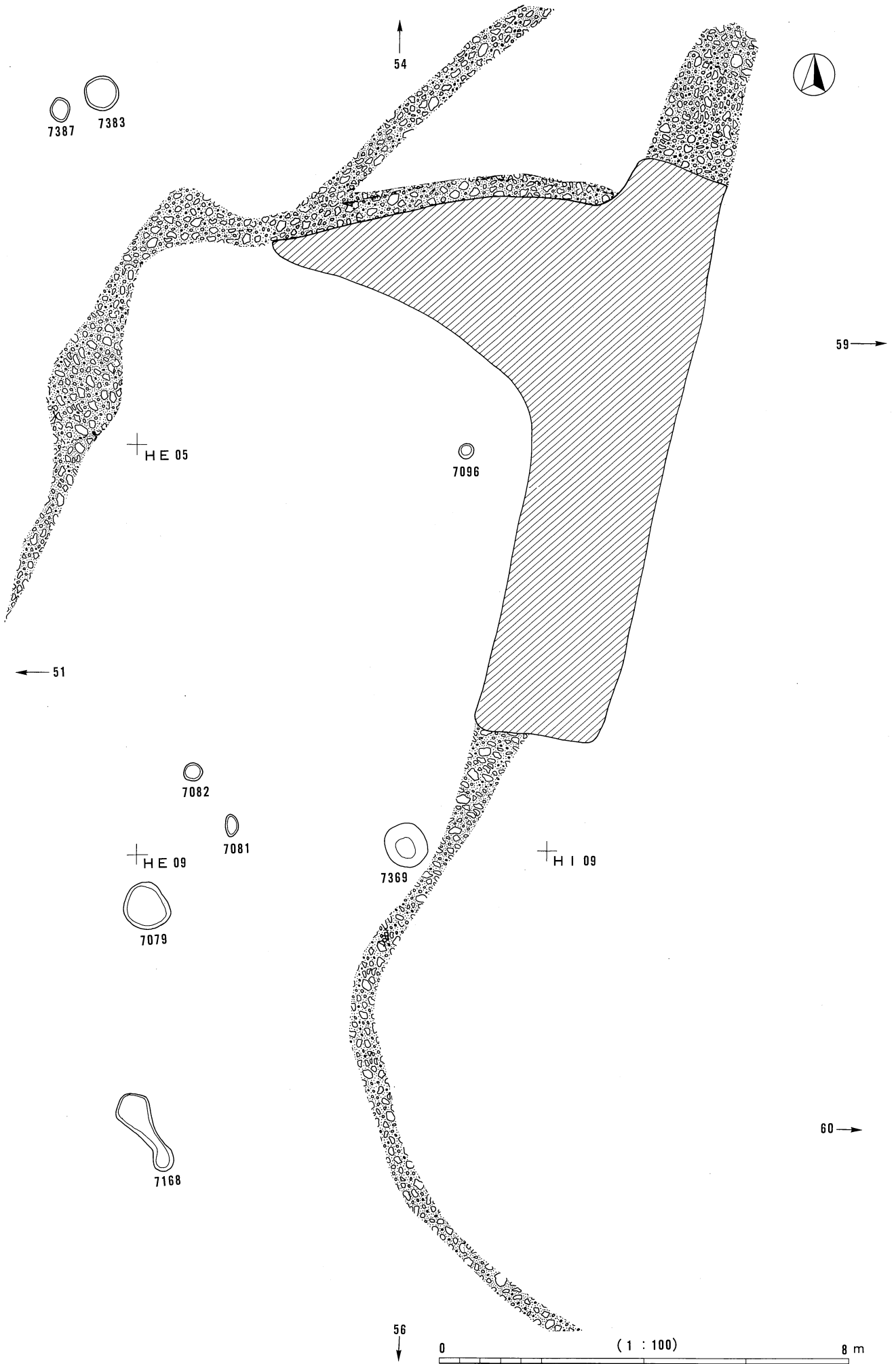

0 (1 : 100) 8 m

図版324 古代割付図56 (SK以外)

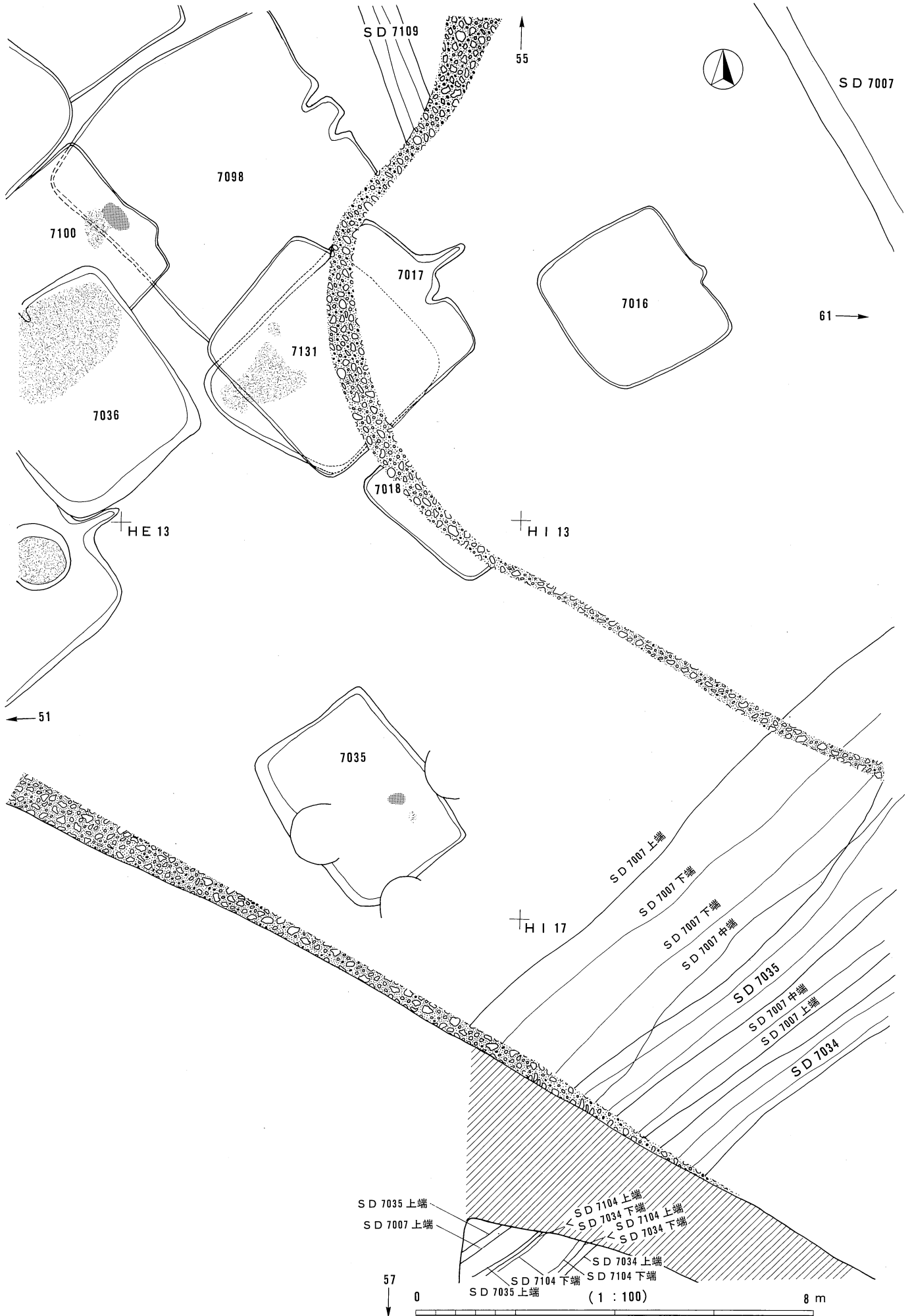

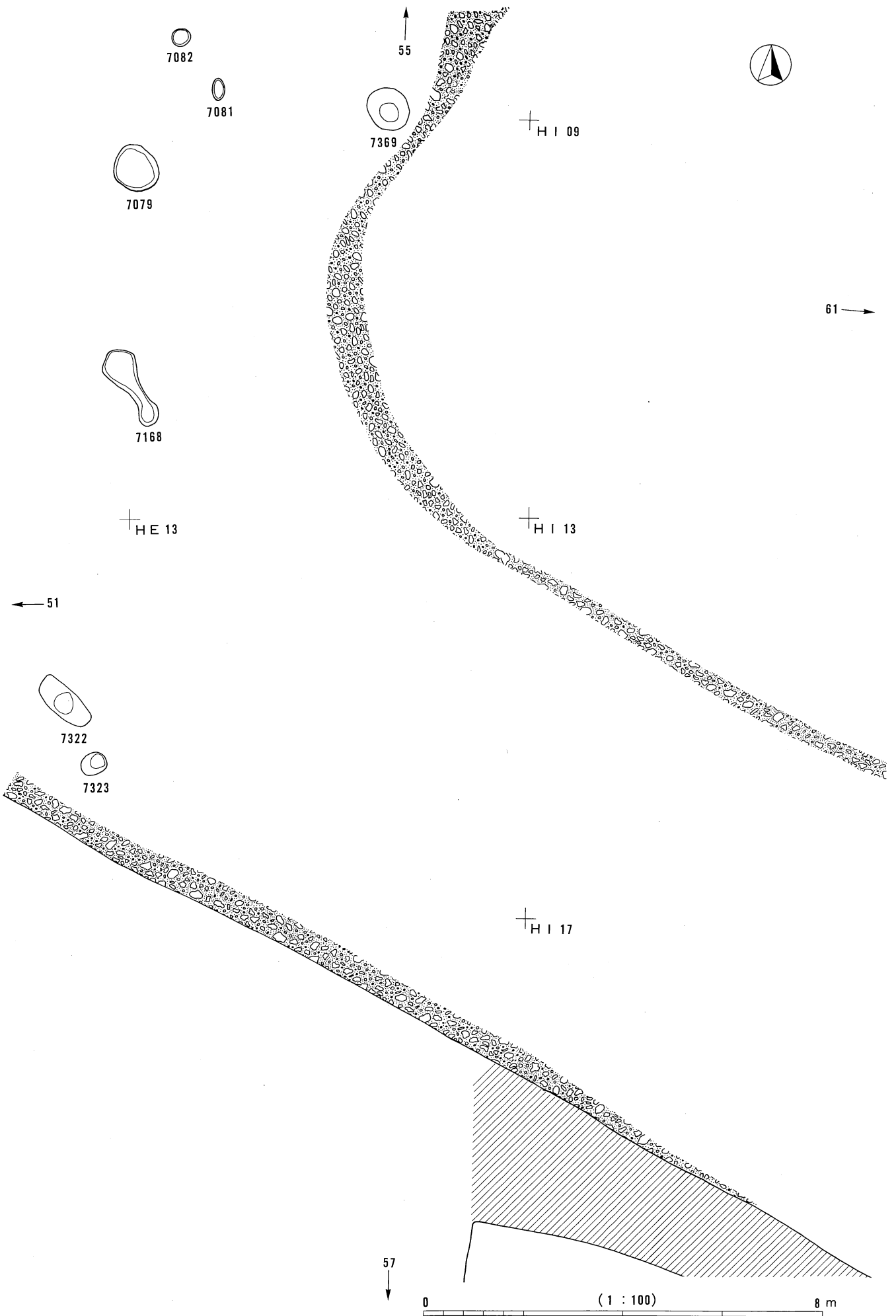

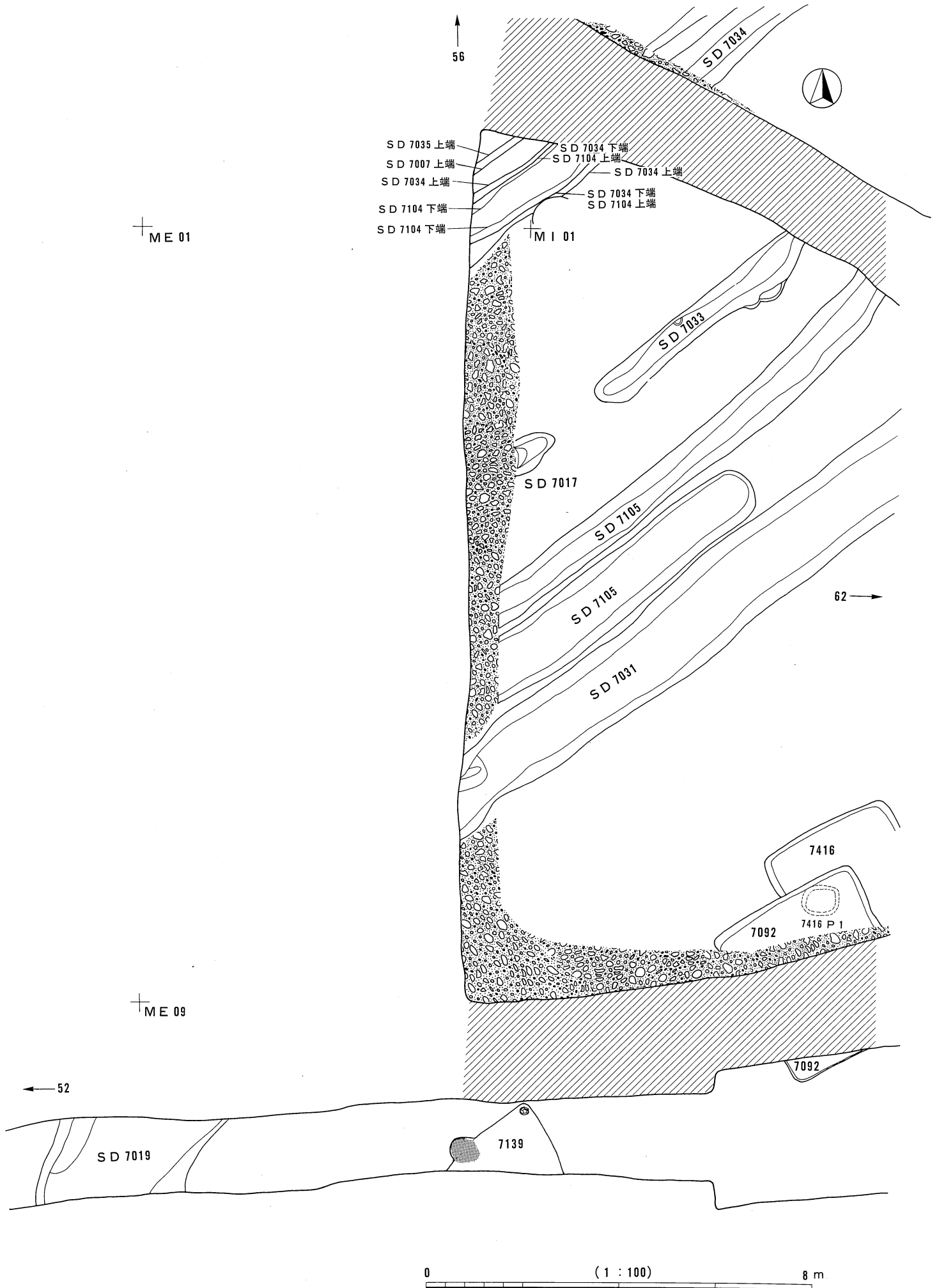



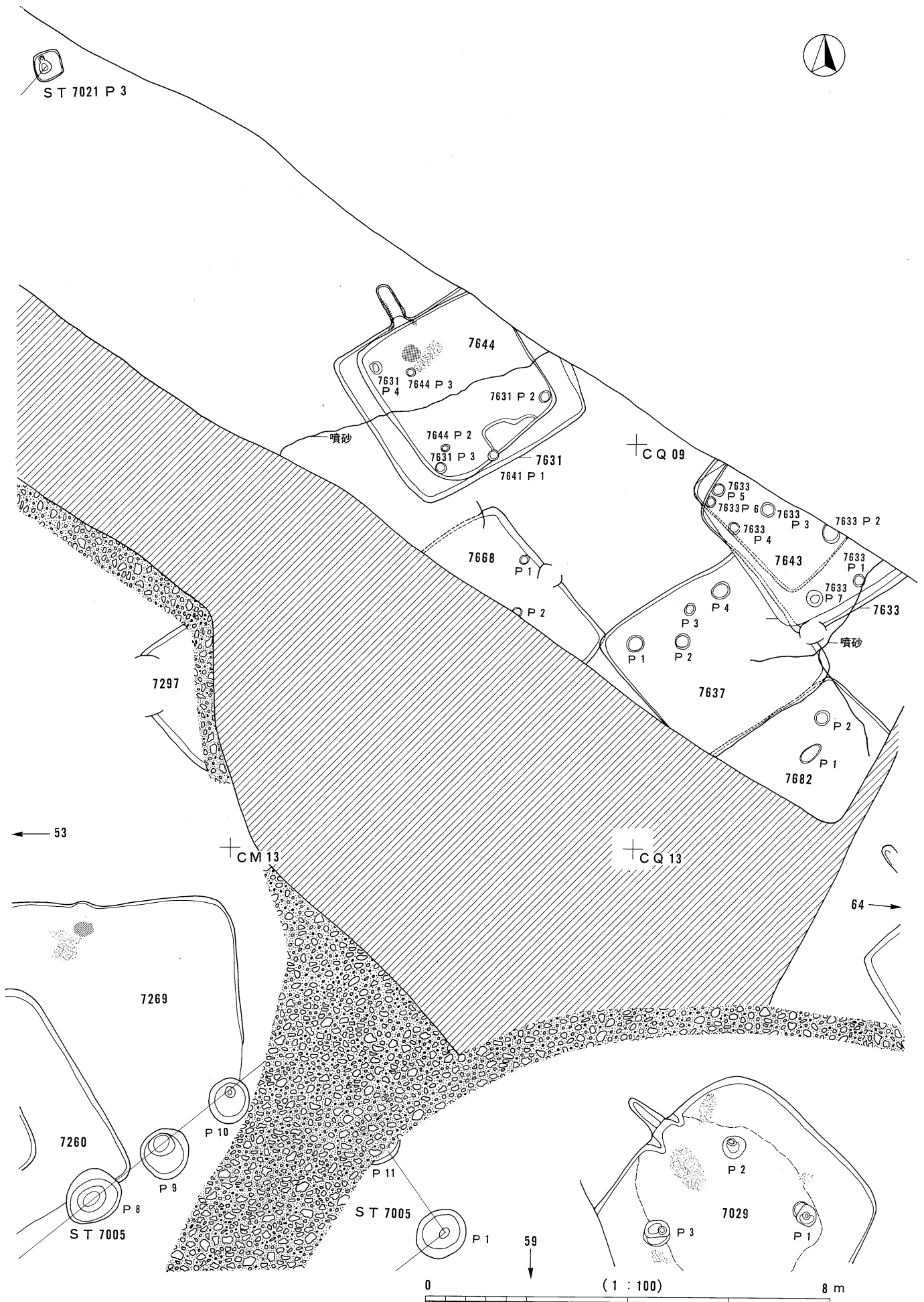

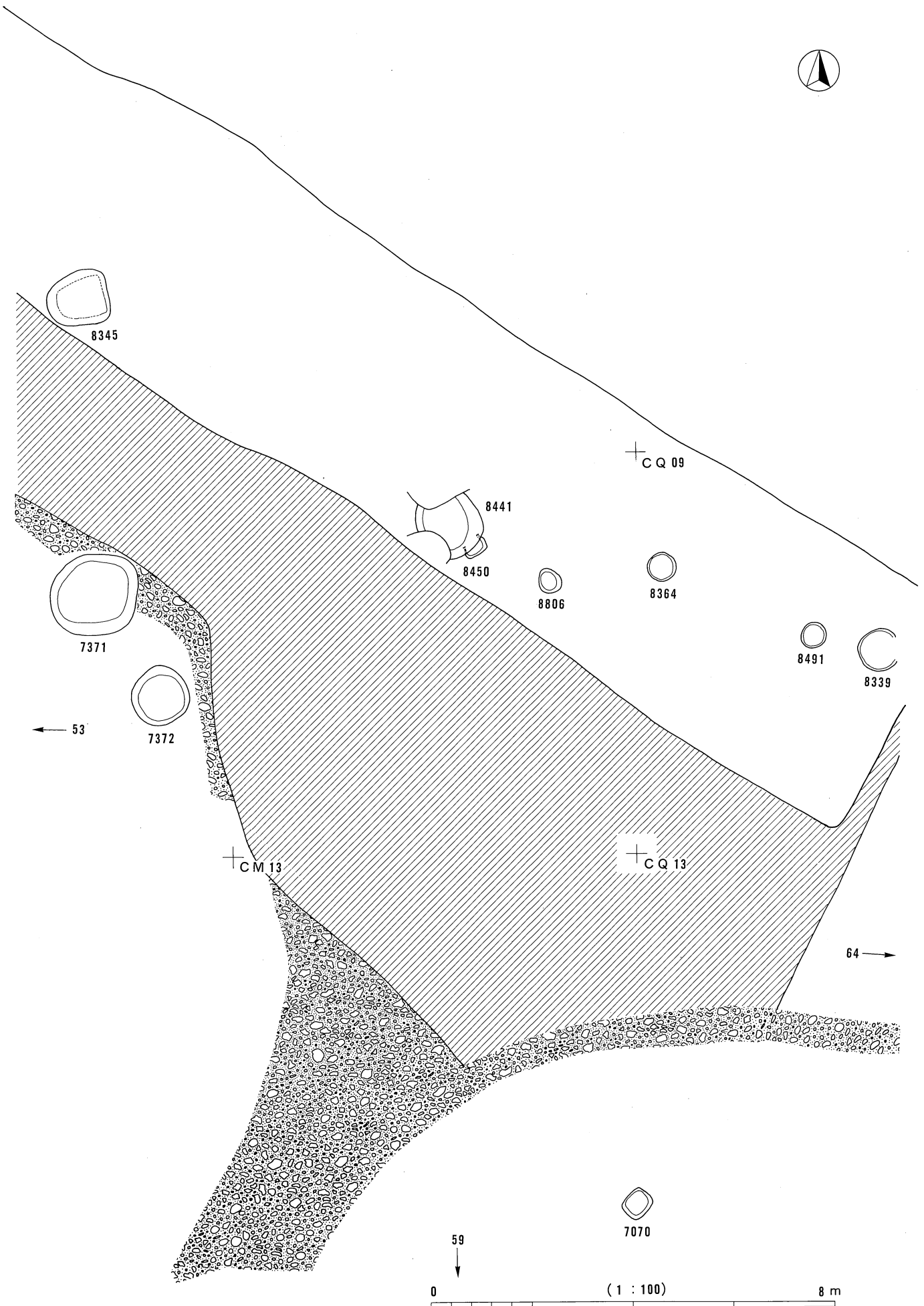

図版330 古代割付図59 (SK以外)

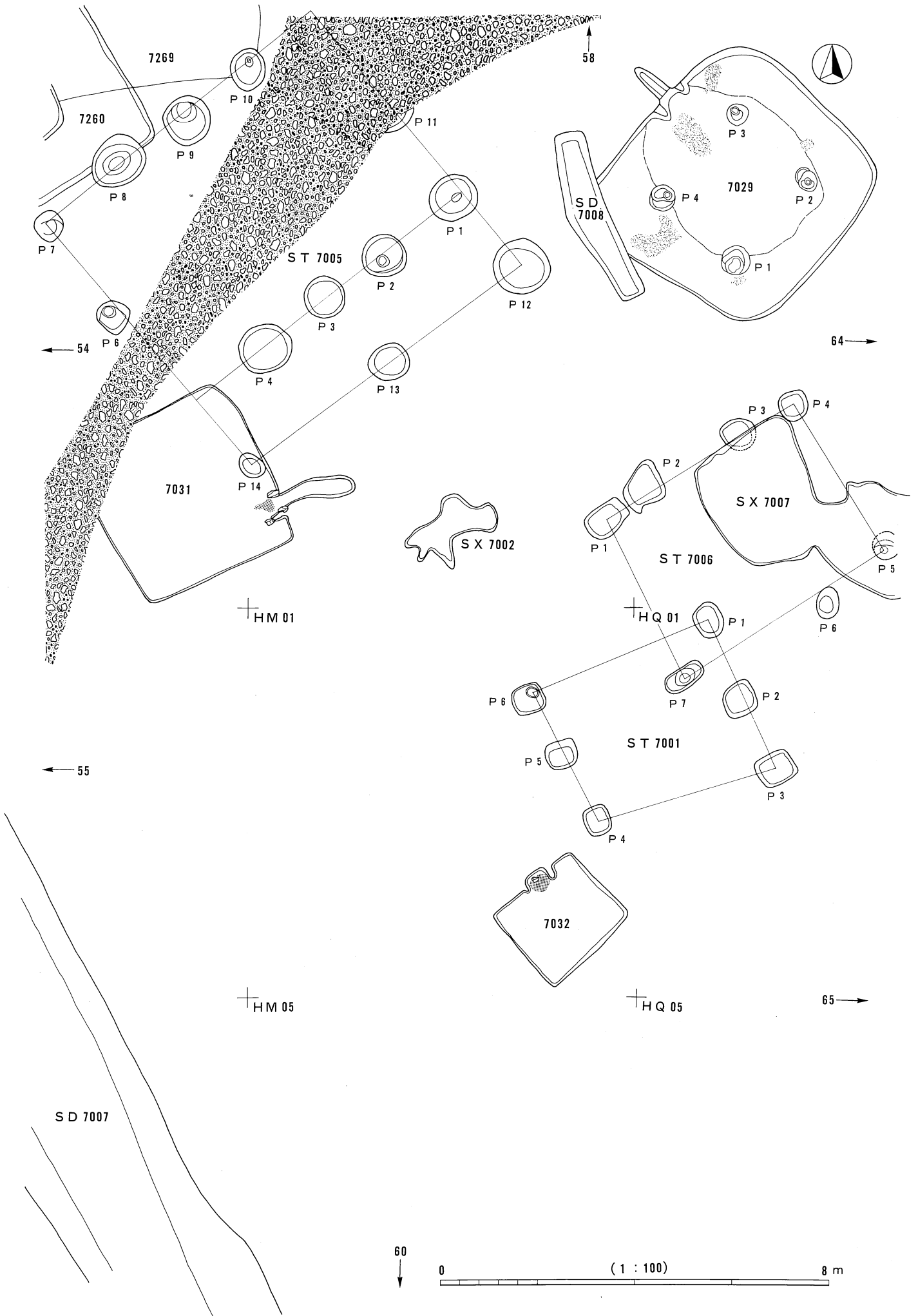

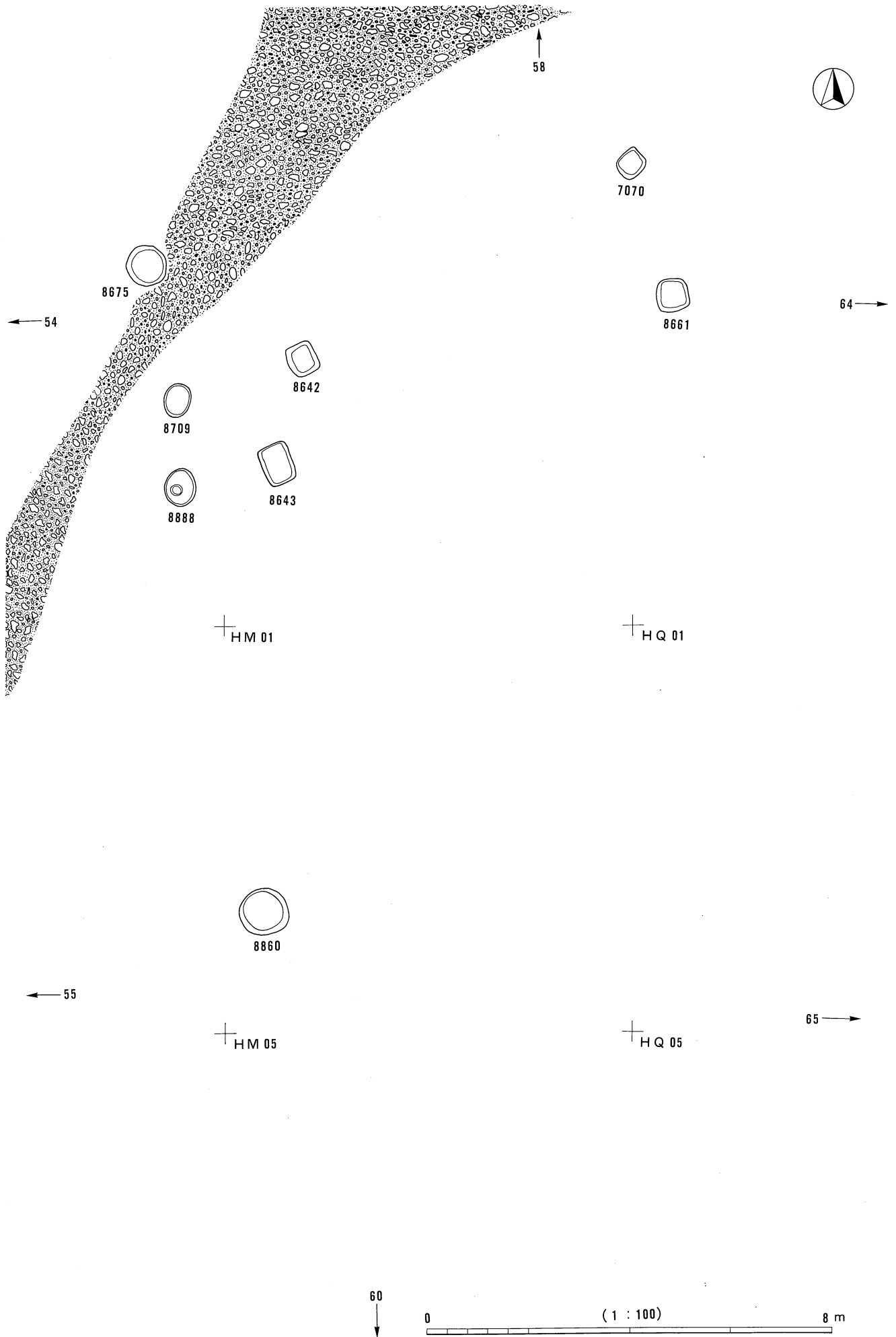

図版332 古代割付図61 (SK以外)

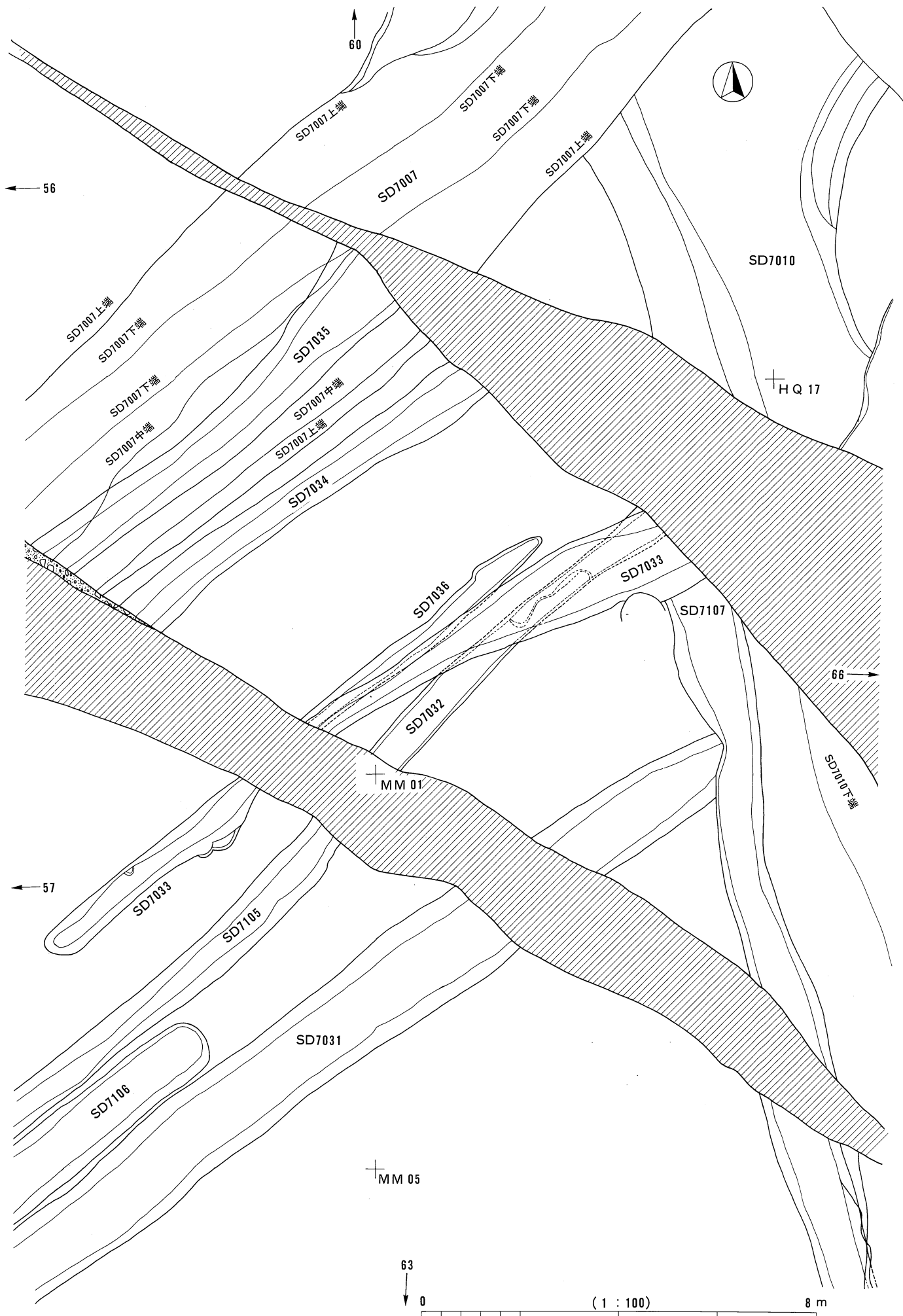

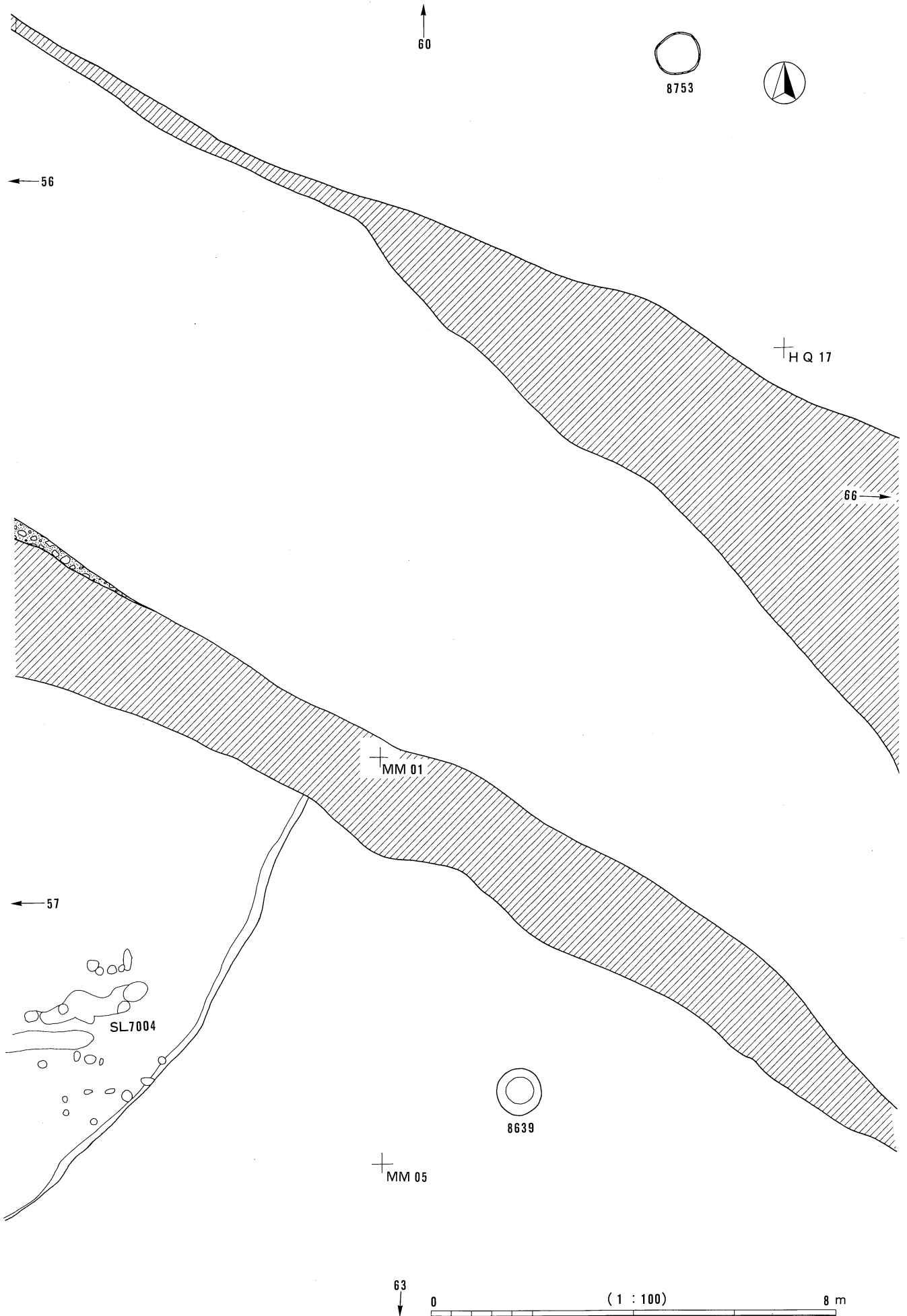

图版334 古代割付图62 (SK以外)

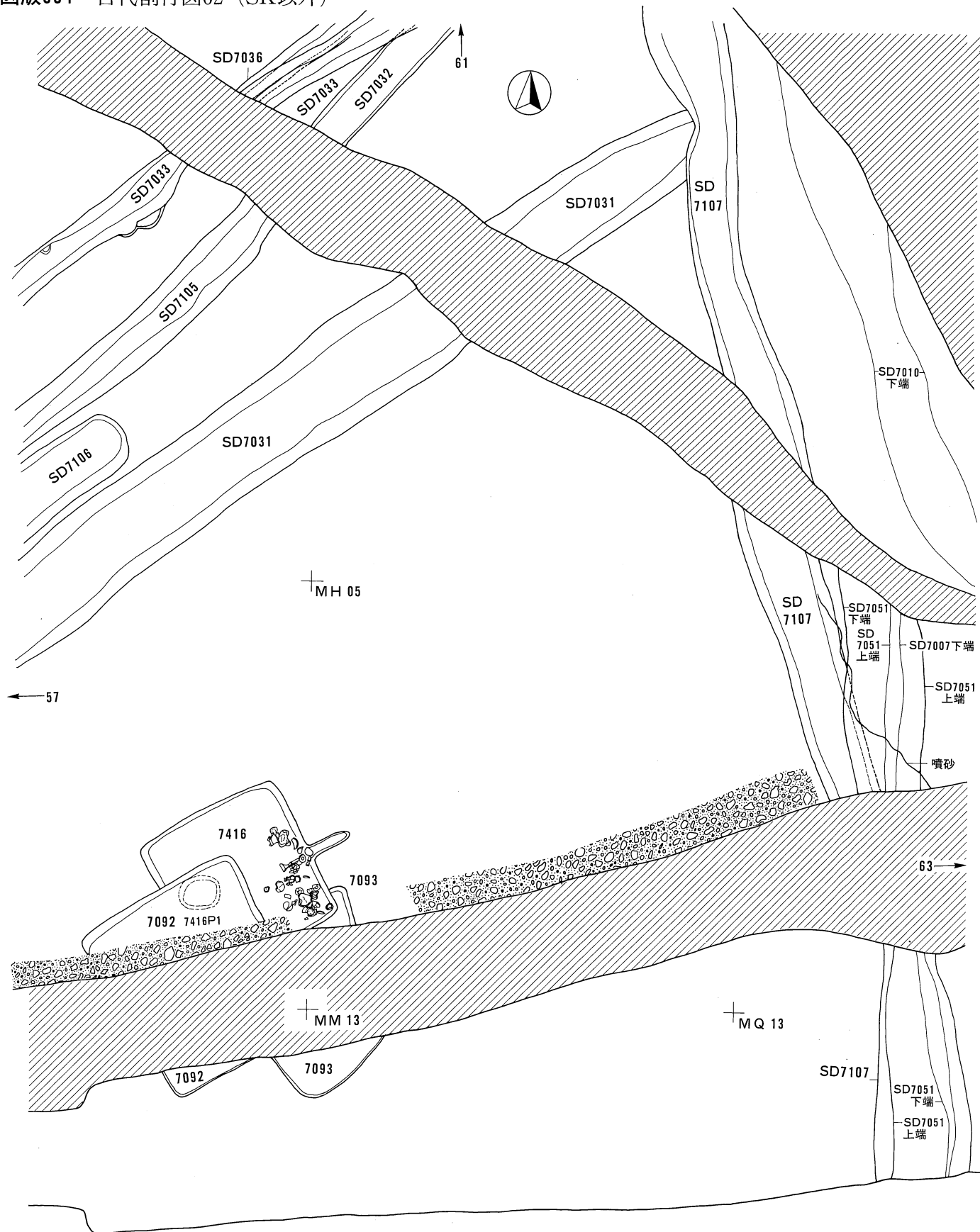

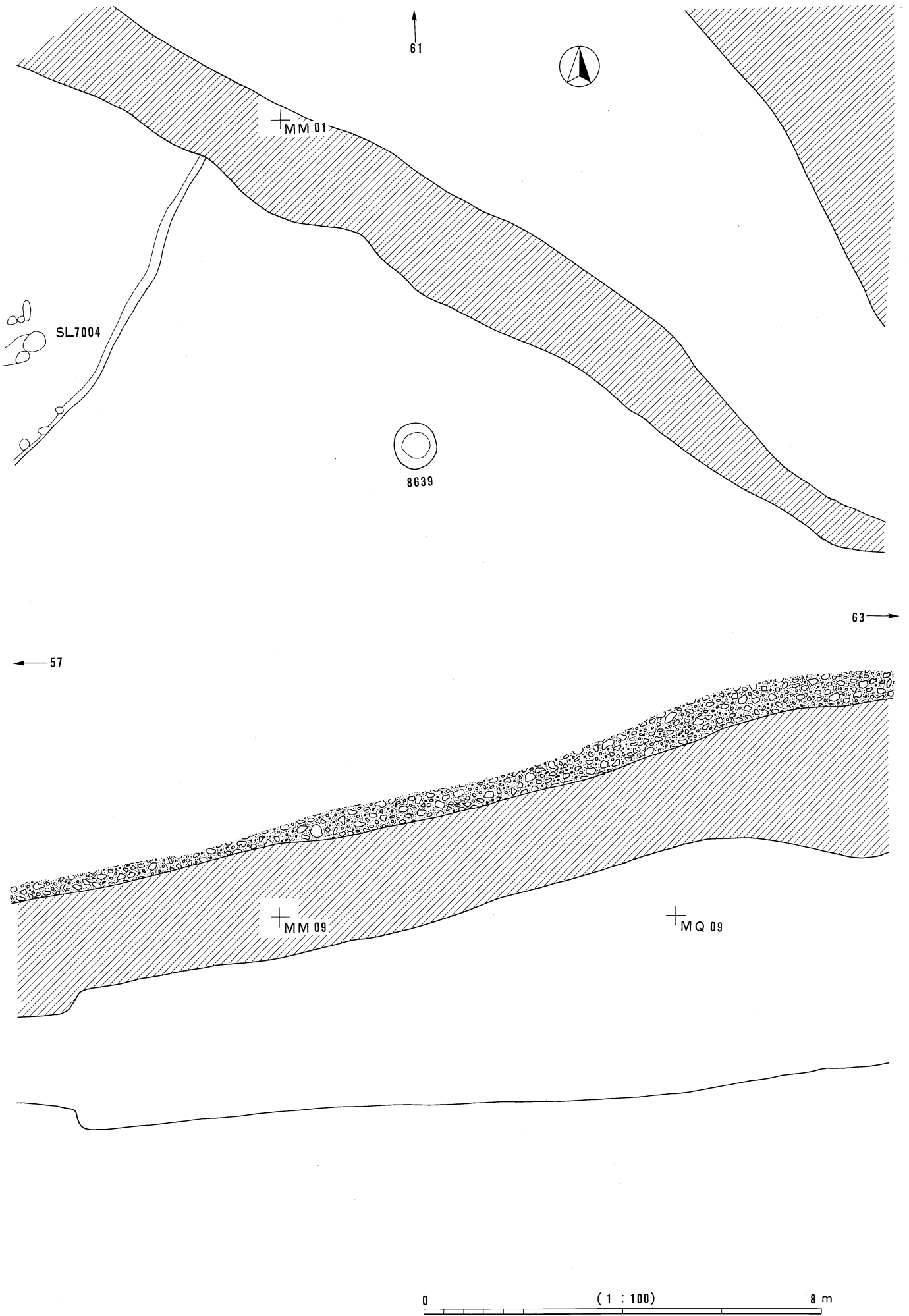

図版336 古代割付図63 (SK以外)

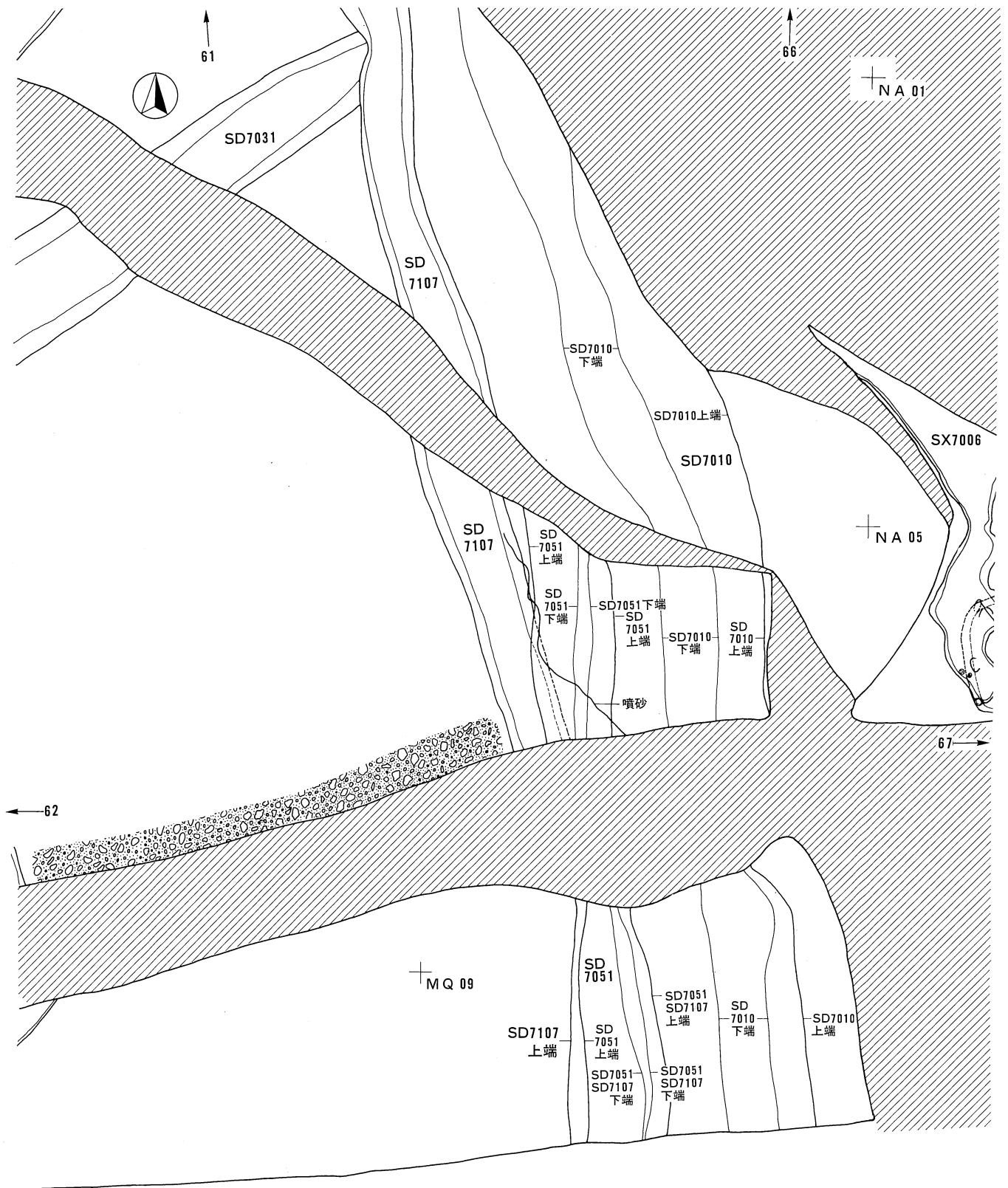

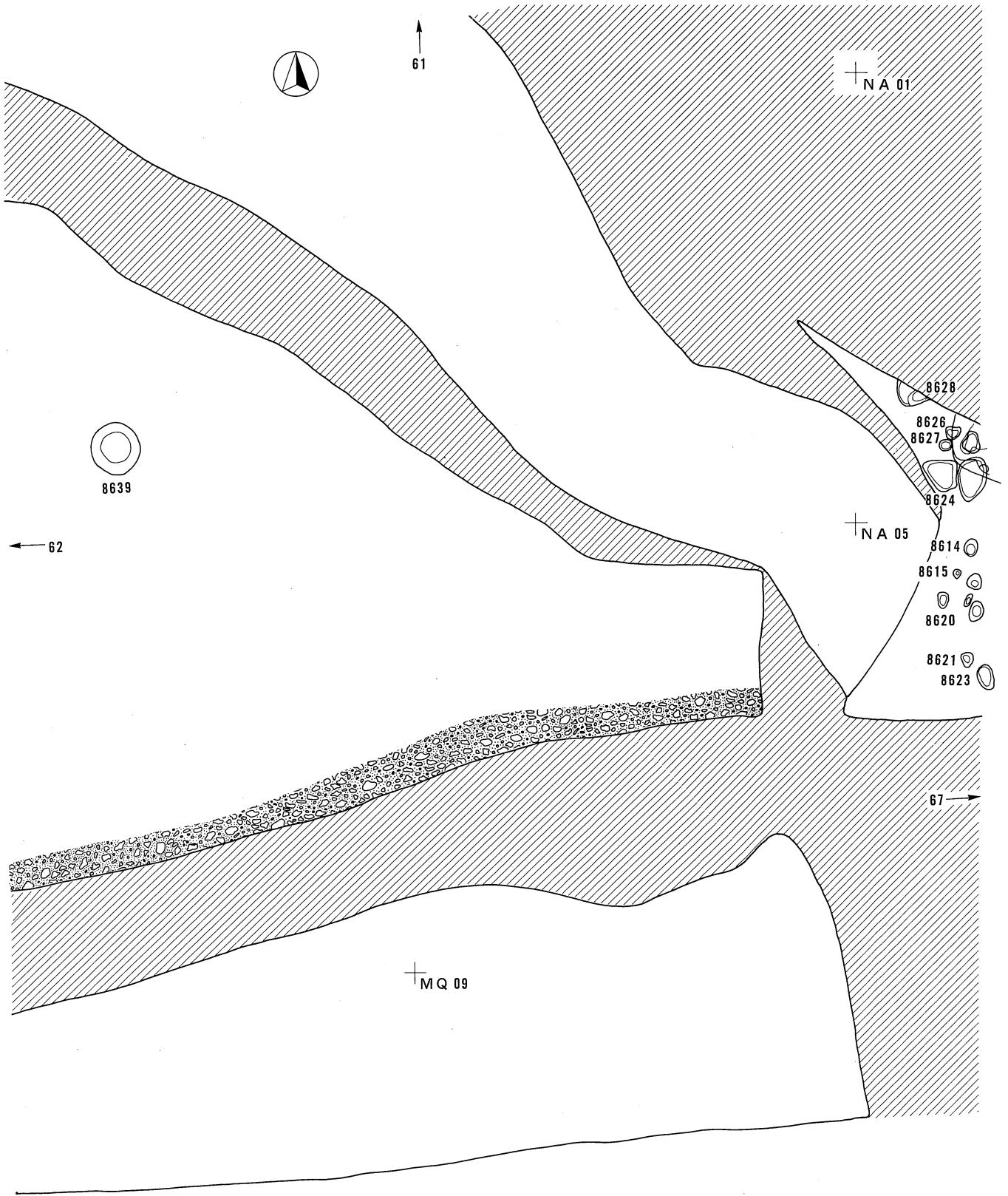

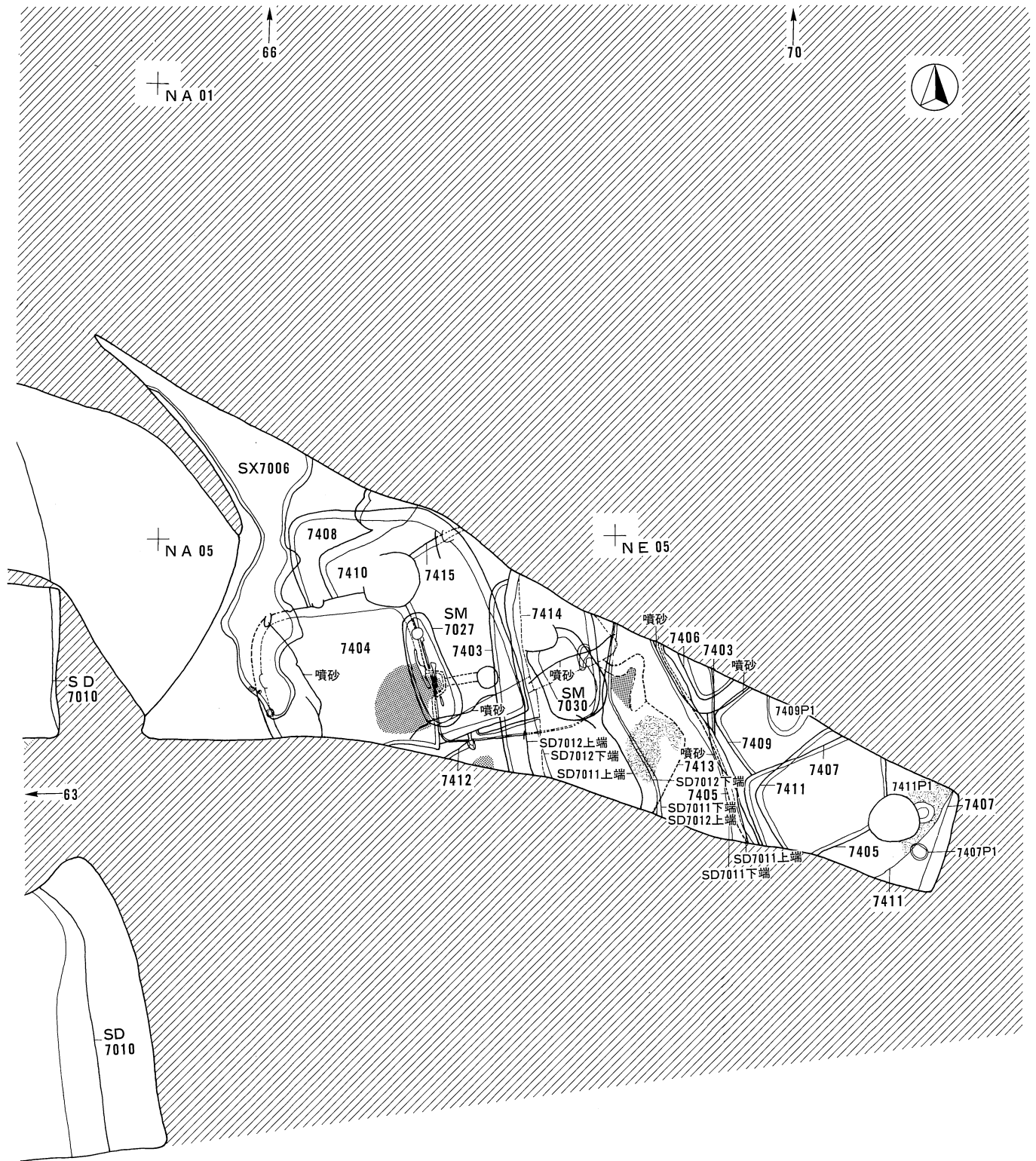

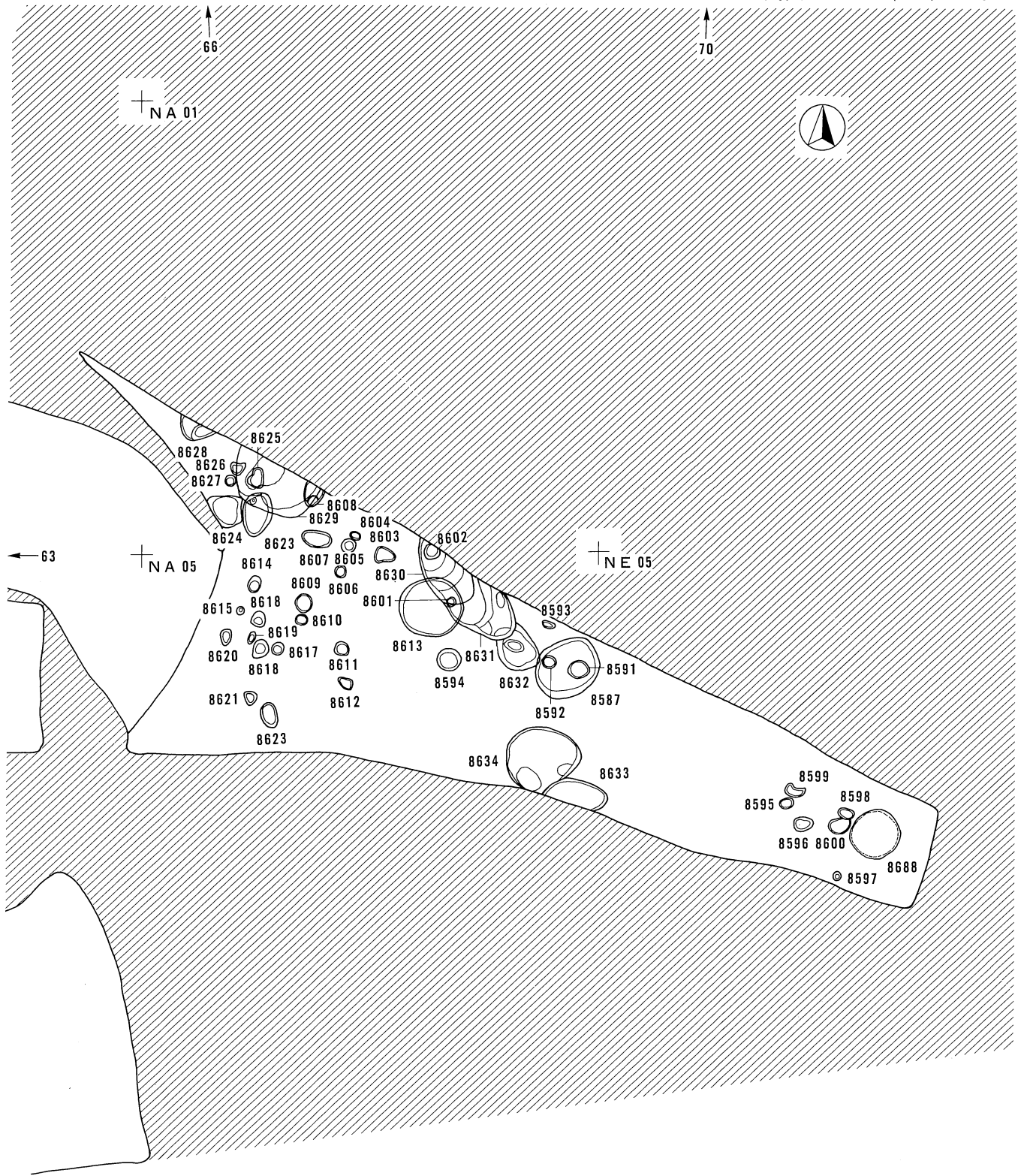

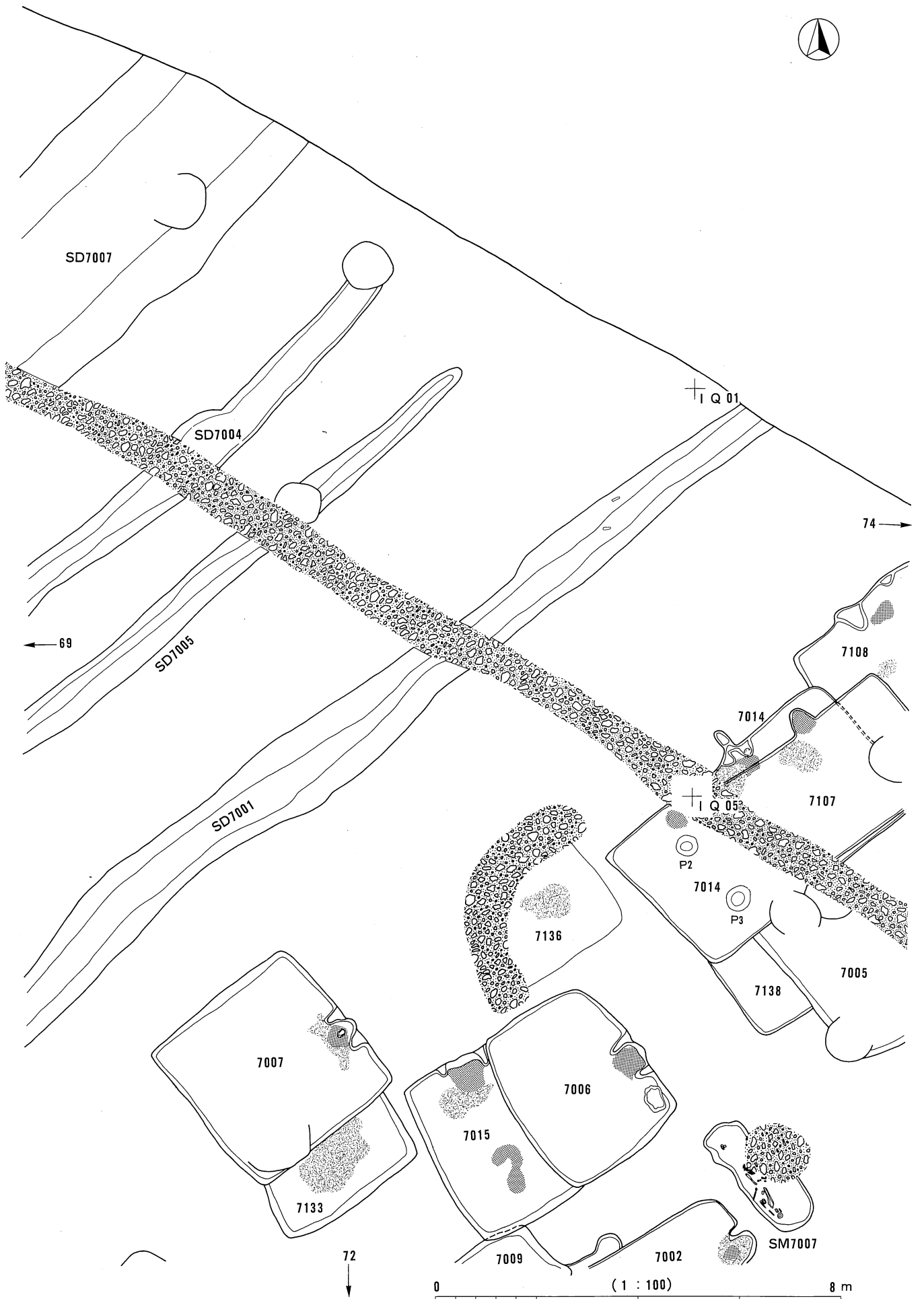

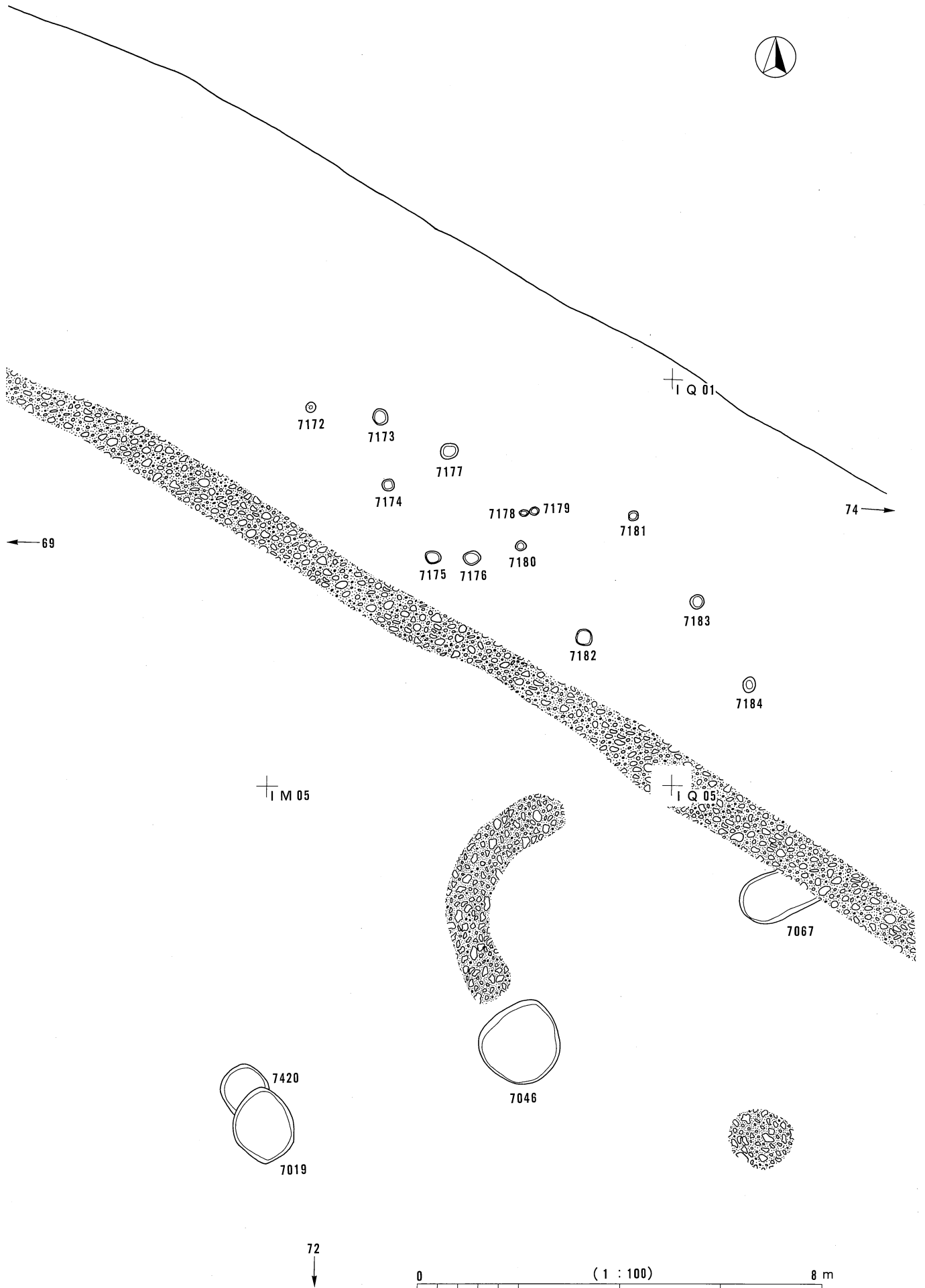

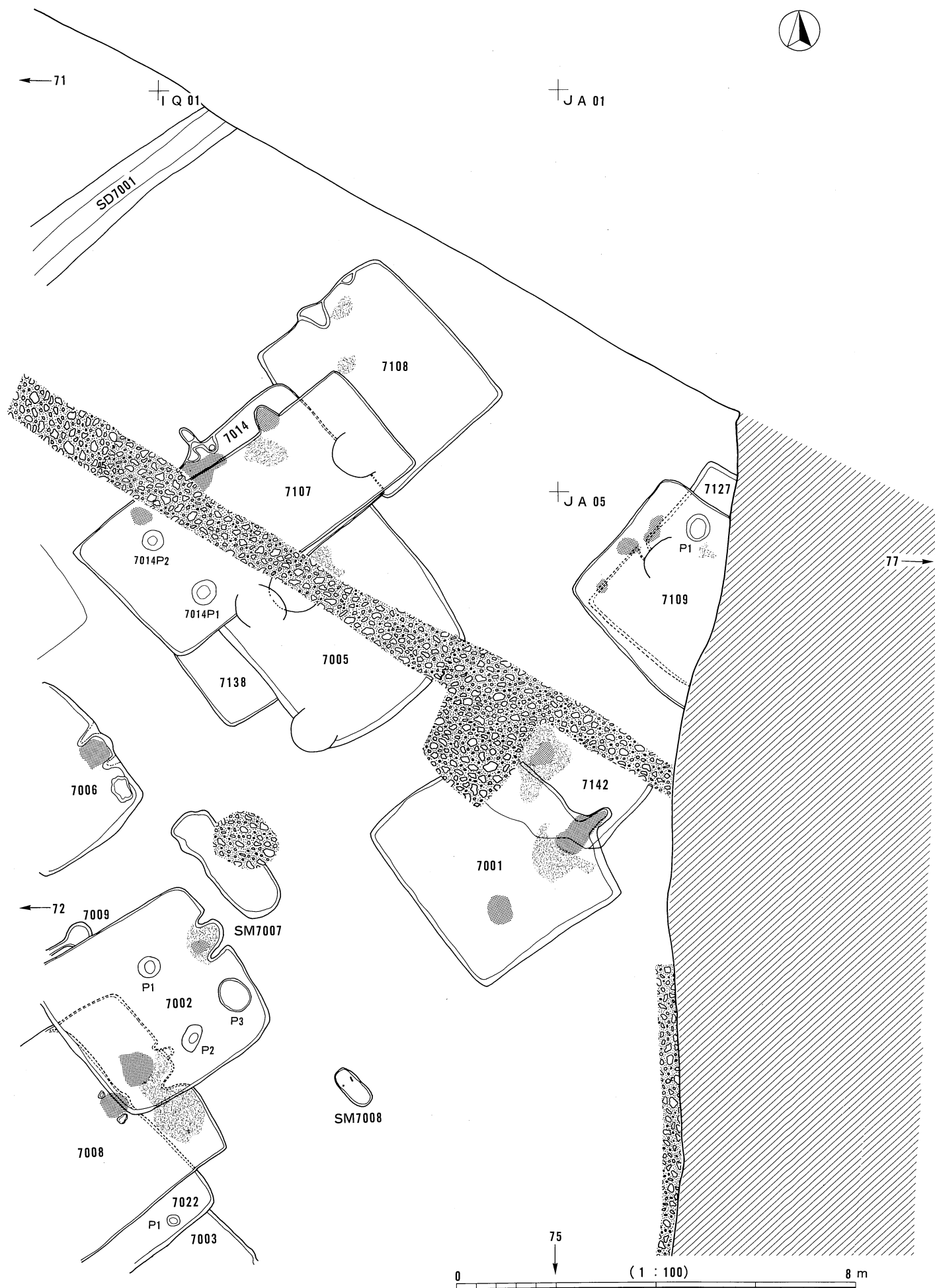

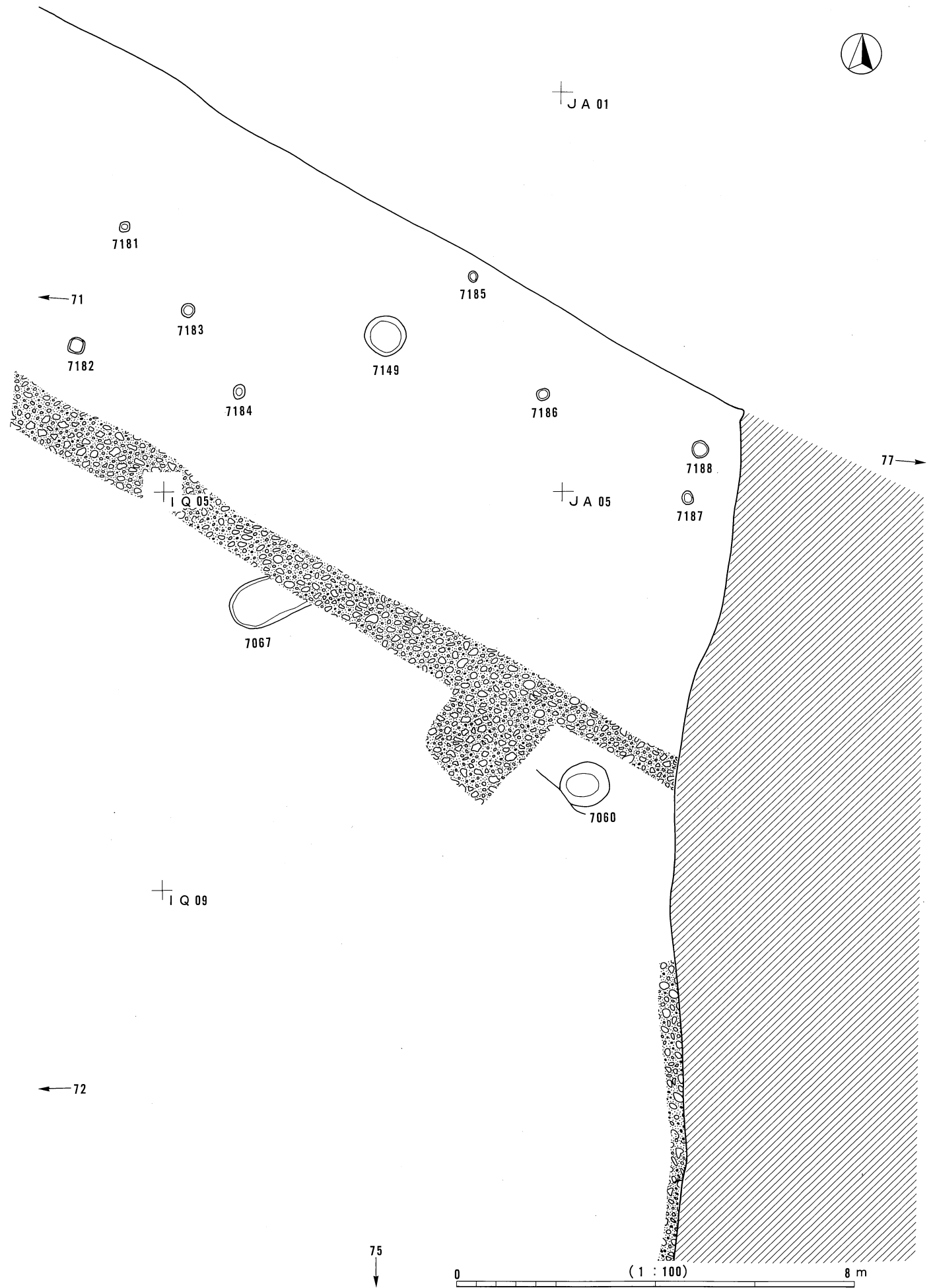



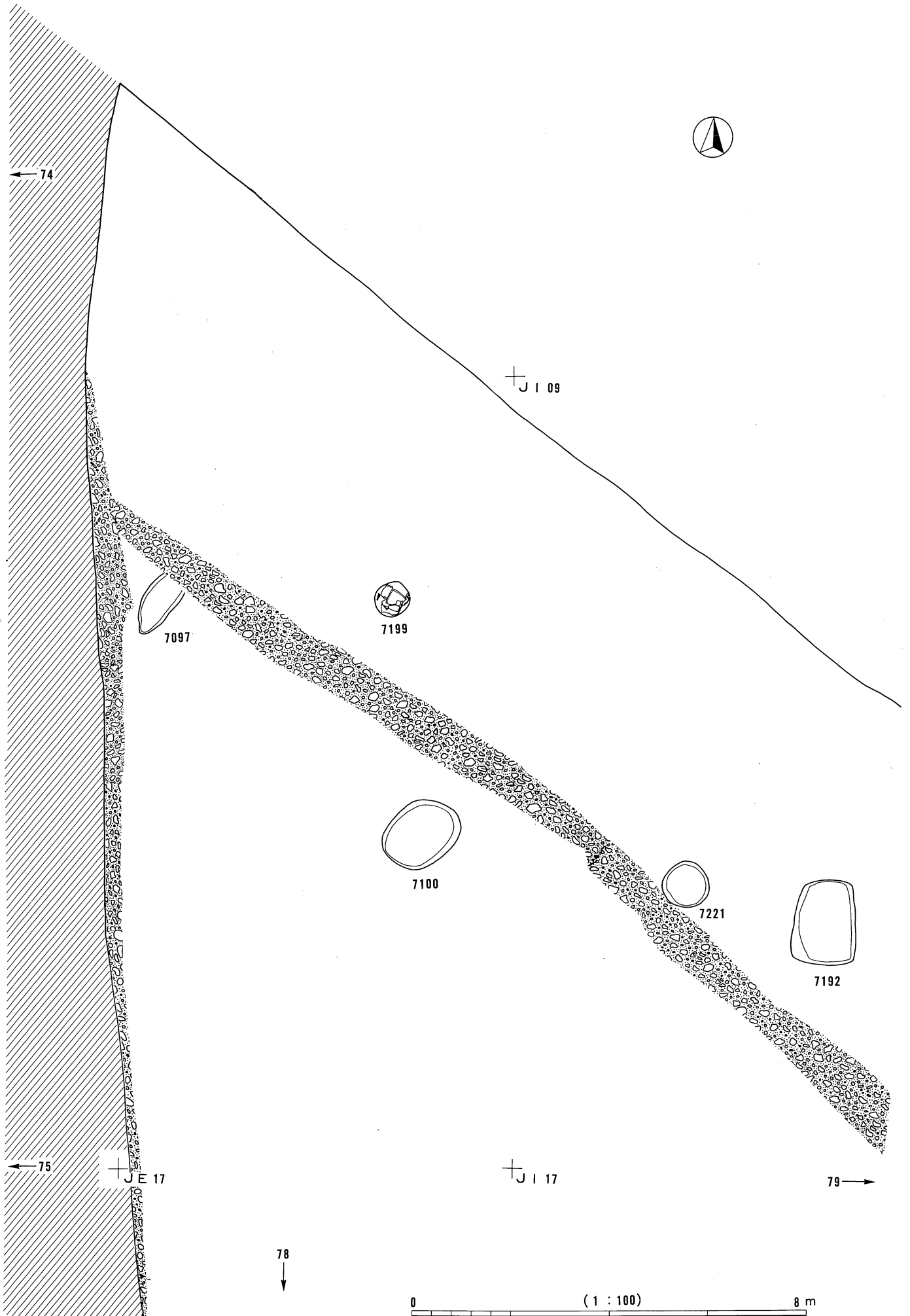

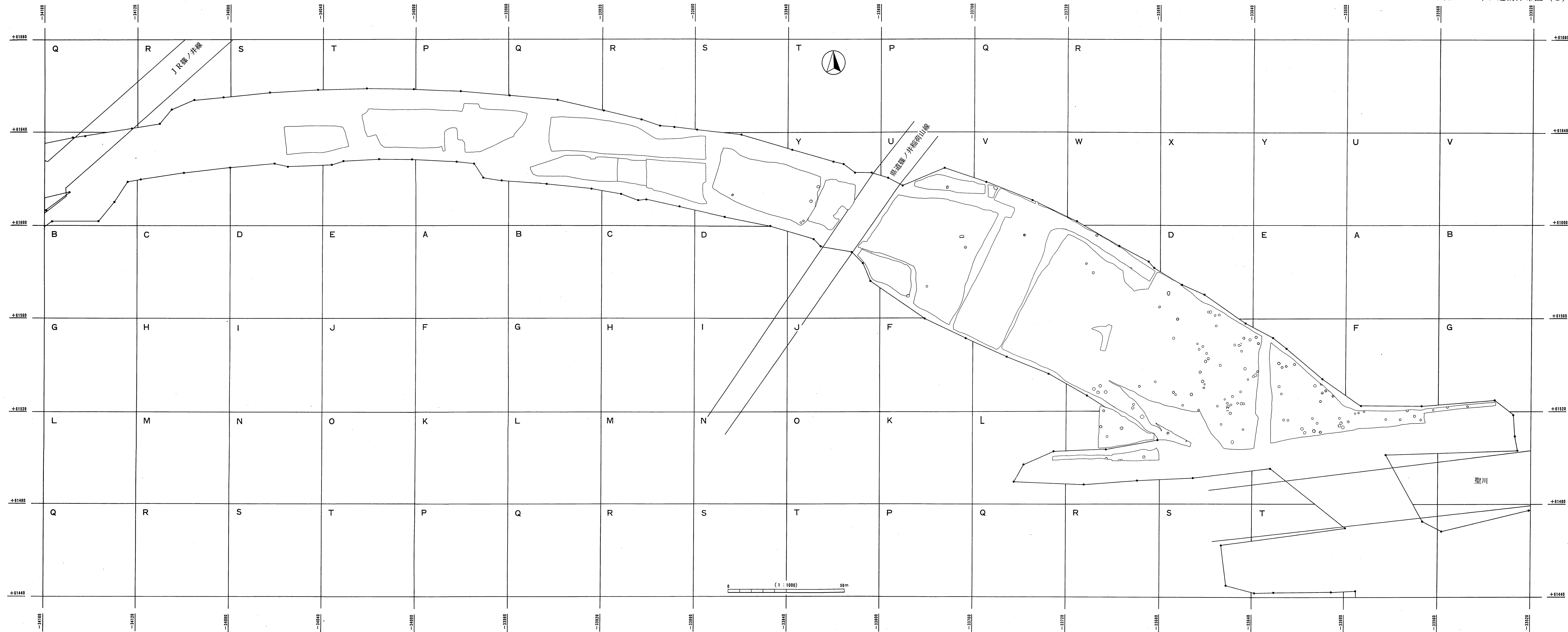

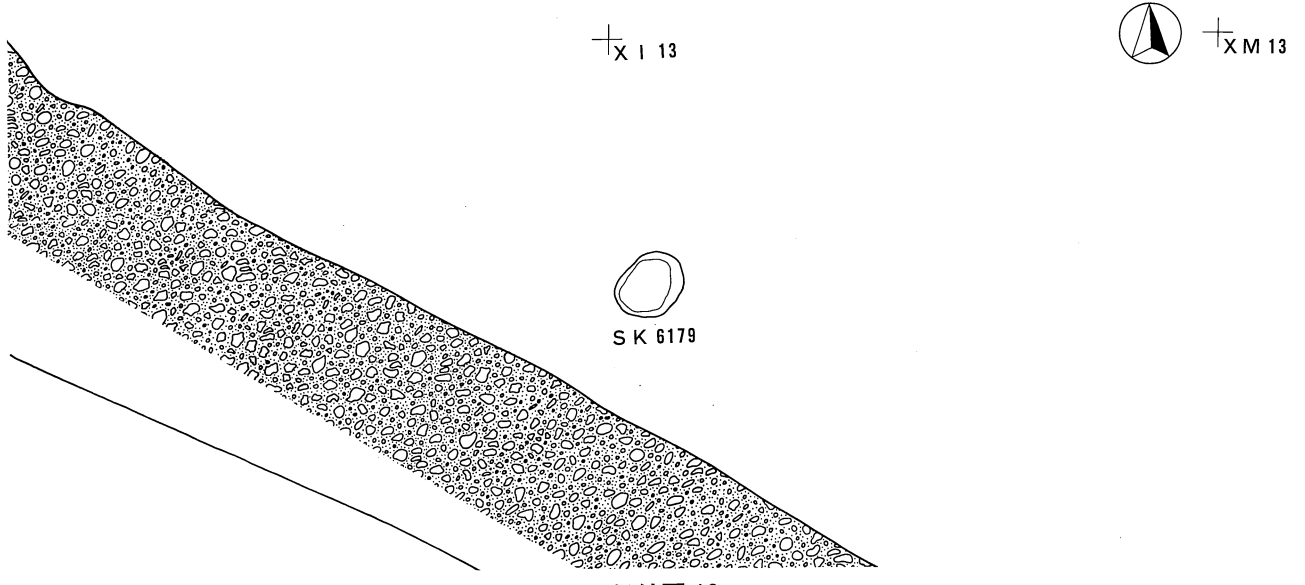

割付図 19

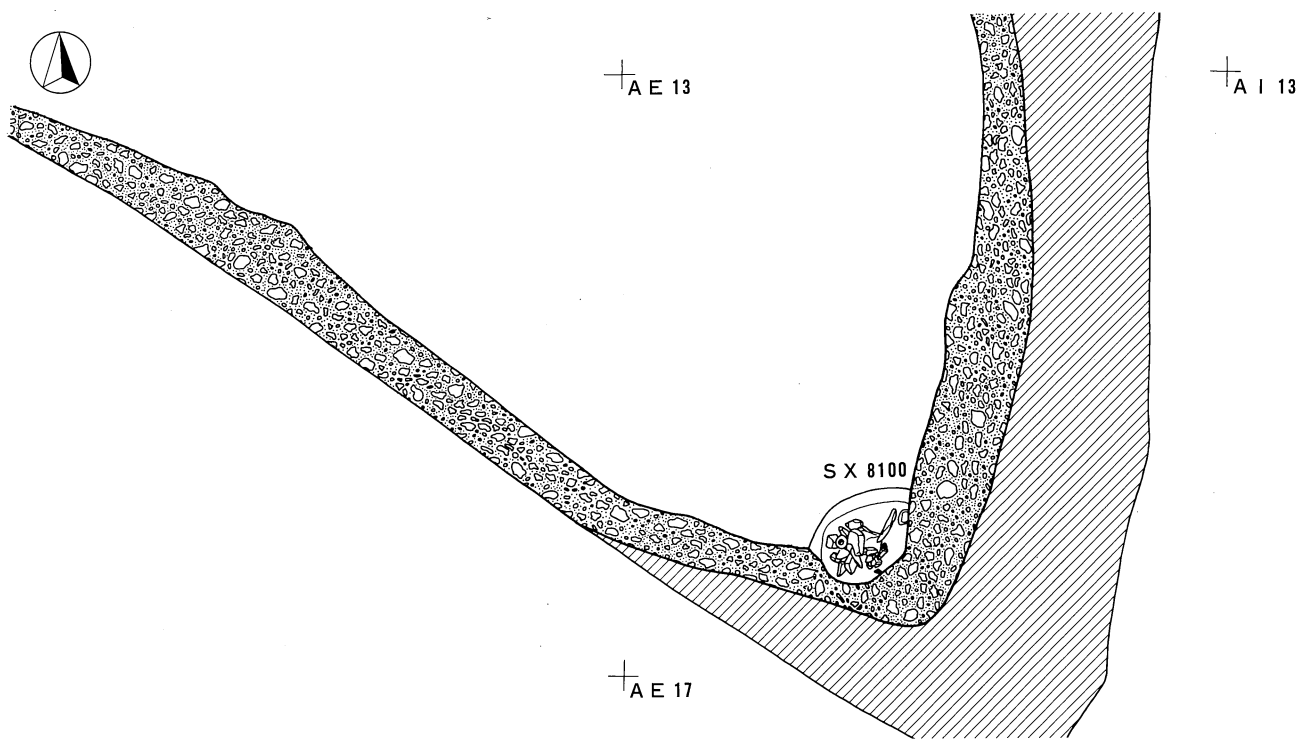

割付図 28

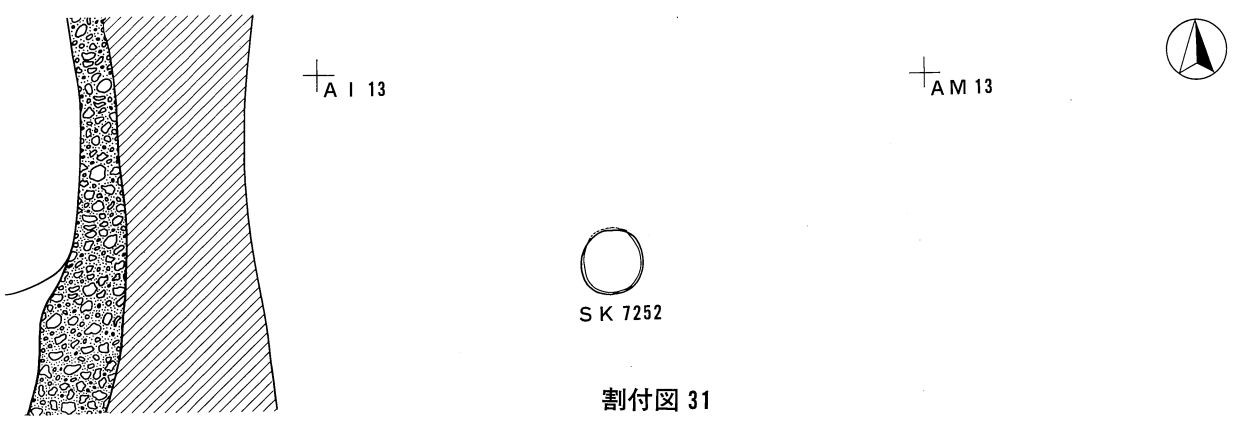

割付図 31

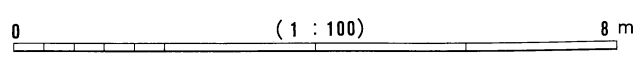

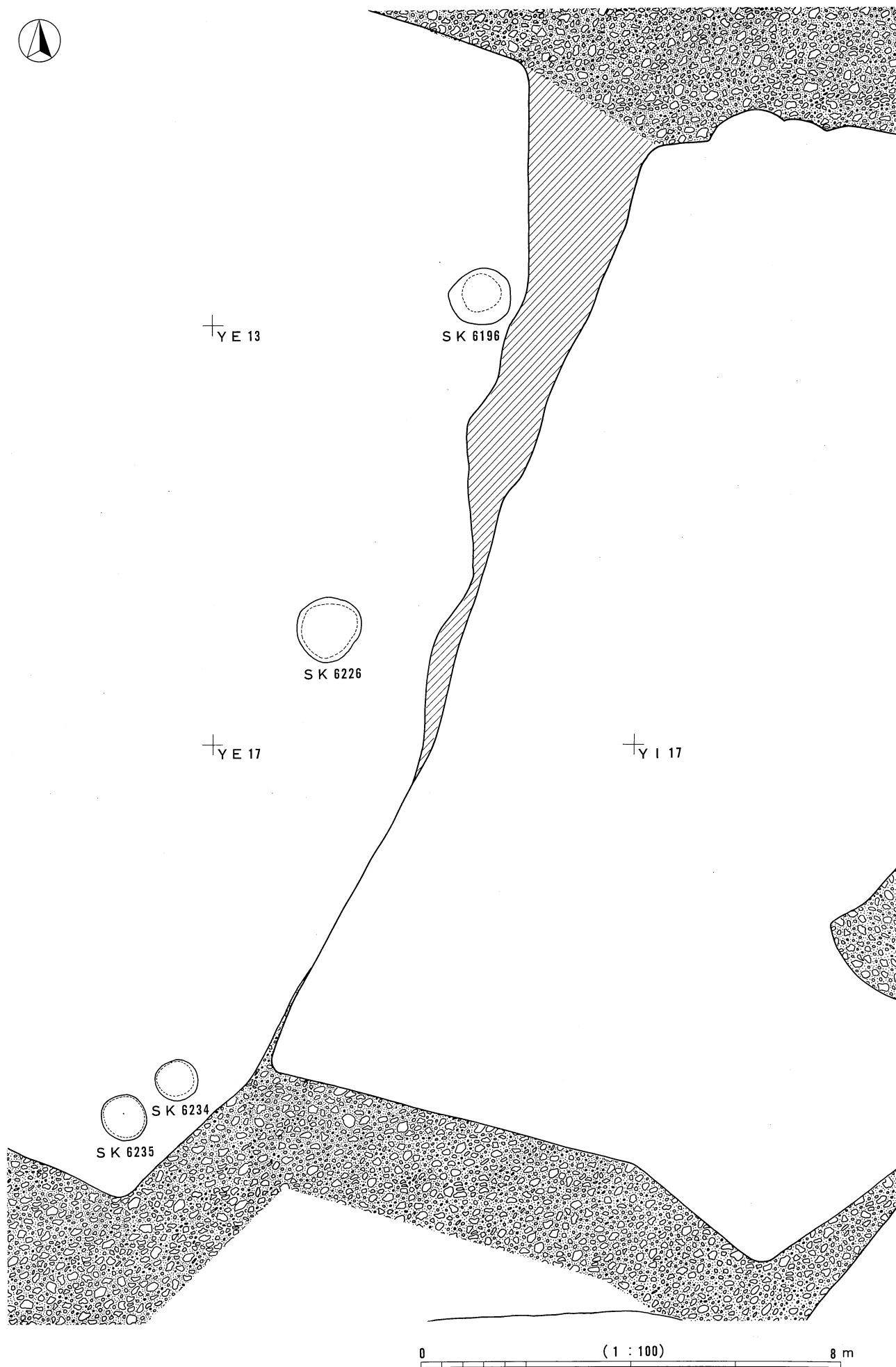

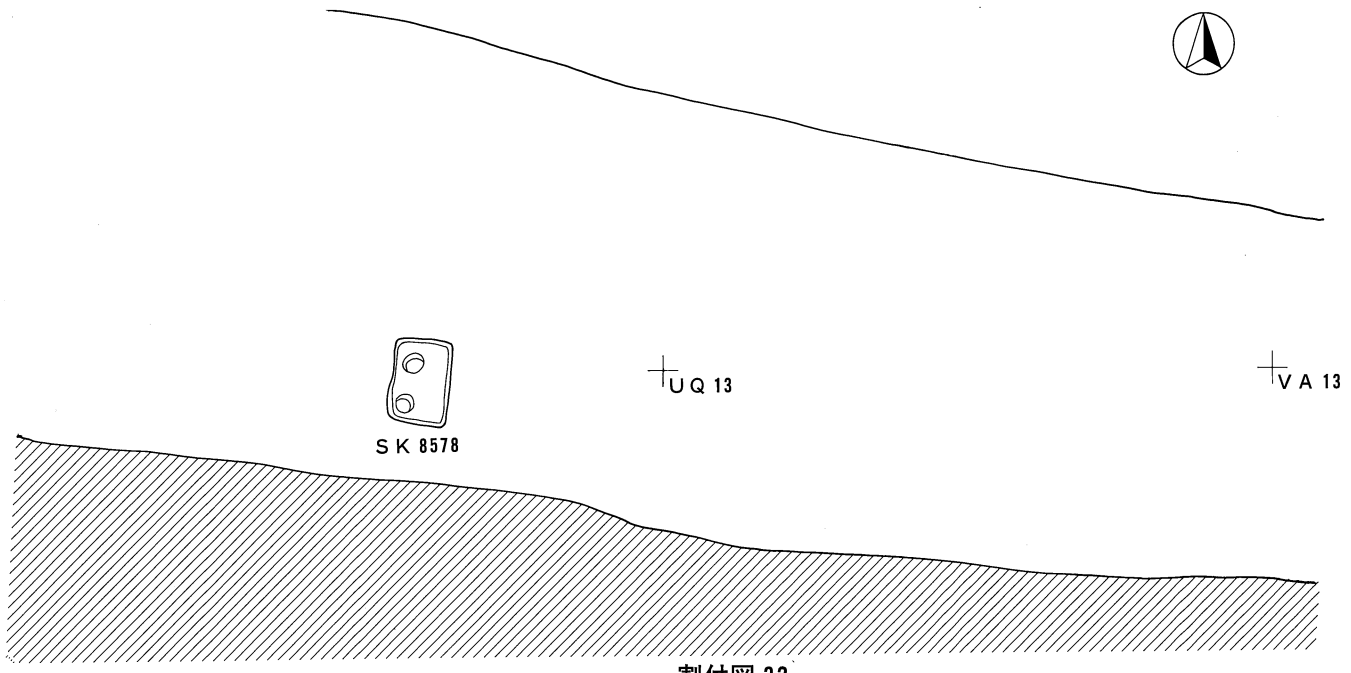

割付図 32

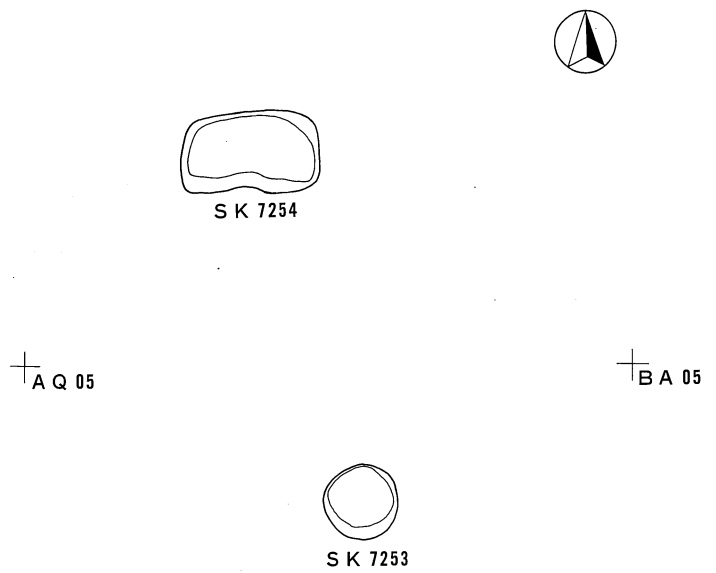

割付図 33

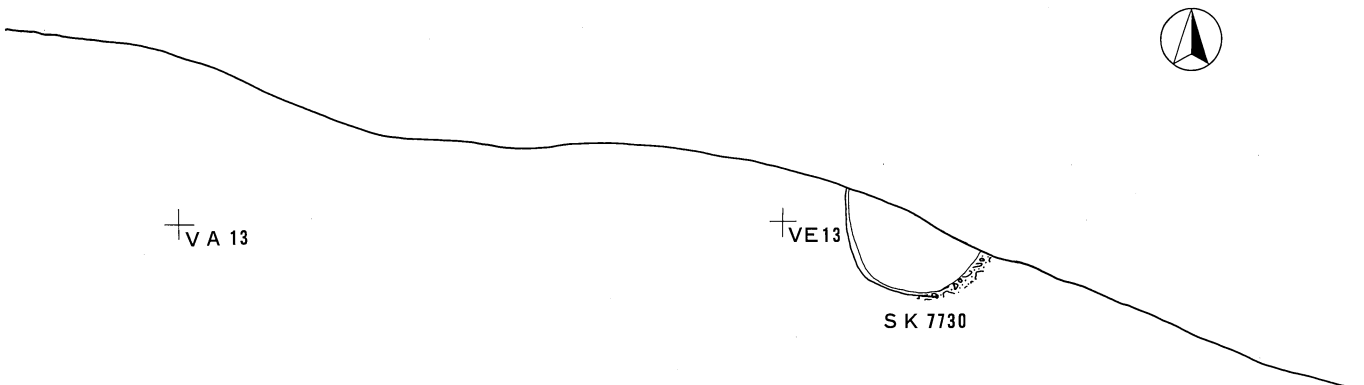

割付図 35

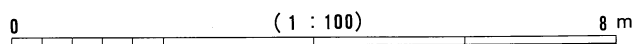



+B I 01

+BM 01



S K 8224

割付图 40

+CA 09



S K 7311

53 →



+CA 13

+CE 13

割付图 49



S K 7124

61 →

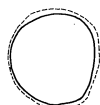

S K 7125

+HE 17



S K 7133

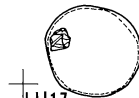

+H117

S K 7134

割付图 56

0 (1 : 100) 8 m

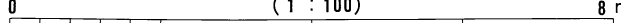

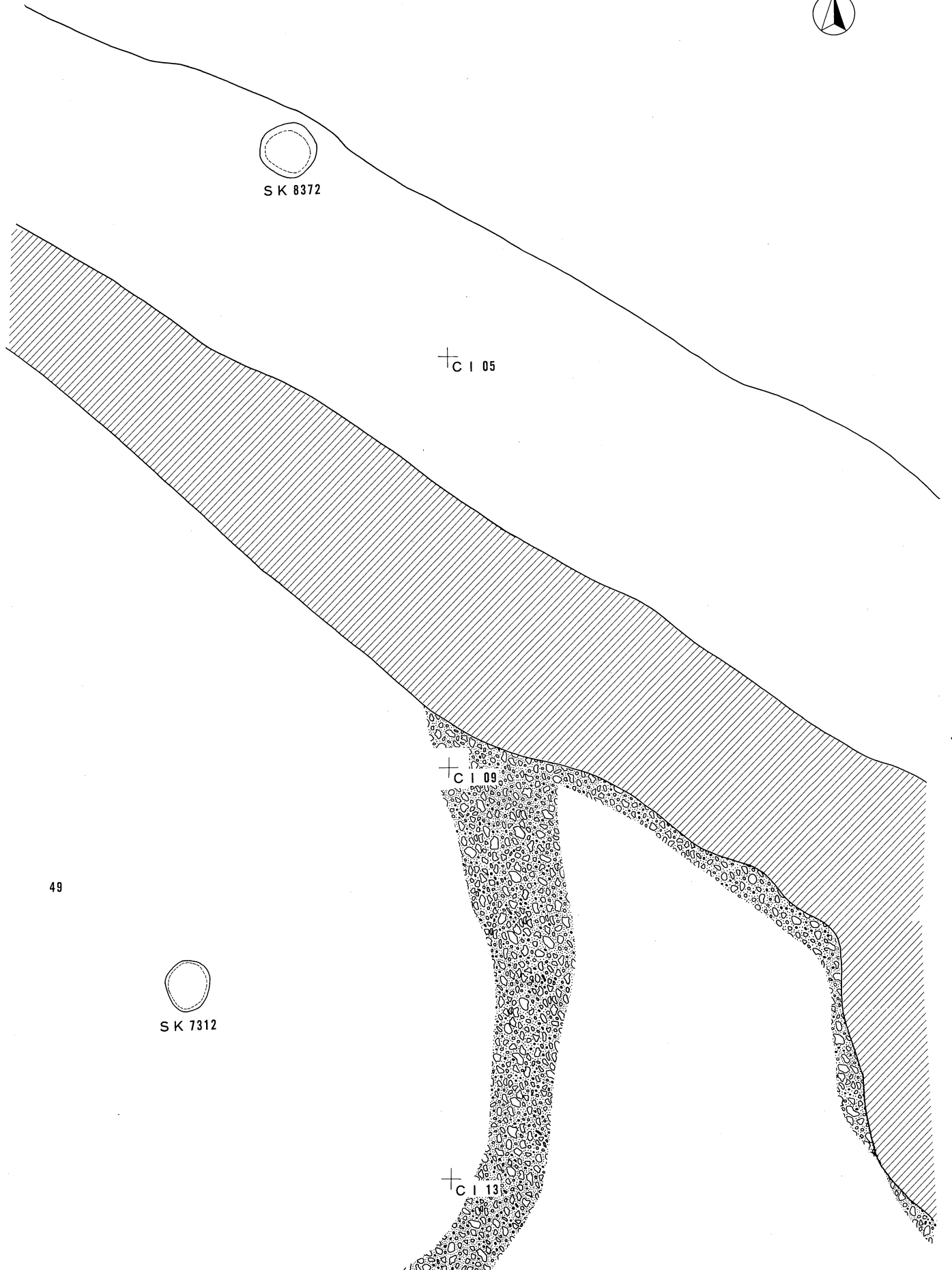

SK 8372

CI 05

CI 09

CI 13

49



SK 7312

0 (1 : 100) 8 m



ME 05

ME 09

S K 8637

S K 8635

MI 05

S K 8636

62 →

S K 7141

S K 7132

0 (1 : 100) 8 m

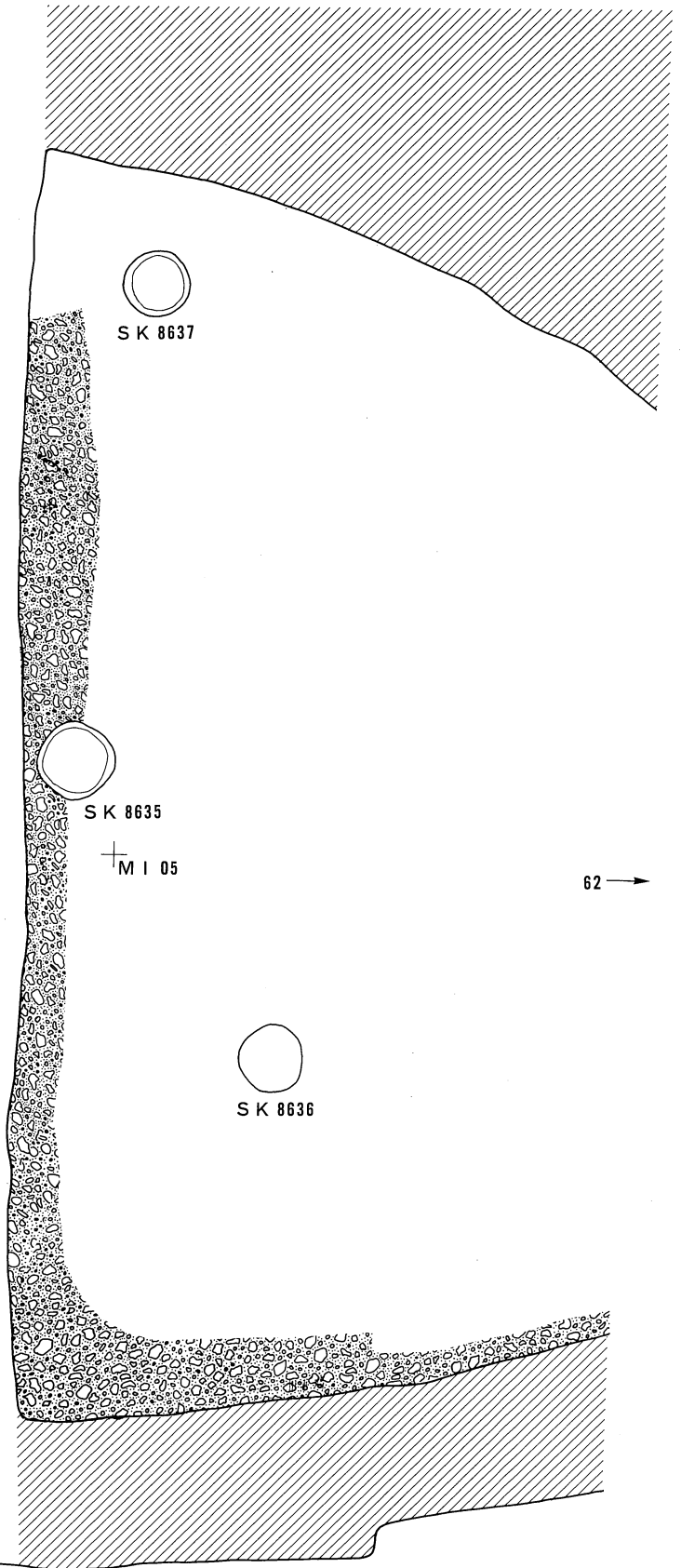

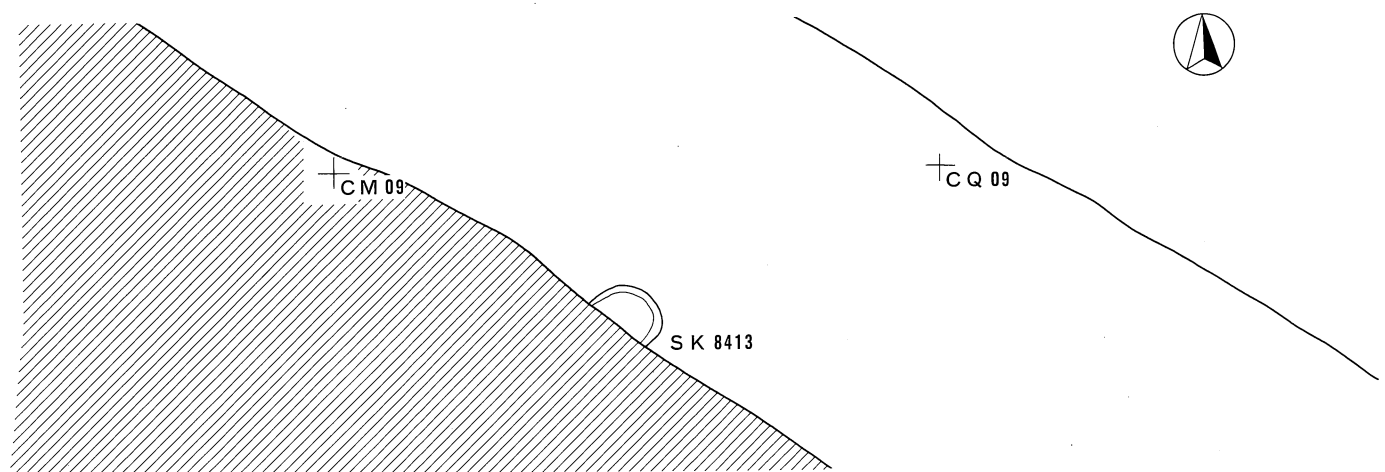

割付図 58

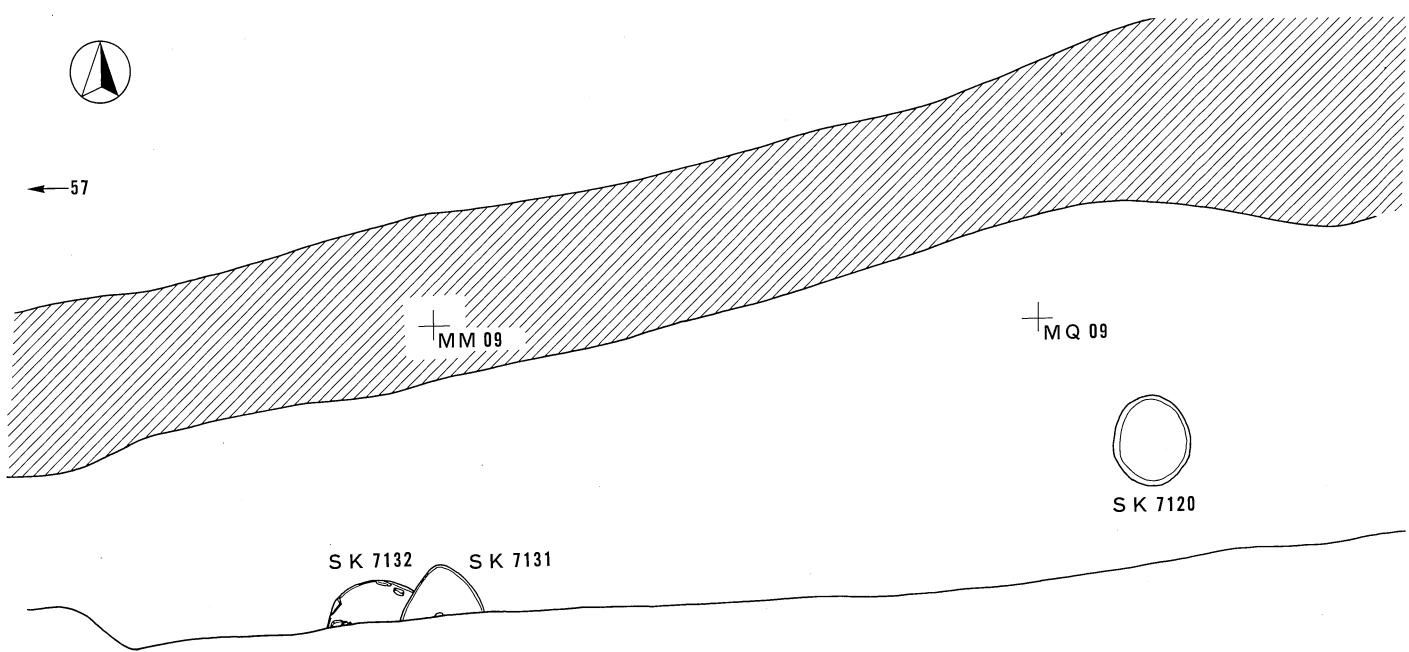

割付図 62

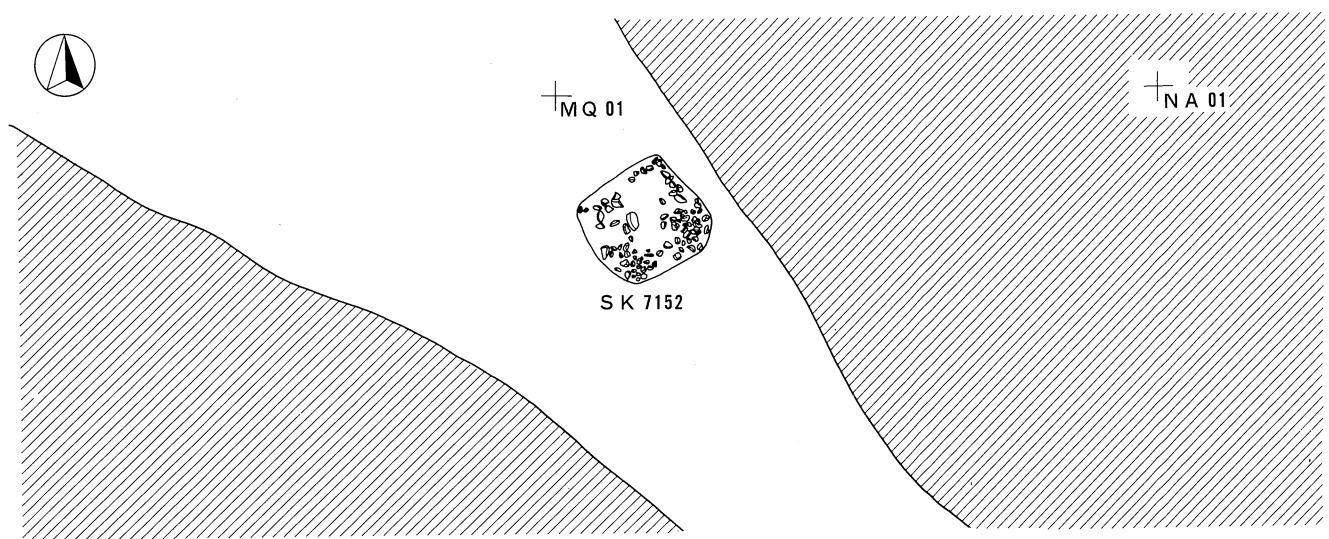

割付図 63

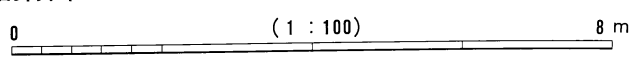

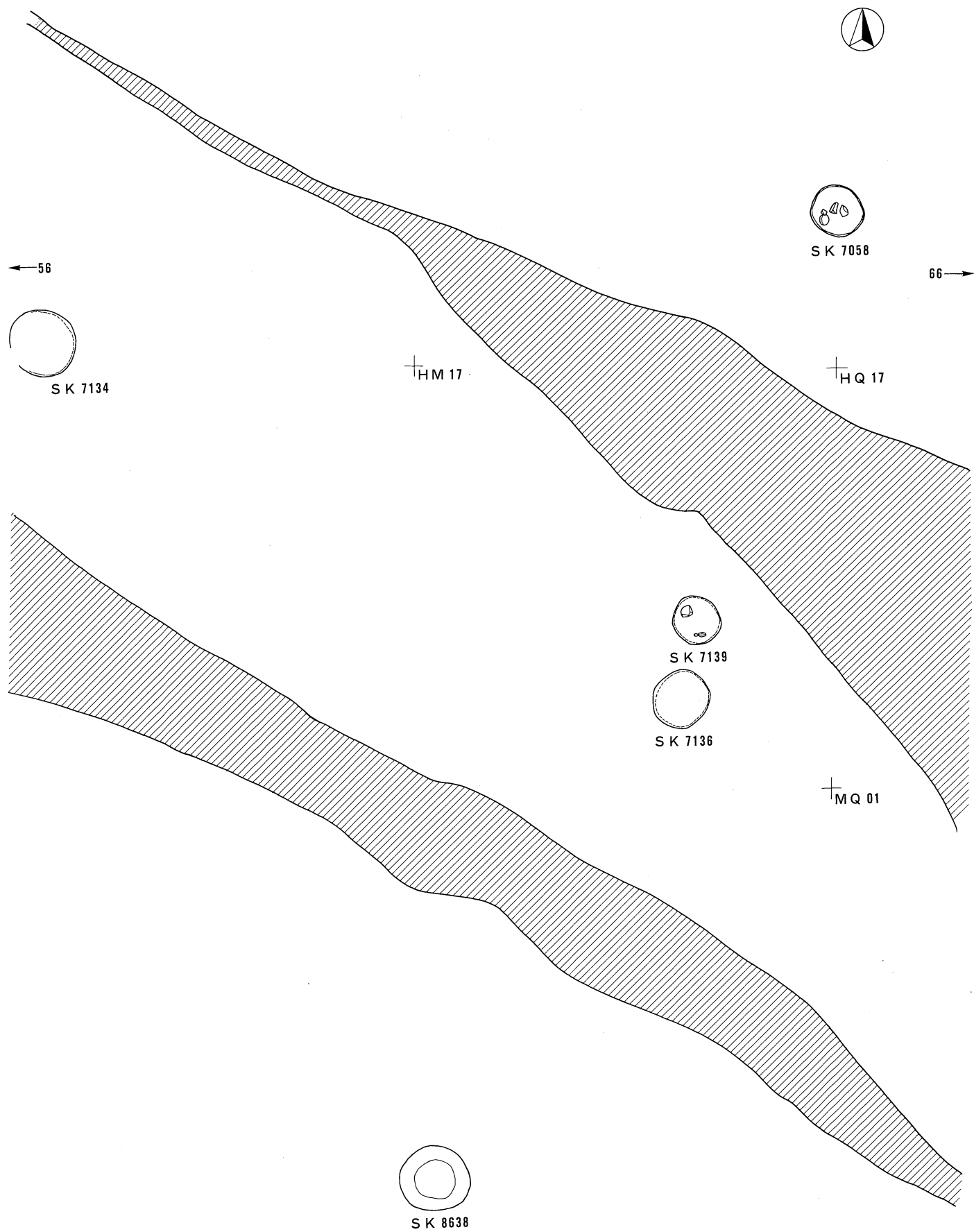

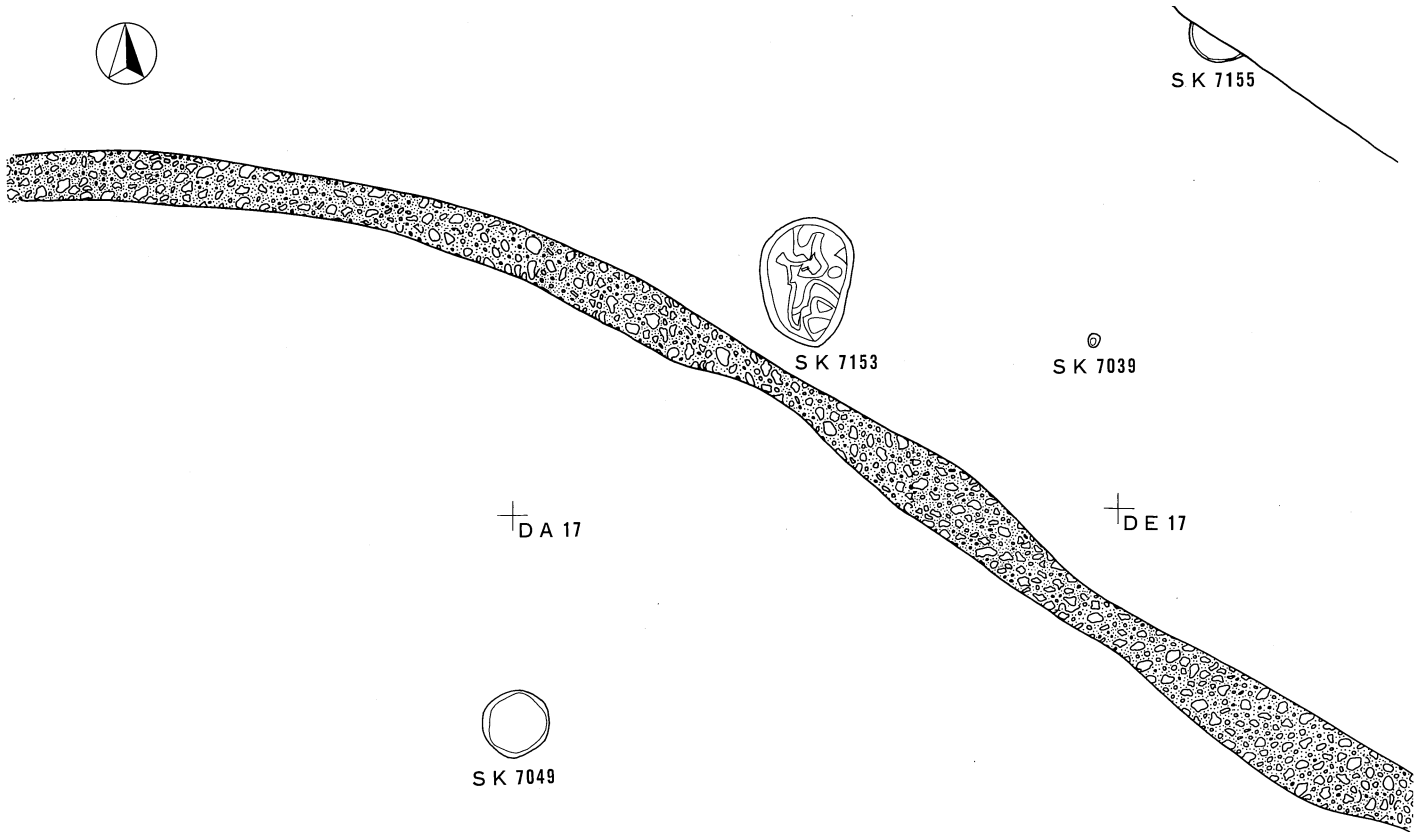

割付図 64

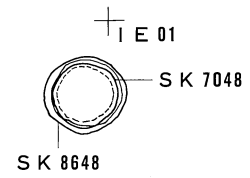

+HQ 17

+I A 17

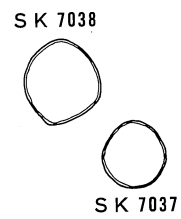

割付図 66

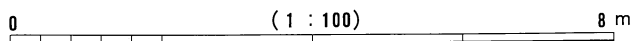

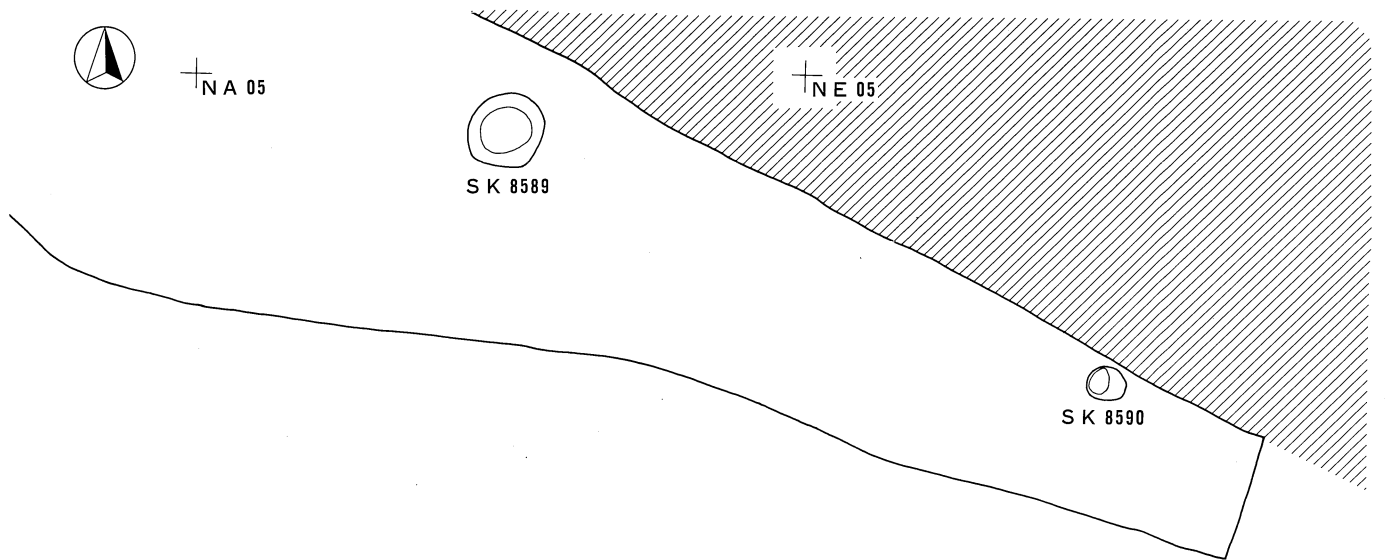

割付图 67

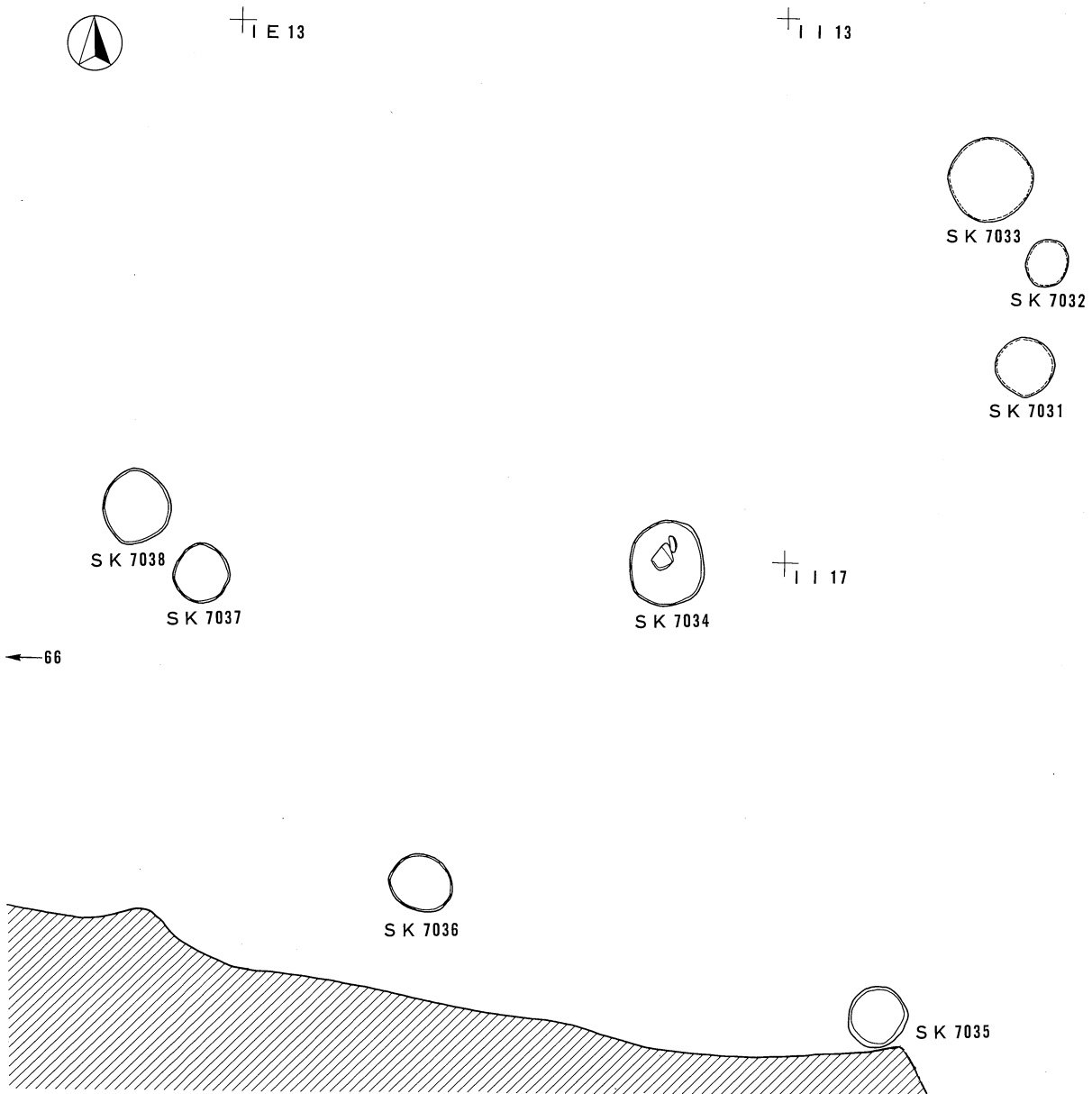

割付图 70

0 (1 : 100) 8 m



S K 7051

+ I E 05

+ I I 05



S K 7042



S K 7043



S K 7045

71 →



S K 7023

+ I I 09



S K 7022

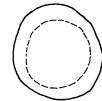

S K 7024



S K 7028

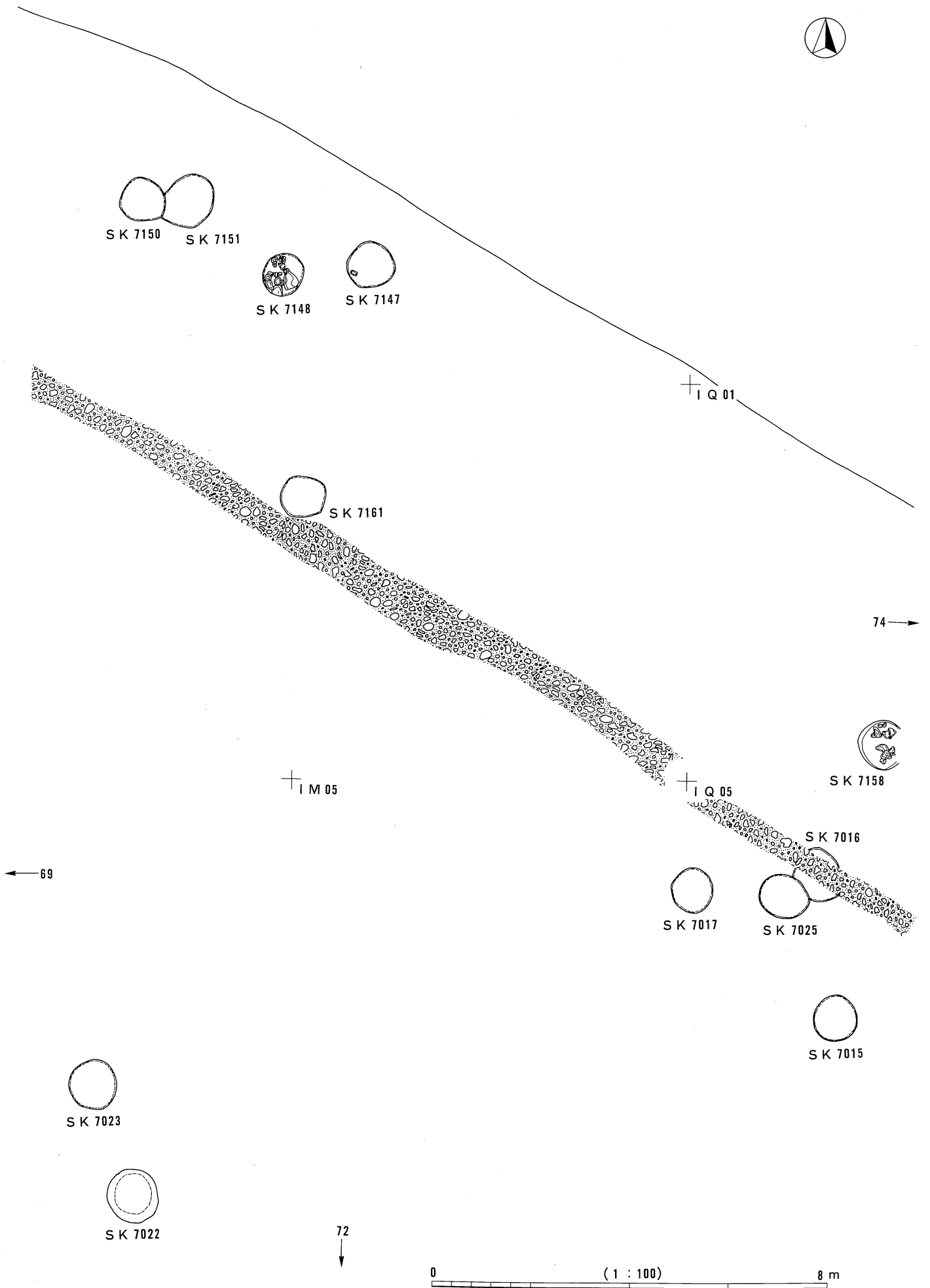



SK 7023



SK 7022

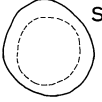

SK 7024



SK 7018



IM 13

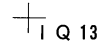

IQ 13



SK 7004



IM 17



SK 7005



SK 7010



SK 7009



SK 7006



SK 7002



SK 7001



SK 7030

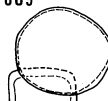

SK 7007

SK 7008

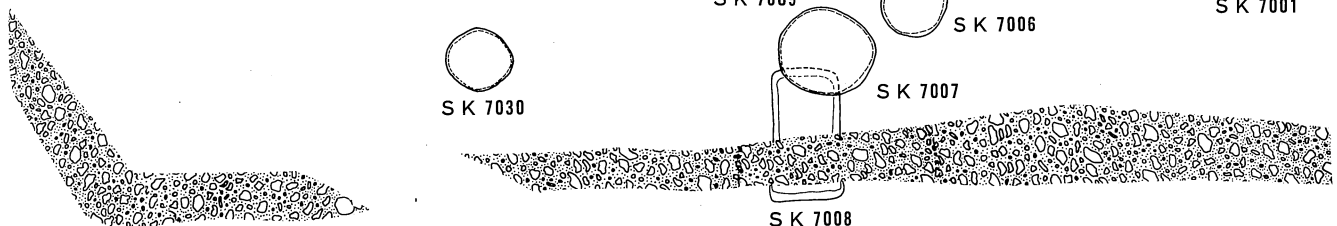

0 (1 : 100) 8 m

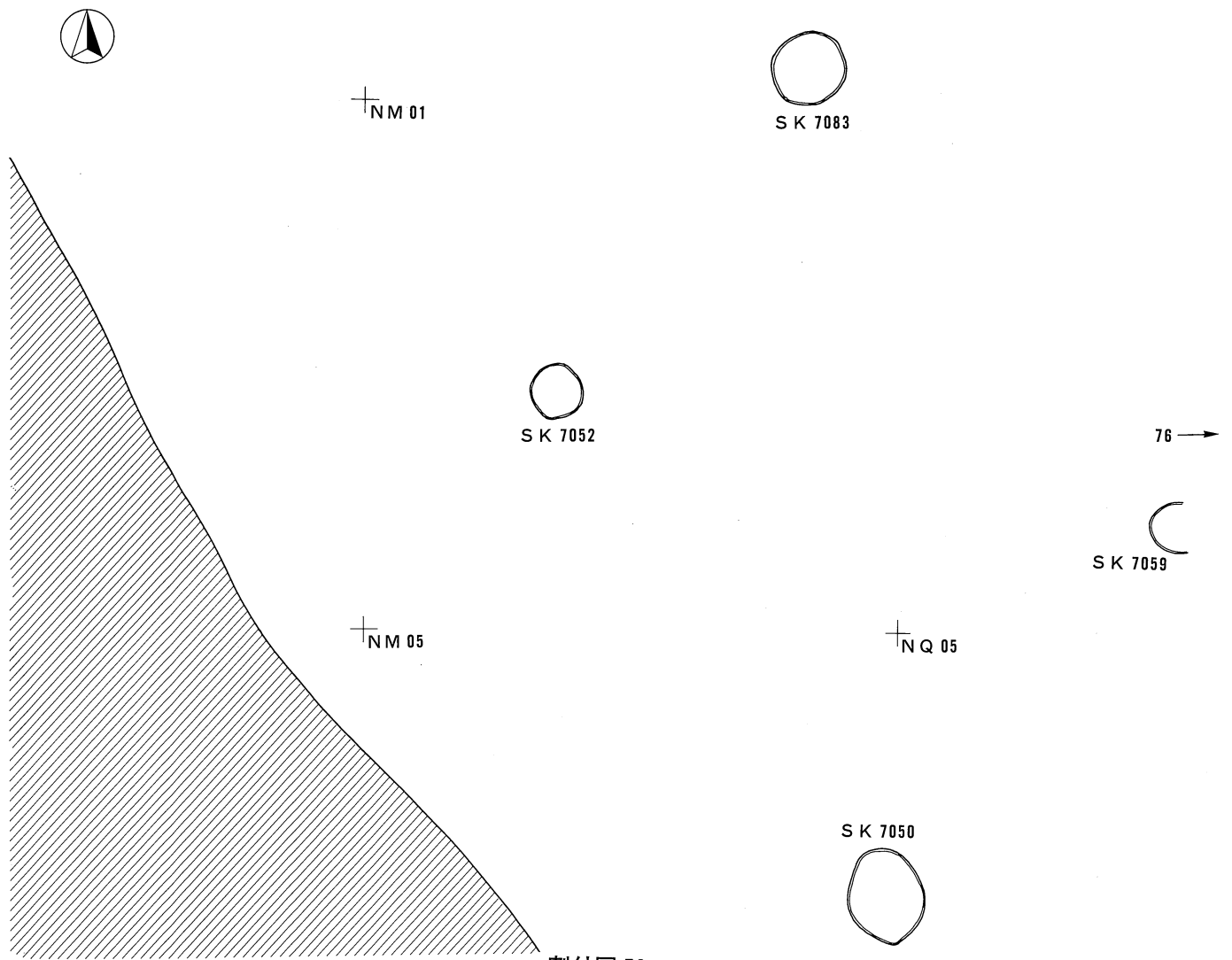

割付图 73

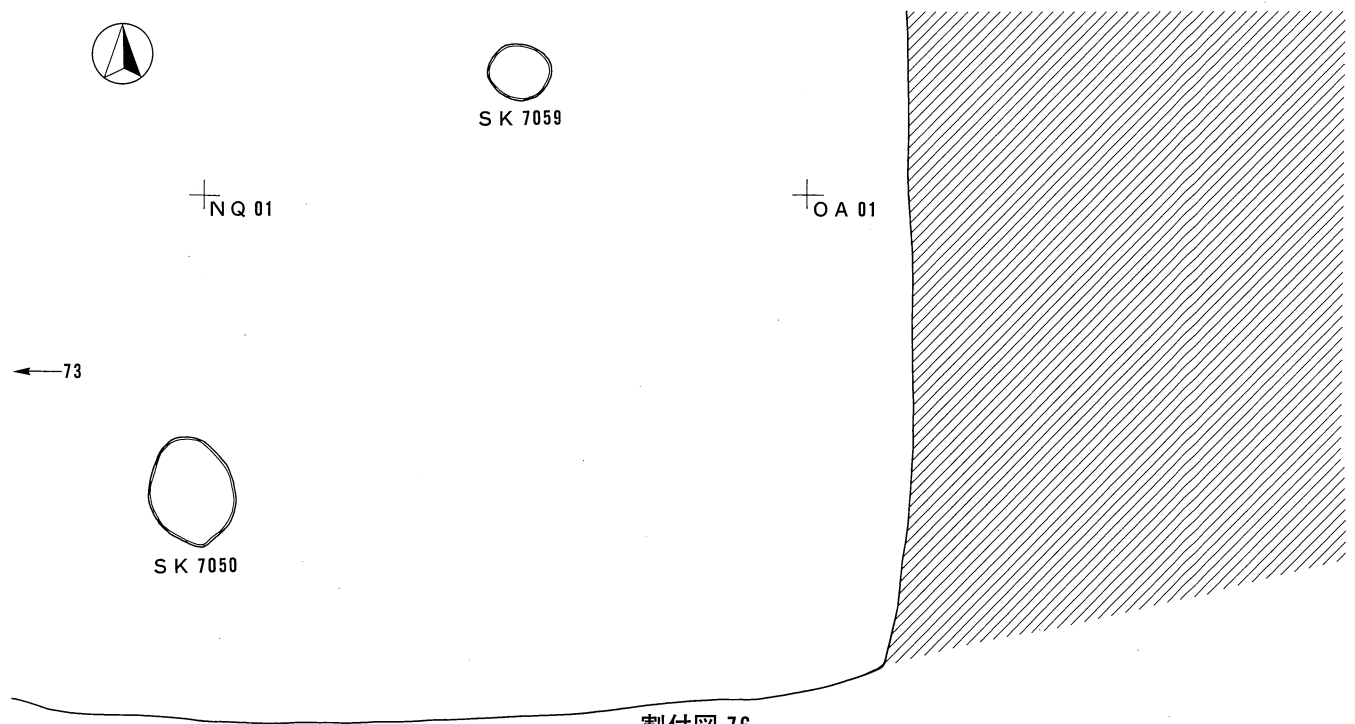

割付图 76

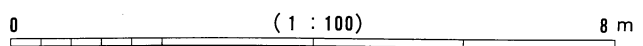



←71

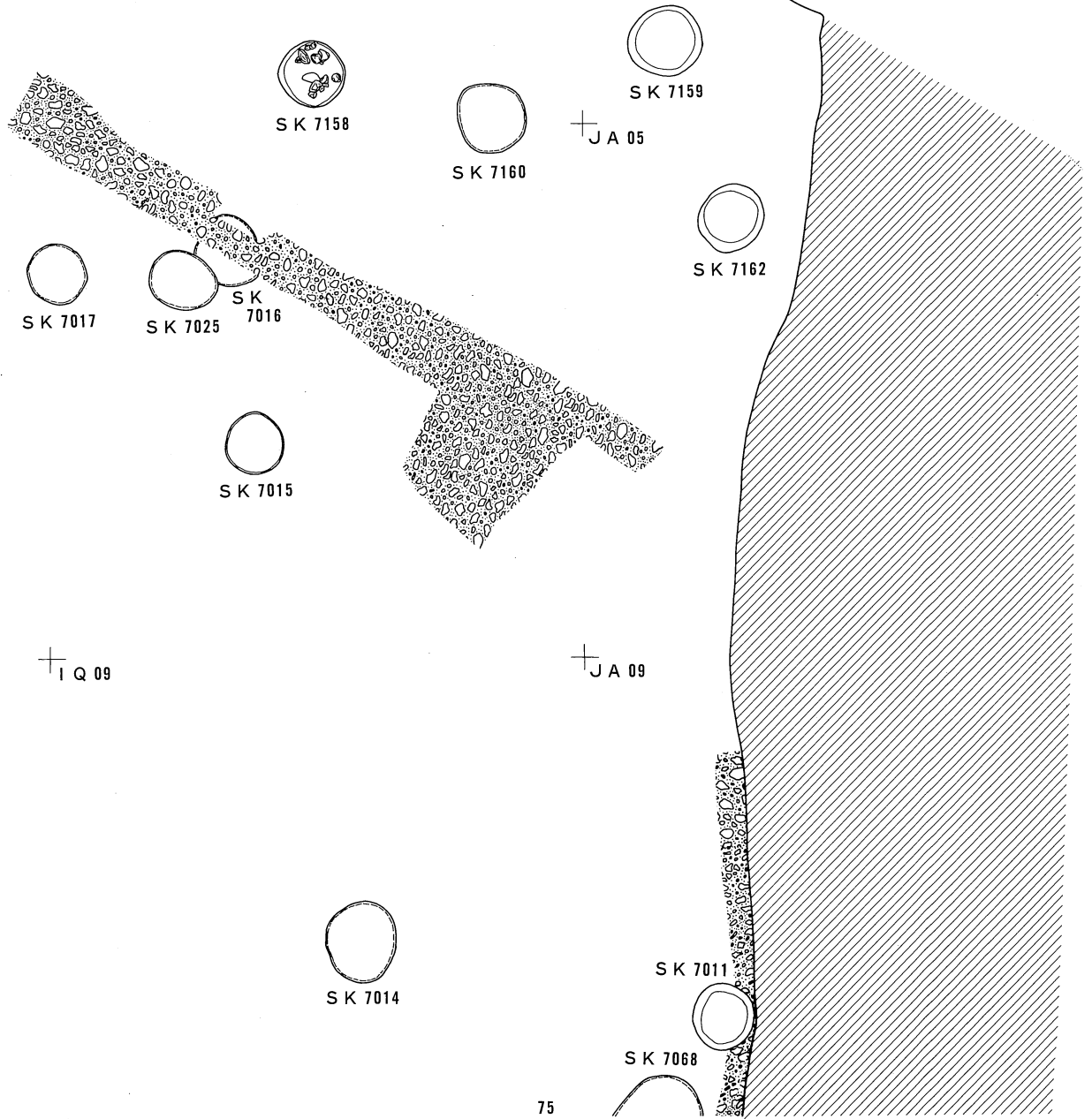

0 (1 : 100) 8 m

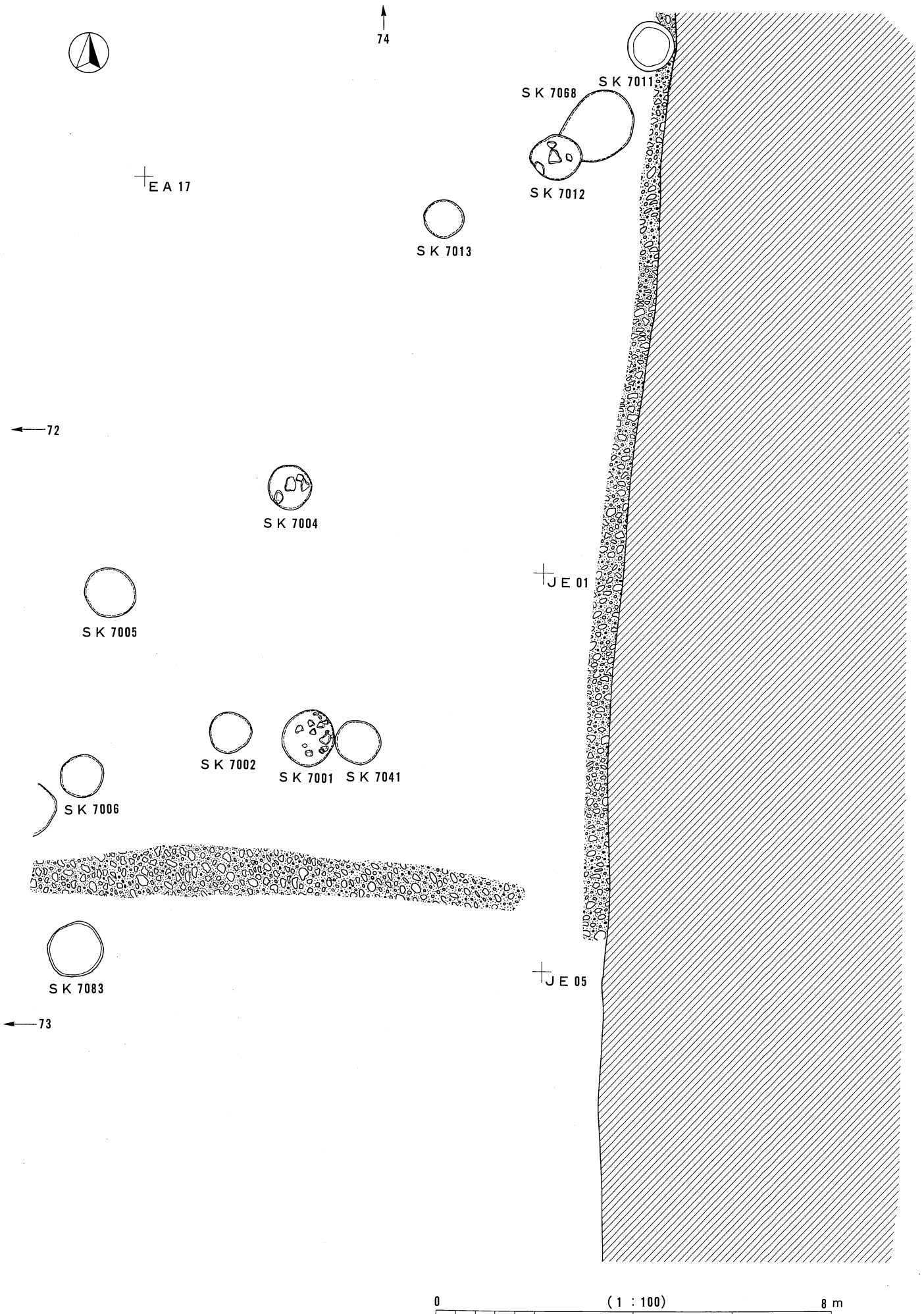

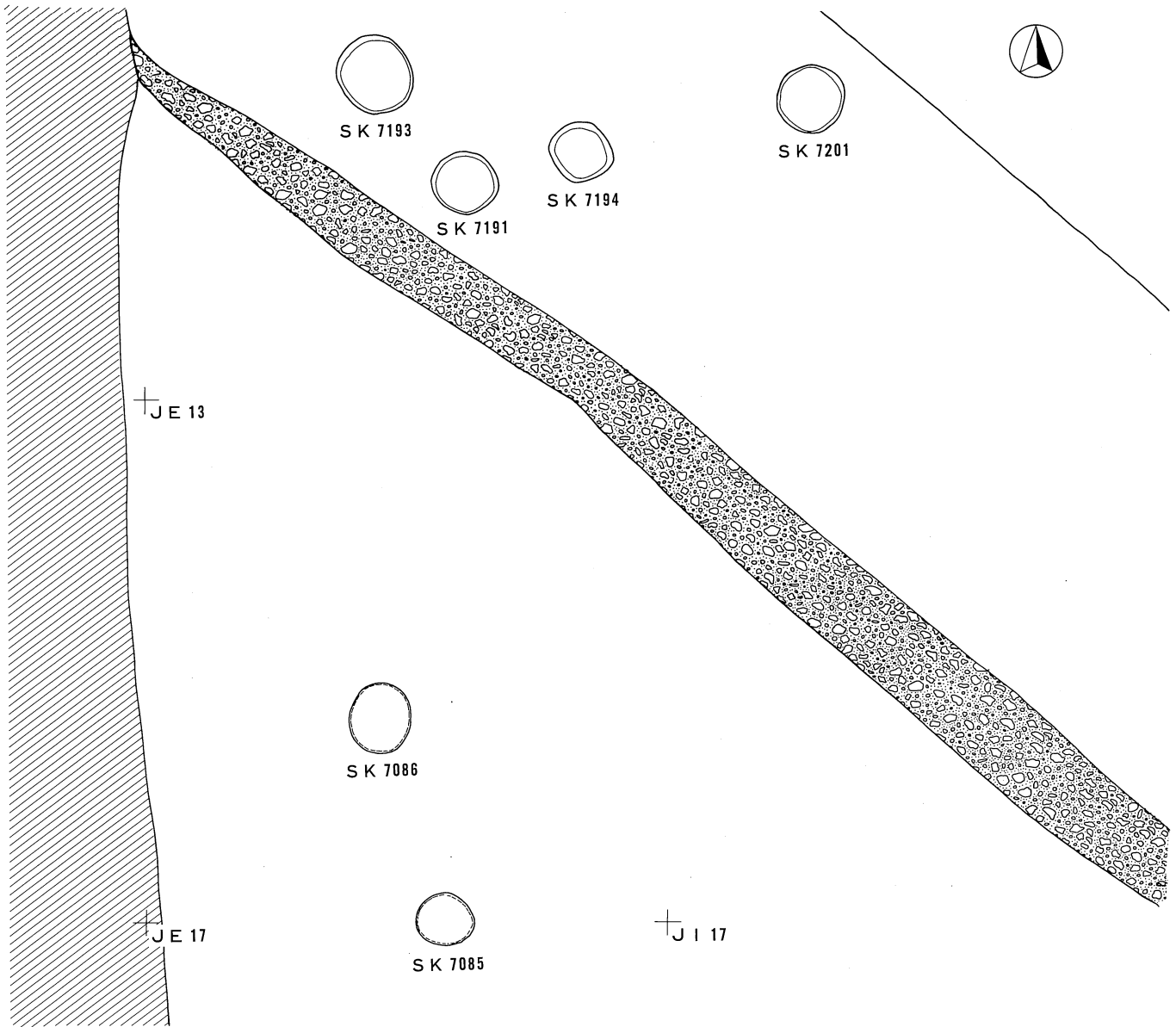

割付図 77

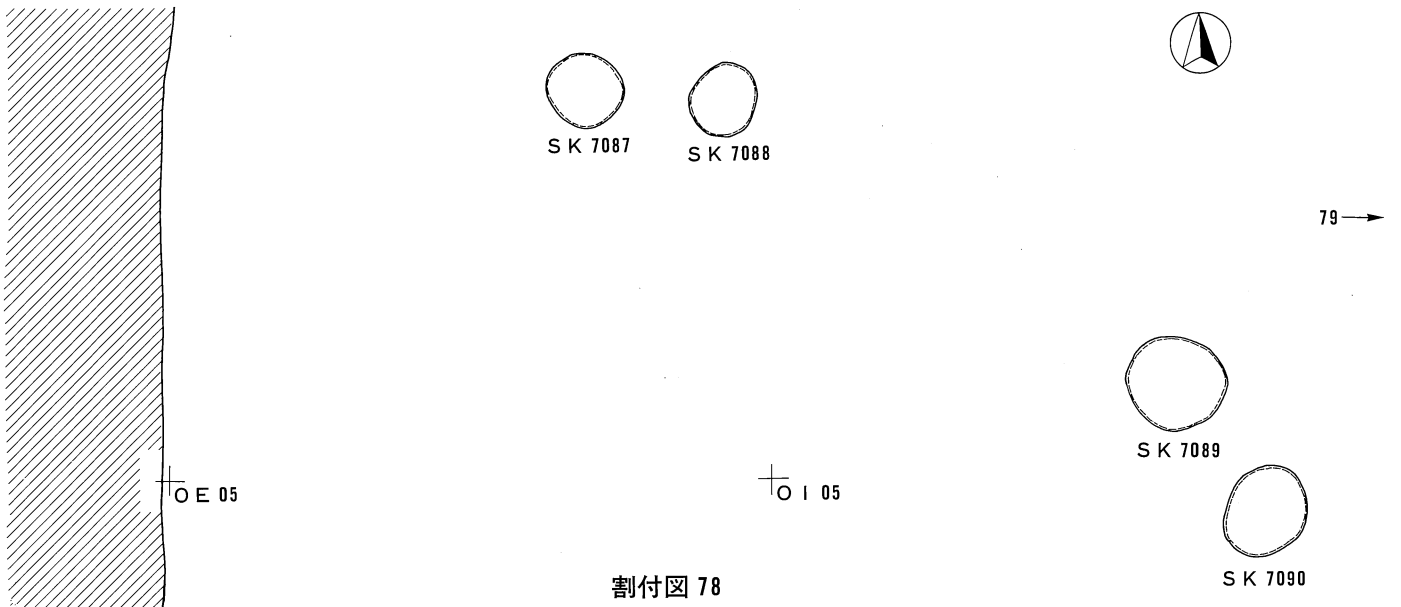

割付図 78

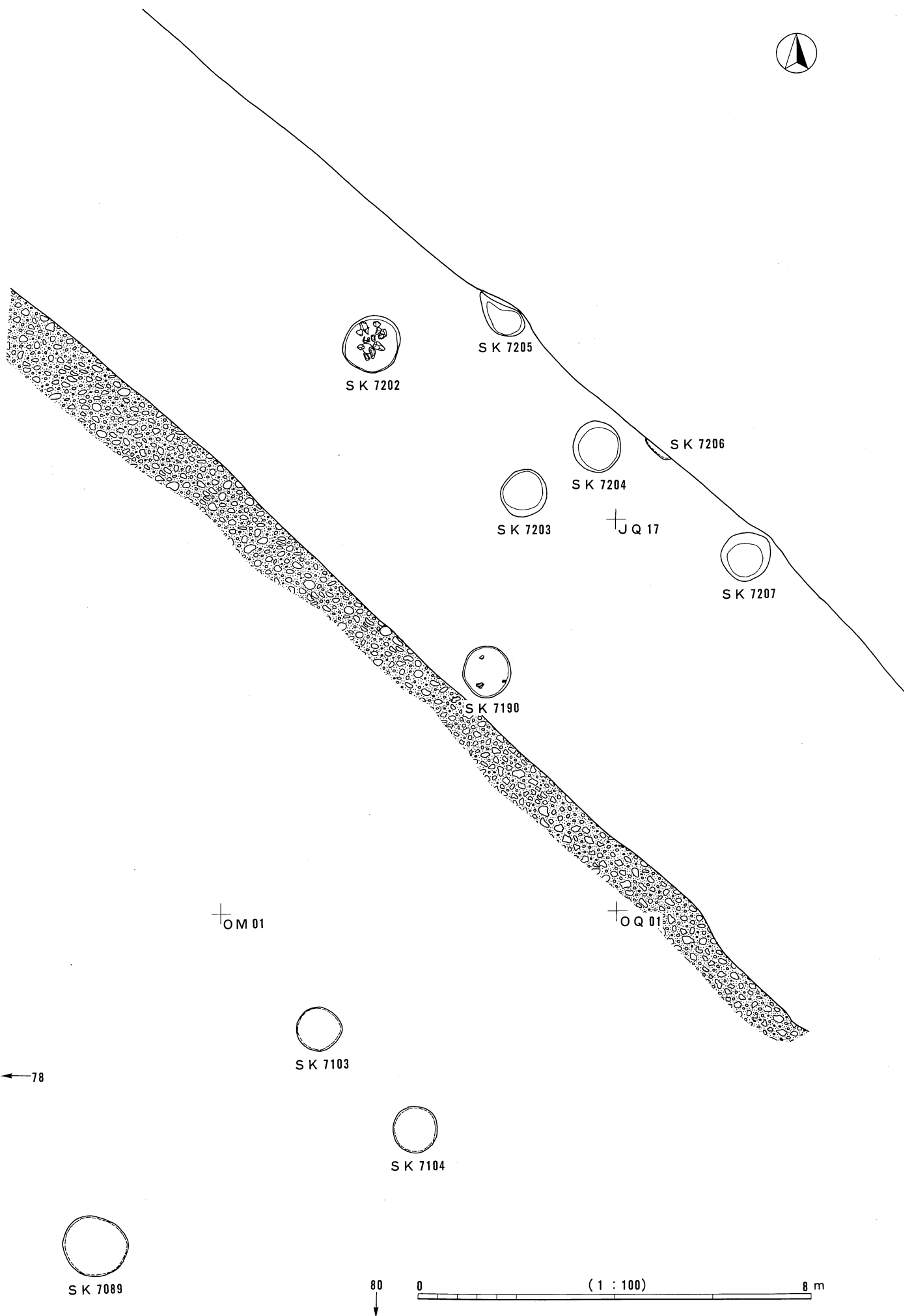

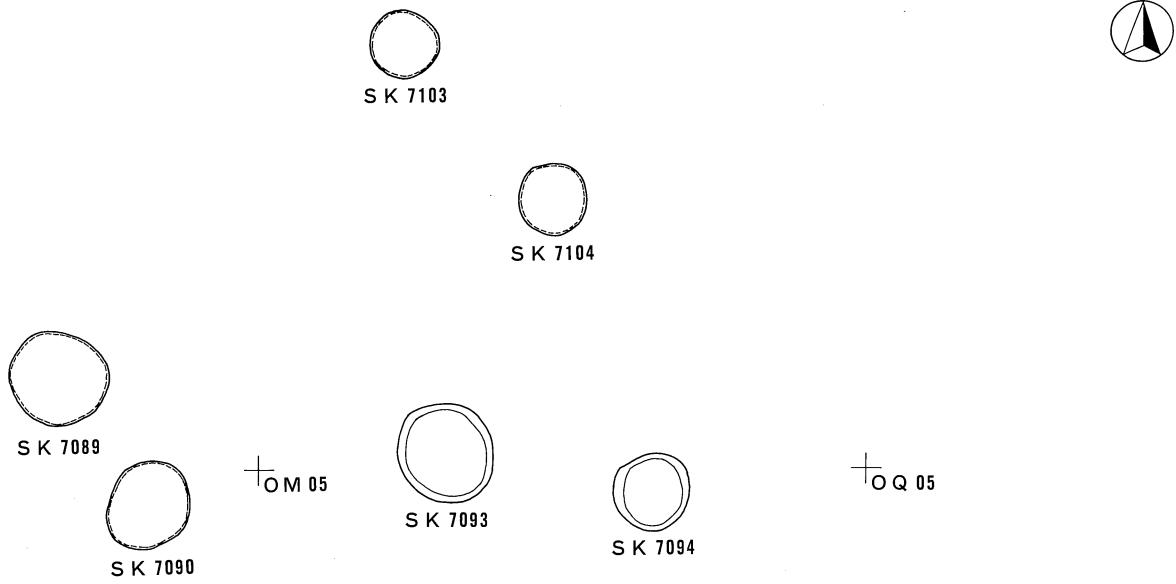

割付図 80

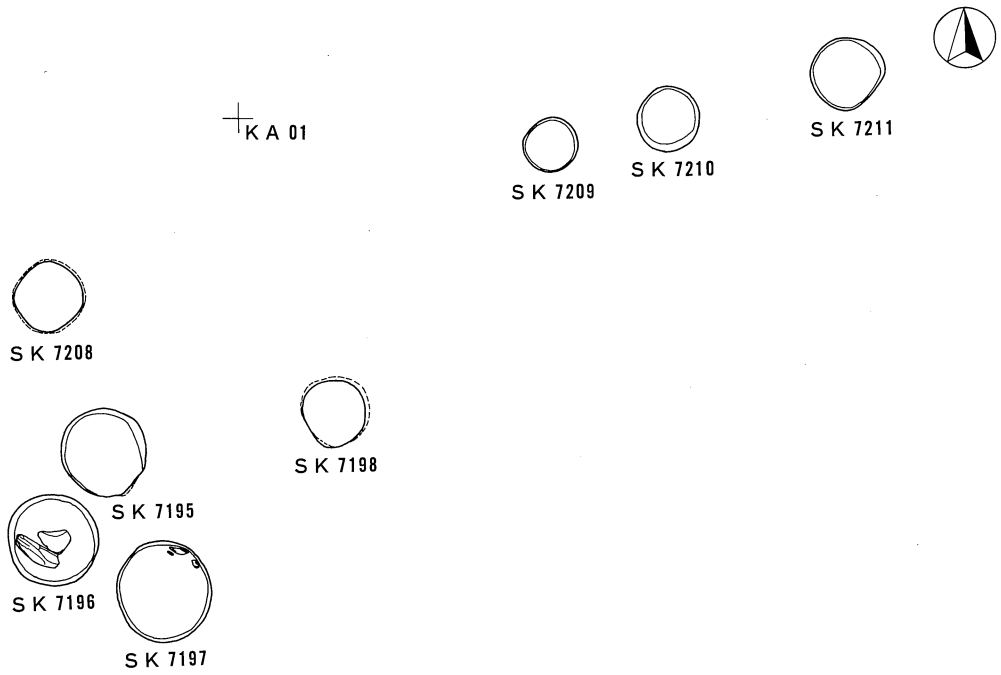

割付図 81



割付図 82

0 (1 : 100) 8 m

82 →

← 81

83 →

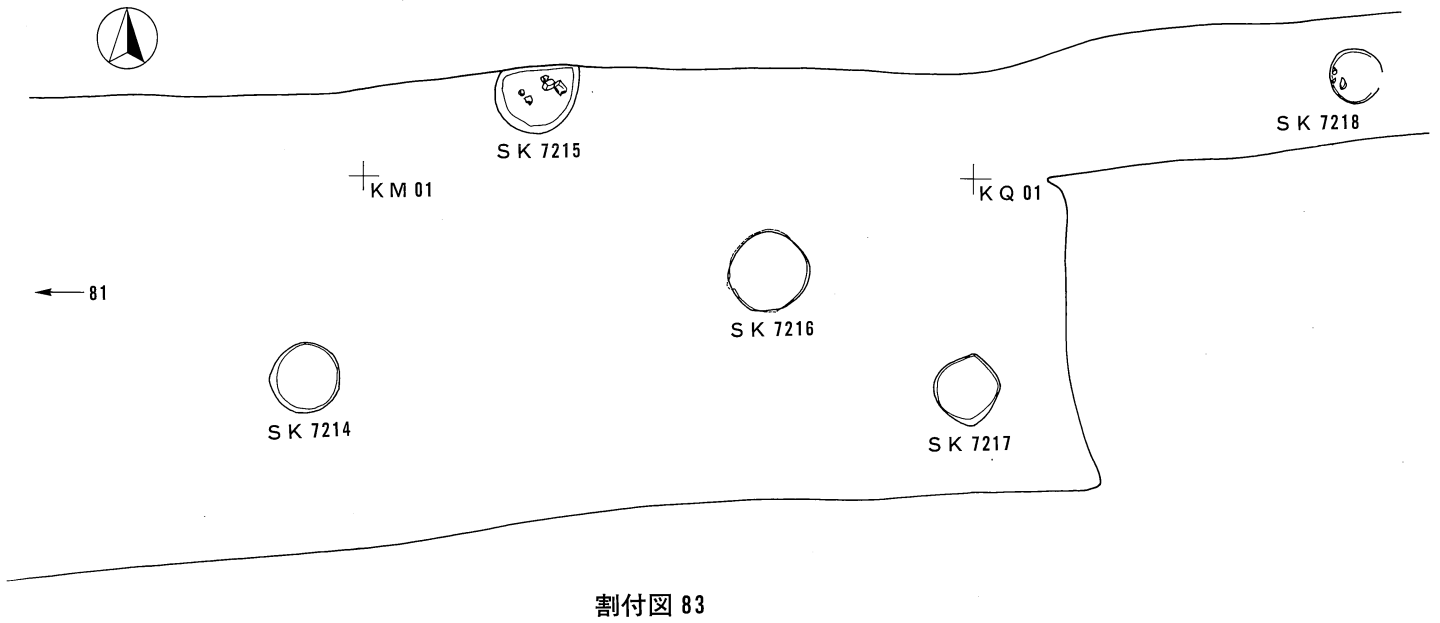

割付図 83

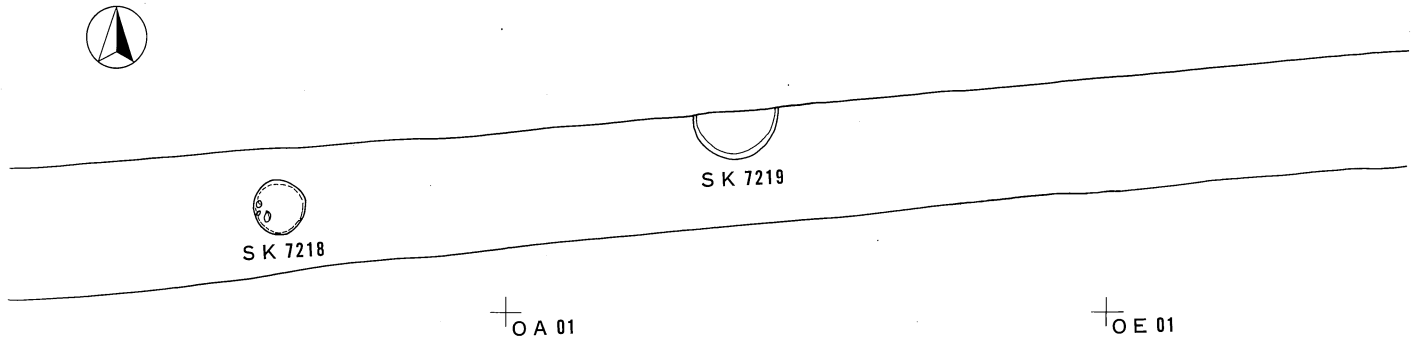

割付図 84

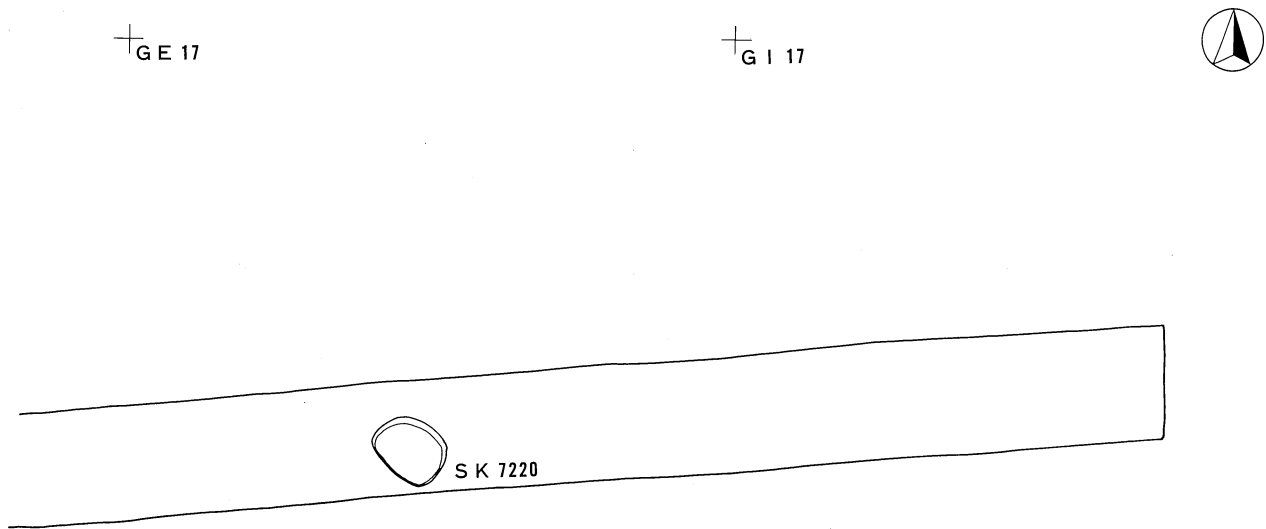

割付図 85

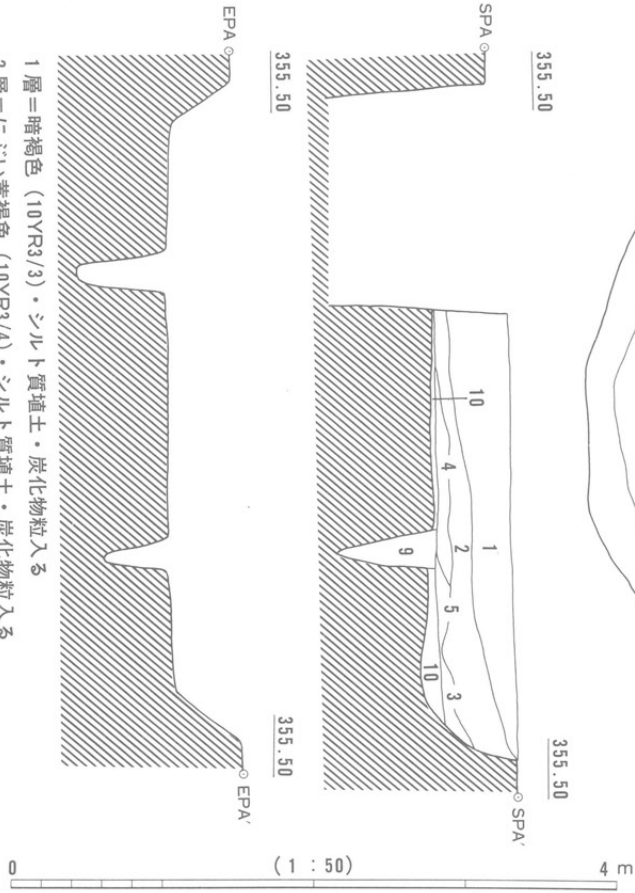
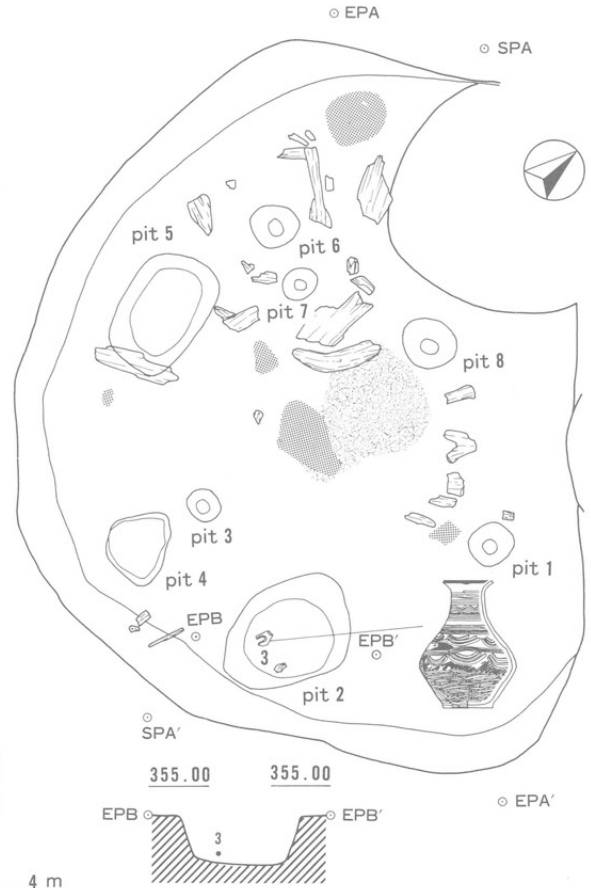

- 1層=暗褐色 (10YR3/3)・シルト質粘土・炭化物粒入る
- 2層=にぶい黄褐色 (10YR3/4)・シルト質粘土・炭化物粒入る
- 3層=にぶい黄褐色 (10YR3/4)・シルト質粘土・炭化物粒入る
- 4層=暗赤褐色 (5YR3/4)・シルト質粘土・炭化物粒・焼土粒入る
- 5層=黒褐色 (10YR2/3)・シルト質粘土・炭化物粒・焼土粒入る
- 9層=暗褐色 (10YR3/3)・シルト質粘土・炭化物粒入る
- 10層=にぶい黄褐色 (10YR3/4)・シルト質粘土

ピット2出土燧石破片



SB7272個別図

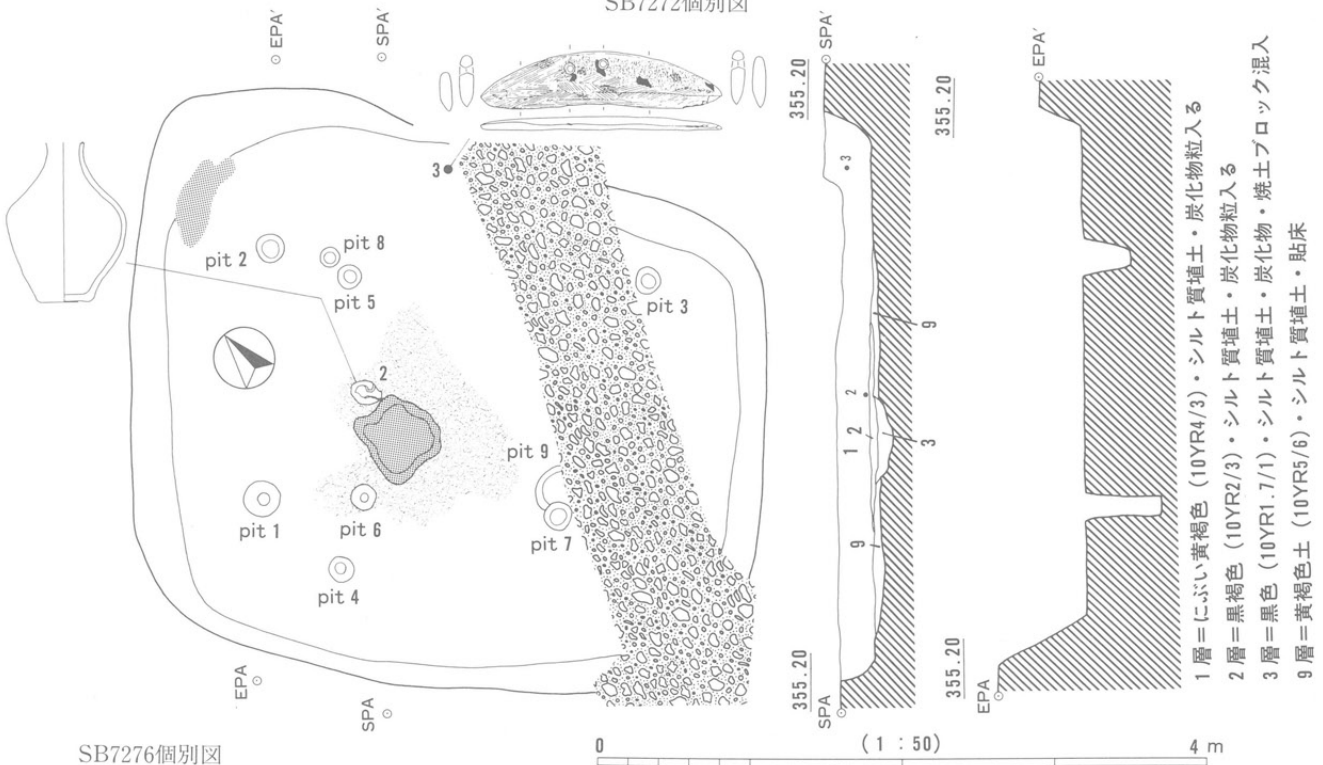

- 1層=にぶい黄褐色 (10YR4/3)・シルト質粘土・炭化物粒入る
- 2層=黒褐色 (10YR2/3)・シルト質粘土・炭化物粒入る
- 3層=黒色 (10YR1.7/1)・シルト質粘土・炭化物・焼土・ブロック混入
- 9層=黄褐色土 (10YR5/6)・シルト質粘土・貼床

SB7276個別図

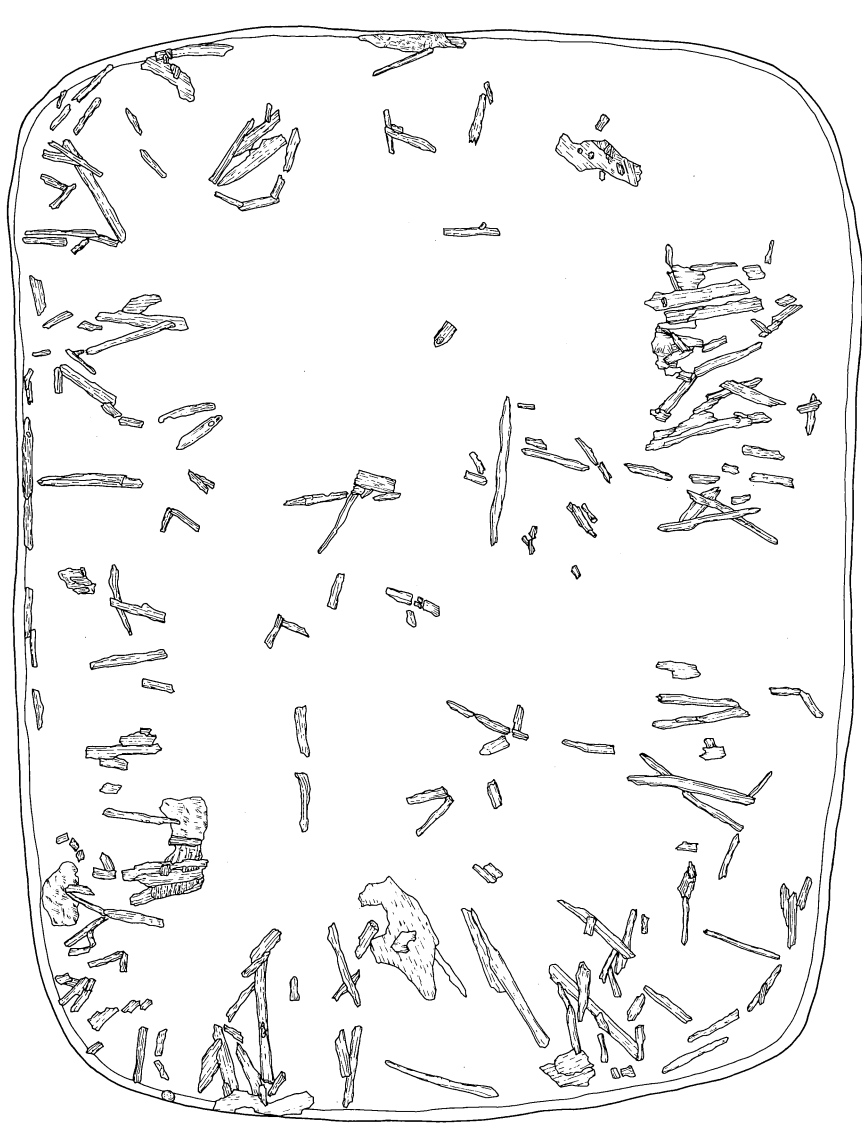

0 (1 : 50) 4 m

SB7078個別図-1 (炭化材出土状況)

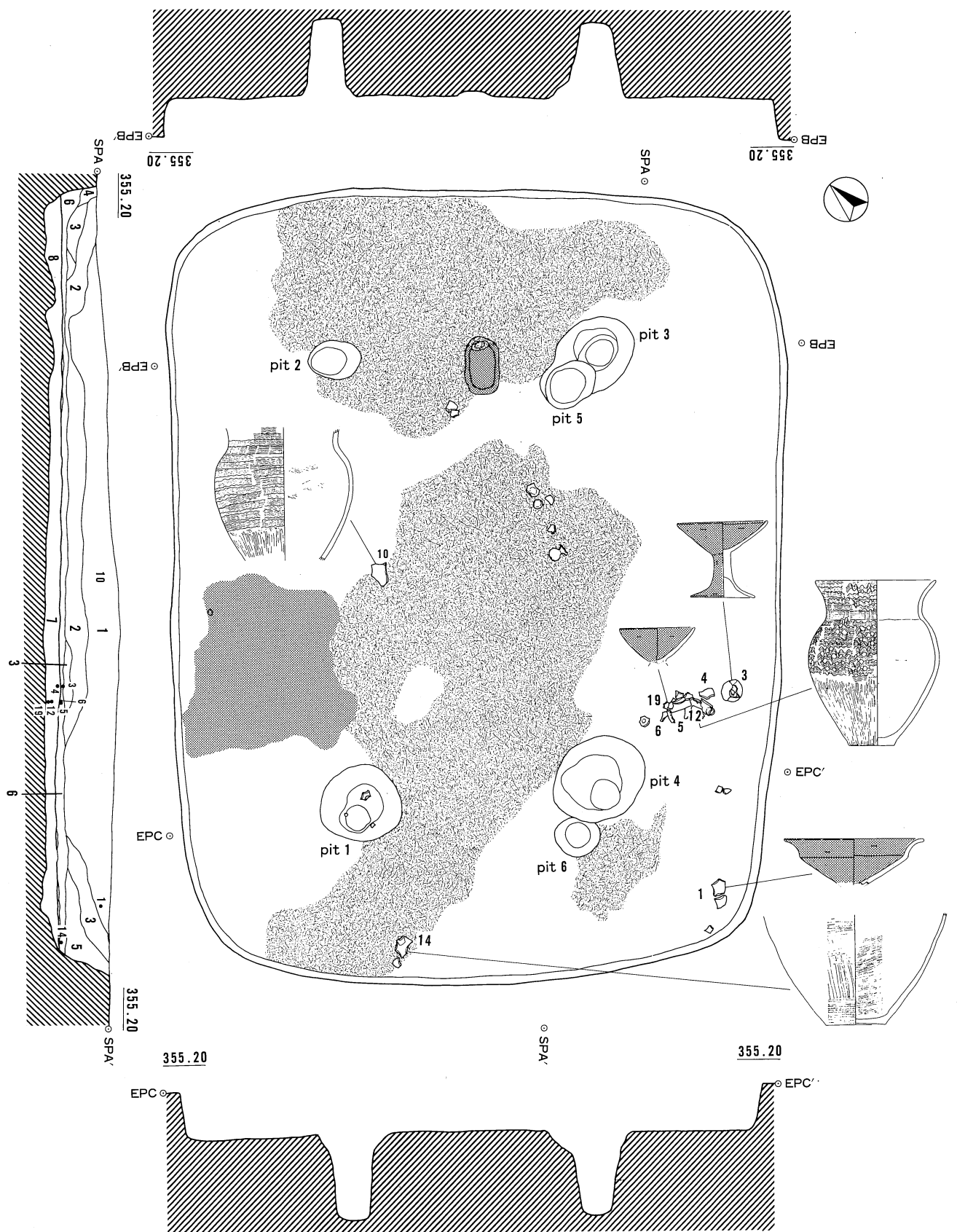

- | | |
|------------------------------------|------------------------------------|
| 1層=暗褐色 (10YR3/3)・シルト質壤土・炭化物粒入る | 5層=暗褐色 (10YR3/4)・シルト質壤土・炭化物粒・焼土粒入る |
| 2層=暗褐色 (10YR3/4)・シルト質壤土・炭化物粒・焼土粒入る | 6層=炭化物層 |
| 3層=にぶい黄褐色 (10YR4/3)・シルト質壤土 | 7層=暗黄色 (10YR3/4)・シルト質壤土 |
| 4層=暗褐色 (10YR3/4)・シルト質壤土・炭化物粒・焼土粒入る | 8層=焼土 |

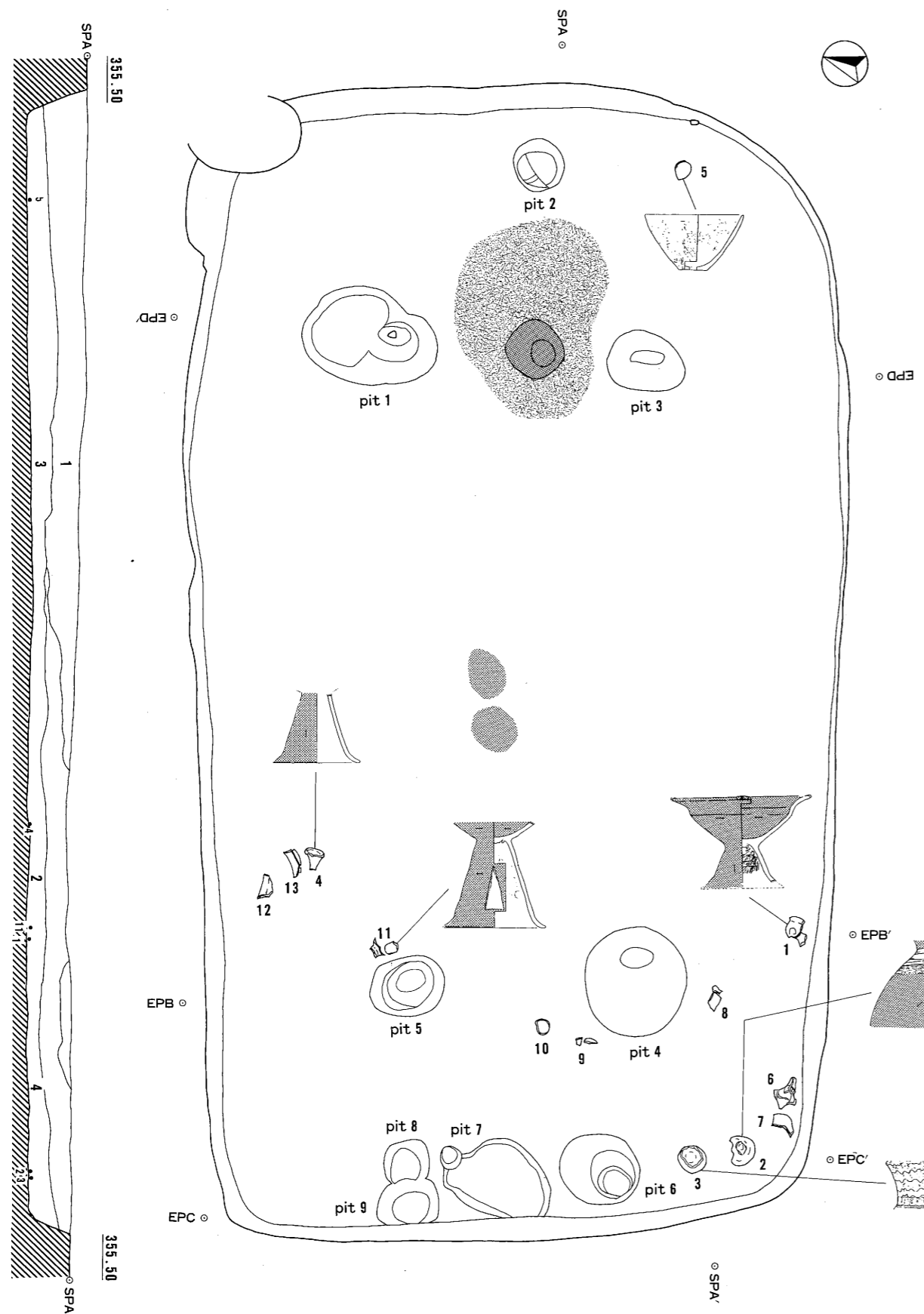

- 1層=にぶい黄褐色 (10YR5/4) ~黄褐色 (10YR5/6)・シルト質壤土・炭化物粒・焼土粒入る
- 2層=黒褐色 (10YR3/1)・シルト質埴土・焼土と炭化物が主体となる層
- 3層=にぶい黄褐色 (10YR5/4) ~黄褐色 (10YR5/6)・シルト質壤土・炭化物小ブロック・焼土小ブロック入る
- 4層=(平安期住居のカマド残り)

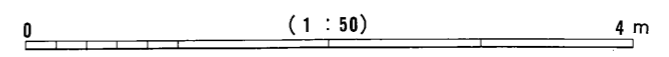
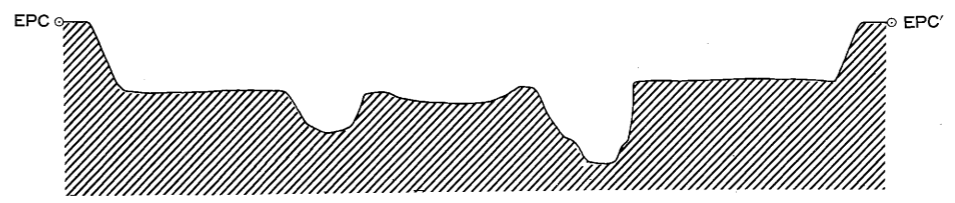
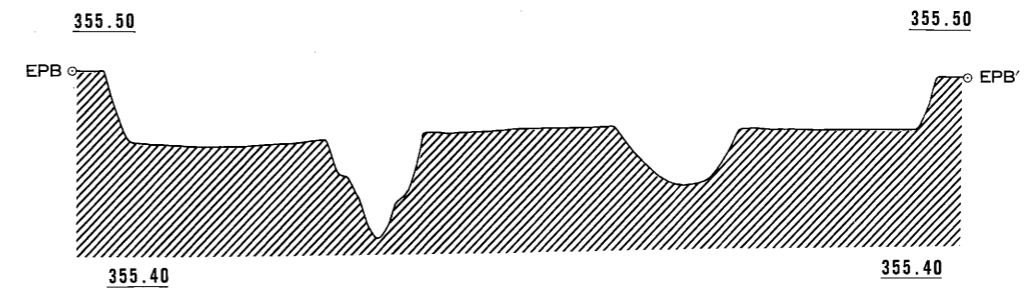
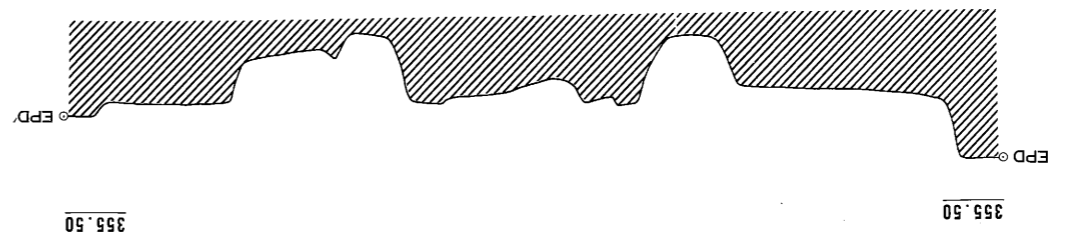

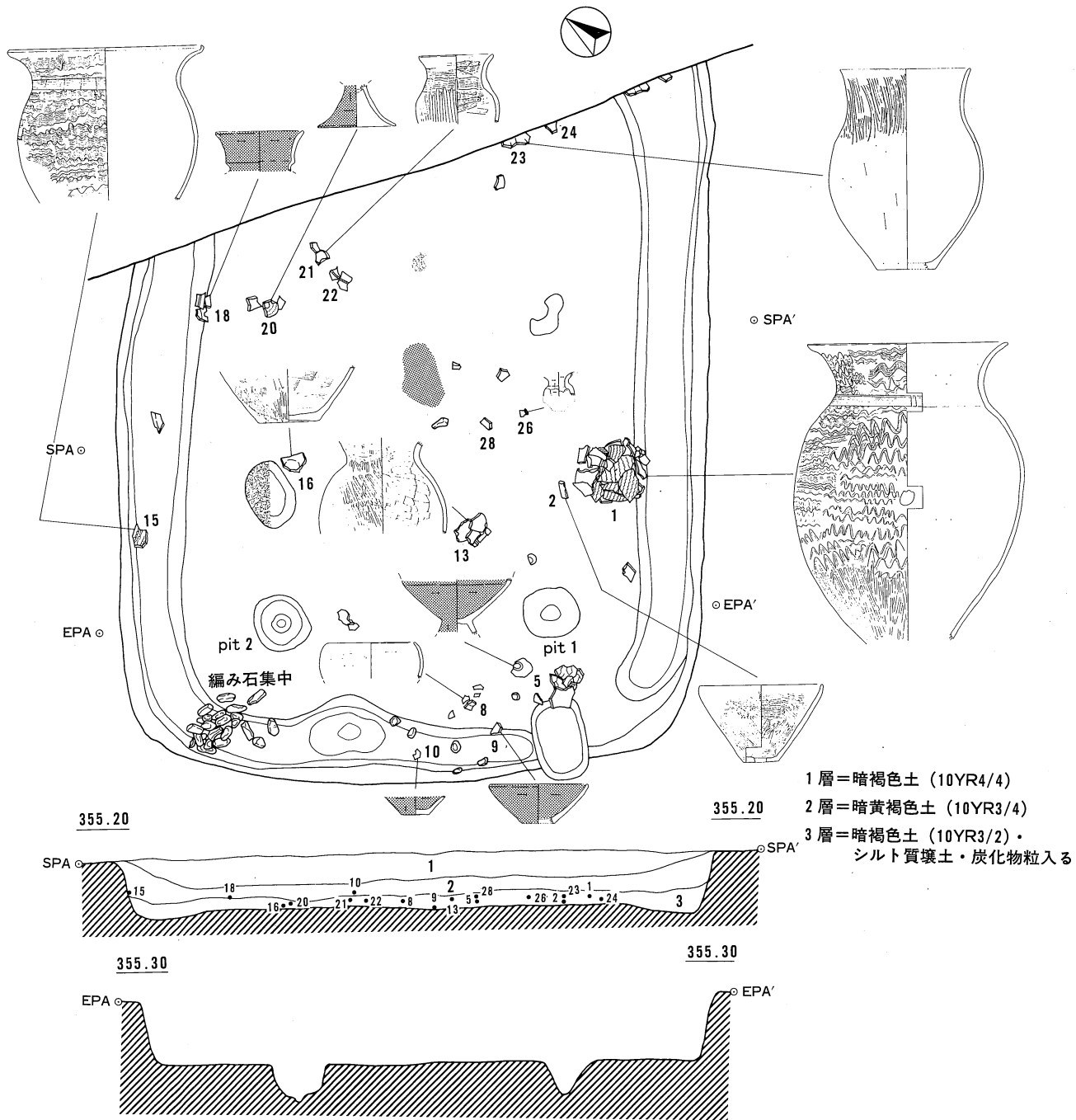

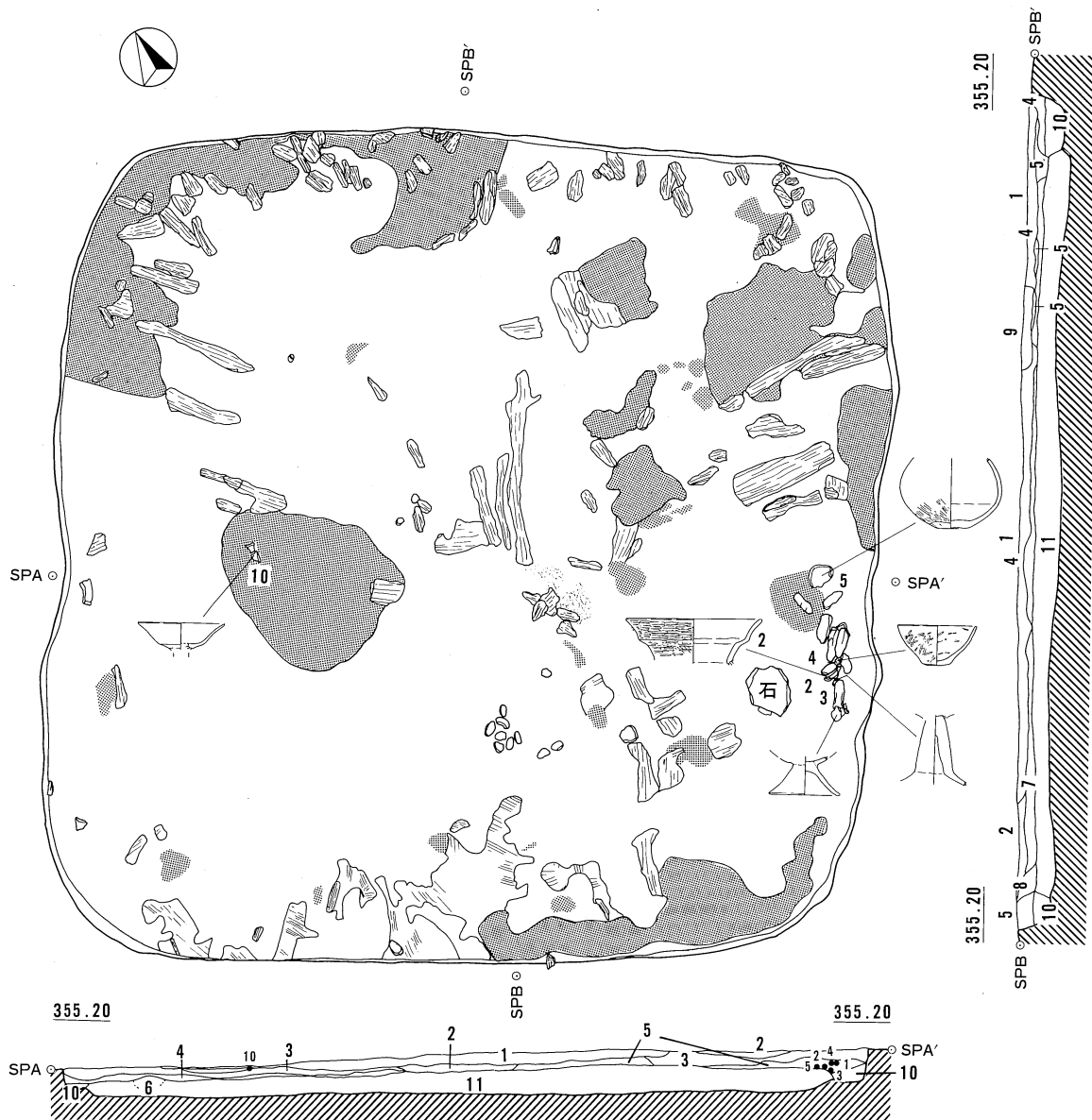

- | | |
|--|---|
| 1層=黄灰色 (2.5Y4/1)・シルト質壤土 | 7層=暗灰黄色 (2.5Y4/2)・シルト質壤土 |
| 2層=浅黄色 (2.5Y7/4)+褐色 (10YR4/4)・シルト質壤土 | 8層=黄灰色 (2.5Y4/1)・重埴土 |
| 3層=黄灰色 (2.5Y4/1)・シルト質壤土 | 9層=黄灰色 (2.5Y4/1)・壤土 |
| 4層=黄灰色 (2.5Y4/1)・シルト質埴壤土 | 10層(周溝土)=黄灰色 (2.5Y4/1)・シルト質埴壤土 |
| 5層=褐灰色 (10YR4/1)+黑色 (10YR1.7/1)+橙色
(7.5YR7/6・6/8)・シルト質壤土・炭化物・焼土入る | 11層(床土)=褐灰色 (10YR4/1)～黒褐色 (10YR3/1)・
シルト質埴壤土 |
| 6層=浅黄色 (2.5Y7/4)・シルト質壤土 | |

0 (1:50) 4 m

SB6013個別図-1 (炭化材・焼土出土状況)

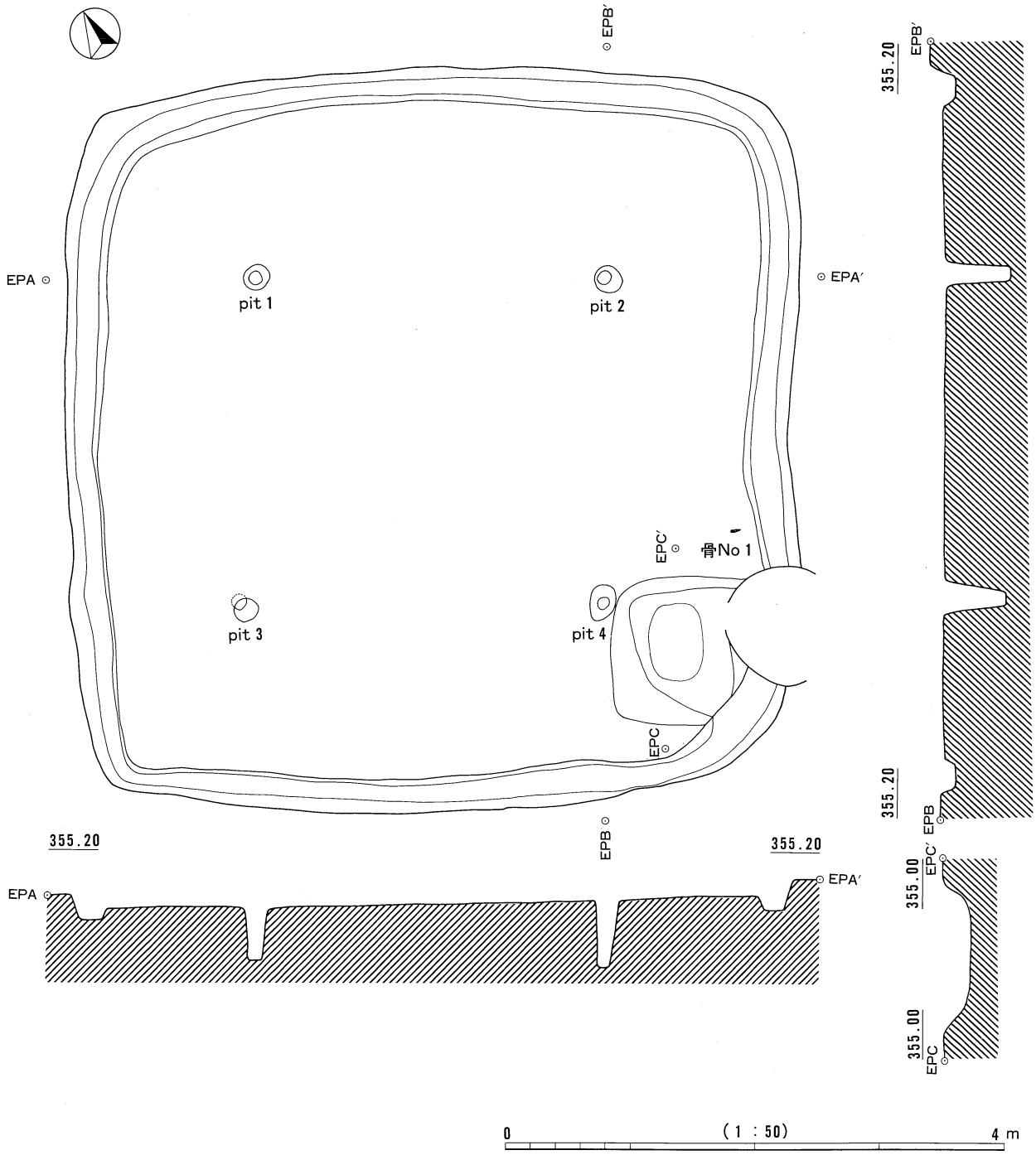

SB6013個別図- 2 (完掘)

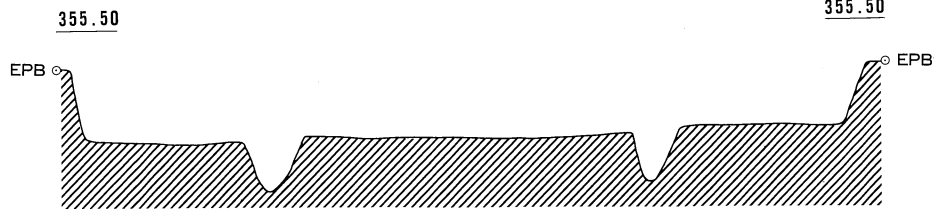
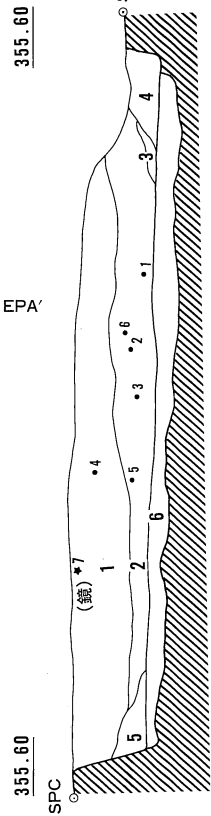
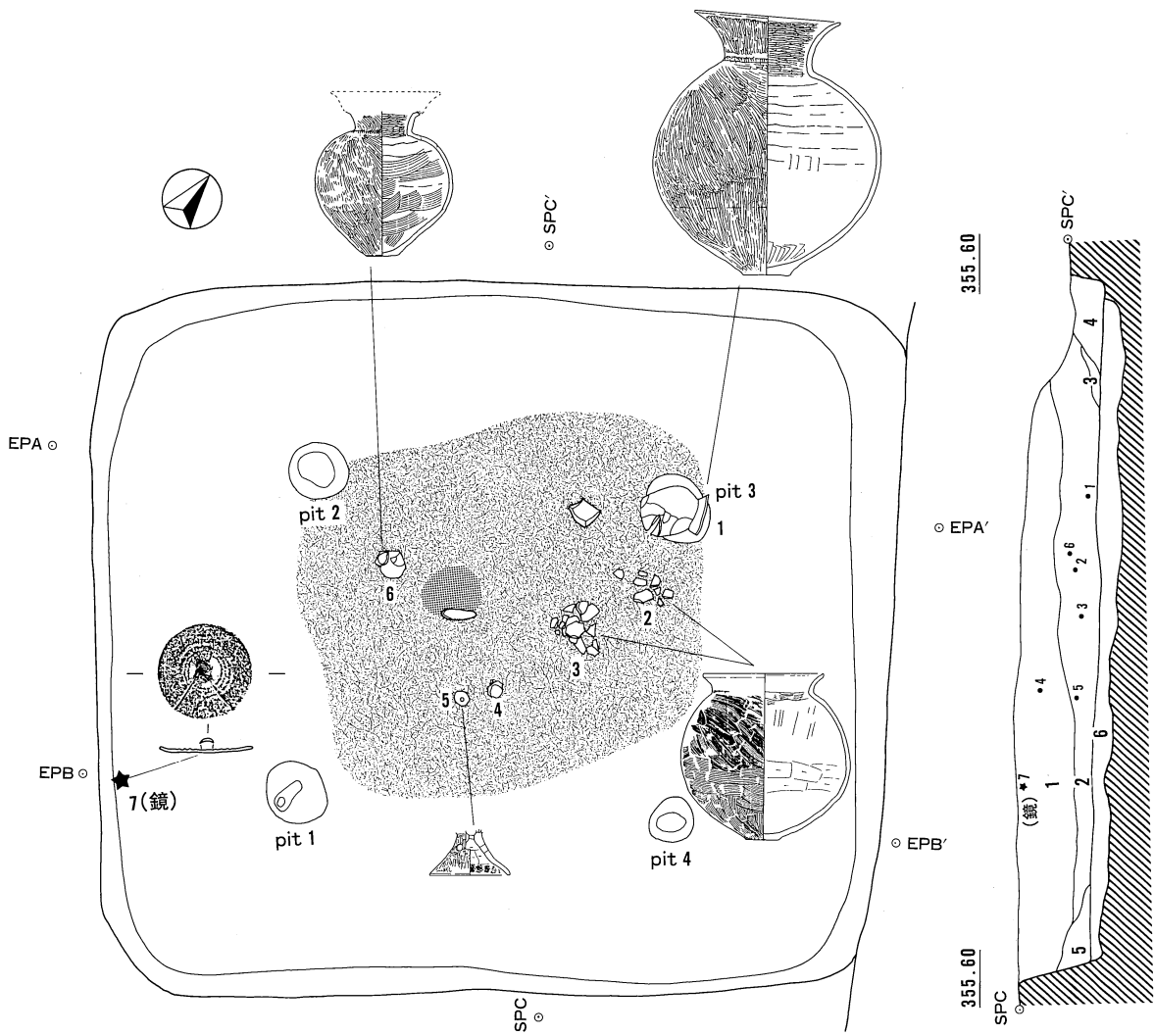

- 1層=暗褐色 (10YR3/3)
- 2層=黒褐色 (10YR3/2)
- 3層=黒褐色 (10YR2/3)
炭化物粒多い
- 4層=黒褐色 (10YR2/2)
- 5層=黒褐色 (10YR3/2)
- 6層=黒褐色 (10YR2/2)

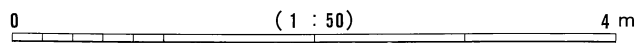
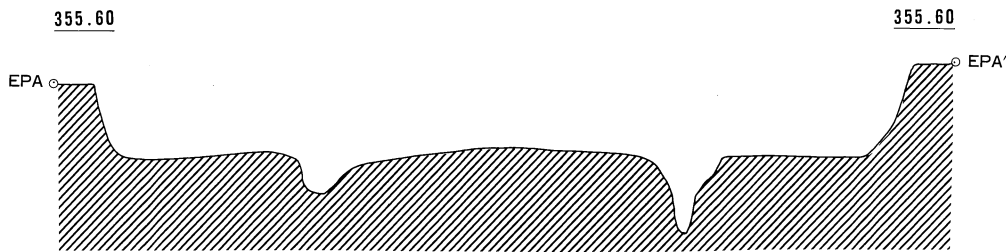

SB7250個別図

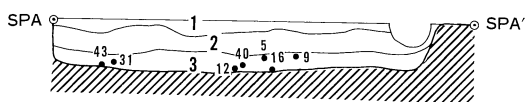
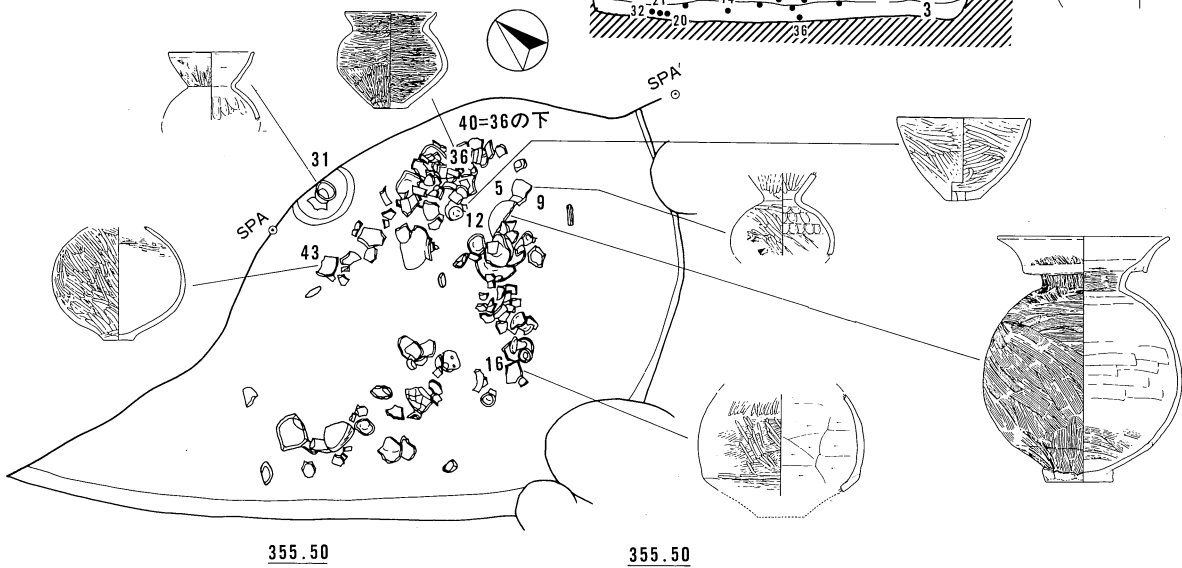
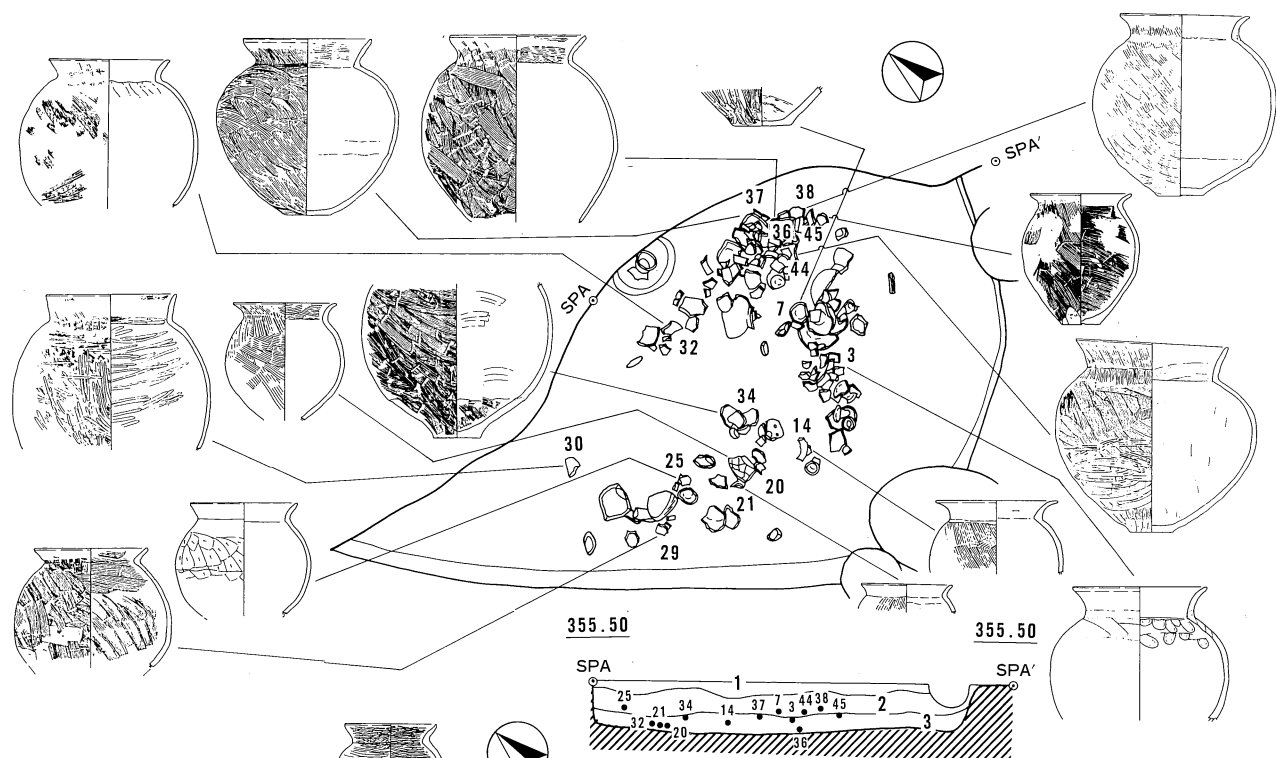

- 1層=暗褐色 (10YR3/3)
- 2層=灰黄褐色 (10YR4/2)
- 3層=黒褐色 (10YR2/2)

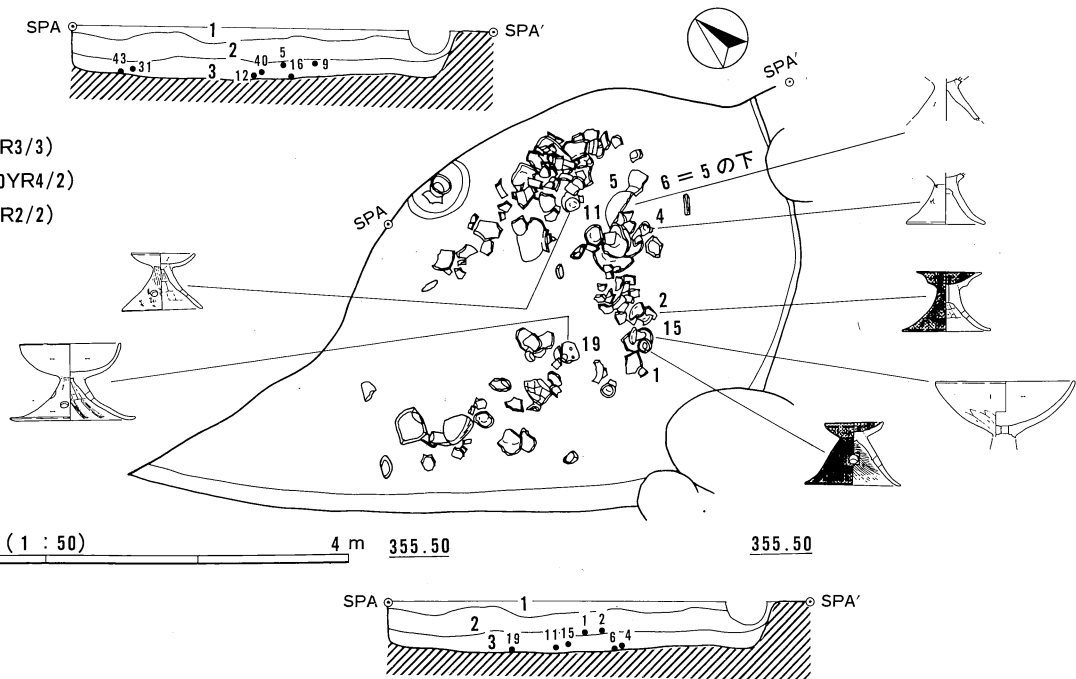

(1:50)

4 m

355.50

355.50

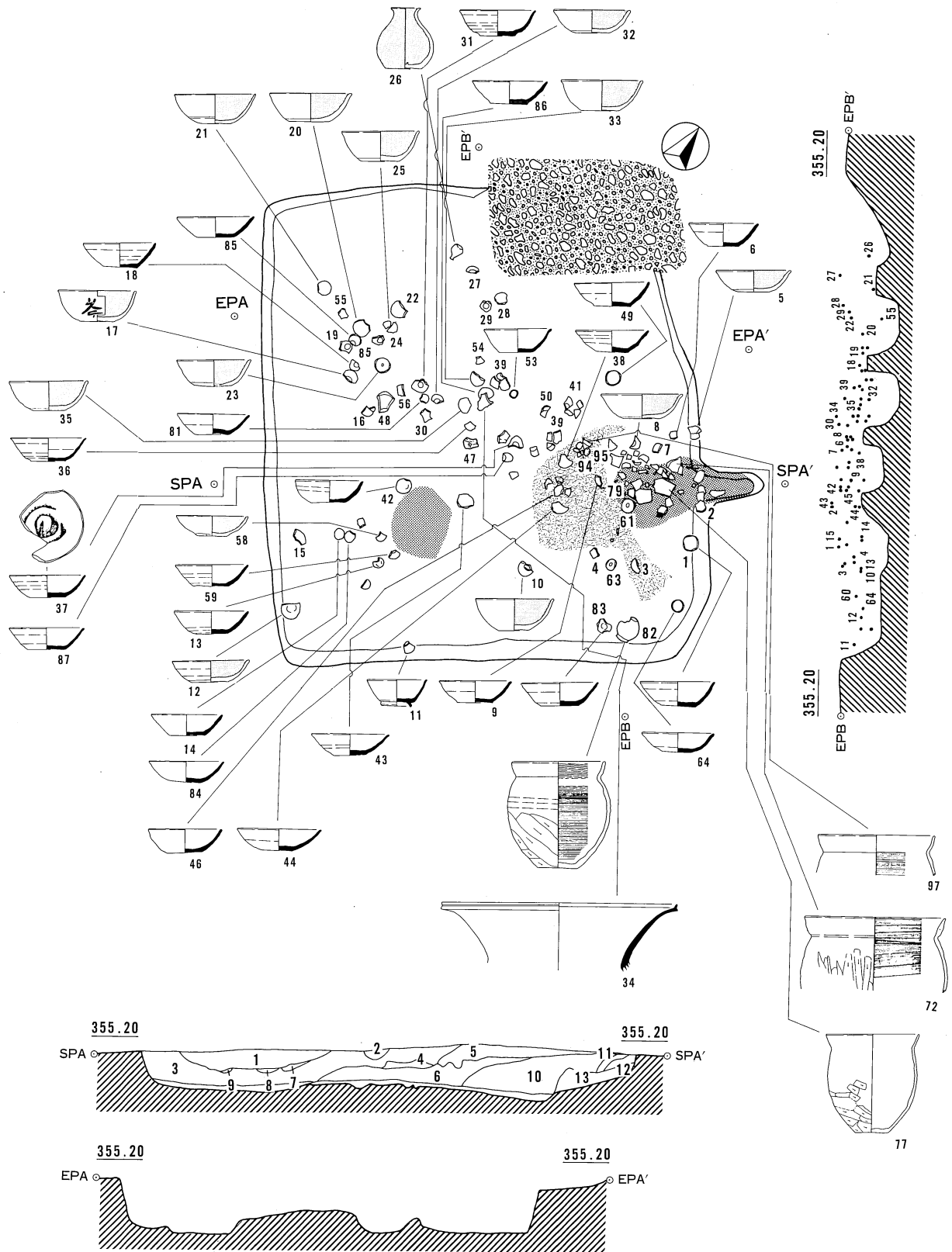

- 1層=暗褐色 (10YR3/3)・砂質埴土+黄褐色 (10YR5/8)
- 2層=にじい黄褐色 (10YR5/3)・砂質埴土
- 3層=暗褐色 (10YR3/4)・砂質埴土
- 4層=黒褐色 (10YR2/3)・砂質埴土
- 5層=褐色 (10YR4/6)・砂質埴土+黄橙 (10YR7/8)

- 6層=にじい黄褐色 (10YR4/3)・砂質埴土+黄橙 (10YR7/8)
- 7層=明黄褐色 (10YR6/8)・砂質埴土・焼土
- 8層=褐色 (10YR4/4)・砂質埴土+黒色 (10YR1.7/1)
- 9層=黒褐色 (10YR2/3)・砂質埴土+黒色 (10YR1.7/1)

- 10層=暗褐 (10YR3/4)・シルト質埴土
- 11層=焼土+炭化物
- 12層=焼土
- 13層=シルト質焼土

0 (1 : 50) 4 m

SB7001個別図

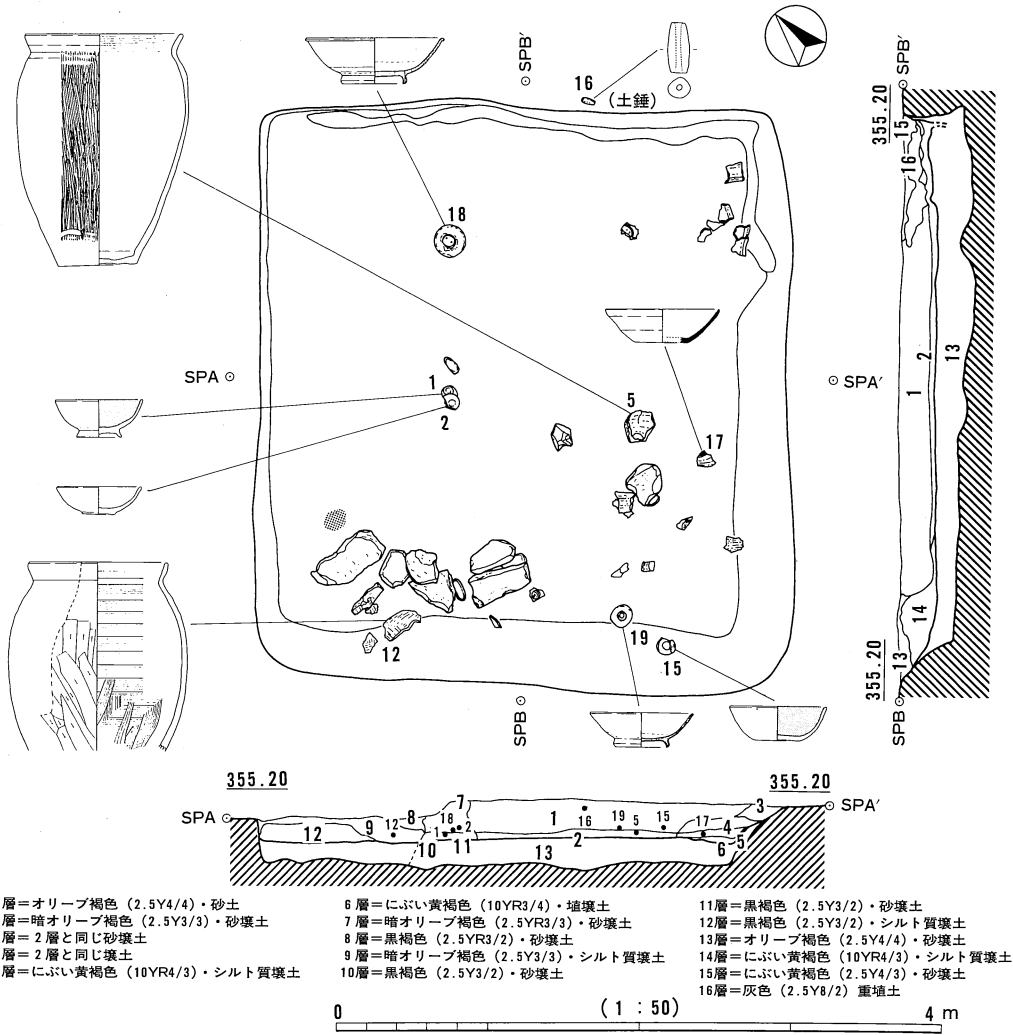

SB7053個別図

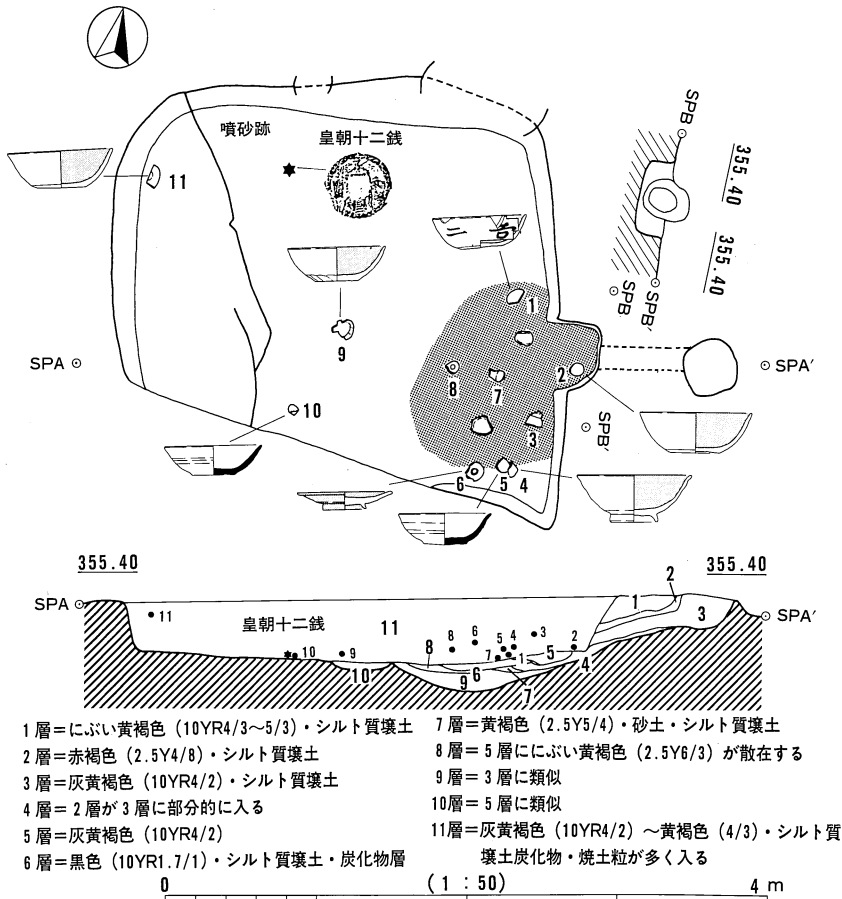

SB7404個別図

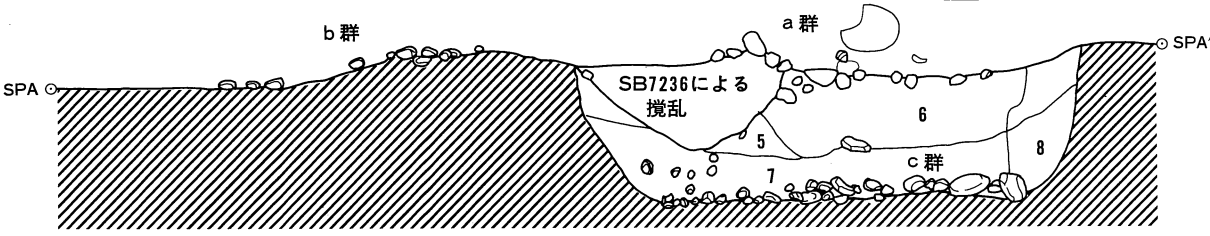
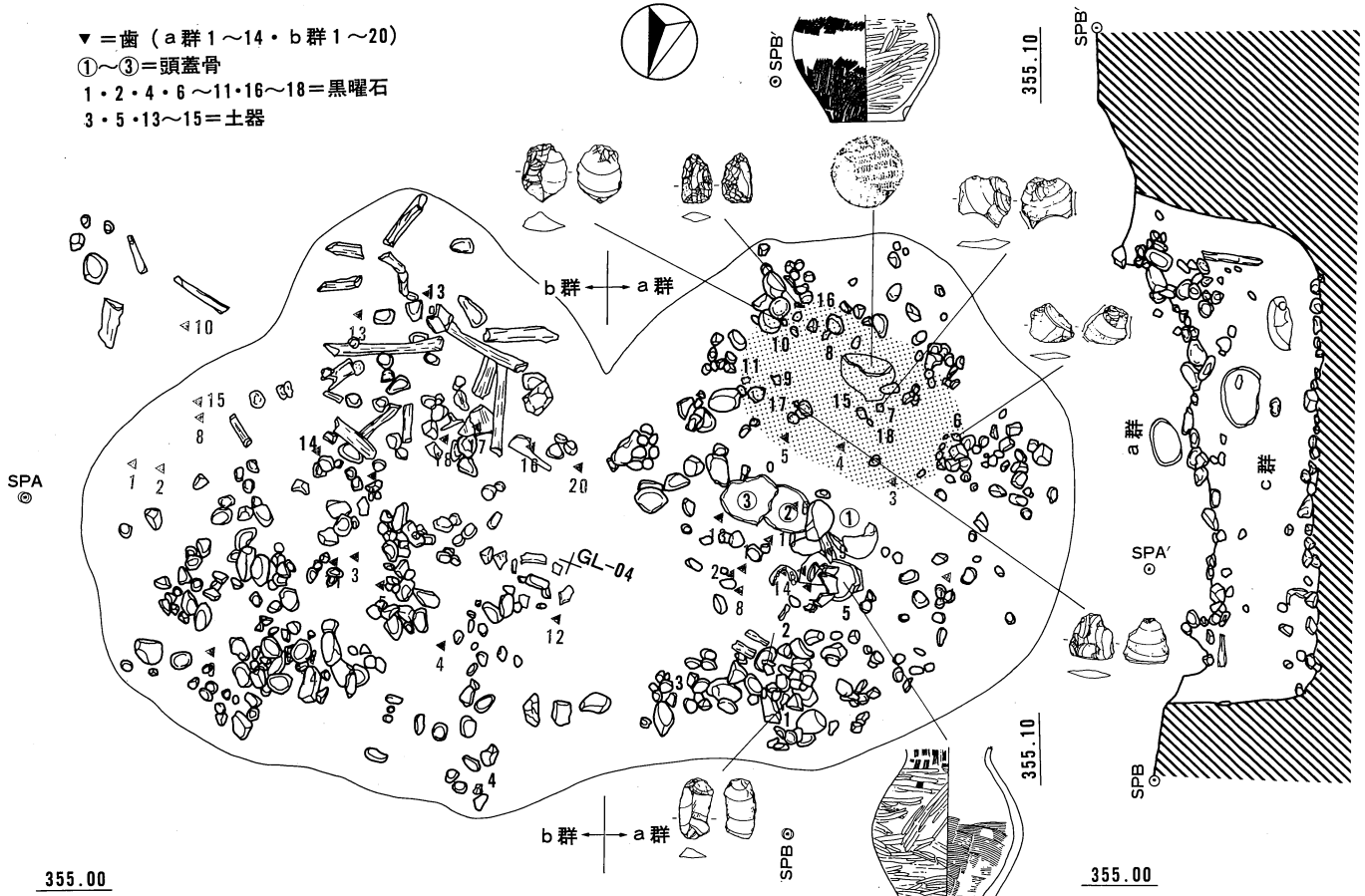

- ◄ = 歯 (C群 30~42)
 ● = 管玉
 ⑤~⑩ = 頭蓋骨
 ①~② = 顎骨
 23 = 天然石
 20~22・25・29・30 = 黒曜石
 31 = 土器

- 5層 = 黄褐色 (10YR5/6)・壤質砂土・少量の骨片を含む。
 6層 = 暗褐色 (10YR4/6)・シルト質壤土・骨を含む。
 7層 = 暗褐色 (10YR4/6)・シルト質壤土中に多量の骨を含む骨の集積層。
 8層 = 赤褐色 (5YR4/6)・壤質砂土・骨は含まれず、地山が変色した層。

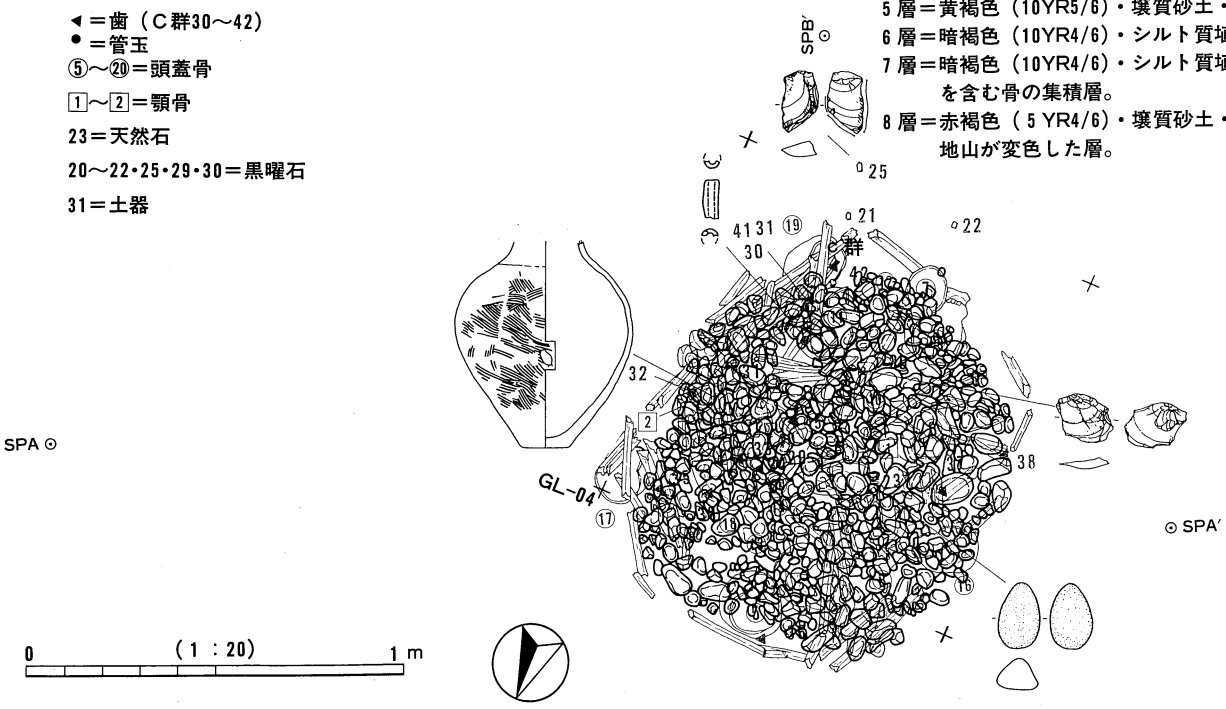

SM7010個別図

SPB

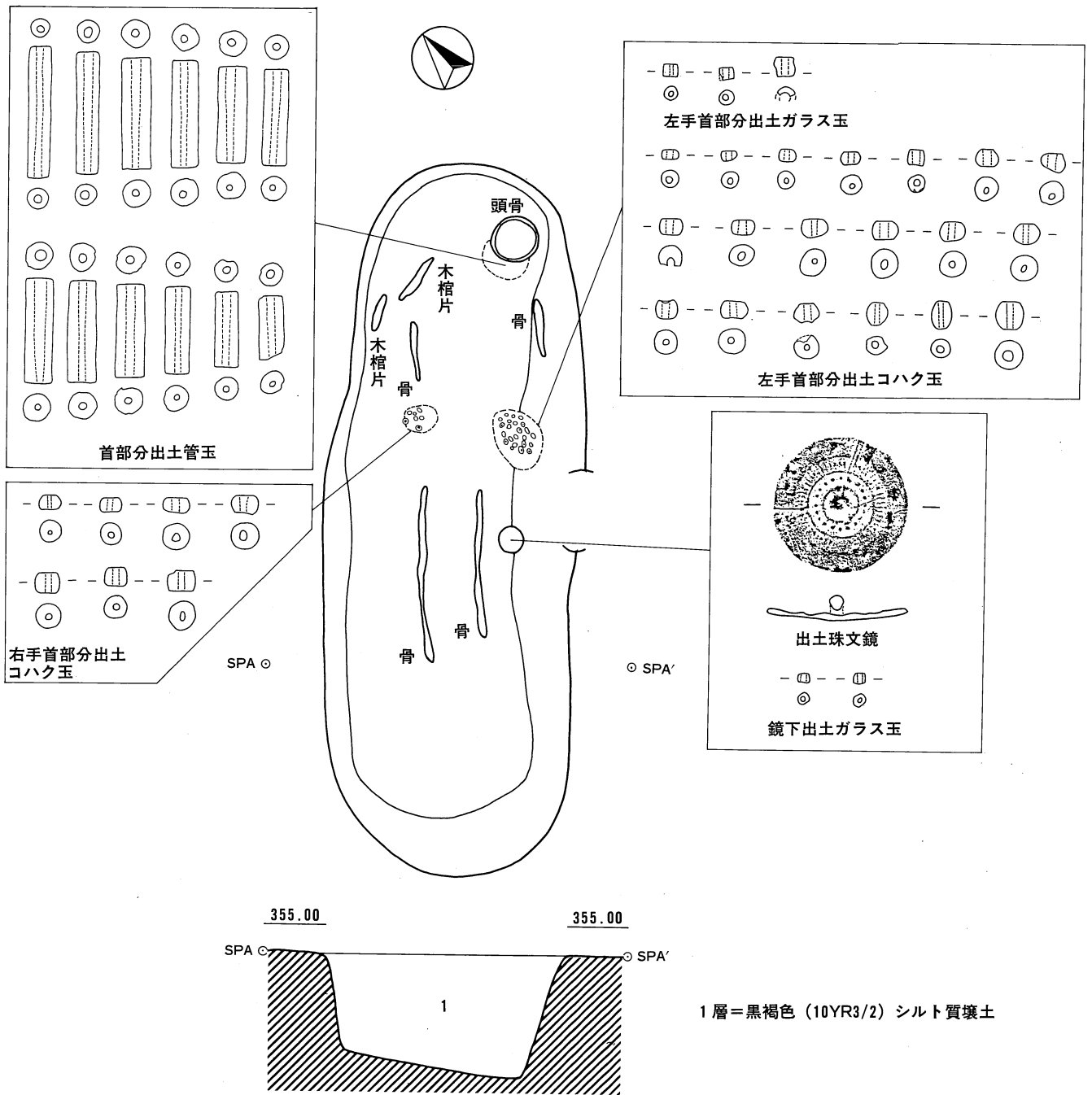

SM7016個別図

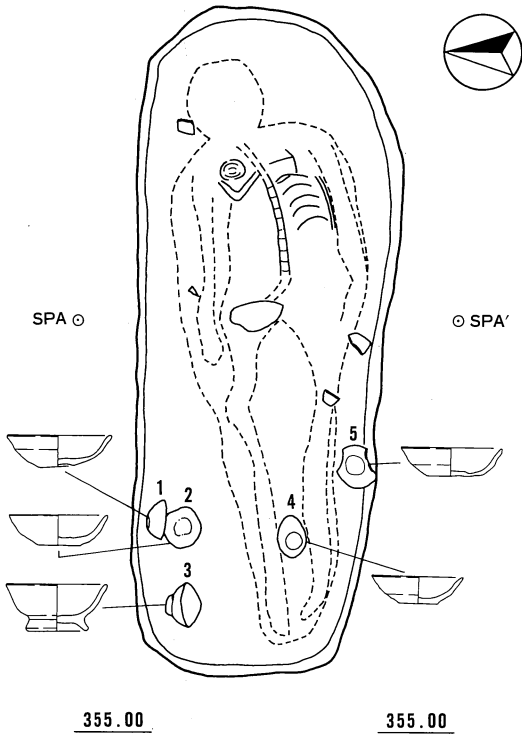

355.00

355.00

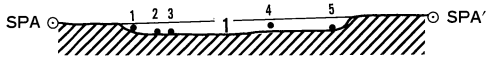

1層=褐色(10YR4/4)・砂土

SM7009個別図

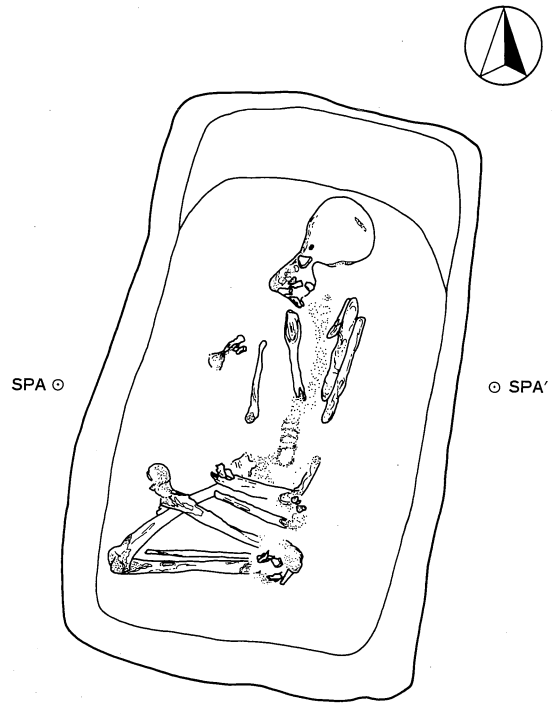

355.30

355.30

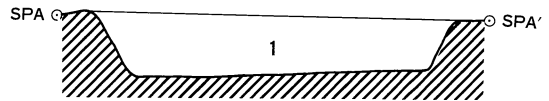

1層=褐色(10YR4/4)・砂土

SM7013個別図

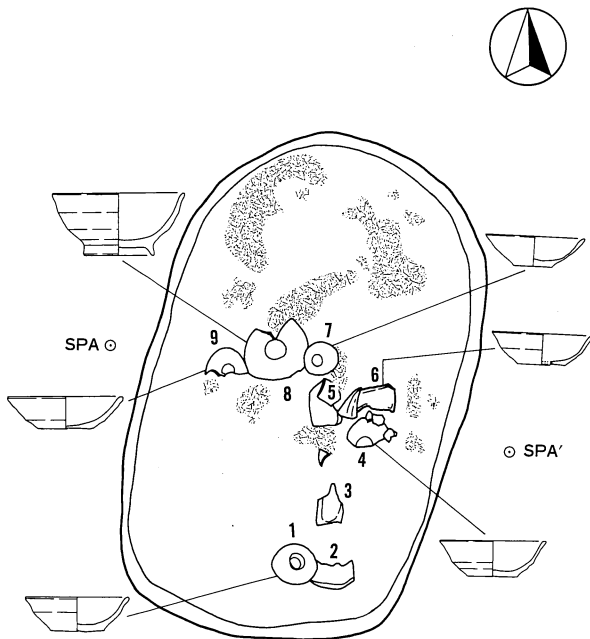

355.00

355.00

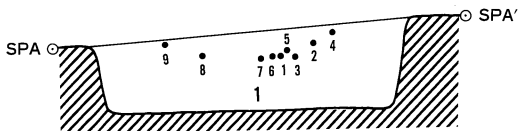

1層=褐灰色(10YR4/1)~灰木褐色(10YR4/2)・シルト質壤土・
焼土粒・炭化物粒が多く入る

SM7017個別図

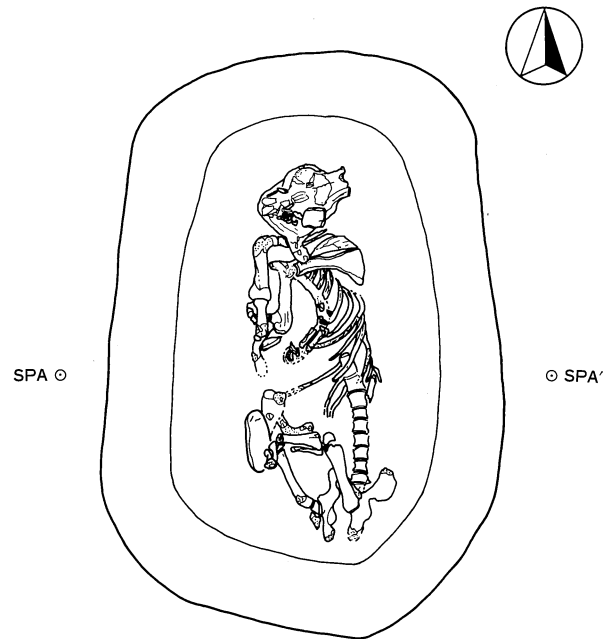

355.30

355.30

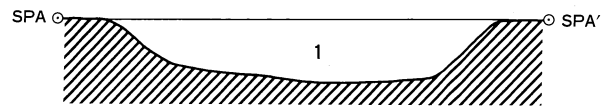

1層=褐色(10YR4/4)・砂質壤土

SM7012個別図

0 (1:20) 1 m

354.00

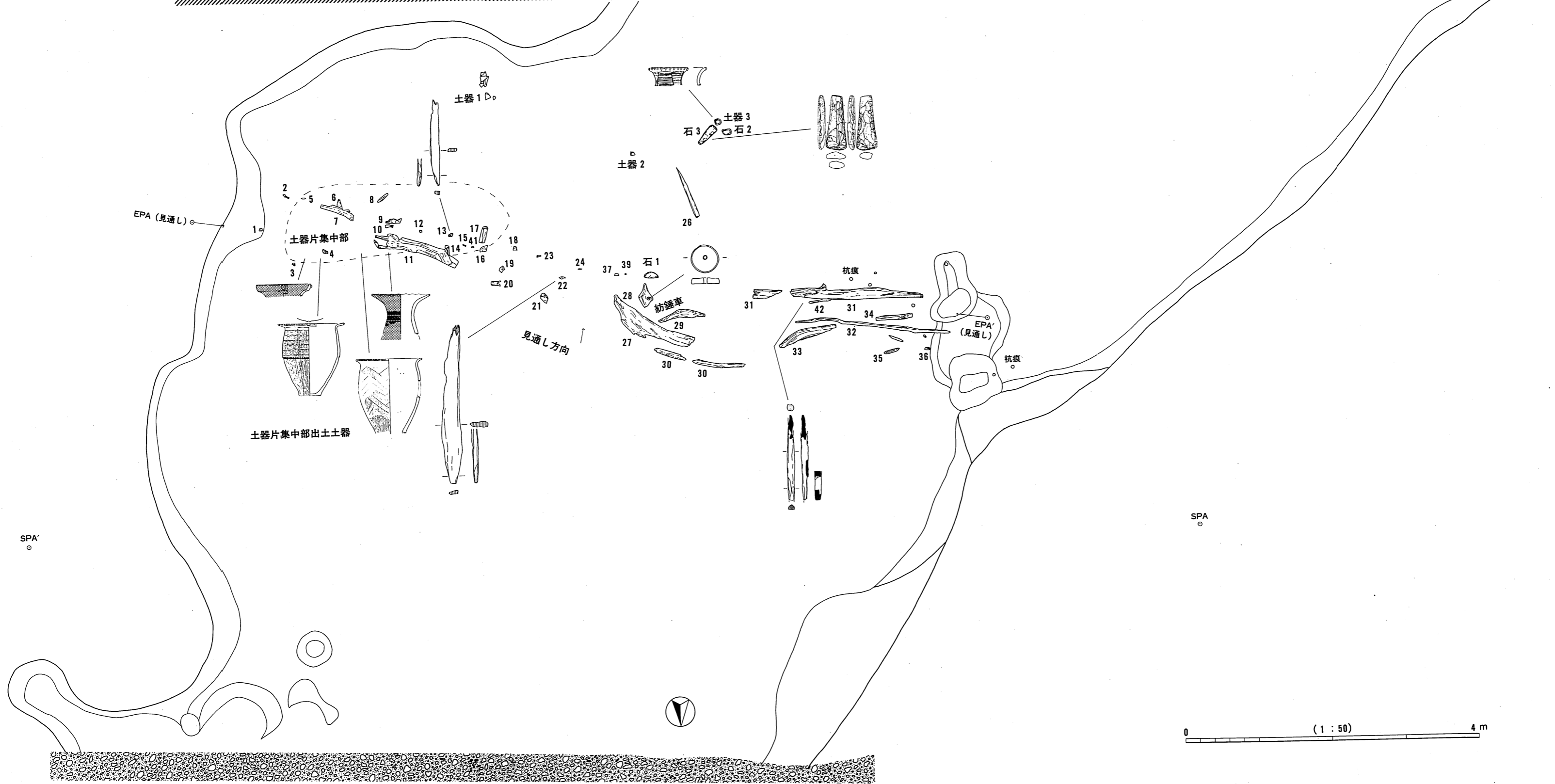
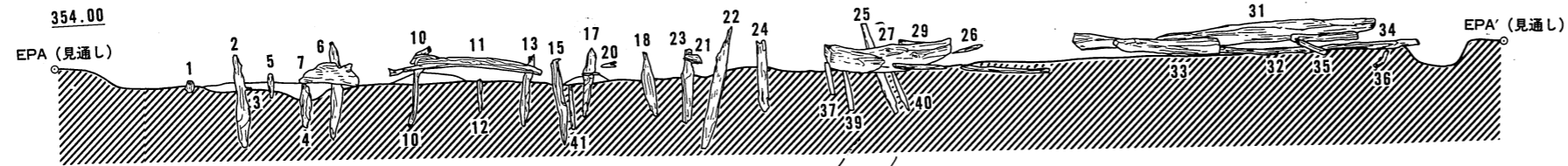

土器片集中部出土土器

見通し方向

1層=暗オリーブ色 (7.5Y4/3)・砂土

SA5001・SD5003個別図 (注=Noのみは杭・木のNo)

0 (1:50) 4m

354.00

354.00

埋土中一括土器

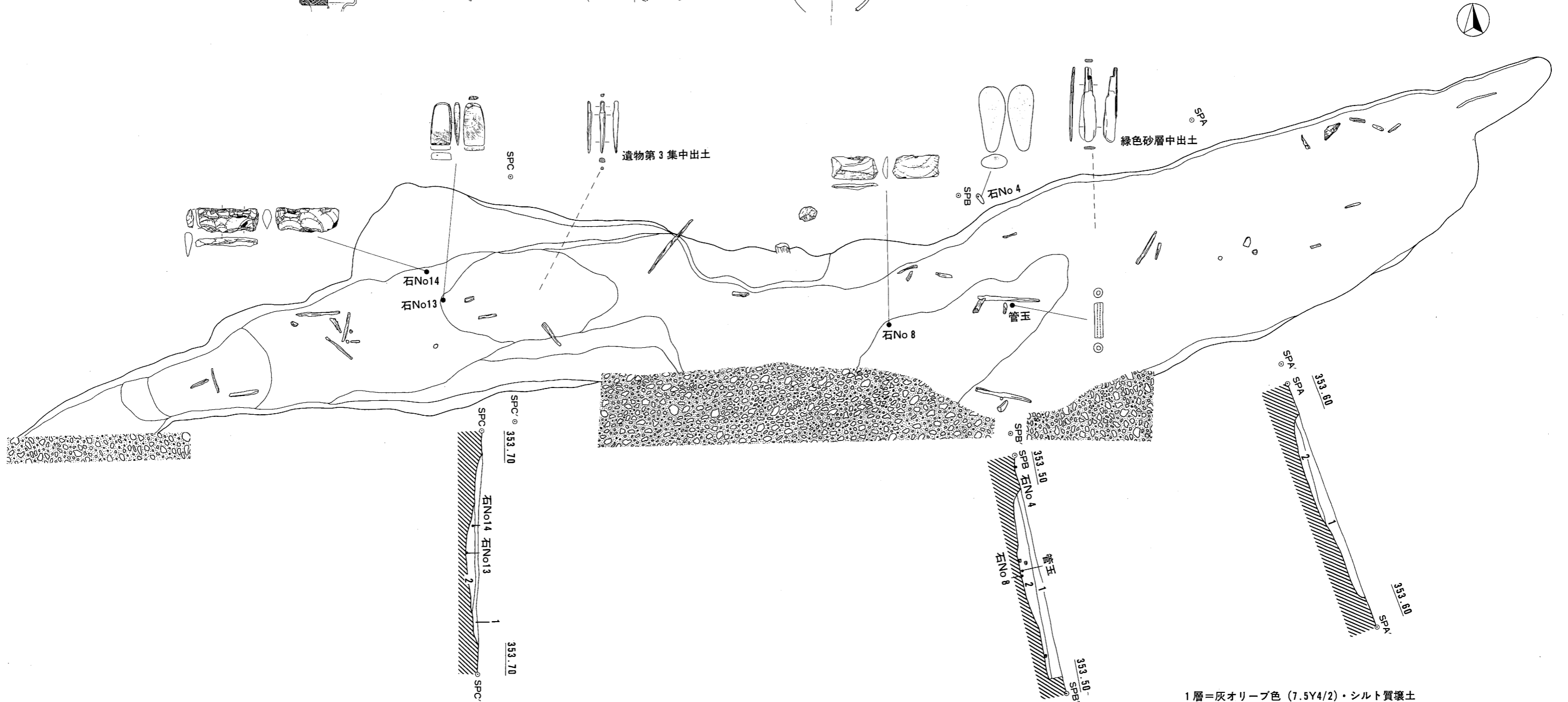
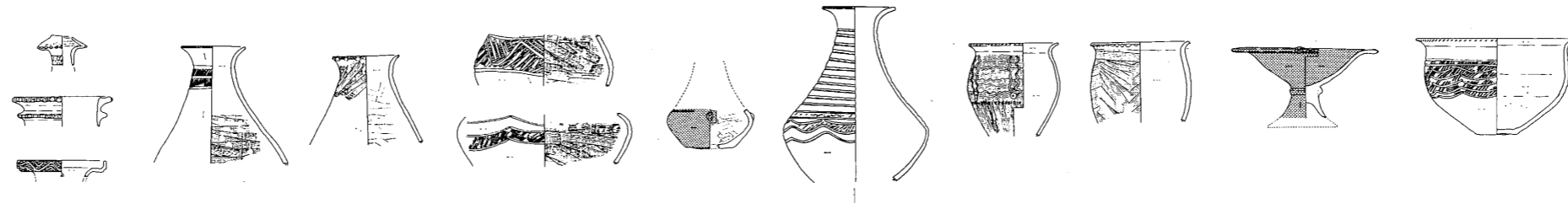

緑色砂層中出土

1層=灰オリーブ色 (7.5Y4/2)・シルト質壤土
 2層=暗オリーブ色 (7.5Y4/3)・砂土

0 (1:50) 4 m

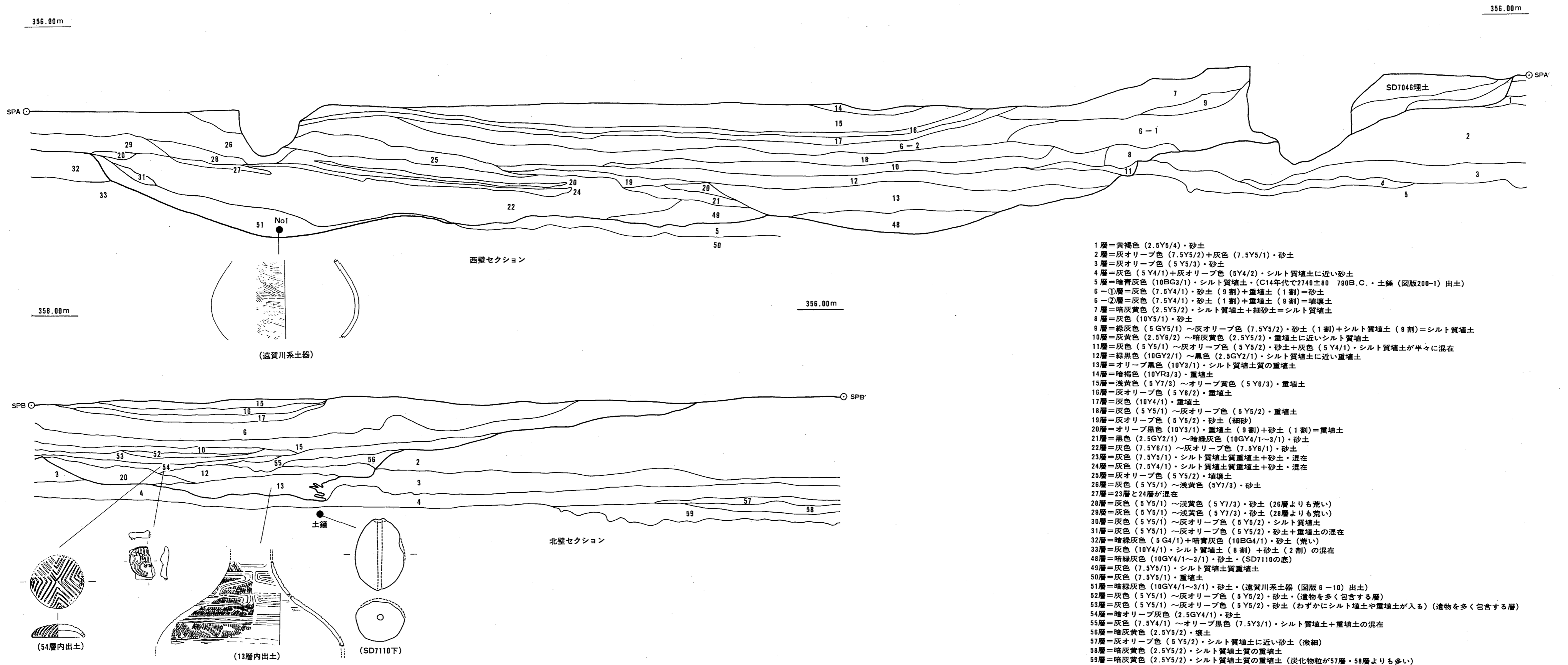

SD7110セクション図 (セクションポイントは図版12・13・14にあり)

SD7014セクション図

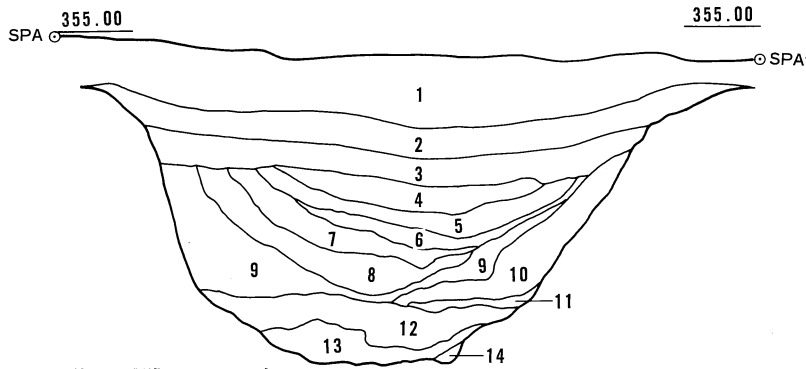

- 1層=暗褐色 (10YR3/3)・壤土
- 2層=暗褐色 (10YR3/4)・壤土
- 3層=褐色 (10YR4/4)・シルト質壤土
- 4層=褐色 (10YR4/6)・シルト質壤土
- 5層=暗褐色 (10YR3/3)・シルト質壤土
- 6層=にぶい黄褐色 (10YR5/3)・シルト質壤土
- 7層=暗褐色 (10YR3/3)・シルト質壤土
- 8層=にぶい黄褐色 (10YR5/4)・シルト質壤土
- 9層=にぶい黄褐色 (10YR4/3)・シルト質壤土
- 10層=にぶい黄褐色 (10YR5/4)・シルト質壤土
- 11層=にぶい黄褐色 (10YR4/3)・シルト質壤土
- 12層=にぶい黄褐色 (10YR5/3)・シルト質壤土
- 13層=黒褐色 (10YR3/2)・シルト質壤土
- 14層=にぶい黄褐色 (10YR4/3)・シルト質壤土

※SPの位置は図版69・71にある

SD7014遺物出土層位図

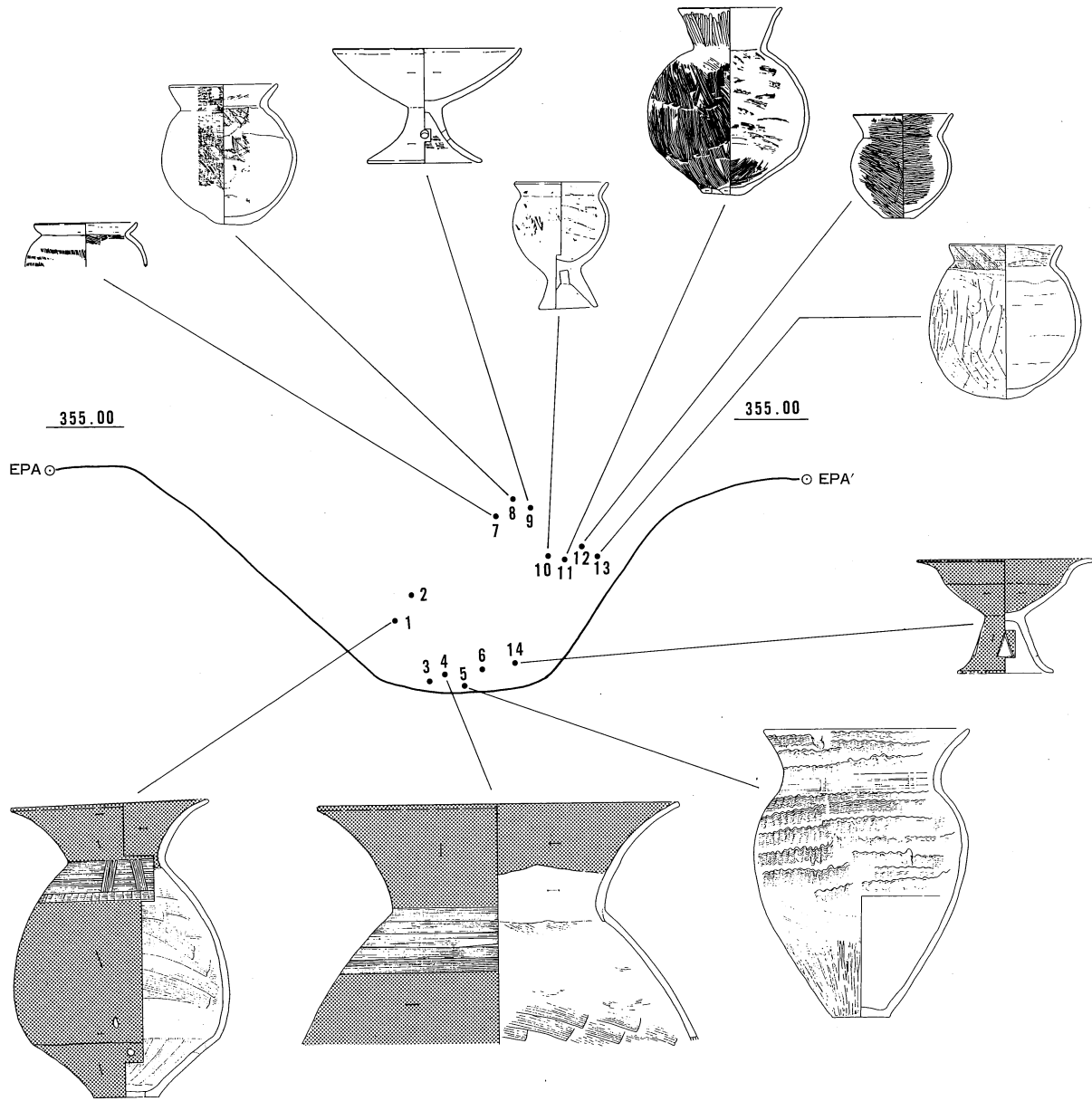

※EPの位置は図版55にある

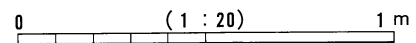

SD7014セクション図・遺物出土層位図

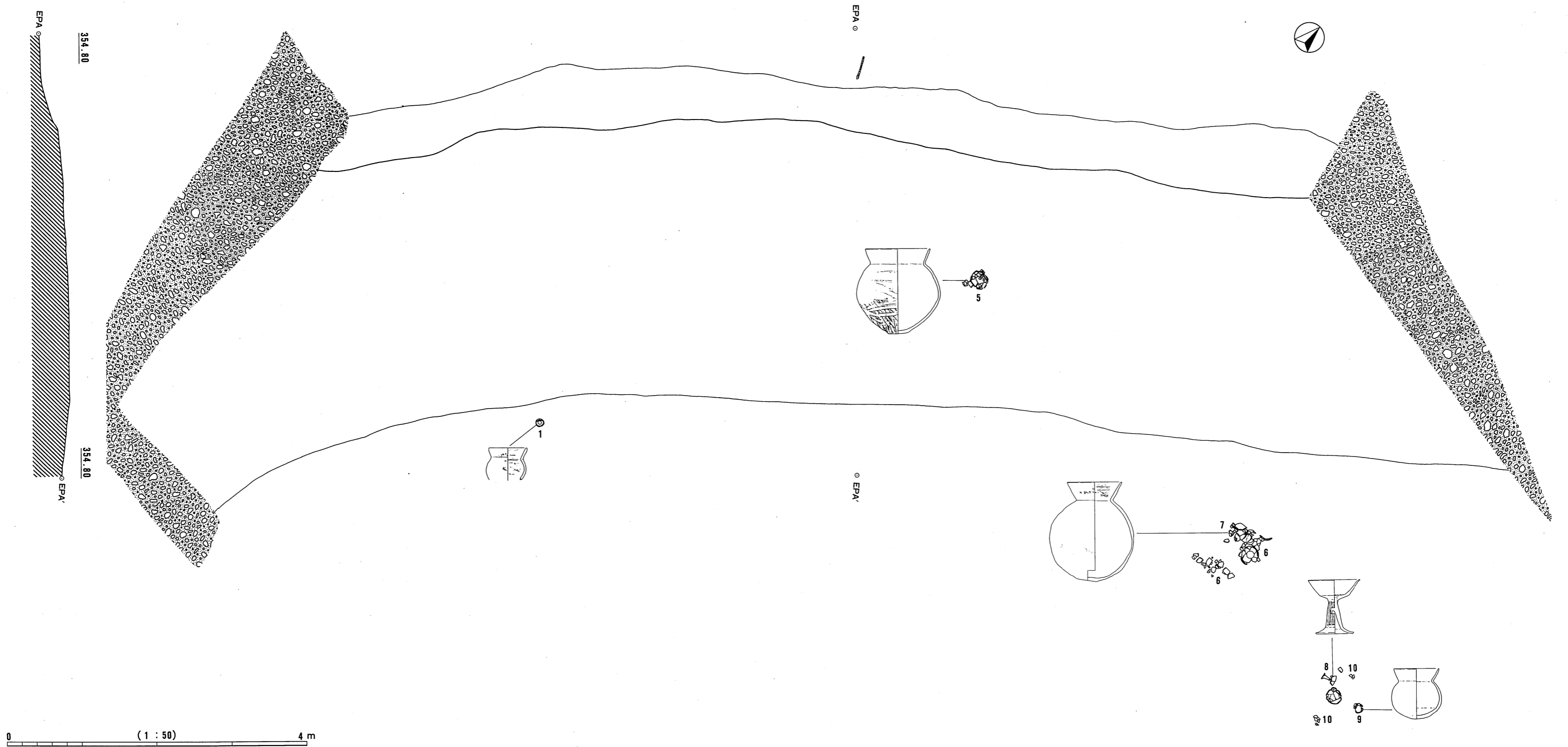

SC6001個別図

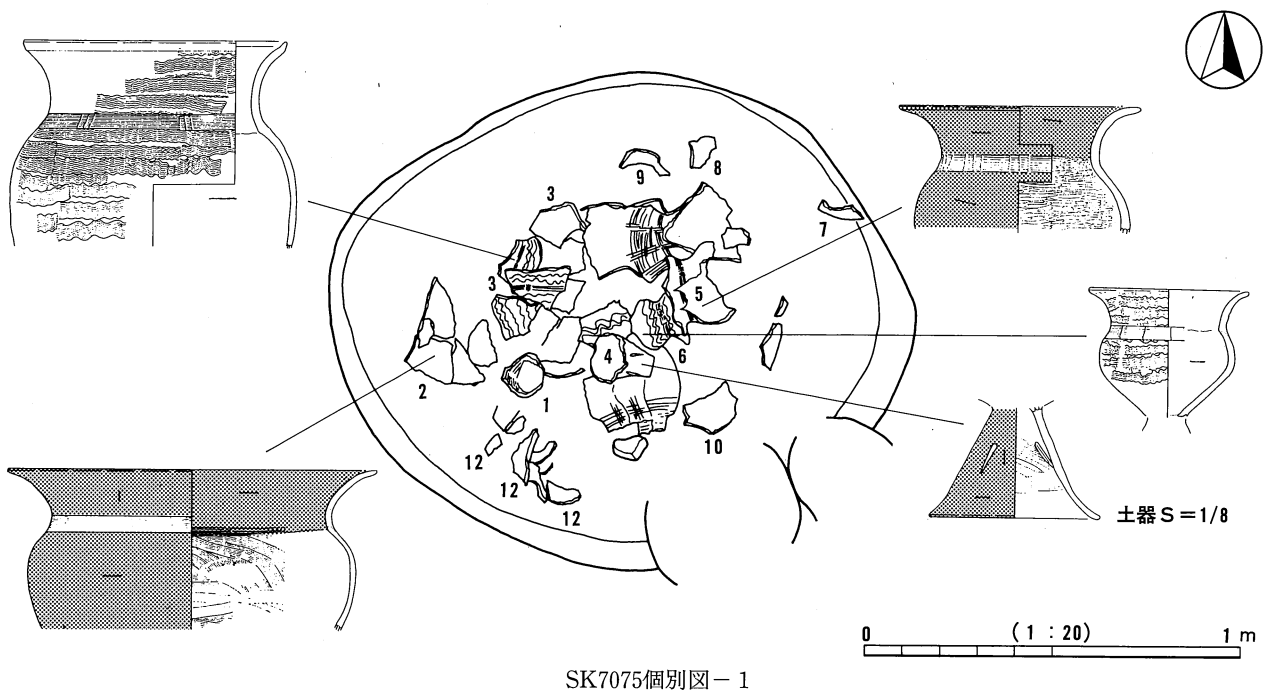
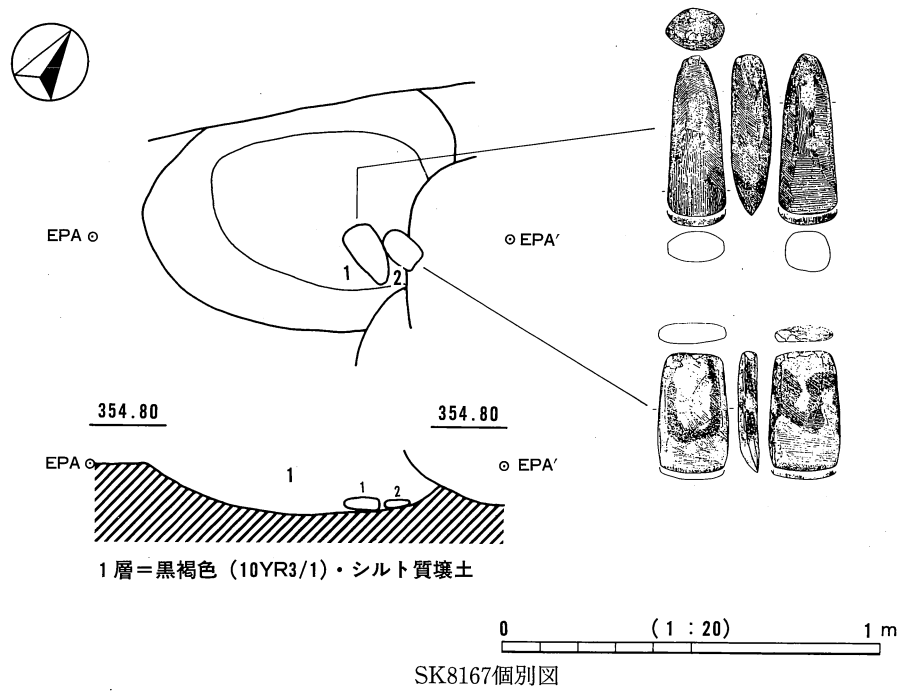

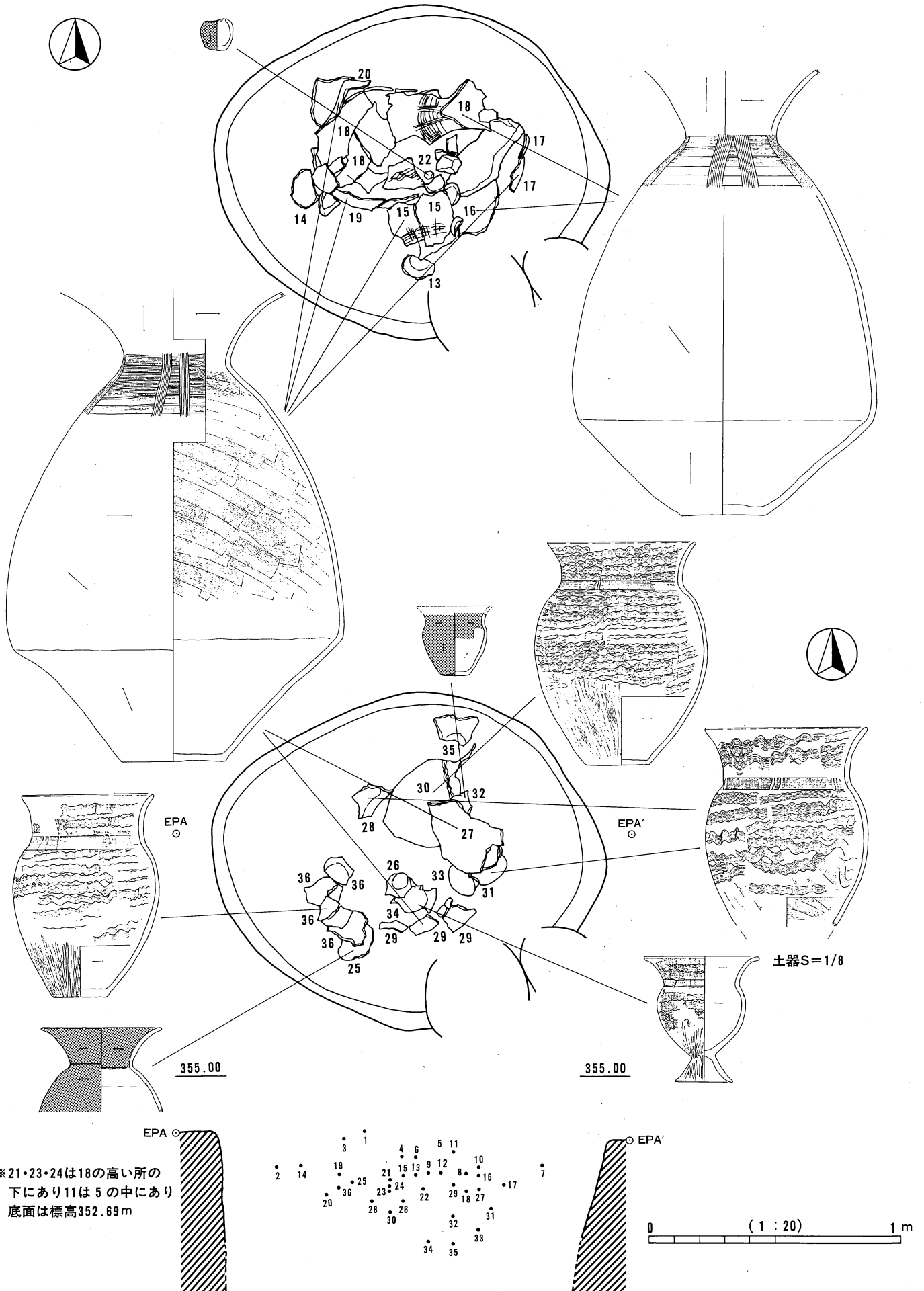

写 真 图 版

航空写真

調査前の塩崎地区
航空写真





航空写真

戦後まもなくの
塩崎地区航空写真

調査区全景



1 B I S
20-1区
西側



2 B I S
20-1区
東側

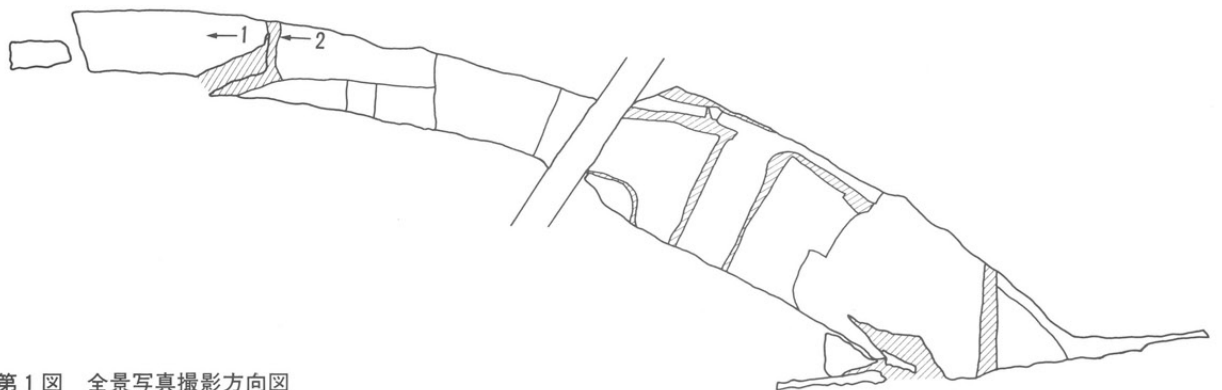

第1図 全景写真撮影方向図

調査区全景



1 1-1-a区



2 1-1-b区

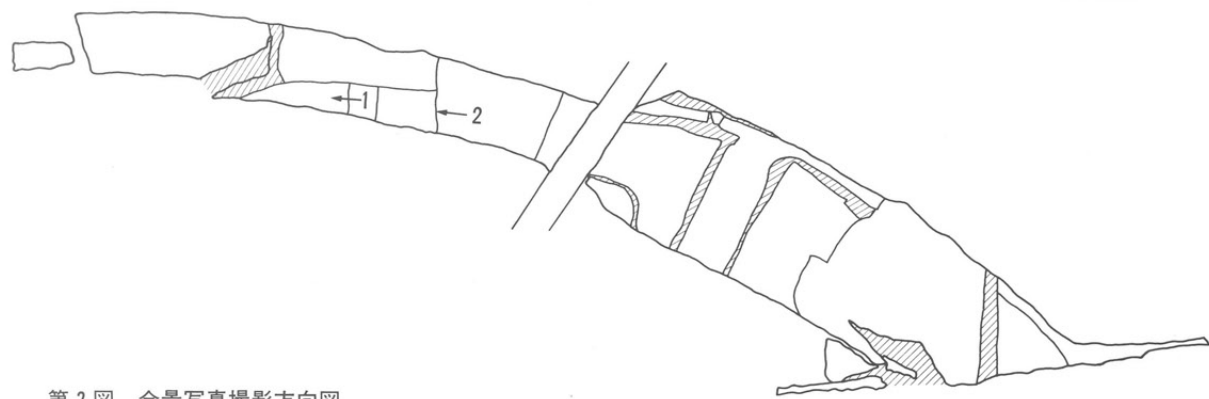

第2図 全景写真撮影方向図

調査区全景



1 1-1-c区



2 1-2区

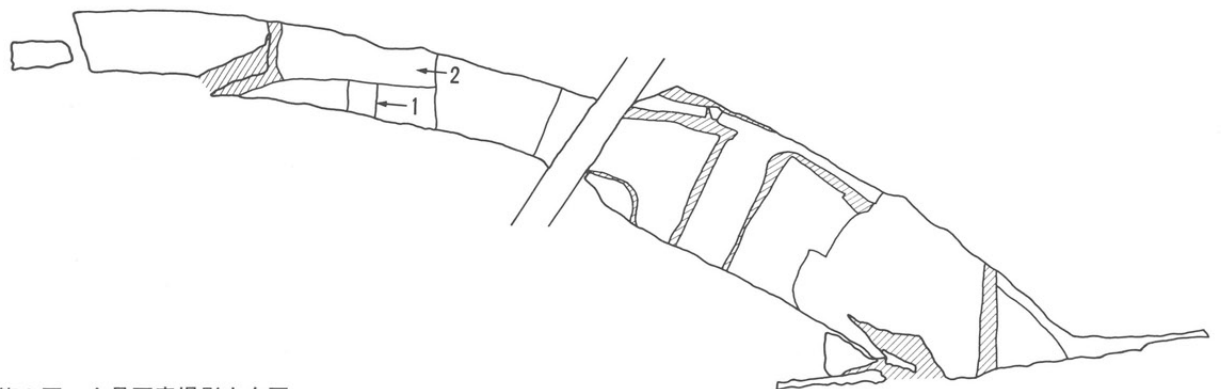

第3図 全景写真撮影方向図