

第295图 接合資料No.20実測図(3)

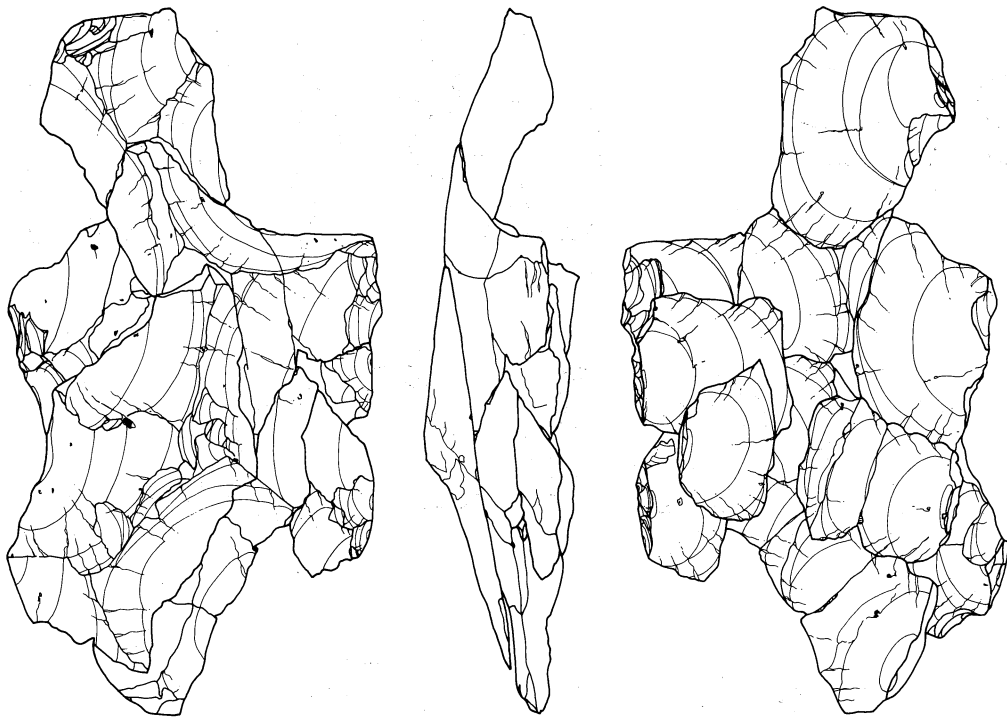

接合No.14

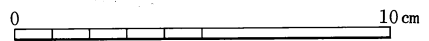
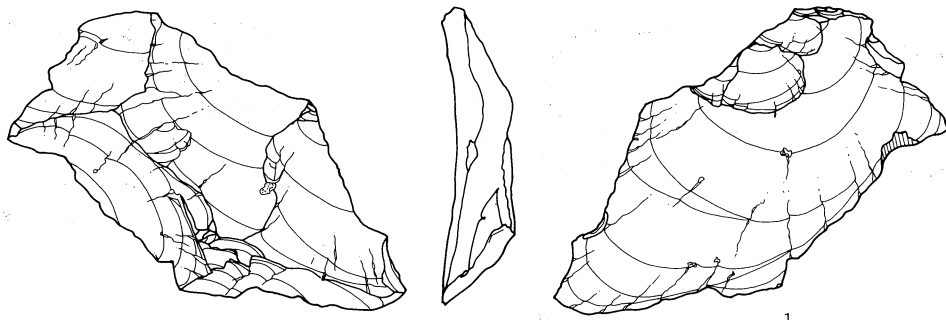
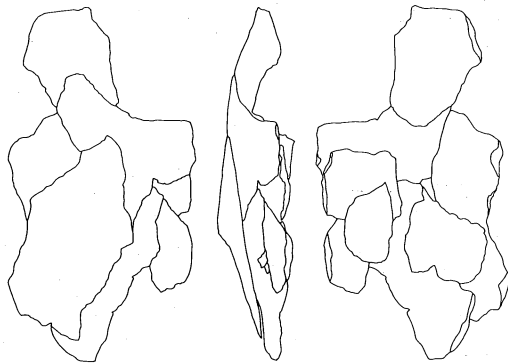

第296図 接合資料No.14実測図(1)

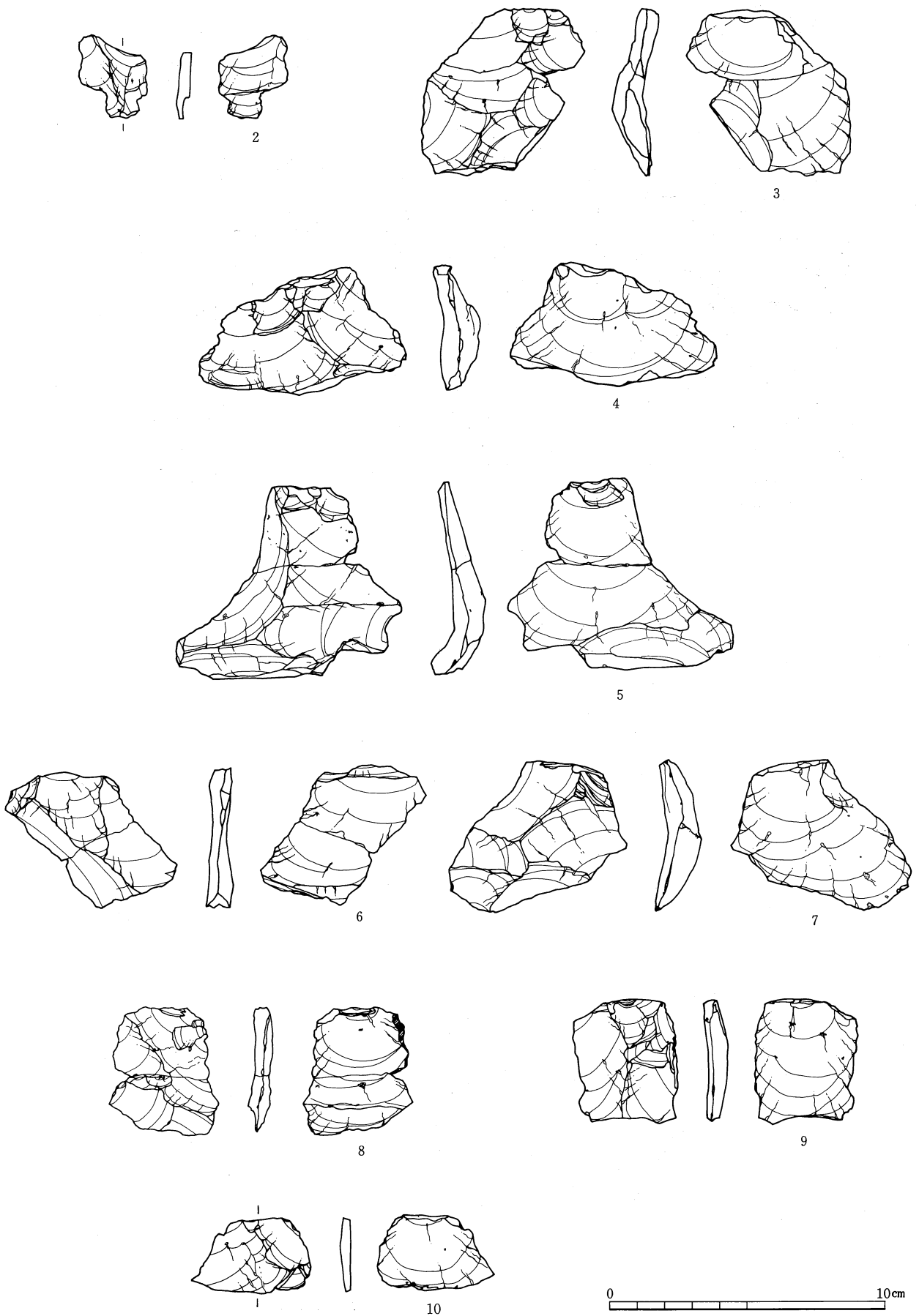

第297図 接合資料No.14実測図(2)

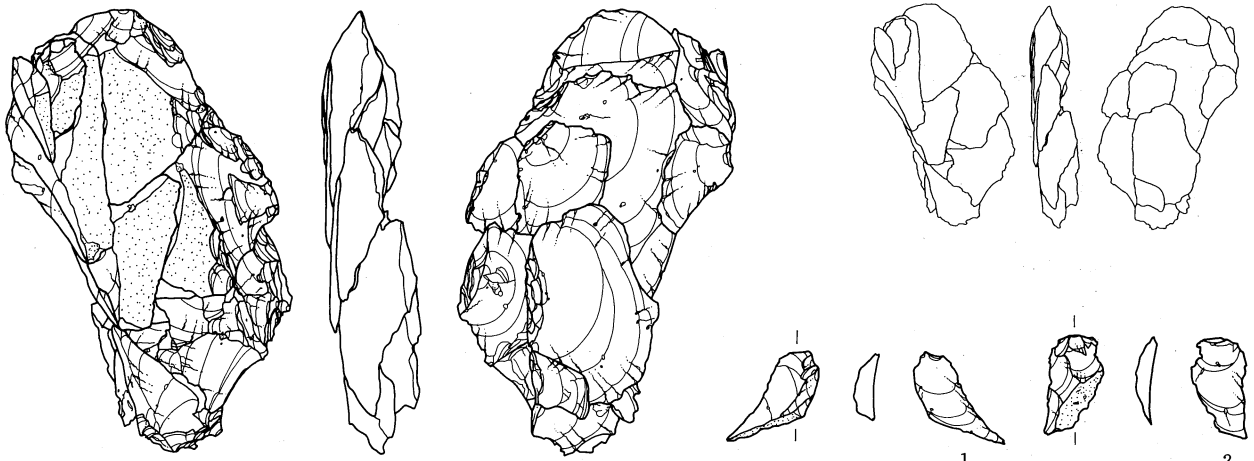

接合No.24

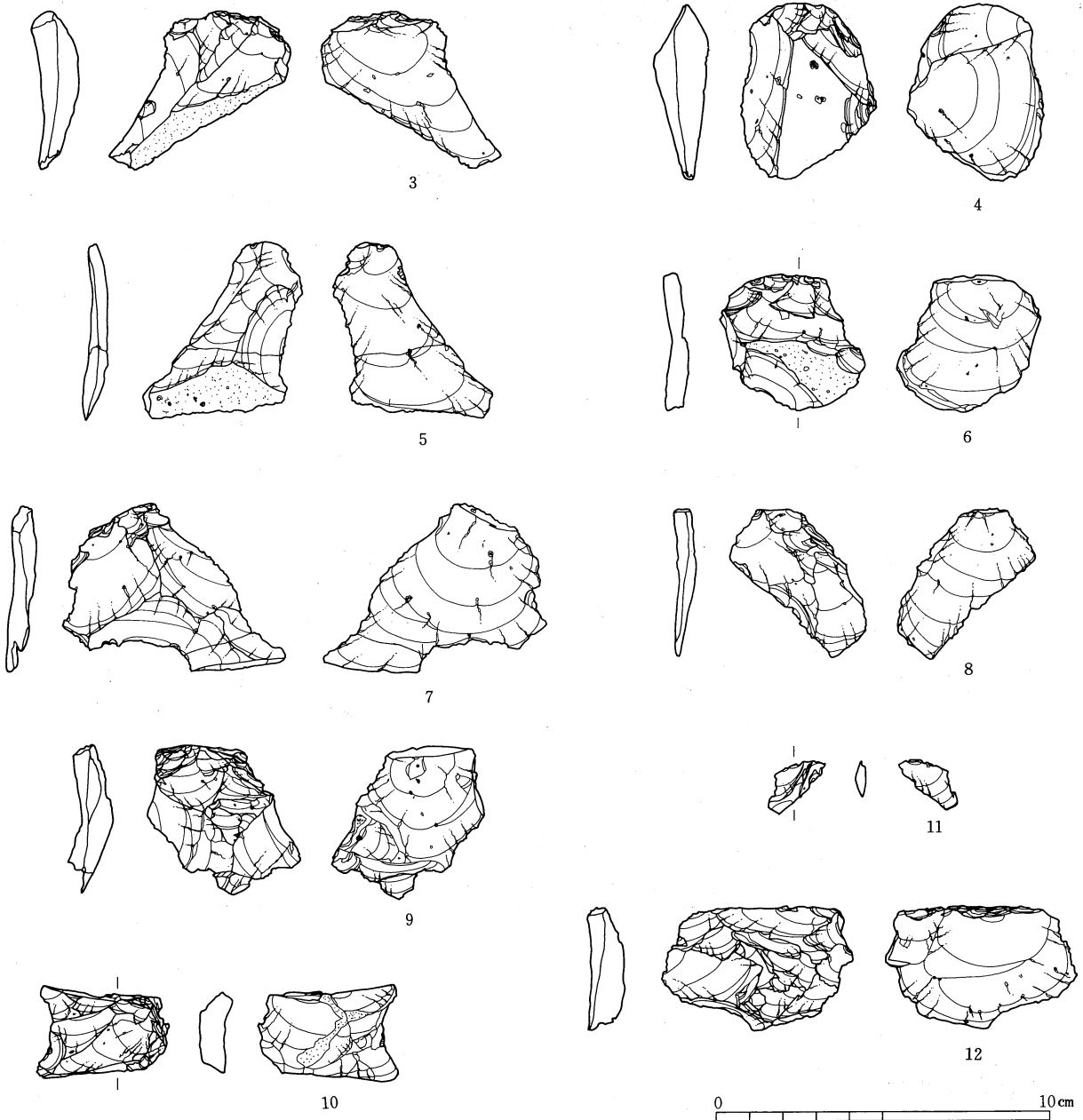

第298図 接合資料No.24実測図

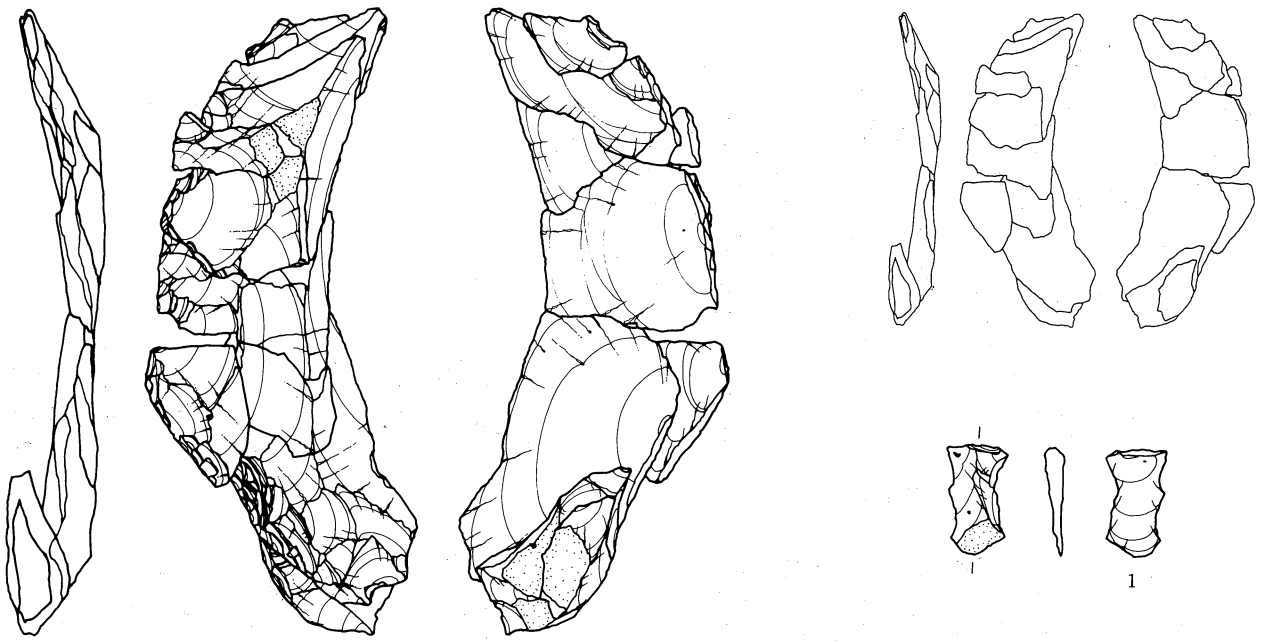

接合No.10

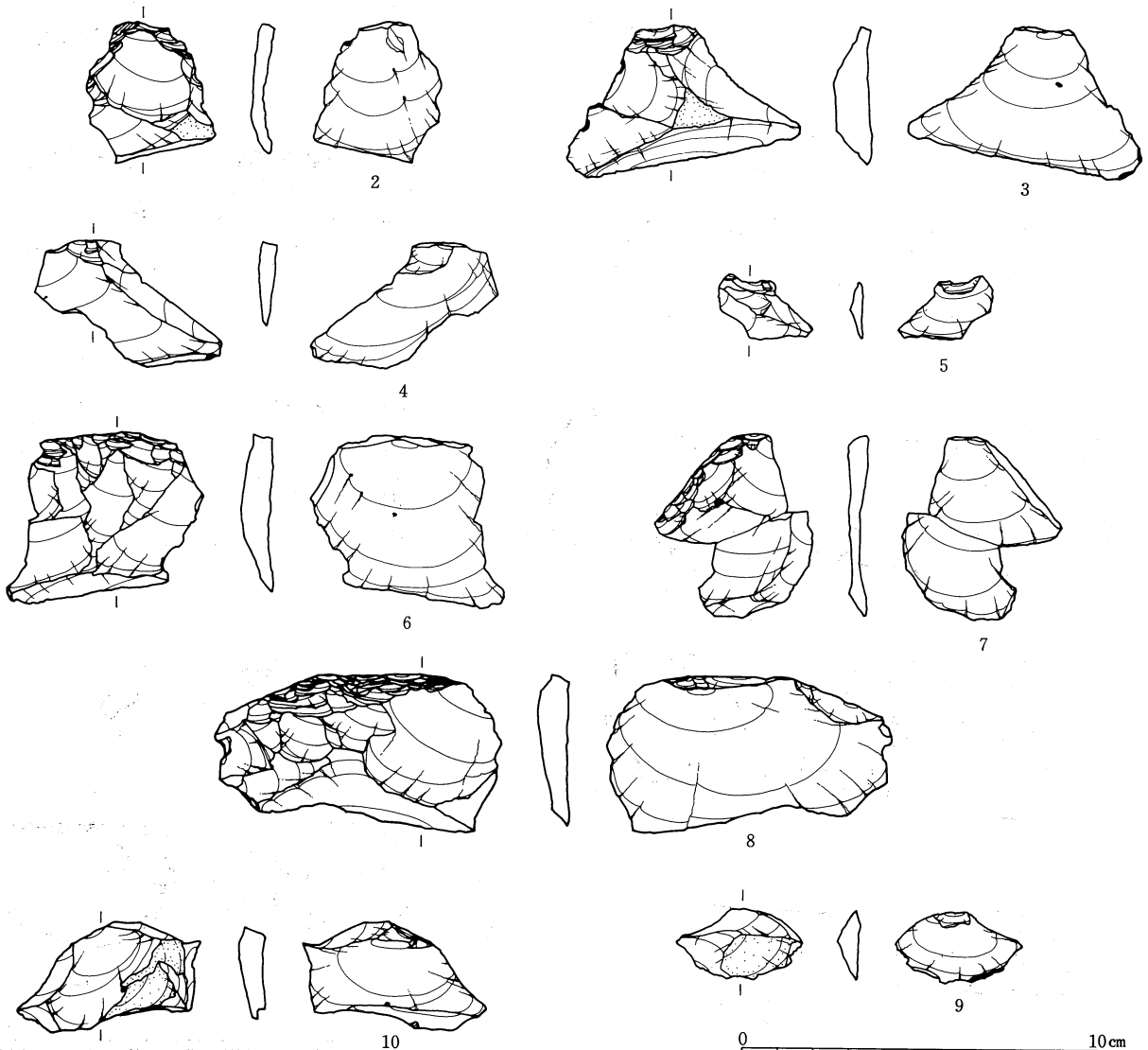

第299図 接合資料No.10実測図

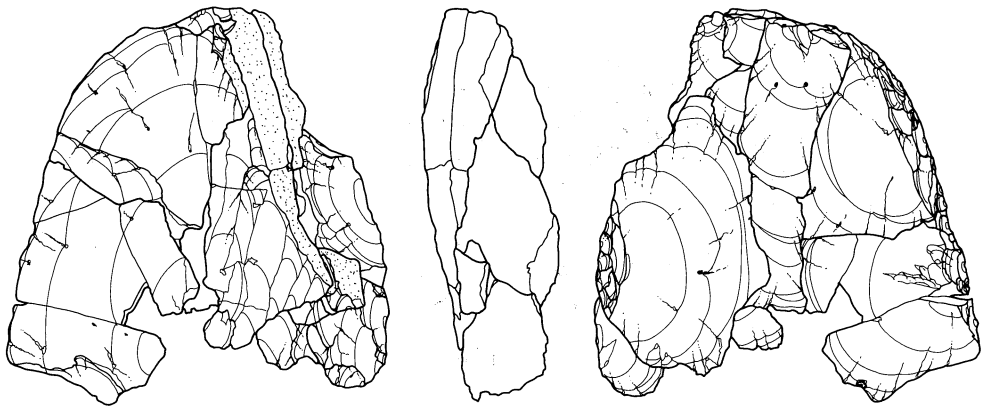

接合No.23

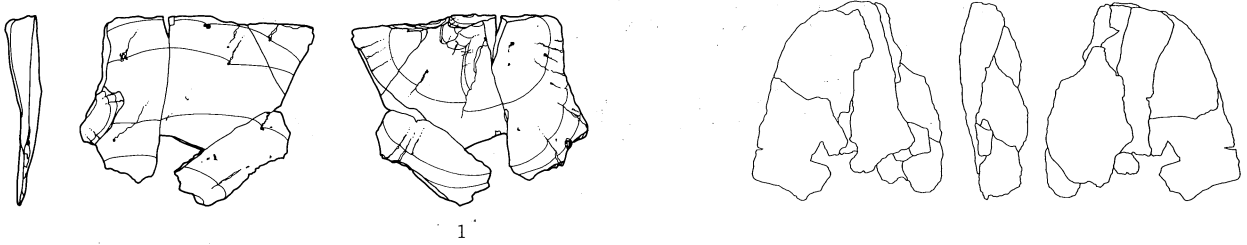

1

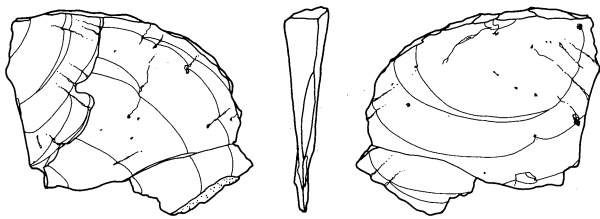

2

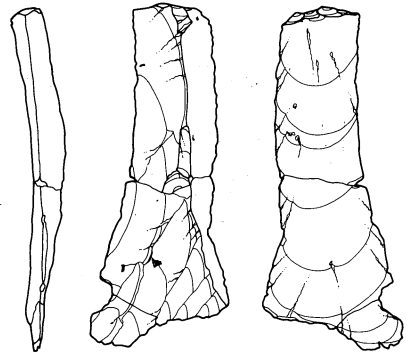

3

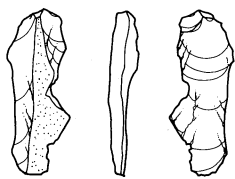

4

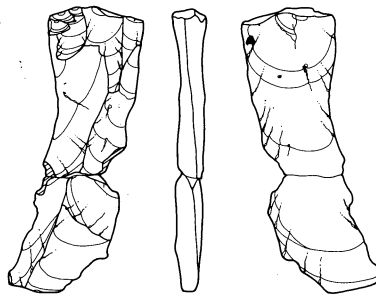

7

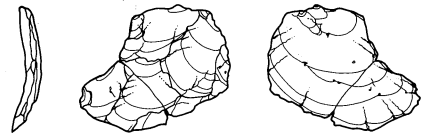

8

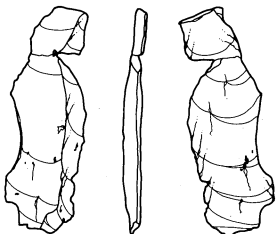

5

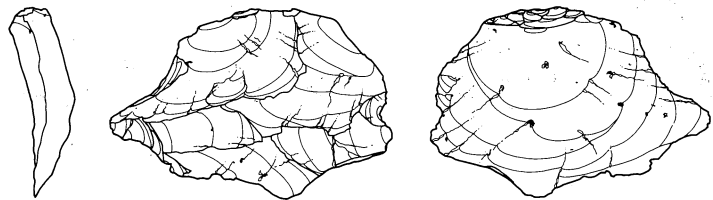

9

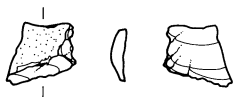

6

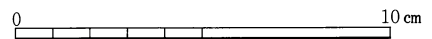

第300図 接合資料No.23実測図

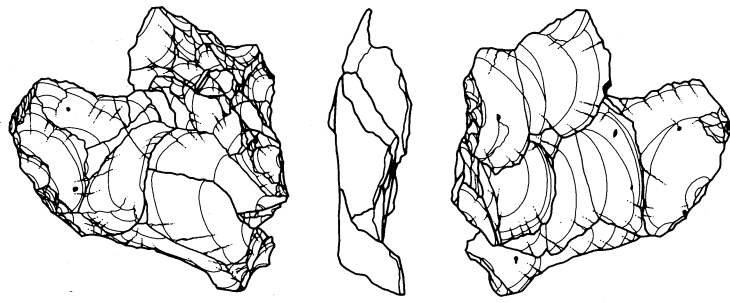

接合 No.12

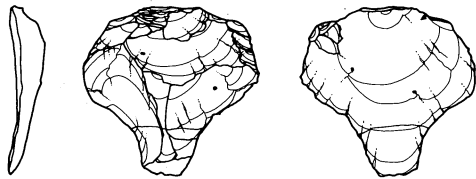
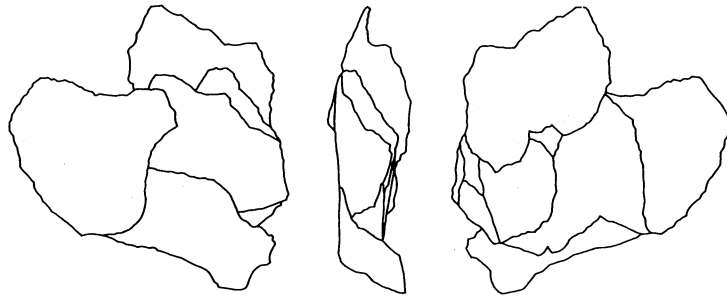

1

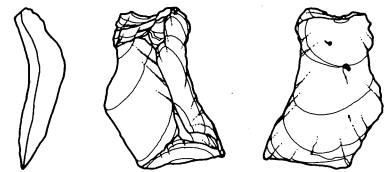

2

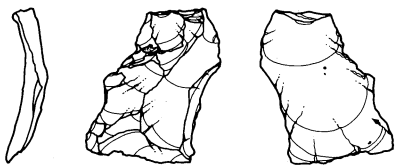

3

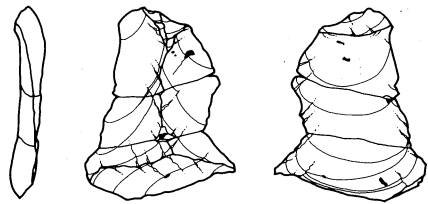

4

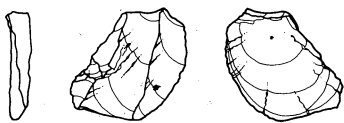

5

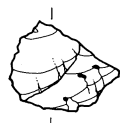

1



6

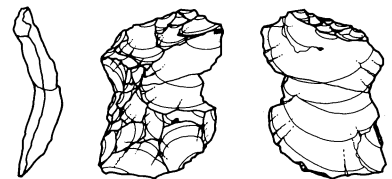

7

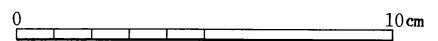

第301图 接合資料No.12実測図

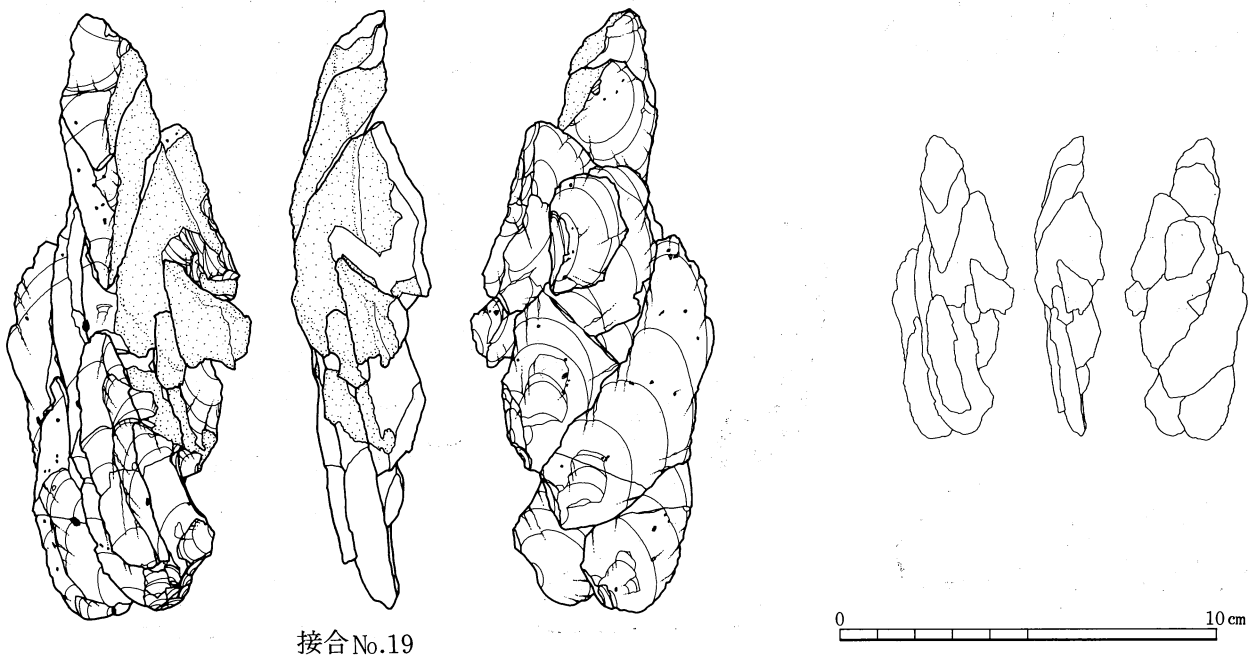
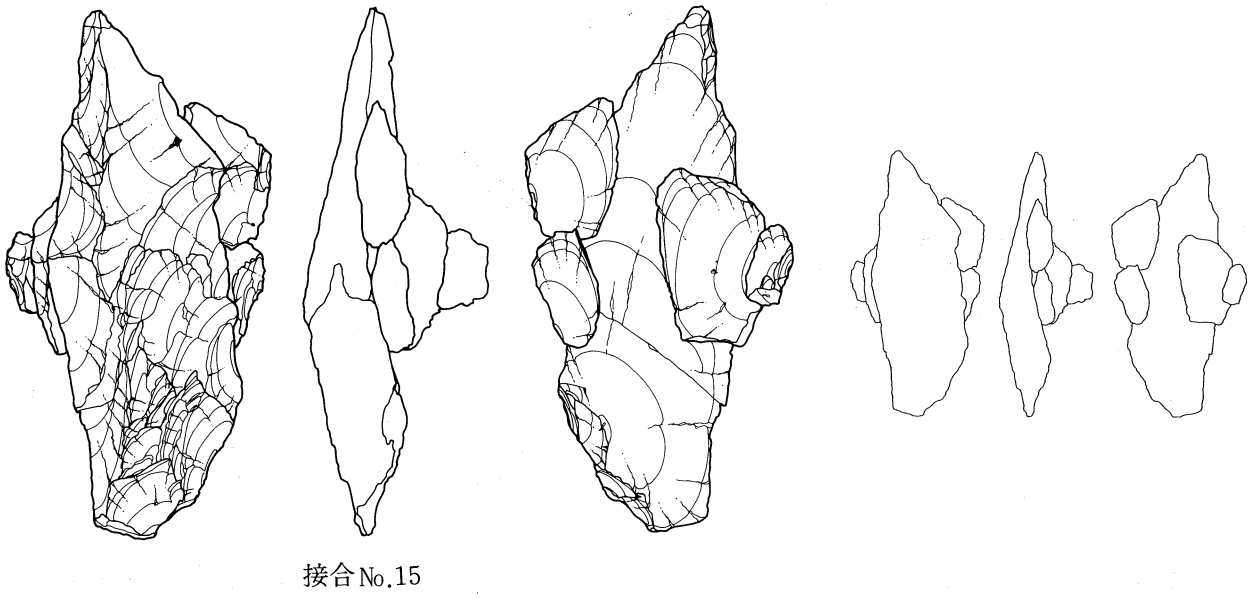
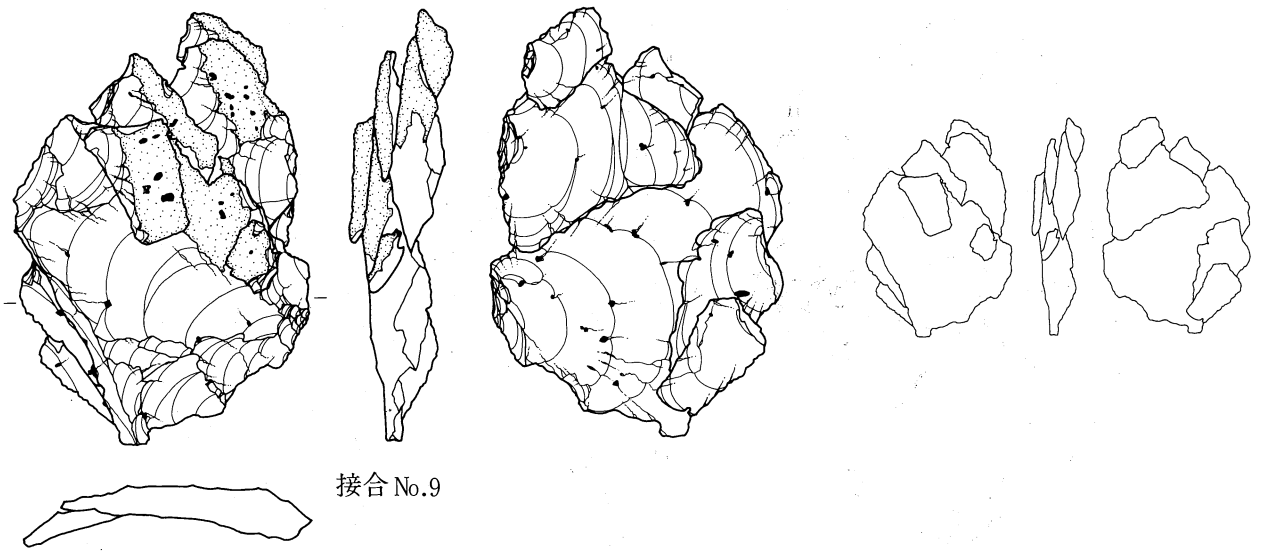

0 10 cm

第302図 接合資料No.9・15・19実測図

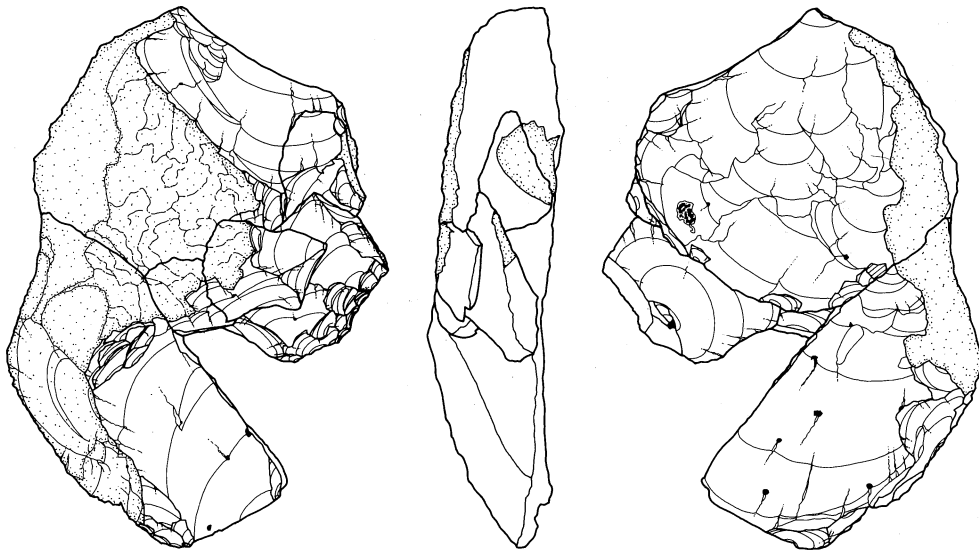

接合 No.11

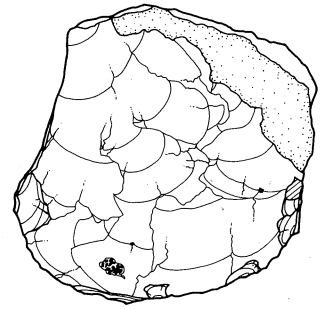
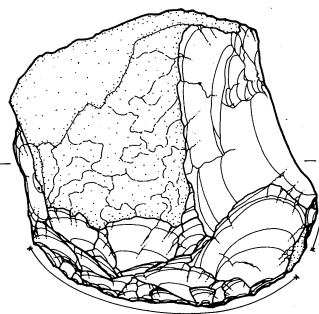
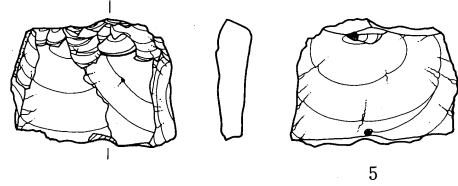
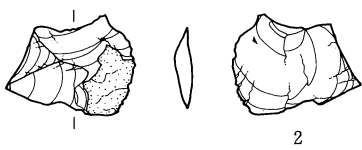
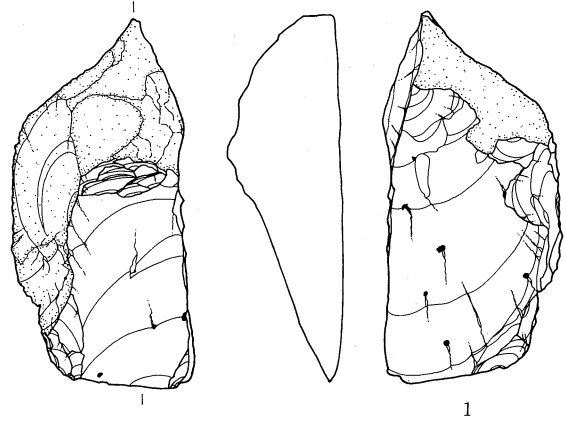
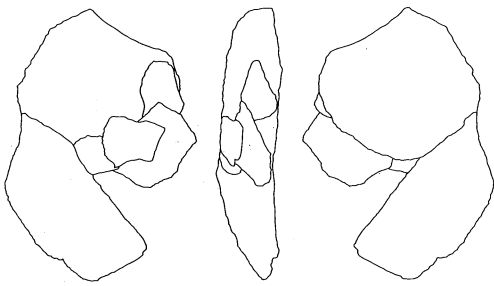

6(141)

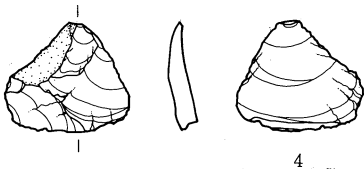

第303図 接合資料No.11実測図

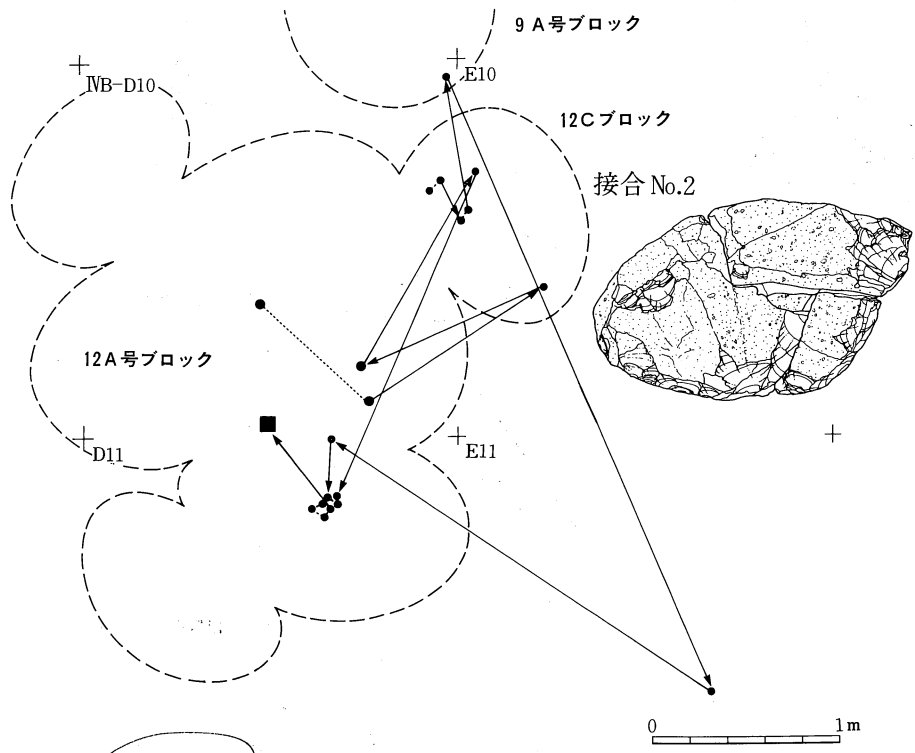
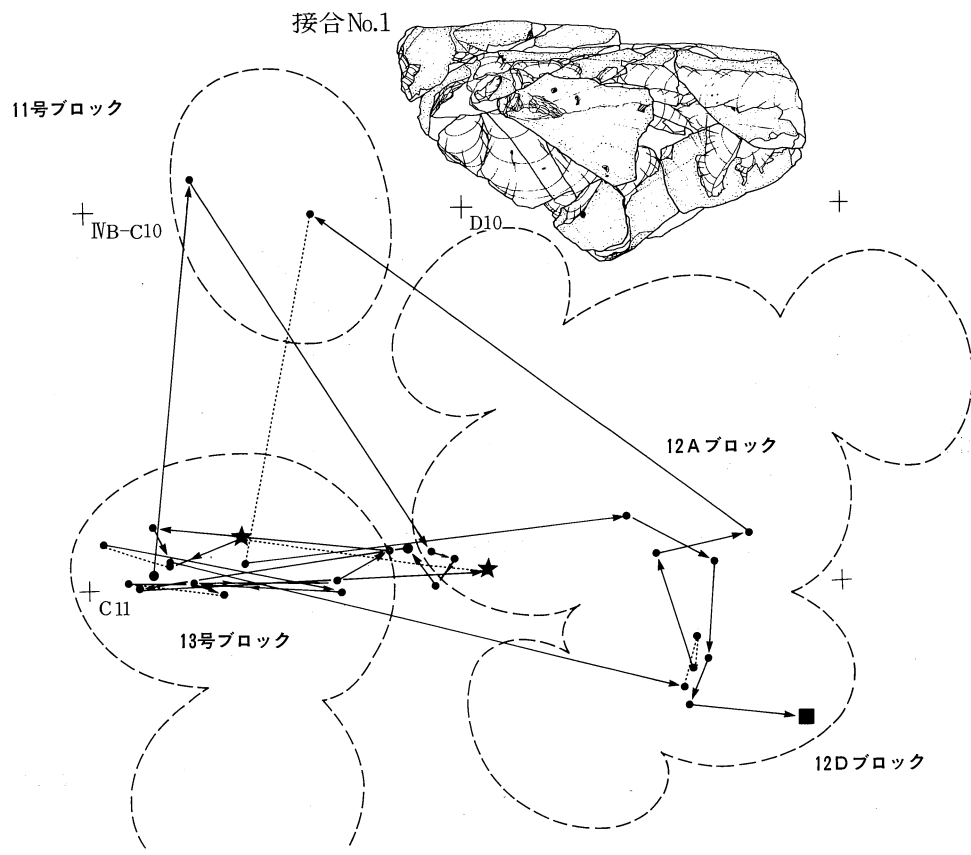

第304図 接合資料No.1・2 分布状況図

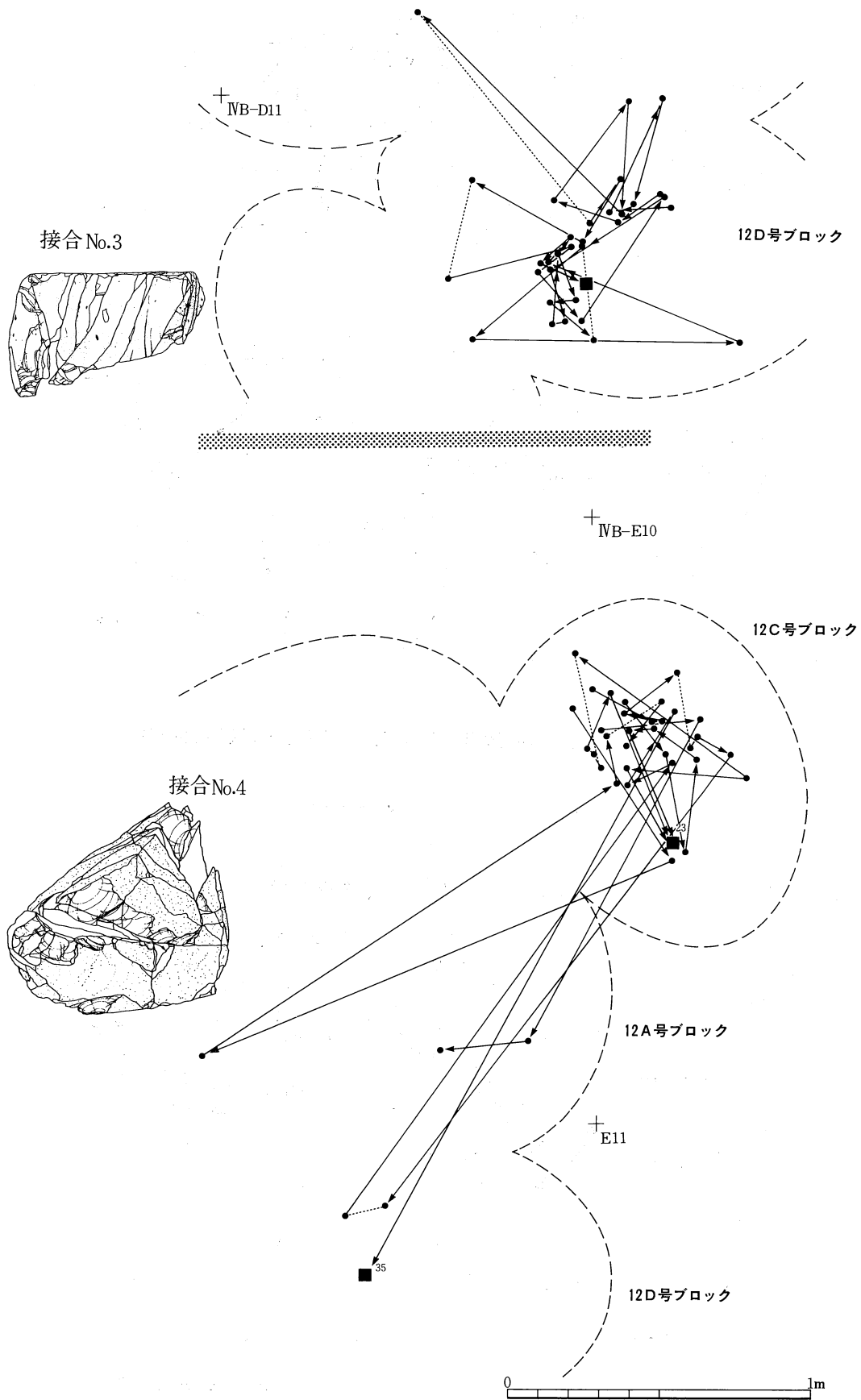

第305図 接合資料No. 3・4 分布状況図

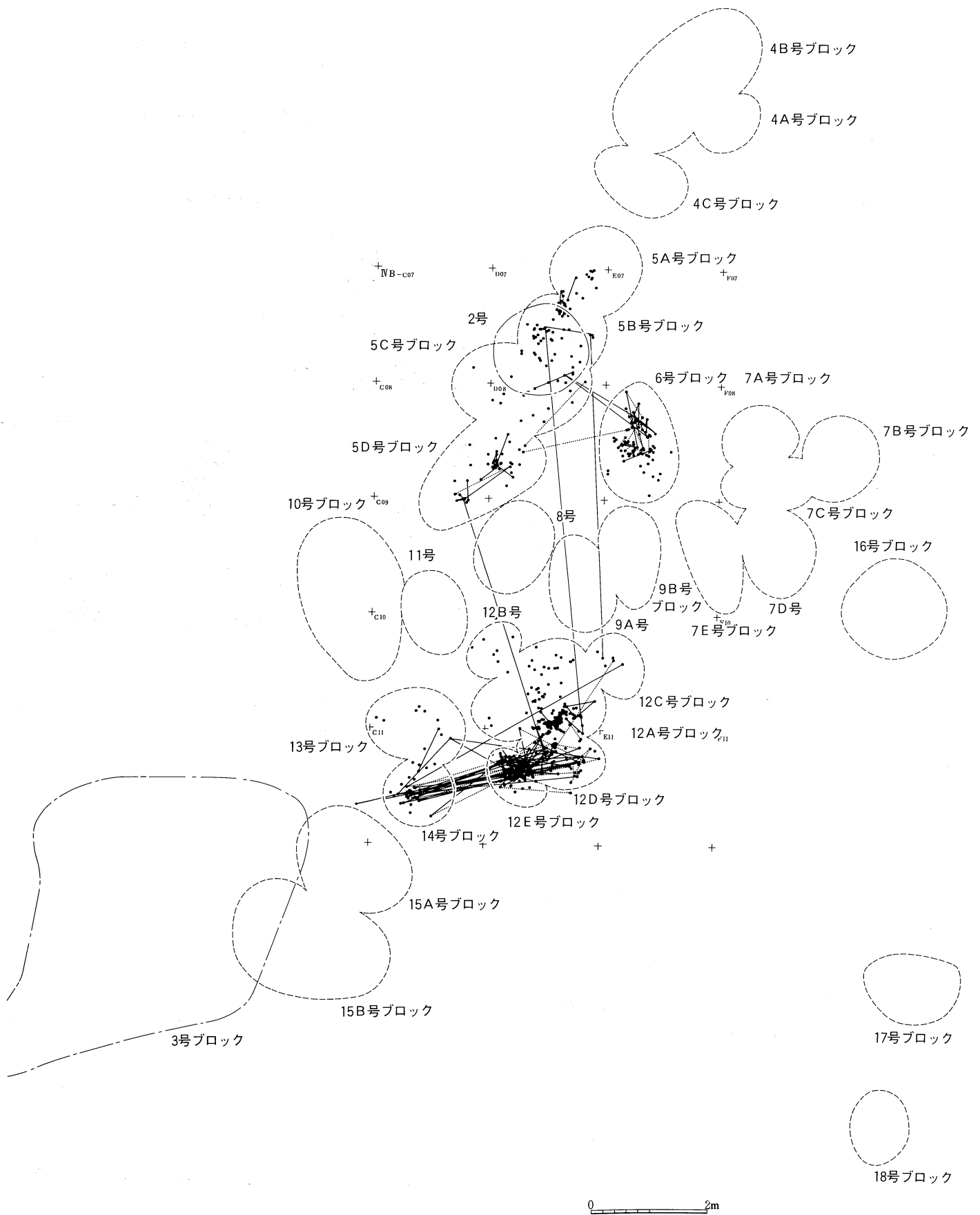

第306図 個体別資料No. 6 分布状況図

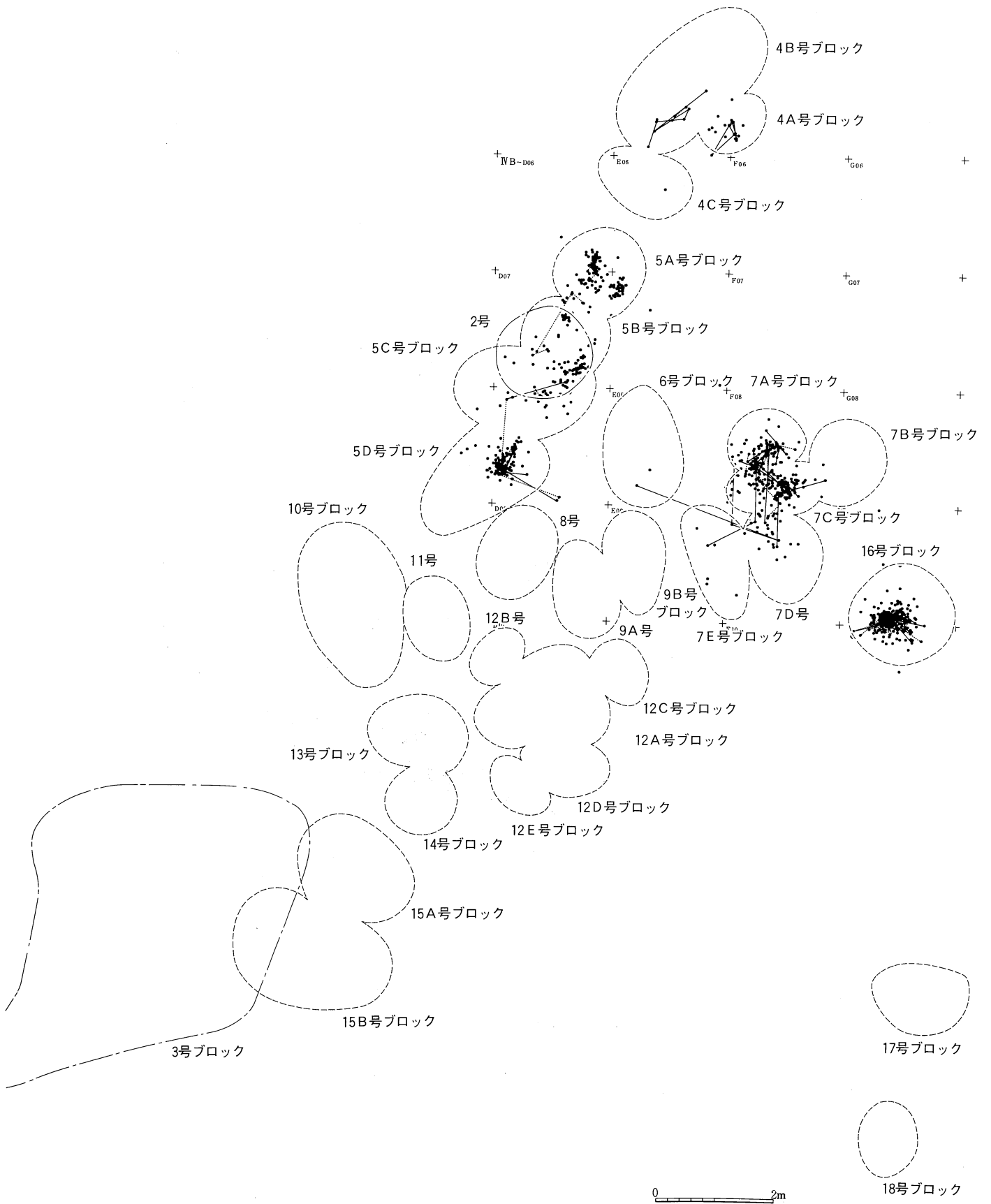

第307図 個体別資料No.11分布状況図

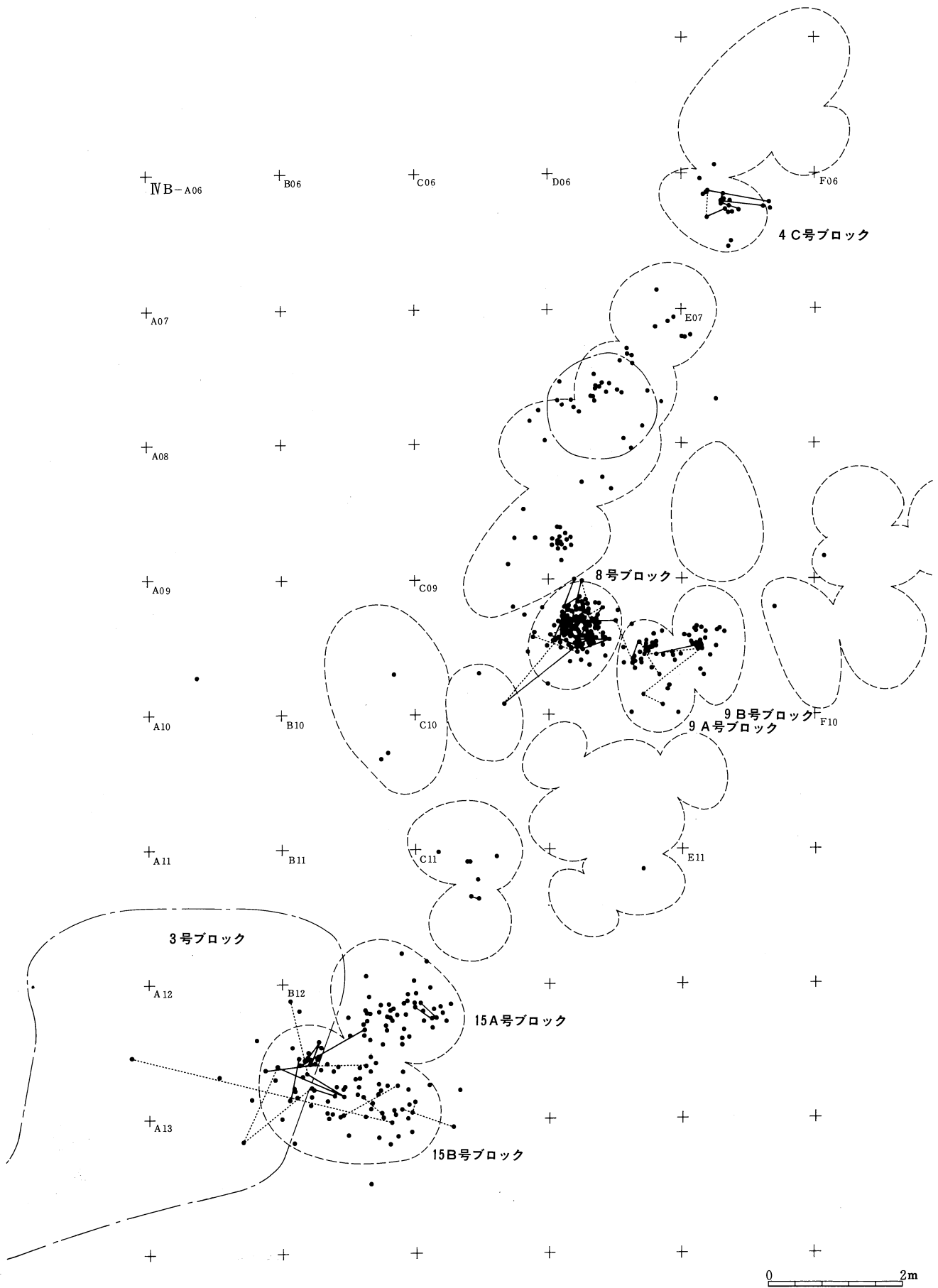

第308図 個体別接合資料No.12分布状況図

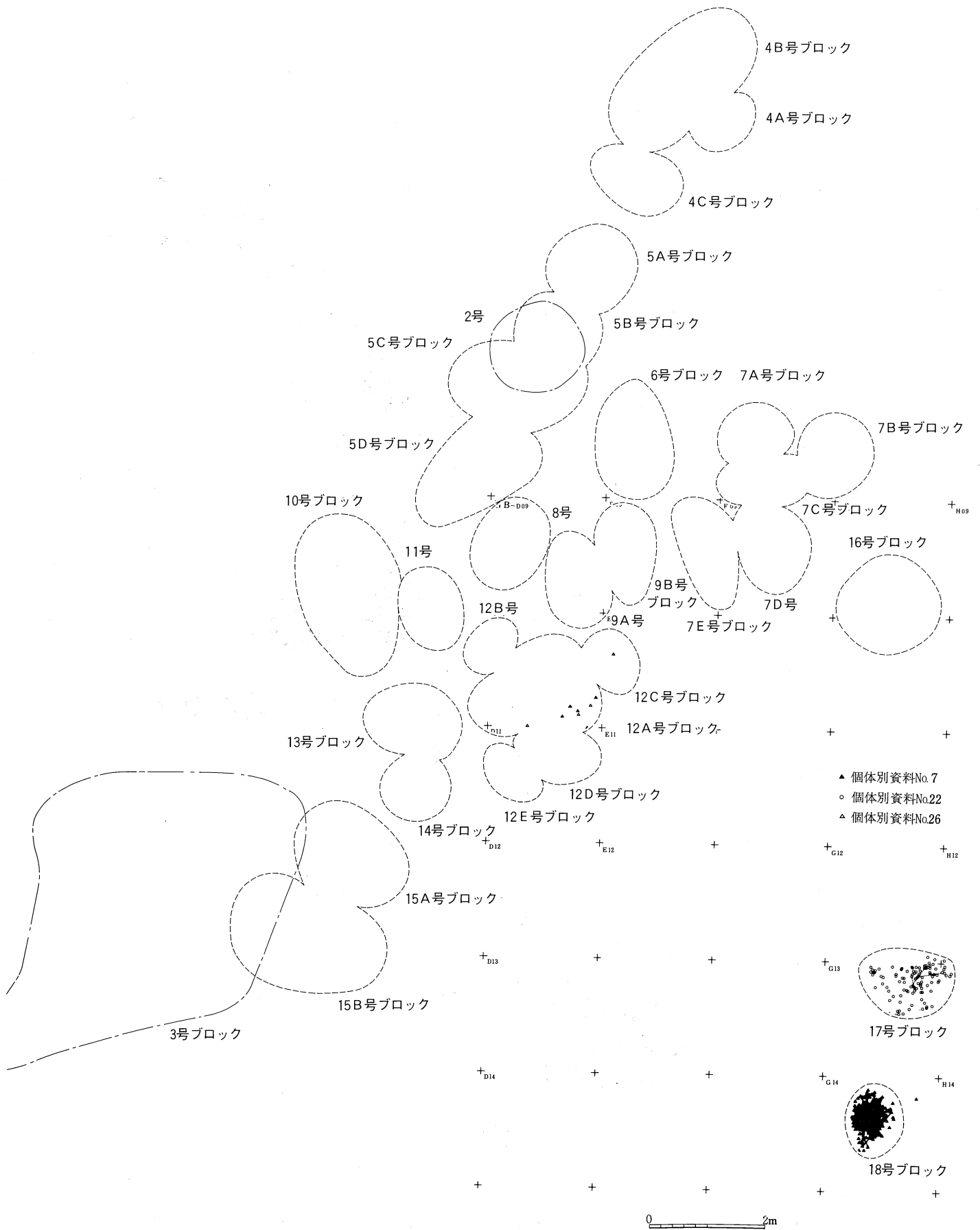

第309図 個別別資料分布状況図

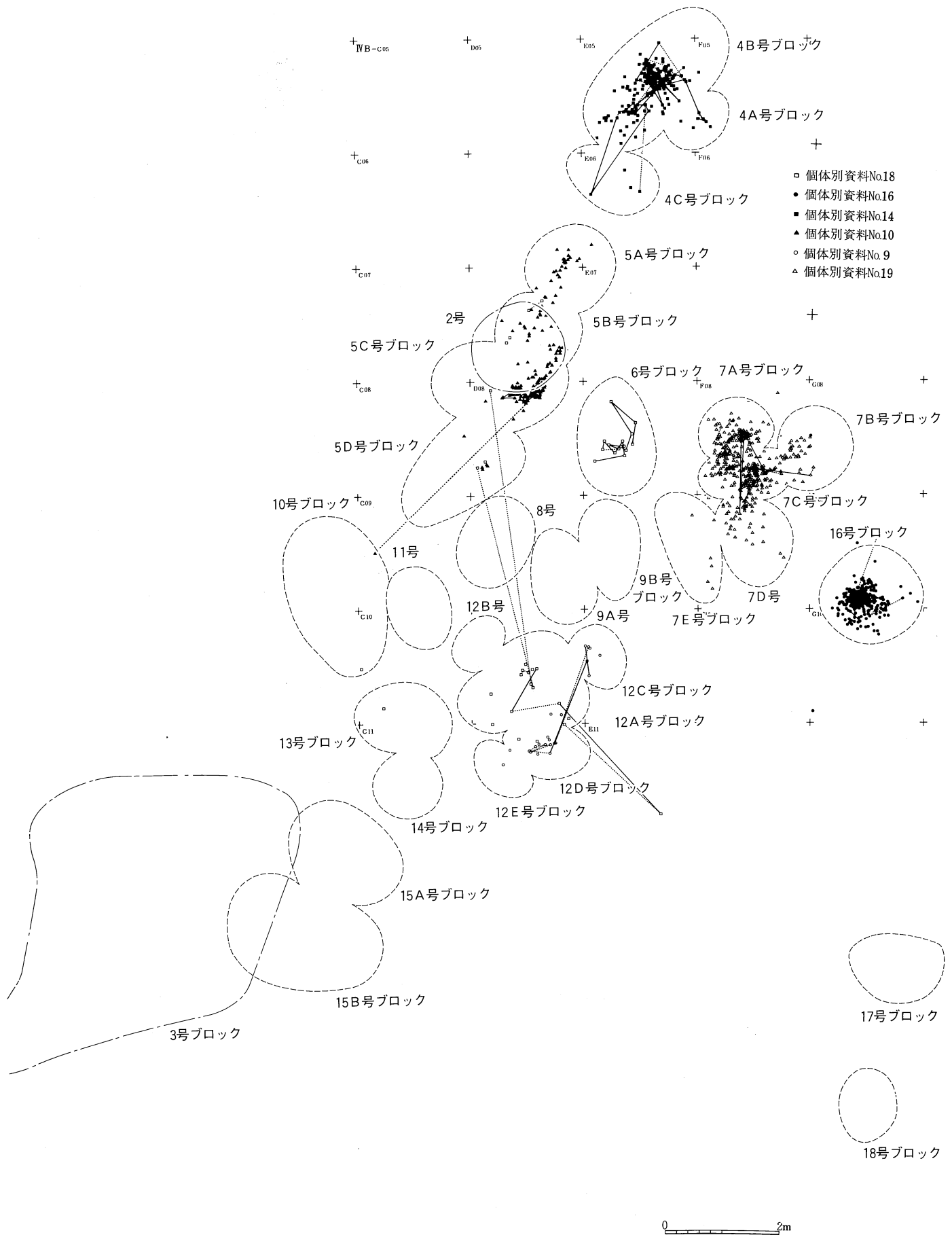

第311図 個別別資料分布状況図

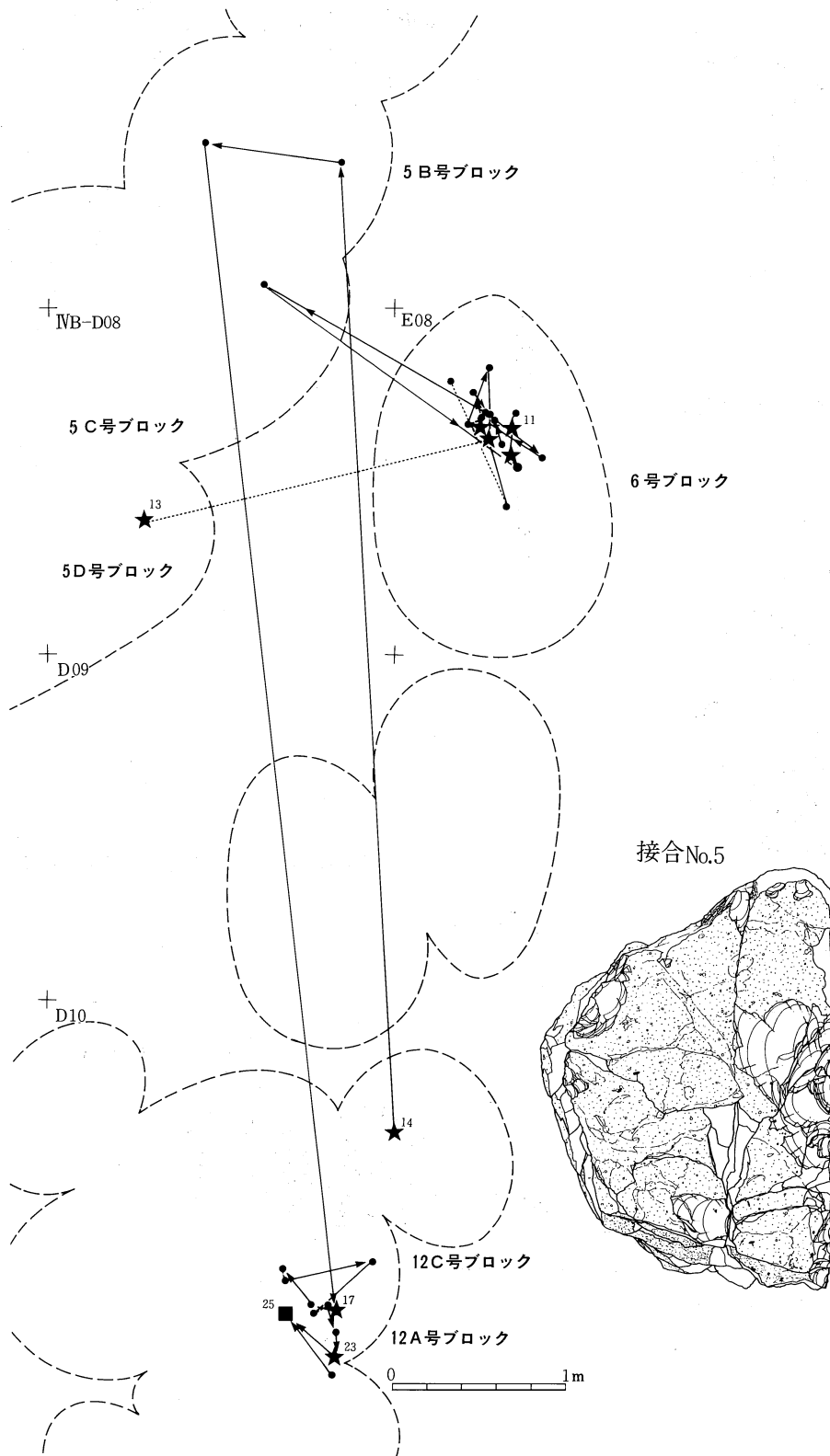

第312図 接合資料No.5 接合状況図

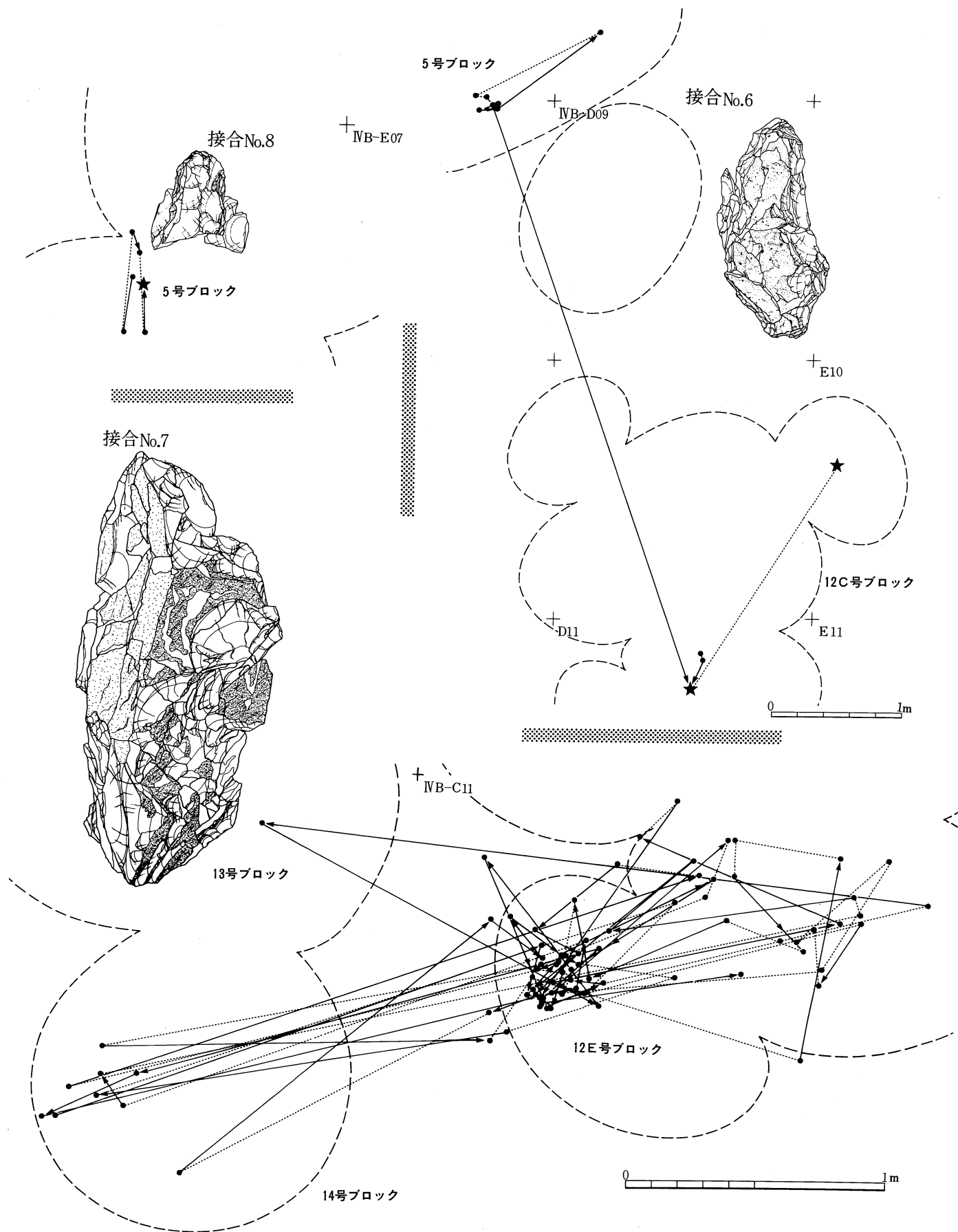

第313図 接合資料No.6～8 接合状況図

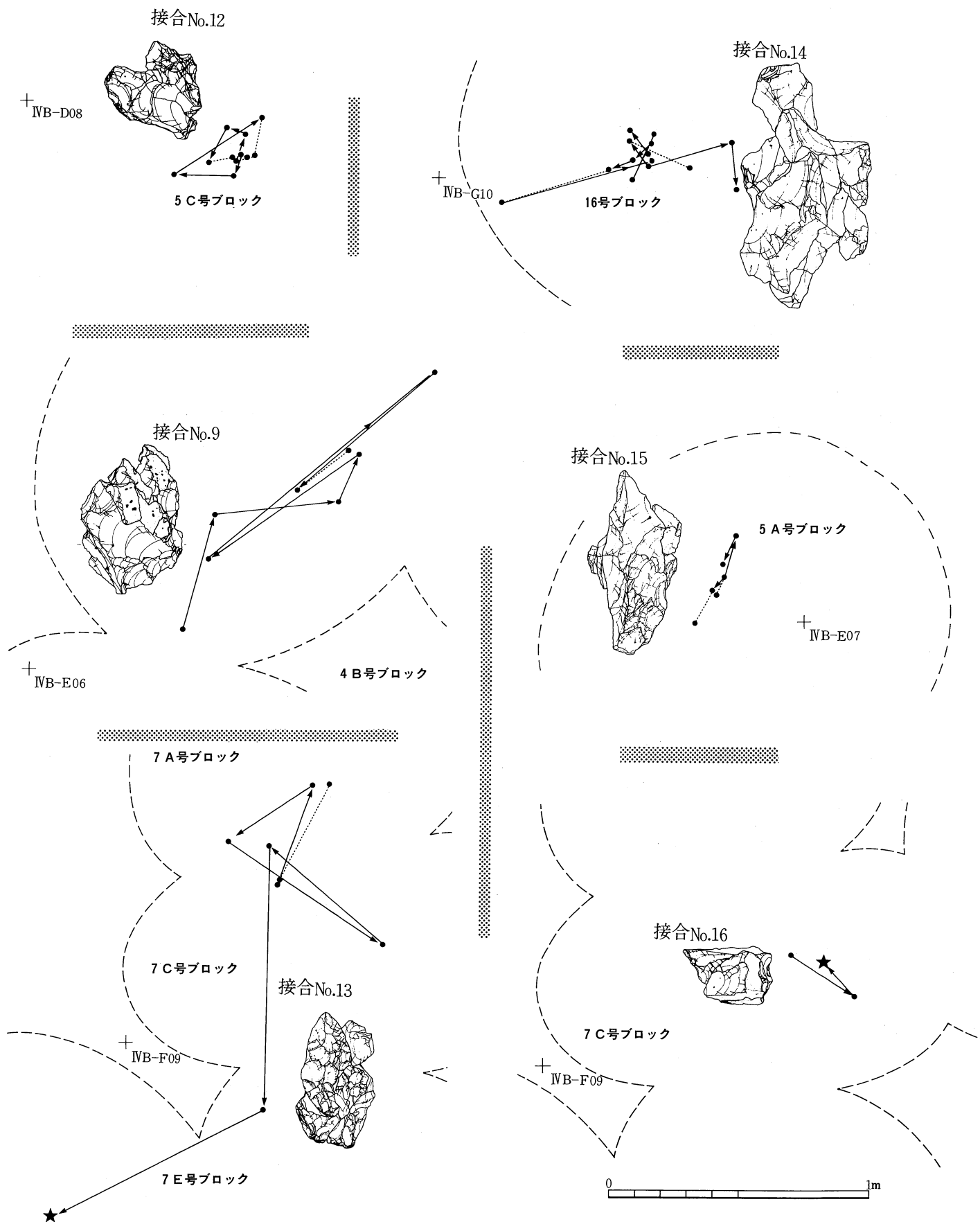

第314図 接合資料No.9・12~16接合状況図

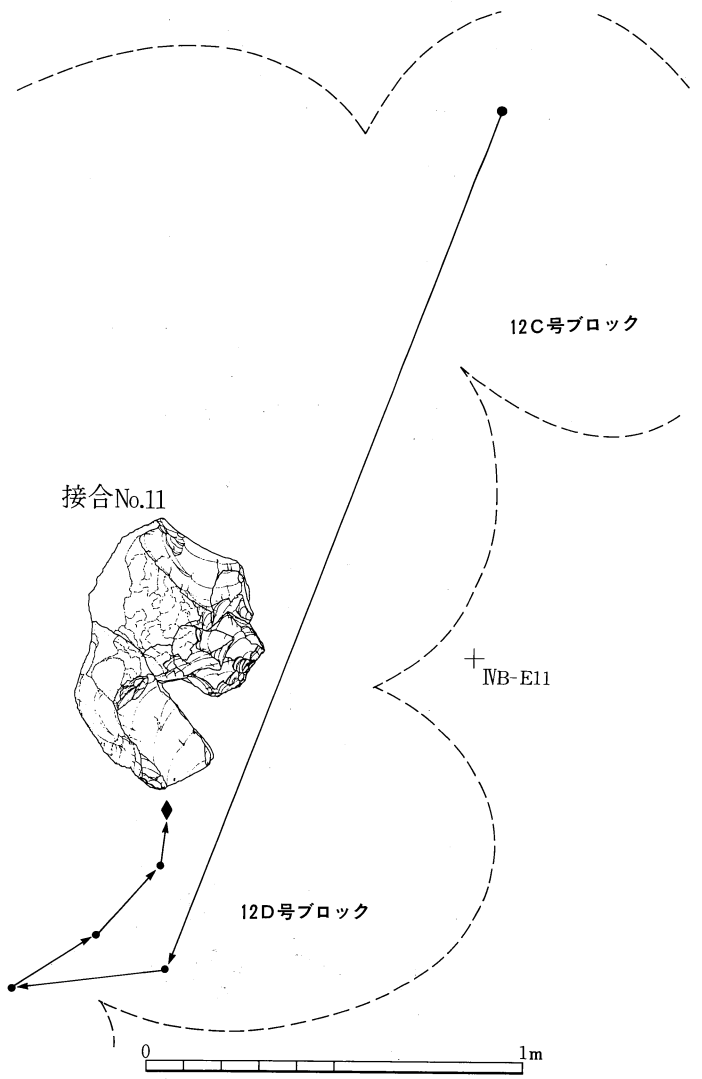
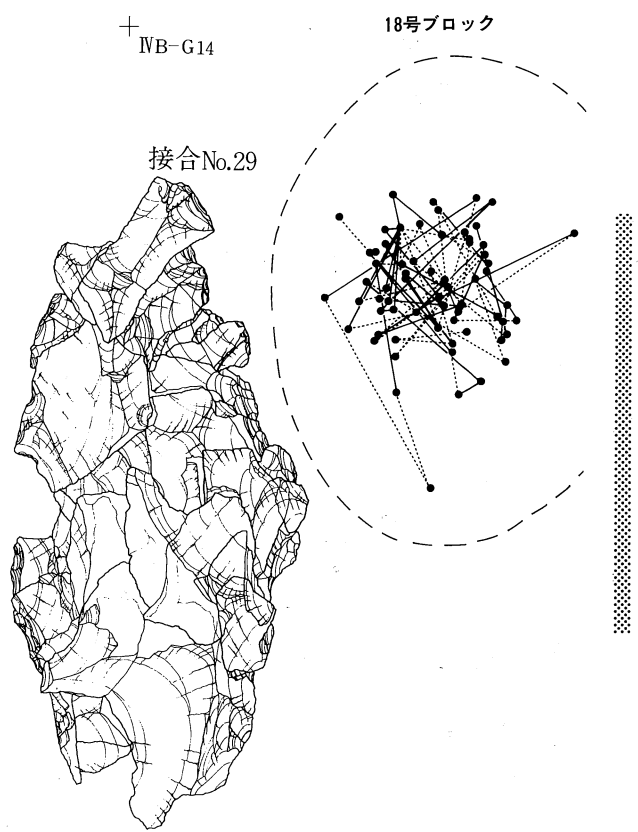
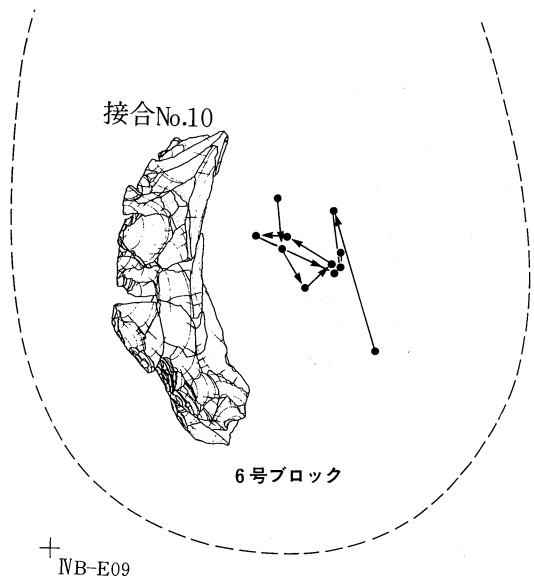
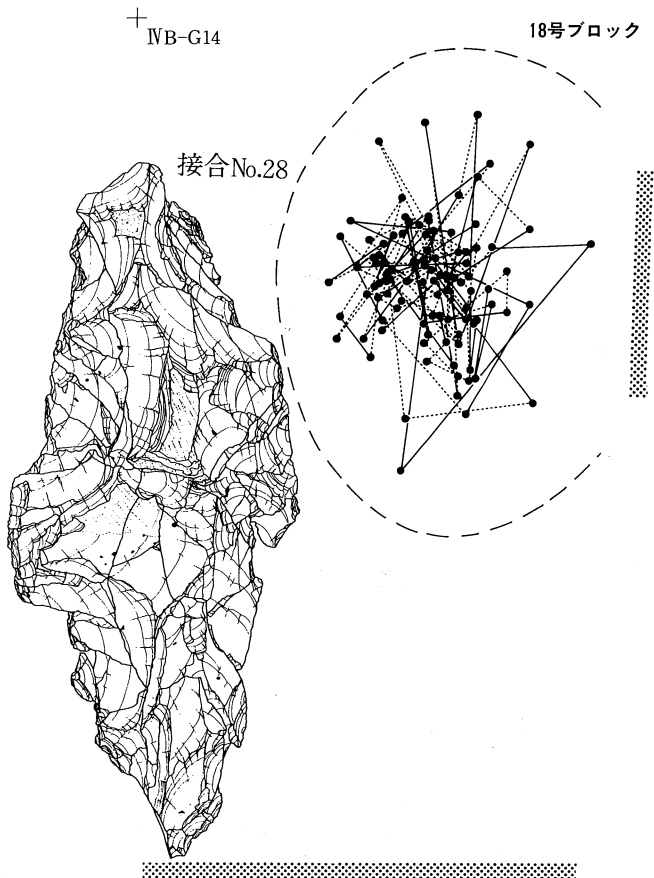

第315図 接合資料No.10・11・28・29接合状況図

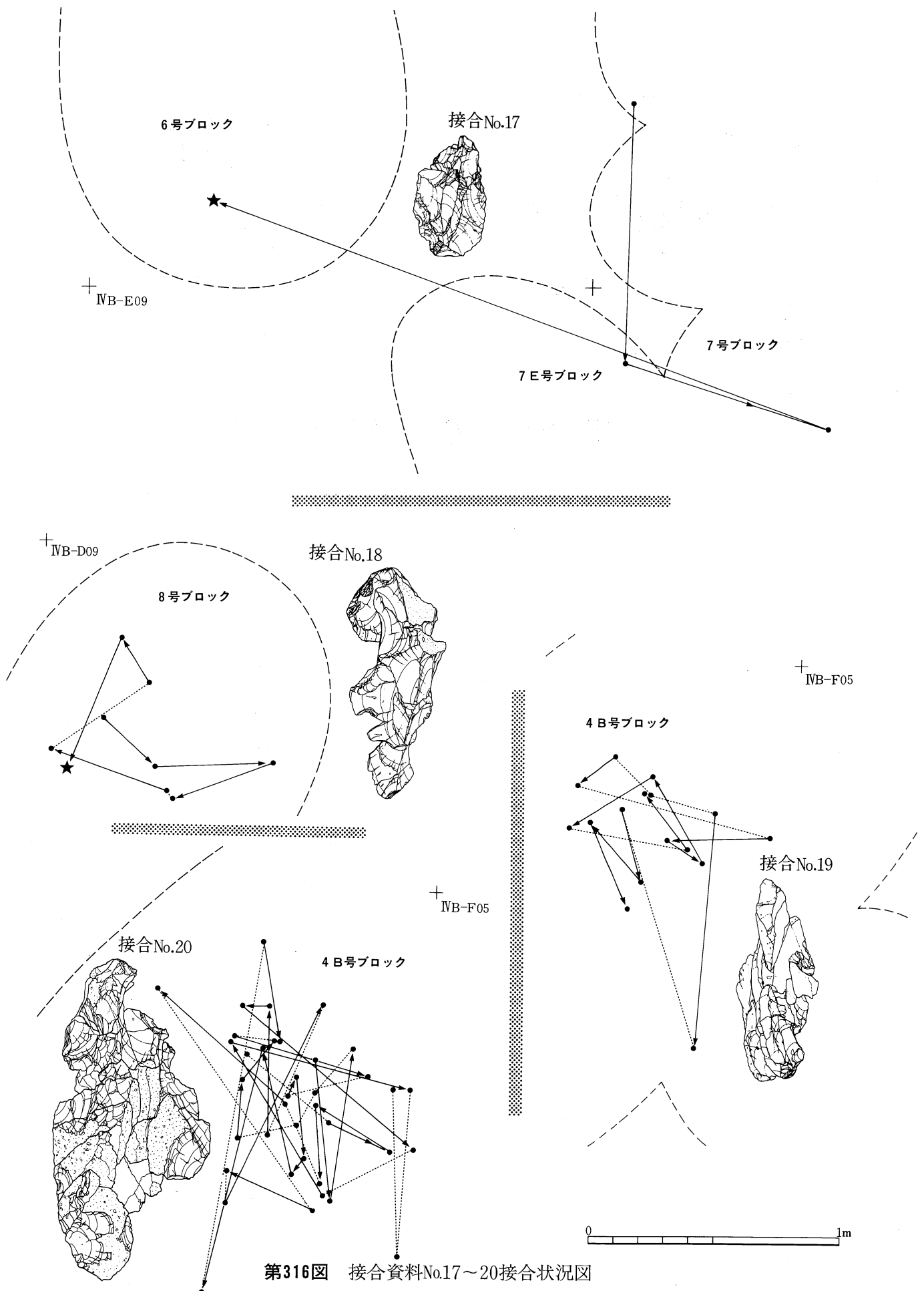

第316図 接合資料No.17~20接合状況図

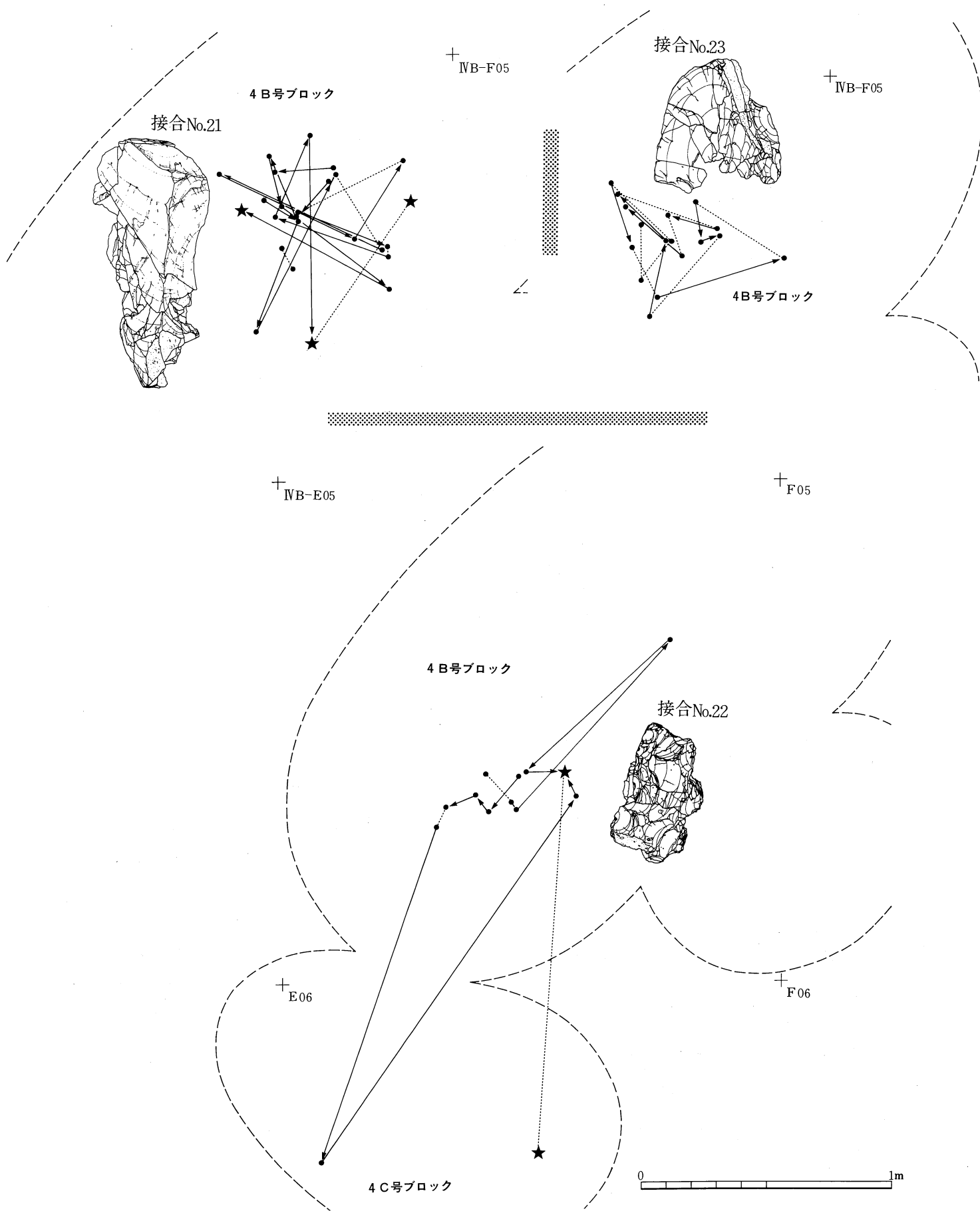

第317図 接合資料No.21~23接合状況図

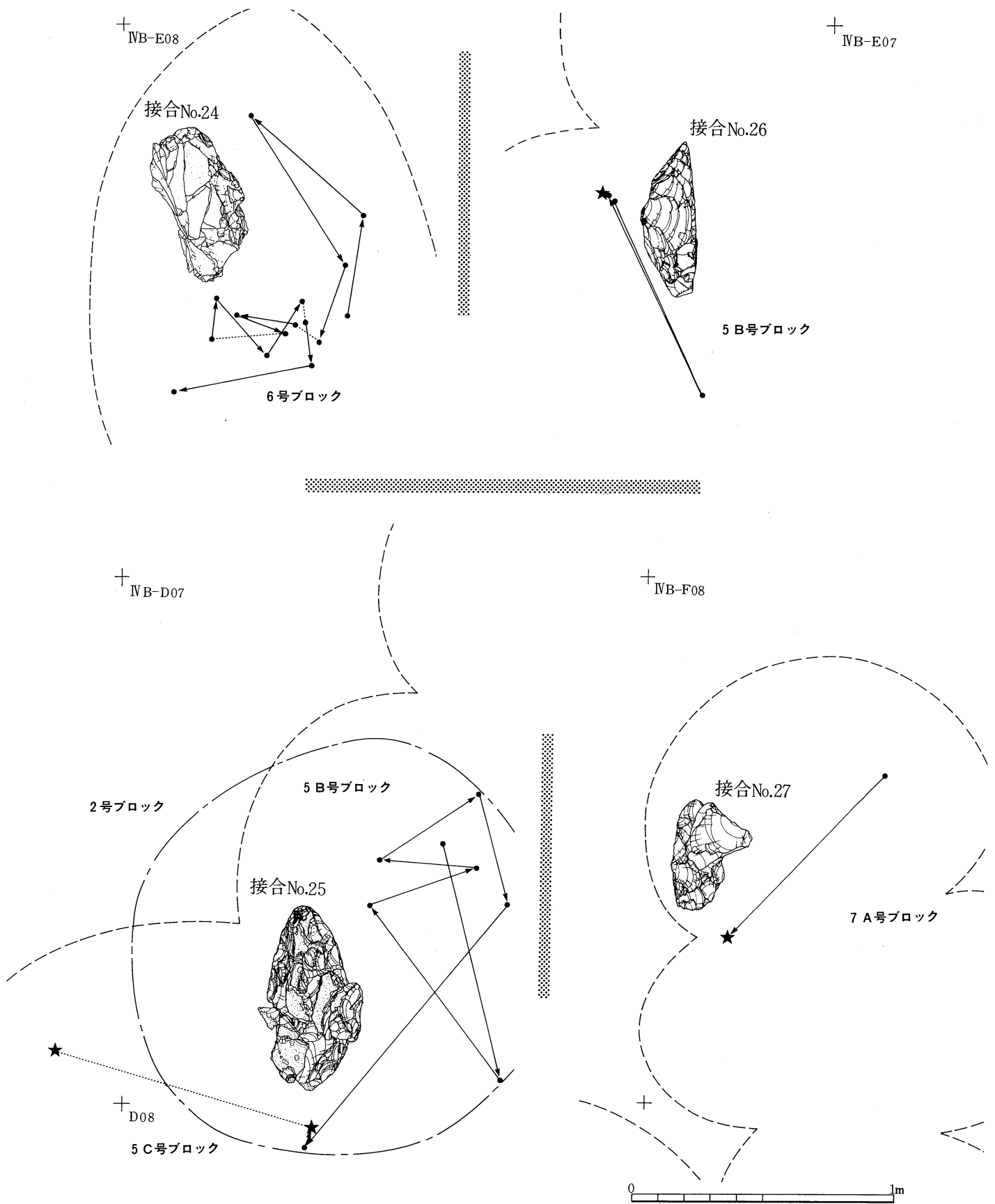

第318図 接合資料No.24~27接合状況図

縄文時代早期～晩期



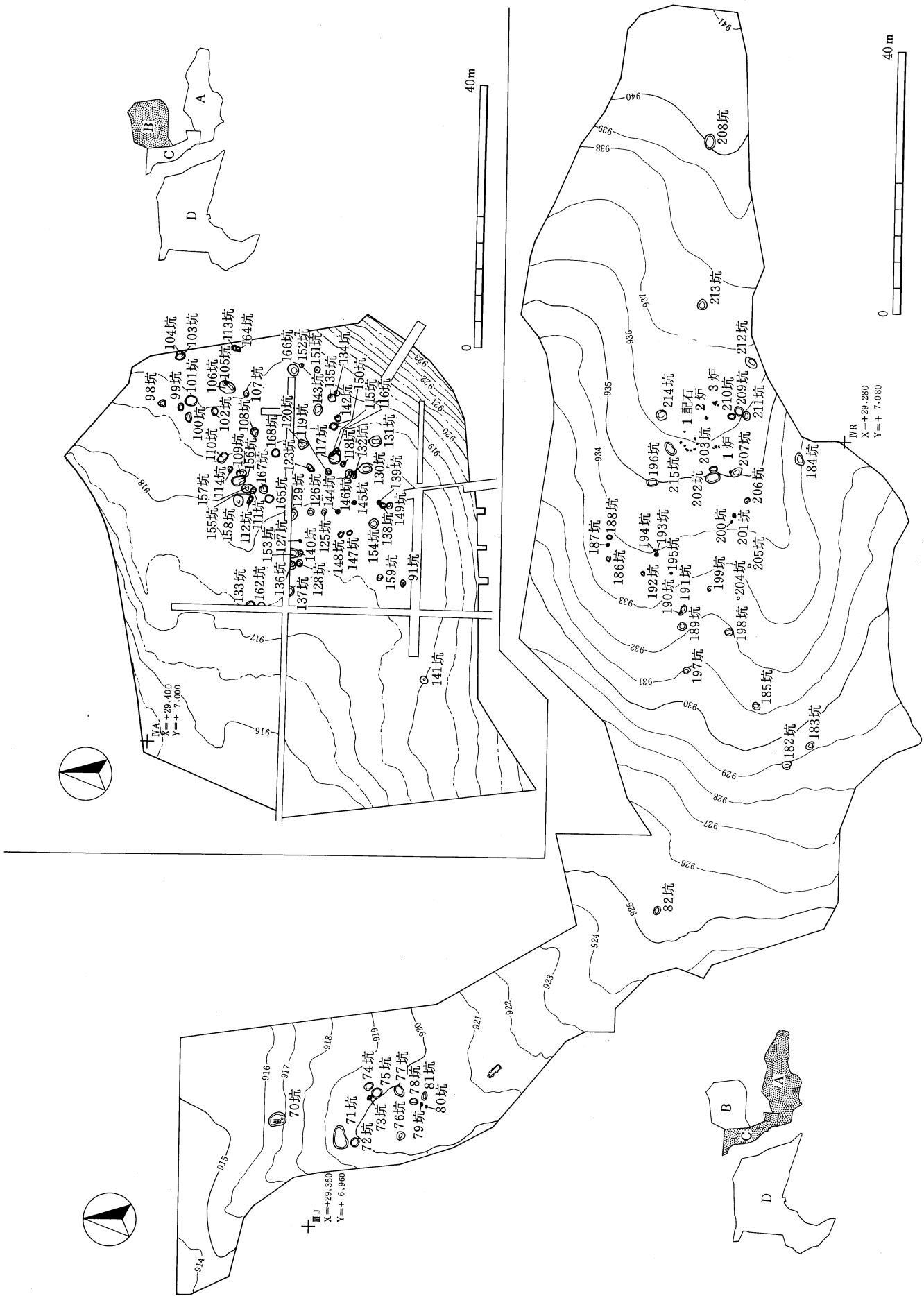

第319图 A·B·C地区遺構配置图

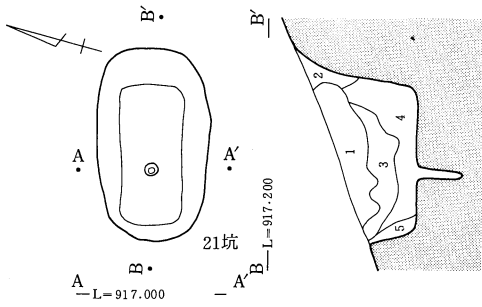

21坑
A-L=917.000
B-L=917.200

- 1: 黒色土 (ShII・パミス少量含。)
- 2: 黒褐色土 (ShII・パミス含。ロームブロック混入。)
- 3: 黒褐色土 (パミス含、しまり良。)
- 4: 黒褐色土 (ShII少量、ローム粒多数。パミス含。しまり良。)
- 5: ローム土 (黒褐色土の混入)

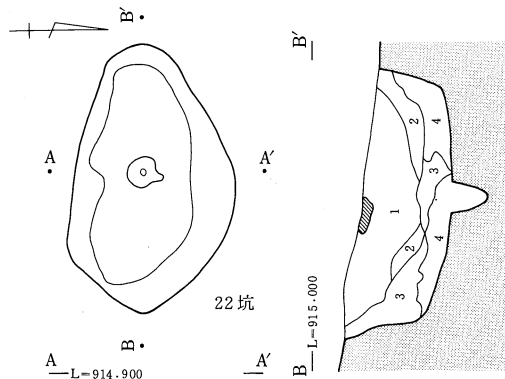
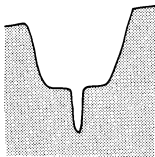

22坑
A-L=914.900
B-L=915.000

- 1: 黒色土 (ShII多量、パミス含)
- 2: 黒色土 (ShII 1層より少)
- 3: 黒褐色土 (ShII・パミス・ローム粒多量に含。しまり硬)
- 4: ローム土 (暗褐色土の混入多)

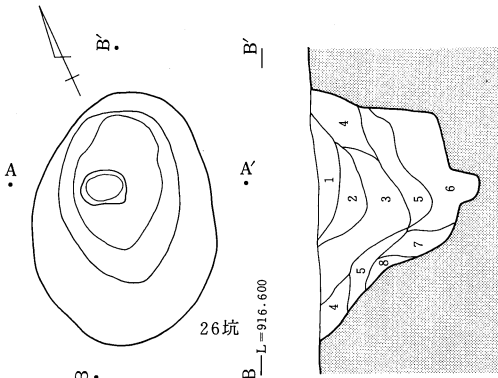
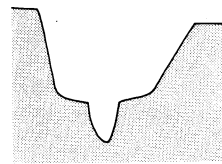

26坑
A-L=916.600
B-L=916.600

- 1: 黒色土 (ShII・パミス含)
- 2: 黒褐色土 (ShII・パミス少量含)
- 3: 黒褐色土 (ローム粒多量、パミス含)
- 4: 暗褐色土 (ローム混入。パミス含)
- 5: 暗褐色土 (ローム粒4より多く含む)
- 6: ローム土・暗褐色土混
- 7: 黒褐色土・暗褐色土混 (パミス含)
- 8: ローム土・暗褐色土混

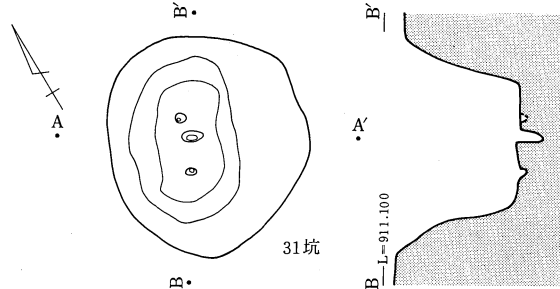
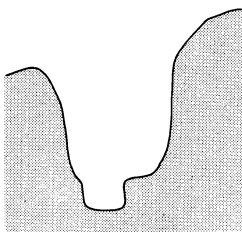

31坑
A-L=911.400
B-L=911.100

- 1: 黒色土 (ShII含)
- 2: 黒褐色土 (ShII・パミス少量含)
- 3: 暗褐色土 (ロームブロック混入)
- 4: 暗褐色土 (パミス多量含。ロームブロック混入。しまり弱)
- 5: 黒褐色土 (ShII・パミス少量含)

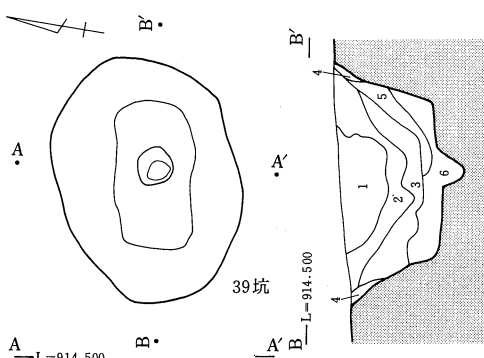
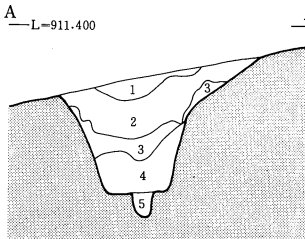

39坑
A-L=914.500
B-L=914.500

- 1: 黒褐色土 (ローム・パミス含。黒褐色土ブロック多量混入)
- 2: 黒褐色土 (ShII少量、パミス含。ロームブロック混入)
- 3: 黒褐色土 (ShII少量含。粘性強)
- 4: 暗褐色土 (パミス含。ローム土混入)
- 5: 黒褐色土 (ローム土・粘土含)
- 6: 暗褐色土 (ローム土混入。粘性あり)

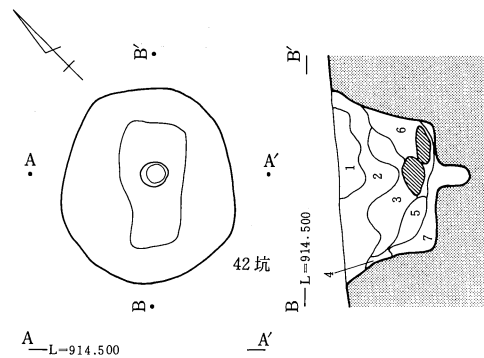
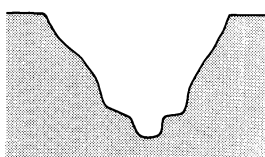

42坑
A-L=914.500
B-L=914.500

- 1: 黒色土 (ShII、パミス少量含)
- 2: 黒褐色土 (ShII・少礫少量含)
- 3: 黒褐色土 (ShII少量含)
- 4: 褐色土 (ローム土含。粘性)
- 5: 黒褐色土 (径7~10mm礫含)
- 6: 暗褐色土 (ShII、パミス少量含)
- 7: 黒褐色土 (粘性強いローム土混入)

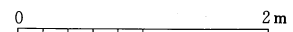
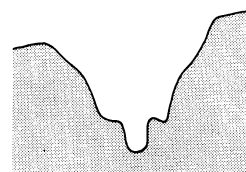

第321図 土坑(1)

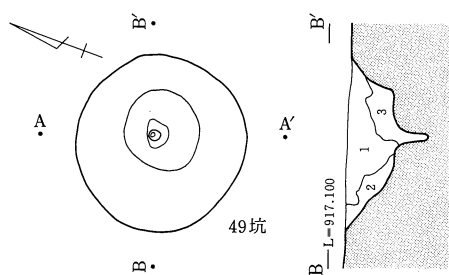

- 1: 黒色土 (ShII・パミス少量含。黒褐色・黄褐色土ブロック混入)
- 2: 黄褐色土 (1・ローム混入)
- 3: 暗褐色土 (ShII少量、パミス含)

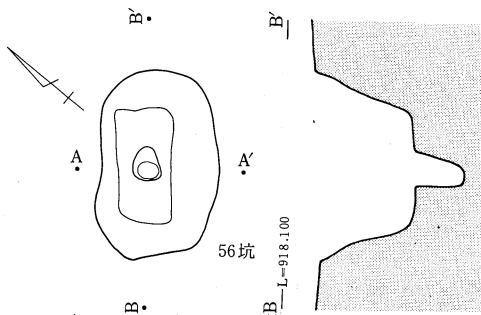

- 1: 暗褐色土 (少礫多量、パミス、ShII少量含)
- 2: 暗褐色土 (炭化物少量混入)
- 3: 黒褐色土 (ShII少量、パミス含。ローム粒・炭化物混入)
- 4: ローム土・暗褐色土混 (パミス含む。炭化物少量混入。しまり弱)
- 5: ローム土 (しまり弱)
- 6: 暗褐色土 (ローム粒多量、パミス含。ローム・炭化物混入)
- 7: 黄褐色土 (ローム粒多量含)
- 8: 暗褐色土 (6層類似。粘性強)

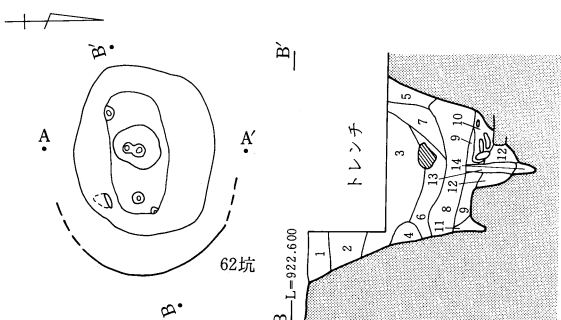

- 黒褐色土 (パミス多量含)
- 暗褐色土 (黒褐色土混入。しまり堅)
- 暗褐色土 (パミス多量含。しまり堅)
- 黒褐色土 (ローム粒多量含)
- ローム土 (黒褐色土混入)
- 黒褐色土 (ShII・パミス少量含)
- 黒褐色土 (ローム粒、パミス少量含)
- 黒褐色土 (ローム多量混入、パミス少量含)
- 黒色土 (腐植化顕著)
- ローム土 (ブロック状。黒褐色土含)
- 黒褐色土 (ローム粒多量含)
- 黒褐色土 (ローム多量に混入)
- 黒褐色土 (ローム・黒色土少量混入)
- 明褐色土 (黒褐色土混入)

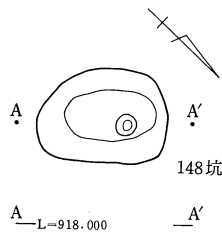
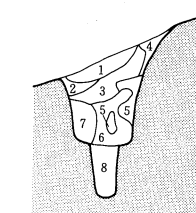

- 1: 黒褐色土 (ShII・パミス少量含)
- 2: 黒褐色土 (1層より混入物少ない)
- 3: 黒褐色土 (ShII・パミス少量含)
- 4: 黒褐色土 (2層と類似)
- 5: 黒褐色土 (ロームブロック混入)
- 6: 黒褐色土 (5層類似。小礫わずかに含)

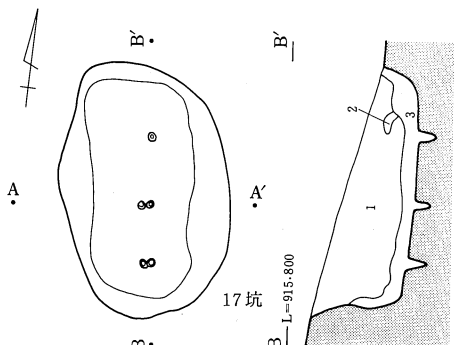

- 1: 黒色土 (ShII多量含)
- 2: 黒褐色土ブロック (ShII少量含)
- 3: 黒褐色土 (ロームブロック混入)

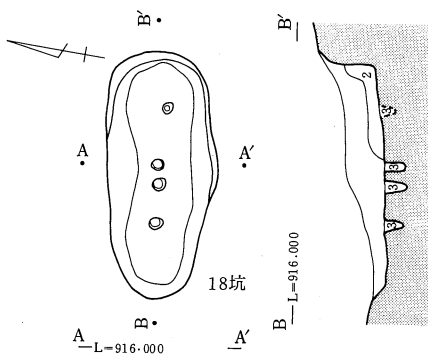

- 1: 黒色土 (ShII多量、パミス含)
- 2: 黒色土 (腐植化進捗)
- 3: 黒褐色土 (パミス含。粘質)

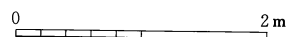

第322図 土坑(2)

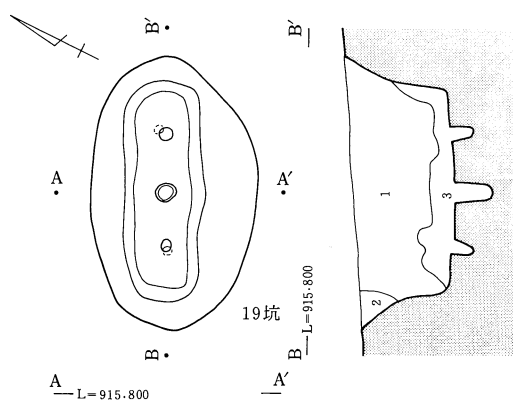

- 1 : 黒色土 (ShII 多量含)
- 2 : 黒褐色土 (ShII 少量含)
- 3 : 黒褐色土 (ローム粒多量含)

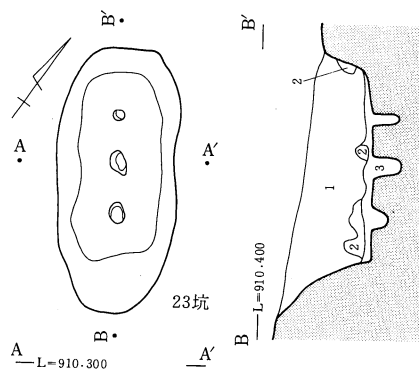

- 1 : 黒色土 (ShII 多量、パミス含。ロームブロック混入)
- 2 : 黒褐色土 (ローム混入。粘質)
- 3 : 黒色土 (ShII・パミス少量含。粘質)

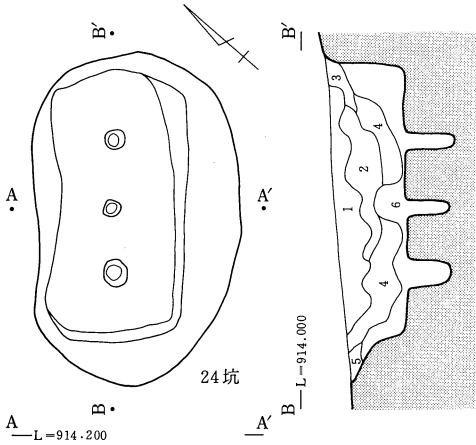

- 1 : 黒色土 (ShII 多量含)
- 2 : 黒色土 (ShII 含)
- 3 : 黒色土 (ShII 含。ロームブロック混入)
- 4 : 黒色土 (ShII 多量、パミス径 2cm 少量含。粘質)
- 5 : 黒褐色土 (ロームブロック含)
- 6 : 黒褐色土 (ロームブロック多量混入。ShII 含)

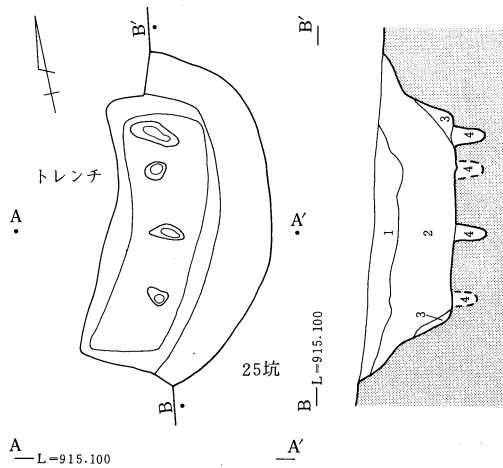

- SK25
- 1 : 黒褐色土 (ShII 多量含)
- 2 : 黒褐色土 (ShII 1 より多量含)
- 3 : 暗褐色土 (ShII 少量、ローム粒・パミス含。しまり弱)
- 4 : 黒褐色土 (パミス・ローム粒含)

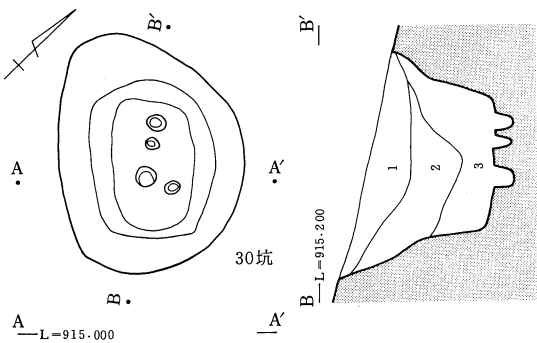

- 1 : 黒色土 (ShII 少量含)
- 2 : 黒褐色土 (粘土質ブロック板状混入)
- 3 : 黒褐色土 (ローム粒多量含)

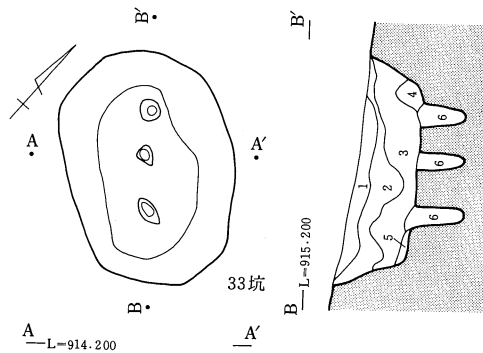

- 1 : 黒色土 (ShII 少量含)
- 2 : 黒褐色土 (ShII 多量含)
- 3 : 黒褐色土 (ShII 多量含。粘性あり)
- 4 : 暗褐色土 (ShII 多量含)
- 5 : 暗褐色土・ローム土混 (パミス含)
- 6 : 黒褐色土 (パミス・ローム粒少量含)

0 2m

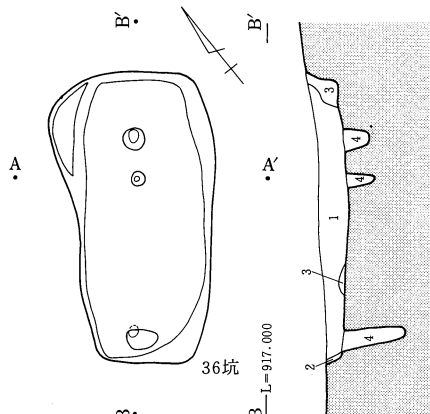

A-L=916.800

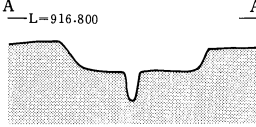

- 1: 黒色土 (ShII 多量、パミス少量含)
- 2: 暗褐色土 (ローム土混入。粘性強)
- 3: 黒褐色土 (ShII 多量、パミス・ローム粒少量含)
- 4: 黒褐色土 (粘性強)

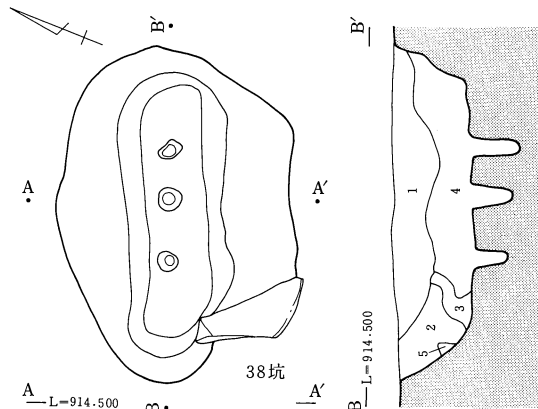

A-L=914.500

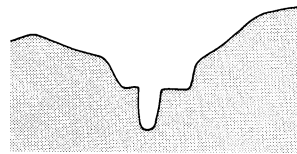

- 1: 黒色土 (ShII 多量、パミス少量含)
- 2: 黒褐色土 (ShII 多量含)
- 3: 黒褐色土 (ShII 多量含)
- 4: 暗褐色土 (ローム粒多量含)
- 5: 暗褐色土 (粘質)

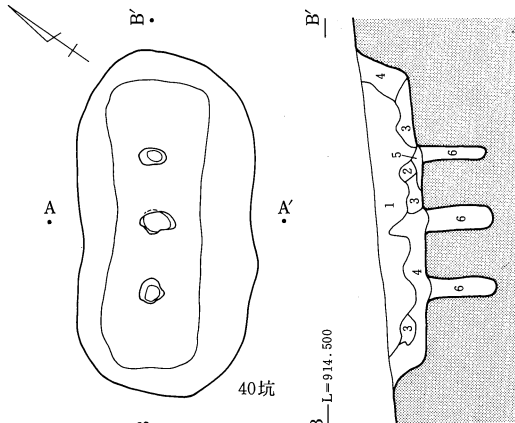

A-L=914.300

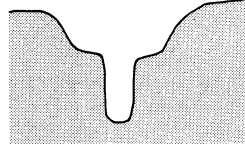

- 1: 黒色土 (ShII 含)
- 2: 暗褐色土 (パミスを含むブロック)
- 3: 黒褐色土 (ローム土混入)
- 4: 黒色土 (ShII 含)
- 5: 黒色土 (ShII 少量含)
- 6: 黒褐色土 (ローム粒少量含。粘性。しまり良.)

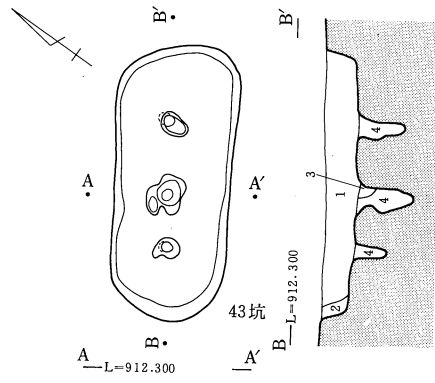

A-L=912.300

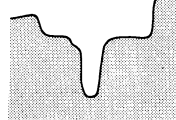

- 1: 黒色土 (ShII 多量、炭化物、小礫含)
- 2: 黒褐色土 (ShII、パミス少量含。ロームブロック状)
- 3: ローム土 (ShII 含。ロームブロック・炭化物、小礫混入)
- 4: 黒色土 (ShII 含。ロームブロック・炭化物・小礫混入)

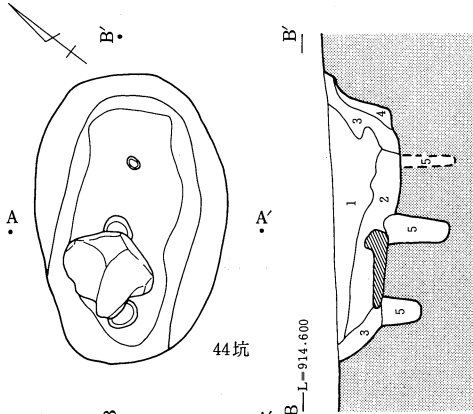

A-L=914.600

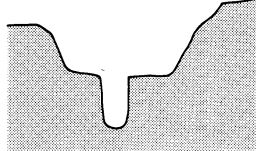

- 1: 黒色土 (ShII 多量、パミス、炭化物、小礫含)
- 2: 黒褐色土 (ShII・小礫・ローム粒多量、パミス、炭化物含)
- 3: 黒褐色土 (ShII 多量含。ローム混入)
- 4: ローム土・黒褐色土 (パミス含)
- 5: 黒褐色土 (ローム粒多量含。粘性)

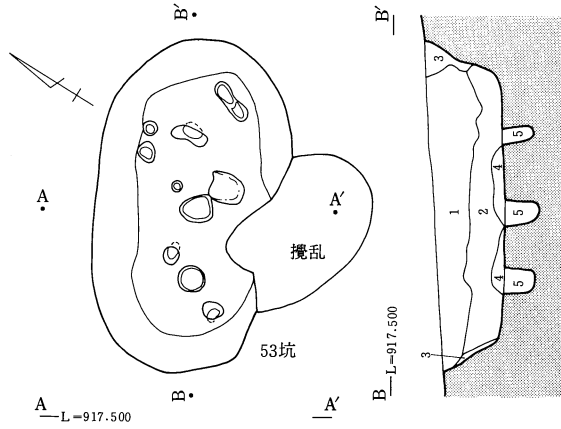

A-L=917.500

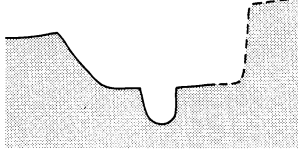

- 1: 黒色土 (ShII 多量に含。しまり良)
- 2: 黒褐色土 (ShII 多量、パミス少量含)
- 3: 黒褐色土 (ShII・パミス・ローム含)
- 4: 黒褐色土 (ShII・ローム粒多量含。ロームブロック混入)
- 5: 黒褐色土 (ShII・パミス、ローム粒多量に含。粘性あり)

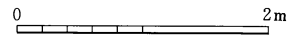

第324図 土坑(4)

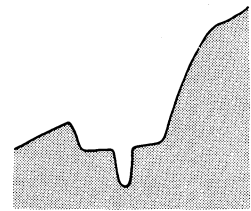
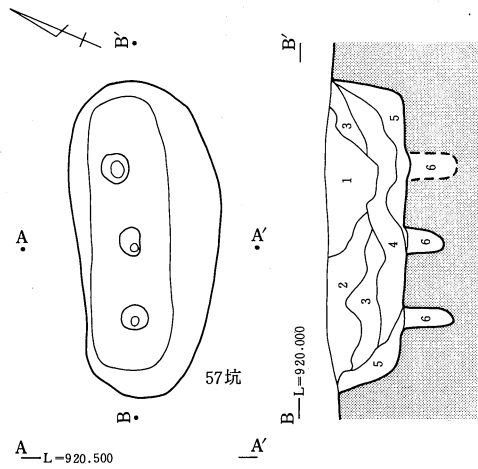

- 1 : 黒褐色土 (ShII 多量に含)
- 2 : 黒色土 (ShII 含)
- 3 : 黒褐色土 (ShII 含)
- 4 : 黒褐色土 (ShII・パミス含)
- 5 : 暗褐色土 (ShII・パミス含)
- 6 : 黒褐色土 (ShII・パミス含。粘性)

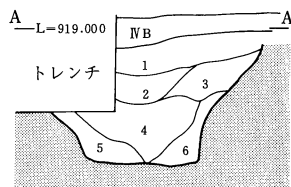
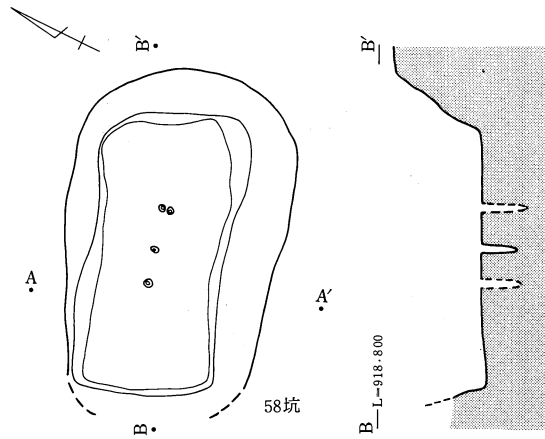

- 1 : 黒褐色土 (VIA層。ShII 含)
- 2 : 黒褐色土 (ShII 多量含)
- 3 : 暗褐色土 (ShII 含)
- 4 : 黒褐色土 (ShII 多量含)
- 5 : 黒褐色土 (ShII・パミス・ローム粒多量含。ロームブロック多量混入)
- 6 : 明褐色土 (ローム土基調。パミス多)

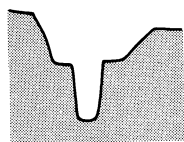
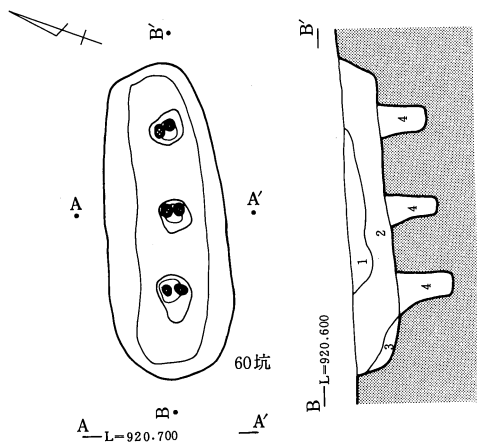

- 1 : 黒褐色土 (VIA層基調。ShII 多量含)
- 2 : 黒褐色土 (褐色土混入)
- 3 : 黒褐色土 (ローム粒多量に含)
- 4 : 黒褐色土・ローム土混 (しまり良)

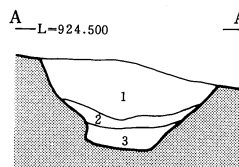
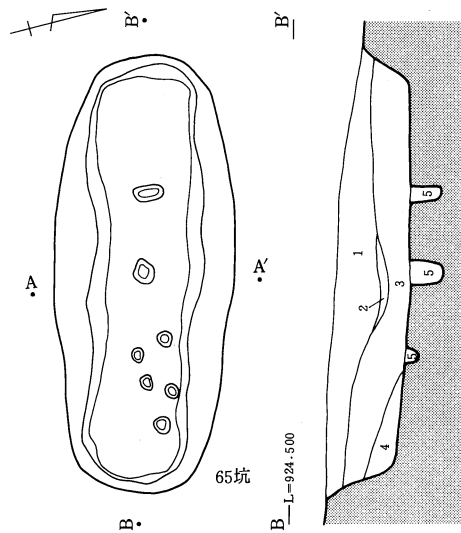

- 1 : 黒褐色土 (ShII 多量含)
- 2 : 黒褐色土 (ShII・ローム粒多量含)
- 3 : 黒褐色土 (ShII 含)
- 4 : 暗褐色土 (パミス多量含。ローム粒・ローム多量に混入)
- 5 : 黒褐色土



第325図 土坑(5)

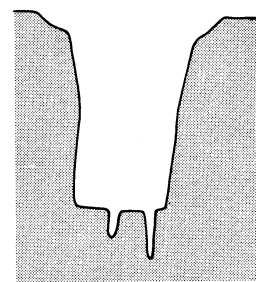
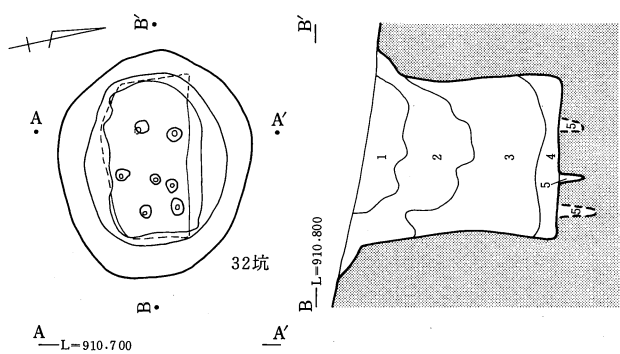

- 1: 黒褐色土 (ShII多量、パミス含。ローム混入)
- 2: 黒色土 (ShII少量含)
- 3: 黒褐色土 (ローム混入多)
- 4: 褐灰色土 (粘性富む。鉄分の溶脱)
- 5: 黒褐色土 (粘性あり)

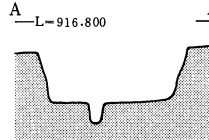
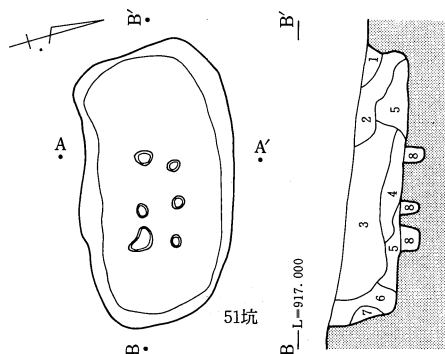

- 1: 黒褐色土 (ShII・パミス、ローム粒多量含)
- 2: 黒褐色土 (ShII・パミス少量含)
- 3: 黒色土 (ShII多量含、パミス少量含。炭化物混入)
- 4: 黒色土 (ShII多量含)
- 5: 黒色土 (ShII多量含、ローム混入)
- 6: 黒褐色土 (ShII・パミス・ローム粒多量に含)
- 7: ローム土・黒褐色土混
- 8: 黒色土 (パミス・ローム粒少量含)

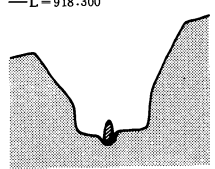
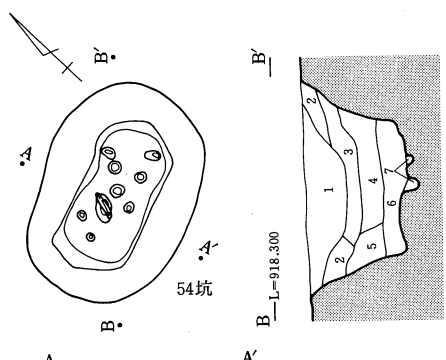

- 1: 黒褐色土 (ShII多量含)
- 2: 暗褐色土 (ローム粒・パミス多量含)
- 3: 黒褐色土 (パミス少量含)
- 4: 暗褐色土 (パミス多量含)
- 5: 暗褐色土 (パミス多量含。ロームブロック多量に混入)
- 6: 暗褐色土 (ローム粒・パミス多量含)
- 7: 黒褐色土

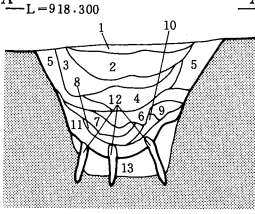
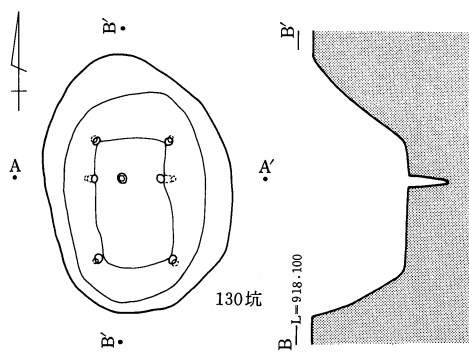

- 1: 黒褐色土 (ShII・パミス含。暗褐色土ブロック・炭化物混入)
- 2: 黒褐色土 (ShII多量・暗褐色土ブロック・炭化物混入)
- 3: 黒褐色土 (ShII・パミス含。炭化物混入)
- 4: 黒褐色土 (3に類似。炭化物混入)
- 5: 黒褐色土 (3に類似。しまり堅)
- 6: 黒褐色土 (3に類似)
- 7: 黒褐色土 (7層酷似)
- 8: 黒褐色土 (パミス含。ロームブロック多量に混入)
- 9: 黒褐色土 (ローム粒多量、パミス含)
- 10: 暗褐色土 (ローム基調)
- 11: 黒褐色土 (ローム粒多量、パミス含)
- 12: 褐色土 (ローム基調。暗褐色土ブロック多量に混入)
- 13: 暗褐色土 (上部黒褐色土混入)
- 14: 黒褐色土 (ローム粒多量、パミス含)

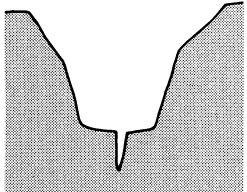
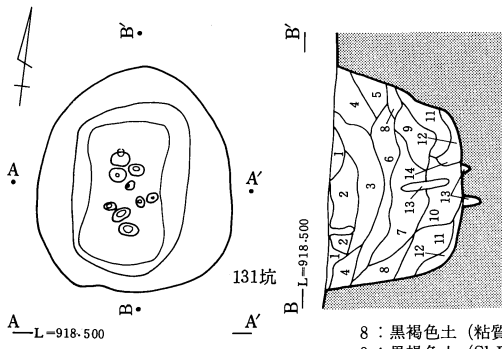

- 1: 黒褐色土 (ShII多量、パミス含)
- 2: 黒色土 (ShII・パミス少量含。炭化物混入)
- 3: 黒褐色土 (ShII・パミス少量含)
- 4: 黒色土 (粘質。黒色土ブロック混入)
- 5: 黒色土 (ShII・パミス少量含)
- 6: 黒褐色土 (ShII多量含)
- 7: 黒色土 (ShII多量、パミス少量含)
- 8: 黒褐色土 (粘質黒色土少量混入)
- 9: 黒褐色土 (ShII・パミス・径5cm以下の小礫含)
- 10: 黒褐色土 (ShII含。粘質黒色土少量混入)
- 11: 黒褐色土 (石英質安山岩多量含)
- 12: 暗褐色土 (VII層基調、ShII少量含)
- 13: 黒褐色土 (パミス微量含。しまり弱)



第326図 土坑(6)

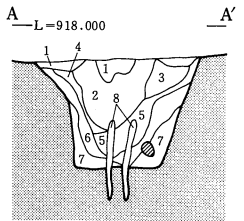
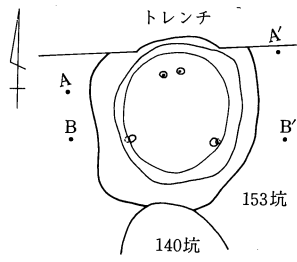

- 1: 黒褐色土 (ShII・パミス少量含。暗褐色土ブロック混入)
- 2: 黒褐色土 (パミス少量、ShII・石英質安山岩含)
- 3: 黒褐色土 (2層と同質。ShII少ない)
- 4: 黒褐色土 (ShII・パミス少量含)
- 5: 黒褐色土 (4層と酷似)
- 6: 黒褐色土 (微粒砂含)
- 7: 暗褐色土 (黒褐色土ブロック混入)
- 8: 黒褐色土 (ShII微量含。しまり弱)

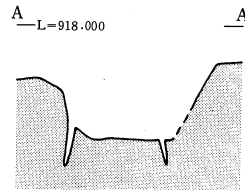
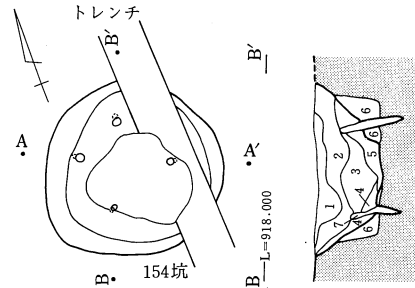
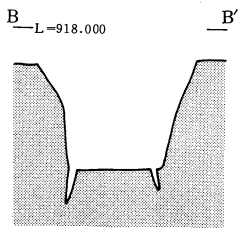

- 1: 黒褐色土 (パミス少量、ShII・小礫含。暗褐色土ブロック混入)
- 2: 黒褐色土 (ShII・パミス少量含)
- 3: 黒褐色土 (2層と酷似)
- 4: 黒褐色土 (ShII少量含)
- 5: 黒褐色土 (ShII・パミス少量含)
- 6: 褐色土 (ローム土基調。黒褐色土ブロック混入)
- 7: 黒褐色土 (石英質安山岩少量含)

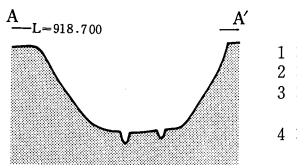
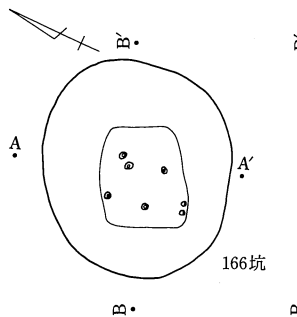

- 1: 黒褐色土 (パミス多量に含)
- 2: 黒色土 (パミス含)
- 3: 黒褐色土 (パミス含。ロームブロック少量混入)
- 4: オリーブ褐色土 (ローム土基調。パミス多量に混入)

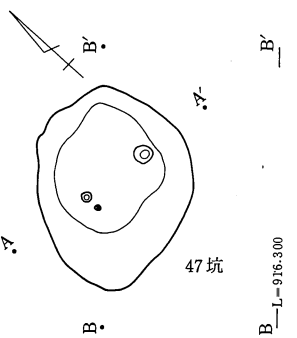

- 1: 黒色土 (ShII・パミス少量含)
- 2: 黒褐色土 (ShII・パミス含。1混入)
- 3: 黒褐色土・ローム土混

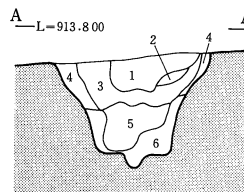
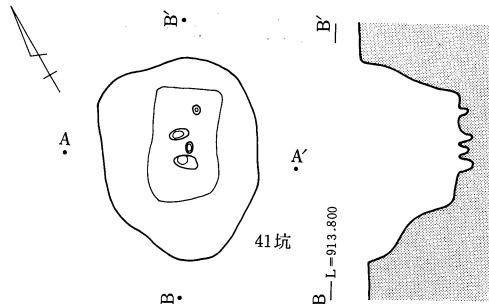

- 1: 黒色土 (ShII、パミス含)
- 2: 黒褐色土 (ShII少量含)
- 3: 黒褐色土 (ShII、パミス少量含)
- 4: 暗褐色土・ローム土混
- 5: 暗褐色土 (ShII含)
- 6: 暗褐色土 (ShII含。ローム土混入多)

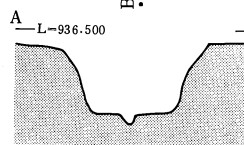
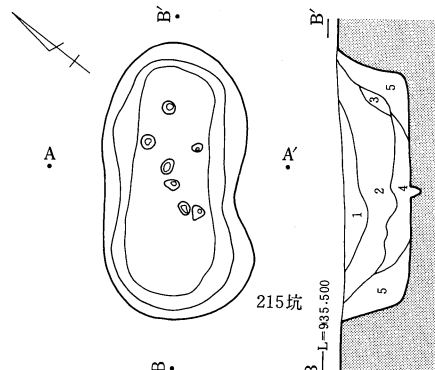

- 1: 黒褐色土 (ShII多量含。粘性)
- 2: 黒褐色土 (ShII多量含)
- 3: 黒褐色土 (パミス含。ローム混入)
- 4: 黒褐色土 (ロームブロック混入)
- 5: 暗褐色土 (パミス含。ロームブロック混入)

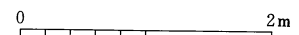

第327図 土坑(7)

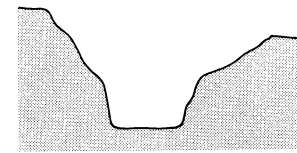
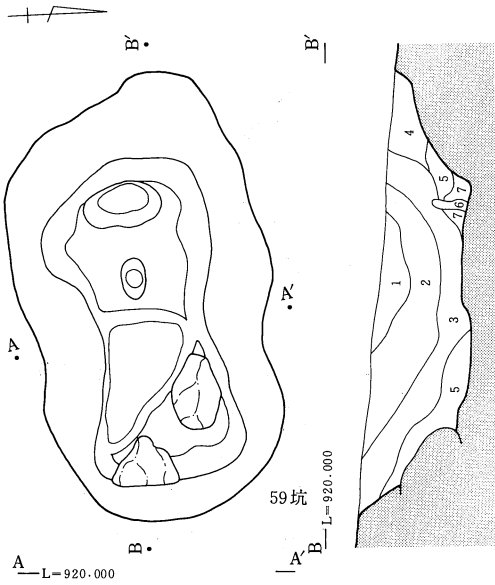

- 1: 黒褐色土 (ShII 多量に含)
- 2: 黒褐色土 (ShII 1 より多量含)
- 3: 黒褐色土 (ShII 多量含。褐色土多量に混入)
- 4: 黒褐色土 (パミス多量含)
- 5: 褐色土 (VII層基調。パミス多量含。黒褐色土混入)
- 6: 黒褐色土 (褐色土少量含)
- 7: 黒褐色土 (パミス多量含。ローム土多量に混入)

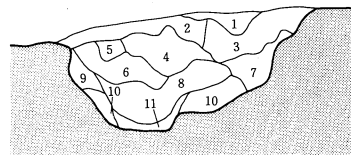
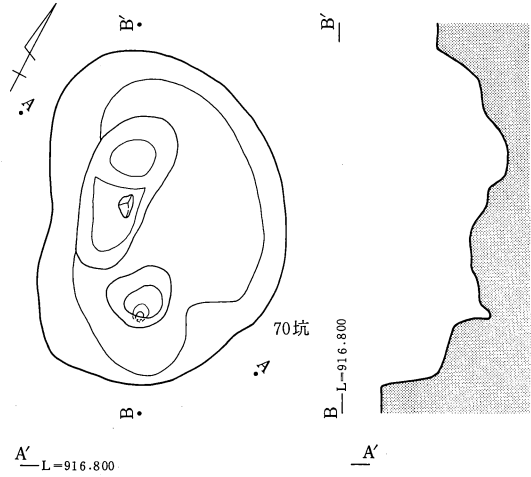

- 1: 暗褐色土 (炭化物混入。小礫多量含)
- 2: 褐色土 (小礫多量含)
- 3: 褐色土 (ShII・小礫多量含)
- 4: 暗褐色土 (ShII・小礫多量含)
- 5: 褐色土 (小礫多量含。4層混入)
- 6: 黒褐色土 (ShII・小礫多量含)
- 7: 暗褐色土 (ロームブロック混入)
- 8: 黒褐色土 (ShIIブロック混入)
- 9: 暗褐色土 (ローム混入。やや粘質)
- 10: 黒褐色土 (石英質安山岩含)
- 11: 黒褐色土 (石英質安山岩含。粘質)

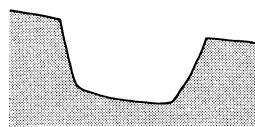
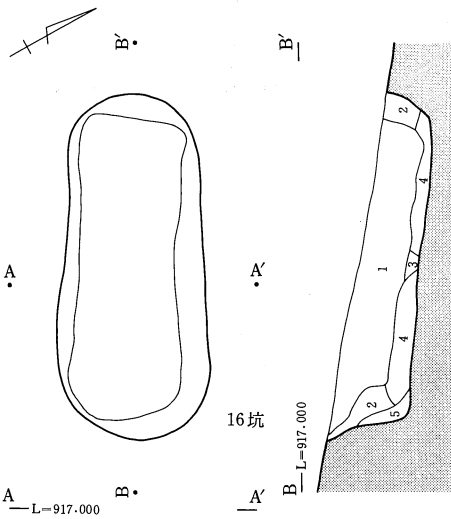

- 1: 黒色土 (ShII 多量含)
- 2: 黒褐色土 (ShII 少量含)
- 3: 黒色土 (ロームブロック混、粘性)
- 4: 黒色土 (ShII 1層より少)
- 5: 黒褐色土 (ローム粒含)

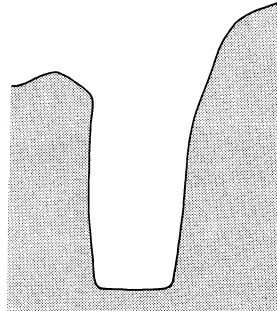
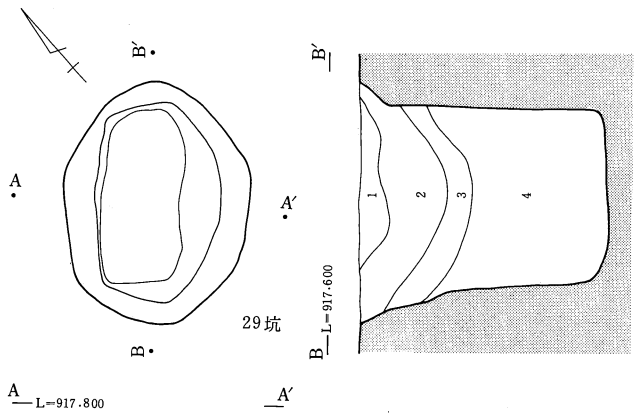

- 1: 褐色土 (IVA層基調。ShII・パミス少量含。炭化物少量混入)
- 2: 暗褐色土 (ShII・パミス少量含)
- 3: 黒褐色土 (ロームブロック多量含)
- 4: 暗褐色土 (ローム粒多量に混入)

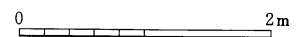

第328図 土坑(8)

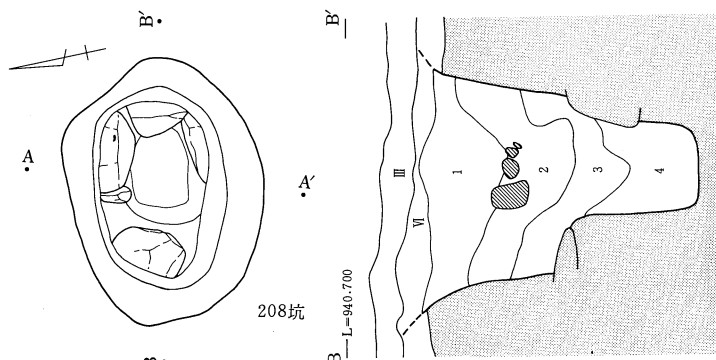

- 1: 暗褐色土 (小礫含。しまりなし)
- 2: 暗褐色土 (バミス含。炭化物少量混入)
- 3: 黄褐色土 (VIII層基調)
- 4: 暗黄褐色土 (ロームブロック混入)

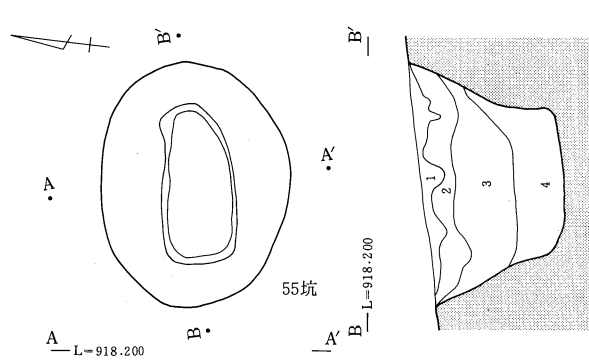
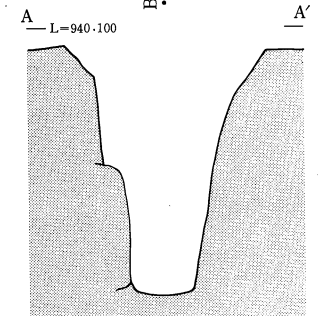

- 1: 黒褐色土 (ShII、バミス少量、小礫多量に含。粘性あり)
- 2: 黒褐色土 (小礫多量含)
- 3: 黒褐色土 (ShII・バミス、小礫多量、ロームブロック混入)
- 4: 黒褐色土 (ShII多量含。ロームブロック多量混入。しまり弱)

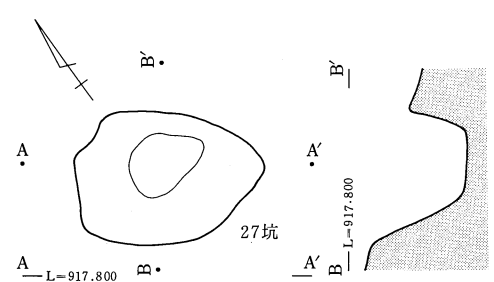

- 1: 黒褐色土 (ShII多量含。ロームブロック混入。炭化物少量混入)
- 2: 黒褐色土 (ShII多量含。炭化物少量混入。しまり堅)
- 3: 暗褐色土 (バミス・ローム粒多量、ShII含。ロームブロック混入。しまり堅)

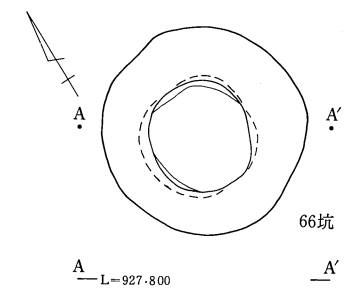

- 1: 黒褐色土 (ShII多量含)
- 2: 黒褐色土 (ShII少量、バミス多量含)
- 3: 暗褐色土 (バミス含)
- 4: 暗褐色土 (バミス多量含。ロームブロック壁際に混入)
- 5: 暗褐色土 (バミス・ローム粒含)
- 6: 暗褐色土 (バミス含。ローム混入)
- 7: 暗褐色土 (ローム粒多量、バミス含。炭化物多量に混入)

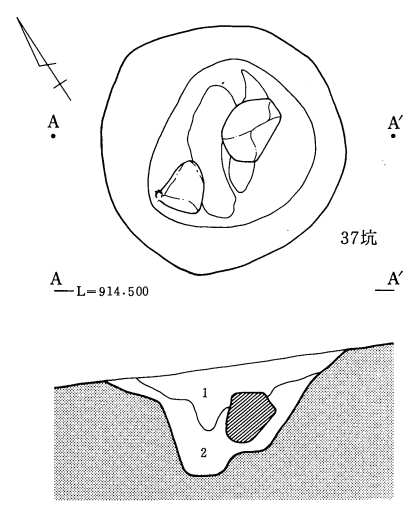

- 1: 黒褐色土 (ShII・小礫含)
- 2: 暗褐色土 (ローム土混入)



第329図 土坑(9)

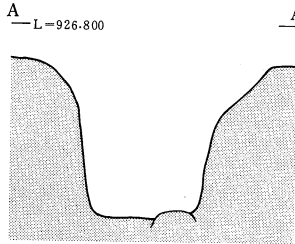
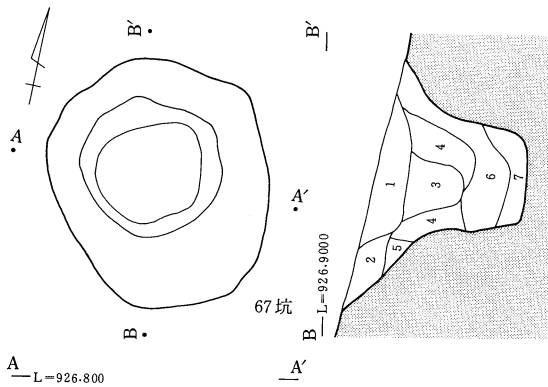

- 1 : ShII集積 (V層)
- 2 : 黒褐色土 (ShII多量含)
- 3 : 黒褐色土 (ローム粒多量、ShII含)
- 4 : 黒褐色土 (ShII・パミス多量含)
- 5 : 暗褐色土 (ShII微量、パミス多量含)
- 6 : 暗褐色土 (ShII微量、パミス多量含。ローム多量に混入)
- 7 : 暗褐色土 (パミス多量含。ロームブロック混入)
- 8 : 褐色土 (ローム多量、暗褐色土混入。炭化物多量に混入)

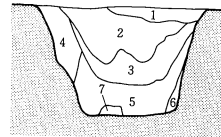
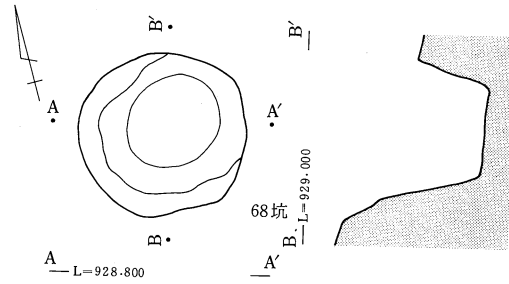

- 1 : 黒褐色土 (ShII少量含)
- 2 : 黒色土 (パミス含)
- 3 : 暗褐色土 (ローム粒多量、パミス含)
- 4 : ローム土・暗褐色土混 (パミス含)
- 5 : 暗褐色土 (ロームブロック混入。しまり弱)
- 6 : ローム土 (パミス含。しまり弱)
- 7 : 褐色土 (ローム基調。暗褐色土混入)

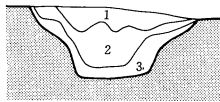
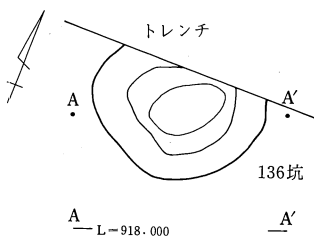

- 1 : 黒褐色土 (ShII含。しまりなし)
- 2 : 黒褐色土 (ShII・小礫含)
- 3 : 黒褐色土 (ローム粒多量含。ロームブロック混入)

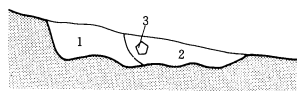
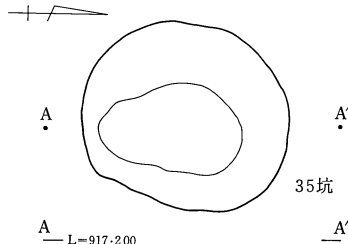

- 1 : 黒褐色土 (ShII多量含。粘土混入)
- 2 : 暗褐色土 (ShII多量含)
- 3 : ロームブロック

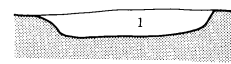
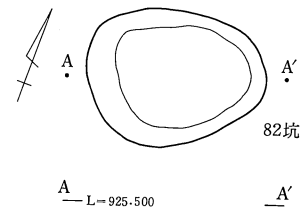

- 1 : 褐色土 (ShIIと黒褐色のブロック炭化物混入、微小礫多.)

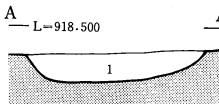
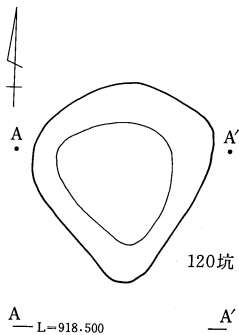

- 1 : 黒褐色土 (ShIIパミス含。下部に炭化散在)

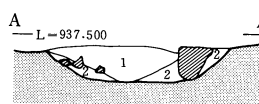
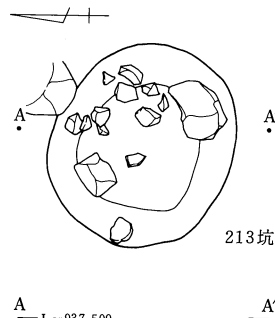

- 1 : 褐色土 (VII層基調。パミス含。しまり良)
- 2 : 黄褐色土 (VIII層基調。パミス含)



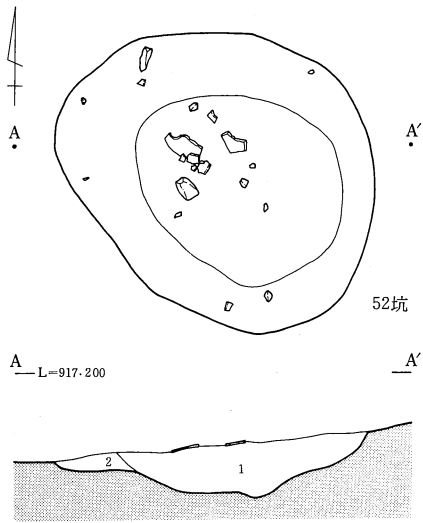

A—L=917.200

52坑

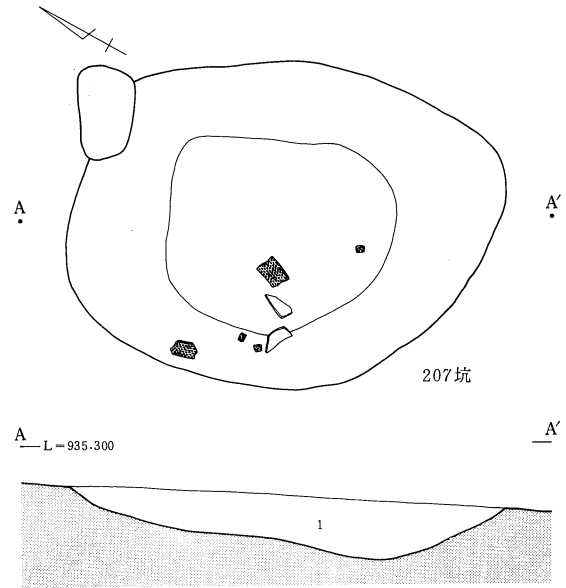

A—L=935.300

207坑

- 1: 黒褐色土 (VII層基調。パミス・ローム粒多量に含。炭化物混入)
 2: 黒褐色土 (ロームブロック多量混入)

- 1: 褐色土 (VII層基調。パミス含。しまり良)

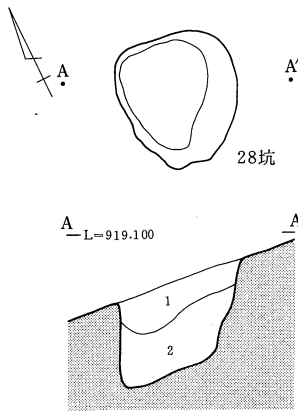

A—L=919.100

28坑

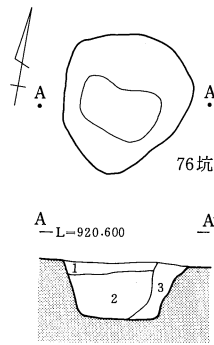

A—L=920.600

76坑

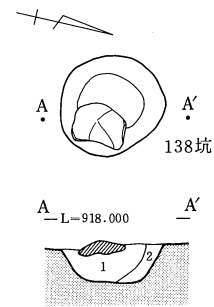

A—L=918.000

138坑

- 1: 黒褐色土 (ShII・パミス含。ロームブロック混入)
 2: 暗褐色土 (ShII・パミス含)

- 1: 褐色土 (微小礫多量含。炭化物、2・3層ブロック状混入)
 2: 暗褐色土 (ShII・微小礫多量含)
 3: 褐色土 (V層基調、パミス・ShII含)

- 1: 黒褐色土 (ShII・パミス含。炭化物混入)
 2: 黒褐色土 (1層類似。しまりあり)

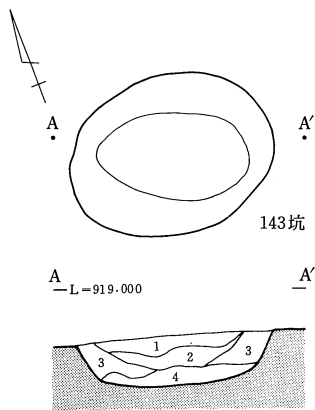

A—L=919.000

143坑

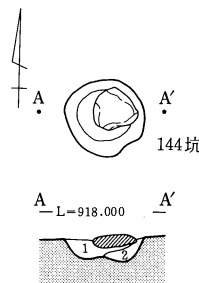

A—L=918.000

144坑

- 1: 黒褐色土 (ShII・パミス含)
 2: 黒褐色土 (ShII・パミス含。しまり良。淘汰良)

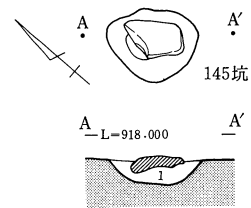

A—L=918.000

145坑

- 1: 黒褐色土 (ShII・パミス含)

- 1: 黒褐色土 (ShII・パミス含)
 2: 黒褐色土 (ShII・パミス少量含)
 3: 暗褐色土 (ロームブロック混入)
 4: 暗褐色土 (3層類似。炭化物散在)

0 1m

0 2m

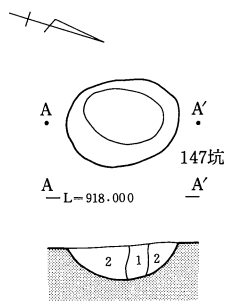

147坑
A—L=918.000 A'

1: 黒褐色土 (ShII少量含。淘汰良)
2: 黒褐色土 (ShII・パミス含)

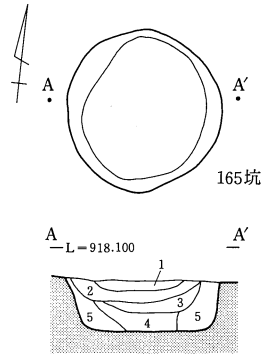

165坑
A—L=918.100 A'

1: 明黄褐色土 (ShII少量含)
2: 黄褐色土 (ShII多量含)
3: 黒色土 (ShII多量含)
4: 黒褐色土 (ShII多量含)
5: 黄褐色土 (ShII含。しまりあり)

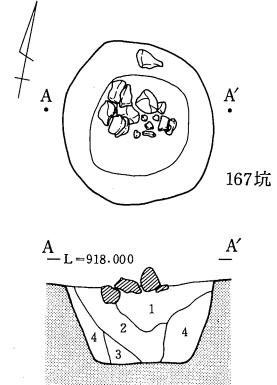

167坑
A—L=918.000 A'

1: 黒色土 (ShII多量、パミス含)
2: 黒褐色土 (ShII多量、ローム粒含)
3: 黒色土 (ShII・パミス少量含)
4: 黄褐色土 (ShII・パミス多量含)

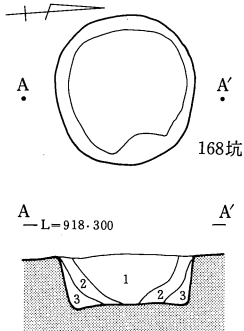

168坑
A—L=918.300 A'

1: 黒色土 (ShII多量含)
2: 黒褐色土 (ShII多量含)
3: 黄褐色土 (ShII少量含。しまりあり)

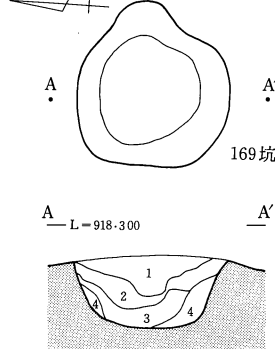

169坑
A—L=918.300 A'

1: 黒褐色土 (VII層基調。パミス含)
2: 褐色土 (パミス顕著に混入)
3: 褐色土 (径1~2cmの軽石混入)
4: 褐色土 (径5~10cmの礫混入)

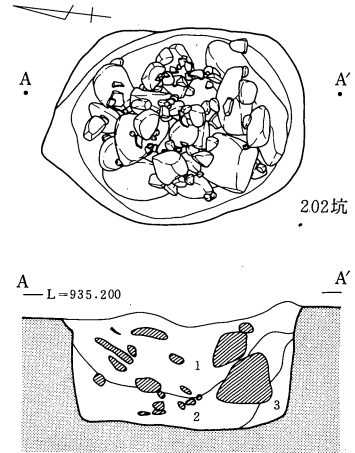

202坑
A—L=935.200 A'

1: 黒褐色土 (ShII・パミス含)
2: 暗褐色土 (ShII少量、パミス含。ロームブロック混入)
3: 褐色土 (ローム基調)

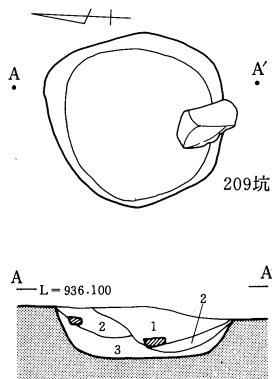

209坑
A—L=936.100 A'

1: 暗褐色土 (ShII多量含。パミス・VII層ブロック混入)
2: 暗褐色土 (VIII層混入。パミス含)
3: 褐色土 (VIII層混入)

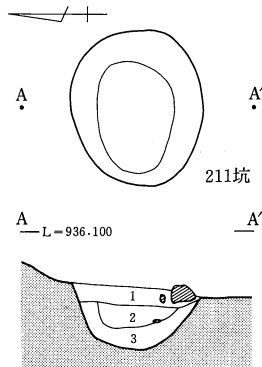

211坑
A—L=936.100 A'

1: 黒褐色土 (ShII・パミス含)
2: 黒褐色土 (ShII含。炭化物混入)
3: 黄褐色土 (パミス含。VII層混入)

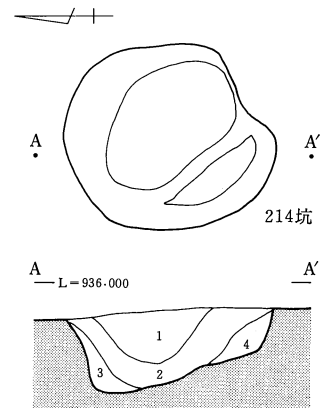

214坑
A—L=936.000 A'

1: 黒褐色土 (ShII・パミス少量含)
2: 黒褐色土 (ロームブロック混入)
3: にぶい黄褐色土 (ローム基調)
4: 褐色土 (VIII層基調。小礫含)

0 2m

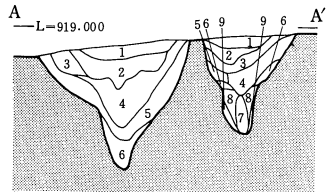
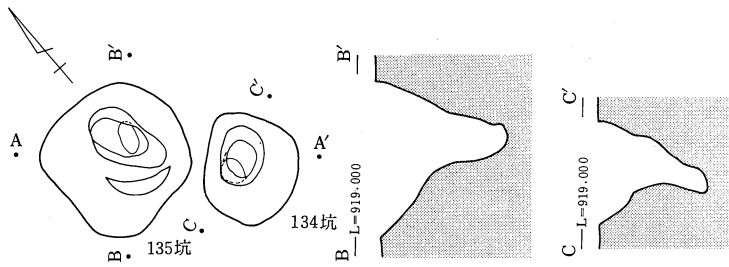

- 1: 褐色土 (IVB基調。しまりなし)
- 2: 黒褐色土 (ShII・パミス少量含)
- 3: ロームブロック
- 4: 黒褐色土 (ShII・パミス含。堅致)
- 5: 褐色土 (VII層基調。黒褐色土ブロック状に混入)
- 6: 黒褐色土 (ShII・パミス含。堅致)

- 1: 褐色土 (IVB基調。しまりなし)
- 2: 黒褐色土 (ShII・パミス少量含)
- 3: 黒褐色土 (ShII・小礫少量含)
- 4: 黒褐色土 (ShII含。しまりあり)
- 5: 黒褐色土 (ShII含。しまりなし)
- 6: ロームブロック
- 7: 黒褐色土 (ShII少量含。淘汰良)
- 8: 褐色土 (VII層基調。黒褐色土ブロック状に混入)
- 9: 黒褐色土 (ShII・パミス含。堅致)

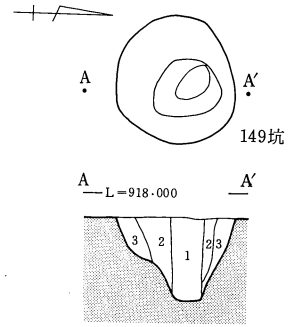

- 1: 黒褐色土 (ShII・パミス少量含。しまりなし)
- 2: 黒褐色土 (VI層基調。しまりあり)
- 3: 黒褐色土ブロック混入

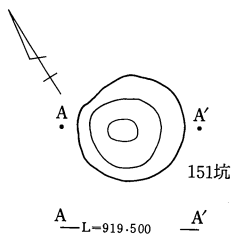

- 1: 黒褐色土 (淘汰極めて良)
- 2: 黒褐色土 (VI層基調。IVB層ブロック状混入。ShII含)

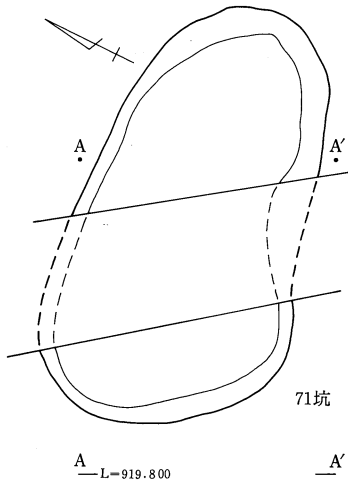

- 1: 暗褐色土 (微小礫多量含。やや砂質)

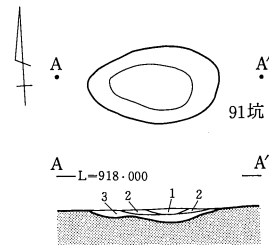

- 1: 黒褐色土 (焼土・炭化物混入)
- 2: 黒色土 (しまりなし)
- 3: 黒褐色土 (ShII・小礫少量含)

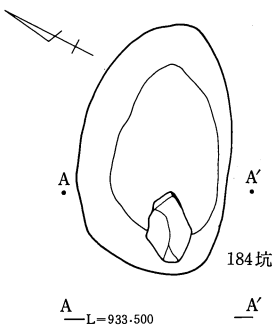

- 1: 褐色土 (ShII・パミス含。炭化物混入)
- 2: 黒褐色土 (ShII・パミス含)
- 3: 黒褐色土 (ShII・パミス多量含)

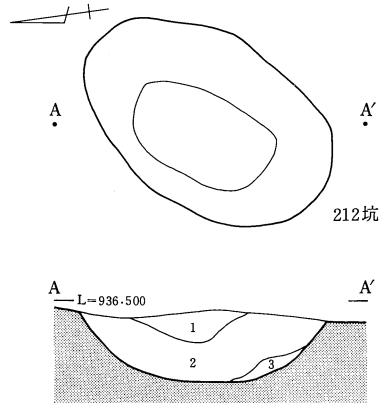

- 1: 褐色土 (砂質)
- 2: 褐色土 (ShII・パミス含。粘性)
- 3: 黄褐色土 (パミス含・ロームブロック混入)

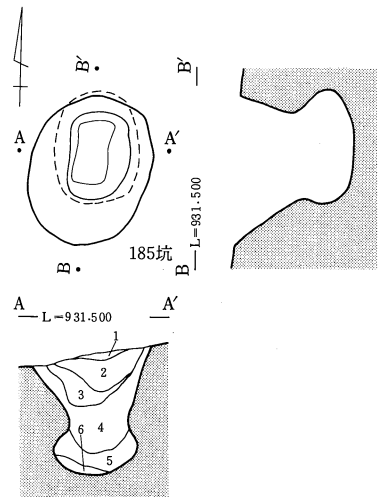

- 1: 褐色土 (VI層基調。ShII・パミス含)
- 2: 暗褐色土 (ShII・パミス含)
- 3: 褐色土 (ShII・パミス含)
- 4: 褐色土 (炭化物、VII層混入)
- 5: 暗褐色土 (下部に炭化物混入)
- 6: 暗褐色土 (ShII含。炭化物顕著)

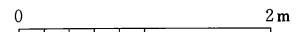

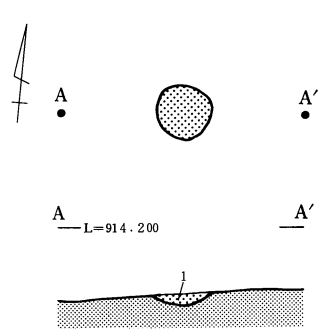

1: 受熱して赤色化

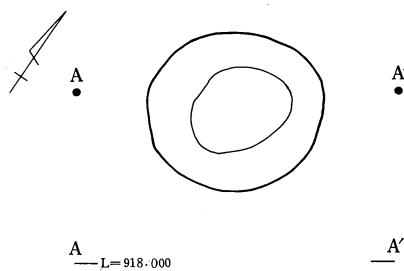

1: 褐色土 (焼土多量含)
2: 黒褐色土 (ShII少量・パミス含。炭化粒・焼土粒少量混入)

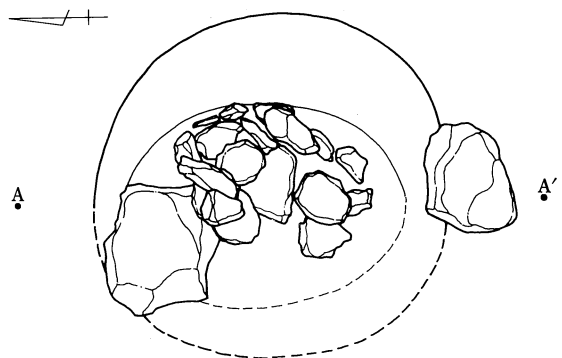

A—L=936.000

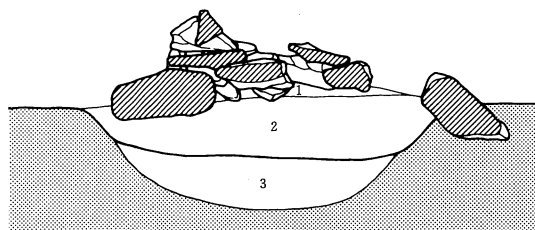

1: 褐色土 (炭化物少量混入)
2: 黒褐色土 (ShII含。炭化物多量混入)
3: 黄褐色土 (炭化粒混入)



A—L=936.500

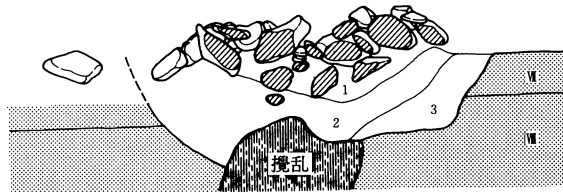

1: 黄褐色土
2: 褐色土 (炭化粒多量混入)
3: 黒褐色土 (下部にパミス・ローム粒含)

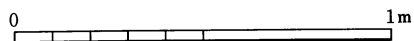

第334図 焼土址・1(左)・2(右)号集石炉

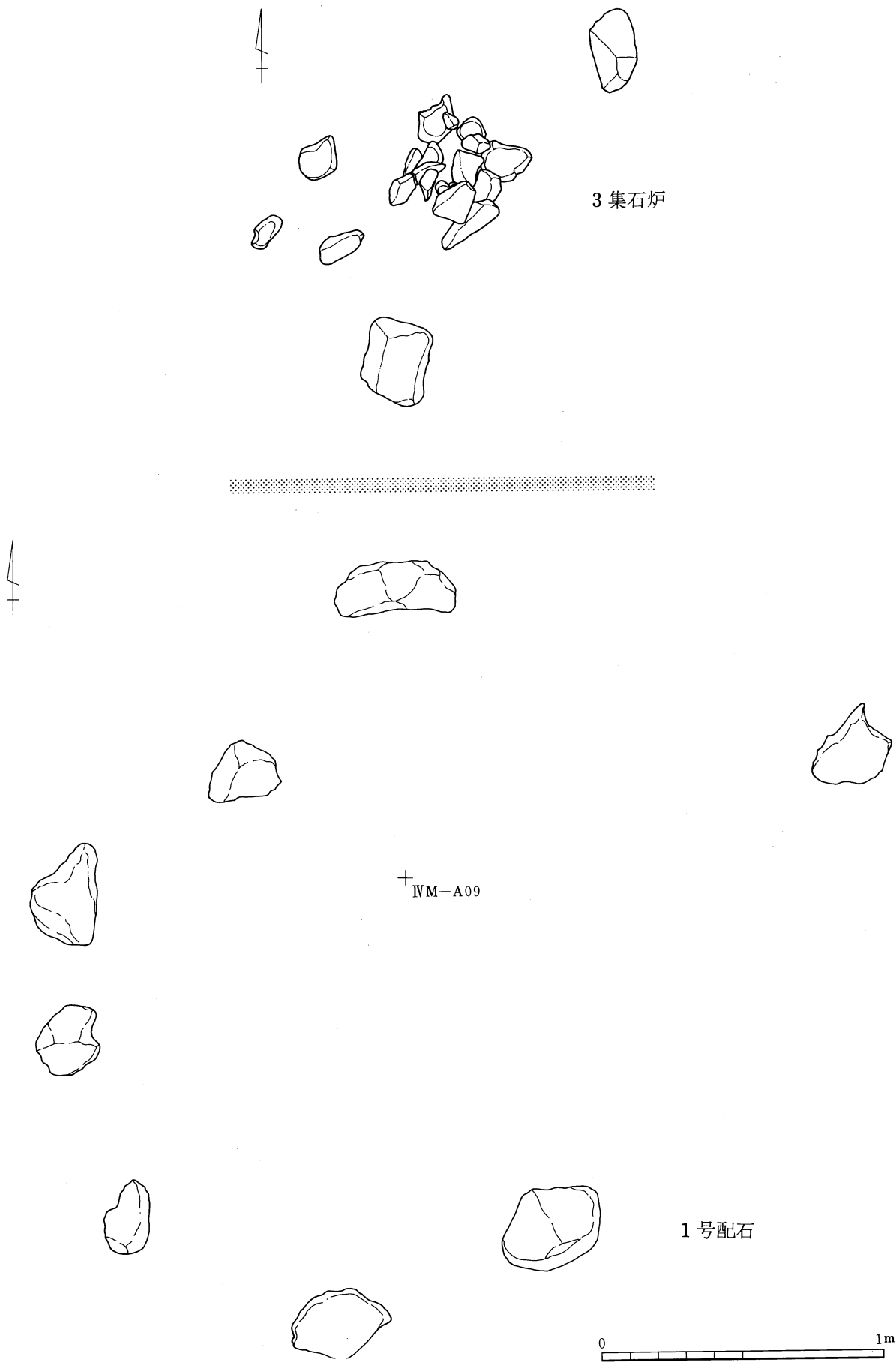

第335图 3号集石炉(上)·配石遺構

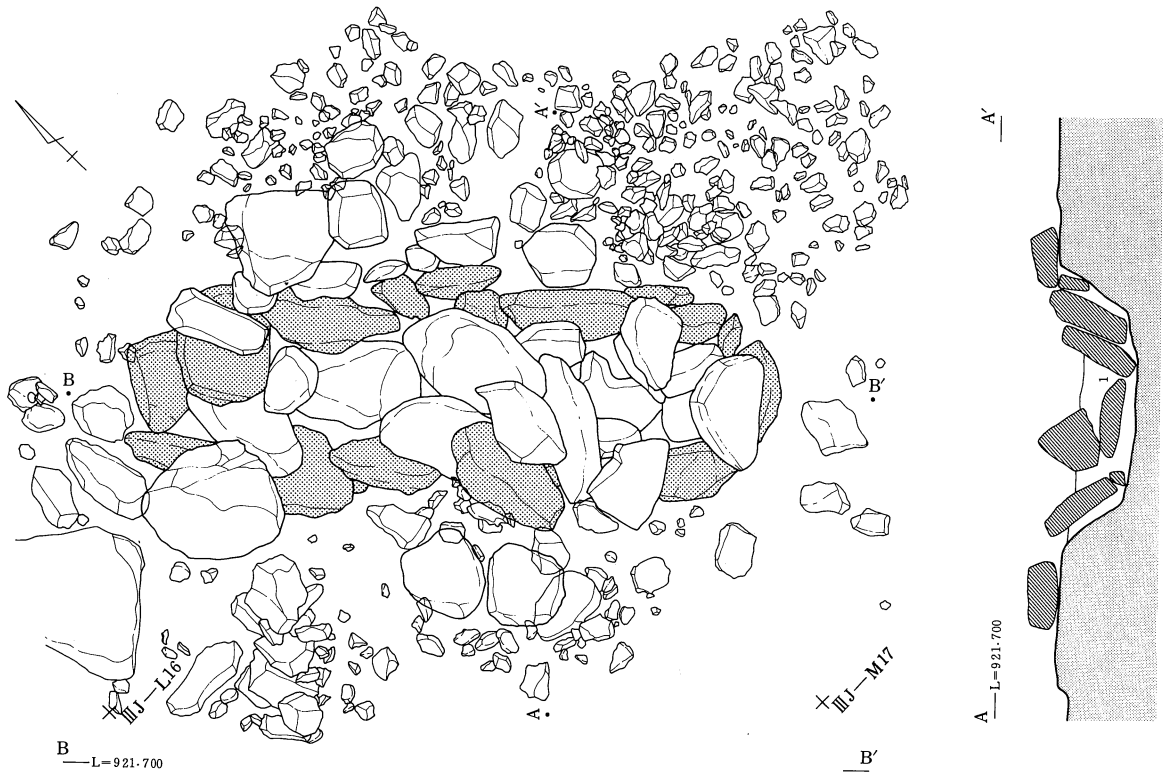

B—L-921.700

B'

A—L-921.700

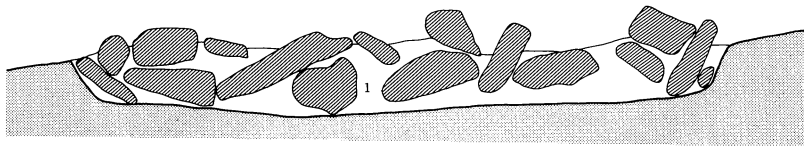

1: 黒褐色土 (礫の混入が多く、III・IV A 層が混入する砂質土。粘性なし)

B—L-921.700

B'

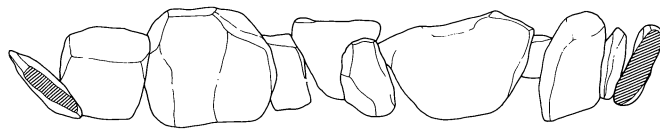

A'

X—L-921.700

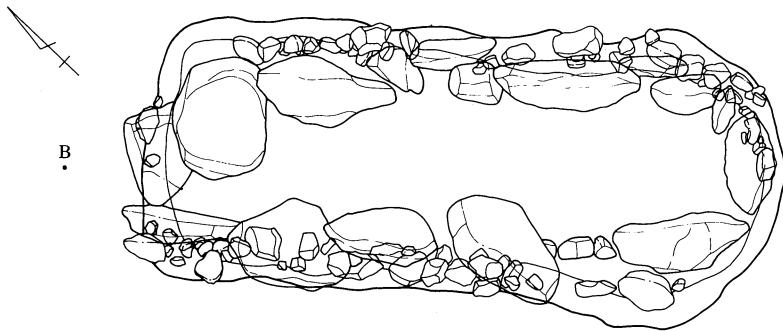

B

A

B'



A

XIII-L16

XIII-M16

0 1m

第336図 石棺墓

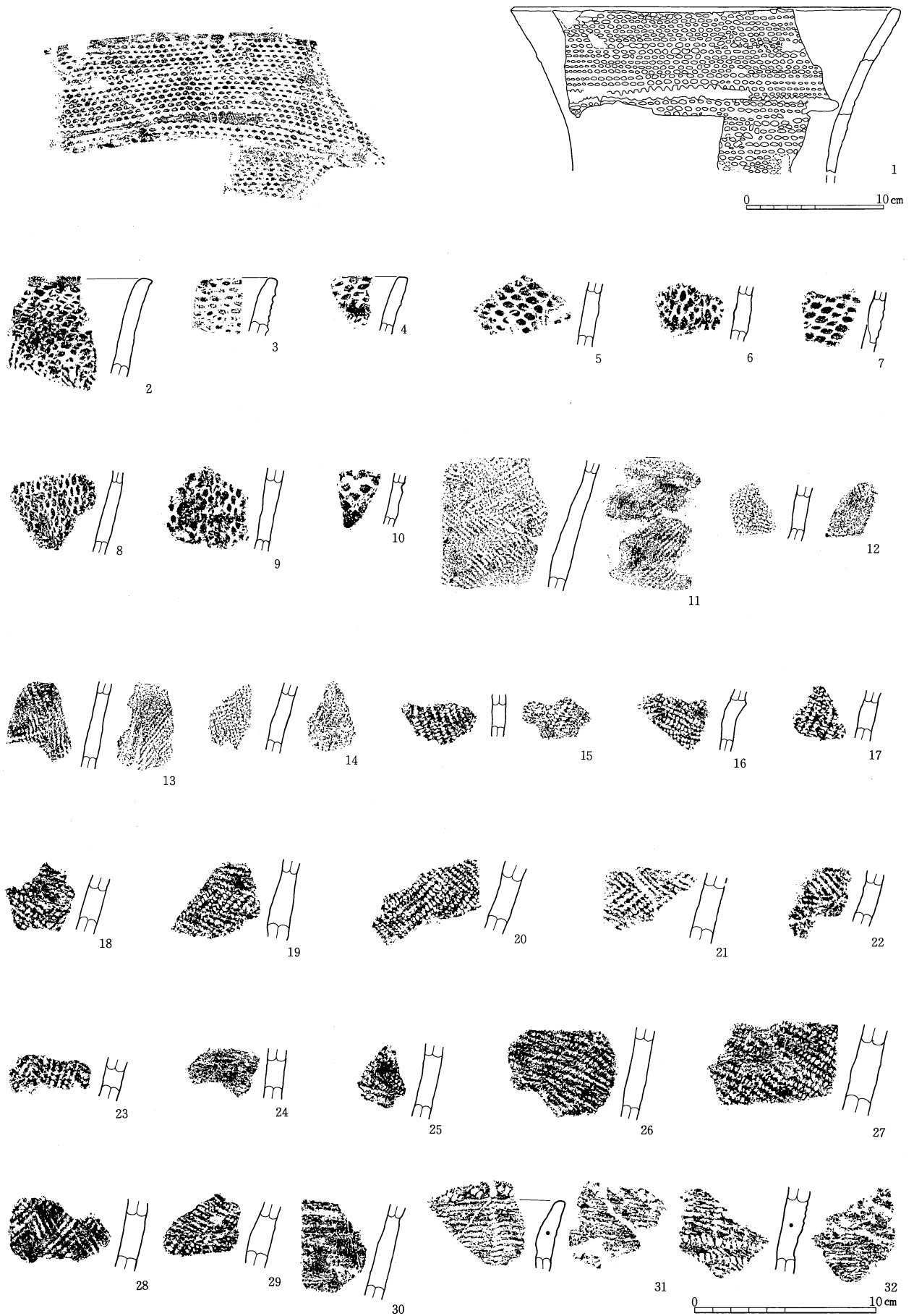

第337图 出土土器(1)

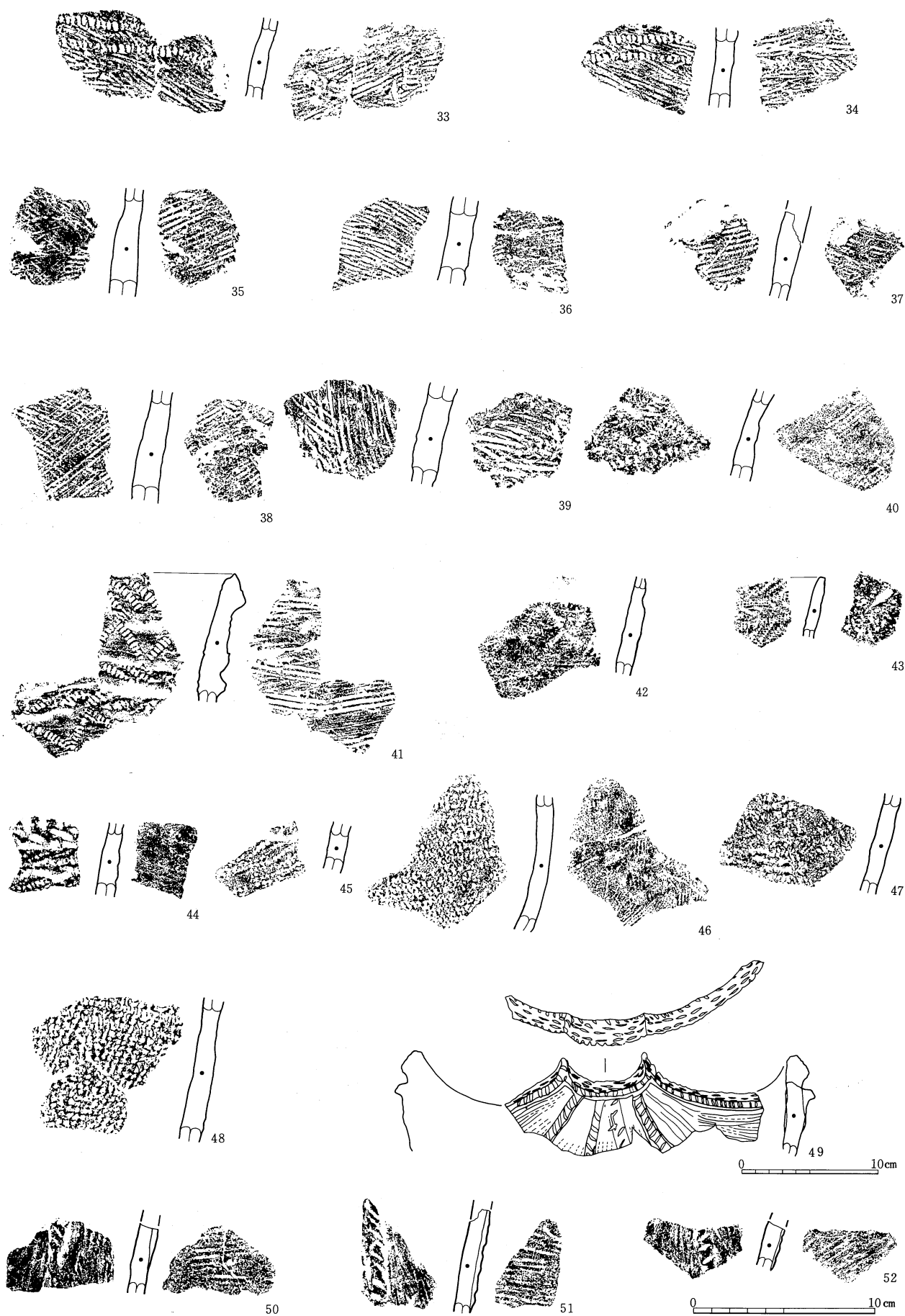

第338图 出土土器(2)

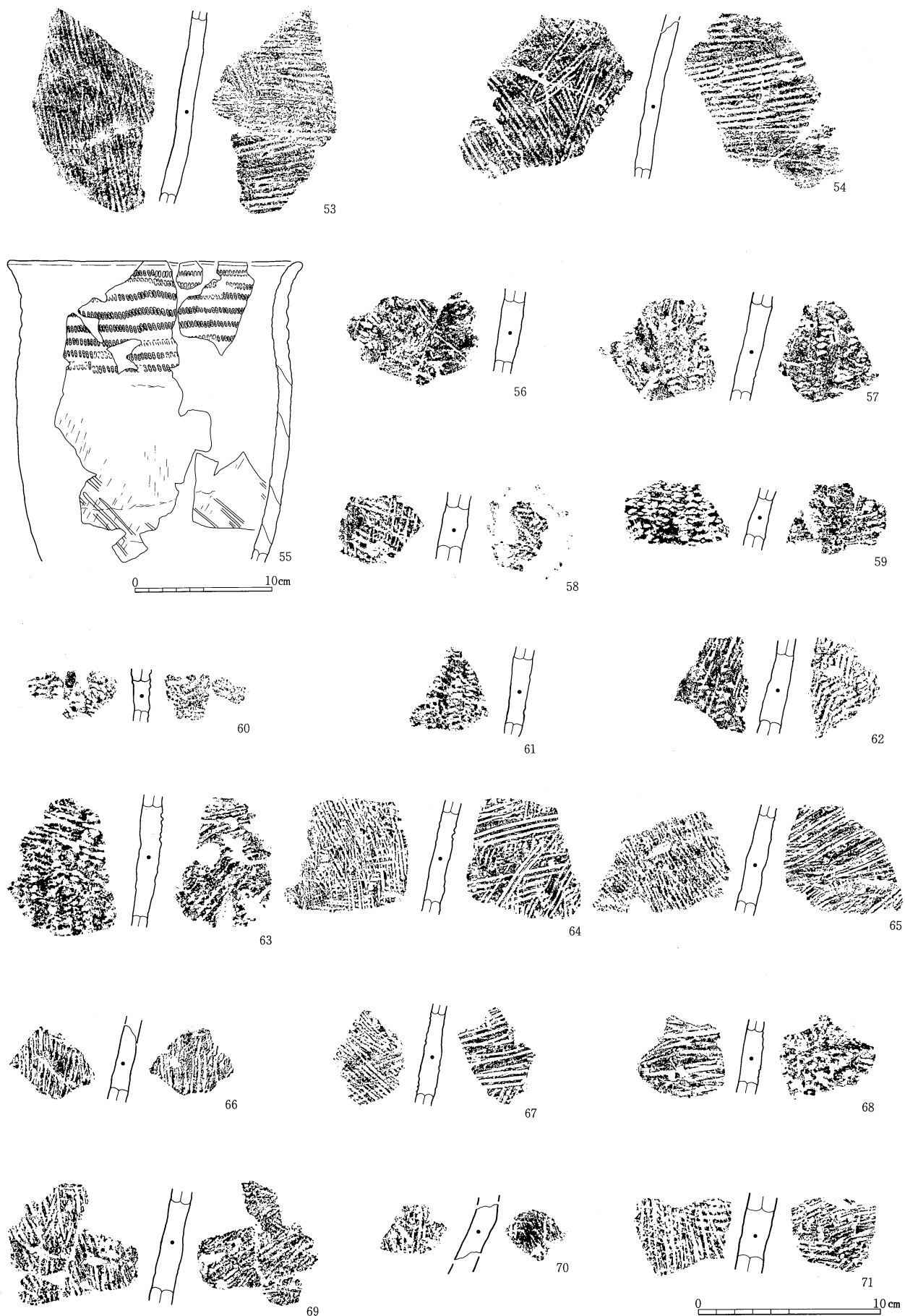

第339图 出土土器(3)

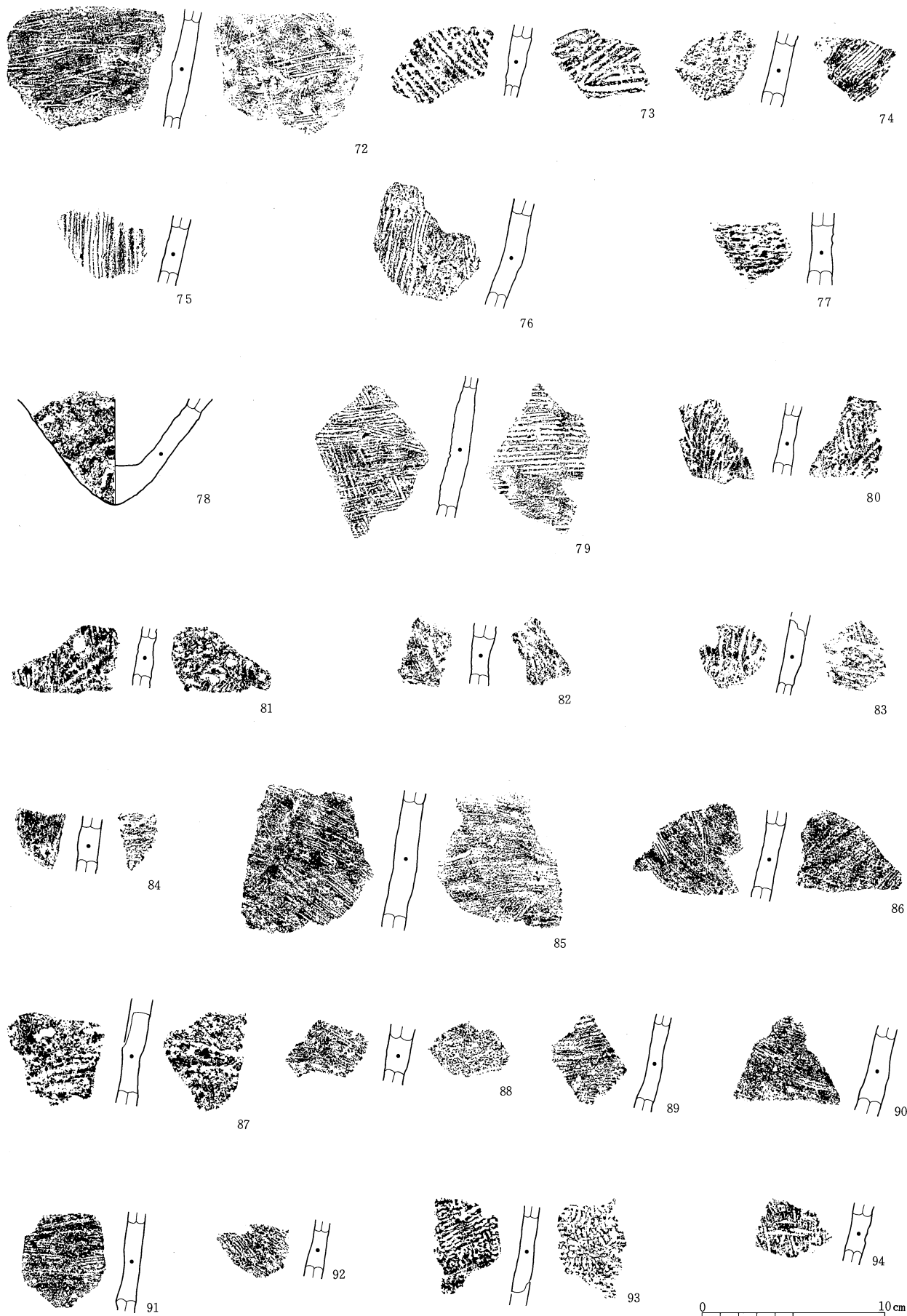

第340图 出土土器(4)

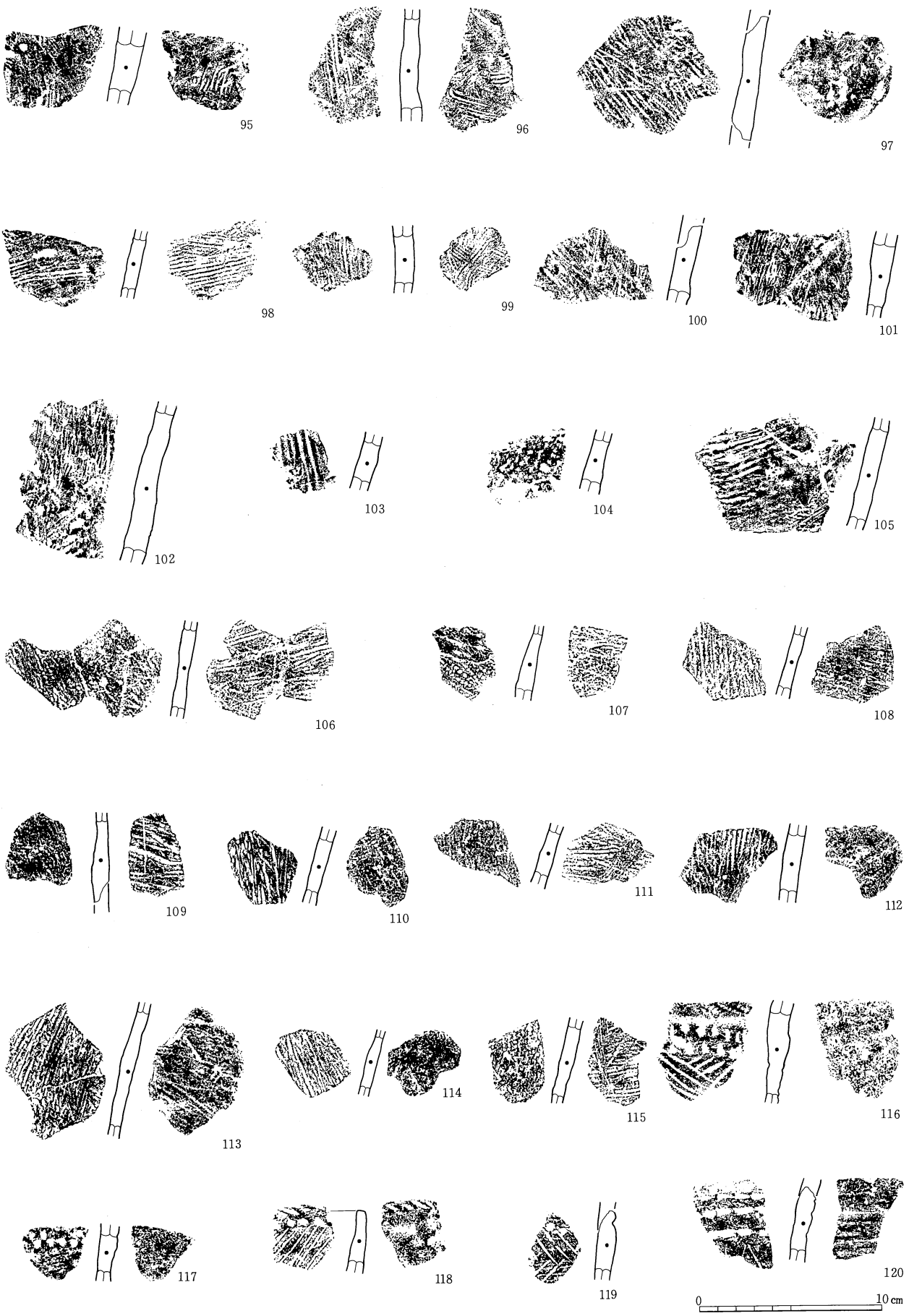

第341图 出土土器(5)

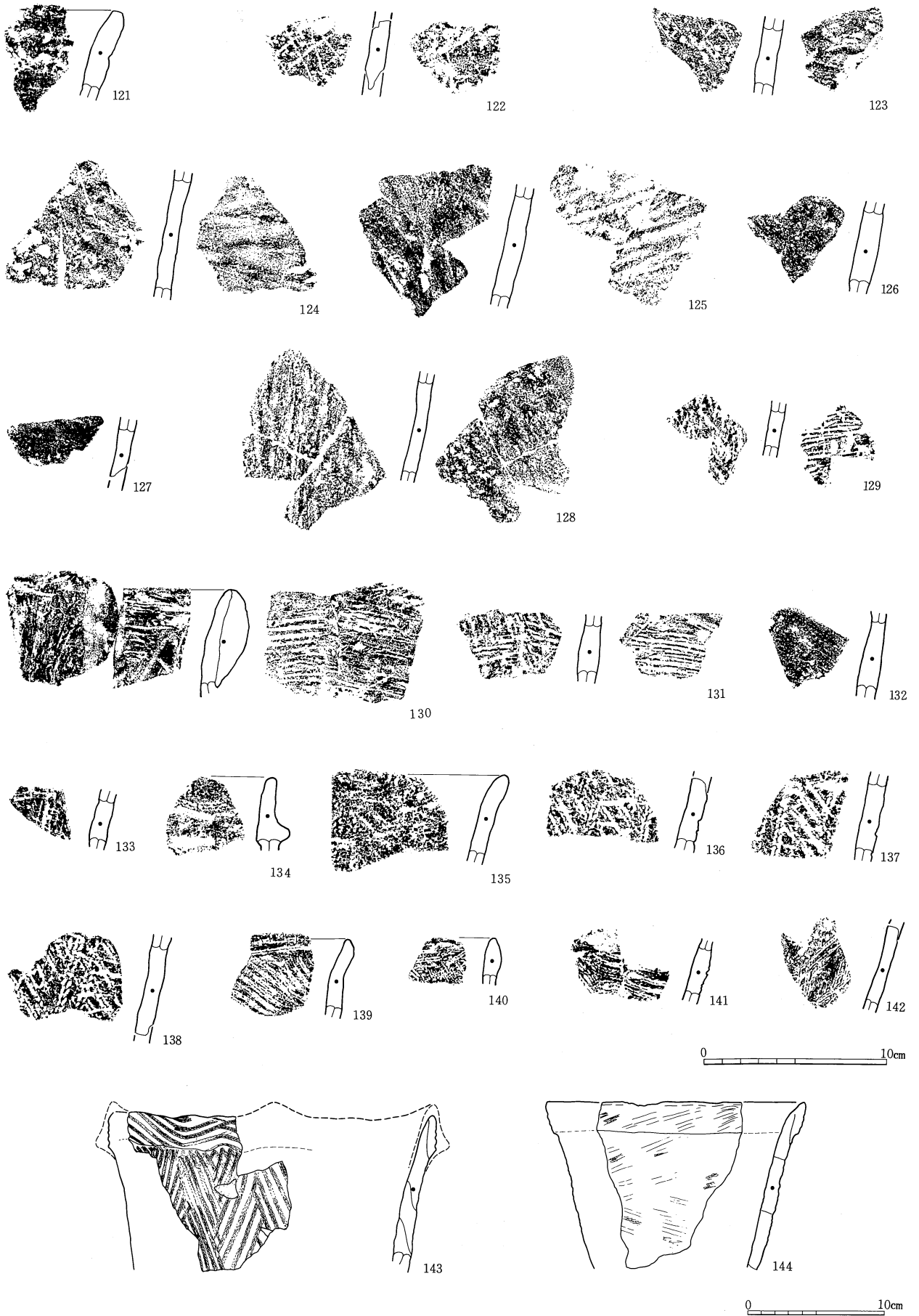

第342图 出土土器(6)

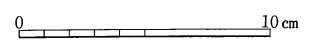
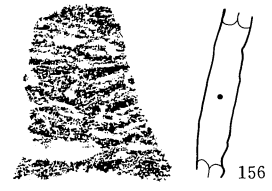
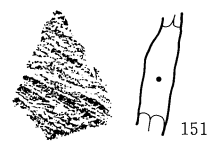
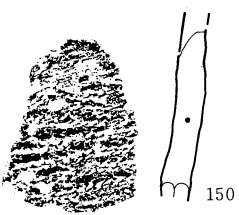
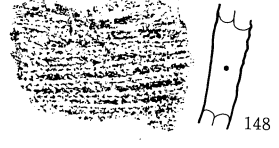
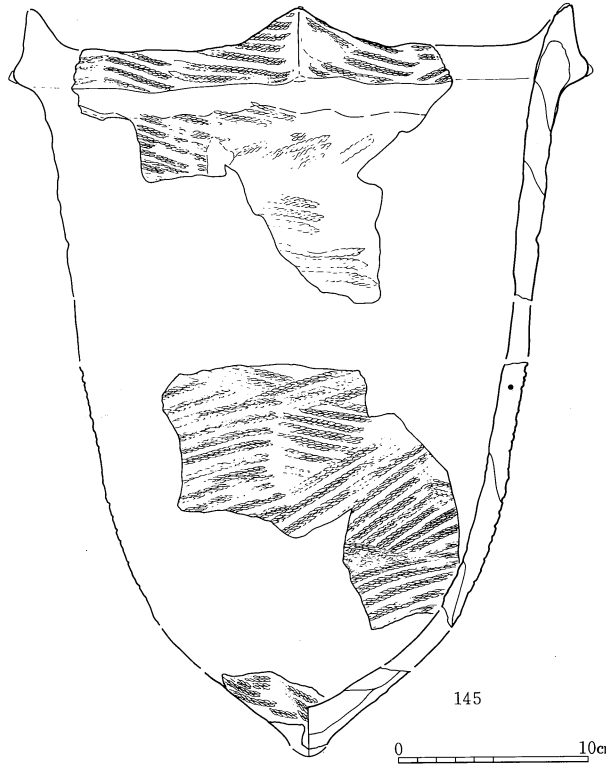

第343图 出土土器(7)

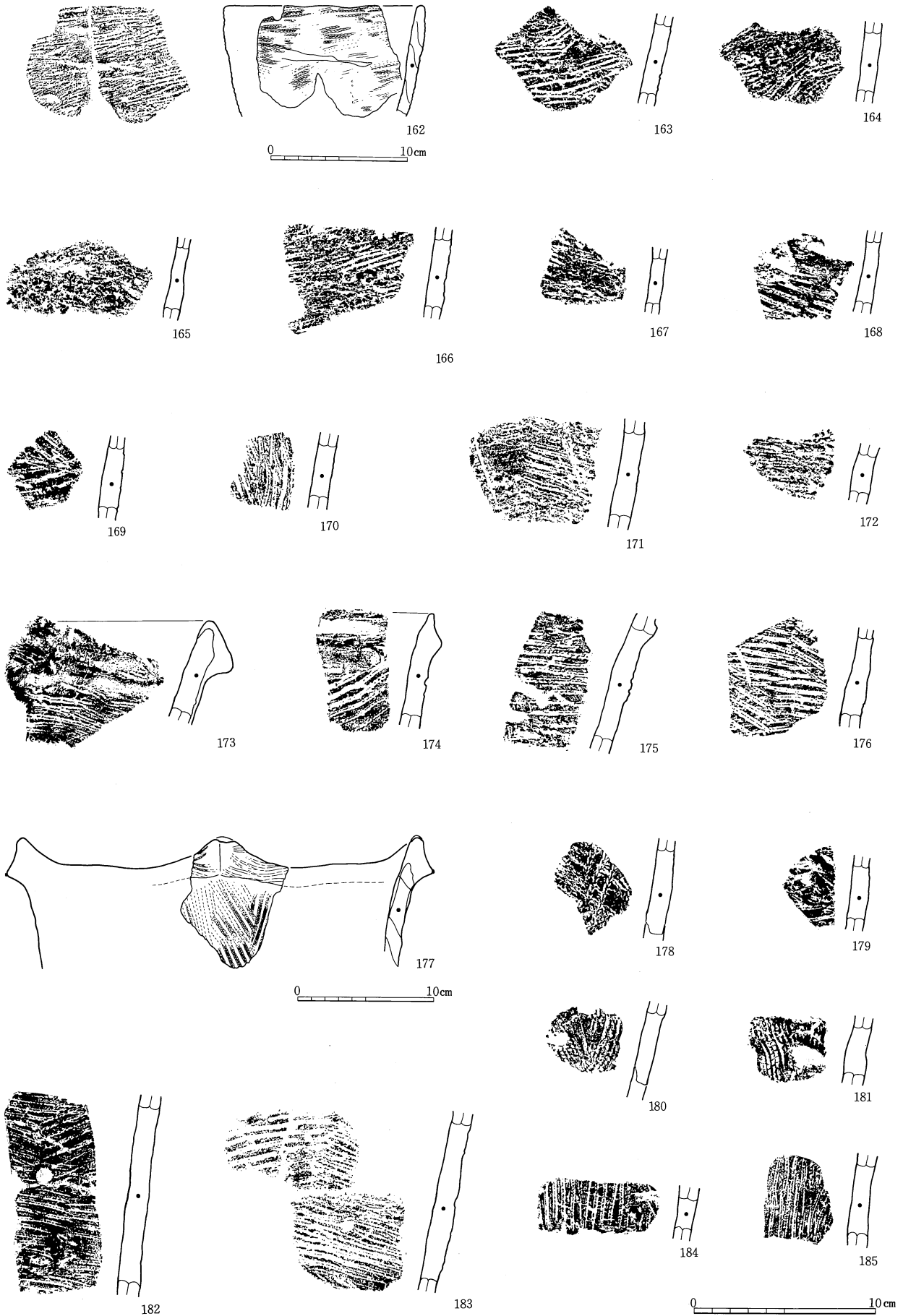

第344图 出土土器(8)

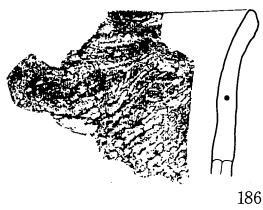

186

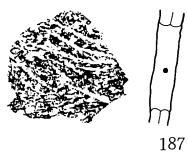

187

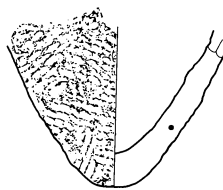

188

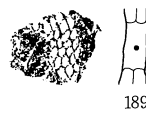

189



190



191



192



193



194

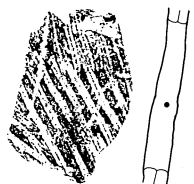

195



196

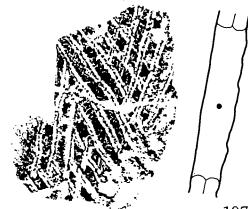

197

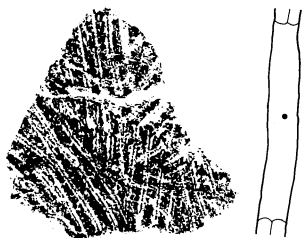

198



199



200



201



202



203



204



205



206



207



208



209



210



211

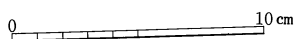

第345图 出土土器(9)

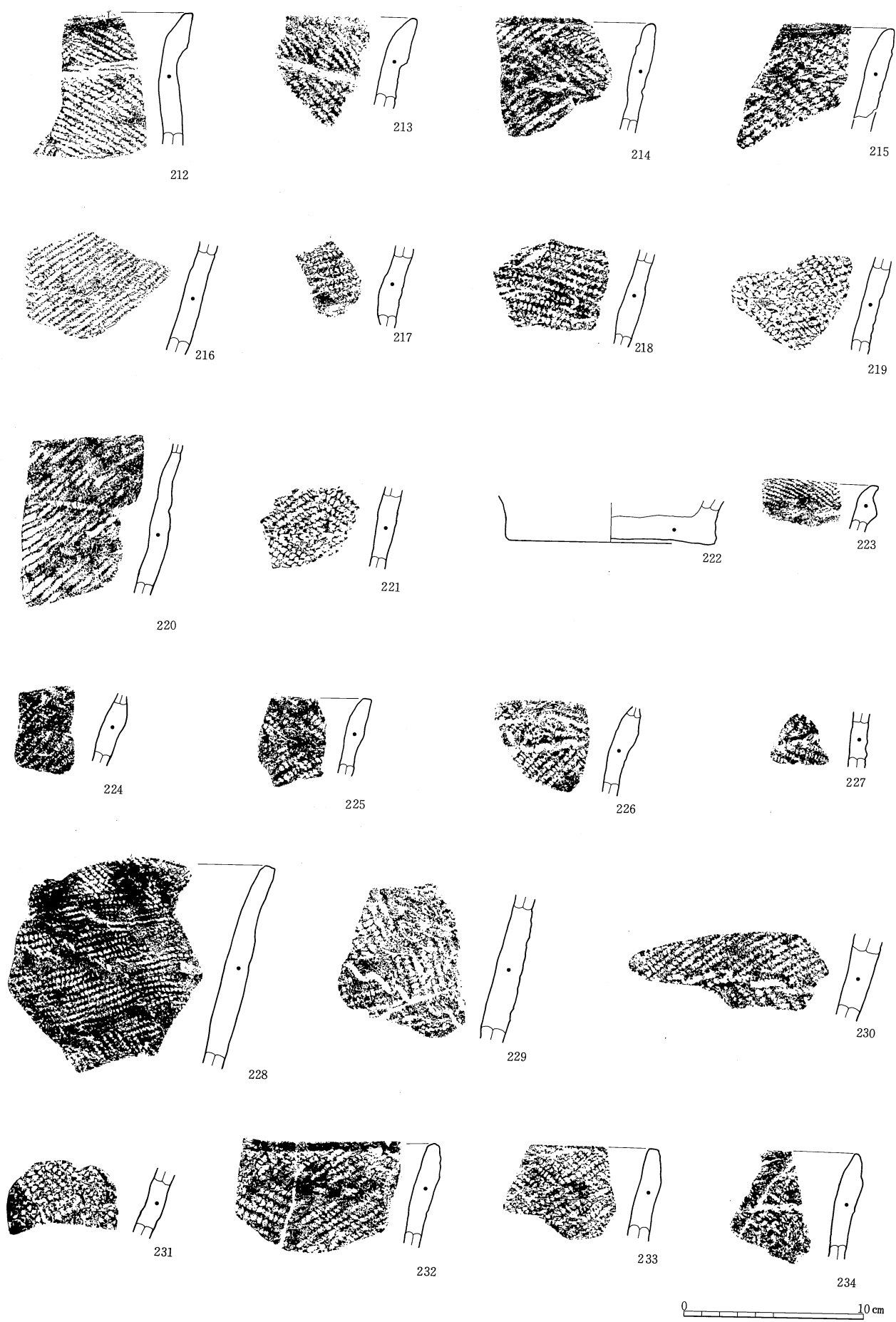

第346图 出土土器(10)

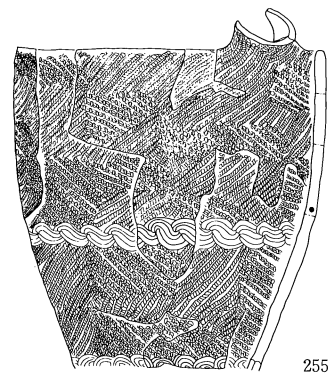

255

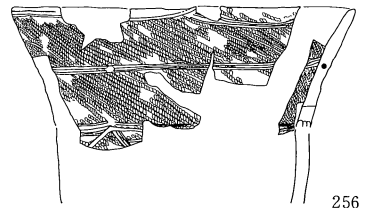

256

254

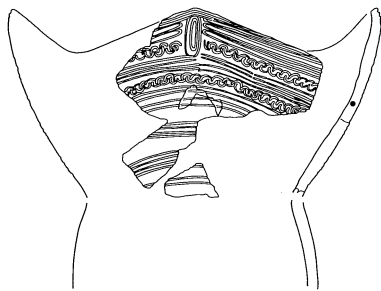

257

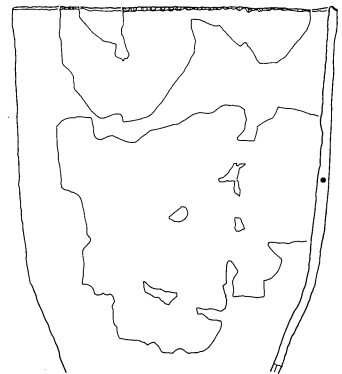

258

0 10cm

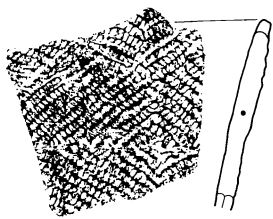

259



260



261



262



263



264



265



266



267

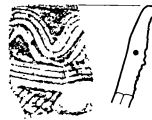

268



269



270

0 10cm

第347图 出土土器(11)

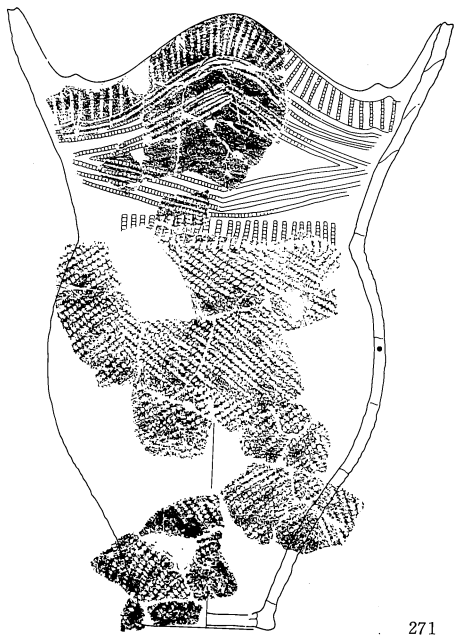

271

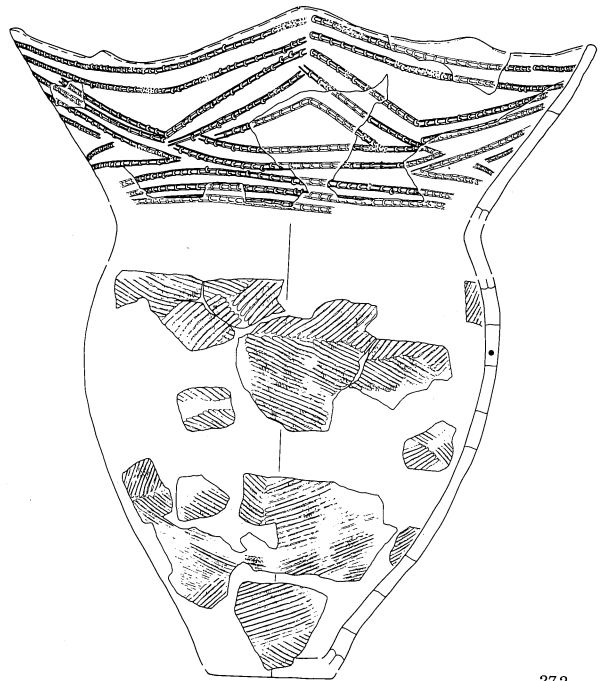

272

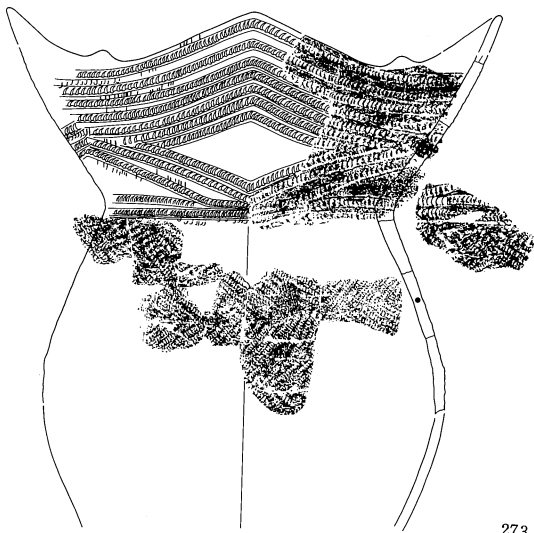

273

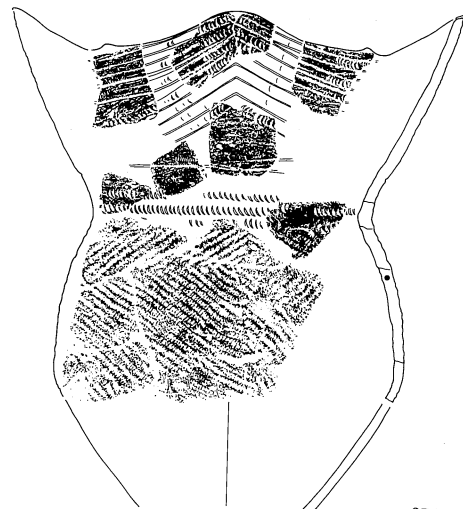

274

0 10cm



275

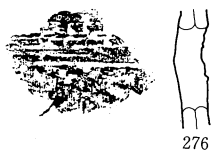

276



277

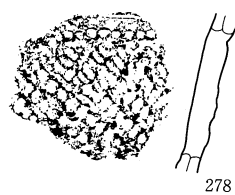

278

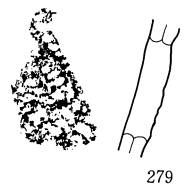

279

0 10 cm

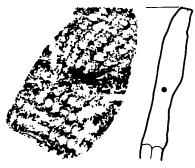

235



236

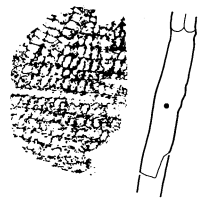

237



238



239

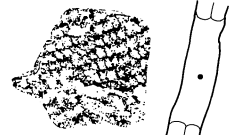

240

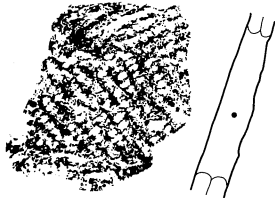

241

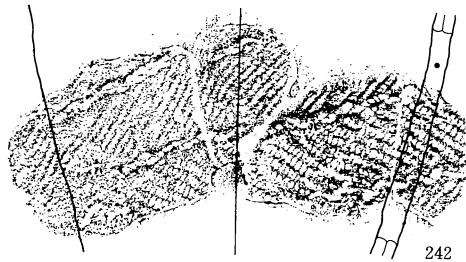

242



243



244



245

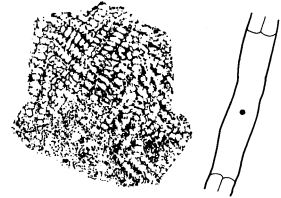

246

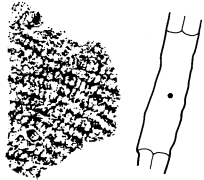

247



248



249



250



251



252



253

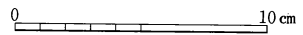

第349图 出土土器(13)

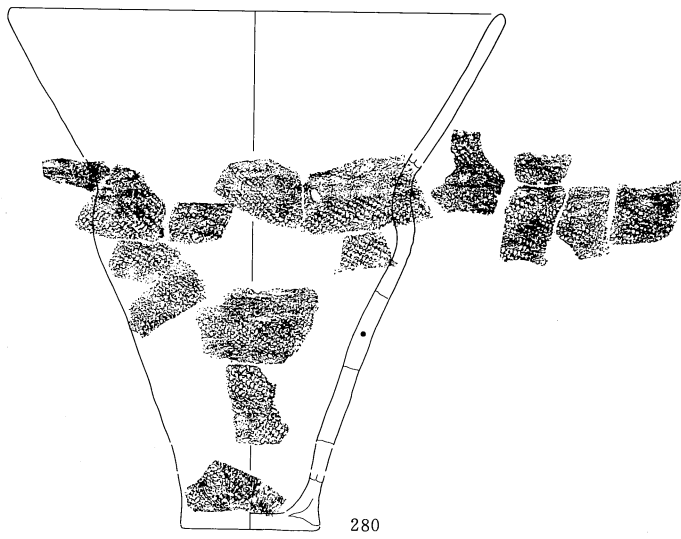

0 10cm

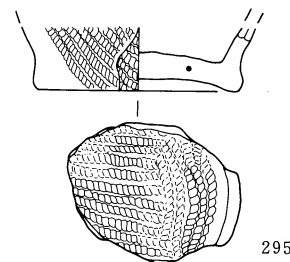
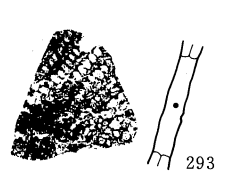
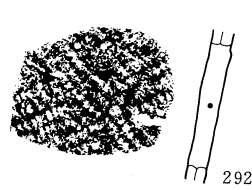
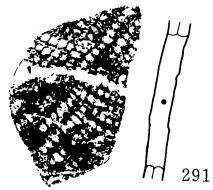
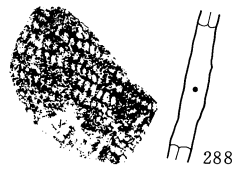
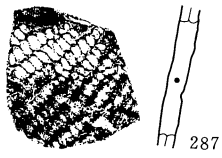
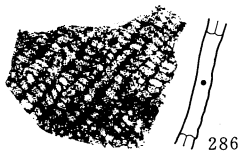
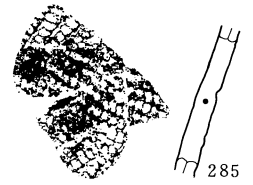
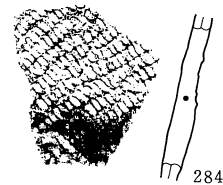

0 10cm

第350图 出土土器(14)

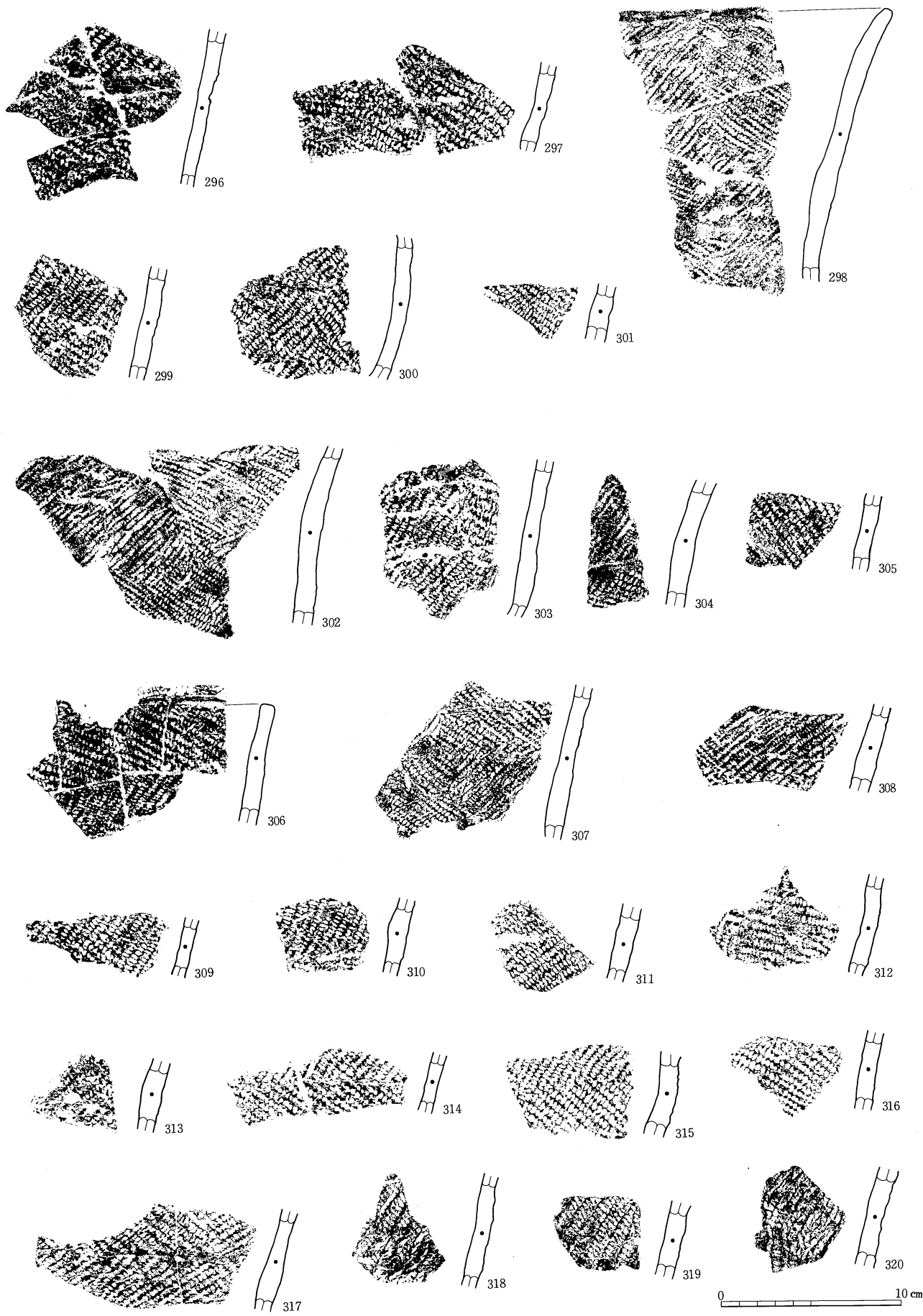

第351图 出土土器(15)

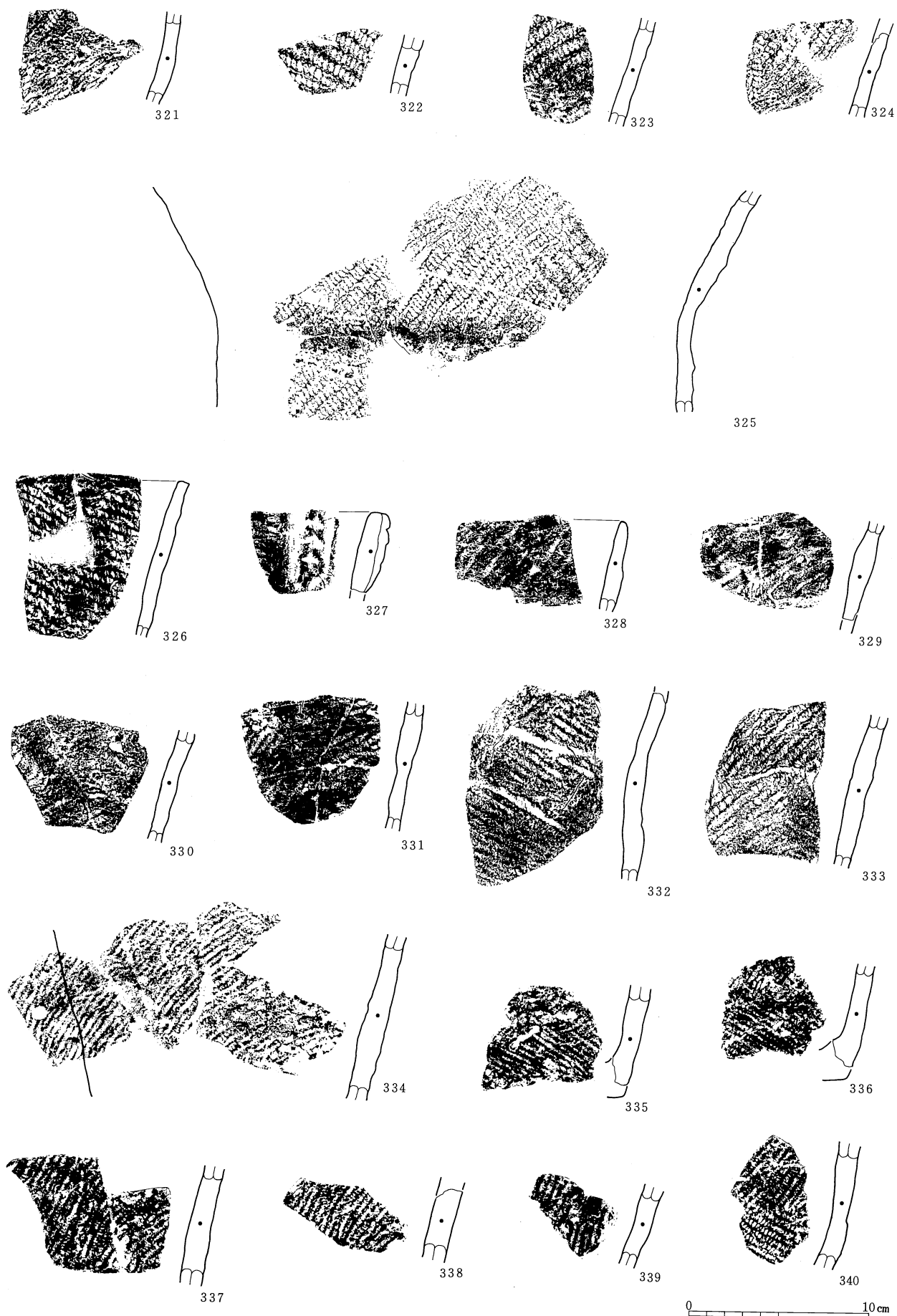

第352图 出土土器(16)

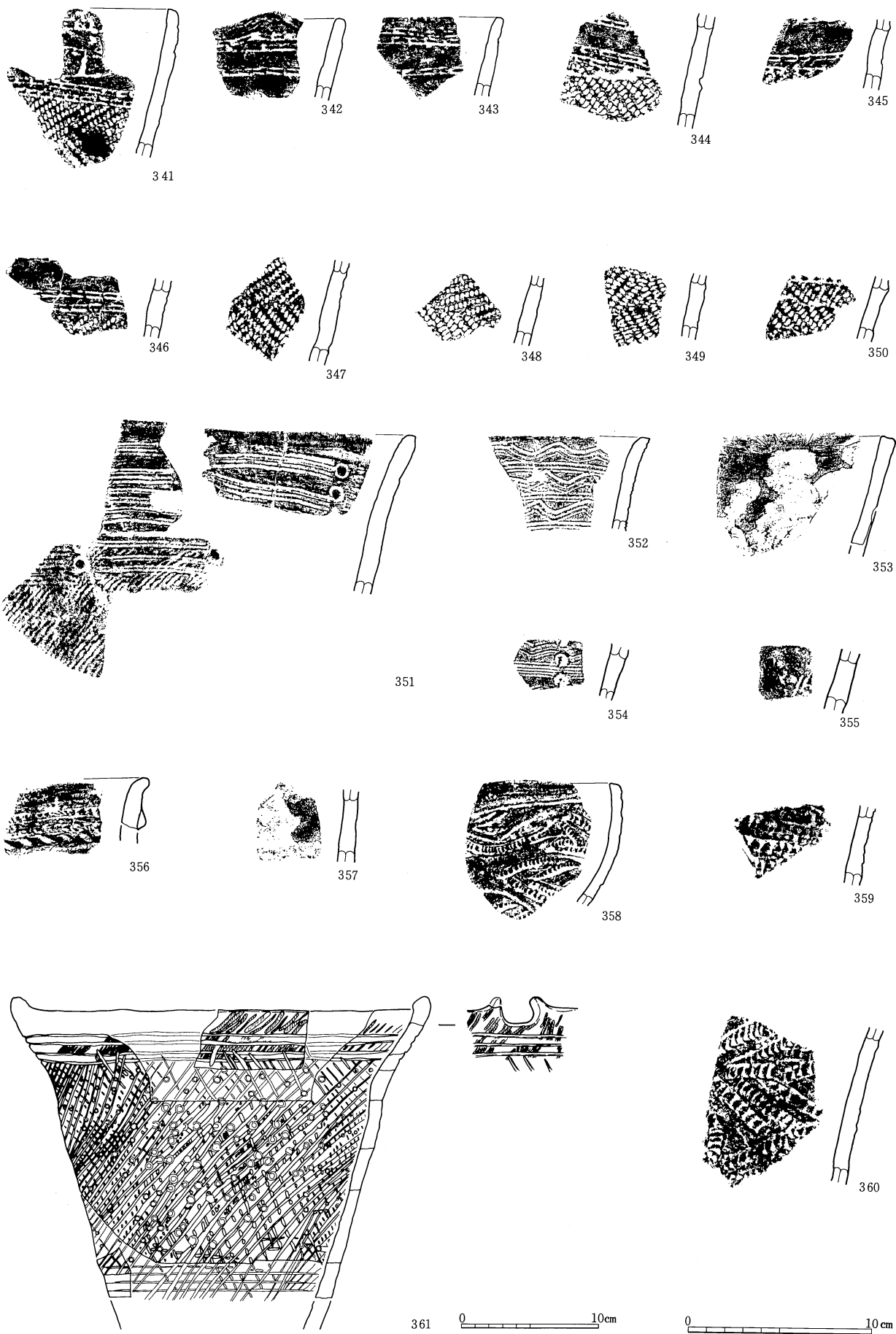

第353图 出土土器(17)

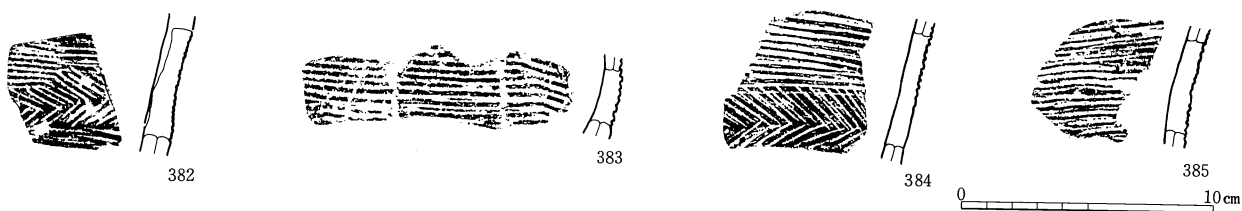
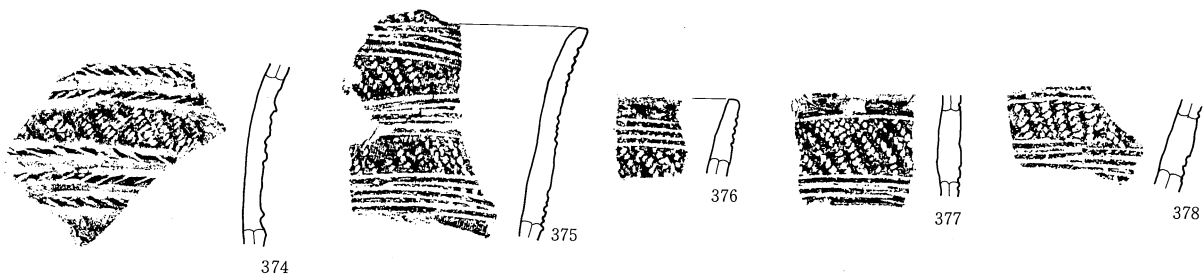
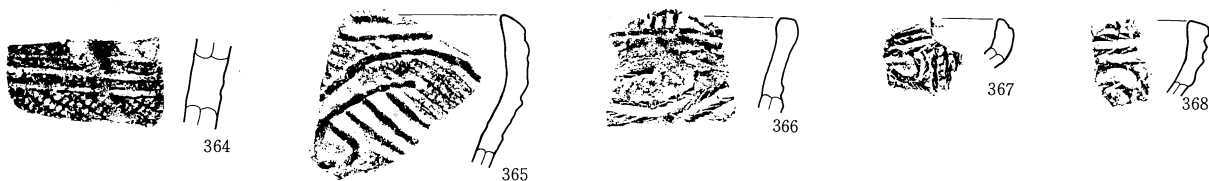
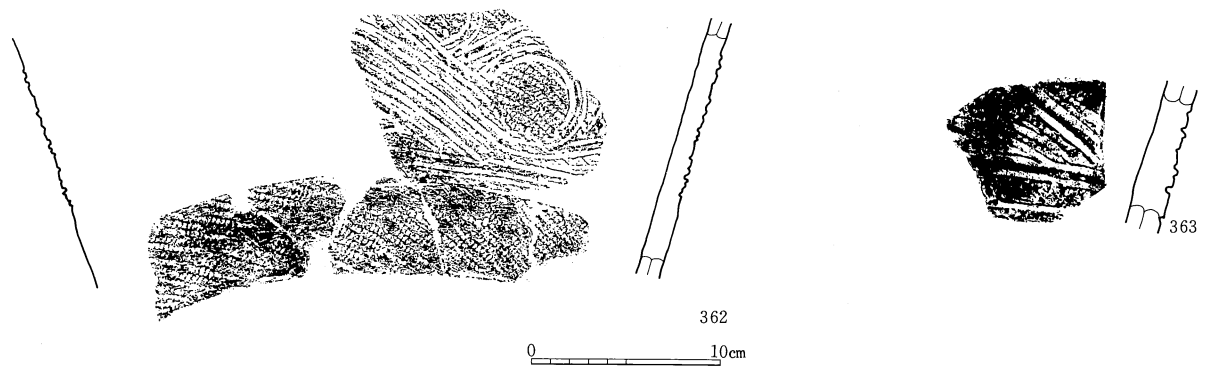

第354图 出土土器(18)

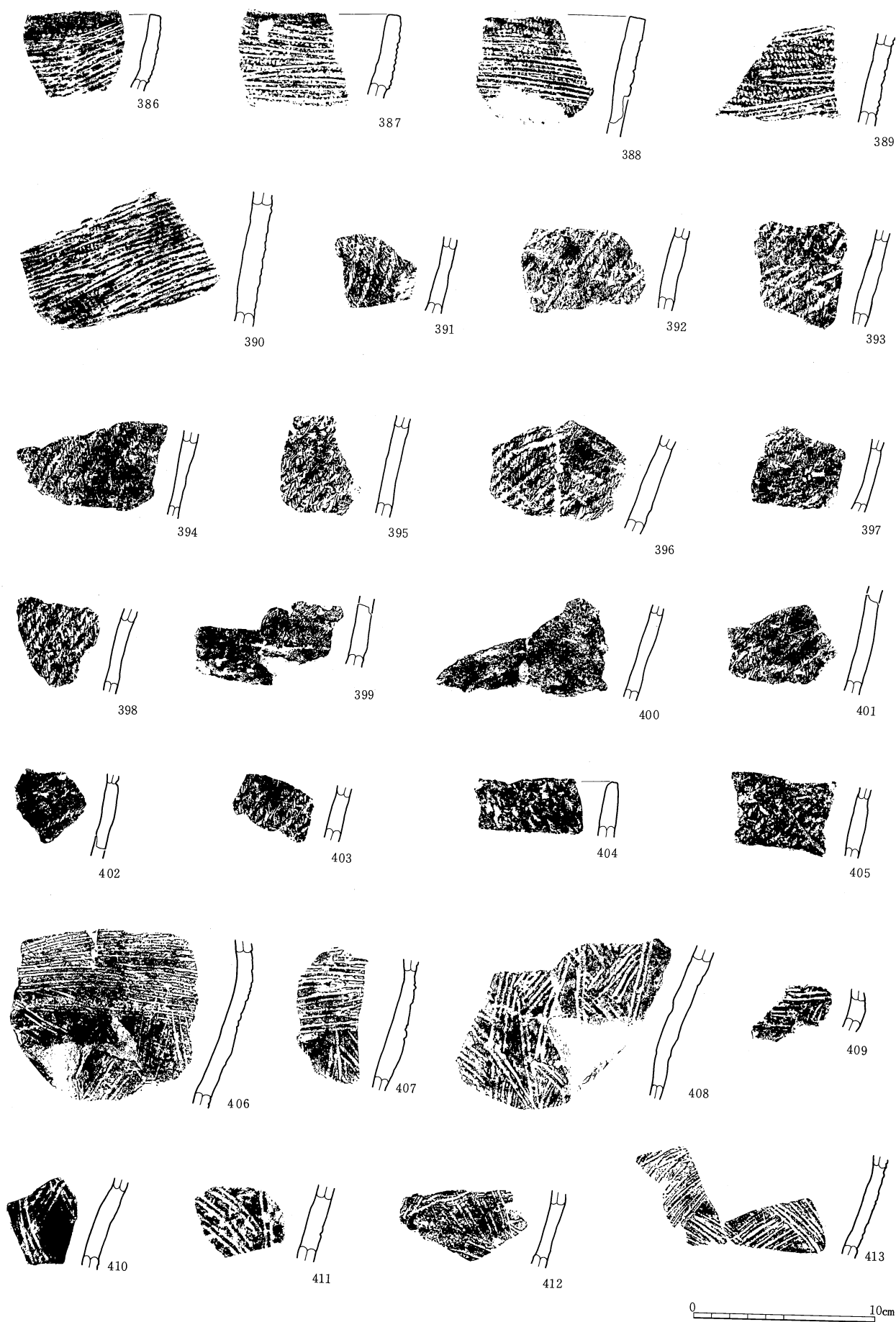

第355图 出土土器(19)

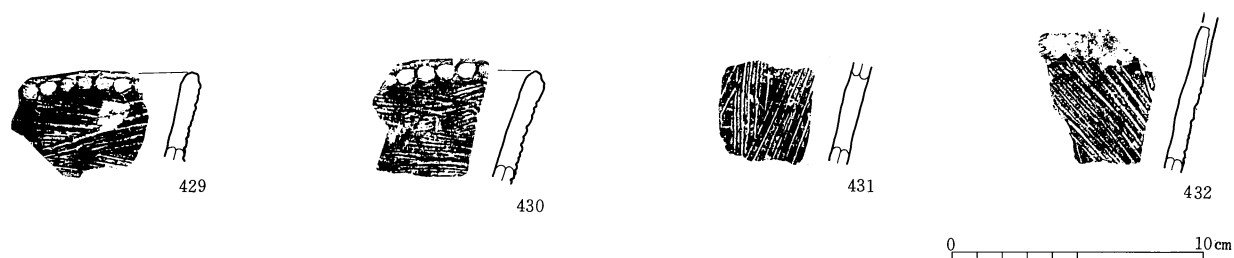
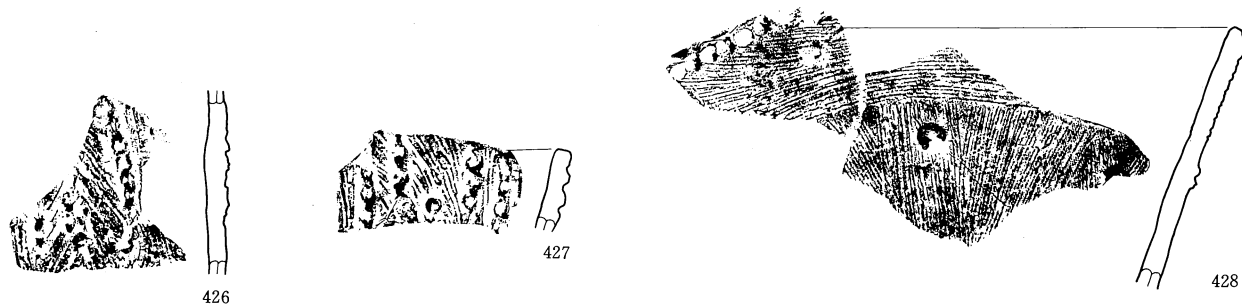
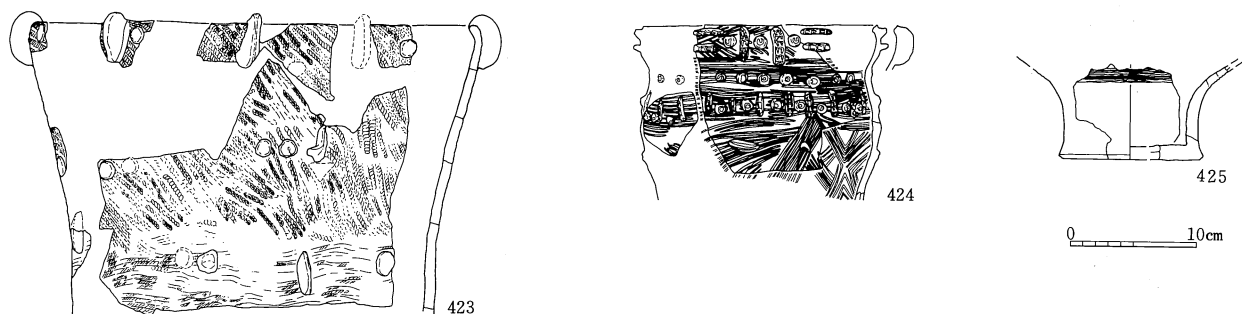
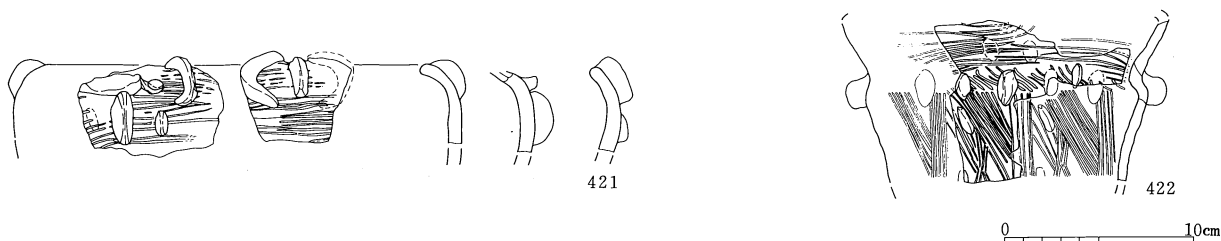
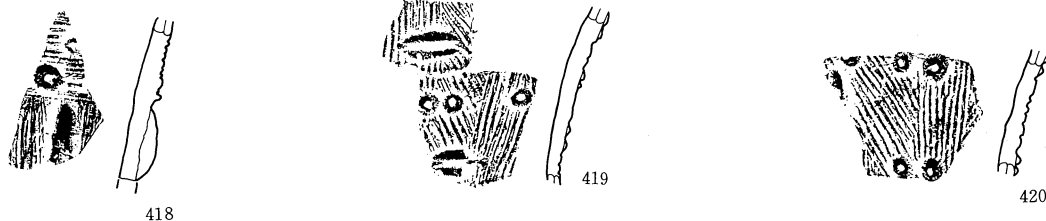

第356图 出土土器(20)

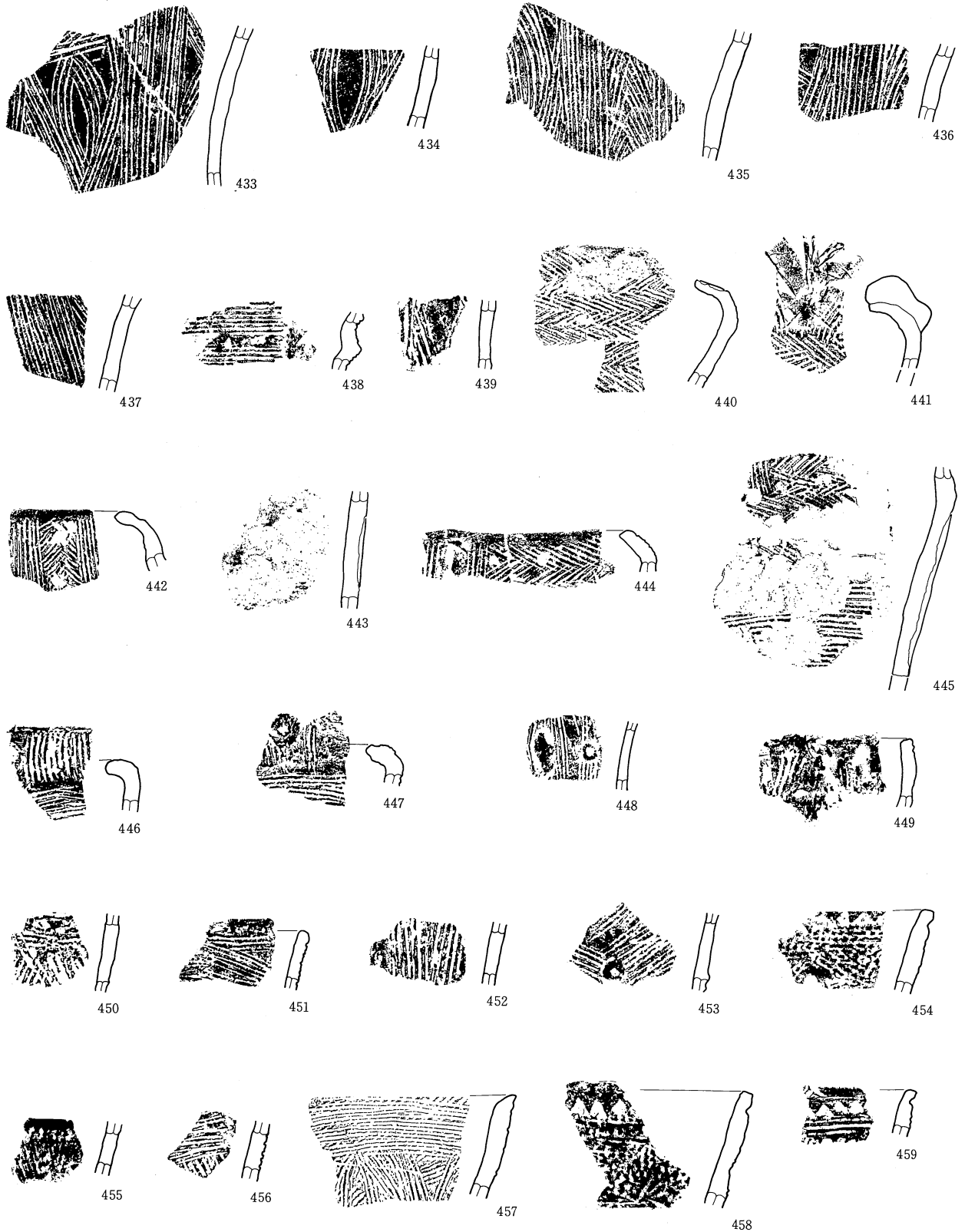

0 10cm

第357图 出土土器(21)

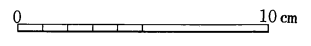
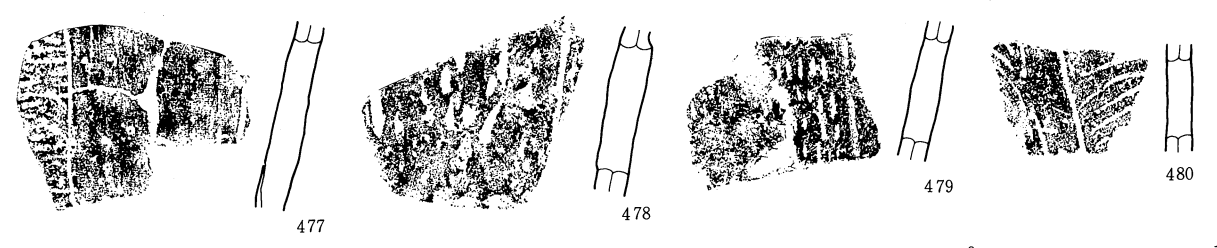
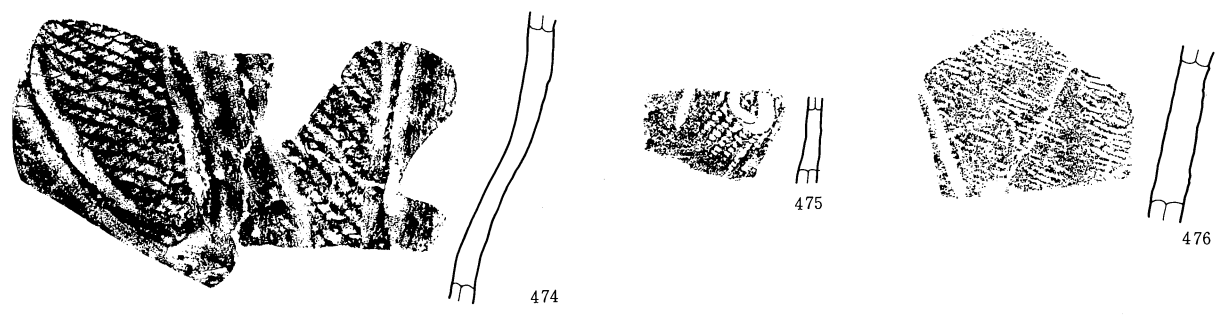
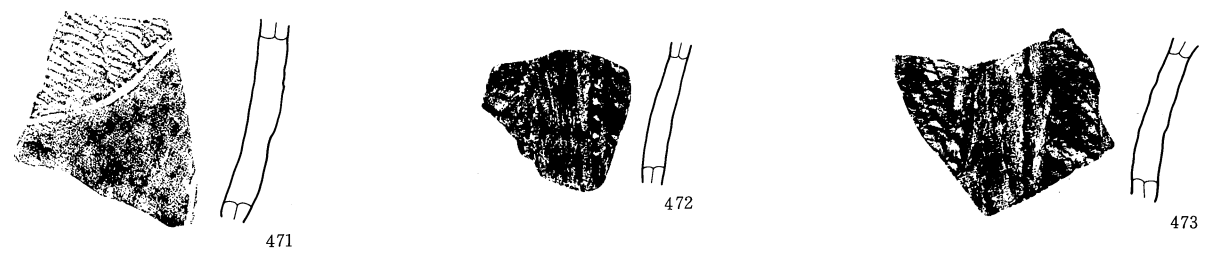
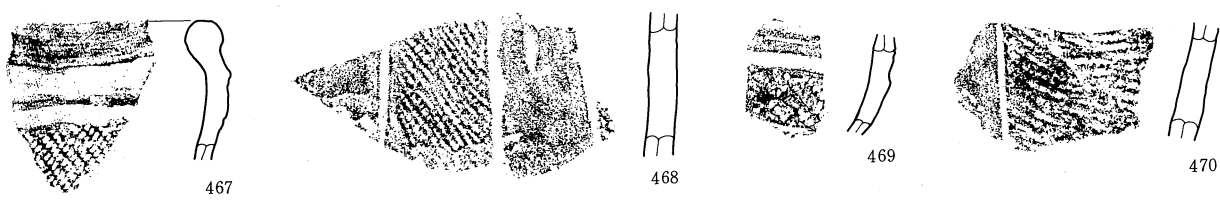
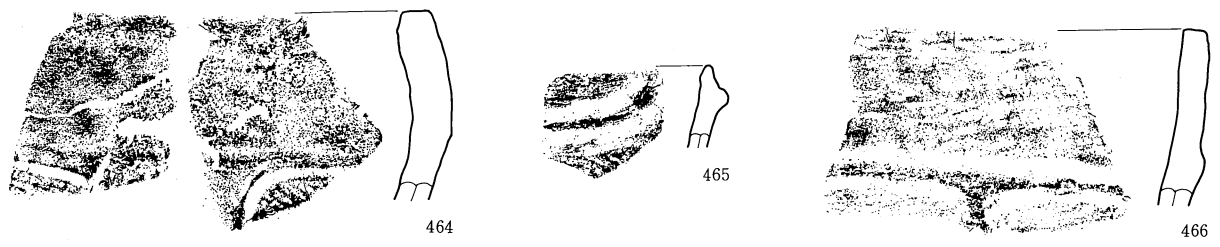

第358图 出土土器(22)

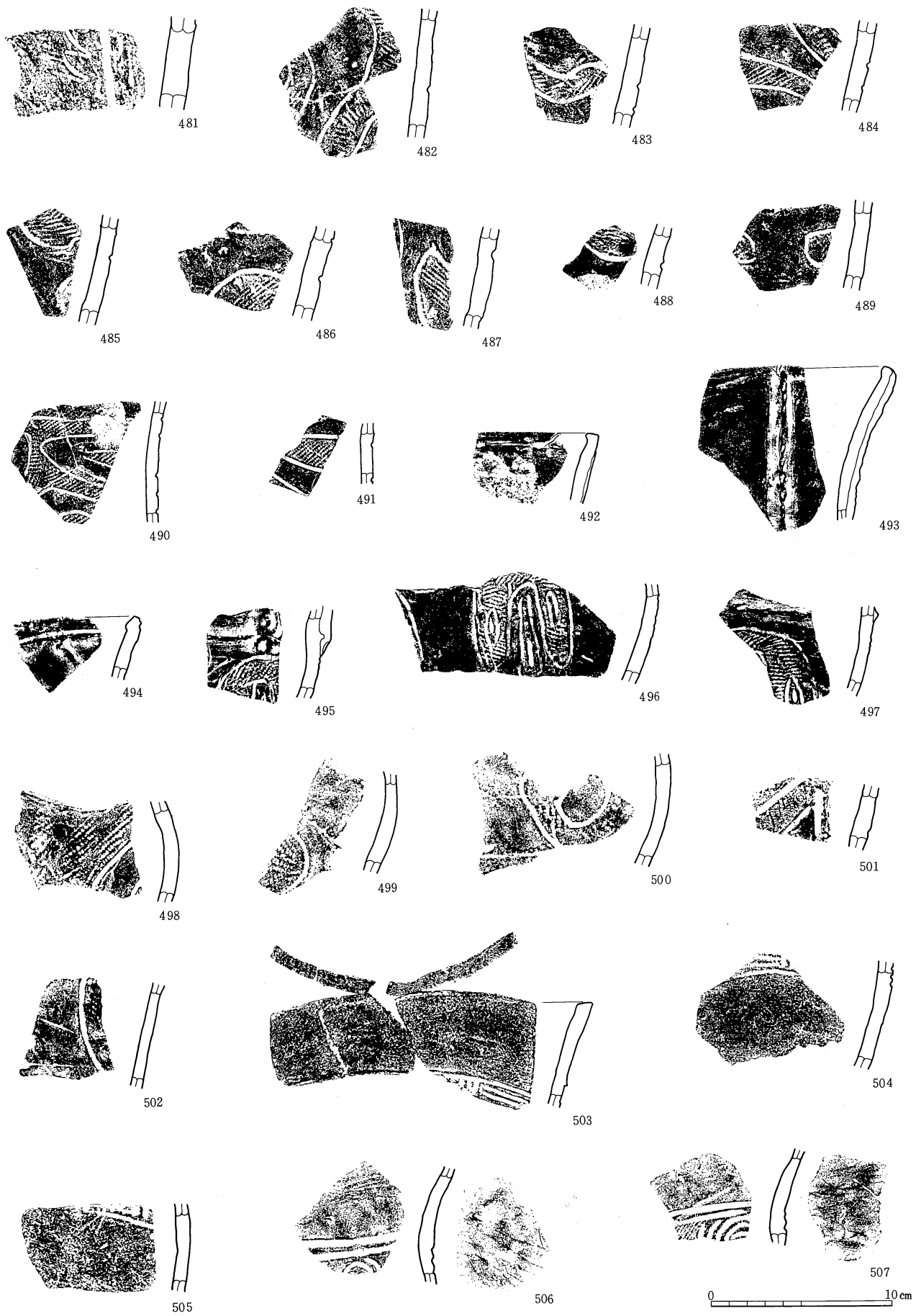

第359图 出土土器(23)

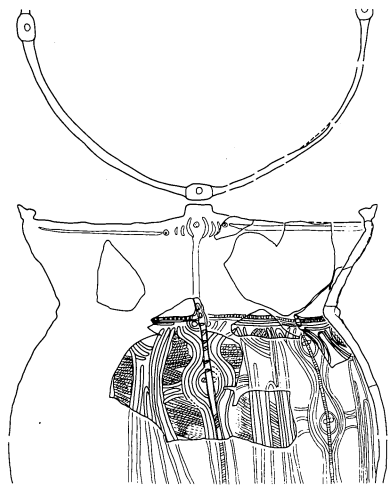

508

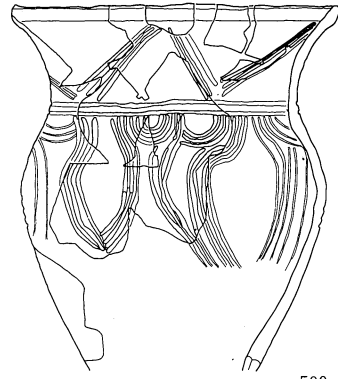

509

0 10cm

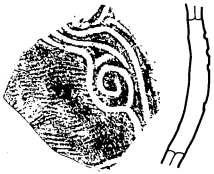

510



511



512



513



514

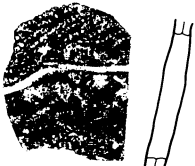

515



516



517



518



519



520

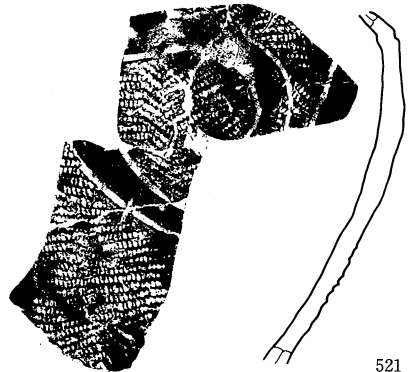

521



522



523

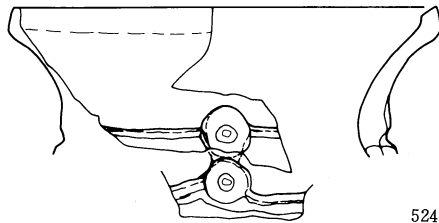

524

0 10cm



525



526



527



528

0 10cm

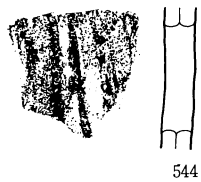
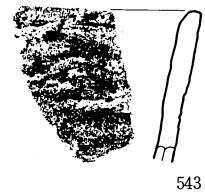
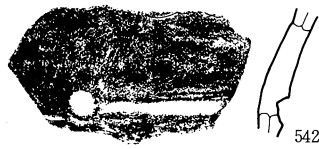
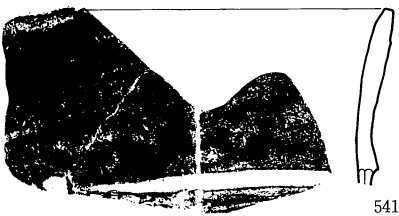
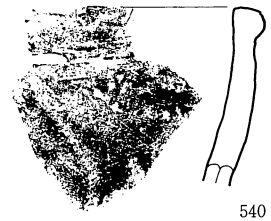
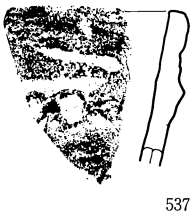
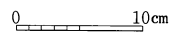
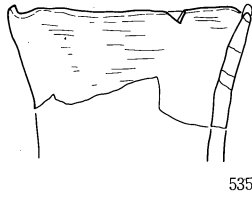
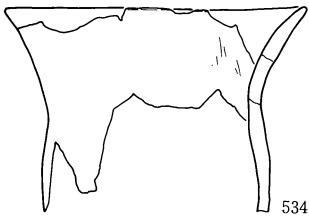
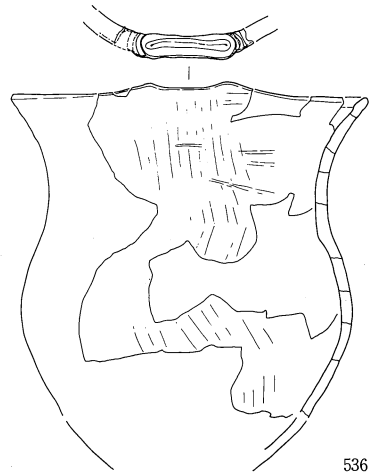
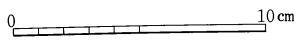
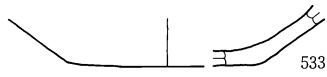
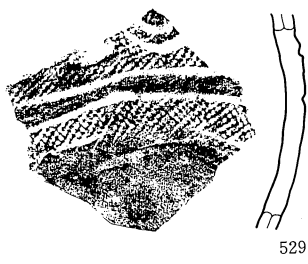

第361图 出土土器(25)

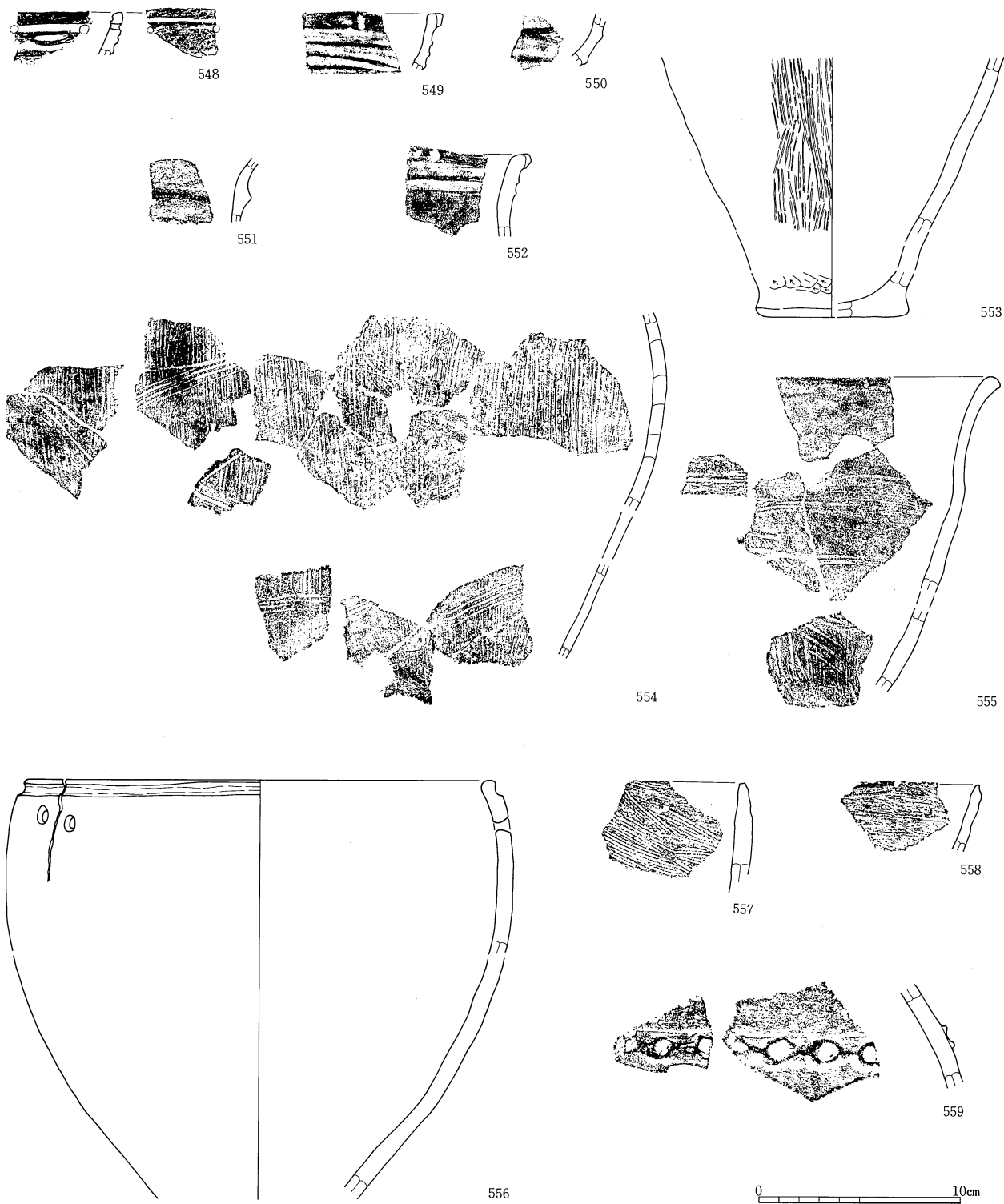

第362图 出土土器(26)

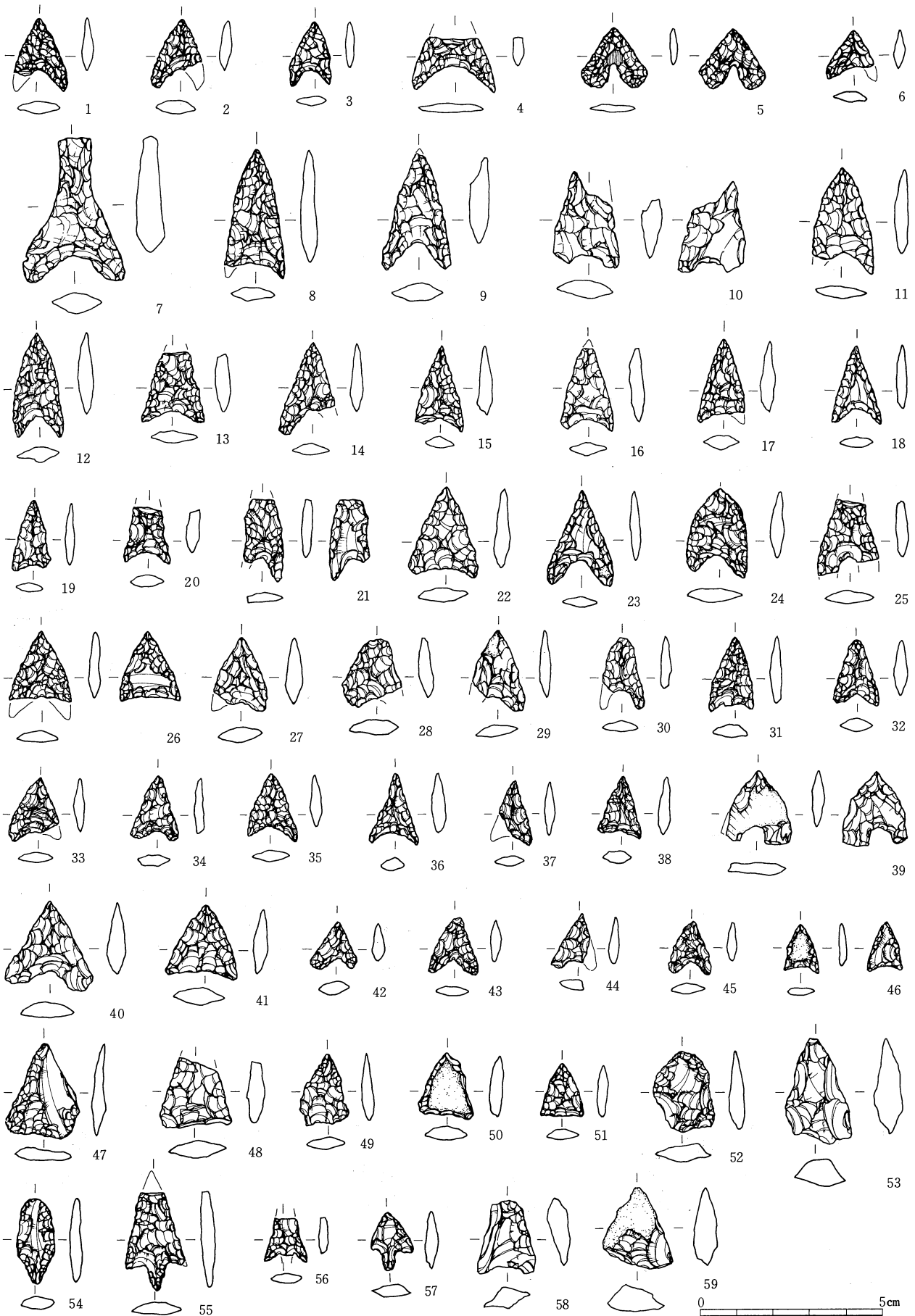

第363图 出土石器(1)

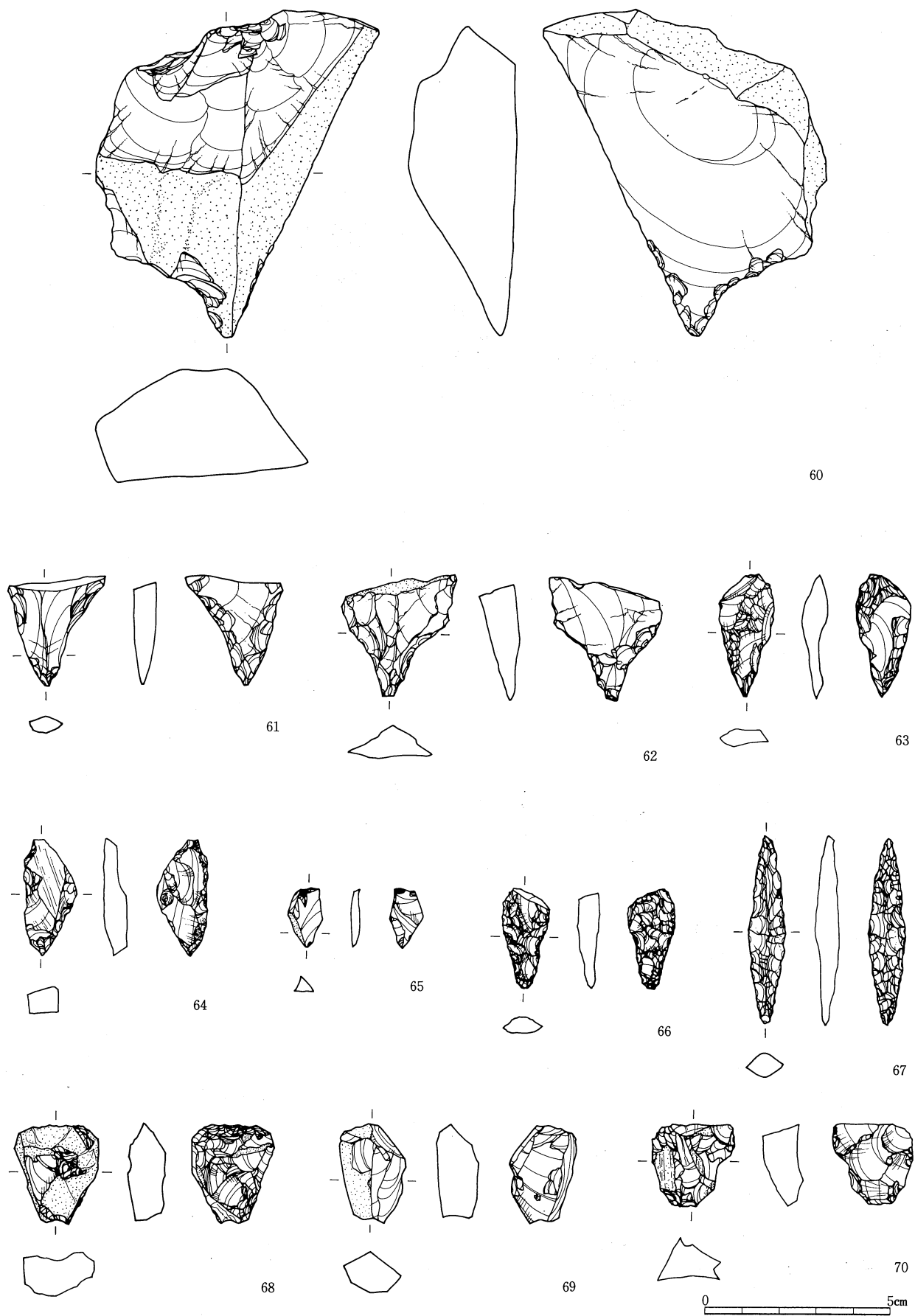

第364图 出土石器(2)

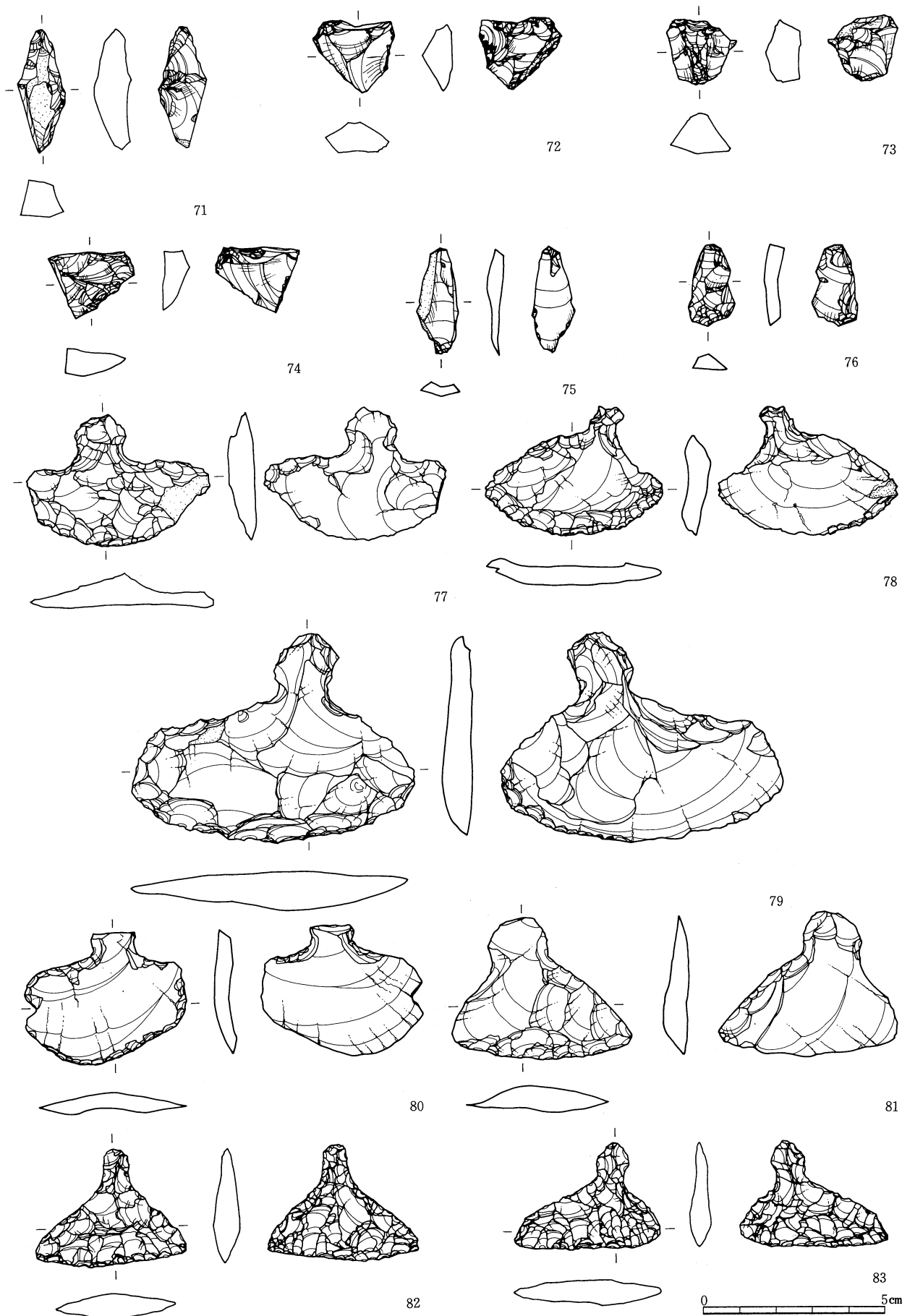

第365图 出土石器(3)

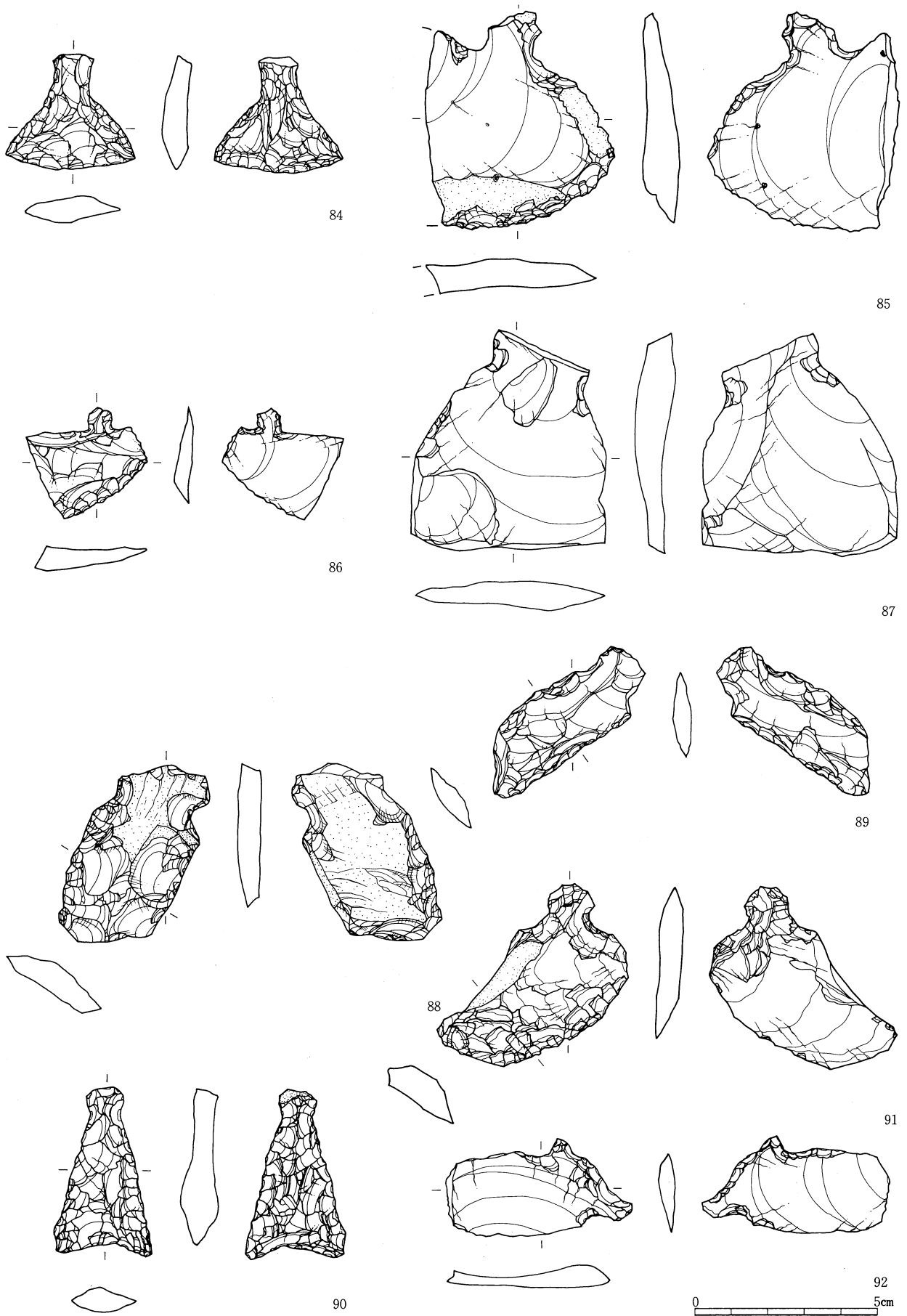

第366图 出土石器(4)



93

94

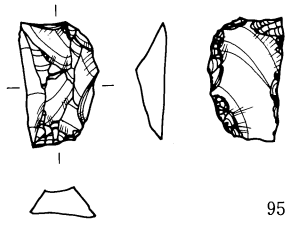

95

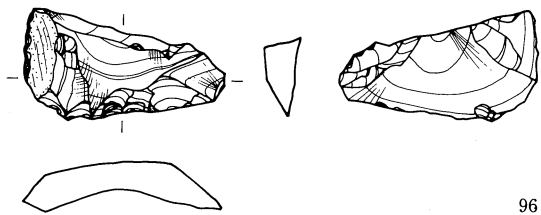

96

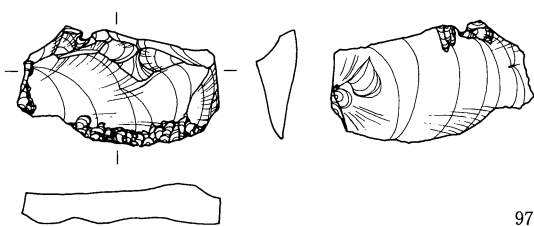

97

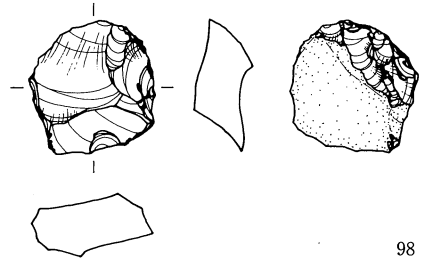

98

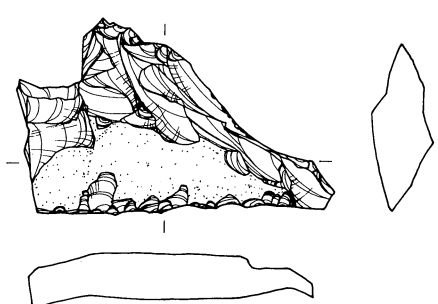

99

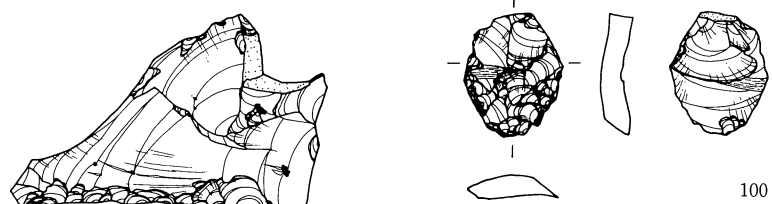

100

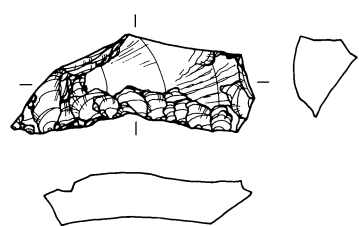

101

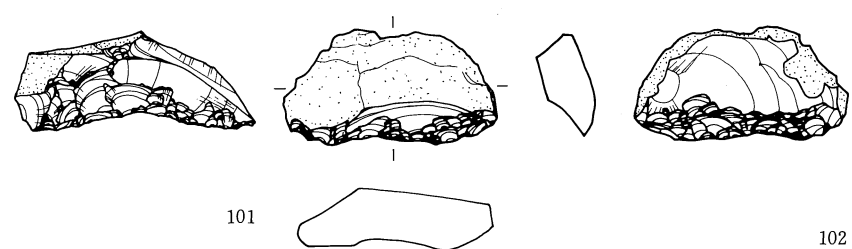

102



第367图 出土石器(5)

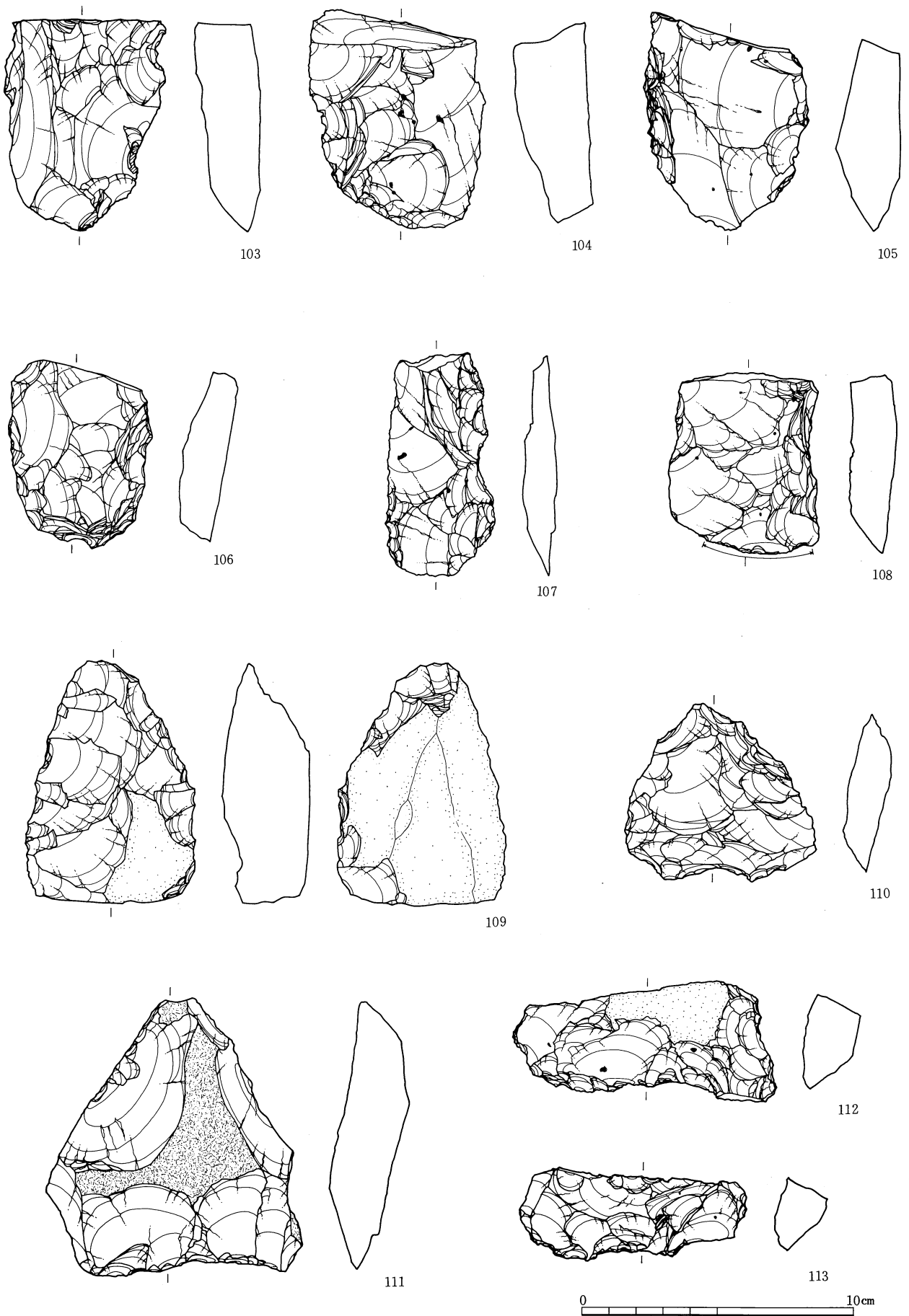

第368图 出土石器(6)

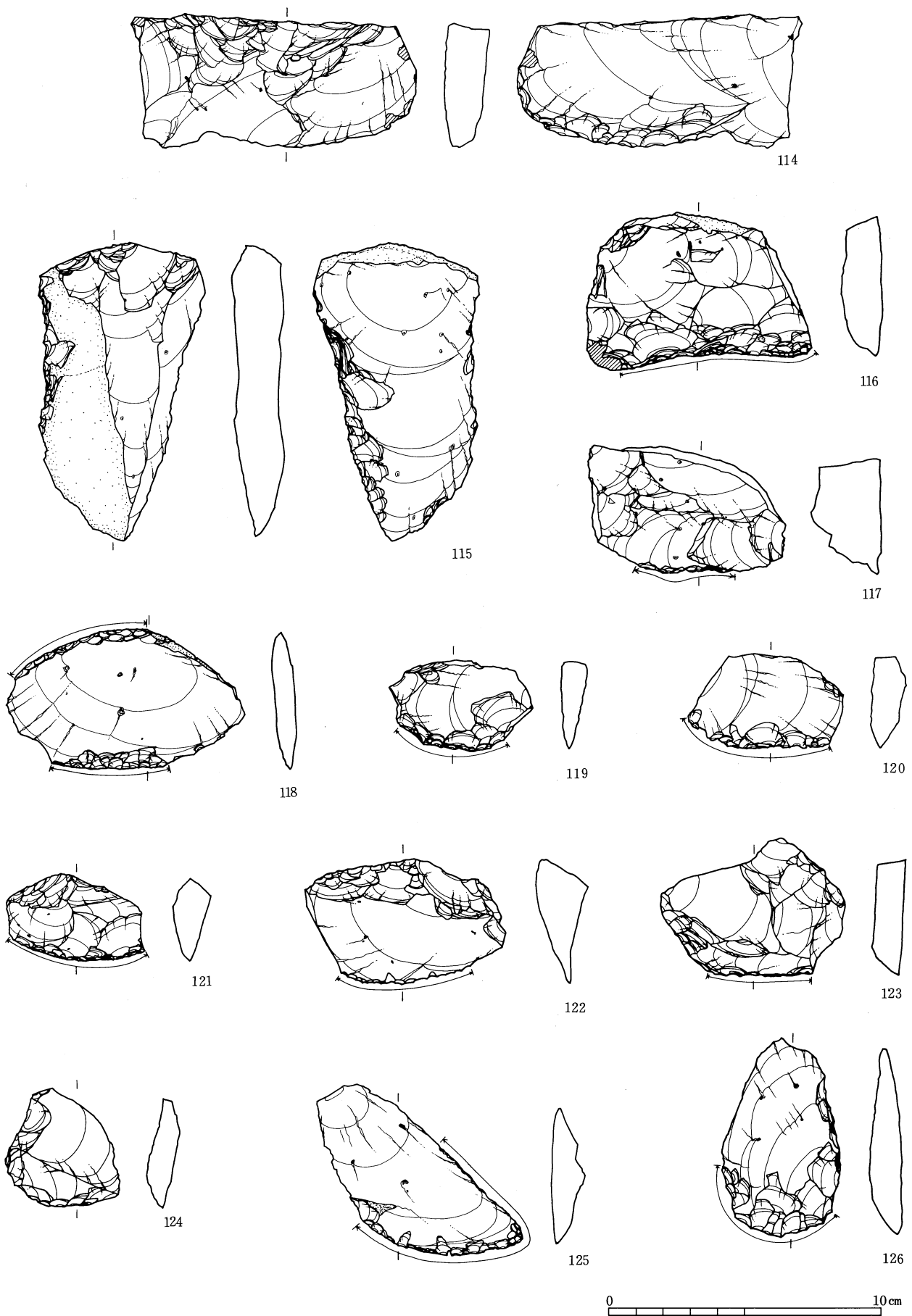

第369图 出土石器(7)

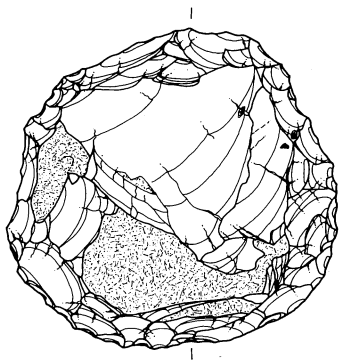

127

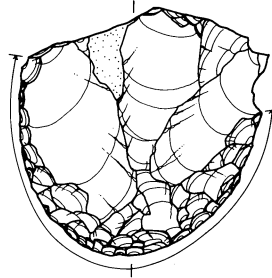

128

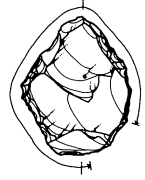

129

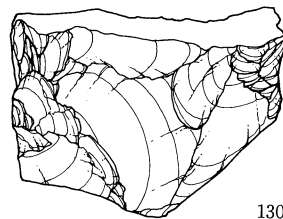
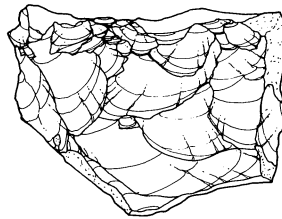
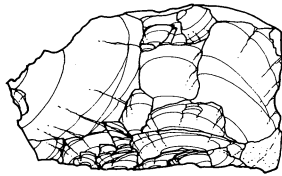

130

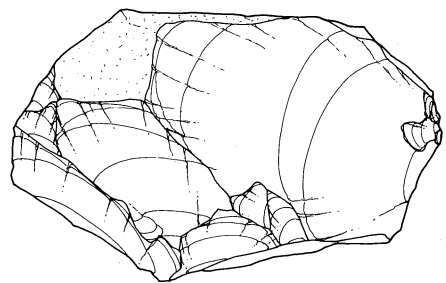
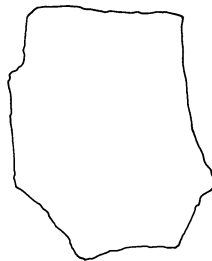
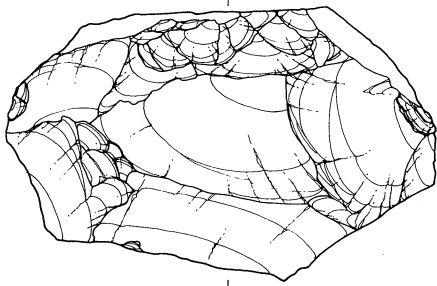

131



第370图 出土石器(8)

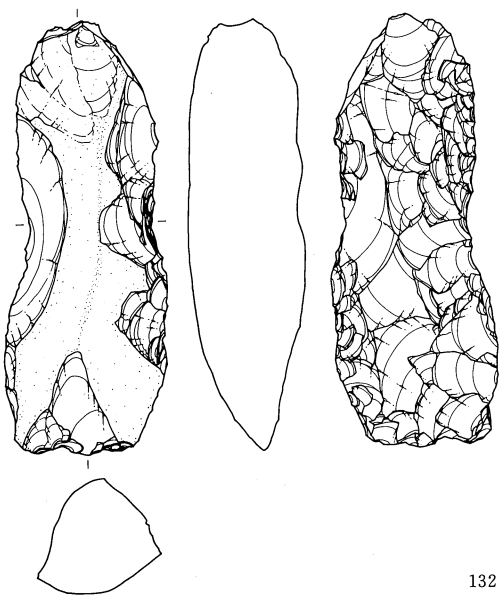

132

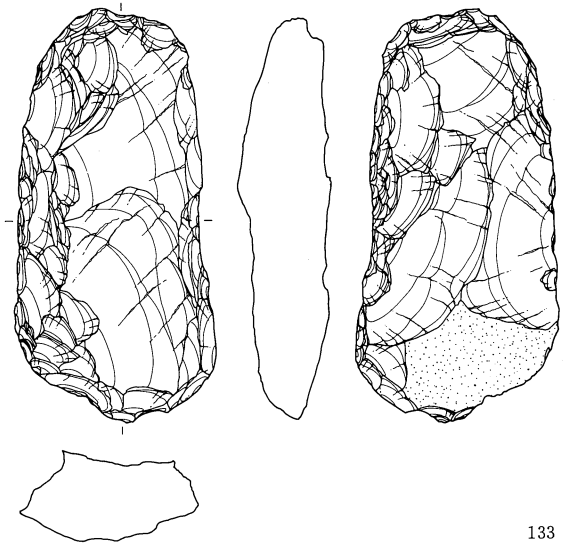

133

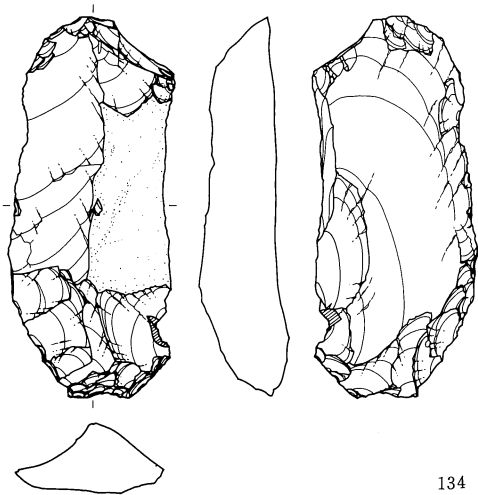

134

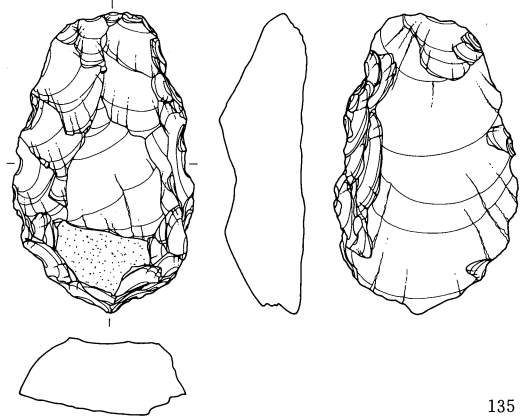

135

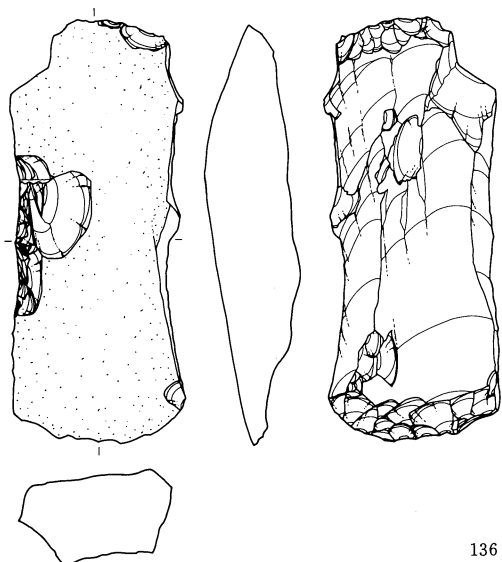

136

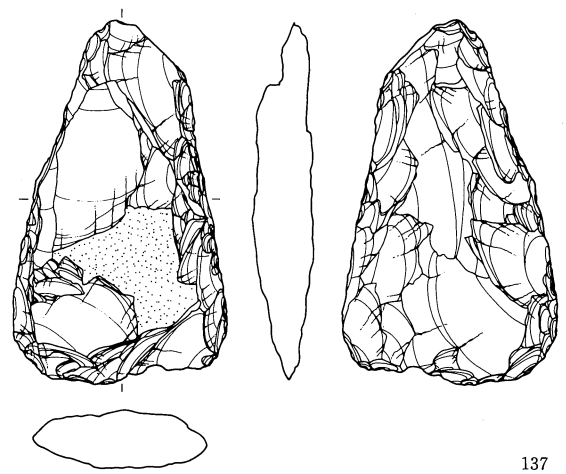

137

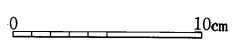

第371图 出土石器(9)

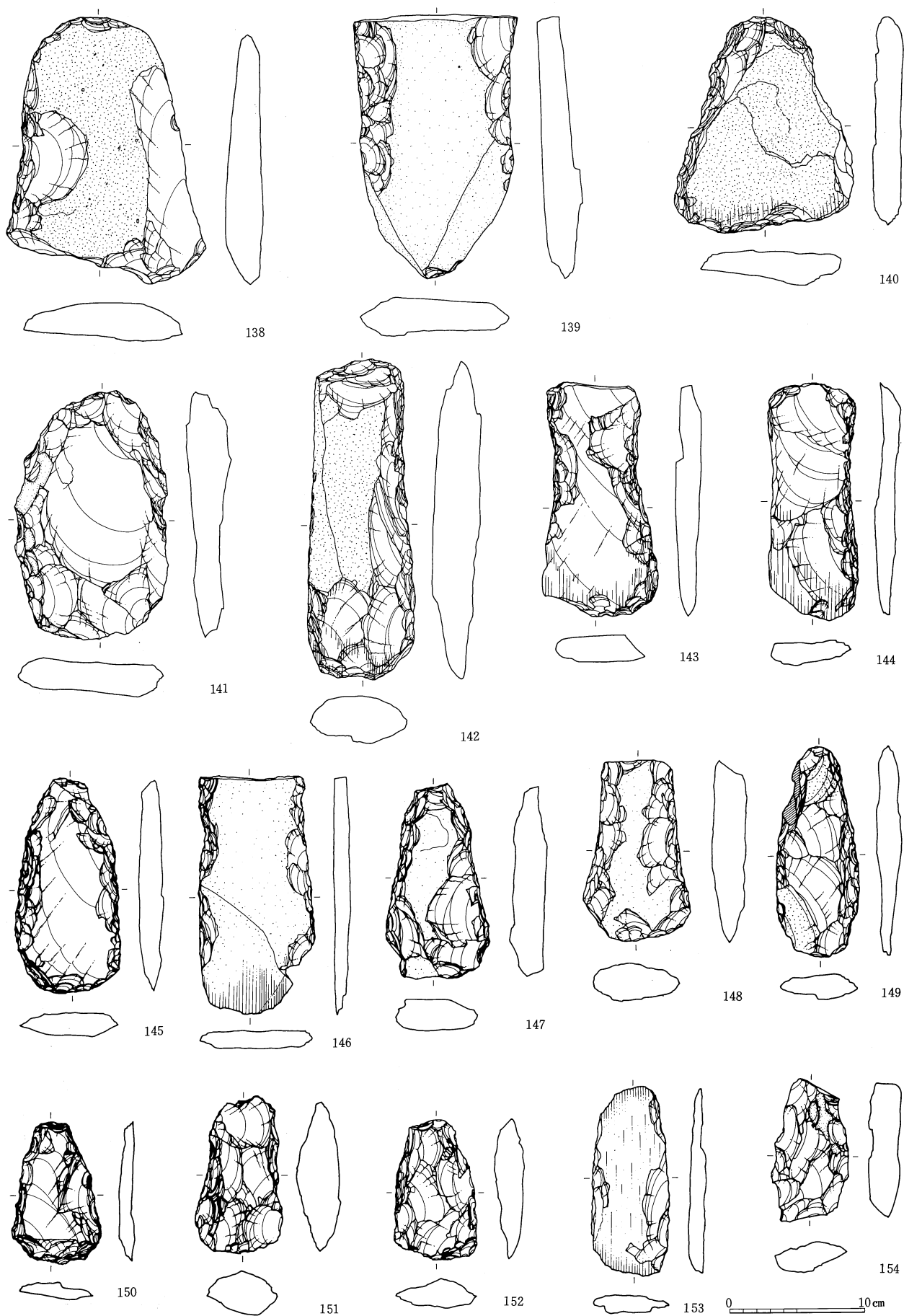

第372图 出土石器(10)

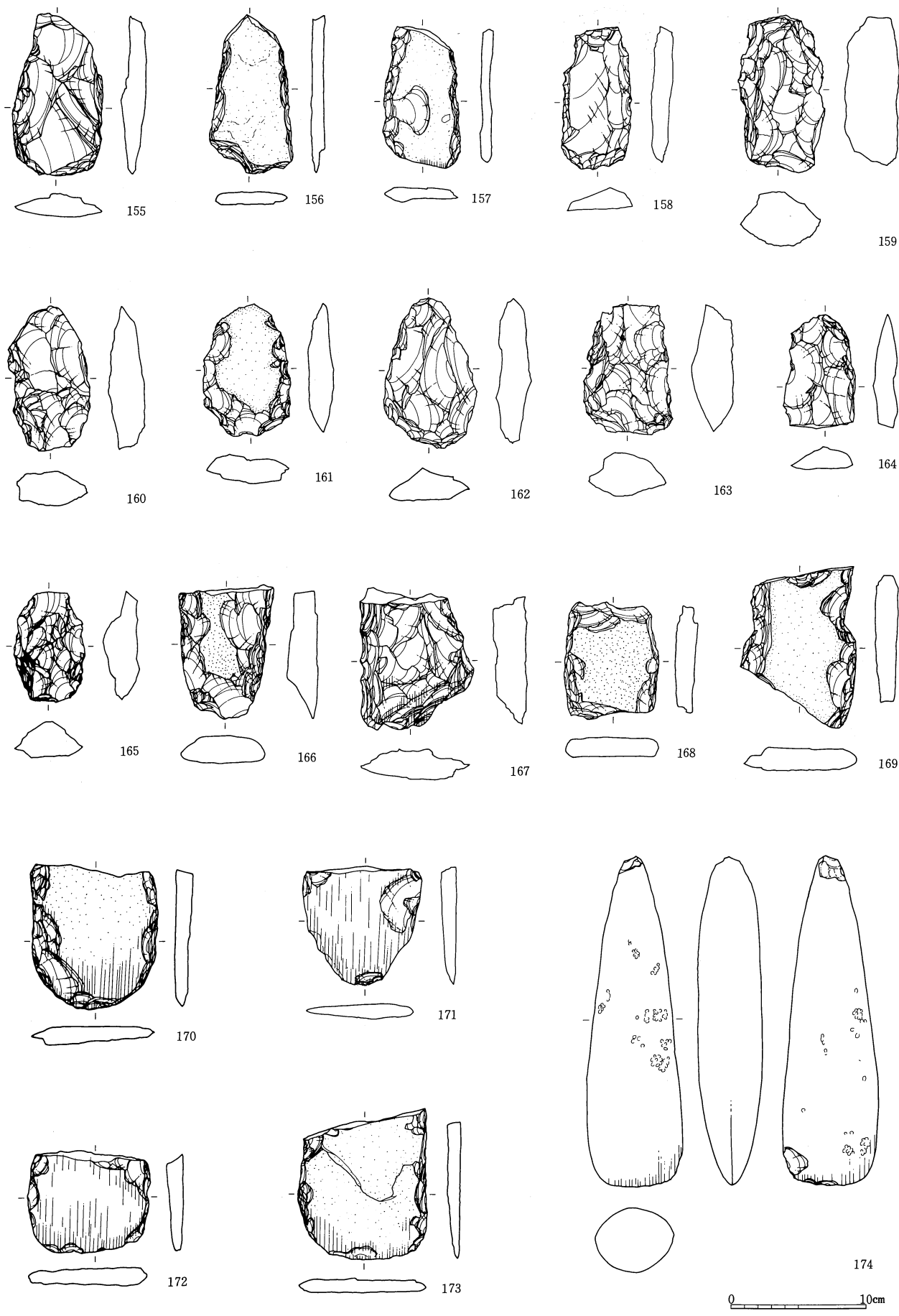

第373图 出土石器(11)

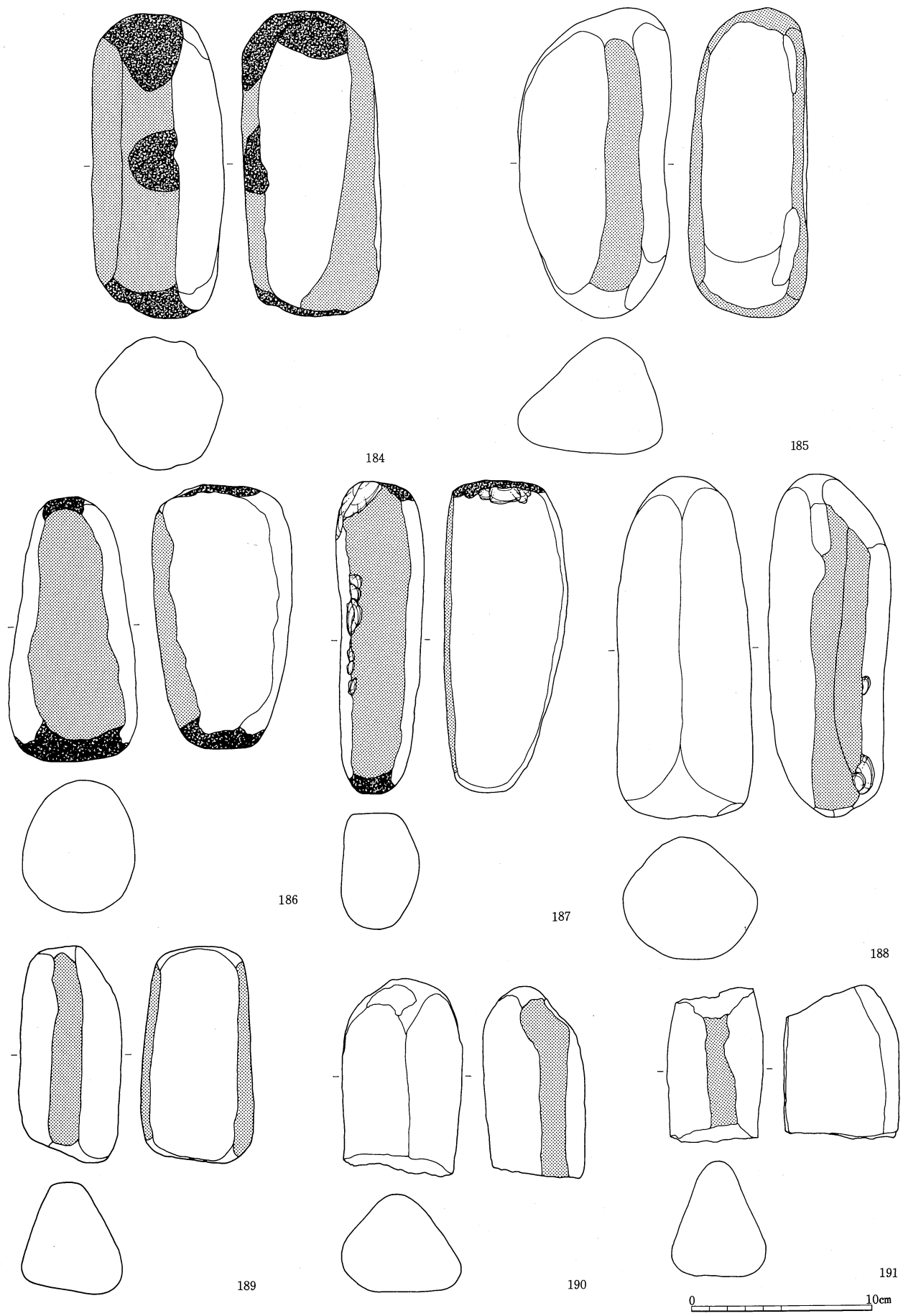

第374图 出土石器(12)

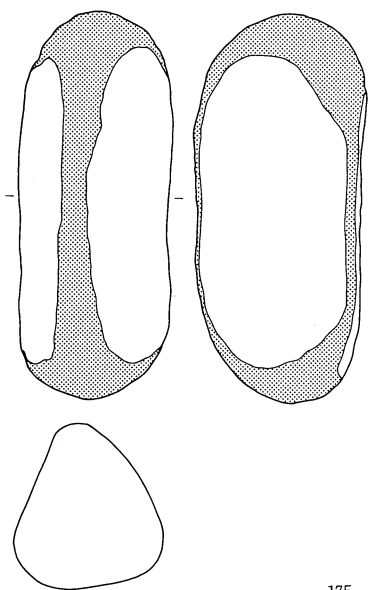

175

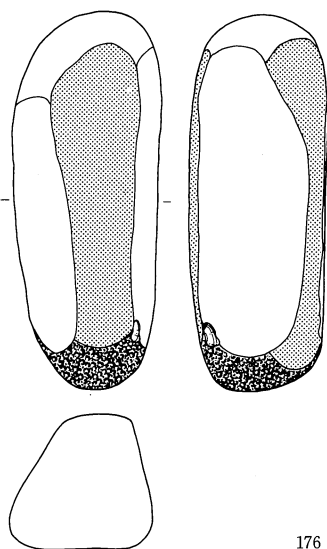

176

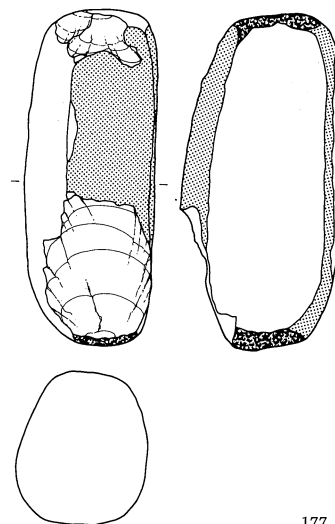

177



178

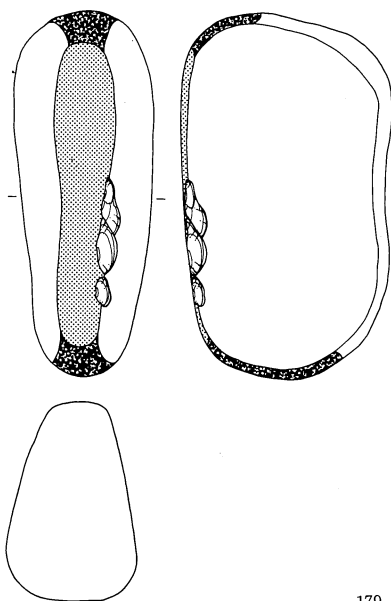

179

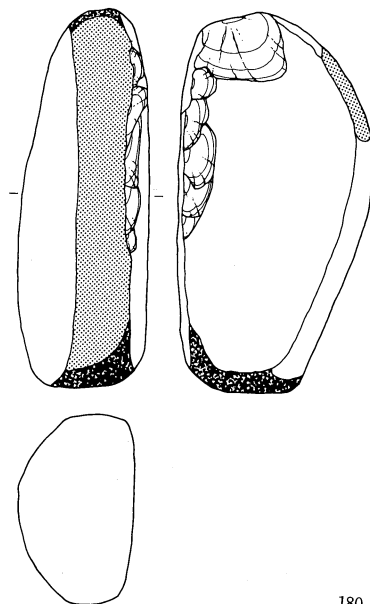

180

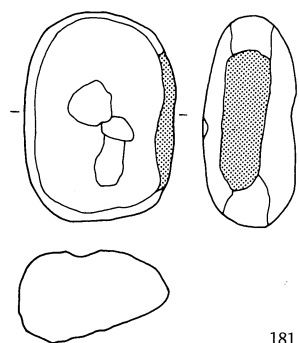

181

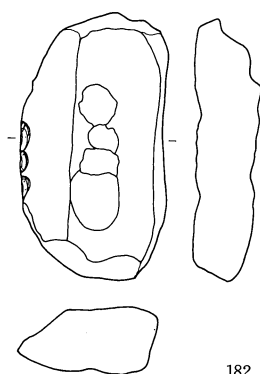

182

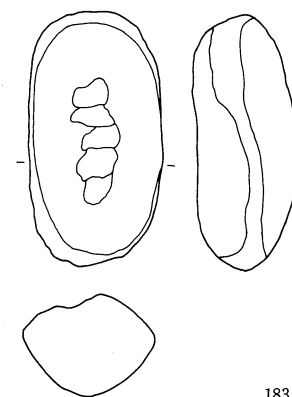

183

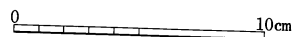

第375图 出土石器(13)

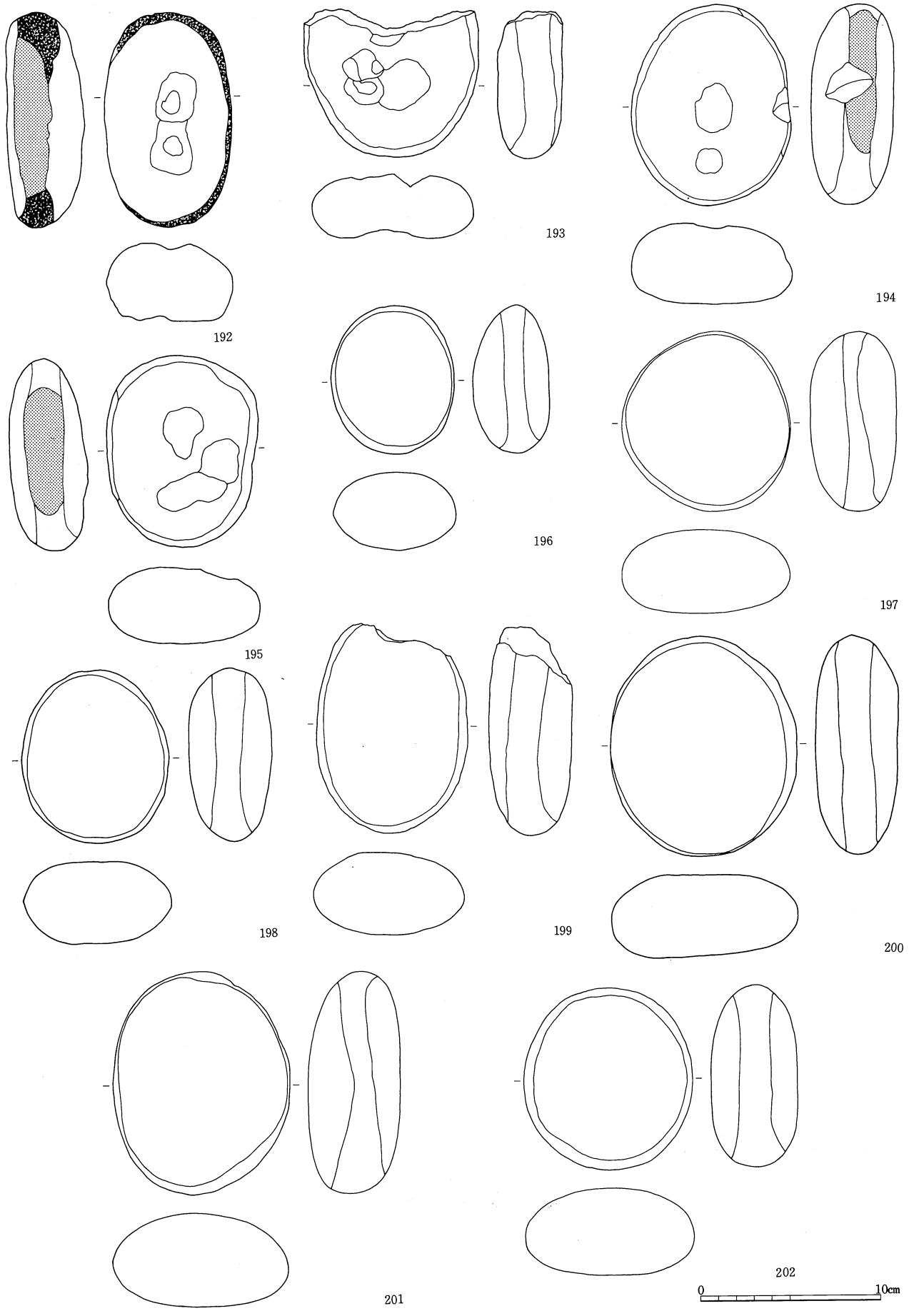

第376图 出土石器(14)

弥生時代～平安時代以降



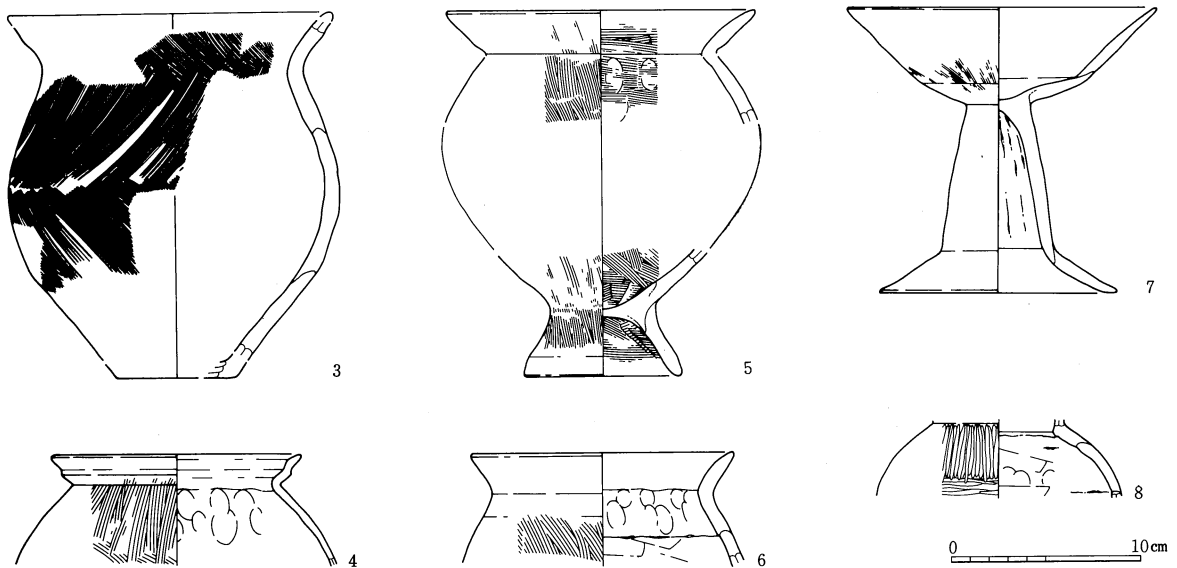
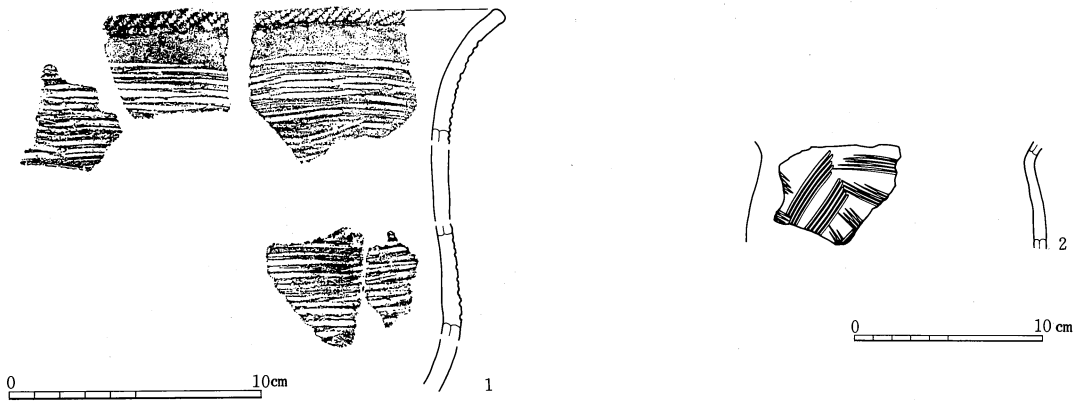
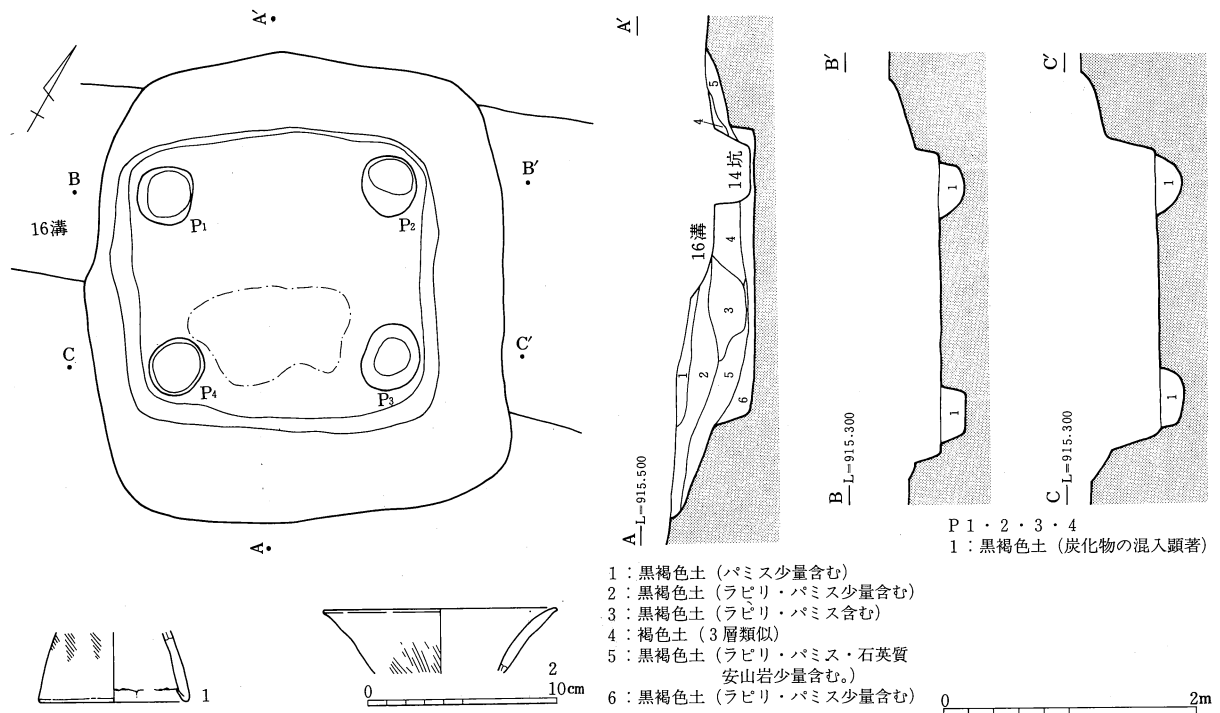

第377図 4号住居址・遺構外出土遺物

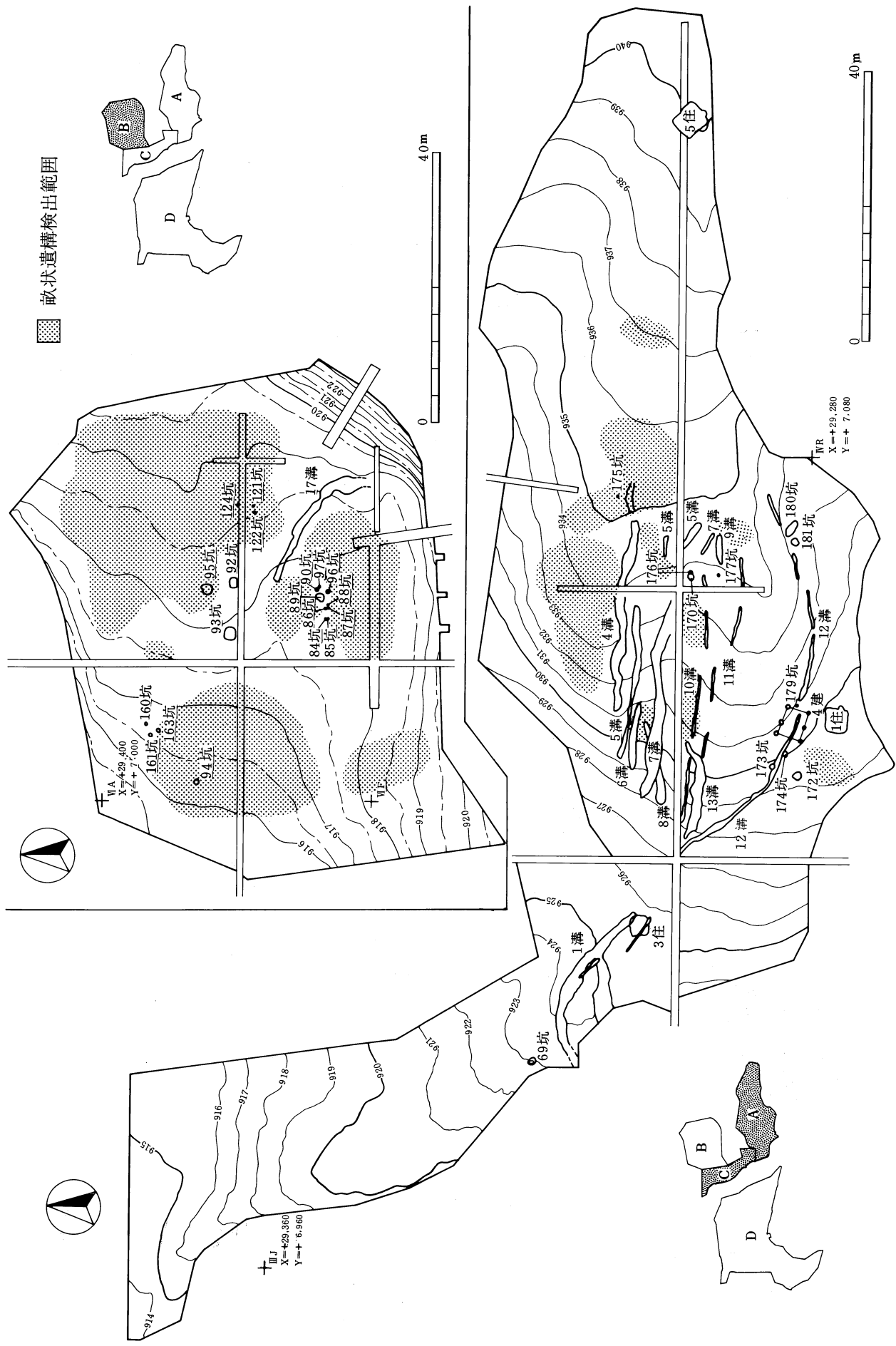

第378図 A・B・C地区遺構配置図

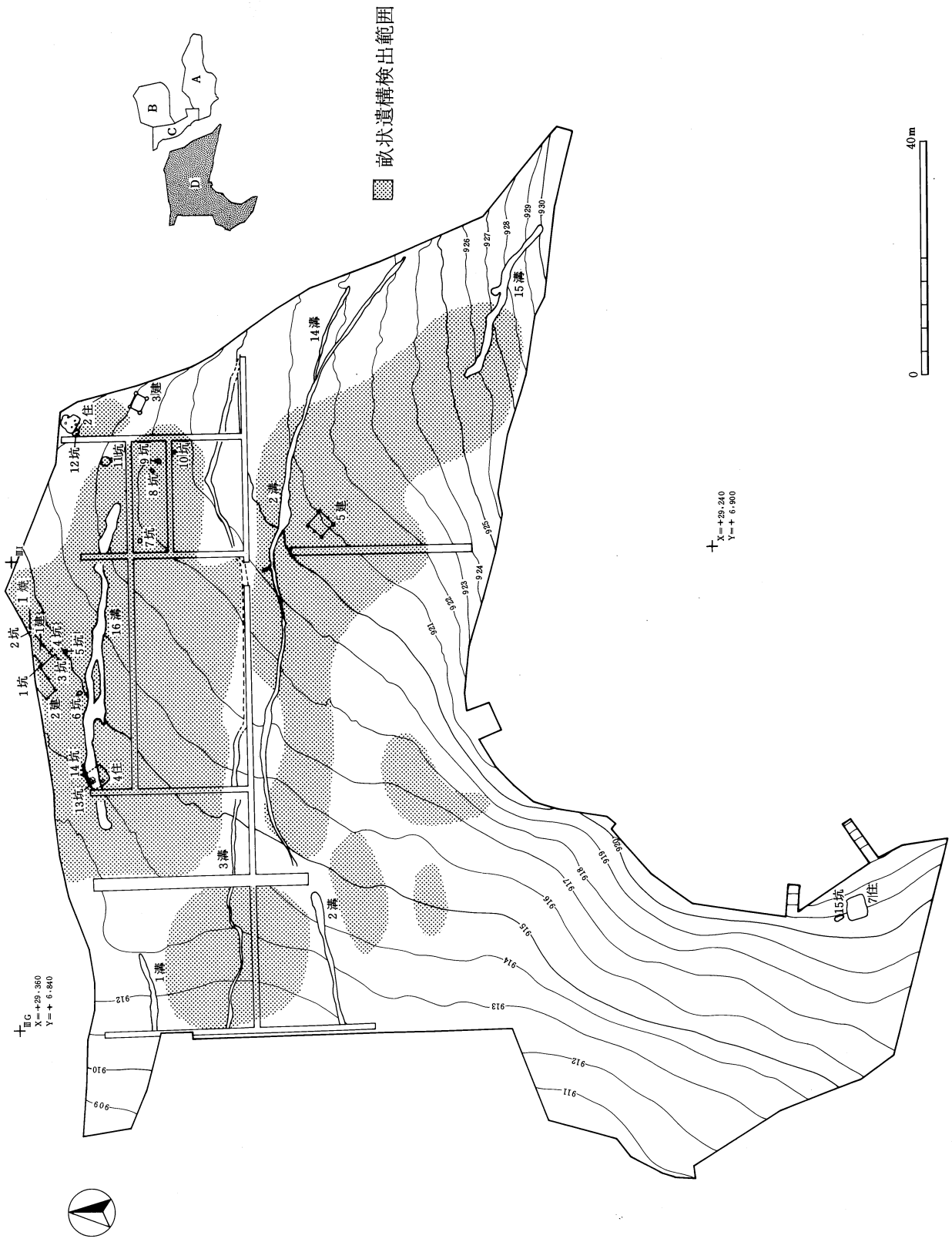

第379图 D地区遺構配置図

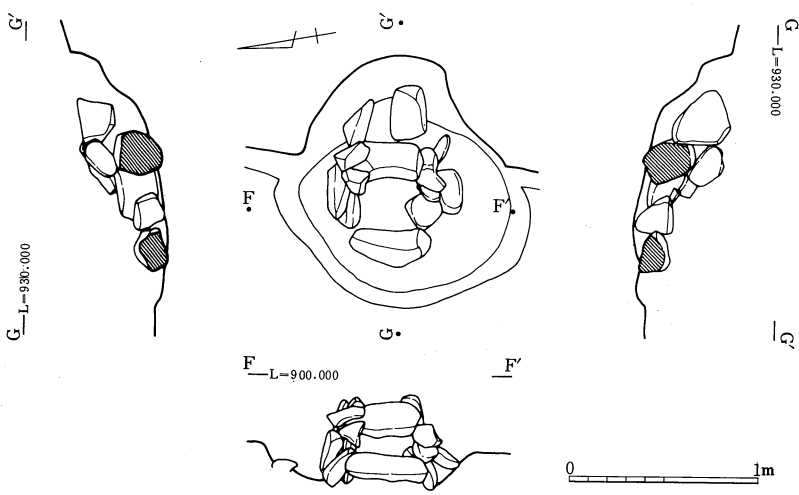
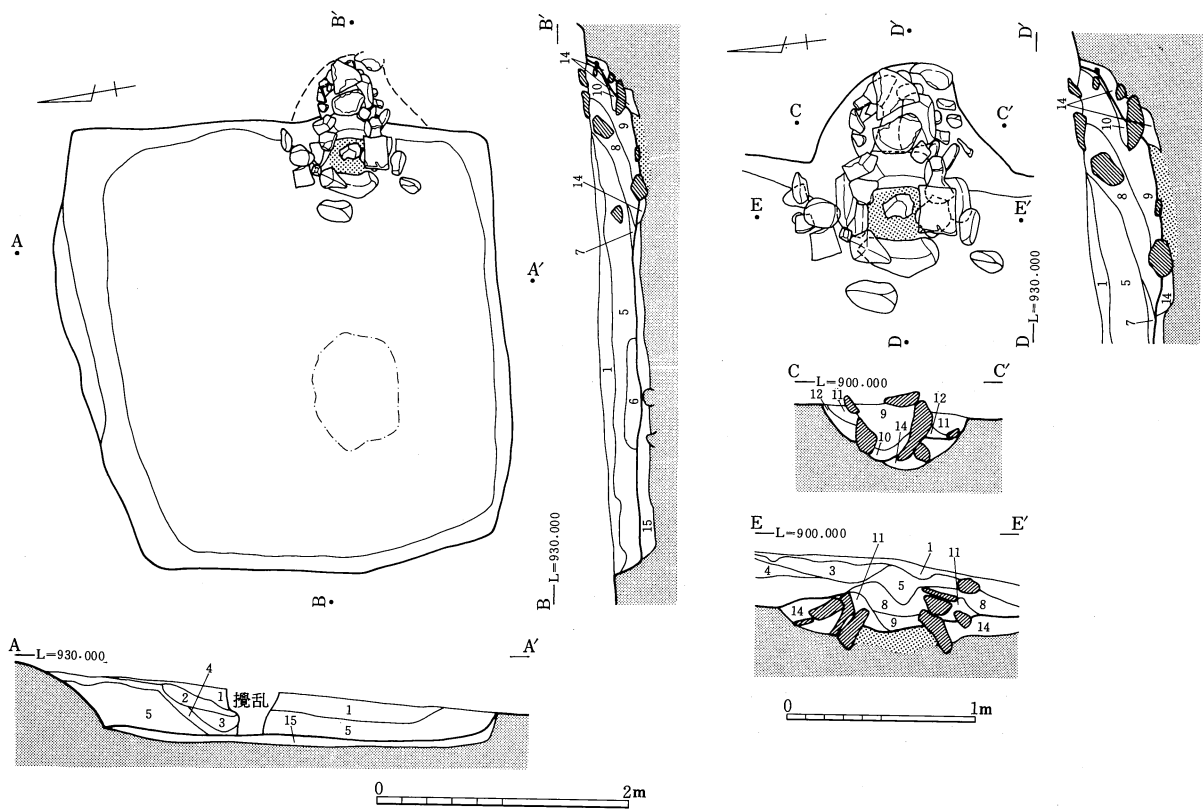

- 1: 黒褐色土 (ラビリ・小礫少量含む)
- 2: 褐色土 (ラビリ・小礫少量含む)
- 3: 黒褐色土 (ラビリ・炭化物少量含む)
- 4: 褐色土 (ラビリ少量含む。炭化材混入)
- 5: 暗褐色土 (小礫・炭化物少量含む)
- 6: 焼土 (炭化材混入)
- 7: 暗褐色土 (砂質)
- 8: 暗褐色土 (ラビリ・小礫含む。砂質)
- 9: 暗褐色土 (焼土粒混入)
- 10: 焼土
- 11: 褐色土 (ラビリ少量含む。しまり良)
- 12: 暗褐色土 (ラビリ・小礫少量含む)
- 13: 焼土 (火床)
- 14: 暗褐色土 (炭化物・焼土アブロック混入)
- 15: 黒褐色土 (小礫・炭化物混入。しまり堅)

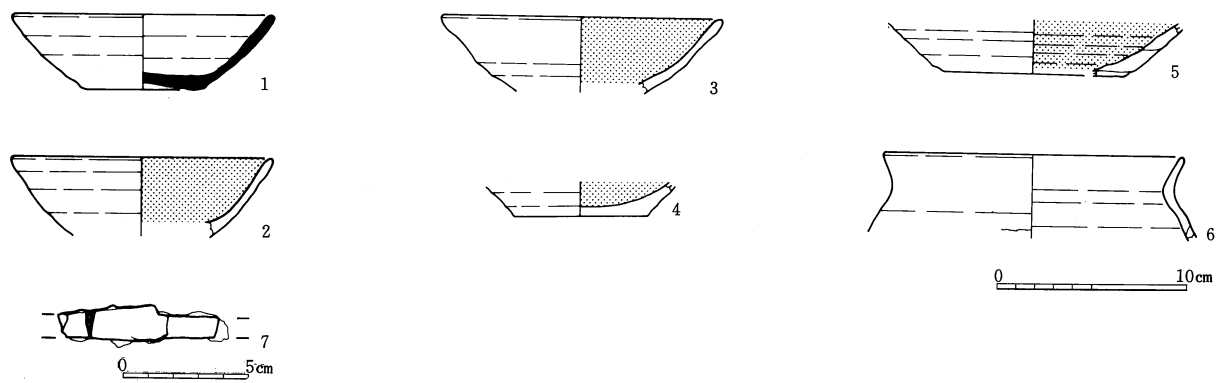

第380図 1号住居址

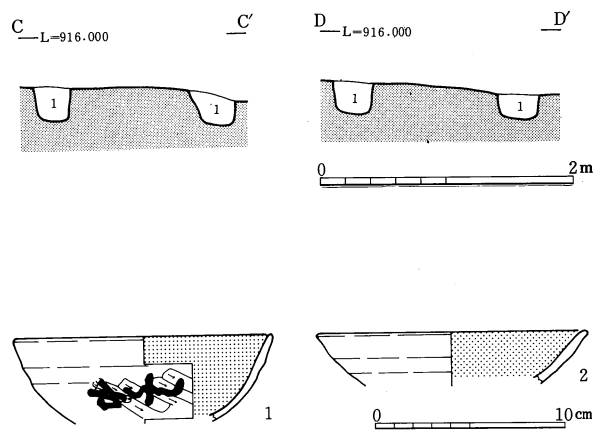
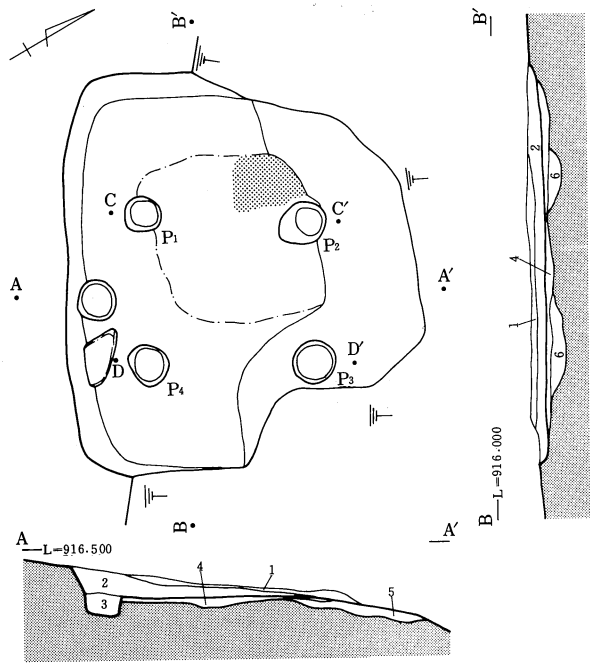

- 1 : 黒褐色土 (ラビリ・バミス・微小礫少量含む)
- 2 : 暗褐色土 (褐色土ブロック・炭化物・焼土粒少量混入)
- 3 : 暗褐色土 (ラビリ・小礫少量含む。褐色土ブロック混入)
- 4 : 暗褐色土 (バミス・微小礫少量含む。炭化物少量混入)
- 5 : 褐色土 (上部に炭化物・焼土顕著)
- 6 : 暗褐色土 (4層酷似。炭化物混入。しまり弱)
- P1・2・3・4
- 1 : 暗褐色土 (3層と同質)

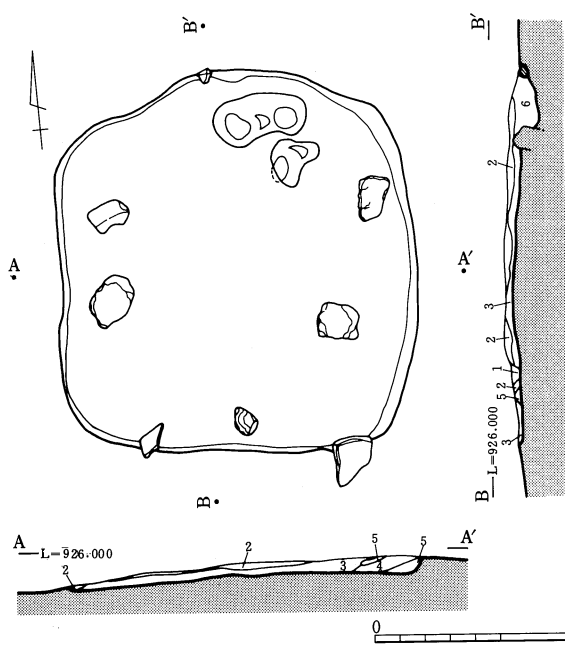

- 1 : 暗褐色土 (砂質。しまり弱)
- 2 : 暗褐色土 (微小礫含む。炭化物混入)
- 3 : 暗褐色土 (ラビリ少量含む。黒褐色土・ロームブロック、炭化物混入)
- 4 : 黒褐色土 (やや砂質)
- 5 : ローム土・暗褐色土混 (ラビリ少量含む)
- 6 : 黒褐色土 (炭化物混入)

第381図 2・3号住居址

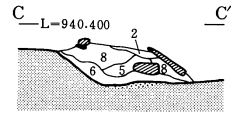
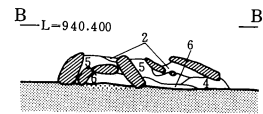
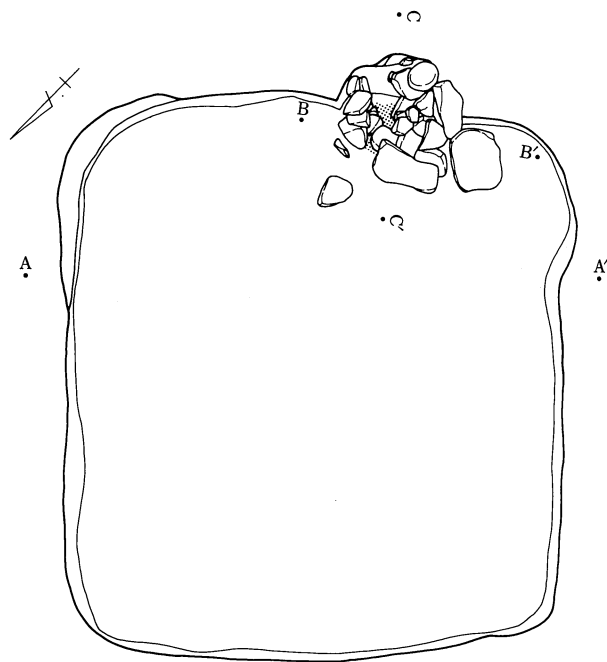

- 1: 暗褐色土 (ラビリ含む。しまり弱)
- 2: 黒色土 (ラビリ・パミス含む)
- 3: 褐色土 (パミス含む。炭化物少量混入)
- 4: 黄褐色土 (ローム基調)
- 5: 暗褐色土 (炭化物少量混入)
- 6: 暗黄褐色土 (ローム基調)
- 7: 黄褐色土 (焼土多量、ロームブロック混入。崩落土)
- 8: 焼土

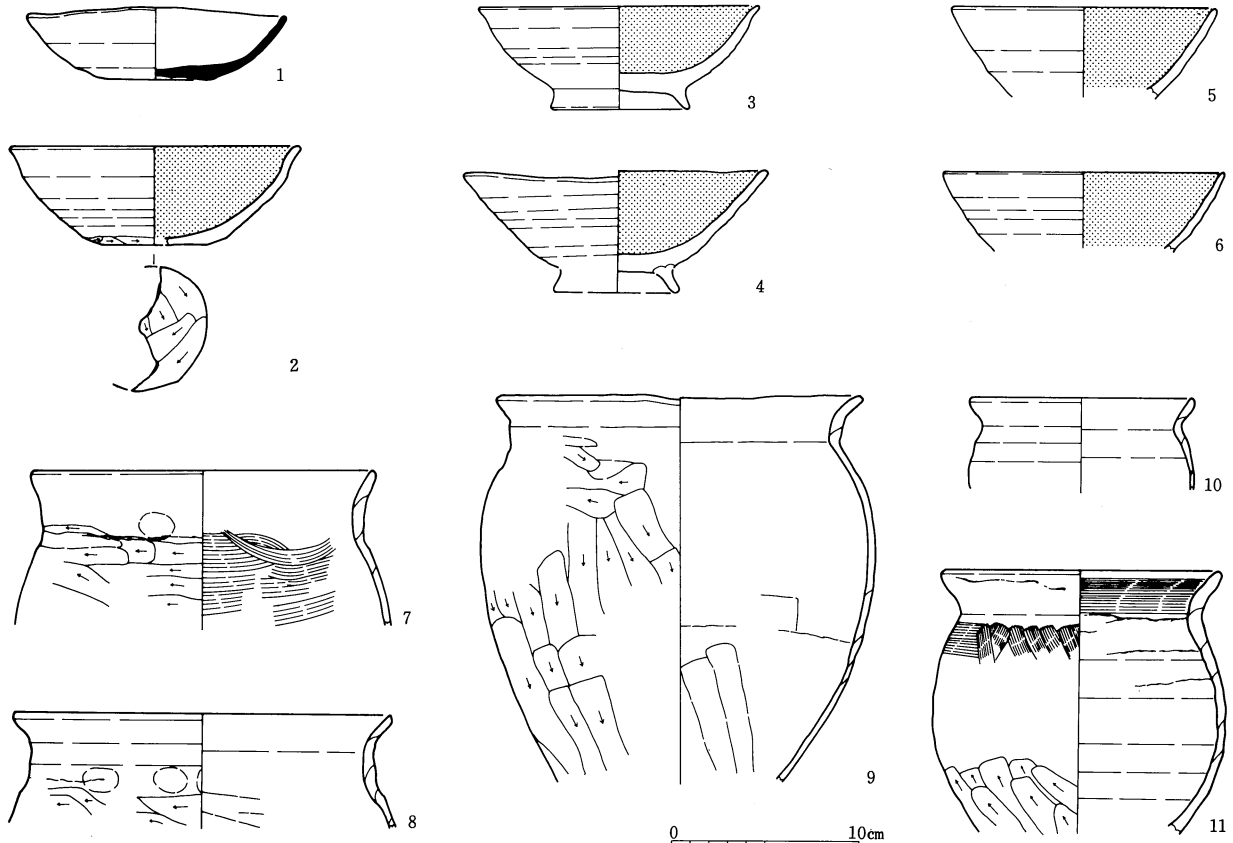
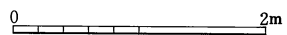
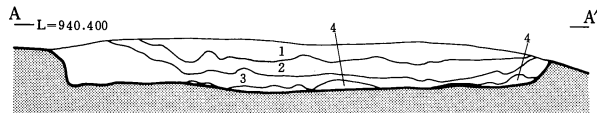

第382図 5号住居址

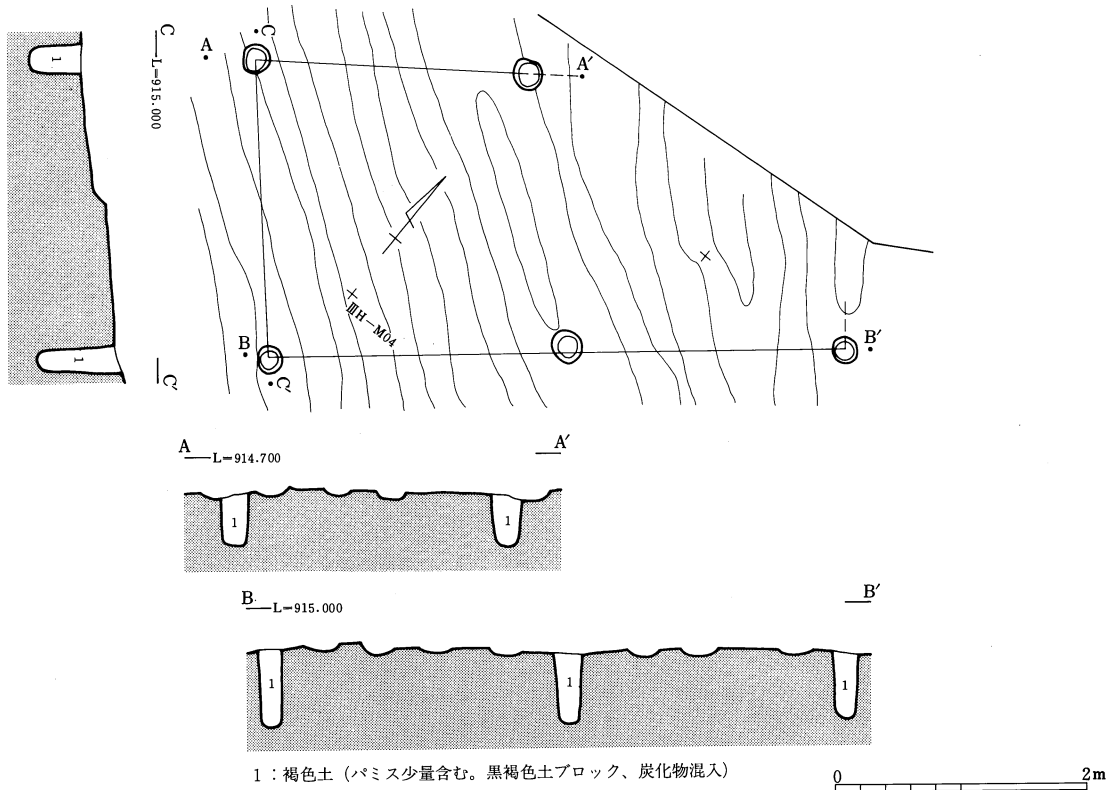
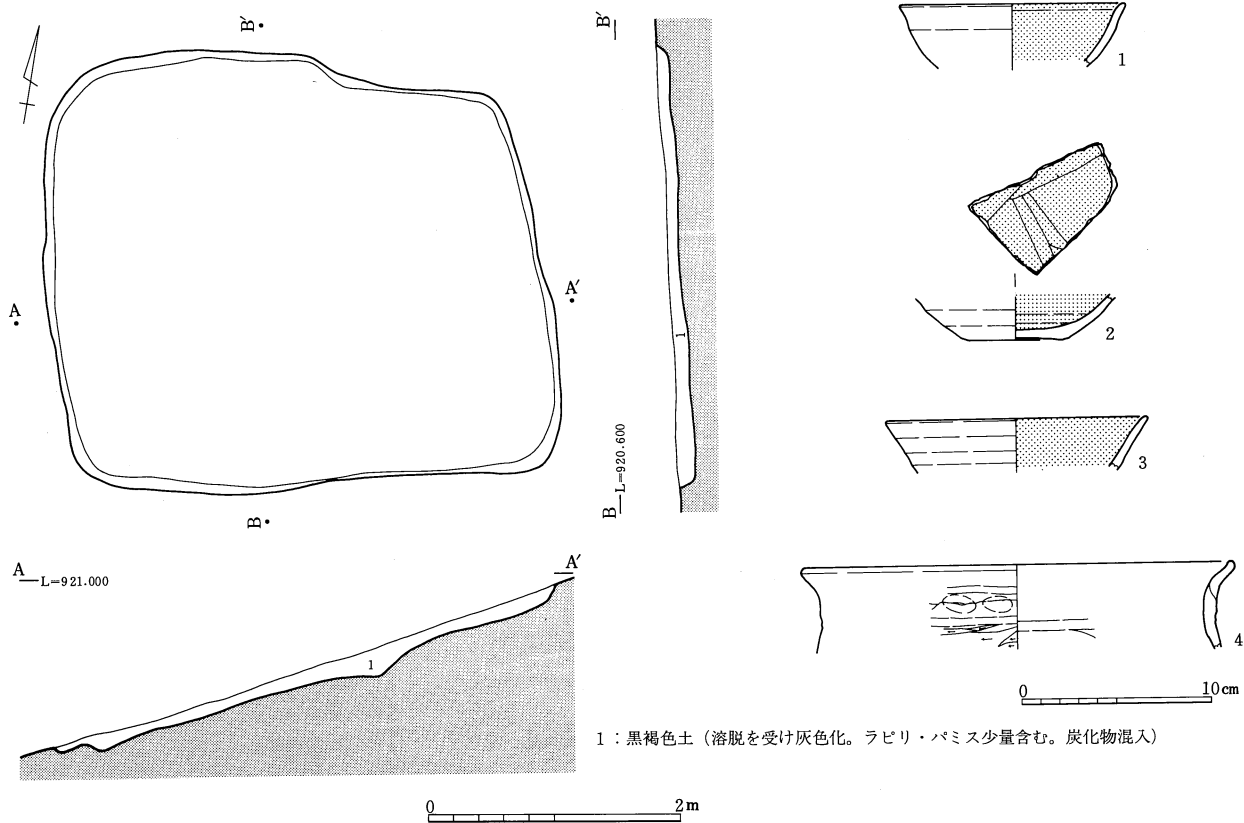

第383図 6号住居址・1号掘立柱建物址

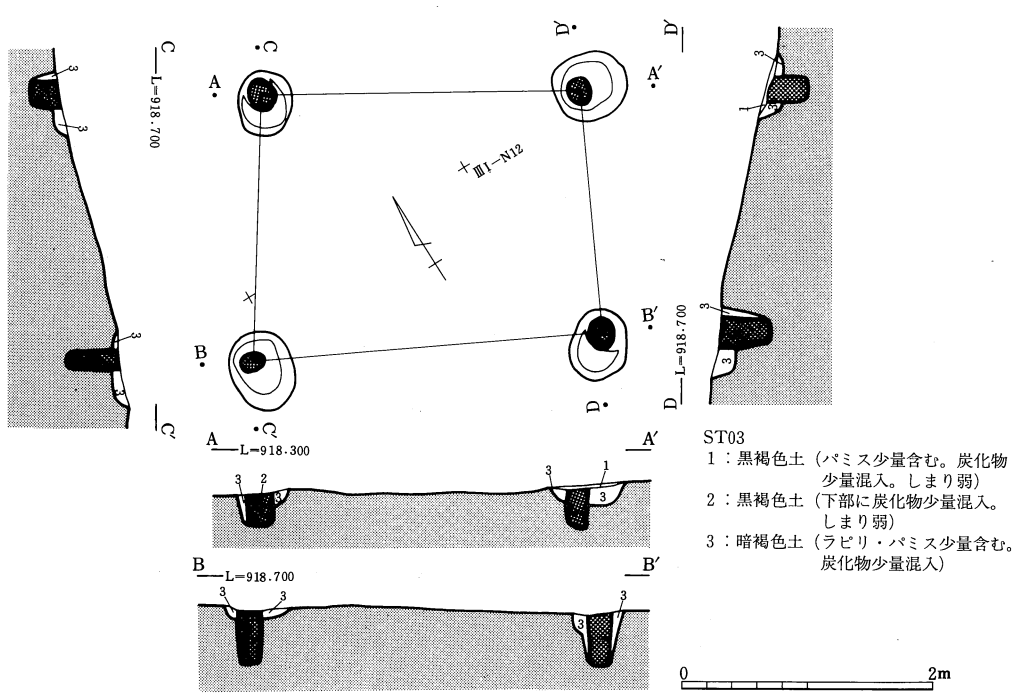
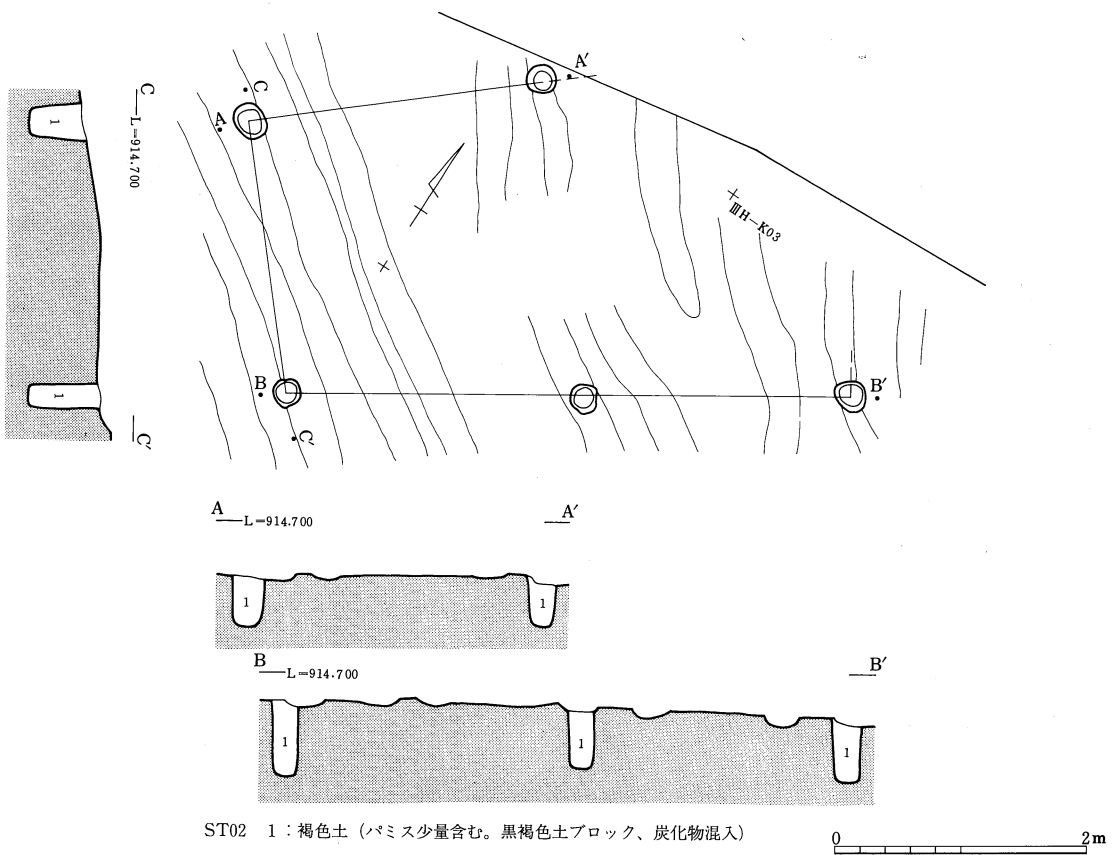

第384図 2・3号掘立柱建物址

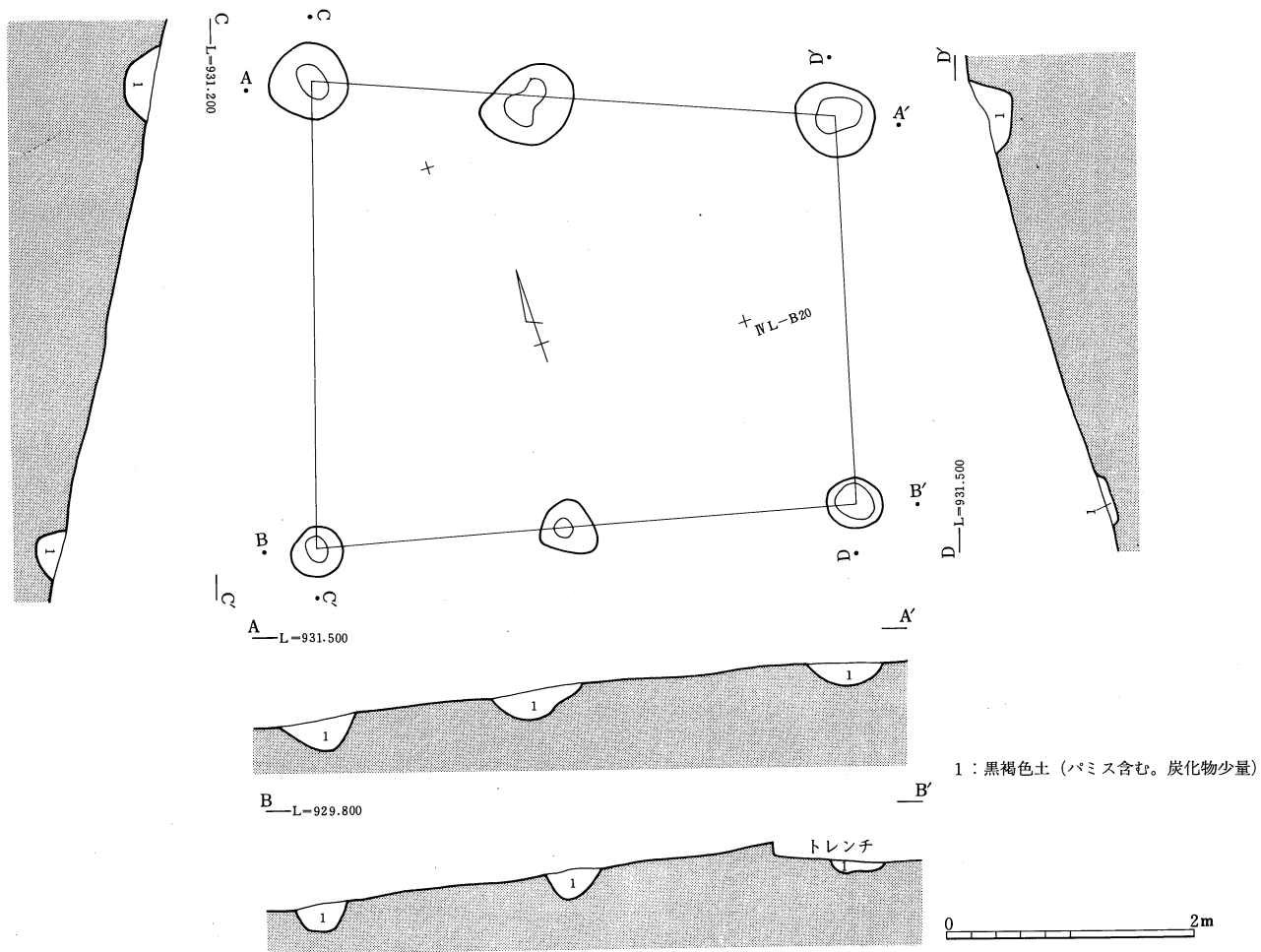

1 : 黒褐色土 (バミス含む。炭化物少量)

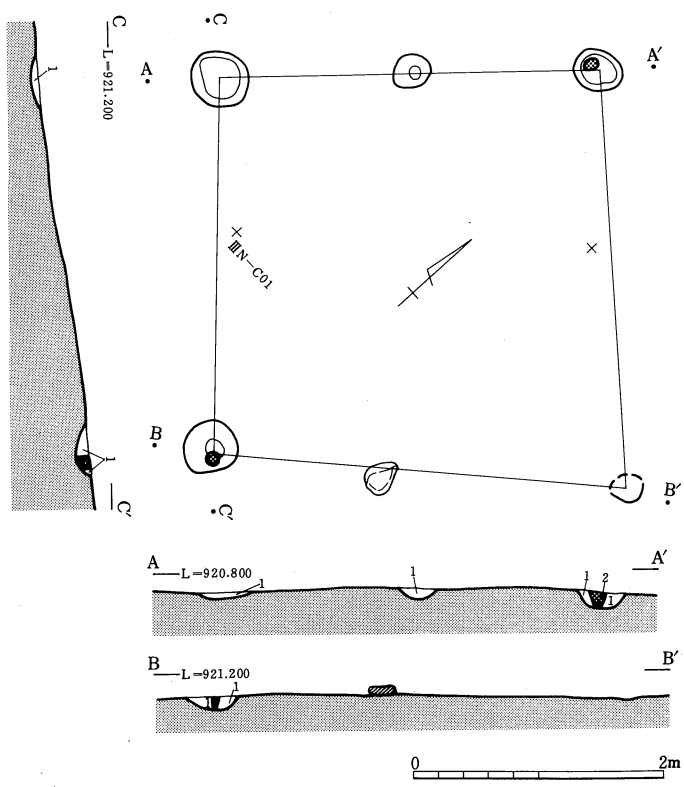

1 : 黒褐色土 (バミス含む)
 2 : 黒褐色土 (下部に炭化物少量混入。しまり弱)

第385図 4・5号掘立柱建物址

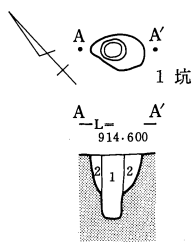

1 坑
A-L-914.600
1: 黒褐色土 (砂質、淘汰良)
2: 褐色土 (VI層ブロック混入)

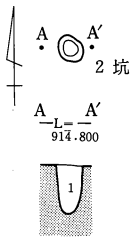

2 坑
A-L-914.800
1: 褐色土 (黒褐色土混入・砂質)

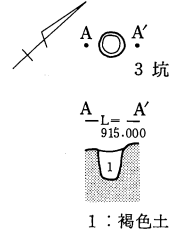

3 坑
A-L-915.000
1: 褐色土 (IVA層基調)

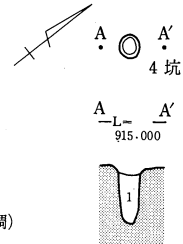

4 坑
A-L-915.000
1: 褐色土 (黒褐色土混入)

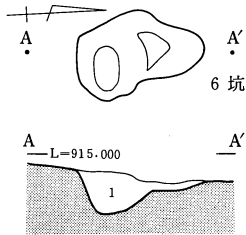

6 坑
A-L-915.000
1: 黒褐色土 (ラビリ・炭化物散在)

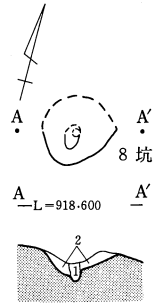

8 坑
A-L-918.600
1: 黒褐色土 (炭化物含)
2: 暗褐色土 (IVA層基調)

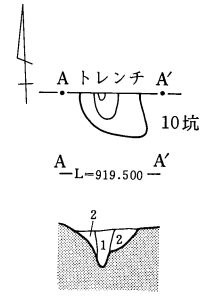

10 坑
A-L-919.500
1: 黒褐色土 (炭化物含)
2: 暗褐色土 (IVA層基調)

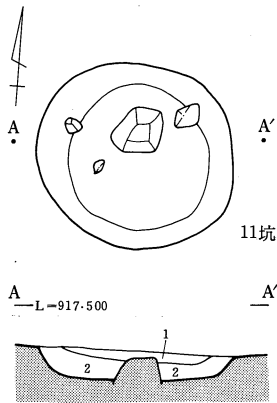

11 坑
A-L-917.500
1: 黒褐色土 (小礫散在)
2: 黒褐色土 (IVA層基調)

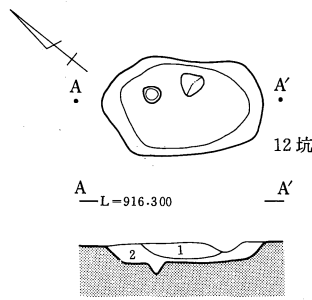

12 坑
A-L-916.300
1: 黒褐色土 (炭化物含)
2: 暗褐色土 (IVA層基調)

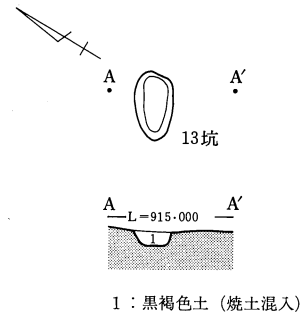

13 坑
A-L-915.000
1: 黒褐色土 (焼土混入)

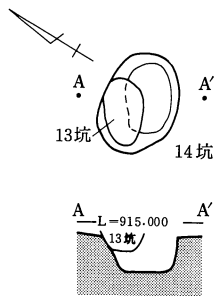

13 坑
A-L-915.000
1: 黒褐色土 (III層基調)

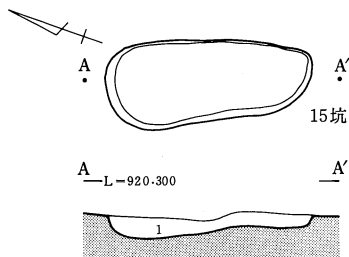

14 坑
A-L-920.300
1: 黒褐色土 (溶脱をうけ灰色・炭化物混入)

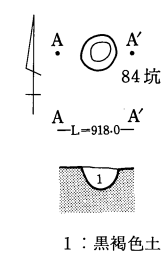

84 坑
A-L-918.0
1: 黒褐色土 (灰色化・粘質)

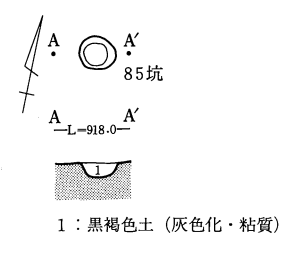

85 坑
A-L-918.0
1: 黒褐色土 (灰色化・粘質)

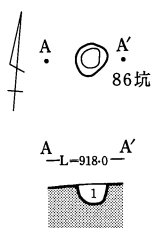

86 坑
A-L-918.0
1: 黒褐色土 (灰色化・粘質)

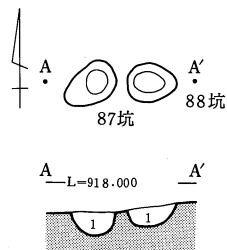

87 坑
A-L-918.000
1: 黒褐色土 (灰色化・粘質)

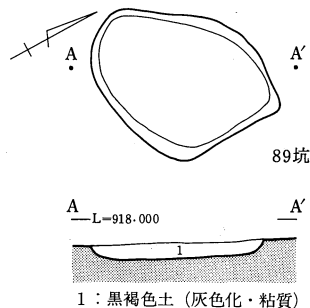

89 坑
A-L-918.000
1: 黒褐色土 (灰色化・粘質)

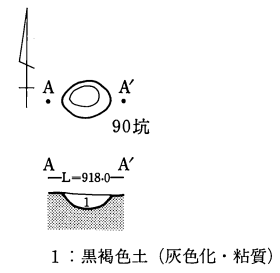

90 坑
A-L-918.0
1: 黒褐色土 (灰色化・粘質)

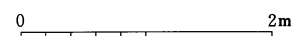

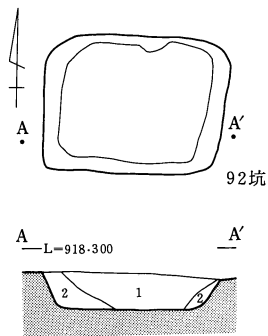

- 1: 黒褐色土 (ローム混入)
- 2: 暗褐色土 (ローム混入)

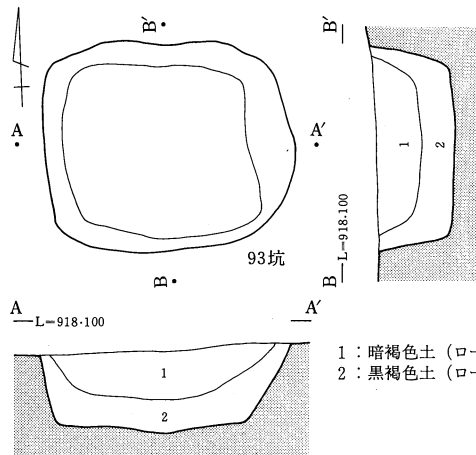

- 1: 暗褐色土 (ローム混入)
- 2: 黒褐色土 (ローム混入)

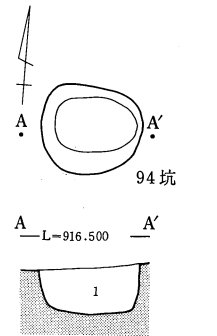

- 1: 黒褐色土 (III層基調)

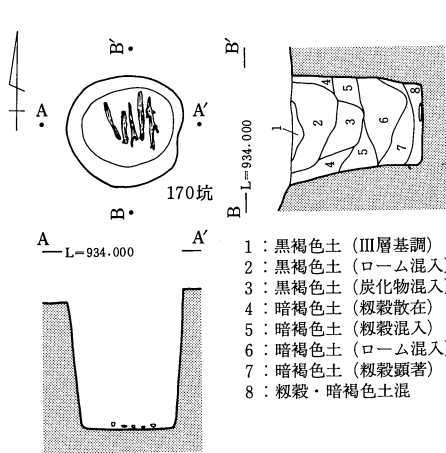

- 1: 黒褐色土 (III層基調)
- 2: 黒褐色土 (ローム混入)
- 3: 黒褐色土 (炭化物混入)
- 4: 暗褐色土 (籾殻散在)
- 5: 暗褐色土 (籾殻混入)
- 6: 暗褐色土 (ローム混入)
- 7: 暗褐色土 (籾殻顕著)
- 8: 籾殻・暗褐色土混

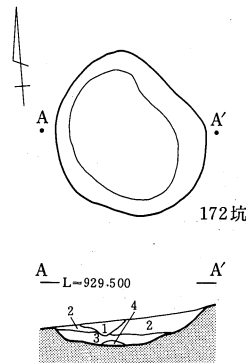

- 1: 黒褐色土 (小礫含)
- 2: 黒褐色土 (IV A層ブロック混入)
- 3: 暗褐色土 (III層ブロック混入)
- 4: 暗褐色土 (炭化物混入)

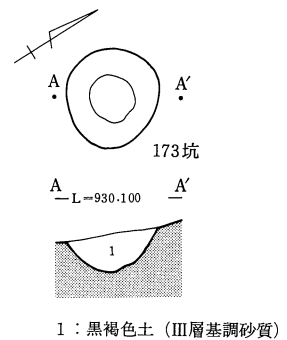

- 1: 黒褐色土 (III層基調砂質)

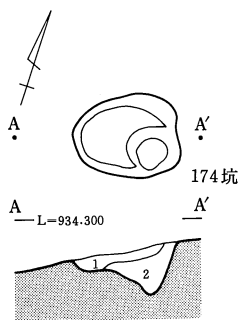

- 1: 黒褐色土 (I層ブロック混入)
- 2: 黒褐色土 (IV A層混入)

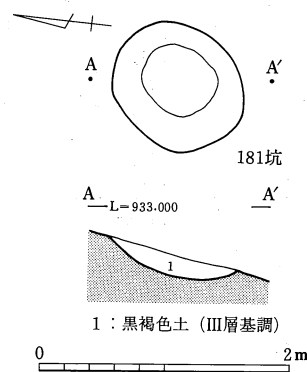

- 1: 黒褐色土 (III層基調)

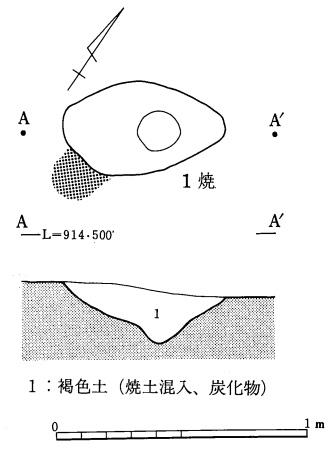

- 1: 褐色土 (焼土混入、炭化物)

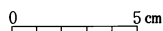
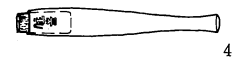
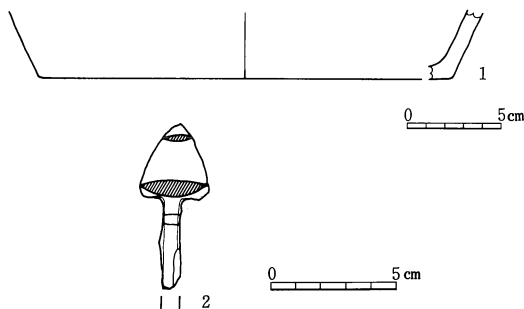

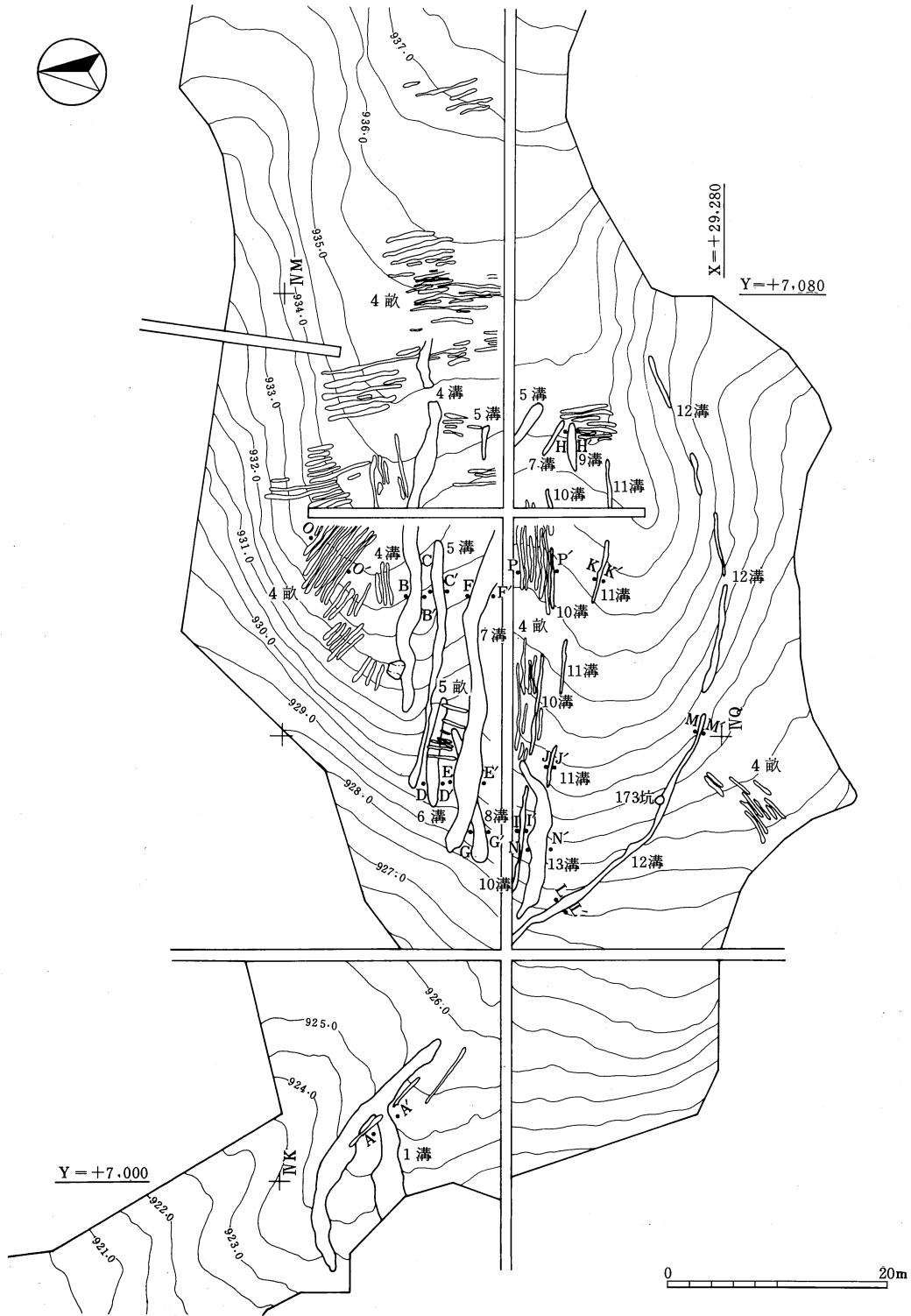

第388图 A·C地区畝状遺構·溝址

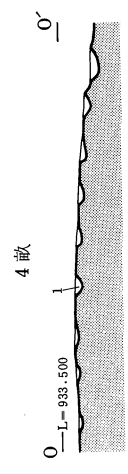
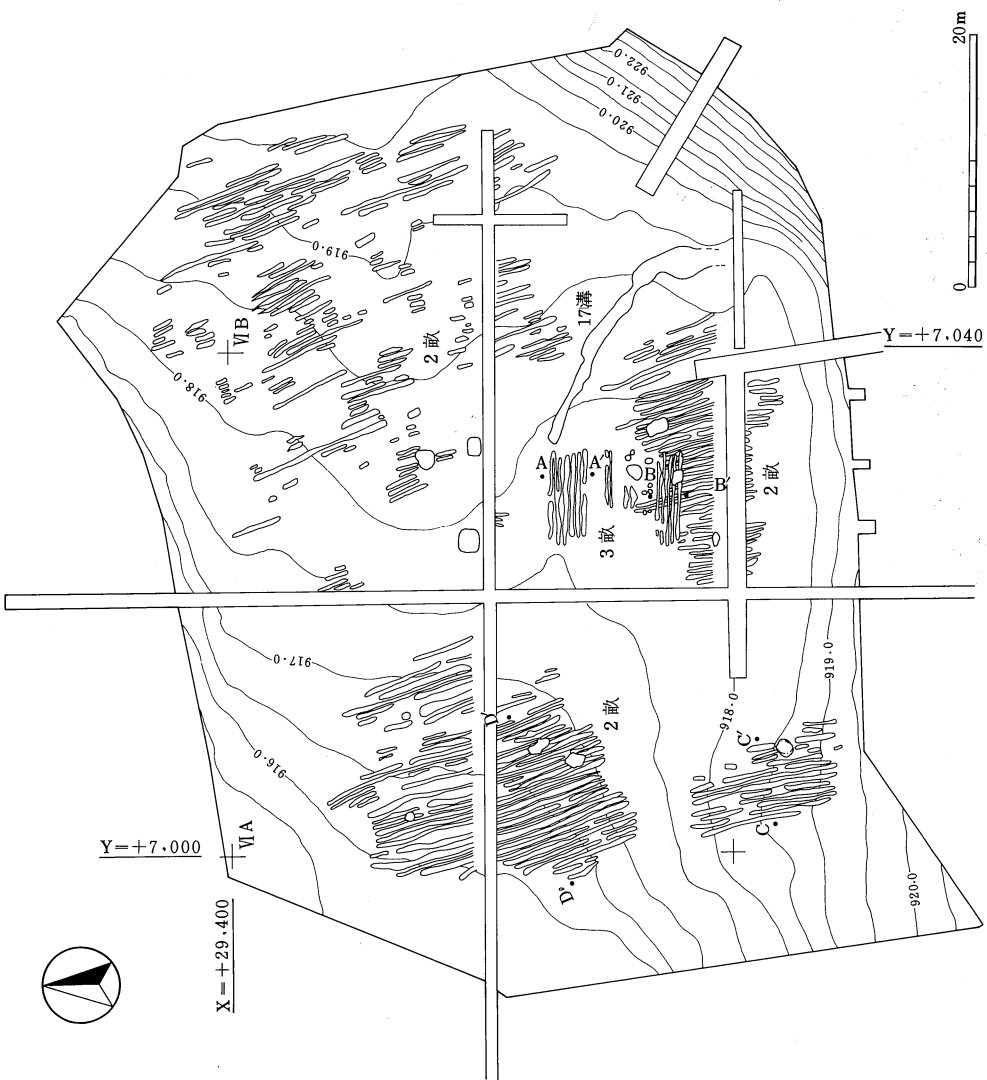

1 : 暗褐色土 (III A層基調。パミス・小礫少量含む。炭化物、III B層・IV A層ブロック混入)

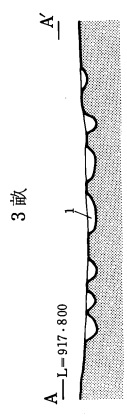

1 : 灰褐色土 (II層基調。グライ化。粘性あり)

2 畝

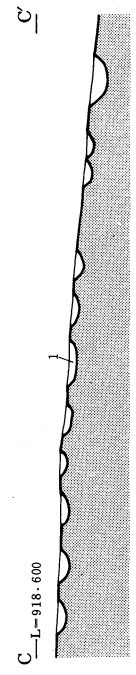

1 : 黒褐色土 (III層酷似。炭化物混入)



第389図 B地区畝状遺構・溝址

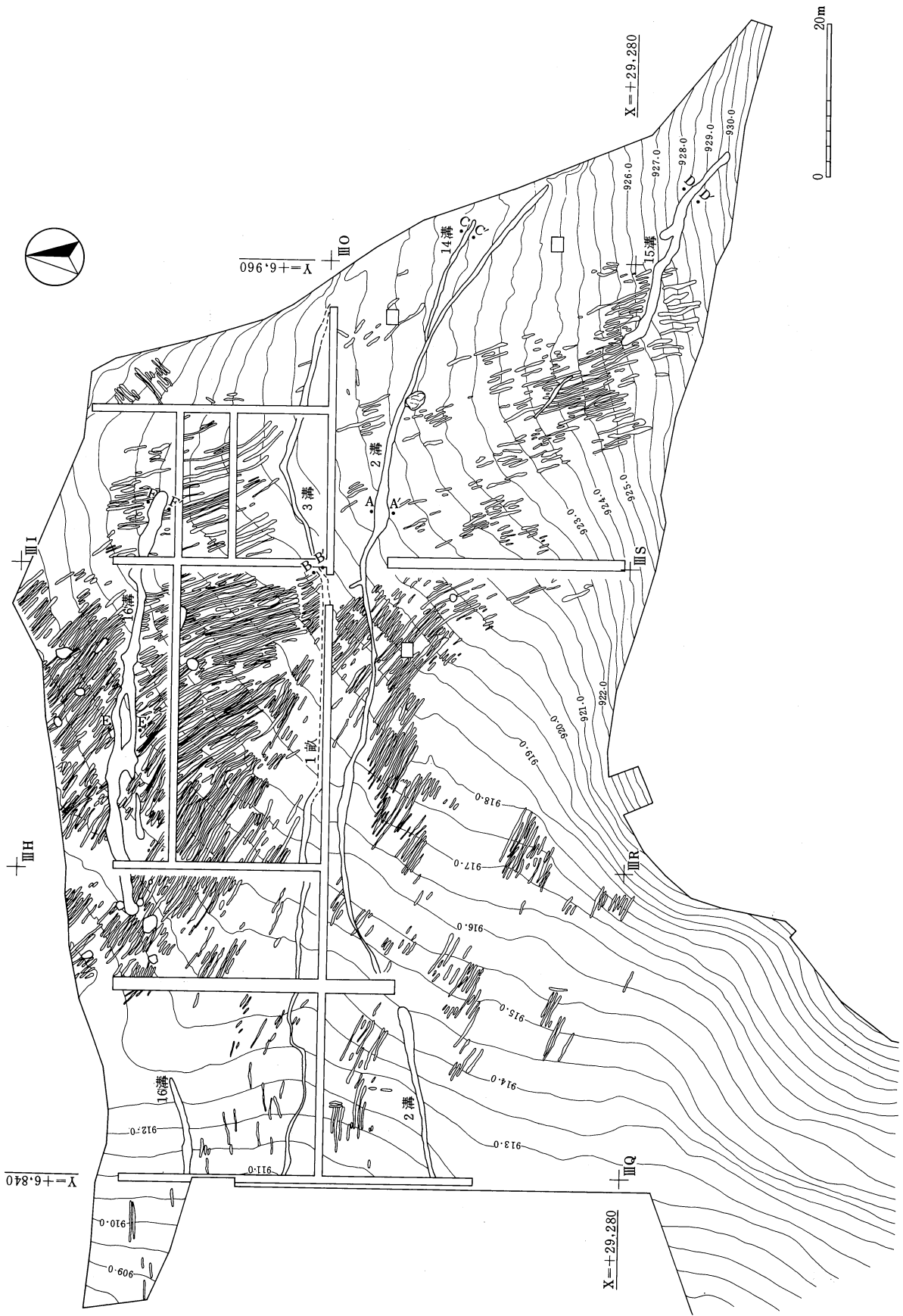

第390图 D地区畝状遺構・溝址

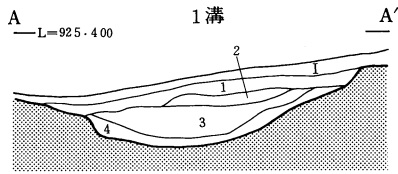

- 1: 黒褐色土 (小礫少量含む)
- 2: 黒褐色土
- 3: 暗褐色土 (灰色粘土ブロック混入。Fe集積あり)
- 4: 褐色土 (小礫含む。黄褐色土ブロック混入)

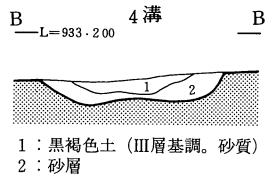

- 1: 黒褐色土 (III層基調。砂質)
- 2: 砂層

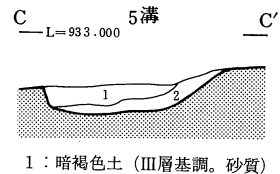

- 1: 暗褐色土 (III層基調。砂質)
- 2: 暗褐色土 (小礫混入。砂質)

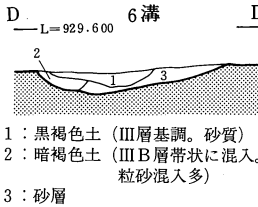

- 1: 黒褐色土 (III層基調。砂質)
- 2: 暗褐色土 (III層帯状に混入。細粒砂混入多)
- 3: 砂層

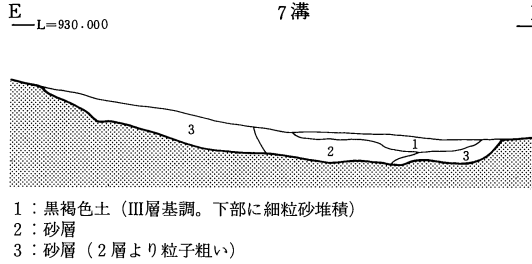

- 1: 黒褐色土 (III層基調。下部に細粒砂堆積)
- 2: 砂層
- 3: 砂層 (2層より粒子粗い)

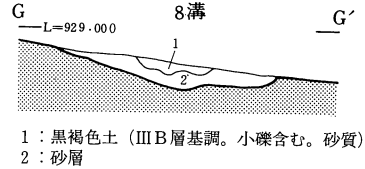

- 1: 黒褐色土 (III層基調。小礫含む。砂質)
- 2: 砂層

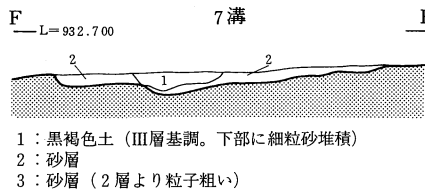

- 1: 黒褐色土 (III層基調。下部に細粒砂堆積)
- 2: 砂層
- 3: 砂層 (2層より粒子粗い)

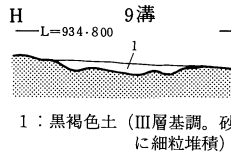

- 1: 黒褐色土 (III層基調。砂質。下部に細粒堆積)

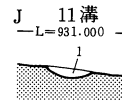

- 1: 黒褐色土 (III層基調。砂質下部に細粒砂堆積)

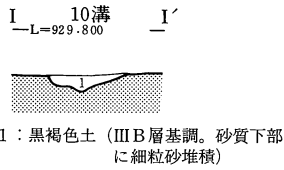
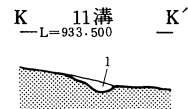

- 1: 黒褐色土 (III層基調。砂質下部に細粒砂堆積)

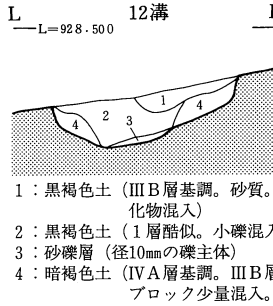

- 1: 黒褐色土 (III層基調。砂質。炭化物混入)
- 2: 黒褐色土 (1層酷似。小礫混入)
- 3: 砂礫層 (径10mmの礫主体)
- 4: 暗褐色土 (IV A層基調。III層土ブロック少量混入。砂質)

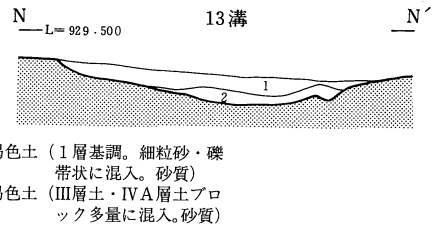
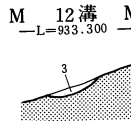

- 1: 黒褐色土 (1層基調。細粒砂・礫帯状に混入。砂質)
- 2: 暗褐色土 (III層土・IV A層土ブロック多量に混入。砂質)

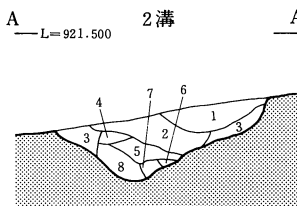

- 1: 黒褐色土 (砂質。しまり弱)
- 2: 黄褐色土 (ローム多量に混入)
- 3: 黒褐色土 (砂質)
- 4: 明黄褐色土 (ローム粒混入)
- 5: 砂礫層 (径5~15mmの小礫)
- 6: 黒色土
- 7: 砂層 (径5~10mmの小礫混入)
- 8: 砂礫層 (径10~30mmの礫混入)

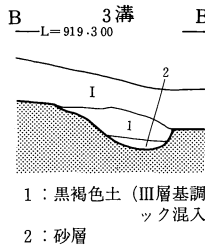

- 1: 黒褐色土 (III層基調。褐色土ブロック混入)
- 2: 砂層

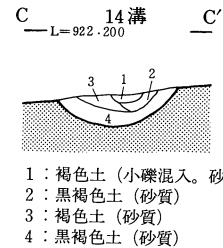

- 1: 褐色土 (小礫混入。砂質)
- 2: 黒褐色土 (砂質)
- 3: 褐色土 (砂質)
- 4: 黒褐色土 (砂質)

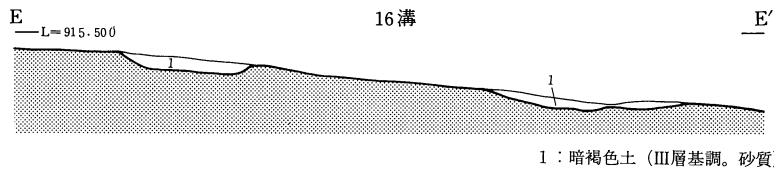

- 1: 暗褐色土 (III層基調。砂質)

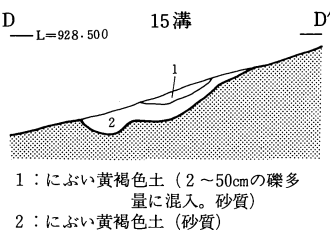

- 1: にぶい黄褐色土 (2~50cmの礫多量に混入。砂質)
- 2: にぶい黄褐色土 (砂質)

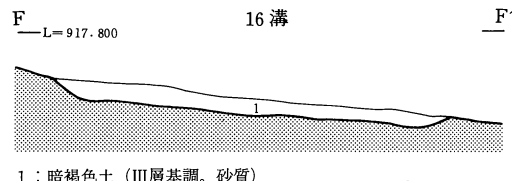

- 1: 暗褐色土 (III層基調。砂質)

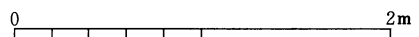

第391図 溝址断面図

写 真 図 版
(P L)



下茂内遺跡
遠景
(北東より)



下茂内遺跡
全景
(北より)



A地区近景
(西より)



B地区近景
(西より)



C地区近景
(手前 茂内沢
奥 B地区)



D地区近景
(東より)



左 茂内沢
右 残雪風景



左 試掘トレンチ
右 同調査風景



左 表土剥ぎ
右 グリッド調査風景



左 調査風景
右 B地区調査風景



B地区VII層下面全景



左 土層断面
(矢印XIV層)
右 旧流路内土層
(IVB-D07
グリッド)



第I文化層
槍先形尖頭器出土
状況 (ブロック外)

第I文化層
1号ブロック
遺物出土状況



第I文化層
2号ブロック
遺物出土状況



第I文化層
2号ブロック
遺物出土状況





第I文化層
4号ブロック
遺物出土状況



第I文化層
9号ブロック
遺物出土状況



第I文化層
10号ブロック
遺物出土状況



第I文化層
15号ブロック
遺物出土状況

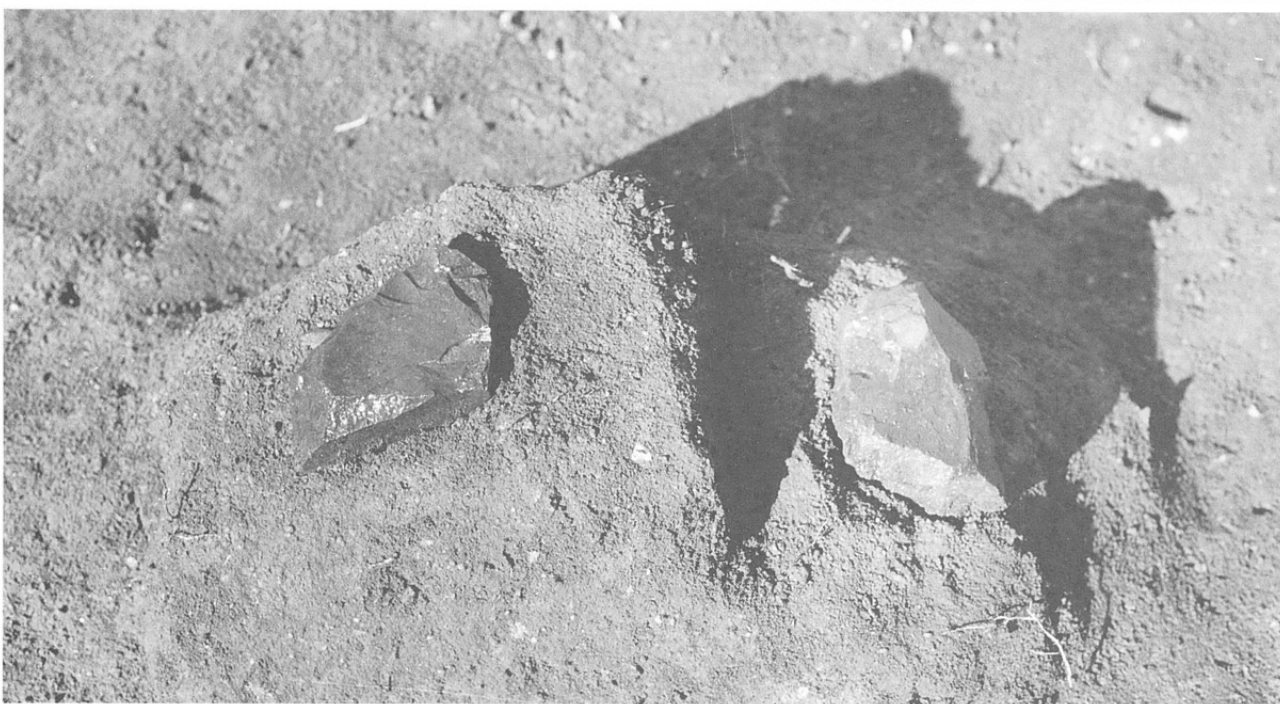

第I文化層
ブロック外出土の
石核



第I文化層
旧流路部近景
(北東より)



第I文化層全景

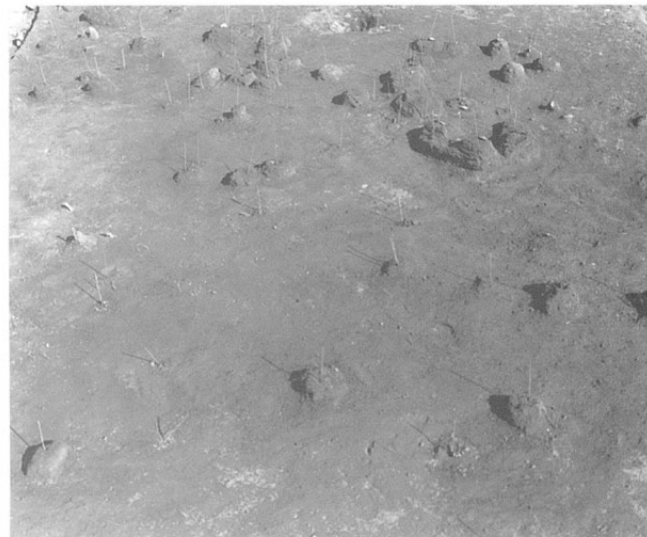

左 第II文化層
3号ブロック
周辺
遺物出土状況
右 第II文化層
15号ブロック
周辺
遺物出土状況



第II文化層
4号ブロック
遺物出土状況

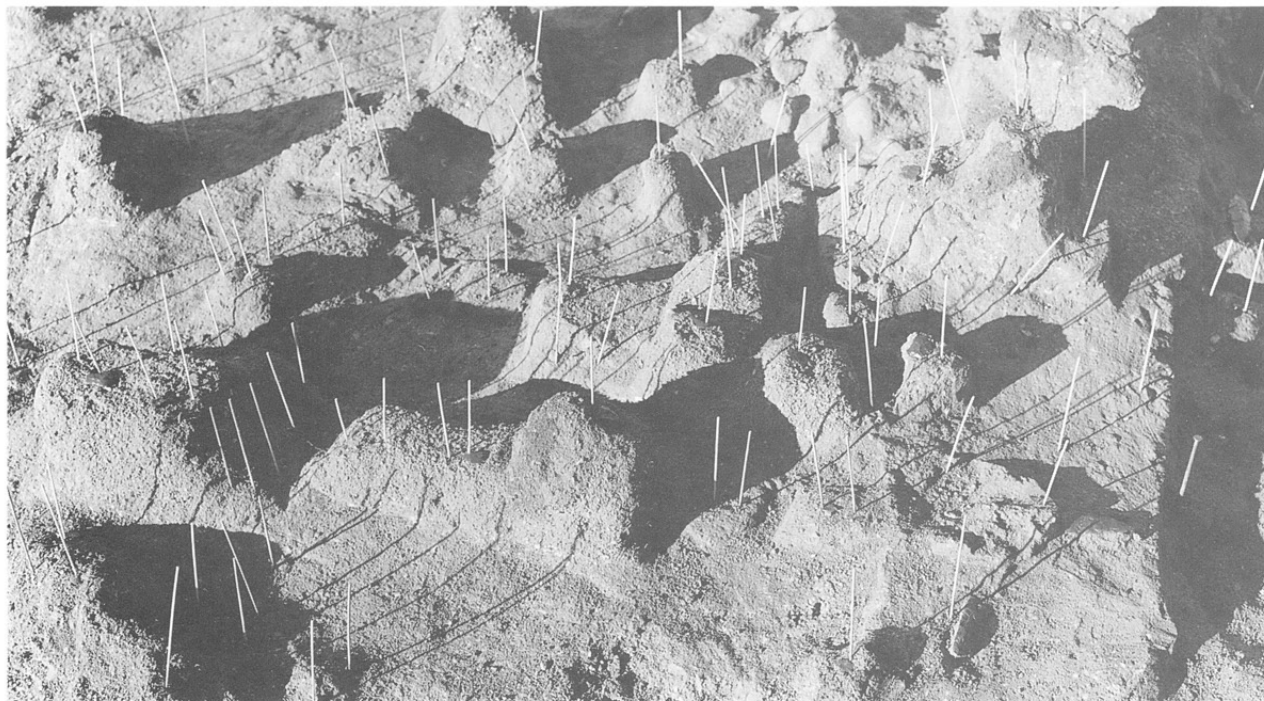

第II文化層
7号ブロック
遺物出土状況



左 第II文化層
8号ブロック
遺物出土状況
右 同上

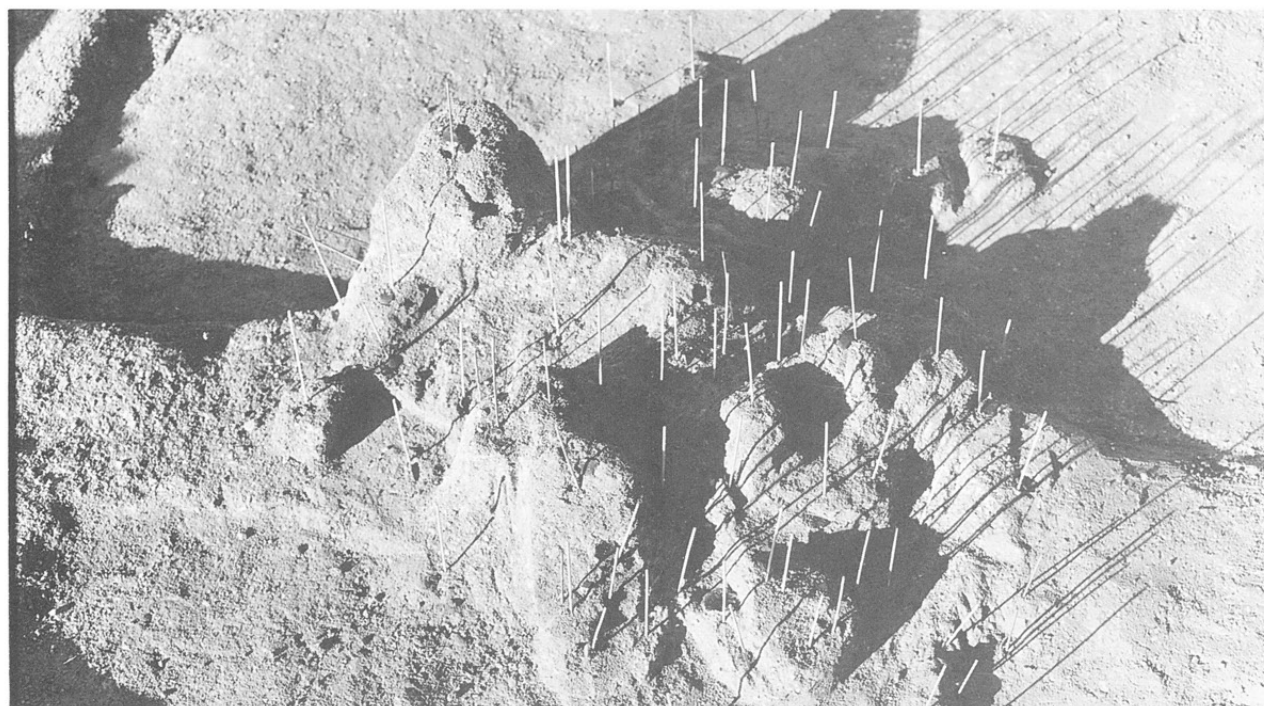

第II文化層
16号ブロック
遺物出土状況



第II文化層
5号ブロック
槍先形尖頭器未完成
品出土状況



第II文化層
5号ブロック
遺物出土状況



第II文化層
12号ブロック
遺物出土状況

第II文化層
12号ブロック
遺物出土状況



第II文化層
12号ブロック
遺物出土状況



第II文化層
15号ブロック
遺物出土状況



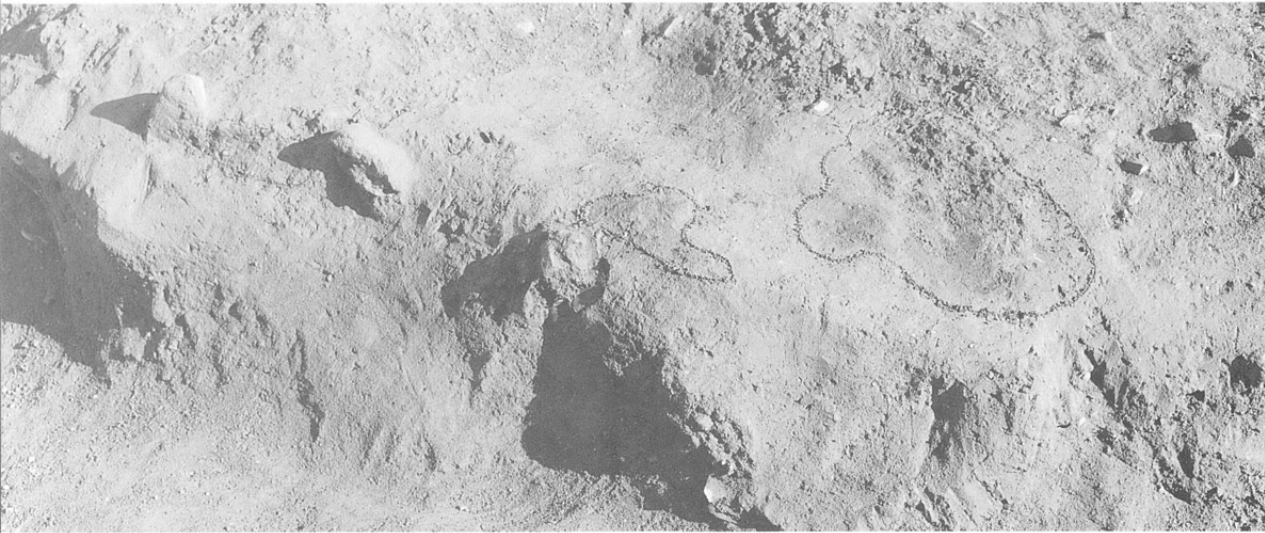

第II文化層
炭化物集中区



左 1号炭化物
集中区
右 2号炭化物
集中区

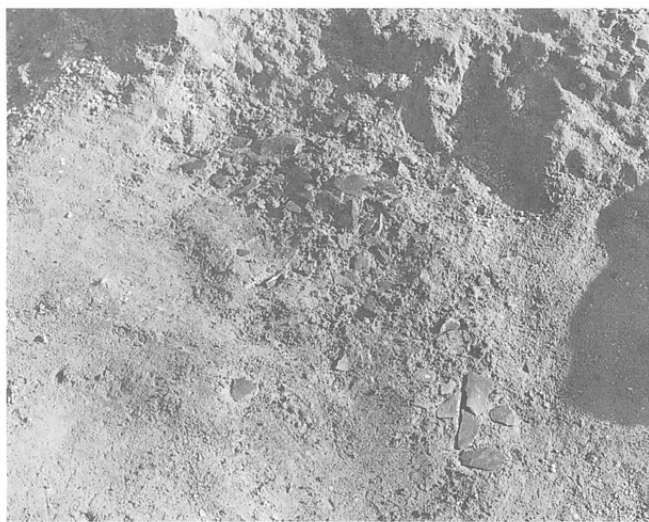

左 3号炭化物
集中区
右 3号炭化物
集中区
遺物出土状況



第II文化層
旧流路近景
(南西より)



A地区IV層面近景
(北より)



B地区IV層面近景
(西より)



C地区VIII層面近景
(北より)



D地区VI層上面近景
(東より)

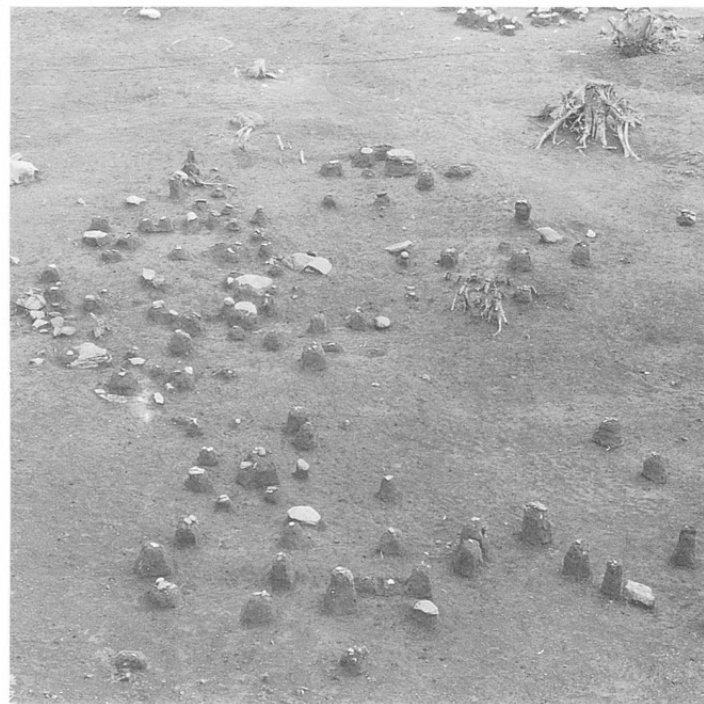

左 B地区
遺物出土状況
右 同上



D地区遺物出土状況



左 16号土坑
右 17号土坑



左 18号土坑
右 19号土坑



左 21号土坑
右 22号土坑

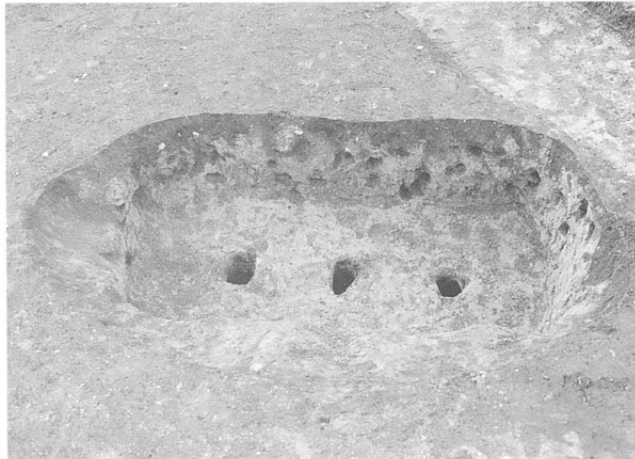

左 23号土坑
右 24号土坑

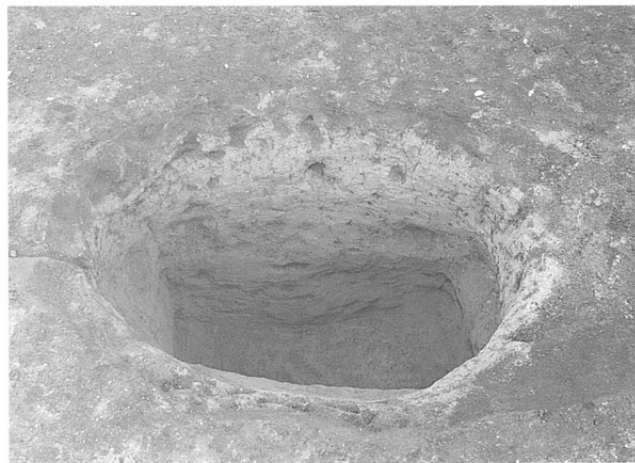

右 29号土坑



左 30号土坑
右 31号土坑



左 32号土坑
右 33号土坑

左 38号土坑
右 40号土坑



左 42号土坑

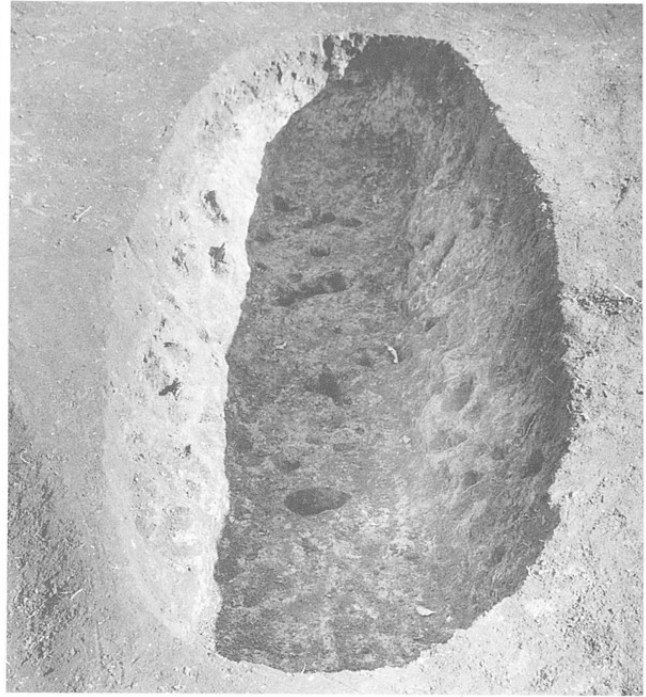

左 44号土坑
右 43号土坑



左 52号土坑
右 53号土坑

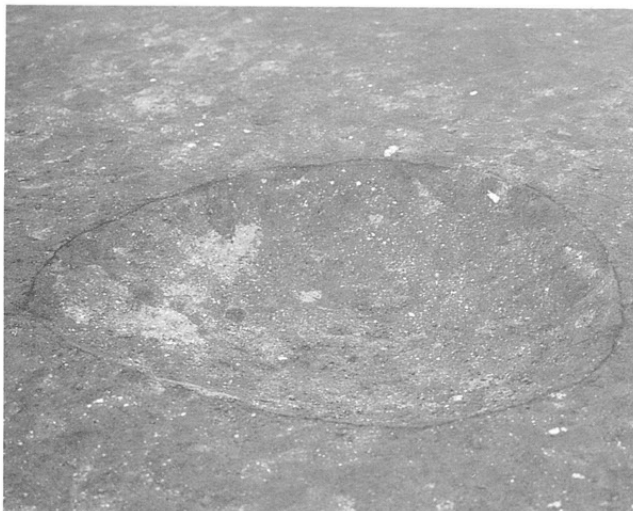

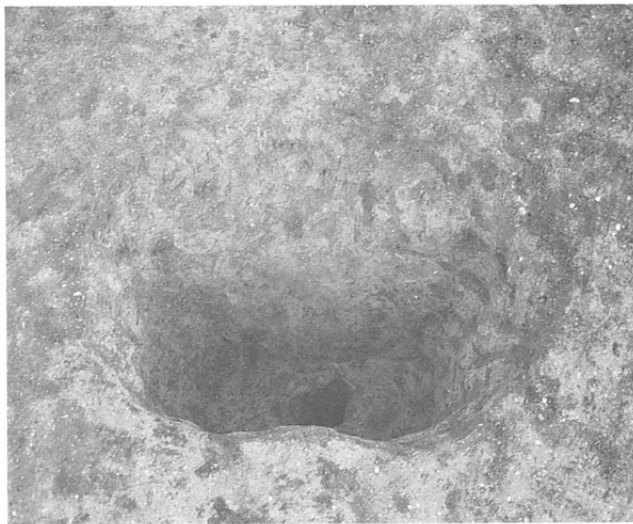

左 55号土坑
右 56号土坑

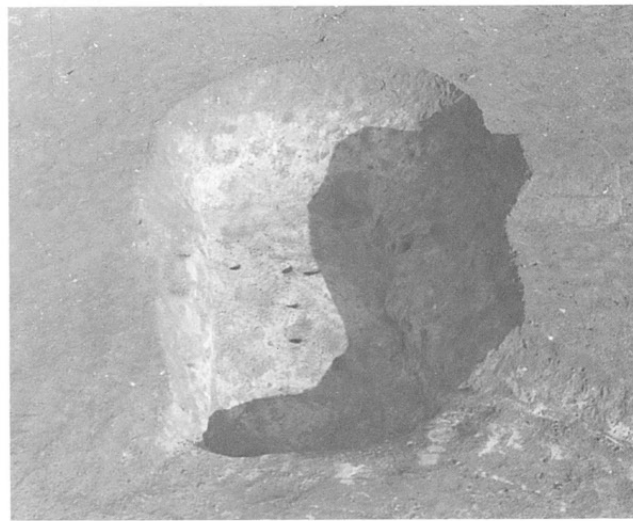
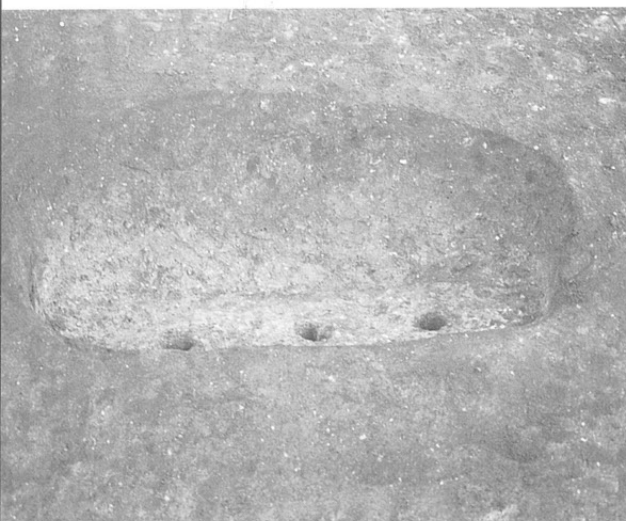

左 57号土坑
右 58号土坑



左 60号土坑
右 62号土坑

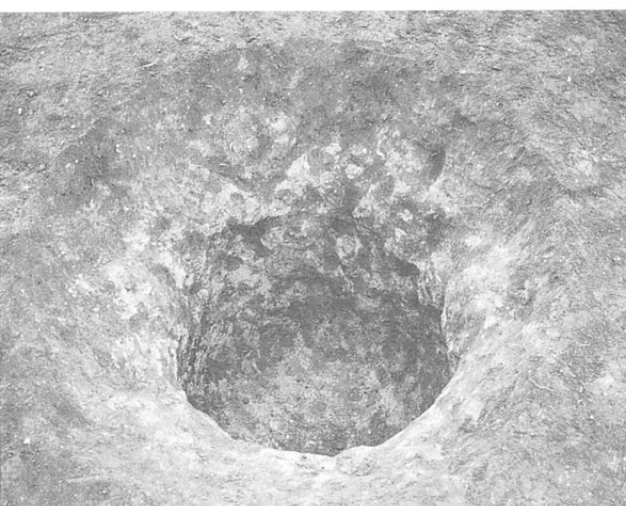

左 66号土坑
右 67号土坑

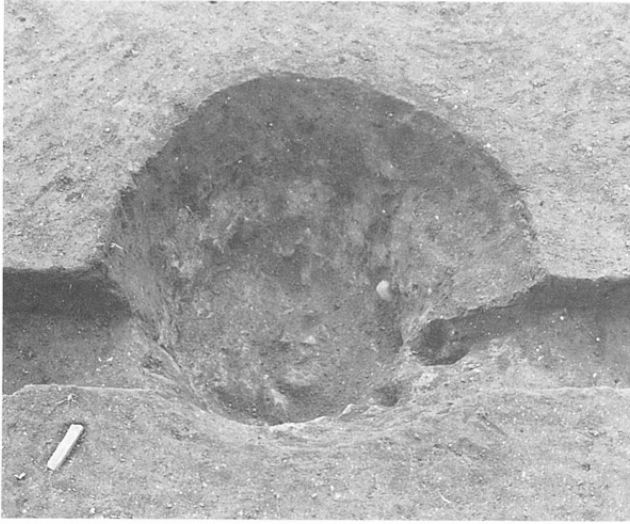

左 154号土坑
右 153号土坑

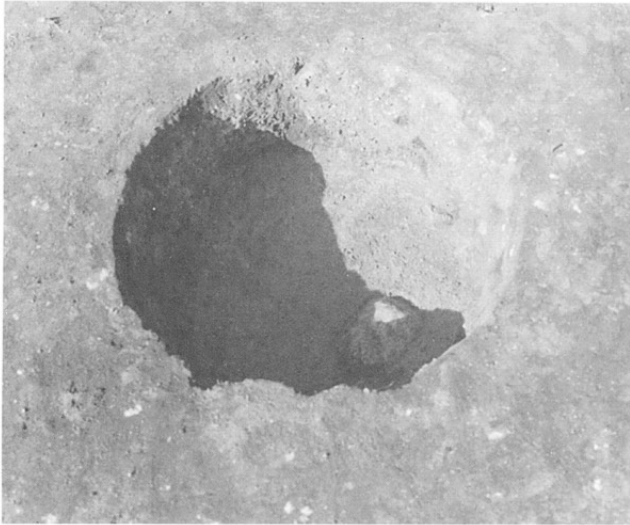

左 165号土坑
右 168号土坑

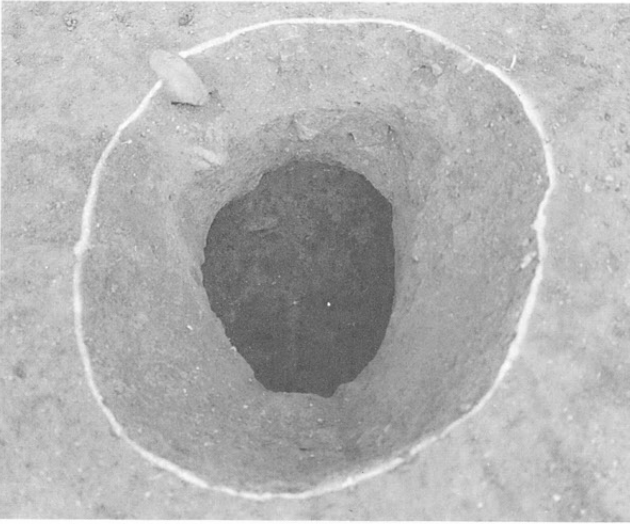
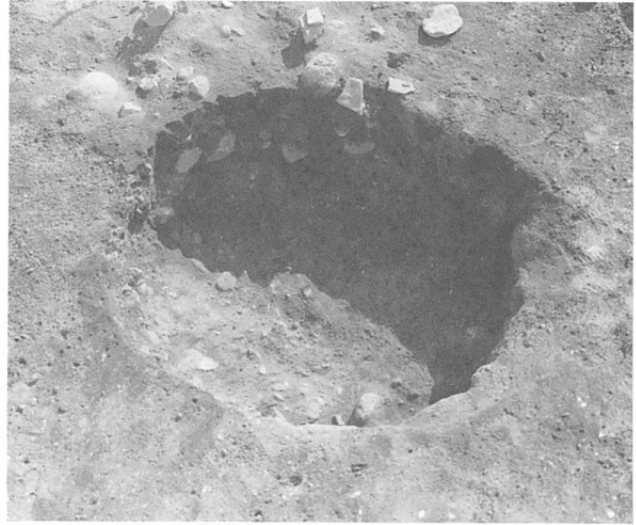

左 185号土坑
右 202号土坑



左 207号土坑
右 207号土坑
遺物出土狀況





左 215号土坑
右 208号土坑

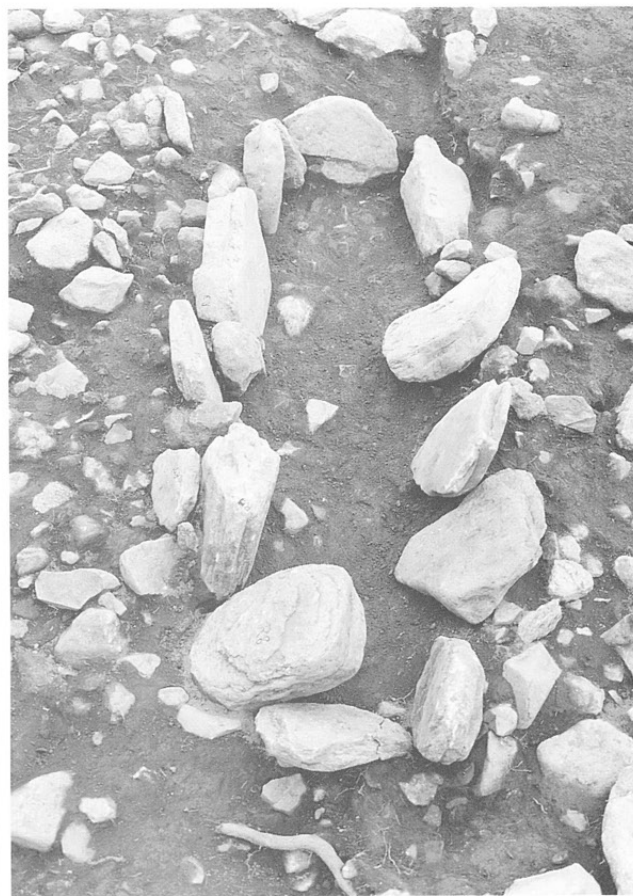

左 1号石棺墓
檢出狀況
右 同完掘



左 2号集石炉
右 同断面

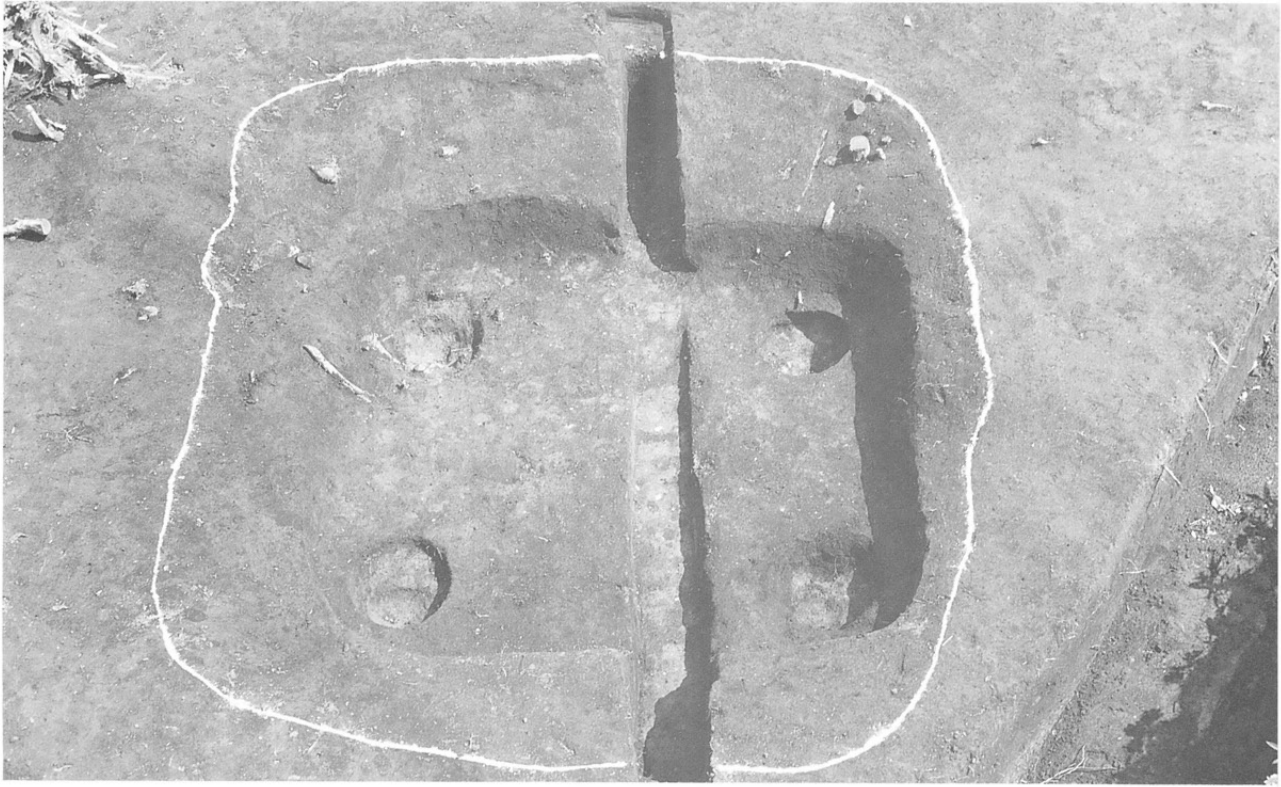

4号住居址

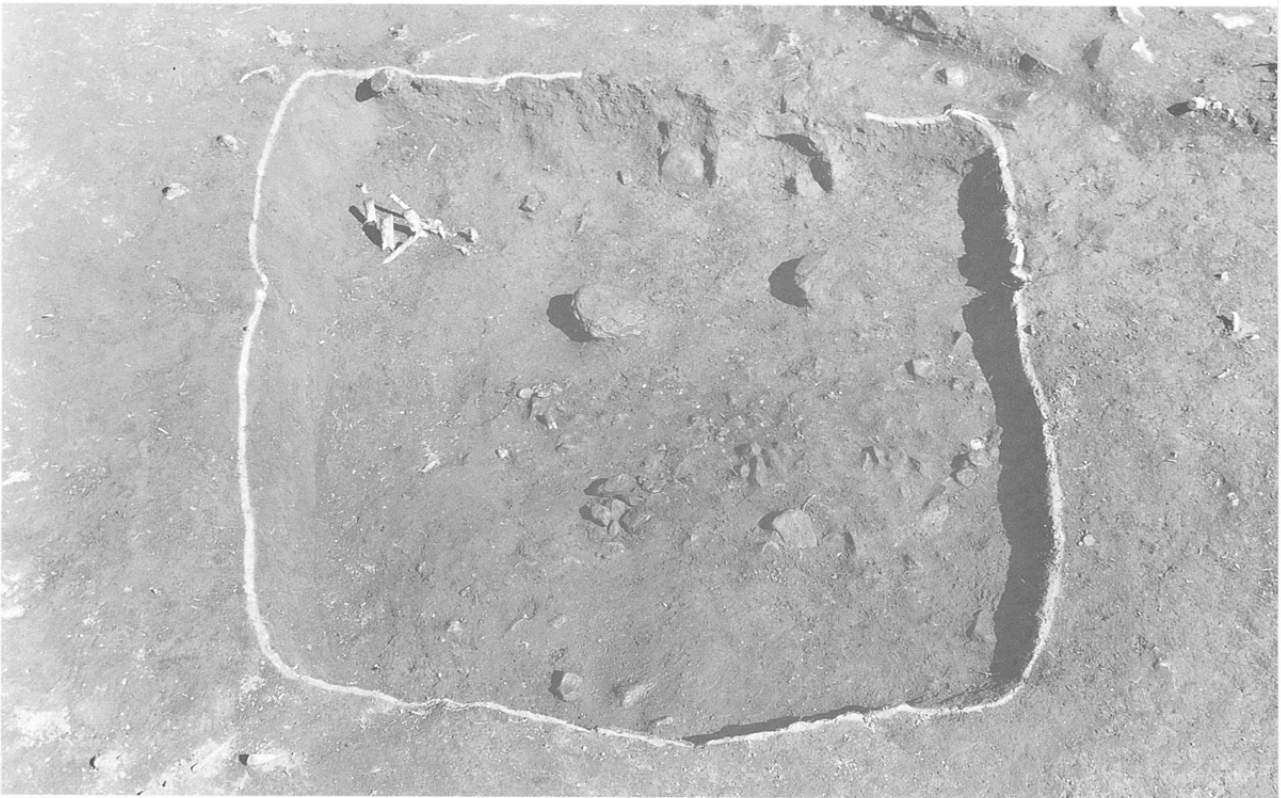

1号住居址

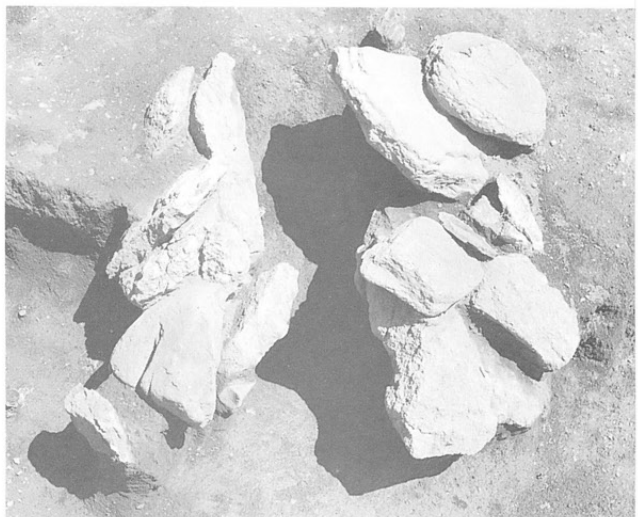

左 1号住居址
カマド
右 5号住居址
カマド