

中央自動車道長野線
埋蔵文化財発掘調査報告書 16

—長野市内 その4—

篠ノ井遺跡群

遺物図版編

1997

日本道路公団名古屋建設局
長野県教育委員会
(財)長野県埋蔵文化財センター

中央自動車道長野線
埋蔵文化財発掘調査報告書 16

—長野市内 その4—

篠ノ井遺跡群

遺物図版編

1997

日本道路公団名古屋建設局
長野県教育委員会
(財)長野県埋蔵文化財センター



SB7177出土の土器内ベンガラ S = 不統一

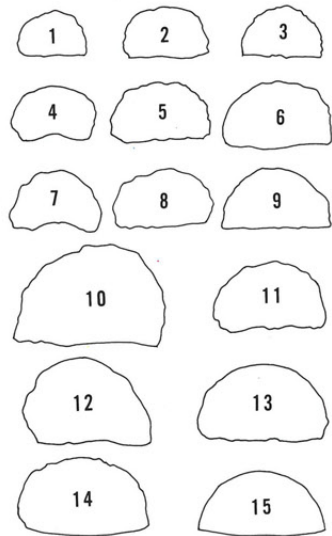
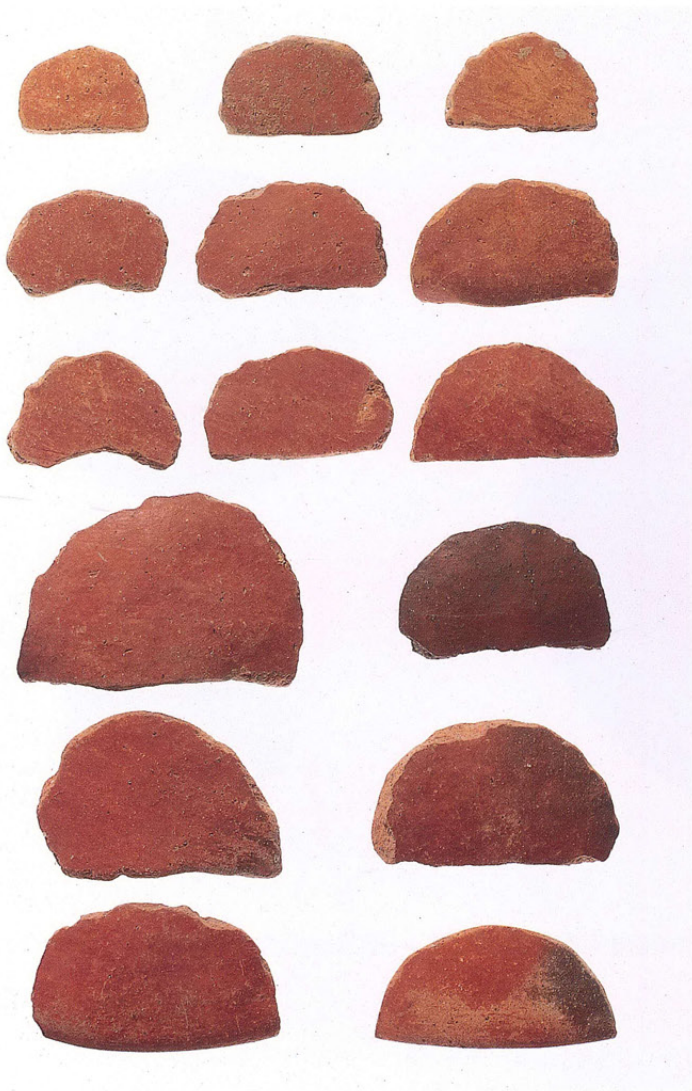

- | | | | |
|---|--------|----|--------|
| 1 | SB7307 | 9 | SD7046 |
| 2 | SD7014 | 10 | SB7627 |
| 3 | SB7650 | 11 | SK8551 |
| 4 | SB7488 | 12 | SB7162 |
| 5 | SB7258 | 13 | SB7082 |
| 6 | SK6222 | 14 | SB7500 |
| 7 | SB7655 | 15 | SD7030 |
| 8 | SB7365 | | |

土器片製半円板 S = 1/2

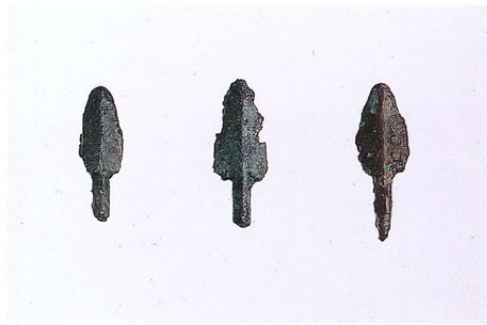

銅鏃 左=SB7128 · 中=SB7488 · 右=SD7052 S=1/1



青銅鏡 左=SM7006出土獸形鏡 · 右上=SM7016出土珠文鏡 · 右下=SB7250出土重圈文鏡 S=1/1

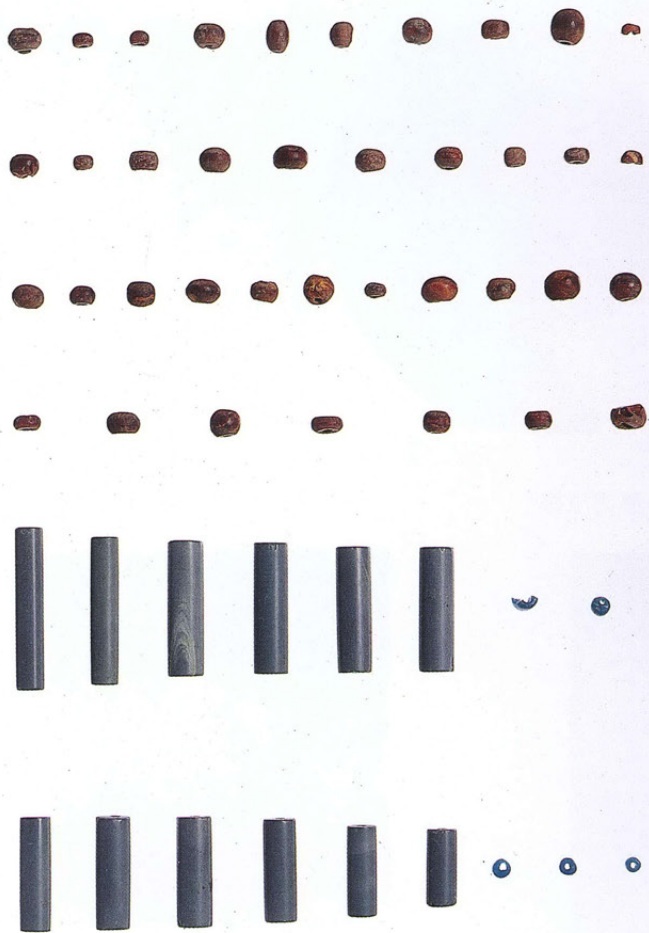

SM7016出土玉類 S=1/2

上4段=コハク玉・下2段左=管玉
・下2段右=ガラス小玉

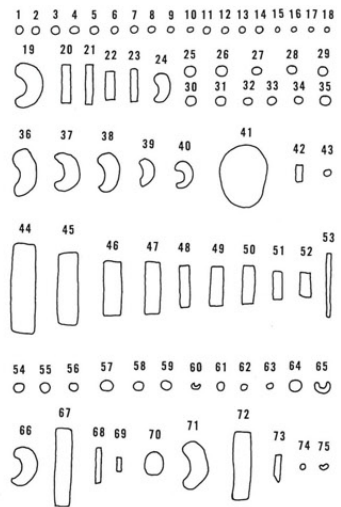
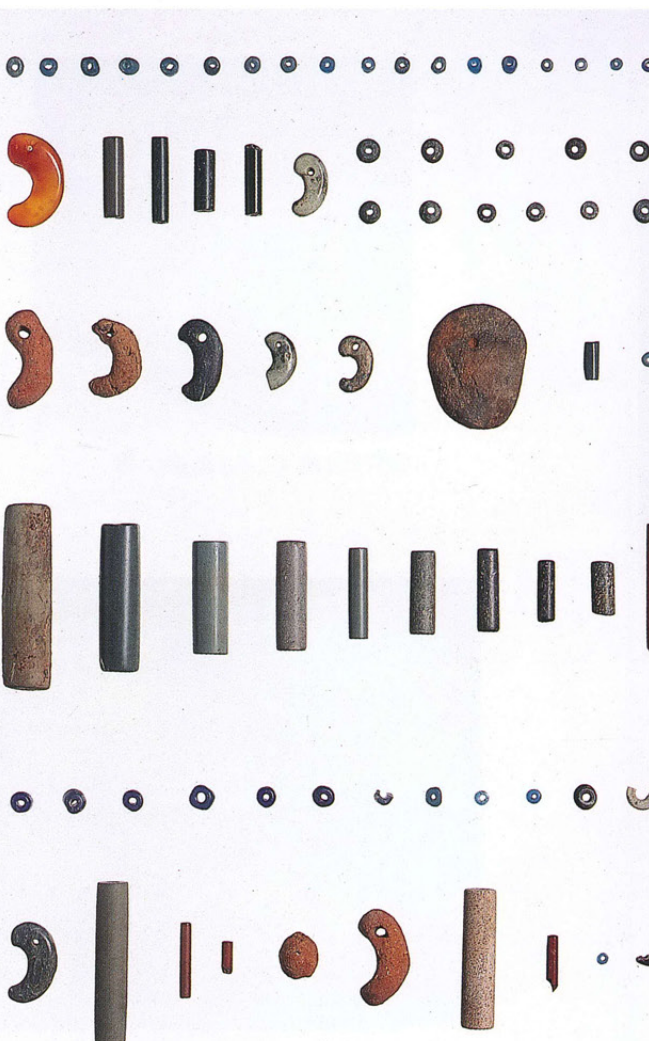

- | | | |
|----|-----------|--------------|
| 1 | 44 SB7716 | 62 SB7573 |
| 2 | 45 SB7425 | 63 SB6014 |
| 3 | 46 SB6019 | 64 SB7246 |
| 4 | 47 SB7383 | 65 SB7434 |
| 5 | 48 SB6019 | 66 SK7258 |
| 6 | 49 SB7379 | 67 SK6321 |
| 7 | 50 SB7428 | 68 SK8109 |
| 8 | 51 SB7387 | 69 SK7846 |
| 9 | 52 SB7387 | 70 SD6035 |
| 10 | 53 SB7024 | 71 2-1区検出面 |
| 11 | 54 | 72 2-2区第1検出面 |
| 12 | 55 | 73 SM7035 |
| 13 | 56 | 74 SB7517 |
| 14 | 57 | 75 2-3区検出面 |
| 15 | 58 | |
| 16 | 59 | |
| 17 | 60 | |
| 18 | 61 SB7428 | |
| 19 | | |
| 20 | | |
| 21 | | |
| 22 | | |
| 23 | | |
| 24 | | |
| 25 | | |
| 26 | | |
| 27 | | |
| 28 | | |
| 29 | | |
| 30 | | |
| 31 | | |
| 32 | | |
| 33 | | |
| 34 | | |
| 35 | | |
| 36 | | |
| 37 | | |
| 38 | | |
| 39 | | |
| 40 | | |
| 41 | | |
| 42 | | |
| 43 | | |
| 44 | | |
| 45 | | |
| 46 | | |
| 47 | | |
| 48 | | |
| 49 | | |
| 50 | | |
| 51 | | |
| 52 | | |
| 53 | | |
| 54 | | |
| 55 | | |
| 56 | | |
| 57 | | |
| 58 | | |
| 59 | | |
| 60 | | |
| 61 | | |
| 62 | | |
| 63 | | |
| 64 | | |
| 65 | | |
| 66 | | |
| 67 | | |
| 68 | | |
| 69 | | |
| 70 | | |
| 71 | | |
| 72 | | |
| 73 | | |
| 74 | | |
| 75 | | |

篠ノ井遺跡群出土玉類 S=1/2



1

SD7001出土(朱)墨書土器



2

SB7011出土(朱)墨書土器



3

SB7011出土(朱)墨書土器



4

SB7001出土(朱)墨書土器



5

SB7021出土(朱)墨書土器



6

SD7038出土(朱)墨書土器

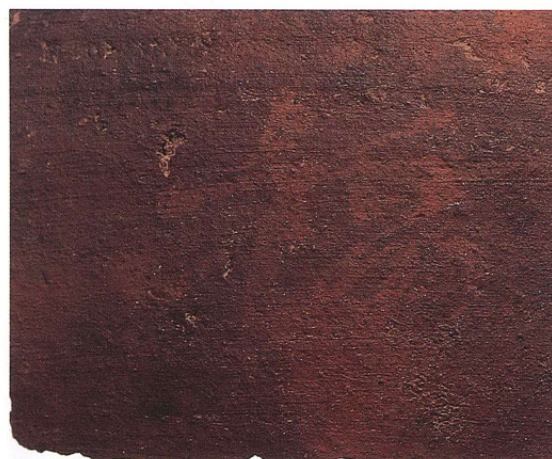

7

SB7203出土(朱)墨書土器

1 : S = 1/2 · 2 ~ 7 : S = 不統一



SD7007出土緑釉陶器皿 S = 1/2



SB7404出土緑釉陶器碗 S = 1/2



篠ノ井遺跡群出土緑釉陶器片 S = 1/2

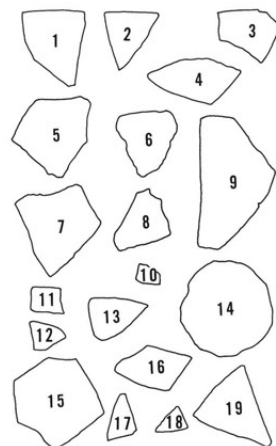

- 1 SK6097
- 2 SD7055
- 3 2-2区第1検出面
- 4 2-2区第1検出面
- 5 SD7061
- 6 2-1-b区南壁12層
- 7 2-1区第1検出面
- 8 SK6097
- 9 SD6008
- 10 2-1区第1検出面
- 11 3区3層上面
- 12 SB7263
- 13 2-3区3層中
- 14 SB7008
- 15 SD7039
- 16 SB7206
- 17 SB7280
- 18 3区3層上面
- 19 SB7041



篠ノ井遺跡群出土の石器 S=1/3

凡 例

1、本書に掲載した実測図や写真の縮尺は、下記のように統一してある。

(1) 遺構実測図

- ・遺構全体図 = 1 : 500 ・ 1 : 1000
- ・遺構個別図 = 1 : 20 ・ 1 : 50
- ・割り付け遺構図 = 1 : 100

(2) 遺物実測図

- ・遺構出土一括図 = 1 : 4
- ・文字関係資料 = 1 : 3
- ・その他器種別実測図 = 1 : 3
- ・土偶、人面、容器形、ミニチュア、土錐、方形板、不整形板、半円板、円板 = 1 : 2
- ・玉類 = 1 : 1
- ・石鏃、原石、石核、剥片A、剥片類 = 1 : 1
- ・打製石斧、磨製石斧、刃器、石包丁 = 1 : 2
- ・磨石、凹石、敲石、砥石 = 1 : 3
- ・石錐 = 2 : 3
- ・台石、石皿 = 1 : 4
- ・カマド石 = 1 : 3
- ・鉄製品 = 1 : 2
- ・青銅製品 = 1 : 2
- ・鏡、銅印、銭貨 = 1 : 1
- ・フイゴの羽口 = 1 : 3
- ・木製品 = 1 : 6

(3) 遺構写真

- ・スケールは不統一

(4) 遺物写真

- ・遺構出土一括土器、器種別土器写真 = 1 : 3
- ・文字関係資料 = スケールは不統一
- ・土偶、人面、容器形、ミニチュア、土錐、方形板、不整形板、半円板、円板 = 1 : 1
- ・玉類 = 1 : 1
- ・石鏃、原石、石核、剥片A、剥片類 = 1 : 1
- ・打製石斧、磨製石斧、刃器、石包丁 = 1 : 2
- ・磨石、凹石、敲石、砥石 = 1 : 3
- ・石錐 = 2 : 3
- ・台石、石皿 = 1 : 6
- ・カマド石 = 1 : 3
- ・鉄製品 = 1 : 2
- ・青銅製品 = 1 : 2
- ・鏡、銅印、銭貨 = 1 : 1
- ・フイゴの羽口 = 1 : 3
- ・木製品 = 1 : 6
- ・実体顕微鏡 [観察倍率×5～×120・撮影倍率×5～×20]
- ・金属顕微鏡 [観察倍率×50～×500・撮影倍率×25～×50]
- ・走査電子顕微鏡 [観察倍率×500～×1000・撮影倍率不明]

2、遺構図中のスクリーントーンは以下の事項を表している。

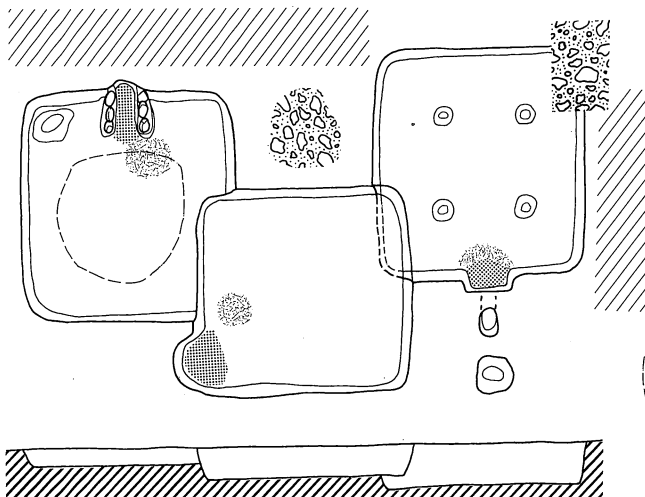

- ① = 遺構図の断面を示す。
- ② = 焼土部分を示す。
- ③ = 炭化物部分を示す。
- ④ = 攪乱部分を示す。
- ⑤ = 未調査部分を示す。

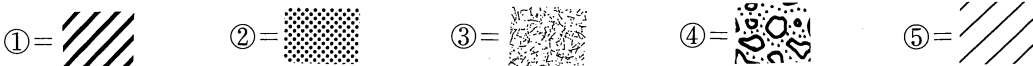

3、遺構図中の遺構番号について、SK以外プレート内での竪穴住居番号はSB記号を省略し、数字のみの標記とした。またSKプレート内での土壇番号もSK記号を省略し、数字のみの標記とした。

4、遺物実測図・遺物写真・遺構写真の番号は、石器以外はすべて図版プレートごとに通しナンバーとした。石器図版については、器種ごとに通しナンバーとした。

各調査区全景写真については、各プレートの下に調査区全体図を載せ、撮影方向を矢印で示した。ただし真上からのものについては矢印は示さなかった。

5、実測図中のスクリーントーンは以下の事項を表している。

(1) 土器

・実測図の断面は、弥生時代中期以前・弥生時代後期・古墳時代前期の土器と古代の土師器・黒色土器は白抜き、須恵器は黒塗りとした。

- ①=灰釉・緑釉・陶磁器類を示す。
- ②=赤彩土器や朱墨痕の赤彩部分を示す。
- ③=古代黒色土器A・Bの黒色処理部分を示す。
- ④=古代土師器の黒色処理部分を示す。
- ⑤=硯類で明確に墨痕がわかるものを示す。
- ⑥=土器などへの付着部分を示す。

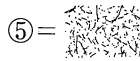
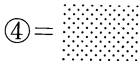
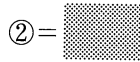
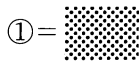

(2) 石製品

- ⑦=石製品の使用痕跡の強弱・種類を示す。
- ⑧=石製品の装着痕跡を示す。
- ⑨=石製品の付着物を示す。

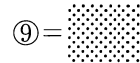
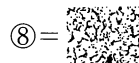
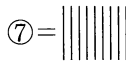
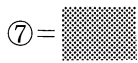
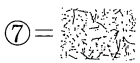

(3) 木製品

- ⑩=木製品の表面炭化物を示す。
- ⑪=木製品の欠損部を示す。
- ⑫=木製品（漆製品）の黒漆部分を示す。

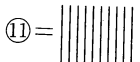
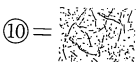

(4) フイゴの羽口

- ⑬=羽口の溶滓付着・タール付着・ガラス状発泡範囲を示す。
- ⑭=被熱による変色（還元青灰色）範囲を示す。

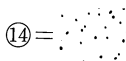
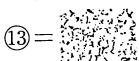

6、実測図中の線表現等は以下の事項を表している。

- ・赤彩土器の赤彩部分での矢印はミガキ方向を示す。
- ・施釉陶磁器の施釉範囲は一点鎖線で示した。
- ・石製品遺物実測図ナンバーに付けられた下線は弥生時代中期後半以前の遺構であることを示し、○付番号は使用痕写真撮影遺物であることを示す。

7、遺構各説での遺構表中の時期や項目についての表記は、以下のとおりである。

(1) 時期の項で縦に並べてある数字については、

- ・明朝数字は、その時期を示す (例：1 = 1期)。
- ・明朝数字+明朝数字は、遺構の継続期間を示す (例：1 3 = 1期から3期にかけて継続)。
- ・ゴシック数字+ゴシック数字は、この範中のいずれかの時期であることを示す (例：1 3 = 1期から3期にかけてのいずれかの時期である)。
- ・数字+「新」は、示した時期の中でも新しい頃を示す (例：3新 = 3期の中でも新しい時期である)。
- ・数字+「古」は、示した時期の中でも古い頃を示す (例：3古 = 3期の中でも古い時期である)。
- ・数字+「先」は、示した時期以前の時期であることを示す (例：3先 = 3期以前の時期である)。
- ・数字+「降」は、示した時期以降の時期であることを示す (例：3降 = 3期以降の時期である)。
- ・「不明」は、時期決定ができないものである。

(2) SK (土壇跡)、SM (墓跡)、SF (火床跡)、SX (不明) については、

・平面形

円 = 円形 方 = 方形 長 = 長方形 楕 = 楕円形 長楕 = 長楕円形 不 = 不明

・断面形

A = なだらかなU字形 B = 急なU字 C = 落ち込みが直で、底面がほぼ平ら D = 底面の凹凸が激しいもの E = 中央部に凹があるもの F = 壁際に凹があるもの G = その他

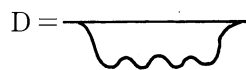
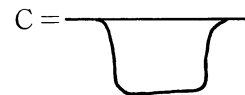
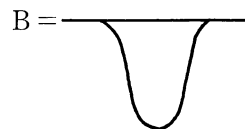

(3) SD (溝跡) については、

・断面形

A = 浅くなだらかなもの B = 深めでなだらかなもの C = V字状 D = U字状 E = その他

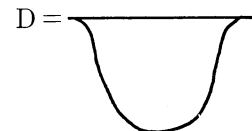
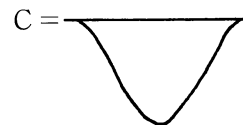
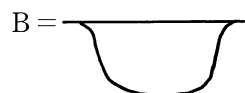

(4) SB (竪穴住居跡) については、

・平面形

円=円形 方=方形 長=長方形 隅=隅丸方形 隅長=隅丸長方形 不=不明

・カマド

粘=粘土のみで構築 石=芯材に自然石を使用 切=切石を使用

・炉

円=円形 方=方形 楕=楕円形 不=不整形

(5) 埋土については、

単層か複層かを、単=単層、複=複層と示した。

8、土性・土色については、「新版標準土色帖」(9版 1989年5月) 農林水産省農林水産技術会議事務局監修・財団法人日本色彩研究所色票監修による。

「遺物図版編」

凡例

カラー写真図版目次

- | | | | |
|-------|-----------------------------|-------|---------------|
| P L 1 | SB7177出土の土器内ベンガラ 土器片製半円板 | P L 4 | (朱) 墨書土器 |
| P L 2 | 銅鍍・青銅鏡 | P L 5 | 篠ノ井遺跡群出土の緑釉陶器 |
| P L 3 | SM7016出土玉類・篠ノ井遺跡群出土玉類 | P L 6 | 篠ノ井遺跡群出土の石器 |

実測図版目次

弥生時代中期以前の土器

- | | | | |
|------|--|------|-------------------------|
| 図版 1 | SB7272・SB7276・SB7438・SM7010 SM7026・SK7294・SK7310・SK7327 出土土器 | 図版 6 | SD7110②出土土器 |
| 図版 2 | SB7438・SD6007①・SD6030・SD7047 SD7098出土土器 (拓本) | 図版 7 | SD7110③出土土器 (拓本) |
| 図版 3 | SD5003・SD6007②出土土器 | 図版 8 | SD7110④・SK7294出土土器 (拓本) |
| 図版 4 | SD6007③出土土器 | 図版 9 | 遺構外出土土器 1 |
| 図版 5 | SD7110①出土土器 (拓本) | 図版10 | 遺構外出土土器 2 (拓本) |
| | | 図版11 | 遺構外出土土器 3 |
| | | 図版12 | 遺構外出土土器 4 (拓本) |

弥生時代後期の土器

- | | | | |
|------|---|------|--|
| 図版13 | SB6014・SB6015出土土器 | 図版30 | SB7132②・SB7166・SB7173・SB7177出 土土器 |
| 図版14 | SB6017・SB6028・SB6030・SB6031 SB6035出土土器 | 図版31 | SB7180・SB7187・SB7191・SB7233出土 土器 |
| 図版15 | SB7020・SB7021・SB7024出土土器 | 図版32 | SB7226・SB7229・SB7237出土土器 |
| 図版16 | SB7034・SB7037・SB7038・SB7039 SB7071出土土器 | 図版33 | SB7236・SB7238・SB7252・SB7258 SB7271出土土器 |
| 図版17 | SB7040①出土土器 | 図版34 | SB7277・SB7293・SB7307・SB7493出土 土器 |
| 図版18 | SB7040②・SB7090・SB7097出土土器 | 図版35 | SB7358・SB7365・SB7417・SB7490 SB7560・SB7573出土土器 |
| 図版19 | SB7078出土土器 | 図版36 | SB7488・SB7495出土土器 |
| 図版20 | SB7079出土土器 | 図版37 | SB7497・SB7500・SB7553・SB7580出土 土器 |
| 図版21 | SB7082出土土器 | 図版38 | SB7593・SB7617・SB7618・SB7630出土 土器 |
| 図版22 | SB7086出土土器 | 図版39 | SB7627・SB7655出土土器 |
| 図版23 | SB7089・SB7091・SB7102・SB7103出土 土器 | 図版40 | SB7669・SB7673・SB7675・SB7693 SB7696・SB7697出土土器 |
| 図版24 | SB7094・SB7095出土土器 | 図版41 | SD6003・SD6035・SD7014①出土土器 |
| 図版25 | SB7099・SB7101①出土土器 | | |
| 図版26 | SB7101②・SB7105・SB7110出土土器 | | |
| 図版27 | SB7126・SB7128・SB7162①出土土器 | | |
| 図版28 | SB7162②・SB7146・SB7147出土土器 | | |
| 図版29 | SB7132①出土土器 | | |

図版42 SD7014②出土土器
 図版43 SD7014③出土土器
 図版44 SD7046①出土土器
 図版45 SD7046②出土土器
 図版46 SK6122・SK6184・SK6213・SK6324出土土器
 図版47 SK6222・SK6352・SK6415・SK6437
 SK7075①出土土器
 図版48 SK7075②出土土器
 図版49 SK7075③出土土器

図版50 SK7075④出土土器
 図版51 SK7075⑤出土土器
 図版52 SK7092・SK7105・SK7135・SK7286
 SK7328出土土器
 図版53 SK7170・SK7331・SK7343出土土器
 図版54 SK7353・SK7359・SK7483出土土器
 図版55 SK7362・SK7445・SK7470・SK8152
 SK8222・SK8320・SK8476・SK8488
 SK8551出土土器
 図版56 遺構外出土土器

古墳時代前期の土器

図版57 SB6001・SB6004・SB6006・SB6007
 SB6009・6011出土土器
 図版58 SB6016・SB7042出土土器
 図版59 SB6013・SB6018・SB6019・SB6025
 SB6027・SB6029出土土器
 図版60 SB7080・SB7129・SB7172・SB7184
 SB7188・SB7193・SB7195・SB7244出土土器
 図版61 SB7213・SB7228・SB7246①出土土器
 図版62 SB7246②・SB7250出土土器
 図版63 SB7254①出土土器
 図版64 SB7254②出土土器
 図版65 SB7255出土土器
 図版66 SB7256①出土土器
 図版67 SB7256②出土土器
 図版68 SB7256③出土土器
 図版69 SB7256④・SB7257・SB7259
 SB7268出土土器
 図版70 SB7283・SB7311・SB7344・SB7345
 SB7346・SB7372・SB7373・SB7383
 SB7386・SB7394出土土器
 図版71 SB7381・SB7401・SB7420出土土器
 図版72 SB7418・SB7446・SB7458・SB7494
 SB7517出土土器
 図版73 SB7442・SB7508①出土土器
 図版74 SB7508②出土土器
 図版75 SB7508③出土土器
 図版76 SB7508④・SB7561・SB7586・SB7596

SB7634・SB7642・SB7646出土土器
 図版77 SB7639・SB7649出土土器
 図版78 SB7654・SB7709・SB7722・SB7726
 SB7745出土土器
 図版79 SB7751・SC6001・SM7001・SM7032
 SM7035出土土器
 図版80 SD6015・SD6016・SD6023①出土土器
 図版81 SD6023②出土土器
 図版82 SD6023③出土土器
 図版83 SD6023④・SD7014①出土土器
 図版84 SD7014②・SD7030①出土土器
 図版85 SD7030②出土土器
 図版86 SD7030③出土土器
 図版87 SD7030④出土土器
 図版88 SD7084・SD7088・SK6048・SK6108
 SK6113・SK6117・SK6133出土土器
 図版89 SK6099・SK6142・SK6150出土土器
 図版90 SK6186・SK6202①・SK6290・SK6296
 SK6310・SK6321出土土器
 図版91 SK6202②出土土器
 図版92 SK6202③出土土器
 図版93 SK6307出土土器
 図版94 SK6406・SK6441・SK7130・SK7146出土土器
 図版95 SK7157・SK7256・SK7326・SK7364
 SK7403・SK7469・SK7480・SK7596出土土器
 図版96 SK7367・SK7608・SK7822・SK8011出土土器

土器

図版97 SK8250・SK8310・SK8397・SK8404
SK8405・SK8442・SK8502・SK8511

SK8855・SK8893出土土器

図版98 遺構外出土土器

古代（7世紀・奈良時代・平安時代）の土器・中世の焼き物

図版99 SB6020・SB6023・SB6024・SB7001①
出土土器

図版100 SB7001②・SB7002・SB7003出土土器

図版101 SB7004・SB7005・SB7006出土土器

図版102 SB7007・SB7008出土土器

図版103 SB7009・SB7010・SB7011・SB7012
SB7014出土土器

図版104 SB7013・SB7015・SB7016・SB7018
SB7022出土土器

図版105 SB7019・SB7025・SB7026出土土器

図版106 SB7029・SB7030出土土器

図版107 SB7031・SB7033・SB7036・SB7041
SB7046・SB7047・SB7059出土土器

図版108 SB7048・SB7052・SB7053出土土器

図版109 SB7054・SB7058・SB7092・SB7098
出土土器

図版110 SB7068・SB7100・SB7106・SB7108
SB7111出土土器

図版111 SB7109・SB7112・SB7113・SB7114
SB7115出土土器

図版112 SB7118・SB7120・SB7121・SB7122
SB7123出土土器

図版113 SB7127・SB7133・SB7134・SB7136
SB7137・SB7141・SB7143出土土器

図版114 SB7144・SB7150・SB7152・SB7153
SB7154・SB7155・SB7156出土土器

図版115 SB7158・SB7159・SB7160・SB7161
SB7164・SB7165・SB7169・SB7171
SB7174・SB7179・SB7185出土土器

図版116 SB7181・SB7196・SB7199・SB7200
出土土器

図版117 SB7201・SB7202・SB7203・SB7204
出土土器

図版118 SB7207・SB7208・SB7210・SB7211
SB7212出土土器

図版119 SB7205・SB7206①出土土器

図版120 SB7206②出土土器

図版121 SB7209・SB7214出土土器

図版122 SB7215・SB7216・SB7218・SB7219
出土土器

図版123 SB7220・SB7221・SB7223出土土器

図版124 SB7222・SB7227・SB7231・SB7235
出土土器

図版125 SB7230・SB7245・SB7248出土土器

図版126 SB7234・SB7249出土土器

図版127 SB7253・SB7260・SB7261・SB7263
出土土器

図版128 SB7264・SB7265・SB7266・SB7267
SB7269・SB7278・SB7279・SB7280
SB7288出土土器

図版129 SB7270・SB7273・SB7287出土土器

図版130 SB7299・SB7301・SB7305・SB7306
SB7308・SB7313・SB7314・SB7315
SB7318出土土器

図版131 SB7317・SB7320・SB7324・SB7325
SB7326・SB7330・SB7331出土土器

図版132 SB7332・SB7335・SB7337・SB7340
SB7341・SB7342・SB7348・SB7354
SB7356出土土器

図版133 SB7357・SB7360・SB7367出土土器

図版134 SB7370・SB7380出土土器

図版135 SB7387・SB7389・SB7390・SB7391
SB7392・SB7396出土土器

図版136 SB7398・SB7399・SB7404・SB7405
SB7407・SB7408出土土器

図版137 SB7409・SB7410・SB7411・SB7412
SB7413・SB7415・SB7421・SB7423
SB7426・SB7428出土土器

図版138 SB7416出土土器

図版139 SB7422・SB7434・SB7435出土土器

図版140 SB7425・SB7437出土土器
 図版141 SB7427出土土器
 図版142 SB7440・SB7449・SB7450・SB7459
 SB7460・SB7469出土土器
 図版143 SB7464・SB7470・SB7477・SB7478
 SB7485・SB7486・SB7505・SB7518
 SB7519・SB7521出土土器
 図版144 SB7528・SB7530・SB7532・SB7533
 SB7534・SB7535・SB7537出土土器
 図版145 SB7538・SB7543・SB7546・SB7549
 SB7551・SB7554・SB7568・SB7571
 SB7587・SB7591出土土器
 図版146 SB7552出土土器
 図版147 SB7601・SB7605・SB7606・SB7610
 SB7619・SB7622・SB7645・SB7667出
 出土土器
 図版148 SB7644・SB7651・SB7700・SB7703
 SB7716・SB7717・SB7735出土土器
 図版149 ST7020・SM7005・SM7007・SM7008
 SM7009・SM7015・SM7017・SM7019
 SM7020・SM7021・SM7022・SM7025
 出土土器
 図版150 SD6008・SD6033・SD7001出土土器
 図版151 SD7002出土土器
 図版152 SD7006①出土土器
 図版153 SD7006②出土土器
 図版154 SD7006③出土土器
 図版155 SD7007出土土器
 図版156 SD7010・SD7011・SD7023・SD7024
 出土土器

図版157 SD7027・SD7029・SD7031・SD7032
 SD7033・SD7036・SD7037・SD7038
 SD7040・SD7041・SD7042出土土器
 図版158 SD7039①出土土器
 図版159 SD7039②・SD7051・SD7052①出土土器
 図版160 SD7052②出土土器
 図版161 SD7054・SD7055・SD7061・SD7067
 SD7068・SD7069・SD7072・SD7078
 SD7079・SD7092・SD7094・SD7101
 SD7102・SD7104出土土器
 図版162 SD7080・SD7083・SD7087・SD7109
 出土土器
 図版163 SK6033・SK6034・SK6035・SK6044
 SK6046・SK6097・SK6154・SK6160
 SK6163・SK6208・SK6398・SK6408
 SK6432・SK7137・SK7154出土土器
 図版164 SK7199・SK7229出土土器
 図版165 SK7228・SK7235・SK7275・SK7303
 SK7305・SK7314・SK7330・SK7361
 SK7369・SK7376・SK7420・SK7422
 SK7425出土土器
 図版166 SK7414・SK7447・SK7459・SK7461
 SK7465・SK7650・SK7683出土土器
 図版167 SK7824・SK7877・SK7995・SK8050
 SK8092・SK8110・SK8135・SK8142
 SK8150・SK8192・SK8226・SK8235
 SK8254・SK8494・SK8577・SK8587
 SK8770出土土器
 図版168 遺構外出土土器・中世以降出土焼き物

その他の土器と土製品

図版169 土偶 人面付土器
 容器形土製品
 図版170 北陸系土器 1 (弥生後期)
 図版171 北陸系土器 2 (弥生後期)
 図版172 北陸系土器 3 (古墳前期)
 東海系土器 1 (古墳前期)
 図版173 東海系土器 2 (古墳前期)
 図版174 畿内系土器 1 (古墳前期)
 図版175 畿内系土器 2 (古墳前期)
 図版176 ミニチュア土器 1
 図版177 ミニチュア土器 2
 図版178 靱痕付土器
 図版179 付着物 (漆等) 土器
 図版180 へら書き 線刻 刻印土器 1
 図版181 へら書き 線刻 刻印土器 2
 図版182 へら書き 線刻 刻印土器 3

図版183 墨書土器 1
図版184 墨書土器 2
図版185 墨書土器 3
図版186 墨書土器 4
図版187 墨書土器 5
図版188 墨書土器 6
図版189 墨書土器 7
図版190 墨書土器 8
図版191 墨書土器 9
図版192 墨書土器10
図版193 墨書土器11
図版194 墨書土器12
図版195 硯類 1

図版196 硯類 2
図版197 硯類 3 緑釉陶器
図版198 特異な内面ヘラミガキ土器 底部木葉痕
土器
図版199 紡錘車
図版200 石錘・土錘 1
図版201 石錘・土錘 2
図版202 石錘・土錘 3
図版203 石錘・土錘 4 土器片製方形板・不製形
板
図版204 土器片製半円板
図版205 土器片製円板
図版206 ファイゴの羽口

鏡類・玉類・古代石製品

図版207 SM7006出土の鏡と玉
図版208 SM7016出土の鏡と玉 1
図版209 SM7016出土の玉 2 SM7028出土の玉

SM7036出土の玉

図版210 その他の玉類 古代の石製品

青銅製品と鉄製品

図版211 青銅製品（銅鏃・鏡・銅印・銭貨・その
他の青銅製品）
図版212 鉄製品 1（紡錘車・苧引き金具・釘）
図版213 鉄製品 2（鉄鏃類）
図版214 鉄製品 3（刀子 1）

図版215 鉄製品 4（刀子 2）
図版216 鉄製品 5（鋤先）
図版217 鉄製品 6（鎌・斧・その他の鉄製品 1）
図版218 鉄製品 7（その他の鉄製品 2）

木製品

図版219 木製品 1（農具・生活具 1）
図版220 木製品 2（生活具 2）
図版221 木製品 3（建築材 1）

図版222 木製品 4（建築材 2）
図版223 木製品 5（杭 1）
図版224 木製品 6（杭 2）

石製品

図版225 弥生時代石器 1（原石・石核 1）
図版226 弥生時代石器 2（原石・石核 2）
図版227 弥生時代石器 3（剥片 A類・剥片 B類）
図版228 弥生時代石器 4（石鏃 1）
図版229 弥生時代石器 5（石鏃 2・石錐）
図版230 弥生時代石器 6（打製石斧 1）
図版231 弥生時代石器 7（打製石斧 2）
図版232 弥生時代石器 8（打製石斧 3）

図版233 弥生時代石器 9（磨石 1）
図版234 弥生時代石器10（磨石 2）
図版235 弥生時代石器11（磨石 3）
図版236 弥生時代石器12（磨石 4）
図版237 弥生時代石器13（凹石 1）
図版238 弥生時代石器14（凹石 2）
図版239 弥生時代石器15（敲石 1）
図版240 弥生時代石器16（敲石 2）

図版241 弥生時代石器17 (敲石 3)
 図版242 弥生時代石器18 (台石 1)
 図版243 弥生時代石器19 (台石 2)
 図版244 弥生時代石器20 (使有石屑)
 図版245 弥生時代石器21 (刃器 1)
 図版246 弥生時代石器22 (刃器 2)
 図版247 弥生時代石器23 (刃器 3)
 図版248 弥生時代石器24 (刃器 4)
 図版249 弥生時代石器25 (刃器 5)
 図版250 弥生時代石器26 (刃器 6)
 図版251 弥生時代石器27 (刃器 7)
 図版252 弥生時代石器28 (刃器 8)
 図版253 弥生時代石器29 (磨製石包丁)
 図版254 弥生時代石器30 (磨製石斧 1)

図版255 弥生時代石器31 (磨製石斧 2)
 図版256 弥生時代石器32 (磨製石斧 3)
 図版257 弥生時代～古代石器33 (砥石 1)
 図版258 弥生時代～古代石器34 (砥石 2)
 図版259 弥生時代～古代石器35 (砥石 3)
 図版260 弥生時代～古代石器36 (砥石 4・くぼみ石 1)
 図版261 弥生時代～古代石器37 (くぼみ石 2・石臼)
 図版262 弥生時代石器38 (みがき石)
 図版263 弥生時代石器39 (玉石・穴開石・軽石・角礫)
 図版264 古代カマド石40 (切石)

写真図版目次

弥生時代中期以前

P L 1 SB7272・SB7276(1)・SM7010
 SM7026・SK7327出土土器
 P L 2 SD5003(1)・SD6007(1)出土土器
 P L 3 遺構外出土土器 1
 P L 4 遺構外出土土器 2
 P L 5 SB7276(2)・SB7438・SD6007(2)
 SD6030・SD7047(1)・SK7294出土土器
 P L 6 SD6007(3)・SD7047(2)・SD7098出土土器
 P L 7 SD5003(2)・SD6007(4)出土土器
 P L 8 SD6007(5)出土土器
 P L 9 SD6007(6)・SD7110(1)出土土器

P L 10 SD7110(2)出土土器
 P L 11 SD7110(3)出土土器
 P L 12 SD7110(4)出土土器
 P L 13 SD7110(5)出土土器
 P L 14 SD7110(6)出土土器
 P L 15 SD7110(7)出土土器
 P L 16 遺構外出土土器 1
 P L 17 遺構外出土土器 2
 P L 18 遺構外出土土器 3
 遺構外出の縄文式土器

弥生時代後期

P L 19 SB6014出土土器
 P L 20 SB6015・SB6017・SB6028出土土器
 P L 21 SB6030・SB6031・SB7021出土土器
 P L 22 SB7034・SB7040・SB7071出土土器
 P L 23 SB7079出土土器
 P L 24 SB7078・SB7082・SB7089出土土器
 P L 25 SB7086(1)出土土器
 P L 26 SB7086(2)・SB7090・SB7099出土土器
 P L 27 SB7091・SB7094出土土器

P L 28 SB7101・SB7102・SB7103
 SB7105出土土器
 P L 29 SB7132出土土器
 P L 30 SB7162(1)出土土器
 P L 31 SB7162(2)・SB7166出土土器
 P L 32 SB7173・SB7180・SB7191
 SB7226出土土器
 P L 33 SB7229・SB7236・SB7277・SB7293
 SB7307出土土器

P L 34 SB7358・SB7417・SB7488出土土器
P L 35 SB7493・SB7495・SB7497出土土器
P L 36 SB7573・SB7627・SB7630・SB7655
出土土器
P L 37 SB7669・SB7673・SB7693・SB7696
出土土器
P L 38 SD6035・SD7014(1)出土土器
P L 39 SD7014(2)出土土器
P L 40 SD7046(1)出土土器
P L 41 SD7046(2)出土土器
P L 42 SD7046(3)出土土器

古墳時代前期

P L 53 SB6001・SB6004・SB6006・SB6011
SB6013・SB6016(1)出土土器
P L 54 SB6016(2)出土土器
P L 55 SB6018・SB6019・SB6025・SB6027
SB7042・SB7080・SB7129・SB7172
SB7184出土土器
P L 56 SB7193・SB7213・SB7228・SB7244
SB7246出土土器
P L 57 SB7250出土土器
P L 58 SB7254・SB7255出土土器
P L 59 SB7256(1)出土土器
P L 60 SB7256(2)・SB7257・SB7311・SB7346
SB7372出土土器
P L 61 SB7418・SB7420出土土器
P L 62 SB7442・SB7508(1)出土土器
P L 63 SB7508(2)出土土器
P L 64 SB7517・SB7561・SB7586・SB7596
SB7634・SB7642・SB7646・SB7709
SB7726出土土器
P L 65 SB7654・SB7751出土土器

古代（7世紀・奈良時代・平安時代）の土器

P L 83 SB6020・SB6023・SB6024・SB7001
出土土器
P L 84 SB7001出土土器
P L 85 SB7002・SB7003・SB7004出土土器
P L 86 SB7005・SB7006出土土器

P L 43 SK6122・SK6222・SK6415・SK7105
出土土器
P L 44 SK7075(1)出土土器
P L 45 SK7075(2)出土土器
P L 46 SK7075(3)出土土器
P L 47 SK7075(4)出土土器
P L 48 SK7075(5)出土土器
P L 49 SK7075(6)・SK7135出土土器
P L 50 SK7170・SK7362・SK8247出土土器
P L 51 SK7331・SK7353出土土器
P L 52 SK7483・SK8152・SK8488出土土器

P L 66 SC6001・SM7001・SM7035出土土器
P L 67 SD6016・SD6023(1)出土土器
P L 68 SD6023(2)出土土器
P L 69 SD6023(3)出土土器
P L 70 SD6023(4)出土土器
P L 71 SD7014出土土器
P L 72 SD7030(1)出土土器
P L 73 SD7030(2)出土土器
P L 74 SD7030(3)・SD7088出土土器
P L 75 SK6048・SK6099・SK6113
SK6142・SK6186出土土器
P L 76 SK6202(1)出土土器
P L 77 SK6202(2)出土土器
P L 78 SK6202(3)出土土器
P L 79 SK6202(4)出土土器
P L 80 SK6307出土土器
P L 81 SK7130・SK7256・SK7364・SK7367
出土土器
P L 82 SK7326・SK7403・SK8011・SK8250
SK8397出土土器

P L 87 SB7007・SB7009出土土器
P L 88 SB7010・SB7011・SB7014・SB7015
SB7016出土土器
P L 89 SB7013・SB7018・SB7019出土土器
P L 90 SB7022・SB7026・SB7031出土土器

| | | |
|---------|--|--|
| P L 91 | SB7029 · SB7030出土土器 | 出土土器 |
| P L 92 | SB7036 · SB7041 · SB7046 · SB7047 出土土器 | P L 114 SB7391 · SB7392 · SB7396 · SB7404 出土土器 |
| P L 93 | SB7048 · SB7052 · SB7053出土土器 | P L 115 SB7407 · SB7408 · SB7421 · SB7422 SB7426 · SB7434 · SB7435 · SB7459 SB7470出土土器 |
| P L 94 | SB7054 · SB7058 · SB7068出土土器 | P L 116 SB7416(1)出土土器 |
| P L 95 | SB7059 · SB7092 · SB7098 · SB7100 SB7106 · SB7108 · SB7111出土土器 | P L 117 SB7416(2) · SB7425出土土器 |
| P L 96 | SB7112出土土器 | P L 118 SB7427 · SB7477 · SB7485 · SB7505 出土土器 |
| P L 97 | SB7113 · SB7114 · SB7115 · SB7118 出土土器 | P L 119 SB7469 · SB7530 · SB7535出土土器 |
| P L 98 | SB7120 · SB7121 · SB7122 · SB7123 SB7127 · SB7133 · SB7134出土土器 | P L 120 SB7534出土土器 |
| P L 99 | SB7137 · SB7141 · SB7143 · SB7144 SB7150 · SB7152 · SB7153出土土器 | P L 121 SB7537 · SB7543 · SB7546 · SB7549 SB7551 · SB7568 · SB7571 · SB7591 SB7605出土土器 |
| P L 100 | SB7154 · SB7155 · SB7156 · SB7158 出土土器 | P L 122 SB7552 · SB7601出土土器 |
| P L 101 | SB7159 · SB7160 · SB7164 · SB7165 SB7169 · SB7171 · SB7174 · SB7179 SB7181 · SB7199 · SB7200出土土器 | P L 123 SB7610 · SB7619 · SB7622 · SB7644 SB7645 · SB7651 · SB7700 · SB7717 出土土器 |
| P L 102 | SB7201 · SB7203 · SB7205出土土器 | P L 124 SM7005 · SM7007 · SM7009 · SM7015 SM7017 · SM7020 · SM7021 · SM7022 SM7025出土土器 |
| P L 103 | SB7206出土土器 | P L 125 SD6008 · SD7001 · SD7002出土土器 |
| P L 104 | SB7207 · SB7208 · SB7210出土土器 | P L 126 SD7006(1)出土土器 |
| P L 105 | SB7209 · SB7214 · SB7215出土土器 | P L 127 SD7006(2)出土土器 |
| P L 106 | SB7216 · SB7218 · SB7219 · SB7220 SB7221出土土器 | P L 128 SD7007 · SD7010 · SD7011 · SD7023 出土土器 |
| P L 107 | SB7222 · SB7223 · SB7227 · SB7230 SB7245出土土器 | P L 129 SD7033 · SD7039出土土器 |
| P L 108 | SB7234 · SB7235 · SB7248出土土器 | P L 130 SD7052出土土器 |
| P L 109 | SB7249 · SB7253 · SB7260 · SB7261 出土土器 | P L 131 SD7040 · SD7067 · SD7079 · SD7080 SD7083 · SD7101出土土器 |
| P L 110 | SB7264 · SB7267 · SB7269 · SB7273 SB7278出土土器 | P L 132 SK6035 · SK6044 · SK6046 · SK7229 SK7235 · SK7275 · SK7303出土土器 |
| P L 111 | SB7287 · SB7288 · SB7299 · SB7301 SB7306 · SB7308 · SB7314出土土器 | P L 133 SK7199出土土器 |
| P L 112 | SB7318 · SB7324 · SB7325 · SB7326 SB7331 · SB7332 · SB7335 · SB7357 SB7370出土土器 | P L 134 SK7376 · SK7414 · SK7420 · SK7459 SK7461 · SK7995 · SK8110 · SK8226 SK8770出土土器 |
| P L 113 | SB7367 · SB7380 · SB7387 · SB7389 | 遺構外出土土器 |

中世の焼き物

P L 135 SK6234・SK7085・SK7162・SK7194
SK7211出土焼き物
遺構外出土焼き物

P L 136 SK7048・SK7051・SK7058・SK7159
SK8578出土焼き物
遺構外出土焼き物

その他の土器と土製品

P L 137 土偶 人面付土器
容器形土製品
P L 138 北陸系土器 1 (弥生時代)
P L 139 北陸系土器 2 (弥生時代・古墳時代)
P L 140 東海系土器 1 (古墳時代)
P L 141 東海系土器 2 (古墳時代)
P L 142 東海系土器 3 (古墳時代)
P L 143 畿内系土器 1 (古墳時代)
P L 144 ミニチュア土器 1
P L 145 ミニチュア土器 2
P L 146 ミニチュア土器 3
P L 147 粳痕付土器
P L 148 附着物(漆・炭化米等)土器
P L 149 ヘラ書き・線刻・刻印土器 1
P L 150 ヘラ書き・線刻・刻印土器 2
P L 151 ヘラ書き・線刻・刻印土器 3
P L 152 ヘラ書き・線刻・刻印土器 4
P L 153 ヘラ書き・線刻・刻印土器 5
P L 154 ヘラ書き・線刻・刻印土器 6
P L 155 ヘラ書き・線刻・刻印土器 7
P L 156 ヘラ書き・線刻・刻印土器 8

P L 157 ヘラ書き・線刻・刻印土器 9
P L 158 墨書土器 1
P L 159 墨書土器 2
P L 160 墨書土器 3
P L 161 墨書土器 4
P L 162 墨書土器 5
P L 163 墨書土器 6
P L 164 硯類 1
P L 165 硯類 2
P L 166 紡錘車
P L 167 土錘 1
P L 168 土錘 2
P L 169 土錘 3
P L 170 土錘 4・石錘
P L 171 土器片製半円板
P L 172 フイゴの羽口
粒状滓 鉄塊剥片 鍛造剥片
P L 173 特異な内面ヘラミガキ土器
土師器・須恵器杯の底部調整 底部木葉
痕土器
P L 174 不明土器

青銅製品・鉄製品

P L 175 青銅製品(銅印・銭貨等)
P L 176 鉄製品 1 (紡錘車・苧引き金具・鉄鏃)

P L 177 鉄製品 2 (刀子・鉄斧・不明品)
P L 178 鉄製品 3 (鋤先・鎌)

木製品

P L 179 木製品 1 (農具・生活具 1)
P L 180 木製品 2 (生活具 2)
P L 181 木製品 3 (建築材 1)

P L 182 木製品 4 (建築材 2)
P L 183 木製品 5 (杭 1)
P L 184 木製品 6 (杭 2)

石製品

P L 185 弥生時代石器 1 (原石・石核 1)
P L 186 弥生時代石器 2 (原石・石核 2)

P L 187 弥生時代石器 3 (剥片 A 類・剥片 B 類)
P L 188 弥生時代石器 4 (石鏃 1)

- P L189 弥生時代石器 5 (石鏃 2・石錐)
- P L190 弥生時代石器 6 (打製石斧 1・表)
- P L191 弥生時代石器 7 (打製石斧 1・裏)
- P L192 弥生時代石器 8 (磨石 1)
- P L193 弥生時代石器 9 (磨石 2)
- P L194 弥生時代石器10 (凹石)
- P L195 弥生時代石器11 (敲石 1・表)
- P L196 弥生時代石器12 (敲石 1・裏)
- P L197 弥生時代石器13 (敲石 2・表)
- P L198 弥生時代石器14 (敲石 2・裏)
- P L199 弥生時代石器15 (台石 1)
- P L200 弥生時代石器16 (台石 2・打製石斧 2)
- P L201 弥生時代石器17 (使有石層)
- P L202 弥生時代石器18 (刃器 1)
- P L203 弥生時代石器19 (刃器 2)
- P L204 弥生時代石器20 (刃器 3)
- P L205 弥生時代石器21 (刃器 4)
- P L206 弥生時代石器22 (刃器 5)
- P L207 弥生時代石器23 (刃器 6)
- P L208 弥生時代石器24 (刃器 7・刃器素材)
- P L209 弥生時代石器25 (刃器 8)
- P L210 弥生時代石器26 (磨製石包丁)
- P L211 弥生時代石器27 (磨製石斧 1)
- P L212 弥生時代石器28 (磨製石斧 2)
- P L213 弥生時代～古代石器29 (砥石 1)
- P L214 弥生時代～古代石器30 (砥石 2)
- P L215 弥生時代～古代石器31 (砥石 3)
- P L216 弥生時代～古代石器32 (砥石 4・くぼみ石・石臼)
- P L217 弥生時代～古代石器33 (軽石製品)
- P L218 弥生時代石器34 (みがき石)
- P L219 弥生時代石器35 (玉石)
- P L220 弥生時代石器36 (穴開石・付着物のある石・角礫)
- P L221 弥生時代石器37 (玉関係 1)
- P L222 弥生時代石器38 (玉関係 2)
- P L223 弥生時代石器39 (SK8189出土の河原石)
- P L224 古代カマド石 1 (切石 1)
- P L225 古代カマド石 2 (切石 2)
- P L226 弥生時代石器40 (使用痕写真 1)
- P L227 弥生時代石器41 (使用痕写真 2)
- P L228 弥生時代石器42 (使用痕写真 3)
- P L229 弥生時代石器43 (使用痕写真 4)
- P L230 弥生時代石器44 (使用痕写真 5)
- P L231 弥生時代石器45 (使用痕写真 6)
- P L232 弥生時代石器46 (使用痕写真 7)
- P L233 弥生時代～古代石器47 (使用痕写真 8)

図 版

SB7272

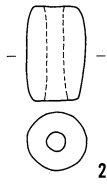
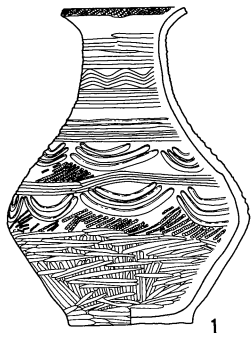

SB7276

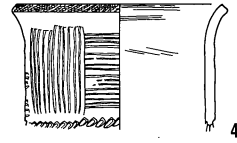
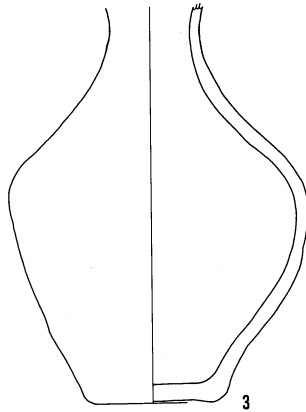

SB7438

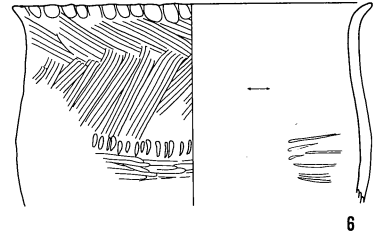

SM7010

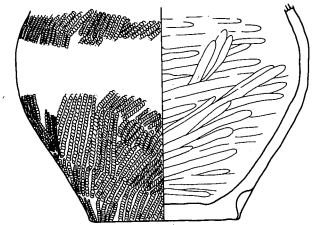
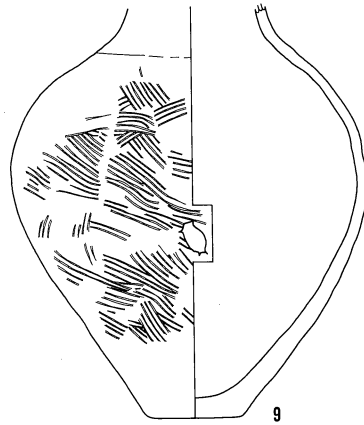
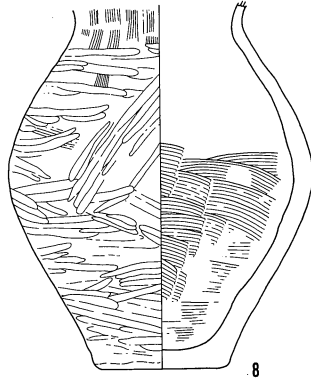

SM7026

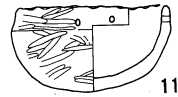

SK7327

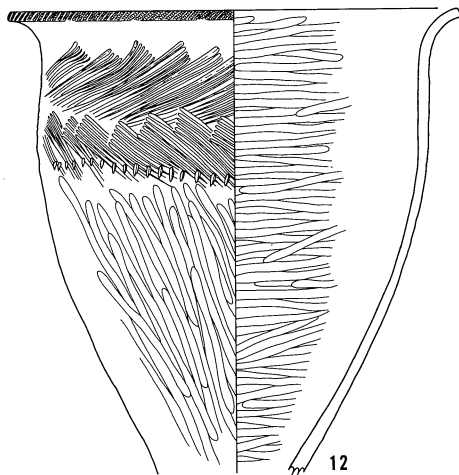

SK7294

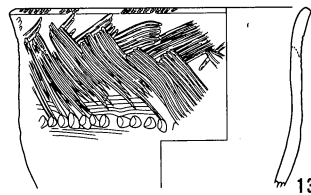

SK7310

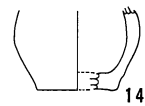

0 (1 : 4) 10cm

图版 2 弥生中期以前土器实测图

SB7438

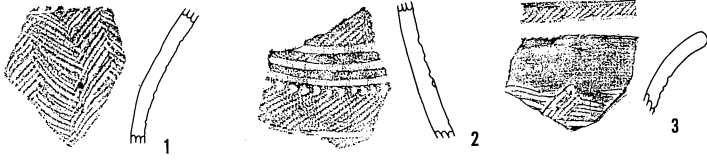

SD6007

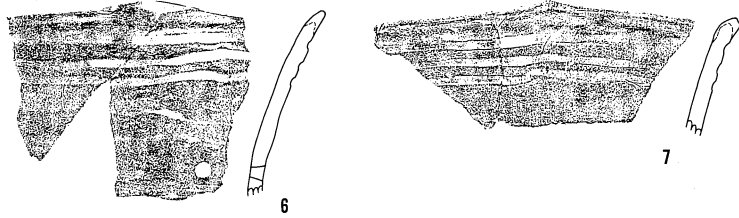
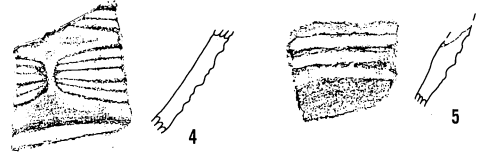

SD6030

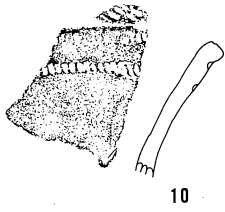

SD7047

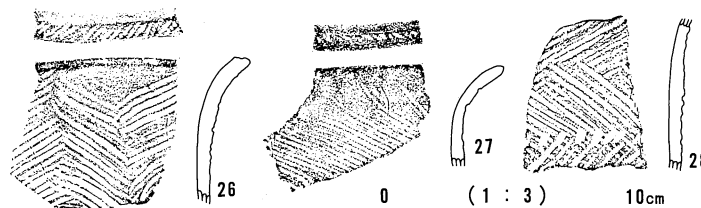
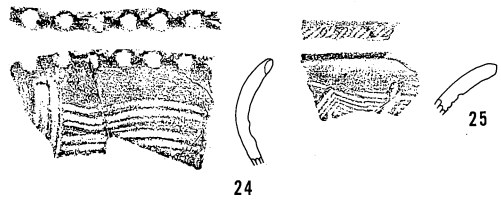
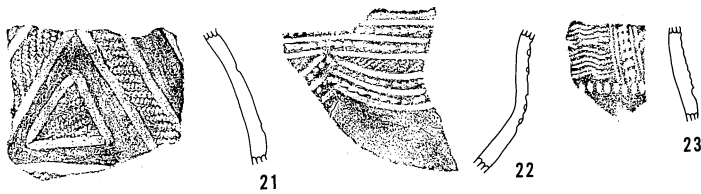
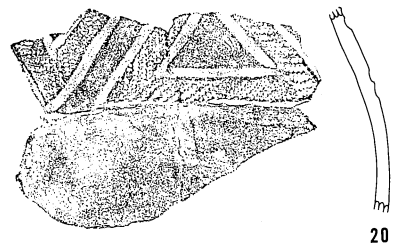
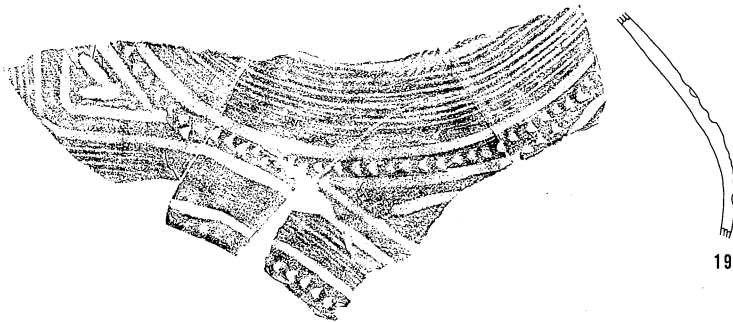
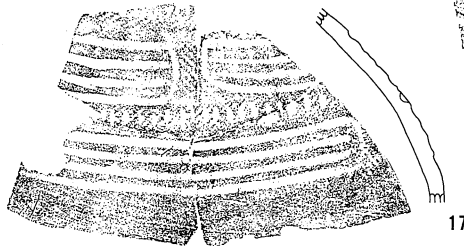
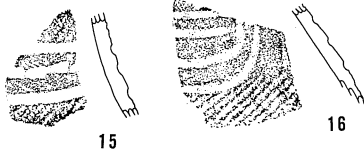
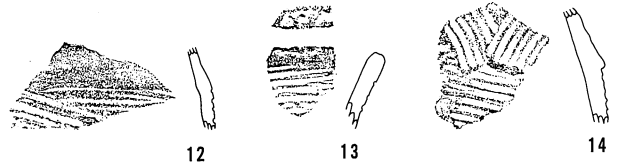
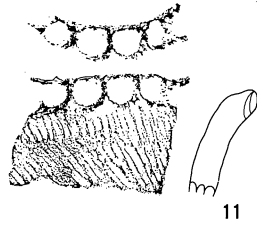

SD7098

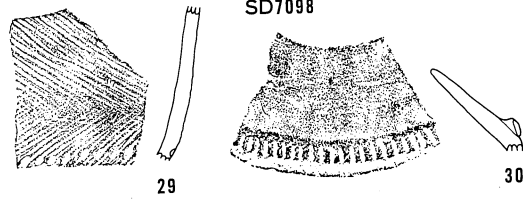

0 (1 : 3) 10cm

SD5003

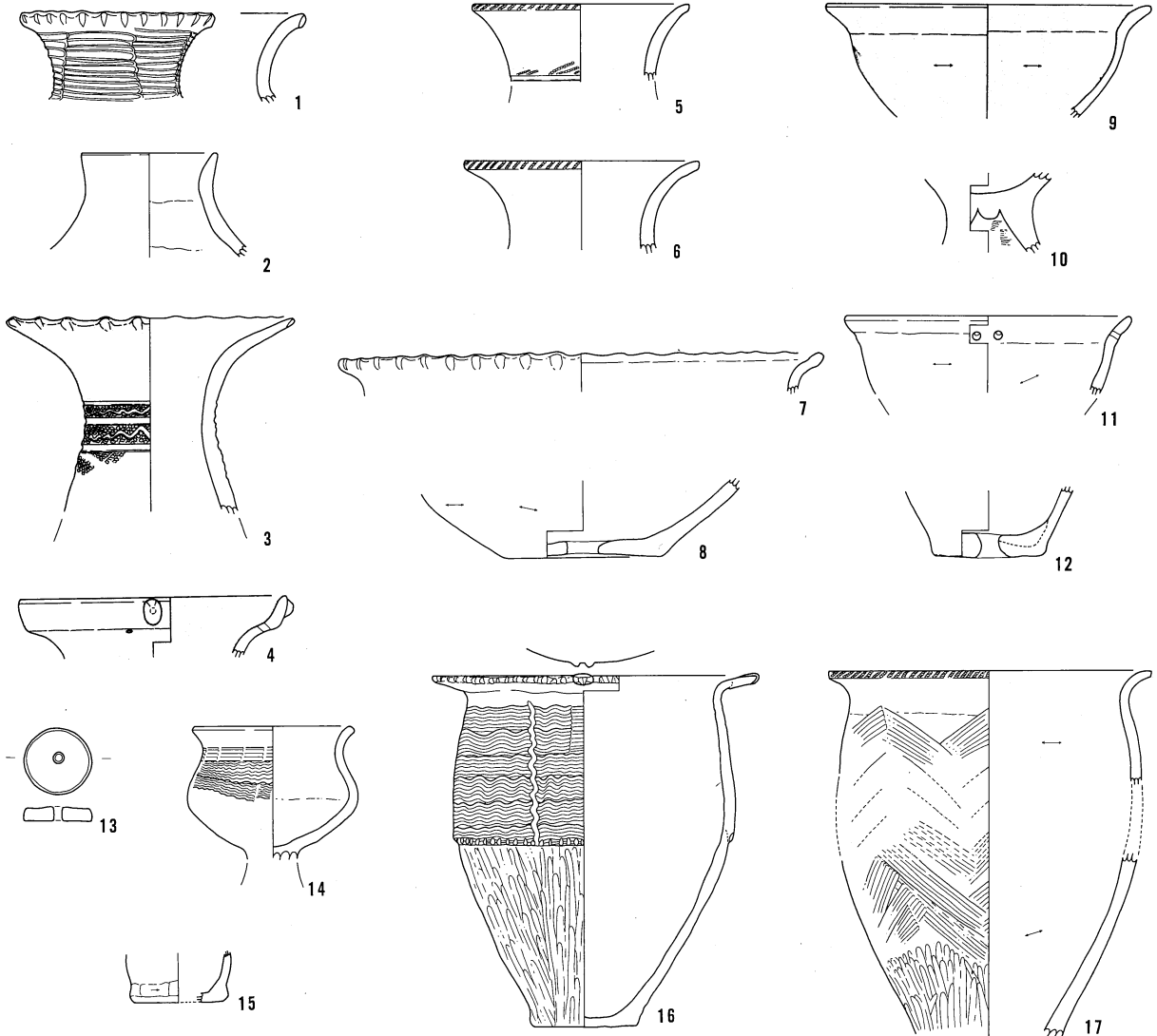

SD6007

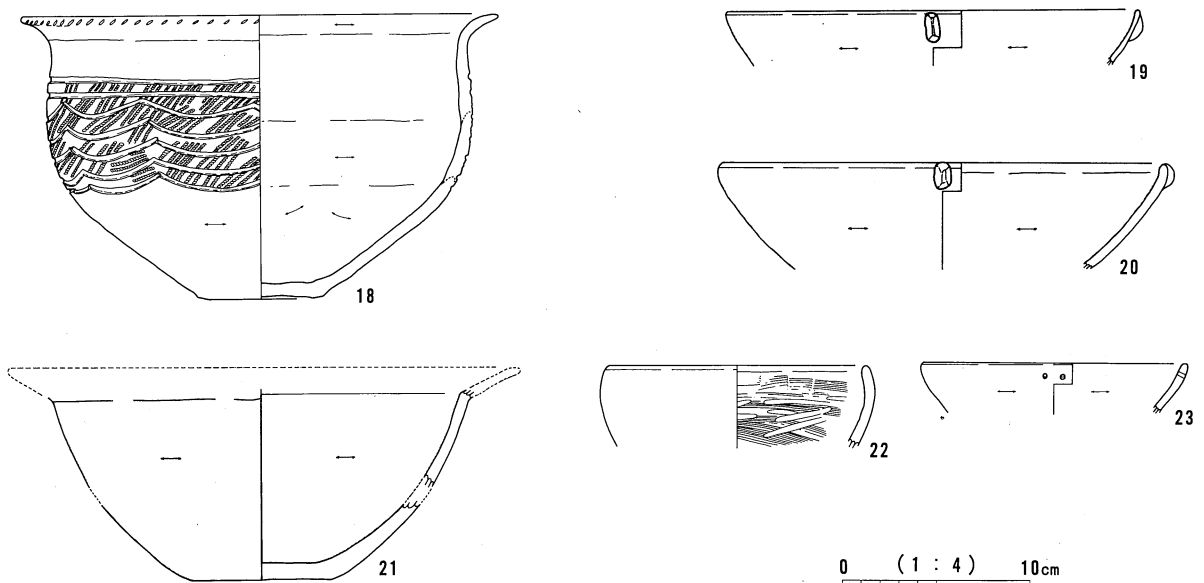

0 (1 : 4) 10cm

SD6007

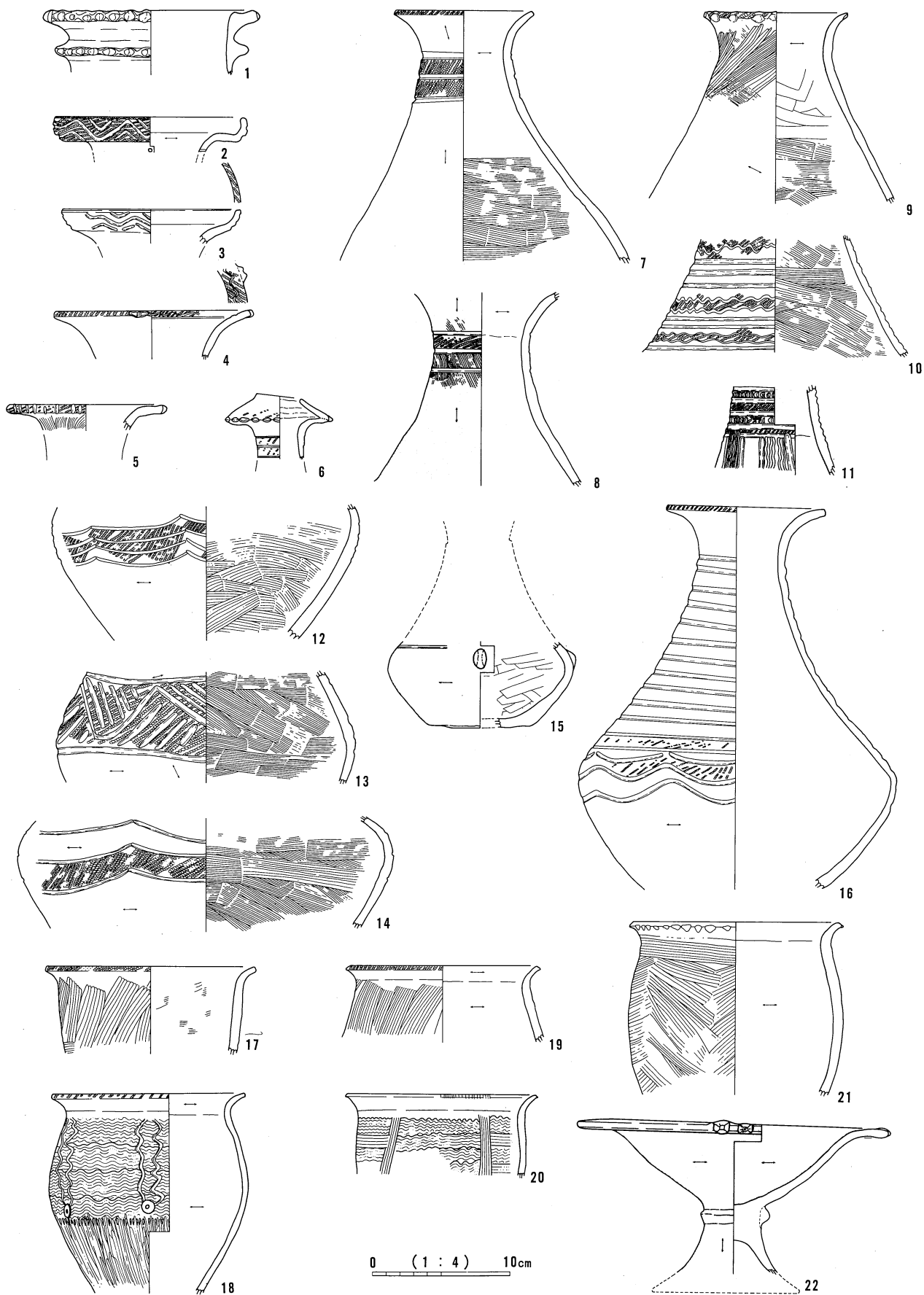

SD7110

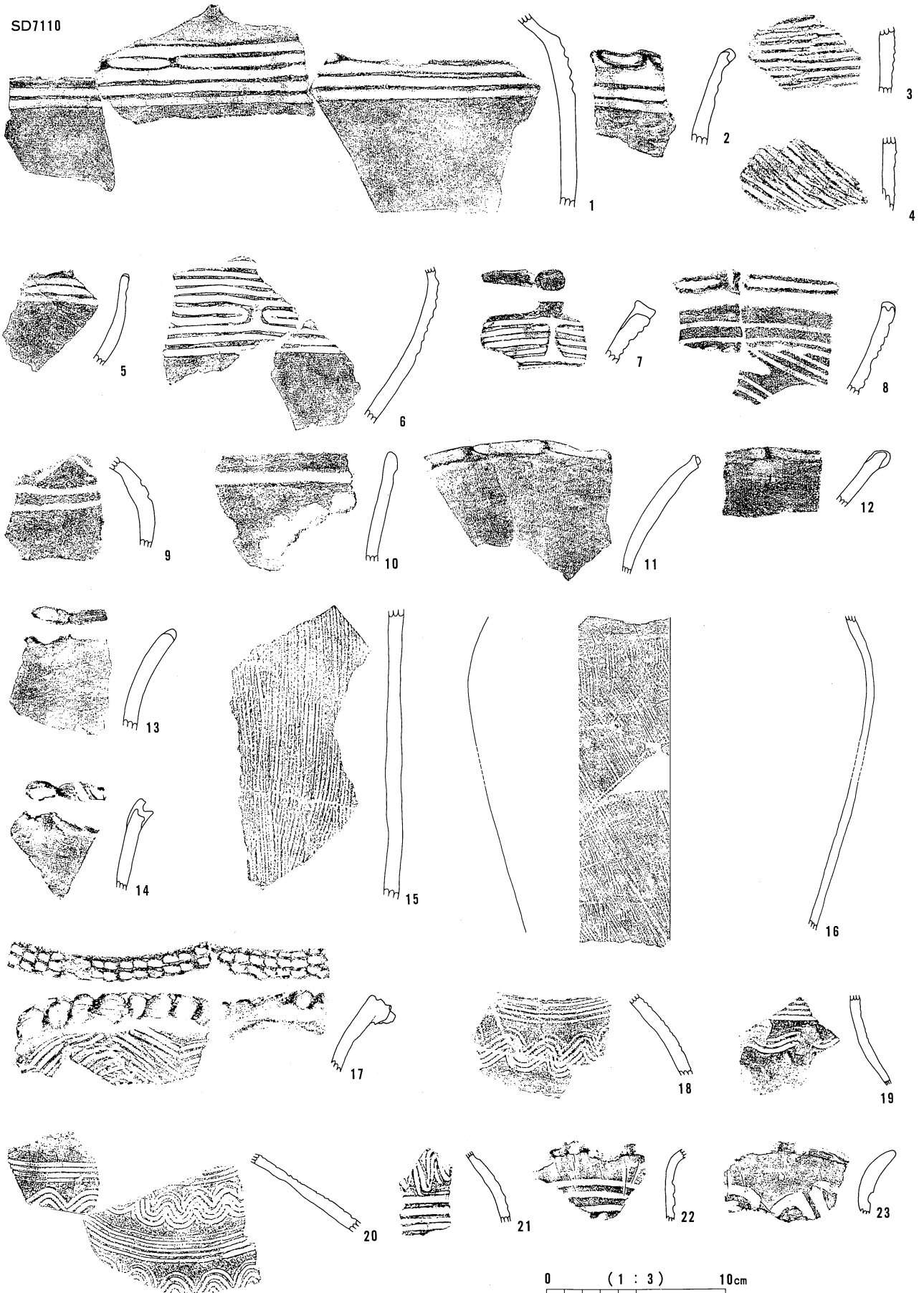

SD7110

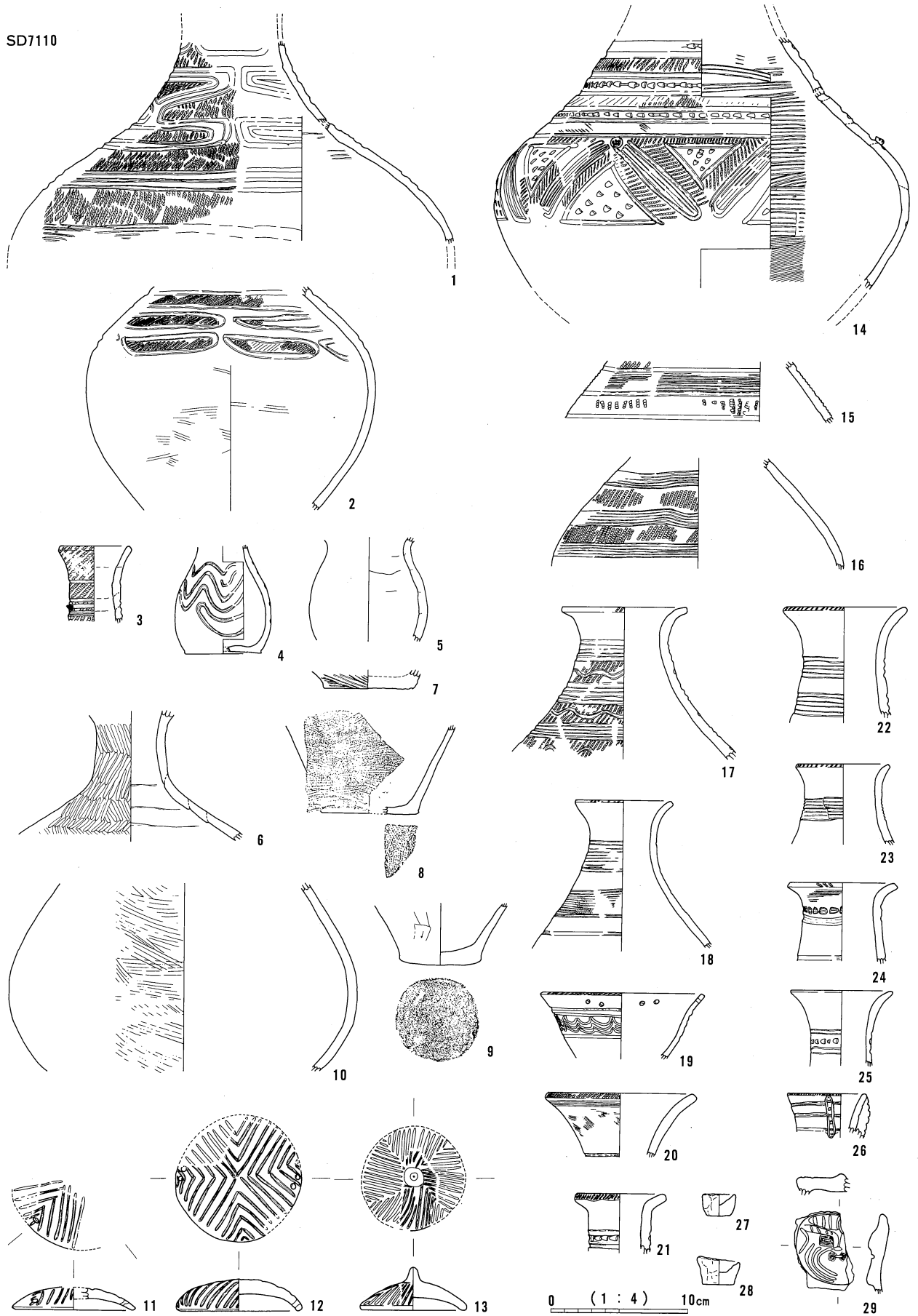

SD7110

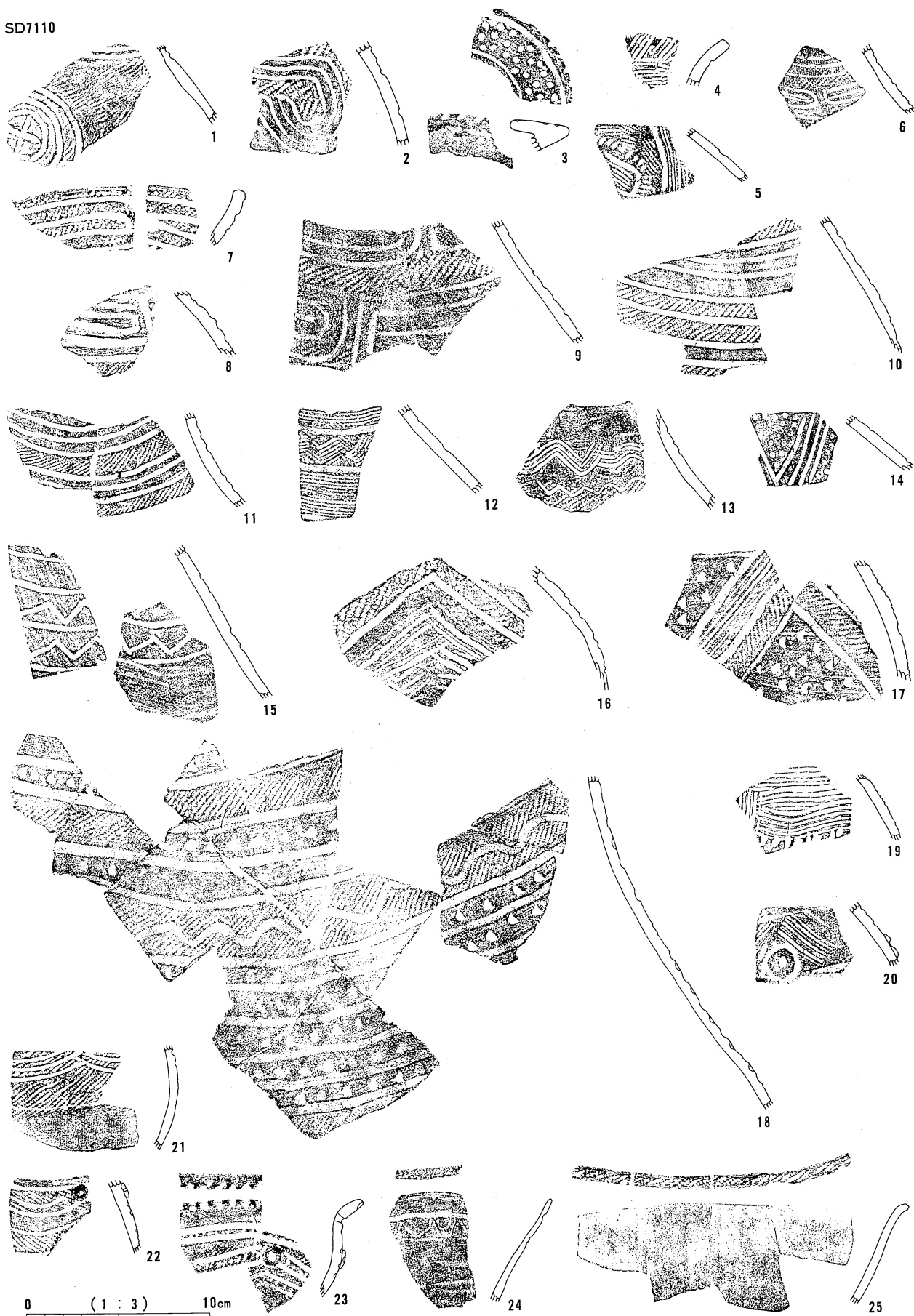

SD7110

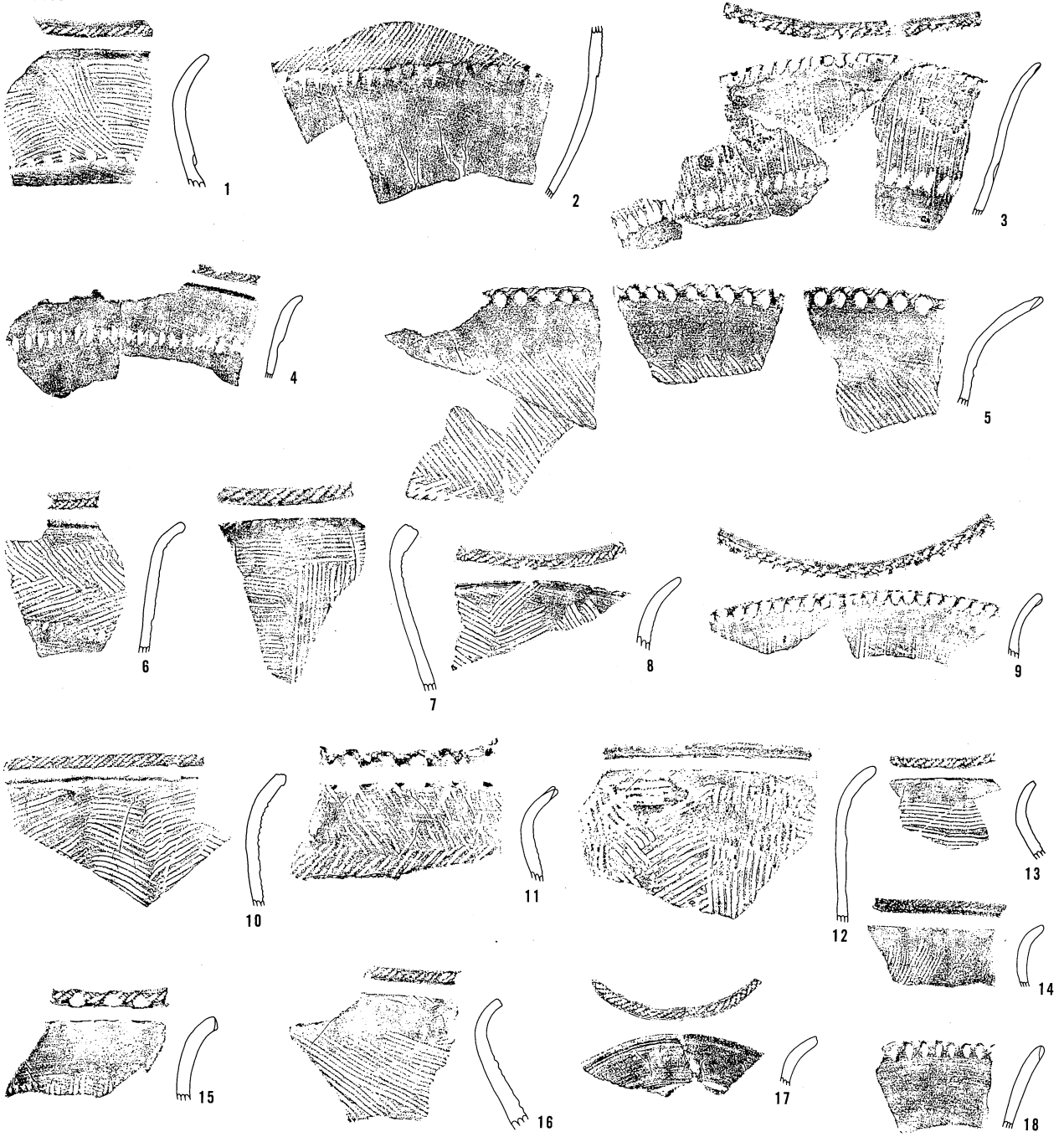

SK7294

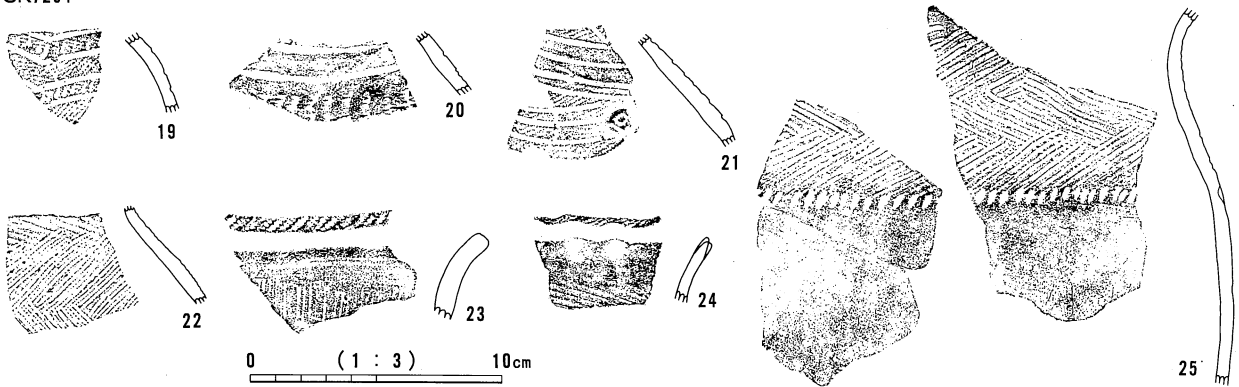

0 (1 : 3) 10cm

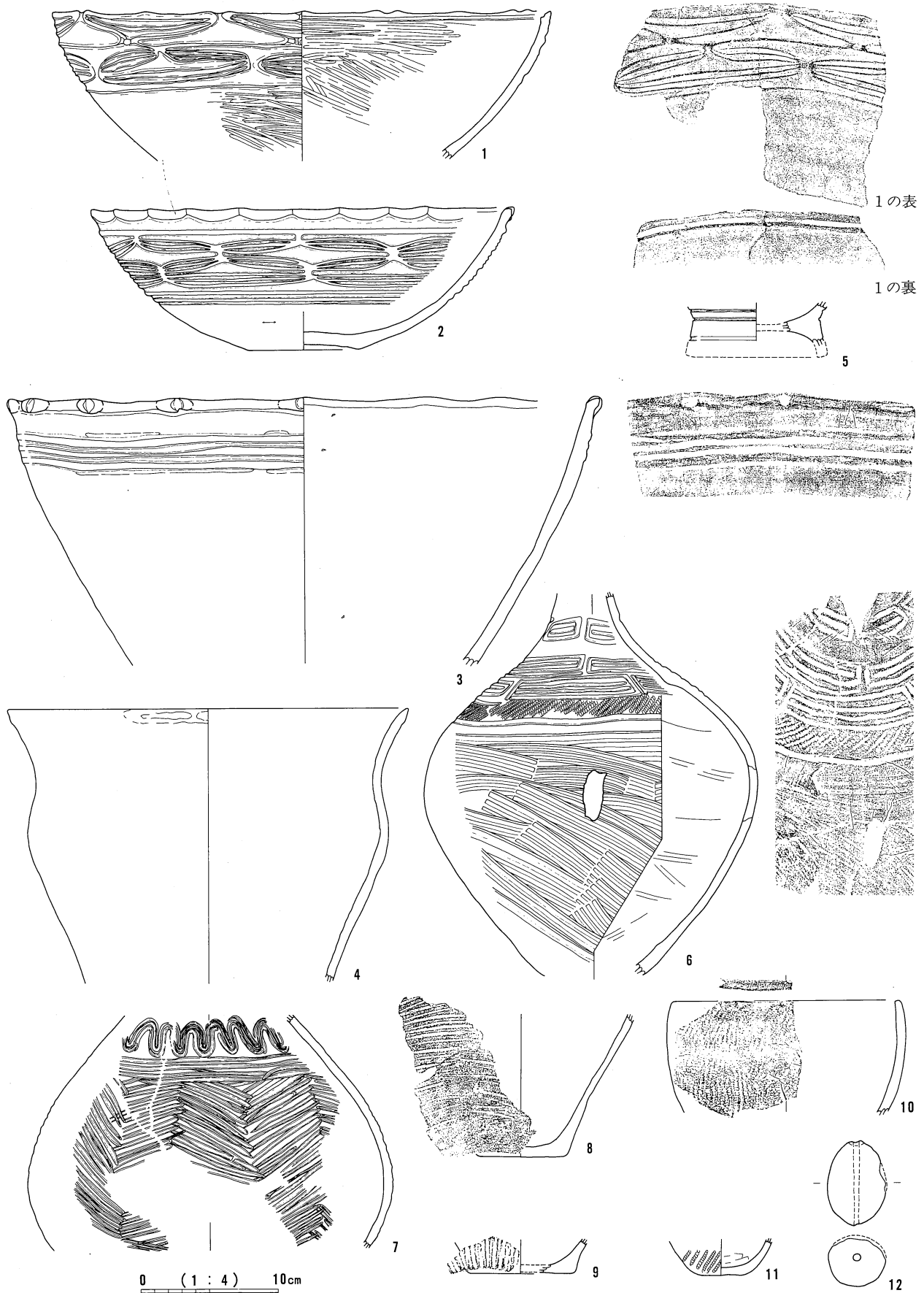

遺構外出土器 1

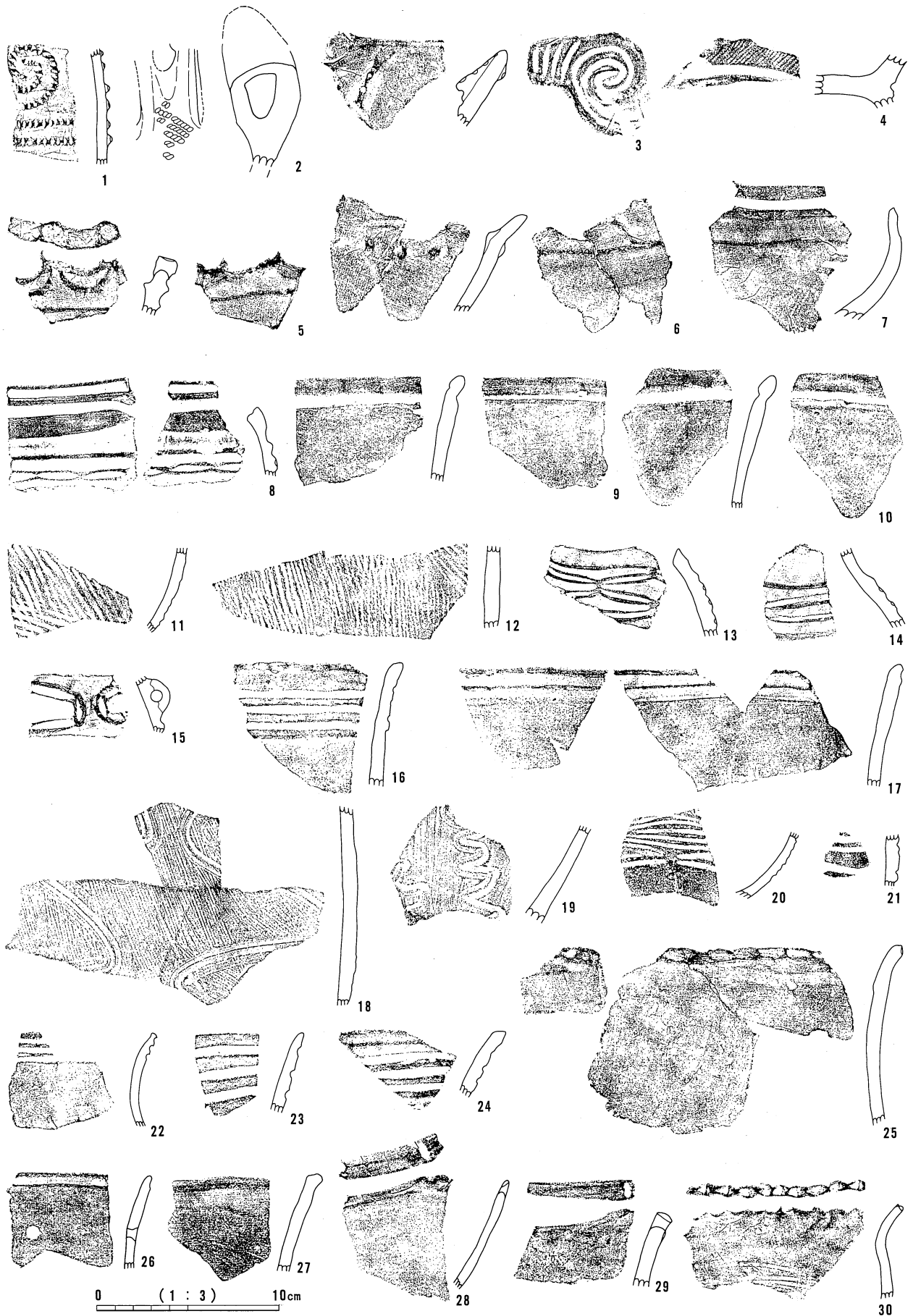

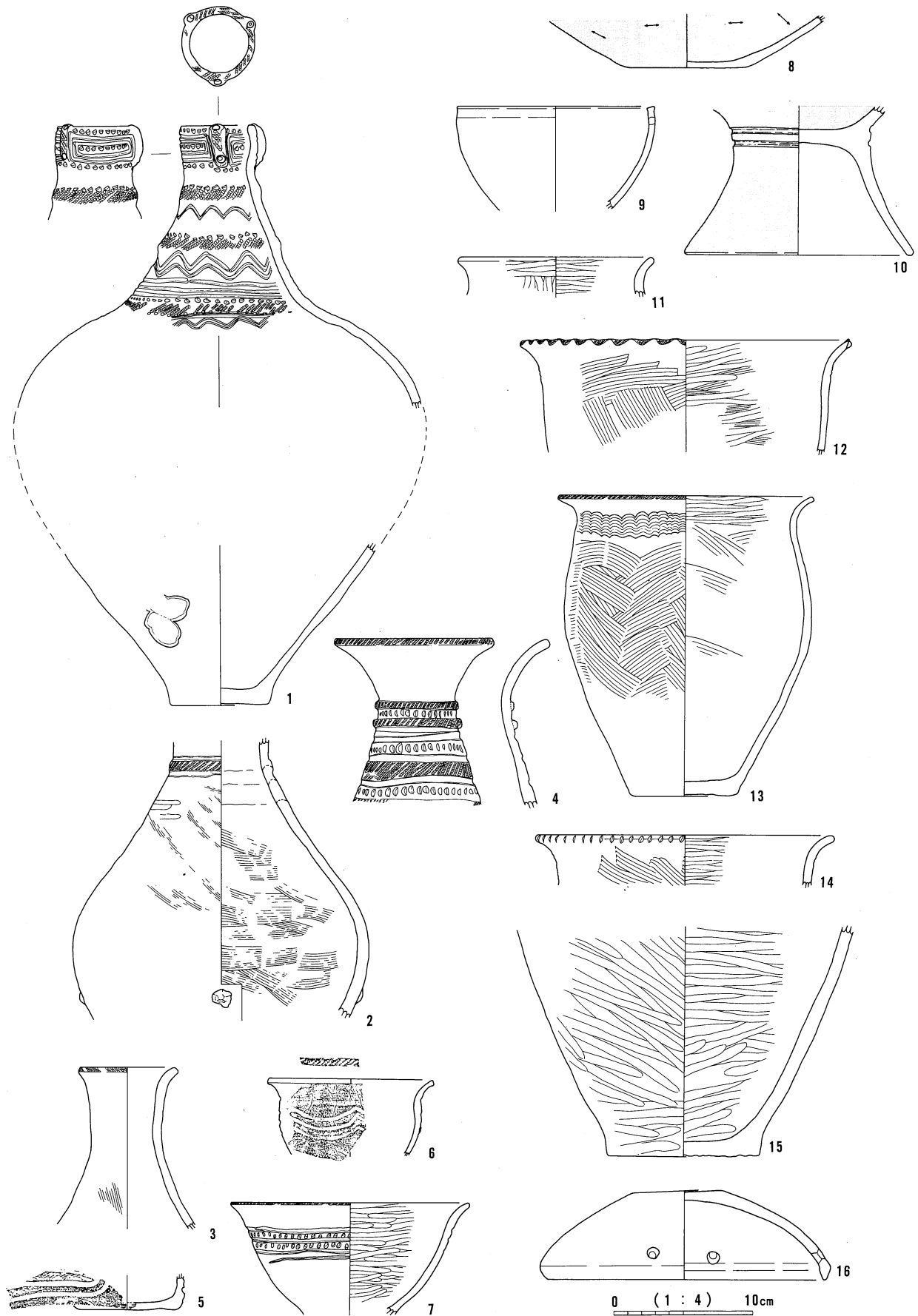

遺構外出土土器 3

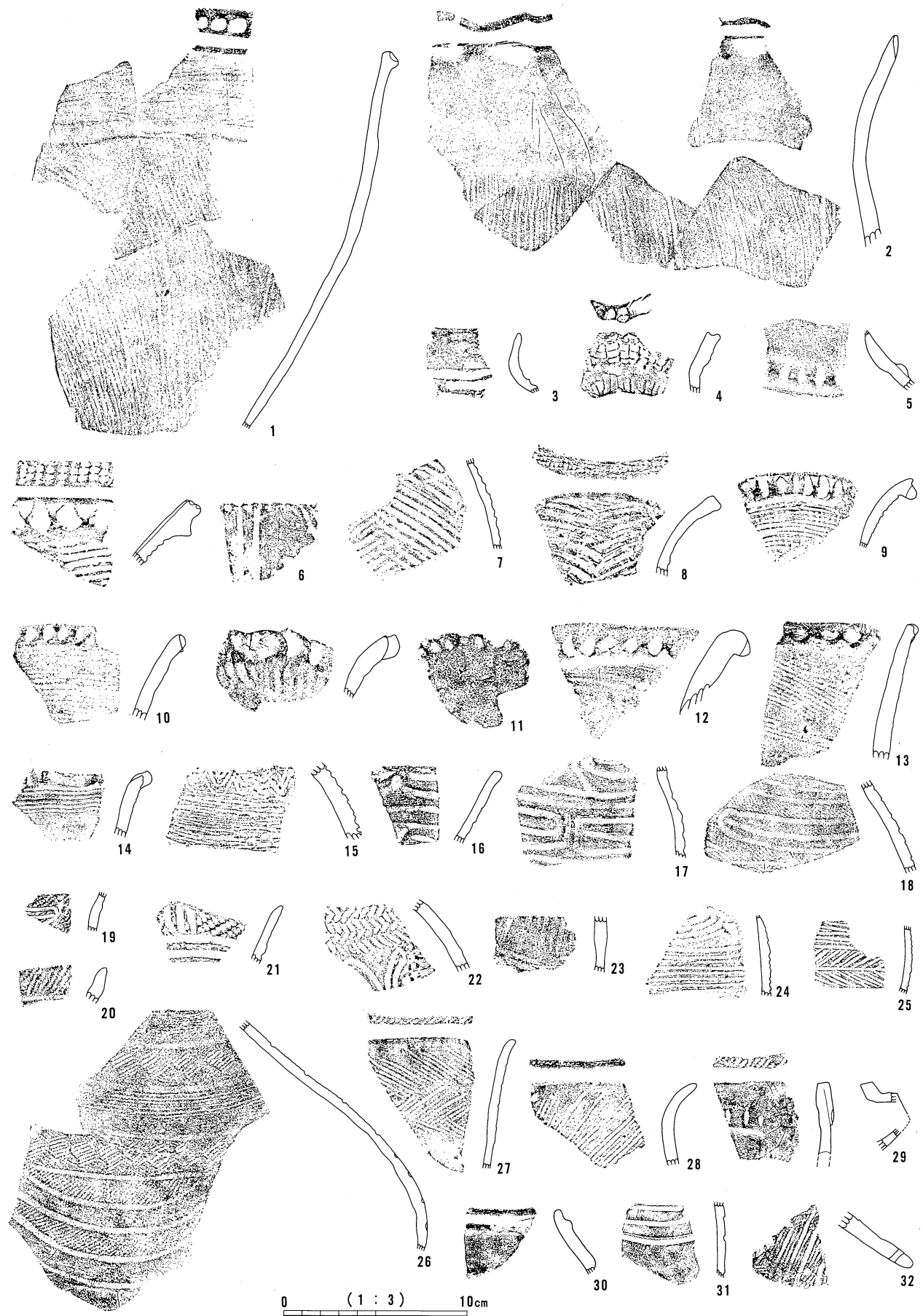

SB6014

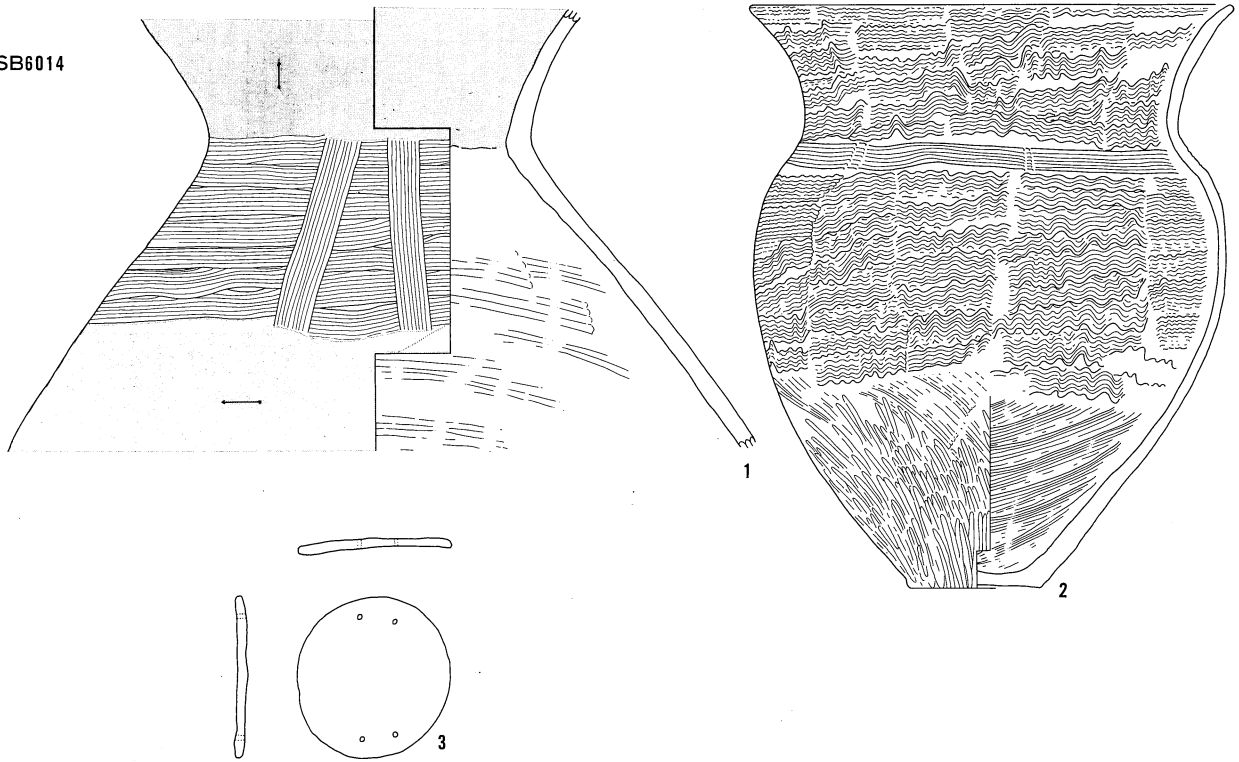

SB6015

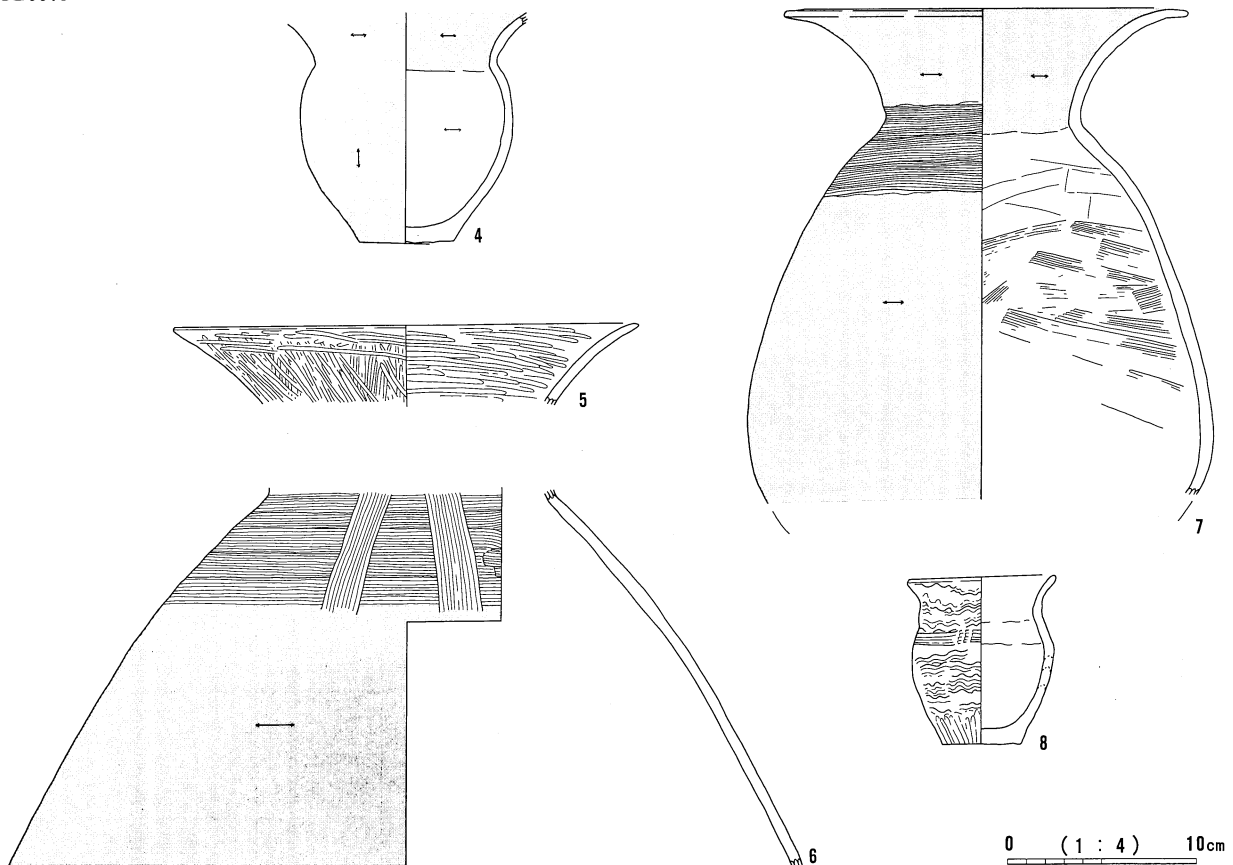

SB6017

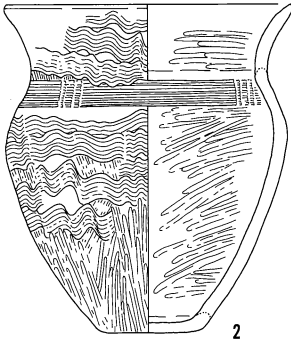
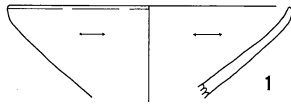

SB6028

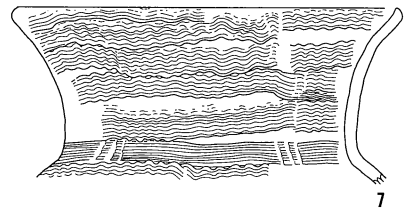
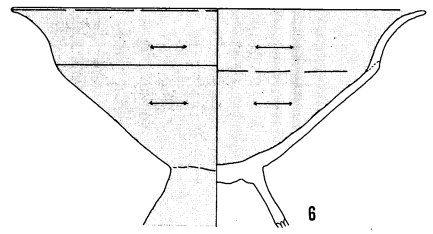
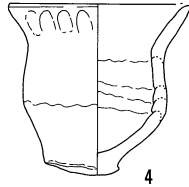
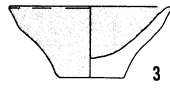

SB6030

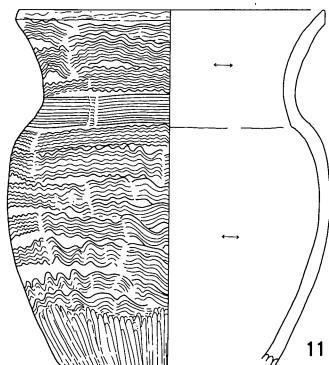
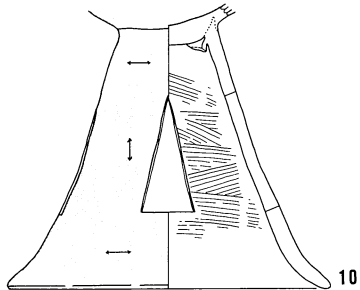
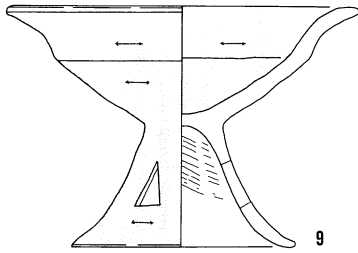
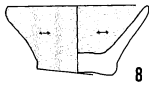

SB6031

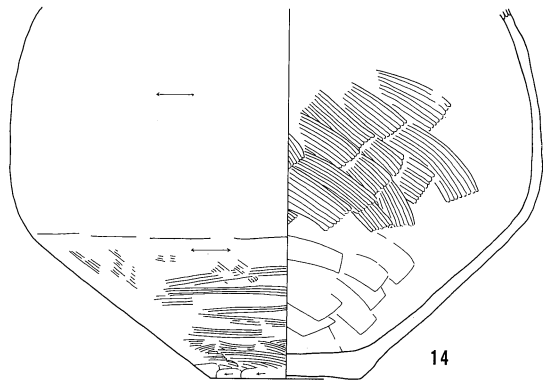
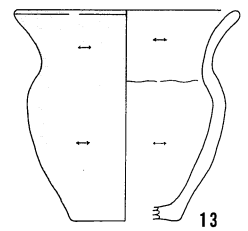
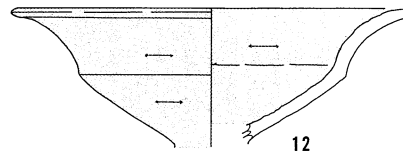

SB6035

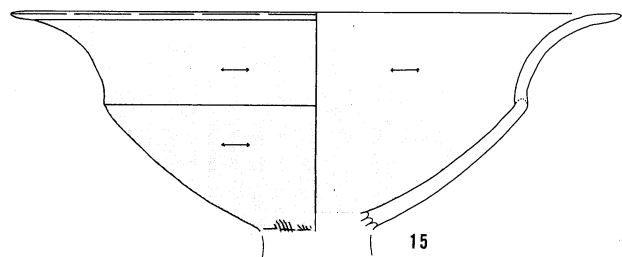

0 (1 : 4) 10cm

SB7020

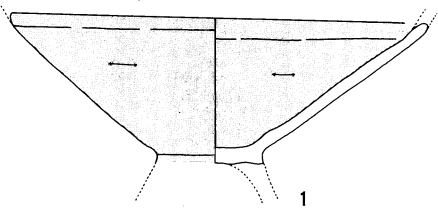

1

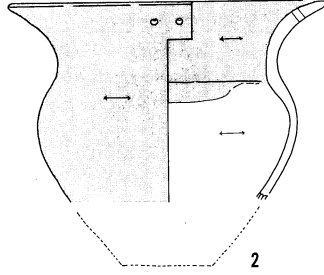

2

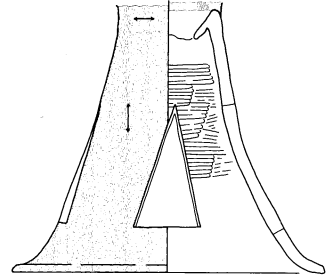

3

SB7021

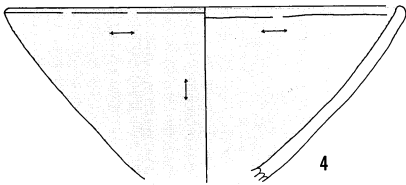

4

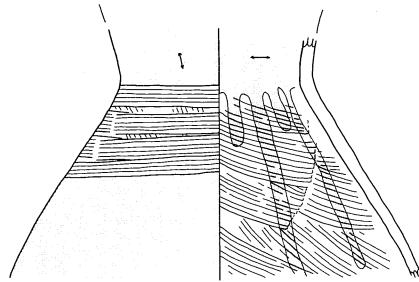

7

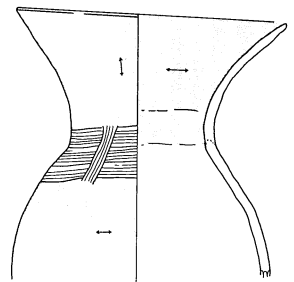

8

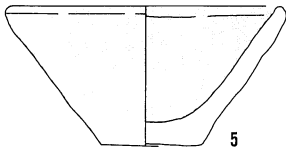

5

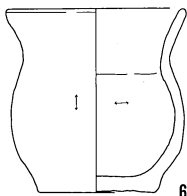

6

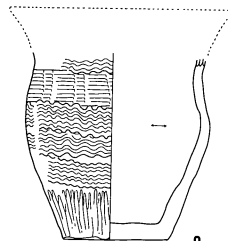

9

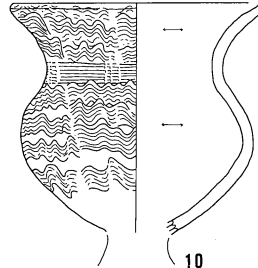

10

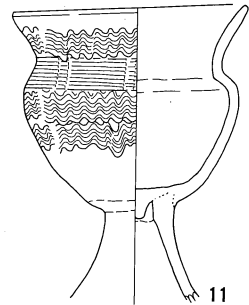

11

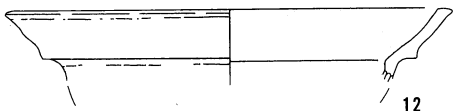

12

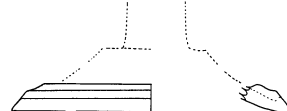

15



13

SB7024

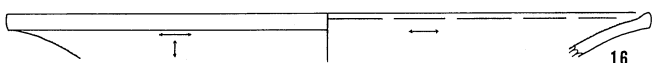

16



14

0 (1 : 4) 10cm

SB7034

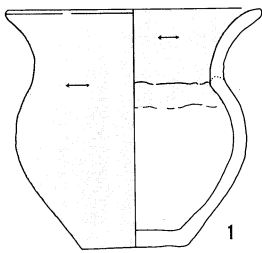

1

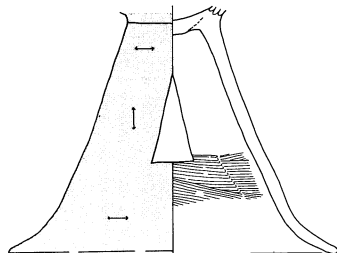

2

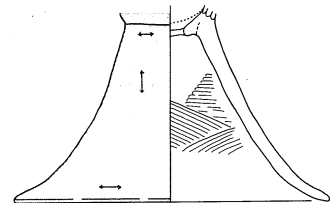

3

SB7037

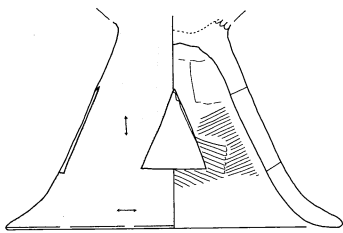

4

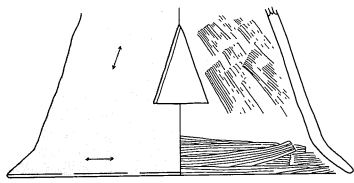

5



6

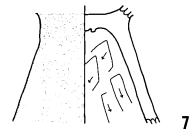

7

SB7038

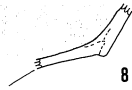
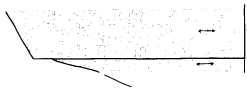

8

SB7039



9

SB7071



10



13

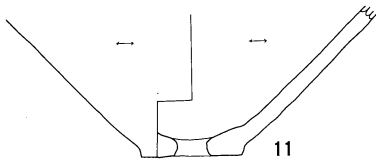

11

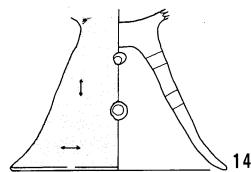

14

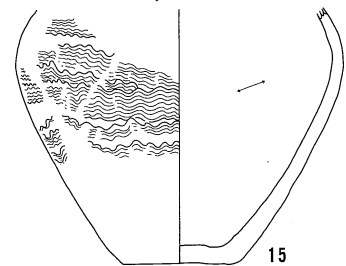

15

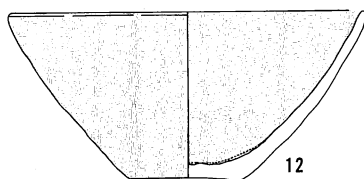

12

0 (1 : 4) 10cm

SB7040-①

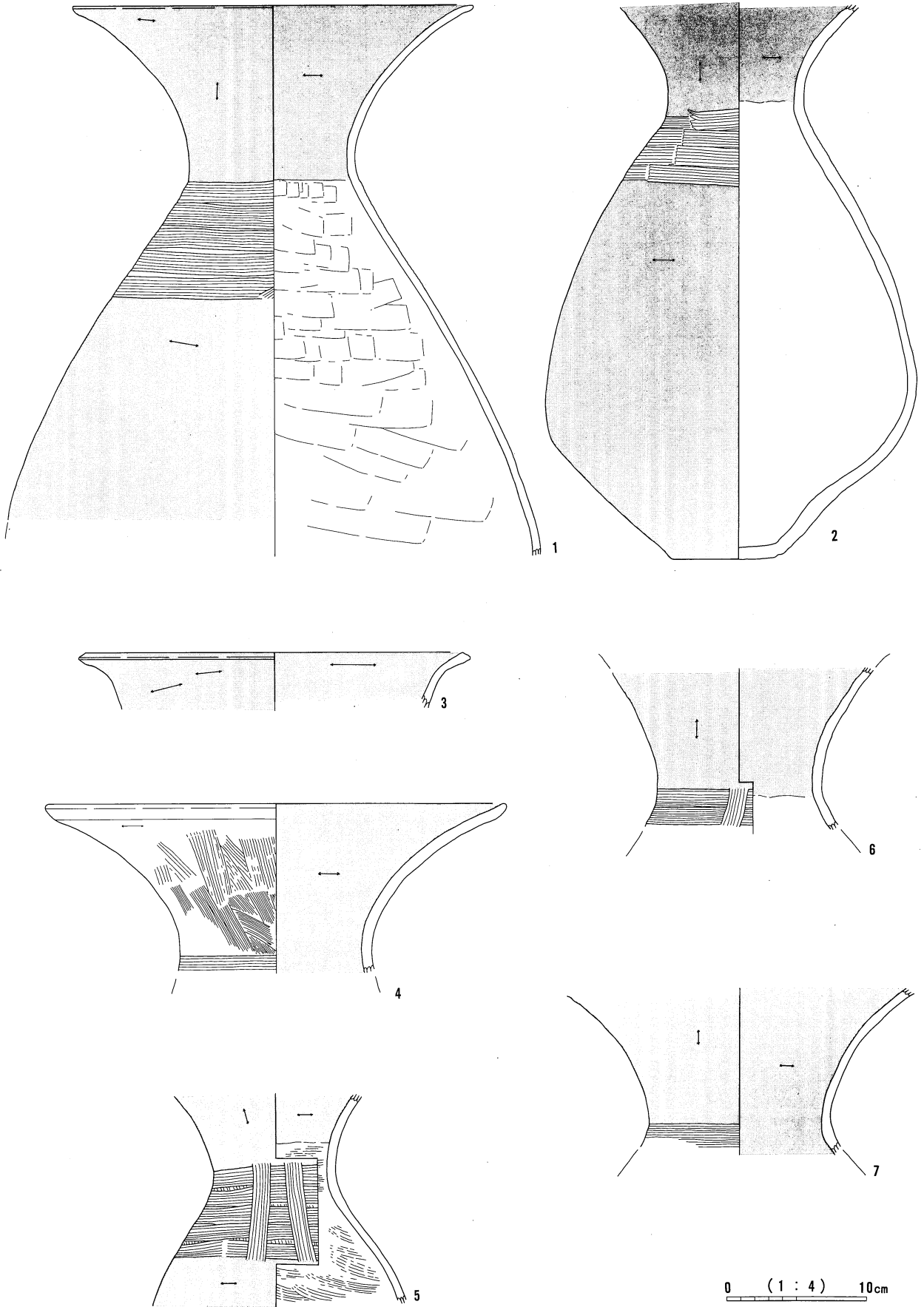

SB7040-①

SB7040-②

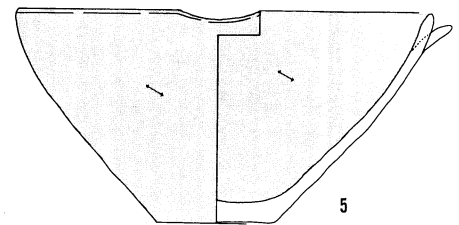
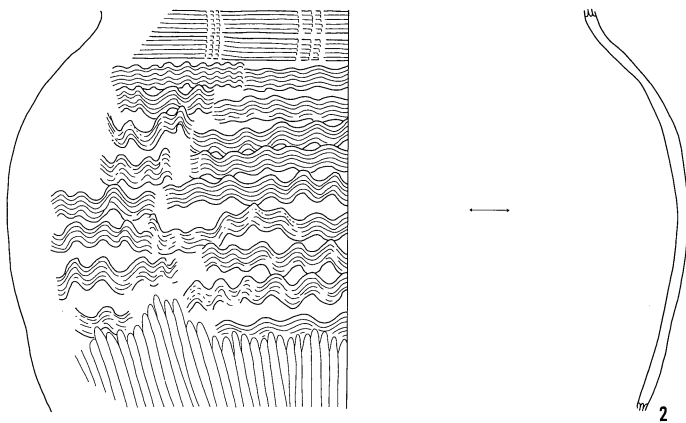
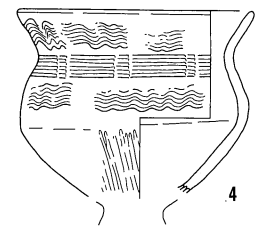
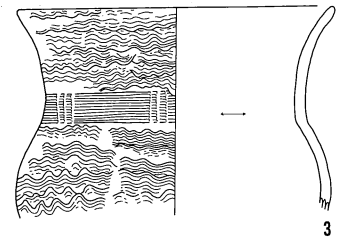
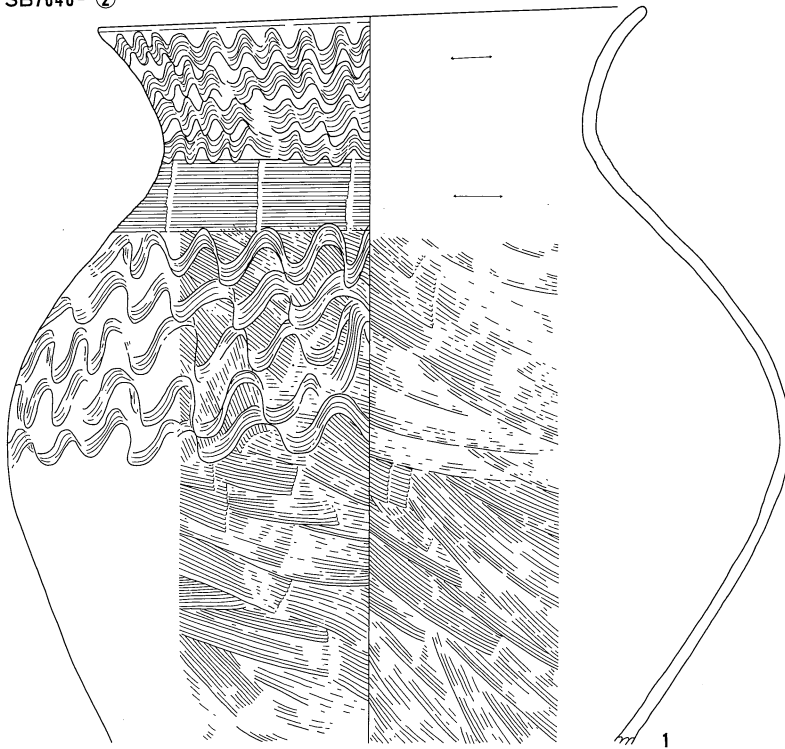

SB7090

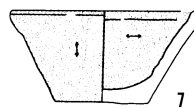
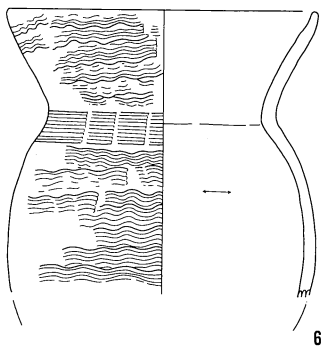

SB7097

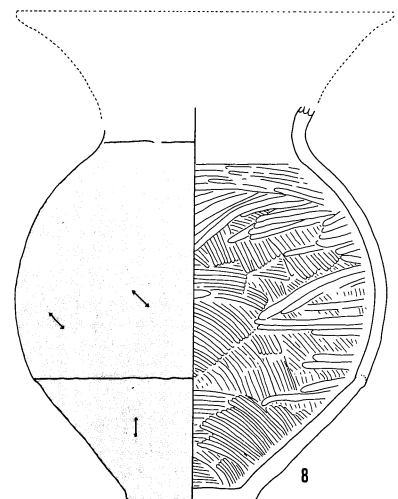

0 (1 : 4) 10cm

SB7078

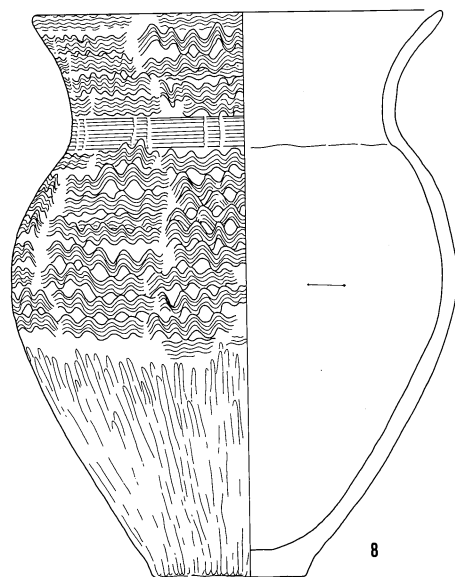
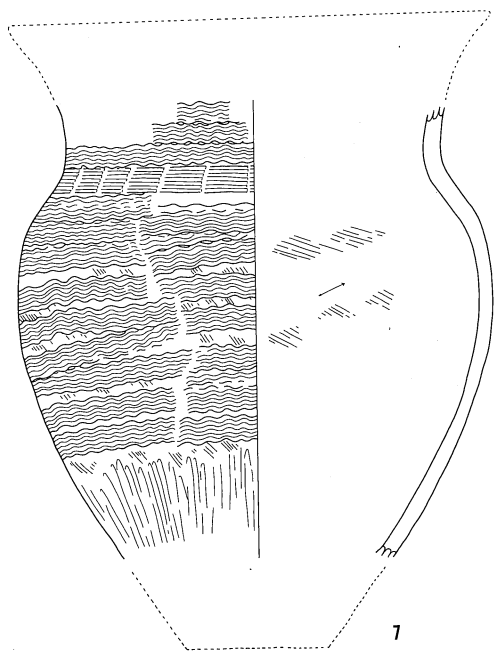
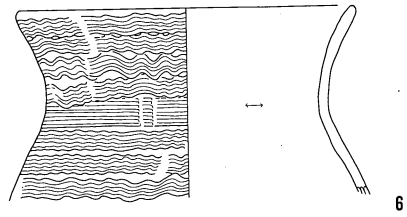
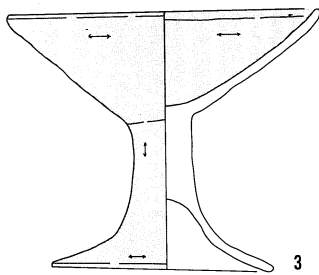
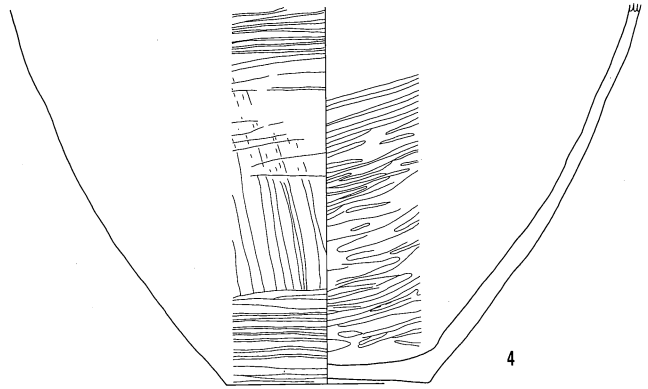
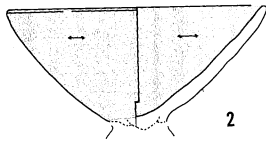
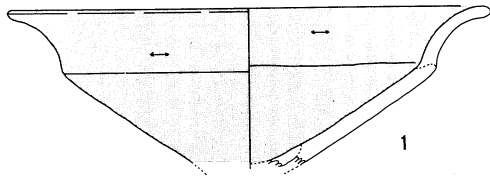

0 (1 : 4) 10cm

SB7078

SB7079

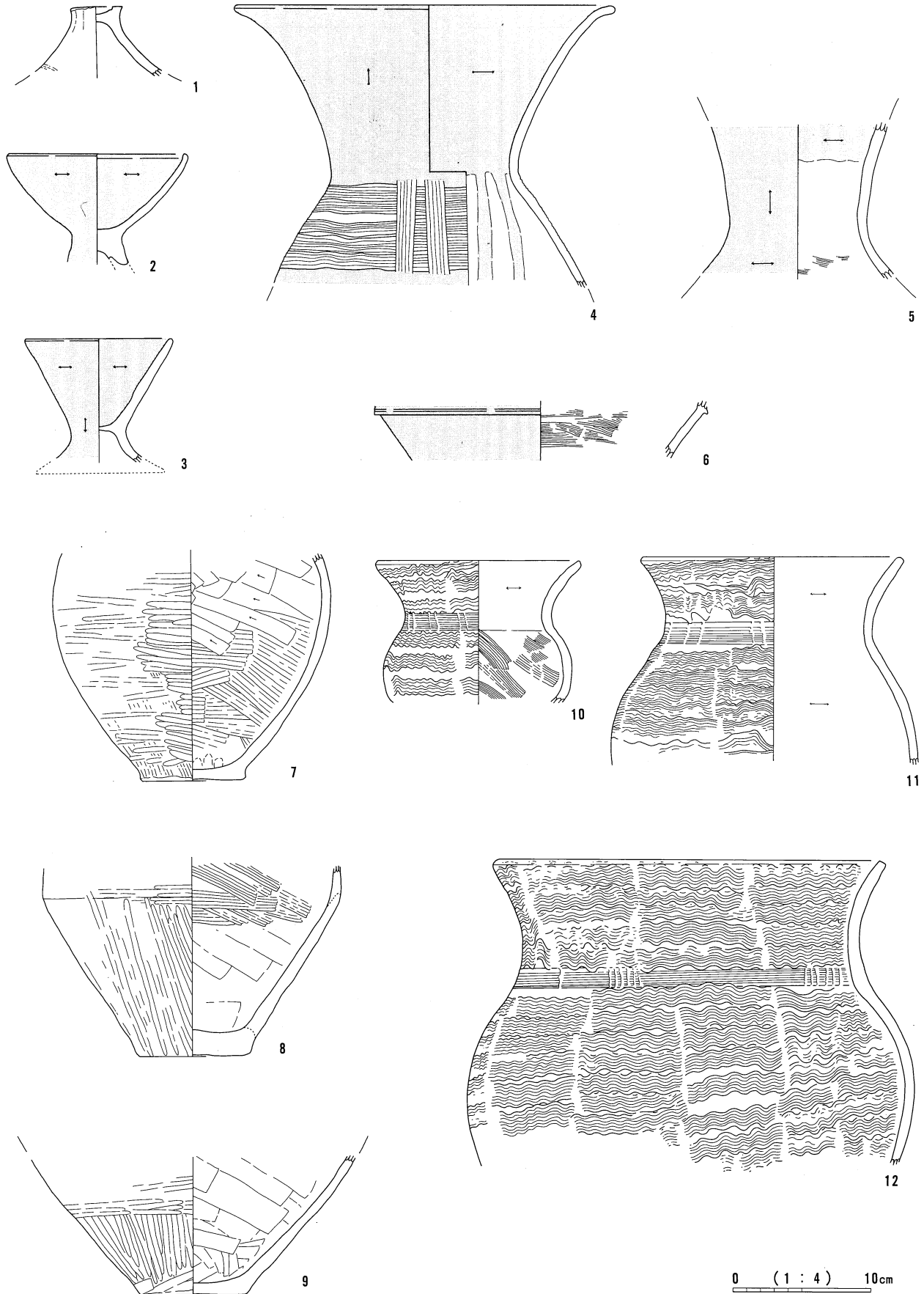

0 (1 : 4) 10cm

SB7079

SB7082

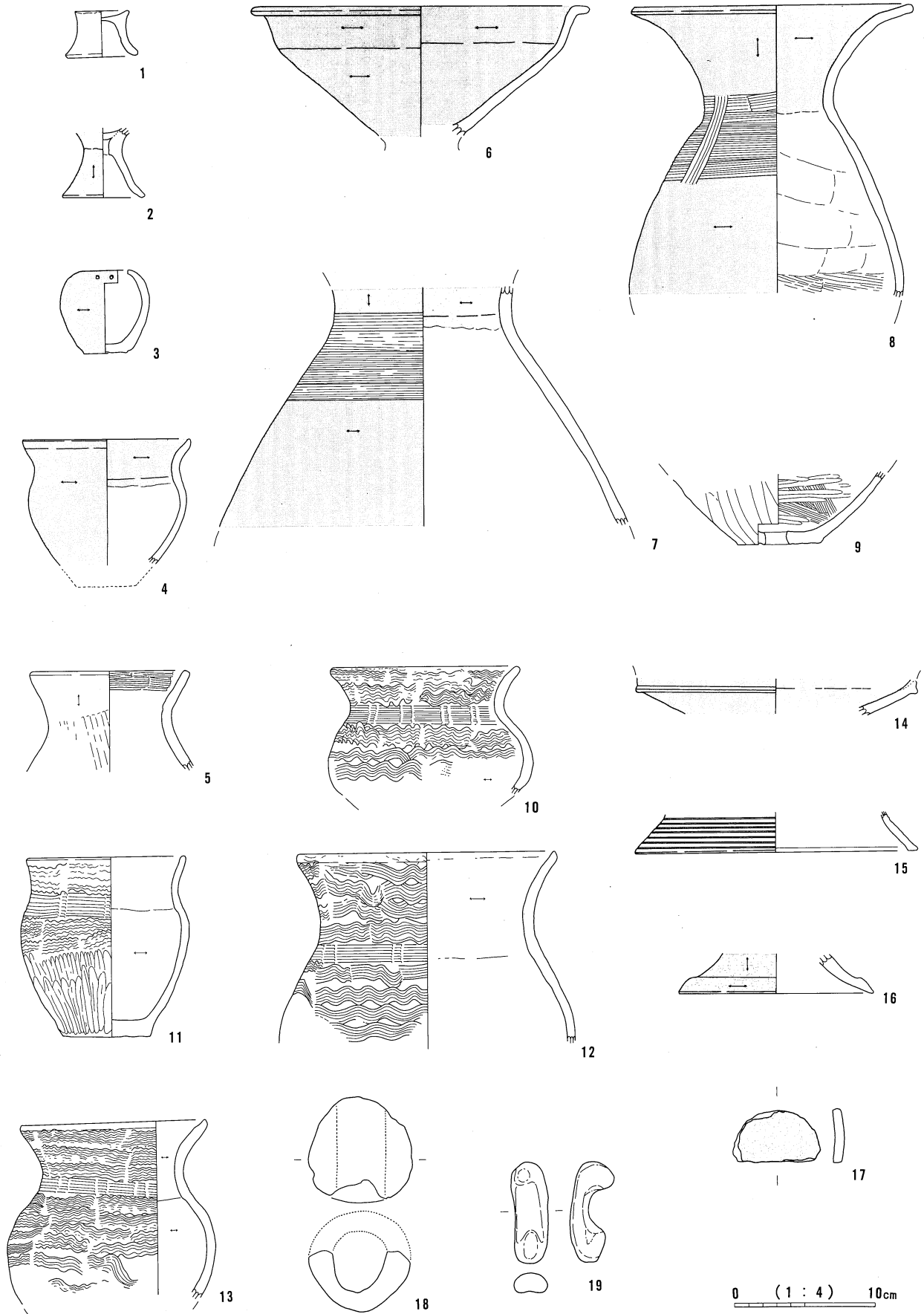

SB7082

SB7086

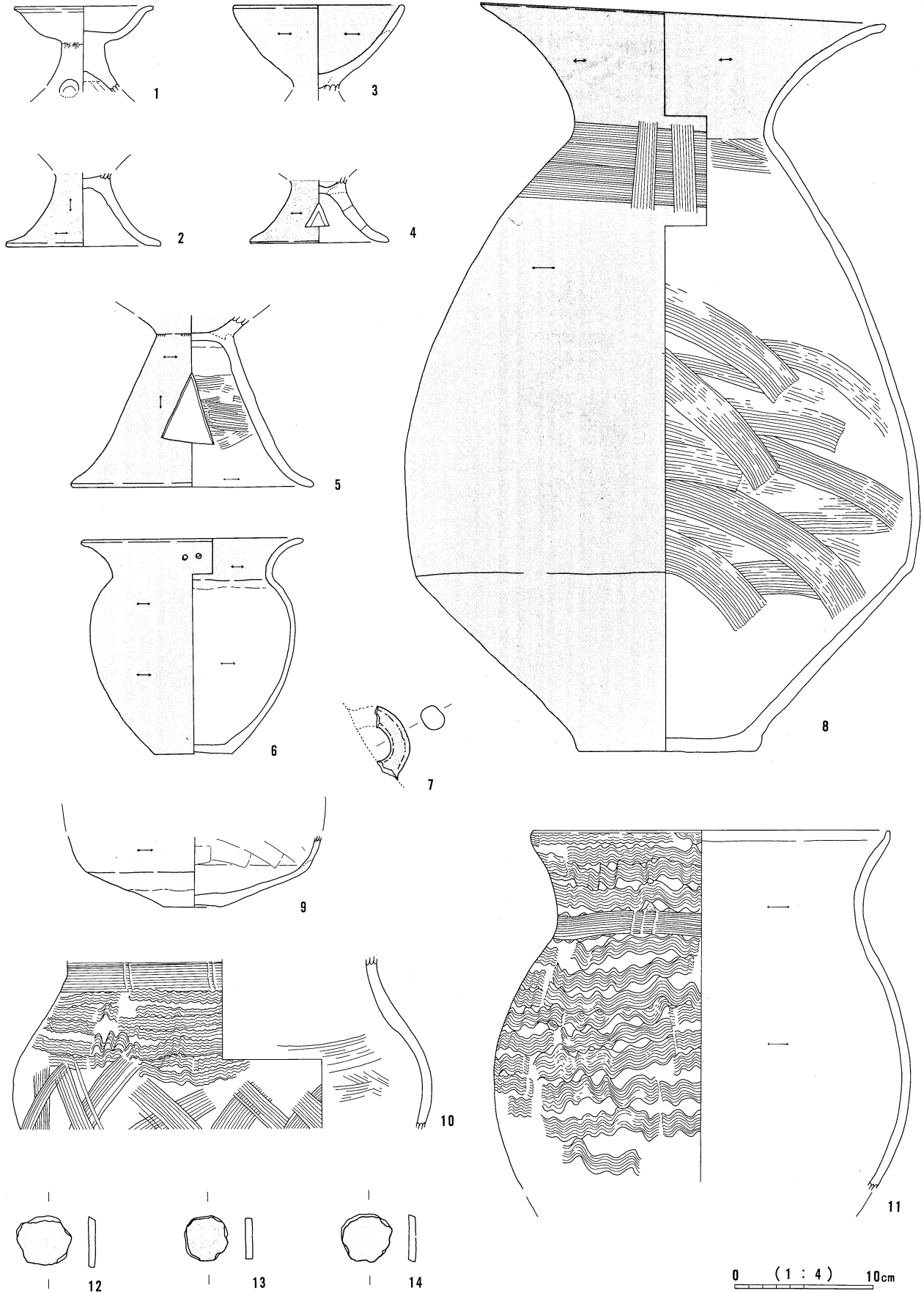

0 (1 : 4) 10cm

SB7089

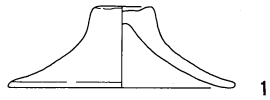

1

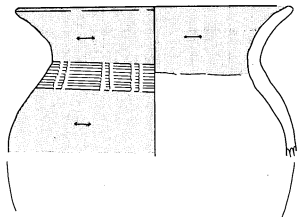

2

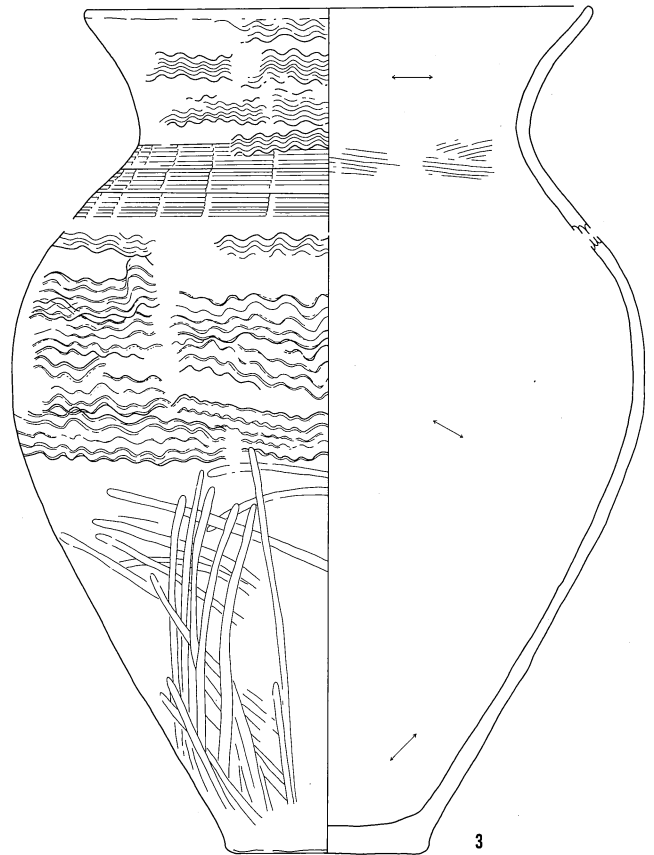

3

SB7091

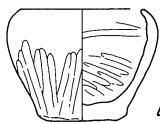

4

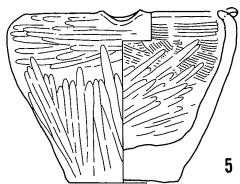

5

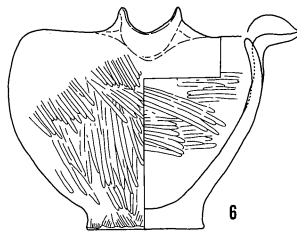

6

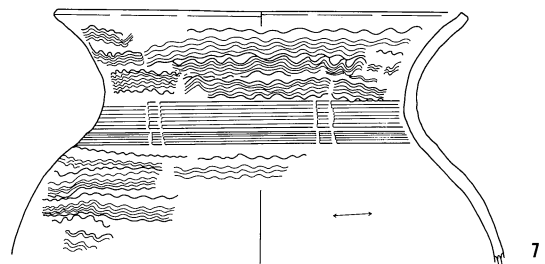

7

SB7102

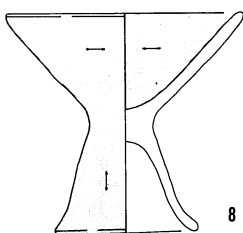

8

SB7103

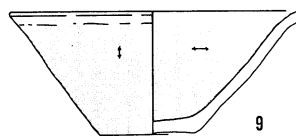

9

0 (1 : 4) 10cm

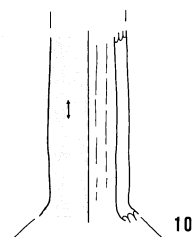

10

SB7094

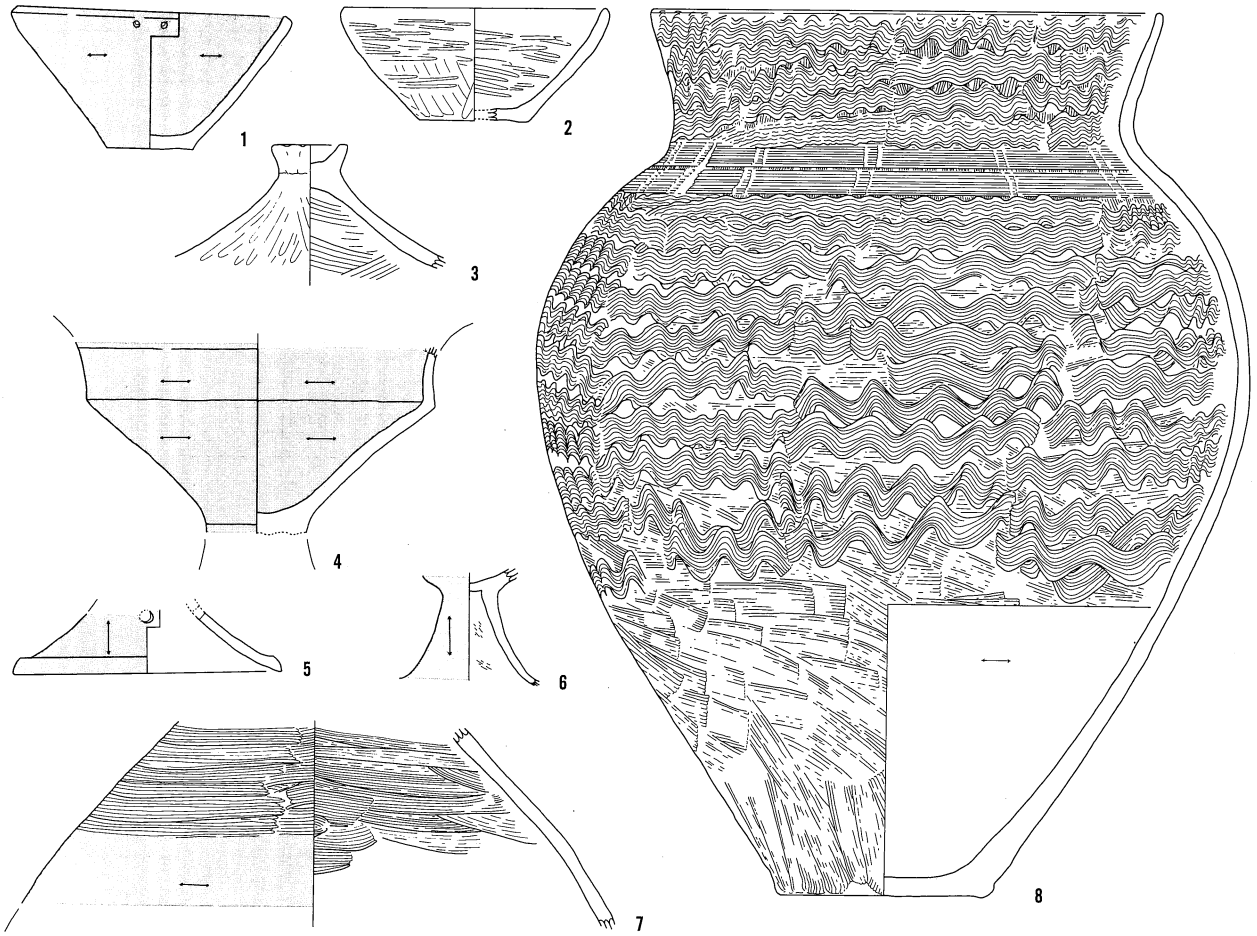

SB7095

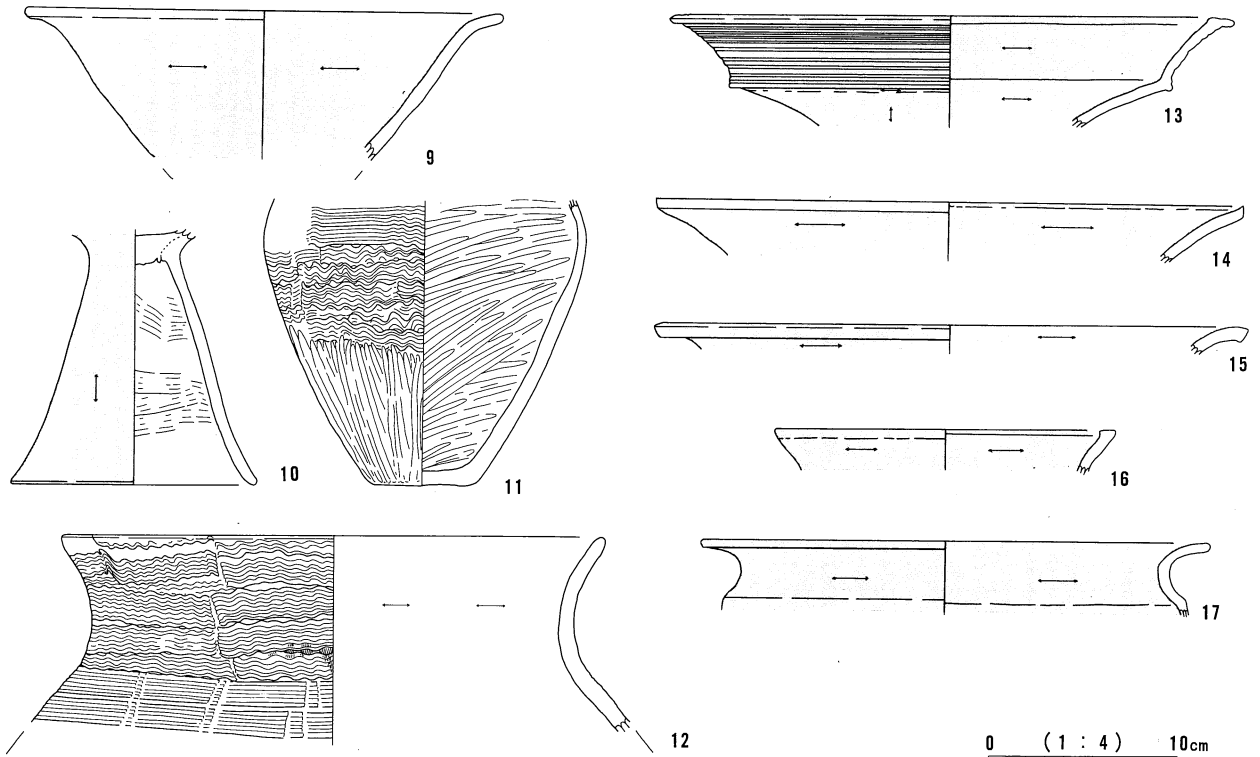

SB7099

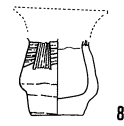
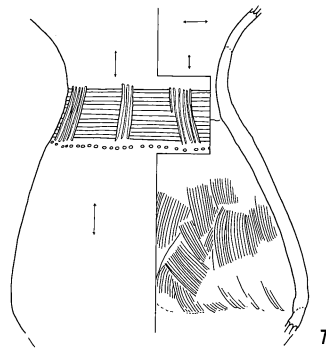
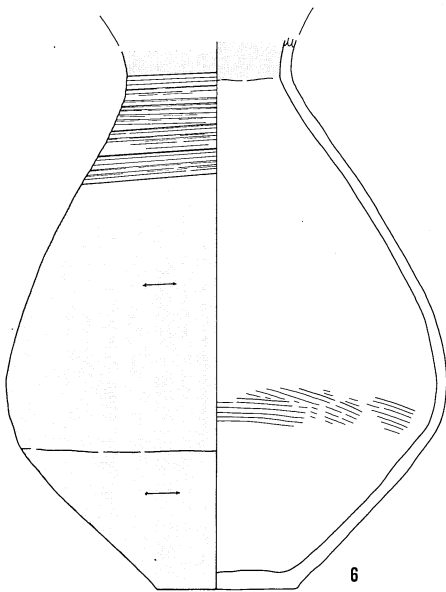
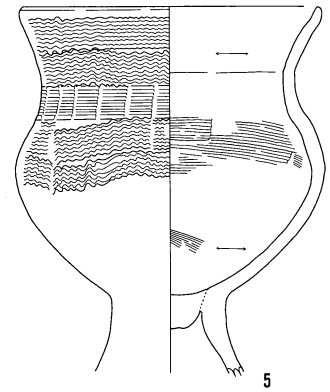
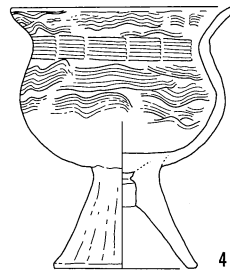
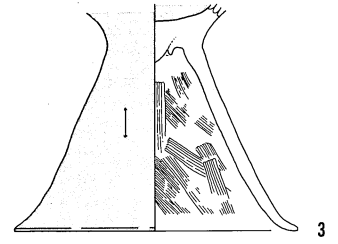
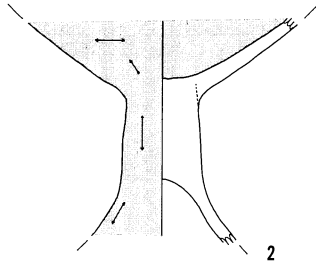
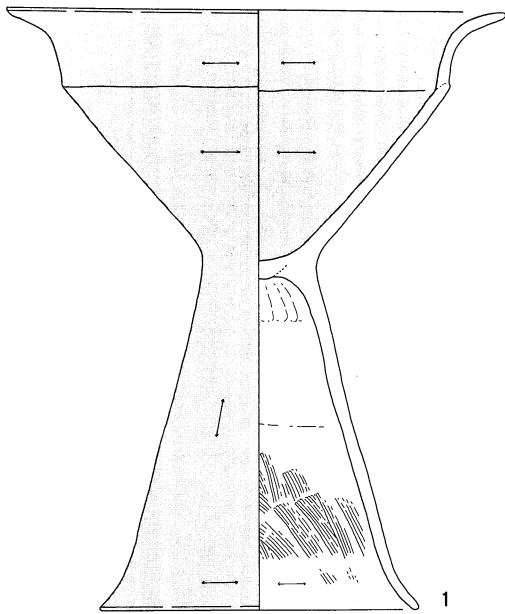

0 (1 : 4) 10cm

SB7101-①

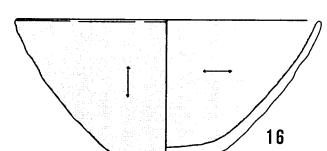
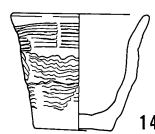
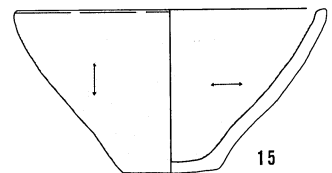
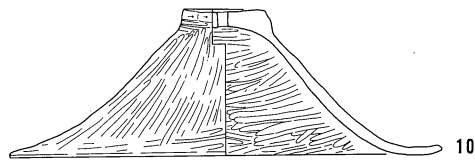
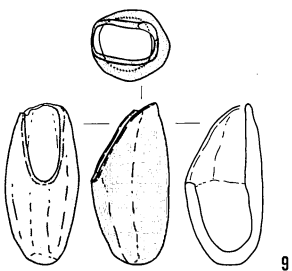

SB7101-②

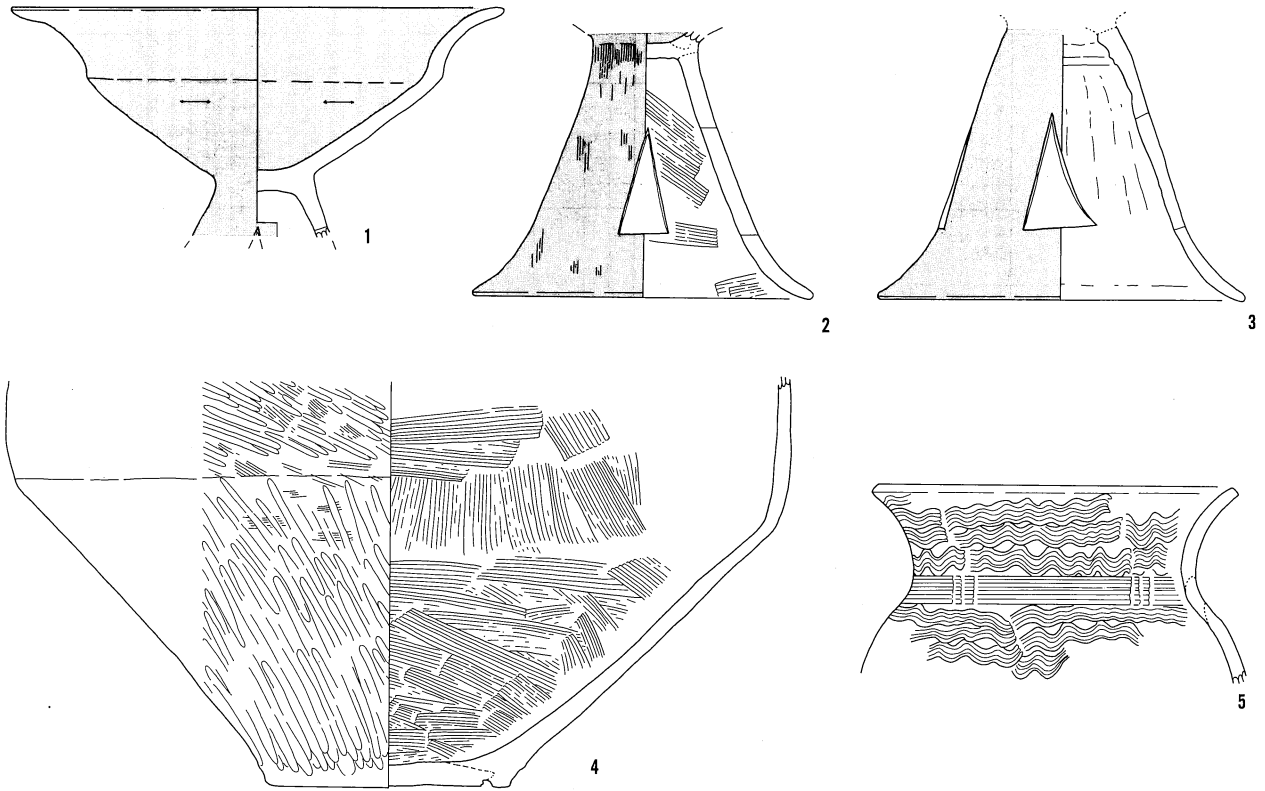

SB7105

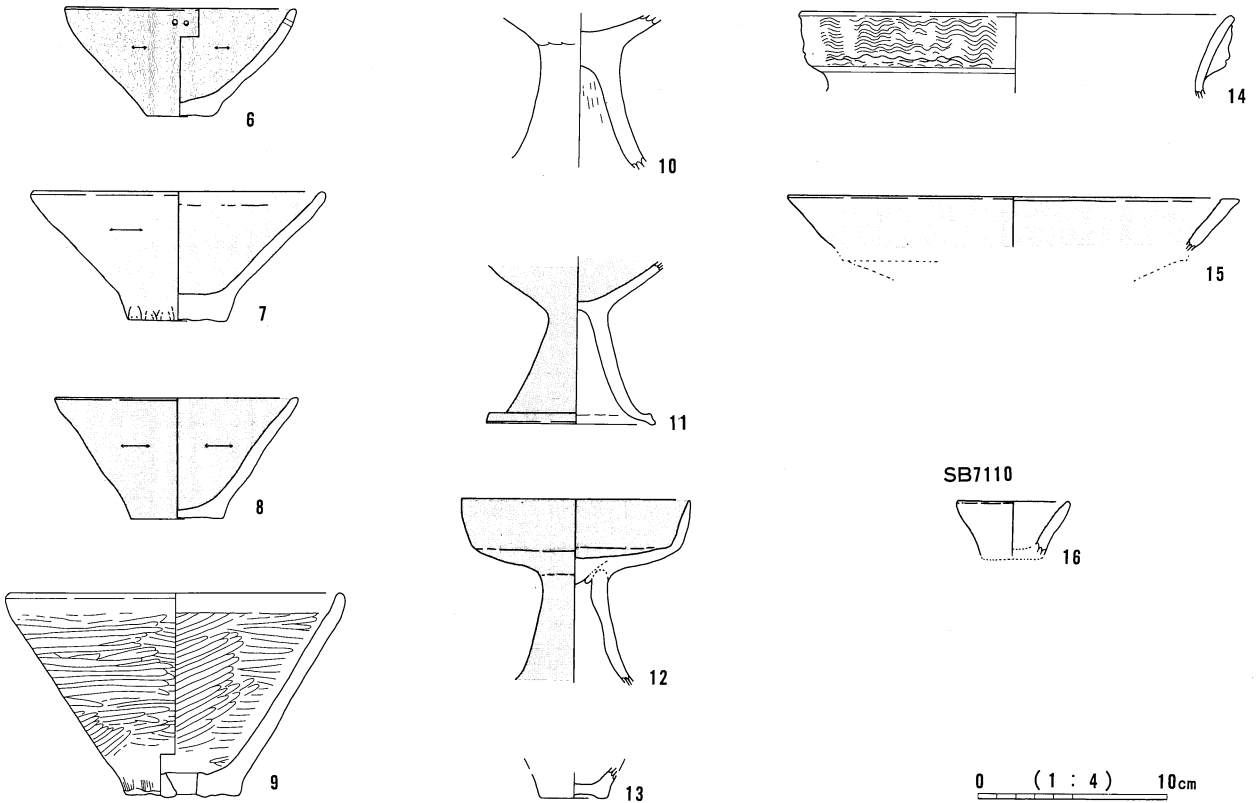

SB7110

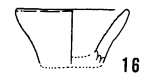

0 (1 : 4) 10cm

SB7126

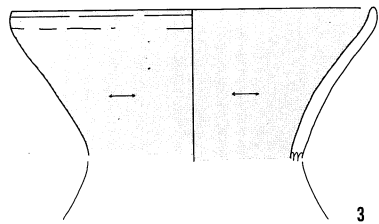
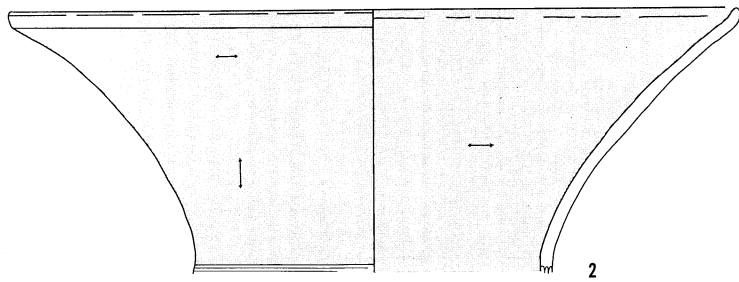
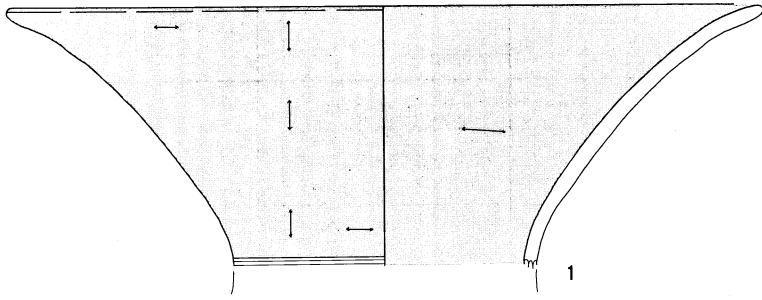

SB7128

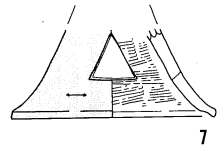
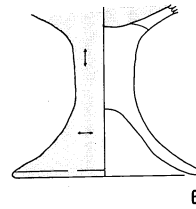
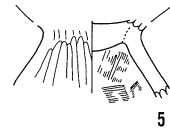
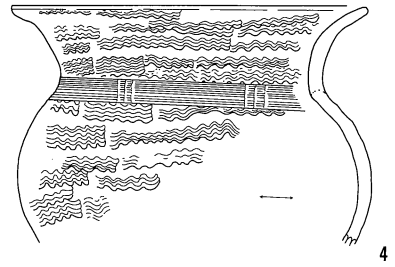

*SB7162-①

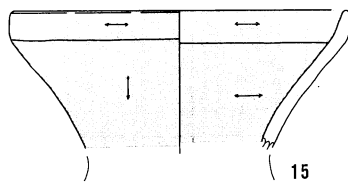
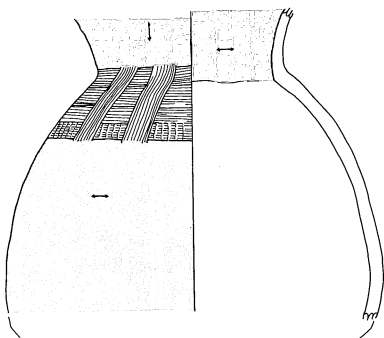
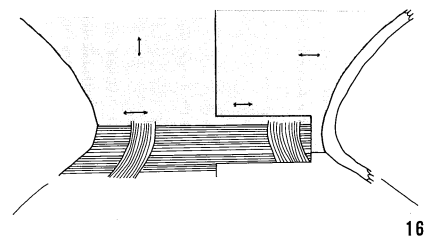
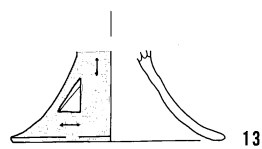
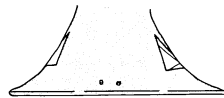
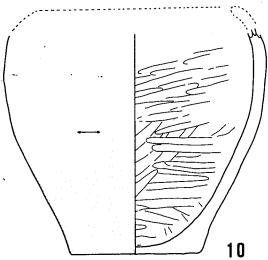
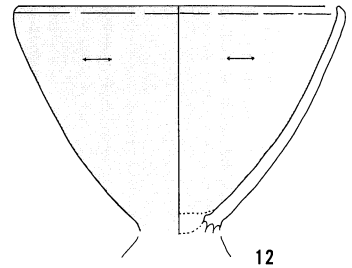
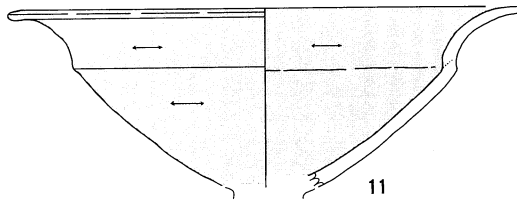
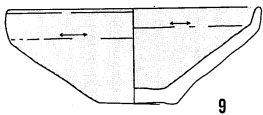

0 (1 : 4) 10cm

SB7162-②

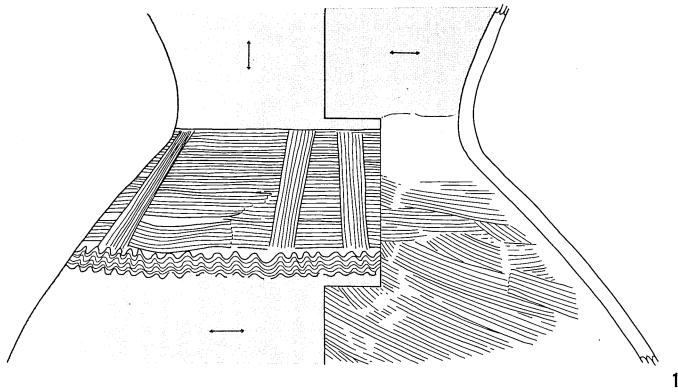

1

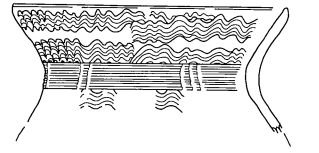

3

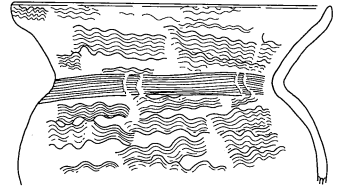

4

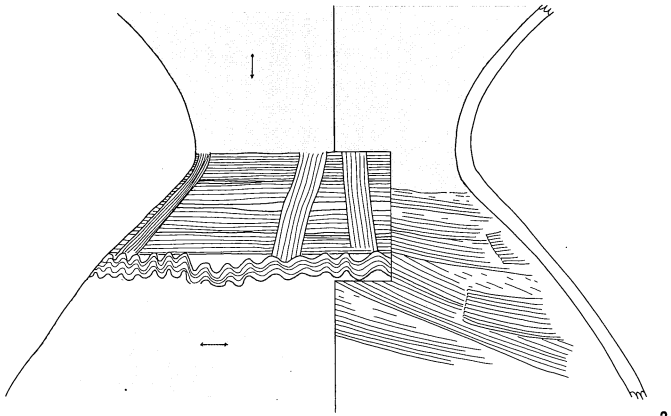

2

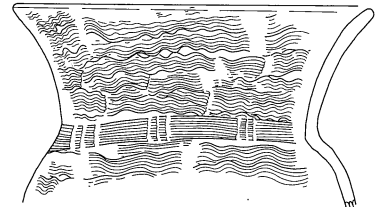

5

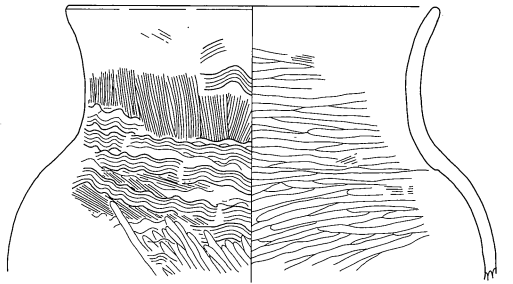

6

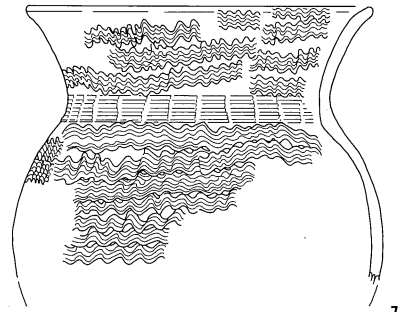

7

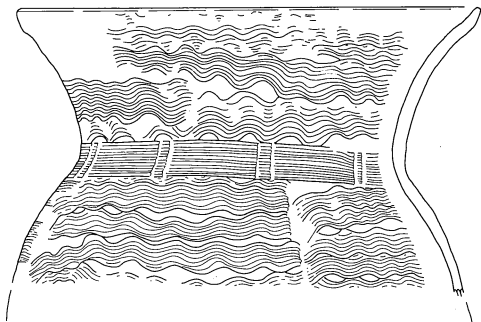

8

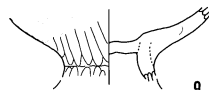

9

SB7146

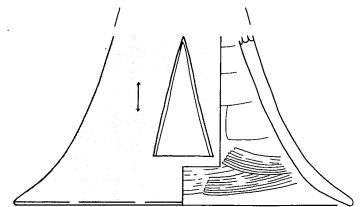

10

SB7147

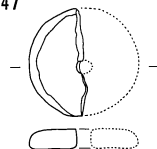

11

0 (1 : 4) 10cm

SB7132-①

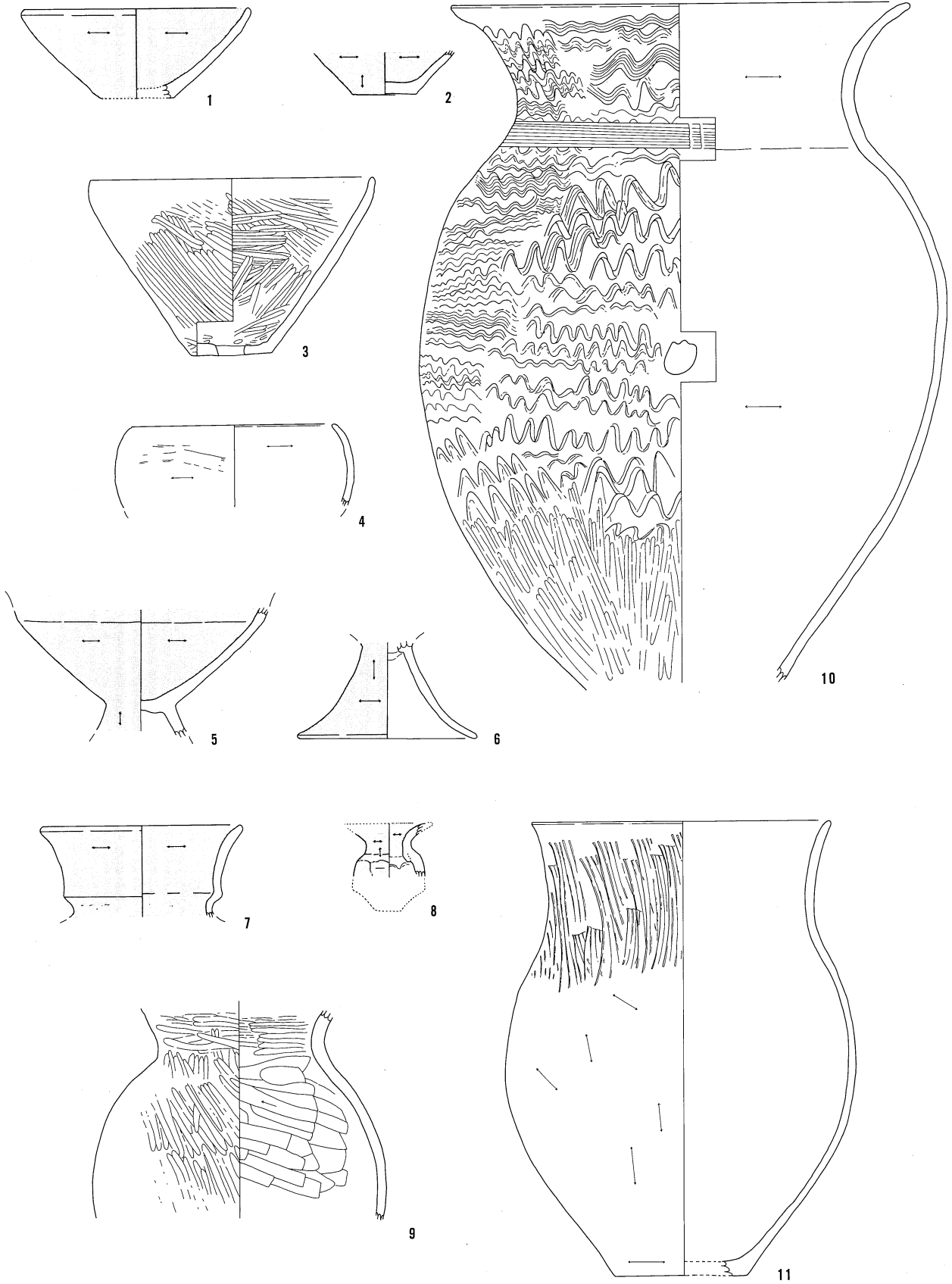

0 (1 : 4) 10cm

SB7132-①

SB7132-②

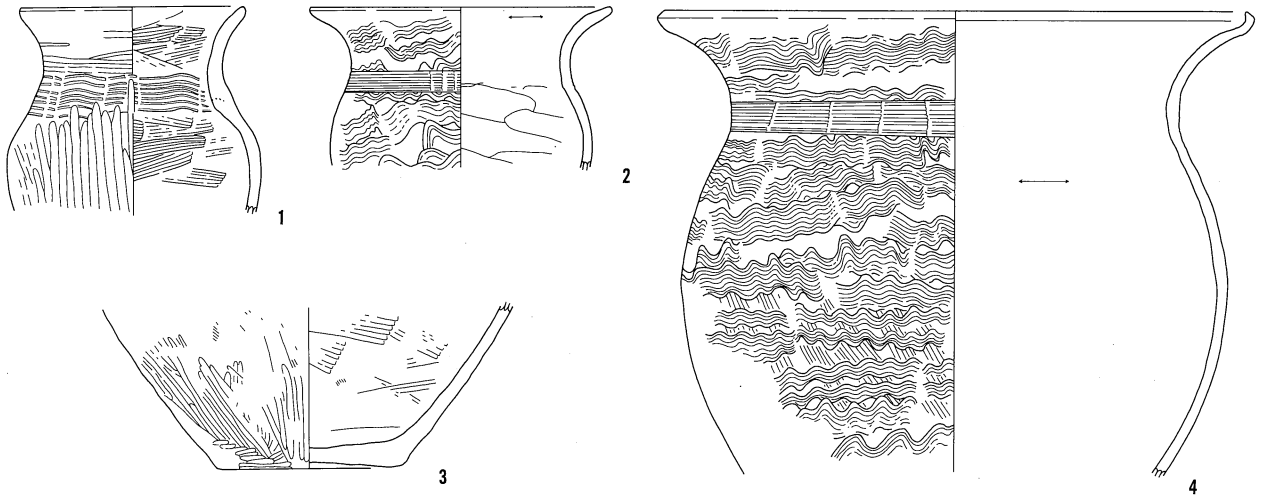

SB7166

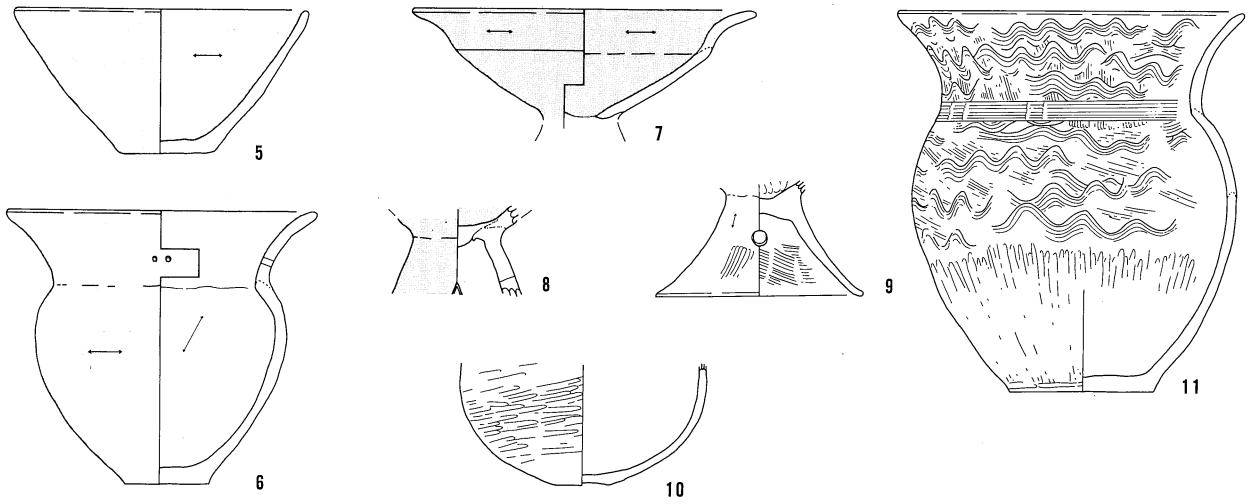

SB7173

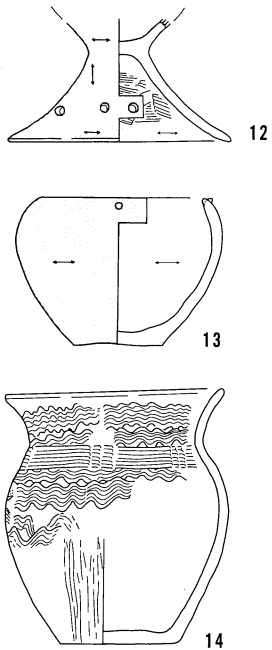

SB7177

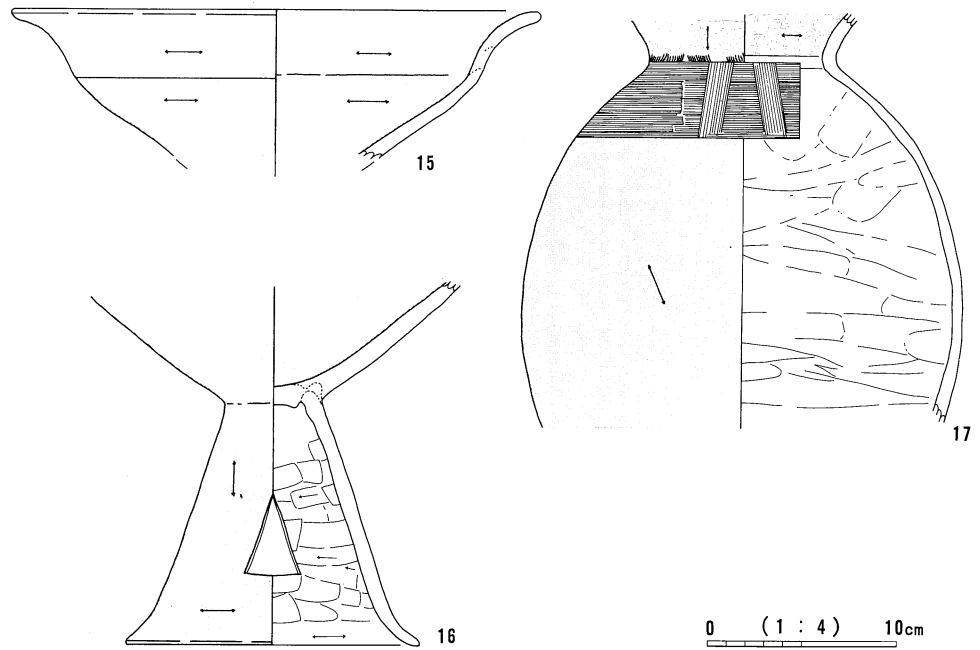

0 (1:4) 10cm

SB7180

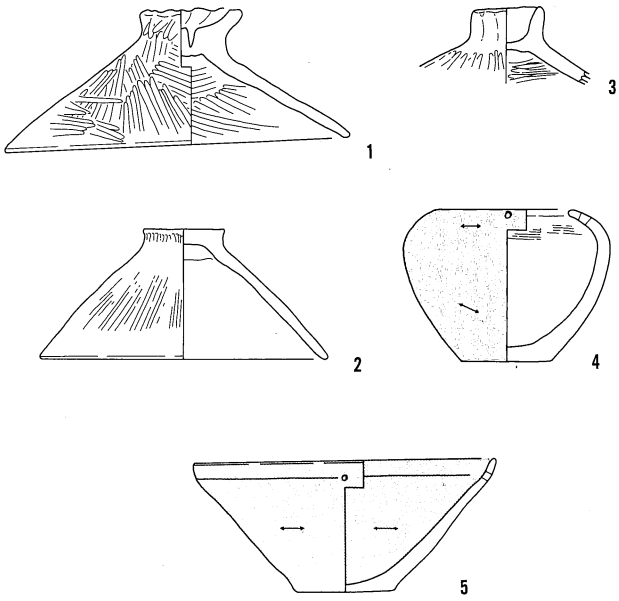

SB7187



SB7191

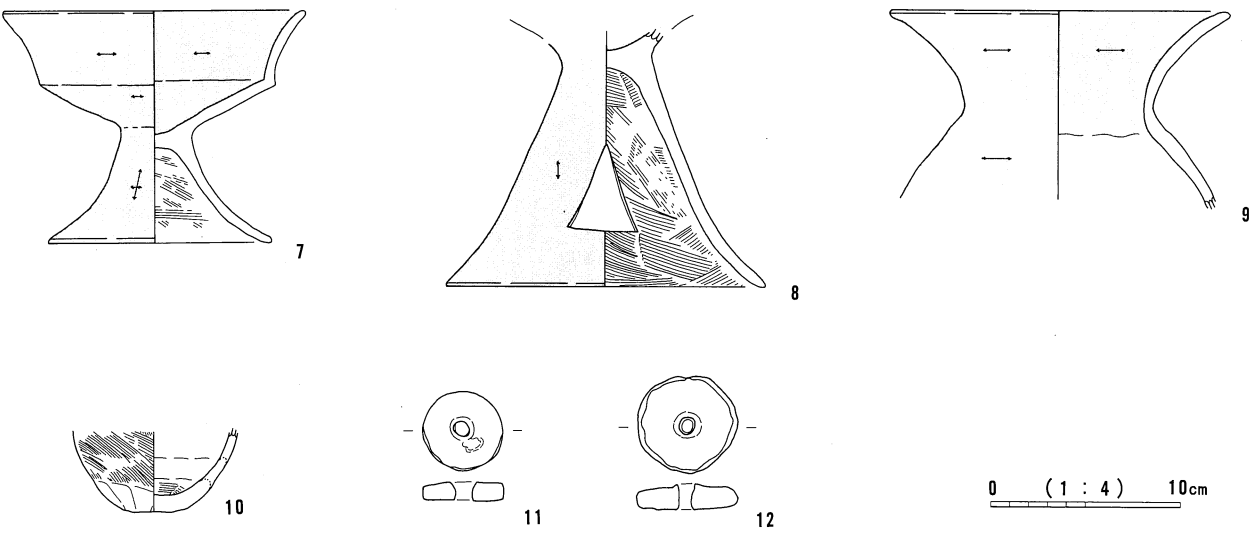

SB7233

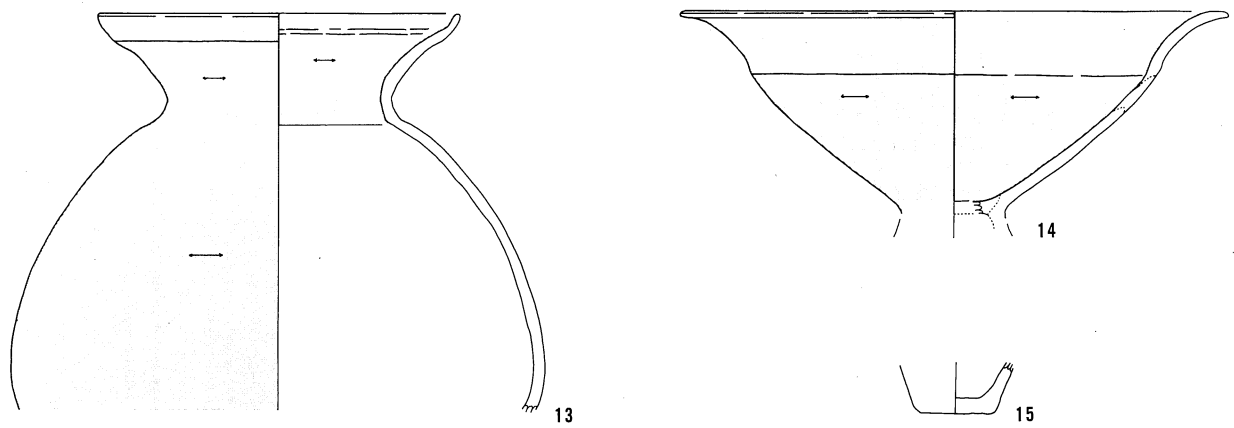

SB7226

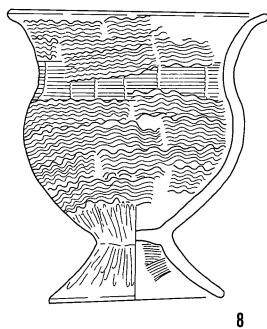
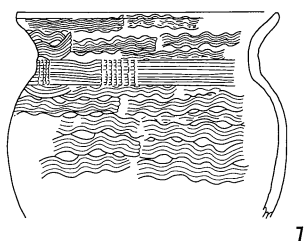
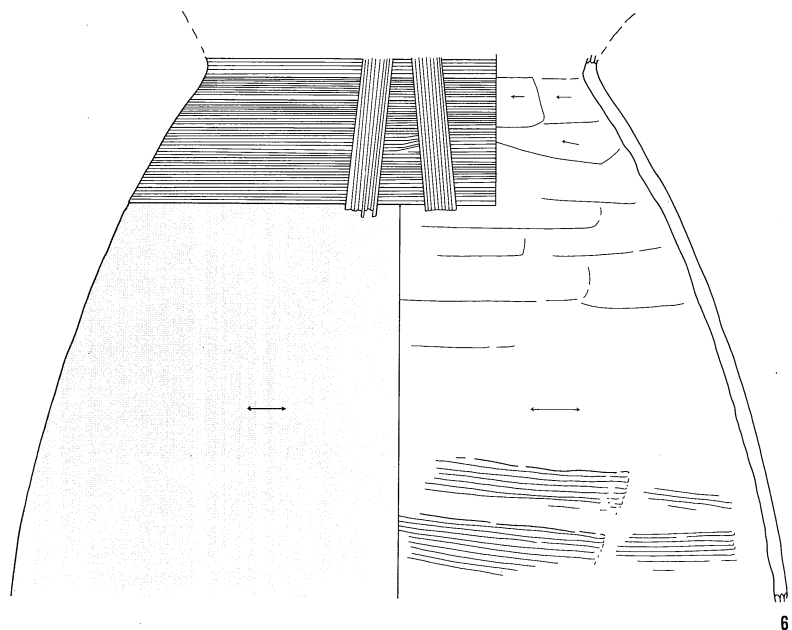
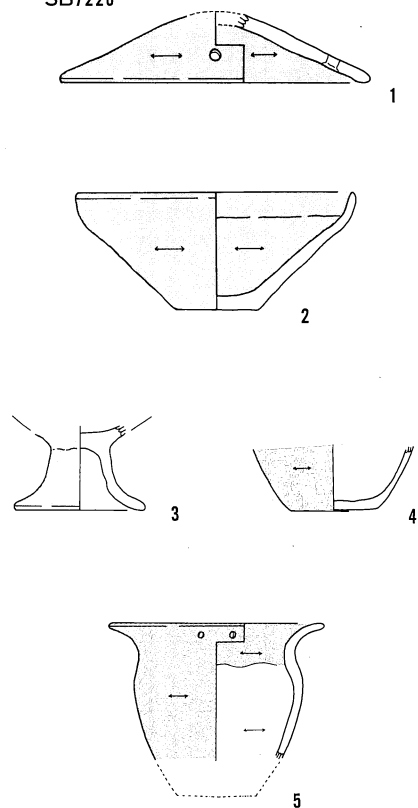

SB7237

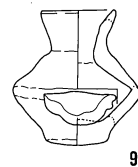

SB7229

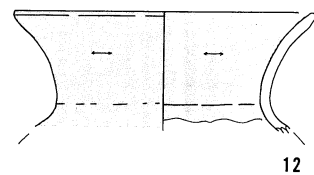
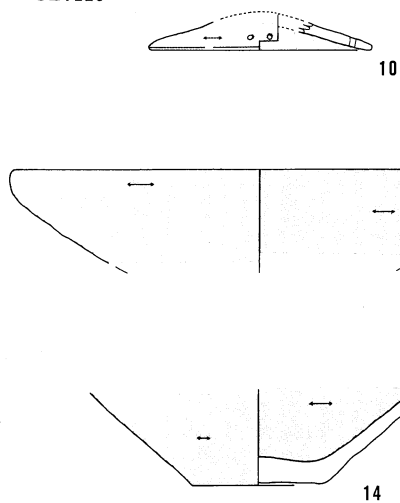

0 (1 : 4) 10cm

SB7236

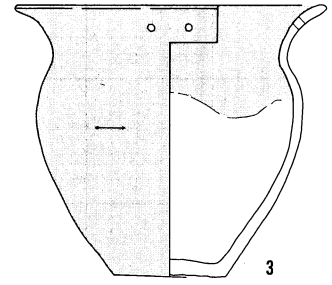
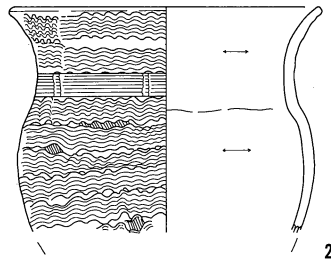
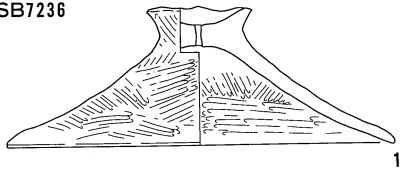

SB7238

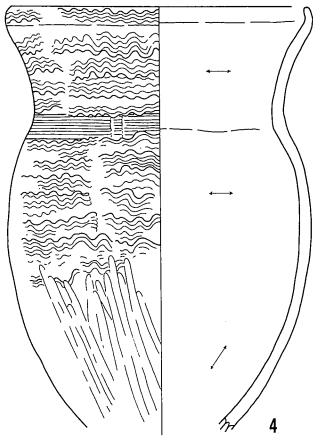

SB7252

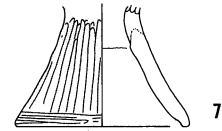
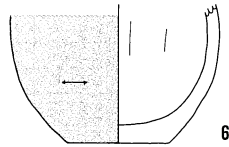
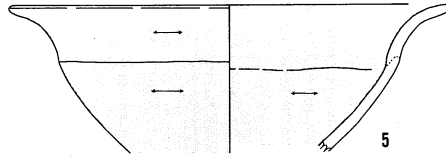

SB7258

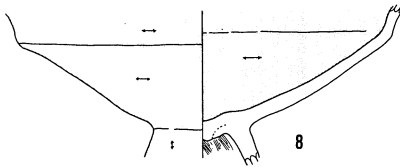

SB7271

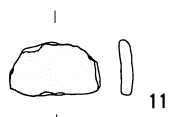
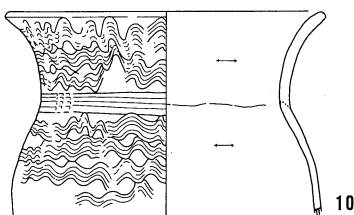
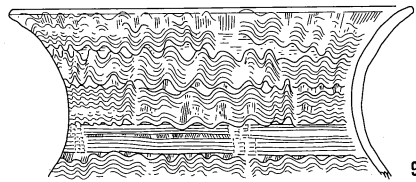
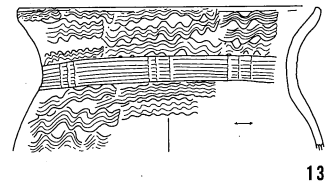
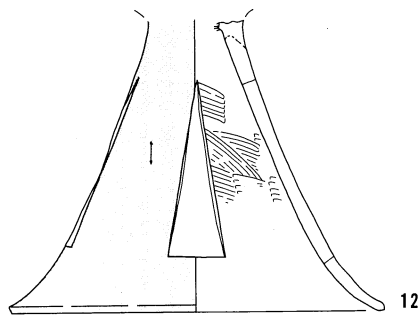

0 (1 : 4) 10cm

SB7277

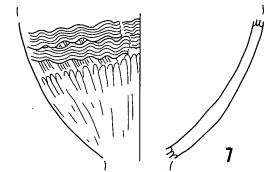
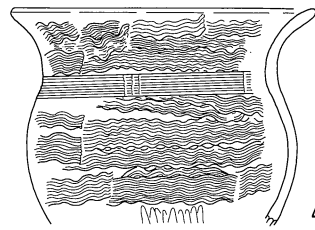
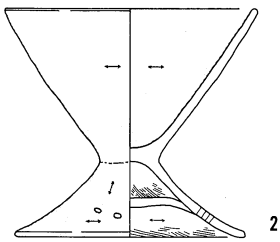
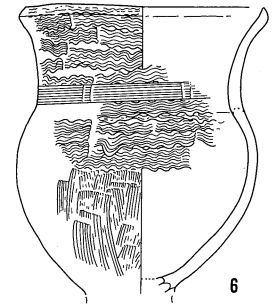
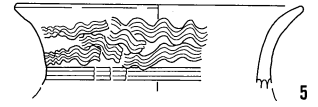
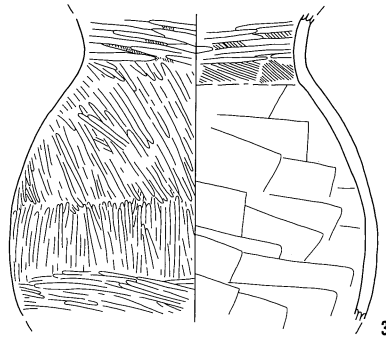
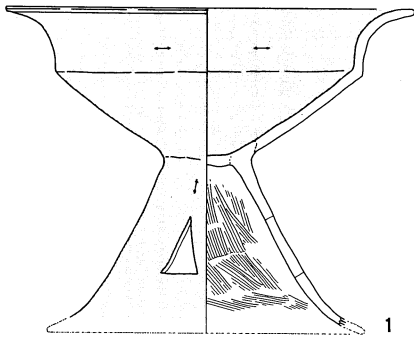

SB7293

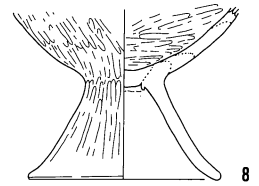
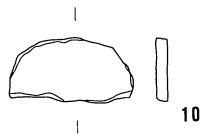

SB7307

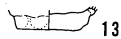
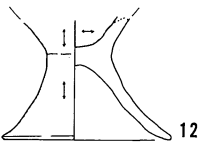
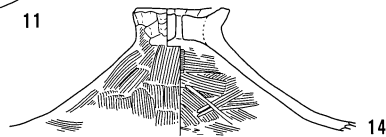
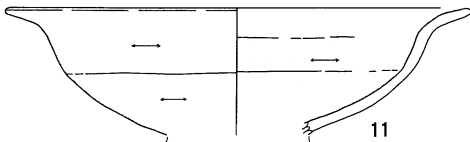

SB7493

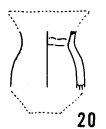
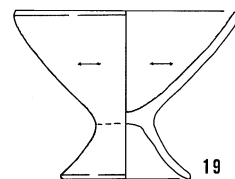
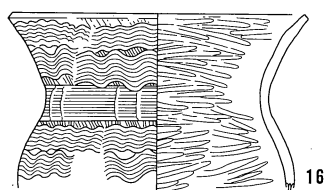
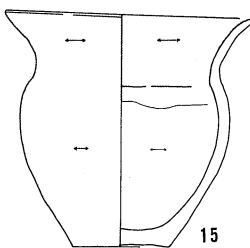
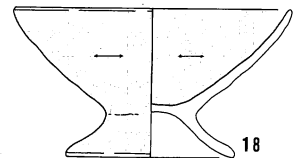
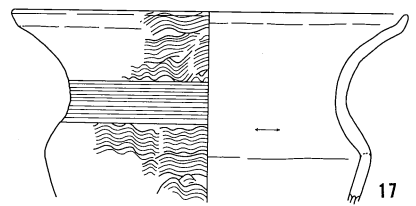

0 (1 : 4) 10cm

SB7358

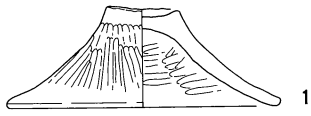

1

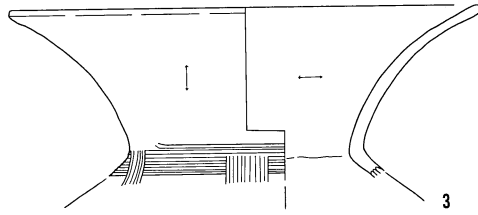

3

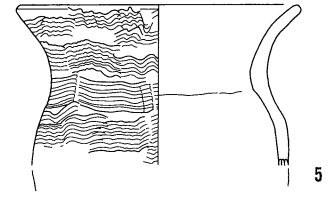

5

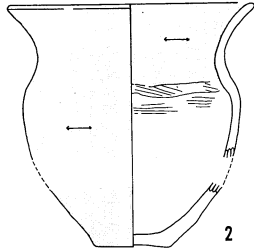

2

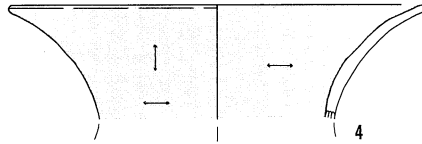

4



6

SB7365

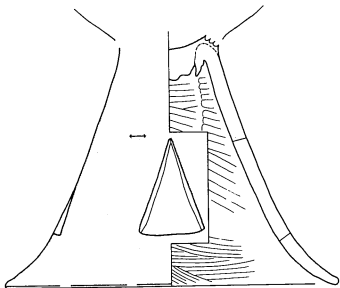

7

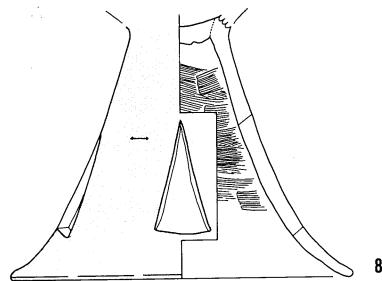

8

SB7417

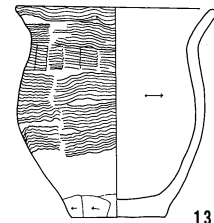

13

SB7490

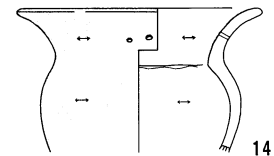

14

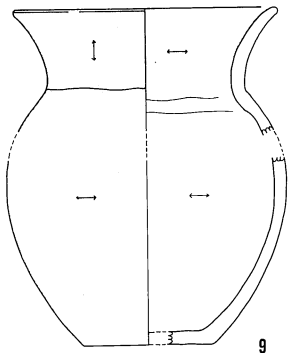

9

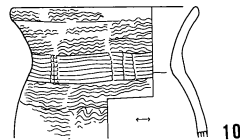

10

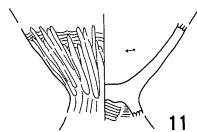

11

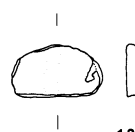

12

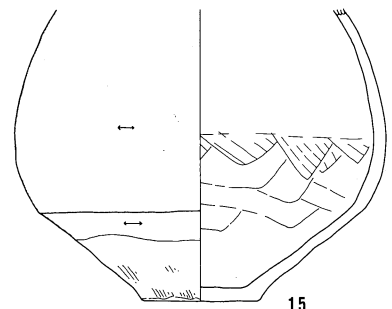

15

SB7573

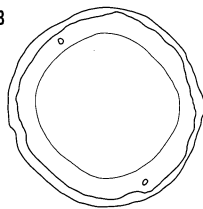

18

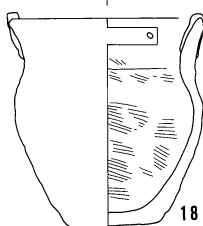

SB7560

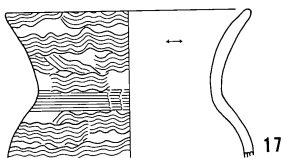

17



16

0 (1 : 4) 10cm

SB7488

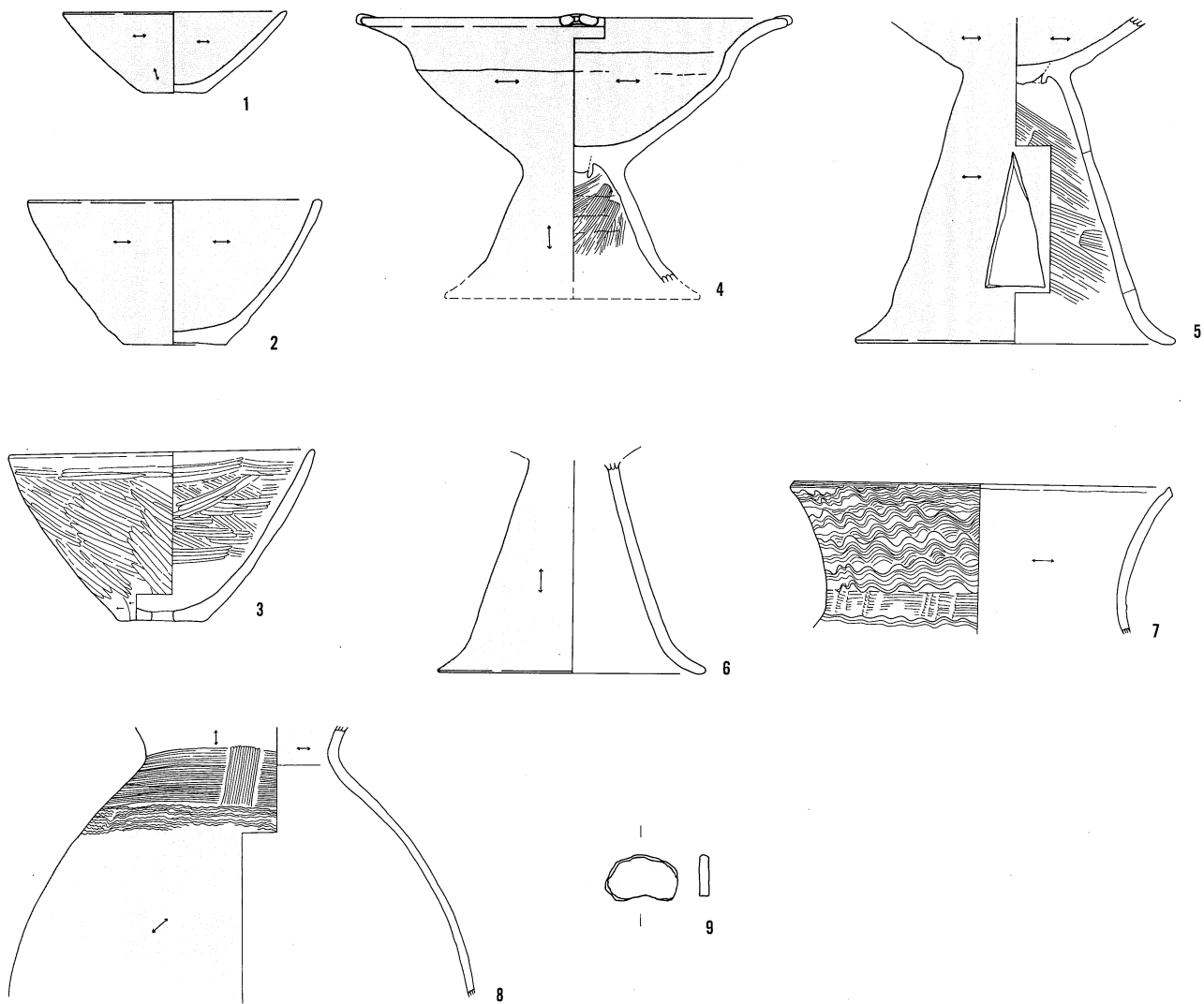

SB7495

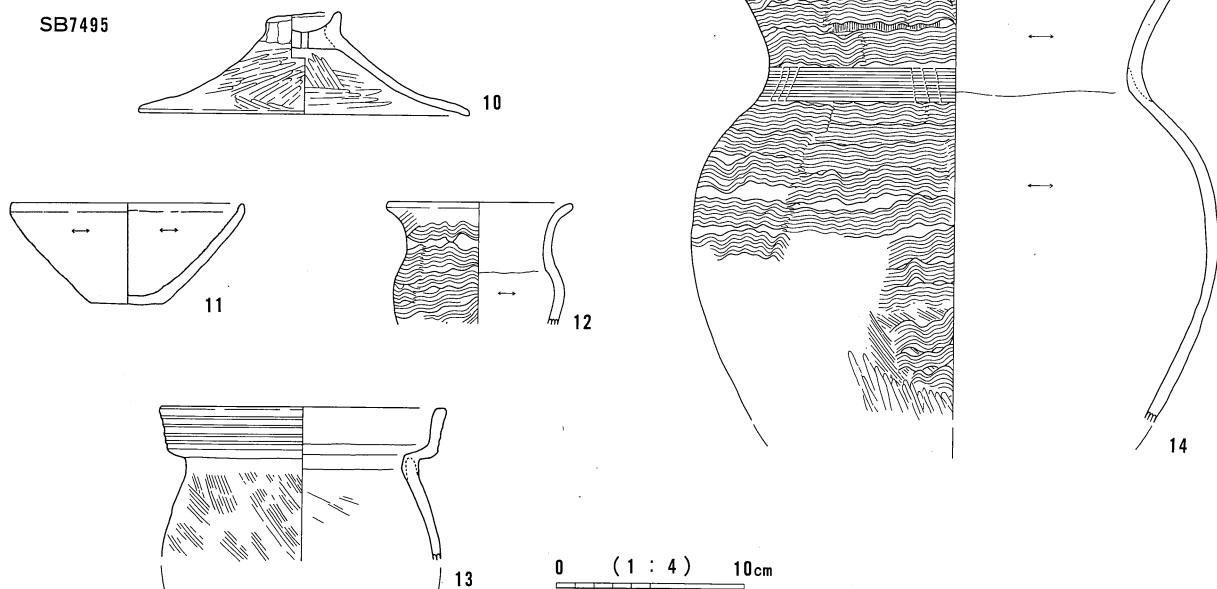

0 (1 : 4) 10cm

SB7497

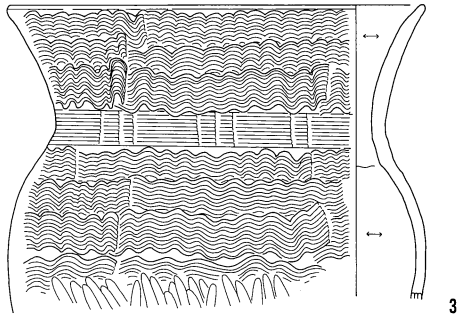
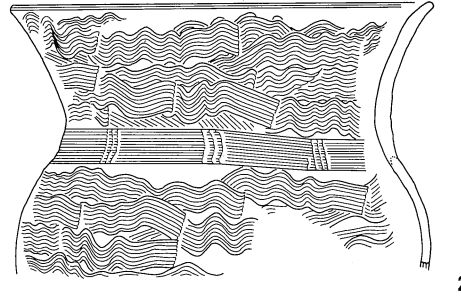
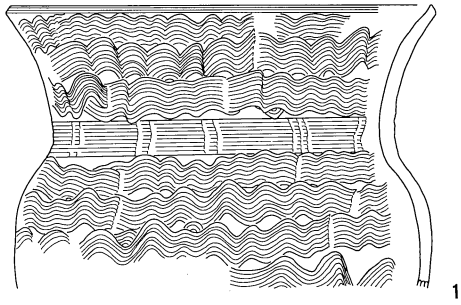

SB7500

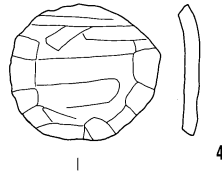

SB7553

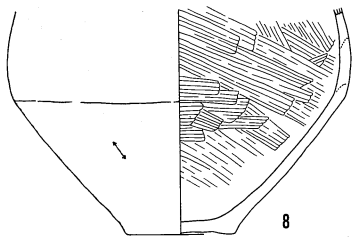
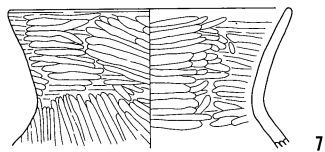
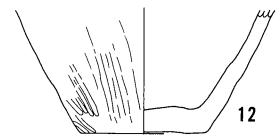
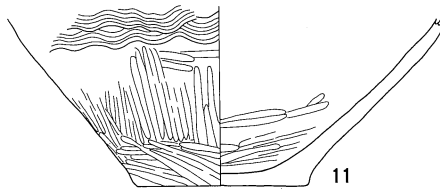
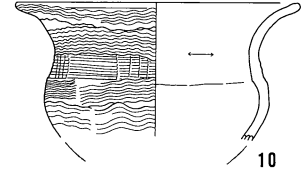
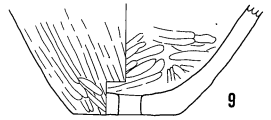
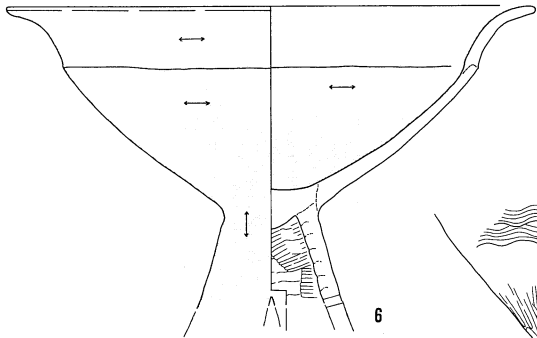

SB7580

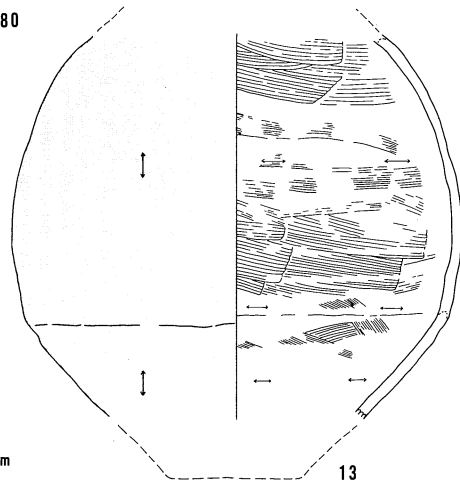

0 (1 : 4) 10cm

SB7593

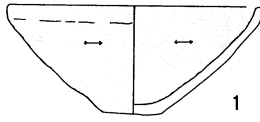

1

SB7618



2

SB7617

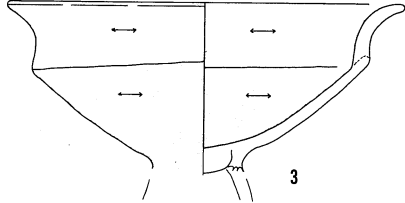

3

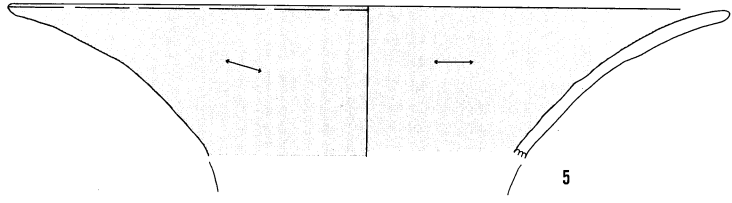

5

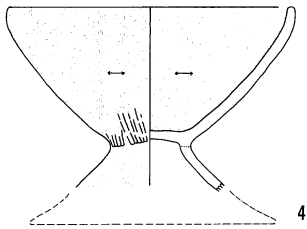

4

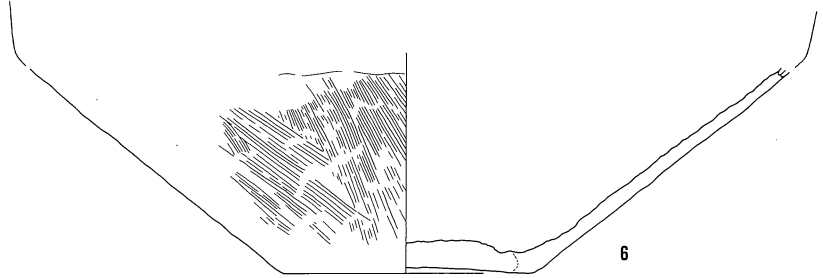

6

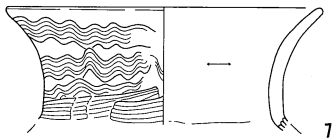

7

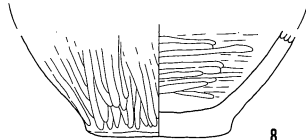

8

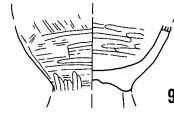

9

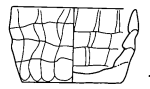

10

SB7630

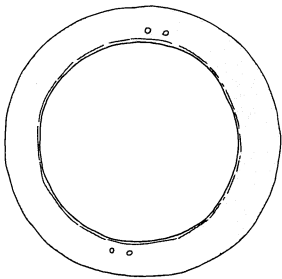

11

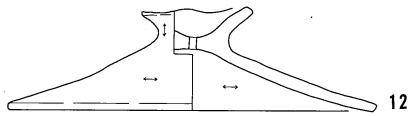

12

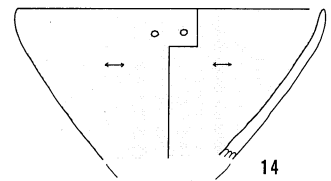

14

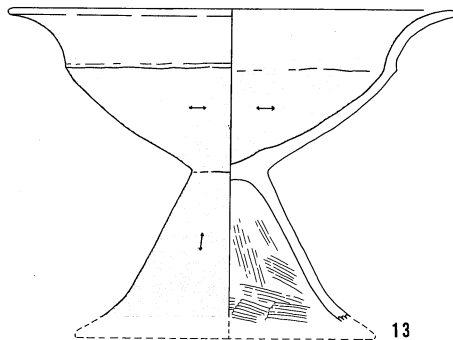

13

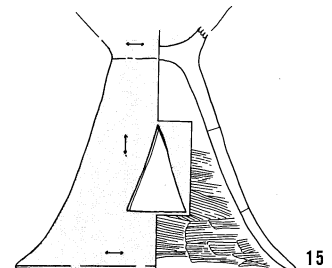

15

0 (1 : 4) 10cm

SB7627

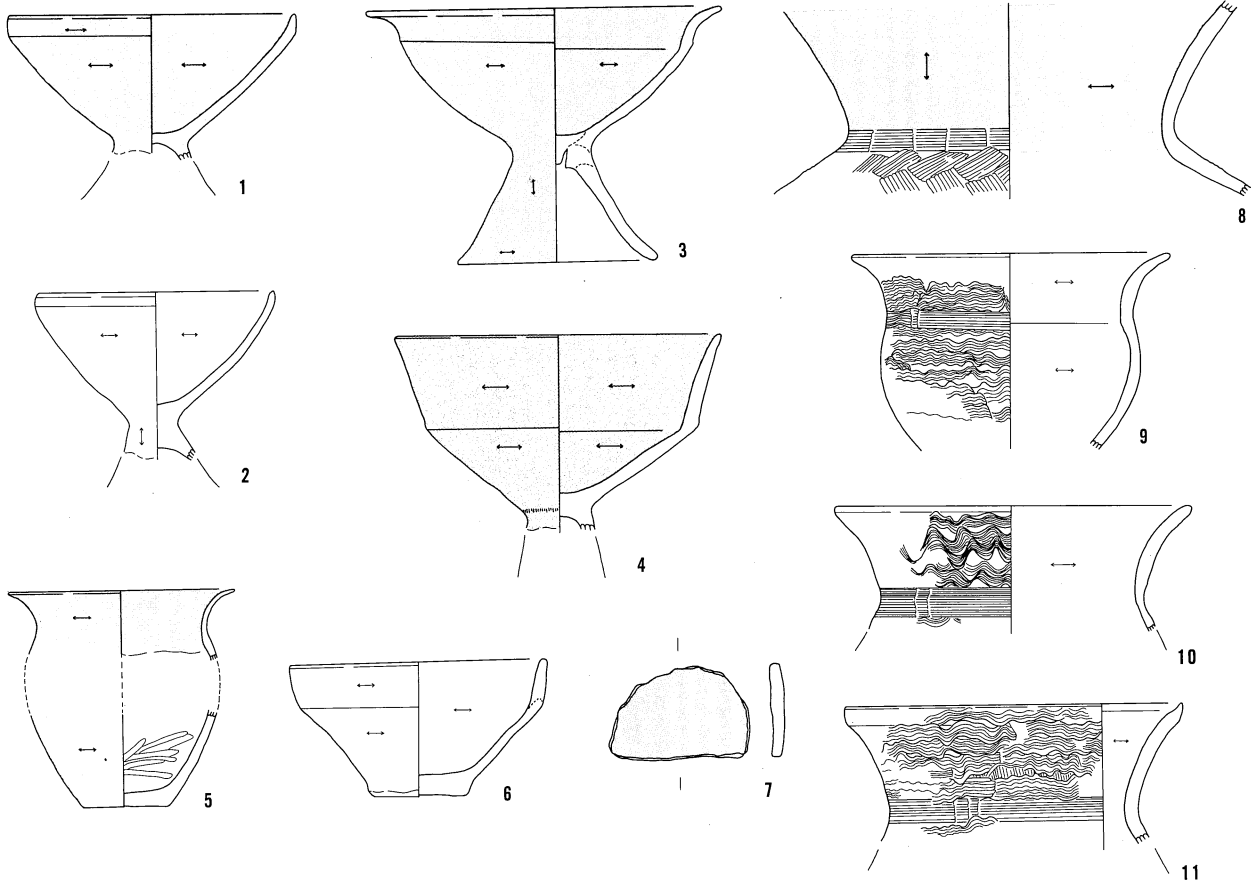

SB7655

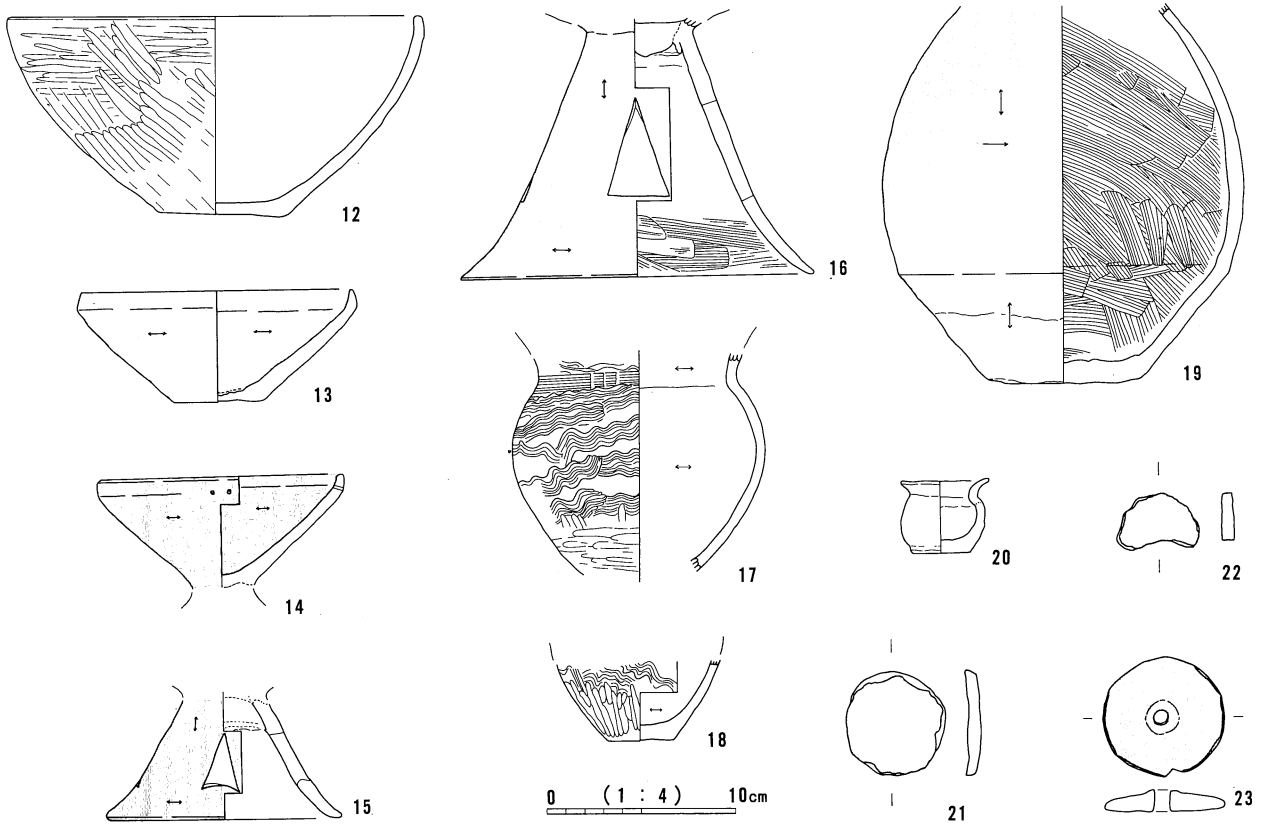

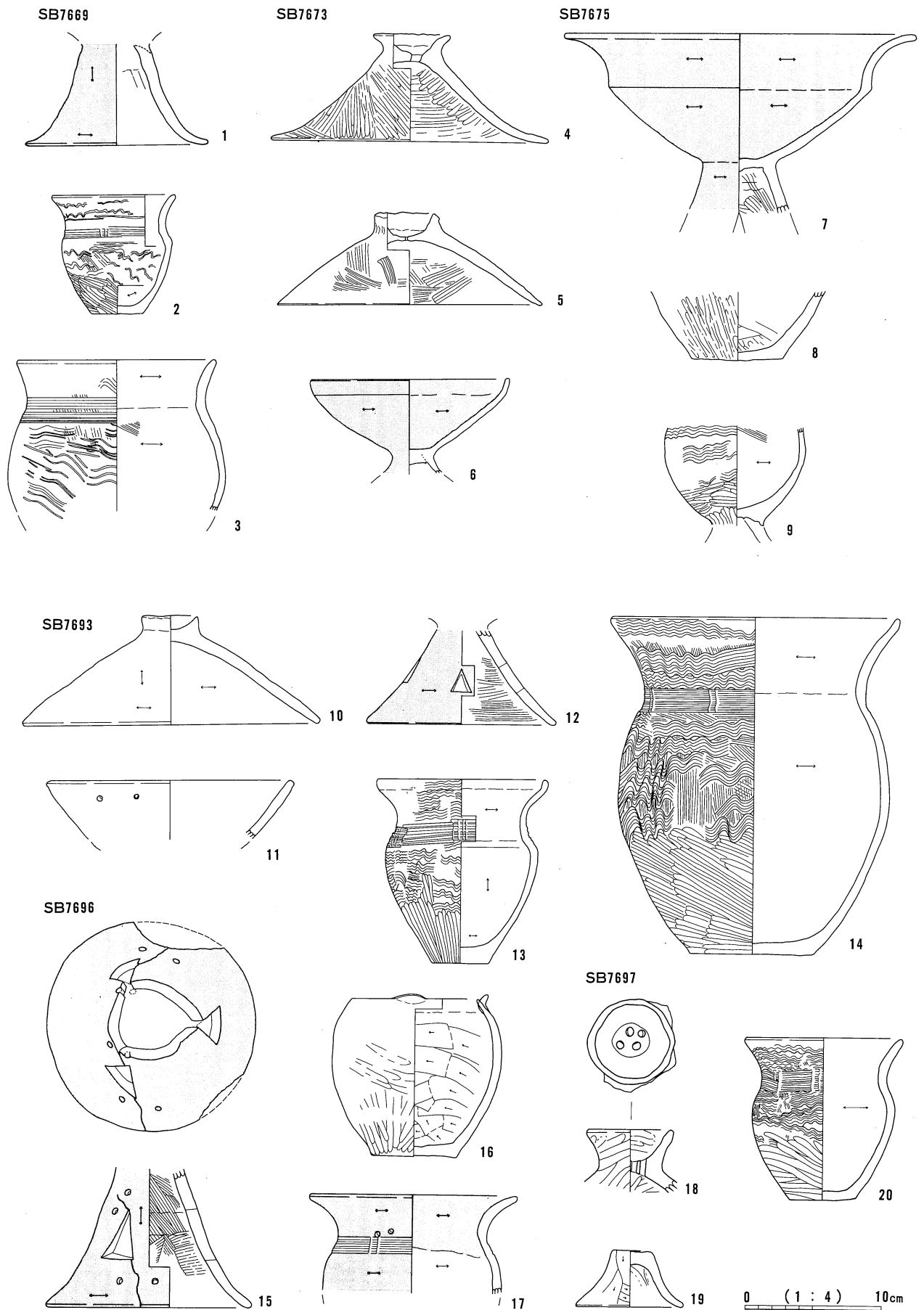

SD6003

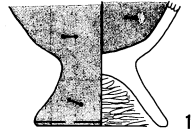

SD6035

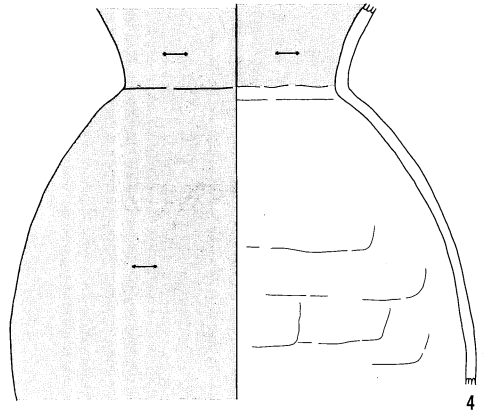
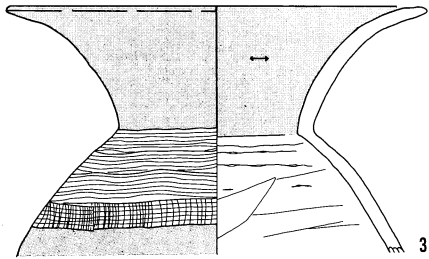
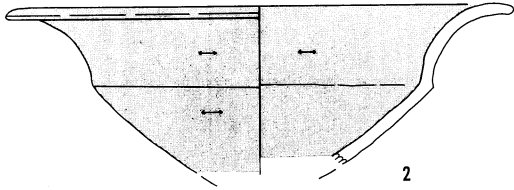

0 (1 : 4) 10cm

SD7014-①

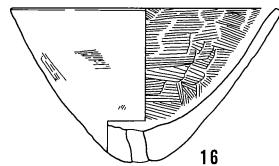
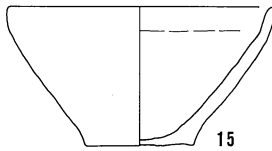
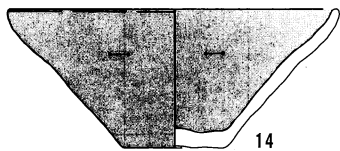
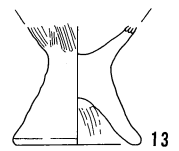
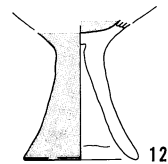
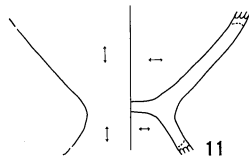
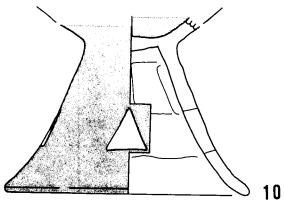
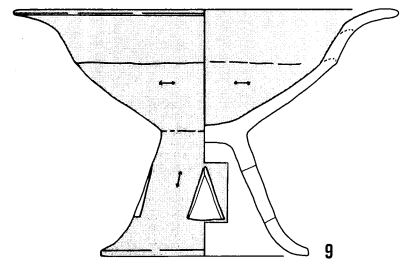
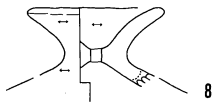
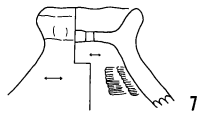
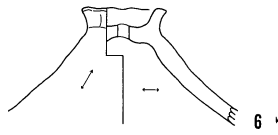
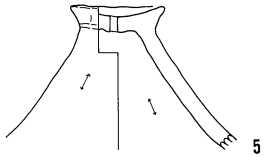

SD7014-②

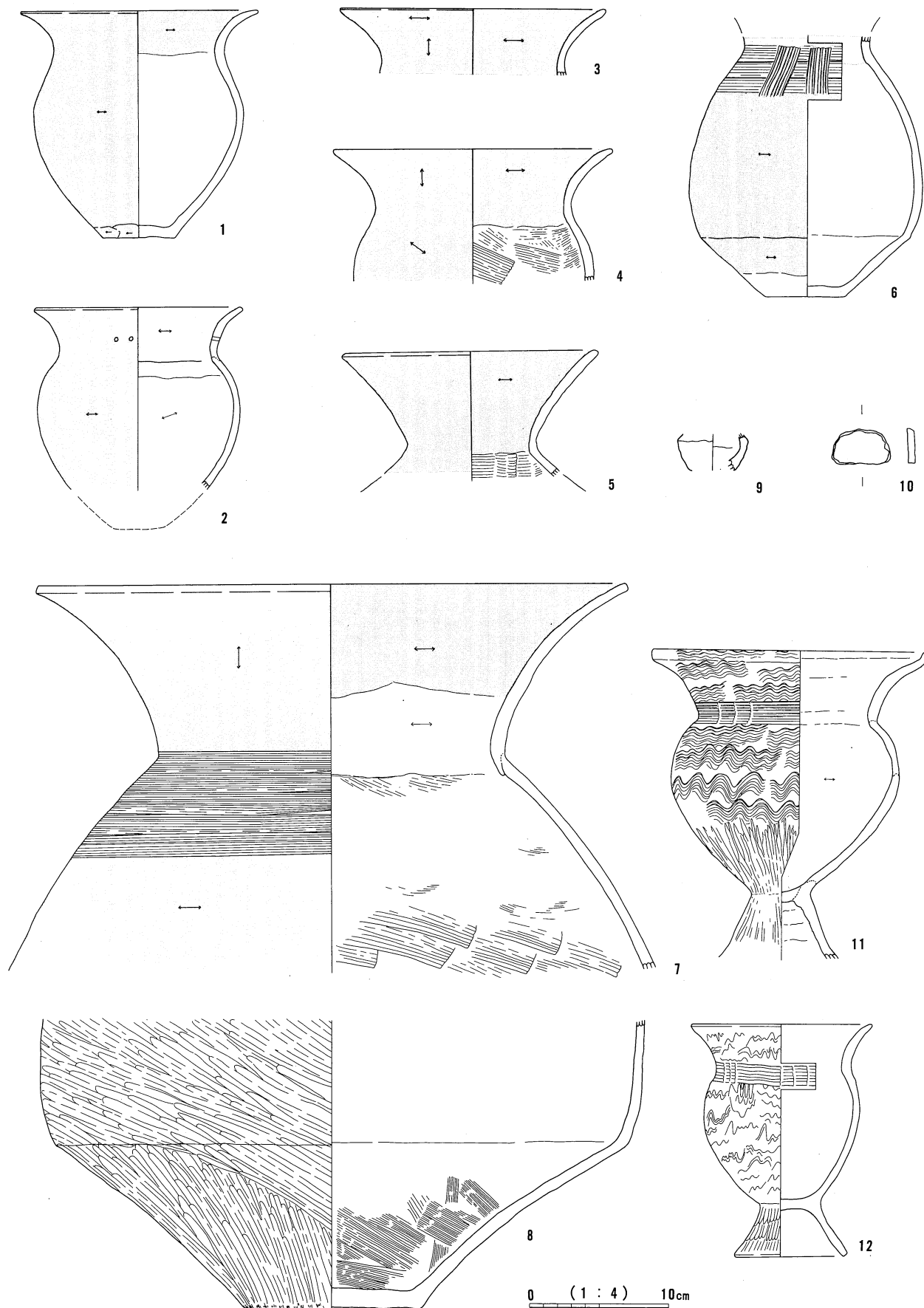

SD7014-②

SD7014-③

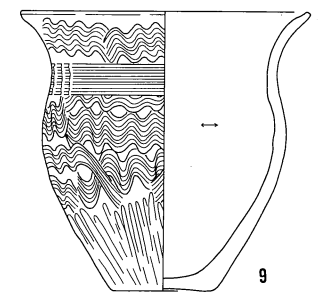
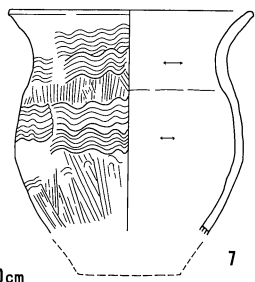
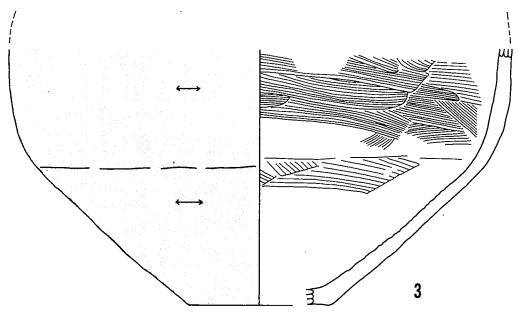
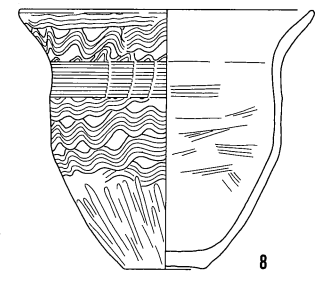
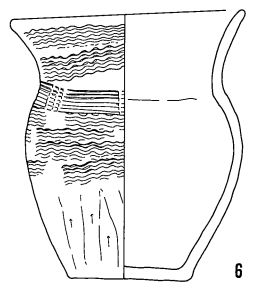
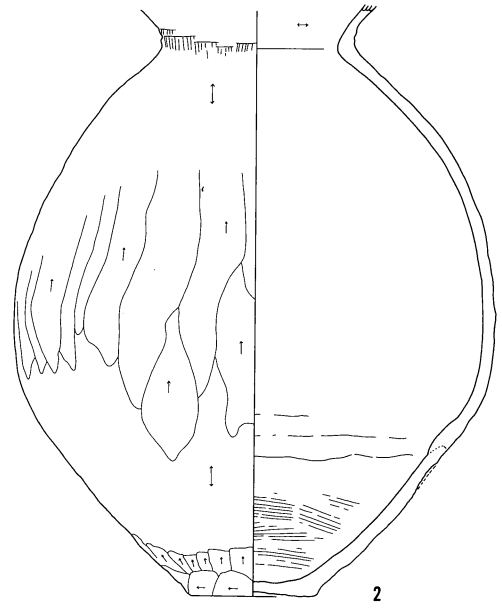
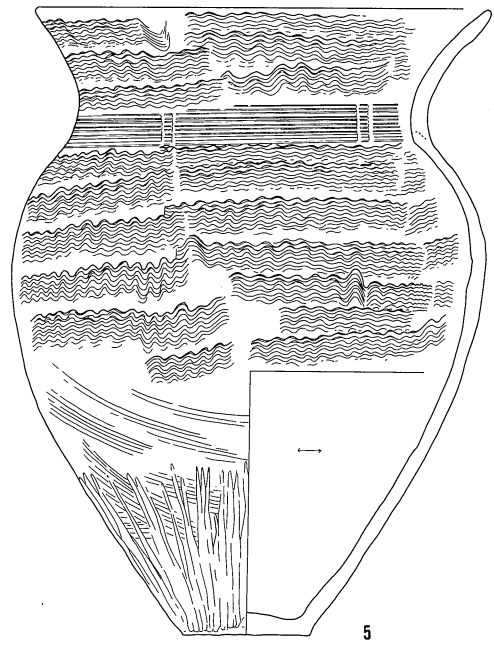
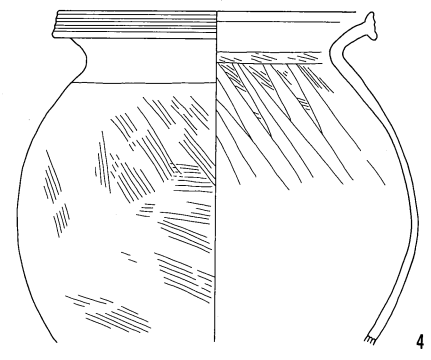
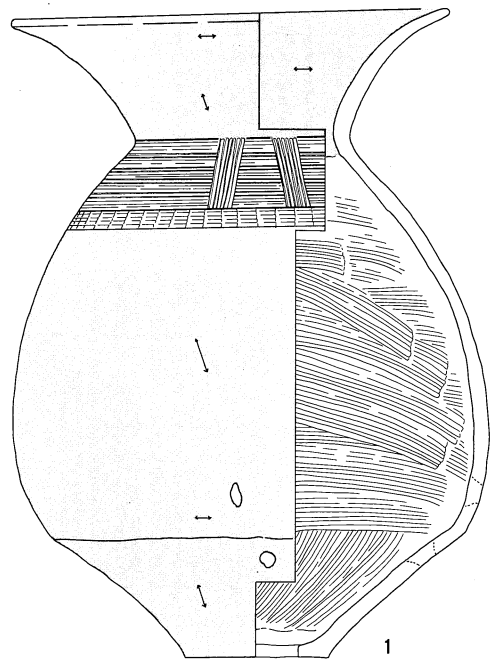

0 (1 : 4) 10cm

SD7014-③

SD7046-①

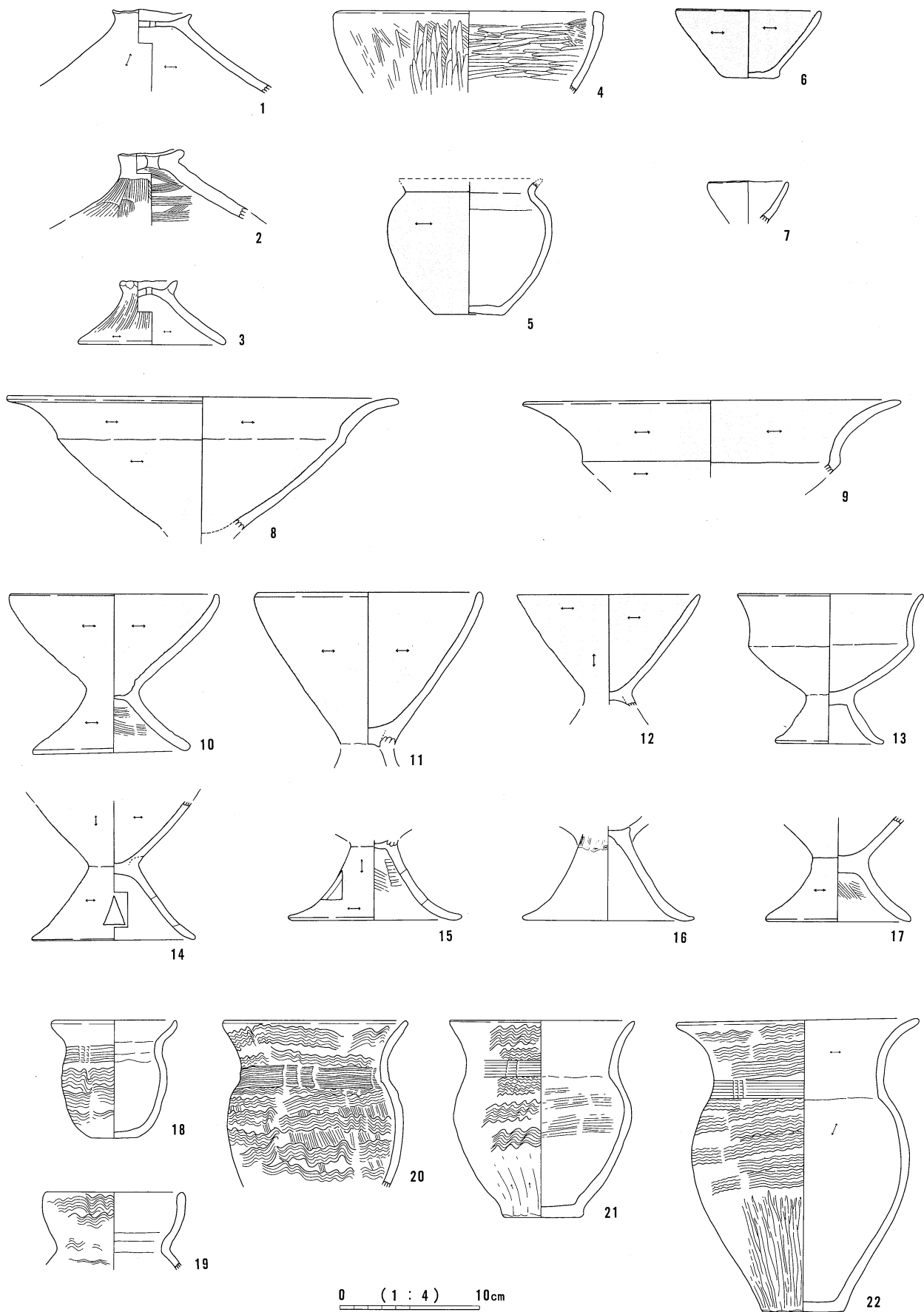

SD7046-②

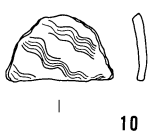
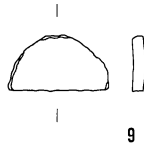
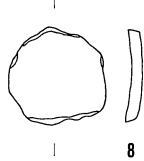
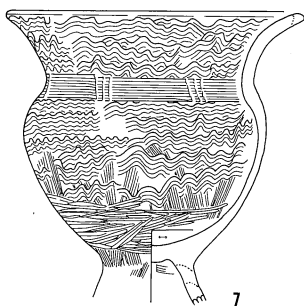
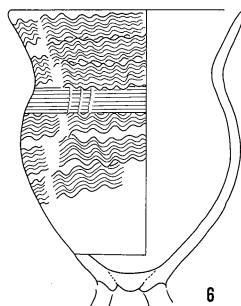
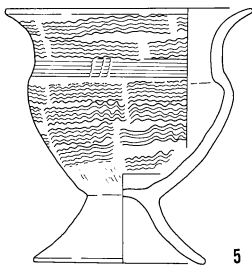
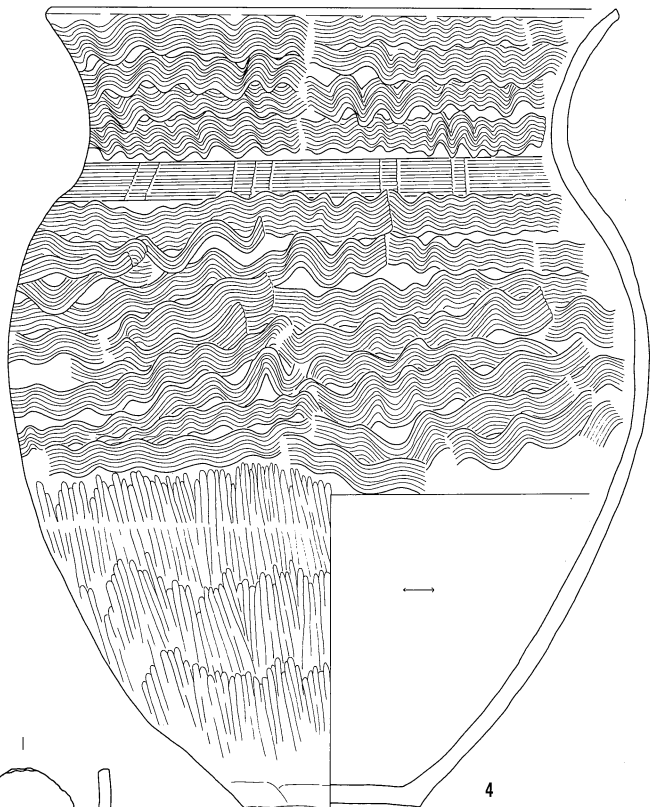
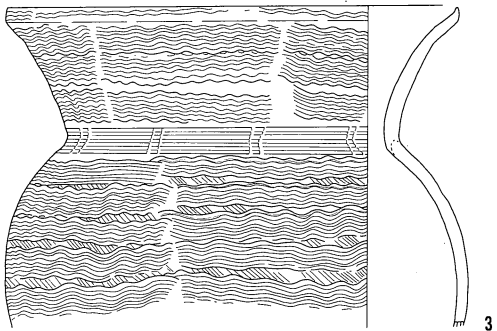
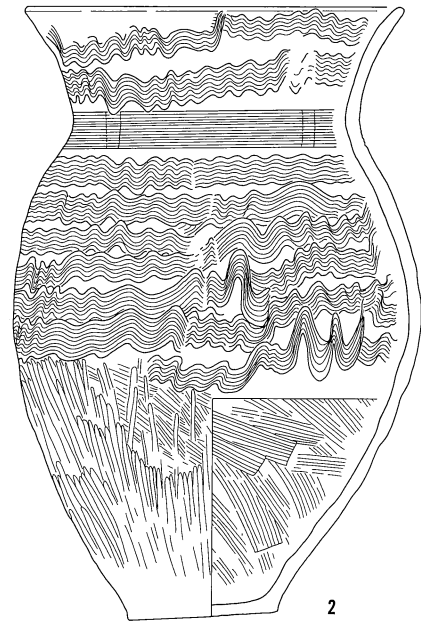

0 (1 : 4) 10cm

SD7046-②

SK6122

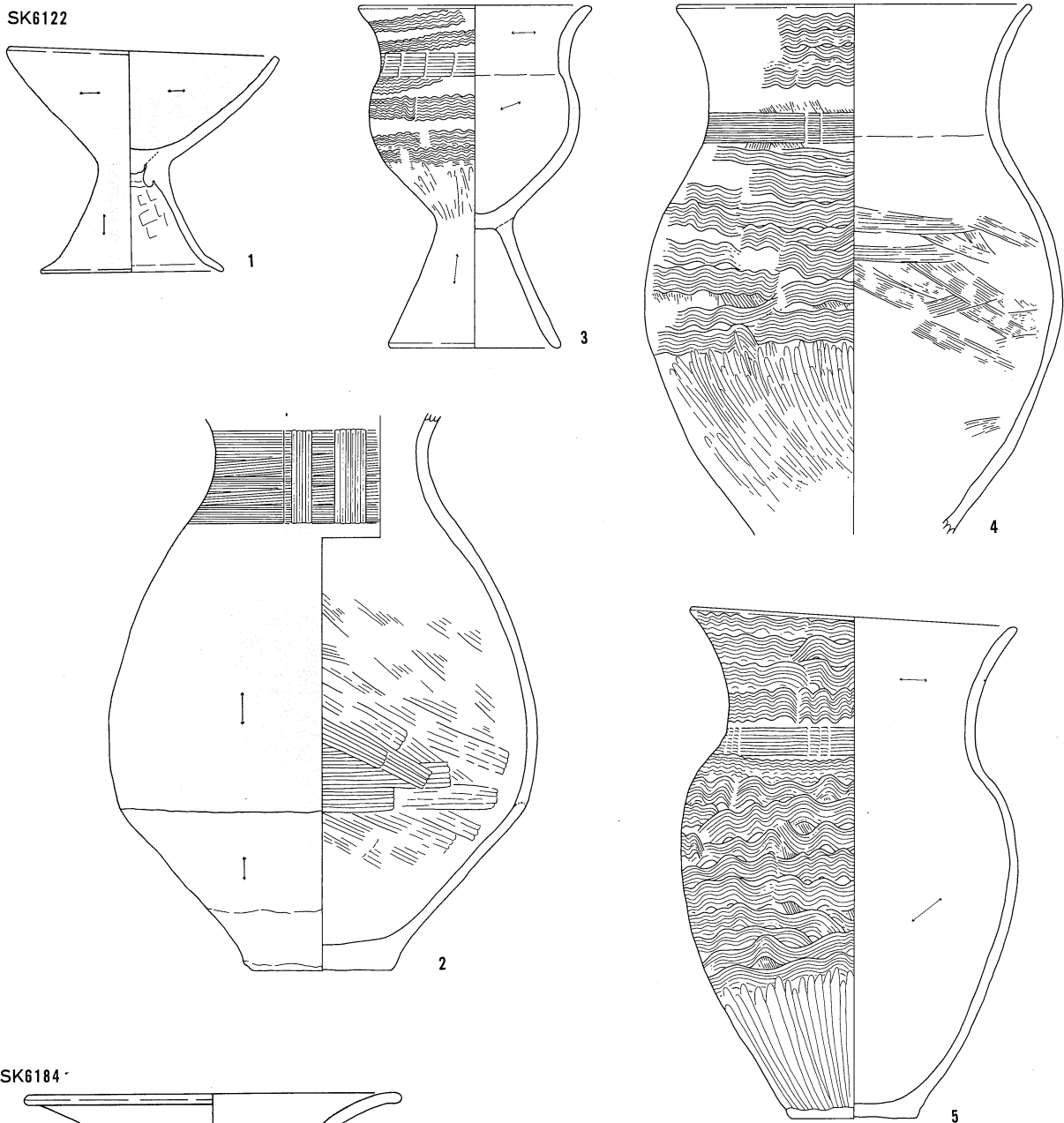

SK6184

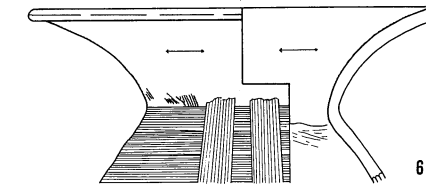

SK6213

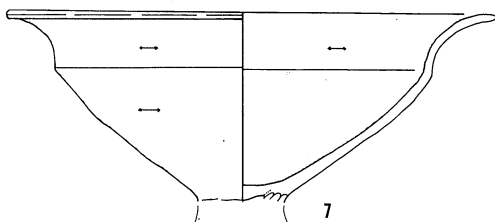

SK6324

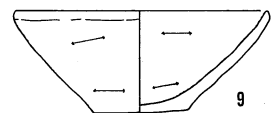
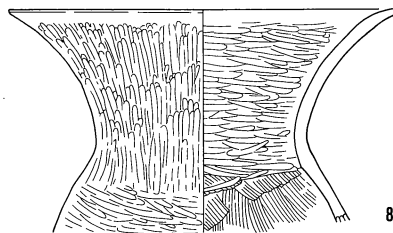

0 (1 : 4) 10cm

SK6222

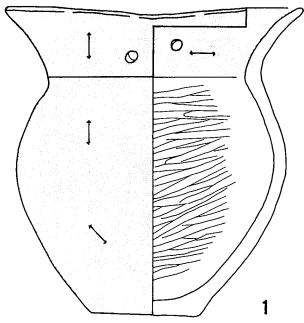

1

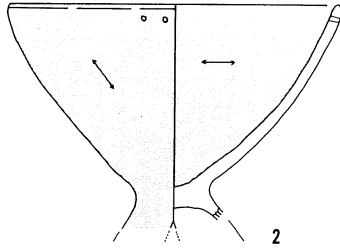

2

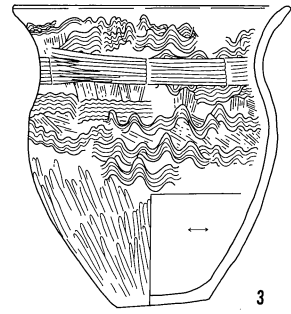

3

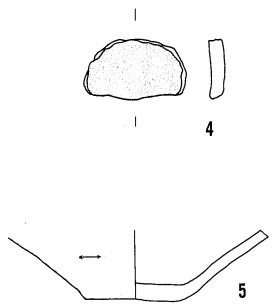

4

SK6352

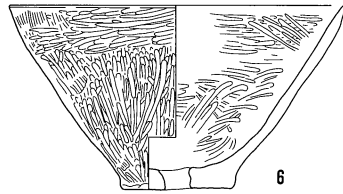

6

SK6437

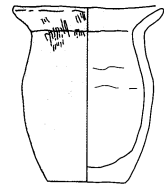

7

SK6415

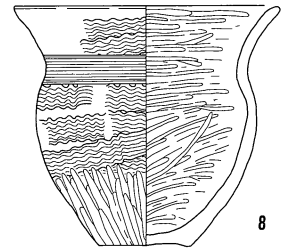

8

SK7075-①

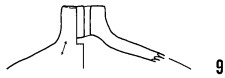

9

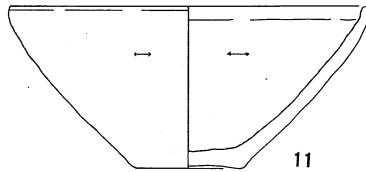

11

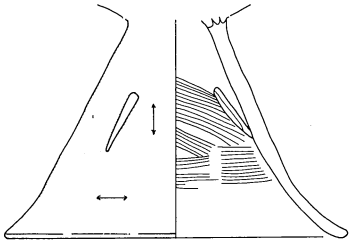

10

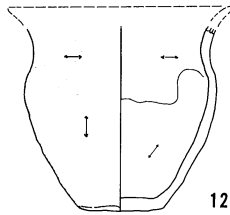

12

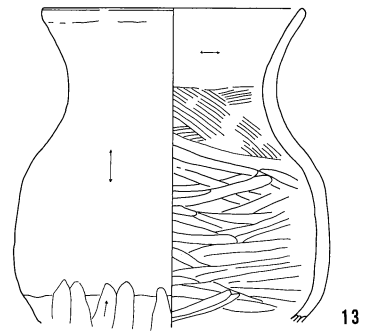

13

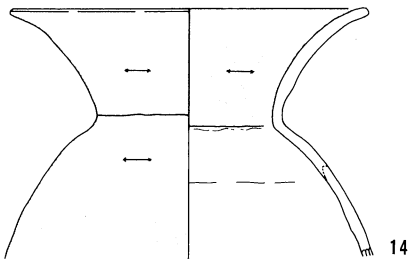

14

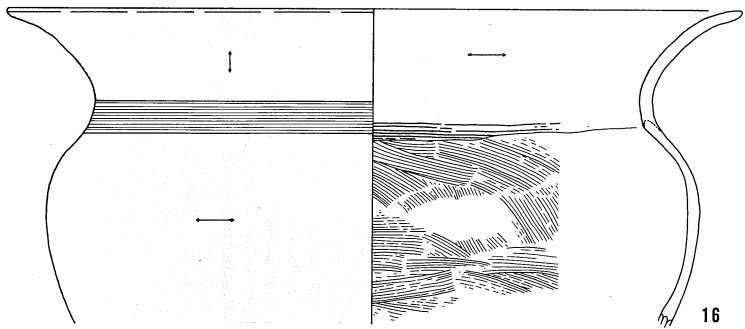

16

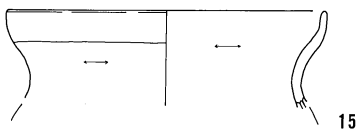

15

0 (1 : 4) 10cm

SK7075-②

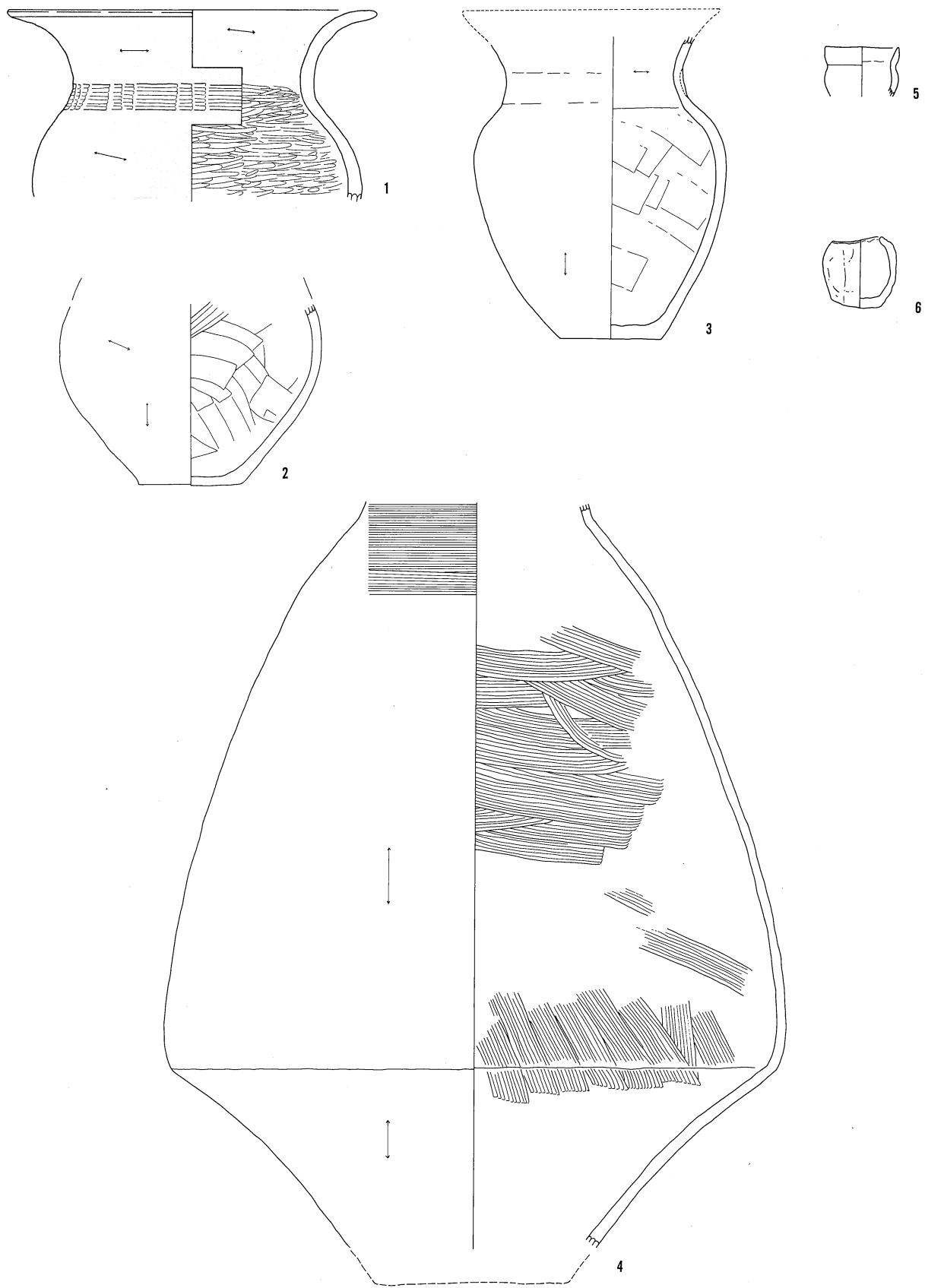

0 (1 : 4) 10cm

SK7075-②

SK7075-③

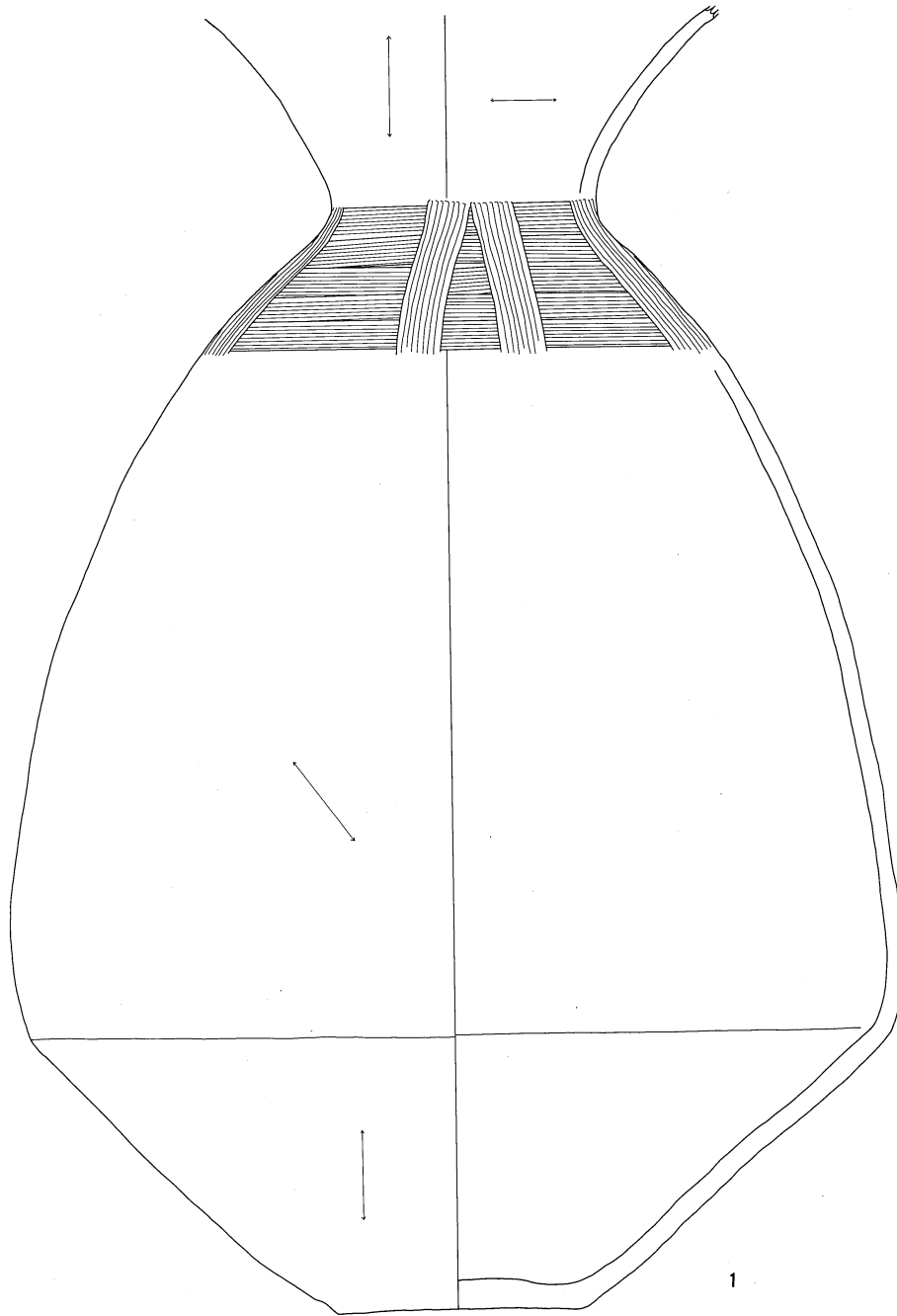

0 (1 : 4) 10cm

SK7075-③

SK7075-④

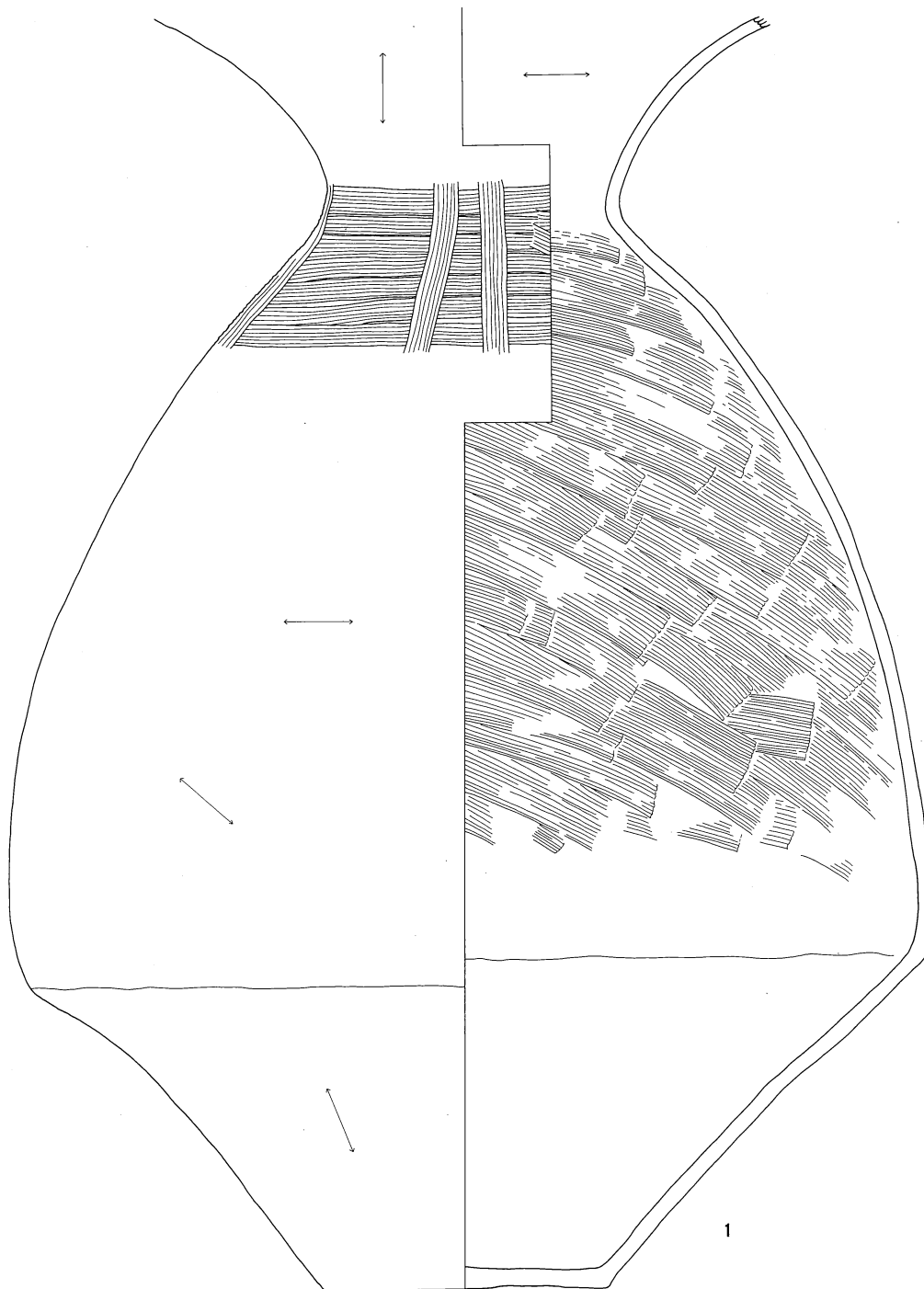

0 (1:4) 10cm

SK7075-④

SK7075-⑤

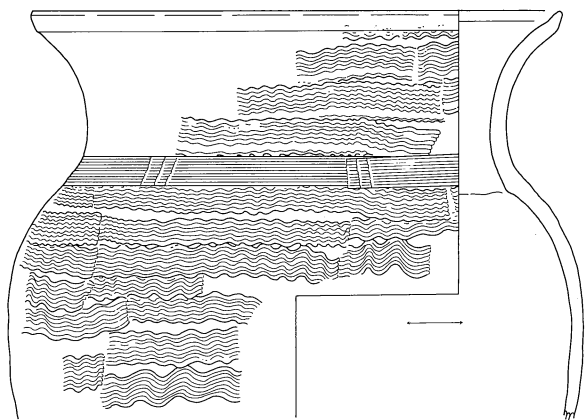

1

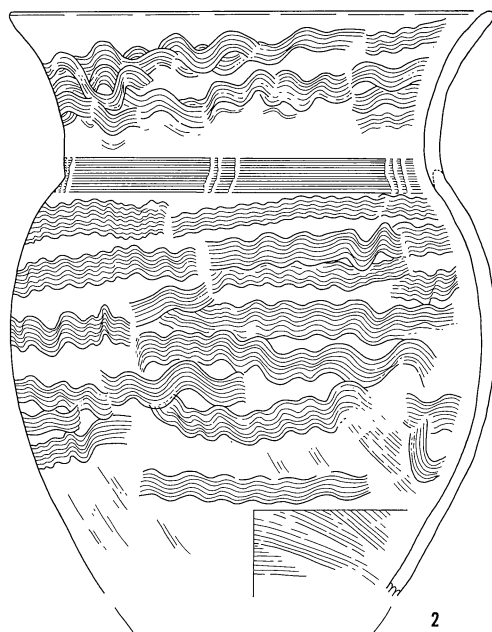

2

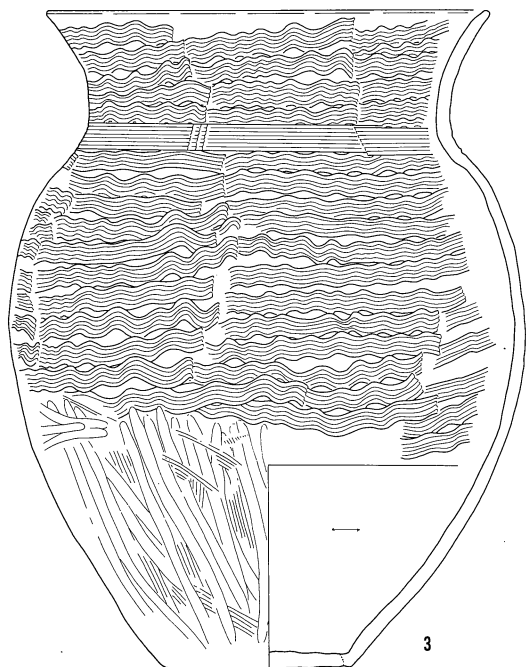

3

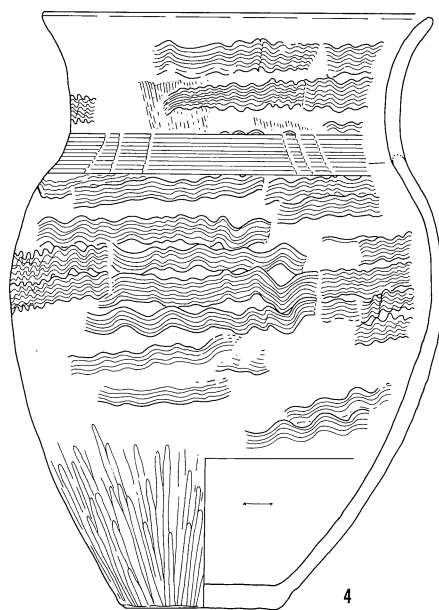

4

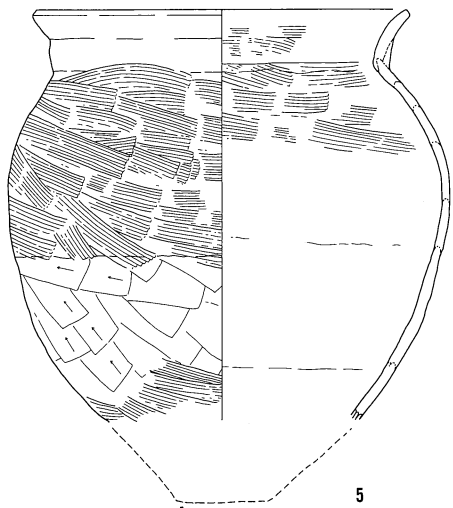

5

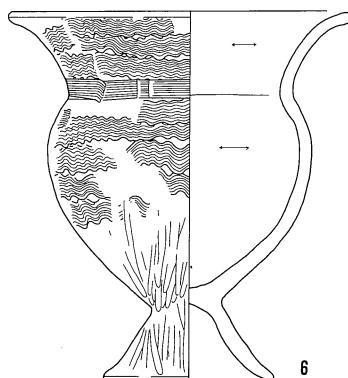

6

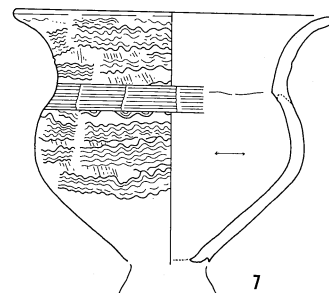

7

0 (1 : 4) 10cm

SK7075-⑤

SK7092

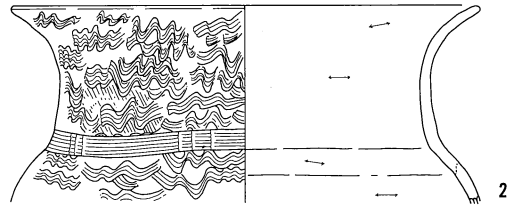
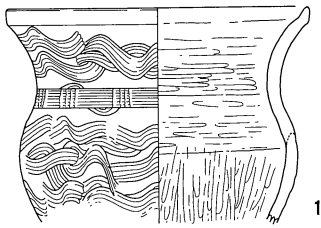

SK7105

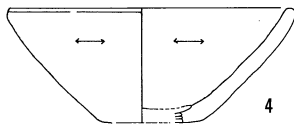
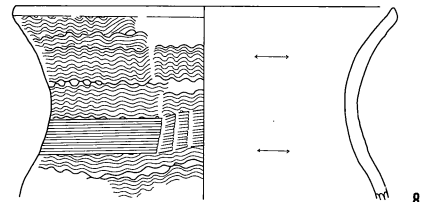
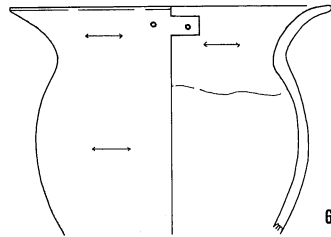
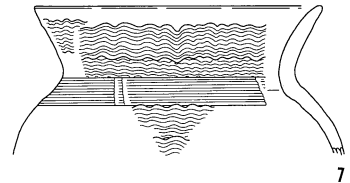
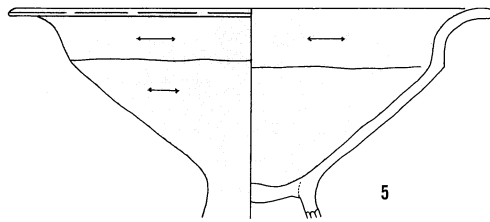
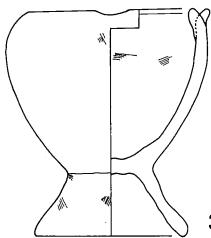
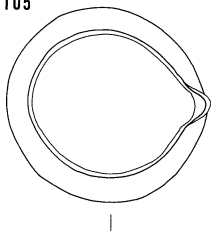

SK7135

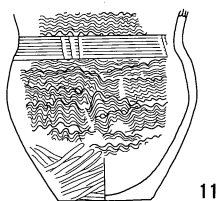
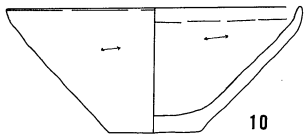
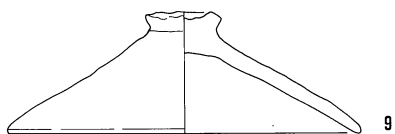

SK7286

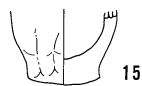
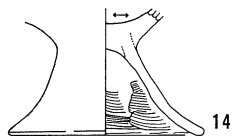
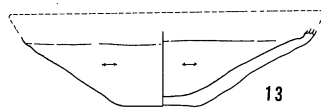
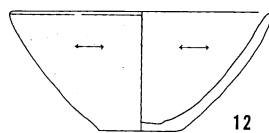

SK7328

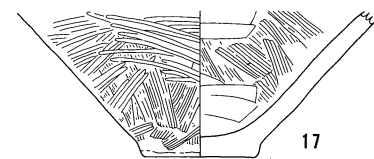
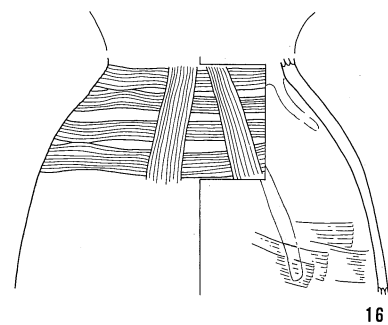

0 (1 : 4) 10cm

SK7170

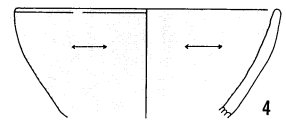
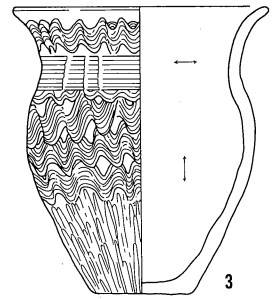
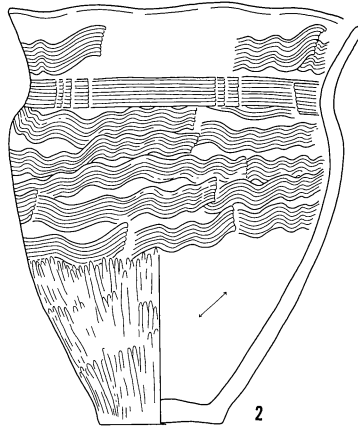
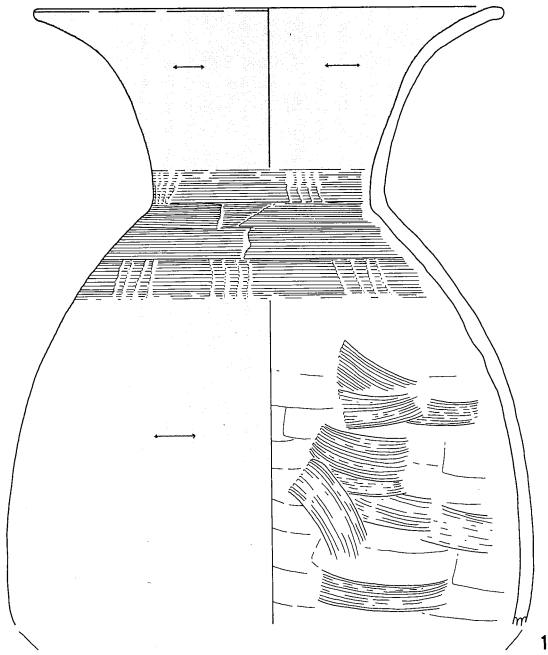

SK7331

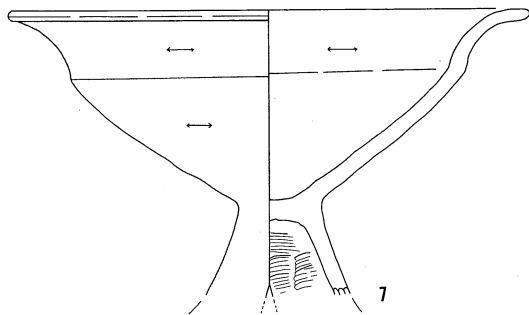
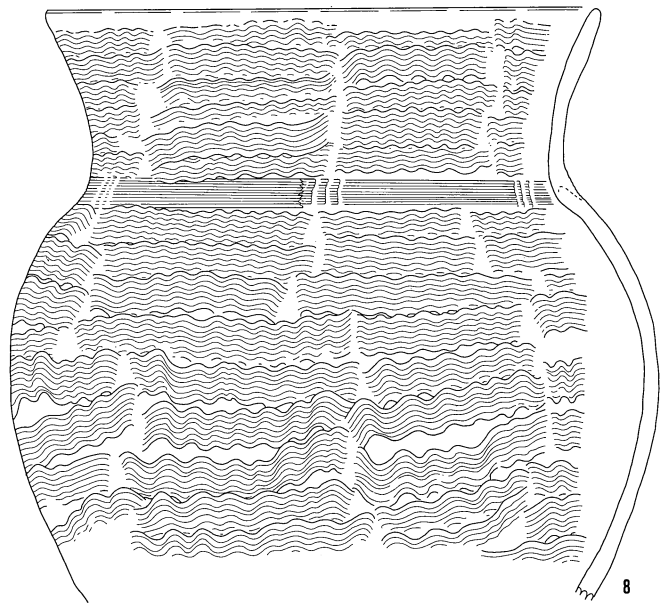
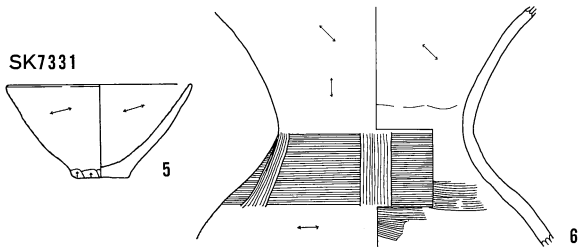

SK7343

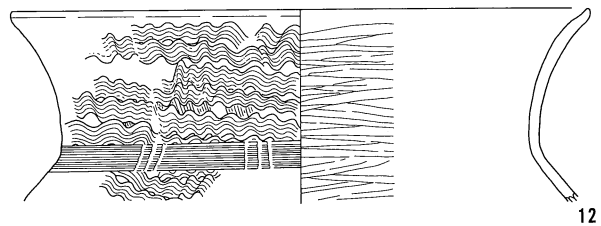
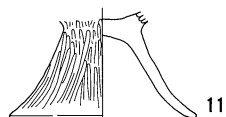
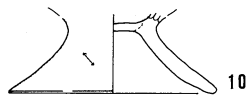
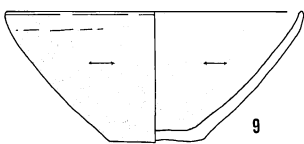

0 (1 : 4) 10cm

SK7359

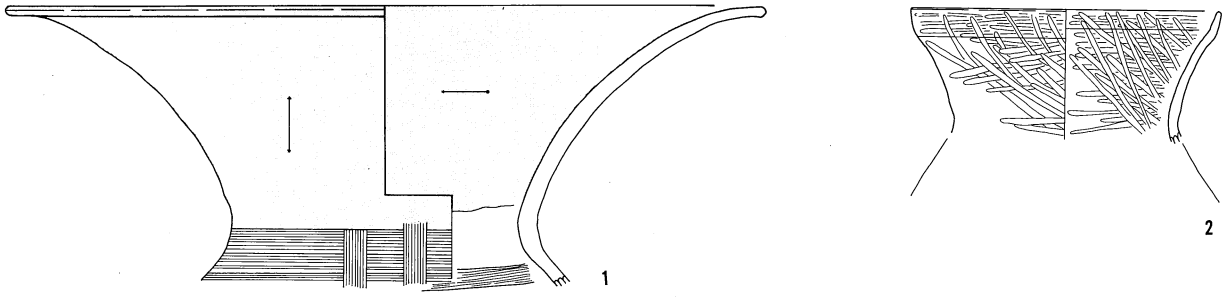

SK7483

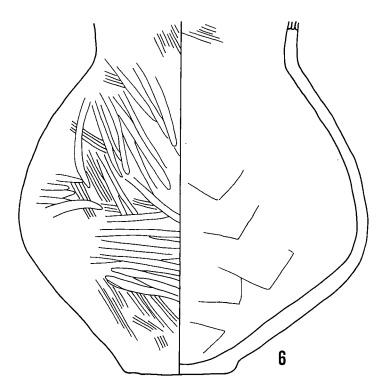
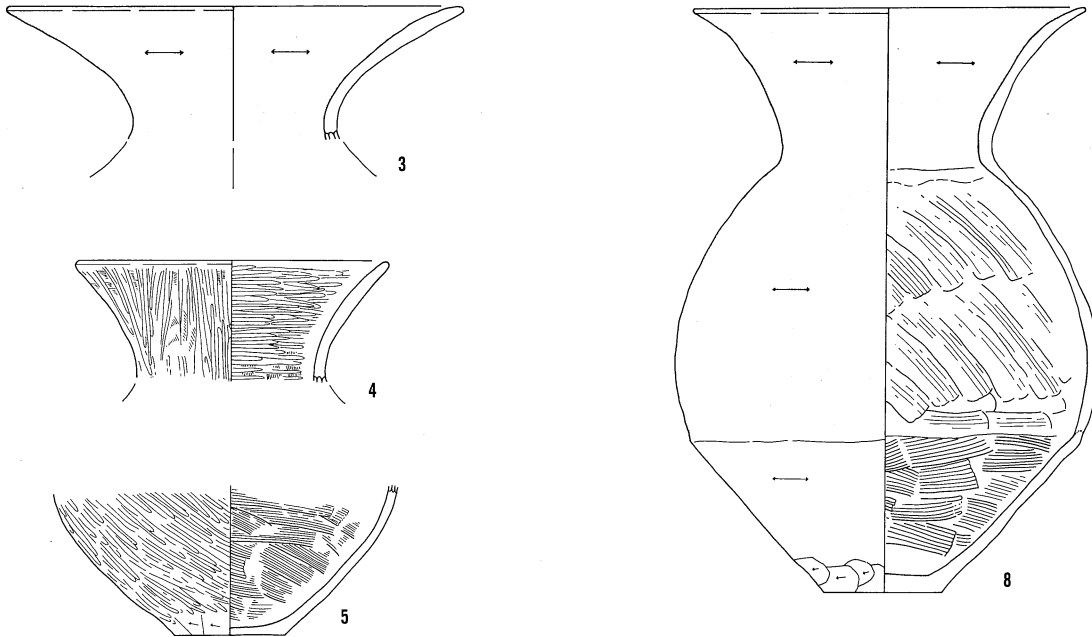

SK7353

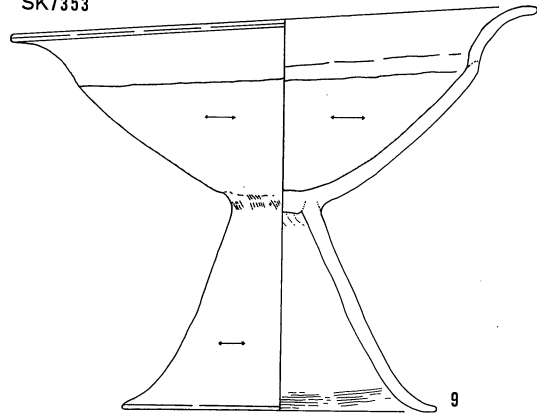

0 (1 : 4) 10cm

SK7362

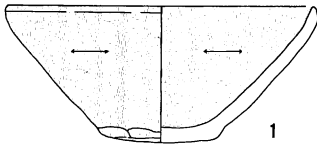

SK7445

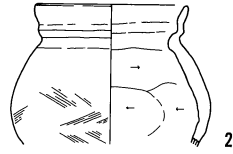

SK7470

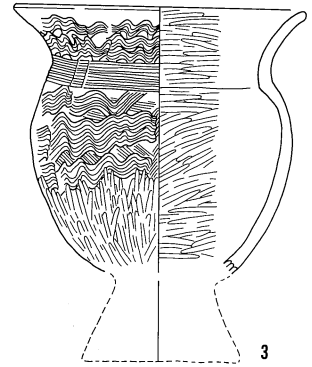

SK8152

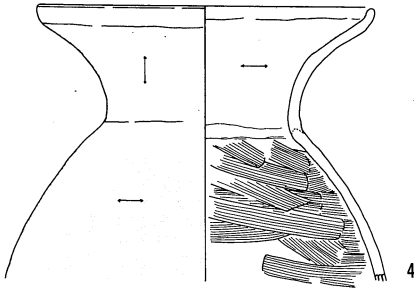

SK8320

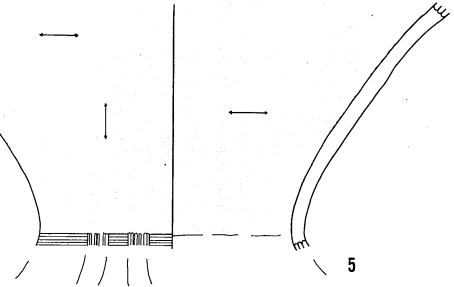

SK8222

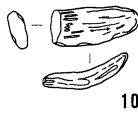
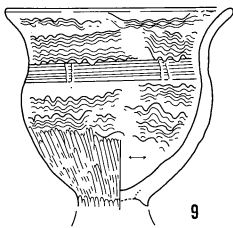
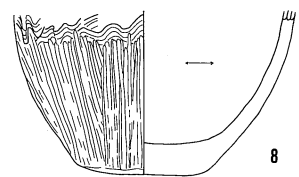
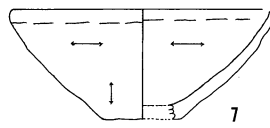
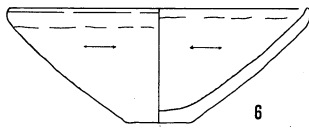

0 (1 : 4) 10cm

SK8476

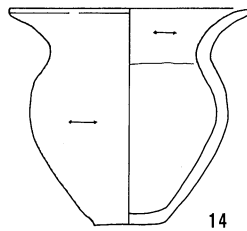
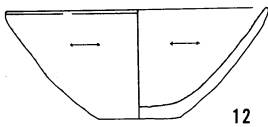

SK8488

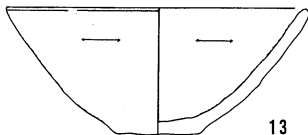
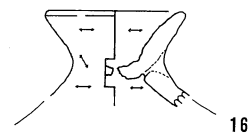

SK8551



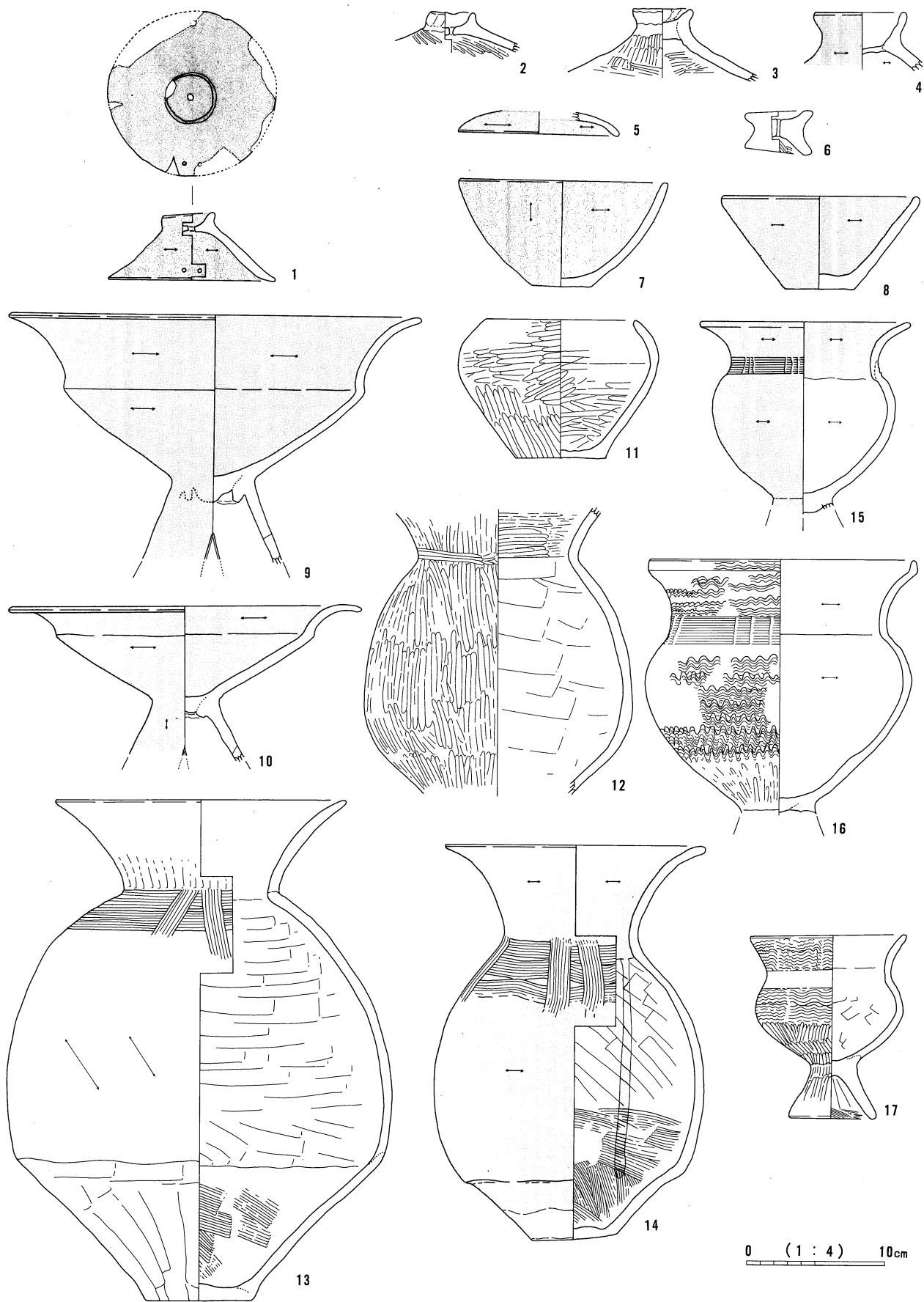

0 (1 : 4) 10cm

SB6001

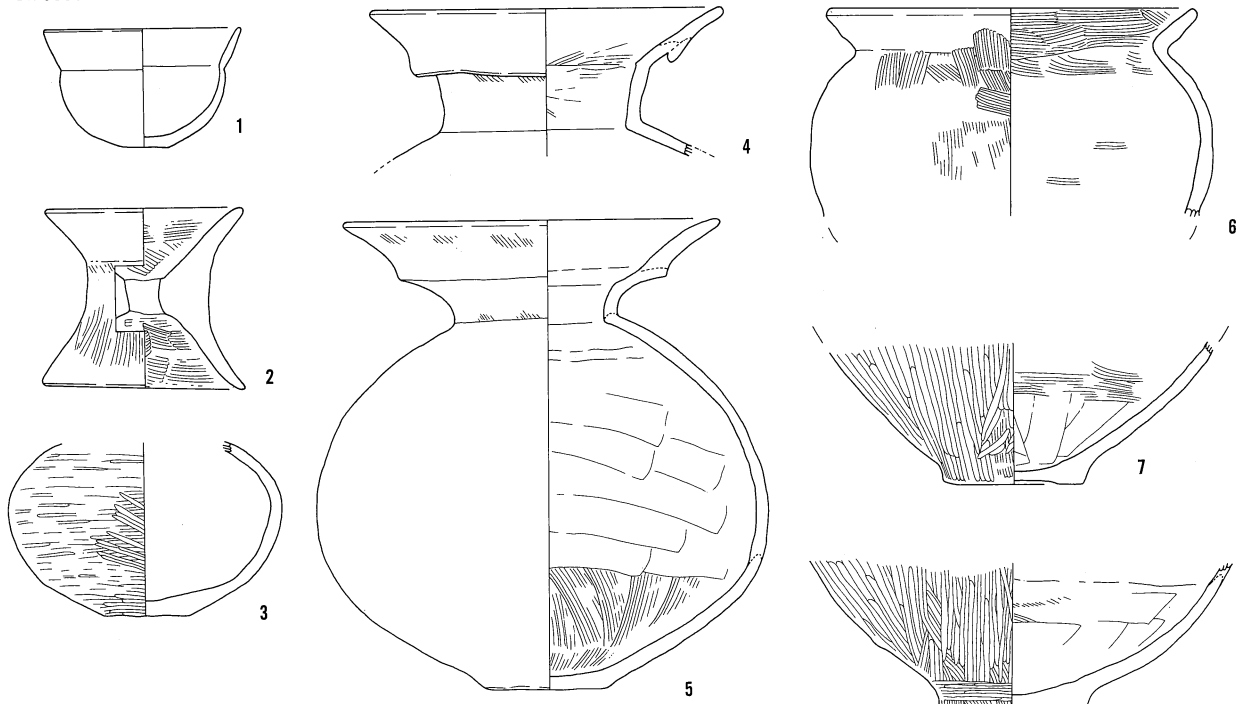

SB6004

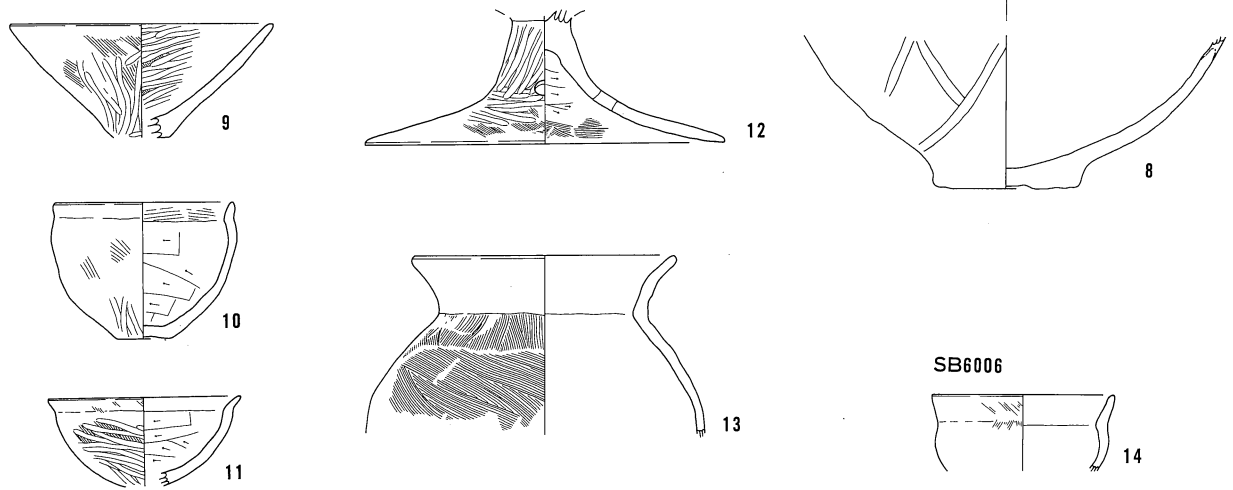

SB6006

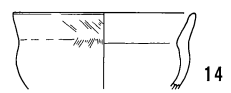

SB6007

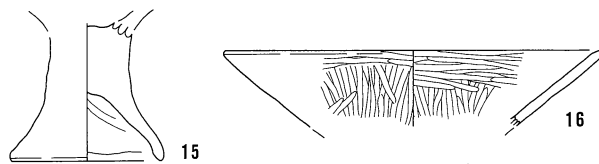

SB6011

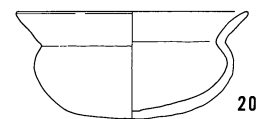

SB6009

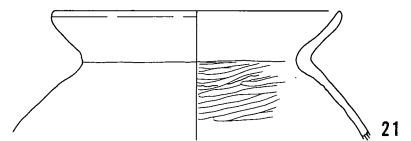
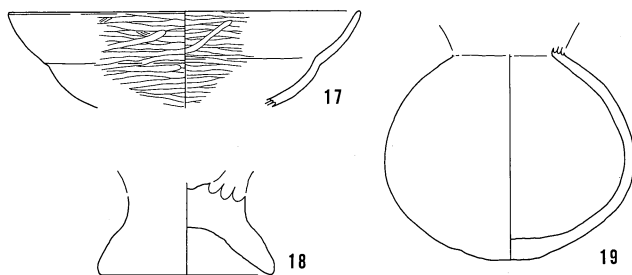

0 (1 : 4) 10cm

SB6016

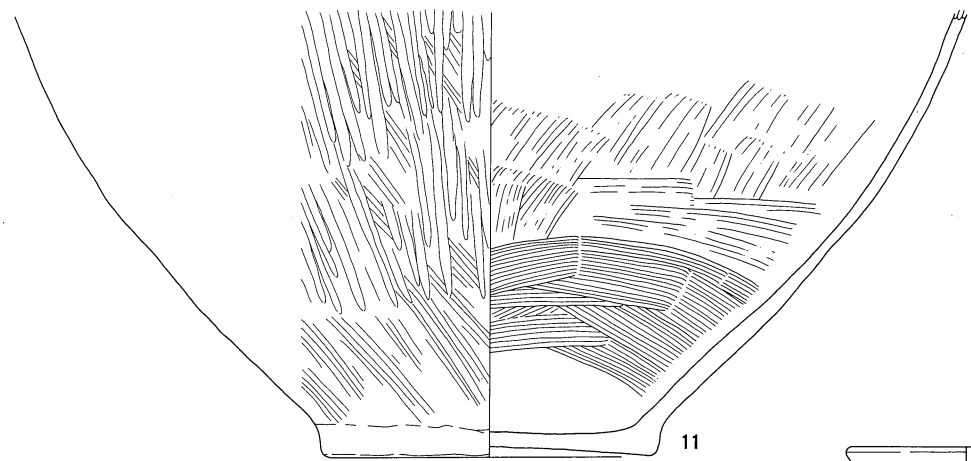
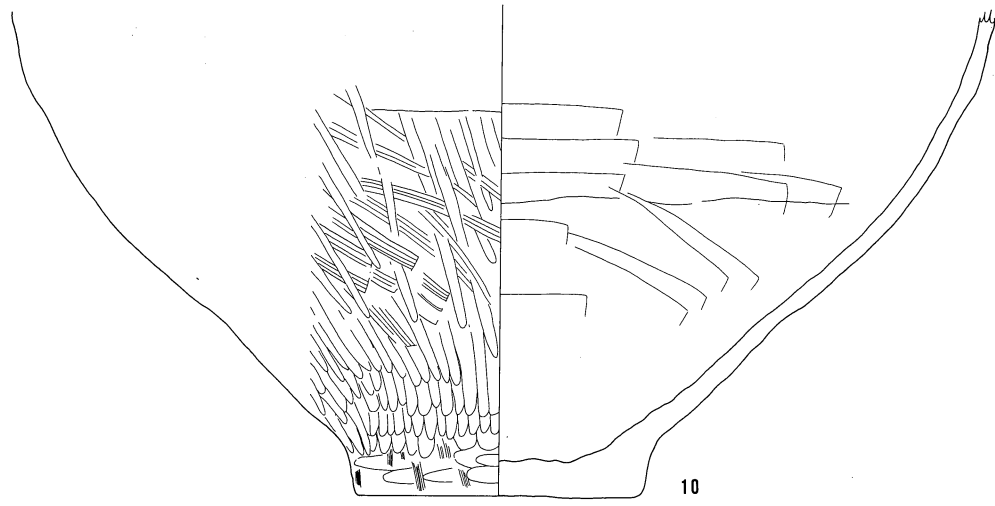
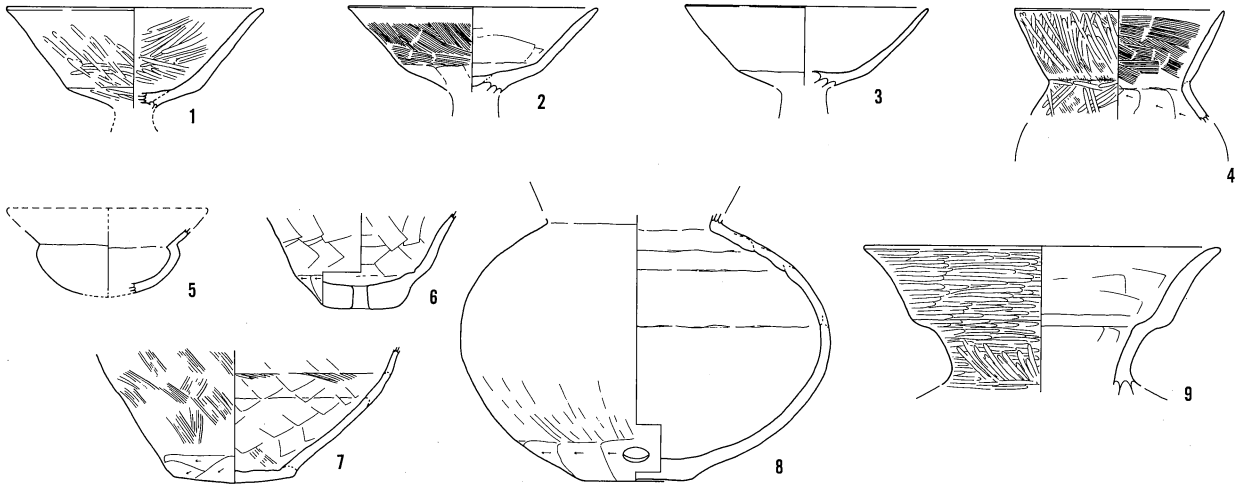

SB7042

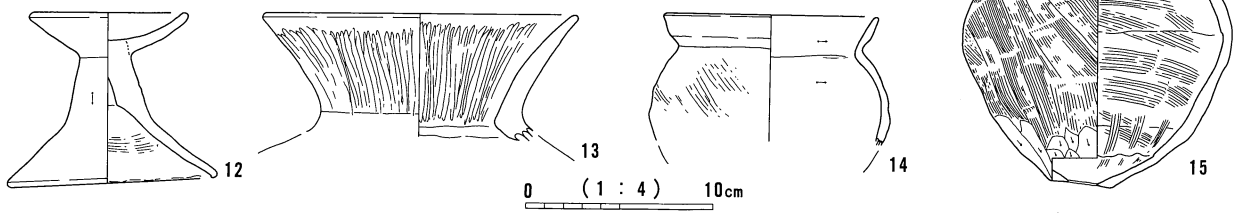

SB6013

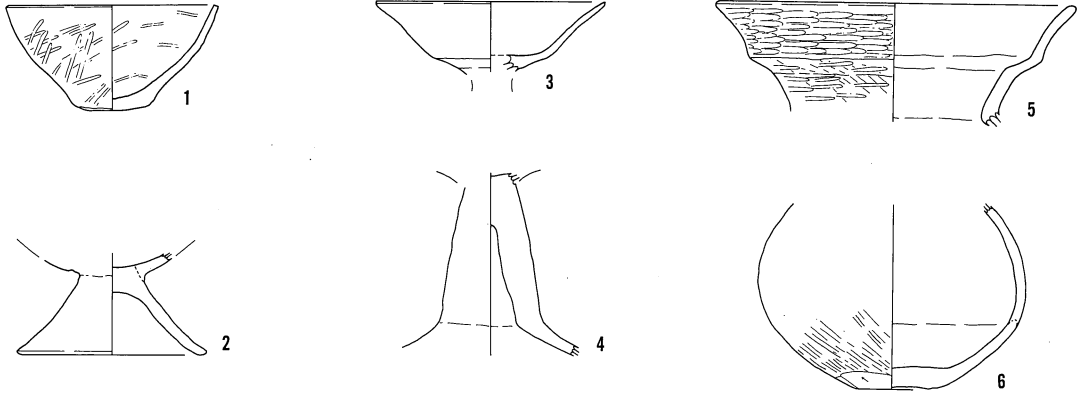

SB6018

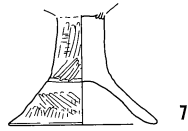

SB6019

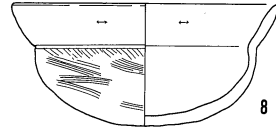

SB6025

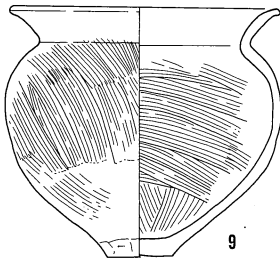

SB6027

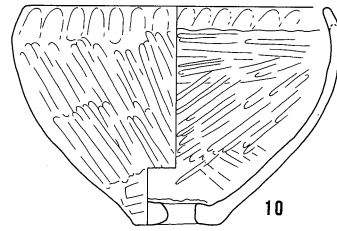

SB6029

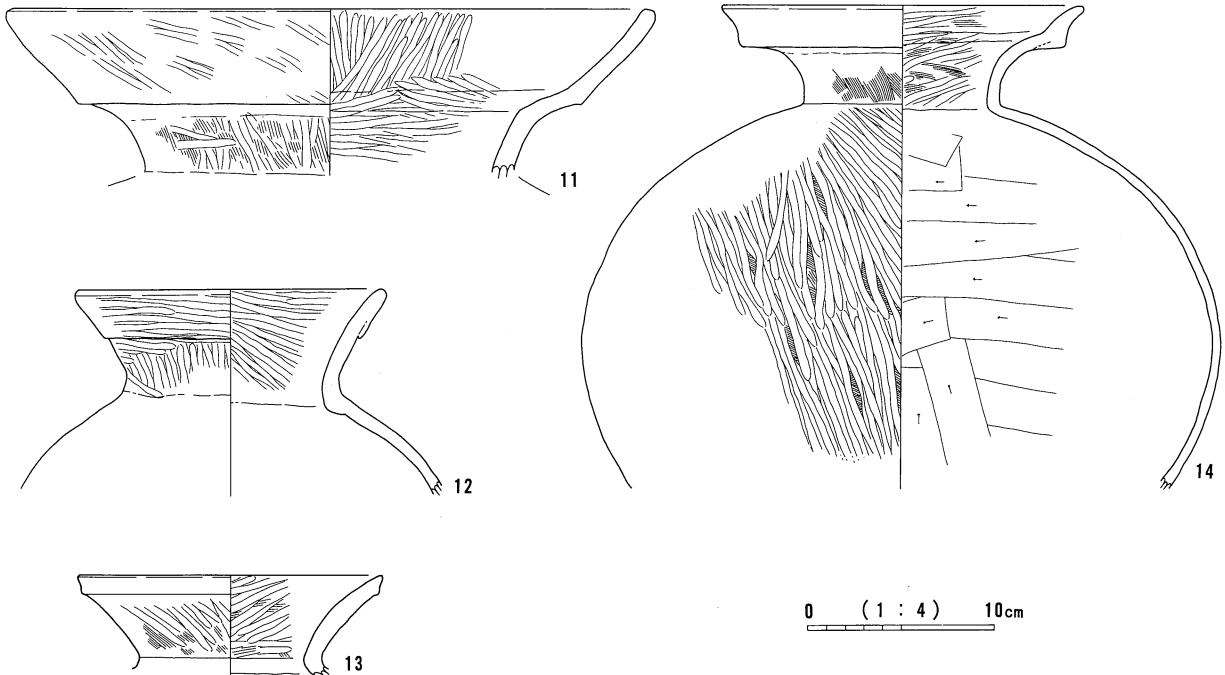

0 (1 : 4) 10cm

SB7080

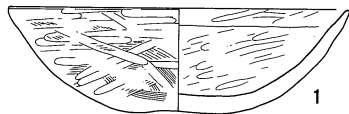

1

SB7129

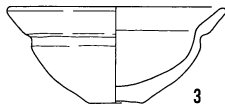

3

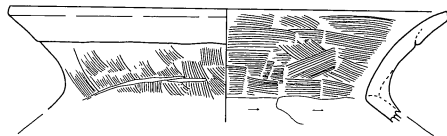

7

SB7195

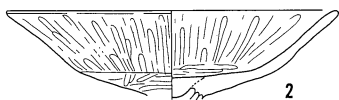

2

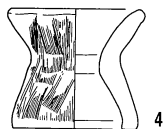

4

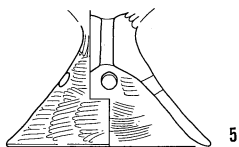

5



6

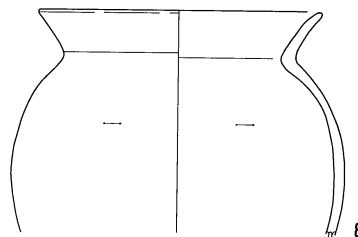

8

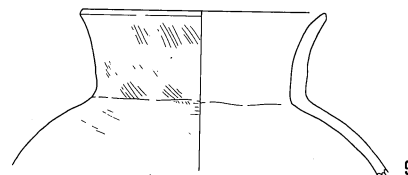

9

SB7172

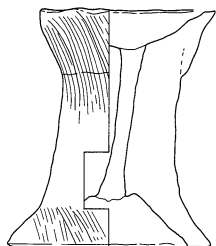

10

SB7184



11



12

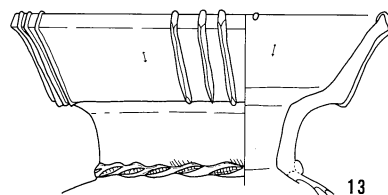

13

SB7193

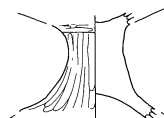

14

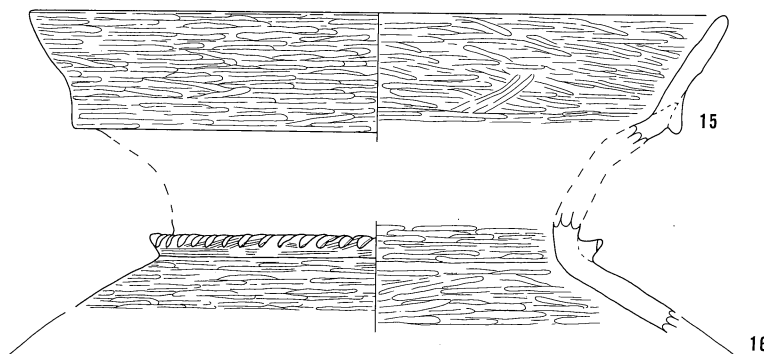

15

16

SB7244

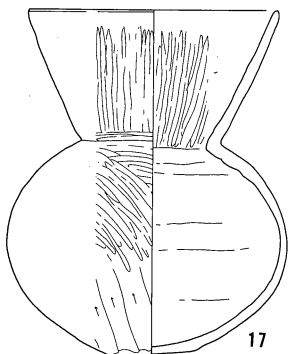

17

SB7188

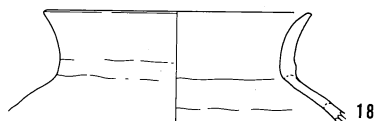

18

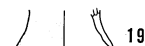

19

0 (1 : 4) 10cm

SB7213

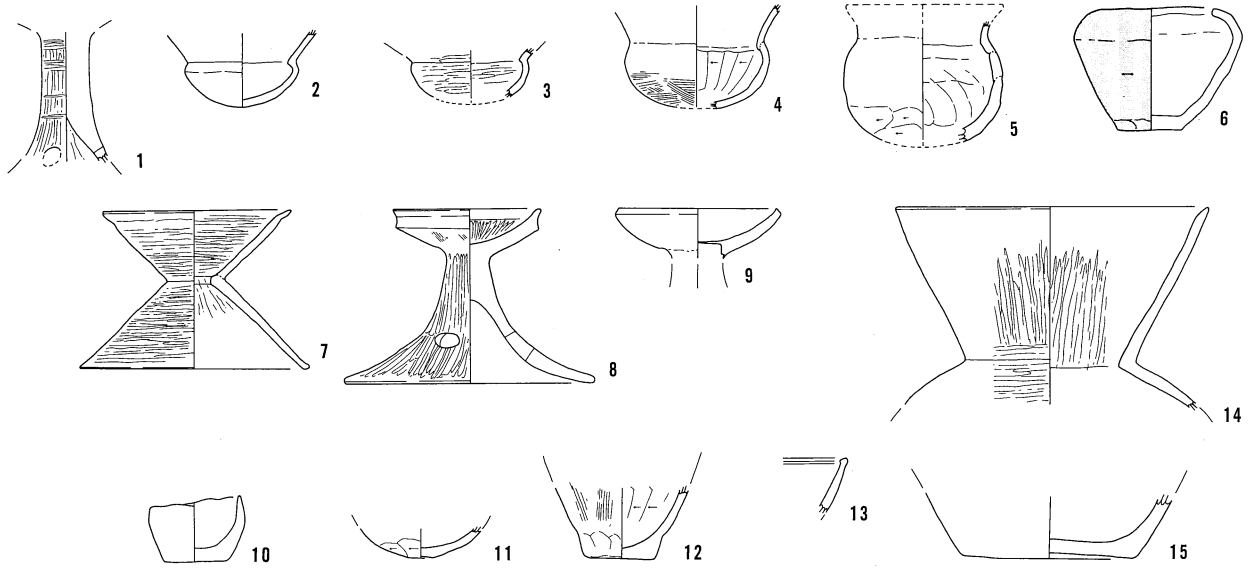

SB7228

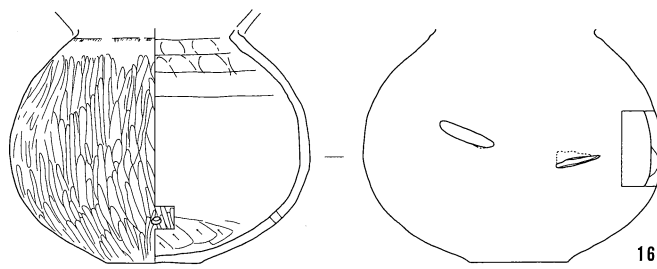

SB7246-①

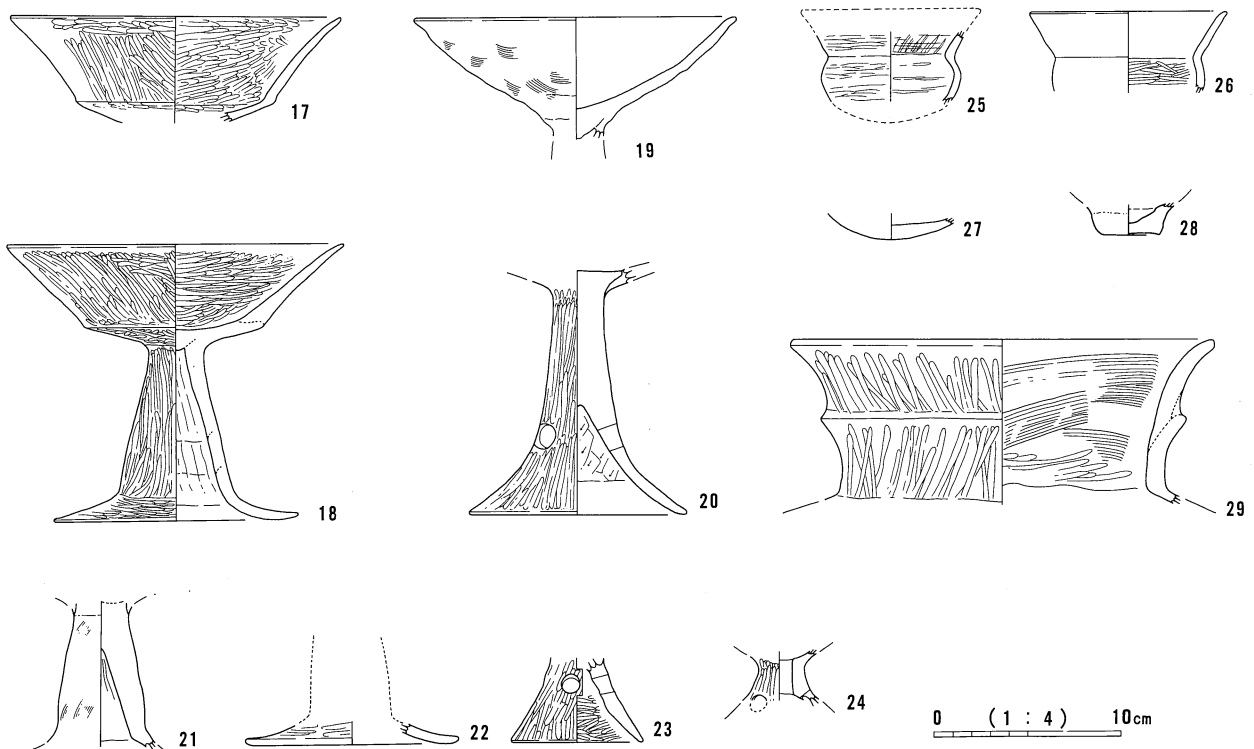

0 (1 : 4) 10cm

SB7246-②

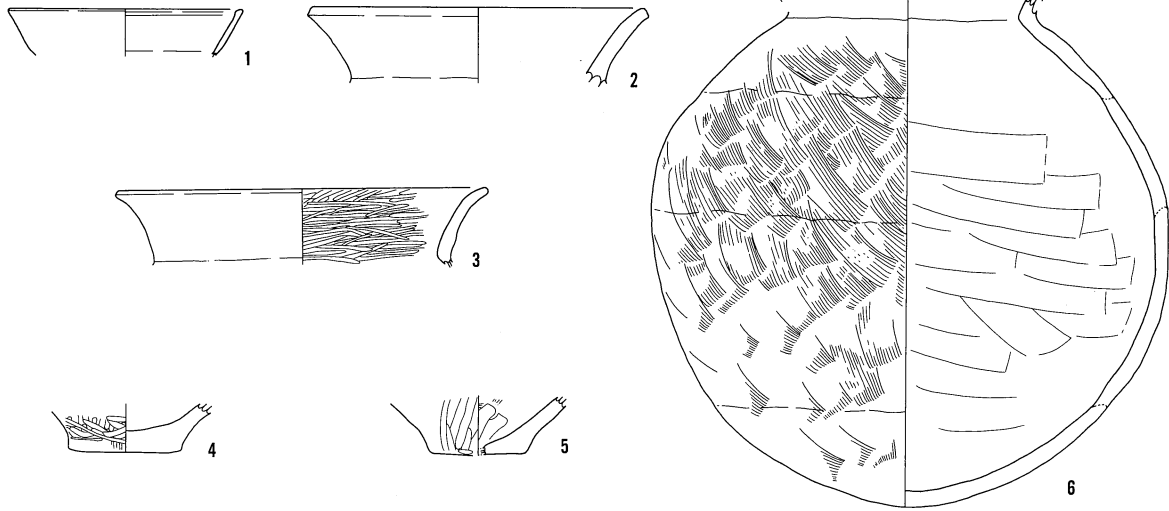

SB7250

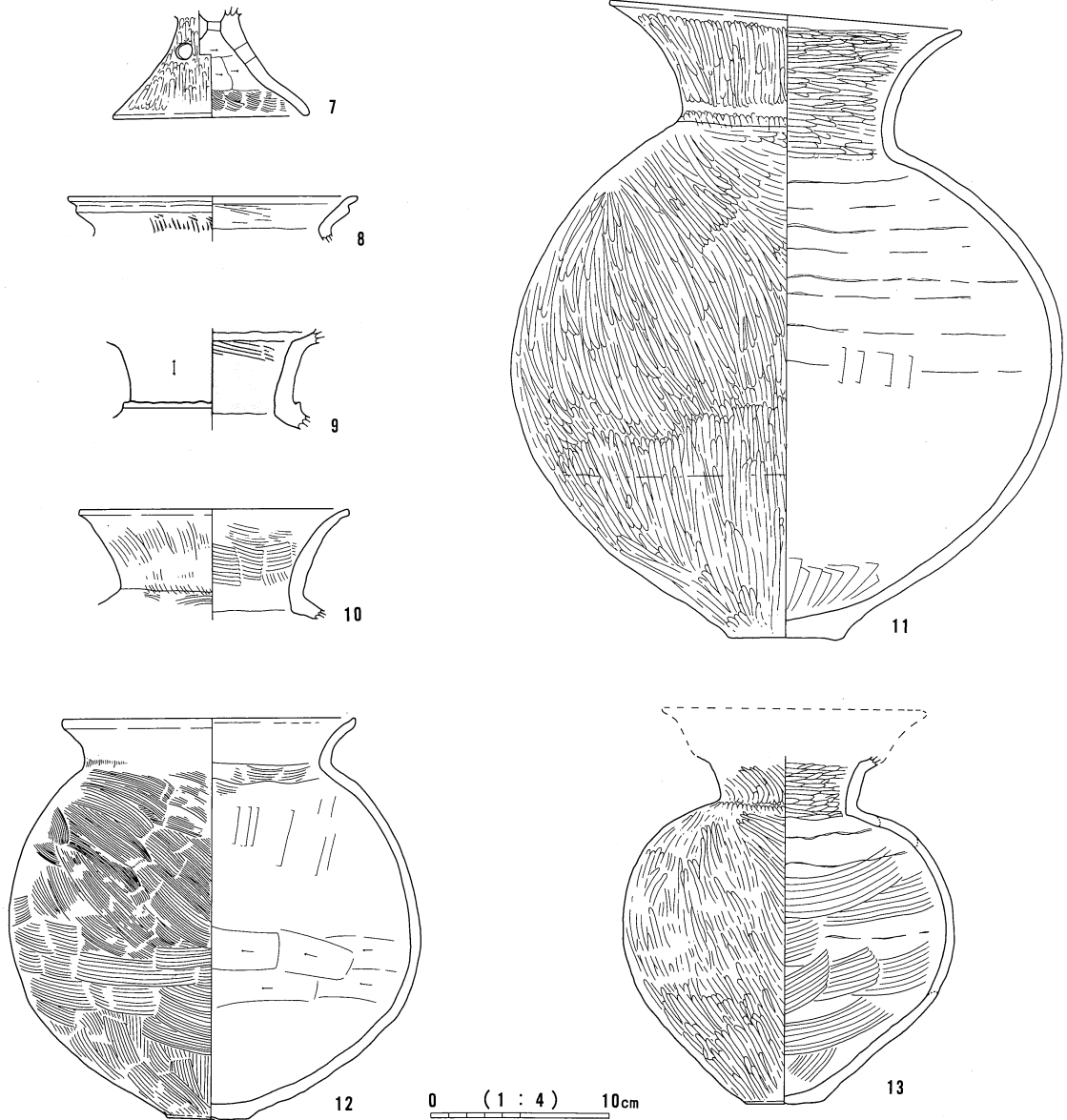

SB7254-①

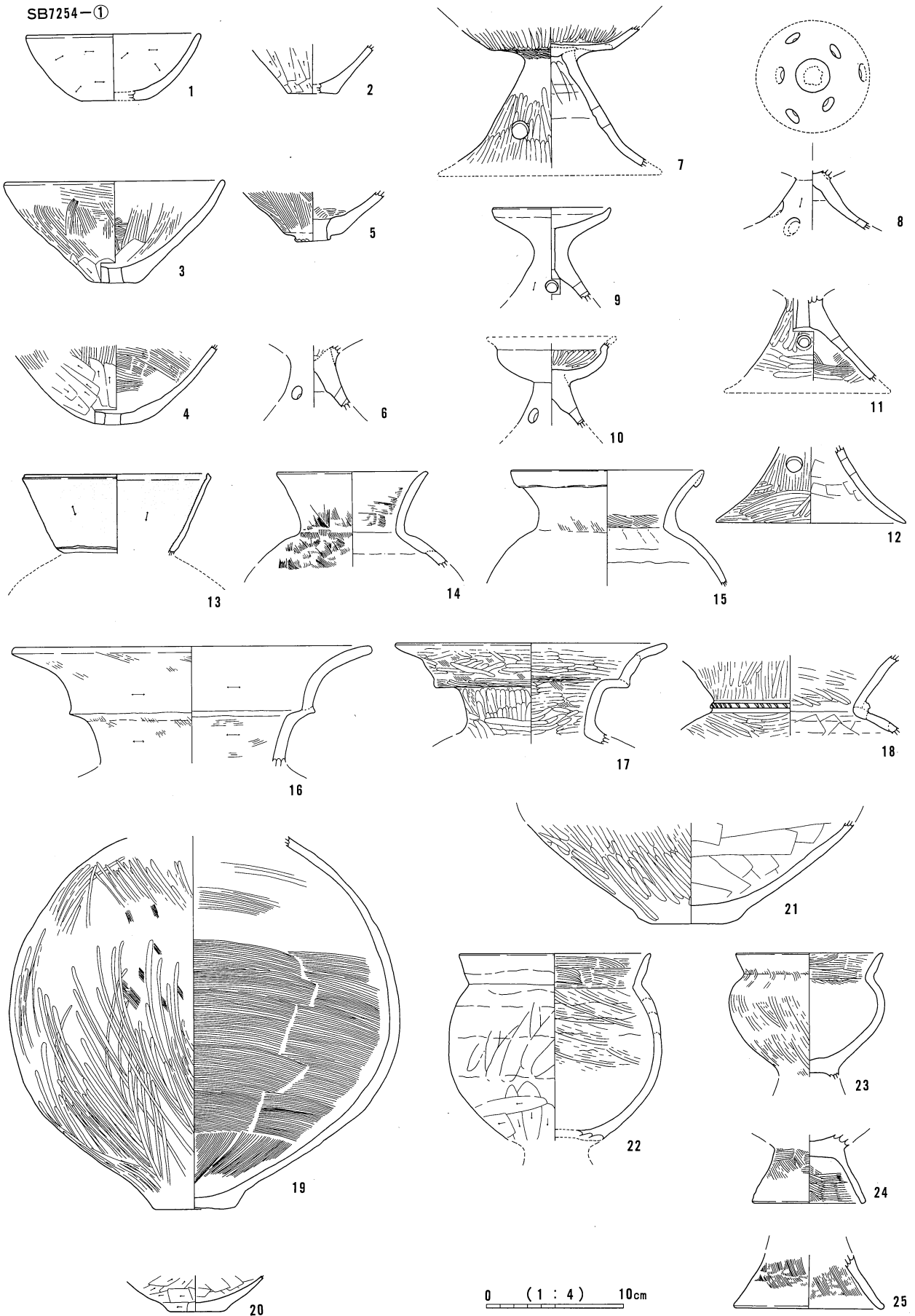

SB7254-①

SB7254-②

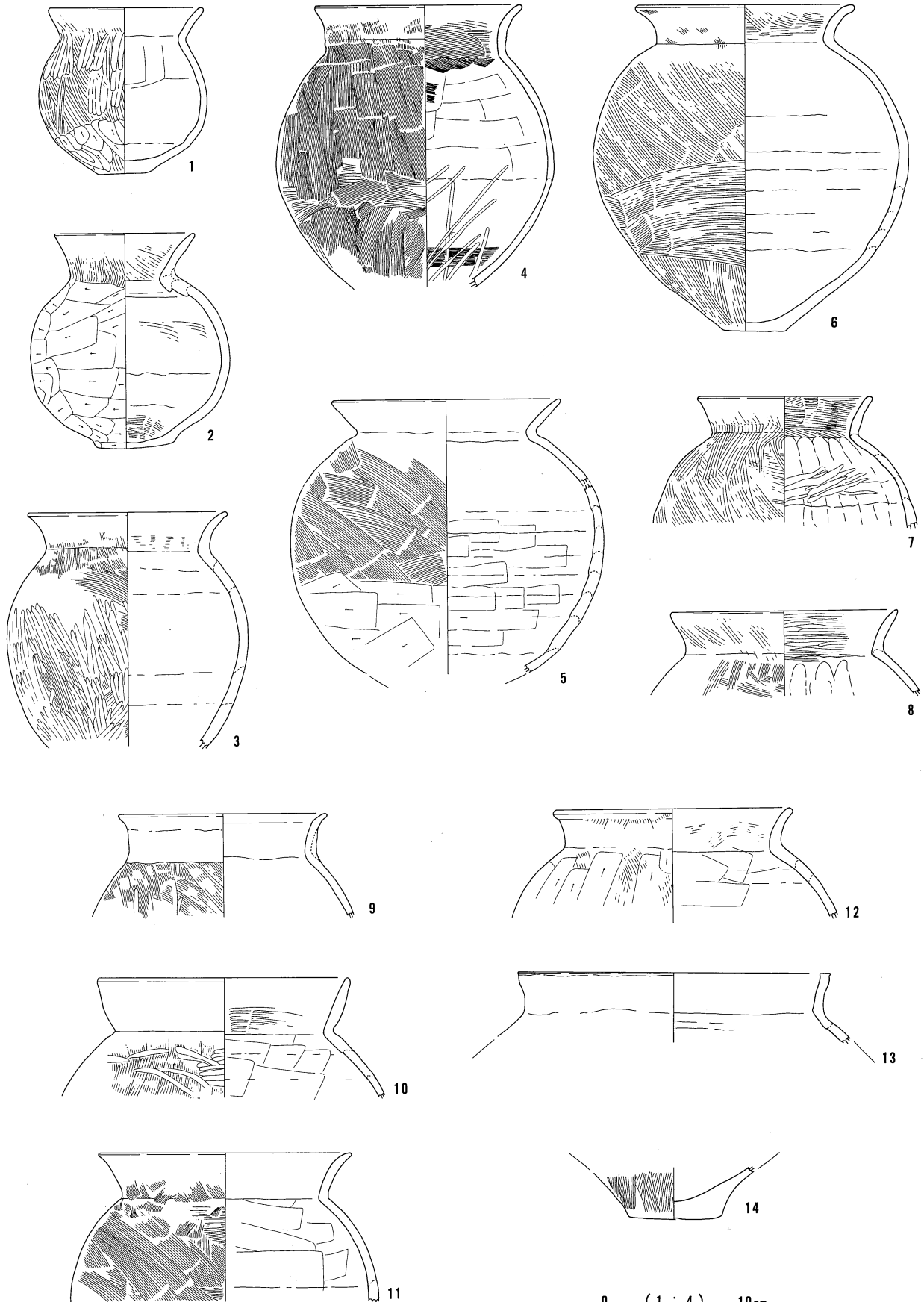

SB7254-②

SB7255

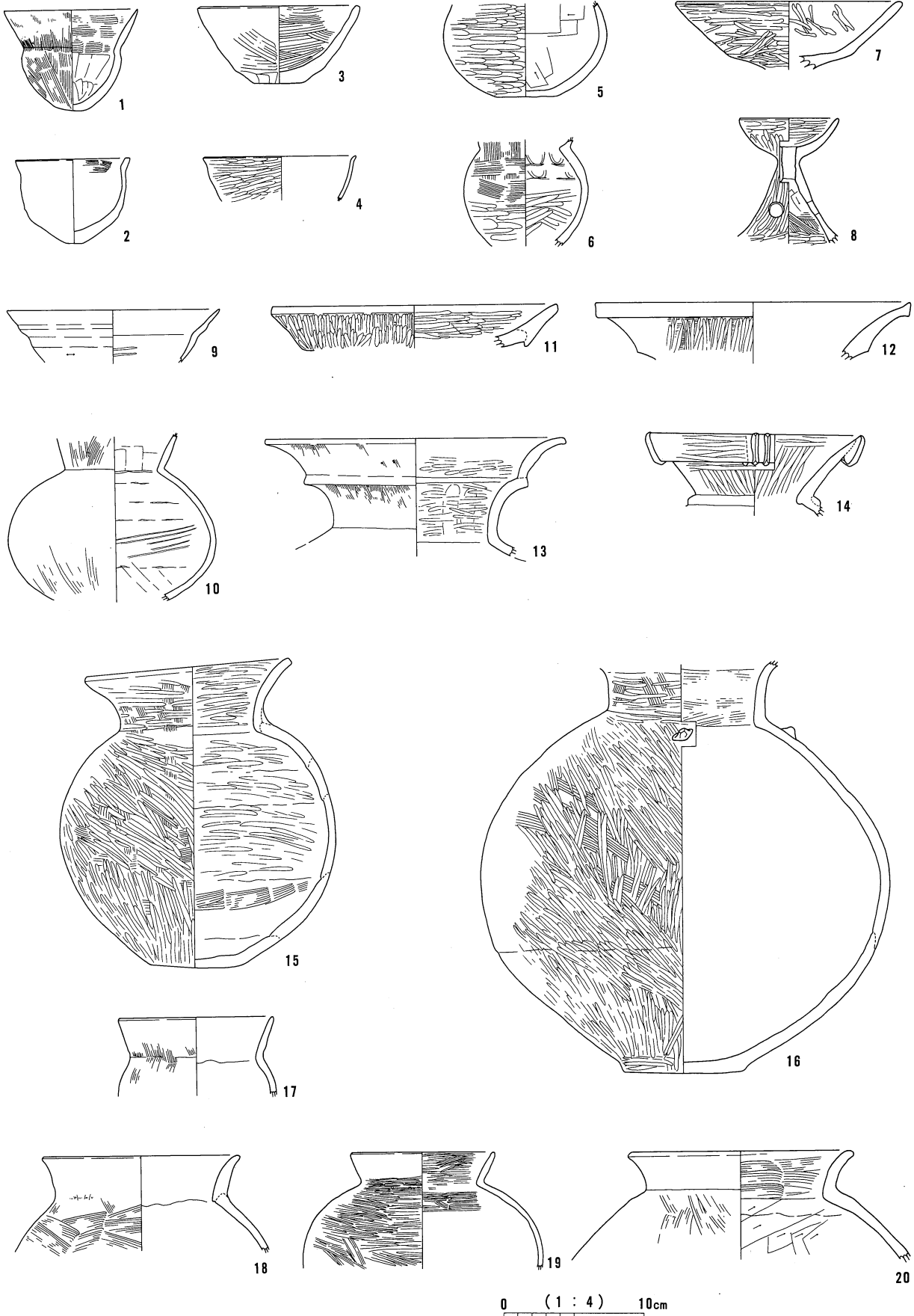

SB7255

SB7256-①

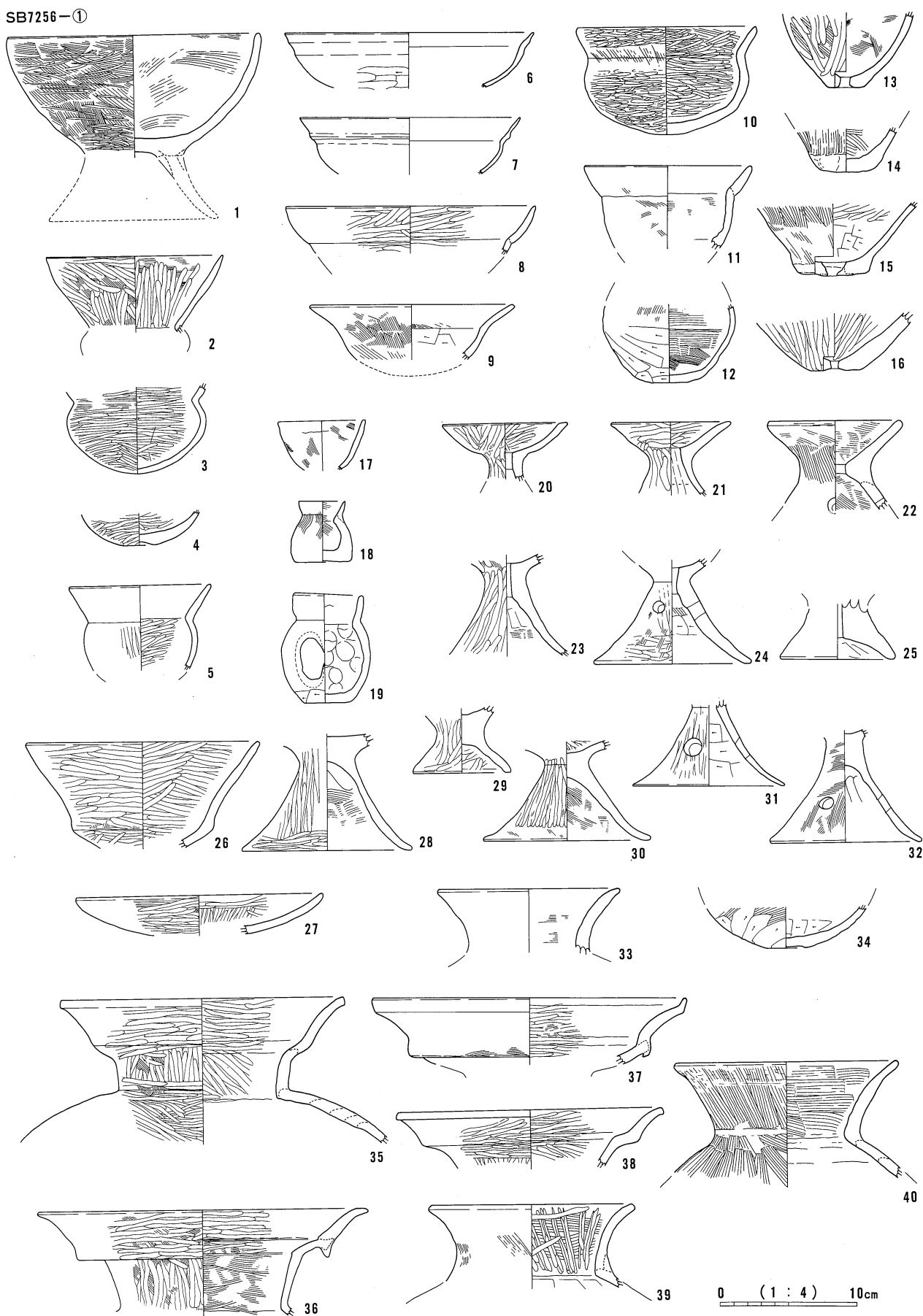

SB7256-①

SB7256-②

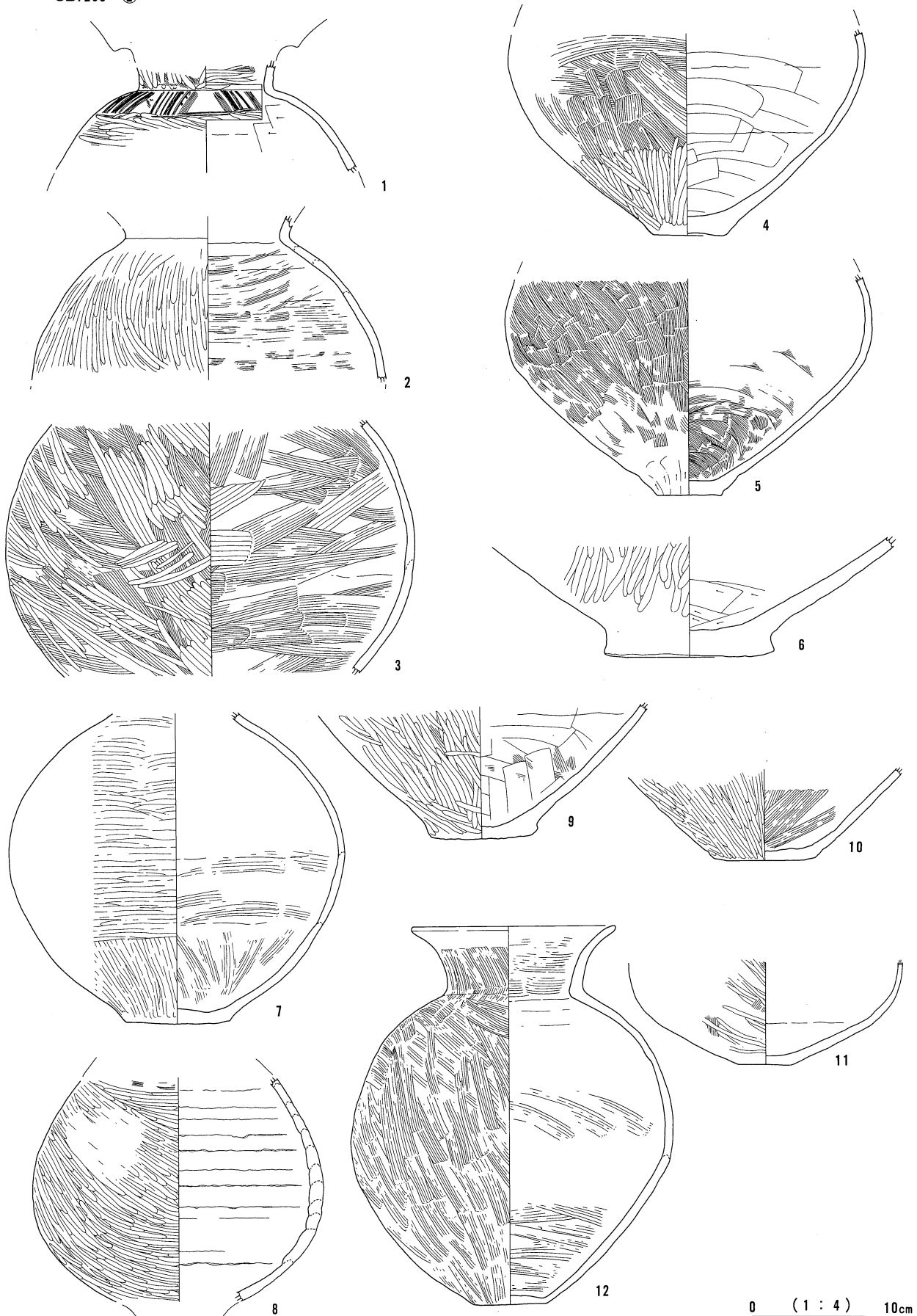

0 (1:4) 10cm

SB7256-②

SB7256-③

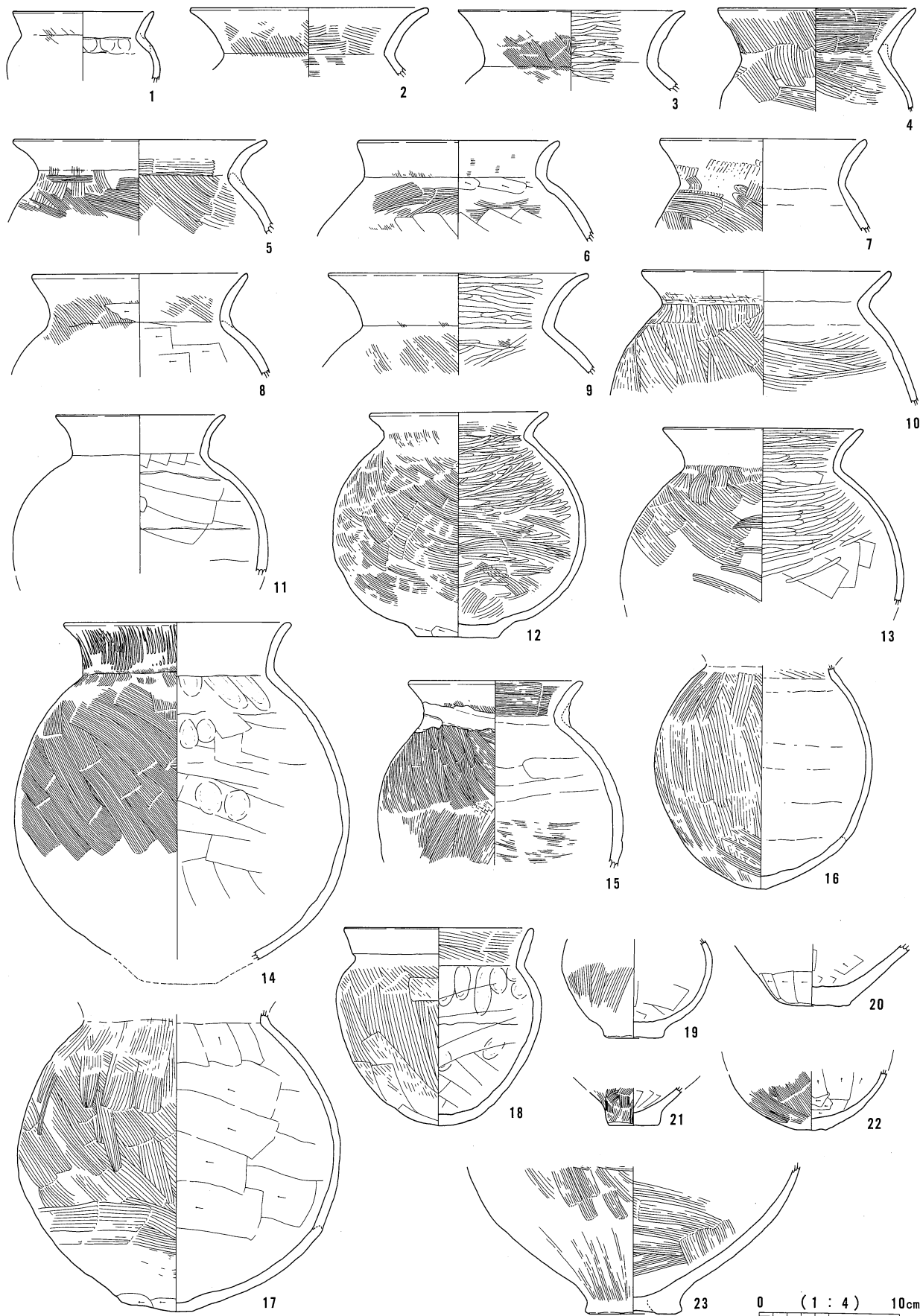

SB7256-③

SB7256-④

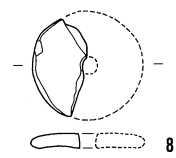
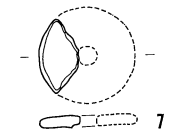
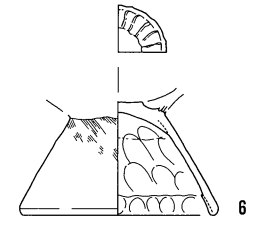
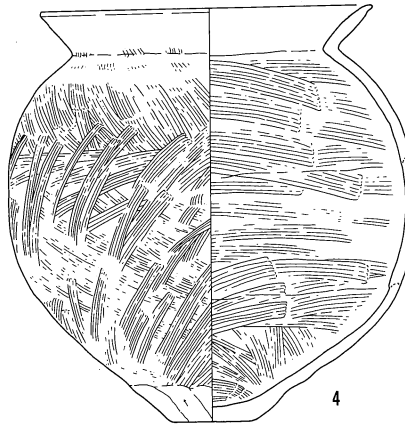
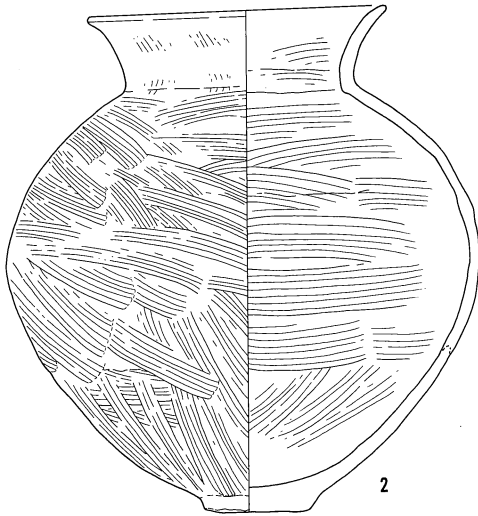
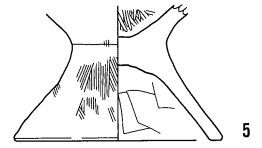
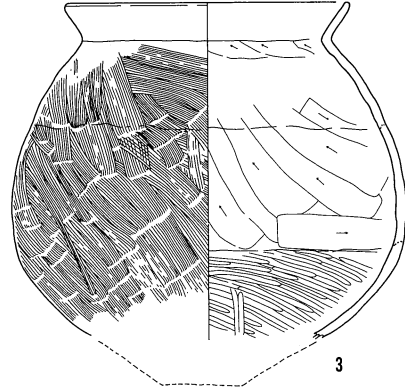
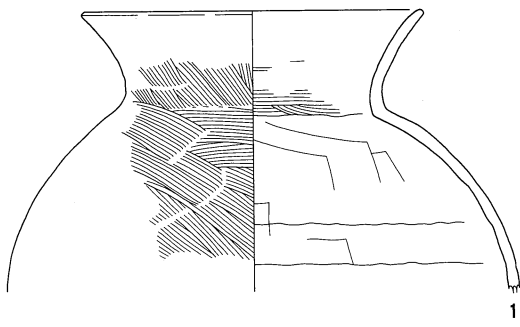

SB7257

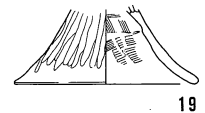
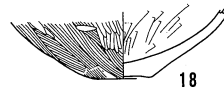
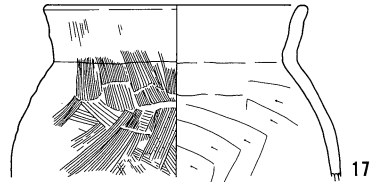
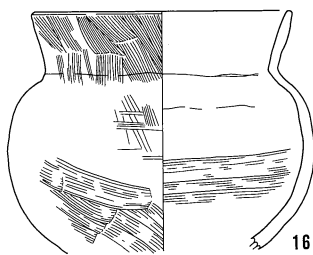
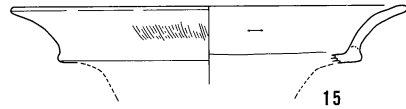
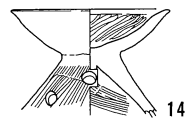
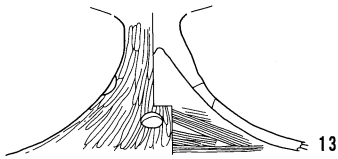
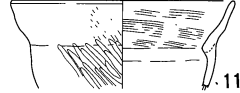
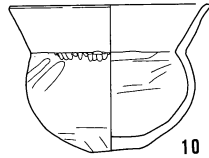
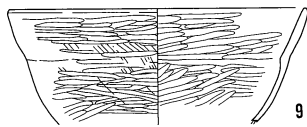

SB7259

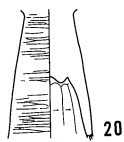

SB7268

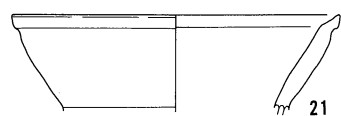

0 (1:4) 10cm

SB7283



SB7311

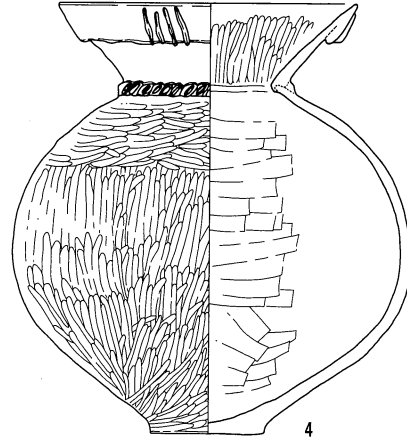

SB7344

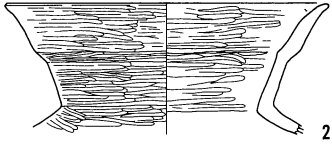

SB7346

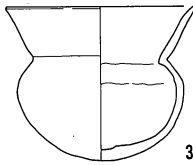

SB7345

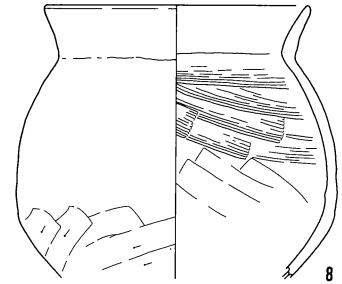
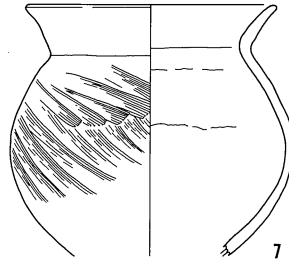
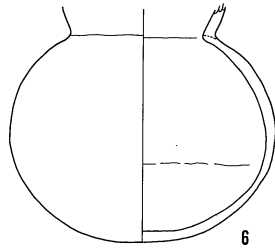
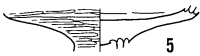

SB7372

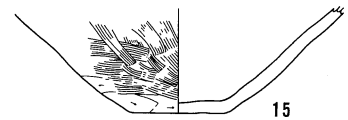
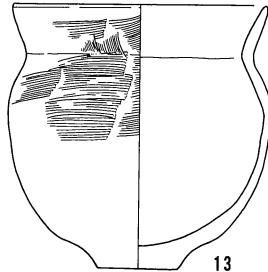
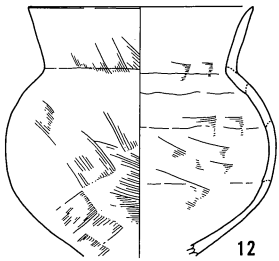
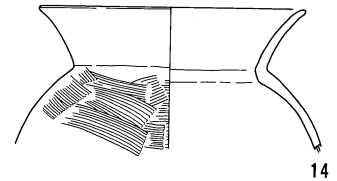
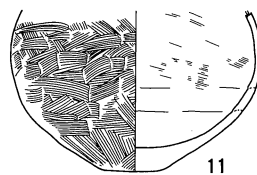
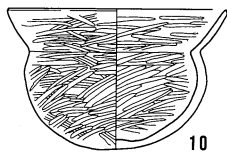
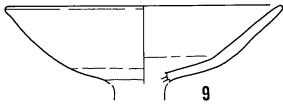

SB7373

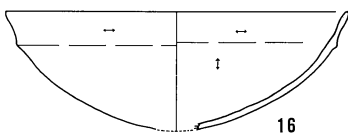

SB7383



SB7386

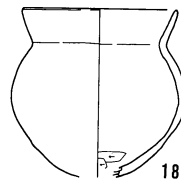

SB7394

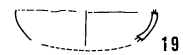

0 (1 : 4) 10cm

SB7381

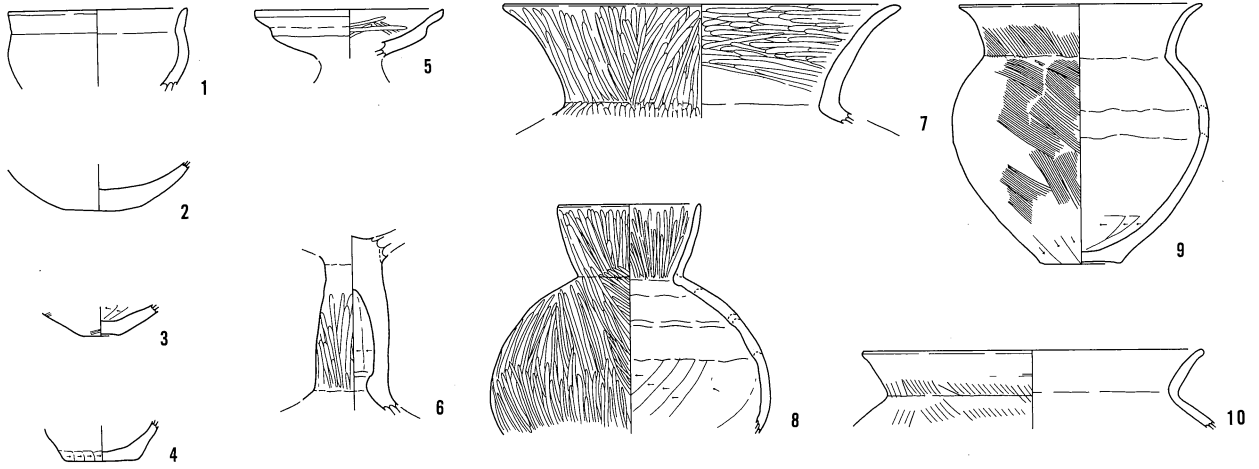

SB7401

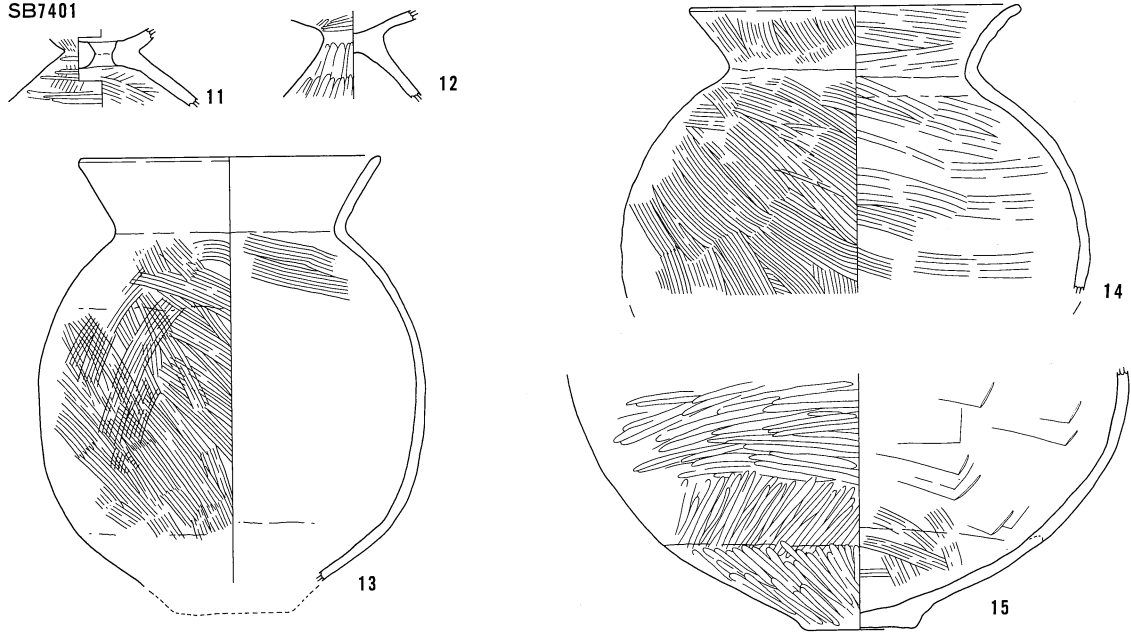

SB7420

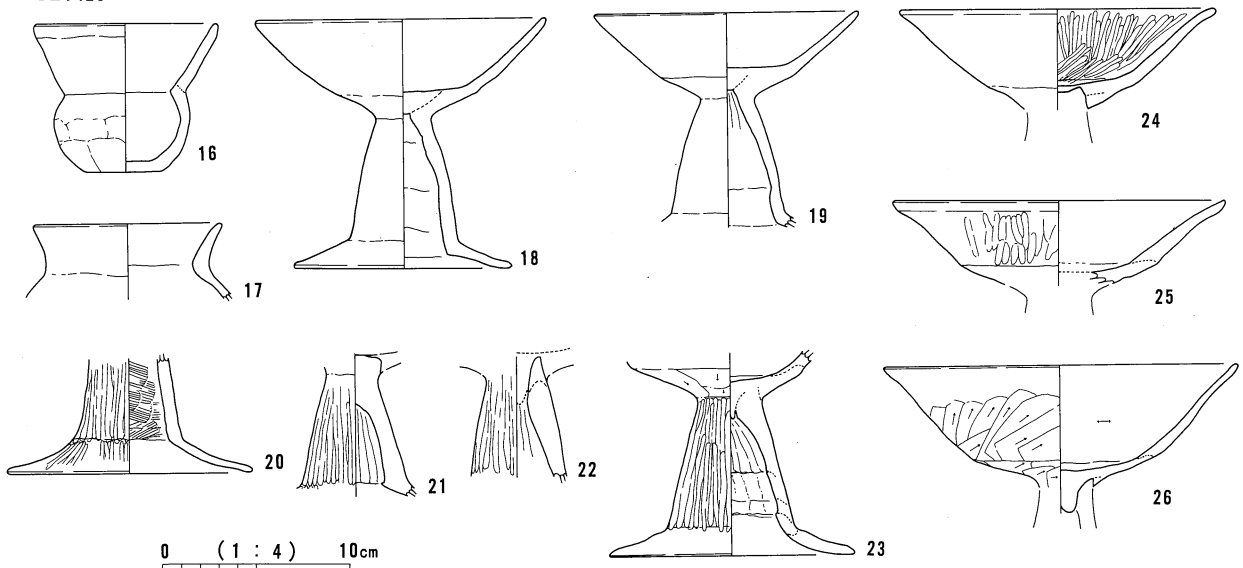

SB7418

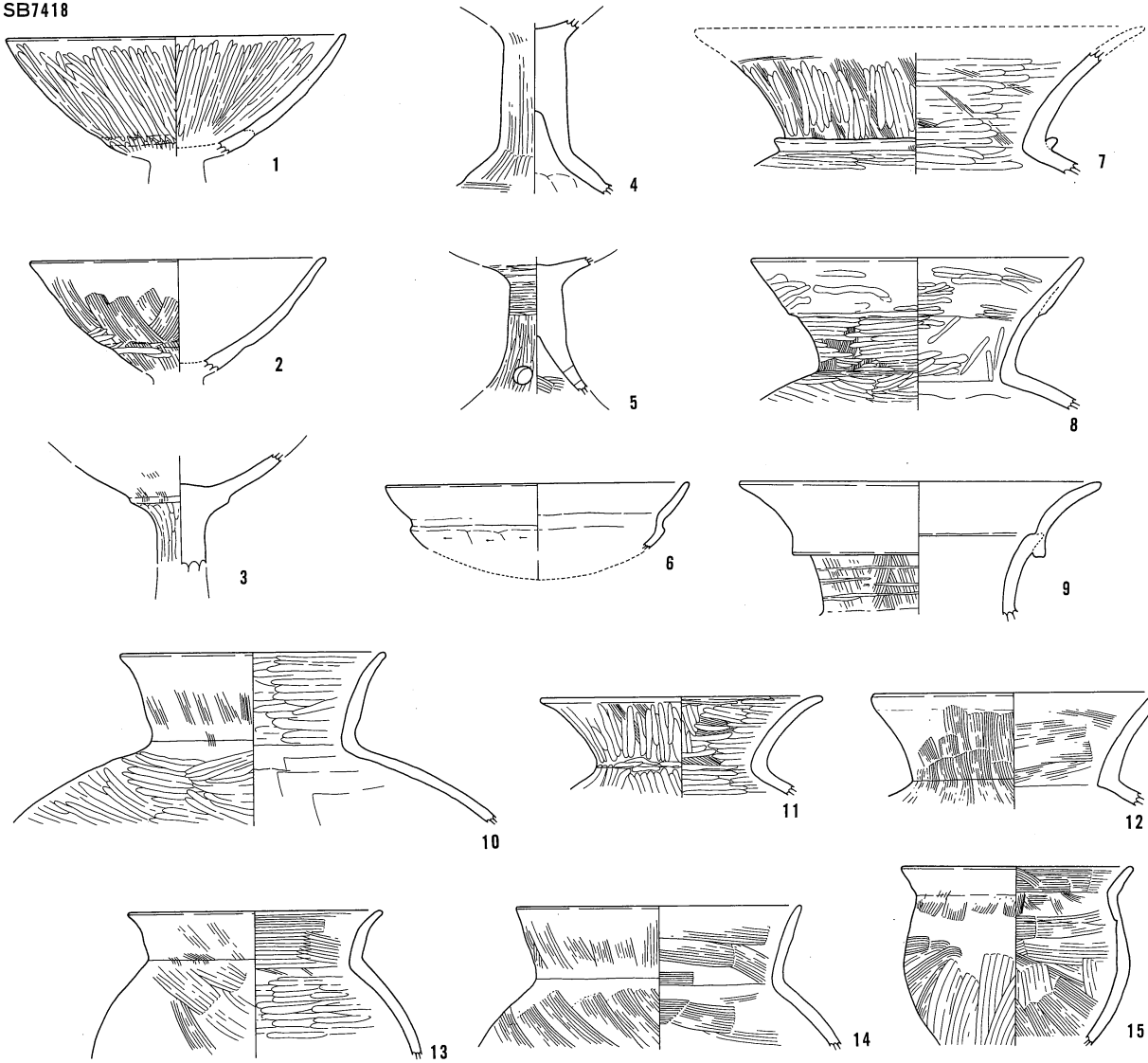

SB7446

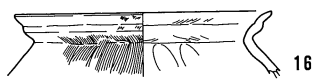

SB7458

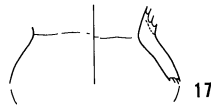

SB7494

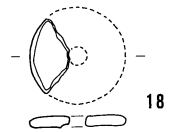

SB7517

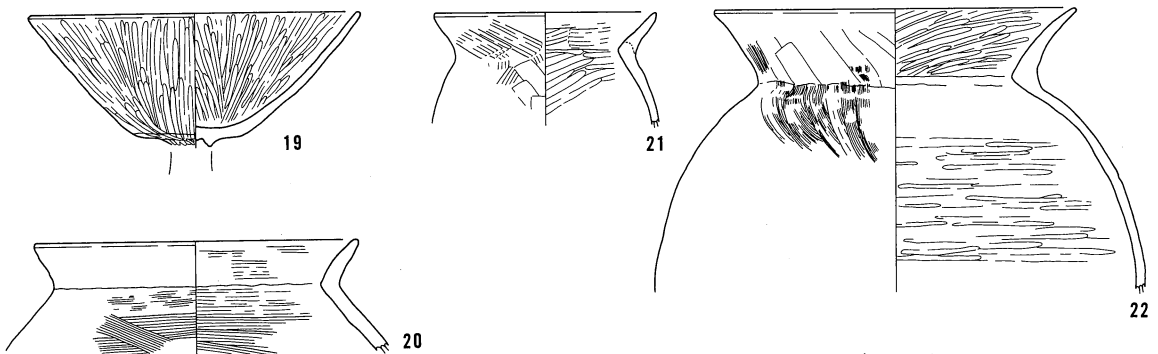

0 (1 : 4) 10cm

SB7442

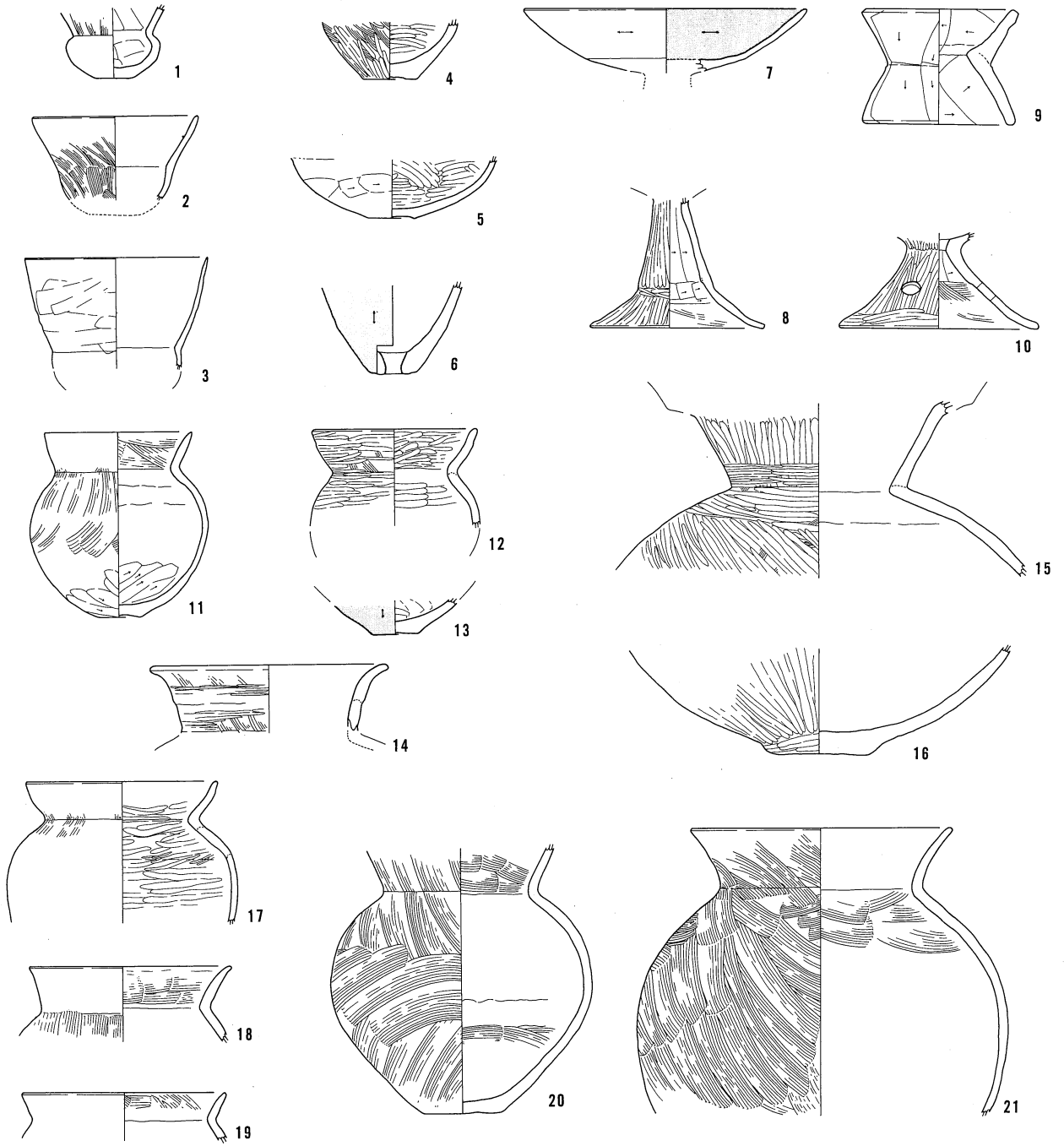

SB7508-①

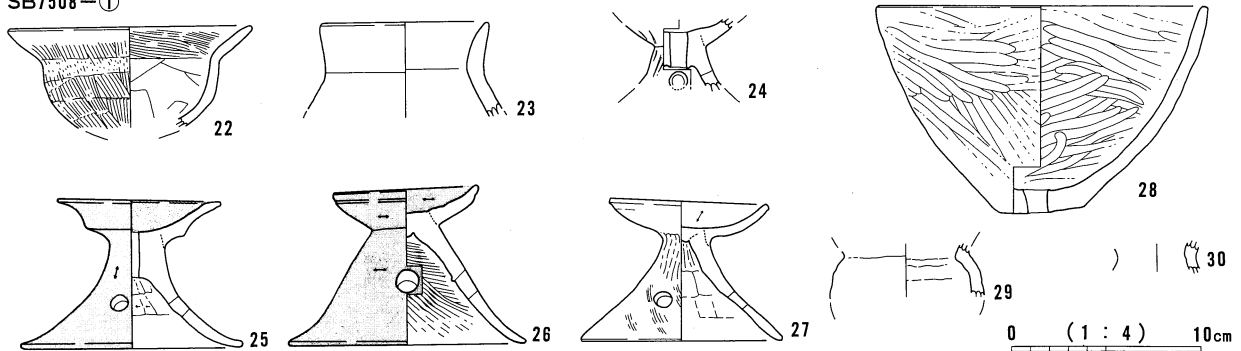

SB7508-②

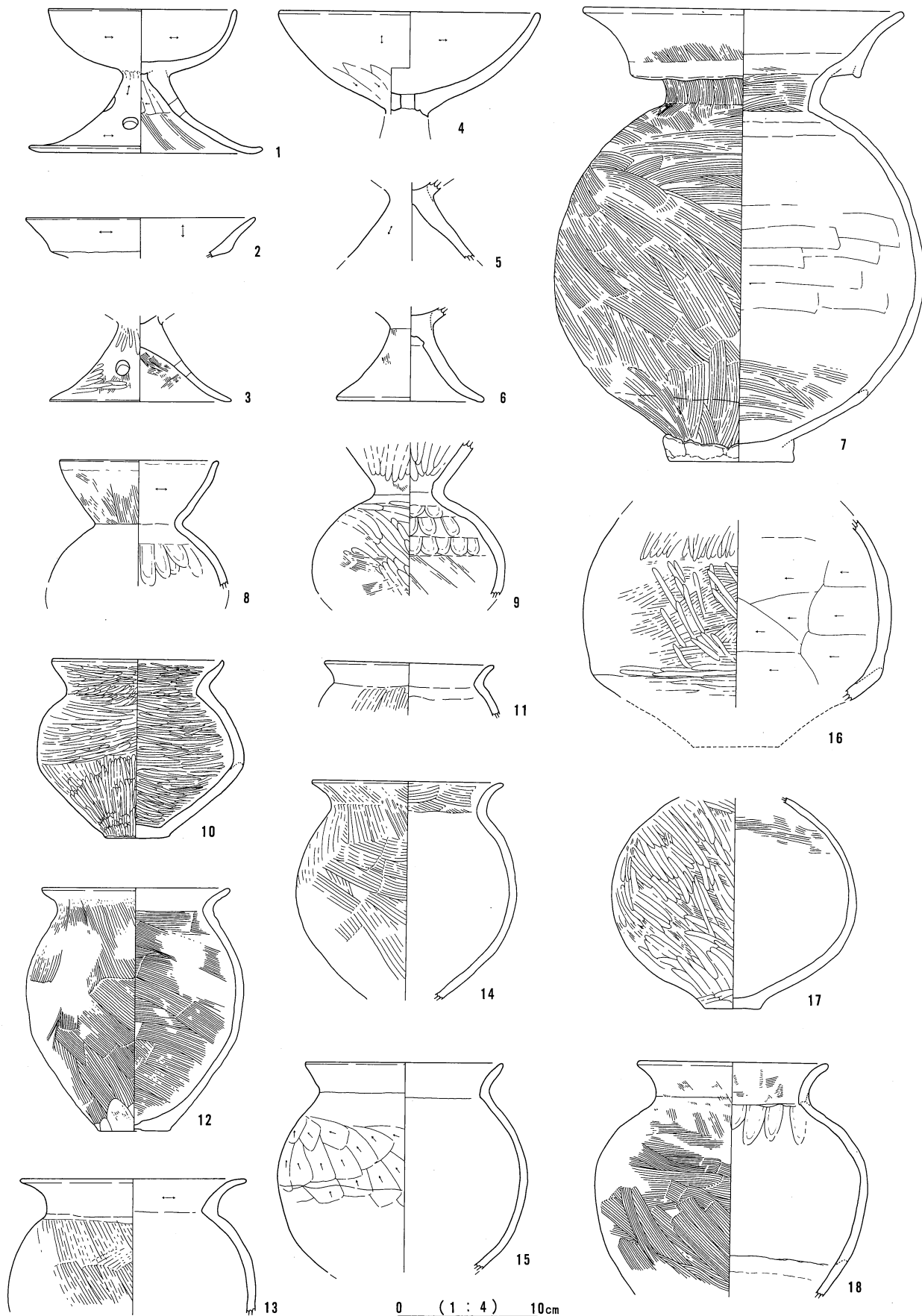

SB7508-②

SB7508-③

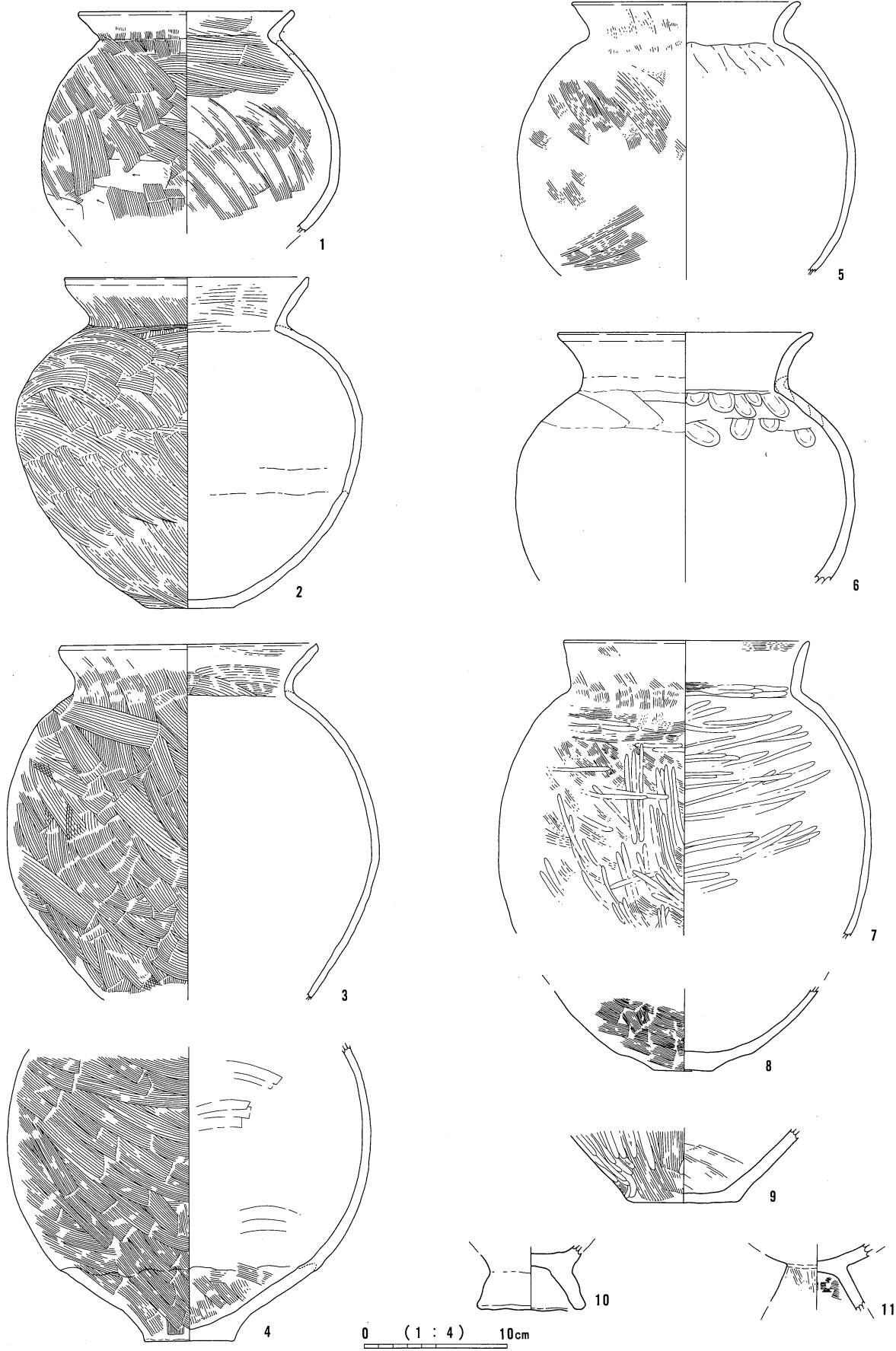

SB7508-③

SB7508-④

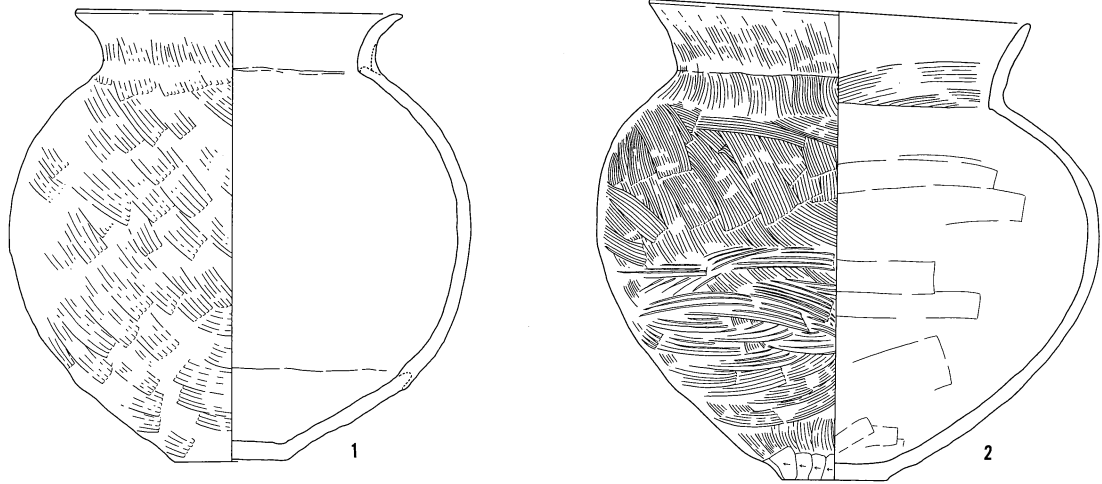

SB7561

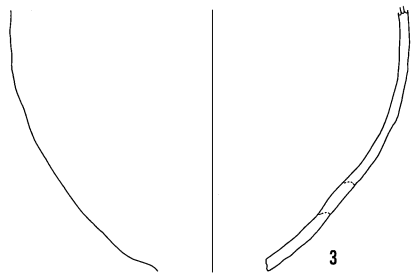

SB7596

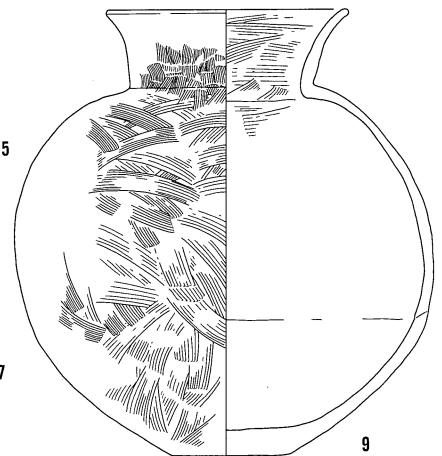
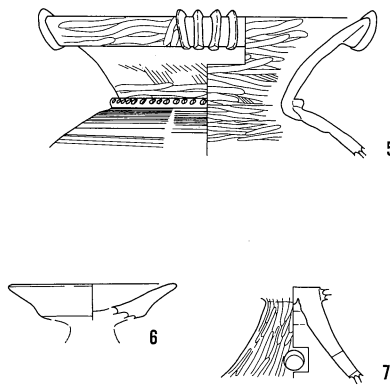

SB7586

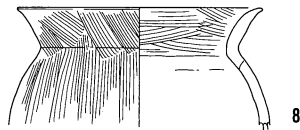
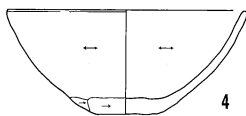

SB7634

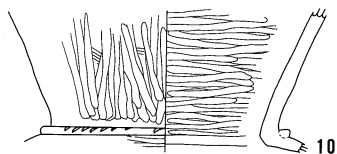

SB7642



SB7646

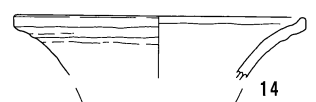
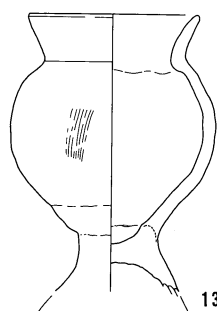

0 (1 : 4) 10cm

SB7639

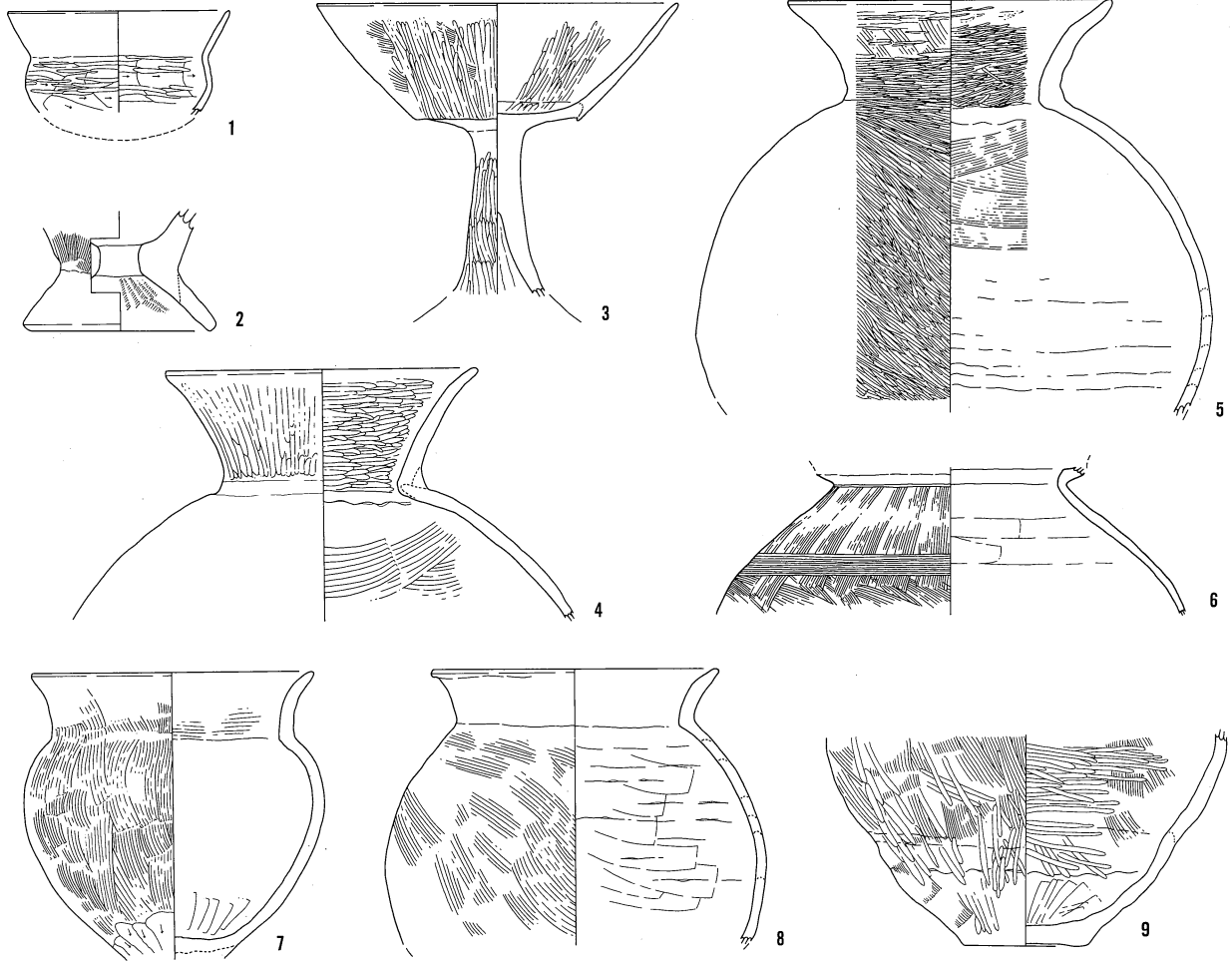

SB7649

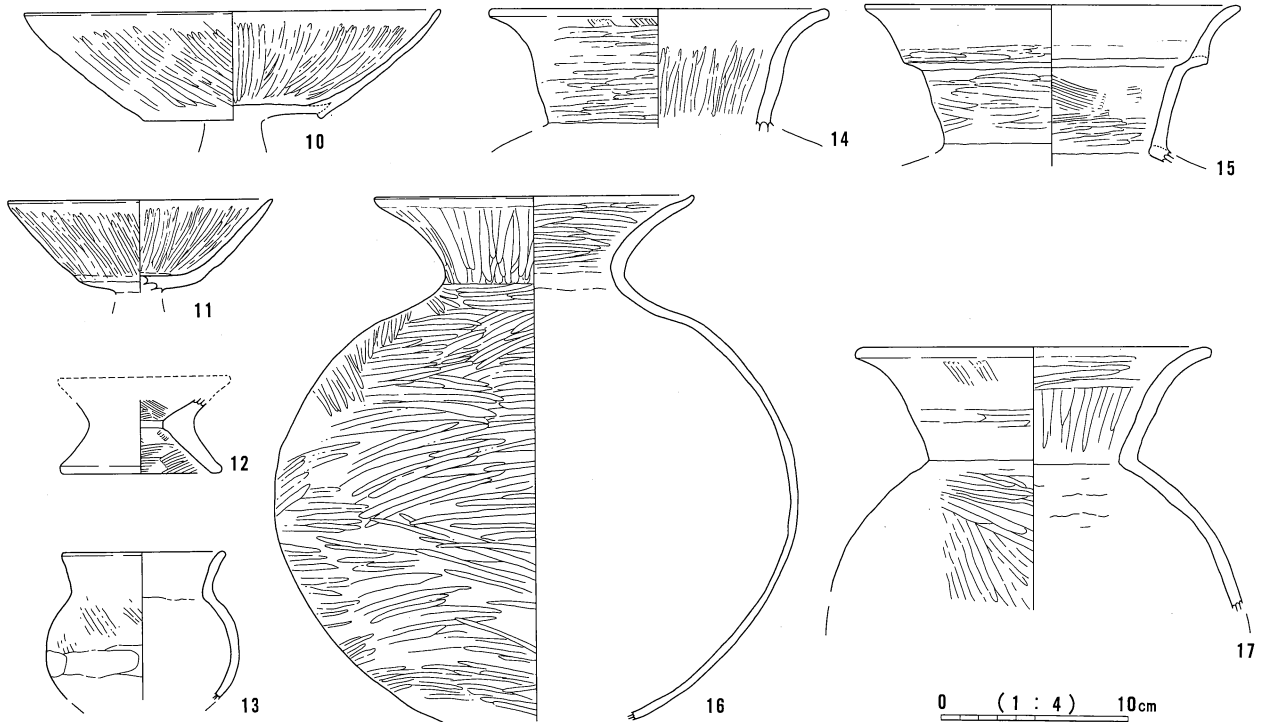

SB7654

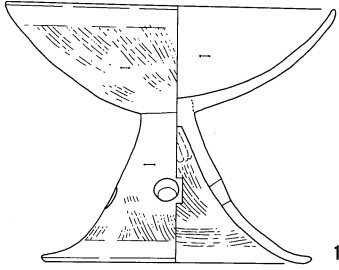

1

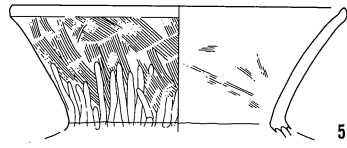

5

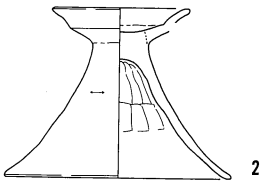

2

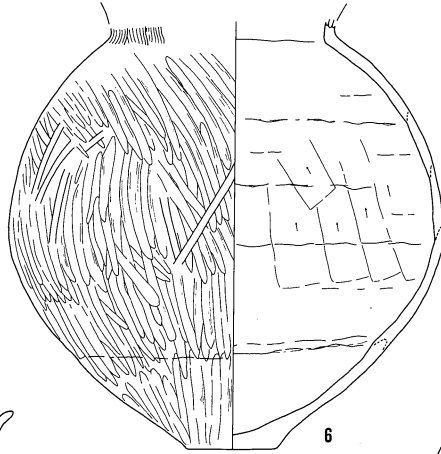

6

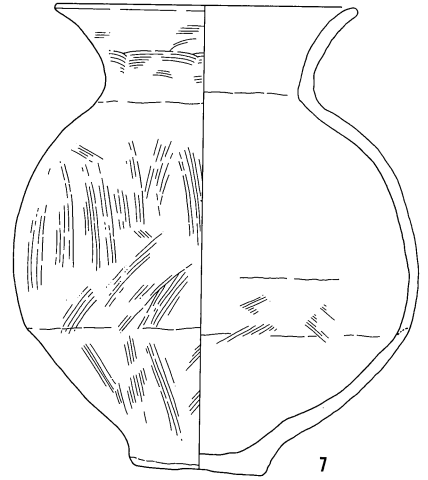

7



3

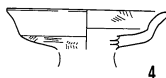

4

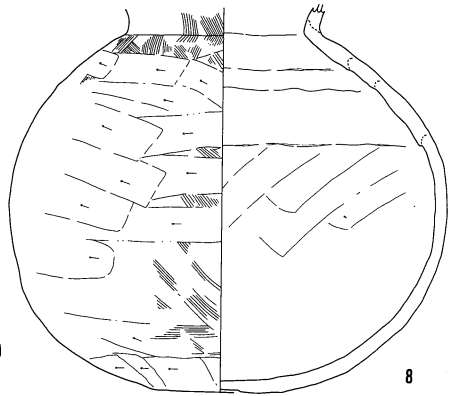

8

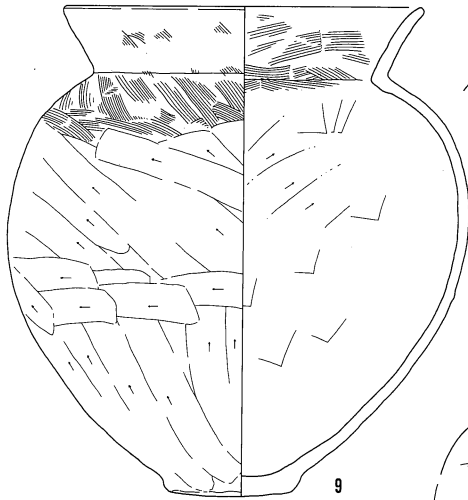

9

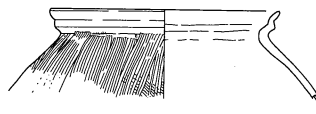

10

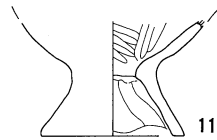

11

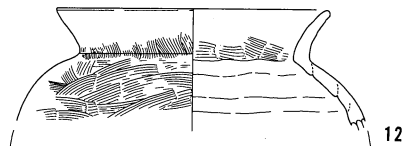

12

SB7709

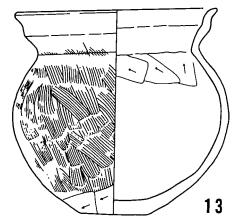

13

SB7722

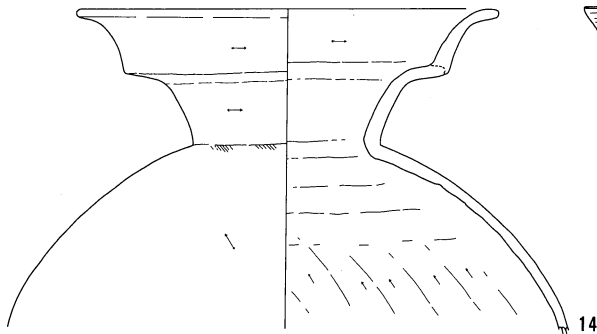

14

SB7726

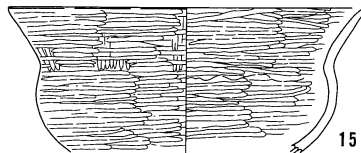

15

SB7745

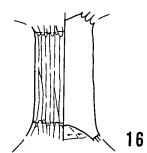

16

0 (1 : 4) 10cm

SB7751

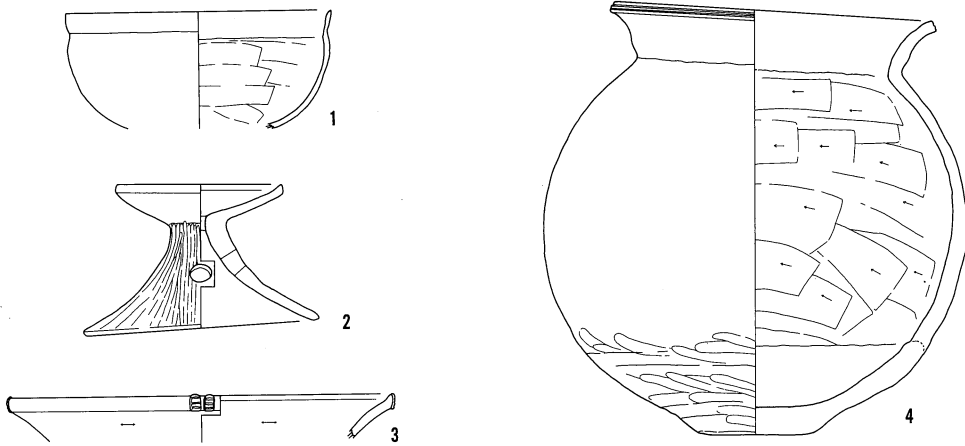

SC6001

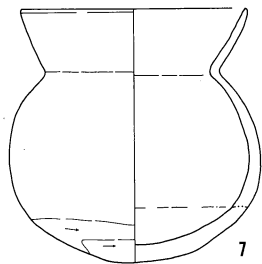
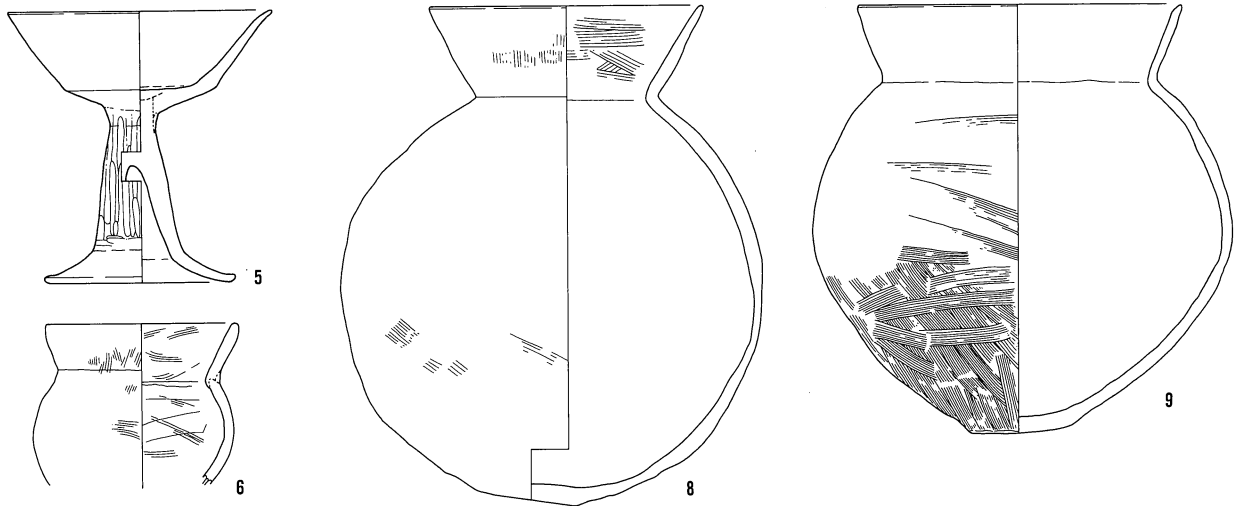

SM7001

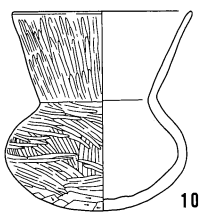

SM7035

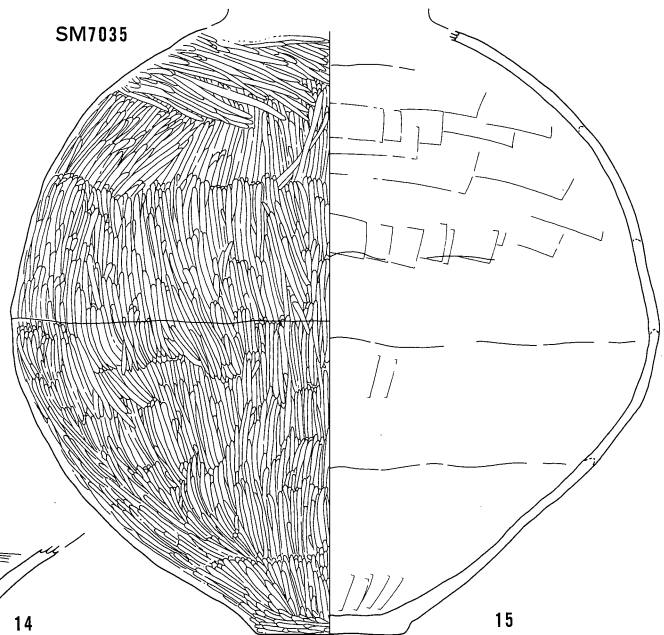

SM7032

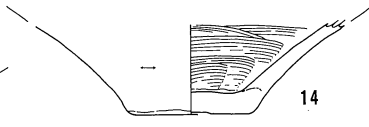
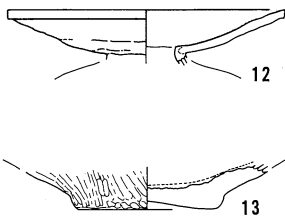

0 (1 : 4) 10cm

SD6015

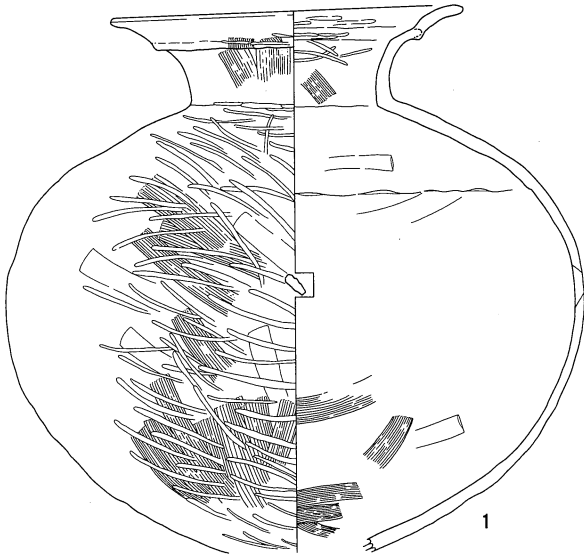

SD6016

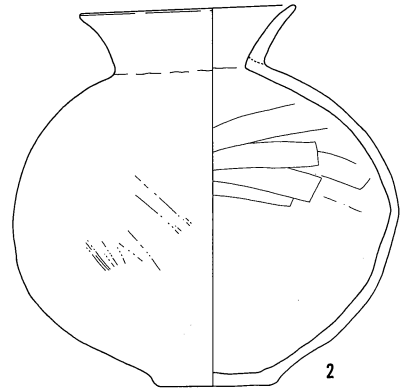

SD6023-①

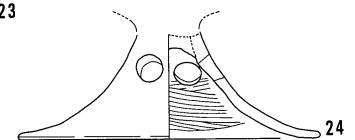
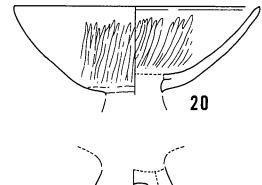
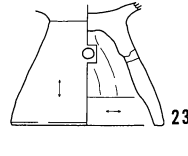
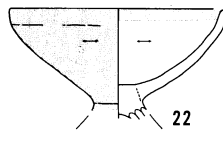
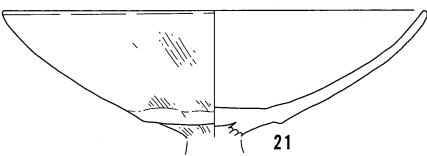
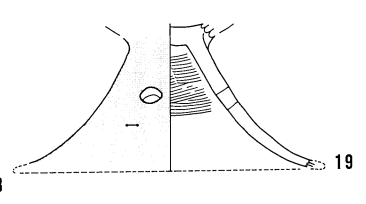
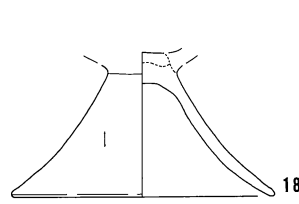
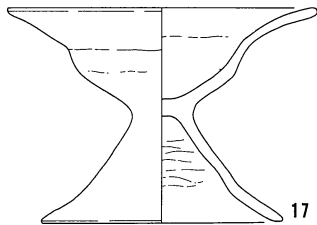
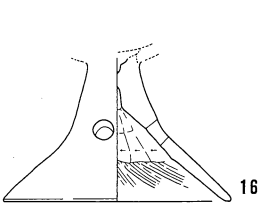
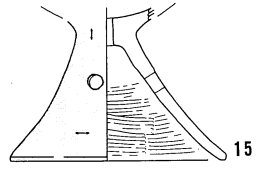
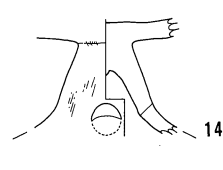
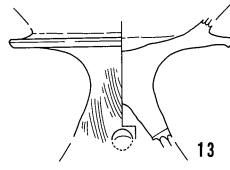
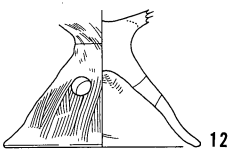
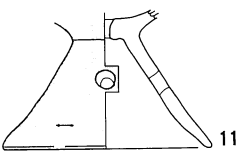
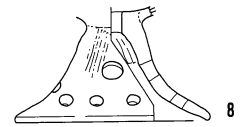
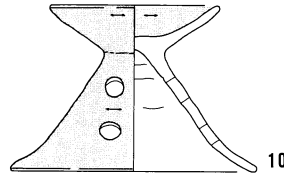
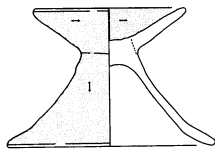
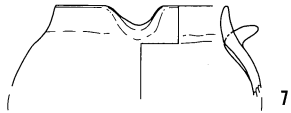
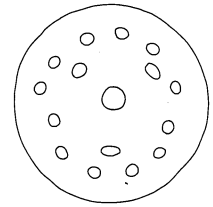
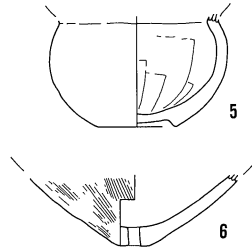
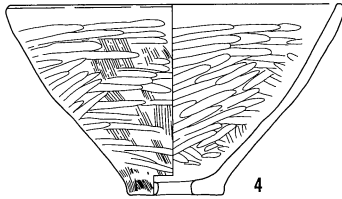
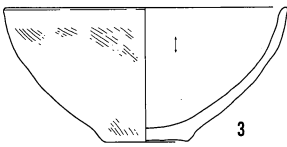

0 (1:4) 10cm

SD6023-②

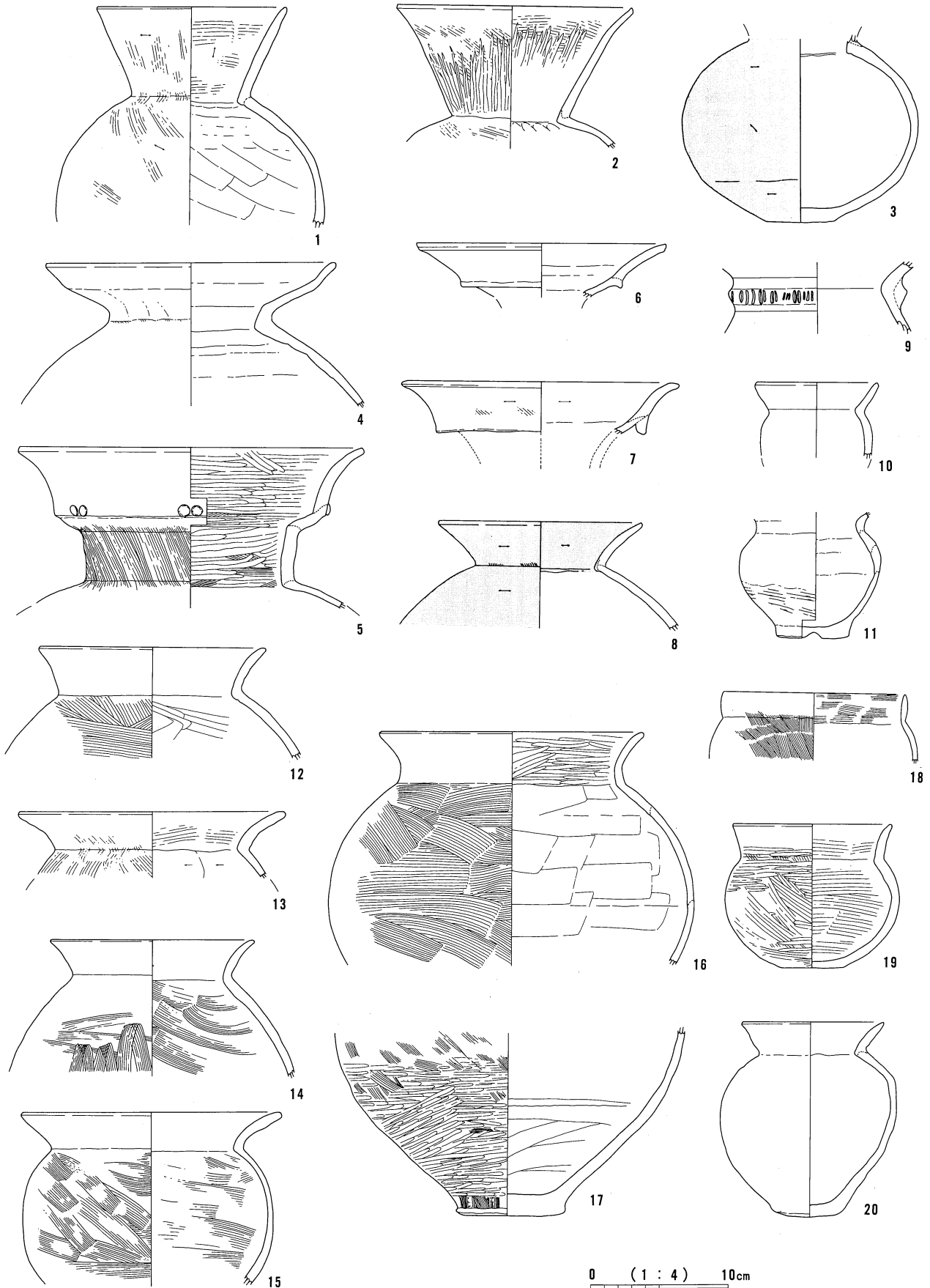

SD6023-②

SD6023-③

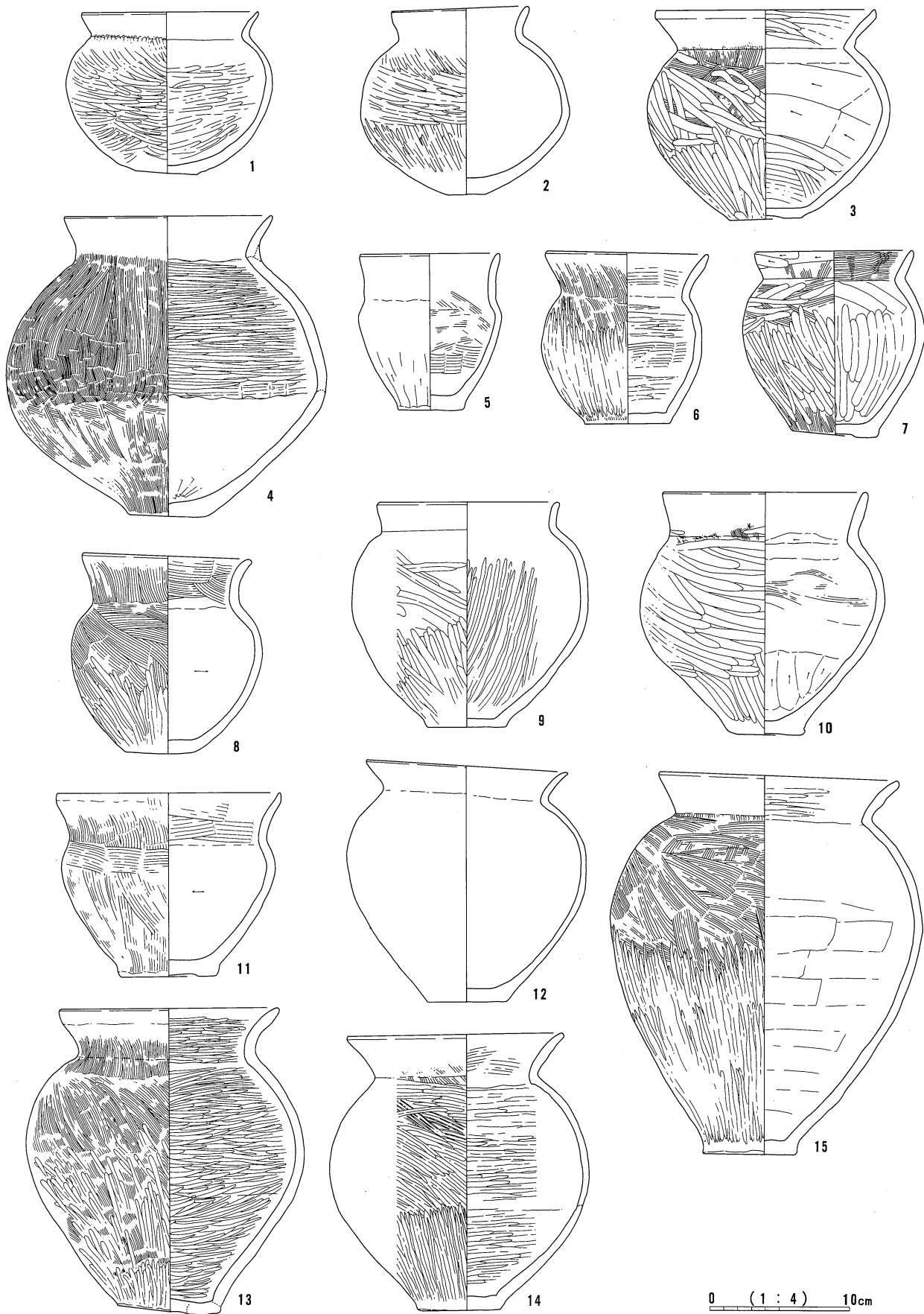

SD6023-③

SD6023-④

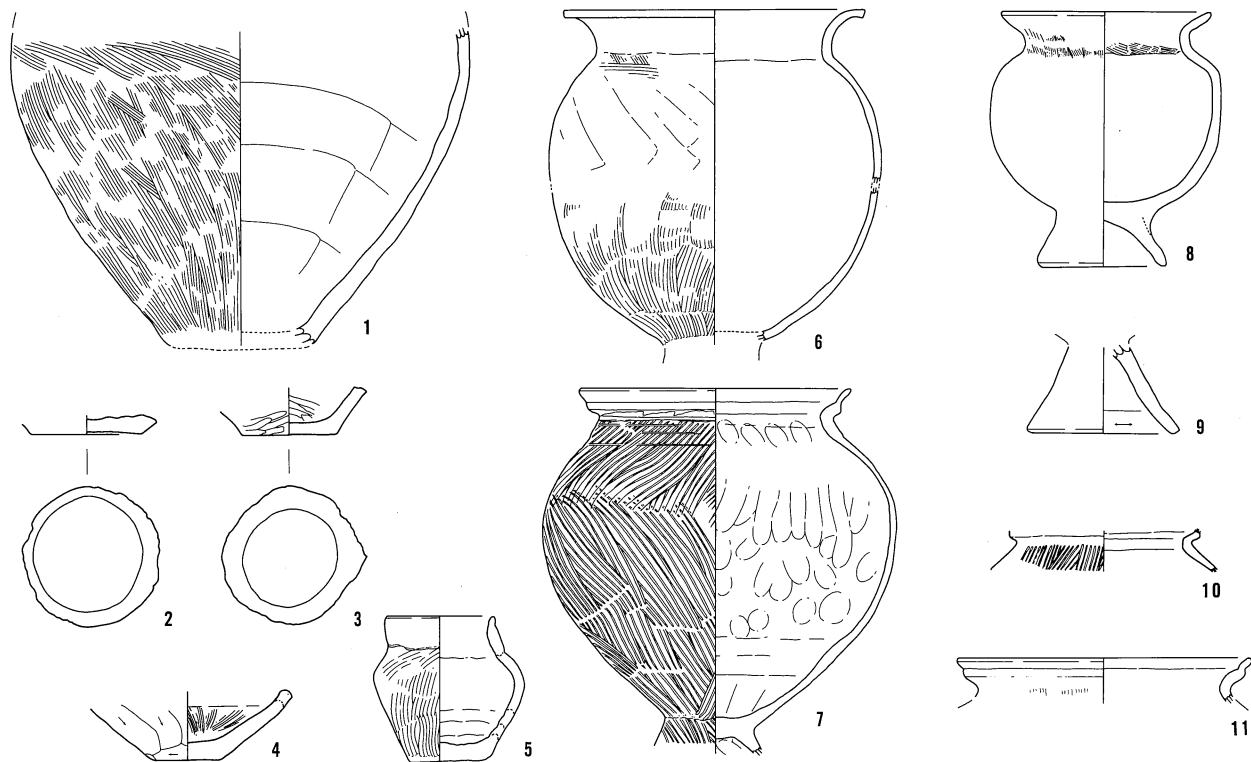

SD7014-①

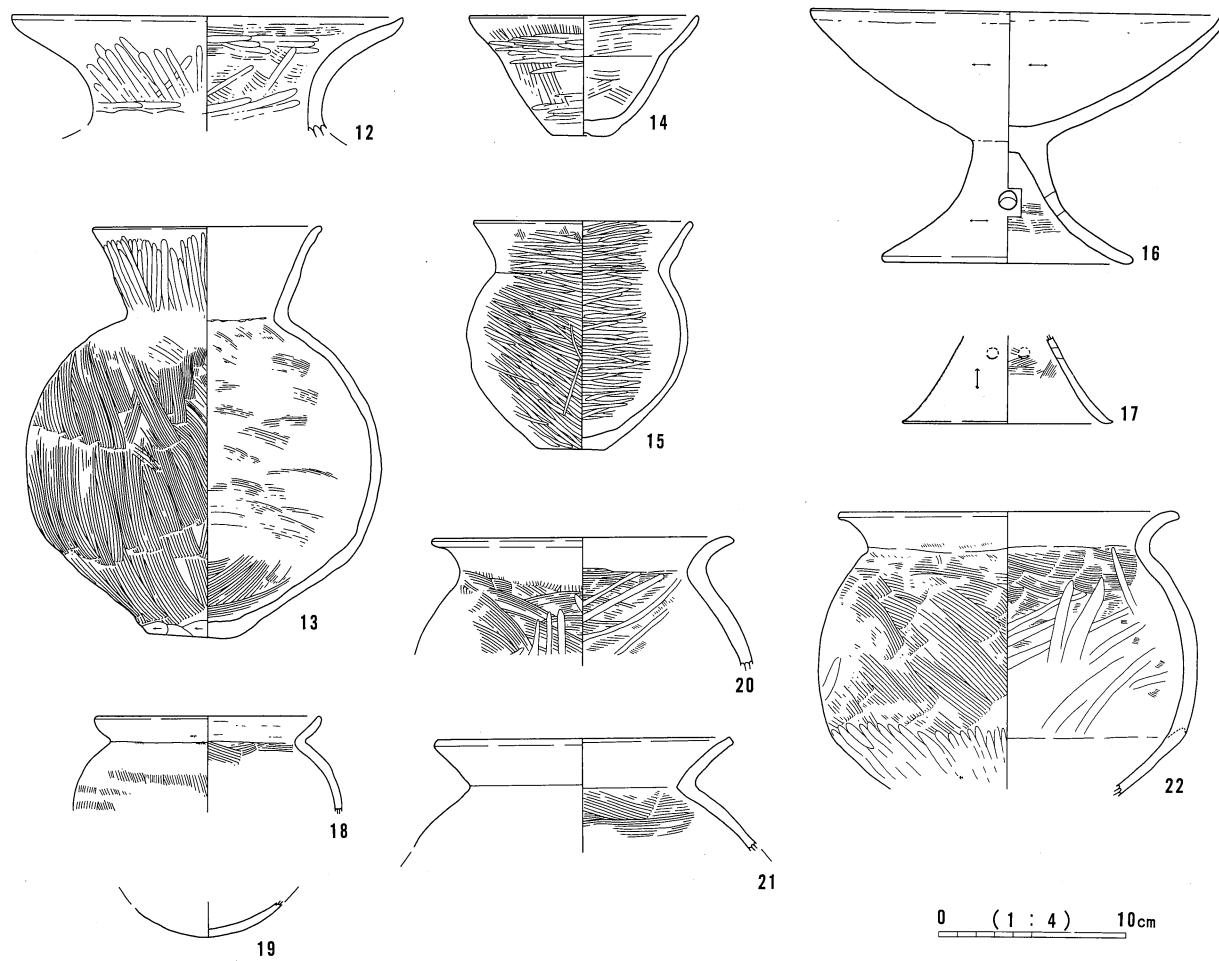

SD7030-②

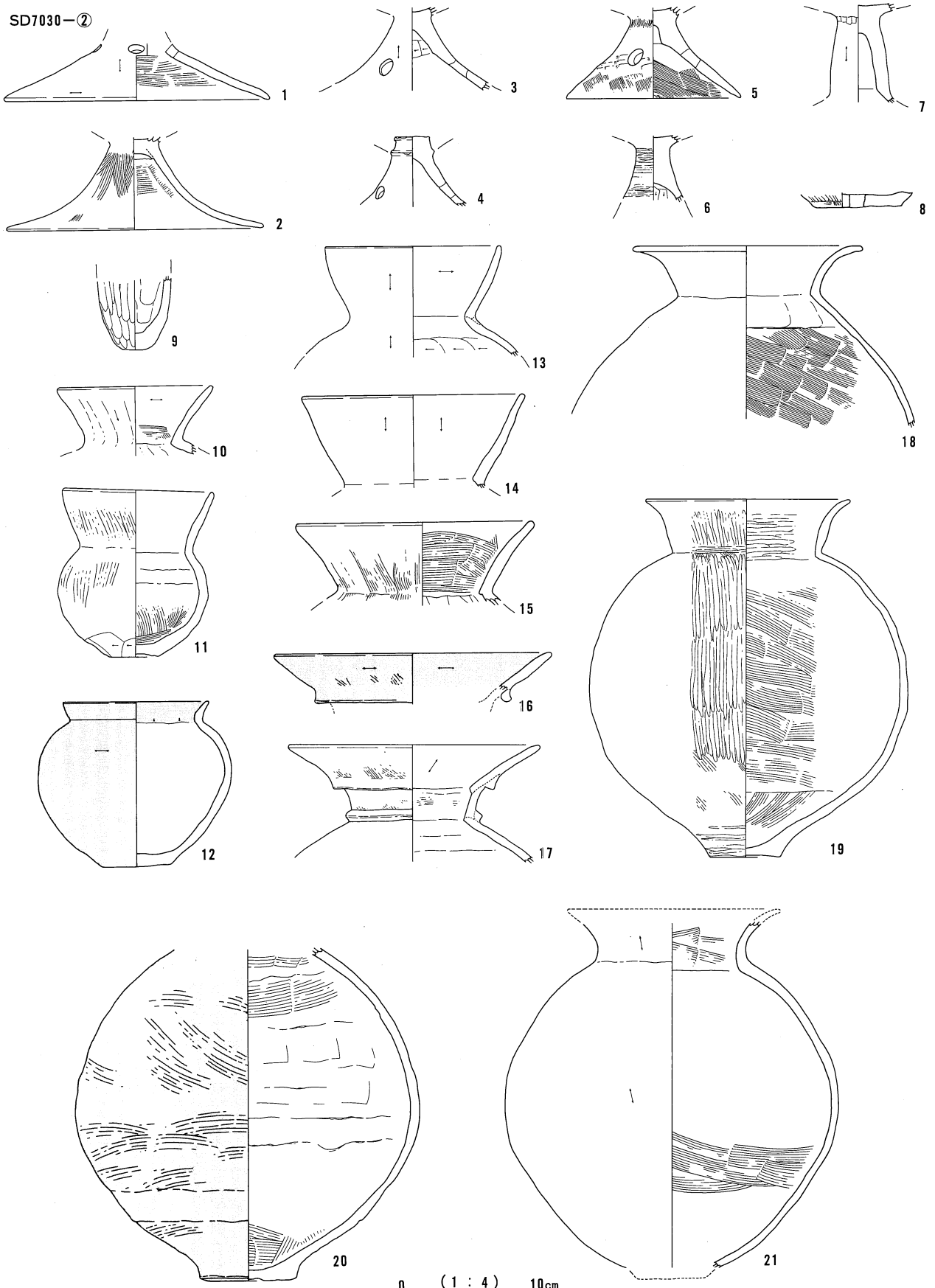

SD7030-②

SD7030-③

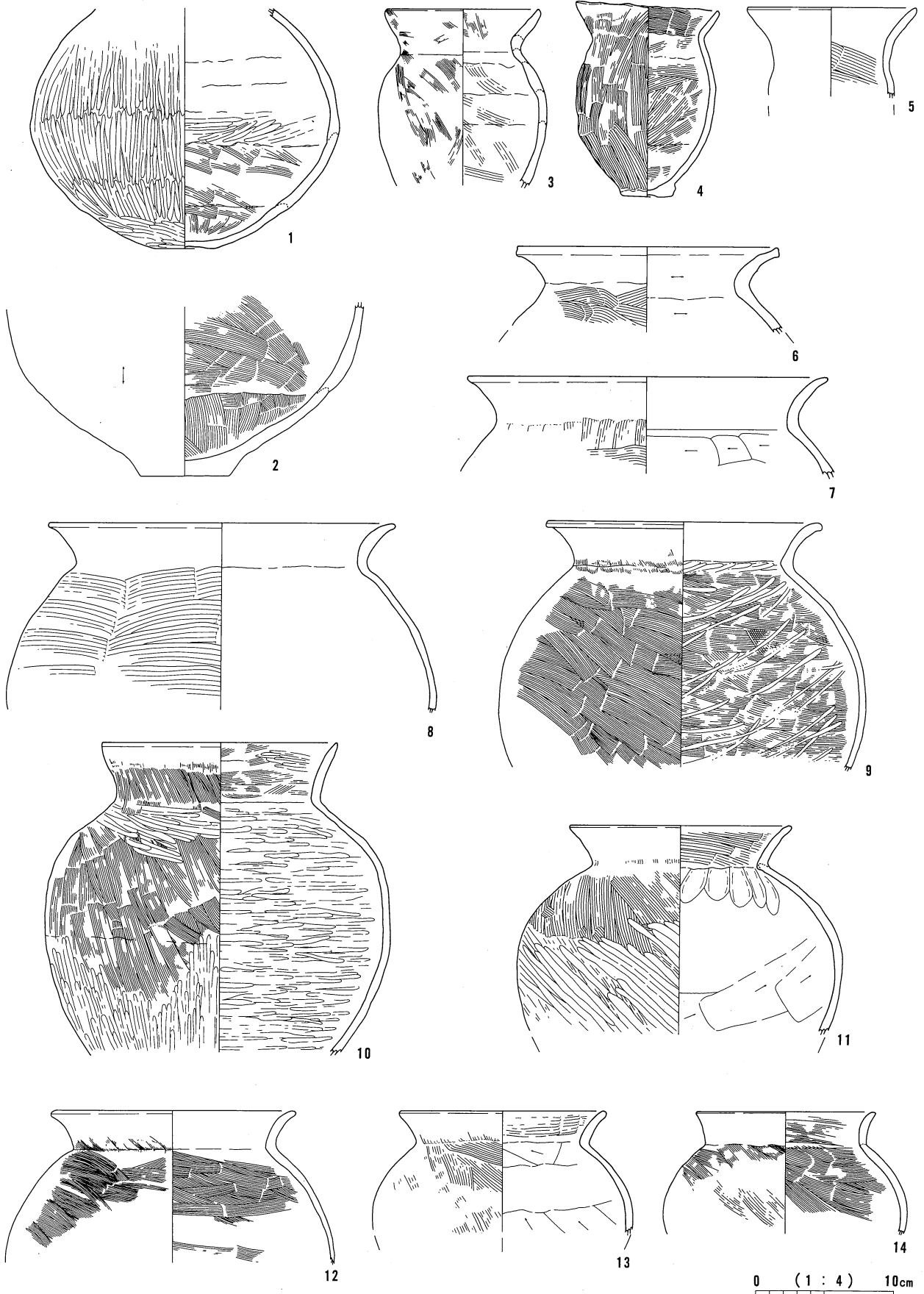

SD7030-③

SD7030-④

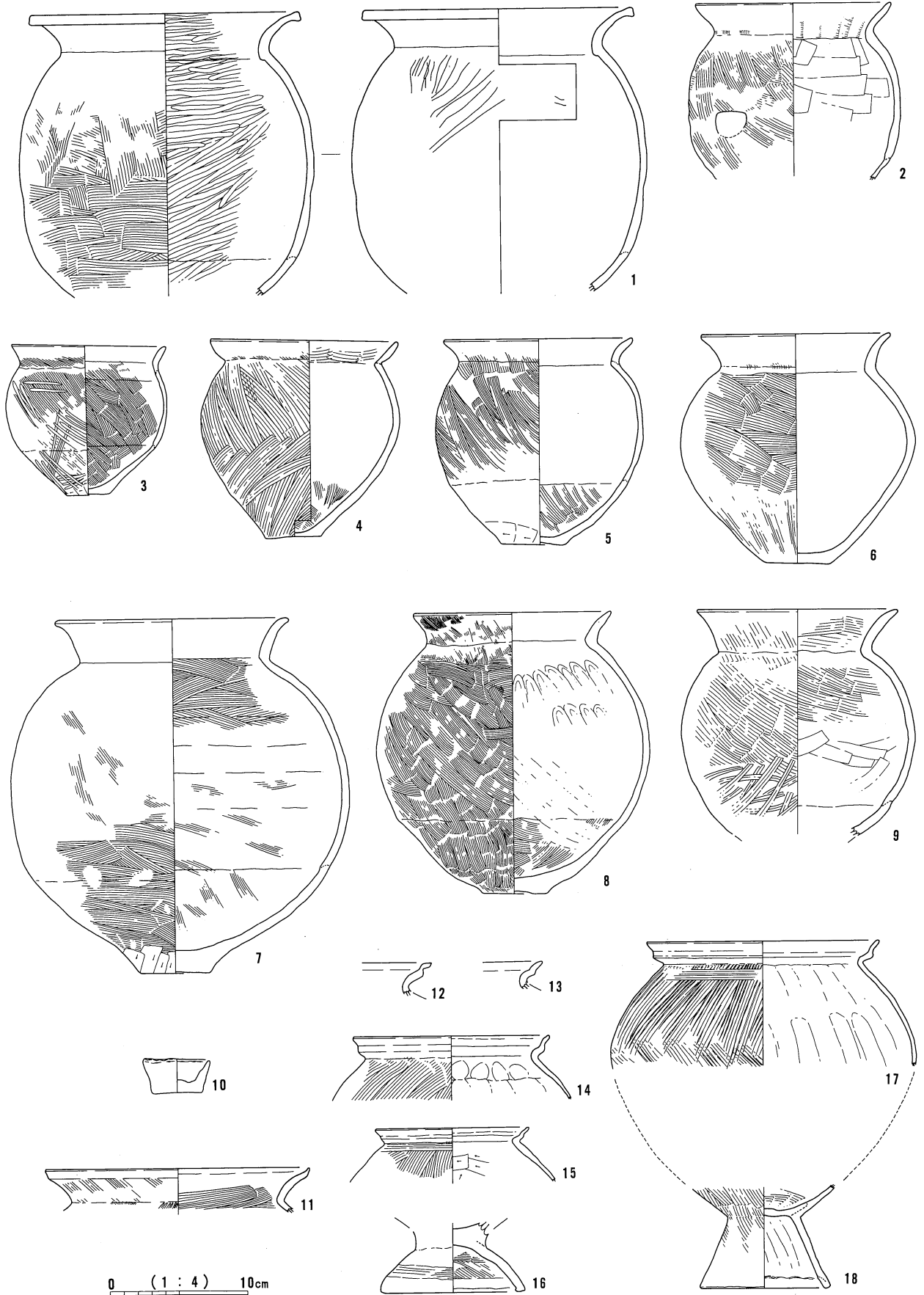

SD7030-④

SD7088

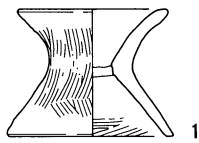

1

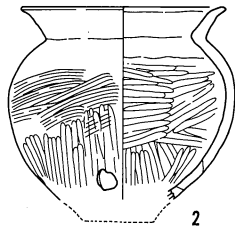

2

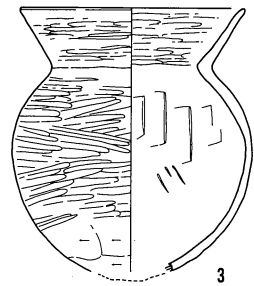

3

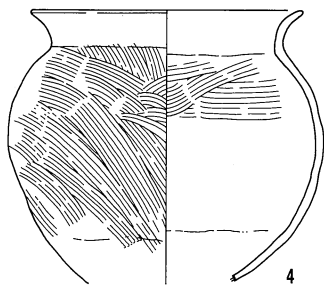

4

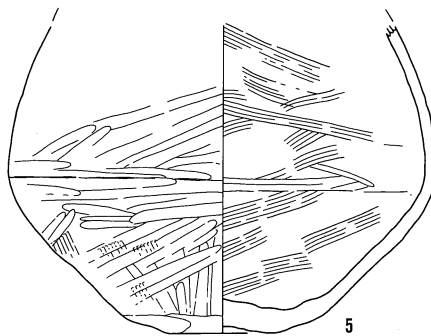

5

SD7084

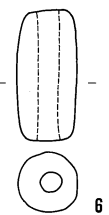

6

SK6048

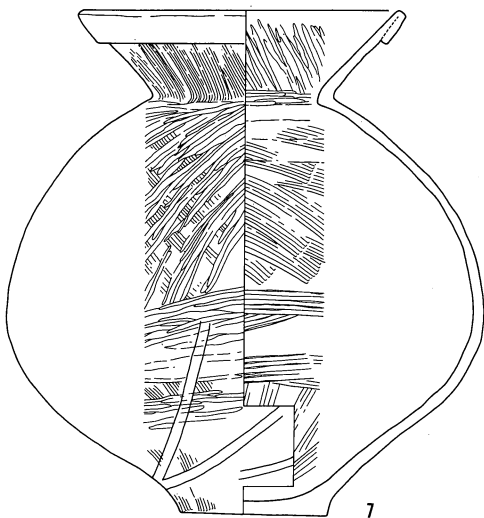

7

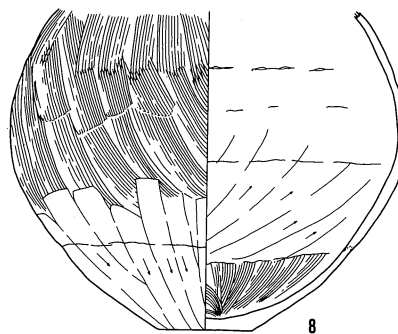

8

SK6108

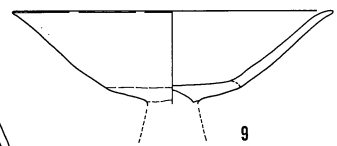

9

SK6113

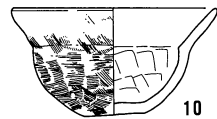

10

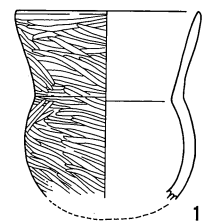

11

SK6117

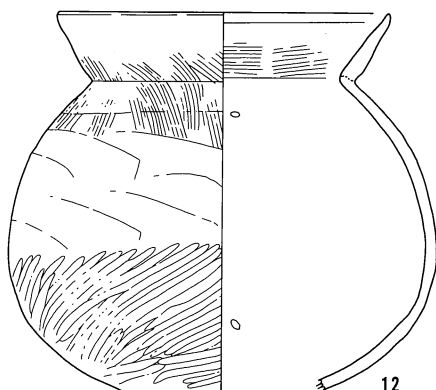

12

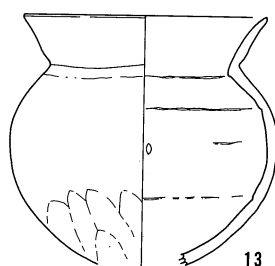

13

SK6133

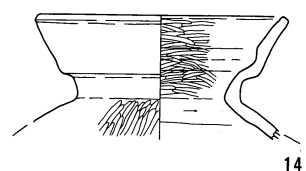

14

0 (1 : 4) 10cm

SK6099

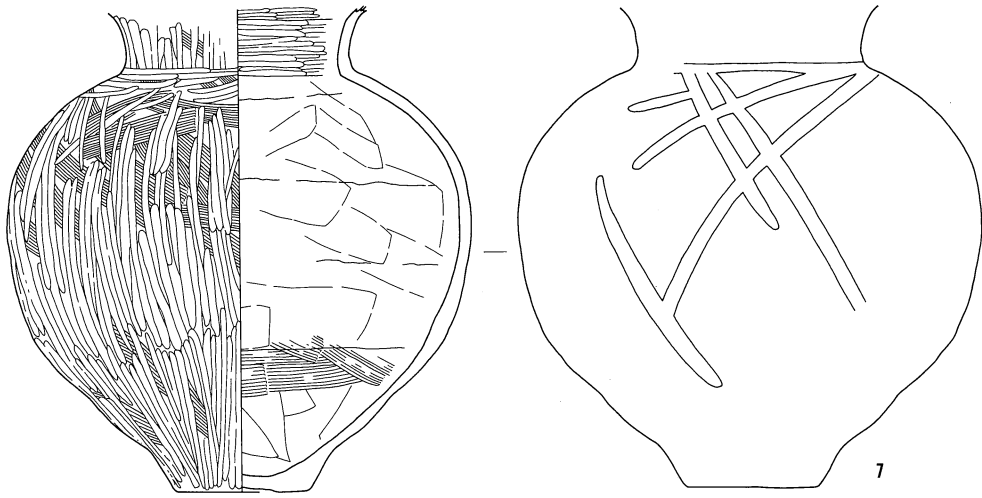
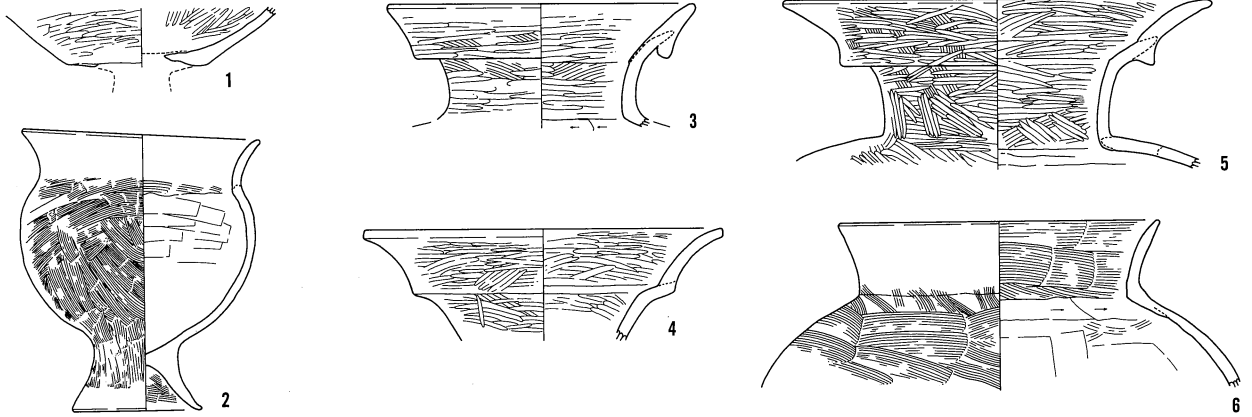

SK6142

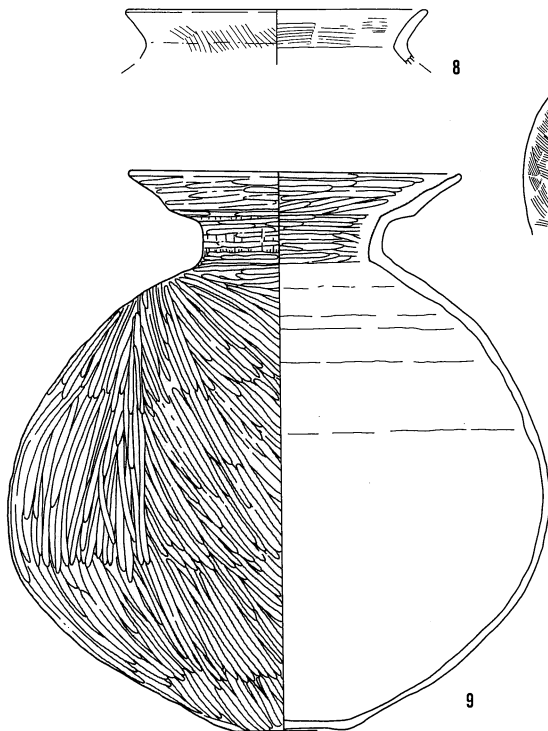

SK6150

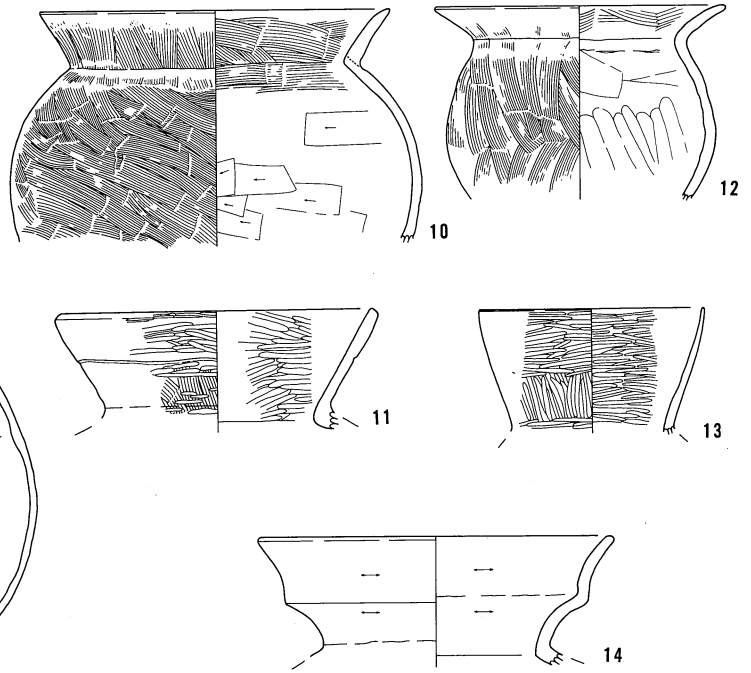

0 (1 : 4) 10cm

SK6186

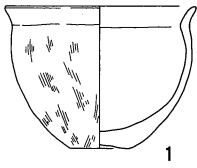

SK6290

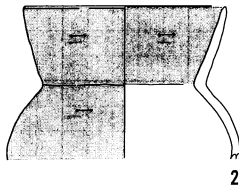

SK6296

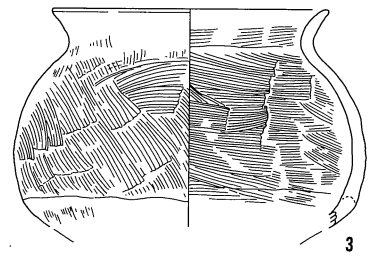

SK6310



SK6321

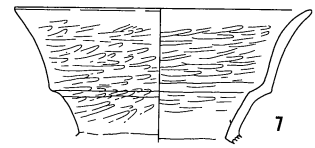
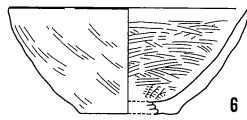
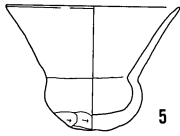

SK6202-①

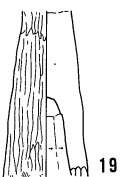
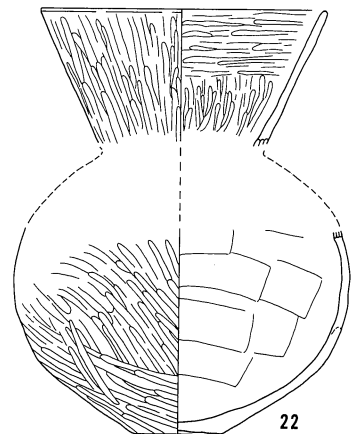
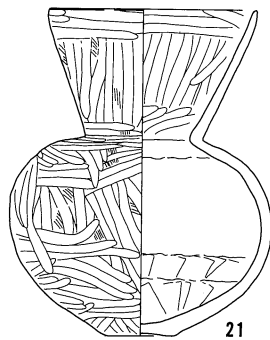
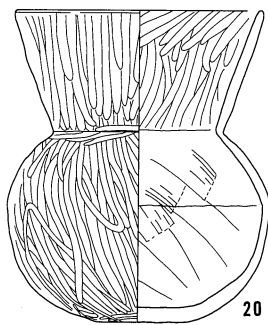
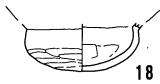
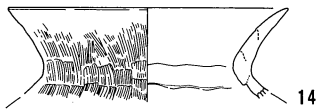
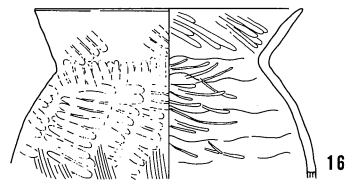
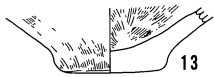
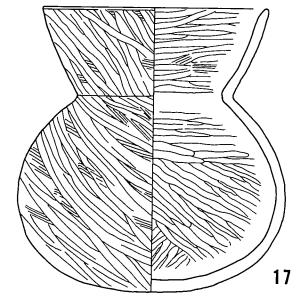
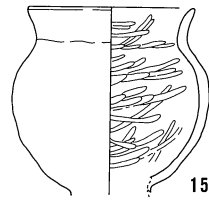
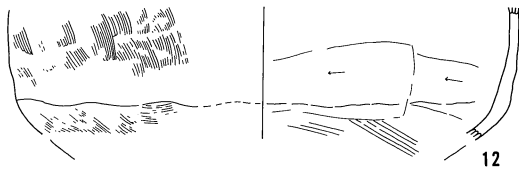
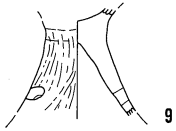
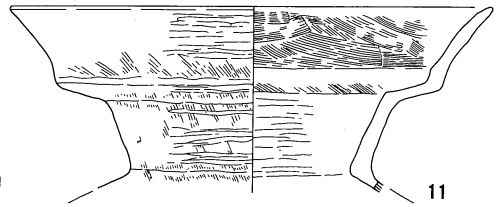
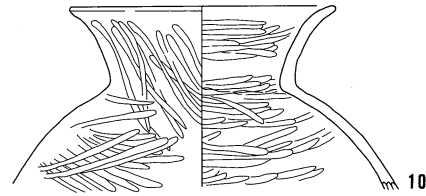
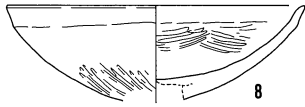

0 (1:4) 10cm

SK6202-②

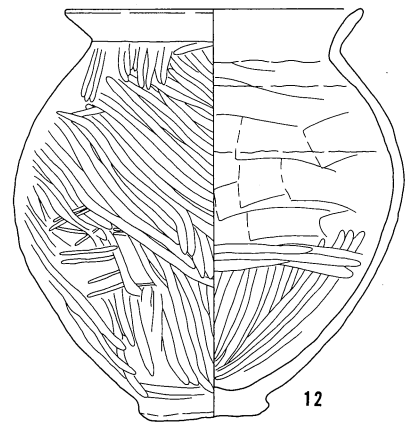
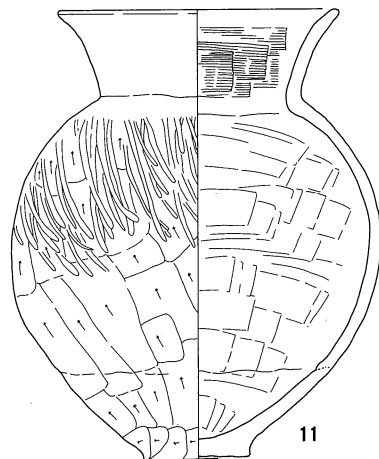
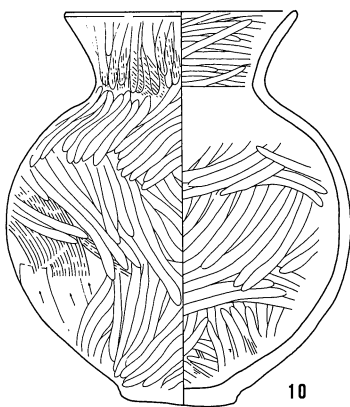
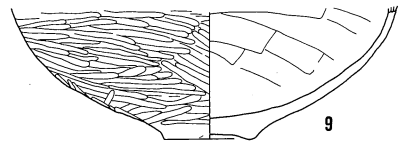
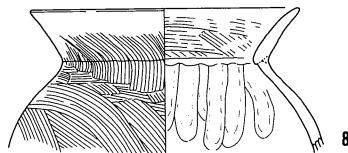
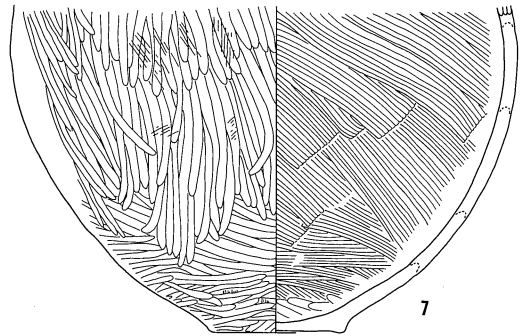
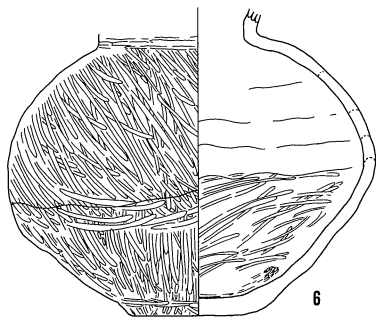
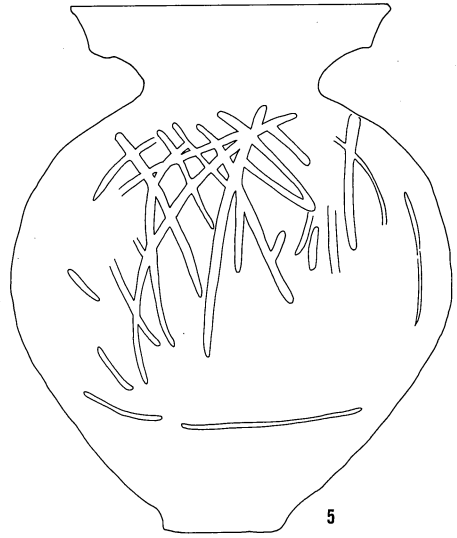
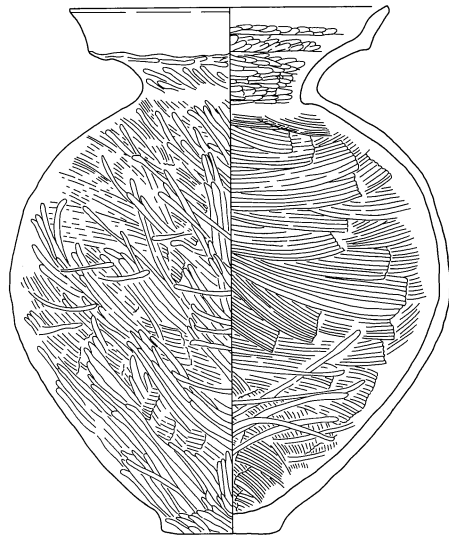
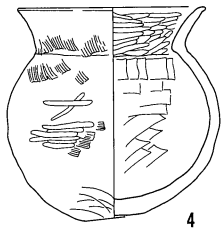
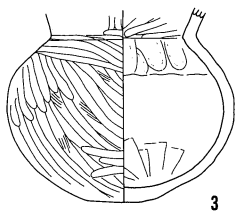
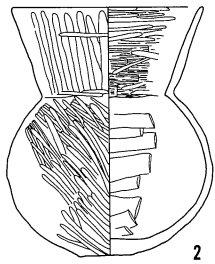
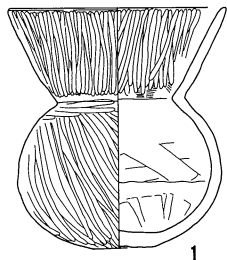

0 (1:4) 10cm

SK6202-②

SK6202-③

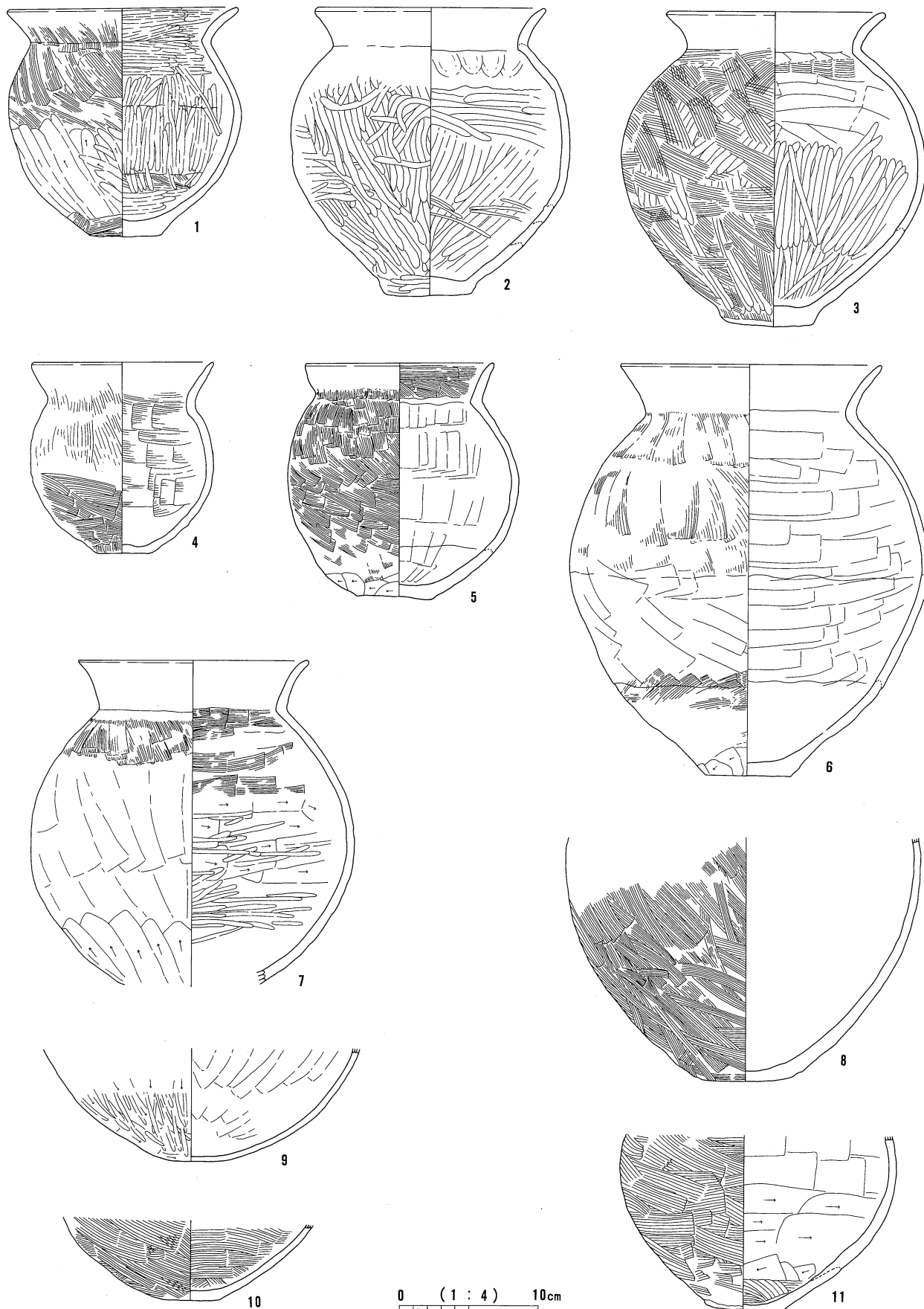

SK6202-③

SK6307

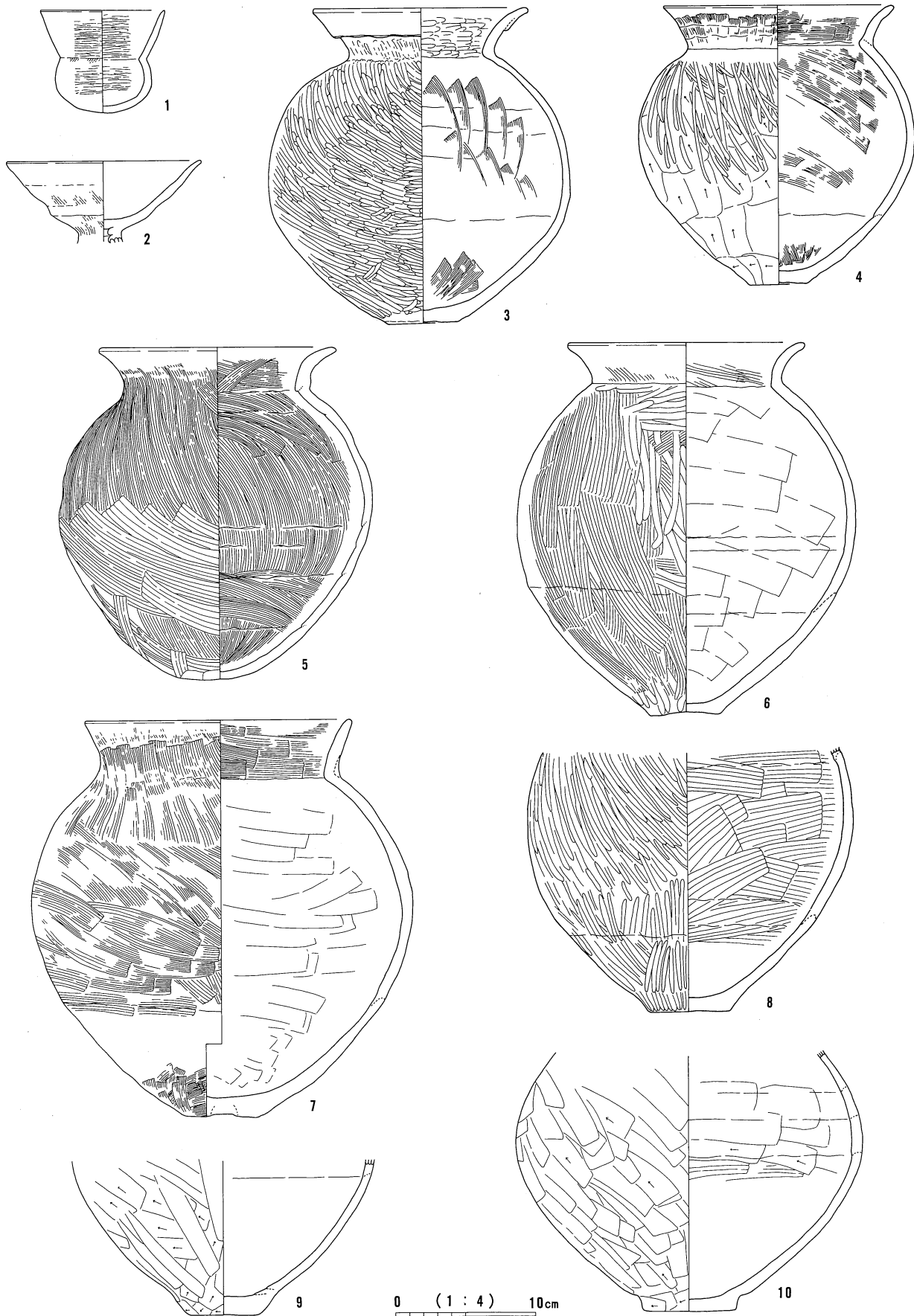

SK6307

SK6406

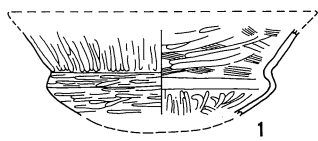

1

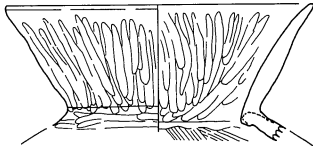

2

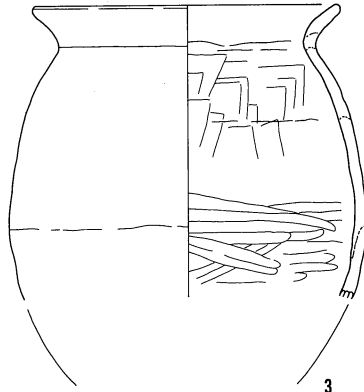

3

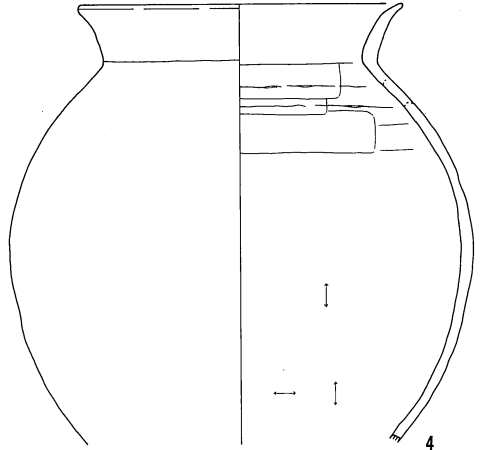

4

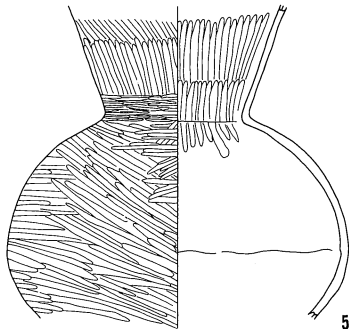

5

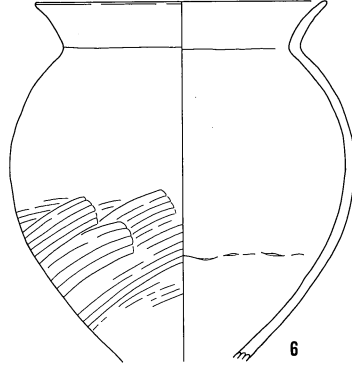

6

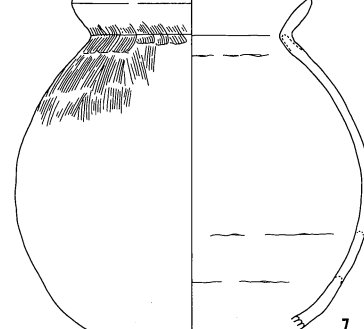

7

SK6441

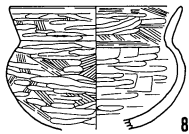

8

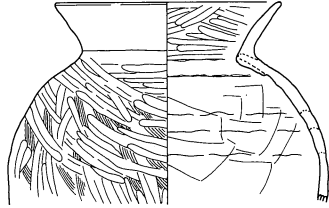

9

SK7146

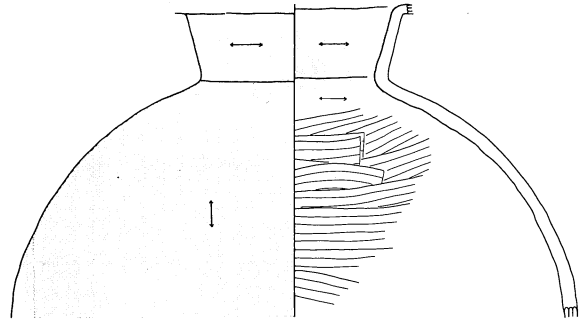

11

SK7130

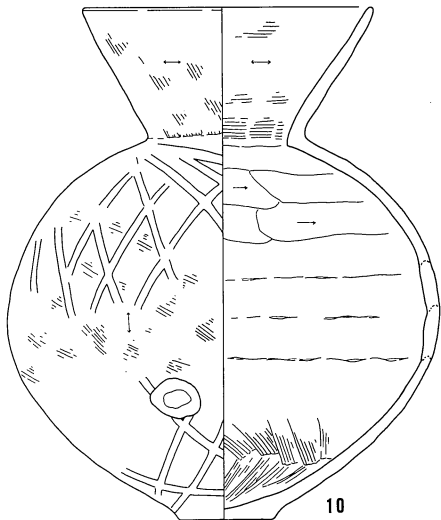

10

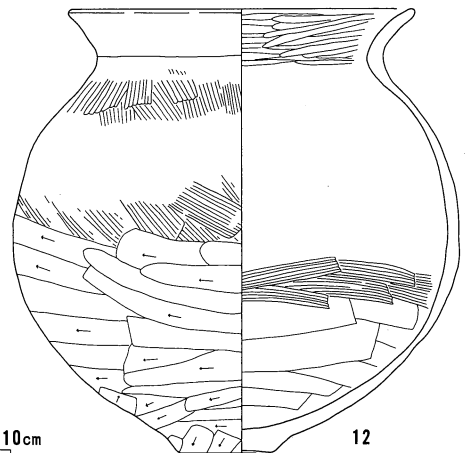

12

0 (1 : 4) 10cm

SK7256

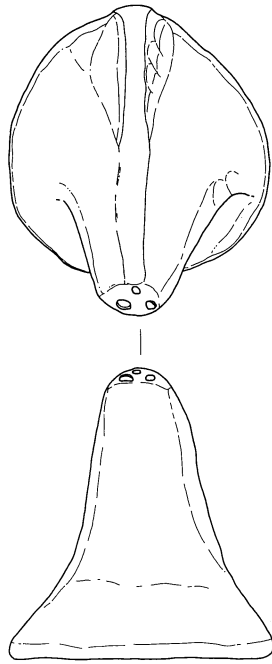

SK7157

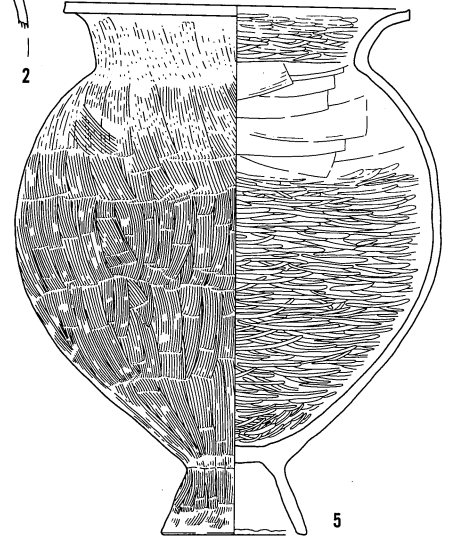
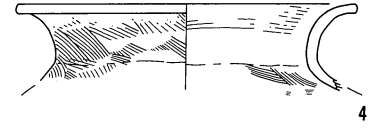
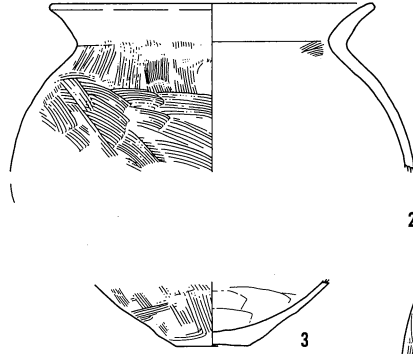

SK7326

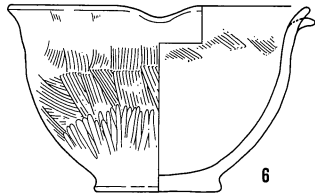

SK7364

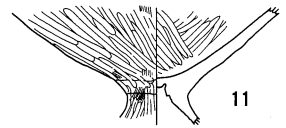
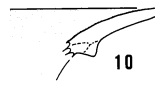
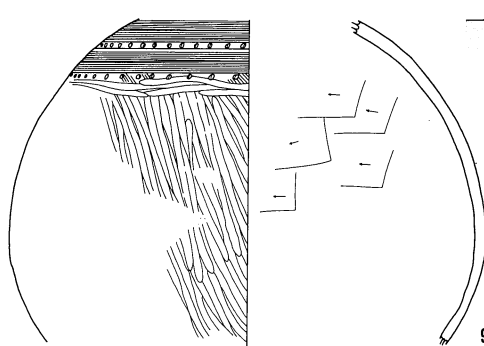

SK7403

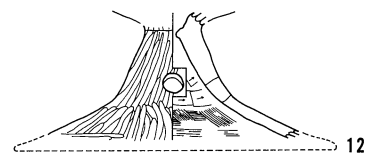
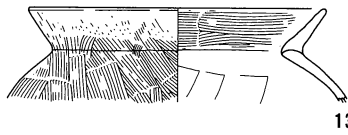
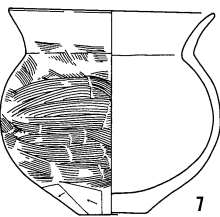

SK7596

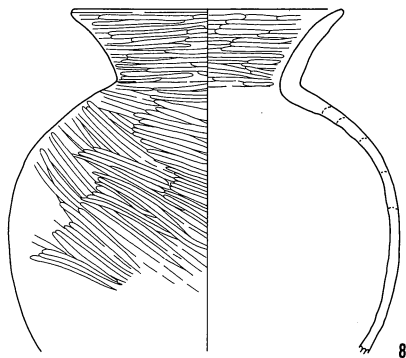

SK7469



SK7480

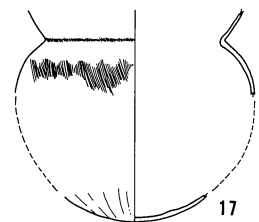
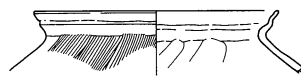

0 (1 : 4) 10cm

SK7367

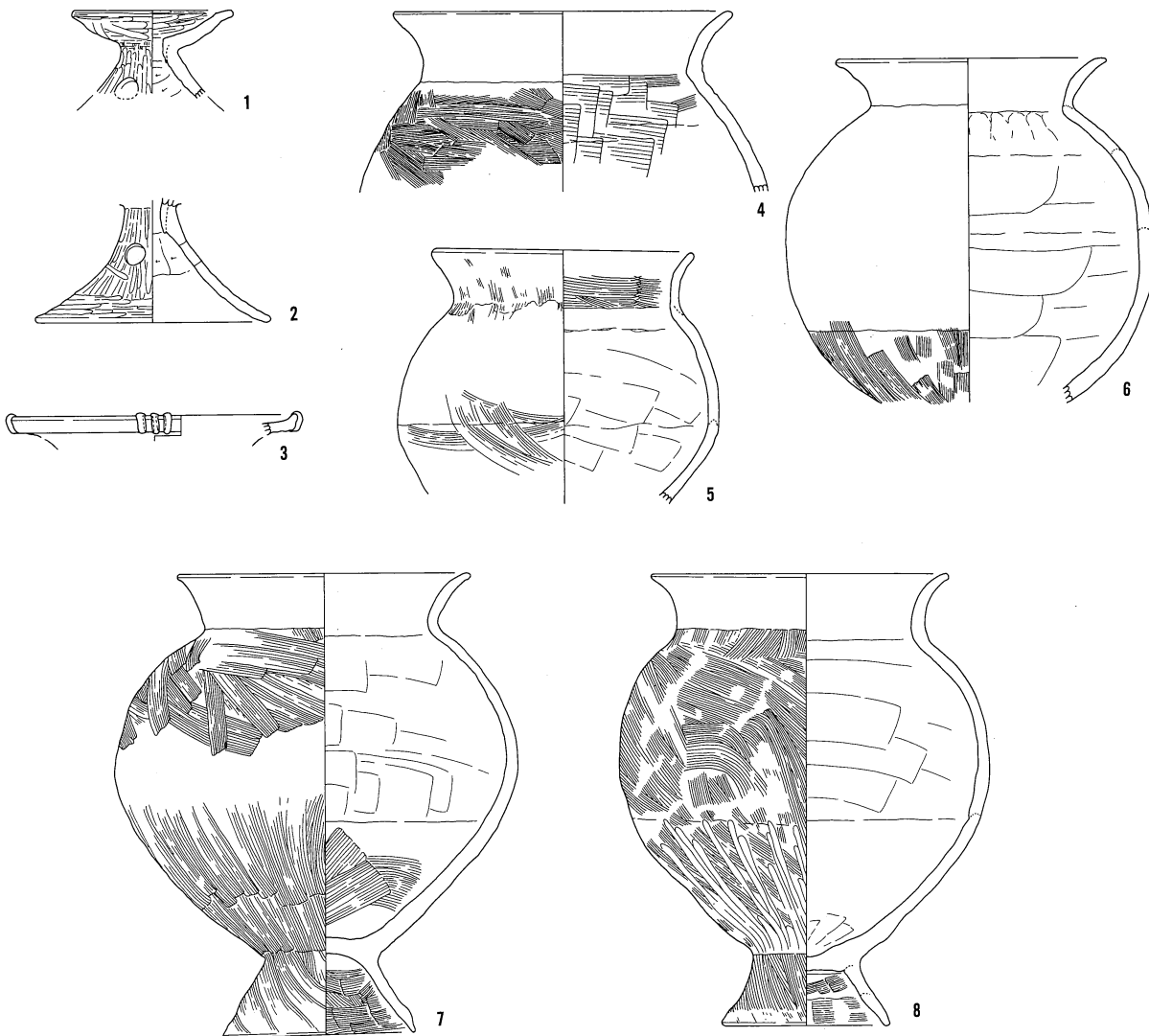

SK7608

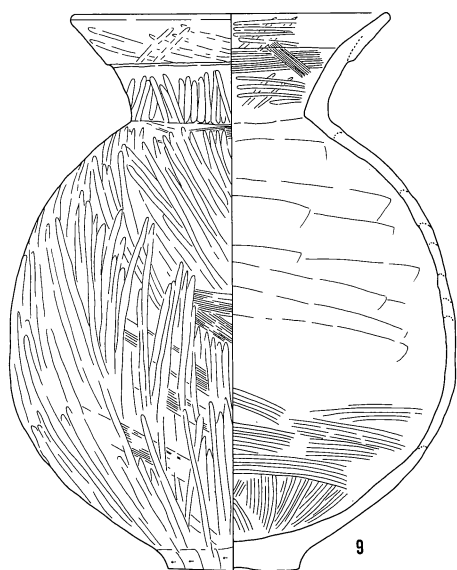

SK8011

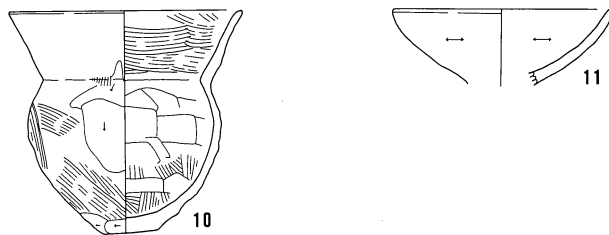

SK7822

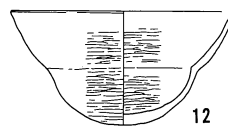

0 (1 : 4) 10cm

SK8250

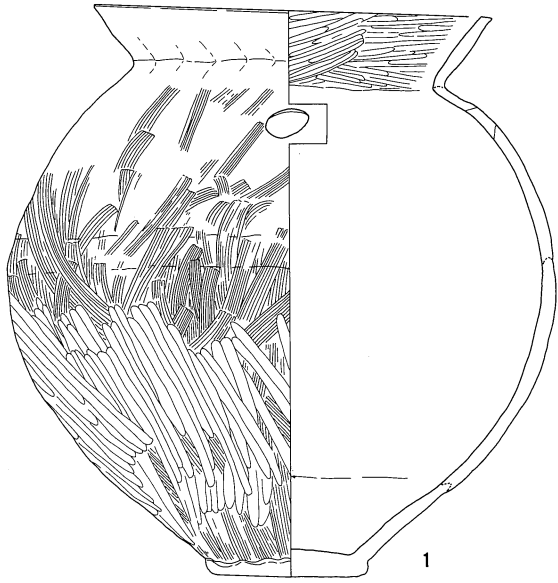

SK8310

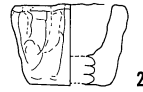

SK8405



SK8397

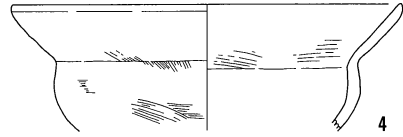

SK8404

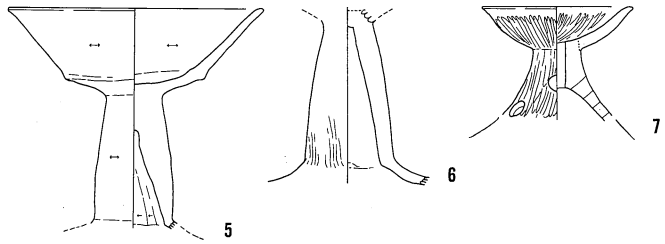

SK8442

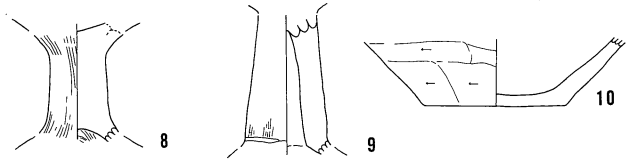
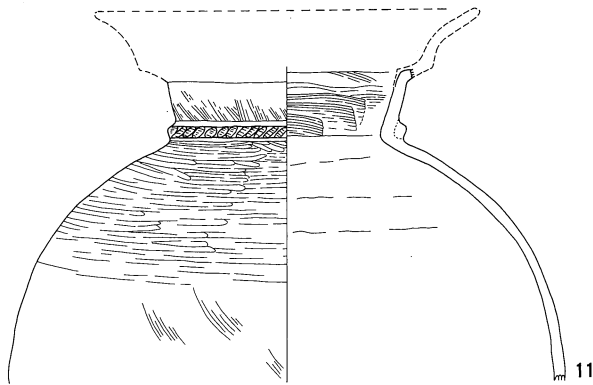

SK8502



SK8511

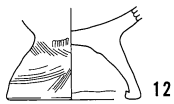

SK8893

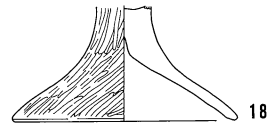
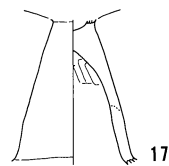
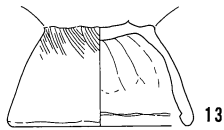

SK8855

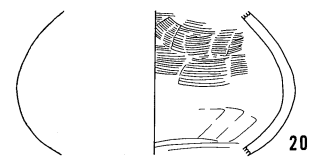
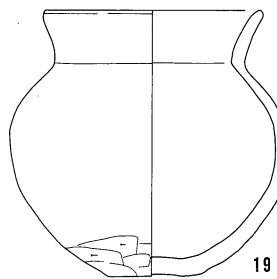
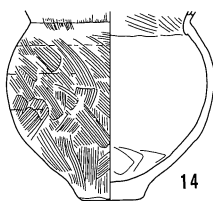

0 (1 : 4) 10cm

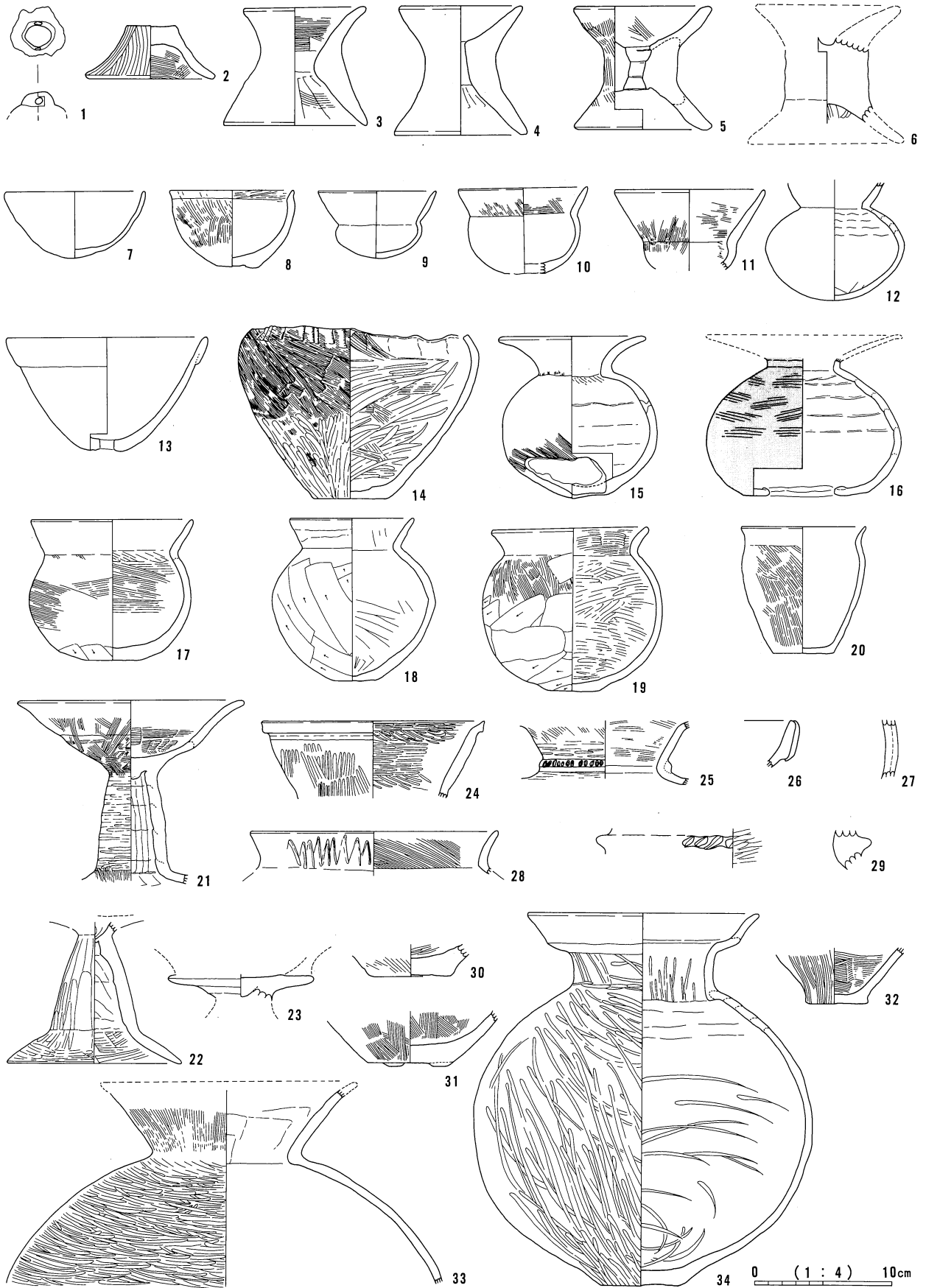

SB6020

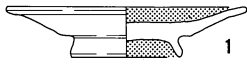

SB6023

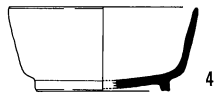
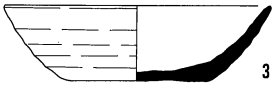

SB6024

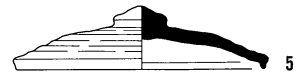

SB7001-①

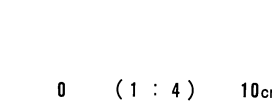
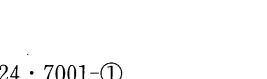
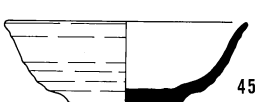
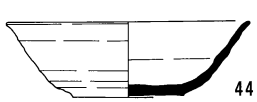
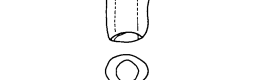
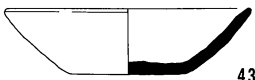
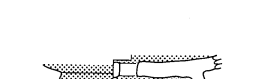
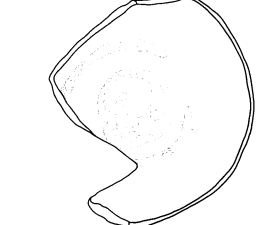
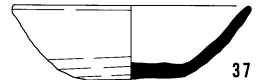
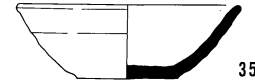
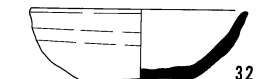
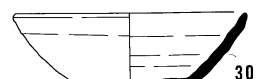
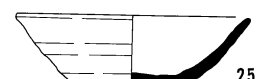
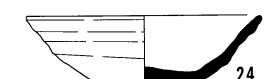
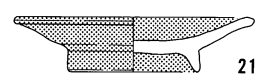
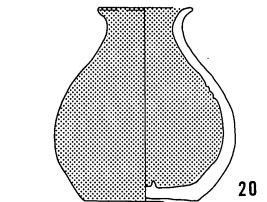
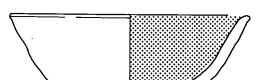
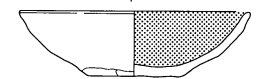
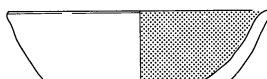
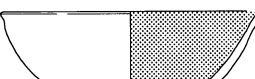
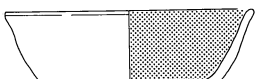
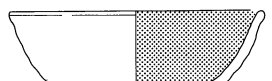
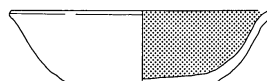
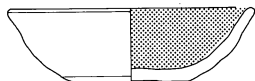
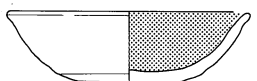
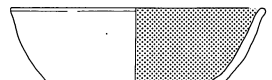
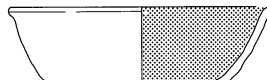
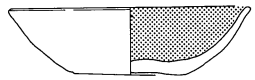
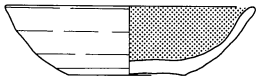

0 (1 : 4) 10cm

SB7001-②

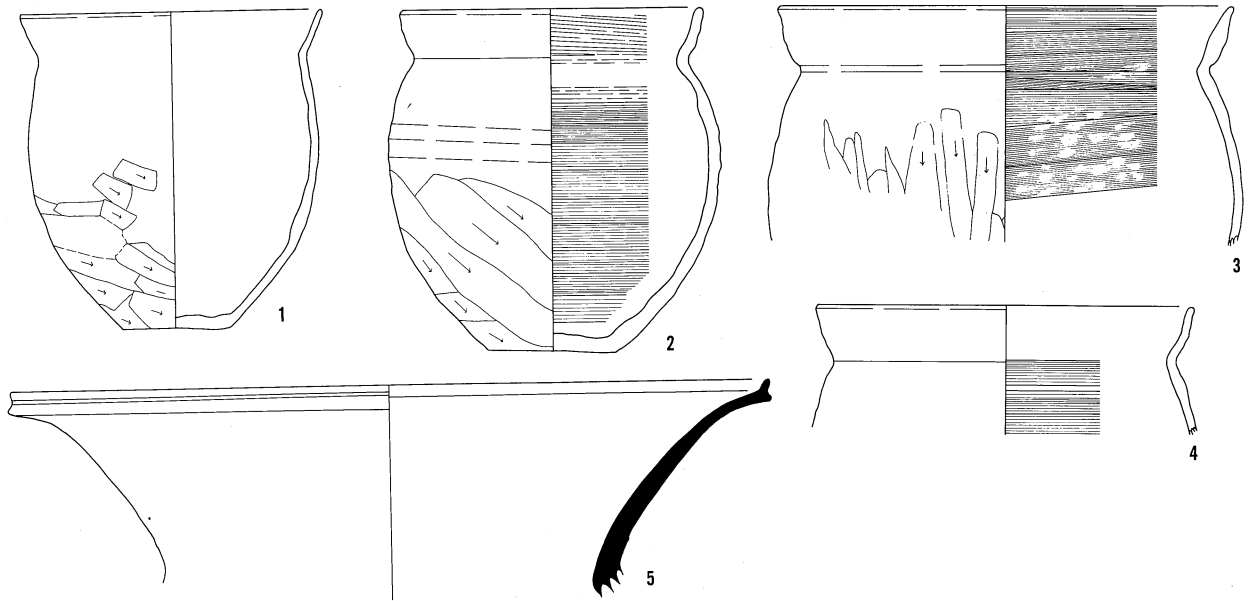

SB7002

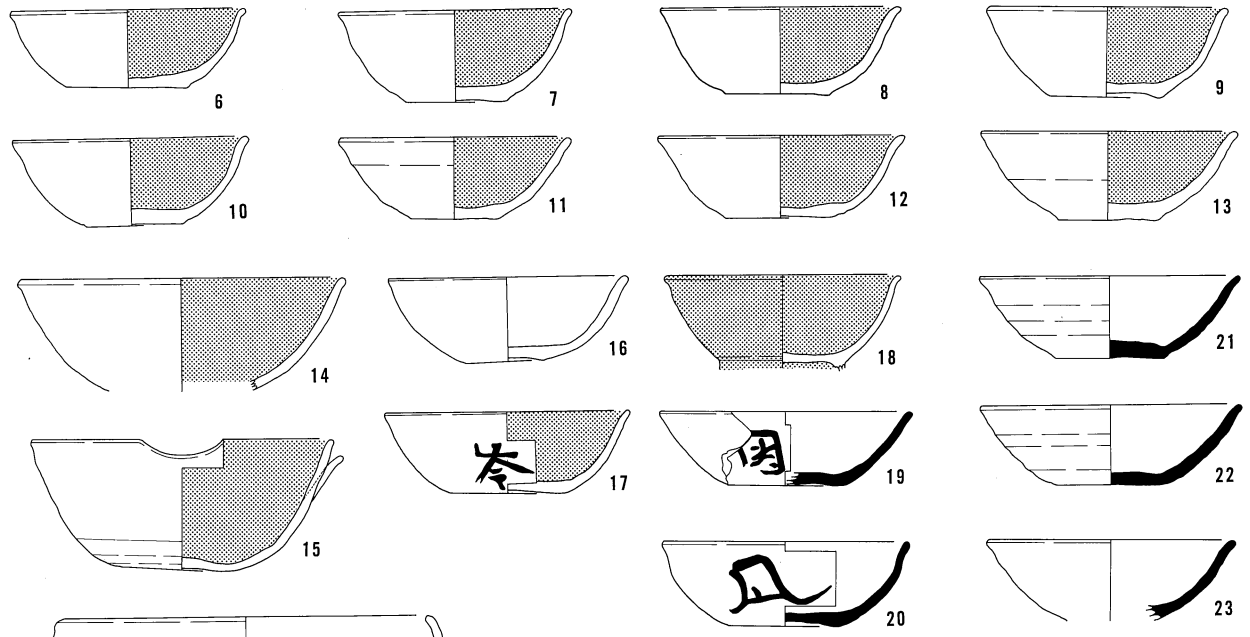

SB7003

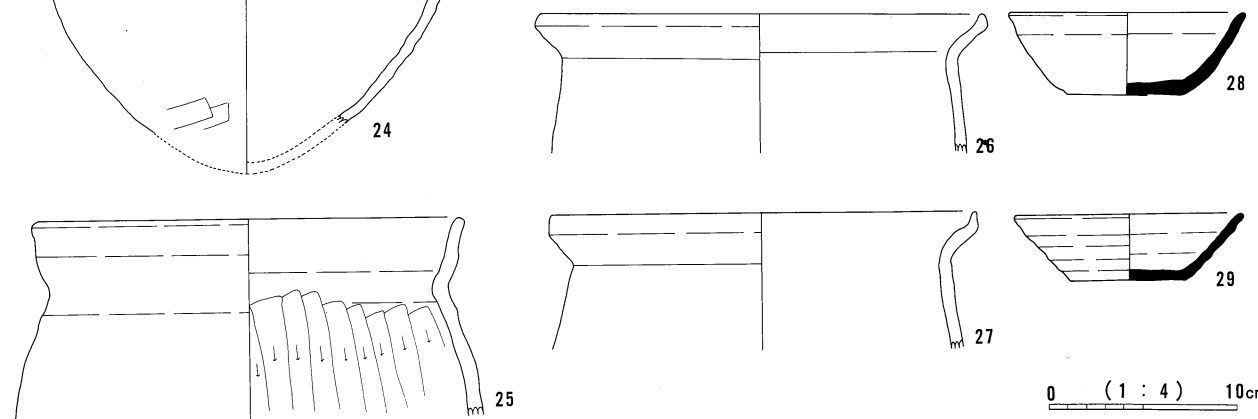

0 (1:4) 10cm

SB7004

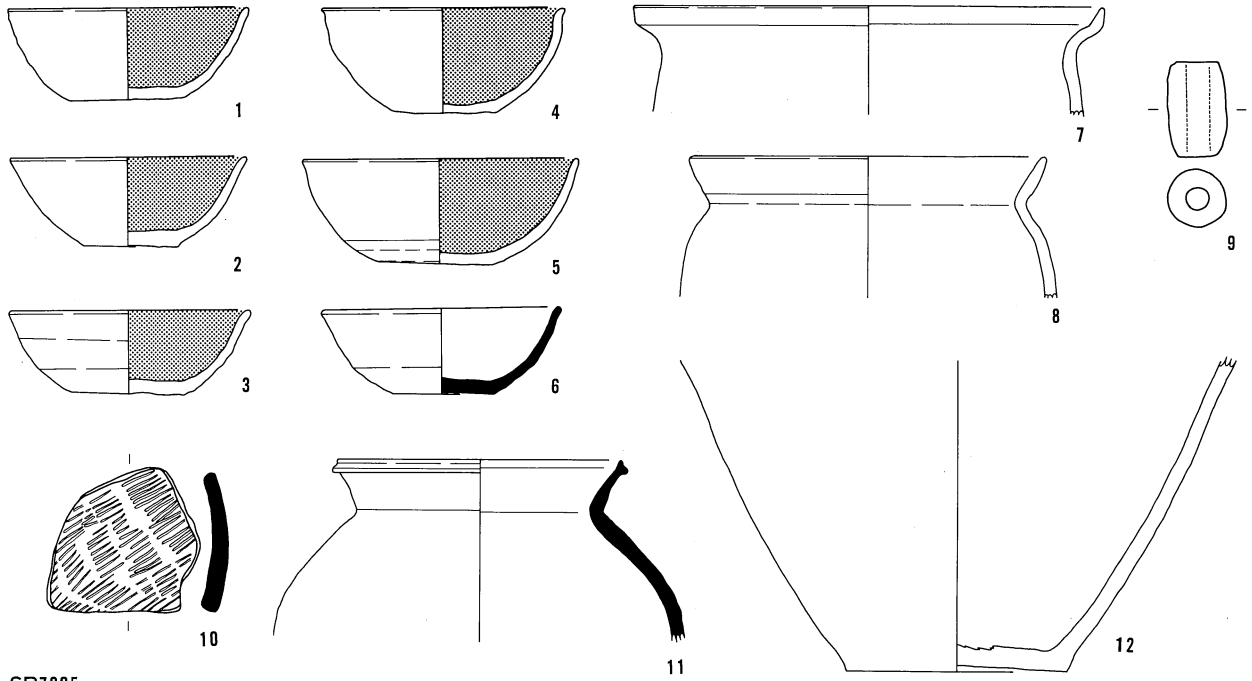

SB7005

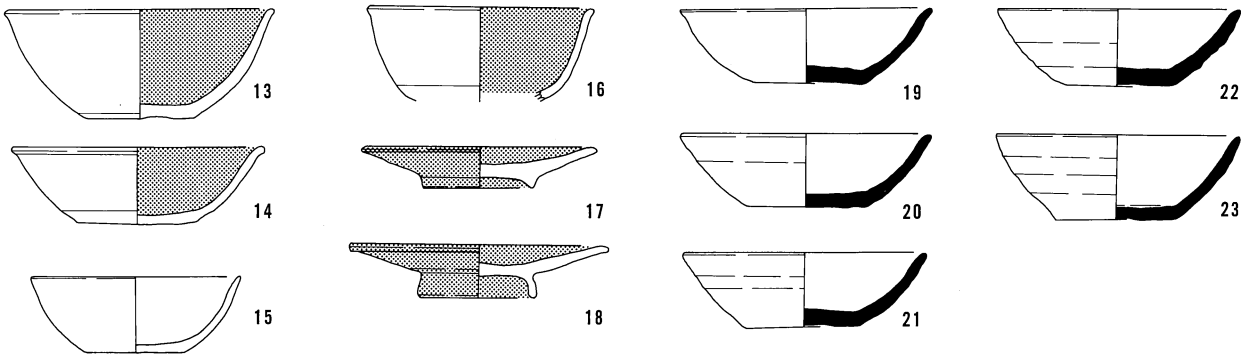

SB7006

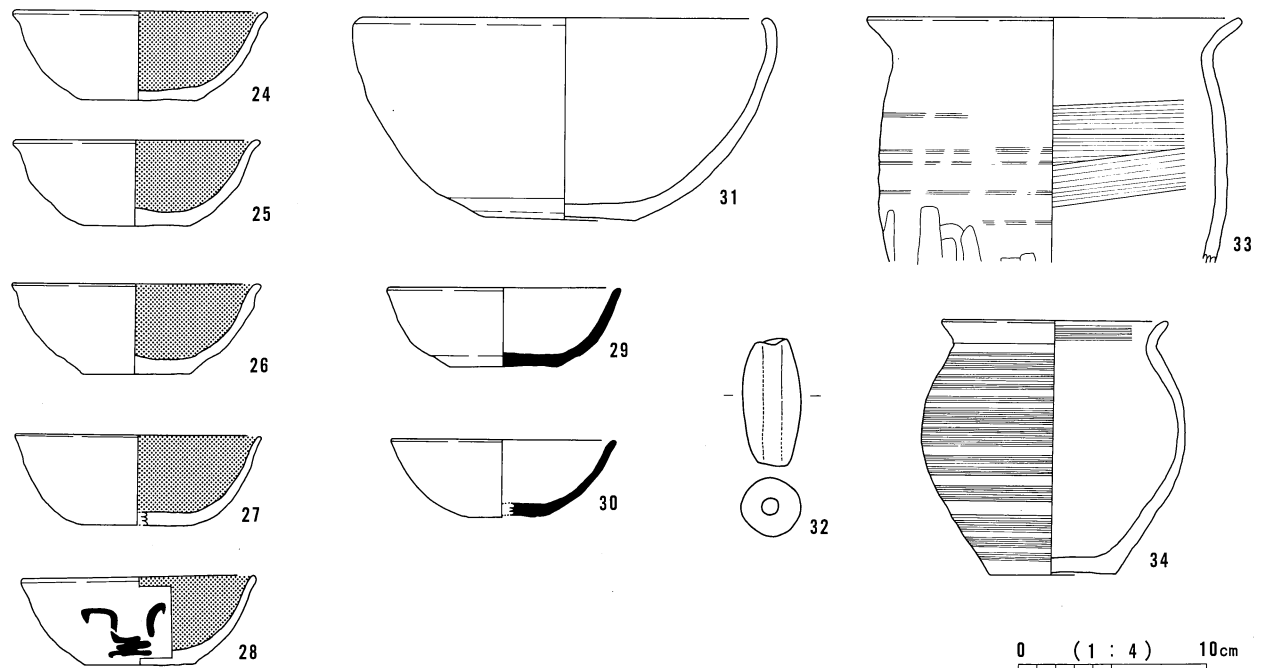

0 (1 : 4) 10cm

SB7007

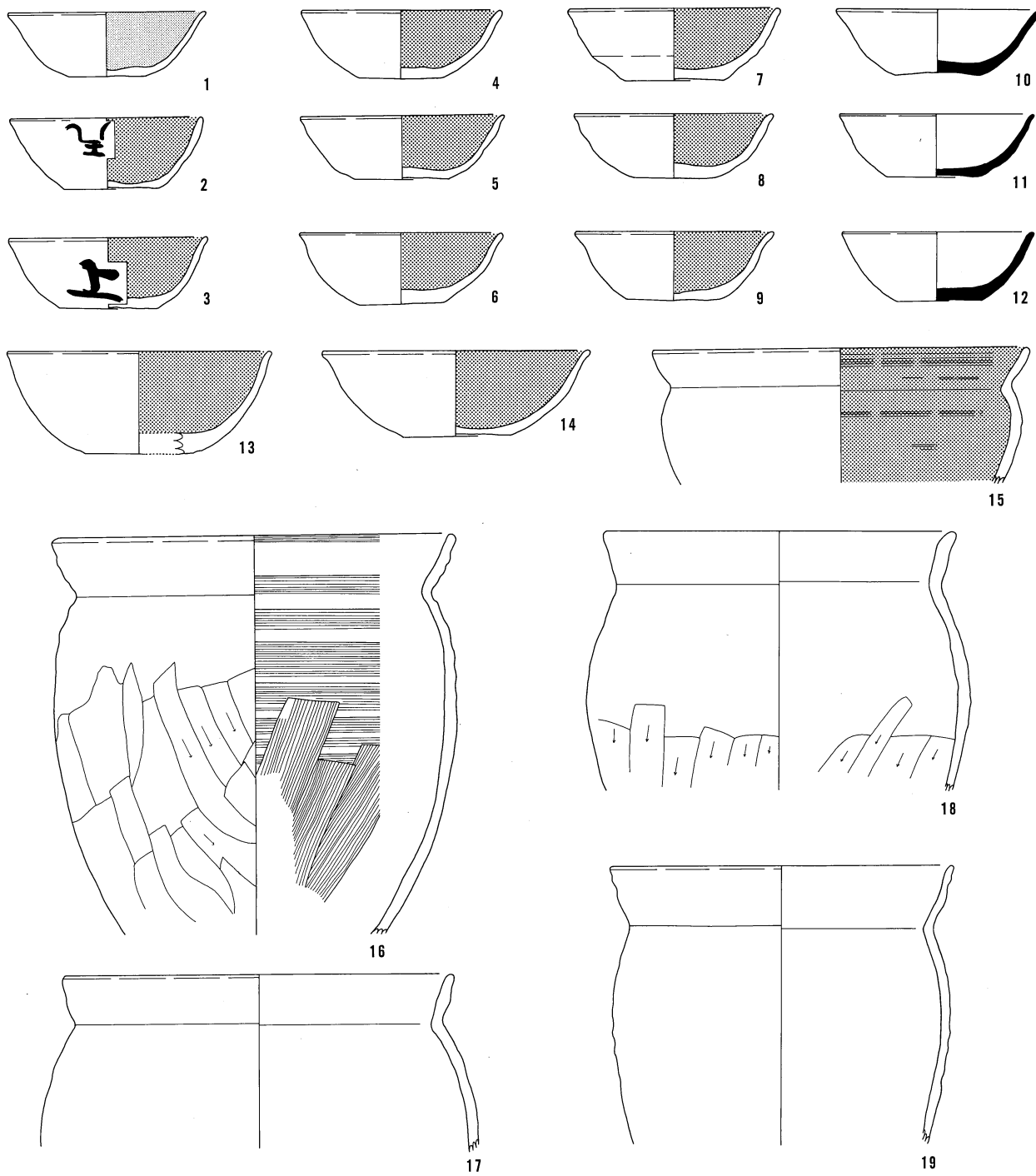

SB7008

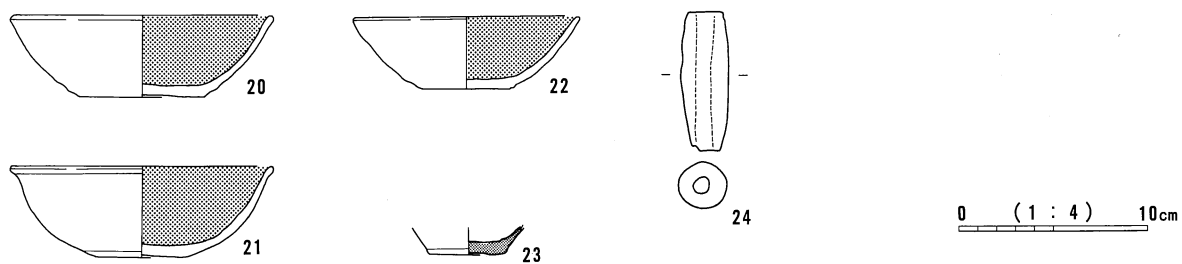

SB7009

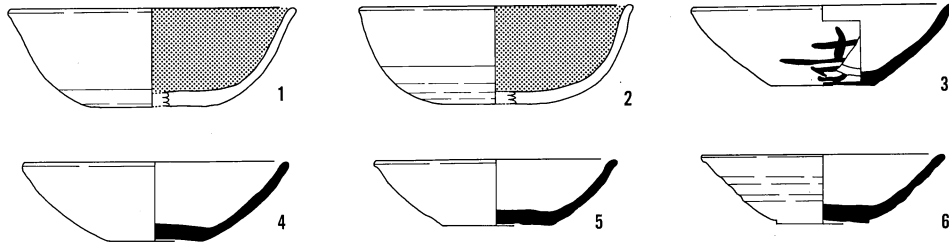

SB7010

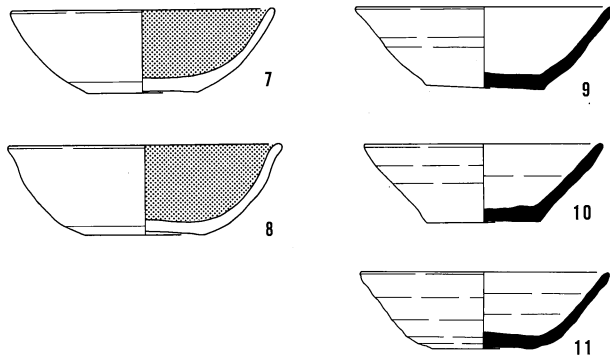

SB7012



SB7011

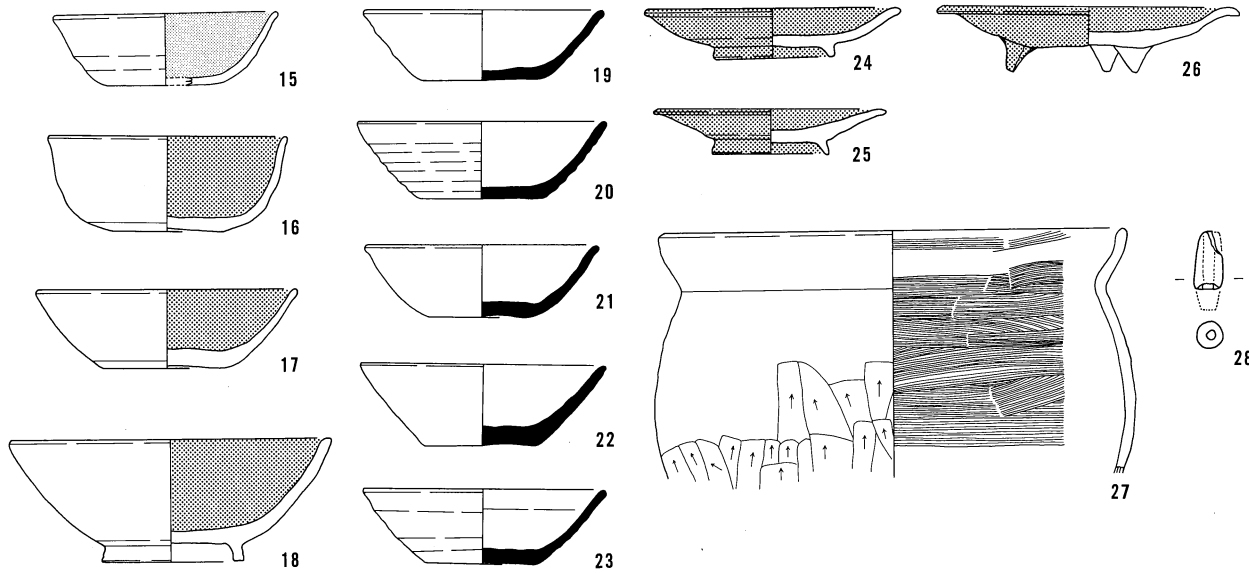

SB7014

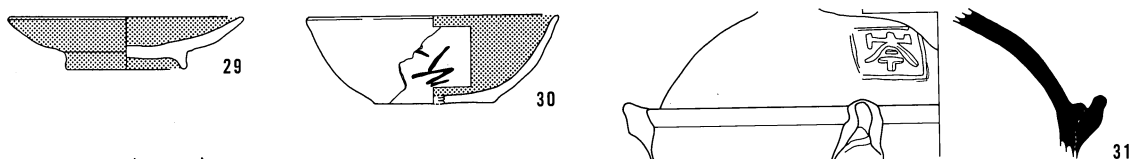

0 (1 : 4) 10cm

SB7013

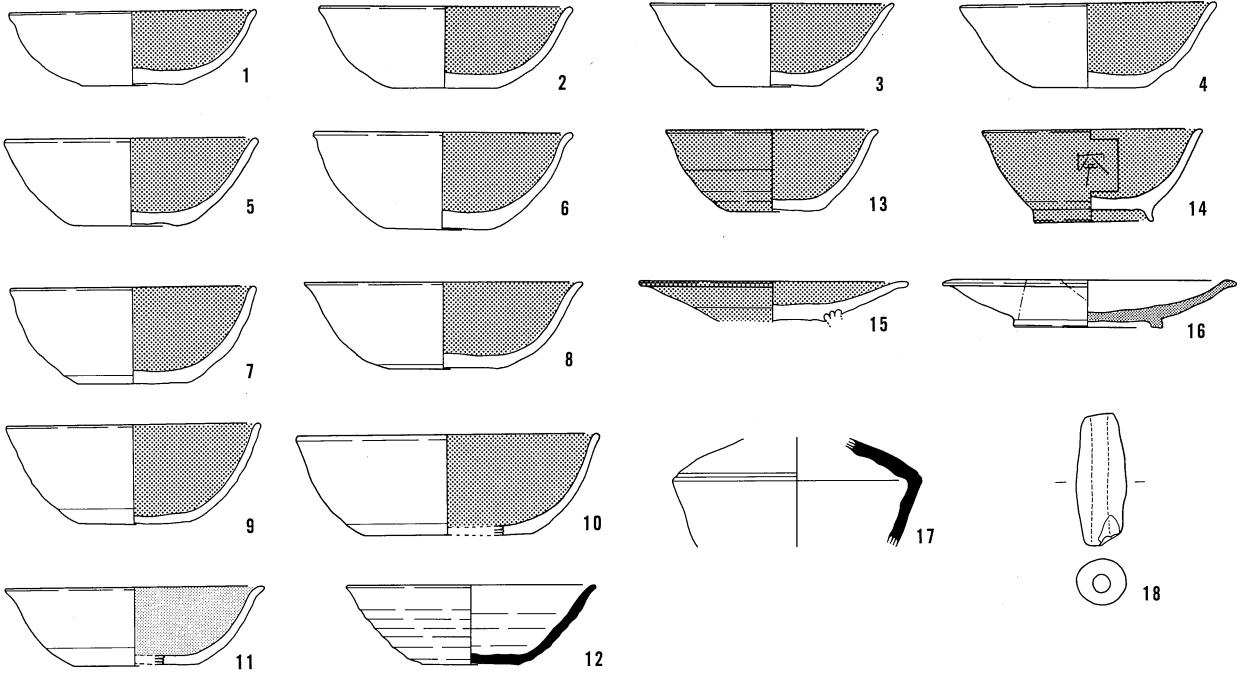

SB7015

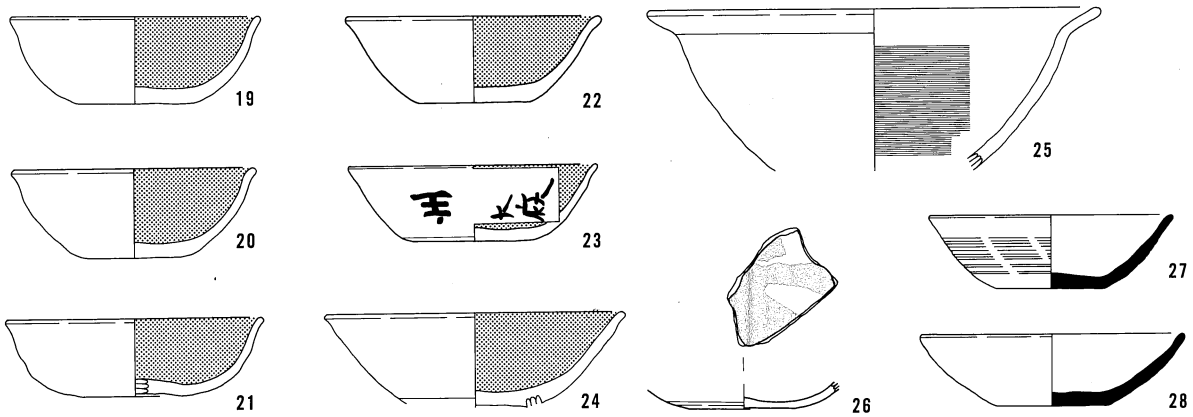

SB7016

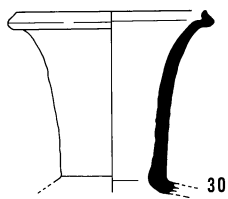
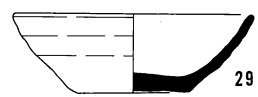

SB7018

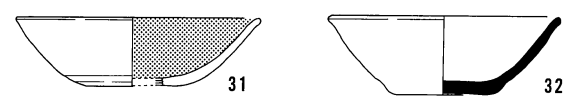

SB7022

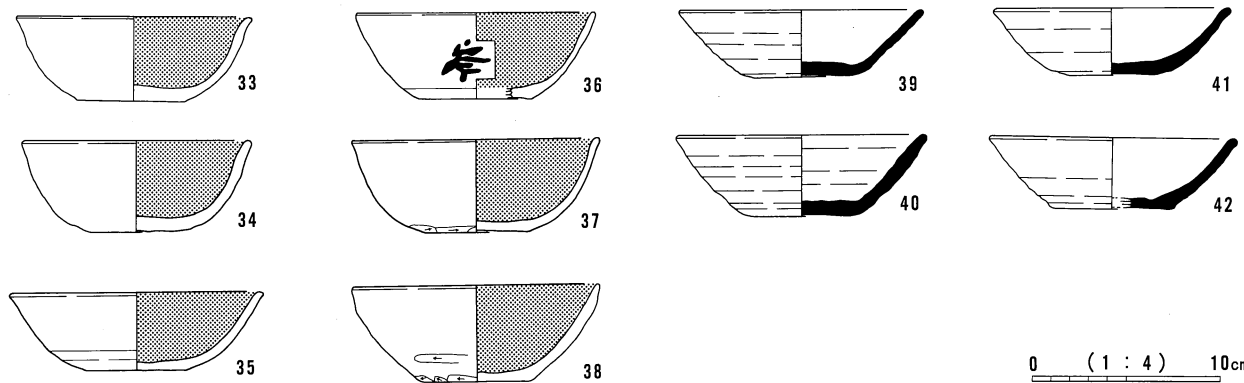

0 (1 : 4) 10cm

SB7019

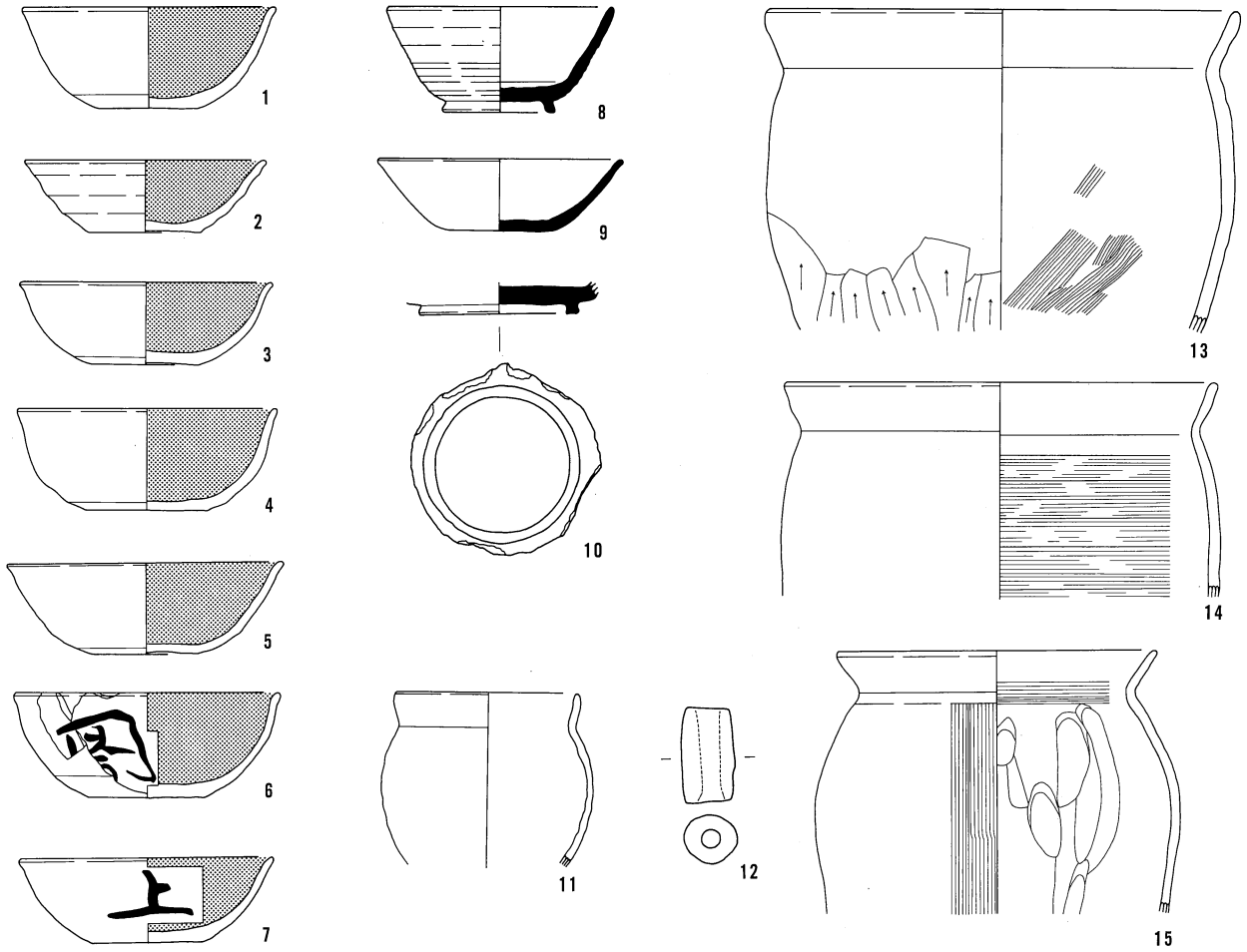

SB7025

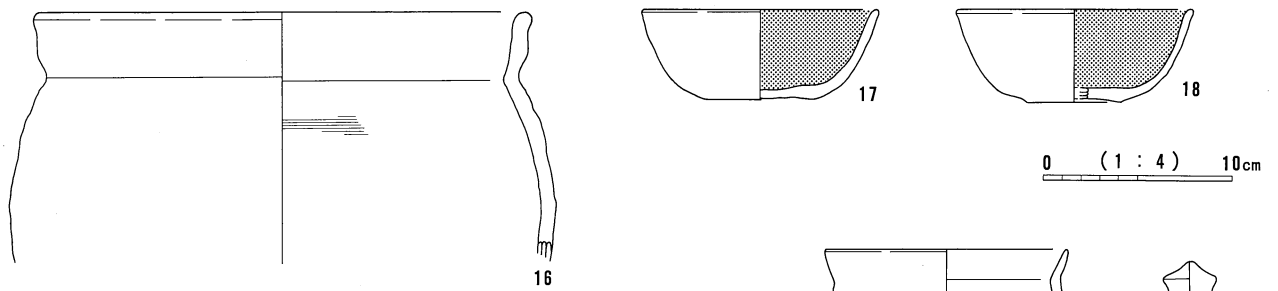

SB7026

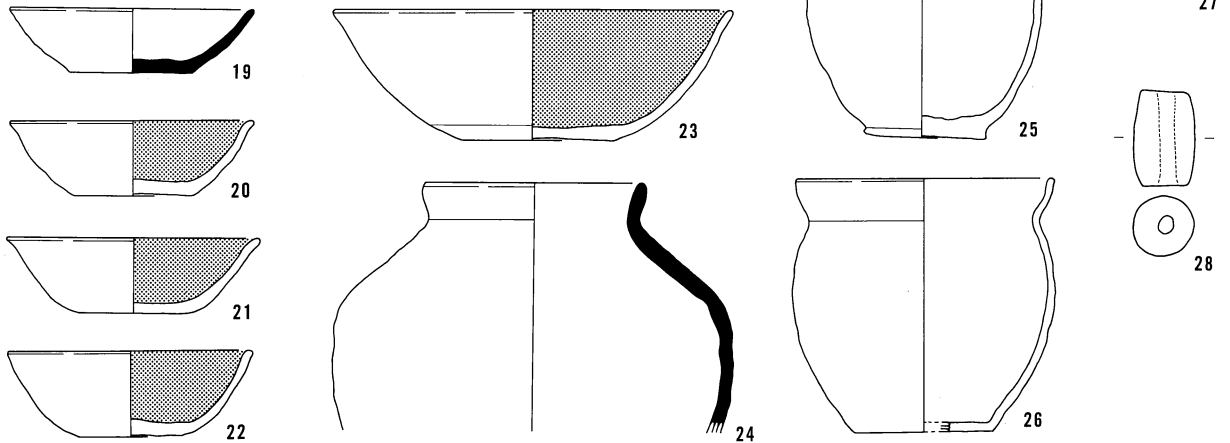

SB7029

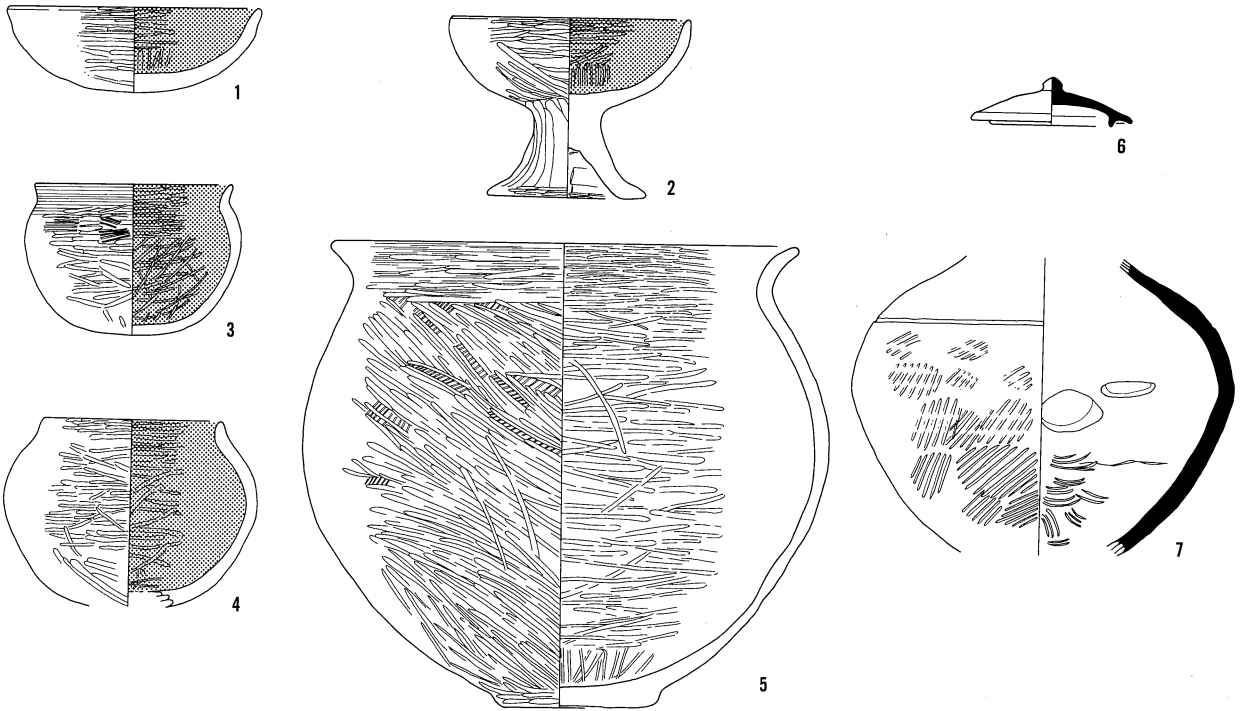

SB7030

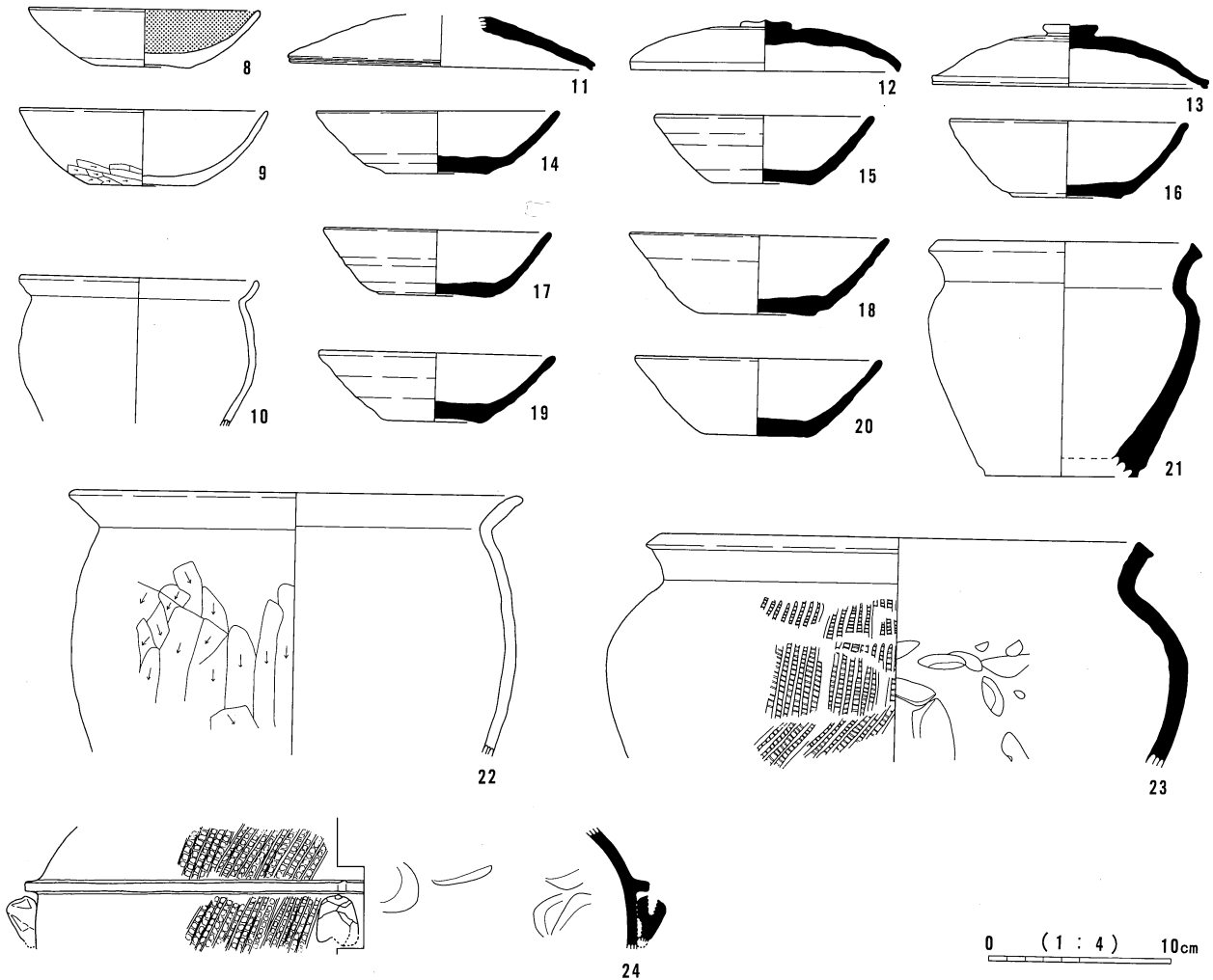

SB7031

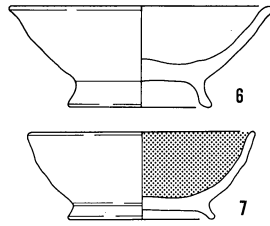
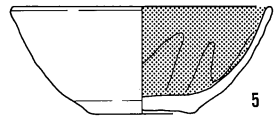
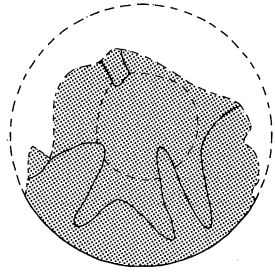
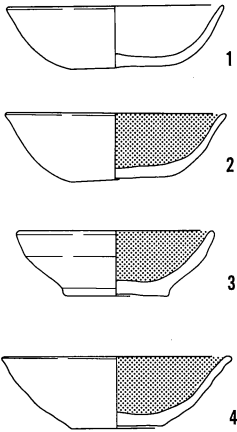

SB7033

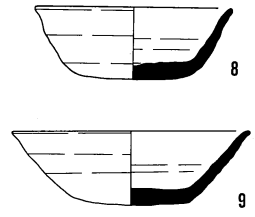

SB7036



SB7041

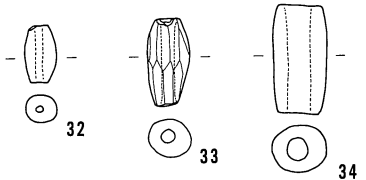
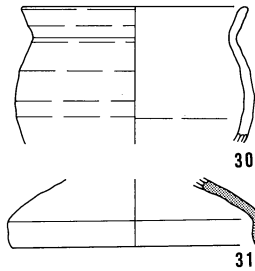
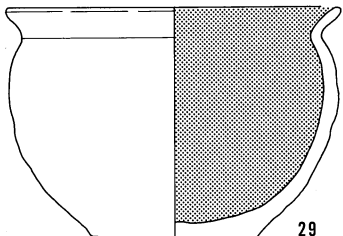
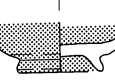
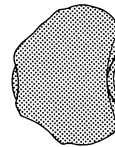
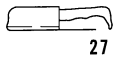
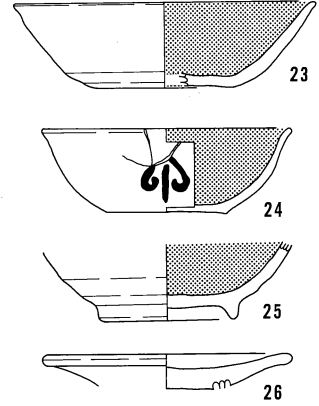
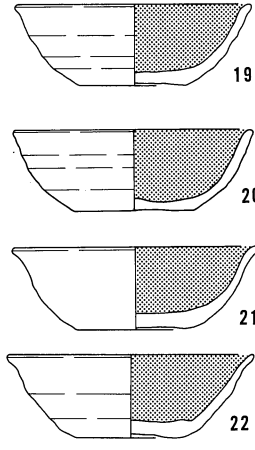
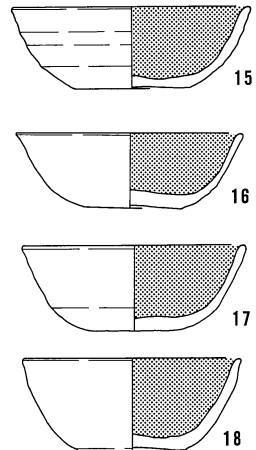
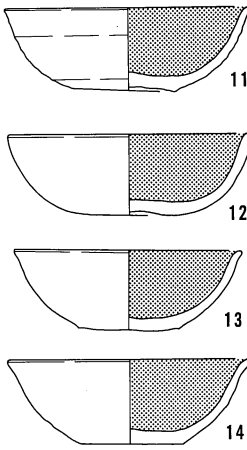

SB7046



SB7047

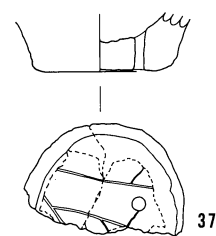
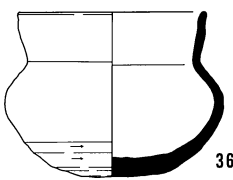

SB7059

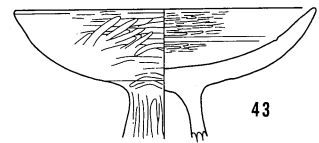
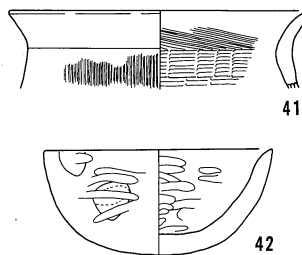
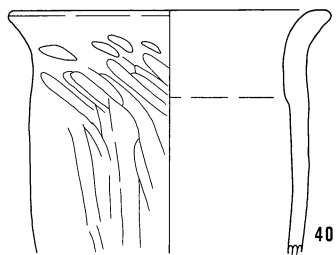
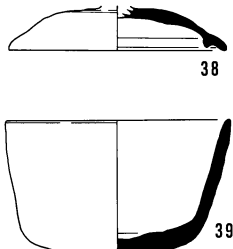

0 (1 : 4) 10cm

SB7048

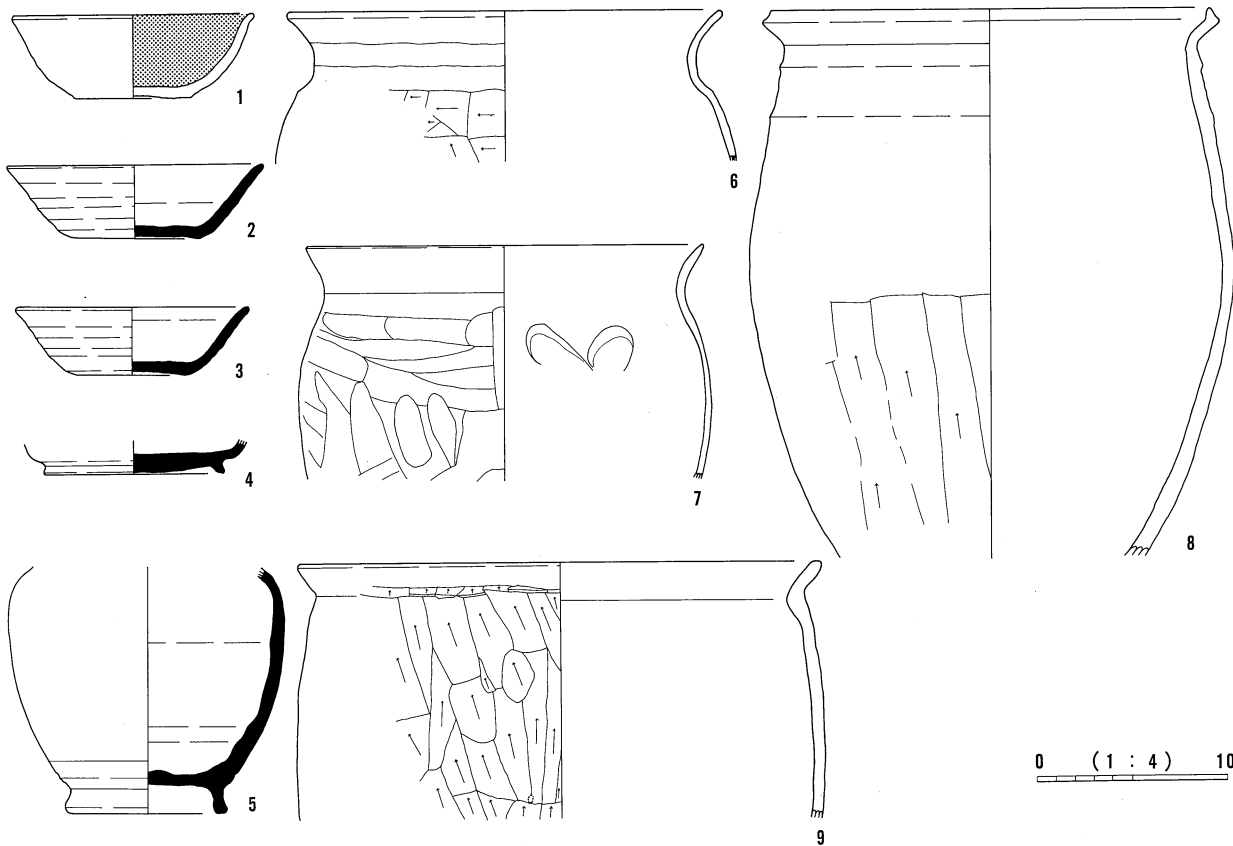

SB7052



SB7053

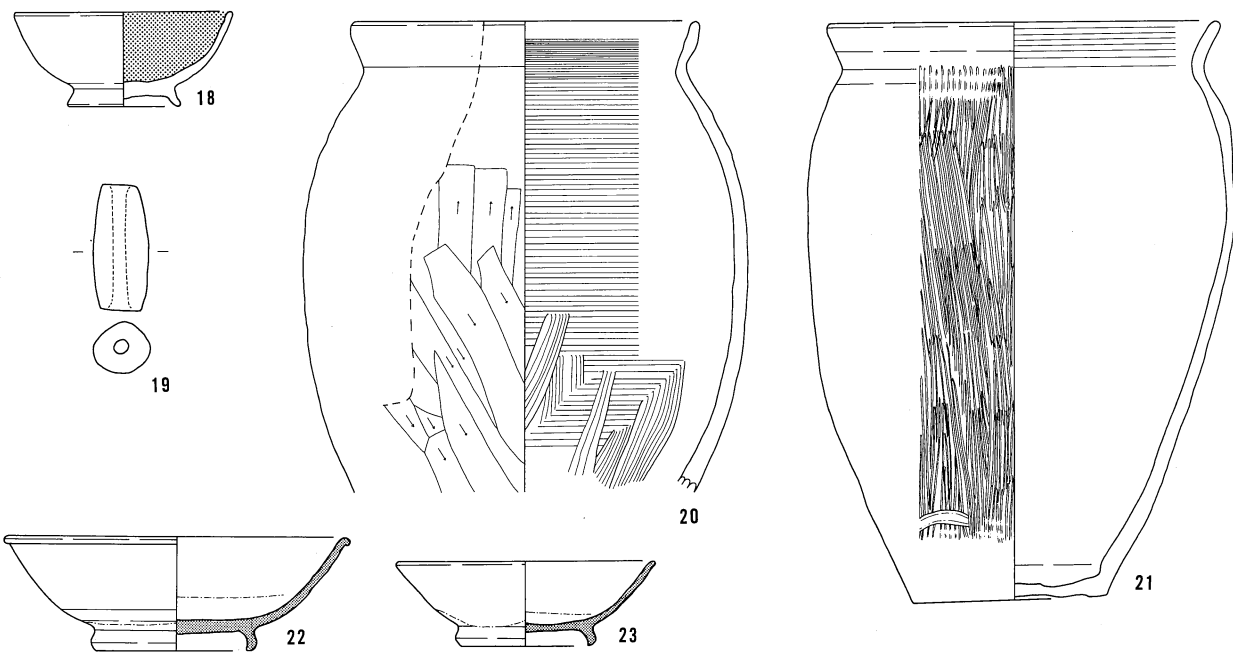
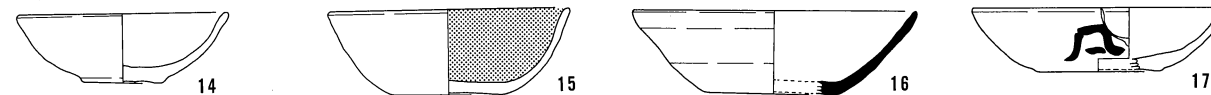

SB7054

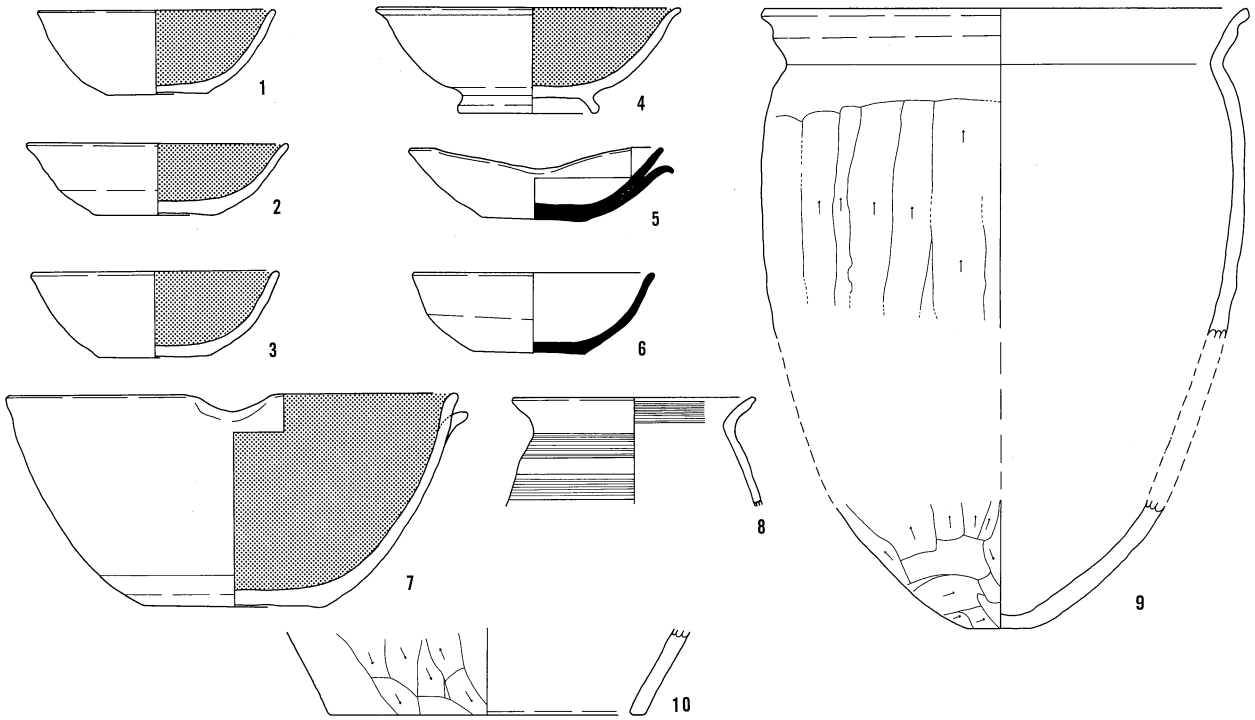

SB7058

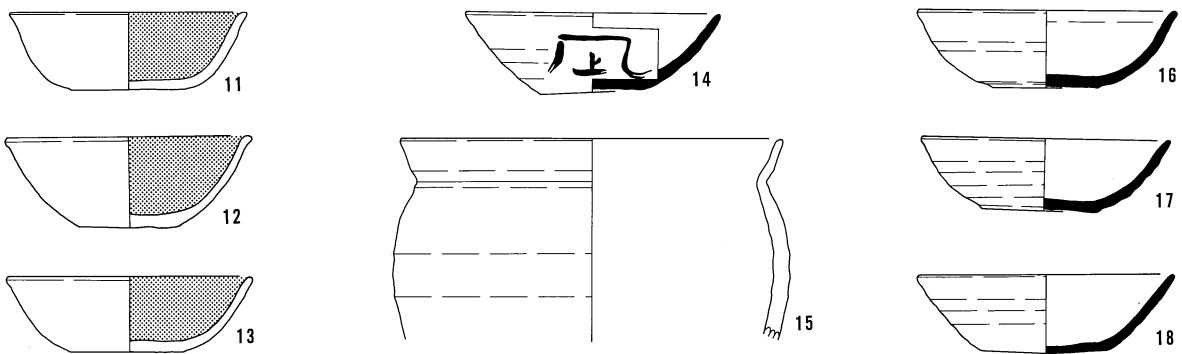

SB7092

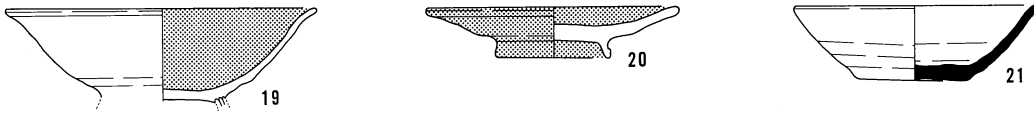

SB7098

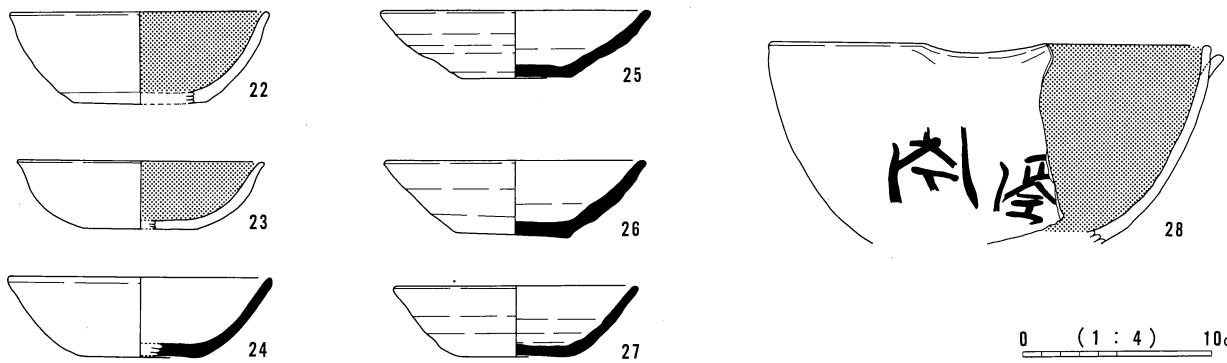

SB7068

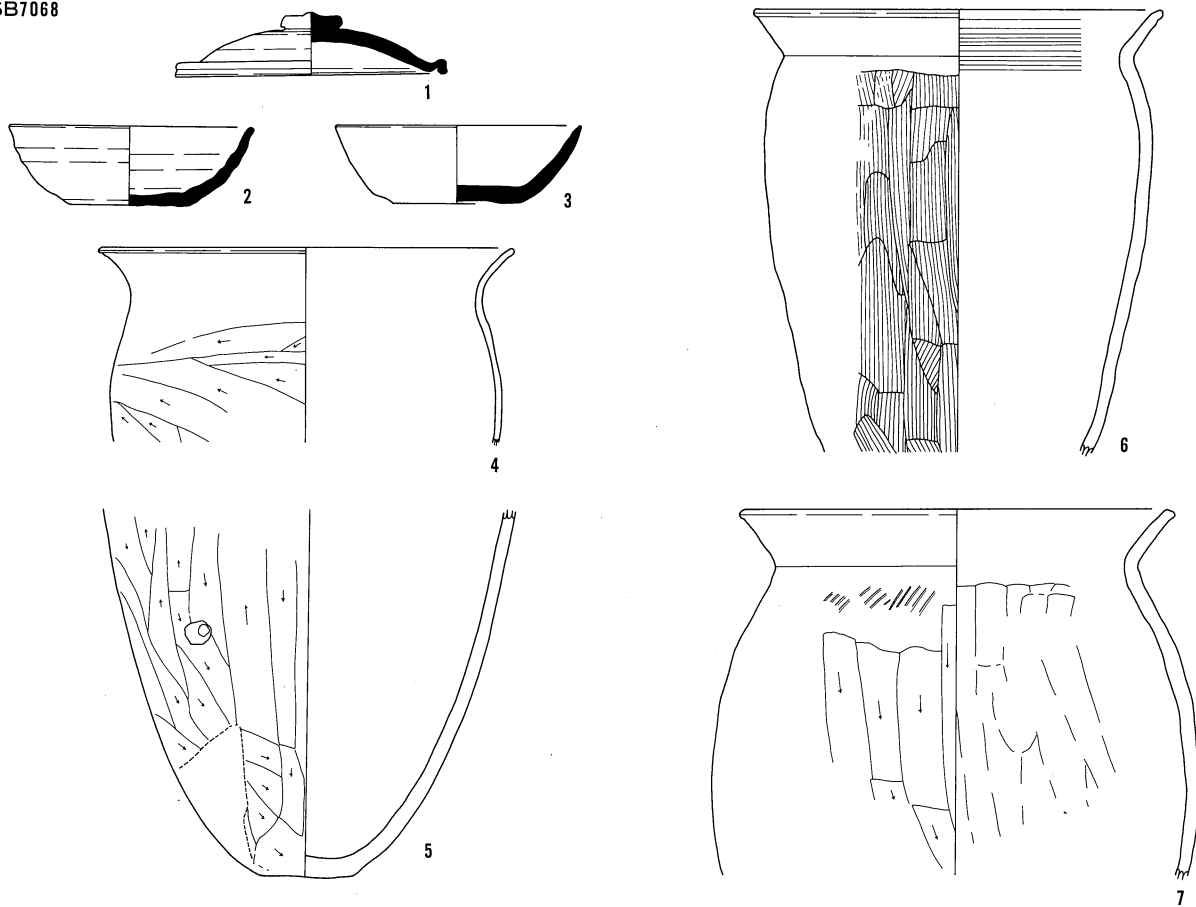

SB7100

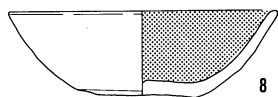

SB7106

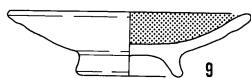

SB7108

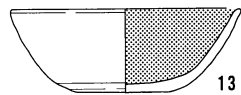
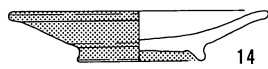
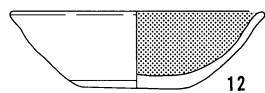

SB7111

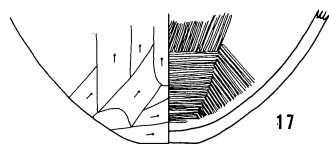
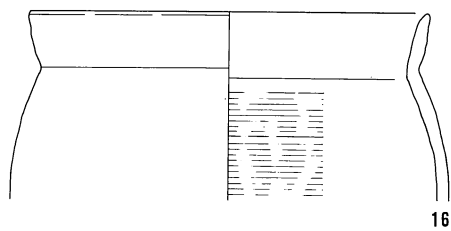
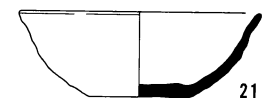
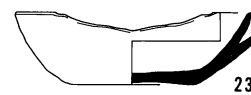
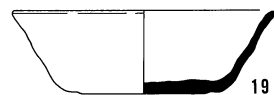
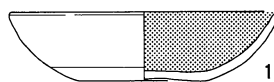

0 (1:4) 10cm

SB7109

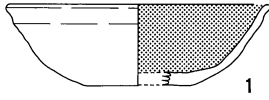

1

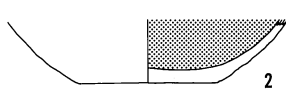

2

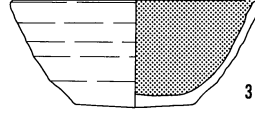

3

SB7113



4

SB7112

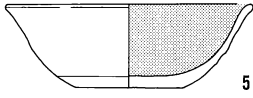

5

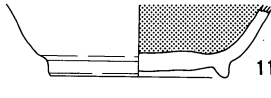

11

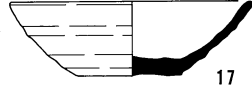

17

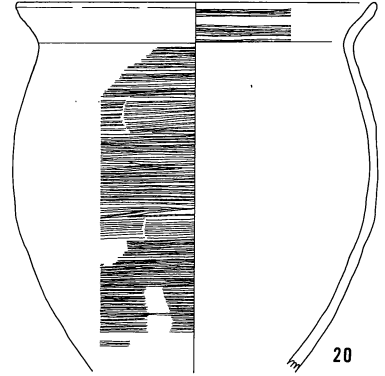

20

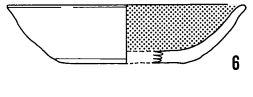

6

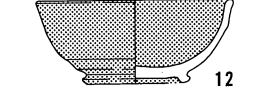

12



18

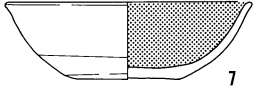

7

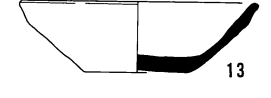

13



19

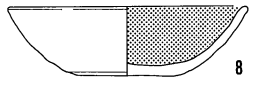

8



14

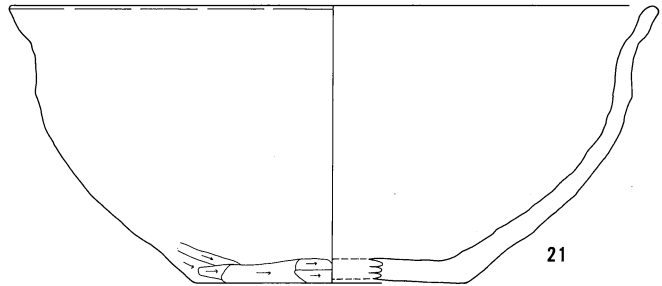

21

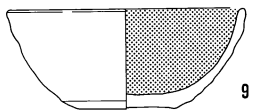

9

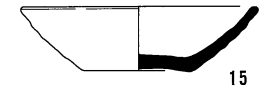

15

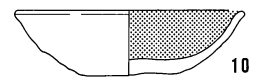

10

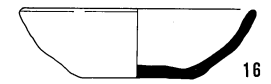

16

SB7114

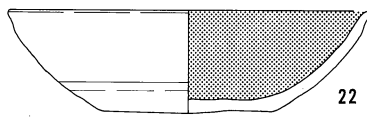

22



24

SB7115

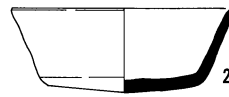

29

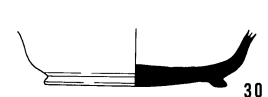

30

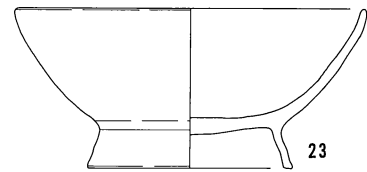

23

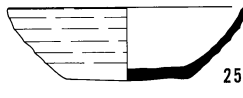

25



26

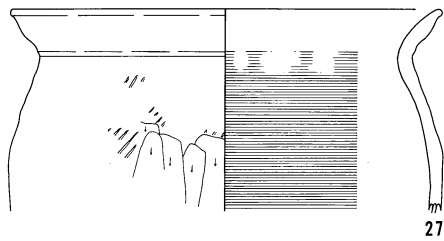

27

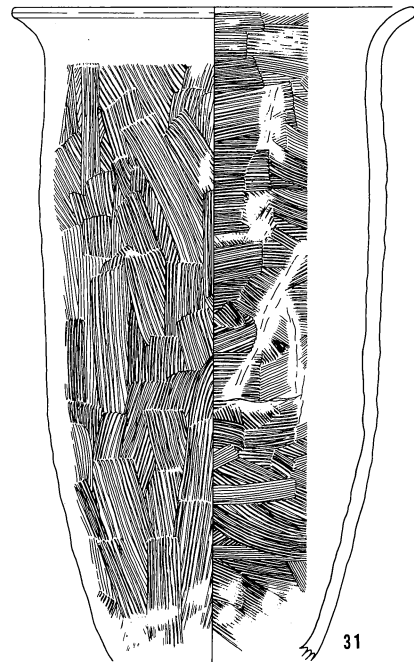

31

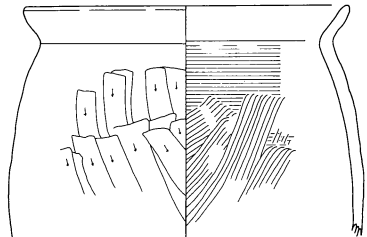

28

0 (1 : 4) 10cm

SB7118

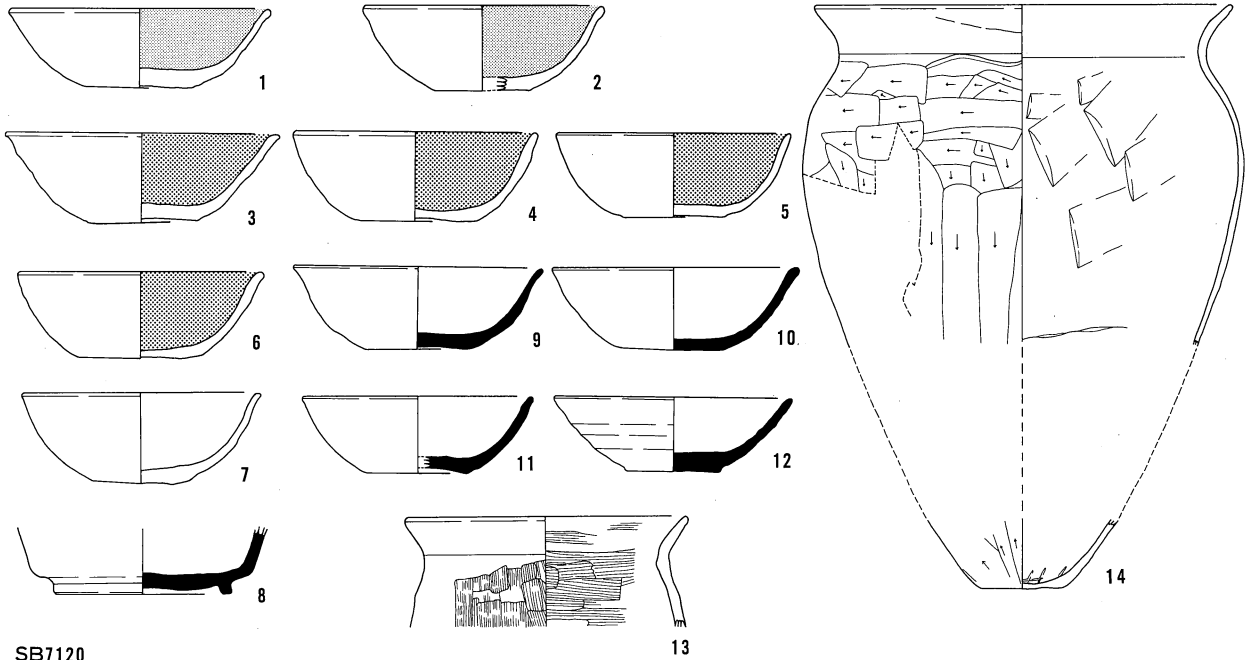

SB7120

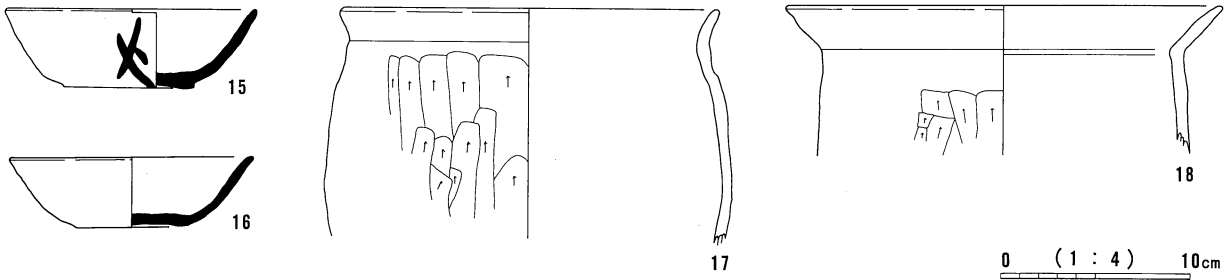

SB7121

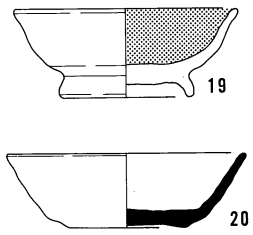

SB7123

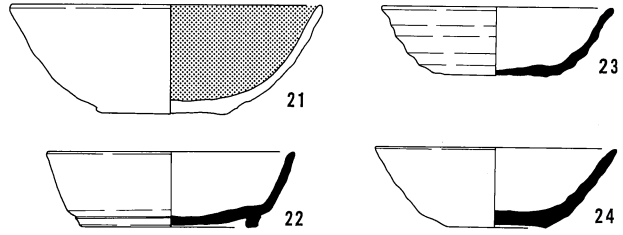

SB7122

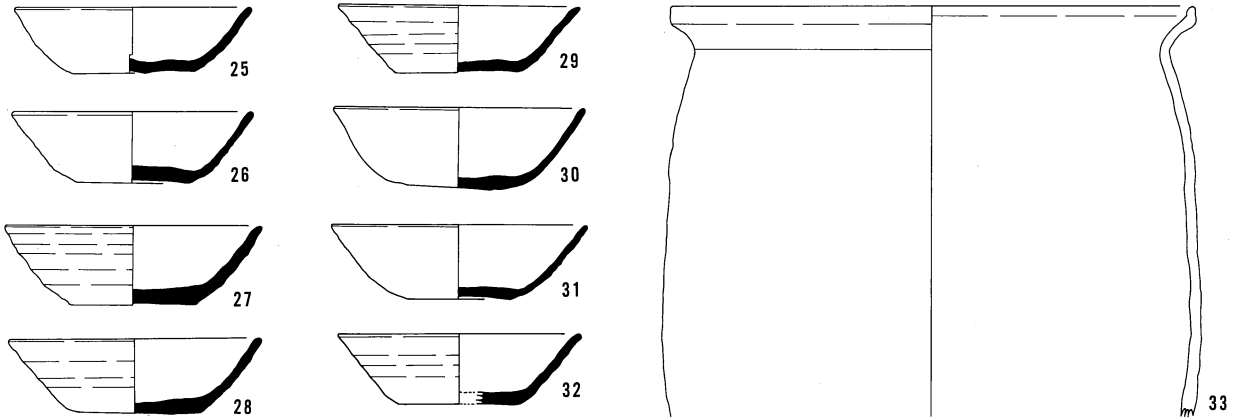

SB7127

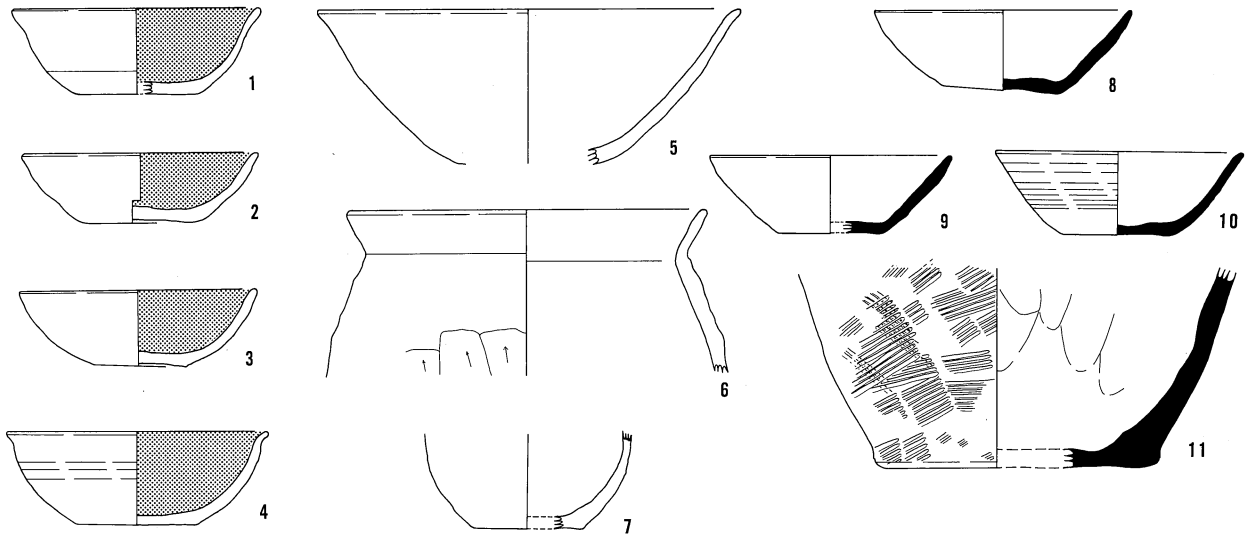

SB7133

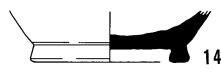
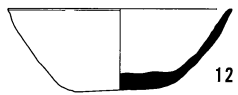

SB7134

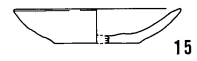

SB7136

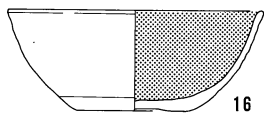

SB7137

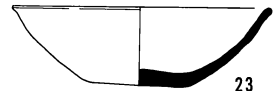
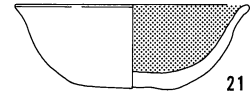
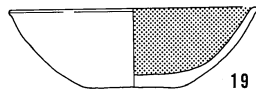
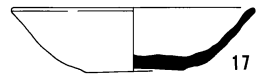
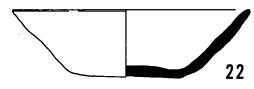
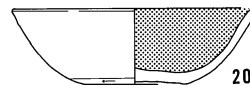
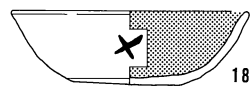

SB7141

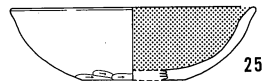
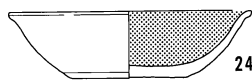

SB7143

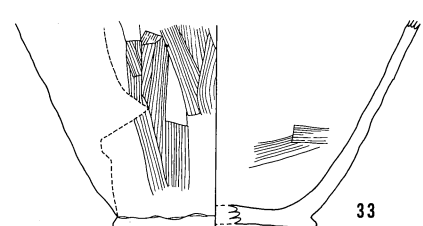
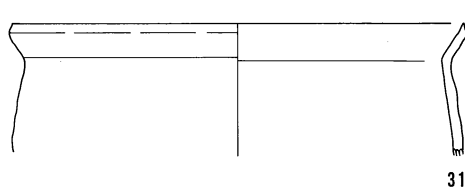
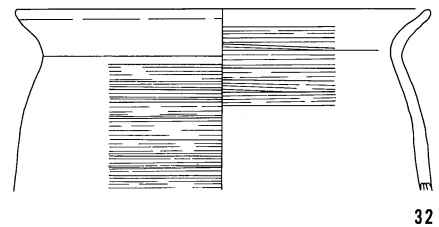
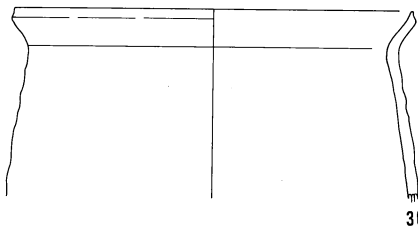

0 (1 : 4) 10cm

SB7144

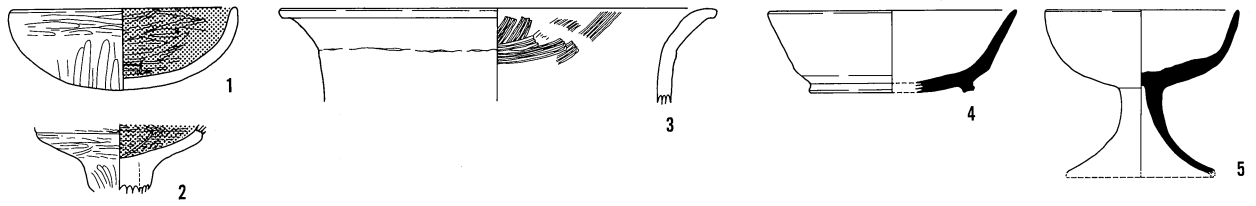

SB7150

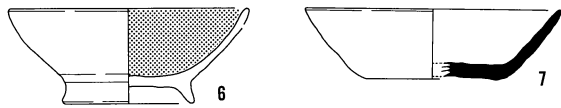

SB7152

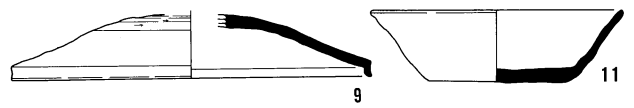

SB7153

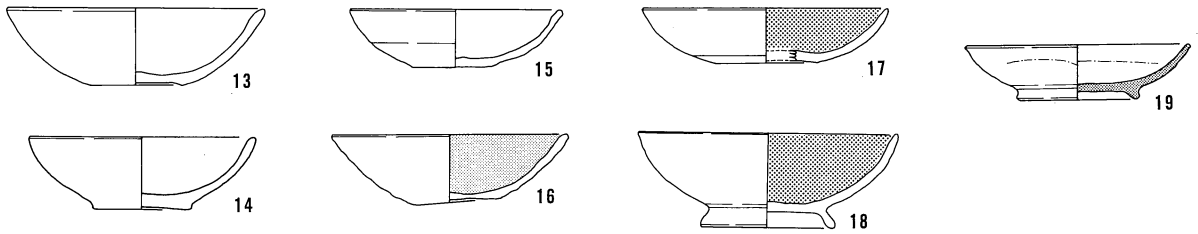

SB7154

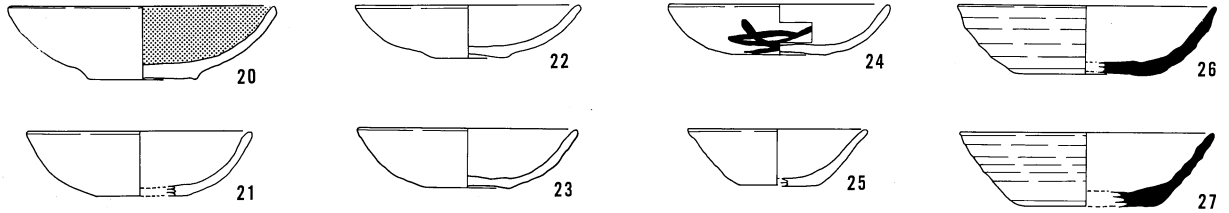

SB7155

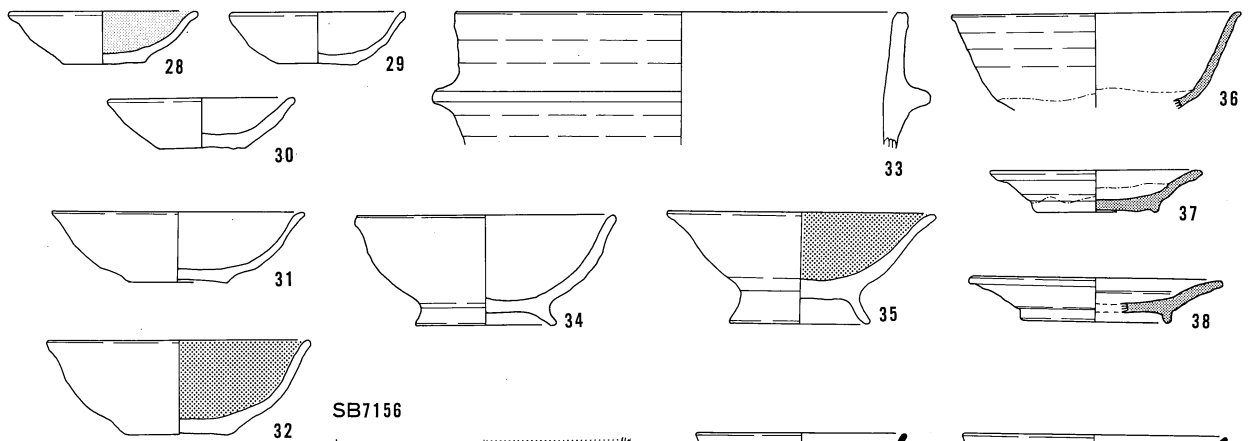

SB7156

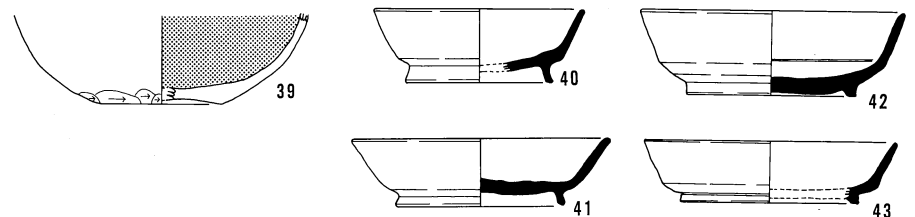

0 (1 : 4) 10cm

SB7158

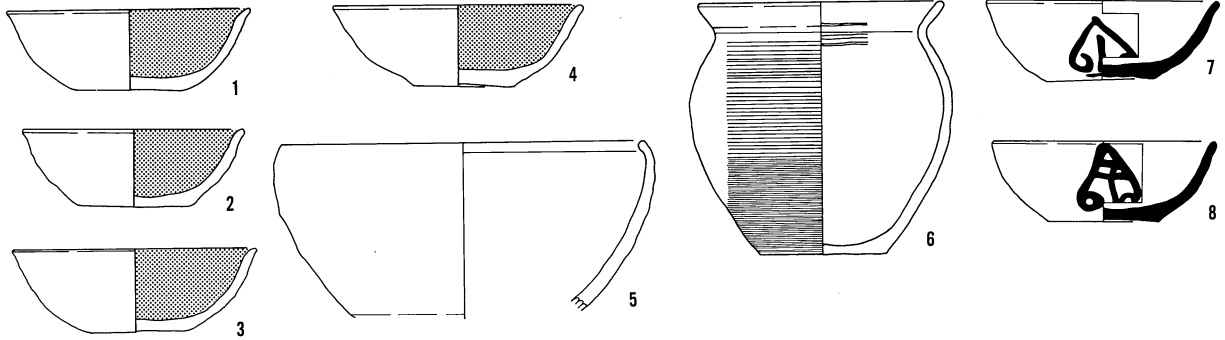

SB7159

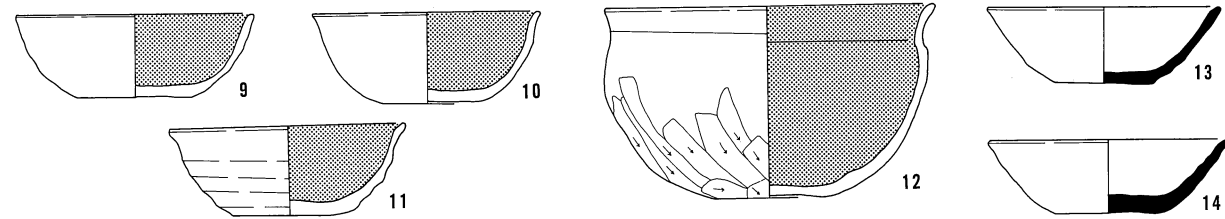

SB7160

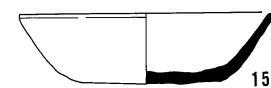

SB7161

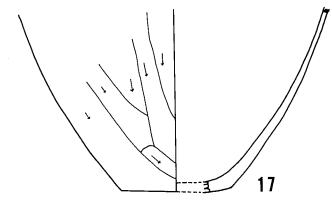

SB7165

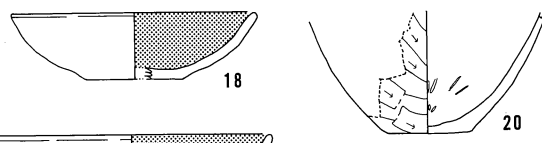

SB7164

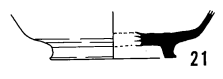
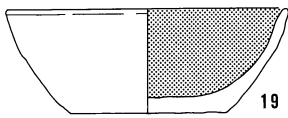
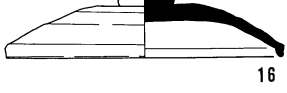

SB7169

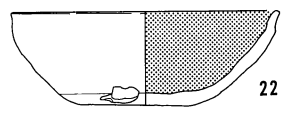

SB7171

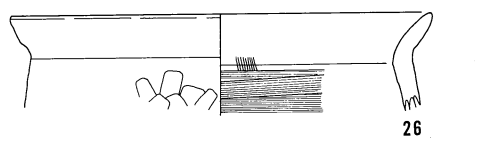

SB7174

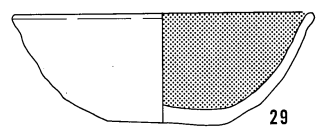
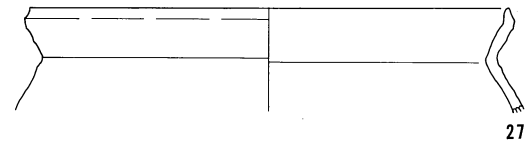
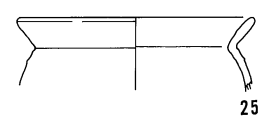
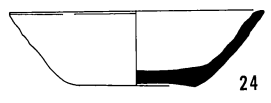
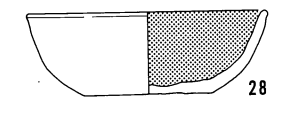

SB7179

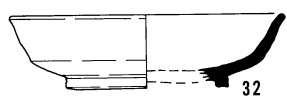

SB7185

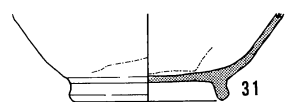
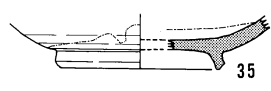
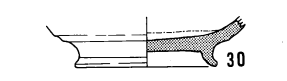
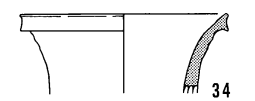

0 (1 : 4) 10cm

SB7181

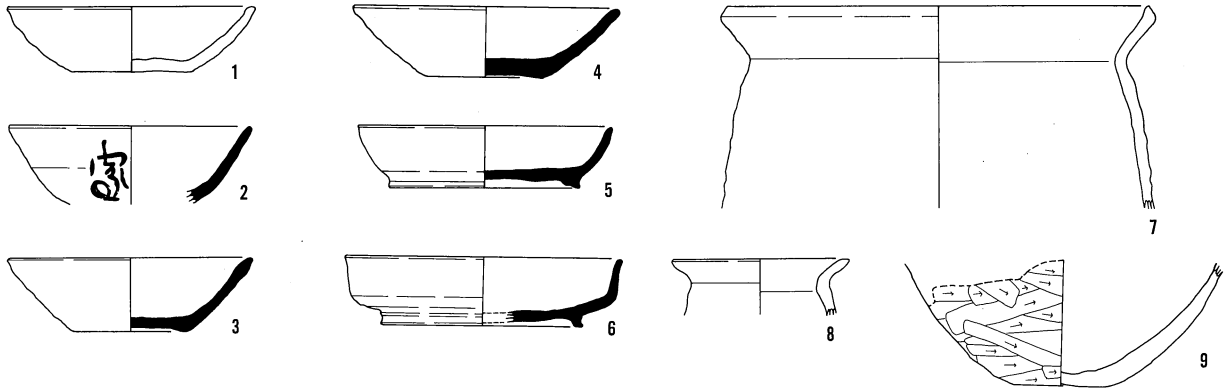

SB7196

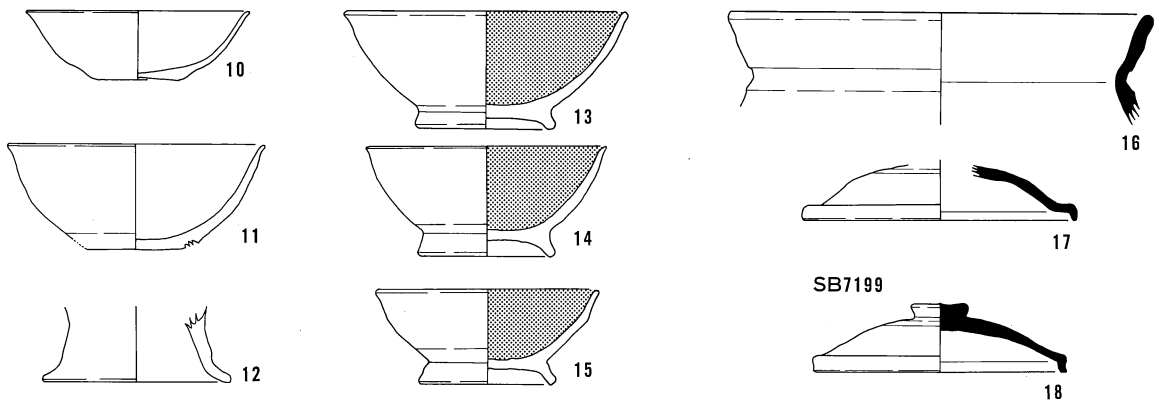

SB7200

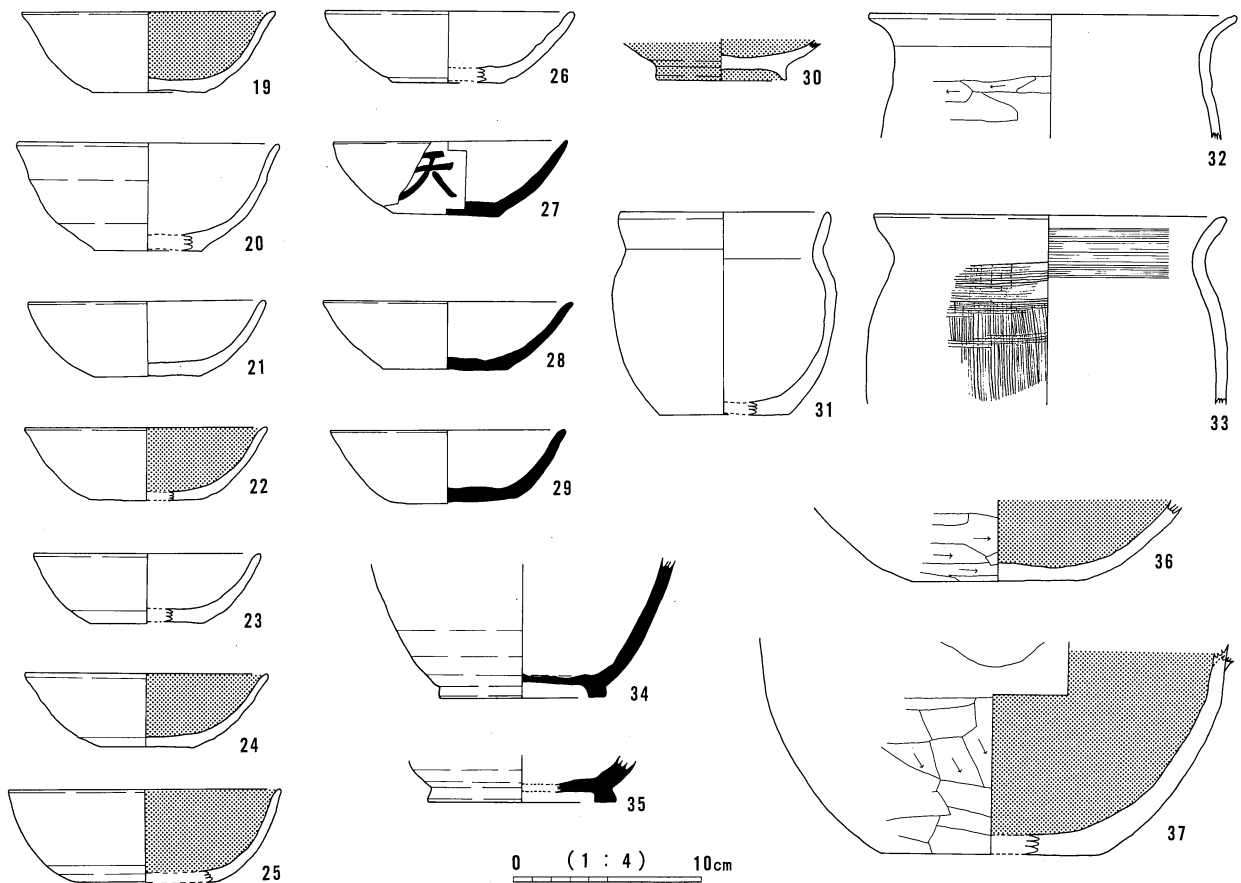

SB7201

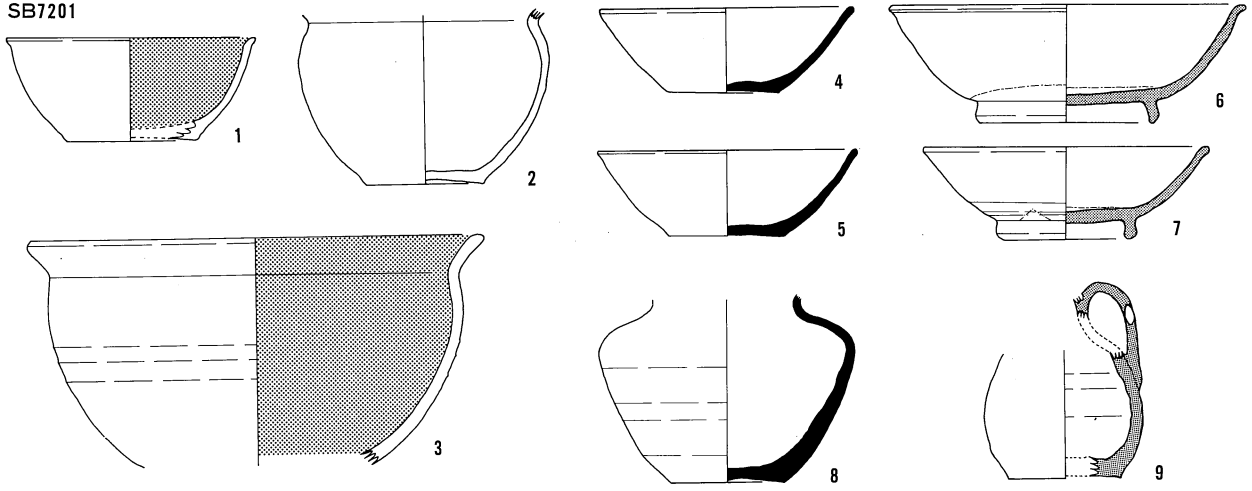

SB7202



SB7203

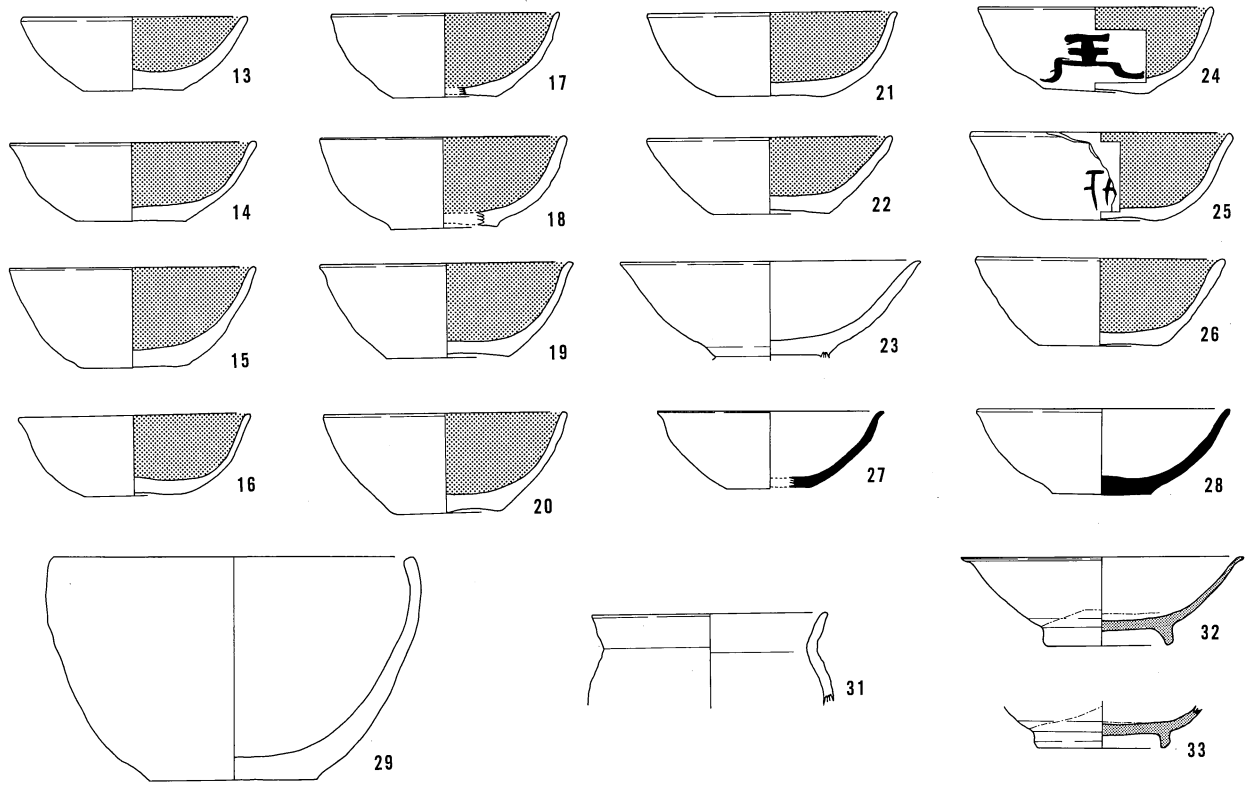

SB7204

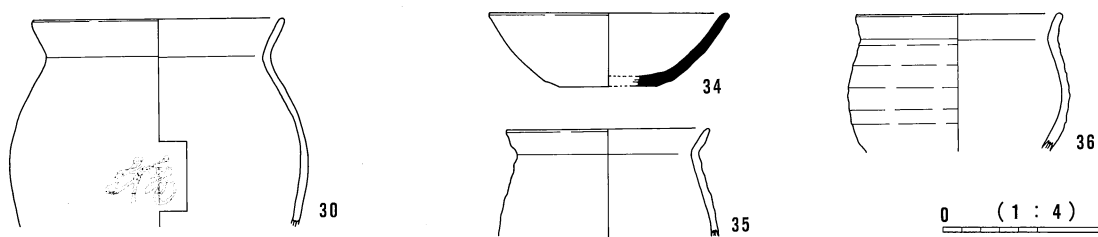

0 (1 : 4) 10cm

SB7207

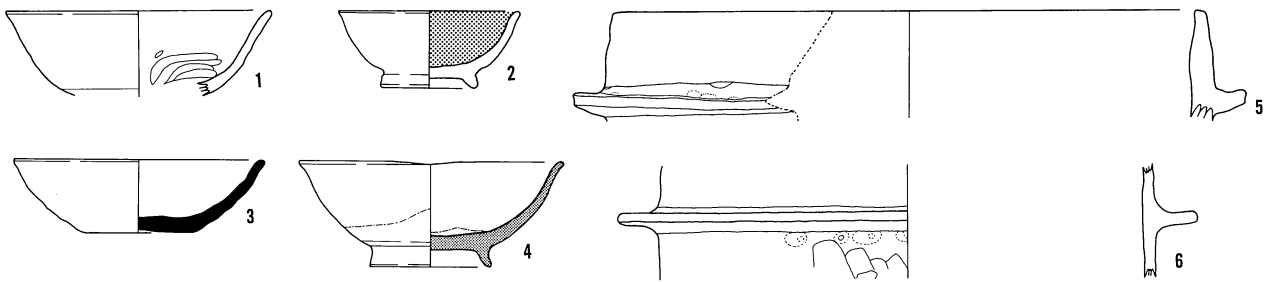

SB7208

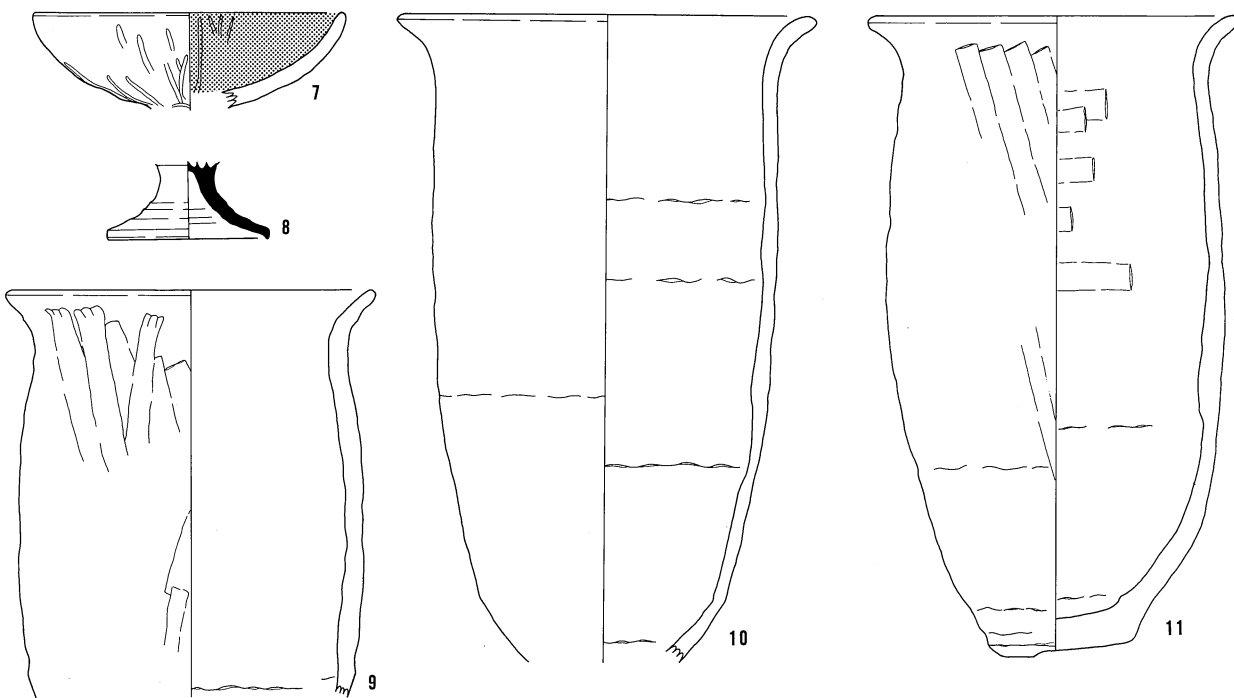

SB7210

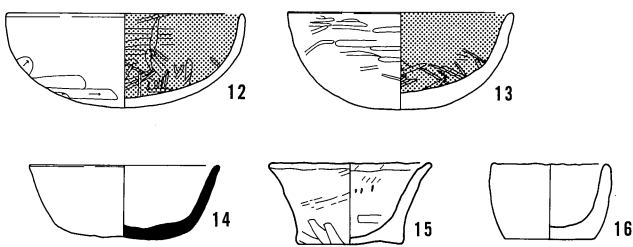

SB7211

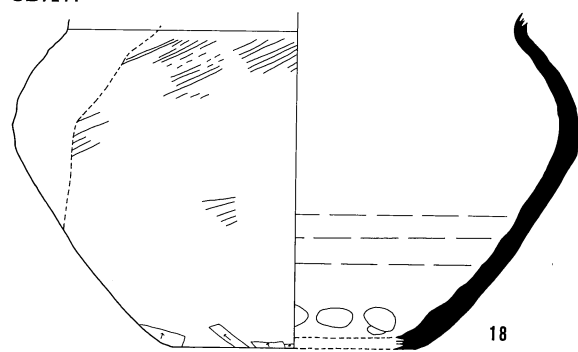

SB7212

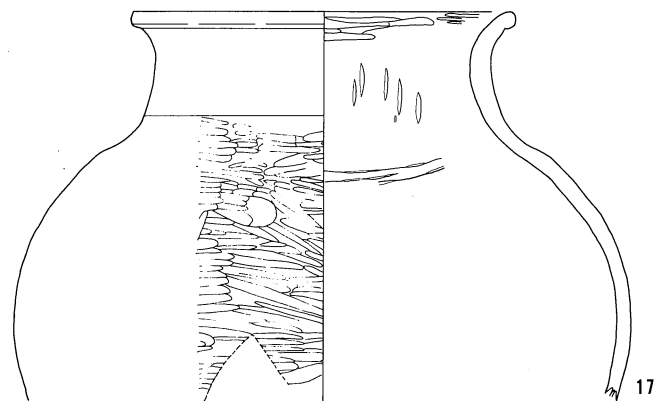

0 (1 : 4) 10cm

SB7205

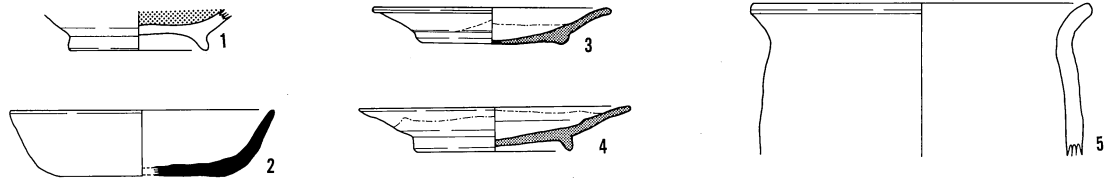

SB7206-①

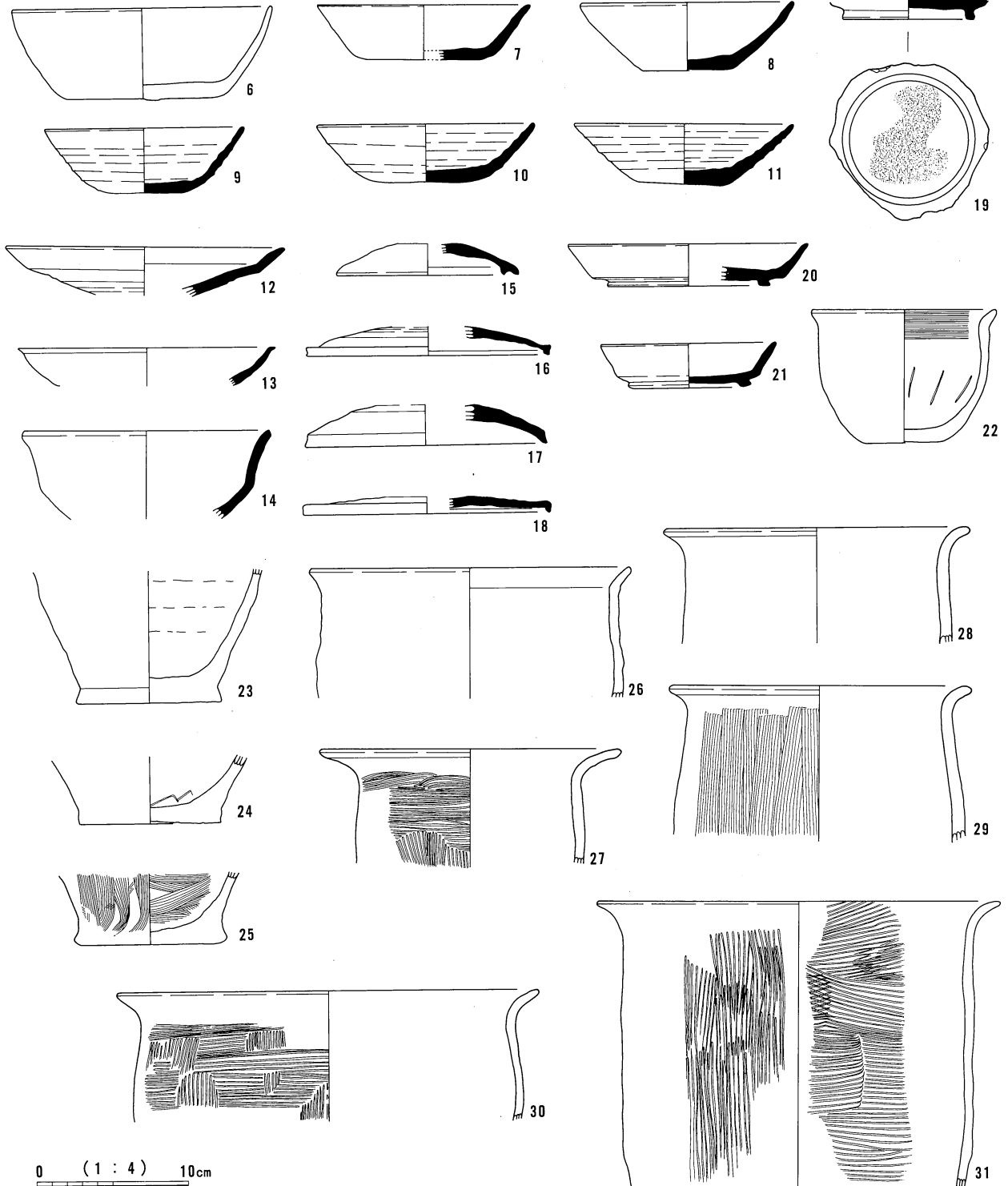

0 (1:4) 10cm

SB7206-②

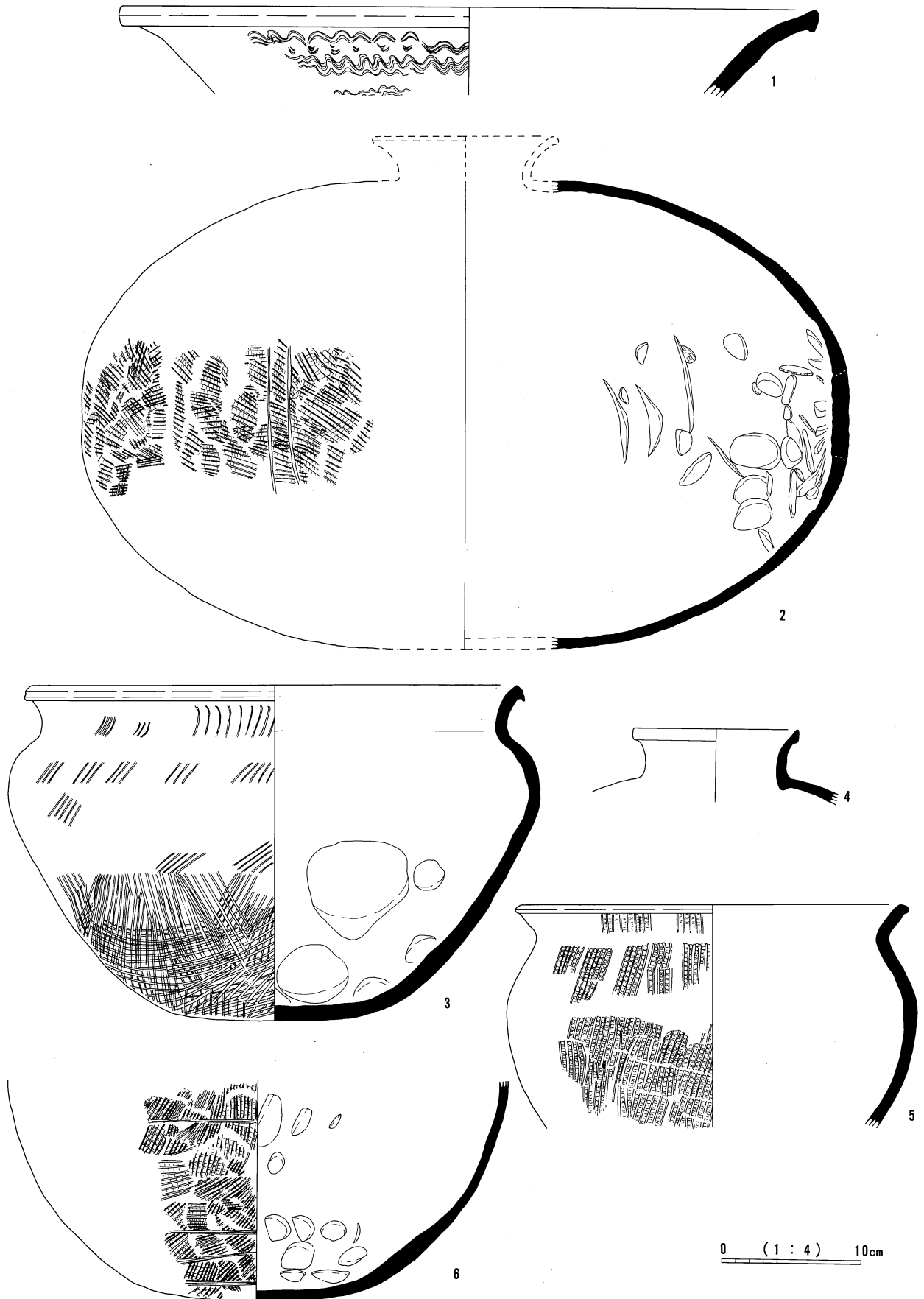

SB7206-②

SB7209

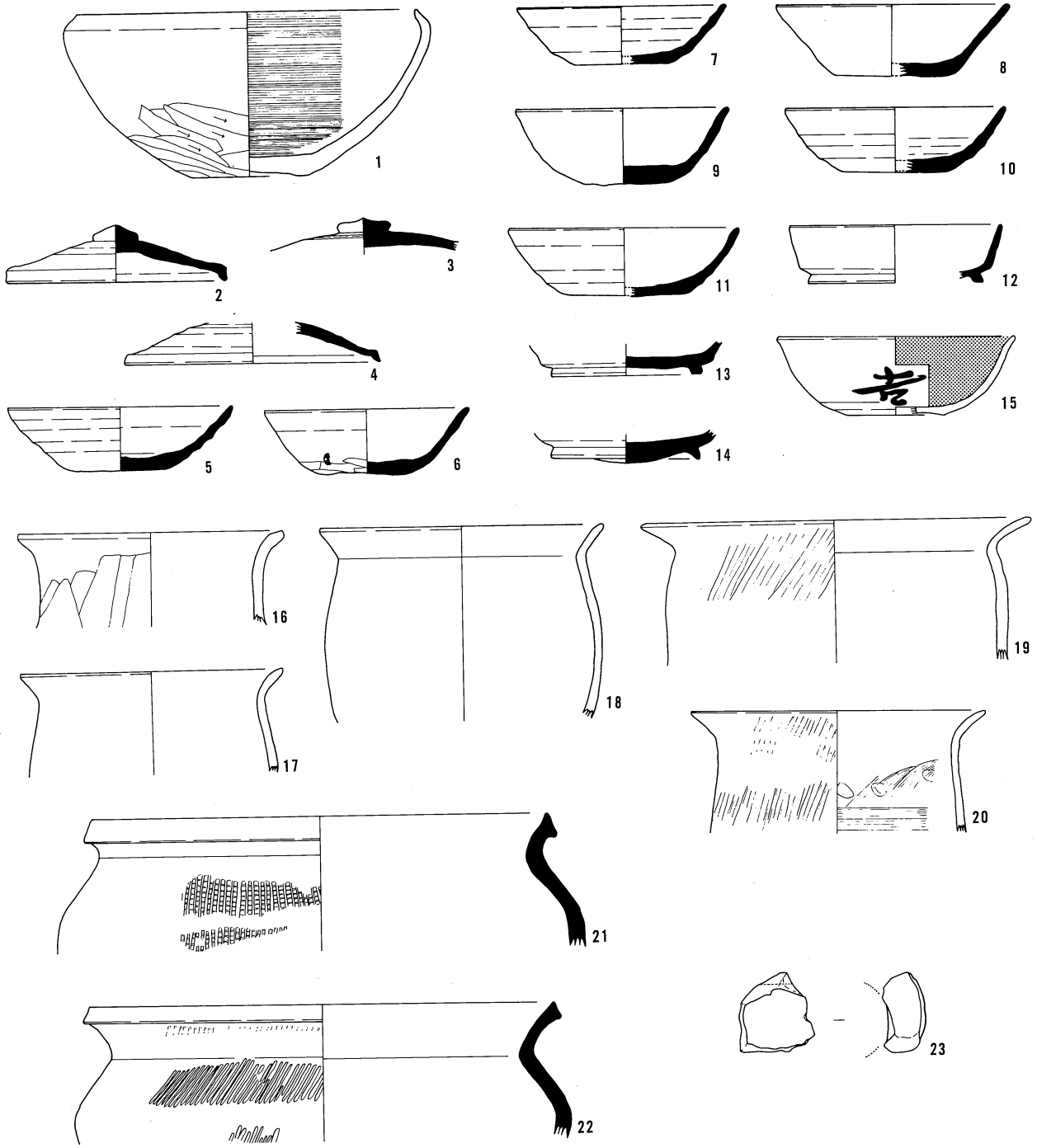

SB7214

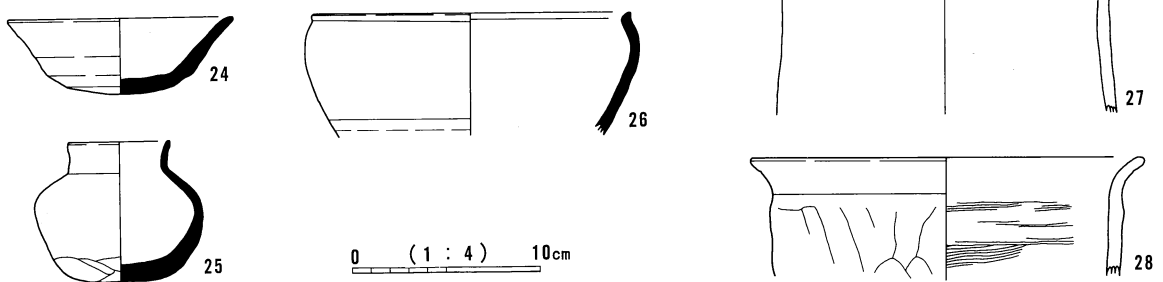

SB7215

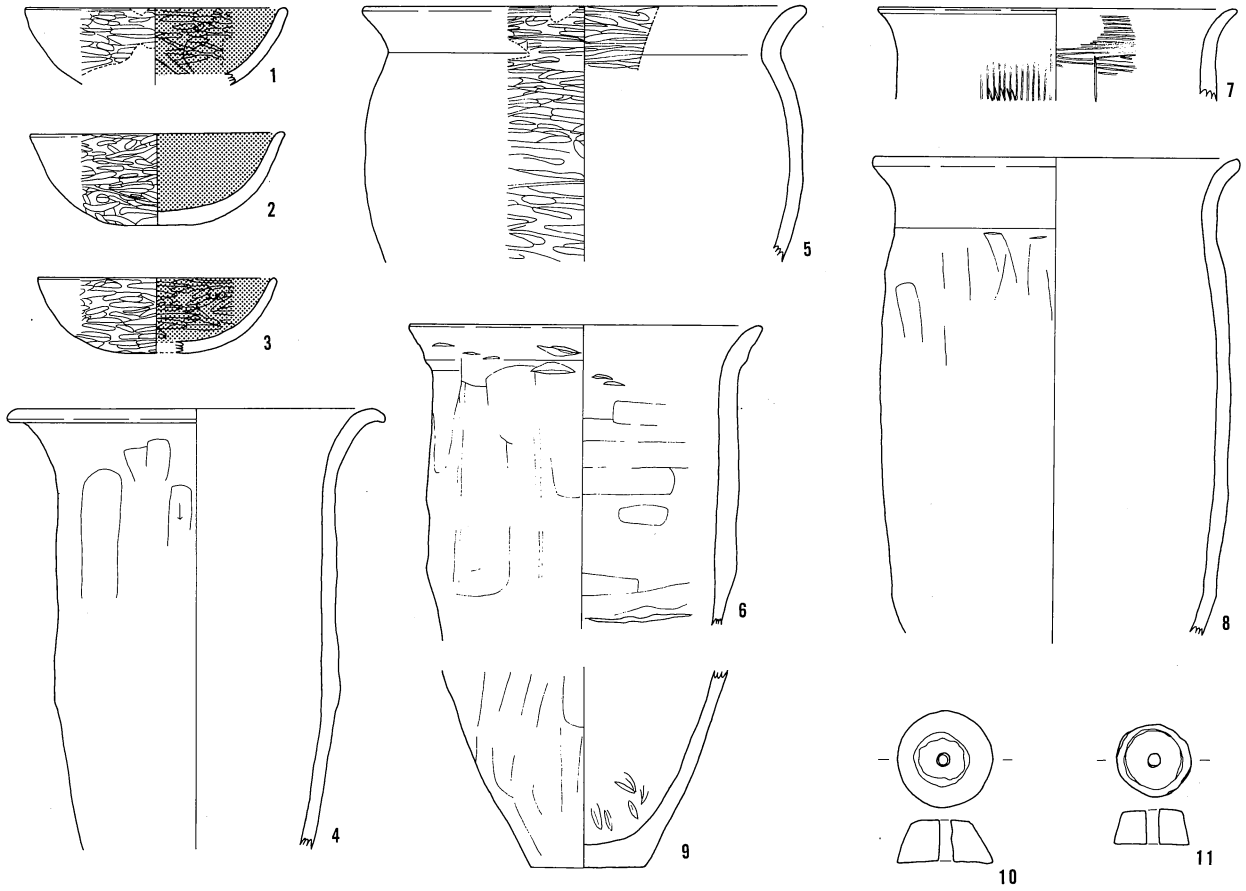

SB7216

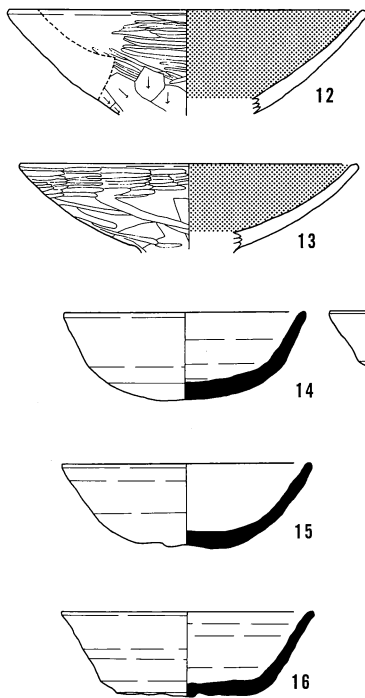

SB7218

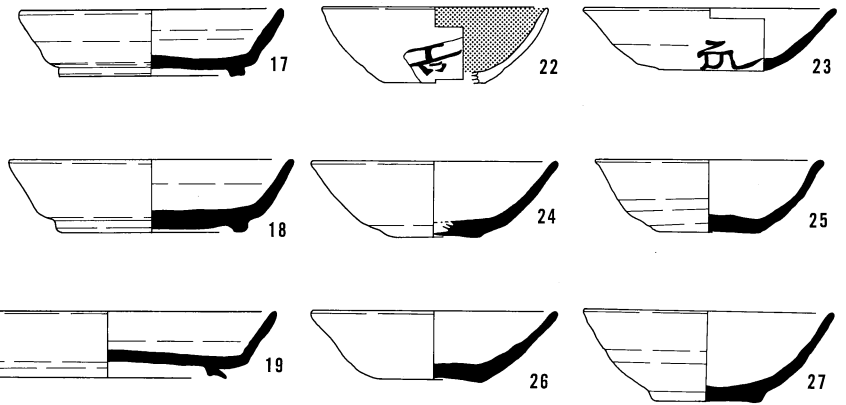

SB7219

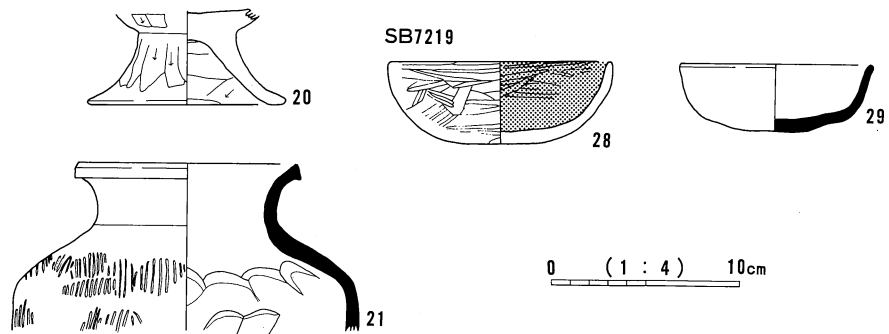

SB7220

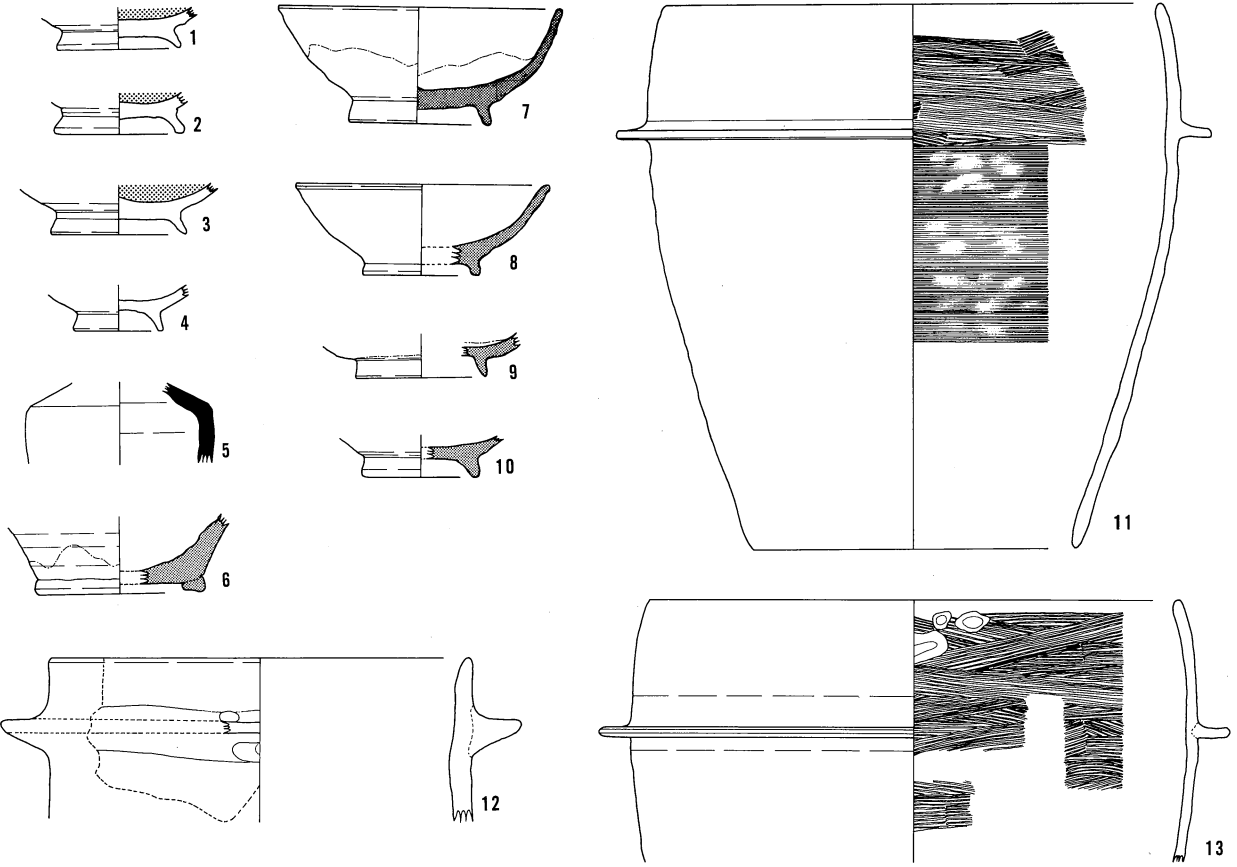

SB7221

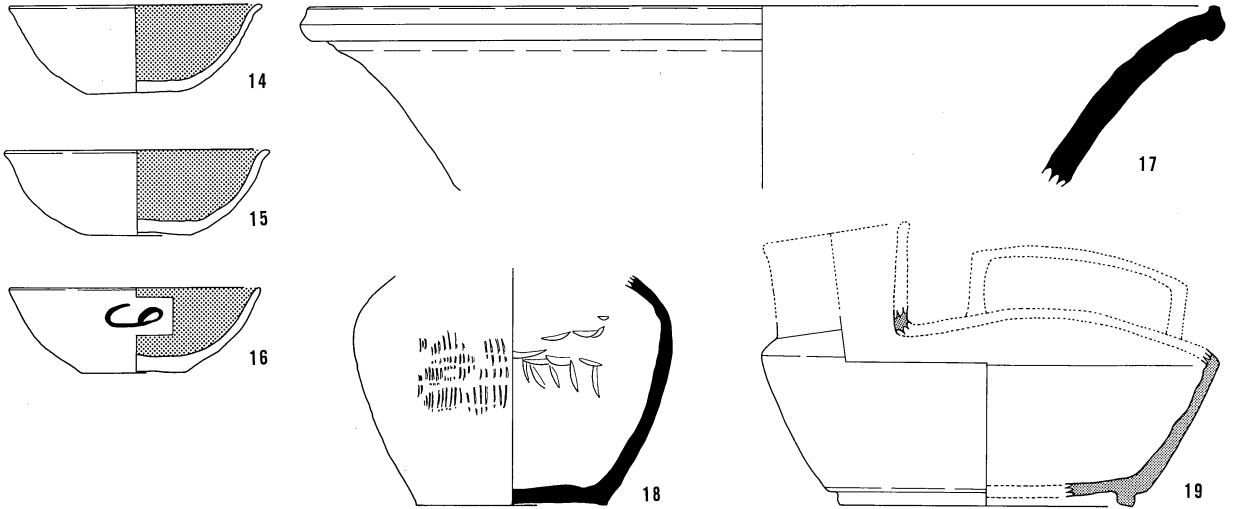

SB7223

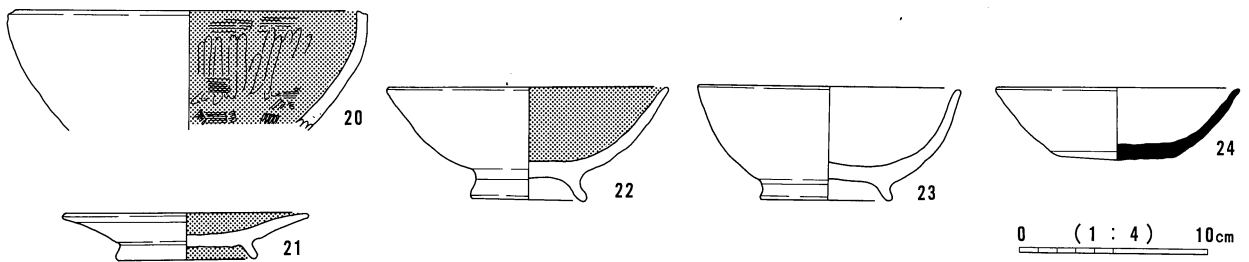

SB7222

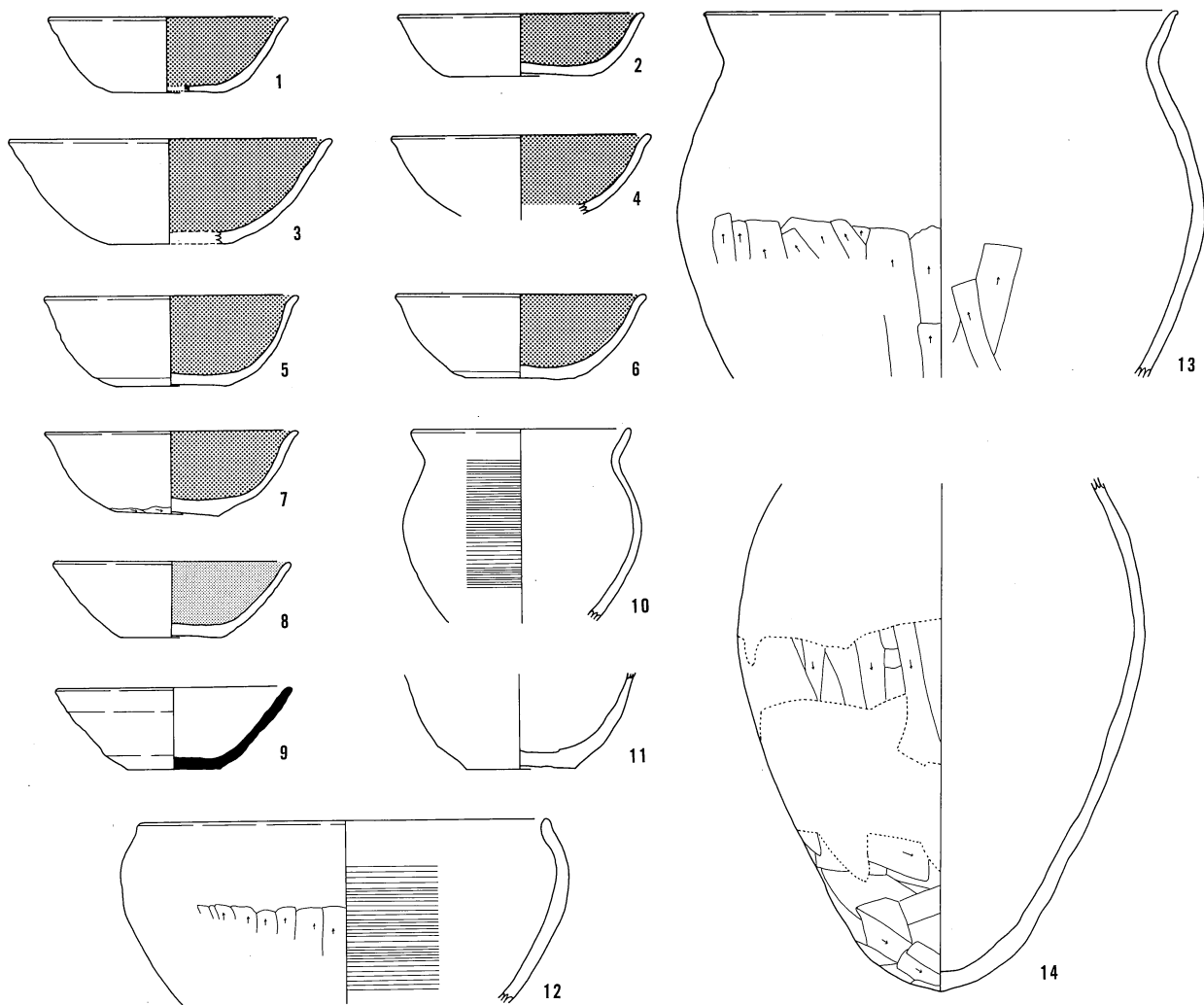

SB7235

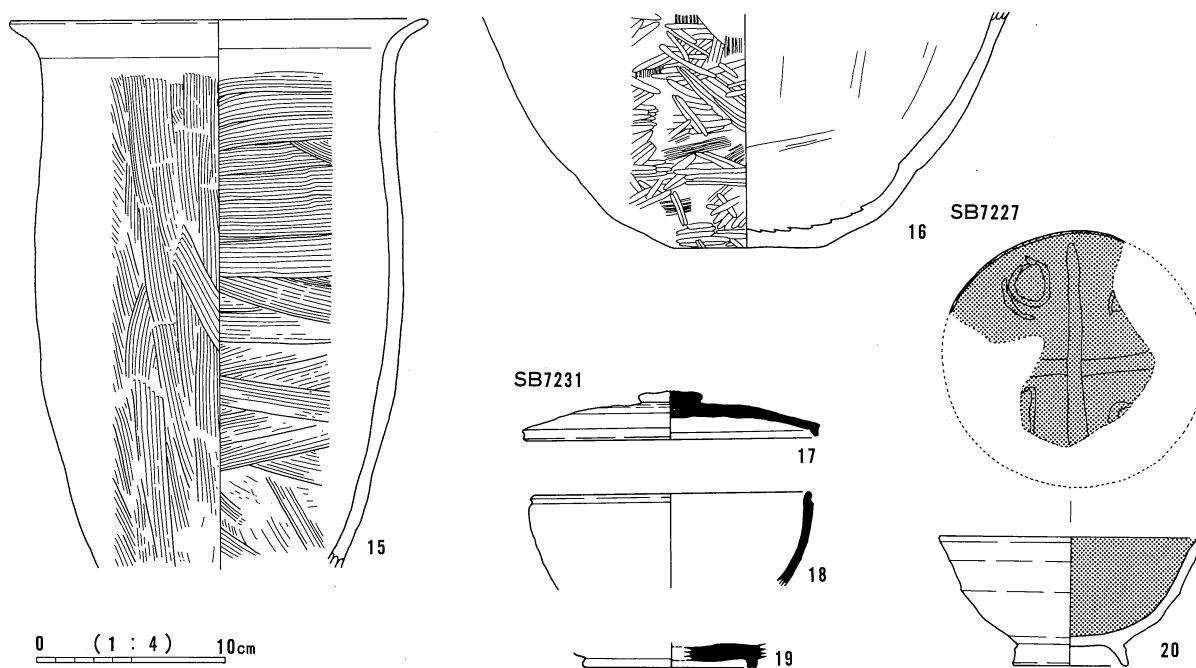

0 (1 : 4) 10cm

SB7230

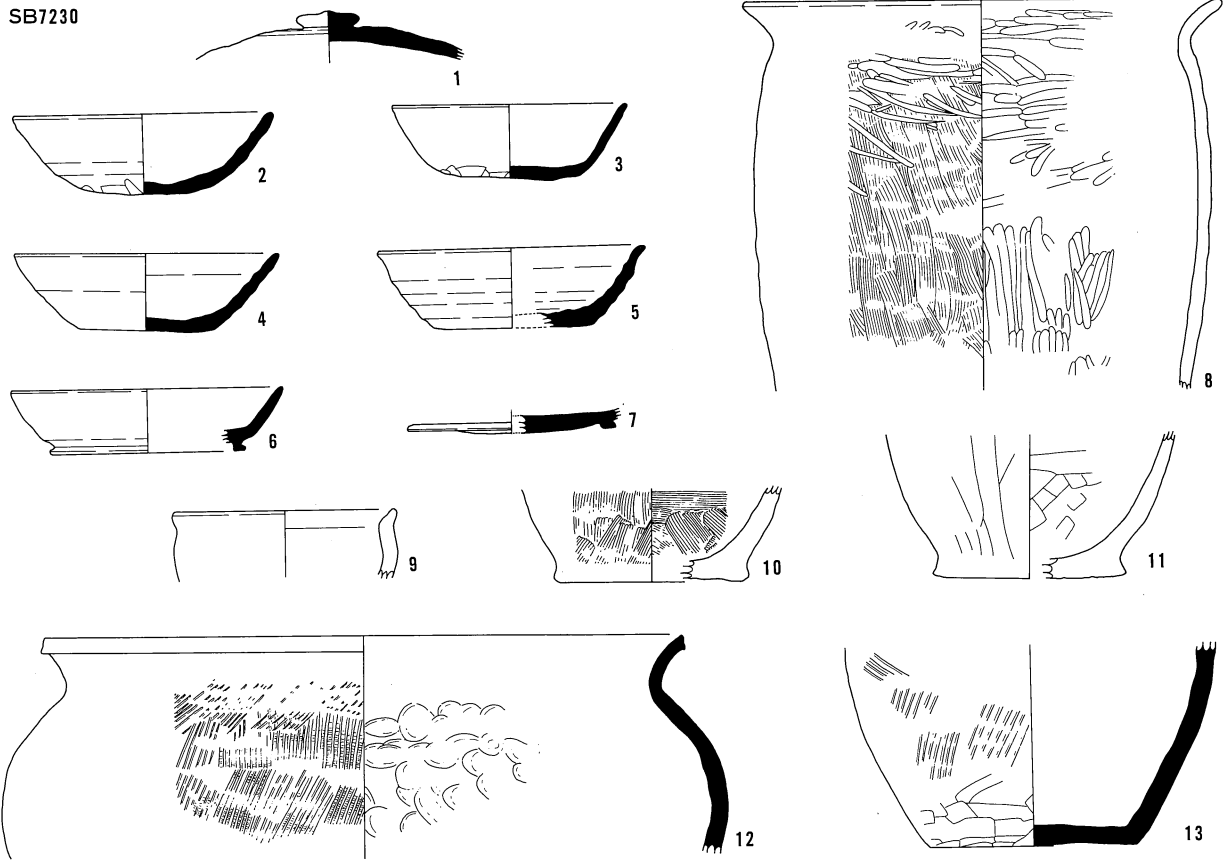

SB7245

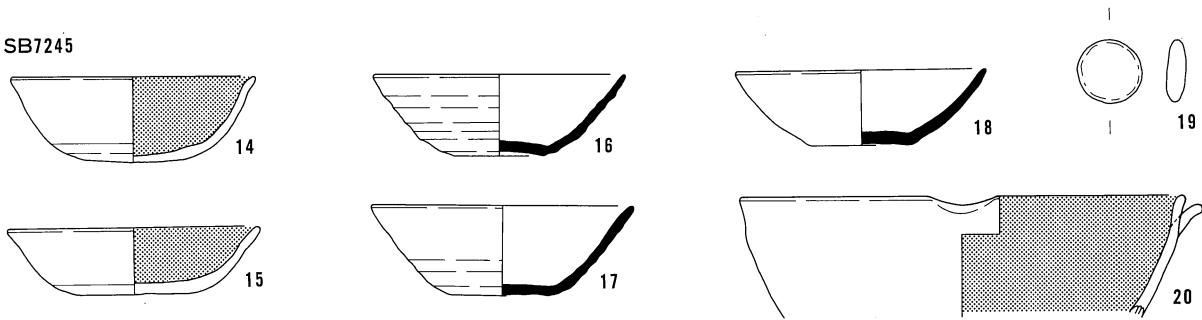

SB7248

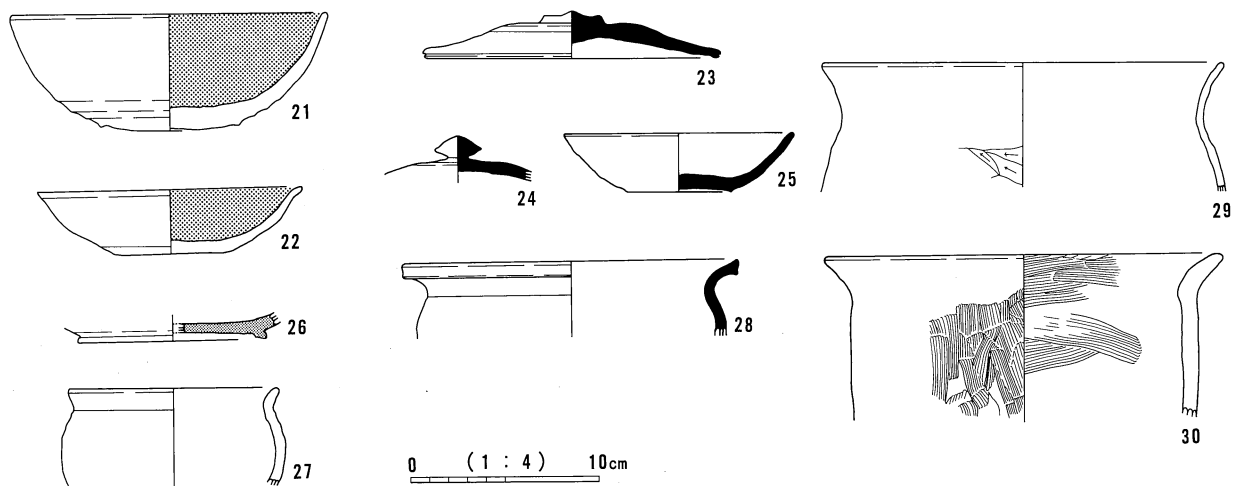

SB7234

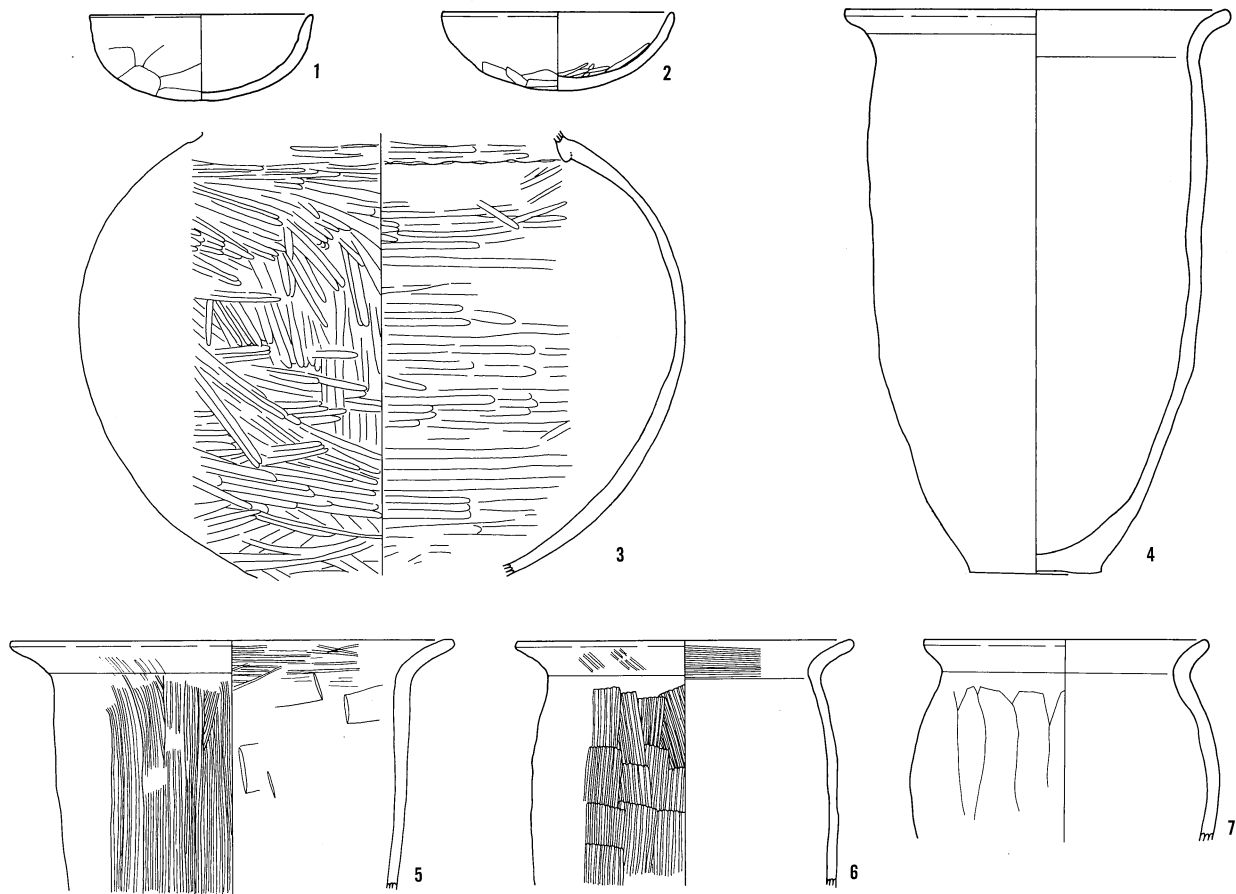

SB7249

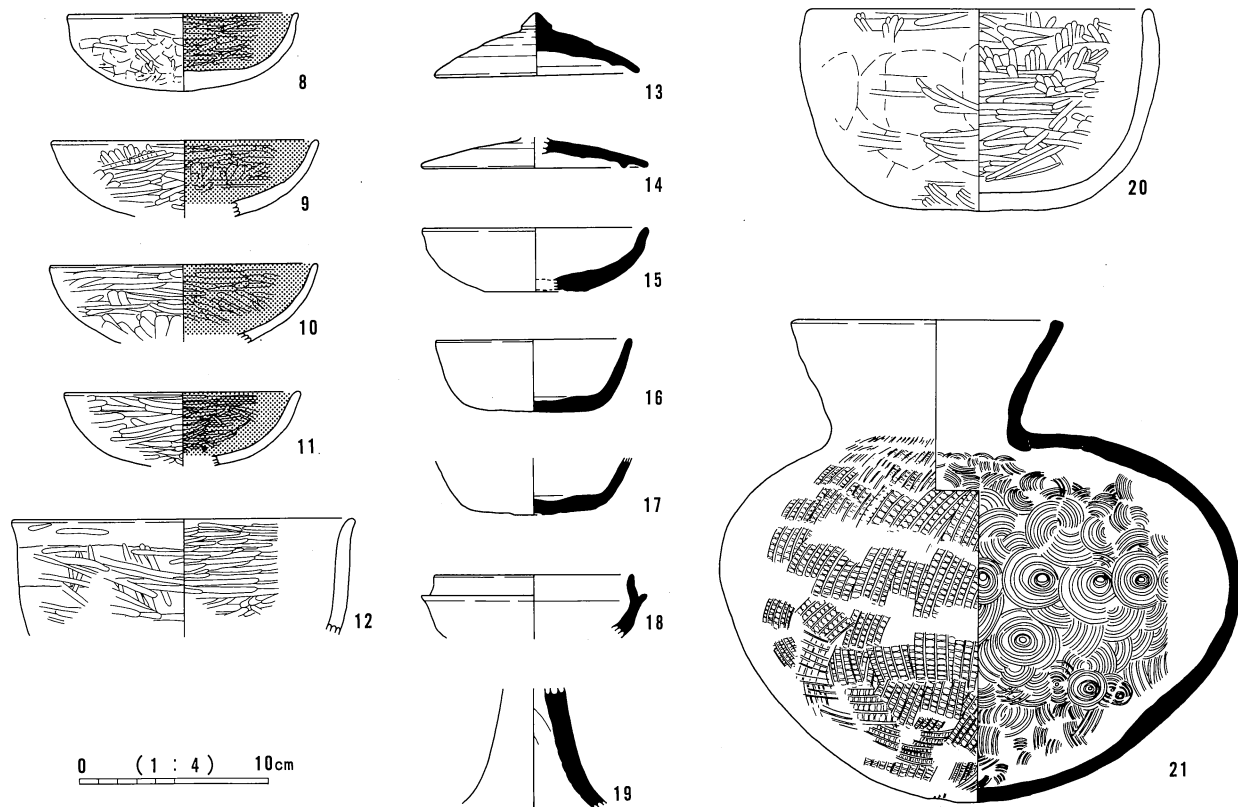

0 (1 : 4) 10cm

SB7253

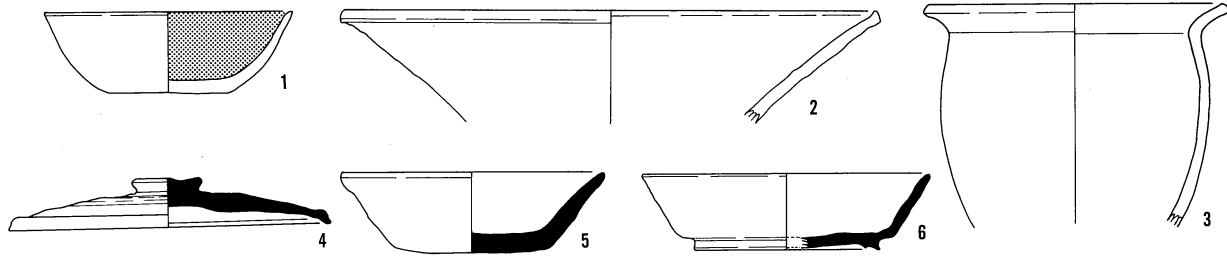

SB7261

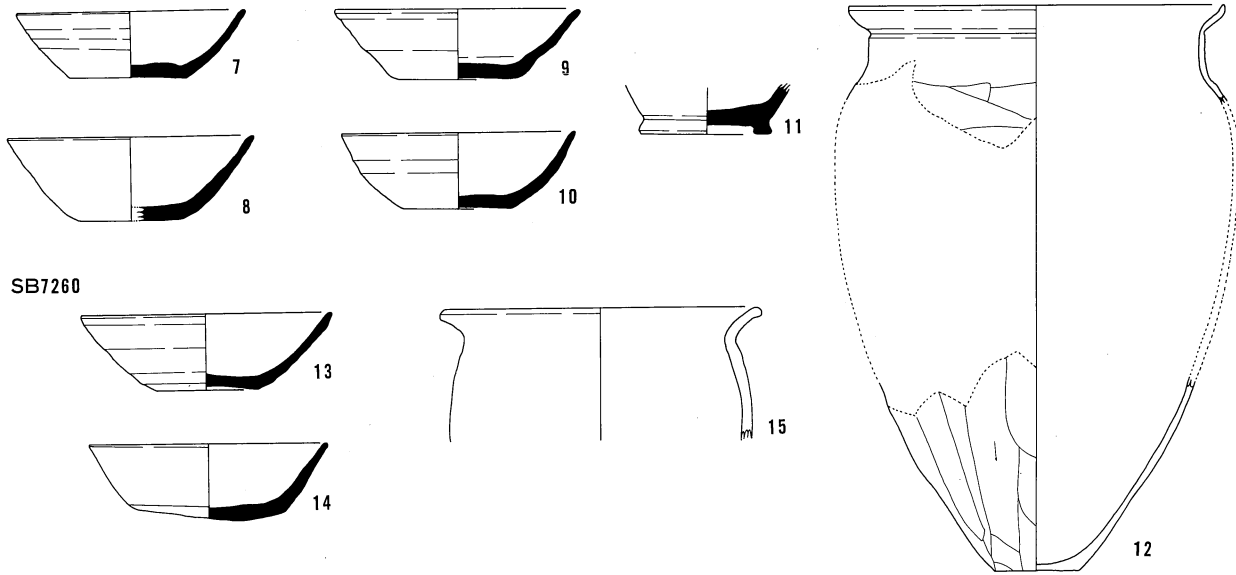

SB7260

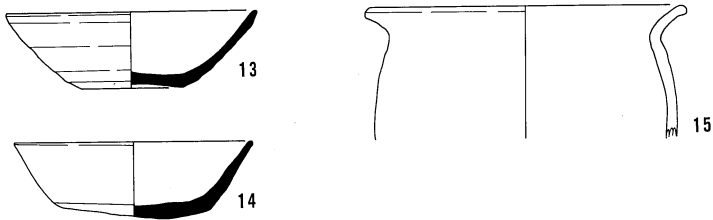

SB7263

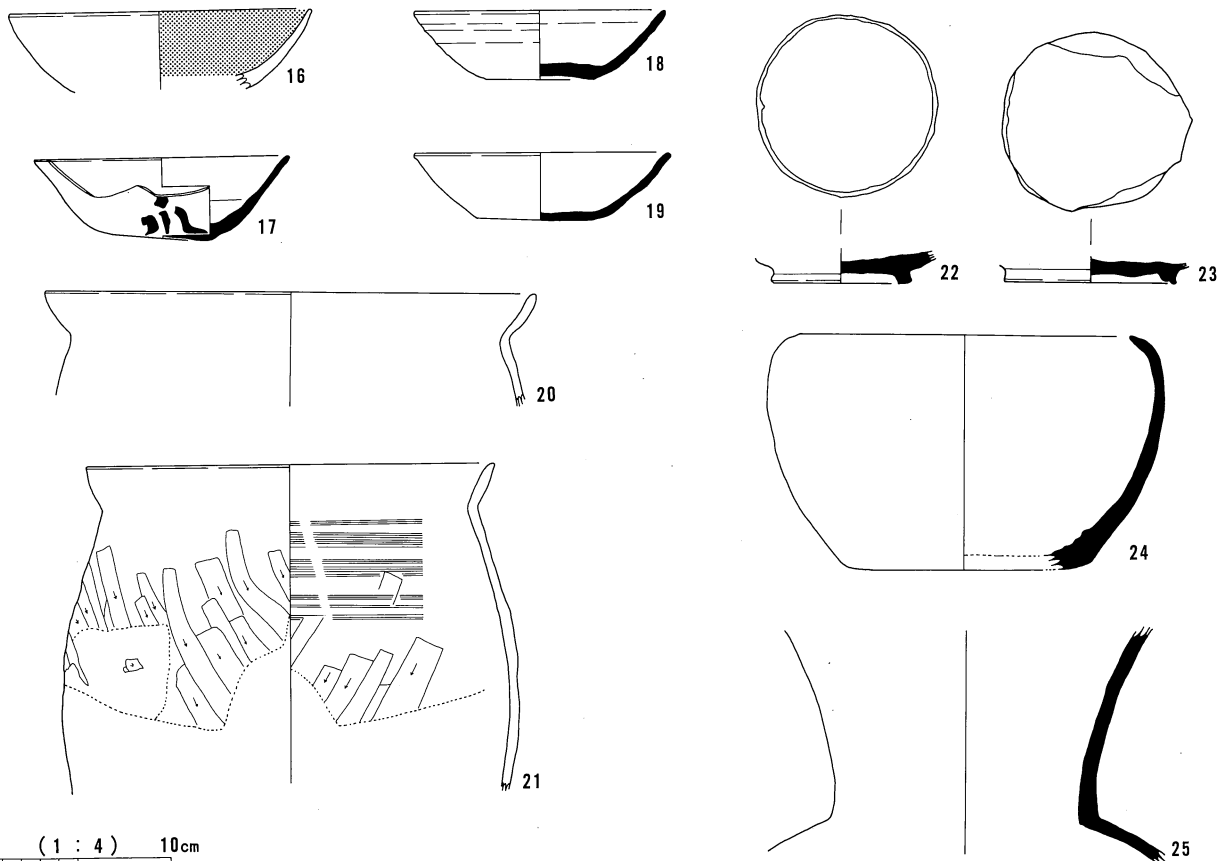

0 (1 : 4) 10cm

SB7264

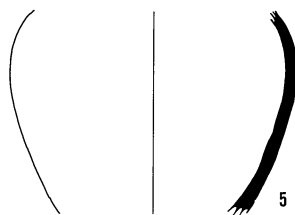
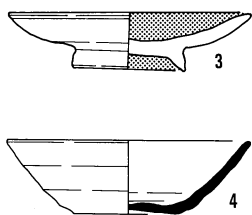
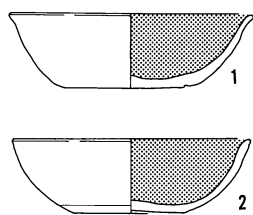

SB7266



SB7265

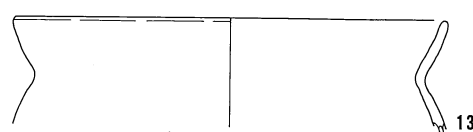
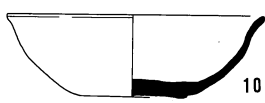
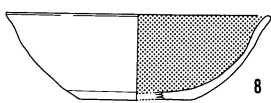
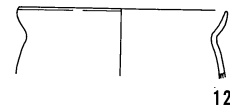
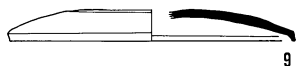
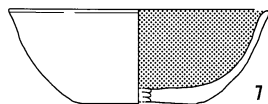

SB7267

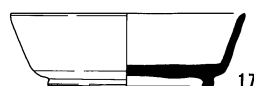
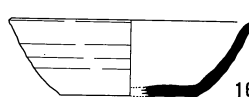
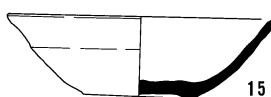
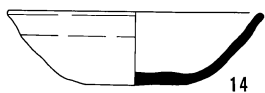

SB7269

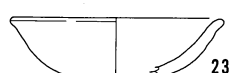
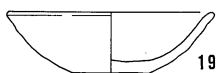
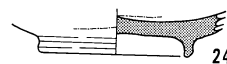

SB7278

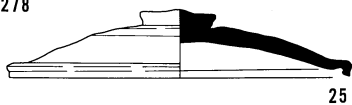

SB7280



SB7288

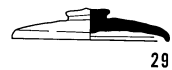

SB7279

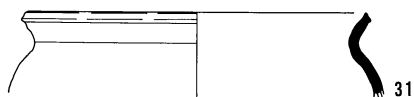
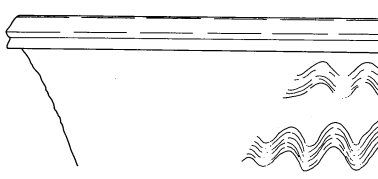
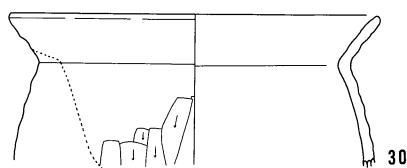

0 (1 : 4) 10cm

SB7273

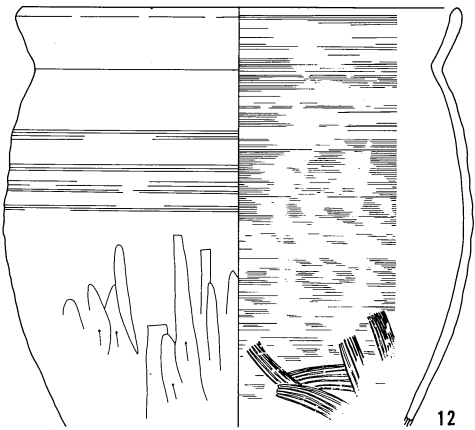
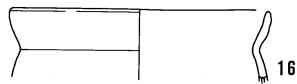
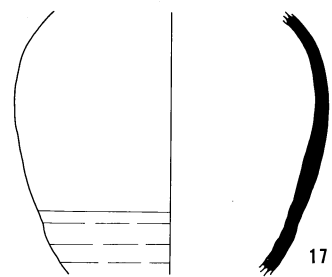
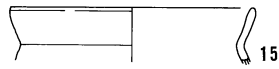
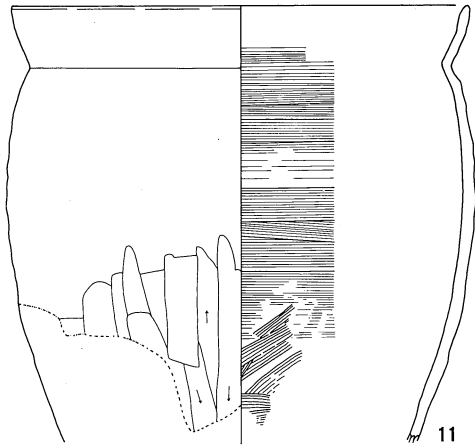
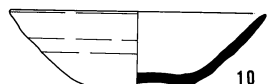
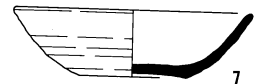
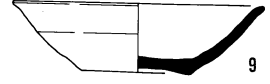
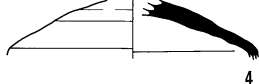
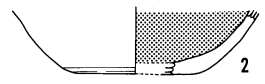
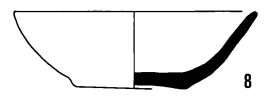
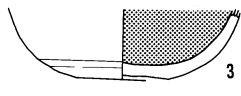
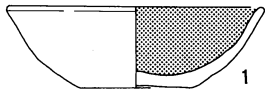

SB7270

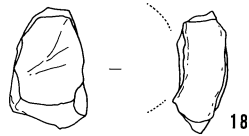

SB7287

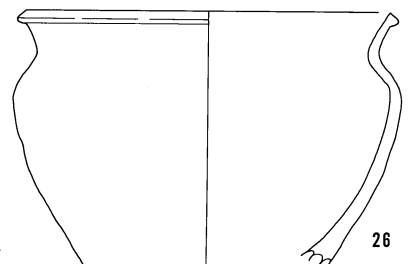
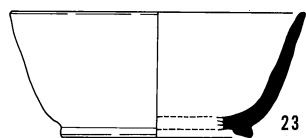
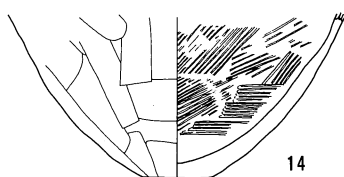
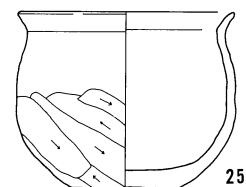
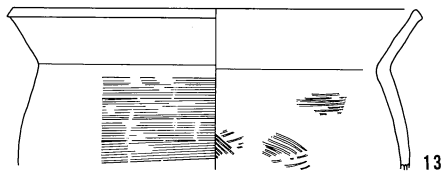
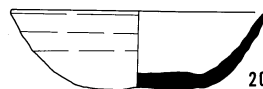
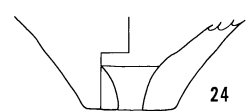

0 (1 : 4) 10cm

SB7299

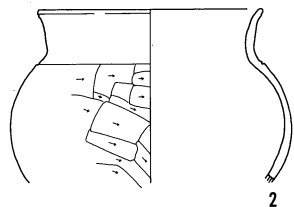
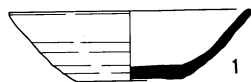

SB7301

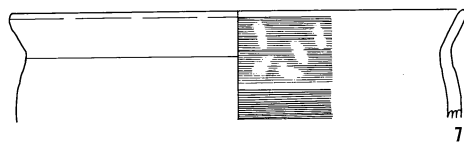
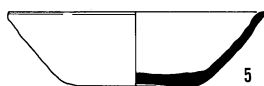
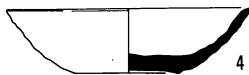
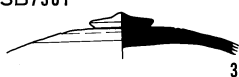

SB7305

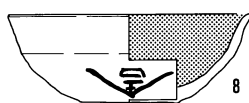

SB7306

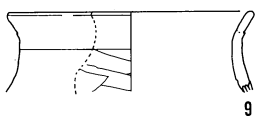

SB7308

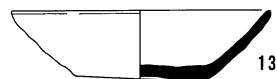
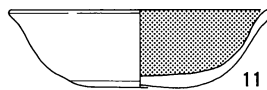

SB7314

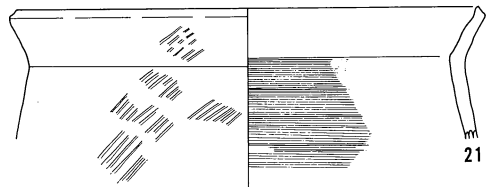
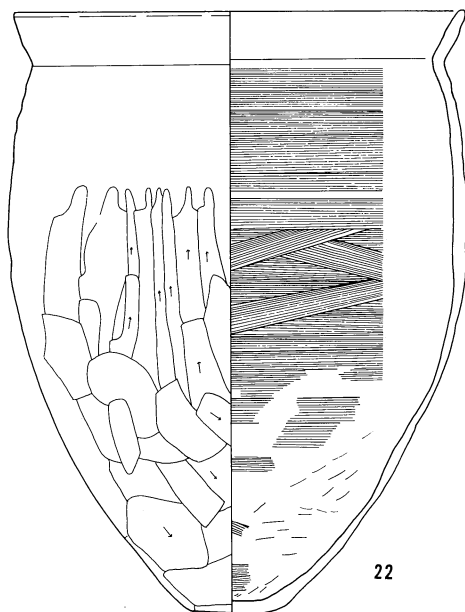
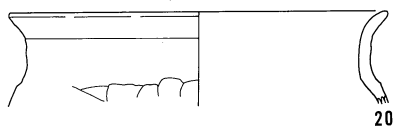
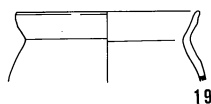
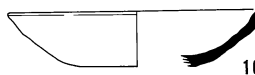
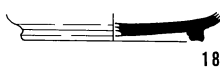
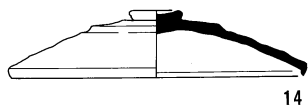

SB7313



SB7315



SB7318

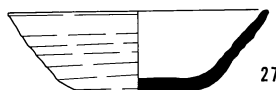

0 (1 : 4) 10cm

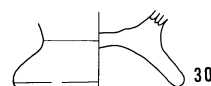

SB7317

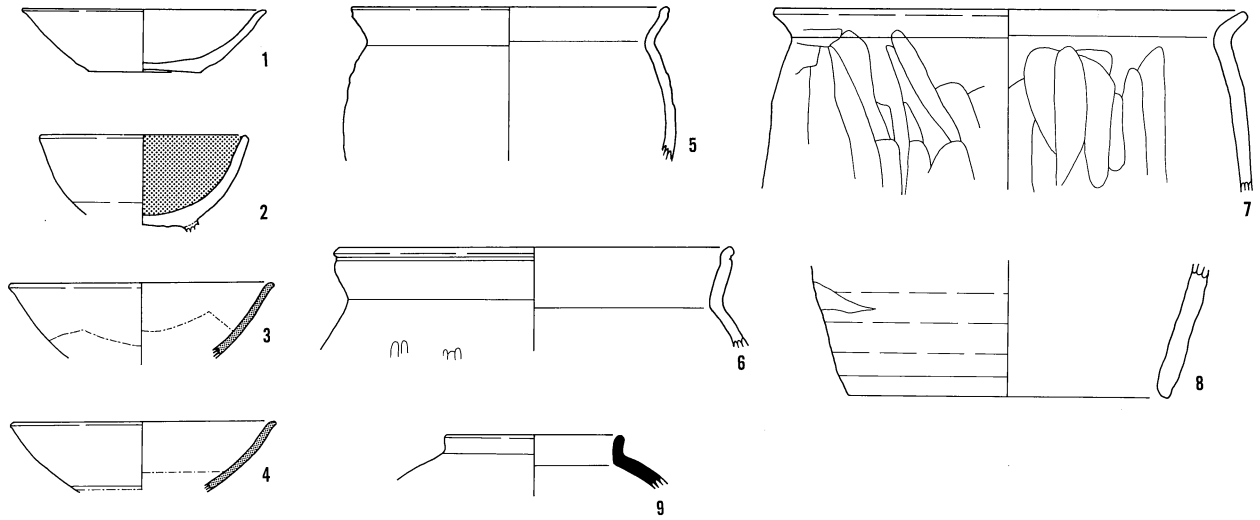

SB7320

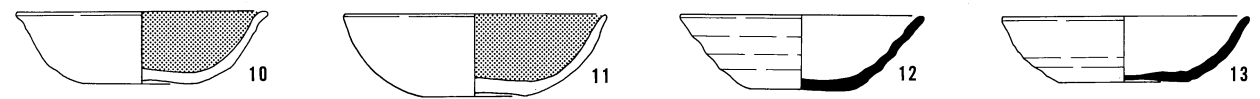

SB7324

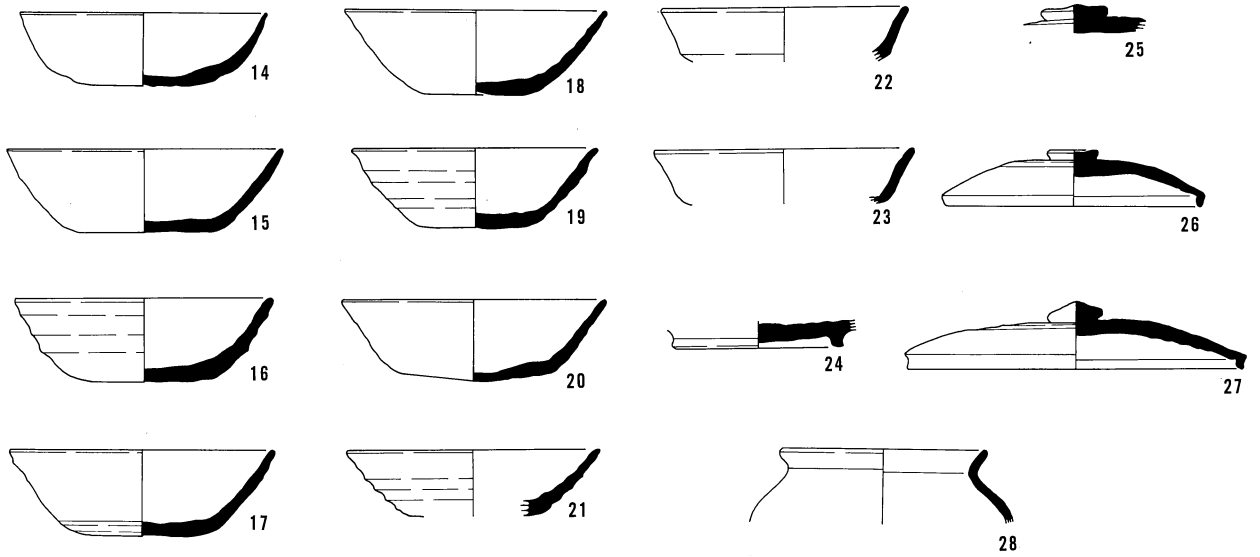

SB7325

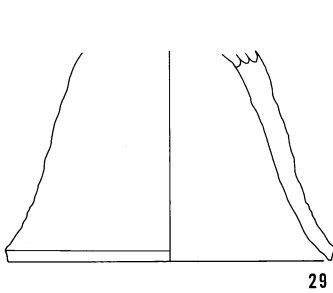

SB7326

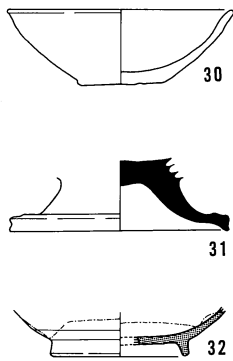

SB7330

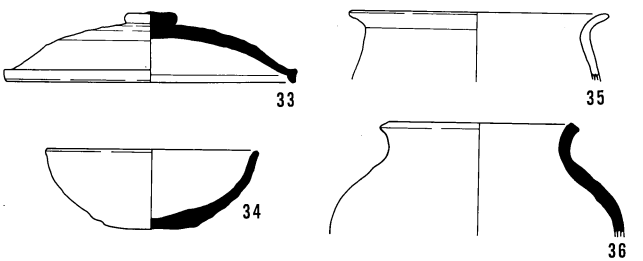

SB7331

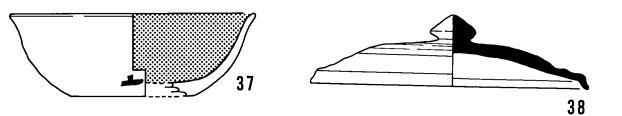

0 (1 : 4) 10cm

SB7332

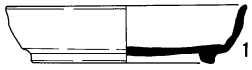

SB7340

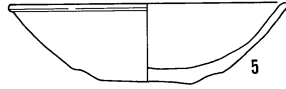

SB7335

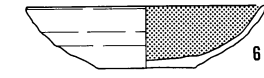

10

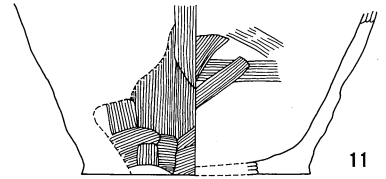
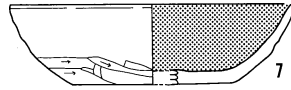
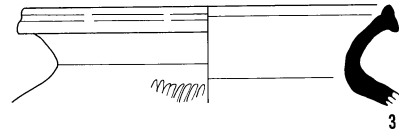

11

SB7337

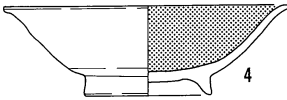

SB7341



SB7348

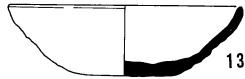
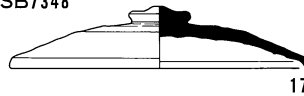

19

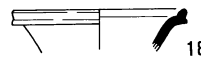
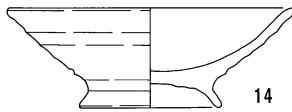

18

SB7354

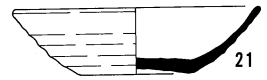
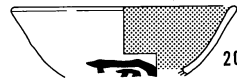

21

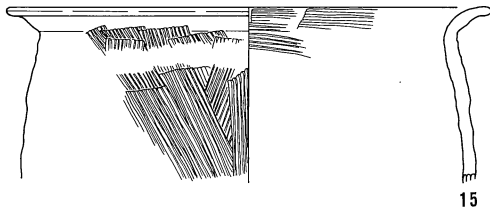

15

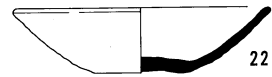

22

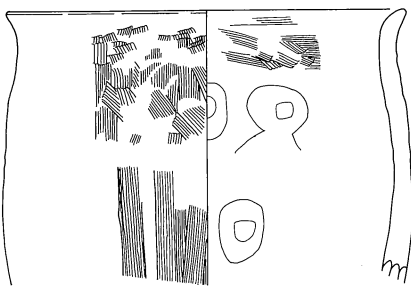

16

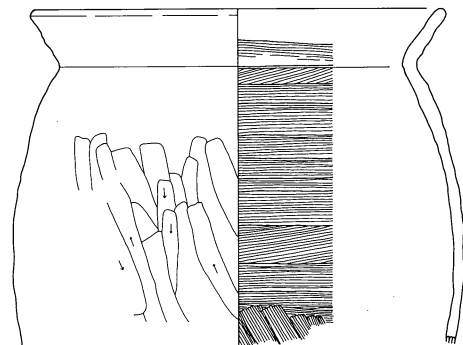

23

SB7342



24

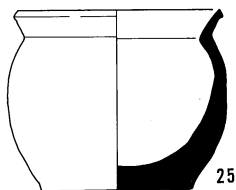

25

SB7356

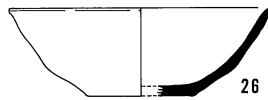

26

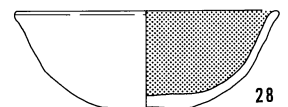

28

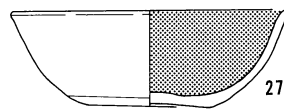

27

0 (1 : 4) 10cm

SB7357

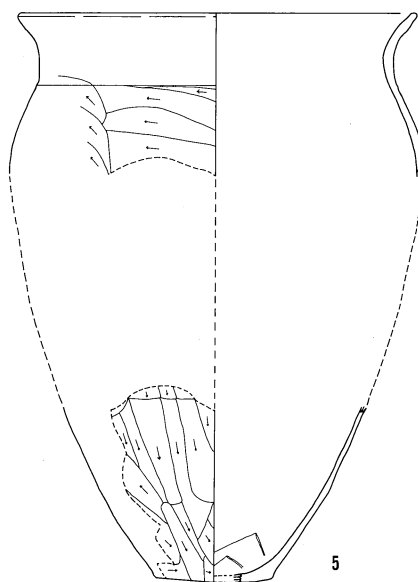
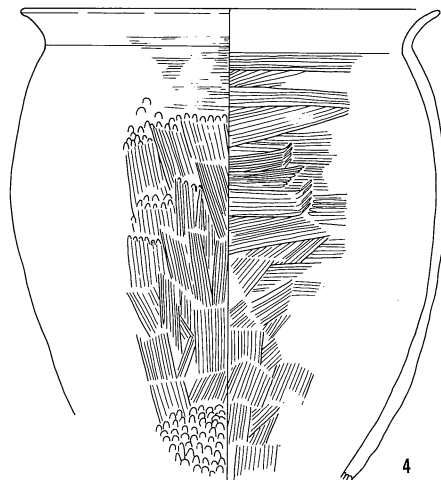
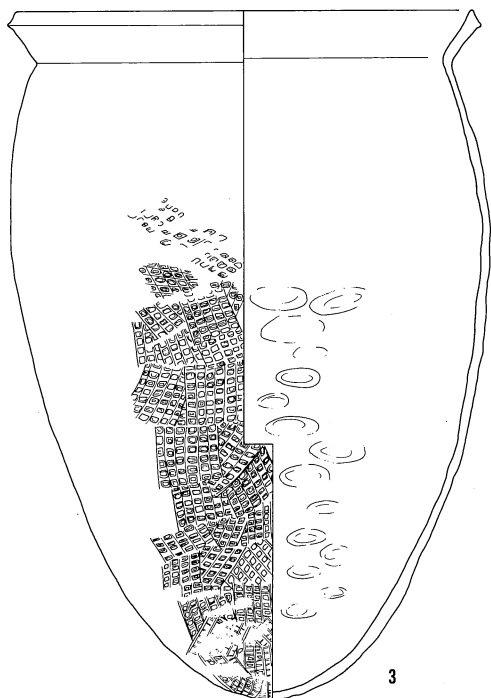
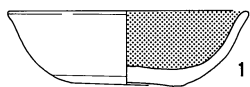

SB7360

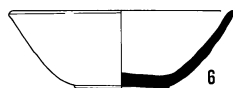

SB7367

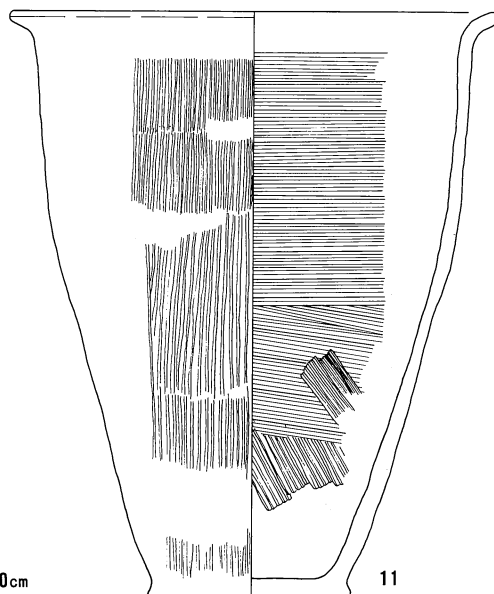
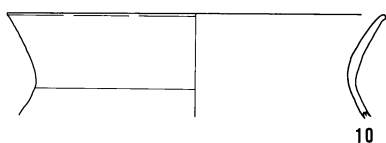
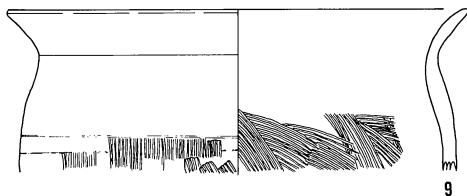
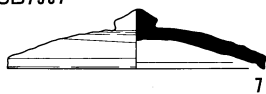

0 (1 : 4) 10cm

SB7370

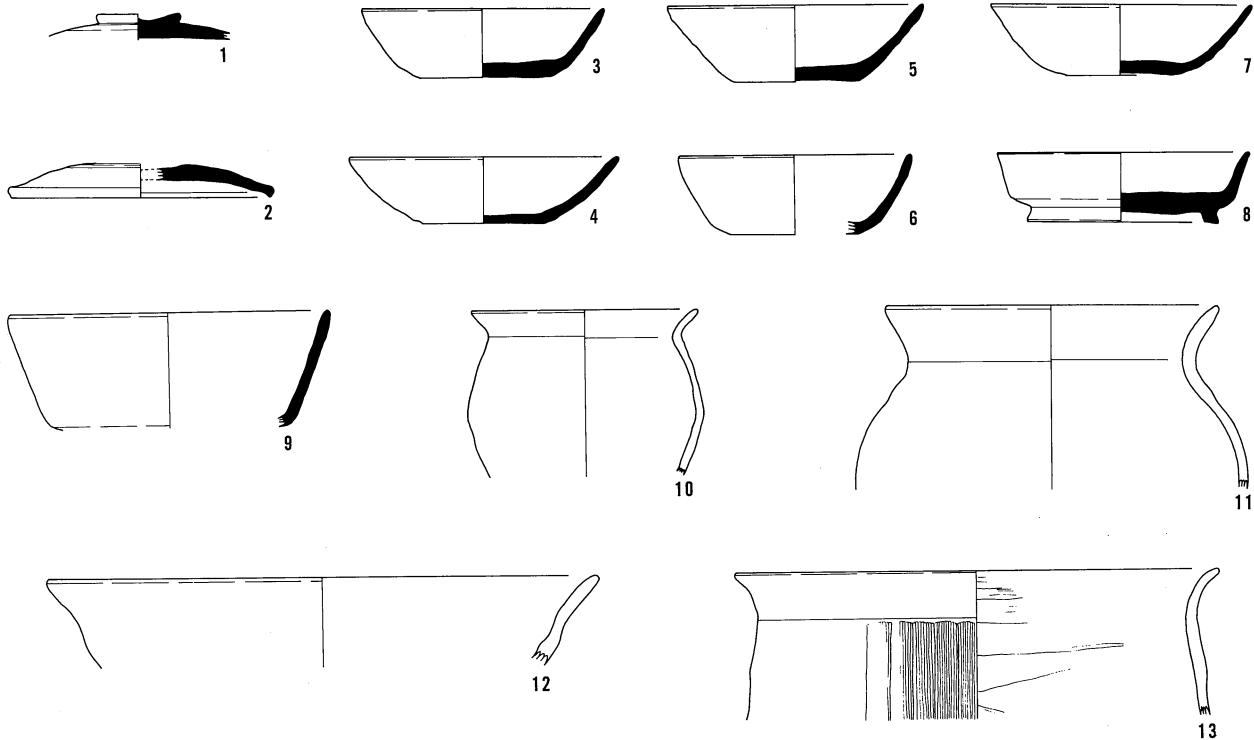

SB7380

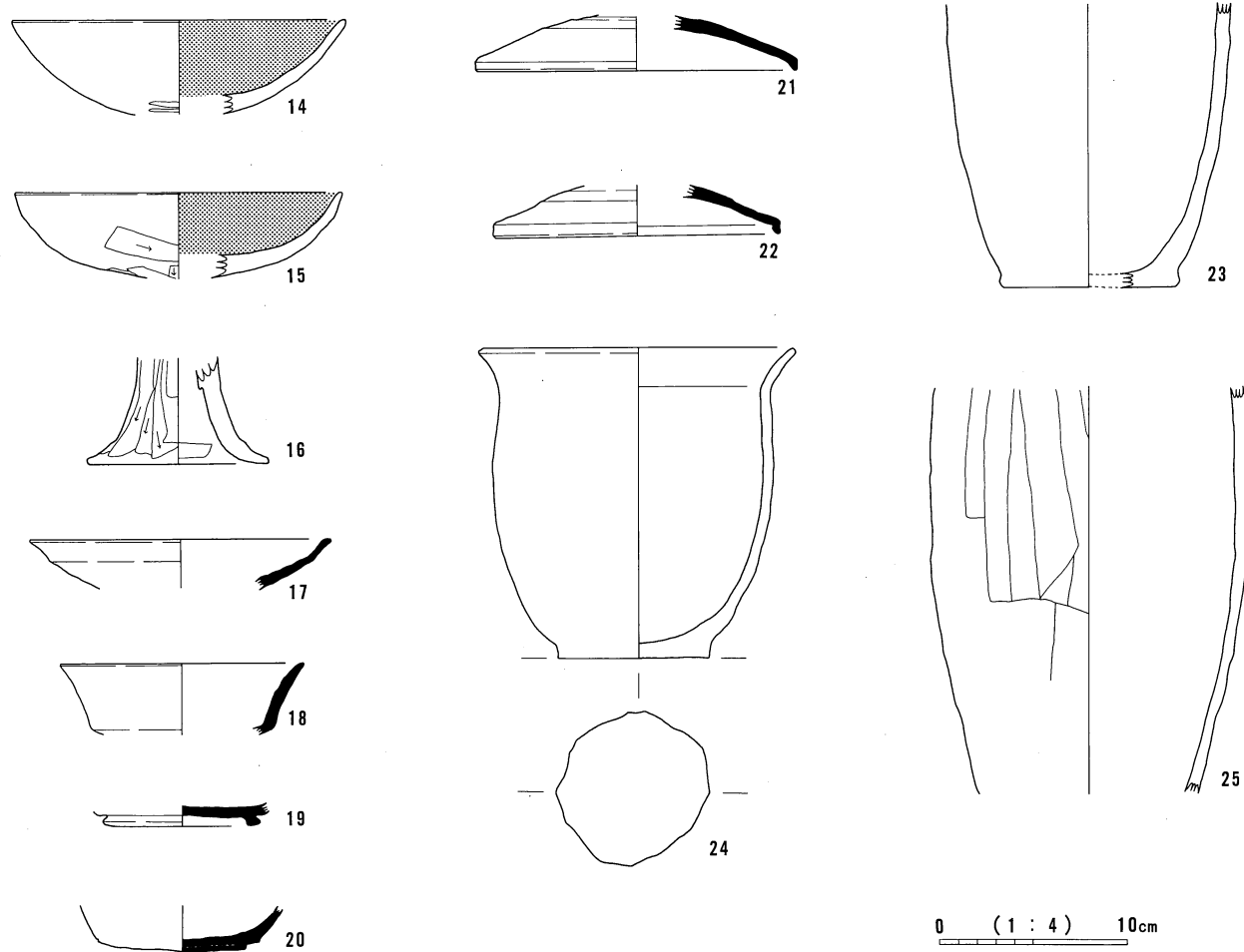

SB7387

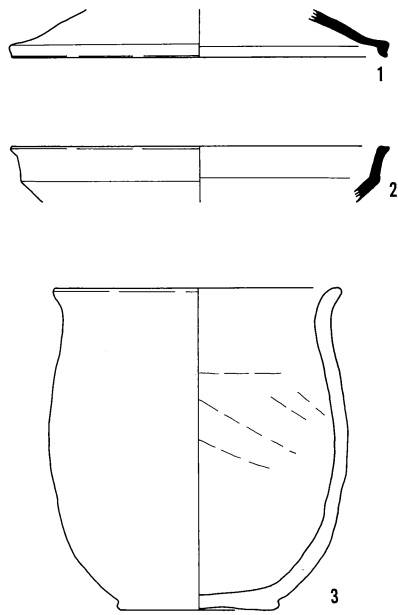

SB7389

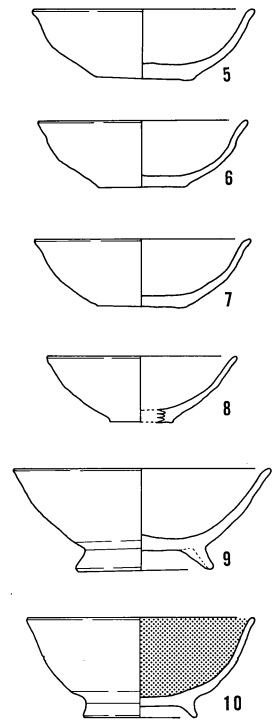

SB7390

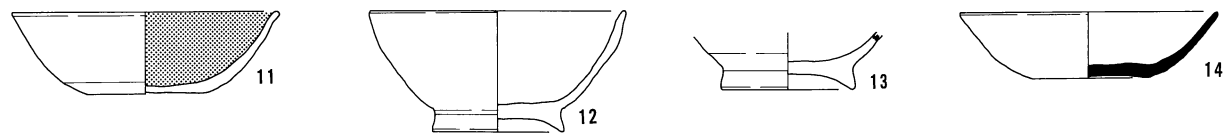

SB7391

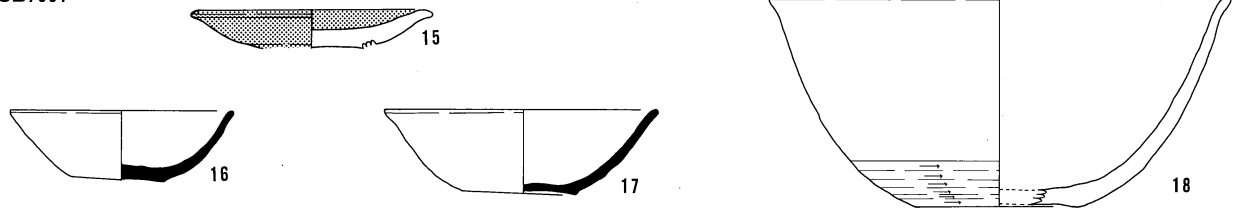

SB7392

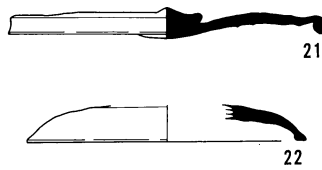

SB7396

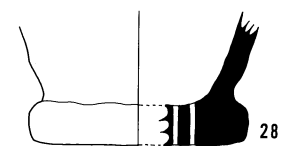
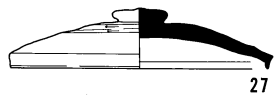
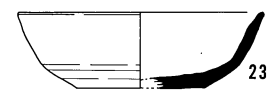
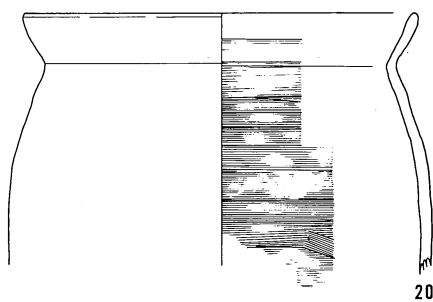
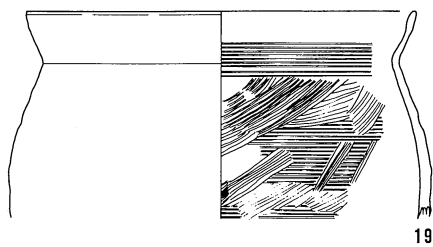
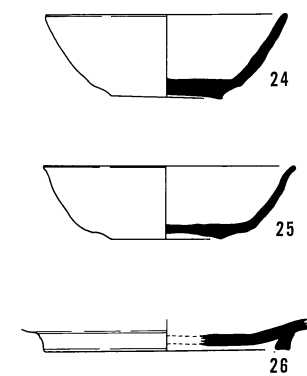

0 (1 : 4) 10cm

SB7398

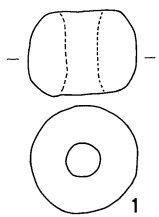

SB7399

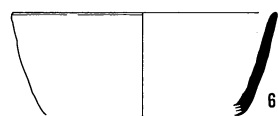
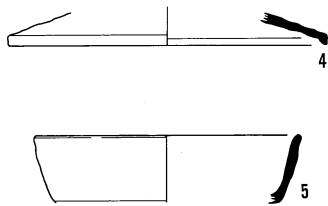
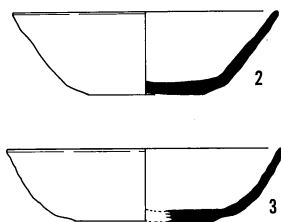

SB7404

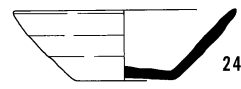
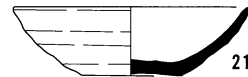
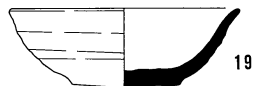
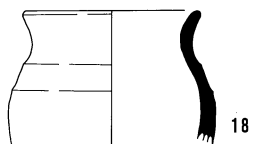
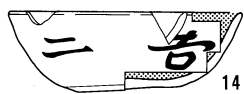
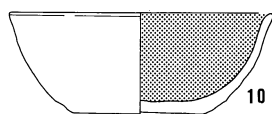
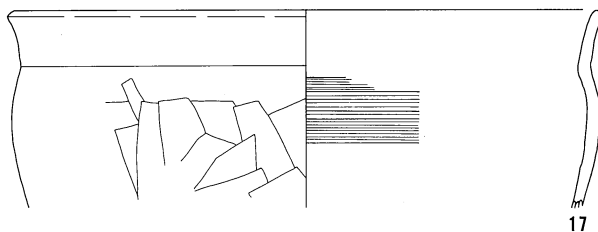
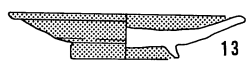
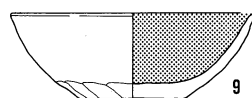
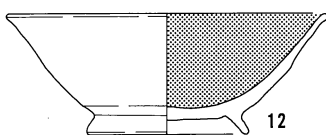
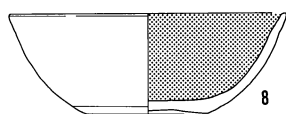
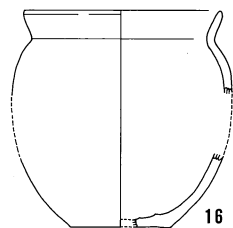
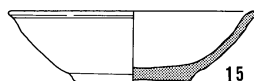
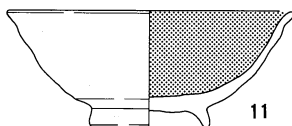
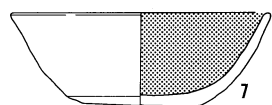

SB7405

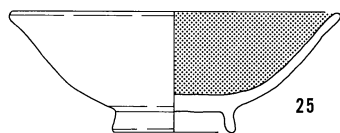

SB7407

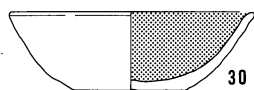

SB7408

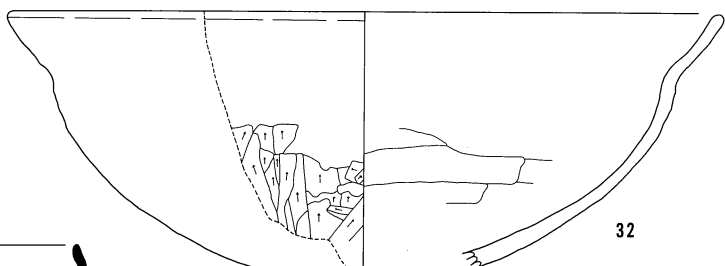

0 (1:4) 10cm

SB7409

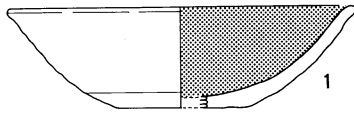

SB7410



SB7412

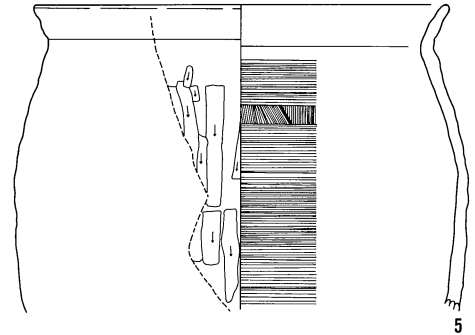
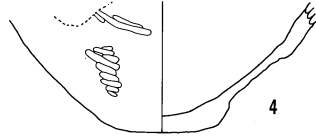
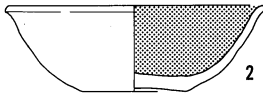

SB7411

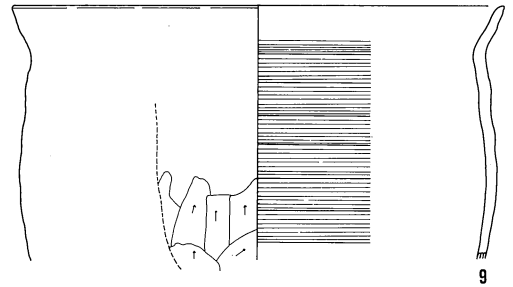
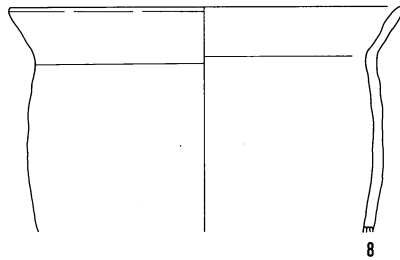
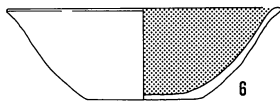

SB7413

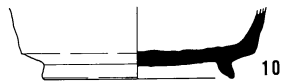

SB7415

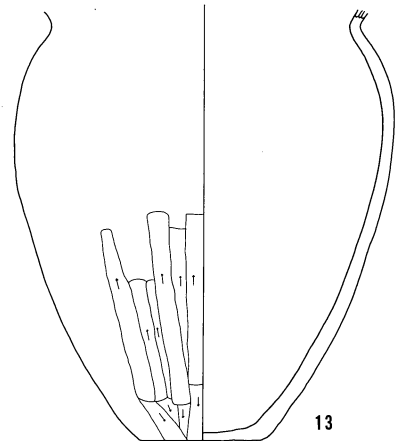
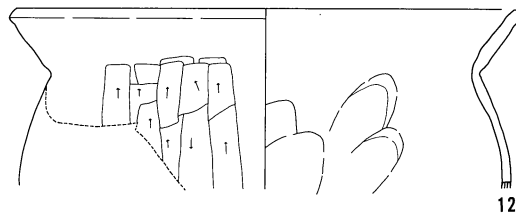
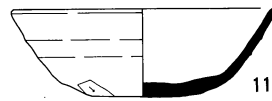

SB7421

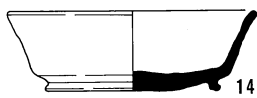

SB7423

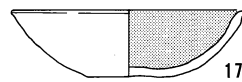

SB7426



SB7428

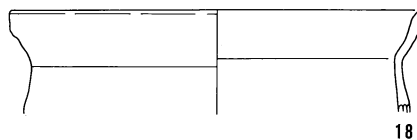

18

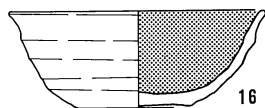

16

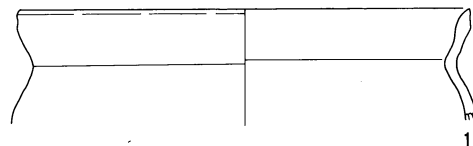

19

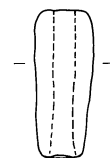

21

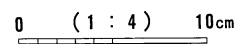

SB7416

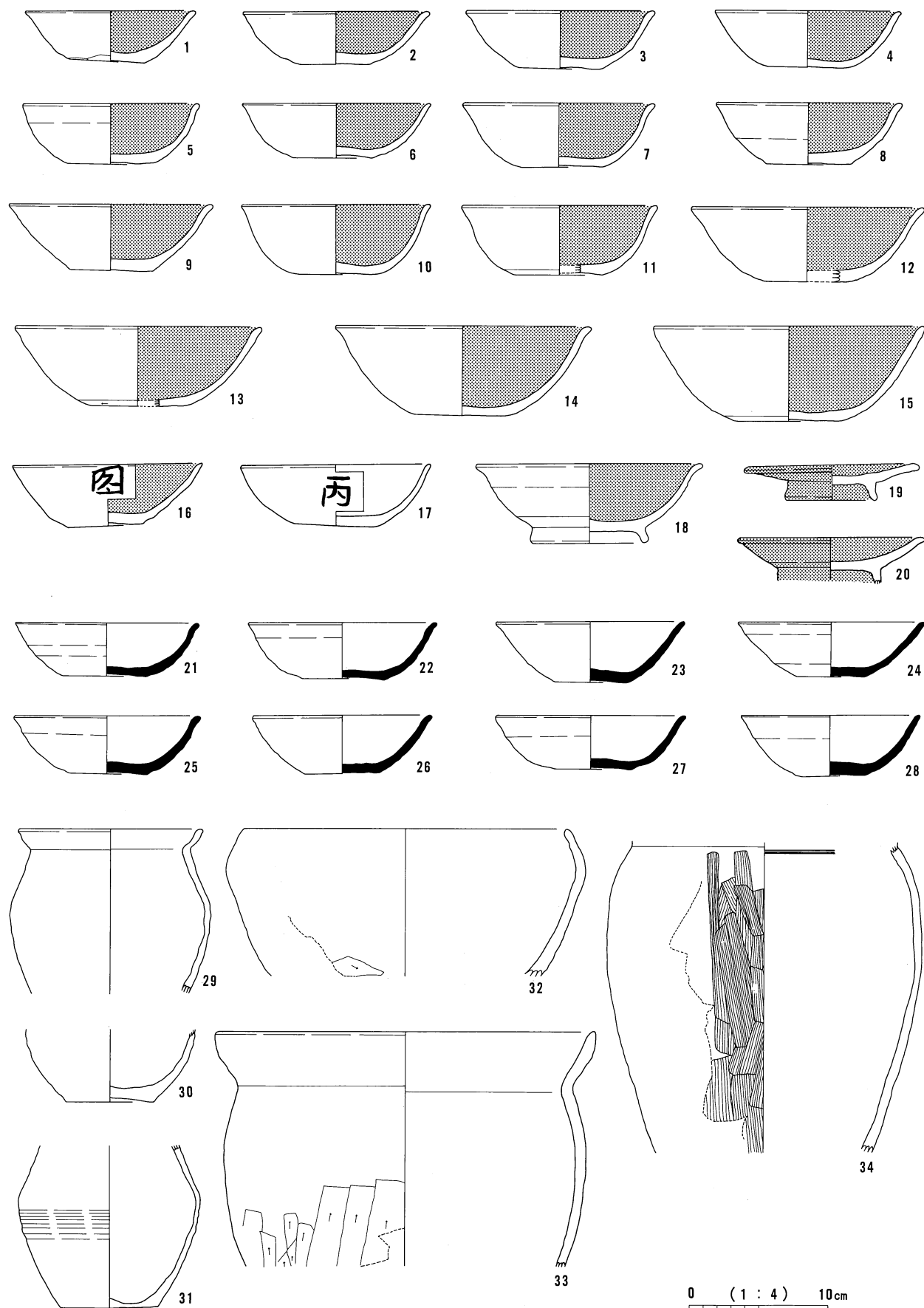

SB7422

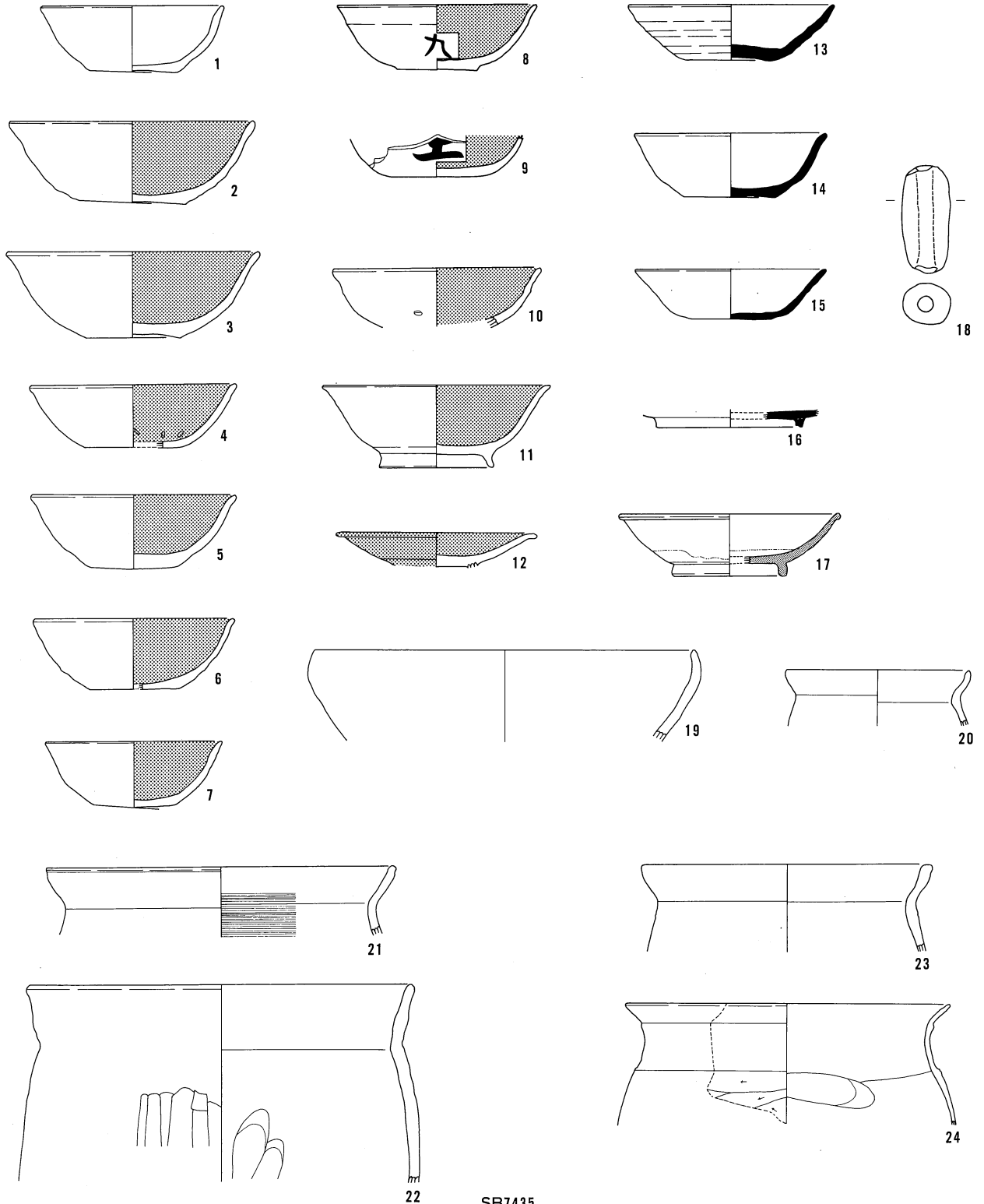

SB7434

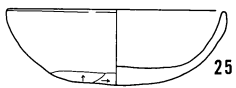

0 (1 : 4) 10cm

SB7435

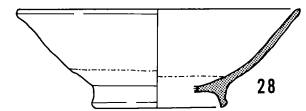
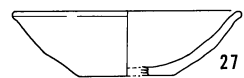
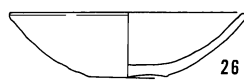

SB7425

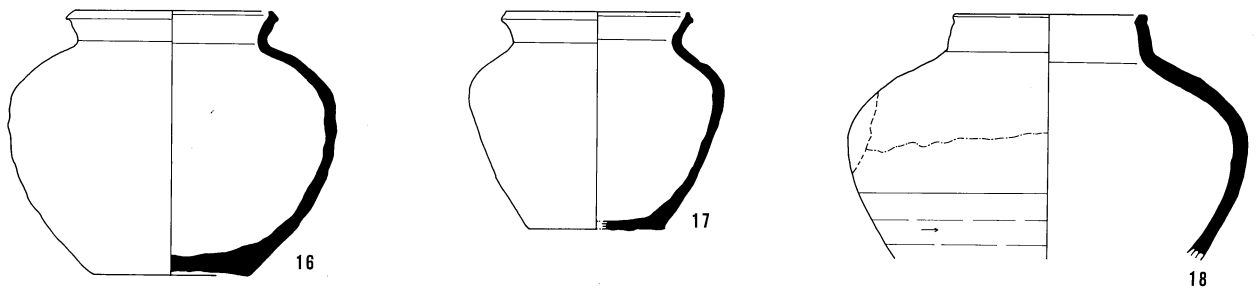
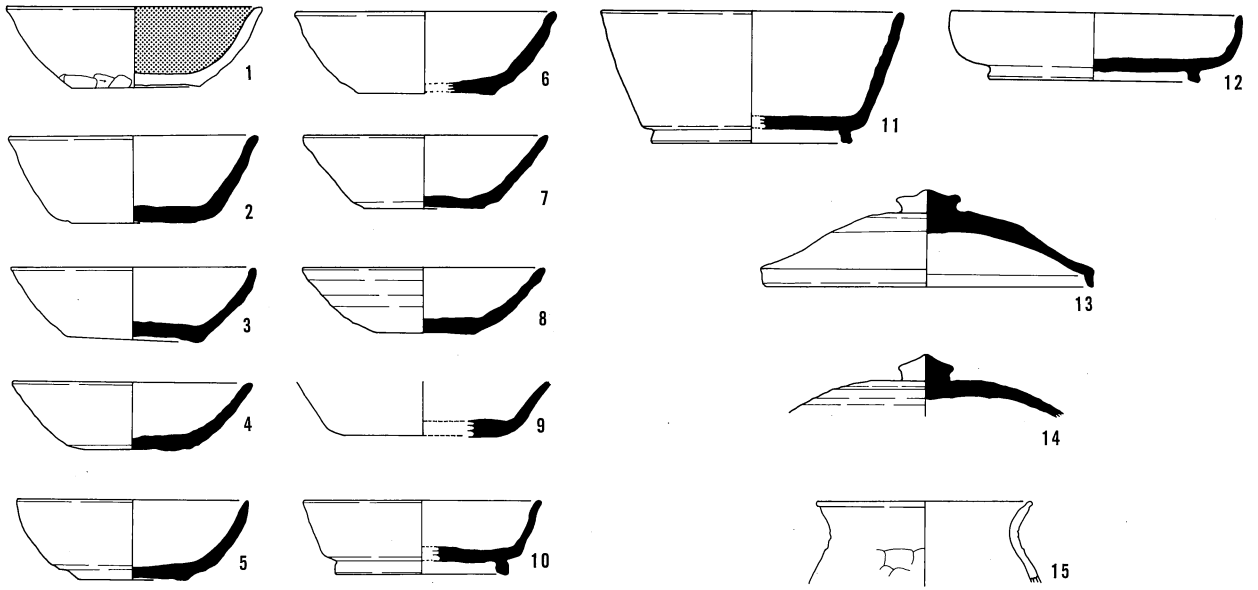

SB7437

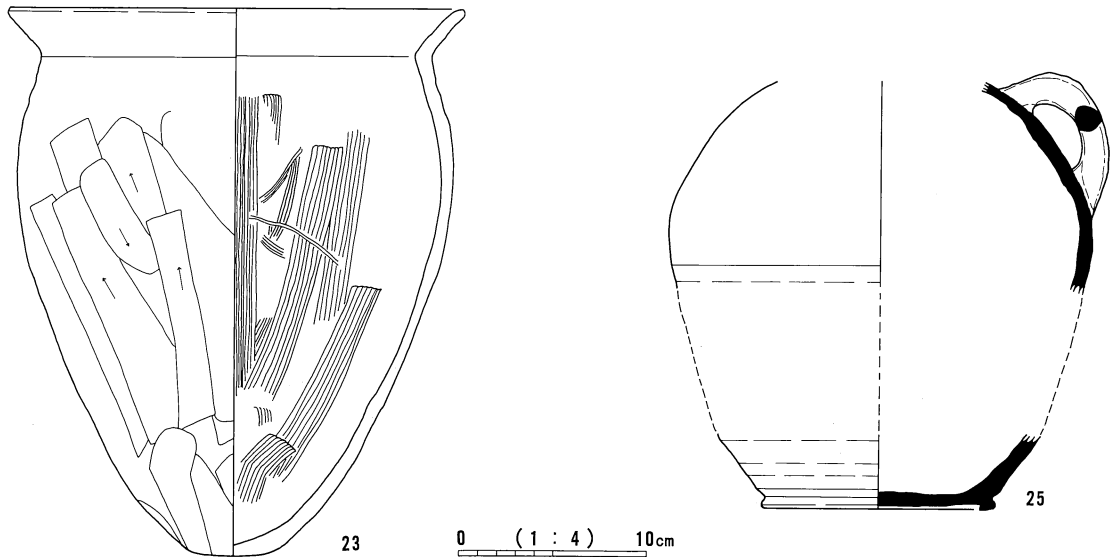
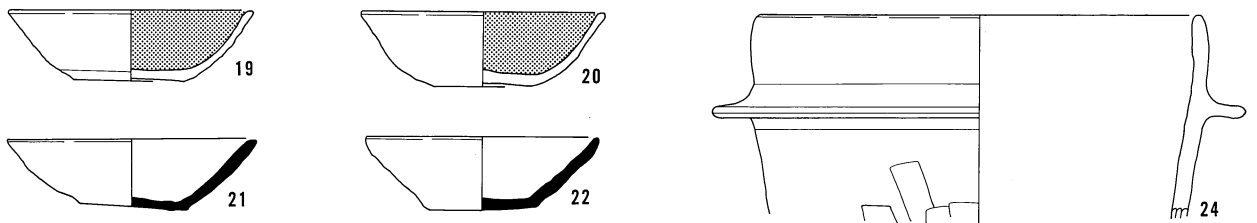

0 (1 : 4) 10cm

SB7427

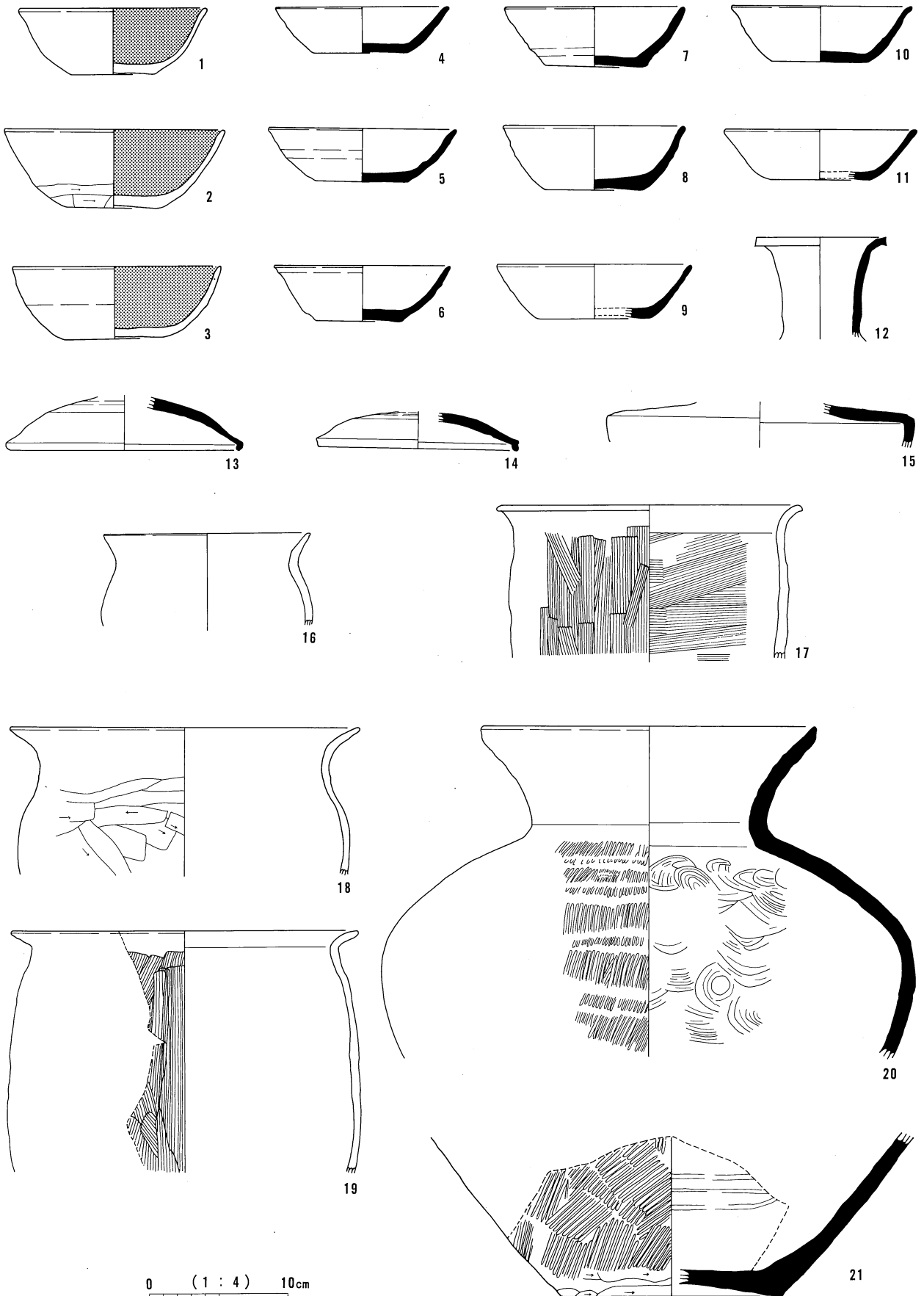

SB7427

SB7440



SB7449

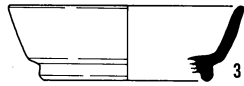

SB7450

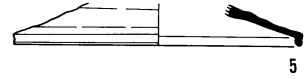

SB7459

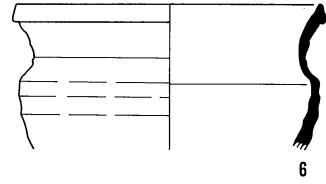
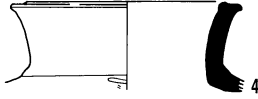
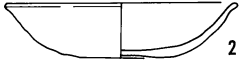

SB7460

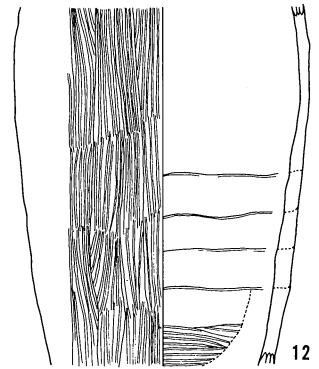
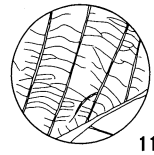
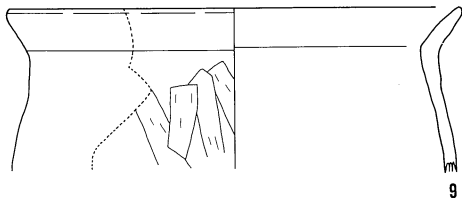
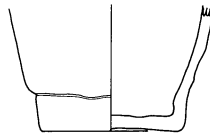
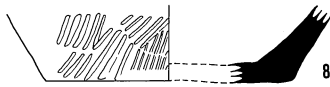
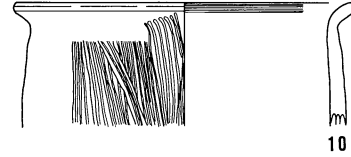
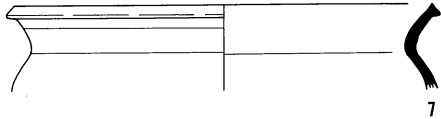

SB7469

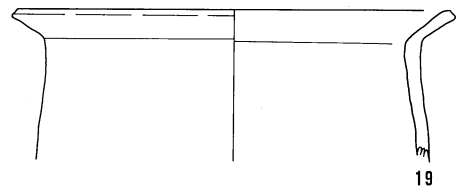
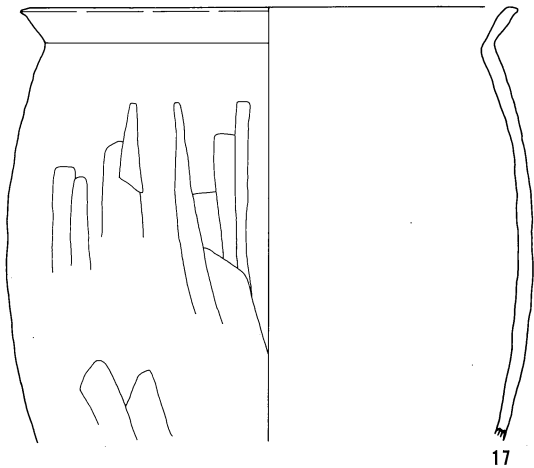
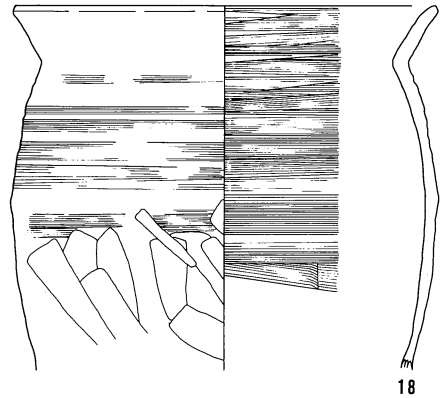
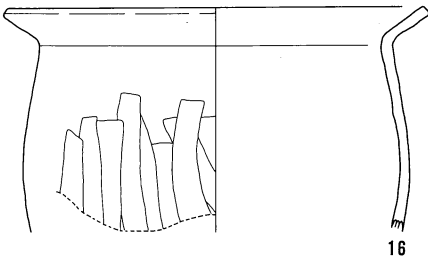
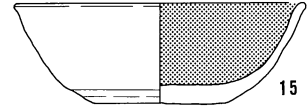
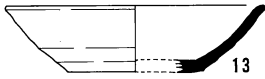

0 (1 : 4) 10cm

SB7464

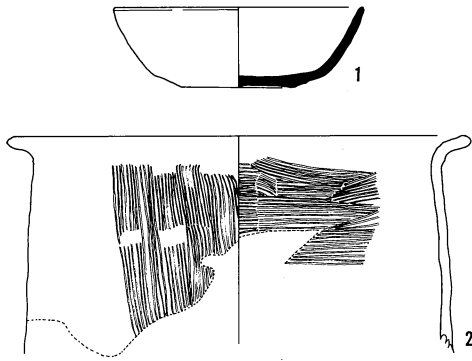

SB7470

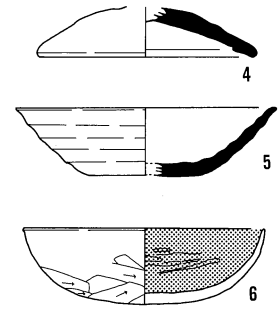
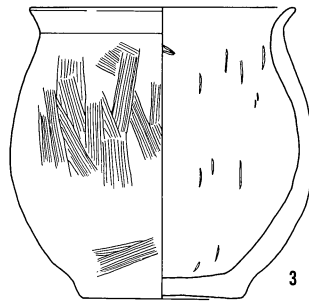

SB7477

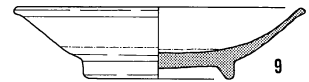
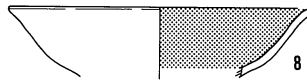
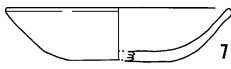

SB7478

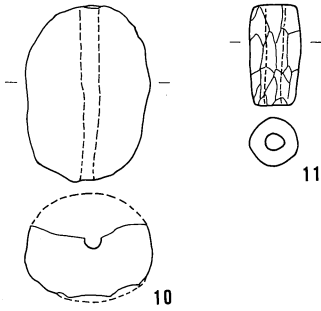

SB7485

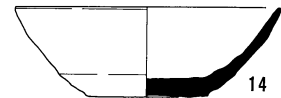
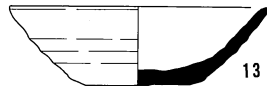
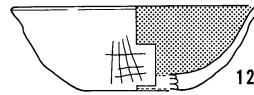

SB7486

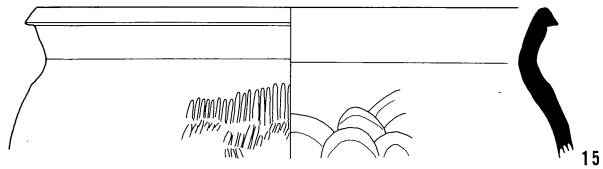
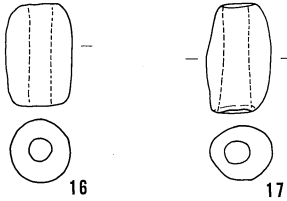

SB7505

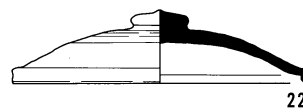
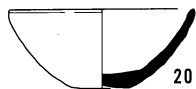
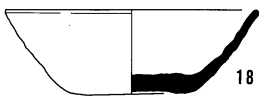

SB7519

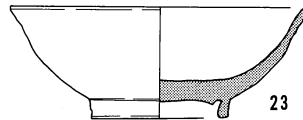
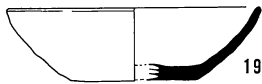
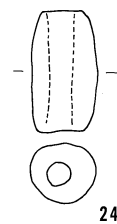

SB7518

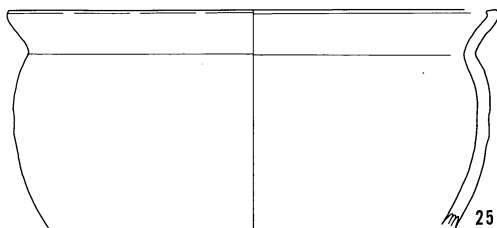

SB7521

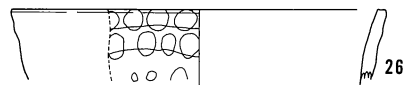

0 (1 : 4) 10cm

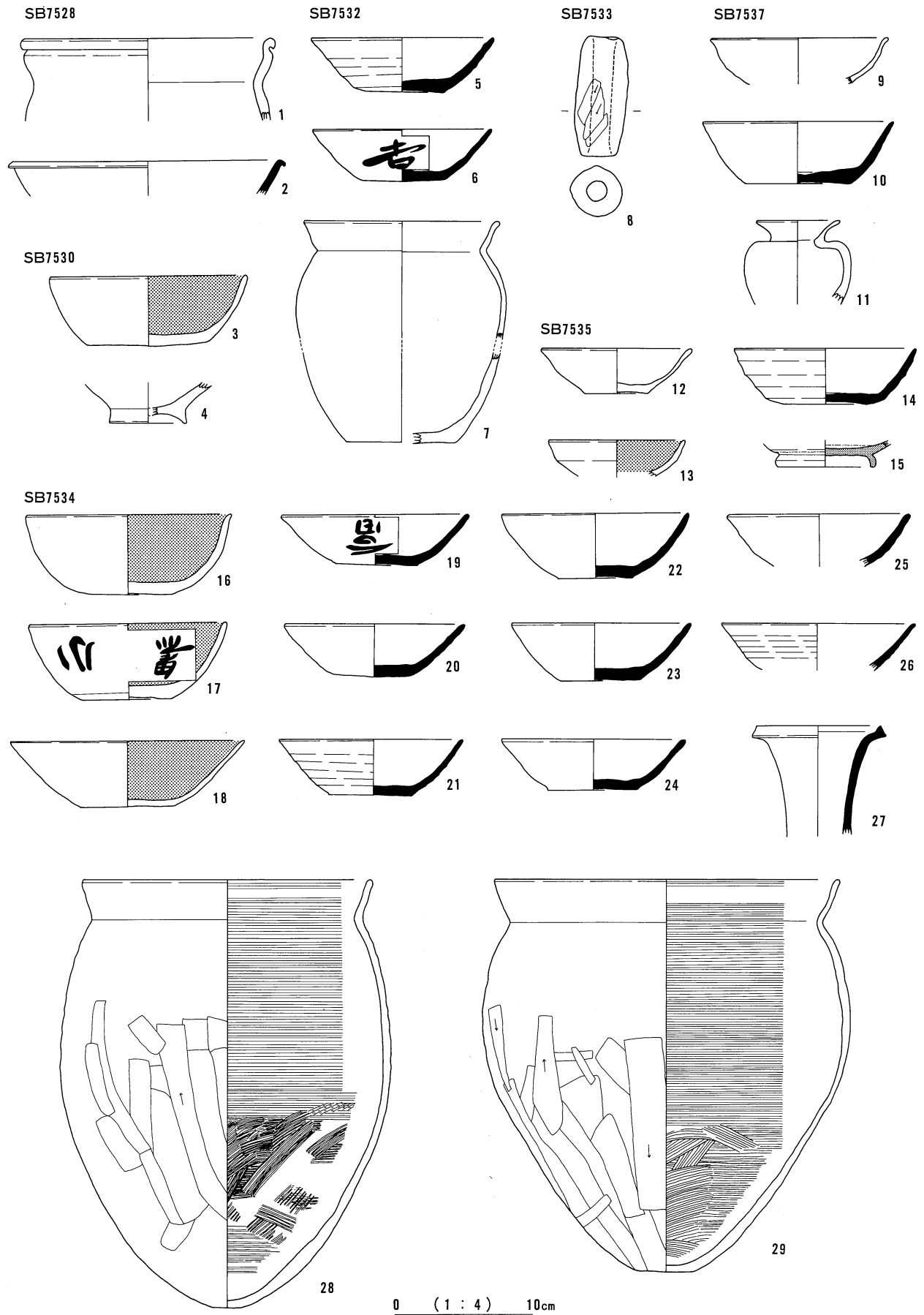

SB7538

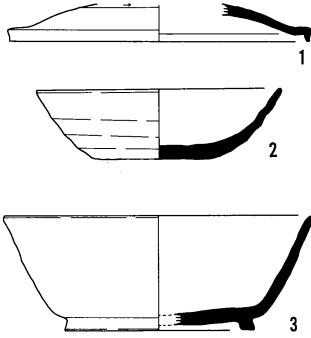

SB7543

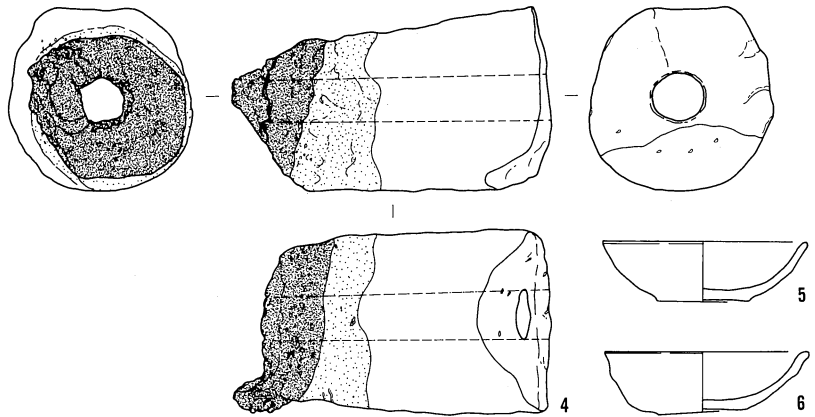

SB7546

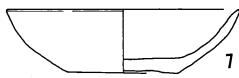

SB7549

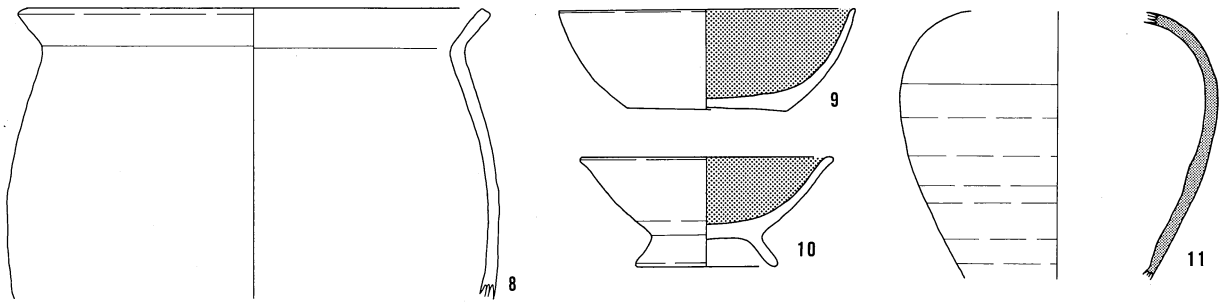

SB7551

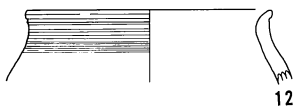

SB7568

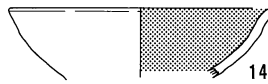

SB7554

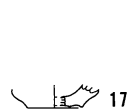

SB7591

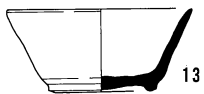

SB7571

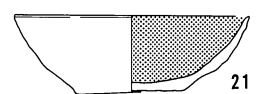
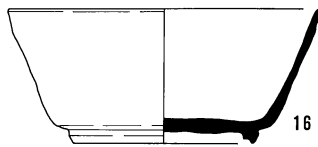
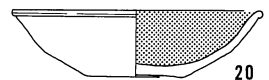
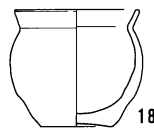

SB7587

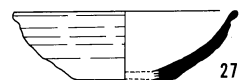
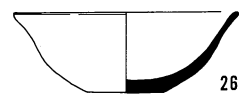
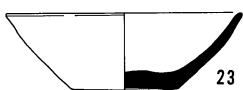
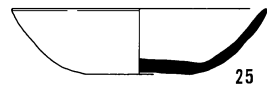
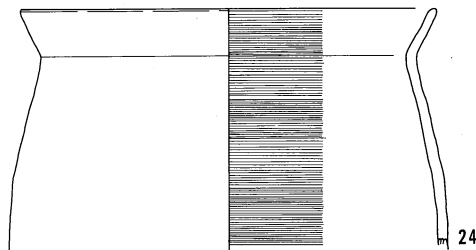
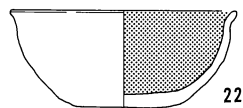

0 (1 : 4) 10cm

SB7552

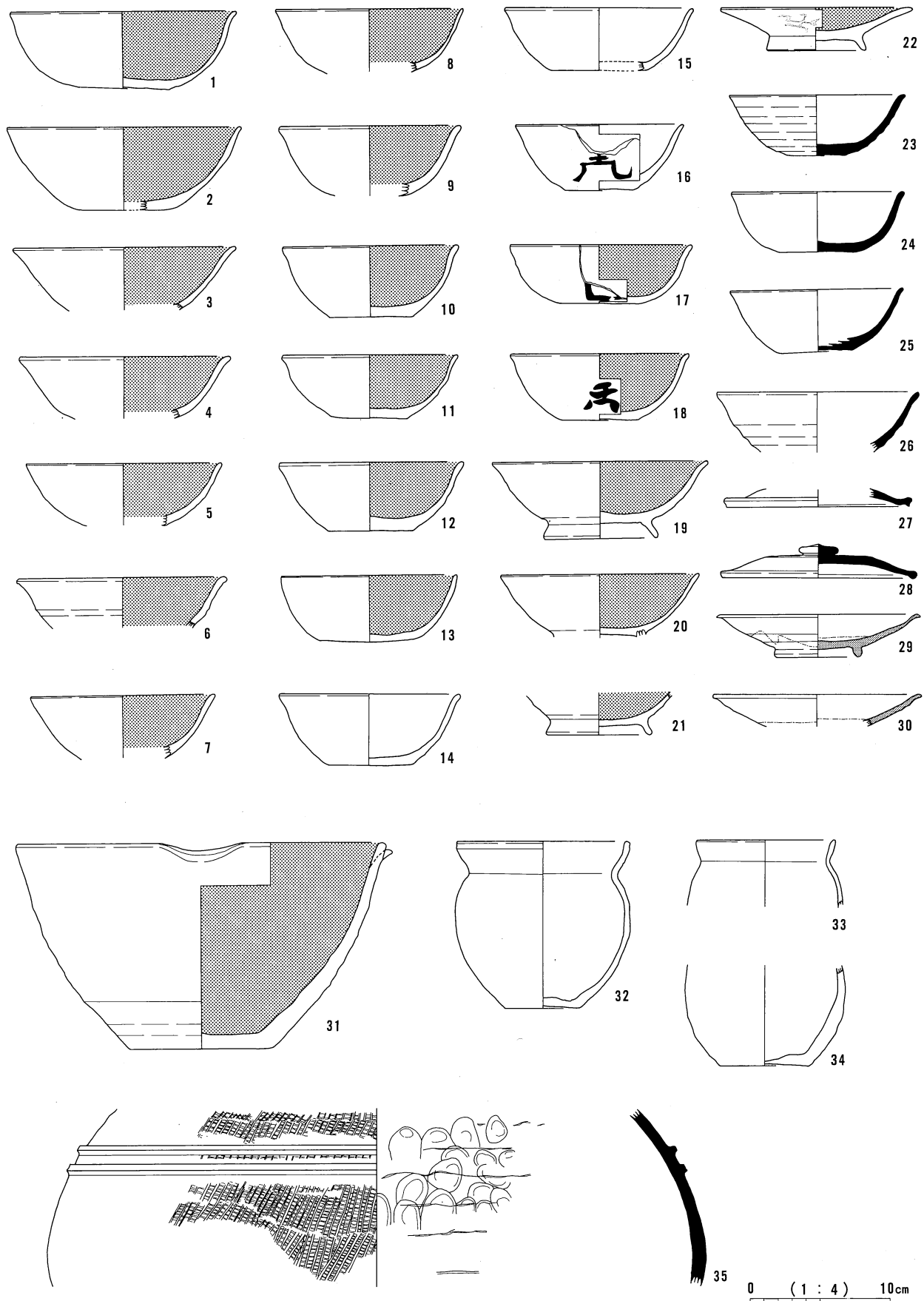

SB7552

SB7601

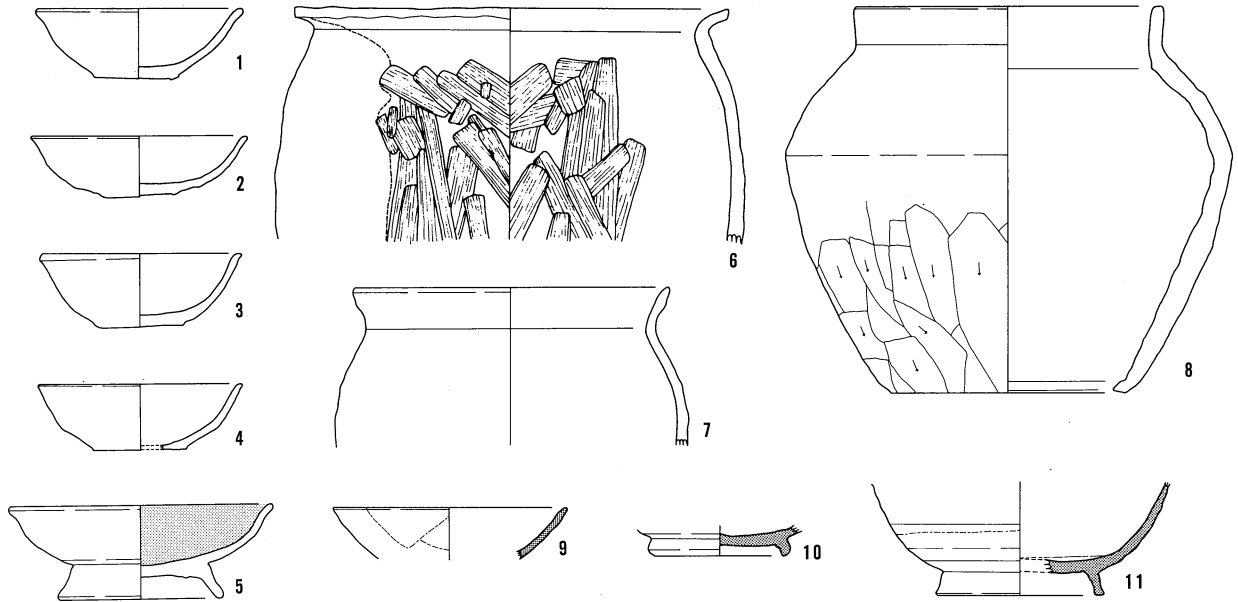

SB7610

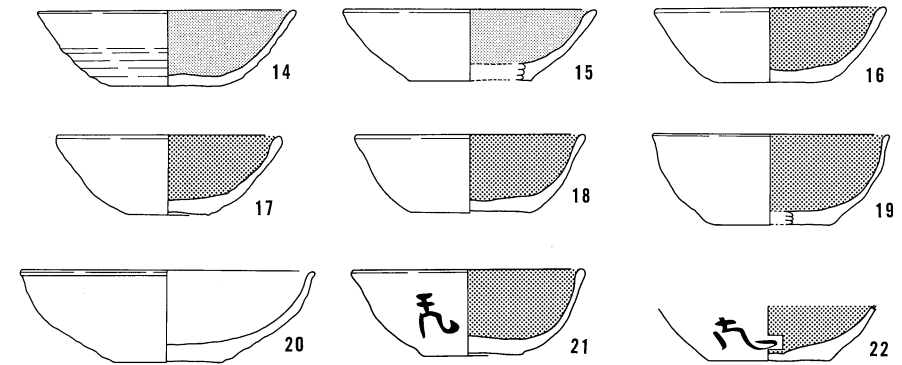

SB7605

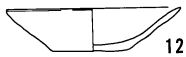

SB7606

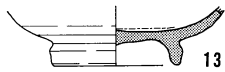

SB7619

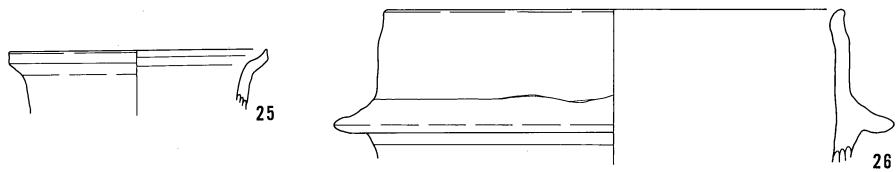
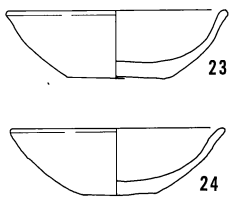

SB7622

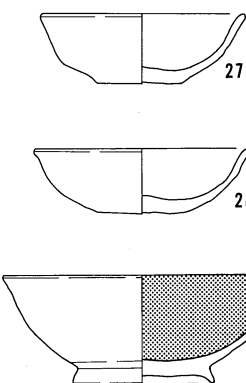

SB7645



SB7667

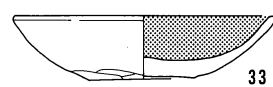

0 (1 : 4) 10cm

SB7644

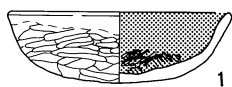

1

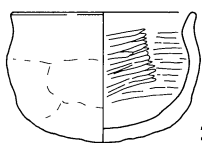

2

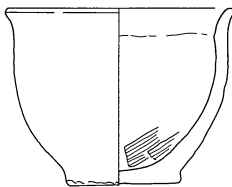

3

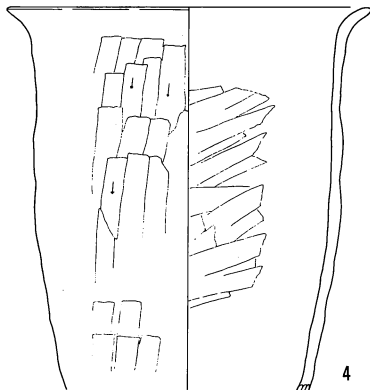

4

SB7700

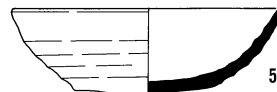

5



6

SB7651

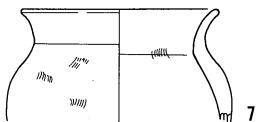

7

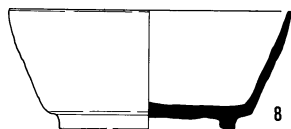

8

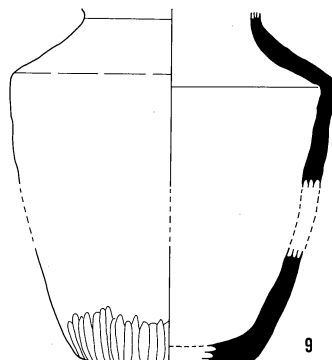

9

SB7703

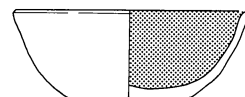

10

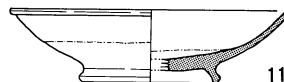

11



12

SB7716

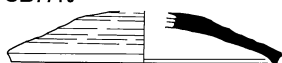

14



15



13

SB7717



16



17

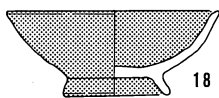

18

SB7735

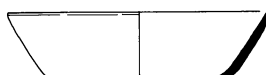

19



20

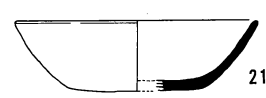

21



22

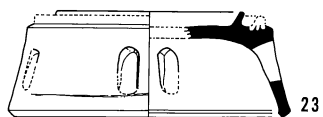

23



24

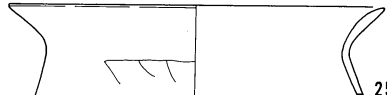

25

0 (1 : 4) 10cm

ST7020

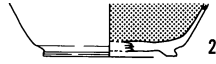
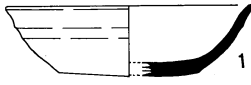

SM7005

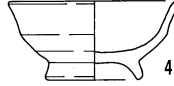

SM7007

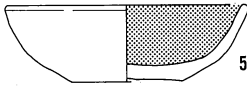

SM7008



SM7015



SM7009

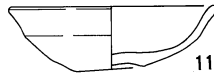
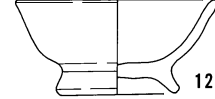
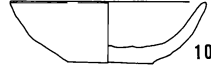

SM7017

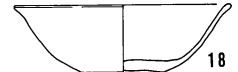
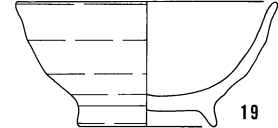
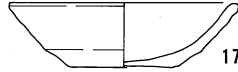
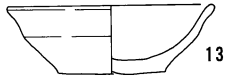

SM7019

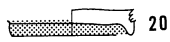

SM7020

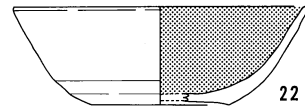

SM7021

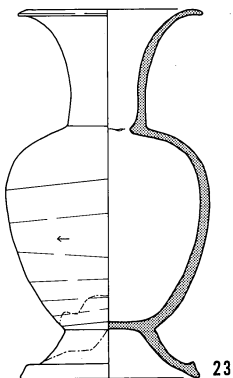

SM7022

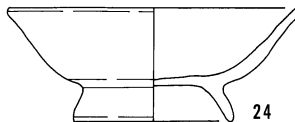

SM7025

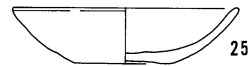

0 (1 : 4) 10cm

SD6008

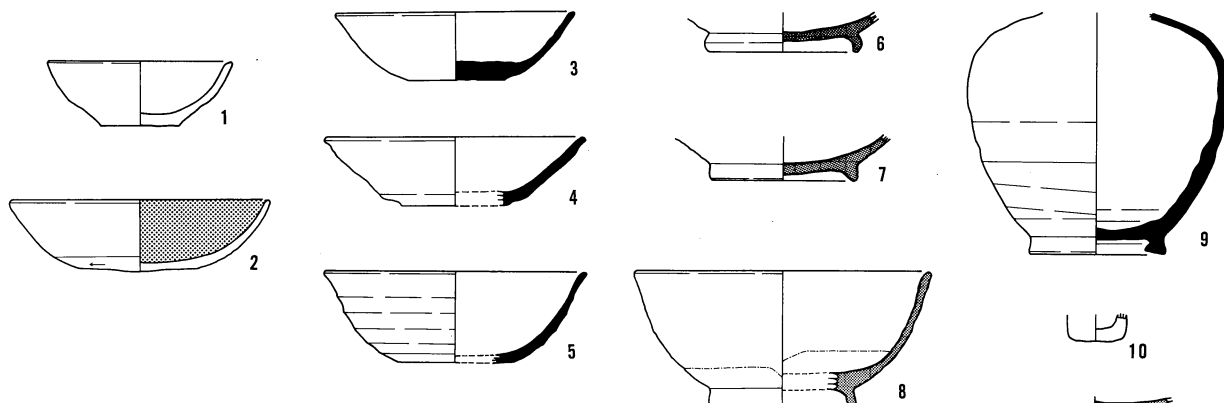

SD6033

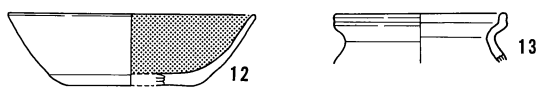

SD7001

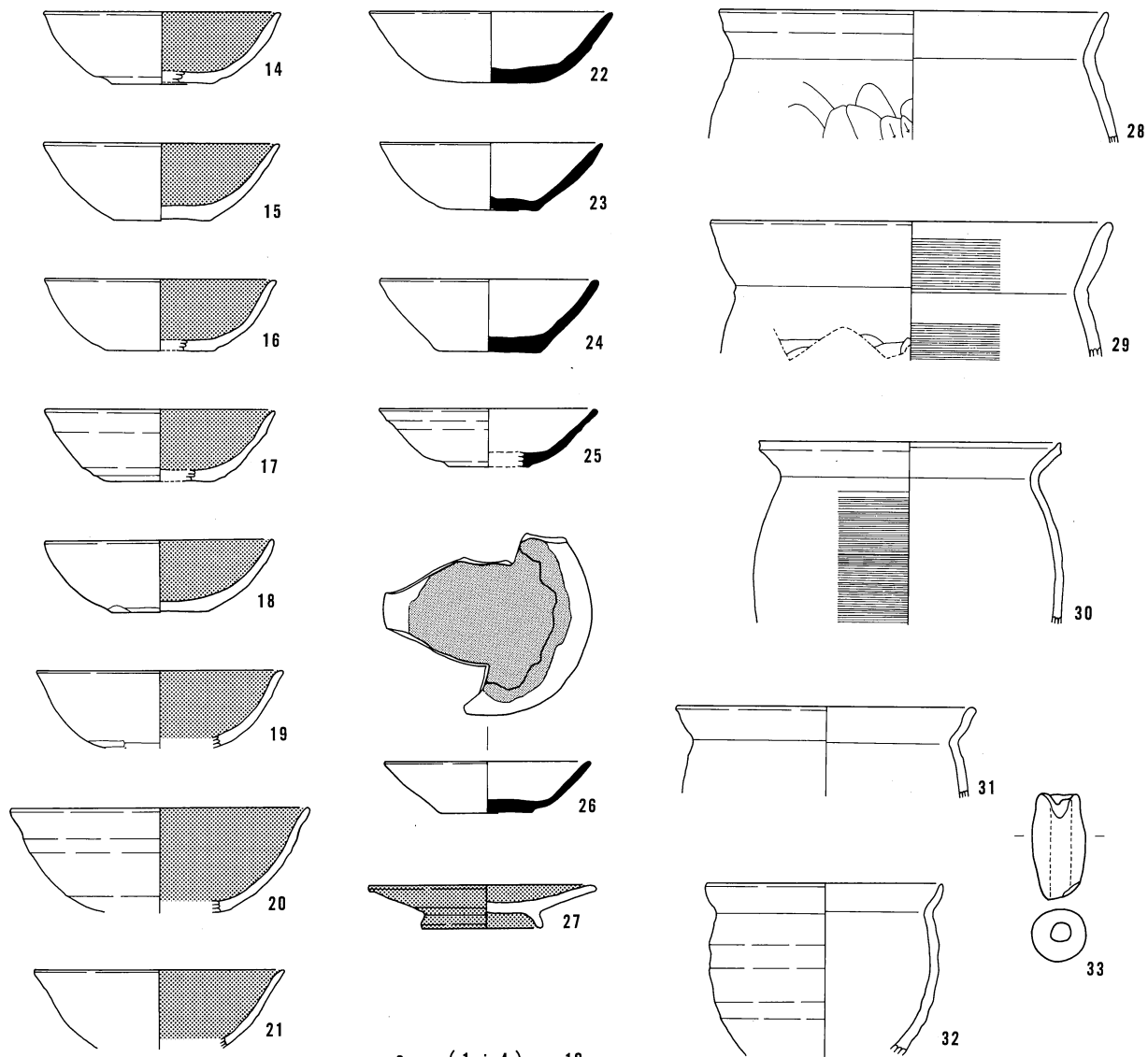

SD7002

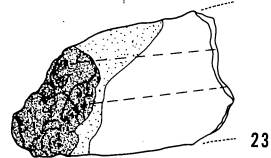
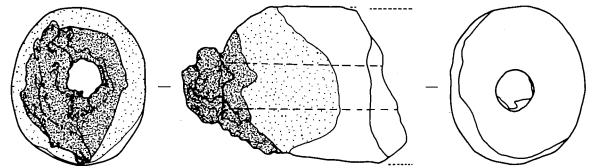
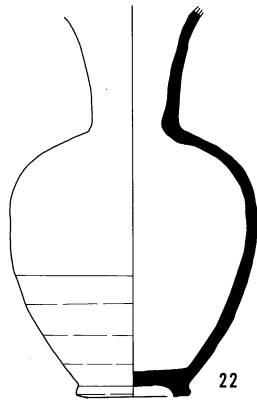
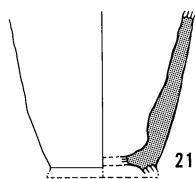
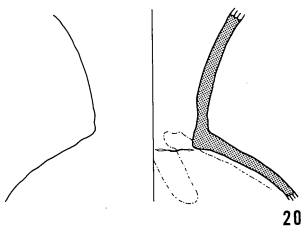
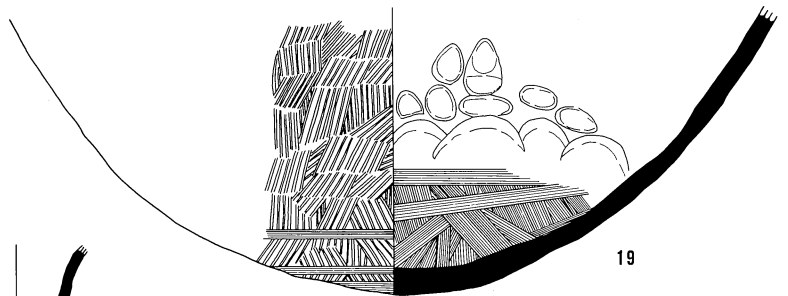
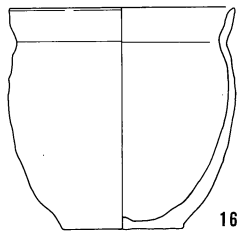
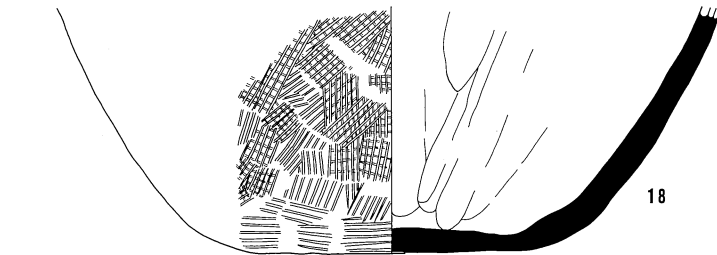
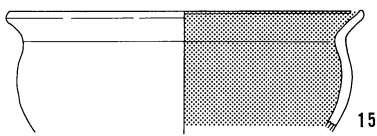
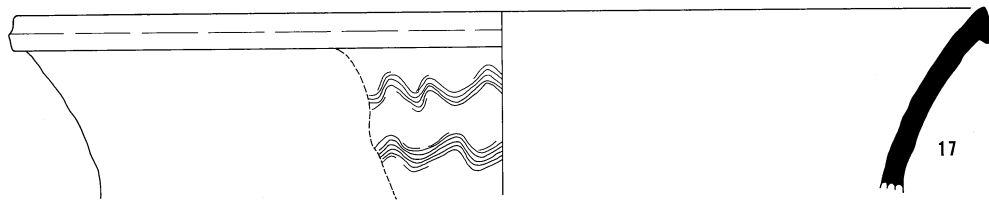
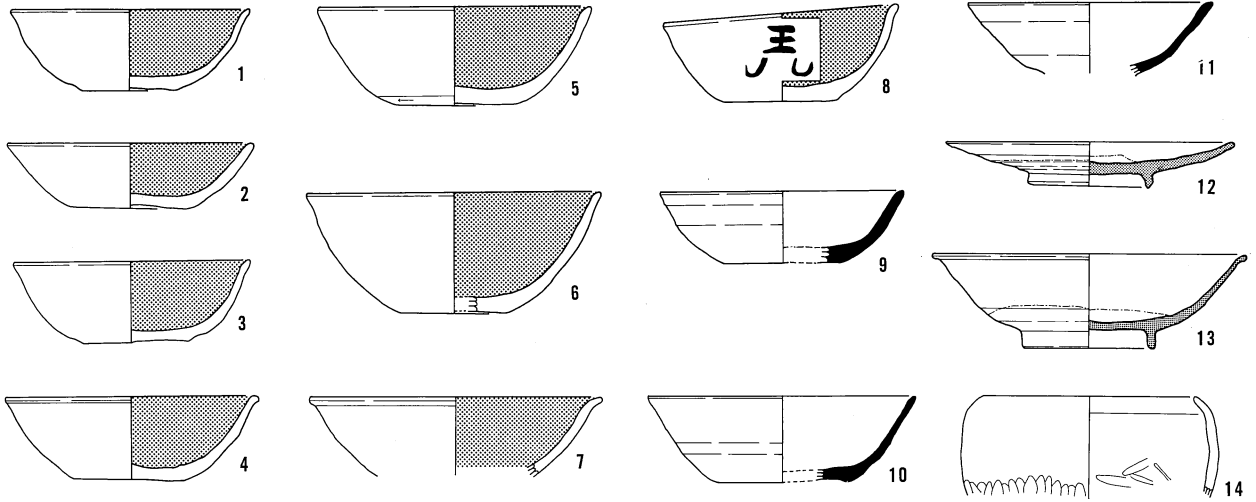

0 (1 : 4) 10cm

SD7002

SD7006-①

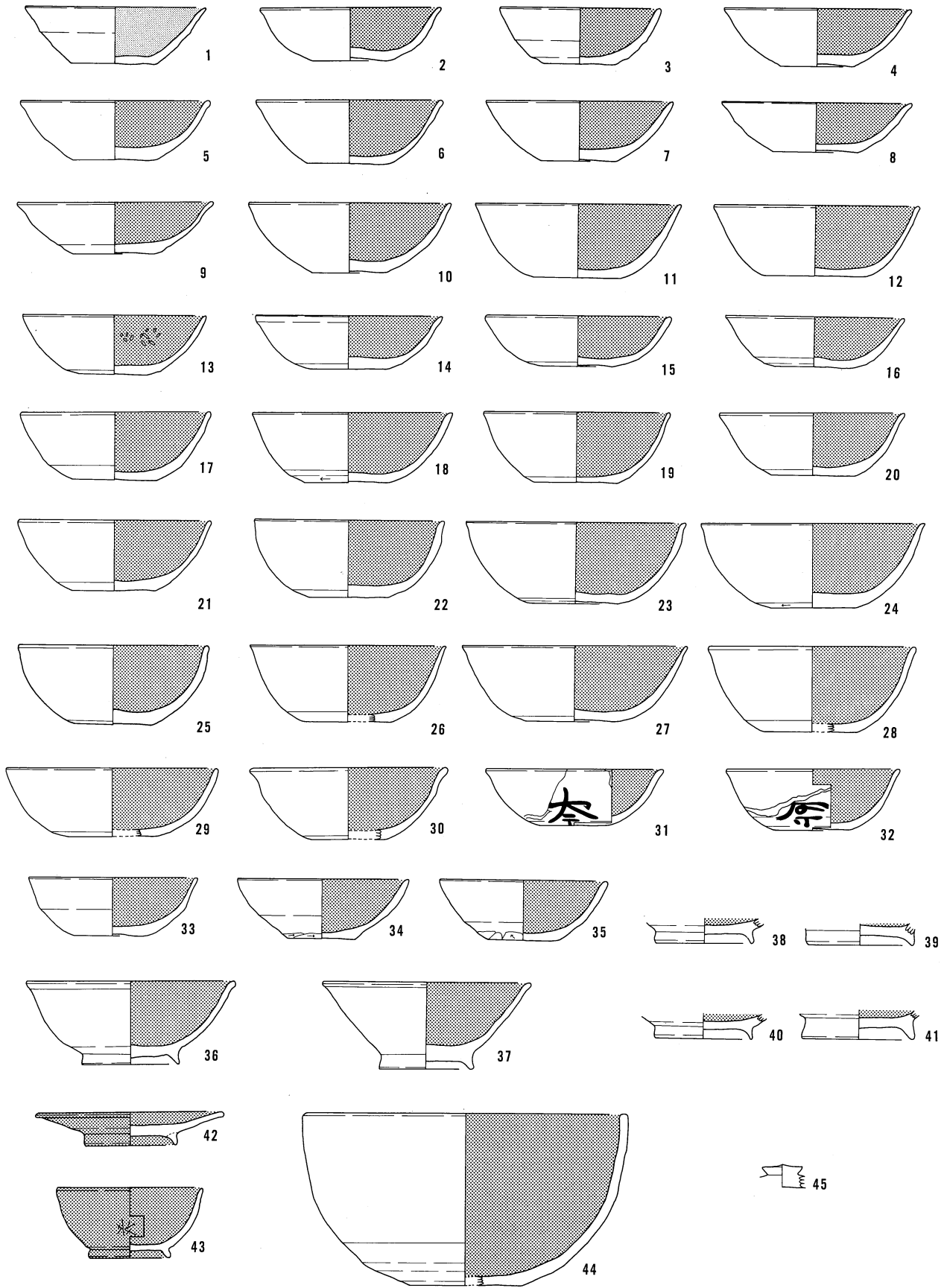

0 (1 : 4) 10cm

SD7006-②

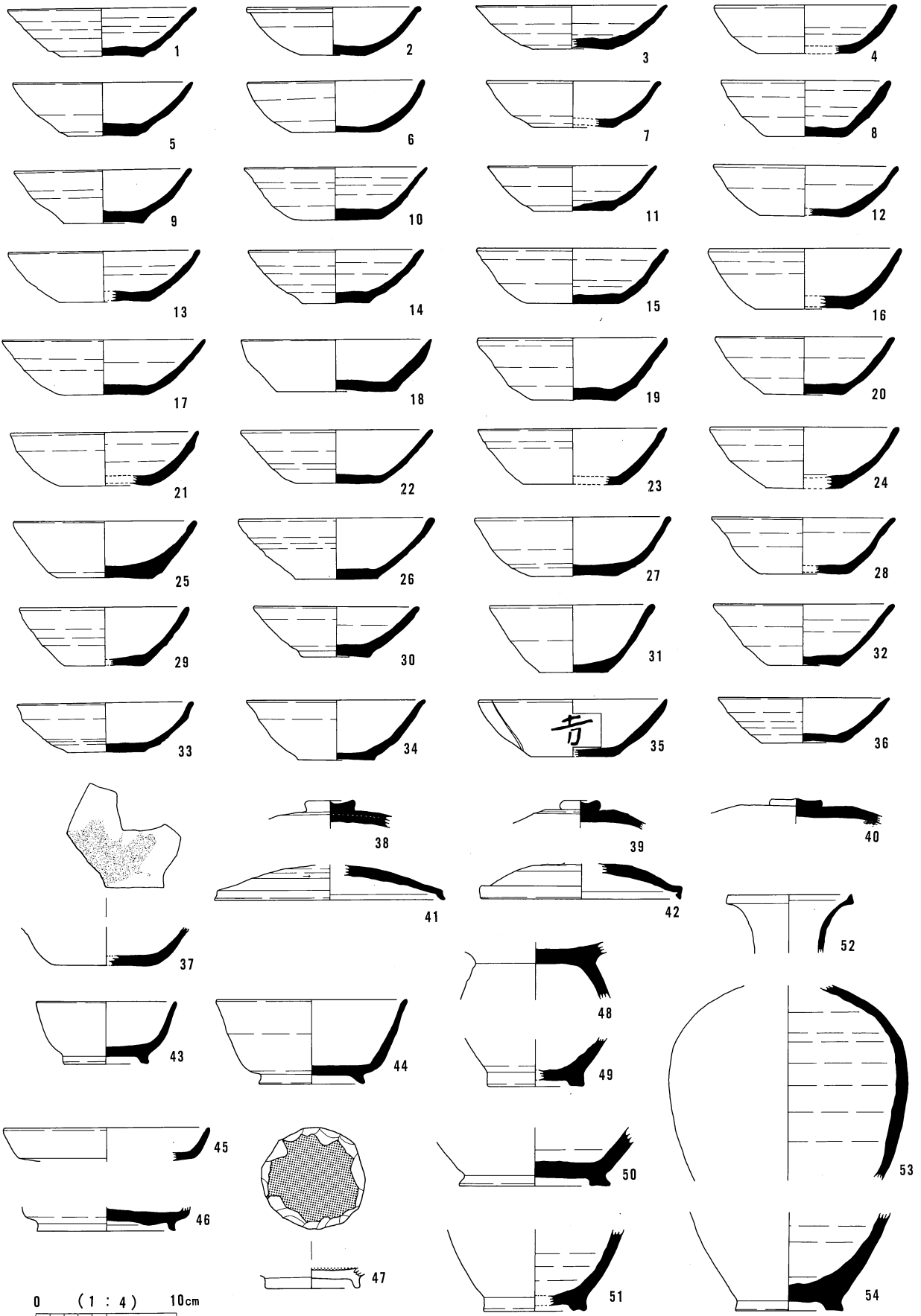

SD7006-③

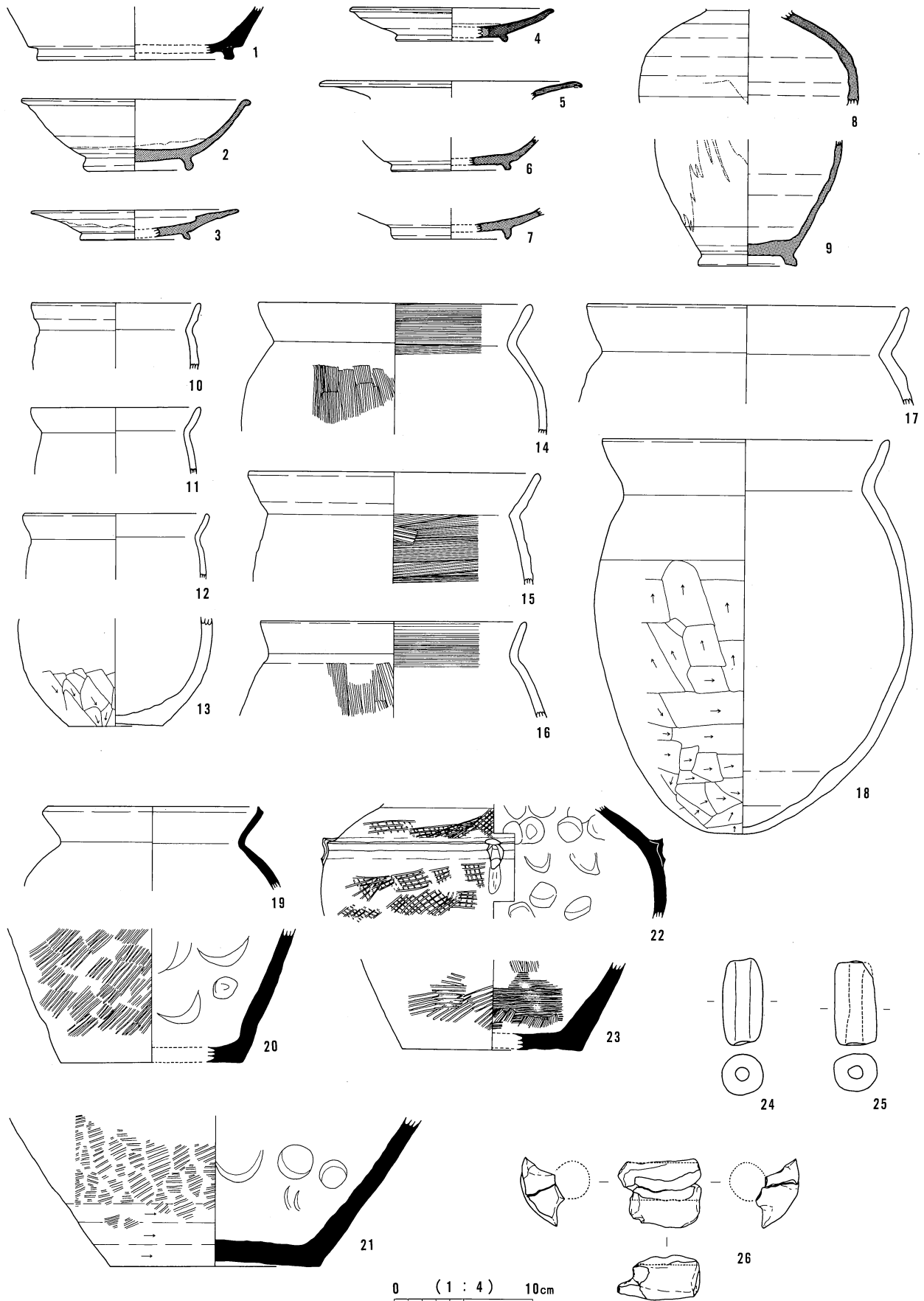

0 (1 : 4) 10cm

SD7006-③

SD7007

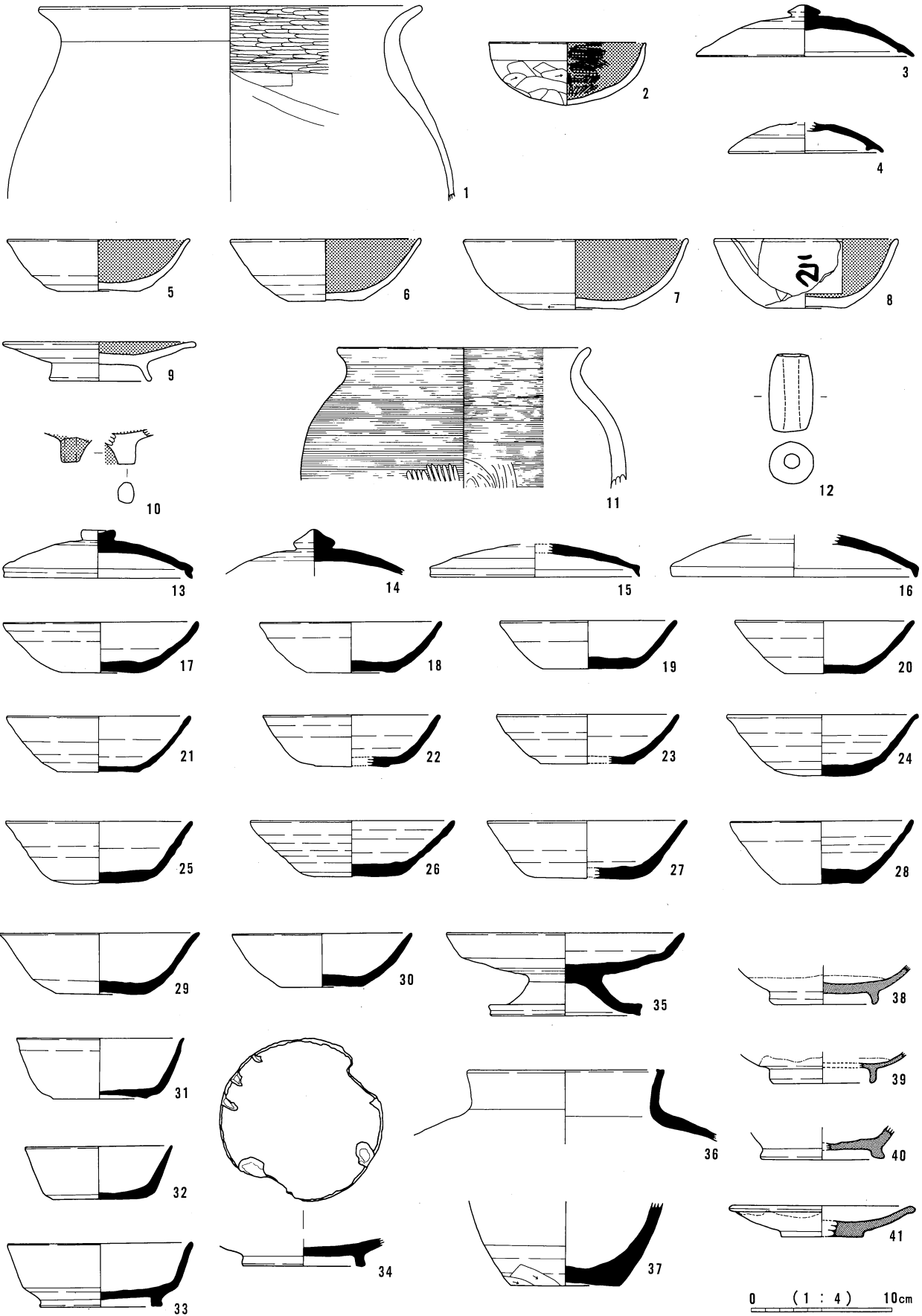

SD7007

SD7010

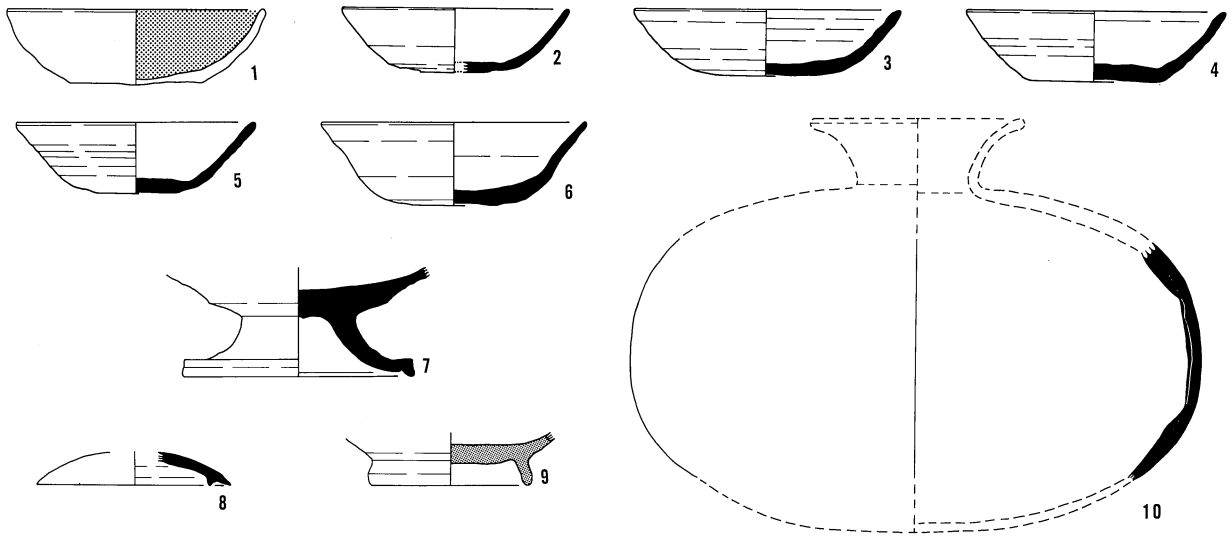

SD7011

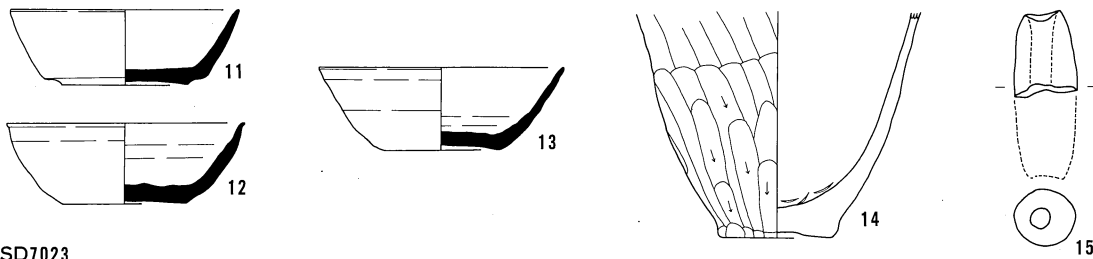

SD7023

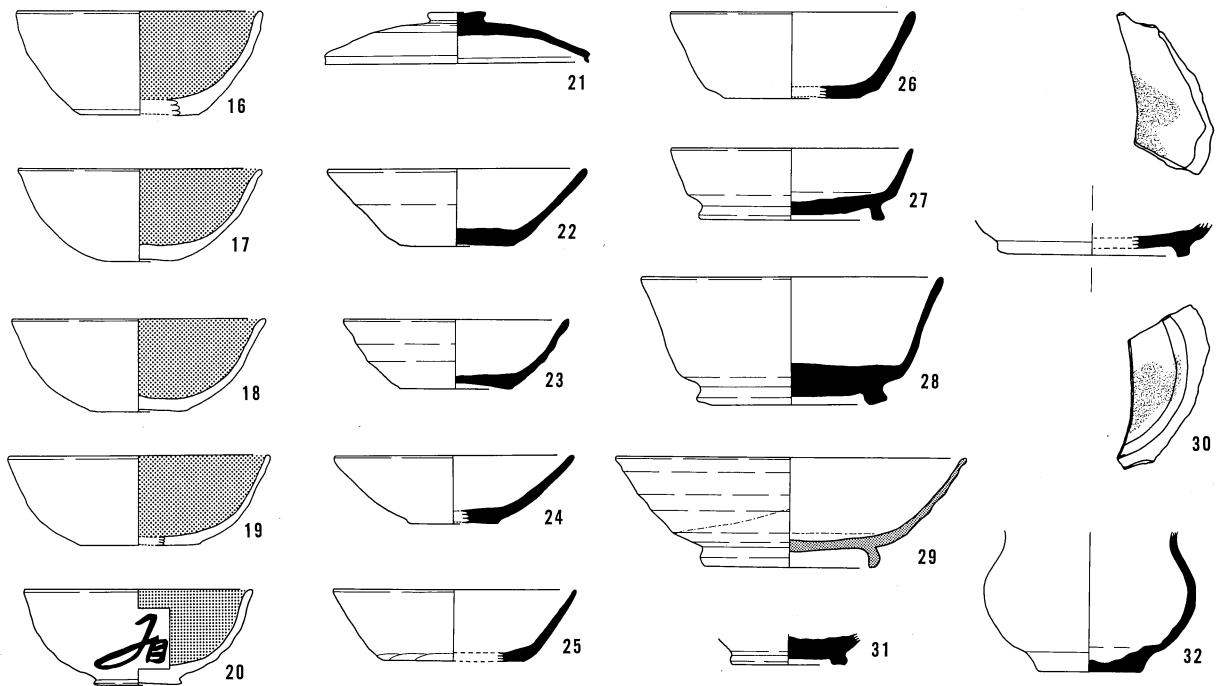

SD7024

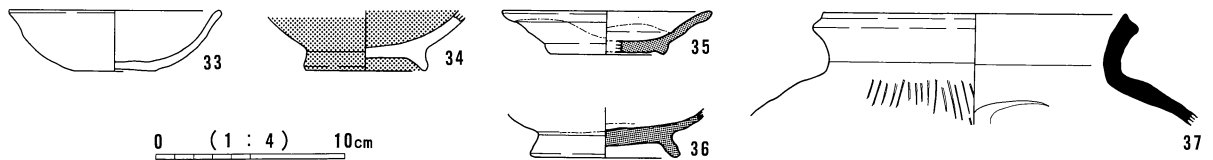

0 (1 : 4) 10cm

SD7027

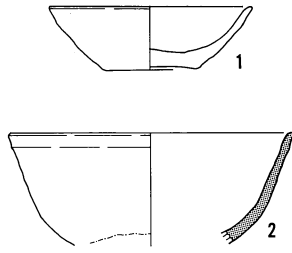

SD7029



SD7031

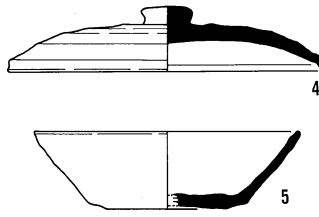

SD7032

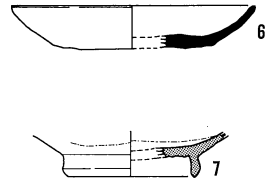

SD7033

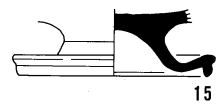
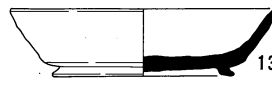
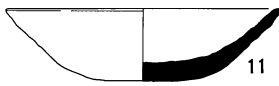
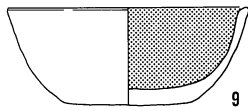
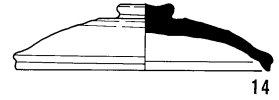
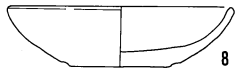

SD7036

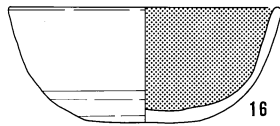

SD7037

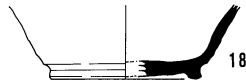

SD7038

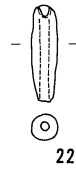
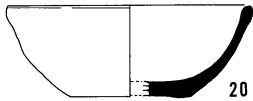

SD7040

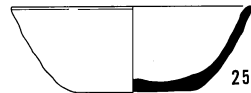
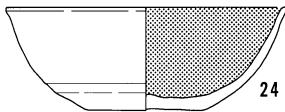

SD7041

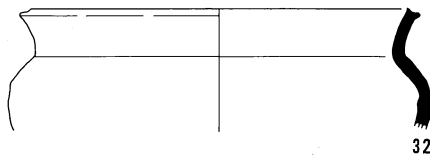

SD7042

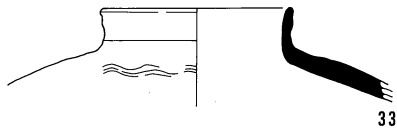
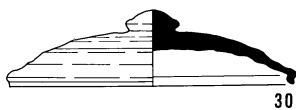
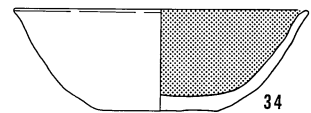

0 (1 : 4) 10cm

SD7039-①

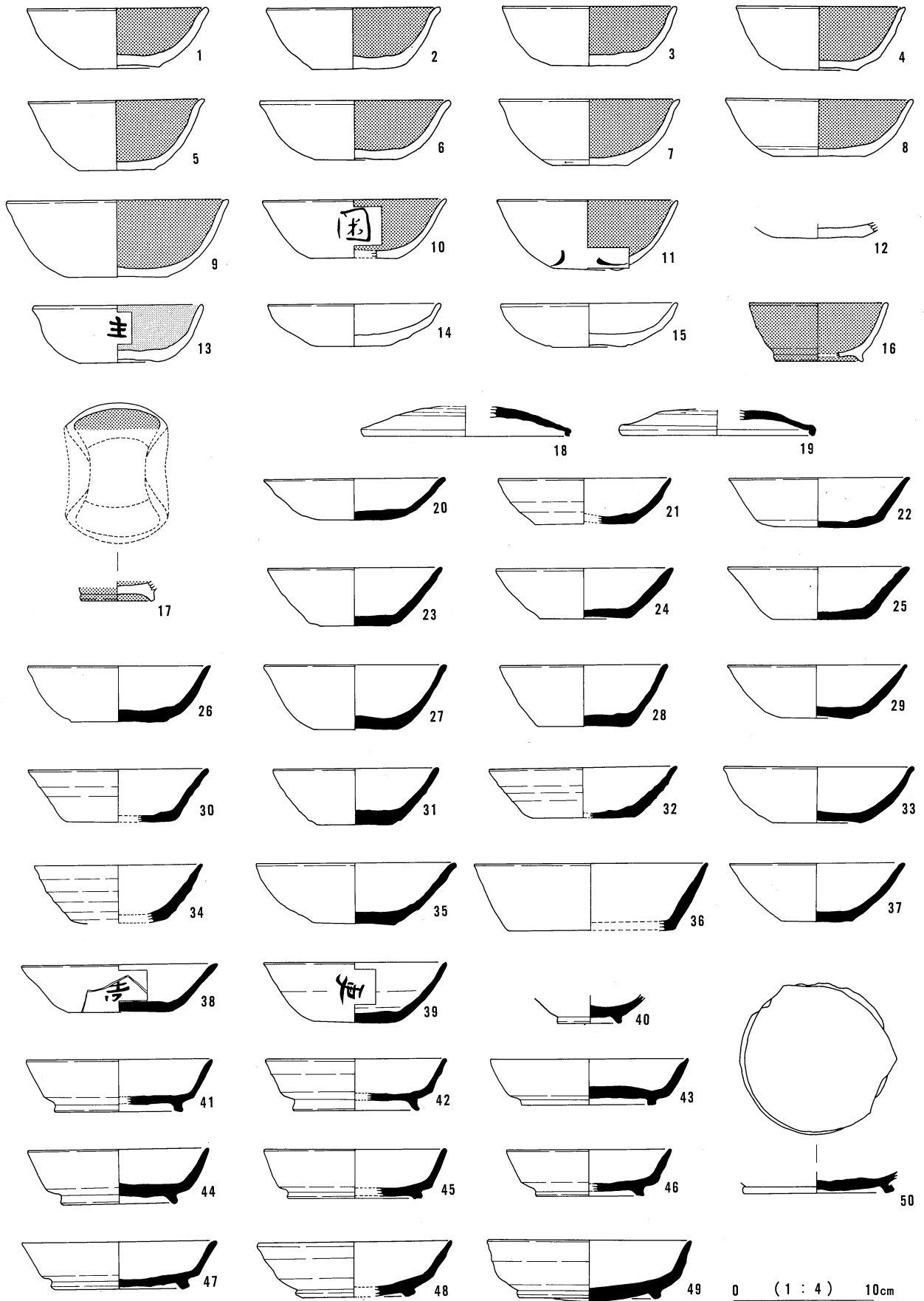

SD7039-①

SD7039-②

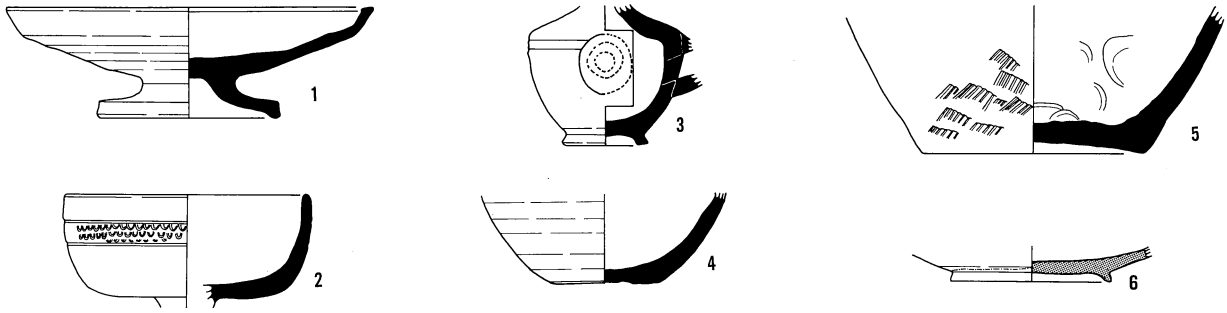

SD7051



SD7052-①

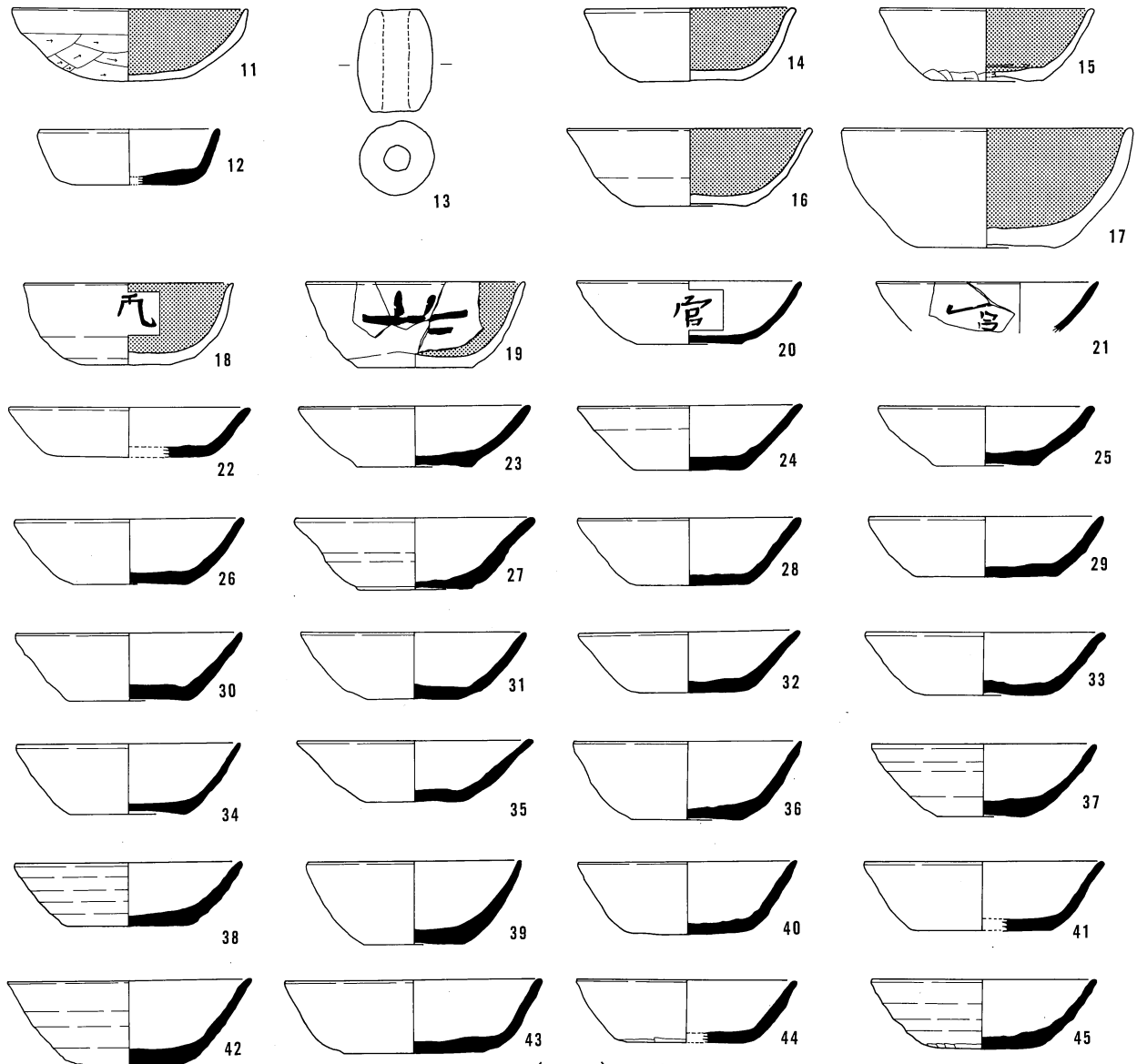

0 (1 : 4) 10cm

SD7052-②

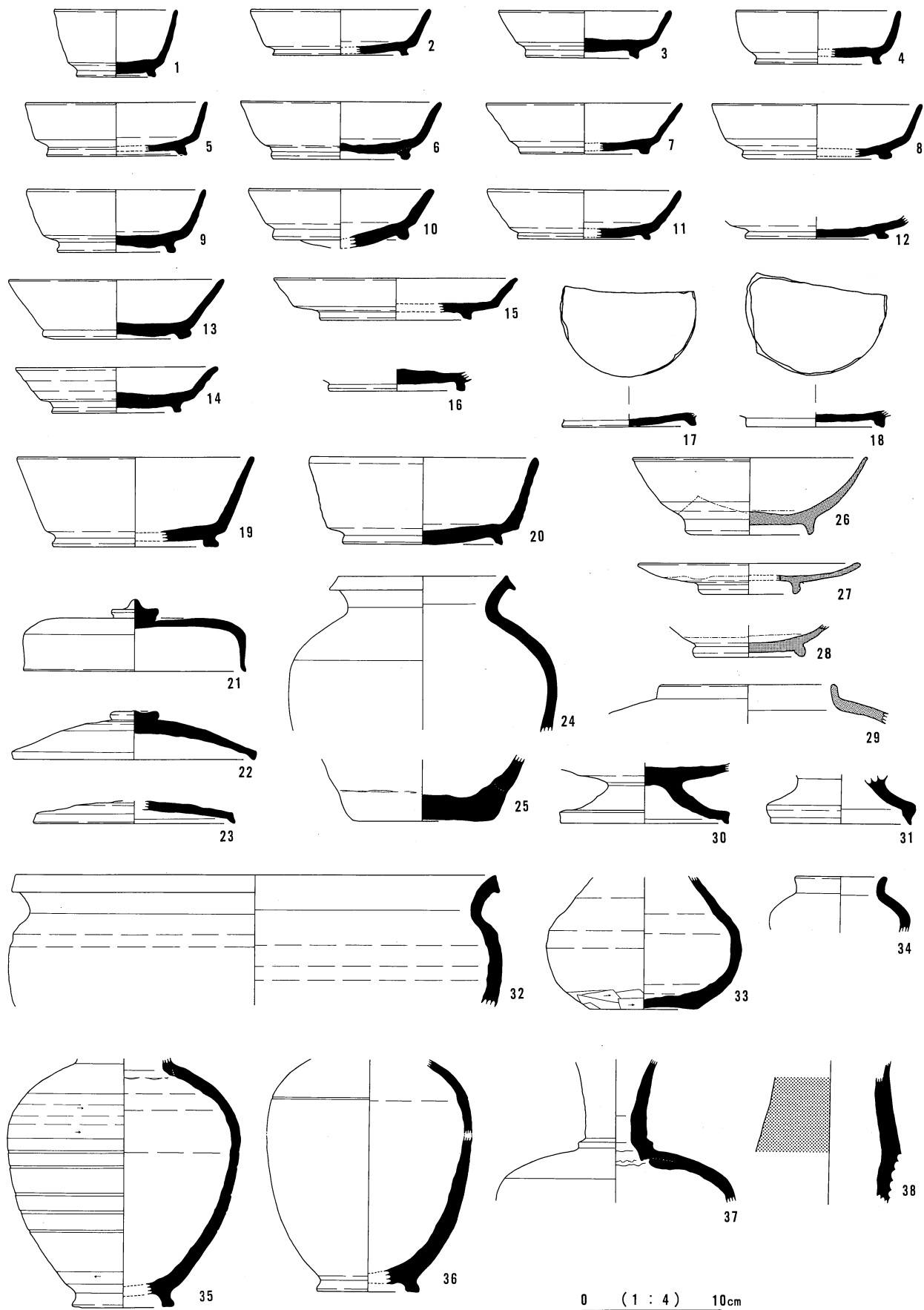

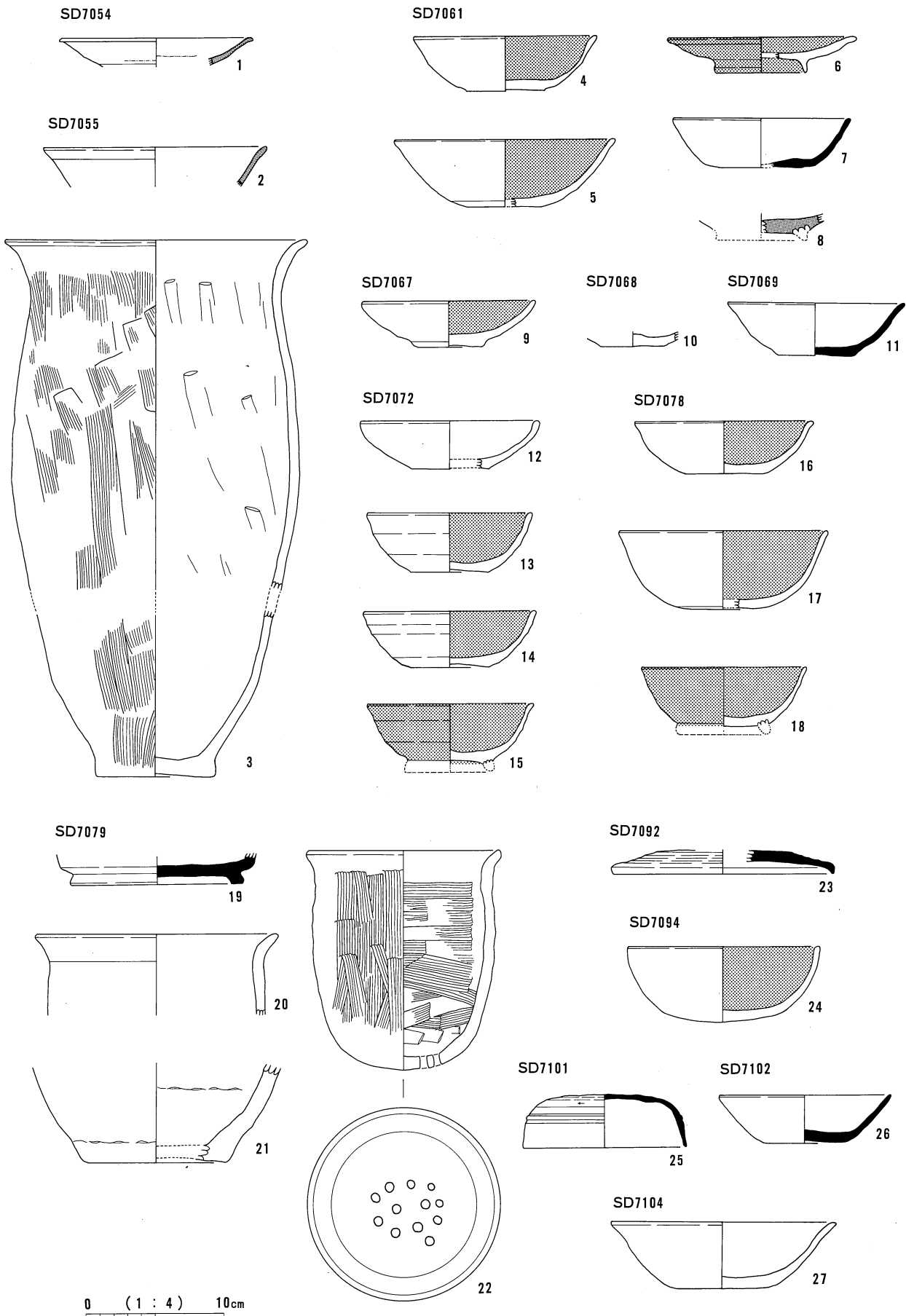

SD7080

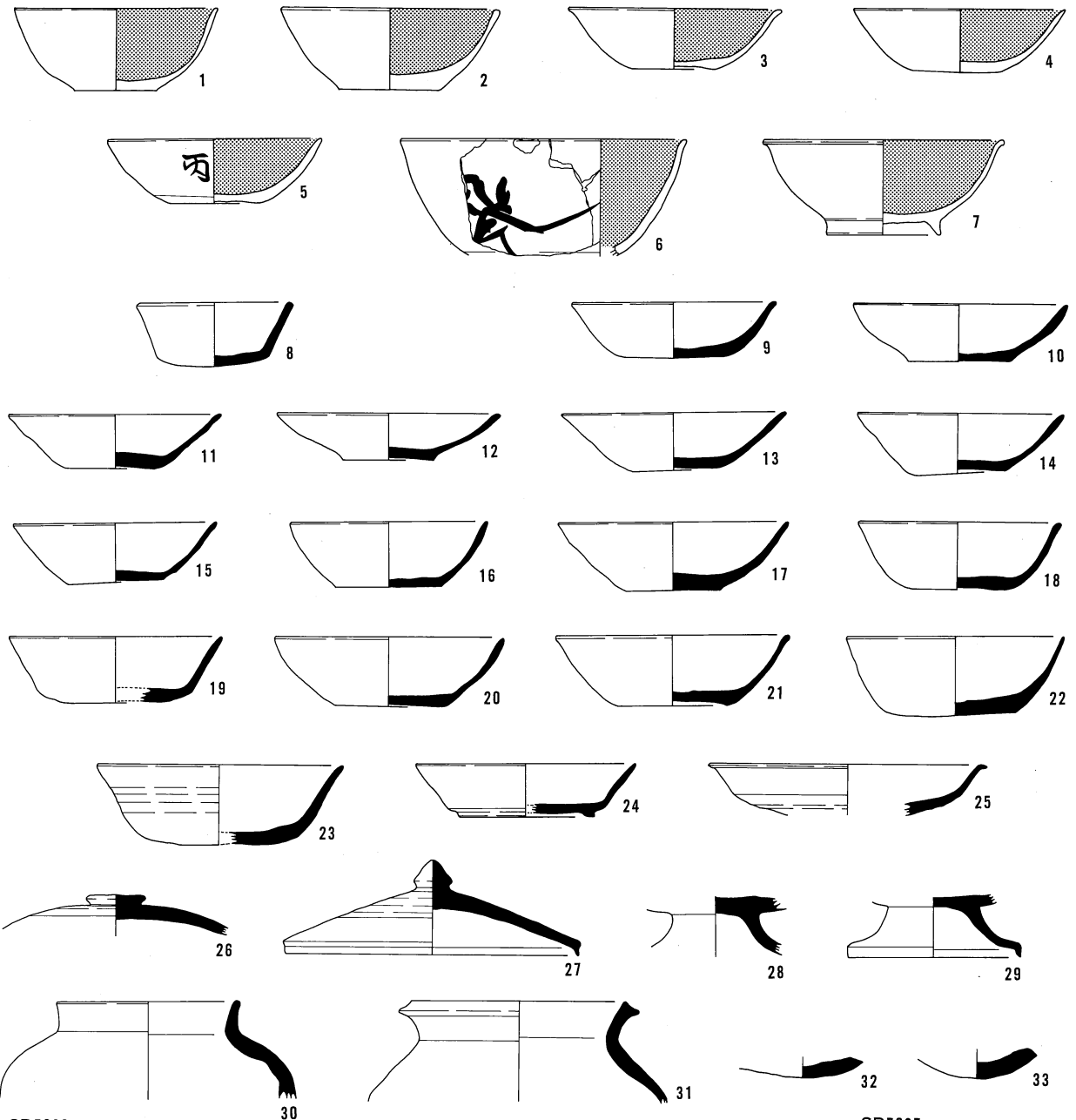

SD7083

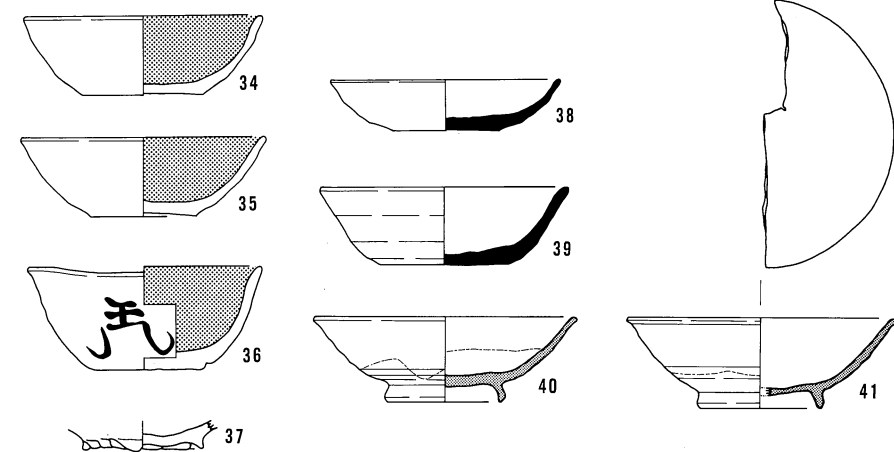

SD7087

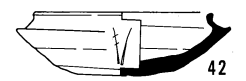

SD7109

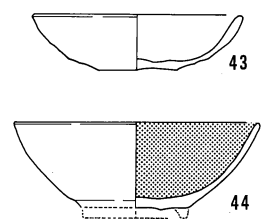

0 (1:4) 10cm

SK6033

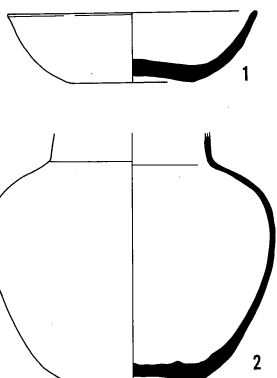

SK6035

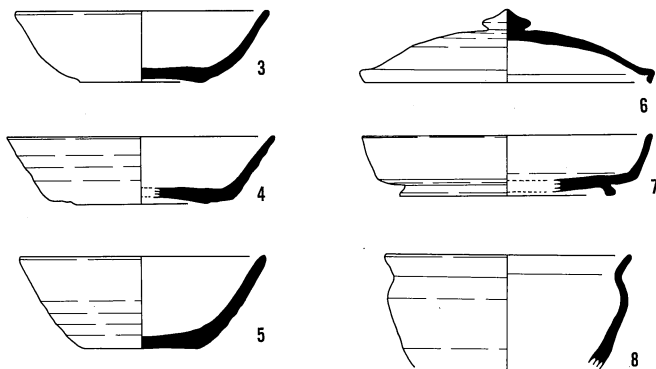

SK6034

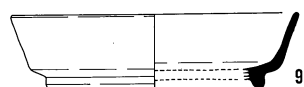

SK6044

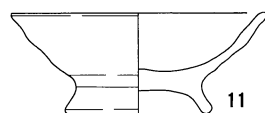

SK6046

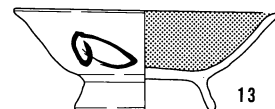
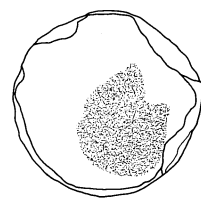

SK6097

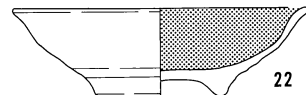
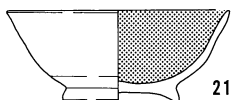
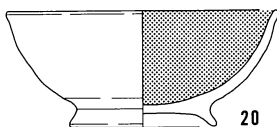
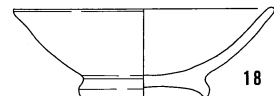
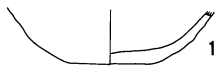

SK6154



SK6208



SK6398



SK6432

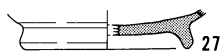
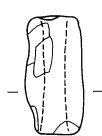

SK6408

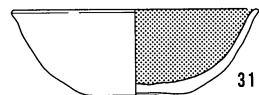

SK6160

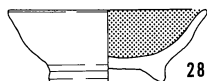

SK7137

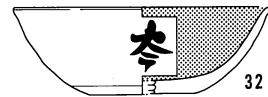

SK6163

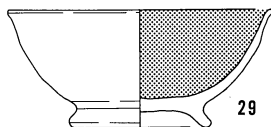

SK7154

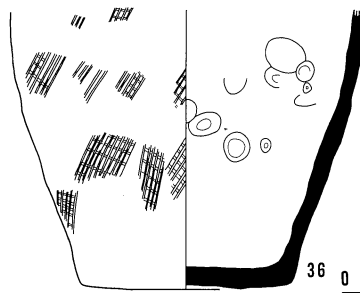
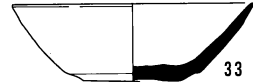

0 (1 : 4) 10cm

SK7199

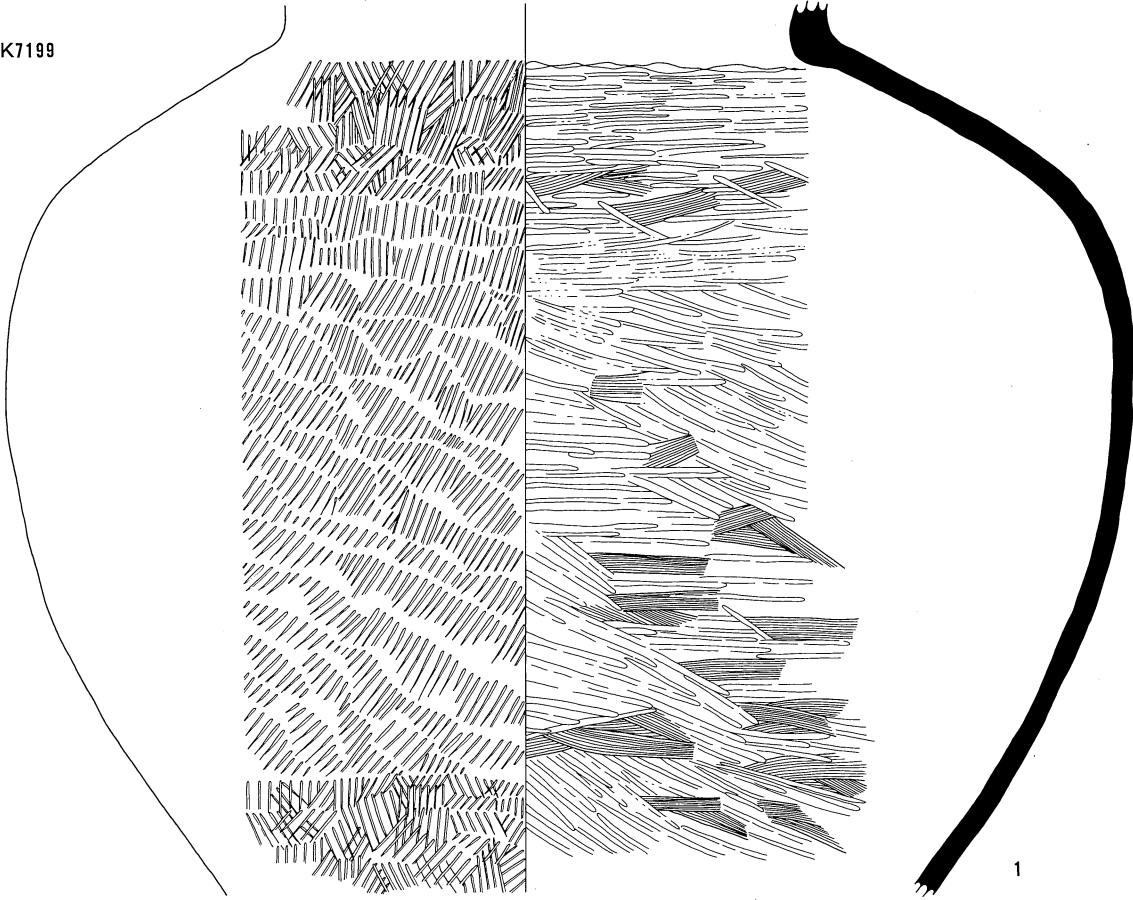

SK7229

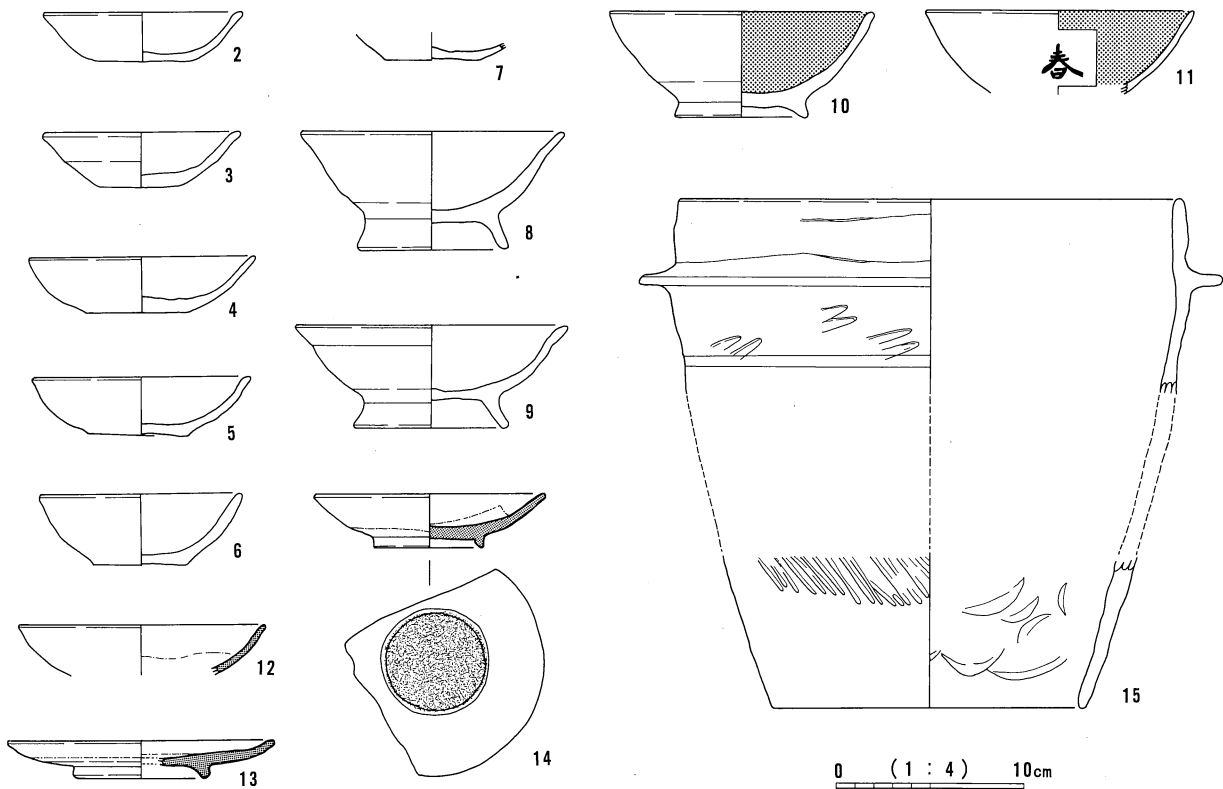

SK7228



SK7275

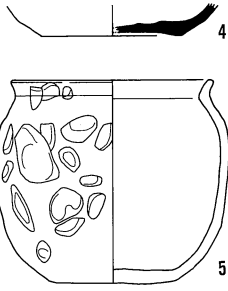

SK7303

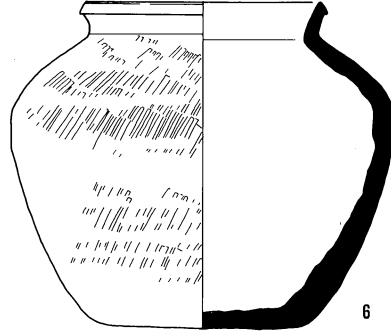

SK7330

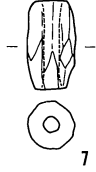

SK7305

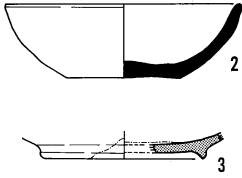

SK7235

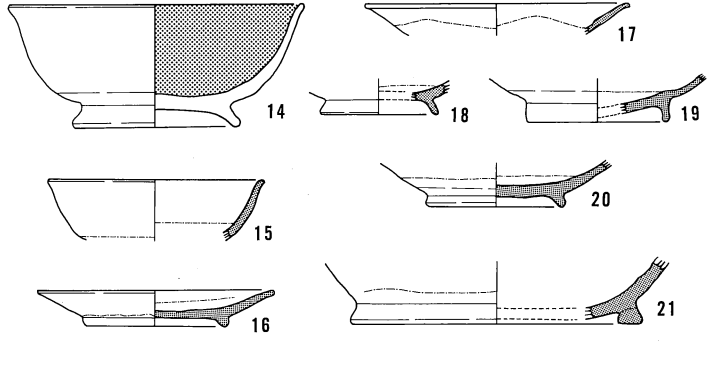
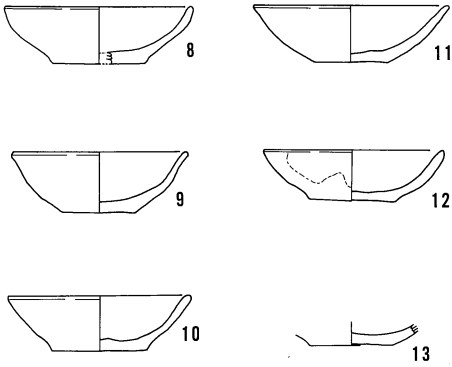

SK7314

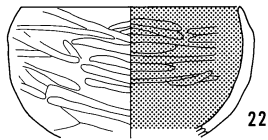

SK7361

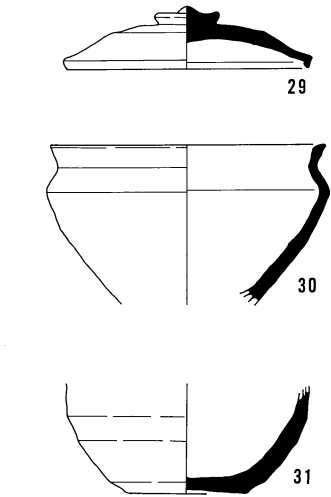
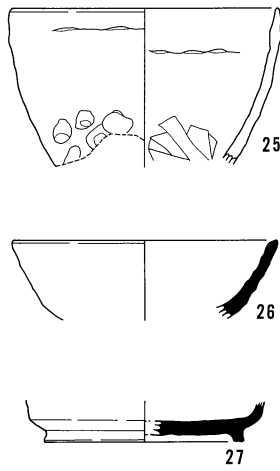
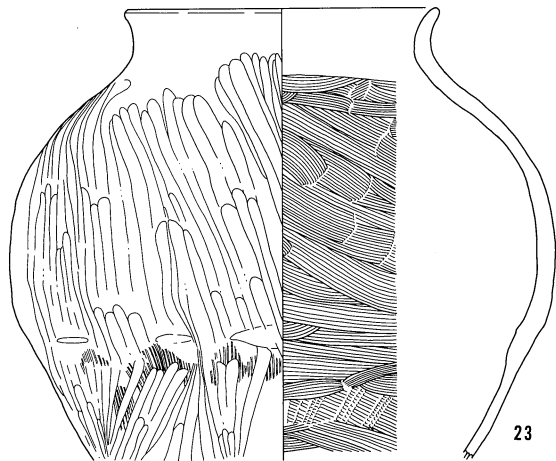
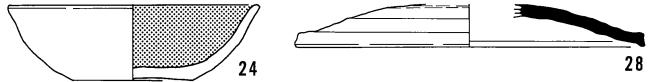

SK7369

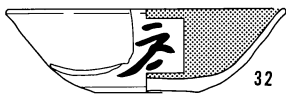

SK7376

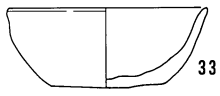

SK7425

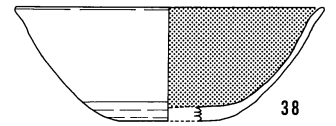
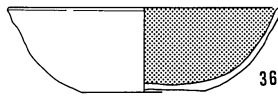

SK7420

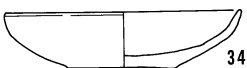

SK7422

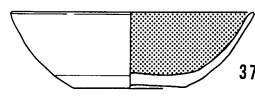

0 (1 : 4) 10cm

SK7414

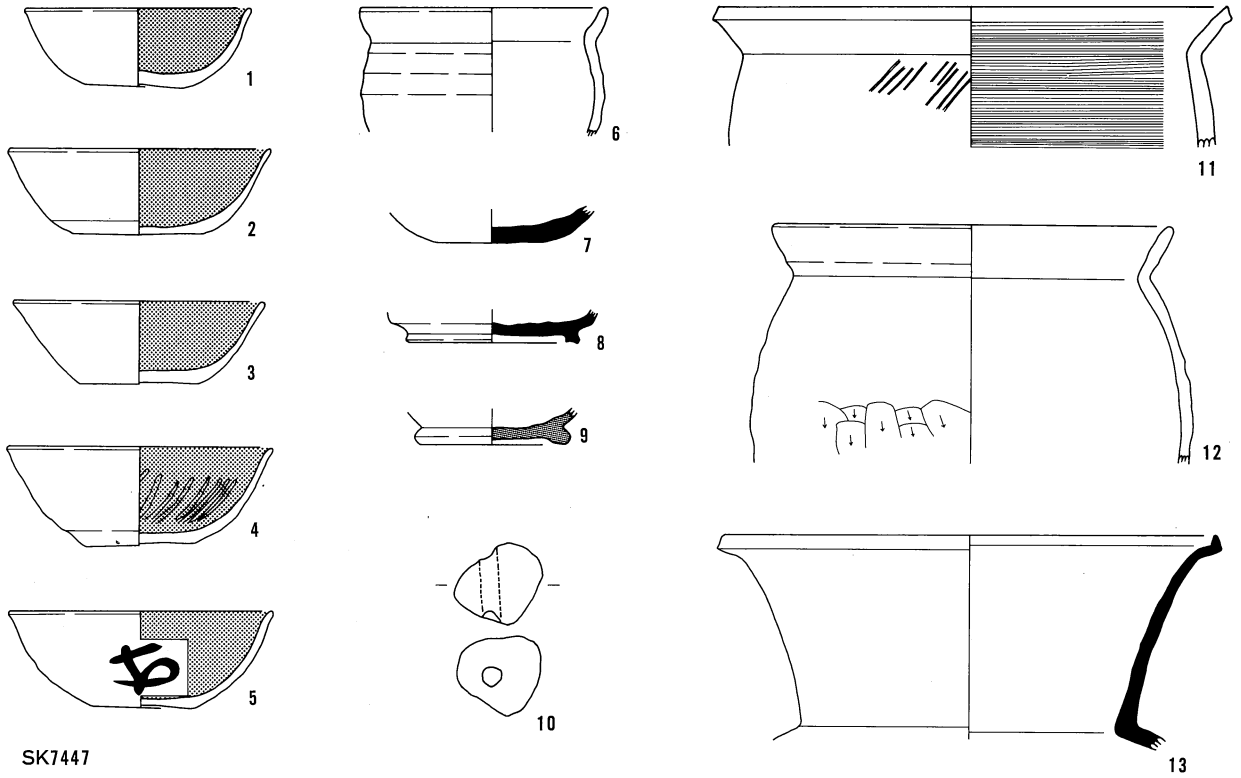

SK7447

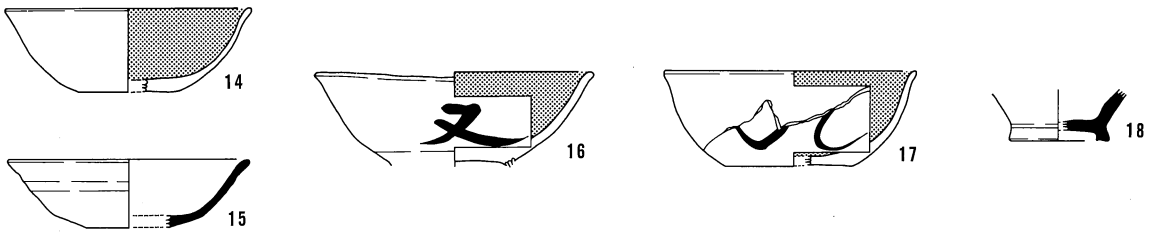

SK7459



SK7461

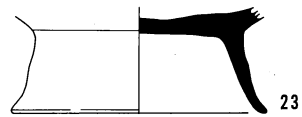
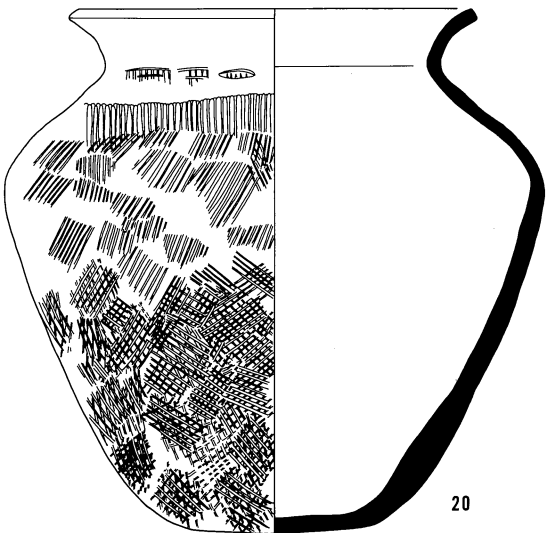
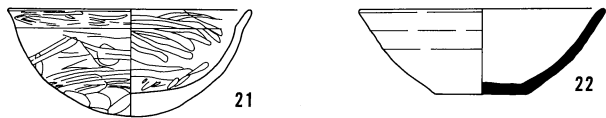

SK7465



SK7683

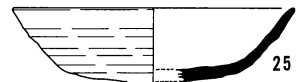

SK7650

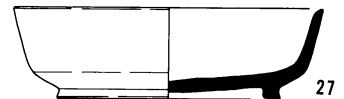
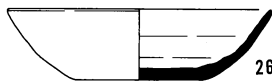

0 (1 : 4) 10cm

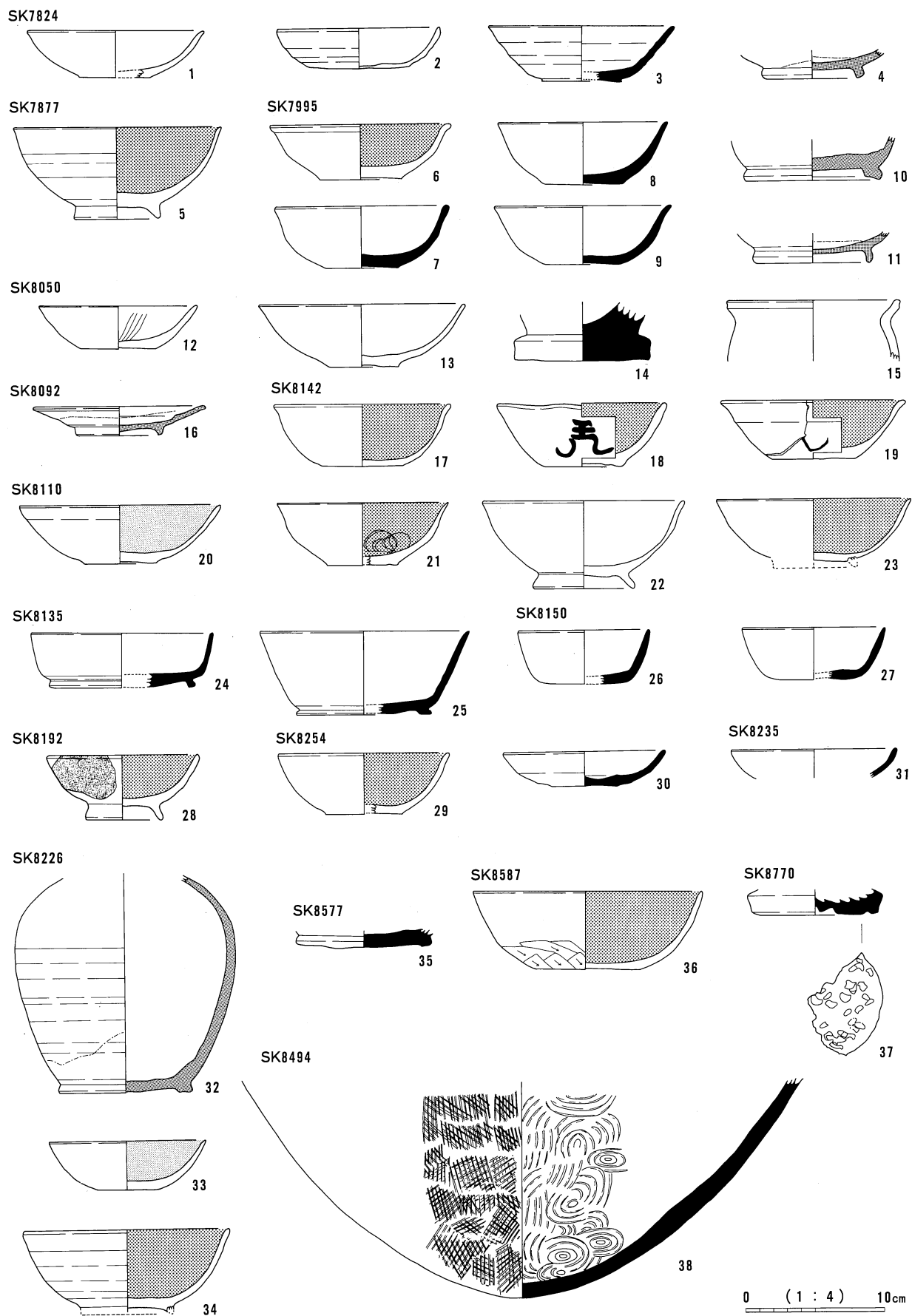

遺構外

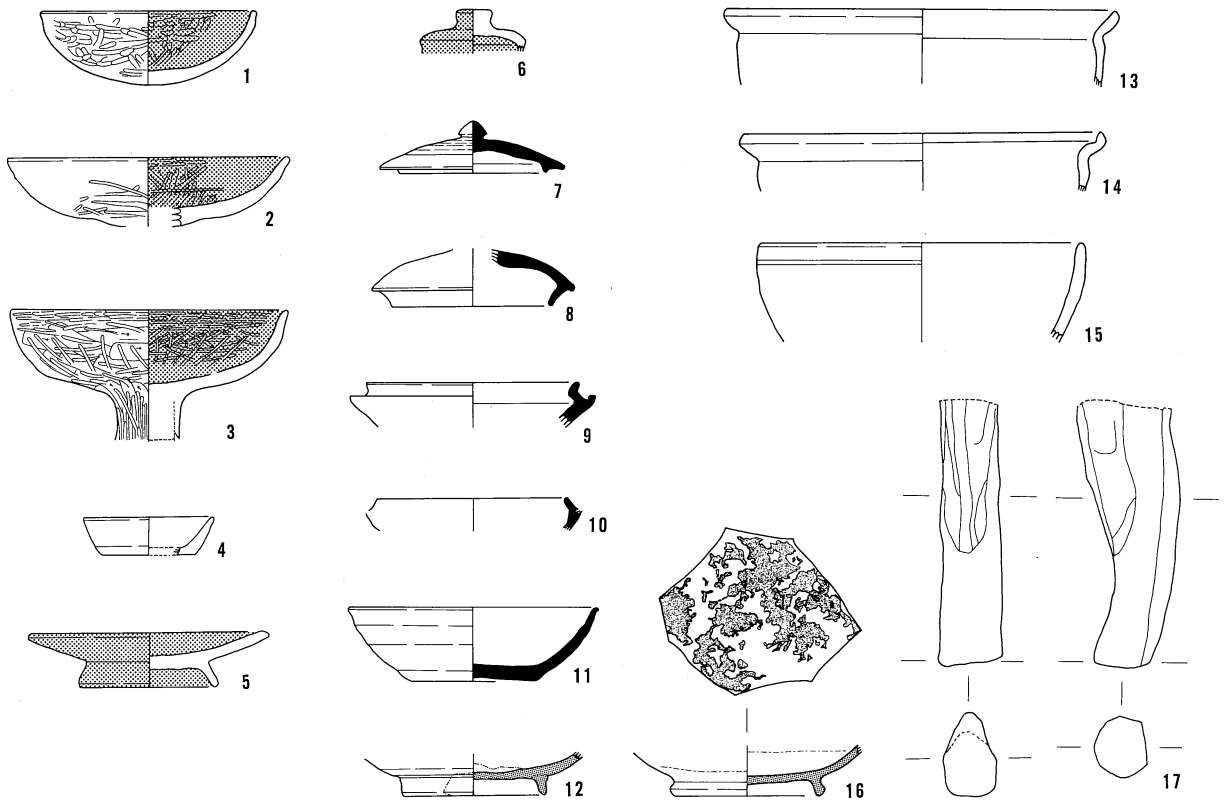

中世以降

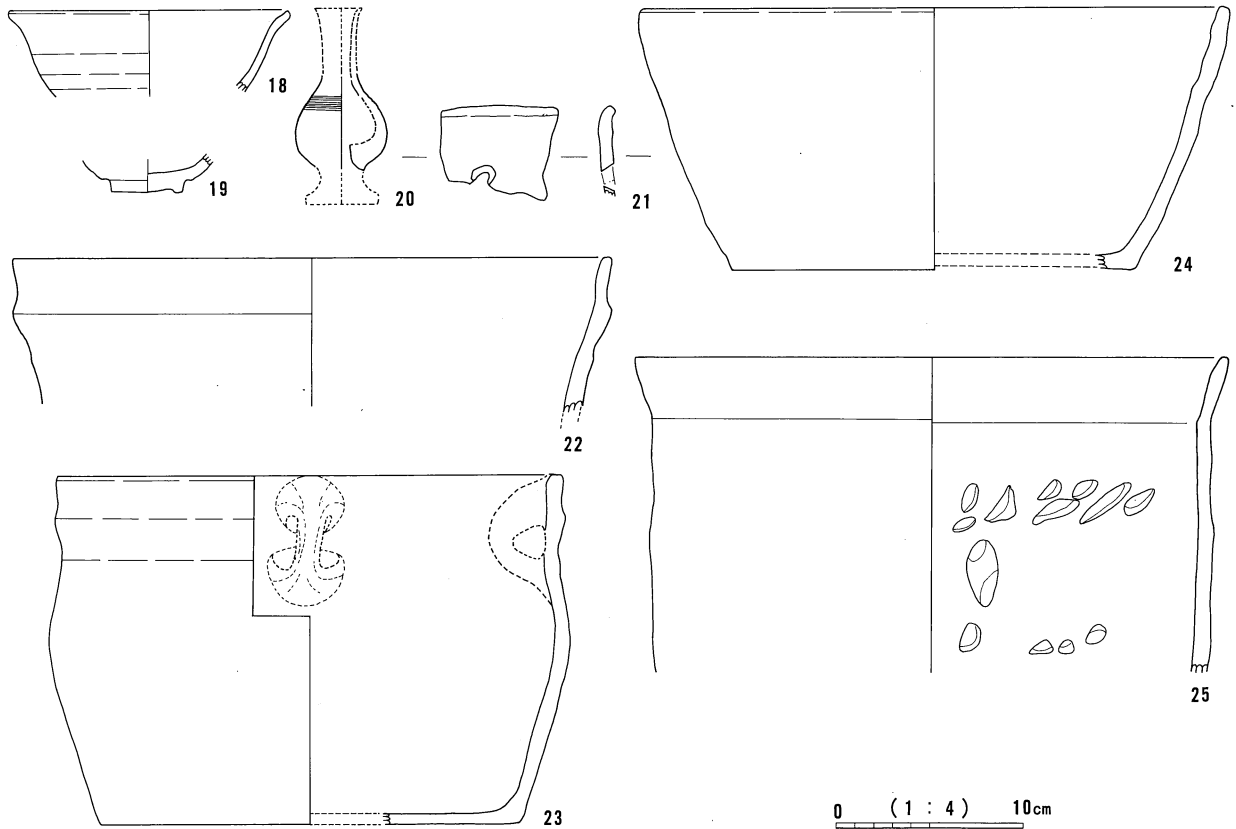

土偶

SB7465

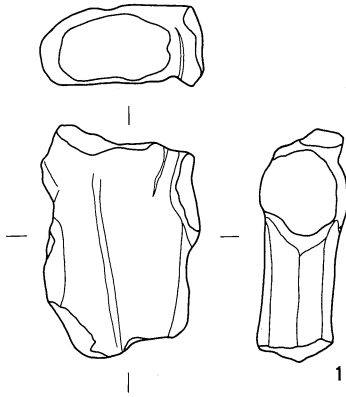

1

SD7067

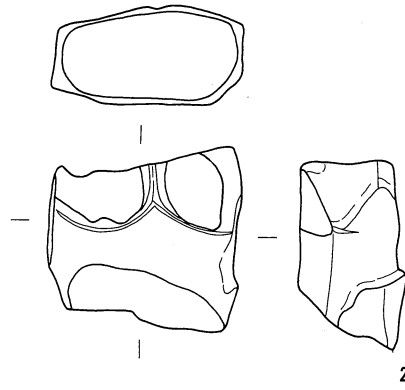

2

人面付土器

SD7110

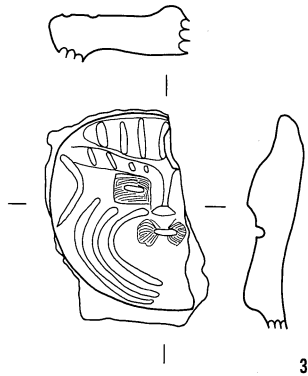

3

2-3区検出面

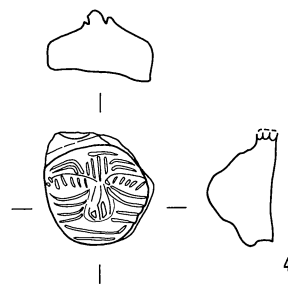

4

容器形土製品

SB7101

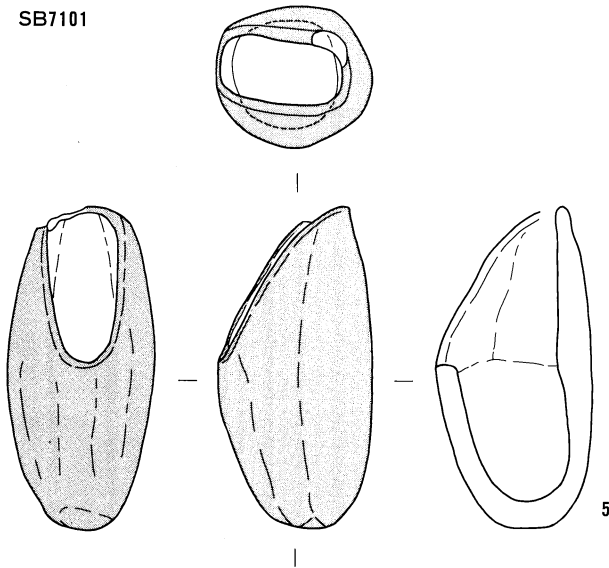

5

SD7001

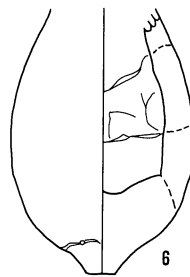

6

SD7030

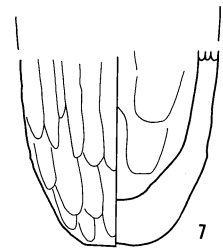

7

SK8222

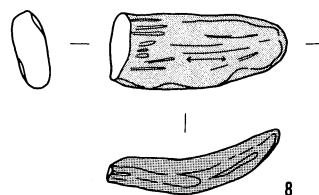

8

0 (1:2) 5cm

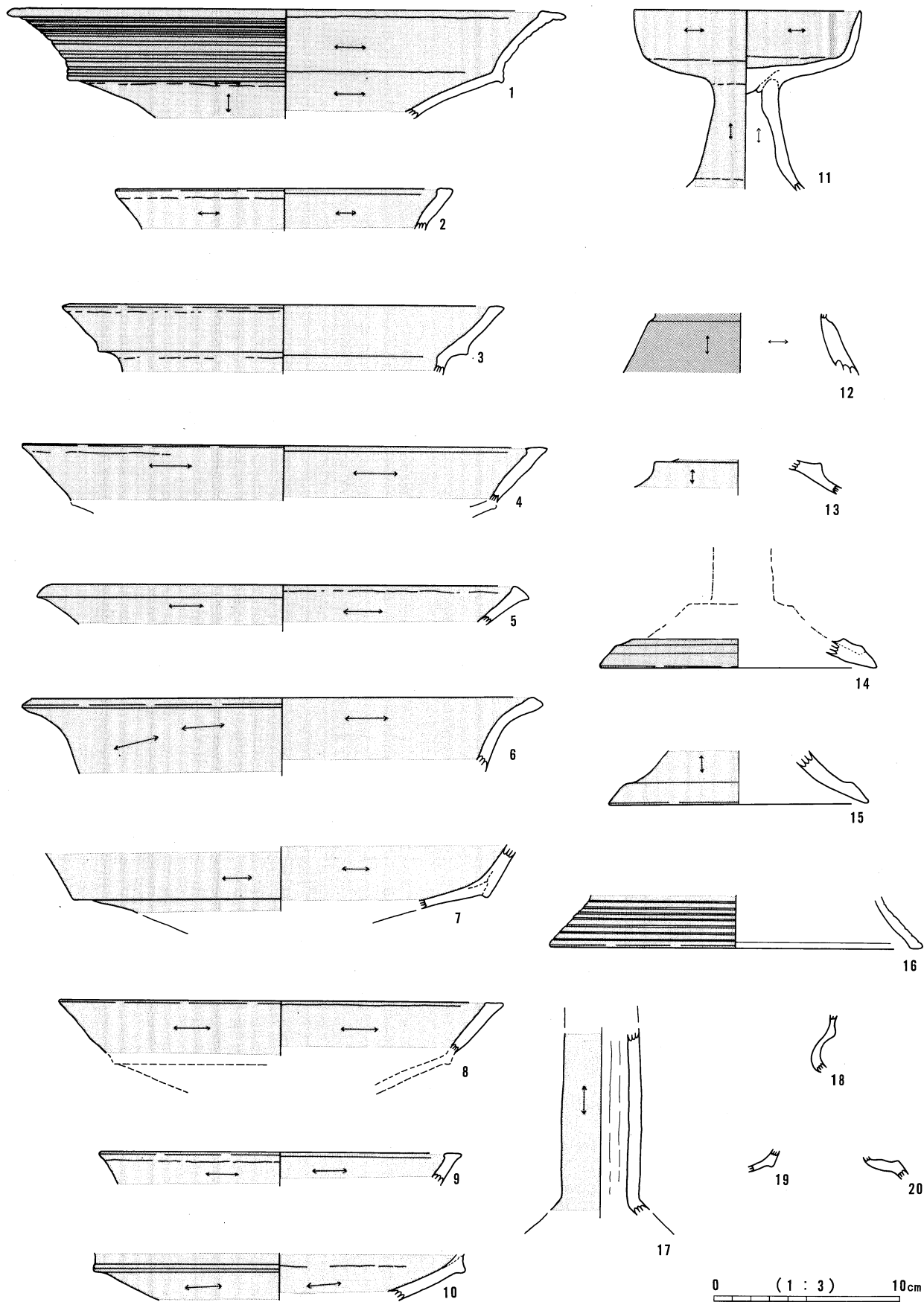

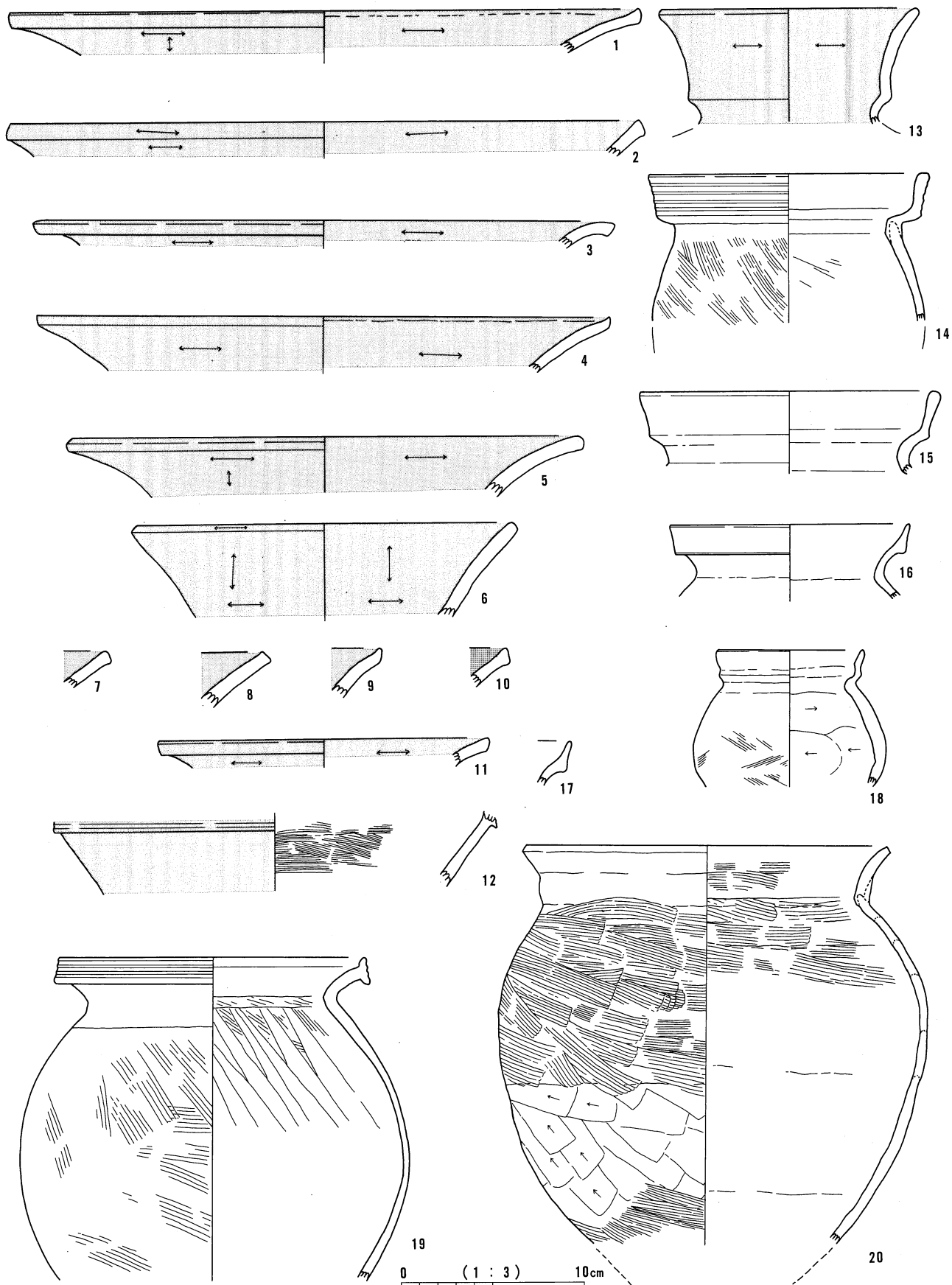

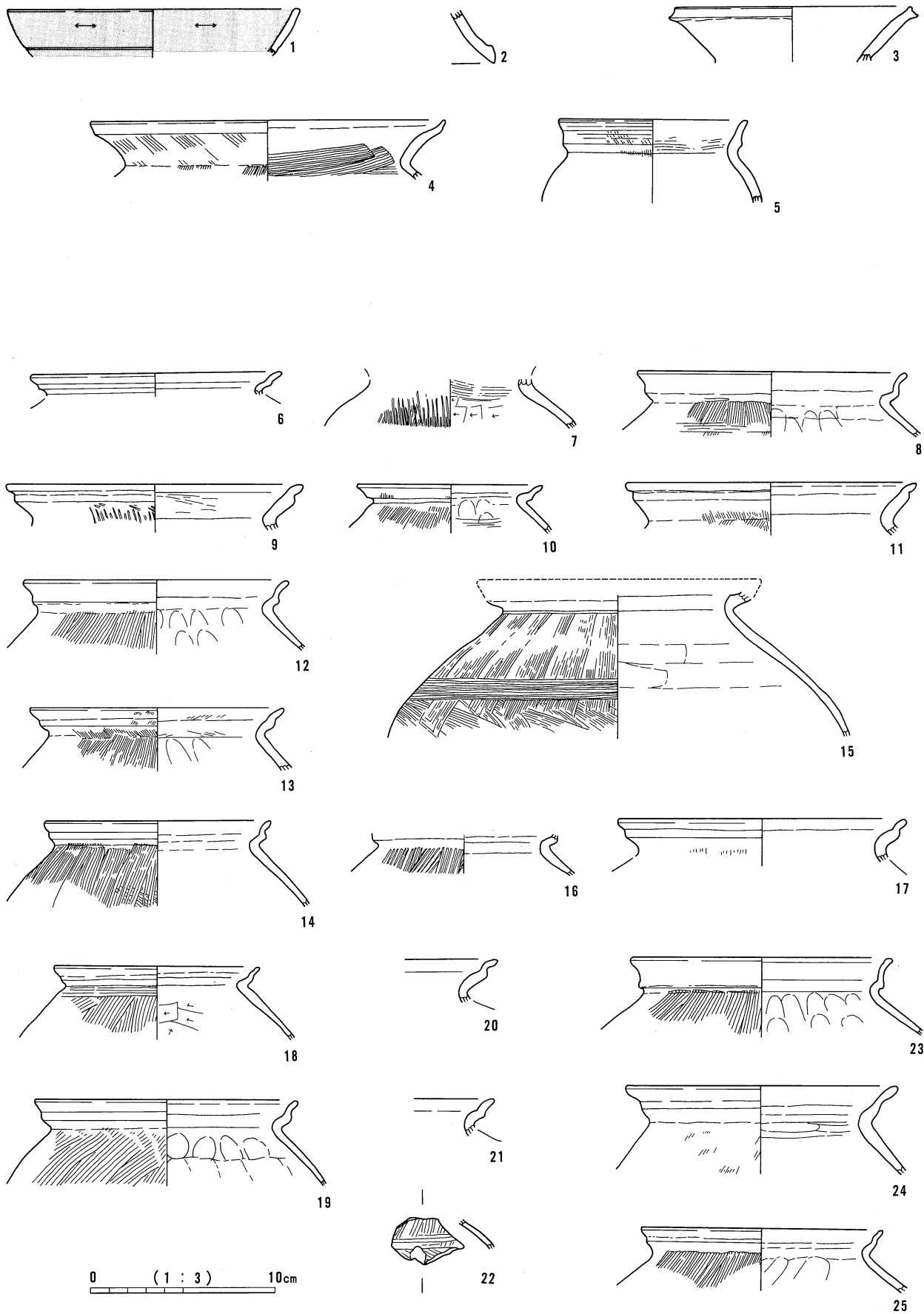

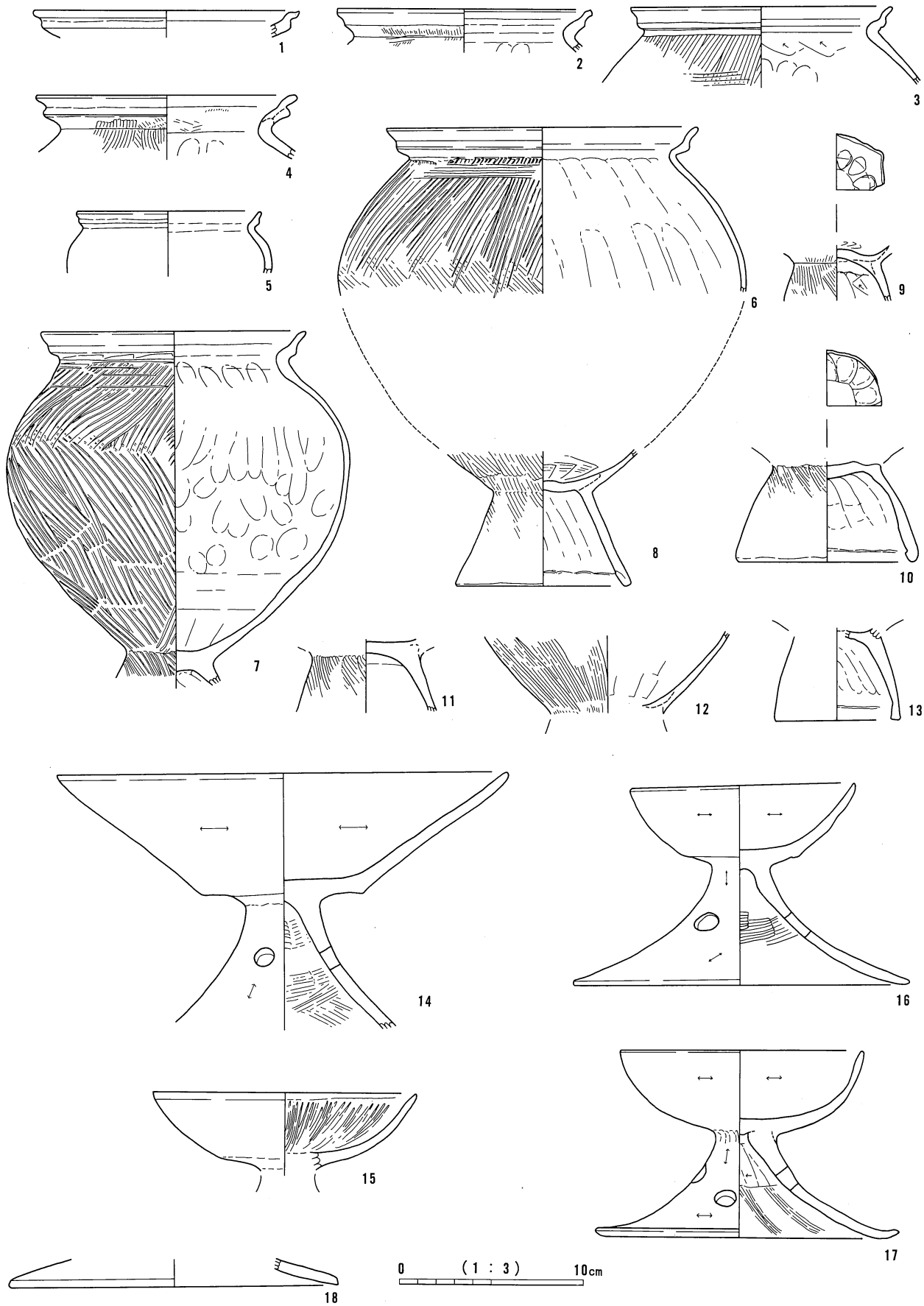

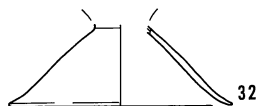
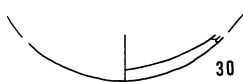
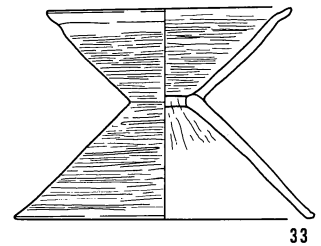
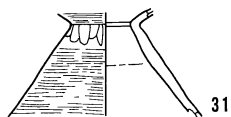
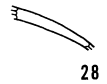
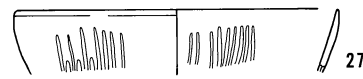
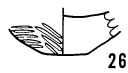
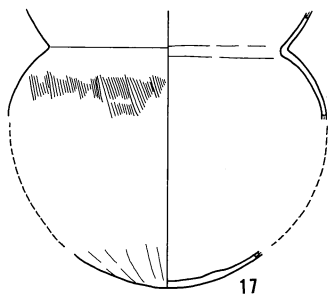
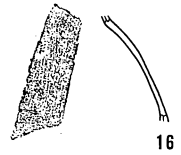
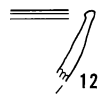
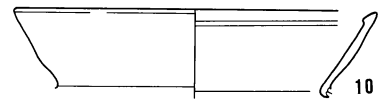
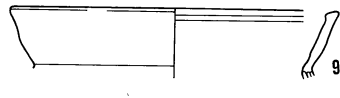
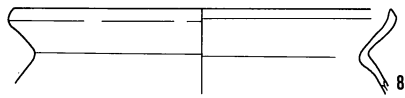
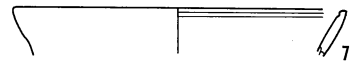
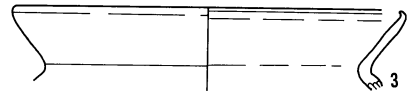
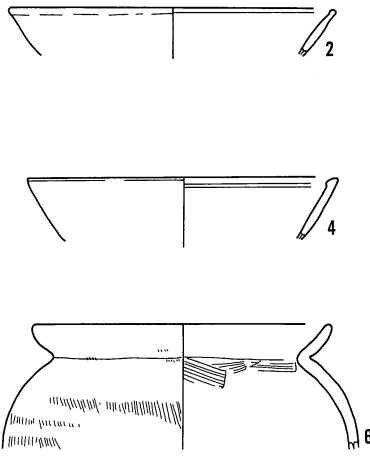
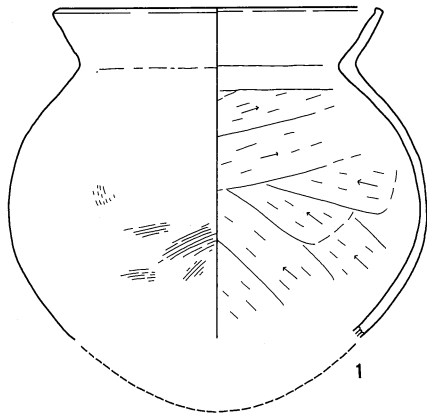

0 (1 : 3) 10cm

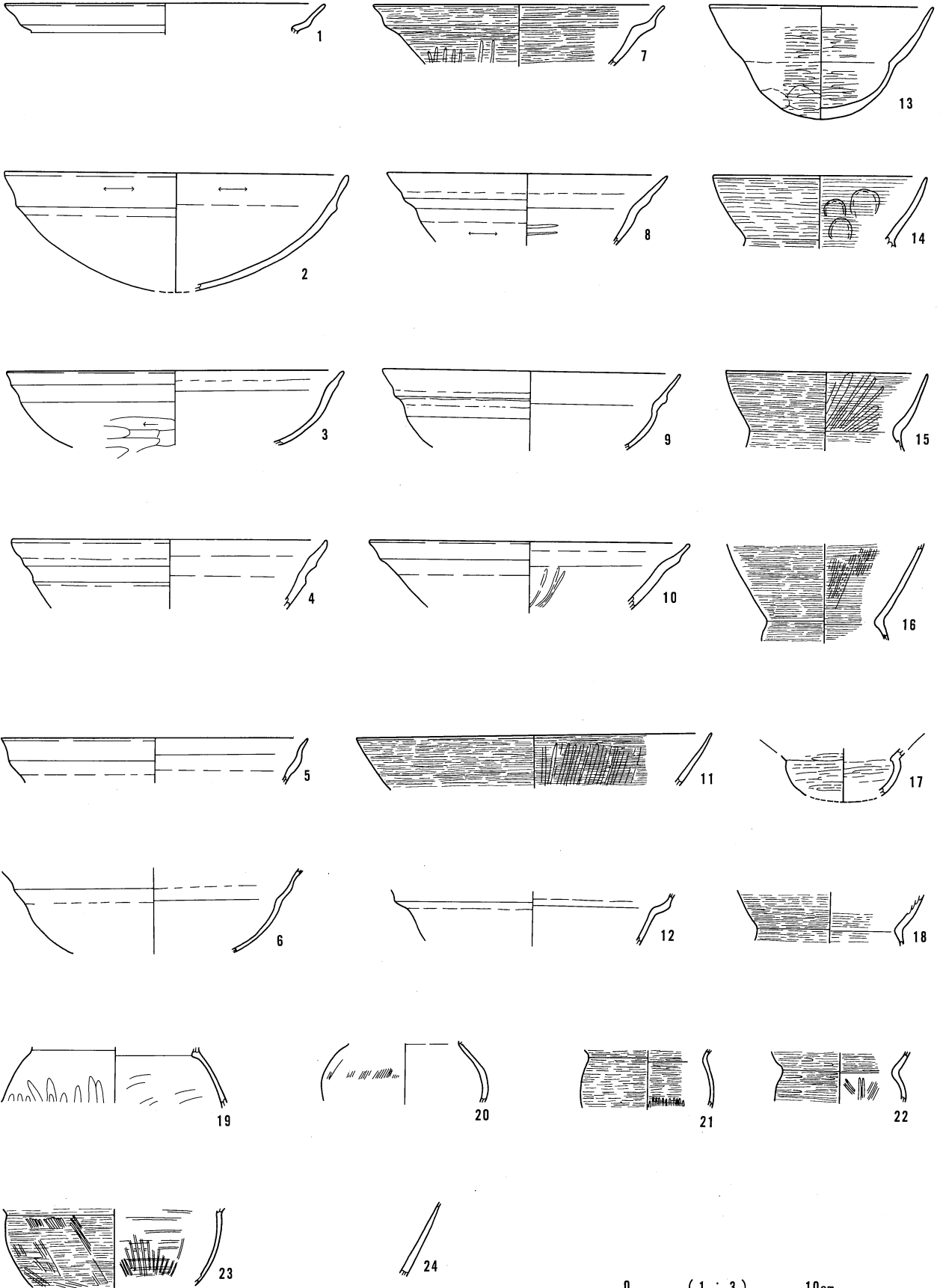

0 (1 : 3) 10cm

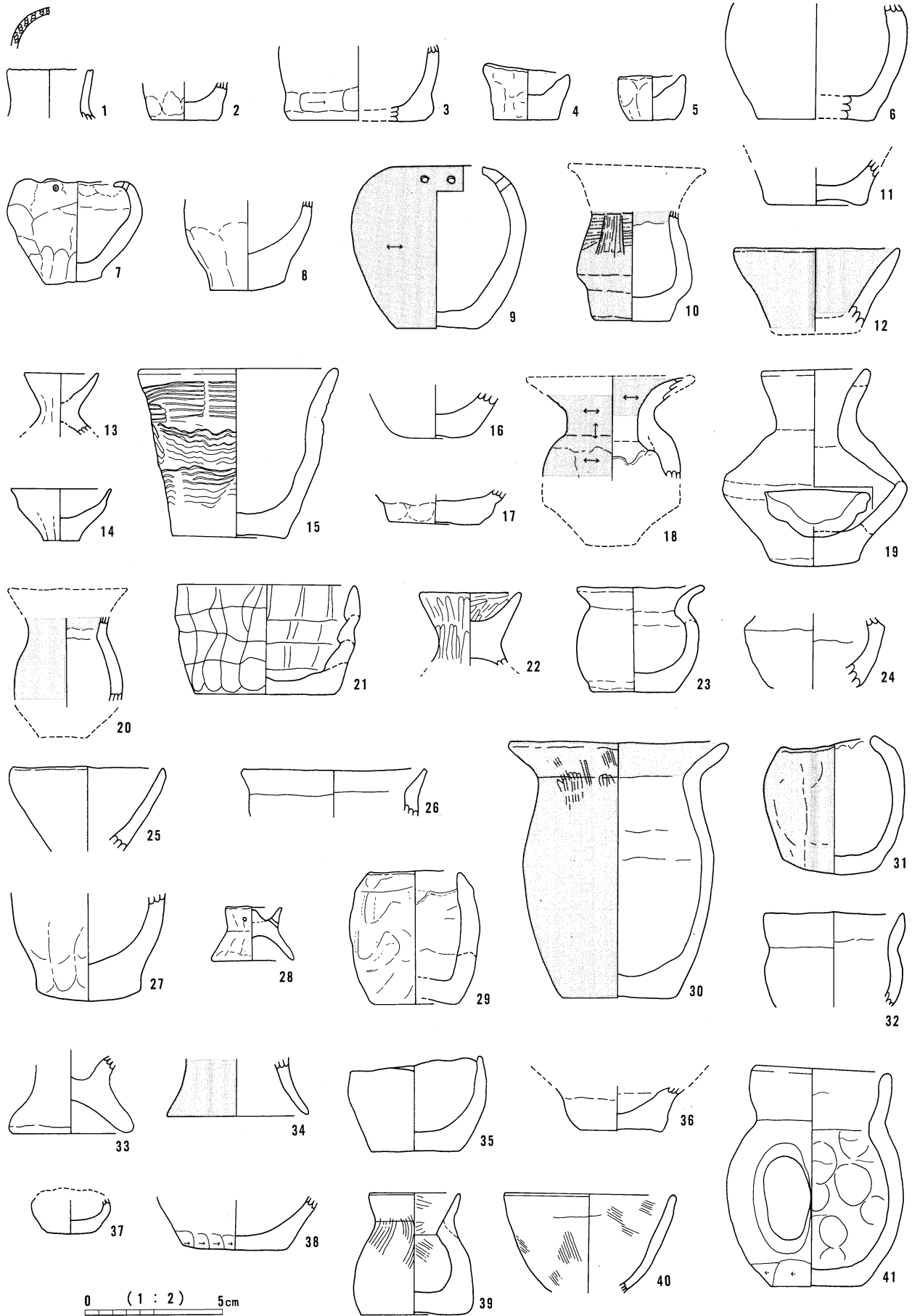

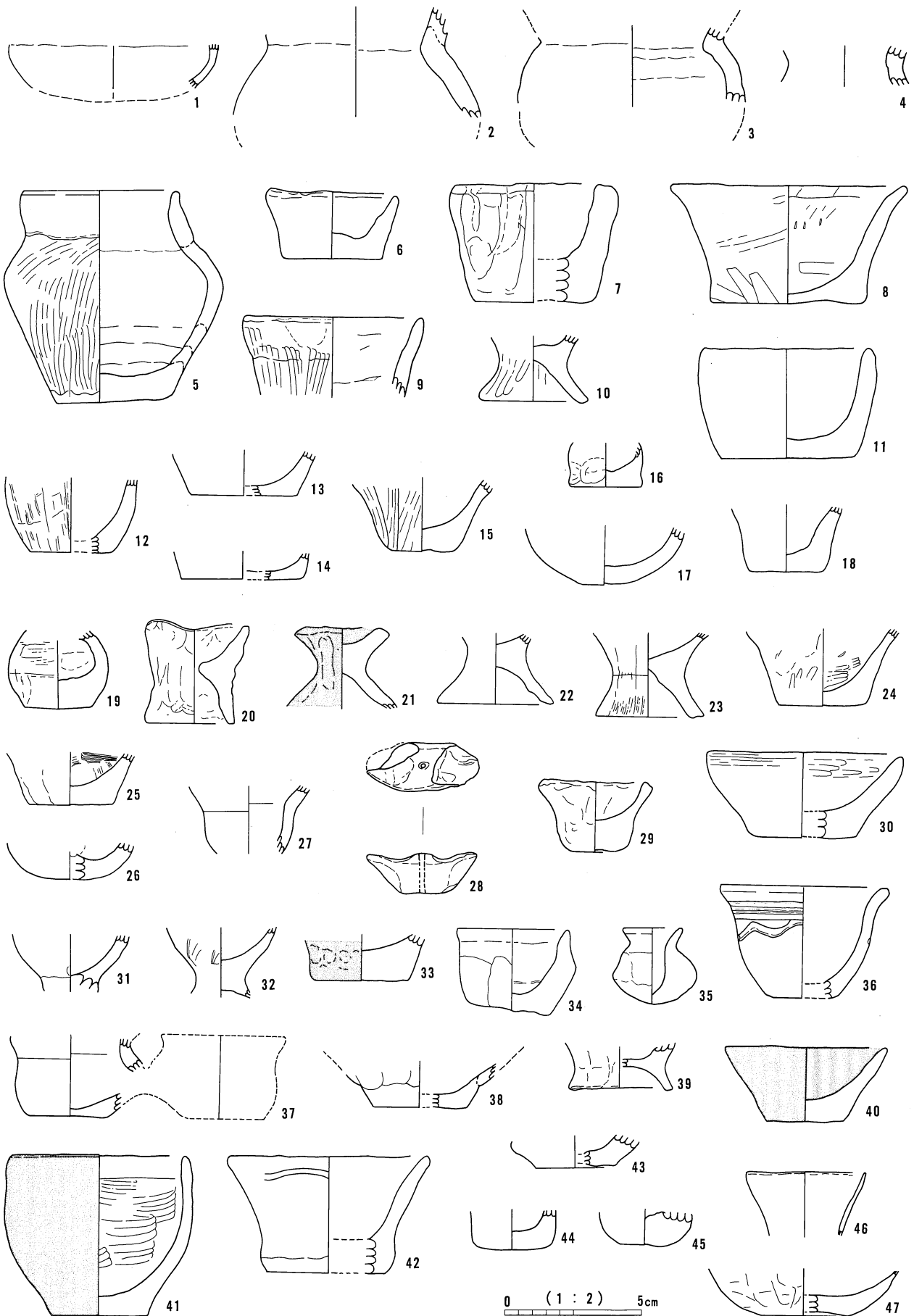

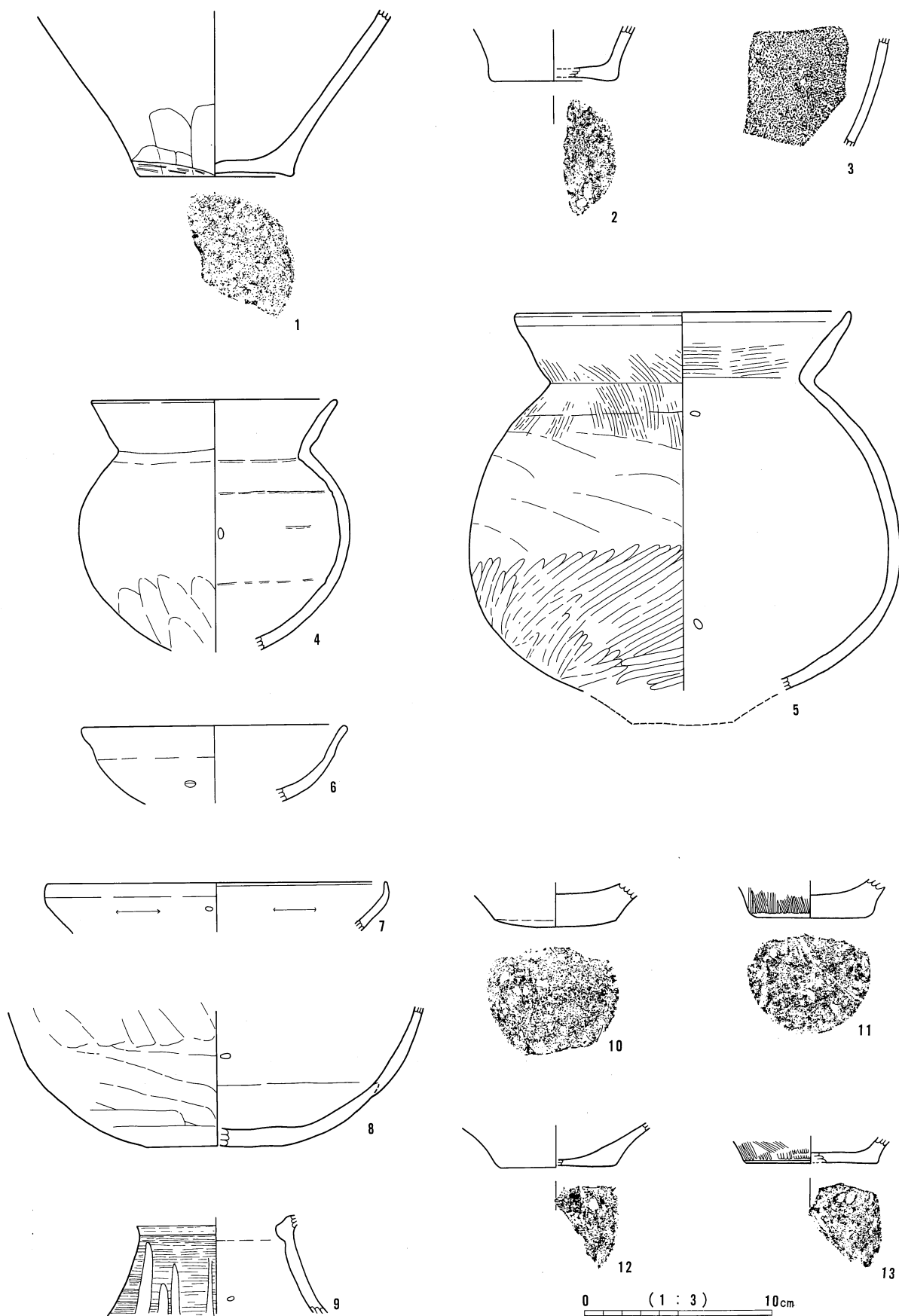

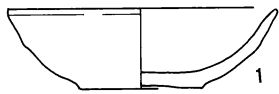
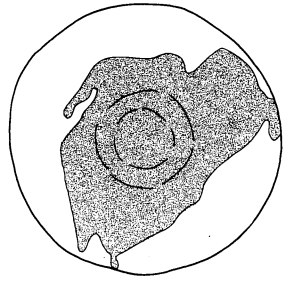

1

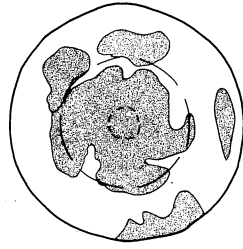

2

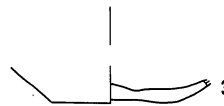
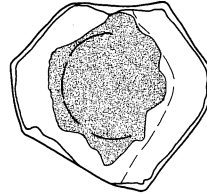

3

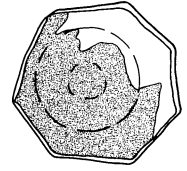

4

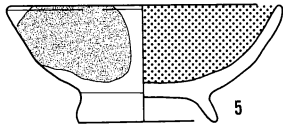
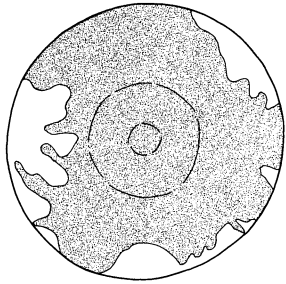

5

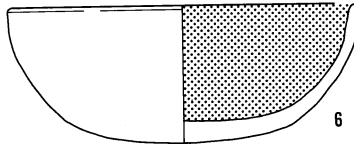
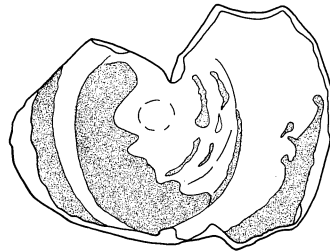

6

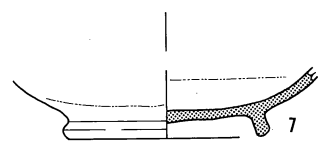
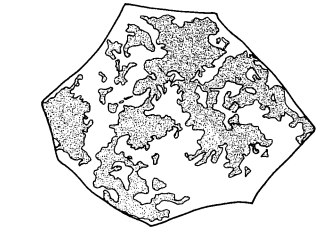

7

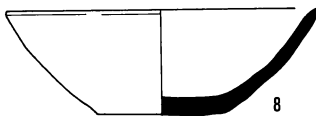
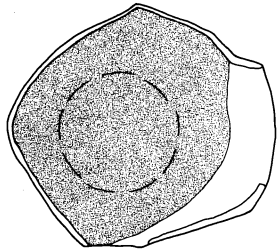

8

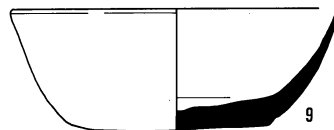
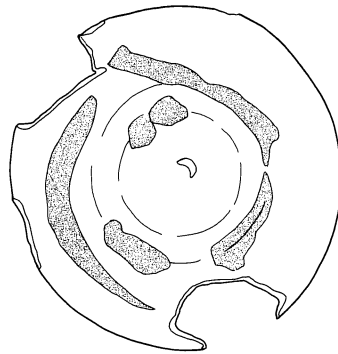

9

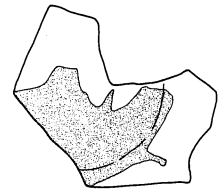

10

0 (1 : 3) 10cm

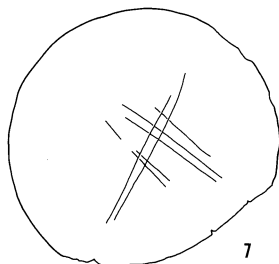
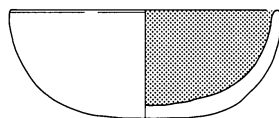
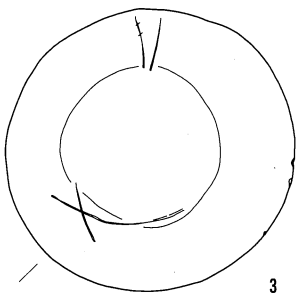
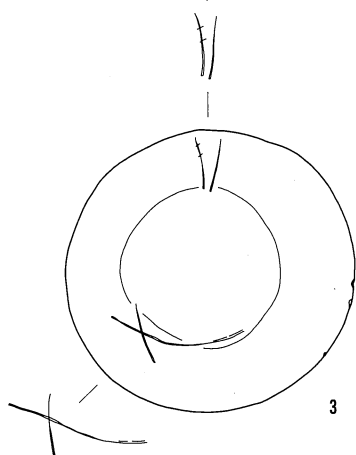
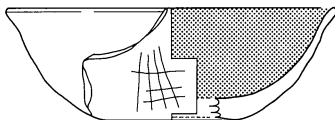
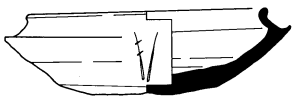
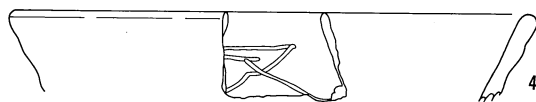
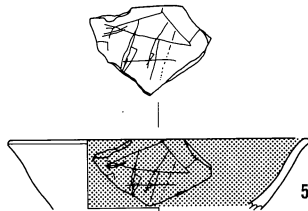
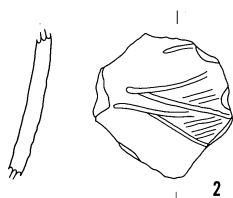
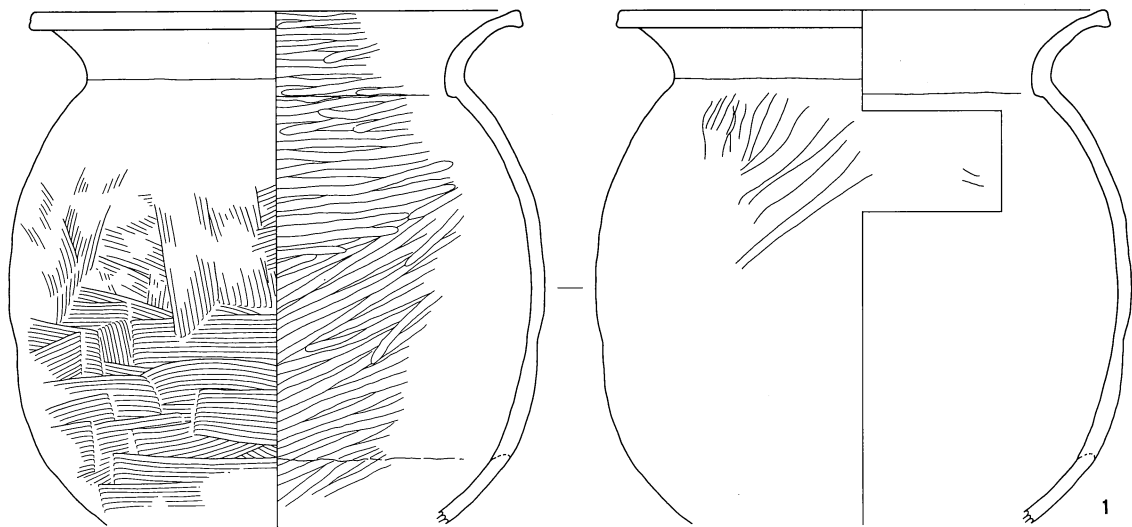

0 (1:3) 10cm

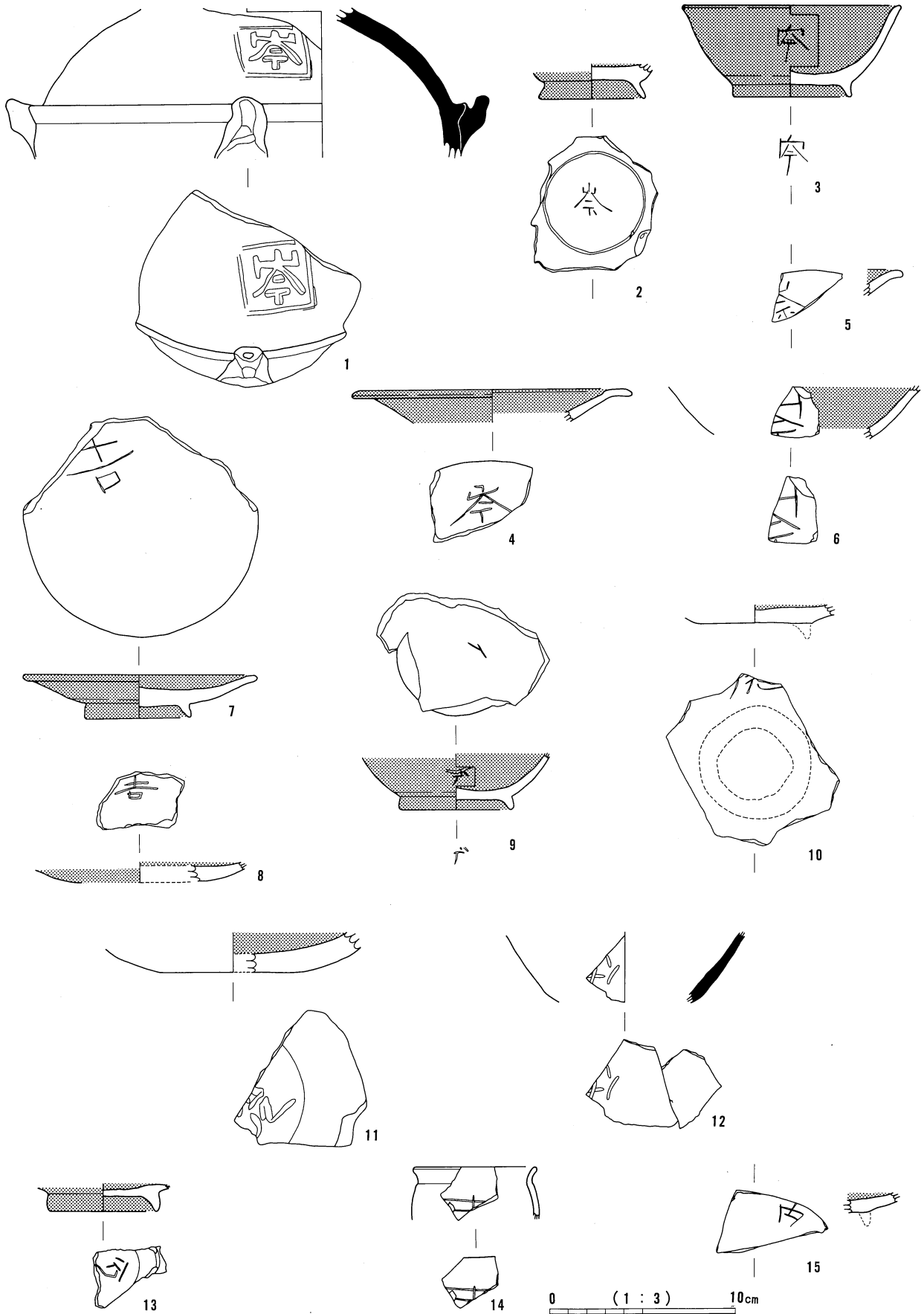

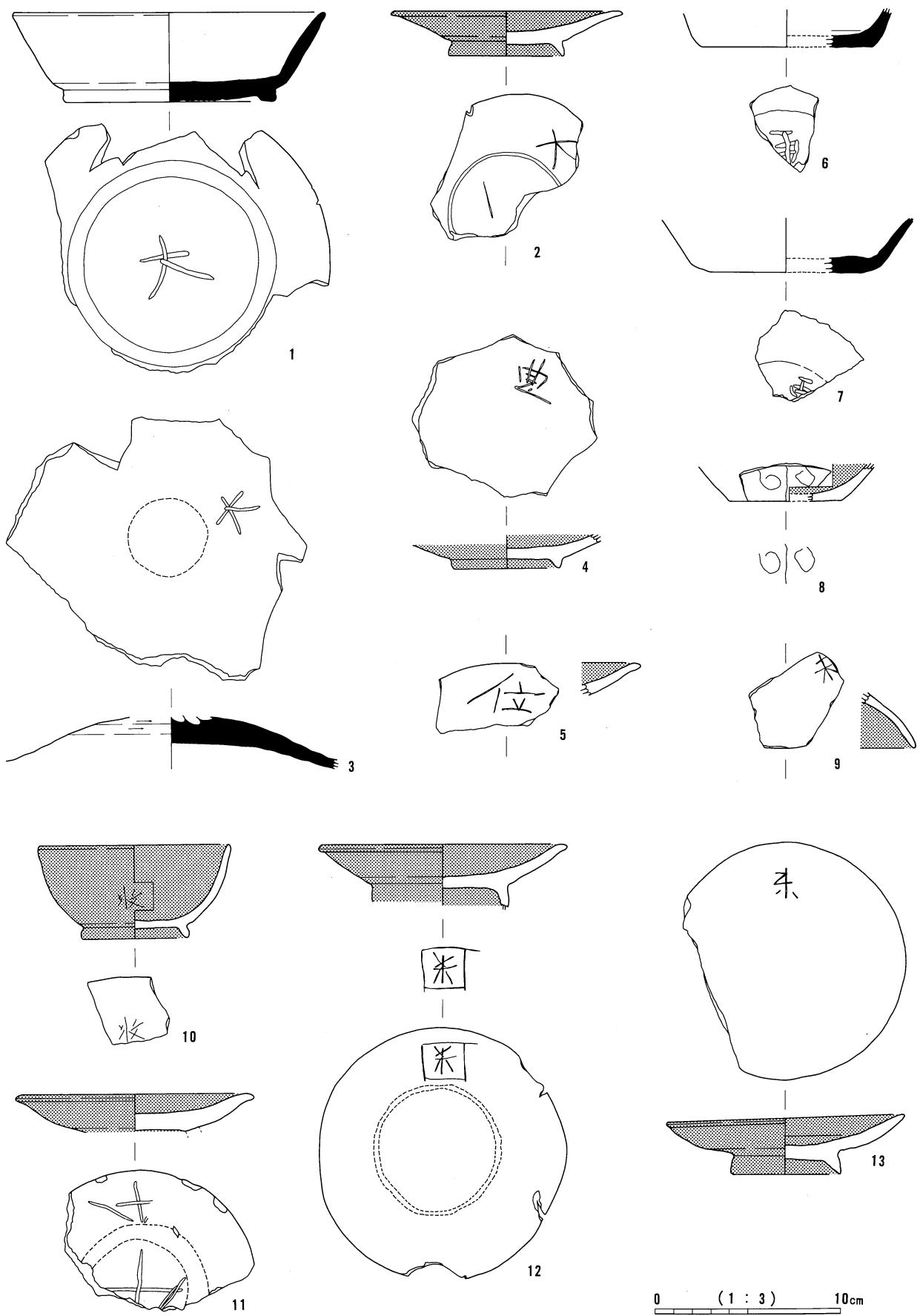

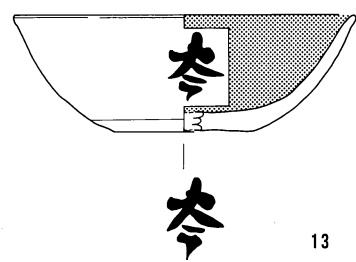
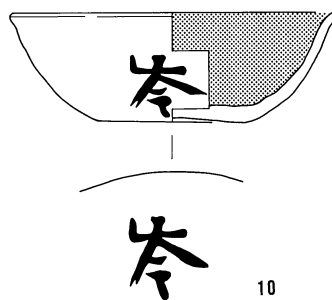
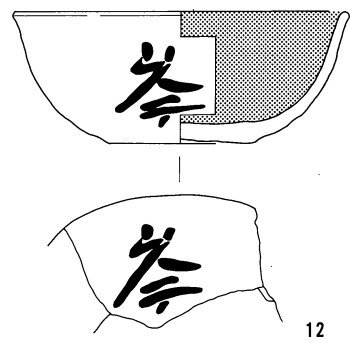
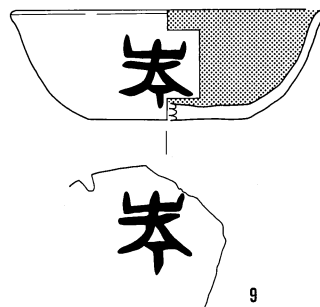
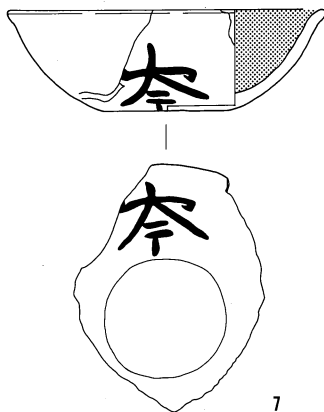
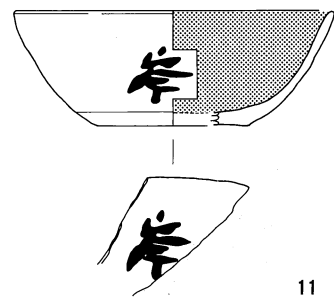
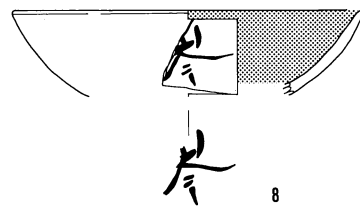
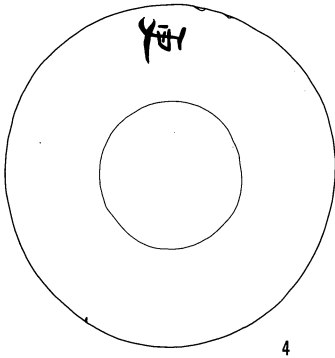
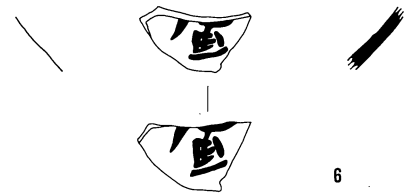
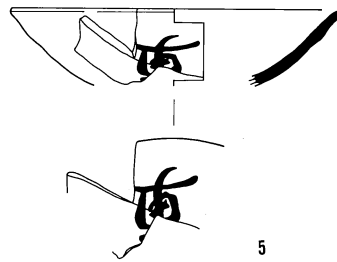
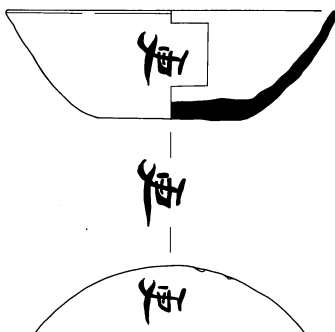
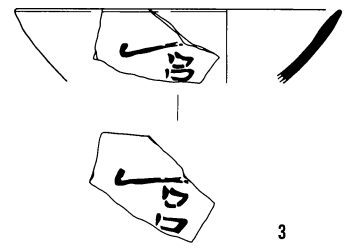
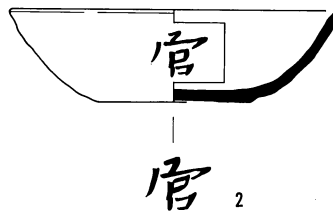
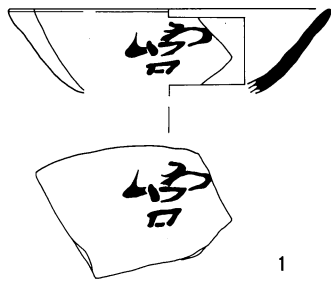

0 (1:3) 10cm

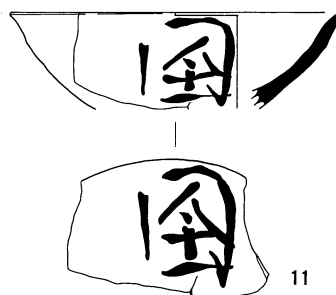
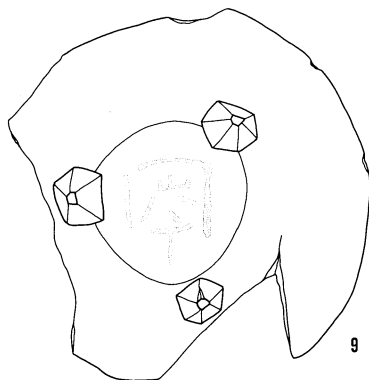
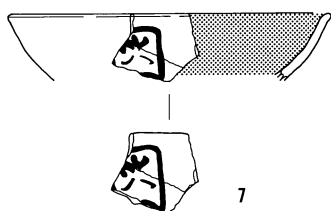
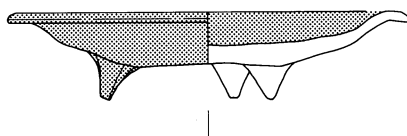
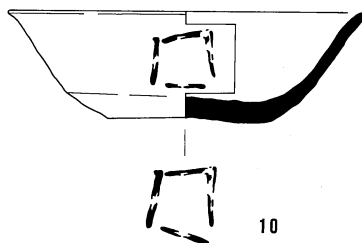
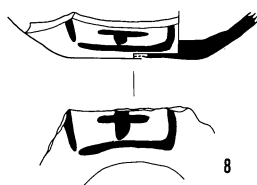
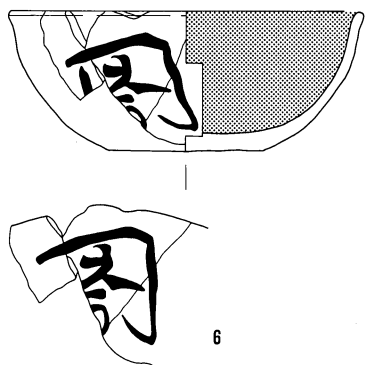
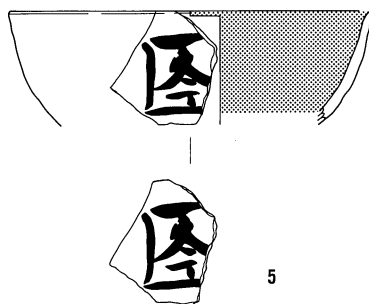
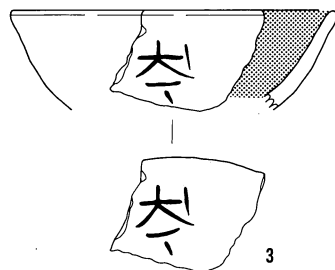
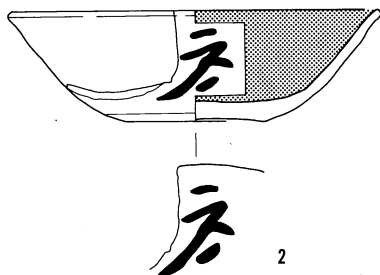
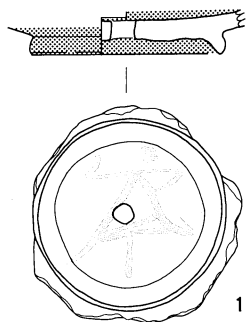

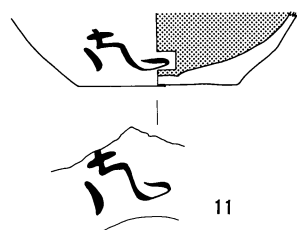
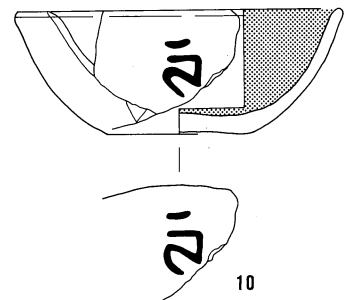
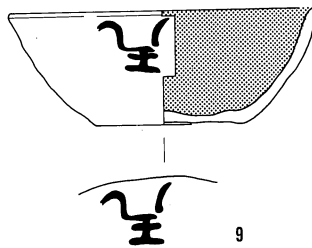
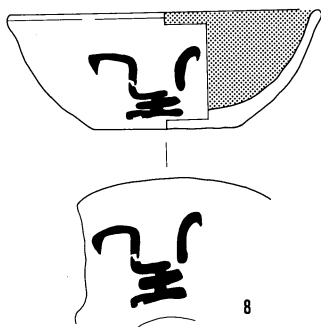
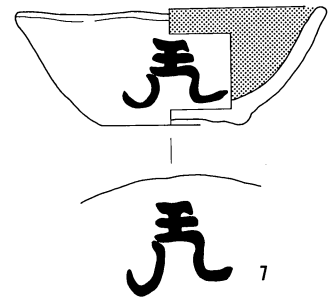
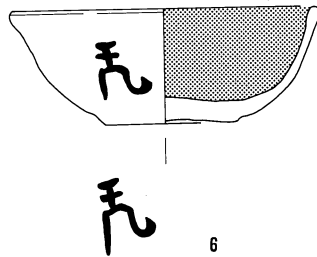
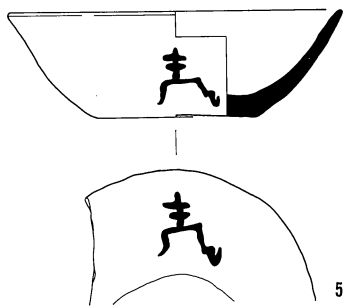
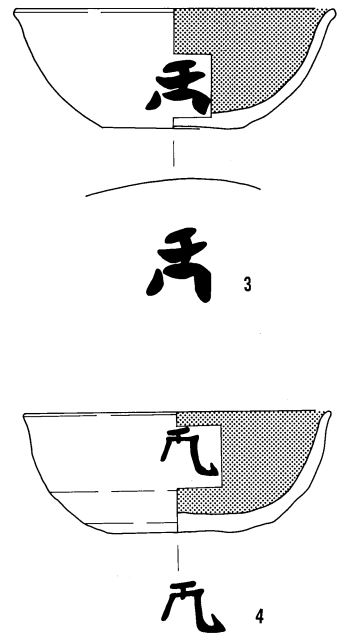
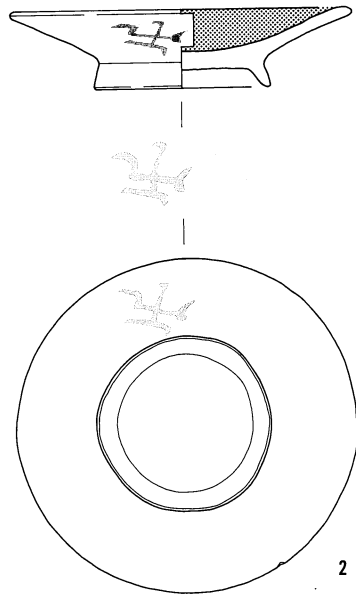
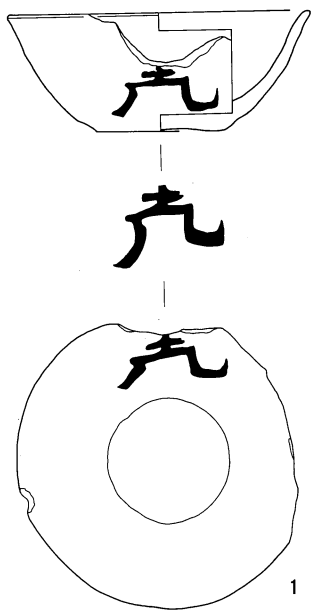

0 (1 : 3) 10cm

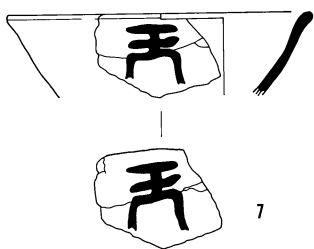
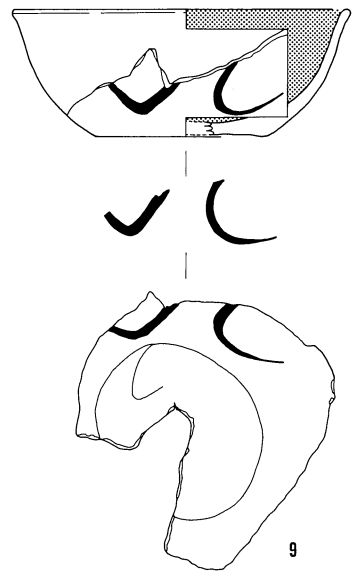
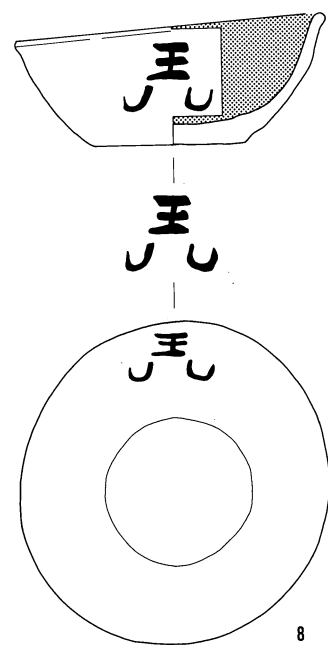
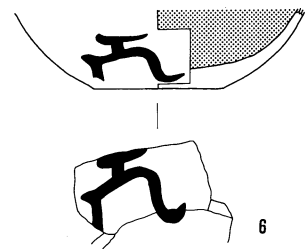
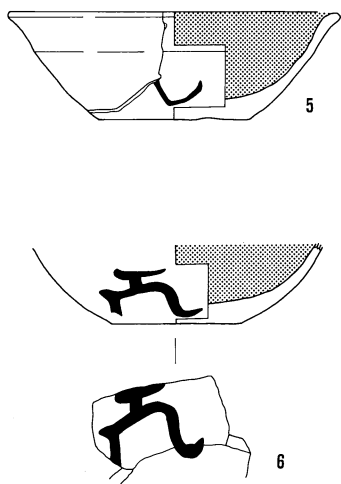
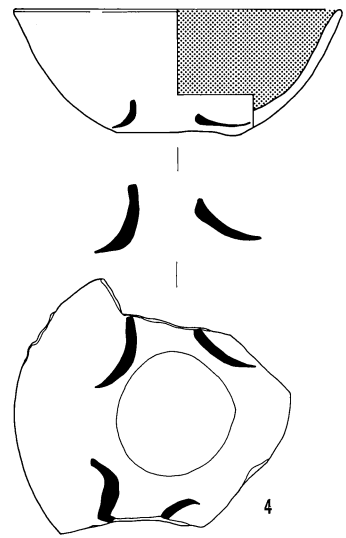
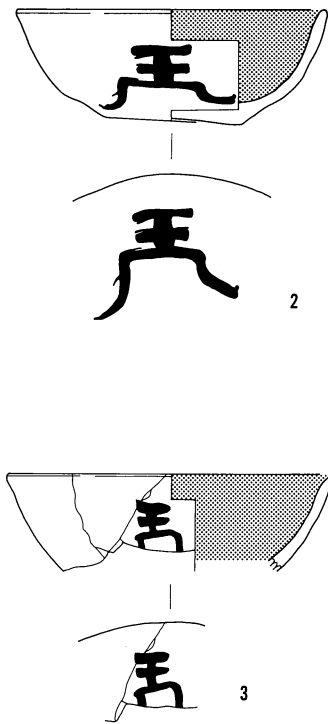
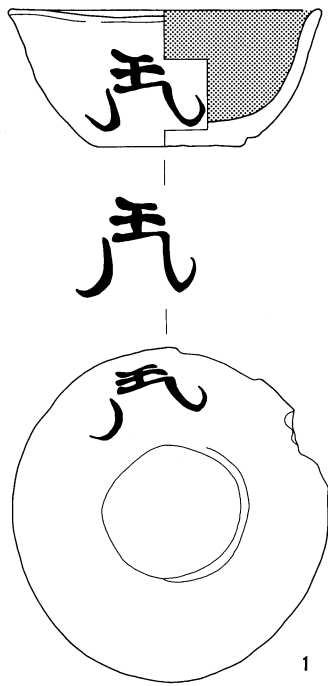

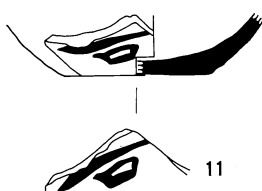
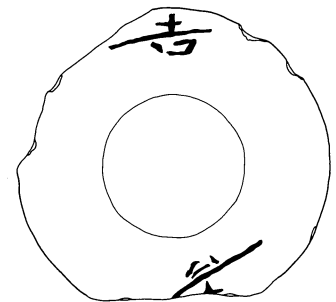
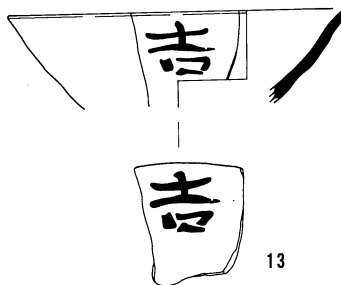
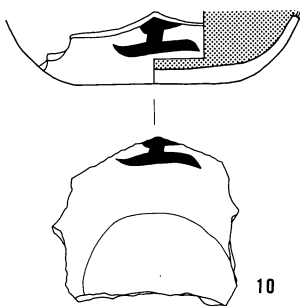
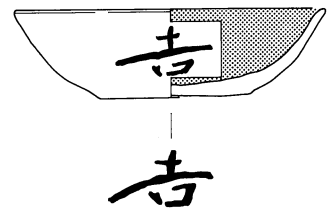
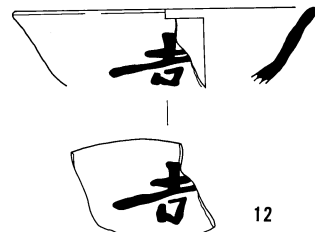
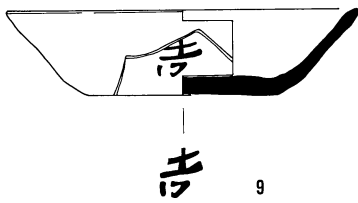
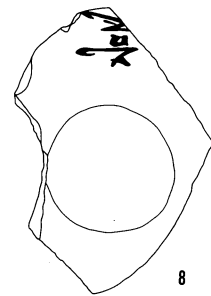
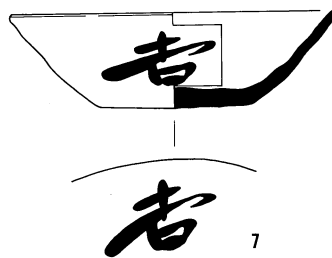
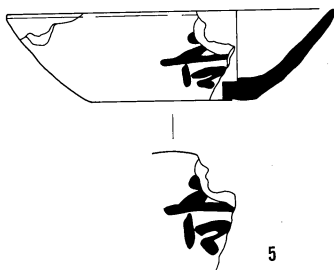
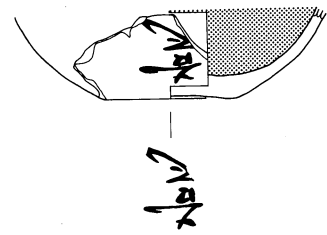
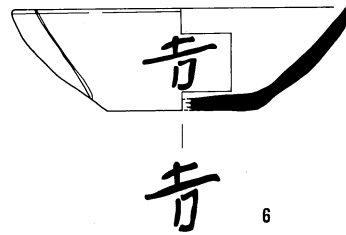
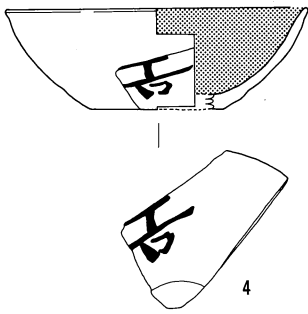
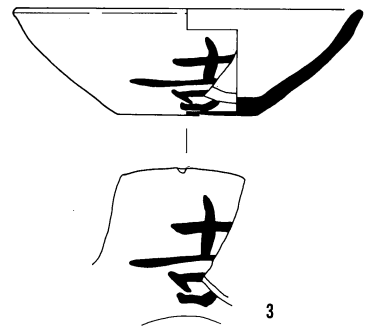
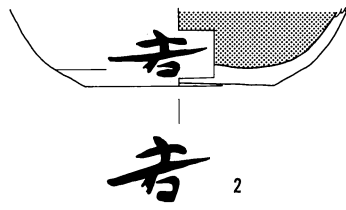
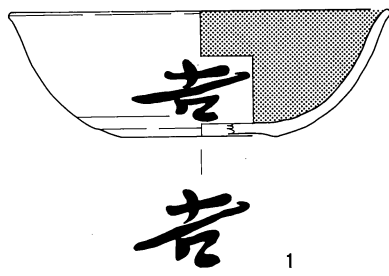

0 (1 : 3) 10cm



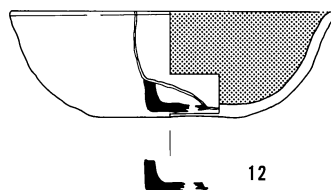
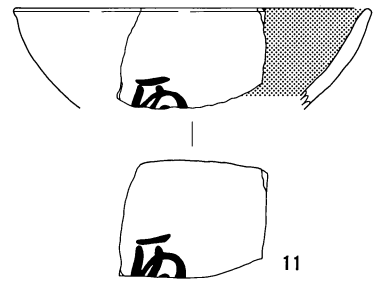
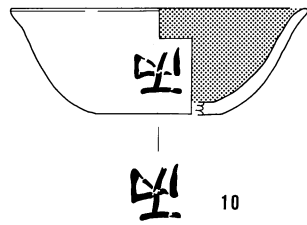
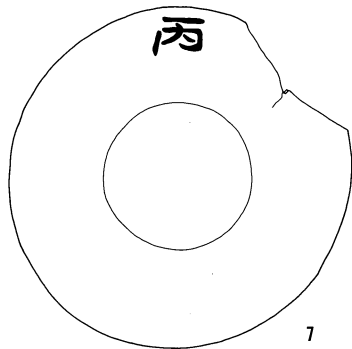
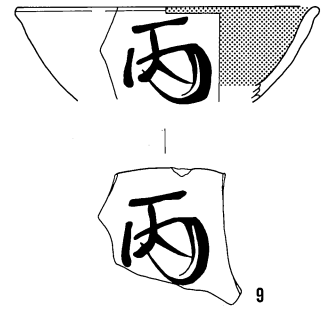
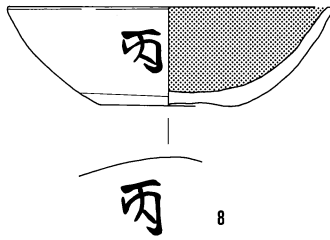
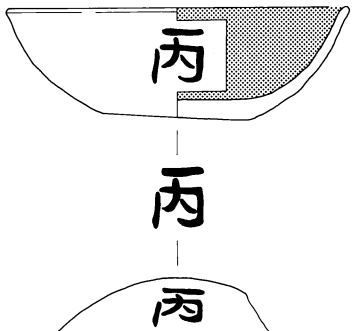
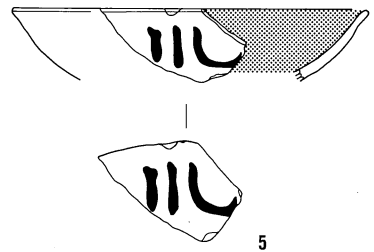
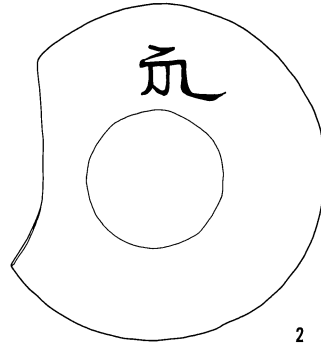
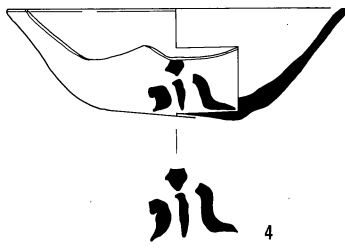
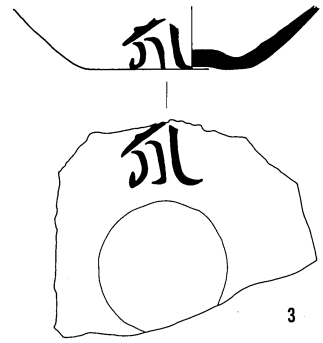
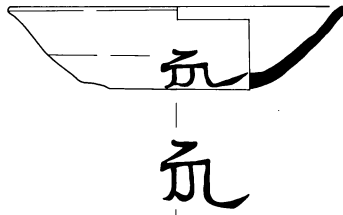
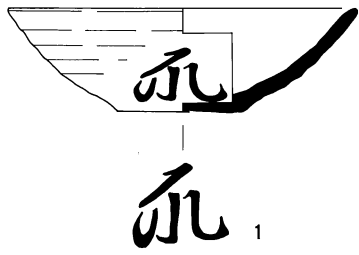

0 (1:3) 10cm

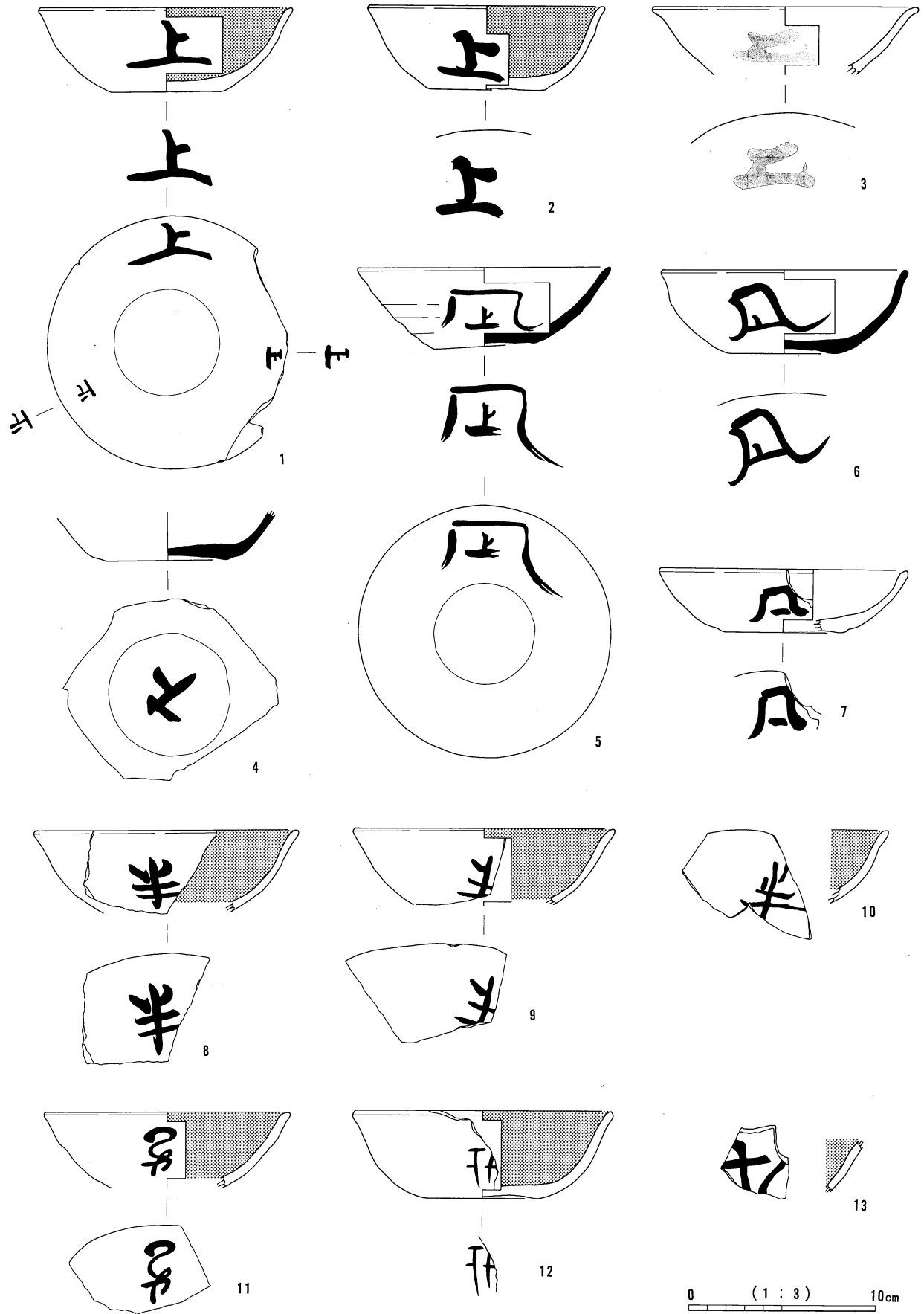

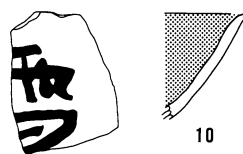
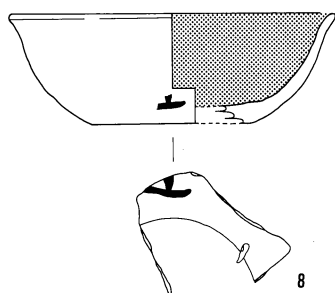
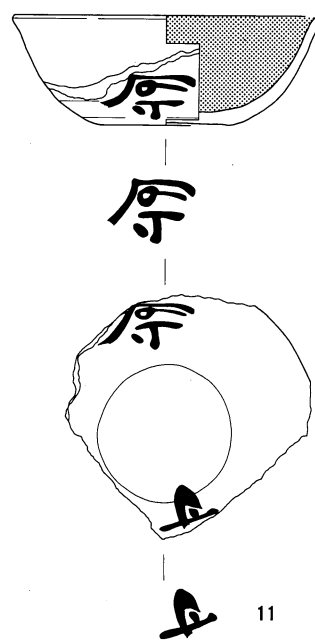
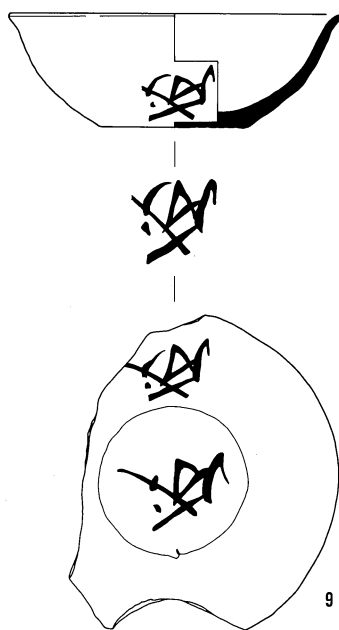
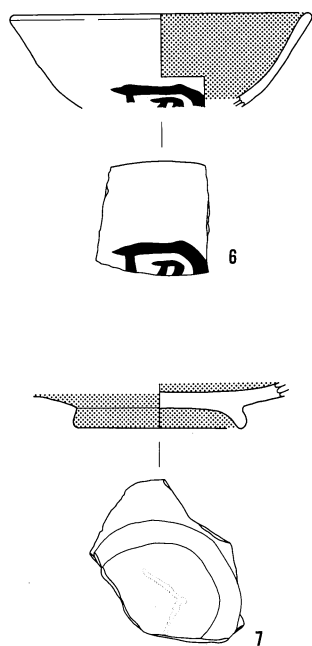
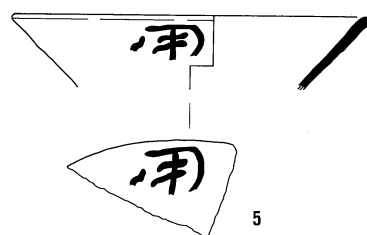
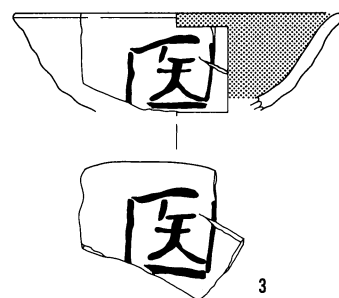
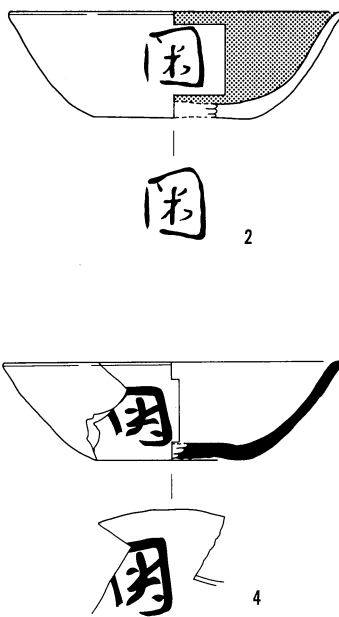
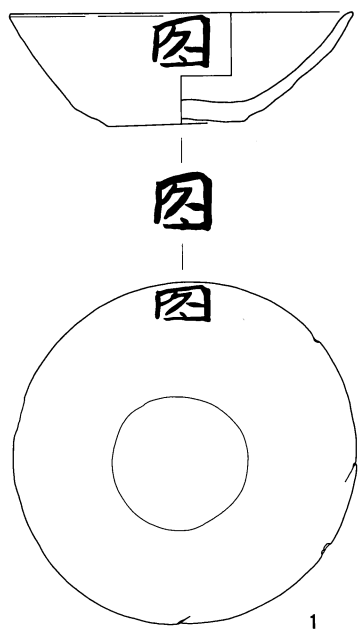

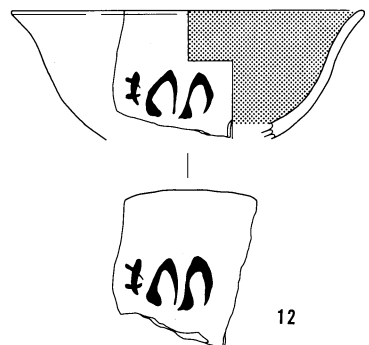
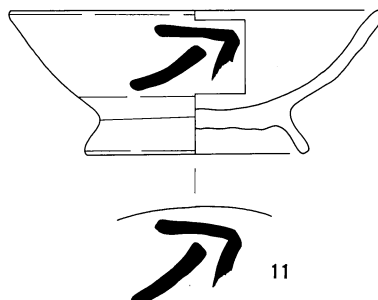
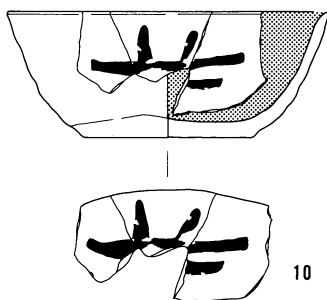
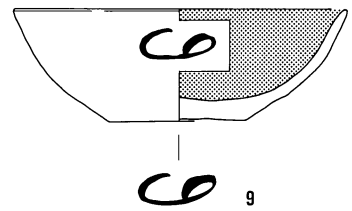
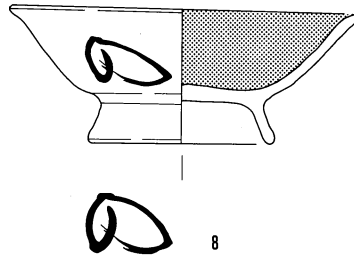
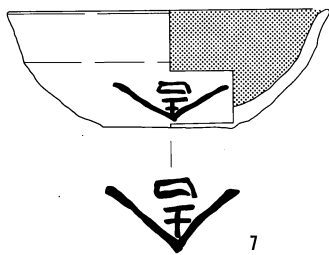
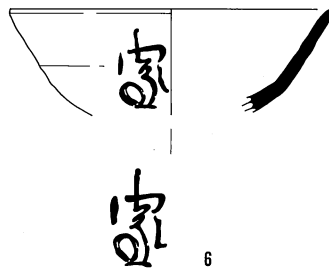
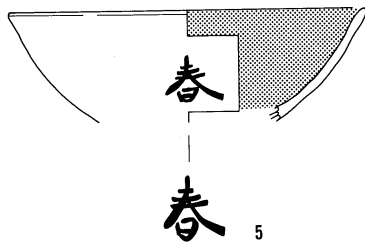
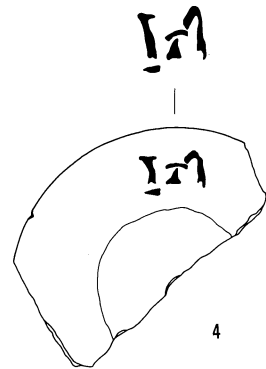
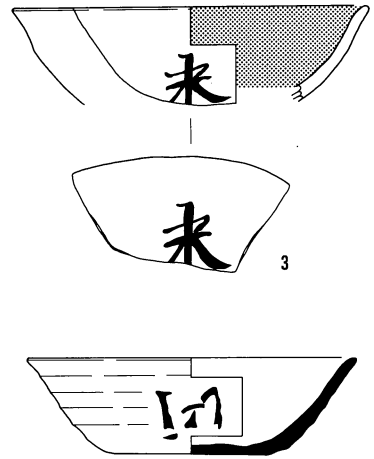
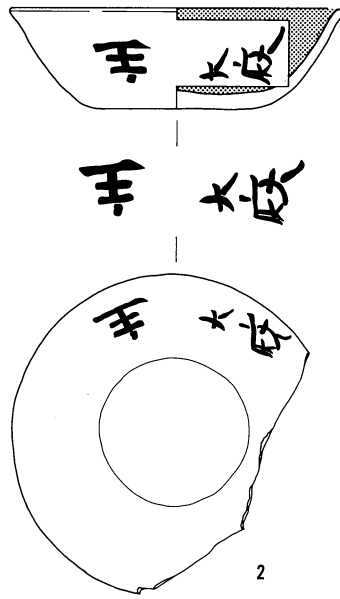
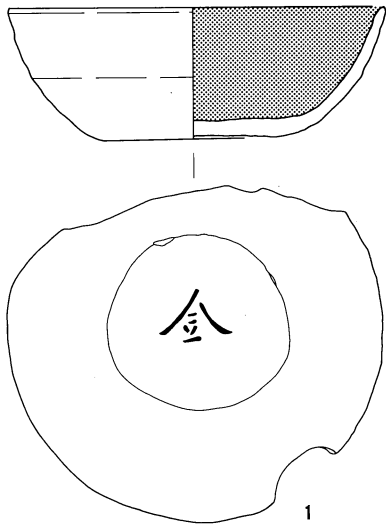

0 (1 : 3) 10cm

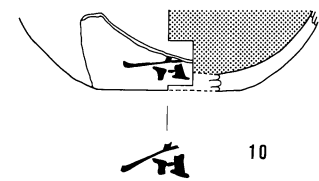
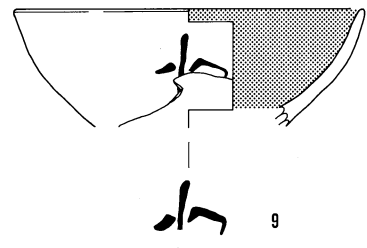
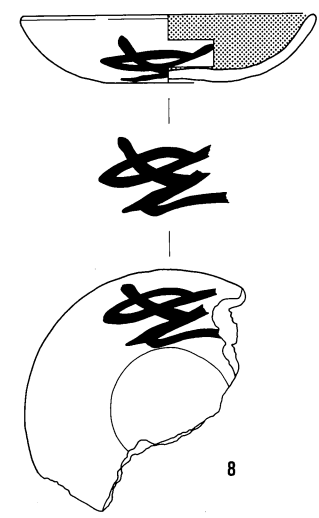
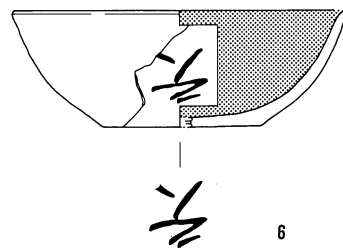
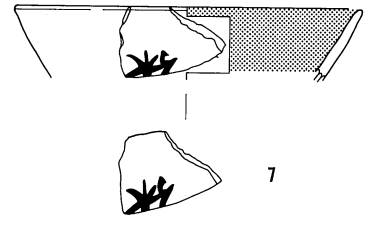
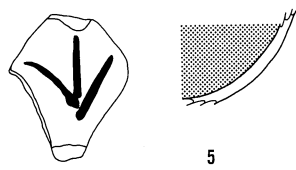
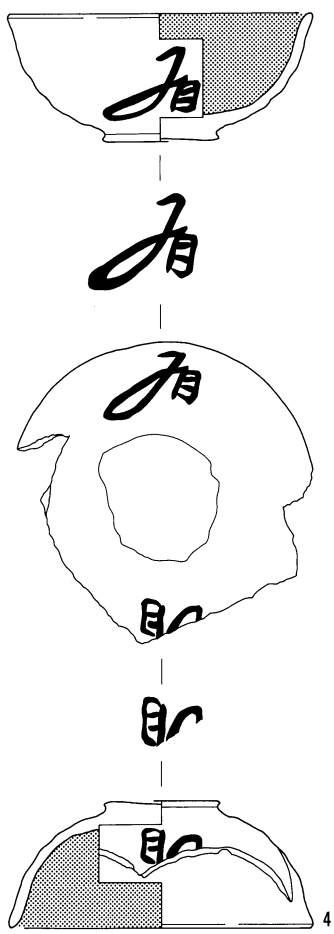
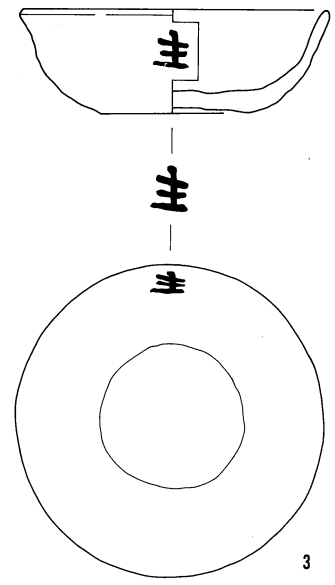
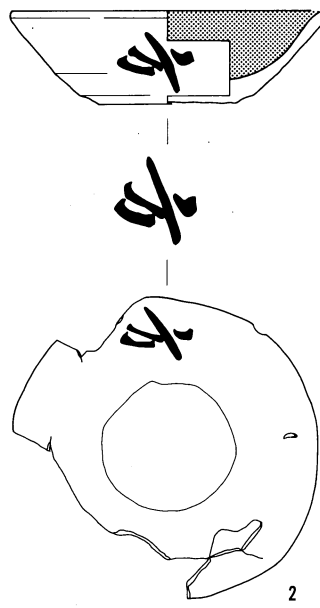
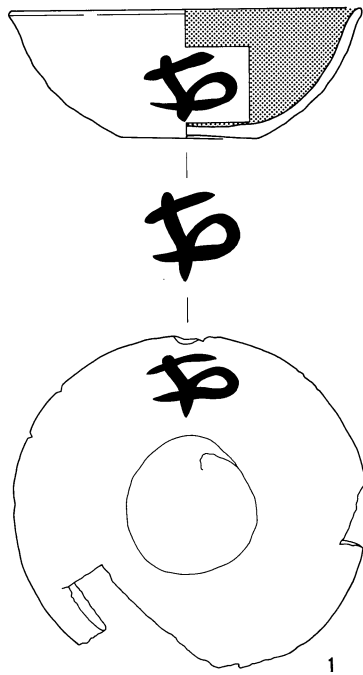

0 (1 : 3) 10cm

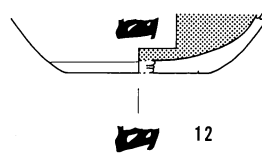
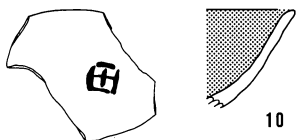
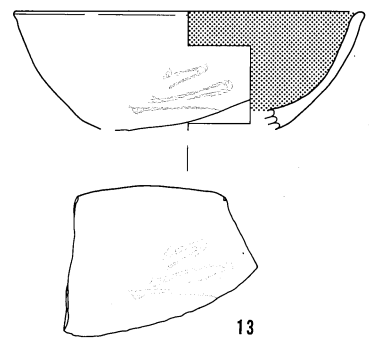
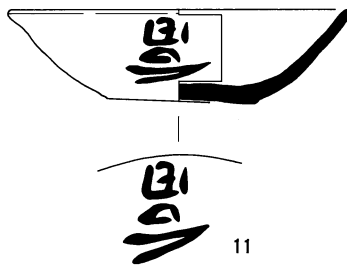
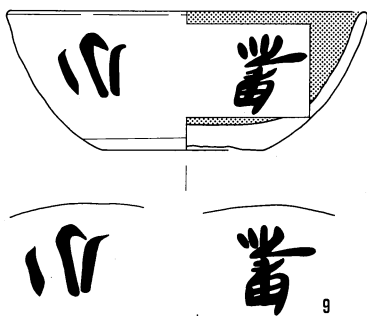
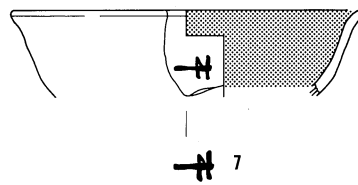
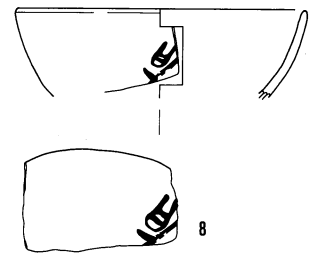
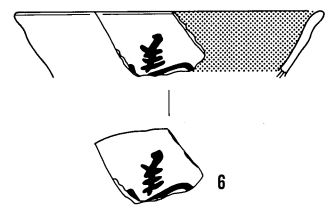
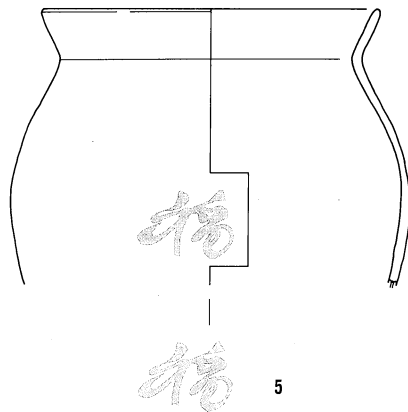
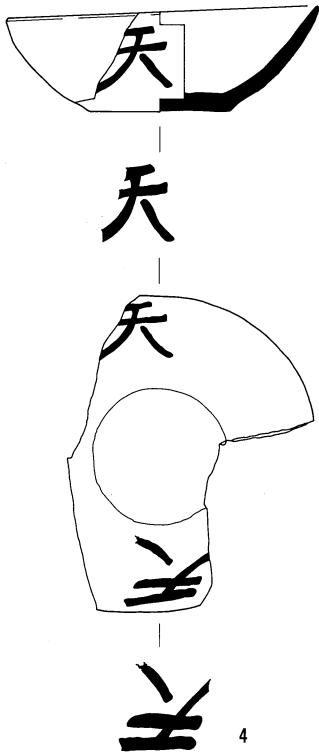
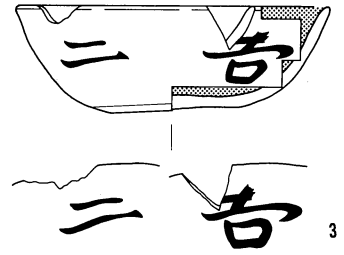
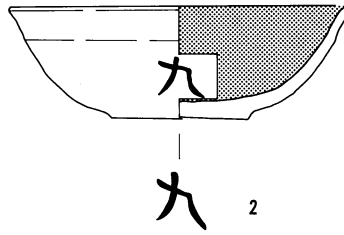
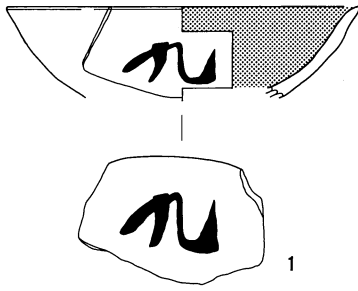

0 (1 : 3) 10cm

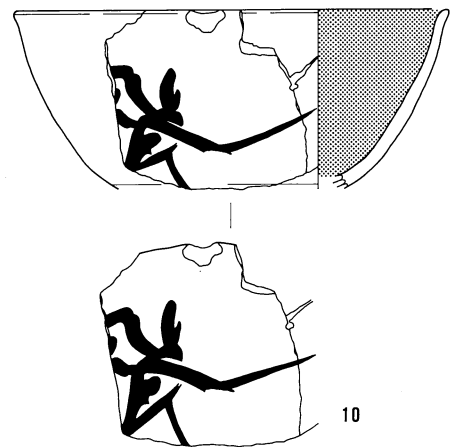
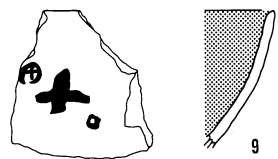
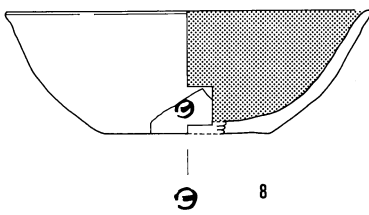
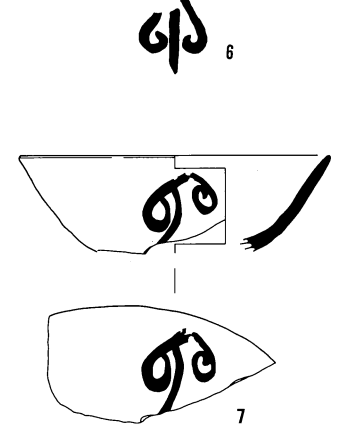
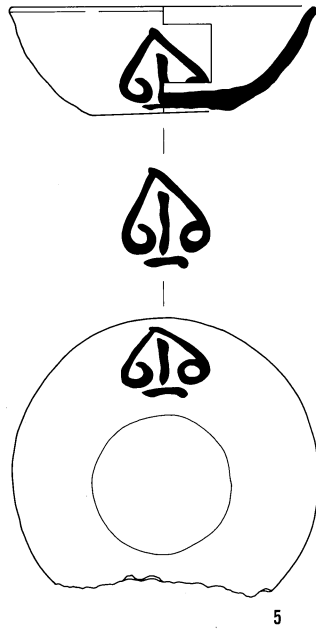
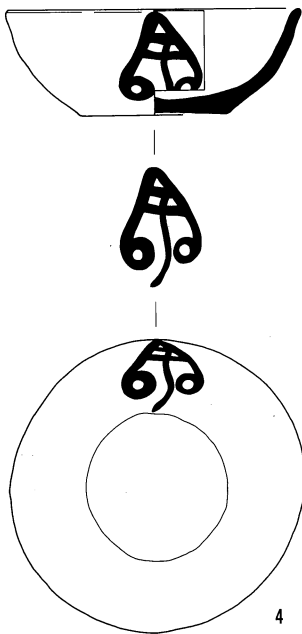
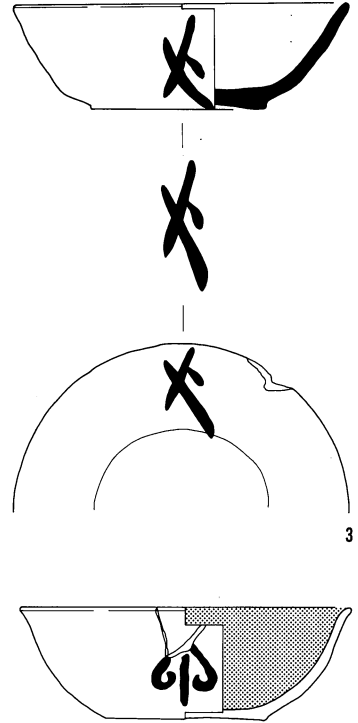
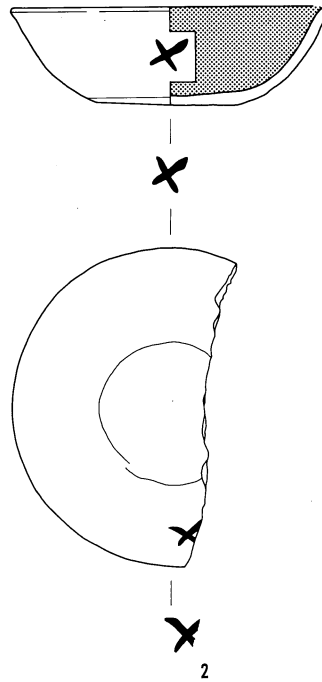
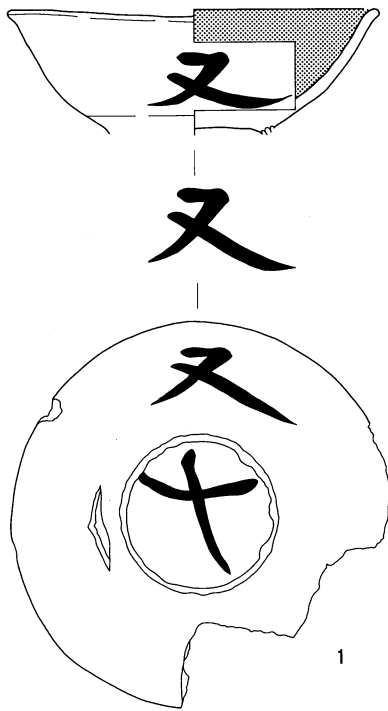

0 (1 : 3) 10cm

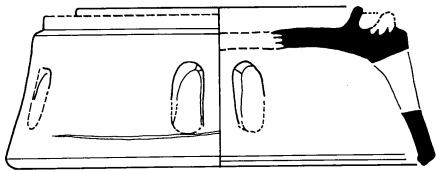
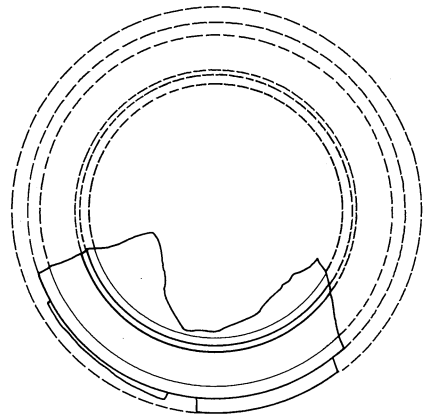

1

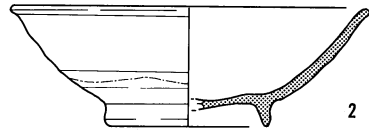
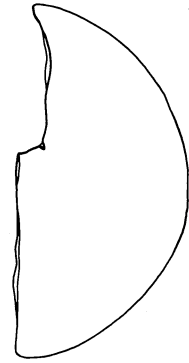

2

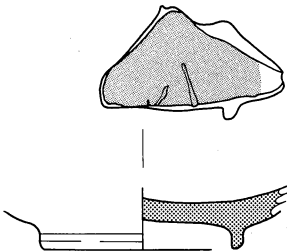

3

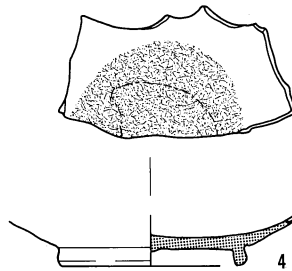

4

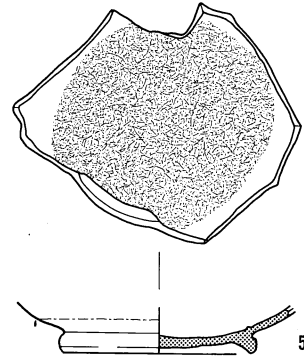

5

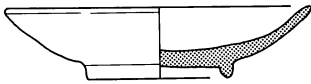

6



7



8

0 (1 : 3) 10cm

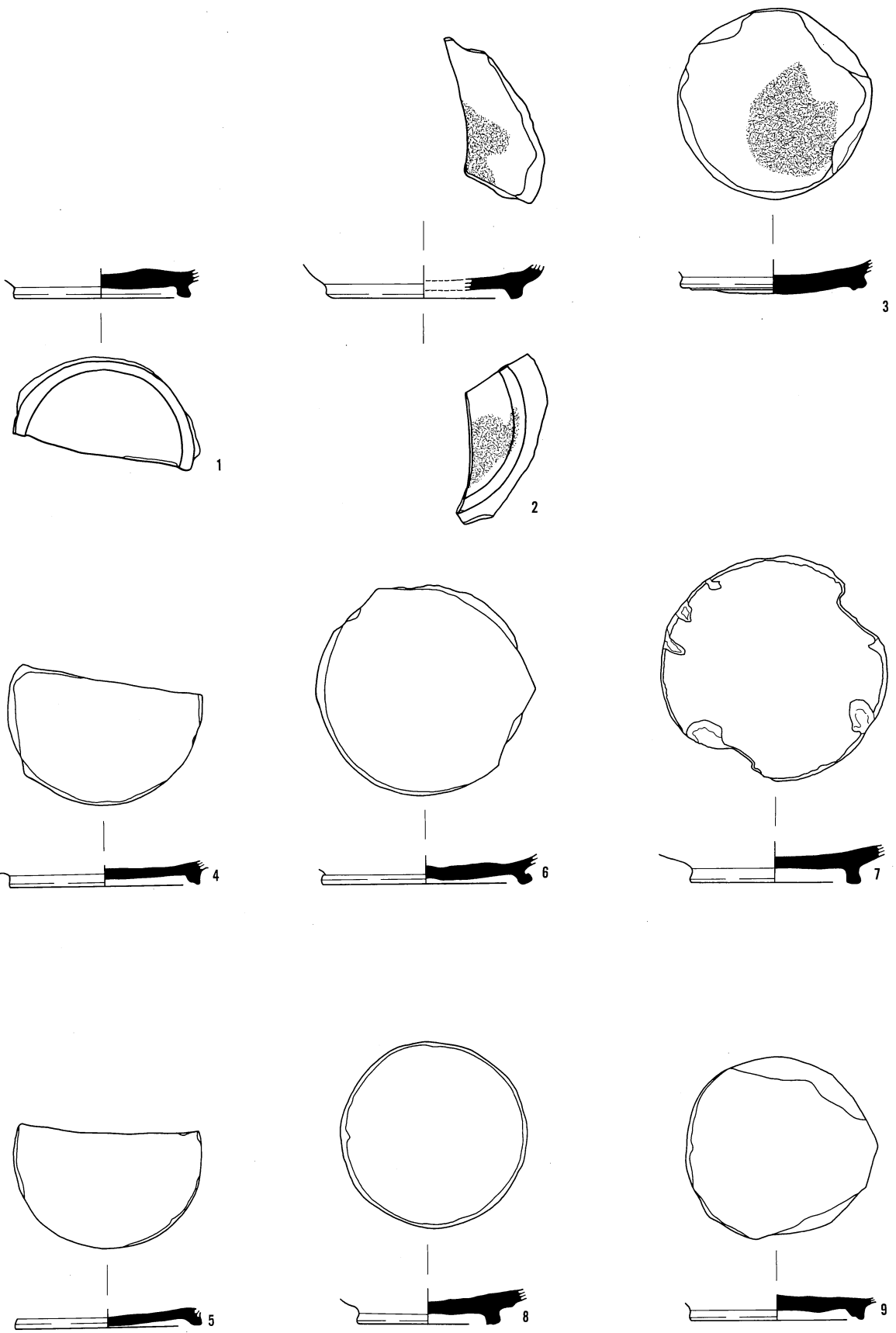

0 (1 : 3) 10cm

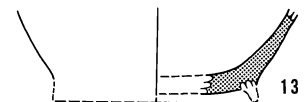
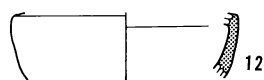
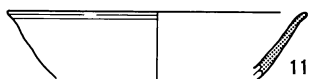
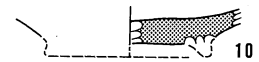
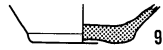
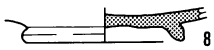
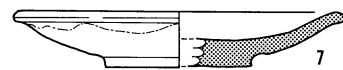
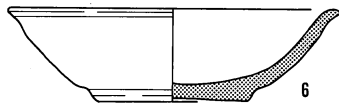
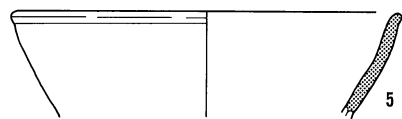
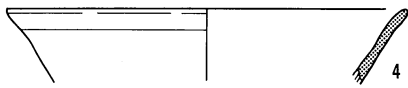
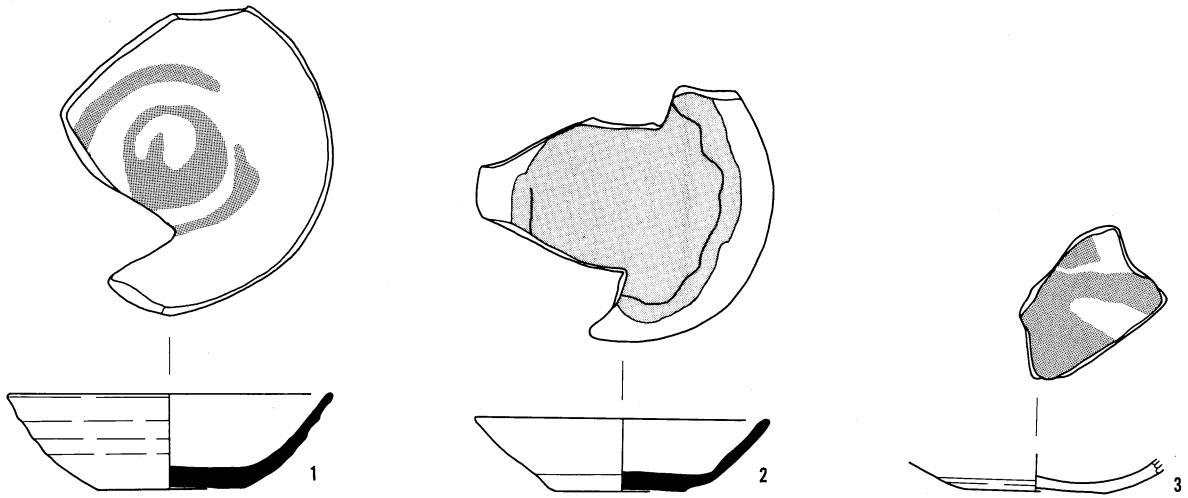

0 (1 : 3) 10cm

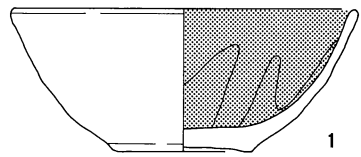
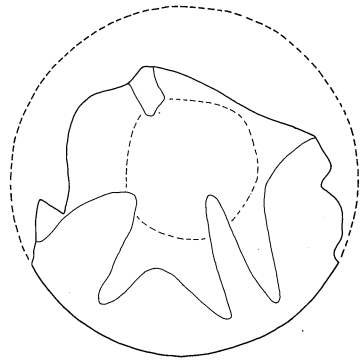

1

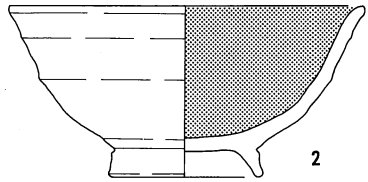
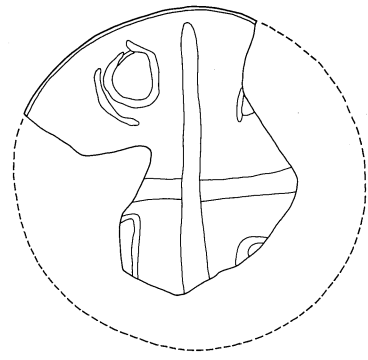

2

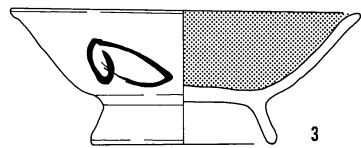
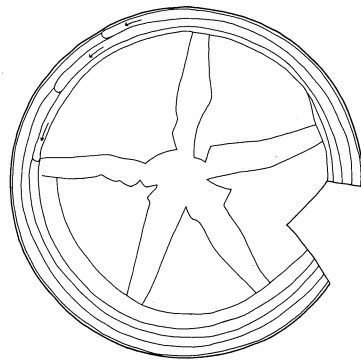

3

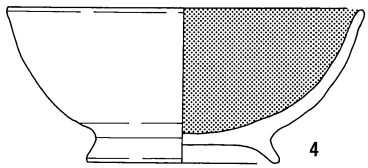
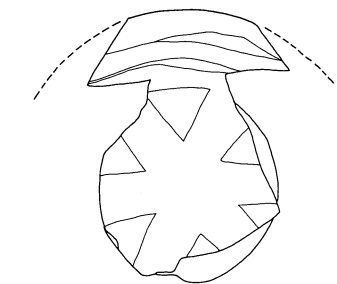

4

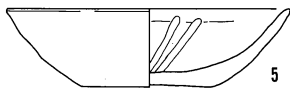
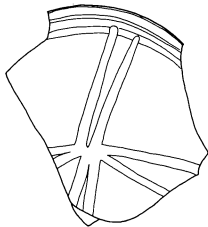

5

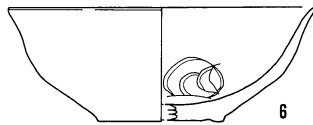
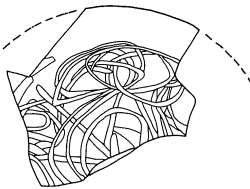

6

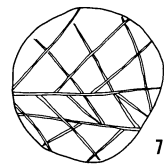
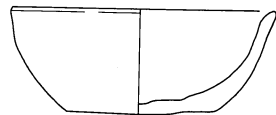

7

0 (1 : 3) 10cm

弥生中期

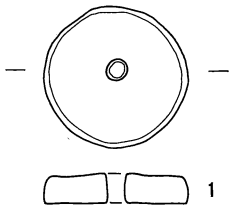

弥生後期

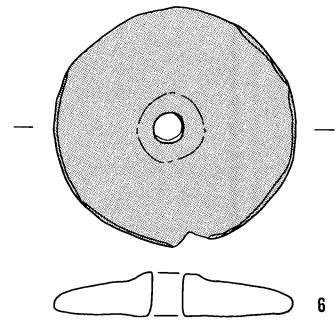
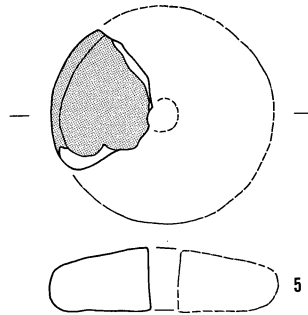
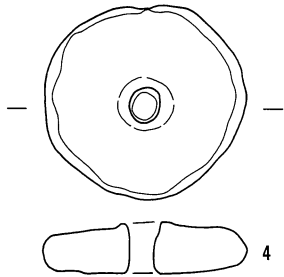
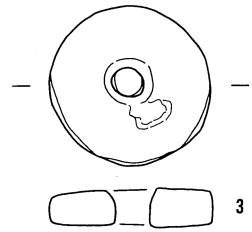
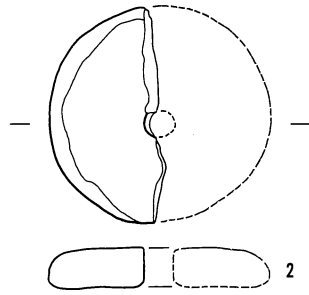

古墳前期

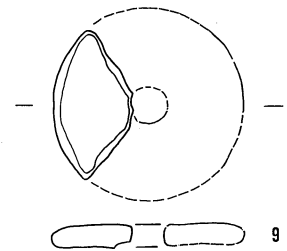
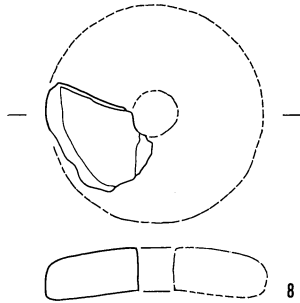
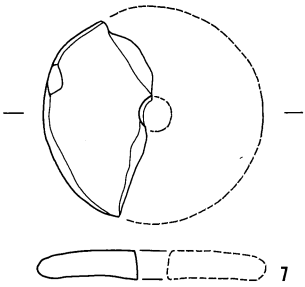

古墳後期 (7C)

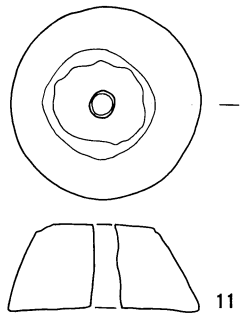
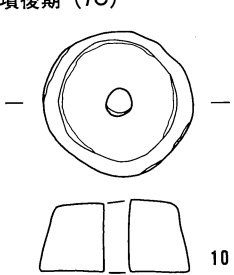

混入

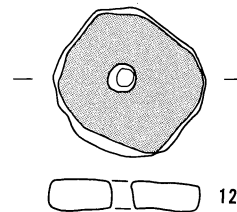

0 (1:2) 5cm

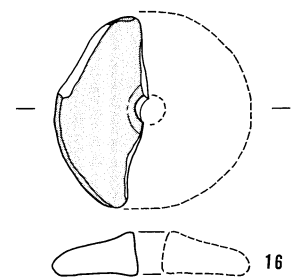
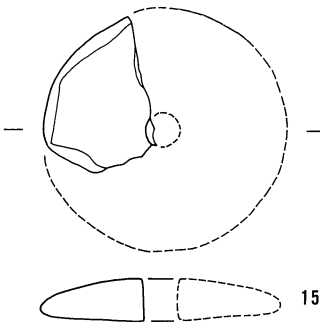
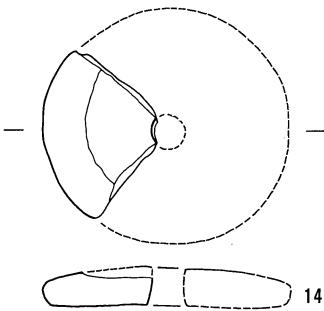
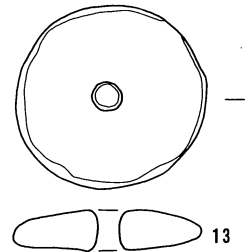

縄文

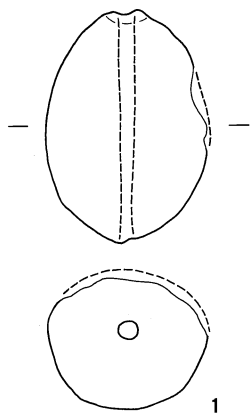

弥生中期

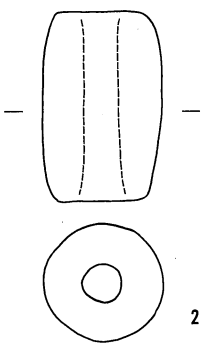

弥生後期

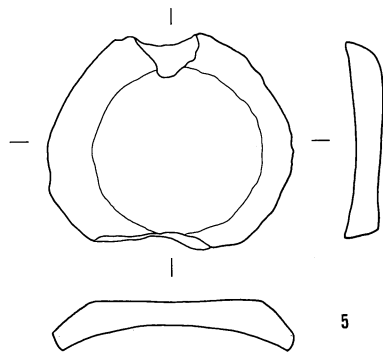
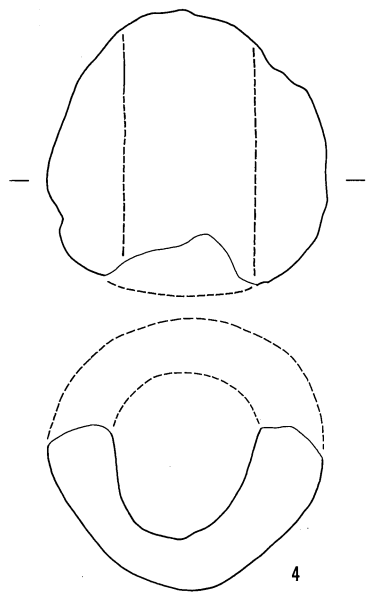
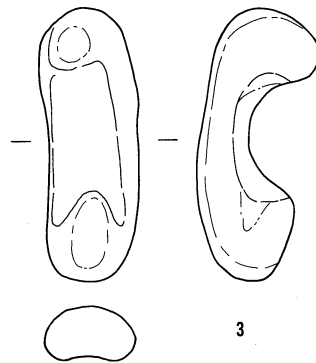

古墳前期

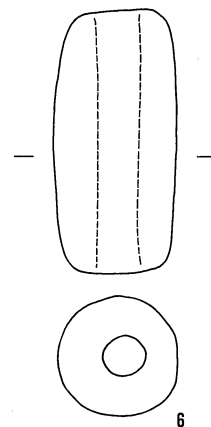

古代

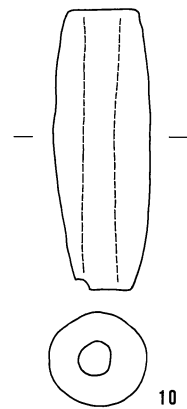
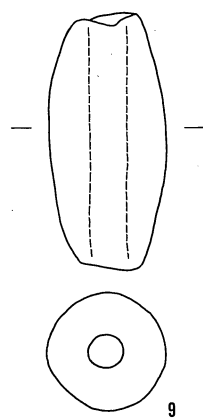
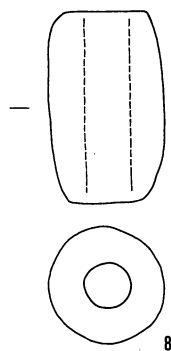
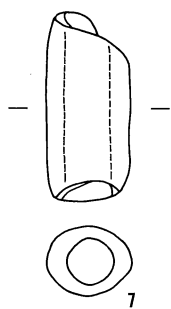

古代

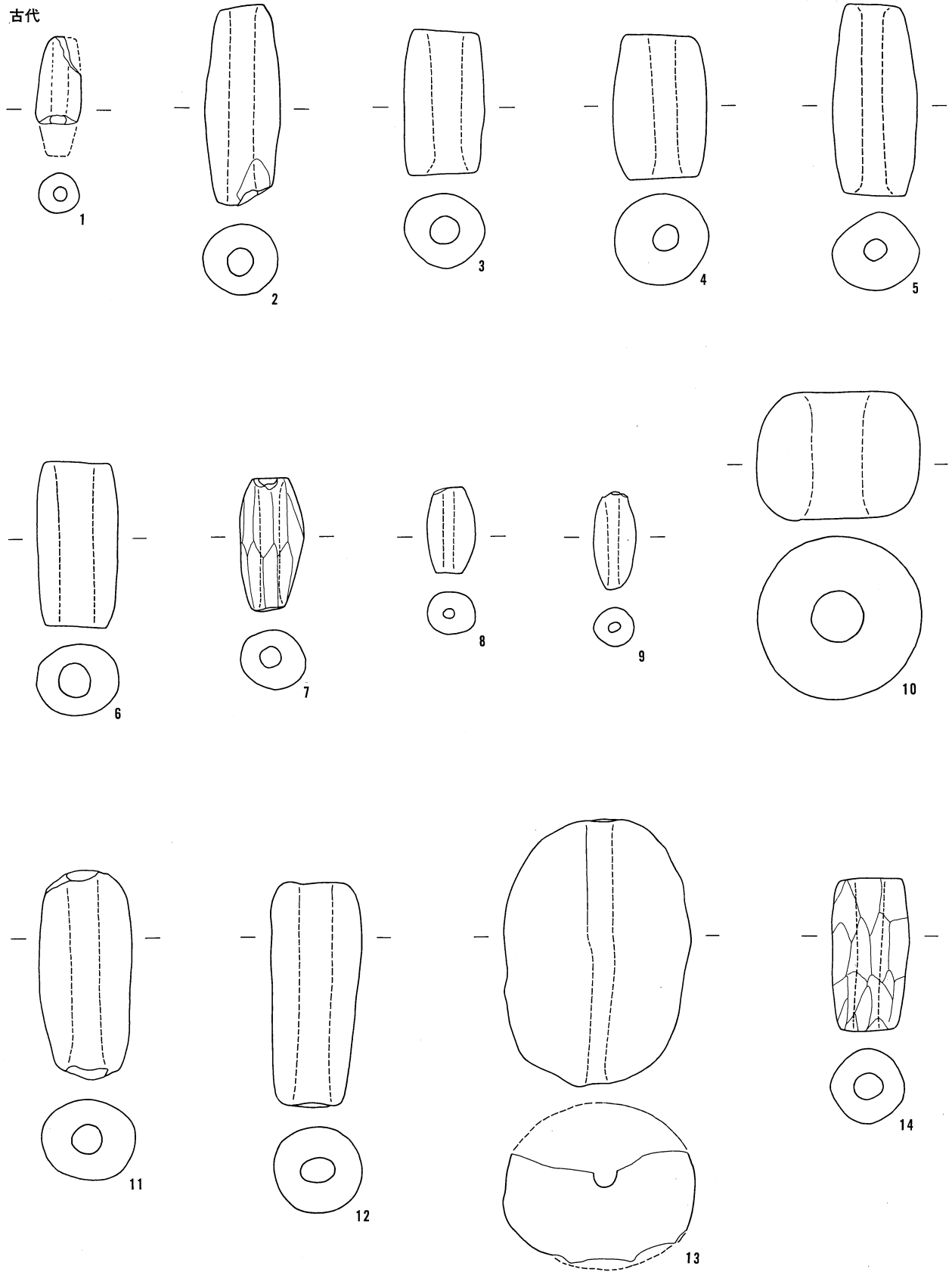

0 (1 : 2) 5cm

古代

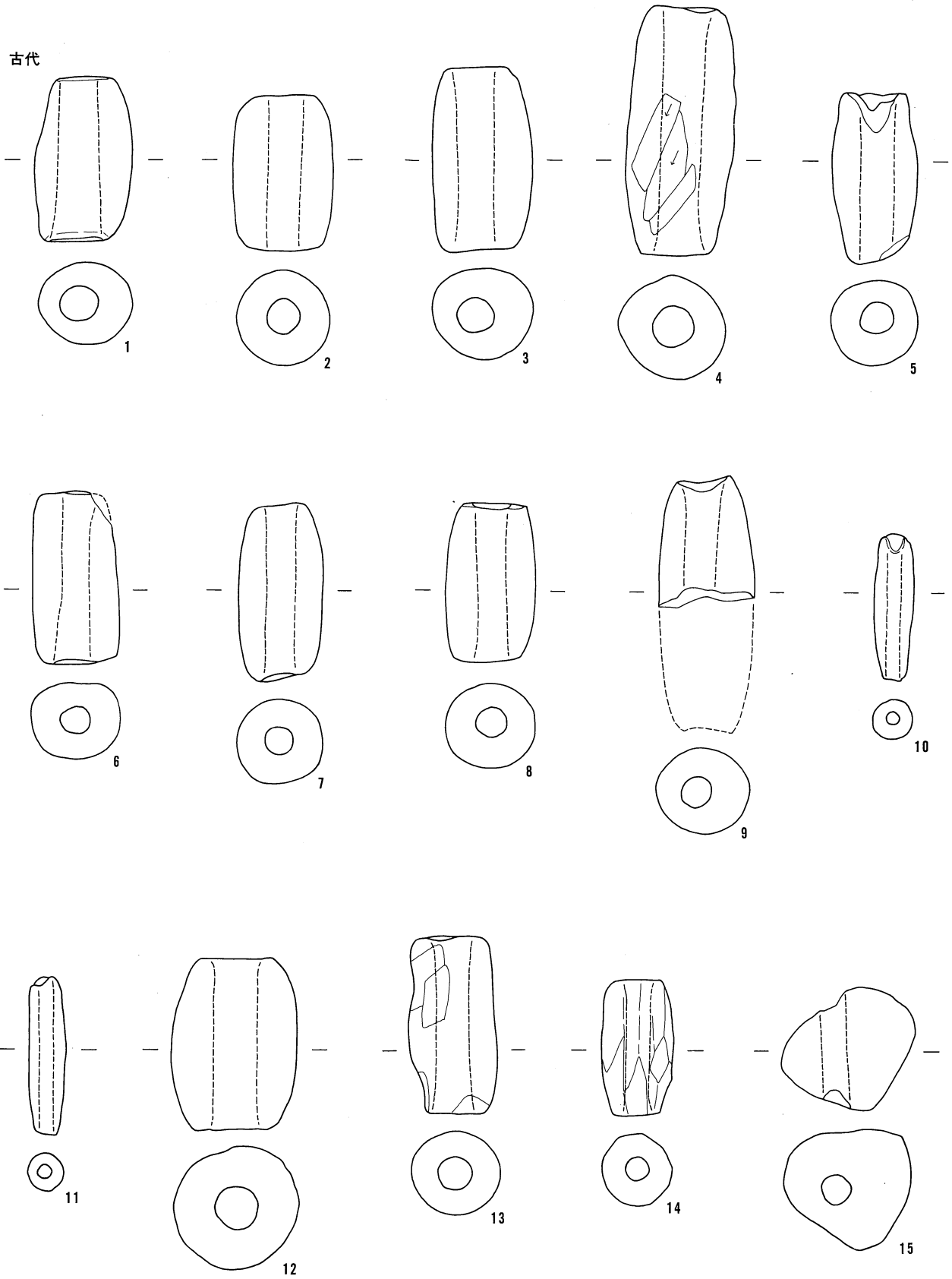

0 (1 : 2) 5cm

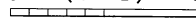

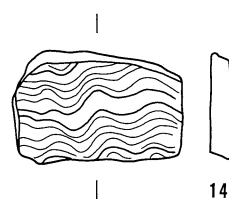
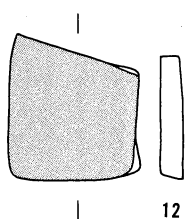
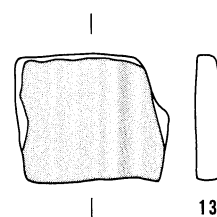
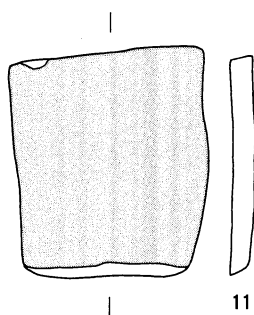
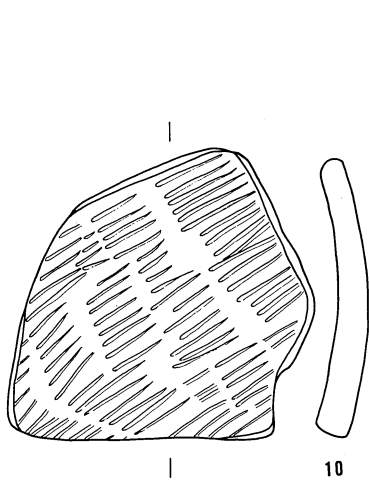
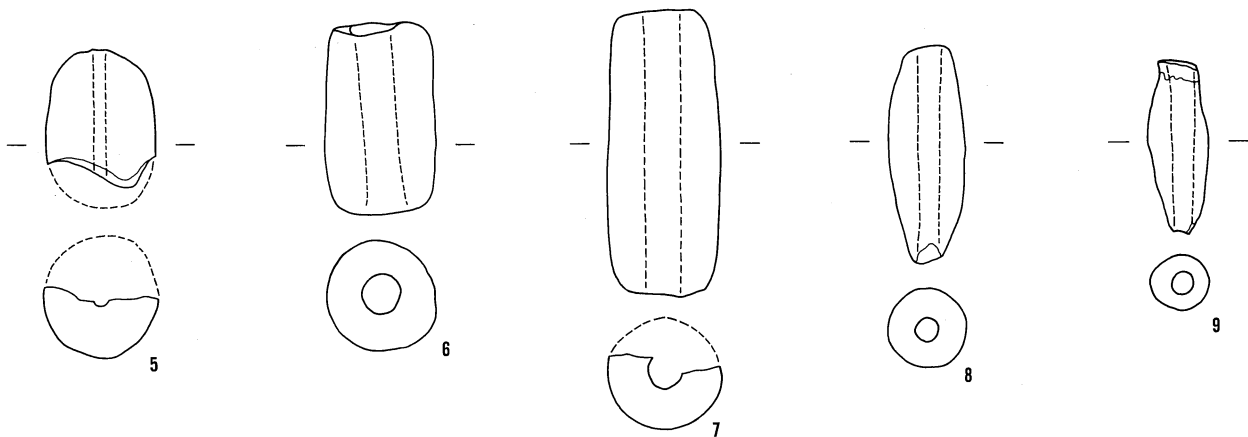
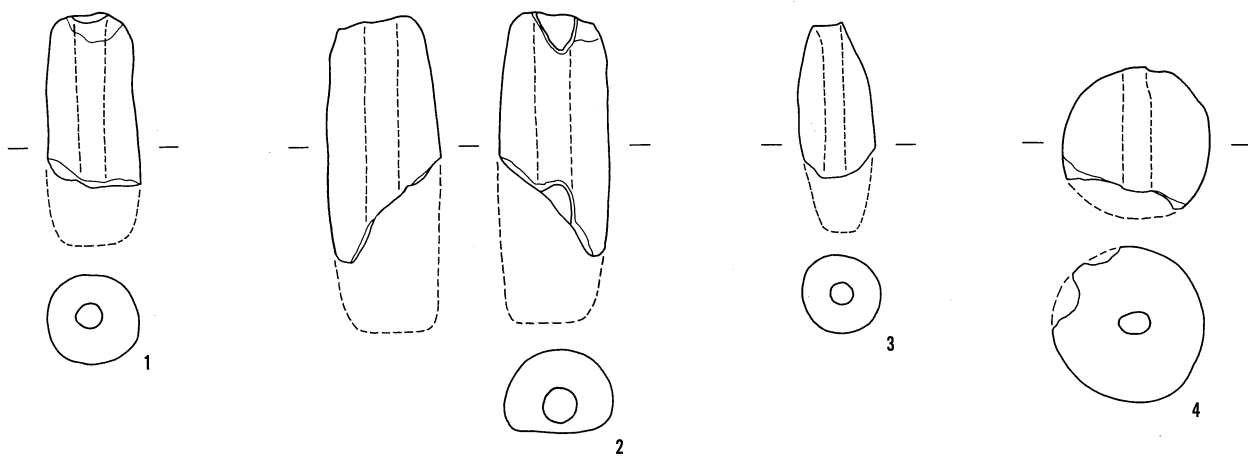

0 (1 : 2) 5cm

