

中央自動車道長野線
埋蔵文化財発掘調査報告書11

—明科町内—

北 村 遺 跡

図 版 編

1 9 9 3

日本道路公団名古屋建設局
長野県教育委員会
（財）長野県埋蔵文化財センター

中央自動車道長野線
埋蔵文化財発掘調査報告書11

—明科町内—

北 村 遺 跡

図 版 編

1 9 9 3

日本道路公団名古屋建設局
長野県教育委員会
(財)長野県埋蔵文化財センター

例 言

- 1 本書は、北村遺跡発掘調査報告書の図版編である。
- 2 実測図をはじめとした図類には『図版』、写真には『PL』をつけ、それぞれ通し番号が付けてある。
- 3 縄文土器の実測図は、(株)パスコの3次元図化機によって作成された下図を基に作成した。石器の実測図は、石鏃・石錐・打製石斧・磨石・凹石についてのみ、(株)シン航空写真のスリット写真を下図に作成した。
- 4 遺跡遠景・地藏菩薩立像の写真は、明科町教育委員会から提供を受けた。
- 5 本編に掲載した実測図および遺物写真の縮尺は、下記のとおりである。個別には各図版の縮尺を参照されたい。なお、掲載した図は、日本道路公団作成の中央自動車道長野線平面図(1:1,000)、明科町および豊科町発行の都市計画図(1:10,000)をもとに作成したほか、建設省国土地理院発行の地形図(1:50,000)を使用した。

(1) 遺構実測図

北村遺跡の位置	1:150,000	遺跡の範囲	1:10,000	周辺の地形と調査範囲	1:3,000
縄文B~D区全体図	1:240	縄文E区全体図	1:160	縄文遺構図	1:60
古代全体図	1:800	古代遺構図	1:80		

(2) 遺物実測図

縄文土器実測図	1:4	縄文土器拓影	1:3
石鏃・石錐・刃器	1:1	石核・打製石斧・磨製石斧・刃器・石剣・石棒	1:2
剥片A類・剥片・碎片	2:3	磨石・凹石・敲石・刃器・石錐・土錘・石剣・石棒	1:3
砥石・石剣・石棒	1:4	石皿・丸石・多孔石	1:6
縄文土製品・石製品	1:2	古代土器実測図	1:4

(3) 遺物写真 以下を除いて実測図と同一

剥片A類	1:2	砥石	1:6	石錐	1:2	石剣・石棒	1:4
------	-----	----	-----	----	-----	-------	-----

- 6 本編中の遺物番号は、図・写真ともに一致している。なお、材質などにより次のように付けてある。
 - (1) 縄文土器・古代土器……………遺構ごとに1から通し番号
 - (2) 石器・土製品・石製品……………器種ごとに1から通し番号
- 7 縄文土器・古代土器で、図版中の遺物番号にアンダーラインのあるものは、PLに掲載されている。また石器で、同じようにアンダーラインのあるものは、PLで使用痕写真が掲載されている。
- 8 遺物図の表現方法は、本文編または図版の各遺物の項で説明されている。また、遺構図のスクリーントーンなどは以下の事項を表わしている。



図 版 目 次

- | | |
|---|---|
| <p>図版 1 北村遺跡の位置 1 (1 : 150,000)</p> <p>図版 2 遺跡の位置 2、遺跡の範囲 (1 : 10,000)</p> <p>図版 3 周辺の地形と発掘調査範囲 (1 : 3,000)</p> <p>図版 4 縄文調査区割り付け図 (1 : 1,000)</p> <p>図版 5 縄文遺構全体図 1 (B・C区) (1 : 240)</p> <p>図版 6 縄文遺構全体図 2 (C・D区)</p> <p>図版 7 縄文遺構全体図 3 (E区第 1 検出面) (1 : 160)</p> <p>図版 8 縄文遺構全体図 4 (E区第 2 検出面)</p> <p>図版 9 縄文遺構全体図 5 (E区第 3 検出面)</p> <p>図版 10 縄文遺構図 1 (SB101上面配石) (1 : 60)</p> <p>図版 11 縄文遺構図 2 (SB101)</p> <p>図版 12 縄文遺構図 3 (SB102)</p> <p>図版 13 縄文遺構図 4 (SB103・104)</p> <p>図版 14 縄文遺構図 5 (SB106~108)</p> <p>図版 15 縄文遺構図 6 (SB105・109~112)</p> <p>図版 16 縄文遺構図 7 (SH11・17~19・30・31)</p> <p>図版 17 縄文遺構図 8 (SH1・4~8・10・32)</p> <p>図版 18 縄文遺構E区割り付け図 (約 1 : 300)</p> <p>図版 19 縄文遺構図 9 (SB577・591・594、SH1129ほか)
(1 : 60)</p> <p>図版 20 縄文遺構図 10 (SH1136ほか)</p> <p>図版 21 縄文遺構図 11 (SB578・592・593・598、SH1129
ほか、SK3219ほか)</p> <p>図版 22 縄文遺構図 12 (SB582、SH1129ほか)</p> <p>図版 23 縄文遺構図 13 (SB584、SH1155、SK2502)</p> <p>図版 24 縄文遺構図 14 (SB587~590・599、SK3398・3399)</p> <p>図版 25 縄文遺構図 15 (SB581・583・599、SH1159ほか)</p> <p>図版 26 縄文遺構図 16 (SB567・580・583、SH1172ほか)</p> <p>図版 27 縄文遺構図 17 (SB566、SH501ほか)</p> <p>図版 28 縄文遺構図 18 (SB577・566、SH501ほか、
SK2577ほか)</p> <p>図版 29 縄文遺構図 19 (SB552・558、SH515ほか)</p> <p>図版 30 縄文遺構図 20 (SB552・558、SH515ほか)</p> <p>図版 31 縄文遺構図 21 (SB507ほか)</p> <p>図版 32 縄文遺構図 22 (SB551・560、SH507ほか、
SK2180ほか)</p> | <p>図版 33 縄文遺構図 23 (SB567・573、SH504ほか、
SK2571ほか)</p> <p>図版 34 縄文遺構図 24 (SB551・560、SH545ほか、
SK2193ほか)</p> <p>図版 35 縄文遺構図 25 (SB571、SH517ほか、SK2913ほか)</p> <p>図版 36 縄文遺構図 26 (SB571、SH1023ほか、SK2913ほ
か)</p> <p>図版 37 縄文遺構図 27 (SH526ほか、SK2029・2030)</p> <p>図版 38 縄文遺構図 28 (SH638ほか、SK2316)</p> <p>図版 39 縄文遺構図 29 (SH1003ほか、SK2957ほか)</p> <p>図版 40 縄文遺構図 30 (SB553・554、SH533ほか)</p> <p>図版 41 縄文遺構図 31 (SH633ほか、SK2002ほか)</p> <p>図版 42 縄文遺構図 32 (SB555、SH527ほか)</p> <p>図版 43 縄文遺構図 33 (SB555、SH527ほか)</p> <p>図版 44 縄文遺構図 34 (SB570、SH601ほか、SK2007ほか)</p> <p>図版 45 縄文遺構図 35 (SH528ほか)</p> <p>図版 46 縄文遺構図 36 (SB564・599、SH529ほか)</p> <p>図版 47 縄文遺構図 37 (SB562、SH741ほか、SK2637ほか)</p> <p>図版 48 縄文遺構図 38 (SB568、SH677ほか、SK2467ほか)</p> <p>図版 49 縄文遺構図 39 (SH750ほか)</p> <p>図版 50 縄文遺構図 40 (SH1056ほか)</p> <p>図版 51 縄文遺構図 41 (SB562・563・572・574、
SH751ほか、SK2646ほか)</p> <p>図版 52 縄文遺構図 42 (SB561、SH529ほか)</p> <p>図版 53 縄文遺構図 43 (SH671ほか、SK2711ほか)</p> <p>図版 54 縄文遺構図 44 (SK1272ほか)</p> <p>図版 55 古代遺構全体図 (1 : 800)</p> <p>図版 56 古代遺構図 1 (SB1~6) (1 : 80)</p> <p>図版 57 古代遺構図 2 (SB7~12)</p> <p>図版 58 古代遺構図 3 (SB13・501・502・504~507)</p> <p>図版 59 古代遺構図 4 (ST1・2)</p> <p>図版 60 古代遺構図 5 (ST3~7)</p> <p>図版 61 古代遺構図 6 (ST8~13・15)</p> <p>図版 62 古代遺構図 7 (SB1、ST14)</p> <p>図版 63 古代遺構図 8 (ST16~21)</p> <p>図版 64 古代遺構図 9 (ST22~24・26・30)</p> |
|---|---|

- 図版65 古代遺構 図10 (ST25・27~29・31)
 図版66 古代遺構 図11 (ST32~35)
 図版67 古代遺構 図12 (ST36~38・501・502・504)
 図版68 古代遺構 図13 (ST503・505・506)
 図版69 古代遺構 図14 (ST507・509・510)
 図版70 古代遺構 図15 (ST508、SX501)
 図版71 縄文遺物 土器 1 (SB101・102・110・555・557)
 図版72 縄文遺物 土器 2 (SB555・558~561)
 図版73 縄文遺物 土器 3 (SB566)
 図版74 縄文遺物 土器 4 (SB562・570・572・580)
 図版75 縄文遺物 土器 5 (SB583・591・592・594・
 598)
 図版76 縄文遺物 土器 6 (SB599、SH17・508)
 図版77 縄文遺物 土器 7 (SH555・607・644・648・658
 ・686)
 図版78 縄文遺物 土器 8 (SB560、SH690・693・714・
 738・785・794・824)
 図版79 縄文遺物 土器 9 (SH784・802・813・952・
 1048)
 図版80 縄文遺物 土器10 (SH979・1081・1082・1165・
 1204)
 図版81 縄文遺物 土器11 (SH1189・1215・1217・1228
 ・1232・1233)
 図版82 縄文遺物 土器12 (SK2080・2020・2232・2419
 ・2541・2813・3071)
 図版83 縄文遺物 土器13 (SK2813・3142・3266・SQ1)
 図版84 縄文遺物 土器14 (SQ1)
 図版85 縄文遺物 土器15 (SQ1)
 図版86 縄文遺物 土器16 (SQ1・2)
 図版87 縄文遺物 土器17 (SQ501・503、遺構外)
 図版88 縄文遺物 土器18 (遺構外)
 図版89 縄文遺物 土器19 (遺構外)
 図版90 縄文遺物 土器20 (遺構外)
 図版91 縄文遺物 土器21 (SB101~103)
 図版92 縄文遺物 土器22 (SB104・108・110・551)
 図版93 縄文遺物 土器23 (SB552~555)
 図版94 縄文遺物 土器24 (SB555)
 図版95 縄文遺物 土器25 (SB555・557)
 図版96 縄文遺物 土器26 (SB558・559)
 図版97 縄文遺物 土器27 (SB559~561)
 図版98 縄文遺物 土器28 (SB562・563)
 図版 99 縄文遺物 土器29 (SB563・566)
 図版100 縄文遺物 土器30 (SB566・570・571)
 図版101 縄文遺物 土器31 (SB571~573)
 図版102 縄文遺物 土器32 (SB573・574・578・580)
 図版103 縄文遺物 土器33 (SB580・581)
 図版104 縄文遺物 土器34 (SB581・582)
 図版105 縄文遺物 土器35 (SB583・584・588)
 図版106 縄文遺物 土器36 (SB588・590・592)
 図版107 縄文遺物 土器37 (SB594・595・599)
 図版108 縄文遺物 土器38 (SB599、SH18)
 図版109 縄文遺物 土器39 (SH19ほか)
 図版110 縄文遺物 土器40 (SH698ほか)
 図版111 縄文遺物 土器41 (SH873ほか)
 図版112 縄文遺物 土器42 (SH1160ほか)
 図版113 縄文遺物 土器43 (SH1180ほか)
 図版114 縄文遺物 土器44 (SH1191ほか)
 図版115 縄文遺物 土器45 (SH1206ほか、SK501ほか)
 図版116 縄文遺物 土器46 (SK2696ほか、SQ5)
 図版117 縄文遺物 土器47 (SQ5・503)
 図版118 縄文遺物 石器 1 (石核1)
 図版119 縄文遺物 石器 2 (石核2)
 図版120 縄文遺物 石器 3 (剥片A類)
 図版121 縄文遺物 石器 4 (剥片・碎片)
 図版122 縄文遺物 石器 5 (石鏃1)
 図版123 縄文遺物 石器 6 (石鏃2)
 図版124 縄文遺物 石器 7 (石鏃3)
 図版125 縄文遺物 石器 8 (石鏃4)
 図版126 縄文遺物 石器 9 (打製石斧1)
 図版127 縄文遺物 石器10 (打製石斧2)
 図版128 縄文遺物 石器11 (打製石斧3)
 図版129 縄文遺物 石器12 (打製石斧4)
 図版130 縄文遺物 石器13 (打製石斧5)
 図版131 縄文遺物 石器14 (打製石斧6)
 図版132 縄文遺物 石器15 (打製石斧7)
 図版133 縄文遺物 石器16 (打製石斧8)
 図版134 縄文遺物 石器17 (磨石・凹石1)
 図版135 縄文遺物 石器18 (磨石・凹石2)
 図版136 縄文遺物 石器19 (磨石・凹石3)
 図版137 縄文遺物 石器20 (磨石・凹石4)
 図版138 縄文遺物 石器21 (磨石・凹石5、敲石、多孔石)
 図版139 縄文遺物 石器22 (石皿1)

- | | | | | | |
|-------|------|--------------------|-------|------|-------------------------------------|
| 図版140 | 縄文遺物 | 石器23 (石皿2) | 図版160 | 縄文遺物 | 土製品6 (土偶6) |
| 図版141 | 縄文遺物 | 石器24 (石皿3) | 図版161 | 縄文遺物 | 土製品7 (小形土器1) |
| 図版142 | 縄文遺物 | 石器25 (石錐1) | 図版162 | 縄文遺物 | 土製品8 (小形土器2、土製匙) |
| 図版143 | 縄文遺物 | 石器26 (石錐2) | 図版163 | 縄文遺物 | 土製品9 (土製蓋、きのこと状土製品、土鈴、土玉、その他) |
| 図版144 | 縄文遺物 | 石器27 (磨製石斧1) | 図版164 | 縄文遺物 | 土製品10・石製品 (耳飾り、石製品、ヒスイ原石、研磨礫、有孔土器片) |
| 図版145 | 縄文遺物 | 石器28 (磨製石斧2) | 図版165 | 縄文遺物 | 土製品11 (土器片円板) |
| 図版146 | 縄文遺物 | 石器29 (磨製石斧3) | 図版166 | 古代遺物 | 土器1 (SB1~5) |
| 図版147 | 縄文遺物 | 石器30 (磨製石斧4) | 図版167 | 古代遺物 | 土器2 (SB5~8) |
| 図版148 | 縄文遺物 | 石器31 (刃器1) | 図版168 | 古代遺物 | 土器3 (SB8・10・12・13・501・502) |
| 図版149 | 縄文遺物 | 石器32 (刃器2) | 図版169 | 古代遺物 | 土器4 (SB502~504・507、ST4ほか) |
| 図版150 | 縄文遺物 | 石器33 (刃器3) | 図版170 | 古代遺物 | 土器5 (ST501、SD6・9~11) |
| 図版151 | 縄文遺物 | 石器34 (砥石、石錘、土錘、丸石) | 図版171 | 古代遺物 | 土器6 (SD11・13) |
| 図版152 | 縄文遺物 | 石器35 (石剣・石棒1) | 図版172 | 古代遺物 | 土器7 (SD20ほか、SK1ほか) |
| 図版153 | 縄文遺物 | 石器36 (石剣・石棒2) | 図版173 | 古代遺物 | 土器8 (SQ501、SX1・3・501) |
| 図版154 | 縄文遺物 | 石器37 (石剣・石棒3) | | | |
| 図版155 | 縄文遺物 | 土製品1 (土偶1) | | | |
| 図版156 | 縄文遺物 | 土製品2 (土偶2) | | | |
| 図版157 | 縄文遺物 | 土製品3 (土偶3) | | | |
| 図版158 | 縄文遺物 | 土製品4 (土偶4) | | | |
| 図版159 | 縄文遺物 | 土製品5 (土偶5) | | | |

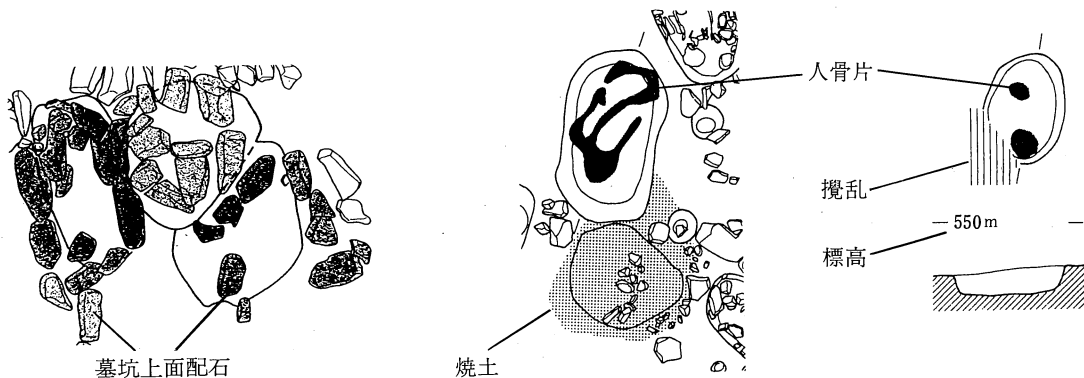
写真図版目次

- PL 1 調査遺跡周辺
 PL 2 遺跡遠景
 PL 3 縄文遺構 1 (SB101上面配石・完掘・土偶出土状態・張り出し先端部、SB102炉体土器出土状態)
 PL 4 縄文遺構 2 (SB105、SB106、SB108)
 PL 5 縄文遺構 3 (SB109完掘・炉体土器出土状態、SB111張り出し部、SB112完掘)
 PL 6 縄文遺構 4 (SB552完掘、SB555完掘・炉周辺部・張り出し部)
 PL 7 縄文遺構 5 (SB562作業風景・炉・埋甕出土状態、SB570完掘・炉)
 PL 8 縄文遺構 6 (SB589、SB591、SB594、SB595完掘)
 PL 9 縄文遺構 7 (SH 1、SH17完掘・土偶出土状態、SH18完掘・石棒出土状態、SH33部分、SQ 2)
 PL10 縄文遺構 8 (SH506配石群、SH510配石群、SH511配石群、SH1111配石群)
 PL11 縄文遺構 9 (SH502～505上面配石、SH503人骨出土状態、SH504人骨出土状態)
 PL12 縄文遺構10 (PL507上面配石・出土人骨、SH512上面配石・出土人骨、SH573上面配石)
 PL13 縄文遺構11 (SH515人骨出土状態、SH542人骨出土状態、SH517上面配石・人骨出土状態、SH518上面配石・人骨出土状態)
 PL14 縄文遺構12 (SH521上面配石・人骨出土状態・出土人骨)
 PL15 縄文遺構13 (SH522上面配石・人骨出土状態、SH538人骨出土状態、SH525配石)
 PL16 縄文遺構14 (SH555上面配石・埋土上位・土器出土状態、SH558上面配石、SB559上面配石)
 PL17 縄文遺構15 (SH573人骨出土状態、SH591、SH529上面配石、SH596上面配石、SH607出土甕被り人骨・出土人骨)
 PL18 縄文遺構16 (SH627完掘・出土人骨、SH638出土人骨、SH659出土人骨、SH672、SH684)
 PL19 縄文遺構17 (SH692完掘・出土人骨、SH693出土人骨、SH711出土人骨、SH717出土人骨・出土人骨B、SH762完掘・出土人骨)
 PL20 縄文遺構18 (SH763完掘・出土人骨、SH784完掘・出土人骨、SH785出土甕被り人骨、出土人骨)
 PL21 縄文遺構19 (SH803完掘・出土人骨、SH805完掘・出土人骨)
 PL22 縄文遺構20 (SH815出土人骨、SH852完掘・出土人骨、SH855完掘・出土人骨、SH857完掘・出土人骨)
 PL23 縄文遺構21 (SH854、SH858完掘・出土人骨、SH859完掘・出土人骨)
 PL24 縄文遺構22 (SH879完掘・出土人骨、SH924完掘・出土人骨、SH979出土人骨)
 PL25 縄文遺構23 (SH958出土人骨、SH973石棺状石組、SH1081土器出土状態、SH1136出土人骨、SH1155完掘・出土人骨、SH1157完掘)
 PL26 縄文遺構24 (SH1156完掘・出土人骨、SH1158出土人骨、SH1160出土人骨、SH1162出土人骨、SH1163出土人骨)
 PL27 縄文遺構25 (SH1165出土甕被り人骨・出土人骨、SH1172出土人骨・頭蓋骨・イノシシ牙製装身具・イノシシ牙製腕輪)
 PL28 縄文遺構26 (SH1176完掘・出土人骨、SH1180出土人骨)
 PL29 縄文遺構27 (SH1181出土人骨、SH1184出土人骨、SH1185出土人骨、SH1189出土甕被り人骨、SH1193出土人骨)
 PL30 縄文遺構28 (SH1199出土人骨、SH1200出土人骨、SH1201出土人骨、SH1202出土人骨、SH1204出土人骨、SH1208出土人骨)
 PL31 縄文遺構29 (SH1215出土甕被り人骨・出土人骨、SH1211出土人骨、SH1228出土人骨、SH1233出土甕被り人骨・出土人骨)
 PL32 弥生・古代遺構 1 (SB511、SB 1、SA 1、SD13)
 PL33 古代遺構 2 (SB 2、SB 3 完掘・カマド・獣骨出土状態、SB 5)

- PL34 古代遺構 3 (SB501完掘・炭化材出土状態、SB503、SB504)
- PL35 古代遺構 4 (ST 3、ST 7、ST 8、ST12)
- PL36 古代遺構 5 (ST15、ST16、ST17、ST18、ST28、ST29)
- PL37 古代遺構 6 (ST506、ST508、ST510)
- PL38 古代遺構 7 (SA502、SD10、SD 4、SD25、SD502、SD507)
- PL39 古代遺構 8 (SK1209馬骨出土状態・出土馬骨、SK1195、SX501)
- PL40 近世遺構 (ST 1 完掘・P₃断面・P₄断面、地藏菩薩立像、石地藏)
- PL41 炭化材顕微鏡写真 (カヤ=SH1206、クリ=SB102・SB555・SB558・SB566・SB594、ケヤキ=SH1111配石群、カエデ属=SK3496)
- PL42 縄文土器 1 (SB101、SB102、SB555、SB557、SB558、SB559)
- PL43 縄文土器 2 (SB560、SB566)
- PL44 縄文土器 3 (SB562、SB572、SB583、SB591、SB592、SB599)
- PL45 縄文土器 4 (SB580、SB583、SH17、SH508、SH555)
- PL46 縄文土器 5 (SH607、SH644、SH648、SH658、SH686、SH693、SH802、SH952)
- PL47 縄文土器 6 (SH784、SH794、SH979、SH1048)
- PL48 縄文土器 7 (SH1081、SH1082、SH1204、SH1215、SH1217、SH1229、SH1232、SK2541)
- PL49 縄文土器 8 (SK2018、SK2232、SK2813、SK3071、SK3142、SK3266、SQ501、遺構外)
- PL50 縄文土器 9 (SQ 1)
- PL51 縄文土器10 (SQ 1)
- PL52 縄文土器11 (SQ 2、遺構外)
- PL53 縄文土器12 (遺構外)
- PL54 縄文土器13 (遺構外)
- PL55 縄文石器 1 (石核、両極剥片、剥片・碎片、石鏃 1)
- PL56 縄文石器 2 (石鏃 2)
- PL57 縄文石器 3 (打製石斧 1)
- PL58 縄文石器 4 (打製石斧 2)
- PL59 縄文石器 5 (打製石斧 3)
- PL60 縄文石器 6 (磨石・凹石)
- PL61 縄文石器 7 (凹石、敲石)
- PL62 縄文石器 8 (多孔石、石皿)
- PL63 縄文石器 9 (石皿、砥石)
- PL64 縄文石器10 (刃器)
- PL65 縄文石器11 (磨製石斧 1)
- PL66 縄文石器12 (磨製石斧 2)
- PL67 縄文石器13 (石錐、石錘、土錘)
- PL68 縄文石器14 (石棒、石剣 1)
- PL69 縄文石器15 (石棒、石剣 2、丸石)
- PL70 縄文石器16 使用痕写真 (石錐、刃器)
- PL71 縄文石器17 使用痕写真 (刃器)
- PL72 縄文石器18 使用痕写真 (打製石斧)
- PL73 縄文石器19 使用痕写真 (磨製石斧)
- PL74 縄文石器20 使用・加工痕写真 (磨石、丸石、凹石、多孔石、敲石)
- PL75 縄文石器21 使用・加工痕写真 (石皿、砥石、石剣)
- PL76 縄文土製品 1 (土器片円板)
- PL77 縄文土製品 2 (土偶 1)
- PL78 縄文土製品 3 (土偶 2)
- PL79 縄文土製品 4 (土偶 3)
- PL80 縄文土製品 5 (土偶 4)
- PL81 縄文土製品 6 (土偶 5)
- PL82 縄文土製品 7 (土偶 6)
- PL83 縄文土製品 8 (小形土器 1)
- PL84 縄文土製品 9 (小形土器 2、土製匙、土製蓋)
- PL85 縄文土製品10・石製品・その他 (耳飾り、石製玉、ヒスイ原石、研磨礫、有孔礫、有孔土器片)
- PL86 古代土器 1 (SB 3、SB 4、SB 5、SB 6、SB 9、SB13、SB501)
- PL87 古代土器 2 (SB501、SB502、SB504、ST14、SK 1、SK 2、SD13)
- PL88 古代土器 3 (SD 9、SD10、SD11、SD13、SK58)

実測図版

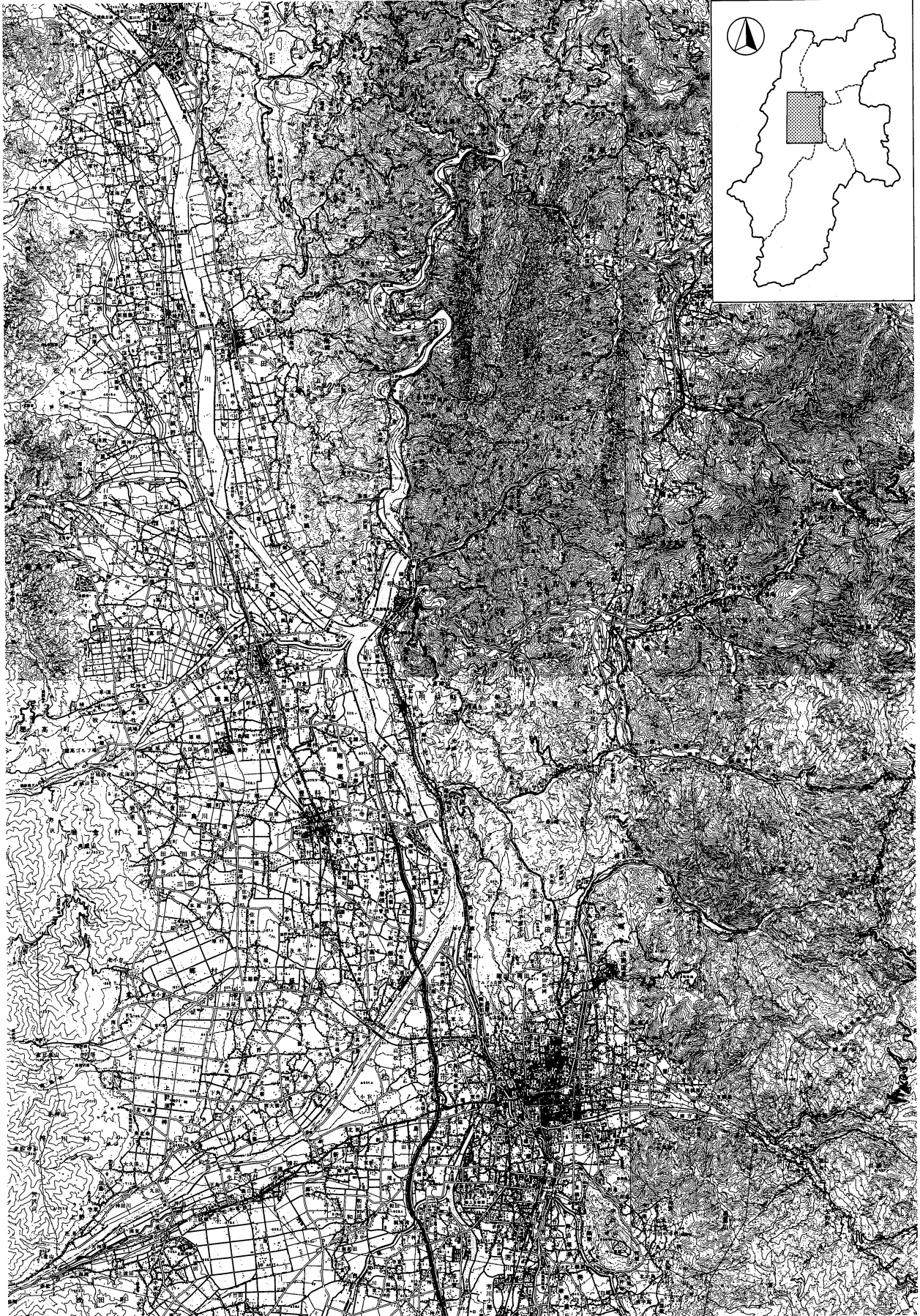

★ 北村遺跡

国土地理院発行5万分の1地形図「信濃池田・松本・坂城・和田」より作成

図版 2 遺跡の位置 2、遺跡の範囲(1:10,000)



—は遺跡範囲 調査範囲
 明科町、豊科町都市計画図より作成

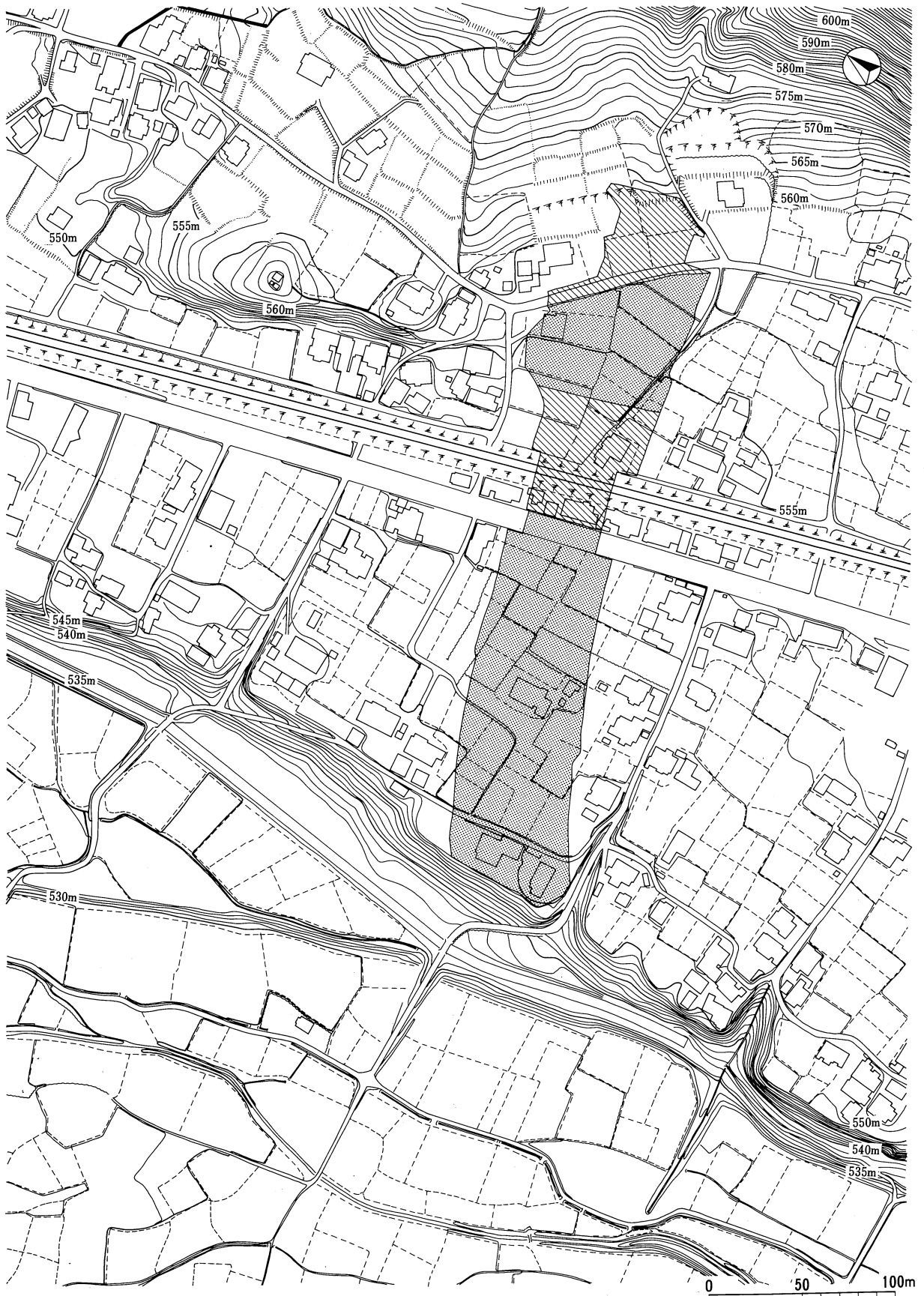

面的調査部分

トレンチ調査または調査除外部分

図版4 縄文調査区割り付け図 (1:1,000)

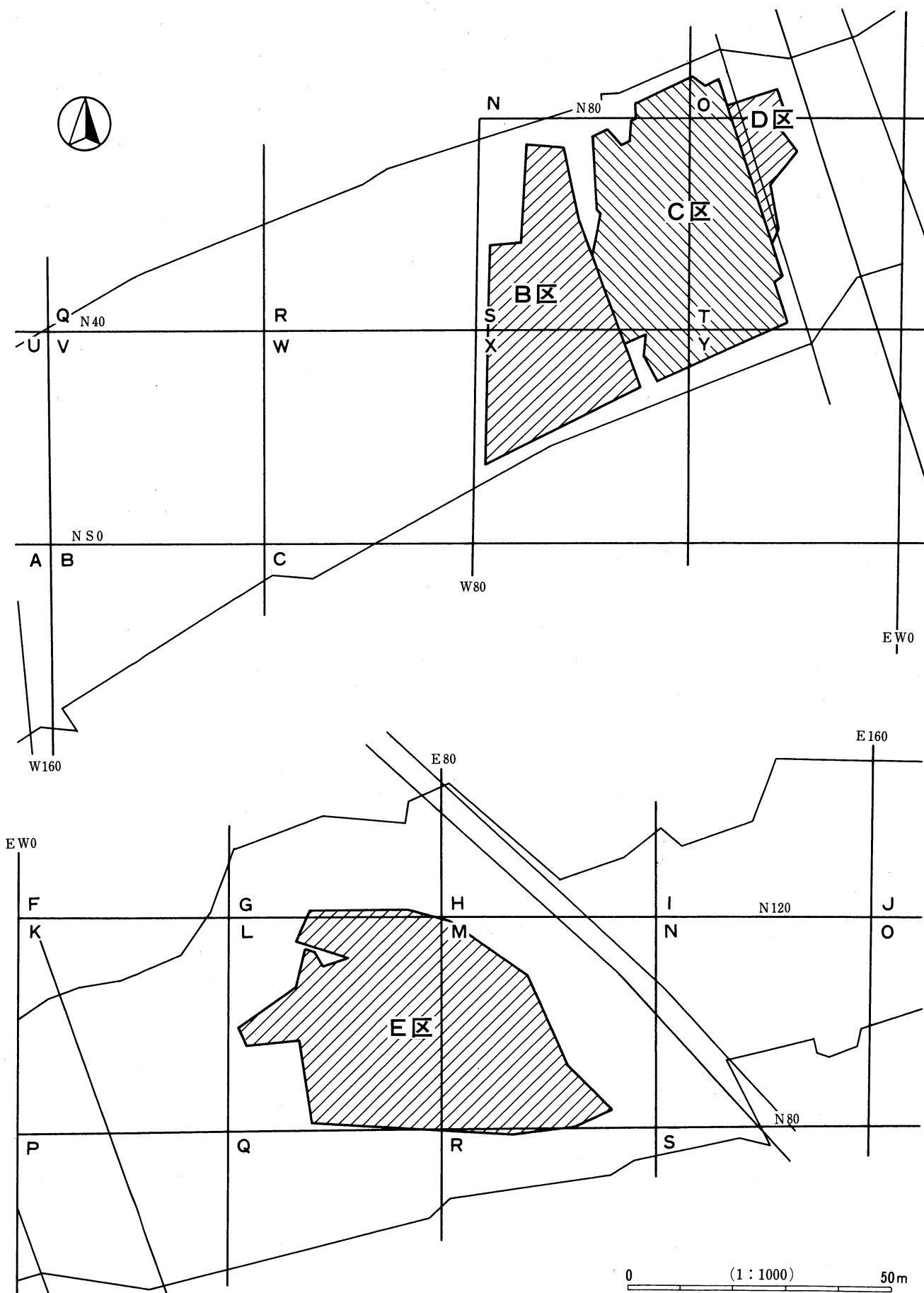

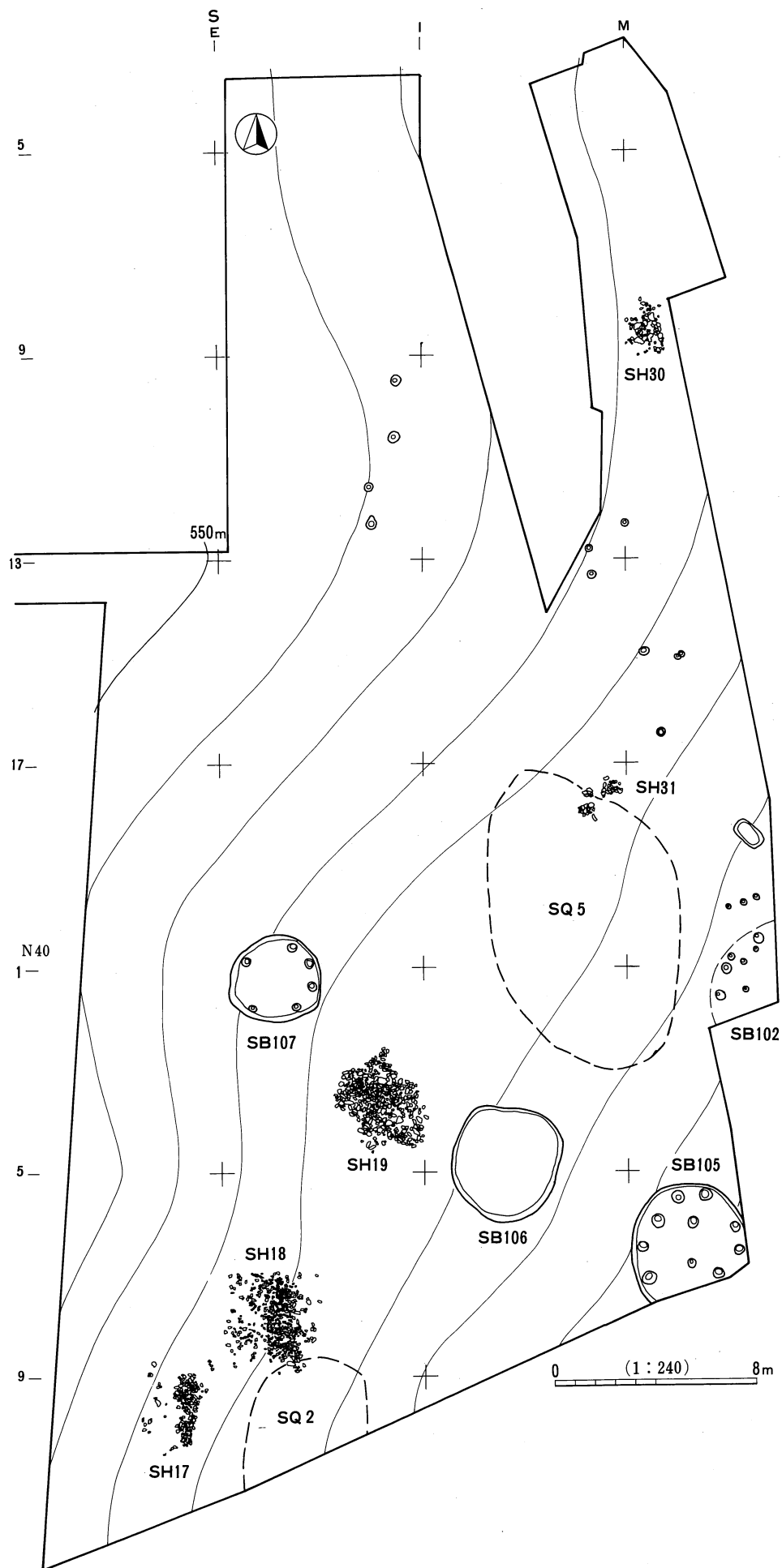

図版 6 縄文遺構全体図 2 (C・D区) (1:240)

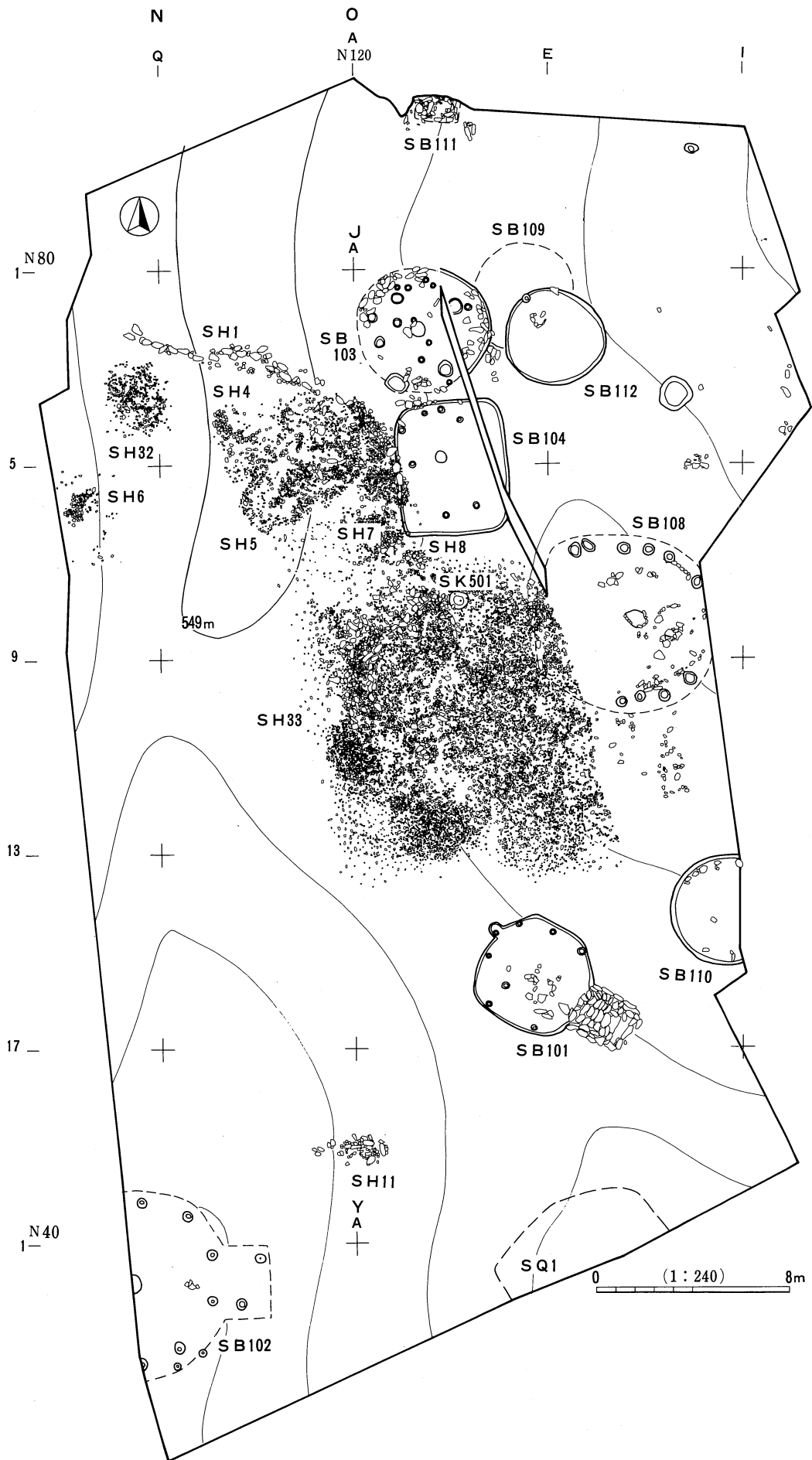

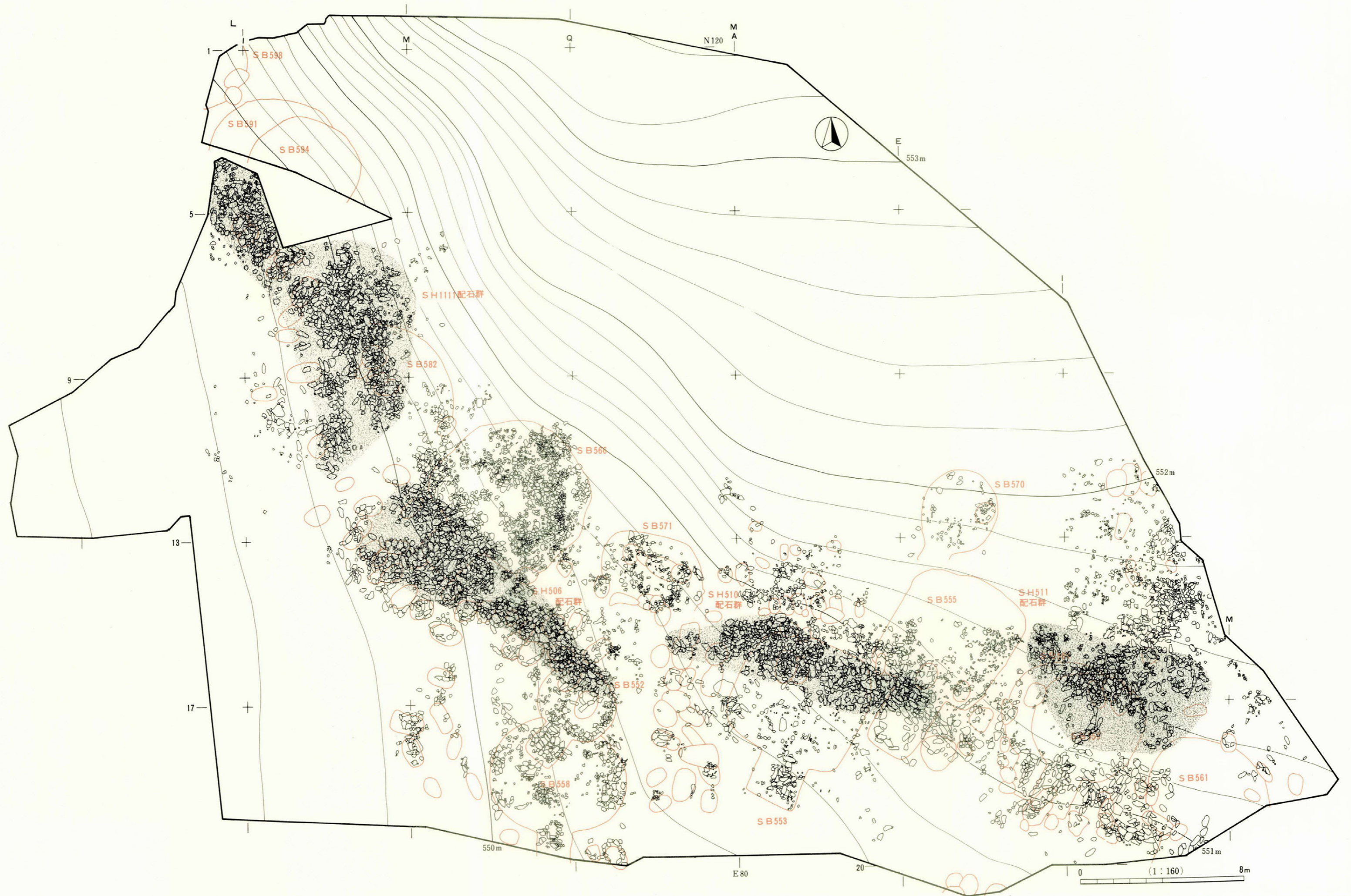

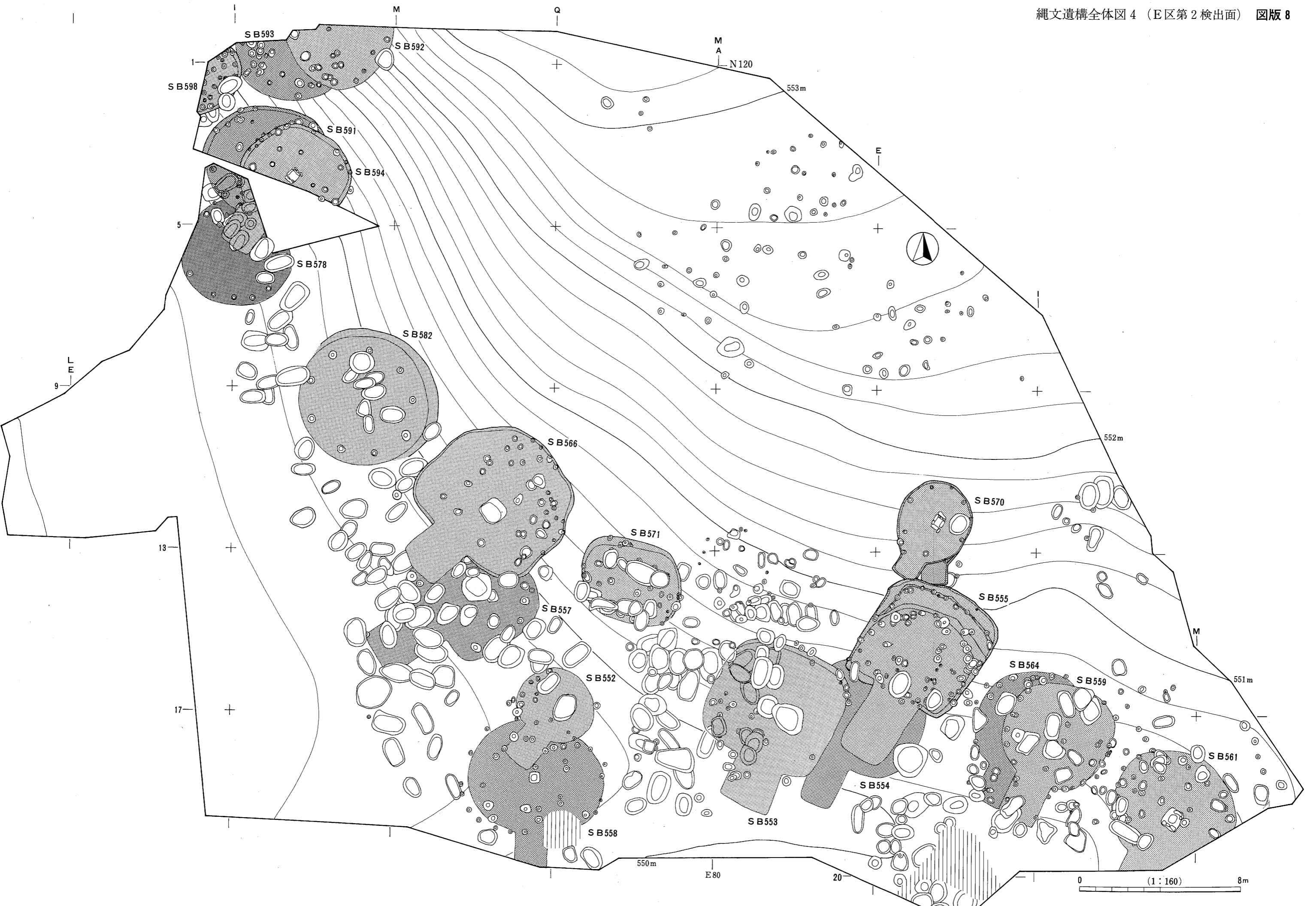

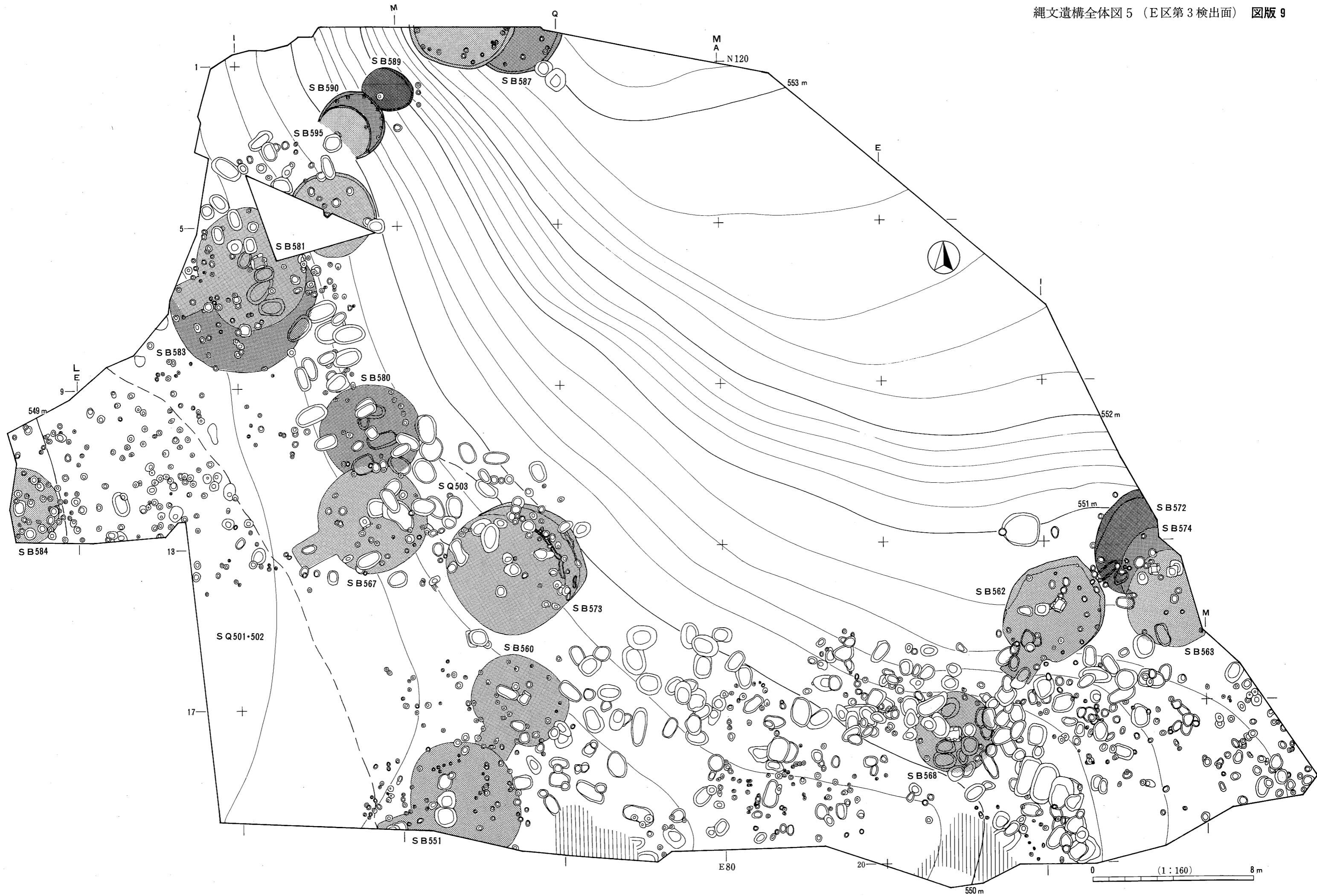

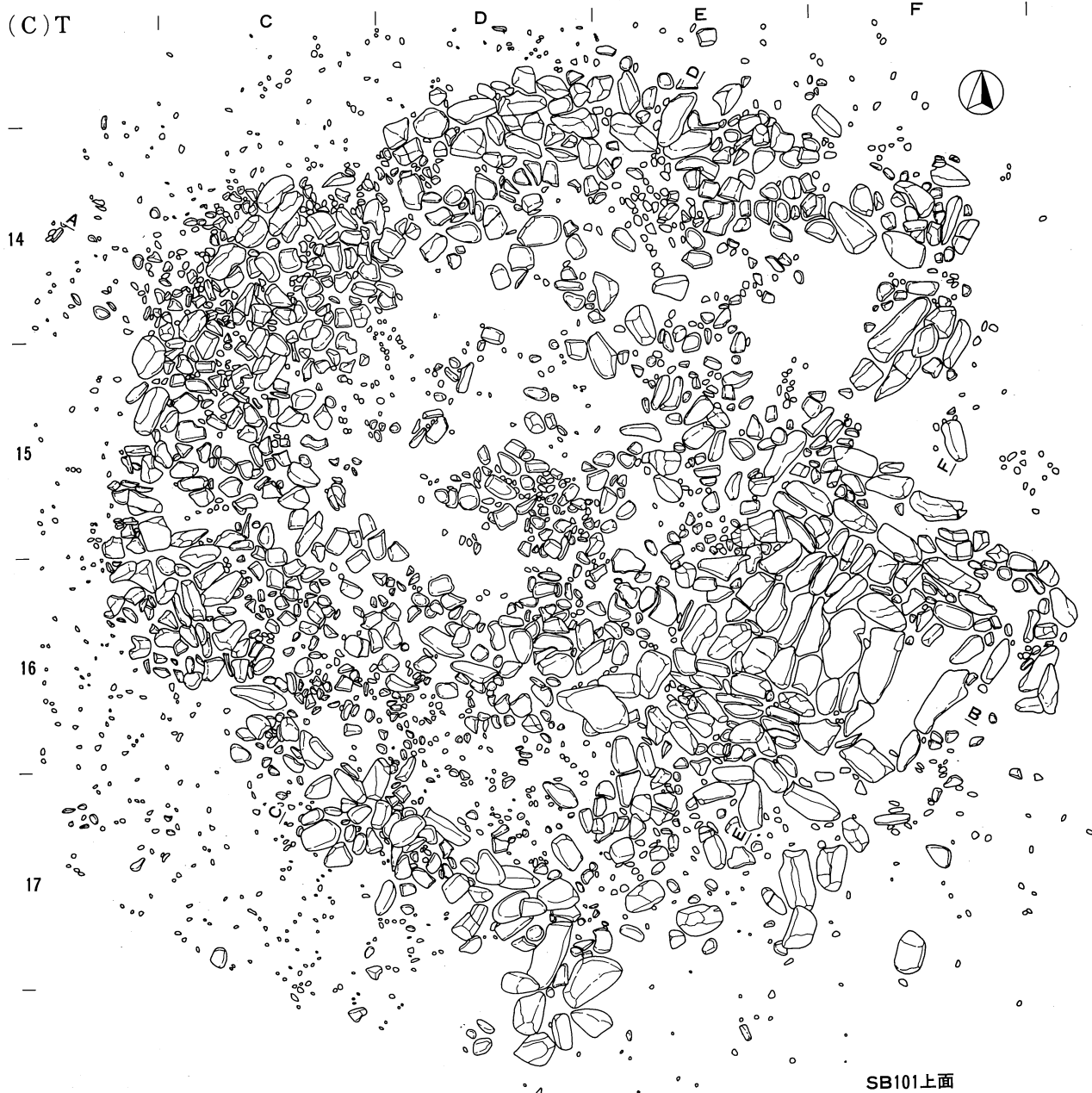

A 550.0m



C 550.0m

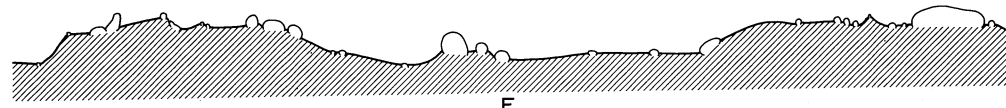

E 550.0m



0 (1:60) 2m

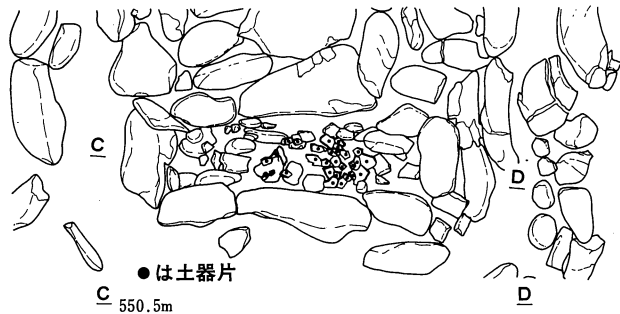
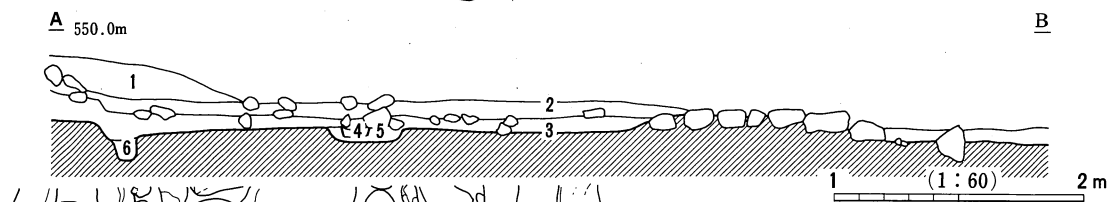
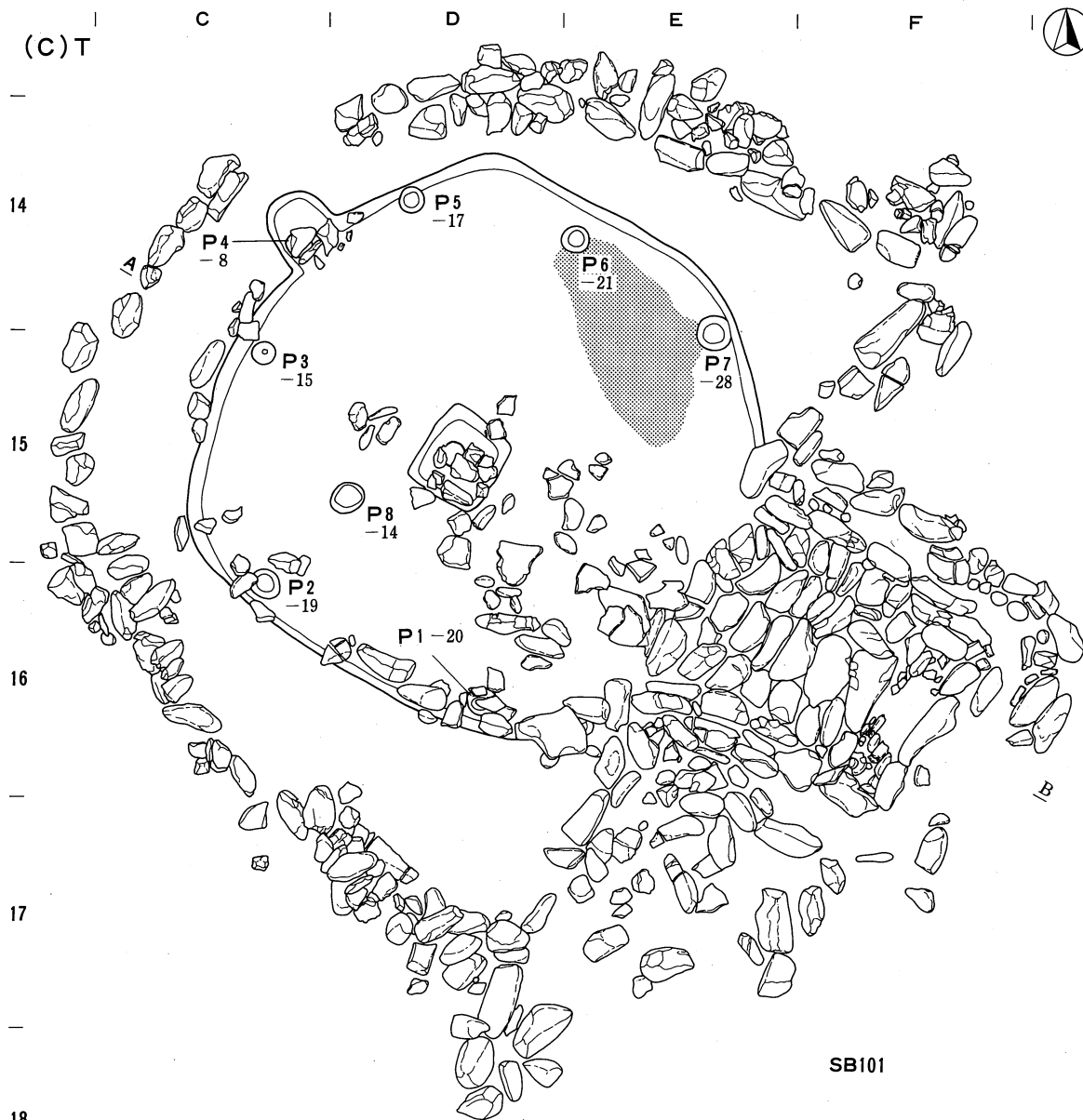

SB101 張り出し部

- 土層
- 1: IID4 黄褐色粘質土を基調とし、礫・炭化粒・土器片が多量に混在している。
 - 2: 暗オリーブ褐色土で細砂～礫を含む。礫・土器片が混在する。
 - 3: 黒褐色土。細砂～礫を多量に含む。炭化物・焼土・焼骨片が上位に混在する。特に焼土は、一部分的に集中して広がる箇所がある。
 - 4: 焼土化した黒褐色土
 - 5: 礫を多量に含む黒褐色土。焼土粒が混在する。炉掘り方
 - 6: 柱穴掘り方。暗オリーブ褐色土

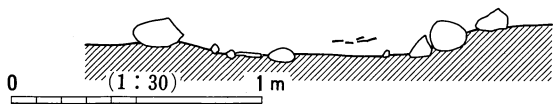



図版13 縄文遺構図4 (SB103・104)

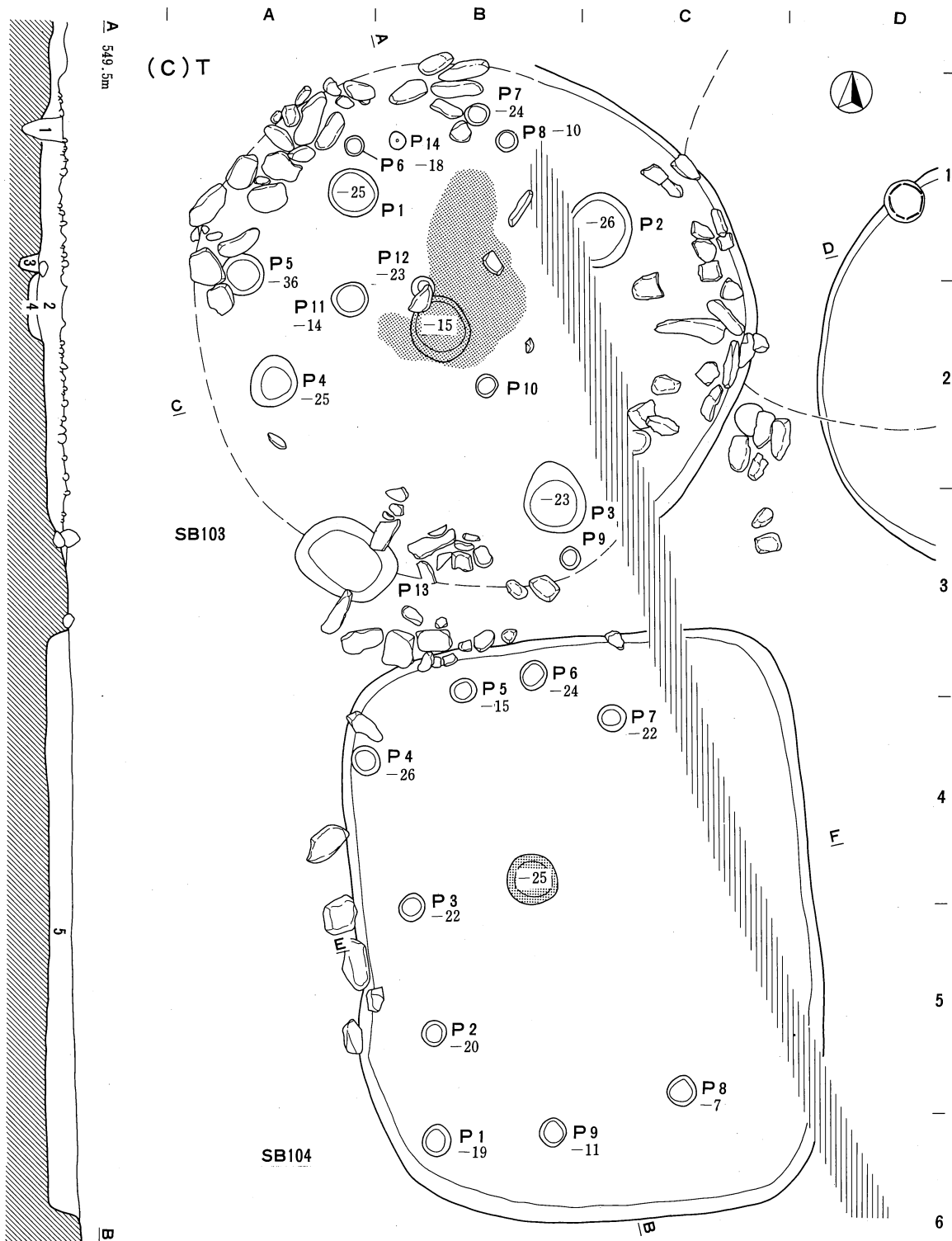

土層

- 1: 含礫黃褐色粘質土
- 2: 黑褐色粘質土・炭化物・礫混在
- 3: 褐色粘土炭化粒・燒土粒混在
- 4: 燒土・炭化物混在
- 5: 黑褐色粘質土・炭化物混在

0 (1:60) 2m

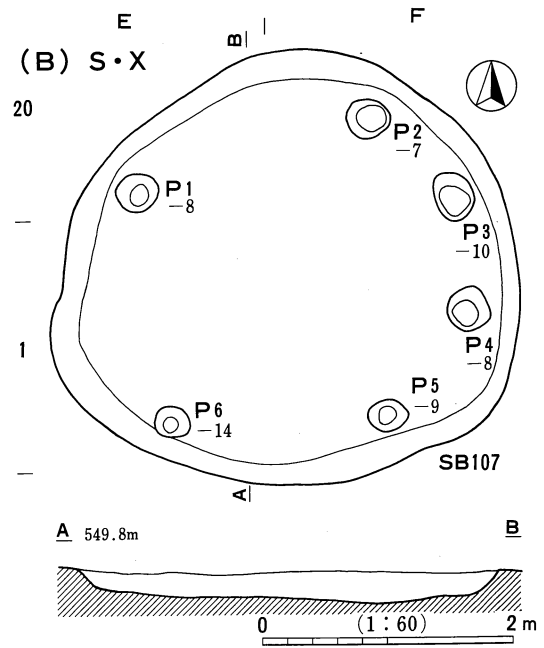
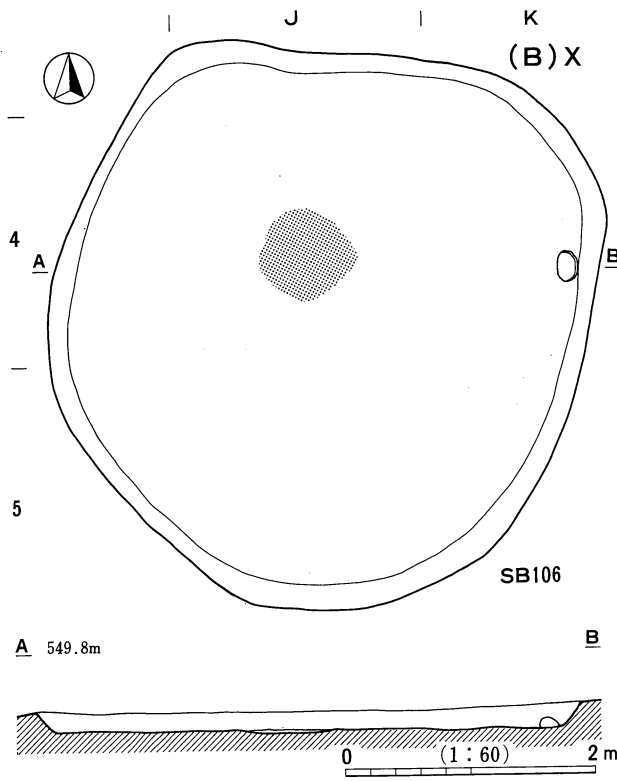

土層 SB106：黒褐色粘質土・炭化物混在
 SB107：暗褐色粗粒砂質土・炭化物混在

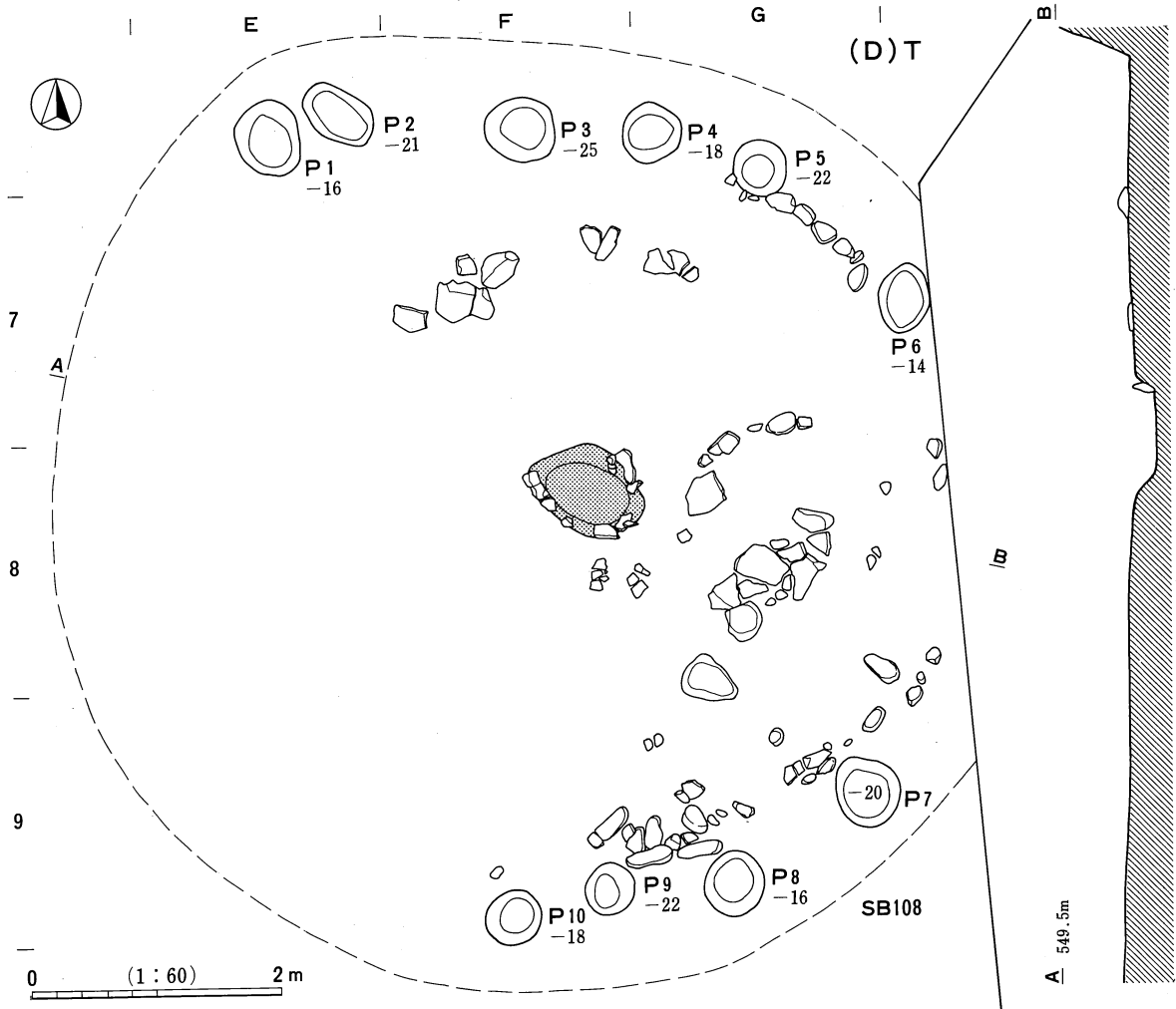

図版15 縄文遺構図6 (S B105・109~112)

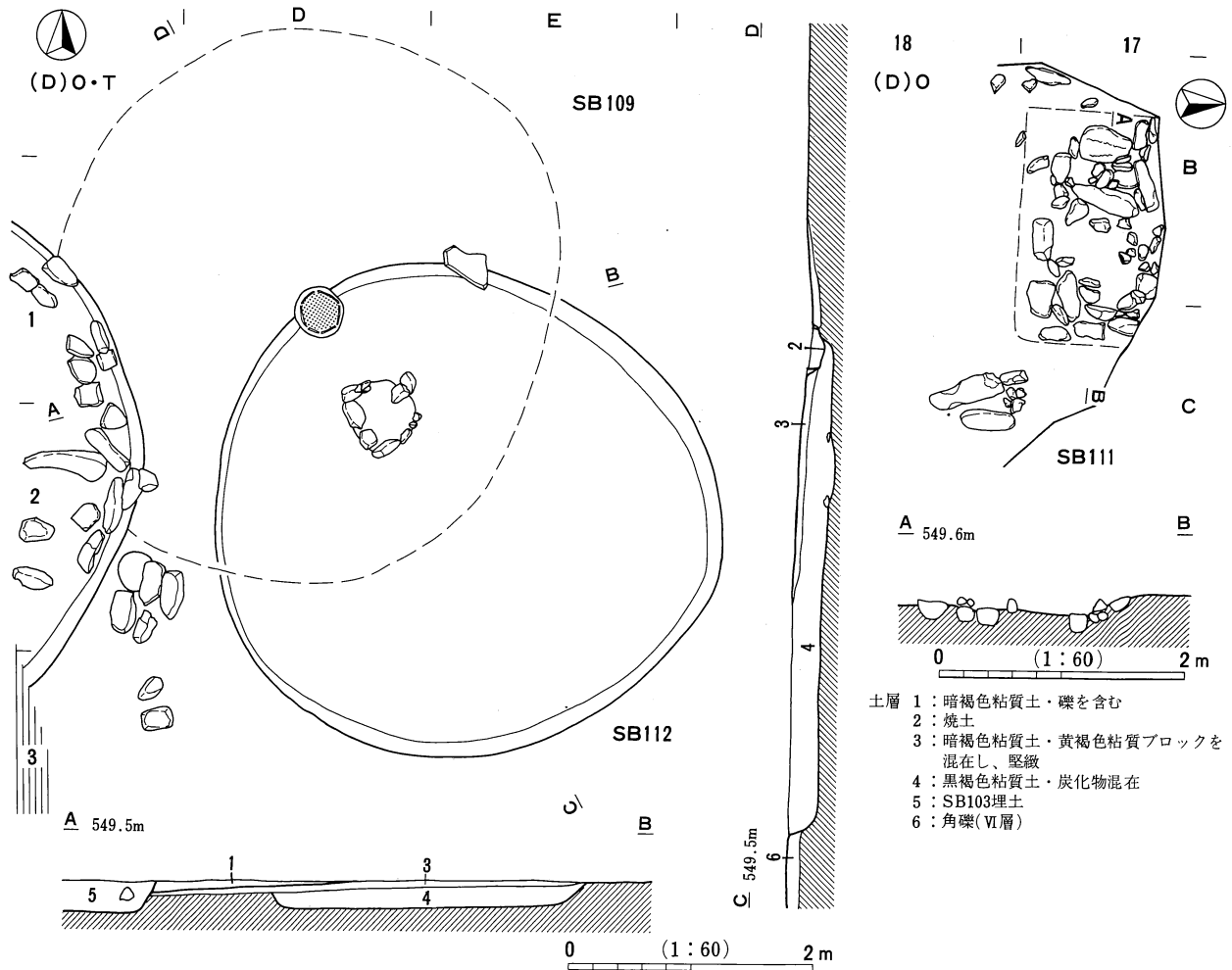
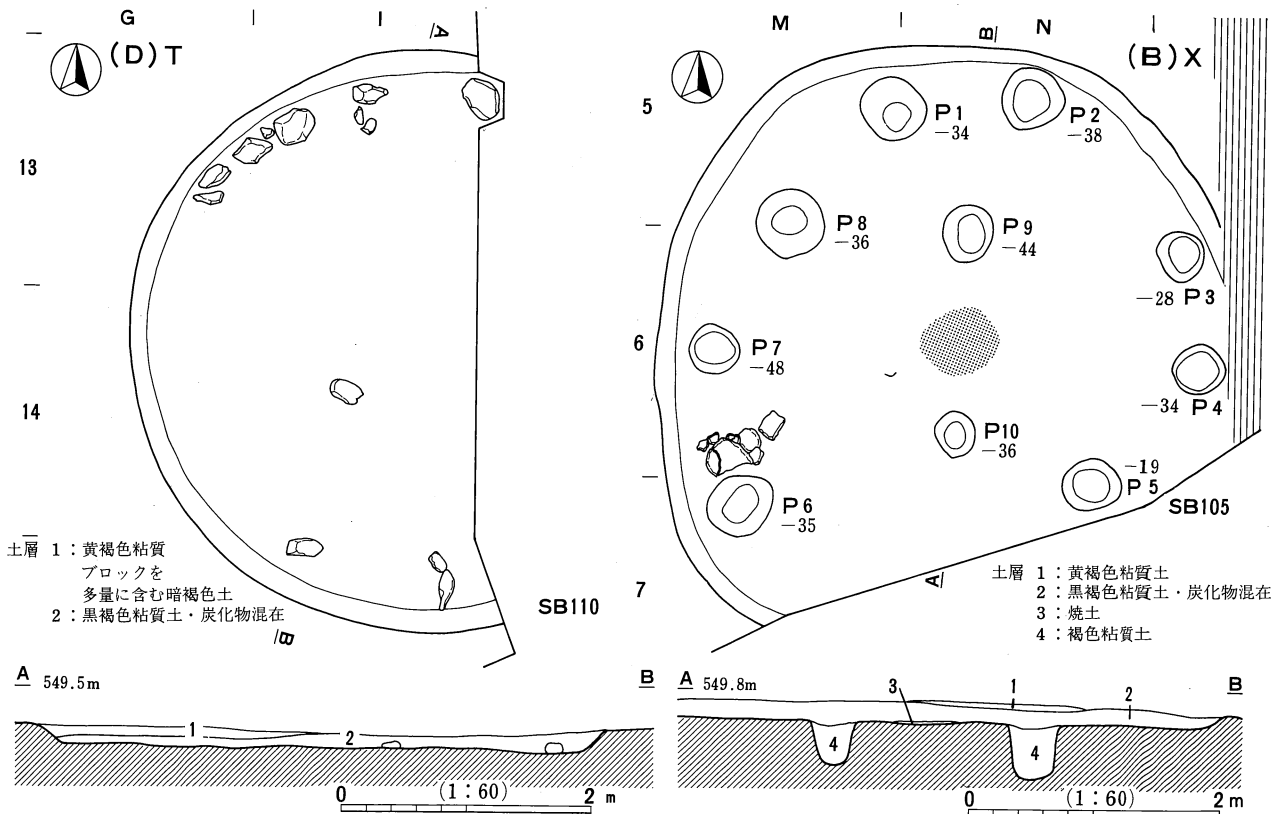

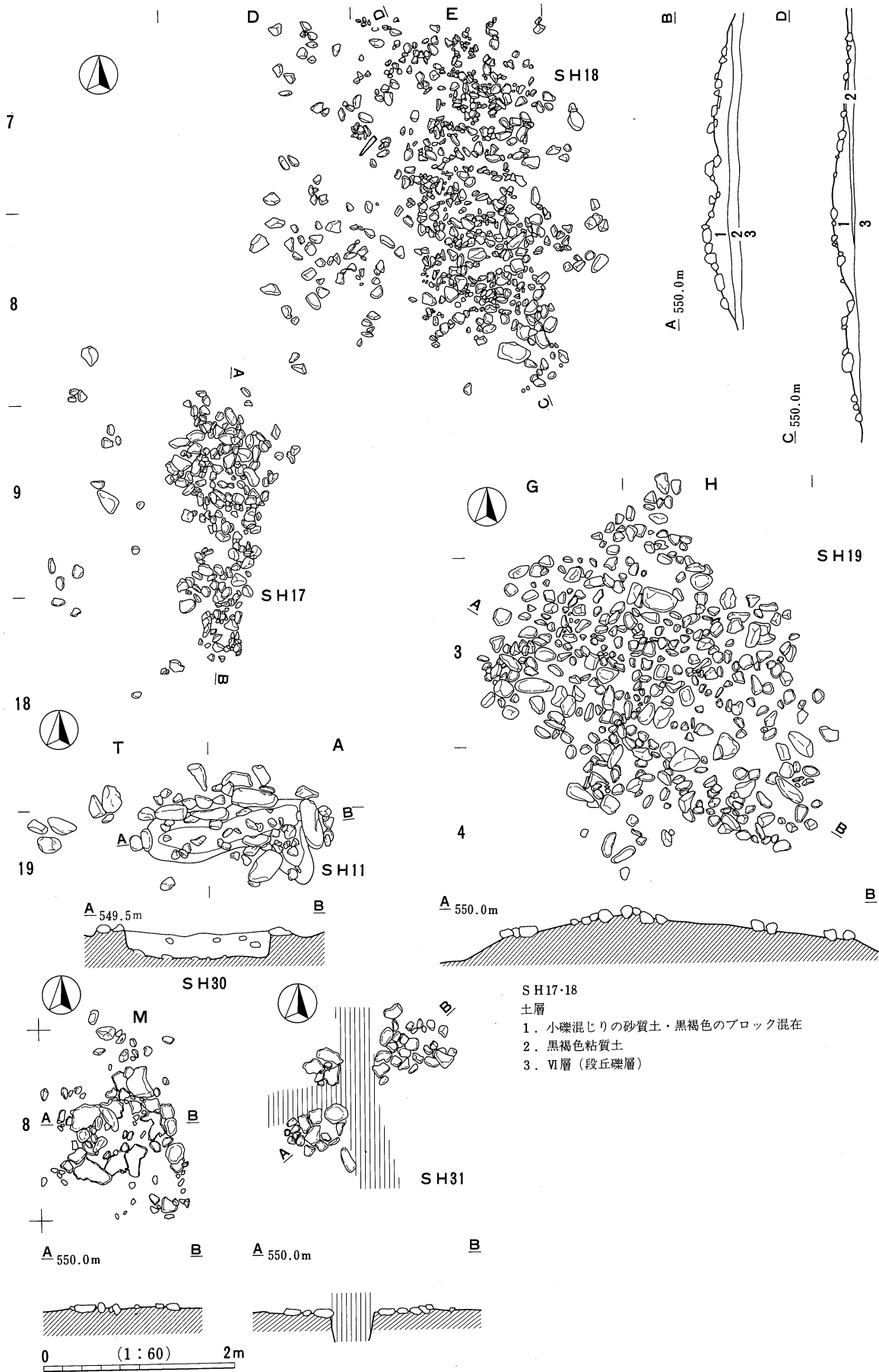

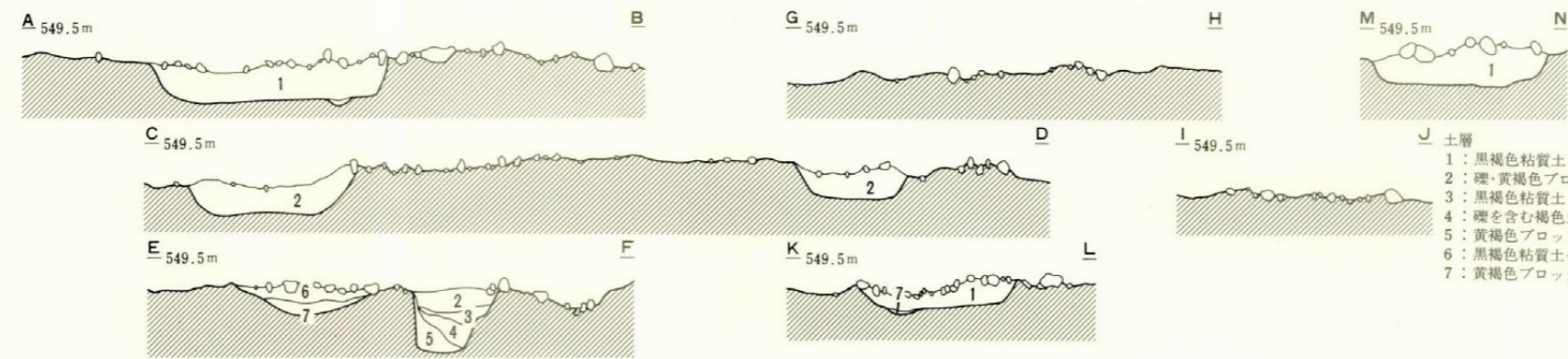
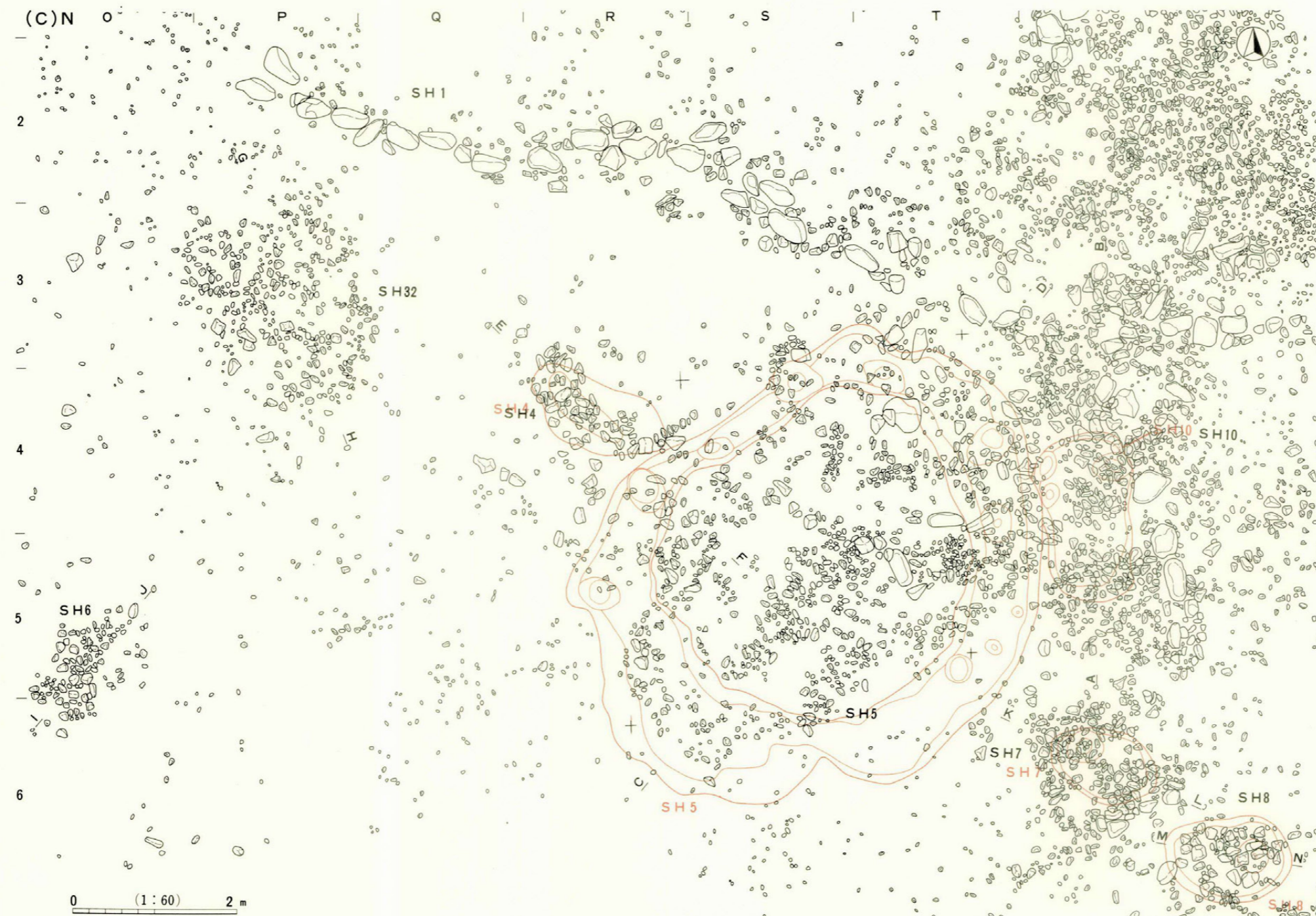

- 土層
- 1: 黒褐色粘質土・炭化物混在
 - 2: 礫・黄褐色ブロックを含む黒褐色粘質土
 - 3: 黒褐色粘質土
 - 4: 礫を含む褐色土
 - 5: 黄褐色ブロックを多量に含む黒褐色粘質土
 - 6: 黒褐色粘質土・炭化物多量に混在
 - 7: 黄褐色ブロックを含む黒褐色粘質土

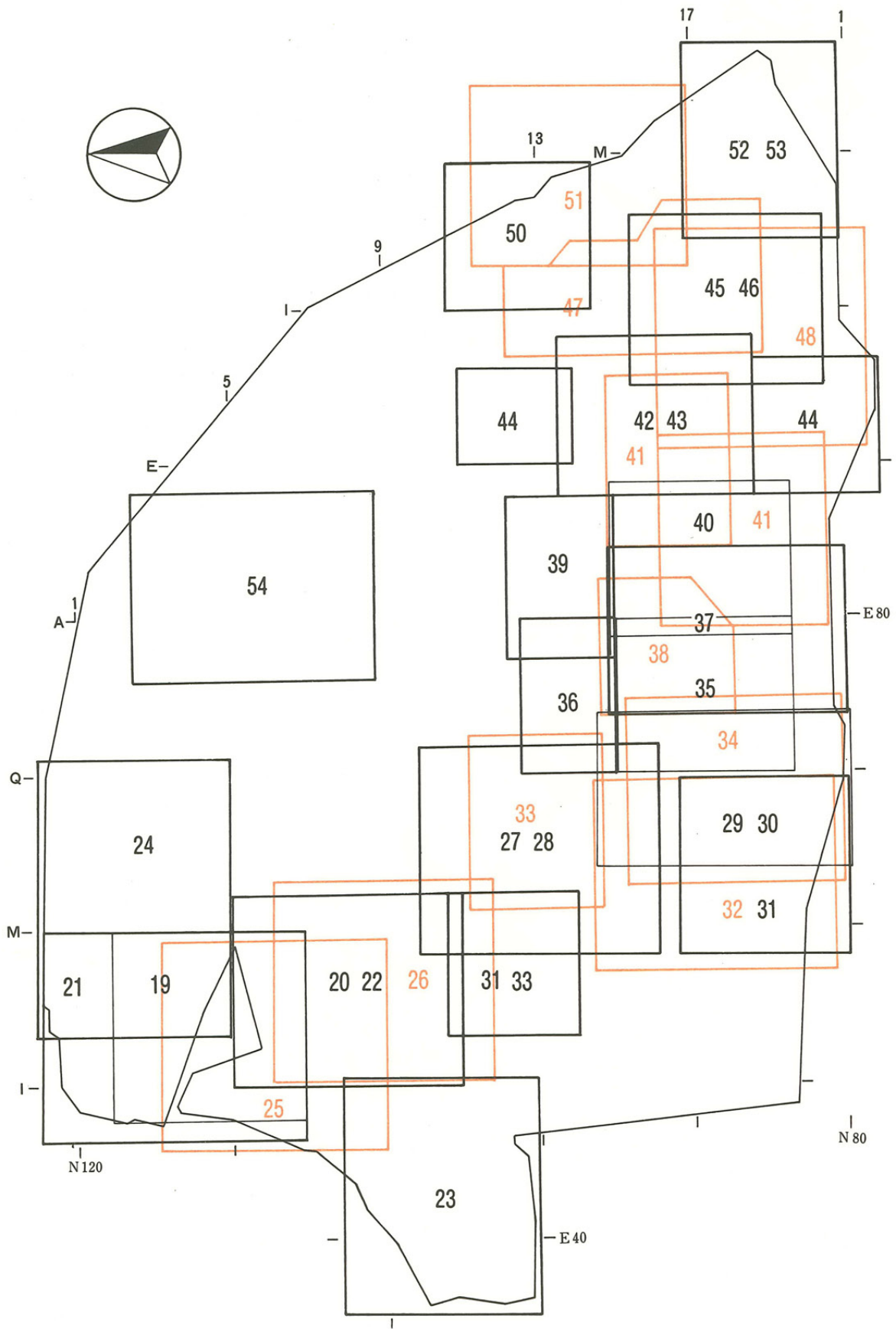

図版19 縄文遺構図9 (S B577・591・594, S H1129ほか) (1:60)

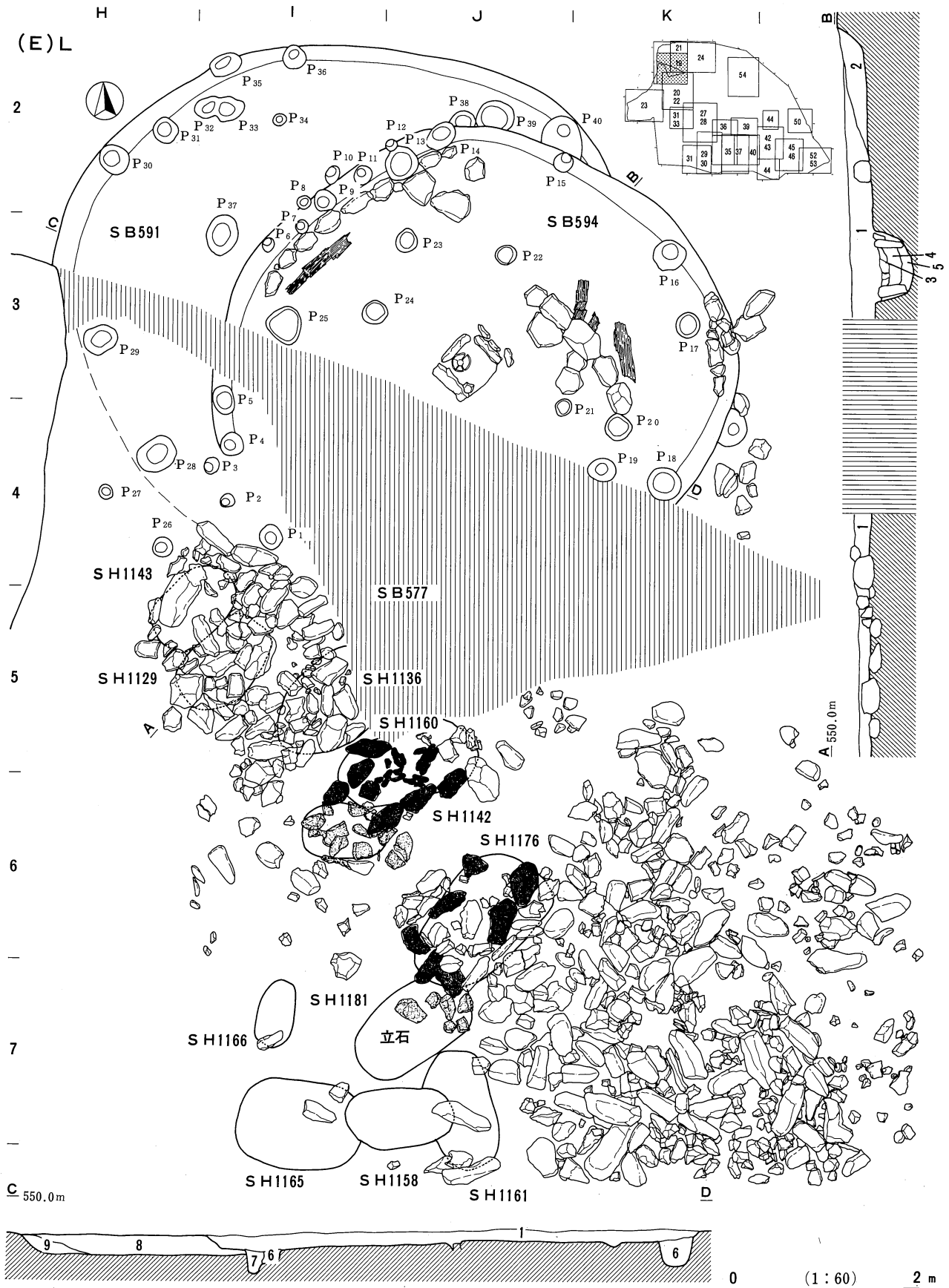

- 土層1: 黒褐色粘質土、礫が混在
- 2: 暗褐色土、炭化物混在
- 3: 暗褐色土、焼土・炭化物混在
- 4: 焼土
- 5: 焼土を多量に含む褐色粘質土
- 6: 褐色土
- 7: 炭化物を含む褐色土
- 8: オリーブ褐色砂質ブロックを含む黒褐色土
- 9: 褐色の砂質土

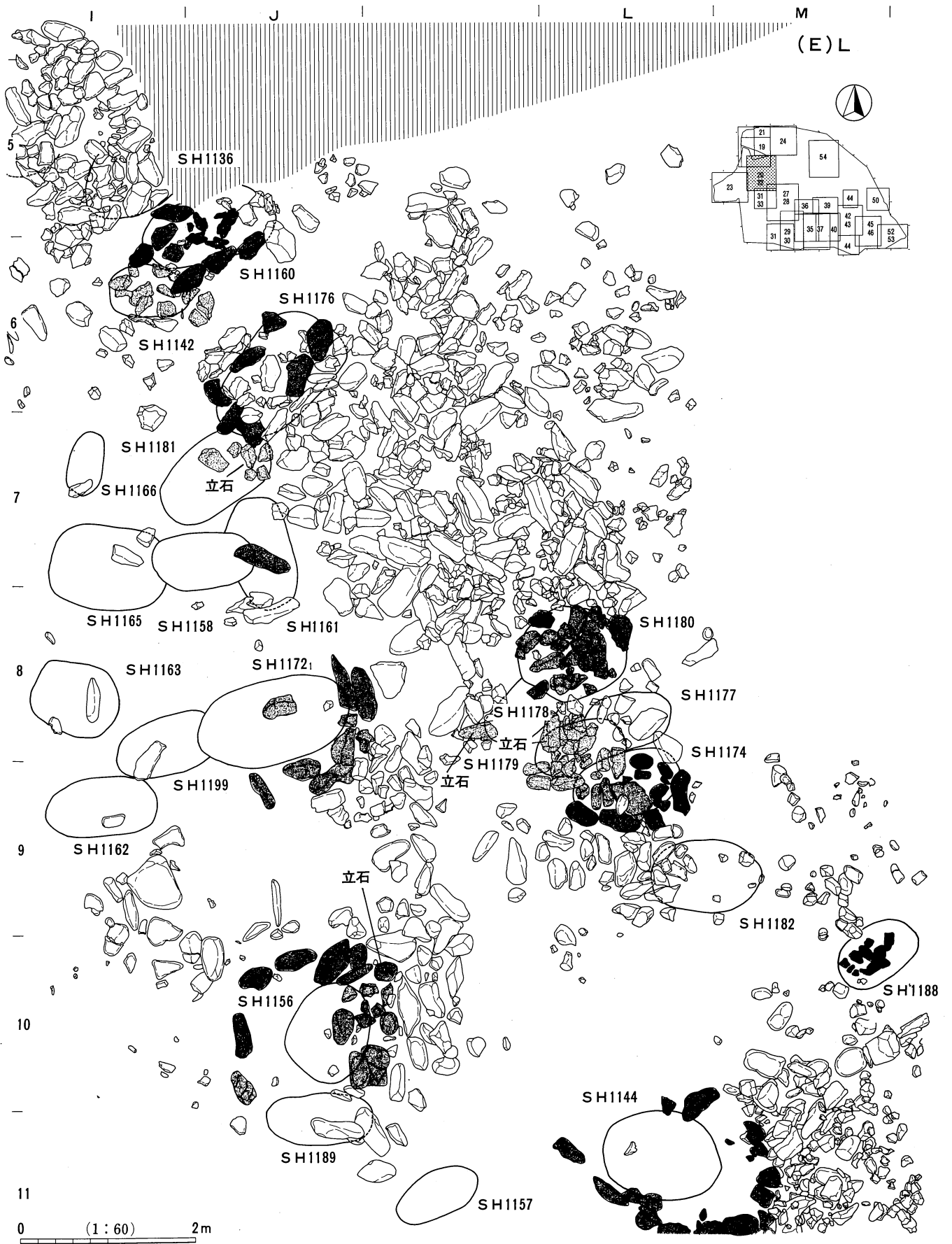

図版21 縄文遺構図11 (S B578・592・593・598, S H1129ほか, S K3219ほか)

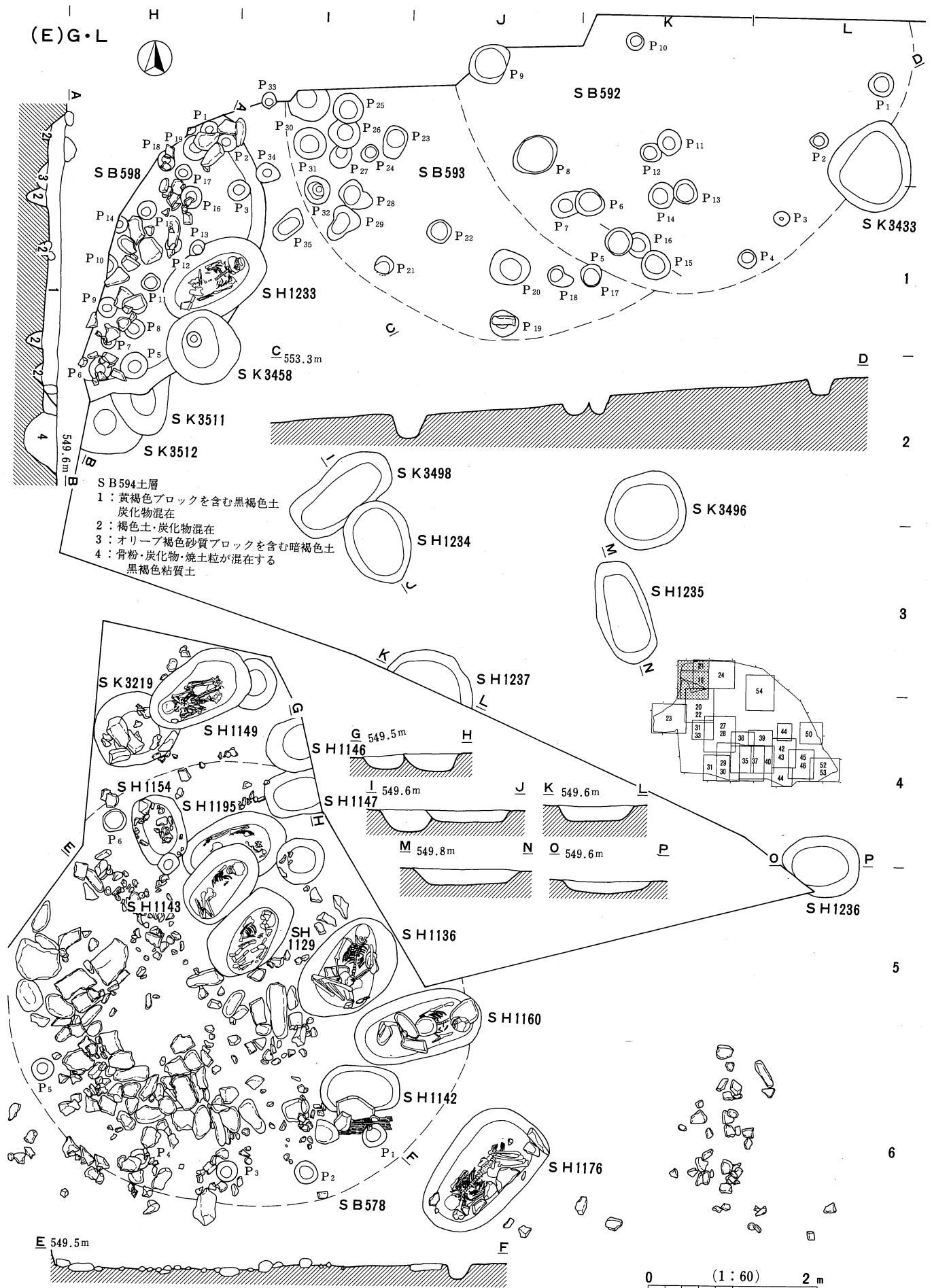

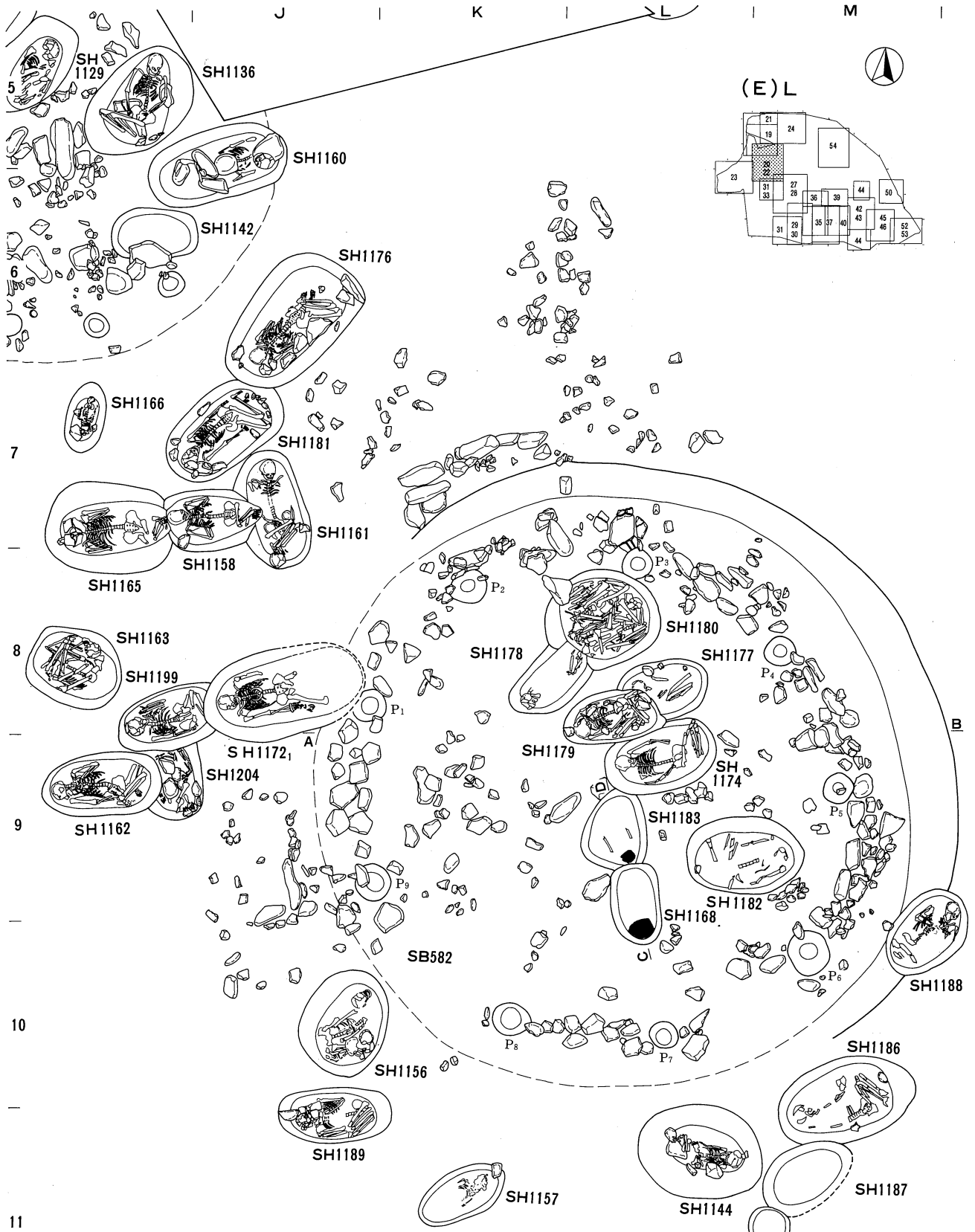

土層 1: 黒褐色粘質土、多量の礫を含む。
 2: 黒褐色土、炭化物・骨粉・礫が混在
 3: SH1179埋土
 4: SH1177埋土

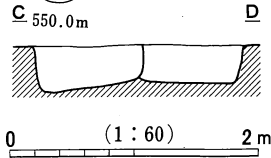
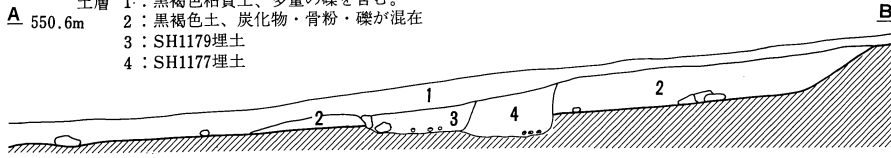

0 (1:60) 2m

図版23 縄文遺構図13 (S B584, S H1155, S K2502)



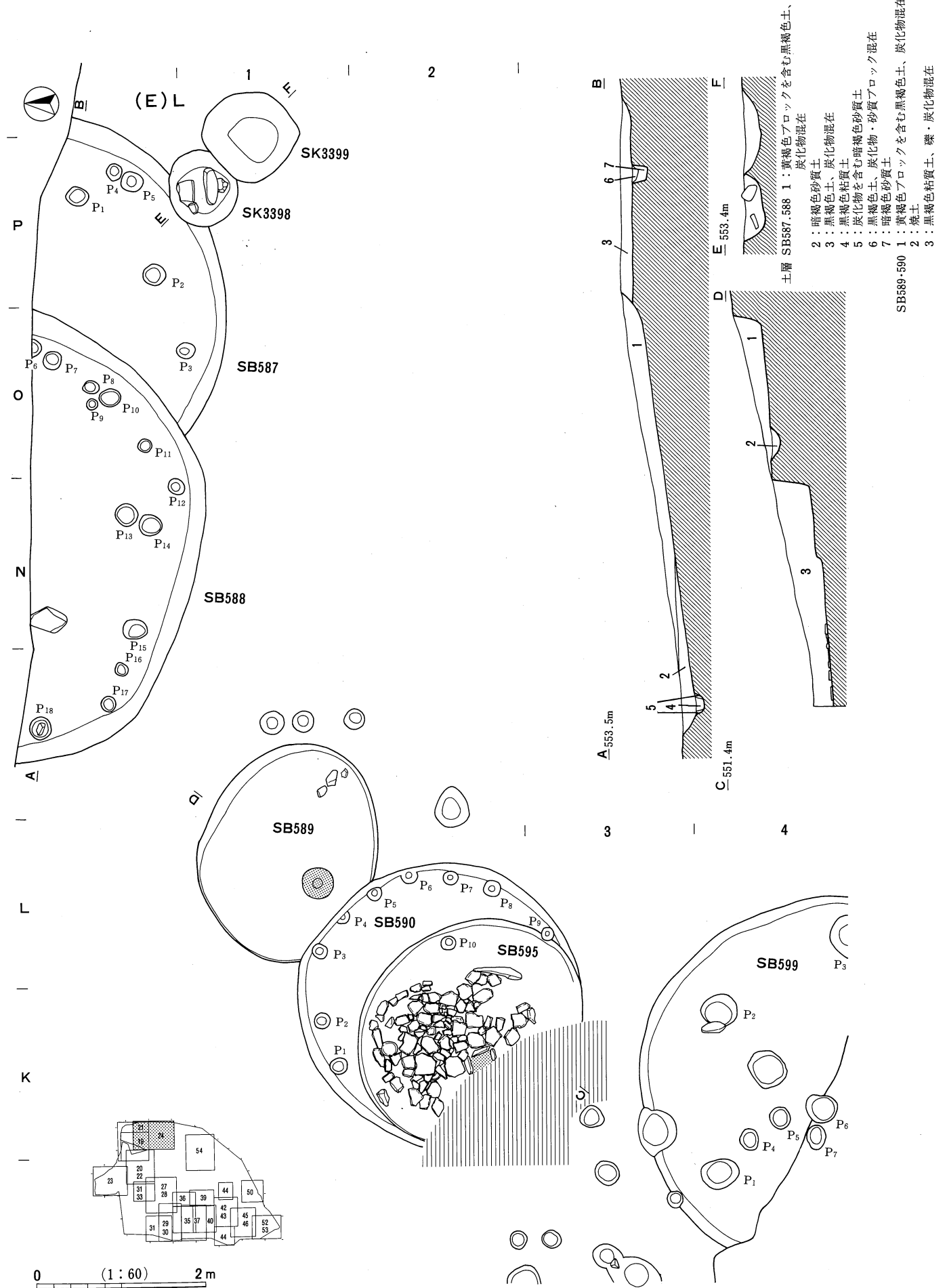

図版25 縄文遺構図15 (S B 581・583・599, S H 1159ほか)

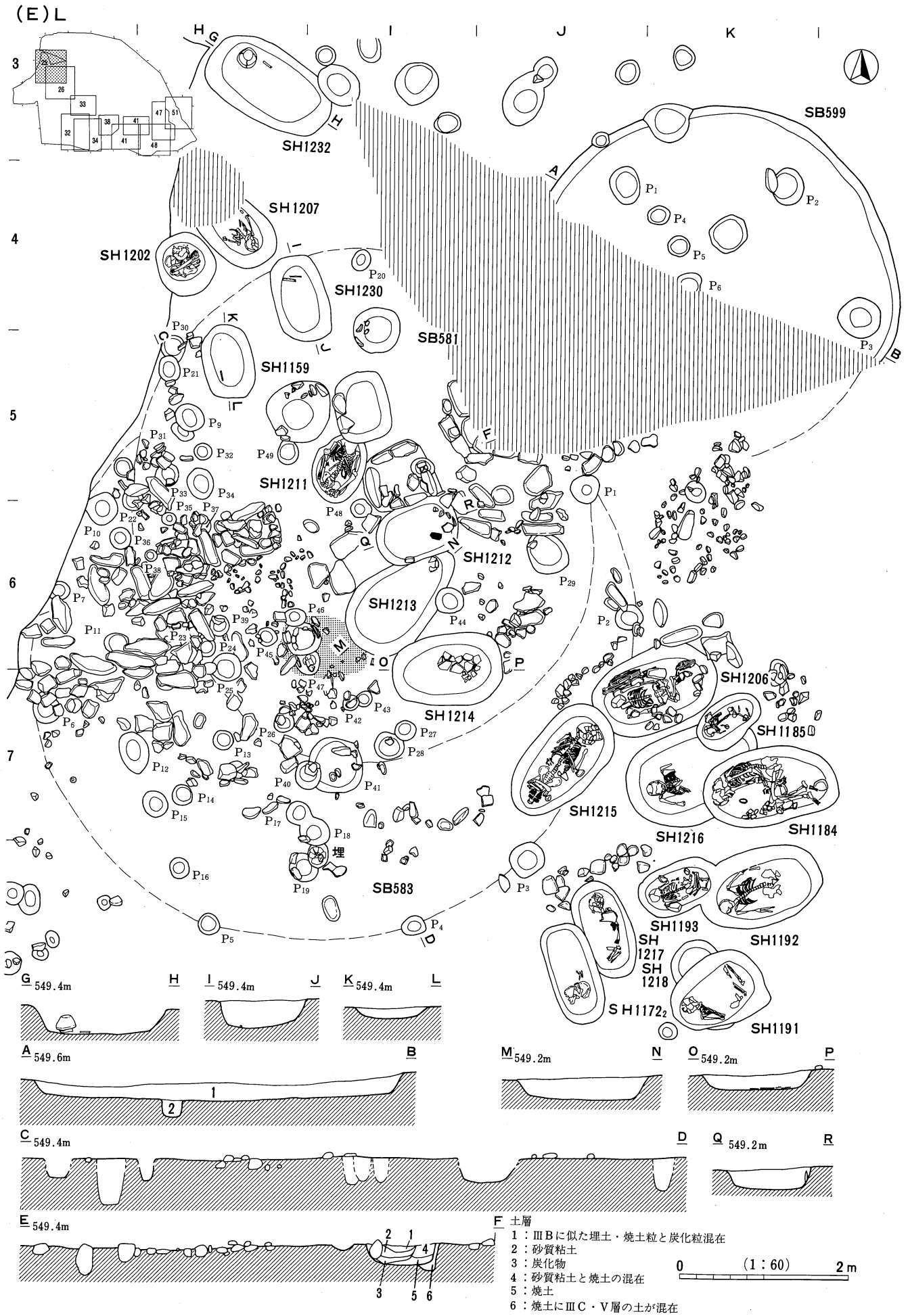

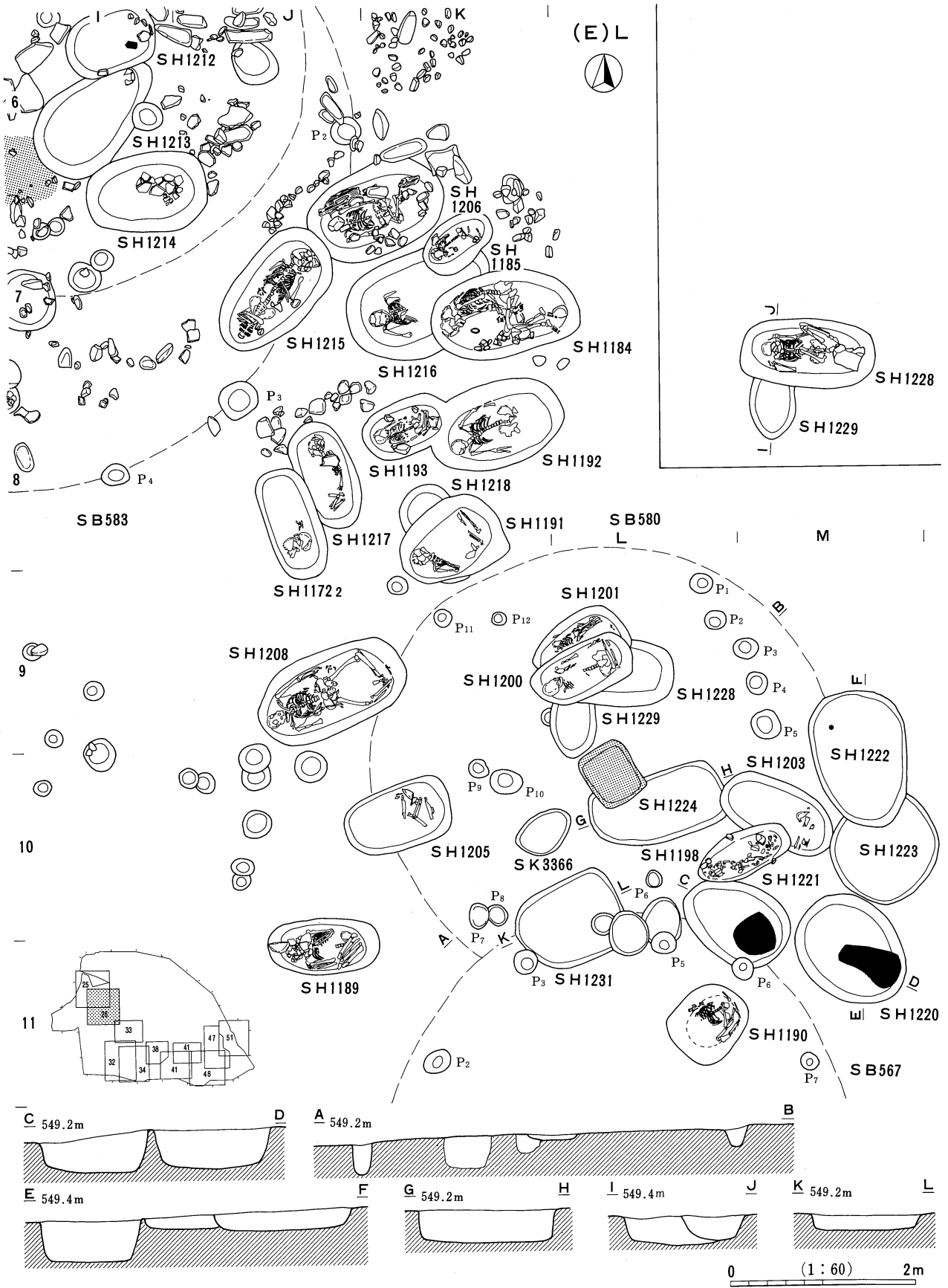

図版27 縄文遺構図17 (S B566, S H501ほか)

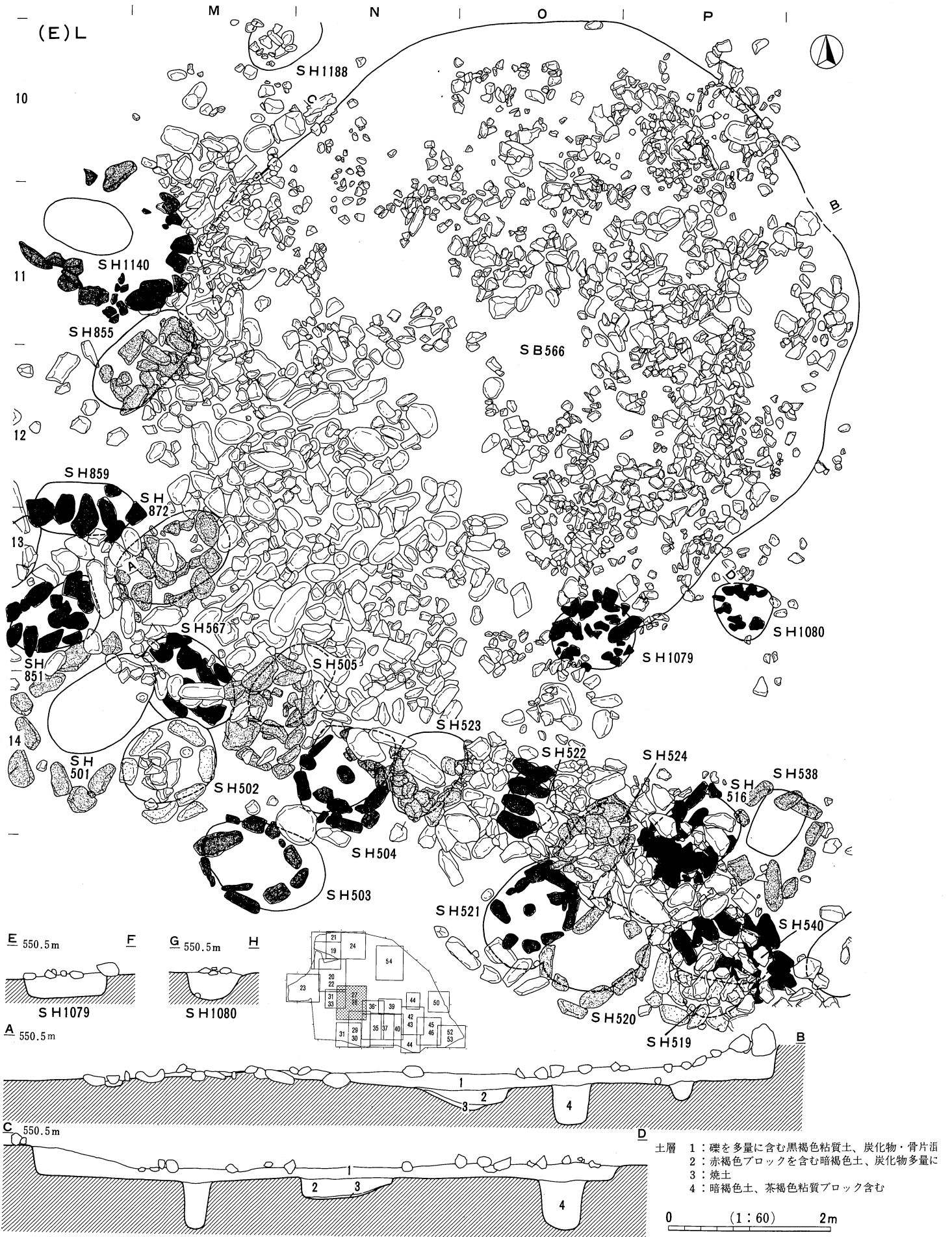

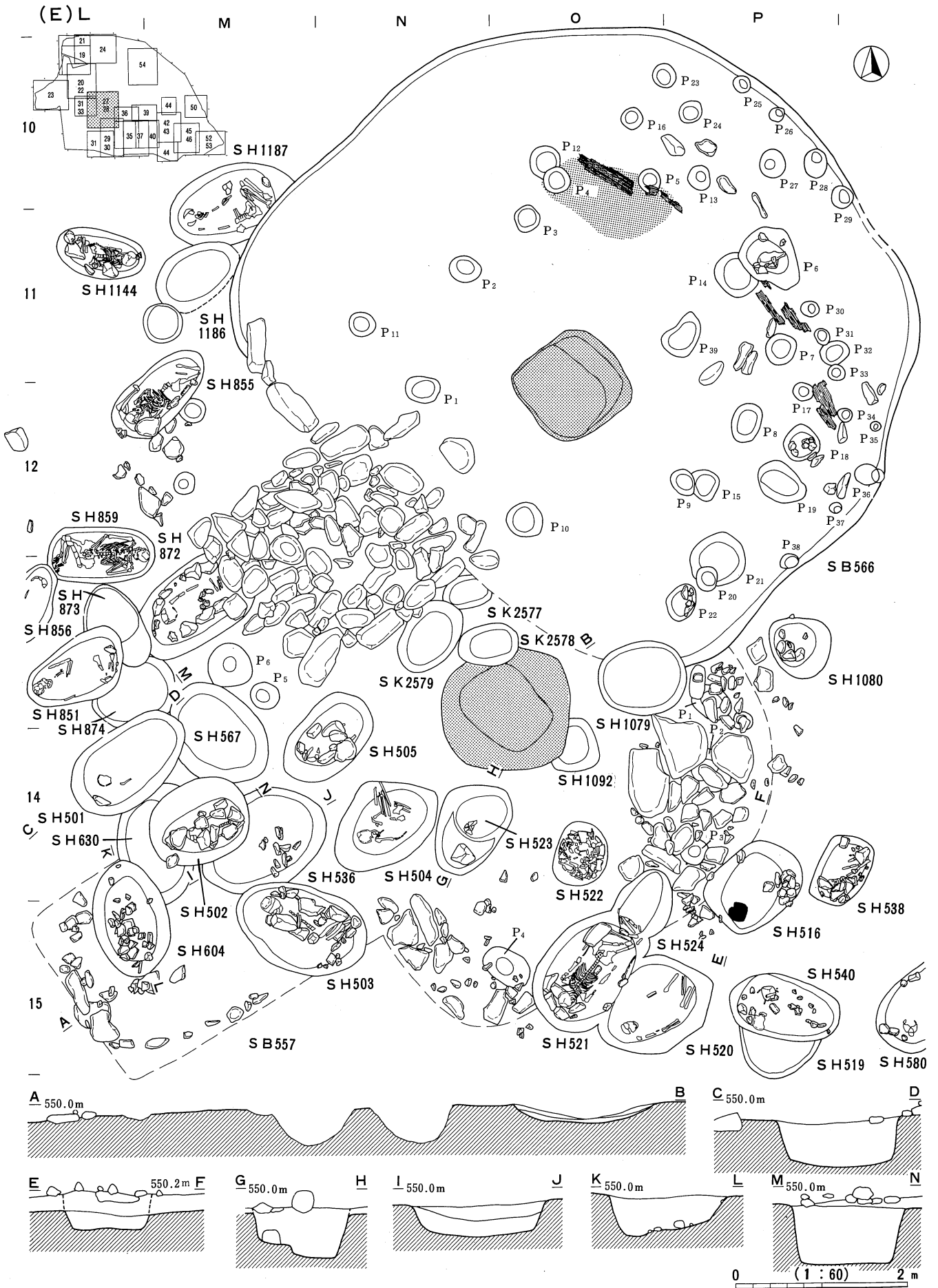

図版29 縄文遺構図19 (S B552・558, S H515ほか)

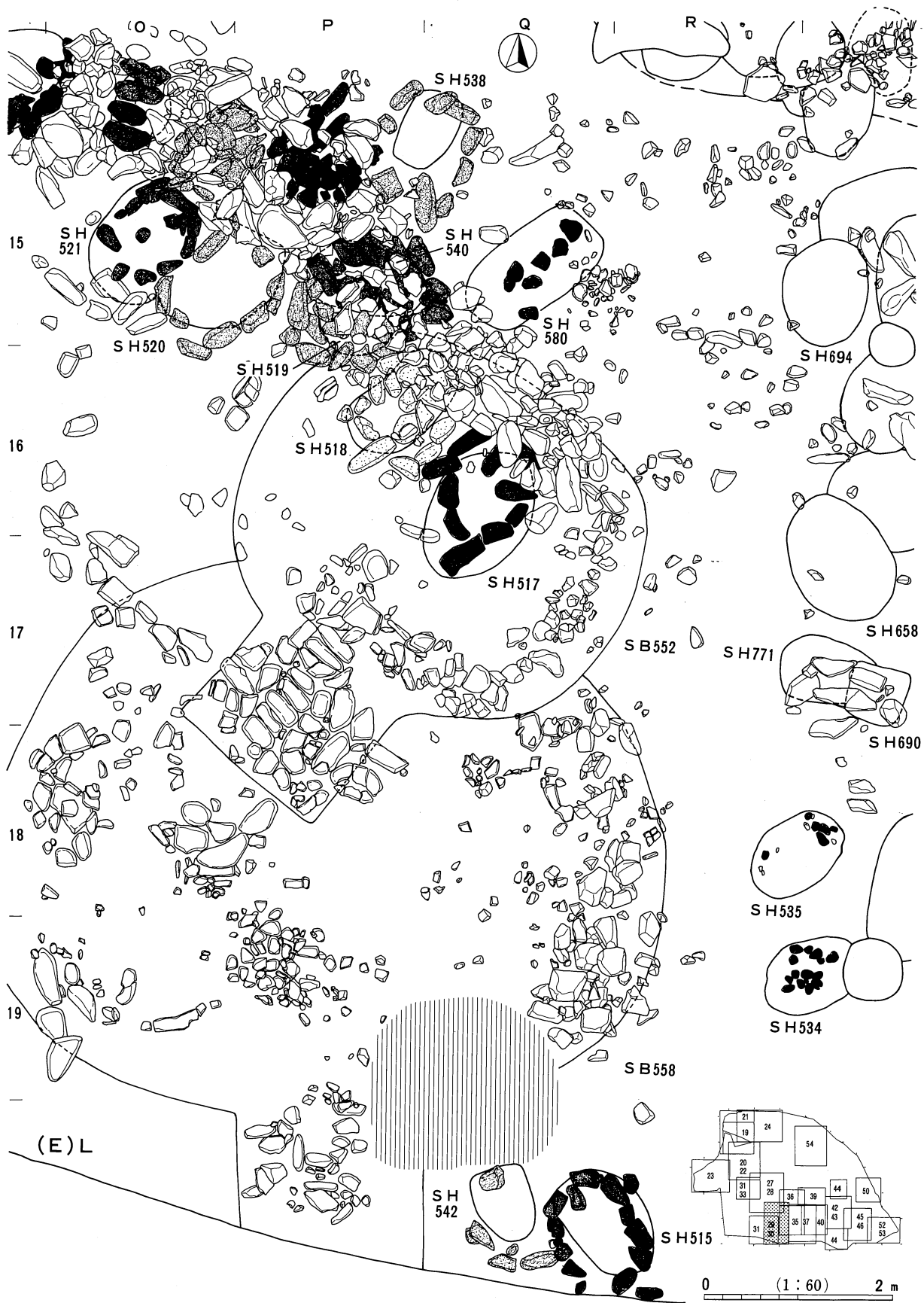

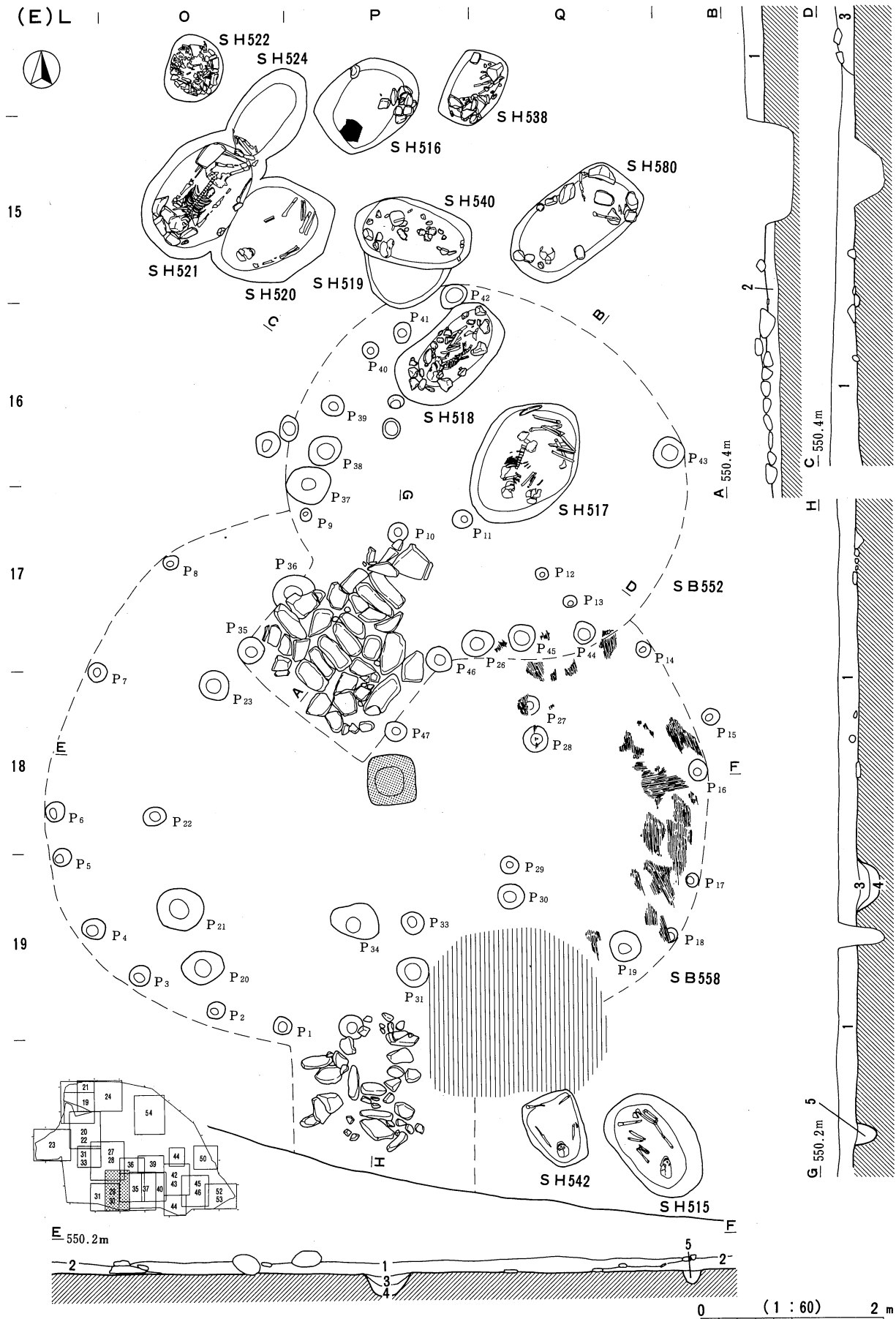

- | | |
|------------------------|------------------------|
| 土層 S B552 | S B558 |
| 1 : 黒褐色粘質土、炭化物・礫を多量に含む | 1 : 黒褐色粘質土、炭化物・礫を多量に含む |
| 2 : 暗褐色土 | 2 : 黒褐色土、黄褐色ブロック・礫を含む |
| 3 : 黒褐色土、黄褐色ブロック礫を含む | 3 : 焼土を含む暗褐色土 |
| | 4 : 焼土 |
| | 5 : 褐色土、オリブ褐色砂質土を含む |

図版31 縄文遺構図21 (SH507ほか)

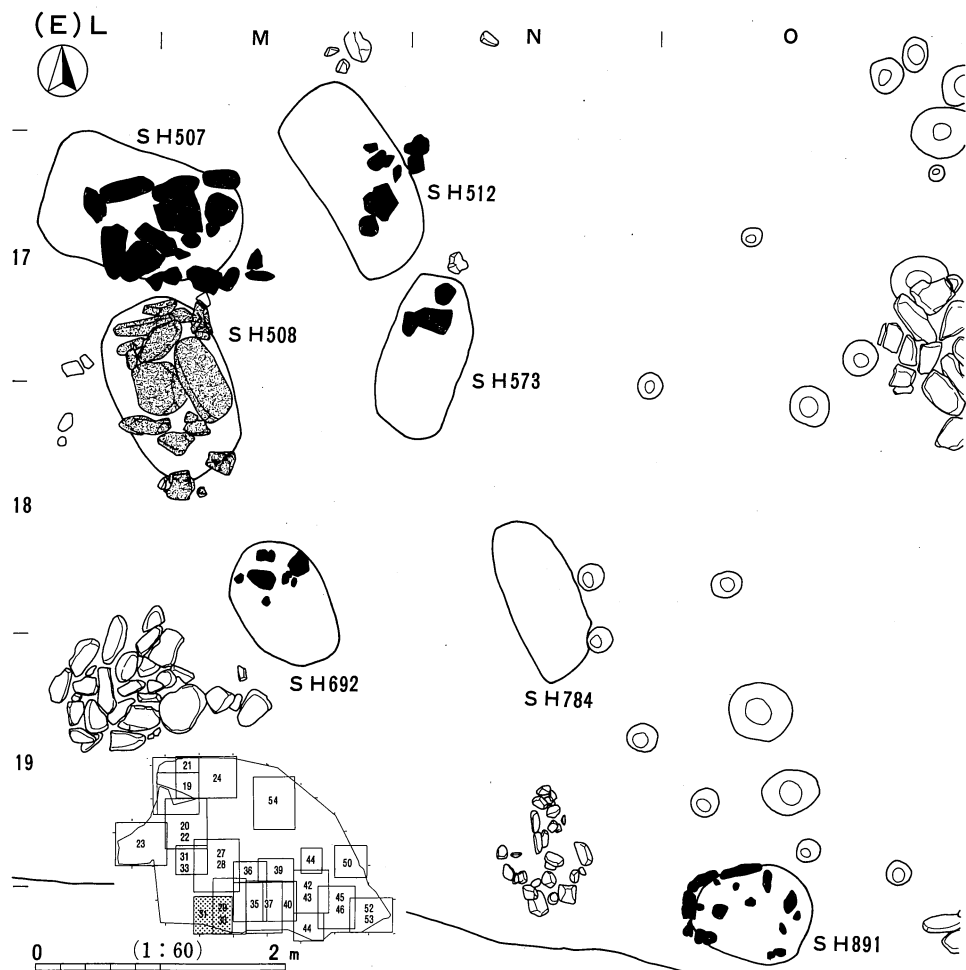
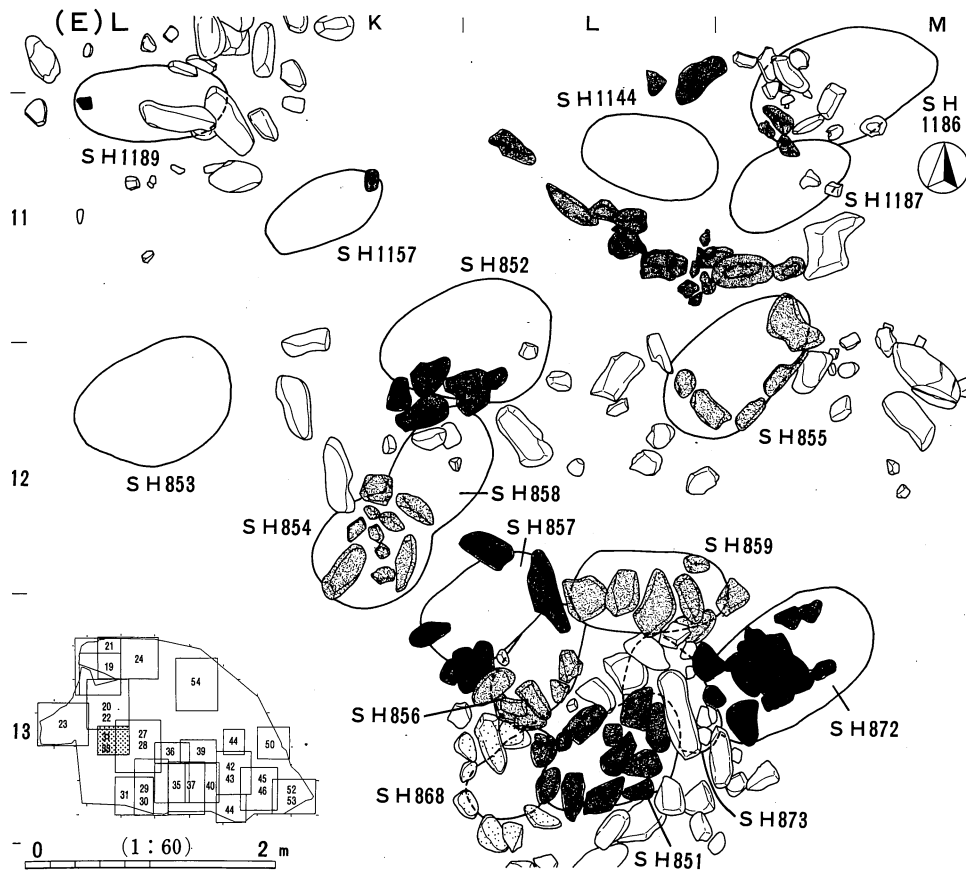

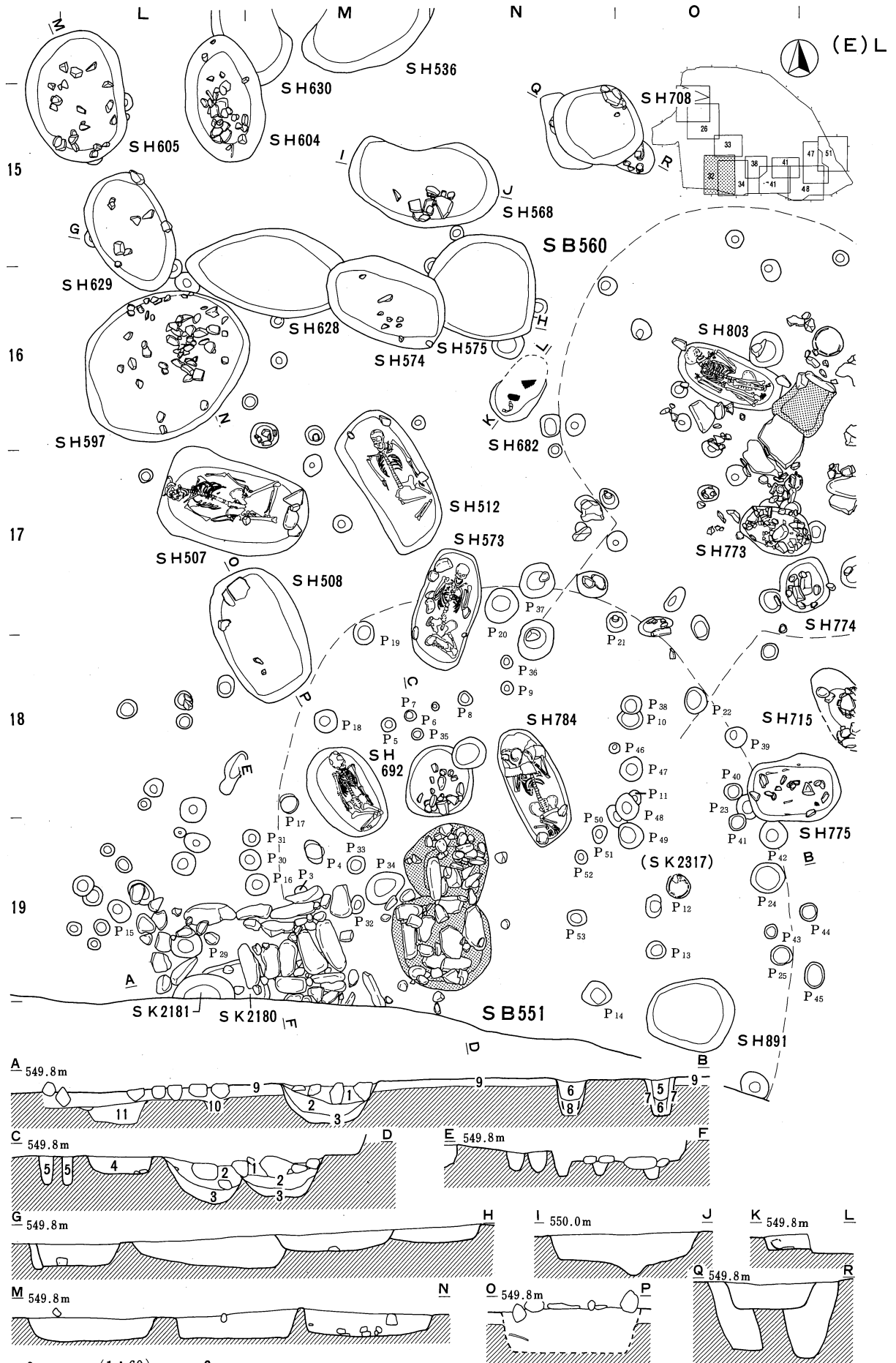

- 土層
- | | |
|------------------------|--------------------------|
| 1: 赤褐色ブロック含む暗褐色土、炭化物混在 | 6: 暗褐色土炭化物混在 |
| 2: 黒褐色粘質土、炭化物混在 | 7: 褐色砂質土 |
| 3: 焼土 | 8: 茶褐色ブロック含むオリブ褐色砂質土 |
| 4: 礫を多量に含む暗褐色土 | 9: 茶褐色土 10: オリブ褐色土 |
| 5: 暗褐色土 | 11: 茶褐色ブロック含むオリブ褐色土炭化物混在 |

図版35 縄文遺構図25 (S B571, S H517ほか, S K2913ほか)

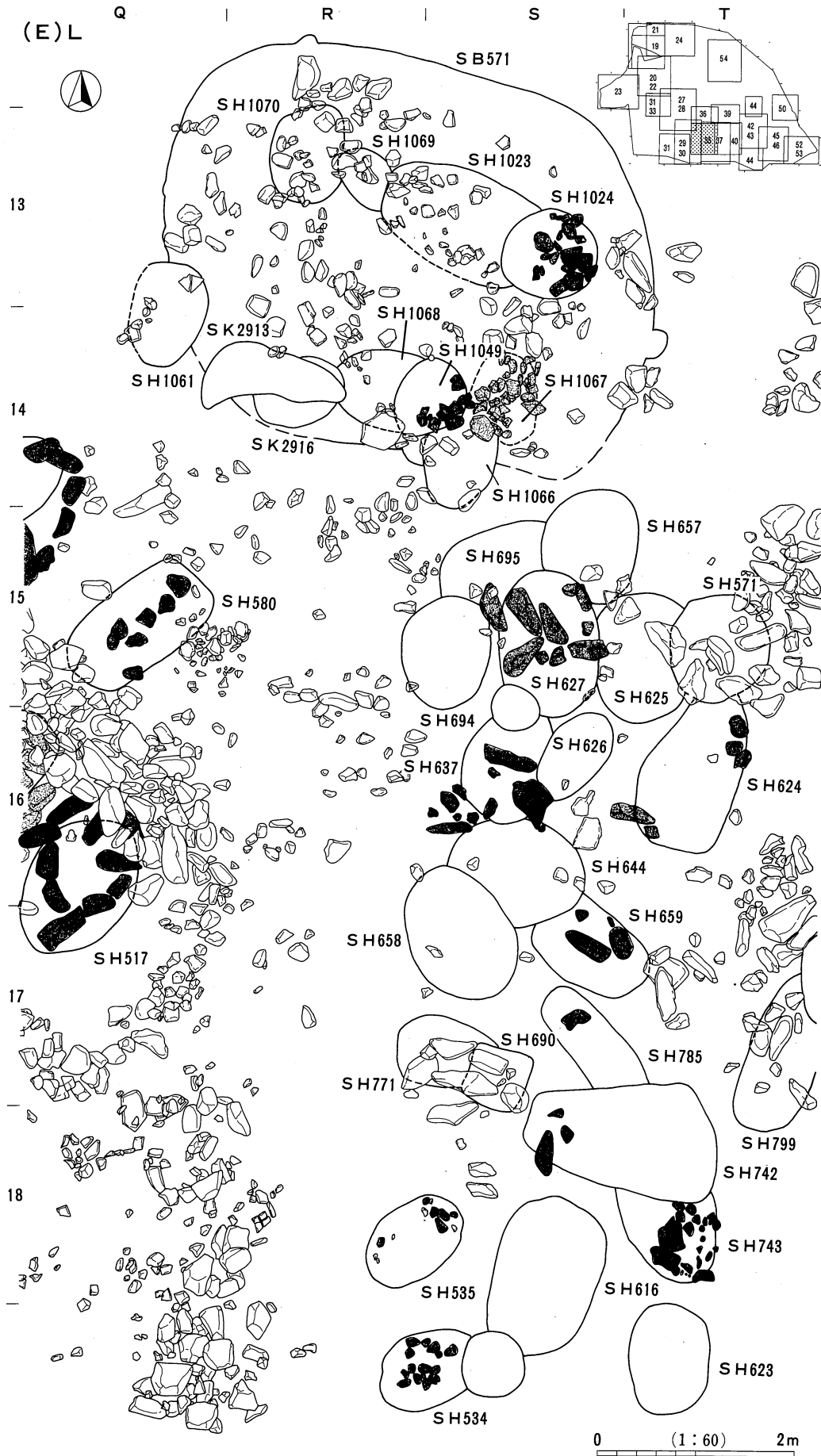

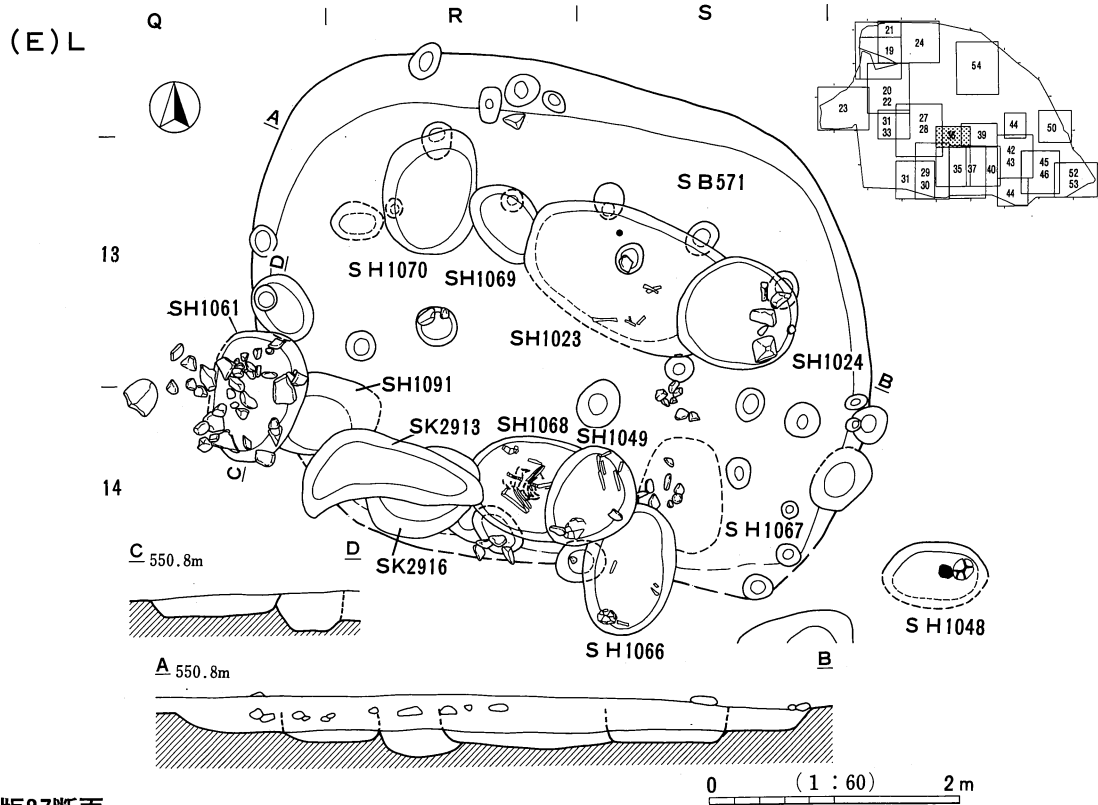

図版37断面

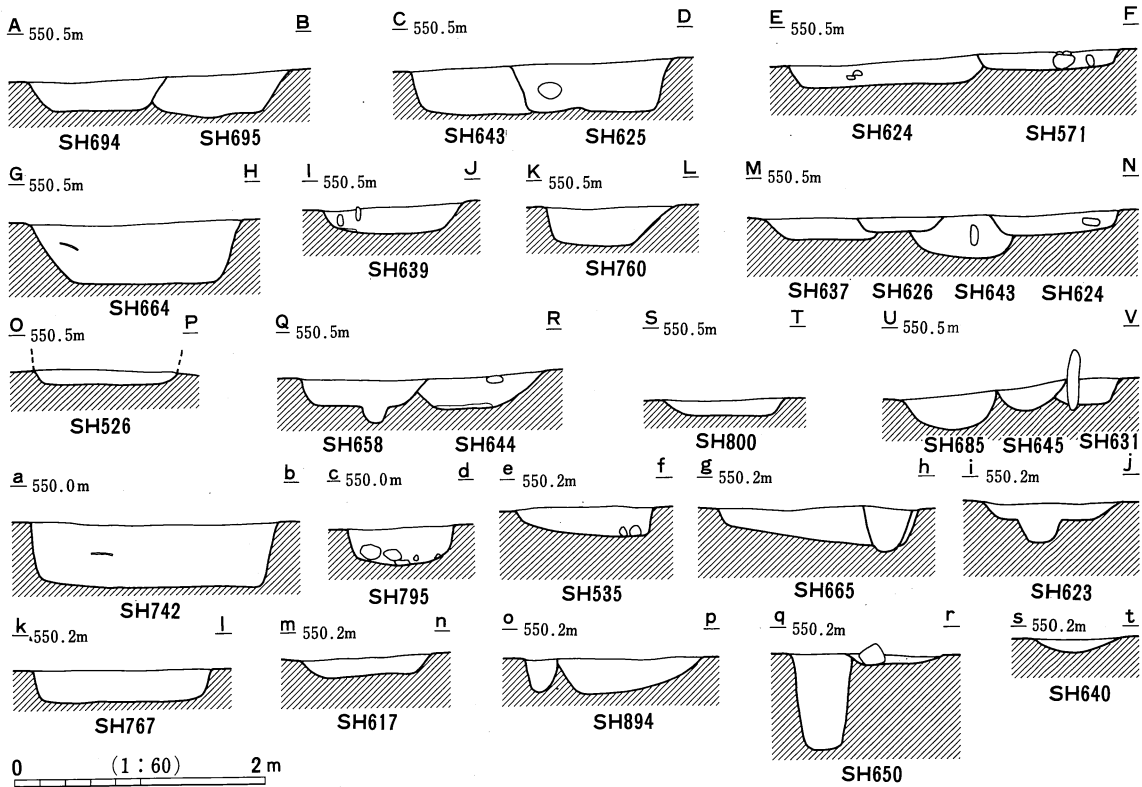

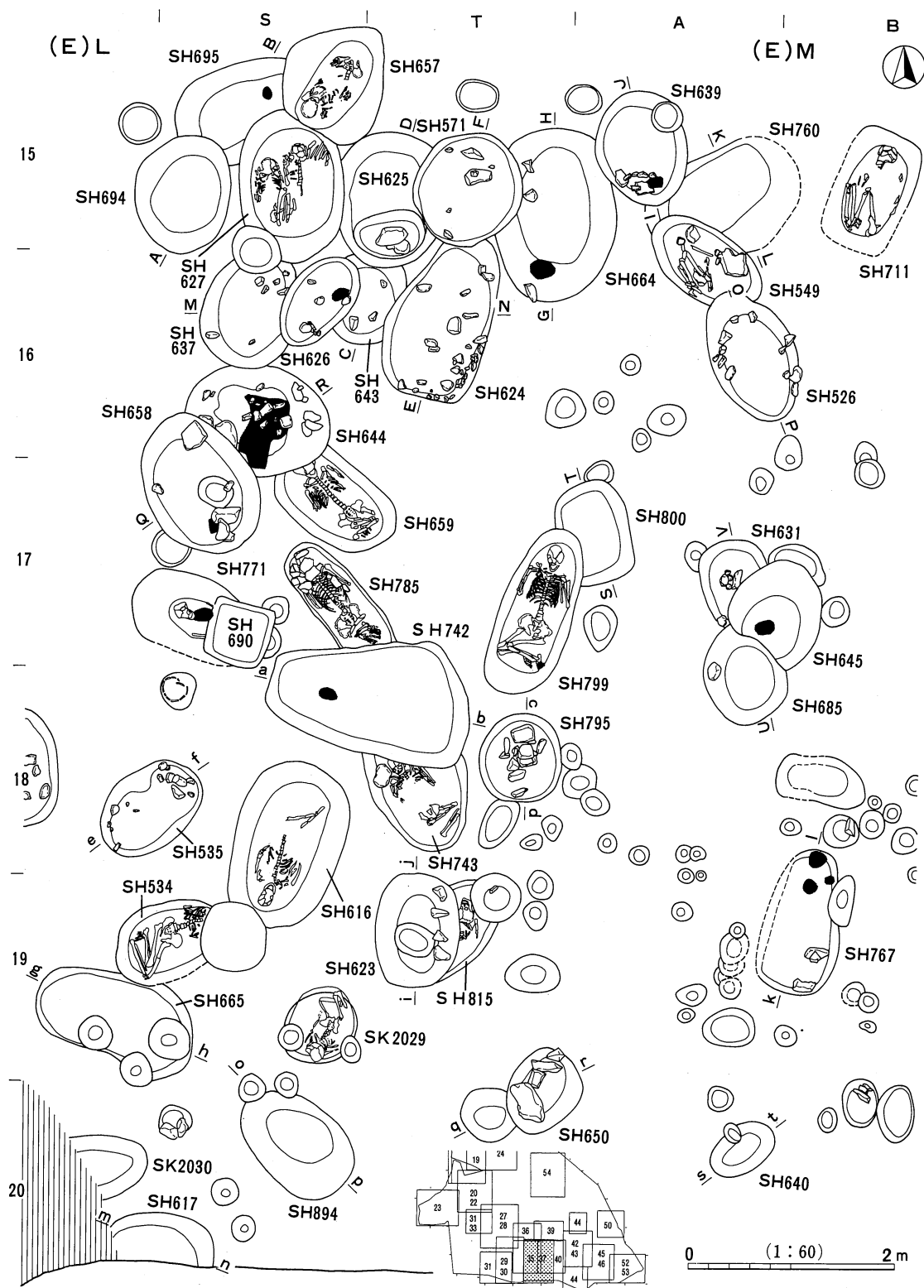

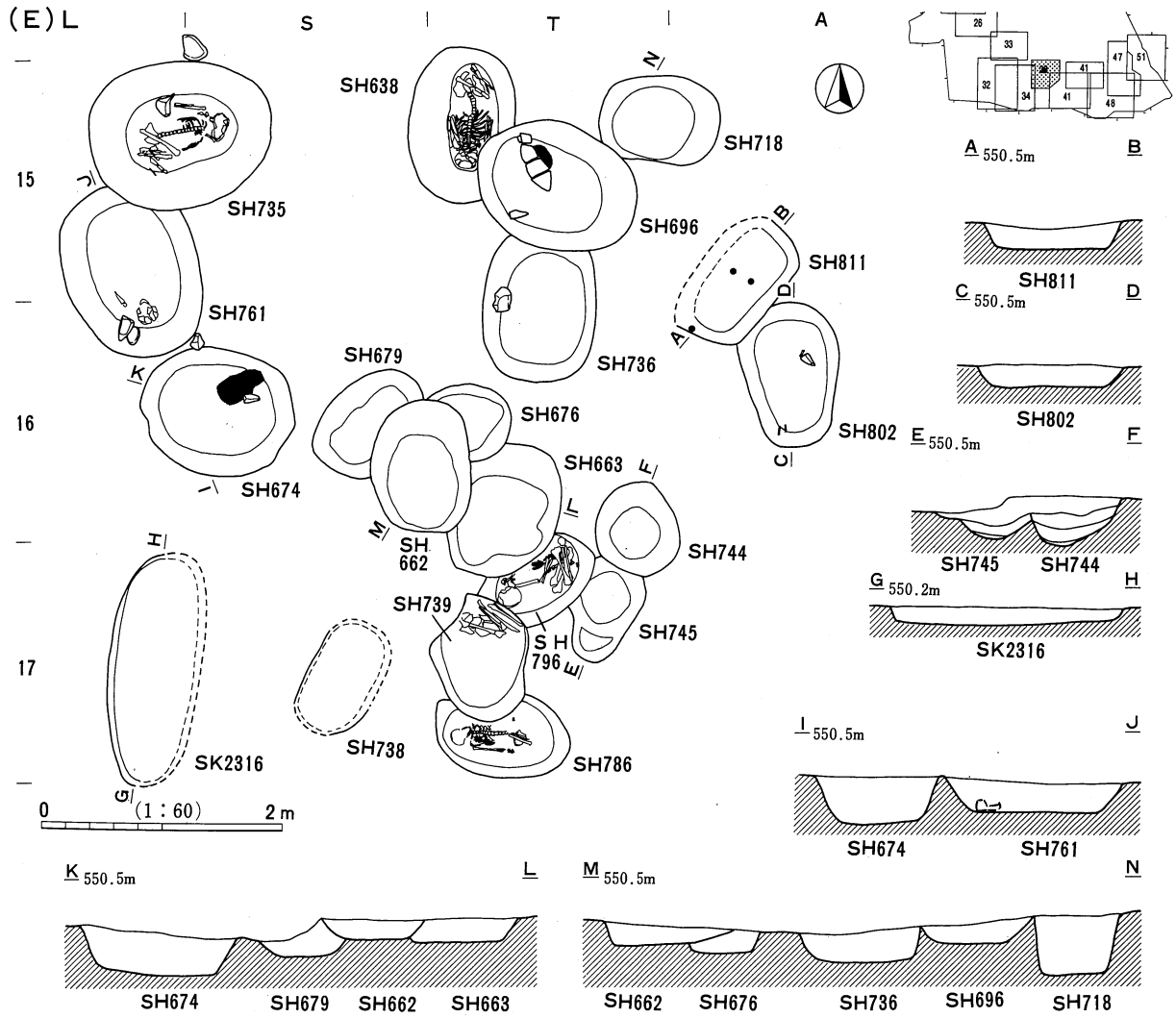

図版41上断面

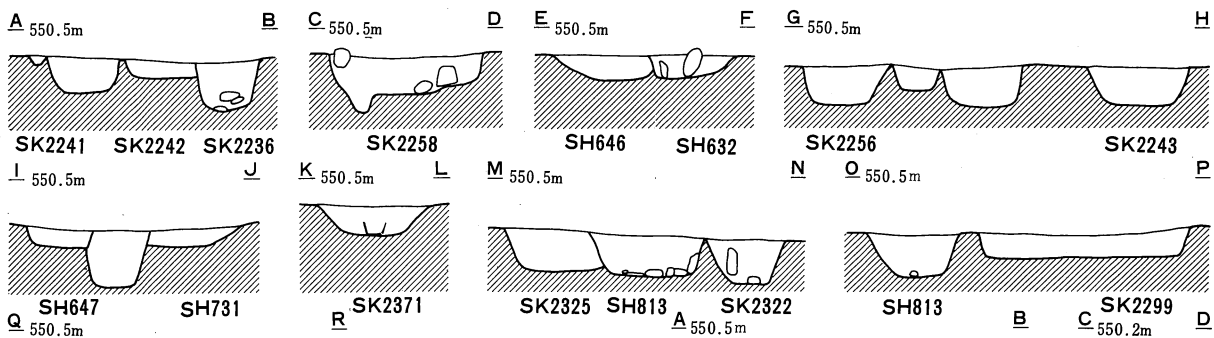

図版41下

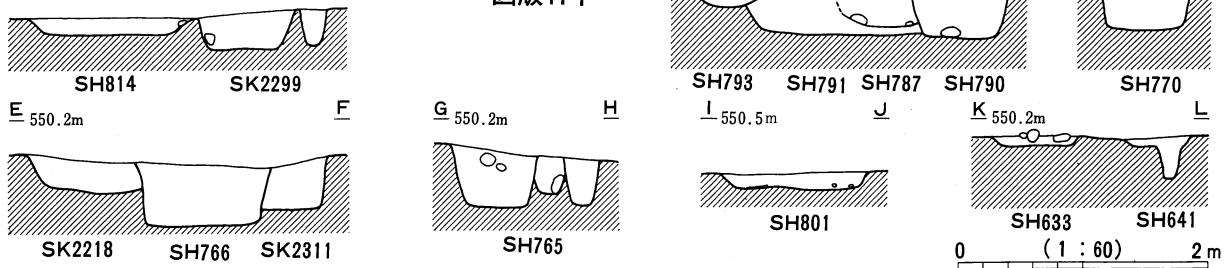

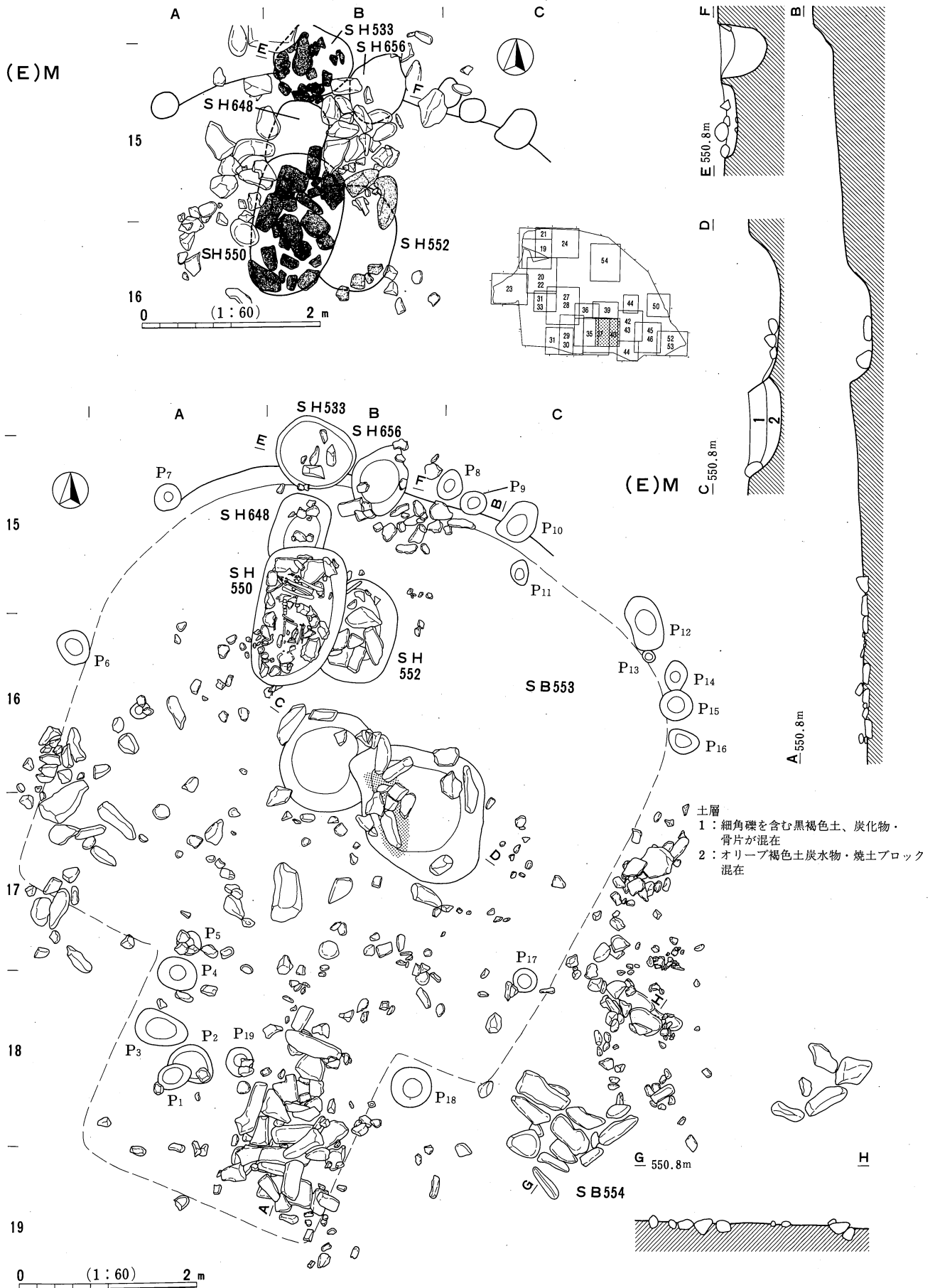

図版41 縄文遺構図31 (SH633ほか, SK2002ほか)

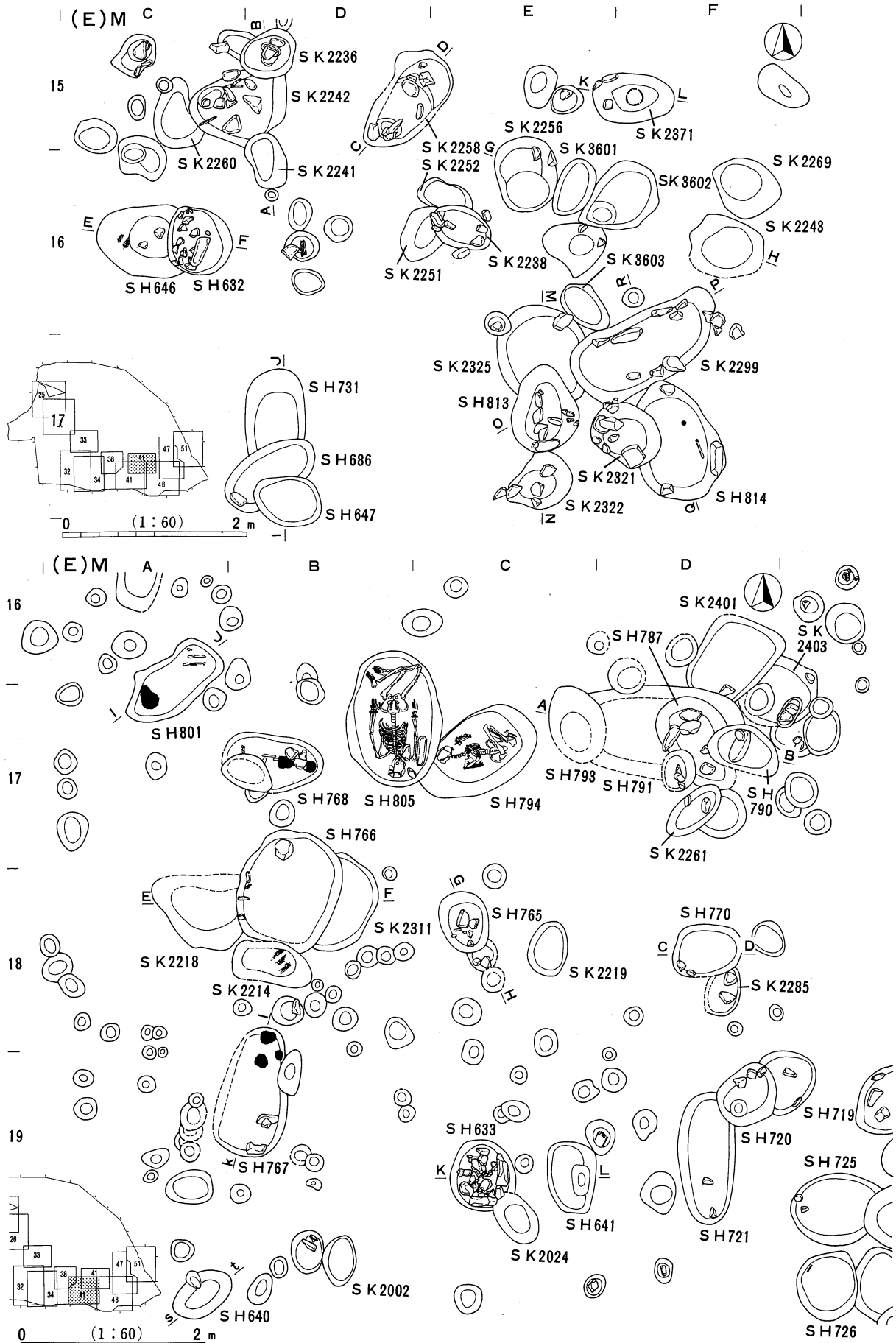

(E)M

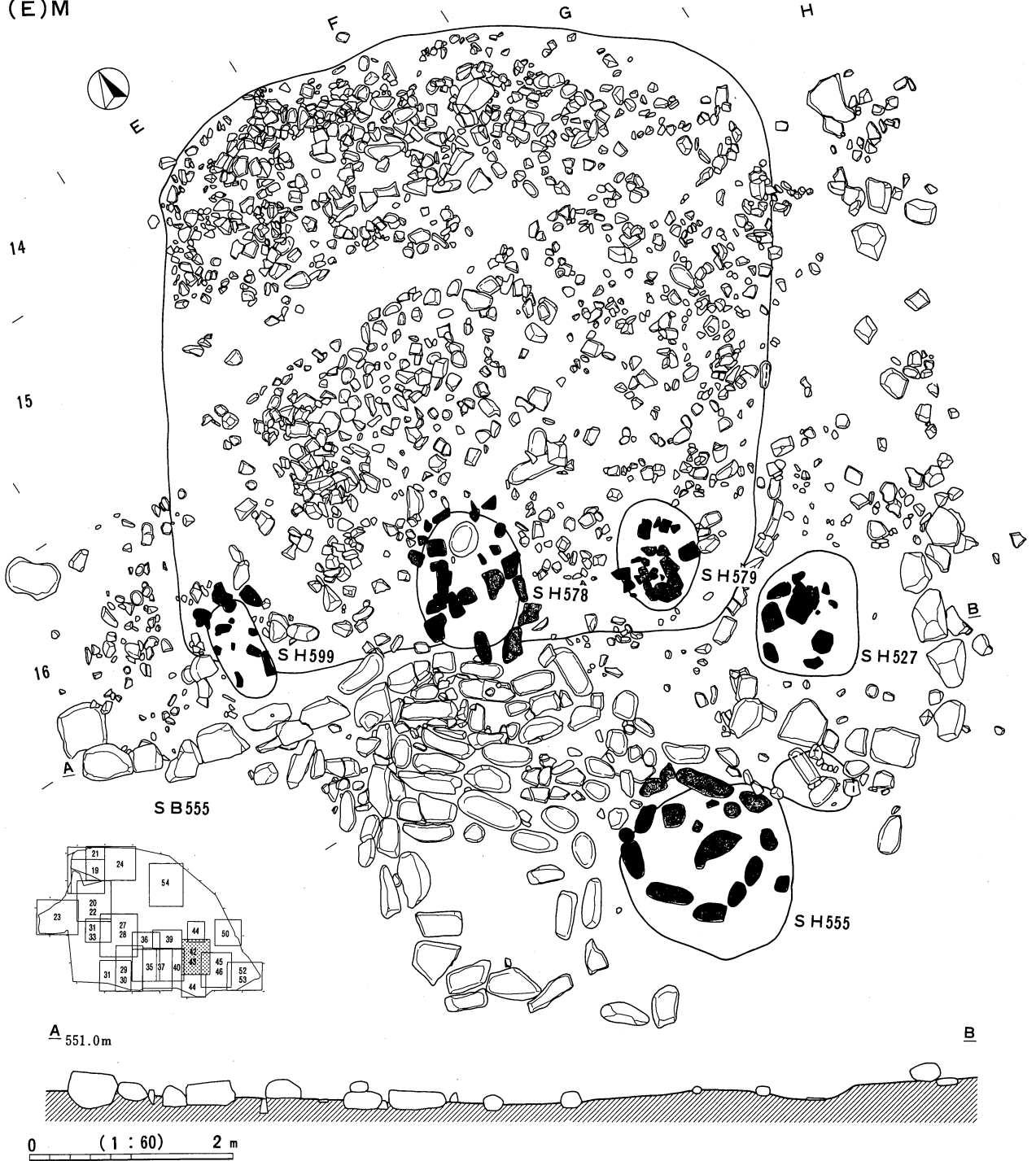

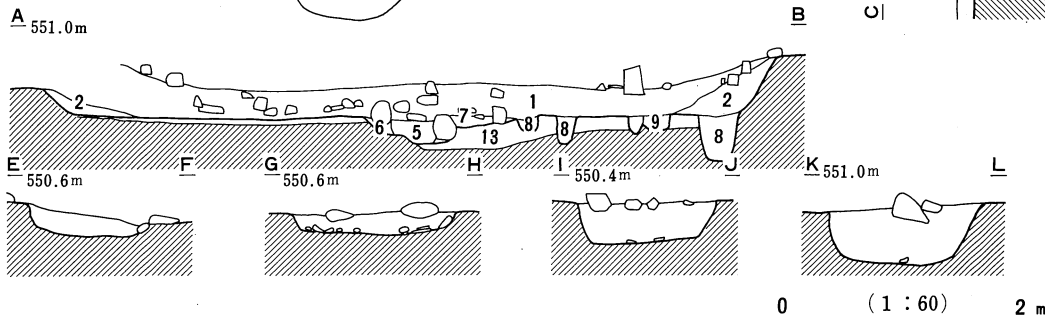
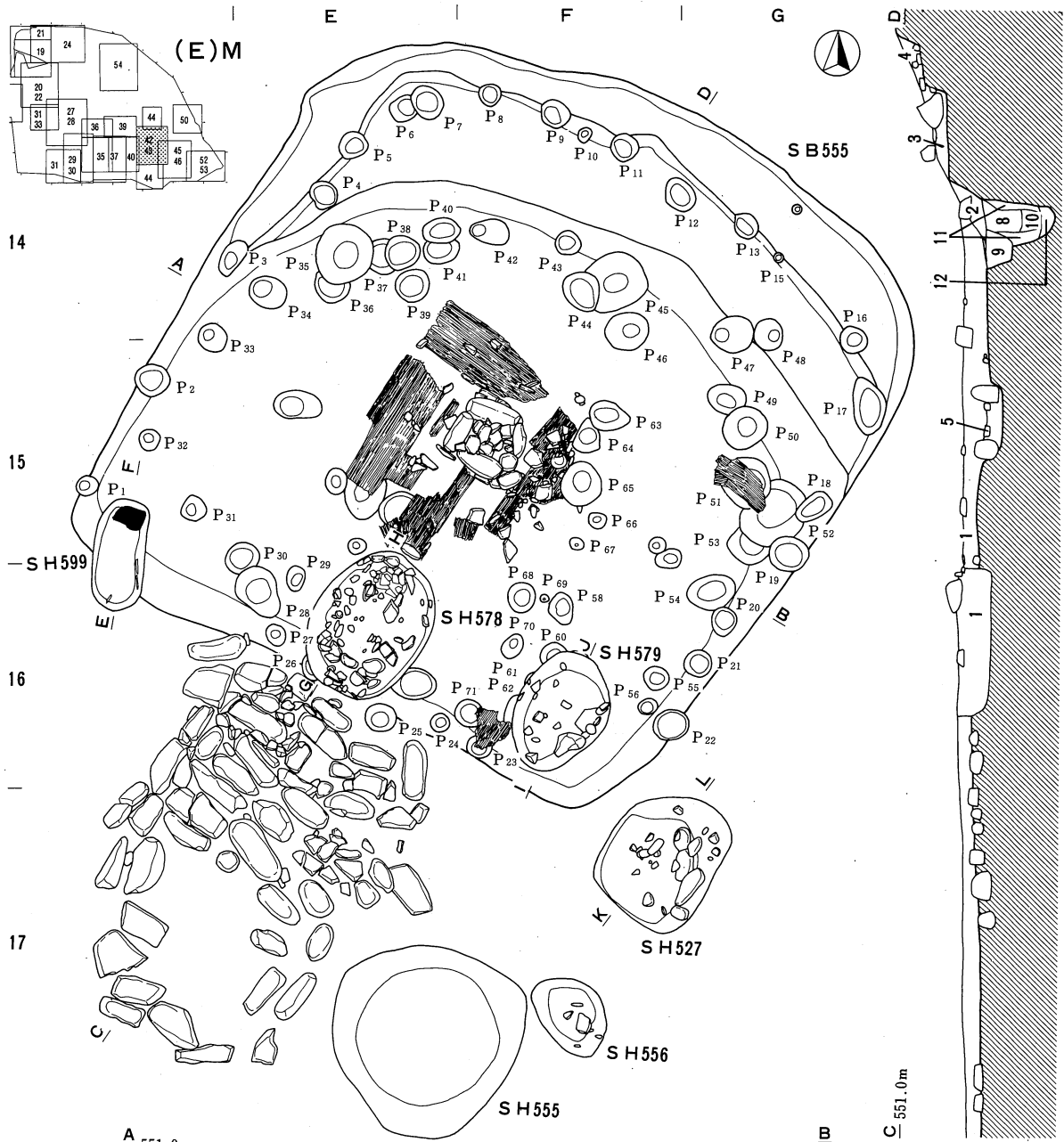

- 土層
- | | |
|------------------------------|-------------------|
| 1: 礫を多量に含む黒褐色粘質土
炭化物、骨片混在 | 6: 赤褐色粒を含む黒褐色土 |
| 2: 暗褐色粘質土 | 7: 赤褐色土、炭化物多量混在 |
| 3: 黄褐色ブロック含む黒褐色粘質土 | 8: 暗褐色土 |
| 4: 礫・黄褐色ブロック含む黒褐色粘質土 | 9: 暗褐色土、炭化物混在 |
| 5: 赤褐色ブロック含む暗褐色土
炭化物多量混在 | 10: 茶褐色ブロック含む暗褐色土 |
| | 11: 黒褐色粘質土 |
| | 12: 褐色砂質土 |
| | 13: 礫を含む茶褐色粘質土 |

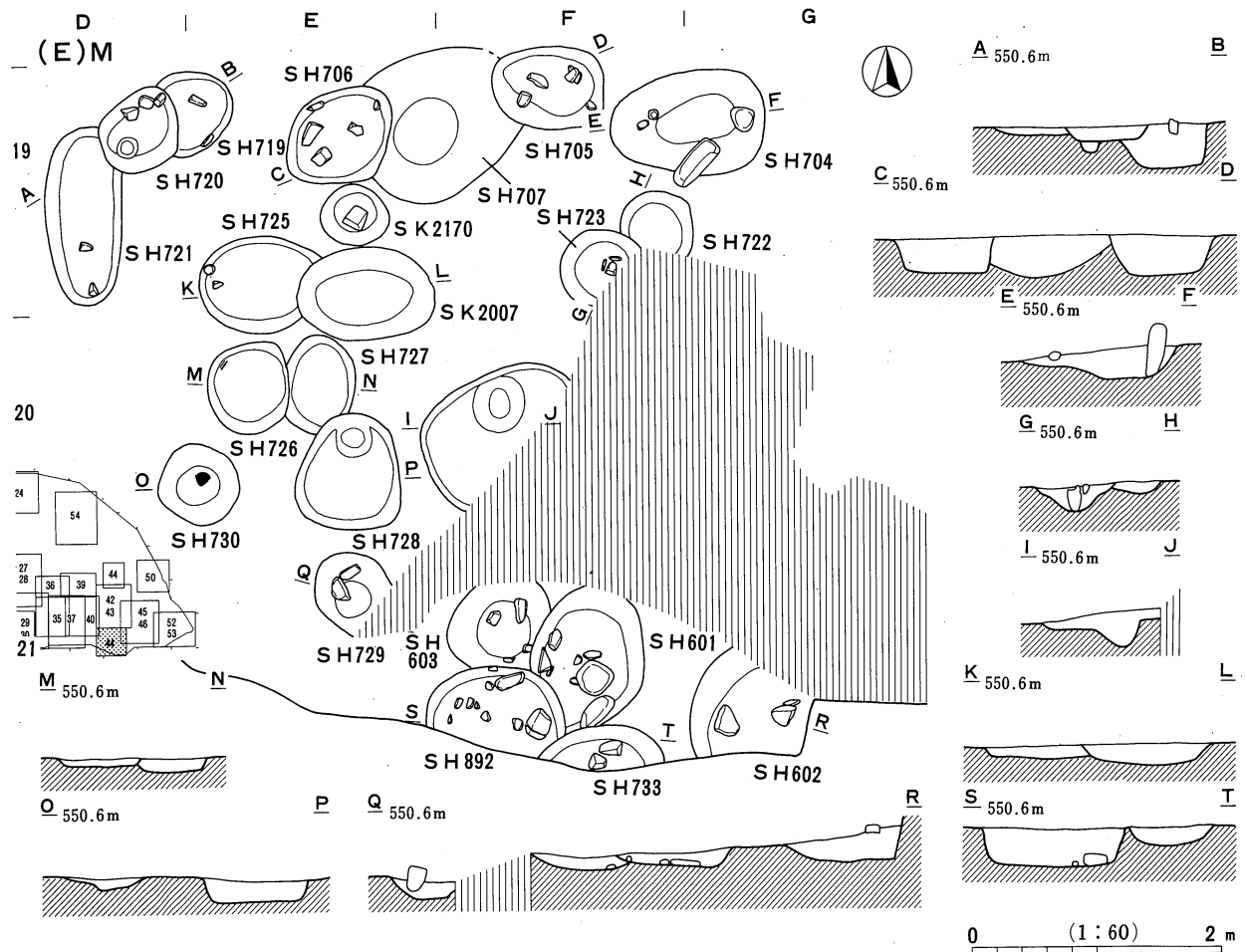
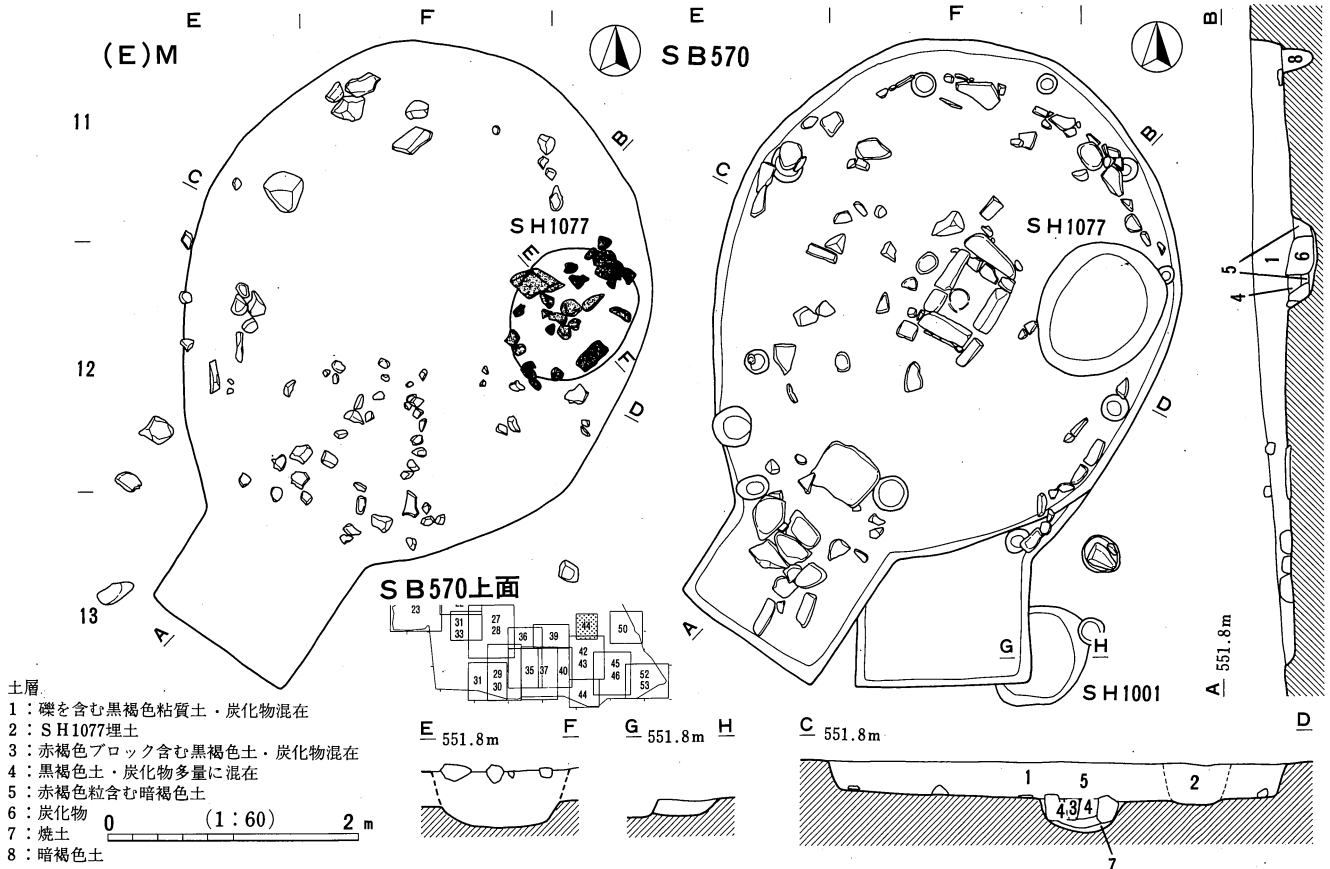

図版45 縄文遺構図35 (SH528ほか)

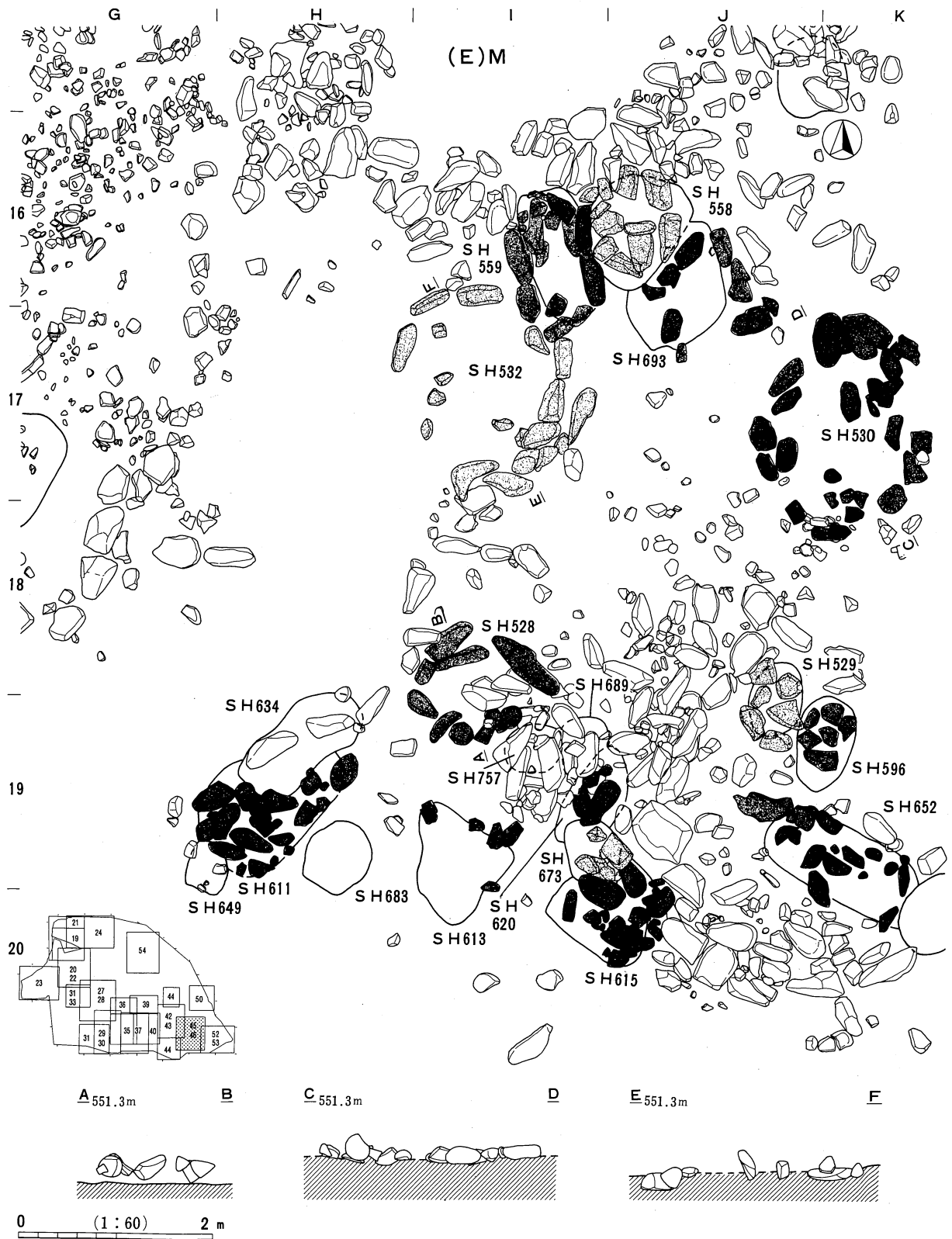

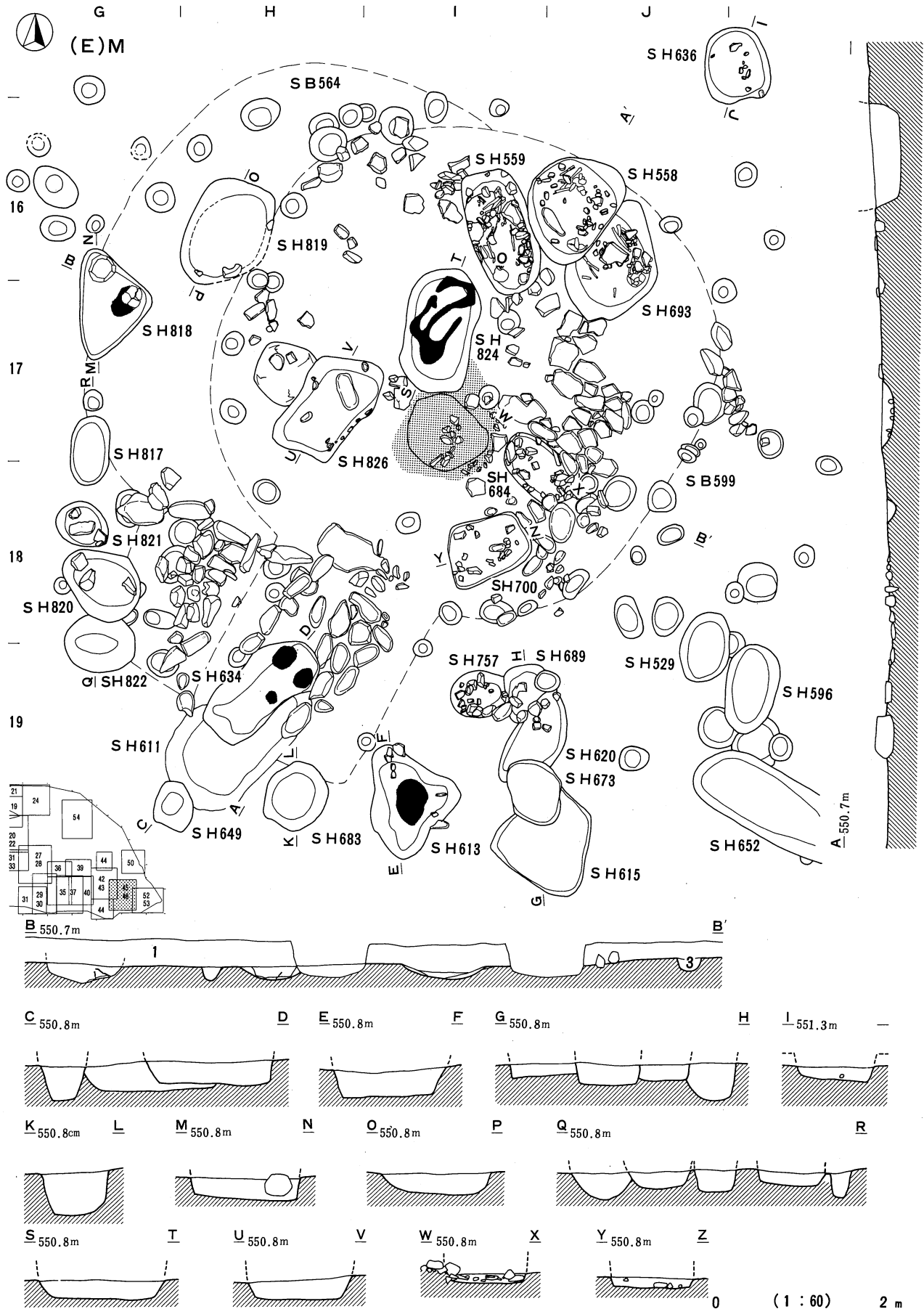

土層

- 1 : 礫を含む黒褐色粘質土、骨片・炭化物混在
- 2 : 暗褐色粘質土
- 3 : 黒褐色粘質土

- 4 : 赤褐色粘質土、炭化物多量に混在
- 5 : 赤褐色アロックを含む暗褐色粘質土、炭化物混在
- 6 : 赤褐色土粒を含む褐色粘質土、炭化物混在

図版47 縄文遺構図37 (S B562, S H741ほか, S K2637ほか)

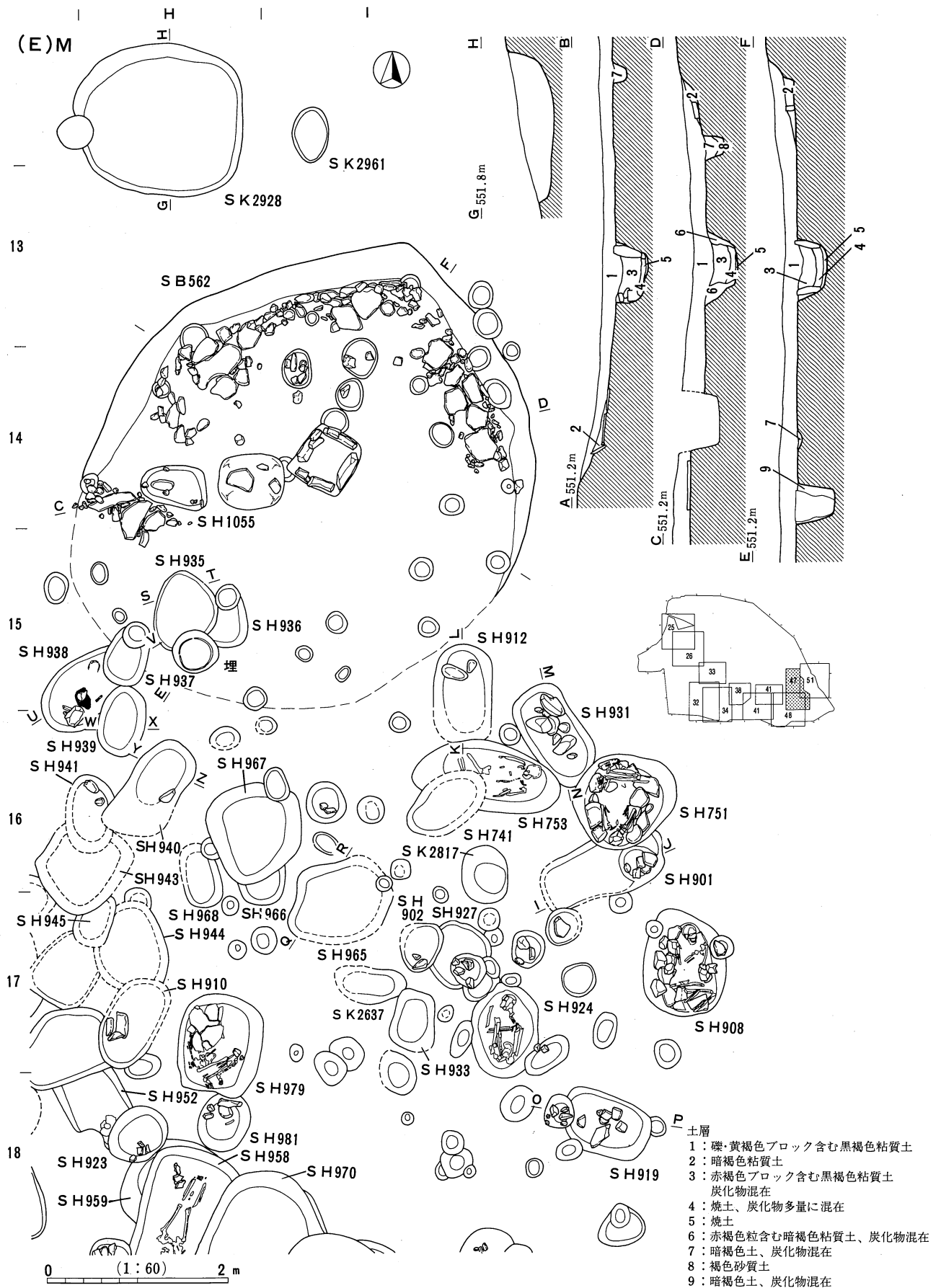

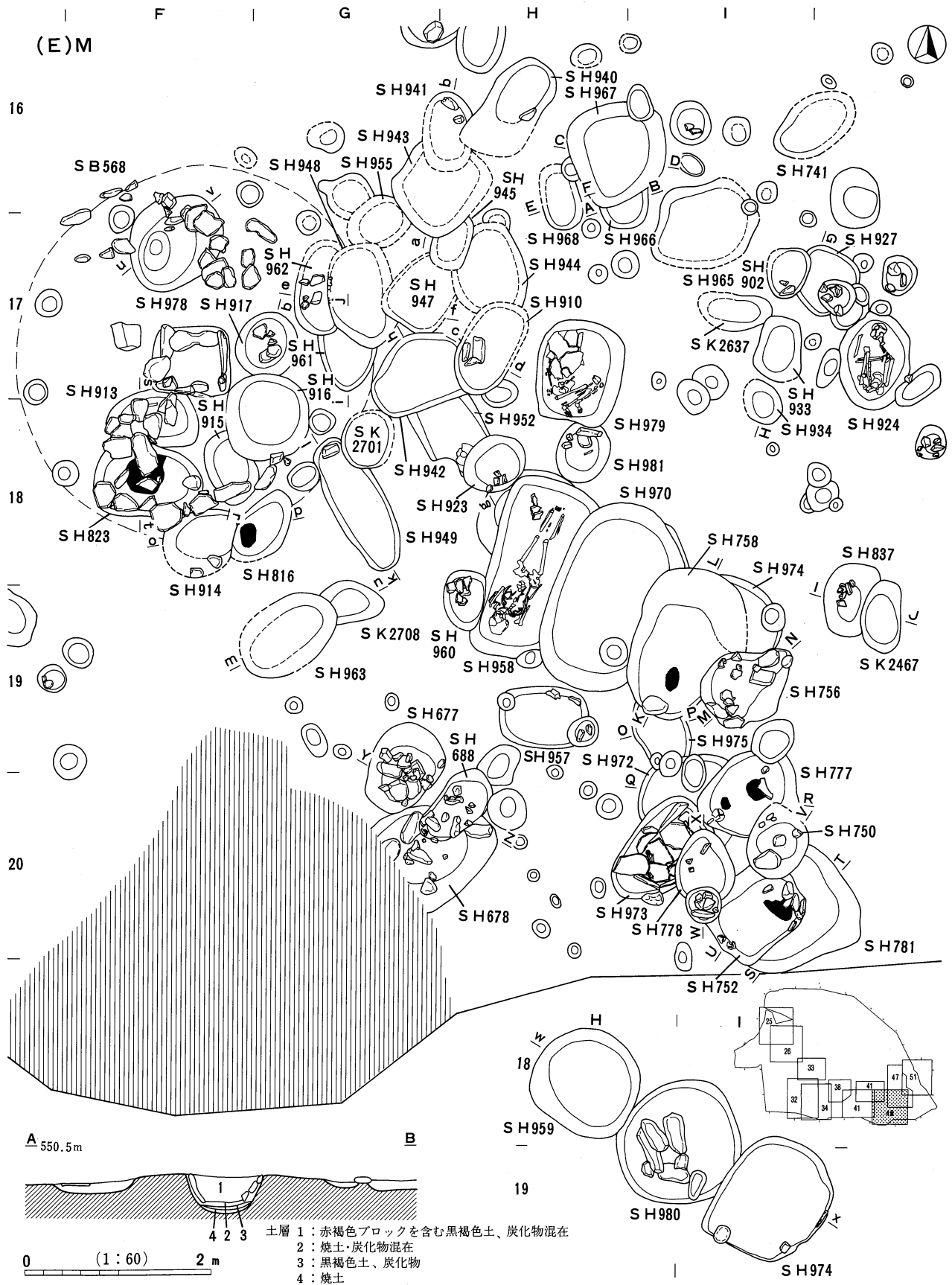

図版47断面

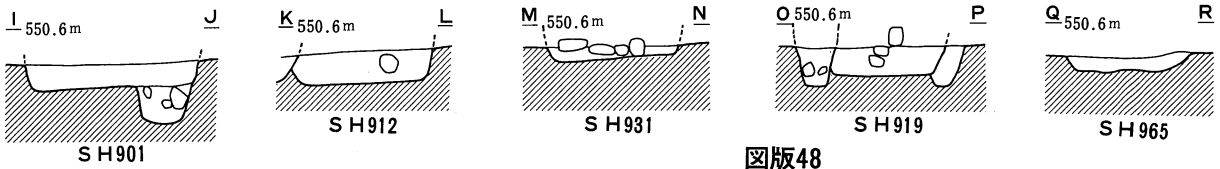

図版48

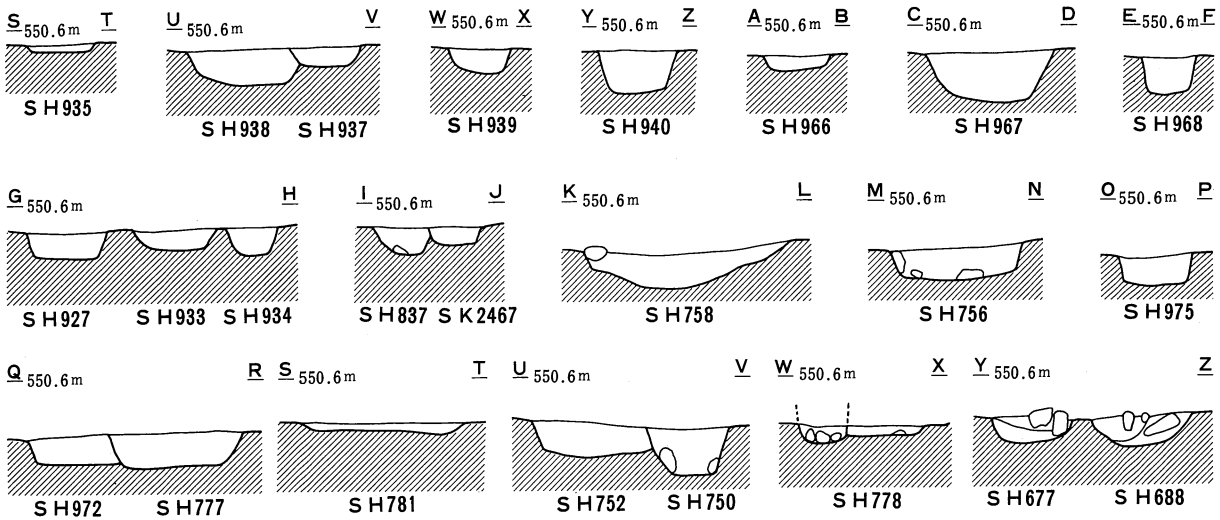

図版48

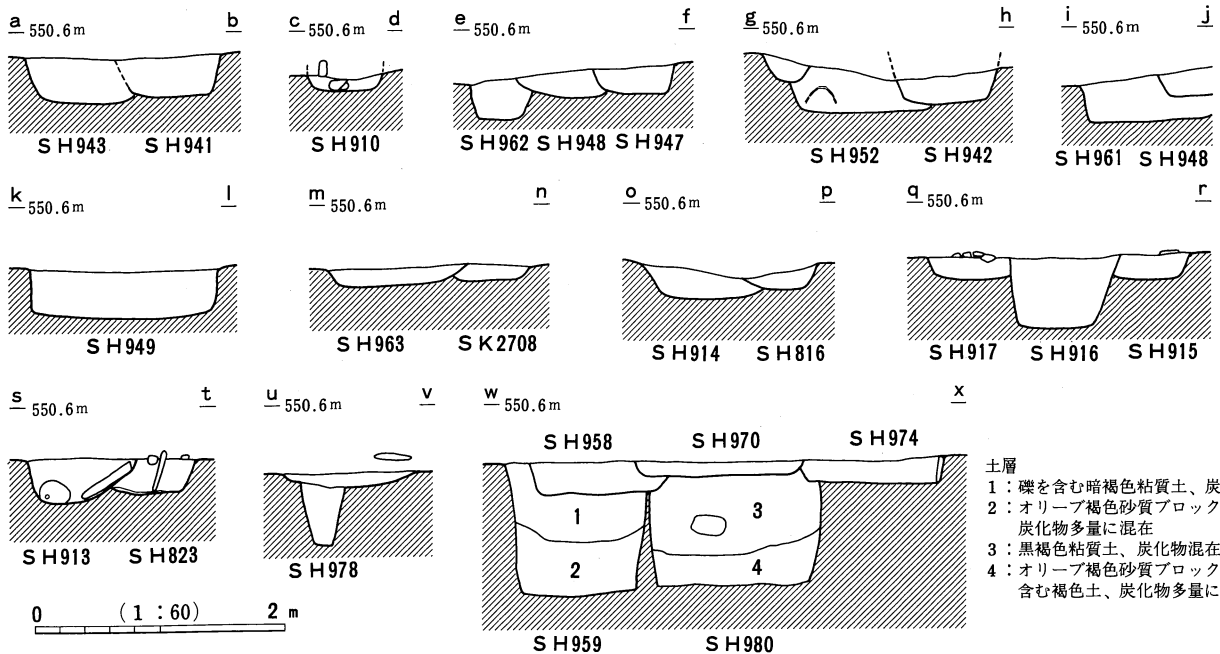

- 土層
- 1 : 礫を含む暗褐色粘質土、炭化物混在
 - 2 : オリーブ褐色砂質ブロックを含む褐色土炭化物多量に混在
 - 3 : 黒褐色粘質土、炭化物混在
 - 4 : オリーブ褐色砂質ブロック・茶褐色粘質ブロック含む褐色土、炭化物多量に混在

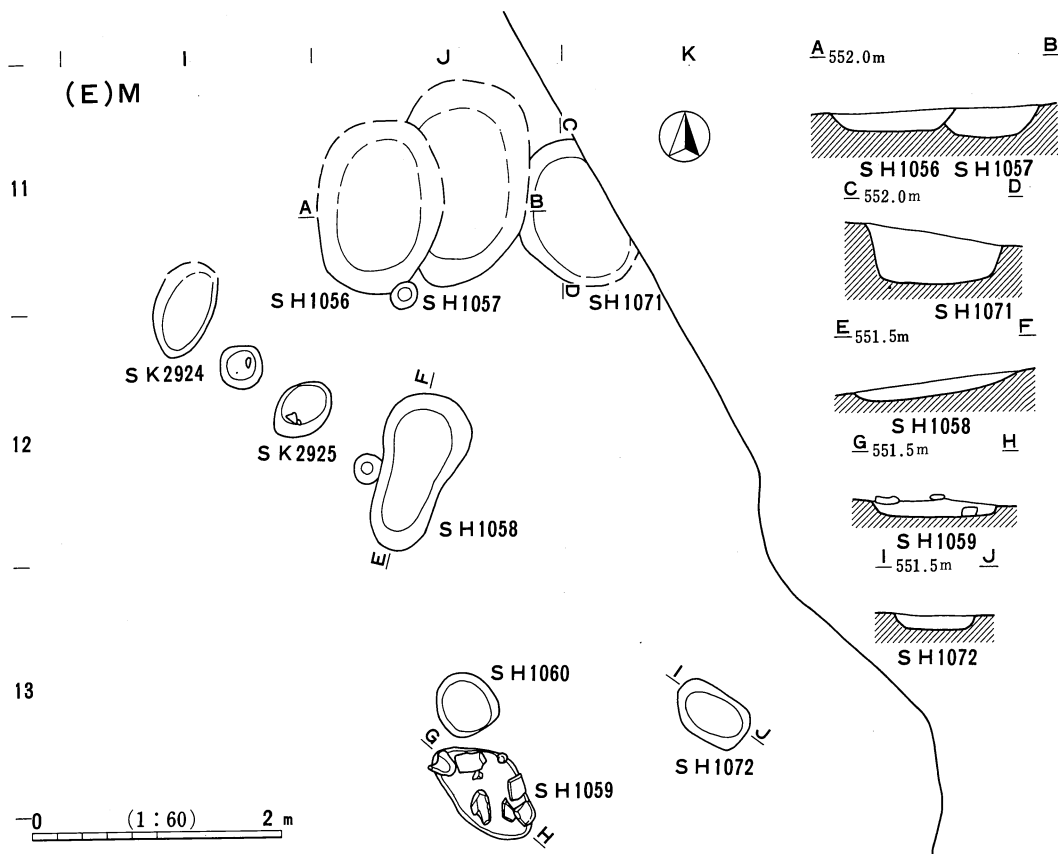
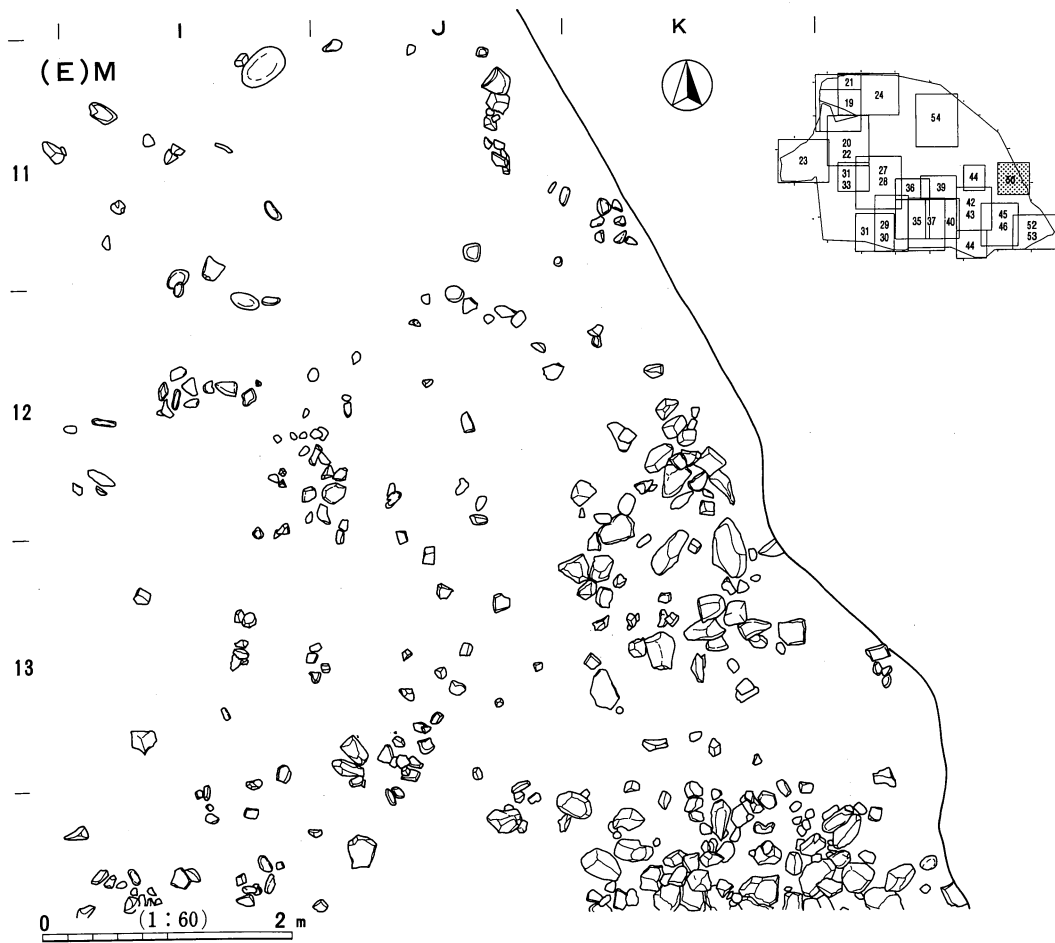

図版51 縄文遺構図41 (S B562・563・572・574, S H751ほか, S K2646ほか)

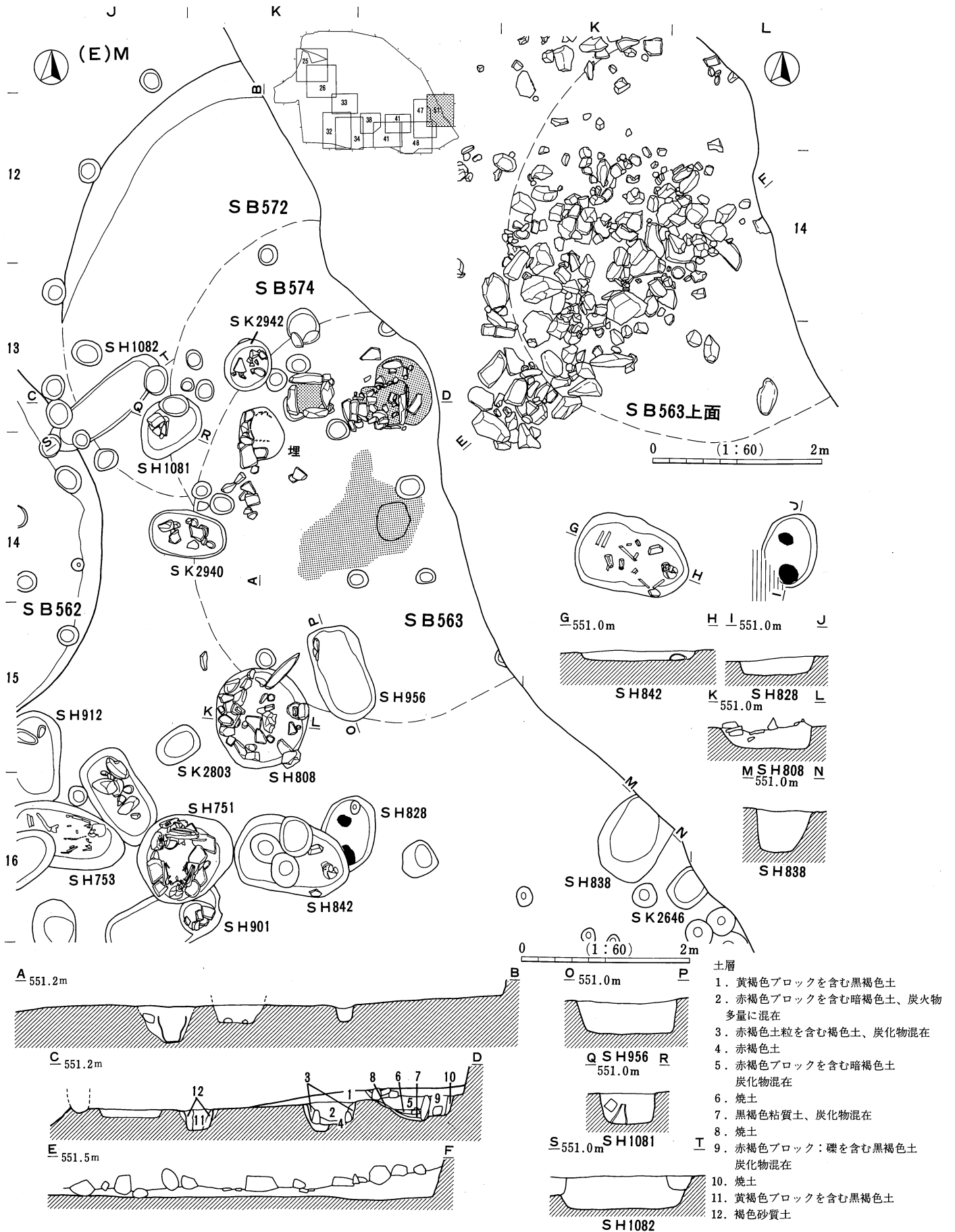

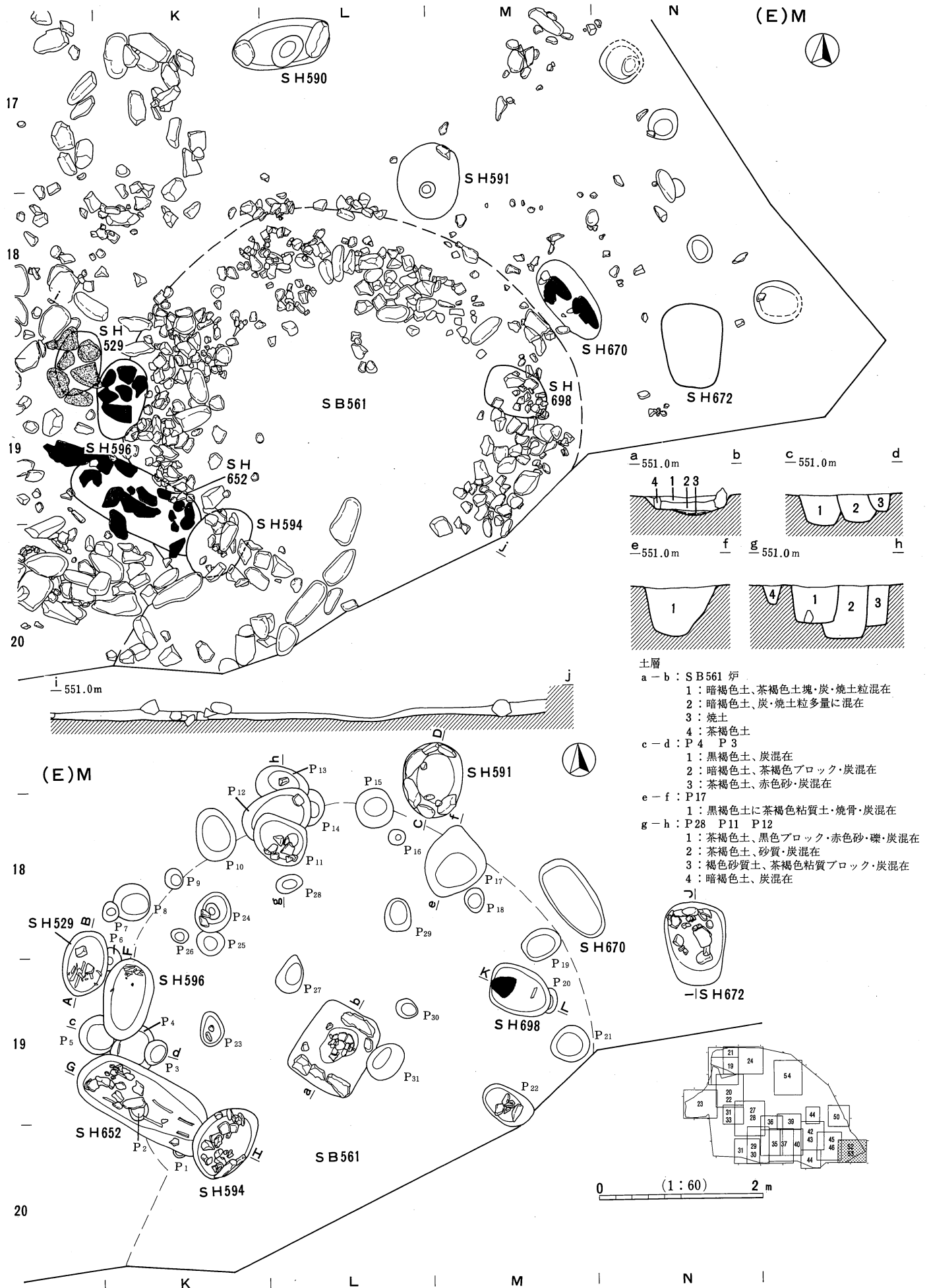

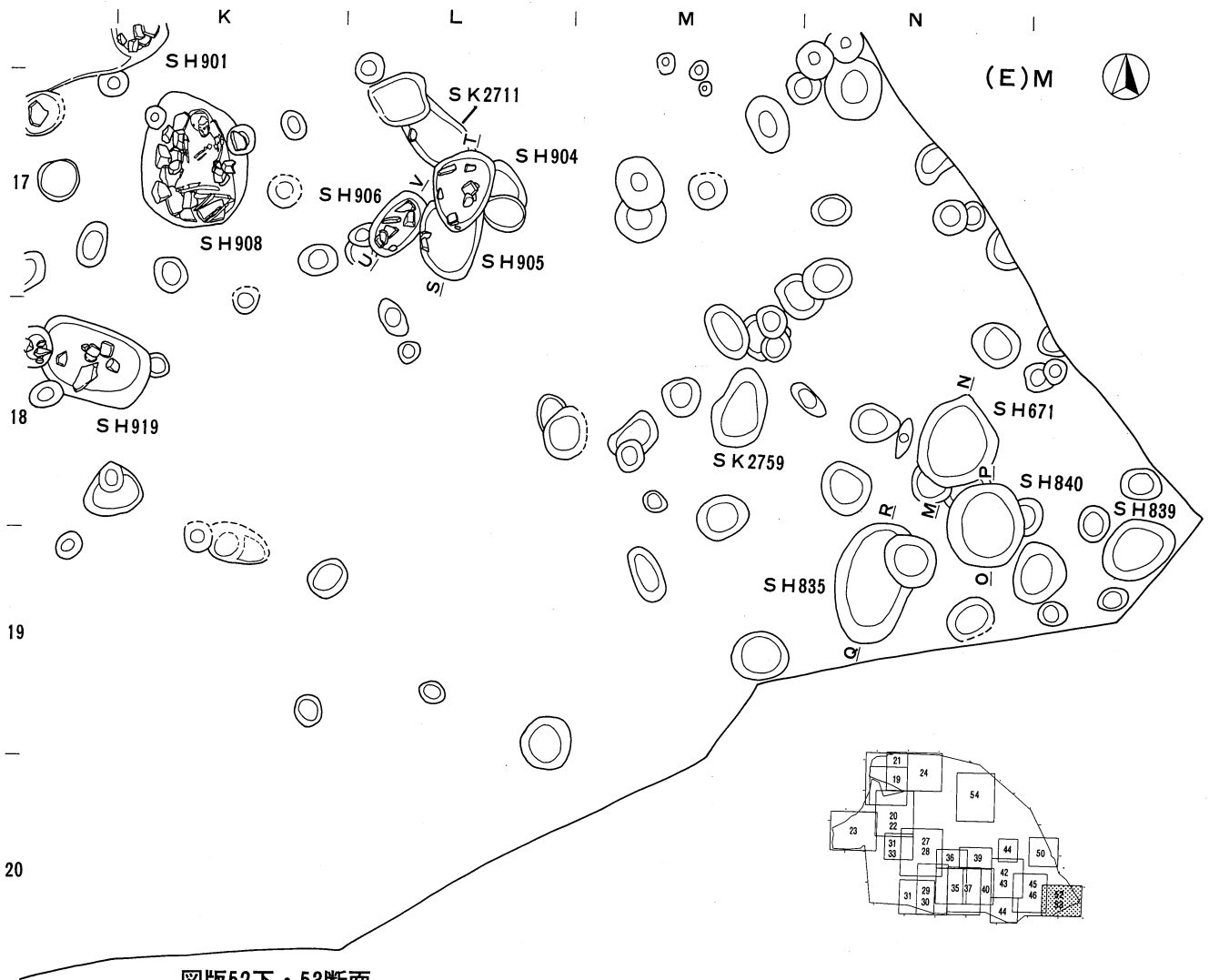

図版52下・53断面

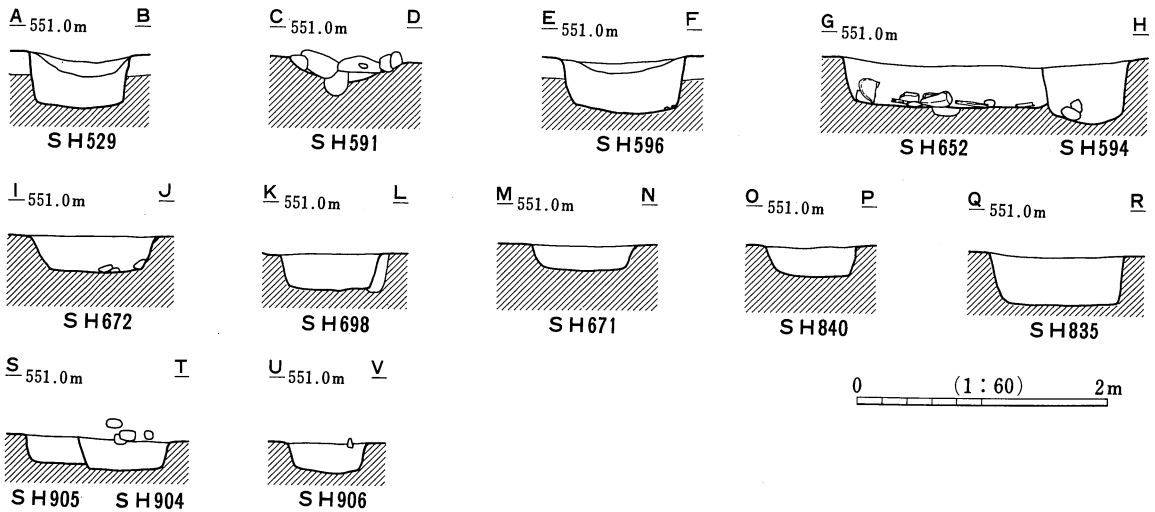

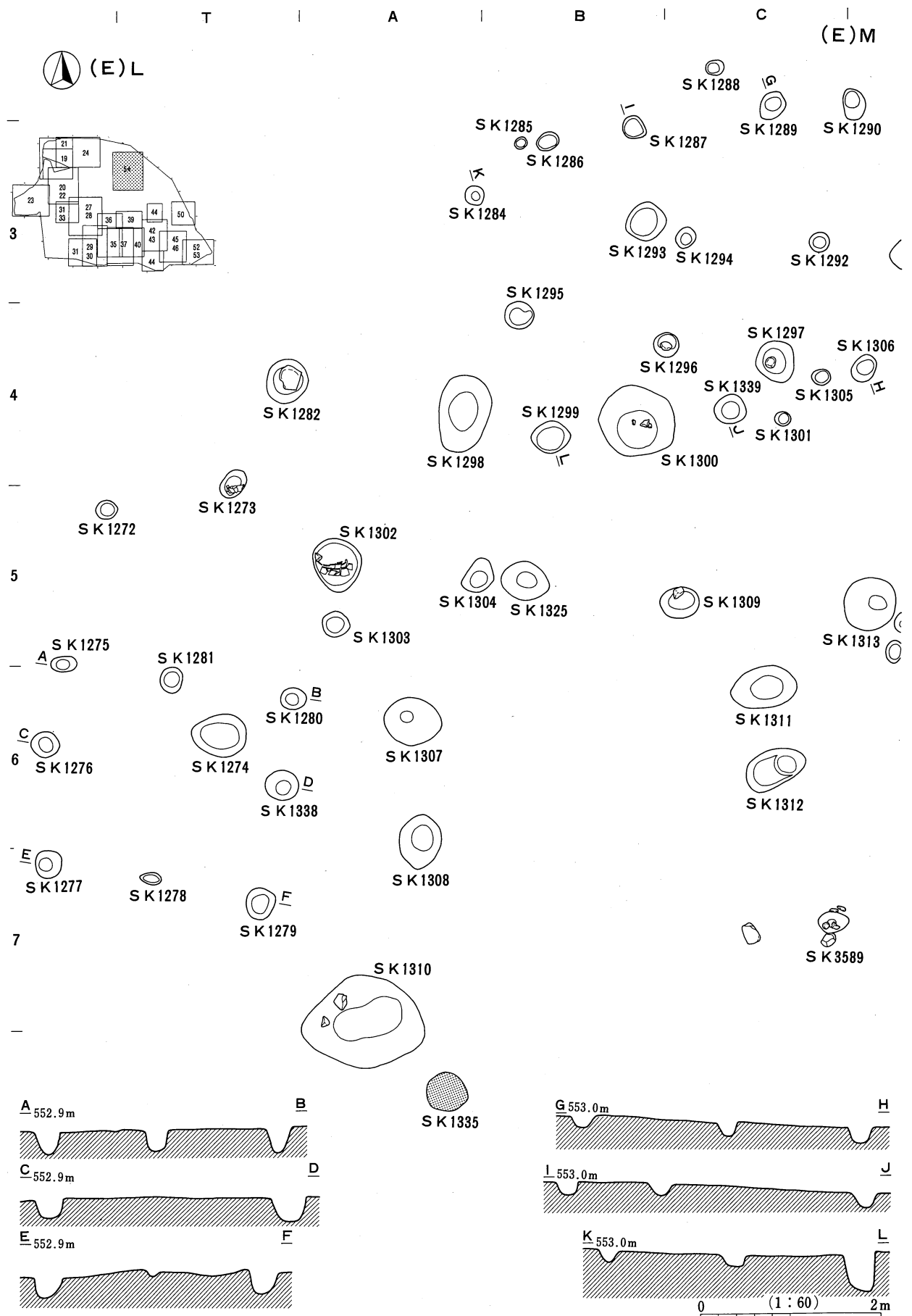

図版55 古代遺構全体図 (1 : 800)

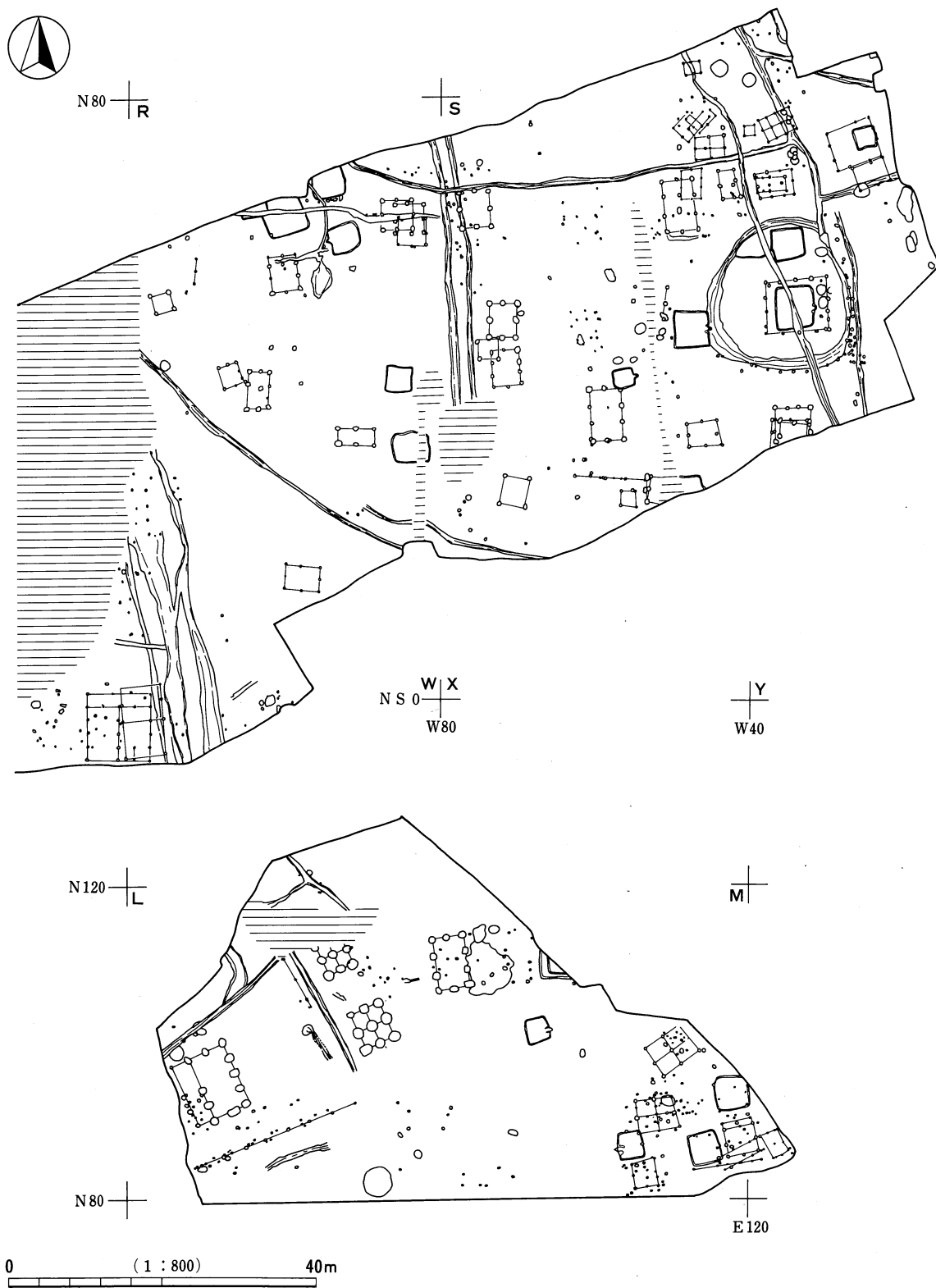

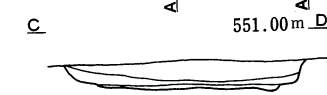
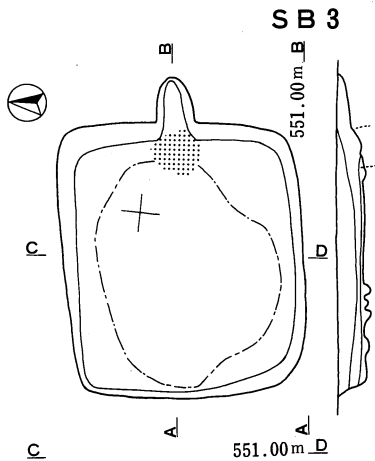
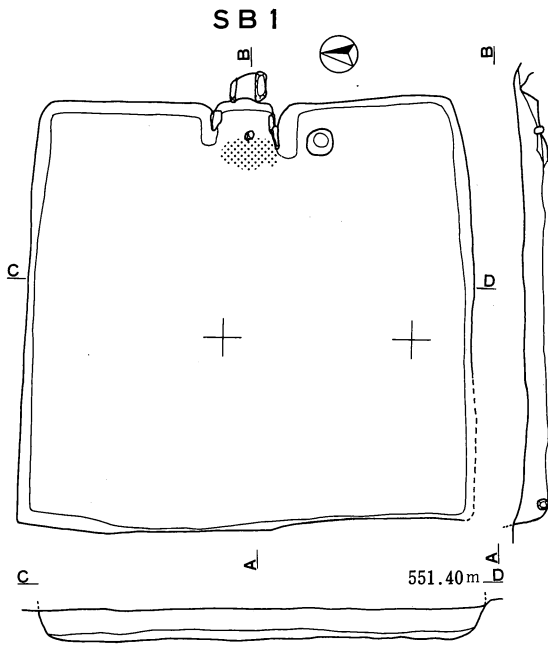
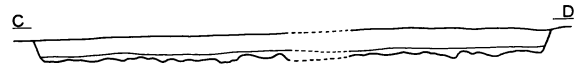
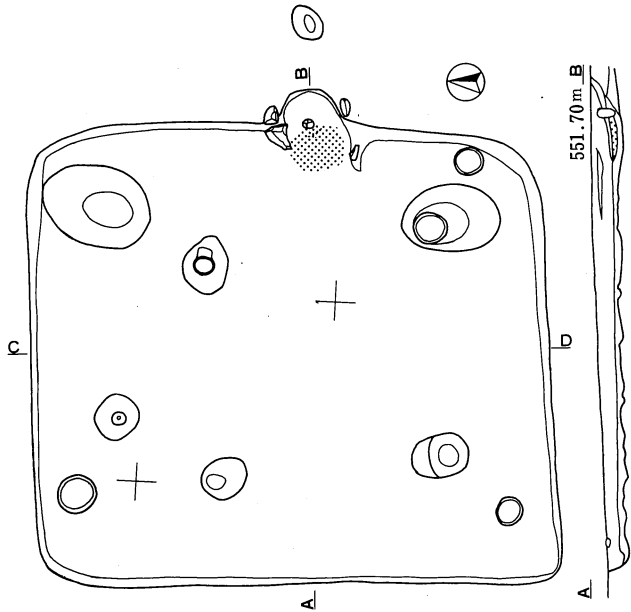

SB5

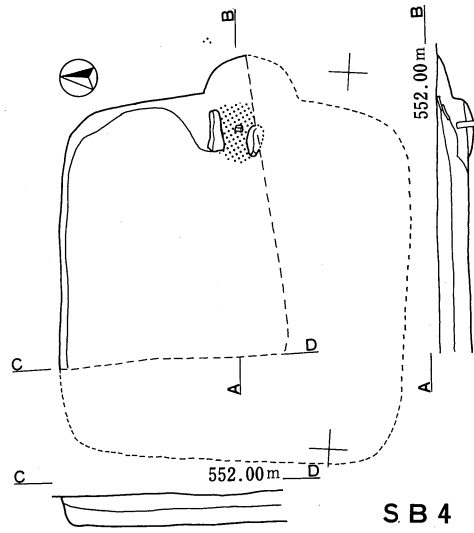
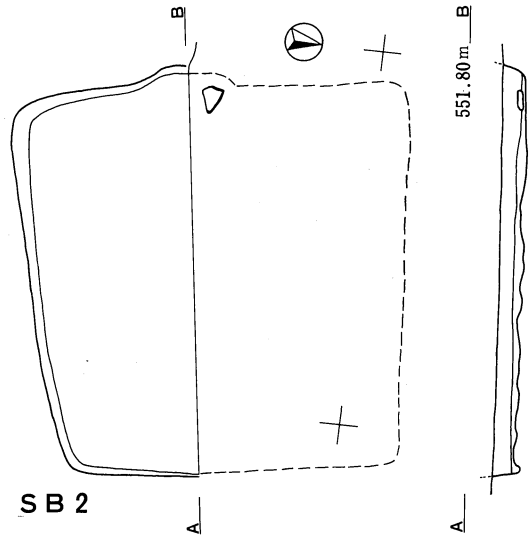

SB4

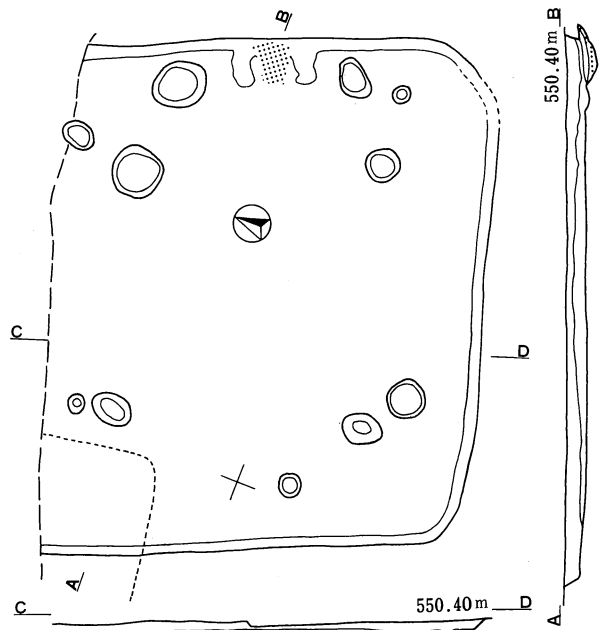

SB6

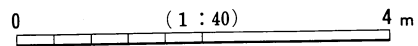

図版57 古代遺構図2 (SB7~12)

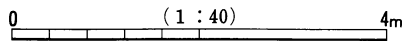
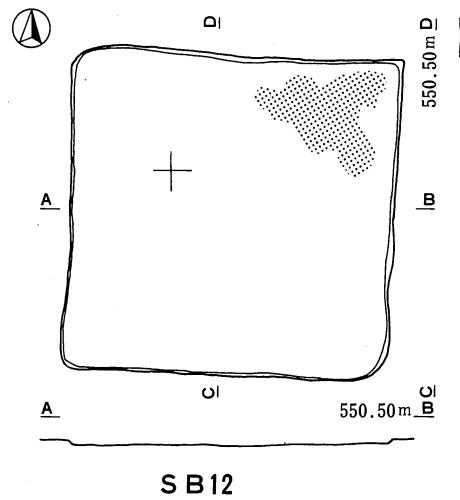
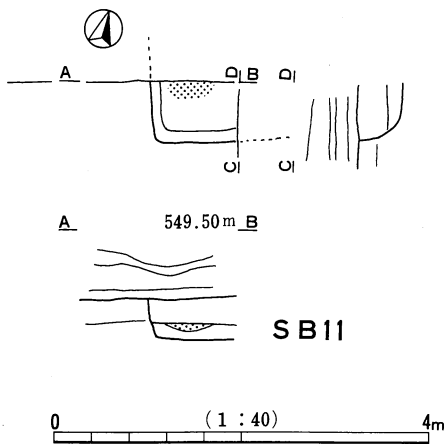
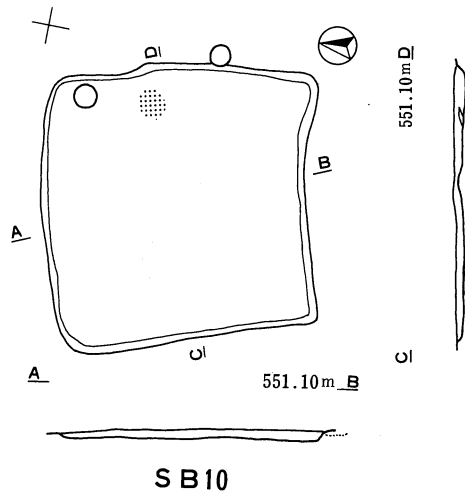
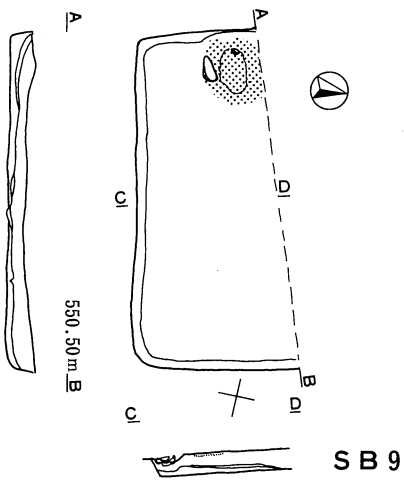
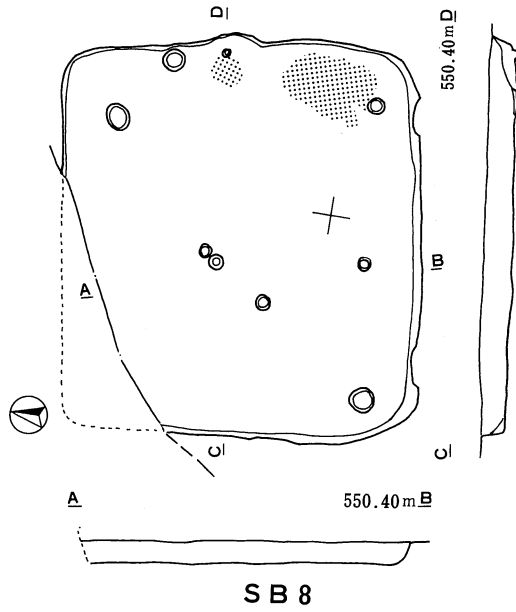
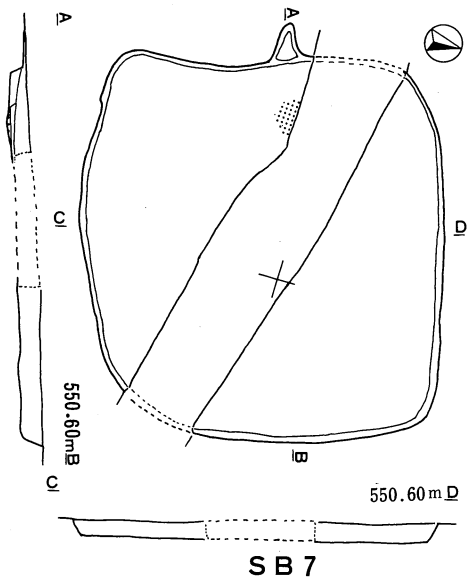

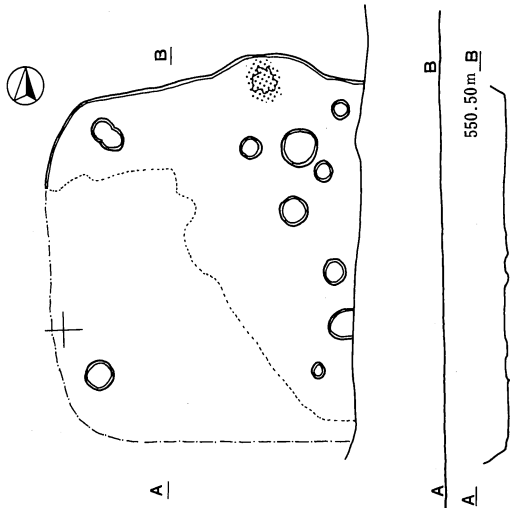

S B13

0 (1:40) 4m

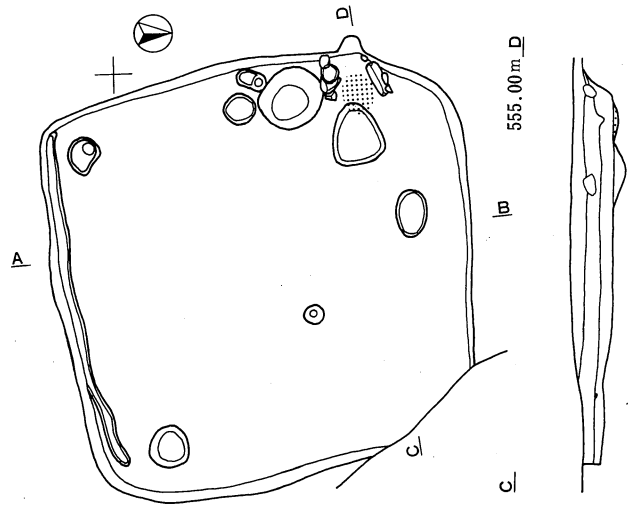

A 555.00m B

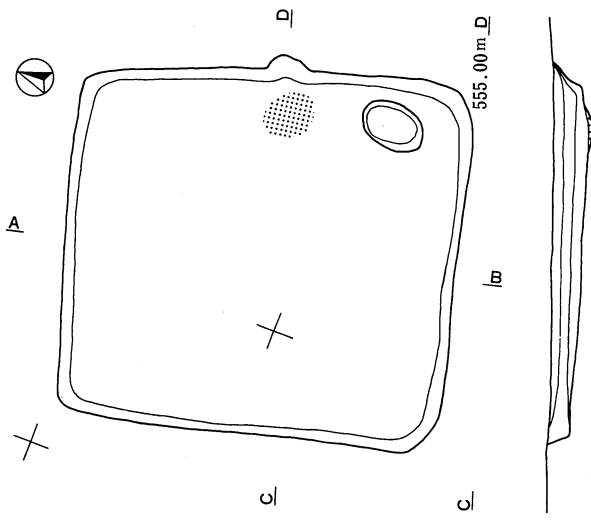

A 555.00m B

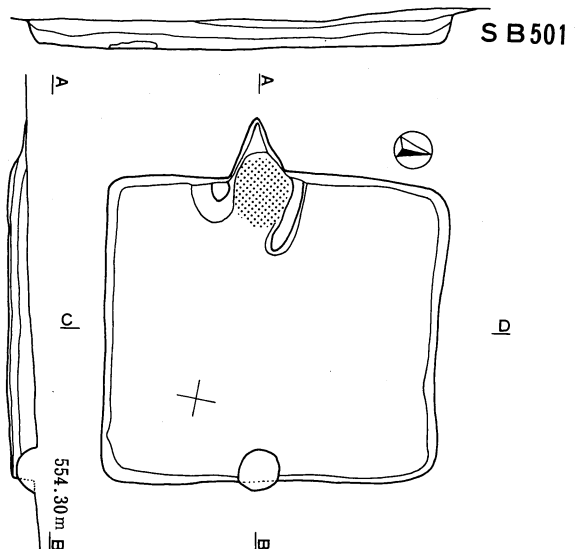

554.30m B 554.30m D

S B505

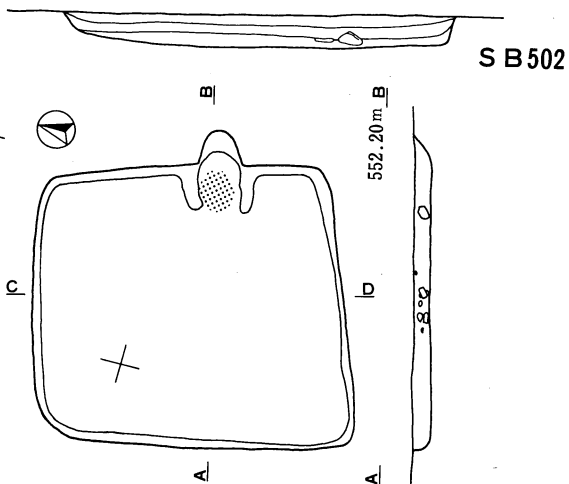

552.20m B 552.20m D

S B504

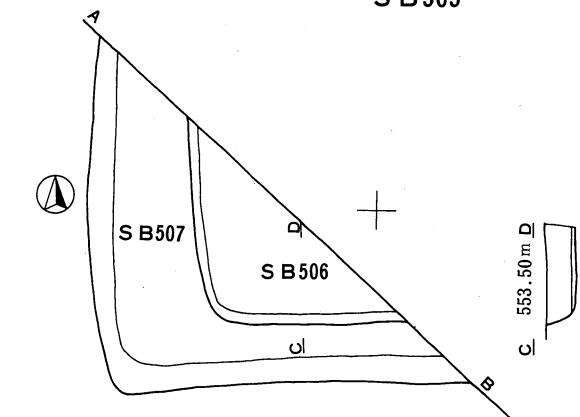

A 553.50m B

S B506・507

図版59 古代遺構図4 (ST1・2)

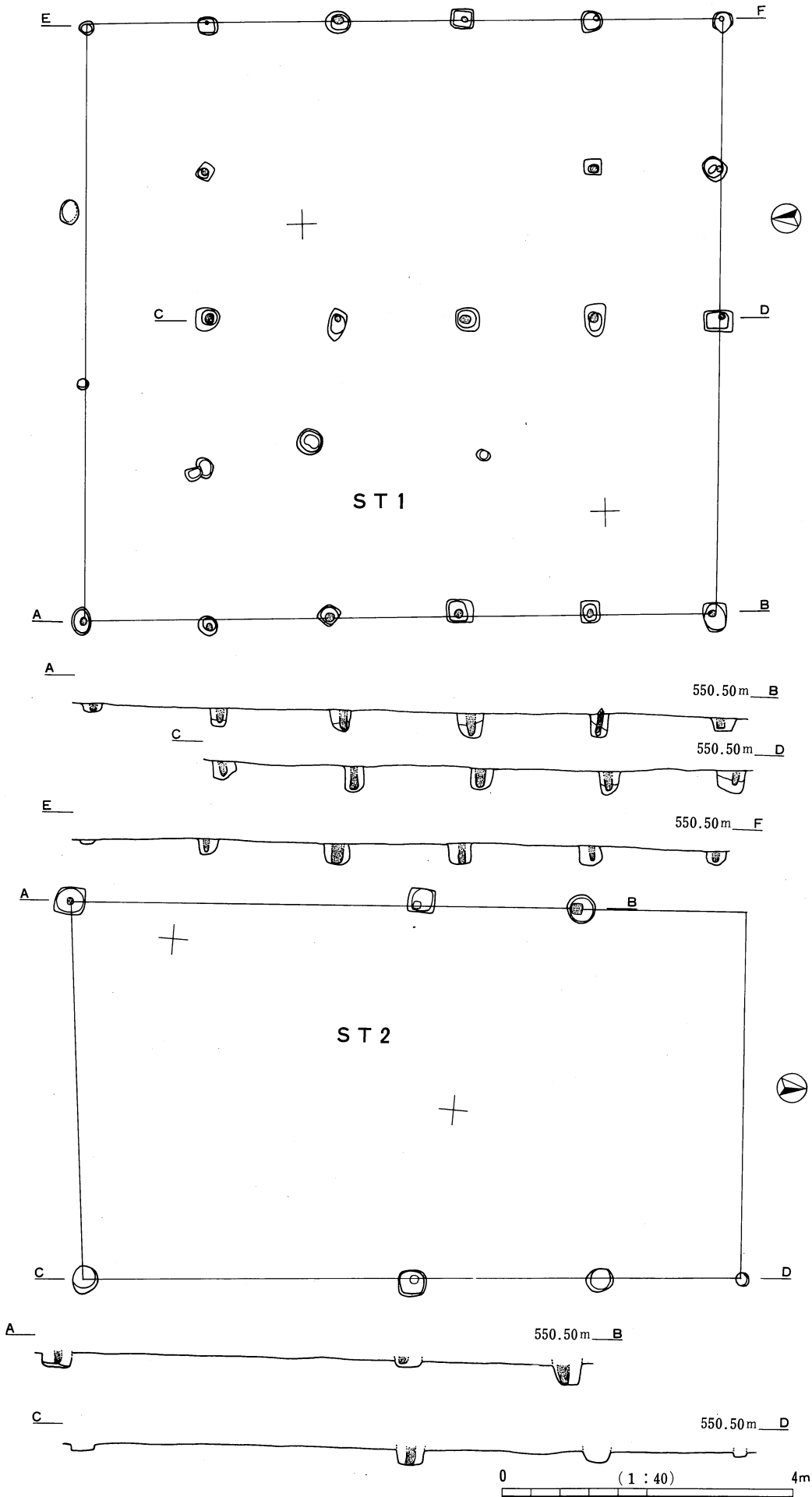

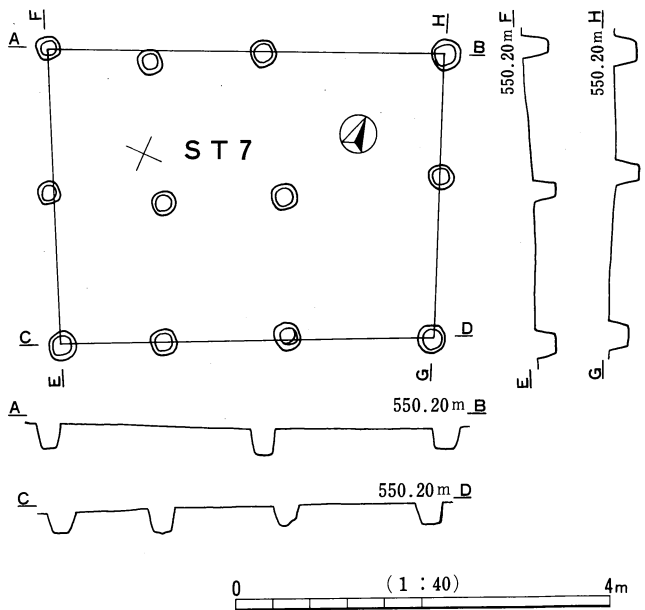
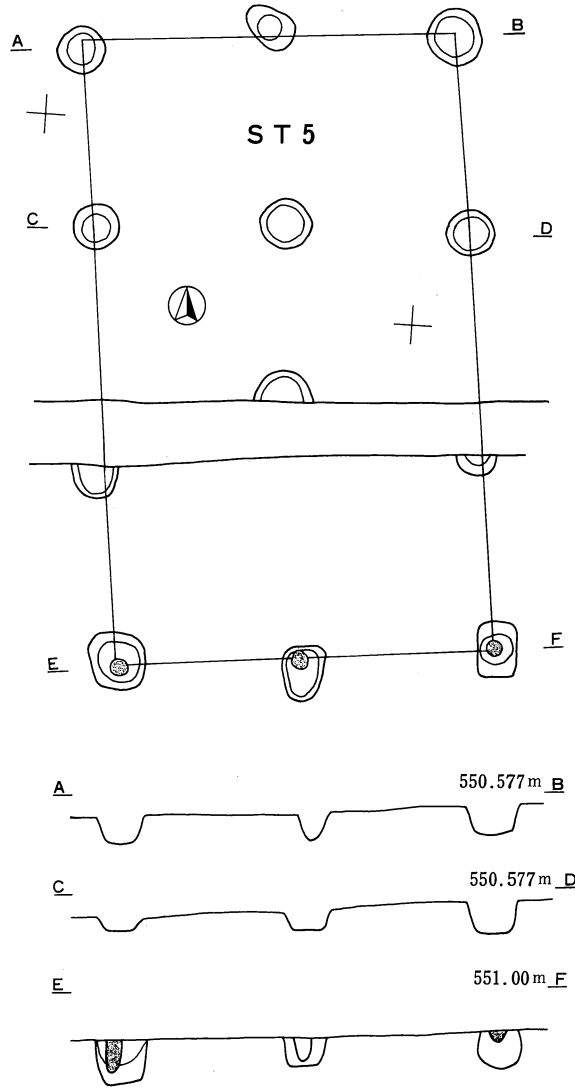
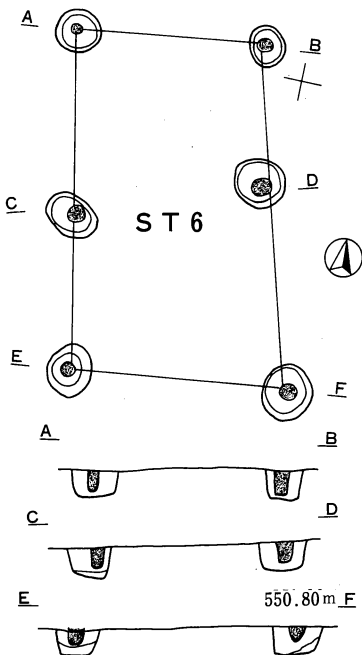
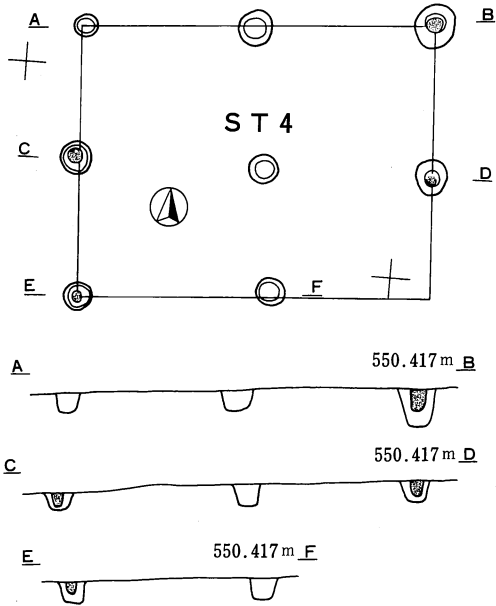
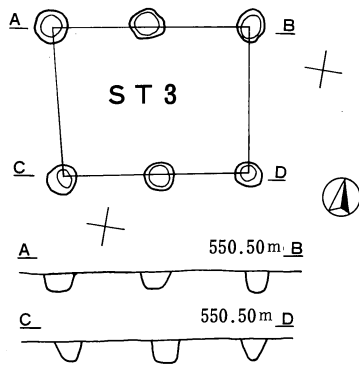

図版61 古代遺構図6 (ST8~13・15)

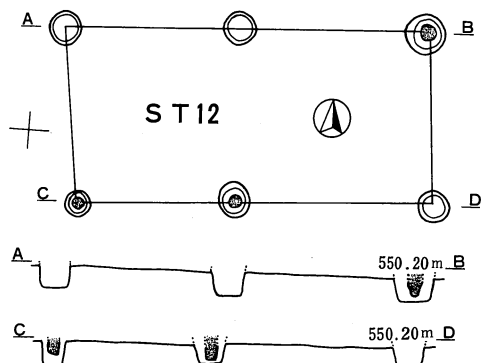
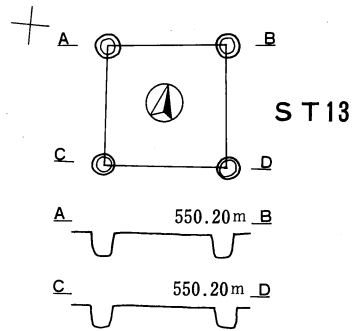
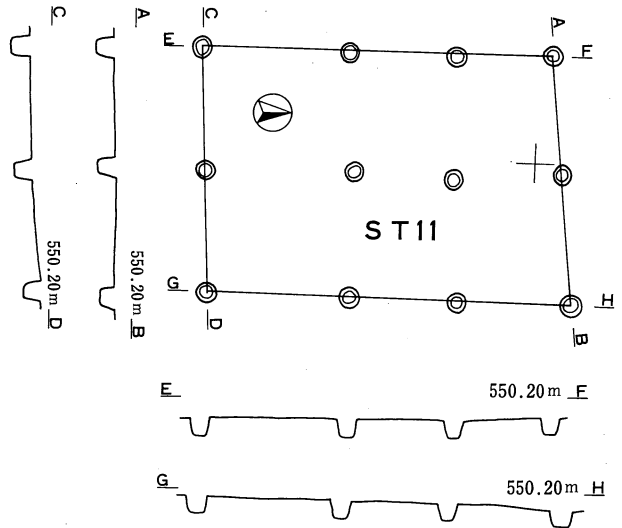
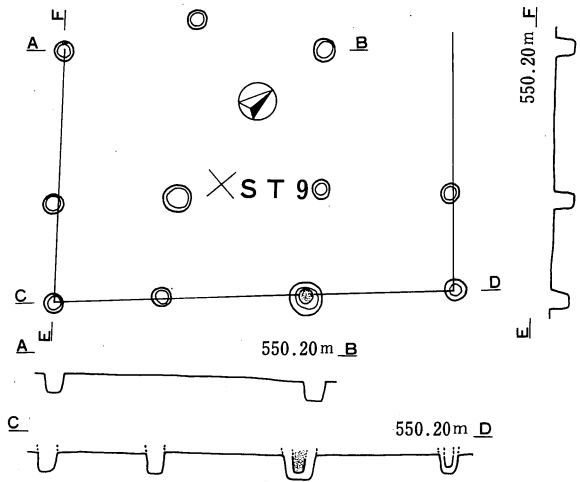
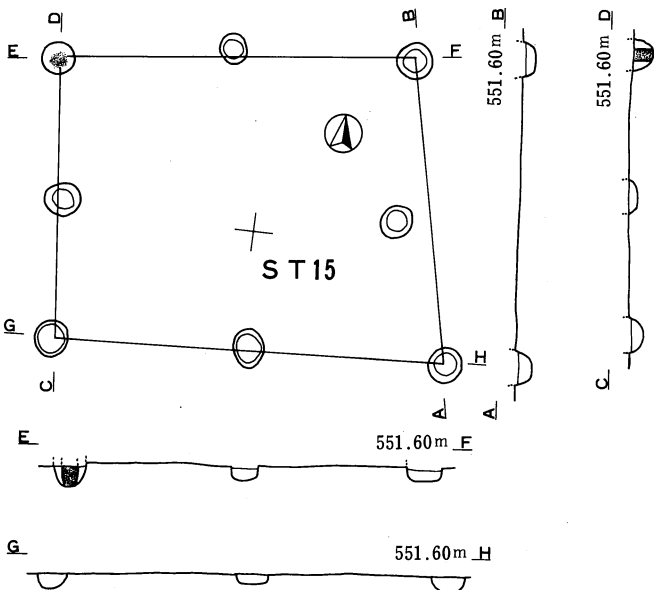
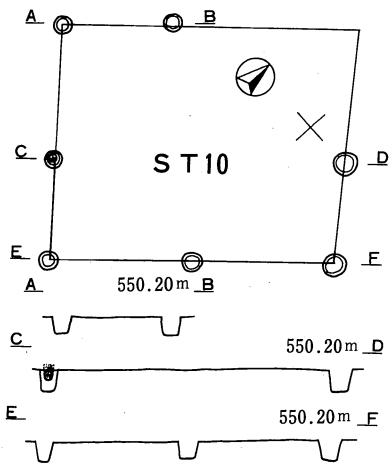
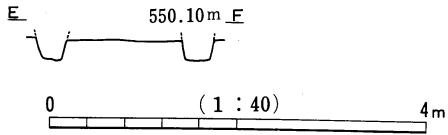
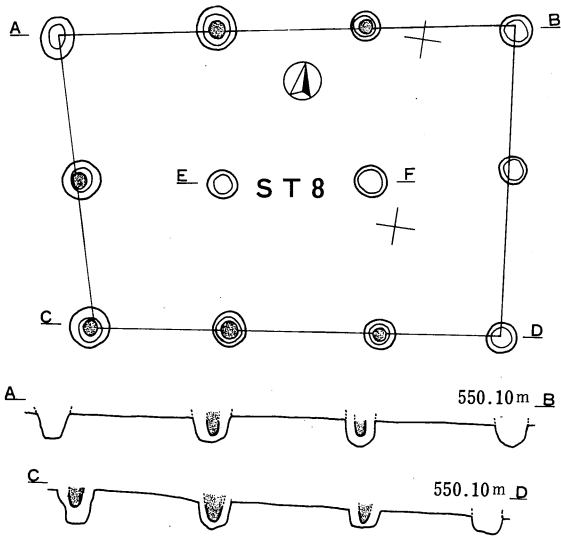

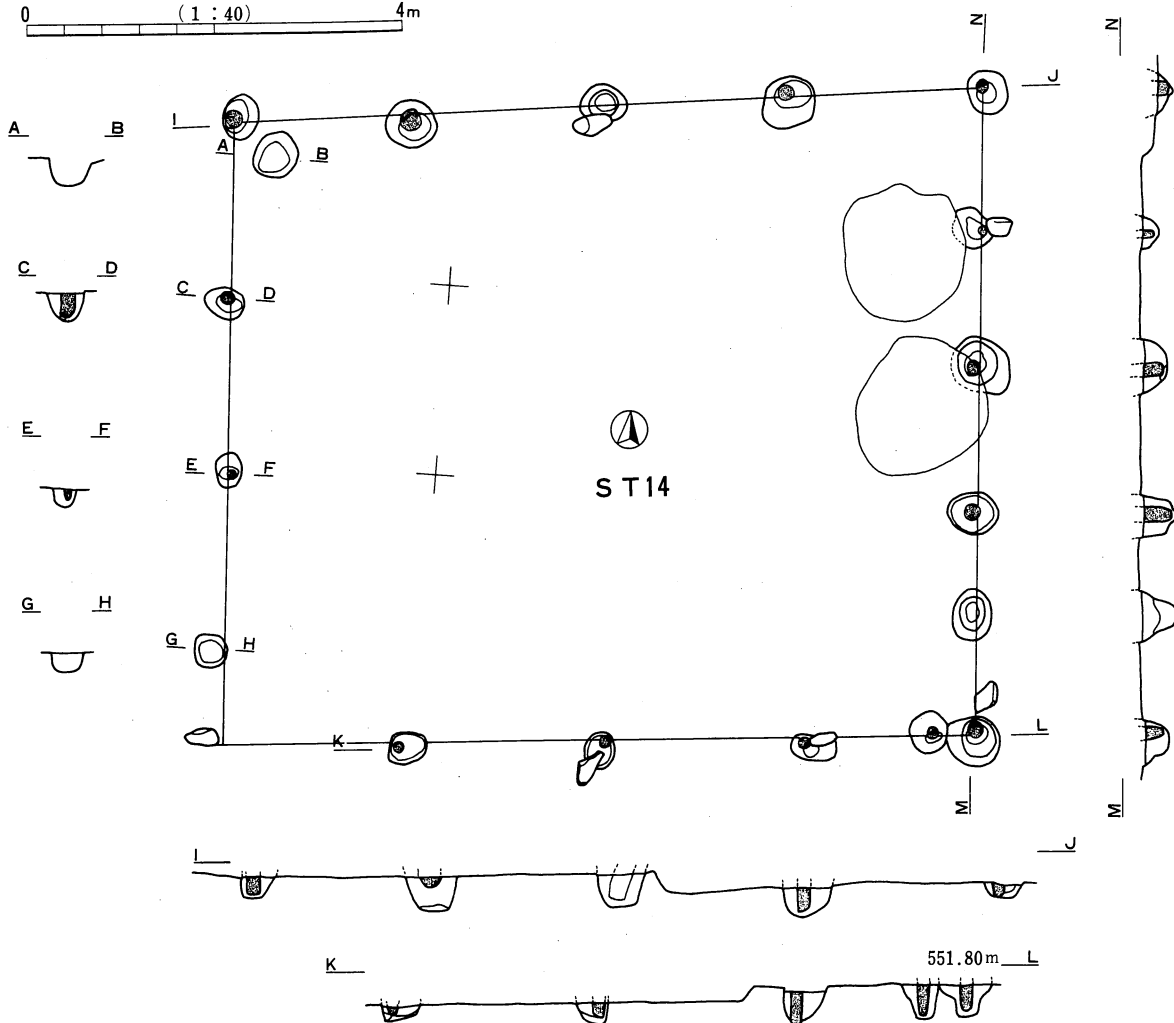
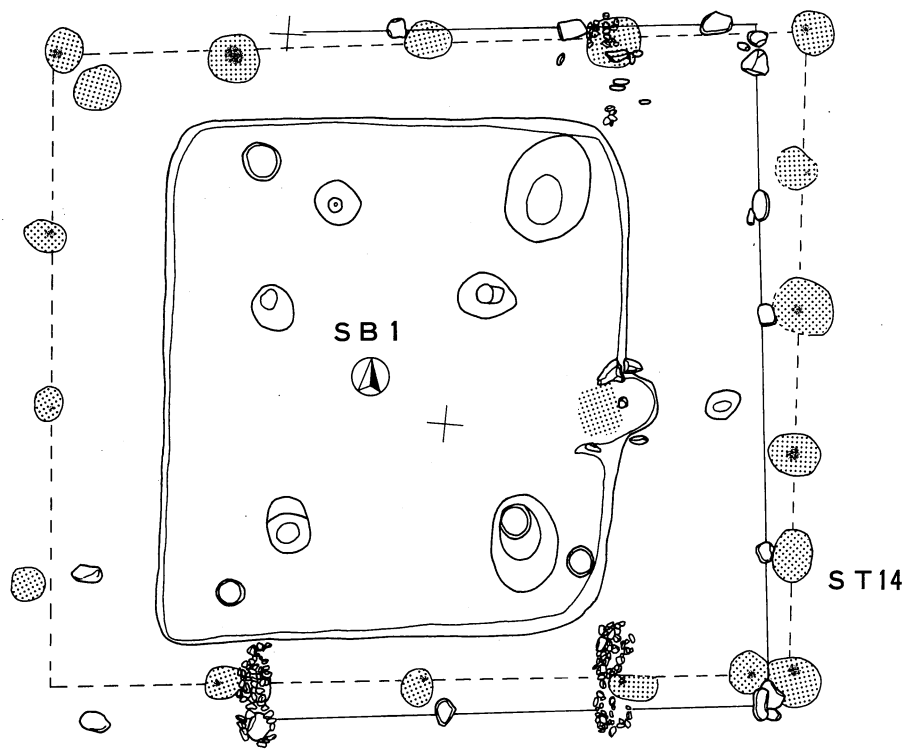

図版63 古代遺構図8 (S T16~21)

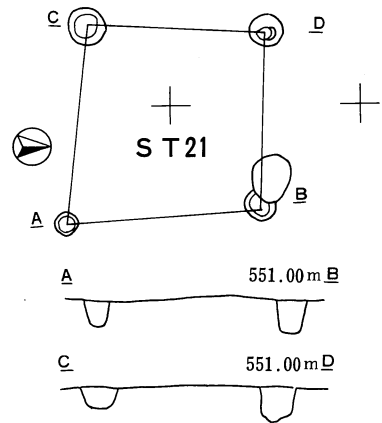
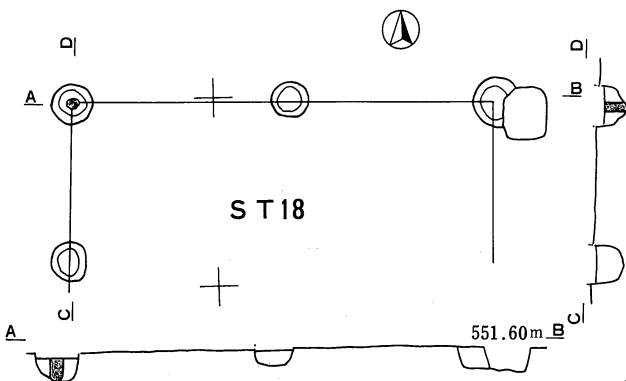
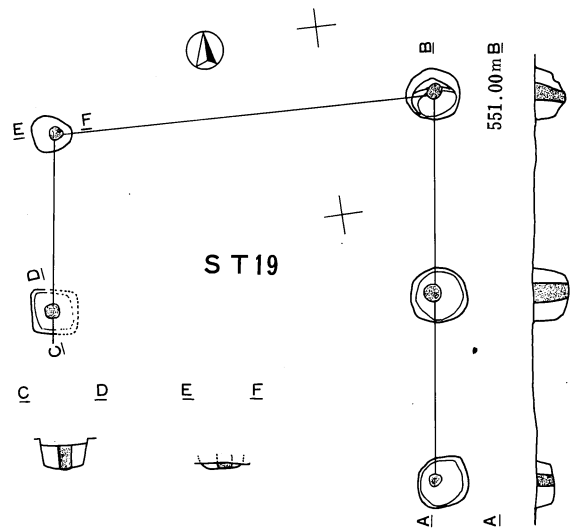
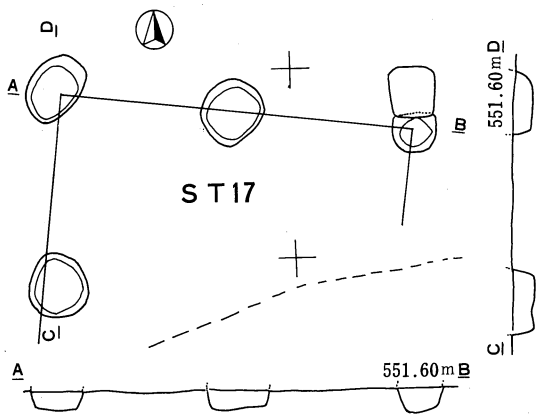
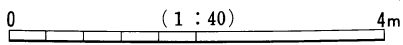
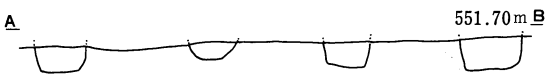
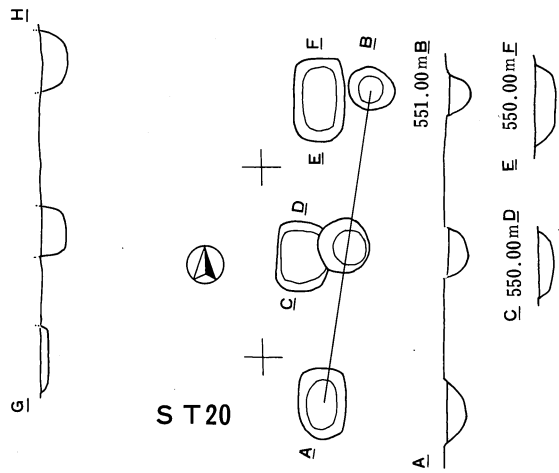
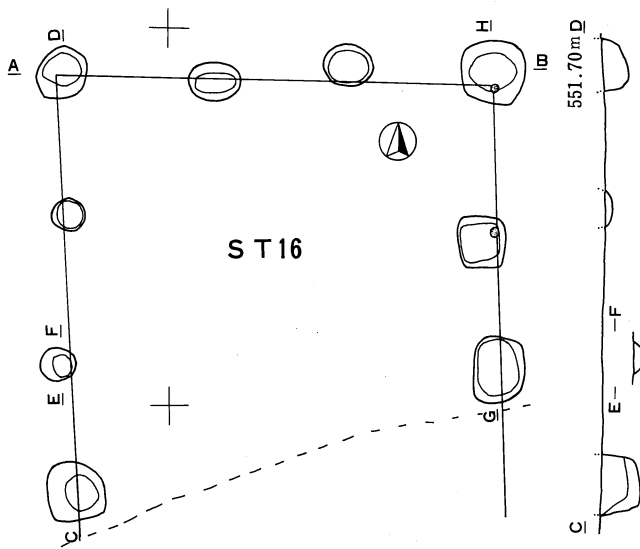

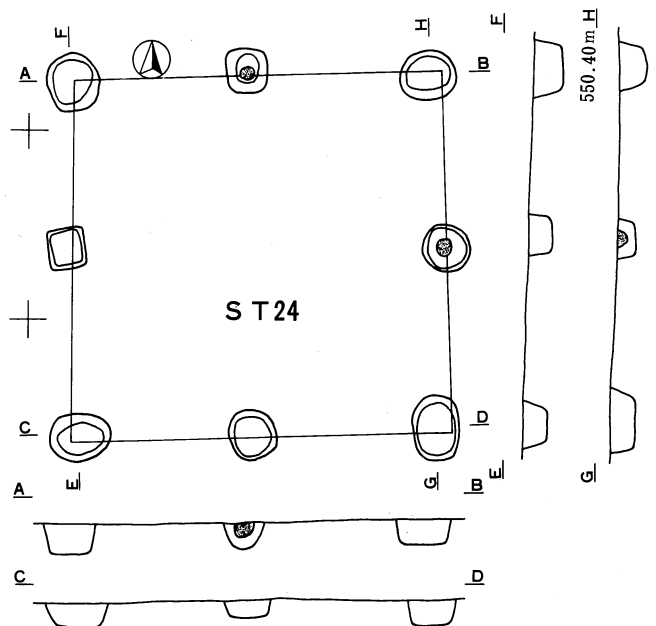
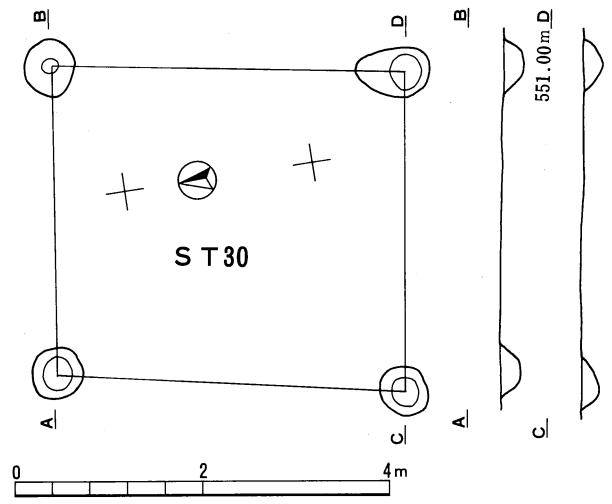
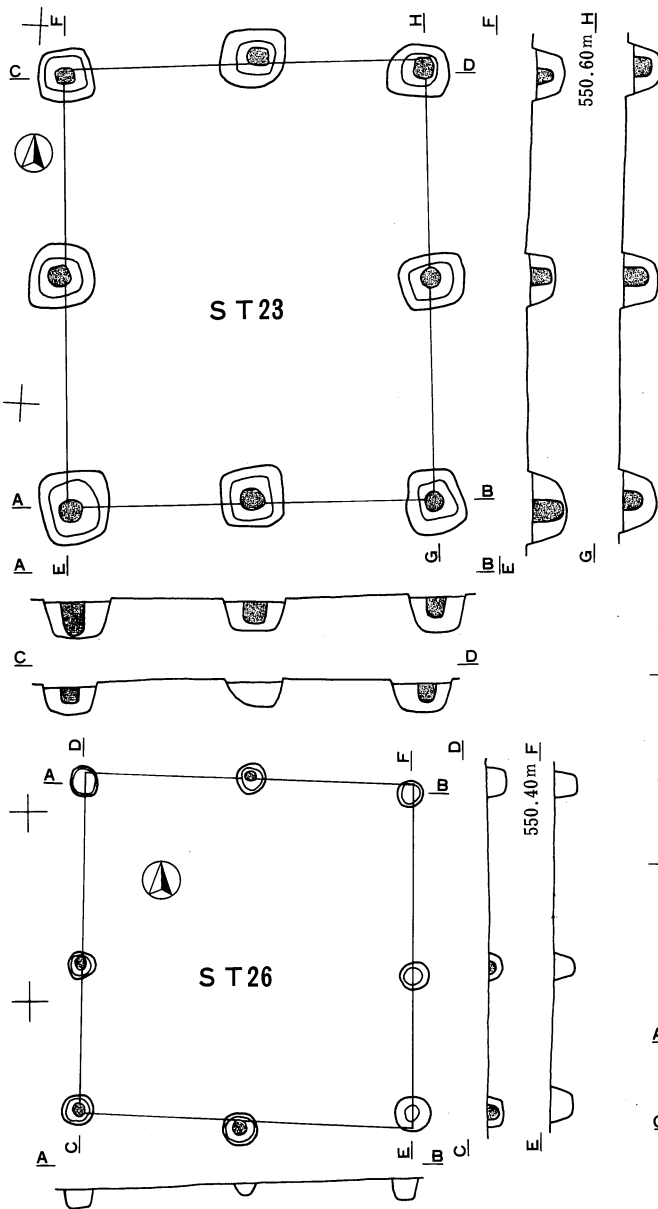
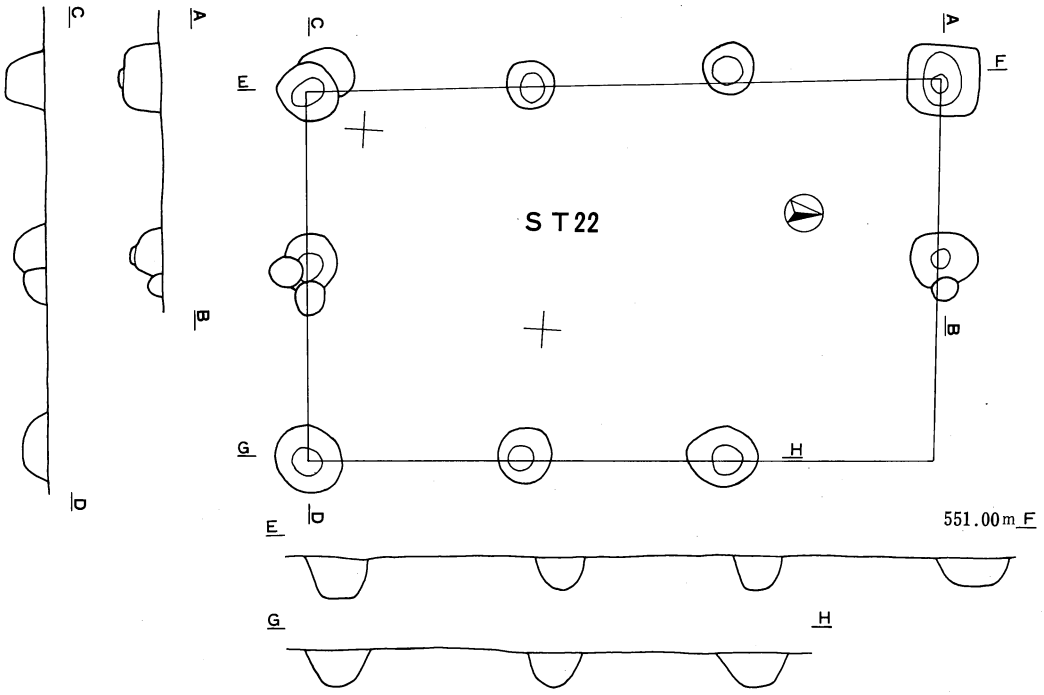

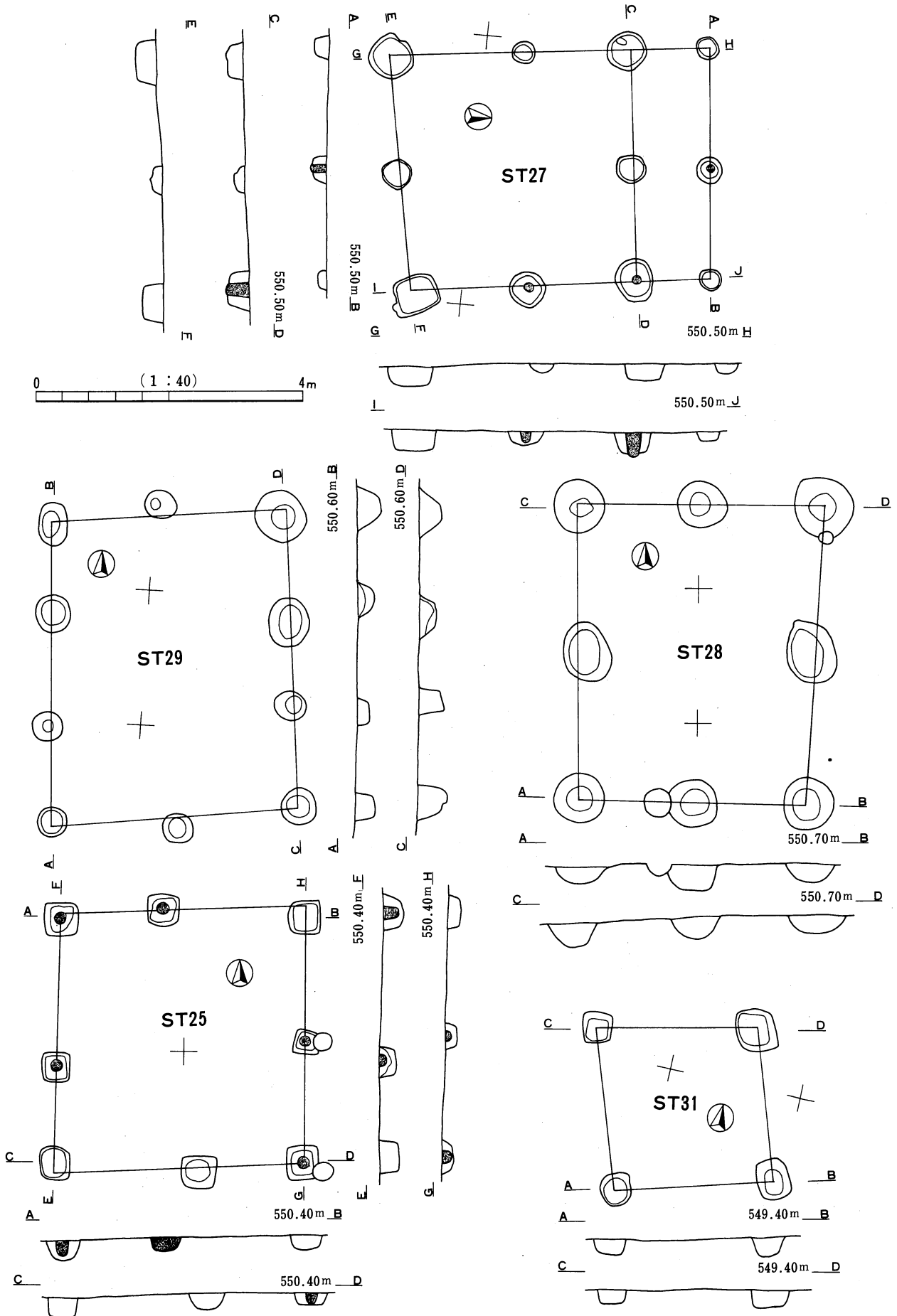

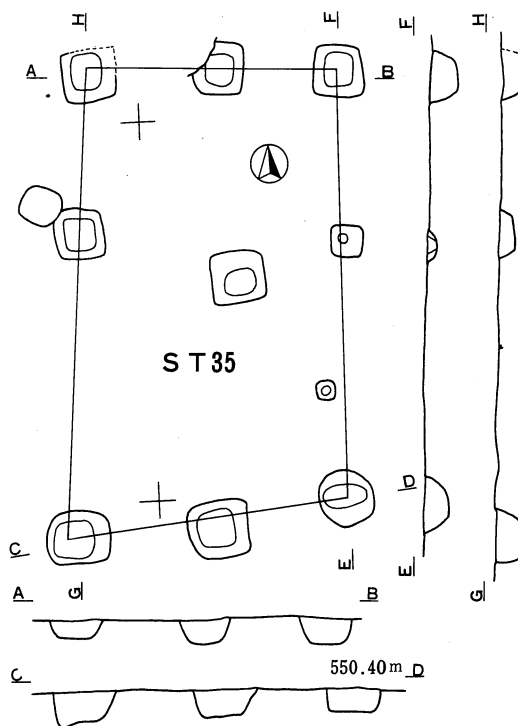
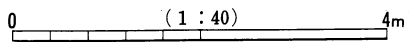
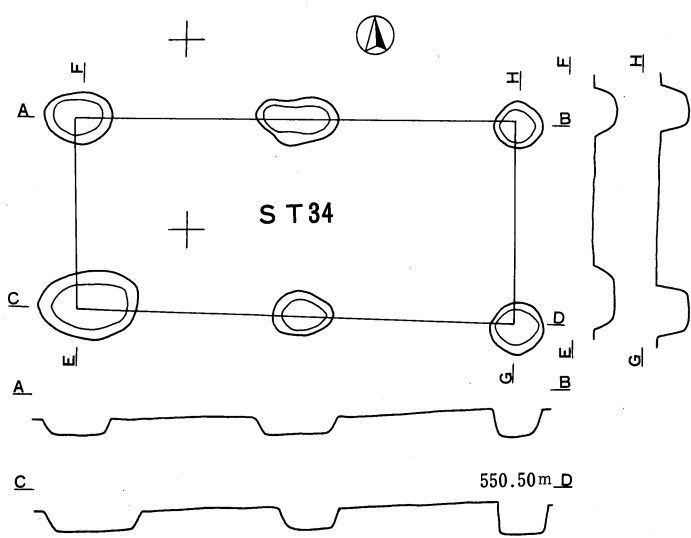
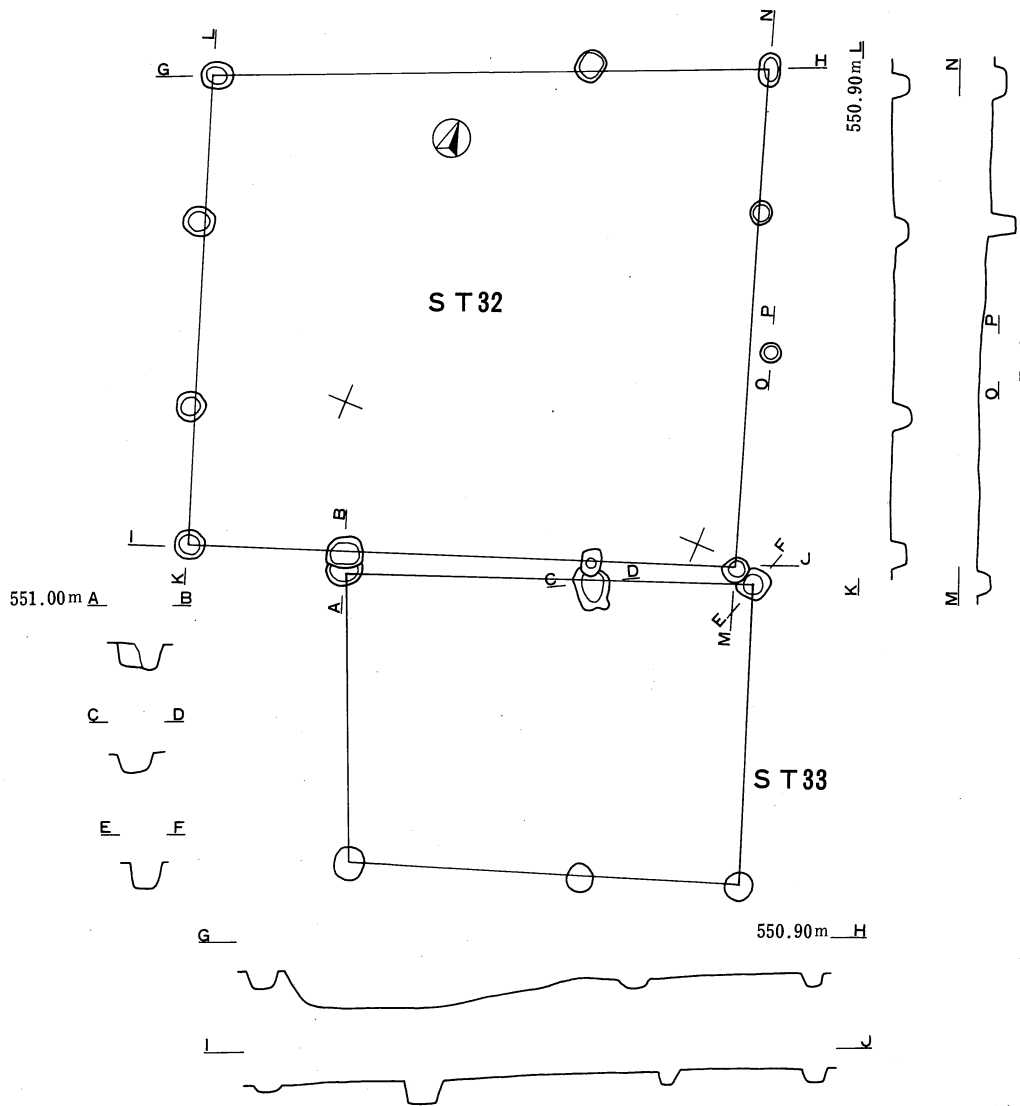

图版67 古代遺構図12 (S T36~38・501・502・504)

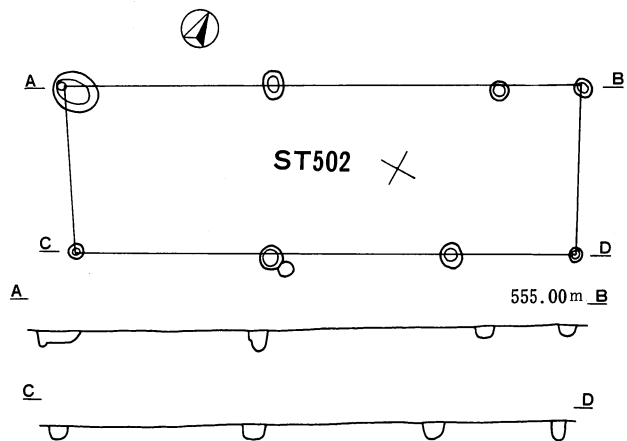
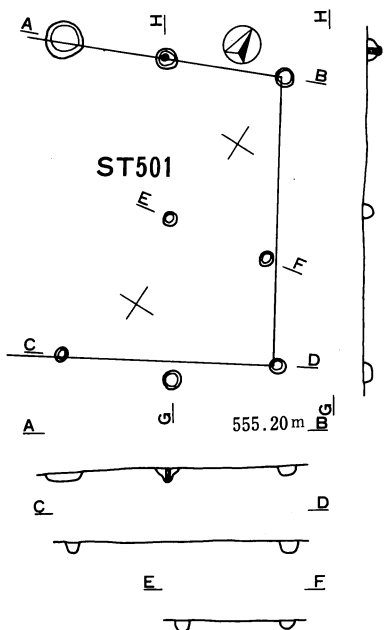
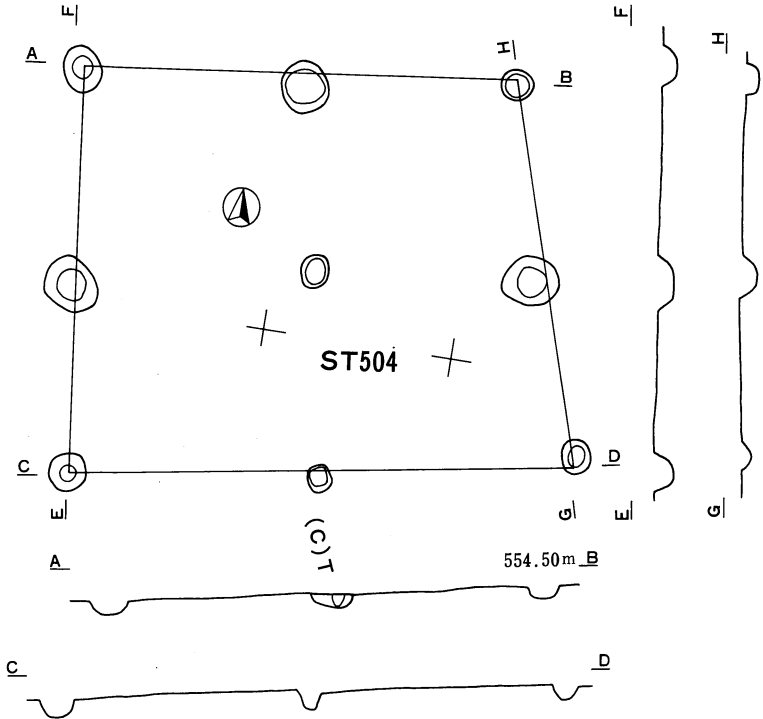
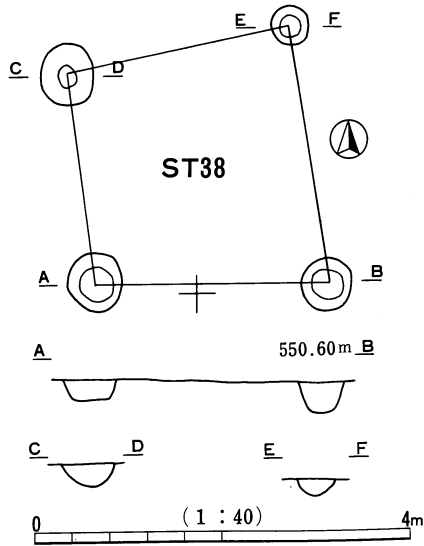
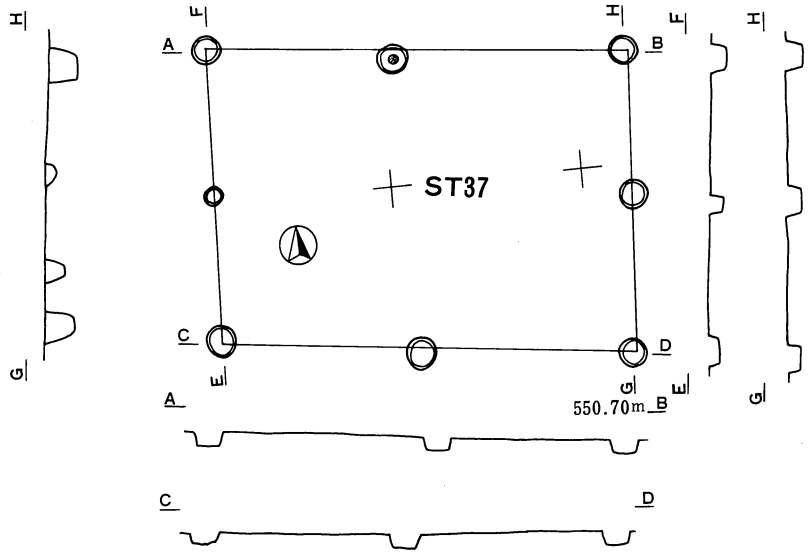
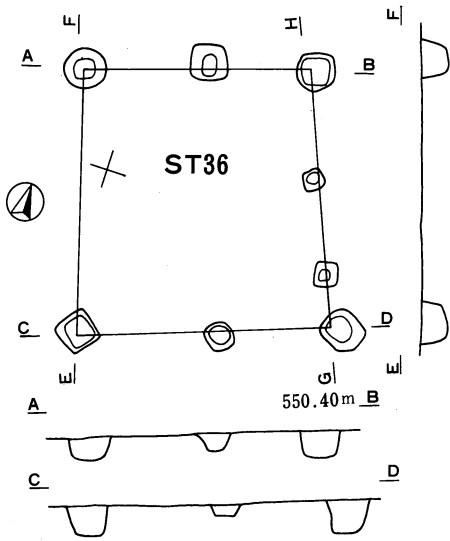

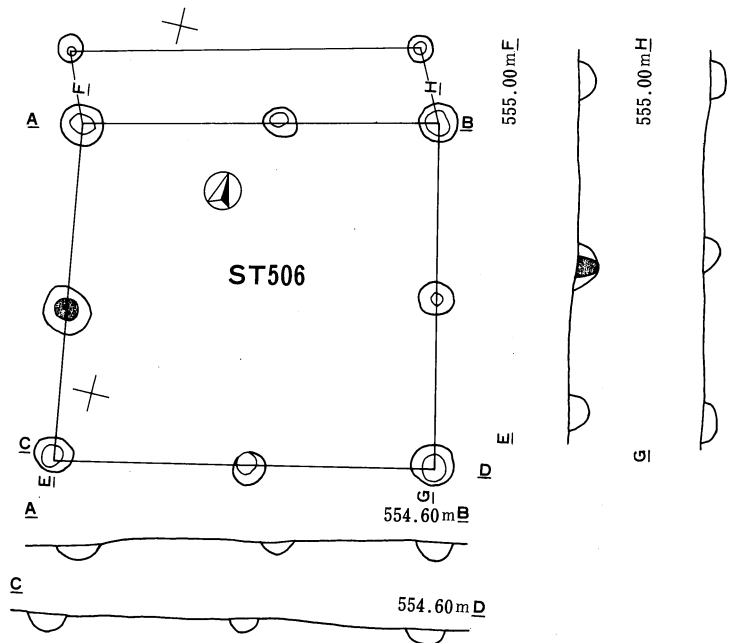
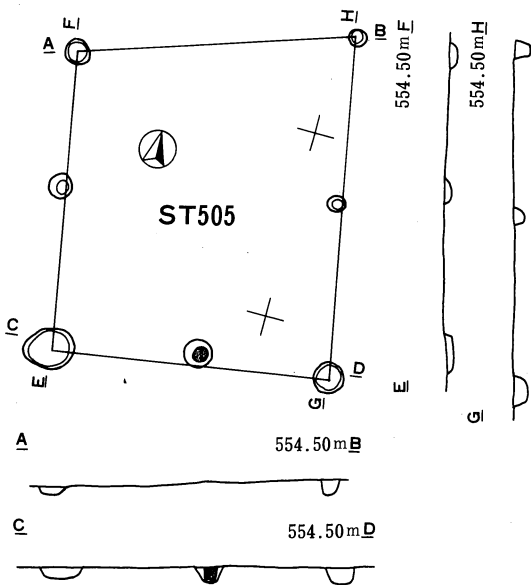
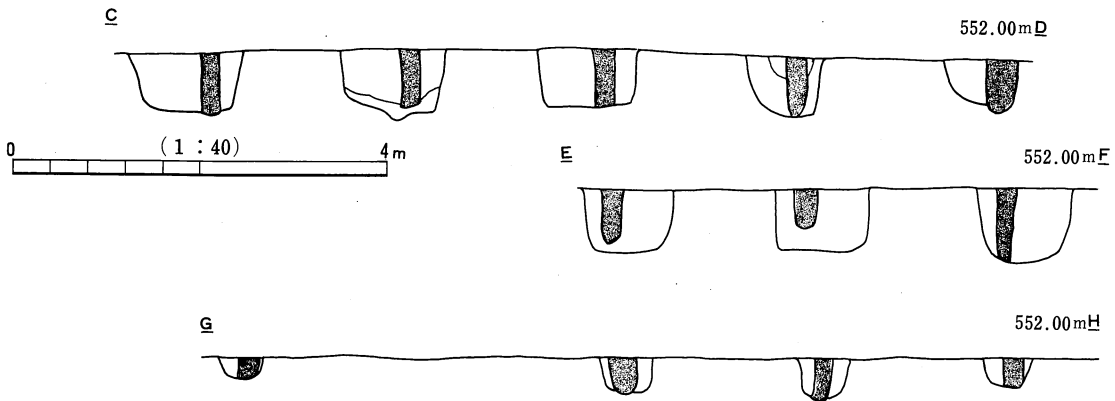
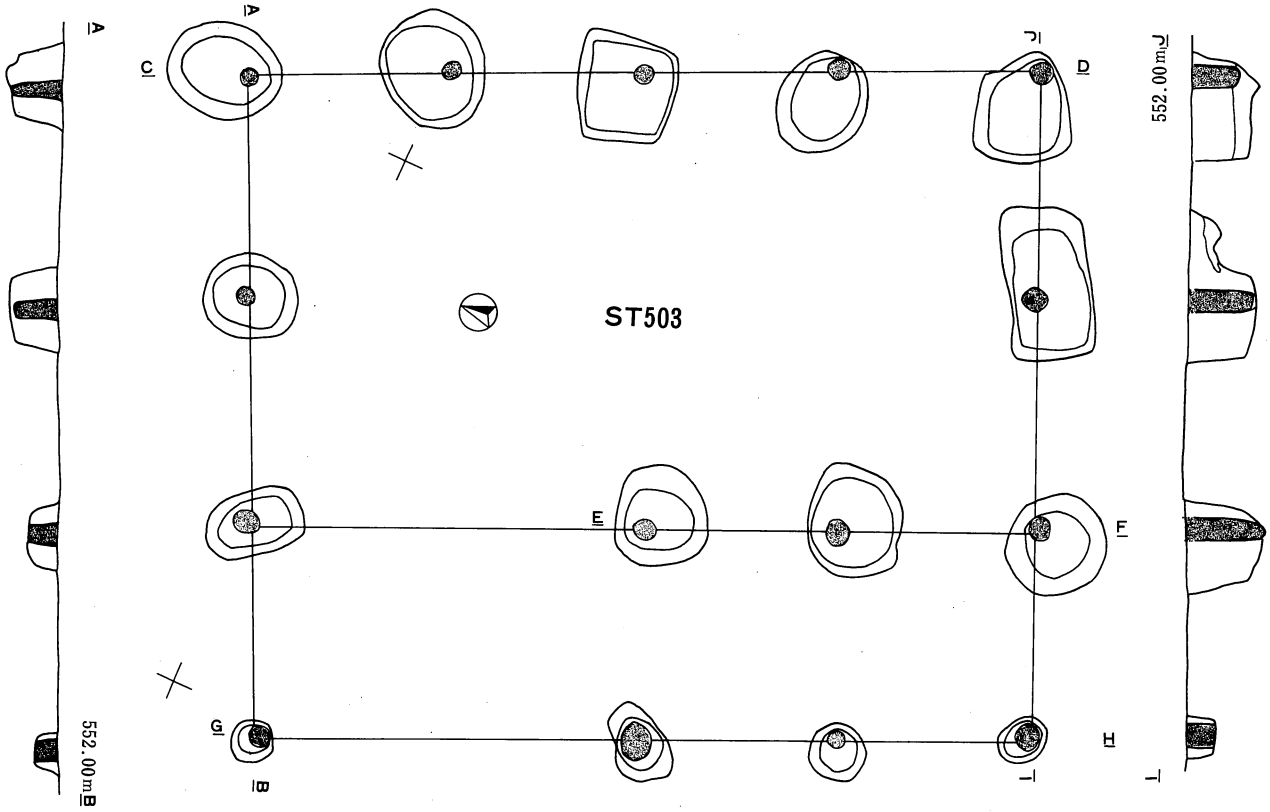

图版69 古代遺構図14 (S T507・509・510)

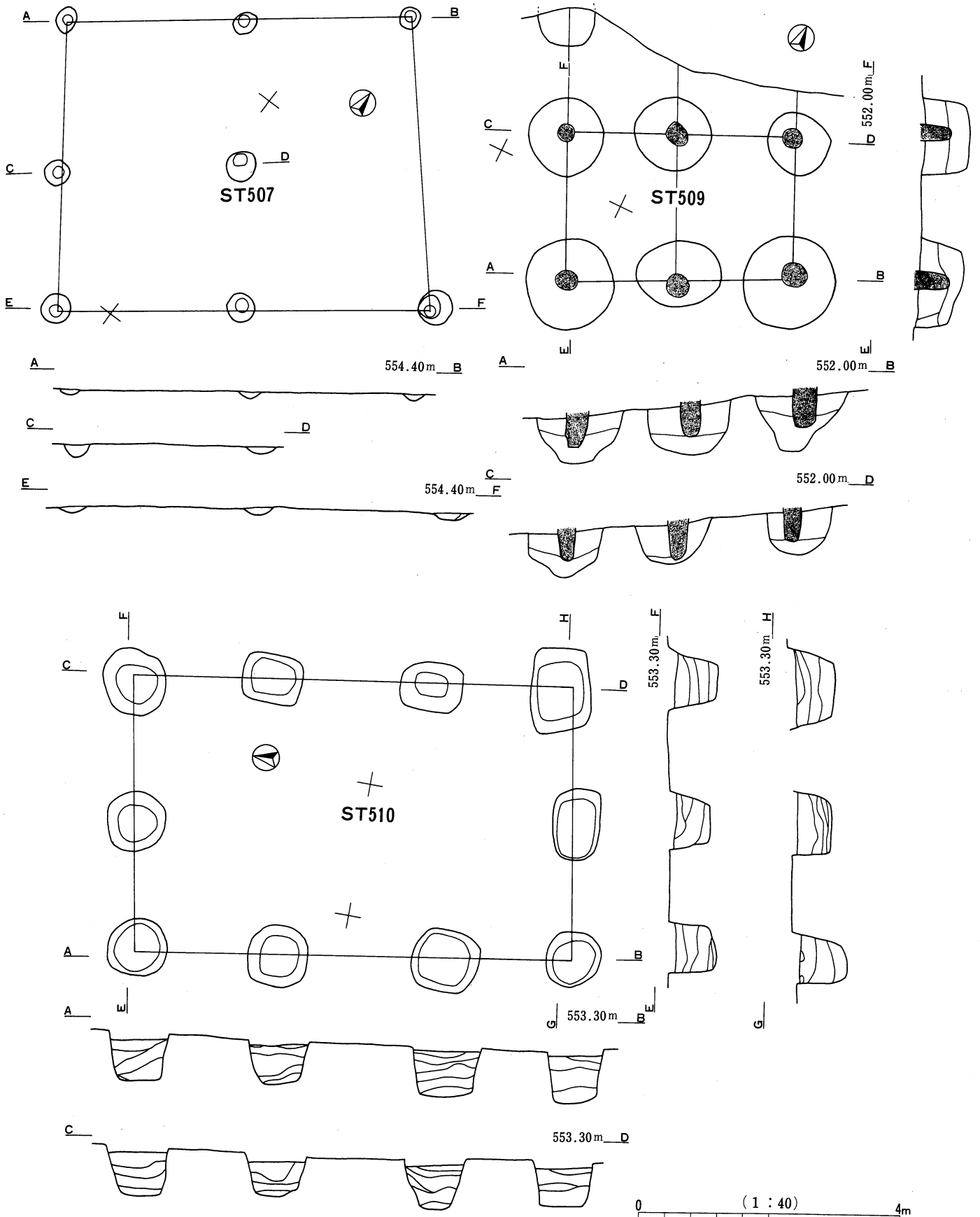

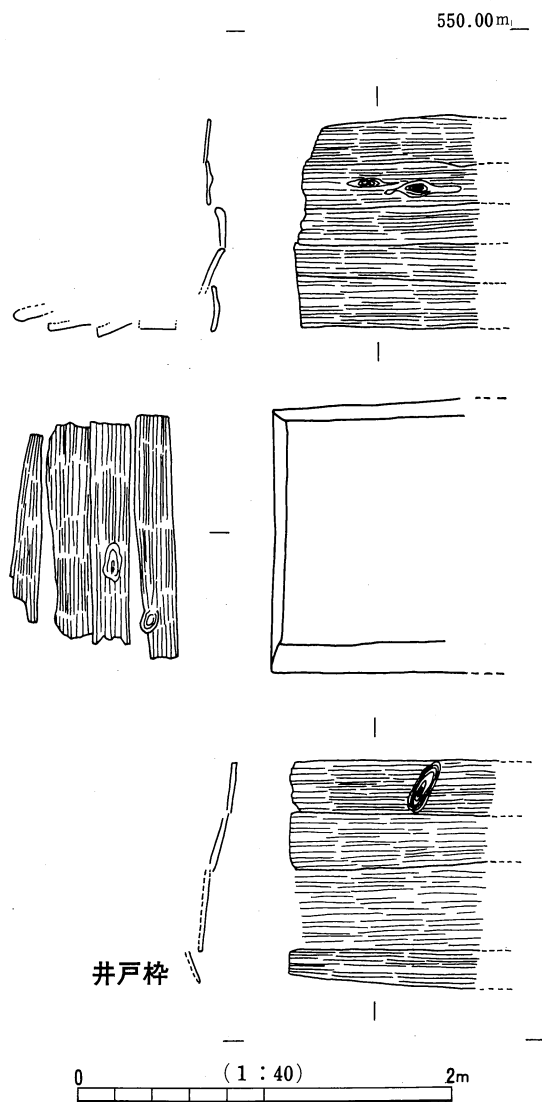
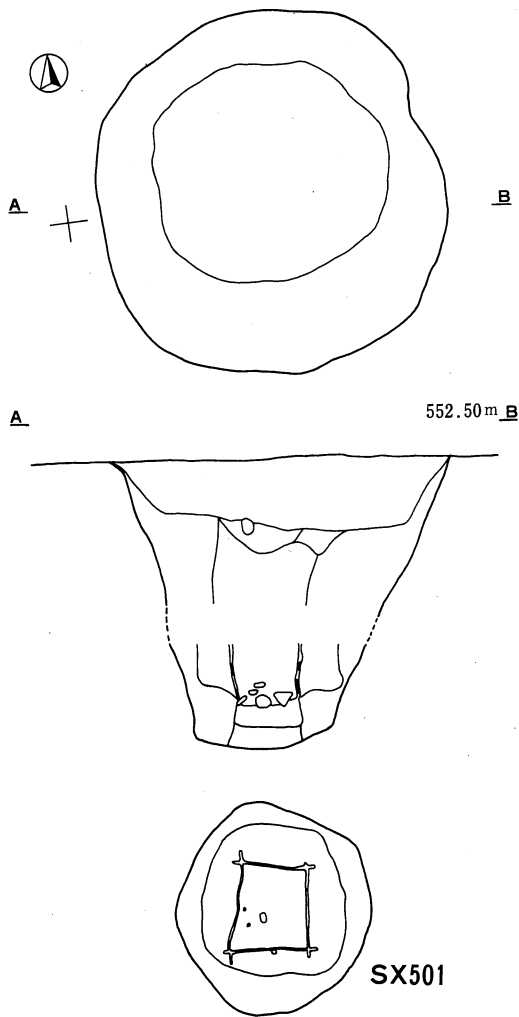
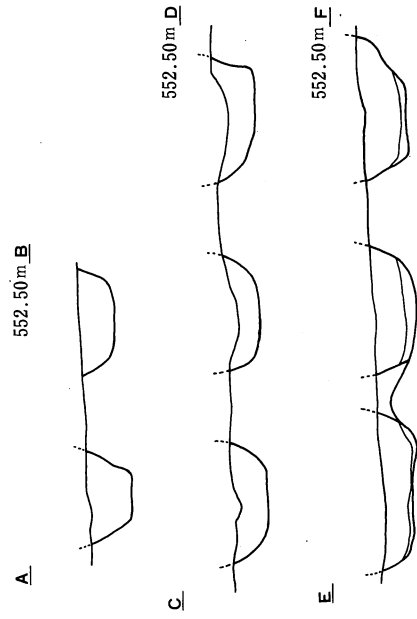
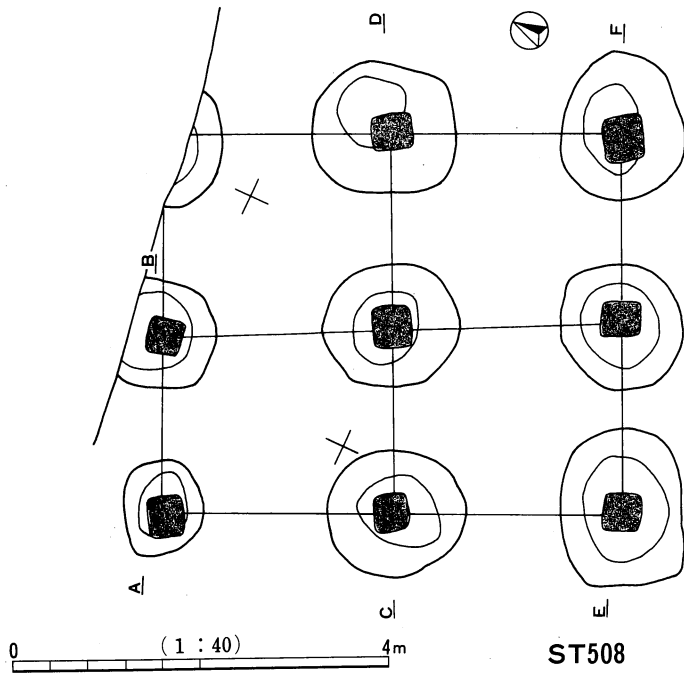

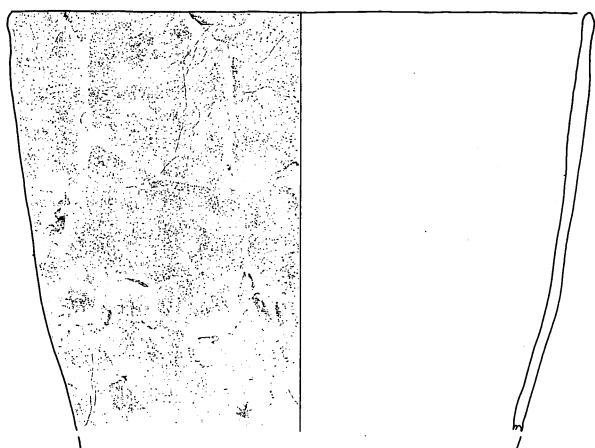

SB101・1

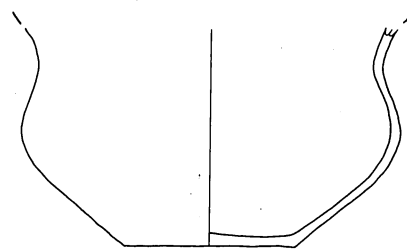

SB101・2

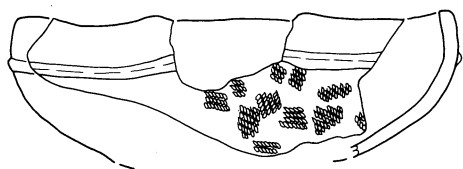

SB101・3

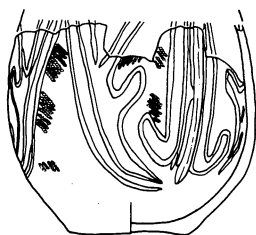
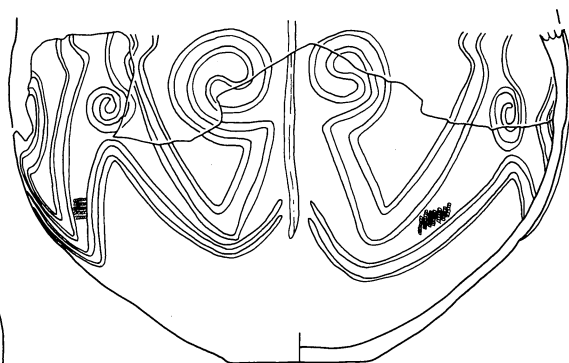

SB557・1

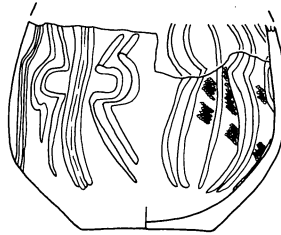

SB102・1



SB102・2



SB110・1

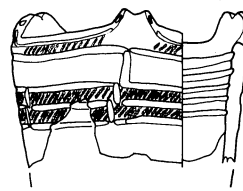

SB555・1

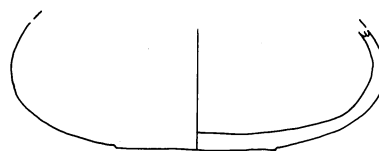

SB555・2

0 (1:4) 20 cm

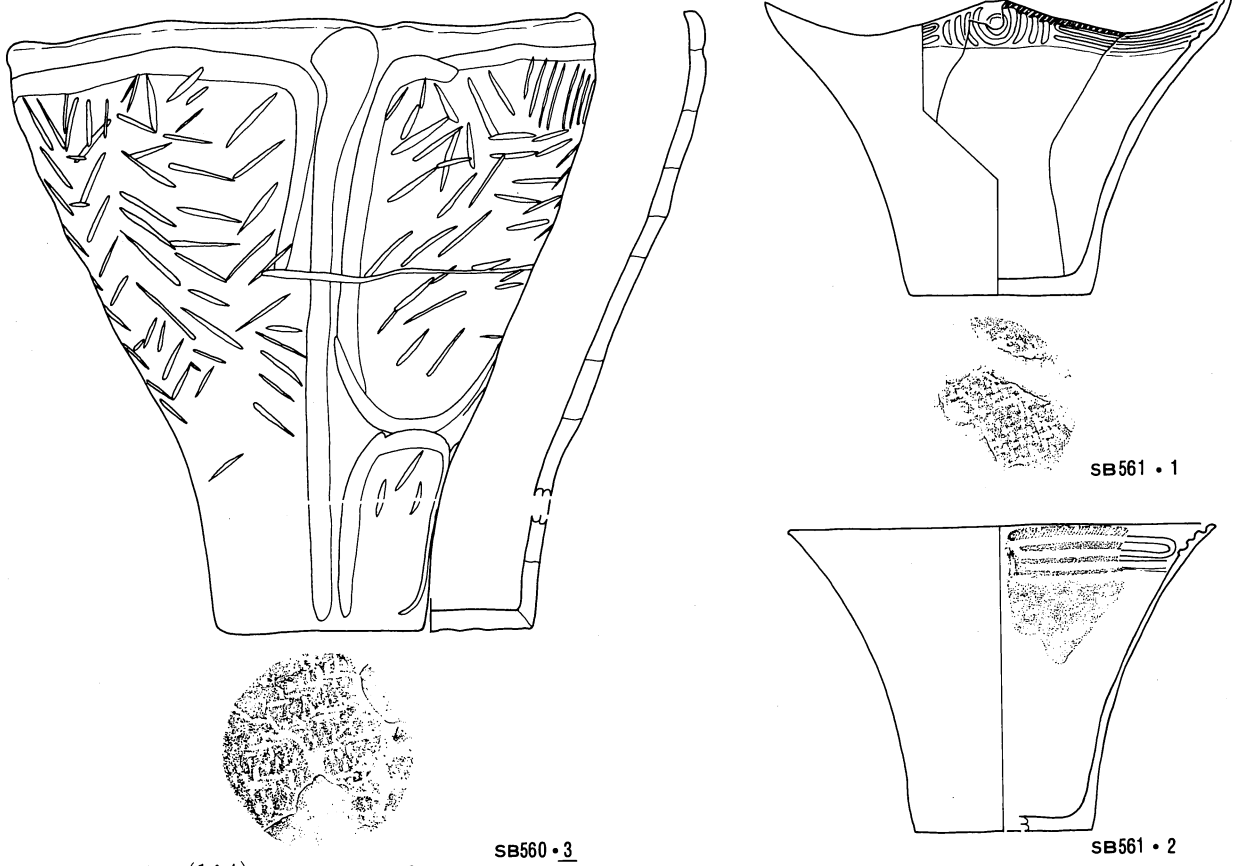
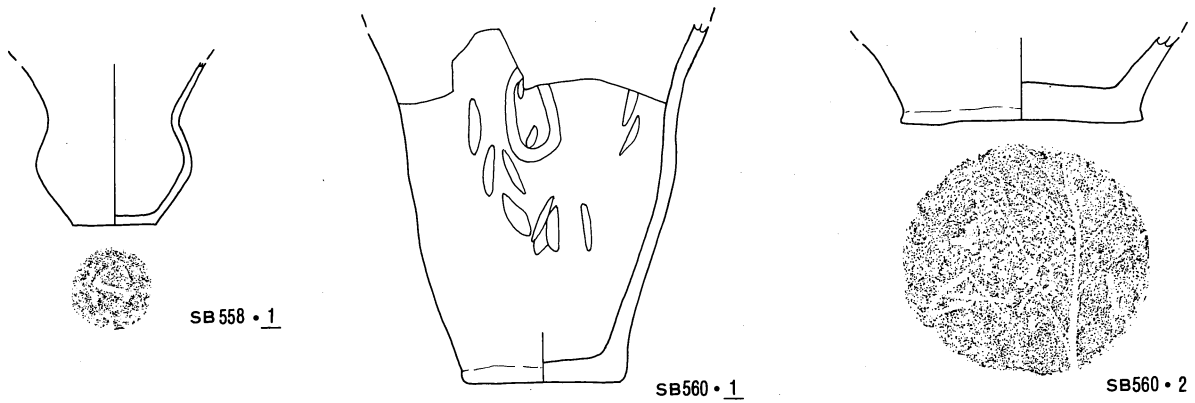
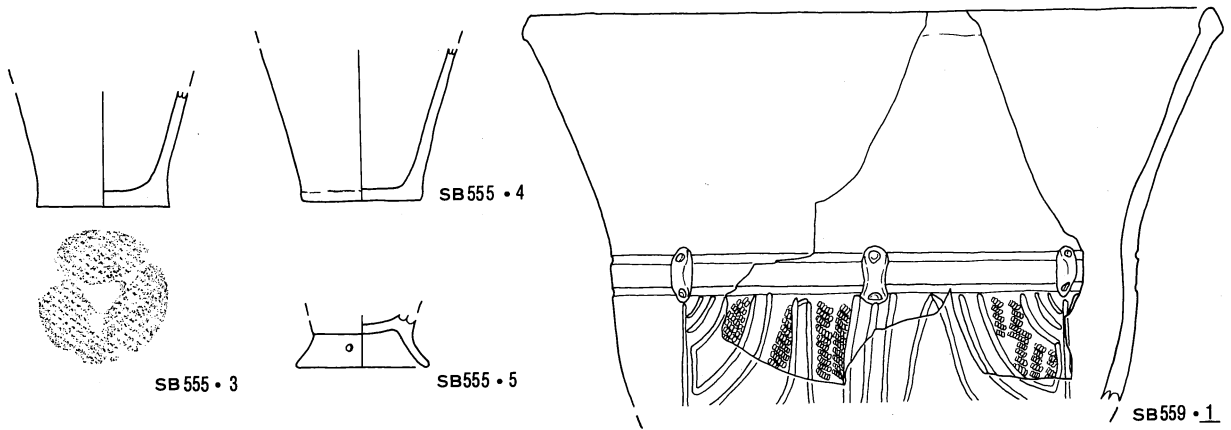

0 (1:4) 20 cm

S B566 (1~10)

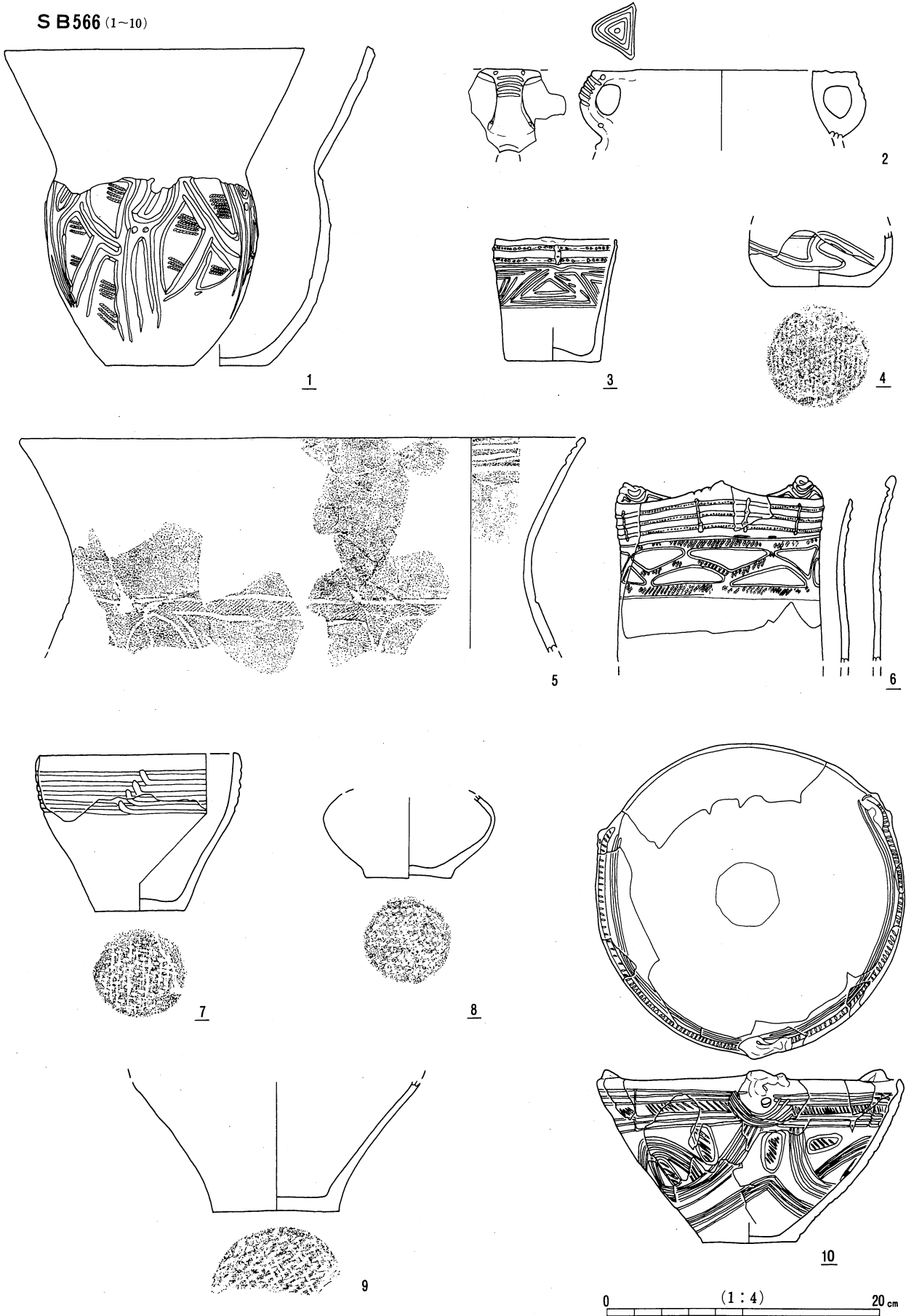

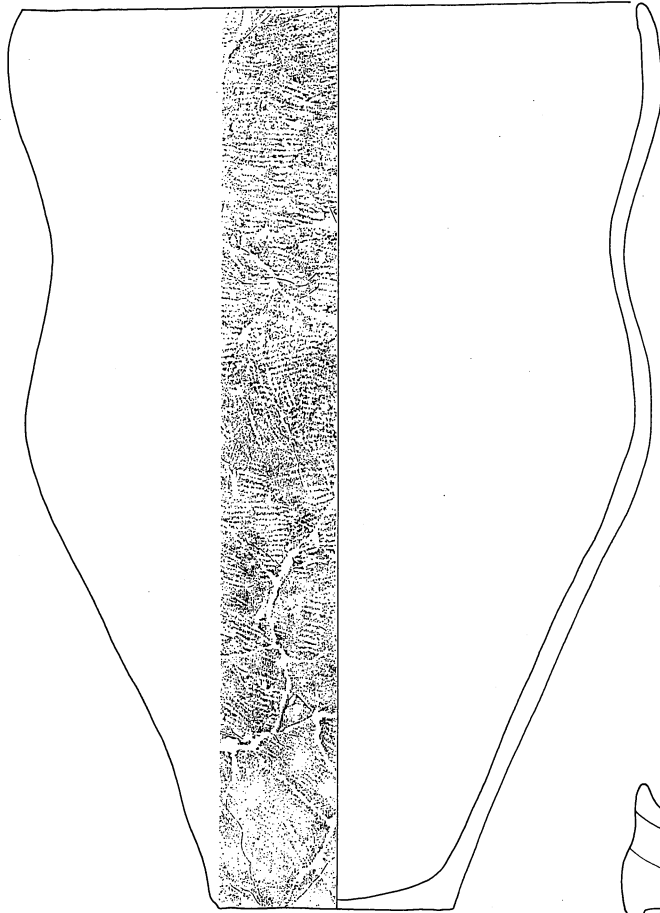

S B570(1~3)

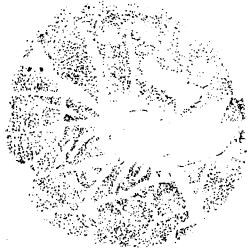
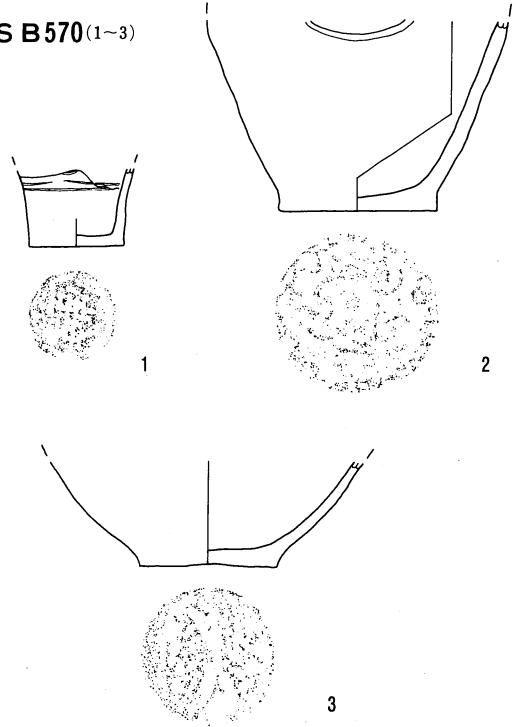

SB562・1

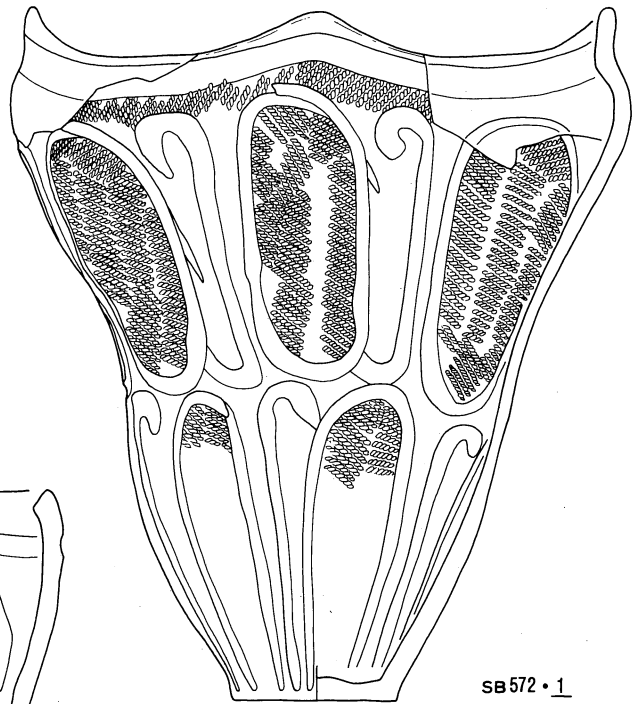

SB572・1



SB580・1



SB580・2

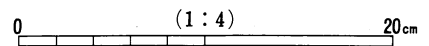

S B583 (1~3)

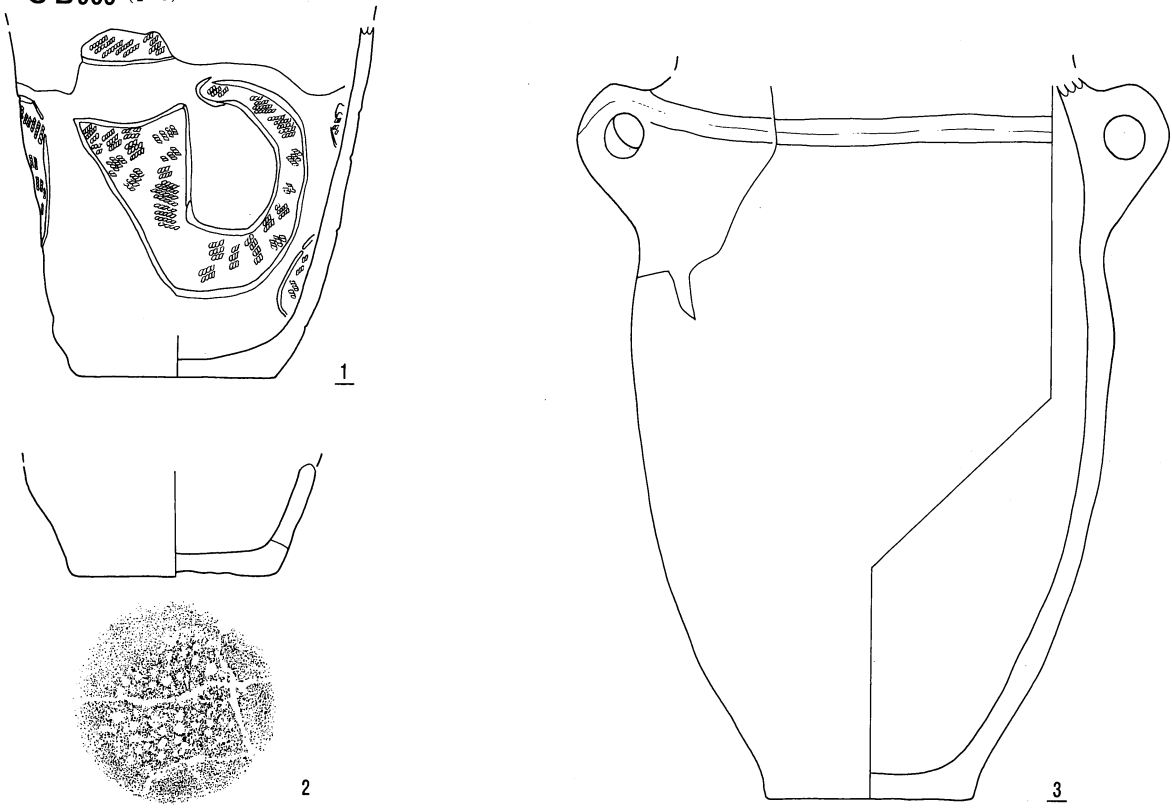

S B591 (1-2)

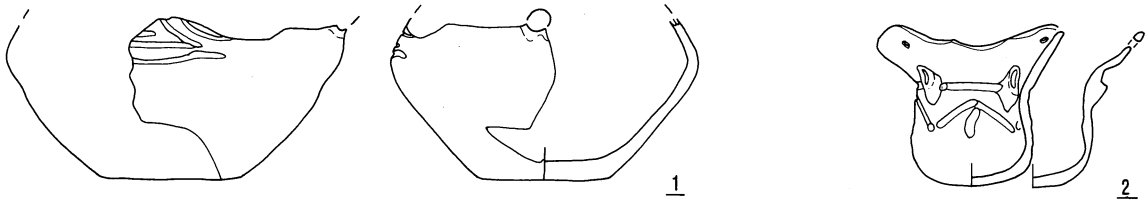

S B592 (1-2)



S B594 (1-2)

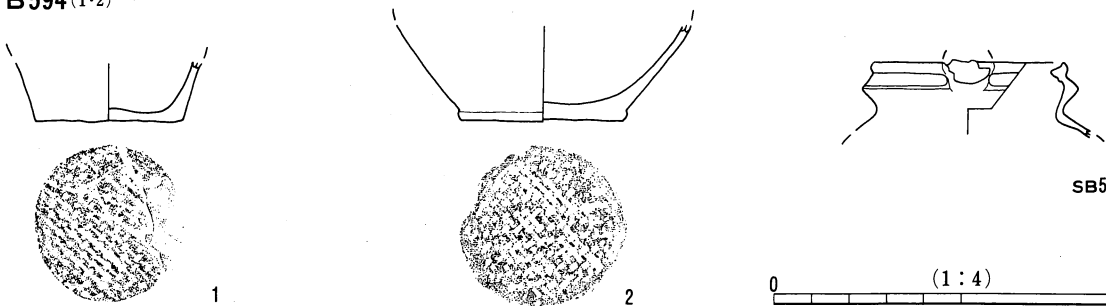

SB598・1

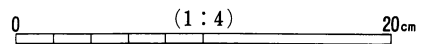

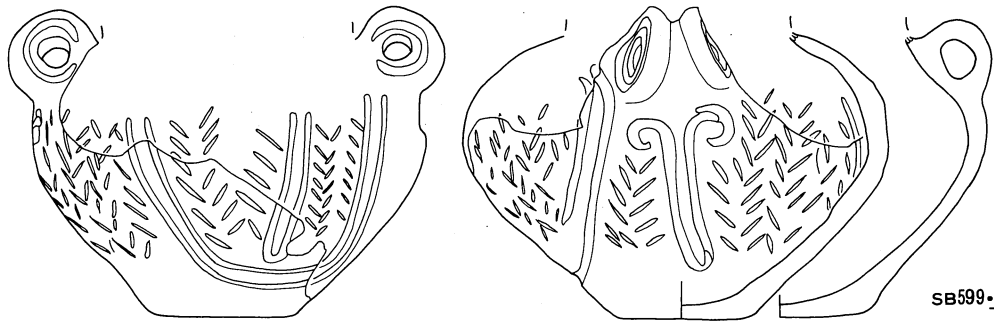

S H17(1~3)

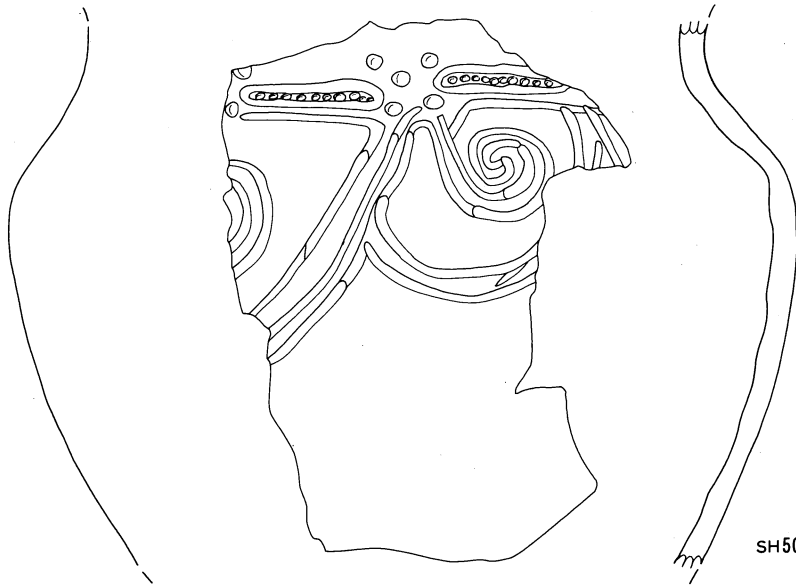
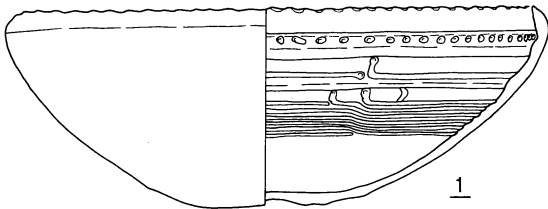
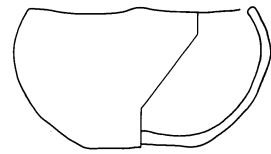
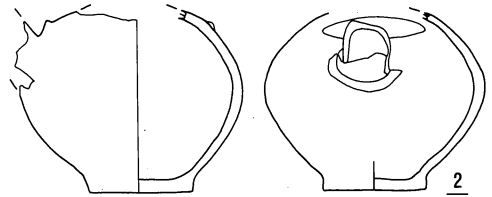
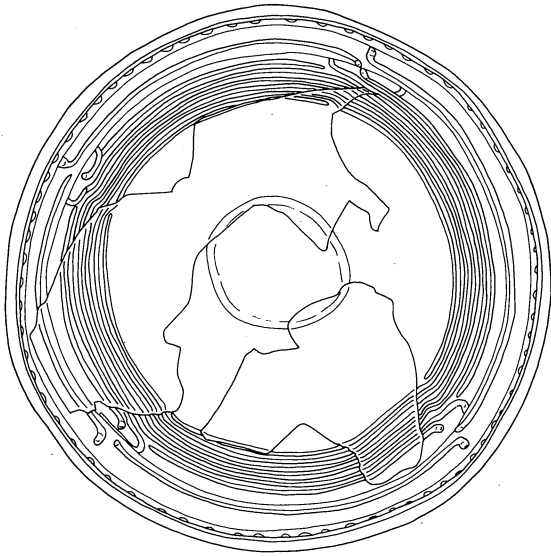

0 (1:4) 20cm

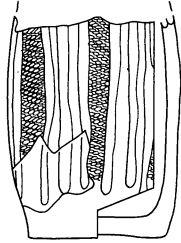
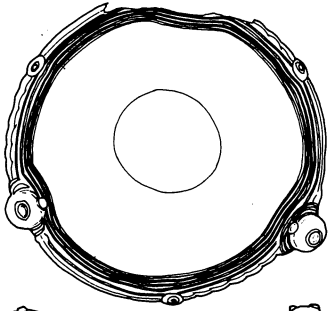

SH555・2

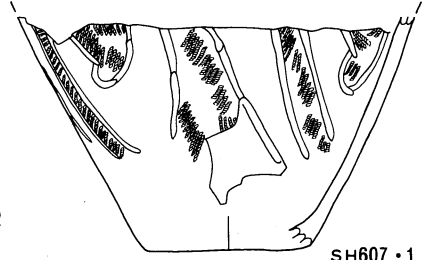

SH607・1

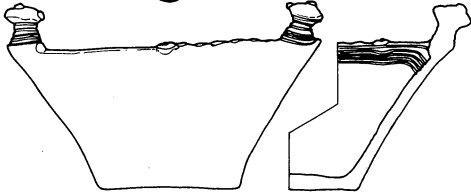

SH555・1

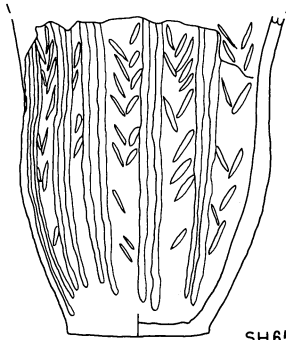

SH658・1

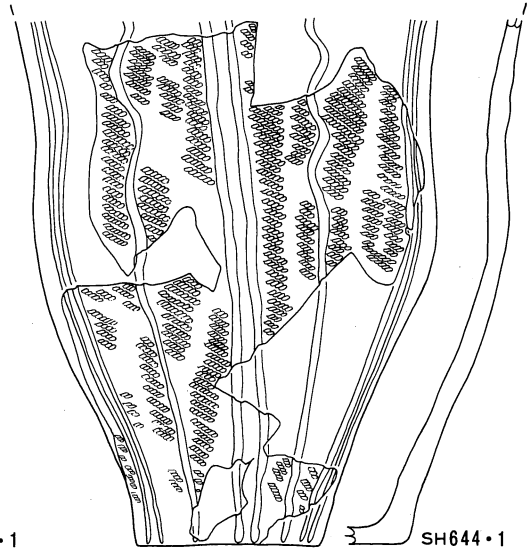

SH644・1

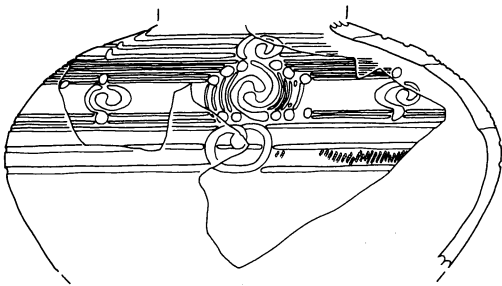

SH648・1

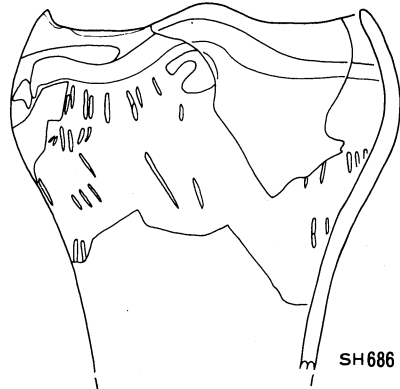

SH686・1

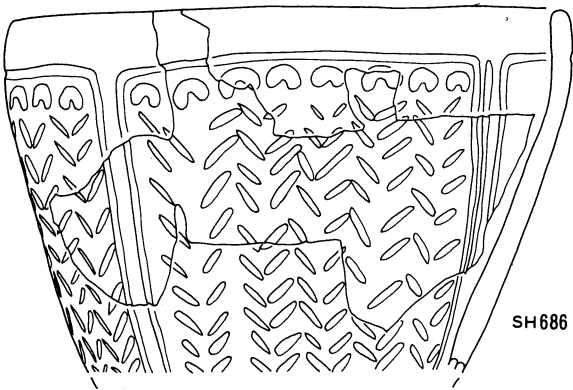

SH686・2

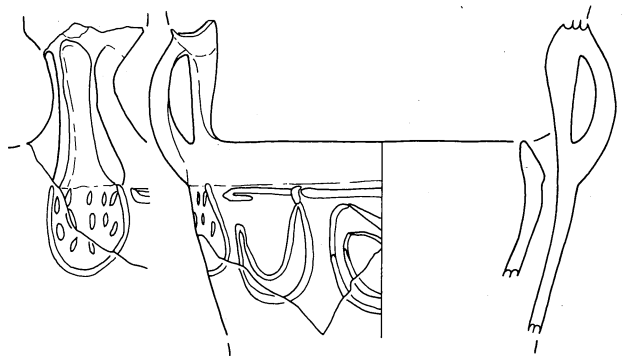

SH686・3

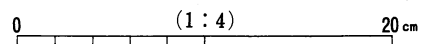

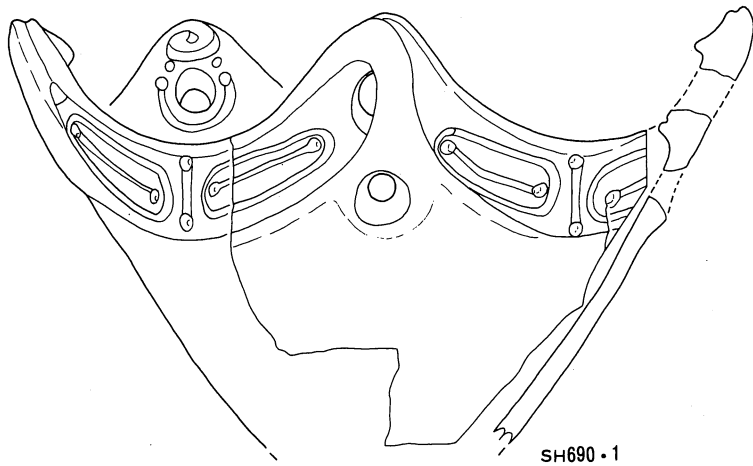

SH690・1

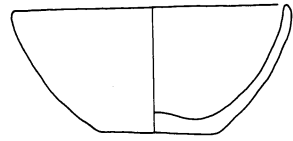

SH693・1

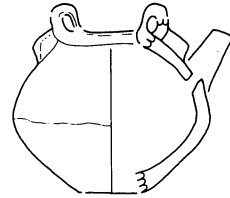

SH714・1

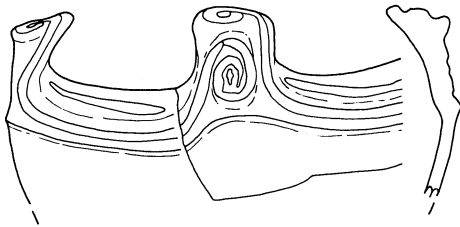

SH738・1

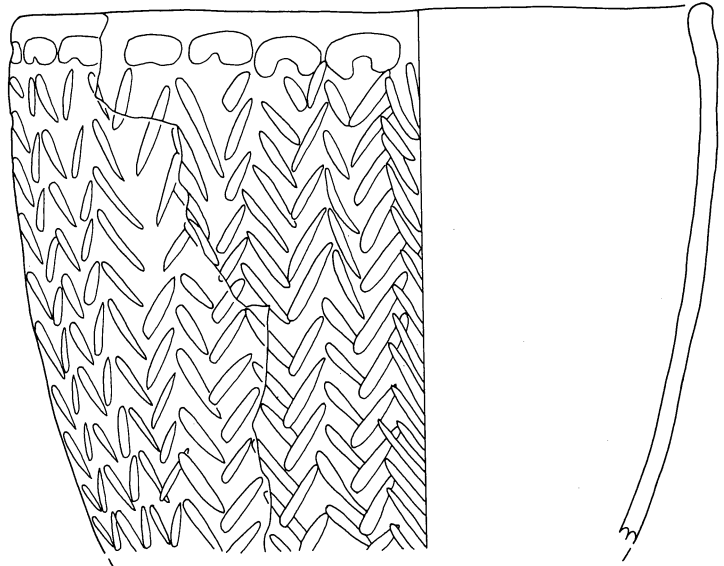

SB560・4

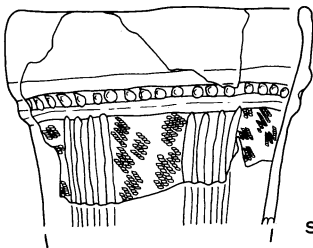

SH794・1



SH785・1

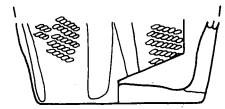

SH824・1

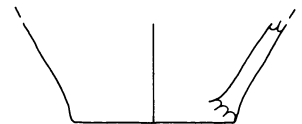

SH824・2

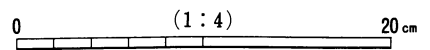

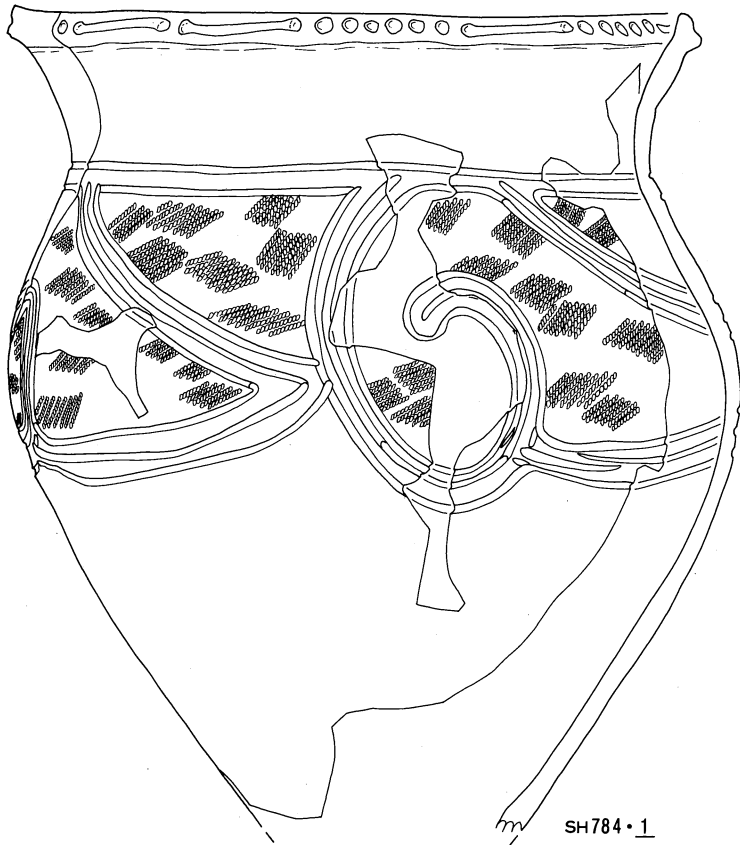

SH784・1

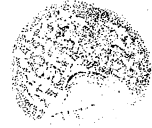
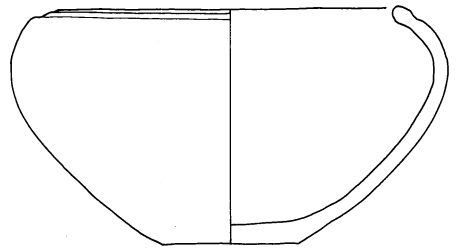

SH952・1

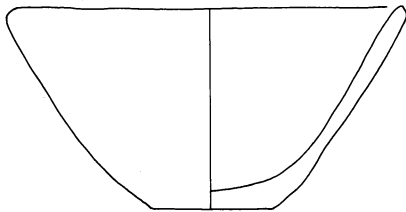

SH952・2

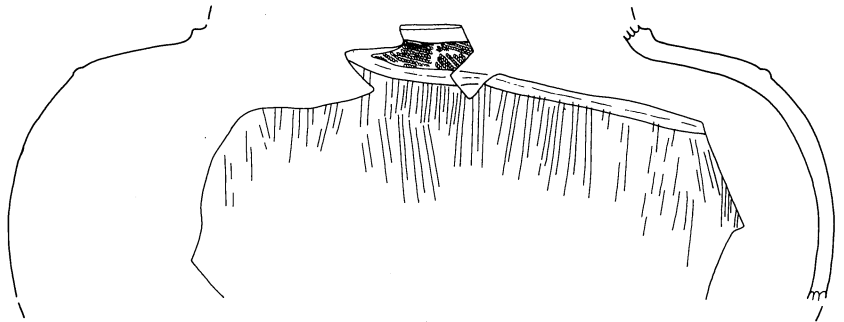

SH813・1

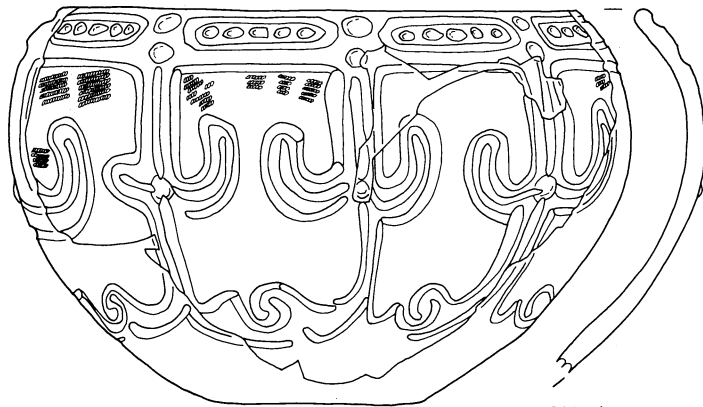

SH802・1

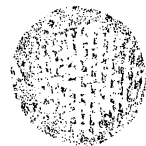
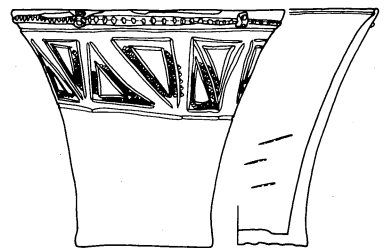

SH1048・1

0 (1:4) 20cm

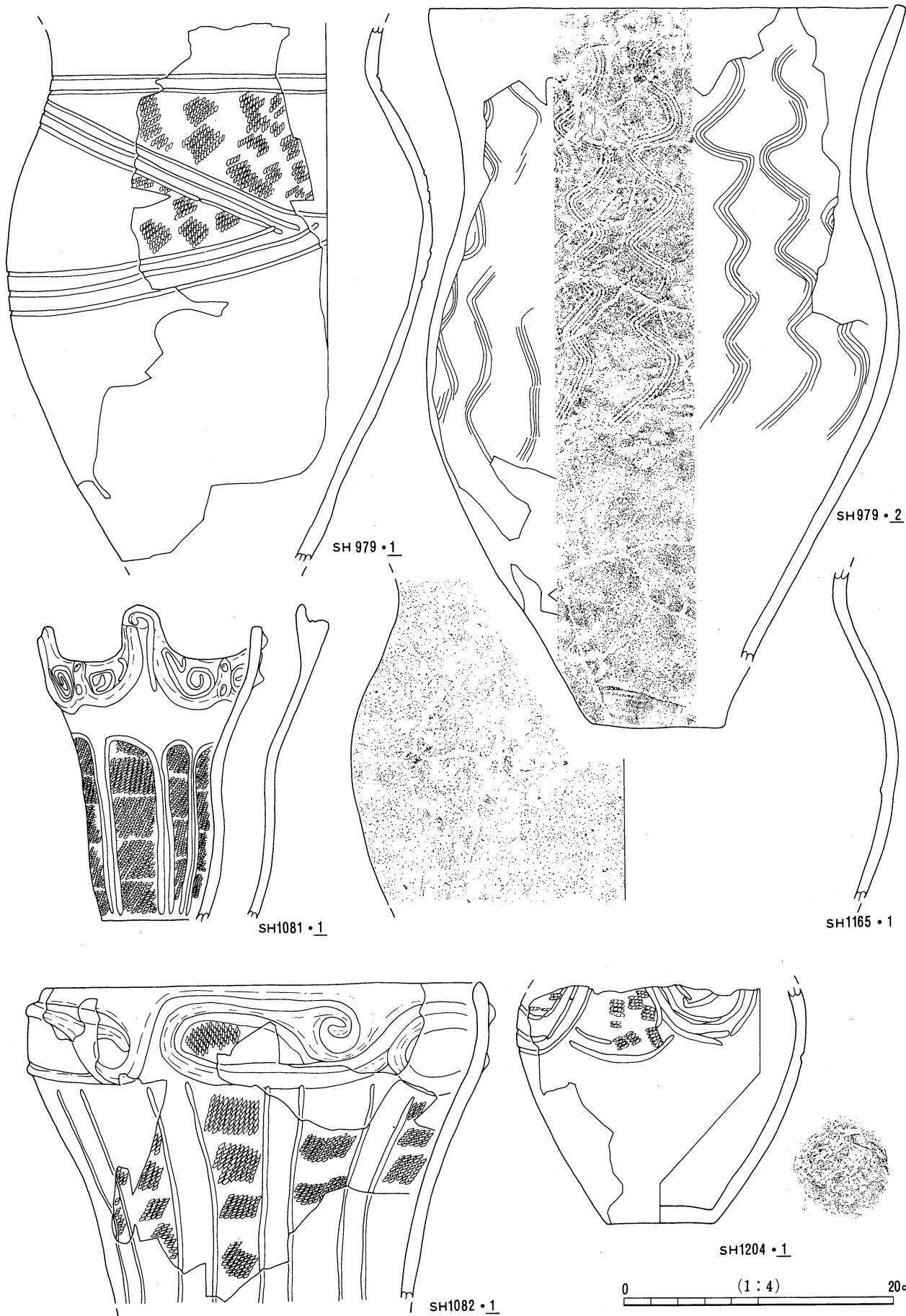

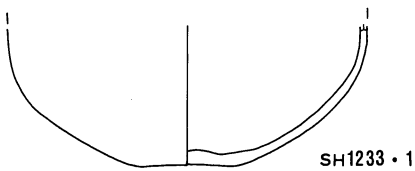
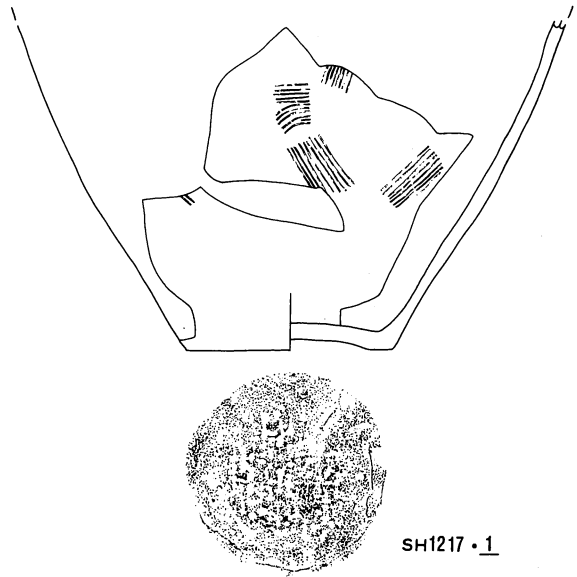
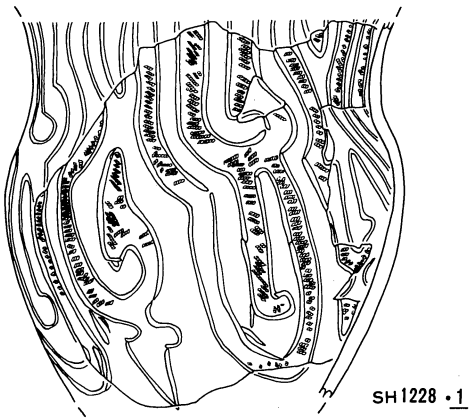
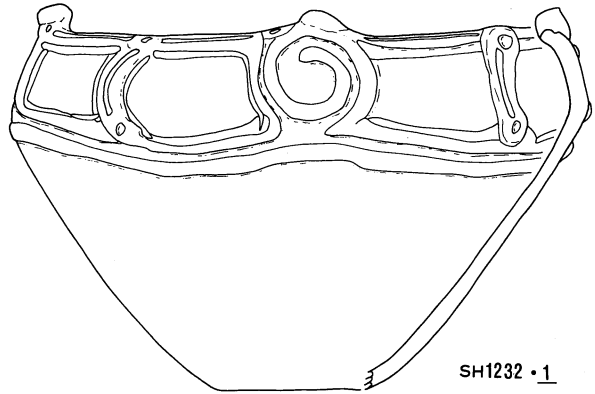
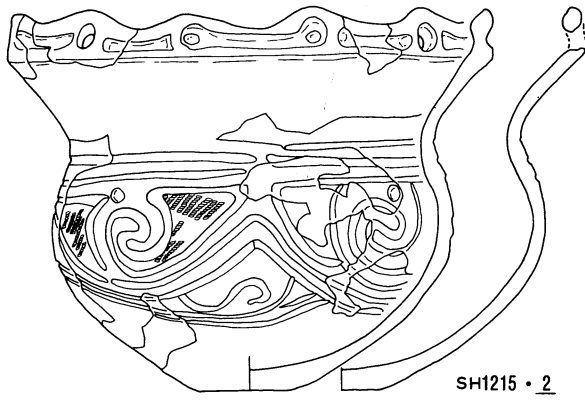
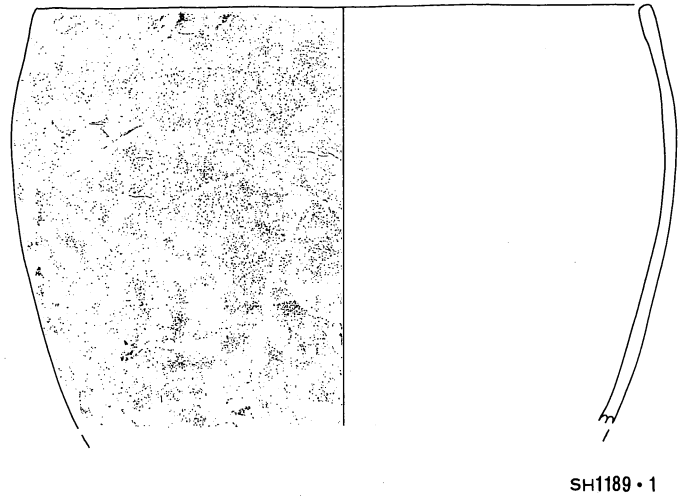
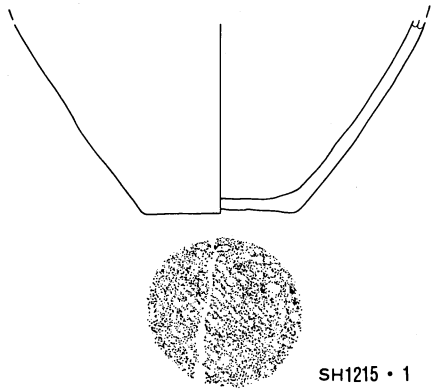

0 (1:4) 20cm

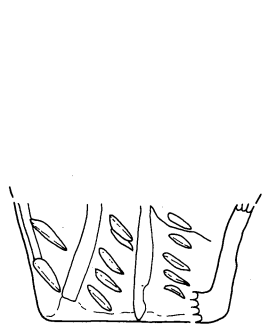

SK2018・1

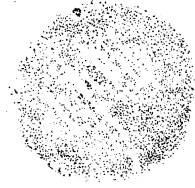
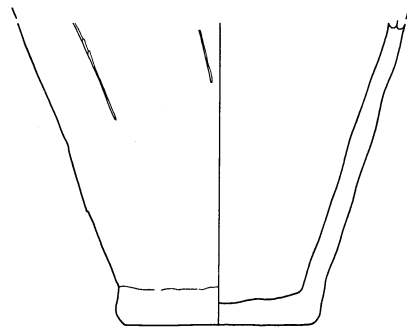

SK2020・1

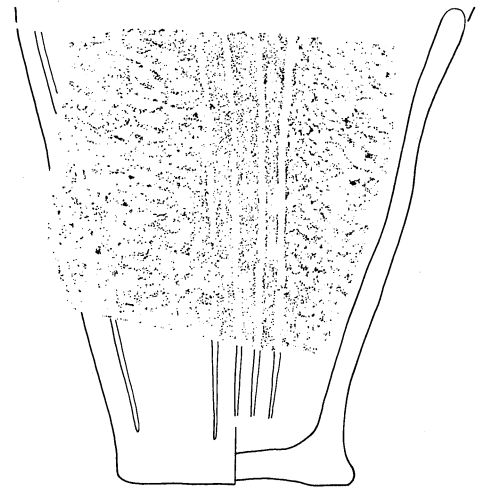

SK2232・1

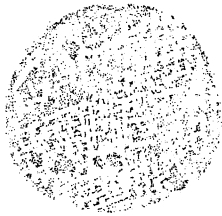
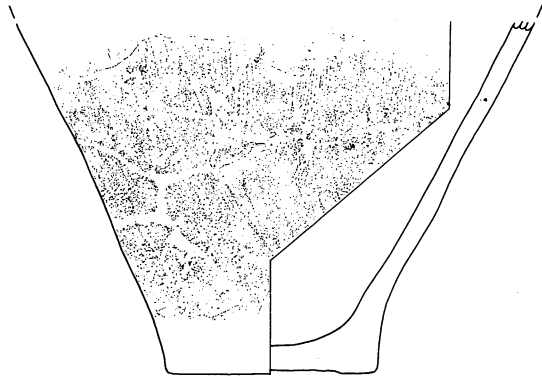

SK2541・1

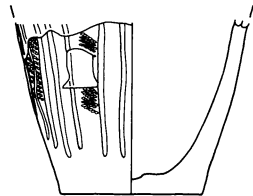

SK3071・1

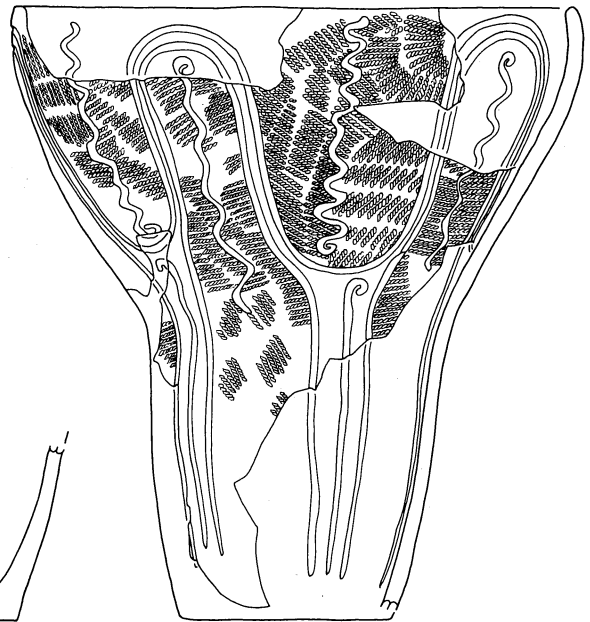

SK2813・1

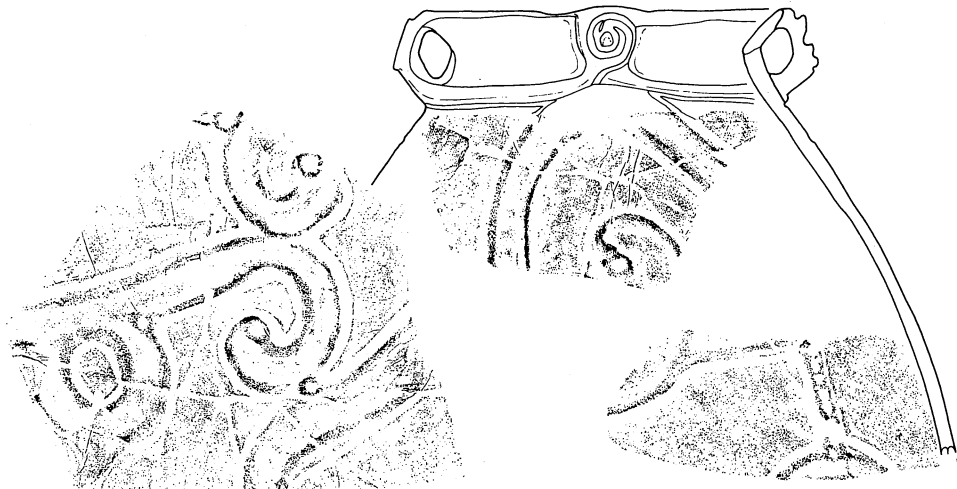

0 (1:4) 20cm

SK2419・1

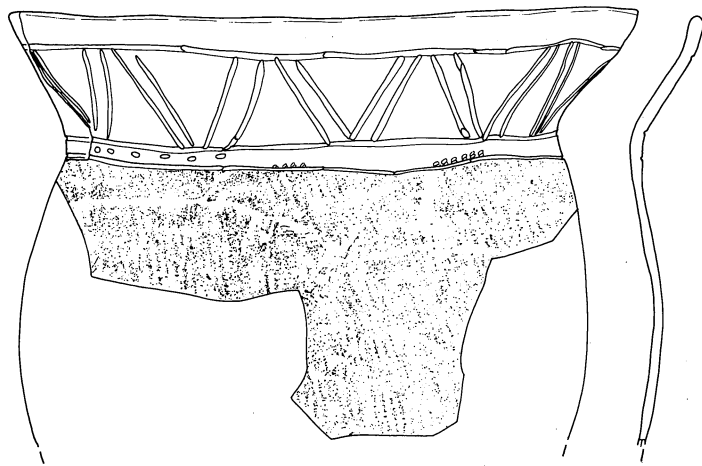

SK3266・1

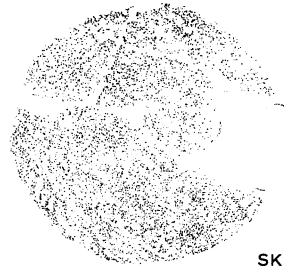
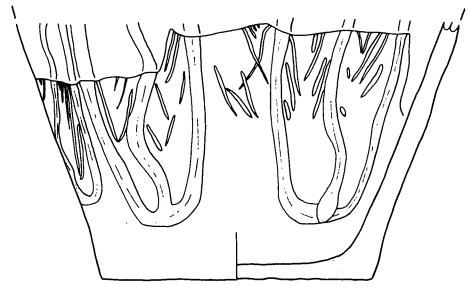

SK2813・2

SQ 1 (1~4)

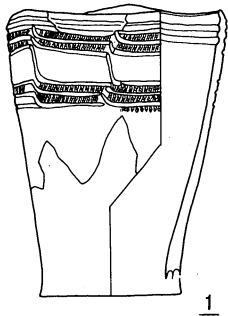

1

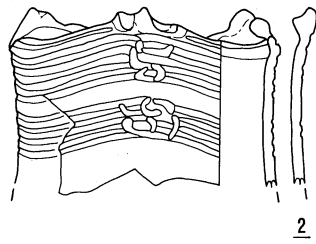

2

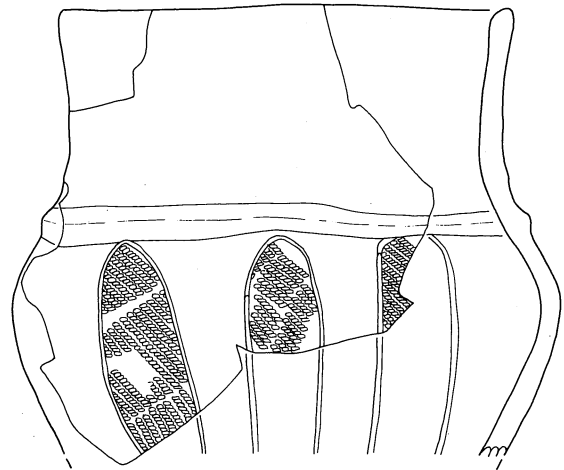

SK3142・1

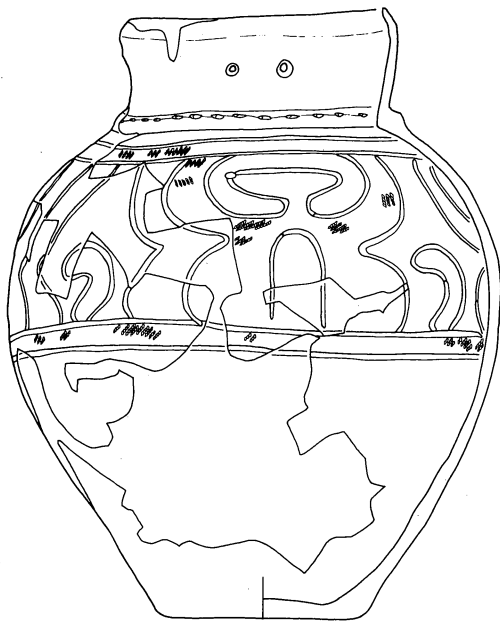

3

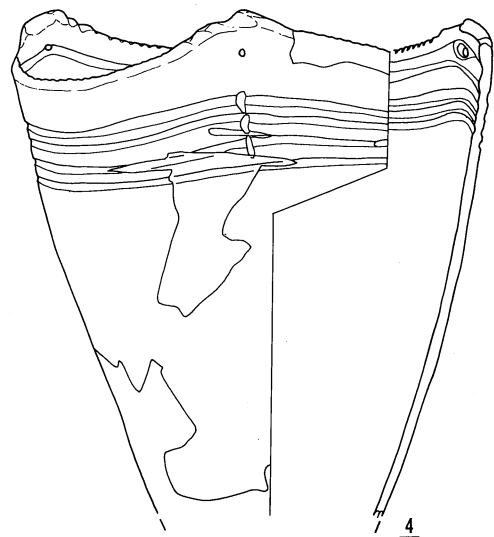

4

0 (1:4) 20cm

SQ1 (5-7)

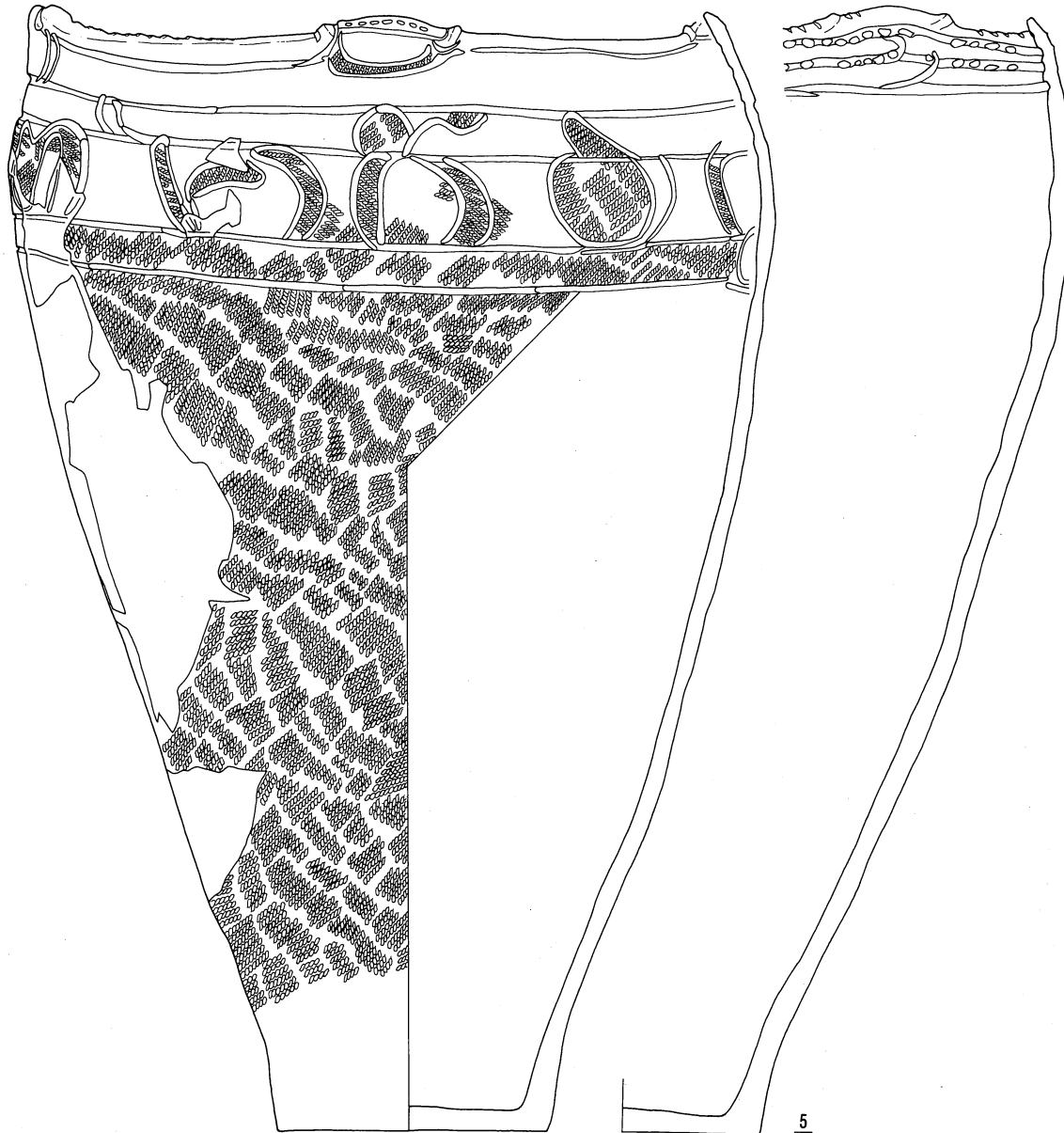

5

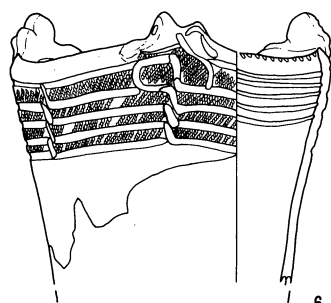
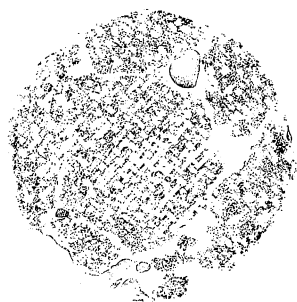

(1:4)

6

0 20cm

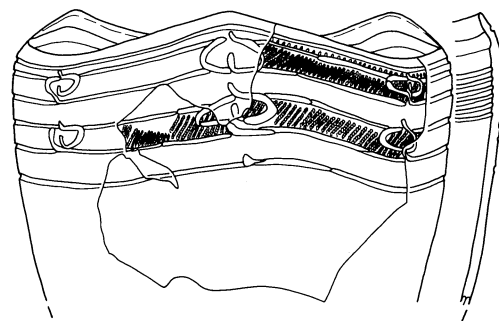

7

SQ1 (8-12)

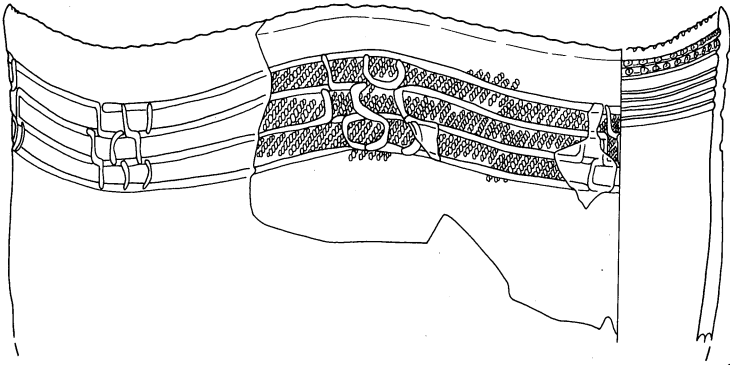

8

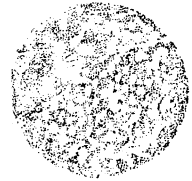
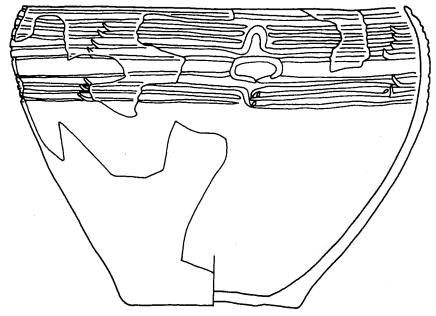

9

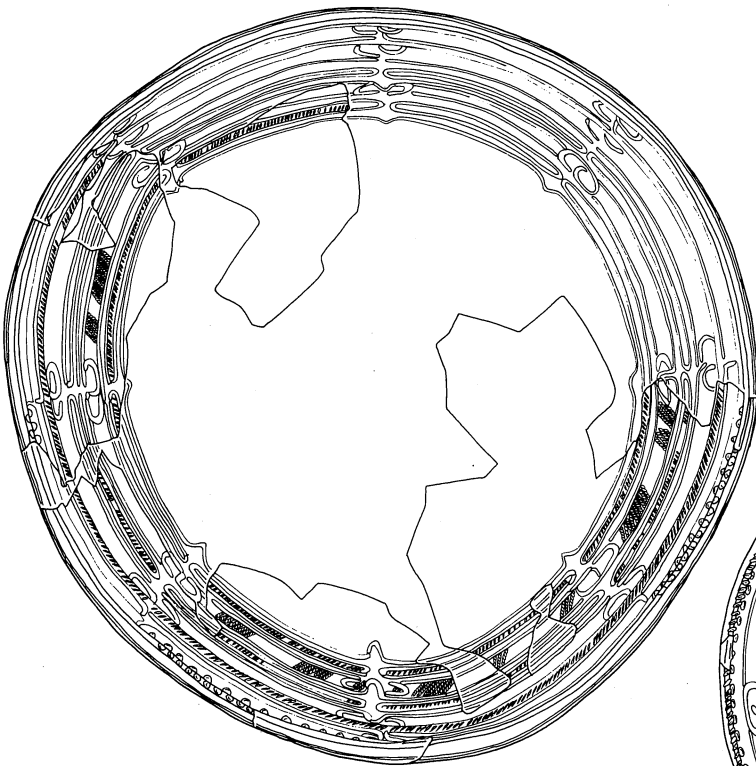

10

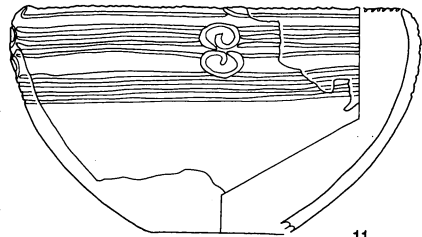

11

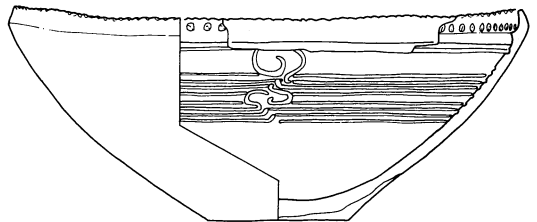
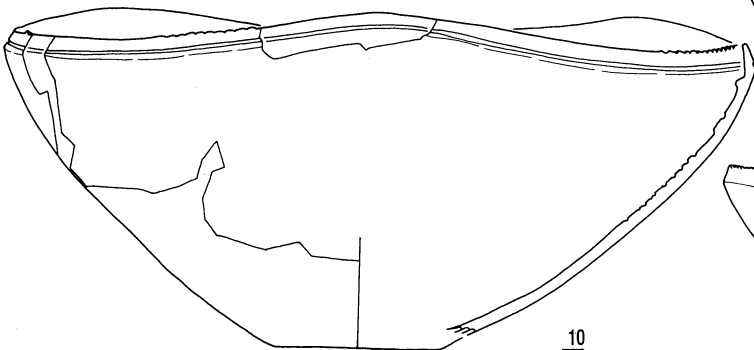
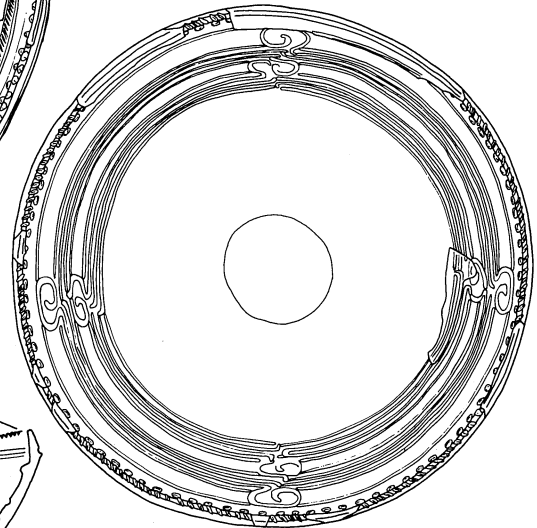

12

0 (1:4) 20cm

SQ1 (13,14)

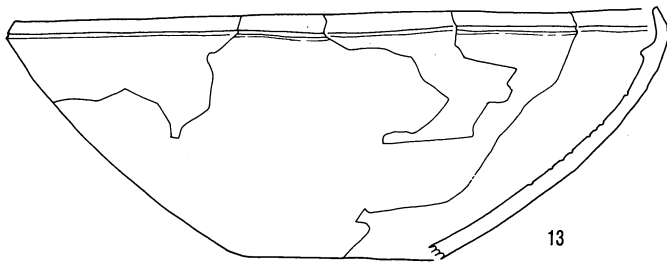
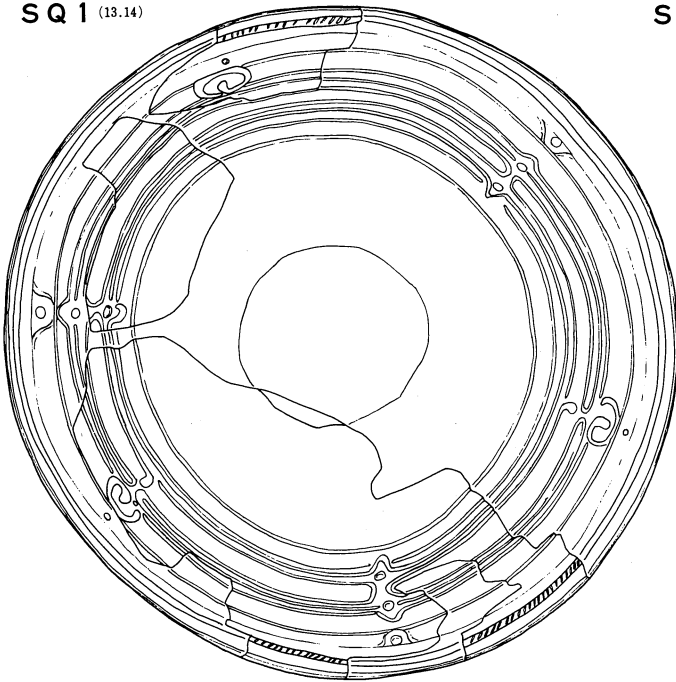

13

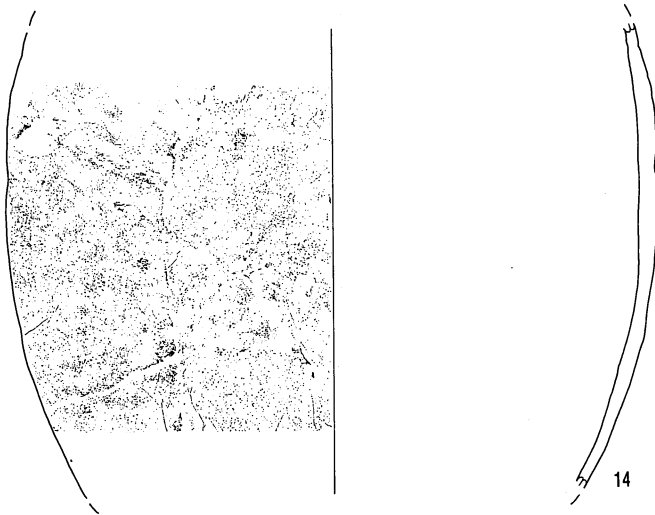

14

SQ2 (1-6)

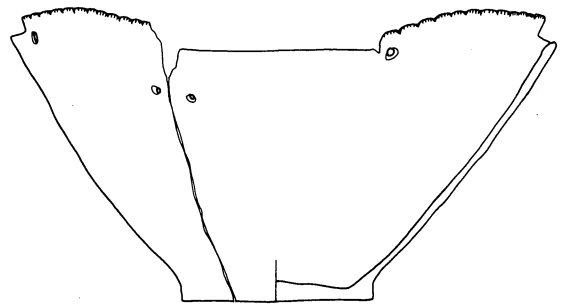
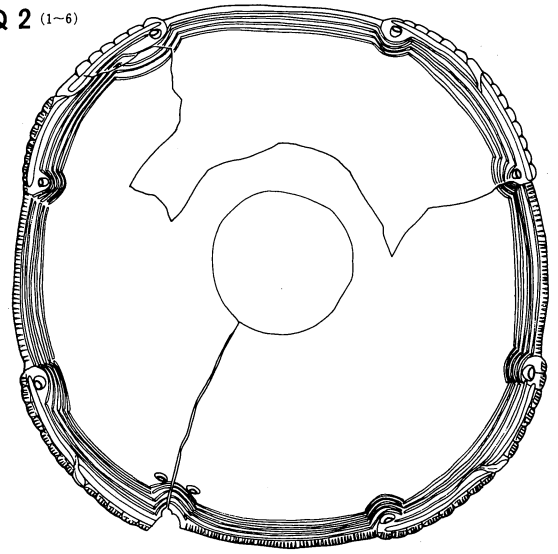

1

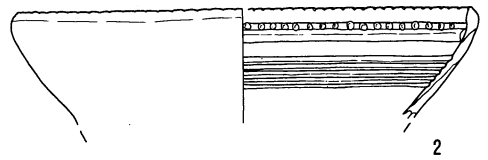

2

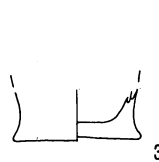

3



4

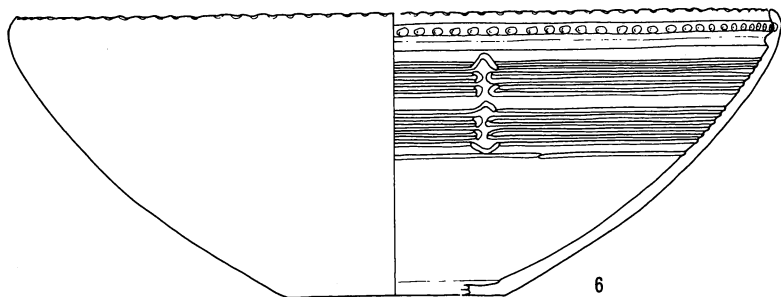

6

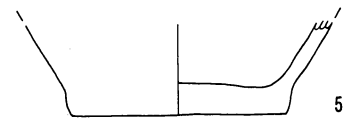

5

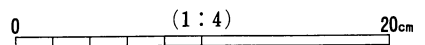

(1:4)

20cm

遺構外 (1-5)

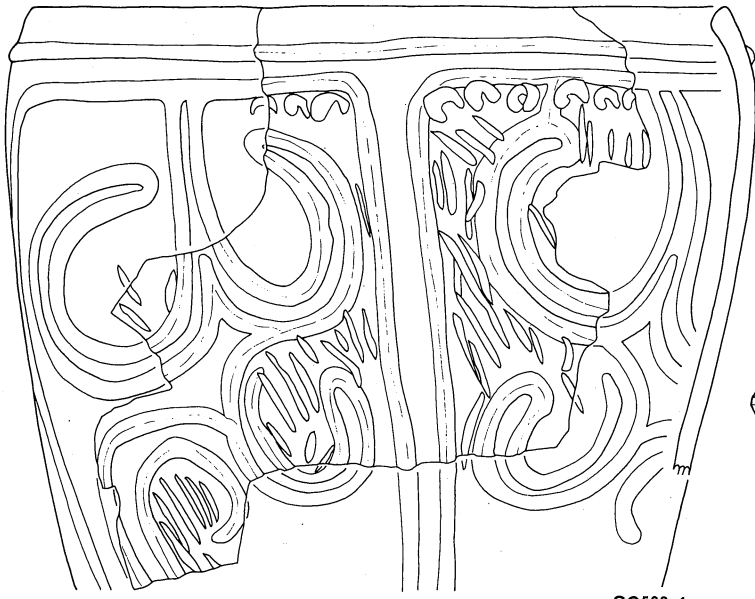

SQ503-1

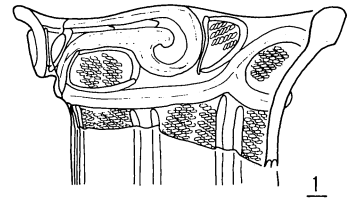

1

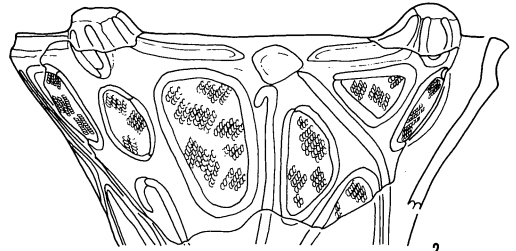

2

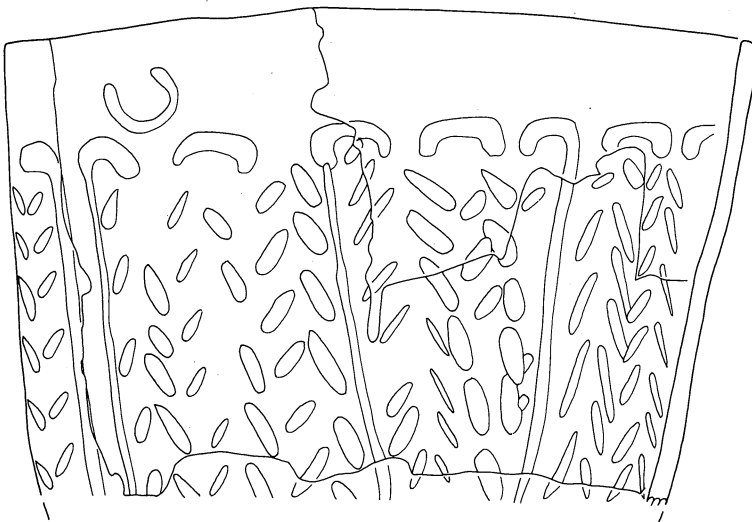

SQ501-1

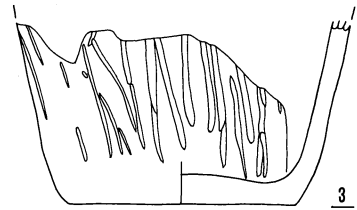

3

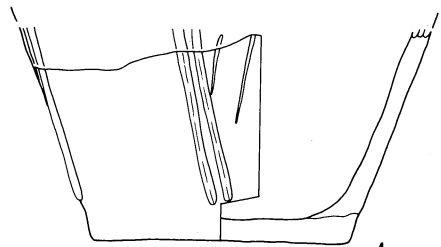

4

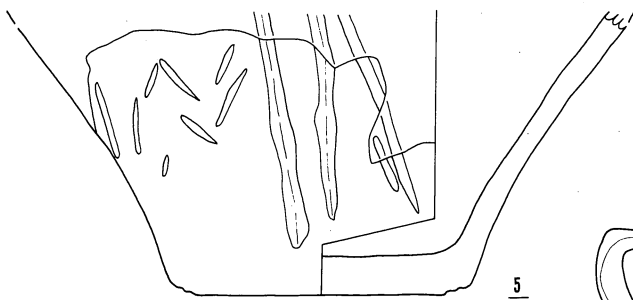

5

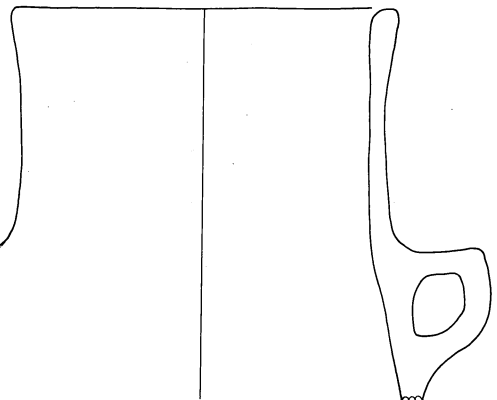

SQ501-2

0 (1:4) 20 cm

遺構外 (6-15)

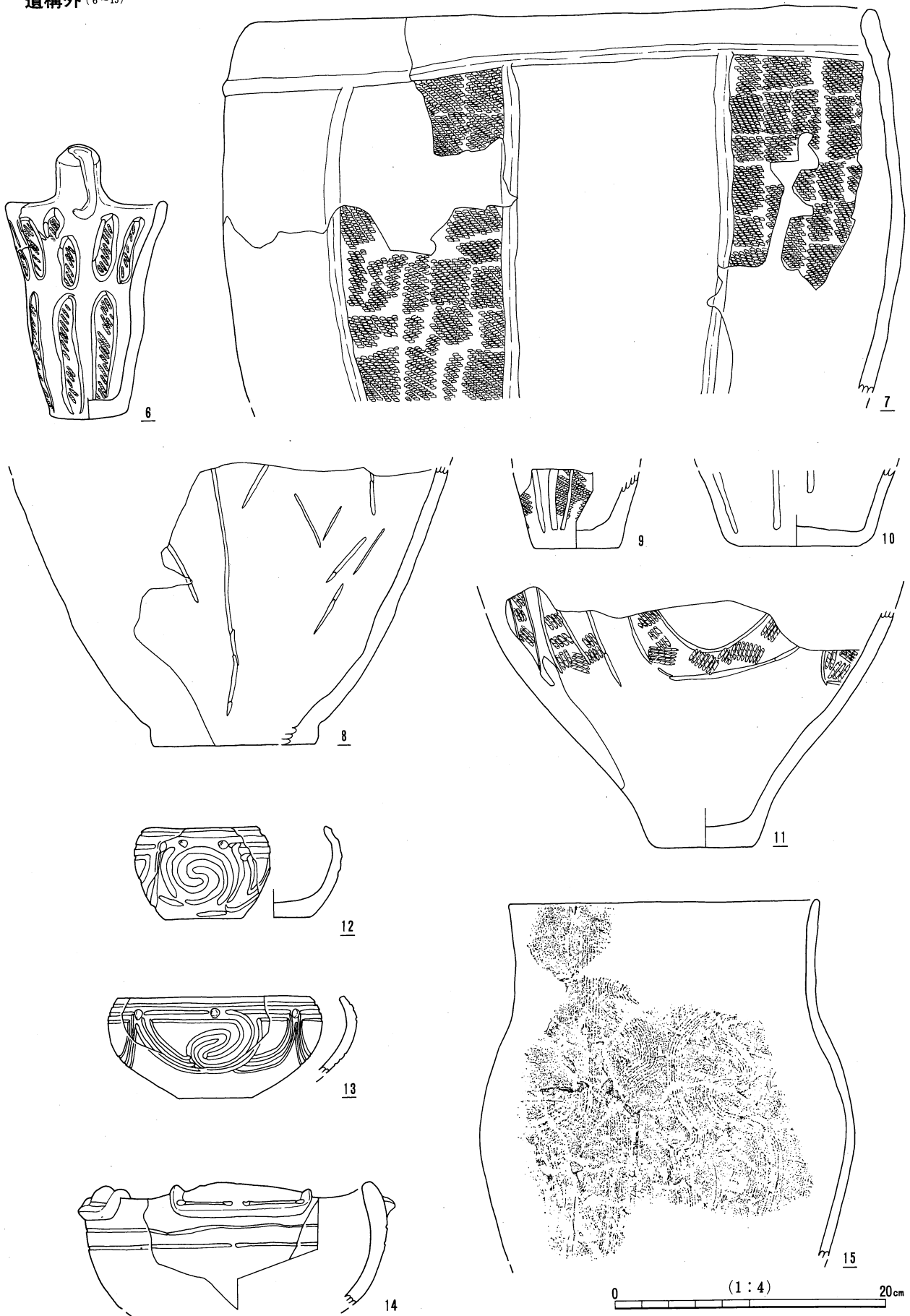

遺構外 (16~24)

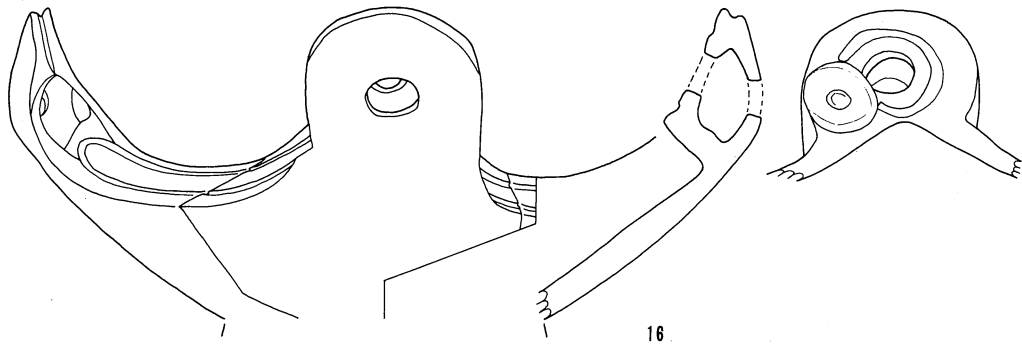

16

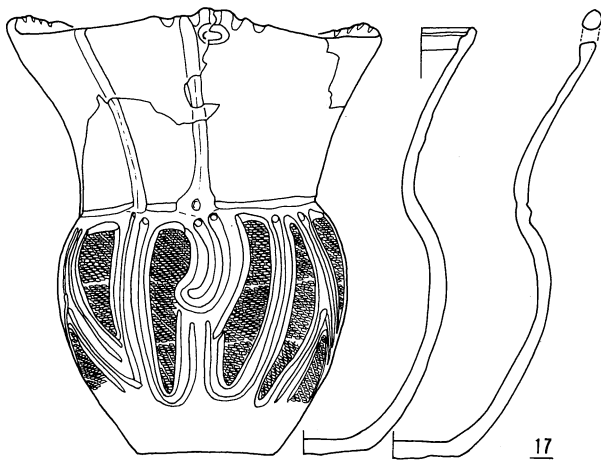

17

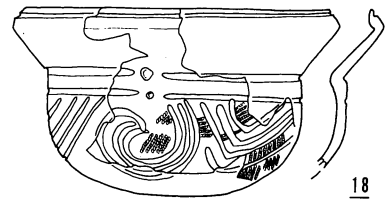

18

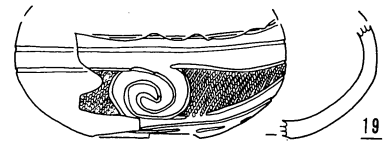

19

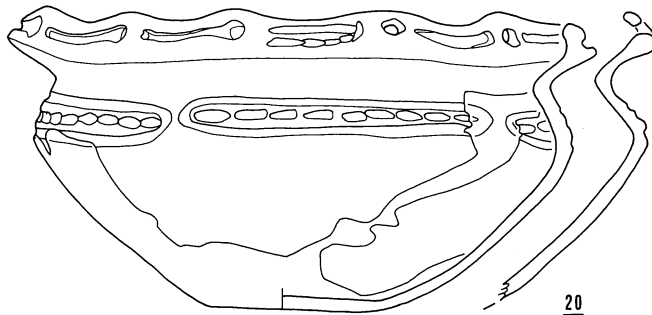
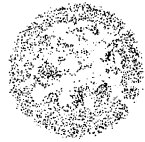

20

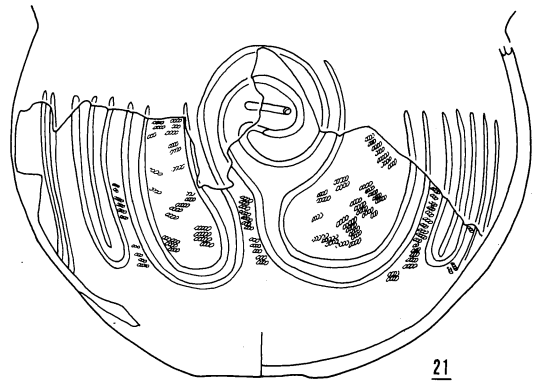

21

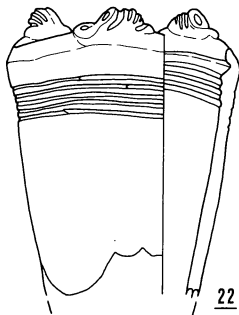

22

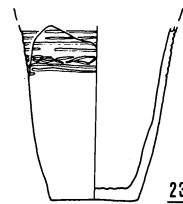

23

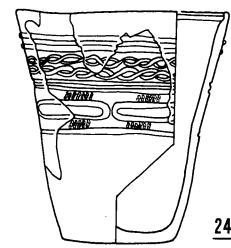

24

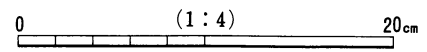

遺構外 (25~37)

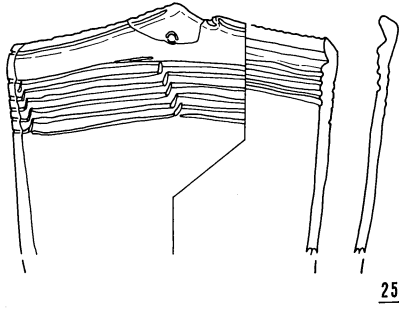

25



26

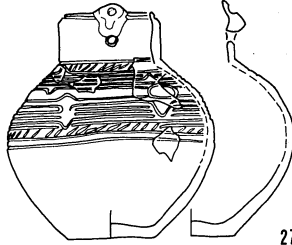

27

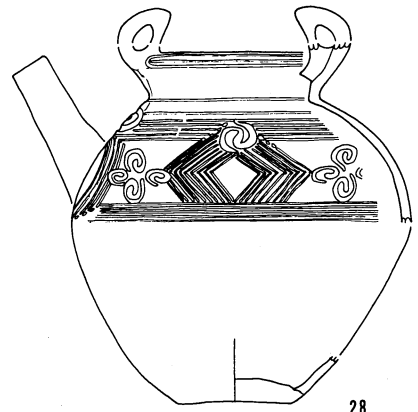

28

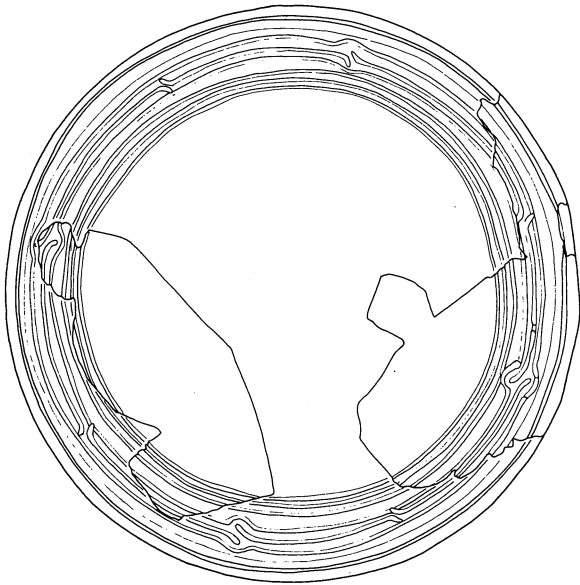

29

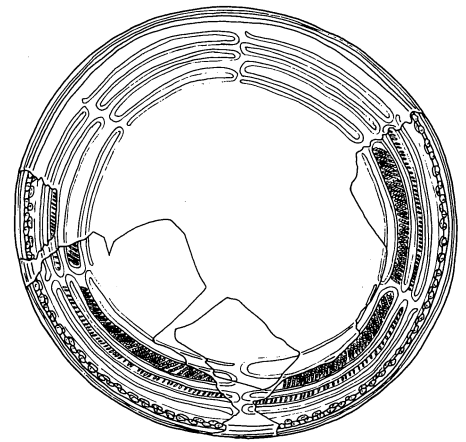

30

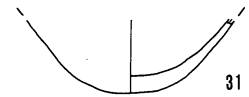
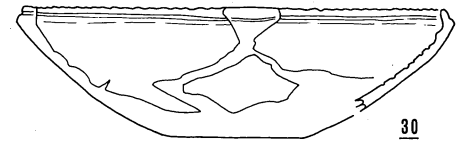
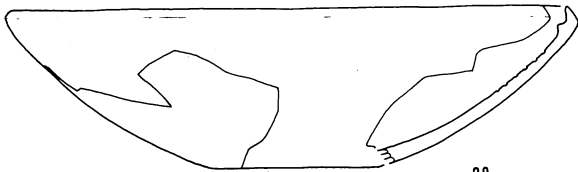

31

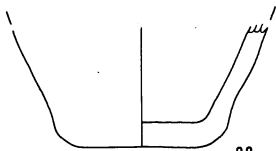

32

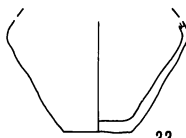

33

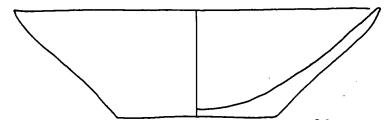

34

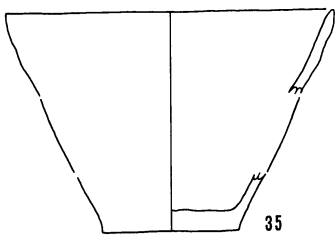

35

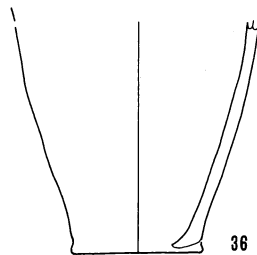

36

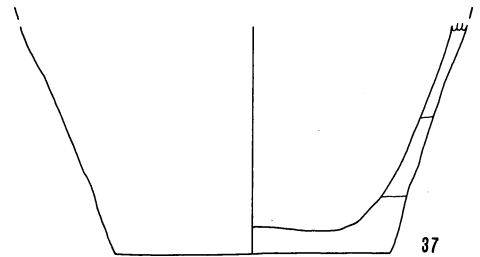

37

0 (1:4) 20cm

SB101 (4~14)

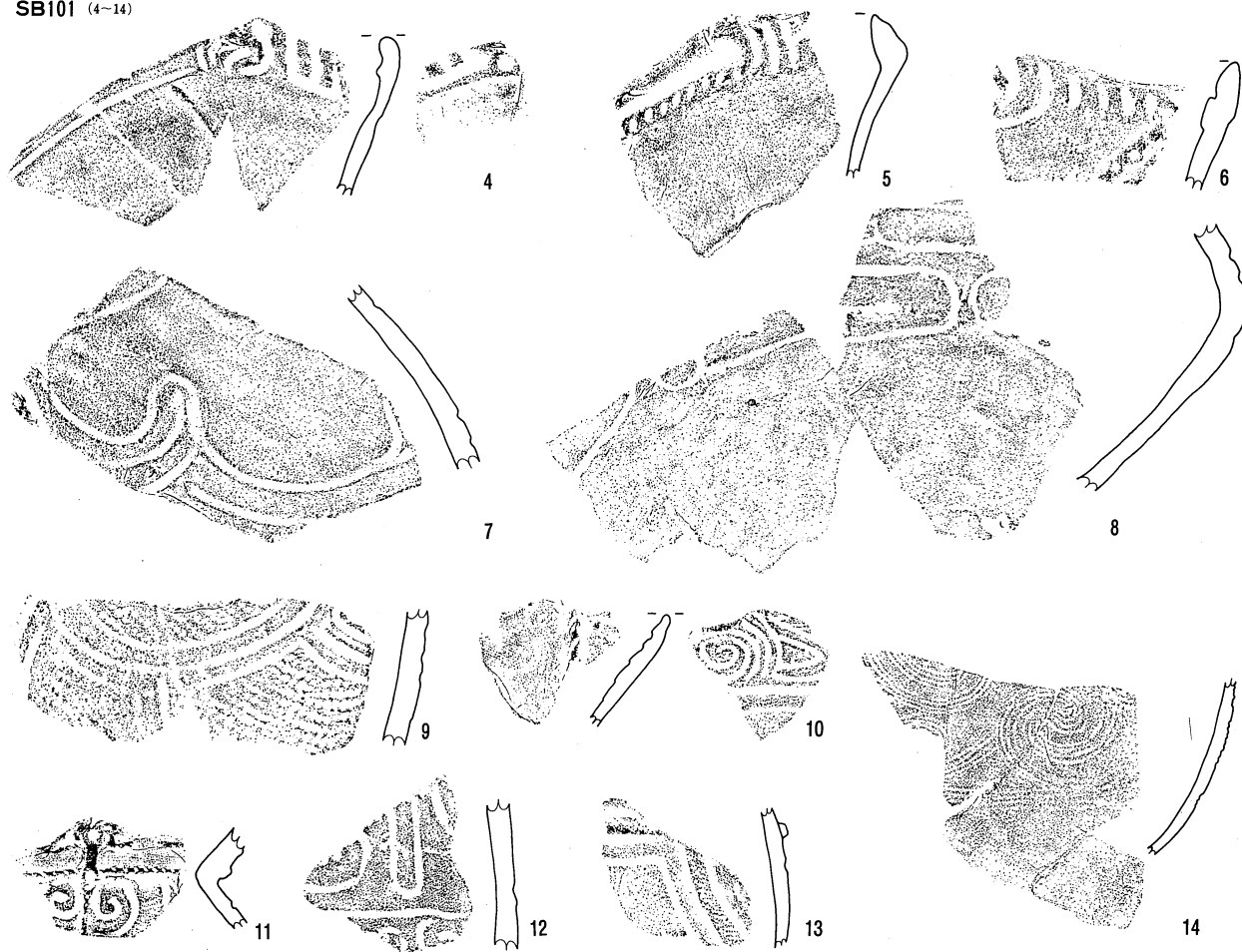

SB102 (3~9)

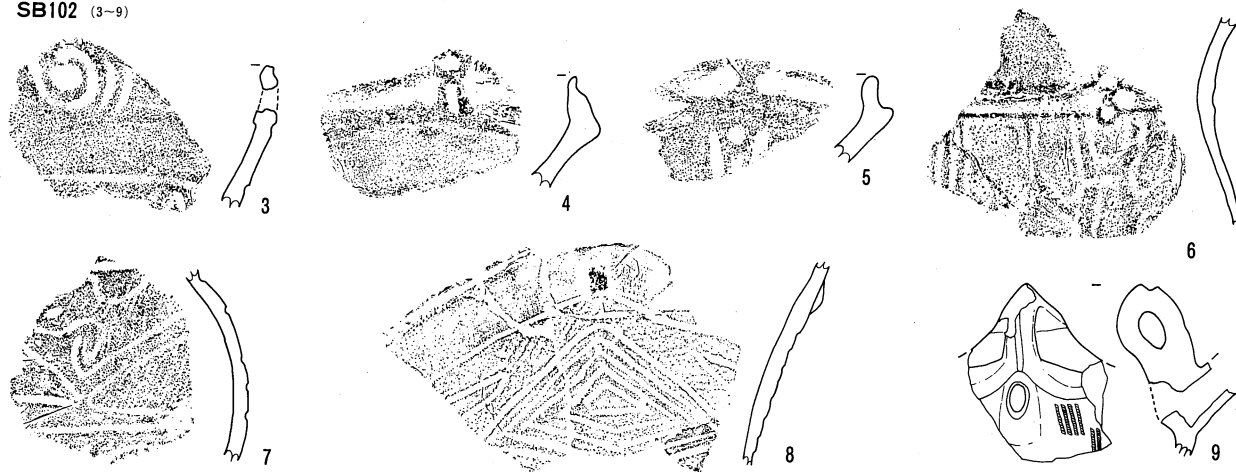

SB103 (1~6)

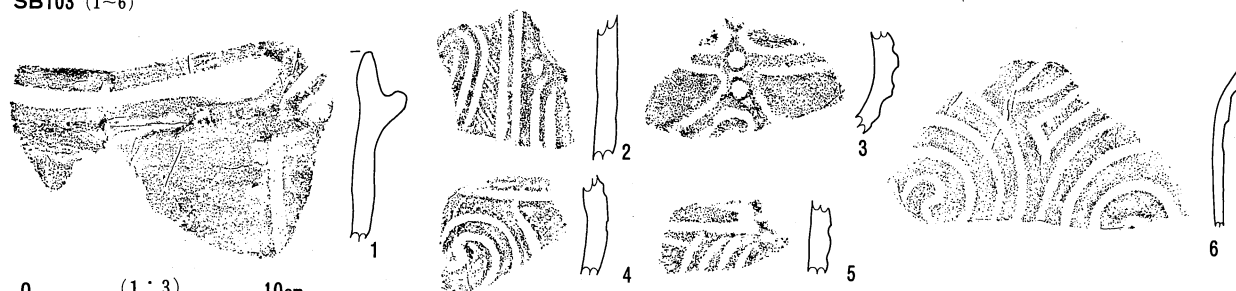

0 (1:3) 10cm

SB104 (1~9)

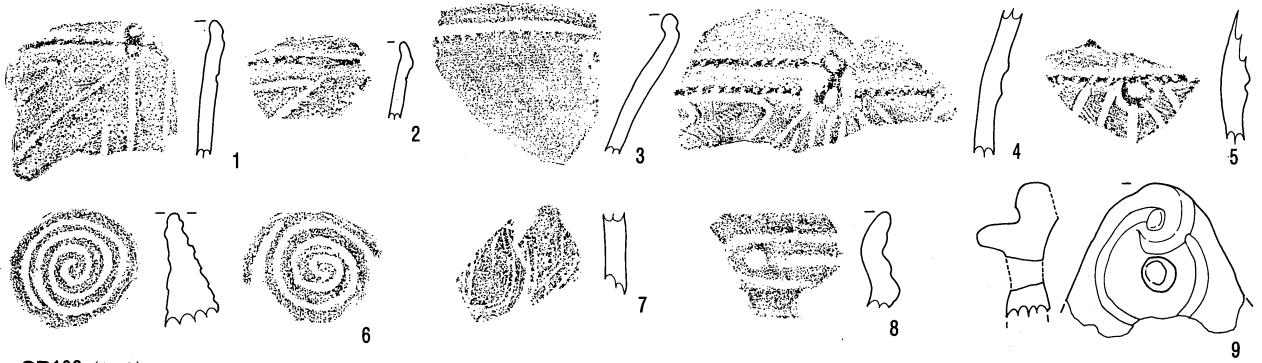

SB108 (1~8)

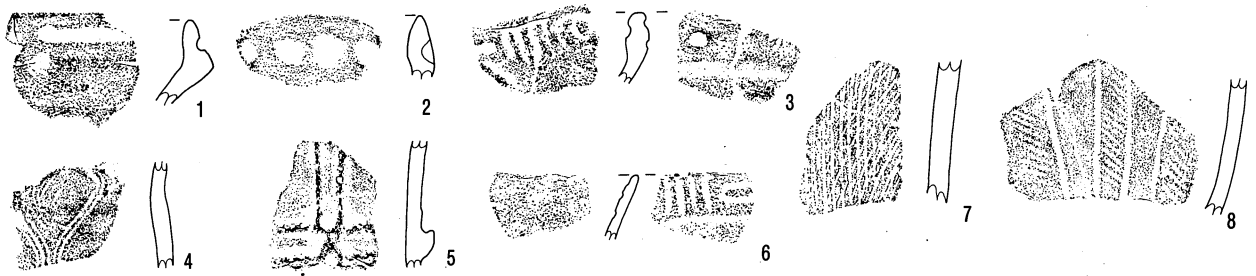

SB110 (1~16)

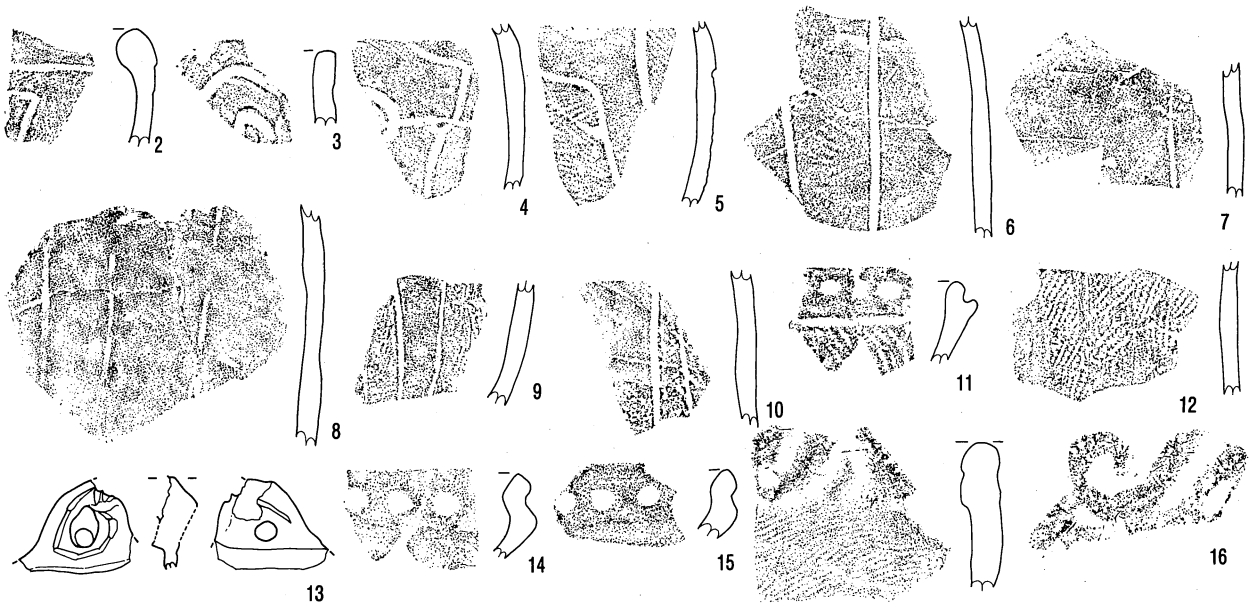

SB551 (1~9)

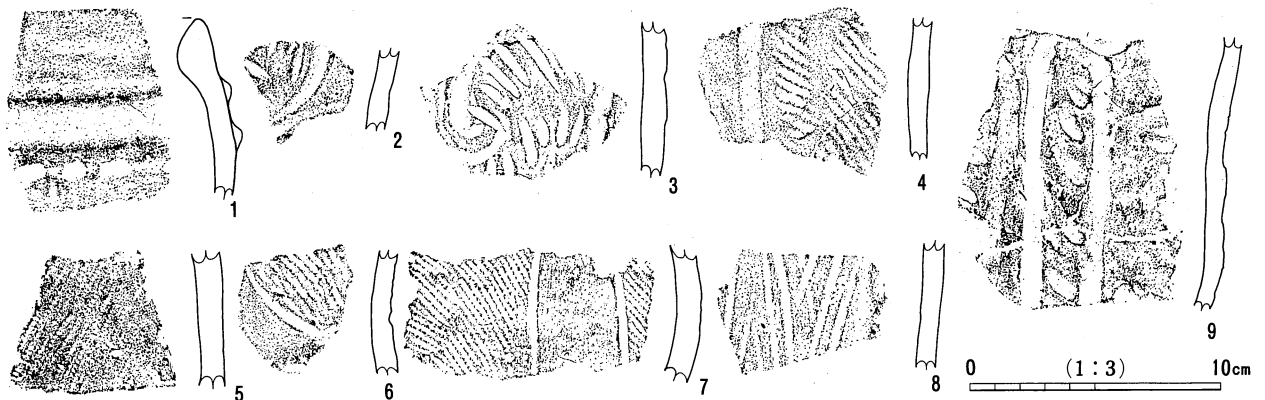

SB552 (1~10)

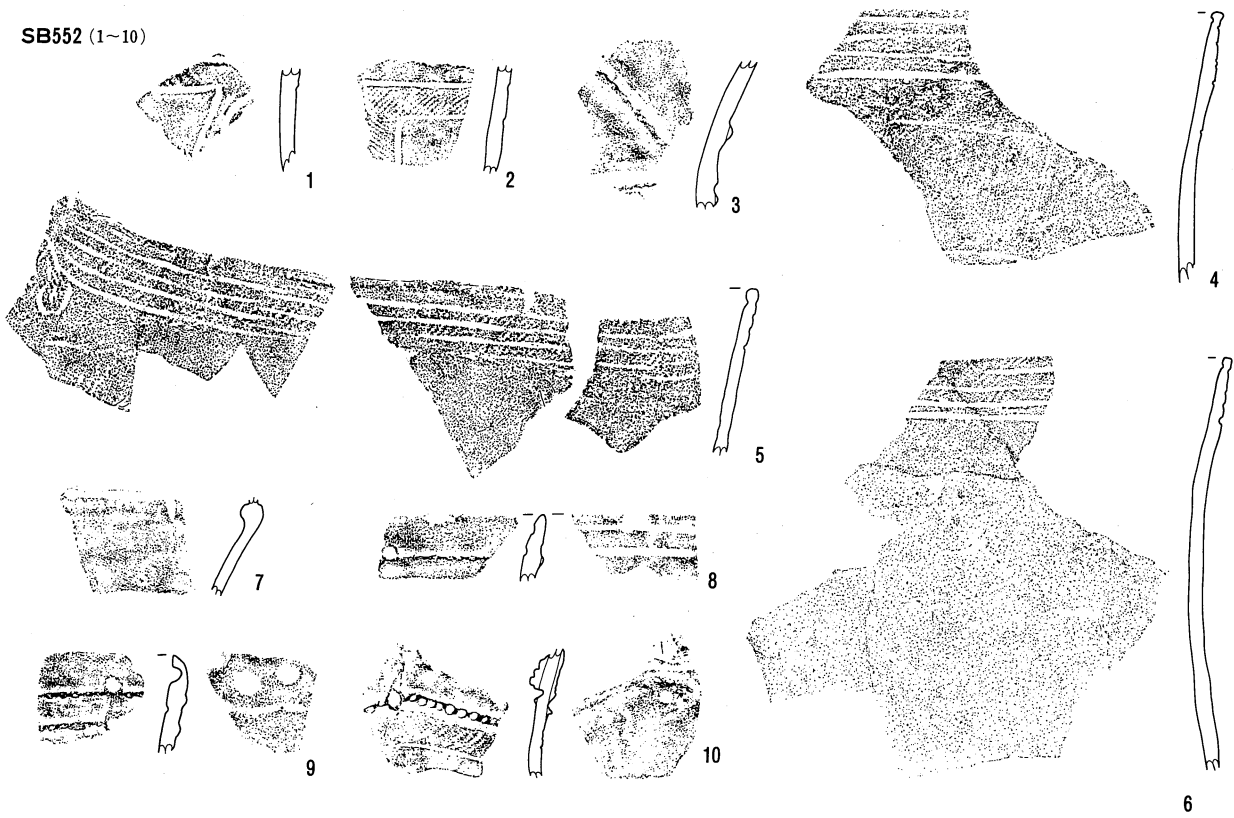

SB553 (1~8)

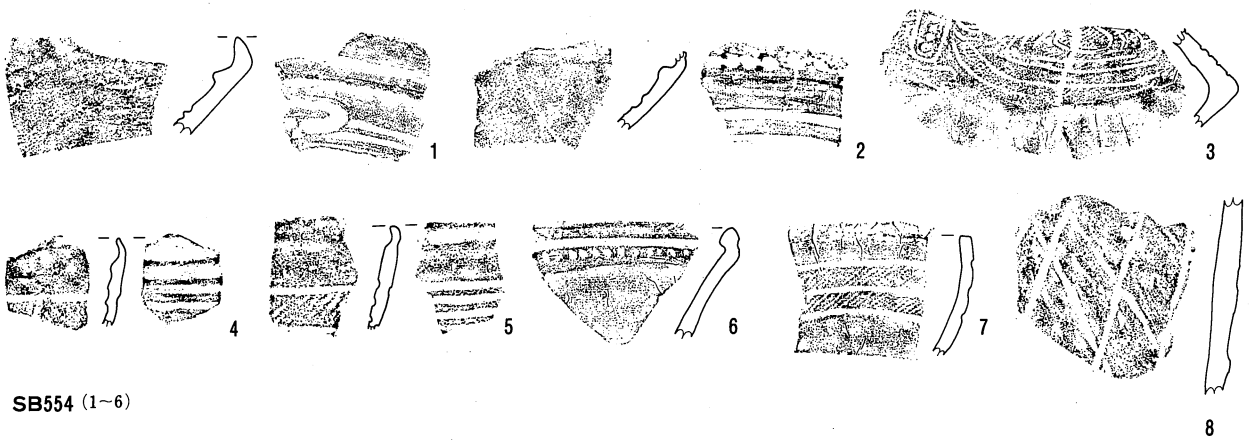

SB554 (1~6)

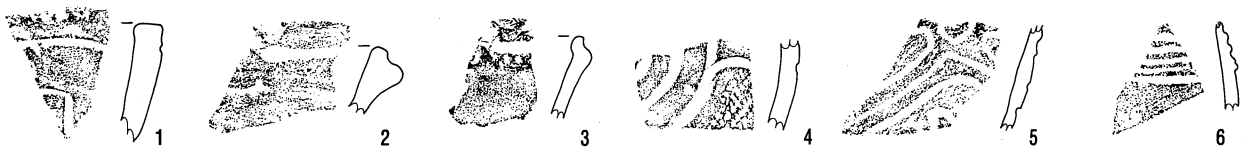

SB555 (6~9)

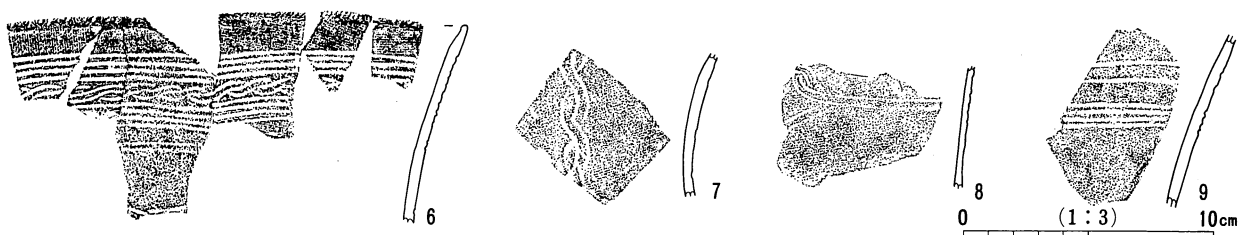

SB555 (10~36)

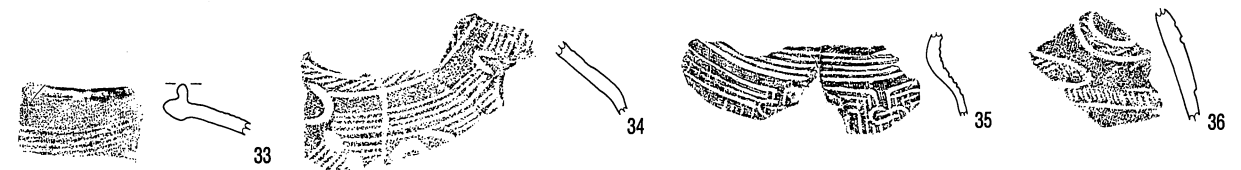
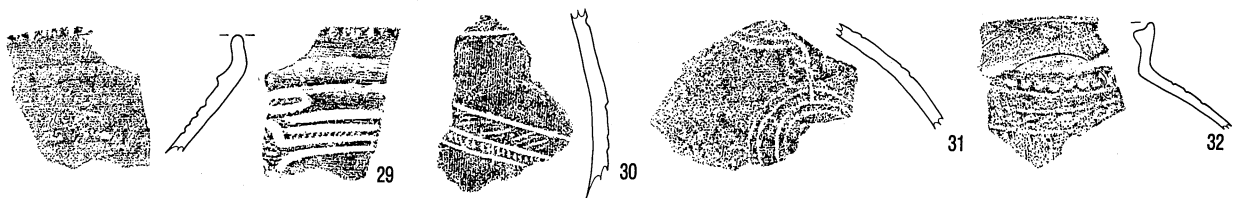
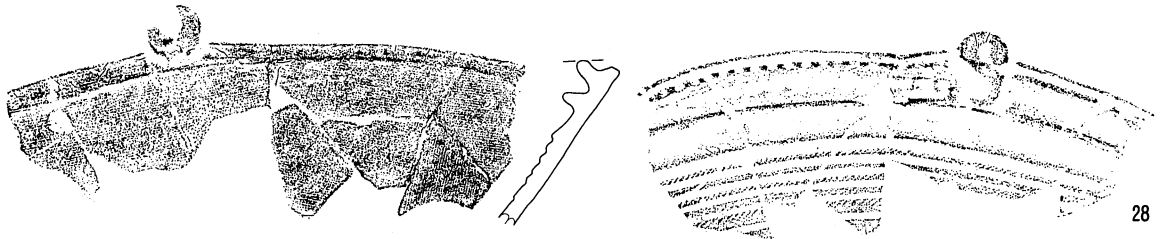
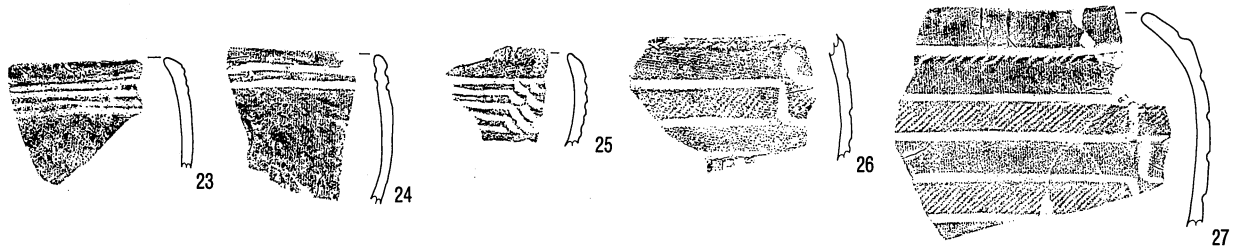
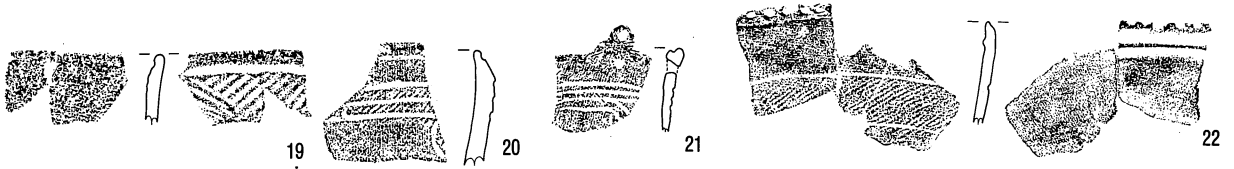
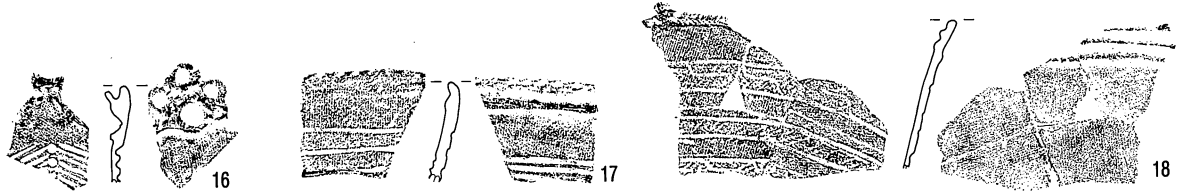
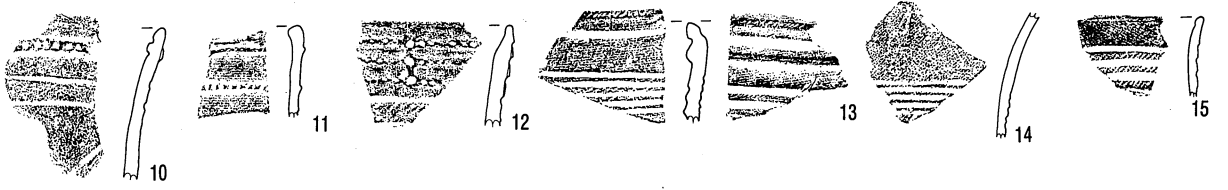

0 (1:3) 10cm

SB555 (37-50)

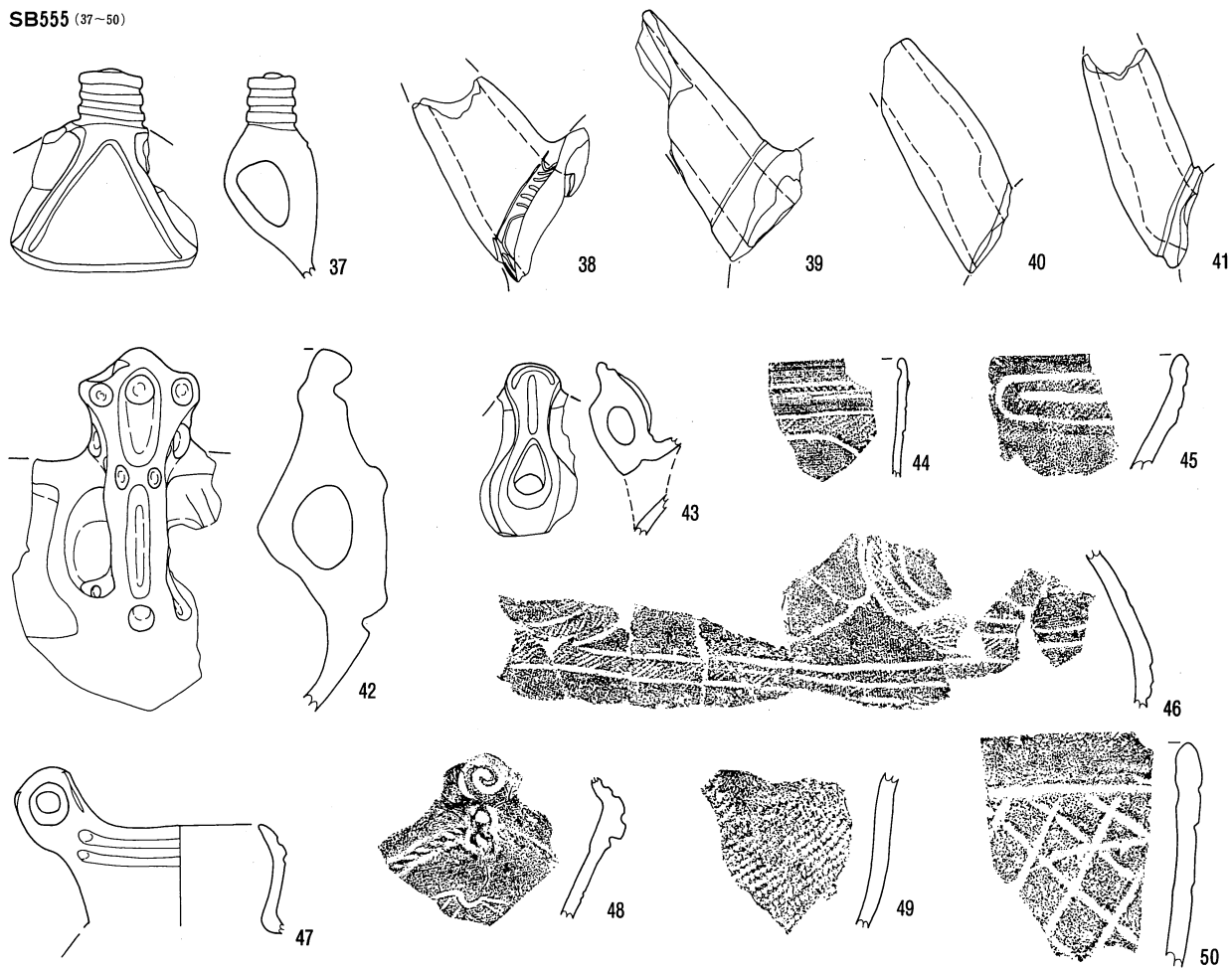

SB557 (1-14)

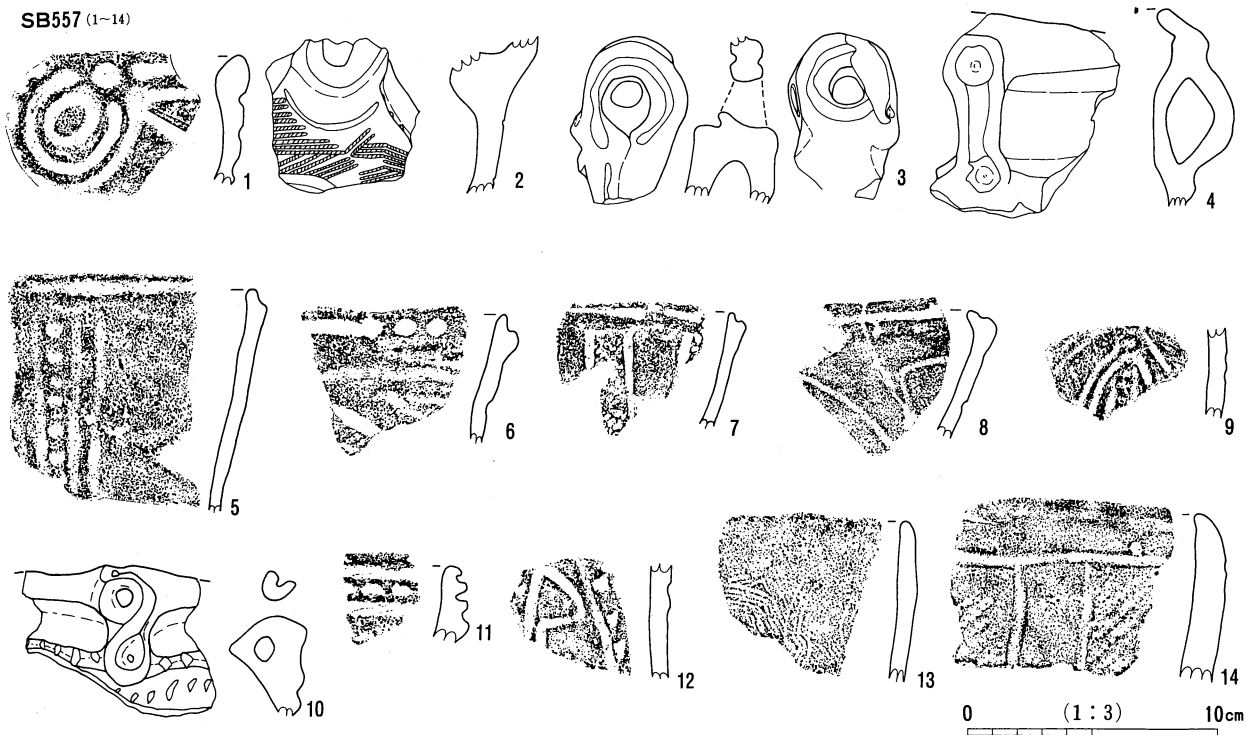

SB558 (2-19)

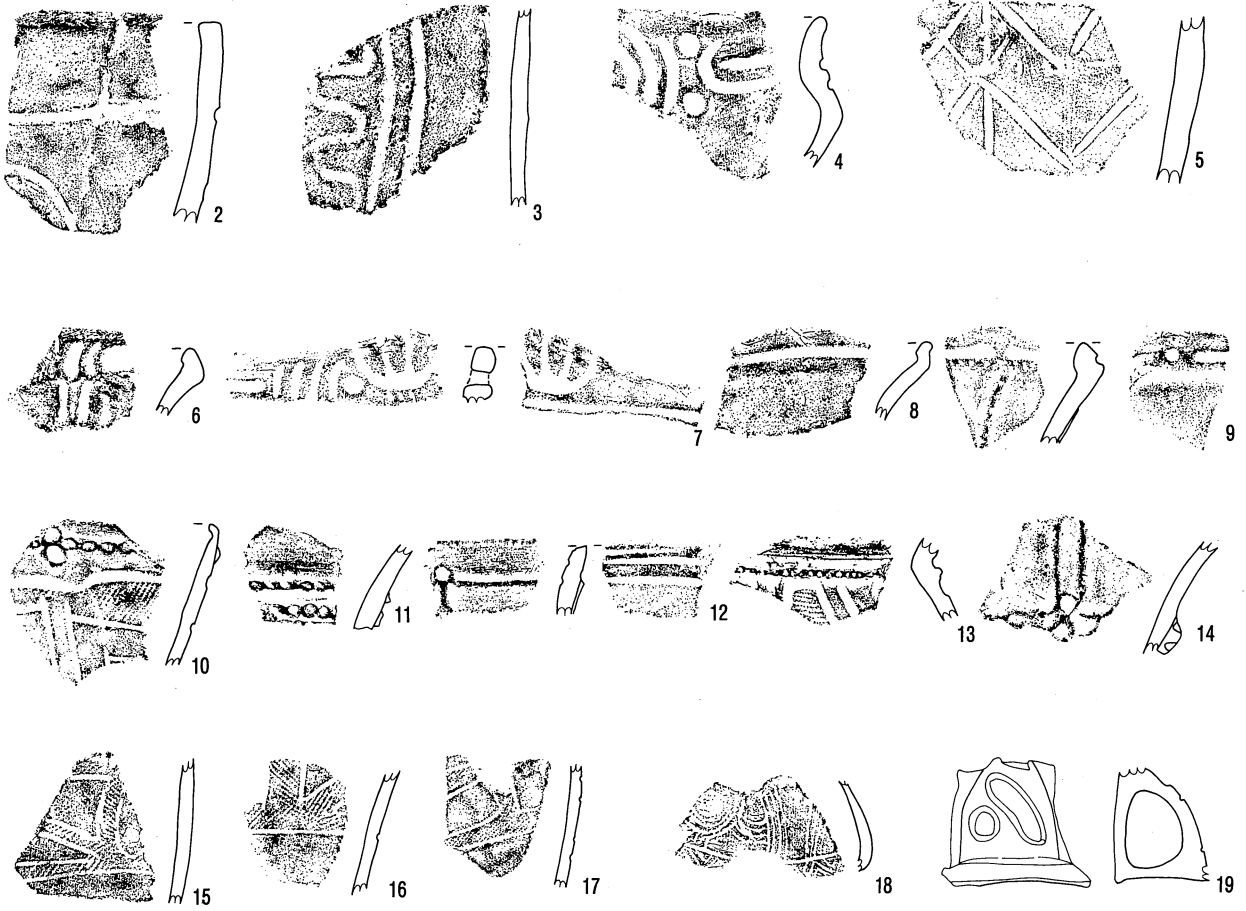

SB559 (2-13)

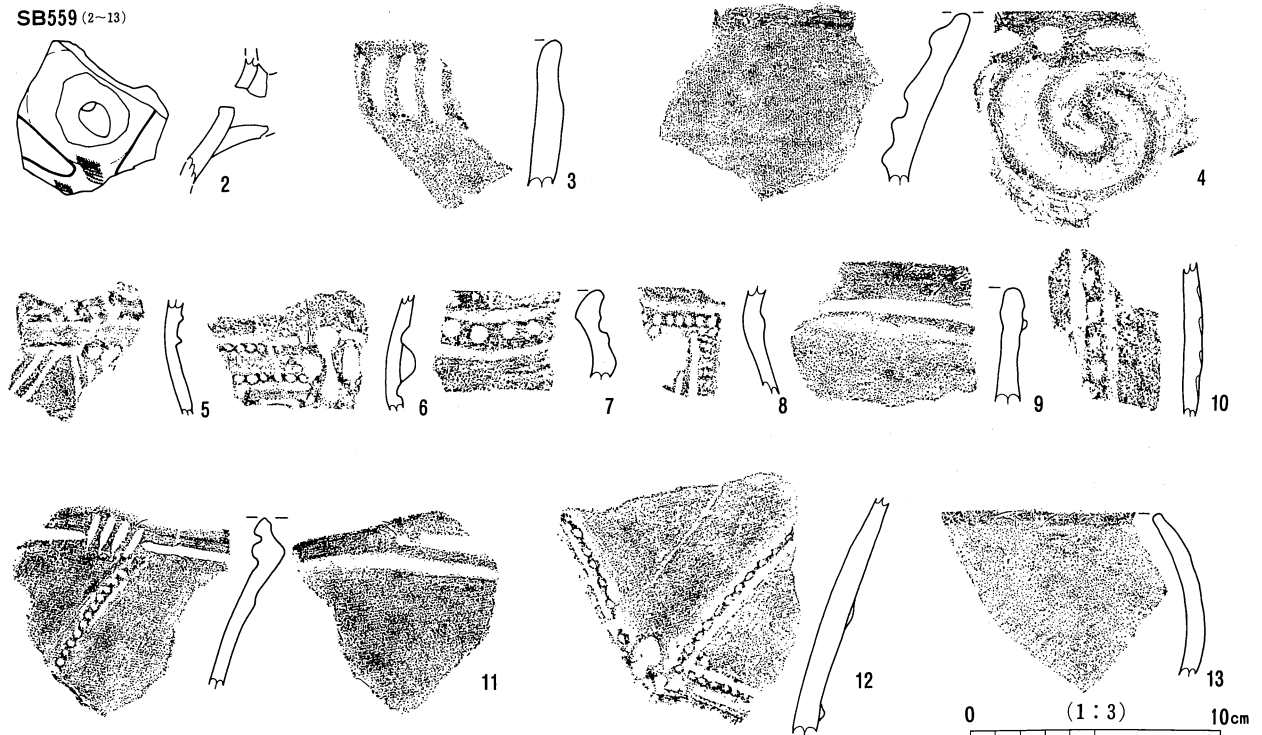

SB559 (14~19)

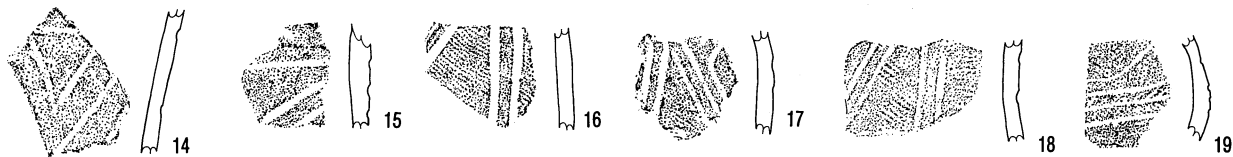

SB560 (5~19)

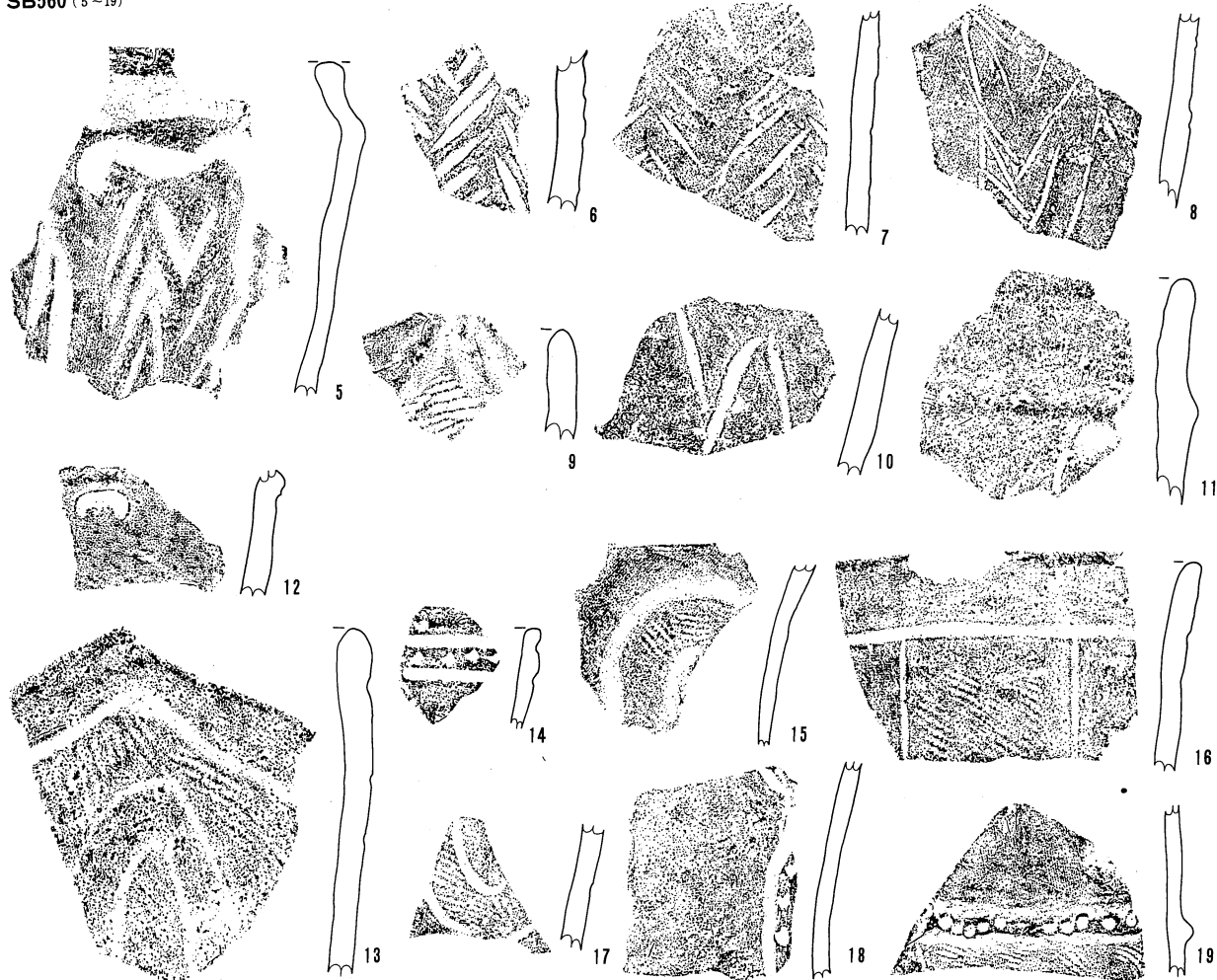

SB561 (3~10)

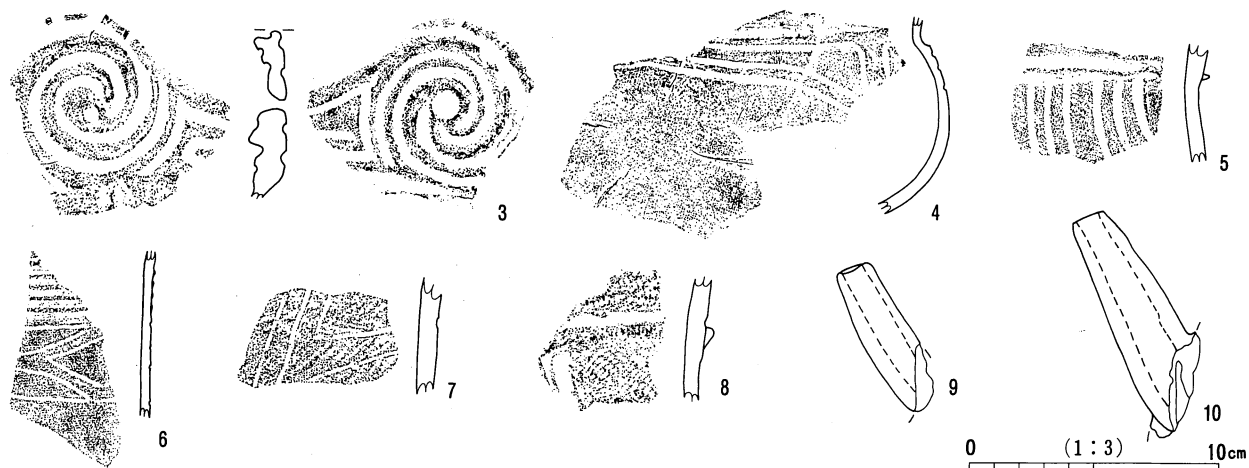

0 (1:3) 10cm

SB562
(2-23)

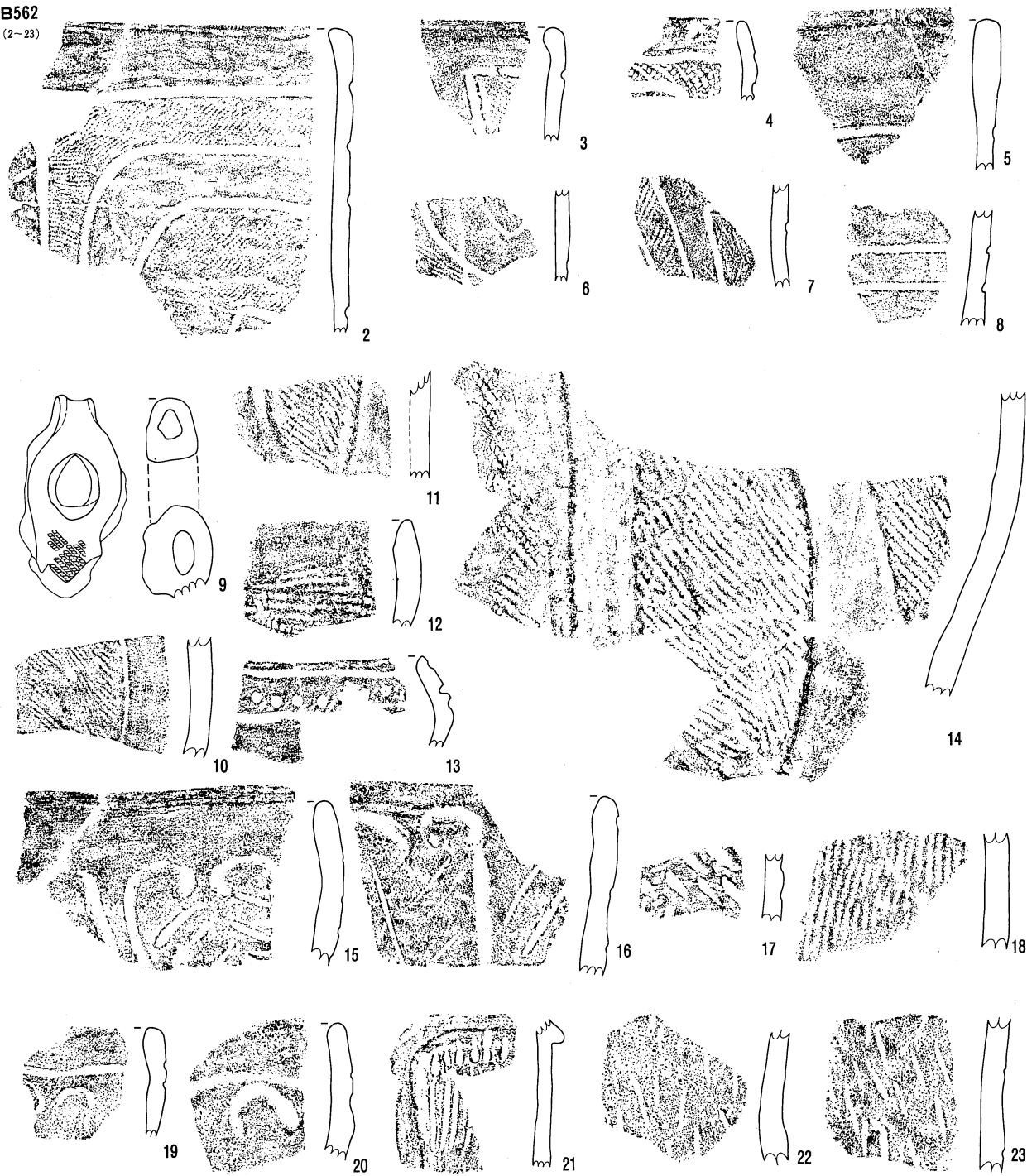

SB563 (1-5)

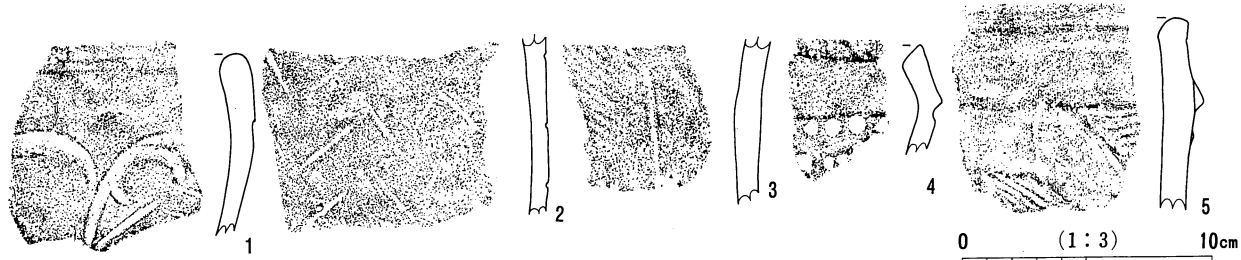

SB563 (6-9)

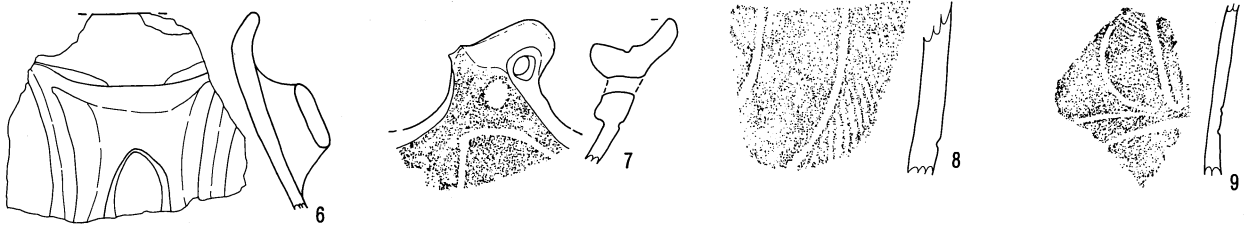

SB566 (11-35)

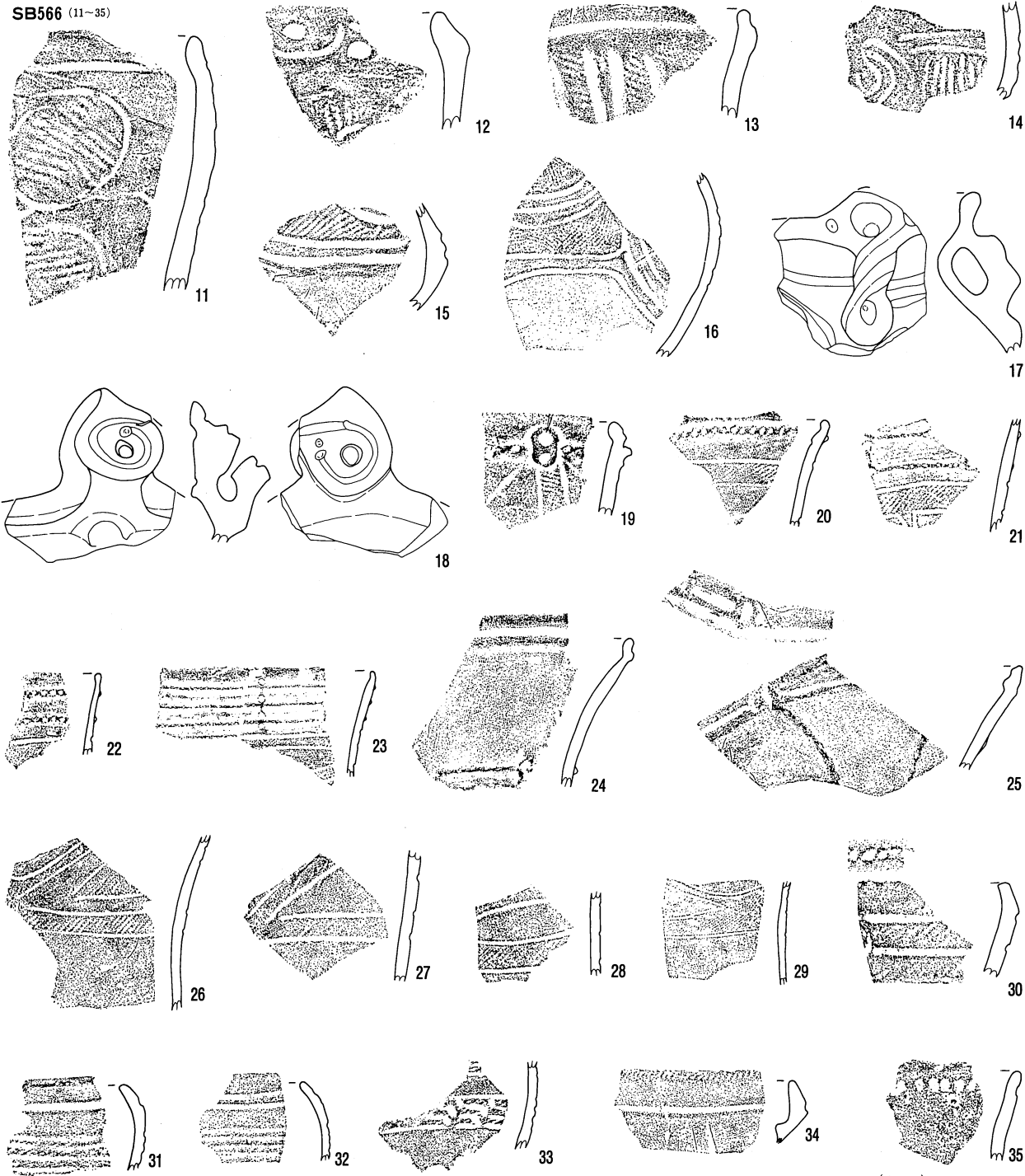

0 (1:3) 10cm

SB566 (36-46)

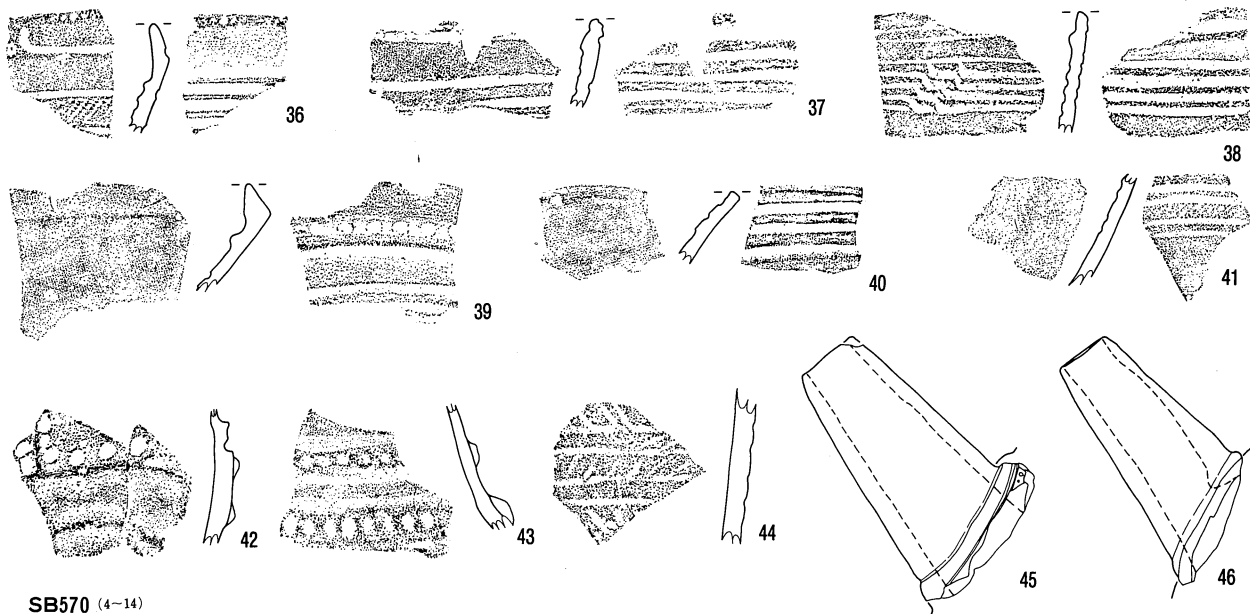

SB570 (4-14)

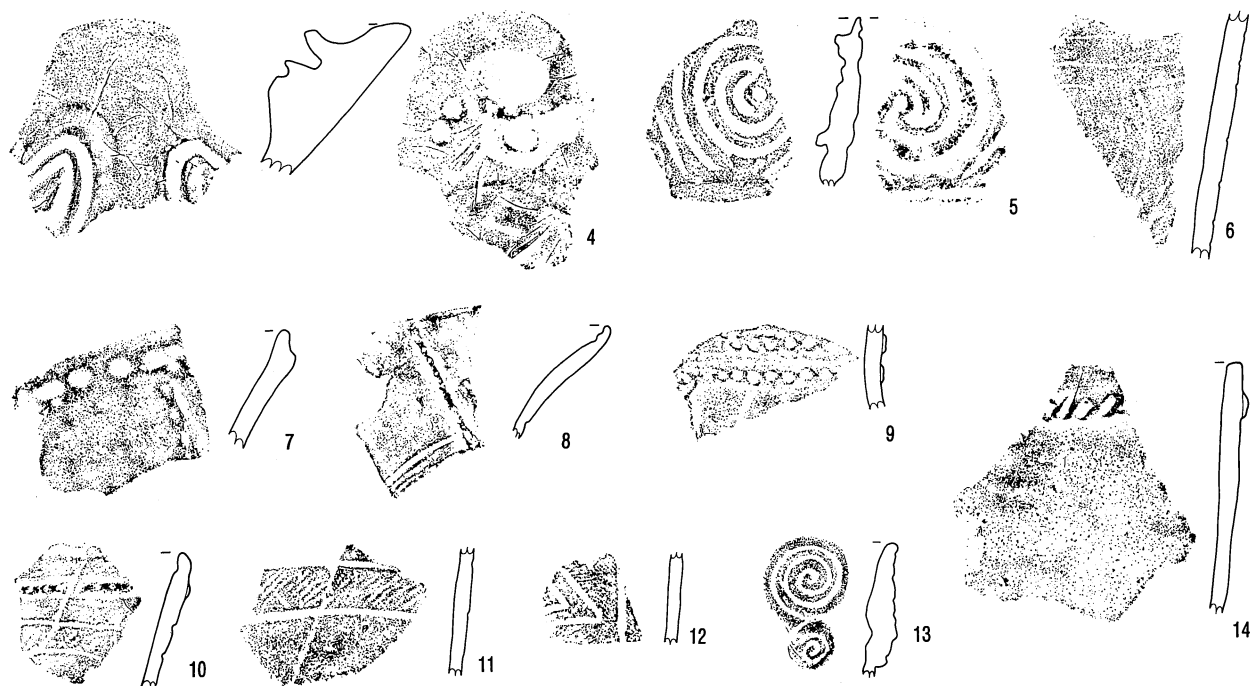

SB571 (1-3)

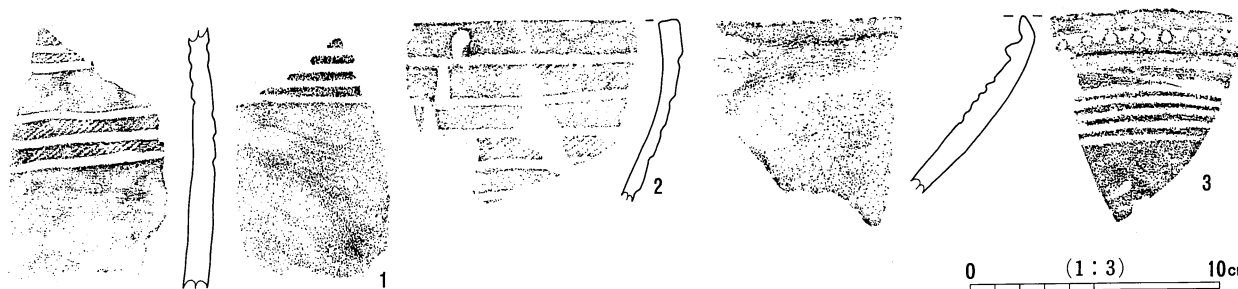

0 (1:3) 10cm

SB571 (4~17)

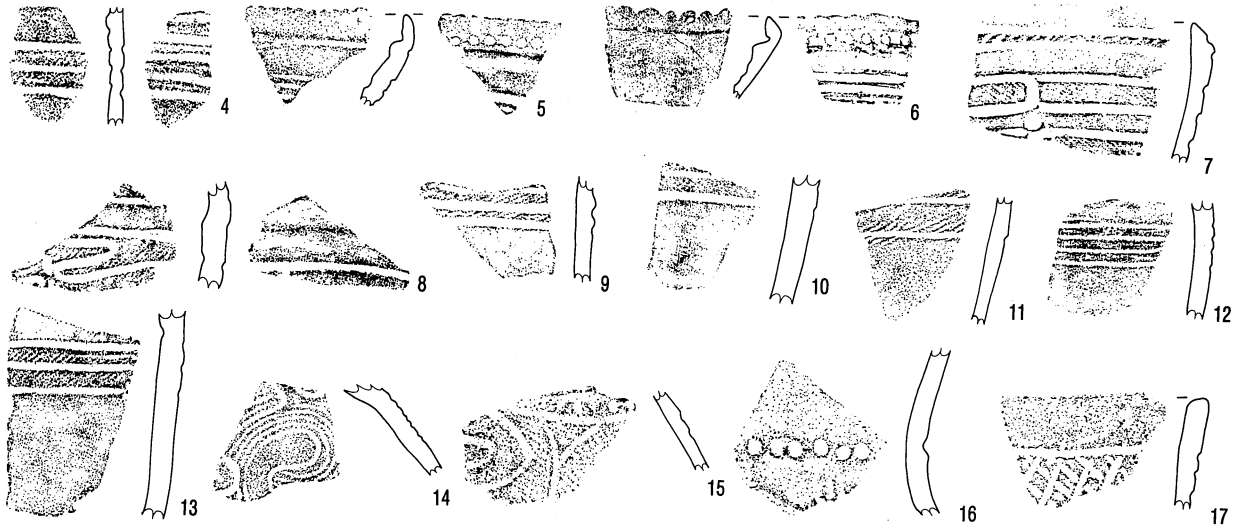

SB572 (2~4)

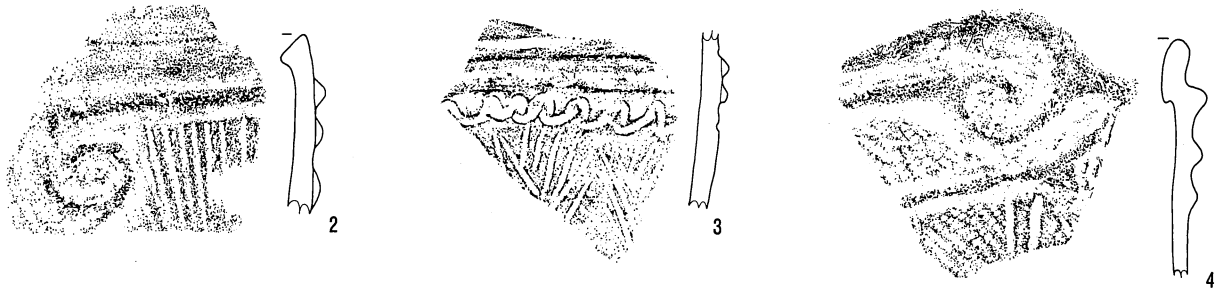

SB573 (1~10)

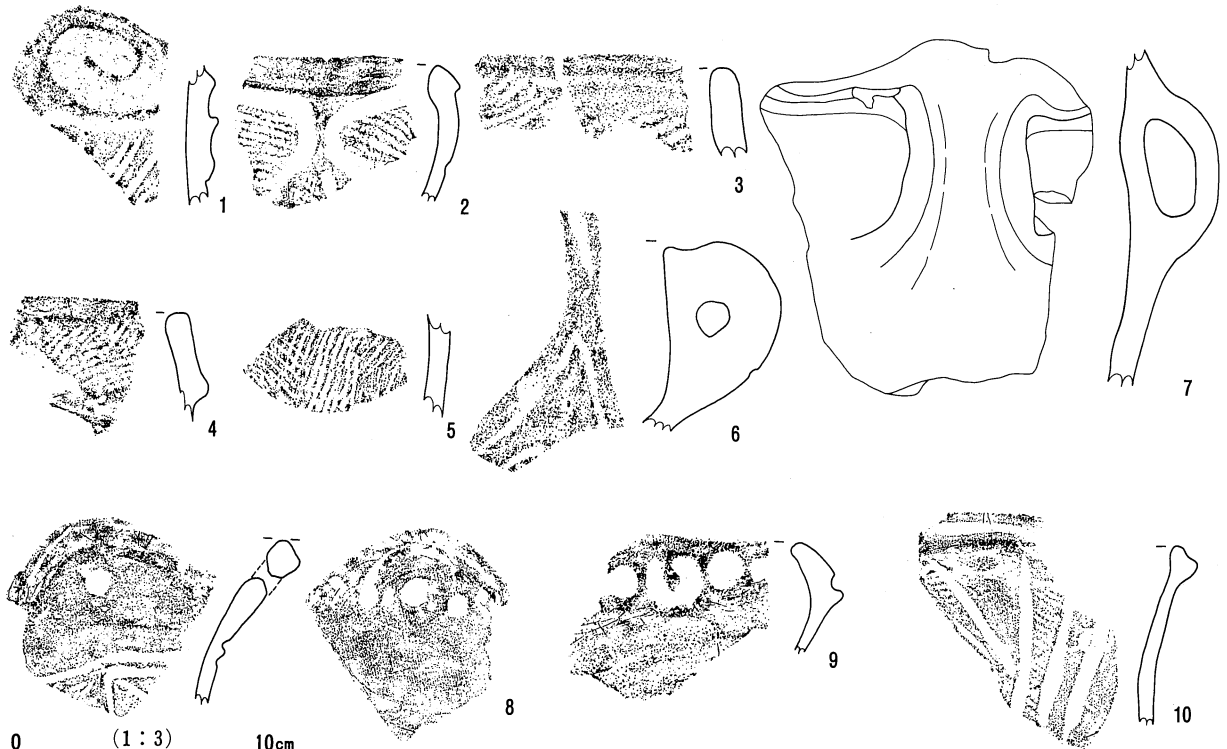

0 (1:3) 10cm

SB573 (11~15)

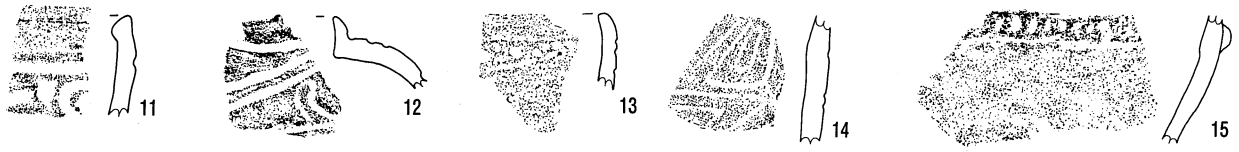

SB574 (1~9)

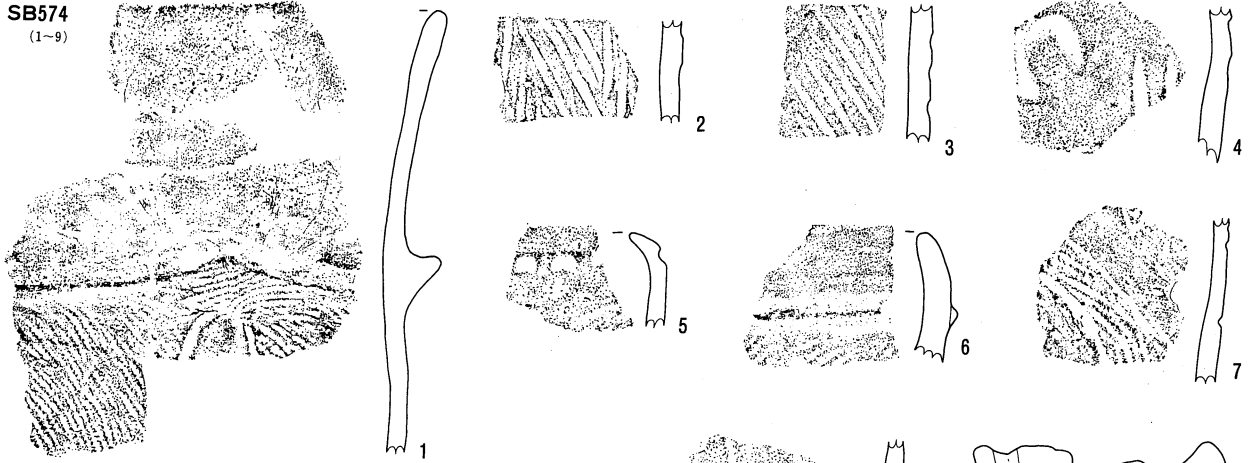

SB578 (1~3)



SB580 (3~13)

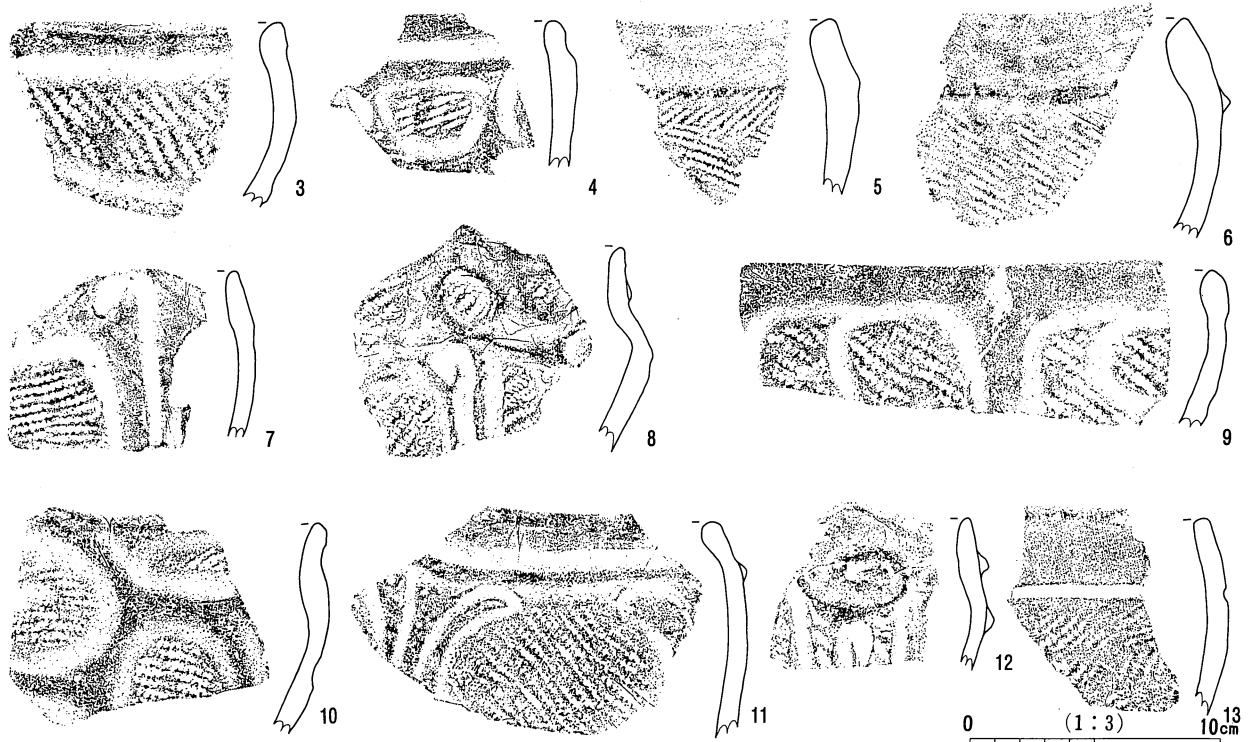

0 (1:3) 10cm

S B580 (14-23)

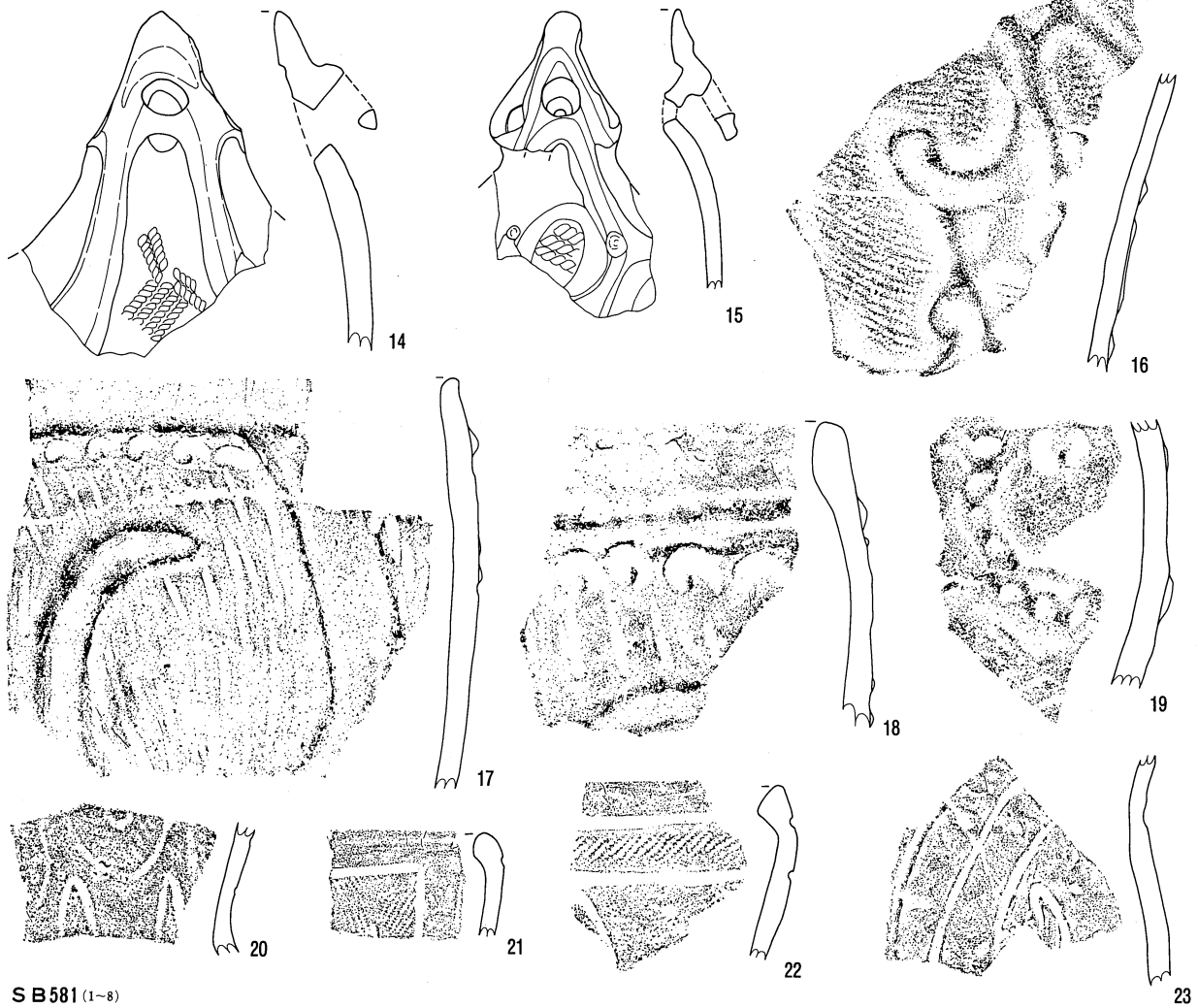

S B581 (1-8)

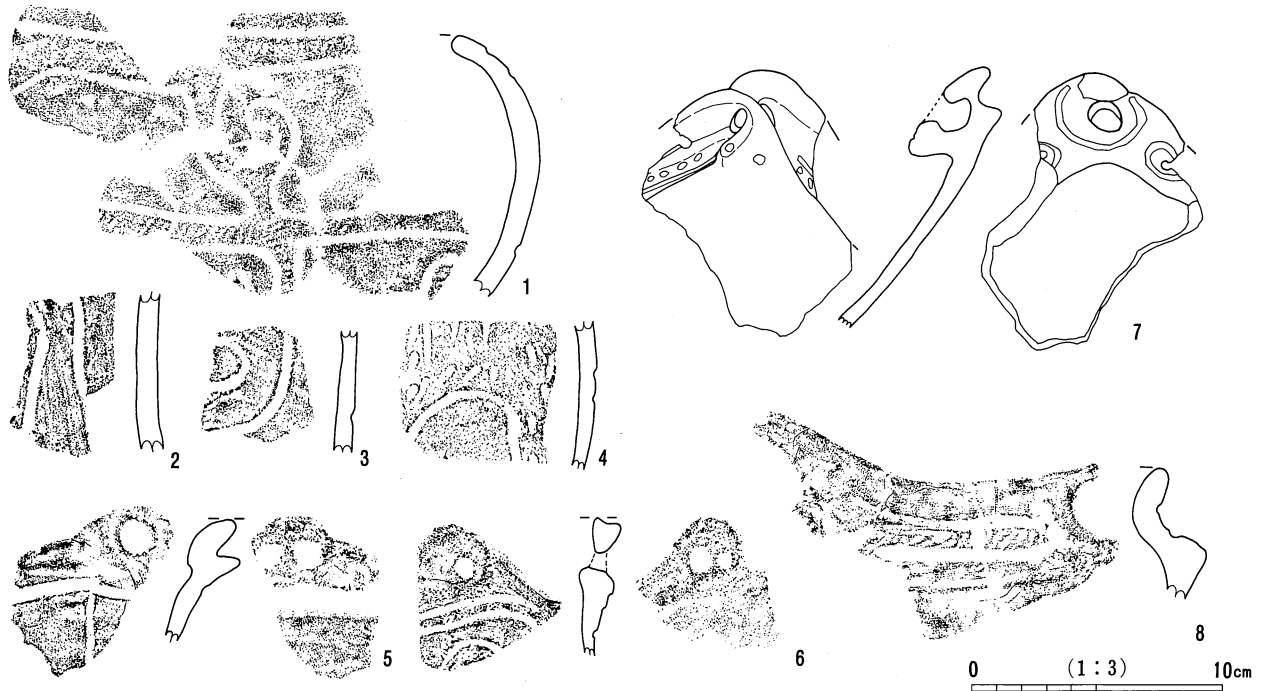

S B 581 (9-32)

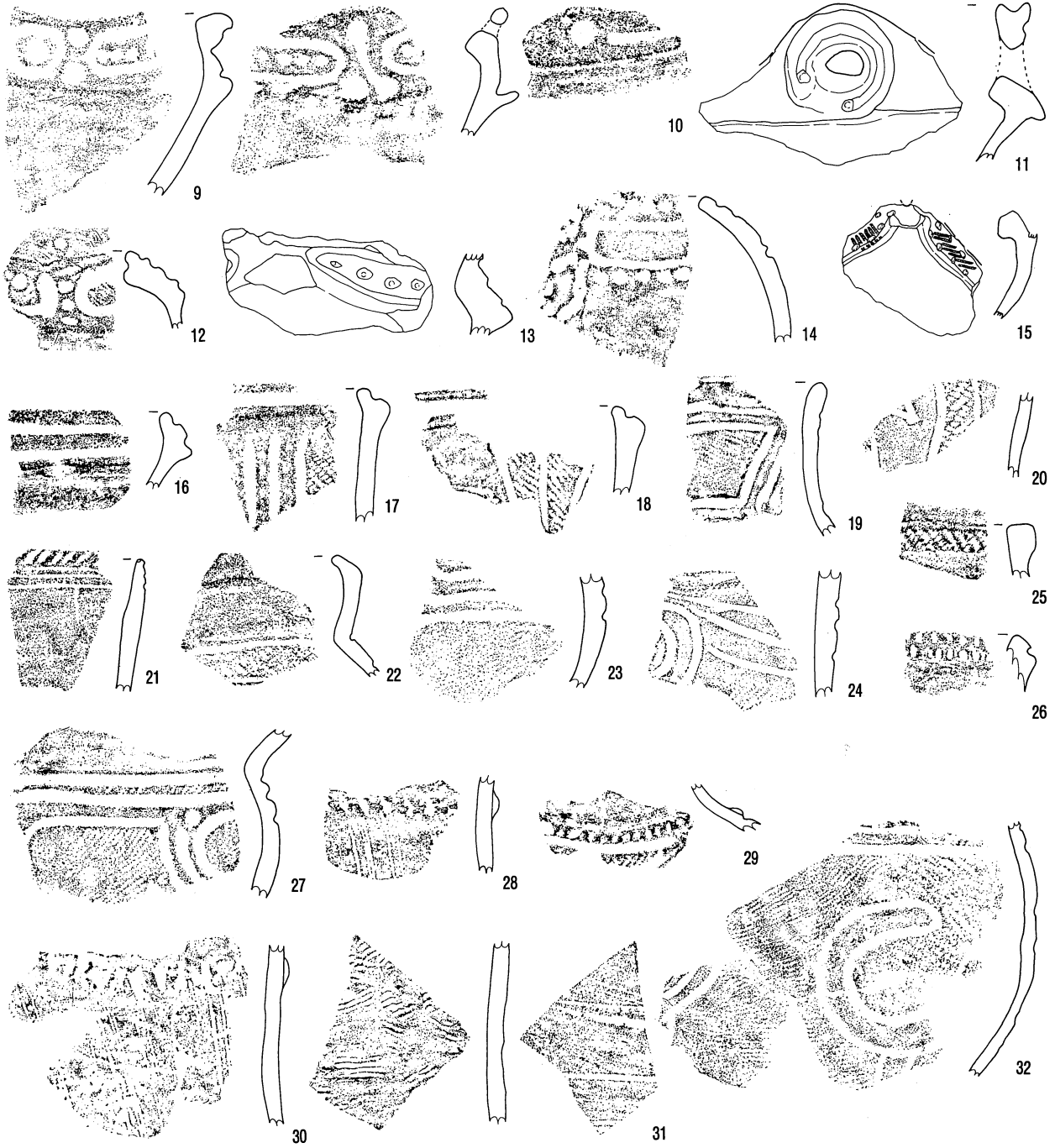

S B 582 (1-5)

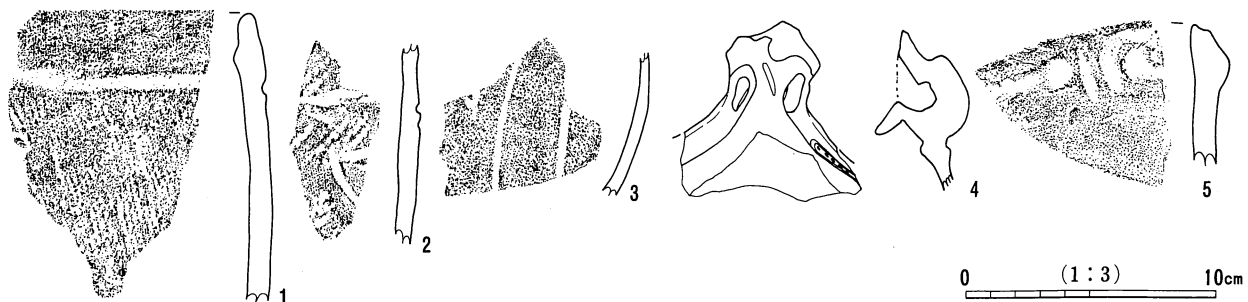

S B583 (4~17)

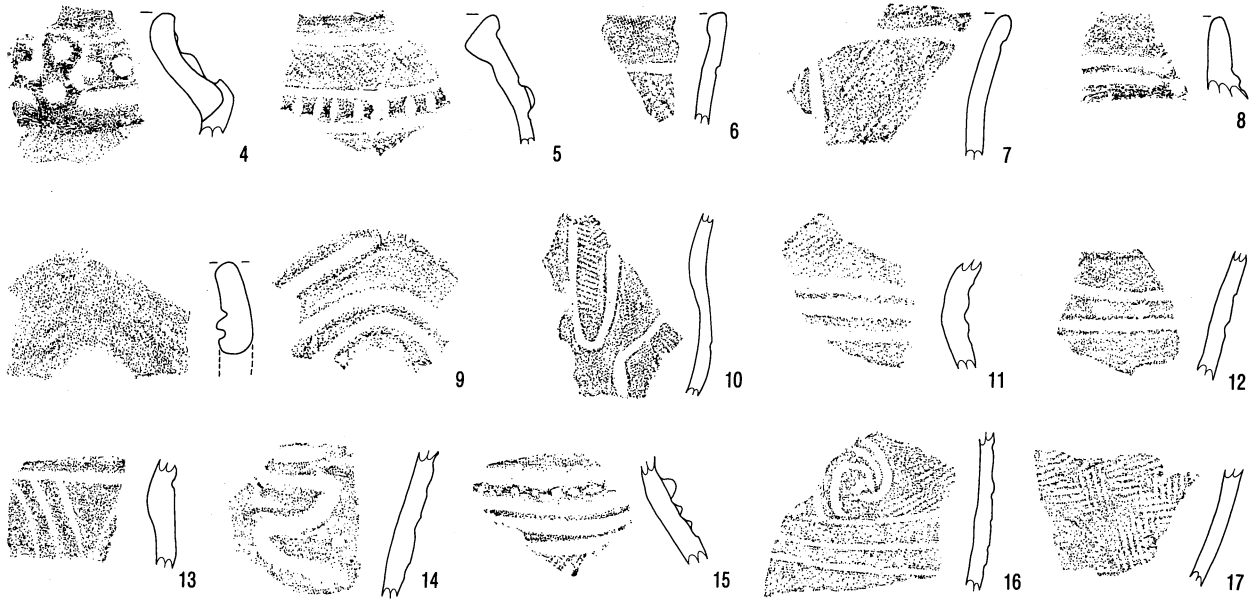

S B584 (1-13)

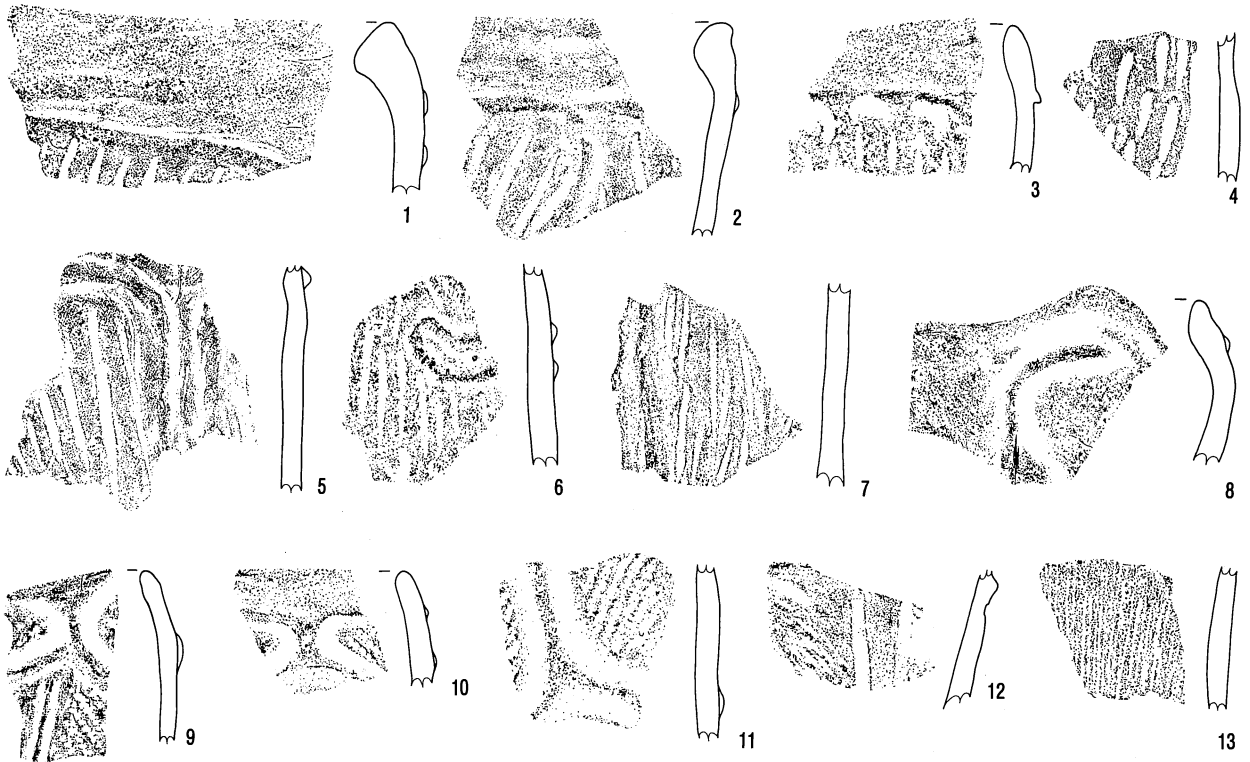

S B588

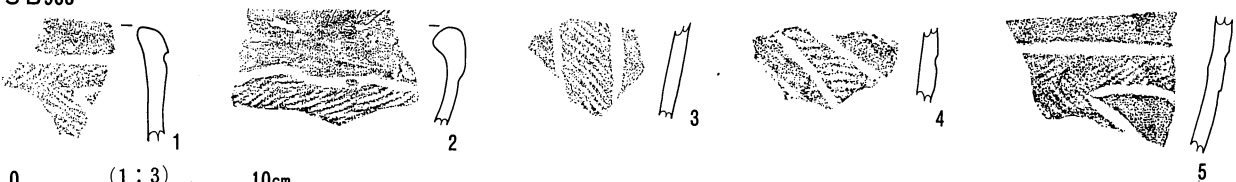

0 (1:3) 10cm

S B588 (6-13)

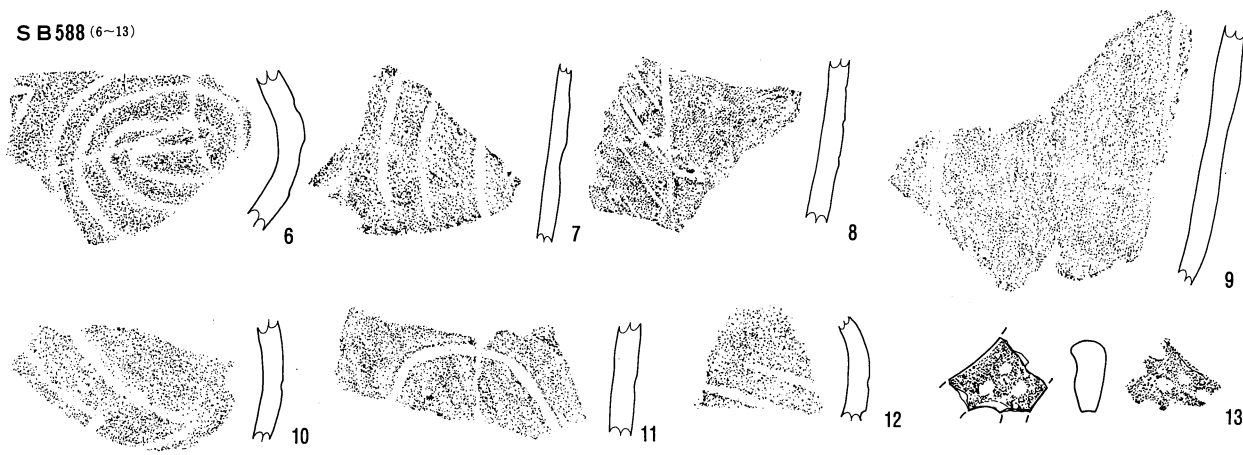

S B590 (1-4)

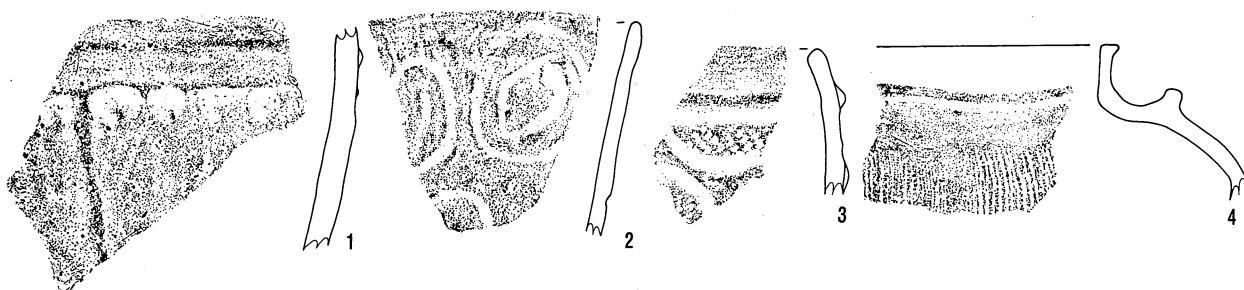

S B592 (3-19)

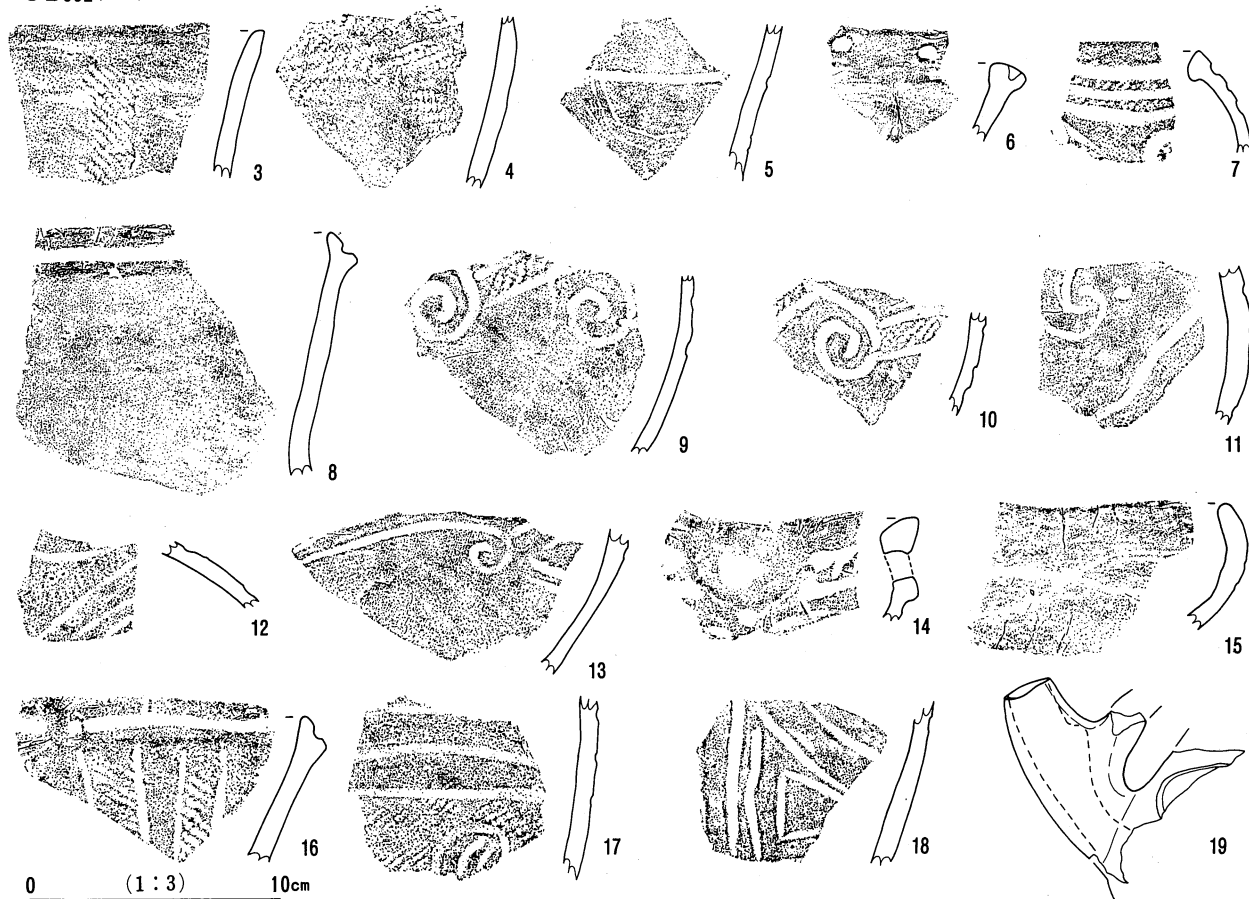

0 (1:3) 10cm

S B594 (3-19)

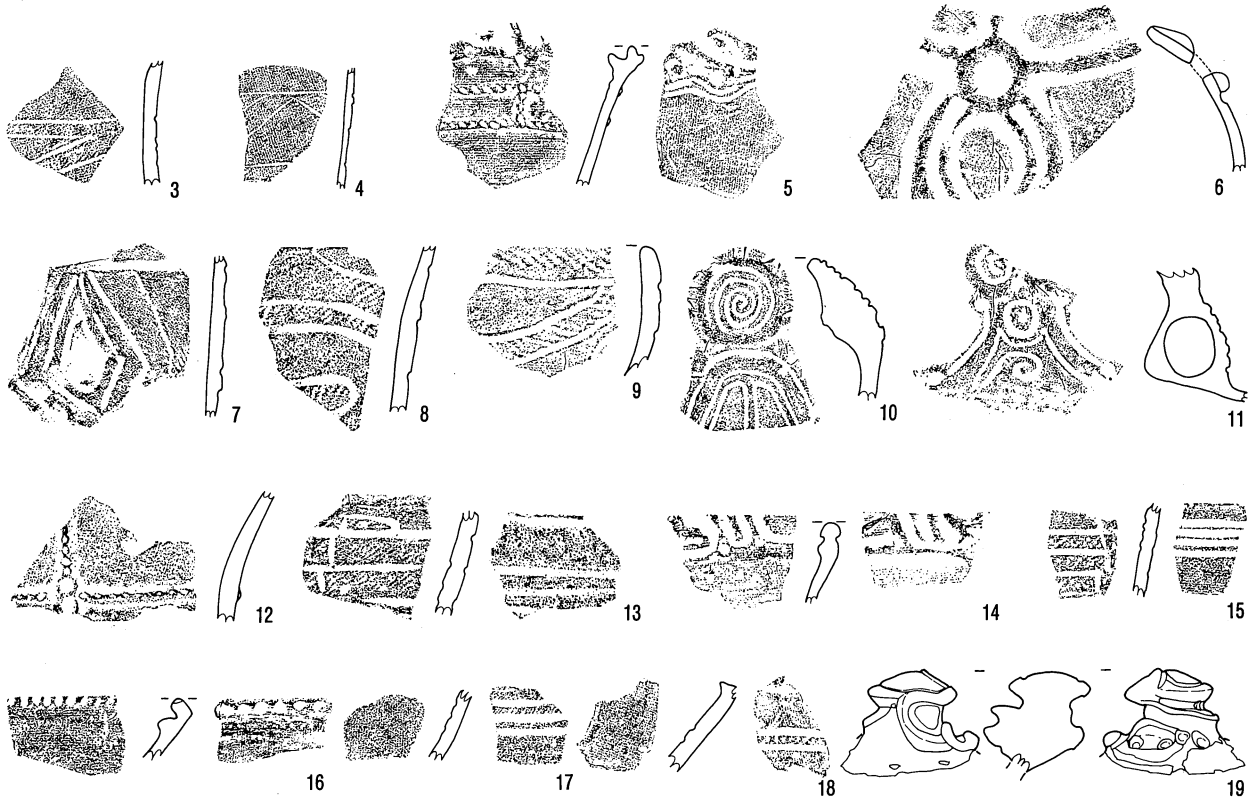

S B595 (1-9)

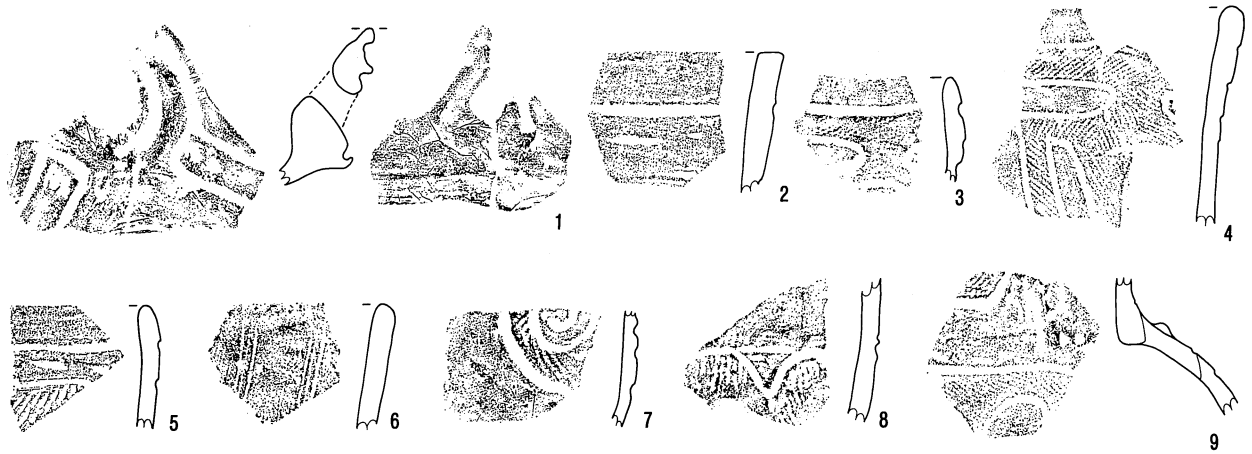

S B599 (2-5)

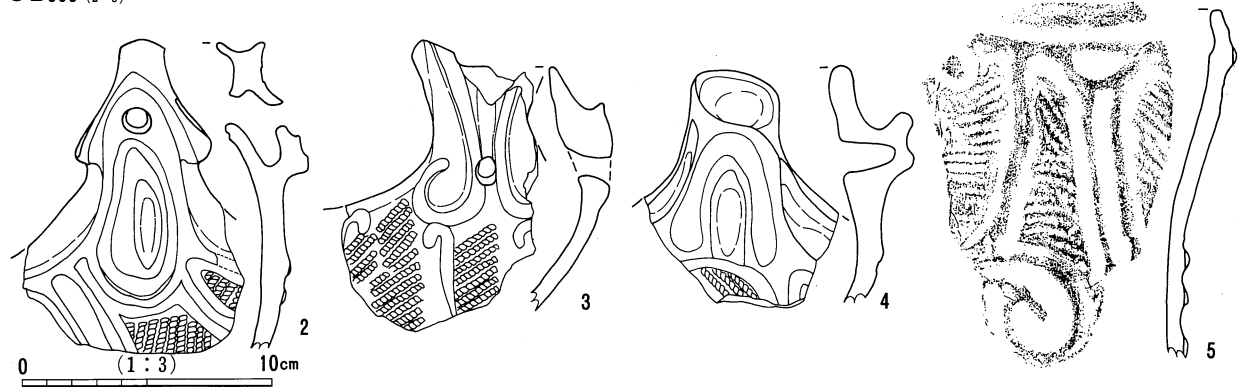

S B599 (6~20)

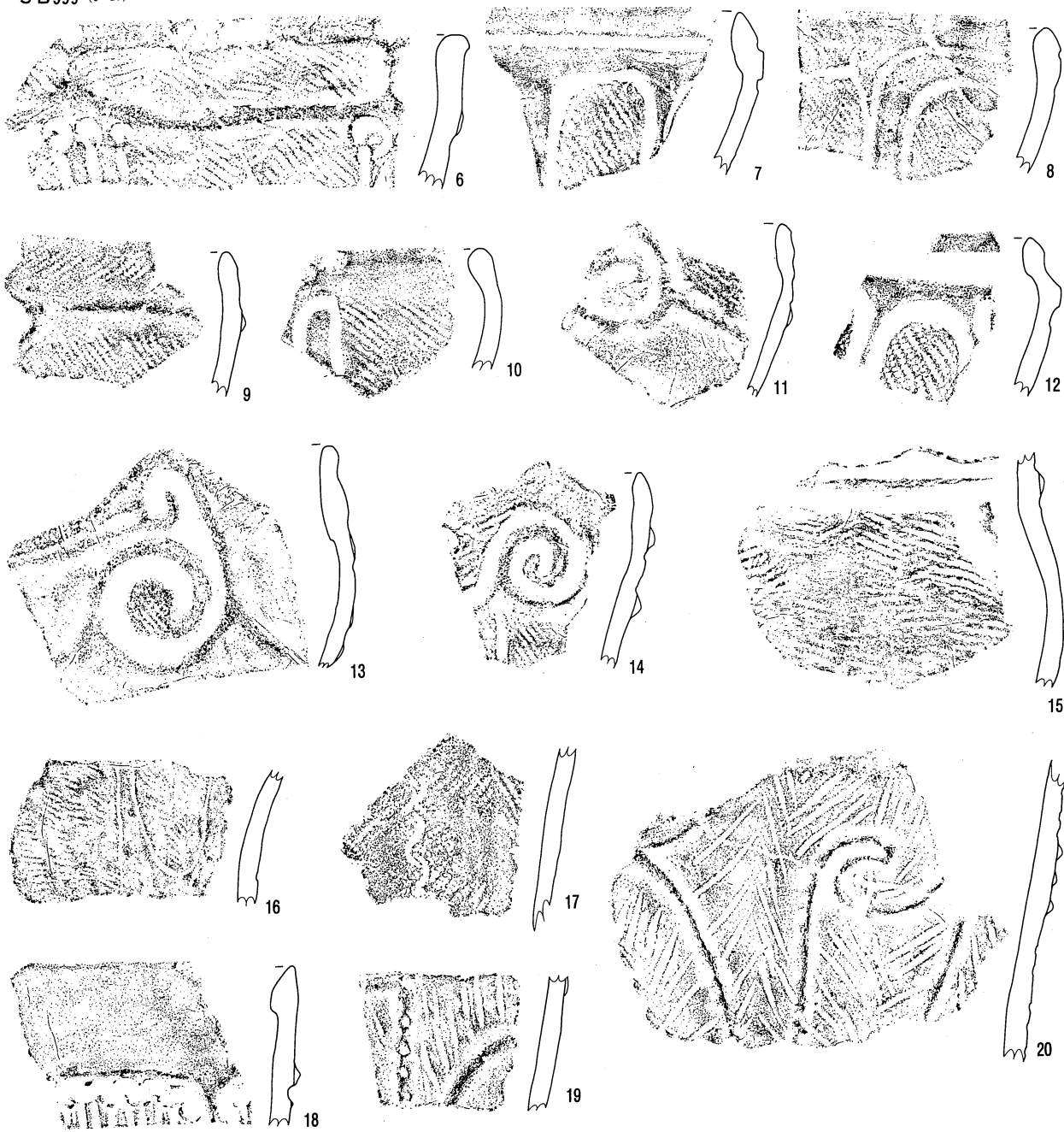

SH18 (1~8)

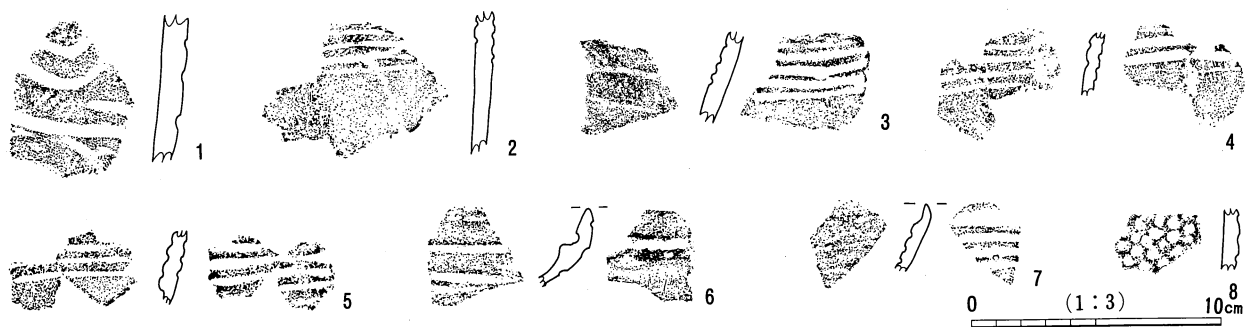

SH19 (1)

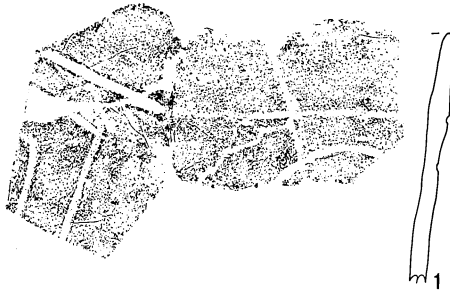

SH507 (1・2)

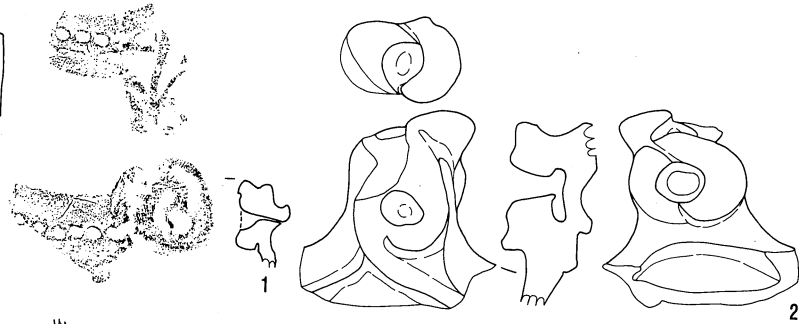

SH515 (1)

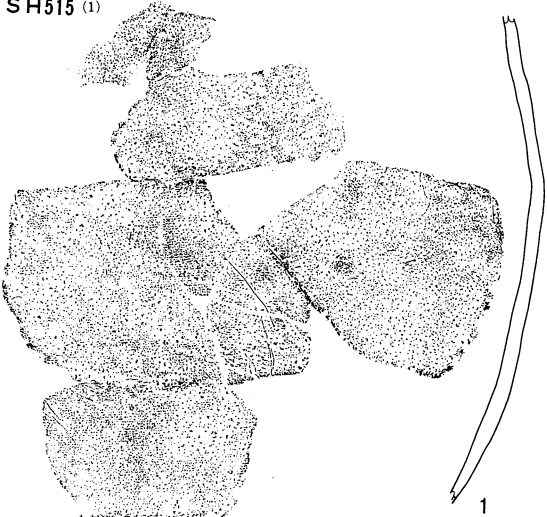

SH549 (1-6)

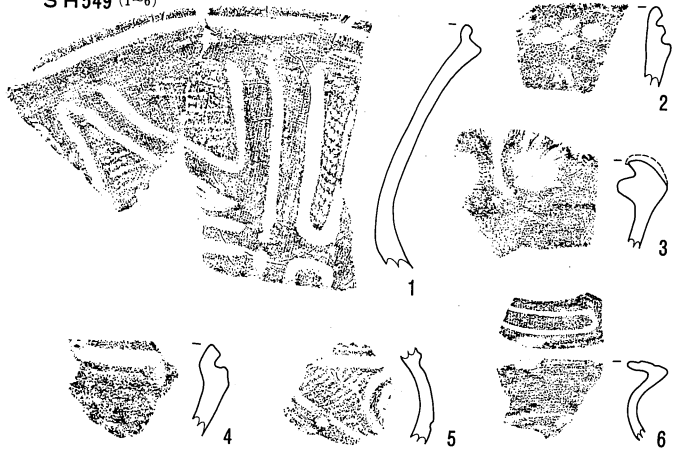

SH573 (1・2)

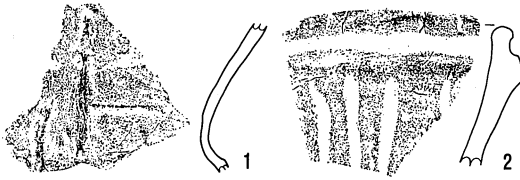

SH613 (1・2)

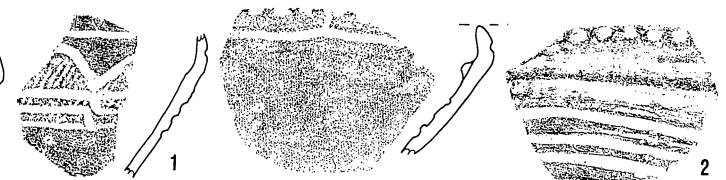

SH639 (1)



SH672 (1-3)

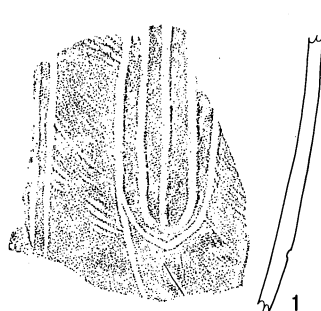

SH688 (1)

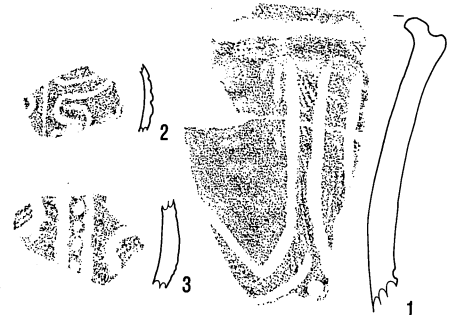

SH674 (1-4)

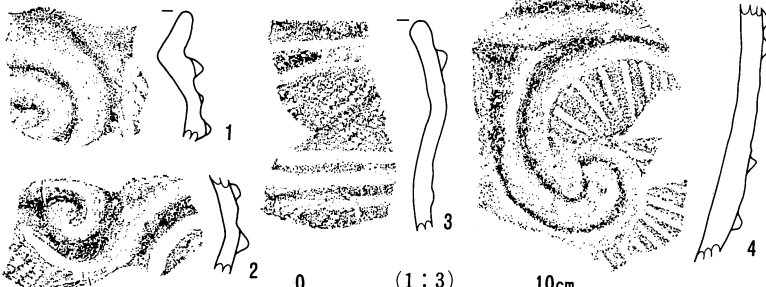

SH684 (1-3)

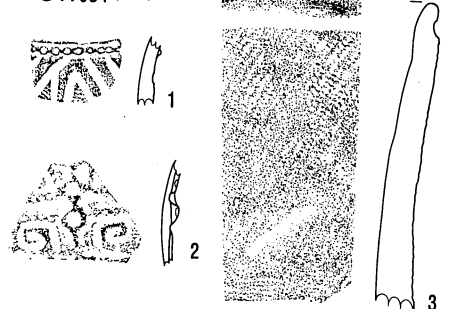

0 (1:3) 10cm

SH698 (1)



SH700 (1-5)

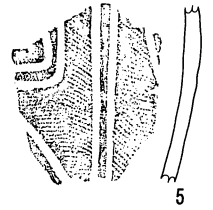
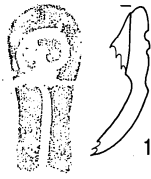

SH730 (1-4)



SH738 (2)

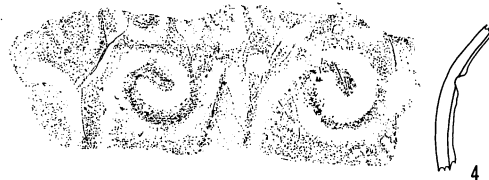

SH742 (1-2)

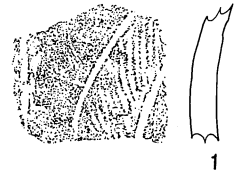

SH778 (1-2)

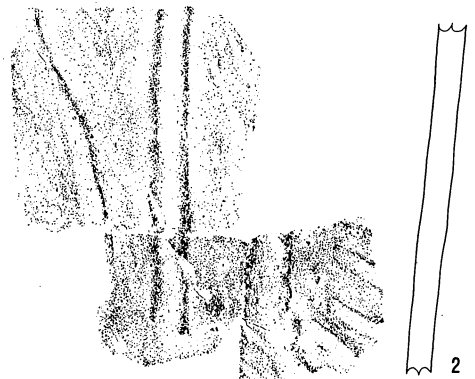
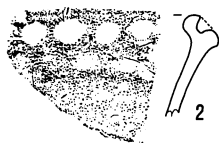

SH785 (2)



SH791 (1-2)



SH799 (1-2)



SH852 (1)

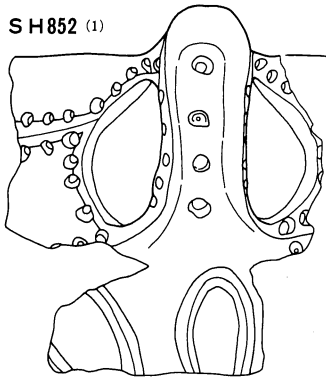

SH842 (1-2)

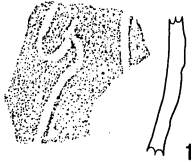

SH860 (1-4)

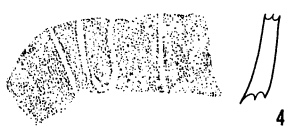
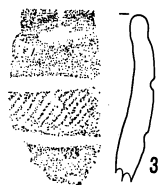
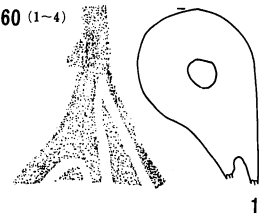
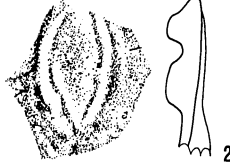

0 (1:3) 10cm

SH873 (1)



SH874 (1)

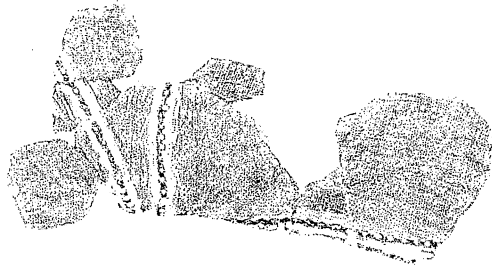

SH908 (1・2)

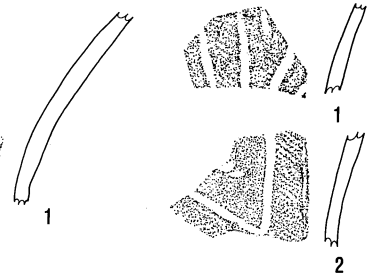

SH1006 (1・2)



SH1007 (1-3)

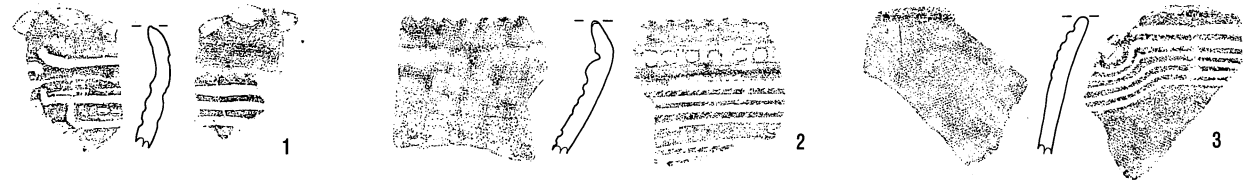

SH1092 (1・2)

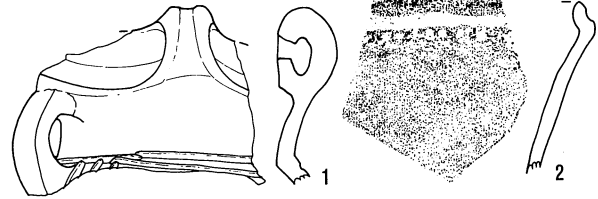

SH1144 (1-3)

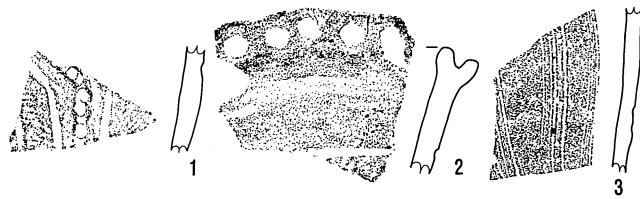

SH1155 (1)

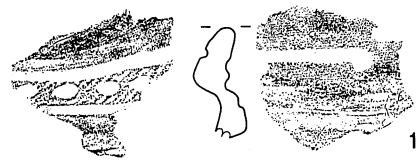

SH1156 (1・2)



SH1158 (1-4)

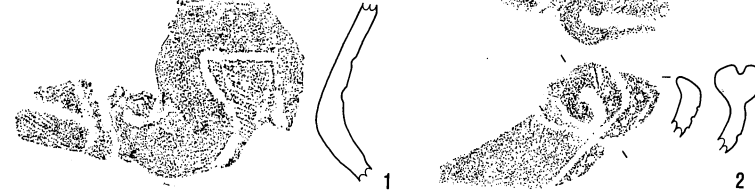

SH1159 (1-3)

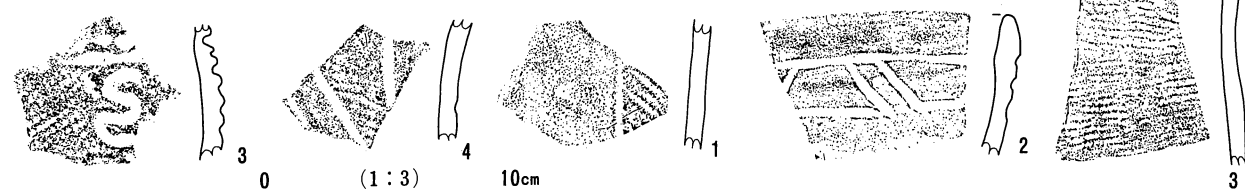

0 (1:3) 10cm

SH1160 (1-4)



SH1168 (1-3)

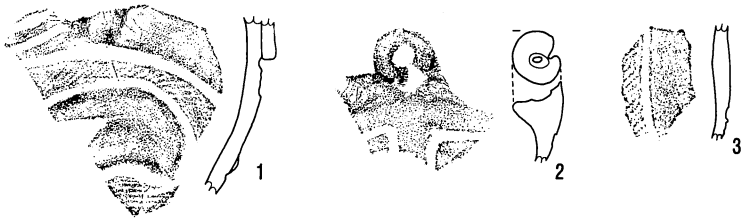

SH1171 (1-3)



SH1172 (1-3)

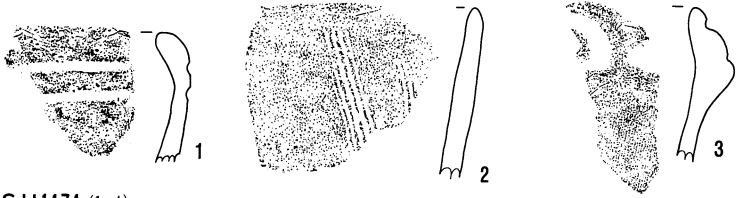

SH1174 (1-4)



SH1176 (1-5)

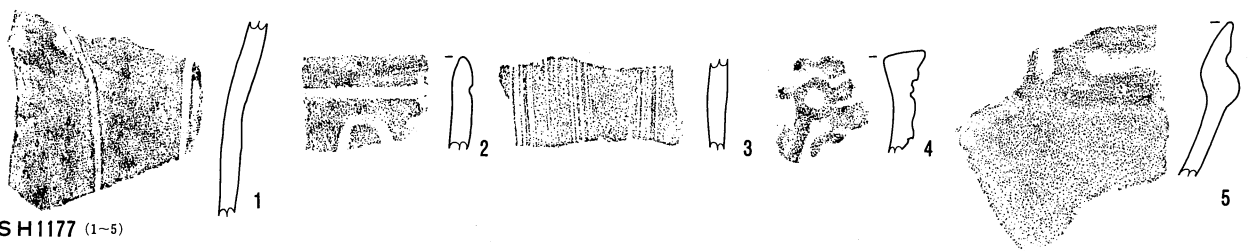

SH1177 (1-5)

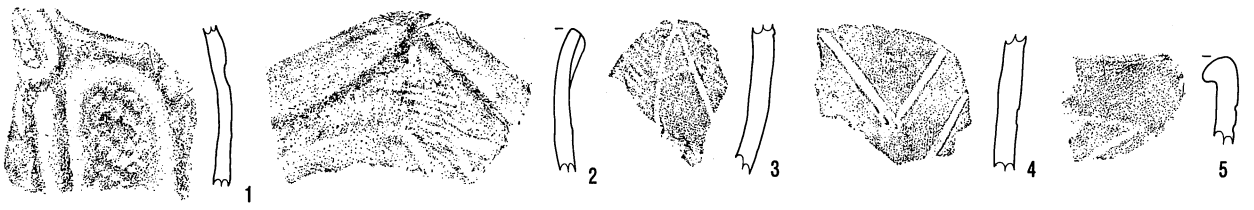

SH1179 (1-5)

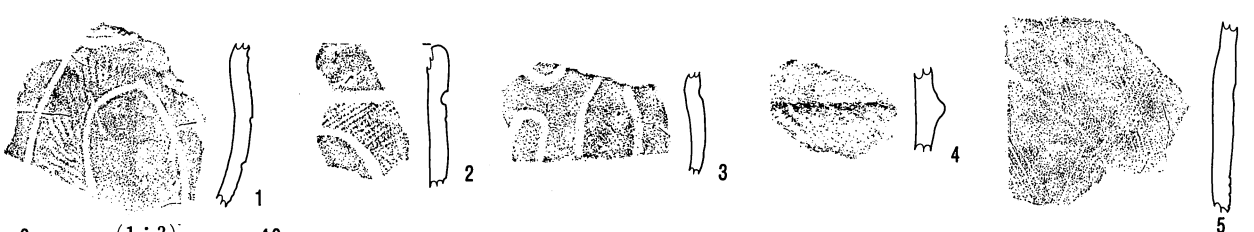

0 (1:3) 10cm

SH1180 (1・2)

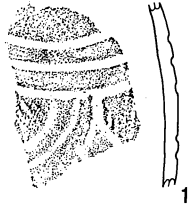

SH1182 (1~3)

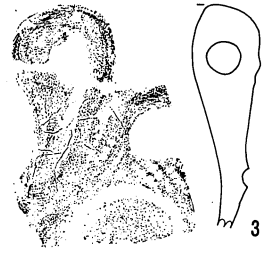
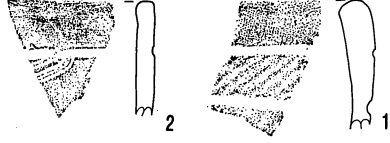

SH1184 (1~5)

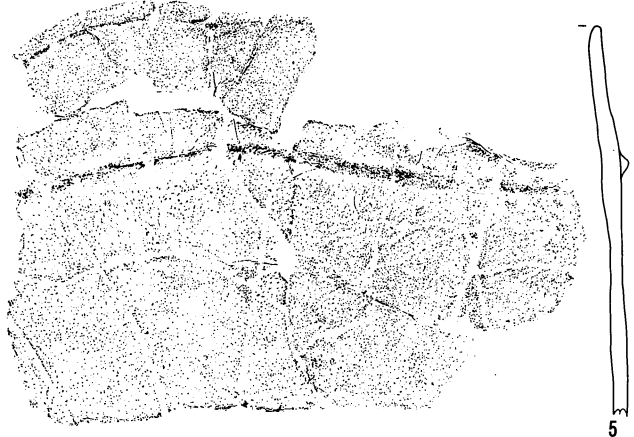

SH1185 (1~5)

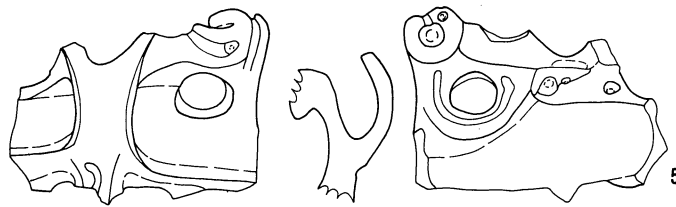
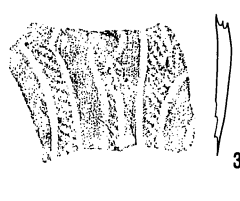
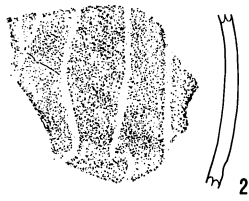
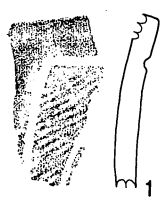

SH1186 (1~2)

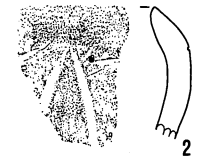

SH1188 (1・2)

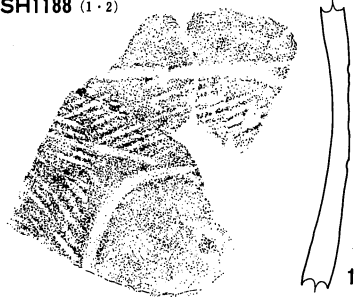

SH1187 (1~5)

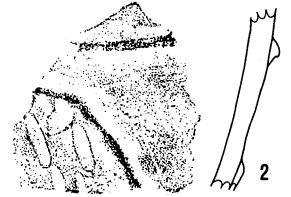
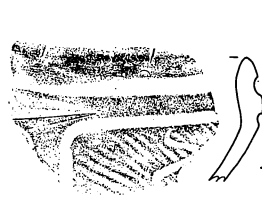

SH1190 (1~5)

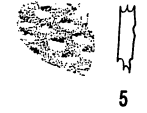
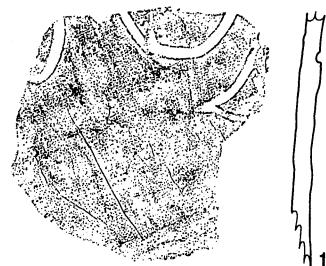

0 (1:3) 10cm

SH1191 (1-3)



SH1192 (1-2)

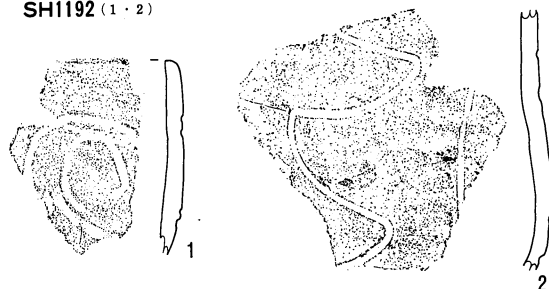

SH1193 (1-5)

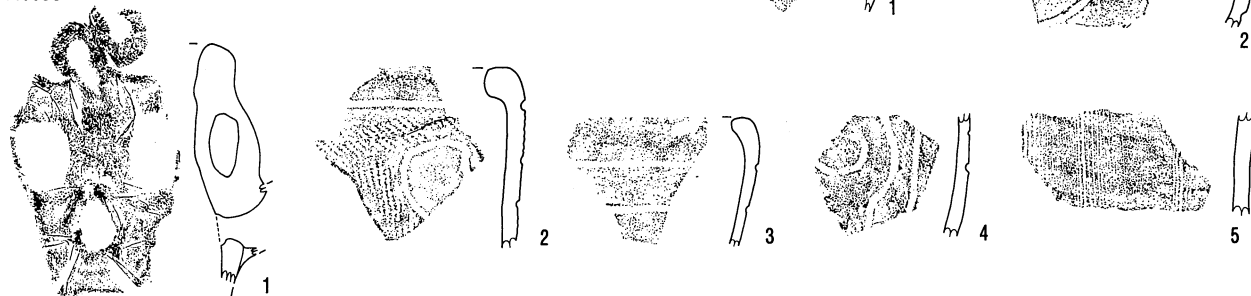

SH1195 (1-5)

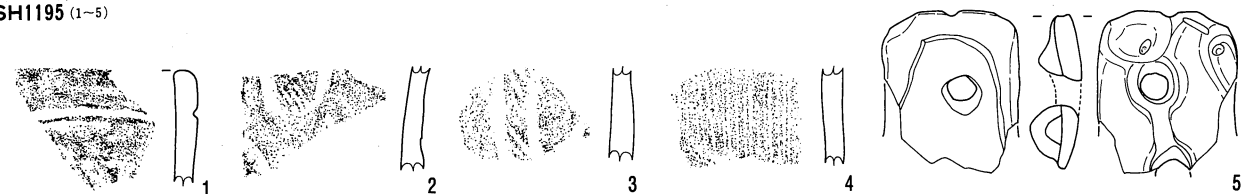

SH1200 (1-3)

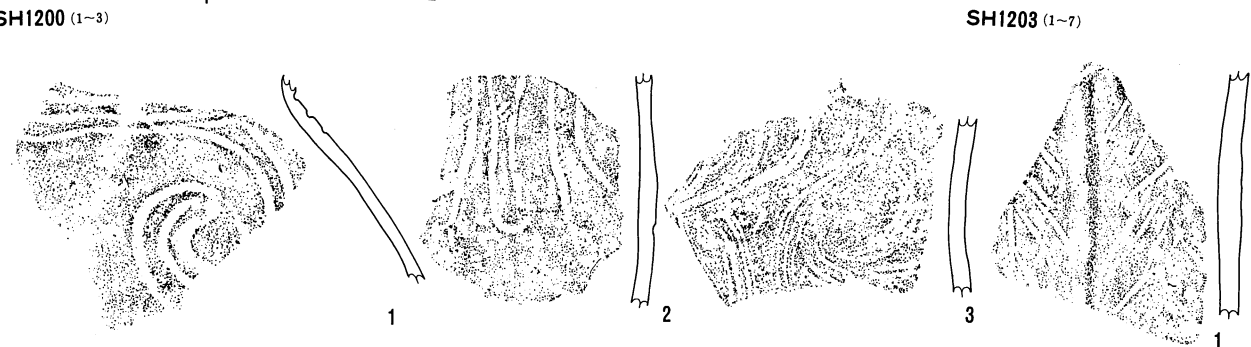

SH1203 (1-7)

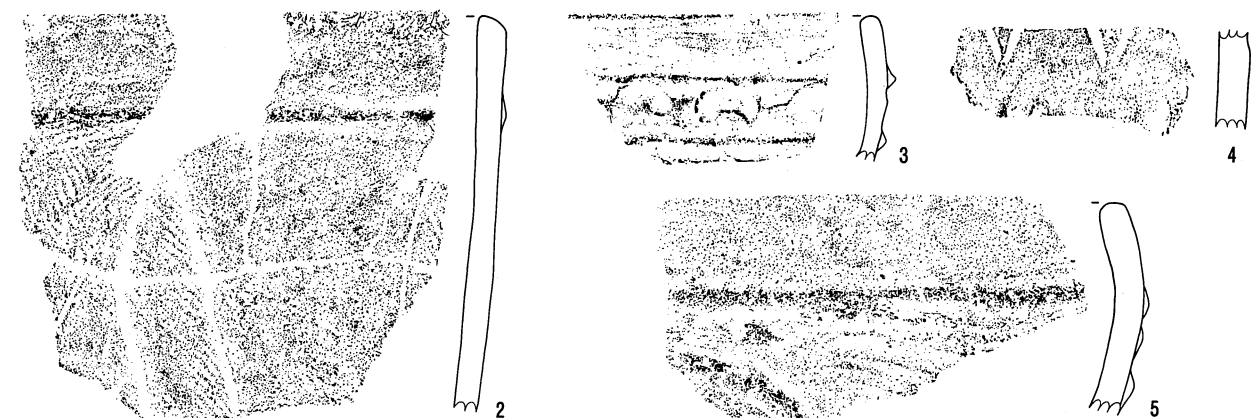
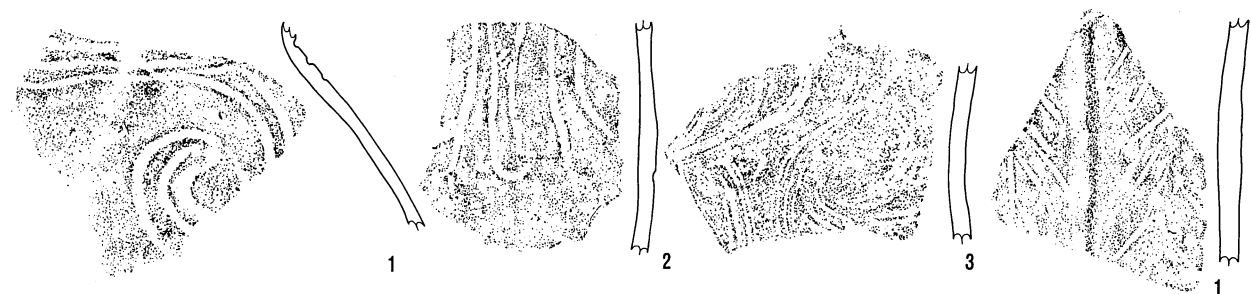

SH1205 (1-2)

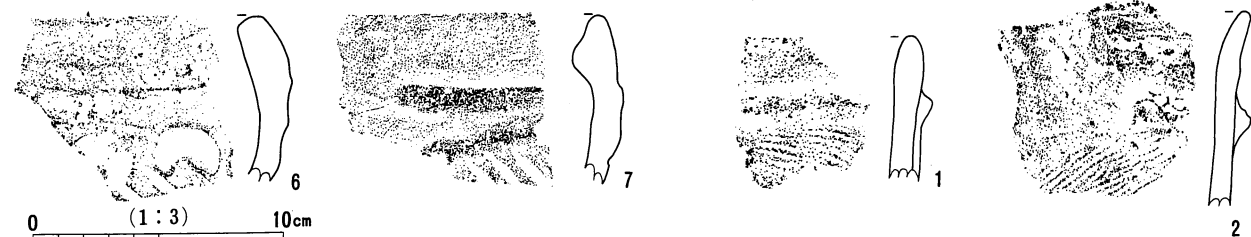

0 (1:3) 10cm

SH1206 (1-10)

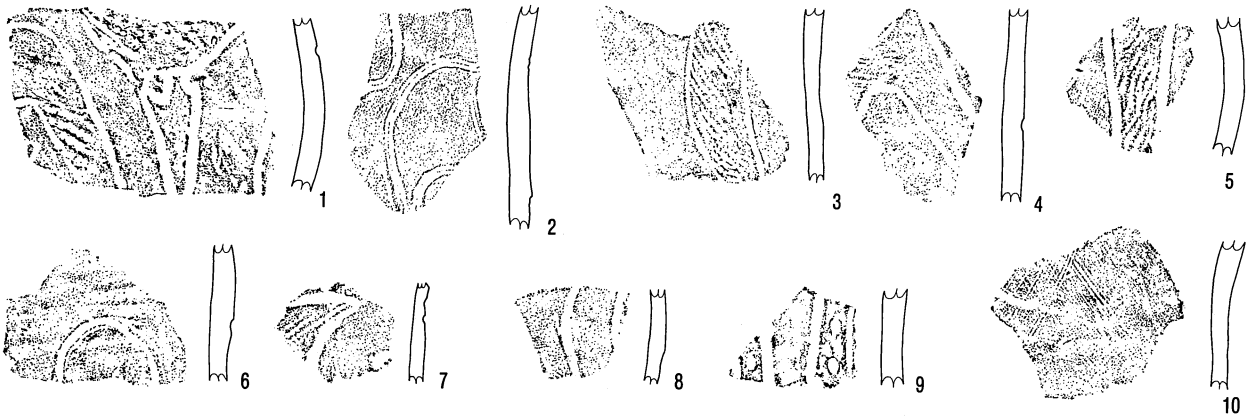

SH1208 (1-5)

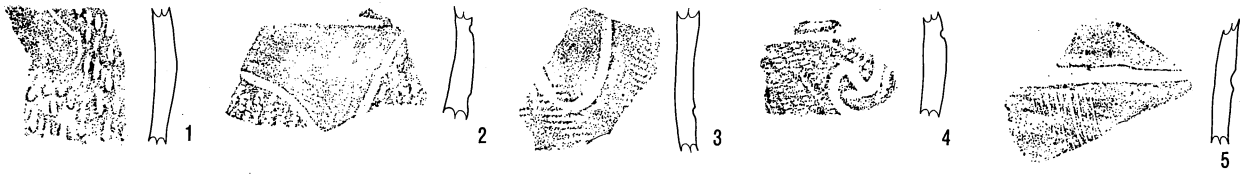

SH1213 (1)

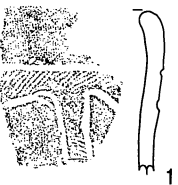

SH1212 (1-3)

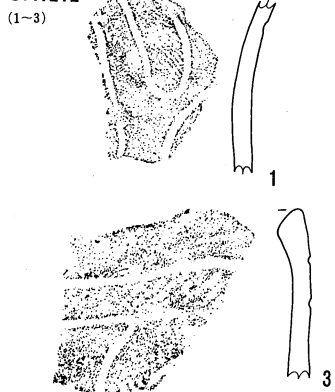

SH1214 (1-2)

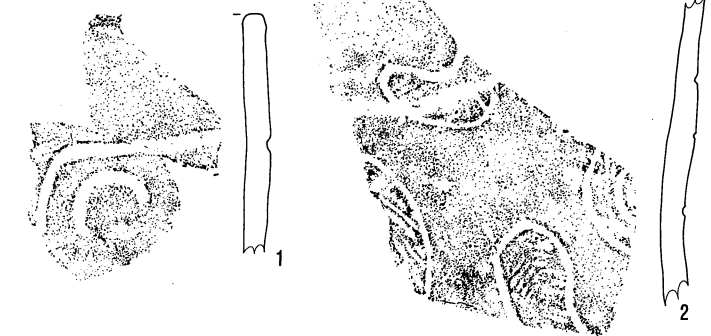

SH1217 (2-5)

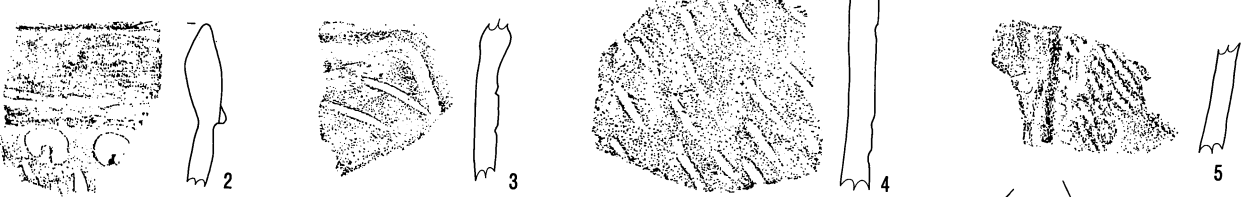

SK501 (1-6)

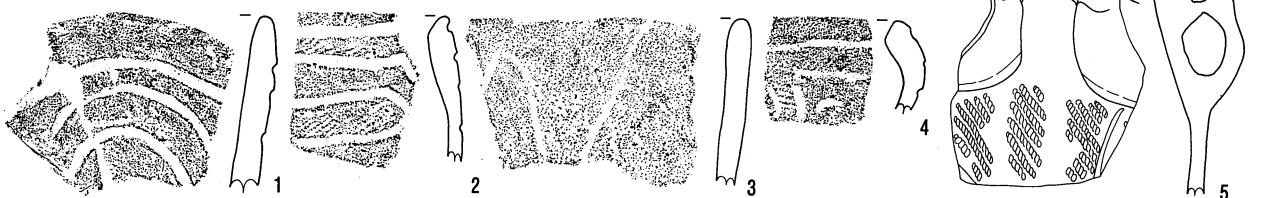

SK2196 (1-2)

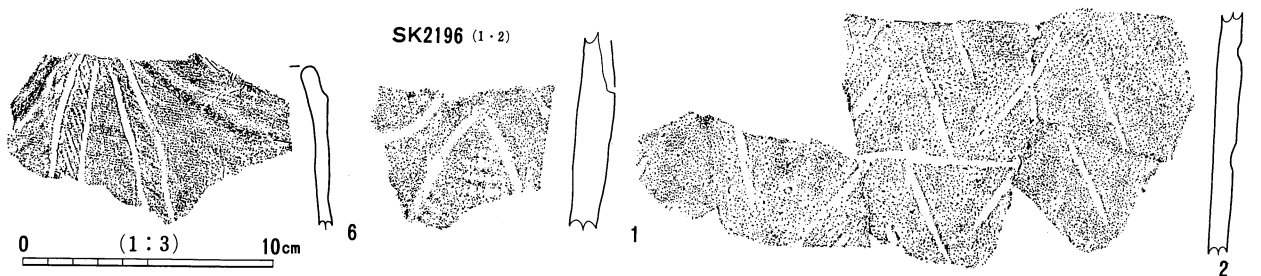

0 (1:3) 10cm

SK2696 (1-3)

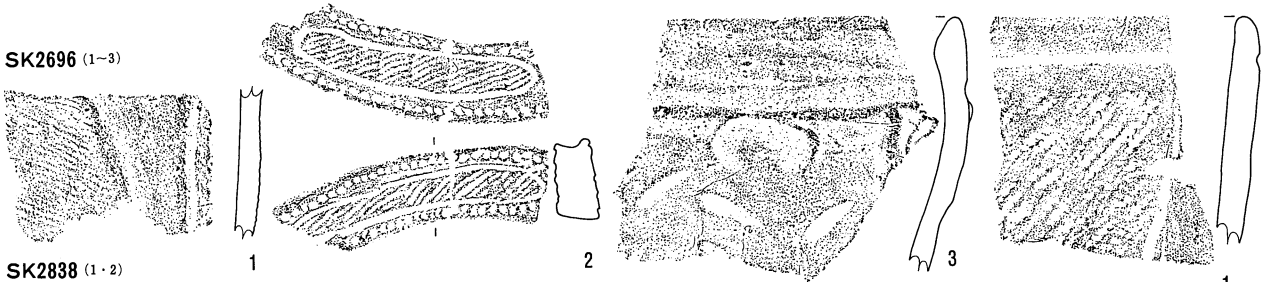

SK3050 (1-2)

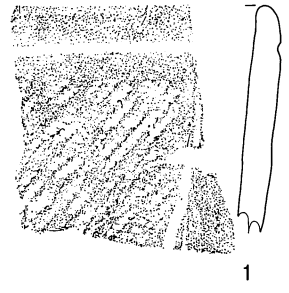

SK2838 (1-2)

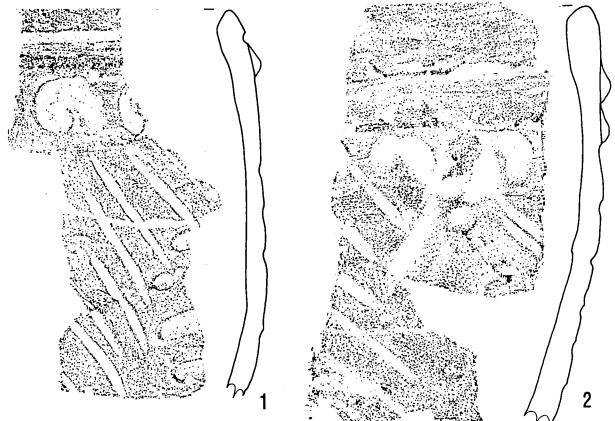

SK3126 (1)



SK3114 (1-2)

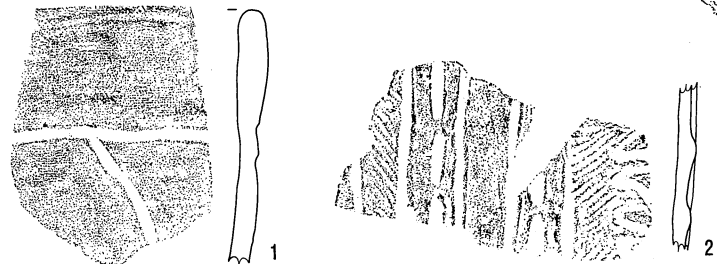

SQ5 (1-9)

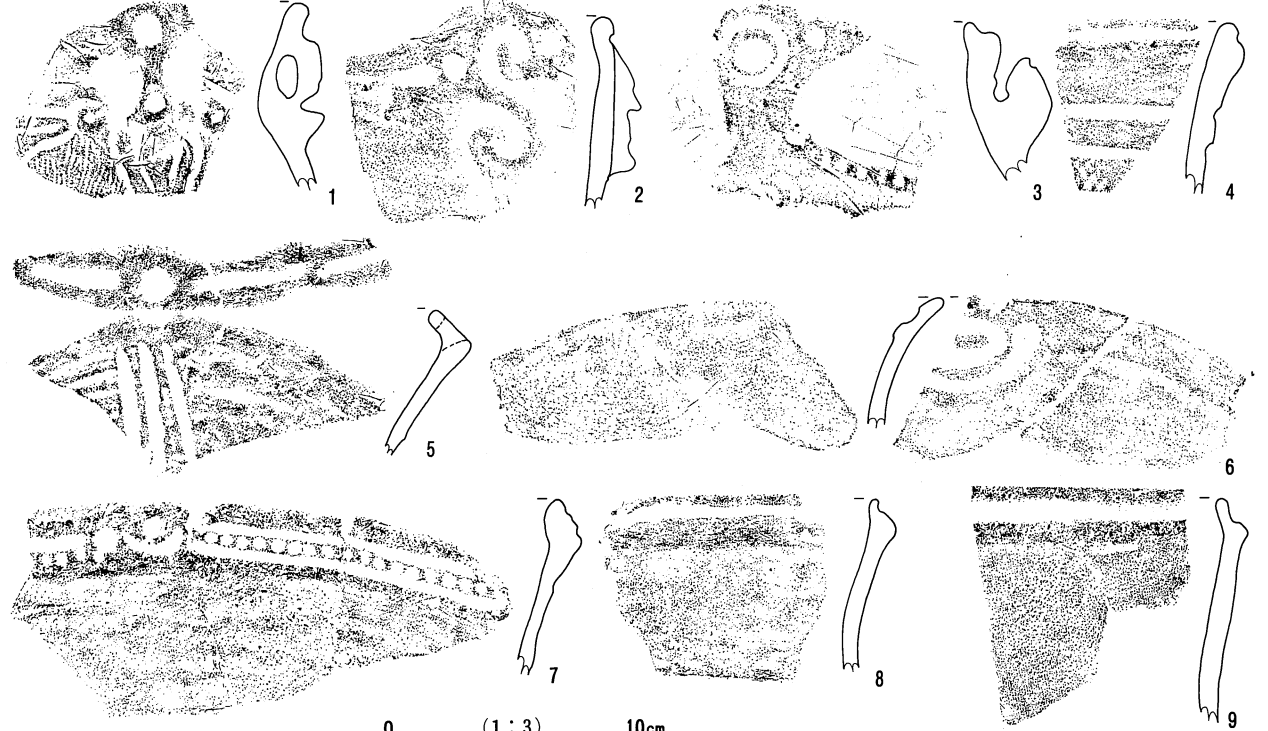

0 (1:3) 10cm

SQ5 (10-34)

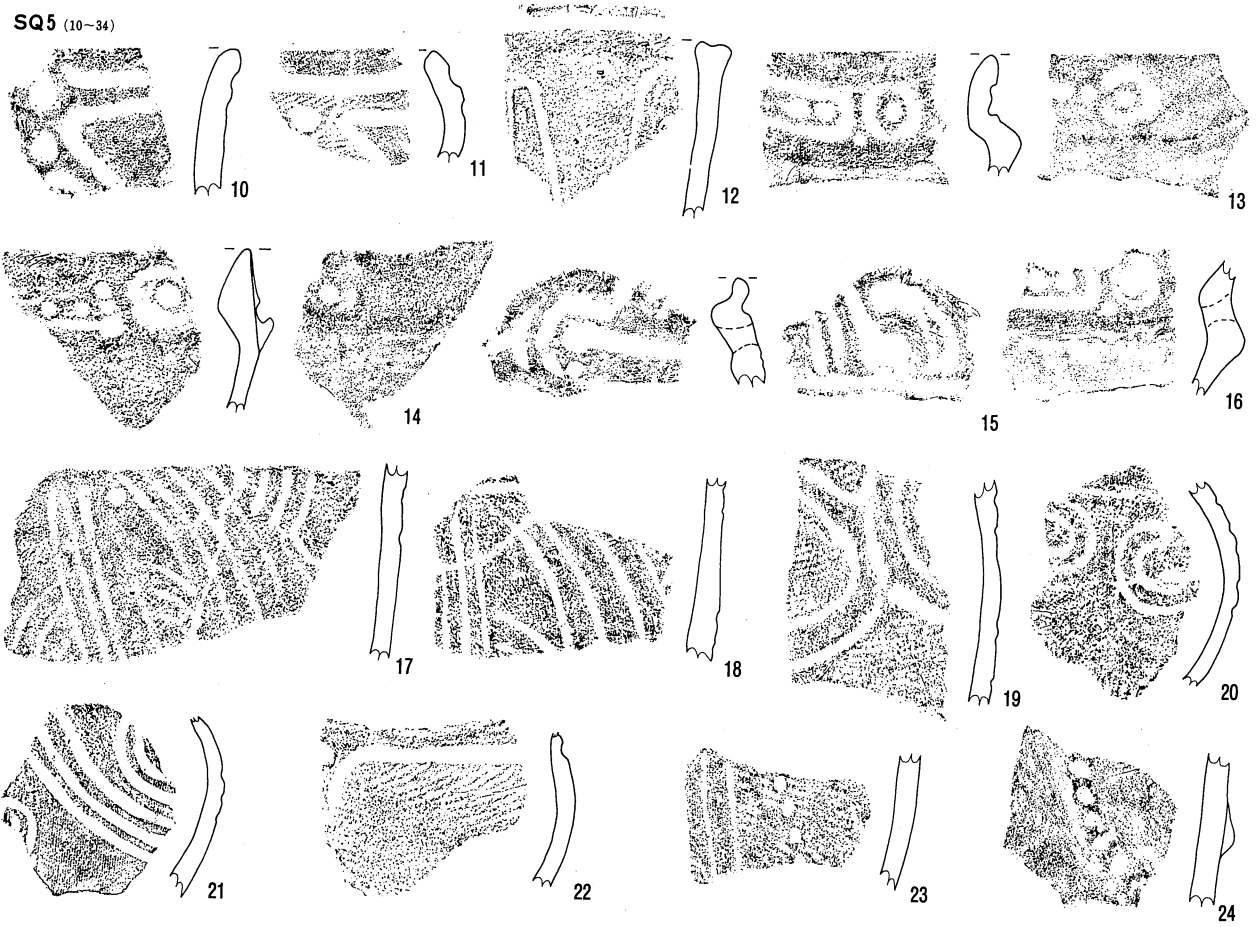

SQ503 (2-10)

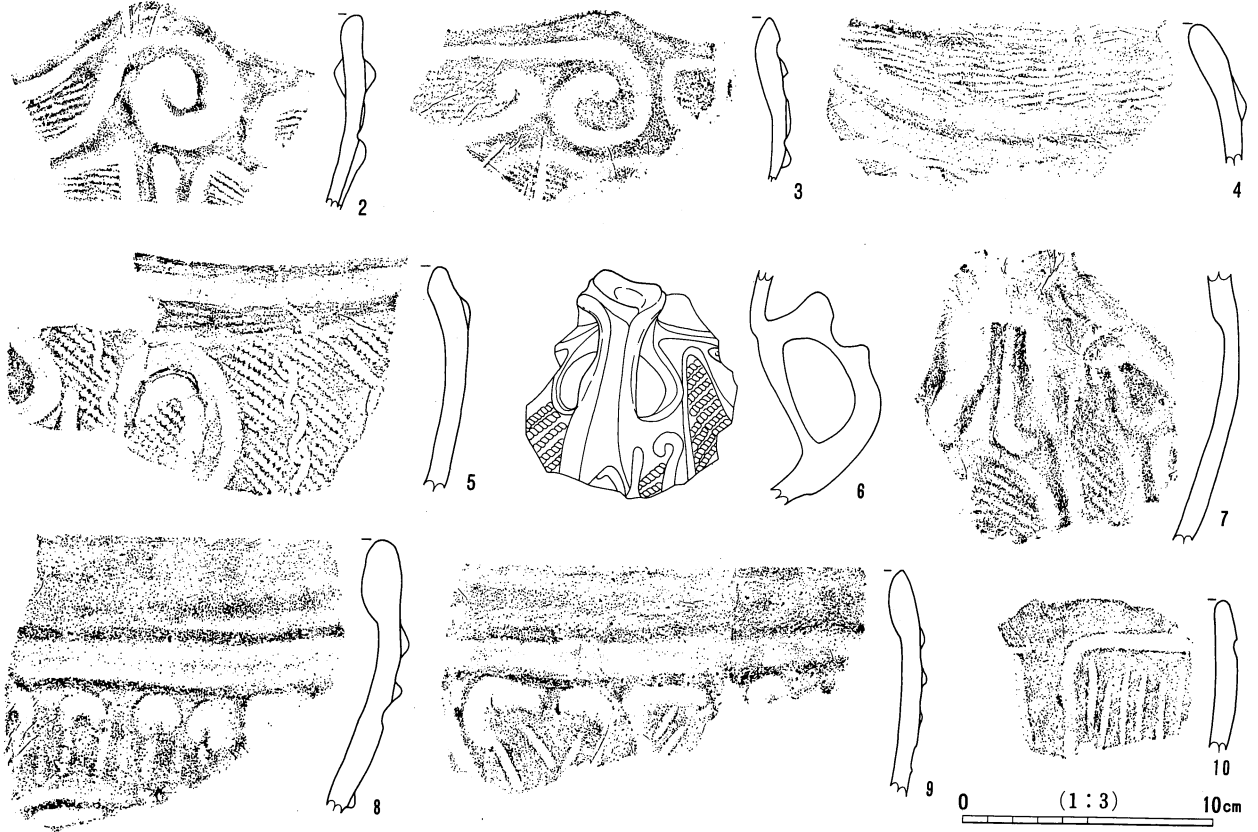

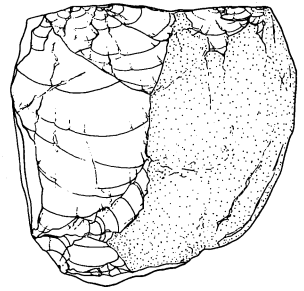
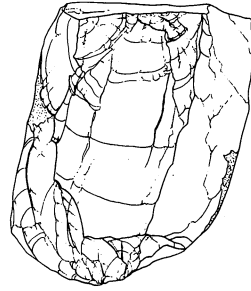
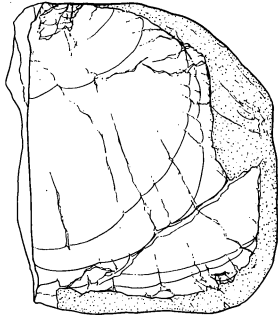
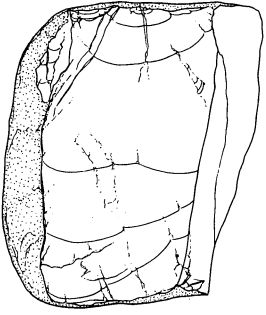
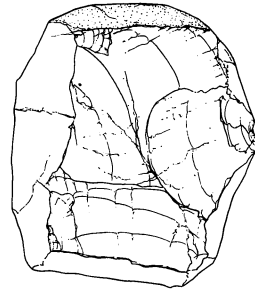
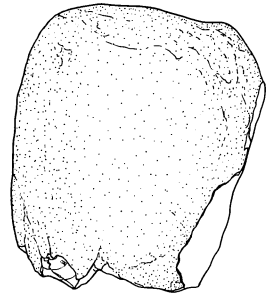

1 (SB577)

2 (SB570)

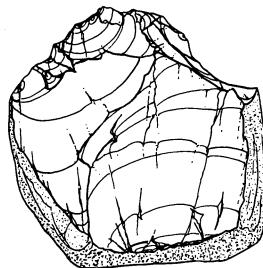
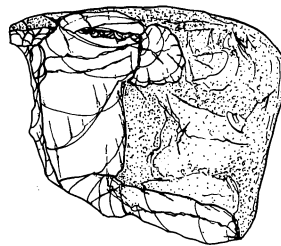
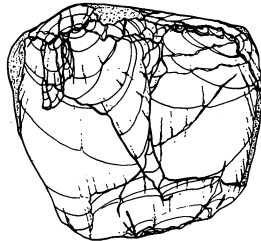
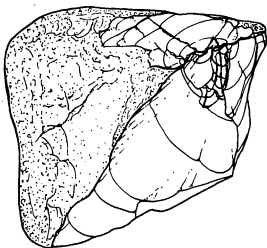
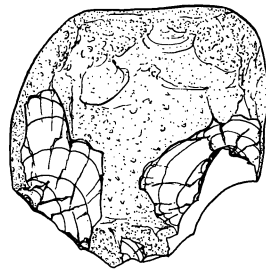

3 (SB590)

0 (1:2) 5 cm

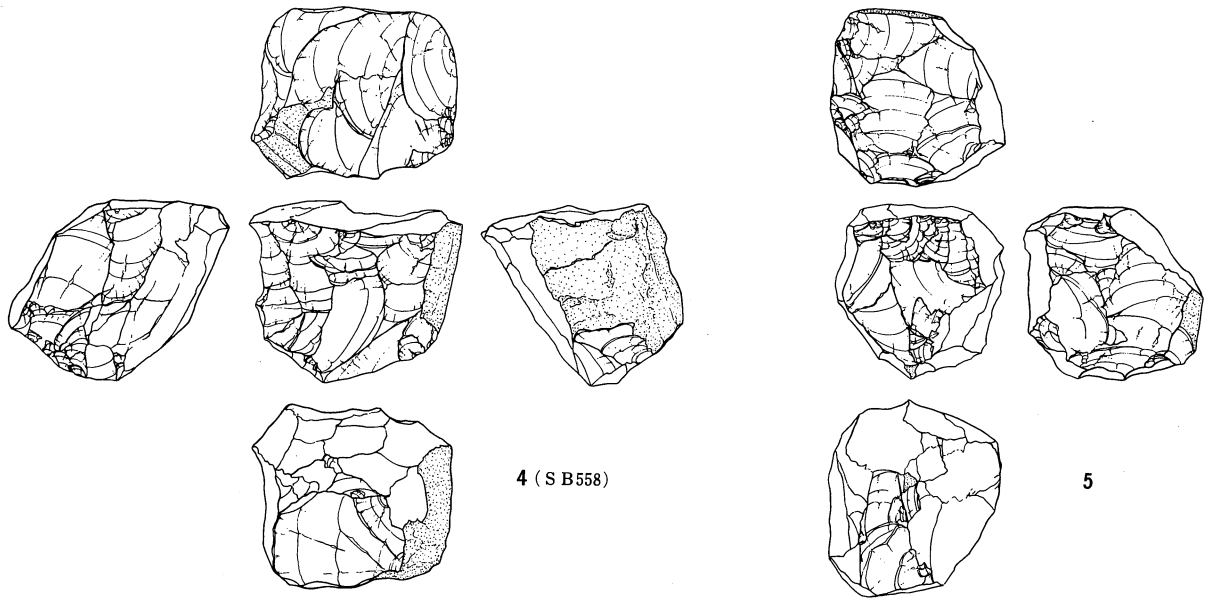

4 (S B558)

5

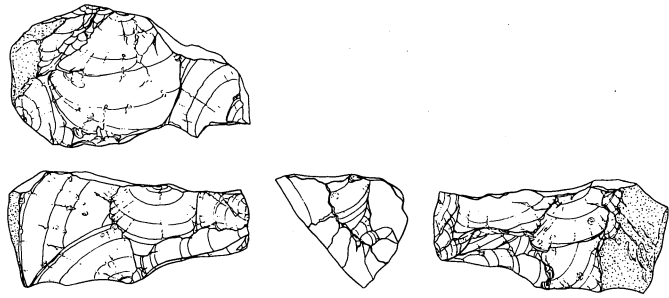

6 (S H581)

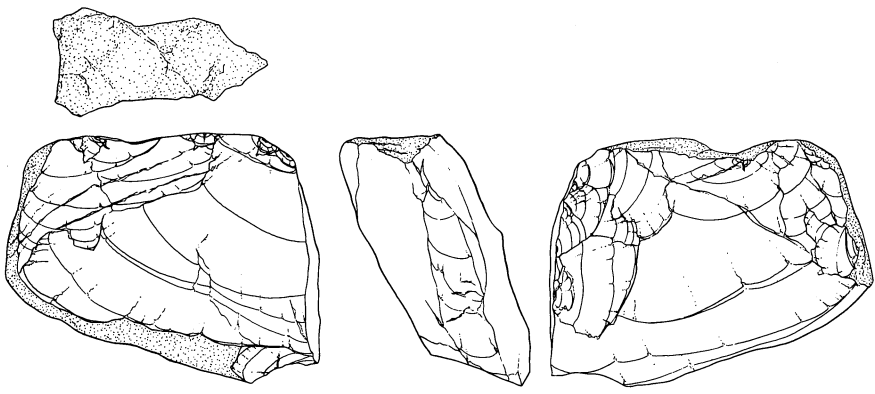

7 (S B566)

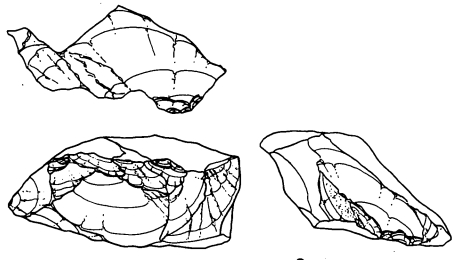

8

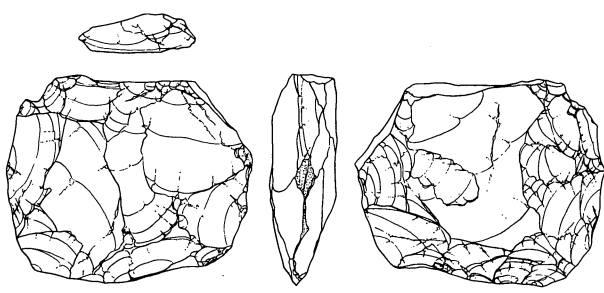

9 (S K2321)

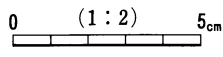

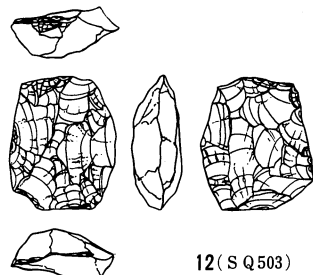
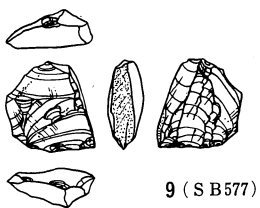
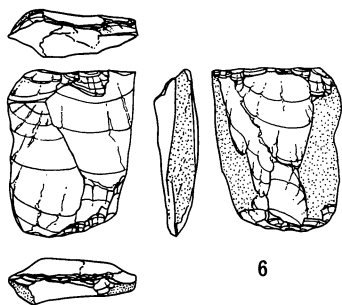
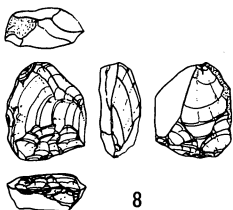
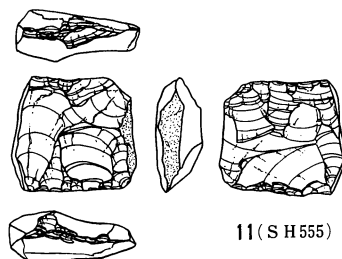
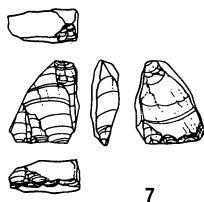
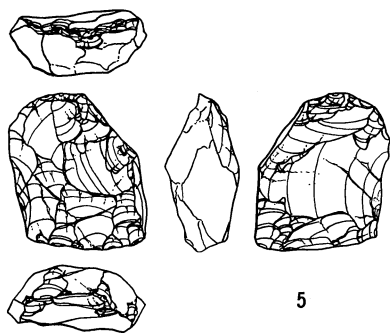
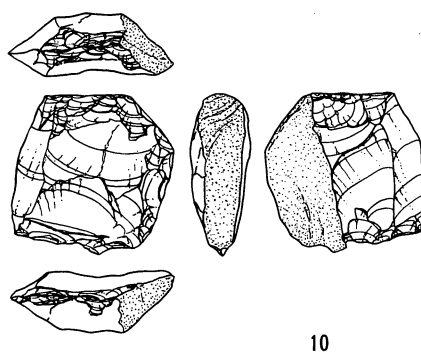
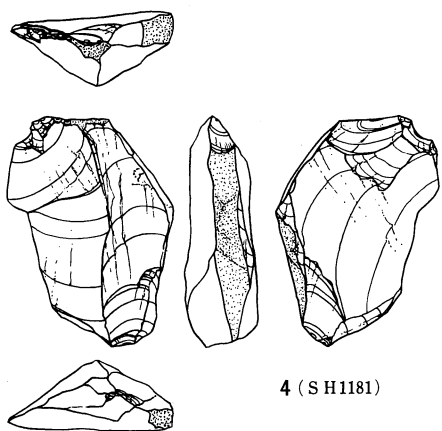
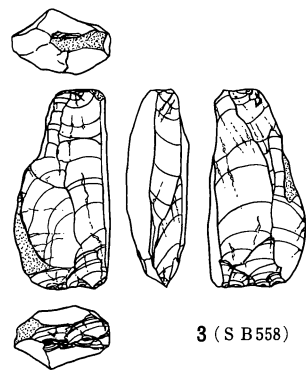
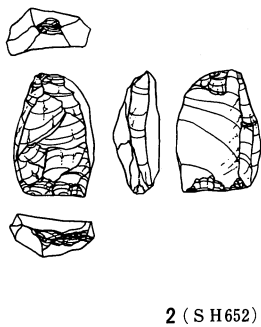
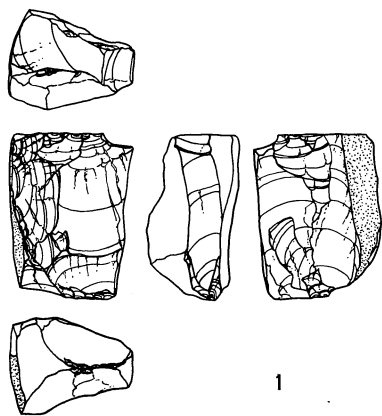

0 (2:3) 5cm

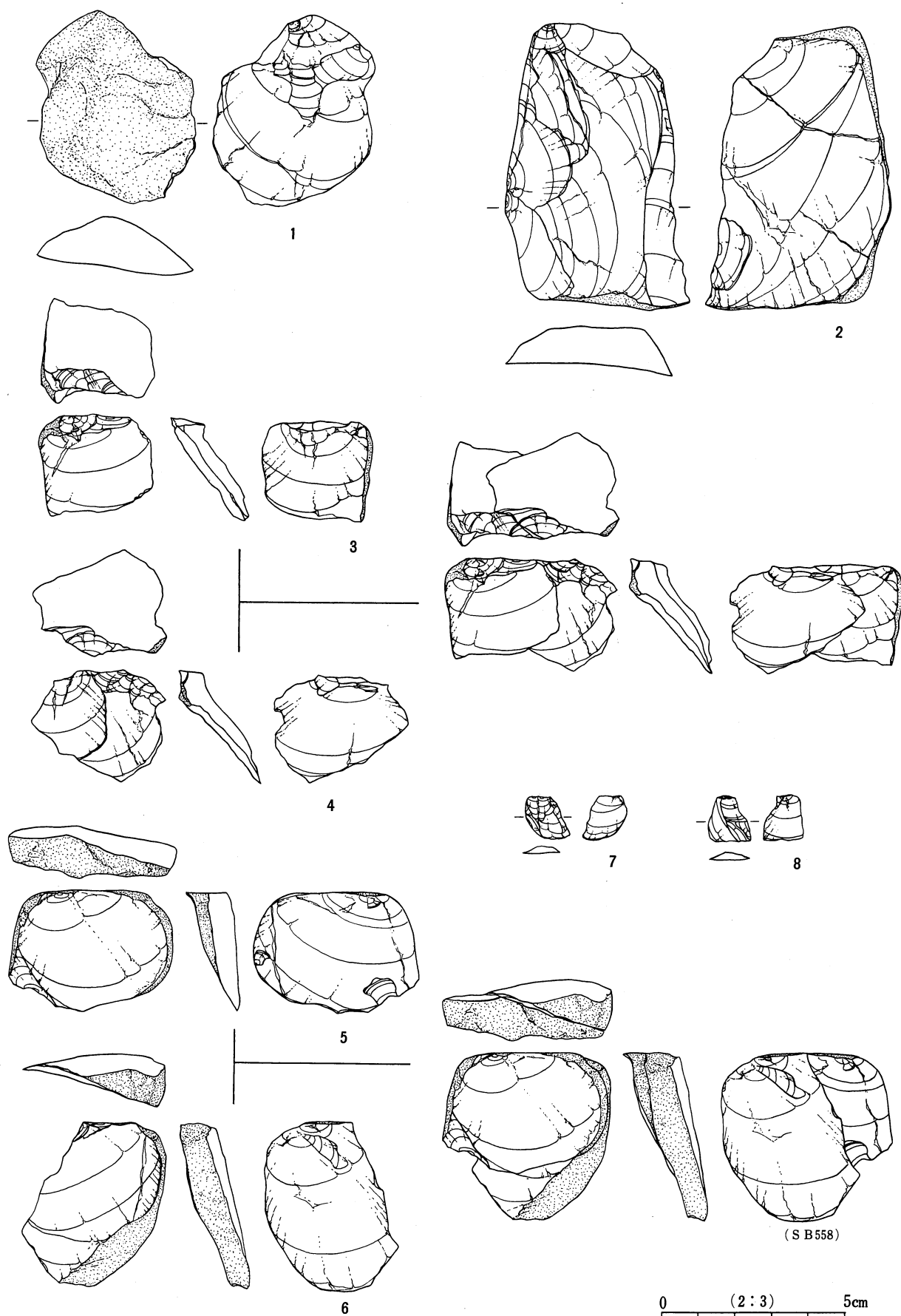

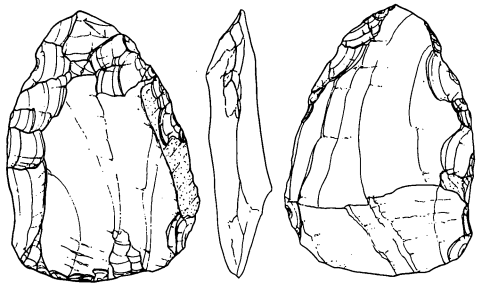

1

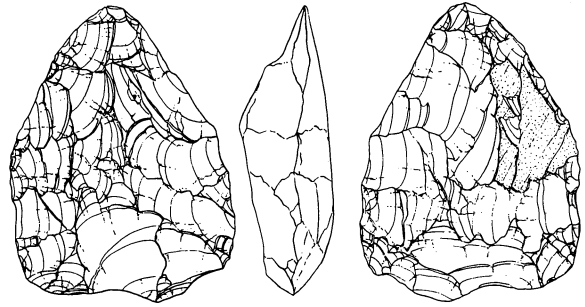

2 (S B553)

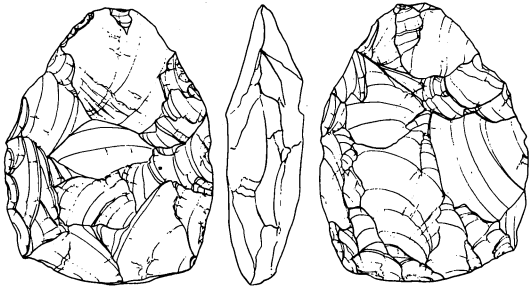

3

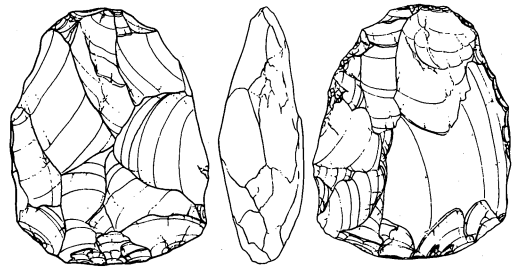

4 (S B110)

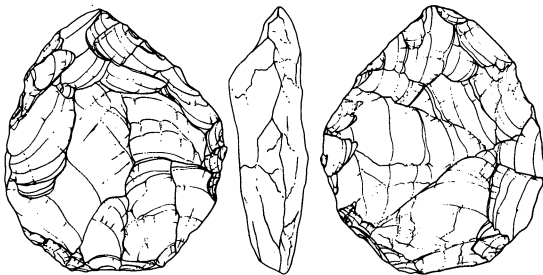

5 (S H826)

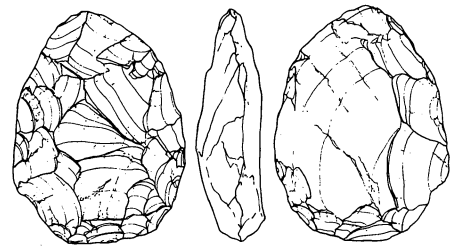

6 (S H550)

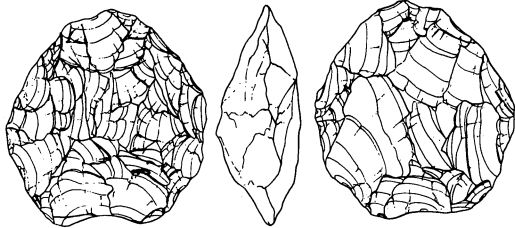

7 (S H540)

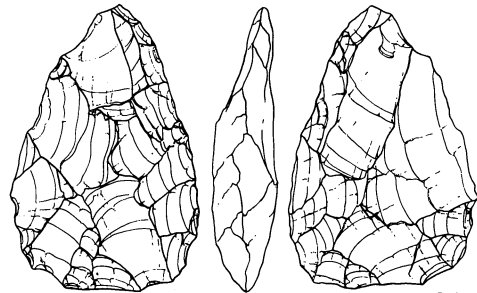

8 (S H527)

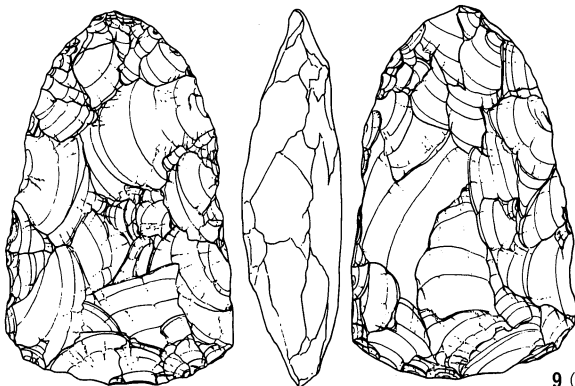

9 (S Q501)

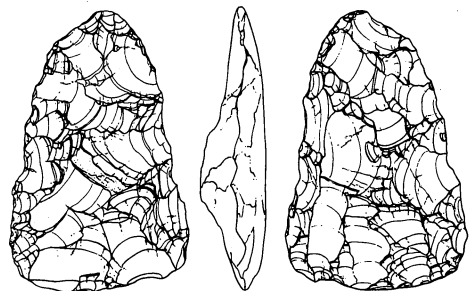

10

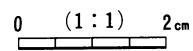

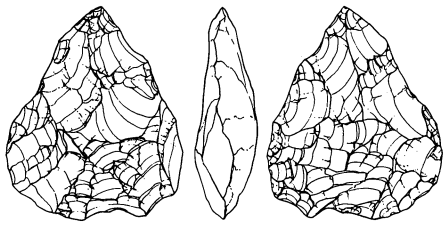

11

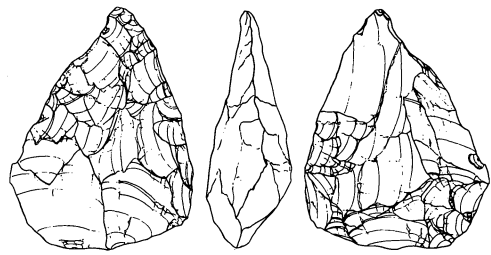

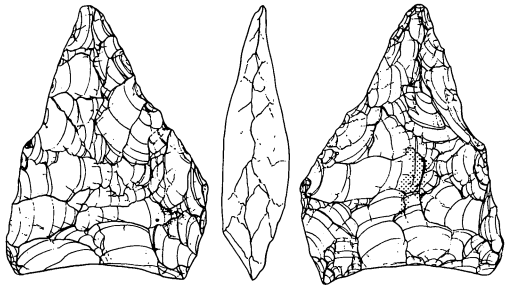

12

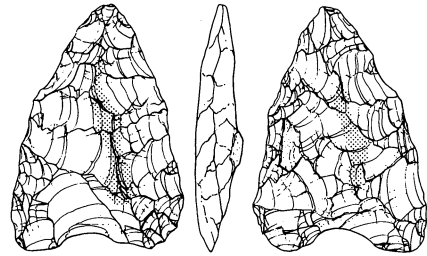

13



14

 付着物
  装着痕
  衝撃痕

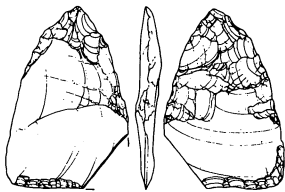

15 (S B557)

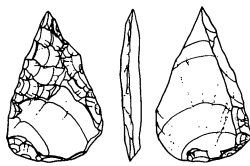

16

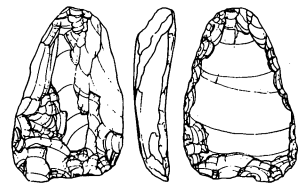

17

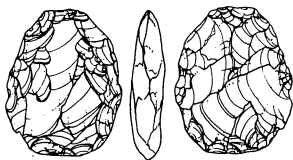

18 (S H549)

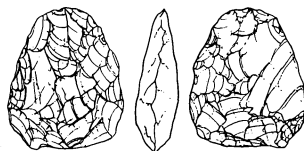

19 (S H1217)

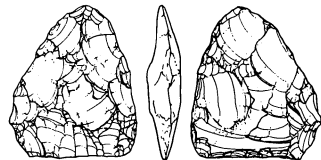

20 (S H1111)

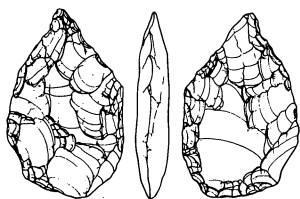

21 (S Q501)

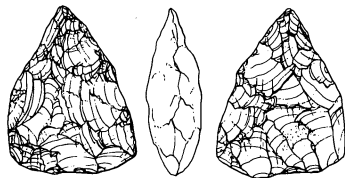

22 (S B566)

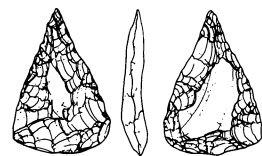

23 (S B566)

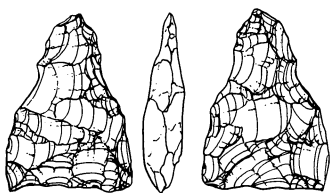

24 (S B571)

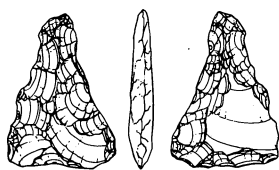

25 (S B566)

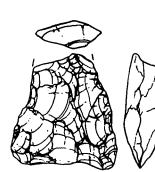

26 (S B555)

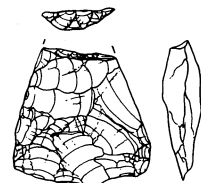

27 (S H506)

0 (1:1) 2 cm

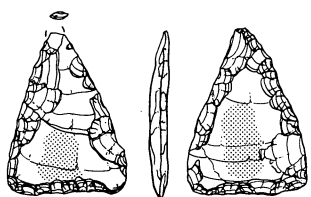

28 (S H742)

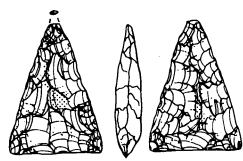

29 (S B563)

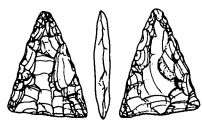

30 (S H555)

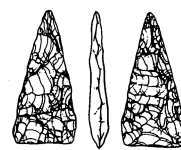

31 (S B555)

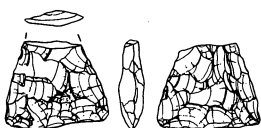

32 (S B566)

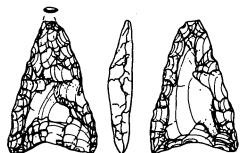

33 (S B555)



34



35 (S H555)

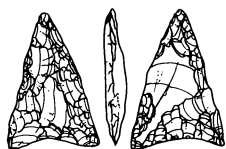

36 (S H560)

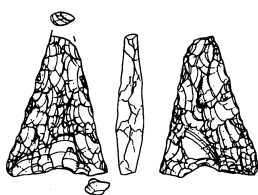

37 (S B102)

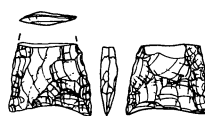

38 (S B562)

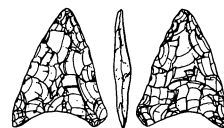

39 (S H506)

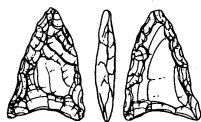

40 (S K1316)

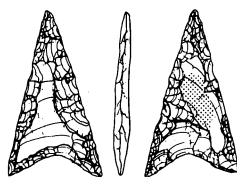

41



42 (S H1129)



43 (S B562)

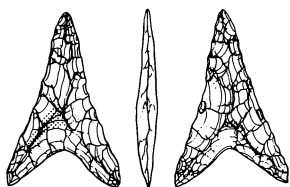

44 (S H1111)

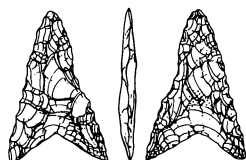

45 (S B566)

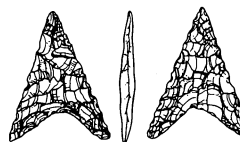

46 (S B566)



47 (S H1091)



48 (S H824)

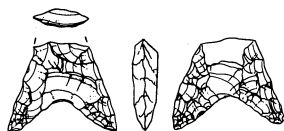

49

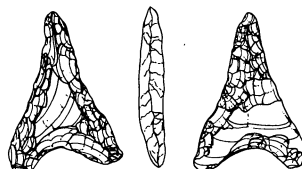

50 (S B553)

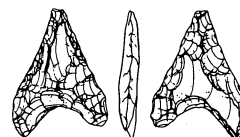

51

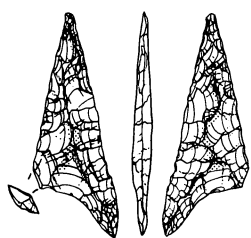

52 (S B580)

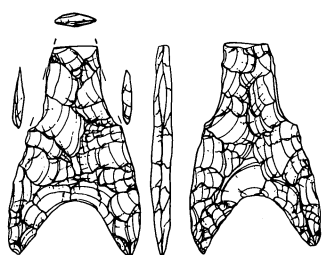

53 (S B102)

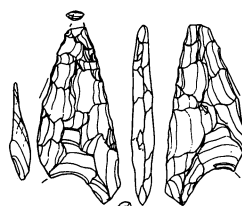

54 (S B562)

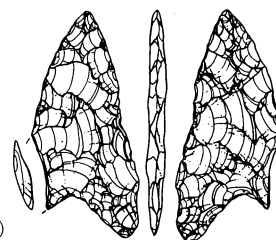

55 (S B566)

0 (1:1) 2cm

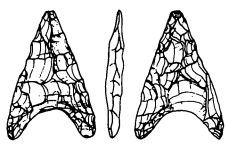

56



57

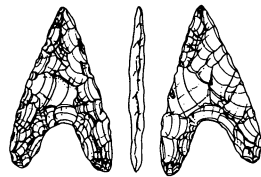

58 (S B 562)

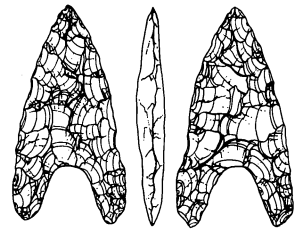

59 (S B 572)

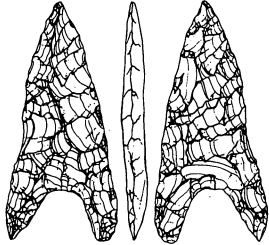

60 (S Q 501)

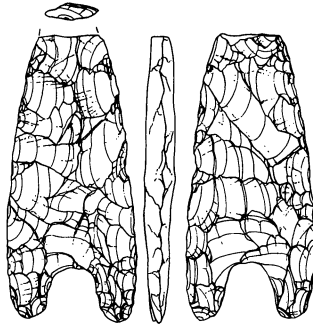

61 (S B 570)

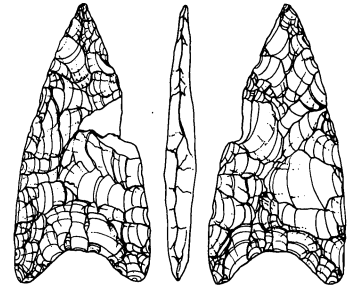

62 (S B 563)

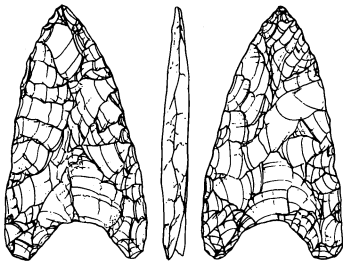

63

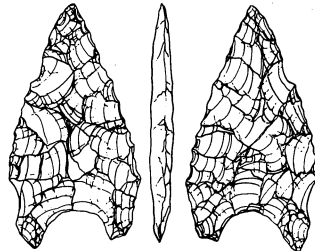

64 (S B 561)

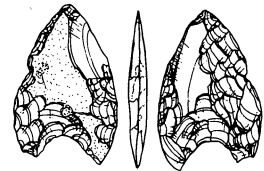

65

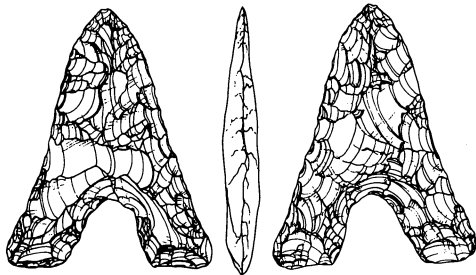

66

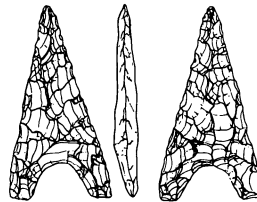

67 (S H 751)



68 (S B 566)



69 (S H 818)

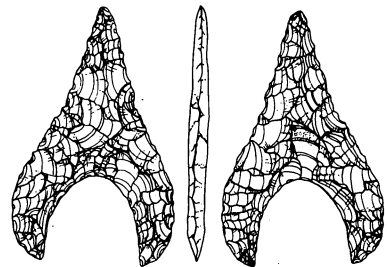

70 (S H 817)

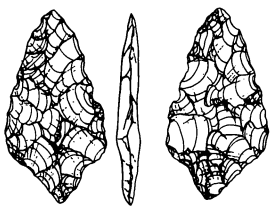

71 (S B 555)

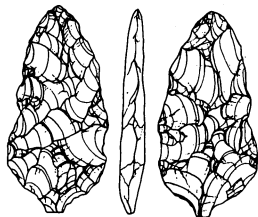

72 (S B 555)

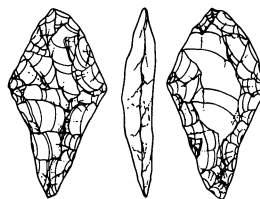

73

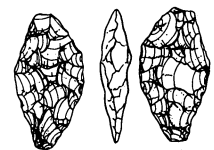

74 (S B 562)

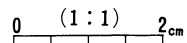

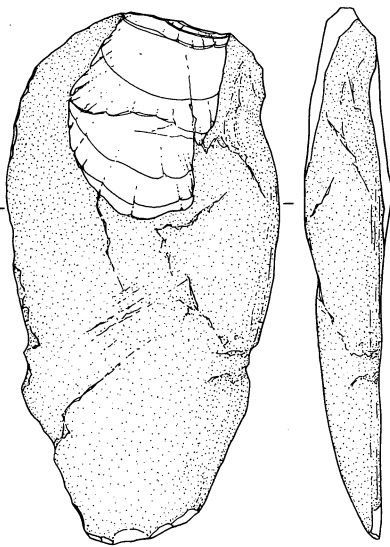

1 (SB562)

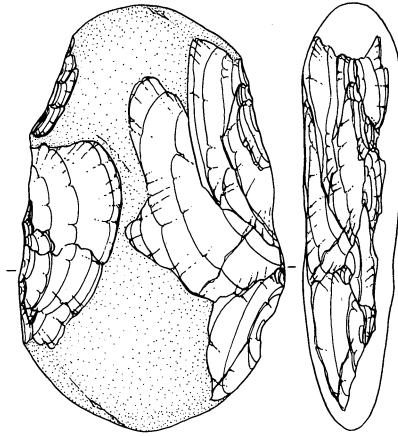

2 (SB594)

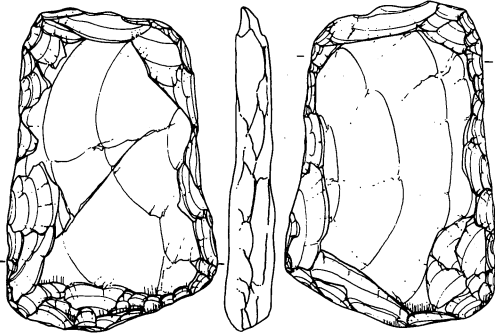
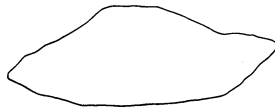

3 (SB581)

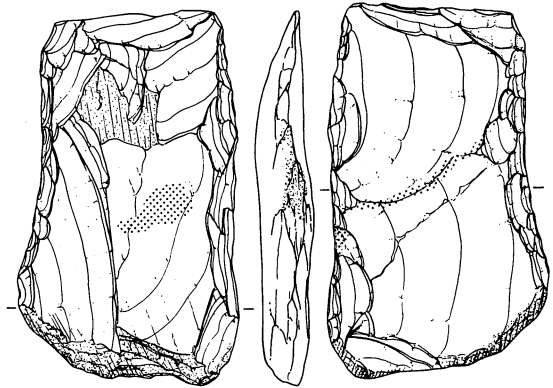
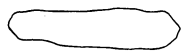

4 (SH552)

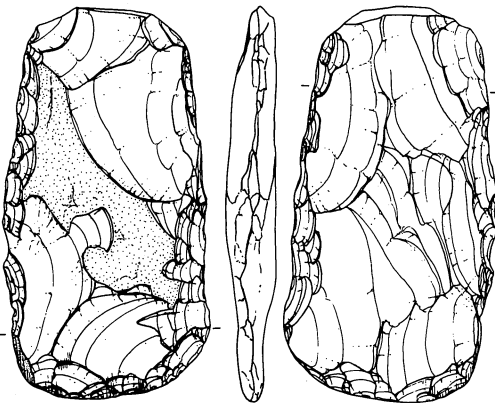

5 (SH506)

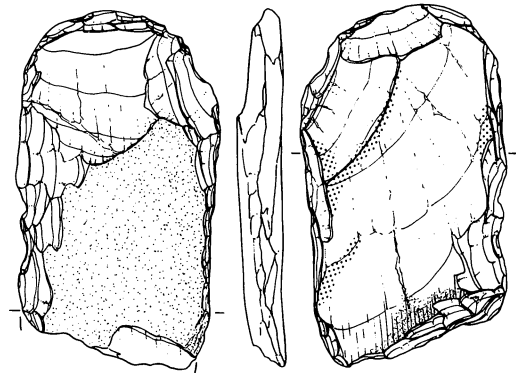
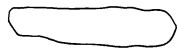
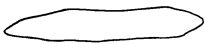

6 (SB580)

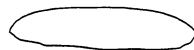

● 摩耗痕
 ■ 装着痕

0 (1:2) 5cm

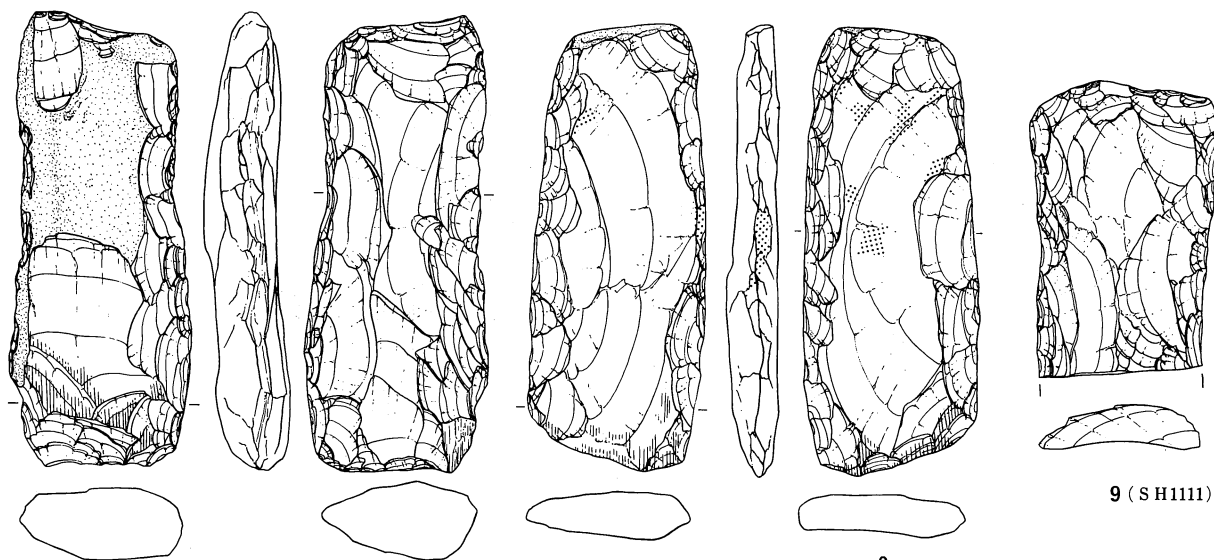

7 (SH698)

8

9 (SH1111)

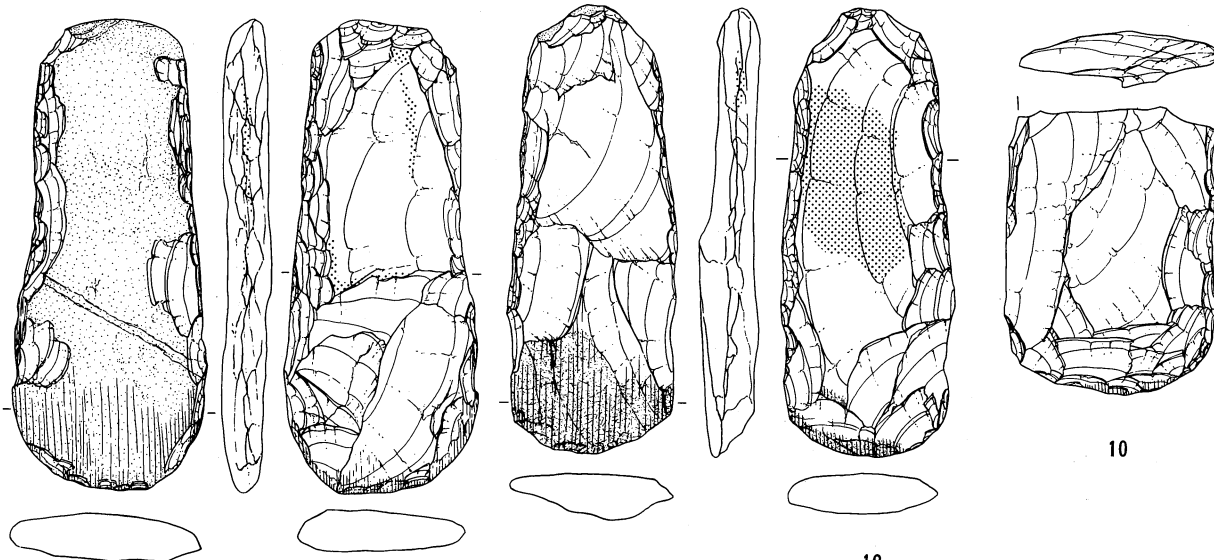

11 (SB560)

12

10

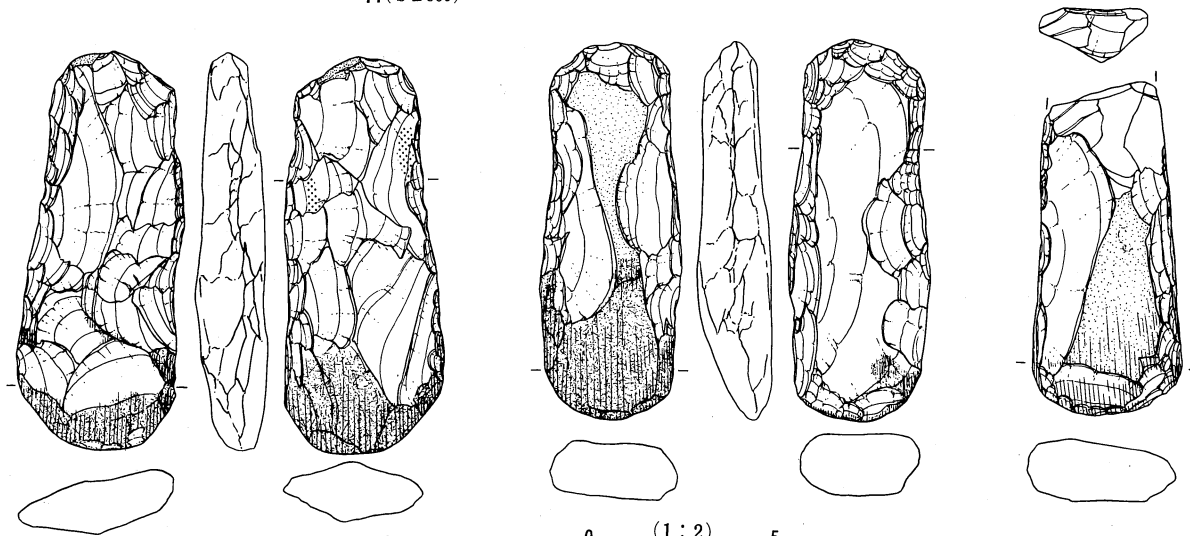

13 (SB599)

14

15

0 (1:2) 5cm

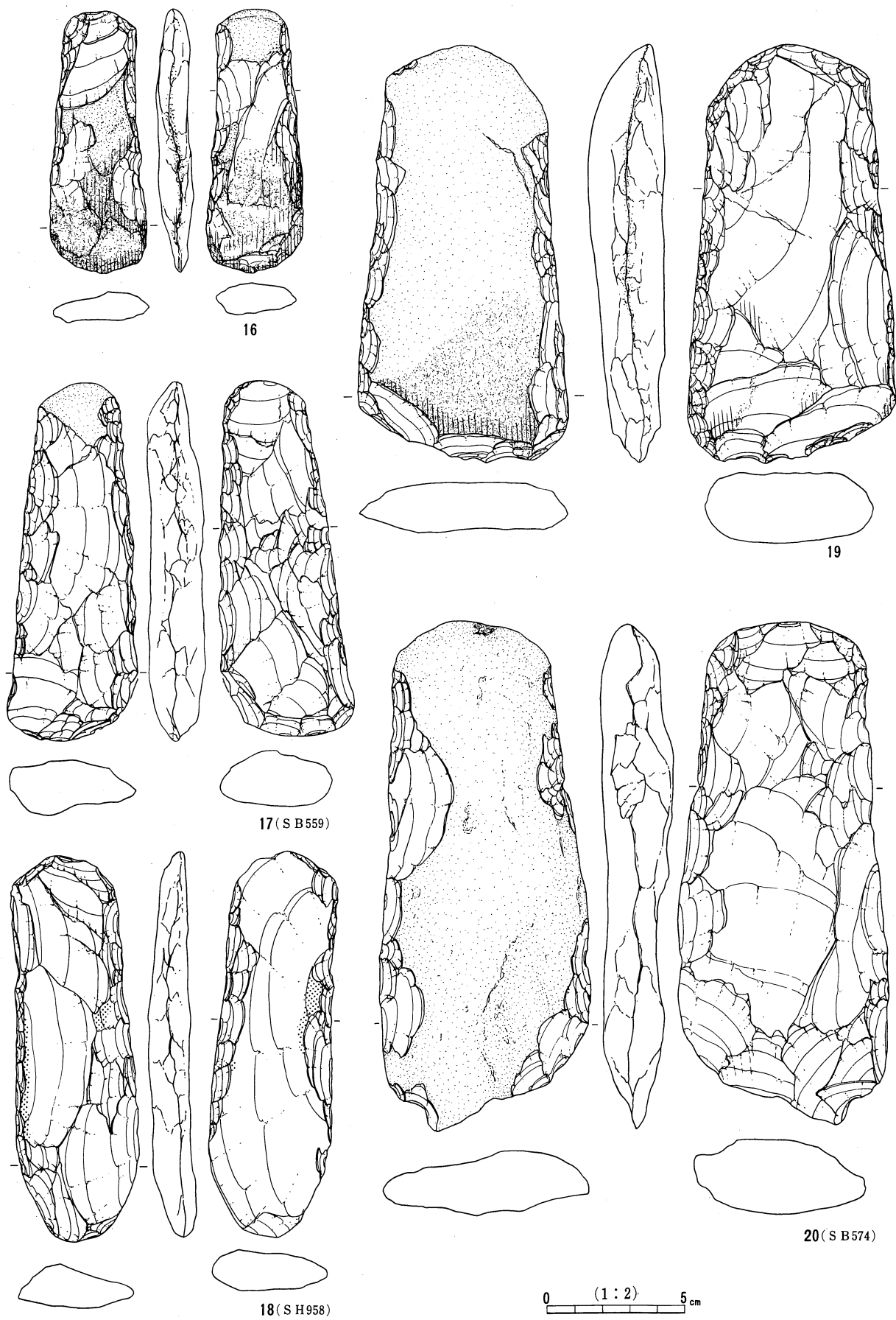

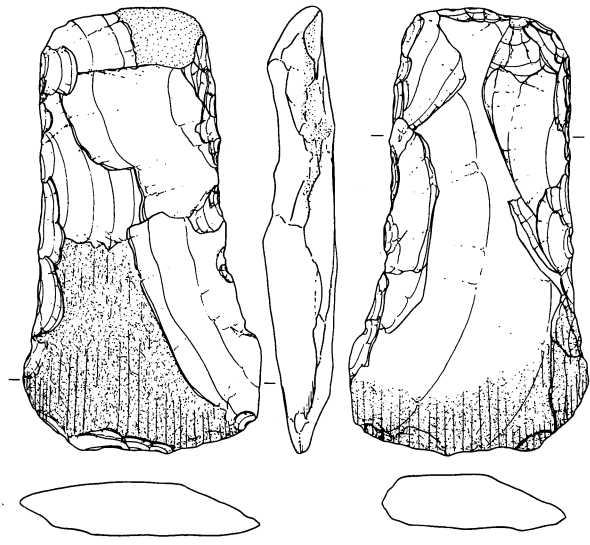

21

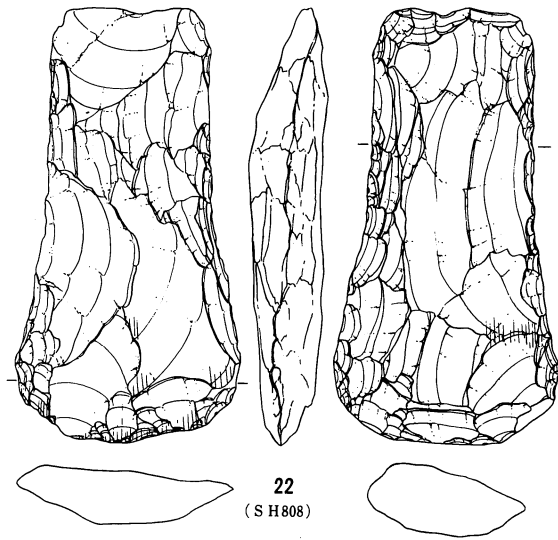

22
(S H808)

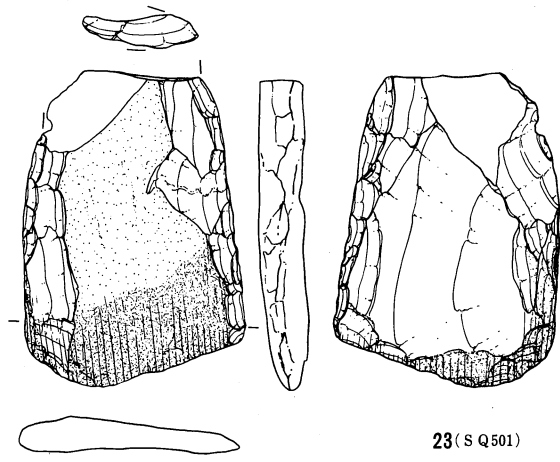

23(S Q501)

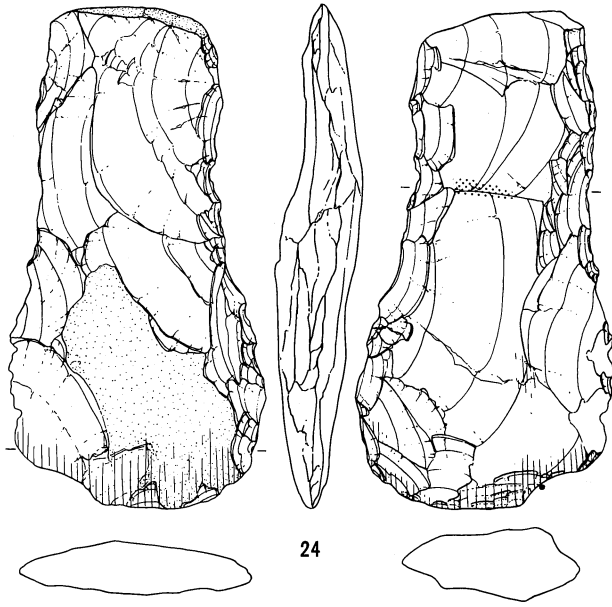

24

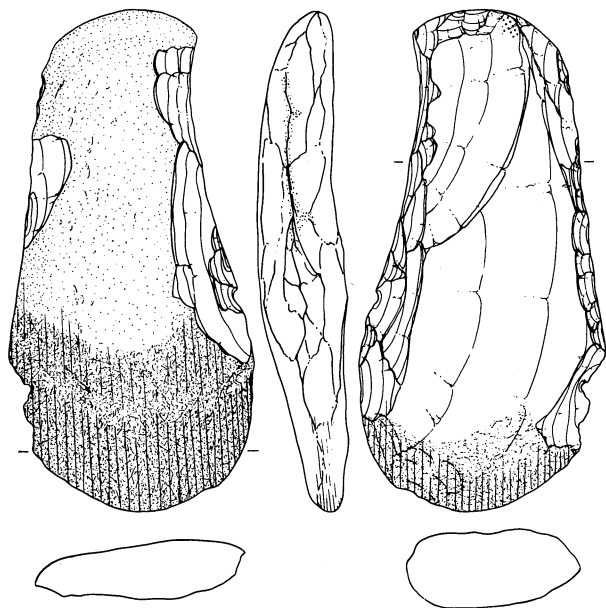

25

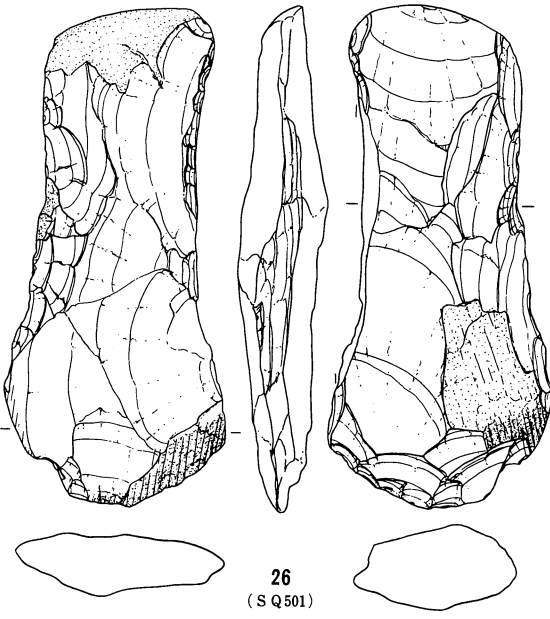

26
(S Q501)

0 (1:2) 5 cm

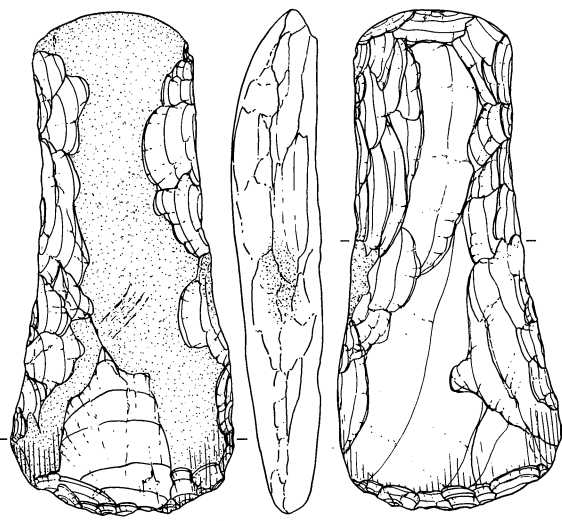

27 (S H738)

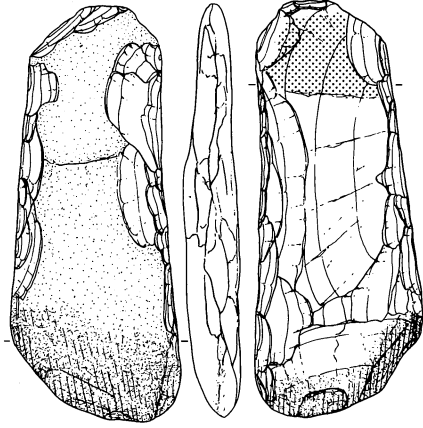

29

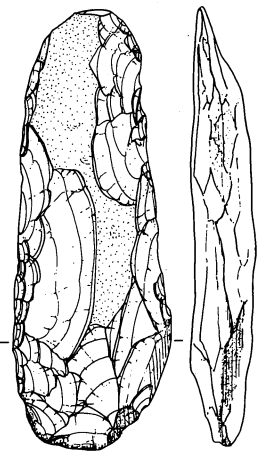

28 (S Q 503)

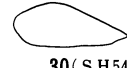
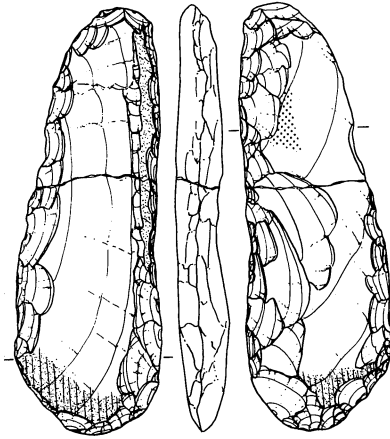

30 (S H549)

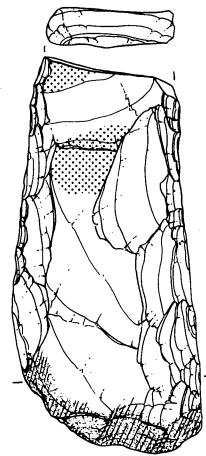

31 (S Q 501)

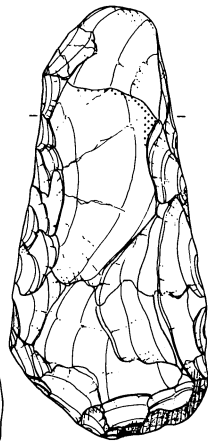
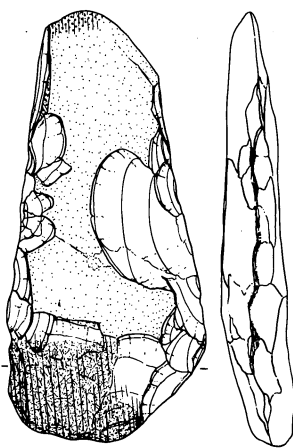

32

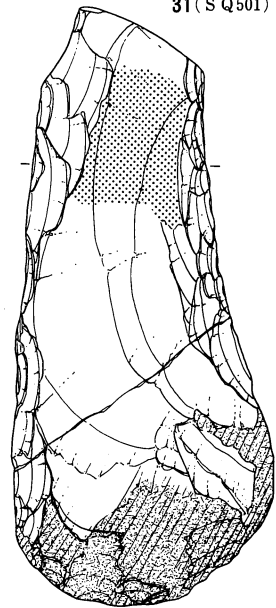
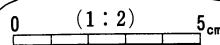
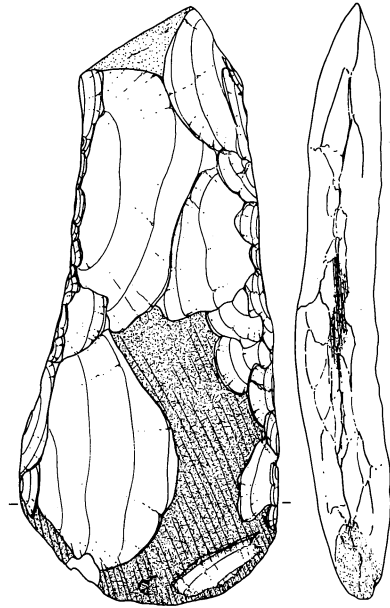

33 (S H813)

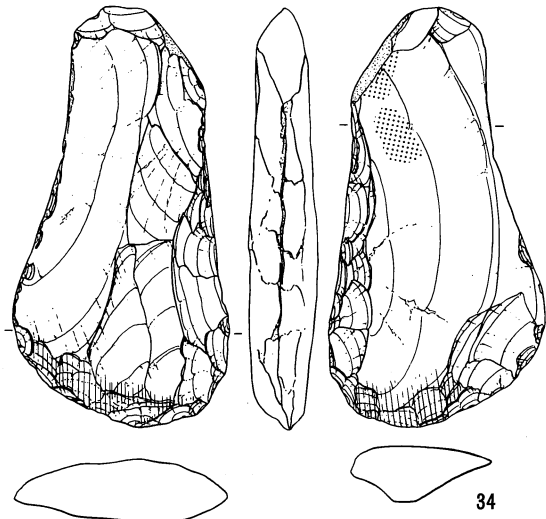

34

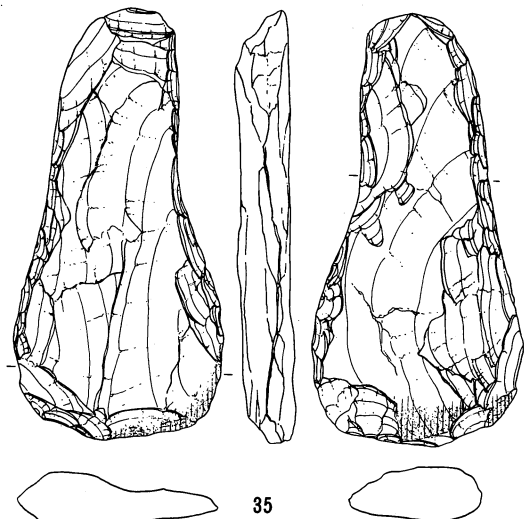

35

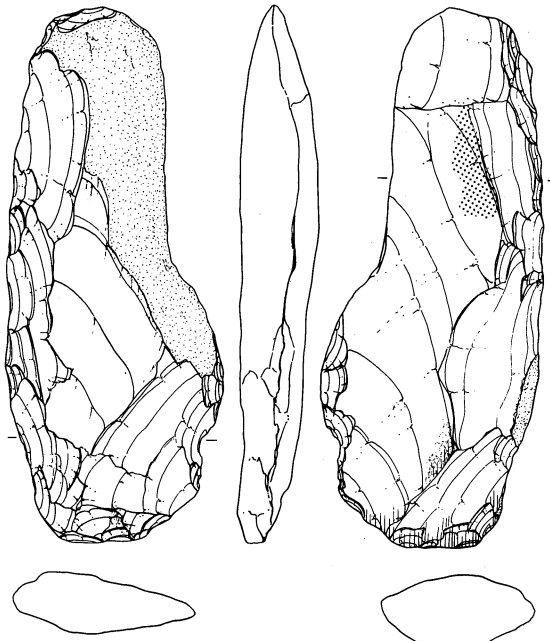

36 (S B 580)

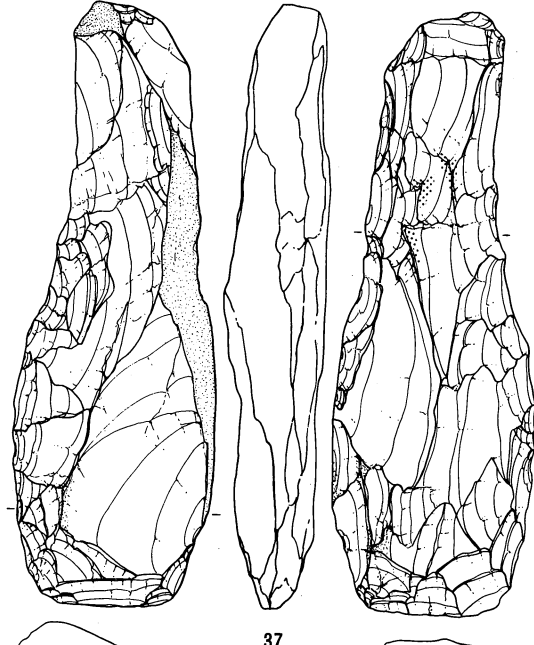

37

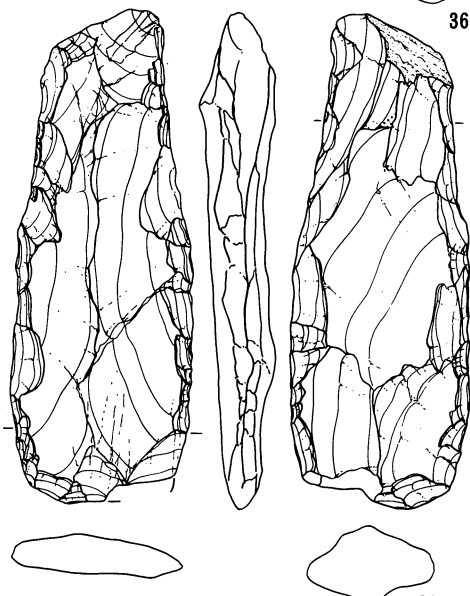

38 (S B 584)

0 (1:2) 3 cm

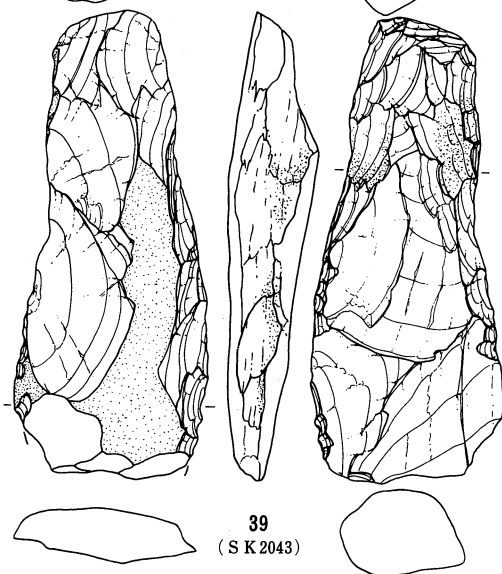

39 (S K 2043)

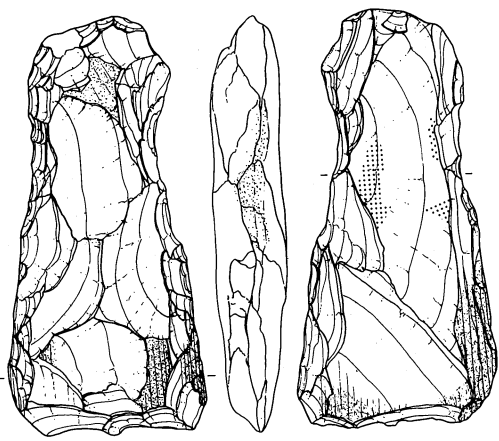

40 (S H824)

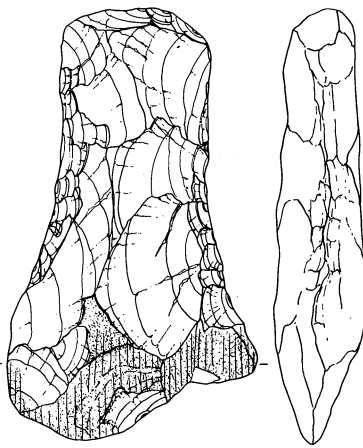

41

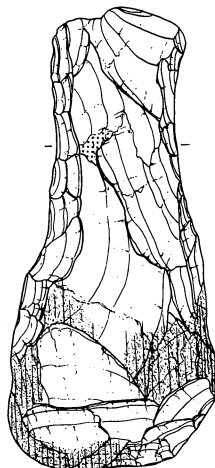
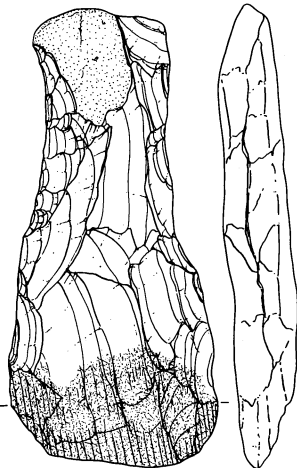
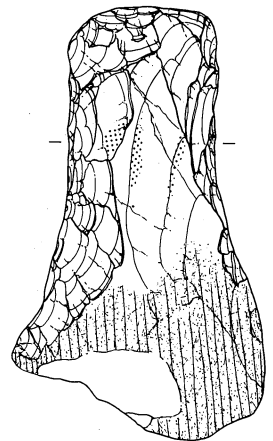

42 (S H590)

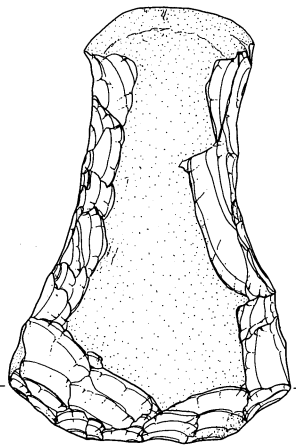

43

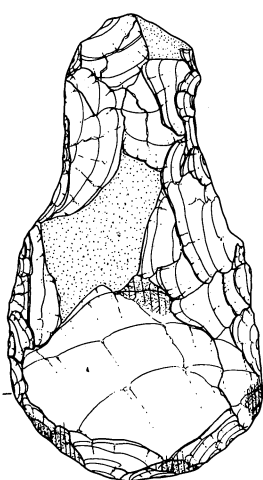
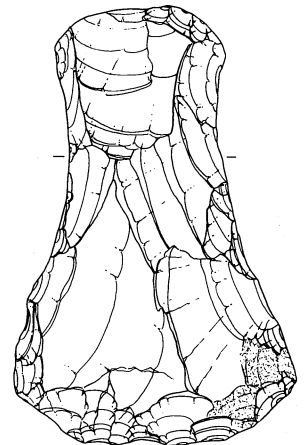

44
(S B580)



45 (S Q503)

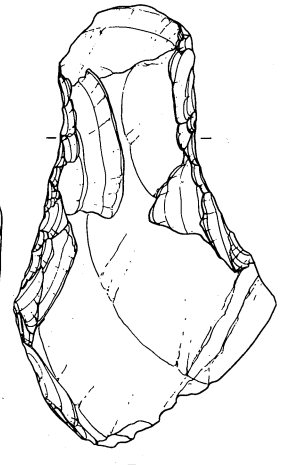

0 (1:2) 5cm

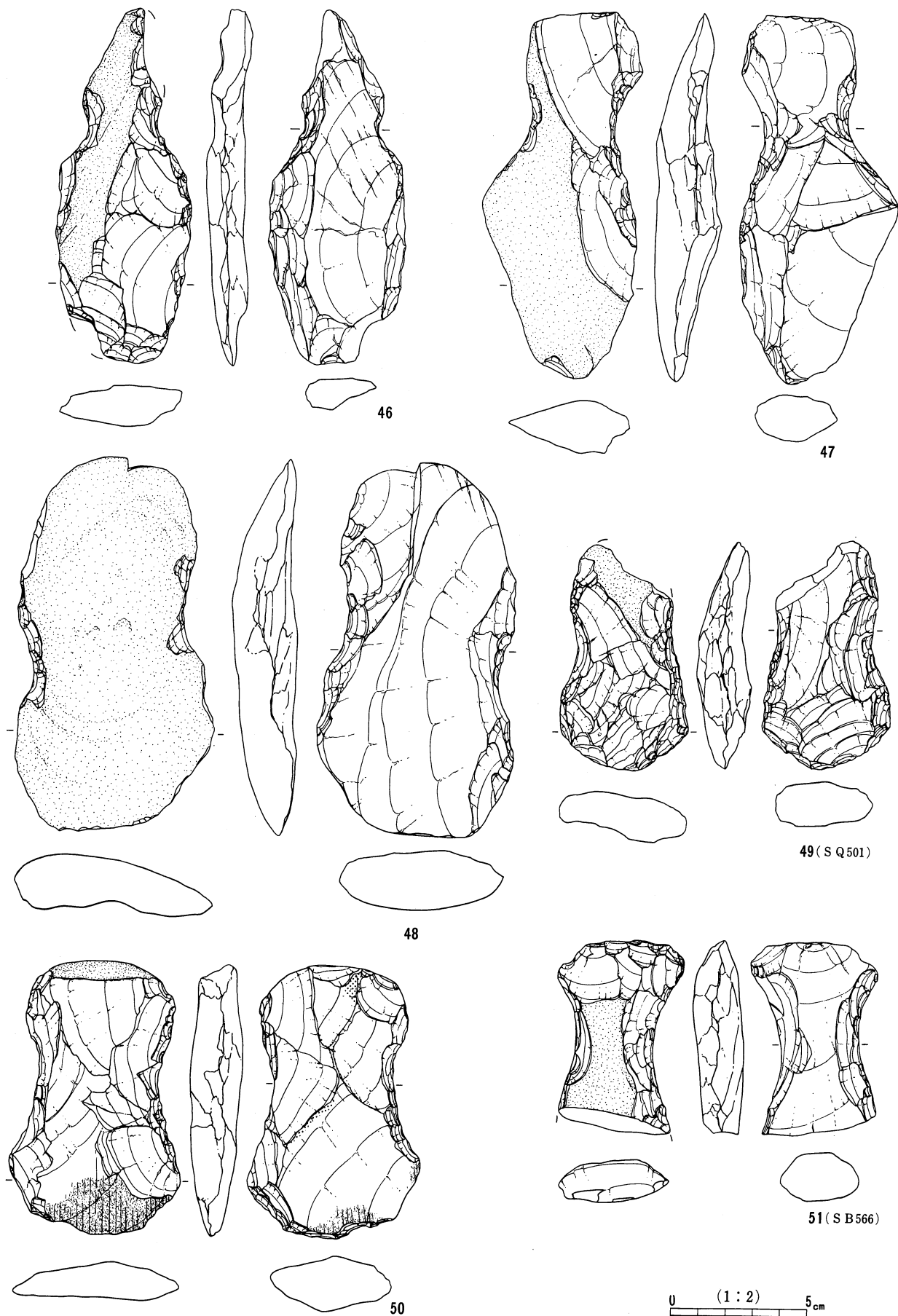

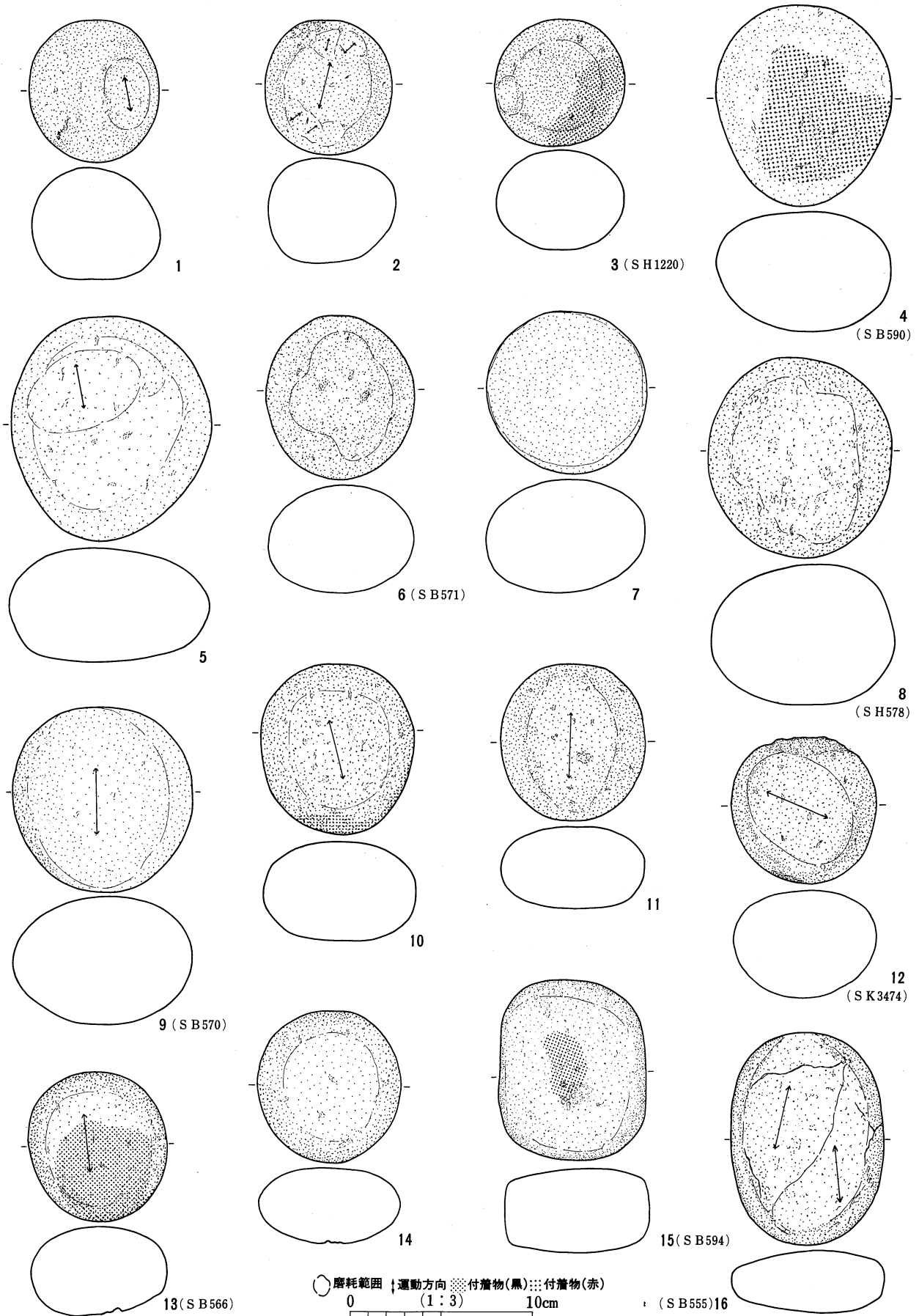

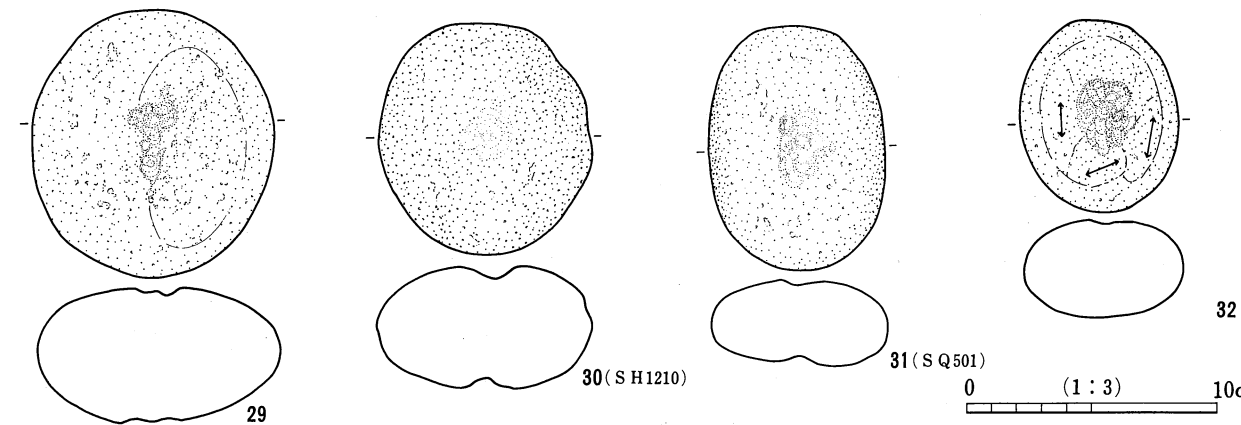
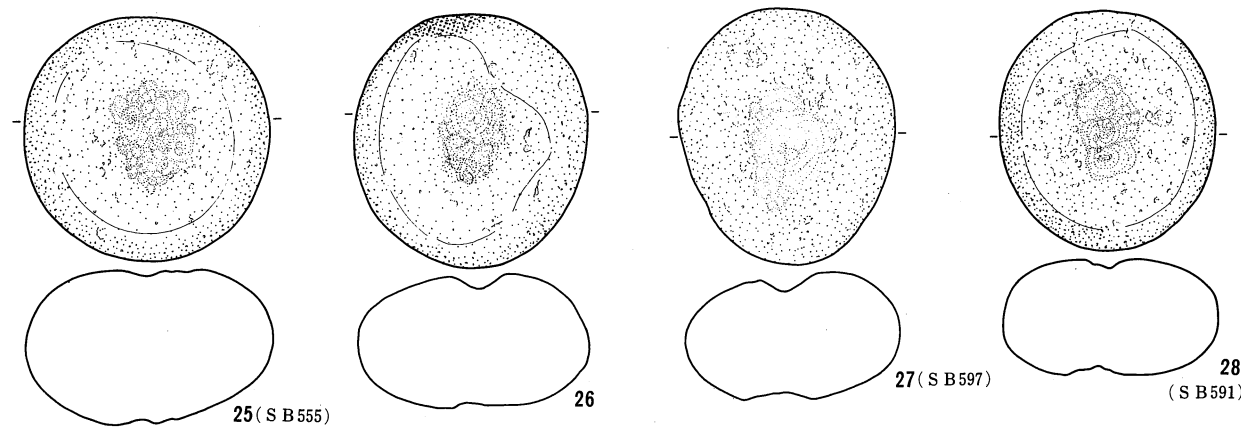
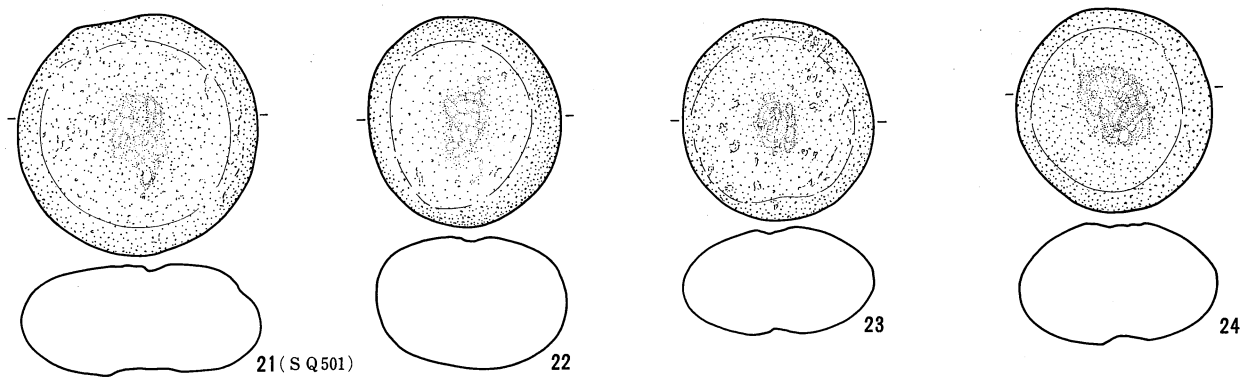
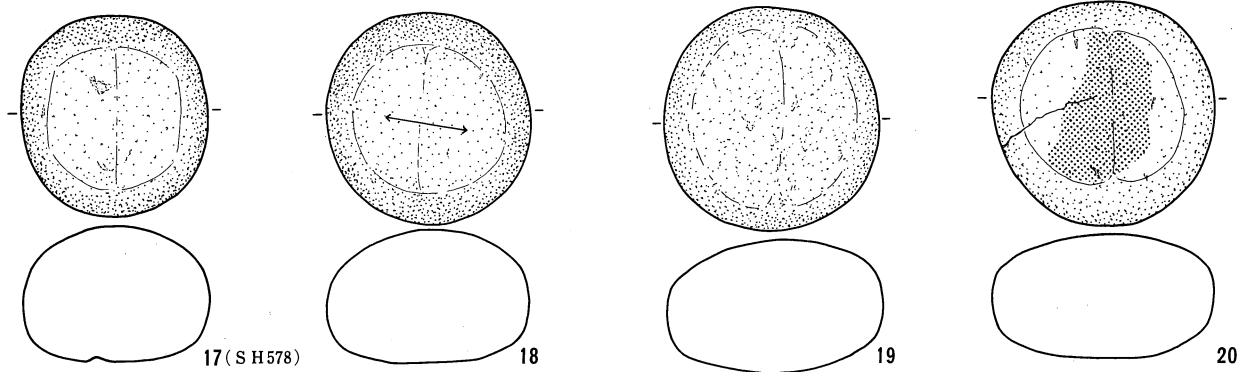

0 (1:3) 10cm

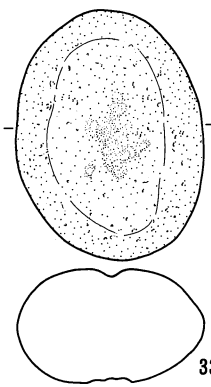

33 (S B 559)

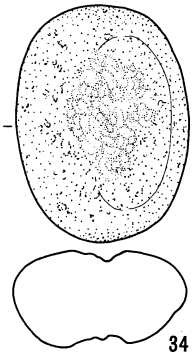

34 (S H 510)

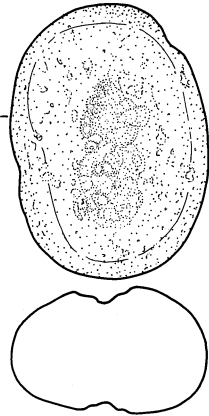

35 (S B 558)

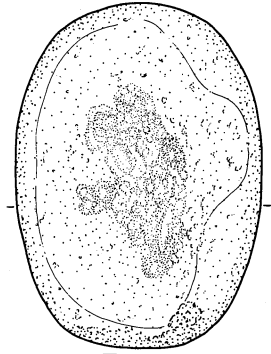

36
(S H 1067)

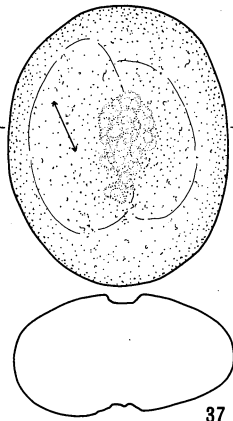

37

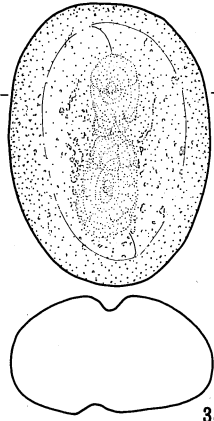

38 (S H 506)

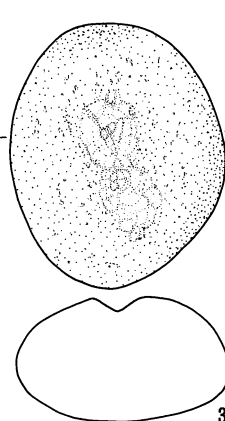

39 (S B 559)

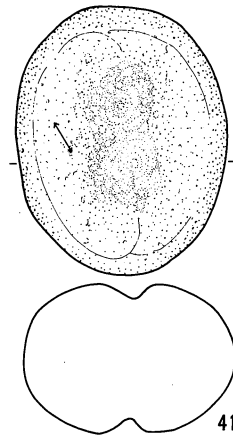
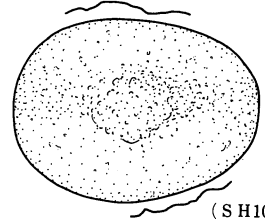

41 (S Q 501)

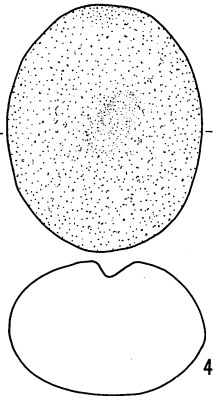

42 (S B 566)

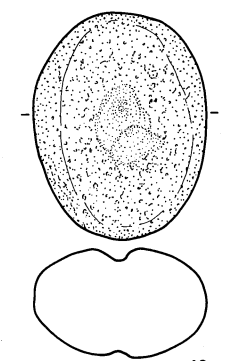

43 (S B 566)

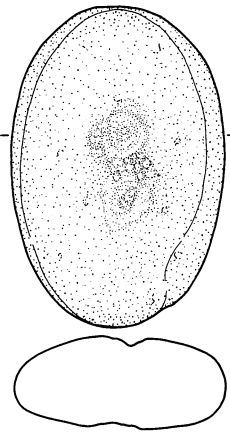

40

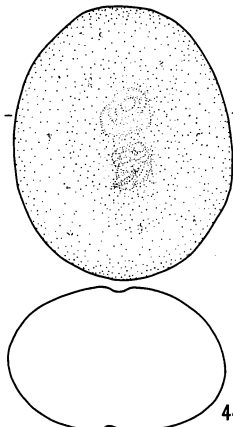

44 (S H 1205)

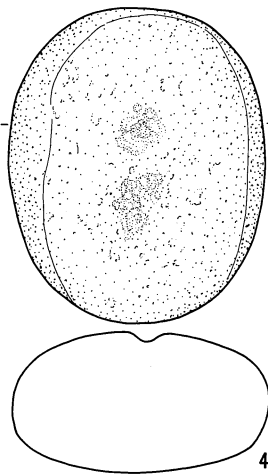

45 (S B 582)

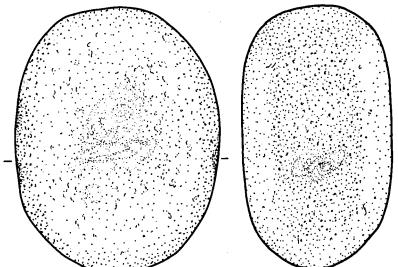

46 (S H 1222)

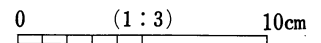

0

(1 : 3)

10cm

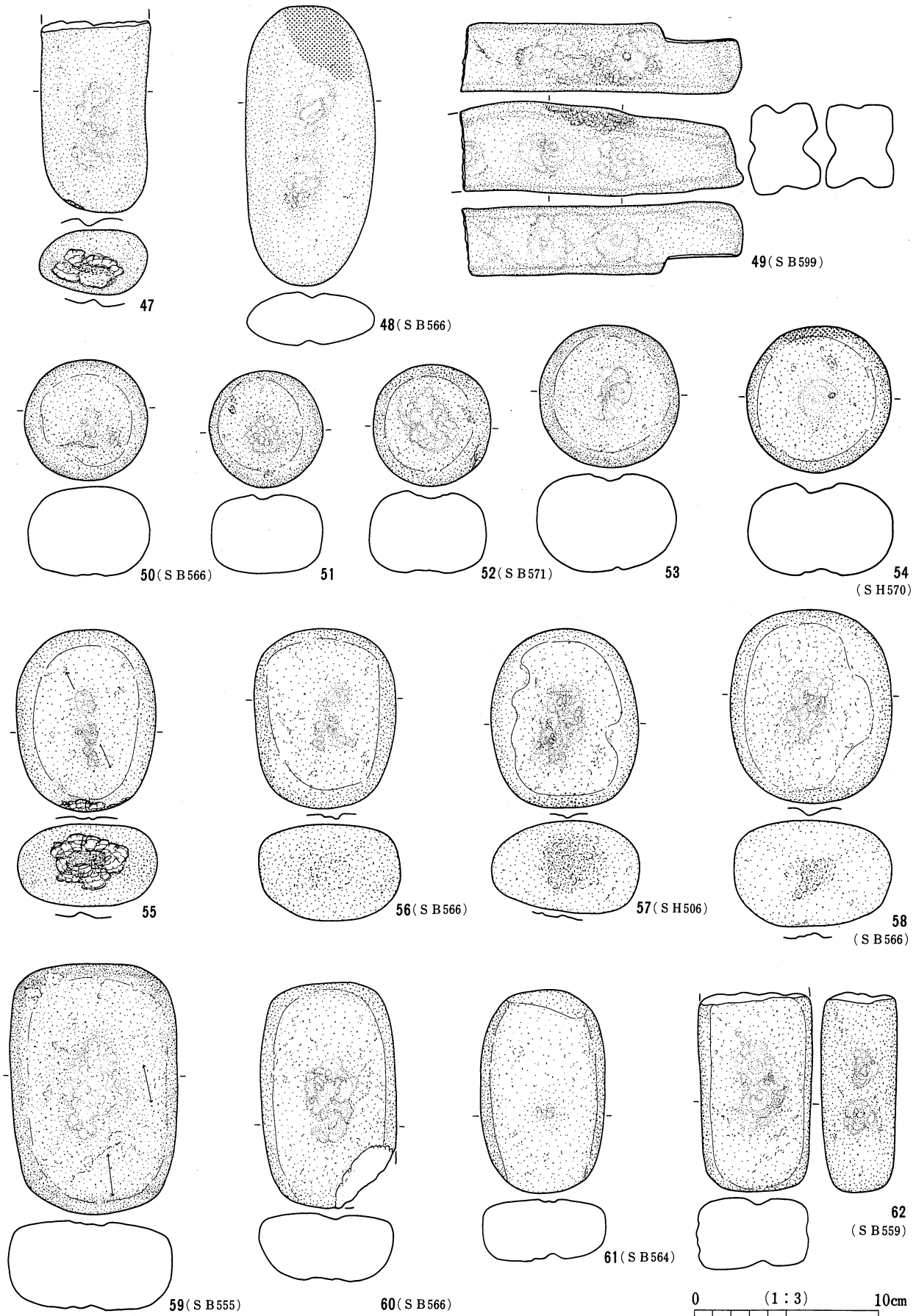

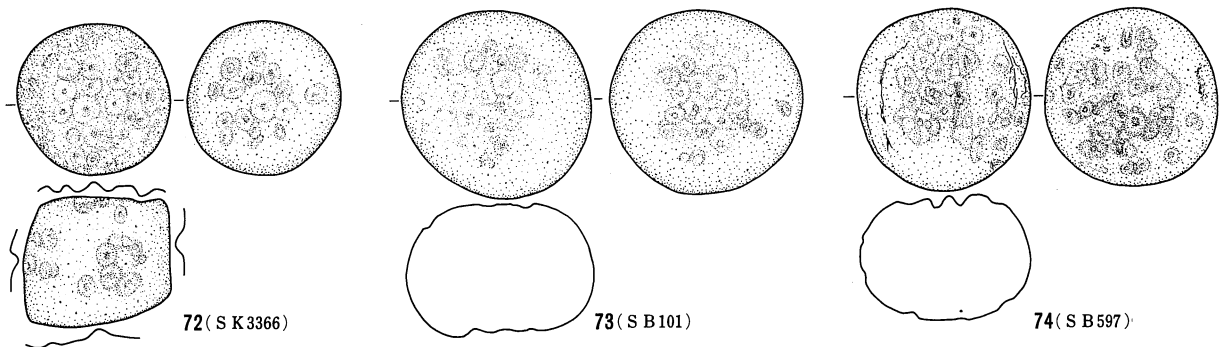
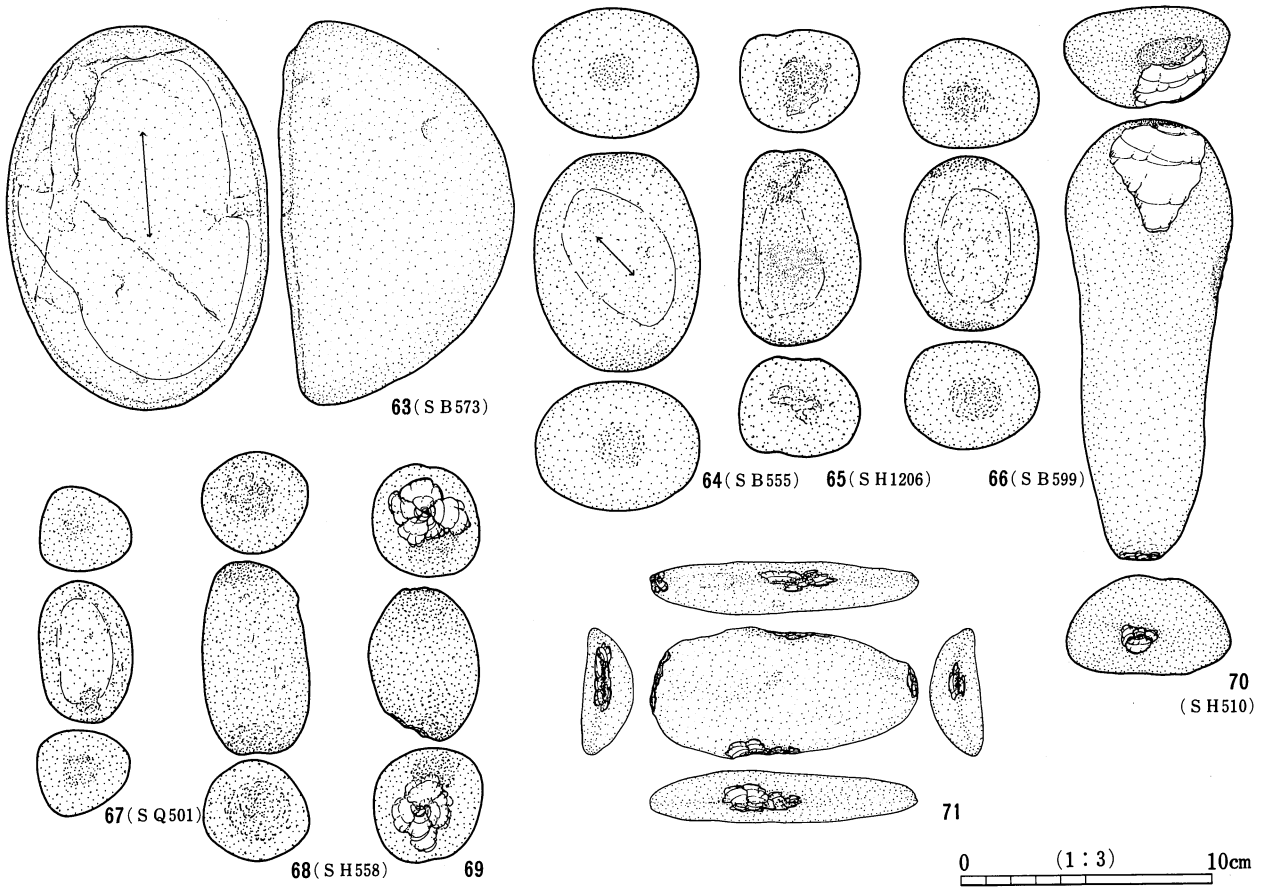

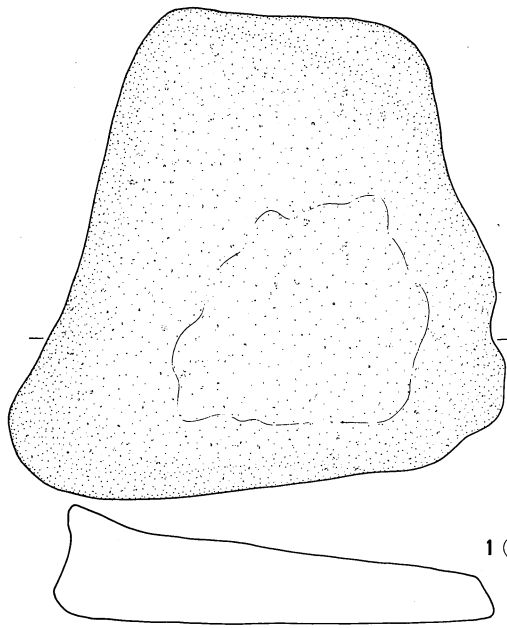

1 (SB580)

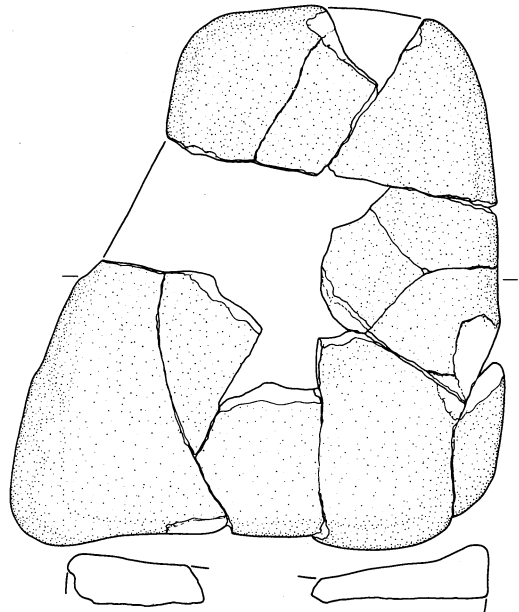

3 (SH5)

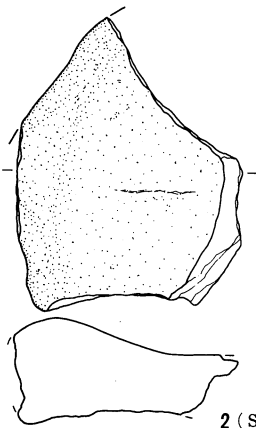

2 (SH517)

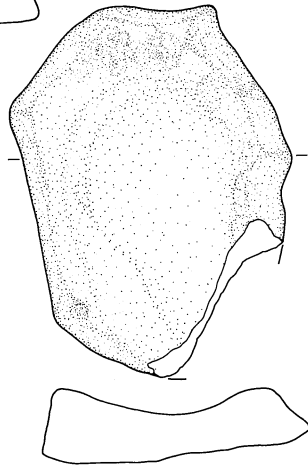

4 (SB597)

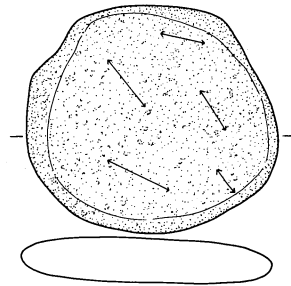

5 (SH559)

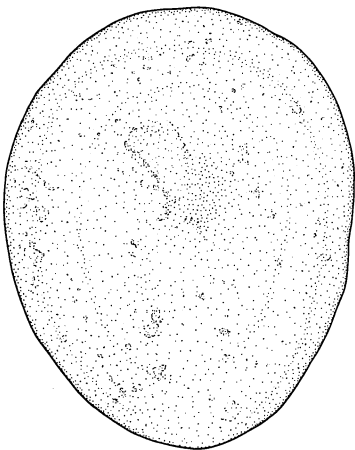

7 (SH526)

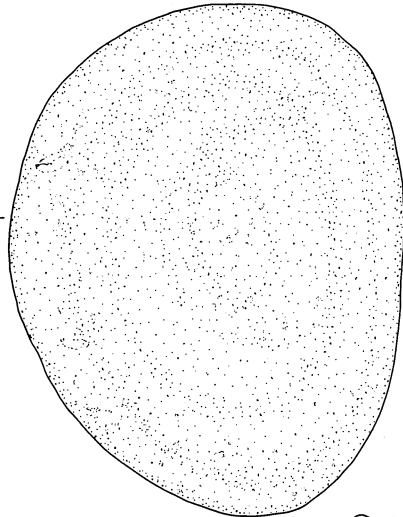

8 (SB566)

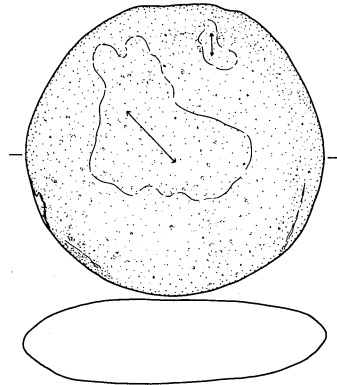

6 (SB580)

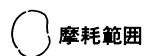

摩耗範囲

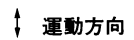

運動方向

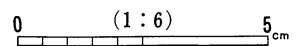

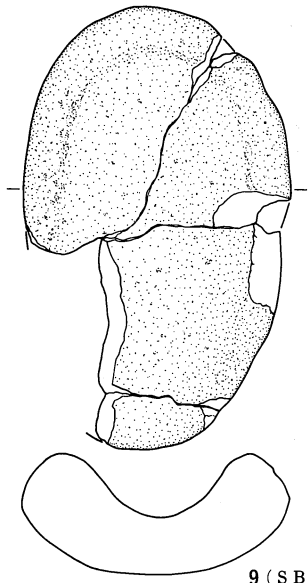

9 (S B566)

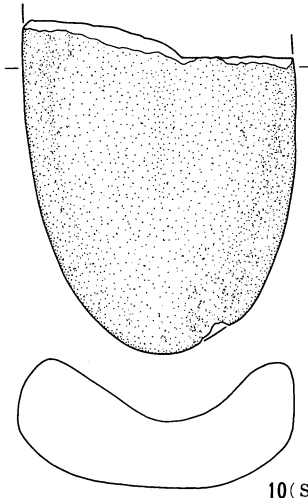

10 (S H510)

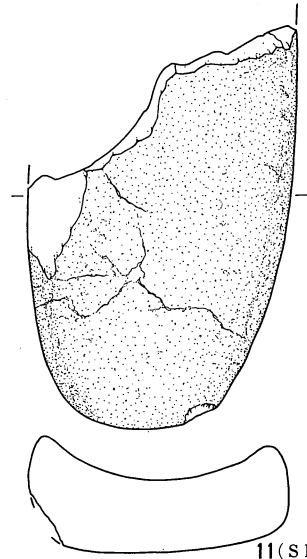

11 (S H575)

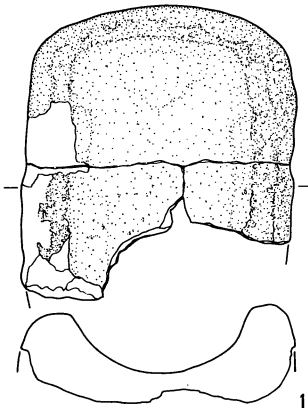

12 (S H1059)

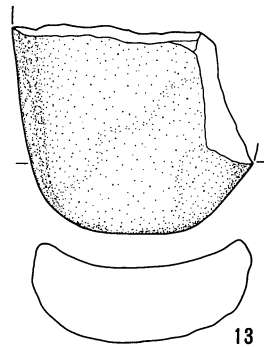

13

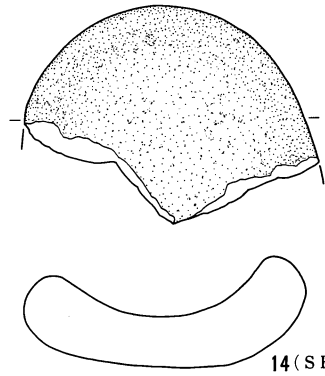

14 (S H33)

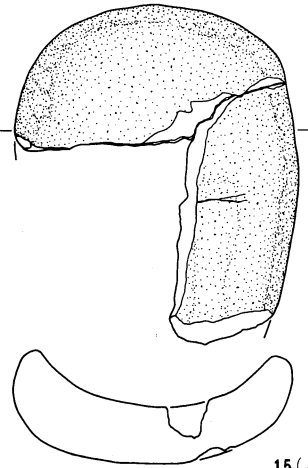

15 (S Q5)

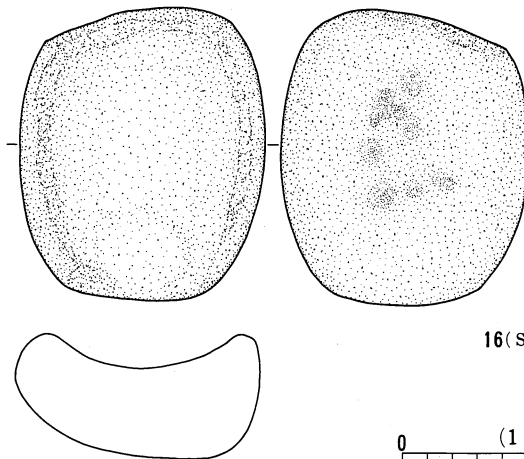

16 (S B591)

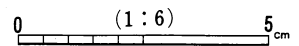

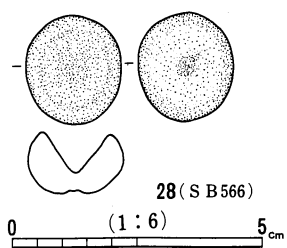
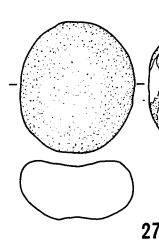
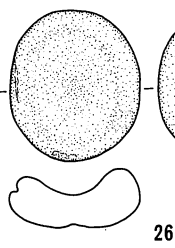
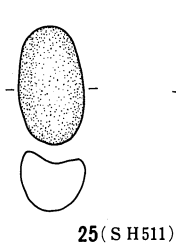
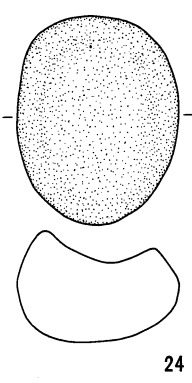
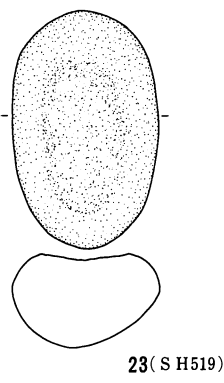
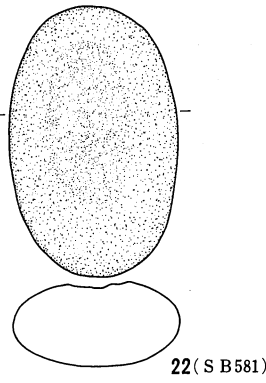
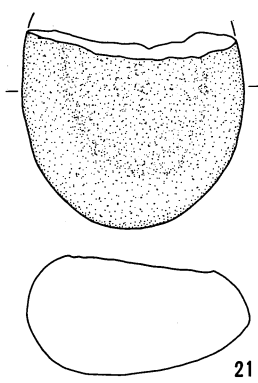
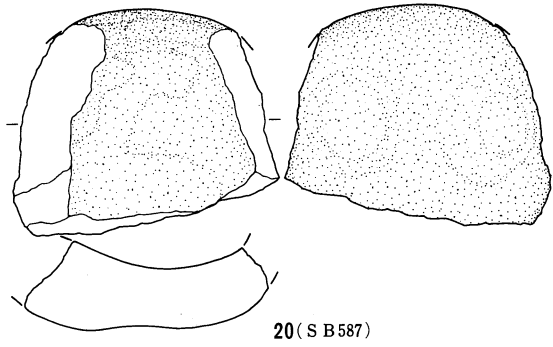
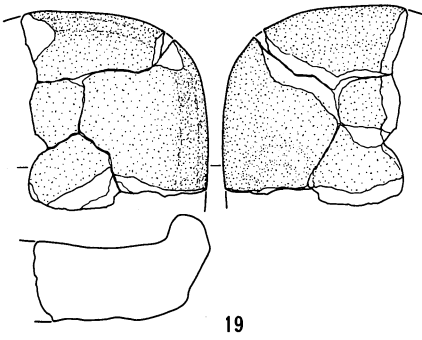
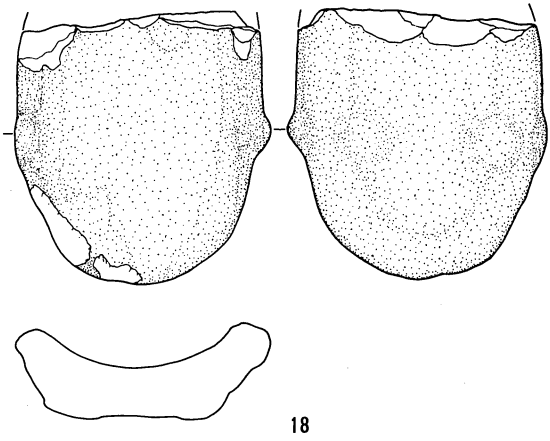
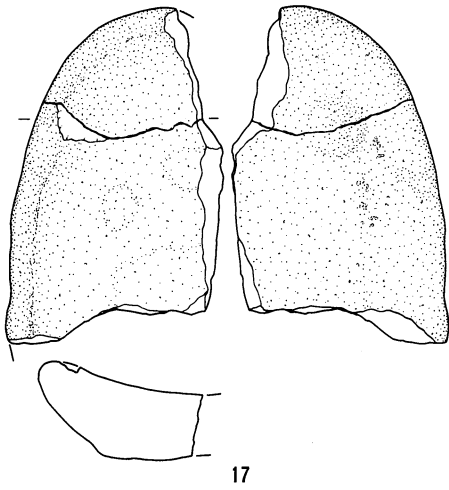

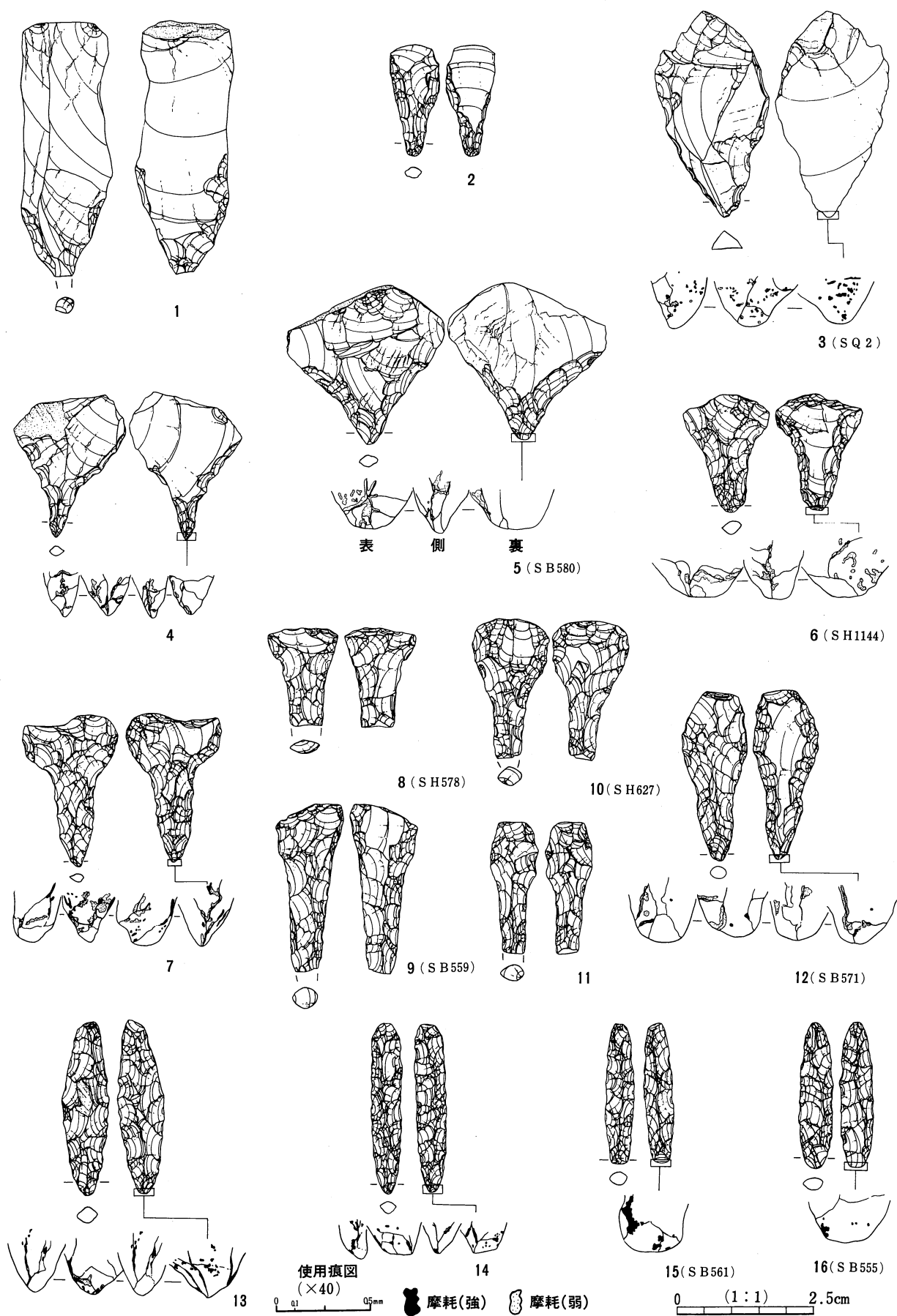

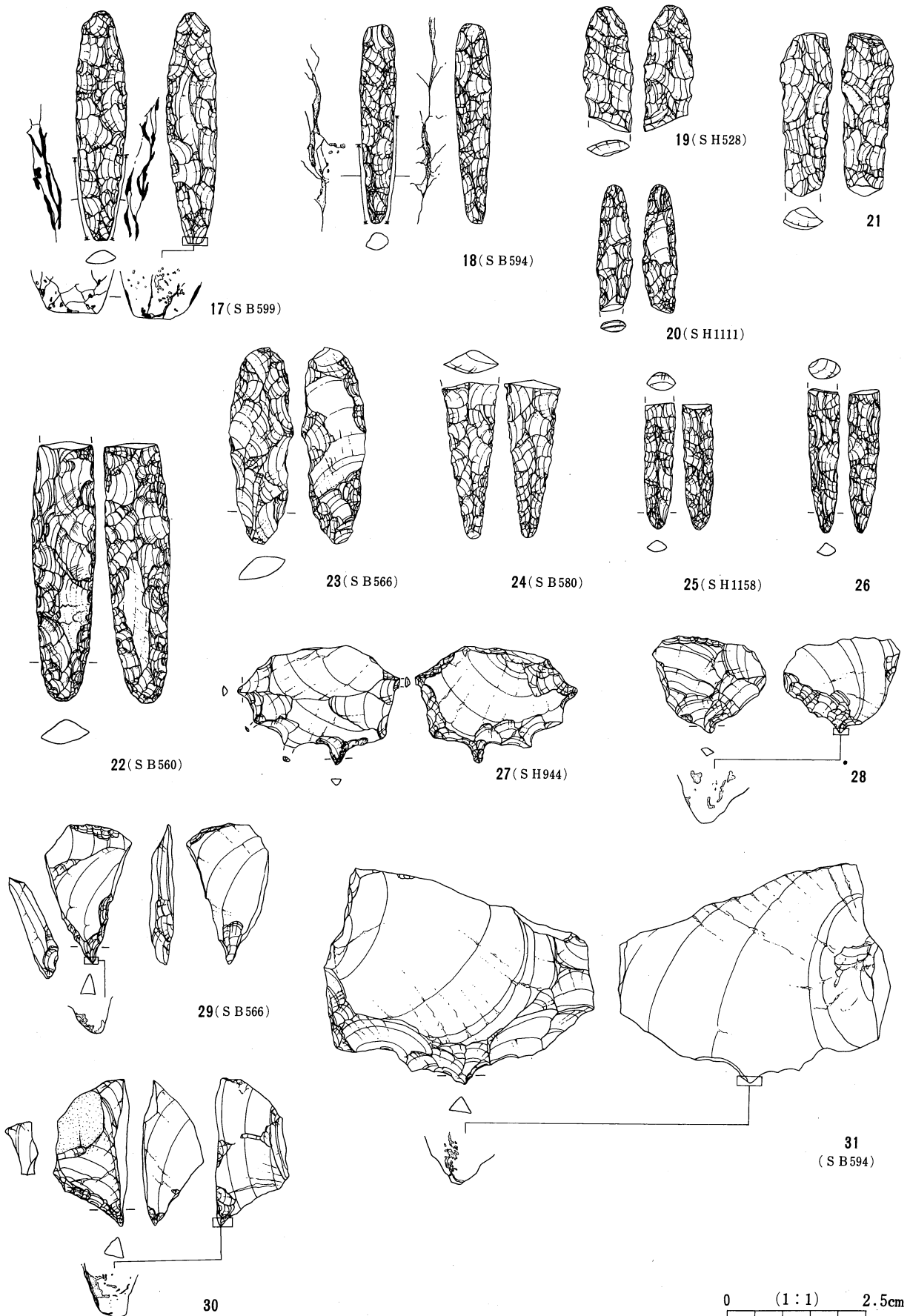

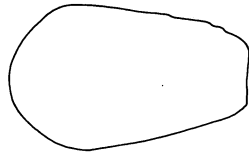
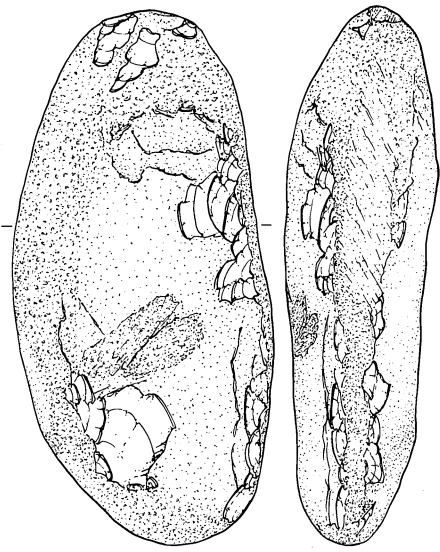

1 (S B551)

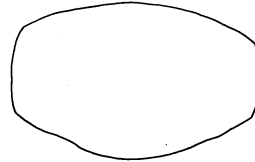
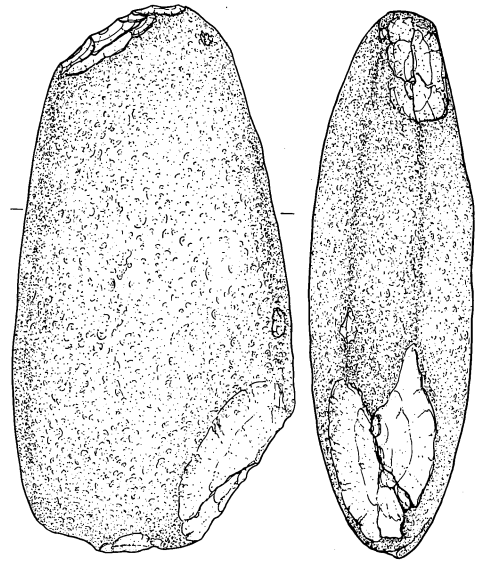

2 (S H1005)

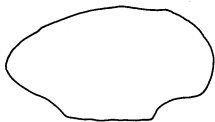
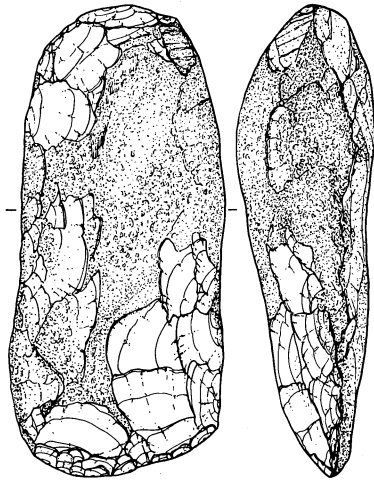

3 (S B559)

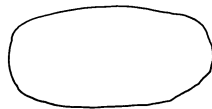
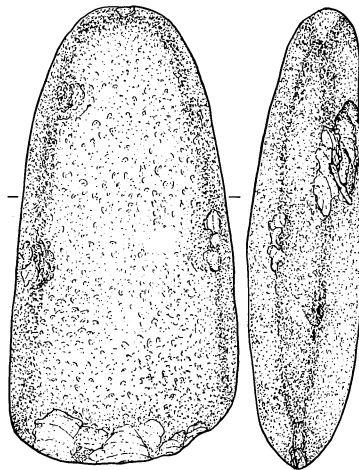

4 (S H1067)

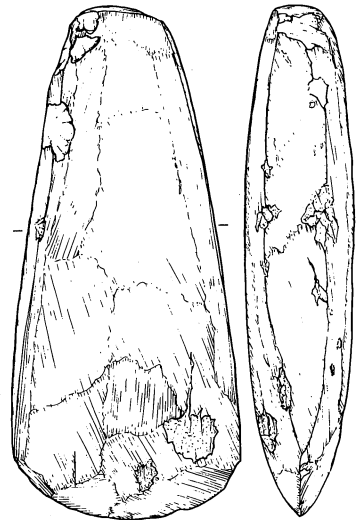

5

0 (1:2) 5 cm

● 磨耗痕 ■ 装着痕

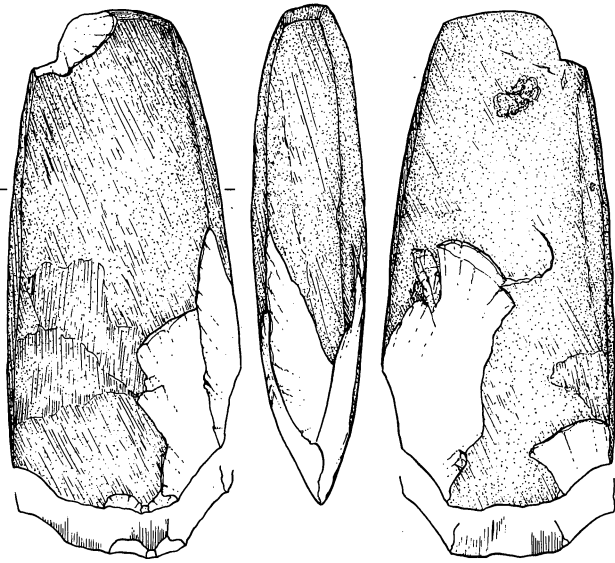

6 (S K2647)

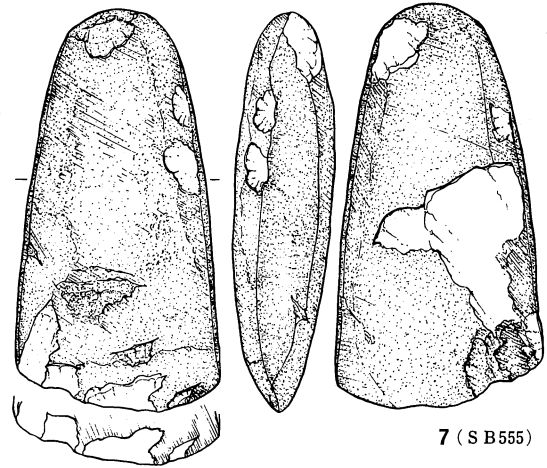

7 (S B555)

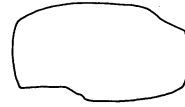

9 (S H672)

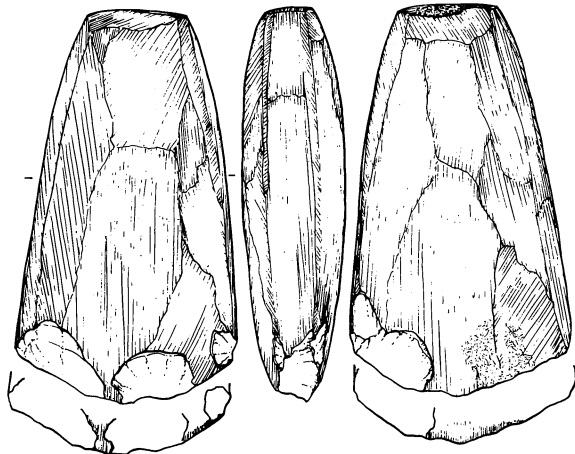

8 (S K2006)

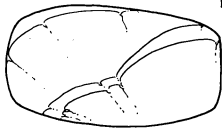
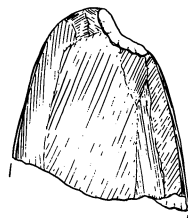
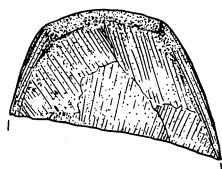
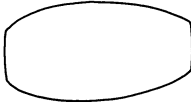
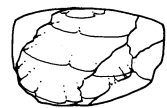
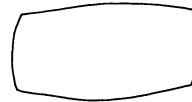
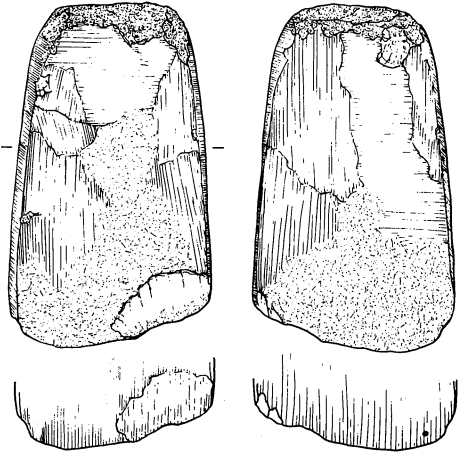

10

11



12 (S B562)

13 (S B561)

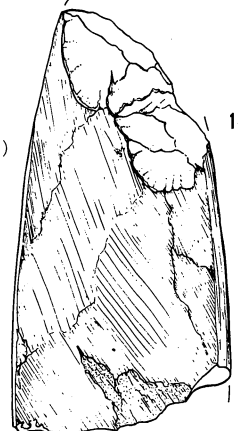
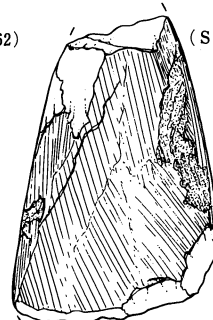
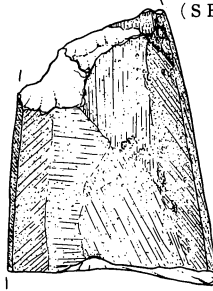

14



0 (1:2) 5cm

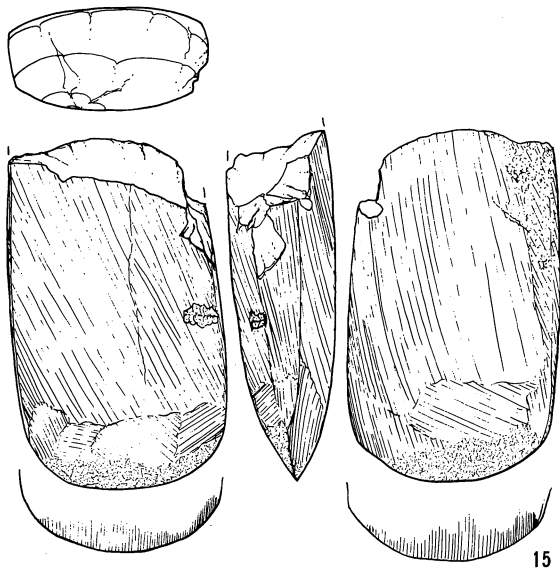

15

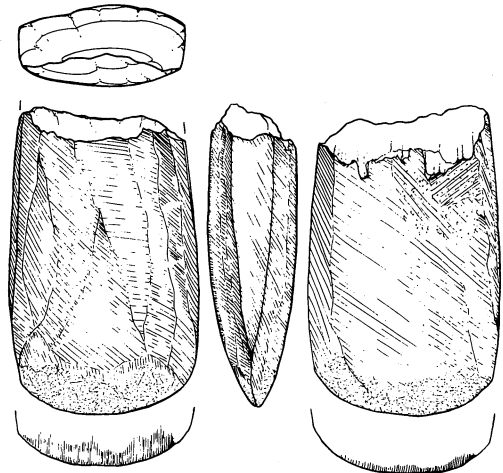

16
(S B555)

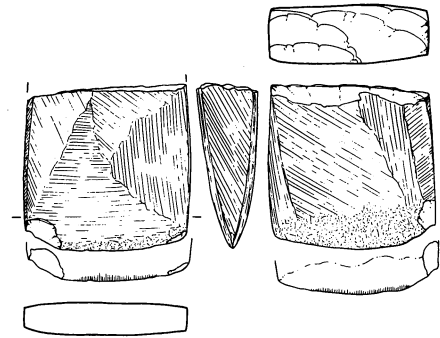

18

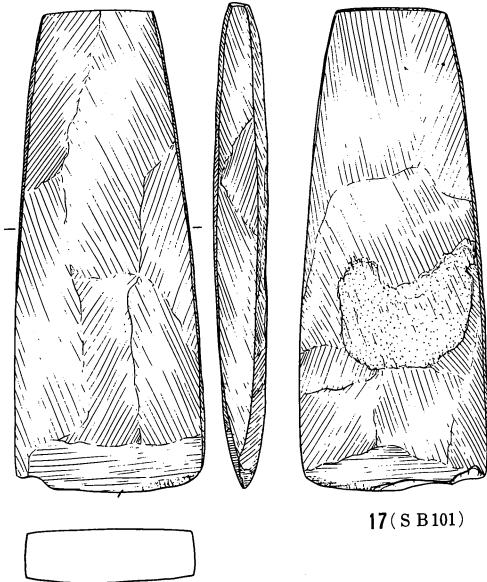

17(S B101)

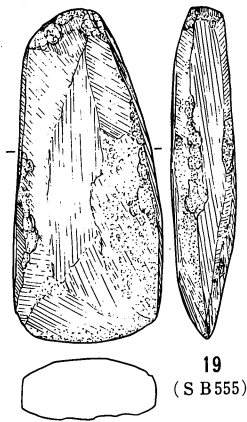

19
(S B555)

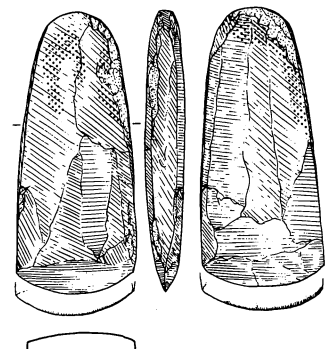

21
(S H873)

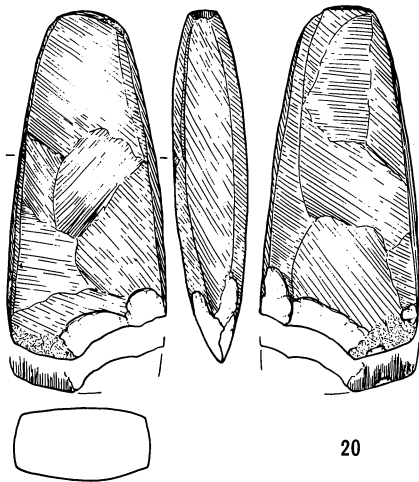

20

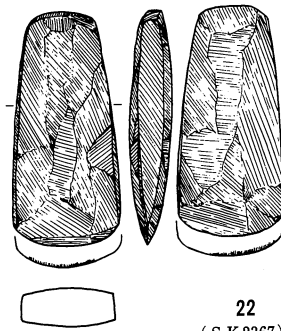

22
(S K2367)

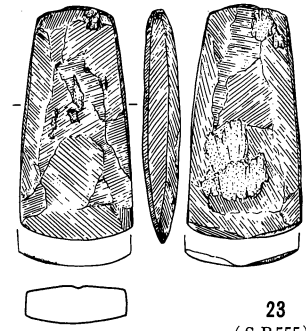

23
(S B555)

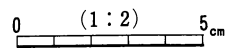

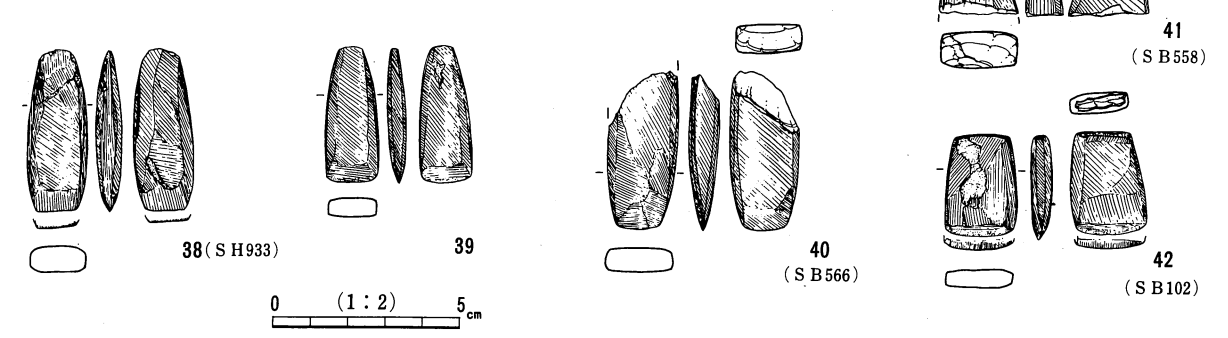
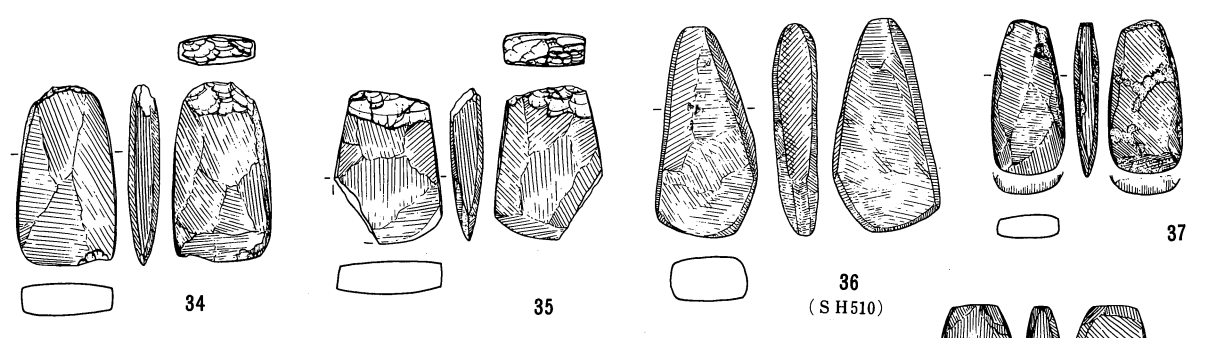
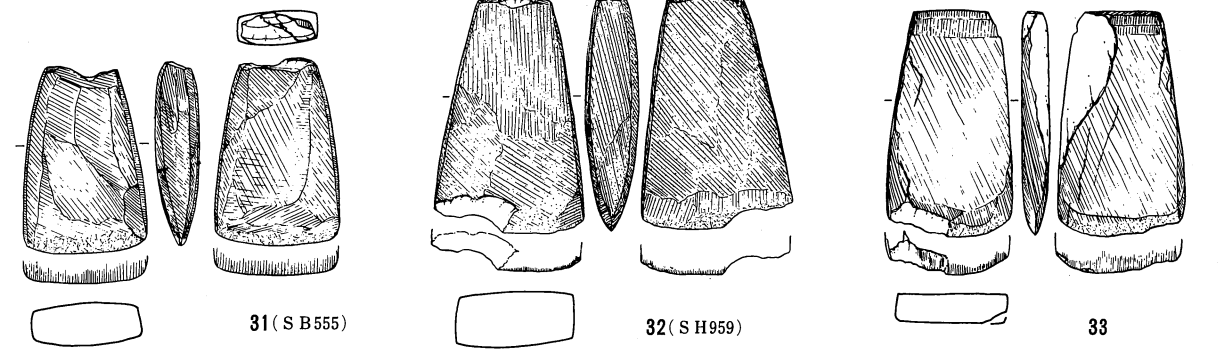
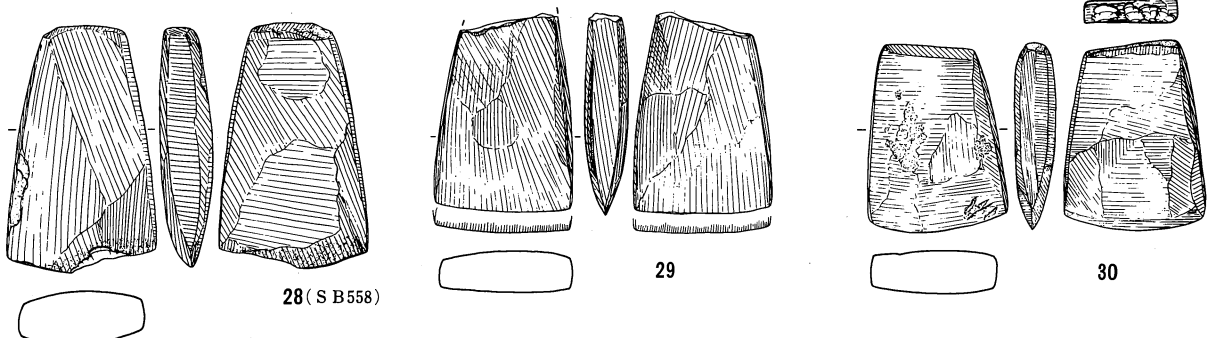
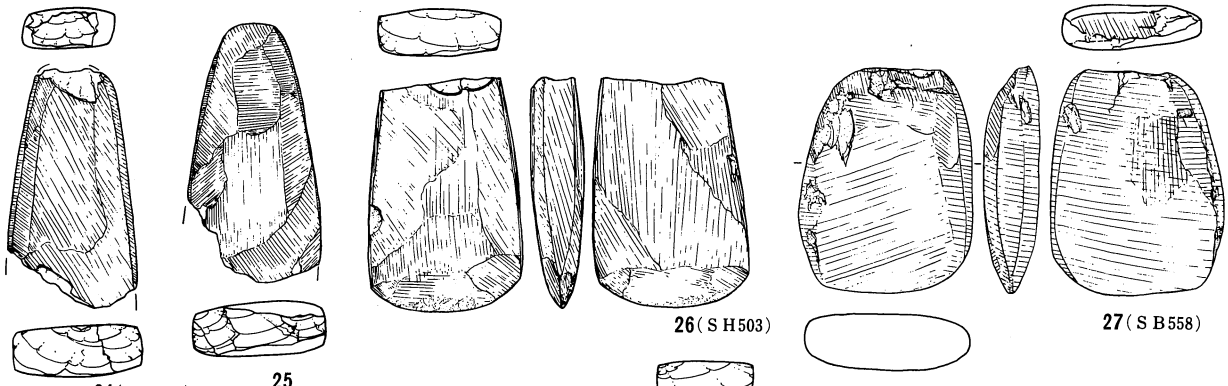

0 (1:2) 5 cm

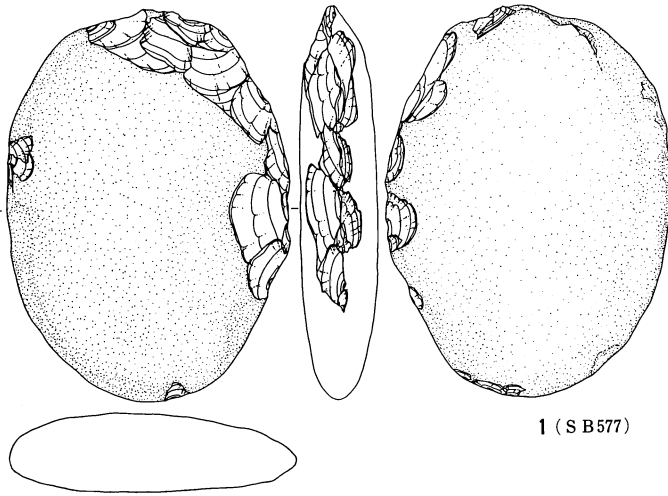

1 (SB577)

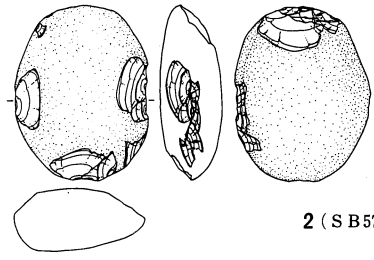

2 (SB573)

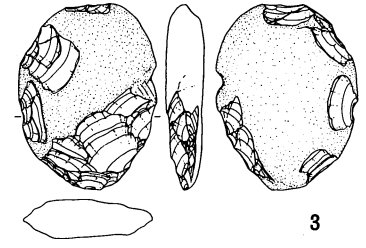

3

0 (1:3) 5cm

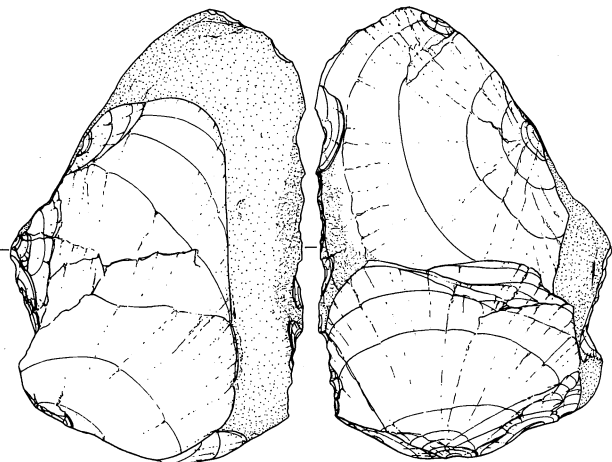
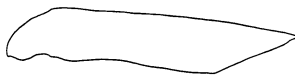

4 (SQ501)

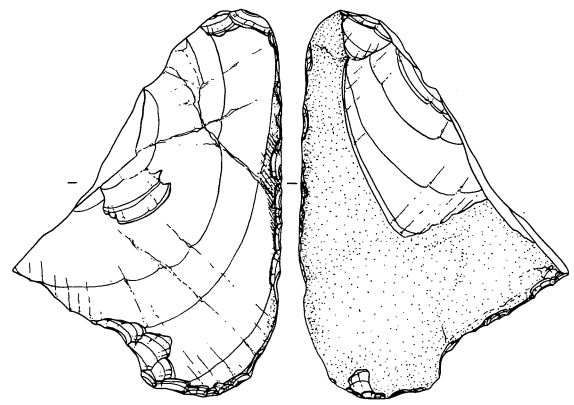

5

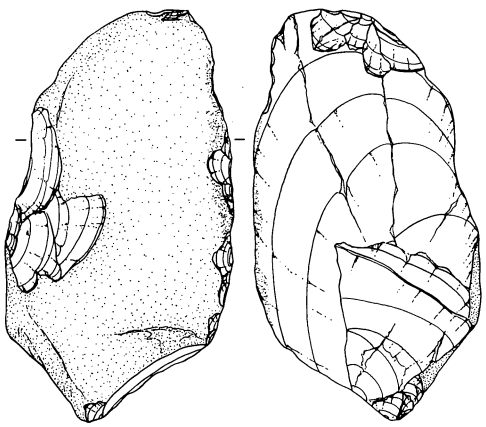
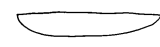

6 (SH567)

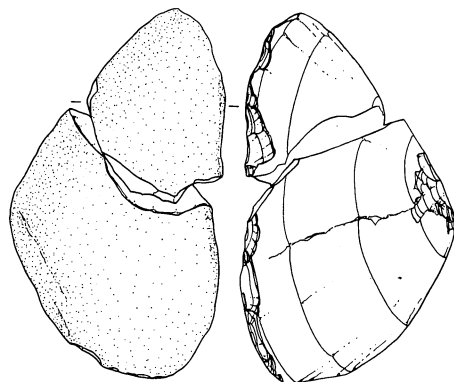

7

0 (1:2) 5cm

摩耗痕

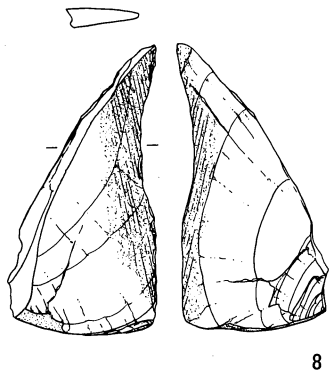

8

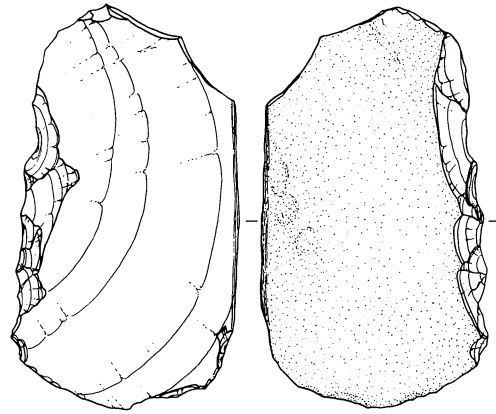

11 (SH550)

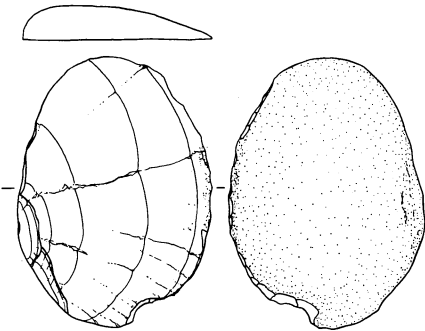

9

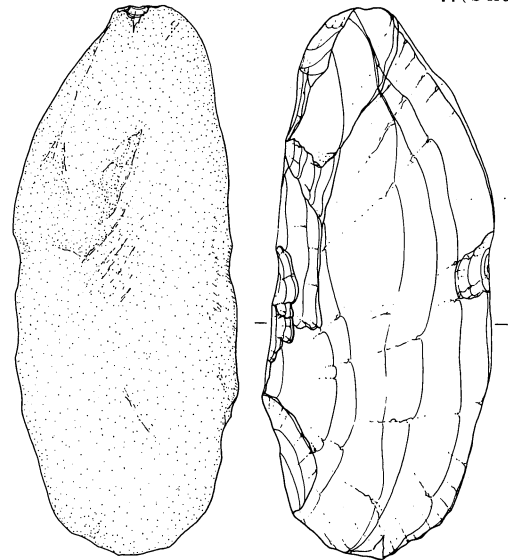

12

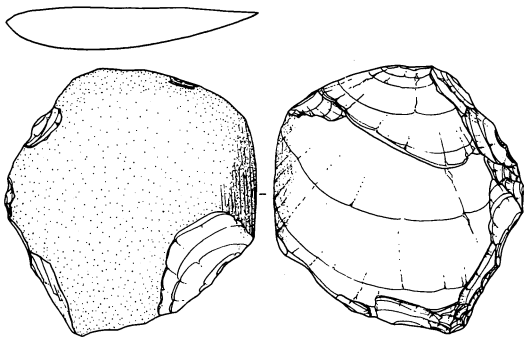

10

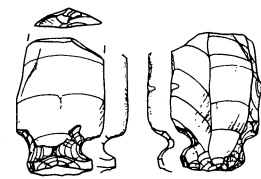

15

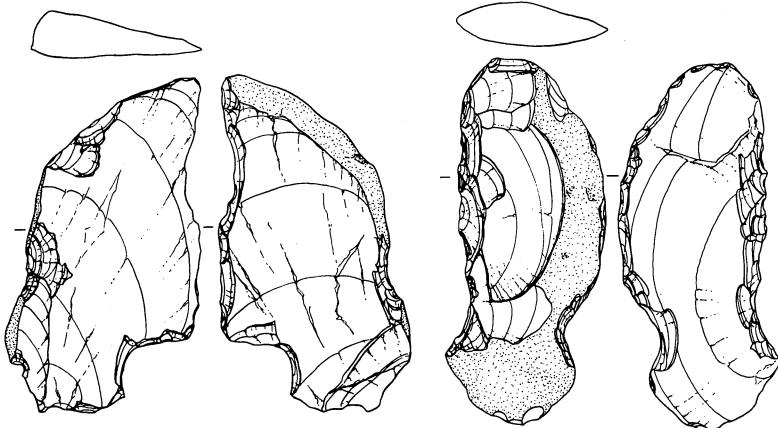

13

14

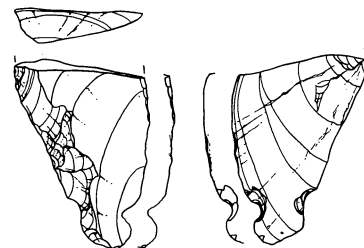

16 (SH558)

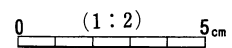

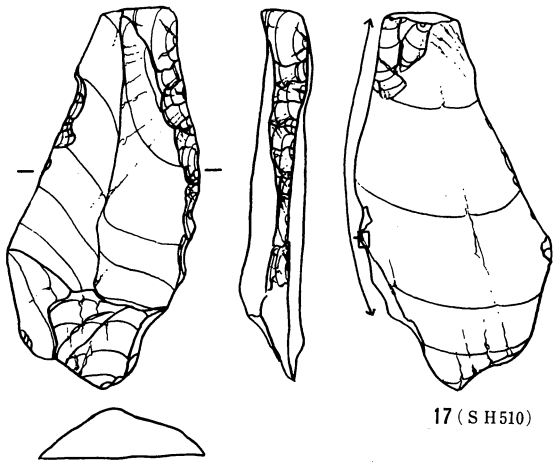

17 (S H510)

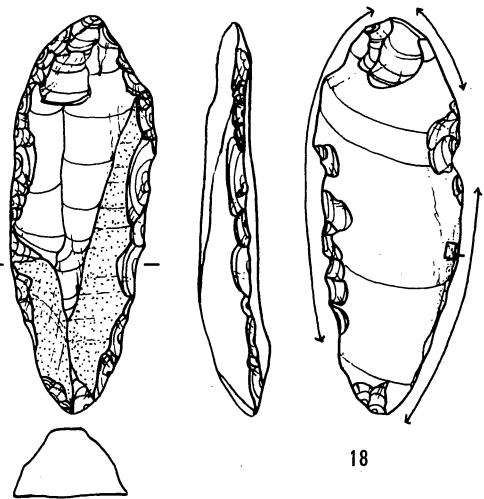

18

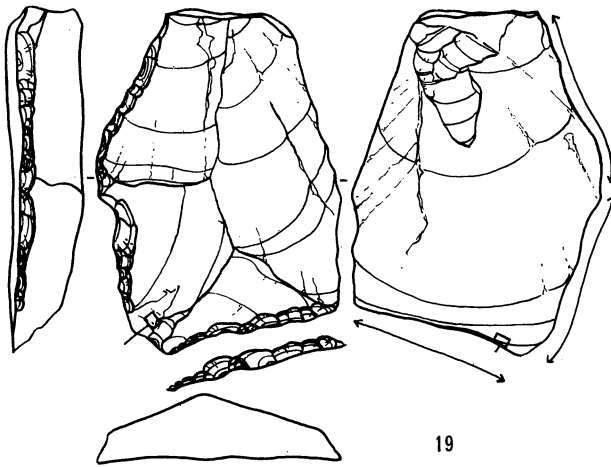

19

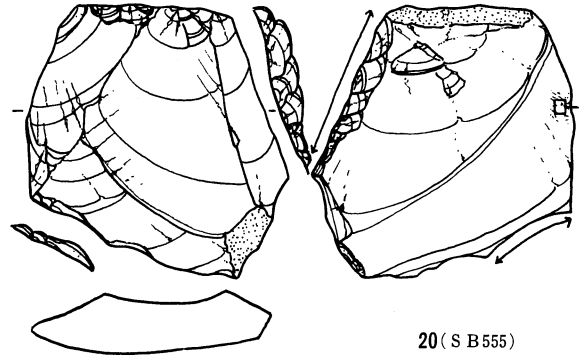

20 (S B555)

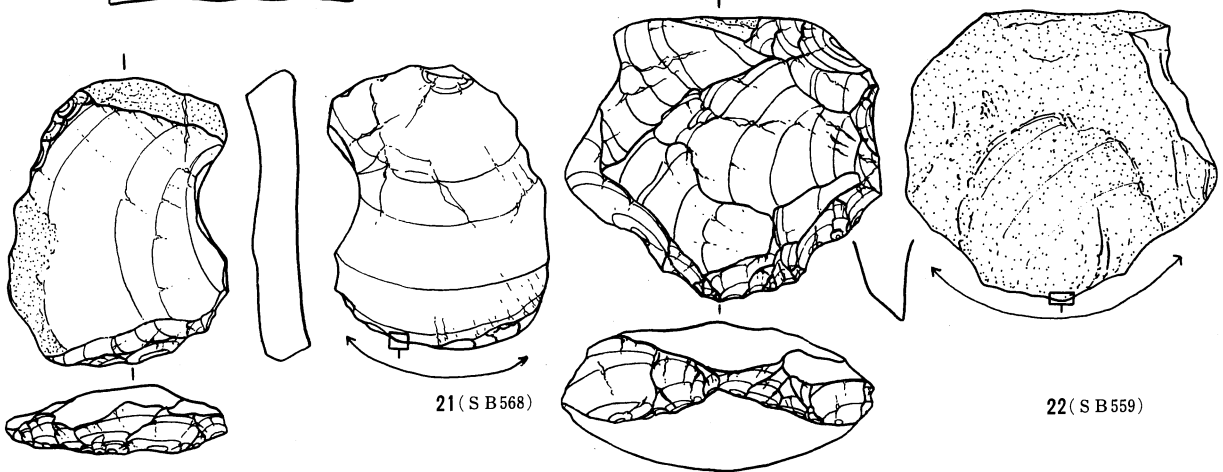

21 (S B568)

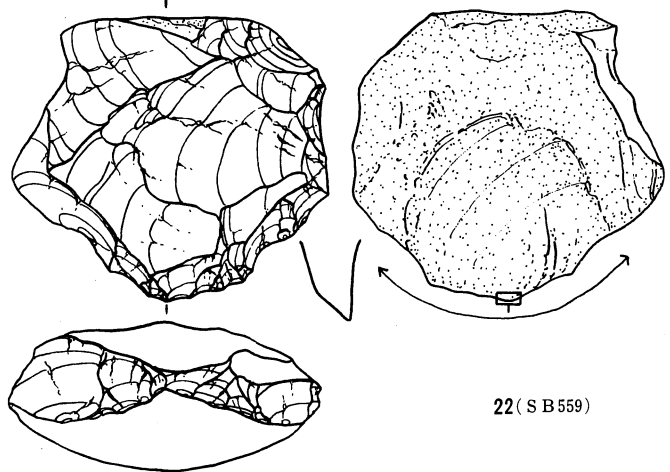

22 (S B559)

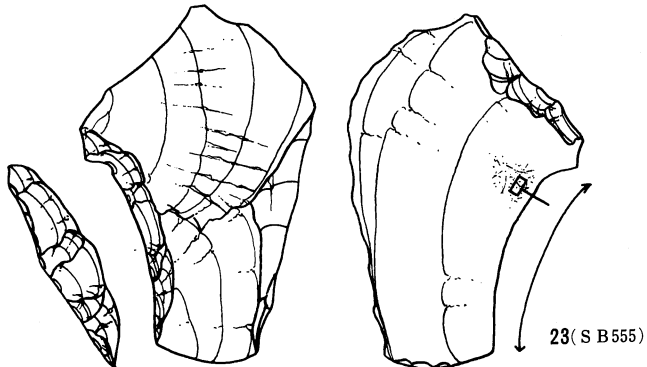

23 (S B555)

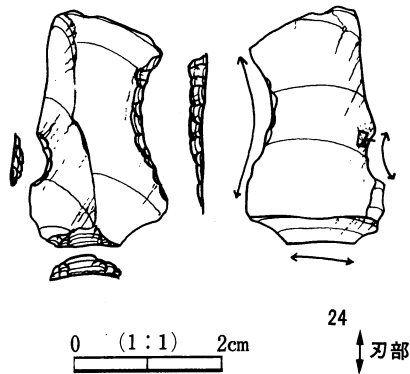

24

0 (1:1) 2cm

刃部

図版151 縄文遺物 石器34 (砥石、石錘、土錘、丸石)

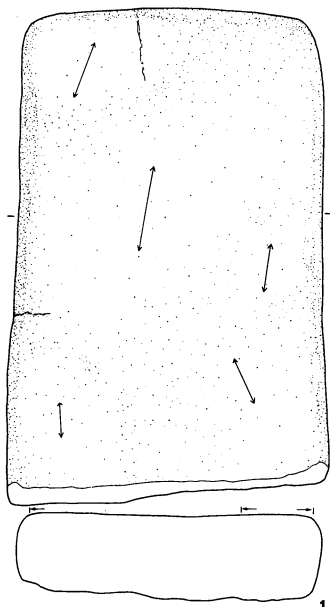

1 (SK3398)

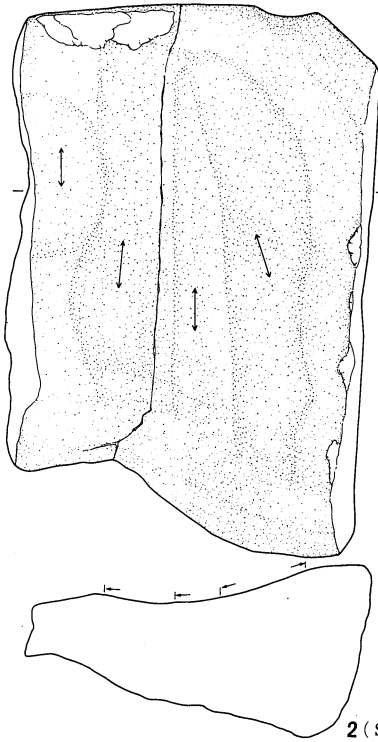

2 (SQ502)

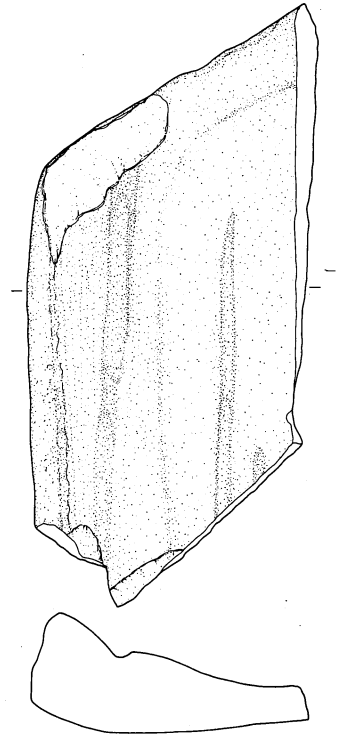

3 (SB101)

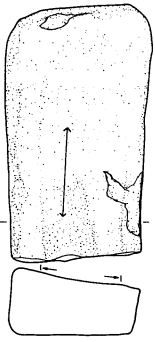

4 (SQ101)

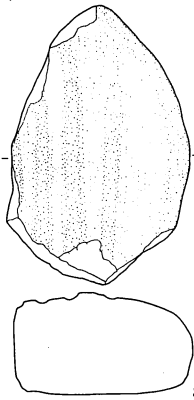

5 (SH506)

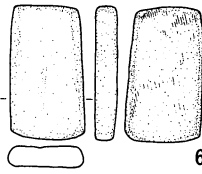

6 (SB555)

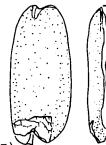

7 (SH1111)

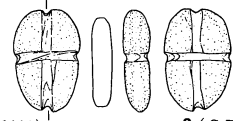

8 (SB555)

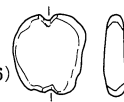

9 (SH1182)

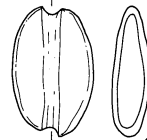

10 (SB555)

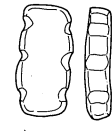

11

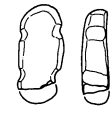

12

0 (1:4) 10cm

0 (1:3) 5cm
(7-12)

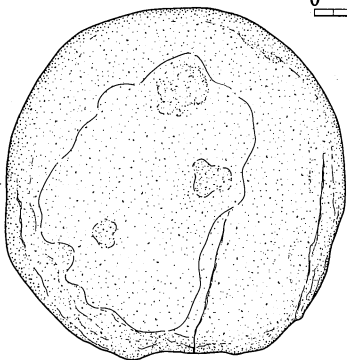

13 (SH956)

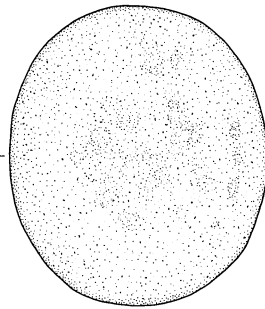

14 (SH766)

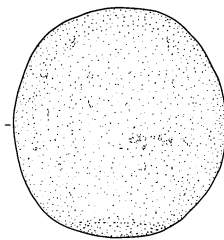

15 (SH1183)

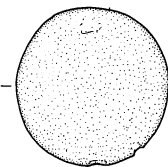

16 (SB561)

0 (1:6) 5cm

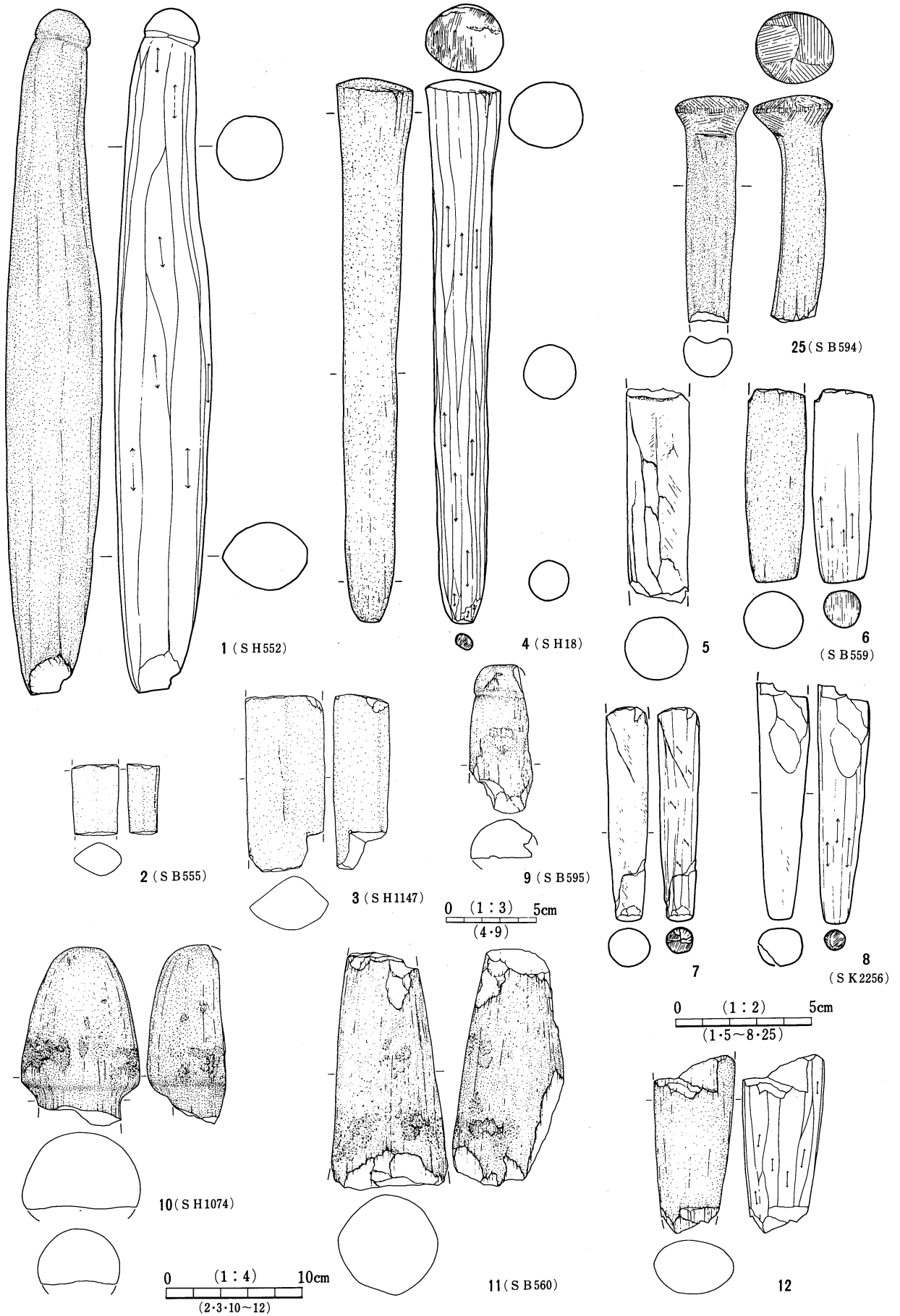

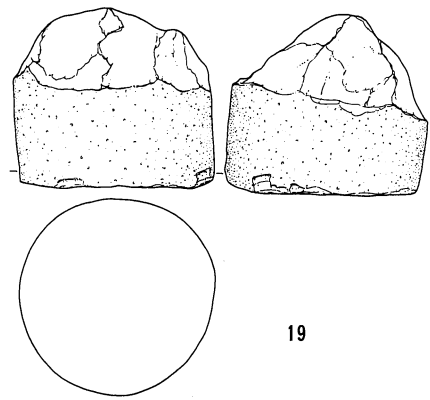
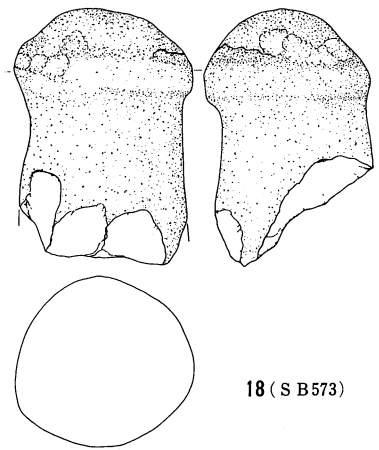
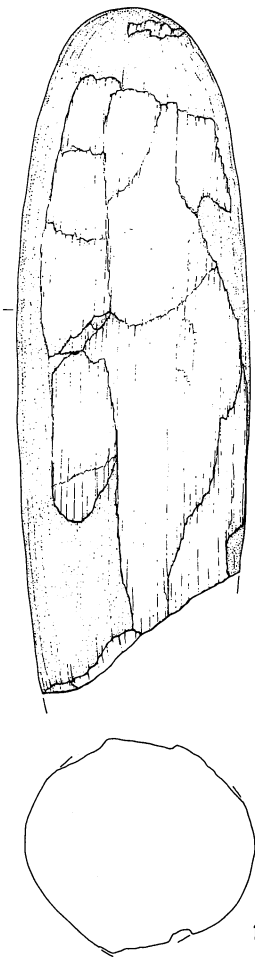
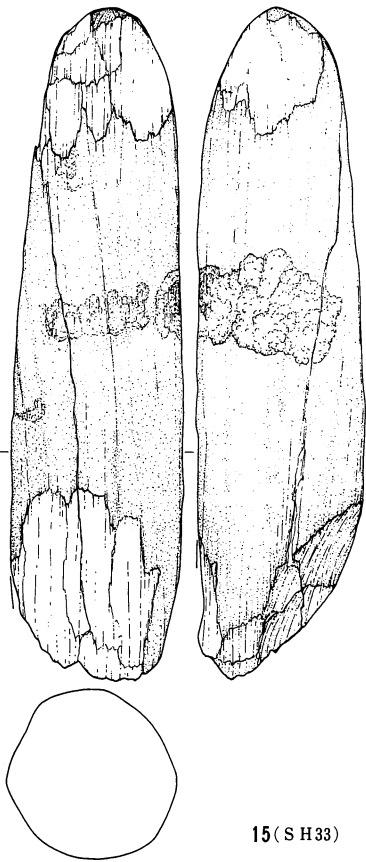
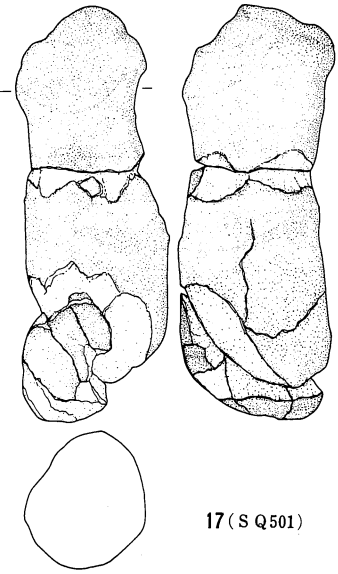
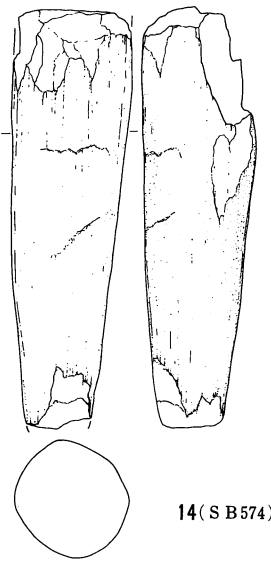
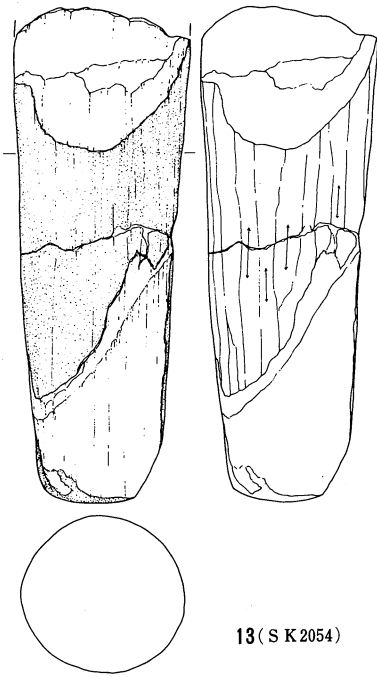

0 (1:4) 10cm

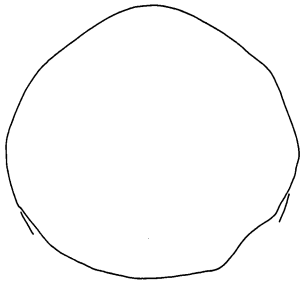
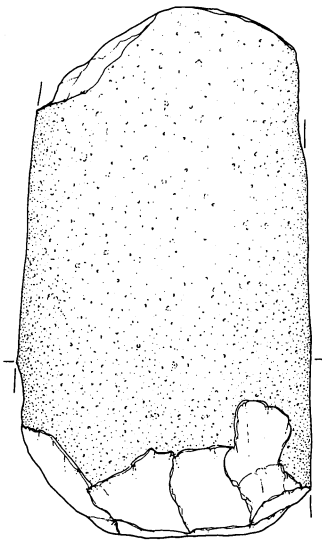

20(S H510)

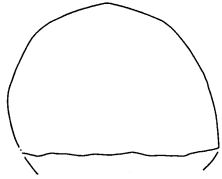
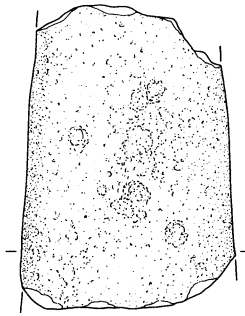

21(S B555)

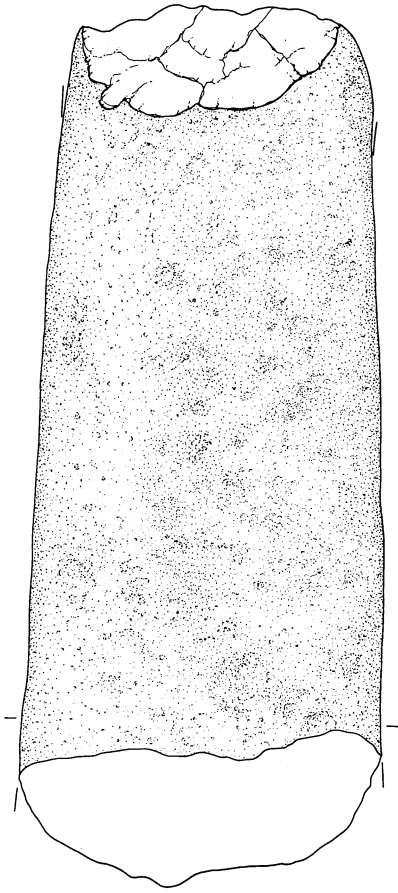

22(S H504)

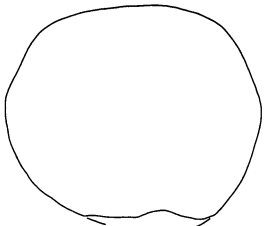
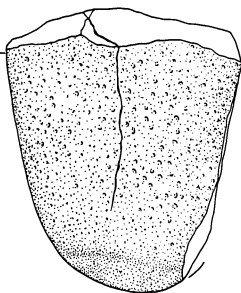
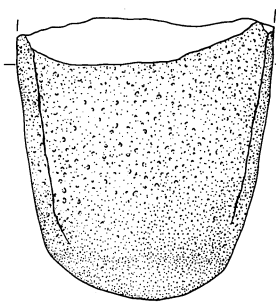

23(S H672)

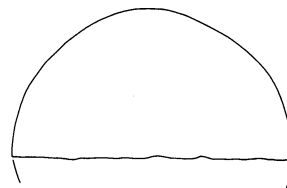
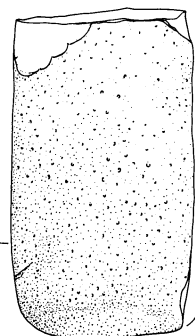
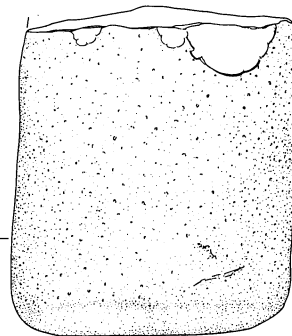

24(S H33)

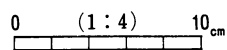

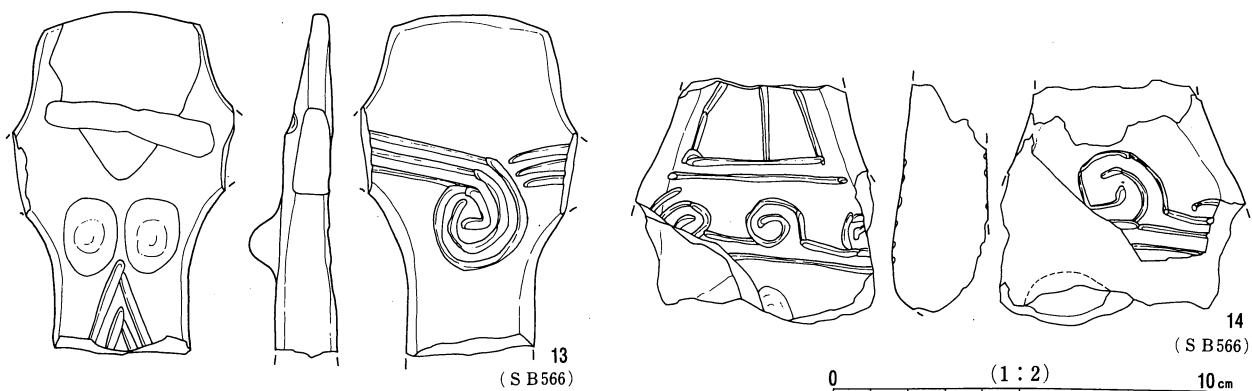
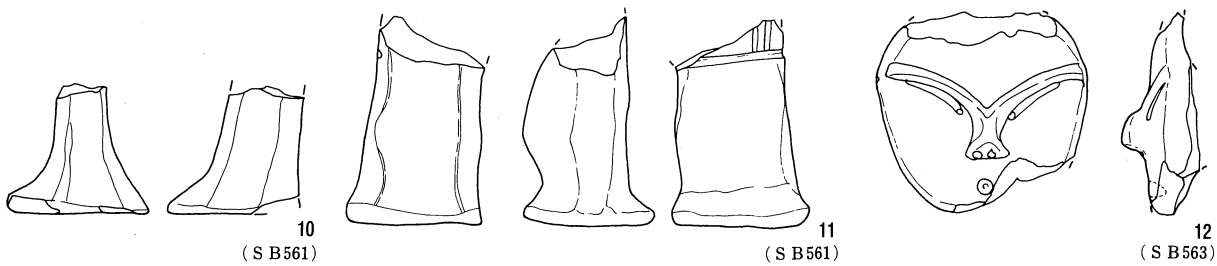
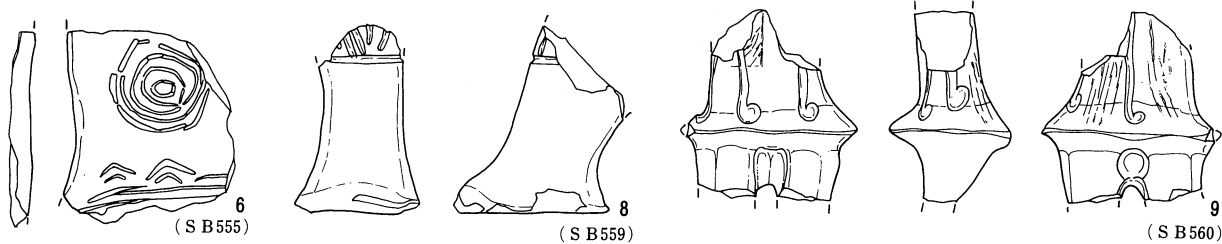
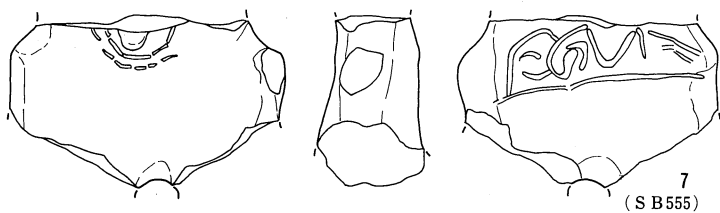
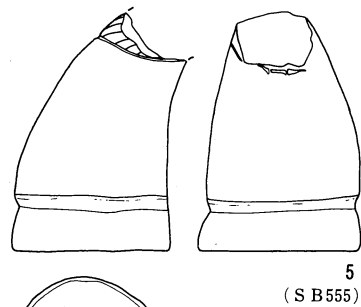
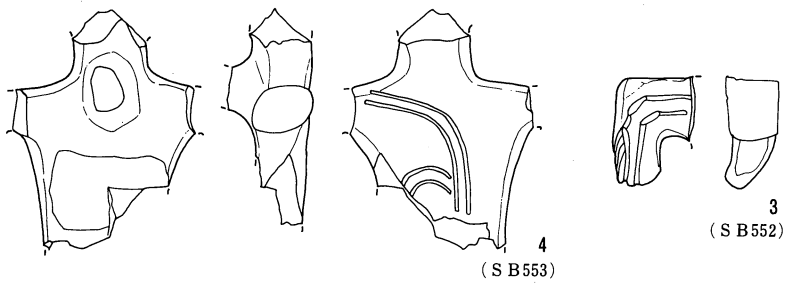
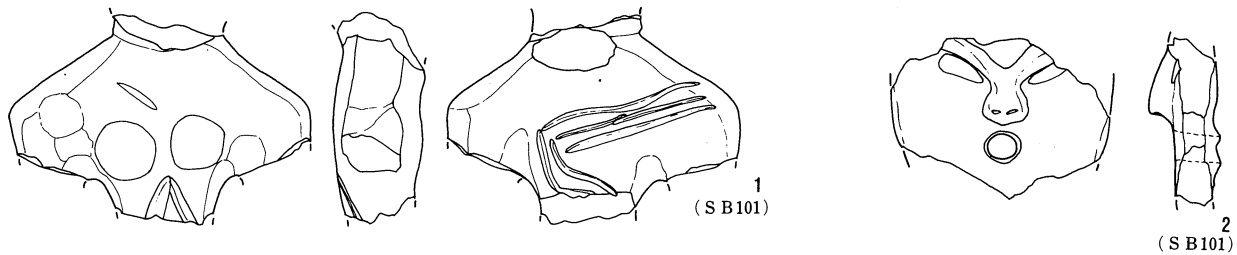

0 (1:2) 10cm

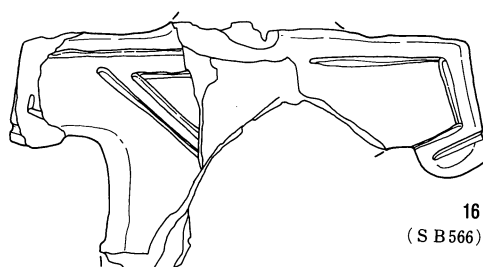
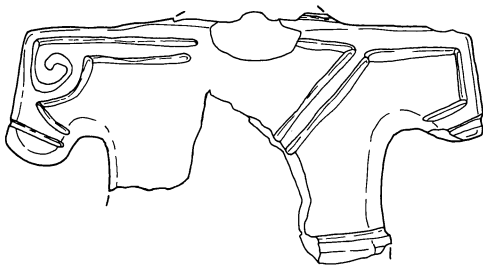
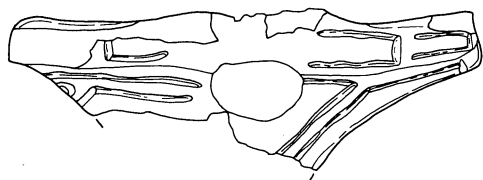

16
(S B 566)

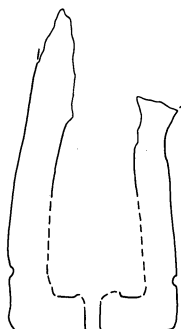
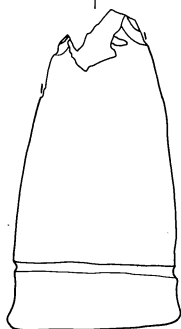
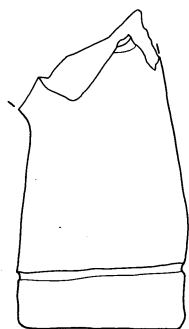

15
(S B 566)

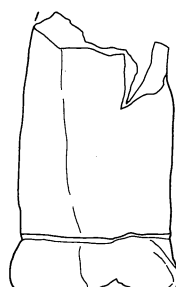

17
(S B 566)

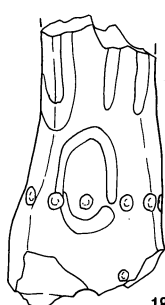
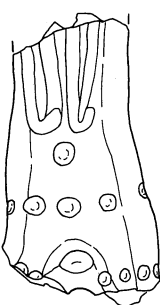
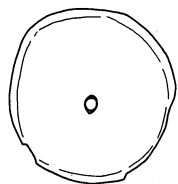

18
(S B 566)

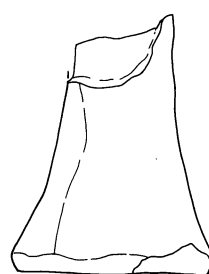
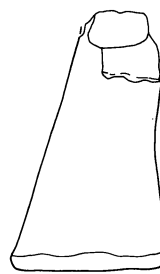

19
(S B 566)

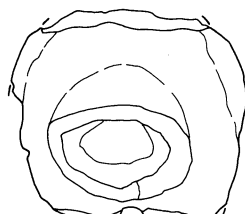
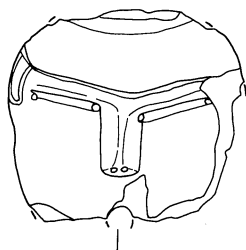

21
(S B 570)

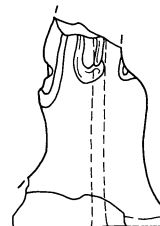
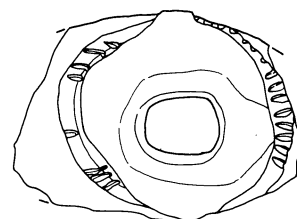

22
(S H 599)

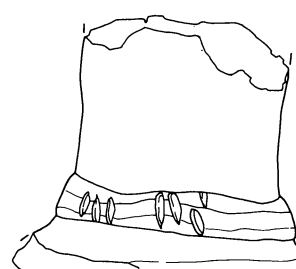
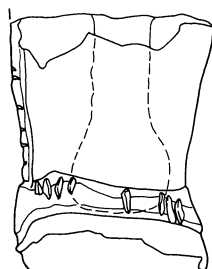
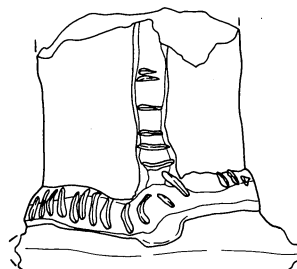

20
(S B 570)

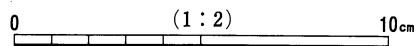

図版157 縄文遺物 土製品 3 (土偶 3)

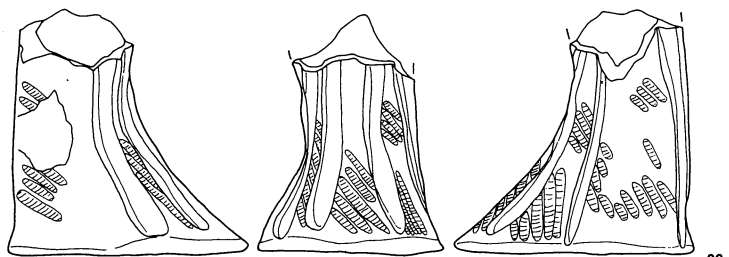

23
(S B599)

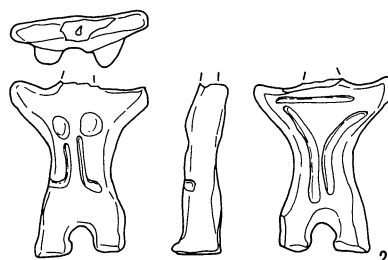

24
(S B599)

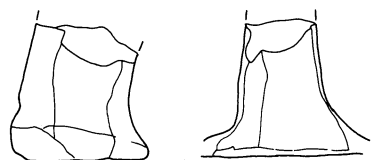

26
(S H555)

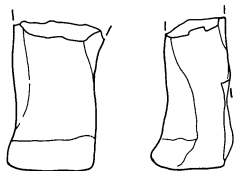

27
(S H787)

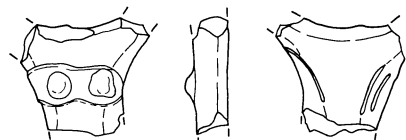

25
(S B599)

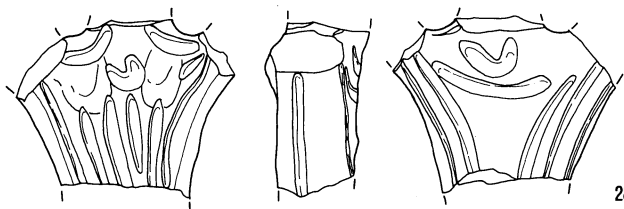

28
(S H797)



30
(S H819)



29
(S H808)

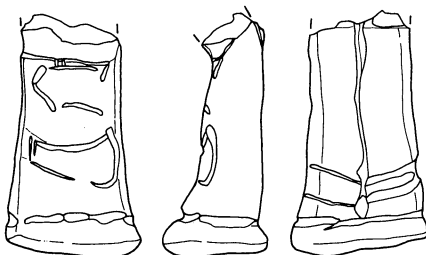
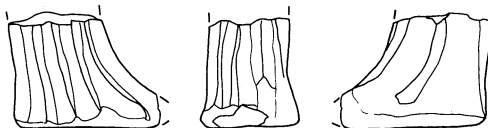

31
(S H974)

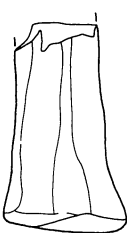

32
(S H1021)

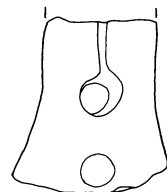

33
(S H1158)

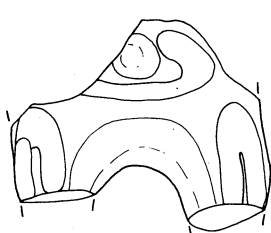

34
(S H1222)

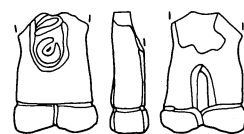
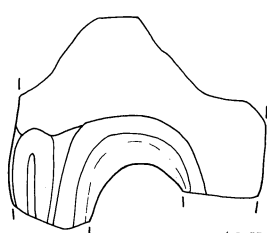

35
(S K2258)

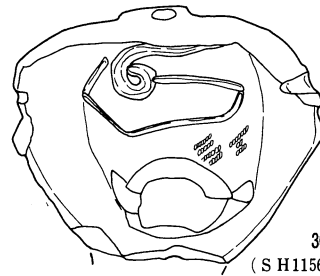
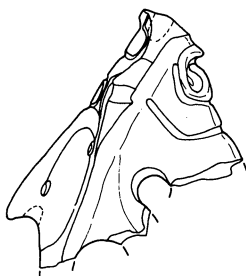
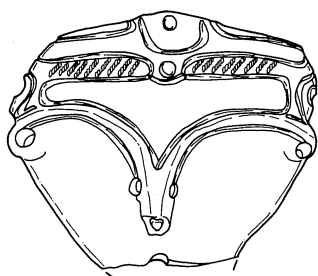

36
(S H1156)

0 (1:2) 10cm

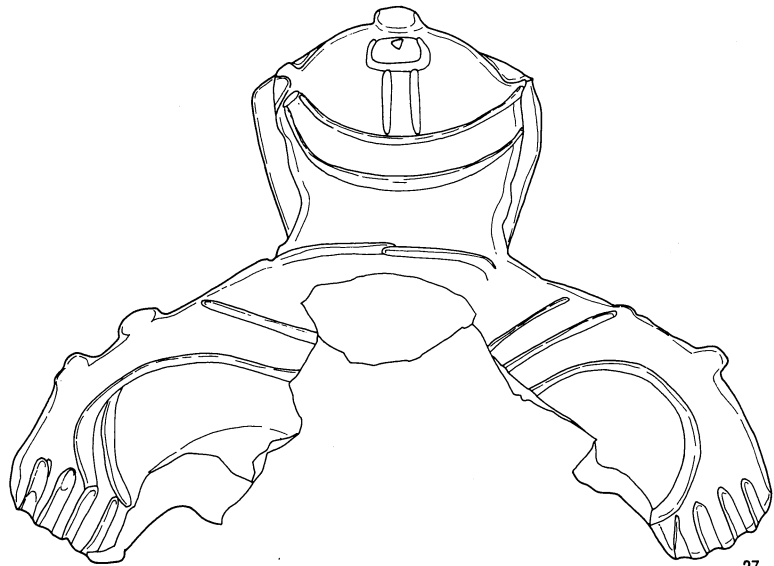
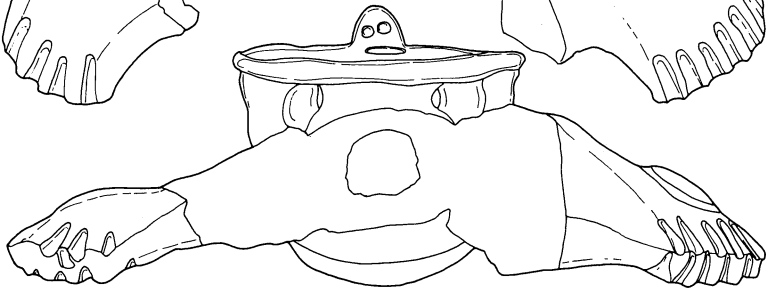
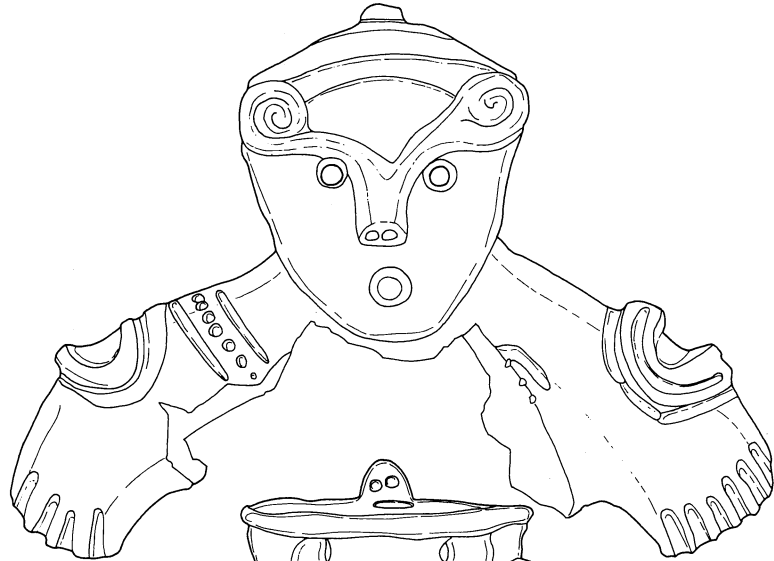
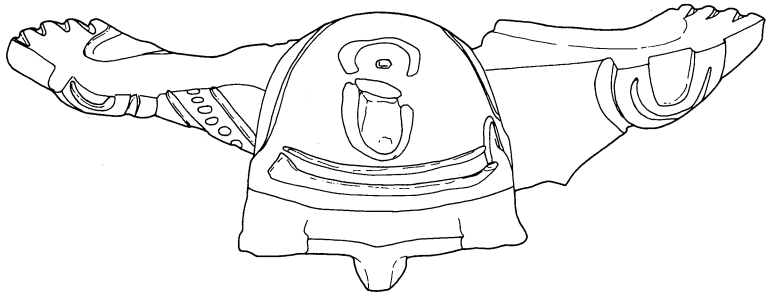

37
(S H17)

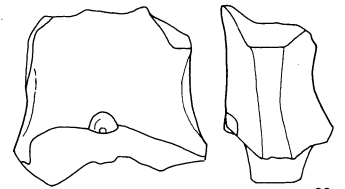
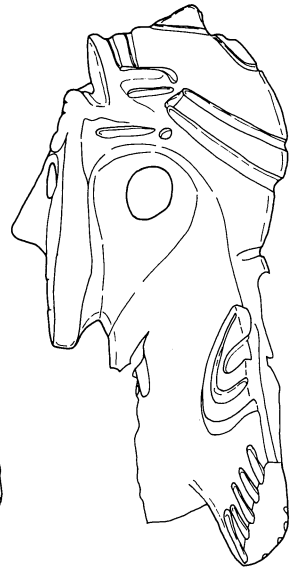

38
(S Q501)

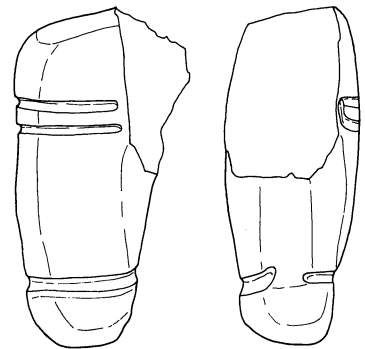

39

0 (1:2) 10 cm

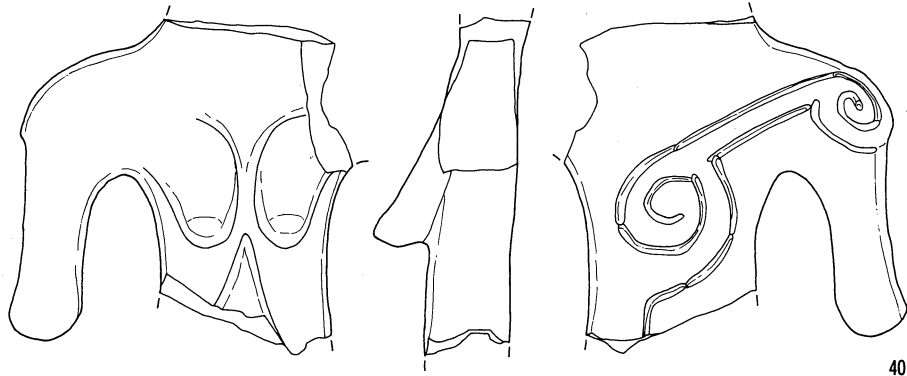

40

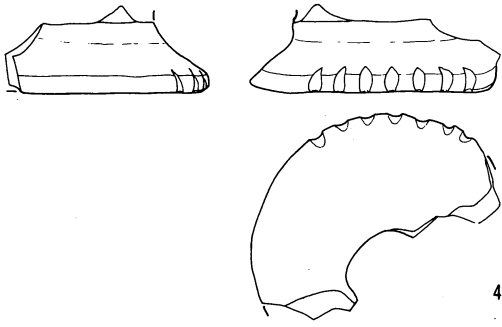

42

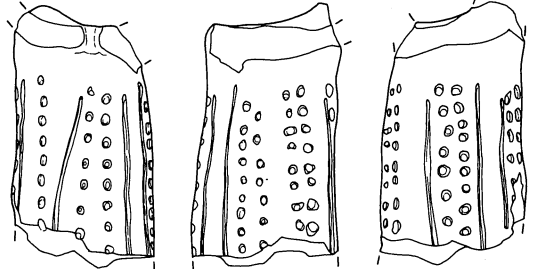

41

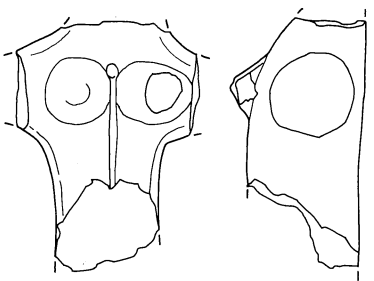
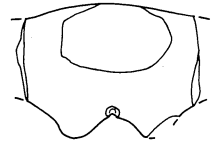

43

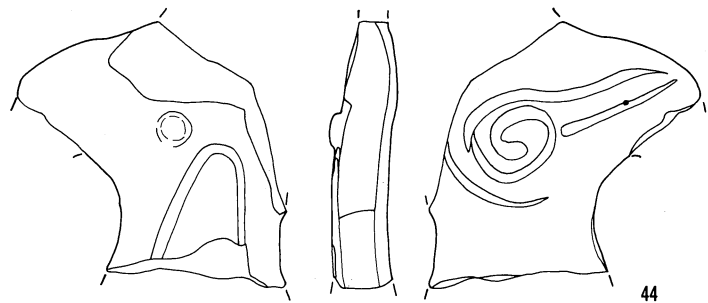

44

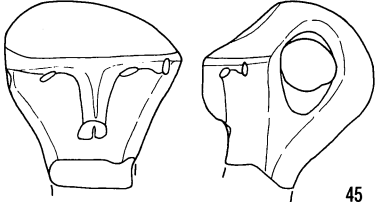

45

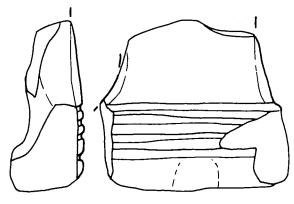

46

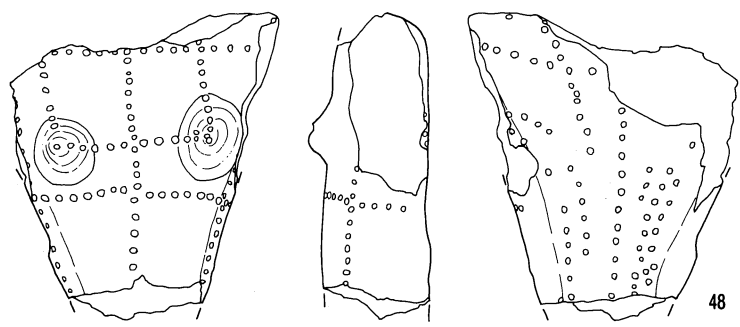

48

0 (1:2) 10cm

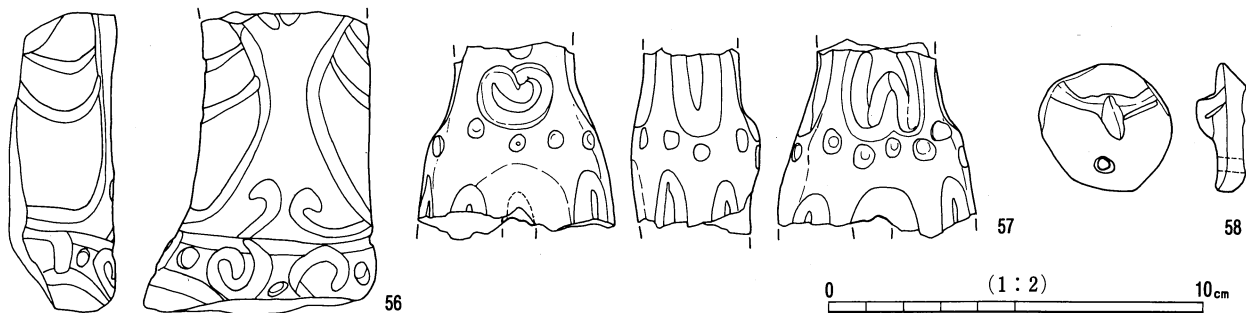
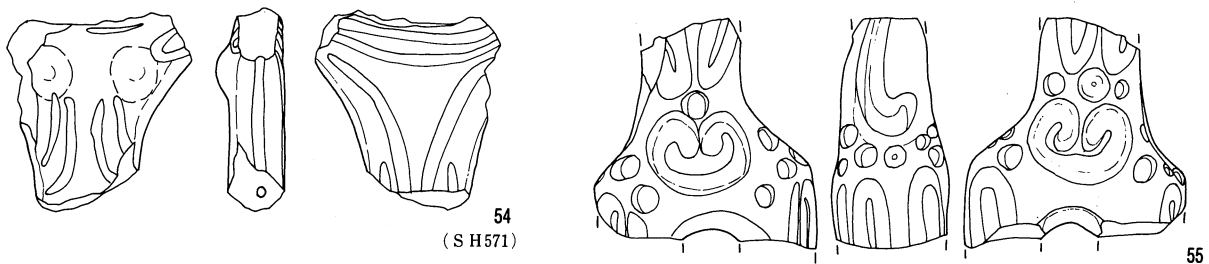
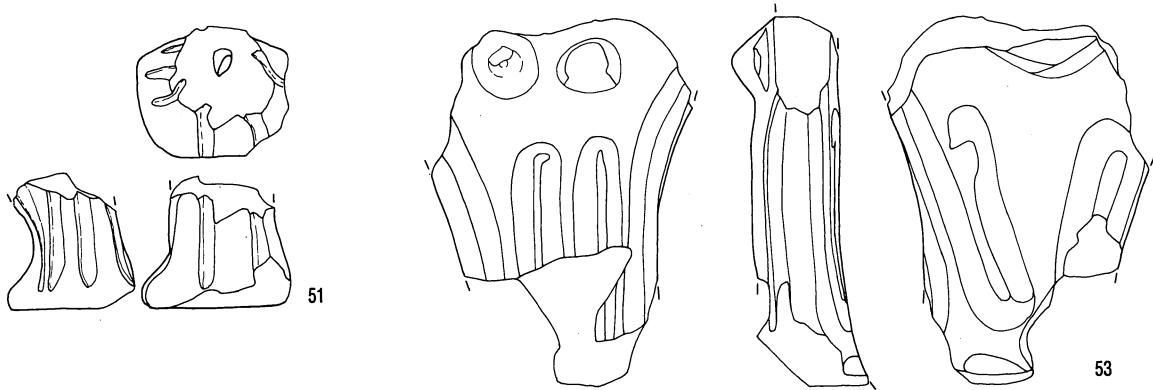
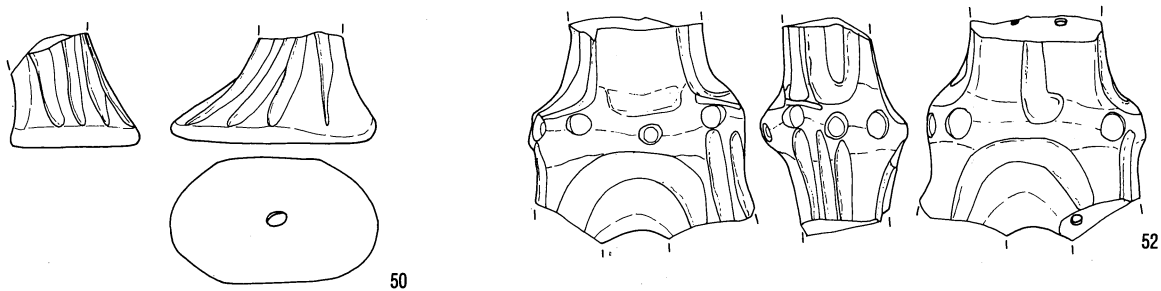
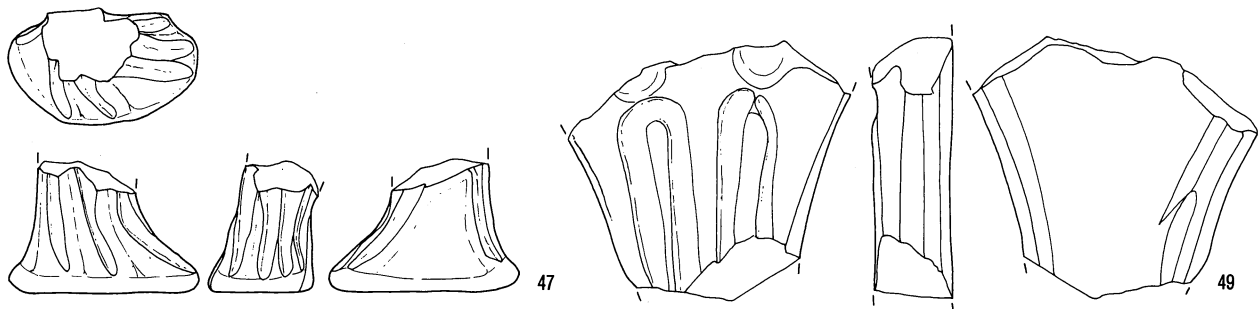

0 (1:2) 10cm

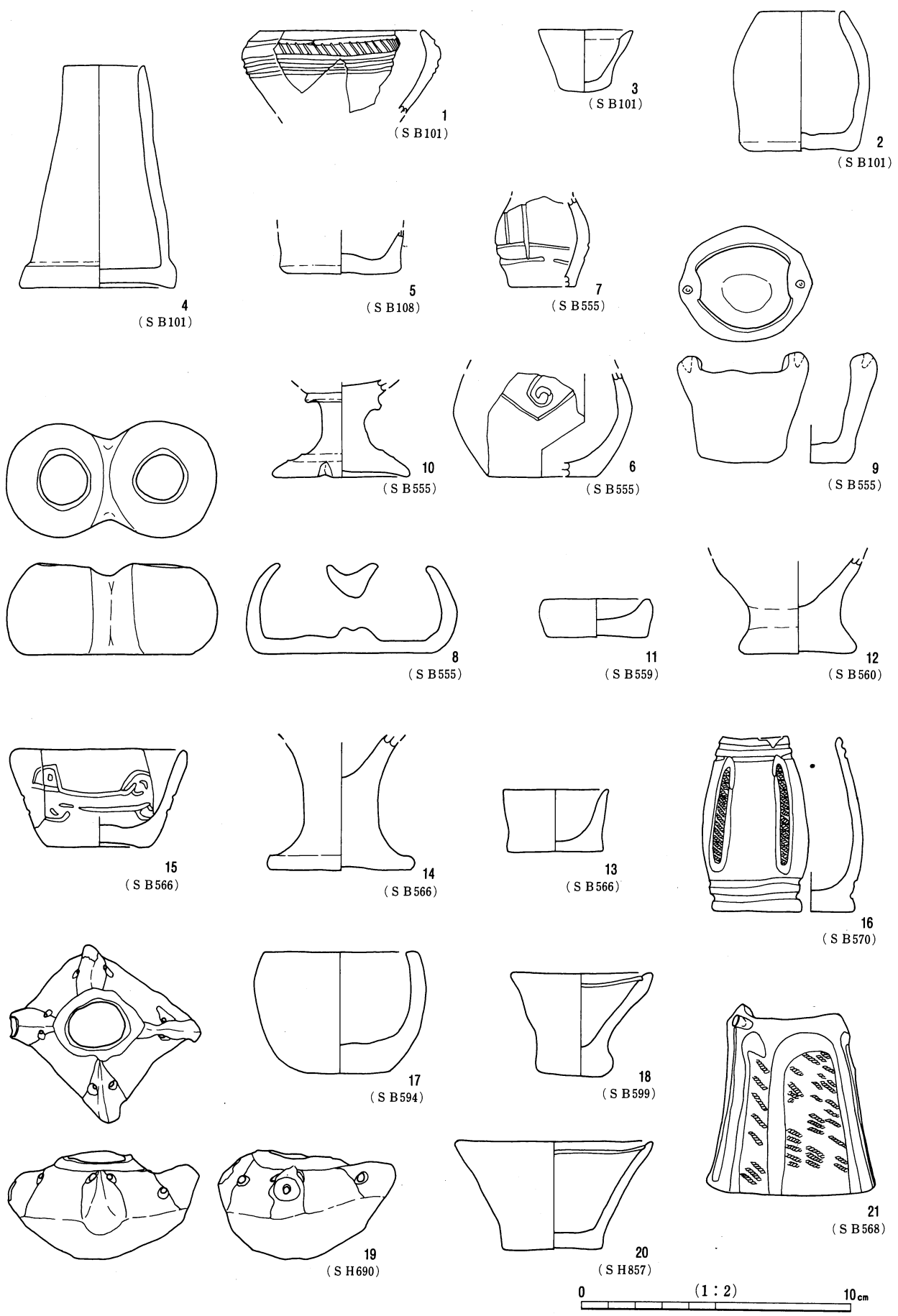

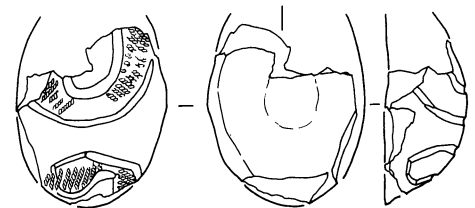
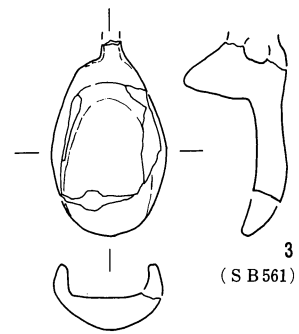
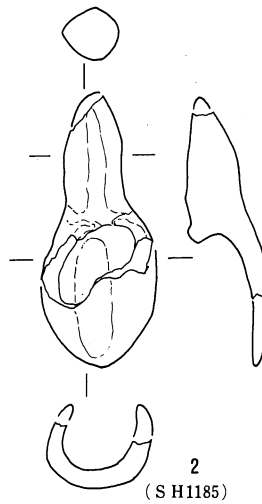
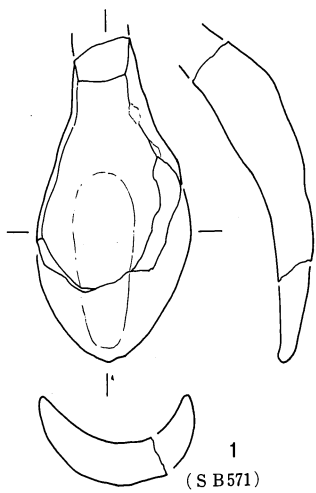
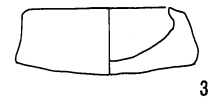
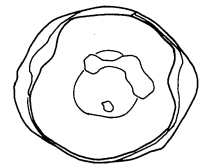
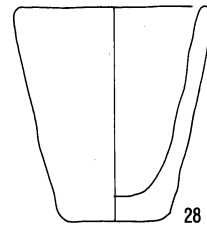
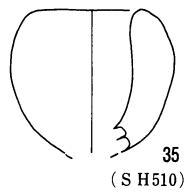
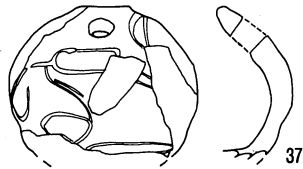
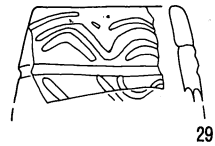
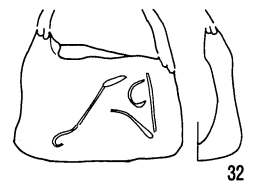
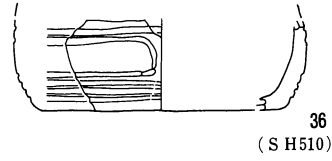
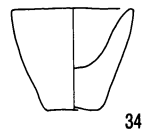
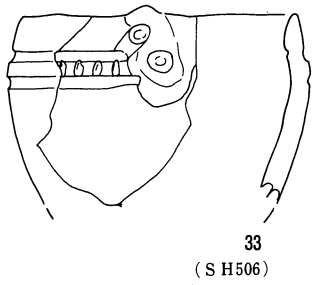
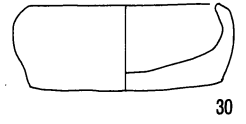
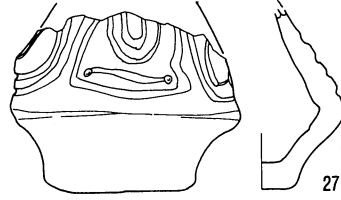
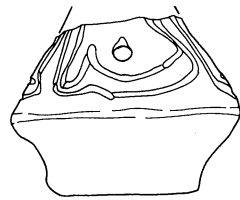
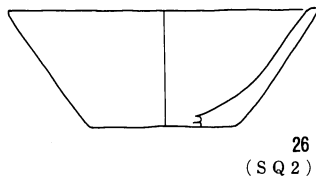
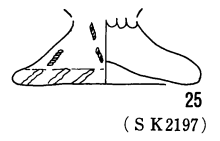
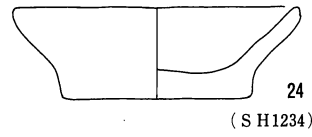
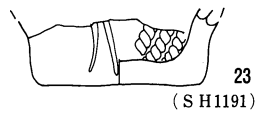
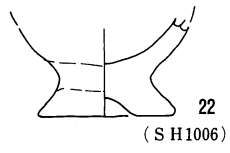

0 (1:2) 10 cm

図版163 縄文遺物 土製品 9 (土製蓋、きのこ状土製品、土鈴、土玉、その他)

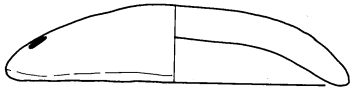
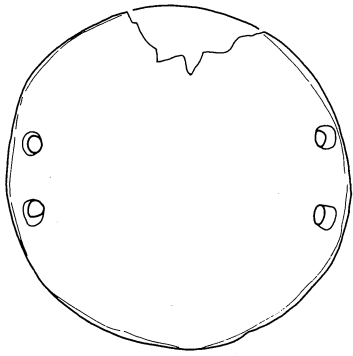

1
(S H864)

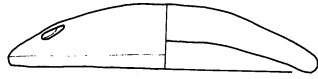
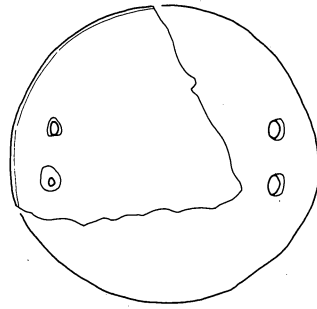

2

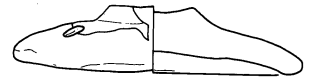
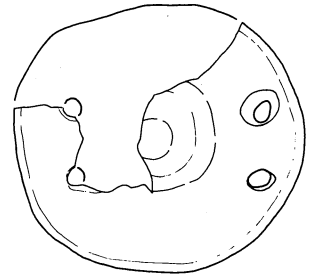

3

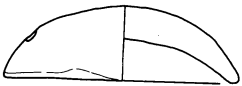
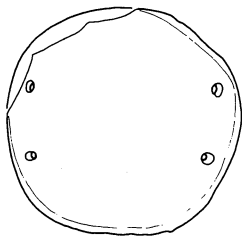

4

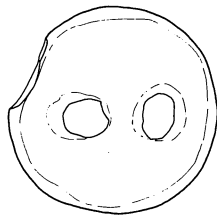

5

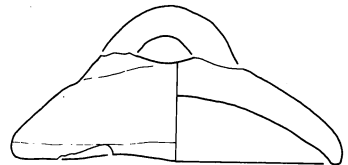
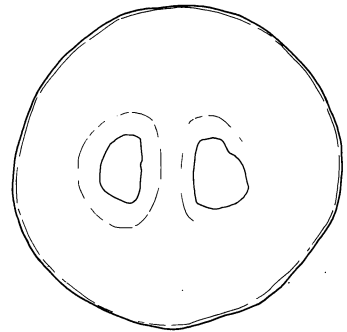

6
(S H1021)

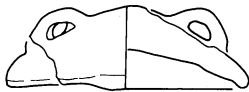
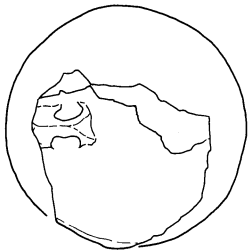

7
(S H1008)

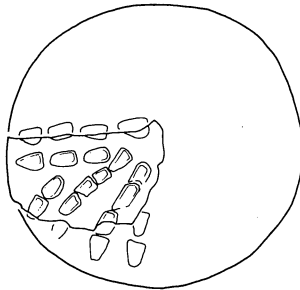

8
(S H1230)

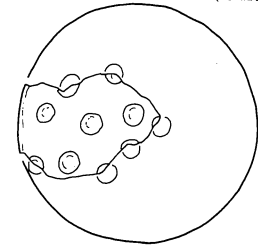

9
(S K3050)

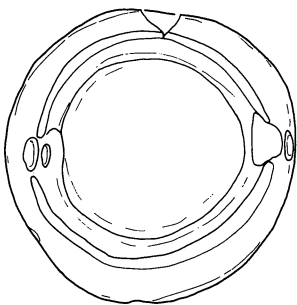
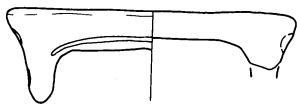

10

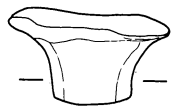

1
(S H646)

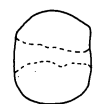
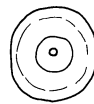

2
(S H522)

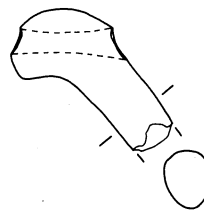

3



4

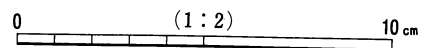

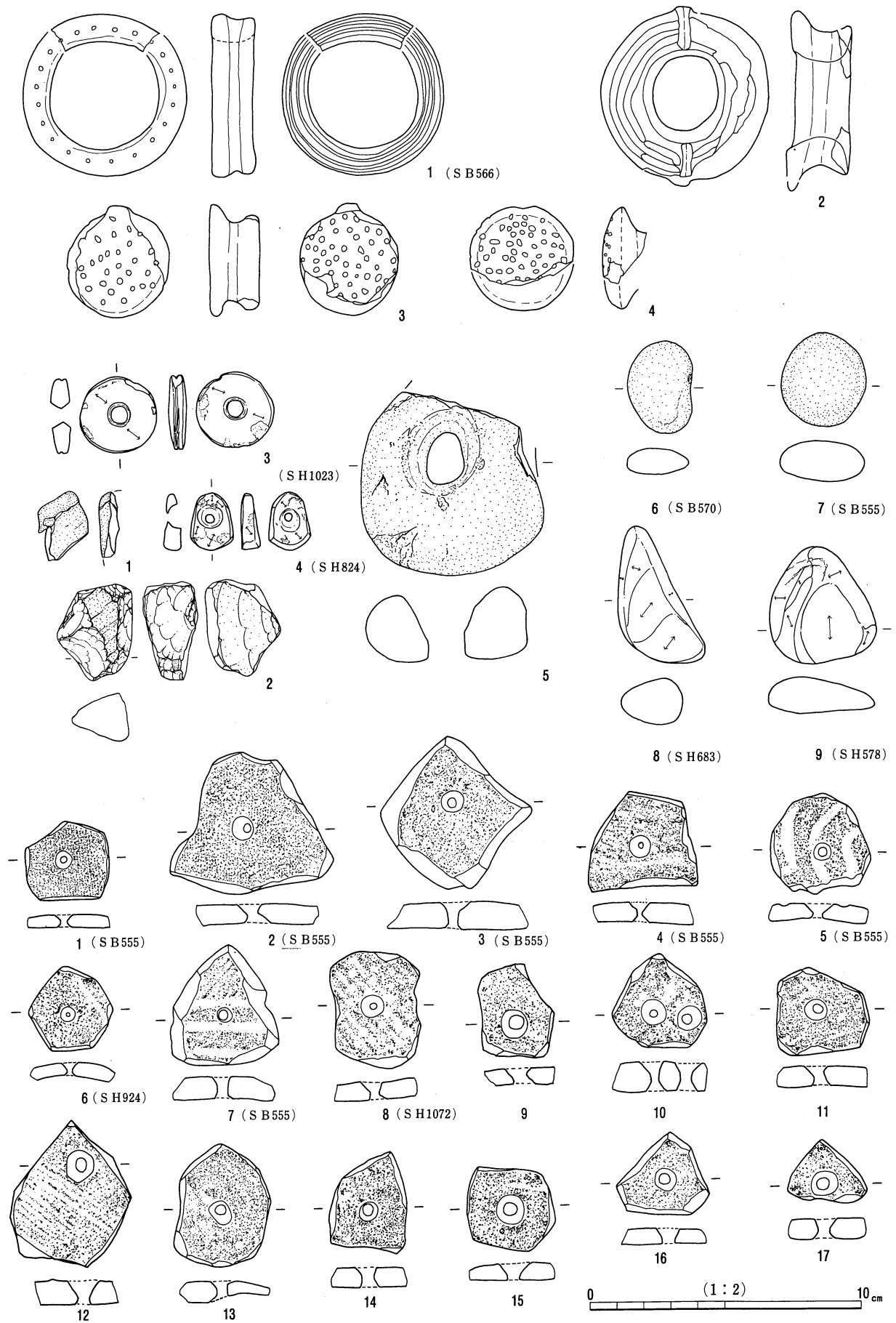

図版165 縄文遺物 土製品11 (土器片円板)

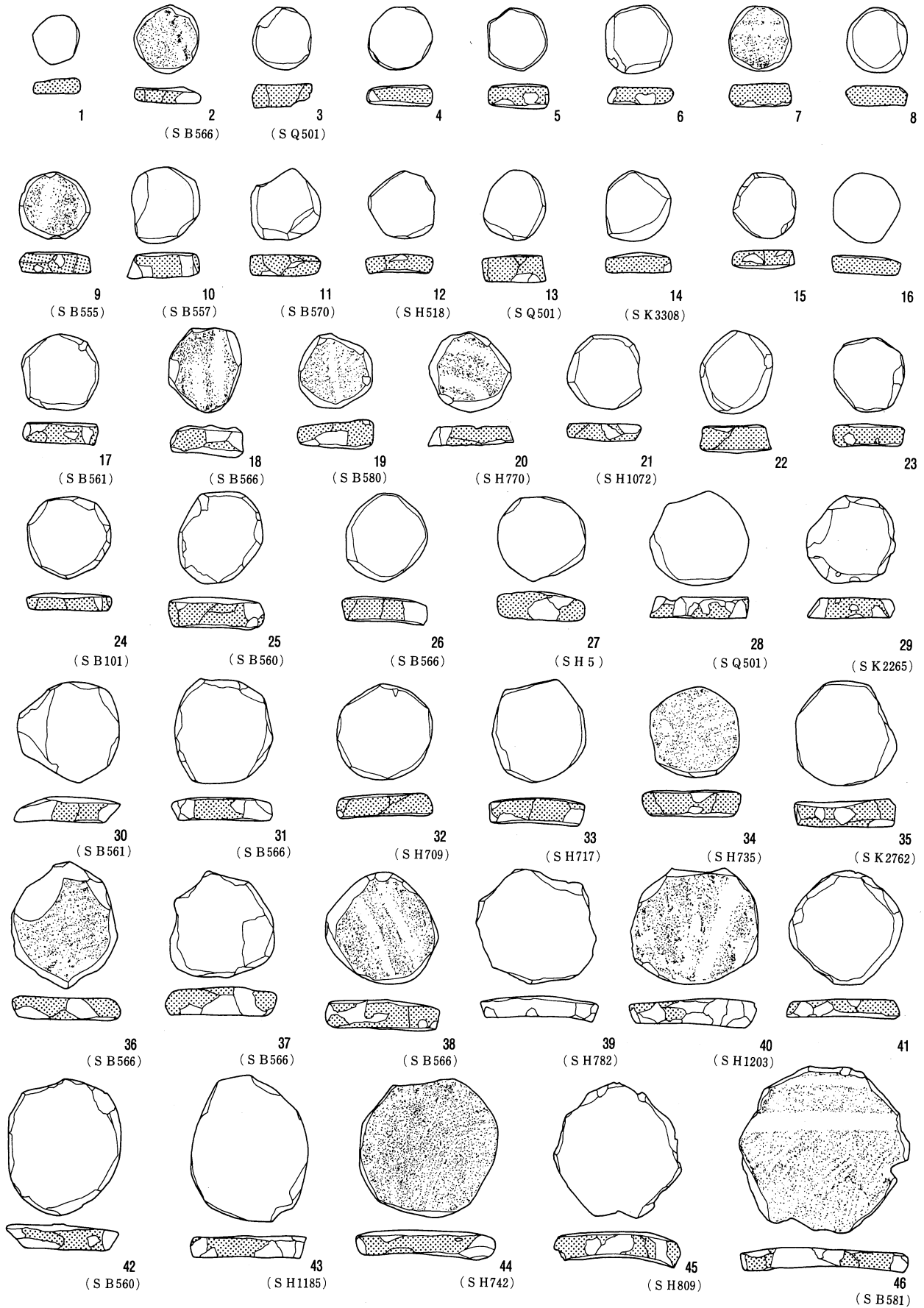

0 (1:2) 10 cm