

上信越自動車道
埋蔵文化財発掘調査報告書 5

—長野市内その3—

松 原 遺 跡

弥生・総論 5

弥生中期・石器図版

2 0 0 0

日 本 道 路 公 団
長 野 県 教 育 委 員 会
長 野 県 埋 蔵 文 化 財 セ ン タ ー

上信越自動車道
埋蔵文化財発掘調査報告書 5

—長野市内その3—

松 原 遺 跡

弥生・総論 5

弥生中期・石器図版

2000

日本道路公団
長野県教育委員会
長野県埋蔵文化財センター



狩猟具・戦闘具及び武器形石製品

— 打製石鏃・磨製石鏃・骨角鏃・磨製石劍・磨製石戈・石鏃状石製品・独鈷石 —



加工具ほか

— ノミ状石器・みがき石・環状石器・砥石ほか —



装飾品

— 勾玉・管玉・指輪状石製品・白玉状石製品・ペン先状石製品・牙製腕輪・竖櫛 —



伐採具及び加工具

— 大型蛤刃石斧・扁平片刃石斧 —



収獲具及び加工具

— 磨製石包丁・大形刃器 —

例 言

1. 本書は長野県長野市松代町東寺尾地籍に所在する松原遺跡の報告書である。
2. 本書は『上信越自動車道埋蔵文化財発掘調査報告書 5 長野市内その 3 松原一弥生・総論一』全 8 分冊中の第 5 分冊、「弥生時代中期の石製品その他」の図版編である。本編は、第一部「遺構別遺物図版」にて遺構内出土遺物（石製品・骨角牙製品・木製品）を遺構順に扱い、第二部「器種別図版」にて遺構外出土遺物を含めて掲載した。
3. 調査は上信越自動車道建設に伴う事前調査として実施し、日本道路公団より長野県教育委員会を通じた委託事業として、財団法人長野県埋蔵文化財センターおよび財団法人文化振興事業団長野県埋蔵文化財センターが実施した。
4. 調査及び整理にあたっては以下の関係機関のご協力を得た。
長野県教育委員会文化財保護課（現文化財生涯学習課）・日本道路公団名古屋建設局・日本道路公団東京第二建設局・長野市教育委員会・J A グリーン長野農協・京都大学霊長類研究所・東北大学理学部・株式会社シン技術コンサル・川崎テクノロジーサーチ株式会社・(株) 第四紀地質調査所・パリーノ・サーヴェイ株式会社・株式会社ズコーシャ・田中写真館
5. 発掘調査から本書の刊行に至るまで多くの方々のご指導、ご協力を得た。本文編第 1 章にお名前を掲載し、厚くお礼申し上げます。
6. なお整理作業にあたっては、担当の調査研究員のもと、以下の方々のご尽力を得ました。

石製品の実測・トレース

島田恵子・多羅沢美恵子・滝沢みゆき が中心となり、大田節子・児玉昌之・清水栄子・高橋美穂・原田美峰子・柳原智子・山崎明子の 7 名が協力した。なお石器実測については、夏季に 2 週間程度、門脇秀典・馬場伸一郎・及川 譲・平井義敏・土屋みづほの学生諸君の協力を得た。

木製品の実測・トレース

宇賀村節子・町田君子・八代聖子・横谷洋子・淀 敏代・高橋美穂

骨角製品の実測・トレース

島田恵子・原田美峰子・高橋美穂

写真全体

北島康子

7. 調査記録、出土遺物は報告書刊行の後、**長野県立歴史館**に移管し保管する。
8. 発掘調査、整理、刊行にかかる体制、委託事業、業務分担は本文編に示した。
9. 編集は町田勝則が行い、百瀬長秀が全体を校閲した。

凡 例

本書に掲載した遺物写真及び実測図の縮尺は、原則として下記のように統一し、枠外の余白に(○：○)のように記した。また第一部及び第二部に関する用語・記号等の詳細は、各部前頁の中扉うらに凡例として示した。

A写真図版

遺構別石製品……原則として2：3とする。ただし図版作成上の制約から、以下の器種については例外がある。

原石(磨製石斧関連)・台石・砥石・大形刃器 1：2もしくは1：3

石核・剥片類・打製石鏃・磨製石鏃・磨製石包丁・小形刃器・石錐・管玉・勾玉・加工痕のある石屑・指輪状石製品・紡錘車状石製品 1：1

器種別石製品……原石・石核・大形刃器の特殊 1：2

原石・石核・剥片A・打製石斧・磨石・凹石・敲石・角礫石・みがき石・玉石・大形刃器・磨製石包丁・磨製石斧・石槌・砥石・軽石製品 2：3

打製石鏃・磨製石鏃・小形刃器・磨製石斧(扁平片刃)・ノミ状石器・石錐・玉関係
・鉄剣形石剣・石刀状石製品・石鉞状石製品・管玉・勾玉・指輪状石製品・紡錘車状石製品・加工痕のある石屑・有樋式石戈・独鈷石・環状石器 1：1

骨角製品……すべて2：3

木製品……縦櫛 4：5 小型高杯 2：3

鎌状木製品・柄状木製品・鋏状木製品 1：4 臼・板材 1：8

加工材 1：6もしくは1：12 杭材 1：8もしくは1：10

B実測図版

石製品……原石・石槌・磨石・凹石・敲石・大形刃器(特殊)・台石・砥石・軽石製品 1：3

石核・剥片A・打製石鏃・磨製石鏃・石錐・ノミ状石器・石匙・有樋式石戈 2：3

打製石斧・みがき石・台石・大形刃器・磨製石包丁・鉄剣形石剣・磨製石斧・石槌・砥石・紡錘車状石製品・環状石器 1：2

砥石(手持) 1：2 (置砥) 1：4 玉関係 1：1

骨角製品……骨牙鏃・骨錐・角製品・牙製腕輪・加工骨 1：1

角製品 1：2 骨針? 2：3

木製品……縦櫛 1：2 小型高杯 1：3 鎌状木製品 1：5

柄状木製品 1：4 鋏状木製品 1：4もしくは1：6

臼 1：6 板材 1：8 加工材 1：8もしくは1：12

杭材 1：8もしくは1：12 縄 1：1

図 版 目 次

第 V 部 弥生時代中期・石製品その他

巻首図版

- 1 カラー図版……………狩猟具・戦闘具及び武器形石製品
- 2 カラー図版……………加工具ほか
- 3 カラー図版……………装飾品
- 4 カラー図版……………伐採具及び加工具
- 5 カラー図版……………収穫具及び加工具

例言・凡例

1、遺構別遺物写真・実測図版

凡 例

P L 1 ……………SB221, 231	P L 29 ……………SB320
P L 2 ……………SB246	<u>P L 30</u> ……………SB319, 320
P L 3 ……………SB246	<u>P L 31</u> ……………SB320, 329
<u>P L 4</u> ……………SB246	P L 32 ……………SB328
P L 5 ……………SB260, 261, 263	P L 33 ……………SB328
P L 6 ……………SB262	<u>P L 34</u> ……………SB328
P L 7 ……………SB264	P L 35 ……………SB329
P L 8 ……………SB265	P L 36 ……………SB329
<u>P L 9</u> ……………SB260, 264, 265	P L 37 ……………SB352
P L 10 ……………SB267, 268, 269, 271, 272	<u>P L 38</u> ……………SB352
P L 11 ……………SB273	P L 39 ……………SB354, 359
<u>P L 12</u> ……………SB267, 273	P L 40 ……………SB358
P L 13 ……………SB274, 275	P L 41 ……………SB360, 361, 362
P L 14 ……………SB277, 280, 281	P L 42 ……………SB363, 364, 368
P L 15 ……………SB283, 284, 285	P L 43 ……………SB369
P L 16 ……………SB286	P L 44 ……………SB384, 389, 390, 391, 399, 400
P L 17 ……………SB287	P L 45 ……………SB401
P L 18 ……………SB287	<u>P L 46</u> ……………SB401
<u>P L 19</u> ……………SB287	P L 47 ……………SB402
<u>P L 20</u> ……………SB287	P L 48 ……………SB402
P L 21 ……………SB290	<u>P L 49</u> ……………SB402
P L 22 ……………SB300, 303, 306	P L 50 ……………SB404, 406, 407
<u>P L 23</u> ……………SB290, 300	P L 51 ……………SB405
P L 24 ……………SB307	P L 52 ……………SB409
<u>P L 25</u> ……………SB307, 309	P L 53 ……………SB409
P L 26 ……………SB308, 309, 310	<u>P L 54</u> ……………SB409
P L 27 ……………SB311, 315, 316	P L 55 ……………SB410, 411, 413, 414, 415
P L 28 ……………SB317, 319, 320	P L 56 ……………SB422, 423

P L 57	SB425	P L 97	SB1276, 1277
P L 58	SB426	P L 98	SB1279
P L 59	SB1102	P L 99	SB1280, 1281, 1282, 1283
P L 60	SB1102	<u>P L 100</u>	SB1264, 1282
<u>P L 61</u>	SB1102	P L 101	SB1284
P L 62	SB1103	P L 102	SB1284
<u>P L 63</u>	SB1103, 1104	P L 103	SB1284
P L 64	SB1104, 1106	<u>P L 104</u>	SB1284
<u>P L 65</u>	SB1106	<u>P L 105</u>	SB1284
P L 66	SB1108	P L 106	SB1285, 1286
P L 67	SB1110, 1112	P L 107	SB1290, 1292, 1294
P L 68	SB1112	P L 108	SB1294
P L 69	SB1113	<u>P L 109</u>	SB1290, 1294
P L 70	SB1123, 1124	P L 110	SB1297, 1298, 1302, 1304
P L 71	SB1124	P L 111	SB1306, 1307, 1308, 1311
<u>P L 72</u>	SB1124, 1128	P L 112	SBH58, 289, 373·ST2005 ·SM103
P L 73	SB1125, 1126	<u>P L 113</u>	SBH58, 289, 373·SM103
P L 74	SB1128, 1130, 1132, 1133, 1136	P L 114	SK131, 148, 150, 151, 156, 158 SK159, 169
P L 75	SB1134, 1138	P L 115	SK156
P L 76	SB1138	P L 116	SK160, 163, 164, 173, 191, 192
P L 77	SB1141, 1142	P L 117	SK213, 236, 325, 352, 353 SK1336, 1381, 1396, 1695, 1718
P L 78	SB1143, 1144	<u>P L 118</u>	SK151, 164, 352, 1336 SK1381, 1695
<u>P L 79</u>	SB1134, 1136	P L 119	SK1738
<u>P L 80</u>	SB1141, 1142, 1143	<u>P L 120</u>	SK1738
<u>P L 81</u>	SB1144	P L 121	SD12
P L 82	SB1145, 1146, 1147, 1153	P L 122	SD12
P L 83	SB1155, 1156, 1157, 1159, 1160	P L 123	SD12
P L 84	SB1161, 1162, 1163	P L 124	SD12
<u>P L 85</u>	SB1161, 1162, 1168, 1172	P L 125	SD12
P L 86	SB1168, 1172, 1174, 1175	P L 126	SD12
P L 87	SB1176, 1177, 1181	P L 127	SD12
<u>P L 88</u>	SB1174, 1175, 1181	P L 128	SD12
P L 89	SB1183, 1186, 1192, 1248	P L 129	SD12
<u>P L 90</u>	SB1248	P L 130	SD12
P L 91	SB1247, 1250, 1255	<u>P L 131</u>	SD12
P L 92	SB1253, 1256, 1257, 1258	<u>P L 132</u>	SD12
P L 93	SB1259, 1260, 1261		
P L 94	SB1262, 1263		
<u>P L 95</u>	SB1258, 1263		
P L 96	SB1264		

<u>P L 133</u>	SD12
<u>P L 134</u>	SD12
<u>P L 135</u>	SD12
<u>P L 136</u>	SD18
<u>P L 137</u>	SD26, 29, 30, 62, 67, 68
<u>P L 138</u>	SD100
<u>P L 139</u>	SD100
<u>P L 140</u>	SD100
<u>P L 141</u>	SD100
<u>P L 142</u>	SD100
<u>P L 143</u>	SD100
<u>P L 144</u>	SD100
<u>P L 145</u>	SD100
<u>P L 146</u>	SD100
<u>P L 147</u>	SD100
<u>P L 148</u>	SD100
<u>P L 149</u>	SD100
<u>P L 150</u>	SD100
<u>P L 151</u>	SD100
<u>P L 152</u>	SD100
<u>P L 153</u>	SD100
<u>P L 154</u>	SD100
<u>P L 155</u>	SD100
<u>P L 156</u>	SD100

<u>P L 157</u>	SD100
<u>P L 158</u>	SD100
<u>P L 159</u>	SD100
<u>P L 160</u>	SD100
<u>P L 161</u>	SD100
<u>P L 162</u>	SD101
<u>P L 163</u>	SD101
<u>P L 164</u>	SD101
<u>P L 165</u>	SD101
<u>P L 166</u>	SD101
<u>P L 167</u>	SD101
<u>P L 168</u>	SD101
<u>P L 169</u>	SD101
<u>P L 170</u>	SD102
<u>P L 171</u>	SD102
<u>P L 172</u>	SD102
<u>P L 173</u>	SD102
<u>P L 174</u>	SD102
<u>P L 175</u>	SD102
<u>P L 176</u>	SD102
<u>P L 177</u>	SD1027
<u>P L 178</u>	SD1027, 1083
<u>P L 179</u>	SD1083

2、器種別遺物写真図版

凡 例

<u>P L 180</u>	大形原石・石核 1
<u>P L 181</u>	大形原石・石核 2
<u>P L 182</u>	小形原石・石核 1
<u>P L 183</u>	小形原石・石核 2
<u>P L 184</u>	大形剝片 A類・小形剝片 A類
<u>P L 185</u>	大形剝片 1
<u>P L 186</u>	大形剝片 2
<u>P L 187</u>	大形剝片 3
<u>P L 188</u>	大形剝片 4・小形剝片
<u>P L 189</u>	打製石鏃 1
<u>P L 190</u>	打製石鏃 2
<u>P L 191</u>	磨製石鏃 1
<u>P L 192</u>	磨製石鏃 2

<u>P L 193</u>	磨製石鏃 3・鉄剣形石剣
<u>P L 194</u>	石刀状石製品・石鏃状石製品
<u>P L 195</u>	有樋式石戈
<u>P L 196</u>	独古石・環状石器
<u>P L 197</u>	打製石斧 1
<u>P L 198</u>	打製石斧 2
<u>P L 199</u>	磨 石
<u>P L 200</u>	凹 石
<u>P L 201</u>	敲石 1
<u>P L 202</u>	敲石 2
<u>P L 203</u>	敲石 3
<u>P L 204</u>	敲石 4
<u>P L 205</u>	敲石 5・角礫石

P L 206みがき石・玉石	P L 237大型蛤刃石斧 6
P L 207大形刃器 1	P L 238扁平片刃石斧 1
P L 208大形刃器 2	P L 239扁平片刃石斧 2
P L 209大形刃器 3	P L 240扁平片刃石斧 3
P L 210大形刃器 4	P L 241扁平片刃石斧 4
P L 211大形刃器 5	P L 242扁平片刃石斧 5
P L 212大形刃器 6	P L 243扁平片刃石斧 6
P L 213大形刃器 7	P L 244扁平片刃石斧 7
P L 214大形刃器 8	P L 245扁平片刃石斧 8
P L 215大形刃器 9	P L 246石 槌 1
P L 216大形刃器 10	P L 247石 槌 2
P L 217大形刃器 11	P L 248石 槌 3
P L 218大形刃器 12	P L 249石 槌 4
P L 219大形刃器 13	P L 250石 槌 5
P L 220大形刃器 14	P L 251打製石錐
P L 221大形刃器 15	P L 252砥 石 1
P L 222大形刃器 16	P L 253砥 石 2
P L 223大形刃器 17	P L 254砥 石 3
P L 224大形刃器 18	P L 255砥 石 4
P L 225大形刃器 19	P L 256軽石製品 1
P L 226大形刃器 20	P L 257軽石製品 2
P L 227磨製石包丁 1	P L 258玉関係 1
P L 228磨製石包丁 2	P L 259玉関係 2
P L 229磨製石包丁 3	P L 260玉関係 3
P L 230磨製石包丁 4	P L 261玉関係 4
P L 231小形刃器	P L 262加工痕のある石屑
P L 232大型蛤刃石斧 1	P L 263骨角牙製品
P L 233大型蛤刃石斧 2	P L 264木製品 1
P L 234大型蛤刃石斧 3	P L 265木製品 2
P L 235大型蛤刃石斧 4	P L 266木製品 3
P L 236大型蛤刃石斧 5	P L 267木製品 4

3、報告書抄録

遺構別遺物写真図版 及び 実測図版

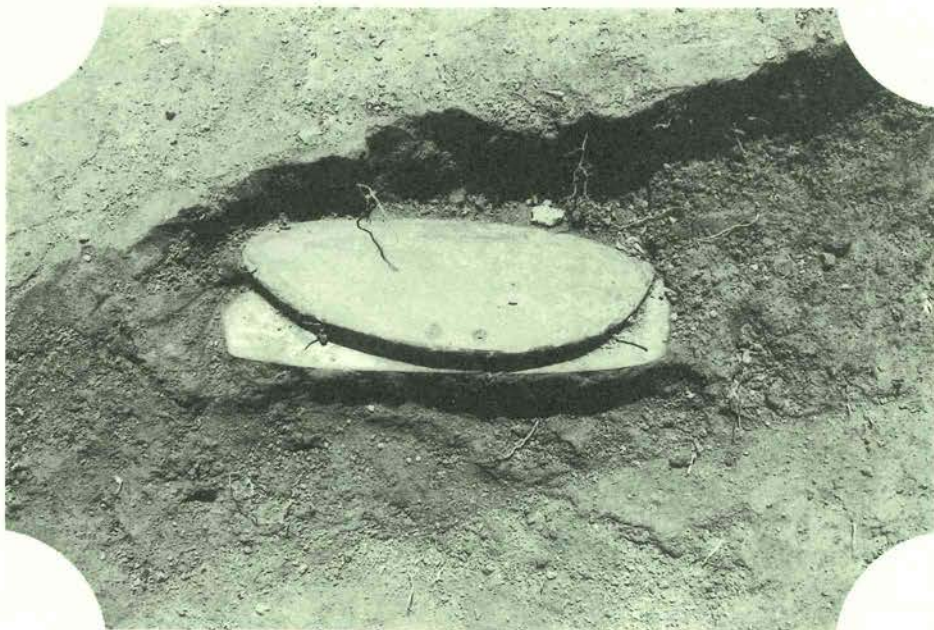

SB1248 出土の磨製石包丁 2点

凡 例

図版はすべて遺構番号の低いものから作成し、竪穴式住居址(SB)・平地式住居址(SBH)・土坑址(SK)・土壙址(SM)、溝址(SD)の順とした。遺構内出土遺物は、特定器種に片寄ることなく、各器種均等に呈示するよう心掛けた。なお遺構ごとの器種別出土数量の詳細は、本文編第2章に記載した。また遺物実測図は、遺構ごとに第II部遺構編で注目された遺構内出土遺物を中心に作成し、それぞれの遺物写真図版の後ろに掲載した。

(1) 番号

遺物はすべて本文編第2章第1表にて記載した器種別項目の順にそって並べ、その番号は遺構ごと、アラビア数字で付した。ただし幾つかの遺構が1頁の図版内で完了している場合や、ひとつの遺構が数頁の図版にまたがる場合には、遺物番号は連番とし、同一器種内では打製→磨製、大形→小形、製品→未製品(未成品≠失敗品)の順とすることを原則とした。実測図版内のPL番号はすべて写真図版内の番号に準拠して付し、それのないものは写真図版がないことを意味するようにした。またPL番号前の記号は△が使用痕写真撮影を、♡が化学分析資料であることを示すようにした。

(2) 名称

写真及び実測図版の枠外には、遺物番号・器種分類名(大別・細別)を付した。細別分類中、不明は欠損により全体形状が不明な分類不能な資料の意味である。

(3) 記号

図版中、遺物右上の再生とは再加工のあることを示し、転用とは別器種に再利用したことを示している。また遺物番号右の“床”とは床面直上の遺物であることを示し、○付き文字は第II部遺構編所収の遺物取り上げ番号と一致し、番号下線は実測図の作成された資料であることを意味している。なお図版中に使用した記号の詳細は、下記のように統一した。

写真図版

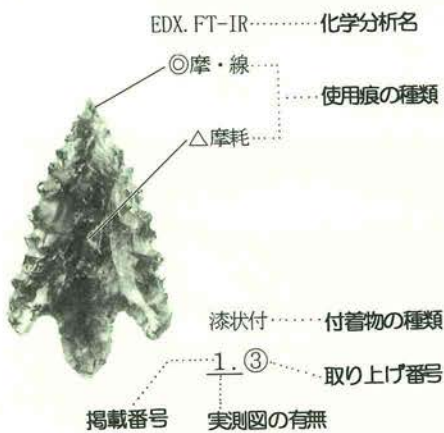

実測図版

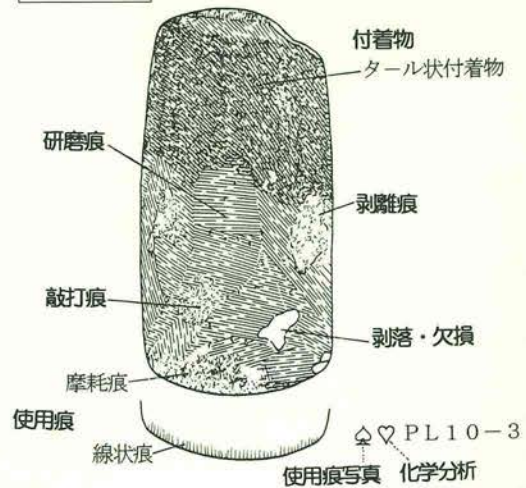

分析の種類

XRF=蛍光X線分析
EDX=器表面元素分析
Hyd=黒曜石水和層分析
FT-IR=赤外線分光分析
Fat=脂肪酸分析

使用痕の種類と強度

潰れ
微細剥離痕
摩耗痕 ◎強い
線状痕 ○中位
光沢痕 △弱い

付着物の種類と記号

赤色粉状
タール状
漆状・白色・油脂状
煤状

石器写真

SB221

- 1 大形剥片 2種
- 2 大形剥片 2種
- 3 敲石ア・オ類
- 4 敲石ア・エ類
- 5 太型蛤刃石斧
失敗品D類
- 6 太型蛤刃石斧
Ic'類
- 7 砥石 IIa類
- 8 砥石 IIa類
- 9 砥石 置砥
(2:3)

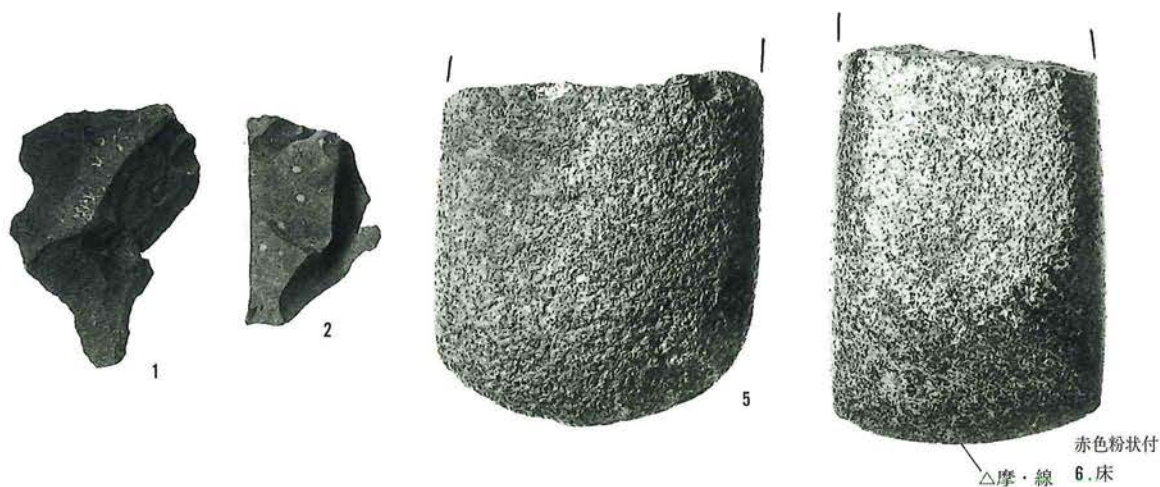

SB231

- 10 磨製石鏃
失敗品1類
- 11 磨製石鏃 不明
(1:1)
- 12 大形刃器 1a類
(2:3)

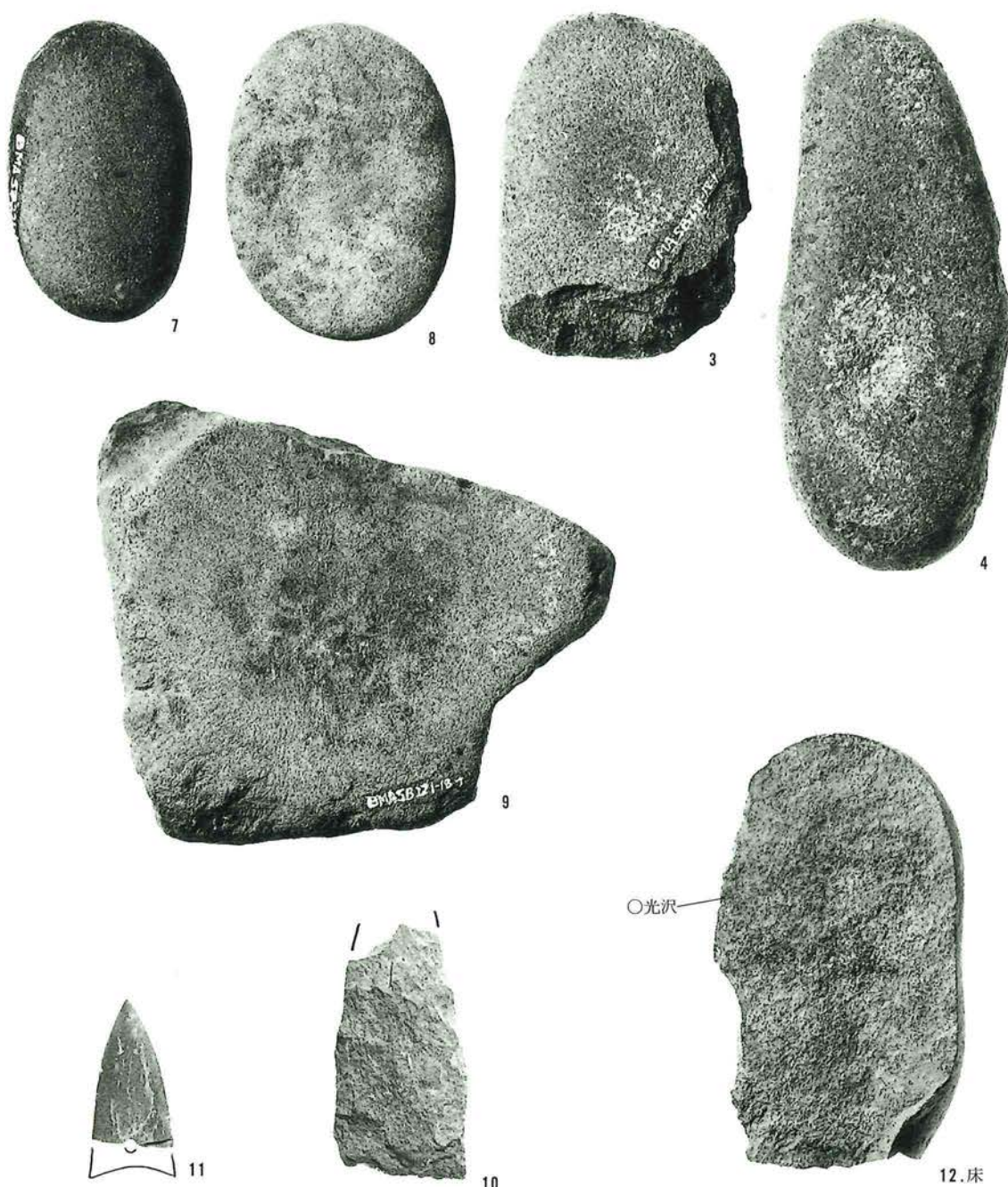

石器写真

SB246

- 1 大形剥片 2種
- 2 打製石鏃
失敗品 2類
- 3 磨製石鏃
失敗品 1類
- 4 磨製石鏃
失敗品 2 A類
- 5 磨製石鏃 IB₁類
- 6 磨製石鏃 不明
(1:1)
- 7 台石 2種 A₂類
(1:3)
- 9 大形刃器 3類
- 10 大形刃器 2 a類
(2:3)
- 11 小形刃器 2 c類
- 12 小形刃器 6 a類
(1:1)
- 13 扁平片刃石斧 c類?
- 14 石槌 蛤刃転用
- 15 砥石 IIa類
- 16 砥石 IIb類
- 17 軽石製品
(2:3)

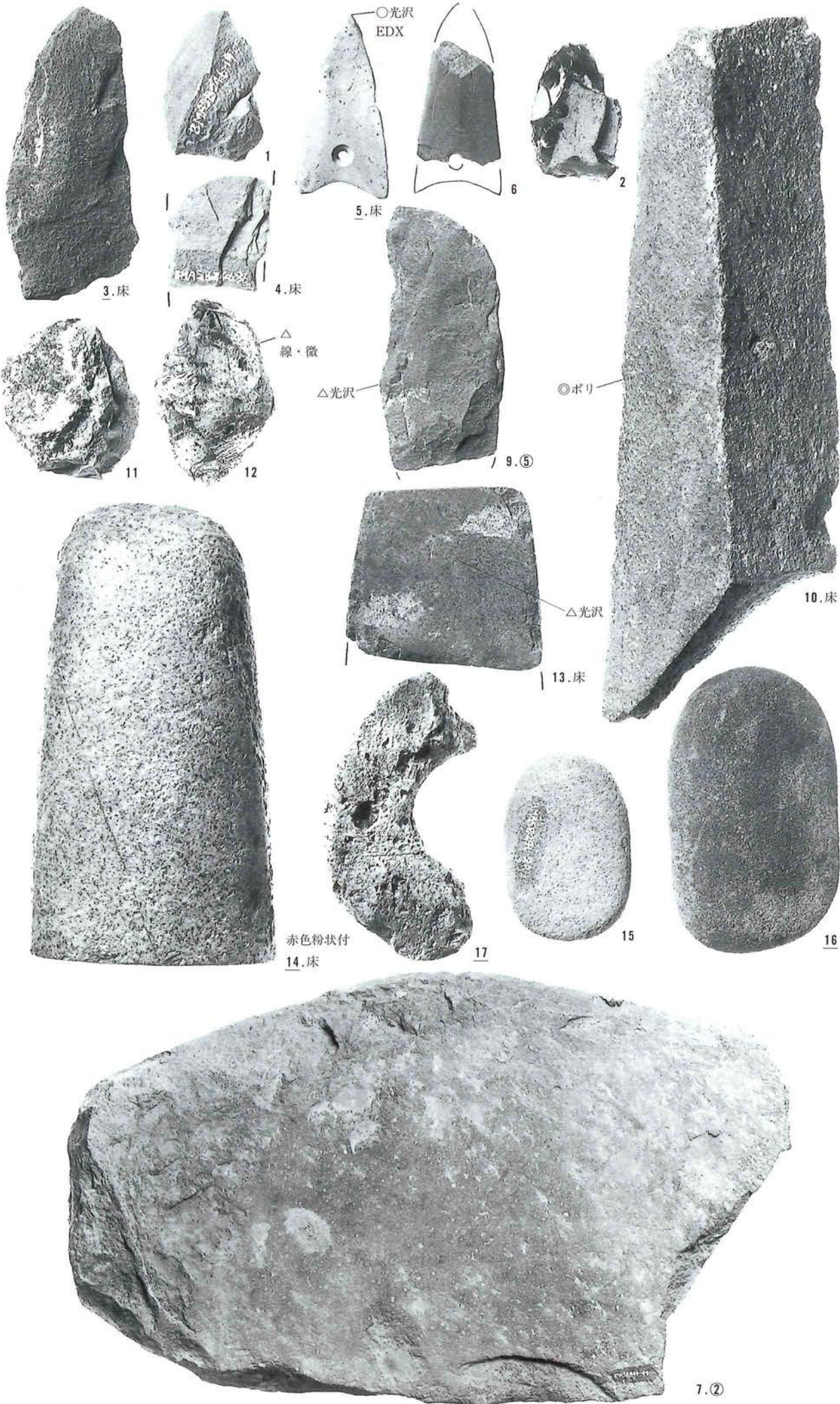

石器写真

SB246

8 台石2種A₂類

(1:2)





遺物出土状況写真

台石No. 8の取り上げ状況

台石No. 8の出土状況

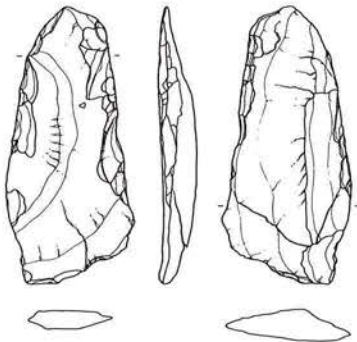

PL2-3

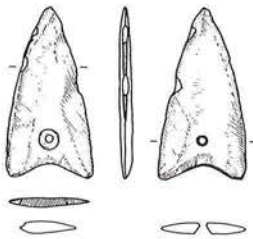

PL2-5



石槌No.14と台石No.8のセット想定写真

石器実測図

SB246

PL 2-3

PL 2-5

(2:3)

PL 2-14

PL 2-16

PL 2-17

(1:3)

PL 3-8

(1:4)

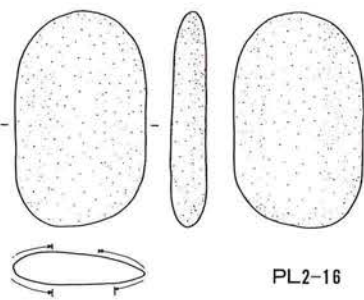

PL2-16

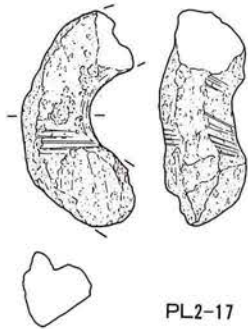

PL2-17

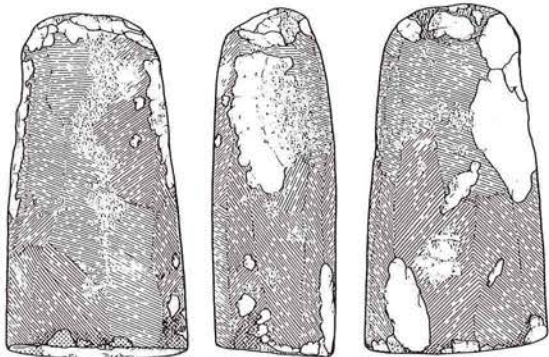

PL2-14

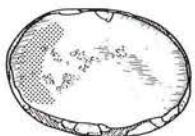

♡ PL3-8



石器写真

SB260

- 1 打製石鏃 IB₁類
 - 2 打製石鏃 IIB₃類?
 - 3 打製石鏃 IIB₃類
 - 4 打製石鏃 IIC₁類
- (1:1)

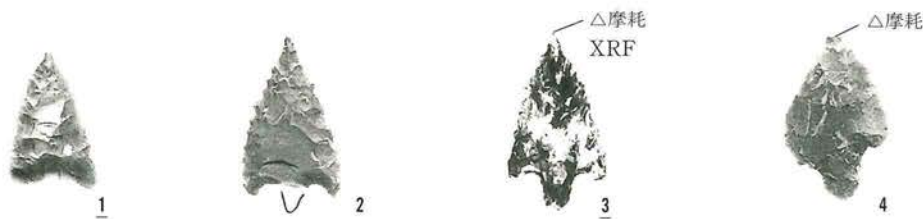

- 5 扁平片刃石斧 IIb₂類



SB261

- 6 小形石核 II2B 類
- 7 剝片 A 類IV
- 8 大形剝片 B 類
- 9 打製石鏃 IIB₁類?
- 10 打製石斧 不明
- 11 大形刃器 1b 類
- 12 大形刃器 1b 類
- 13 大形刃器 2c 類
- 14 磨製石包丁 不明
- 15 砥石 不明

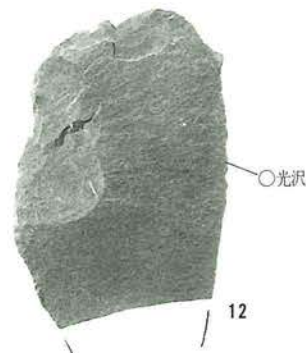

SB263

- 16 大形刃器 2c 類
 - 17 大形刃器 1b 類
 - 18 小形刃器 2c 類
 - 19 敲石ア類
 - 20 みがき石 IIe 類
- (2:3)

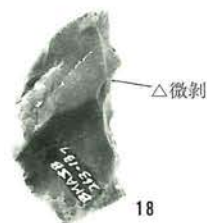
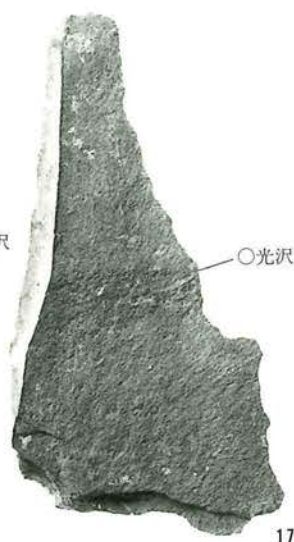
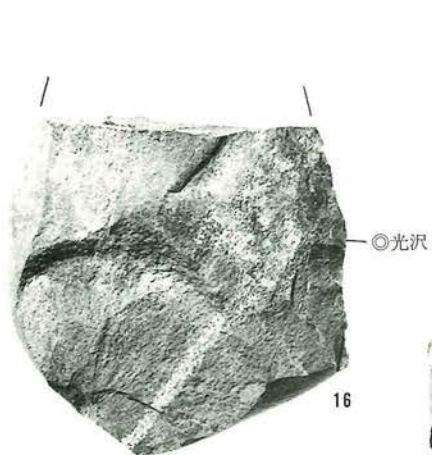

石器写真

SB262

- 1 小形石核 I1B 類
- 2 小形石核 IIIA 類
- 3 剥片 A 類V
- 4 打製石鏃
失敗品 2 類
- 5 磨製石鏃
失敗品 1 類
- 6 磨製石鏃 IB₀ 類
- 7 打製石斧 不明
- 8 打製石斧 不明
- 9 磨石 II2 c 類
- 10 みがき石 II2d 類
- 11 大形刃器 7 類
- 12 大形刃器 2 c 類
- 13 大形刃器 2 b 類
- 14 大形刃器 2 a 類
- 15 磨製石包丁
失敗品 B 類
- 16 小形刃器 2 c 類
- 17 小形刃器 2 c 類
- 18 砥石 I2 類
- 19 砥石 I2 類
(2:3)

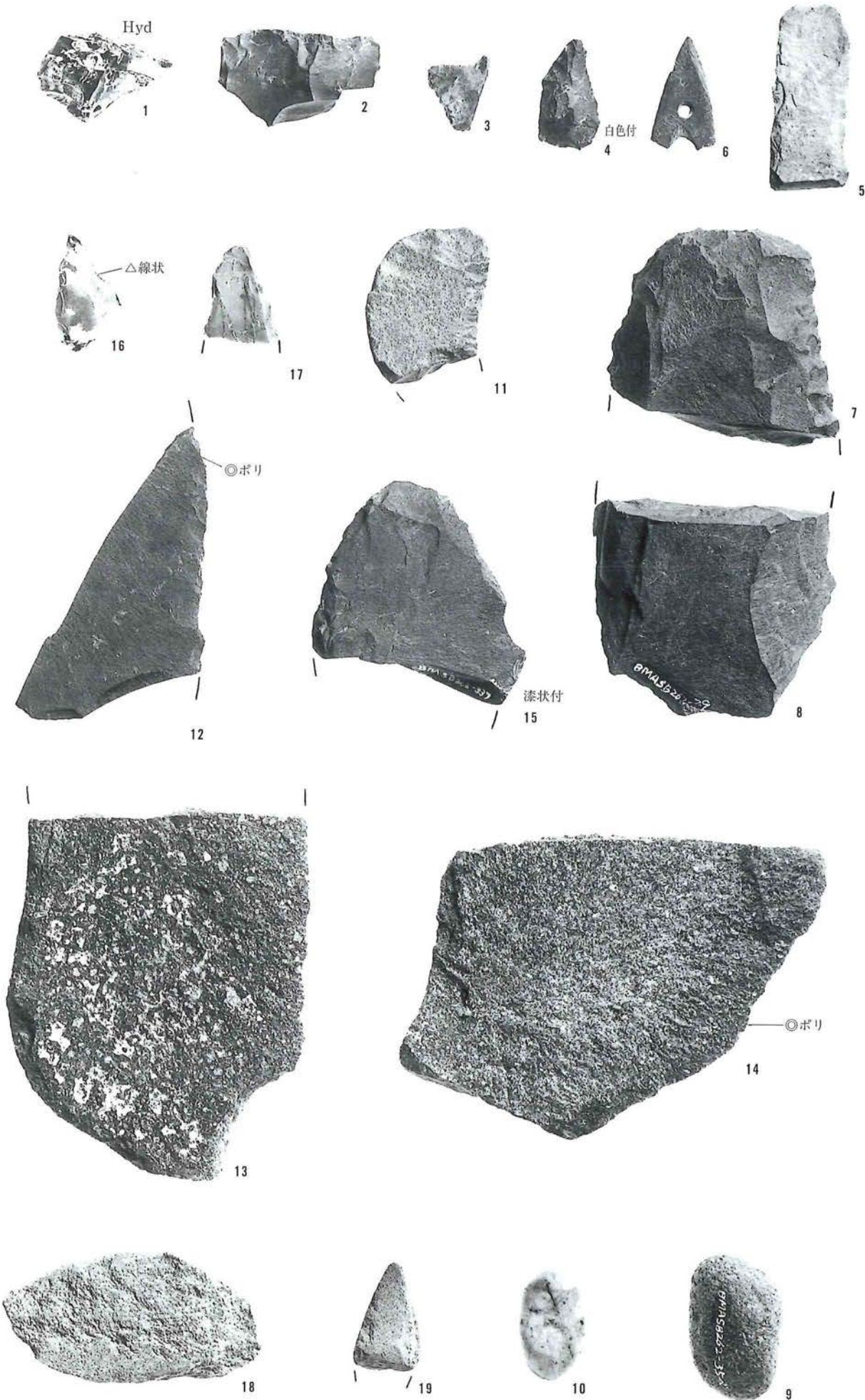

石器写真

S B 264

1 剥片 A 類IV

2 剥片 A 類IV

3 大形剥片 碎片

4 大形剥片 碎片

5 打製石鏃 IIB₂ 類?

6 打製石鏃 IIB₁ 類

7 打製石鏃 IIB₃ 類?

8 打製石鏃 IIB₂ 類?

9 打製石鏃
失敗品 1 類

(1:1)

10 大形刃器 1b 類

11 大形刃器 1b 類

12 大形刃器 3 類

13 大形刃器 2a 類?

(2:3)

14 小形刃器 6a 類

(1:1)

15 大形石核 II2A 類

16 敲石 不明

17 敲石キ類

(2:3)

18 原石(磨製石斧関連)

(1:3)

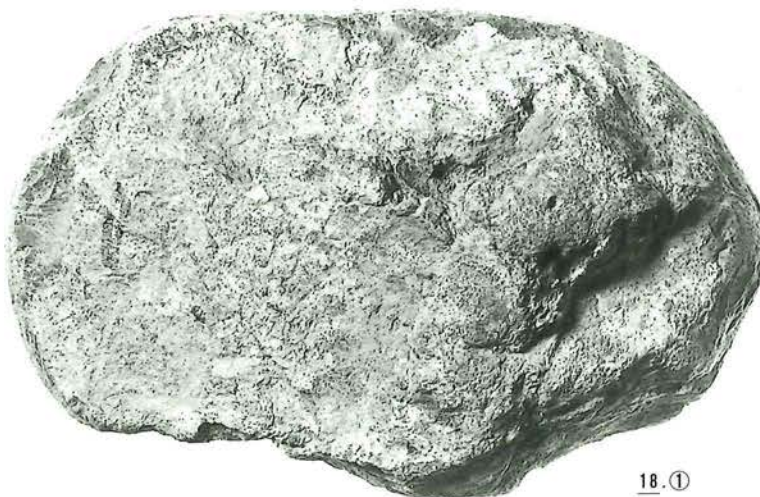
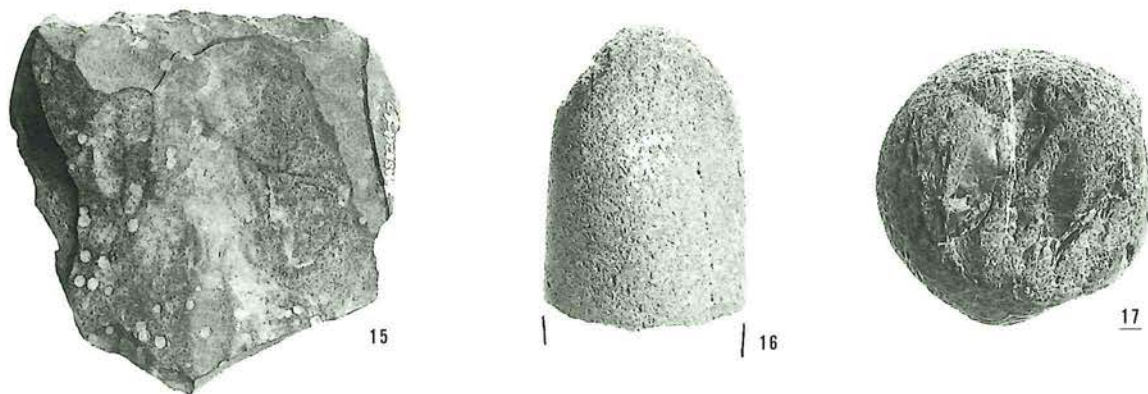
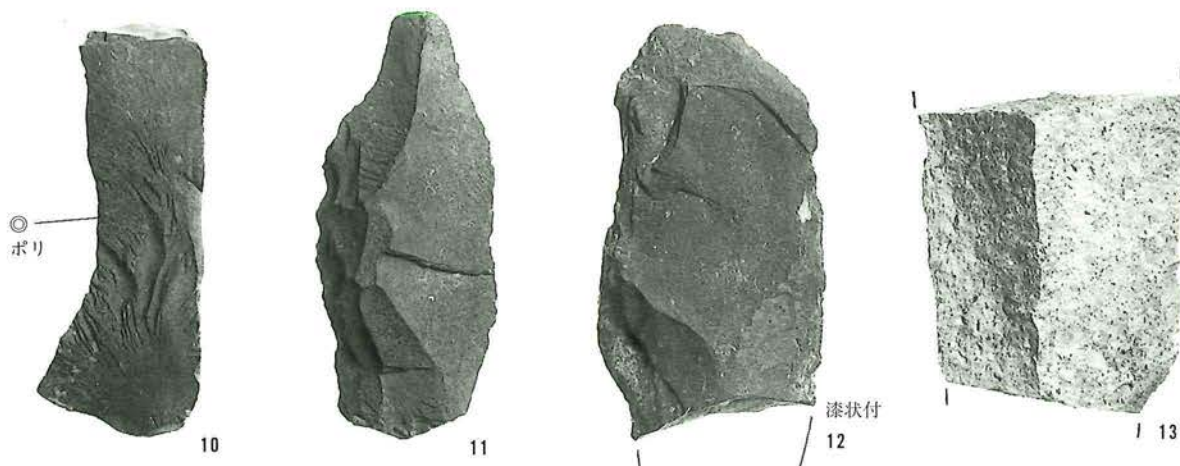
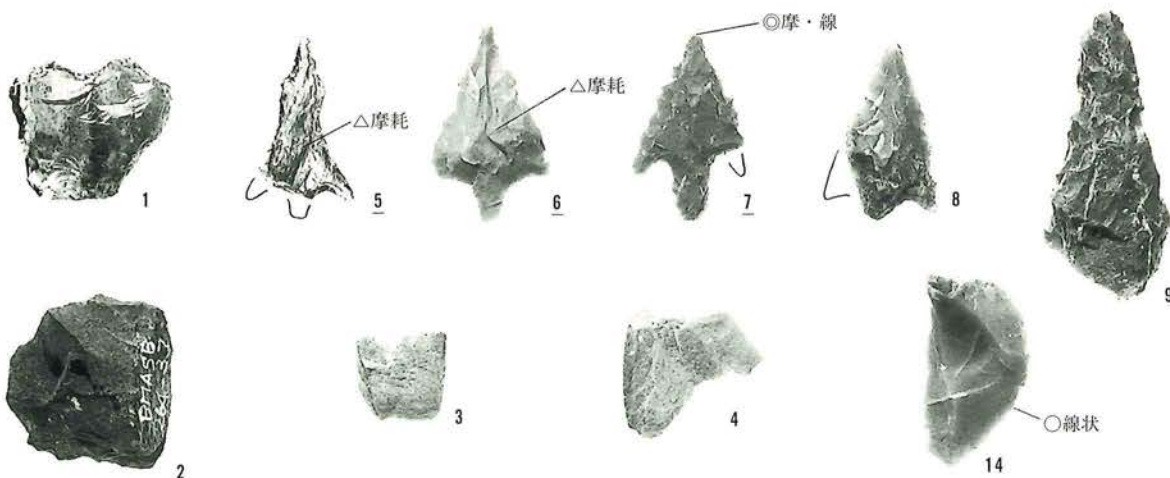

18.①

石器写真

S B 265

- 1 小形剥片 2 種
- 2 打製石鏃 IIB₂ 類
- 3 磨製石鏃
失敗品 1 類
- 4 大形刃器 1b 類
- 5 磨製石包丁
失敗品 B 類
- 6 小形刃器 2c 類
- 7 太型蛤刃石斧
Ib' 類
- 8 扁平片刃石斧
IIb₂ 類?
- 9 扁平片刃石斧 不明
- 10 扁平片刃石斧 f 類?
- 11 石槌
- 12 砥石 IIa 類
(2:3)

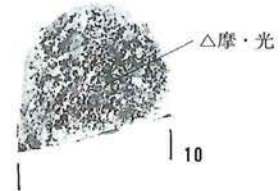
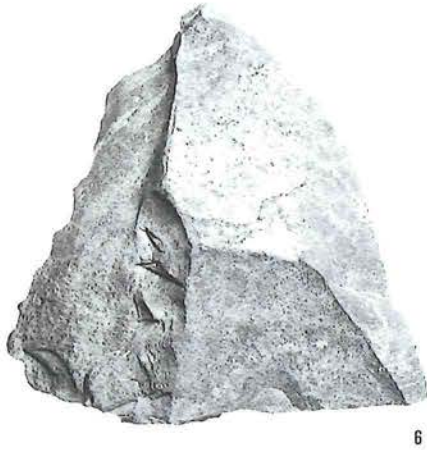

11. ①

1

石器实测图
骨角器实测图

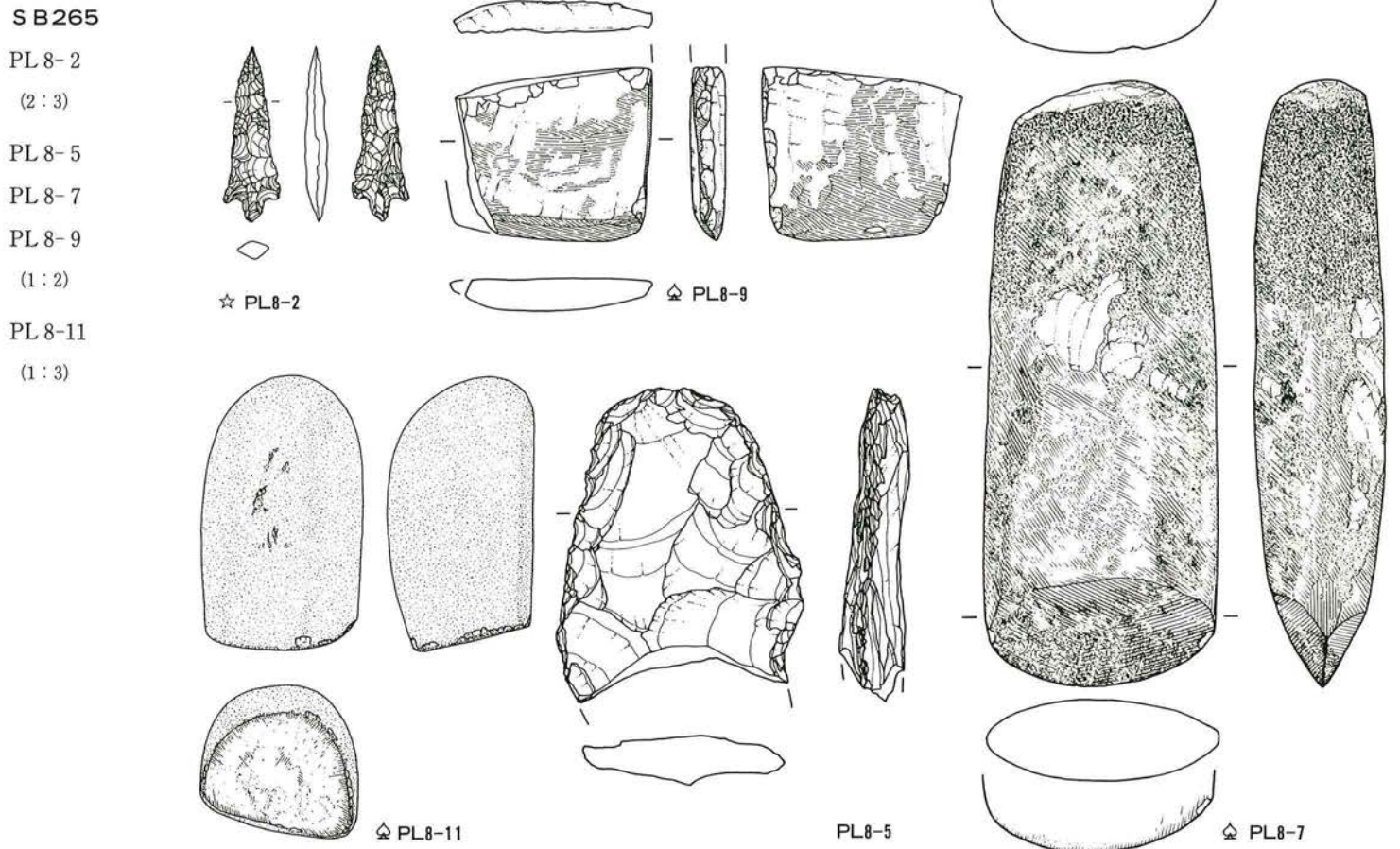
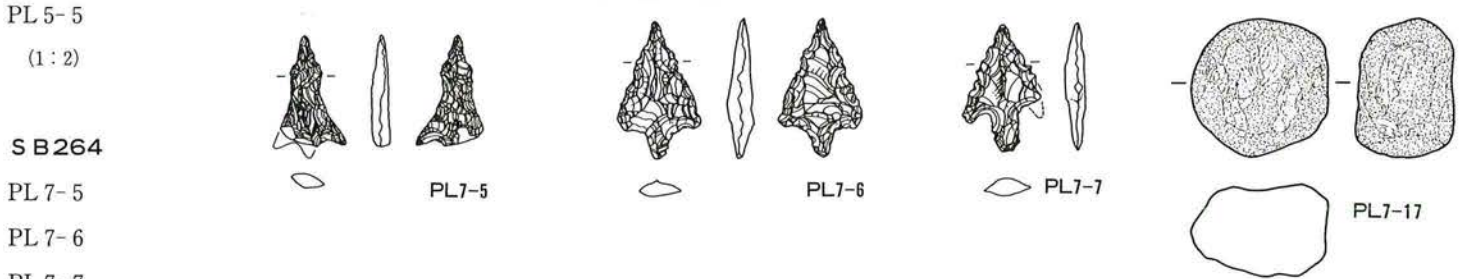
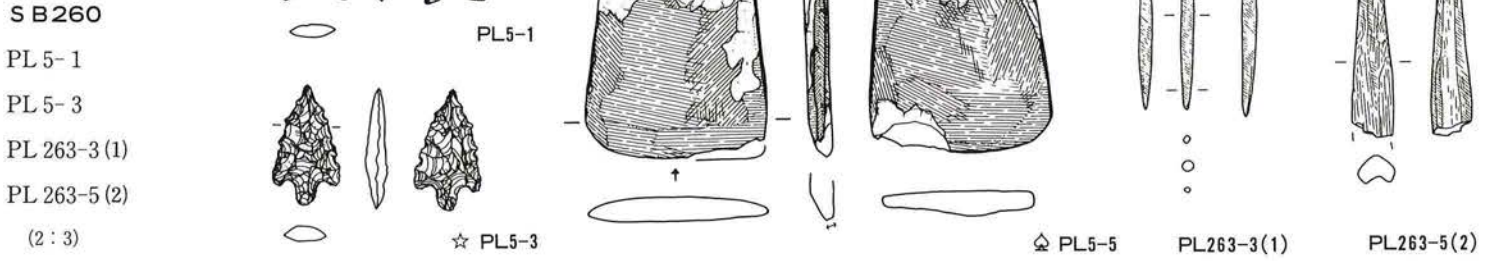

石器写真

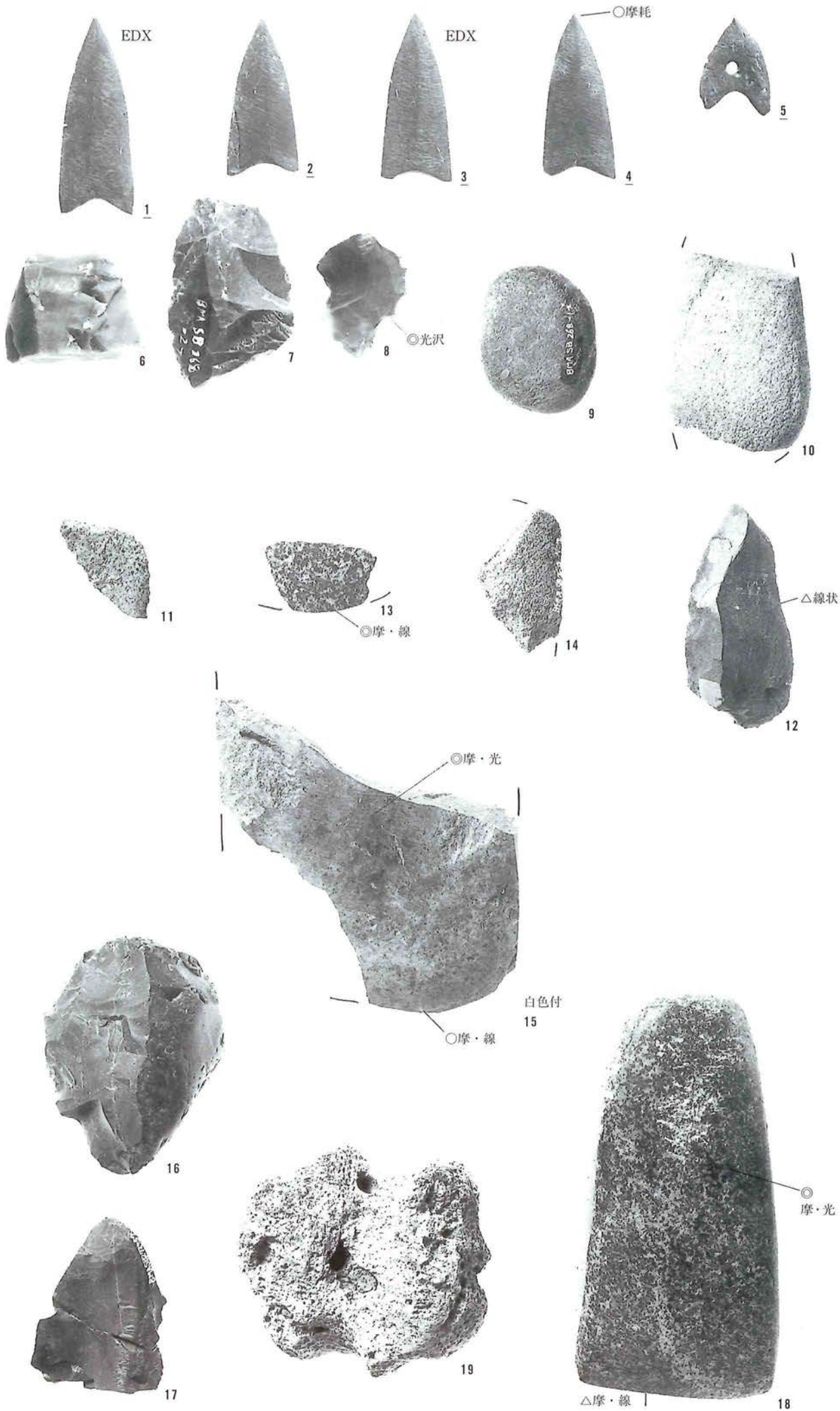

S B 267

- 1 磨製石鏃
失敗品 2 B 類
- 2 磨製石鏃
失敗品 2 B 類
- 3 磨製石鏃
失敗品 2 B 類
- 4 磨製石鏃
失敗品 2 B 類
- 5 磨製石鏃 IB₃類

S B 268

- 6 小形石核 IIIA 類
- 7 小形刃器 2c 類
- 8 小形刃器 2c 類
(1:1)
- 9 みがき石 IIc 類
- 10 砥石 IIa 類

S B 269

- 11 大形刃器 不明
- 12 大形刃器 2c 類
- 13 大型蛤刃石斧 不明
- 14 砥石 I2 類

S B 271

- 15 扁平片刃石斧 不明

S B 272

- 16 小形石核 I2A 類
- 17 小形剥片 2種
- 18 大型蛤刃石斧
Ic'類
- 19 軽石製品
(2:3)

石器写真

SB273

- 1 小形石核 IIA 類
- 2 剥片 A 類 不明
- 3 磨製石鏃
- 失敗品 1 類
- 4 石錐 2 A 類
- 5 大形刃器 1 b 類
- 6 大形刃器 1 b 類
- 7 大形刃器 2 a 類
- 8 大形刃器 2 a 類
- 9 大形刃器 8 類
- 10 敲石ク類
- 11 太形蛤刃石斧
- 失敗品 D 類
- 12 扁平片刃石斧
- IIb₁類
- 13 砥石 I2 類
- (2:3)

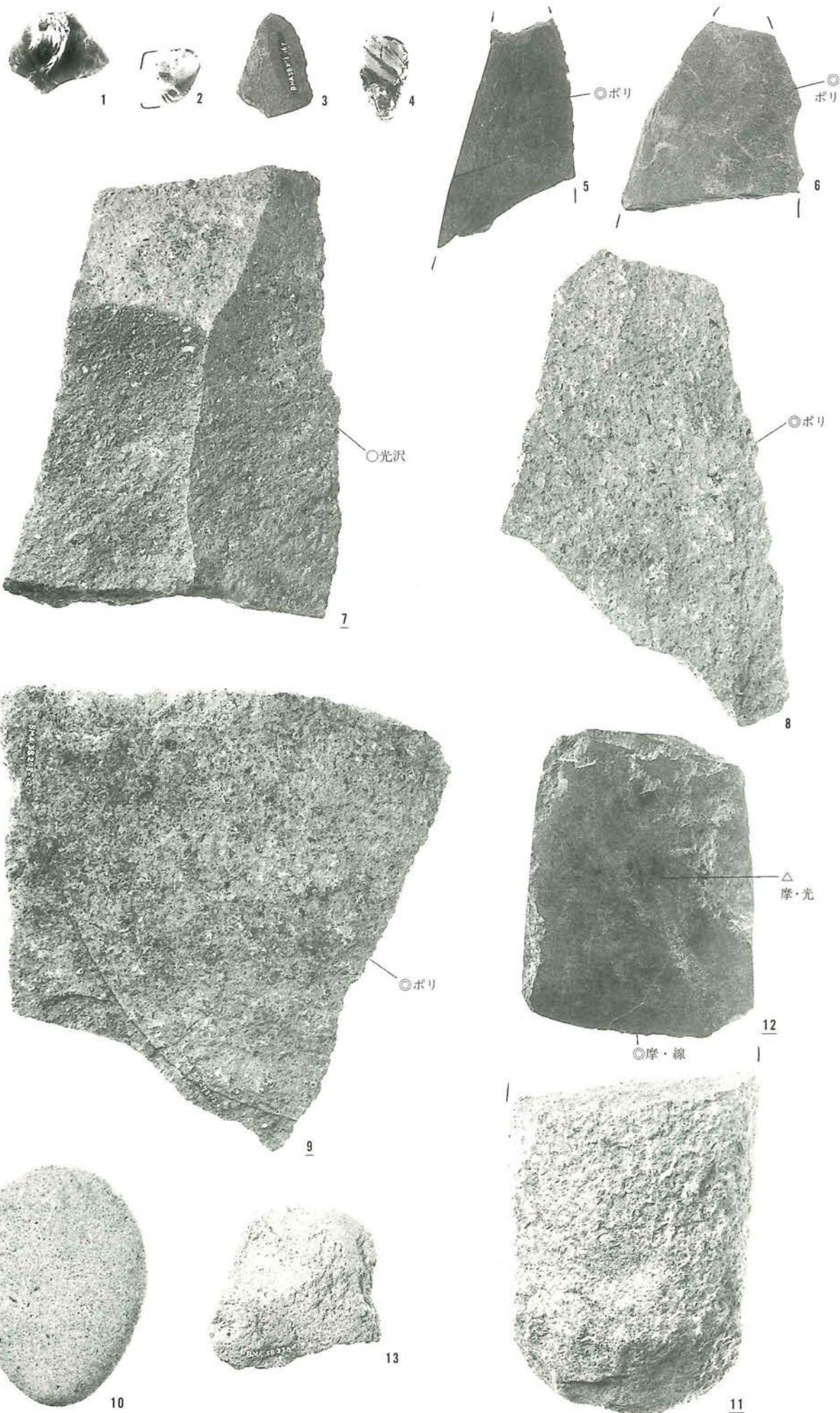

PL 12

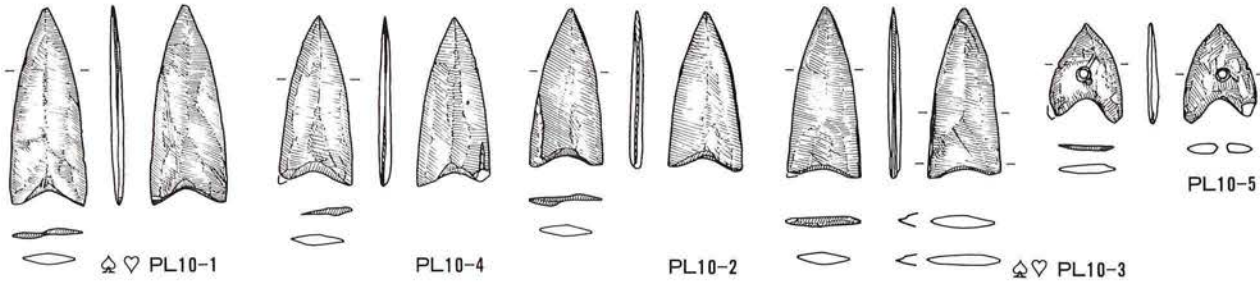

石器实测图

S B 267

PL 10-1

PL 10-2

PL 10-3

PL 10-4

PL 10-5

(2:3)

S B 273

PL 11-7

PL 11-9

PL 11-11

PL 11-12

(1:2)

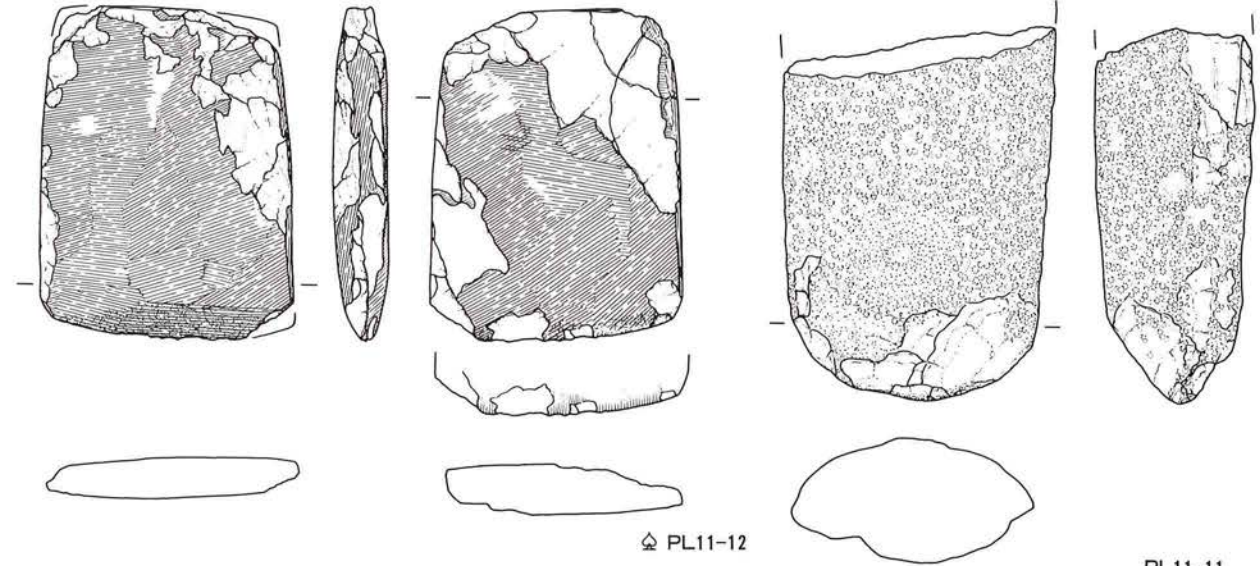

PL 11-12

PL 11-11

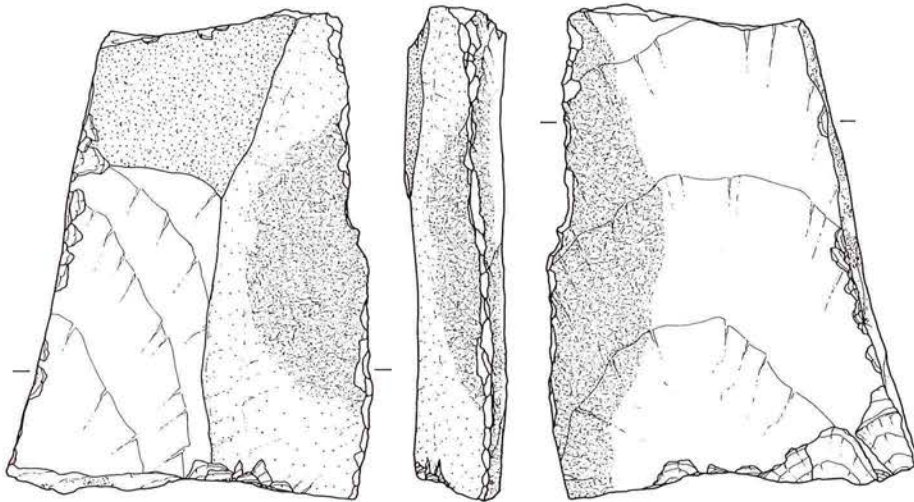

PL 11-7

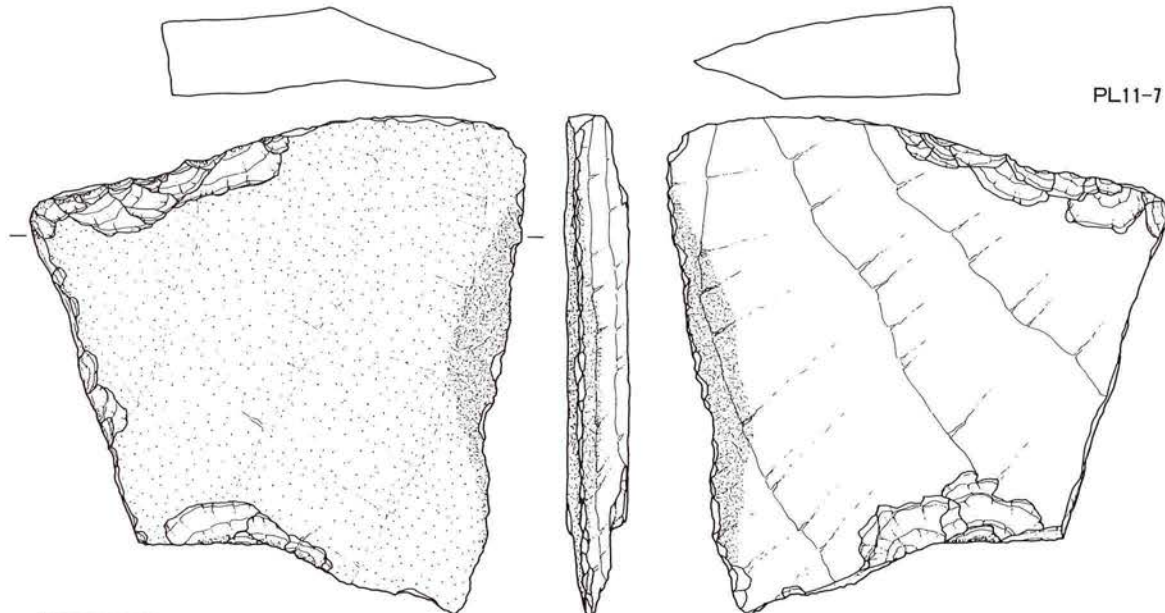

PL 11-9

石器写真

SB274

- 1 原石
- 2 剥片 A 類III
- 3 剥片 A 類II
- 4 磨製石鏃
失敗品 1 類
- 5 大形刃器 8 類
- 6 大形刃器 1b 類
- 7 扁平片刃石斧
IIb₂類
- 8 扁平片刃石斧
IIb₂類?
- 9 砥石 IIb 類

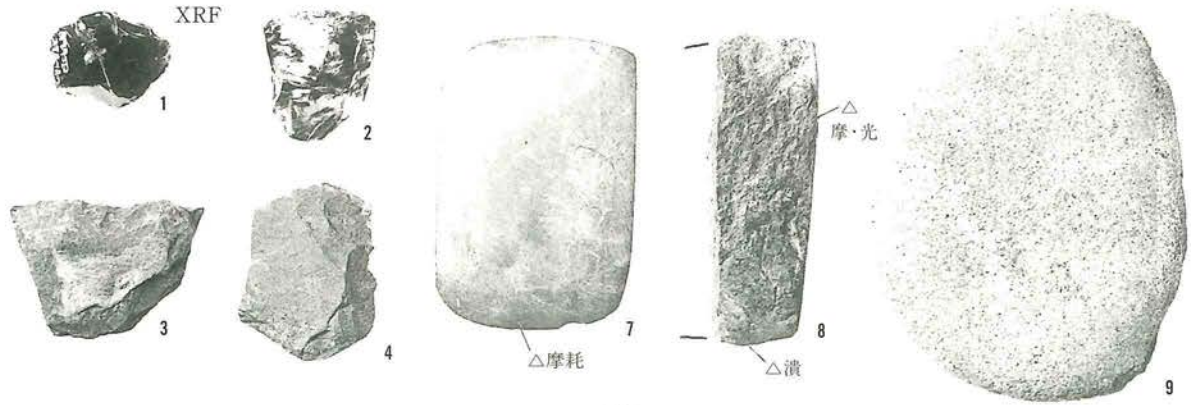

SB275

- 10 大形刃器 8 類
- 11 大形刃器 2c 類
(2:3)

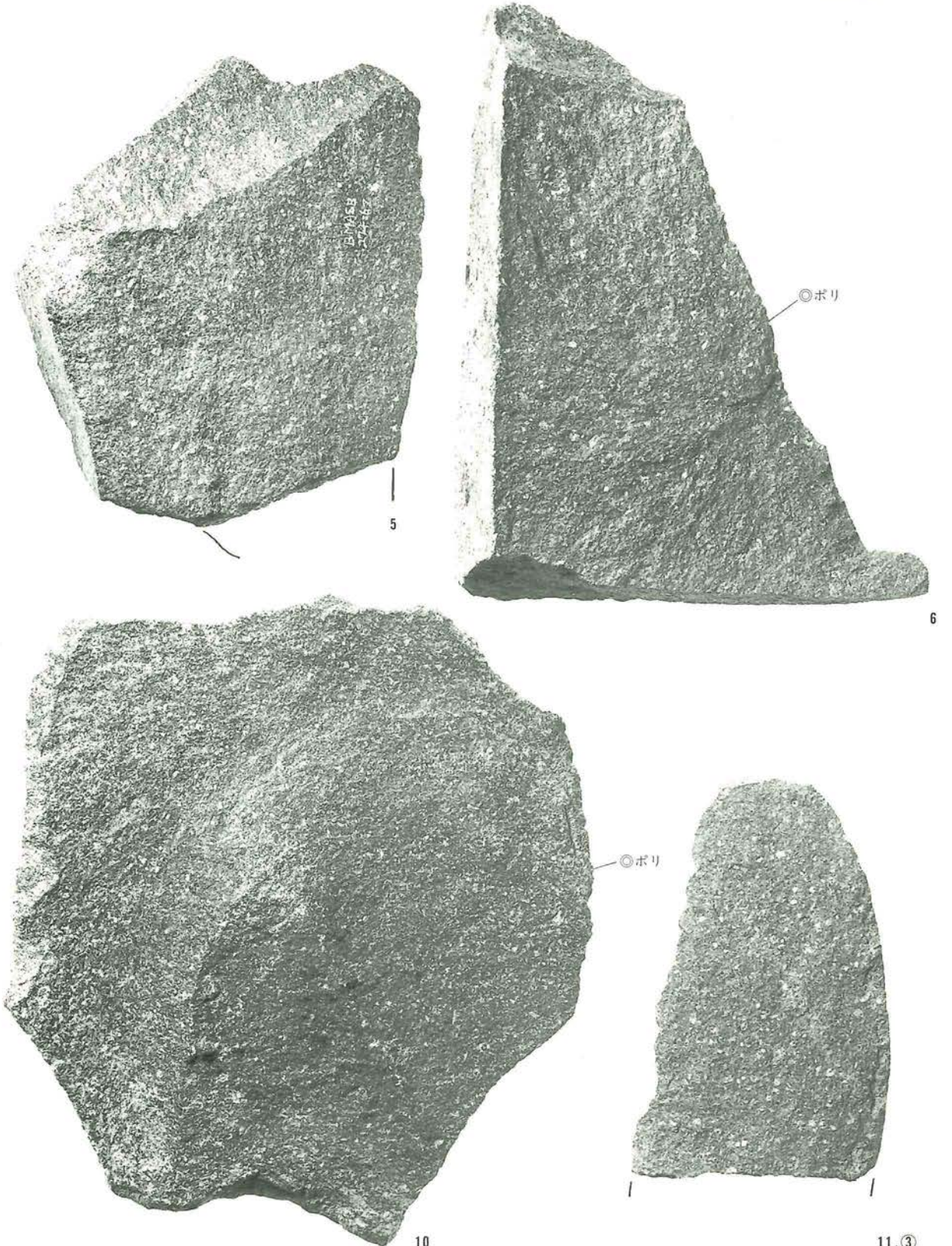

石器写真

SB277

- 1 大形刃器 7 類
- 2 石槌 蛤刃転用
- 3 砥石 IIc 類

SB280

- 4 太型蛤刃石斧 Ic'類
(2:3)

SB281

- 5 原石
- 6 小形石核 IIa 類
- 7 小形石核 IIIa 類
- 8 磨製石鏃
失敗品 1 類
- 9 磨製石鏃
失敗品 2 B 類
(1:1)

- 10 大形刃器 7 類
- 11 大形刃器 2 a 類
(2:3)
- 12 小形刃器 2 c 類
- 13 石錐 2 B 類
(1:1)

- 14 軽石製品
(2:3)

- 15 管 玉
(1:1)

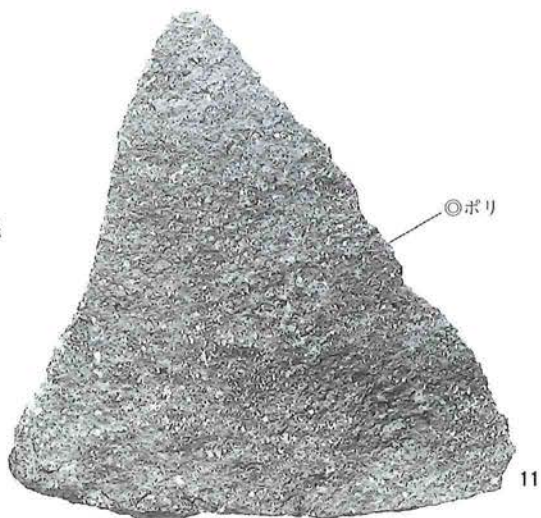
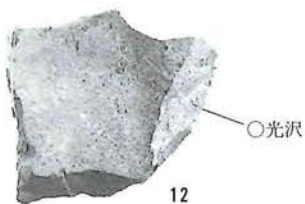
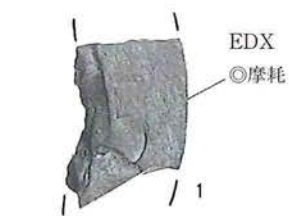

石器写真

SB283

- 1 剥片 A 類IV
- 2 磨製石鏃
失敗品 1 類
- 3 大形刃器 2b 類
- 4 小形刃器 6a・6c 類

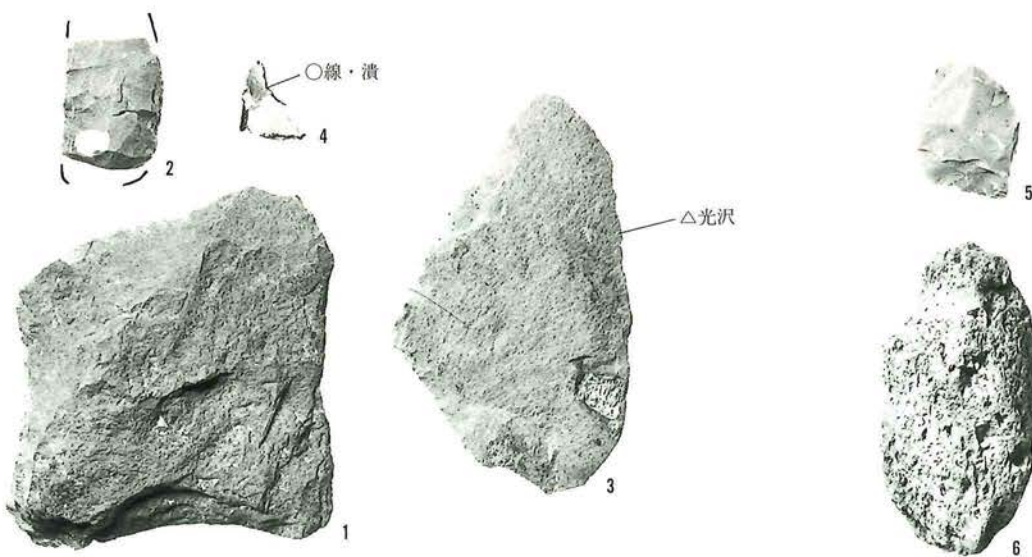

SB284

- 5 剥片 A 類II
- 6 軽石製品

SB285

- 7 剥片 A 類IV
- 8 打製石鏃 IIB₃ 類?
- 9 打製石鏃
失敗品 2 類
- 10 打製石斧 A 類?
- 11 大形刃器 2a 類
- 12 大形刃器 2a 類
- 13 小形刃器 6c 類
- 14 小形刃器 6a 類
- 15 扁平片刃石斧
失敗品 E₁ 類
- 16 砥石 I2 類
(2:3)

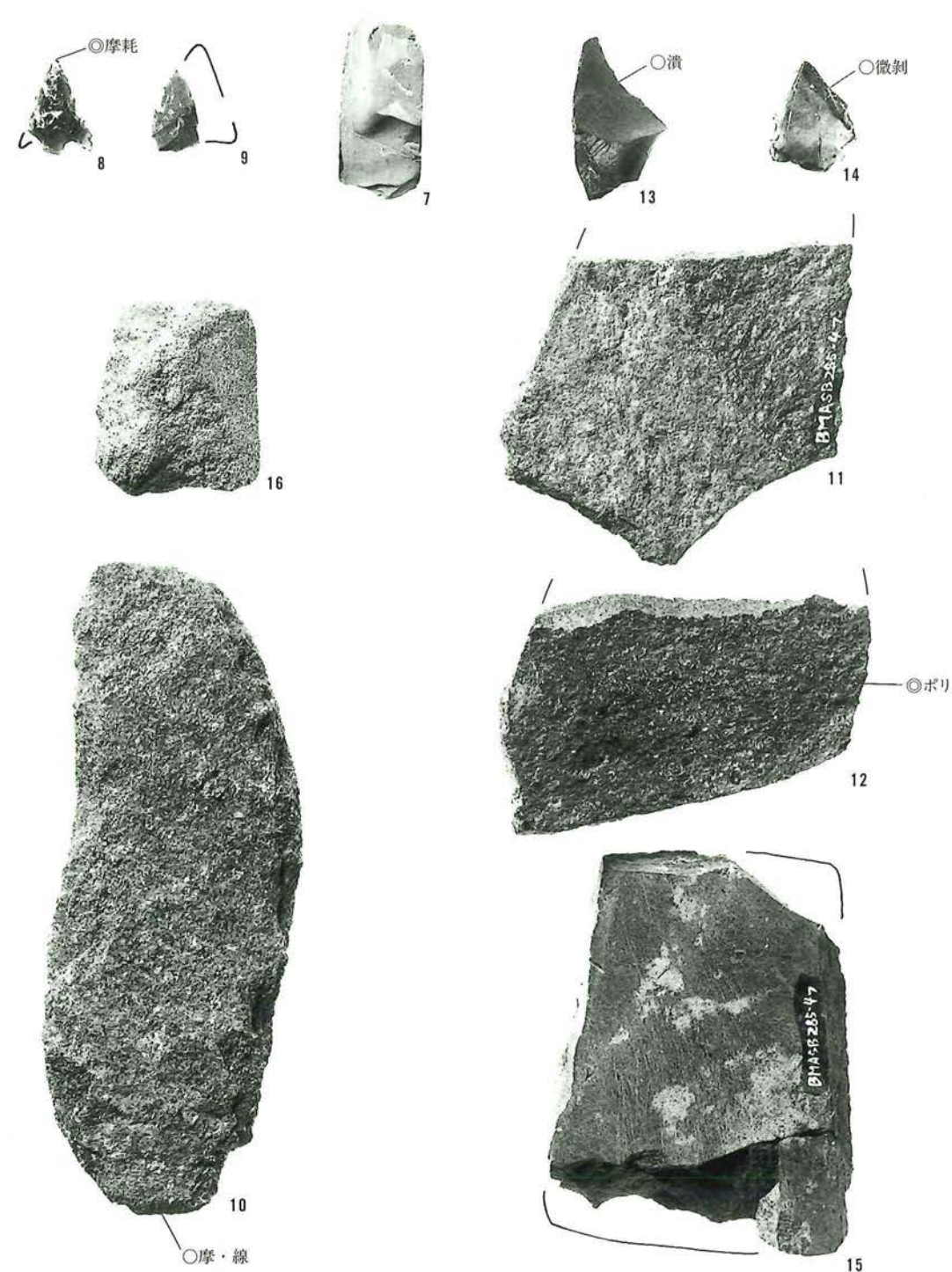

石器写真

SB286

- 1 みがき石 IIc 類
- 2 大形刃器 2b 類
- 3 大形刃器 2c 類
- 4 大形刃器 礫器
- 5 大形刃器 礫器
- 6 大形刃器 2d 類
- 7 小形刃器 6b 類
- 8 扁平片刃石斧
失敗品 E₃ 類
- 9 石錐 大形
- 10 砥石 IIa 類
- 11 研磨痕のある剥片
(2:3)

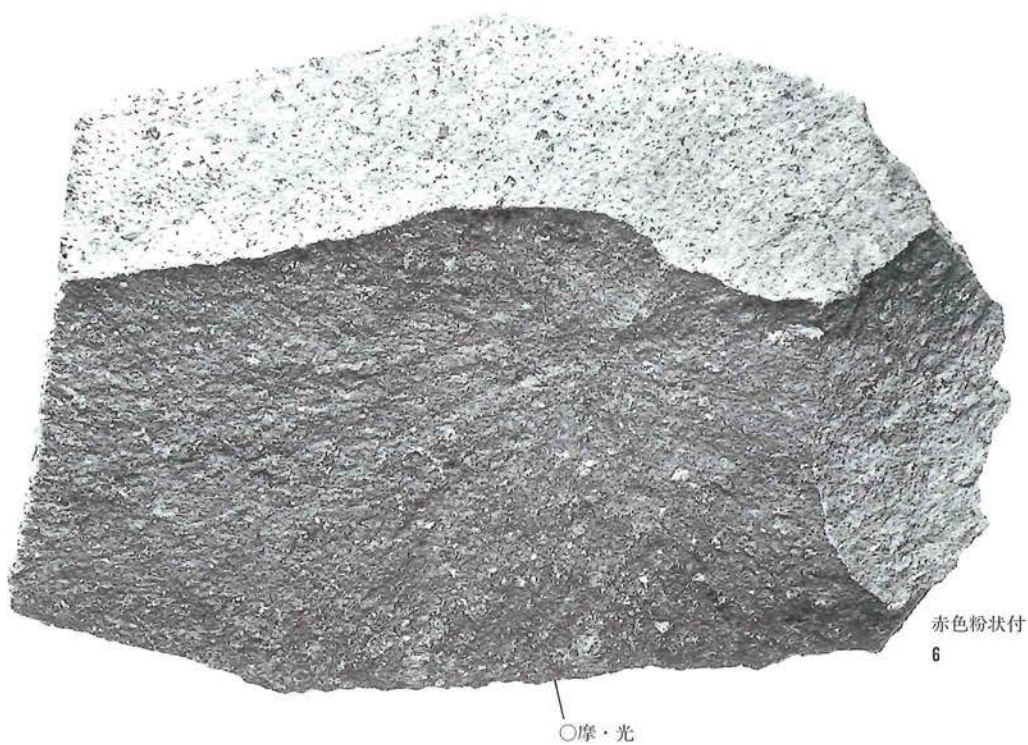
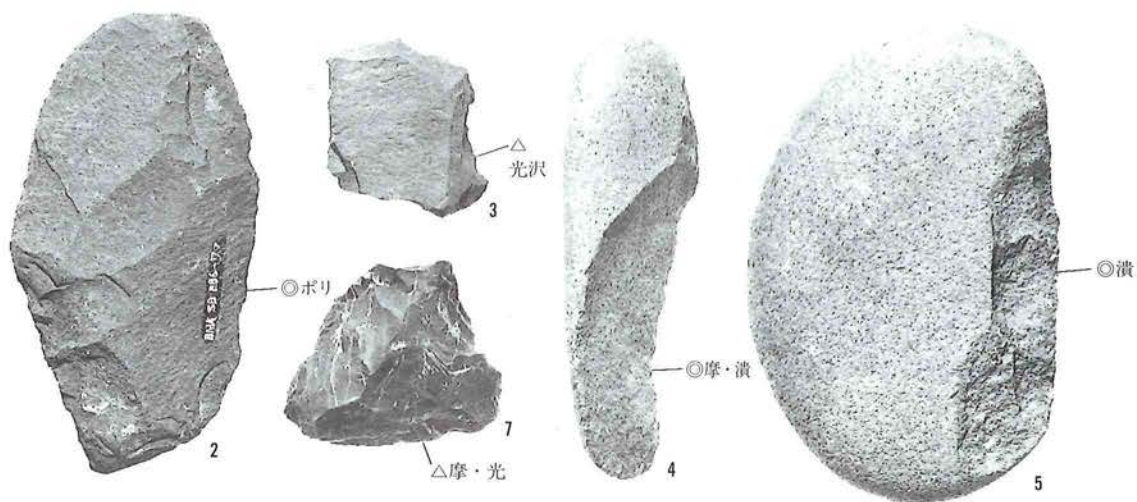

石器写真

SB287

- 1 小形石核 IIIA 類
- 2 小形石核 IIIA 類
- 3 剥片 A 類IV
- 4 大形剥片 2種
- 5 大形剥片 2種
- 6 大形剥片 碎片
- 7 大形剥片 碎片
- 8 磨製石鏃 IB₁類
- 9 敲石 不明
- 11 大形刃器 1b 類
- 12 大形刃器 特殊
- 13 小形刃器 2c 類
- 17 石錐 2A 類
- 18 石錐 2A 類
- 19 砥石 I2 類
- 20 砥石 特殊
- 21 砥石 I1b 類
- 22 砥石 I1b 類
- 23 砥石 I1b 類

(2:3)

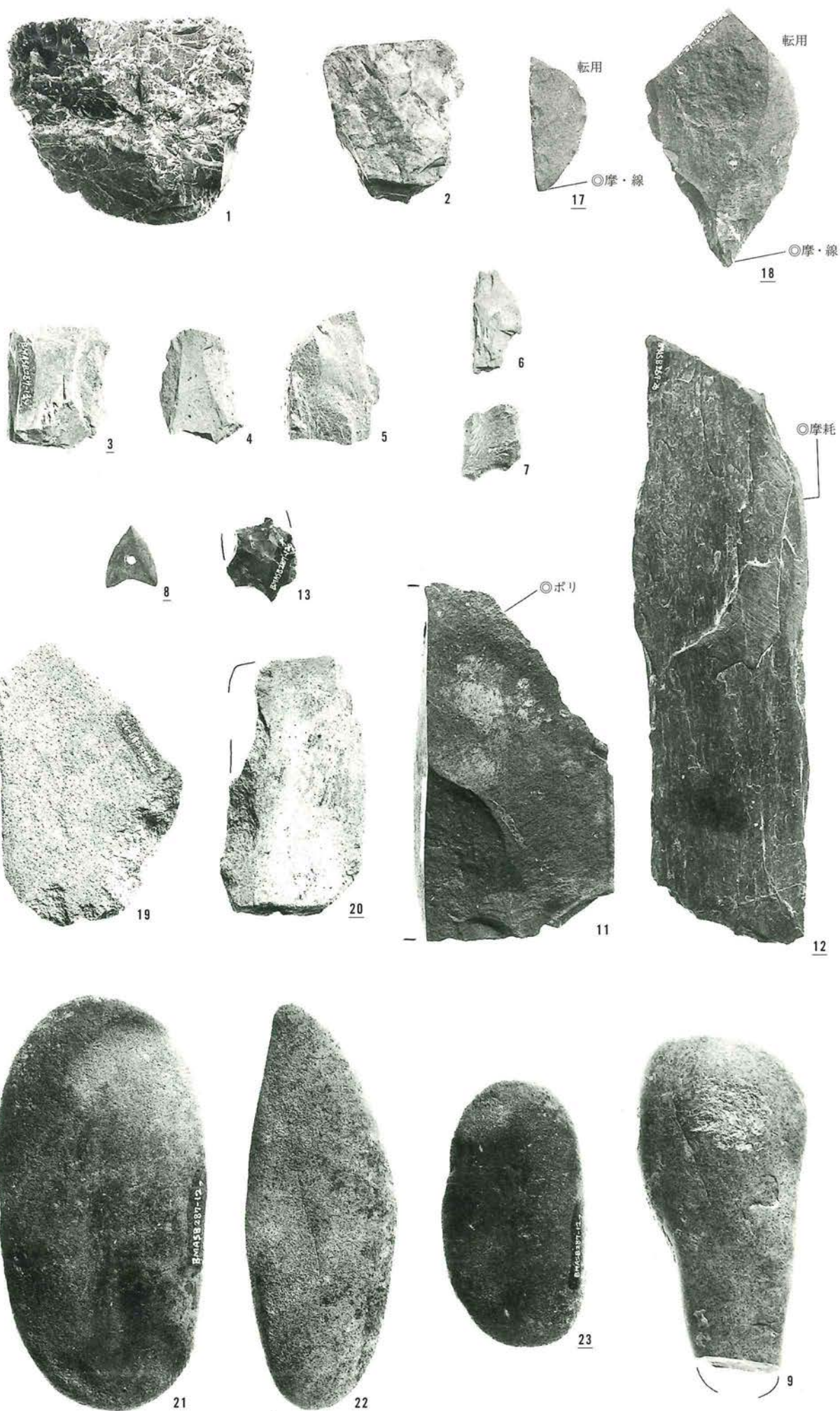

石器写真

S B287

- 10 砥石 置砥
- 14 太型蛤刃石斧 不明
- 15 石槌 蛤刃未転用
- 16 扁平片刃石斧
失敗品 D 類
- 24 扁平片刃石斧
IIb₁類
- 25 石鈔状石製品
(2:3)

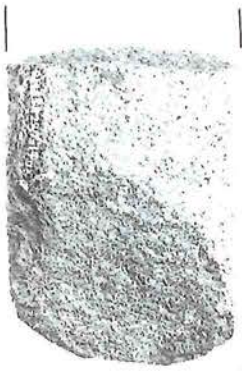

16

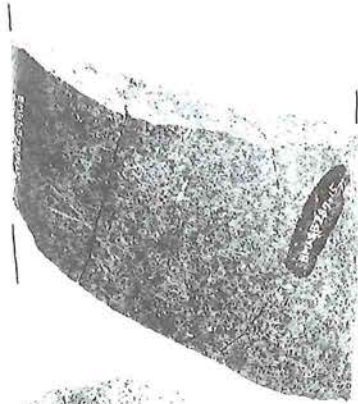

14

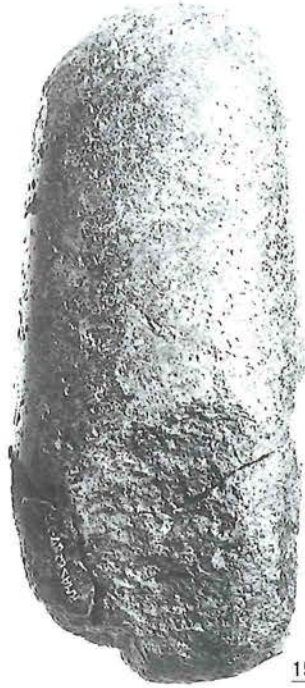

15



転用

10.①

遺物出土状況写真



24



25. 床



砥石No.10の出土状況



砥石No.10と大型蛤刃石斧No.15のセット想定写真

石器実測図

SB287

PL18-15

(1:2)

PL18-10

(1:3)

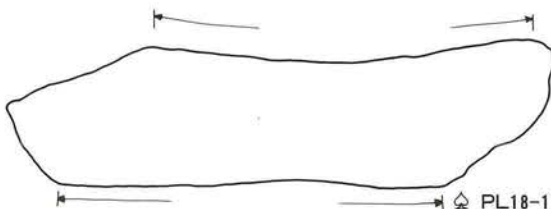
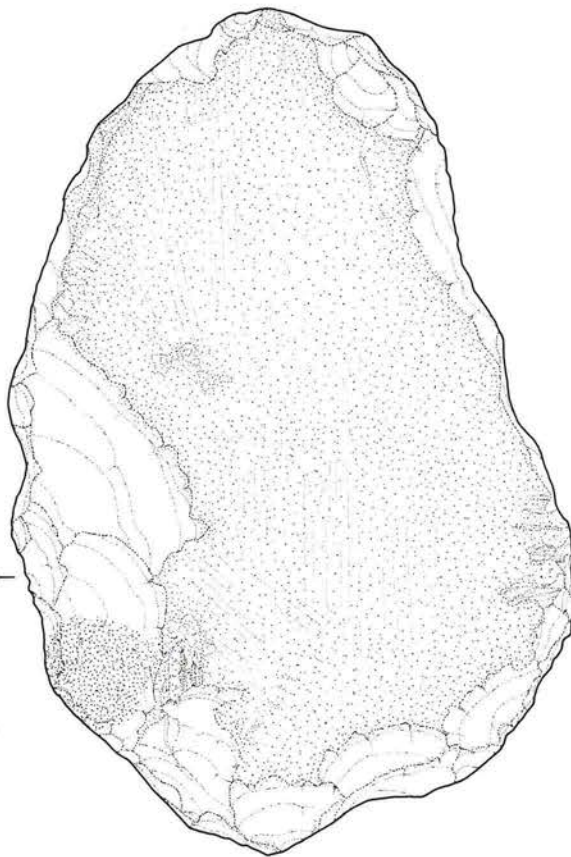

PL18-10

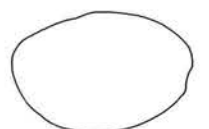
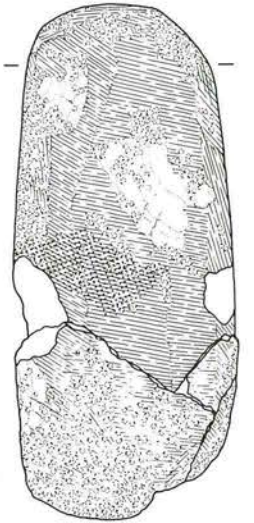
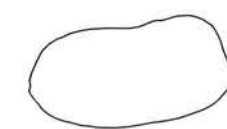
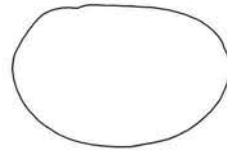

PL18-15

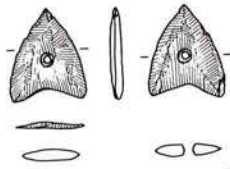

PL17-8

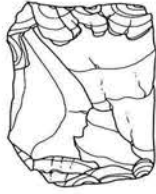
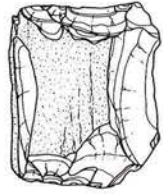

PL17-3

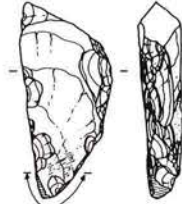

PL17-17

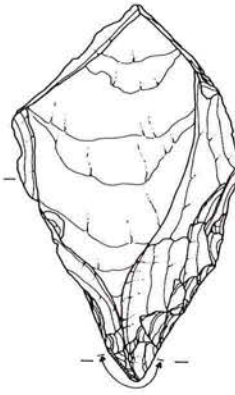
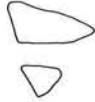

PL17-18



S B287

PL 17-8

PL 17-3

PL 17-17

PL 17-18

(2:3)

PL 17-12

PL 18-16

PL 19-24

PL 17-20

PL 17-23

PL 19-25

(1:2)

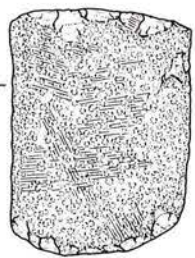
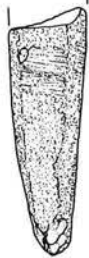
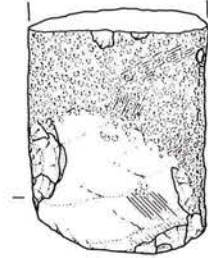

PL18-16



PL19-24

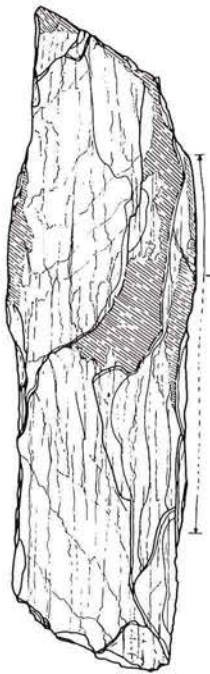

PL17-12

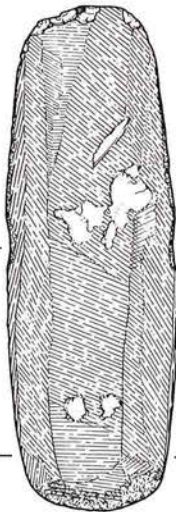

PL19-25

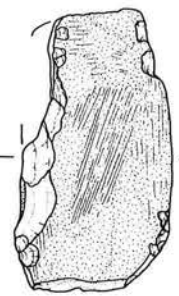

PL17-20

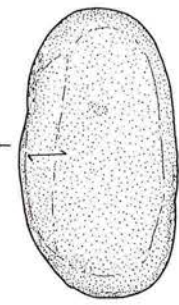

PL17-23

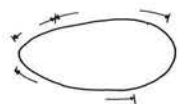

石器写真

SB290

- 1 打製石鏃IIB₃類
- 2 打製石鏃IIB₂類?
- 3 打製石鏃IIB₃類
- 4 打製石鏃IIB₃類
- 5 台石2種A₂類
- 6 大形刃器2c類
- 7 大形刃器1b類
- 8 軽石製品

(2:3)

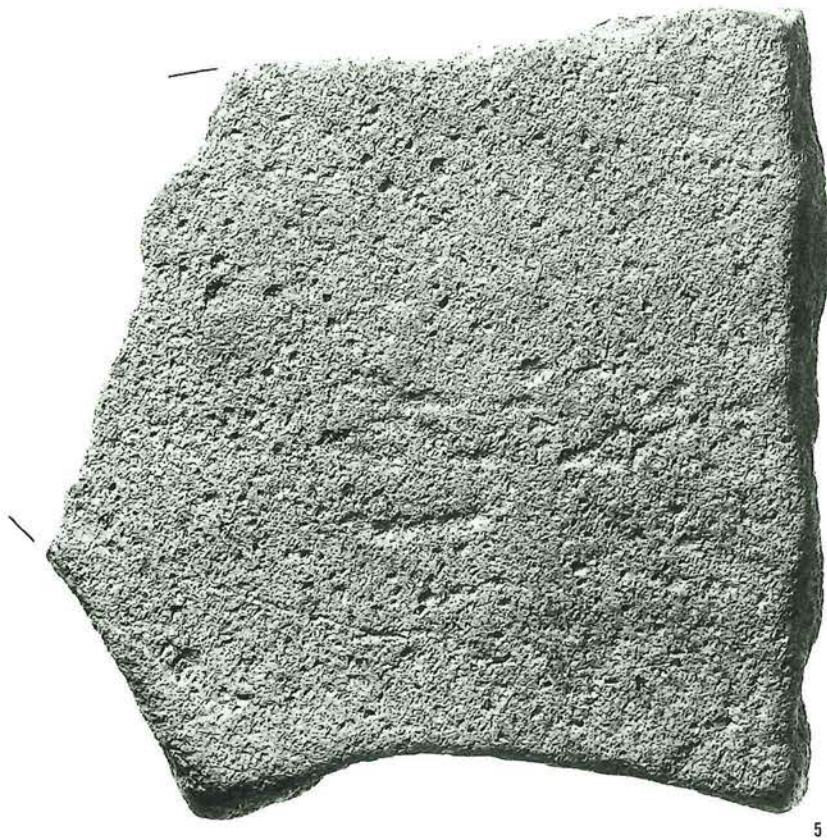
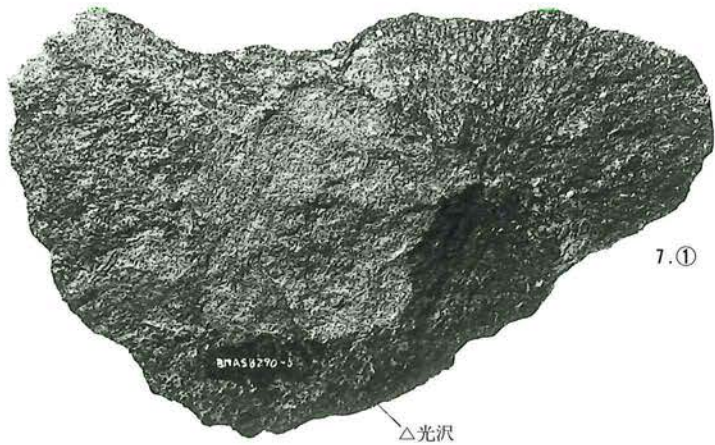
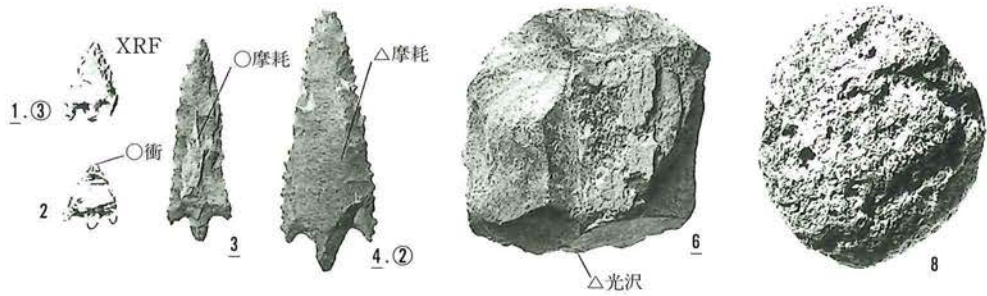

石器写真

S B 300

- 1 大形刃器 8 類
- 2 太型蛤刃石斧 Ic'類

S B 303

- 3 敲石イ類
- 4 扁平片刃石斧
失敗品 E₁類

S B 306

- 5 剥片 A 類IV
- 6 磨製石鏃
失敗品 1 類
- 7 大形刃器 1 a 類
- 8 太型蛤刃石斧
失敗品 D 類
- 9 扁平片刃石斧
失敗品 B 類
(2 : 3)

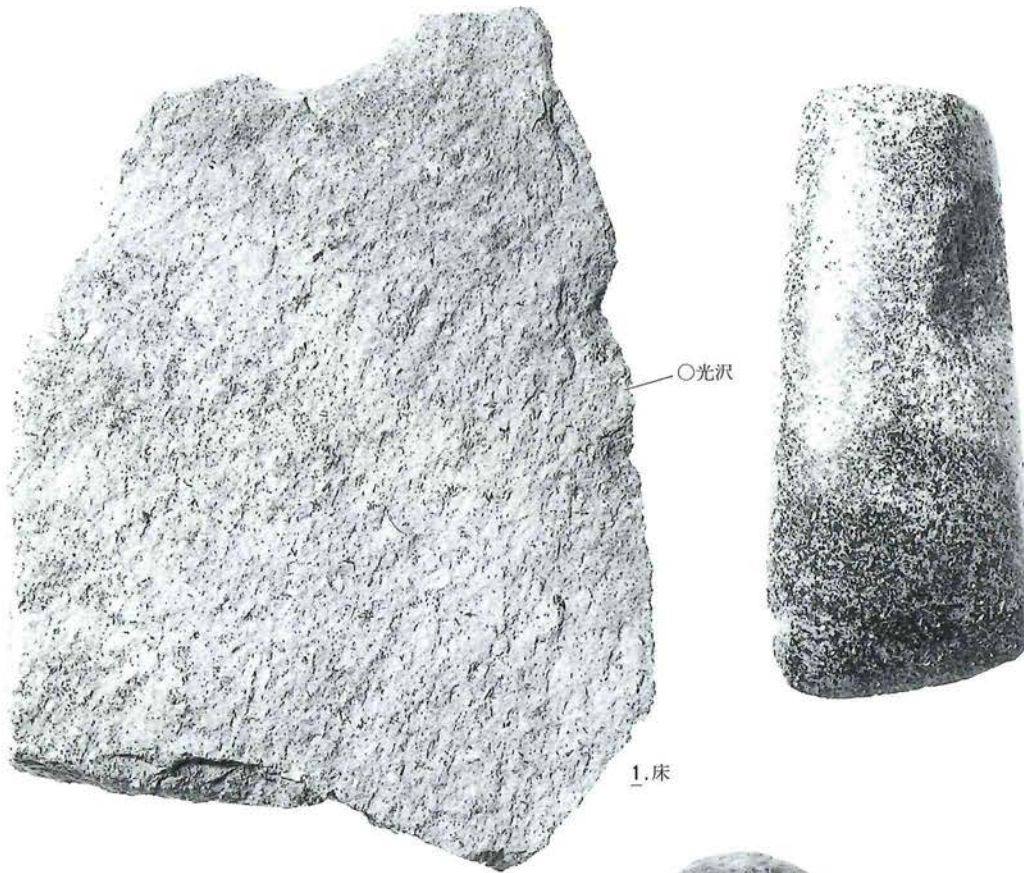

赤色粉状付
2.①



石器実測図

S B 290

PL 21-1

PL 21-3

PL 21-4

(2 : 3)

PL 21-6

(1 : 2)

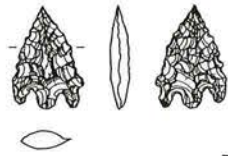

PL21-1

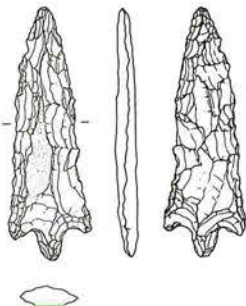

PL21-3

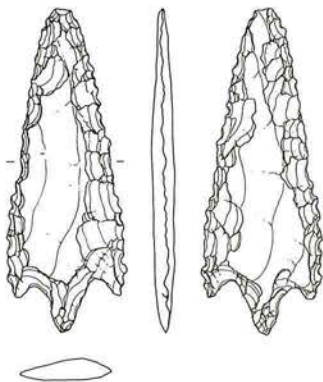

PL21-4

PL 23

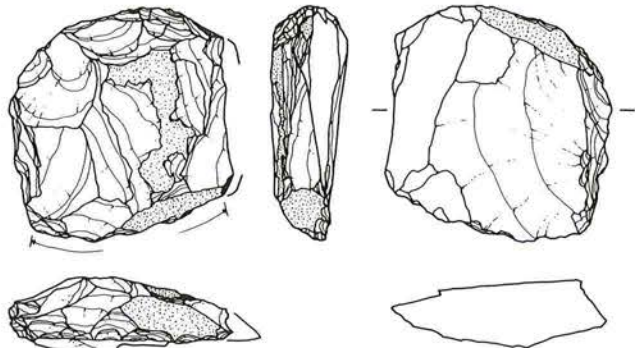

PL21-6

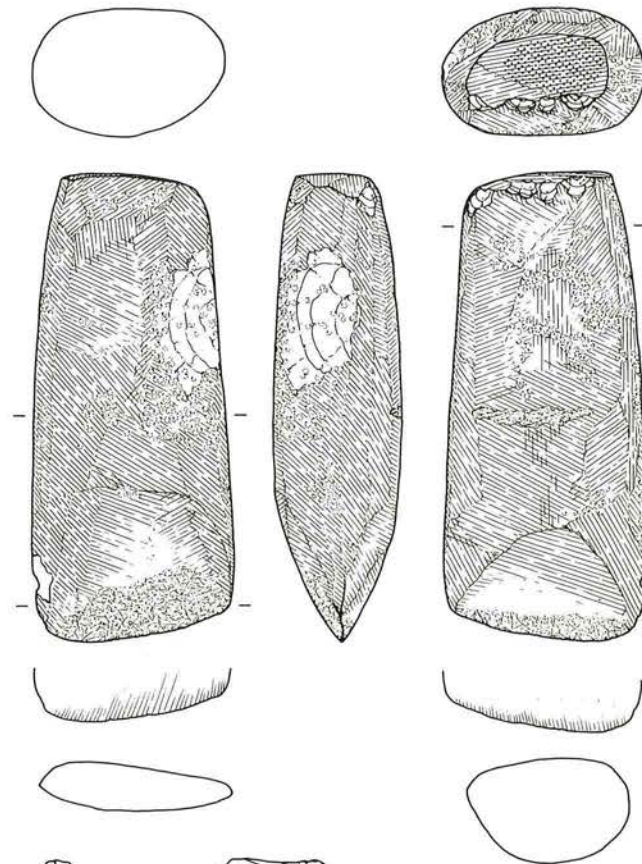

PL22-2

S B 300

PL 22-1

PL 22-2

(1 : 2)

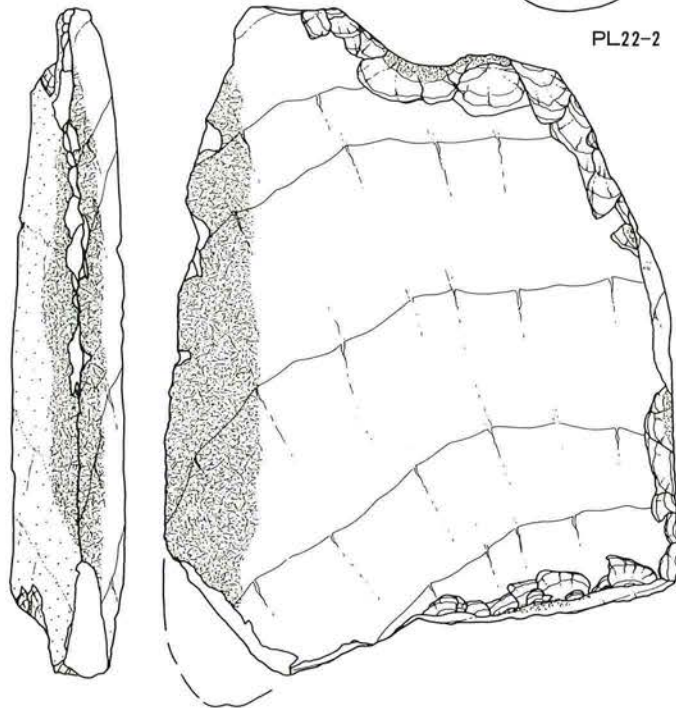
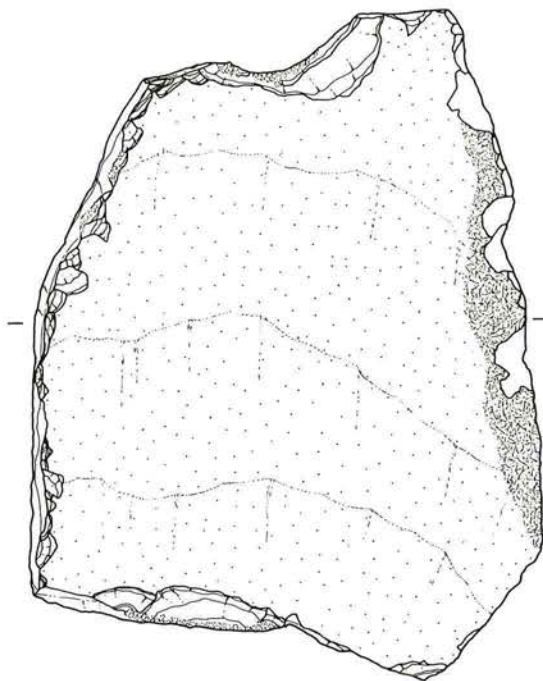

PL22-1

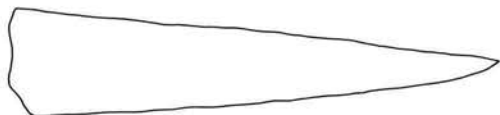

石器写真

SB307

- 1 原石
- 2 小形石核 I2 B 類
- 3 剥片 A 類IV
- 4 剥片 A 類IV
- 5 磨製石鏃
失敗品 2 A 類
- 6 磨製石鏃
失敗品 2 B 類
- 7 磨製石鏃
失敗品 2 B 類
(1:1)
- 8 大形剥片 B 類
(2:3)
- 9 加工痕のある石屑
(1:1)

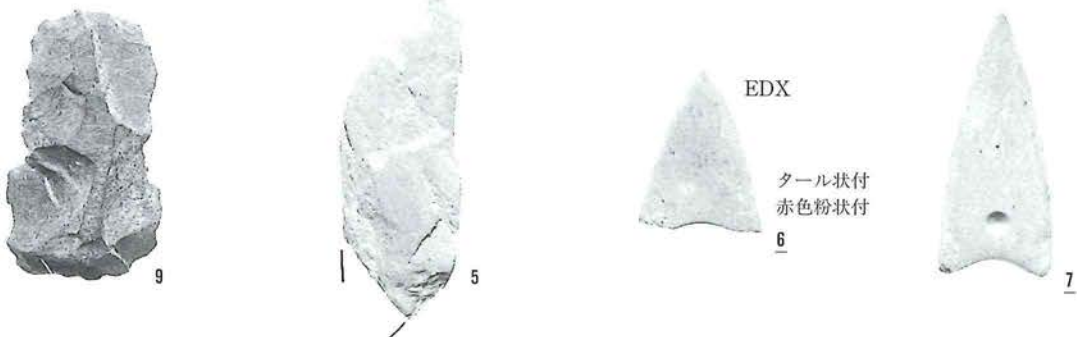

遺物出土状況写真



SB 307 遺物出土状況



磨製石鏃No.7の出土状況

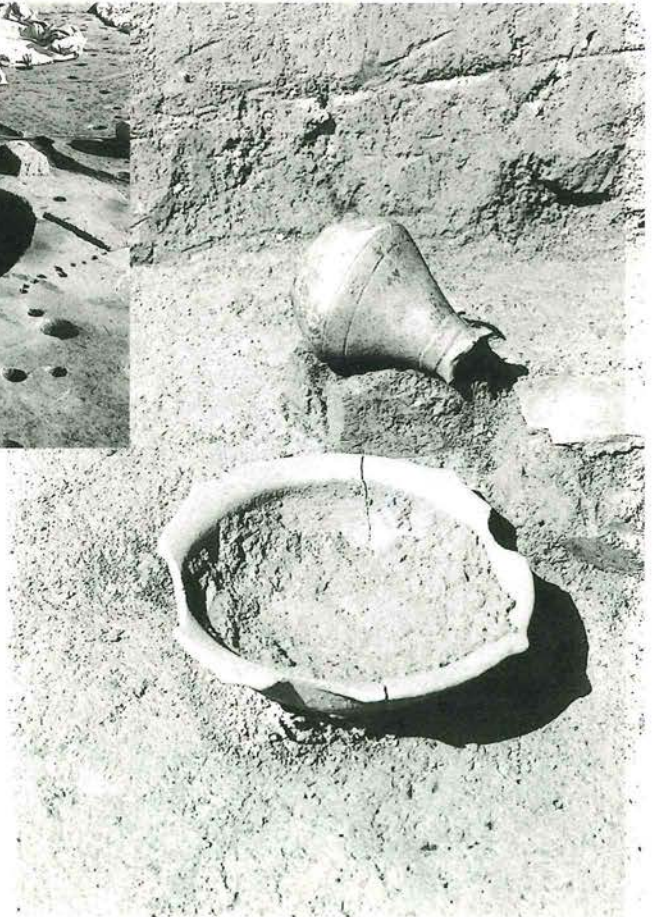

注口土器No.272 と赤色粉の充填した鉢No.275 B の出土状況

石器実測図

S B 307

PL 24-2

PL 24-6

PL 24-7

(2 : 3)

PL 24-8

(1 : 2)

S B 309

PL 26-4

(1 : 2)

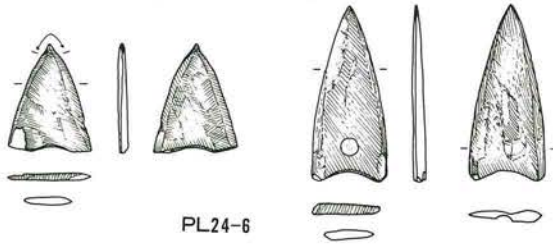

PL24-6

PL24-7

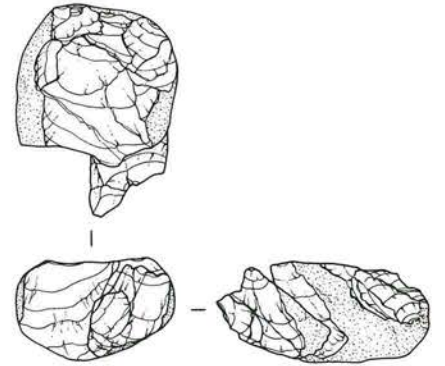

PL24-2

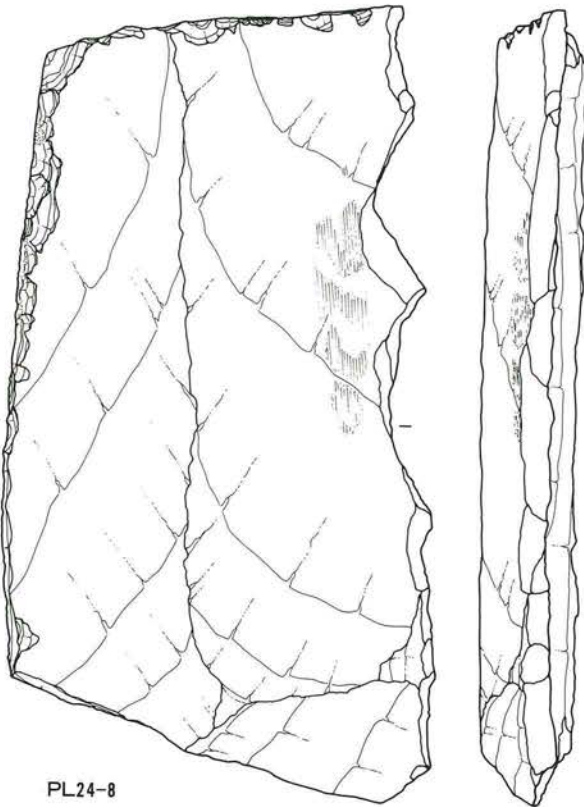

PL24-8

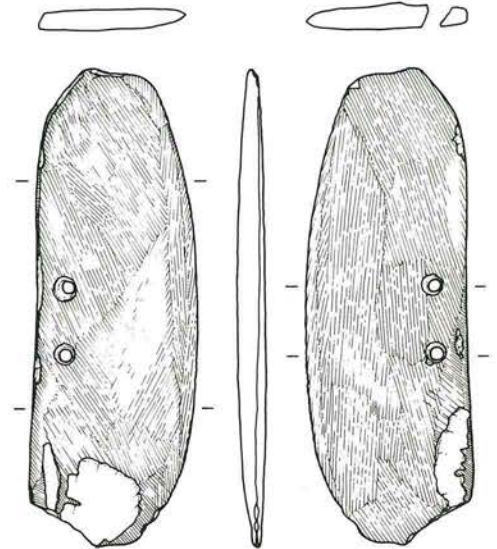

PL26-4

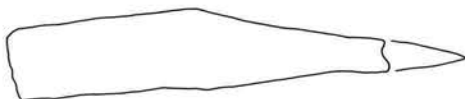

石器写真

S B 308

- 1 みがき石 I2d 類
- 2 大型蛤刃石斧
Ia'類?
- 3 砥石 I2 類

S B 309

- 4 磨製石包丁 半月形
- 5 軽石製品

S B 310

- 6 小形石核 II2B 類
- 7 小形剥片 B 類
- 8 打製石鏃
失敗品 2 類
- 9 打製石鏃 II A 類
- 10 磨製石鏃 IB₃ 類
- 11 磨製石鏃
失敗品 2 A 類
- 12 みがき石 IIIa 類
- 13 敲石 不明
- 14 大形刃器 2 d 類
- 15 小形刃器 2 c 類
- 16 扁平片刃石斧
失敗品 E₁ 類
- 17 ノミ状石器 不明
- 18 砥石 IIa 類
- 19 加工痕のある石屑
(2 : 3)

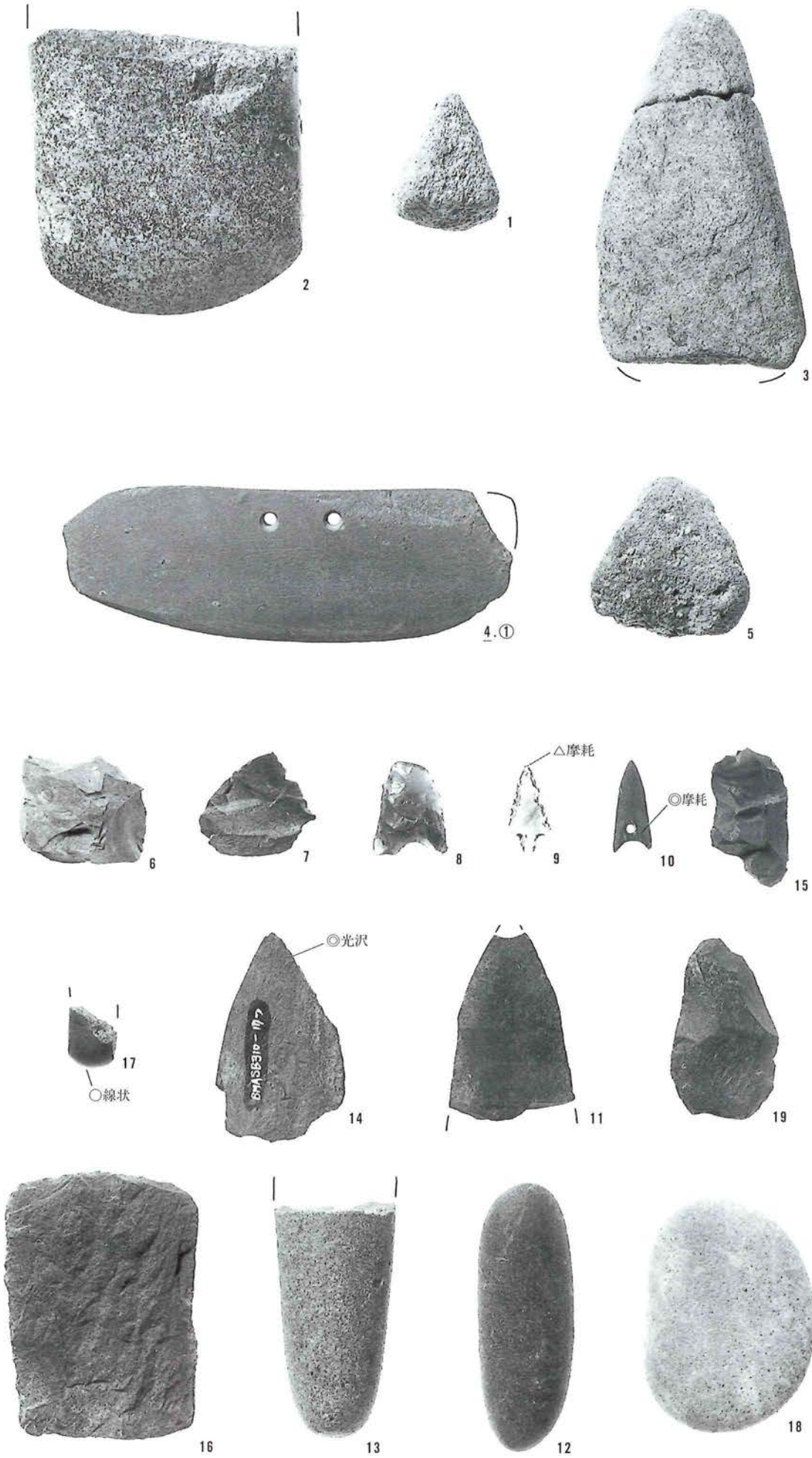

石器写真

SB311

- 1 原石
- 2 小形石核II2A類
- 3 剥片A類IV
- 4 打製石鏃
失敗品1類
- 5 敲石才類
- 6 大形刃器7類
- 7 大形刃器7類
- 8 小形刃器6a類
- 9 扁平片刃石斧 不明

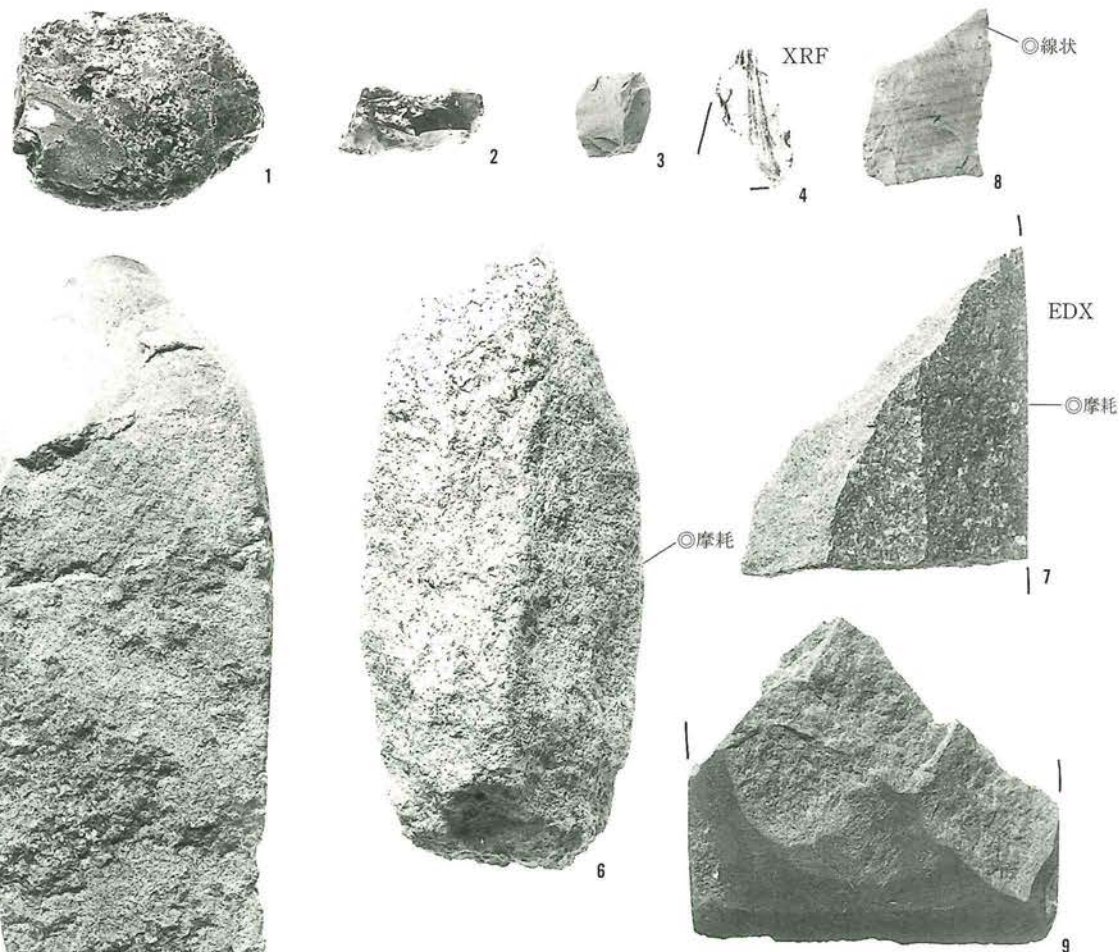

SB315

- 10 大形刃器4類
- 11 軽石製品

SB316

- 12 小形石核III1B類
- 13 敲石工類
- 14 大形刃器1a類
- 15 小形刃器6a・6c類
(2:3)

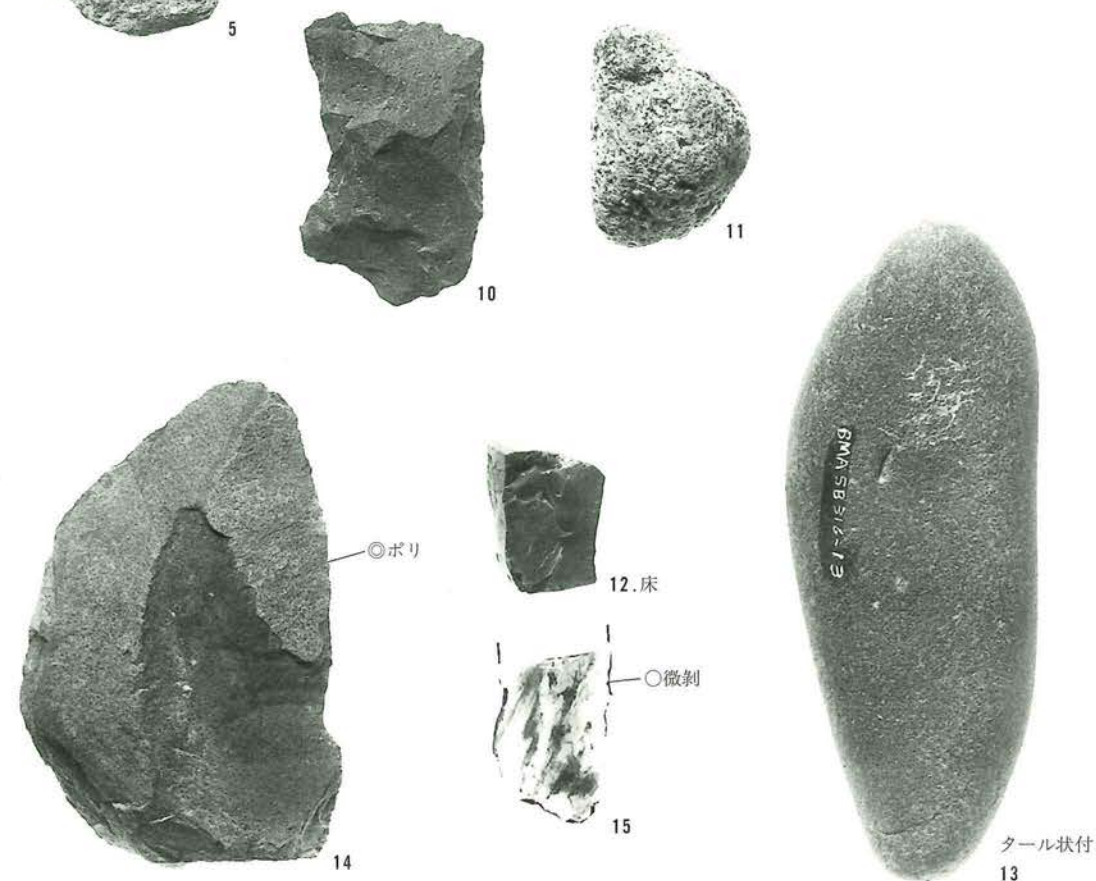

石器写真

SB317

- 1 小形石核II2B類
- 2 大形刃器1b類
- 3 大形刃器7類
- 4 扁平片刃石斧
失敗品B類

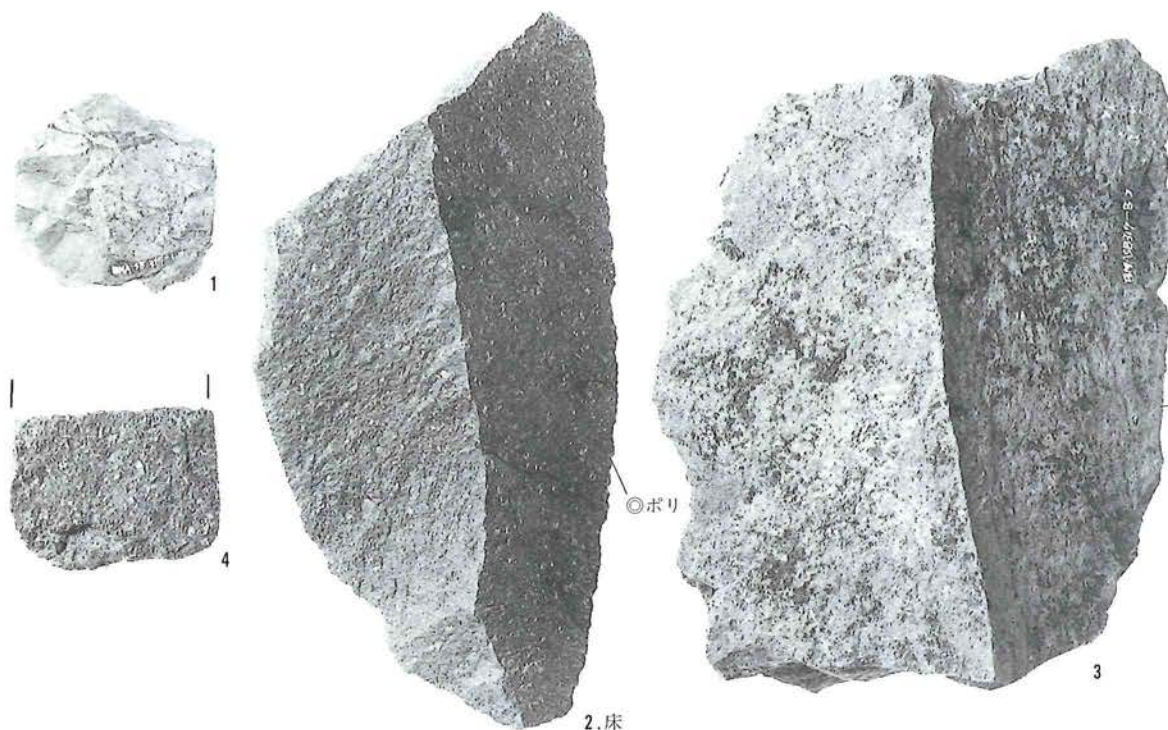

SB319

- 5 磨製石鏃 不明
- 6 磨製石鏃 IB₁類?
- 7 太型蛤刃石斧
Ic'類



SB320

- 10 磨製石包丁
失敗品E₃類
- 11 太型蛤刃石斧
Id'類
- 12 石槌 蛤刃転用
- 13 砥石 I1b類
(2:3)

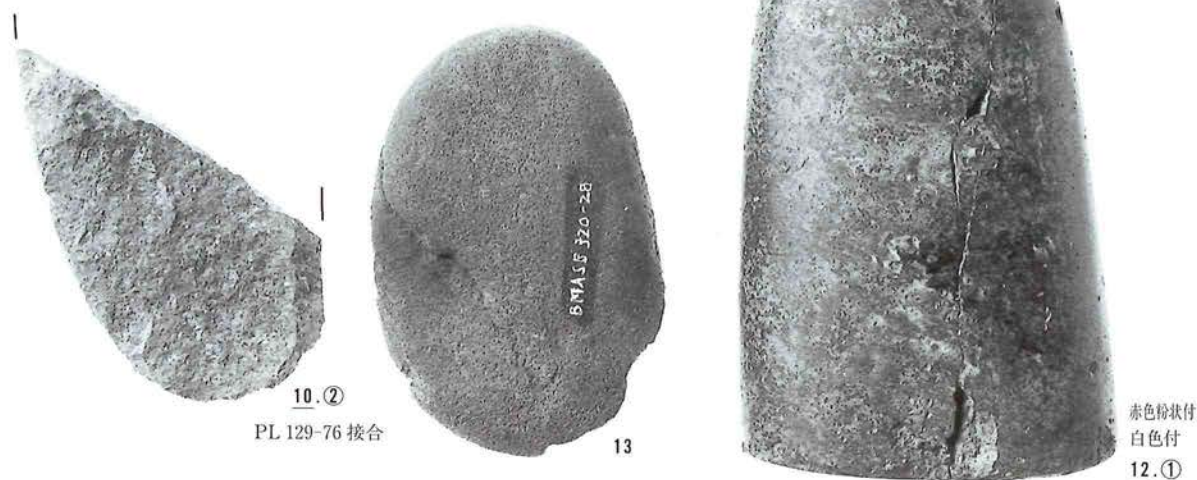

石器写真

S B320

8 原石(磨製石斧関連)

(1:2)

9 台石2種A₂類

(1:3)



8

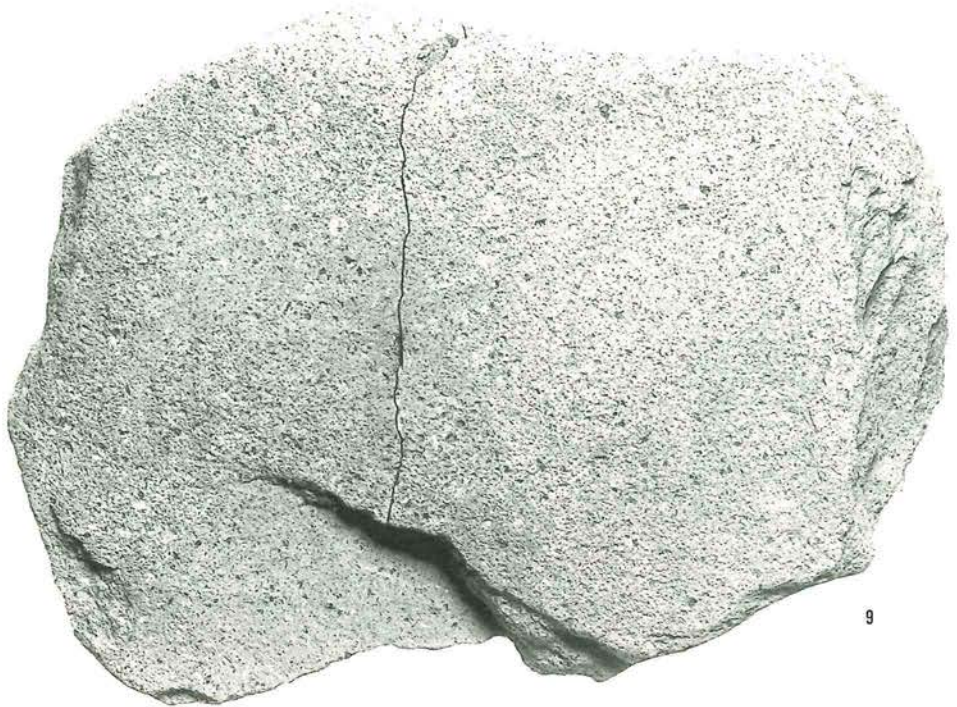

9



SB 319 遺物出土状況

石器実測図

SB 319

PL 28- 6

(2 : 3)

PL 28- 7

(1 : 2)

シカの角出土状況

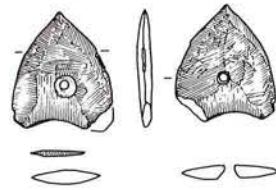

PL28-6

SB 320

PL 28-10

PL 28-11

PL 28-12

(1 : 2)

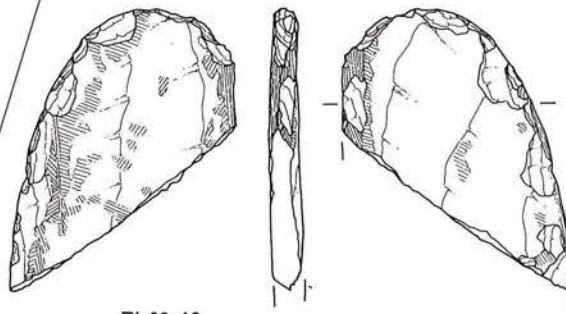

PL28-10

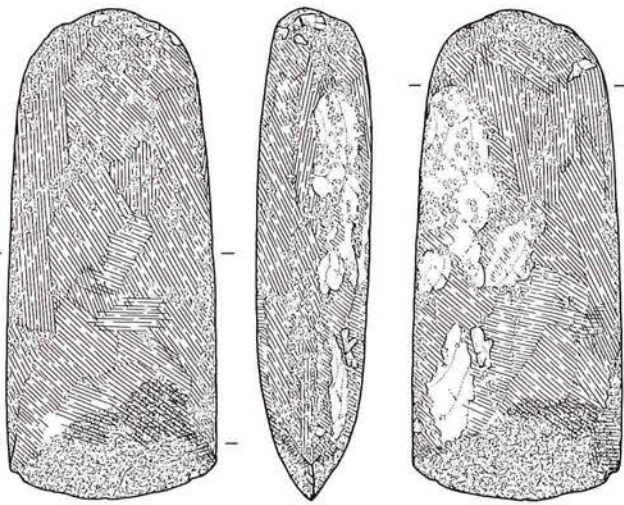

⊕ PL28-7

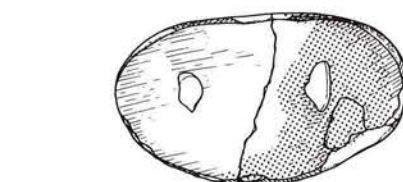
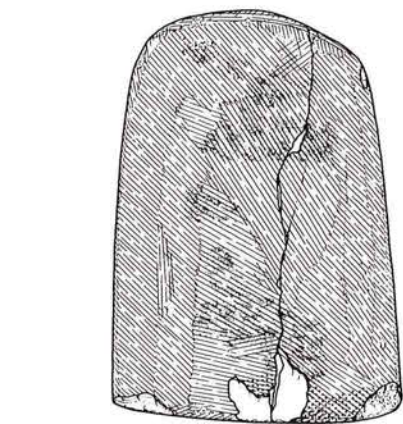

PL28-12

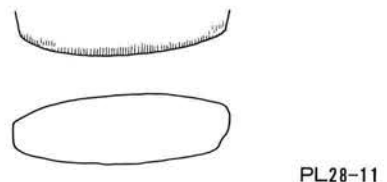
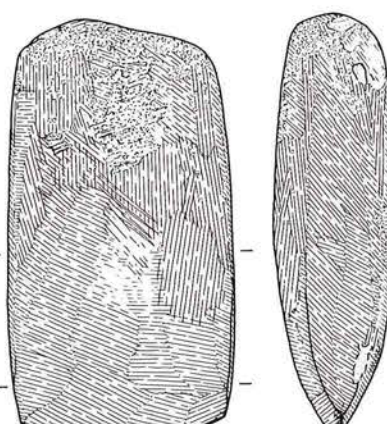

PL28-11

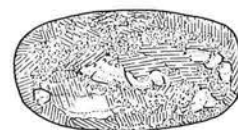
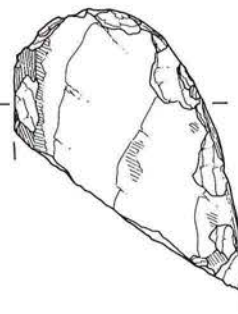

石器実測図

SB320

PL29-8

(1:3)

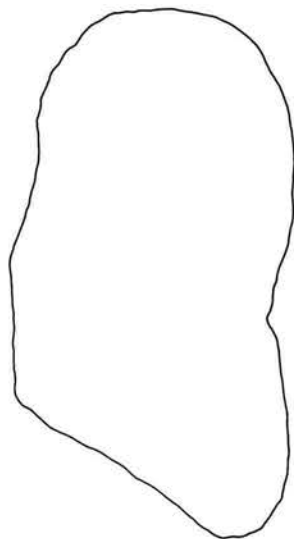

SB329

PL35-11

PL35-3

(1:2)

PL36-5

(1:3)

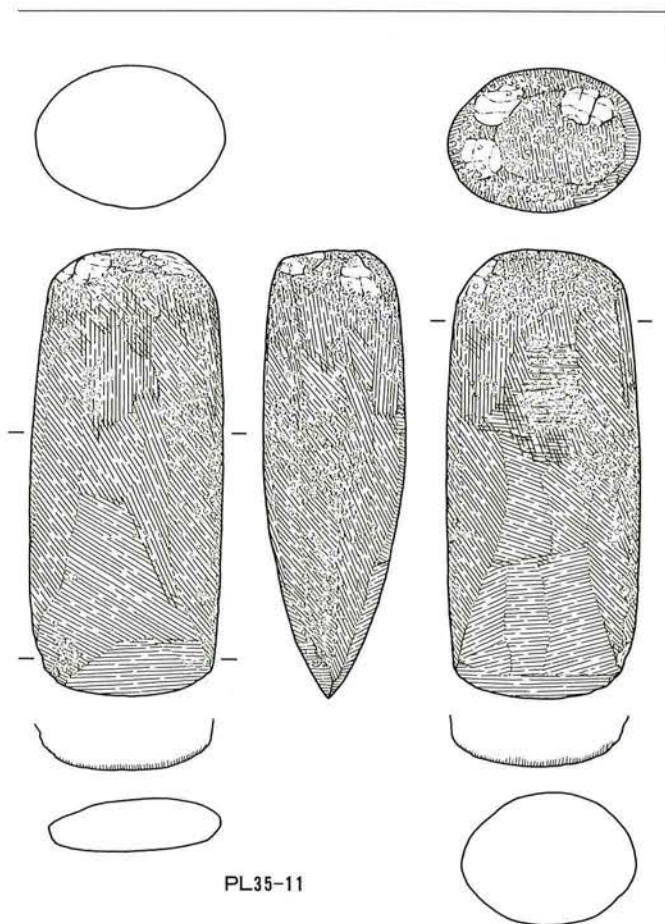

PL35-11

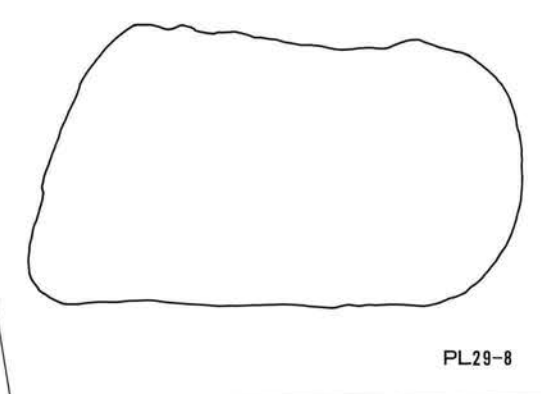

PL29-8

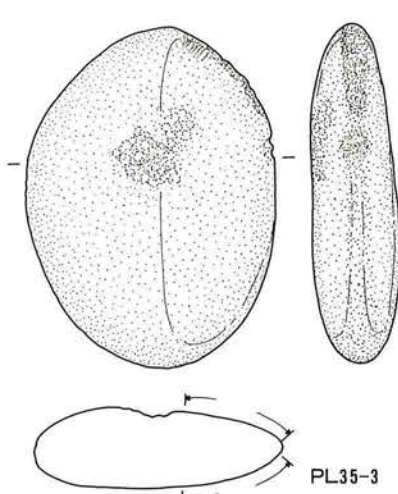
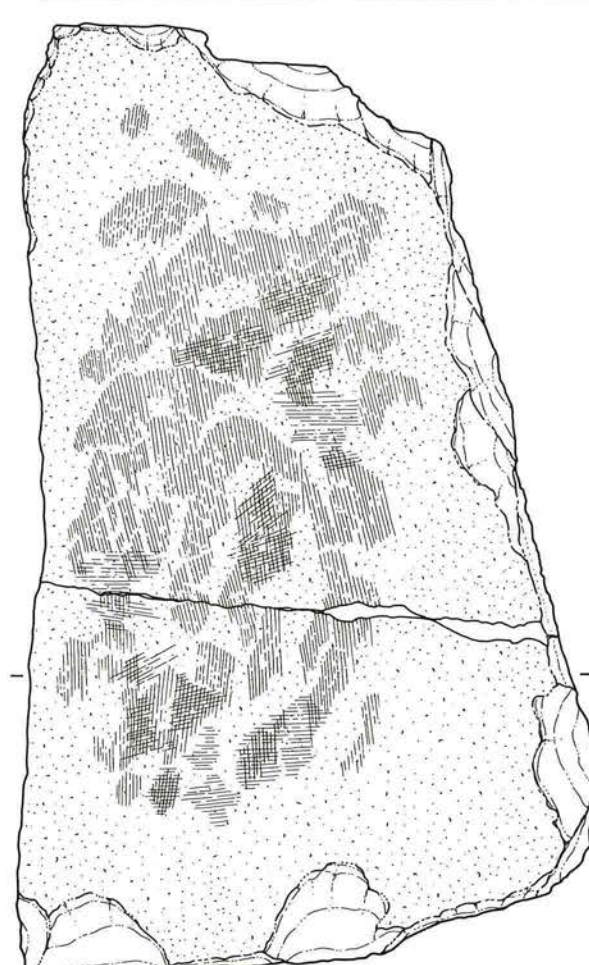

PL35-3

PL36-5

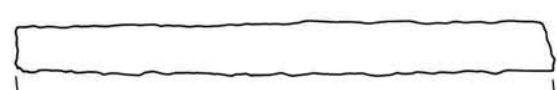

石器写真

SB328

- 1 剥片 A 類II
- 3 大形刃器 2b 類
- 4 大形刃器 7 類
- 5 磨製石包丁 半月形
- 6 扁平片刃石斧 IIb₁類
- 7 石槌 蛤刃転用
- 8 石錐 1 類
- 9 軽石製品
- 10 軽石製品

FT-IR
再生

漆状付
5

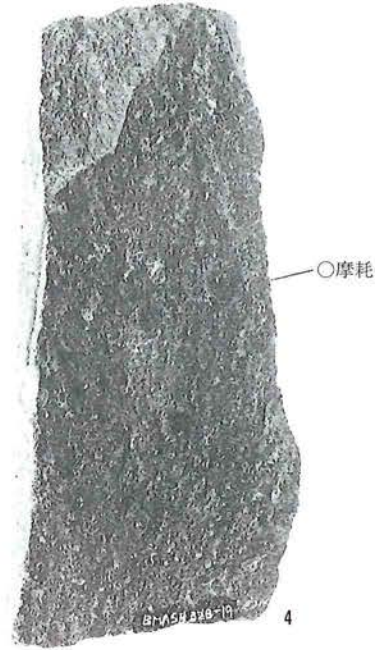
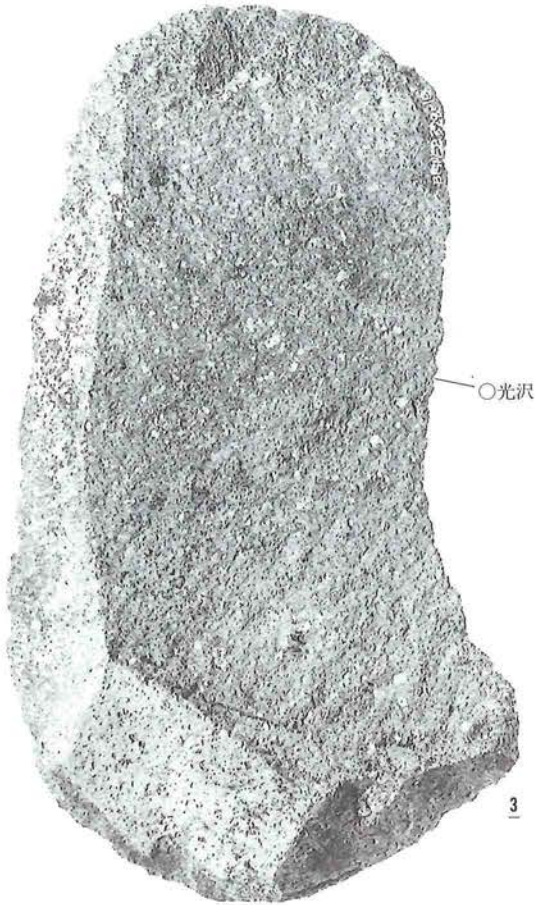
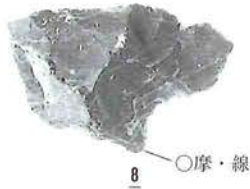

油脂状付



石器写真

SB328

2 台石 2 種 A₂類

(2:3)



PL34

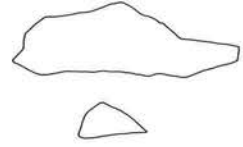
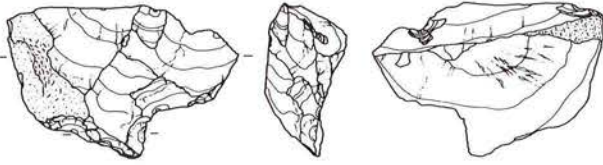

PL32-8

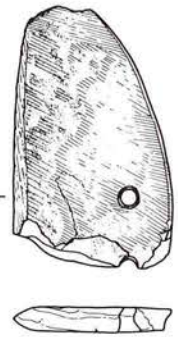
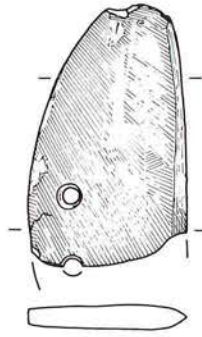

石器実測図

SB328

PL32-5

PL32-3

PL32-6

(1:2)

PL32-2

(1:3)

PL32-8

(2:3)

△▽ PL32-5

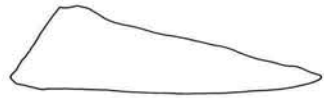
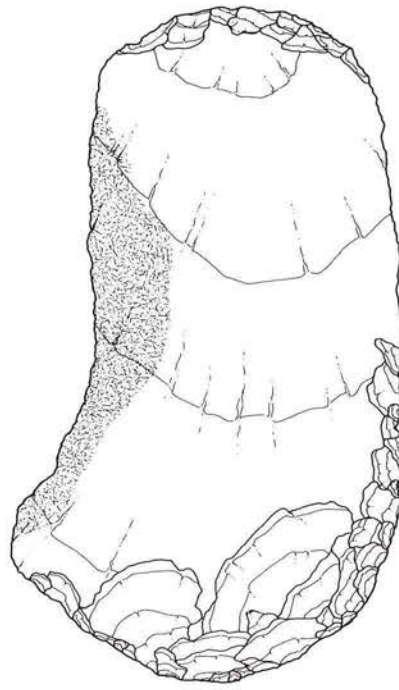
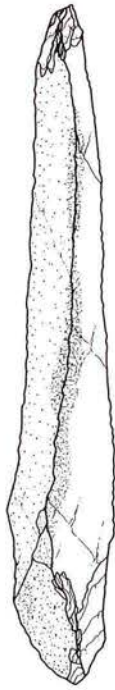
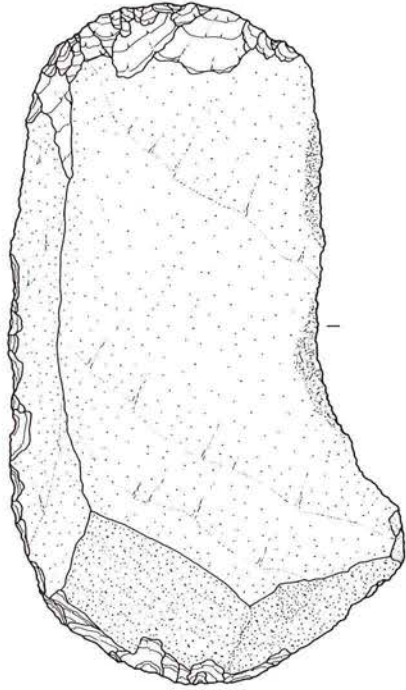

PL32-3

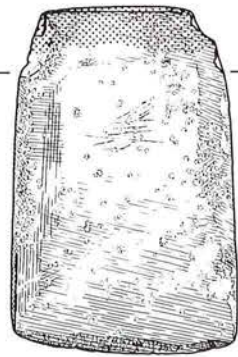
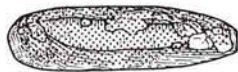
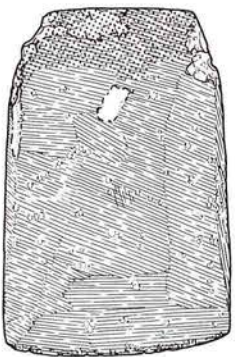

PL32-6

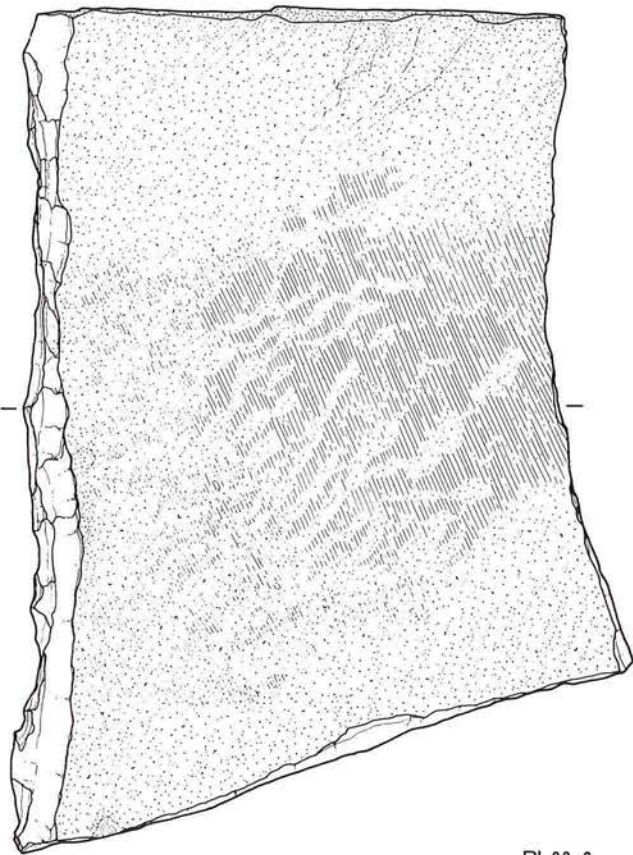

PL33-2



石器写真

SB329

- 1 剥片 A 類IV
- 2 大形剥片 2 種
- 3 凹石 I1a 類
- 4 台石 2 種 A₂ 類
- 6 大形刃器 2 c 類
- 7 大形刃器 7 類
- 8 大形刃器 7 類
- 9 小形刃器 6 c 類
- 10 磨製石包丁
失敗品 B 類
- 11 太型蛤刃石斧
Id' 類
- 12 砥石 I2 類
- 13 軽石製品
(2:3)

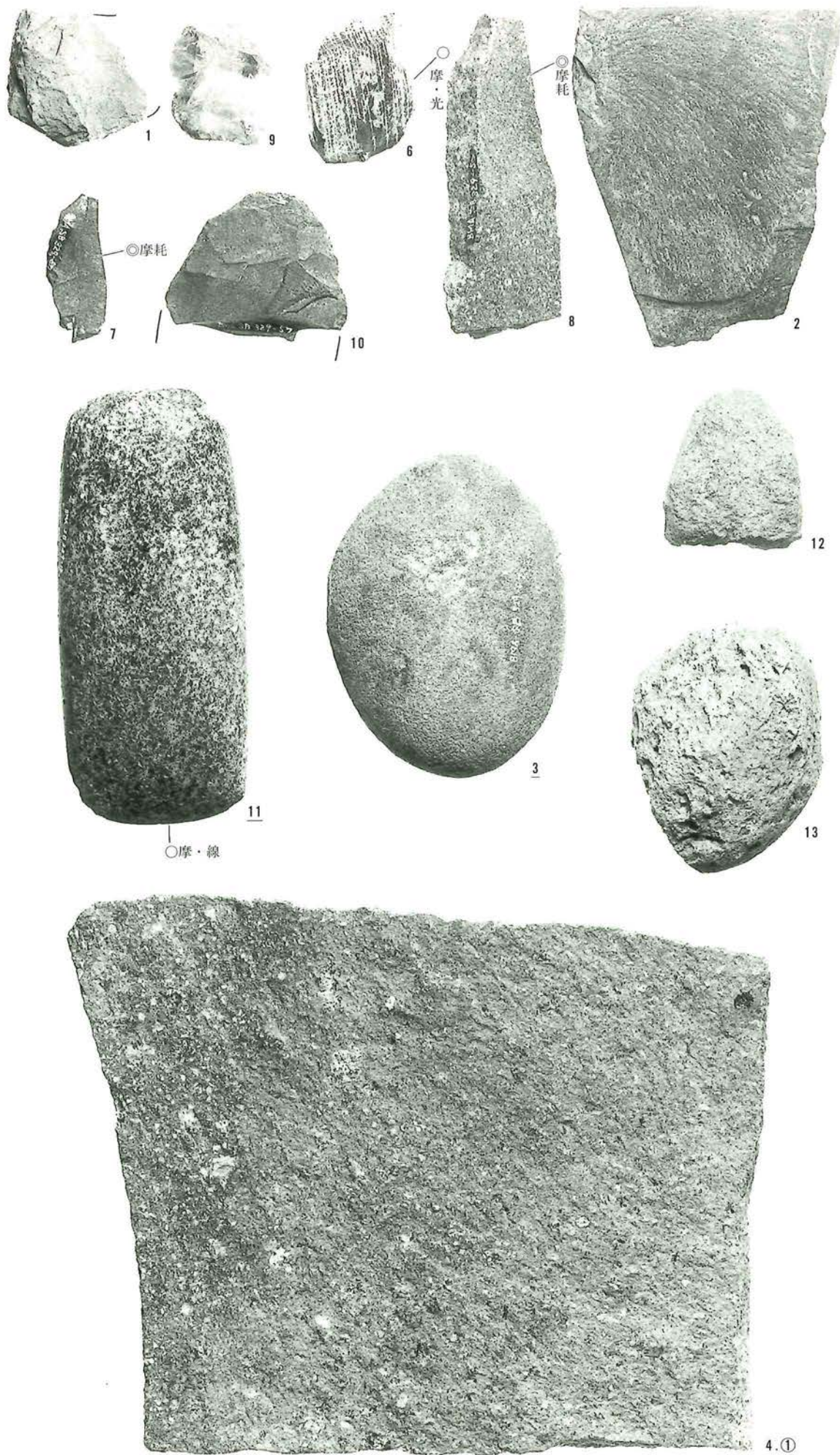



石器写真

SB352

- 1 大形石核 I2B 類
- 2 小形石核 II2A 類
- 3 剥片 A 類IV
- 4 大形剥片 1種
- 5 打製石鏃 IIC₃類
- 6 磨製石鏃 不明
- 7 磨製石鏃 不明
- 8 磨製石鏃
失敗品 2B 類
- 9 磨製石鏃
失敗品 2B 類?
- 10 磨製石鏃 IB₃類
- 11 敲石工類
- 12 大形刃器 7 類
- 13 大形刃器 7 類
- 14 小形刃器 6a 類
- 15 小形刃器 6c 類
- 16 大型蛤刃石斧
失敗品 E₃類
- 17 扁平片刃石斧
IIb₁類?
- 18 石錐 2 A 類
(2:3)

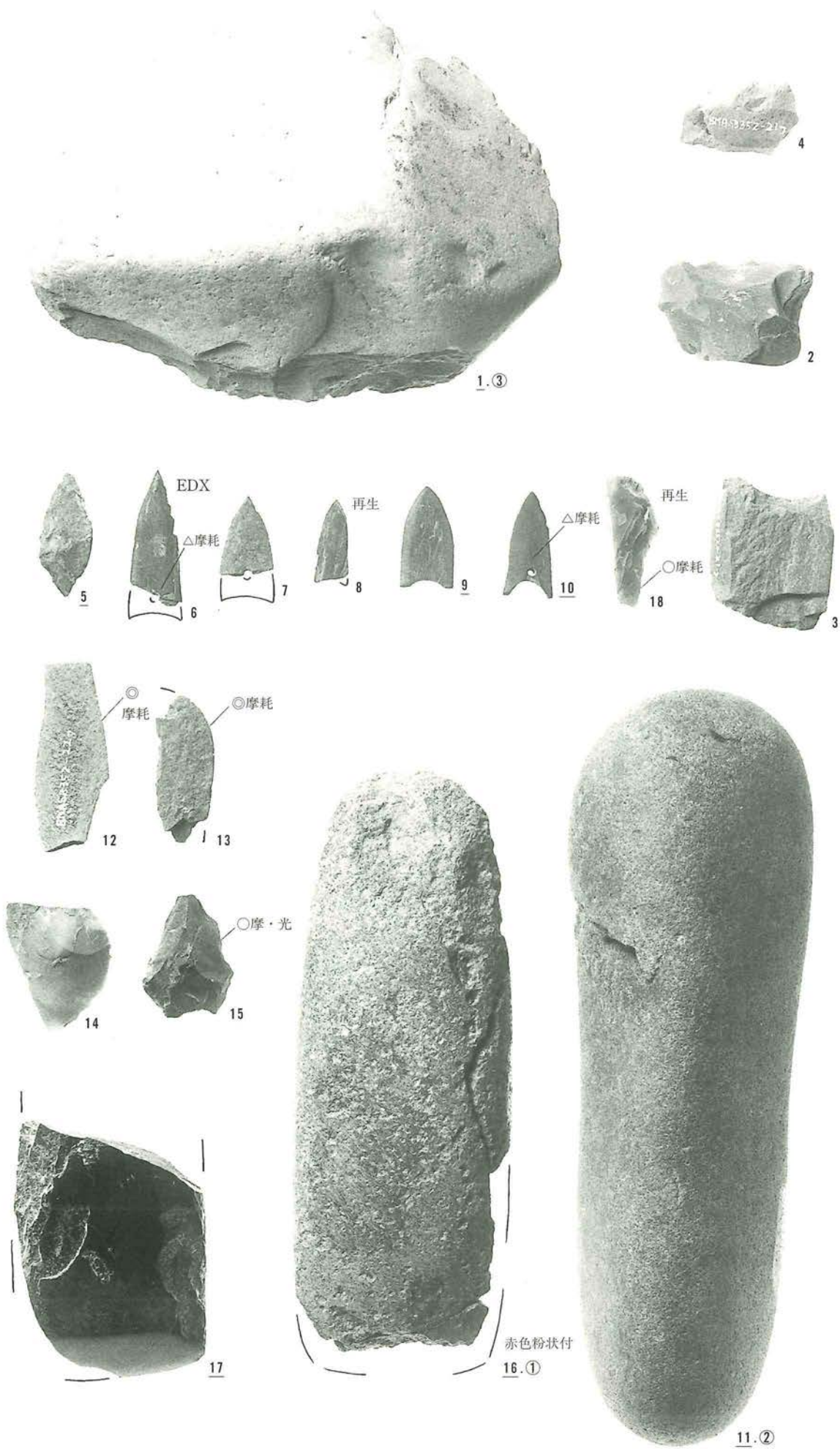

S B 352

PL 37-1

PL 37-11

PL 37-16

PL 37-17

(1 : 2)

PL 37-5

PL 37-9

PL 37-10

(2 : 3)

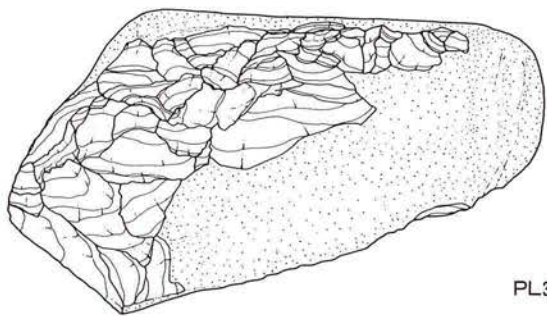
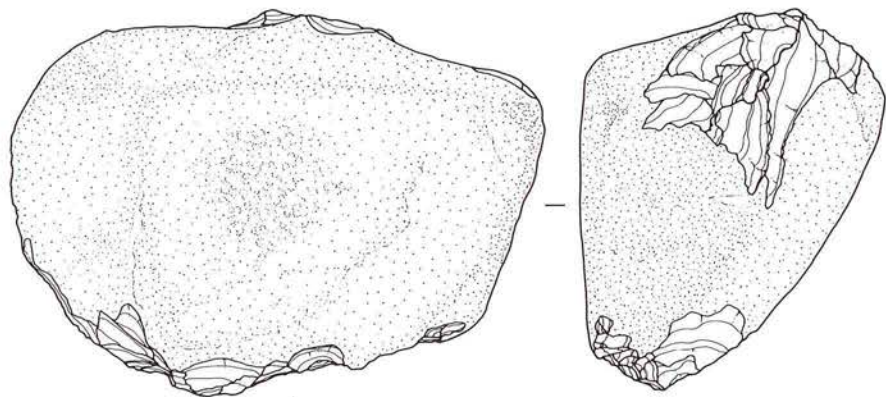

PL37-1

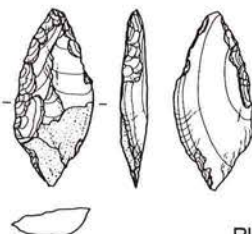

PL37-5

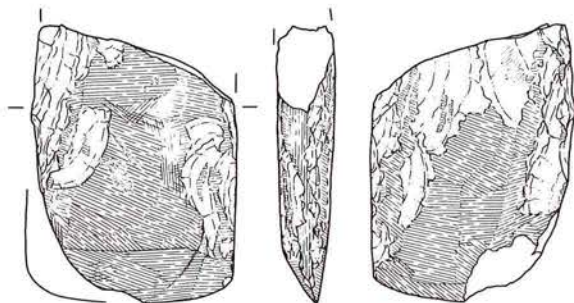

PL37-17

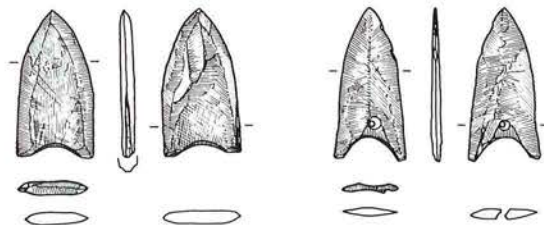

PL37-9

PL37-10

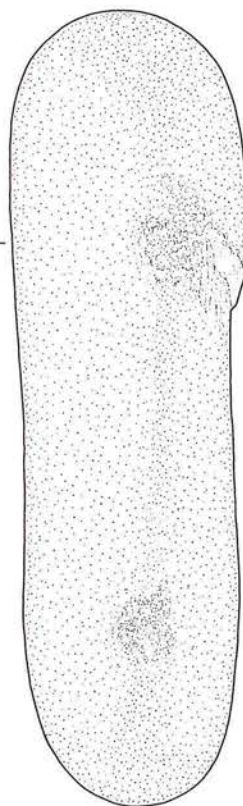

PL37-11

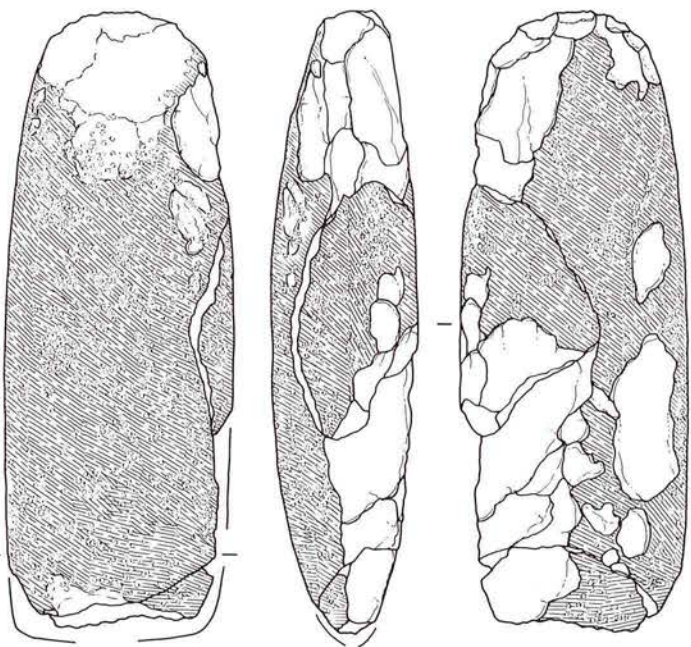

PL37-16

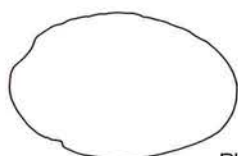
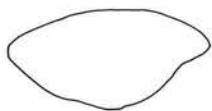

石器写真

SB354

- 1 打製石鏃 IIB₂類
- 2 磨製石鏃 不明
- 3 台石 2種 A₂類
- 4 大形刃器 1b類
- 5 大形刃器 2d類
- 6 小形刃器 6c類
- 7 扁平片刃石斧
失敗品 E₃類
- 8 玉, 剝片 1種

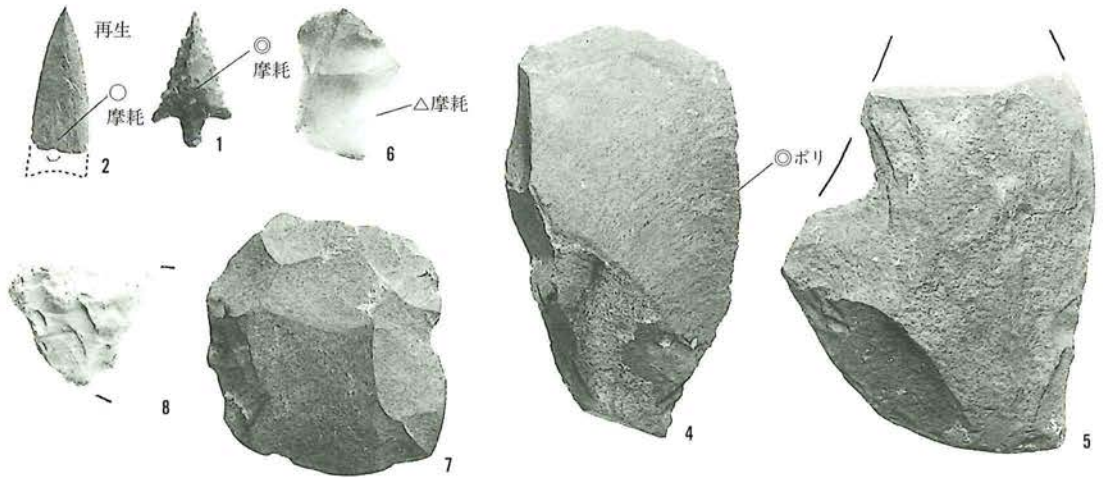

SB359

- 9 小形石核 I2A類
- 10 大形刃器 2a類
(2:3)

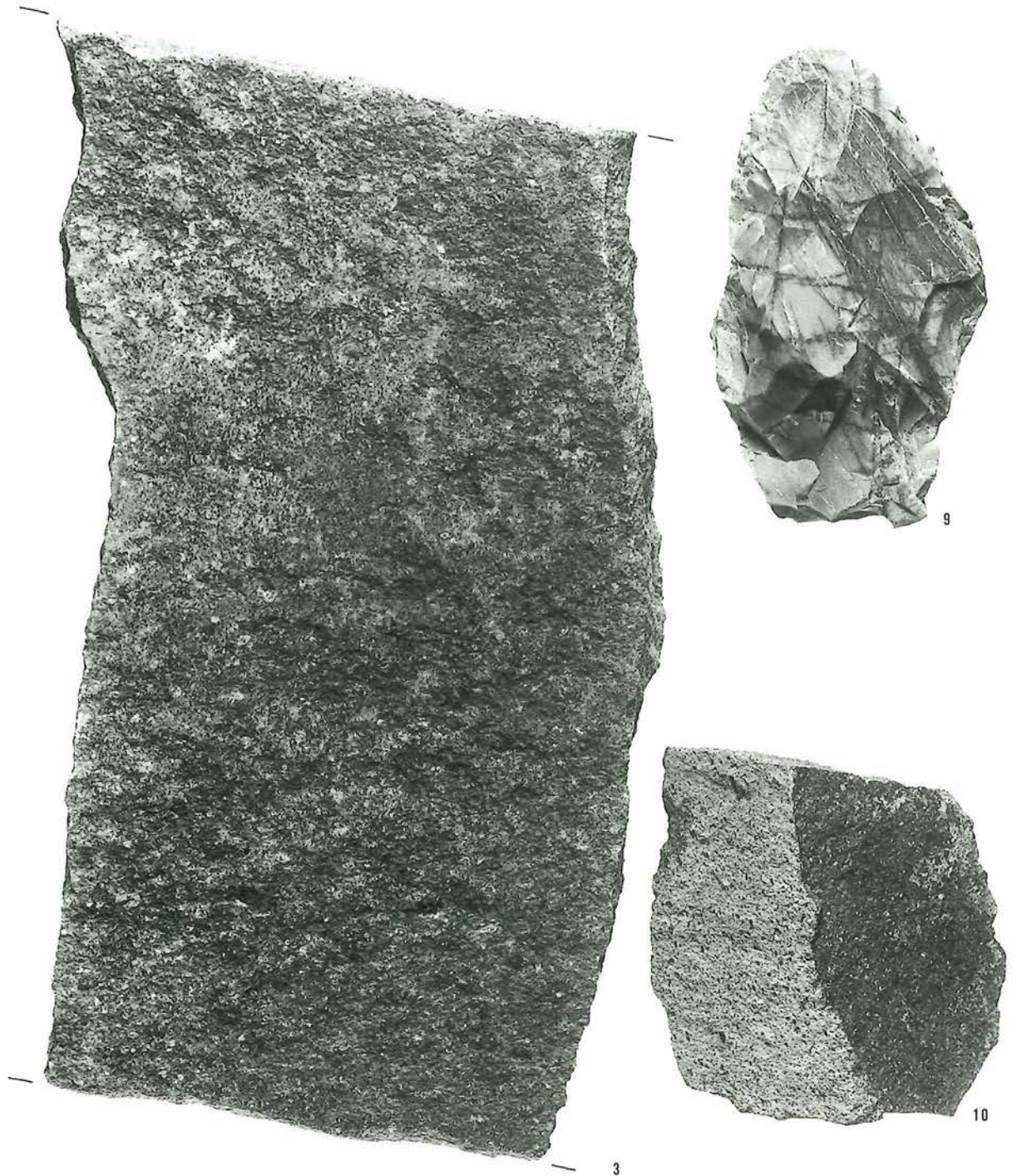



石器写真

SB360

1 扁平片刃石斧
IIb₂類

2 砥石 置砥
(2:3)

3 管 玉
(1:1)

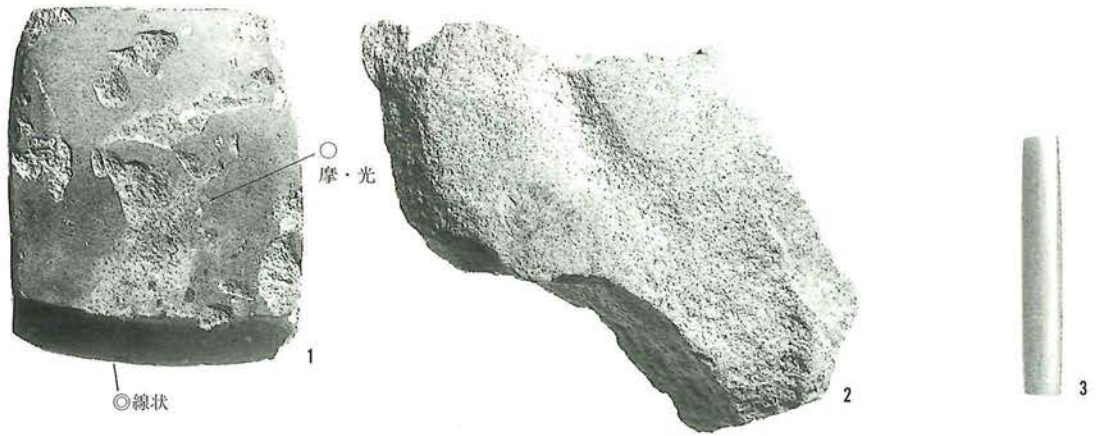

SB361

4 大形刃器 2b類

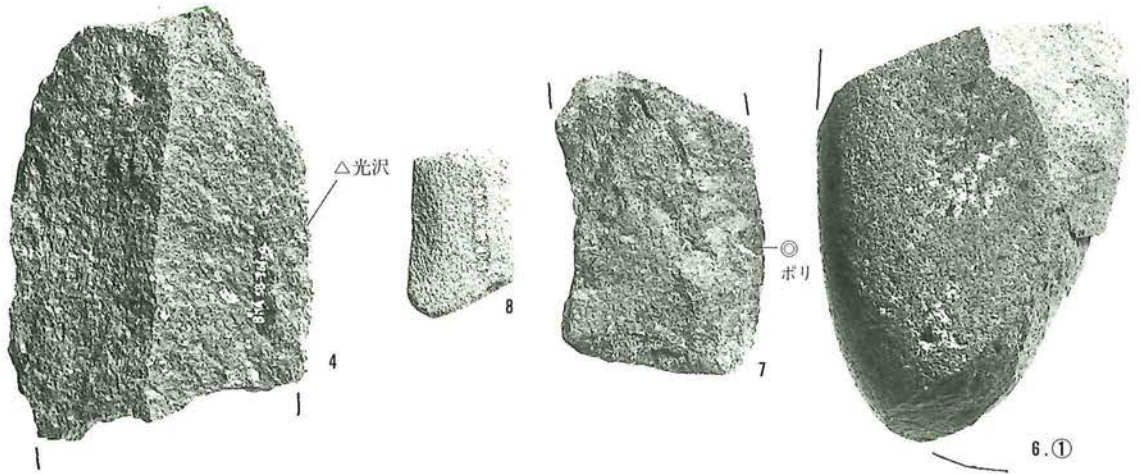

SB362

5 台石 2種 A₂類

6 敲石 不明

7 大形刃器 1b類

8 砥石 IIc類
(2:3)

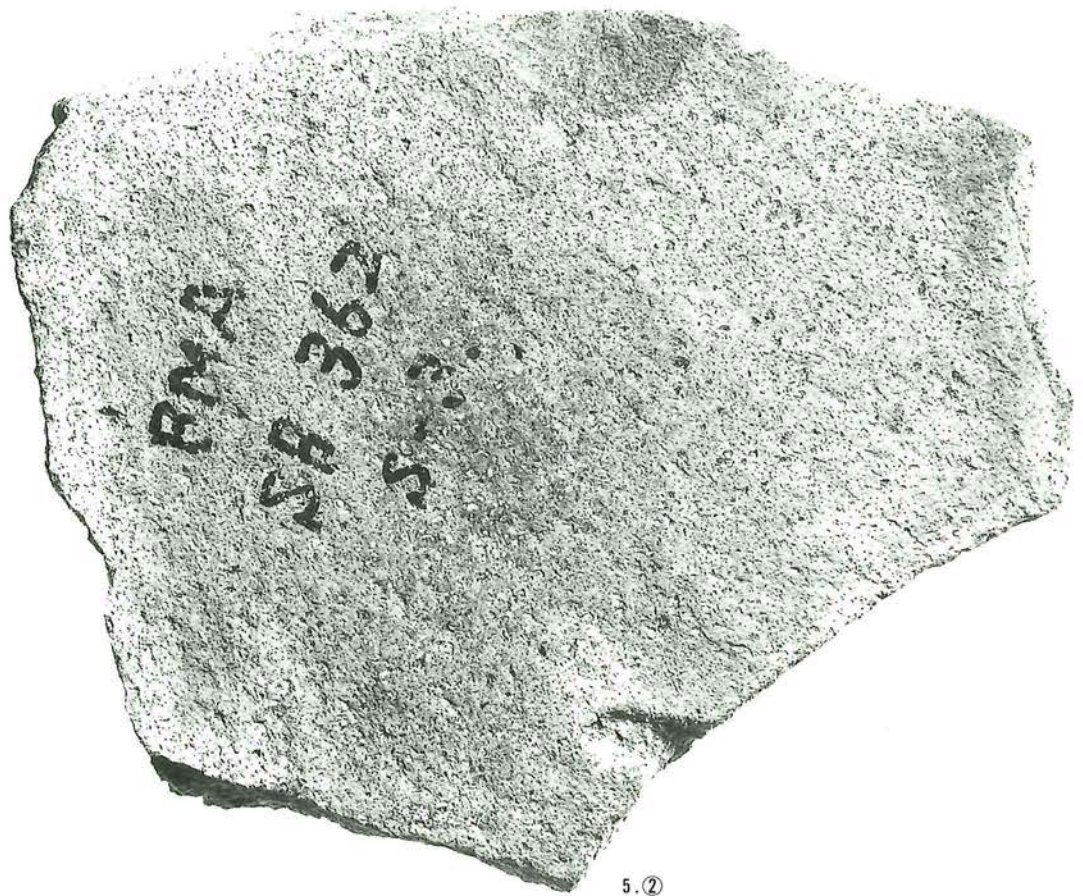

石器写真

S B 363

- 1 みがき石II2a 類
- 2 大形刃器 2b 類

S B 368

- 3 磨石 IIc 類
- 4 大形刃器 3 類
- 5 太型蛤刃石斧 Id' 類

S B 364

- 6 剥片 A 類II
 - 7 剥片 A 類IV
 - 8 台石 2 種 A₂ 類
 - 9 大形刃器 7 類
 - 10 研磨痕のある剥片
 - 11 研磨痕のある剥片
- (2 : 3)

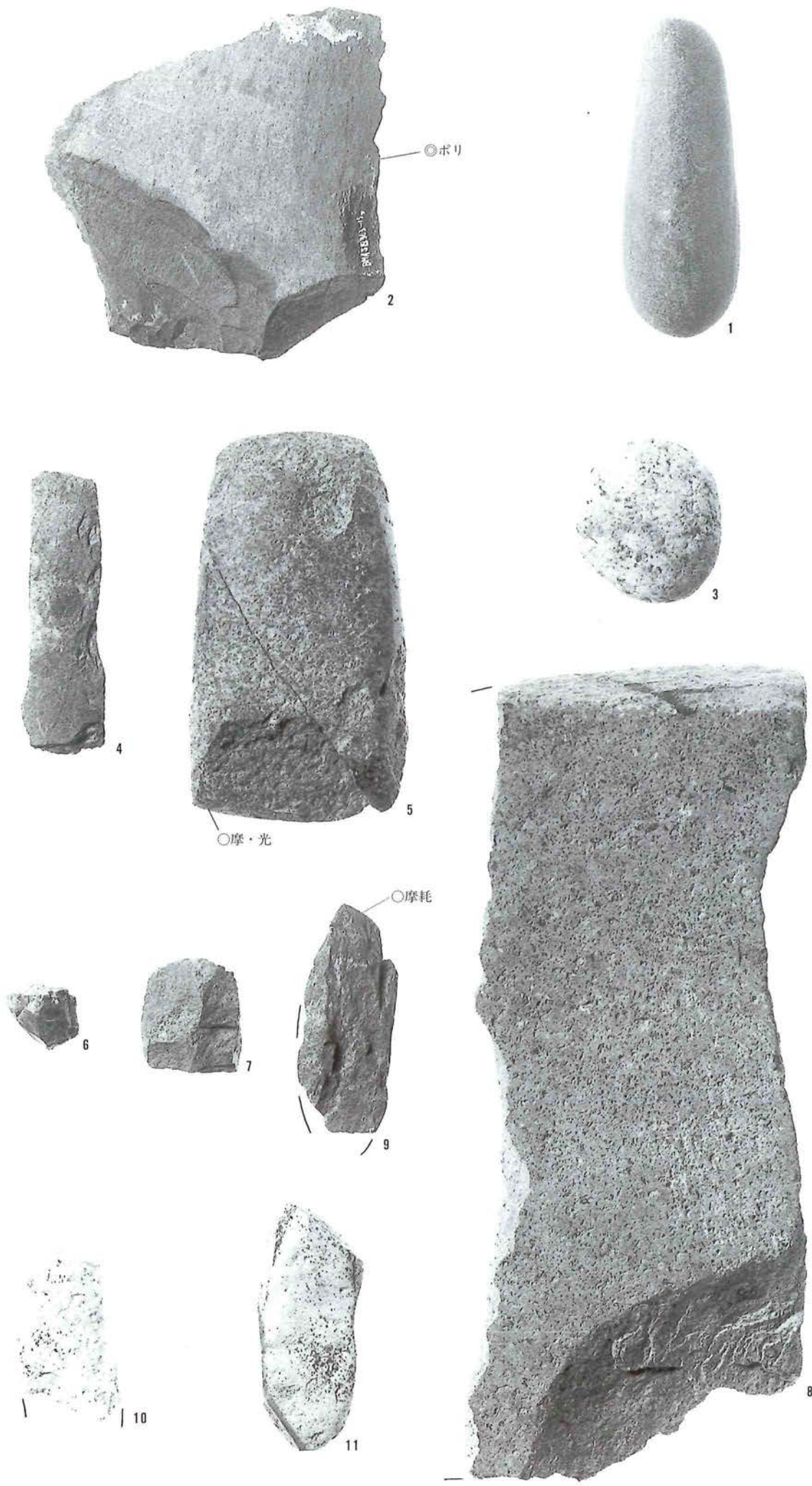

石器写真

S B369

1 小形石核II1A 類

2 剝片 A 類VI

3 打製石鏃
失敗品 1 類

4 磨製石鏃
失敗品 1 類

5 敲石 不明

6 太型蛤刃石斧 不明

7 扁平片刃石斧
失敗品 D 類

8 砥石 III 類

9 砥石 置砥

10 玉, 剝片 1 種
(2: 3)



5



転用

6



転用

7



S B369 7

9

石器写真

SB384

- 1 剥片 A 類IV
- 2 石槌 蛤刃転用
- 3 加工痕のある石屑

SB389

- 4 大形刃器 2c 類
- 5 大形剥片 1 種

SB390

- 6 小形石核 IIIA 類
- 7 剥片 A 類V
- 8 大形刃器 2c 類
- 9 大形剥片 2 種

SB391

- 10 小形刃器 6a 類

SB399

- 11 打製石鏃 IIB₂ 類

SB400

- 12 小形石核 II2B 類
- 13 小形剥片 1 種
- 14 小形剥片 1 種
- 15 小形剥片 2 種
- 16 打製石鏃 IA 類

(2:3)

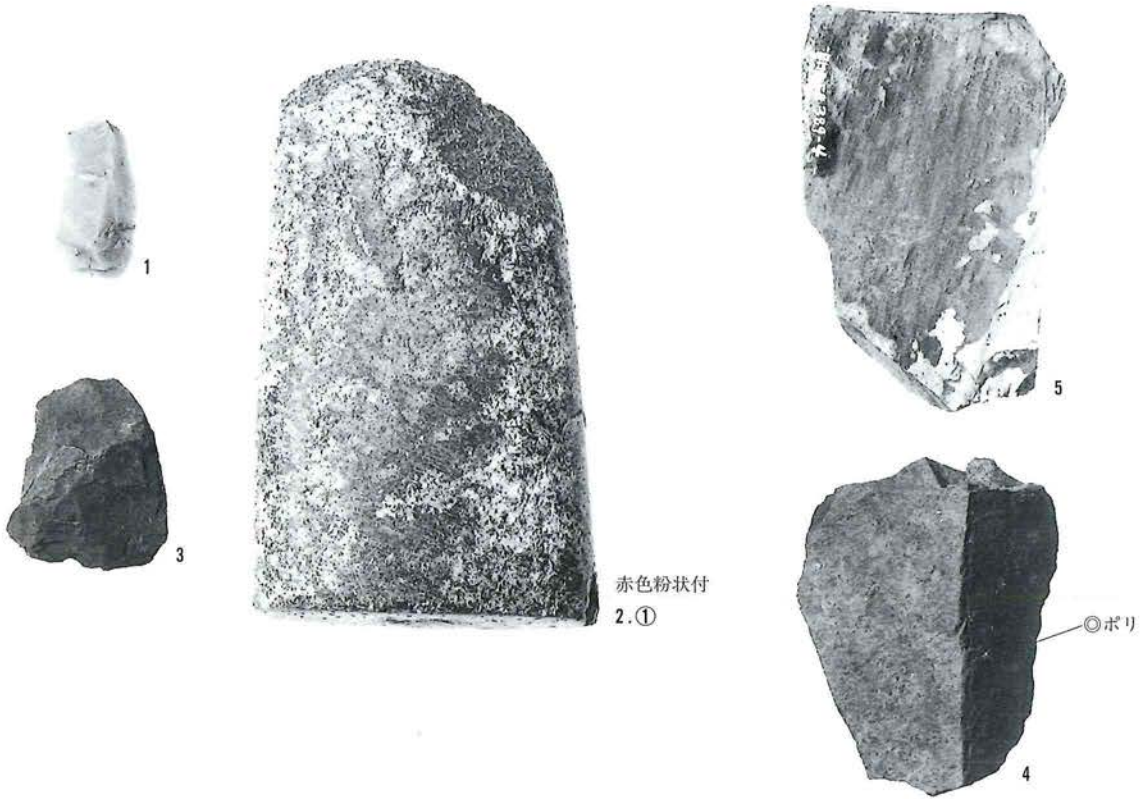

赤色粉状付
2.①

◎ポリ



石器写真

SB401

- 1 大形刃器 7 類
- 2 大形刃器 2d 類
- 3 大型蛤刃石斧
失敗品 E₁ 類
- 4 大型蛤刃石斧
Ib' 類?
- 5 みがき石 II2c 類
- 6 砥石 置砥
- 7 砥石 置砥
(2:3)



FT-IR

タール状付
5



○摩耗

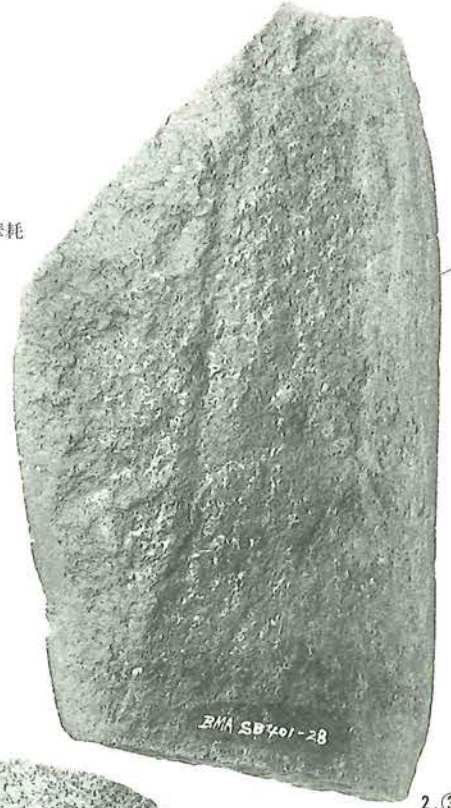

○摩耗

BMA SB401-28

2.③



3.⑤



4.①

○摩・線



転用

6.②

十
接合



転用

7.④

SB401

PL 45-3

PL 45-4

PL 45-5

PL 45-6

+
PL 45-7

(1:2)

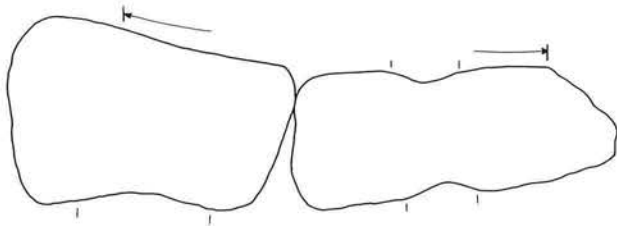
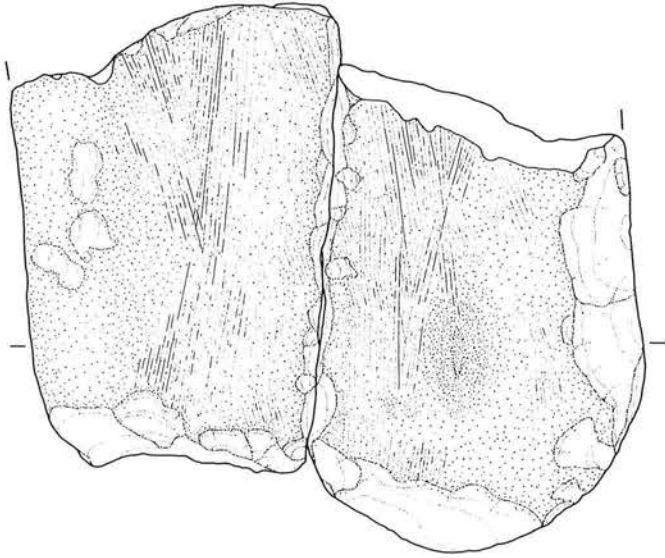

大型蛤刃石斧No.3と砥石No.6・7のセット想定写真

PL45-6+PL45-7

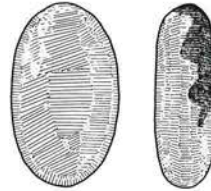

♡ PL45-5

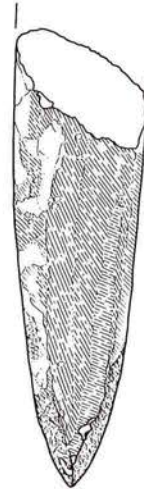
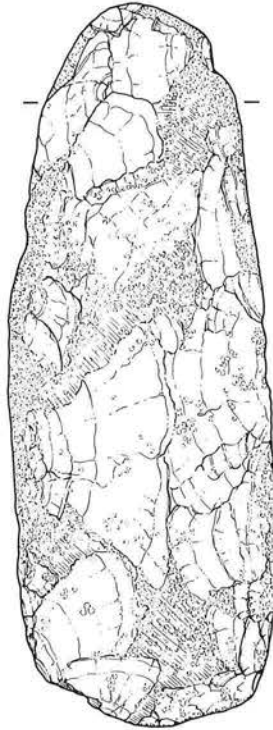
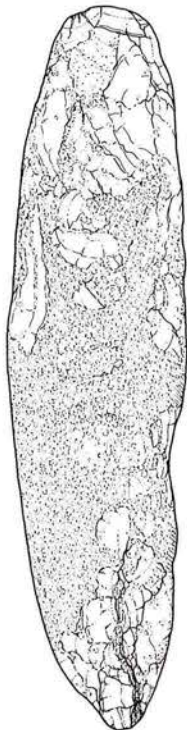
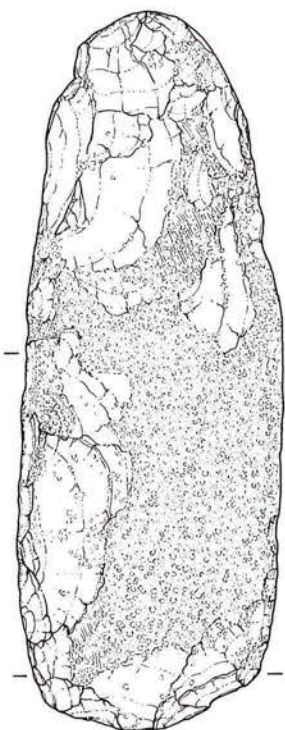
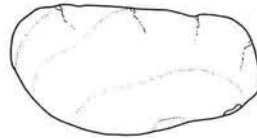
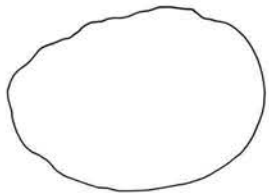

♡ PL45-4

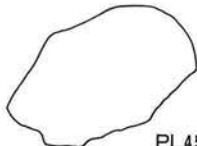
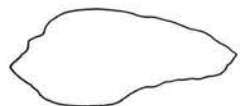

PL45-3

石器写真

SB402

1 小形石核III B類

2 打製石鏃IIA類

(2:3)

3 原石(磨製石斧関連)

(約2:3)

5 大形刃器2d類

6 大形刃器1b類

7 小形刃器6a類

8 太形蛤刃石斧 不明

9 石槌 蛤刃転用

(2:3)

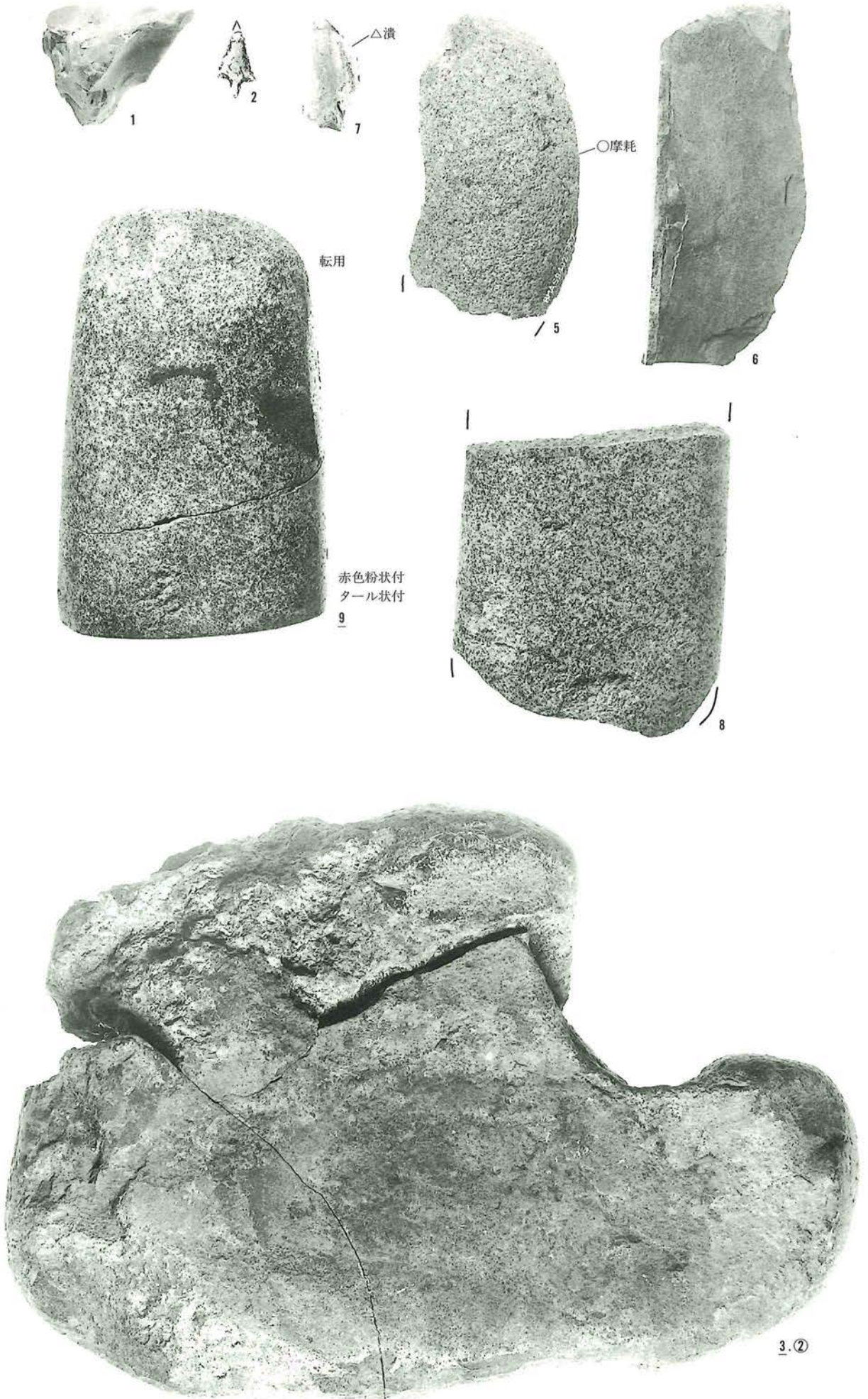



赤色粉状付
4.①

石器実測図

SB402

PL47-3

PL48-4

(1:3)

PL47-9

(1:2)

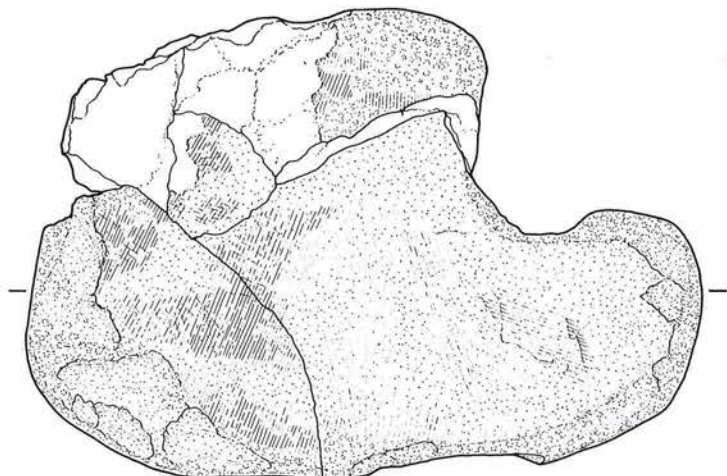

石槌No.9と台石No.4のセット想定写真

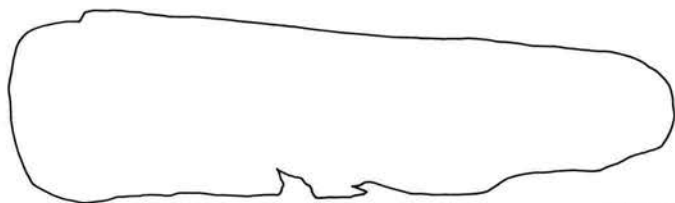

PL47-3

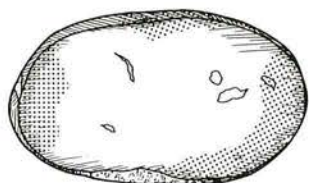
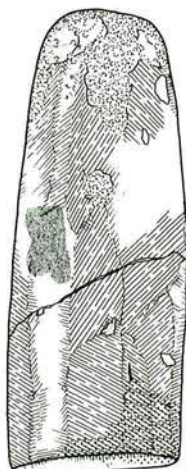
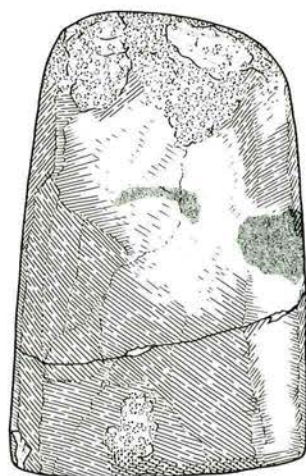

PL47-9

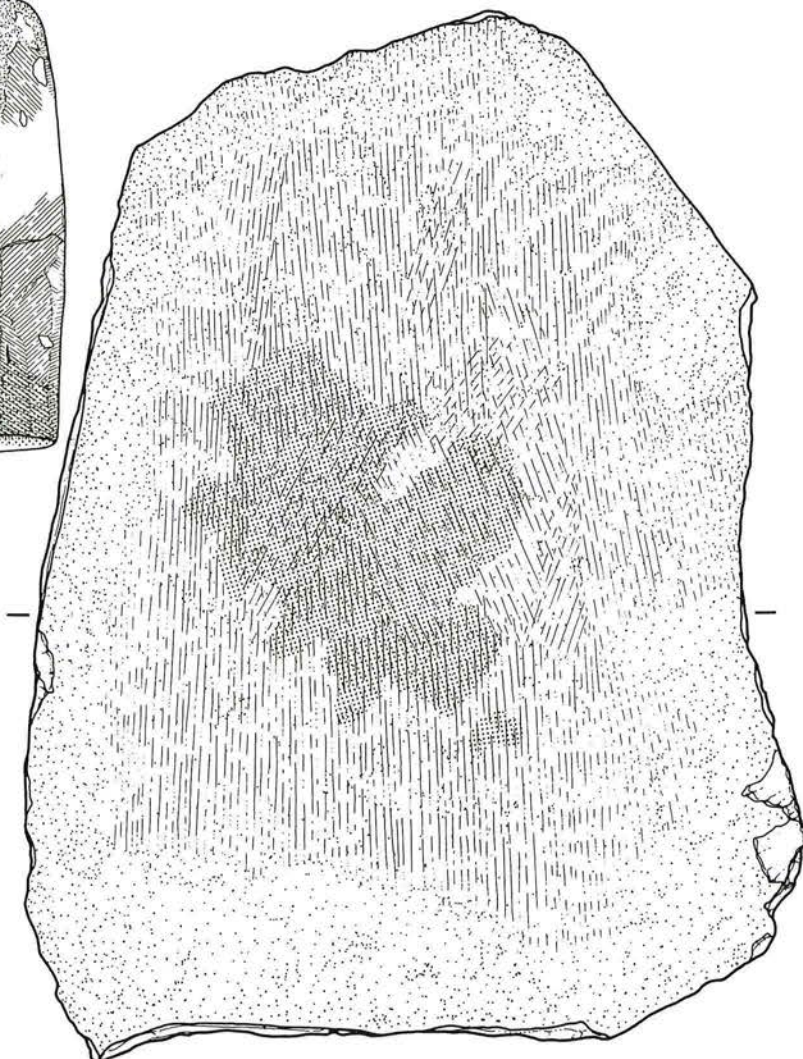

縄実測図

PL49-(1)

PL265-24(2a・b)

(1:1)



PL265-24(2a・b)



PL49-(1)

PL48-4



石器写真

SB404

- 1 小形石核II1A 類
- 2 打製石鏃
失敗品1類
- 3 磨製石鏃
失敗品1類
- 4 大形刃器 不明
- 5 敲石ア類
- 6 砥石I2類
- 7 砥石I1b類

SB406

- 8 小形剝片B類
- 9 大形刃器7類
- 10 砥石I1a類

SB407

- 11 打製石鏃IIB₂類
- 12 敲石エ類
- 13 軽石製品
(2:3)

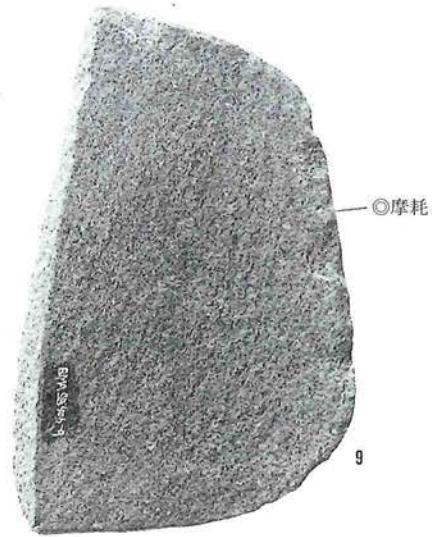
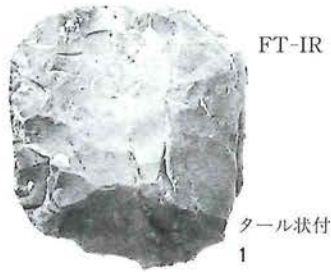
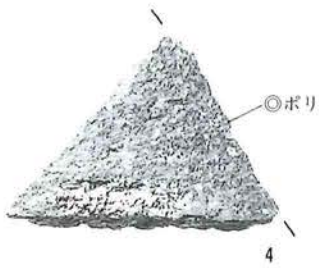

石器写真

SB405

- 1 大形石核III1A 類
- 2 小形石核II2B 類
- 3 打製石鏃II B₃ 類
- 4 打製石鏃II A 類
- 5 敲石ウ類
- 6 大形刃器2 a 類
- 7 大形刃器2 d 類
- 8 大形刃器2 b 類
- 9 大形刃器2 b 類
- 10 扁平片刃石斧
失敗品 E₃ 類
- 11 石錐1 類

(2:3)

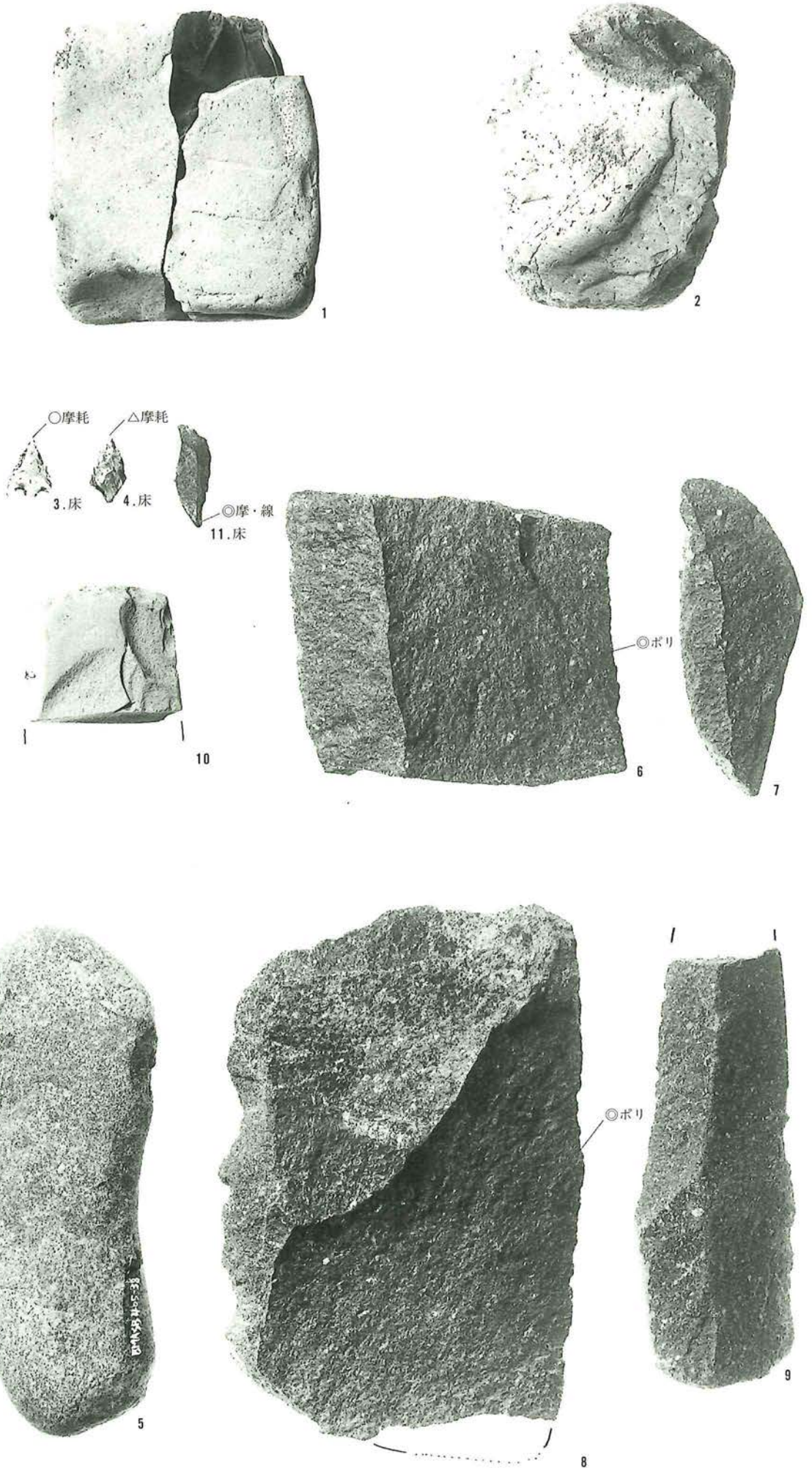

石器写真

SB409

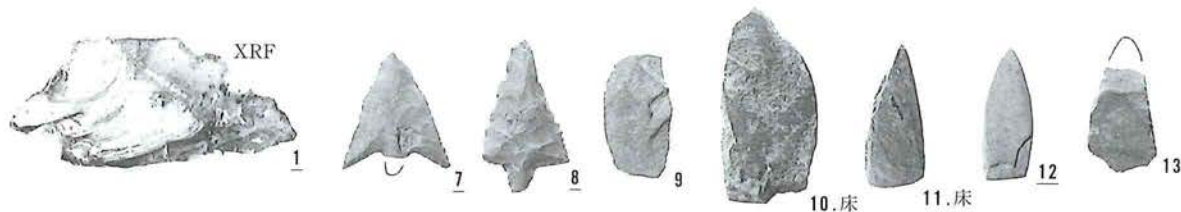

- 1 原石
- 7 打製石鏃IIB₃類
- 8 打製石鏃IIA類
- 9 磨製石鏃
失敗品2A類
- 10 磨製石鏃
失敗品2A類
- 11 磨製石鏃
失敗品2B類
- 12 磨製石鏃
失敗品2B類
- 13 磨製石鏃
失敗品1類
- 14 みがき石IIIc類
- 15 大形刃器3類
- 16 大形刃器1b類
- 17 大形刃器7類
- 18 大形刃器2b類
- 19 磨製石包丁 杏仁形



15



◎ボリ



14

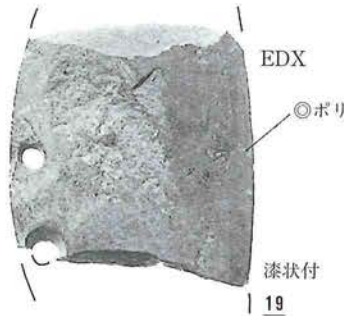

EDX

◎ボリ

漆状付

19



22



23



◎摩耗

17



18



24

- 20 大型蛤刃石斧
Id'類
- 21 扁平片刃石斧
IIa類
- 22 扁平片刃石斧
失敗品E₂類
- 23 扁平片刃石斧
IIIf類
- 24 扁平片刃石斧
失敗品B類
- 25 石槌 蛤刃転用
(2:3)



タール状付

25

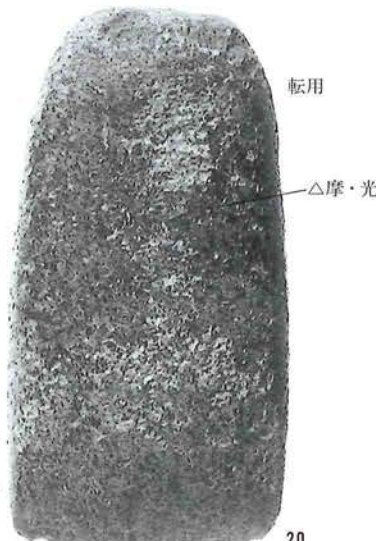

転用

△摩・光

20

◎摩・潰

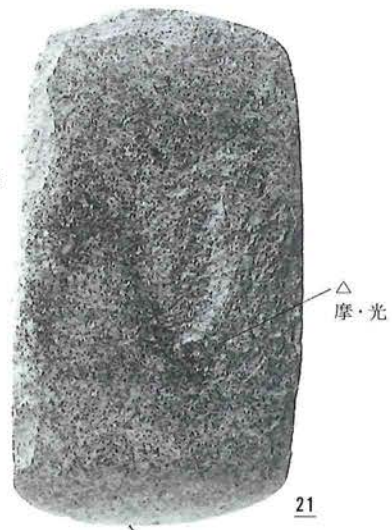

△摩・光

21

◎摩・光

石器写真

SB409

- 2 大形剥片 1種
- 3 大形剥片 2種
- 4 大形剥片 2種
- 5 大形剥片 2種
- 6 大形剥片 B類
- 26 砥石 置砥
- 27 砥石 置砥
(2:3)

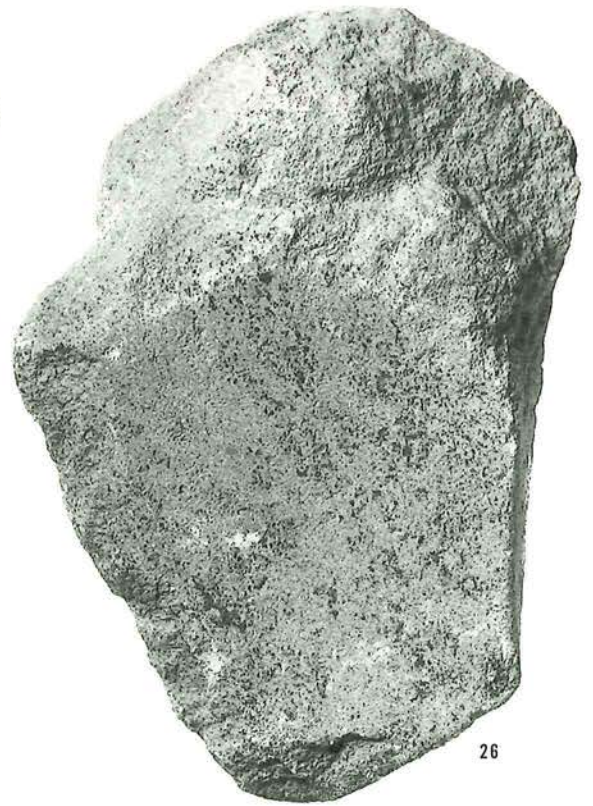
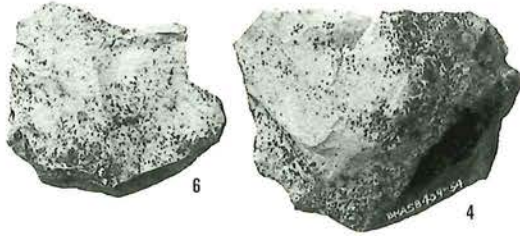
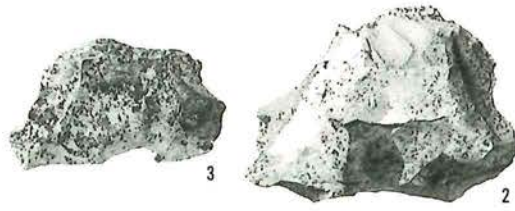

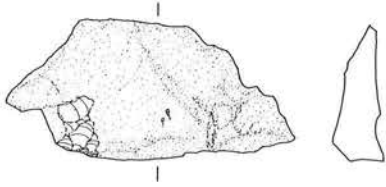

☆ PL52-1

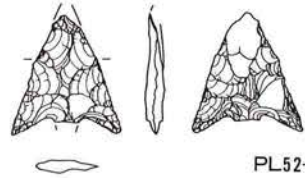

PL52-7

S B 409

PL 52-1

PL 52-23

PL 52-7

PL 52-8

PL 52-12

(2:3)

PL 52-17

PL 52-19

PL 52-20

PL 52-21

PL 52-22

(1:2)

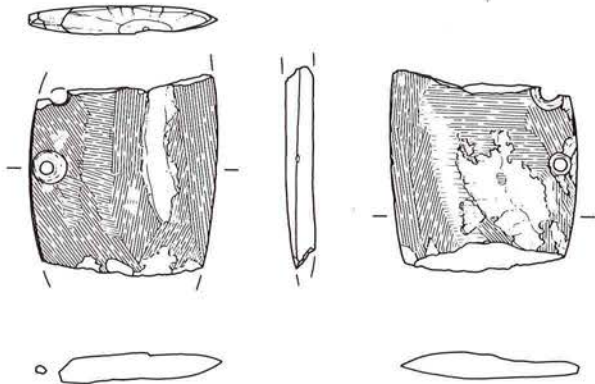

♡ PL52-19

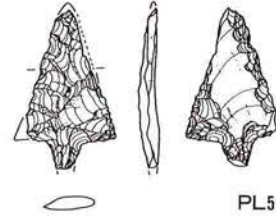

PL52-8

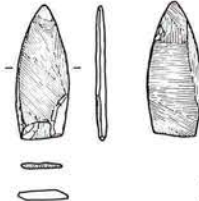

PL52-12

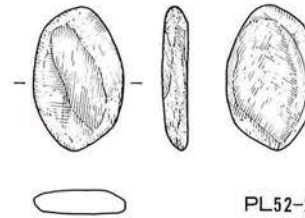

PL52-22

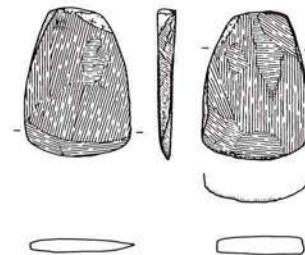

PL52-23

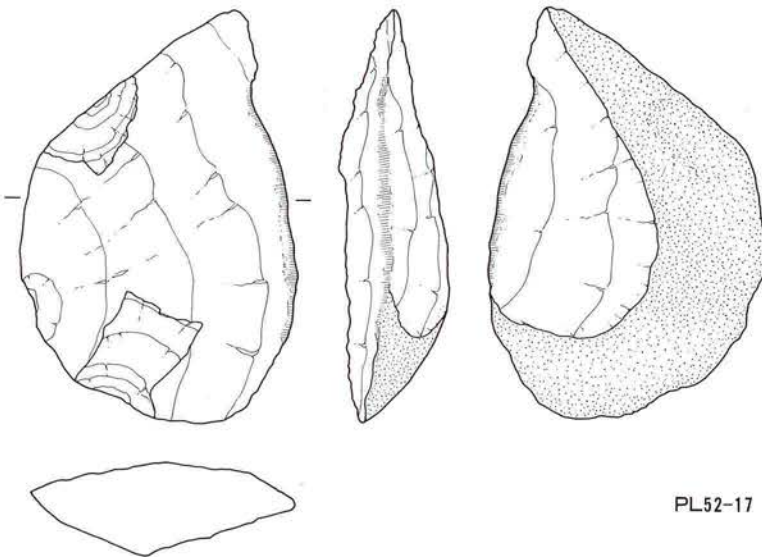

PL52-17

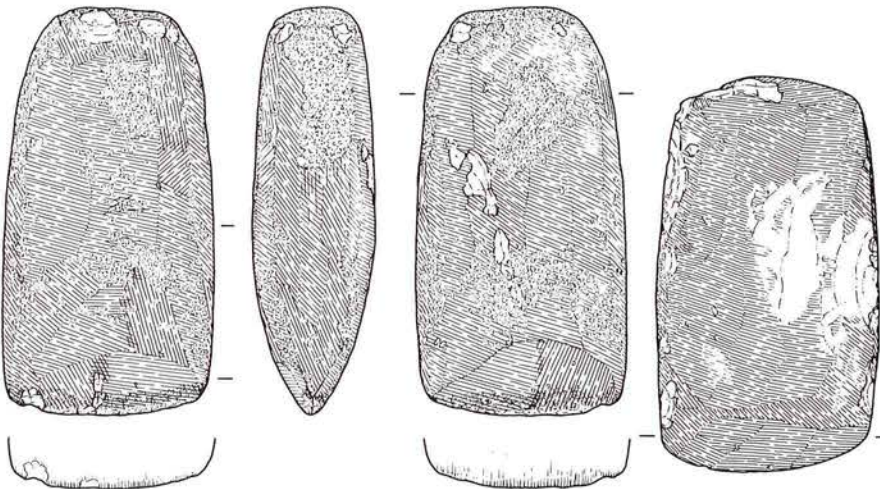

PL52-20

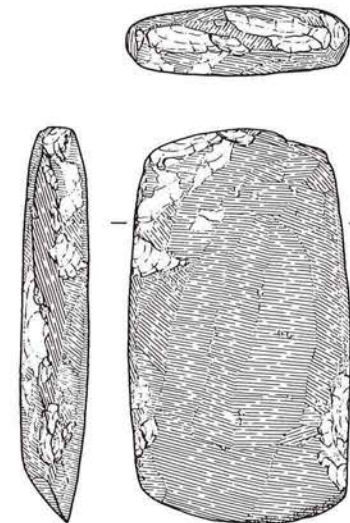

PL52-21

石器写真

SB410

1 玉石Ile類



SB411

2 大形刃器2a類



SB413

3 大形刃器1b類

4 扁平片刃石斧
Ie類

(2:3)

5 管玉

(1:1)

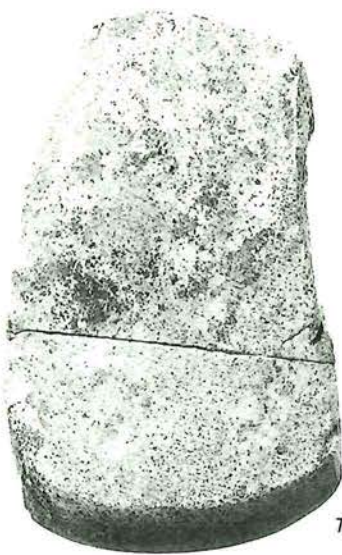

SB414

6 大形刃器2c類

7 扁平片刃石斧
IIa類

SB415

8 打製石斧 礫器

9 石槌 蛤刃転用

10 砥石 IIb類

(2:3)

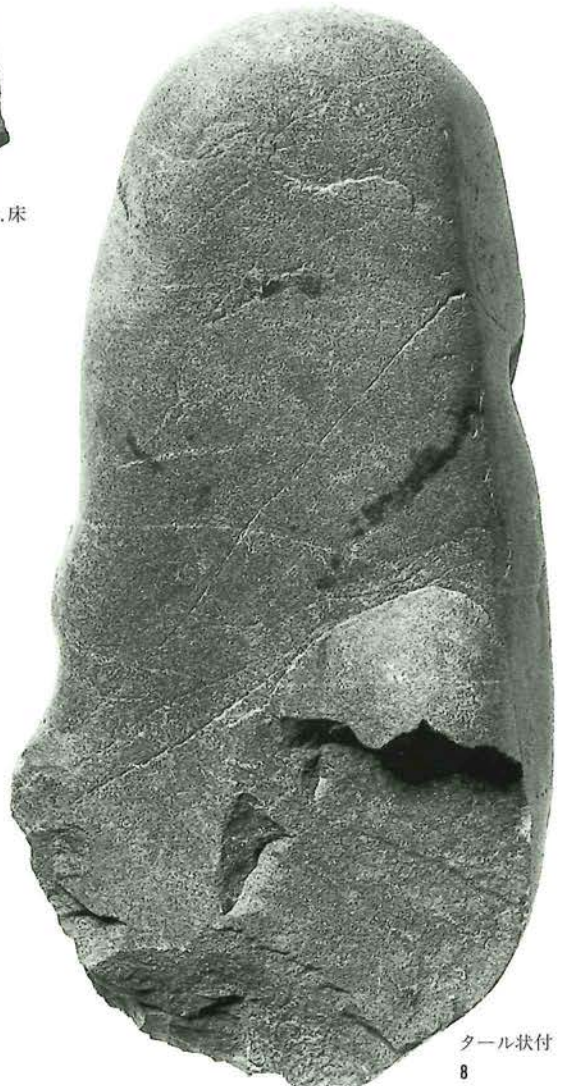

FT-IR

◎ボリ

白色付
2.床

タール状付
8

石器写真

SB422

- 1 碎片(磨製石斧関連)
- 2 碎片(磨製石斧関連)
- 3 碎片(磨製石斧関連)
- 4 碎片(磨製石斧関連)
- 5 碎片(磨製石斧関連)
- 6 碎片(磨製石斧関連)
- 7 碎片(磨製石斧関連)
- 8 敲石カ類
- 9 大形刃器 2b 類
- 10 小形刃器 2c 類
- 11 太形蛤刃石斧
失敗品 D 類
- 12 扁平片刃石斧
Id 類
- 13 ノミ状石器 II f 類
- 14 ノミ状石器 II f 類
- 15 砥石 I 2 類
- 16 砥石 II b 類
(2:3)
- 17 管玉
(1:1)

SB423

- 18 大形刃器 2a 類
- 19 小形刃器 6a・6b 類
- 20 扁平片刃石斧
失敗品 E₃ 類
(2:3)

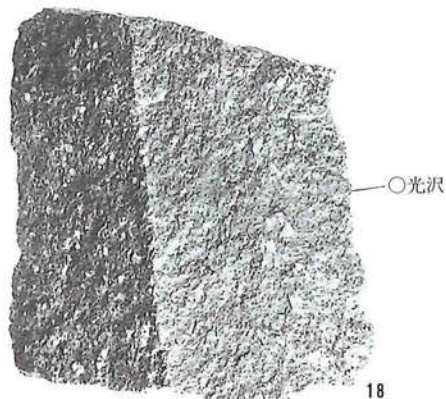
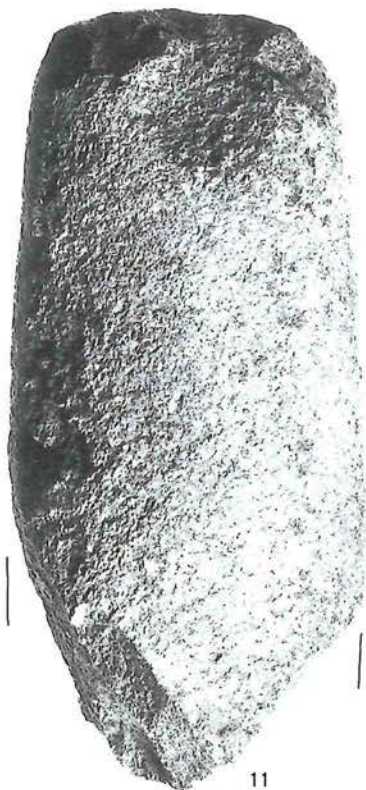
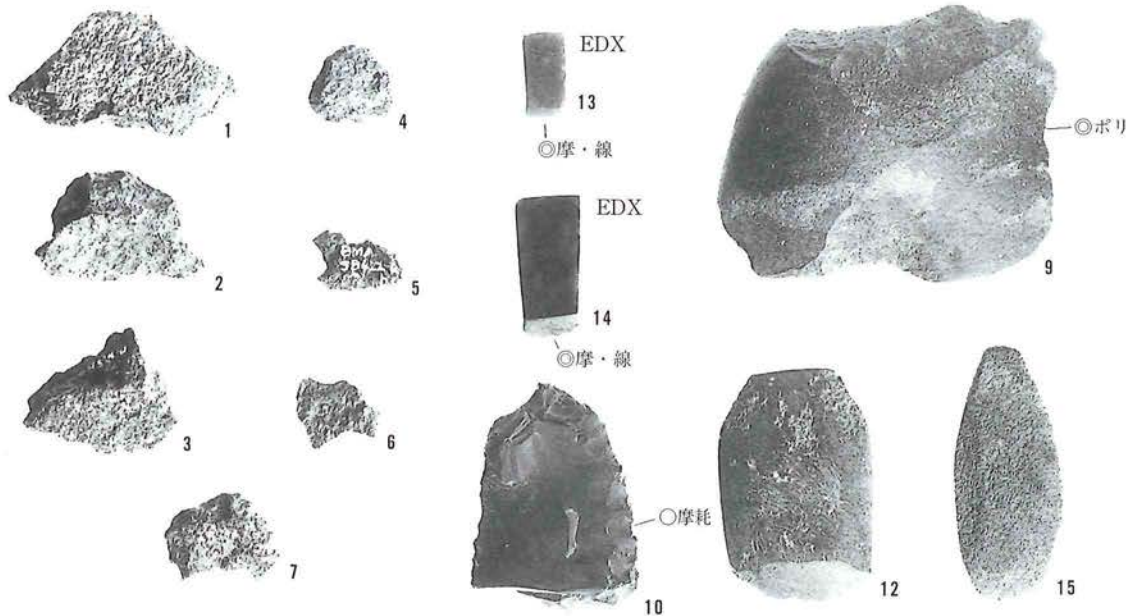

石器写真

SB425

1 打製石鏃IIA類

2 打製石鏃 不明

(2:3)

3 台石2種A₂類

(1:2)

4 大形刃器1b類

5 石槌 蛤刃転用

6 石錐1類

(2:3)

7 管 玉

(1:1)

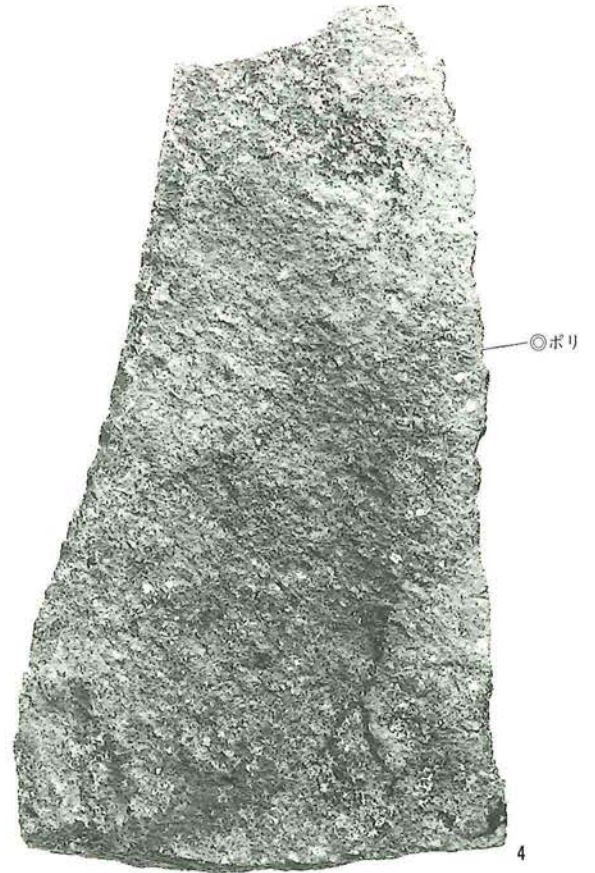
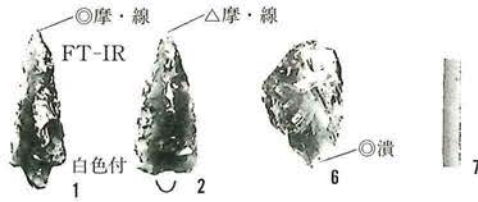

3.②

石器写真

SB426

- 1 剥片 A 類IV
- 2 打製石鏃 IIB₂類
- 3 打製石鏃 IIB₃類
- 4 磨製石鏃
失敗品 2 A 類
- 5 磨石 I2c 類
- 6 大形刃器 1 b 類
- 7 大形剥片 B 類
- 8 ノミ状石器
失敗品 E₃類
- 9 砥石 II3 類
- 10 砥石 II a 類
- 11 砥石 I2 類
- 12 管 玉
(1:1)

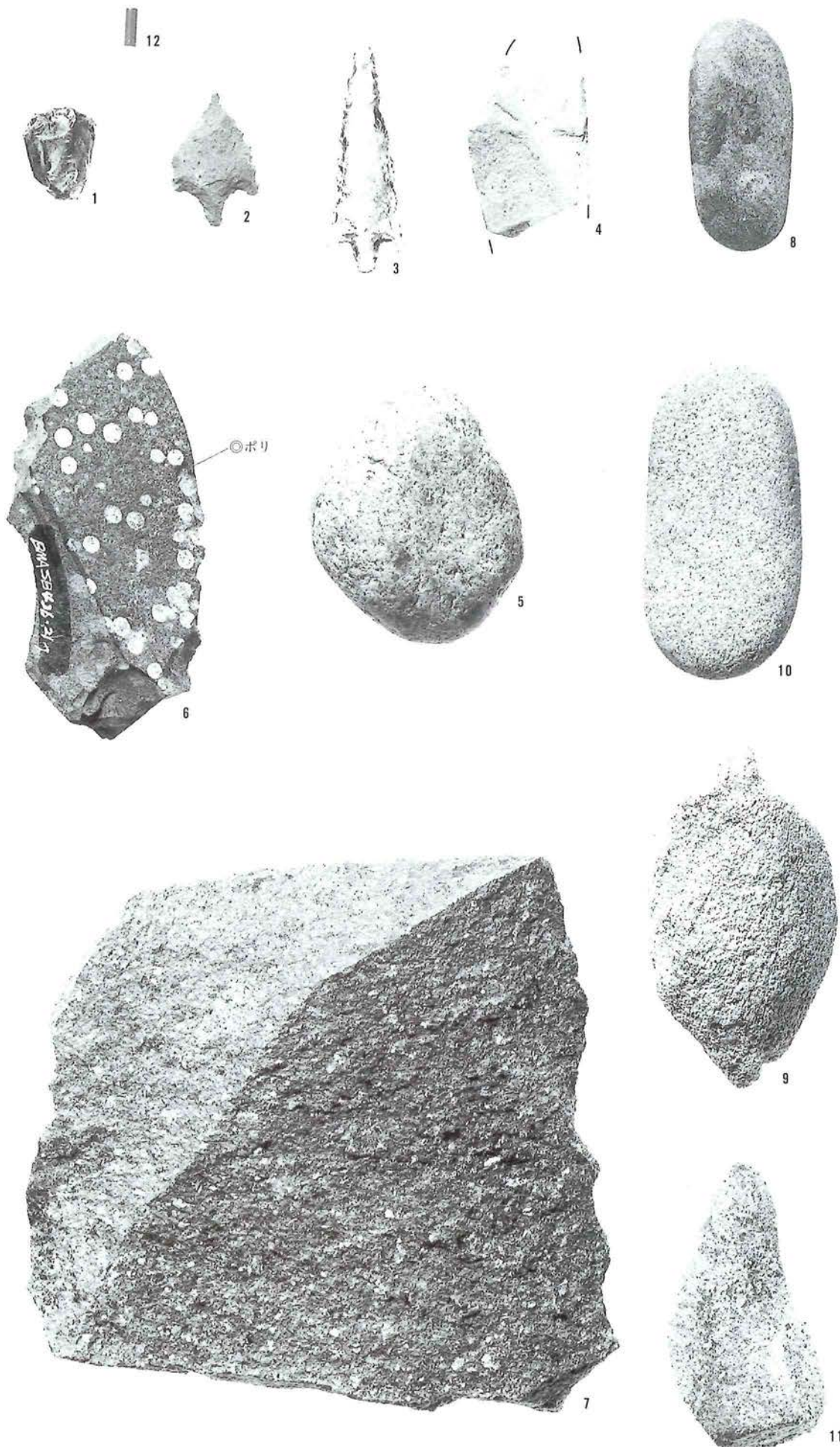

石器写真

SB1102

- 1 小形石核II2B類
- 2 小形石核III1A類
- 3 剥片A類IV
- 4 磨製石鏃
- 失敗品2B類
- 6 大形刃器2d類
- 7 大形刃器4類
- 8 大形刃器8類
- 9 敲石イ類
- 10 敲石ウ・エ類
- 11 大型蛤刃石斧 不明
- 12 石槌 蛤刃転用
- 13 軽石製品
- 14 加工痕のある石屑
- (2:3)

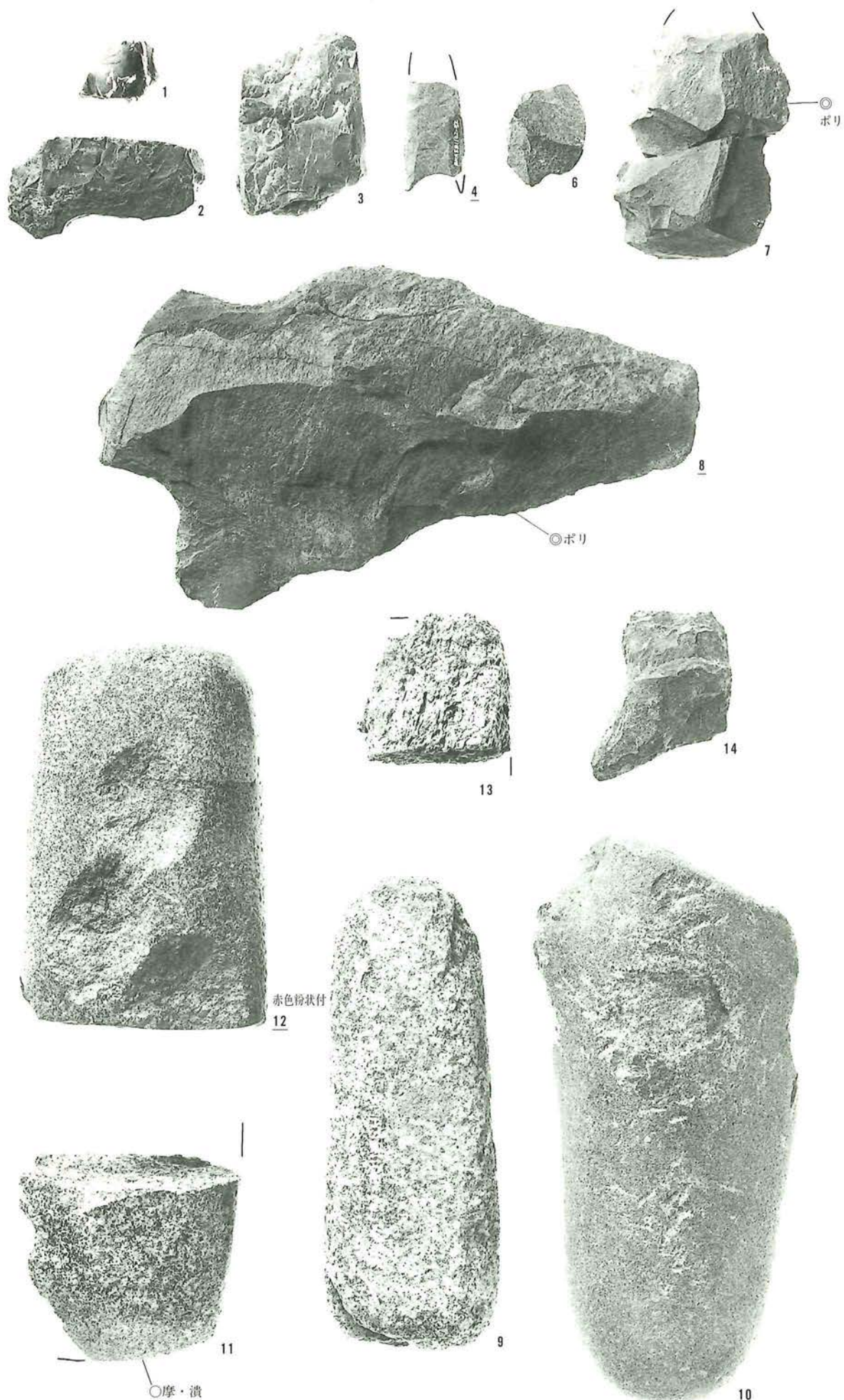



石器実測図
骨角器実測図

SB1102

PL 59-4

(2:3)

PL 59-8

PL 59-12

PL 61-1

(1:2)

PL 60-5

(1:3)

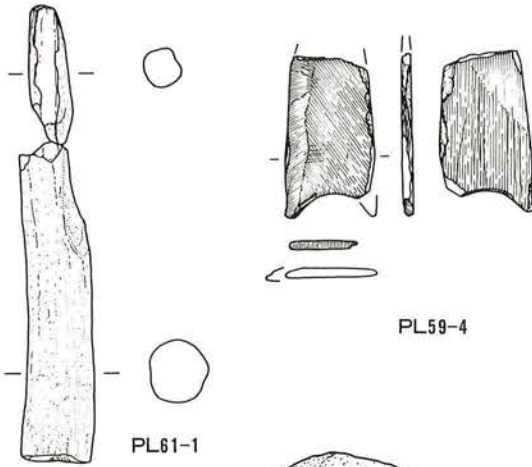

PL59-4

PL61-1



石槌No.12と台石No.5のセット想定写真

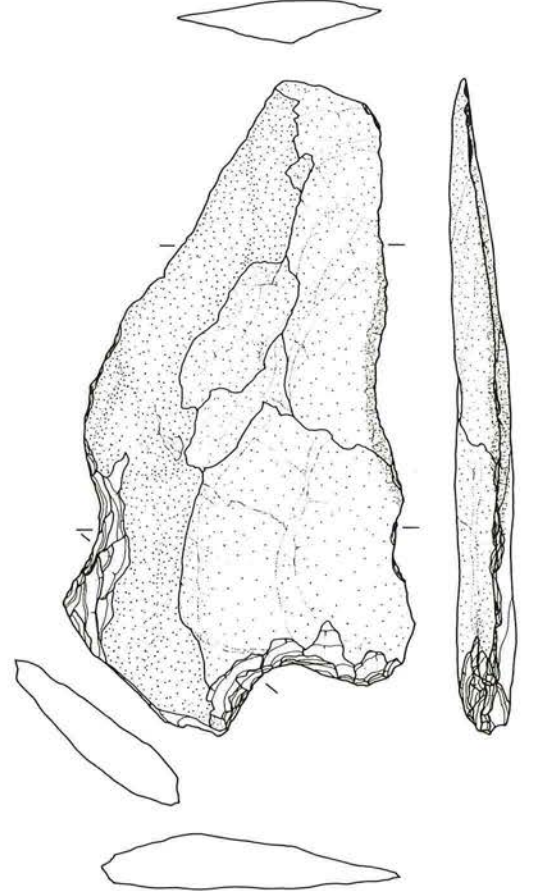
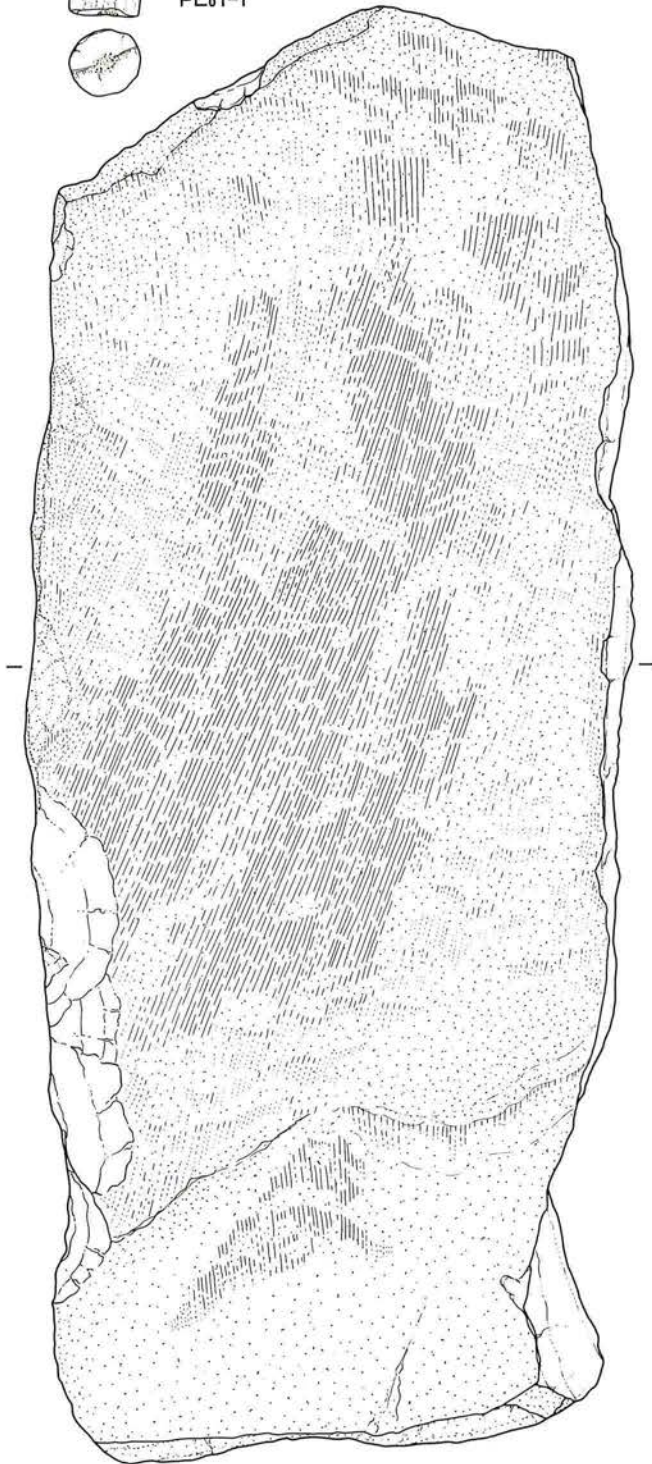

△ PL59-8

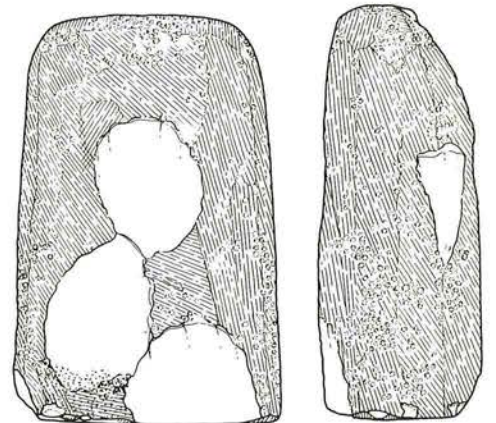

PL60-5

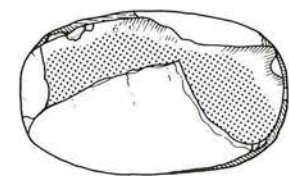

PL59-12

石器写真

SB1103

- 1 小形石核 II A 類
- 2 剥片 A 類IV
- 3 剥片 A 類IV
- 4 剥片 A 類IV
- 5 台石 1 種 A₂ 類
- 6 大形刃器 3 類
- 7 大形刃器 2 a 類
- 8 大型蛤刃石斧 Ib' 類?
- 9 大型蛤刃石斧 Id' 類
- 10 ノミ状石器 II f 類
- 11 砥石 II a 類
(2:3)



1



2



3



4



6

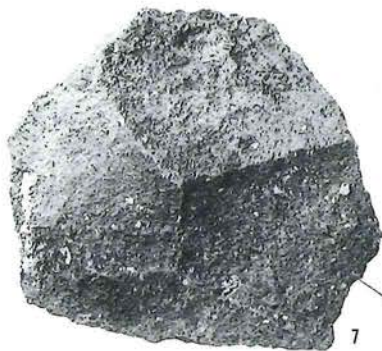

7



EDX

10

○摩・線

△摩・光



8

○摩・潰

転用



9

○摩・線

転用



11



5

石器実測図

SB1103

PL 62-3

PL 62-10

(2:3)

PL 62-8

PL 62-9

PL 62-11

(1:2)

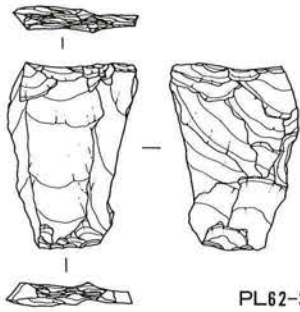

PL62-3

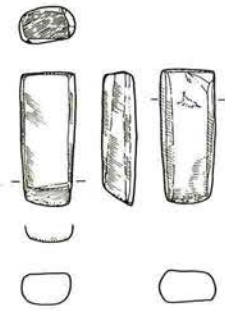

PL62-10

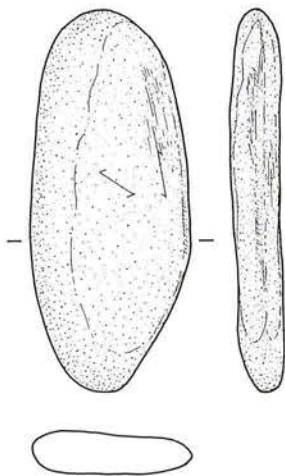

PL62-11

SB1104

PL 64-3

PL 64-9

(2:3)

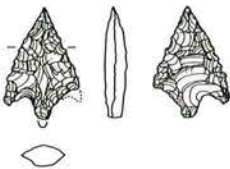

PL64-3

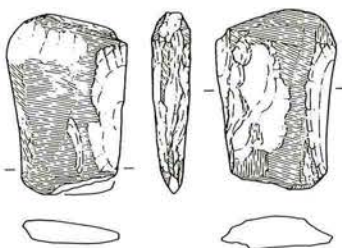

PL64-9

PL63

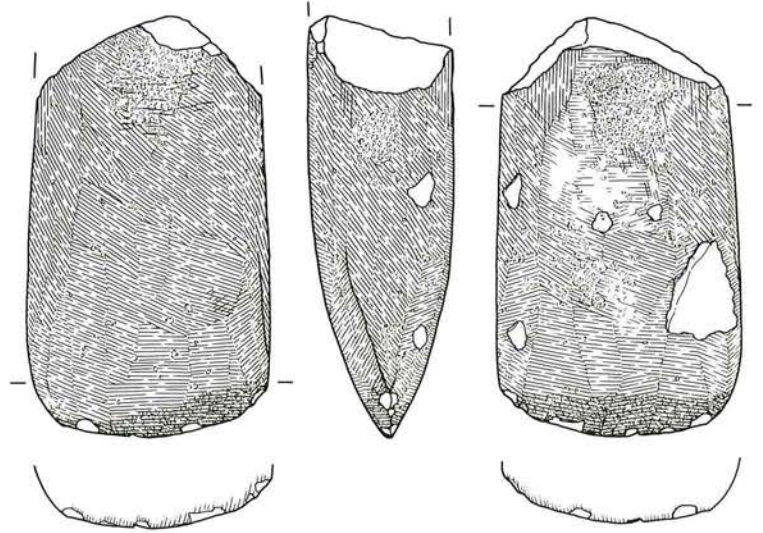
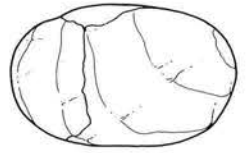

PL62-8

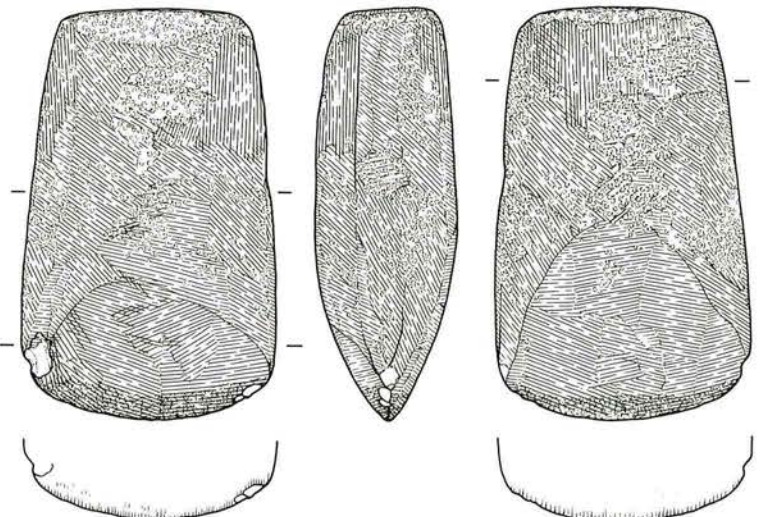
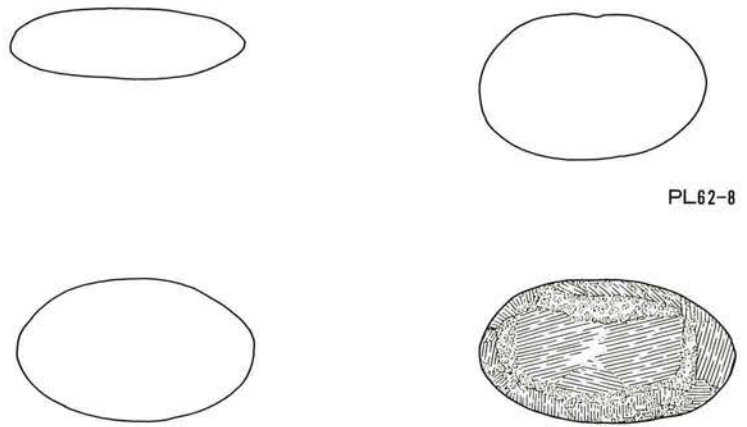

PL62-9

石器写真

SB1104

- 1 小形石核 IIB 類
- 2 剥片 A 類II
- 3 打製石鏃 IIB₃ 類
- 4 磨製石鏃
失敗品 1 類
- 5 台石 2 種 A₂ 類
- 6 大形刃器 1b 類
- 7 大形刃器 1b 類
- 8 大形刃器 1b 類
- 9 扁平片刃石斧
Ie 類
- 10 みがき石 不明
(2:3)
- 11 管 玉
(1:1)

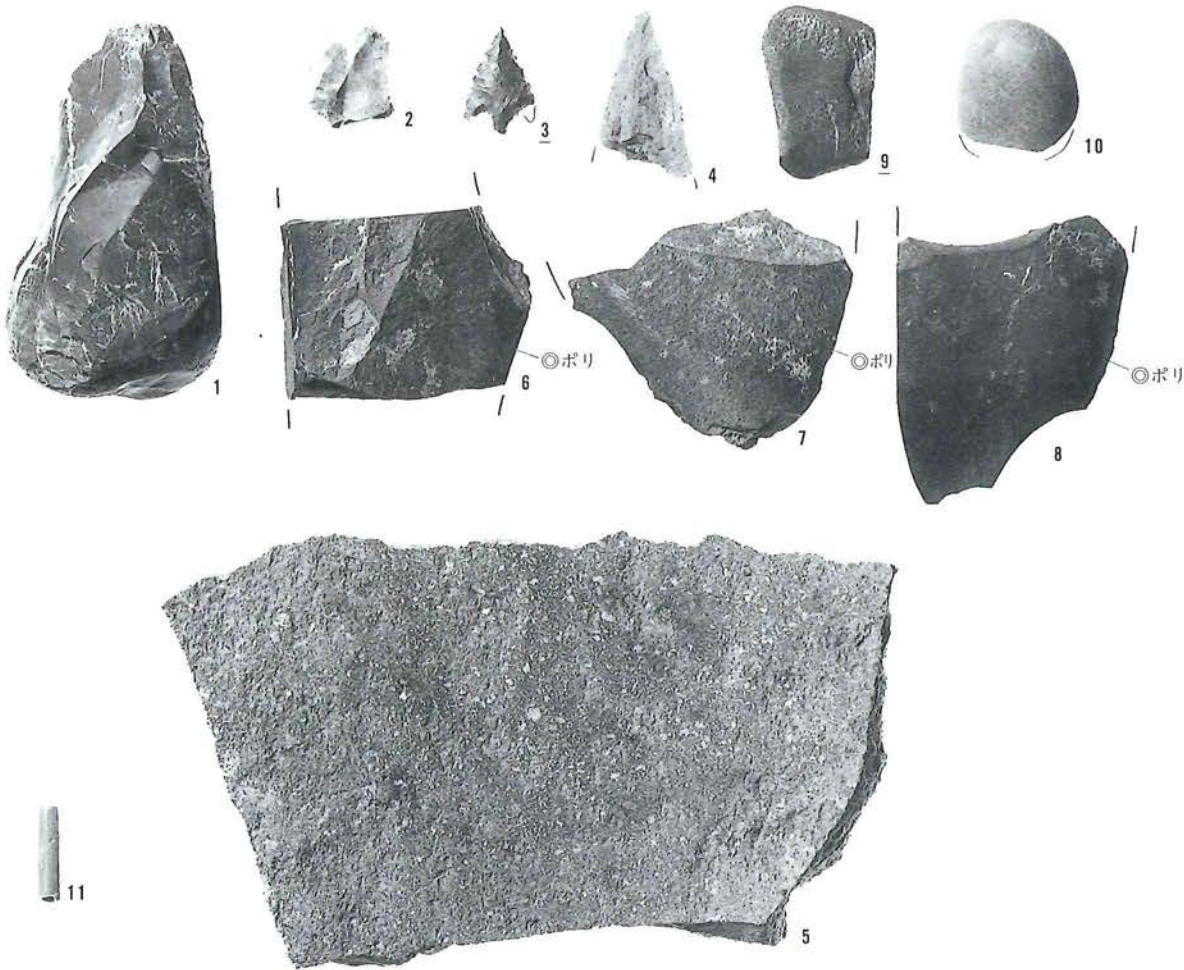

SB1106

- 12 打製石鏃 IIB₂ 類
- 13 磨製石鏃 不明
- 14 磨製石劍 鉄劍形
- 15 大形刃器 1b 類
- 16 扁平片刃石斧 不明
- 17 扁平片刃石斧 不明
- 18 扁平片刃石斧
失敗品 E₃ 類
(2:3)

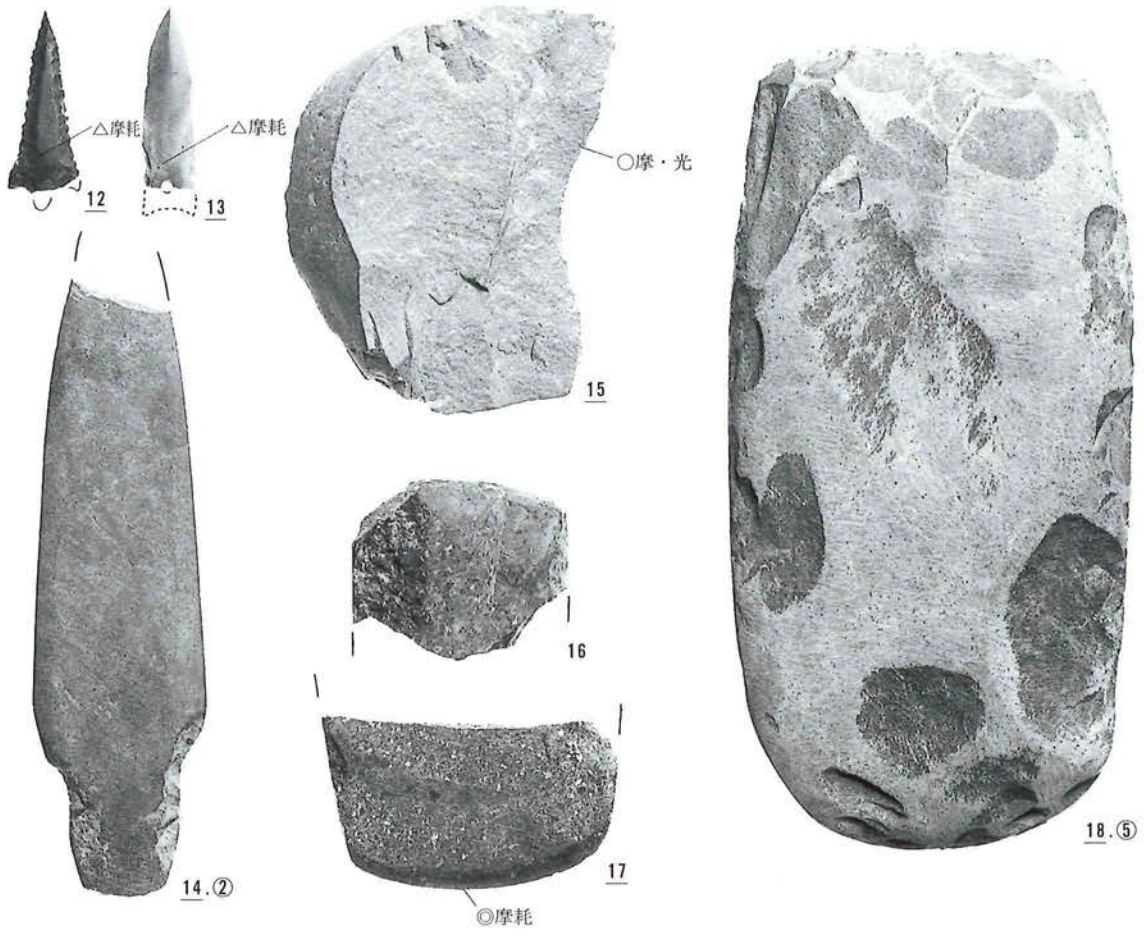

石器实测图

SB1106

PL 64-12

PL 64-13

(2:3)

PL 64-14

PL 64-15

PL 64-17

PL 64-18

(1:2)

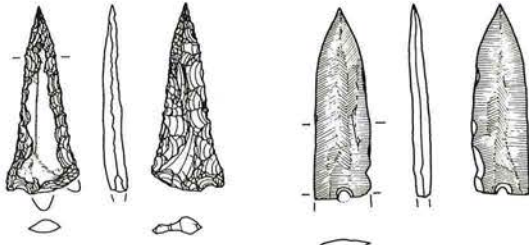

PL64-12

PL64-13

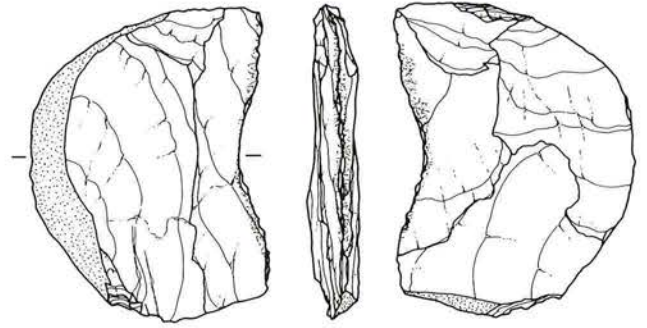

PL64-15

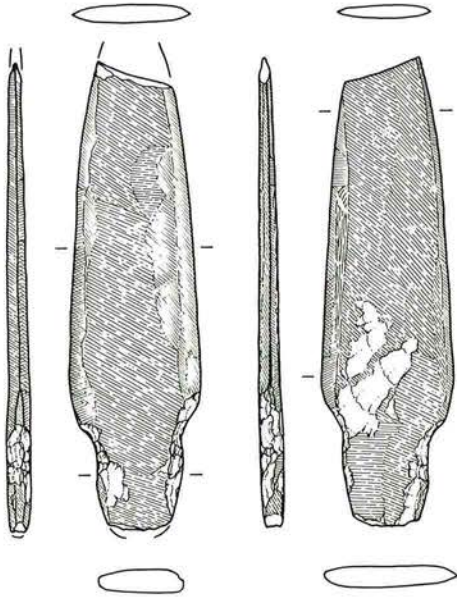

PL64-14

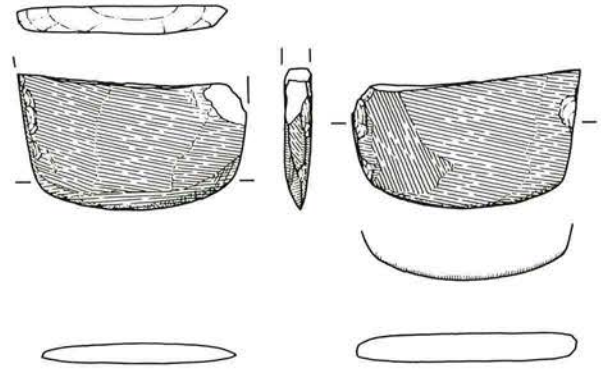

PL64-17

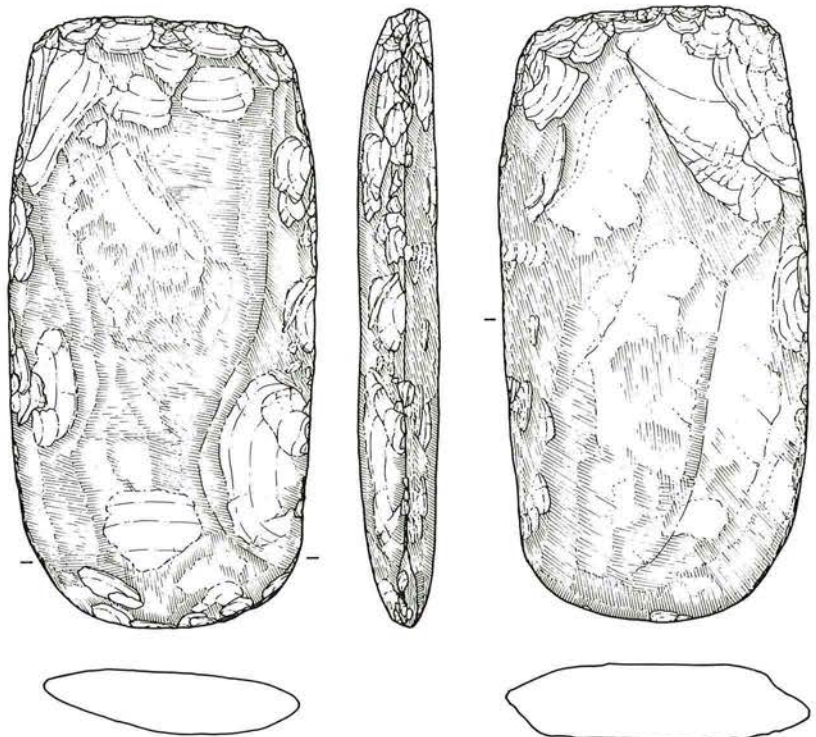

PL64-18

石器写真

SB1108

- 1 小形石核II2B類
- 2 打製石鏃II B₃類
- 3 打製石鏃II類不明
- 4 敲石工類
- 5 大形刃器2c類
- 6 磨製石包丁
失敗品B類
- 7 太型蛤刃石斧
1d'類
- 8 石槌 蛤刃転用
- 9 砥石 置砥
- 10 軽石製品
(2:3)

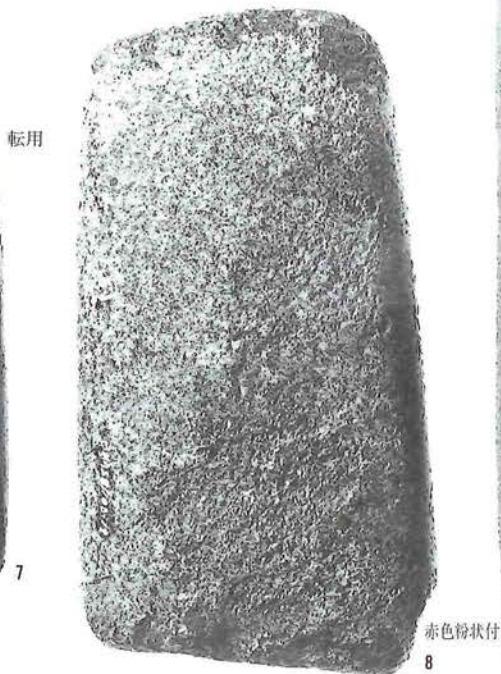
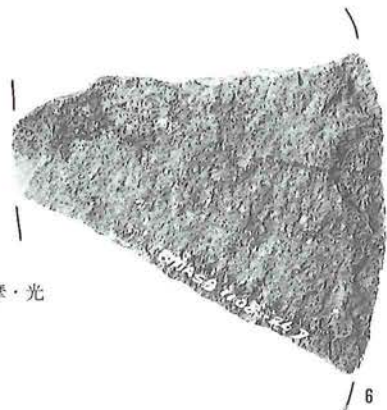

石器写真

SB1110

- 1 小形石核 I2B 類
- 2 小形石核 I1A 類
- 3 小形石核 I2B 類
- 4 大形刃器 2b 類
- 5 大形刃器 1b 類
- 6 大型蛤刃石斧 Ic' 類
- 7 扁平片刃石斧 失敗品 B 類
- 8 砥石 I1d 類

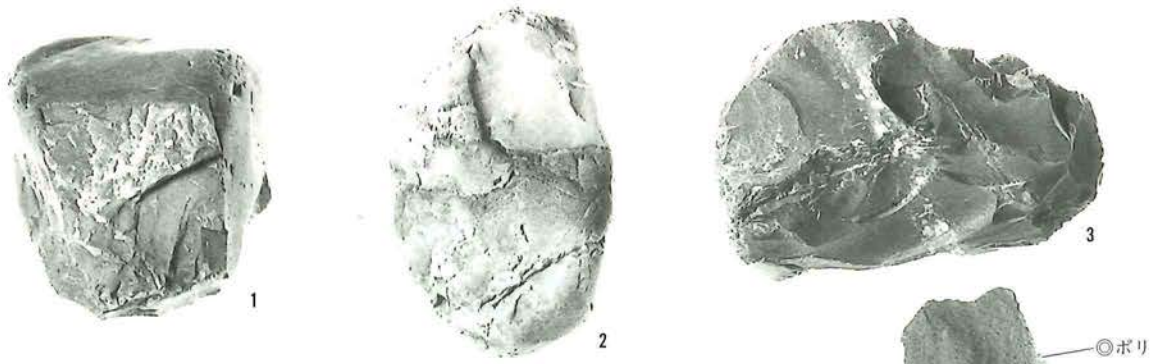

SB1112

- 9 大形石核 I1A 類
 - 10 小形石核 I1A 類
 - 11 剥片 A 類IV
 - 13 大形刃器 2c 類
 - 14 大形刃器 2b 類
 - 15 大形刃器 1a 類
 - 16 小形刃器 6a 類
- (2:3)

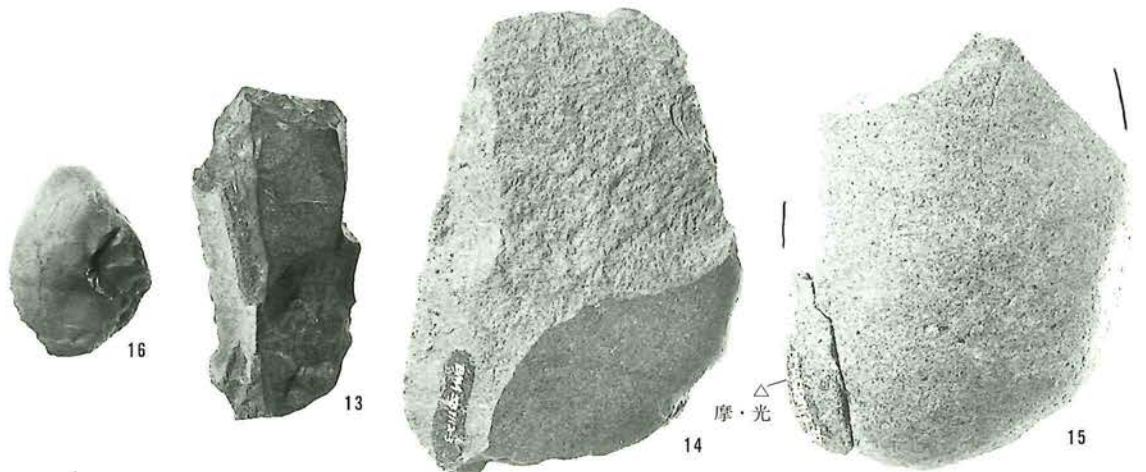
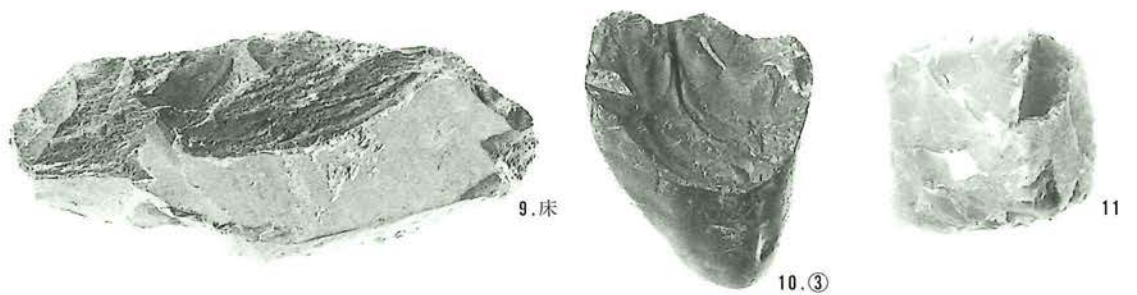
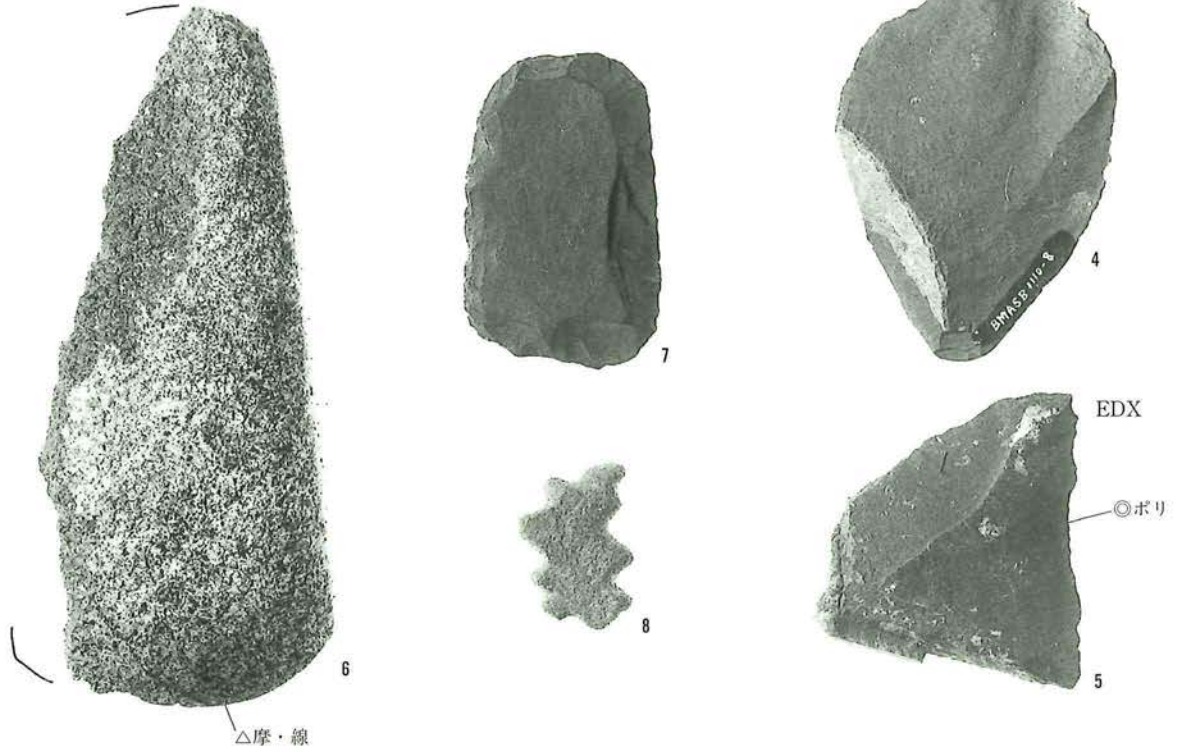



赤色粉状付
12.①

石器写真

SB1113

1 剥片 A 類IV

2 磨製石鏃

失敗品 2 A 類

3 みがき石 II2c 類

4 みがき石 III1c 類

5 台石 2 種 A₂ 類

6 大形刃器 2 b 類

7 大形刃器 2 c 類

8 大形刃器 2 a 類

9 太型蛤刃石斧

I a' 類?

10 扁平片刃石斧

失敗品 E₂ 類

11 扁平片刃石斧

II a 類

12 砥石 I 2 類

(2:3)

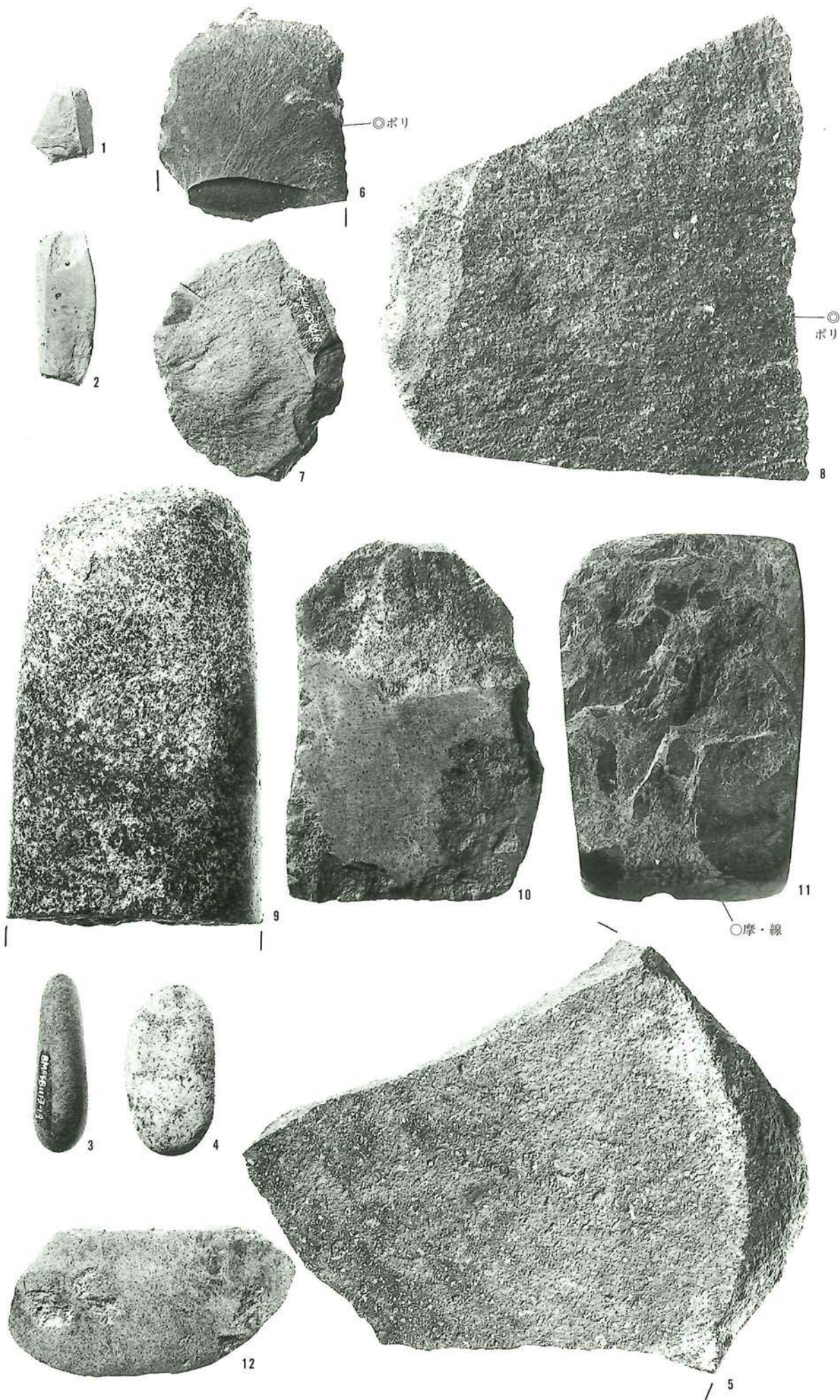

石器写真

SB1123

- 1 打製石鏃 II B₃ 類
- 2 大型蛤刃石斧 Ic' 類
- 3 ノミ状石器 II e 類?
- 4 玉, 碎片 (2:3)
- 5 管 玉 (1:1)

SB1124

- 6 小形石核 II 2B 類
- 7 小形石核 II 1A 類
- 9 大形刃器 2 a 類?
- 10 大形刃器 8 類
- 11 磨製石包丁 失敗品 B 類
- 12 大型蛤刃石斧 Ia' 類?
- 13 砥石 II b 類?
- 14 砥石 II a 類
- 15 軽石製品 (2:3)

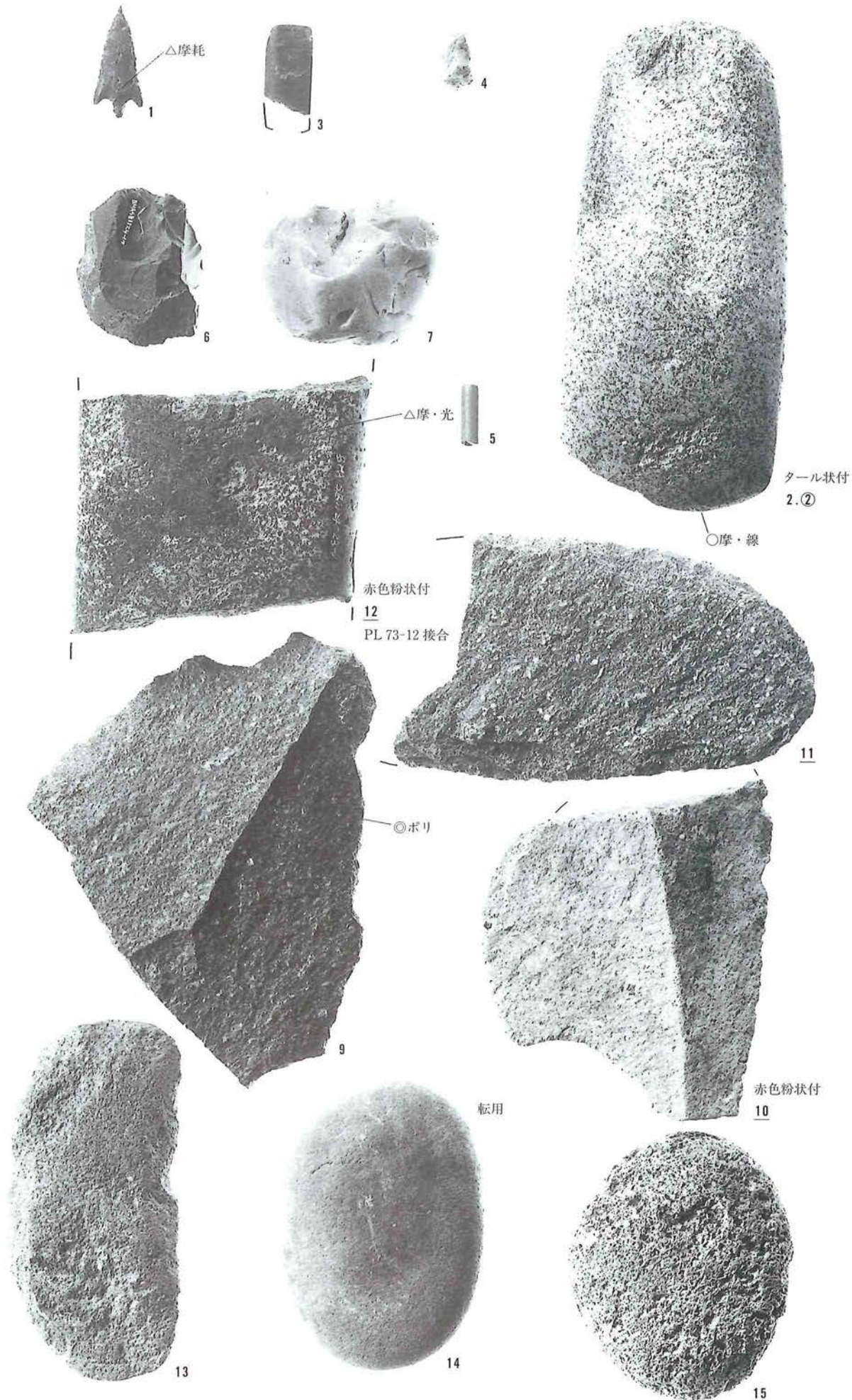

石器写真

SB1124

8 台石2種A₂類

(1:2)

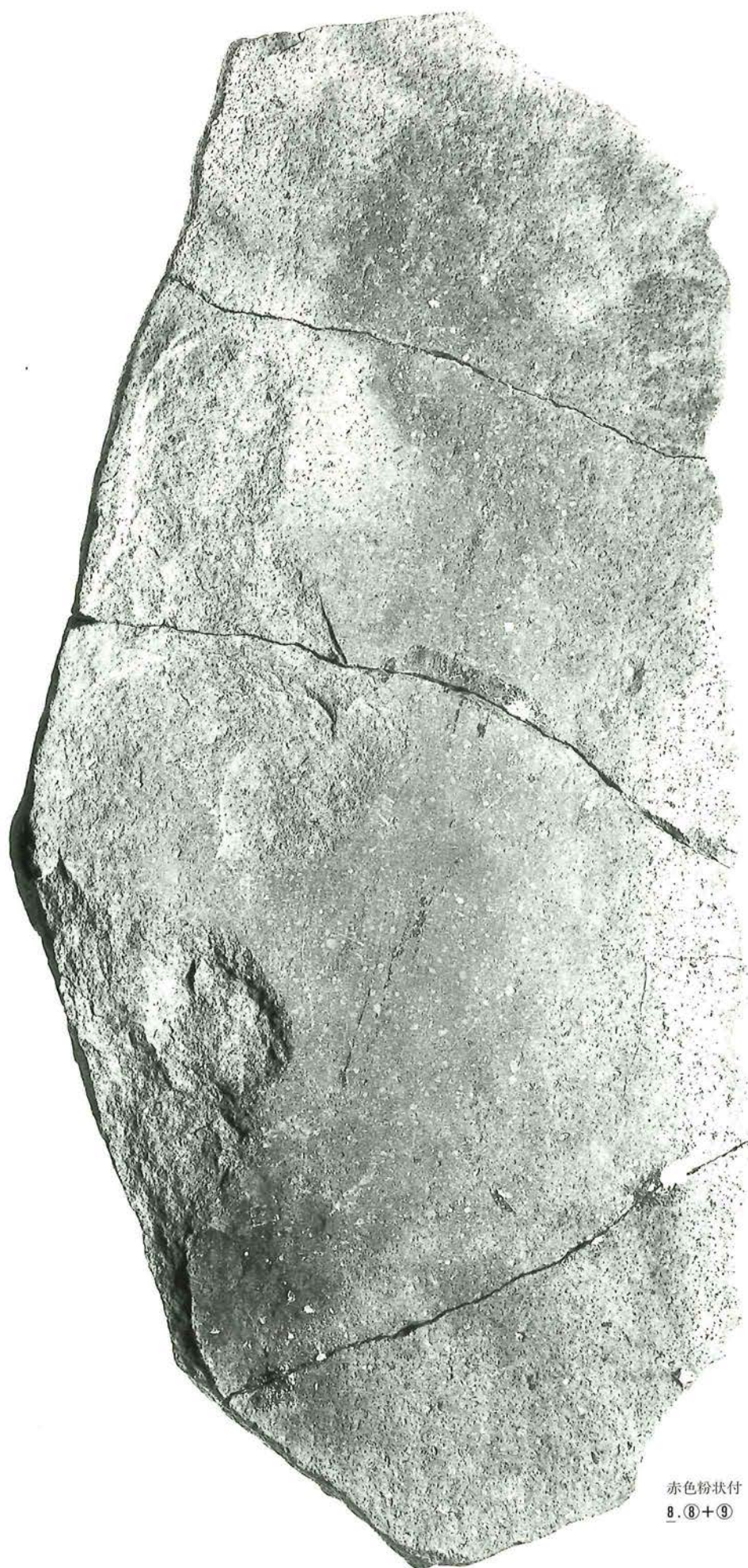

赤色粉状付
8.⑧+⑨

SB1128

PL74-1

(2:3)

PL74-2

(1:3)

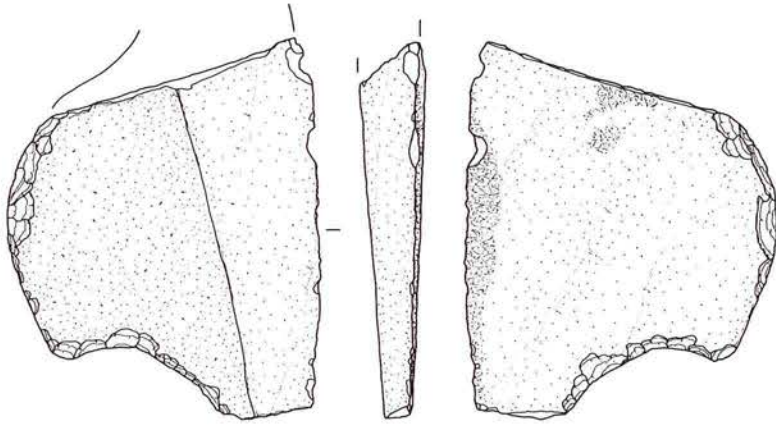

PL70-10

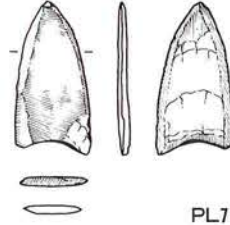

PL74-1

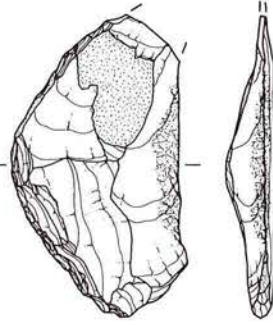

PL74-2

SB1124

PL70-10

PL70-11

PL70-12

(1:2)

PL71-8

(1:4)

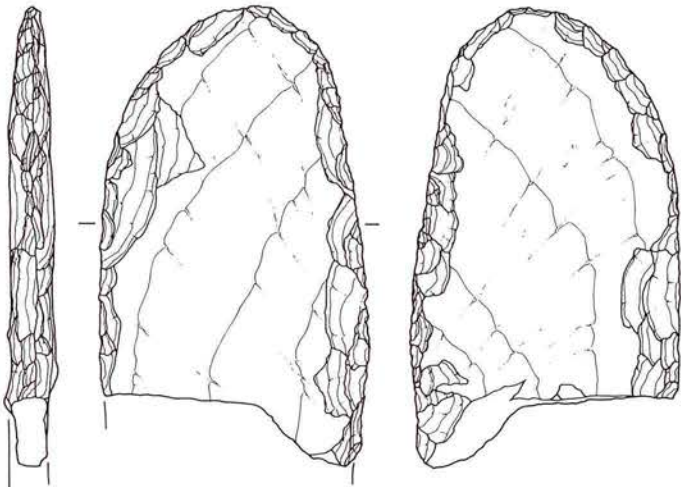

PL70-11

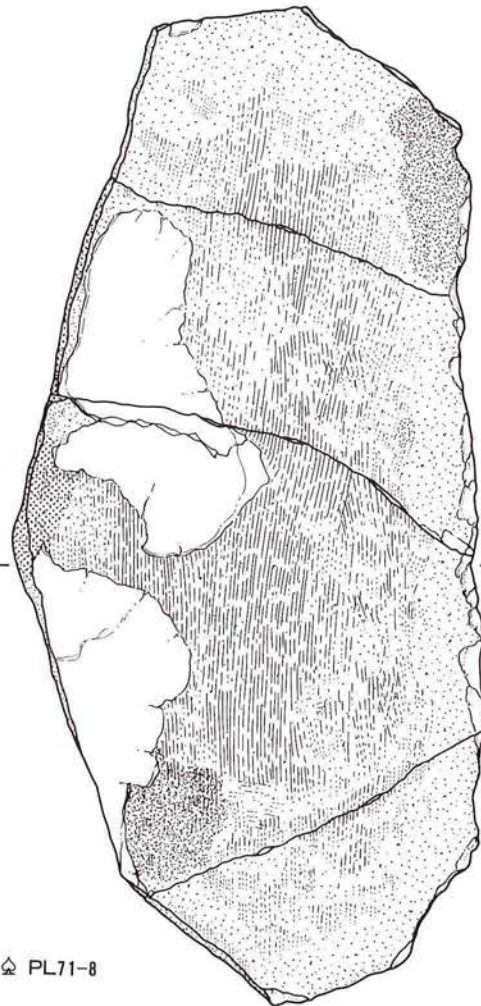

PL71-8

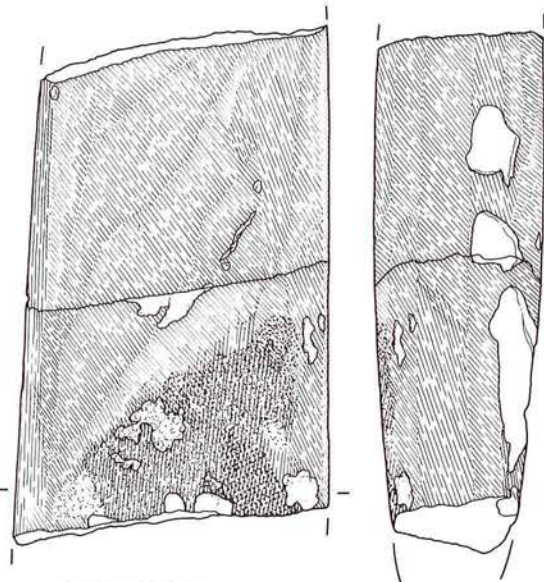

PL70-12+PL73-12

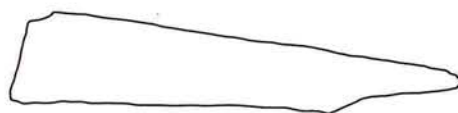

石器写真

SB1125

- 1 剥片 A 類IV
- 2 磨製石鏃
失敗品 1 類
- 3 磨製石鏃
失敗品 1 類
- 4 敲石キ類
- 5 敲石ア類
- 6 大形刃器 2c 類
- 7 磨製石包丁 半月形
- 8 石槌

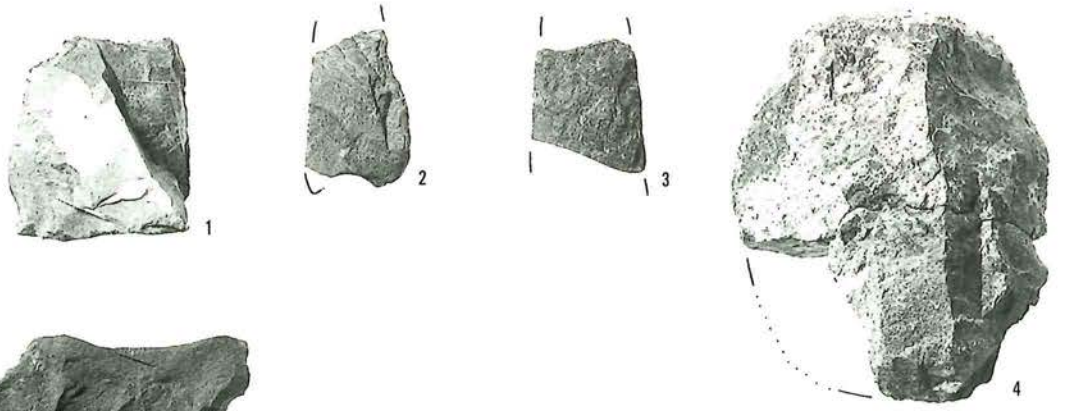

SB1126

- 9 磨製石鏃 IB₃類?
- 10 敲石イ類
- 11 大形刃器 2b 類
- 12 太型蛤刃石斧
Ia'類?
- 13 太型蛤刃石斧
失敗品 E₂類
(2:3)

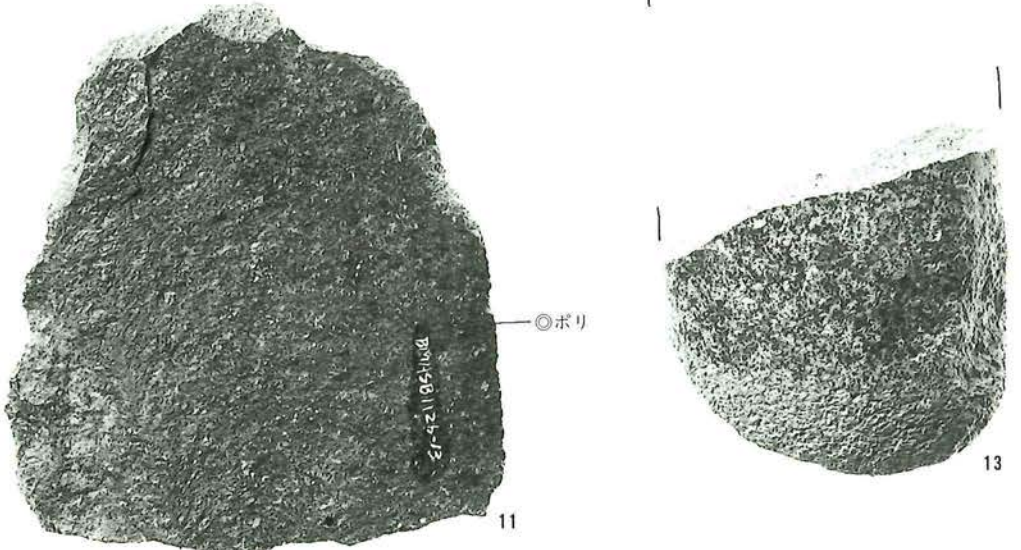
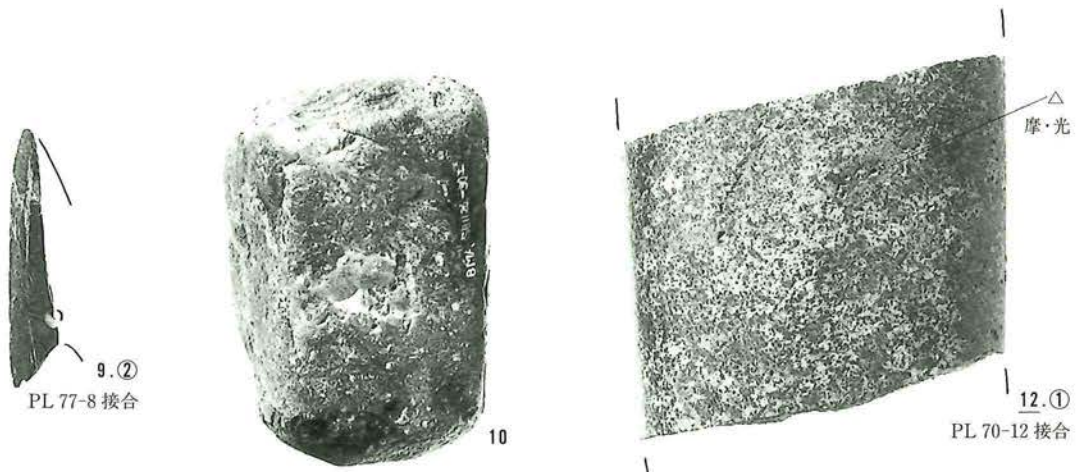
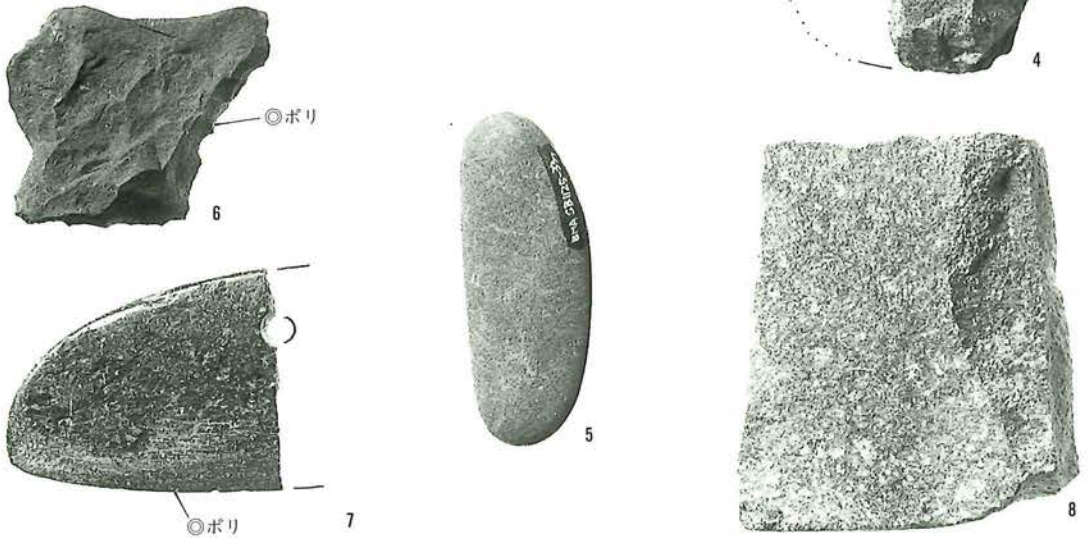

石器写真

SB1128

- 1 磨製石鏃
失敗品 2 B 類
- 2 大形刃器 2 b 類

SB1130

- 3 小形剥片 2 種
- 4 小形剥片 2 種
- 5 小形剥片 2 種
- 6 小形剥片 2 種

SB1132

- 7 砥石 II3 類

SB1133

- 8 ペン先状石製品

SB1136

- 9 敲石エ類
- 10 大型蛤刃石斧
失敗品 D 類
- 11 扁平片刃石斧
IIa 類
- 12 石錐 2 A 類
- 13 石錐 大形
(2 : 3)
- 14 紡錘車状石製品
(1 : 1)

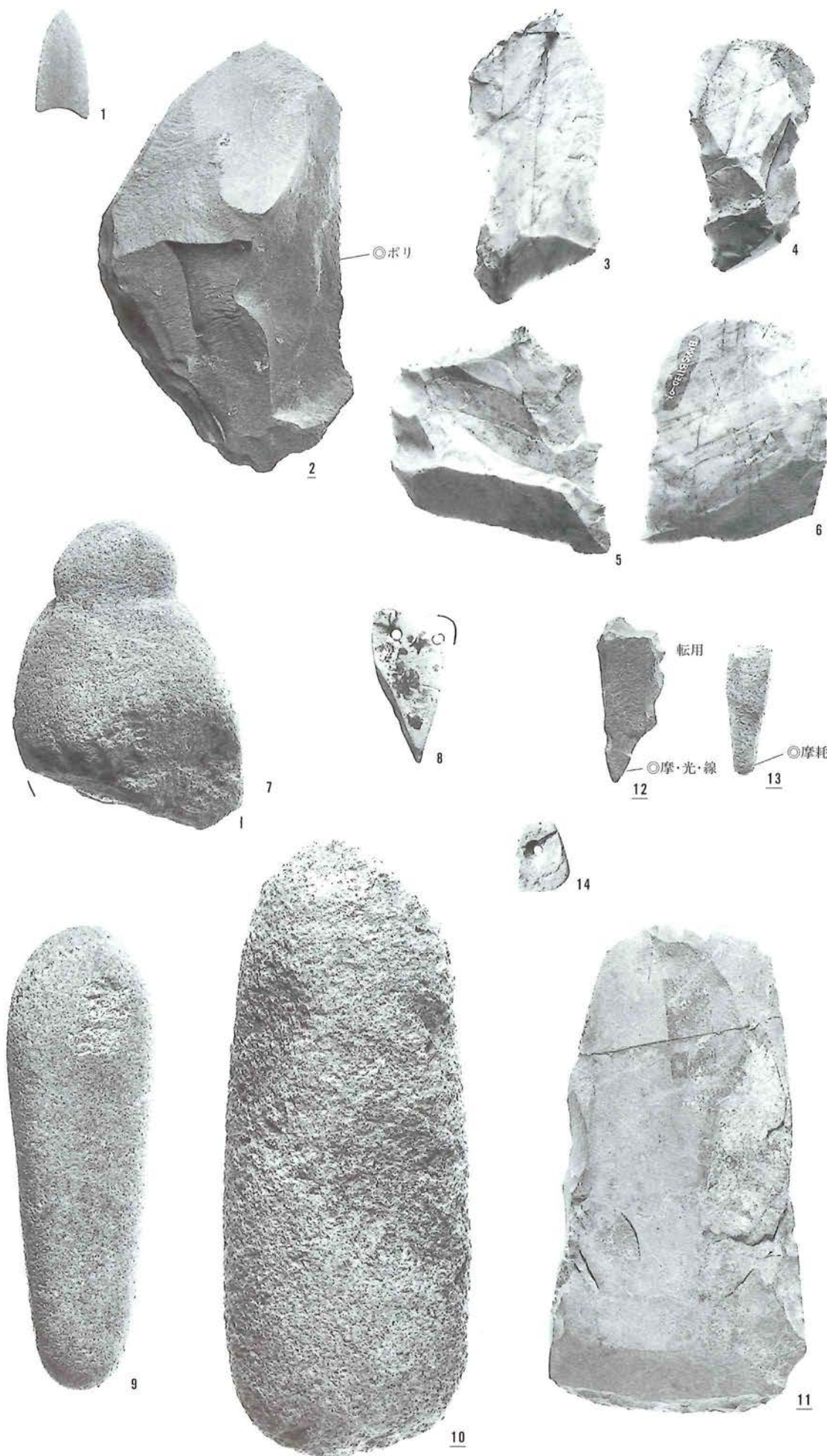

石器写真

SB1134

- 1 打製石鏃IB₃類
- 2 磨製石鏃
失敗品1類
- 3 磨製石鏃
失敗品1類
- 4 磨製石鏃IB₁類
- 5 磨製石鏃IB₃類
- 6 磨製石鏃 不明
- 7 大形刃器1b類
- 8 小形刃器6b類
- 9 石槌 蛤刃転用
- 10 砥石IIa類
- 11 玉, 石核IIIa類

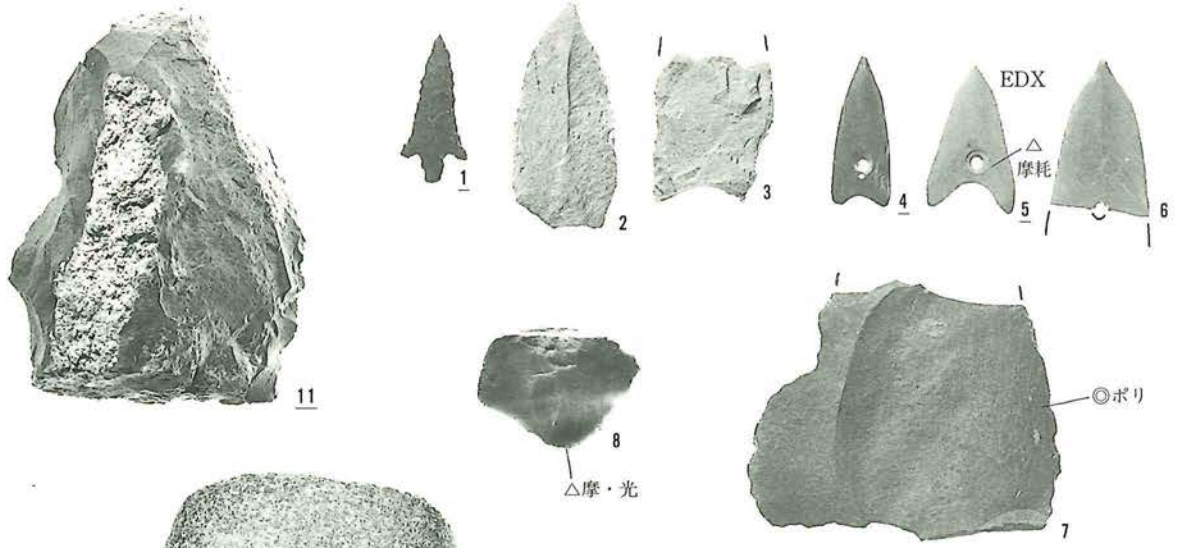

SB1138

- 12 剥片A類IV
- 13 剥片A類IV
- 14 敲石才類
- 16 大形刃器2a類
- 17 大形刃器1b類
- 18 石錐2A類
- 19 砥石 礫状
(2:3)

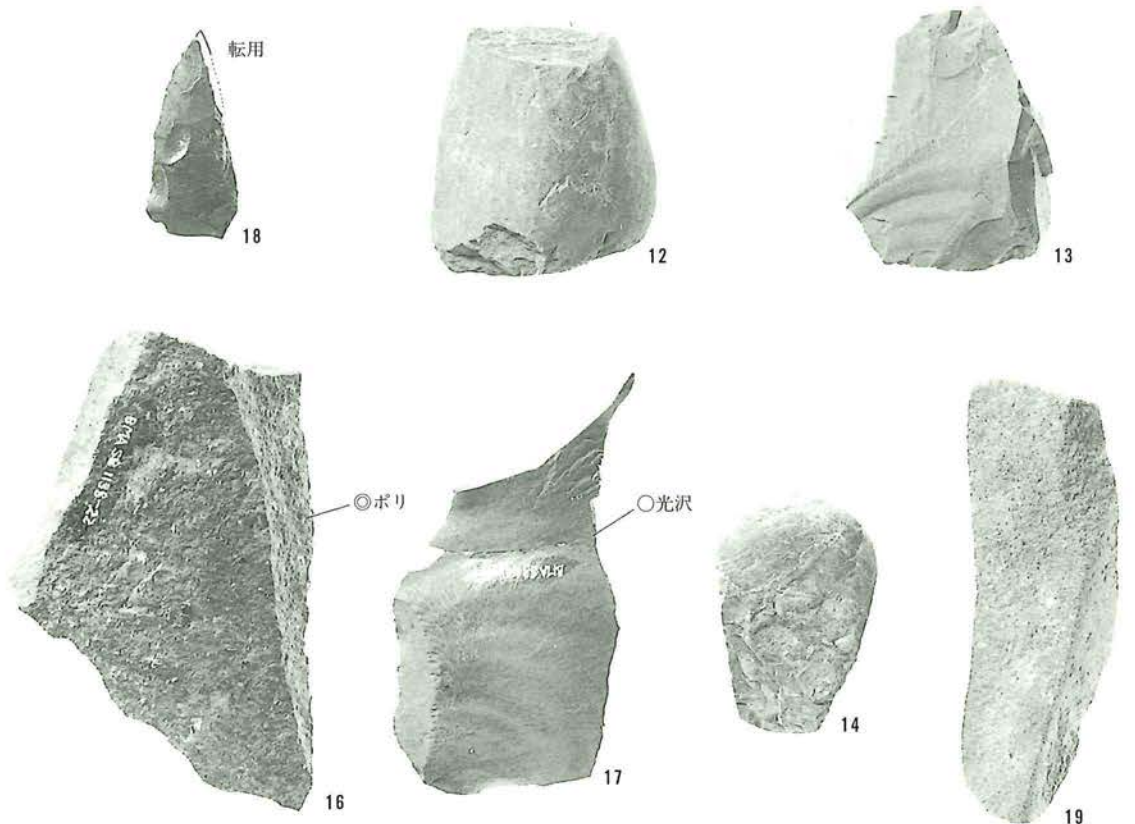



石器写真

SB1141

- 1 大形刃器 2b 類
- 2 扁平片刃石斧
失敗品 E₃ 類
- 3 砥石 II2 類

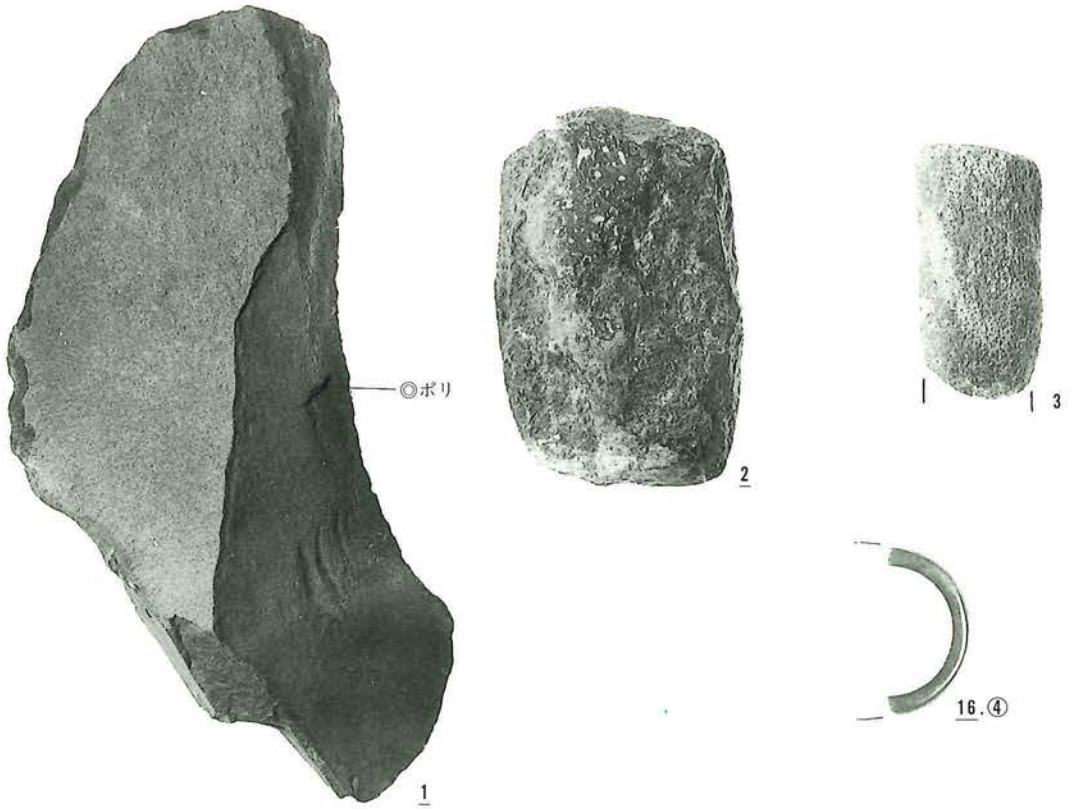

SB1142

- 4 打製石鏃
失敗品 1 類
- 5 磨製石鏃
失敗品 1 類
- 6 磨製石鏃
失敗品 1 類
- 7 磨製石鏃 不明
- 8 磨製石鏃 IB₃ 類?
- 9 みがき石 II1c 類
- 10 大形刃器 1b 類
- 11 大形刃器 2b 類
- 12 大形刃器 3 類
- 13 大形刃器 1b 類
- 14 扁平片刃石斧
IIa 類?
- 15 ノミ状石器 II f 類
(2:3)
- 16 指輪状石製品
(1:1)

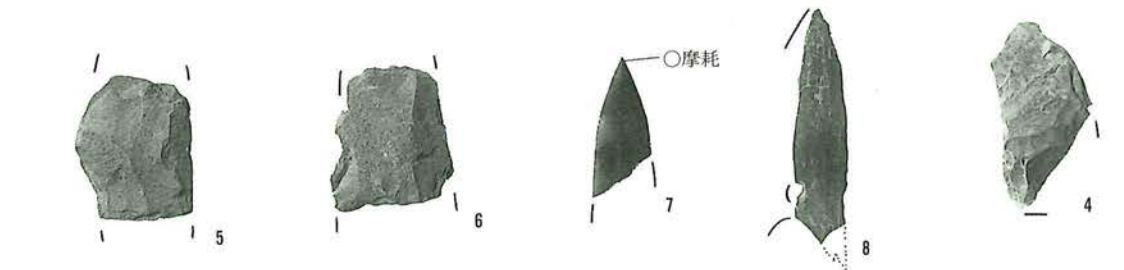

PL 73-9 接合

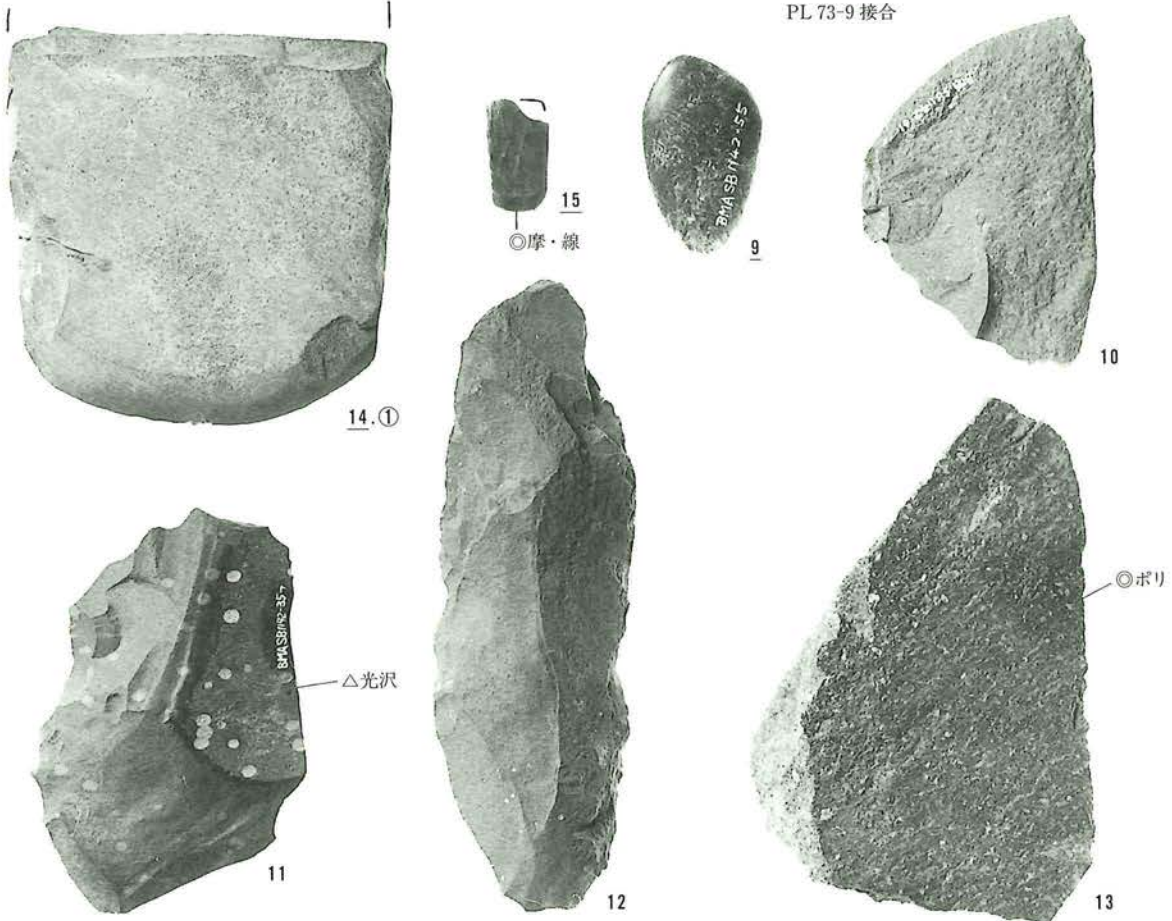

石器写真

SB1143

- 1 打製石鏃II類不明
- 2 磨製石鏃
失敗品2B類
- 3 磨製石鏃
失敗品2B類
- 4 磨製石鏃
失敗品1類
- 5 みがき石IIIa類
- 6 大形刃器1a類
- 7 大形刃器1b類
- 8 扁平片刃石斧
IIa類
- 9 紡錘車状石製品
- 10 軽石製品

SB1144

- 11 磨製石鏃
失敗品1類
- 12 磨製石鏃
失敗品1類
- 13 磨製石鏃IB₂類?
- 14 大形刃器1b類
- 15 大形刃器1b類
- 16 太型蛤刃石斧
Ic'類
- 17 砥石I2類
(2:3)
- 18 砥石 置砥
(1:3)

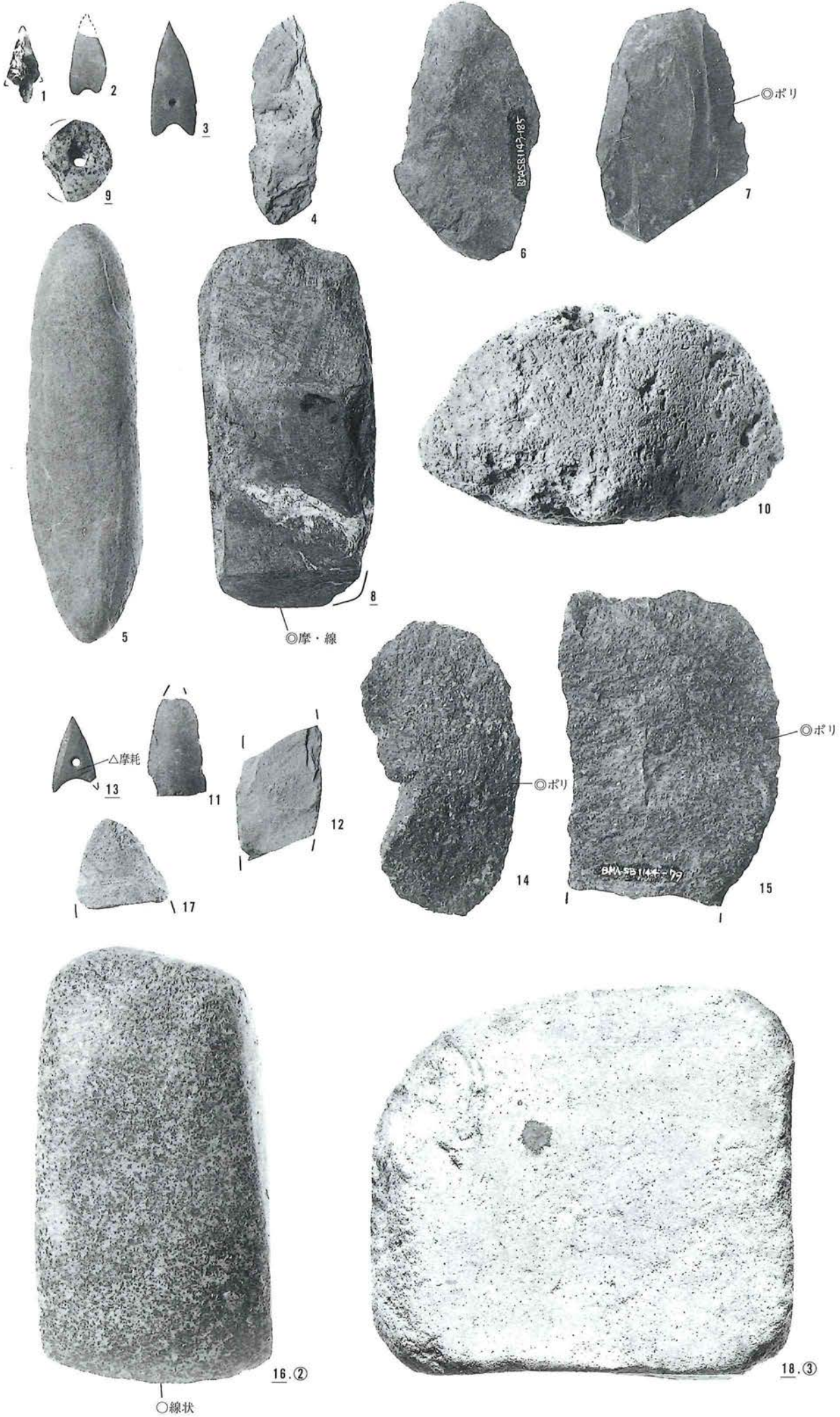

◎線状

石器实测图

SB1134

PL75-1

PL75-4

PL75-5

PL75-11

(2:3)

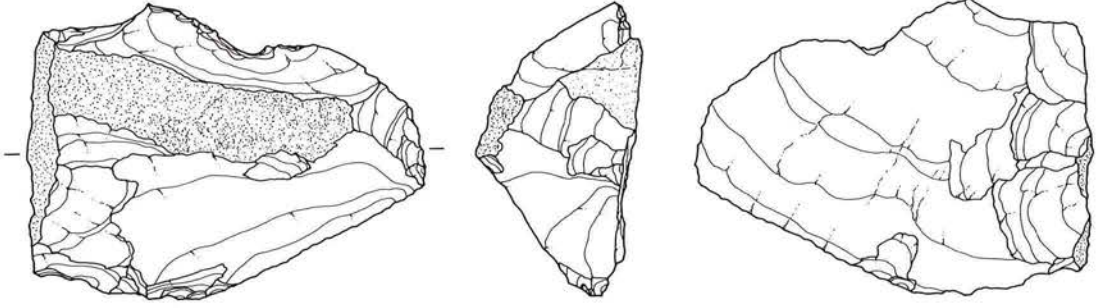

PL75-11

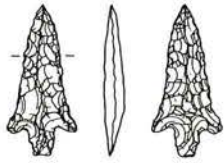
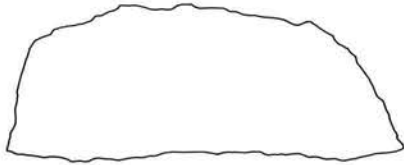

PL75-1

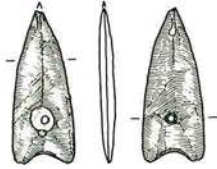

PL75-4

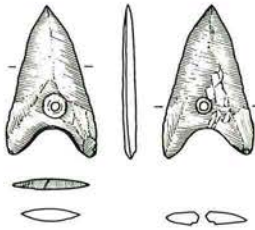

PL75-5

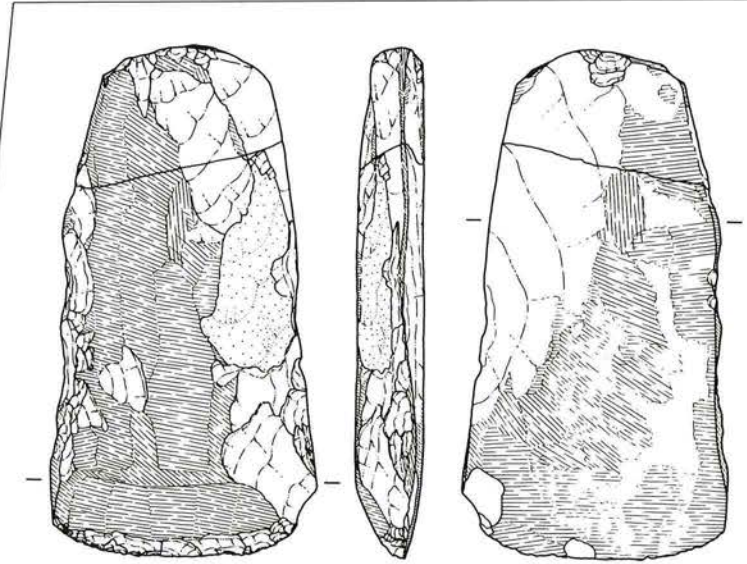

PL74-11

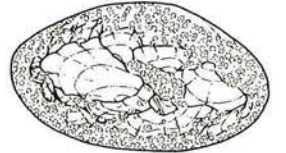
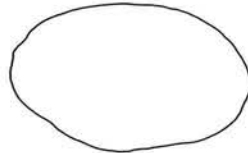
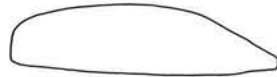

SB1136

PL74-12

PL74-13

(2:3)

PL74-10

PL74-11

(1:2)

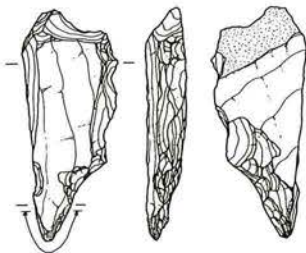

PL74-12

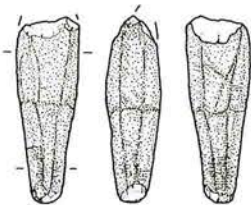

PL74-13

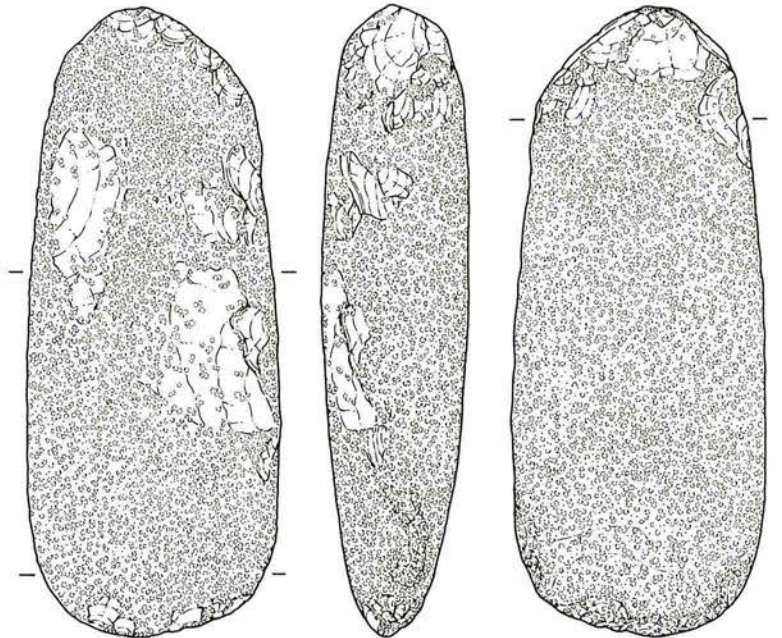
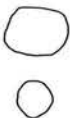

PL74-10

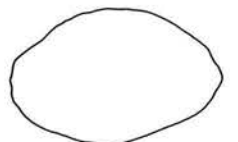

SB1141

PL77-1

PL77-2

(1:2)

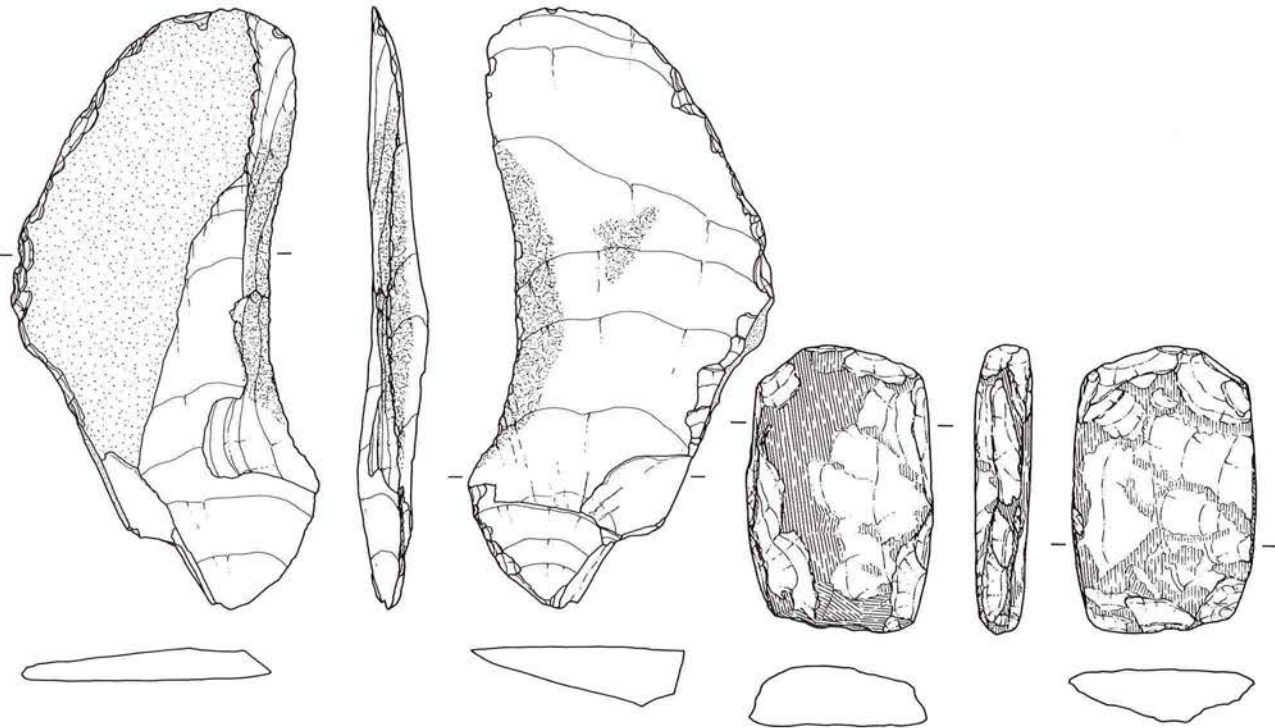

△ PL77-1

PL77-2

SB1142

PL77-9

PL77-15

(2:3)

PL77-14

(1:2)

PL77-16

(1:1)

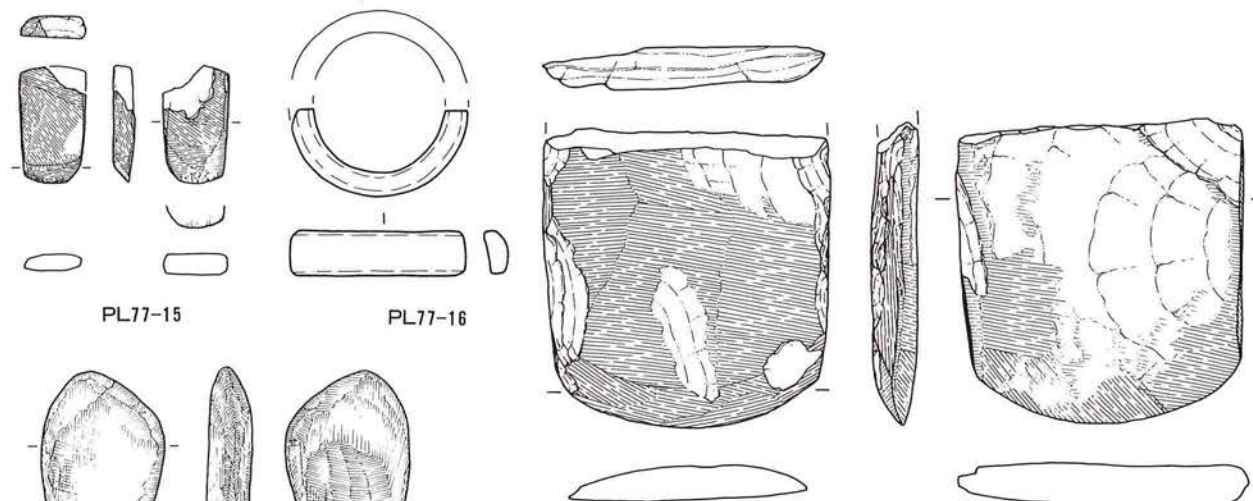

PL77-15

PL77-16

PL77-14

SB1143

PL78-3

(2:3)

PL78-8

PL78-9

(1:2)

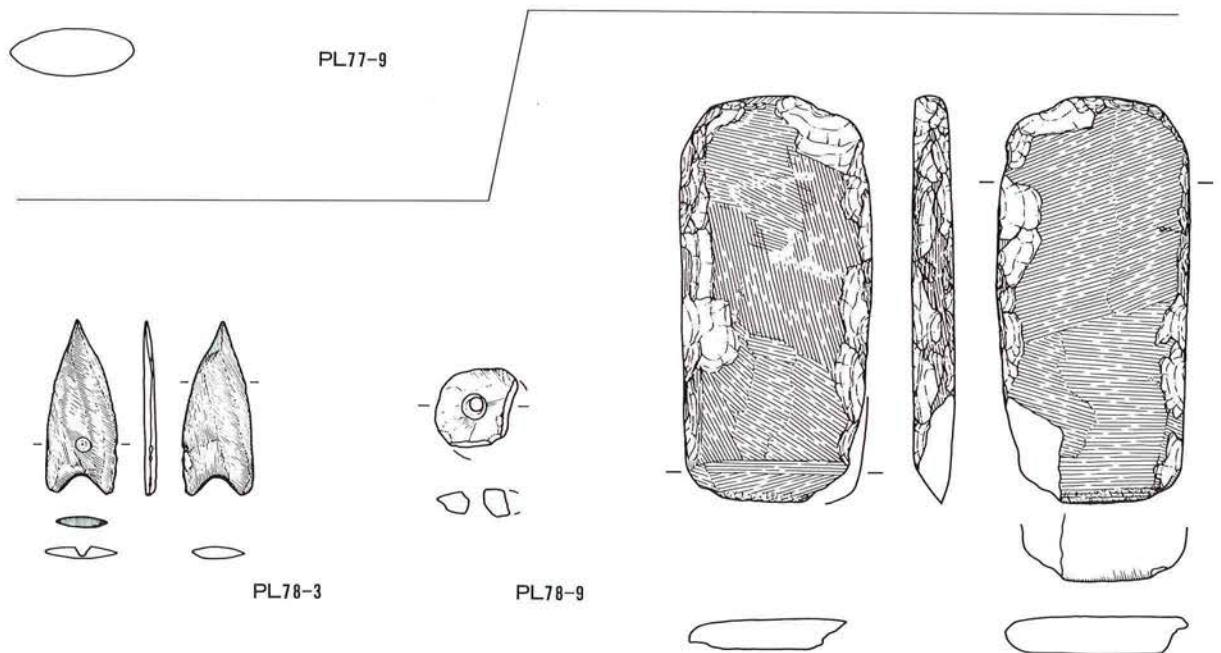

PL78-3

PL78-9

PL78-8

石器実測図

SB1144

PL 78-13

(2:3)

PL 78-16

(1:2)

PL 78-18

(1:3)

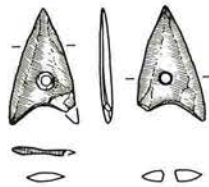

PL78-13

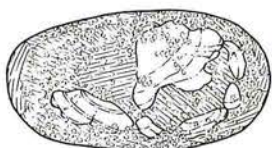
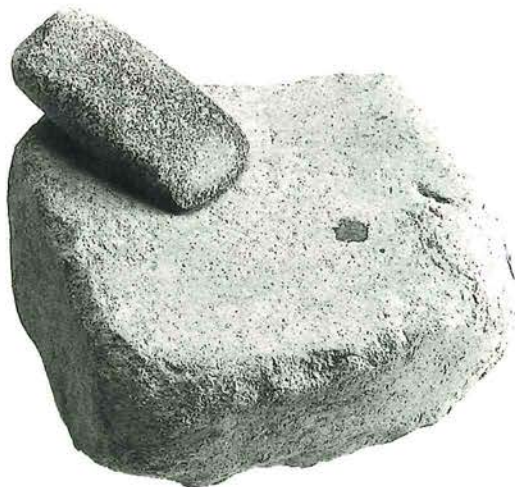

大型蛤刃石斧No.16と砥石No.18のセット 想定写真

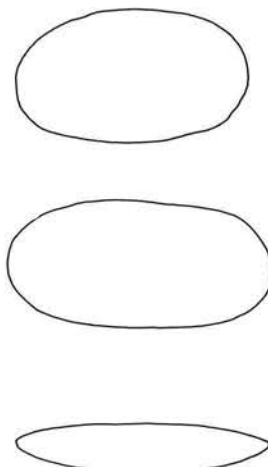
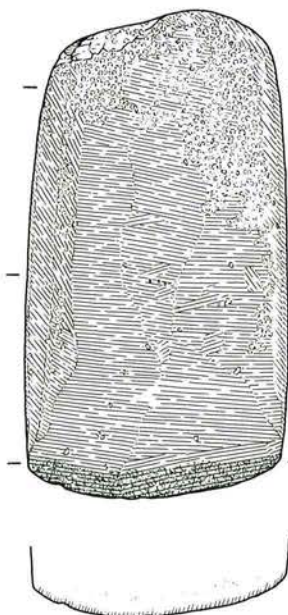
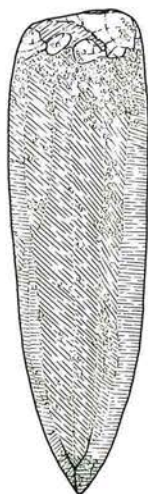
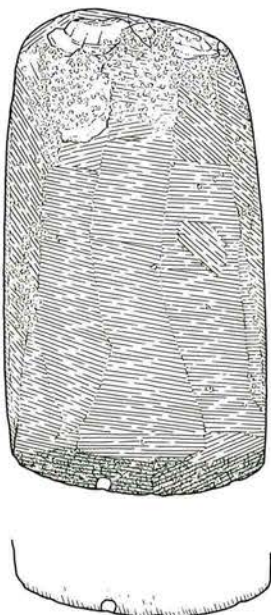

PL78-16

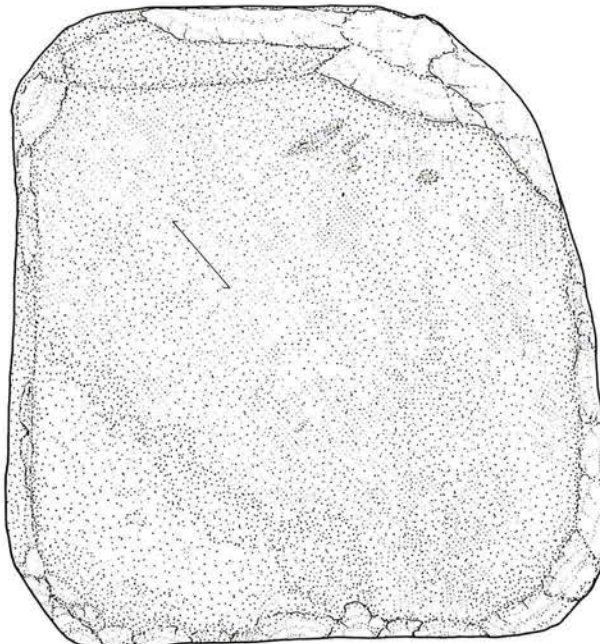
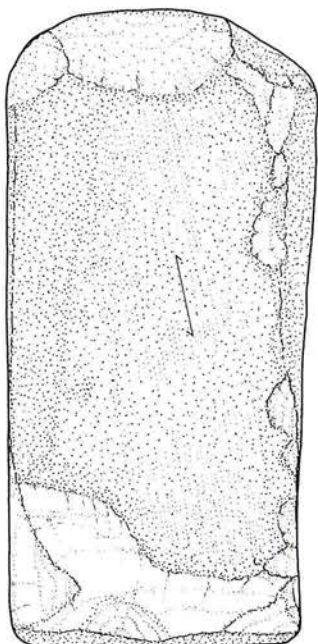

石器写真

SB1145

- 1 小形石核 IIa 類
- 2 磨製石鏃
失敗品 1 類
- 3 大形刃器 1a 類
- 4 大形刃器 1b 類
- 5 大形刃器 2d 類
- 6 太型蛤刃石斧
1b'類?
- 7 砥石 IIb 類
- 8 軽石製品

SB1146

- 9 石槌 蛤刃転用
(2:3)
- 10 紡錘車状石製品
(1:1)

SB1147

- 11 敲石工類
- 12 大形刃器 2b 類

SB1153

- 13 砥石 III 類
(2:3)

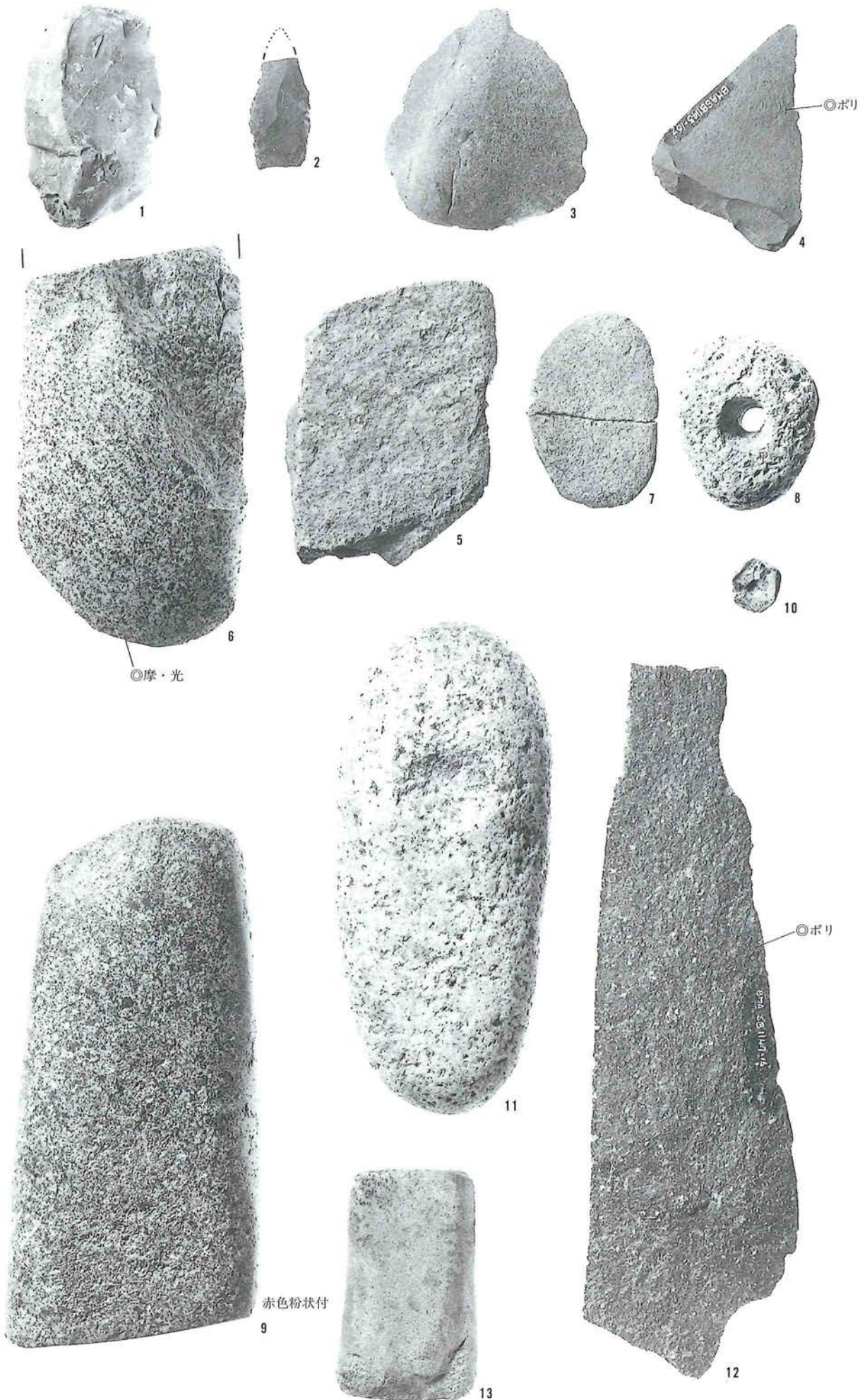

石器写真

SB1155

- 1 大形剥片碎片集合
- 2 大形剥片碎片集合
- 3 磨製石鏃
失敗品1類
- 4 磨製石鏃
失敗品1類
- 5 磨製石鏃
失敗品2B類
(特殊石製品)
- 6 磨製石鏃
失敗品2B類
(特殊石製品)
- 7 敲石才類
- 8 大型蛤刃石斧
Ib'類?
- 9 砥石 特殊
- 10 玉, 剥片1種

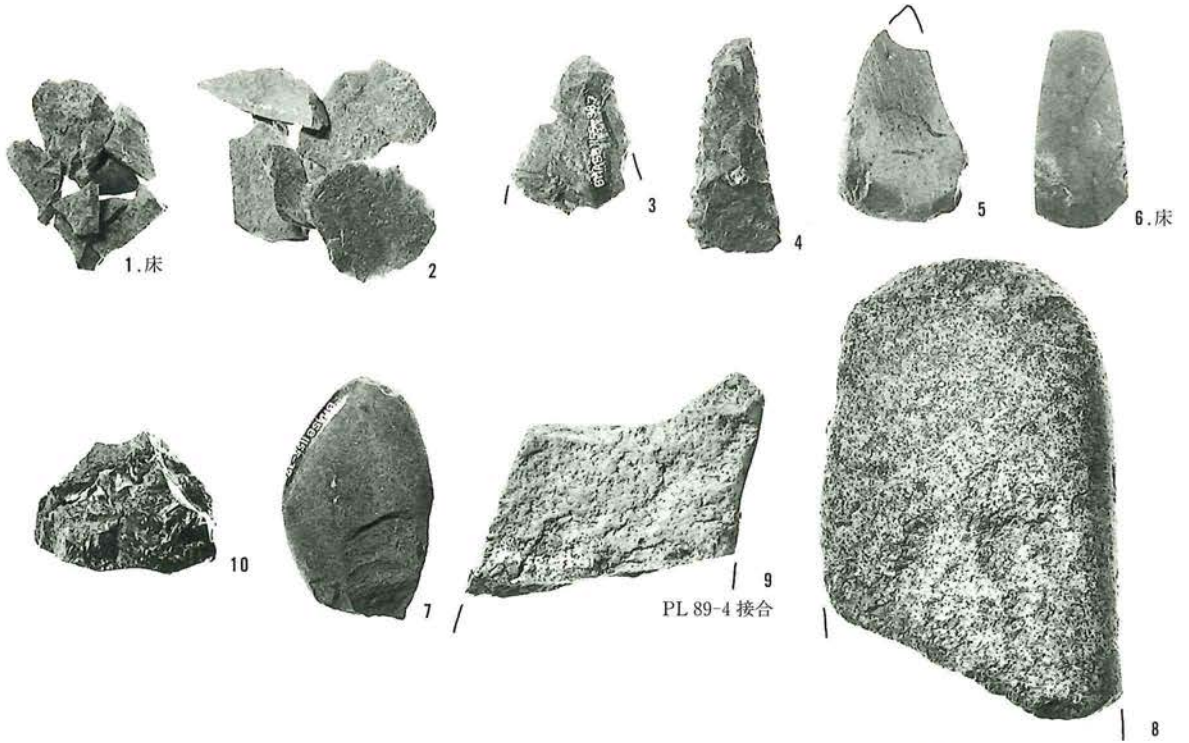

SB1156

- 11 敲石了類
- 12 扁平片刃石斧
IIc類
- 13 石槌

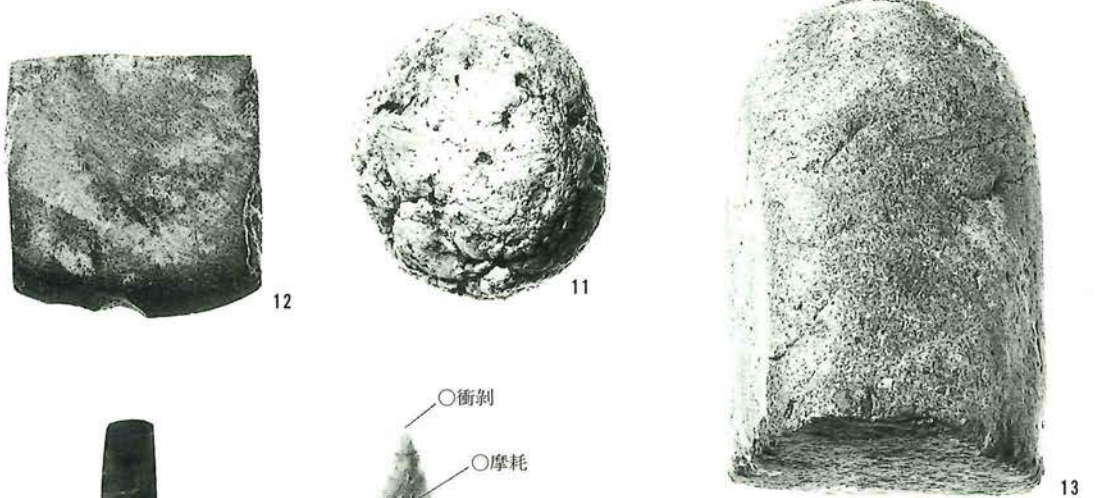

SB1157

- 14 ノミ状石器IIIf類



SB1159

- 15 打製石鏃 IB,類



SB1160

- 16 大形石核 IIA類
- 17 大形刃器 Ib類
- 18 石槌 蛤刃転用
- 19 紡錘車状石製品
(2:3)

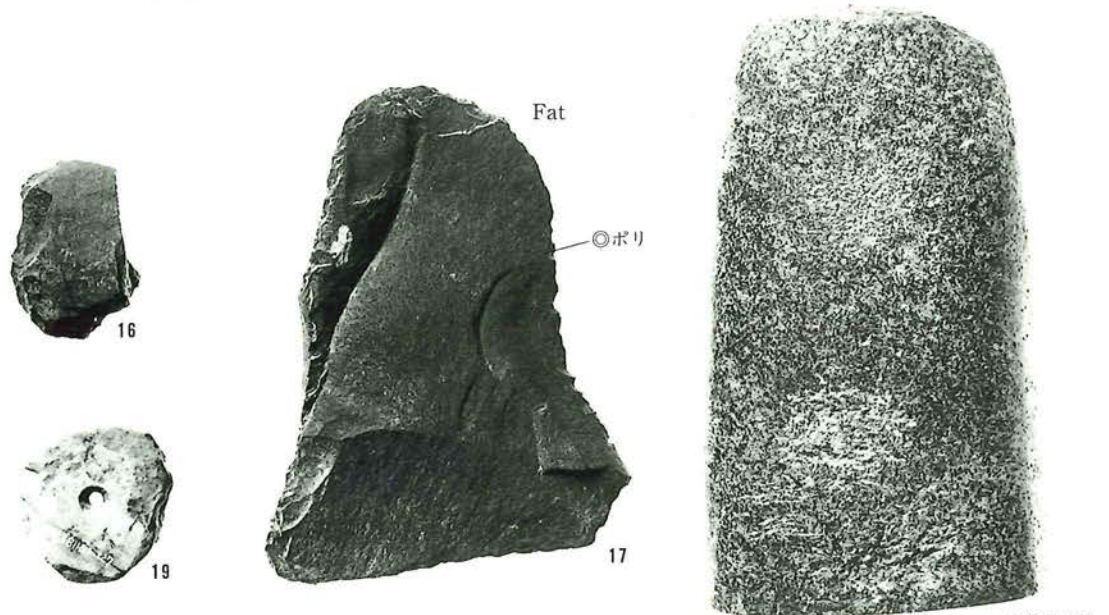

石器写真

SB1161

- 1 剥片 A 類II
- 2 剥片 A 類IV
- 3 磨製石鏃 IB₁類
- 4 大形刃器 2c 類
- 5 扁平片刃石斧
失敗品 E₃類
- 6 扁平片刃石斧
IIb₂類
- 7 扁平片刃石斧
IIb₁類
- 8 扁平片刃石斧
失敗品 B 類

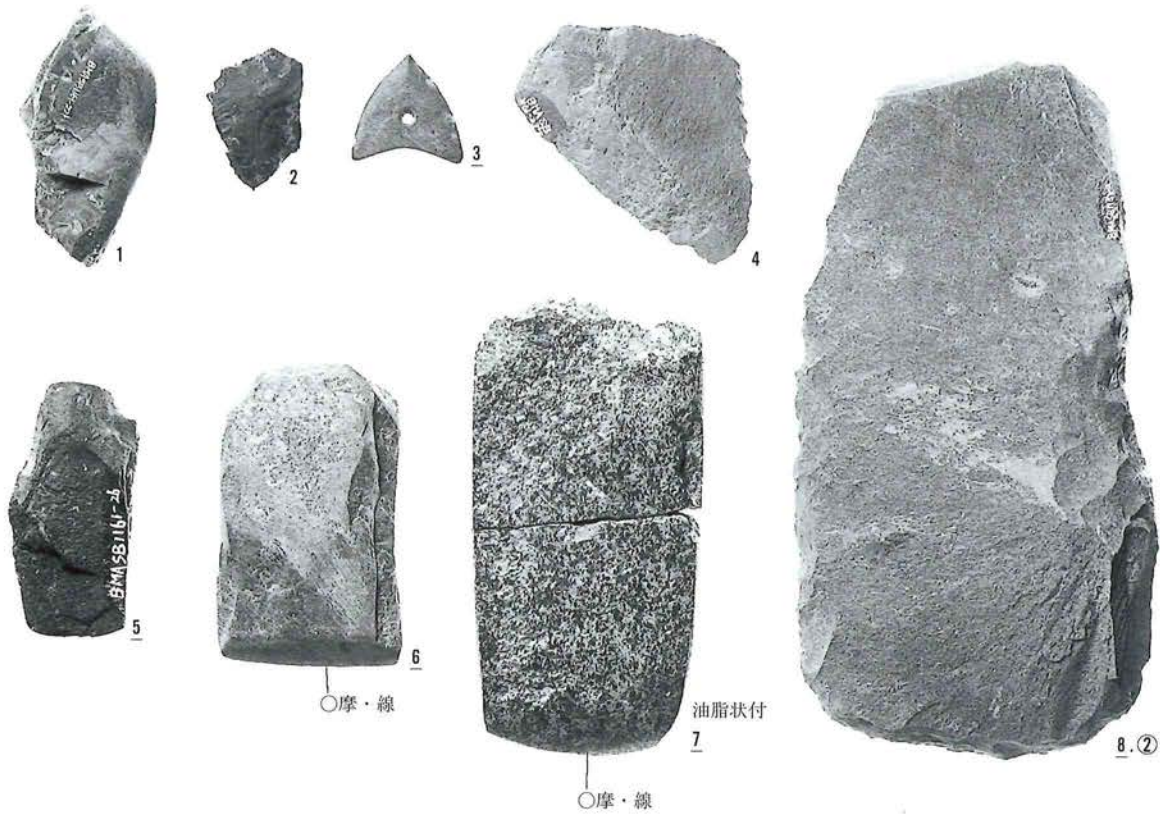

SB1162

- 9 磨製石鏃
失敗品 2A 類
- 10 扁平片刃石斧
IIe 類
- 11 扁平片刃石斧
失敗品 E₃類
- 12 研磨痕のある剥片



SB1163

- 13 磨製石鏃
失敗品 1 類
- 14 磨製石鏃
失敗品 2A 類
- 15 敲石ア・エ類
- 16 大形刃器 2c 円盤
- 17 扁平片刃石斧
IIb₂類
(2:3)



石器実測図

SB1161

PL 84-3
(2:3)

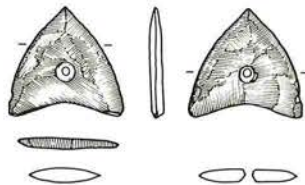

PL 84-5



PL 84-6



PL 84-7

PL 84-8

(1:2)

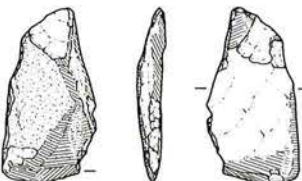

PL84-3

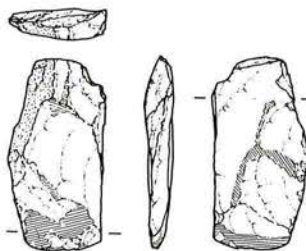

PL84-5

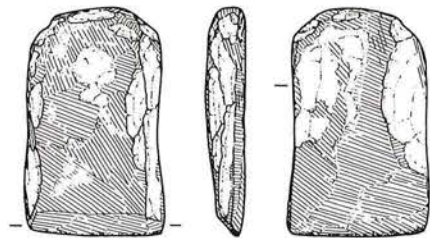

PL 85

PL84-6

SB1162

PL 84-10

(2:3)

PL 84-11

PL 84-12

(1:2)

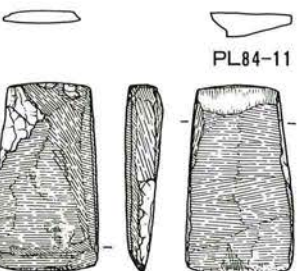

PL84-11



PL84-10

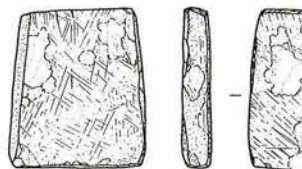

PL84-12

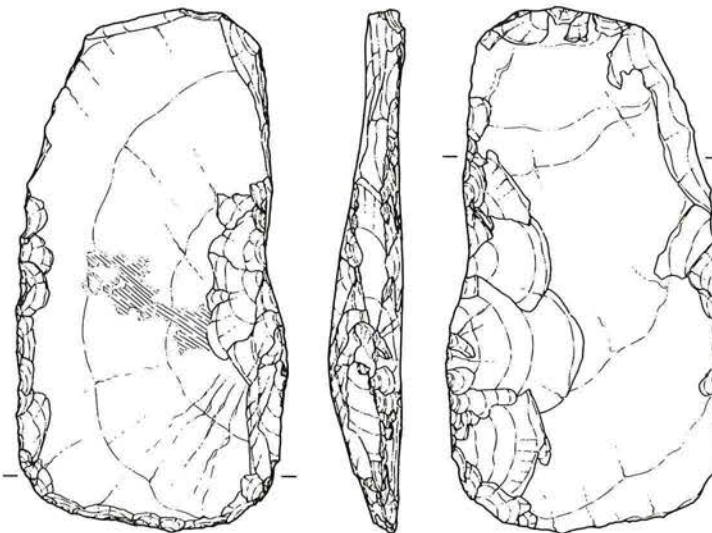

PL84-8

SB1168

PL 86-1

(1:2)

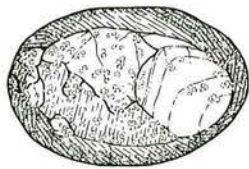
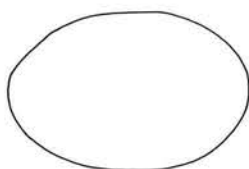

SB1172

PL 86-5

(1:2)

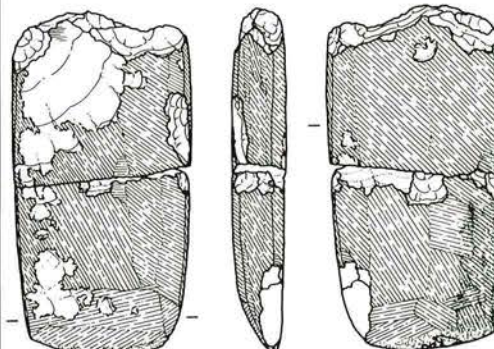
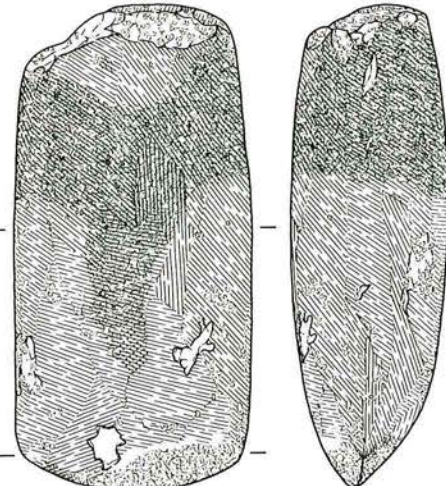

PL84-7

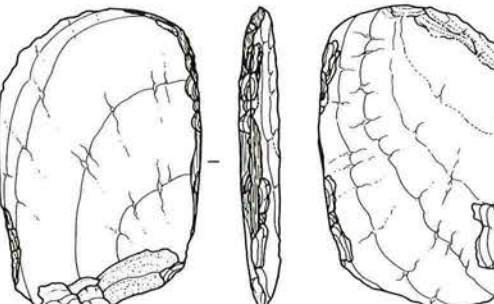

PL86-1

PL86-5

石器写真

SB1168

- 1 大型蛤刃石斧 Ic'類
- 2 石槌 蛤刃転用

SB1172

- 3 剥片 A類IV
- 4 小形刃器 6a類
- 5 扁平片刃石斧 失敗品 E₂類

SB1174

- 6 磨製石鏃 失敗品 2A類
- 7 磨製石鏃 不明
- 8 磨石 IIa類

SB1175

- 9 大形刃器 2b類
- 10 石槌 蛤刃転用 (2:3)

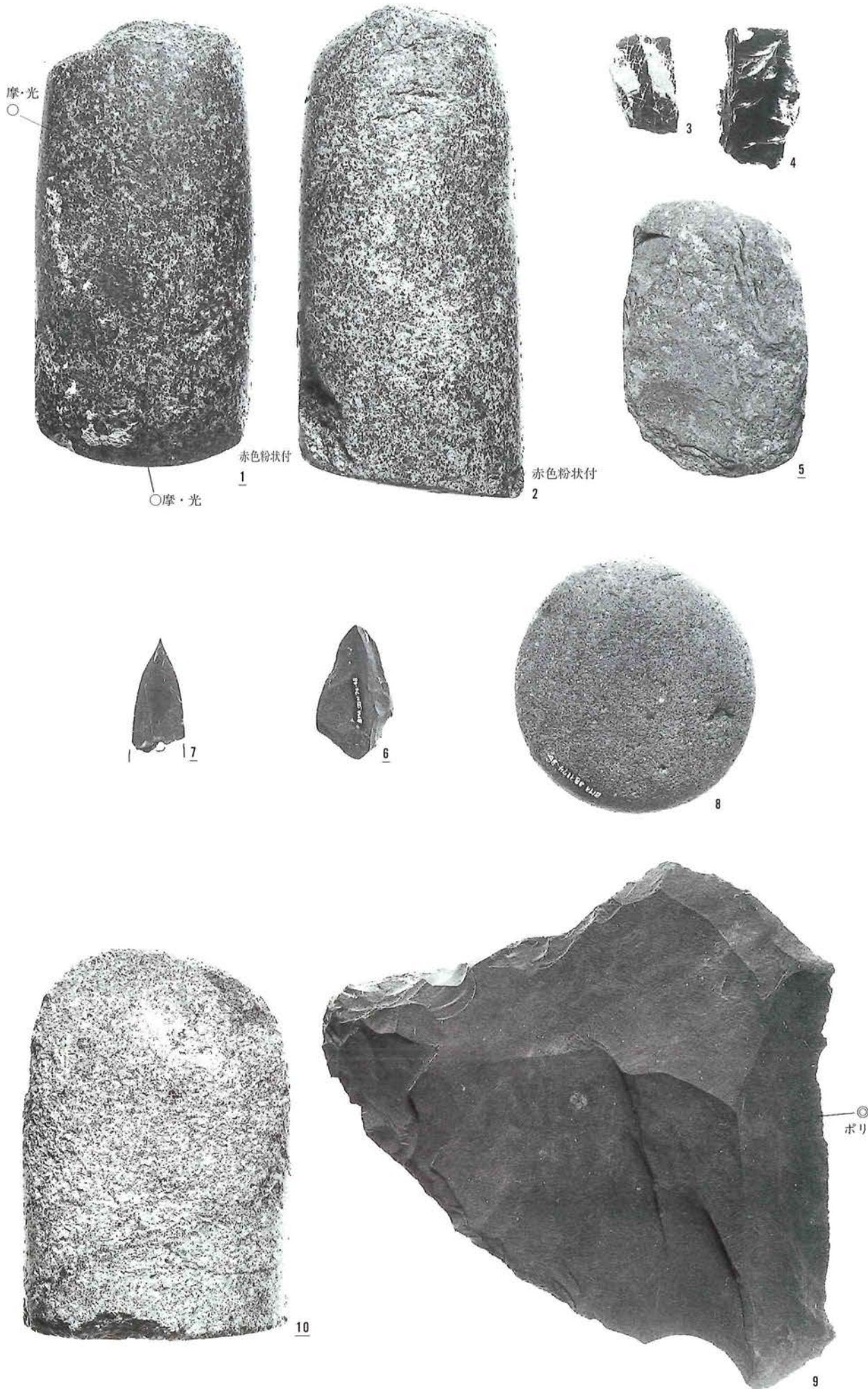

石器写真

SB1176

- 1 大形刃器 8類
- 2 扁平片刃石斧 Ib₂類

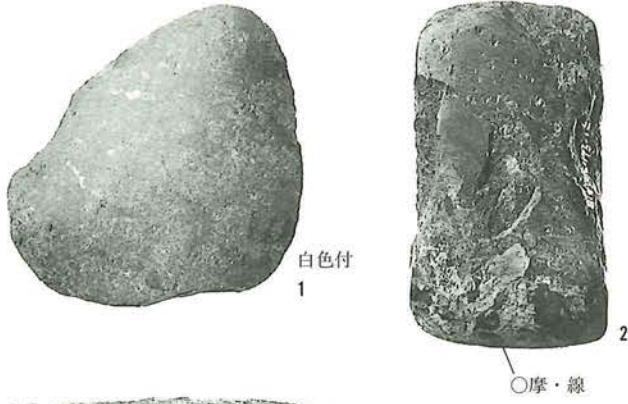

白色付
1

○摩・線
2

SB1177

- 3 台石 2種 A₂類
- 4 磨製石包丁 失敗品 E₃類
- 5 石槌 蛤刃転用
- 6 砥石 I2類

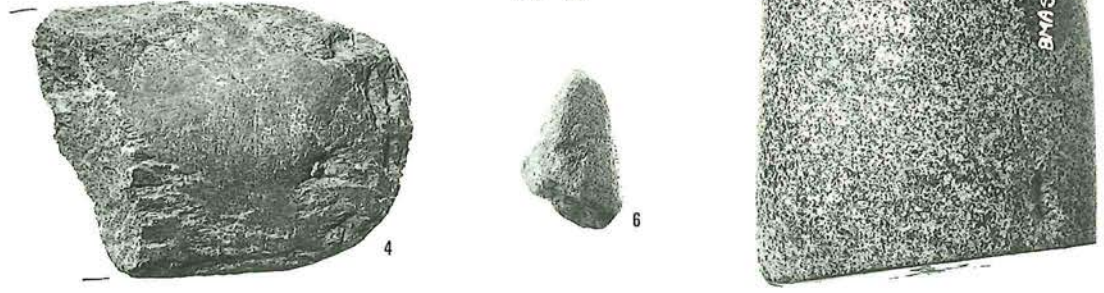

赤色粉状付
5

SB1181

- 7 磨製石鏃 失敗品 2A類
- 8 太型蛤刃石斧 Ic'類 (2:3)

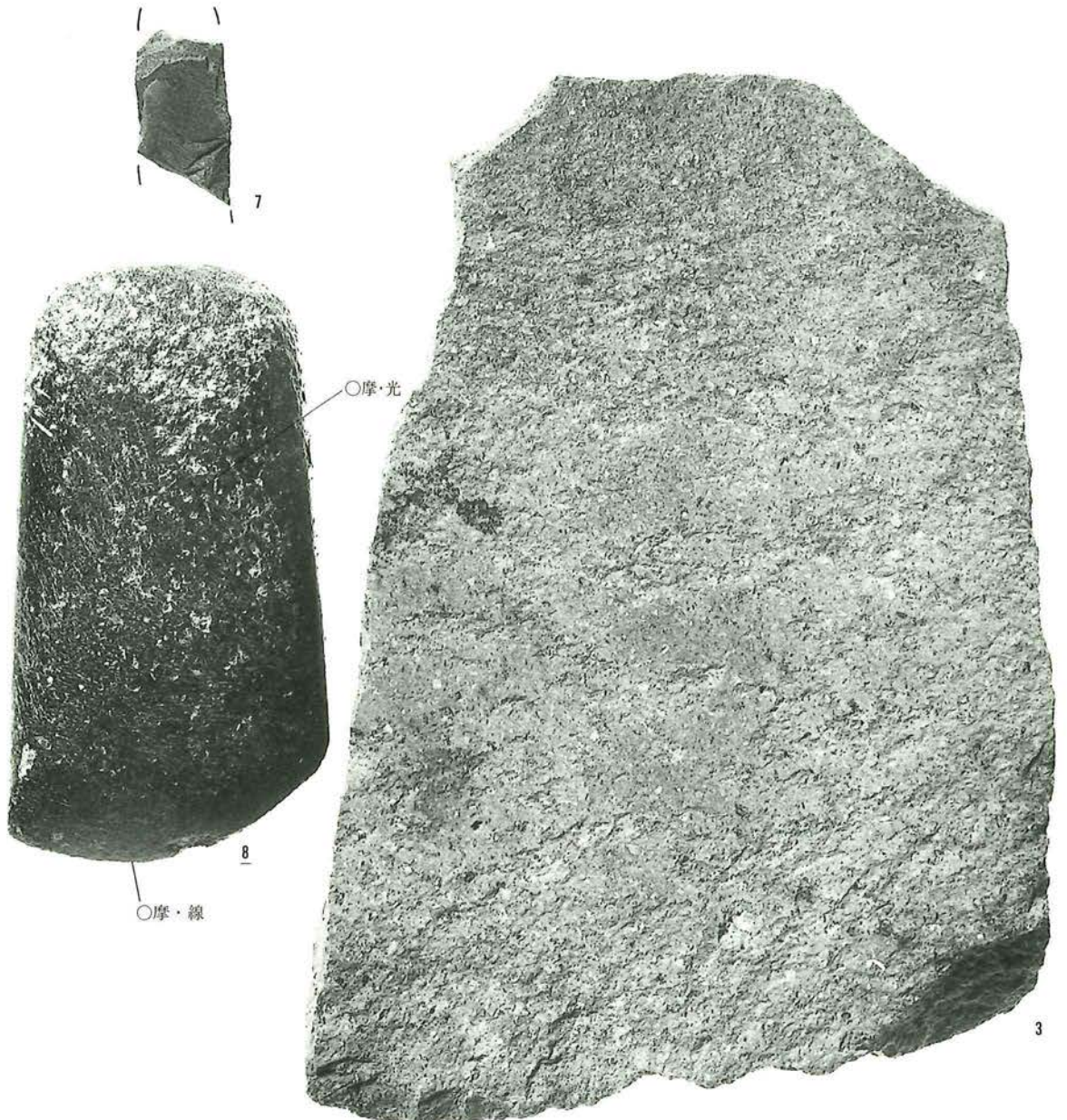

○摩・光

○摩・線

PL88

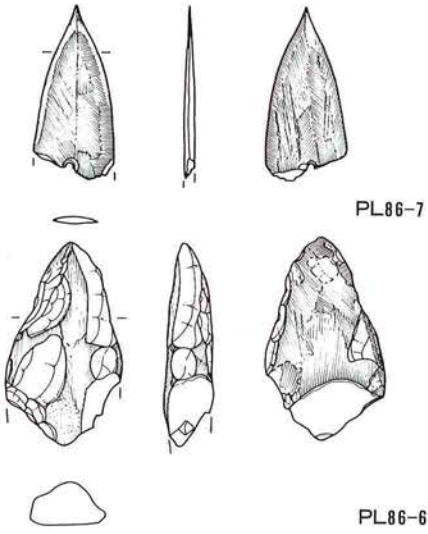

PL86-7

PL86-6

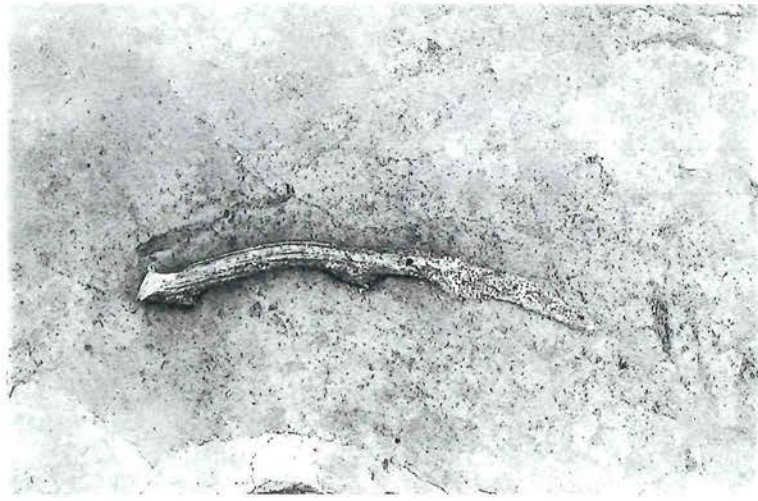

鹿角製品出土状況 (SB 1174)

遺物出土状況写真

石器実測図

SB 1174

PL 86-6

PL 86-7

(2:3)

SB 1175

PL 86-9

PL 86-10

(1:2)

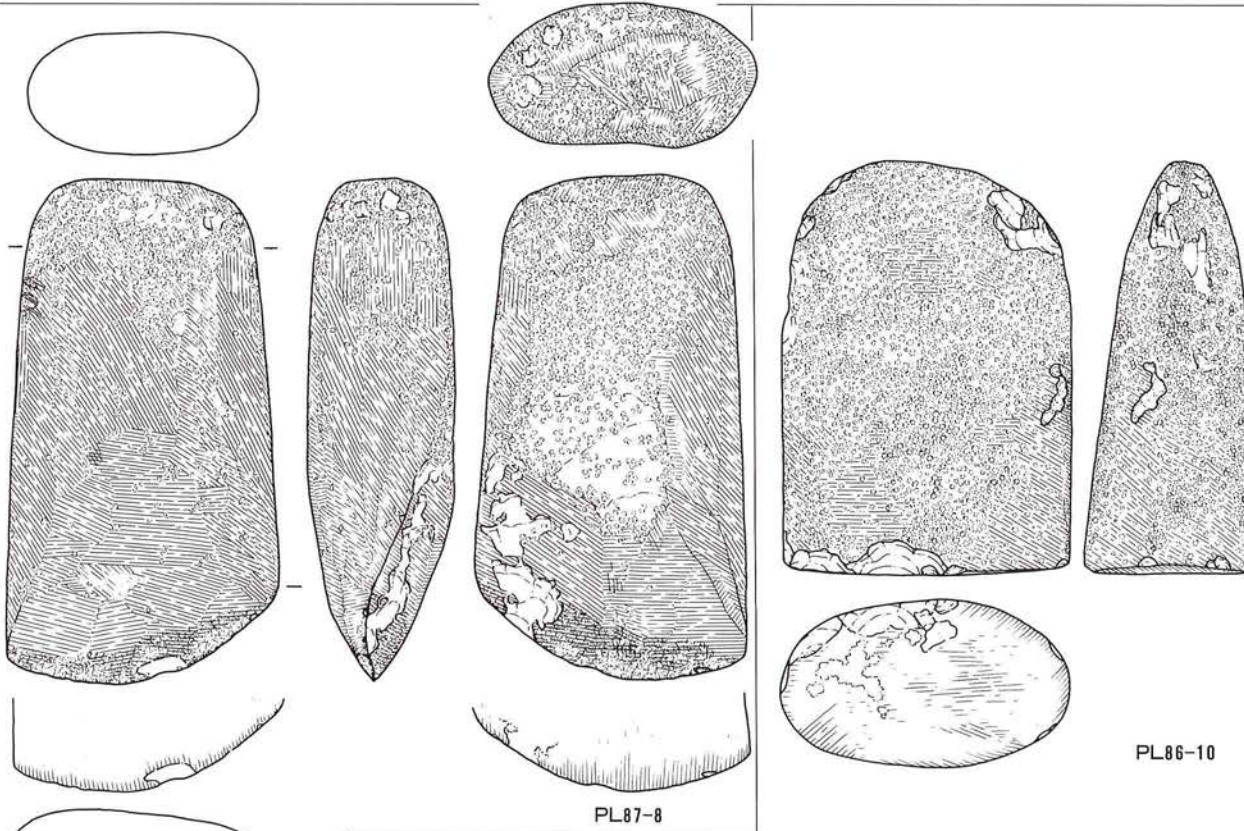

PL87-8

PL86-10

SB 1181

PL 87-8

(1:2)

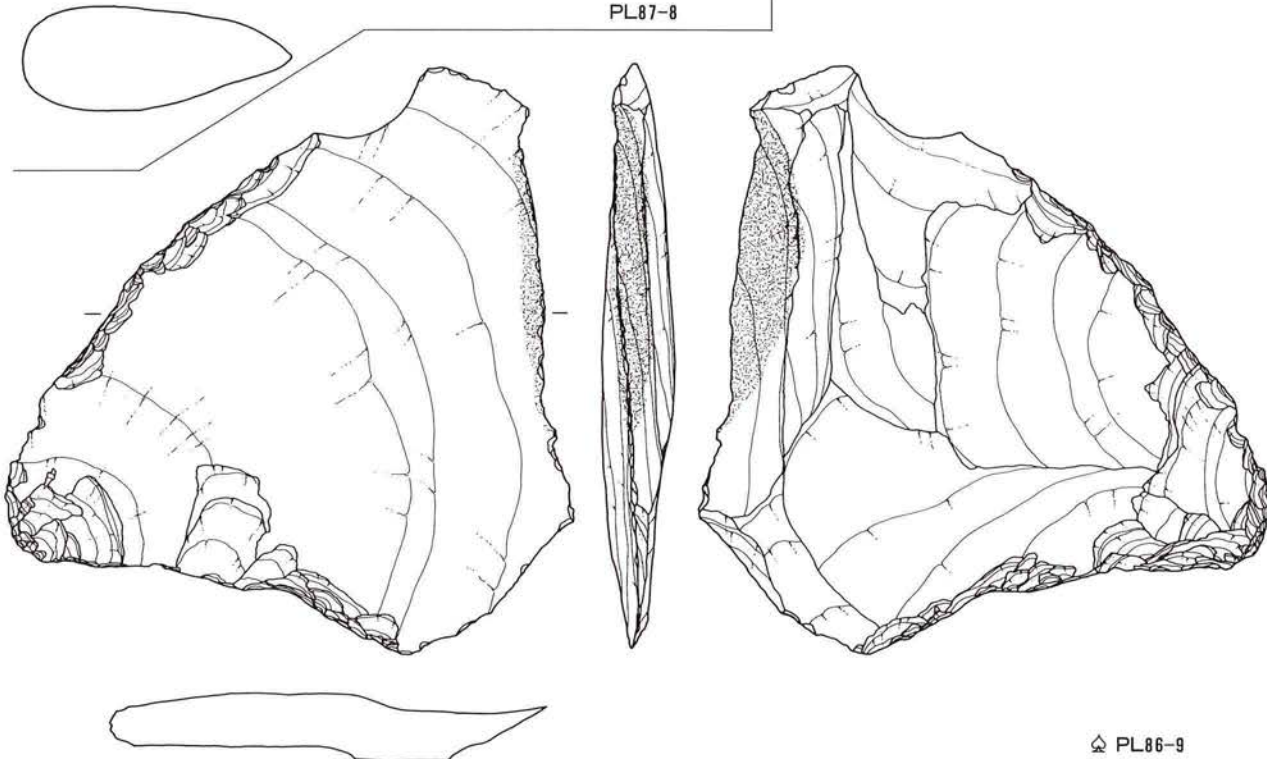

PL 86-9

石器写真

SB1183

- 1 大形刃器 1b 類
- 2 砥石 置砥

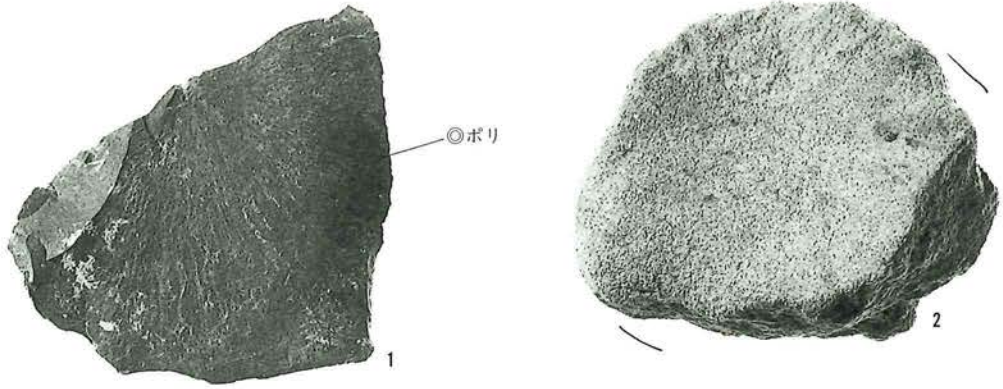

SB1186

- 3 打製石斧 不明
- 4 砥石 特殊

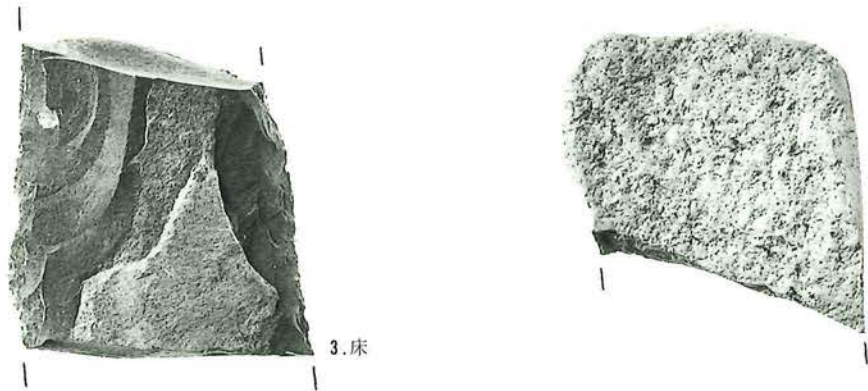

SB1192

- 5 磨製石鏃 不明
- 6 みがき石 IIc 類
- 7 みがき石 IIc 類
- 8 扁平片刃石斧 IIc 類

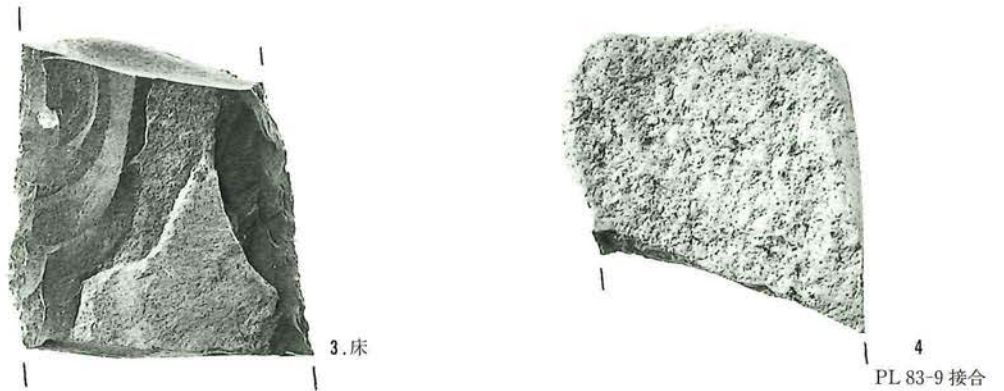

SB1248

- 9 磨製石包丁 杏仁形
 - 10 磨製石包丁 半月形
- (2:3)

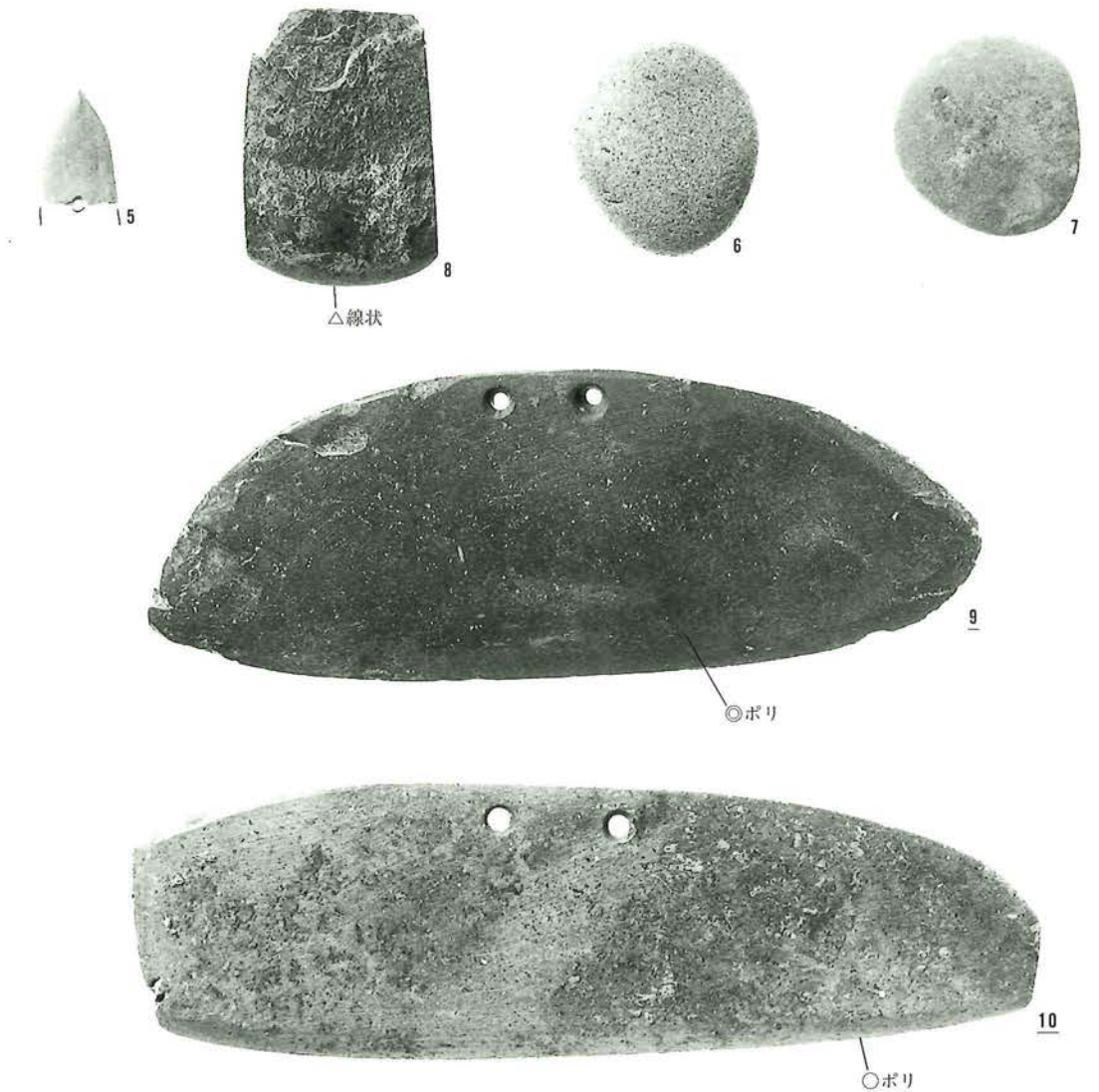

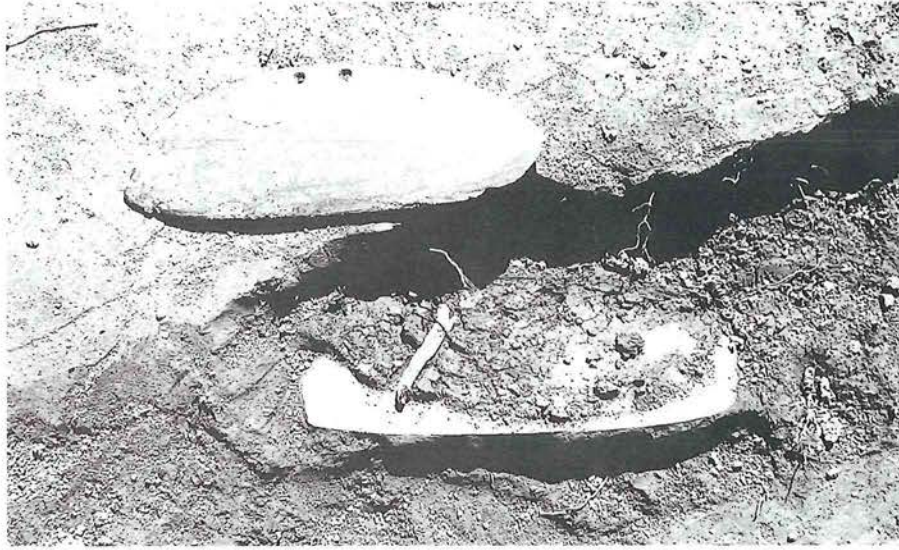

磨製石包丁No.9 (上) とNo.10 (下) の出土状況

石器実測図

SB1248

PL 89-9

PL 89-10

(1:2)

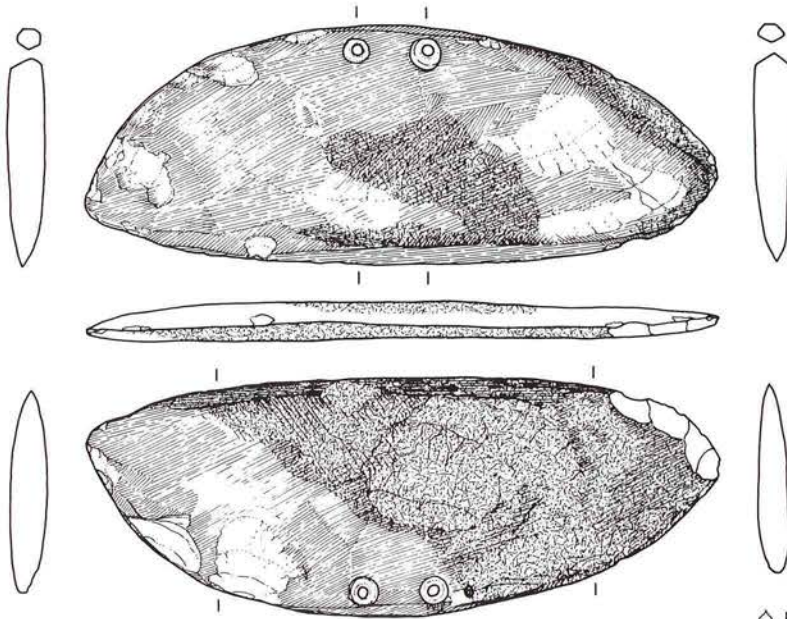

△ PL89-9

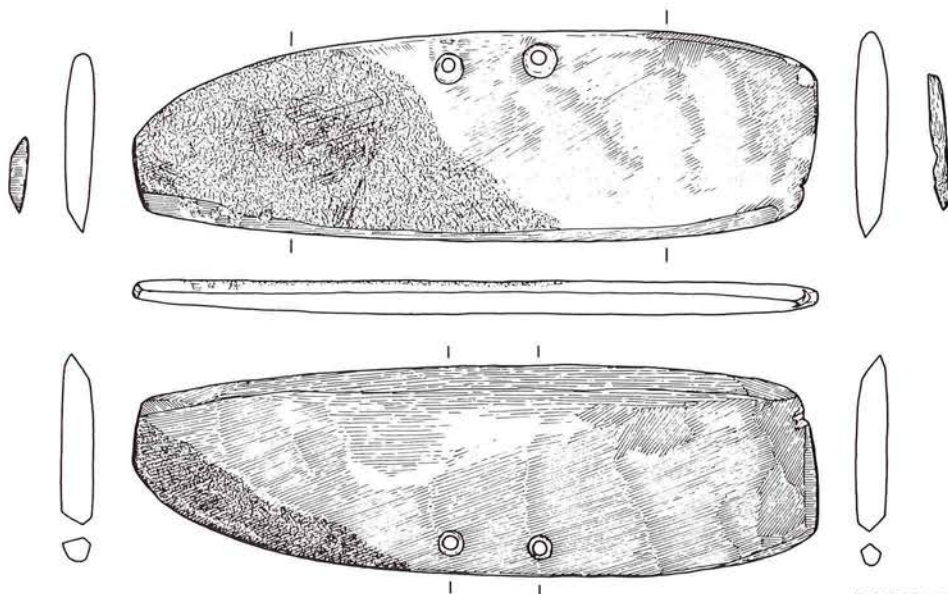

△ PL89-10

石器写真

SB1247

- 1 小形剥片 2種
- 2 小形剥片 B類
- 3 小形剥片碎片集合
- 4 小形剥片 B類
- 5 打製石鏃
失敗品 1類
- 6 打製石鏃 IIA類
- 7 打製石鏃 IIB₃類
- 8 打製石鏃 IIB₃類
- 9 打製石鏃 IIB₃類?
- 10 磨製石鏃
失敗品 2 B類
- 11 大形刃器 7類
- 12 大形刃器 7類
- 13 ノミ状石器
失敗品 E₁類
- 14 砥石 置砥
- 15 軽石製品

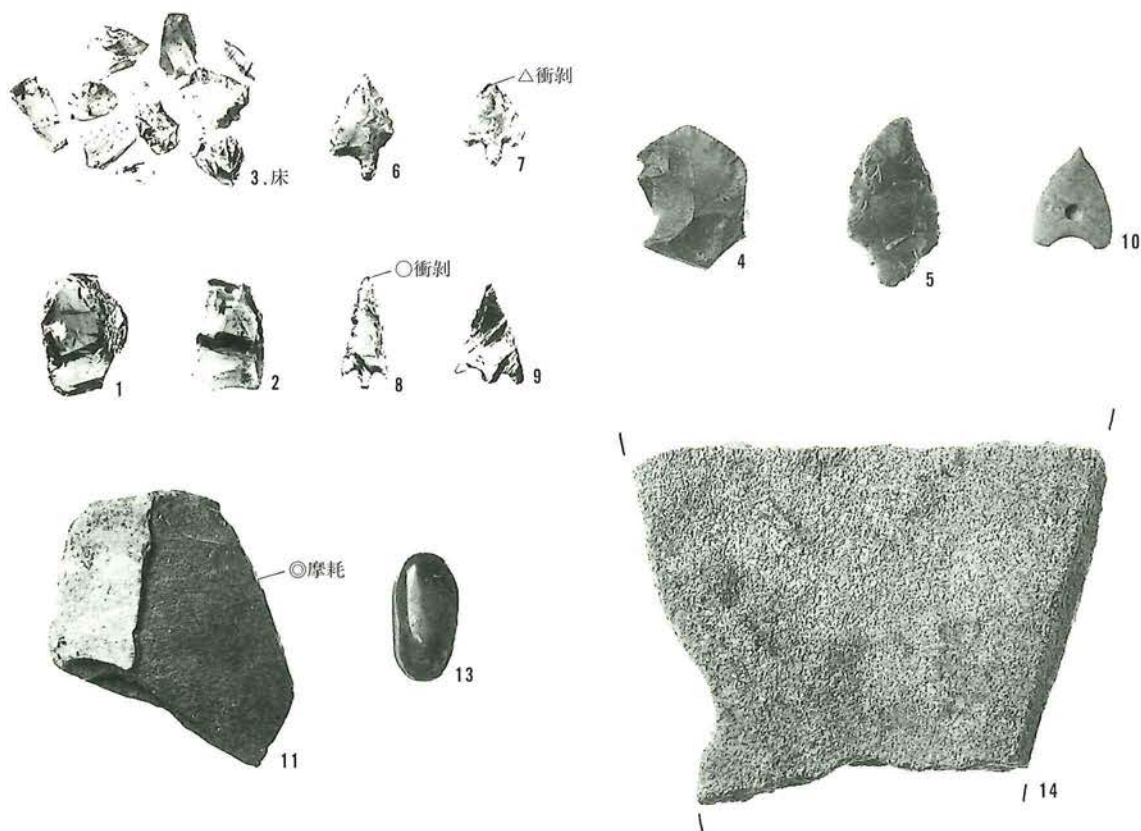

SB1250

- 16 剥片 A類VI
- 17 小形剥片碎片集合
- 18 小形剥片碎片集合
- 19 小形剥片 2種
- 20 小形剥片 2種

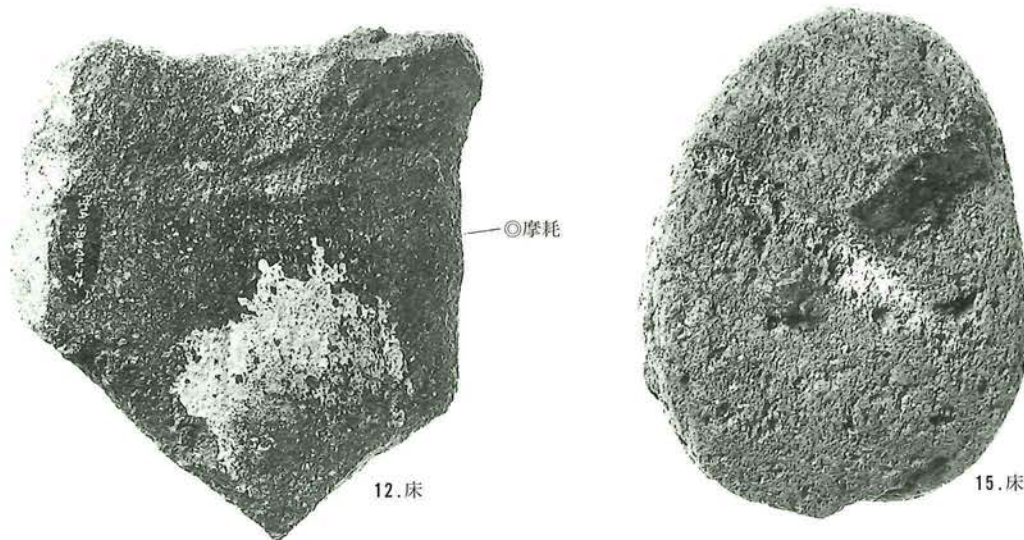

SB1255

- 21 大形剥片碎片集合
- 22 小形剥片碎片集合
- 23 みかき石 I類不明
(2:3)

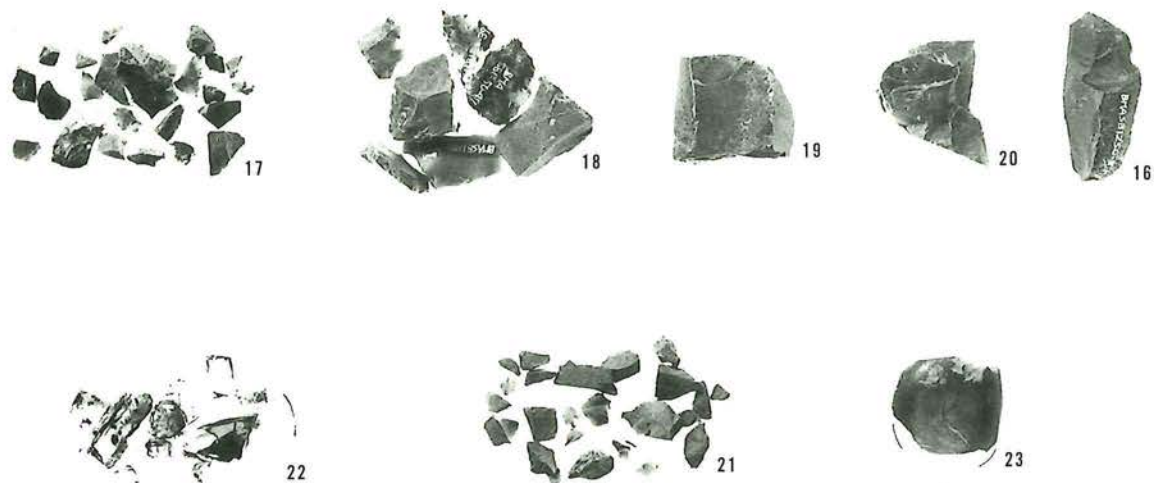

石器写真

SB1253

- 1 磨石 II2 a 類
- 2 台石 2 種 A₂ 類
- 3 ノミ状石器 III f 類

SB1256

- 4 打製石鏃 II B₁ 類

SB1257

- 5 打製石斧 不明
- 6 扁平片刃石斧 II e 類

SB1258

- 7 大形剝片 B 類
- 8 扁平片刃石斧 II b₁ 類
- 9 石槌 蛤刃転用
- 10 砥石 II b 類
(2:3)



1



2



3
◎摩・線



4.①
○摩耗



6



5



7



8.①
△摩耗



10



9.②

石器写真

SB1259

- 1 小形石核II2B類
- 2 磨製石鏃IB₂類
- 3 大形刃器1b類
- 4 太型蛤刃石斧Id'類
- 5 ノミ状石器IIf類

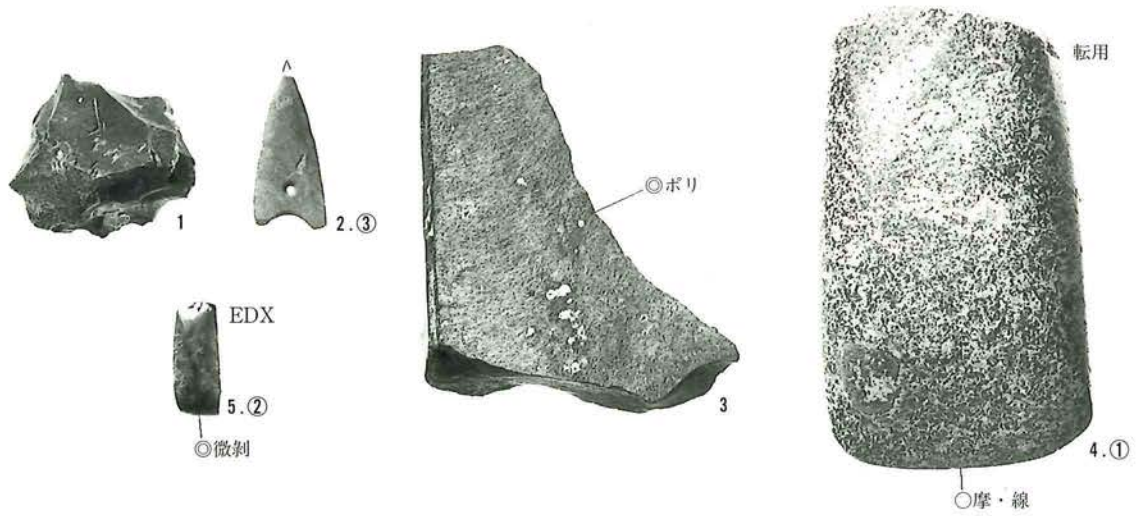

SB1260

- 6 小形石核IIA類
- 7 大形刃器2d類
- 8 大形刃器1b類
- 9 扁平片刃石斧d類?



SB1261

- 10 みがき石II2c類
- 11 台石2種A₂類
- 12 砥石IIC類
(2:3)

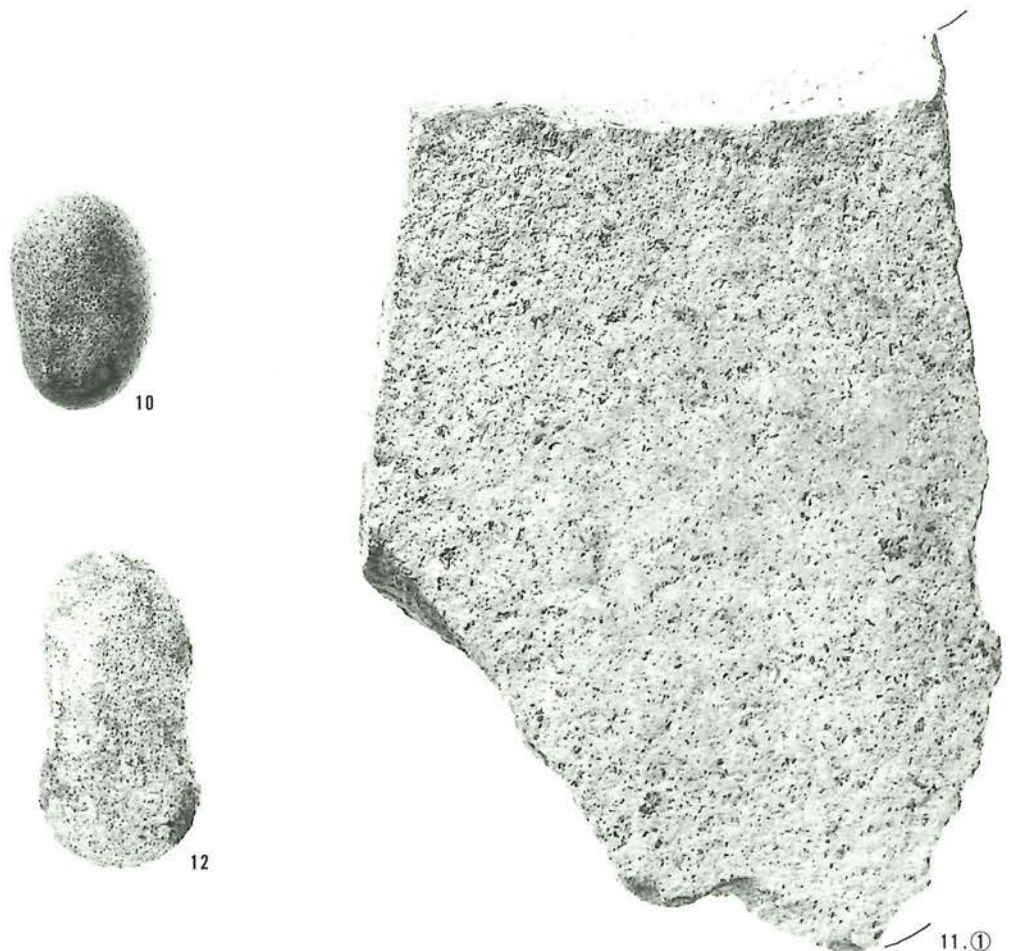

石器写真

SB1262

- 1 磨製石鏃 IB₁類
- 2 磨石 IIIa 類
- 3 大形刃器 2a 類
- 4 太型蛤刃石斧 不明

SB1263

- 5 大形刃器 1b 類
- 6 大形刃器 1b 類
- 7 磨製石包丁
失敗品 B 類
- 8 扁平片刃石斧
IIb₁類
- 9 石錐 2A 類
(2:3)

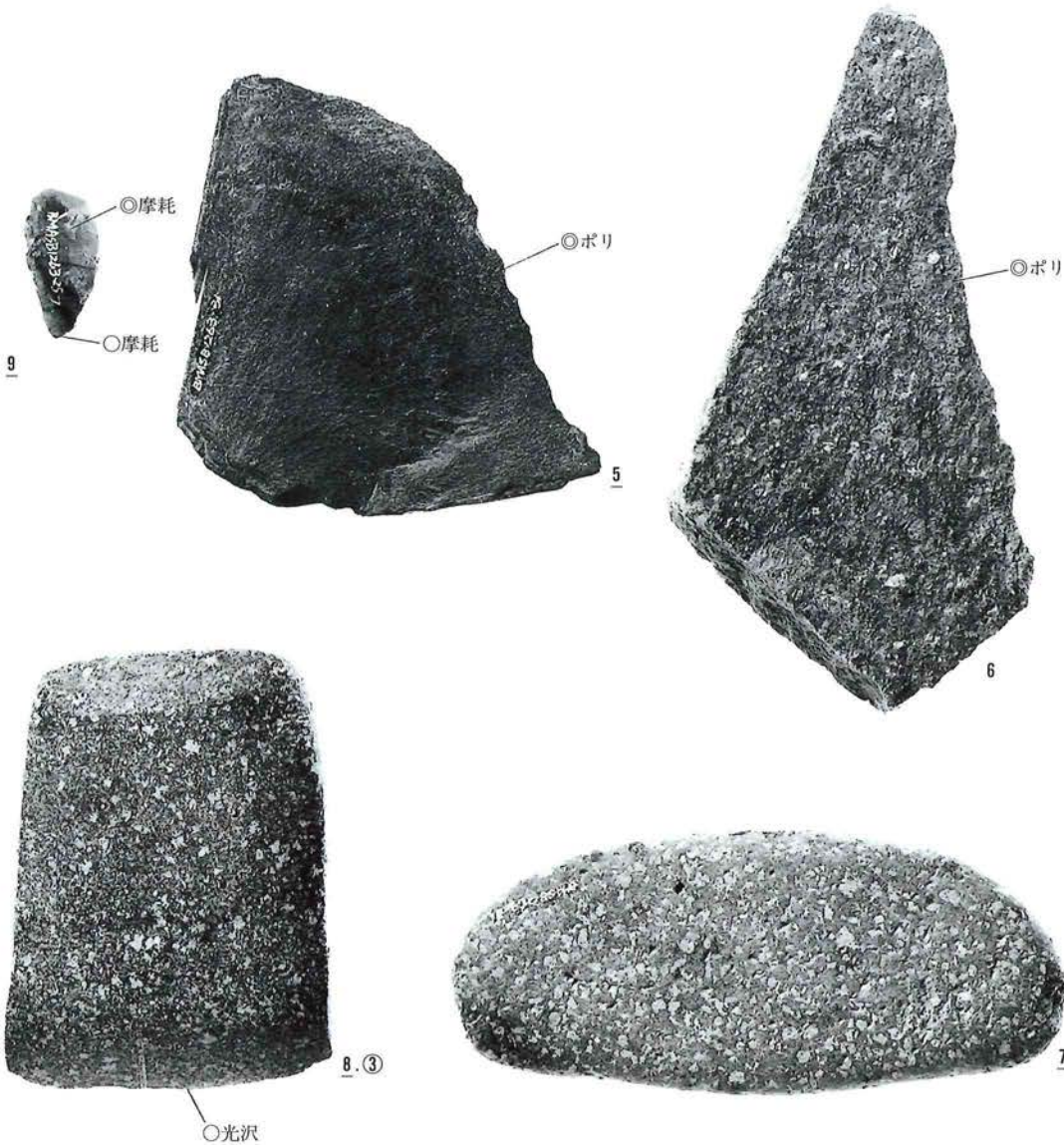
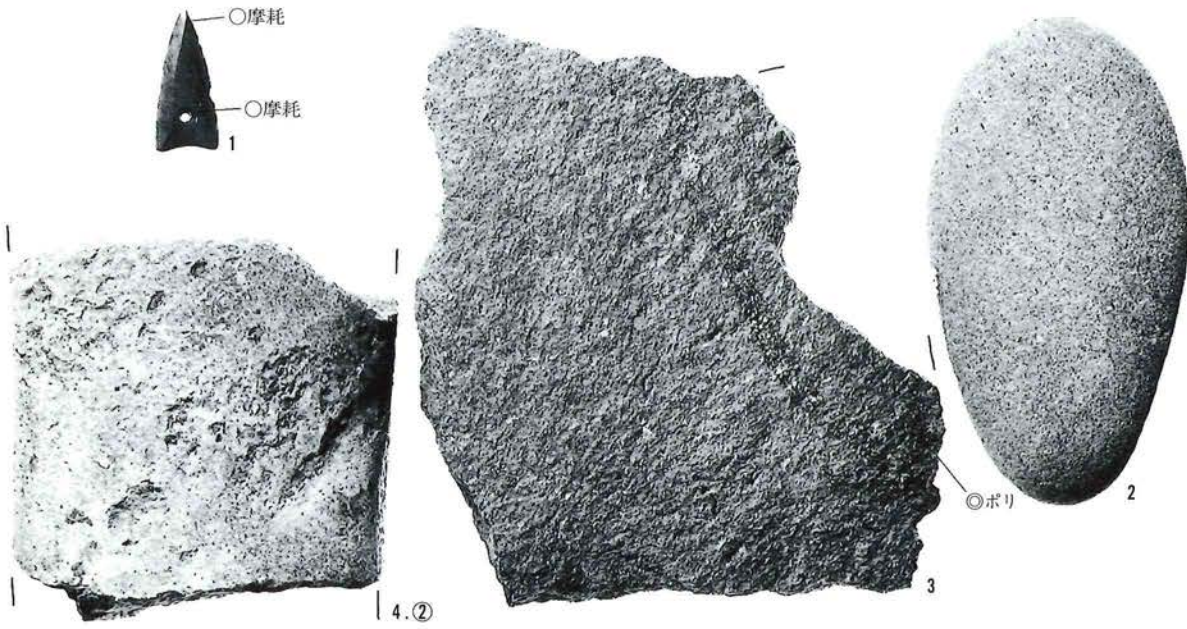

石器实测图

SB1258

PL92-8

PL92-9

(1:2)

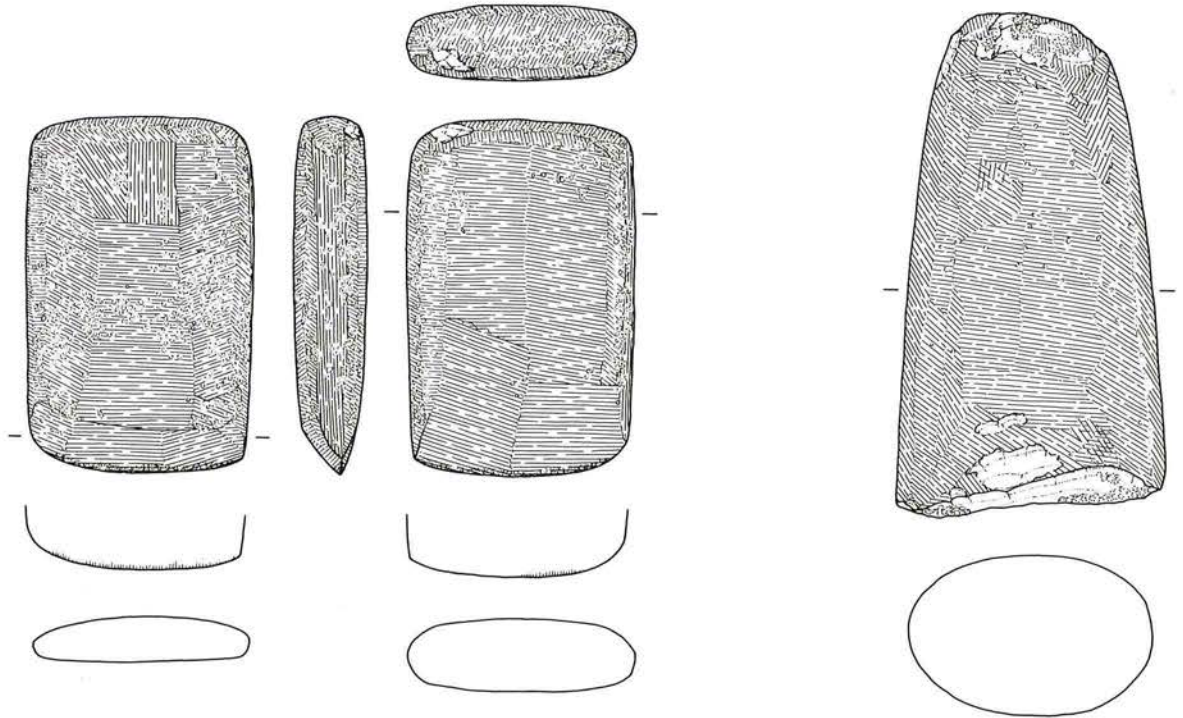

PL92-8

PL92-9

SB1263

PL94-9

(2:3)

PL94-5

PL94-7

PL94-8

(1:2)

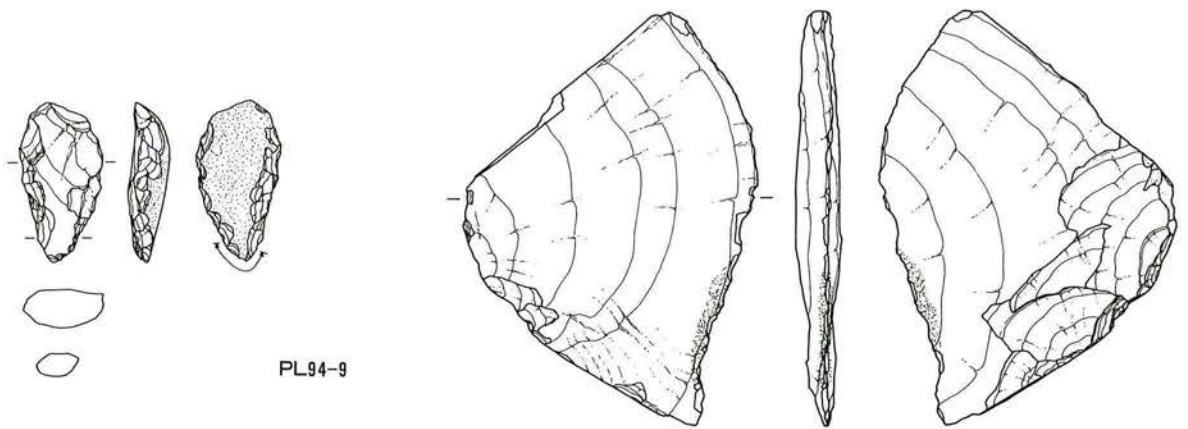

PL94-9

PL94-5

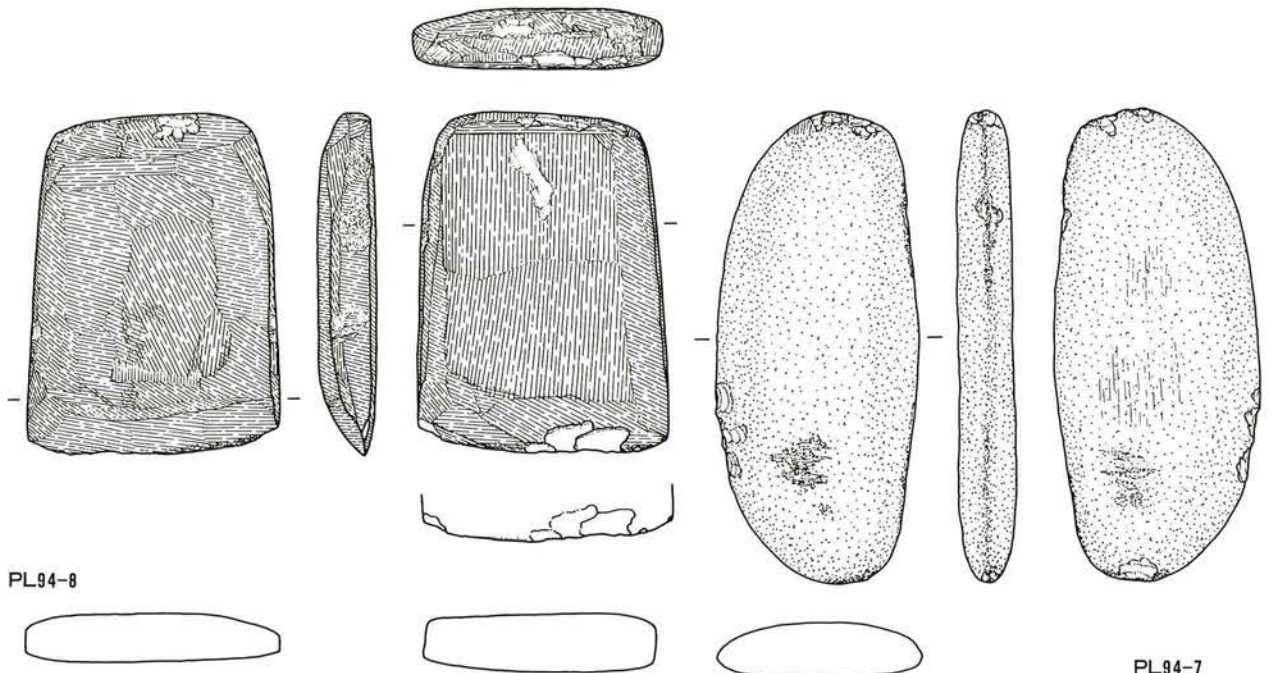

PL94-8

PL94-7

石器写真

SB1264

1 打製石斧 E₁類

2 敲石ア類

(2:3)

3 台石2種 A₂類

(1:3)

4 大形刃器 2b類

5 磨製石包丁 杏仁形

(2:3)

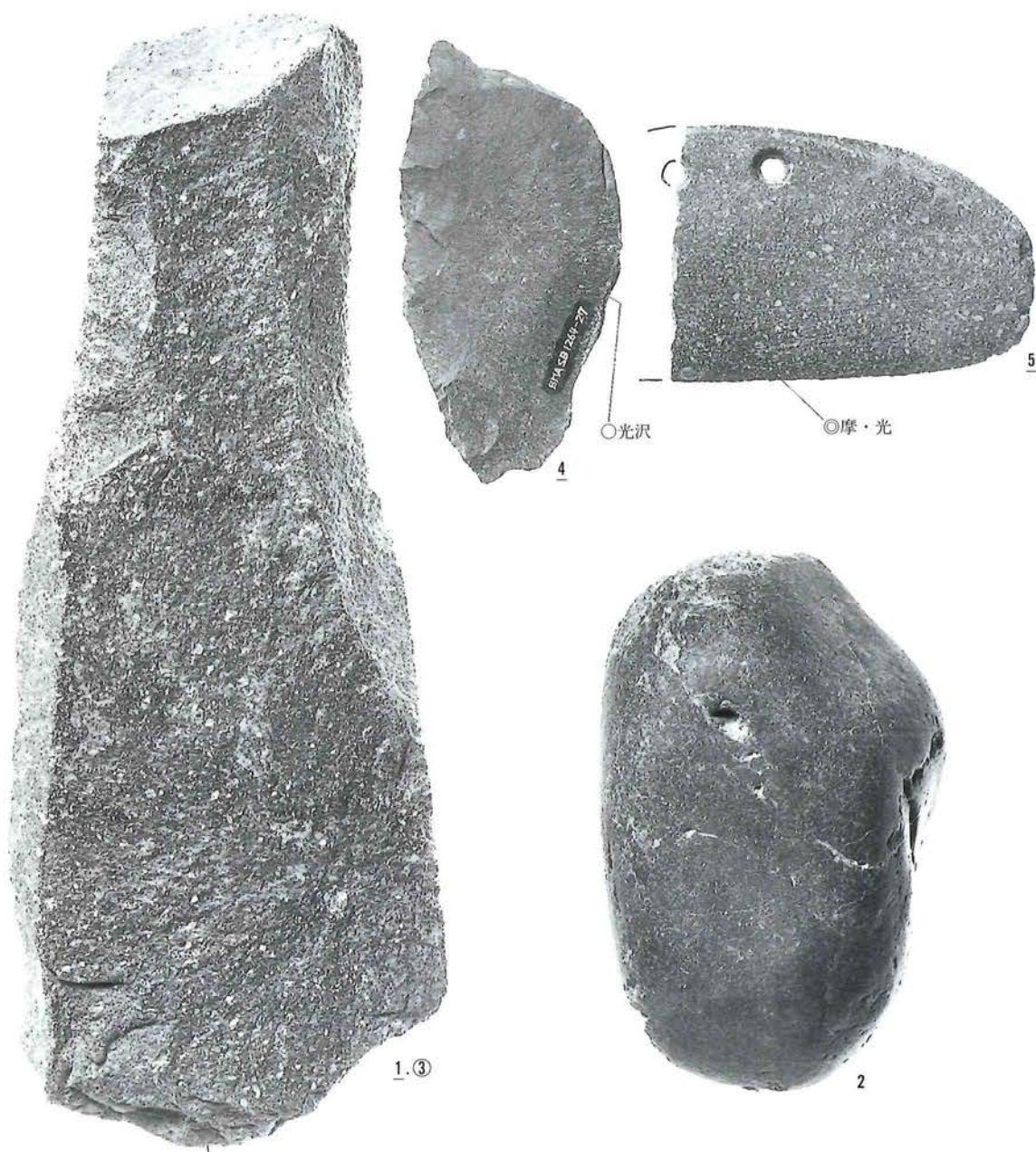

○光沢

◎摩・光

1.③

2

◎摩・線

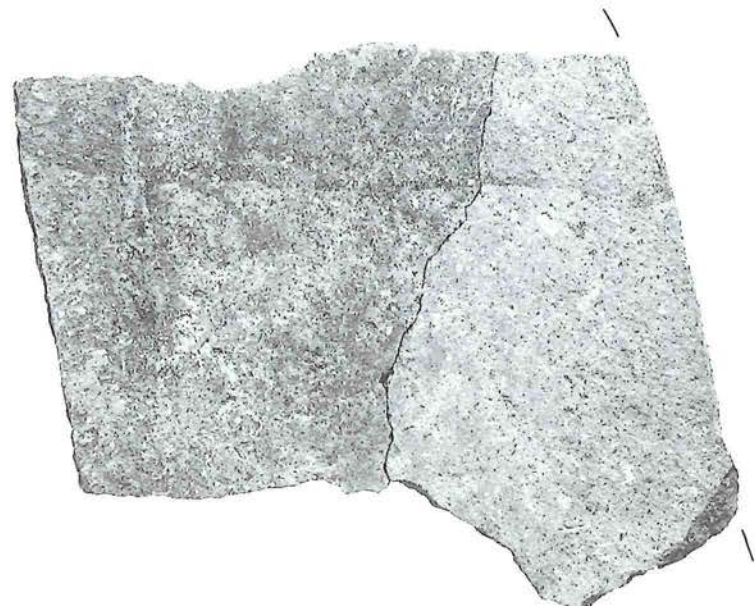

赤色粉状付
3.④+⑤

石器写真

SB1276

- 1 原石
- 2 大形石核II2B類
- 3 剥片A類V
- 4 磨石II2a類
- 5 磨石IIIa類
- 6 砥石II3類



SB1277

- 7 大形刃器1b類
- 8 大形刃器1b類
- 9 扁平片刃石斧
失敗品B類
- 10 砥石III1類
- 11 紡錘車状石製品
(2:3)



石器写真

SB1279

1 台石2種A₂類
(約2:3)

2 大形刃器1b類

3 砥石 置砥
(2:3)

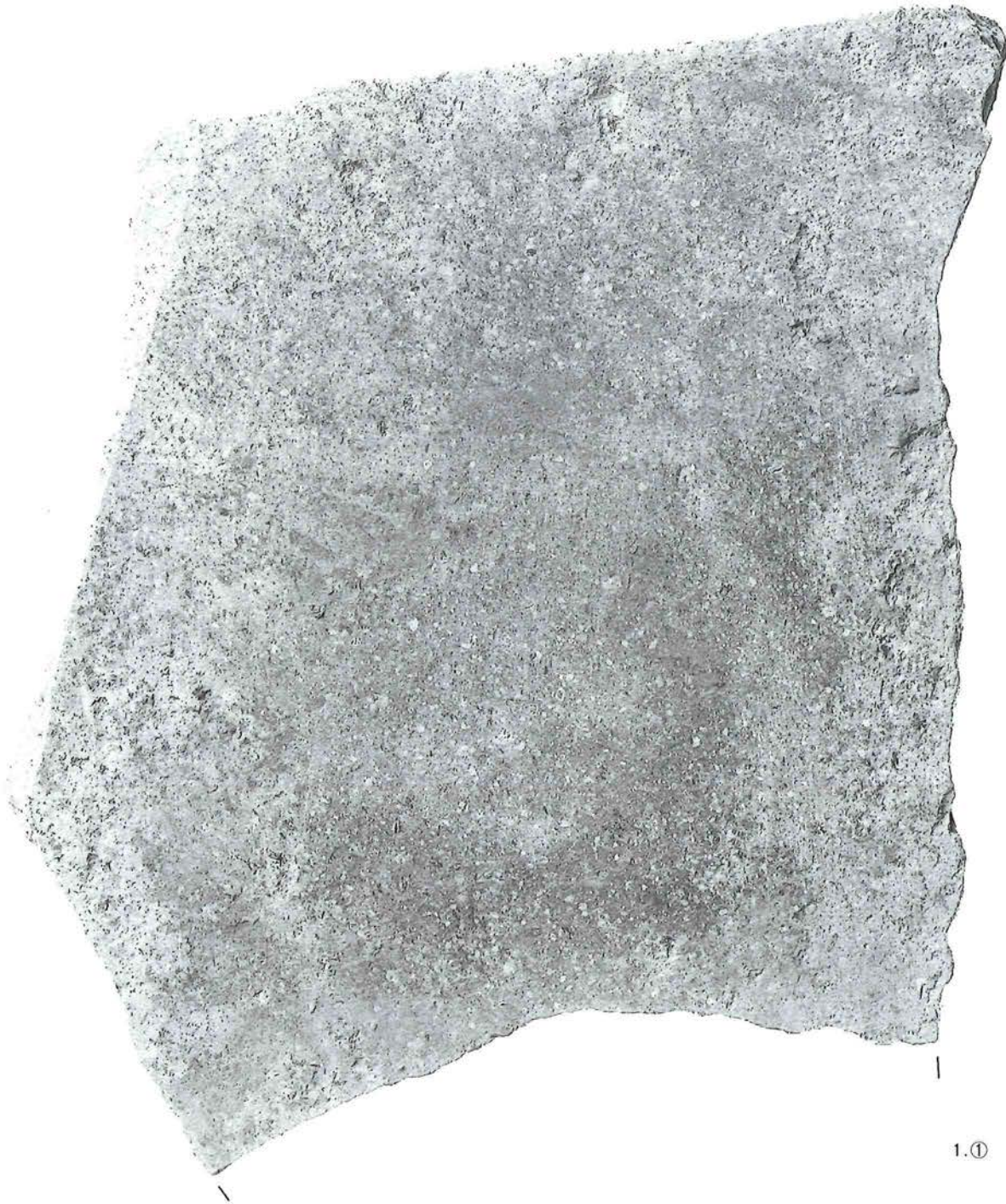
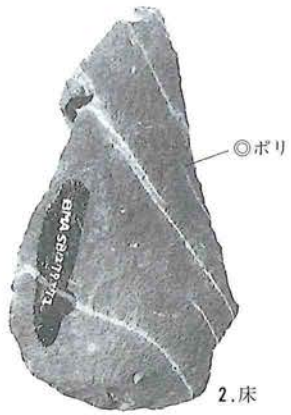

1.①

石器写真

SB1280

- 1 敲石ウ類
- 2 扁平片刃石斧
IIc 類
- 3 ノミ状石器 IIIf 類
- 4 石錐 1 類
- 5 研磨痕のある剥片
- 6 紡錘車状石製品
- 7 紡錘車状石製品
- 8 紡錘車状石製品
- 9 特殊石製品

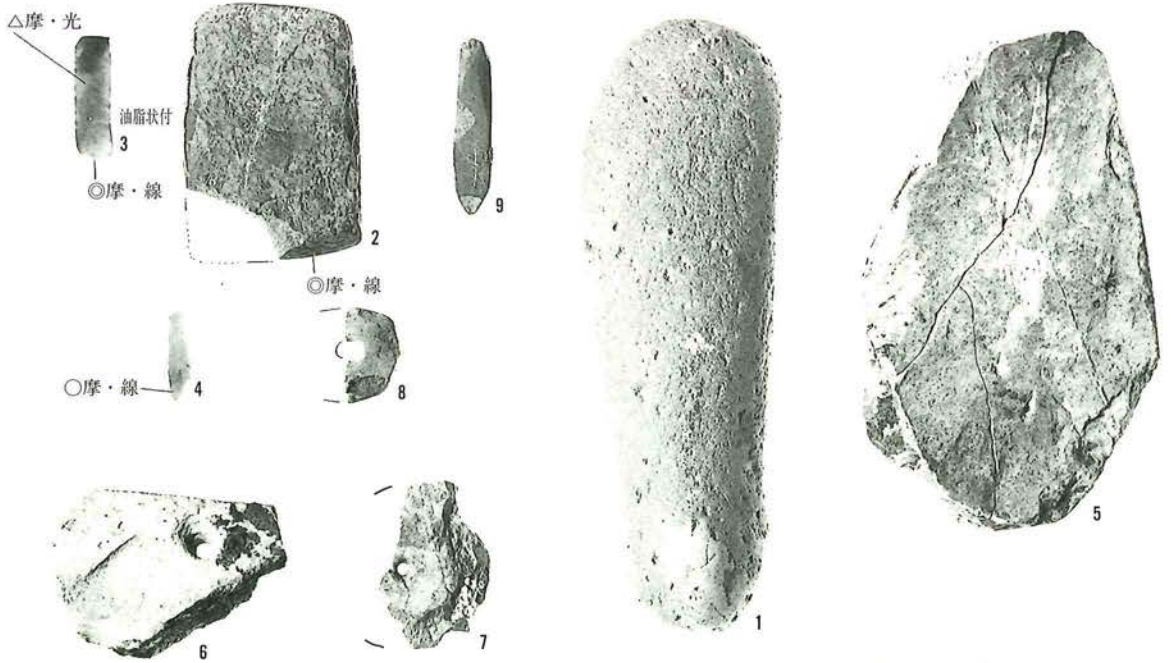

SB1281

- 10 大形刃器 1a 類
- 11 石槌 蛤刃転用
- 12 砥石 IIId 類

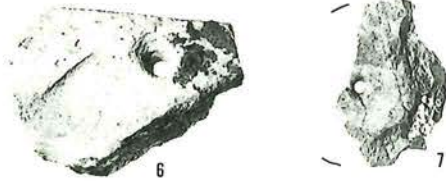

SB1282

- 13 剥片 A 類 II
- 14 磨製石鏃
失敗品 1 類
- 15 磨製石鏃
失敗品 2 B 類
- 16 磨製石鏃 不明
- 17 大形刃器 2c 類
- 18 扁平片刃石斧
IIe 類
- 19 ノミ状石器 IIIf 類

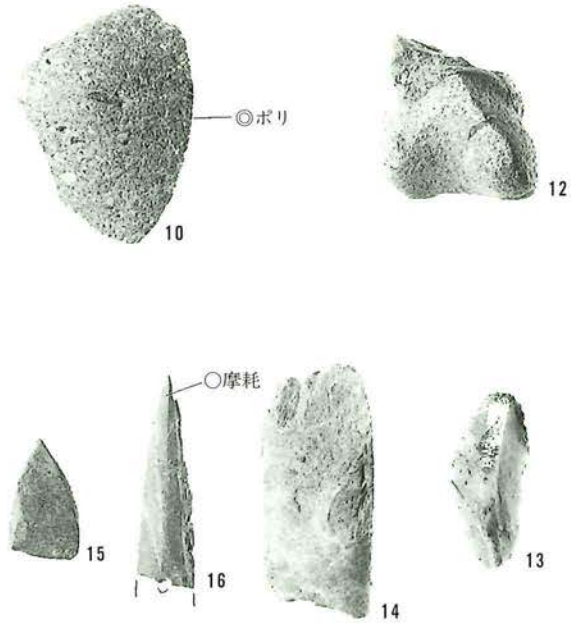

SB1283

- 20 大形刃器 8 類
- 21 扁平片刃石斧
IIe 類?
- 22 石錐 1 類
(2:3)

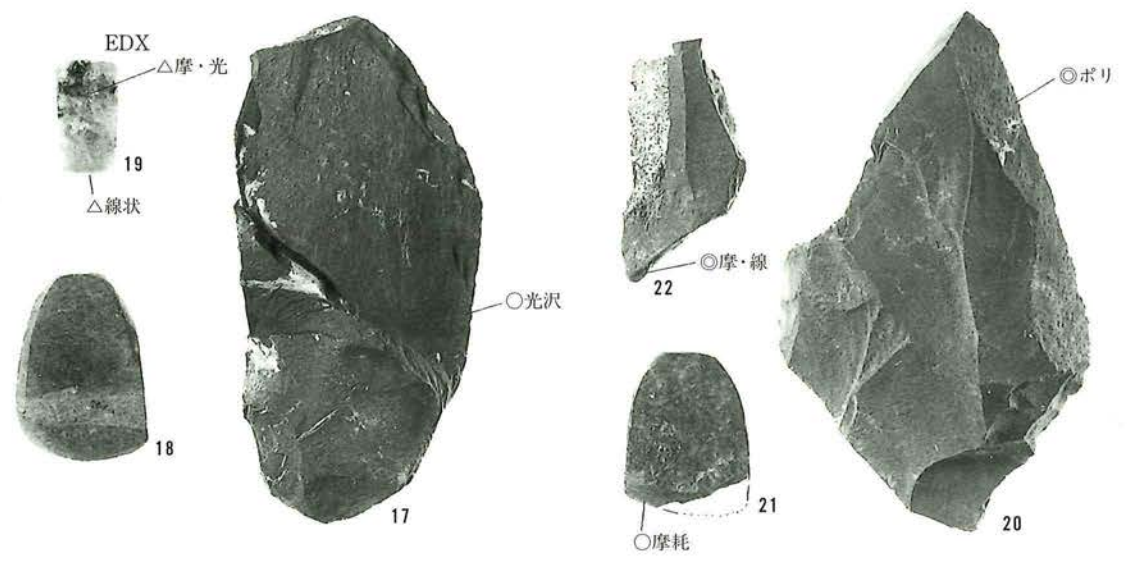

石器实测图

SB1264

PL96-1

PL96-4

PL96-5

(1:2)

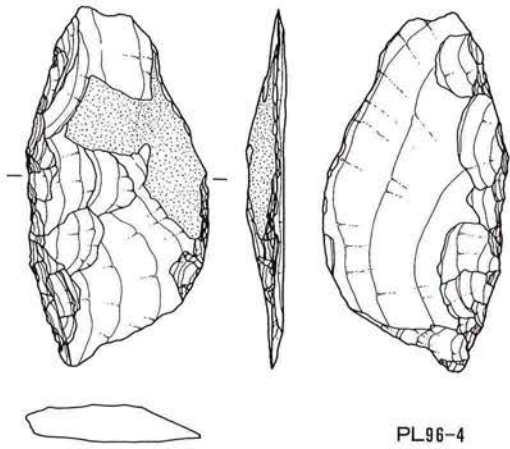

PL96-4

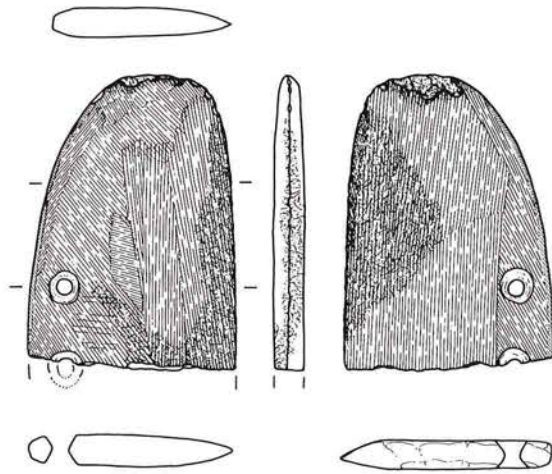

♠ PL96-5

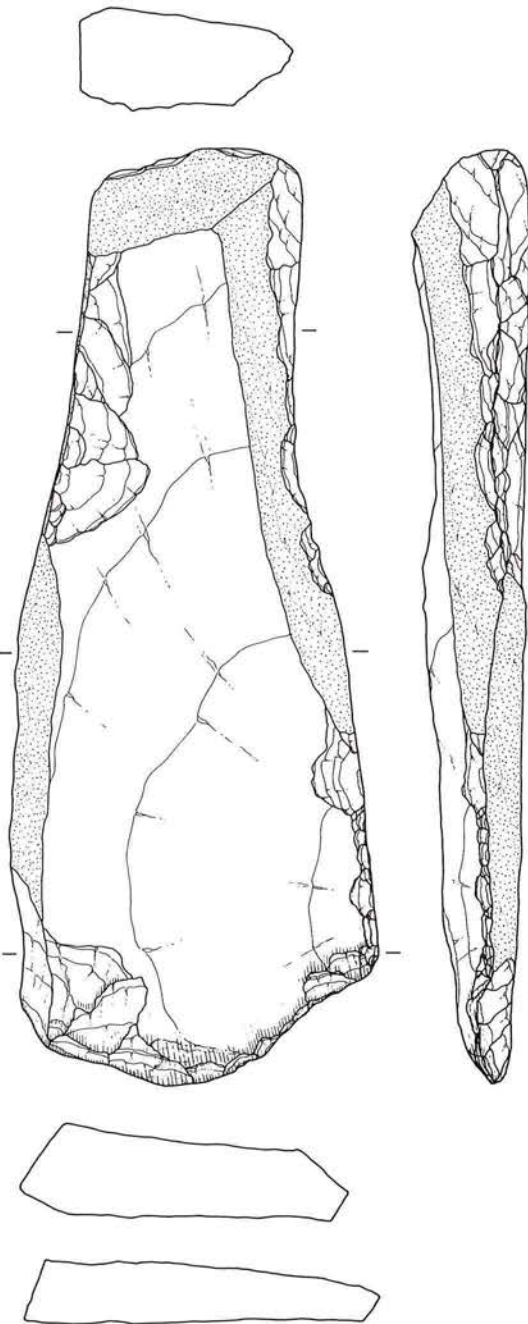

♠ PL96-1

骨角器实测图

SB1282

PL263-14(1)

(1:2)

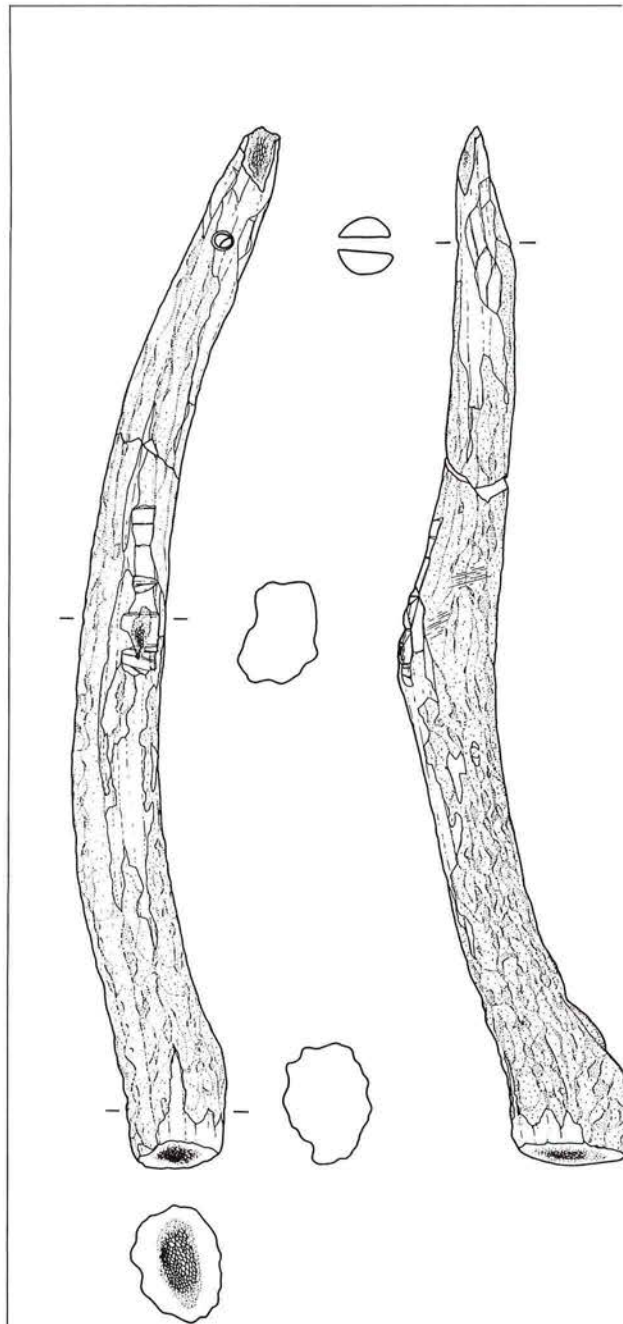

PL263-14(1)

石器写真

SB1284

- 1 敲石才類
- 3 大形刃器 1b 類
- 4 太型蛤刃石斧
失敗品 E₃ 類?
- 5 太型蛤刃石斧
Ic' 類
- 6 太型蛤刃石斧
Id' 類
- 7 石槌 蛤刃転用
- 8 砥石 IIa 類
- 9 砥石 II3 類
- 12 研磨痕のある剥片
(2:3)

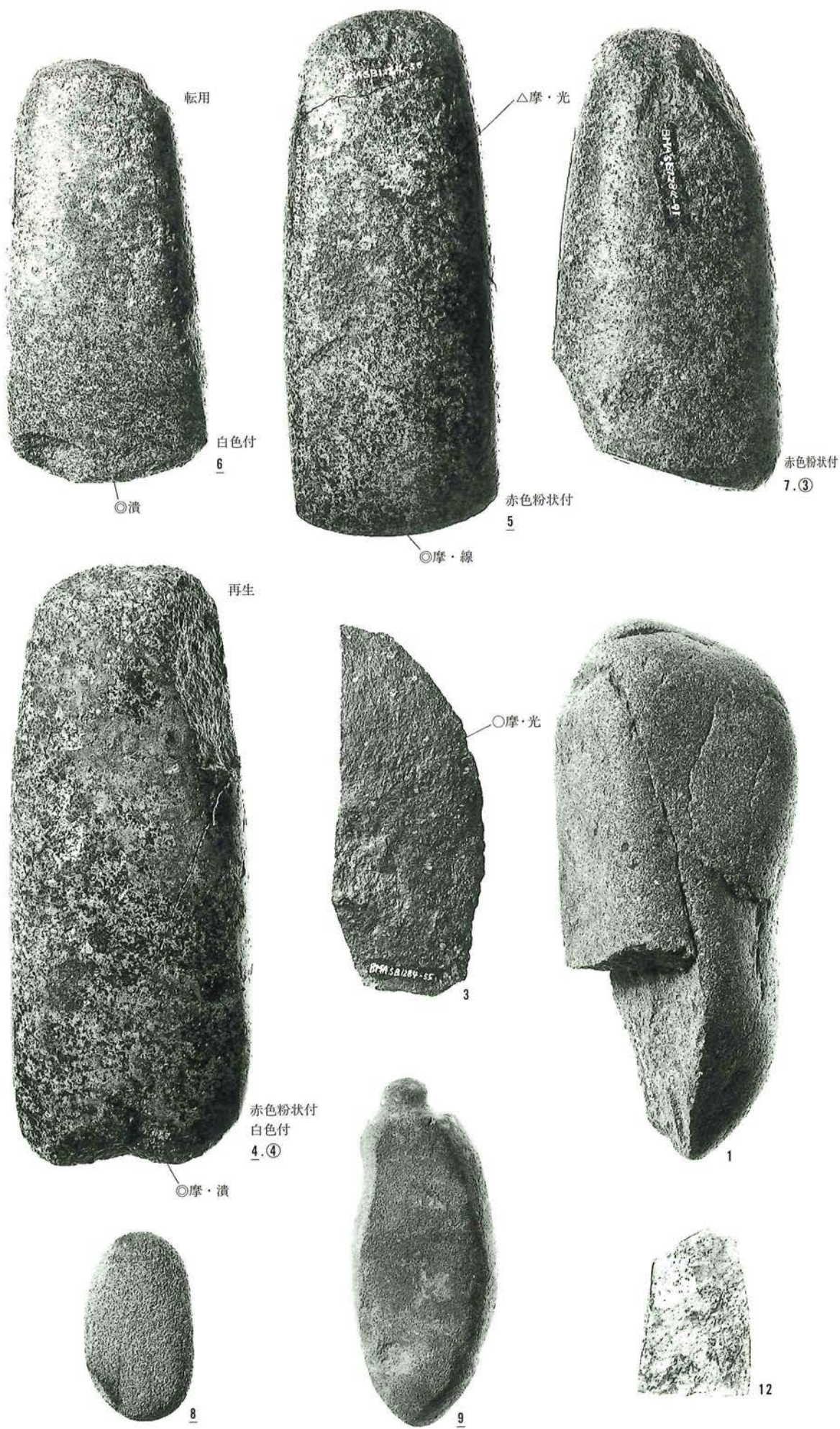

石器写真

SB1284

2 台石 2種 A₂類

(1:2)



2.①+②

石器写真

SB1284

10 砥石 置砥

11 砥石 置砥

(1:2)



10.⑤

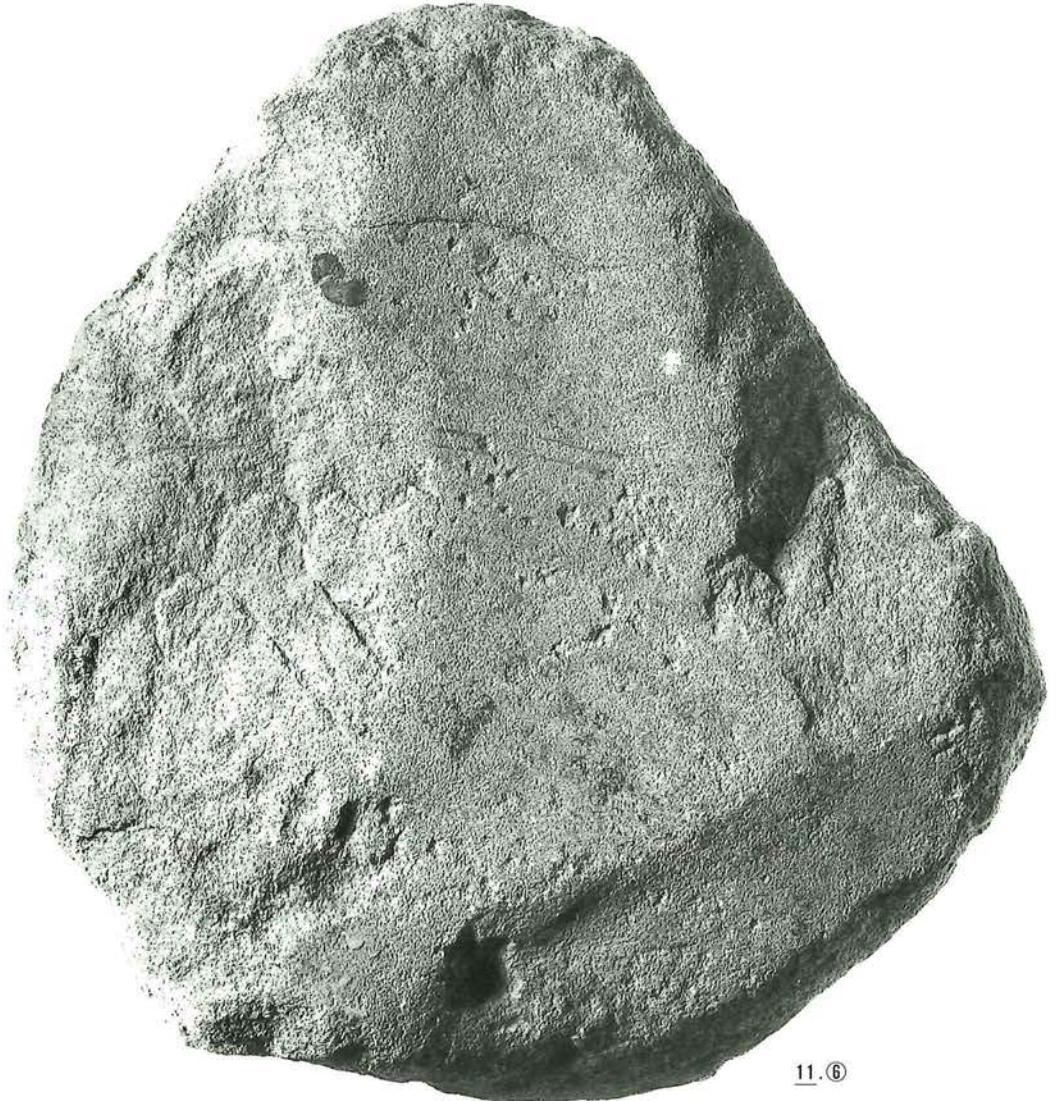

11.⑥

SB1284

PL101-4

PL101-5

PL101-6

(1:2)

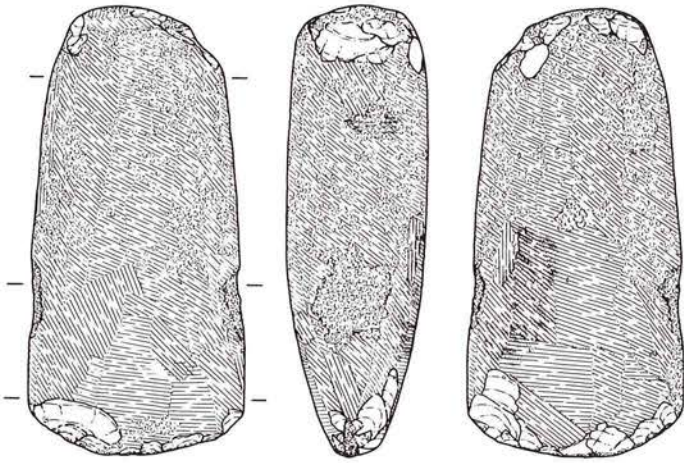

PL101-6

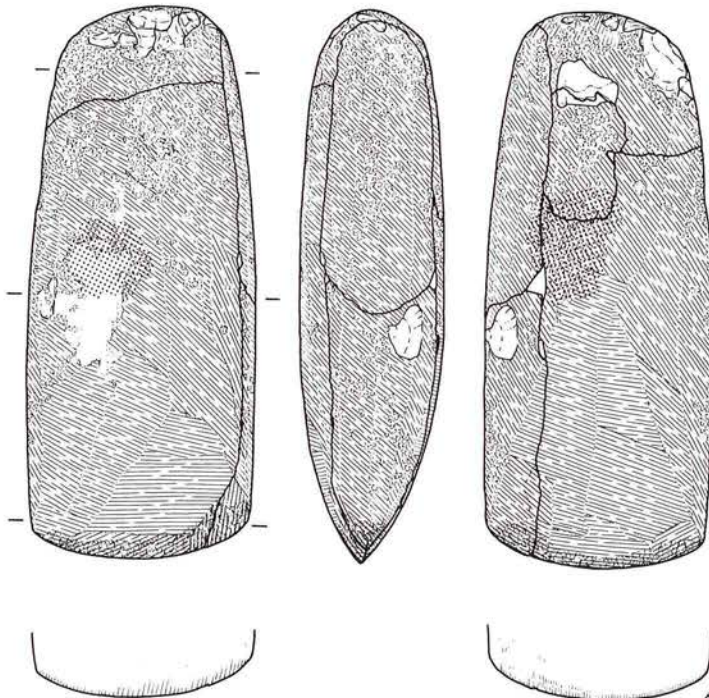
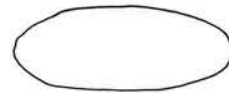
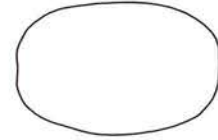
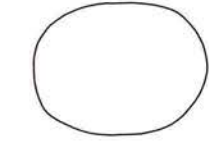
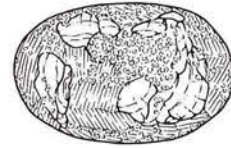

PL101-5

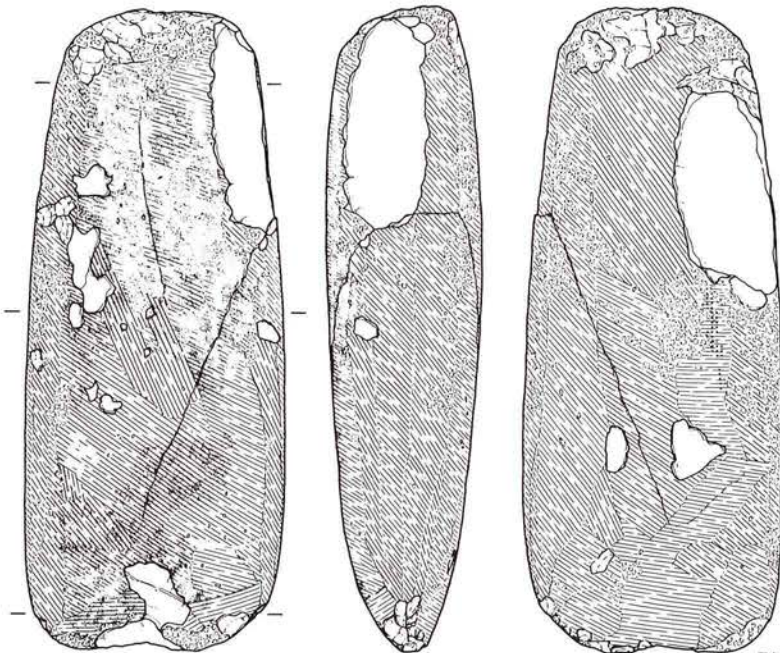
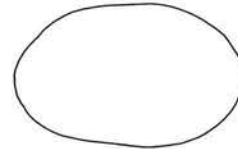
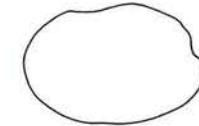
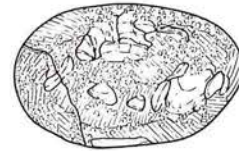

PL101-4

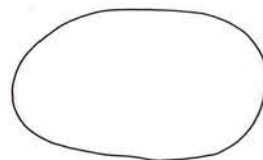
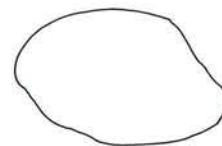
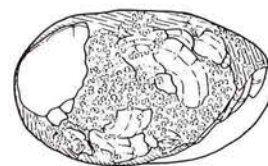

遺物出土状況写真



砥石No.11の出土状況

石器実測図

S B 1 284

PL 101- 8

PL 101- 9

(1 : 2)

PL 103-11

(1 : 4)

PL 102- 2

(1 : 3)

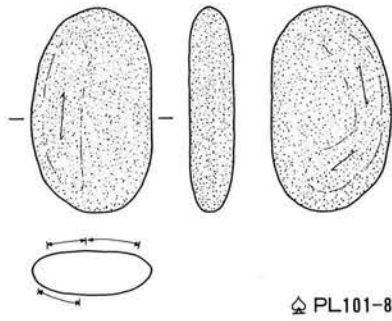

PL101-8

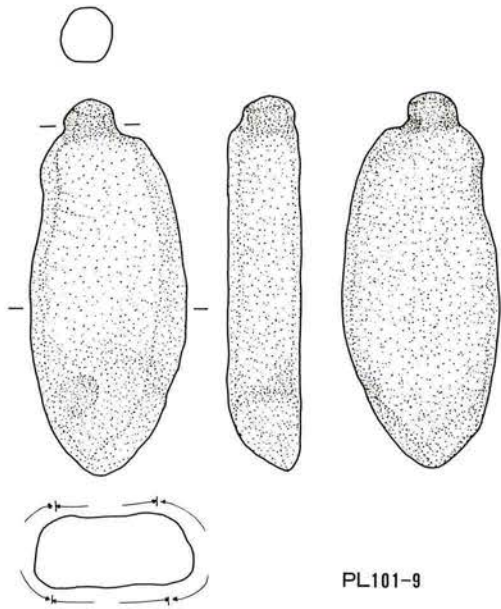

PL101-9

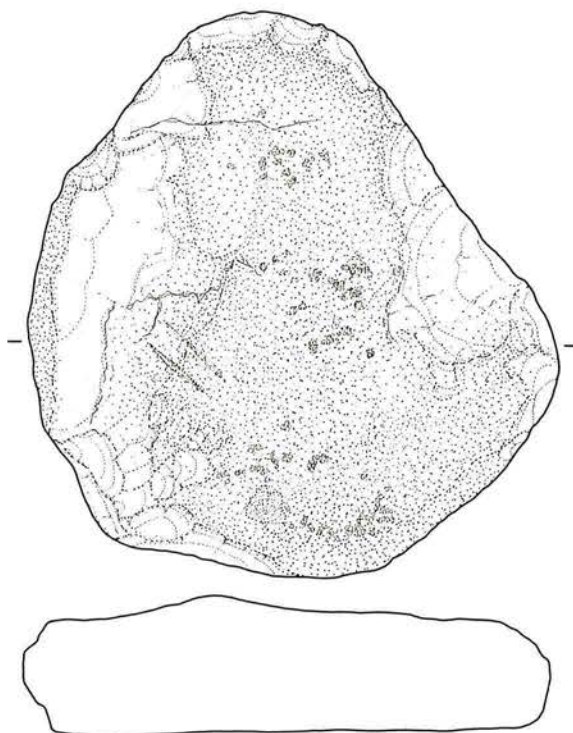

PL103-11

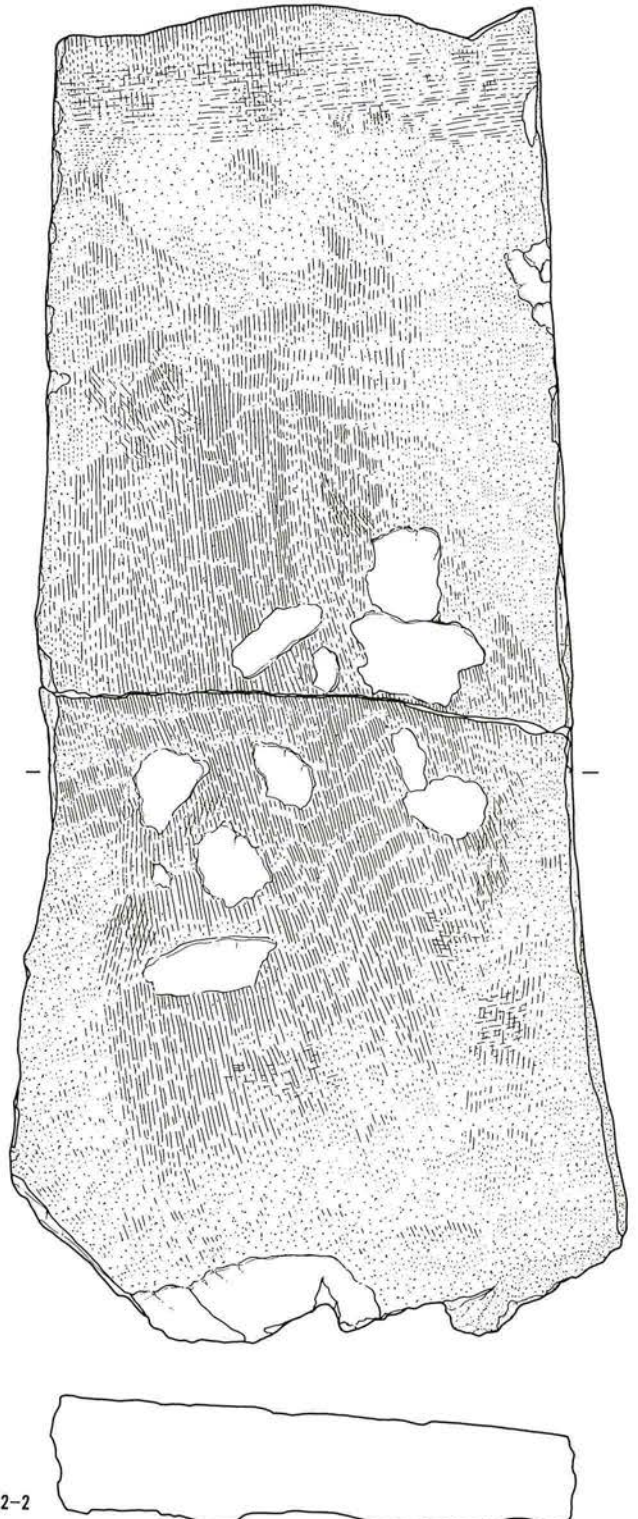

PL102-2

石器写真

SB1285

1 大形刃器 8類

SB1286

2 磨製石包丁
失敗品 B類?

3 扁平片刃石斧
失敗品 B類
(2:3)

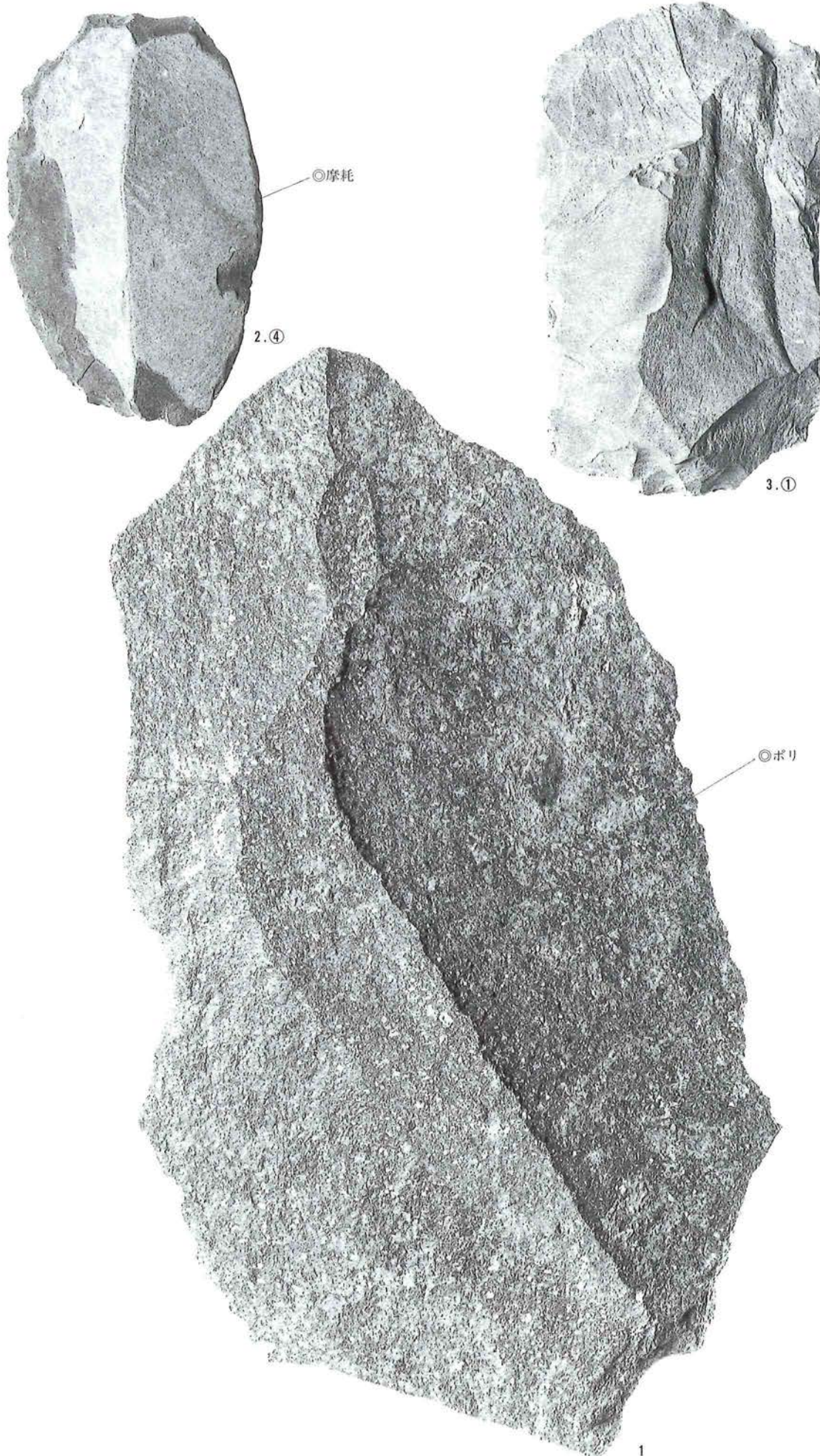

石器写真

SB1290

- 1 剥片 A類V
- 2 剥片 A類V
- 3 太型蛤刃石斧
Id'類
- 4 砥石 特殊

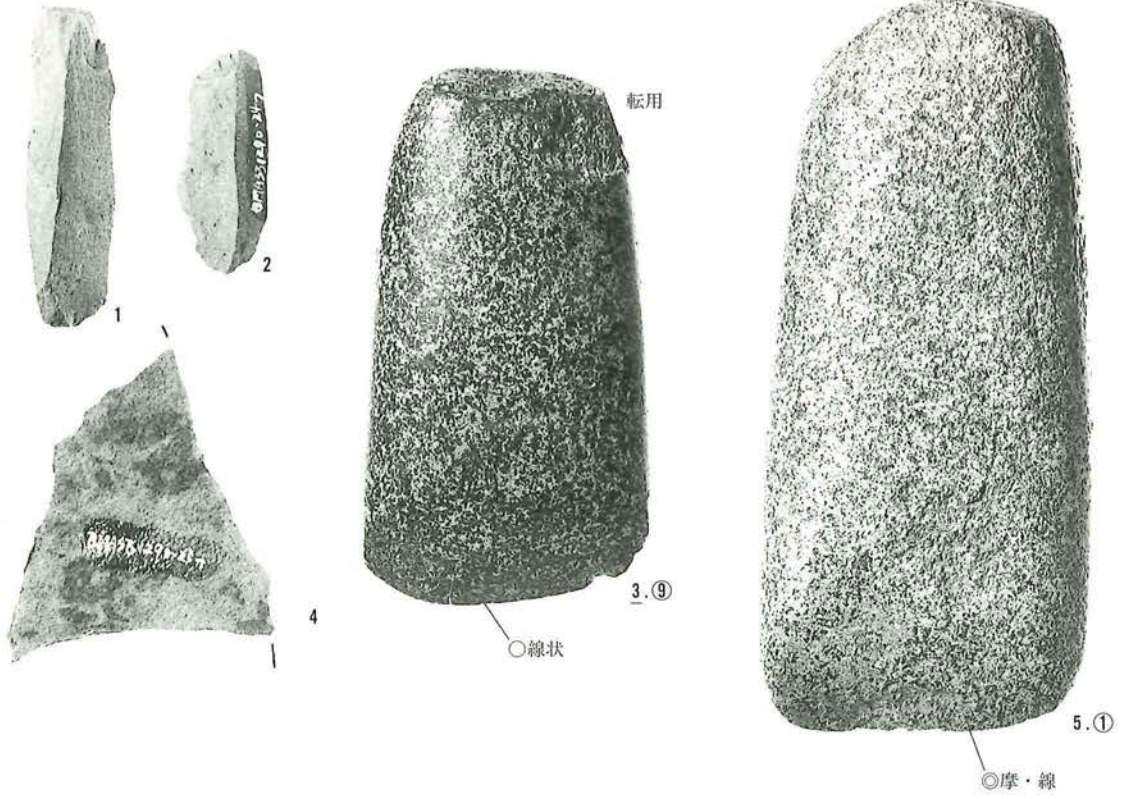

SB1292

- 5 太型蛤刃石斧
Ic'類

SB1294

- 6 敲石工類
- 7 太型蛤刃石斧
Ib'類
(2:3)

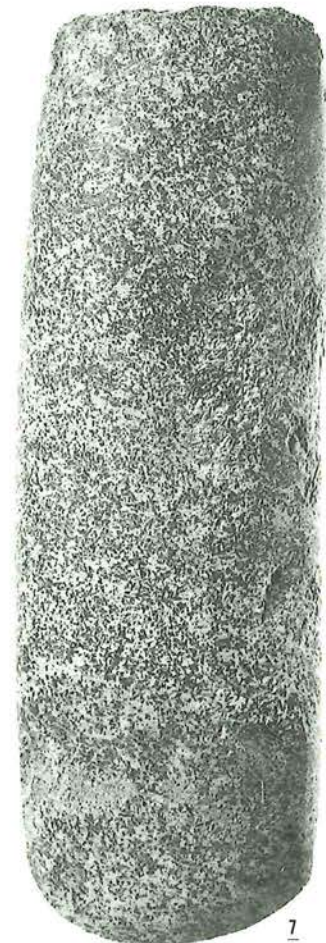
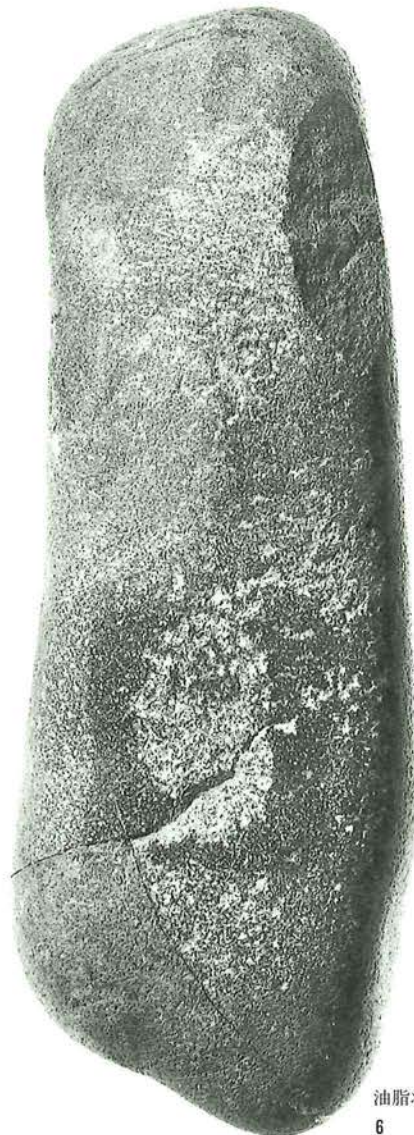

油脂状付
6

石器写真

SB1294

8 砥石 置砥

(約1:2)



8.②



大型蛤刃石斧No.7と

砥石No.8のセット

想定写真

石器実測図

SB 1290

PL 107-3

(1:2)

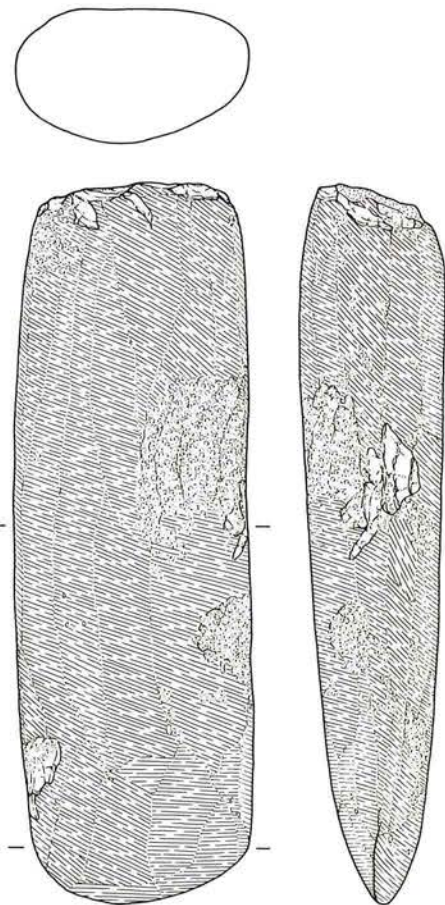
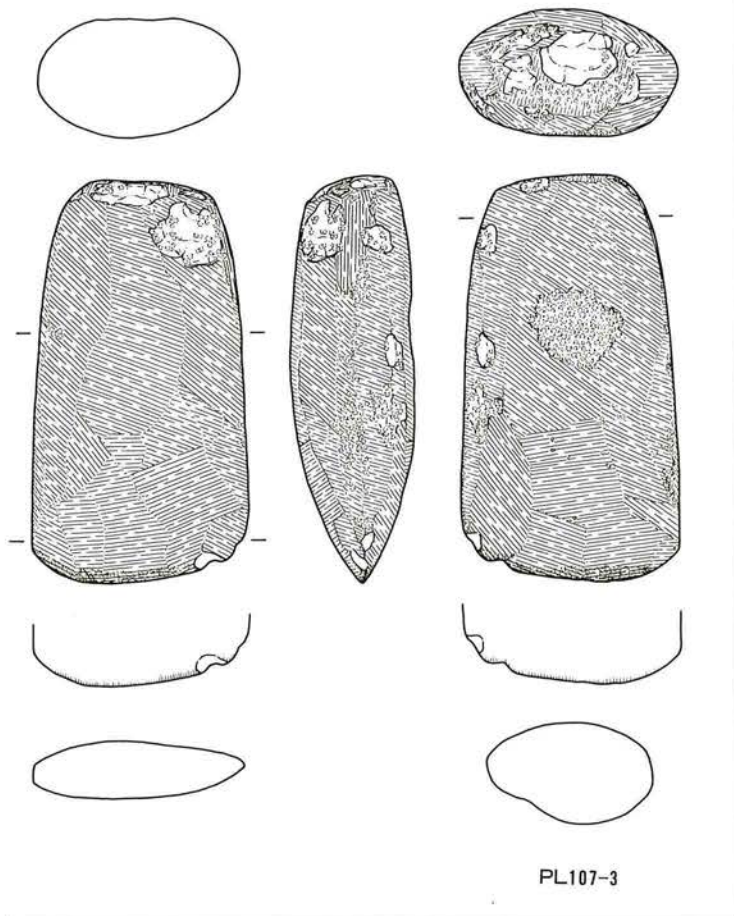

SB 1294

PL 107-7

(1:2)

PL 108-8

(1:4)

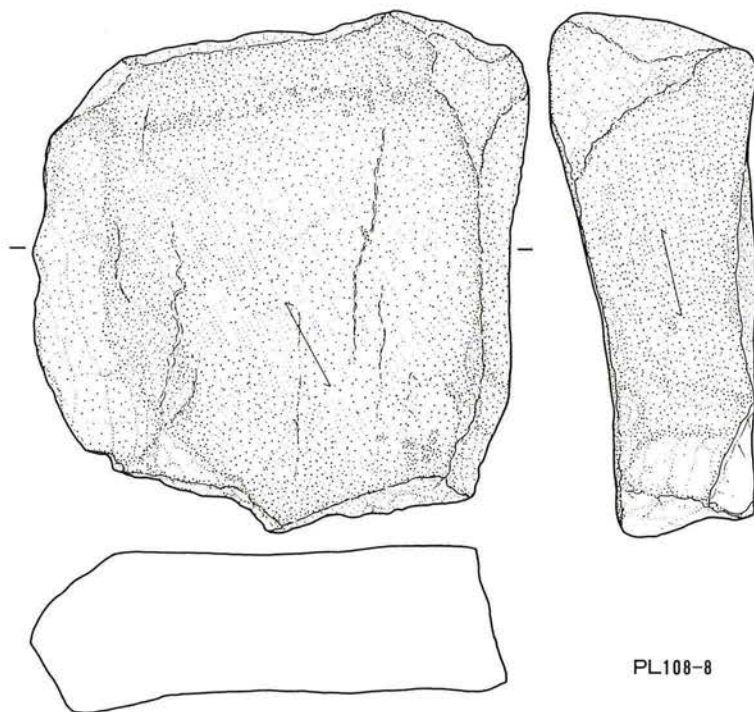

PL107-7

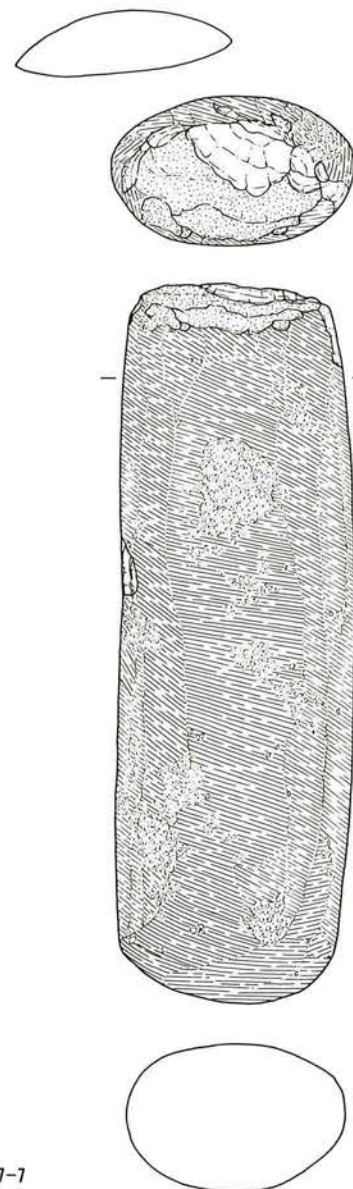

石器写真

SB1297

- 1 磨製石鏃
- 失敗品 1 類
- 2 軽石製品

SB1298

- 3 磨製石鏃 不明
- 4 打製石斧 E₁類?
- 5 大形刃器 2d 類
- 6 紡錘車状石製品

SB1302

- 7 剝片 A 類IV
- 8 打製石鏃 II B₃類
- 9 磨製石鏃
- 失敗品 2 A 類
- 10 砥石 置砥
- 11 紡錘車状石製品

SB1304

- 12 打製石鏃
- 失敗品 1 類
- 13 打製石鏃
- 失敗品 2 類
- 14 扁平片刃石斧 II b₁類
- 15 砥石 II b 類
- (2:3)

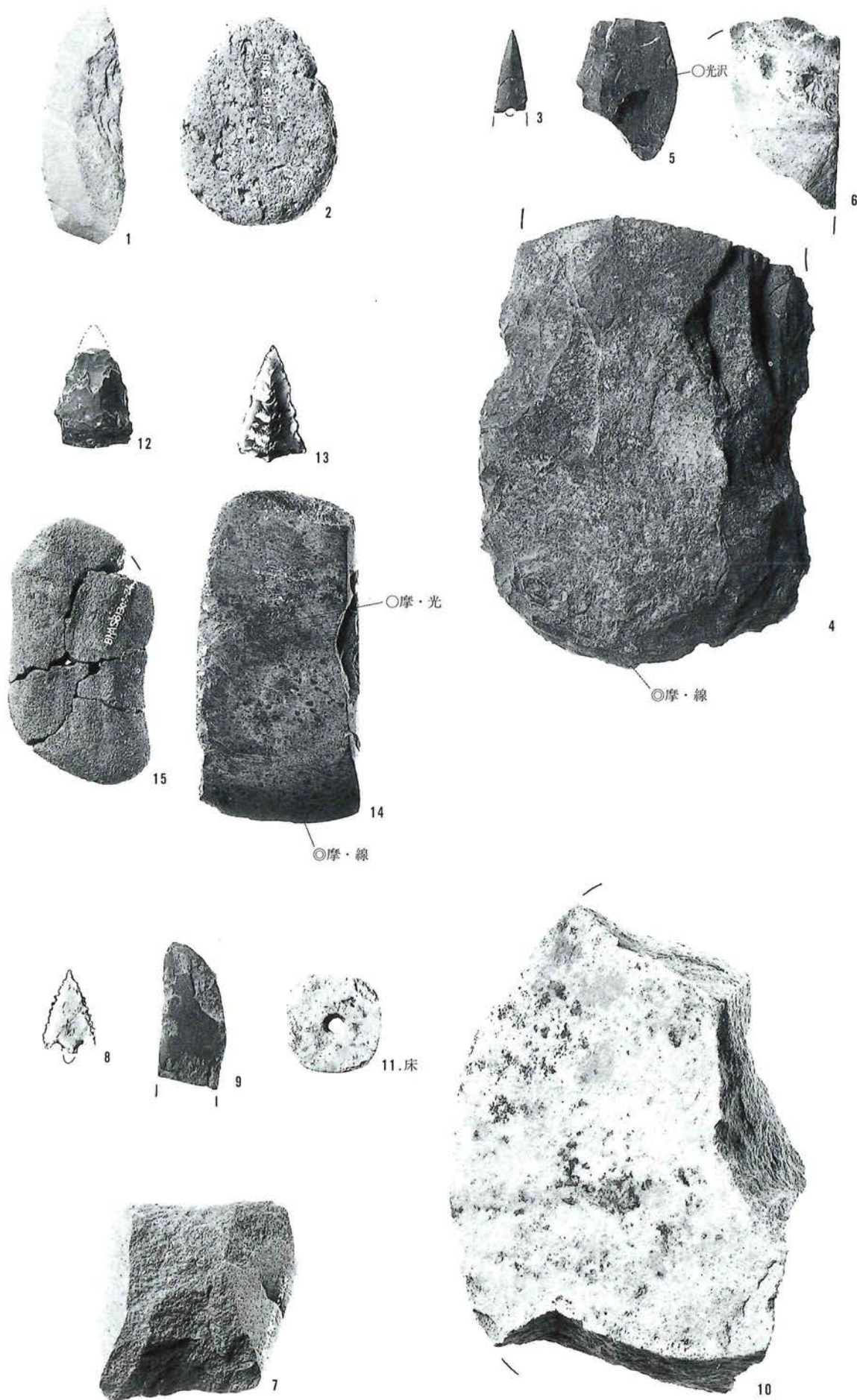

石器写真

SB1306

- 1 敲石イ類
- 2 大形刃器 1a 類
- 3 大形刃器 2c 類
- 4 扁平片刃石斧
失敗品 E₁ 類
- 5 砥石 IIa 類
- 6 研磨痕のある剥片
- 7 紡錘車状石製品

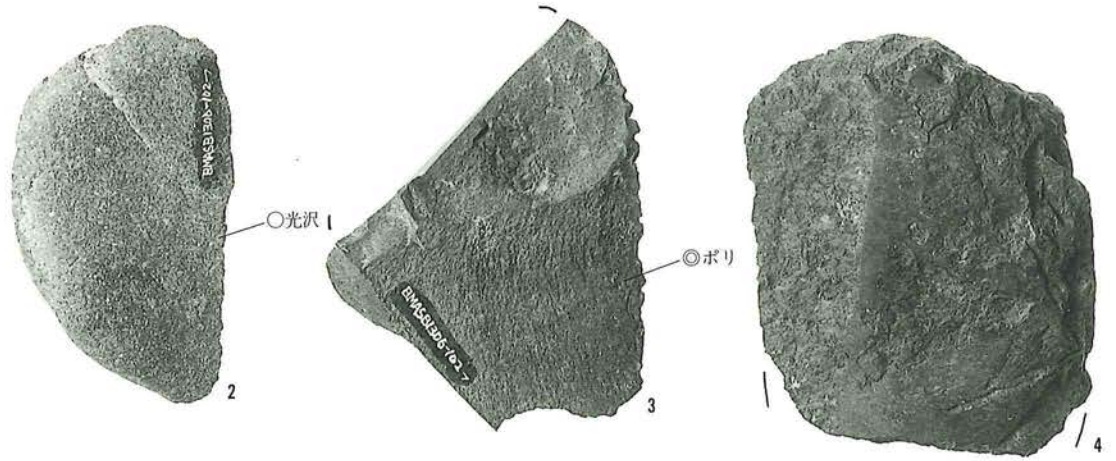

SB1307

- 8 大形刃器 2b 類
- 9 大形刃器 1a 類

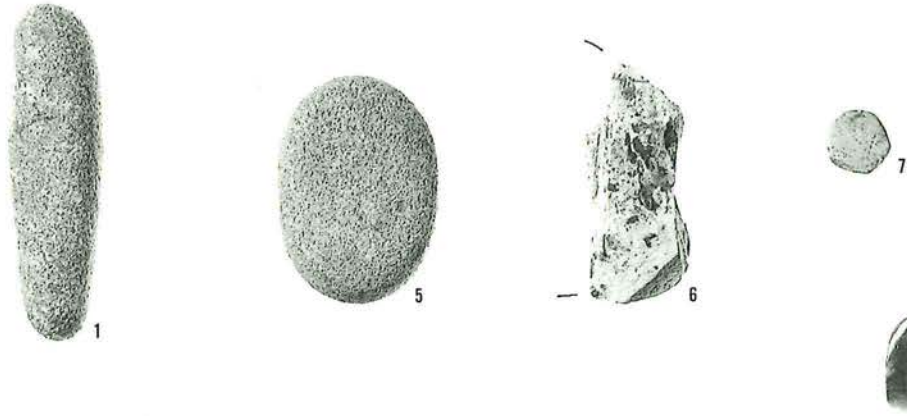

SB1308

- 10 扁平片刃石斧
II f 類



SB1311

- 11 敲石ウ・エ類
- 12 扁平片刃石斧 不明
(2:3)

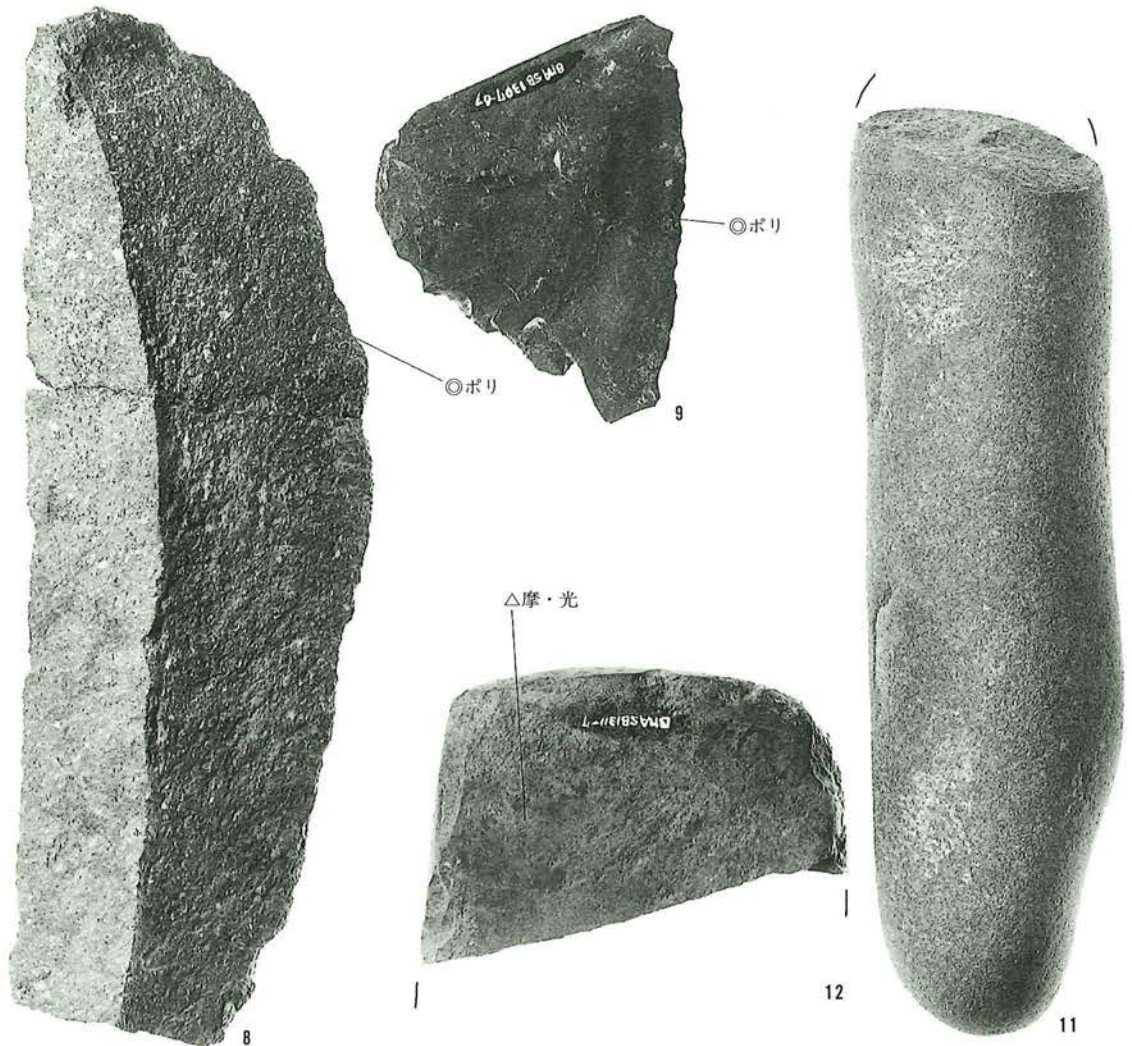

石器写真

SBH58

1 扁平片刃石斧
IIe類

SBH289

2 大形刃器 1b類

SBH373

3 大形刃器 7類

ST2005

4 大形剥片 2種

5 大形剥片 碎片

SM103

6 管玉

7 管玉

8 管玉

9 管玉

10 管玉

11 管玉

12 管玉

13 管玉

14 管玉

15 管玉

16 管玉

17 管玉

(1:1)

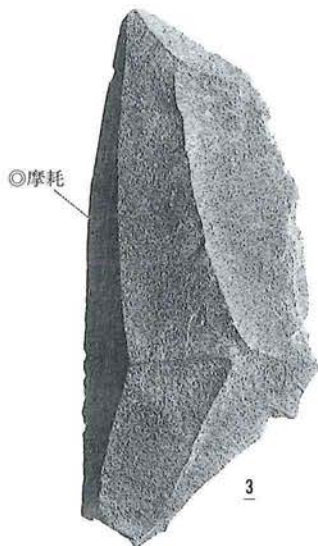

石器实测图

SBH58

PL 112-1

(2:3)

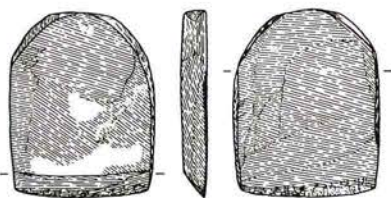

SBH289

PL 112-2

(1:2)



△♡ PL112-1

SBH373

PL 112-3

(1:2)

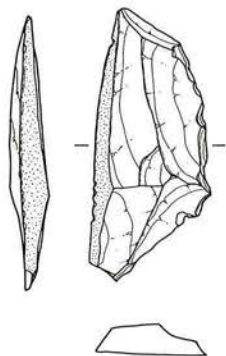

PL112-3

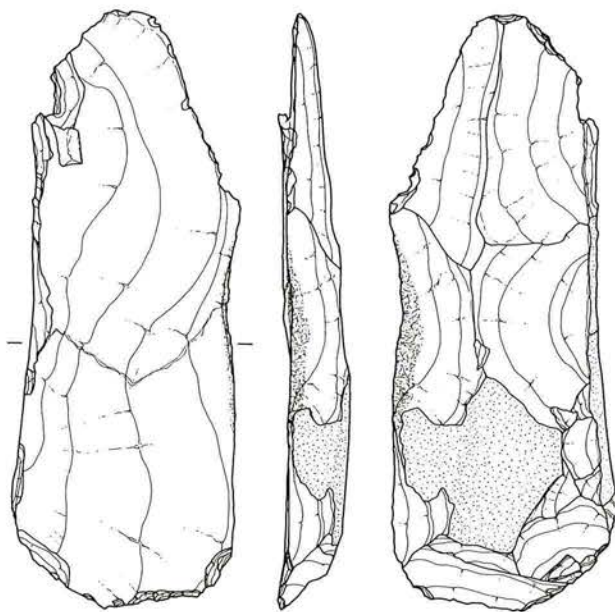

PL112-2

SM103

PL 112-6

PL 112-7

PL 112-8

PL 112-9

PL 112-10

PL 112-11

PL 112-12

PL 112-13

PL 112-14

PL 112-15

PL 112-16

PL 112-17

(1:1)



PL112-6



PL112-7



PL112-8



PL112-9



PL112-10



PL112-11



PL112-12



PL112-13



PL112-14



PL112-15



PL112-16



PL112-17

石器写真

SK131

- 1 小形石核II1 類
- 2 小形石核II2A 類
- 3 敲石7 類

SK148

- 4 大形刃器7 類
- 5 磨製石包丁
失敗品B 類
- 6 砥石 特殊

SK150

- 7 石錐2A 類

SK151

- 8 扁平片刃石斧
IIe 類
- 9 紡錘車状石製品
- 10 紡錘車状石製品

SK156

- 11 打製石鏃
失敗品2 類

SK158

- 13 砥石II3 類

SK159

- 14 敲石ア 類
- 15 敲石キ 類

SK169

- 16 大形刃器2a 類
(2:3)

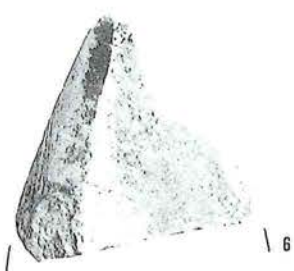
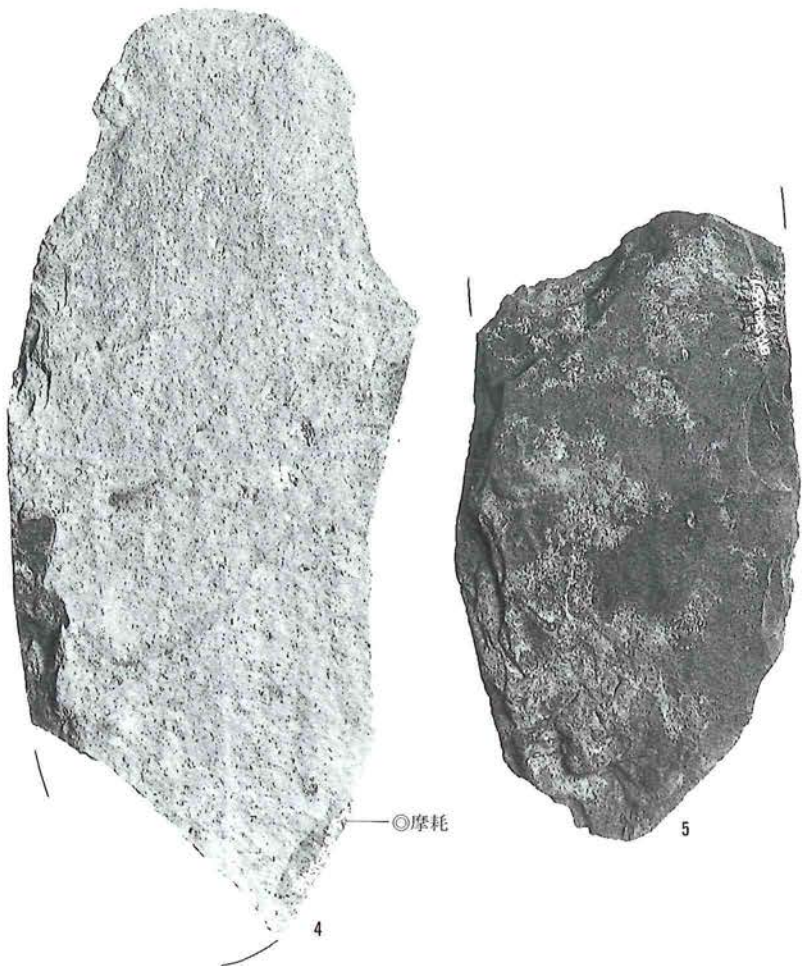
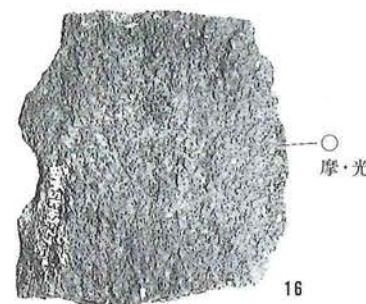
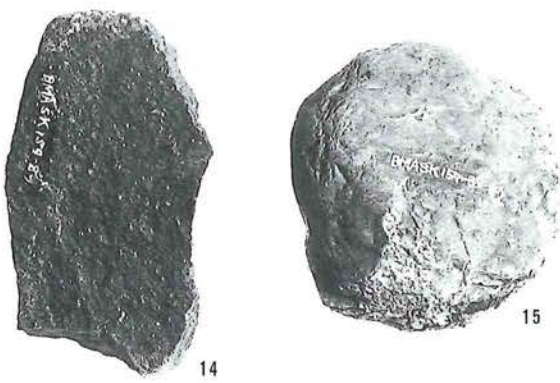
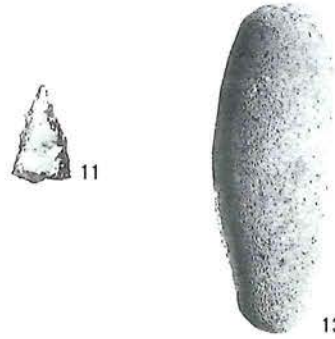
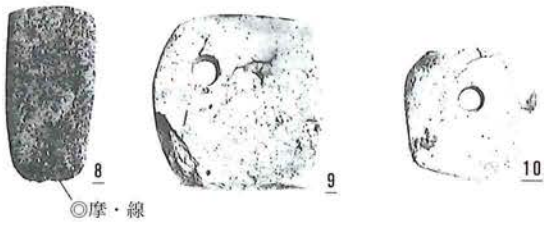

石器写真

SK156

12 台石 2種 A₂類

(2:3)



石器写真

SK160

- 1 敲石ア類
- 2 磨製石包丁
失敗品B類

SK163

- 3 大形刃器1b類
- 4 大形刃器2c類

SK164

- 5 磨製石鏃
失敗品1類
- 6 大形刃器2c類
- 7 大形刃器7類
- 8 小形刃器2c類
- 9 小形刃器2c類
- 10 軽石製品

SK173

- 11 敲石ア・ウ類

SK191

- 12 砥石III類

SK192

- 13 大形刃器1b類
- 14 扁平片刃石斧
Ib₂類
(2:3)

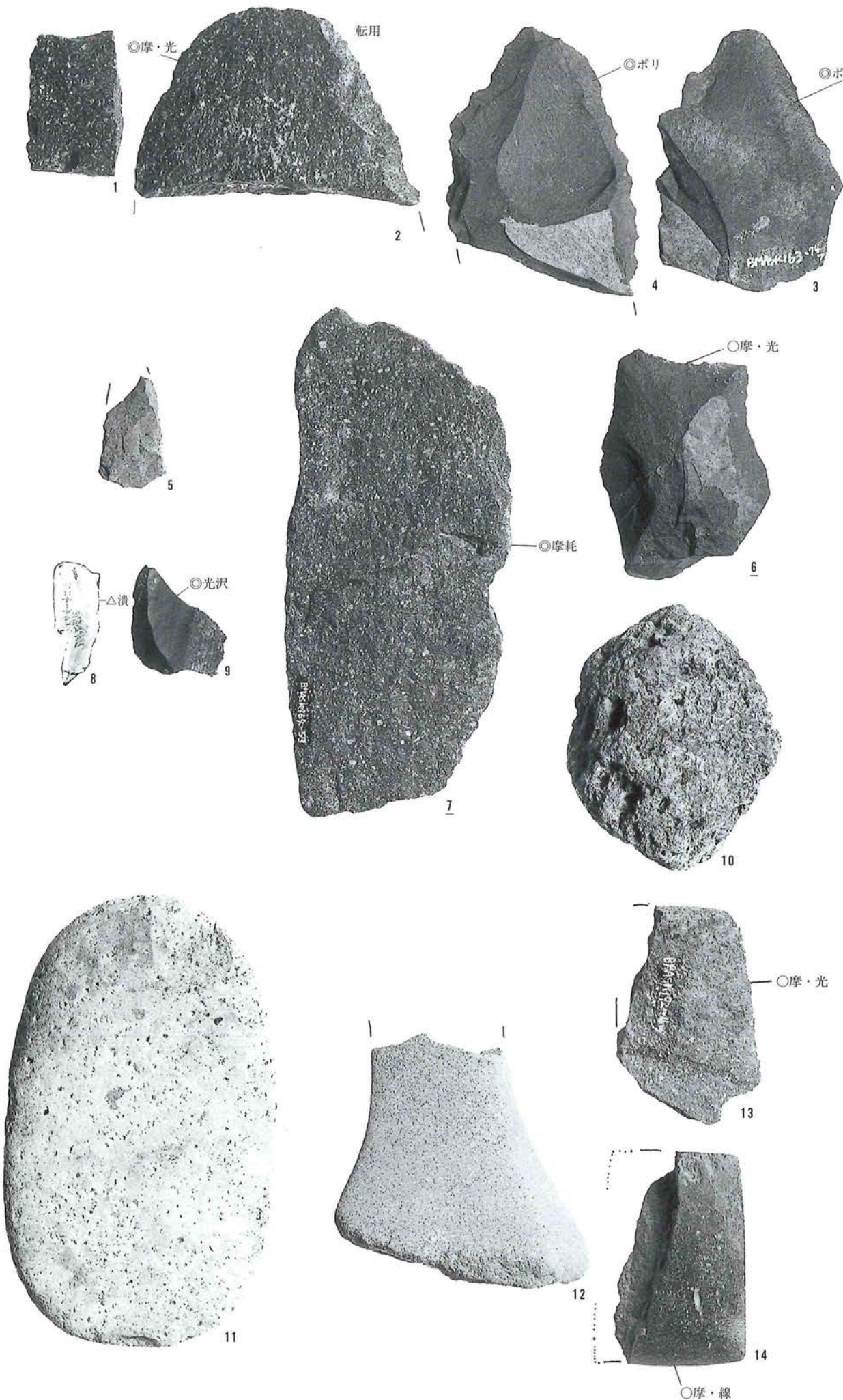

石器写真

S K 213

1 打製石鏃 IIB₂類



1

S K 236

2 大形刃器 1b 類



再生

8

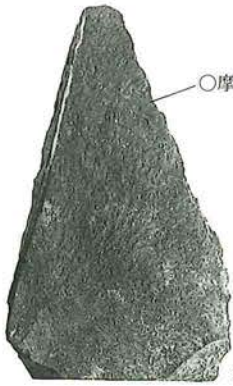

○摩・光

2



3



5

S K 325

3 みがき石 II2c 類

4 大形刃器 2b 類

5 大形刃器 3 類

6 扁平片刃石斧
失敗品 E₁ 類

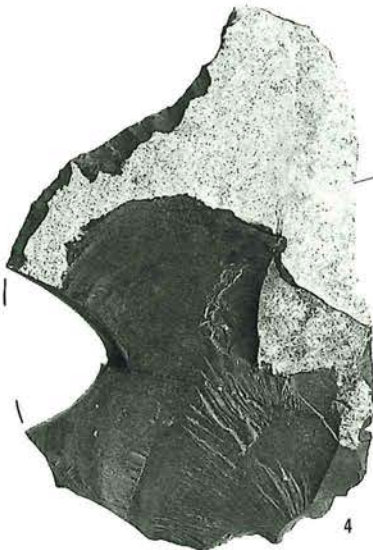

○ポリ

4



6



漆状付

7

○摩・線

S K 352

7 扁平片刃石斧
IIc 類

S K 353

8 磨製石鏃
失敗品 2B 類

S K 1336

9 管 玉



9



11

S K 1381

10 大型蛤刃石斧
Ic' 類

S K 1396

11 砥石 IIc 類

S K 1695

12 扁平片刃石斧
IIb₁ 類



○摩・線

12



○摩・光

10

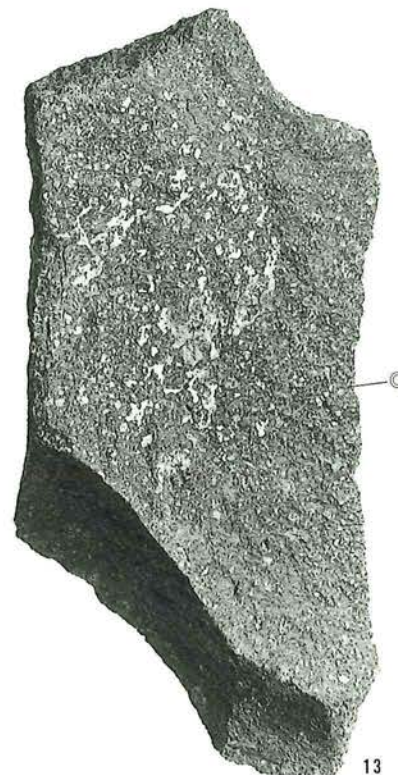

13

○ポリ

PL118

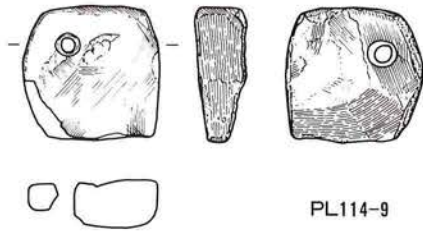
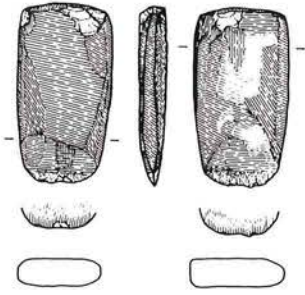

PL114-9

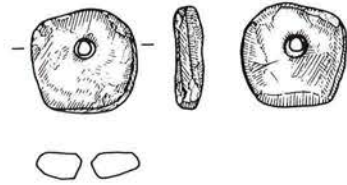

PL114-10

石器实测图

SK 151
PL 114-8
(2:3)

PL 114-9
PL 114-10
(1:2)

PL114-8

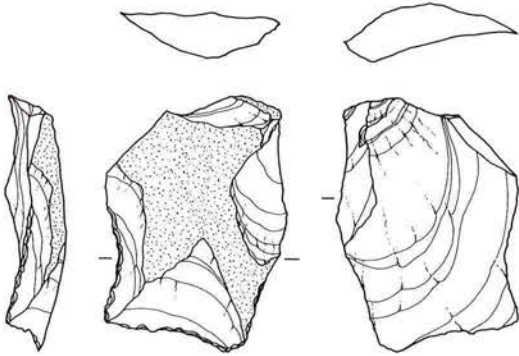

SK 164
PL 116-6
PL 116-7
(1:2)

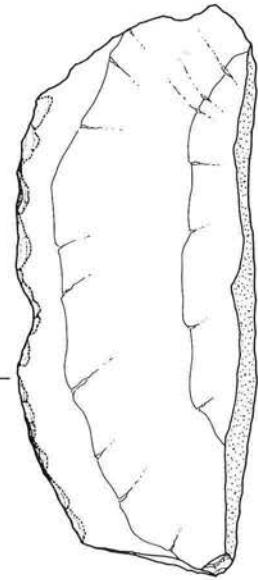
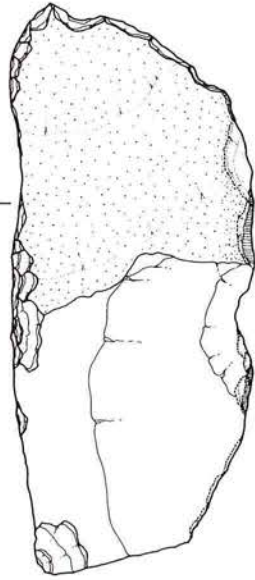

SK 352
PL 117-7
(1:2)



PL116-6

SK 1336
PL 117-9
(1:1)

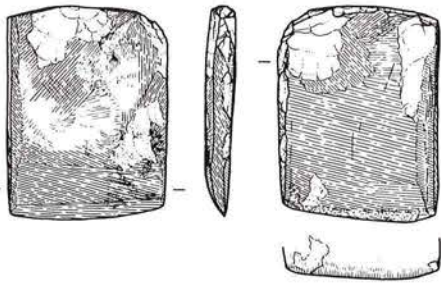

SK 1381
PL 117-10
(1:2)



PL116-7

SK 1695
PL 117-12
(1:2)



♠ PL117-7

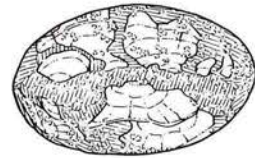
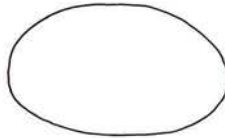

PL117-9

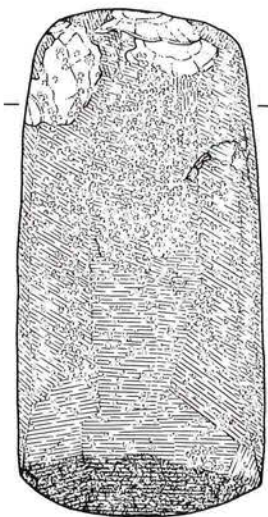
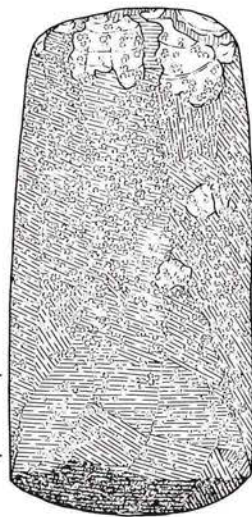
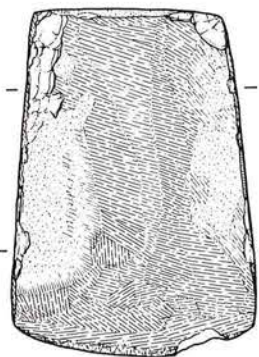
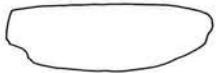

♠ PL117-12



PL117-10

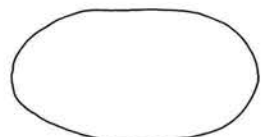

石器写真

S K1738

1 大形刃器 特殊

(1:2)



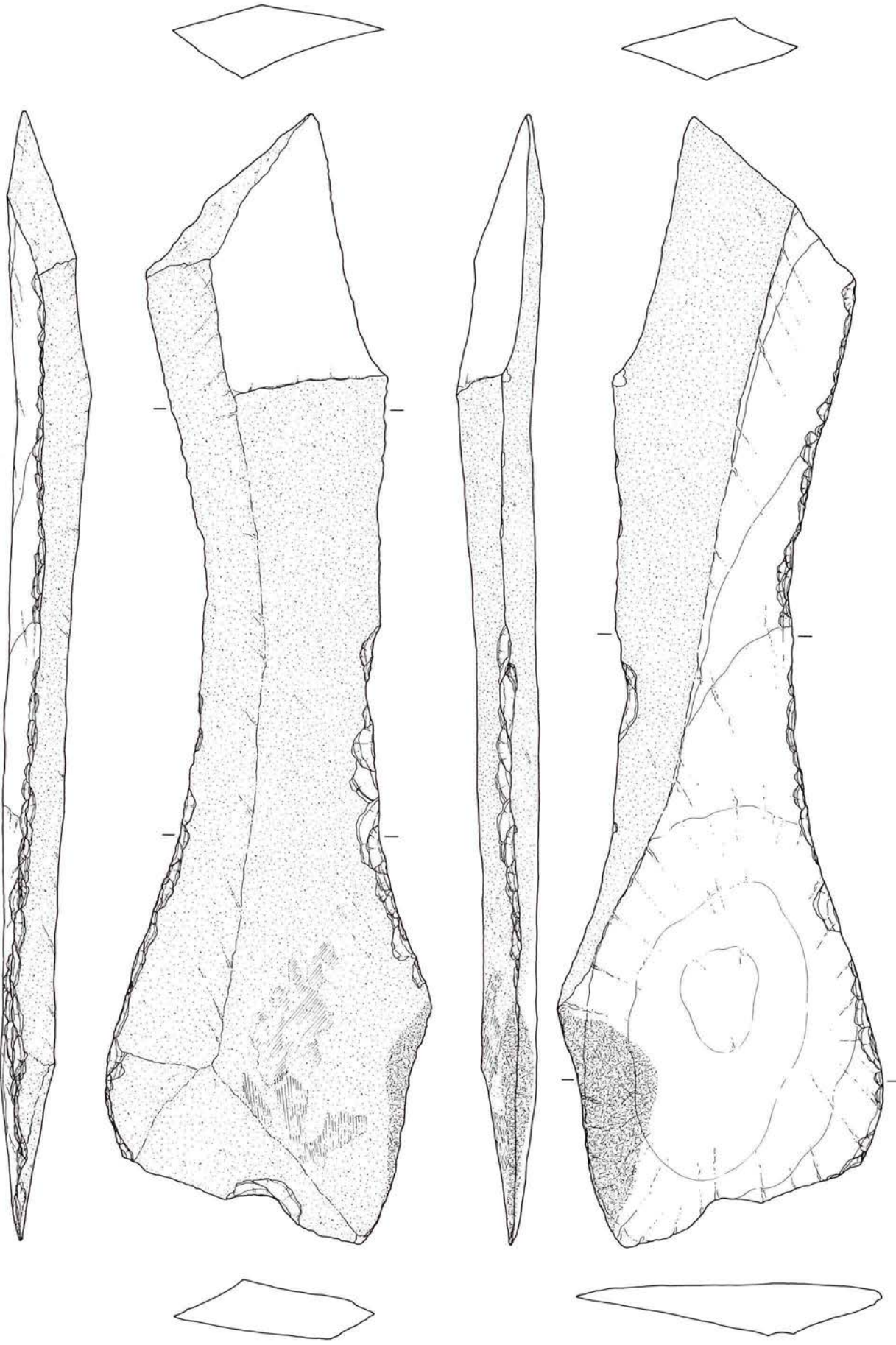

石器写真

SD12

- 1 大形石核II2B類
- 2 大形石核II2B類
- 3 小形石核III1A類
- 4 小形石核III1A類
- 5 小形石核II2A類
- 6 小形石核III1A類
- 7 小形石核II2A類
- 8 小形石核II2B類
- 9 剥片A類IV
- 10 剥片A類IV
- 11 剥片A類IV
- 12 剥片A類IV
- 13 剥片A類V
- 14 剥片A類V
- 15 大形剥片2種
- 16 小形剥片B類
- 17 小形剥片B類

(2:3)

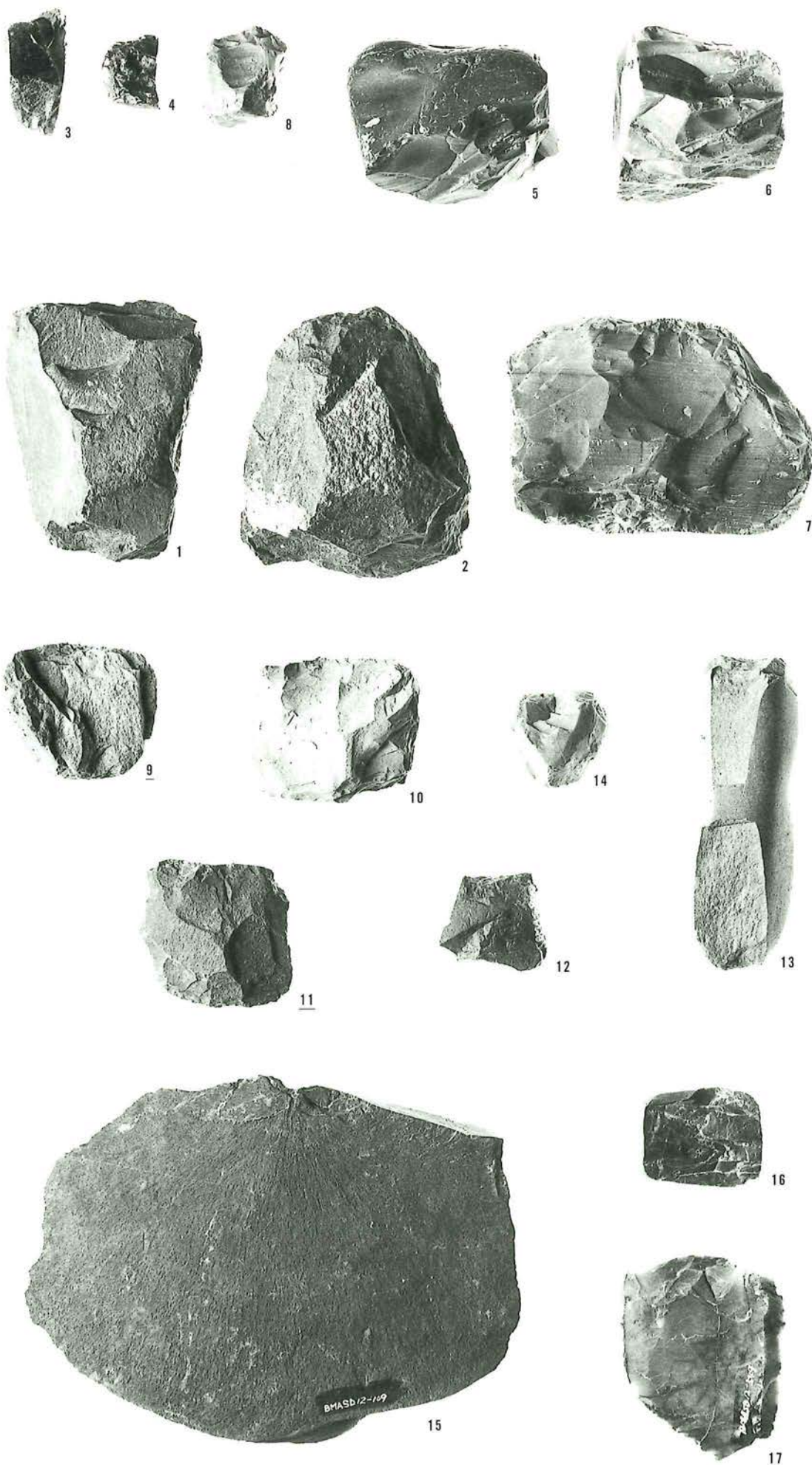

石器写真

SD12

18 打製石鏃IIB₂類

19 打製石鏃IIB₃類

20 磨製石鏃
失敗品1類

21 磨製石鏃
失敗品2A類

22 磨製石鏃
失敗品2B類
(1:1)

23 磨石I1b類

24 磨石I2a類

25 凹石 台石状

26 凹石I2a類

44 みがき石I1e類

45 みがき石I1d類

46 みがき石II2c類

47 みがき石III1b類

48 みがき石III1a類

49 台石1種A₂類
(2:3)

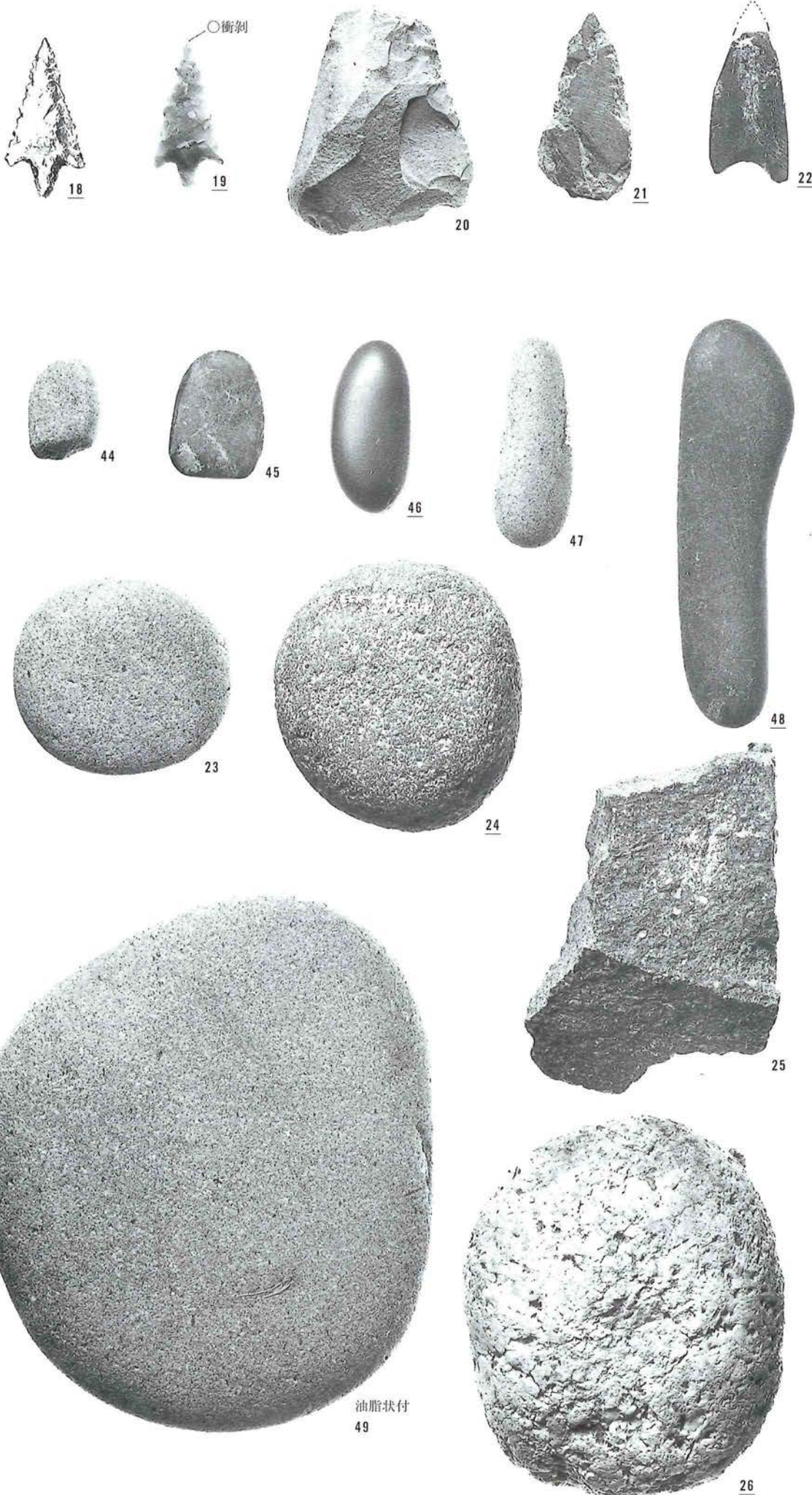

油脂状付
49

26

石器写真

SD12

27 敲石ア類

28 敲石ア類

29 敲石ア類

30 敲石ア類

31 敲石ア類

32 敲石ア・エ・オ類

33 敲石ア・エ類

34 敲石ア・エ・オ類

35 敲石ア・ウ類

36 敲石イ類

37 敲石イ類

38 敲石イ・オ類

39 敲石イ・ウ類

40 敲石キ類

41 敲石ウ・オ類

42 敲石ウ・エ類

43 敲石ウ類

(1:2)



27

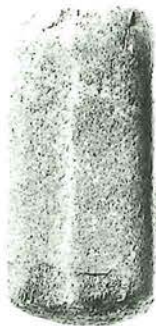

タール状付
28



35



赤色粉状付
29



30



31



40



再生
33



39



43



36



37



38



34



32



41



42

石器写真

SD12

50 台石 2種 A₂類

51 台石 2種 A₂類

(2:3)



50



51

石器写真

SD12

- 52 大形刃器 1b 類
 - 53 大形刃器 1b 類
 - 54 大形刃器 1b 類
 - 55 大形刃器 1b 類
 - 56 大形刃器 1b 類
 - 57 大形刃器 1a 類
 - 58 大形刃器 2b 類
- (2:3)

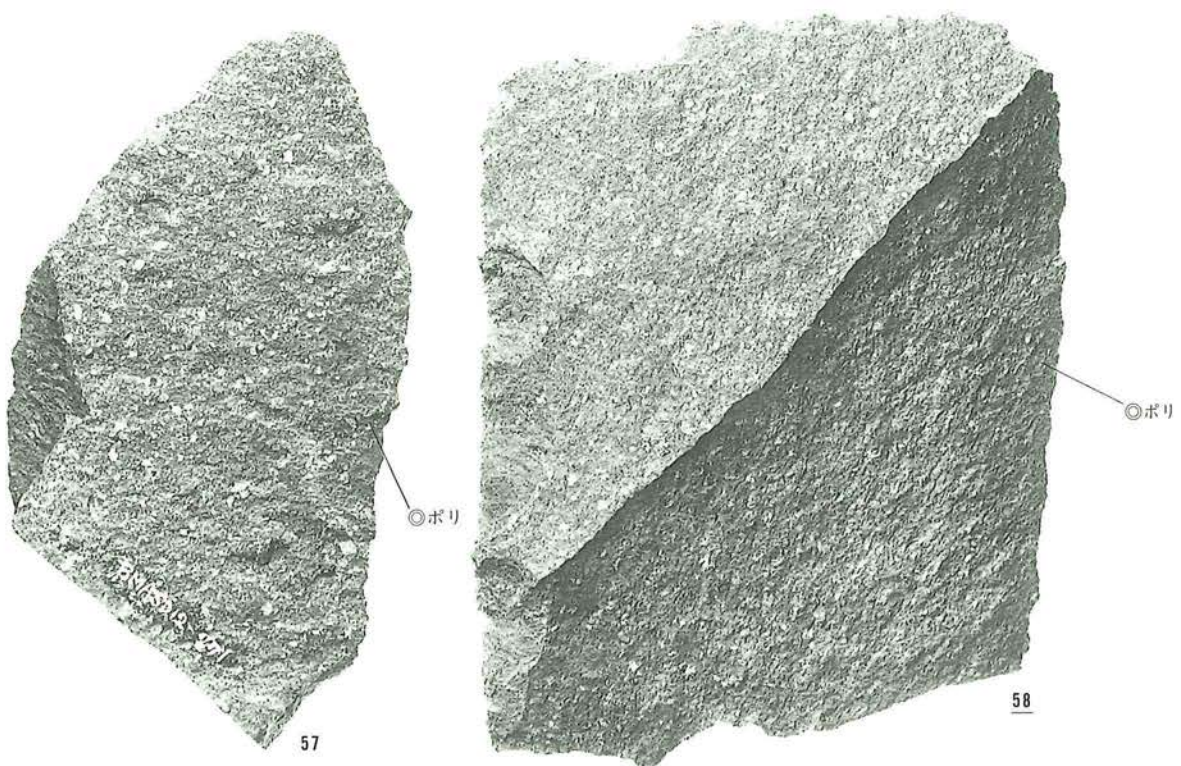
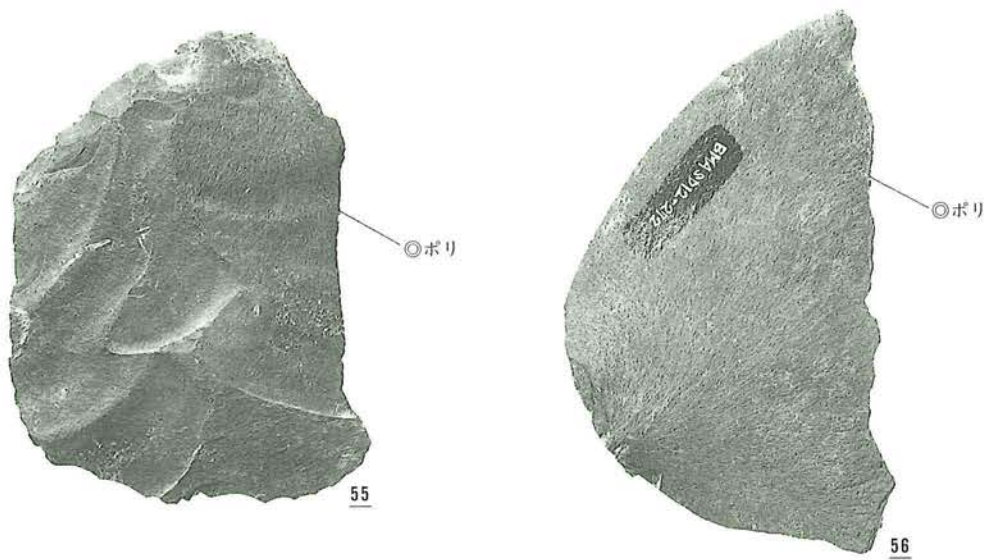
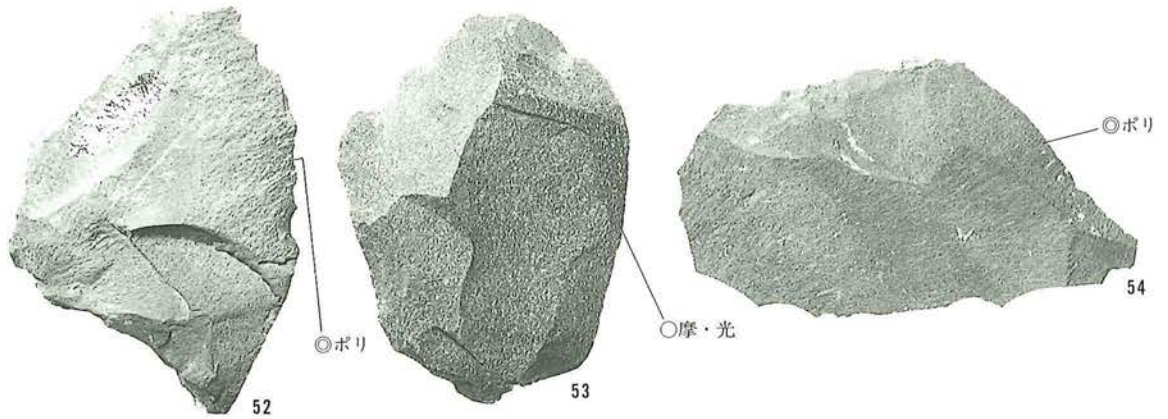

石器写真

SD12

- 59 大形刃器 1b 類
- 60 大形刃器 2b 類
- 61 大形刃器 1b 類
- 62 大形刃器 2b 類
- 63 大形刃器 2b 類
- 64 大形刃器 2b 類
- 65 大形刃器 2b 類
- 66 大形刃器 2d 類

(2:3)

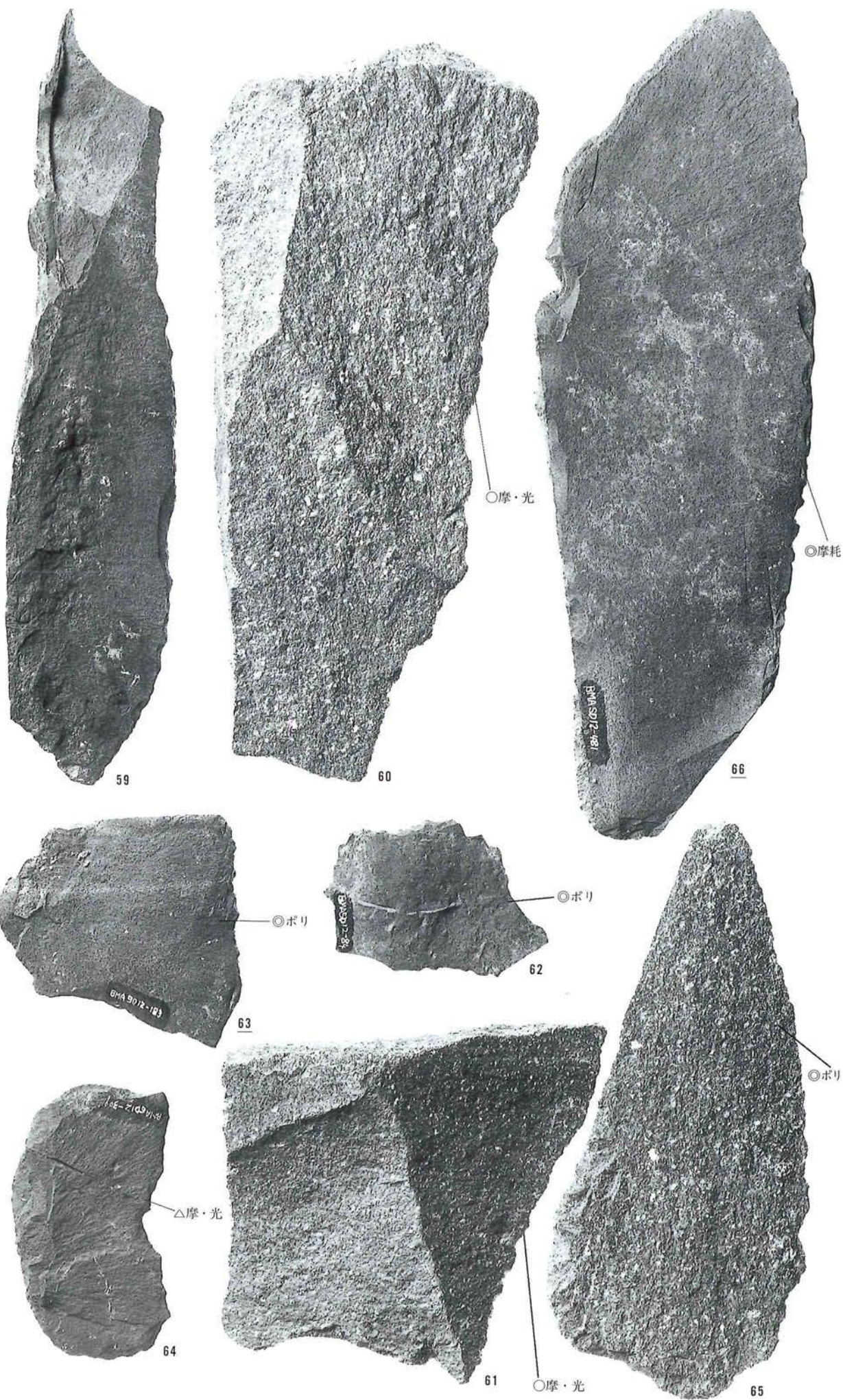

59

60

66

○摩・光

○摩耗

○ポリ

○ポリ

62

63

△摩・光

64

○摩・光

61

○ポリ

65

石器写真

SD12

- 67 大形刃器 2b類
- 68 大形刃器 2b類
- 69 大形刃器 2b類
- 70 大形刃器 7類
- 71 大形刃器 7類
- 72 大形刃器 7類
- 73 大形刃器 8類
- 74 大形刃器 8類
- 75 大形刃器 大形石匙

(2:3)

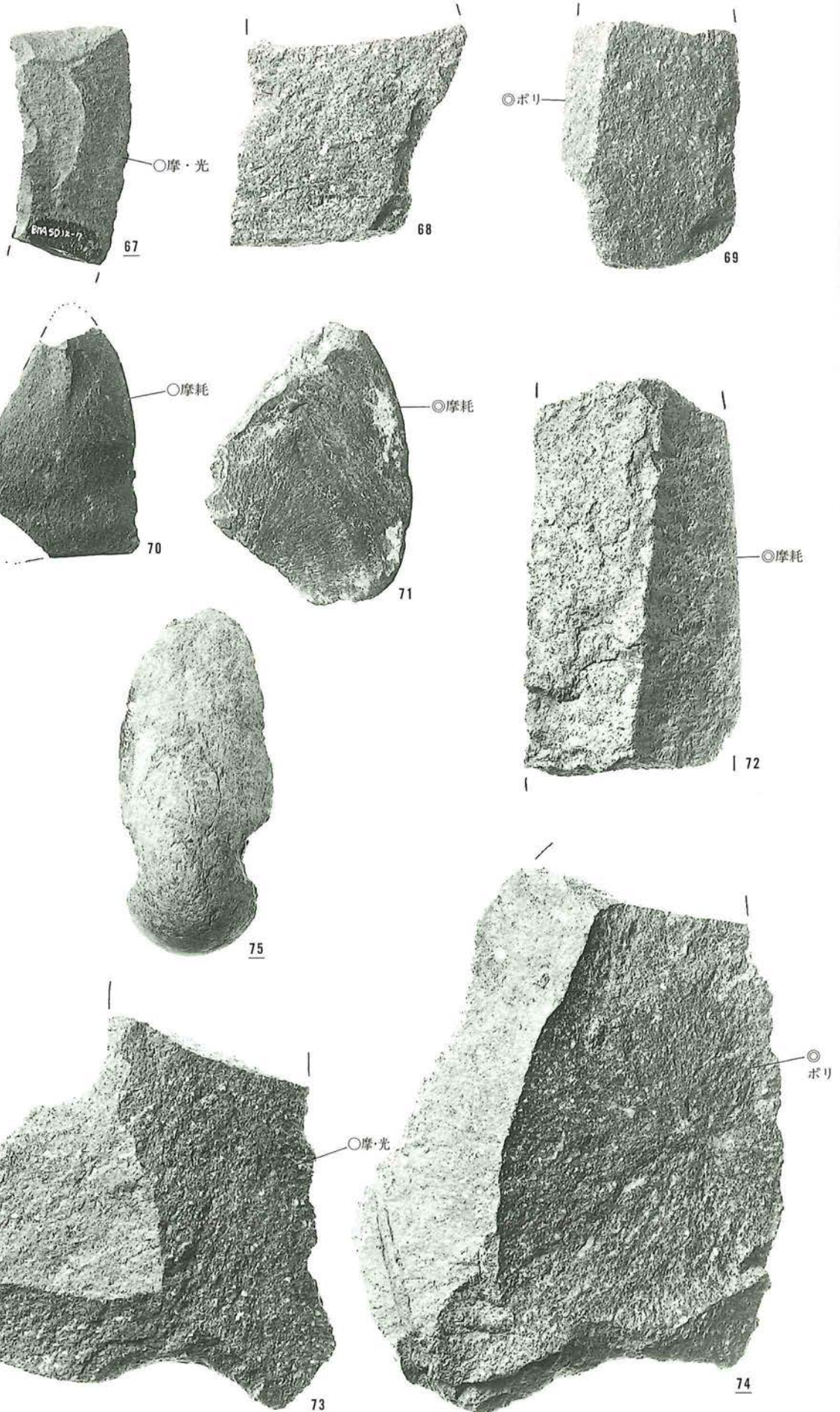

石器写真

SD12

77 太型蛤刃石斧 不明

78 太型蛤刃石斧
Ib'類?

79 石槌 蛤刃未転用

80 石槌 蛤刃未転用

81 石槌 蛤刃転用

82 石槌 蛤刃転用

83 石槌 蛤刃転用

84 石槌 敲石転用

85 石槌 大形刃器転用
(2:3)



79

PL 152-128 接合



80



転用
77



78



81



赤色粉状付
82

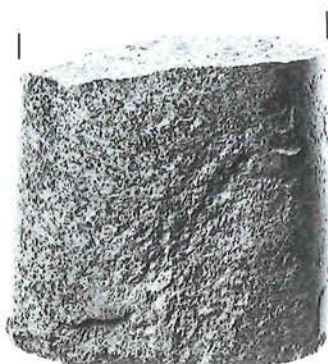

赤色粉状付
83



転用
84



転用
85

石器写真

SD12

- 76 磨製石包丁
失敗品 E₃類
- 86 扁平片刃石斧
失敗品 E₁類
- 87 扁平片刃石斧
失敗品 E₂類
- 88 扁平片刃石斧
失敗品 E₂類?
- 89 扁平片刃石斧
IIa 類?
- 90 扁平片刃石斧
失敗品 E₃類
- 91 扁平片刃石斧
失敗品 E₃類
- 92 扁平片刃石斧
II d 類
- 93 扁平片刃石斧
II e 類
- 94 扁平片刃石斧 不明
- 95 扁平片刃石斧 不明
- 96 石錐 1類
- 97 玉, 原石
- 98 環狀石器
(2:3)

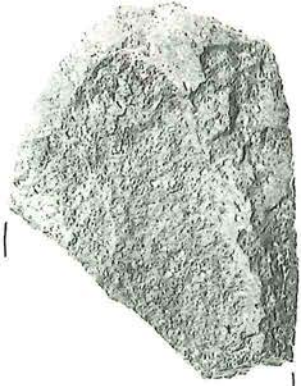

76

PL 28-10 接合

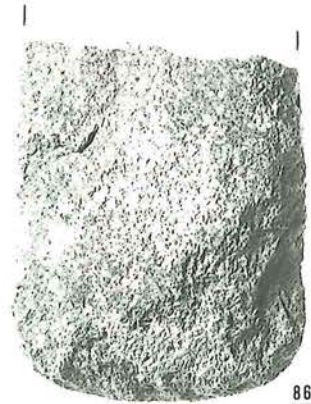

86

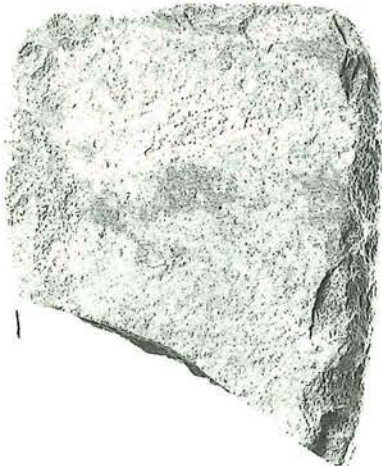

87

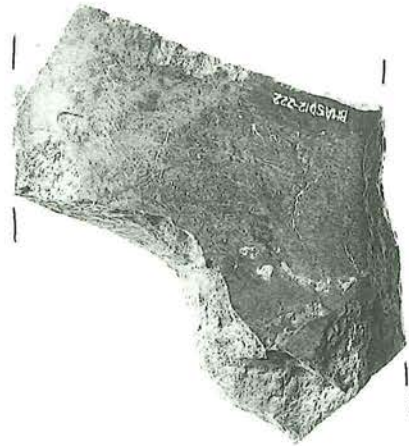

88



89

○光沢



90



91



94



92



96

転用

○摩・線



95

再生

○摩・線



93

△摩・光



97

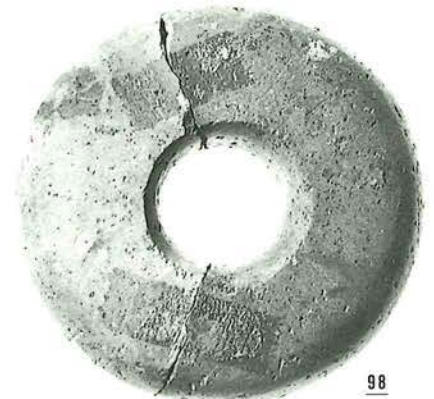

98

石器写真

SD12

99 砥石 I1a 類

100 砥石 I1b 類

101 砥石 I1b 類

102 砥石 I1b 類

103 砥石 I2 類

104 砥石 I2 類

105 砥石 I1c 類

106 砥石 II3 類

107 砥石 置砥

108 軽石製品

109 軽石製品

110 軽石製品

111 軽石製品

(2:3)

112 指輪状石製品

113 白玉

114 管玉

(1:1)



石器实测图

SD12

PL121-9

PL121-11

PL122-18

PL122-19

PL122-21

PL122-22

(2:3)

PL122-46

PL122-48

(1:2)

PL122-24

PL122-26

PL123-32

PL123-34

PL123-40

PL123-41

(1:3)

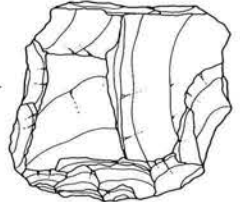
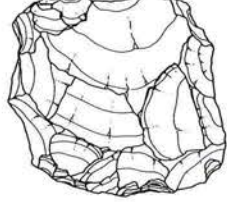
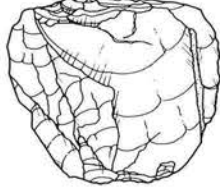
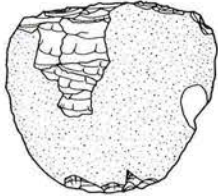
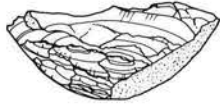

PL121-11

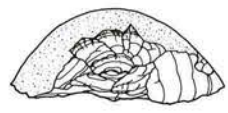

PL121-9



PL122-18



PL122-19

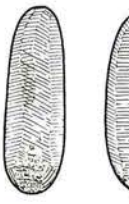
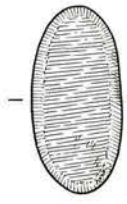

PL122-46



PL122-21



PL122-22

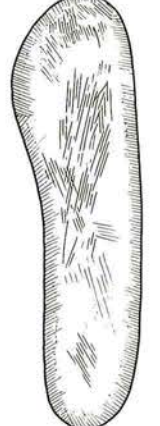
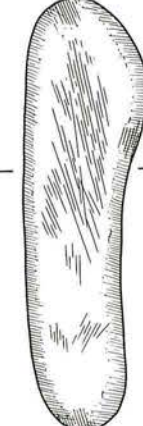

PL122-48

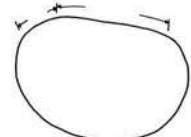
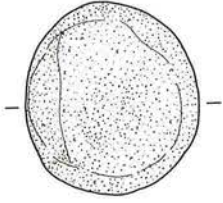
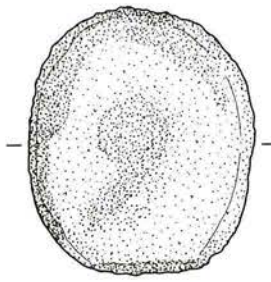

PL122-24

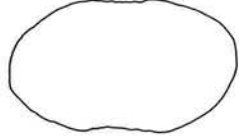

PL122-26

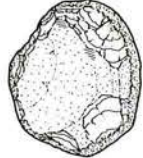

PL123-40

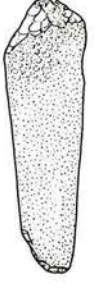
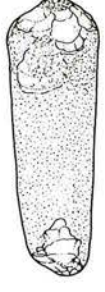

PL123-34

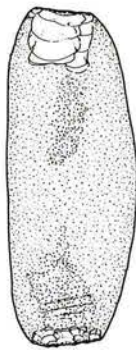

PL123-32

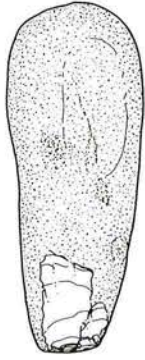

PL123-41

SD12

PL 125-55

PL 125-56

PL 125-58

PL 126-63

PL 127-67

(1:2)

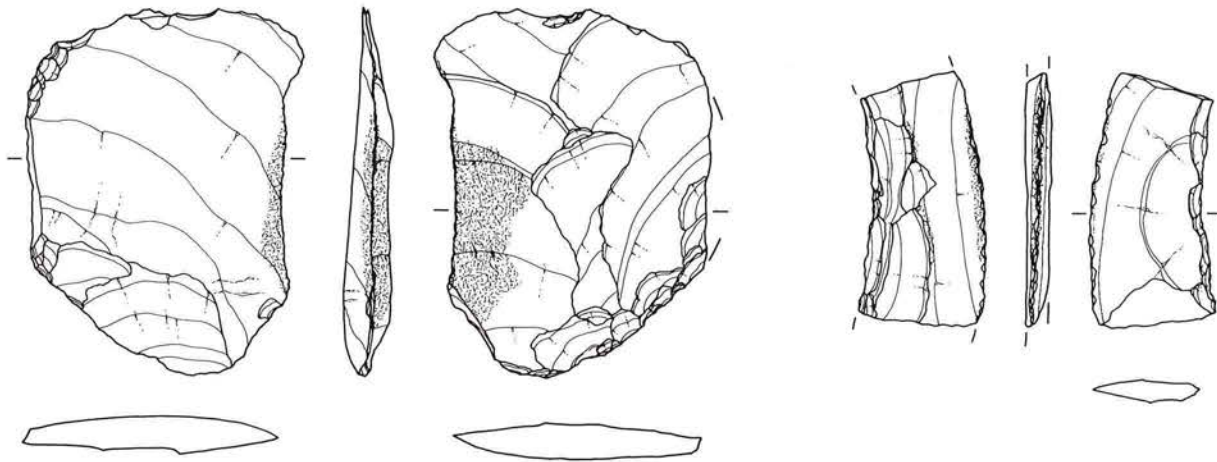

PL125-55

PL127-67

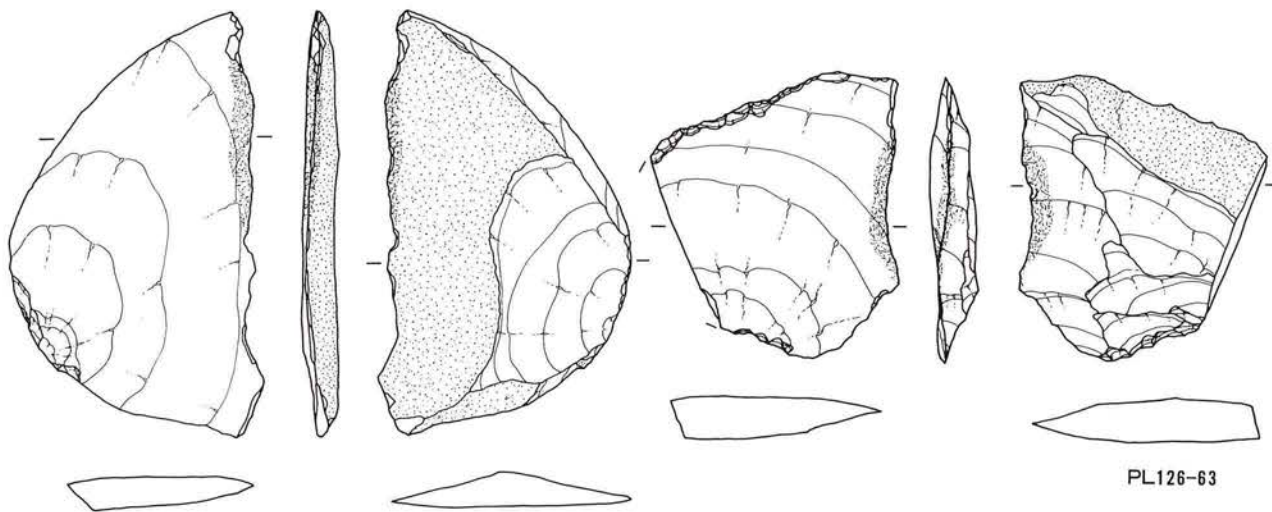

PL125-56

PL126-63

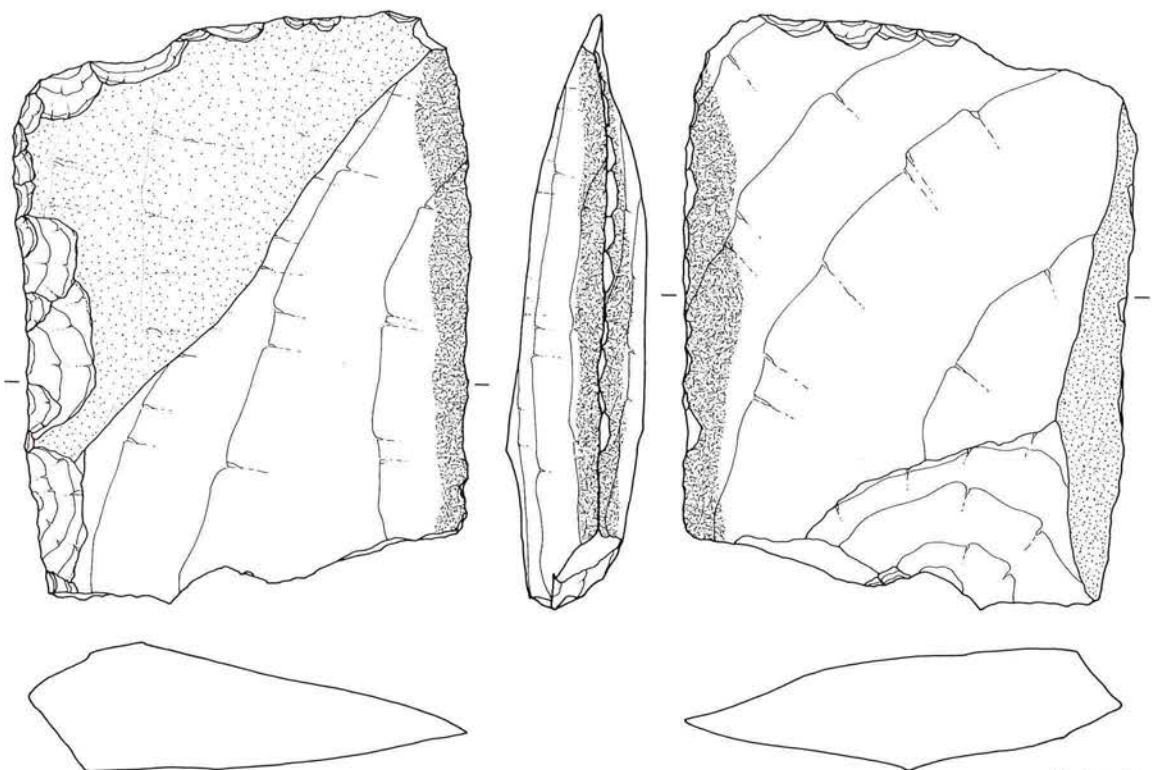

PL125-58

石器実測図

SD12

PL 127-73

PL 127-74

PL 127-75

PL 129-76

(1:2)

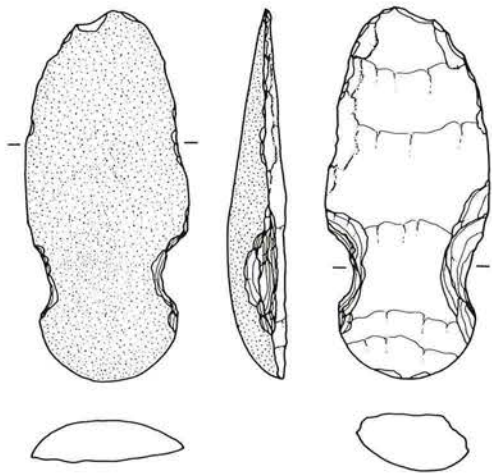

PL127-75

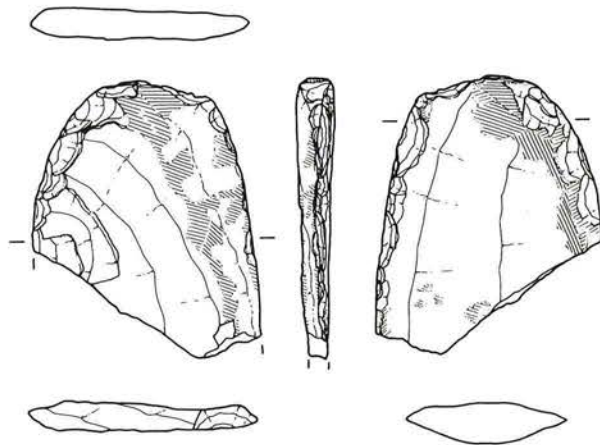

PL129-76

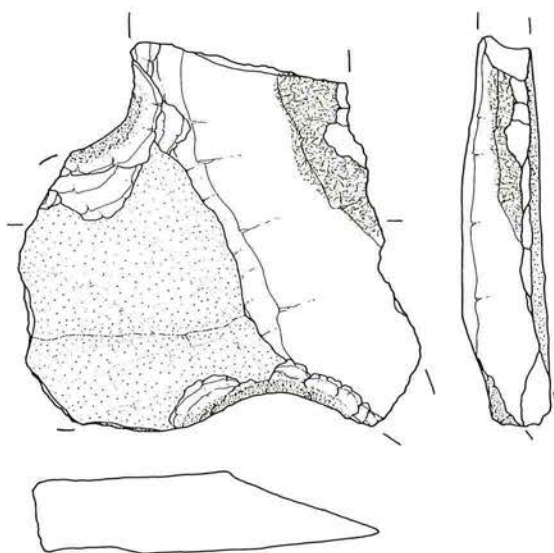

PL127-73

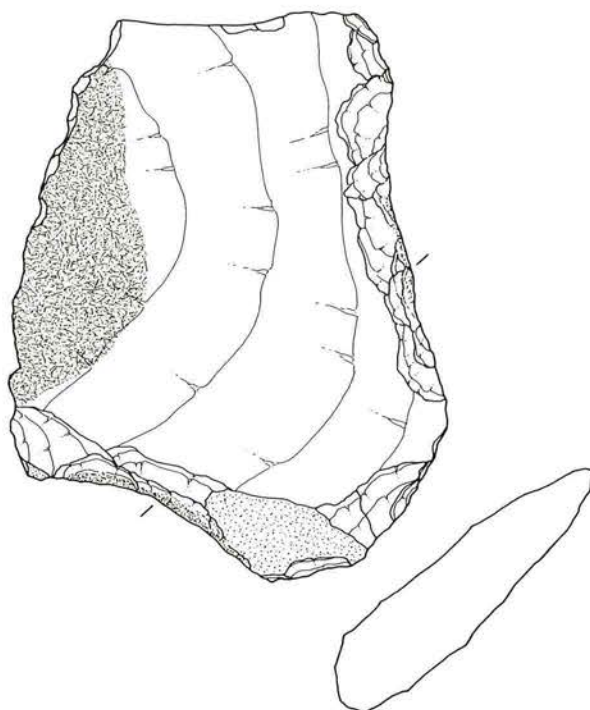
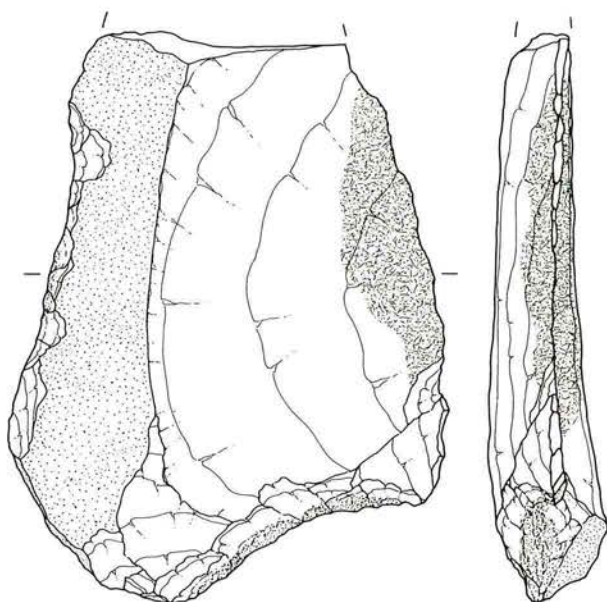

PL127-74

SD12

PL126-66

PL128-82

PL128-79

PL128-84

PL128-85

(1:2)

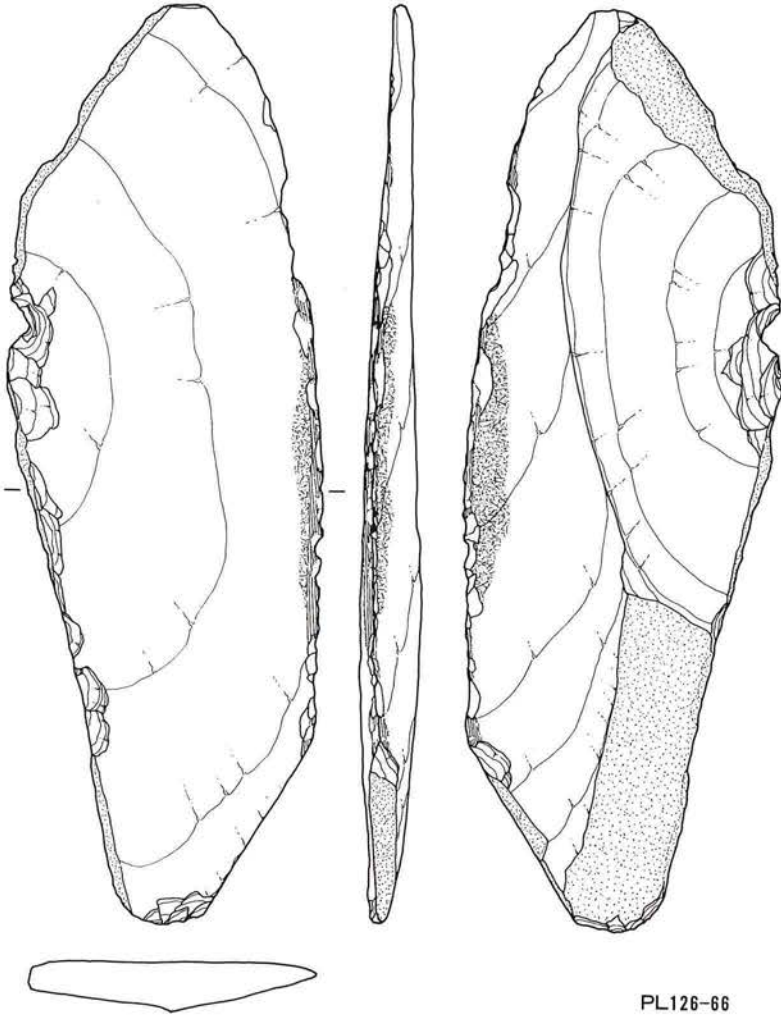

PL126-66

PL128-84

PL128-85

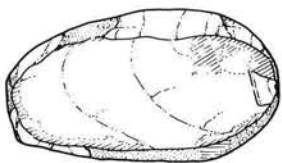
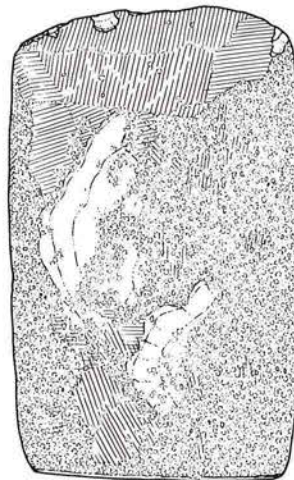
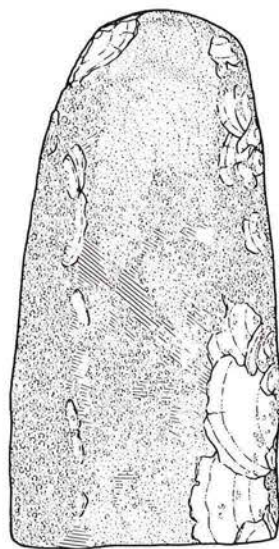
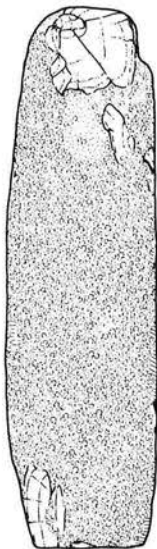
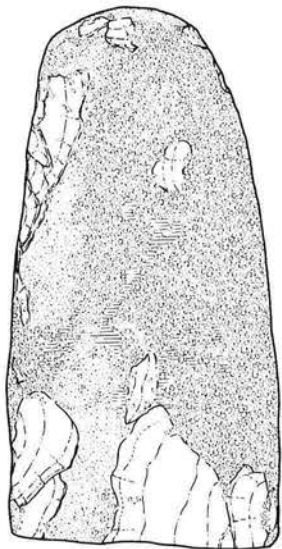
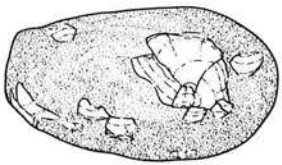
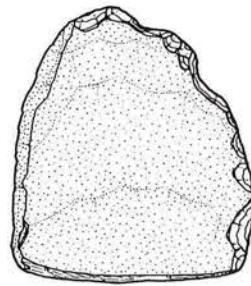
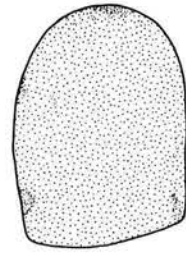

PL128-79



PL128-82

石器実測図

SD12

PL 129-92

PL 129-93

PL 135-1

(2:3)

PL 129-86

PL 129-98

PL 130-105

PL 130-106

(1:2)

PL 130-112

PL 130-113

(1:1)

PL 135

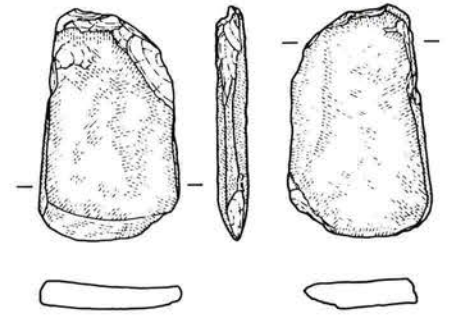
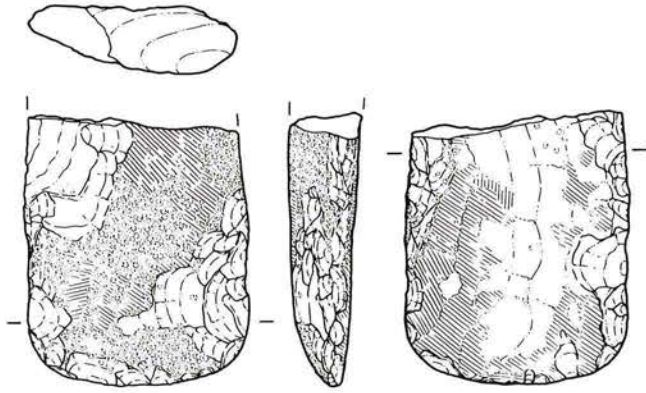

PL129-92



PL129-86

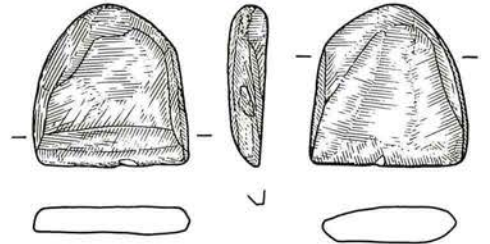

PL129-93

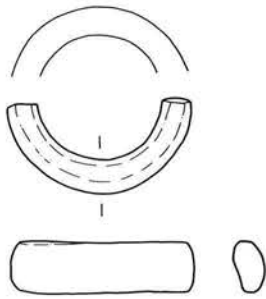

PL130-112



PL130-113

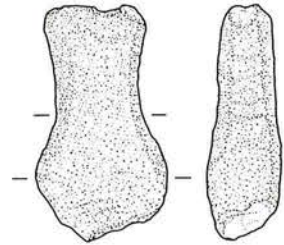

PL130-105

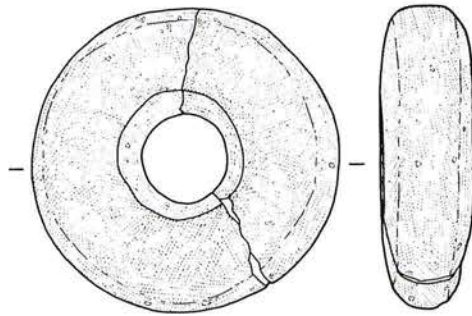

PL129-98

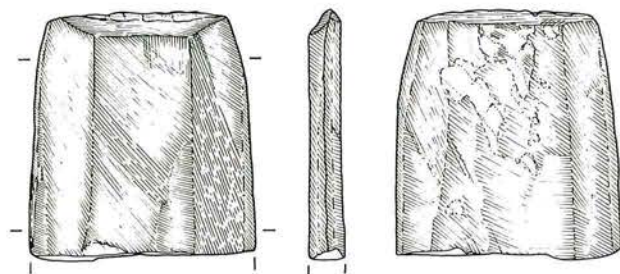

PL135-1

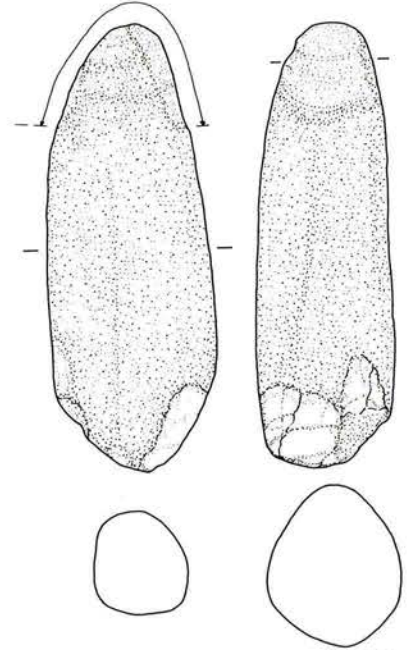

PL130-106

石器写真

SD18

- 1 原石
- 2 小形石核III1A類
- 3 剥片A類IV
- 4 打製石鏃II_B類?
- 5 打製石斧E₂類?
- 6 敲石イ・ウ類
- 7 みがき石IIc類
- 8 台石2種A₂類
- 9 大形刃器2b類
- 10 大形刃器7類
- 11 大形刃器2c類
- 12 砥石II3類
- 13 砥石I2類

(2:3)



石器写真

SD26

- 1 打製石鏃IIB₂類
- 2 打製石鏃IIB₃類

(1:1)

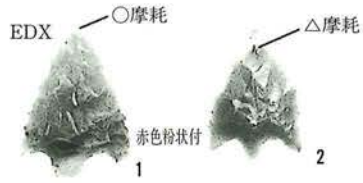

SD29

- 4 大形刃器7類
- 5 扁平片刃石斧 不明
- 6 砥石IIa類

(2:3)

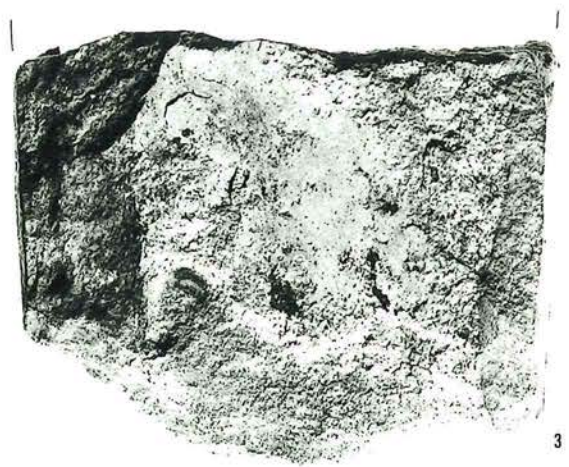

SD30

- 7 磨製石鏃IB₁類
- 8 ノミ状石器IIe類

(1:1)

(2:3)

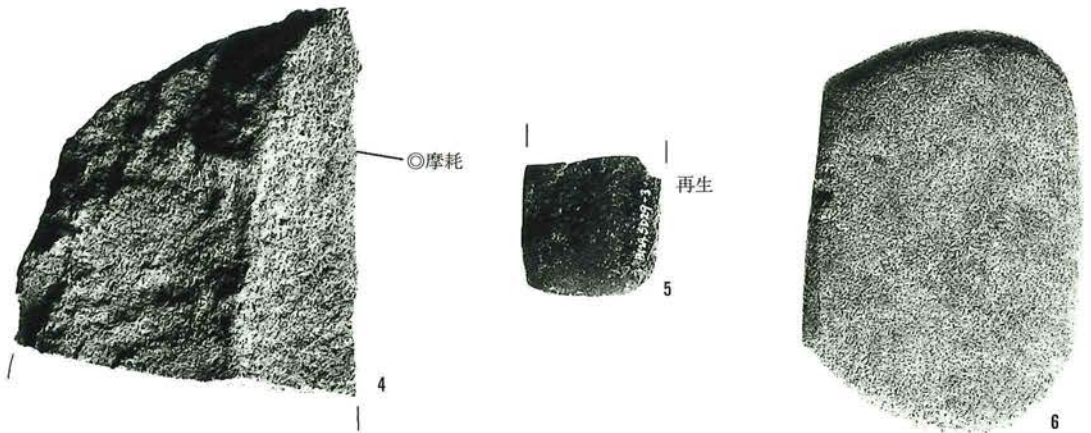

SD62

- 9 打製石鏃IIB₃類

(1:1)

SD67

- 10 磨製石包丁 杏仁形
- 11 扁平片刃石斧 失敗品 E₃類

(2:3)



SD68

- 12 打製石鏃IIA類

(1:1)

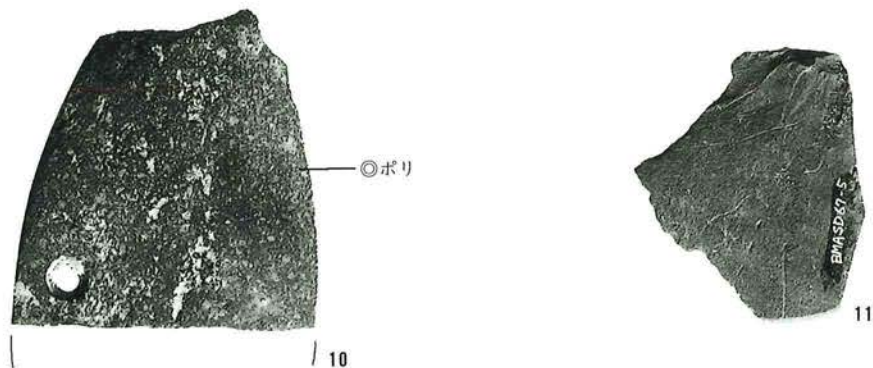

石器写真

SD100

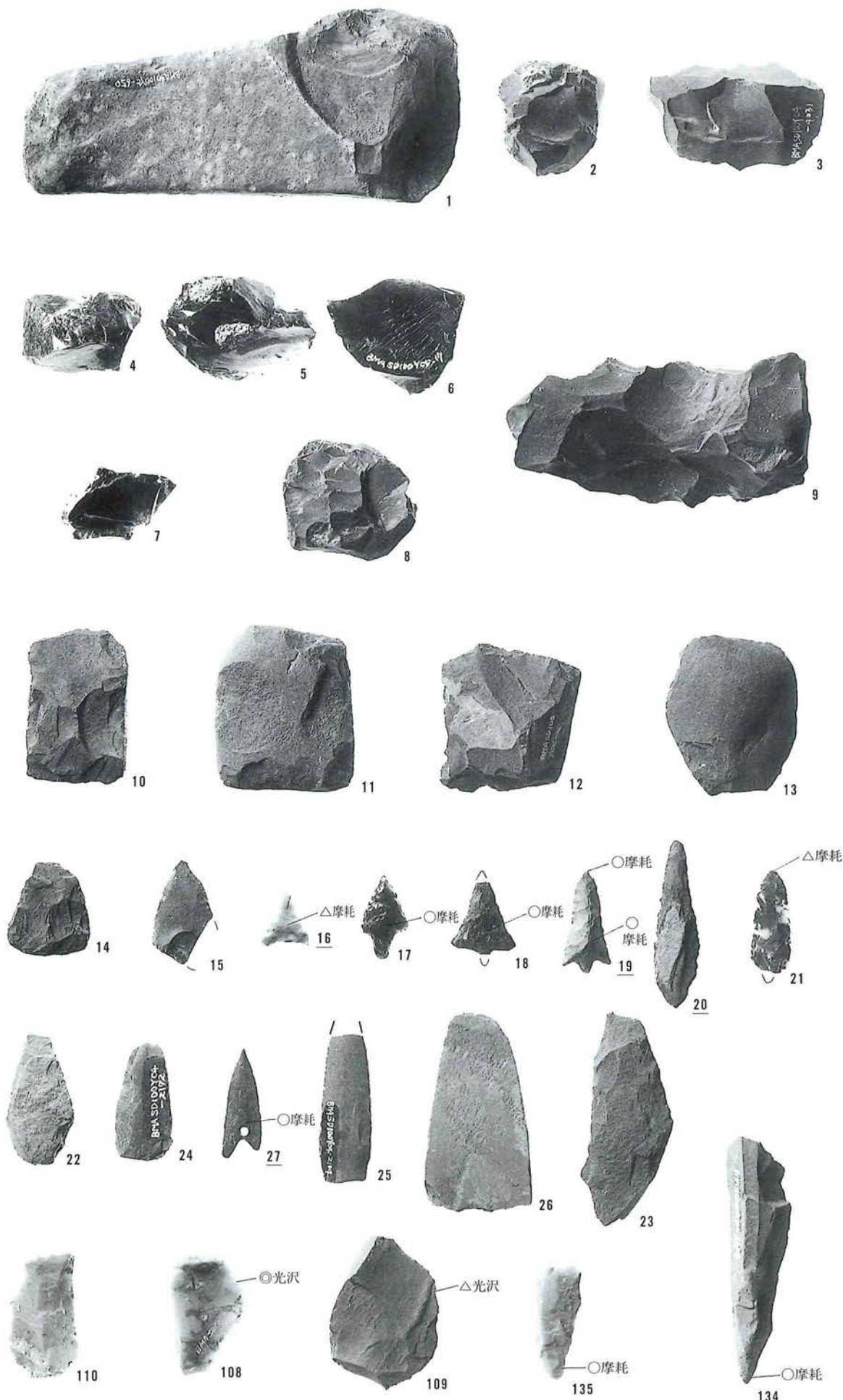

- 1 大形石核 IIA 類
- 2 大形石核 IIIA 類
- 3 大形石核 IIIB 類
- 4 原石
- 5 原石
- 6 原石
- 7 小形石核 IIIA 類
- 8 小形石核 II2B 類
- 9 小形石核 II2B 類
- 10 剥片 A 類 II
- 11 剥片 A 類 IV
- 12 剥片 A 類 IV
- 13 剥片 A 類 IV
- 14 打製石鏃
失敗品 2 類
- 15 打製石鏃
失敗品 2 類?
- 16 打製石鏃 IA 類
- 17 打製石鏃 IIA 類
- 18 打製石鏃 IIA 類
- 19 打製石鏃 IIB₂ 類
- 20 打製石鏃 IC₃ 類
- 21 打製石鏃 IC₃ 類
- 22 磨製石鏃
失敗品 1 類
- 23 磨製石鏃
失敗品 1 類
- 24 磨製石鏃
失敗品 2 A 類
- 25 磨製石鏃
失敗品 2 A 類
- 26 磨製石鏃
失敗品 2 A 類
- 27 磨製石鏃 IB₃ 類
- 108 小形刃器 2c 類
- 109 小形刃器 2c 類
- 110 小形刃器 6a 類
- 134 石錐 1 類
- 135 石錐 2 A 類
(2:3)

石器写真

SD100

- 28 打製石斧 A類
 - 29 打製石斧 B₁類
 - 30 打製石斧 E₁類
 - 31 打製石斧 不明
 - 32 打製石斧 E₂類
 - 33 打製石斧 E₂類
 - 148 軽石製品
 - 149 軽石製品
 - 150 軽石製品
 - 151 軽石製品
- (2:3)

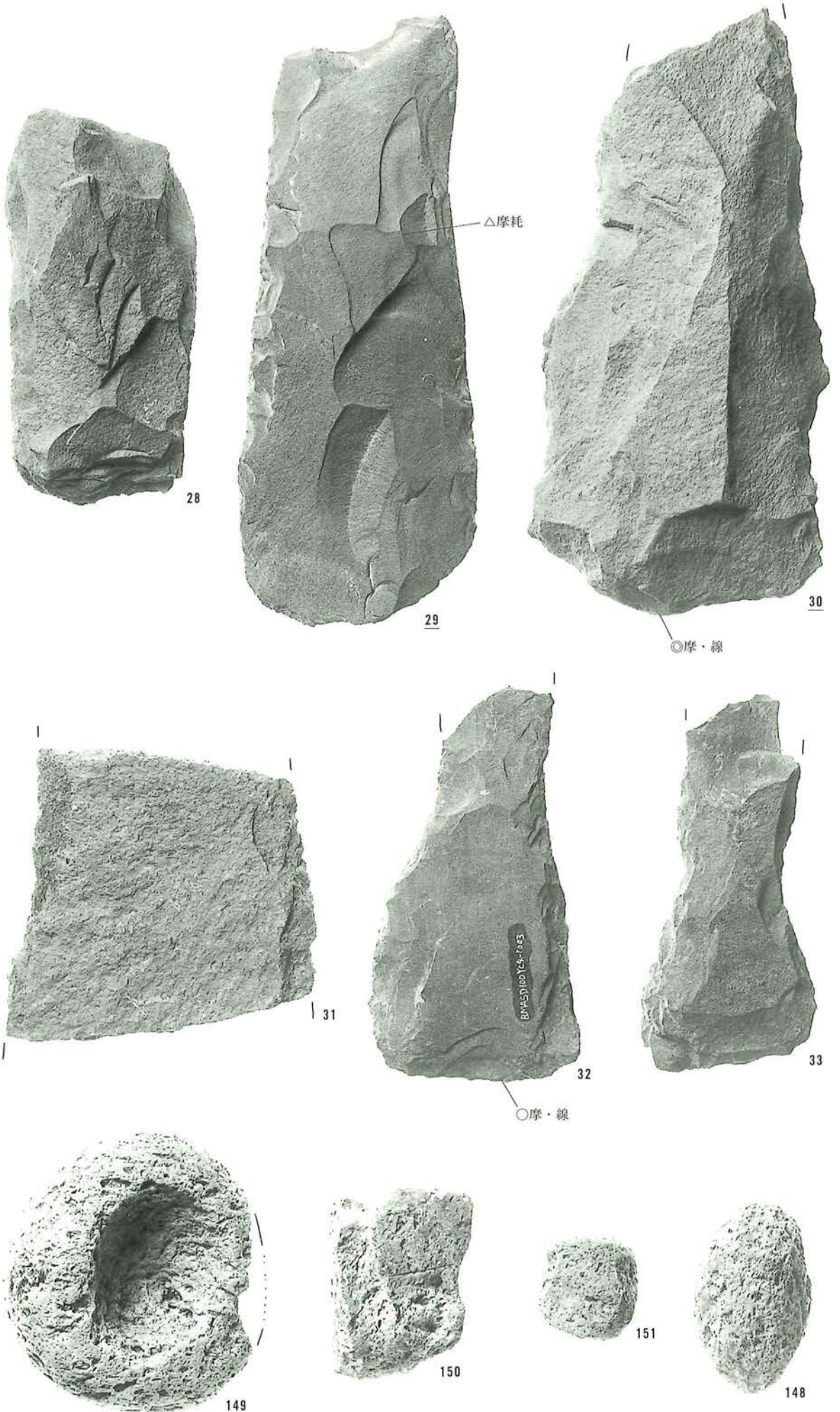

石器写真

SD100

34 磨石 I1a 類

35 磨石 I1b 類

36 磨石 I1b 類

37 磨石 I2a 類

38 磨石 I2c 類

39 磨石 I2c 類

40 磨石 I2d 類

41 凹石 I1a 類

42 凹石 I2a 類

43 凹石 I2a 類

(2:3)



34



35



36



37



38



39



40



41



42



43

石器写真

SD100

44 敲石ア類

45 敲石イ類

46 敲石イ類

47 敲石イ類

48 敲石エ類

49 敲石ウ・エ類

50 敲石オ類

51 敲石カ類

52 敲石カ類

(2:3)



44



45



47



46



48



49



50



51



52

石器写真

SD100

53 みがき石 II d 類

54 みがき石 II d 類

55 みがき石 II c 類

56 みがき石 II c 類

57 みがき石 III c 類

58 みがき石 II 2 c 類

59 みがき石 II 2 b 類

60 みがき石 不明

152 玉, 原石

153 玉, 剝片 2 種

154 玉, 原石

155 勾 玉

156 勾 玉

157 勾 玉

158 管 玉

159 管 玉

(1:1)

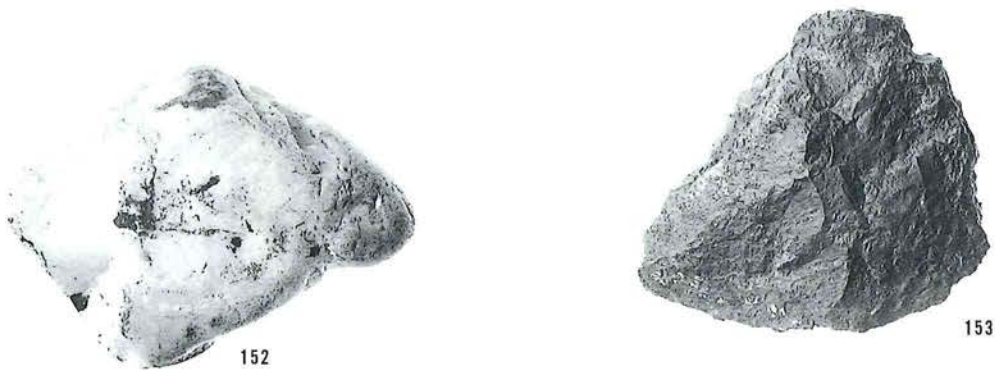
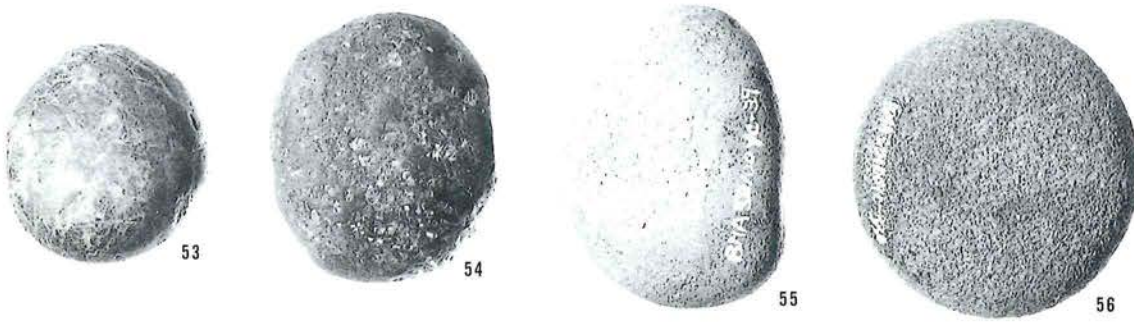

石器写真

SD100

61 台石 1種 A₂類

62 台石 1種 A₂類

63 台石 2種 A₂類

64 台石 2種 A₂類

65 石 皿

66 台 石

(1:2)



61



62

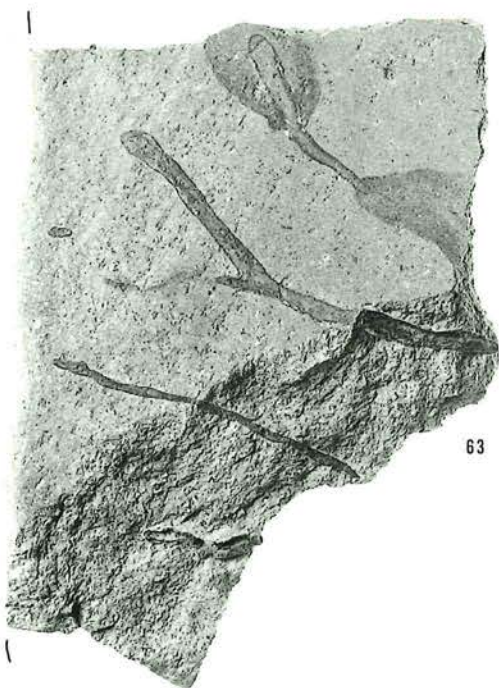

63

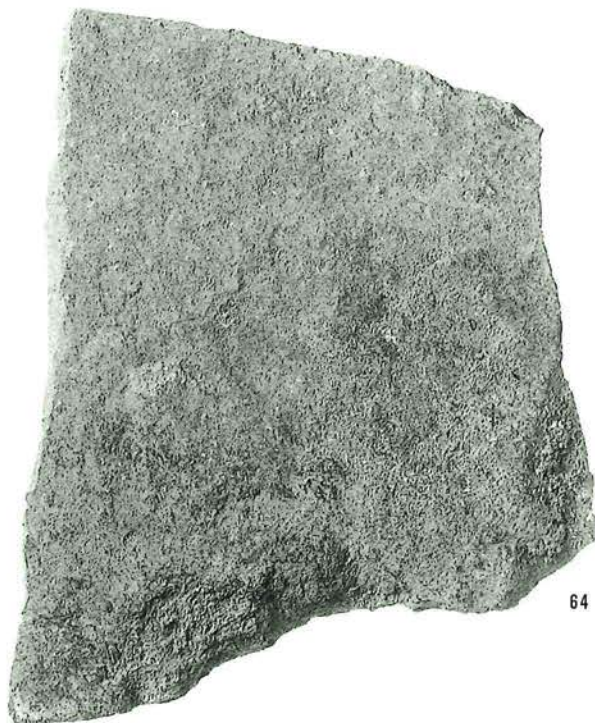

64



65



66



石器写真

SD100

68 大形刃器 2a 類

69 大形刃器 2a 類

70 大形刃器 2b 類

(2:3)

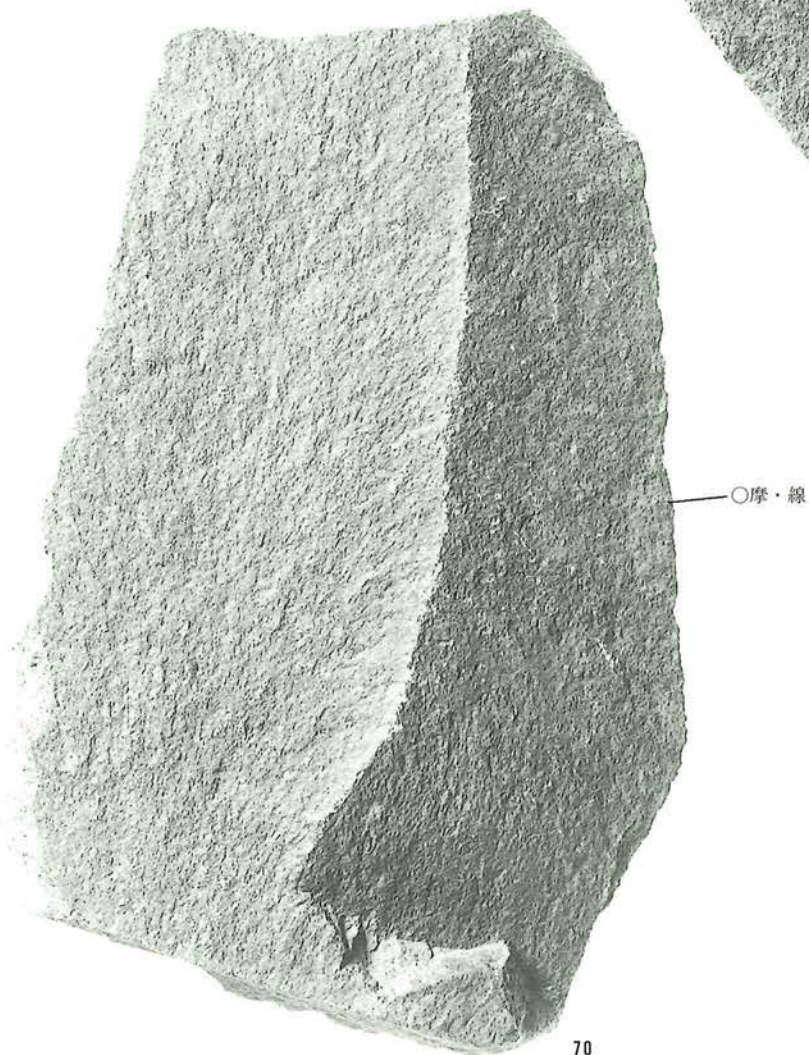
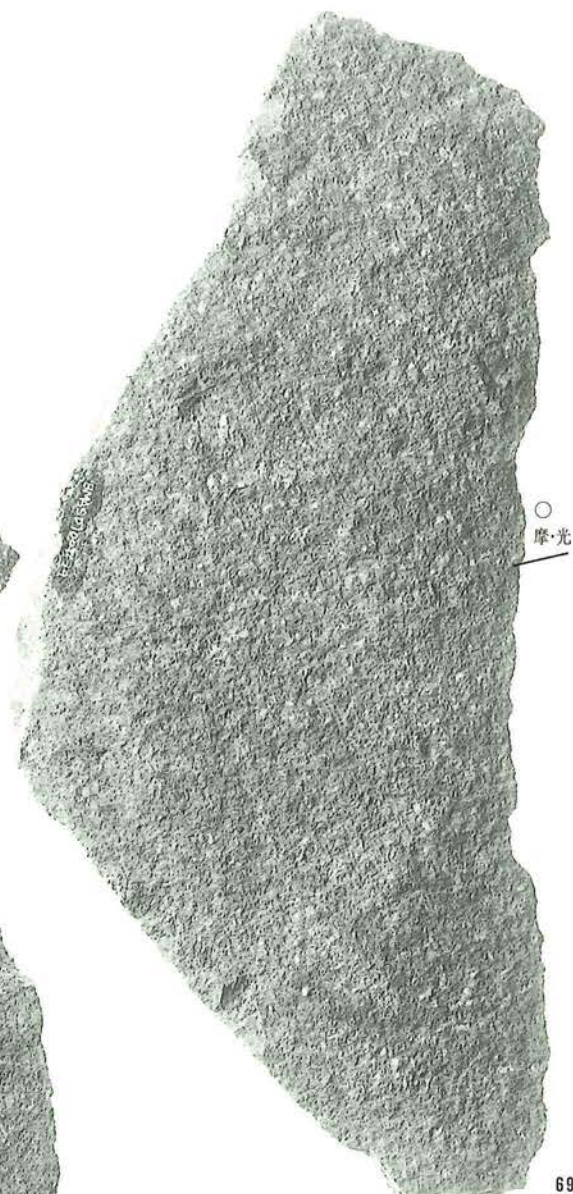
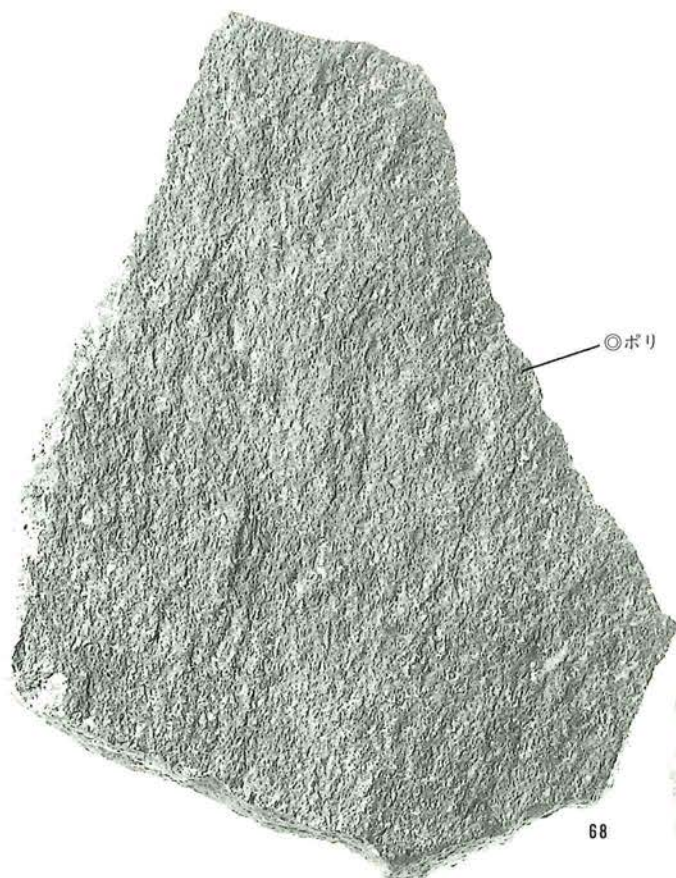

石器写真

SD100

- 71 大形刃器 1b 類
- 72 大形刃器 2b 類
- 73 大形刃器 2c 類
- 74 大形刃器 2b 類
- 75 大形刃器 2b 類
- 76 大形刃器 2b 類
- 77 大形刃器 2b 類
- 78 大形刃器 2b 類

(2:3)



71



72



78



73

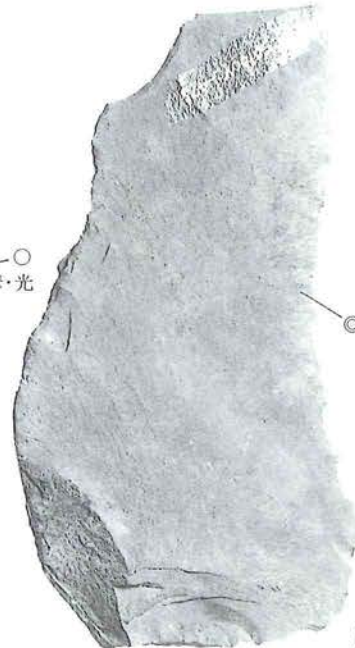

74



75

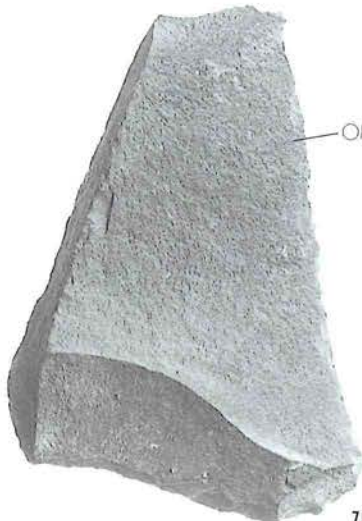

76



77

石器写真

SD100

- 79 大形刃器 2c類
- 80 大形刃器 2c類
- 81 大形刃器 2c円盤
- 82 大形刃器 2c円盤
- 83 大形刃器 2c円盤
- 84 大形刃器 3類
- 85 大形刃器 2b類
- 86 大形刃器 2b類
- 87 大形刃器 4類

(2:3)



80

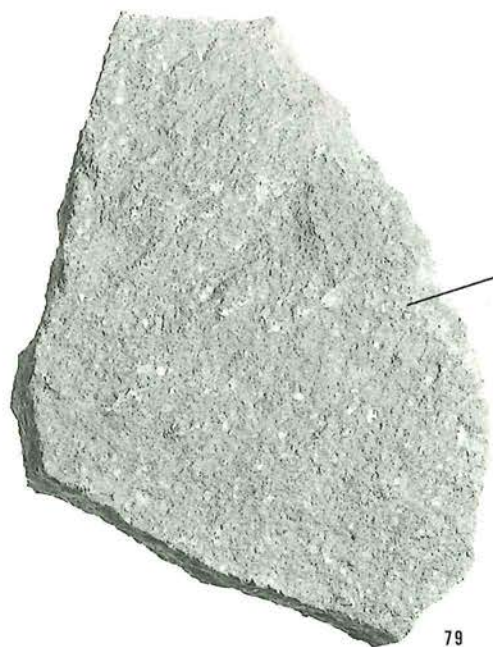

79

○ 摩・光

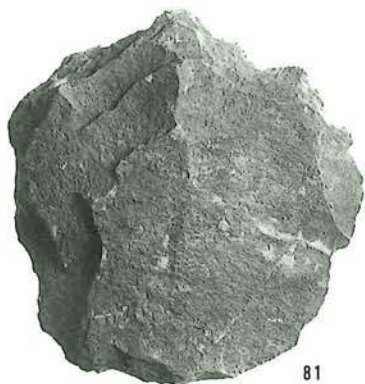

81



82

○ 摩耗

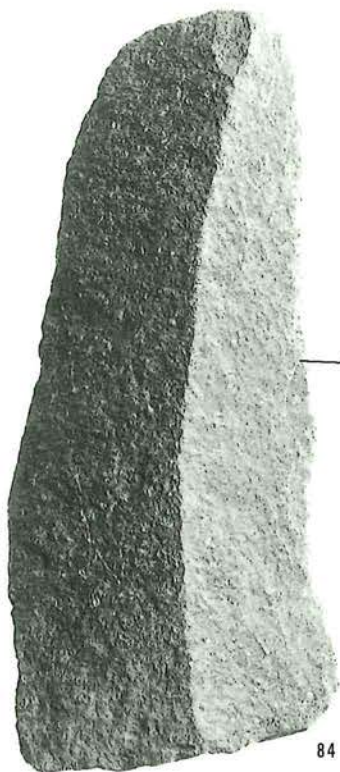

84

○ 摩・光



85



83



87

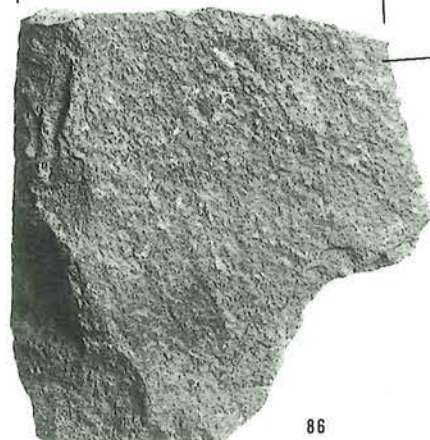

86

○ 光沢

石器写真

SD100

88 大形刃器 7類

89 大形刃器 7類

90 大形刃器 7類

91 大形刃器 7類

92 大形刃器 7類

93 大形刃器 8類

94 大形刃器 8類

95 大形刃器 8類

96 大形刃器 8類

97 大形刃器 8類

(2:3)

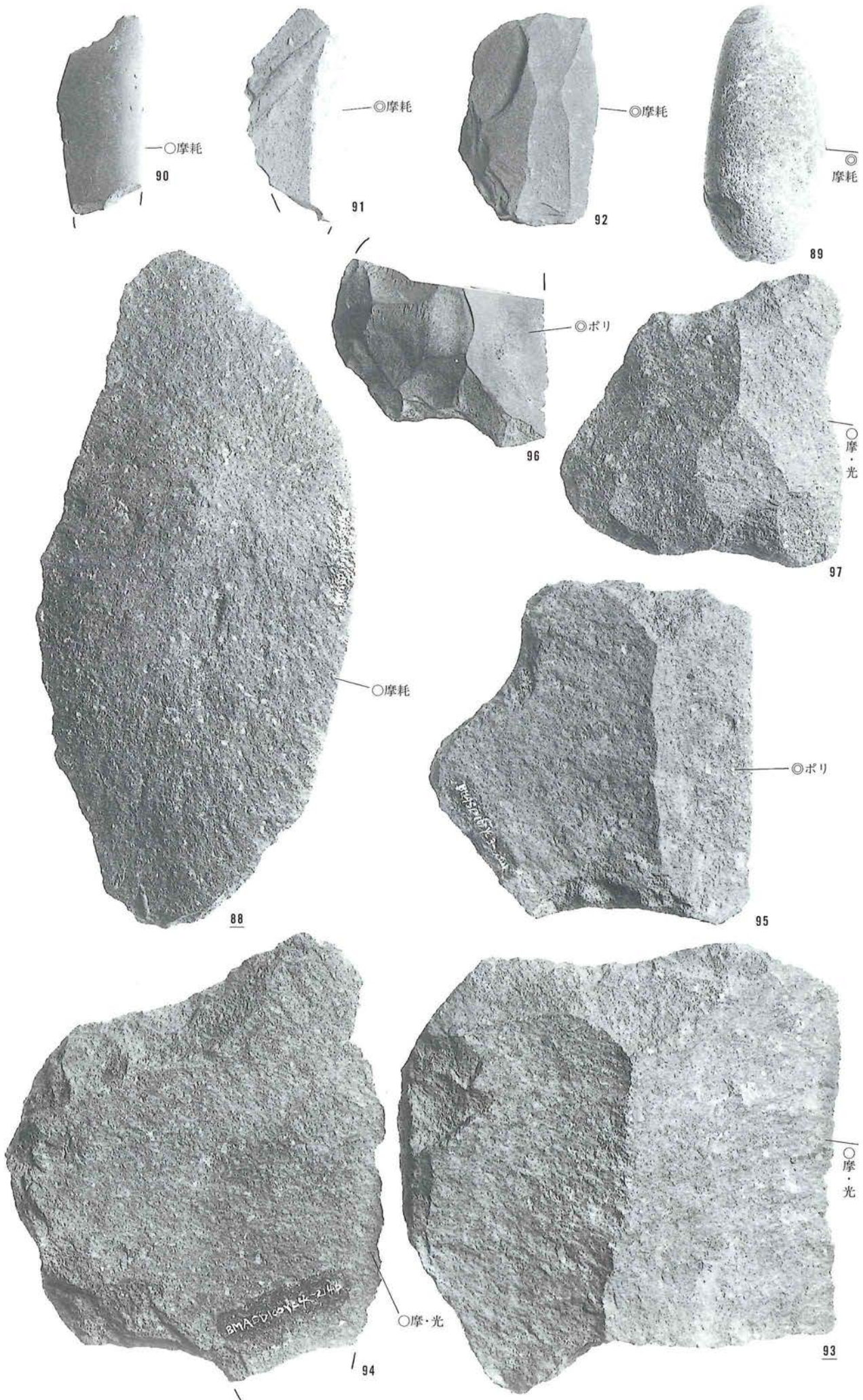

石器写真

SD100

98 大形刃器 8類

99 大形刃器 8類

100 大形刃器 8類

101 大形刃器 8類

(2:3)

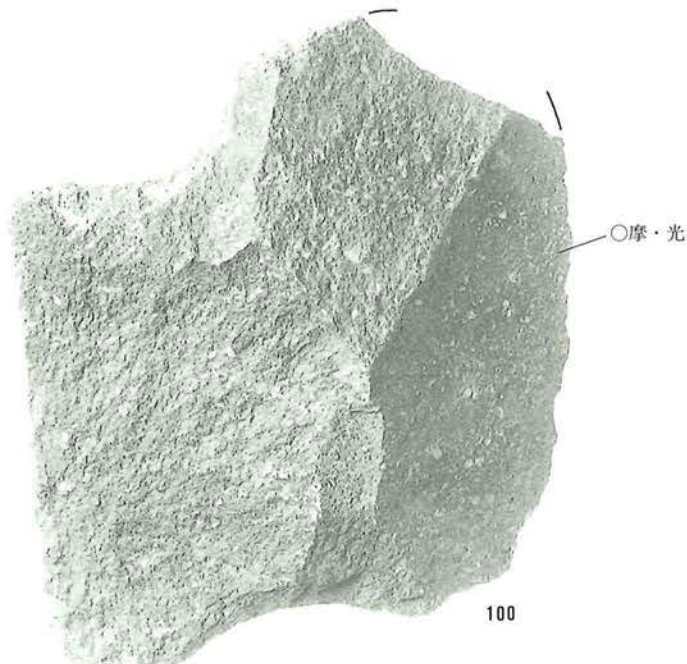
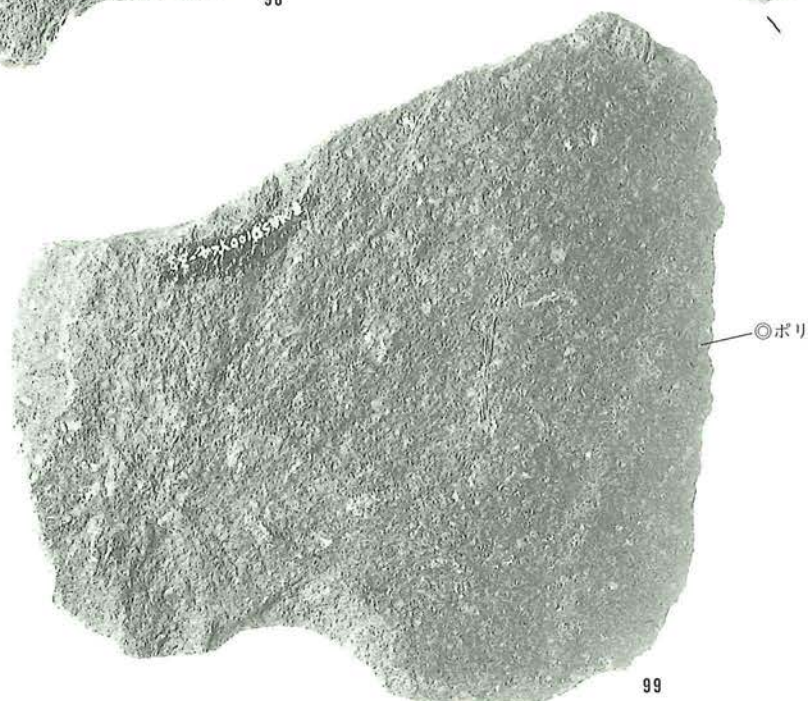
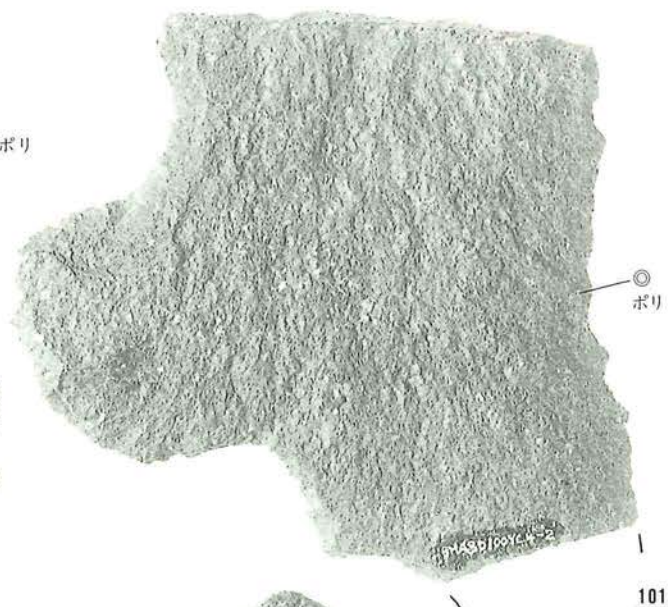
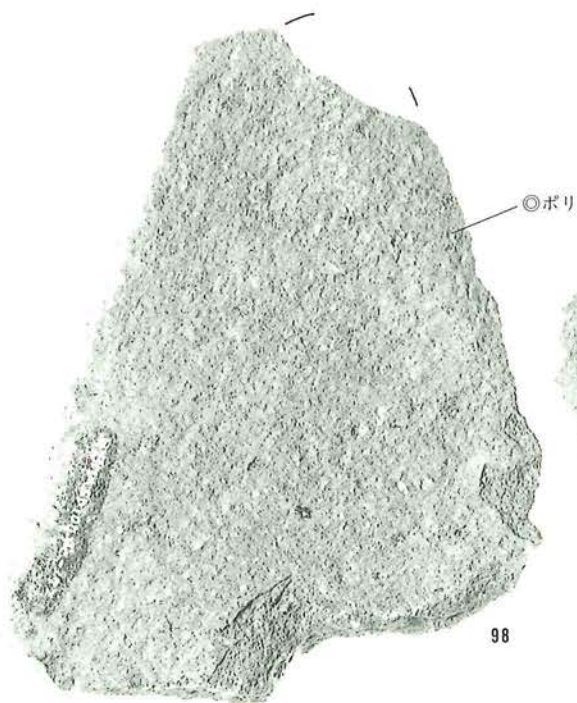

石器写真

SD100

102 磨製石包丁
失敗品B類

103 磨製石包丁 半月形

104 磨製石包丁 半月形

105 磨製石包丁 杏仁形

106 磨製石包丁 半月形

107 磨製石包丁 半月形

(1:1)

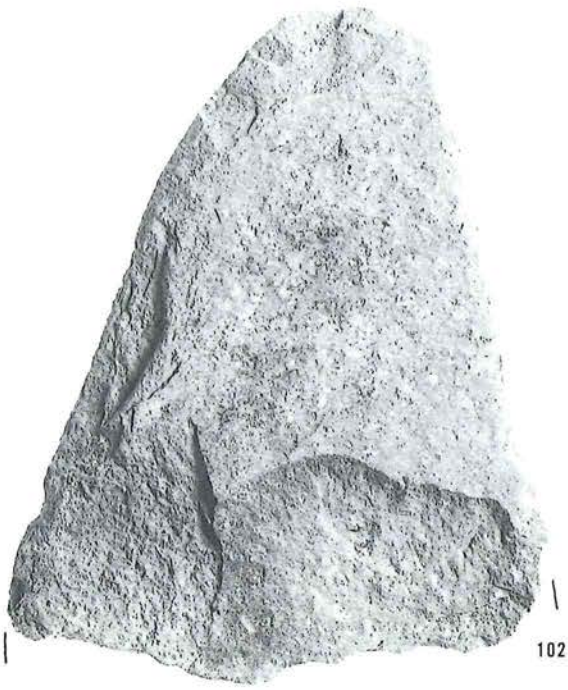

102



103



104

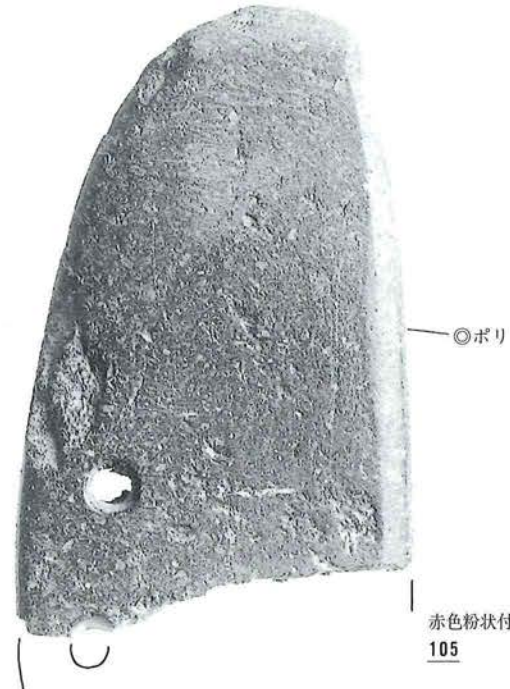

赤色粉状付
105

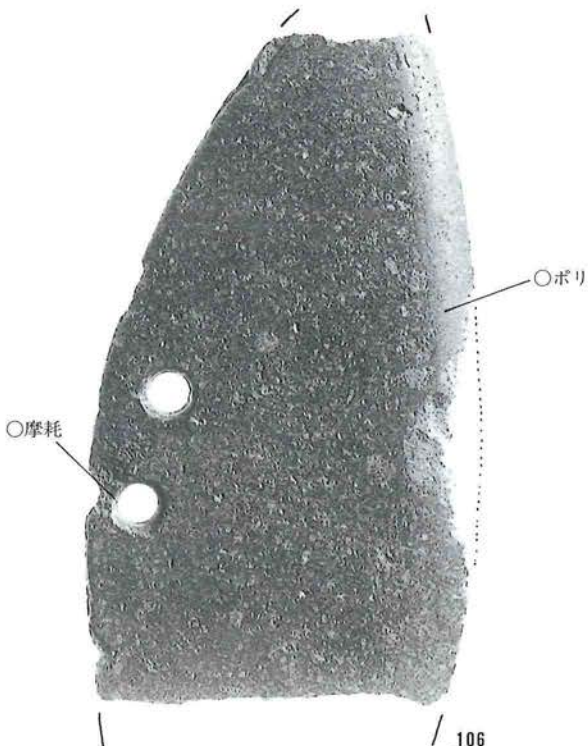

106

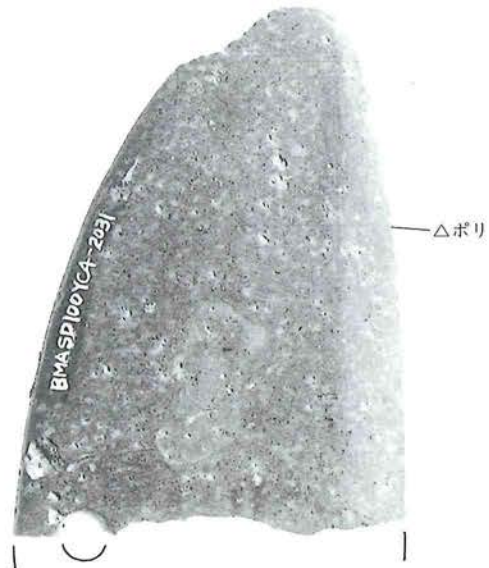

107

石器写真

SD100

- 111 太型蛤刃石斧
失敗品 E₂類
- 112 太型蛤刃石斧
失敗品 E₂類
- 113 太型蛤刃石斧 不明
- 114 太型蛤刃石斧 不明
- 115 太型蛤刃石斧
Ic'類
- 116 太型蛤刃石斧
Ib'類?
- 117 太型蛤刃石斧
Ia'類?
- 118 太型蛤刃石斧
Ia'類?
- 119 太型蛤刃石斧 不明
- 120 太型蛤刃石斧 不明
(2:3)

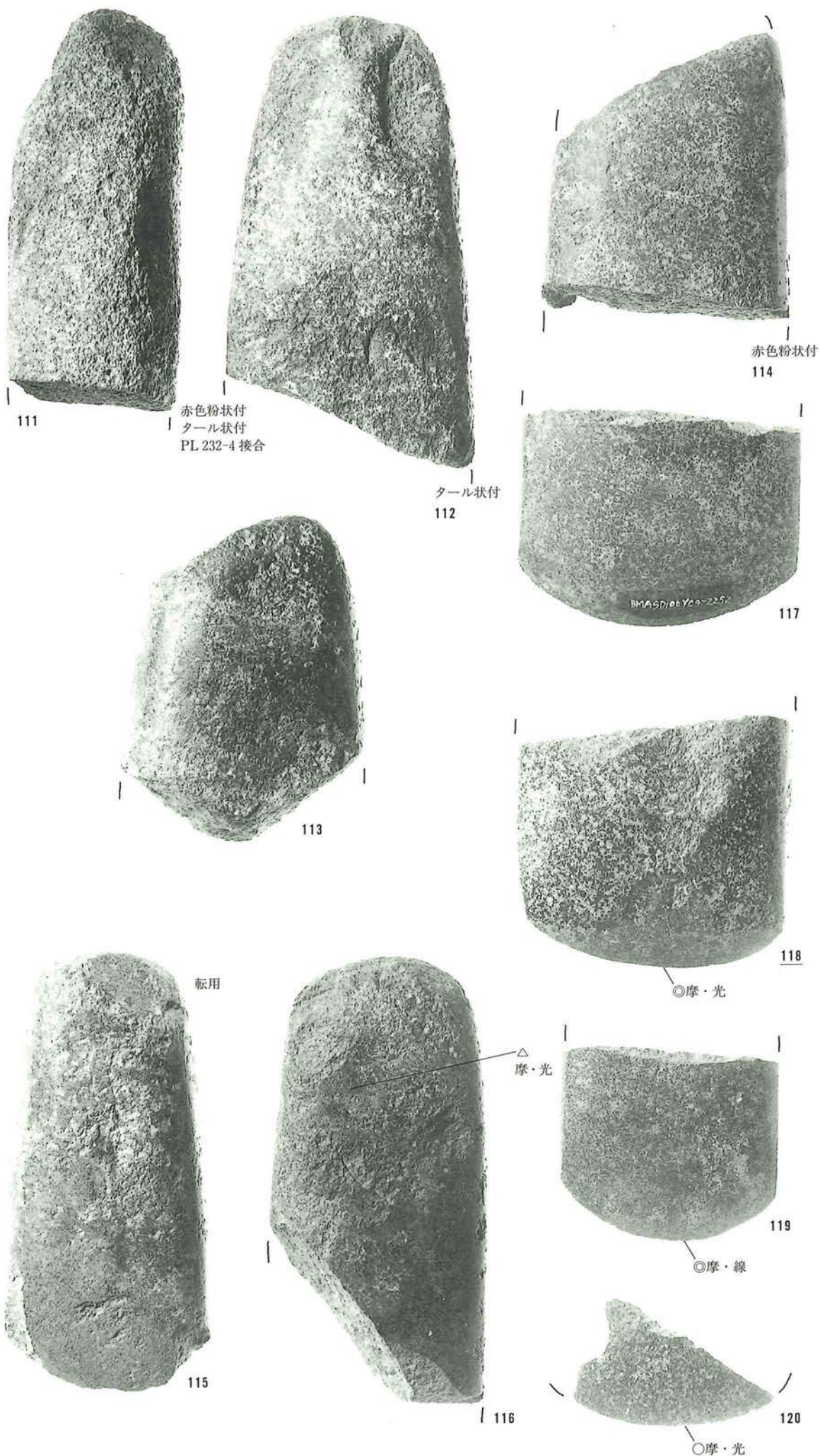

石器写真

SD100

- 121 扁平片刃石斧
失敗品 E₂類
- 122 扁平片刃石斧
失敗品 E₂類
- 123 扁平片刃石斧
失敗品 E₃類
- 124 扁平片刃石斧
IIc 類
- 125 扁平片刃石斧
IIb₁類?
- 126 扁平片刃石斧
IIa 類
- 127 扁平片刃石斧
IIb₁類?
- 128 石槌 蛤刃未転用
- 129 石槌 蛤刃転用
- 130 石槌 蛤刃転用
- 131 石槌 蛤刃転用
- 132 石槌 蛤刃転用
- 133 石槌 両刃石斧転用



125

○摩・線



126

○摩・線



127

○摩・光



121



122



123



124

再生



128

PL 128-79 接合



129



赤色粉状付

130



132



タール状付

133



赤色粉状付

131

(2 : 3)

石器写真

SD100

136 砥石 IIa 類

137 砥石 IIa 類

138 砥石 IIb 類

139 砥石 IIb 類

140 砥石 IIb 類

141 砥石 III 類

142 砥石 I2 類

143 砥石 I2 類

144 砥石 III 類

145 砥石 礫状

146 砥石 IIId 類

147 砥石 礫状

160 環状石器 失敗品

(2:3)



136



137



138



139



140



141



144



145



142



143



146



147

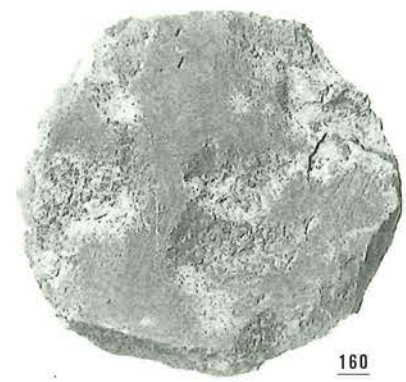

160

SD100

PL138-16

PL138-19

PL138-20

PL138-27

(2:3)

PL139-29

PL139-30

PL142-58

PL140-37

PL140-42

PL141-49

(1:2)

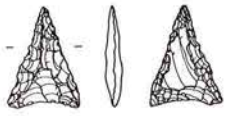

PL138-16

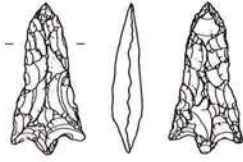

PL138-19

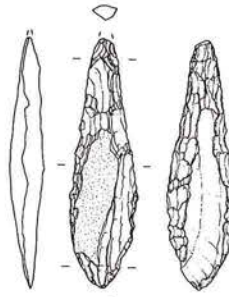

PL138-20

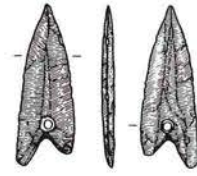

PL138-27

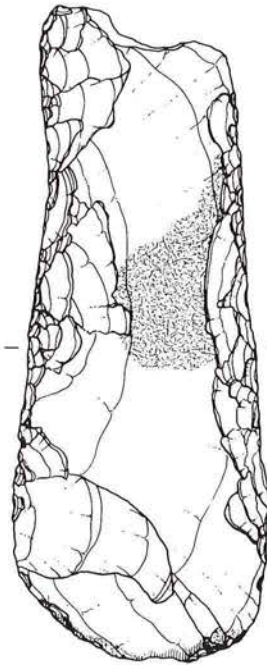
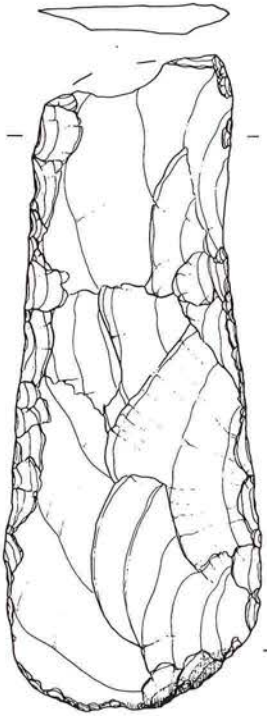

PL139-29

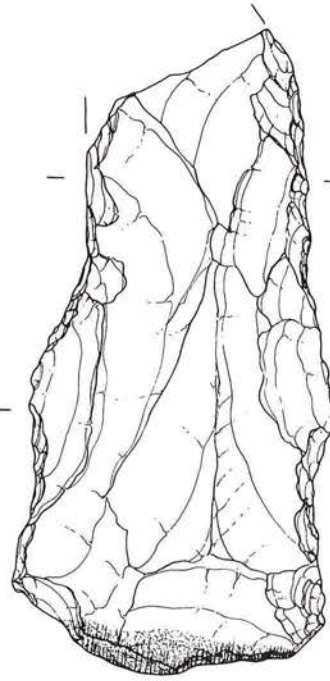

PL139-30

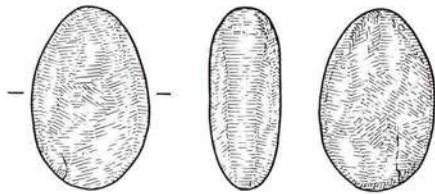

PL142-58

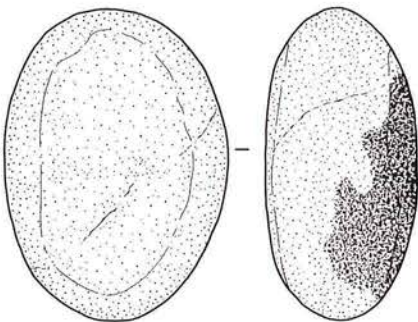
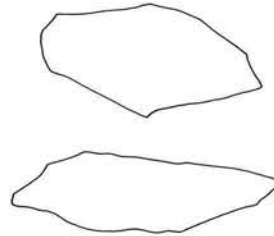

PL140-37

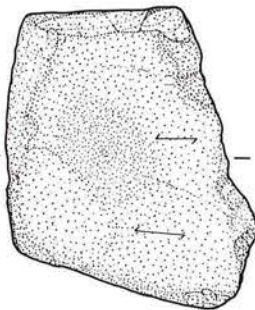

PL140-42

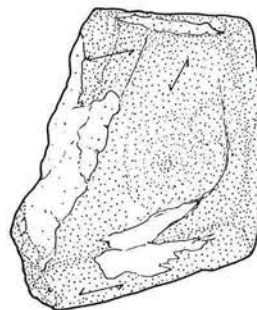

PL141-49

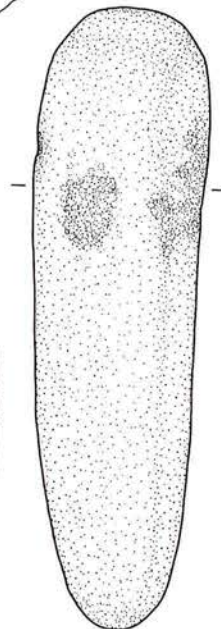

石器実測図

SD100

PL143-65

PL143-66

PL153-146

(1:2)

PL144-67

(1:3)

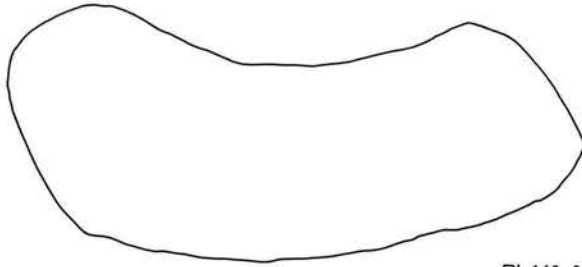
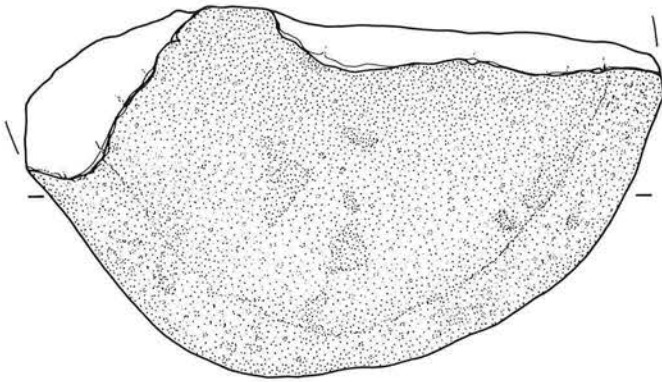

PL143-65

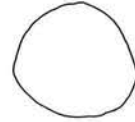
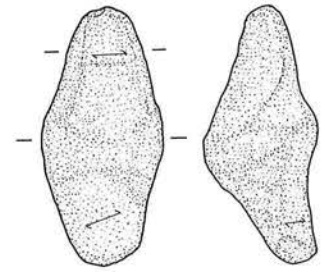

PL153-146

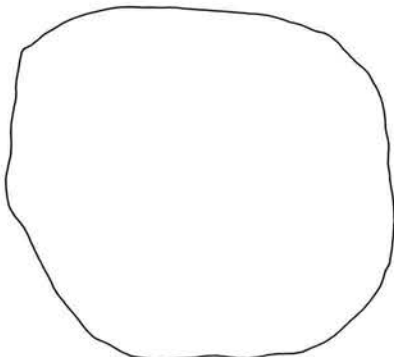
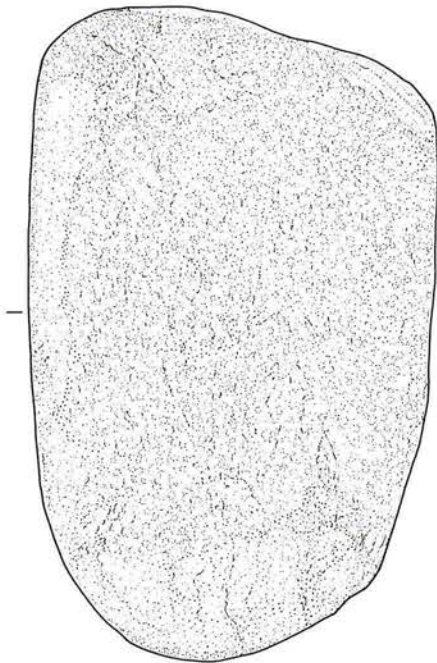

PL143-66

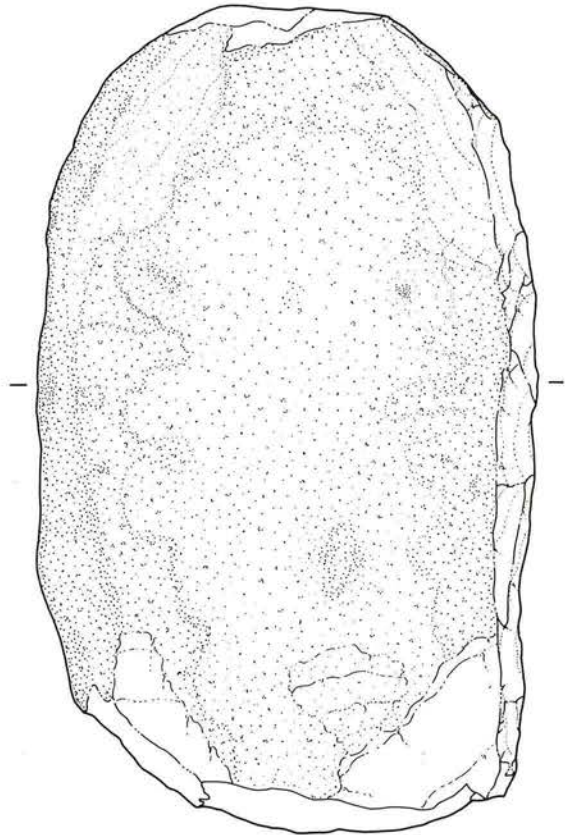

PL144-67

SD 100

PL 146-74

PL 146-78

PL 148-88

PL 148-93

(1:2)

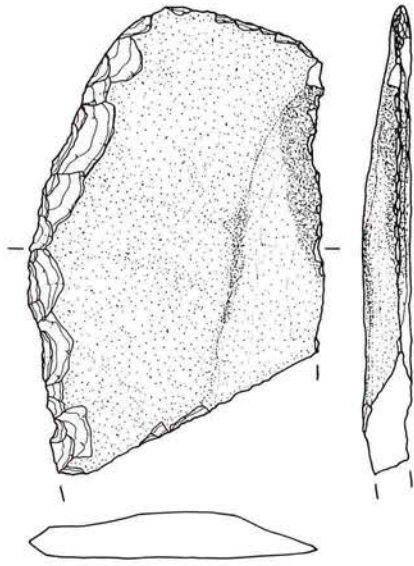

PL146-78

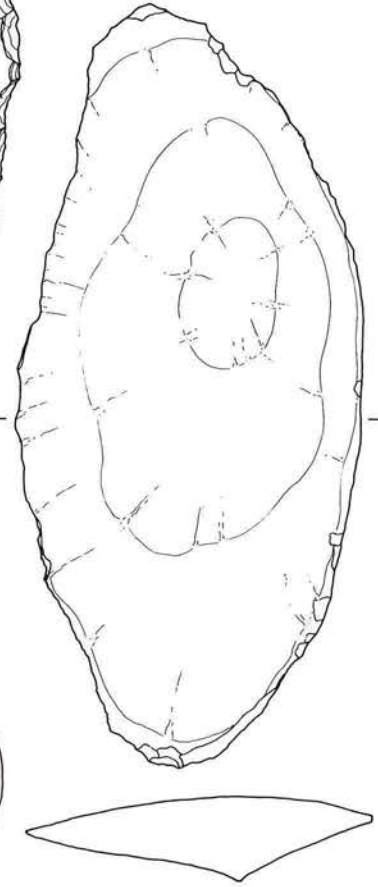
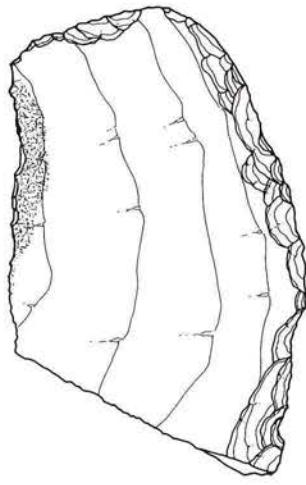

PL148-88

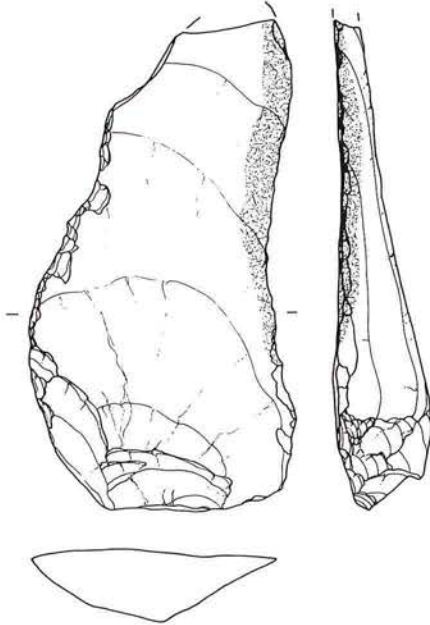

PL146-74

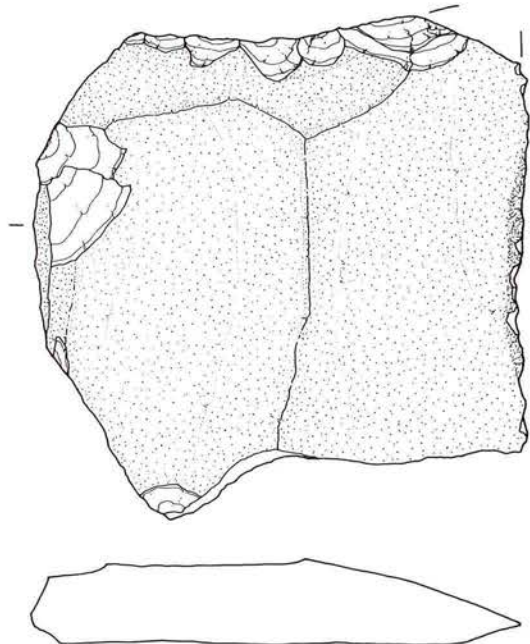
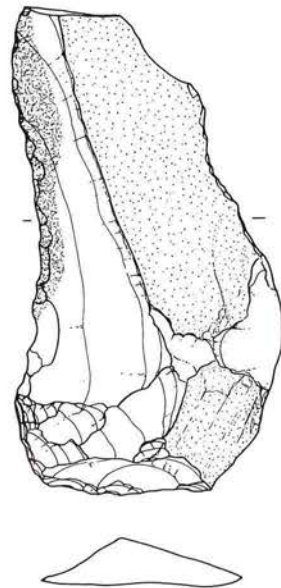

PL148-93

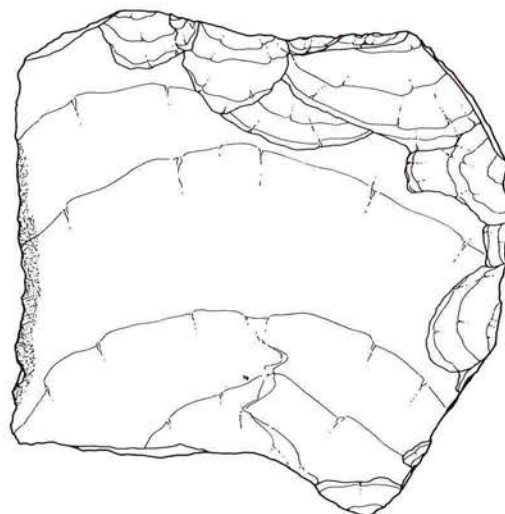
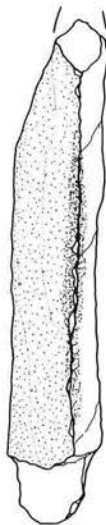

石器实测图

SD100

PL 149-101

PL 150-104

PL 150-105

PL 150-106

PL 150-107

(1:2)

PL 142-156

PL 142-157

PL 142-158

PL 142-159

(1:1)

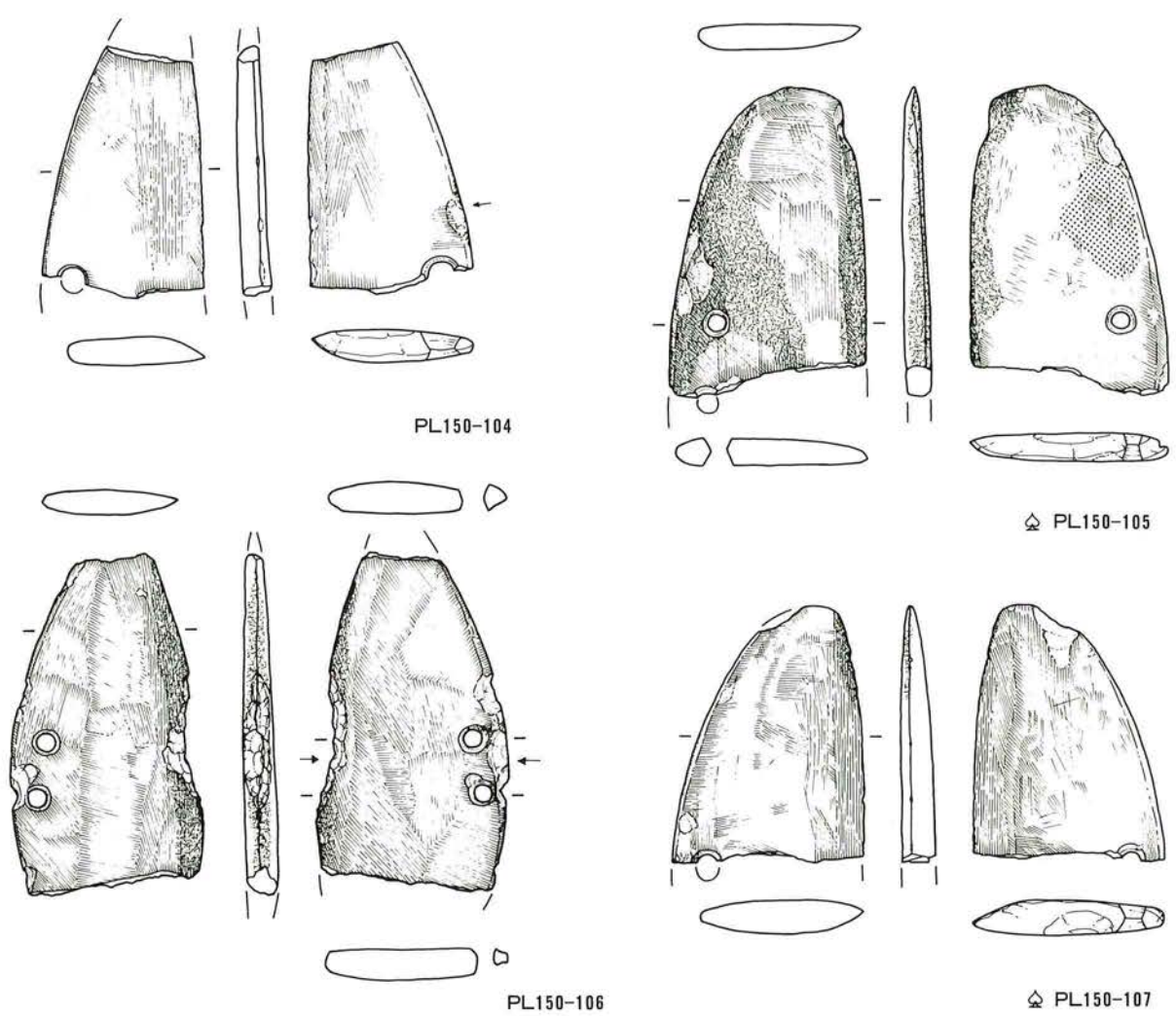
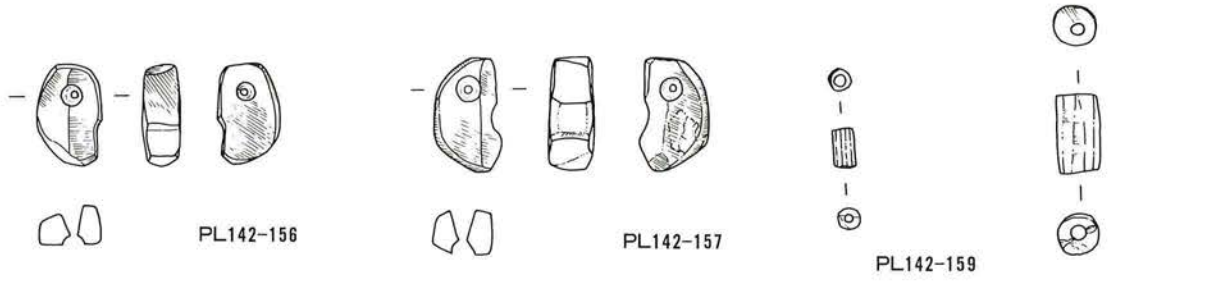
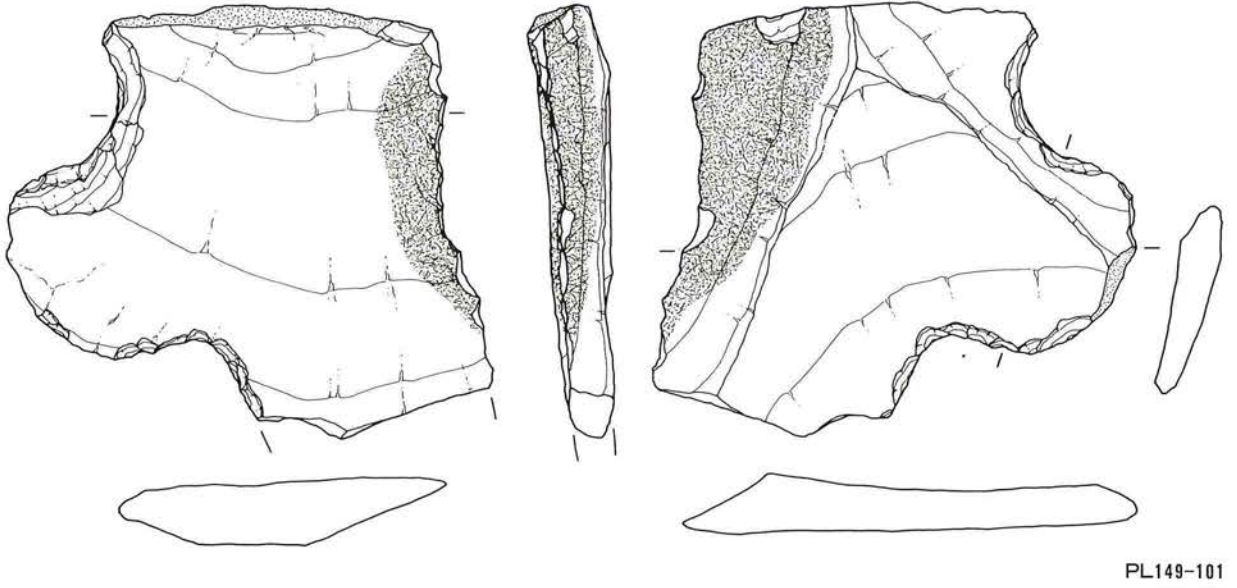

PL158

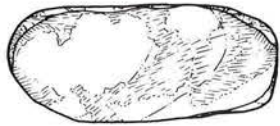
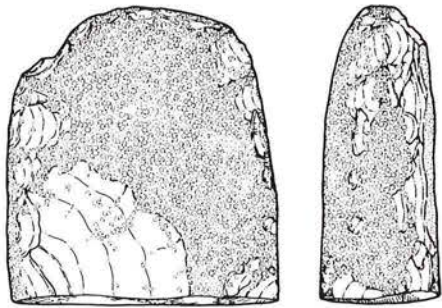

PL152-128

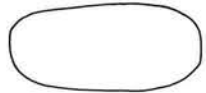
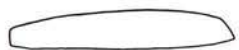
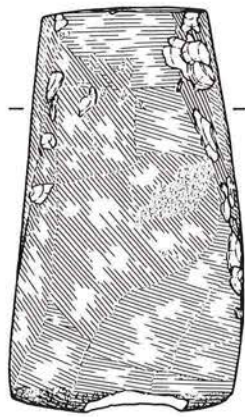
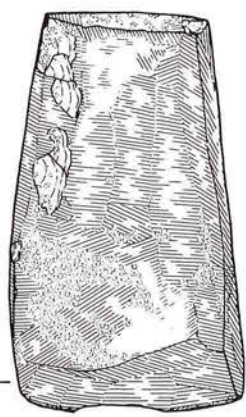

PL152-126

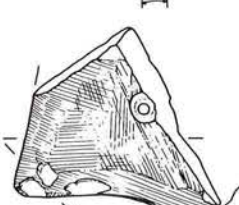
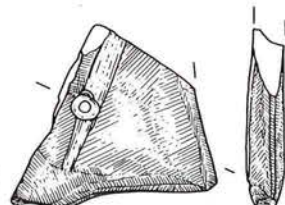
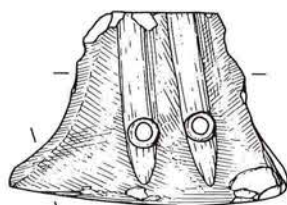
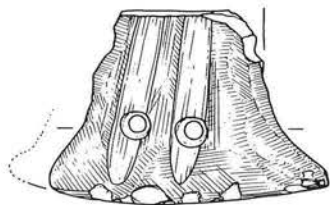

PL195-1



PL195-2

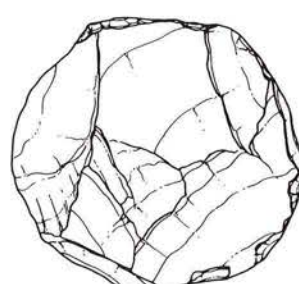
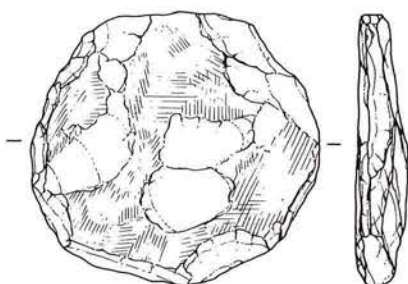

PL153-160

石器実測図

SD100

PL 152-123

(2:3)

PL 151-118

PL 152-126

PL 152-128

PL 153-160

PL 195- 1

PL 195- 2

(1:2)

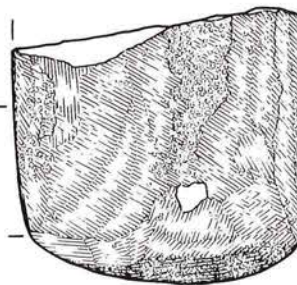

PL151-118

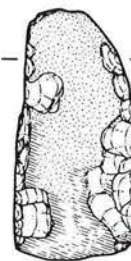
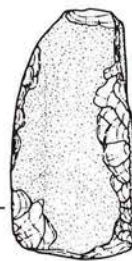

PL152-123

SD100

調査全景写真

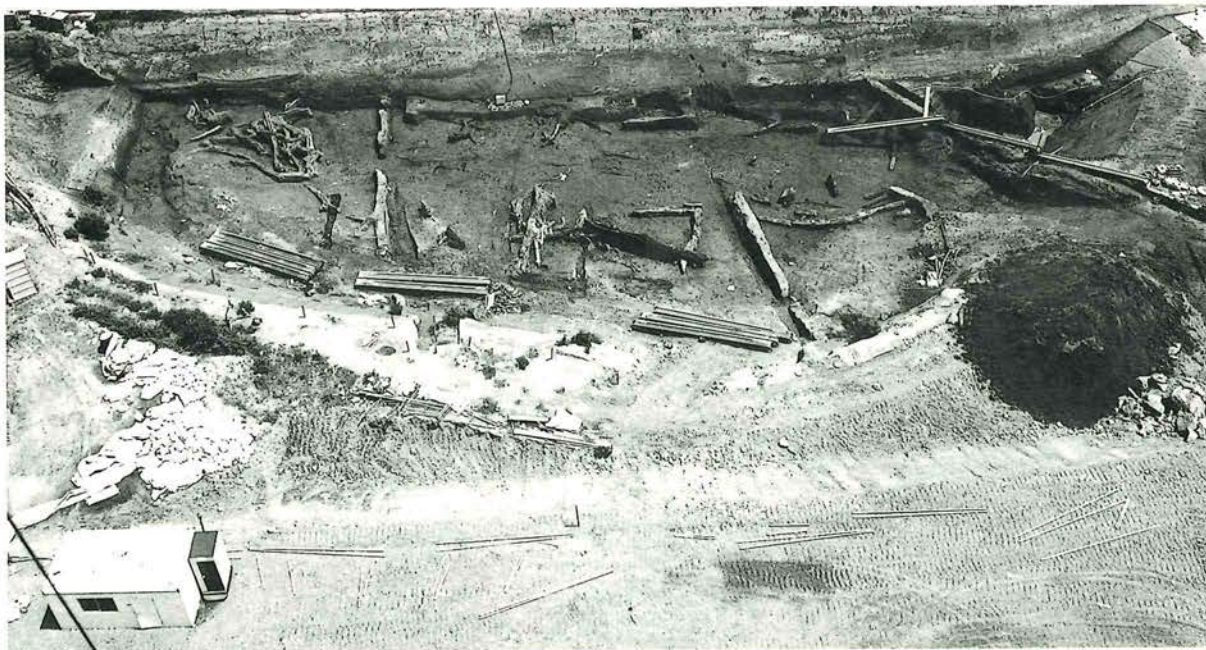

B 地点の調査全景

遺物出土状況写真



A 地点、木製品出土状況



B 地点、小型高杯状木製品No.1 の出土状況

牙製品実測図

PL 263-10 (1)

PL 263-11 (2)

(1:1)

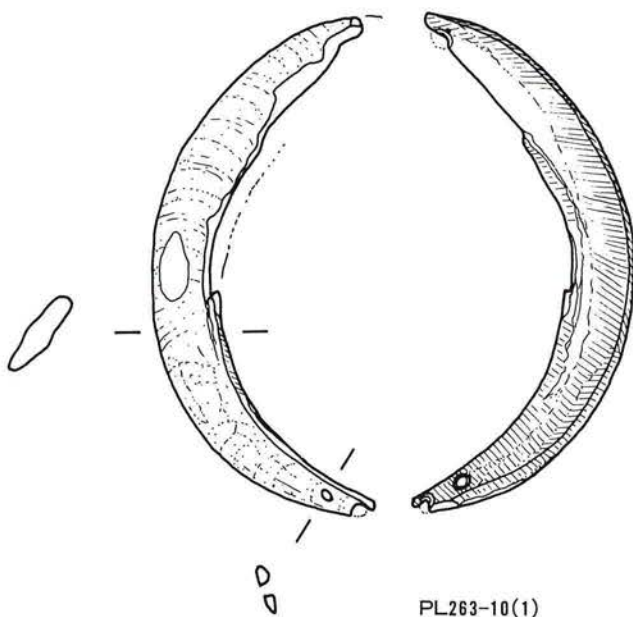

PL263-10(1)

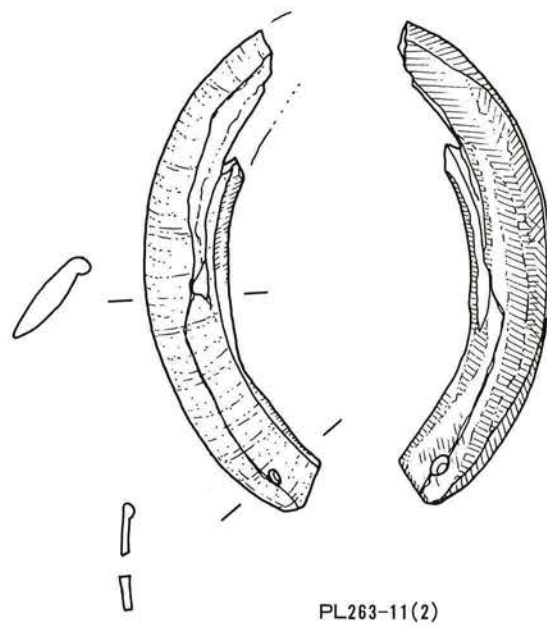

PL263-11(2)



小型高杯状木製品No.1 (復元補強前の状況)

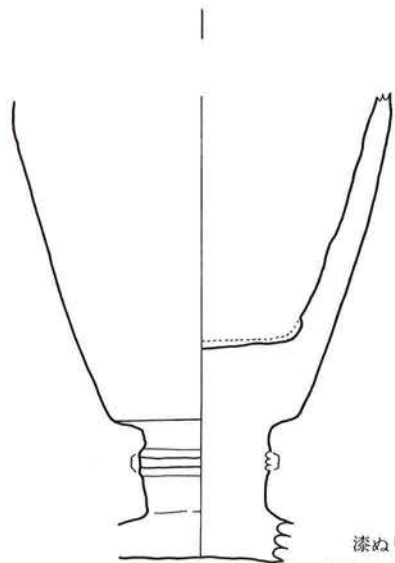
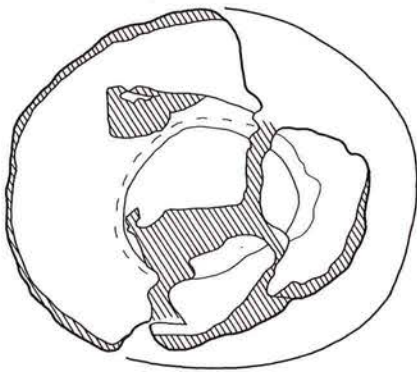

漆ぬり
PL160-1



小型高杯状木製品No.1 (補強後)

木製品実測図

SD100

柄形状木製品

PL 265-5 (1)

(1:4)

杭材

PL 266-14 (2)

PL 266-15 (3)

PL 267-19 (4)

PL 266-16 (5)

(1:8)

板材

PL 265-8 (6)

(1:6)

PL 265-9 (7)

PL 265-10 (8)

PL 161-9

PL 265-7 (10)

(1:8)

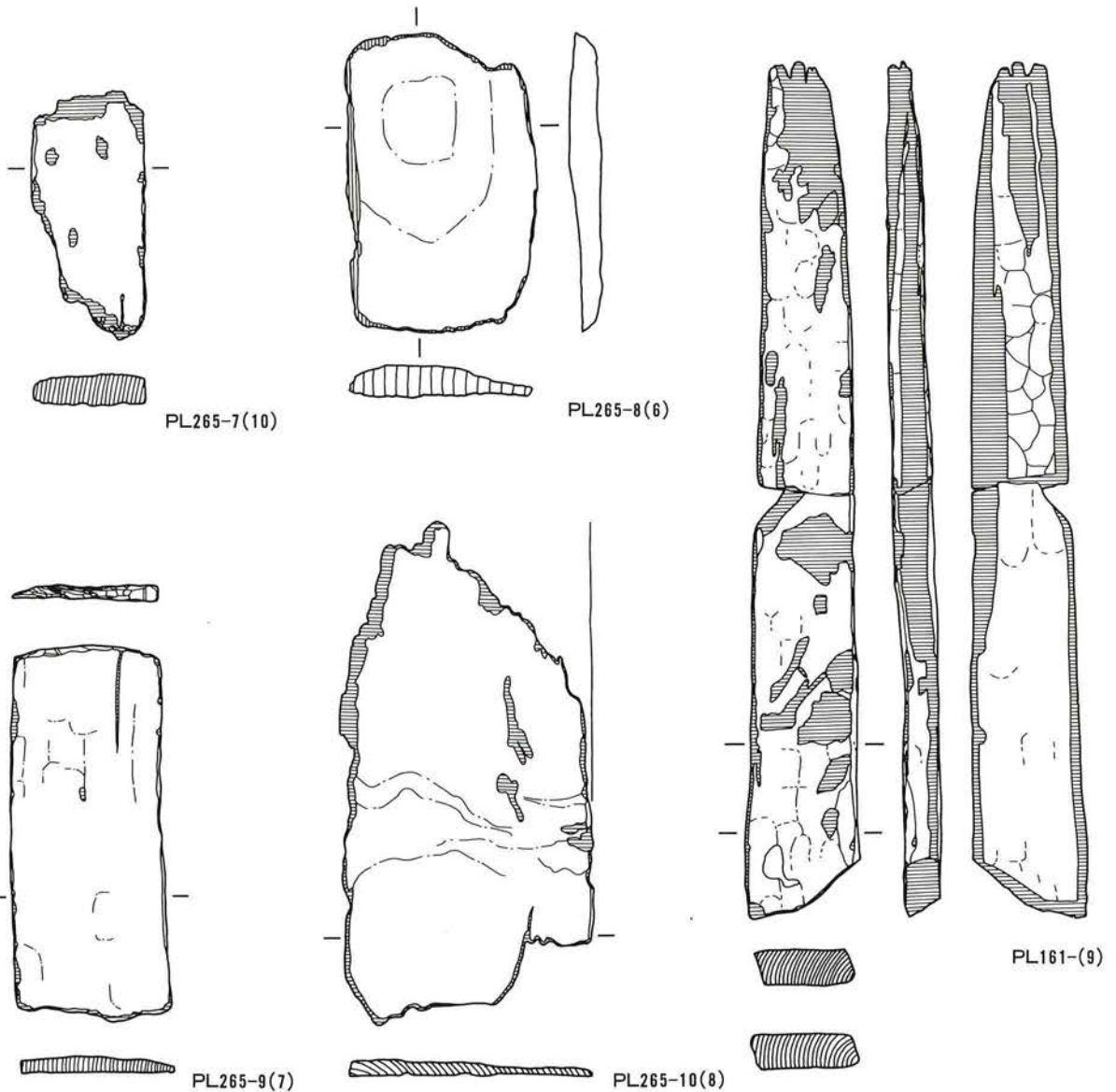
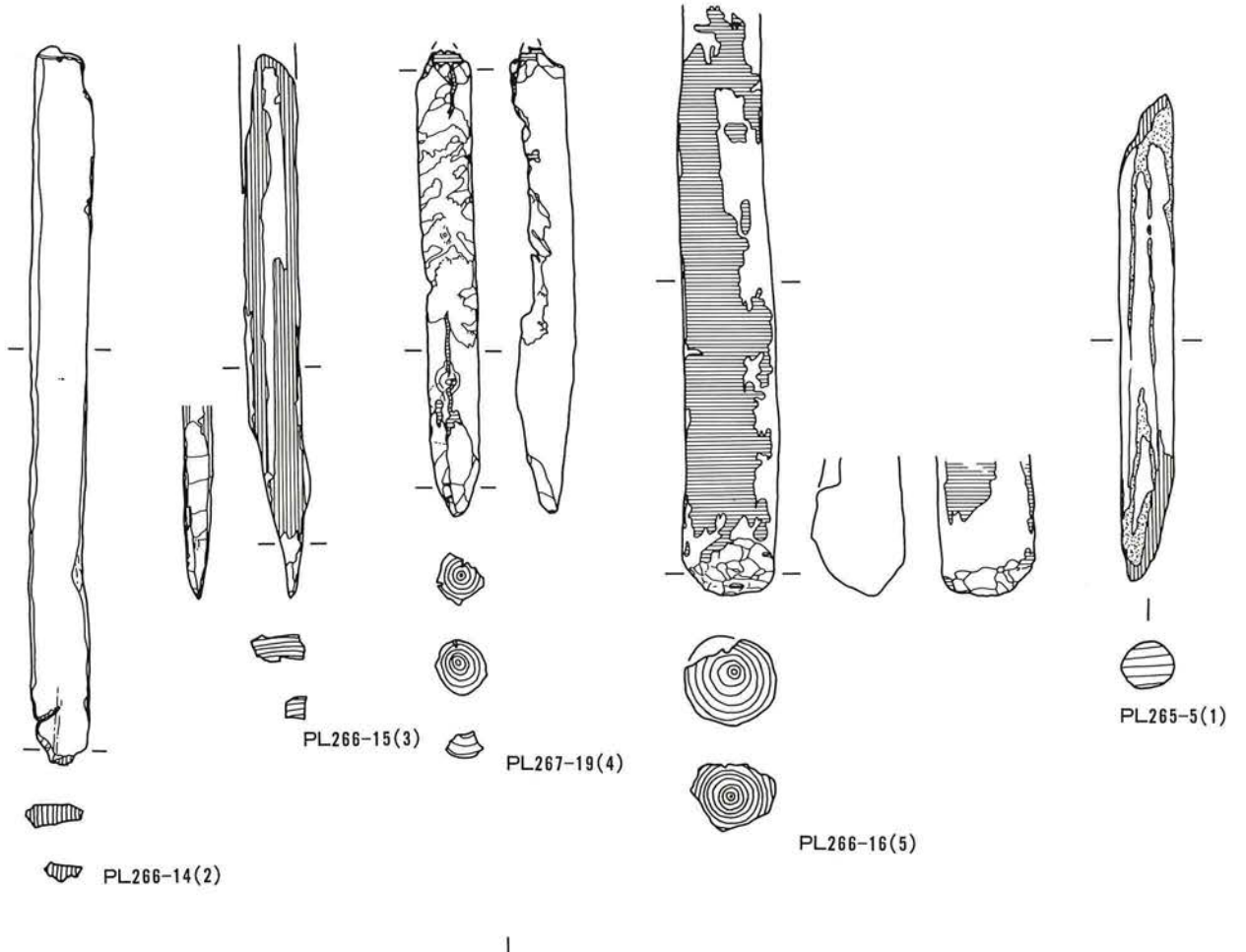

石器写真

SD101

- 1 大形石核III類
- 2 大形石核III類
- 3 小形石核IIA類
- 4 小形石核IIA類
- 5 剥片A類IV
- 6 剥片A類IV
- 13 凹石IIa類?
- 14 敲石ア類
- 15 敲石ア・エ類
- 16 みがき石IIe類
- 17 みがき石IIIId類
- 18 玉石IIe類
- 19 玉石IIIf類
- 20 玉石IIIle類?

(2:3)



1



2



3



4



5



6



16



17



18



19



20



14



13



15

石器写真

SD101

- 7 打製石鏃IIB₃類
- 8 打製石鏃IIB₃類?
- 9 磨製石鏃
失敗品1類
- 10 磨製石鏃IB₁類
- 11 打製石斧 不明
- 12 打製石斧 不明
- 40 磨製石包丁
失敗品B類?
- 41 磨製石包丁
失敗品E₁類
- 42 磨製石包丁 杏仁形
- 43 磨製石包丁 杏仁形
- 44 磨製石包丁 杏仁形
- 45 磨製石包丁 不明
- 46 石匙 縦位
- 47 小形刃器2c類
- 48 小形刃器6a類
- 49 小形刃器6b類
- 50 小形刃器6c類
- 57 石錐3類
(2:3)
- 62 管 玉
- 63 管 玉
(1:1)

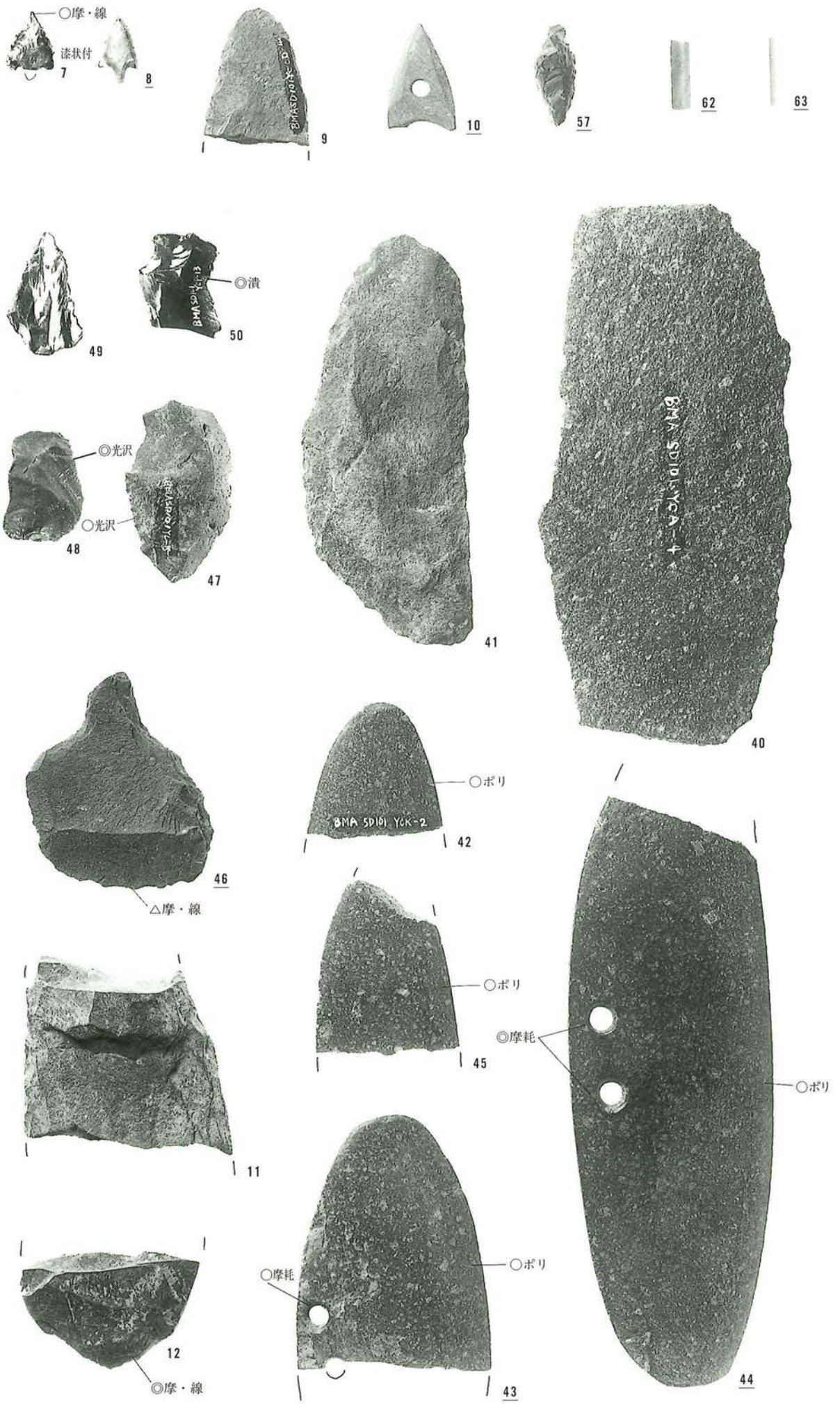

石器写真

SD101

- 22 大形刃器 1b 類
- 23 大形刃器 1b 類
- 26 大形刃器 2b 類
- 29 大形刃器 2c 類
- 30 大形刃器 2c 類
- 31 大形刃器 2c 円盤
- 32 大形刃器 3 類
- 33 大形刃器 3 類
- 34 大形刃器 3 類
- 35 大形刃器 3 類
- 36 大形刃器 7 類
- 37 大形刃器 7 類

(2:3)

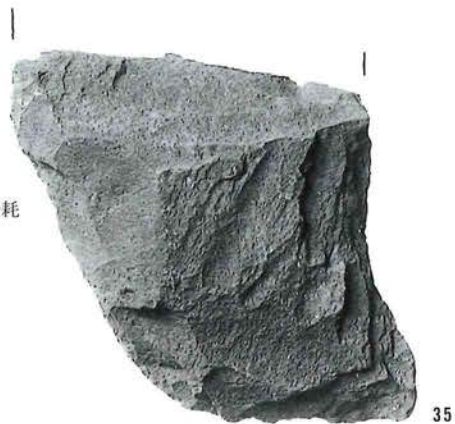
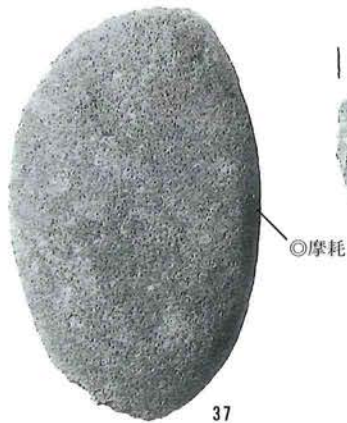
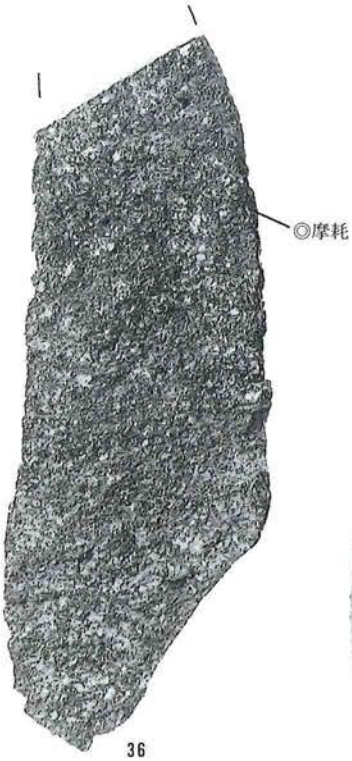
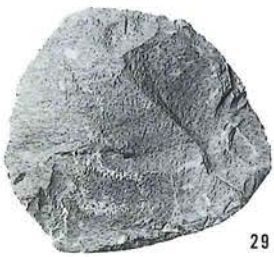
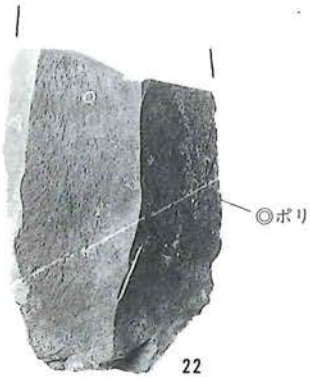

石器写真

SD101

24 大形刃器 1b 類

25 大形刃器 2a 類

27 大形刃器 2b 類

28 大形刃器 2b 類

38 大形刃器 8 類

39 大形刃器 2b 類

(1:2)

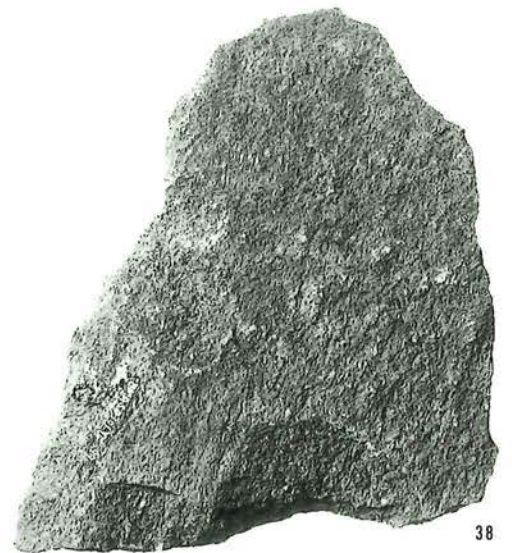
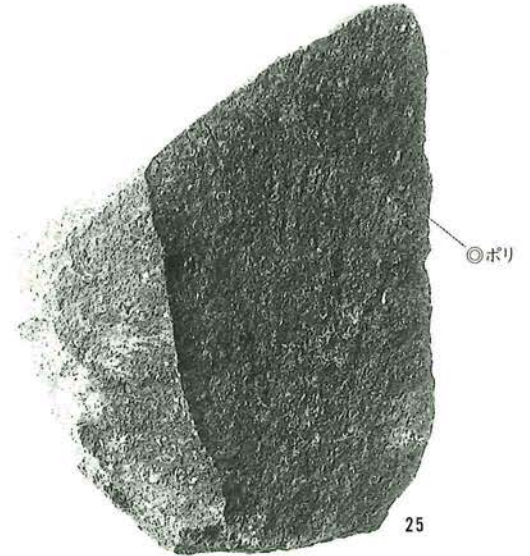
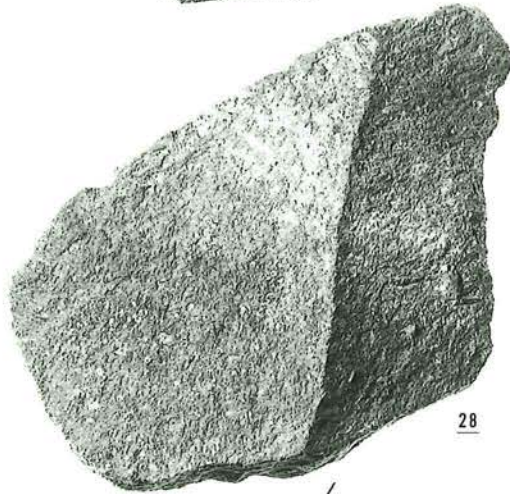
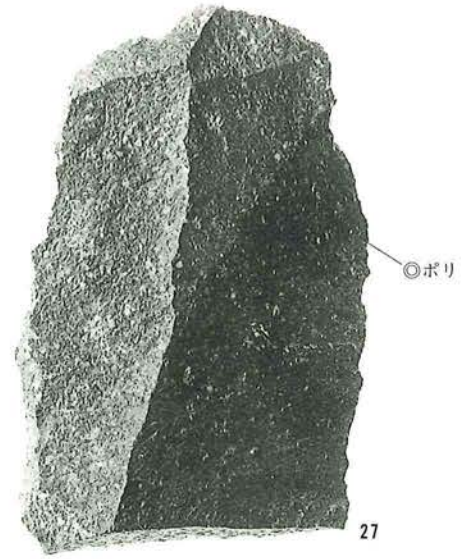
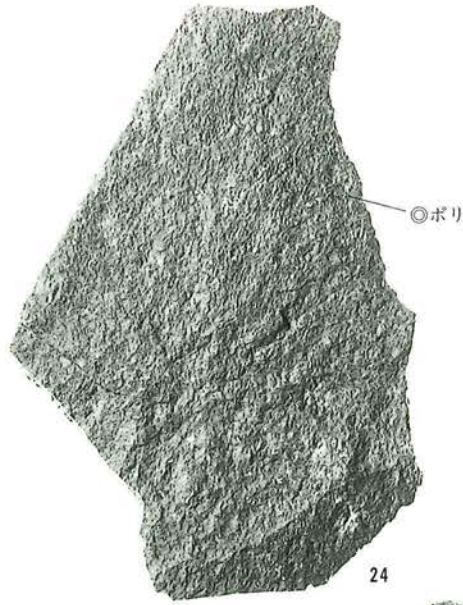

石器写真

SD101

21 台石 I 種 A₂類

51 扁平片刃石斧
失敗品 B類

52 扁平片刃石斧
失敗品 D類

53 扁平片刃石斧
失敗品 E₂類

54 石槌

55 石槌 蛤刃転用

56 石槌 蛤刃転用

58 砥石 III 類

59 砥石 I 2 類

60 軽石製品

61 軽石製品

(2:3)

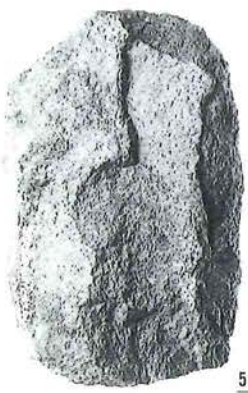

51



52



53



54



55



56



58



59



61



21



60

石器实测图

SD101

PL 163-8

PL 163-10

PL 163-57

PL 163-46

(2:3)

PL 164-26

PL 164-32

PL 164-33

PL 164-34

PL 163-43

PL 163-44

(1:2)

PL167

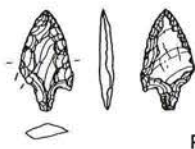

PL163-8

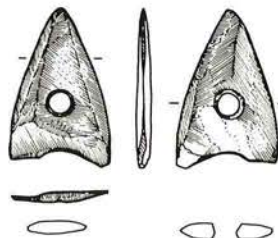

PL163-10

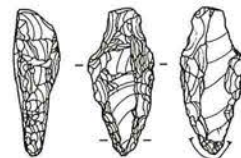

PL163-57

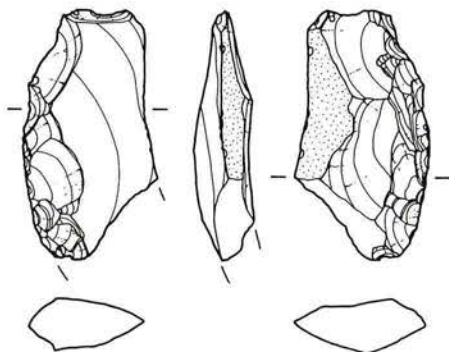

PL164-26

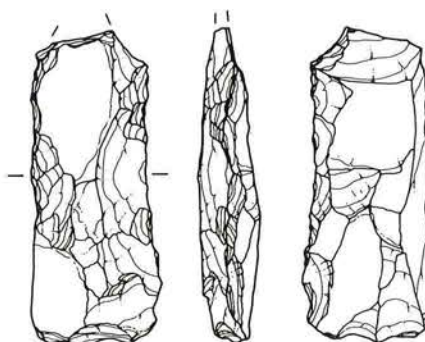

PL164-32

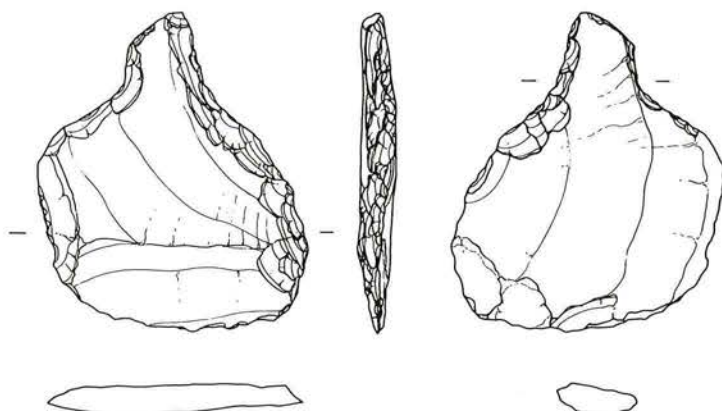

PL163-46

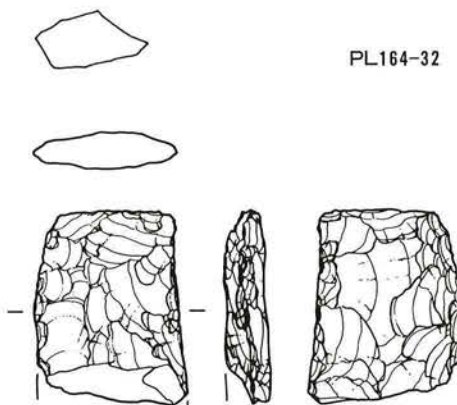

PL164-33

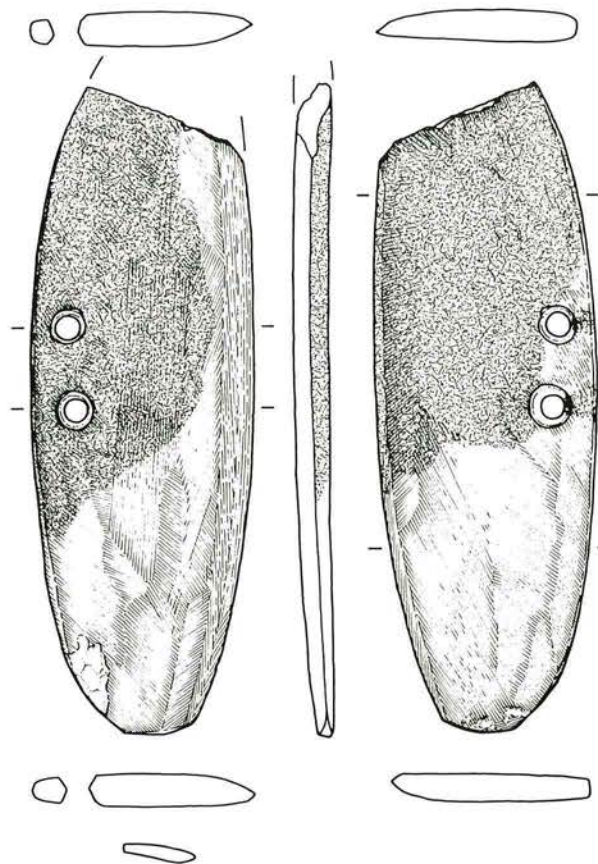

PL163-44

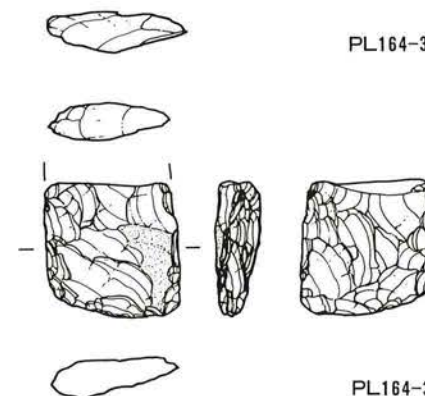

PL164-34

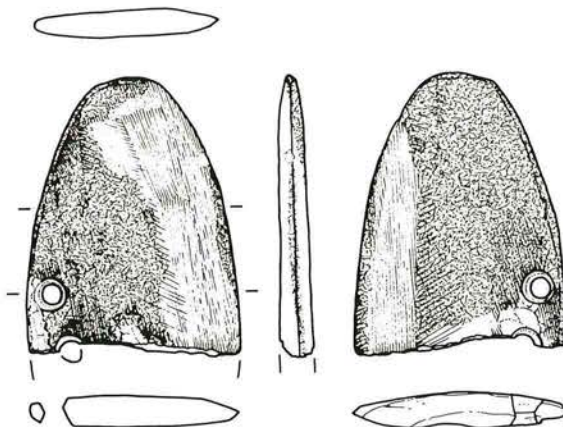

PL163-43

PL168

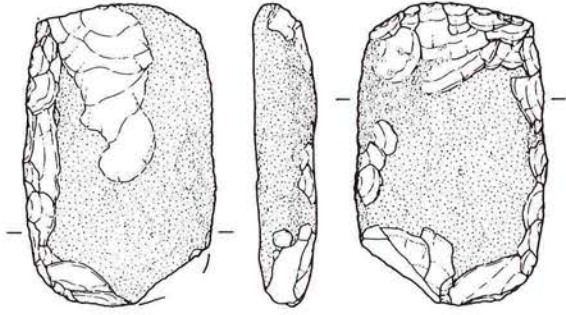

PL163-62



PL163-63

石器实测图

SD101

PL 166-28

PL 165-39

PL 166-51

PL 166-52

(1:2)

PL 163-62

PL 163-63

(1:1)

PL166-51

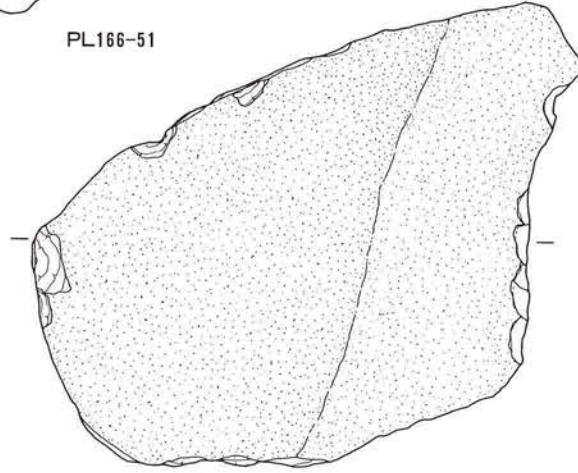

PL165-28

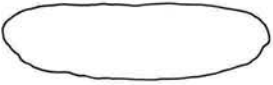

PL166-52

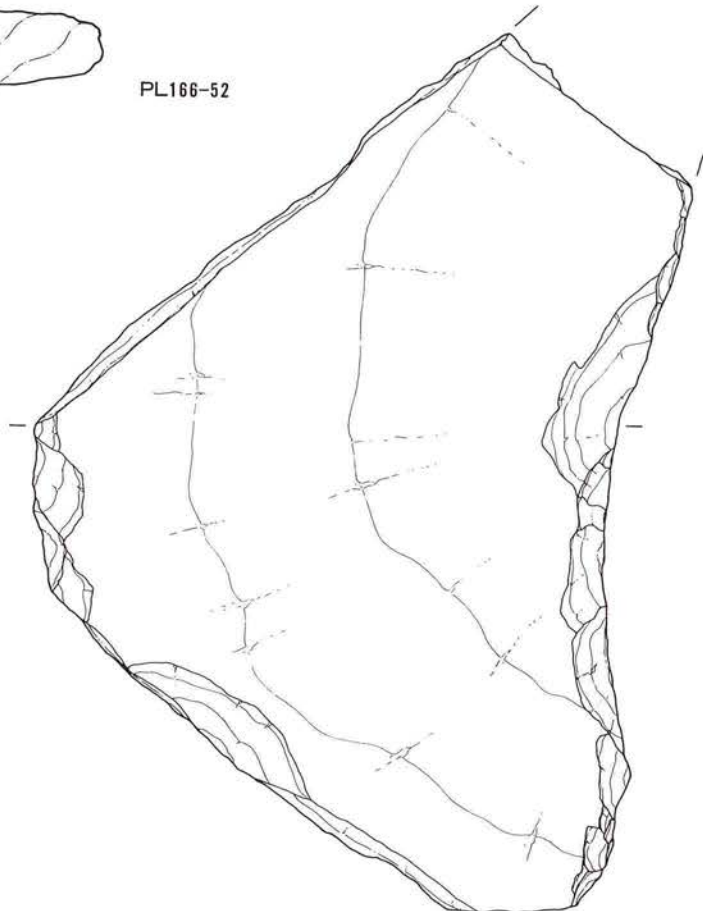
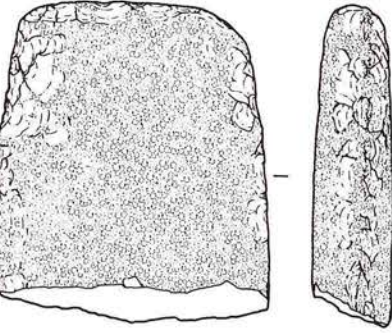

PL165-39

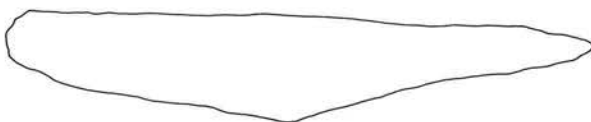

木製品実測図

SD101

杭材

PL 267-20 (1)

PL 267-21 (2)

PL 267-22 (3)

PL 266-17 (4)

PL 266-18 (6)

(1:8)

PL 267-23 (5)

(1:12)

加工材

PL 266-13 (7)

(1:12)

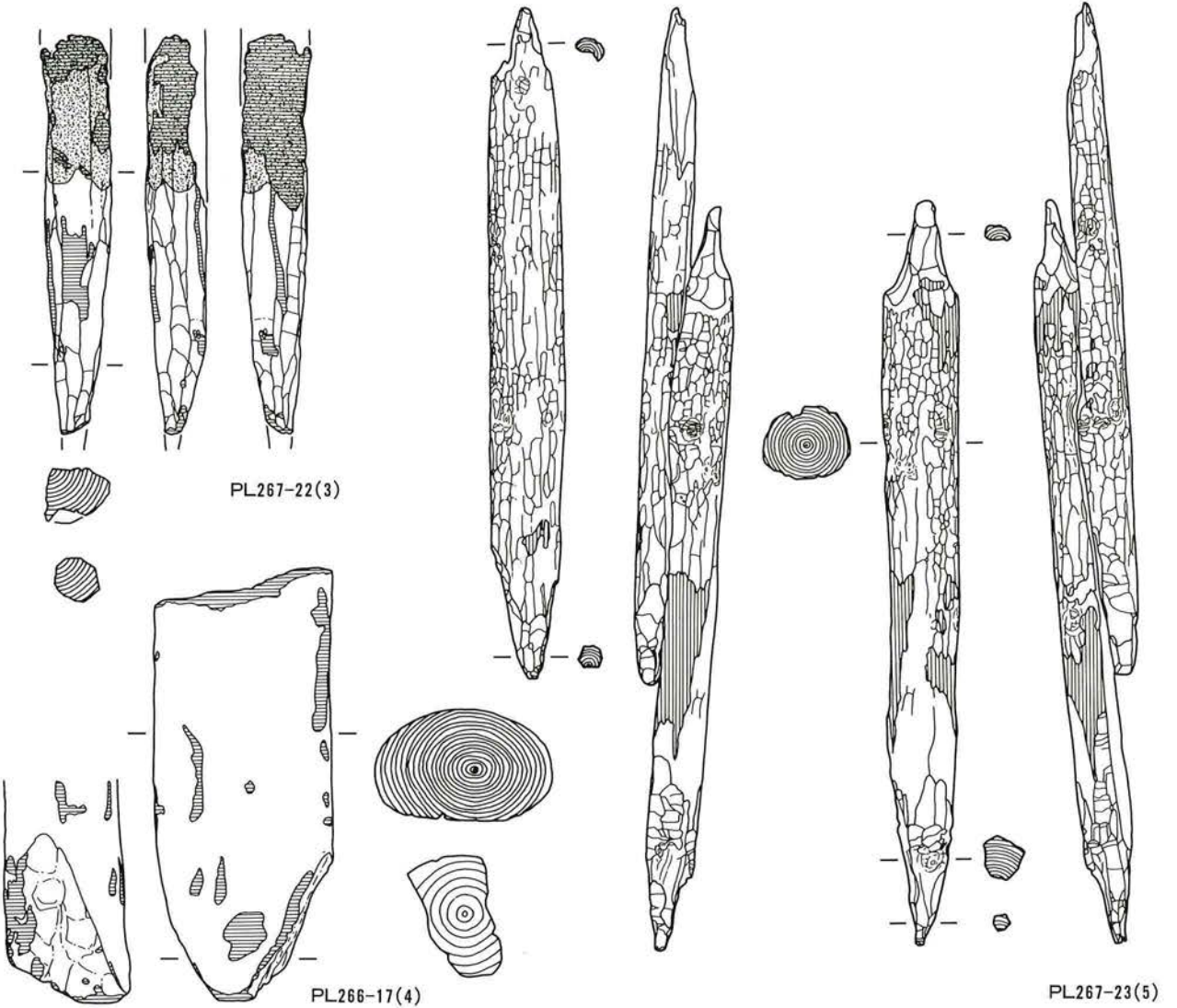
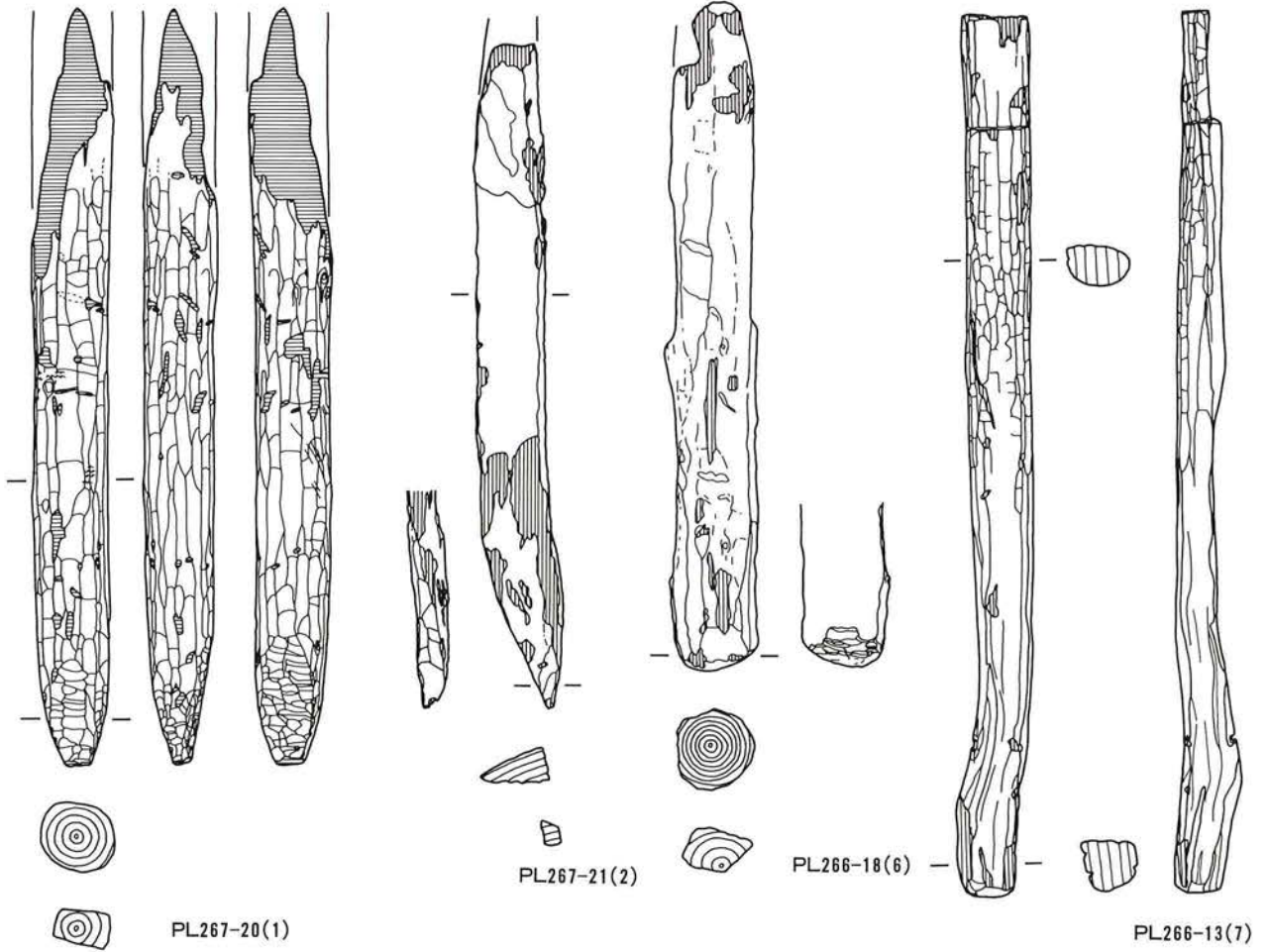

石器写真

SD102

- 1 大形石核 I2A 類
- 2 大形石核 II2A 類
- 3 小形石核 II1 類
- 4 小形石核 II1A 類
- 7 敲石ア・エ類
- 8 敲石オ類
- 9 敲石ウ類
- 10 みがき石 I1c 類
- 11 みがき石 I2d 類
- 20 大型蛤刃石斧
Ib'類?
- 21 扁平片刃石斧
失敗品 E₃類
- 22 石槌 敲石転用
(2:3)



1

2

3

4

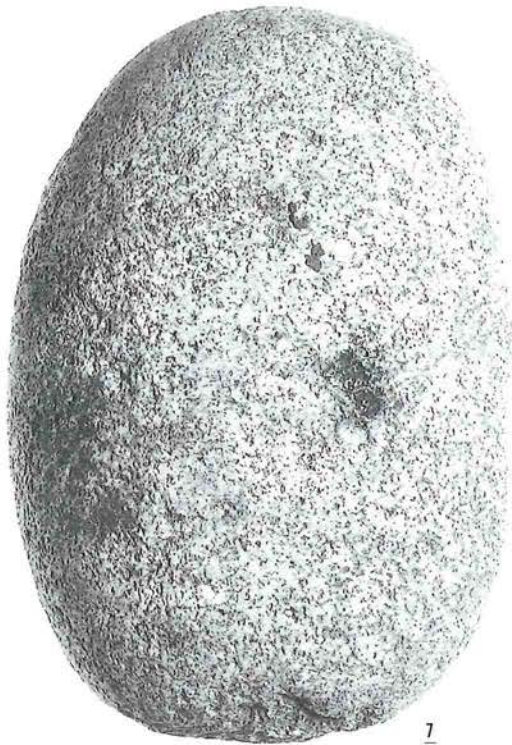

7



8



9



10



赤色粉状付
11



赤色粉状付
20

○摩・光



22

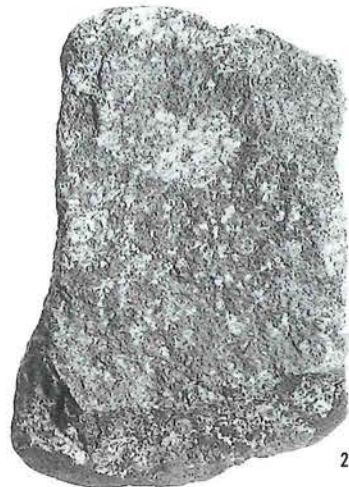

21

石器写真

SD102

5 打製石鏃IIB₃類?

6 打製石鏃IIB₁類

(2:3)

12 大形刃器2a類

13 大形刃器2a類

14 大形刃器2b類

15 大形刃器2b類

16 大形刃器2b類

(1:2)

17 磨製石包丁 半月形

18 磨製石包丁 杏仁形

19 磨製石包丁 杏仁形

(2:3)

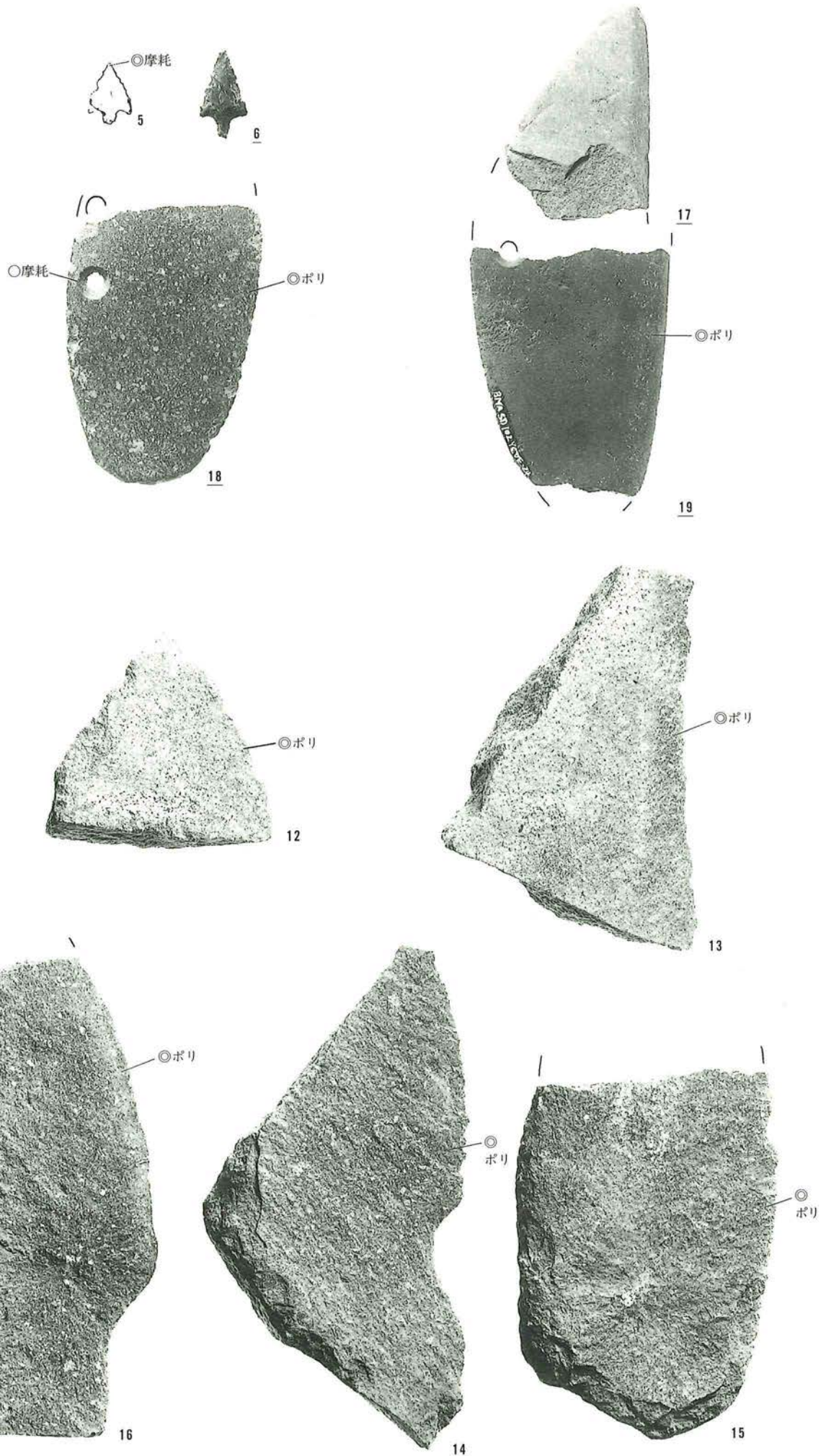

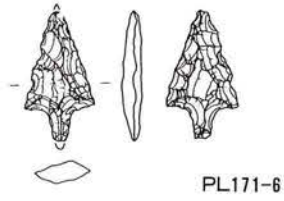

PL171-6

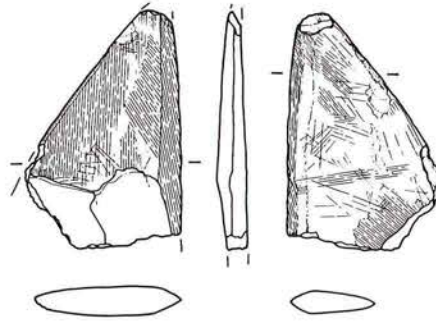

PL171-17

SD102

PL171-6
(2:3)

PL171-14

PL171-17

PL171-18

PL171-19

(1:2)

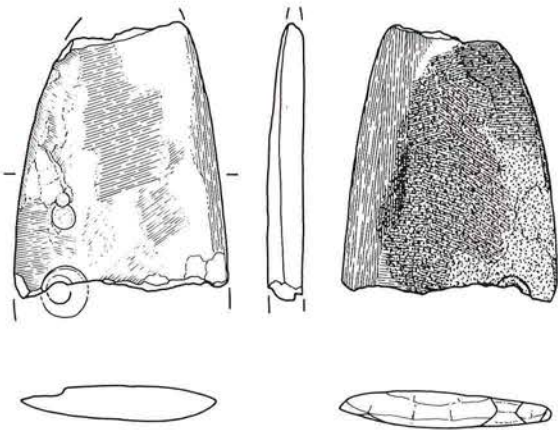

PL171-19

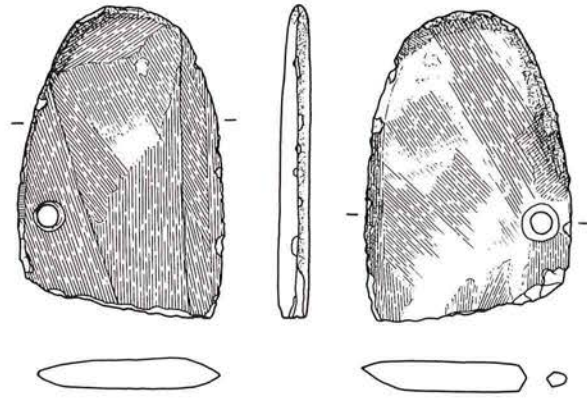

PL171-18

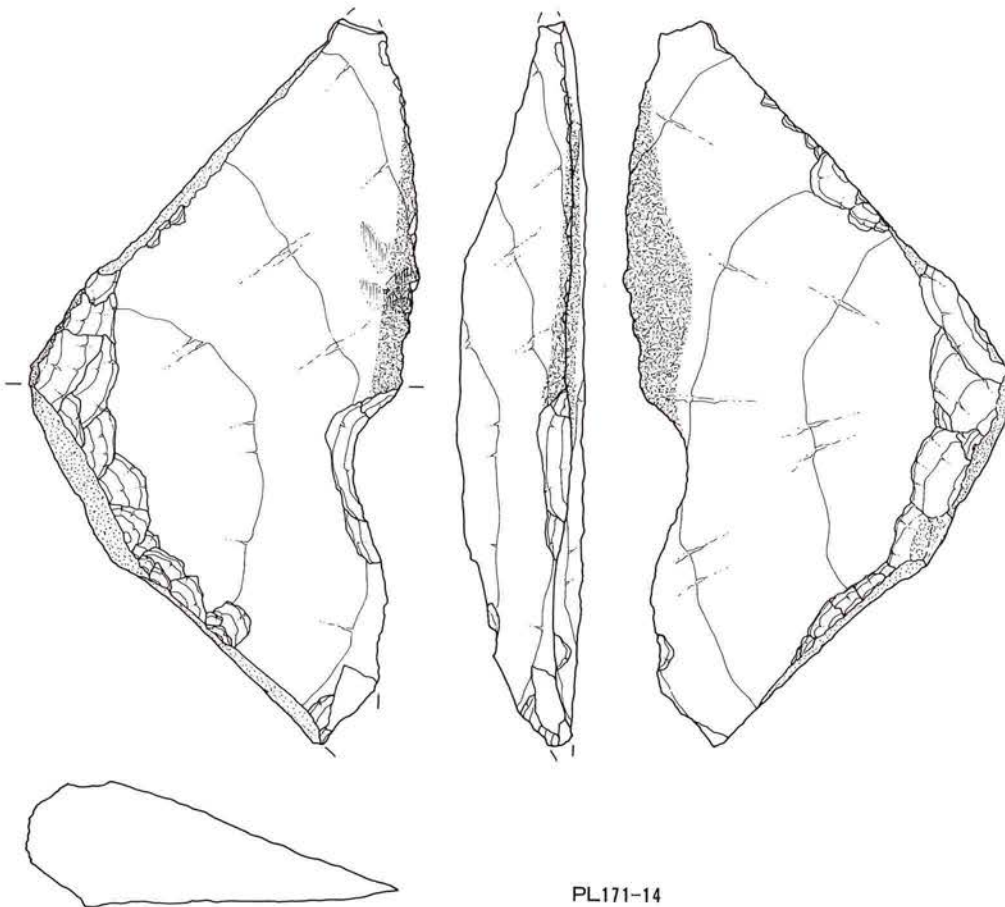

PL171-14

石器实测图

SD102

PL170-7

PL170-8

PL170-9

PL170-10

PL170-20

PL170-22

(1:2)

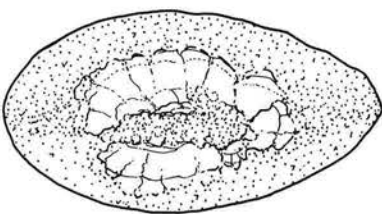
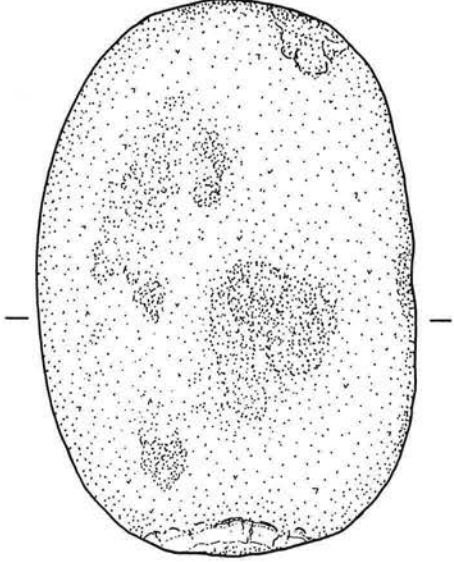
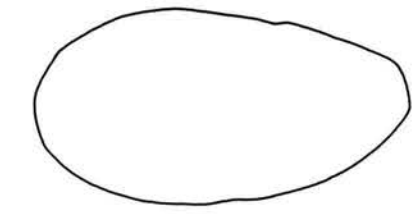

PL170-7

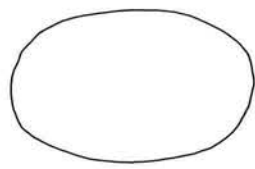
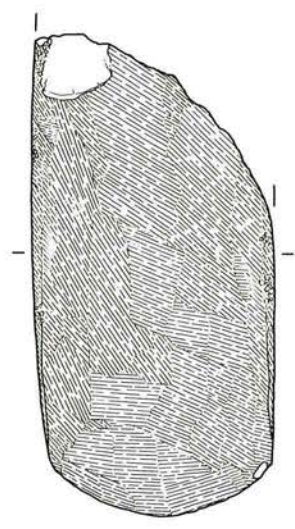

PL170-20

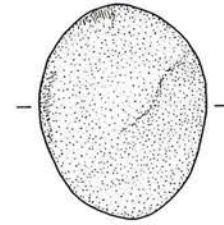

PL170-10

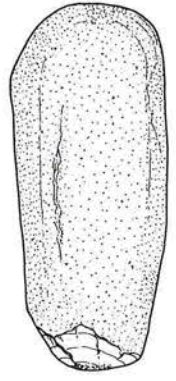
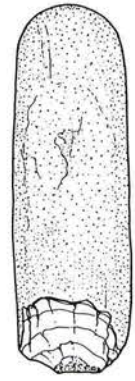

PL170-8

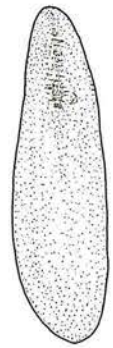
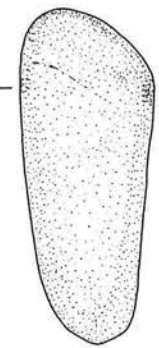

PL170-9

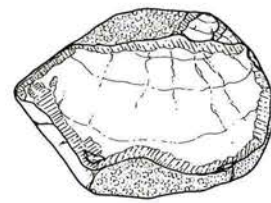
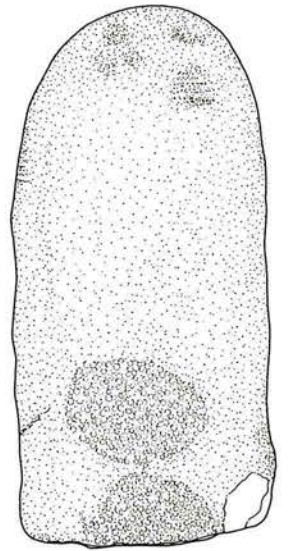
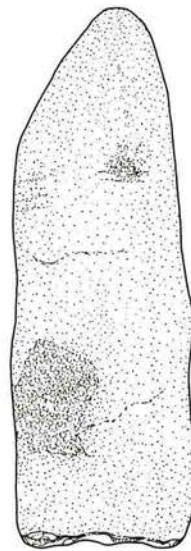
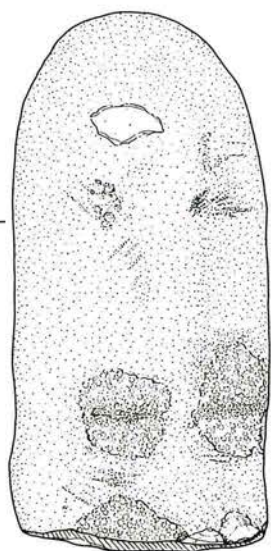

PL170-22

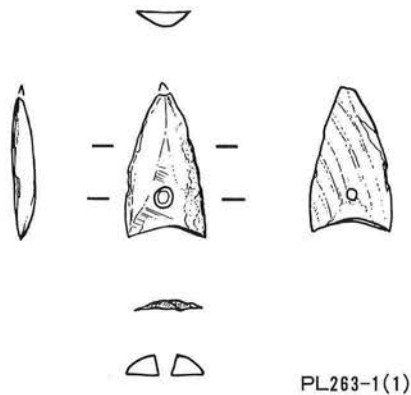

PL263-1(1)

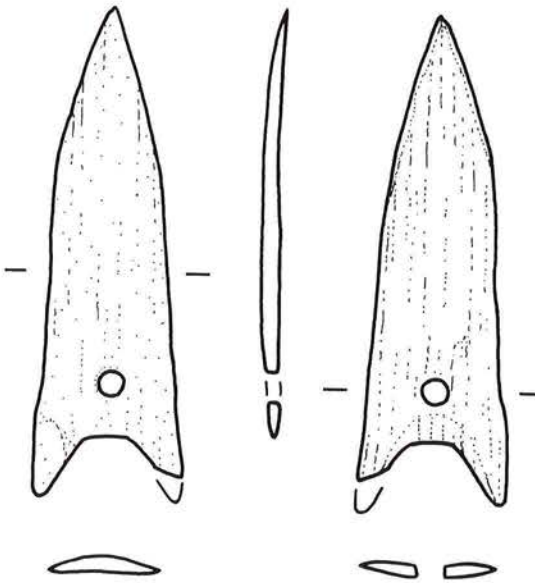

PL263-2(2)

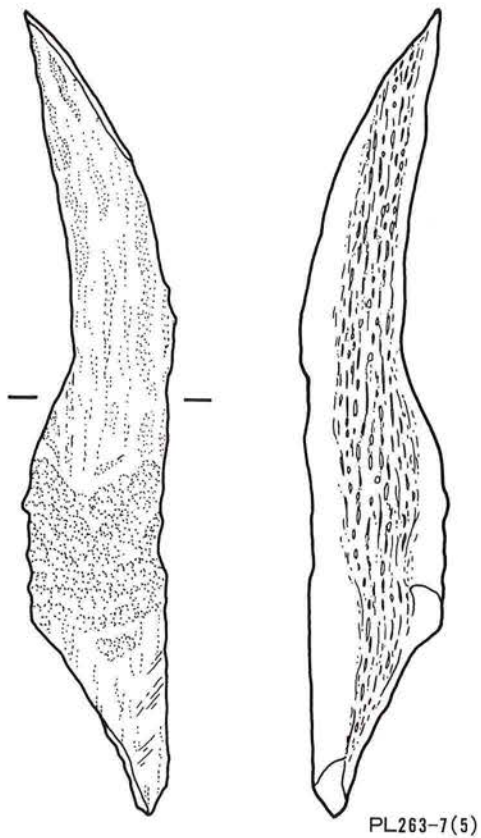

PL263-7(5)

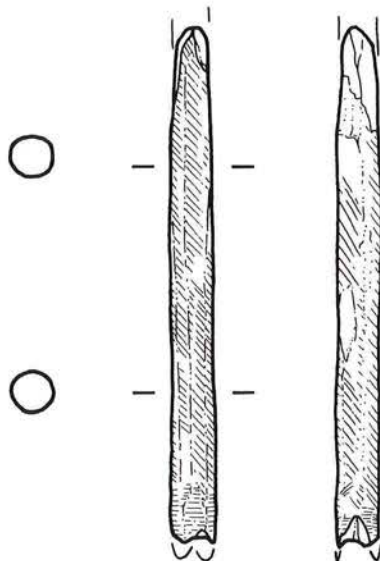

PL263-4(3)

遺物出土状況写真

骨角牙製品実測図

S D 102

牙鏃

PL 263- 1 (1)

骨鏃

PL 263- 2 (2)

矢柄状骨製品

PL 263- 4 (3)

牙製腕輪

PL 263-12 (4)

角製品

PL 263- 7 (5)

(1 : 1)



牙製腕輪No(4)の出土状況

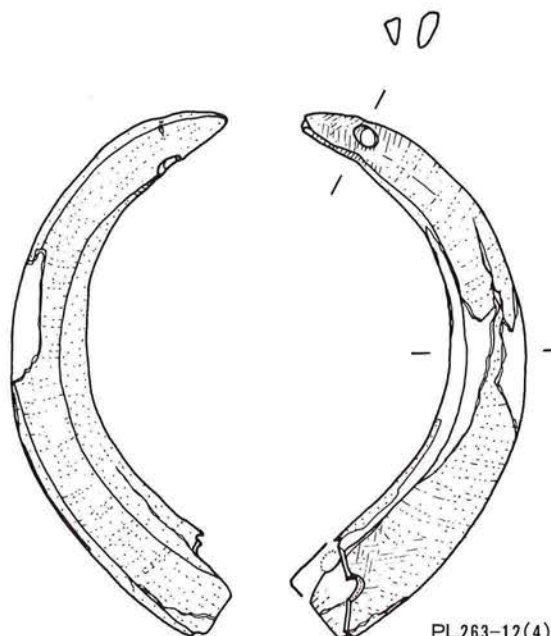

PL263-12(4)



遺物出土状況写真

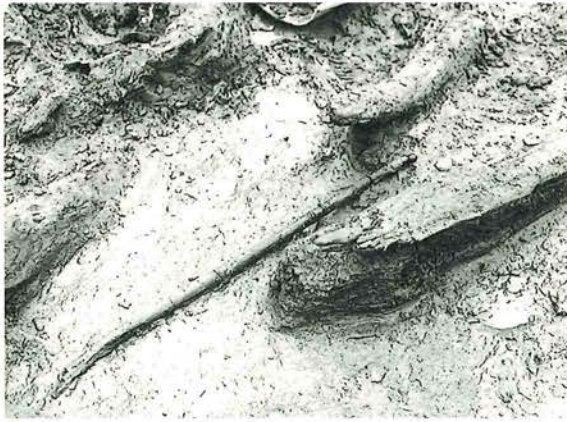

加工材No(5)の出土状況



木製竖櫛No(1)の出土状況

木製品実測図

SD102

竖櫛

PL 264-(1)

(1:2)

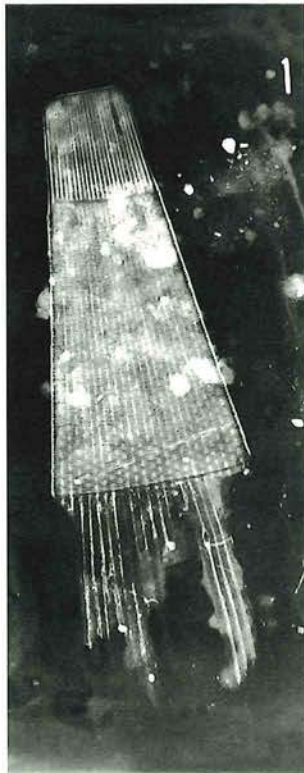

No.1 の X 線透過写真

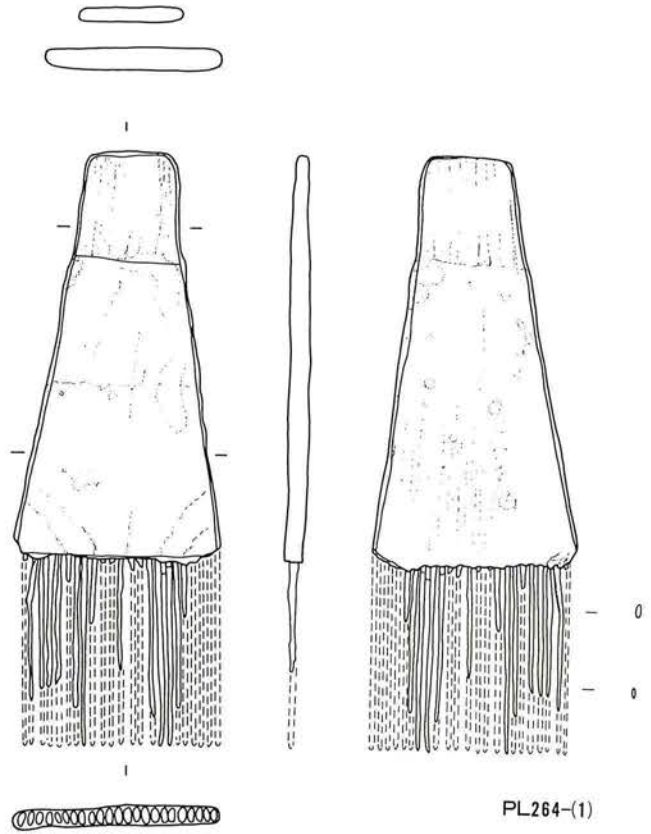

PL264-(1)



木製白 PL 176-(2)

木製品実測図

SD102

臼

PL265-4(2)

(1:6)

鎌形状木製品

PL265-6(3)

(1:4)

鎌形状木製品

PL265-3(4)

(1:5)

加工材

PL266-12(5)

(1:12)

PL265-11(6)

(1:6)

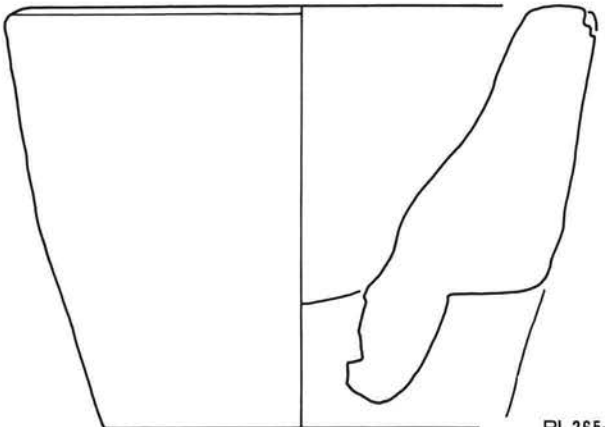
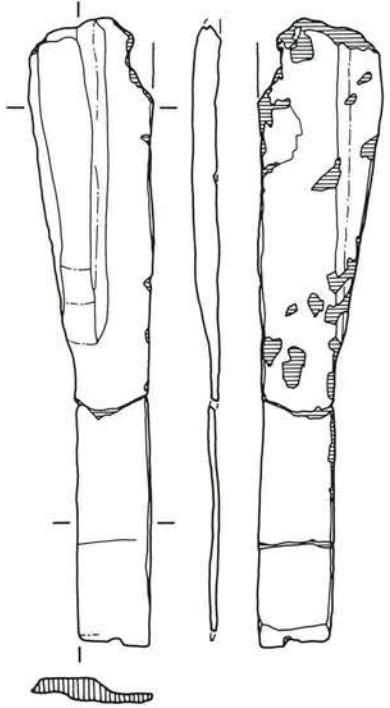
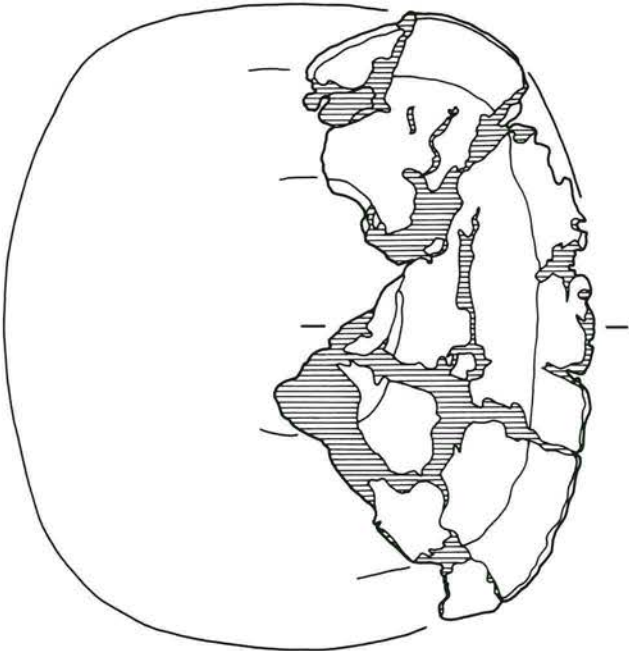
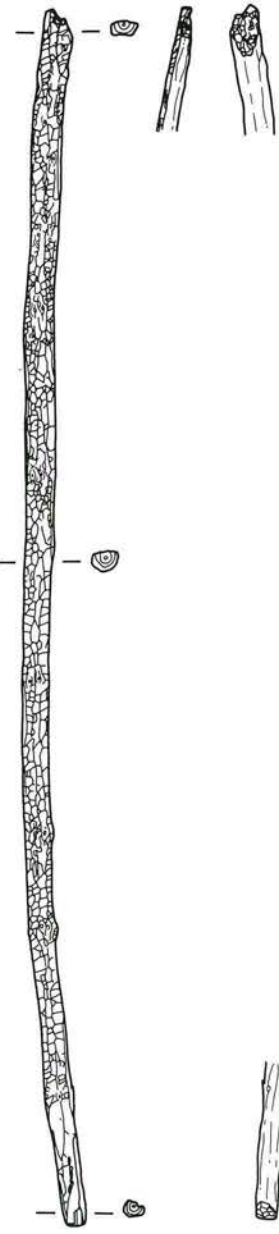
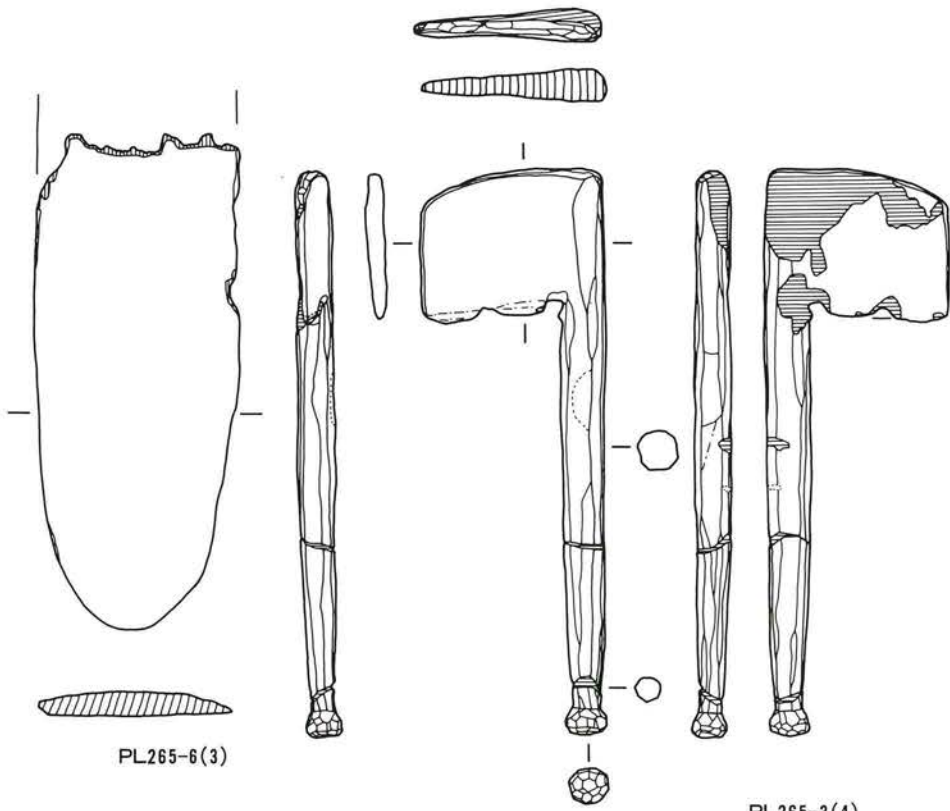

PL265-4(2)

PL265-11(6)

石器写真

SD1027

1 小形石核II2A 類

2 剥片 A 類IV

3 打製石斧 E₁類?

4 敲石キ類

5 敲石キ類

6 敲石ウ類

7 太型蛤刃石斧
Ib'類

8 扁平片刃石斧
失敗品 E₁類

9 扁平片刃石斧
失敗品 E₃類

10 ペン先状石製品
(2:3)

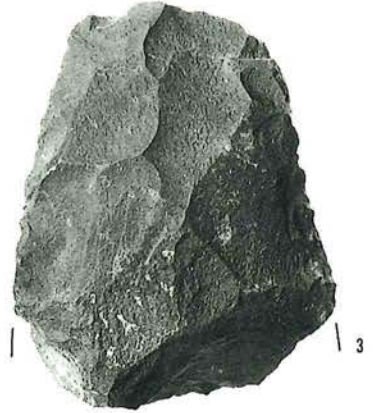

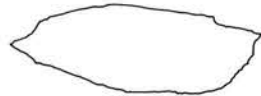
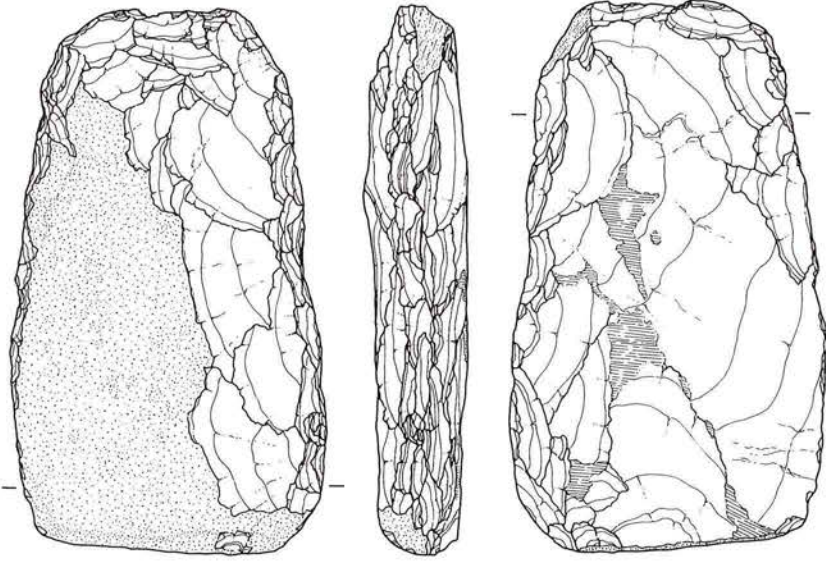

PL177-8

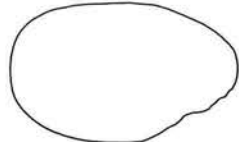
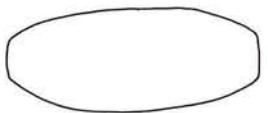
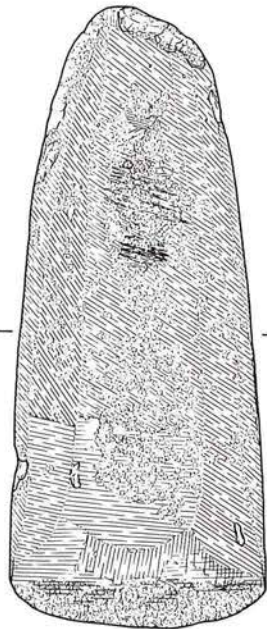
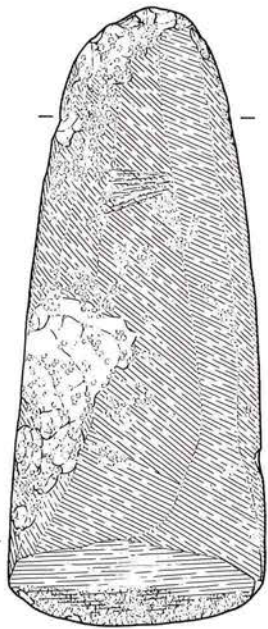
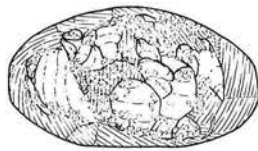
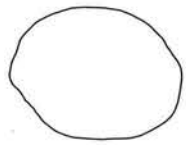

PL177-7

石器実測図

SD1027

PL177-7

PL177-8

(1:2)

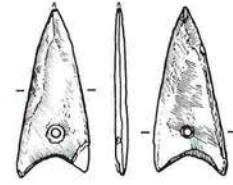

SD1083

PL179-5

PL179-6

(2:3)

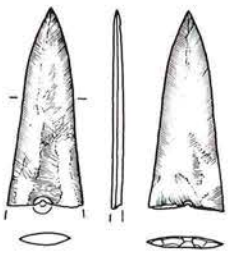

PL179-6

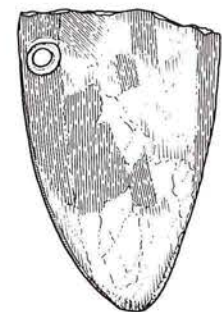
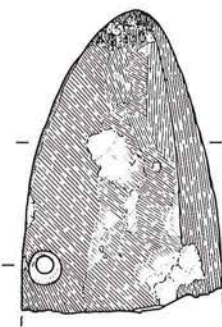

PL179-11

石器写真

SD1083

- 1 剥片 A 類IV
 - 2 剥片 A 類IV
 - 3 大形剥片 2 種
 - 4 磨製石鏃
 - 失敗品 1 類
 - 5 磨製石鏃 IB_s 類
 - 6 磨製石鏃 不明
 - 7 敲石ウ・エ類
 - 8 大形刃器 1b 類
 - 9 大形刃器 2b 類
 - 10 大形刃器 1b 類
 - 11 磨製石包丁 半月形
 - 12 太型蛤刃石斧 不明
 - 13 砥石 IIa 類
 - 14 砥石 IIa 類
- (2:3)

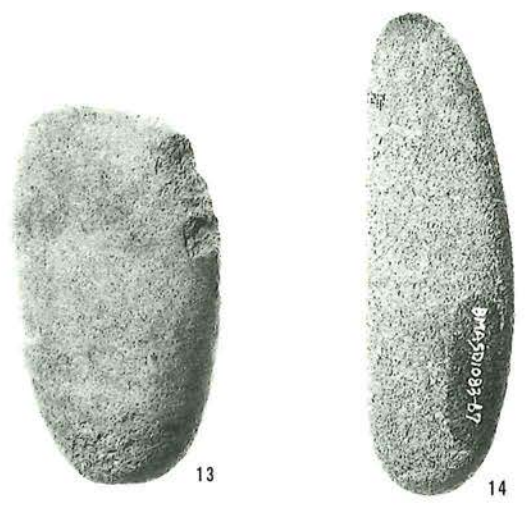
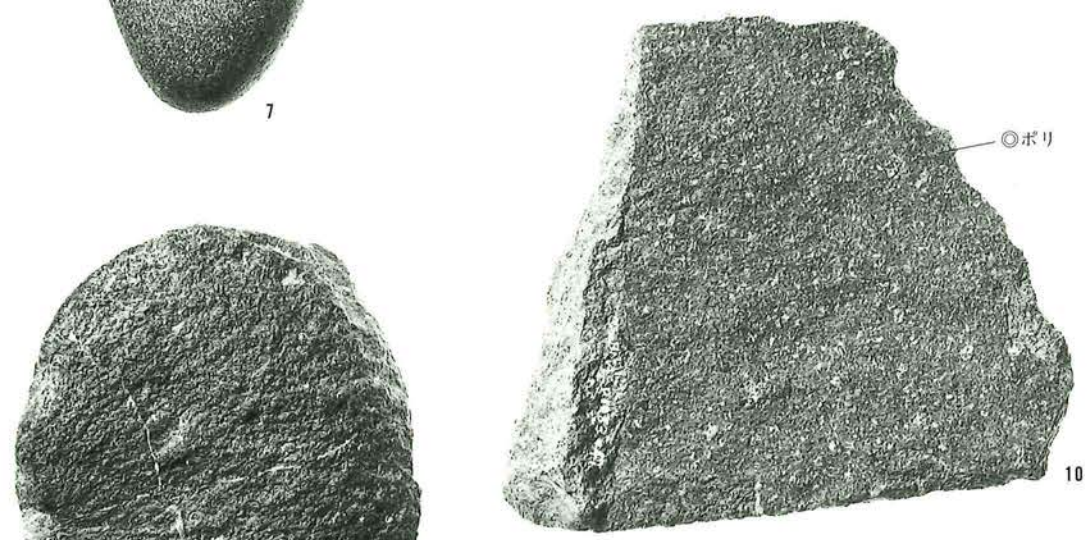
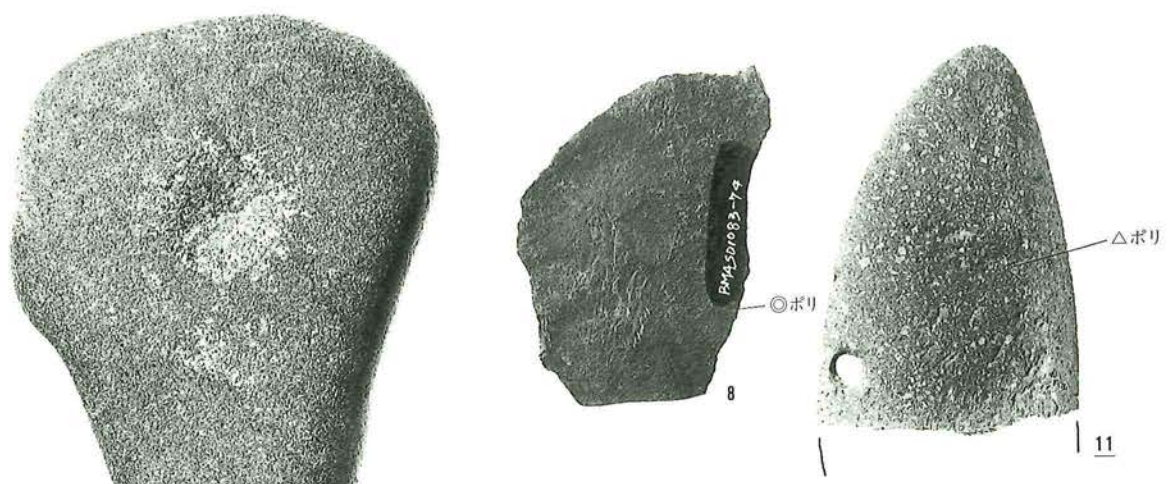
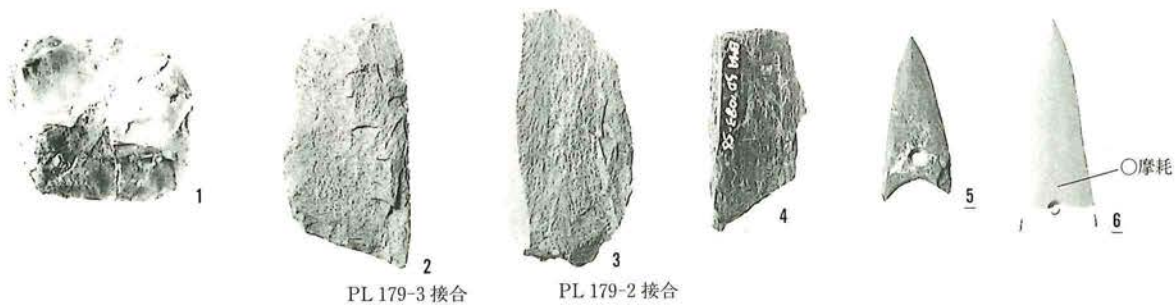

石器実測図

遺構外

PL 190-71

PL 192-34

PL 193-64

(2:3)

PL 218-110

PL 193-75

PL 195-3

PL 194-1

PL 196-1

(1:2)

PL 260-3

(1:1)

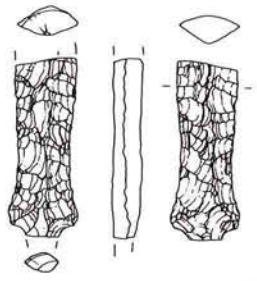

PL190-71

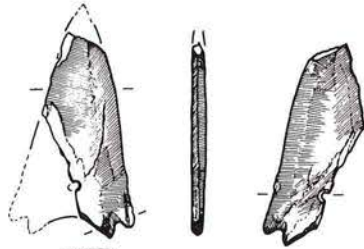

PL193-64

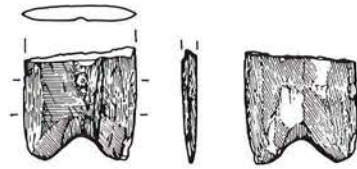

PL192-34

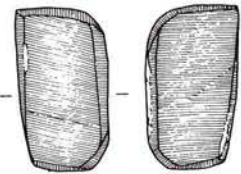

PL260-3

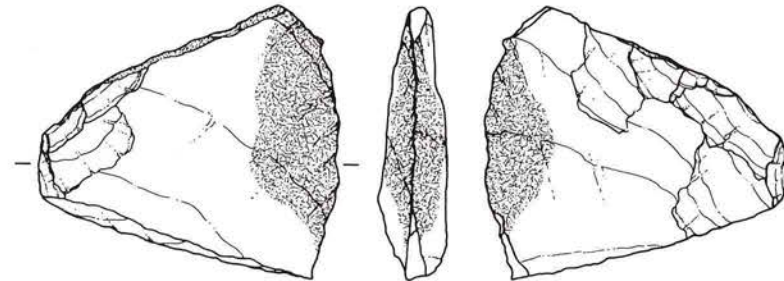

♠ PL218-110

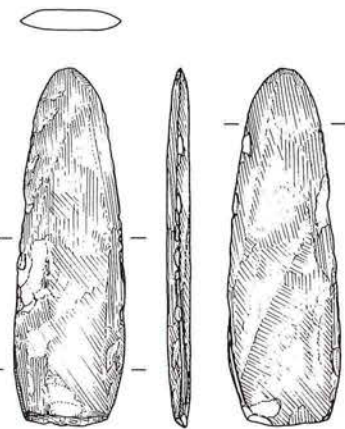
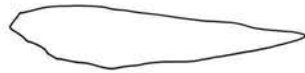

♠ PL193-75

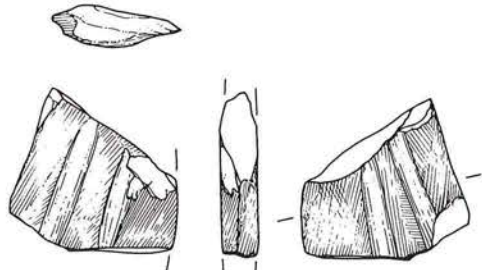

PL195-3

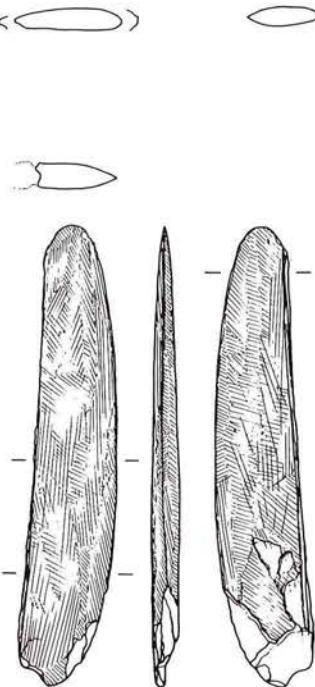

♠ PL194-1

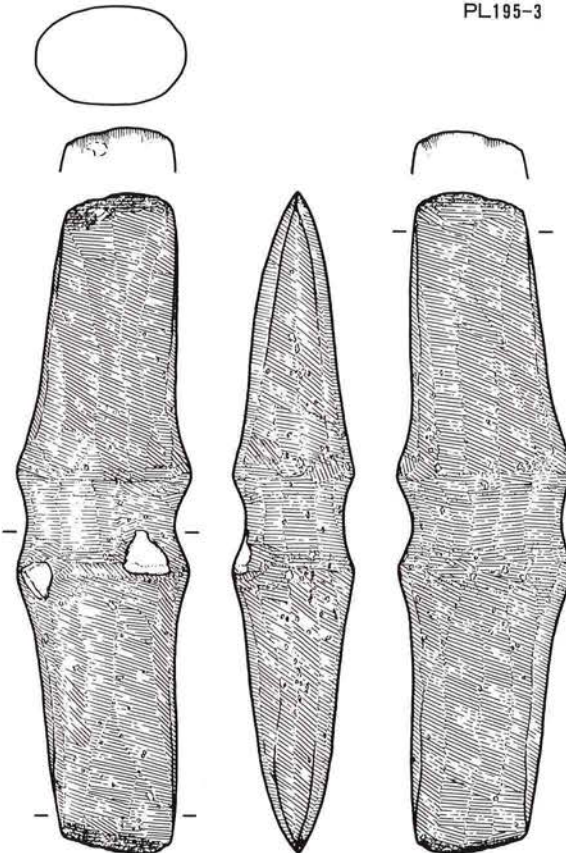

♠ PL196-1

器種別遺物写真図版

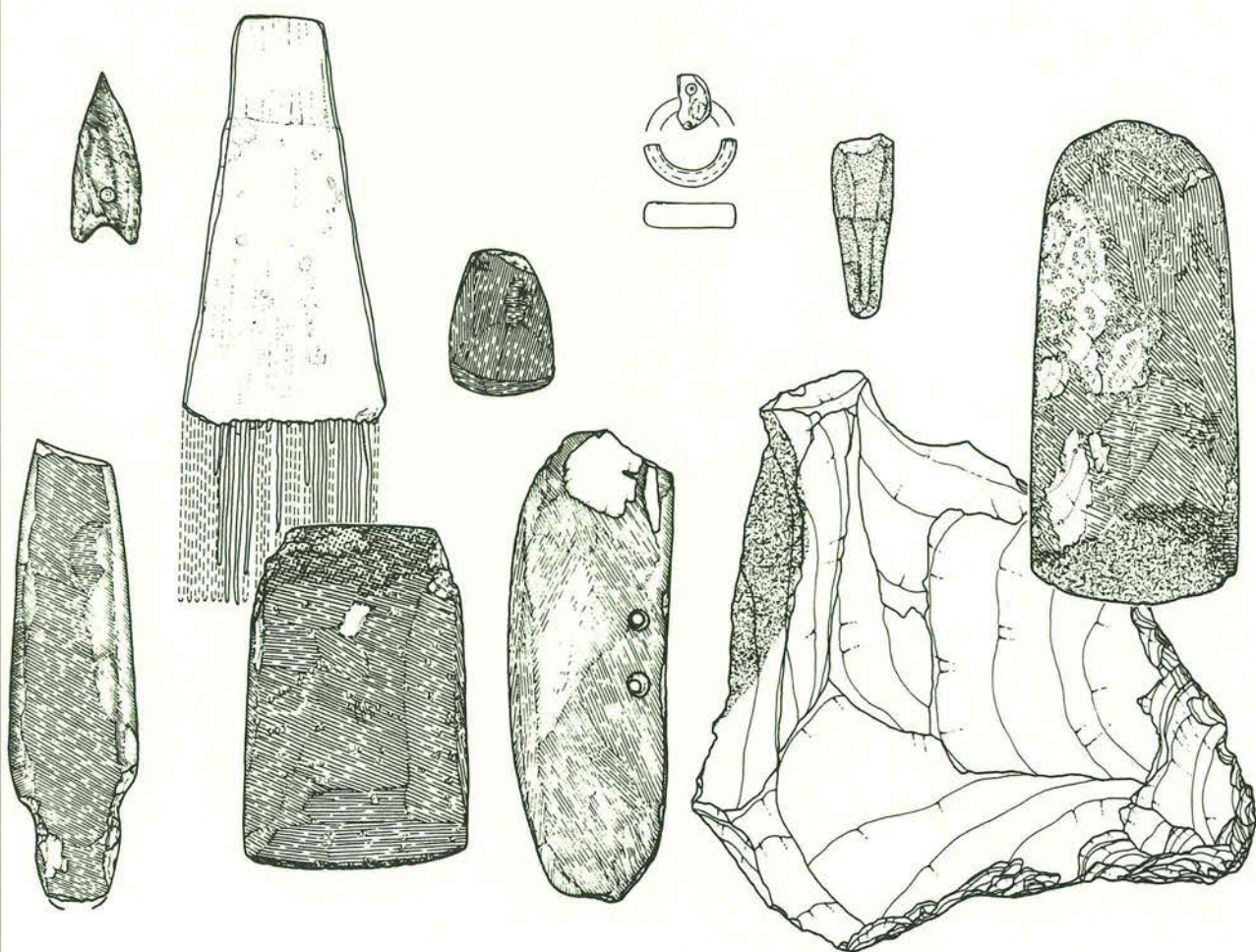

凡 例

図版は、本文編第2章第1表にて記載した器種別項目の順にそって並べ、遺物は器種別分類(大別・細別)順、さらに未製品(未成品≠失敗品)→製品の順とした。また掲載遺物は遺構外出土遺物に重点を置き、前部の「遺構別遺物写真図版」にて使用した資料も再録している。

(1) 番号と名称

各図版の遺物番号は器種別分類(大別・細別)にそって付し、同一分類内はすべて石材別とした。分類名で不明とは製品でありながら欠損によって分類ができない資料に当たる。器種名及び石材名下のPL番号は、「遺構別遺物写真図版」で使用した資料の再録を意味し、そのPL番号を付した。さらに、その下に示した△VII部第4章とは、第7分冊VII部考察編で掲載した遺物であることを示している。

(2) 石材と器種

本書で使用する主な石材名及び石器の種類は、以下のようにまとめられる。

火成岩類	堆積岩類	変成岩類
変輝緑岩・閃緑岩	砂岩・硬砂岩	片麻岩
斑柘岩・変質玄武岩	黑色頁岩(泥岩)	綠色片岩・結晶片岩
単斜輝石安山岩	珉質頁岩	ホルンフェルス
斑岩・流紋岩	凝灰岩	セリサイト質変質岩
花崗岩	チャート	変質泥岩
蛇紋岩・黒曜岩		

製作技術的分類の枠組

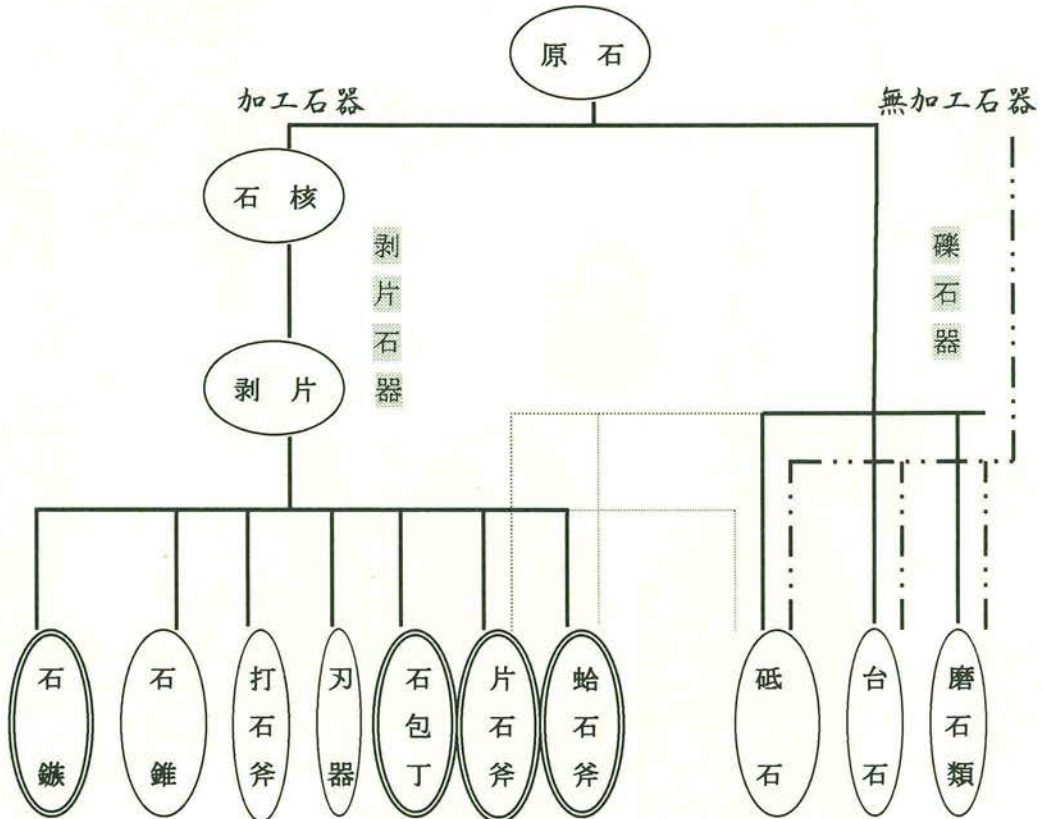

= 磨製技術の介在するもの

大形原石・石核 1

黒色頁岩 A

- 1 原石
- 3 石核 I1A 類
△VII部第4章

珪質岩 A

- 2 原石
- 4 石核 I1A 類
PL 67-9
- 5 石核 I2B 類
PL 37-1
- 6 石核 III1A 類
PL 51-1
△VII部第4章
- 7 石核 III1B 類
- 8 石核 II2B 類
PL 97-2

(2:3)

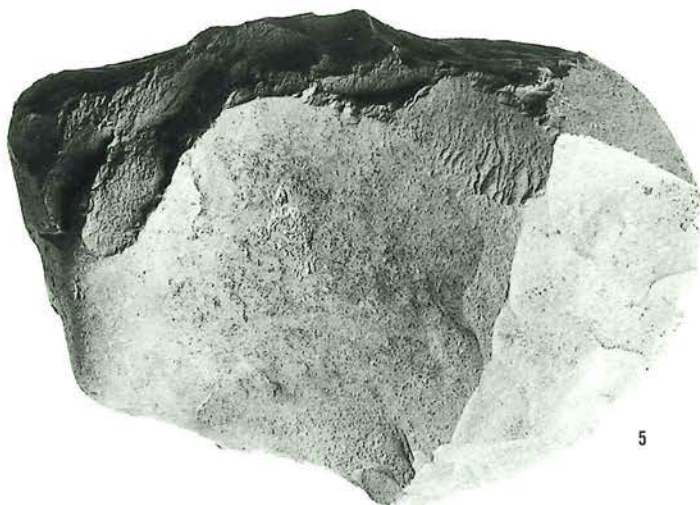

輝石安山岩

9 原材・原石

10 原材・剥片 1種
△VII部第4章

11 原材・剥片 1種
(1:2)



9

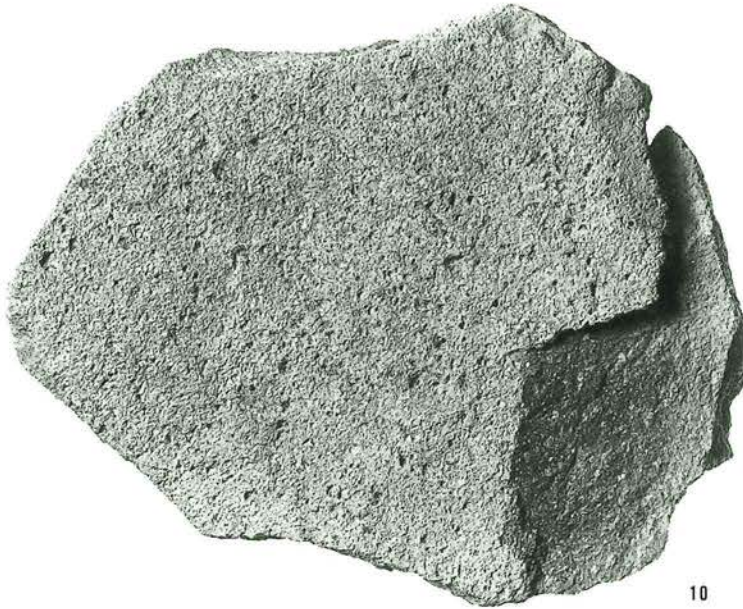

10



11

小形原石・石核 1

黒曜石

- 1 原石
PL 27-1
△VII部第 4 章
- 2 原石
PL 14-5
- 6 石核 I1A 類



チャート

- 3 原石
△VII部第 4 章
- 4 原石
- 7 石核 I1A 類
PL 62-1
- 8 石核 I1A 類
PL 70-7
- 14 石核 I2B 類
PL 24-2
△VII部第 4 章
- 9 石核 I1A 類
PL 67-10
- 15 石核 I2B 類
- 11 石核 I1B 類
PL 64-1



黒色頁岩 C

- 5 原石
PL 97-1
△VII部第 4 章
- 10 石核 I1A 類
PL 93-6
- 12 石核 I2A 類
PL 10-16
- 13 石核 I2B 類
PL 67-3
△VII部第 4 章
(2:3)



小形原石・石核 2

黒曜石

18・19 石核III1A 類

27 石核III1B 類
△VII部第4章

28 石核II1B 類

31・32 石核II2A 類

35 石核II2B 類

36 石核II2B 類

チャート

16・17 石核III1 類

20 石核III1A 類

21 石核III1A 類
PL 50-1

22 石核III1A 類

23 石核III1A 類
PL 43-1
△VII部第4章

24・25 石核III1A 類

29 石核III1B 類
PL 27-12

30 石核III1B 類

37 石核II2B 類

黒色頁岩 C

26 石核III1A 類

33・34 石核II2A 類

(2 : 3)



18



27



31



35



19



28



32



36



16



17

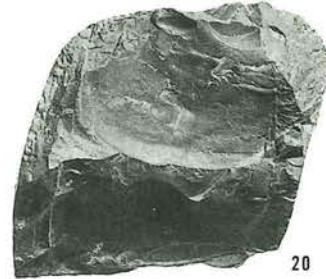

20



21



22



23



24



29



30



37



33



34



25



26

剥片 A 類大形

黑色頁岩 A

- 1 剥片 A 類 II
- 2 剥片 A 類 II
PL 13-3
- 3 剥片 A 類 II
- 5 剥片 A 類 IV
PL 15-1
- 6 剥片 A 類 IV
△VII部第 4 章
- 7~10 剥片 A 類 IV

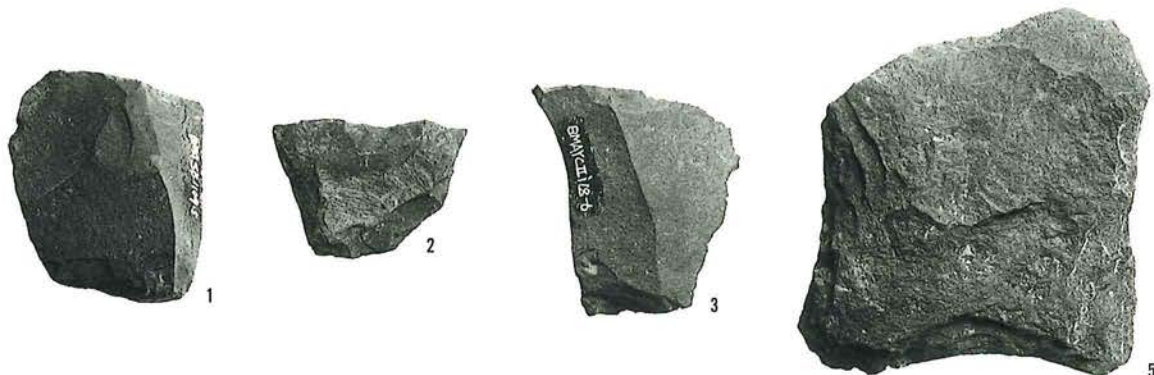

黑色頁岩 E

- 15 剥片 A 類 IV
△VII部第 4 章

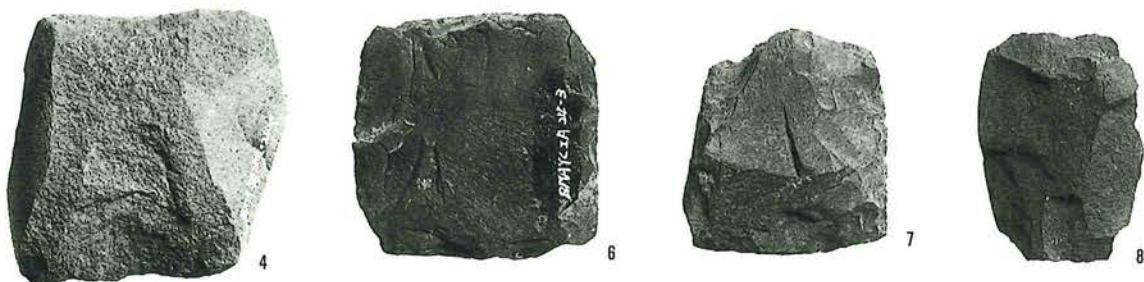

珪質岩 A

- 11 剥片 A 類 IV
PL 62-2
- 12 剥片 A 類 IV
△VII部第 4 章
- 13 剥片 A 類 IV
- 14 剥片 A 類 IV
PL 17-3
- 16 剥片 A 類 V

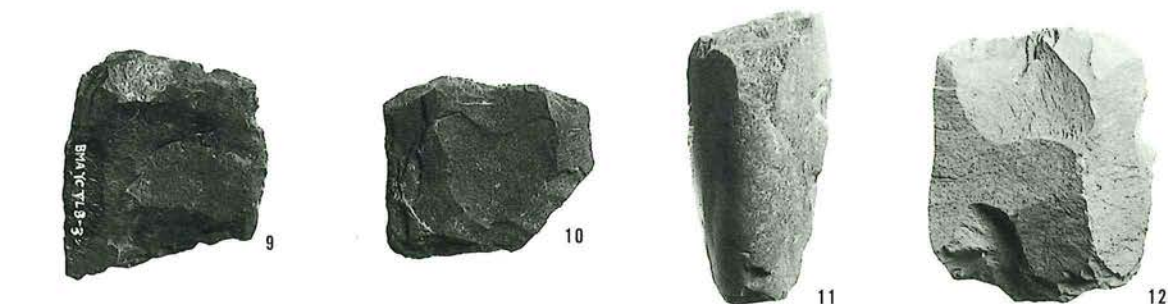

硬砂岩

- 4 剥片 A 類 IV
PL 110-7
△VII部第 4 章



剥片 A 類小形

黒曜石

- 20 剥片 A 類 III
PL 13-2
△VII部第 4 章
- 21 剥片 A 類 IV
- 27 剥片 A 類 V

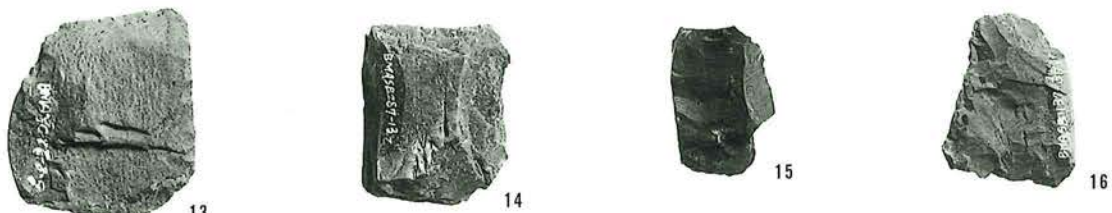

チャート

- 18 剥片 A 類 II
- 19 剥片 A 類 II
- 17 剥片 A 類 I
- 24 剥片 A 類 IV
PL 67-11
- 25 剥片 A 類 IV
△VII部第 4 章
- 26 剥片 A 類 IV
- 28 剥片 A 類 V

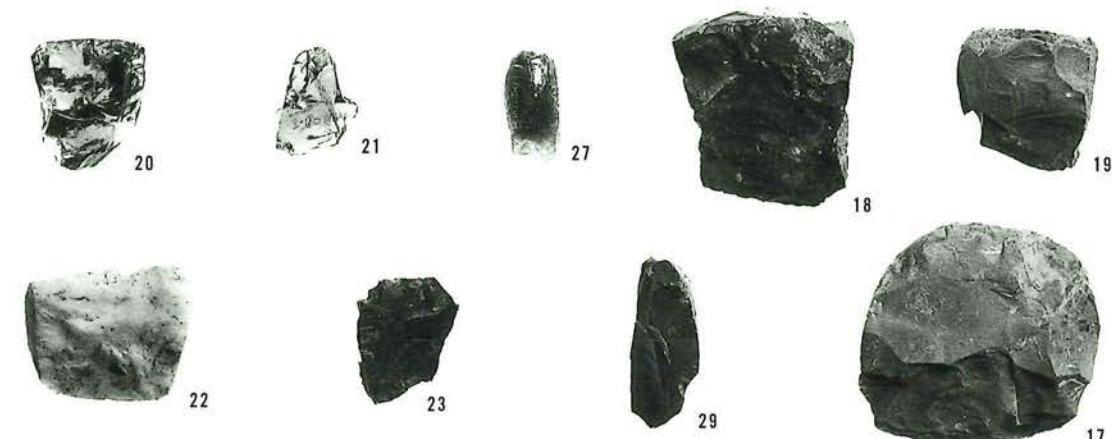

石英

- 22 剥片 A 類 IV

黑色頁岩 C

- 23 剥片 A 類 IV
PL 84-2
△VII部第 4 章
- 29 剥片 A 類 VI
PL 91-16



大形剥片 1

黒色頁岩 A

1 剥片 2種
△VII部第4章

2 剥片 2種
PL 35-2

3 剥片 B類

黒色頁岩 D

10 剥片 2種

11 剥片 B類

12 剥片 B類
PL 92-7

珪質岩 A

13 剥片 1種
PL 53-2

14 剥片 2種
PL 53-4
△VII部第4章

15 剥片 B類
PL 53-6

硬砂岩

7 剥片 1種
△VII部第4章

8 剥片 1種

9 剥片 2種
△VII部第4章

ホルンフェルス

4・5 剥片 1種

6 剥片 2種
(2:3)



大形剥片 2

輝石安山岩

- 1 剥片 1種
- 2 剥片 1種
- 3 剥片 1種
- 4 剥片 1種
- 5 剥片 1種
- 6 剥片 2種
- 7 剥片 2種
- 8 剥片 2種

PL 44-9

(2:3)

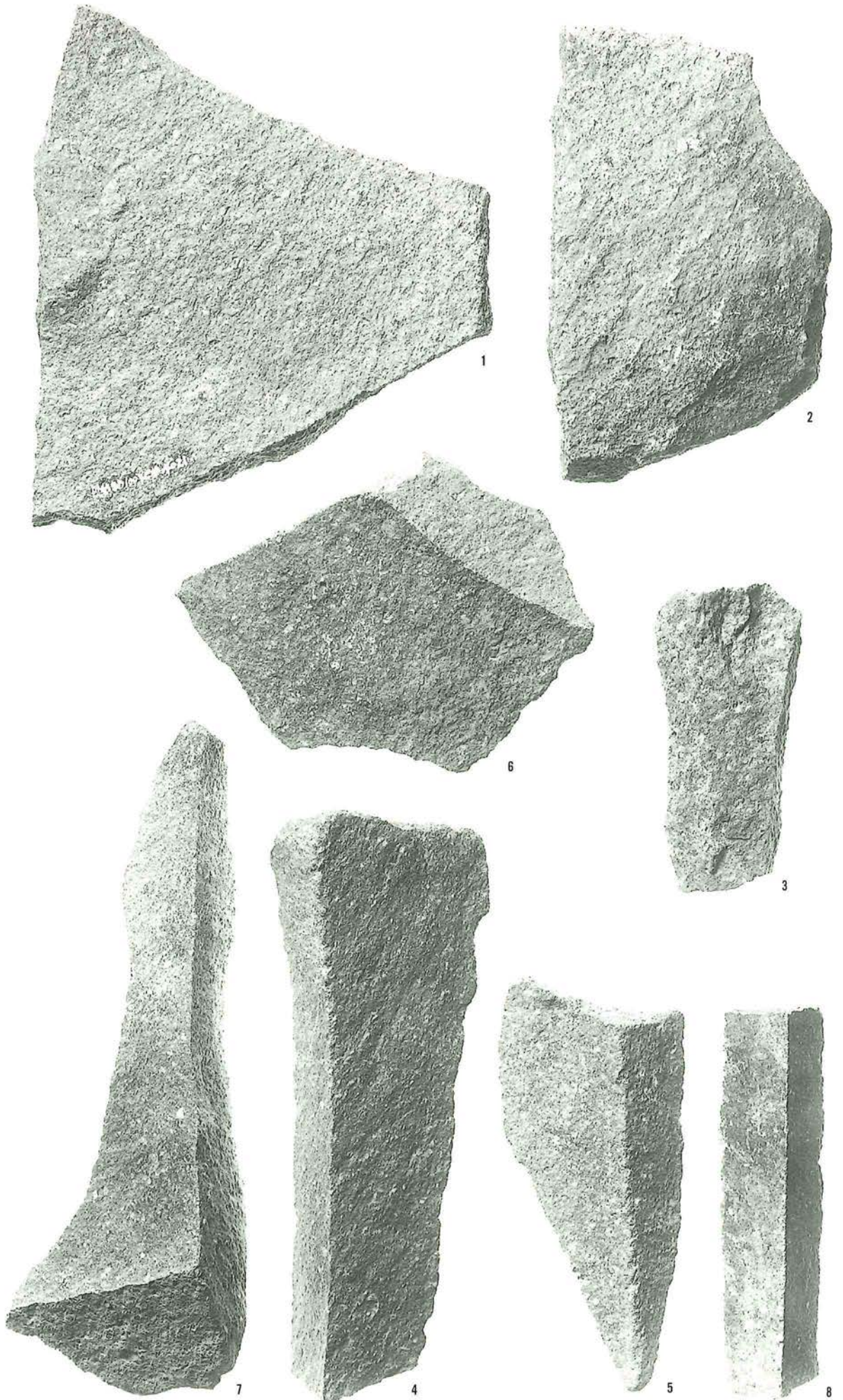

大形剥片 3

輝石安山岩

9 剥片 B 類
PL 24-8

10 剥片 B 類

11 剥片 B 類
PL 5-8

12 剥片 B 類
PL 58-7

△VII部第 4 章

13 剥片 B 類
(2:3)

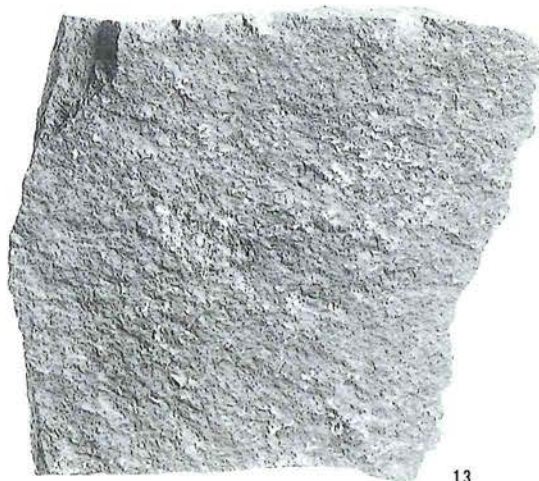
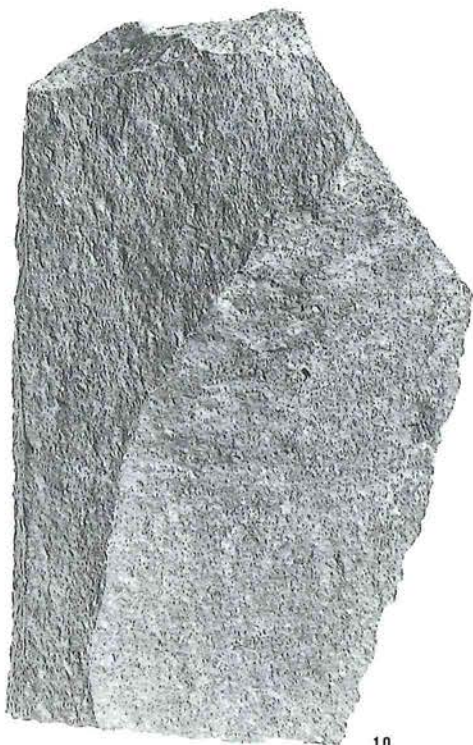
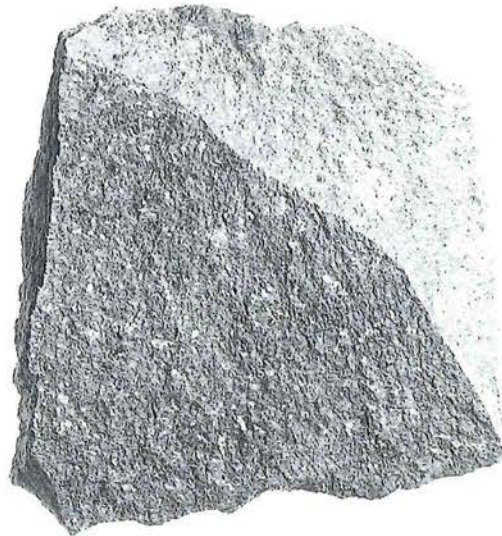
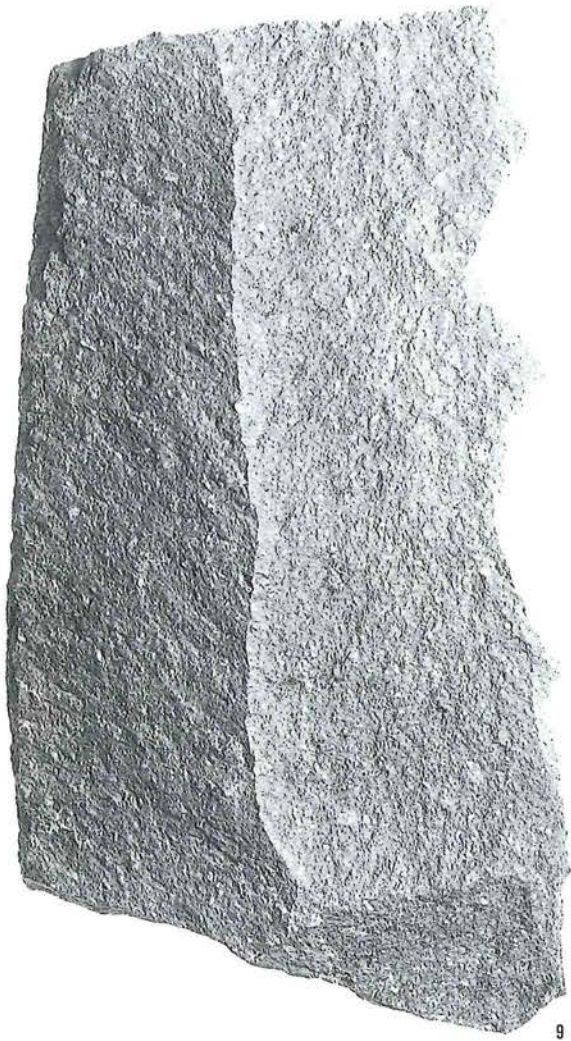

11

12

10

13

大形剥片 4

セリサイト質ろう石

- 1 剥片 1種
- 2 剥片 1種
PL 44-5
PL 261-1
△VII部第4章
- 3 剥片 2種
- 4 剥片 2種
(研磨痕のある剥片)
PL 101-12
- 5 剥片 2種
- 6 剥片 2種
PL 261-5

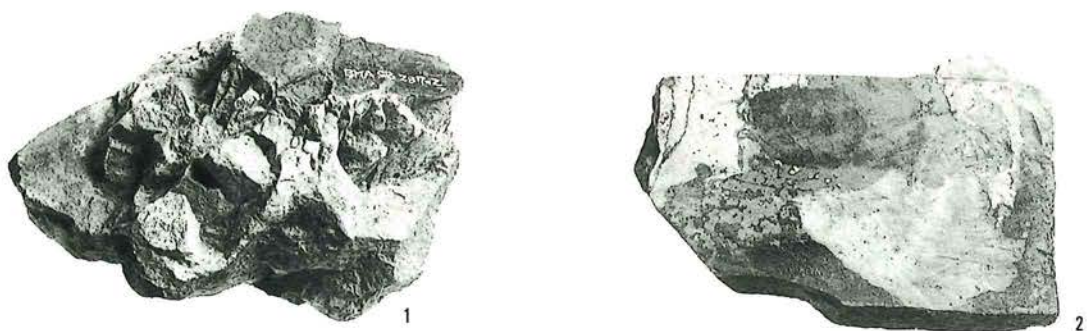

小形剥片

黒曜石

- 7 剥片 1種
- 8 剥片 1種
PL 44-13
- 9 剥片 2種
PL 44-15
△VII部第4章
- 10 剥片 2種
- 11 剥片 B類
- 12 剥片 B類
PL 91-2

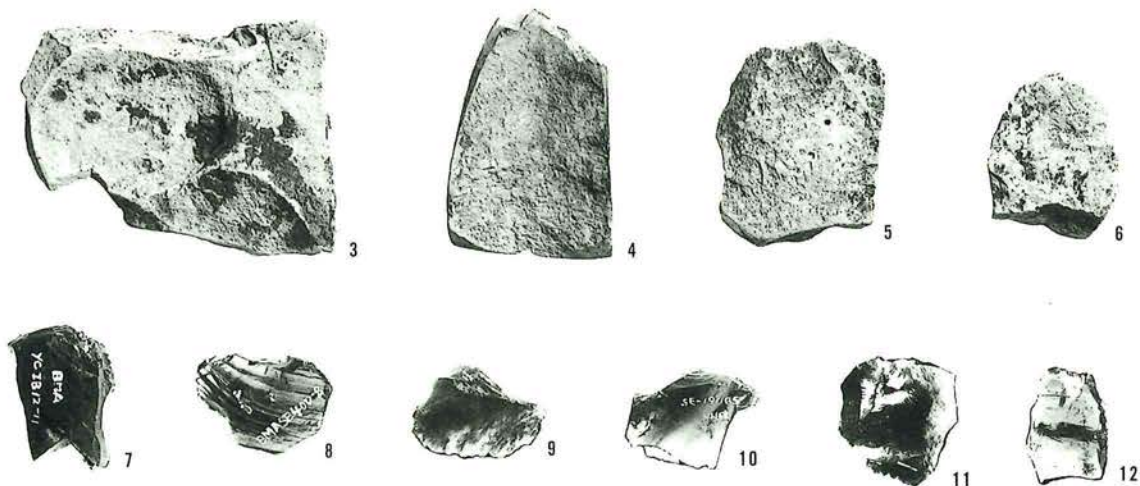

チャート

- 13 剥片 1種
- 14 剥片 2種
PL 74-4
- 15 剥片 2種
PL 74-3
- 16 剥片 2種
PL 74-6
- 17 剥片 2種
PL 74-5
- 18 剥片 B類
- 19 剥片 B類
△VII部第4章

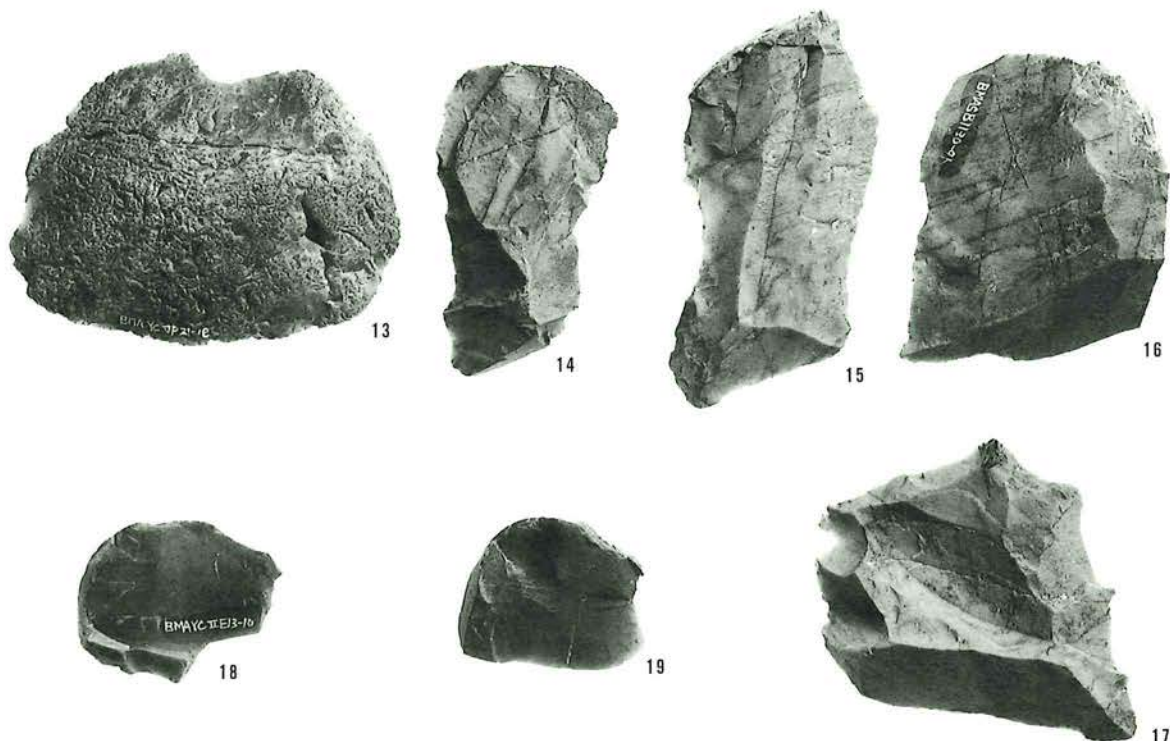

黒色頁岩 C

- 22 剥片 2種
PL 10-17
- 23 剥片 B類
△VII部第4章

黒色頁岩 D

- 20 剥片 1種
- 21 剥片 1種
(2:3)



打製石鏃 1

失敗品1類

- 1 黒曜石
PL 43-3
△VII部第4章
- 2 チャート
PL 91-5
△VII部第4章
- 3 チャート
PL 7-9
- 4 黒色頁岩 D
PL 50-2
- 5 黒色頁岩 C
PL 110-12

失敗品2類

- 6 黒曜石
PL 2-2
- 7 黒曜石
- 8 黒曜石
PL 110-13
- 9 黒色頁岩 D
- 10 黒色頁岩 C
PL 6-4
△VII部第4章

IA類

- 11 チャート
PL 138-16

IB₁類

- 12 チャート
PL 83-15
- 13 黒色頁岩 C
△VII部第4章

IB₂類

- 14 黒曜石

IIA類

- 15 黒曜石
PL 26-9
- 16 黒色頁岩 C
PL 52-8
- 17 黒色頁岩 A
- 18 黒色頁岩 C
- 19 黒色頁岩 C
PL 137-12
- 20 黒曜石
PL 57-1

IIB₁類

- 21 黒曜石
- 22 チャート
PL 7-6
- 23 黒色頁岩 C
- 24 黒色頁岩 C
PL 92-4

IIB₂類

- 25 珪質岩 A
PL 117-1
- 26 珪質岩 A
PL 58-2
△VII部第4章
- 27 チャート
PL 137-1
△VII部第4章
- 28 チャート
- 29 黒色頁岩 D
PL 44-11
- 30 黒曜石
PL 122-18
- 31 黒色頁岩 C
PL 39-1
- 32 黒色頁岩 A
- 33 黒曜石
PL 7-5
- 34 黒曜石
- 35 黒曜石
PL 8-2
- 36 黒色頁岩 C
PL 50-11
- 37 黒色頁岩 C
PL 64-12

(1:1)

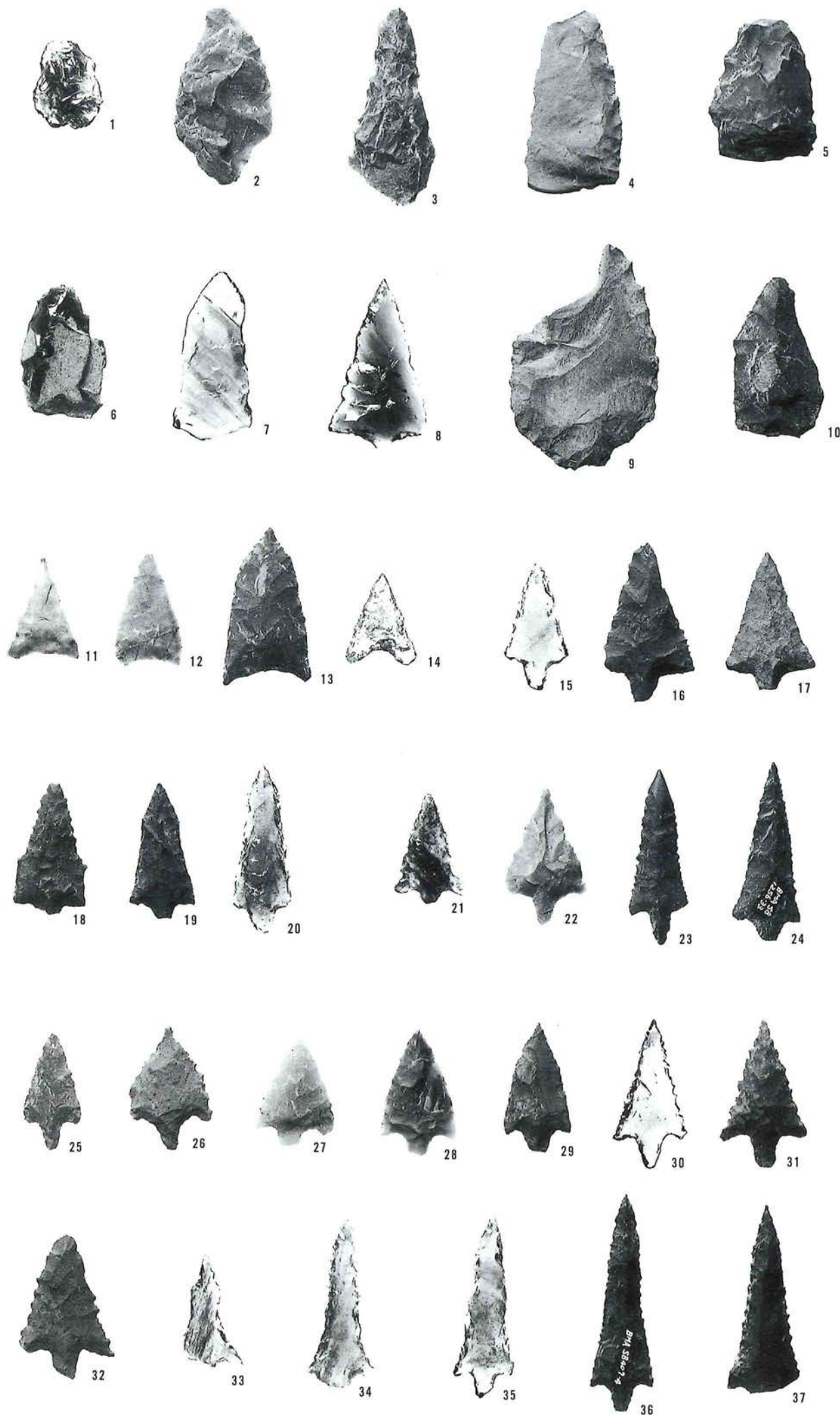

打製石鏃 2

IIB₃類

- 38 黒曜石
PL 137-9
- 39 チャート
PL 137-2
- 40 黒曜石
PL 21-1
- 41~44 黒曜石
- 45 黒曜石
PL 5-3
- 46 黒曜石
- 47 チャート
PL 64-3
- 48 黒曜石
PL 110-8
- 49 黒曜石
PL 15-8
- 50 黒曜石
- 51 チャート
- 52 チャート
PL 122-19
- 53 黒曜石
PL 91-8
- 54 黒曜石
△VII部第4章
- 55 黒曜石
- 56 黒曜石
PL 66-2
- 57 黒色頁岩 C
- 58 チャート
PL 7-7
- 59 黒曜石
- 60 黒色頁岩 C
PL 52-7
- 61 黒色頁岩 C
PL 70-1
- 62 黒色頁岩 C
PL 75-1
- 63 黒曜石
PL 58-3
- 64 黒色頁岩 C
- 65 黒色頁岩 A
PL 21-3
- 66 黒色頁岩 A
PL 21-4
△VII部第4章

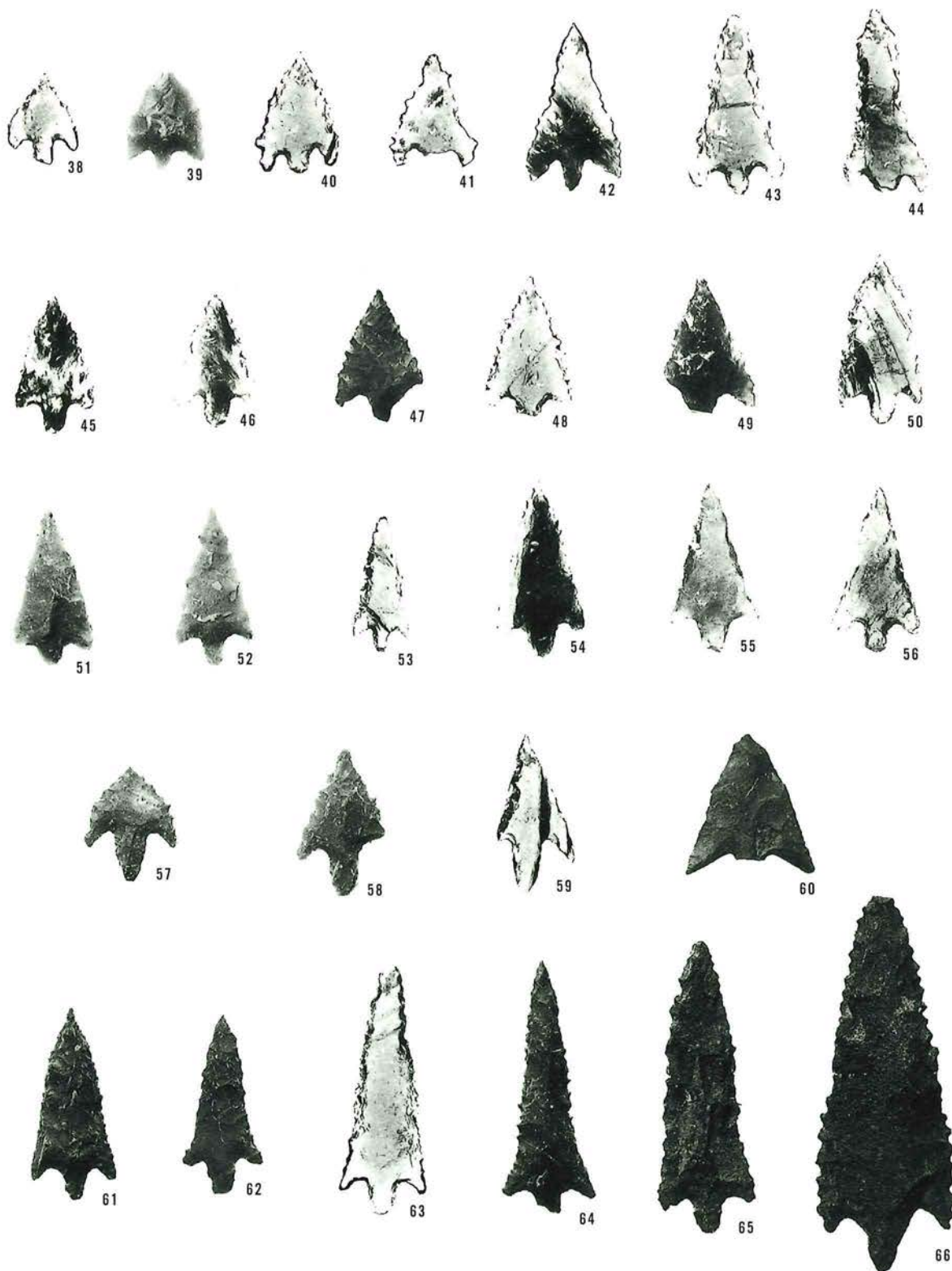

IC₃類

- 67 チャート
PL 138-21
- 68 黒色頁岩 A
PL 138-20

IIC₃類

- 69 珪質岩 C
PL 37-5
- 70 黒色頁岩 D

IIA 類 (特殊)

- 71 ガラス質安山岩
△VII部第4章

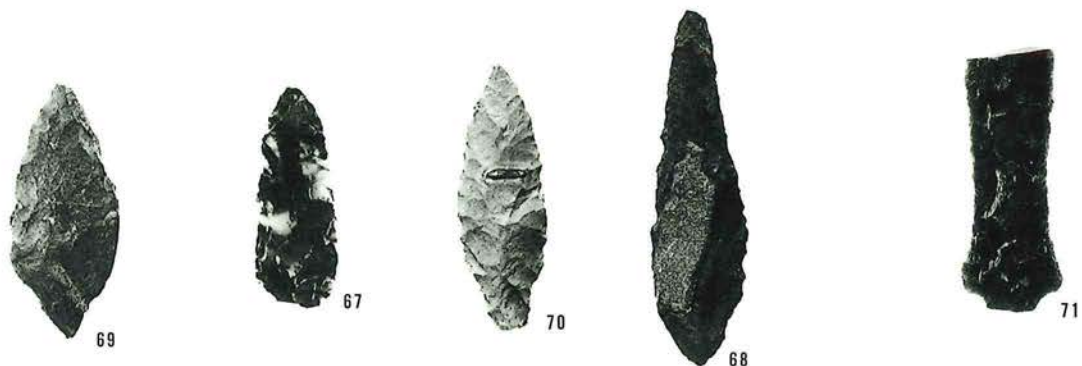

磨製石鏃 1

失敗品 1類

- 1 珪質岩 A
PL 110-1
- 2 珪質岩 A
PL 78-4
- 3 珪質岩 A
- 4 珪質岩 A
PL 83-4
- 5 珪質岩 A
- 6 珪質岩 B
PL 179-4
- 7 珪質岩 A
- 8 黑色頁岩 A
- 9 黑色頁岩 A
PL 2-3

失敗品 2A類

- 10 珪質岩 A
PL 84-9
- 11 珪質岩 A
△VII部第 4 章
- 12 凝灰岩(紫)
PL 84-14
- 13·14 珪質岩 A
- 15 黑色頁岩 A
- 16 黑色頁岩 D

失敗品 2B類

- 17·18 珪質岩 A
- 19 黑色頁岩 D
- 20 黑色頁岩 B
PL 99-15
- 21 珪質岩 B
PL 52-11
(1:1)

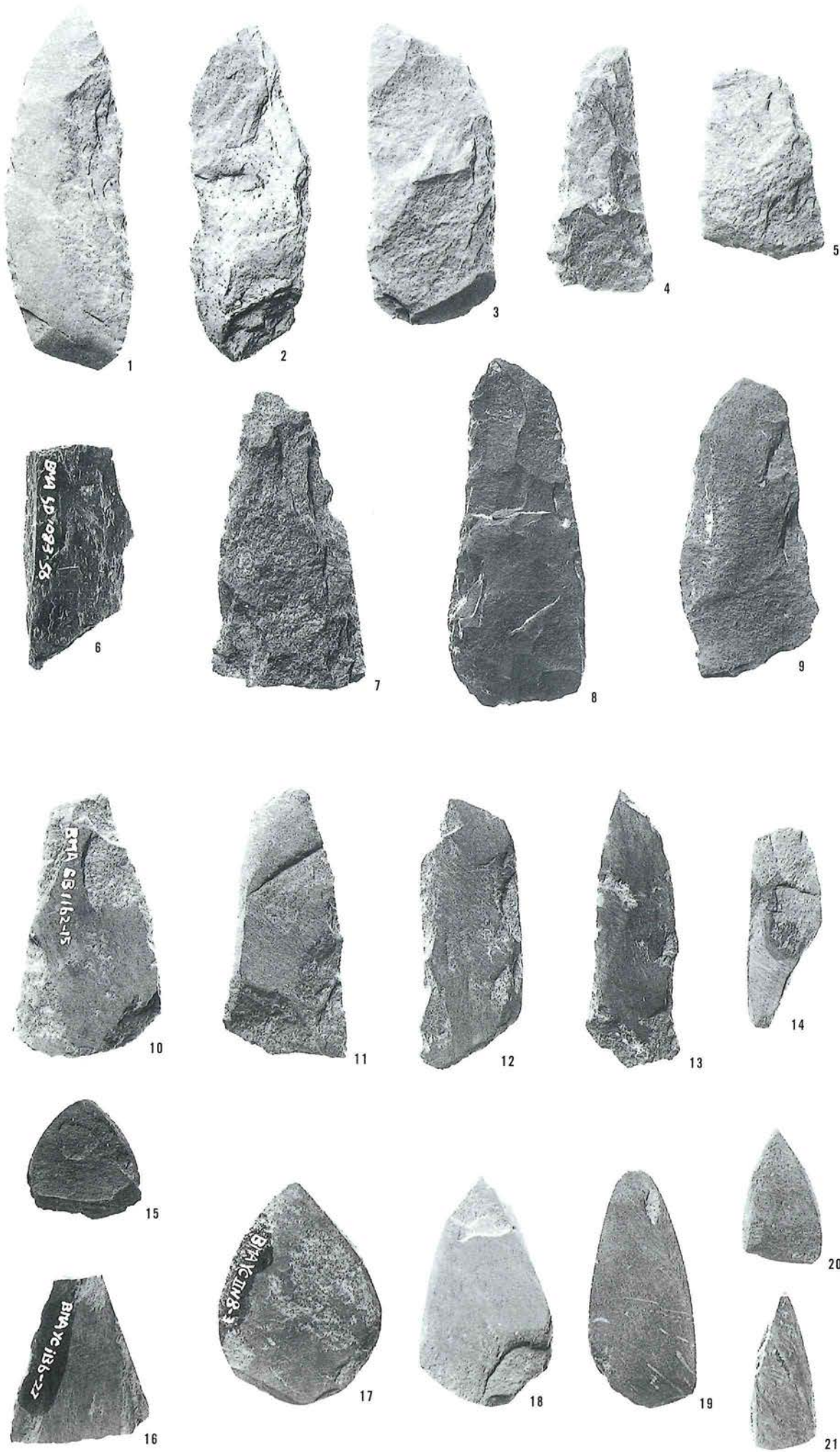

磨製石鏃 2

失敗品 2B 類

- 22 珪質岩 A
PL 10-1
- 23 珪質岩 A
PL 10-3
△VII部第 4 章
- 24 珪質岩 A
PL 10-4
- 25 珪質岩 A
PL 10-2
- 26 珪質岩 B
PL 37-9
- 27 珪質岩 A
PL 74-1
- 28 石墨片岩
PL 59-4
- 29 石墨片岩
PL 122-22
△VII部第 4 章
- 30 片岩
PL 14-9
- 31 黑色頁岩 D
- 32 珪質岩 A
PL 24-6
- 33 珪質岩 B
PL 117-8
- 34 石墨片岩
- 35 珪質岩 A
PL 24-7
△VII部第 4 章
- 36 溶岩
PL 78-3
- 37 珪質岩 A
PL 91-10

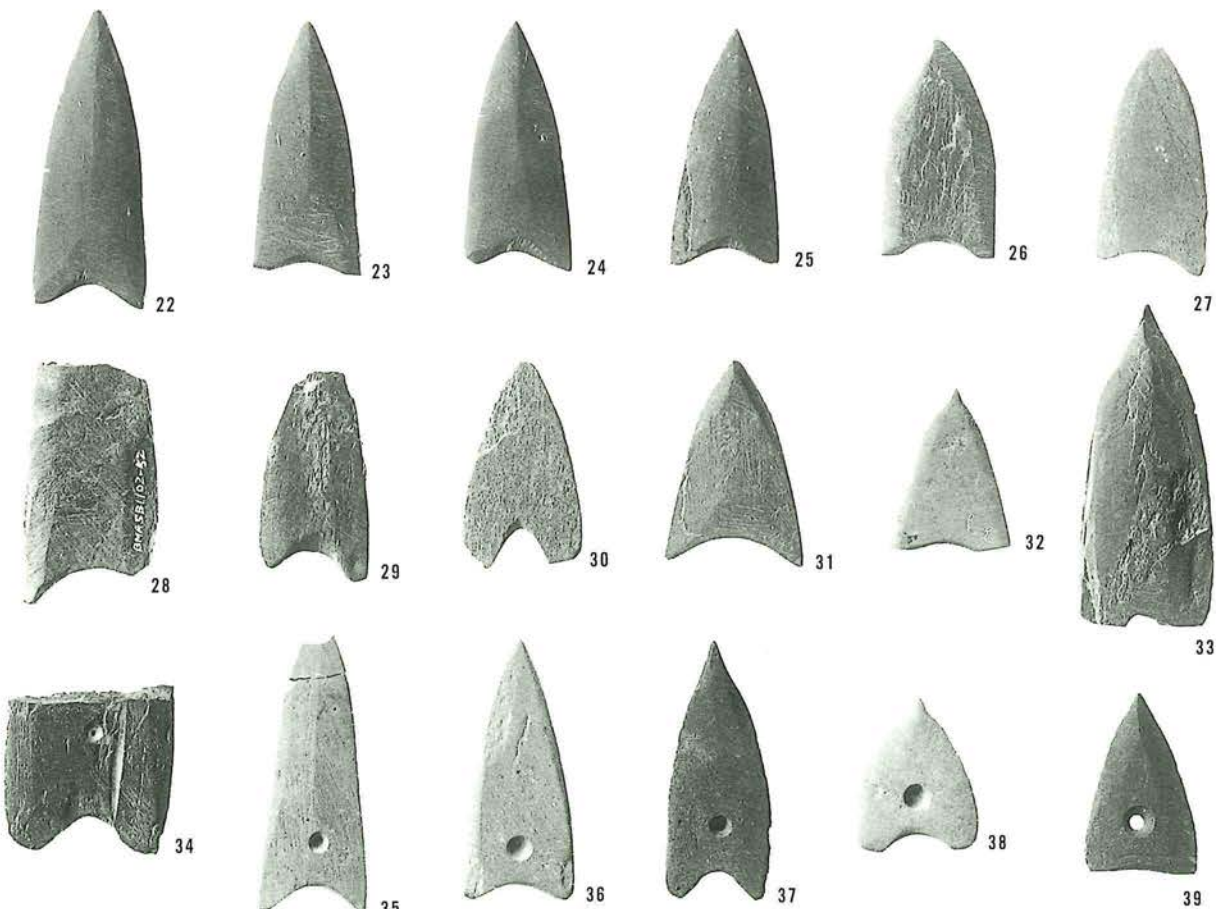

IA 類

- 39 珪質岩 A

IB₁ 類

- 40 珪質岩 B
- 41 黑色頁岩 A
PL 75-4
△VII部第 4 章
- 42 黑色頁岩 D
PL 2-5
- 43 蛇紋岩
PL 94-1
- 44 黑色頁岩 A
PL 28-6
- 45 珪質岩 A
PL 84-3
- 46 珪質岩 A
PL 137-7
- 47 珪質岩 B
PL 17-8

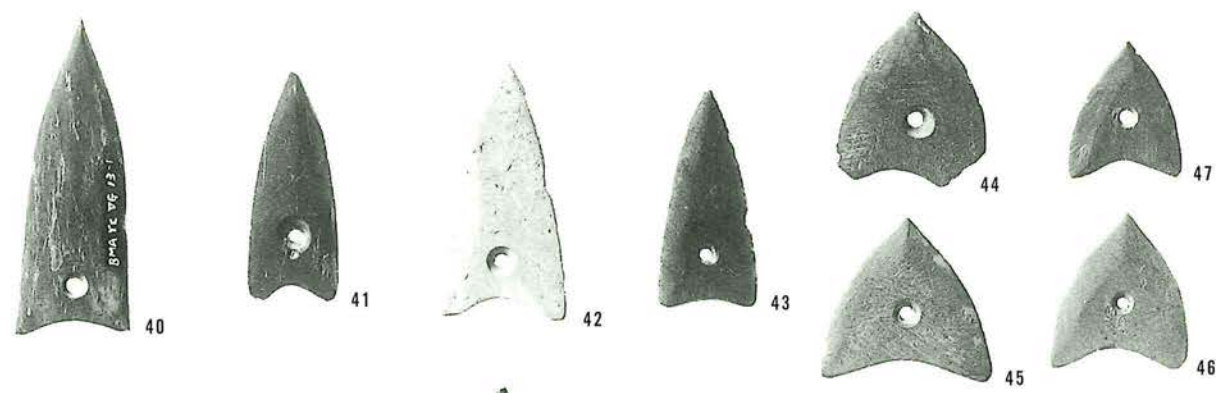

IB₂ 類

- 48 珪質岩 A
PL 6-6
- 49 珪質岩 A
PL 93-2
- 50 珪質岩 A
- 51 珪質岩 A
PL 78-13
- 52 珪質岩 A



IB₃ 類

- 53 珪質岩 A
PL 75-5
△VII部第 4 章
- 54 黑色頁岩 A
- 55 珪質岩 B
- 56 珪質岩 B
PL 179-5
- 57 珪質岩 A
- 58 珪質岩 B
PL 37-10
- 59 珪質岩 B
PL 26-10
- 60 石墨片岩
PL 10-5
△VII部第 4 章

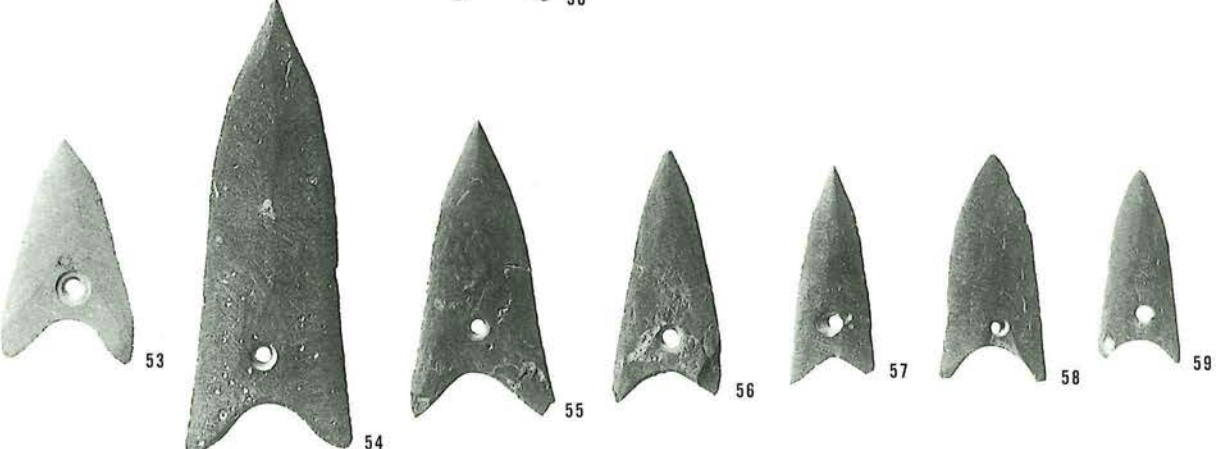

磨製石鏃 3

不明

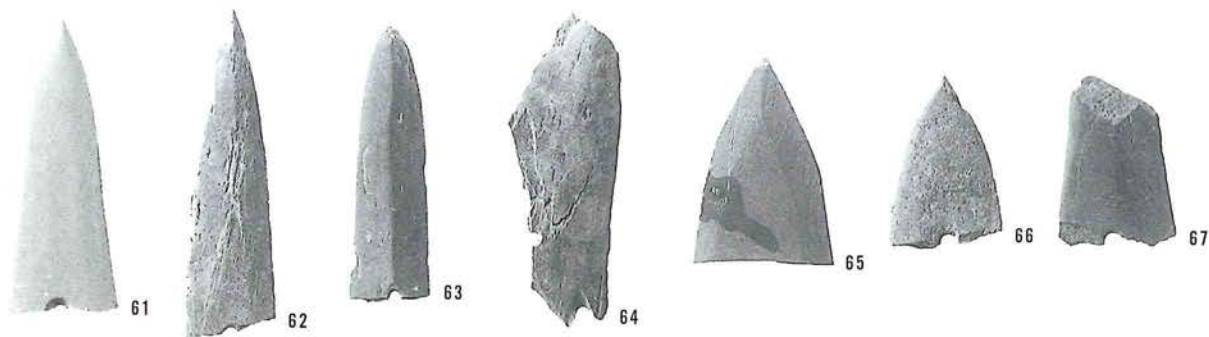

- 61 珪質岩 A
PL 179-6
- 62 珪質岩 B
PL 99-16
- 63 珪質岩 B
- 64 珪質岩 B
- 65 珪質岩 A
- 66 片岩
PL 37-7
- 67 黑色頁岩 A
PL 2-6

失敗品 1類

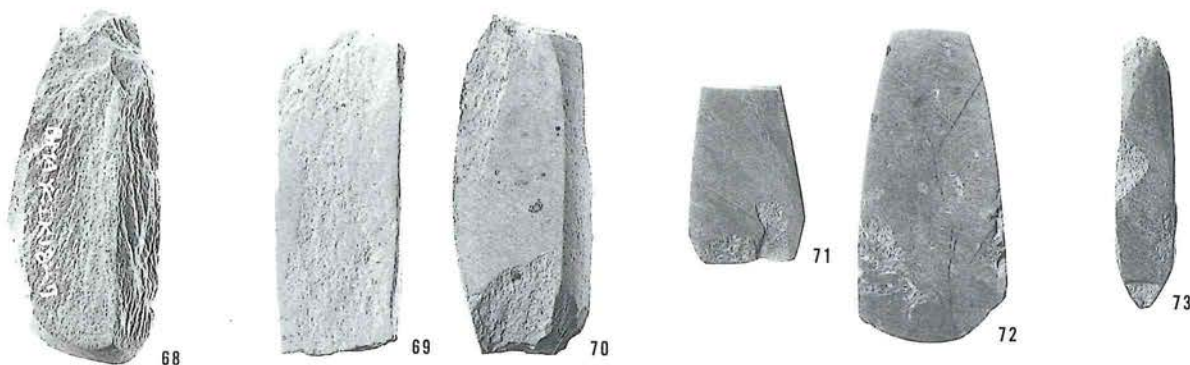

- 68 珪質岩 A
△VII部第 4 章

失敗品 2A 類

- 69 珪質岩 A
- 70 珪質岩 A
PL 69-2

失敗品 2B 類
(特殊石製品)

- 71 珪質岩 A
- 72 珪質岩 A
PL 83-6
- 73 黑色頁岩 A
PL 99-9

鉄剣形石劍

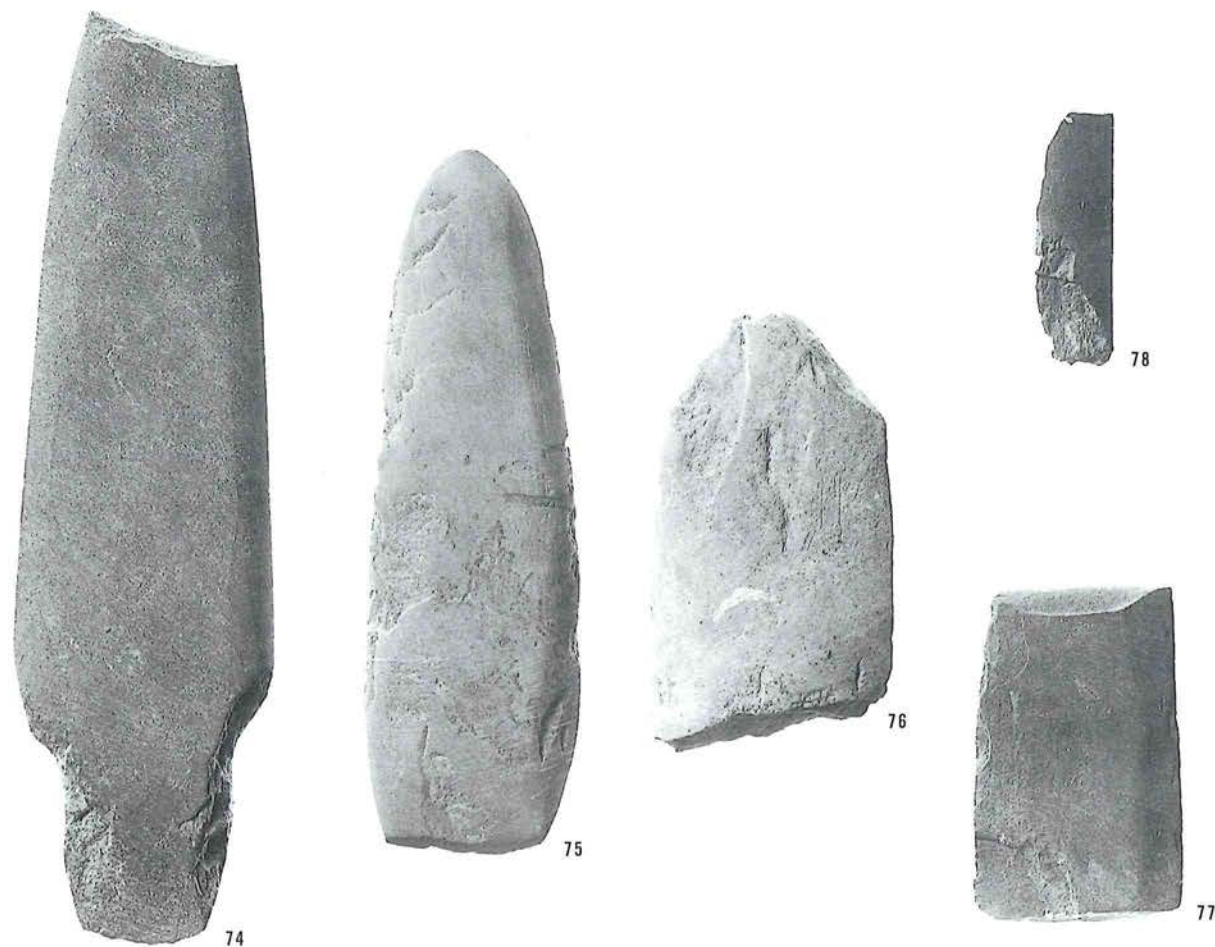

- 74 珪質岩 A
PL 64-14
△VII部第 4 章
- 75 珪質岩 A
- 76 凝灰岩
- 77 黑色頁岩 A
△VII部第 4 章
- 78 黑色頁岩 A
(1:1)

石刀状石製品

- 1 珪質岩 C
- 2 珪質岩 C
- (1:1)

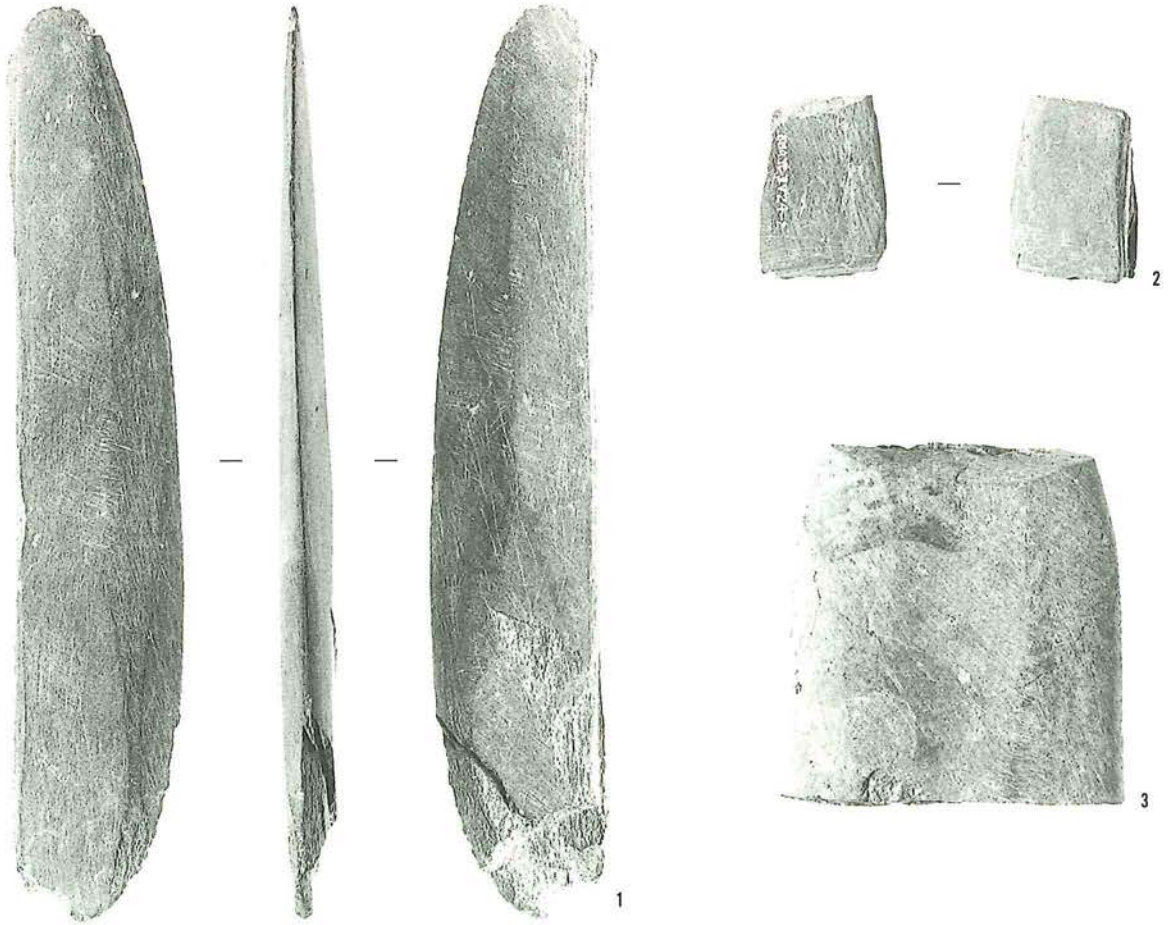

石鈔状石製品

- 3 珪質岩 C
- 4 変質輝緑岩 PL 19-25
- (1:1)

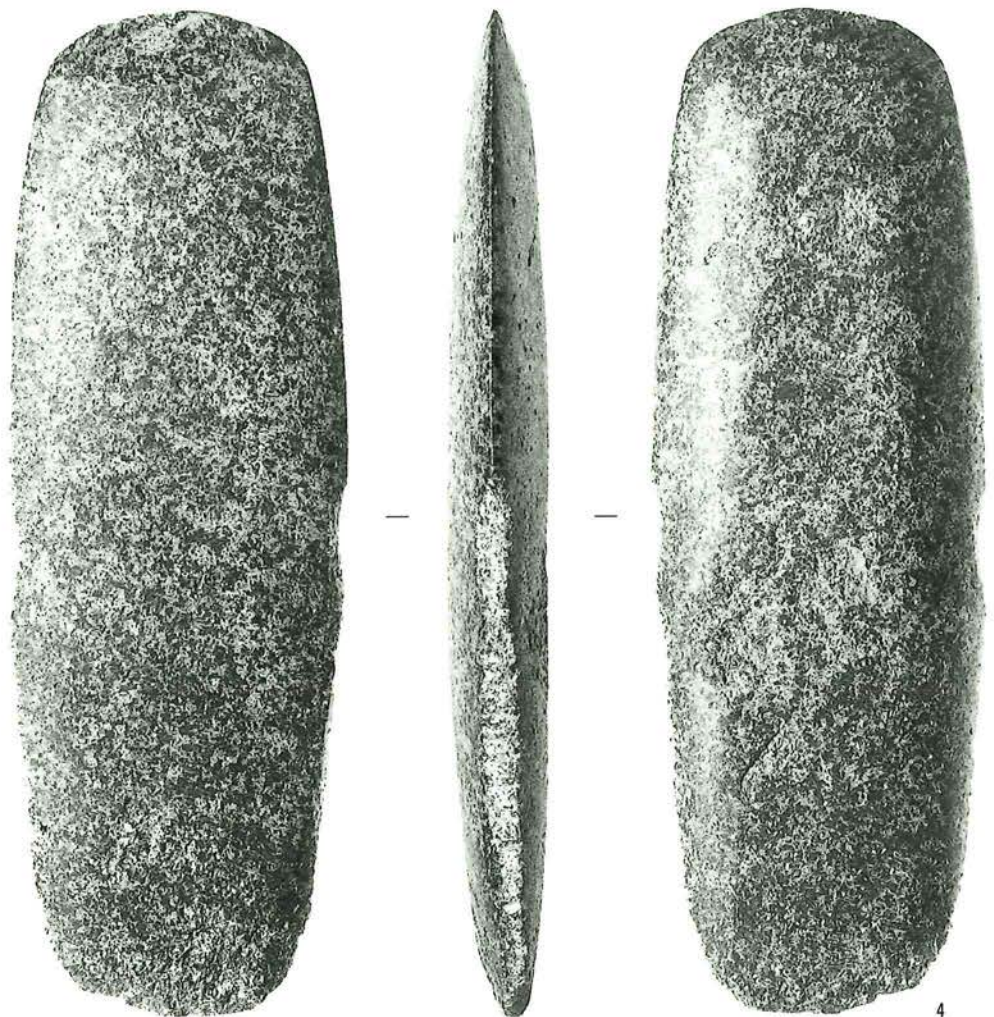

有樋式石戈

1 黑色頁岩 D

2 黑色頁岩 D

3 黑色頁岩 D

(1:1)

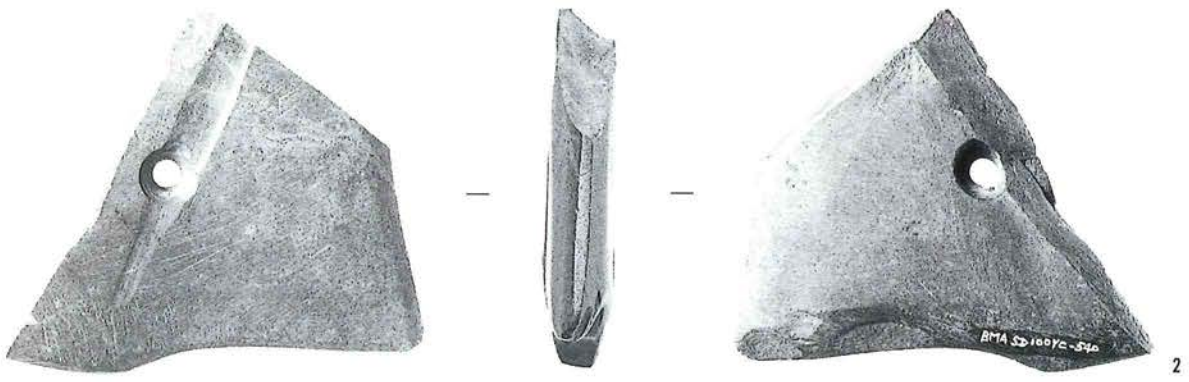
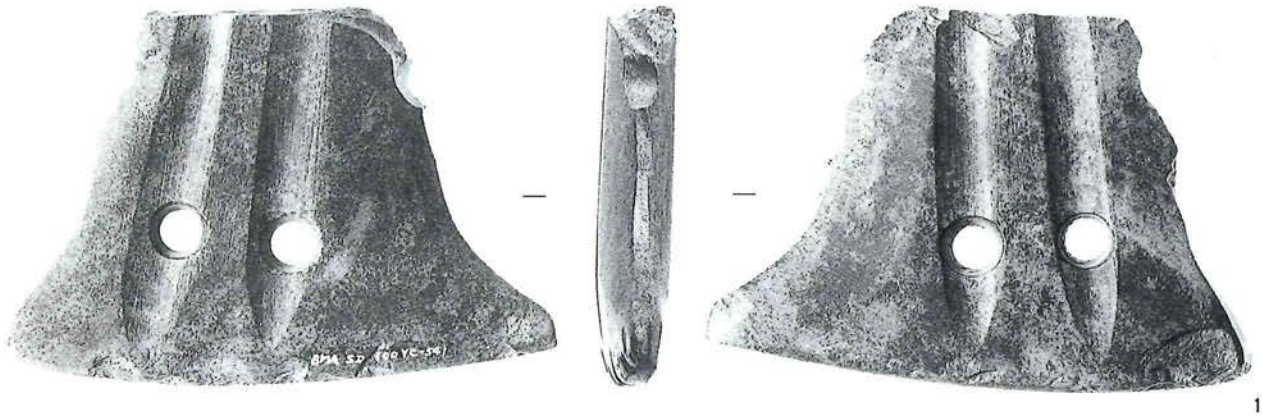

独古石

1 変質輝緑岩

(1:1)

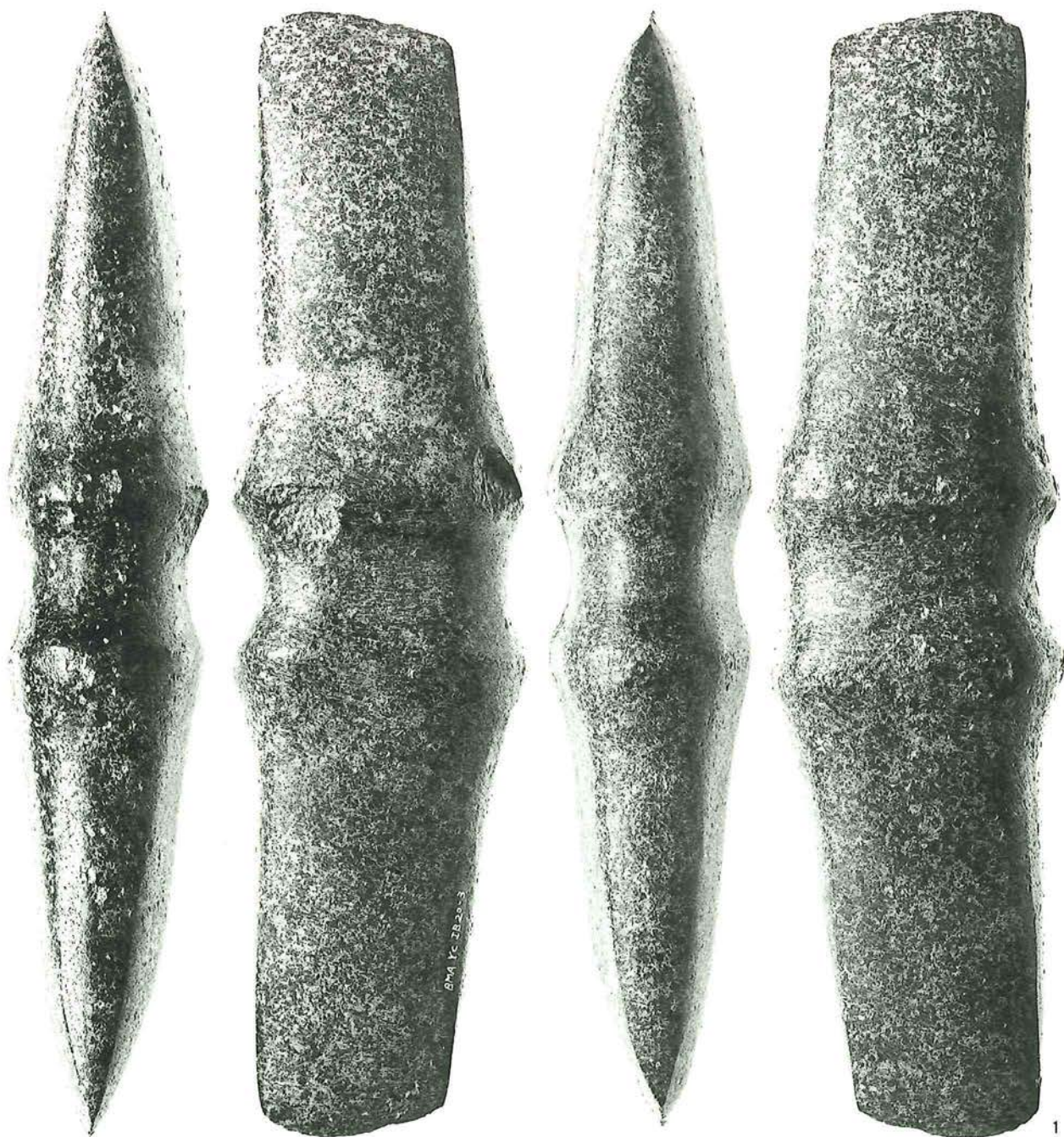

環状石器

2 花崗岩

PL 129-98

(1:1)

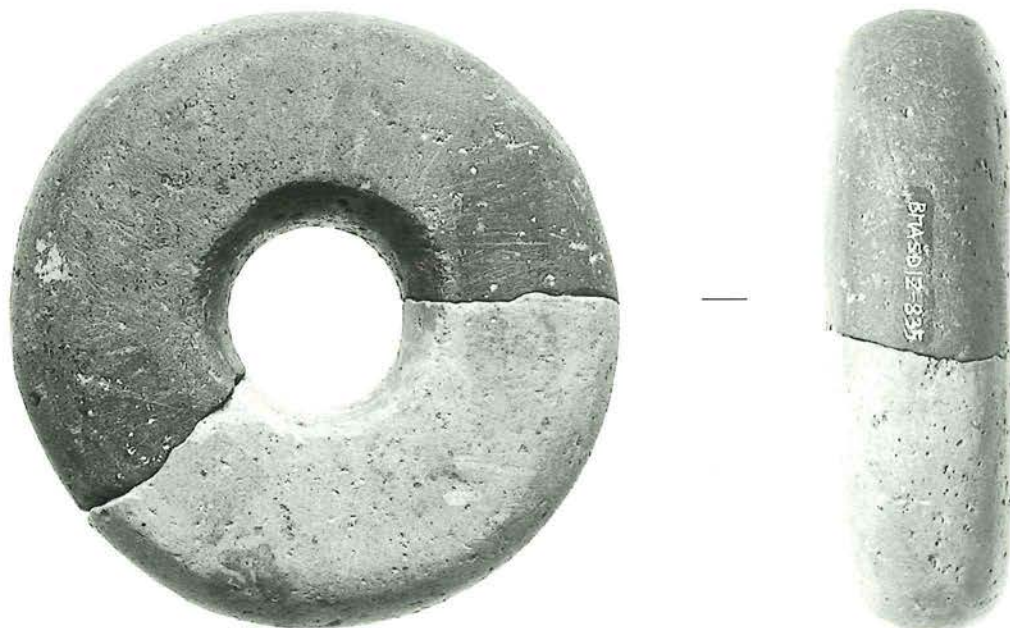

打製石斧 1

A類

- 1 黑色頁岩 B
PL 139-28
- 2 輝石安山岩
PL 15-10

B₁類

- 3 黑色頁岩 A
PL 139-29
△VII部第4章

不 明

- 4 黑色頁岩 A
- 5 黑色頁岩 A
PL 89-3
- 6 黑色頁岩 D

E₂類

- 12 黑色頁岩 B
PL 136-5
- 13 黑色頁岩 A
PL 139-32
- 14 黑色頁岩 A
PL 139-33
(2:3)



1



4



3



5



2



6



12



13



14

打製石斧 2

E₁類

- 7 黑色頁岩 B
PL 139-30
- 8 黑色頁岩 A
PL 110-4
- 10 輝石安山岩
- 11 輝石安山岩
PL 96-1
△VII部第 4 章

不 明

- 9 輝石安山岩
PL 139-31
(2:3)

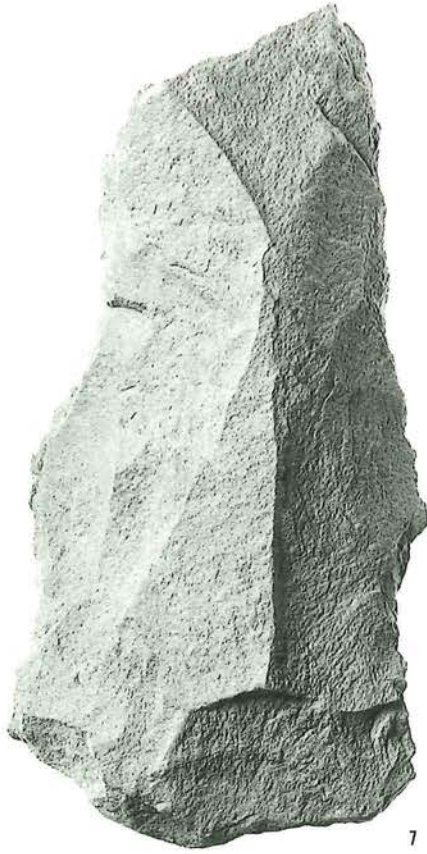

7



8

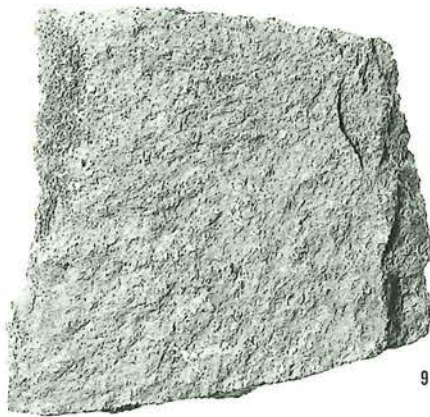

9

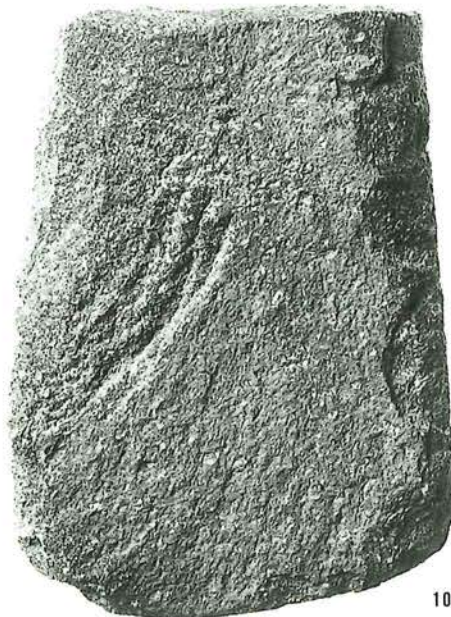

10

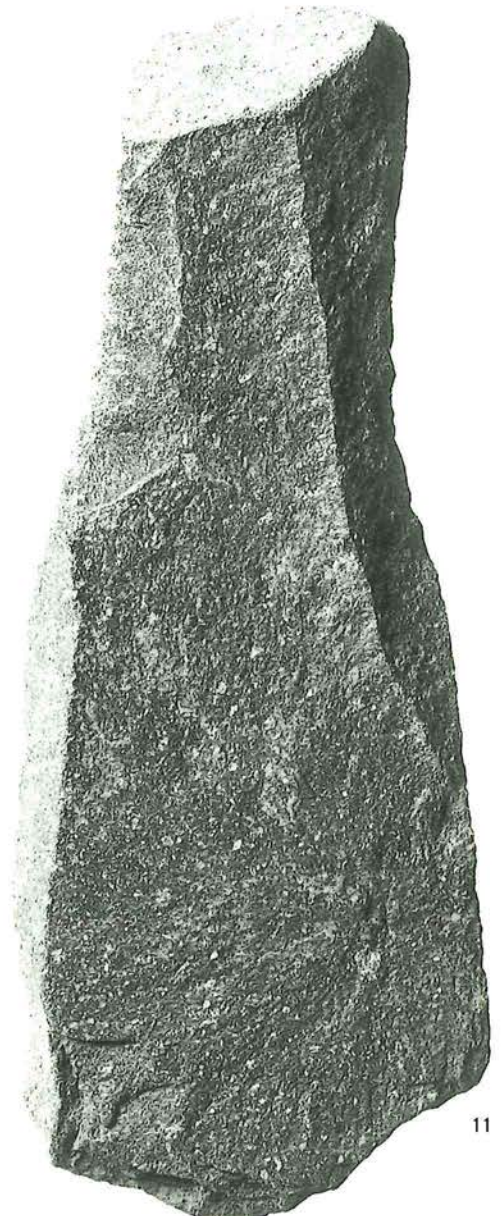

11

磨石

I1a類

- 1 硬砂岩
PL 86-8

I1b類

- 2 安山岩
- 3 花崗岩

I1c類

- 4 砂岩

I2a類

- 5 安山岩
PL 122-24

I2b類

- 6 花崗岩

I2c類

- 7 安山岩

II1a類

- 8 硬砂岩
PL 94-2
- 9 砂岩

II2a類

- 10 砂岩
PL 92-1

II2c類

- 11 花崗岩

I2b類 (特殊)

- 12 ホルンフェルス
(2:3)

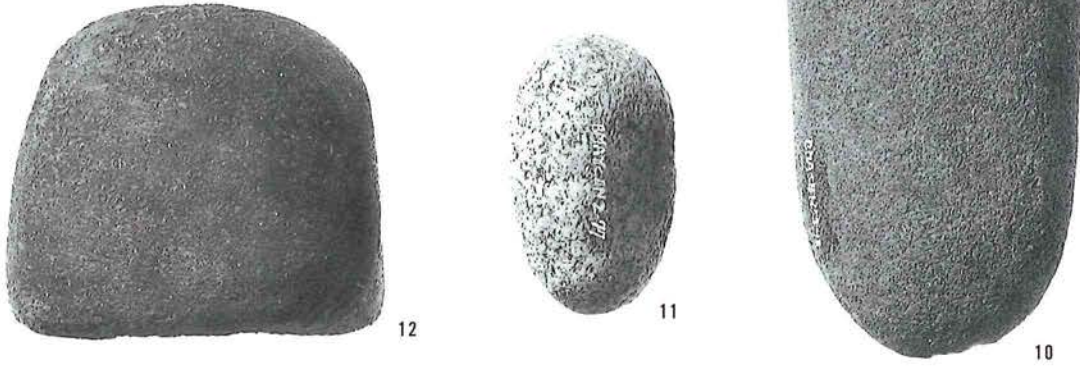
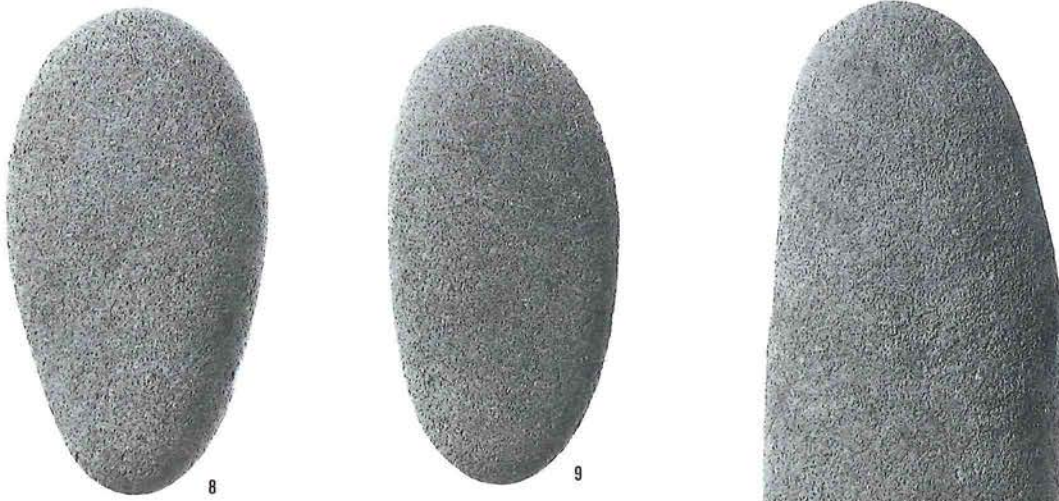
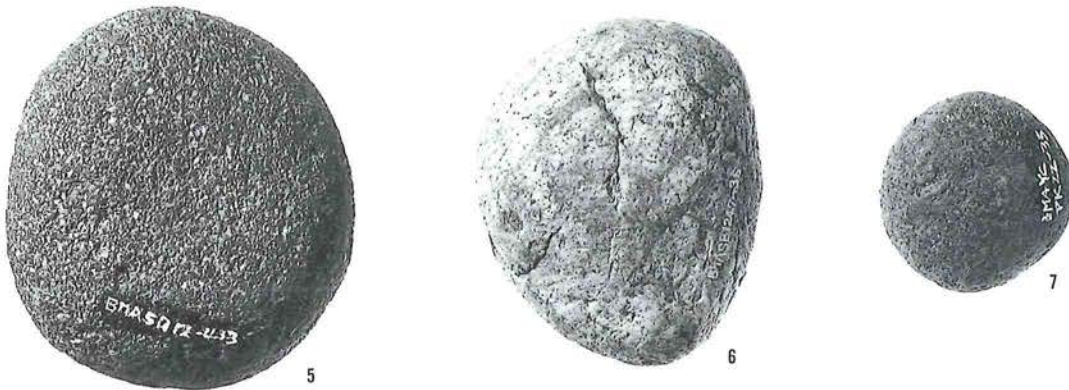
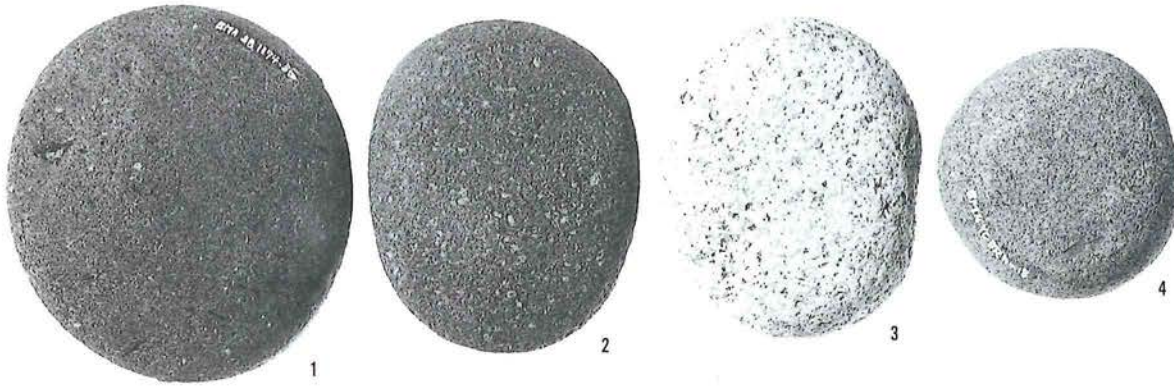

凹石

I1a類

- 1 砂岩
PL 35-3
- 2 安山岩

I2a類

- 3 花崗岩
PL 122-26

台石状(I1a)類

- 7 安山岩

台石状(I1b)類

- 4 輝石安山岩
PL 122-25

台石状(II1a)類

- 5 輝石安山岩
- 6 輝石安山岩
(2:3)

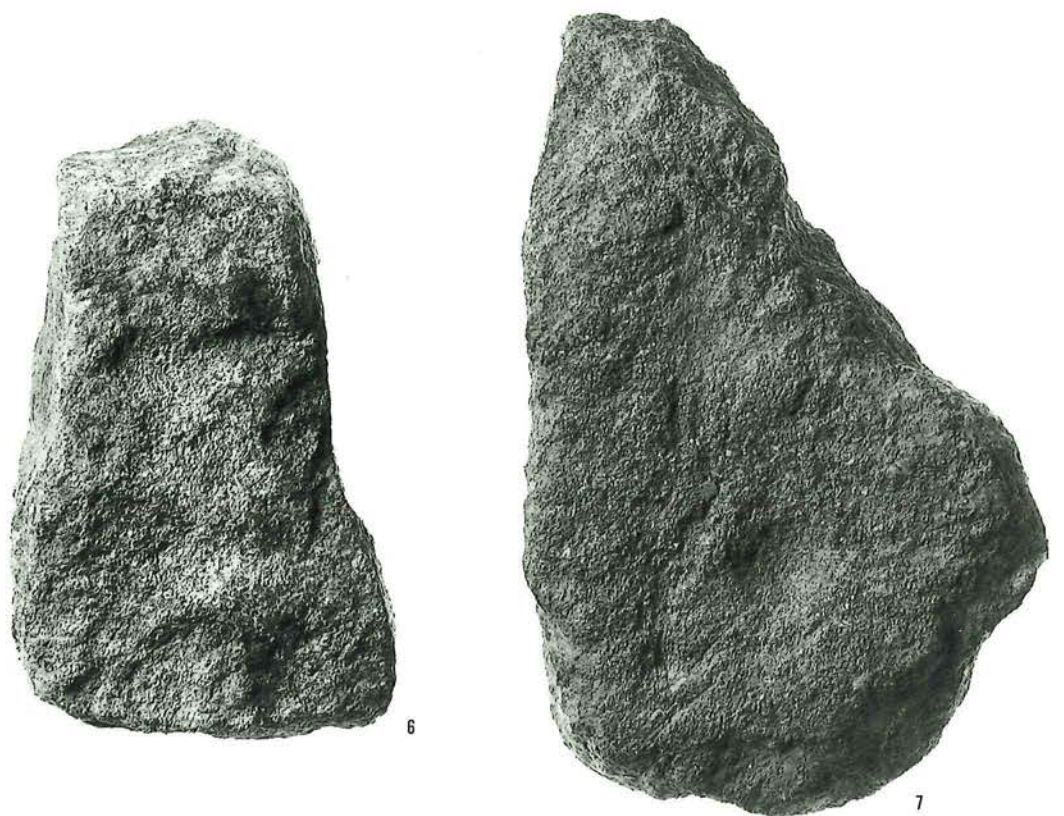
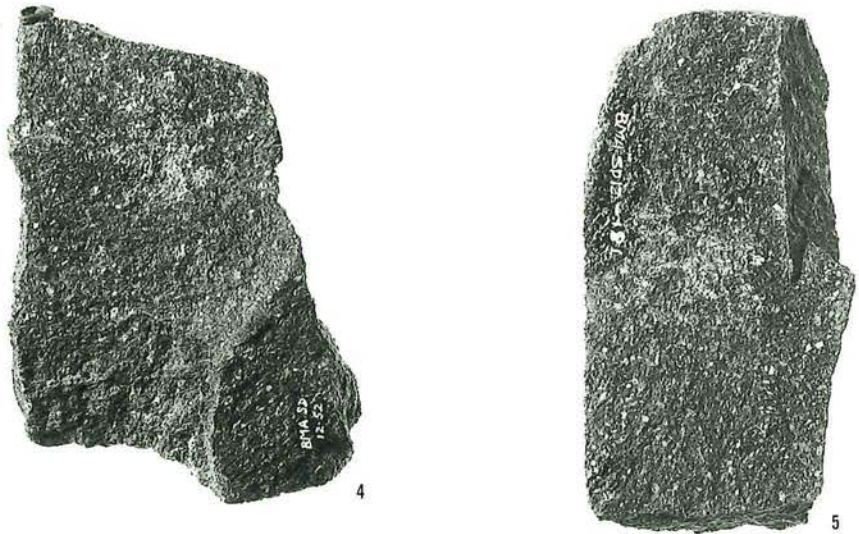

敲石 1

ア類

- 1 硬砂岩
- 2 輝石安山岩
PL 116-1
- 3 チャート
PL 123-31
- 4 硬砂岩
PL 114-3
- 5 輝石安山岩
PL 114-14
- 6 硬砂岩
- 7 チャート
PL 123-28
- 8 硬砂岩

イ類

- 9 黒色頁岩 A
PL 123-36
- 10 硬砂岩
PL 22-3
- 11 硬砂岩
PL 123-37
- 12 変質溶結凝灰岩
- 13 硬砂岩
PL 111-1
- 14 チャート
(2:3)

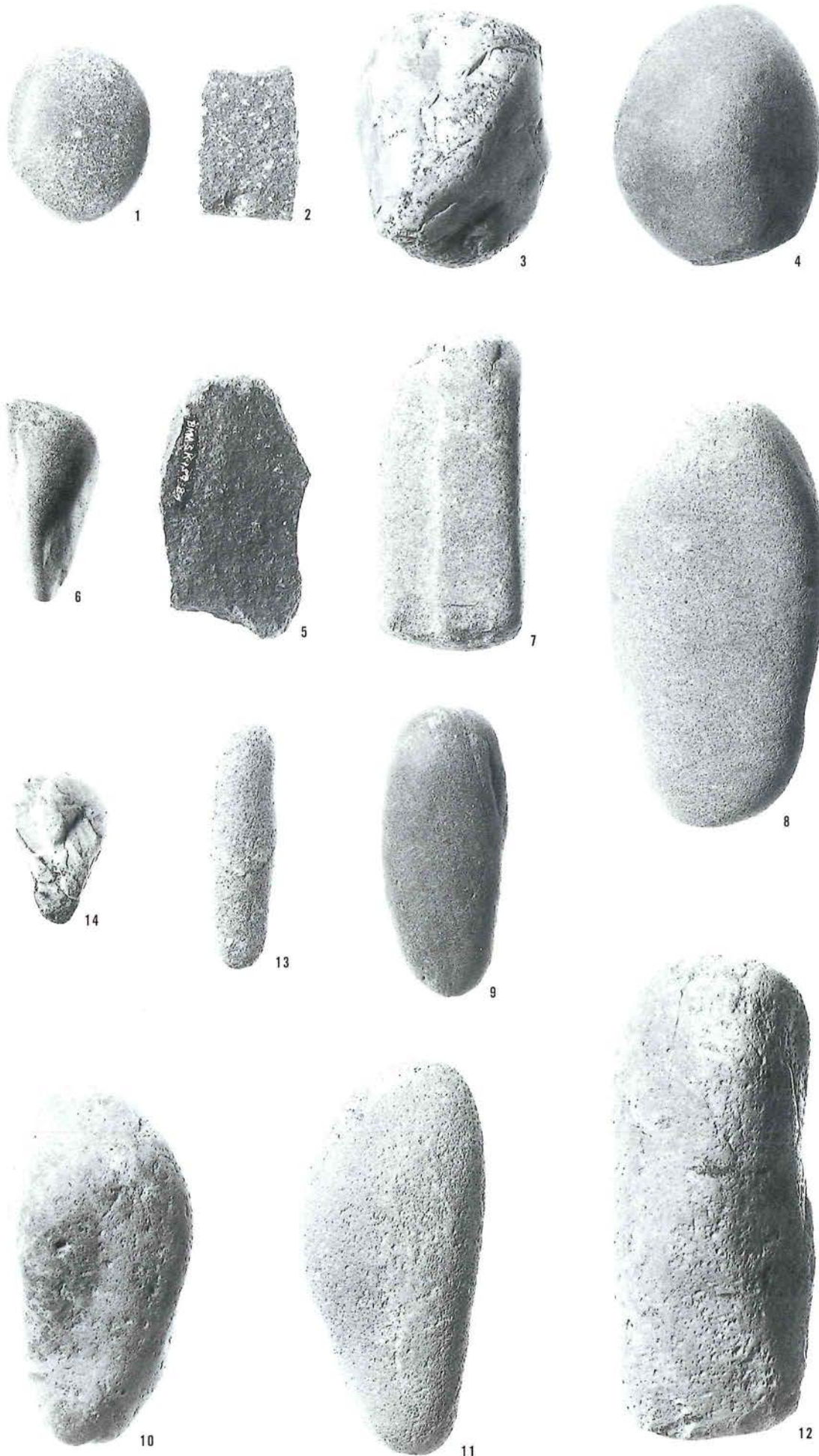

敲石2

ウ類

- 15 ホルンフェルス
PL 51-5
- 16 硬砂岩
PL 177-6
- 17 珪質岩 A

エ類

- 18 黒色頁岩 A
- 19 硬砂岩
PL 74-9
- 20 硬砂岩
- 24 花崗岩
PL 82-11
- 26 硬砂岩
(2:3)



17



15



16



18



19



20



21



22



23

敲石 3

ア・エ類

- 27 硬砂岩
- 28 硬砂岩
PL 1-4

ア・エ・オ類

- 29 花崗閃緑岩
PL 123-34
- 30 硬砂岩
PL 123-32

ウ・エ類

- 21 硬砂岩
PL 179-7
- 22 硬砂岩
- 23 砂岩
- 25 砂岩

ウ・オ類

- 31 硬砂岩
PL 123-41
(2:3)



24



25



26



28



29



27



30



31

敲石 4

工類

39 硬砂岩
PL 37-11

40 硬砂岩
PL 66-4

才類

32 花崗岩
PL 170-8

33 チャート

34 チャート
PL 75-14

35 ホルンフェルス
PL 83-7

カ類

36 硬砂岩
PL 56-8

37 チャート

ク類

38 硬砂岩
PL 11-10
(2:3)



32



33



34



35



36



38



37



39



40

敲石5

キ類

- 41 チャート
PL 73-4
- 42 チャート
- 43 チャート
- 44 チャート
PL 177-4
- 45 チャート
- 46 変質溶結凝灰岩
- 47 チャート
PL 114-15
- 48 チャート
PL 177-5
- 49 チャート
PL 7-17

(2:3)



41



42



46



43



44



45



47



48



49

角礫石

- 50 花崗岩
- 51 硬砂岩
- 52 輝石安山岩

(2:3)

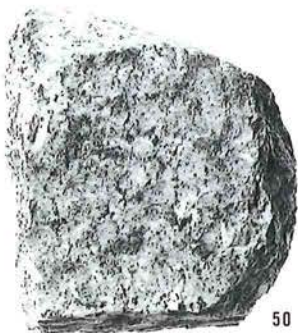

50



51



52

みがき石

I1a類

1 黒色頁岩 A

I1c類

2 黒色頁岩 A
PL 170-10
3 黒色頁岩 A
4 黒色頁岩 D
PL 89-7
5 珪質岩 A

I1d類

6 蛇紋岩
7 黒色頁岩 A
8 蛇紋岩
9 黒色頁岩 A
10 黒色頁岩 A
PL 122-45

I1e類

11 砂岩
PL 162-16

I不明

12 蛇紋岩
PL 91-23

I2d類

13 黒色頁岩 A

II1a類

14 蛇紋岩
15 黒色頁岩 A
PL 122-48

II1b類

16 硬砂岩
PL 122-47

II1c類

17 黒色頁岩 A
PL 52-14
18 蛇紋岩
19 蛇紋岩
PL 77-9

II1e類

20 黒色頁岩 B

II2c類

21 硬砂岩
22 砂岩
PL 69-3
24 黒色頁岩 A
PL 117-3
25 黒色頁岩 D
PL 45-5
26 黒色頁岩 A
27 黒色頁岩 A
PL 122-46
22 砂岩

玉石

I1e類

28 チャート
29 蛇紋岩
PL 55-1
30 黒色頁岩 A
PL 162-18

I1f類

31 チャート
32 チャート

I2f類

33 チャート

(II1e類)

34 黒色頁岩 D
PL 162-20

II2e類

35 黒色頁岩 D

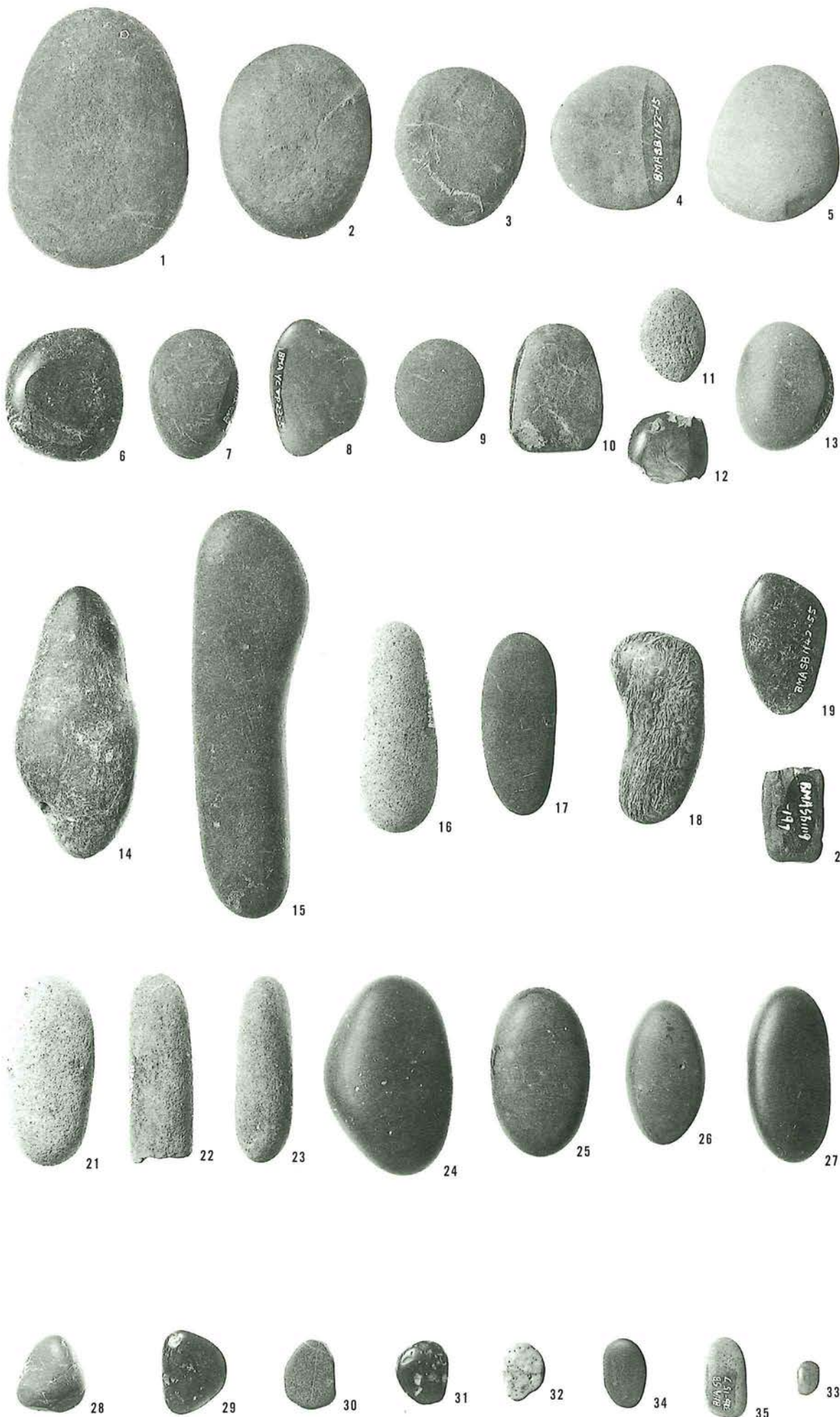

大形刃器 1

1a類

- 1 ホルンフェルス
△VII部第4章
- 2 硬砂岩
PL 111-2
- 3 ホルンフェルス
- 4 硬砂岩
PL 99-10
- 5 黑色頁岩 A
PL 111-9

1b類

- 6 黑色頁岩 A
- 7 黑色頁岩 A
PL 83-17
- 8 黒岩頁岩 A
- 9 黑色頁岩 A
PL 17-11
- 10 黑色頁岩 A
- 11 黑色頁岩 A
PL 112-2
- 12 黑色頁岩 A
PL 47-6
- 13 黑色頁岩 A
△VII部第4章
- 14 黑色頁岩 A
PL 125-56
(2:3)

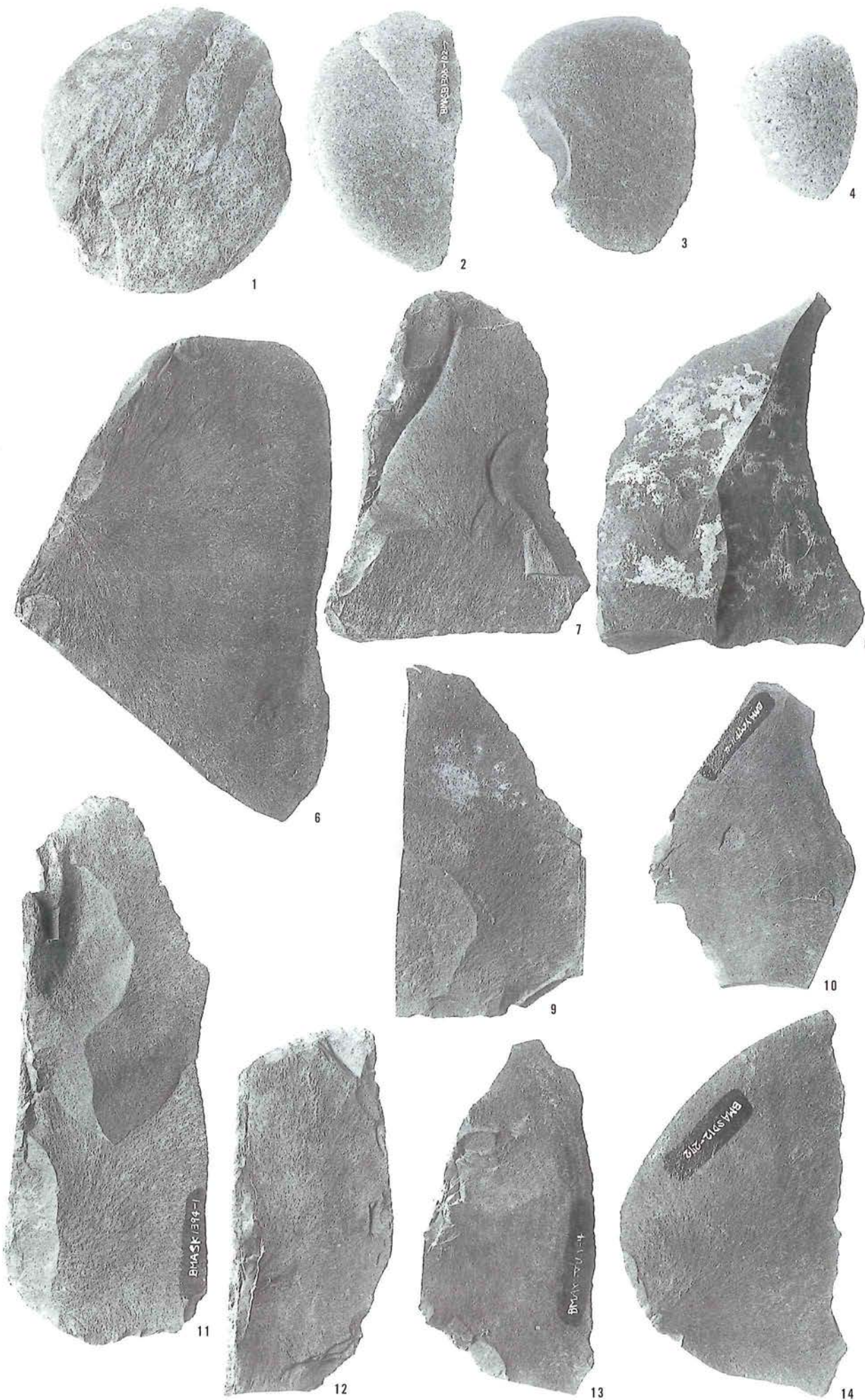

大形刃器 2

1b類

15 黒色頁岩 A

16 珪質岩 A
PL 64-15
△VII部第4章

17 珪質岩 A

18 黒色頁岩 A
PL 5-11

19 黒色頁岩 A
PL 39-4

20 黒色頁岩 A
PL 116-3

21 黒色頁岩 A
PL 179-8

22 ホルンフェルス
PL 125-52

23 黒色頁岩 A
PL 58-6

24 黒色頁岩 A

25 黒色頁岩 A
PL 78-7

26 黒色頁岩 A

27 赤色頁岩?
PL 77-10

28 黒色頁岩 A
PL 67-5

29 ホルンフェルス
(2:3)

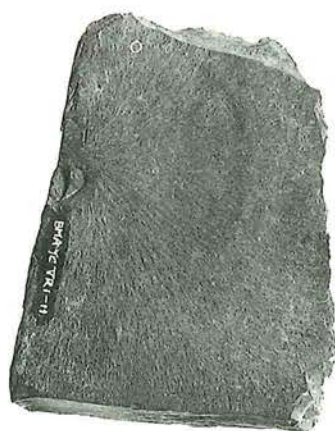

15



16

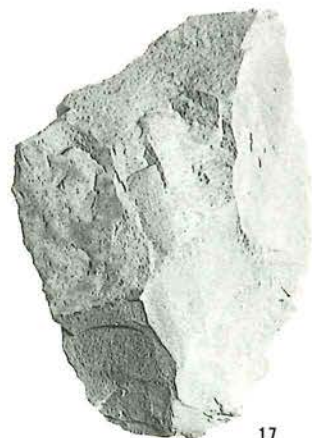

17

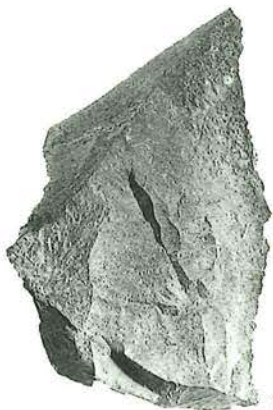

18



19



20



21



22



23



24



25



28

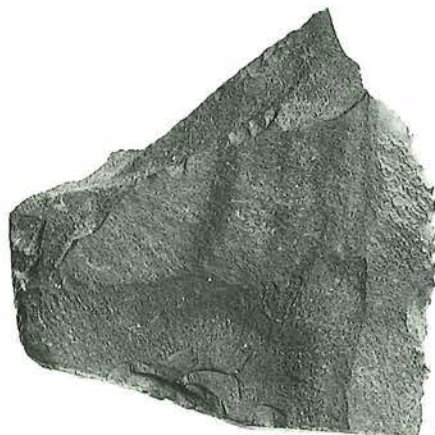

26



5



27

大形刃器 3

2b類

30 黒色頁岩 A
PL 86-9

31 黒色頁岩 A

32 黒色頁岩 A
PL 42-2

33 黒色頁岩 A

34 黒色頁岩 A

(2:3)

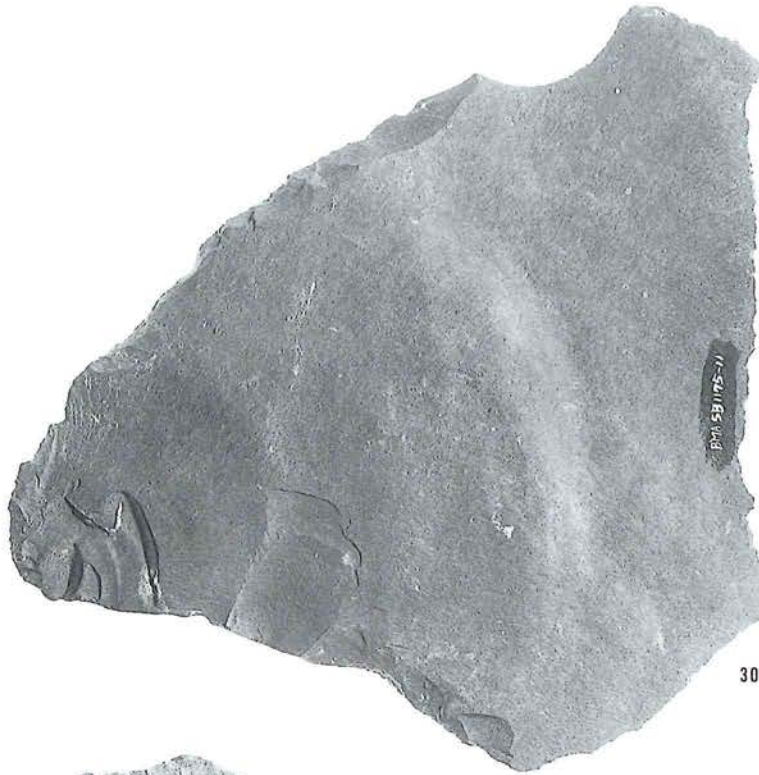

30

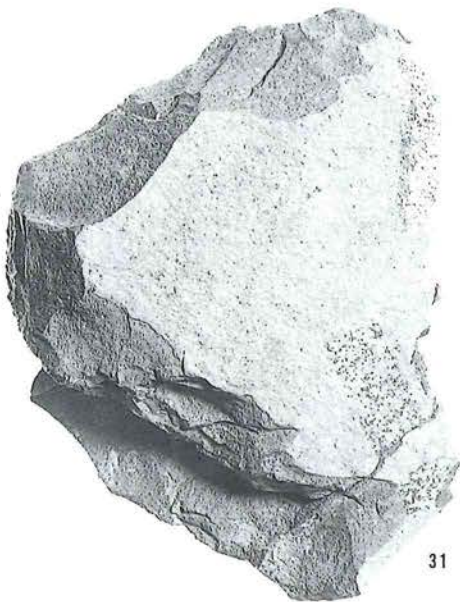

31

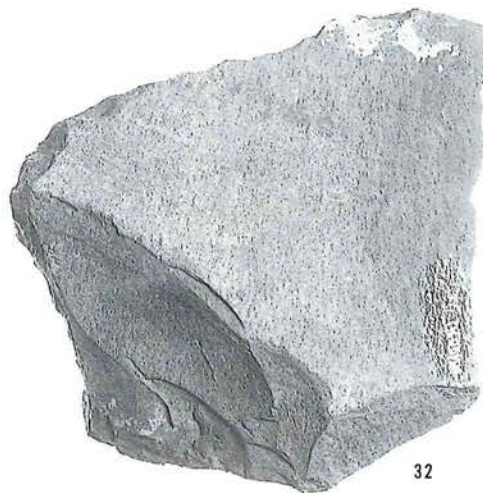

32

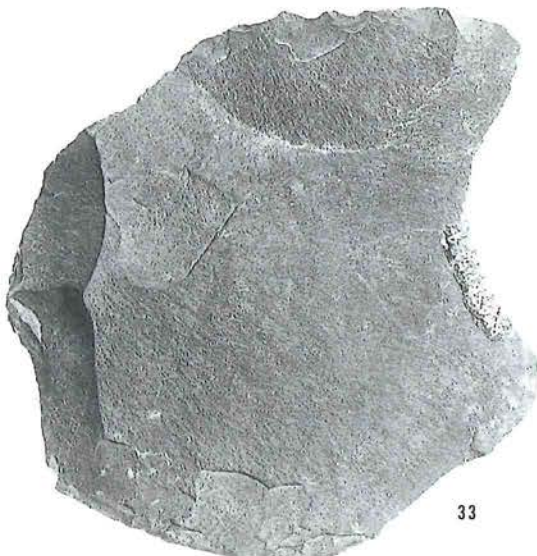

33



34

大形刃器 4

2b類

- 35 黑色頁岩 A
- 36 黑色頁岩 A
PL 117-4
- 37 珪質岩 A
PL 67-14
- 38 黑色頁岩 A
PL 16-2
△VII部第 4 章
- 39 黑色頁岩 A
PL 96-4
- 40 黑色頁岩 A
- 41 黑色頁岩 B
- 42 黑色頁岩 A
- 43 黑色頁岩 A
- 44 黑色頁岩 A
- 45 珪質岩 A
PL 164-26
△VII部第 4 章
(2 : 3)



35

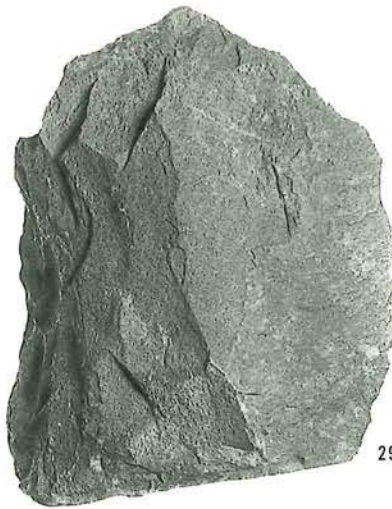

29



36



37



38



39



53

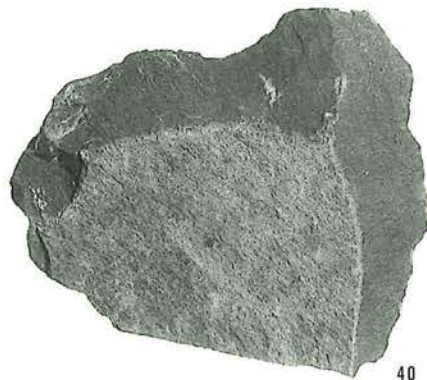

40



41



42



43



44



45

大形刃器 5

2b類

- 46 珪質岩 A
PL 126-62
- 47 黒色頁岩 A
PL 69-6
- 48 ホルンフェルス
PL 179-9
- 49 ホルンフェルス
- 50 ホルンフェルス
PL 56-9
- 51 黒色頁岩 A
PL 77-1
- 52 黒色頁岩 A
PL 127-67

2c類

- 53 黒色頁岩 D
- 54 黒色頁岩 A
- 55 珪質岩 A
PL 55-6
- 56 黒色頁岩 A
PL 44-4
- 57 黒色頁岩 A
- 58 珪質岩 A
△VII部第4章
- 59 黒色頁岩 D
PL 35-6
- 60 珪質岩 A
PL 16-3

2c(円盤)類

- 61 ホルンフェルス
- 62 黒色頁岩 A
- 63 黒色頁岩 B
- 64 黒色頁岩 A
(2:3)



46



47



76



54



48



49



50



55



56



57



58



59



60



61



62



63



64

大形刃器 6

2d類

- 65 硬砂岩
△VII部第4章
- 66 黒色頁岩 A
PL 39-5
- 67 黒色頁岩 E
△VII部第4章
- 68 黒色頁岩 A
PL 93-7
- 69 黒色頁岩 A
PL 126-66

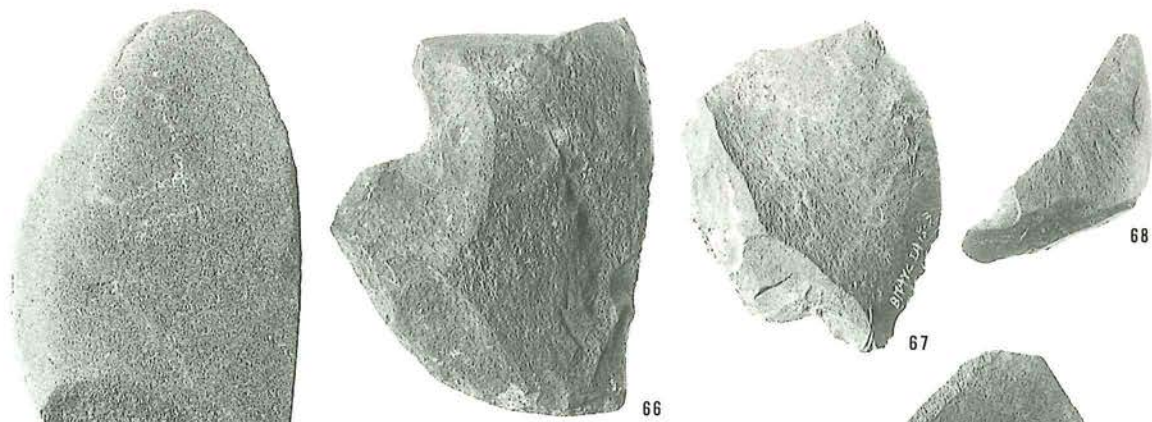

3類

- 70 ホルンフェルス
- 71 黒色頁岩 A
PL 77-12
- 72 黒色頁岩 A
PL 2-9
- 73 黒色頁岩 A
PL 164-33
PL 164-34
- 74 黒色頁岩 A
PL 164-32
- 75 ホルンフェルス
PL 42-4
△VII部第4章

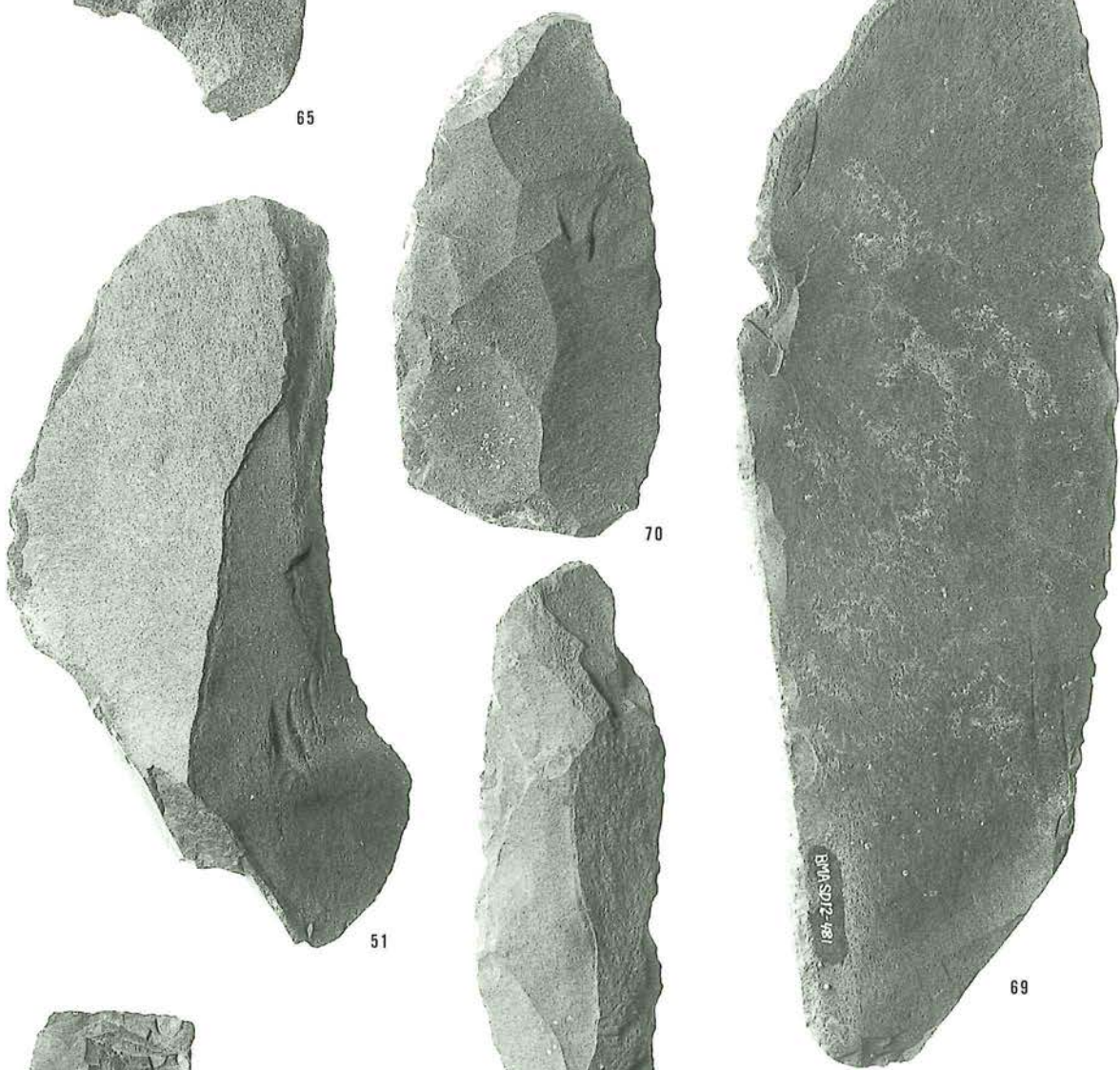

3類?

- 76 黒色頁岩 A
(2:3)

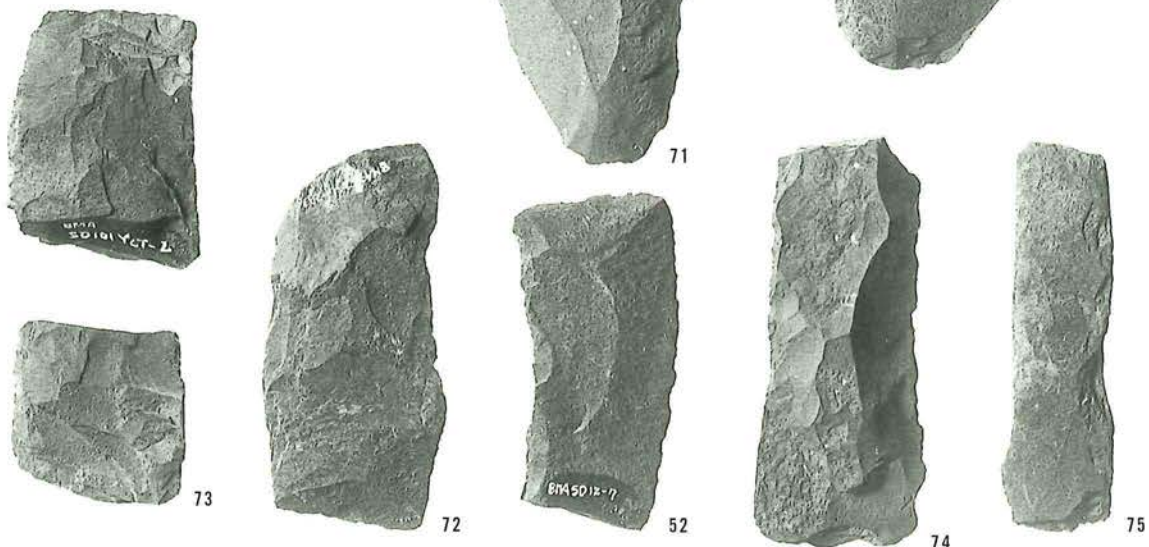

大形刃器 7

7 類

77 安山岩
PL 52-17

78 硬砂岩
PL 50-9

79 硬砂岩
PL 164-37

80 黑色頁岩 A
PL 127-71

81 黑色頁岩 D

82 珪質岩 A

83 黑色頁岩 A

84 珪質岩 A
PL 37-12

85 黑色頁岩 A
PL 14-1

8 類

86 黑色頁岩 A
PL 59-8

87 黑色頁岩 A
PL 99-20

88 珪質岩 A
PL 87-1

特殊

89 珪質岩 B
PL 17-12

(2 : 3)



80



81



82



83



77



78



79



85



84



86



88



87



89

大形刃器 8

1b類

90 輝石安山岩

91 輝石安山岩
PL 57-4

92 輝石安山岩
PL 165-24

93 輝石安山岩
(2:3)



90

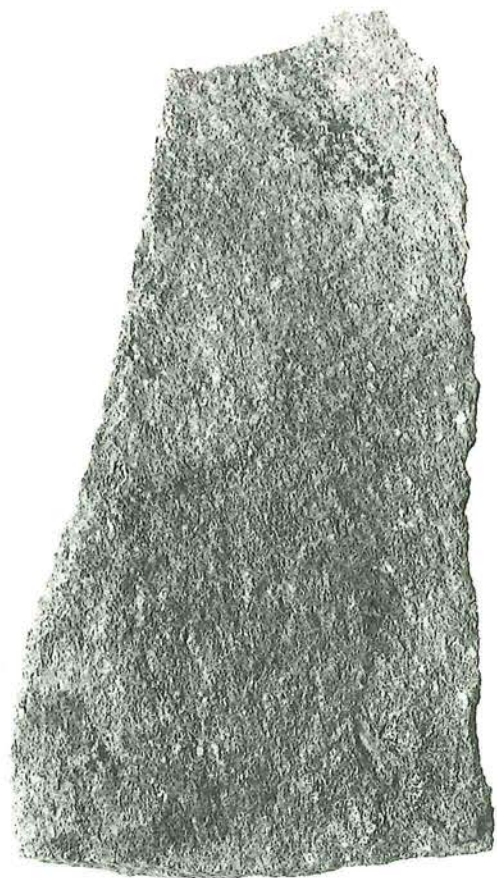

91

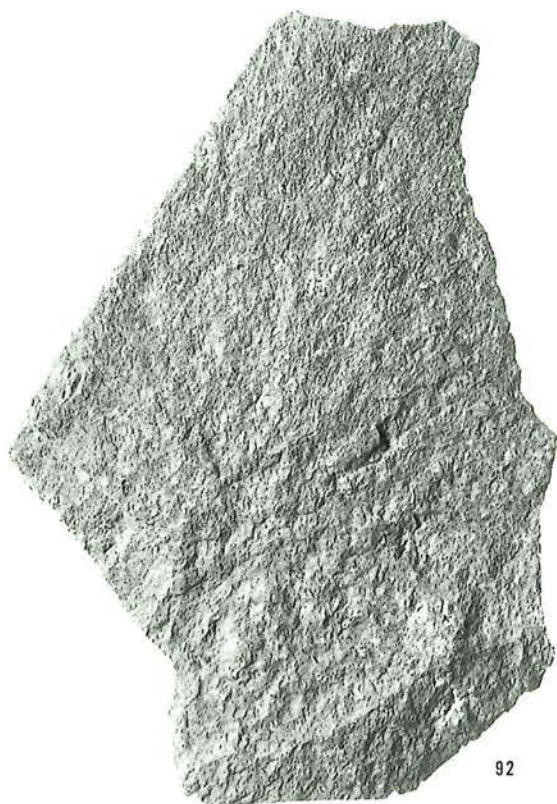

92

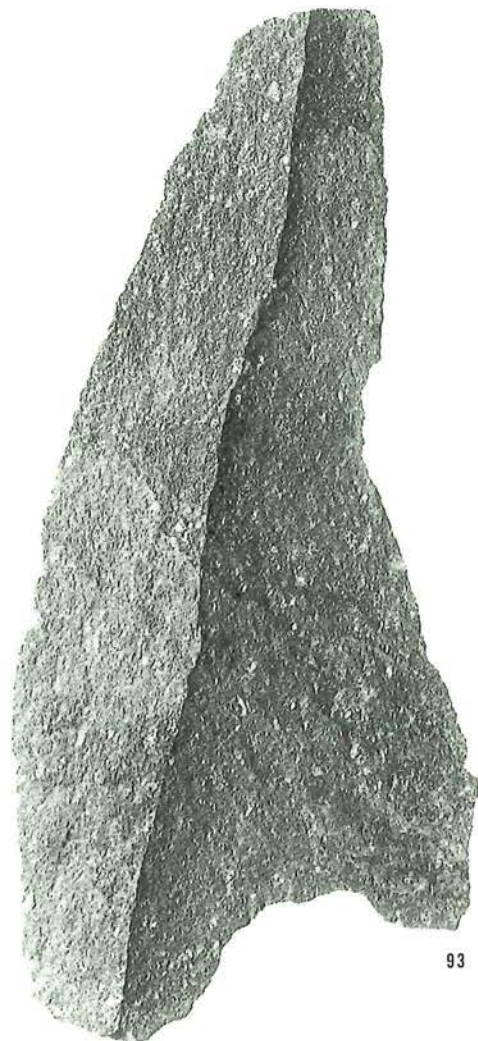

93

大形刃器 9

1b類

- 94 輝石安山岩
PL 94-6
- 95 輝石安山岩
PL 28-2
- 96 輝石安山岩
PL 77-13
- 97 輝石安山岩
PL 78-15
- 98 輝石安山岩
- 99 輝石安山岩
PL 78-14
- 100 輝石安山岩
PL 179-10
- 101 輝石安山岩
PL 126-61

(2 : 3)



94



95



96



97

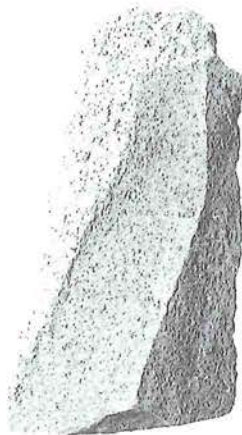

98



99



100

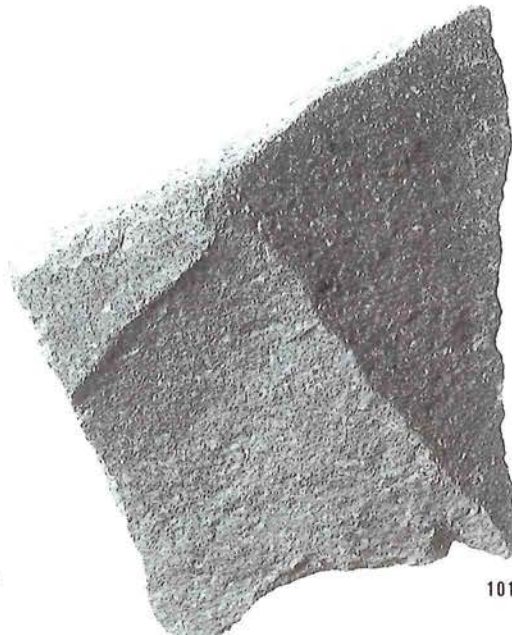

101

大形刃器 10

1b類

- 102 輝石安山岩
PL 97-8
- 103 輝石安山岩

2b類

- 120 輝石安山岩
PL 126-60
- 121 輝石安山岩
PL 82-12
- 122 輝石安山岩
PL 111-8
(2:3)

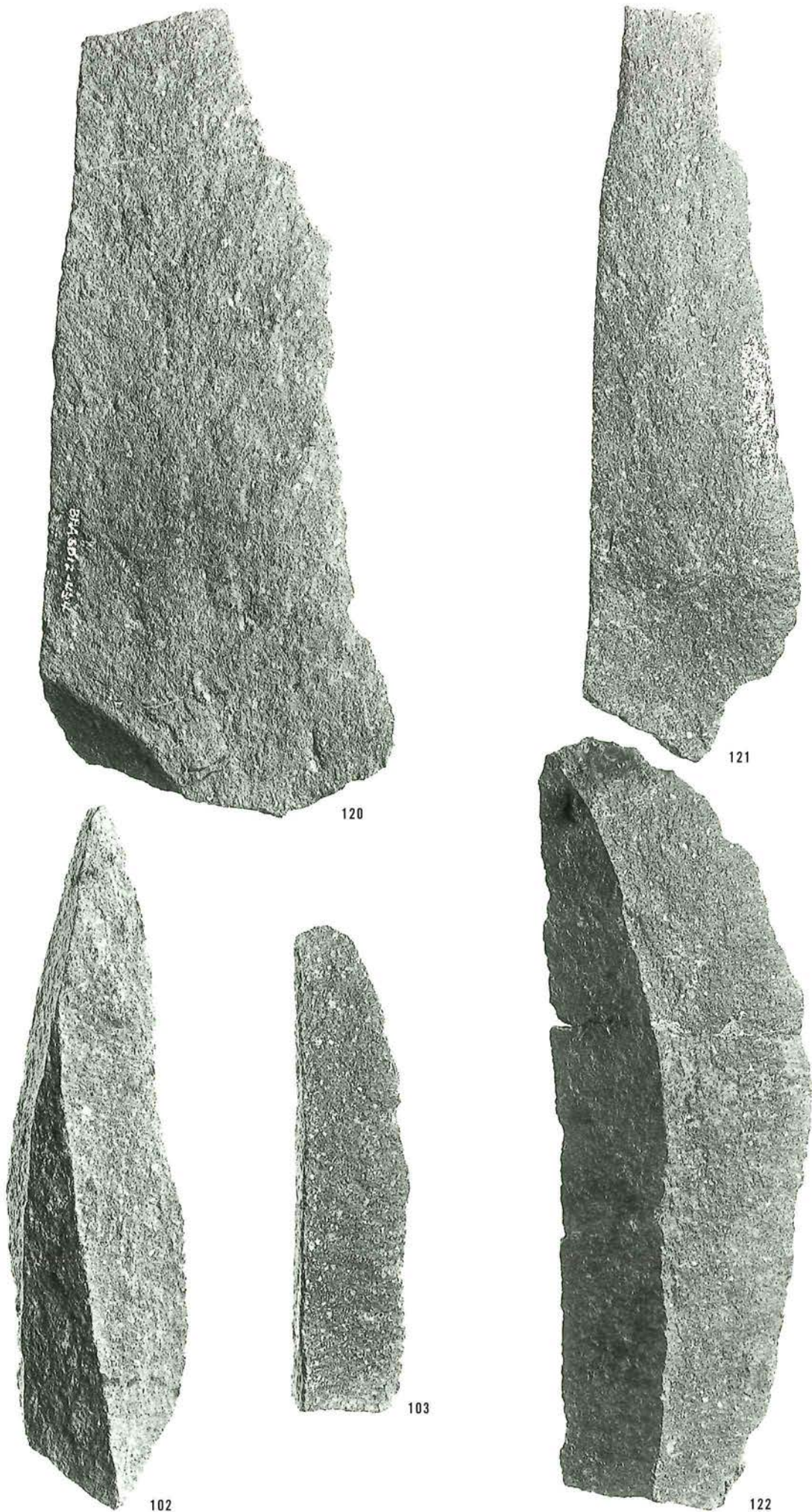

大形刃器 11

2a類

104 輝石安山岩
PL 69-8

105 輝石安山岩
PL 171-13

106 輝石安山岩
PL 11-8

107 輝石安山岩
PL 75-16

108 輝石安山岩
PL 2-10

(2:3)

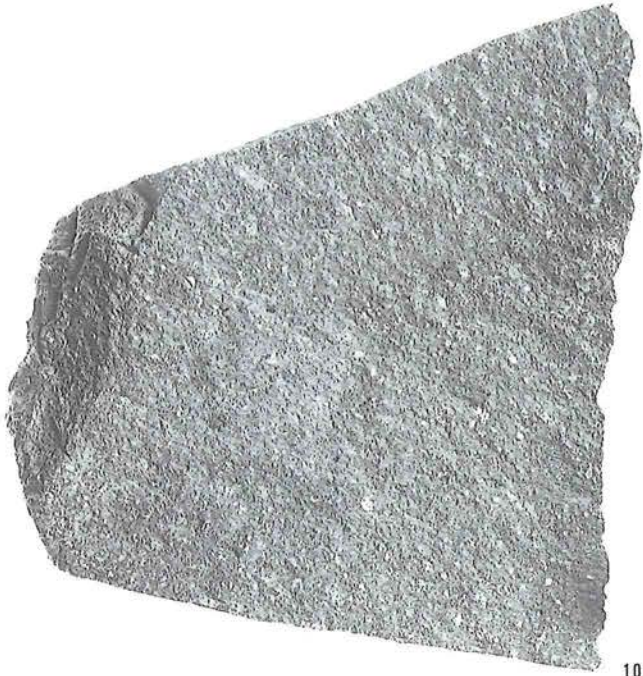

104



105

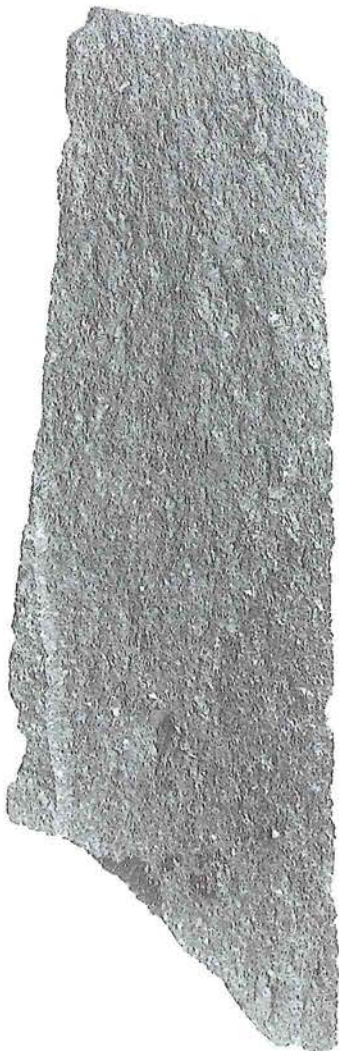

108



106



107

大形刃器 12

2a類

109 輝石安山岩
PL 171-12



109

110 輝石安山岩
△VII部第4章



110

111 輝石安山岩

112 輝石安山岩

113 輝石安山岩
PL 51-6.

114 輝石安山岩

115 輝石安山岩
PL 56-18

116 輝石安山岩
PL 7-13

117 輝石安山岩
PL 14-11

118 輝石安山岩
PL 145-68

119 輝石安山岩
PL 145-69

(2:3)

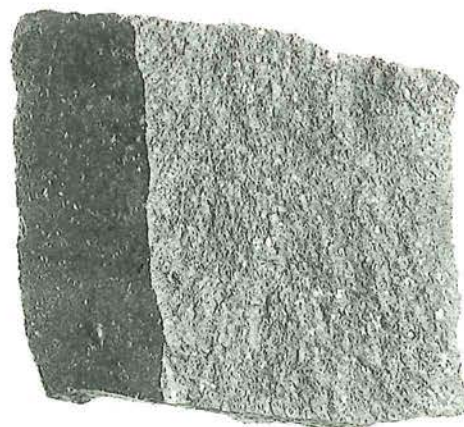

113

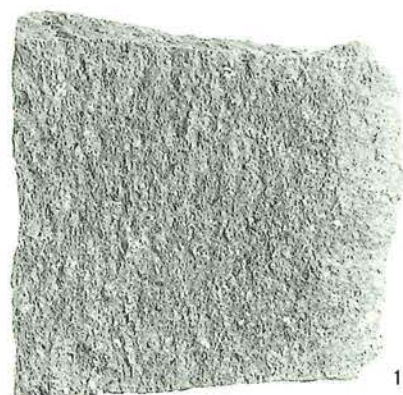

114

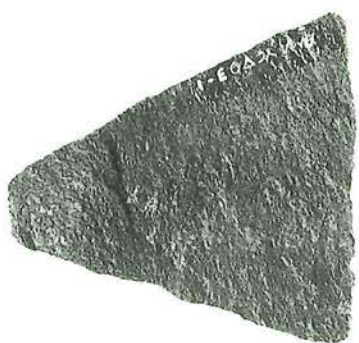

111



115



112

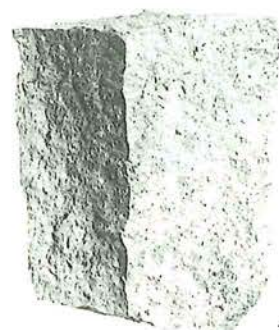

116

大形刃器 13

2b類

123 輝石安山岩
PL 125-58

124 輝石安山岩
PL 51-8

126 輝石安山岩
PL 171-14

132 輝石安山岩
(2:3)

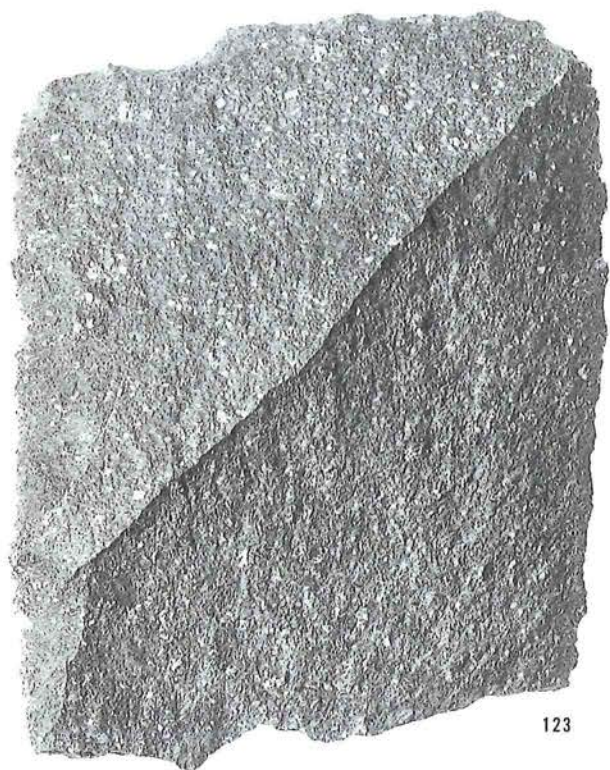

123



126

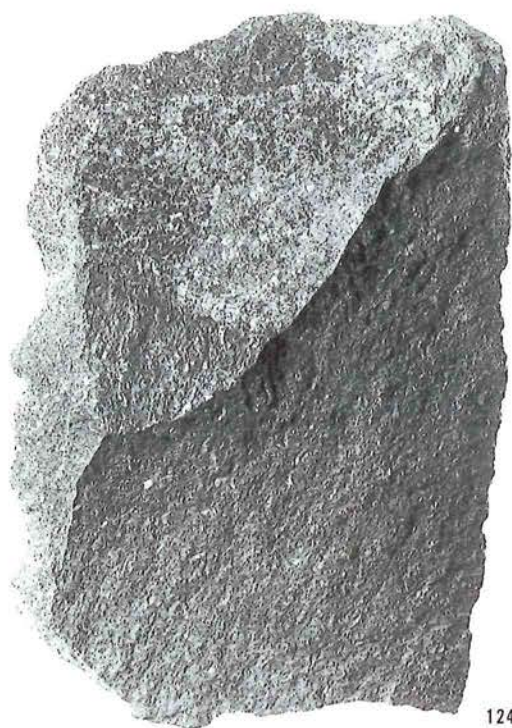

124

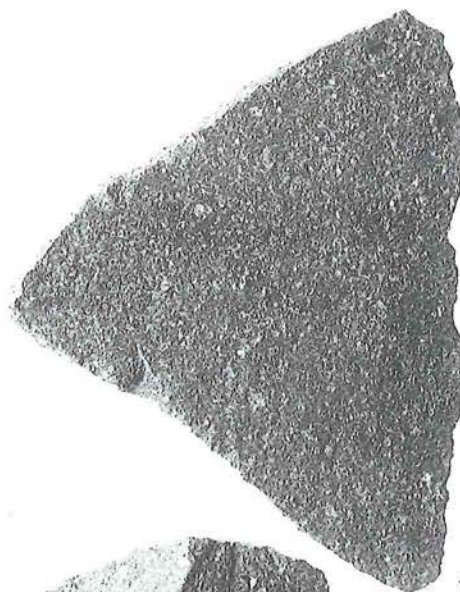

117



132

大形刃器 14

2b類

- 125 輝石安山岩
PL 171-15
- 127 輝石安山岩
PL 165-39
- 128 輝石安山岩
PL 127-68
- 129 輝石安山岩
PL 171-16
- 130 輝石安山岩
PL 127-69
- 131 輝石安山岩
PL 51-9



125



133

2c(円盤)類

- 133 輝石安山岩

2d類

- 134 輝石安山岩
PL 45-2
- 135 輝石安山岩
(2:3)

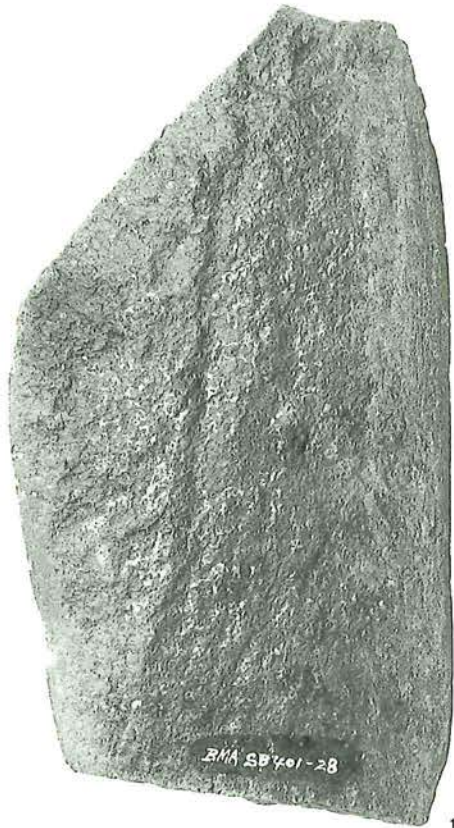

134



128



130



135

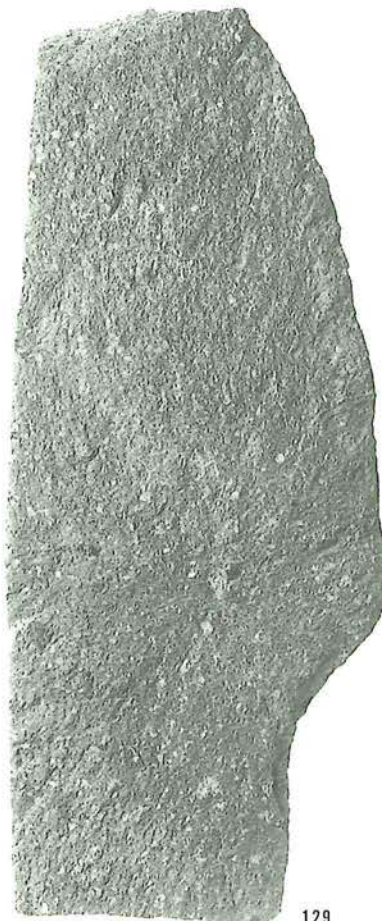

129



131

2d類

136 輝石安山岩

PL 16-6

(2:3)



118



127

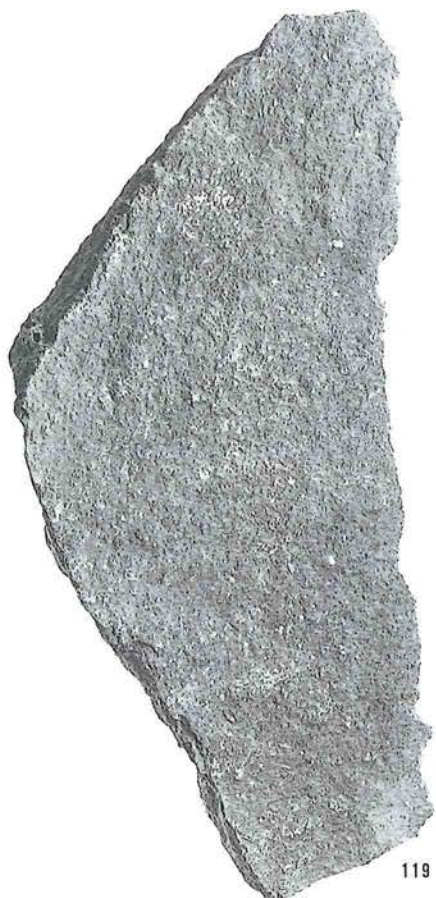

119

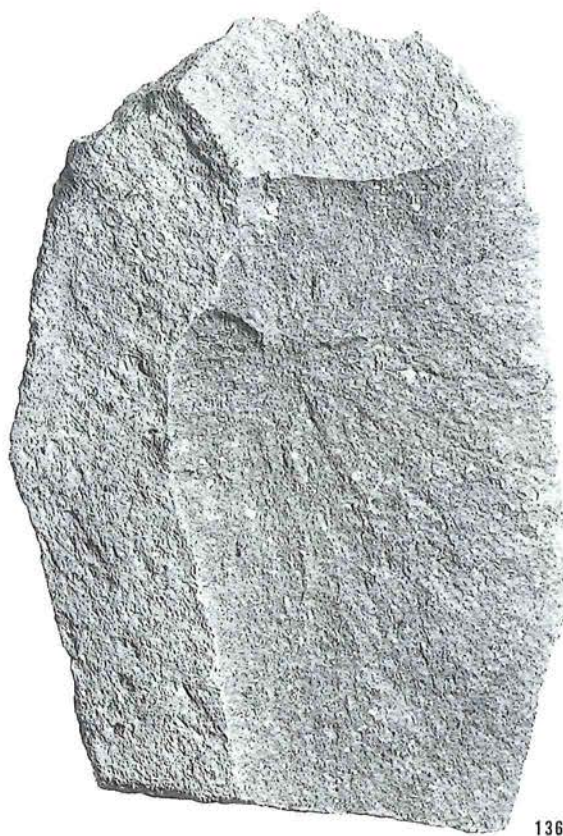

136

大形刃器 16

7 類

- 137 輝石安山岩
- 138 輝石安山岩
PL 114-4
- 139 輝石安山岩
- 140 輝石安山岩
PL 91-12
- 141 輝石安山岩
PL 27-7
- 142 輝石安山岩
PL 127-72
- 143 輝石安山岩
PL 14-10
(2:3)

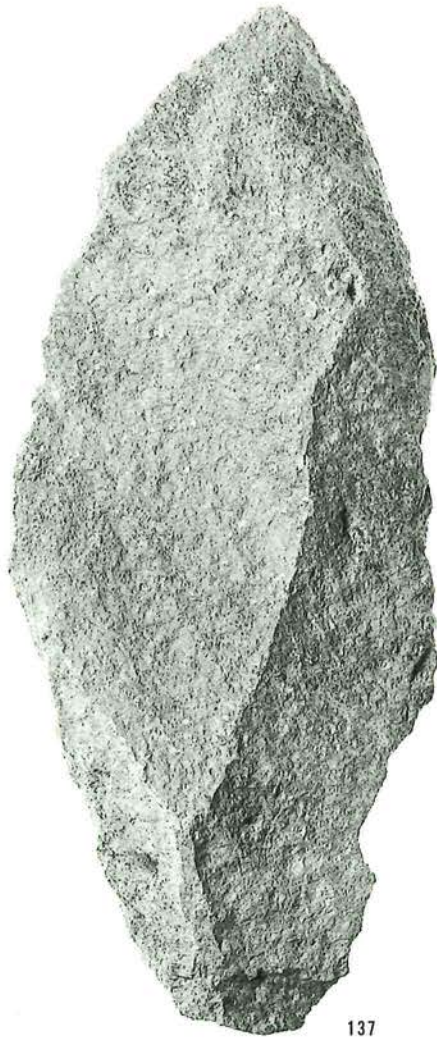

137

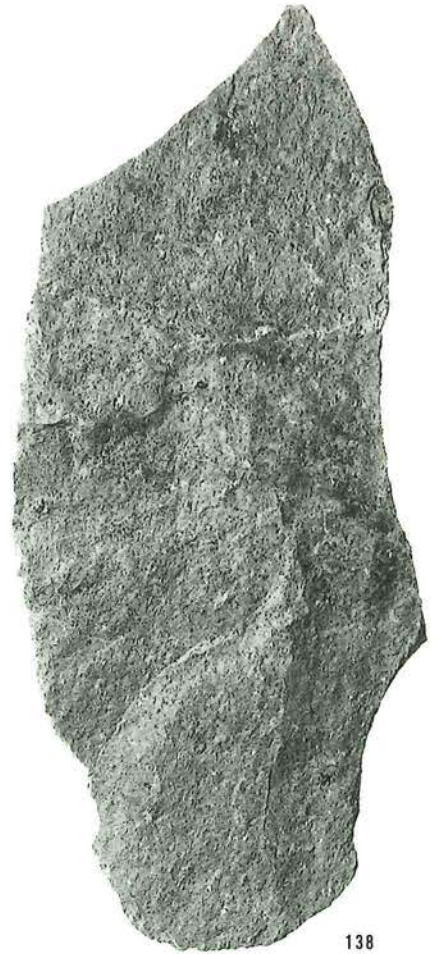

138

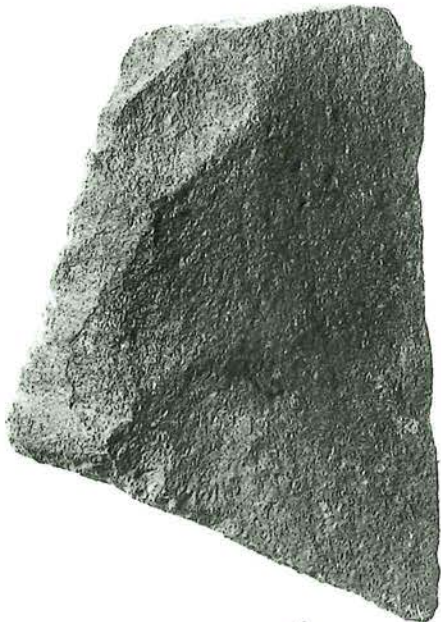

139

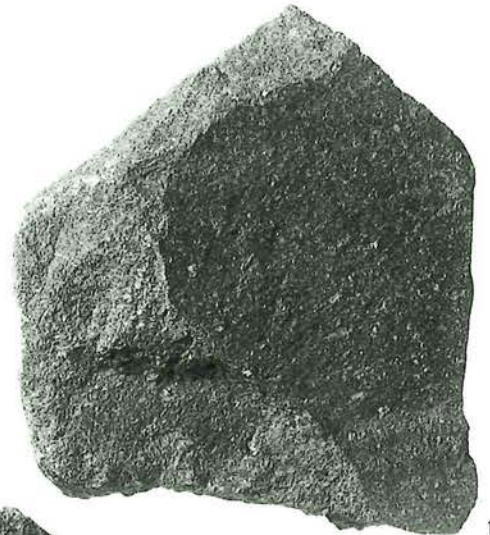

140

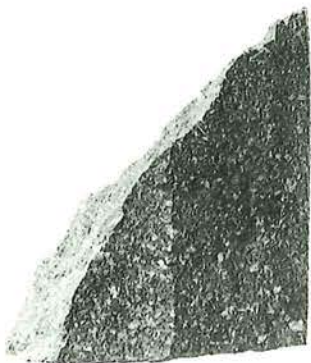

141

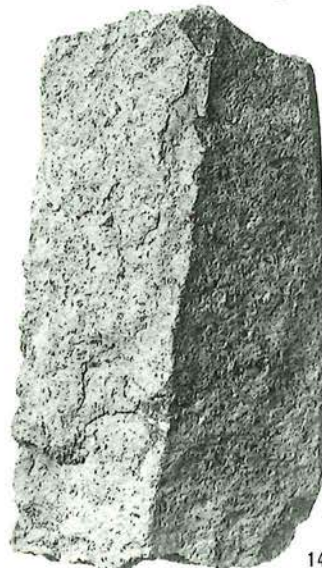

142



143

8 類

146 輝石安山岩
PL 148-94

147 輝石安山岩
PL 149-100

148 輝石安山岩

152 輝石安山岩
PL 127-74

153 輝石安山岩
PL 149-98

154 輝石安山岩
PL 148-95

(2:3)

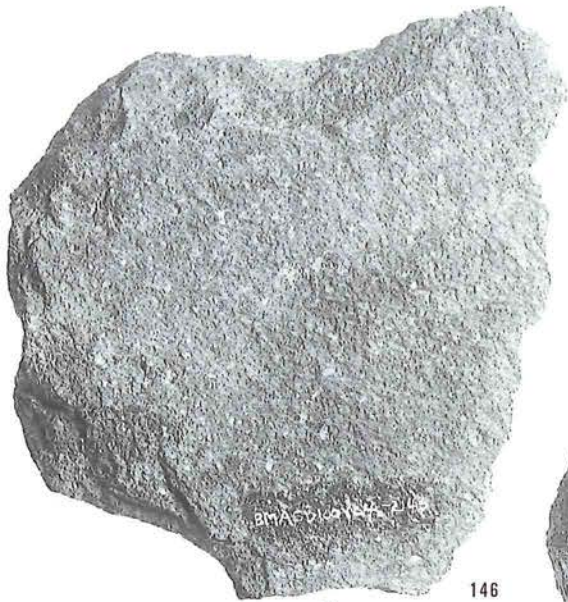

146

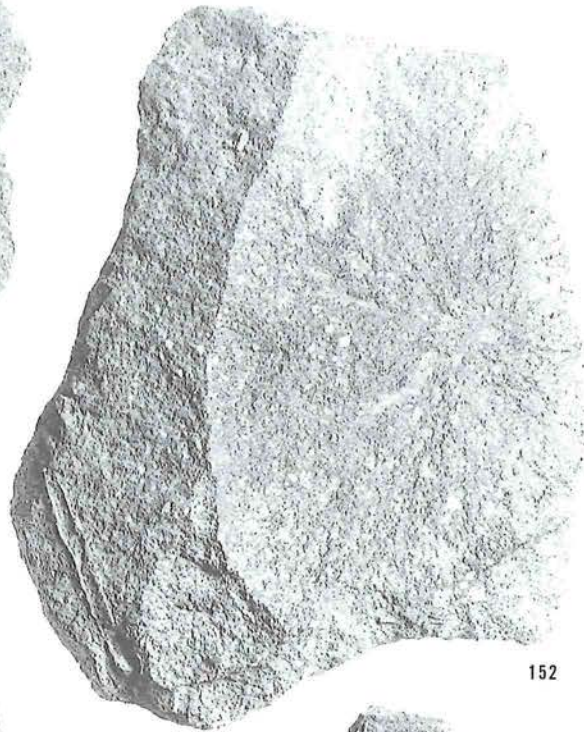

152

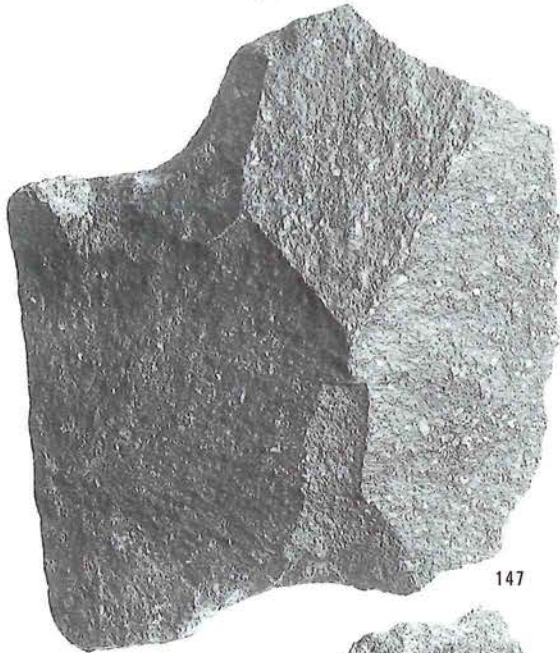

147

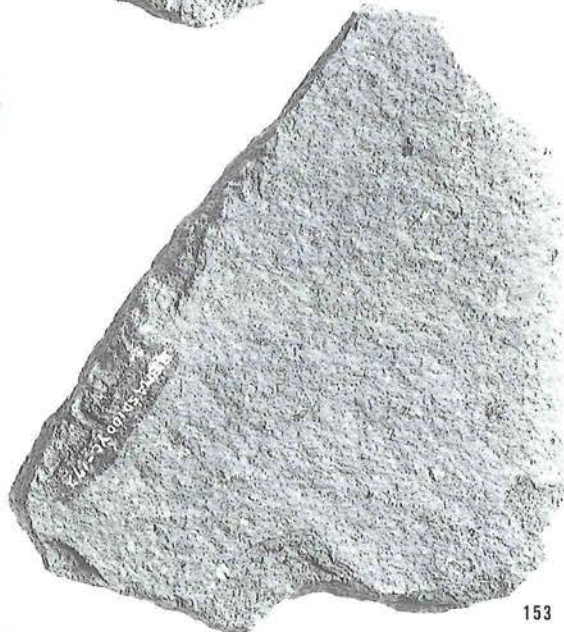

153

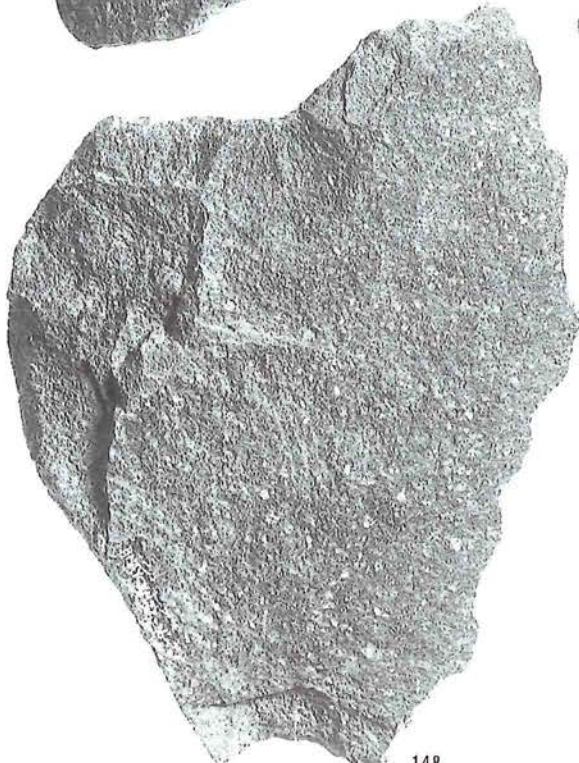

148

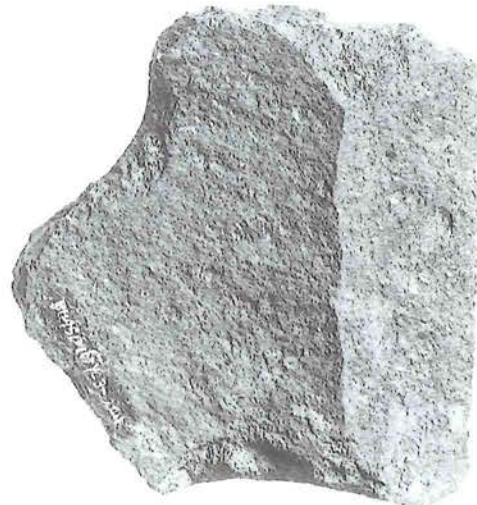

154

大形刃器 18

8 類

- 144 輝石安山岩
PL 11-9
- 145 輝石安山岩
PL 148-93
- 149 輝石安山岩
PL 149-99
- 150 黑色頁岩 A
PL 148-96
- 151 輝石安山岩
PL 148-97
- 155 輝石安山岩
PL 127-73
- 156 輝石安山岩
PL 149-101

(2 : 3)

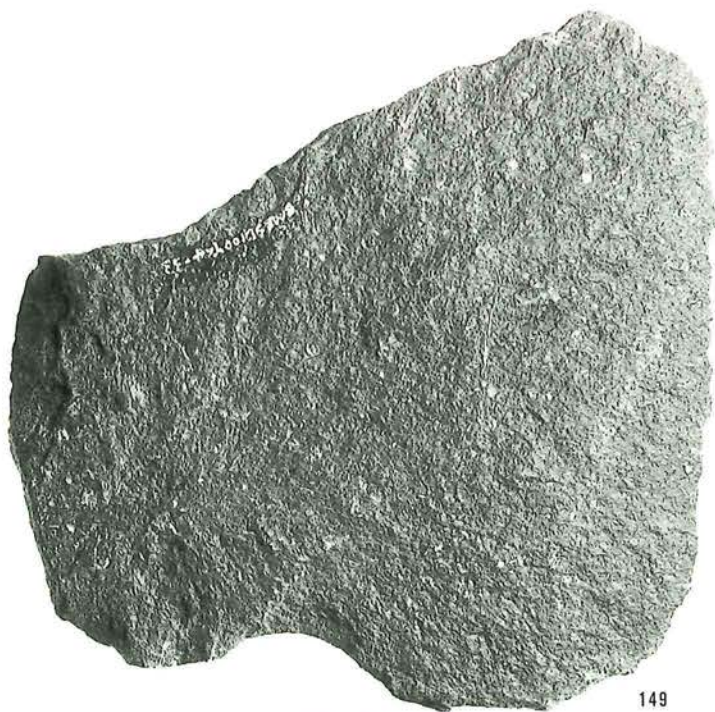

149



150

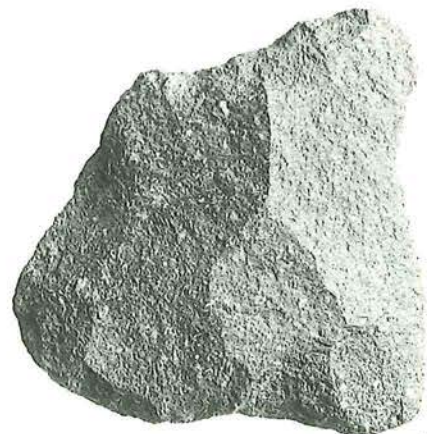

151

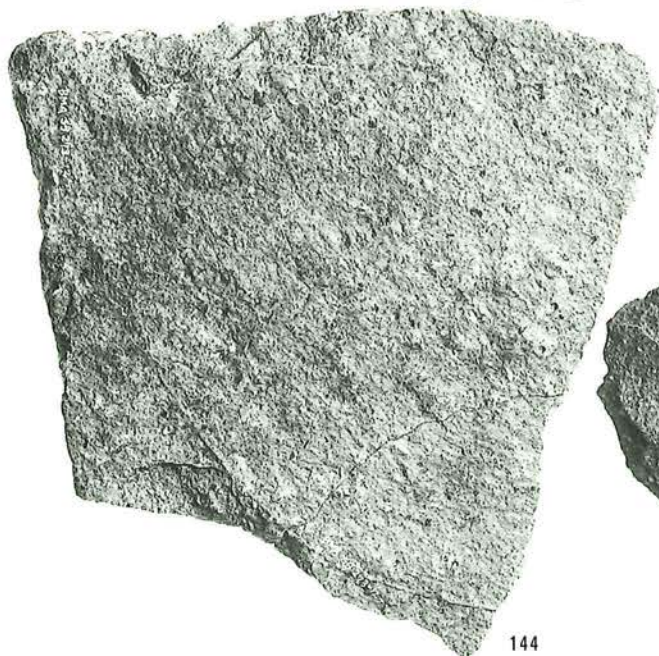

144

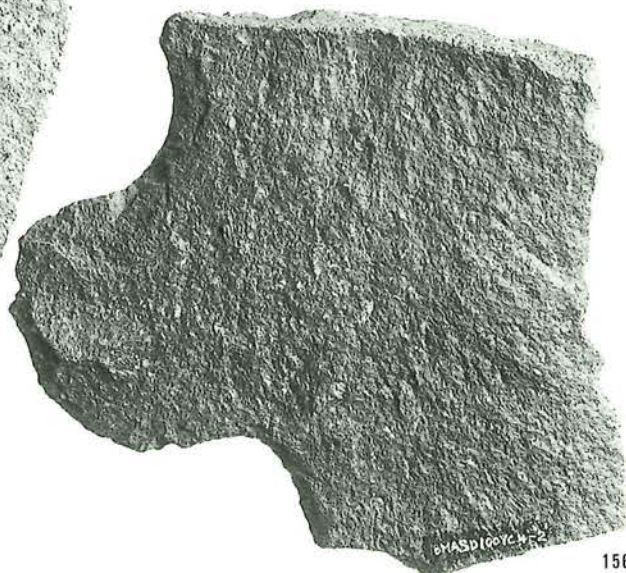

156

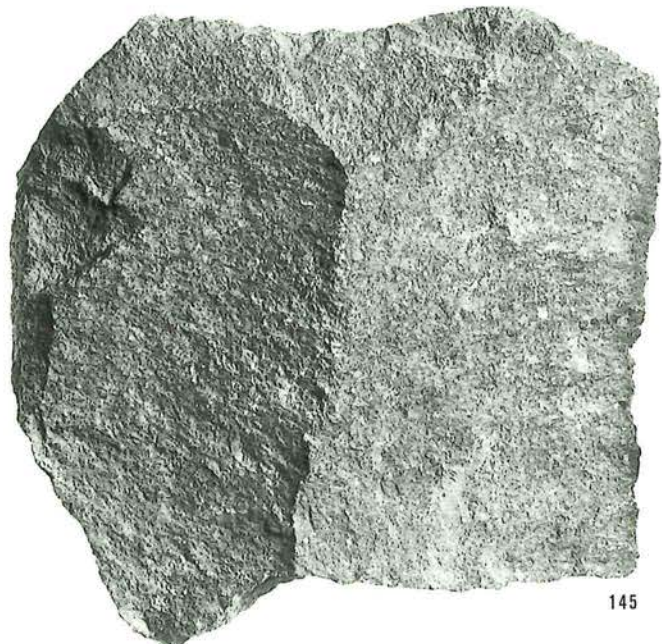

145

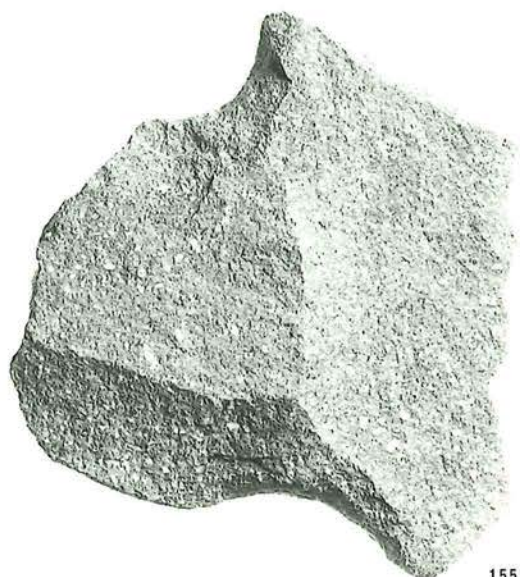

155

8 類

157 輝石安山岩
PL 165-38

158 輝石安山岩
PL 22-1

159 輝石安山岩

160 輝石安山岩
PL 13-10

161 輝石安山岩
PL 106-1

(2 : 3)

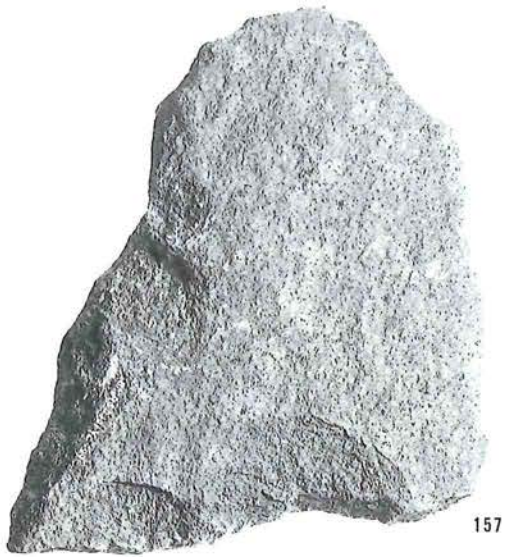

157

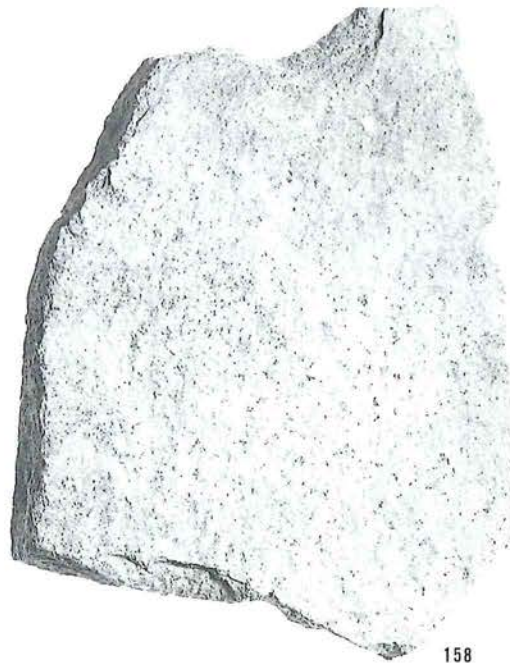

158

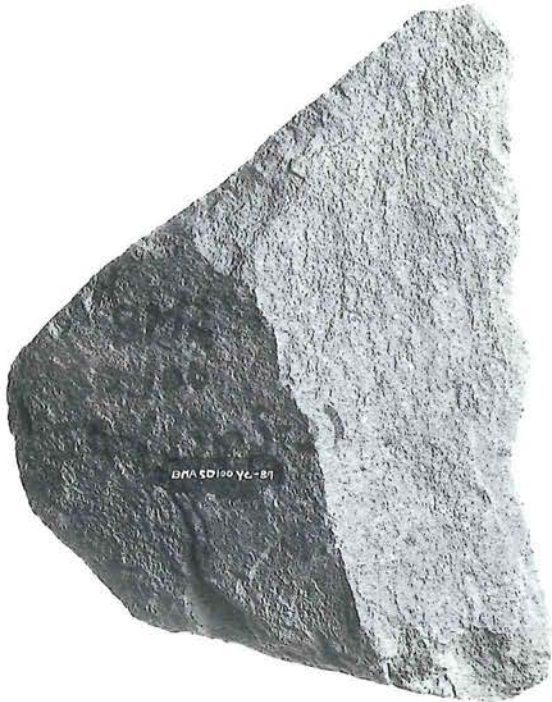

159

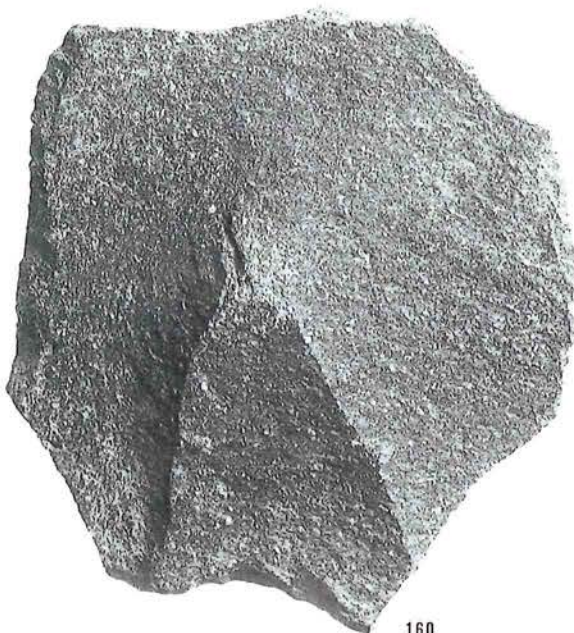

160

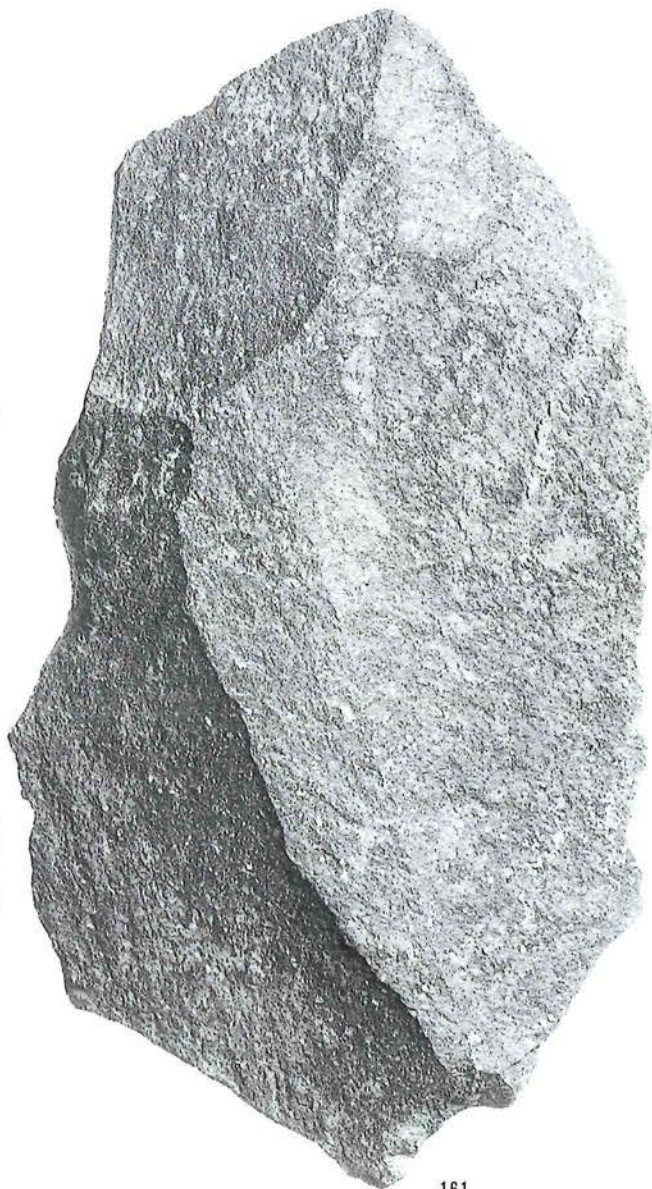

161

大形刃器 20

特 殊

162 輝石安山岩

PL 119-1

(約 1 : 2)

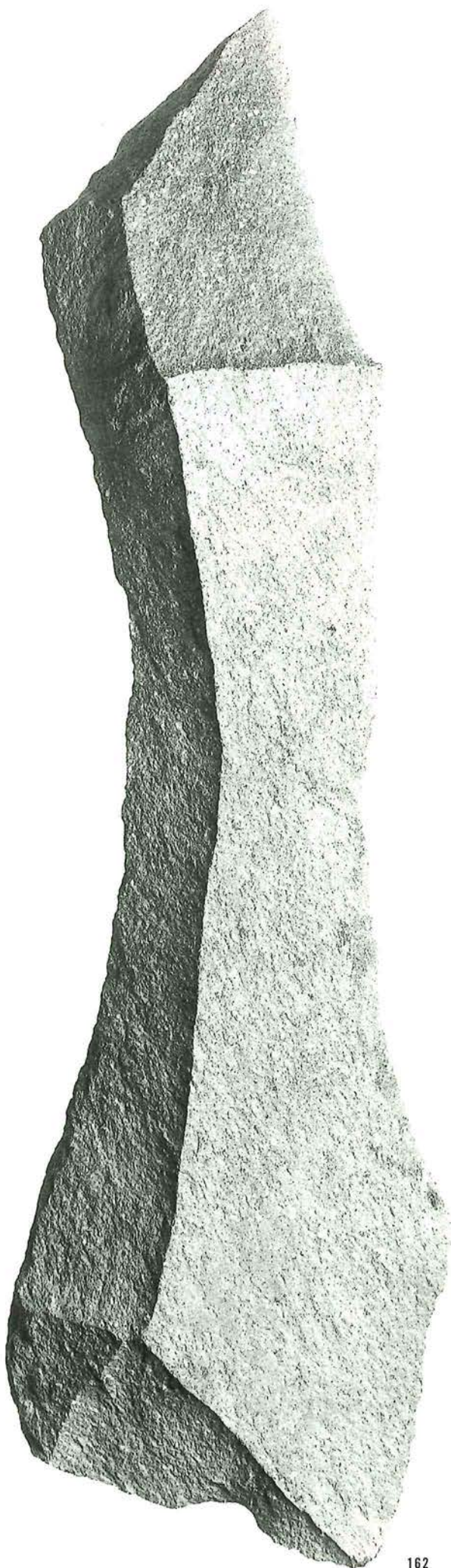

磨製石包丁 1

失敗品 B 類

- 1 黑色頁岩 A
PL 114-5
- 3 黑色頁岩 A
- 4 黑色頁岩 A
PL 6-15
- 5 黑色頁岩 A
PL 35-10
- 6 黑色頁岩 A
- 8 凝灰岩質砂岩

失敗品 B 類?

- 2 黑色頁岩 A
PL 106-2

失敗品 E₁類

- 7 黑色頁岩 A
PL 163-41
- 10 珪質岩 A

失敗品 E₂類

- 9 珪質岩 B
PL 87-4
(2:3)

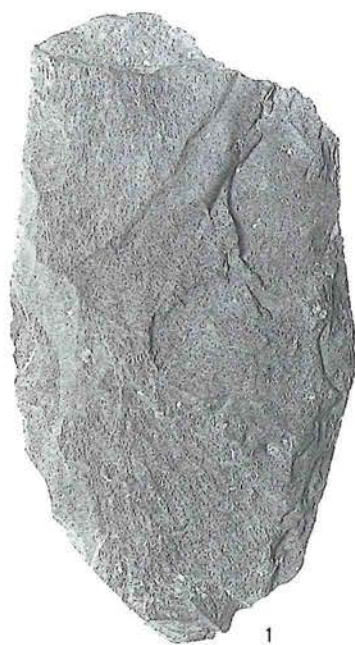

1



2



3

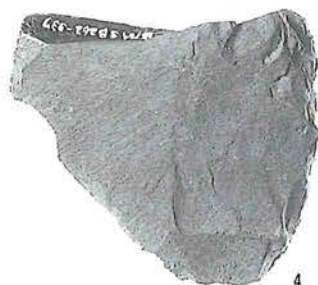

4



6



7



5



8



9



10

磨製石包丁 2

失敗品 B 類

- 12 輝石安山岩
PL 70-11

失敗品 B 類 ?

- 11 輝石安山岩
PL 163-40

失敗品 E₁ 類

- 13 輝石安山岩

失敗品 E₃ 類

- 14 輝石安山岩
PL 28-10
PL 129-76
- 15 輝石安山岩
- 16 輝石安山岩
- 17 輝石安山岩
(2 : 3)

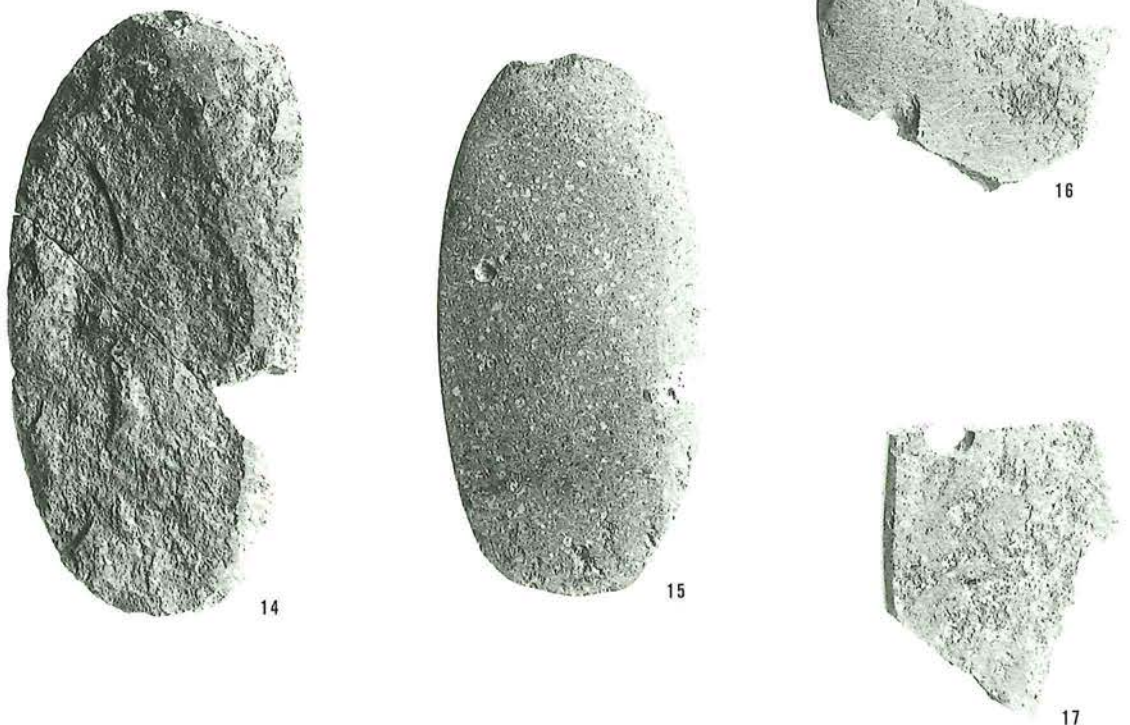
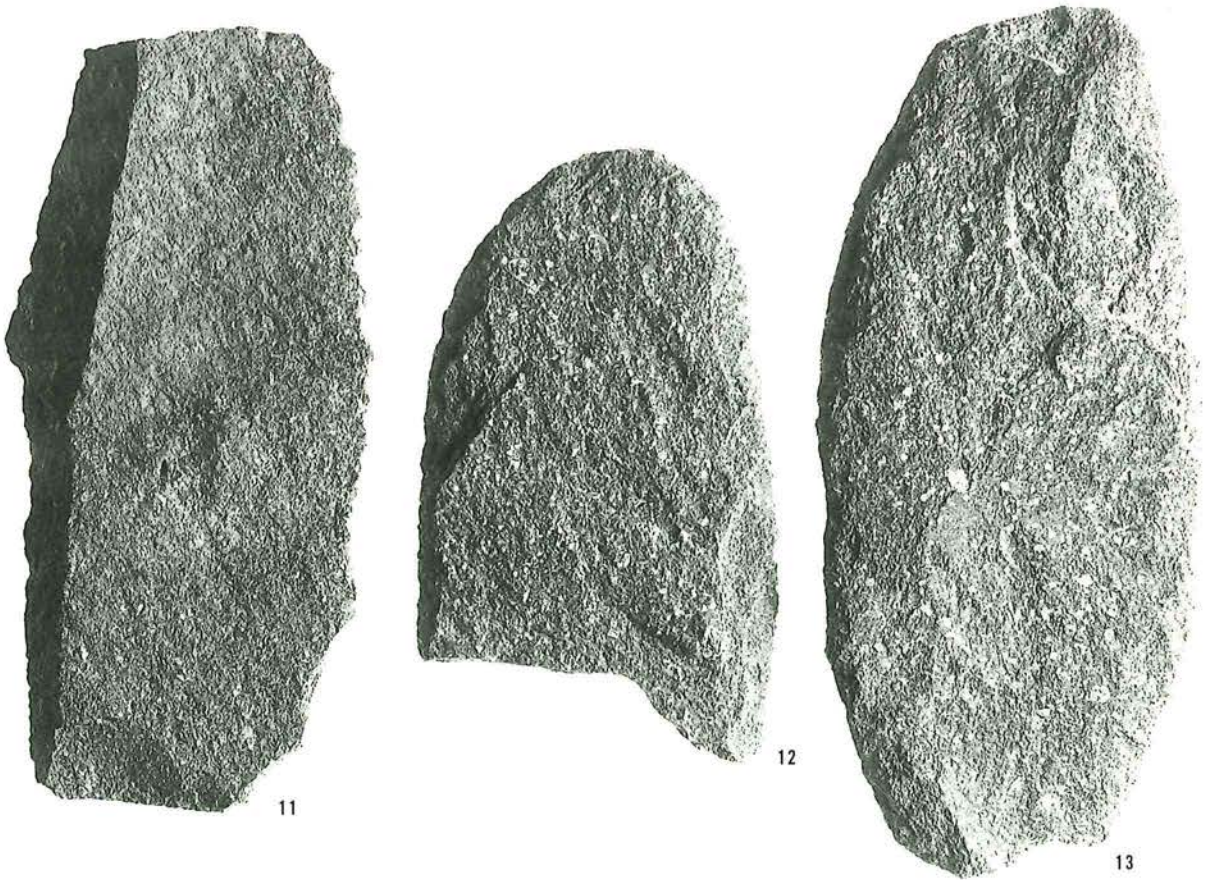

磨製石包丁 3

半月形 (外湾刃)

18 珪質岩 C
PL 26-4

半月形 (直線刃)

19 珪質岩 C
PL 171-17

20 ホルンフェルス
△VII部第 4 章

21 珪質岩 A
PL 32-5
△VII部第 4 章

22 輝石安山岩

23 輝石安山岩
PL 150-104

24 輝石安山岩

25 輝石安山岩

26 輝石安山岩
PL 150-107

27 輝石安山岩
PL 150-103

28 輝石安山岩

29 輝石安山岩
PL 73-7

31 輝石安山岩
PL 179-11

34 輝石安山岩
PL 89-10

(2 : 3)

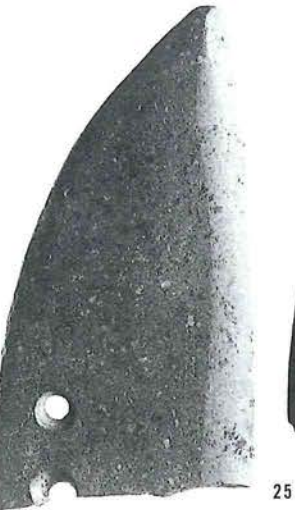

磨製石包丁 4

杏仁形 (外湾刃)

- 30 黑色頁岩 A
PL 89-9
- 32 輝石安山岩
PL 150-105
- 33 輝石安山岩
PL 96-5
- 35 黑色頁岩 B
- 36 黑色頁岩 A
PL 52-19
△VII部第 4 章
- 37 輝石安山岩
- 38 輝石安山岩
- 39 輝石安山岩
PL 171-18
- 40 輝石安山岩
PL 137-10
- 41 輝石安山岩
- 42 輝石安山岩
PL 163-43
- 43 輝石安山岩
PL 163-44
△VII部第 4 章

(2 : 3)



30



35



37



38



36



39



31



41



40



42



43

小形刃器

2c類

- 1 黒曜石
PL 116-8
- 2 チャート
PL 5-18
- 3 チャート
- 4 黒色頁岩 C
PL 56-10
△VII部第4章
- 5 黒色頁岩 D
PL 2-11
- 6 黒色頁岩 D
PL 14-12
- 7 チャート
- 8 チャート
PL 10-7

6a類

- 9 黒曜石
- 10 チャート
PL 27-8
- 11 チャート
- 12 チャート
PL 67-16
- 17 黒曜石
PL 86-4
△VII部第4章
- 18 チャート
PL 37-14
△VII部第4章

6b類

- 13 チャート
PL 75-8

6c類

- 14 黒曜石
- 15 黒色頁岩 C
△VII部第4章
- 16 チャート
PL 35-9

6a・6c類

- 19 黒曜石
PL 27-15
- 20 黒曜石
PL 15-4

(1:1)

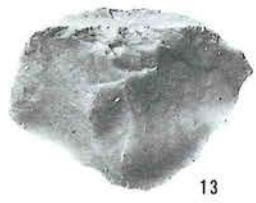
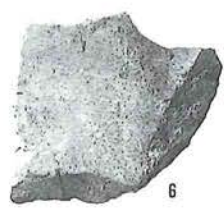

太形蛤刃石斧 1

失敗品 D 類

- 3 変質輝緑岩
PL 74 - 10

失敗品 E₁ 類

- 1 変質粗粒玄武岩
PL 128-79
PL 152-128
PL 247-9
PL 250-36
△VII部第4章

- 2 変質粗粒玄武岩
PL 45 - 3

失敗品 E₂ 類

- 4 変質粗粒玄武岩
PL 151-111

失敗品 E₃ 類

- 5 安山岩
PL 37 - 16
- 6 変質輝緑岩
PL 101-4
(2:3)



太型蛤刃石斧 2

Ia'類

A類

7 変質輝緑岩
PL 26-2

8 変質安山岩

不明

9 変質輝緑岩
PL 73-12
PL 70-12

10 変質輝緑岩
PL 69-9

11 変質輝緑岩
PL 151-117

Ib'類

A類

13 変質輝緑岩
PL 45-4

(2:3)



9



10



11

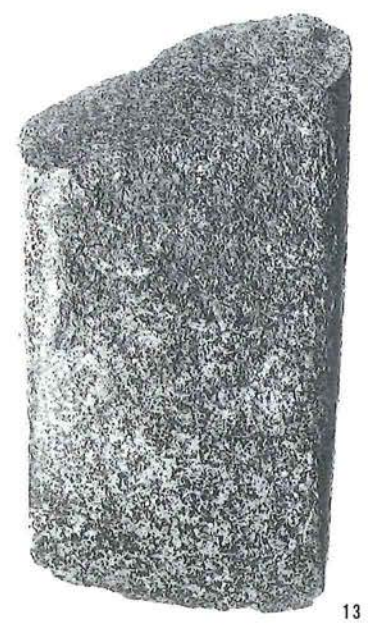

13



7



8

太型蛤刃石斧 3

Ib'類

12 玄武岩

A類

14 変質輝緑岩
PL 107-7

15 変質輝緑岩

16 変質輝緑岩
△VII部第4章

17 変質輝緑岩
PL 8-7

B類

18 変質輝緑岩
PL 177-7

(2:3)

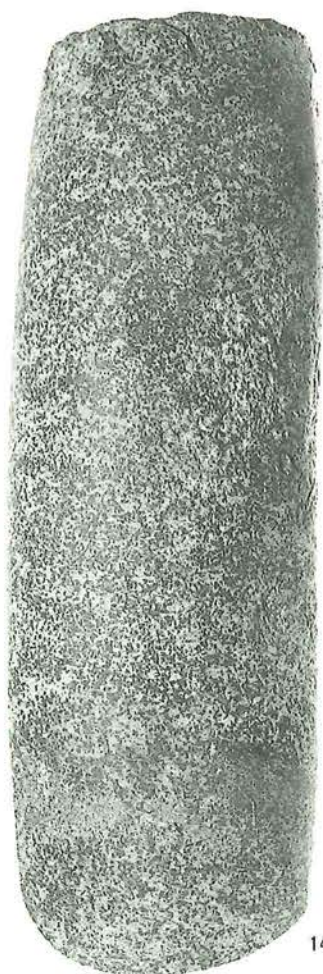

14



16



12



15



17



18

大型蛤刃石斧 4

Ic'類

A類

19 變質輝綠岩
PL 107-5

20 變質輝綠岩
PL 70-2

21 變質輝綠岩

22 變質輝綠岩
PL 14-4

23 變質輝綠岩
PL 101-5

24 變質輝綠岩
PL 1-6

25 變質輝綠岩

B類

26 變質輝綠岩

不明

27 變質輝綠岩

(2 : 3)



19



21



26



20



22



23



27



24



25

太型蛤刃石斧 5

Ic'類

A類

28 変質輝緑岩
PL 86-1

29 変質輝緑岩
PL 117-10

30 変質輝緑岩
PL 28-7

31 変質粗粒玄武岩
PL 151-115

32 変質粗粒玄武岩
PL 87-8

33 変質輝緑岩
PL 78-16

34 変質輝緑岩

35 変質輝緑岩
PL 10-18

36 変質輝緑岩
PL 22-2

(2:3)



28

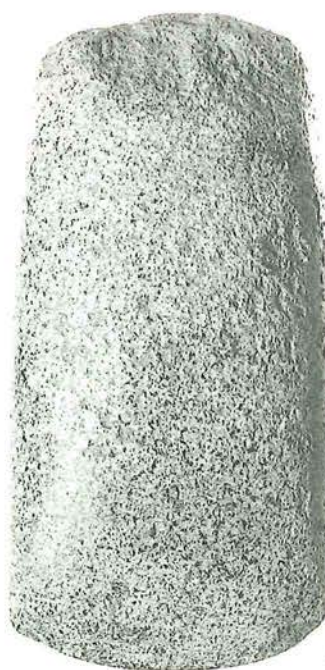

29



30



32



33



34



31



35



36

太型蛤刃石斧 6

Id'類

A類

- 37 變質輝綠岩
PL 35-11
- 38 變質輝綠岩
- 39 變質粗粒玄武岩
PL 66-7
- 40 變質輝綠岩
PL 52-20
- 41 變質輝綠岩
PL 107-3
- 42 變質粗粒玄武岩
PL 28-11
- 43 變質粗粒玄武岩
PL 62-9
- 44 變質輝綠岩
PL 93-4
- 45 變質粗粒玄武岩

(2:3)

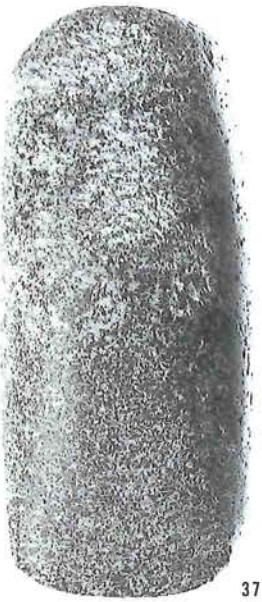

37



38



39



40



41



42



43



44



45

扁平片刃石斧 1

失敗品 B 類

- 1 變質粗粒玄武岩
- 2 珪質岩 C
PL 106-3
- 3 珪質岩 C
- 4 珪質岩 C
PL 84-8
△VII部第 4 章
- 5 變質粗粒玄武岩
PL 166-51
- 6 輝石安山岩
PL 28-4
- 7 黑色頁岩 A
PL 67-7
- 8 黑色頁岩 A
PL 22-9
- 9 黑色頁岩 D

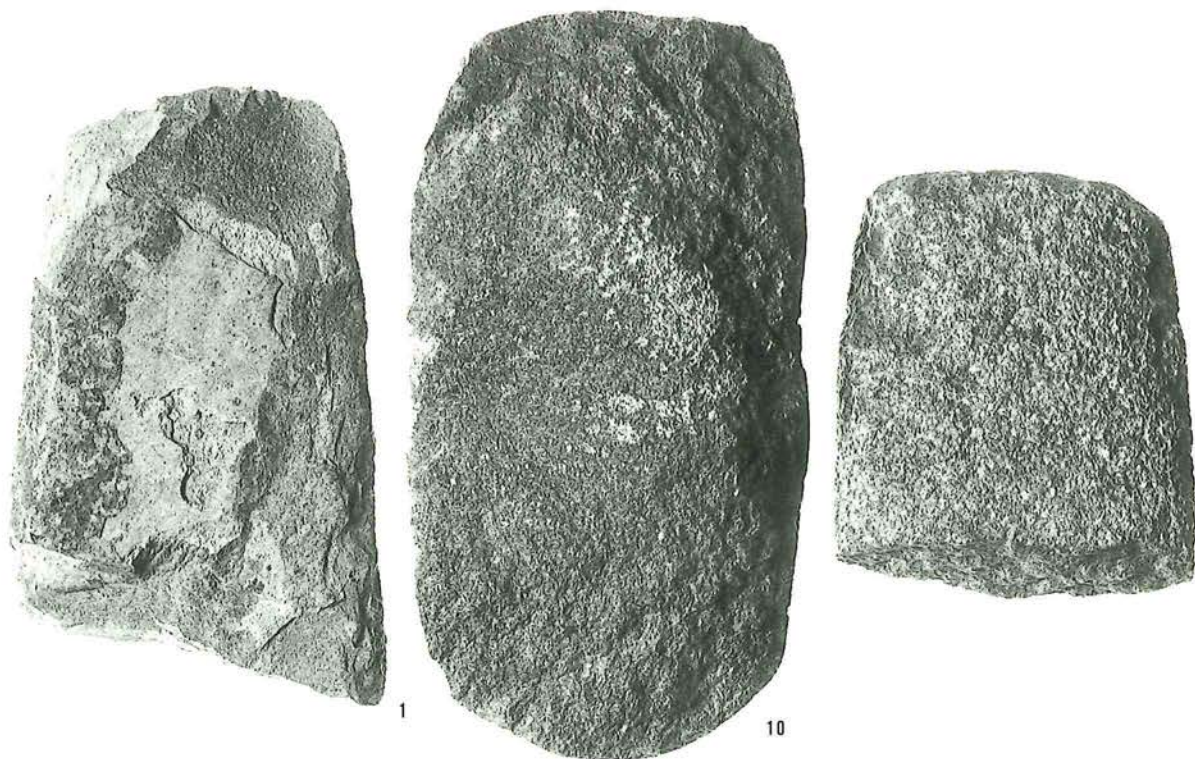

失敗品 C₂類

- 10 變質輝綠岩
△VII部第 4 章

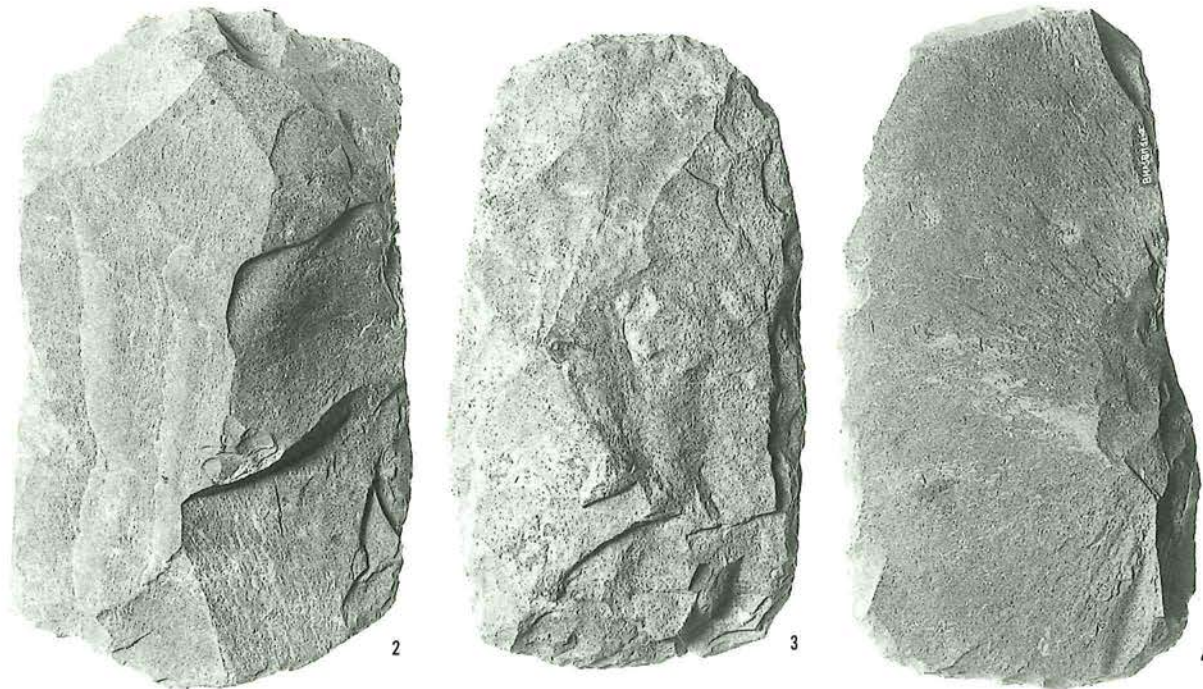

失敗品 D 類

- 11 變質粗粒玄武岩
PL 166-52
(2:3)

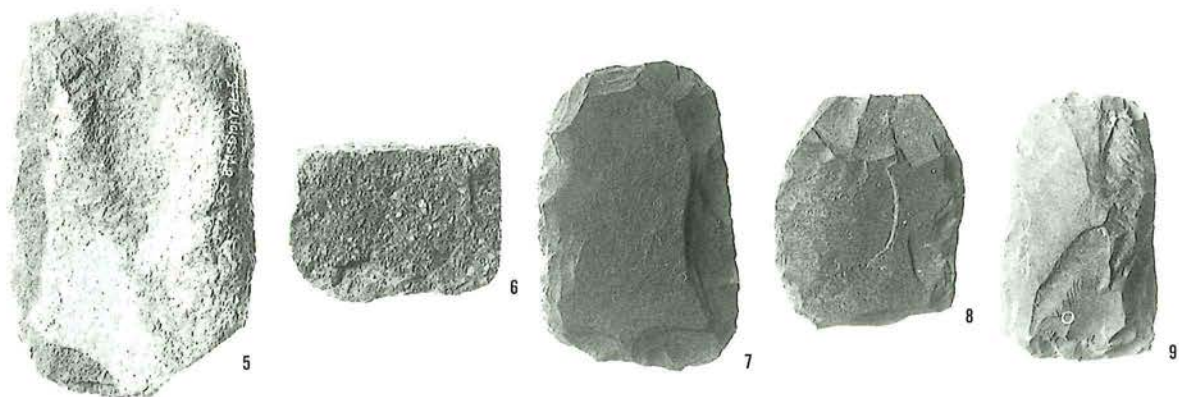

扁平片刃石斧 2

失敗品 E₁類

- 12 片麻岩
PL 177-8
- 13 珪質岩 C
- 14 黑色頁岩 B
PL 26-16
- 15 變質玄武岩
- 16 變質輝綠岩
PL 117-6
- 17 變質輝綠岩
PL 129-86
- 18 片麻岩
PL 22-4
- 19 珪質岩 A

失敗品 E₂類

- 20 片麻岩
(2:3)



15

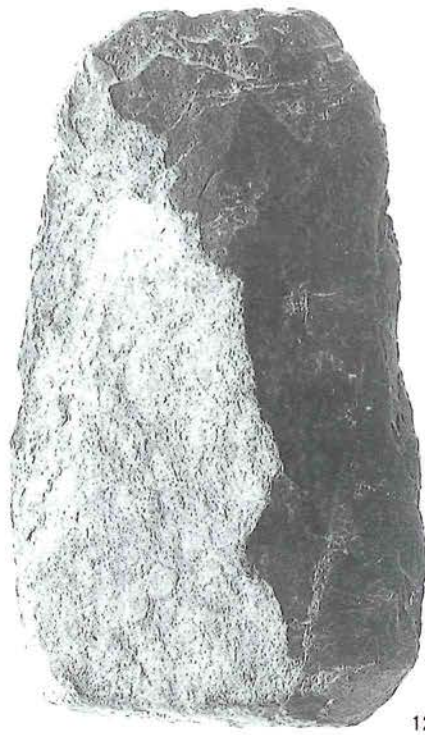

12

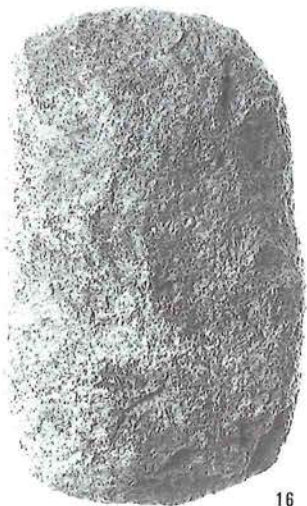

16



17



13



14



20



18



19

扁平片刃石斧 3

失敗品 E₂類

- 21 變質玄武岩
PL 69 - 10
- 22 變質粗粒玄武岩
PL 129- 87
- 23 變質玄武岩
PL 166- 53
- 24 珪質岩 C
PL 86 - 5
- 25 蛇紋岩
- 26 片麻岩
- 27 片麻岩
- 28 蛇紋岩
PL 152-121
△VII部第 4 章
- 29 蛇紋岩
PL 152-122

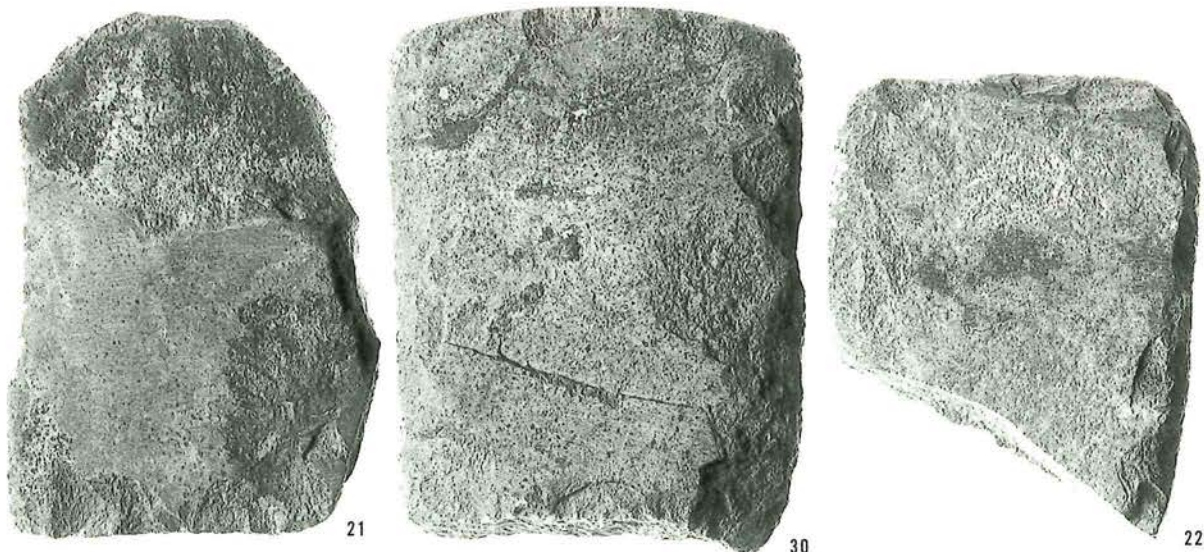

失敗品 E₃類

- 30 變質粗粒玄武岩
- 31 變質玄武岩
- 32 珪質岩 A
PL 51 - 10
- 33 片麻岩
PL 152-123
- 34 珪質岩 A
PL 177- 9
(2 : 3)

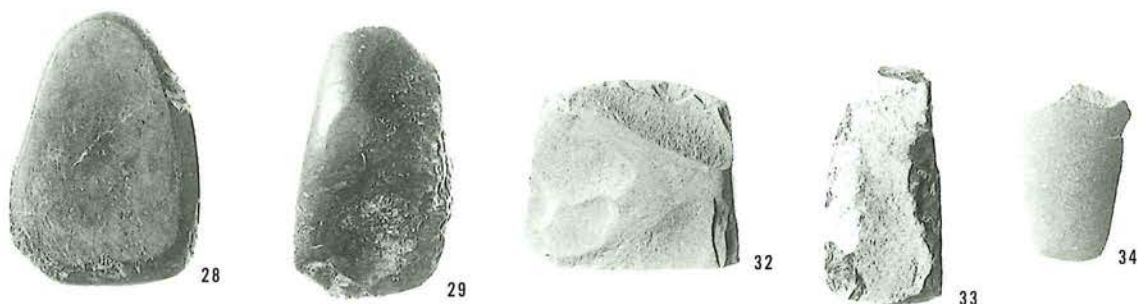
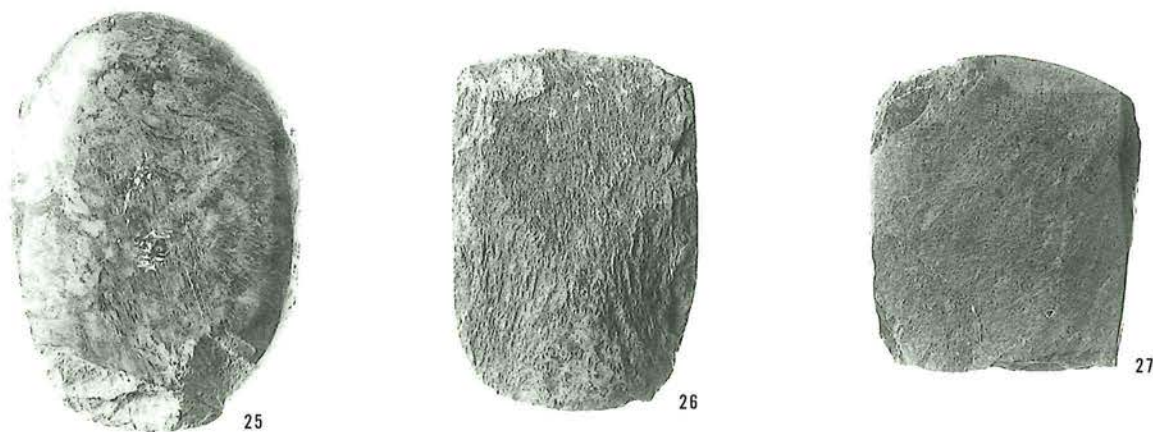

扁平片刃石斧 4

失敗品 E₃類

- 35 片麻岩
- 36 珪質岩 C
PL 64-18
- 37 珪質岩 C

IIa類

I類

- 38 珪質岩 C
PL 74-11

II類

- 39 珪質岩 C
△VII部第4章
- 40 安山岩
- 41 珪質岩 C
PL 77-14

不明

- 42 變質玄武岩
- 43 變質玄武岩
PL 10-15
- 44 變質玄武岩
PL 111-12

(2:3)



35



36



38



39



37

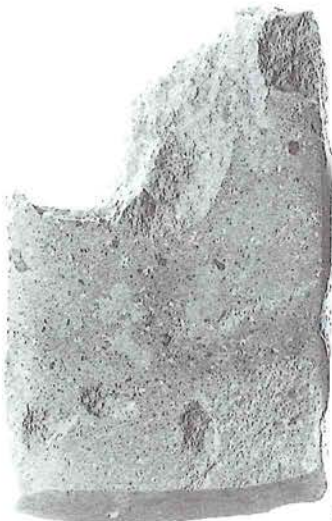

40



42



41

扁平片刃石斧 5

IIa類

I類

45 変質玄武岩
PL 55 - 7
△VII部第4章

51 変質玄武岩
PL 152-126

II類

47 変質輝緑岩
PL 52 - 21
△VII部第4章

48 片麻岩
PL 78 - 8

IV類

49 片麻岩
PL 69 - 11

不明

50 変質輝緑岩

IIb₁類

I類

46 変質玄武岩
PL 94 - 8

52 変質玄武岩
PL 32 - 6

54 変質玄武岩
PL 117- 12

II類

55 変質輝緑岩
PL 92 - 8

56 変質玄武岩
PL 19 - 24

57 片麻岩

58 変質玄武岩
PL 110- 14

(2:3)



49



61



48

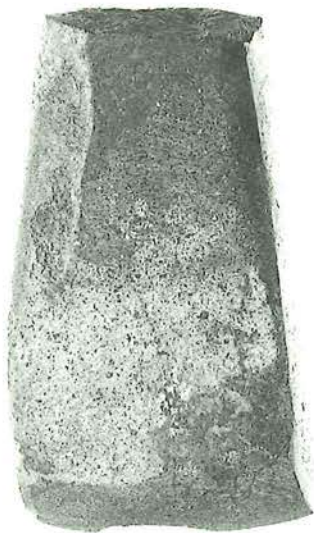

51

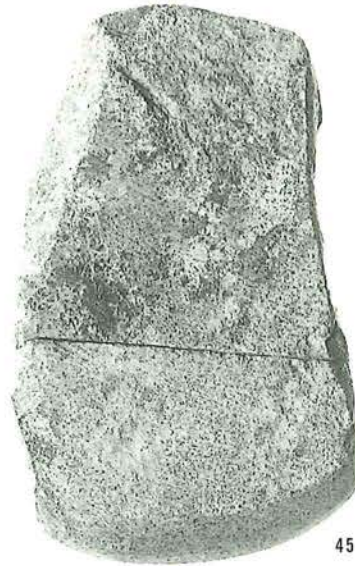

45



50



52



53



47

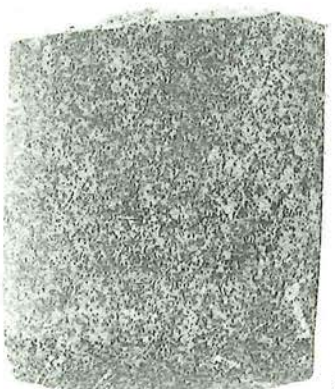

54

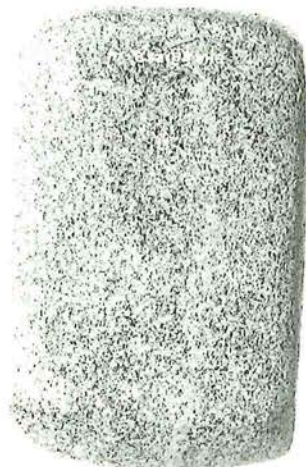

55



58

扁平片刃石斧 6

IIb₁類

III類

59 變質輝綠岩

60 蛇紋岩
PL 11-12

IV類

61 片麻岩

62 變質輝綠岩
PL 84-7

不明

63 變質輝綠岩

64 片麻岩

65 珪質岩 C
PL 8-9

66 變質玄武岩
PL 64-17

Ib₁類

J類

67 砂岩

(2:3)



46



54



56



60



67



58

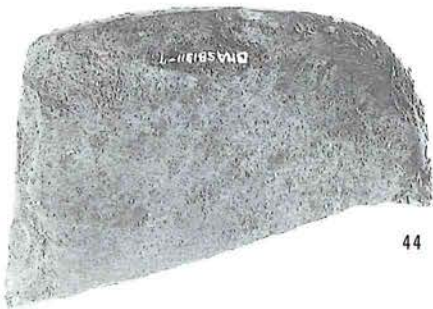

44



50



64



43

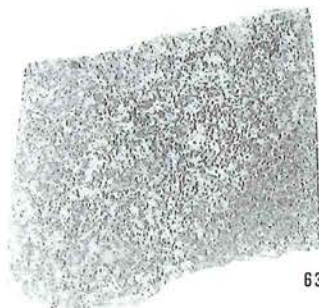

63



65



66

扁平片刃石斧 7

IIb₂類

I類

68 片麻岩

69 片麻岩

PL 5-5

70 變質玄武岩

71 片麻岩

II類

72 變質輝綠岩

74 珪質岩 C

PL 13-7

75 珪質岩 C

PL 84-6

III類

76 變質輝綠岩

PL 84-17

77 變質玄武岩

PL 41-1

IV類

78 變質玄武岩

J類

79 蛇紋岩

Ib₂類

II類

73 片麻岩

PL 87-2

IIc類

I類

80 片麻岩

II類

81 珪質片岩

82 片麻岩

PL 89-8

83 片麻岩

PL 99-2

84 綠色片岩

III類

85 變質玄武岩

PL 83-12

86 變質玄武岩

PL 117-7

87 珪質片岩

△VII部第4章

(2:3)

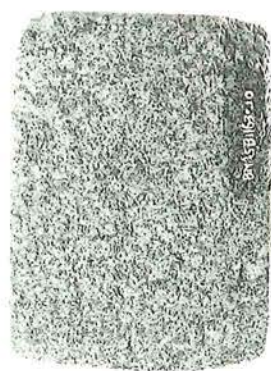

76



72



68



73



77



85



78



69



70



74



75



81



86



71



82



80



87



83



84



79

扁平片刃石斧 8



88



89



108



90



91



92



95



98



100



101



102



103



104



105



107



110



109



111



106



93



94



97



99



96

- 失敗品 E 類
- 93 凝灰岩
- IId 類
- II 類
- 88 片麻岩
- 94 蛇紋岩
- Id 類
- II 類
- 89 變質玄武岩
PL 56-12
- 不明
- 90 片麻岩
PL 93-9
- 91 片麻岩
- 92 黑色頁岩 A
- Iie 類
- I 類
- 95 變質輝綠岩
PL 92-6
- 96 珪質岩 A
△VII部第 4 章
- II 類
- 97 片麻岩
PL 84-10
- III 類
- 98 蛇紋岩
△VII部第 4 章
- IV 類
- 99 變質輝綠岩
PL 114-8
- V 類
- 100 蛇紋岩
- 101 變質玄武岩
PL 99-18
- 102 蛇紋岩
PL 112-1
- 103 蛇紋岩
PL 129-93
- 104 蛇紋岩
PL 99-21
- 105 蛇紋岩
- 不明
- 106 黑色頁岩 D
- Ie 類
- I 類
- 107 蛇紋岩
PL 55-4
- II 類
- 108 硬砂岩
△VII部第 4 章
- IIIf 類
- I 類
- 109 蛇紋岩
PL 52-23
- II 類
- 110 變質輝綠岩
- V 類
- 111 蛇紋岩
PL 111-10

石 槌 1

自然石使用

- 1 安山岩
- 2 硬砂岩
PL 8-11
- 3 硬砂岩
PL 83-13
- 5 輝石安山岩
- 6 輝石安山岩
PL 73-8
- 8 輝石安山岩
PL 166-54

大形刃器転用

- 7 輝石安山岩
PL 128-85

敲石転用

- 4 硬砂岩
PL 128-84
(2:3)

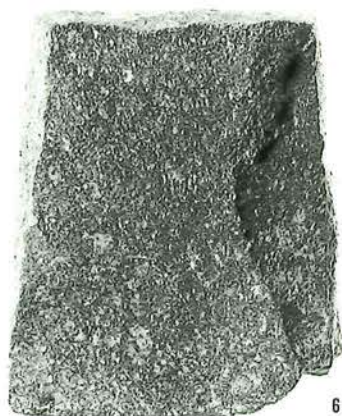
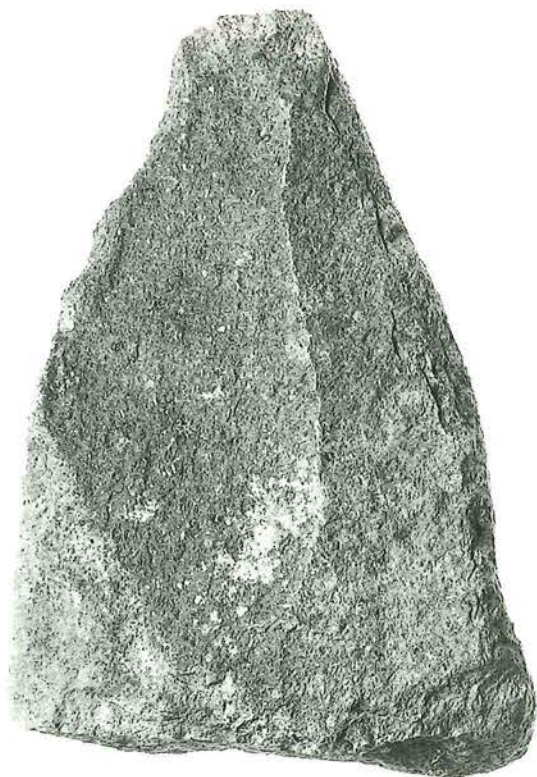

石 槌 2

蛤刃転用

- 9 変質粗粒玄武岩
PL 128-79
△VII部第4章
- 10 変質輝緑岩
PL 66-8
- 11 変質輝緑岩
PL 92-9
- 12 変質輝緑岩
PL 86-2
- 13 変質輝緑岩
PL 2-14
- 14 変質輝緑岩
PL 82-9

(2:3)



9



10



11



12



13



14

石 槌 3

蛤 刃 転 用

- 15 変質輝緑岩
- 16 変質粗粒玄武岩
PL 99-11
- 17 変質粗粒玄武岩
PL 14-2
- 18 変質輝緑岩
PL 47-9
- 19 変質輝緑岩
PL 83-18
- 20 変質輝緑岩
PL 101-7
- 21 変質輝緑岩
- 22 変質輝緑岩
PL 44-2
- 23 変質輝緑岩
PL 87-5

(2:3)

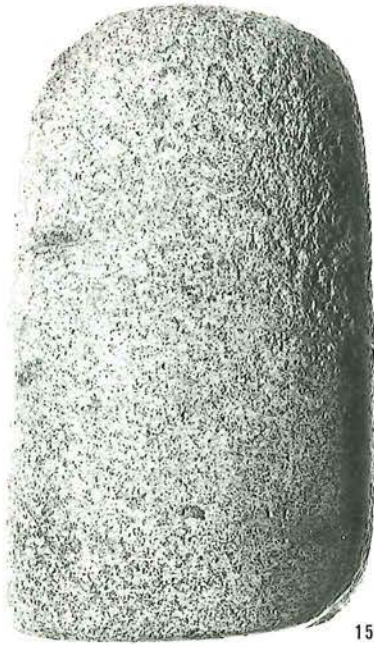

15



16



17



18



19



20



21

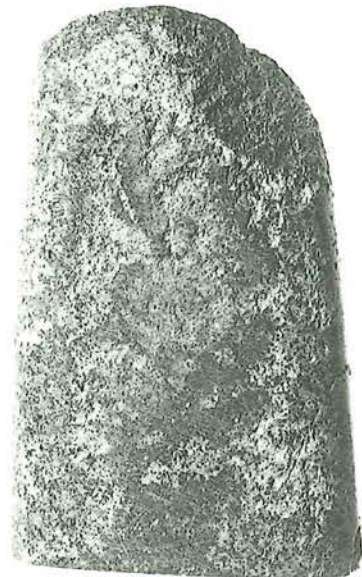

22



23

BNA SB / 1777-11

石槌 4

蛤刃転用

24 変質粗粒玄武岩
PL 166-56

25 変質輝緑岩
PL 59-12

26 変質輝緑岩
PL 28-12

27 変質輝緑岩
PL 57-5

28 変質粗粒玄武岩

29 変質輝緑岩

30 変質粗粒玄武岩

31 変質輝緑岩
PL 55-9

32 変質輝緑岩

(2:3)



24



25



26



27



28



29

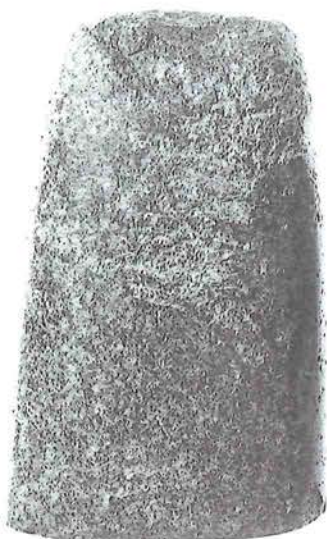

30



31



32

石 槌 5

蛤刃転用

33 変質輝緑岩
PL 52 - 25



33

34 変質粗粒玄武岩



34

35 変質粗粒玄武岩



35

36 変質粗粒玄武岩
PL 152-128
△Ⅶ部第4章



36

37 変質輝緑岩



37

38 変質粗粒玄武岩
PL 152-130



38

39 変質輝緑岩
PL 128- 82



39

40 変質輝緑岩



40

41 変質輝緑岩
PL 75 - 9



41

(2 : 3)

打製石錐

1 類

- 1 黑色頁岩 A
PL 99-22
- 2 黑色頁岩 A
- 3 黑色頁岩 A
- 4 黑色頁岩 A
PL 129-96
- 5 黑色頁岩 A
PL 51-11
- 6 黒曜石
PL 57-6
- 7 黒曜石
- 8 石 英
PL 99-4
- 9 チャート
PL 32-8

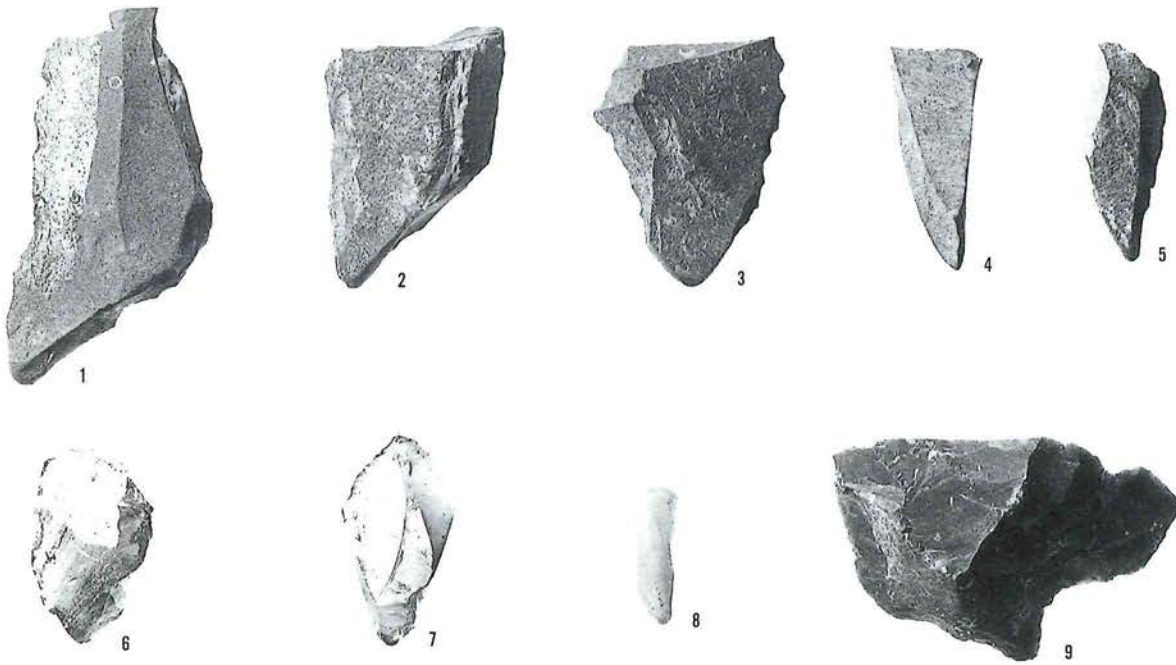

2A 類

- 10 黑色頁岩 A
PL 75-18
- 11 黑色頁岩 A
PL 17-17
- 12 黑色頁岩 C
△VII部第 4 章
- 13 チャート
PL 94-9
- 14 黑色頁岩 C
- 15 黑色頁岩 A
PL 74-12
△VII部第 4 章

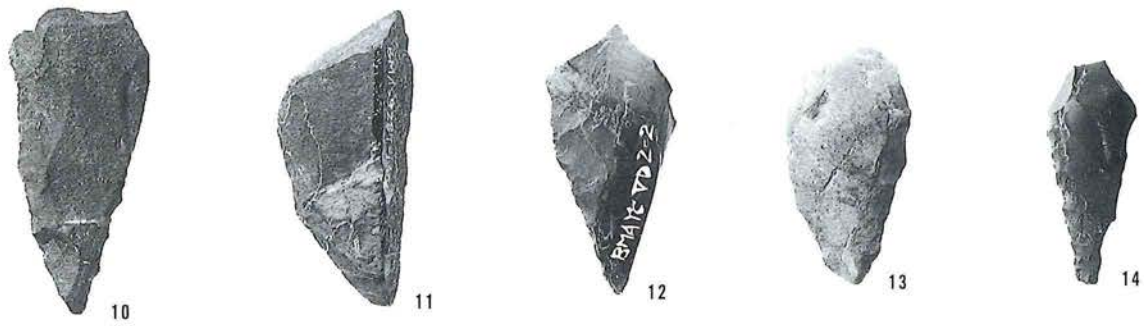

2B 類

- 16 黒曜石
△VII部第 4 章
- 17 珪質岩 A
PL 14-13
- 18 黑色頁岩 A

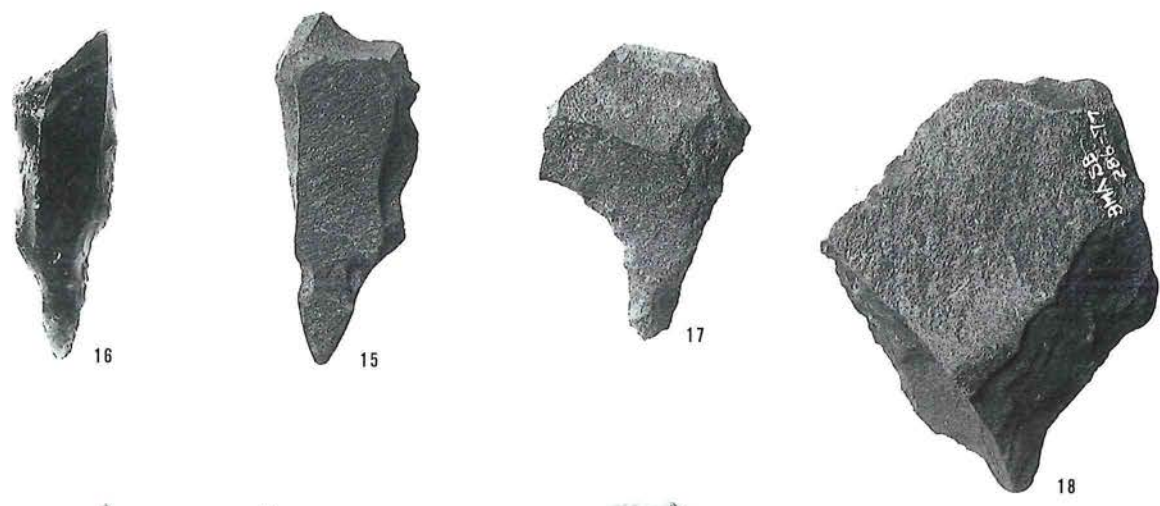

3 類

- 19 黑色頁岩 E



大形石錐

- 20 黑色頁岩 A
PL 16-9
- 21 砂岩
PL 74-13
△VII部第 4 章
(1:1)

砥石 1

I1a類

- 2 硬砂岩
PL 1 - 8
- 3 凝灰岩
PL 26 - 18
- 4 硬砂岩
PL 153-137
- 5 砂岩
- 6 砂岩
PL 75 - 10
- 7 硬砂岩
PL 179- 14
- 8 砂岩
PL 101- 8
- 9 砂岩
PL 111- 5
- 10 砂岩
- 11 砂岩
PL 137- 6
- 12 砂岩
- 13 砂岩
- 14 砂岩
PL 179- 13

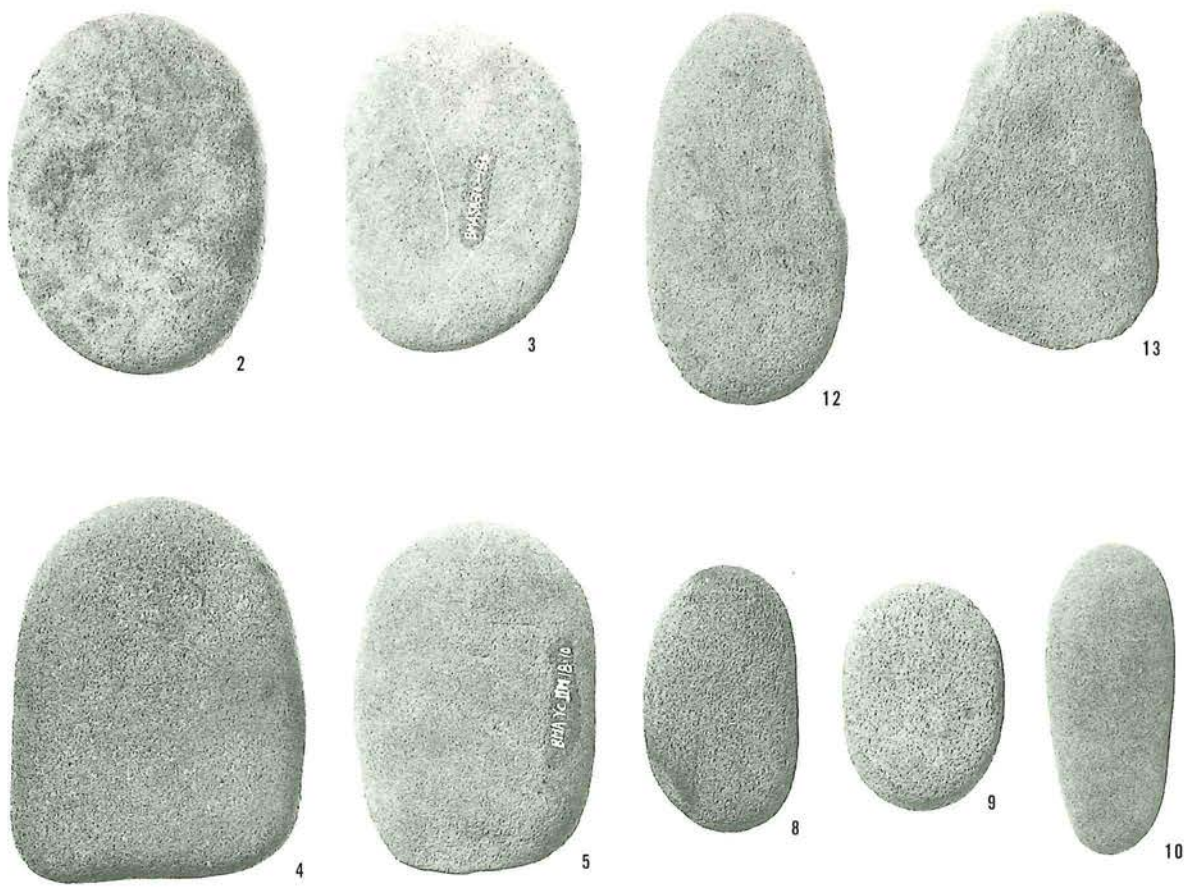

II1類

- 43 砂岩
PL 153-141
- 44 砂岩
PL 82 - 13
- 45 砂岩
PL 166- 58
- 46 砂岩
PL 153-144
(2 : 3)

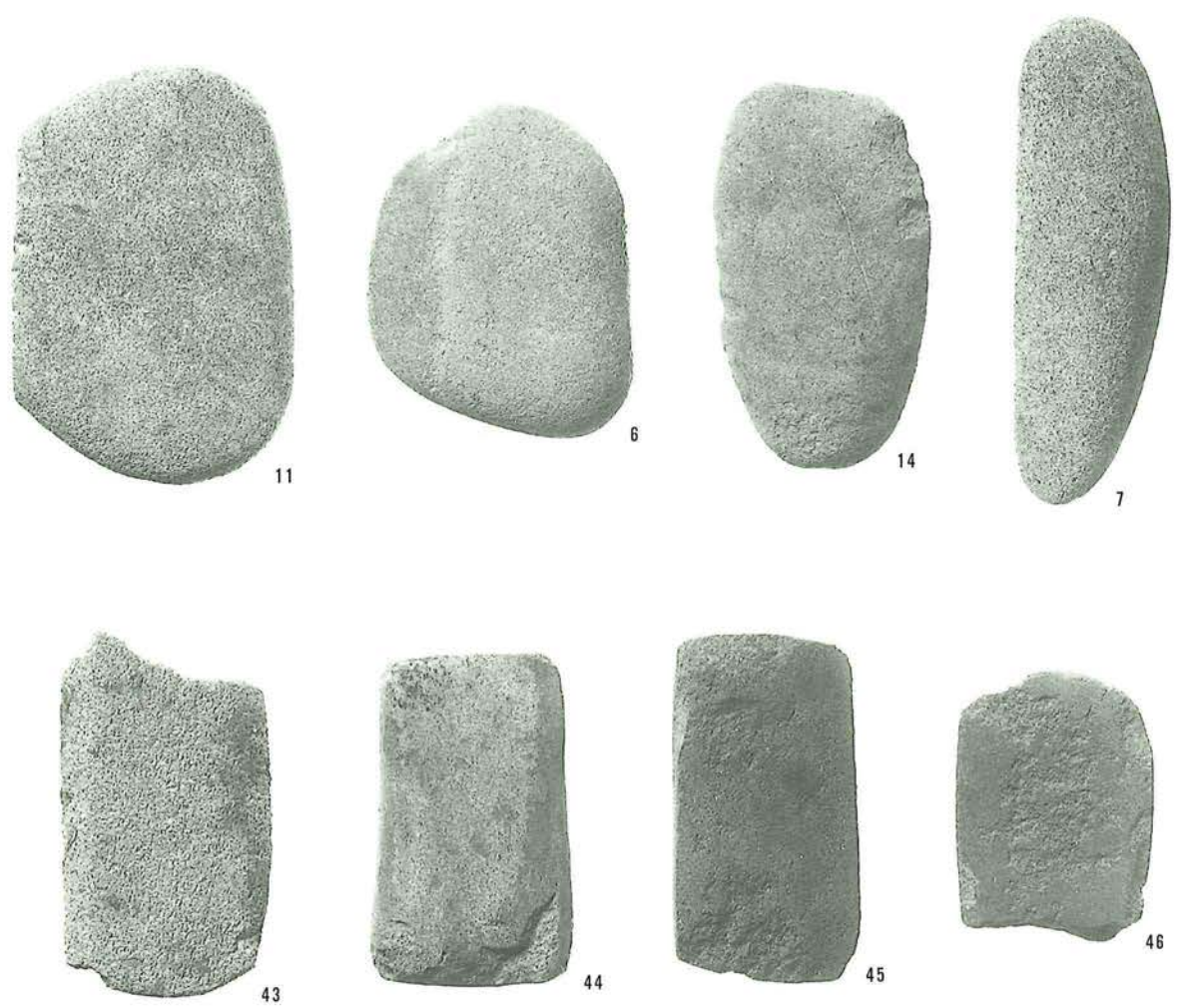

砥石 2

原石

1 凝灰岩

I1b類

- 15 砂岩
PL 13-9
 - 16 砂岩
PL 55-10
 - 17 砂岩
PL 92-10
 - 18 砂岩
 - 19 砂岩
PL 2-16
 - 20 砂岩
 - 21 砂岩
PL 130-100
 - 22 綠色片岩
 - 23 砂岩
 - 24 砂岩
PL 17-21
 - 25 砂岩
PL 17-22
 - 26 硬砂岩
PL 50-7
 - 27 砂岩
PL 56-16
- (2:3)



15



16



17



18



19



20



21



22



23



24



25



26



27

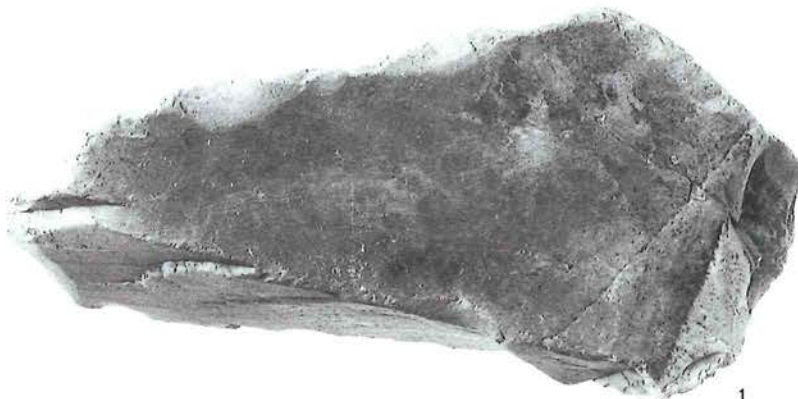

1

砥石 3

I2類

28 砂岩
PL 6 - 19



28



29



30



31



32



33

29 砂岩
PL 10 - 14

31 砂岩
PL 130-104

32 砂岩
PL 56 - 15

33 砂岩
PL 58 - 11

34 砂岩
PL 50 - 6



34



35



36



37



38

35 砂岩
PL 50 - 6

36 砂岩
PL 6 - 18

39 砂岩
PL 166- 59

40 砂岩
PL 136- 13

41 砂岩
PL 69 - 12

42 砂岩
PL 69 - 12



39



40



41



42

II2類

47 砂岩
PL 77 - 3

礫 状

48 砂岩

49 砂岩

50 砂岩

(2 : 3)



47



48



49

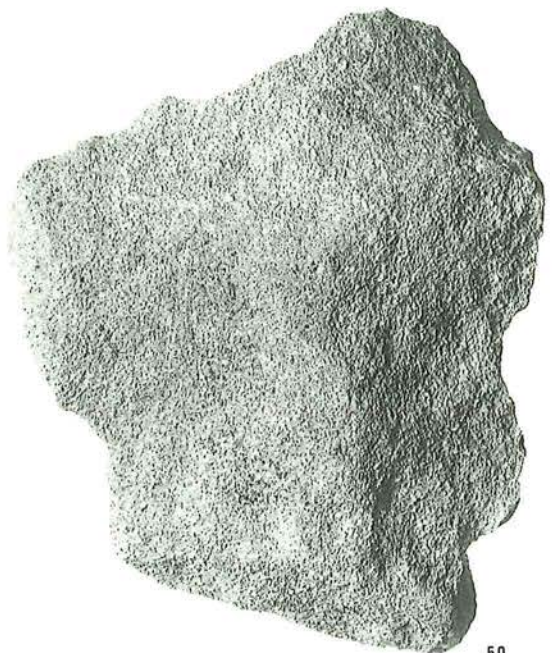

50

砥石 4

II3類

- 51 砂岩
PL 136-12
- 52 砂岩
PL 58-9
- 53 砂岩
- 54 砂岩
PL 114-13
- 55 砂岩
- 56 砂岩
PL 101-9
- 57 砂岩
- 58 砂岩
PL 130-106
- 59 砂岩
PL 74-7

I1c類

- 60 砂岩
PL 14-3
- 61 砂岩
- 62 砂岩
PL 130-105
- 63 砂岩
- 64 凝灰岩
PL 117-11

I1d類

- 65 砂岩
PL 99-12
- 66 砂岩
PL 153-146
- 67 砂岩
PL 67-8

特殊

- 68 砂岩
- 69 凝灰岩
PL 83-9
PL 89-4
- 70 石墨片岩
(2:3)

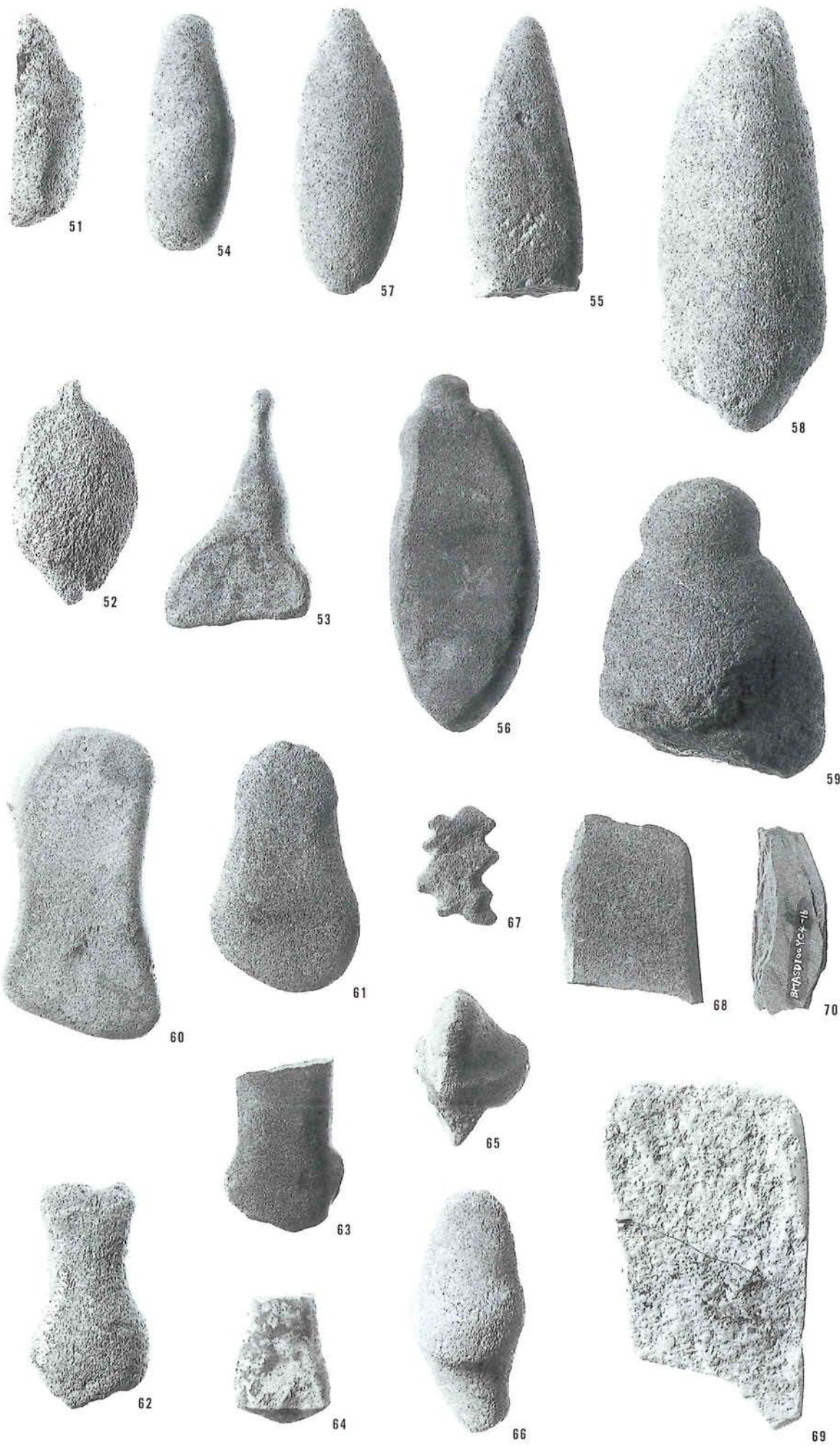

軽石製品 1

面状砥面

- 1 PL 70-15
- 2 ~ 4
- 5 PL 130-109
- 6 PL 130-108
- 7 ~ 8
- 9 PL 110-2
- 10 PL 130-110
- 11~12
- 13 PL 91-15
- 14 PL 26-5
- 15~17

(2:3)

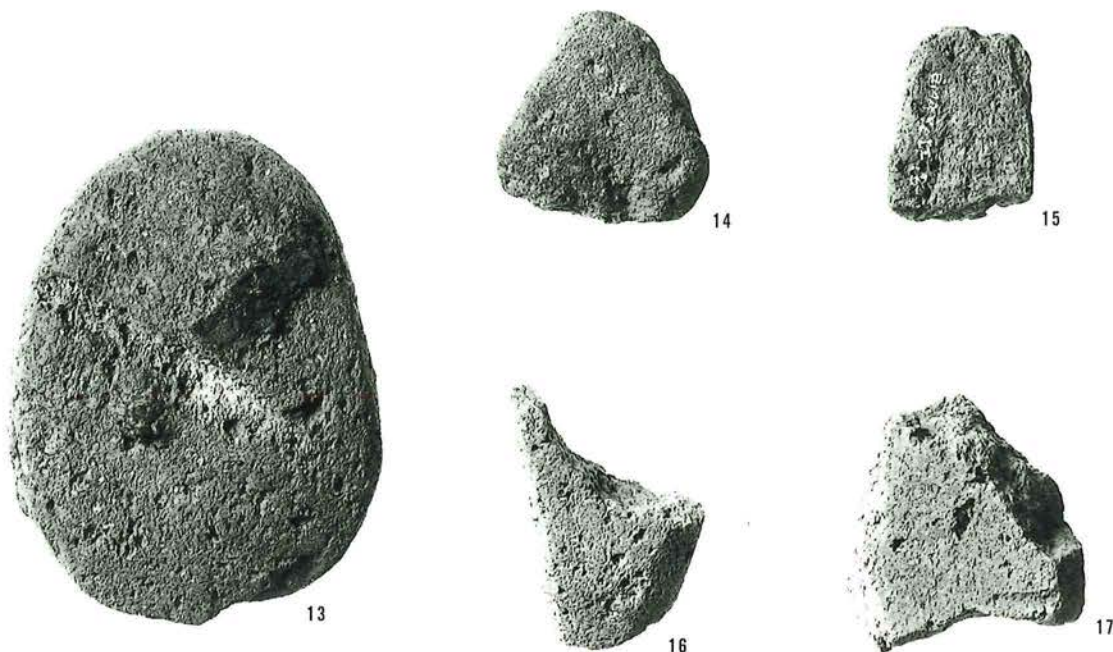
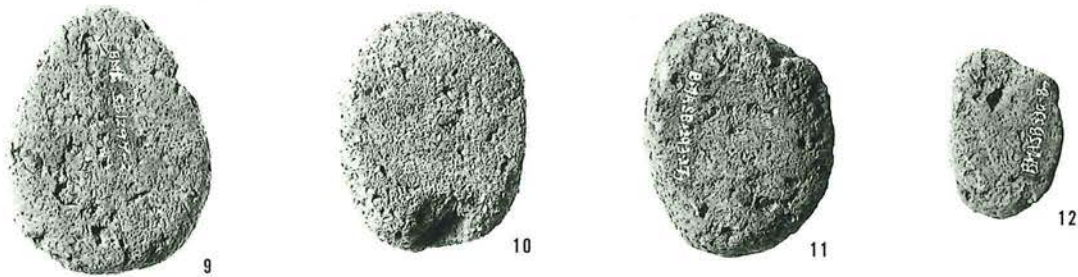
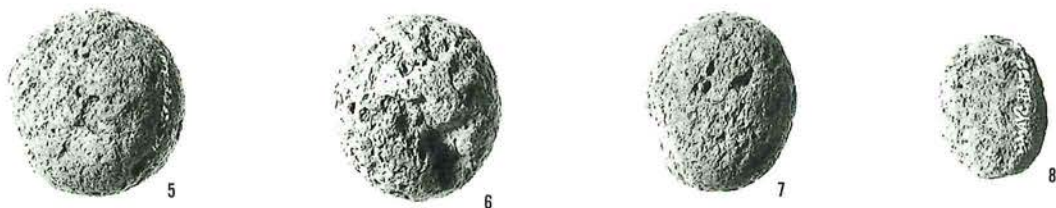
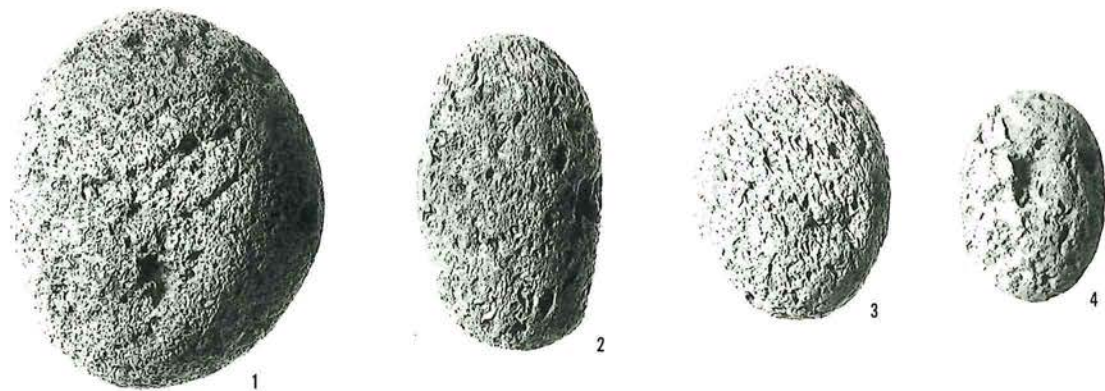

軽石製品 2

穴開き

18 PL 166-61

19~20

21 PL 82-8

22 PL 32-10

筋状・溝状砥面

23

24 PL 50-13

25 PL 14-14

26

27 PL 2-17

28 PL 10-19

29~30

(2:3)

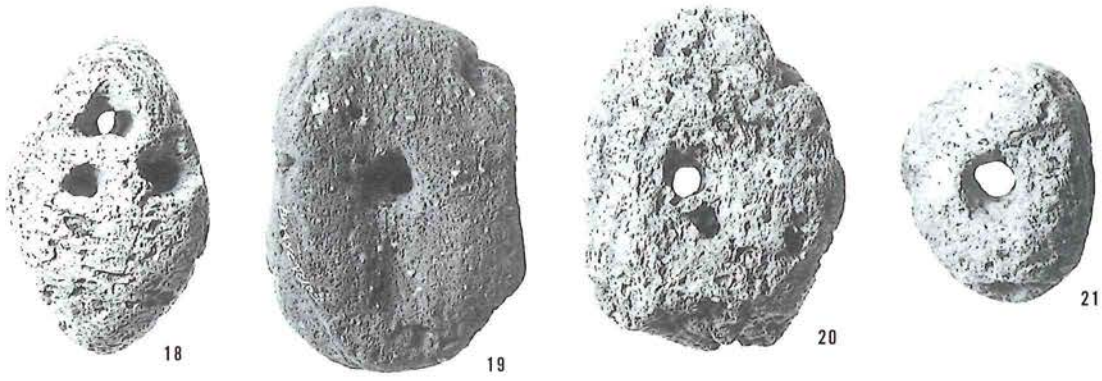

玉關係 1

鉄石英

- 1 石核 IIIA 類
PL 75-11
- 2 剝片 1種
- 3 碎片
- 4 碎片



碧玉

- 5 剝片 2種
- 6 剝片 2種
- 7 剝片 2種



玉髓

- 8 剝片 1種
PL 39-8
- 9 剝片 1種
PL 43-10
- 10 剝片 1種
PL 83-10
- 11 剝片 2種
- 12 剝片 2種



珪化岩

- 13 剝片 2種



翡翠

- 15 剝片 2種
- 16 碎片
PL 70-4
△VII部第4章



軟玉岩?

- 14 原石
PL 129-97
△VII部第4章
(1:1)



10

13

16

5

6

3

4

1

2

8

9

11

12

14

15

玉関係 2

石英

17 原石

18 原石

19 石核III A 類

セリサイト質変質岩

20 剥片 1 種

21 剥片 2 種

22 剥片 2 種

23 剥片 2 種

24 剥片 1 種

25 剥片 2 種

26 剥片 2 種

ベンガラ

27 剥片 2 種

28 剥片 1 種

29 剥片 2 種

30 碎片

31 碎片

(1:1)



17



18



19



20



21



22



23



24



25



27



28



26



29



30



31

玉關係 3

装身具類

指輪状石製品

- 1 蛇紋岩 PL 130-112
- 2 綠色凝灰岩 PL 77-16 △VII部第4章



角柱状石製品

- 3 翡翠 △VII部第4章



勾玉

- 4 翡翠 PL 142-156 △VII部第4章
- 5 翡翠 PL 142-157



白玉

- 6 玉髓? PL 130-113

管玉

- 7 黑色頁岩 D PL 117-9
- 8 綠色凝灰岩 PL 130-114 鉄石英

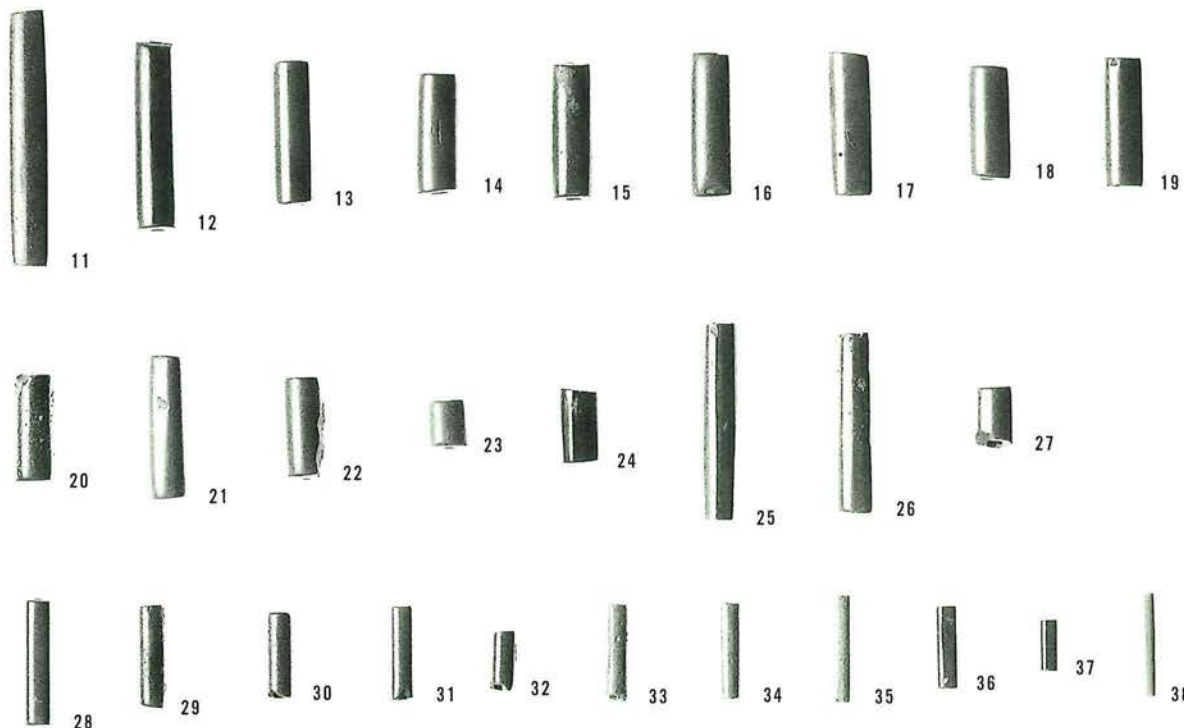

- 9 PL 142-159 綠色凝灰岩
- 11 PL 41-3
- 12
- 13 PL 112-16
- 14 PL 112-14
- 15 PL 112-17
- 16 PL 112-13
- 17 PL 112-7
- 18 PL 112-10
- 19 PL 112-12
- 20 PL 112-8
- 21 PL 112-15
- 22 PL 112-11
- 23 PL 112-9
- 24 PL 142-158
- 25 PL 112-6
- 26
- 27
- 28 PL 14-15
- 29 PL 163-62
- 30 PL 70-5
- 31 PL 56-17
- 32 PL 55-5
- 33 PL 64-11
- 34
- 35 PL 57-7
- 36
- 37 PL 58-12
- 38 PL 163-63

(1:1)

ノミ状石器

失敗品 E₁類

- 39 蛇紋岩 PL 91-13

IIe 類

- 40 蛇紋岩
- 41 蛇紋岩 PL 137-8
- 42 層灰岩

IIf 類

- 43 蛇紋岩 PL 56-14
- 44 PL 83-14
- 45
- 46 PL 62-10
- 47 PL 99-3
- 48 △VII部第4章
- 49
- 50 黑色頁岩 A △VII部第4章
- 51 蛇紋岩 PL 92-3
- 52 PL 93-5
- 53 PL 77-15
- 54 PL 56-13
- 55 PL 99-19

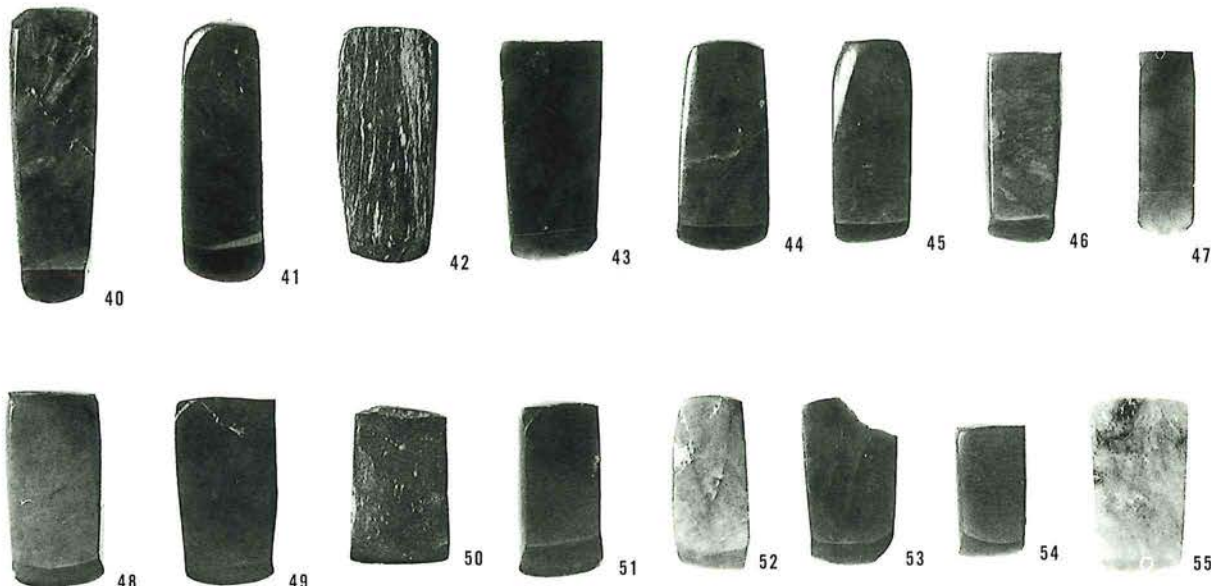

(1:1)

玉関係 4

セリサイト質ろう石
剥片1種

- 1 PL 44-5
PL 188-2
△VII部第4章
- 5 PL 188-6

研磨痕のある剥片

- 2 PL 101-12
PL 188-4
- 3 PL 84-12
- 23

紡錘車状石製品

穴なし

- 4 △VII部第4章
- 6 PL 111-7
△VII部第4章

1穴あり

- 7 PL 114-9
- 8 PL 83-19
- 9
- 10 PL 114-10
- 11 PL 110-11
△VII部第4章
- 12 PL 78-9
- 13
- 14 PL 99-8
- 15 PL 82-10
△VII部第4章
- 16 PL 74-14

ペン先状石製品

- 17 PL 74-8
- 18
- 19 △VII部第4章
- 20 △VII部第4章
- 21 PL 177-10
- 22

(1:1)

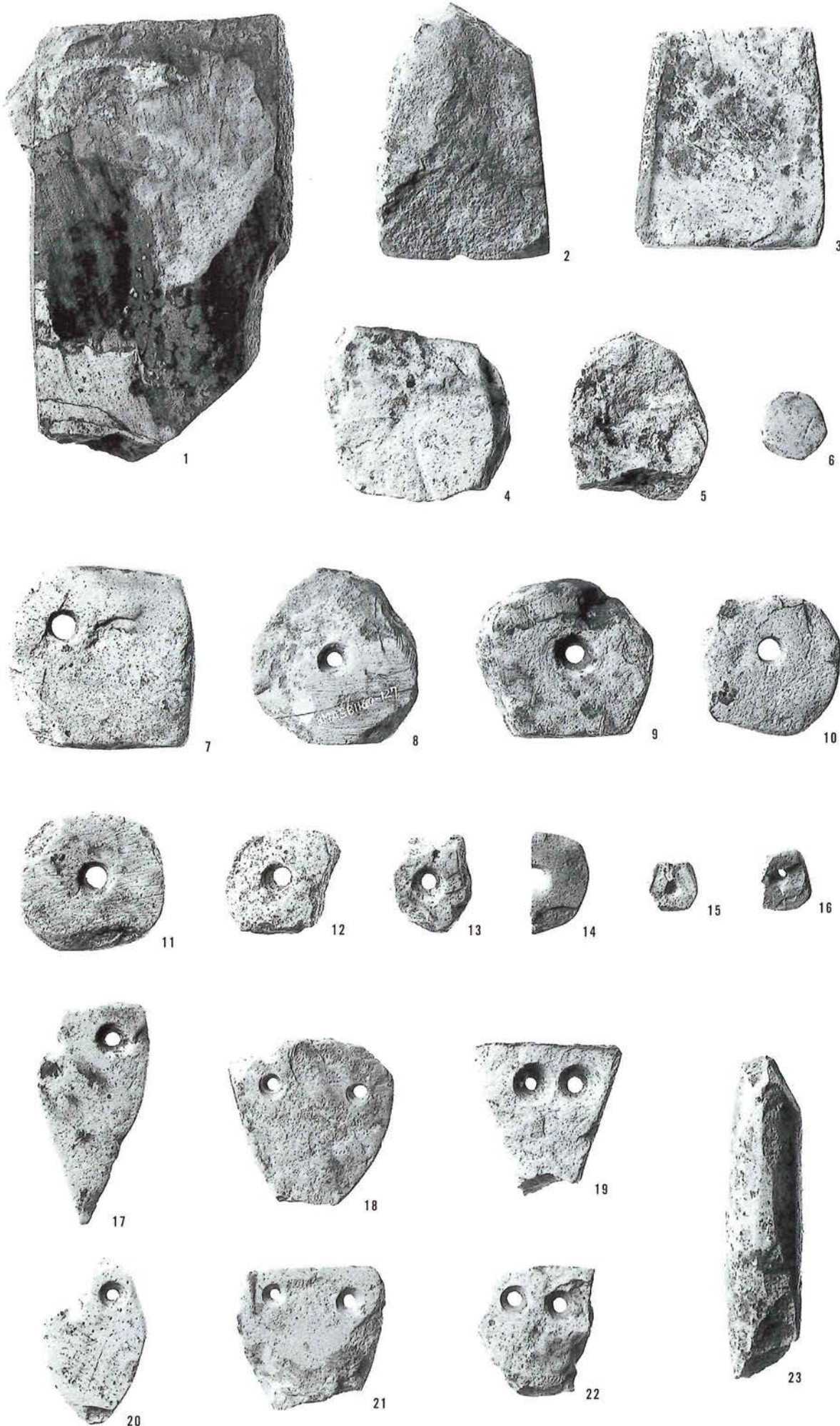

加工痕のある石屑

- 1 黒曜石
 - 2 黒曜石
 - 3 チャート
 - 4 チャート
 - 5 チャート
 - 6 黒色頁岩 A
 - 7 輝石安山岩
 - 8 黒色頁岩 A
 - 9 輝石安山岩
- (1:1)

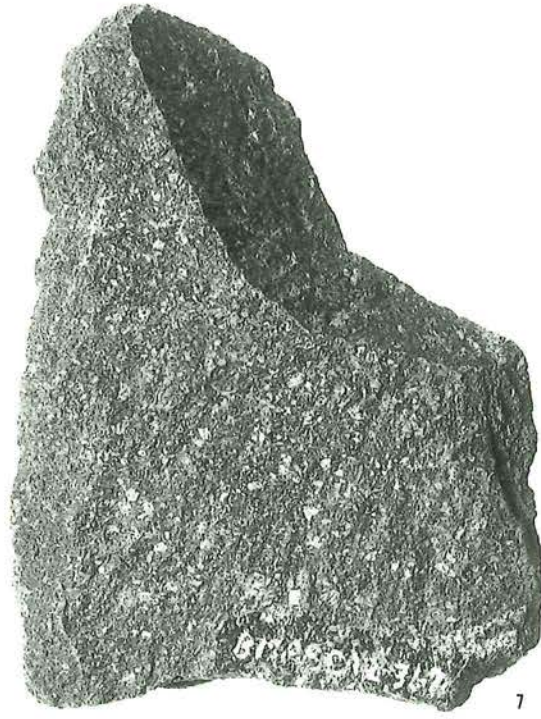
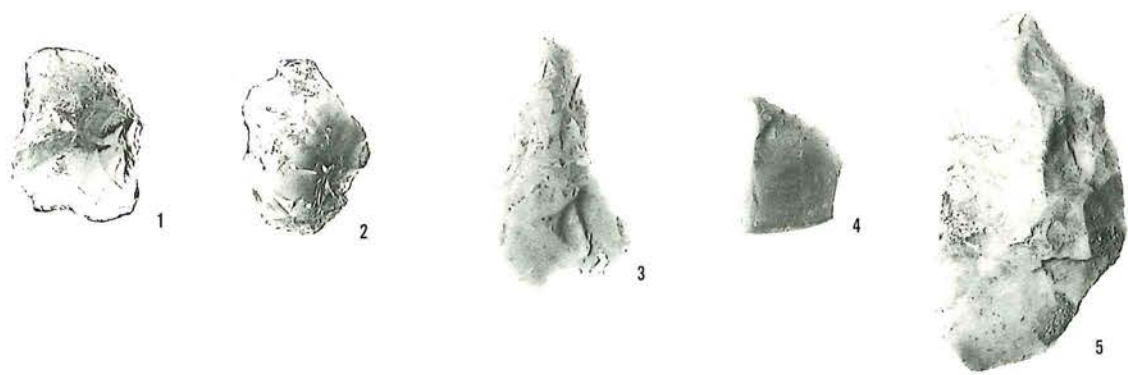

骨角牙製品

牙 鏃

1 イノシシ
PL 174-(1)

骨 鏃

2 イノシシ
PL 174-(2)

骨 針

3 シカ
PL 9 -(1)

4 シカ
PL 174-(3)

5 シカ
PL 9 -(2)

骨 錐

6 シカ

角製品

7 シカ
PL 174-(5)

8 シカ

13 シカ

14 シカ
PL 100-(1)

15 シカ

16 イノシシ

牙製品

9 イノシシ

骨製品

17 シカ

牙製腕輪

10 イノシシ
PL 159-(1)

11 イノシシ
PL 159-(2)

12 イノシシ
PL 174-(4)

(2:3)

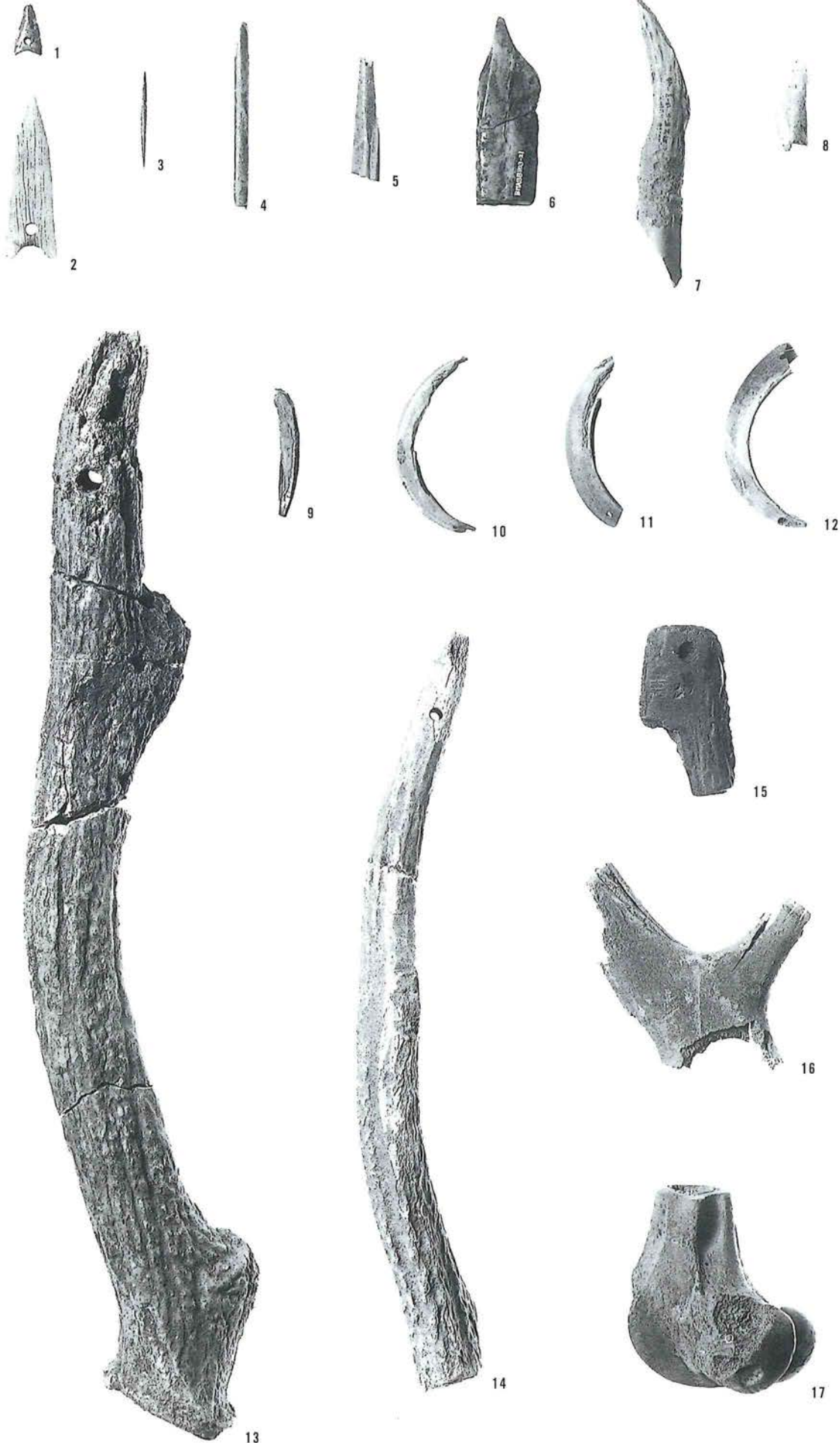

木製品 1

木製竪櫛

1 タケ亜科
PL 175-(1)
(4:5)



木製小型高杯?

2 ケヤキ
PL 160-1
(2:3)

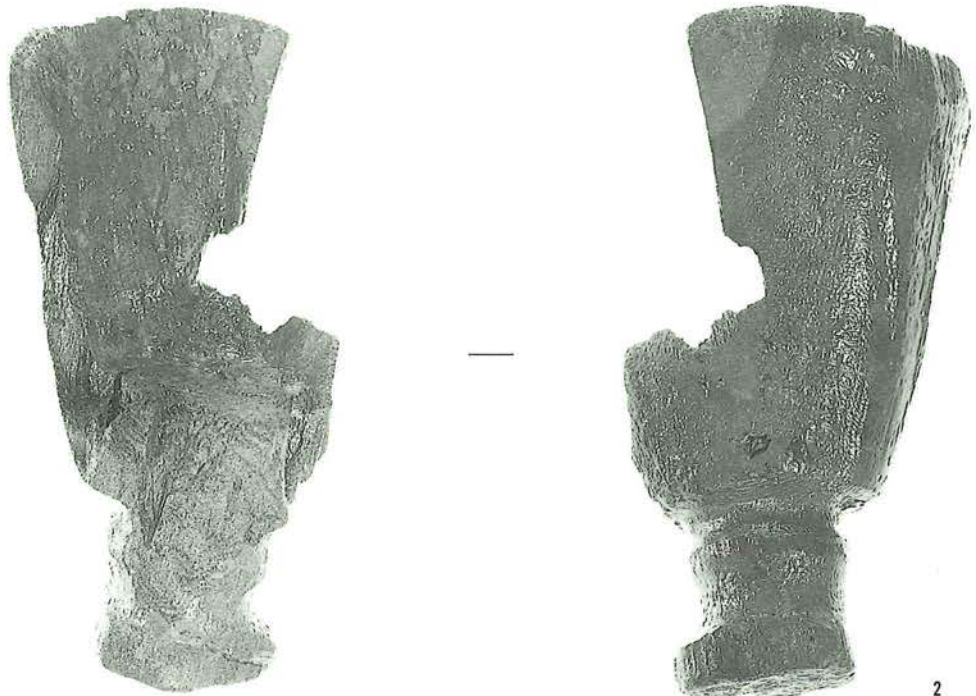

木製品 2

縄

- 24 PL 49-(2a·b)
(1:2)

木製鎌?

- 3 コナラ属クヌギ節
PL 176-(4)
(1:4)

木製臼

- 4 トチノキ
PL 176-(2)
(1:8)

木製柄?

- 5 モミ属
PL 161-(1)
(1:4)

木製鋏?

- 6 カバノキ属
PL 176-(3)
(1:4)

板 材

- 7 モミ属
PL 161-(10)
- 8 コナラ属コナラ節
PL 161-(6)
- 9 フジキ
PL 161-(7)
- 10 ケヤキ
PL 161-(8)
(1:8)

加工材

- 11 ケヤキ
PL 176-(6)
(1:6)

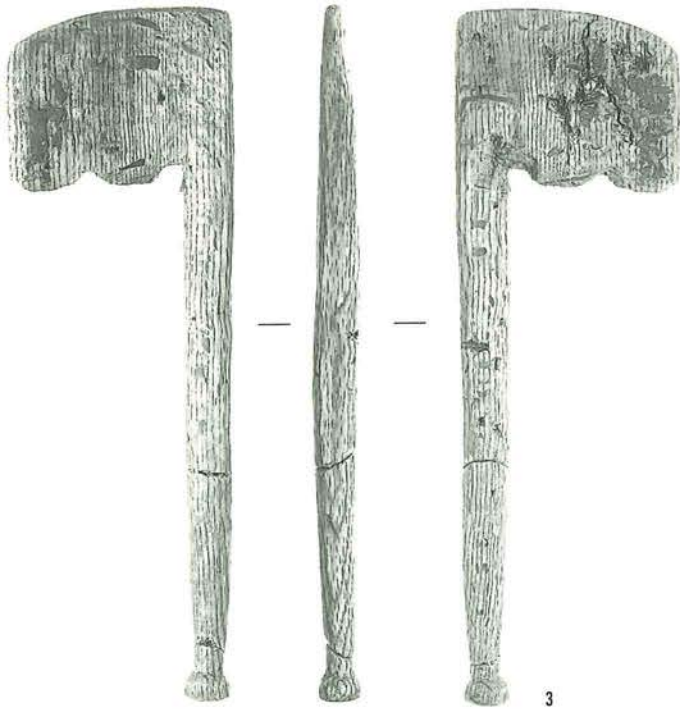

3

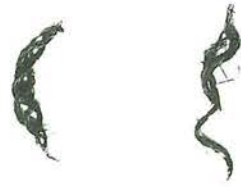

24

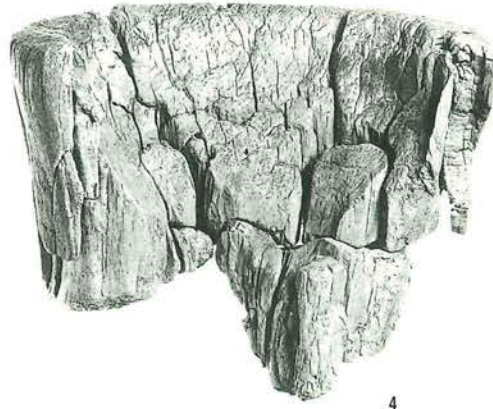

4



5

6

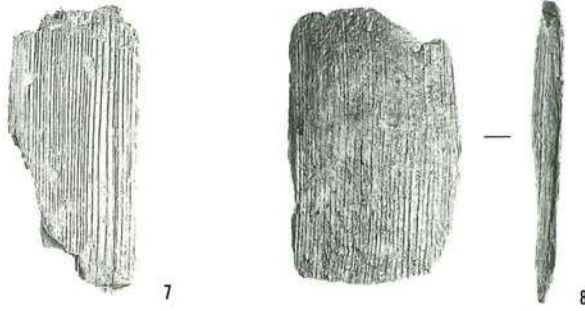

7

8

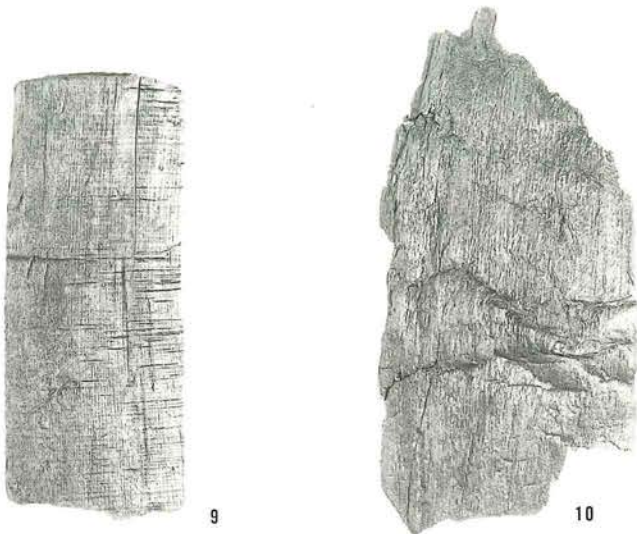

9

10

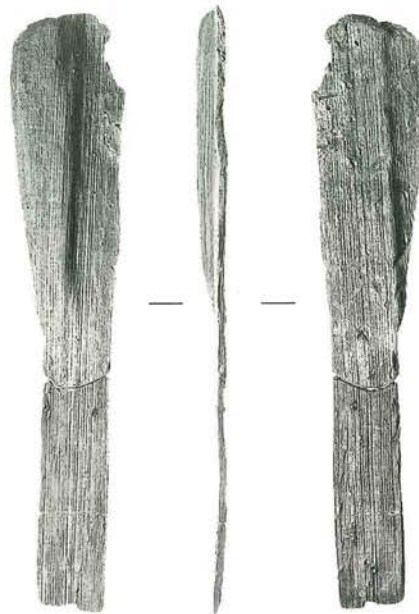

11

木製品 3

加工材

- 12 イヌガヤ
PL 176-(5)
- 13 カヤ
PL 169-(7)
(1:12)

杭材

- 14 ヤマグワ
PL 161-(2)
- 15 カヤ
PL 161-(3)
- 16 カヤ
PL 161-(5)
- 17 エノキ属
PL 169-(4)
- 18 コナラ属クヌギ節
PL 169-(6)
(1:8)

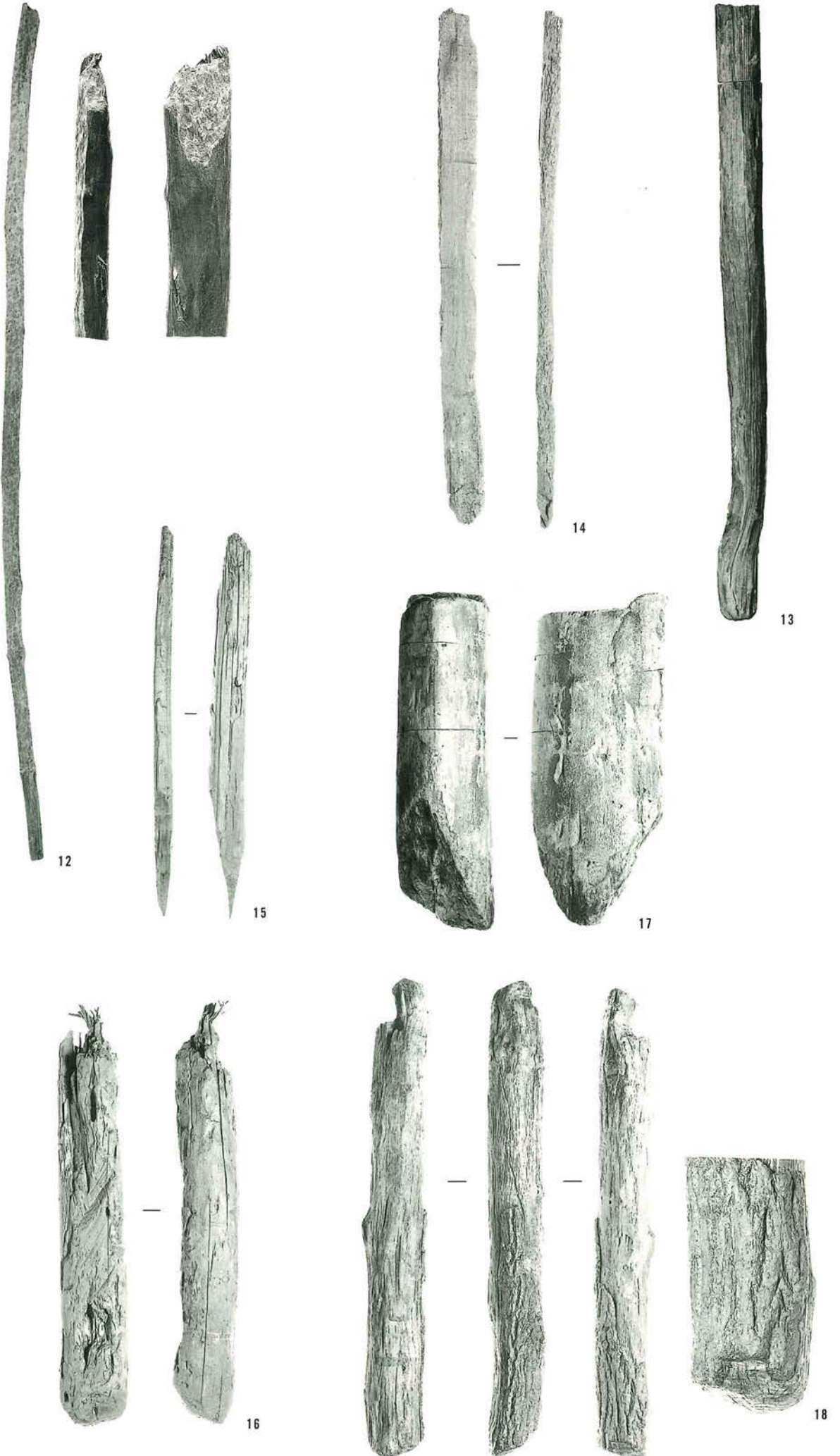

木製品 4

杭材

19 カヤ
PL 161-(4)

20 カヤ
PL 169-(1)

21 フジキ
PL 169-(2)

22 コナラ属コナラ節
PL 169-(3)
(1 : 8)

23 カヤ
PL 169-(5)
(1 : 10)

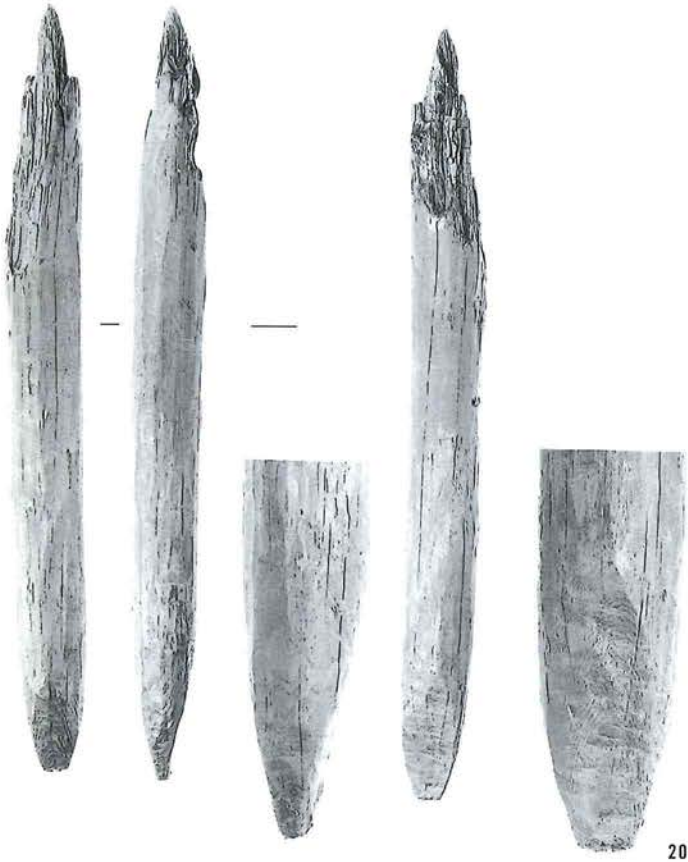

20

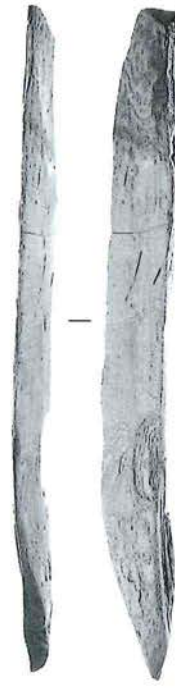

21



19



23



22

報 告 書 抄 録

ふりがな	じょうしんえつじどうしゃどうまいぞうぶんかざいはくつちょうさほうこくしょ 5							
書名	上信越自動車道埋蔵文化財発掘調査報告書 5							
副書名	松原遺跡 弥生・総論 5 弥生中期・石器 図版							
巻次	長野市内 その3							
シリーズ名	長野県埋蔵文化財センター発掘調査報告書							
シリーズ番号	36							
編著者名	町田勝則 西 香子							
編集機関	財団法人 長野県文化振興事業団 長野県埋蔵文化財センター							
所在地	〒387-0007 長野県更埴市屋代清水260-6 TEL026-274-3891 FAX026-274-3892							
発行年月日	西暦2000年3月31日							
ふりがな 所収遺跡名	ふりがな 所在地	コード		北緯 。 / ' "	東経 。 / ' "	調査期間	調査面積 m ²	調査原因
		市町村	遺跡番号					
まつばら 松原	ながの けん 長野県 ながの し 長野市 まつしろ まち 松代町	20201	6177	36度 34分 40秒	138度 12分 25秒	19900418 ～ 19920530	46,000	道路 (上信越自 動車道) 建 設に伴う事 前調査
所収遺跡名	種 別	主な時代		主 な 遺 物				
松 原	集 落	弥生時代中期		石製品 打製石鏃・磨製石鏃・打製石斧・磨石類・台石類 鉄剣形石剣・有樋式石戈・独鈷石・環状石器 大型蛤刃石斧・扁平片刃石斧・ノミ状石器・磨製石包丁 刃器類・石錐・砥石・勾玉・管玉 木製品 漆塗豎櫛・漆塗小型高杯・木製鎌・木製臼・杭材・板材 骨角牙製品 骨鏃・牙鏃・骨針・猪牙製腕輪				

長野県埋蔵文化財センター発掘調査報告書 36

上信越自動車道埋蔵文化財発掘調査報告書 5

—長野市内その3—

松原遺跡

弥生・総論 5

弥生中期・石器 図版

発行	平成 12 年 3 月 31 日
発行者	日本道路公団 長野県教育委員会 (財)長野県文化振興事業団 長野県埋蔵文化財センター TEL 026-274-3891 FAX 274-3892
印刷	第一法規出版株式会社 TEL 026-226-4901 FAX 226-8939