

上西根遺跡

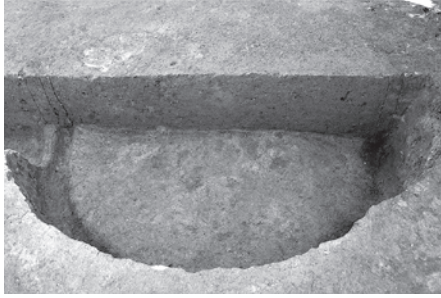

1. 3区32号土坑土層断面(西から)



2. 3区33号土坑全景(東から)



3. 3区34号土坑全景(南から)

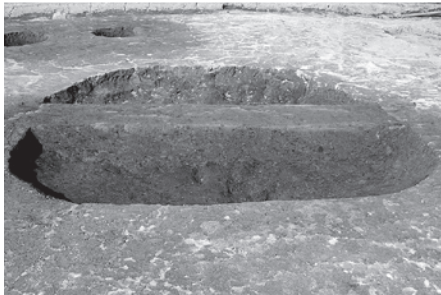

4. 3区34号土坑土層断面(南から)



5. 3区35～37号土坑全景(東から)



6. 3区35～37号土坑全景(南から)



7. 3区35・37号土坑土層断面(東から)

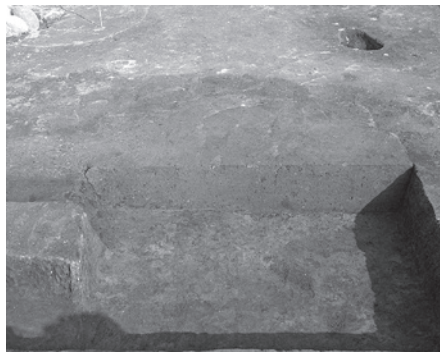

8. 3区36・37号土坑土層断面(西から)



9. 3区38号土坑全景(南から)

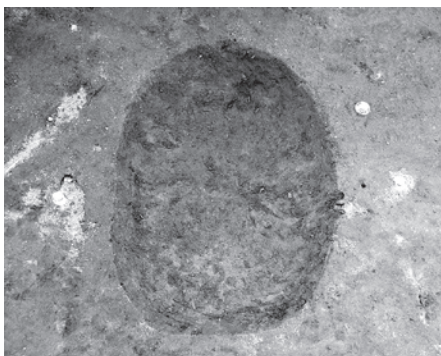

10. 3区39号土坑全景(北から)



11. 3区39号土坑土層断面(南から)

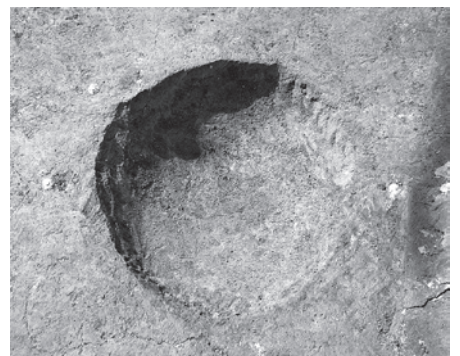

12. 3区40号土坑全景(北から)



13. 3区40号土坑土層断面(南から)

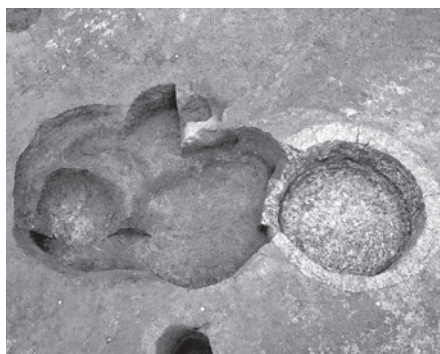

14. 3区41～43号土坑全景(南から)



15. 3区41・42号土坑全景(南から)



1. 3区41号土坑土層断面(東から)



2. 3区41号土坑掘方土層断面(東から)



3. 3区41号土坑掘方土層断面(東から)

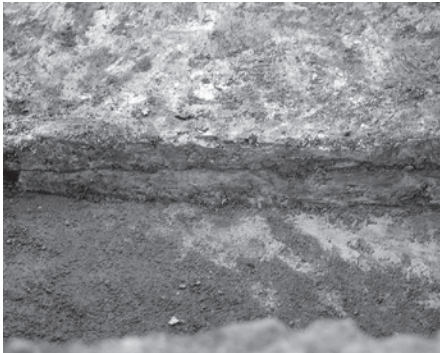

4. 3区41号土坑掘方土層断面(東から)



5. 3区41号土坑掘方全景(東から)



6. 3区42号土坑土層断面(東から)



7. 3区43号土坑全景(南から)



8. 3区43号土層断面(東から)



9. 3区44号土坑全景(西から)



10. 3区45号土坑全景(西から)



11. 3区45号土坑土層断面(西から)



12. 3区46号土坑全景(西から)



13. 3区48号土坑全景(東から)

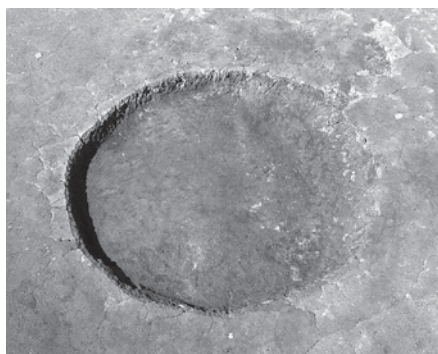

14. 3区49号土坑全景(東から)



15. 3区作業風景(南から)

上西根遺跡



1. 4区全景(北から)



2. 4区全景(南から)



1. 4区2号住居全景(西から)



2. 4区2号住居土層断面A-A' (東から)

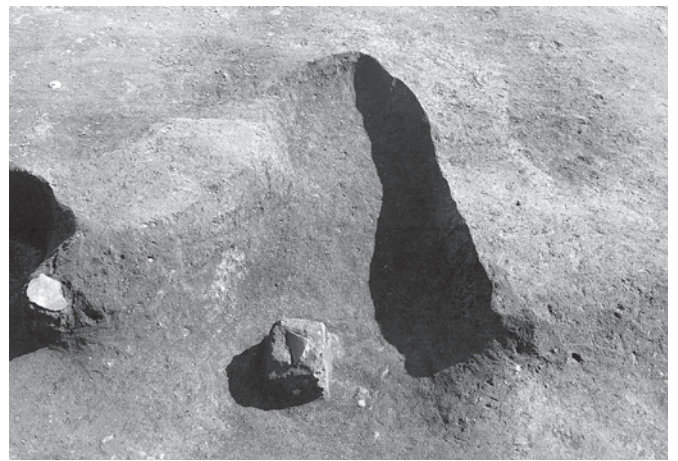

3. 4区2号カマド住居全景(西から)



4. 4区2号住居カマド土層断面D-D' (西から)



5. 4区2号住居カマド土層断面C-C' (南から)



1. 4区2号住居カマド掘方全景(西から)



2. 4区2号住居P 1全景(南から)



3. 4区2号住居掘方全景(西から)



4. 4区2号住居掘方全景(南西から)

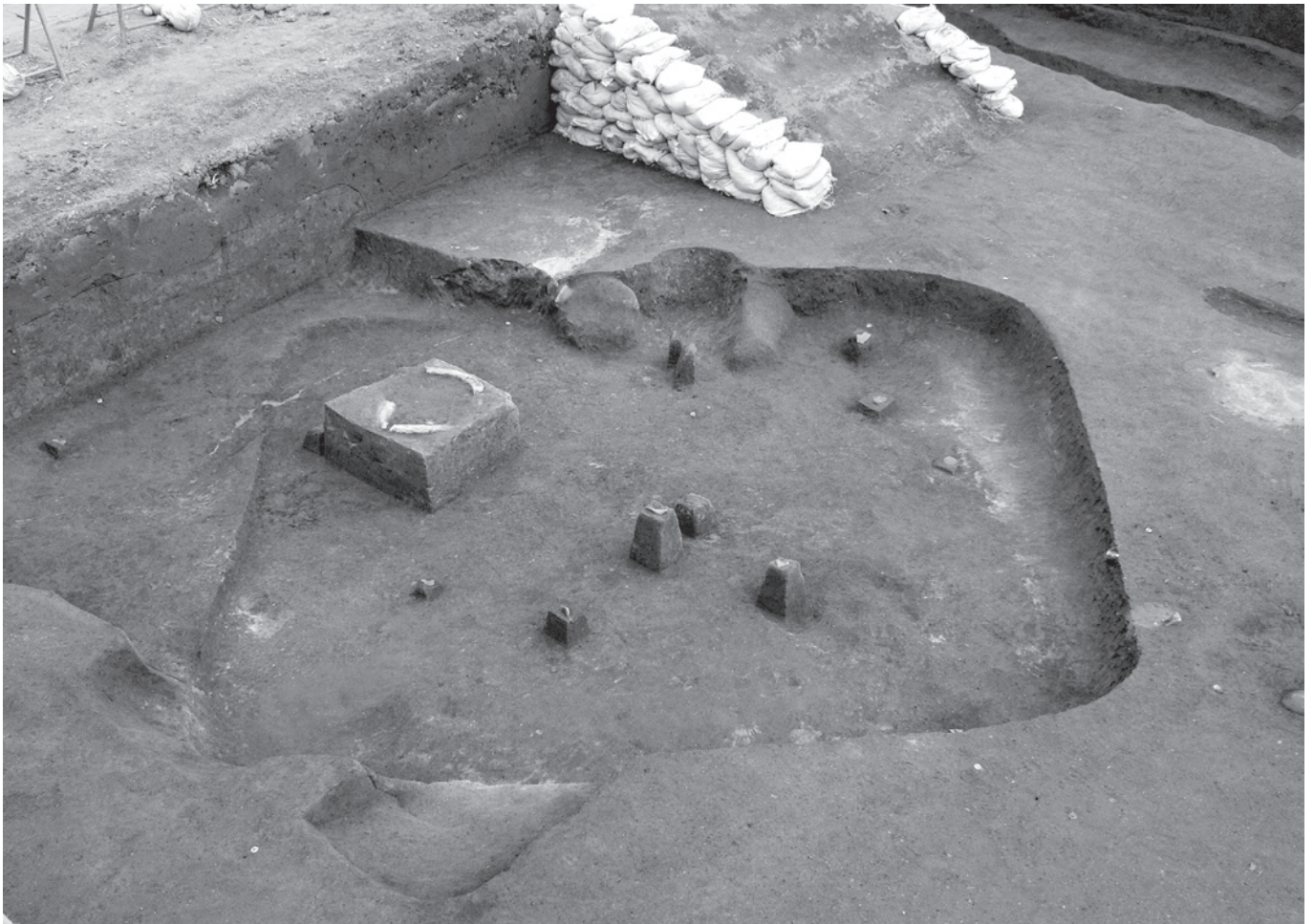

5. 4区3号住居全景(南西から)



1. 4区3号住居土層断面C-C' (南から)

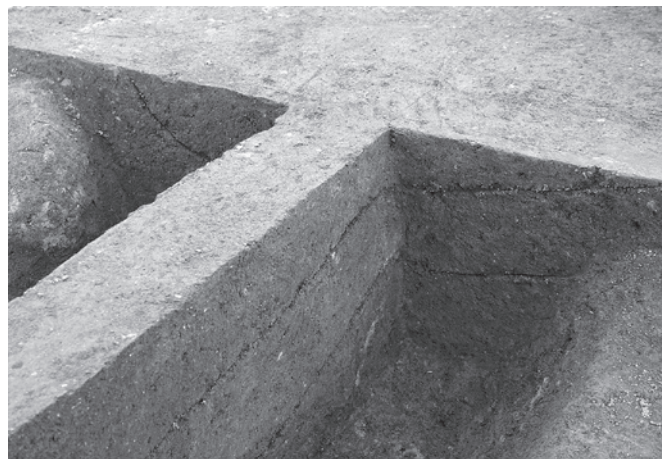

2. 4区3号住居カマド土層断面C-C'・D-D' (南西から)



3. 4区3号住居P 1土層断面(南から)

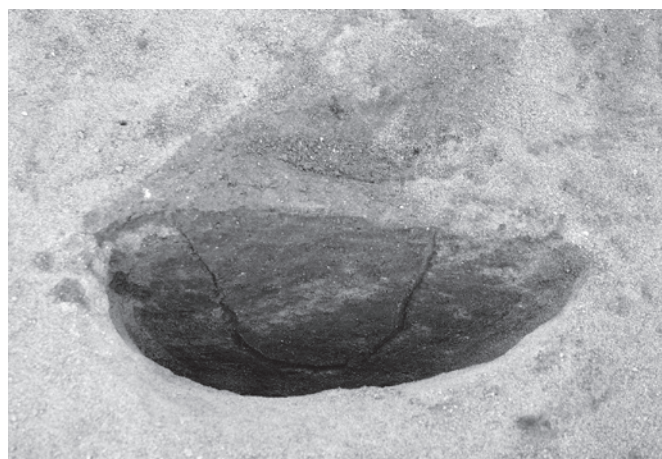

4. 4区3号住居P 3土層断面(南から)

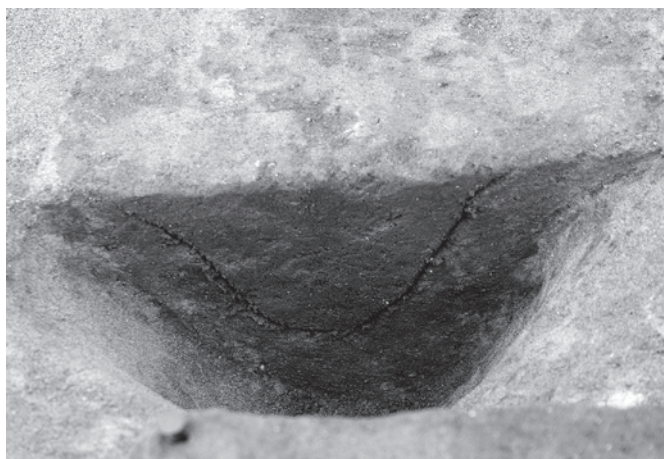

5. 4区3号住居P 4土層断面(南から)



6. 4区3・4号住居掘方全景(西から)



7. 4区4号住居掘方土層断面A-A' (西から)



8. 4区調査風景(南から)



1. 4区5号住居全景(西から)



2. 4区5号住居土層断面A-A'(東から)



3. 4区5号住居カマド全景(西から)



4. 4区5号住居カマド土層断面B-B'(北から)



5. 4区6号住居掘方全景(西から)

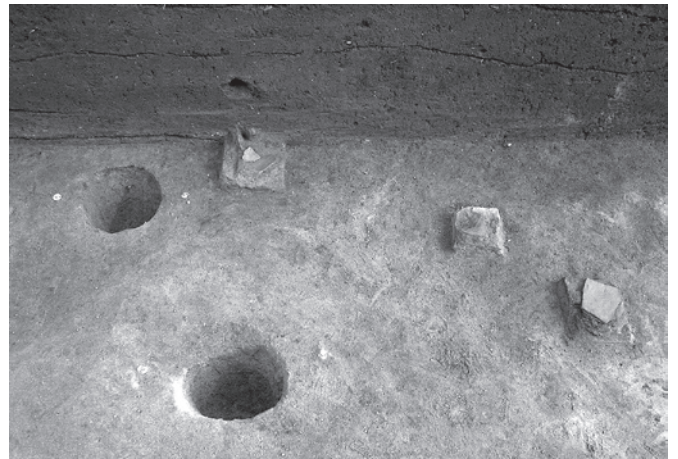

6. 4区6号住居遺物出土状態(西から)



7. 4区1号竪穴状遺構全景(西から)



8. 4区1号竪穴状遺構土層断面A-A'(東から)



1. 4区1号溝全景(北から)

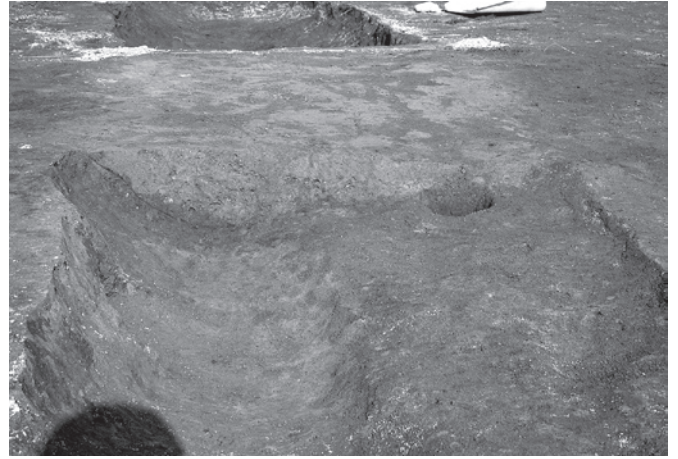

2. 4区1号溝土層断面(南から)



3. 4区2号溝全景(南から)



4. 4区2号溝土層断面(北から)



5. 4区3～7号溝全景(北から)

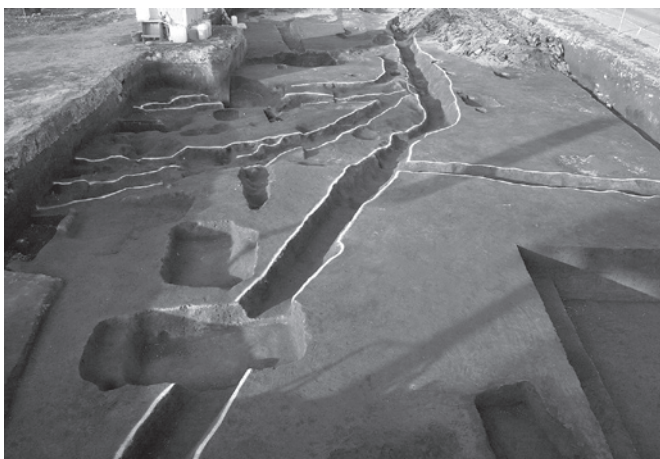

6. 4区3～7号溝全景(南から)

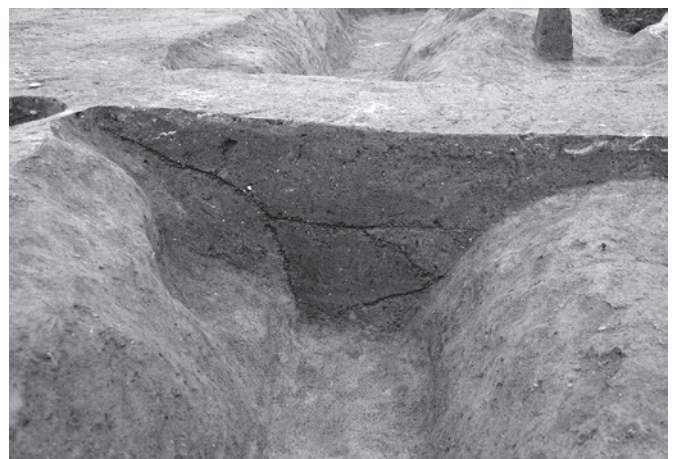

7. 4区3号溝土層断面(北から)

上西根遺跡



1. 4区3～7号溝全景(東から)



2. 4区3～7号溝全景(西から)



3. 4区3・4・7号溝土層断面(南西から)



4. 4区7号溝土層断面(南西から)



5. 4区7号溝遺物出土状態(西から)

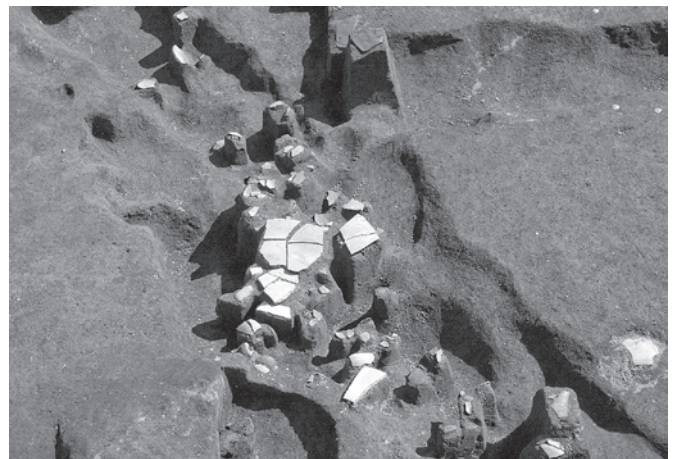

6. 4区7号溝遺物出土状態(西から)

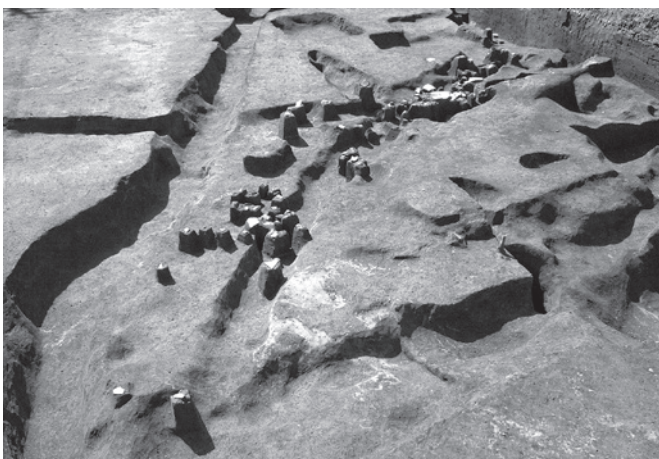

7. 4区7号溝遺物出土状態(北から)



8. 4区7号溝遺物出土状態(東から)



1. 4区1号井戸全景(南から)

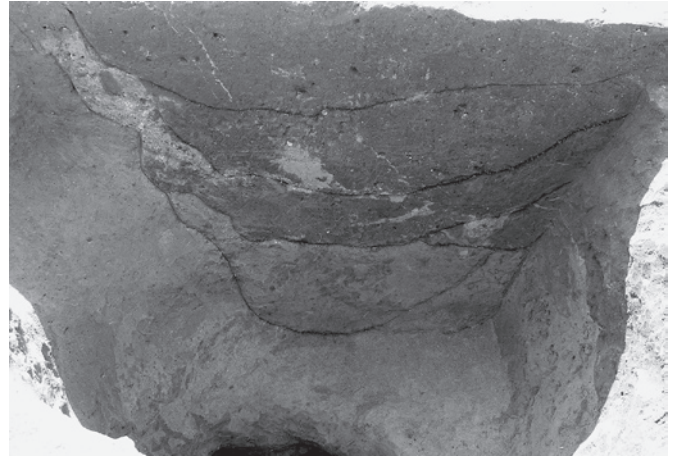

2. 4区1号井戸土層断面(北から)

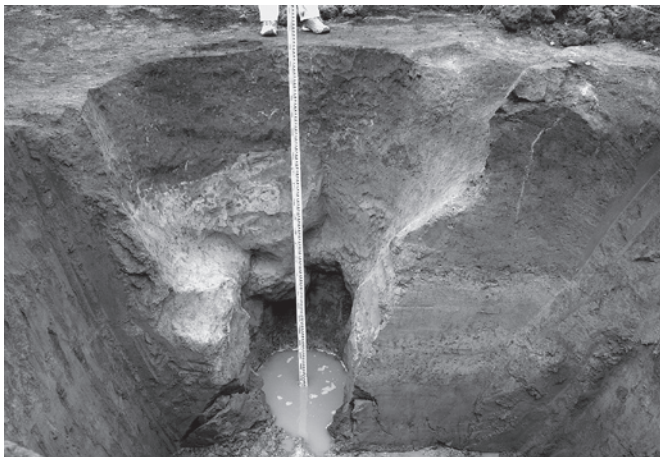

3. 4区1号井戸土層断面(南から)



4. 4区1号井戸完掘状況(南から)

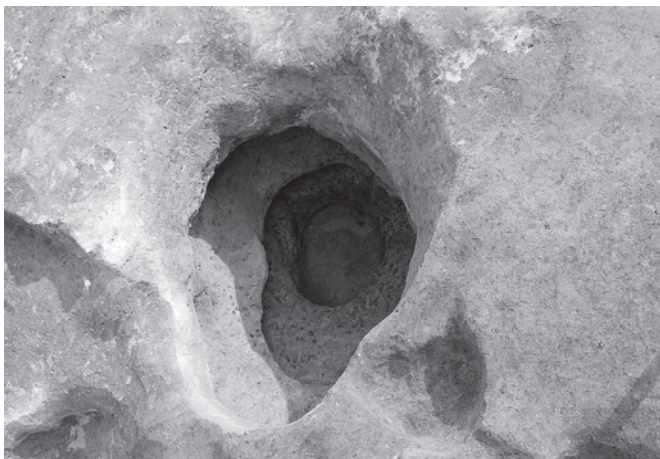

5. 4区2号井戸全景(北西から)



6. 4区2号井戸土層断面(西から)

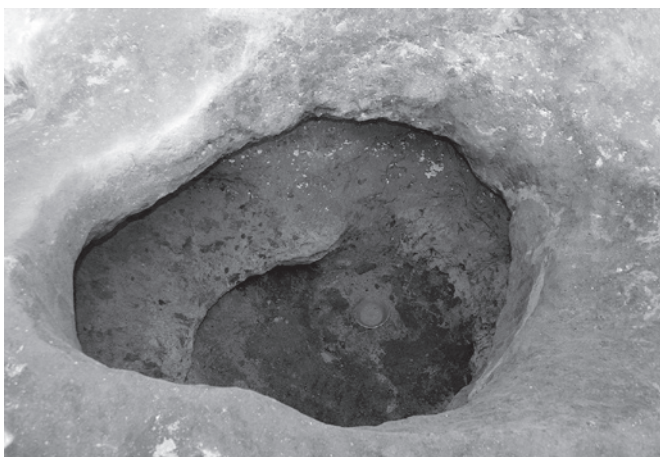

7. 4区2号井戸遺物出土状態(南から)

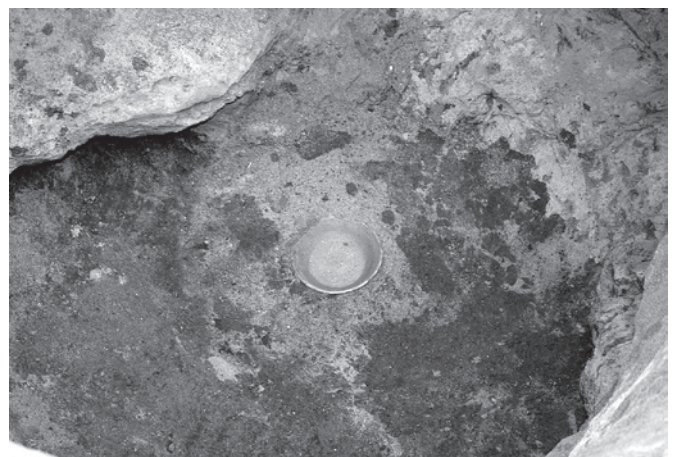

8. 4区2号井戸遺物出土状態(南から)



1. 4区1・2号土坑全景(東から)



2. 4区1・2号土坑土層断面(東から)

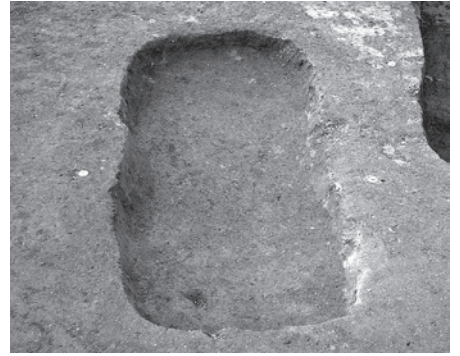

3. 4区3号土坑全景(東から)



4. 4区3号土坑土層断面(南東から)



5. 4区4号土坑全景(東から)



6. 4区4号土坑土層断面(南から)



7. 4区5号土坑全景(東から)



8. 4区5号土坑土層断面(東から)

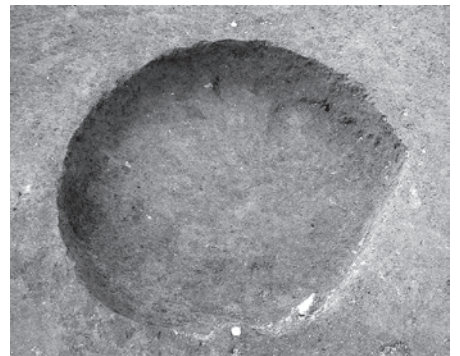

9. 4区6号土坑全景(東から)

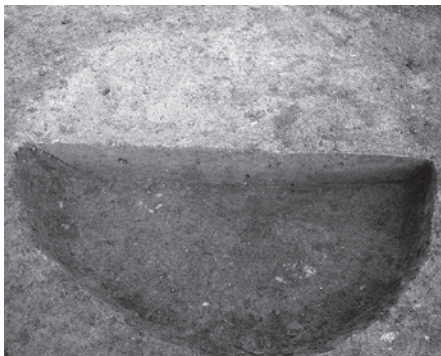

10. 4区6号土坑土層断面(南から)



11. 4区7号土坑全景(南から)



12. 4区7号土坑土層断面(南から)



13. 4区8号土坑全景(南から)



14. 4区8号土坑土層断面(南西から)



15. 4区9号土坑全景(東から)



1. 4区9号土坑土層断面(西から)

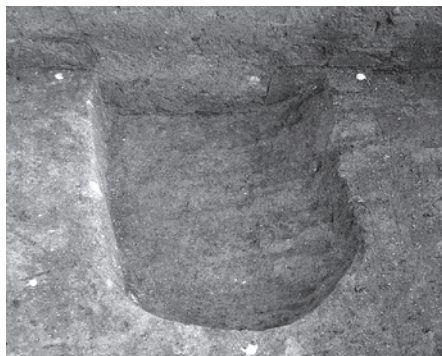

2. 4区10号土坑全景(東から)



3. 4区11・12号土坑全景(東から)



4. 4区11・12号土坑土層断面(東から)



5. 4区13・14号土坑全景(東から)



6. 4区13号土坑土層断面(東から)



7. 4区14号土坑全景(東から)



8. 4区14号土坑土層断面(西から)



9. 4区15号土坑全景(東から)



10. 4区15号土坑土層断面(東から)



11. 4区16号土坑全景(北から)



12. 4区16号土坑土層断面(北から)

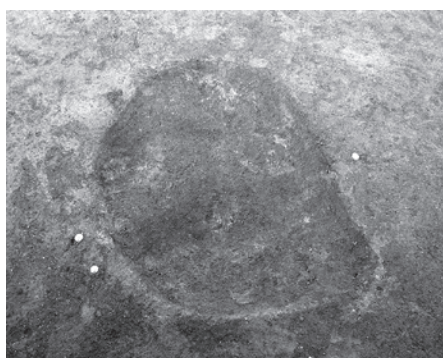

13. 4区17号土坑全景(南から)



14. 4区18・19号土坑全景(南から)



15. 4区18号土坑土層断面(南から)



1. 4区19号土坑全景(南から)



2. 4区20号土坑全景(東から)



3. 4区20号土坑土層断面(東から)



4. 4区21・22号土坑全景(南から)



5. 4区21・22号土坑土層断面(南から)



6. 4区24号土坑全景(東から)

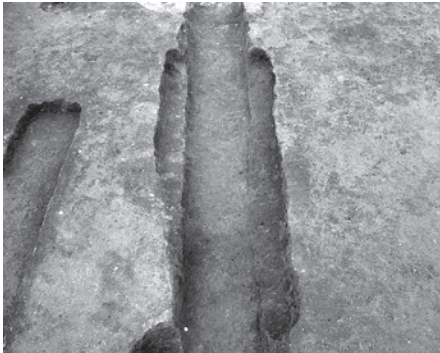

7. 4区23号土坑全景(南から)



8. 4区25号土坑全景(東から)



9. 4区26・27号土坑全景(西から)



10. 4区26・27号土坑土層断面(南から)



11. 4区27号土坑遺物出土状態(南から)



12. 4区27号土坑遺物出土状態(南から)

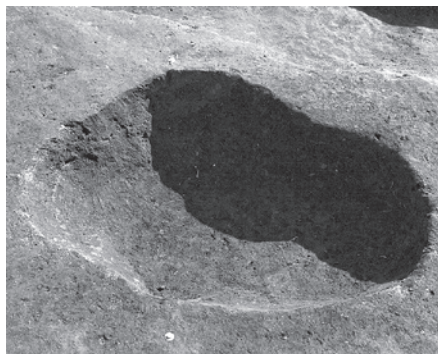

13. 4区28号土坑全景(西から)



14. 4区28号土坑土層断面(南から)



1. 4区29号土坑全景(西から)



2. 4区29号土坑土層断面(南から)

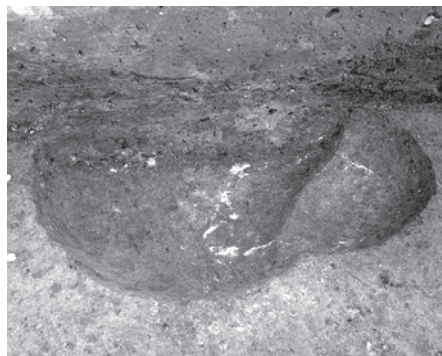

3. 4区30・31号土坑全景(東から)



4. 4区32号土坑全景(南から)



5. 4区32号土坑土層断面(南から)



6. 4区35号土坑土層断面(南から)

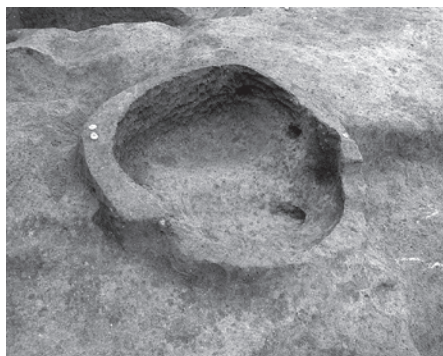

7. 4区36号全景(南から)



8. 4区36号土坑土層断面(南から)



9. 4区37号土坑土層断面(北から)



10. 4区38号土坑全景(北から)



11. 4区38号土坑土層断面(南から)



12. 4区40号土坑土層断面(南東から)

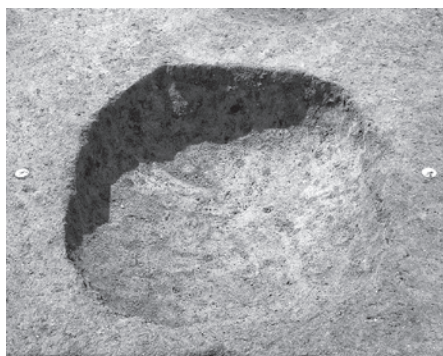

13. 4区41号土坑全景(北から)



14. 4区41号土坑土層断面(南から)

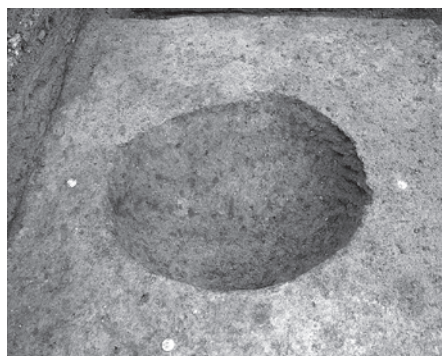

15. 4区43号土坑全景(東から)



1.5区全景(北から)



2.5区全景(北から)



1.5区全景(南から)



2.5区調査風景(北から)



1. 5区1号住居全景(南西から)



2. 5区1号住居土層断面B-B' (南から)



3. 5区1号住居カマド土層断面C-C' (東から)



4. 5区1号住居カマド掘方土層断面D-D' (南から)



5. 5区1号住居掘方全景(南西から)



1. 5区2号住居全景(南から)



2. 5区2号住居遺物出土状態(南から)



3. 5区2号住居遺物出土状態(南東から)



4. 5区2号住居遺物出土状態(南東から)



5. 5区2号住居遺物出土状態(南東から)



1. 5区2号住居全景(南から)



2. 5区2号住居土層断面(南東から)



3. 5区2号住居カマド土層断面E-E' (南から)



4. 5区2号住居カマド土層断面D-D' (西から)

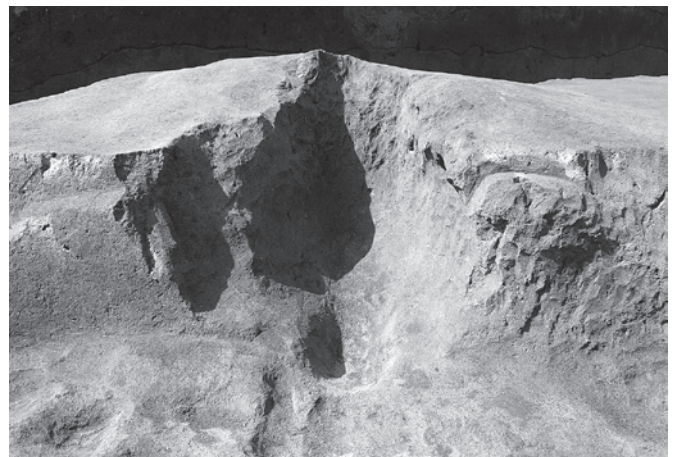

5. 5区2号住居カマド掘方全景(南から)



1. 5区2号住居貯蔵穴全景(南から)

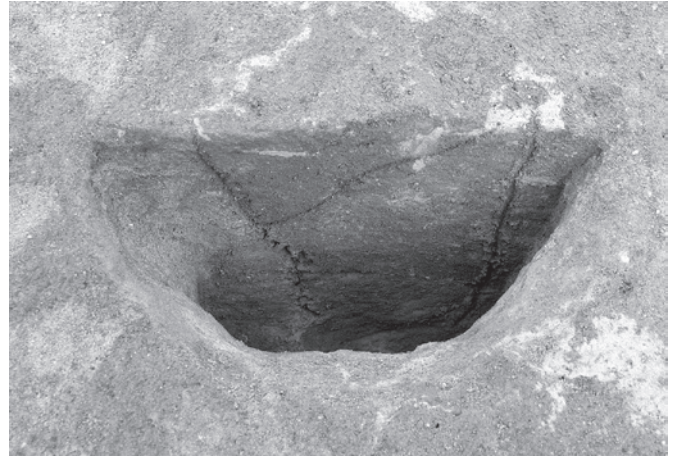

2. 5区2号住居P 2土層断面(南から)



3. 5区2号住居P 3土層断面(南から)

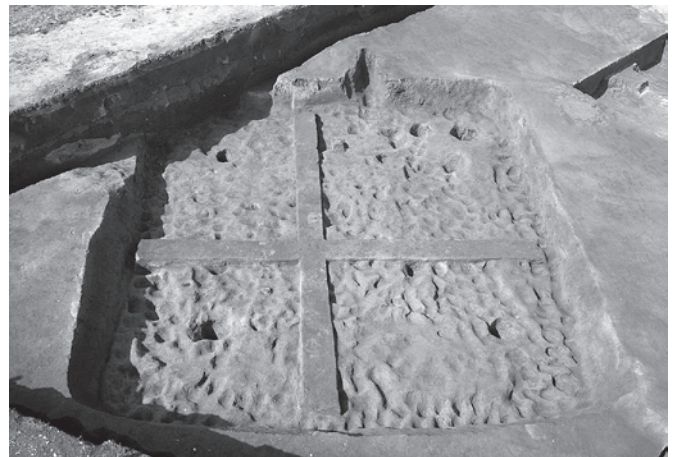

4. 5区2号住居掘方全景(南から)



5. 5区1号溝全景(西から)



6. 5区1号溝土層断面(東から)

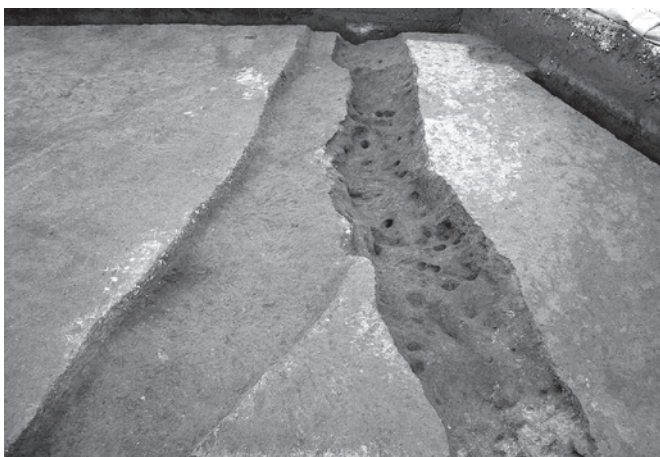

7. 5区2号溝全景(西から)



8. 5区2号溝全景(西から)

上西根遺跡



1. 5区3号溝全景(西から)



2. 5区3号溝土層断面(西から)



3. 5区1号井戸遺物出土状態(南から)



5. 5区1号井戸土層断面(南から)



4. 5区2号井戸土層断面(西から)



6. 5区2号井戸土層断面(西から)



7. 5区2号井戸土層断面(西から)

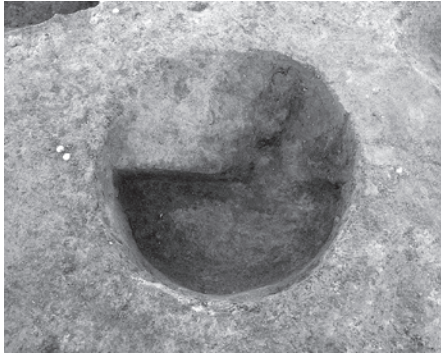

1. 5区2号土坑全景(南東から)



2. 5区2号土坑土層断面(北東から)

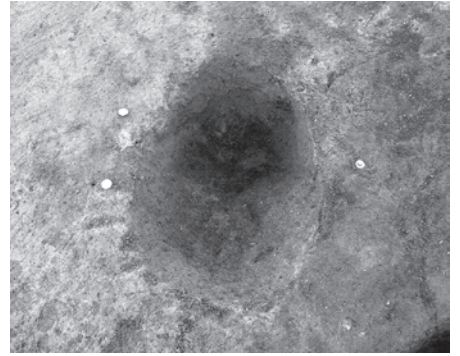

3. 5区3号土坑全景(南西から)



4. 5区3号土坑土層断面(南東から)

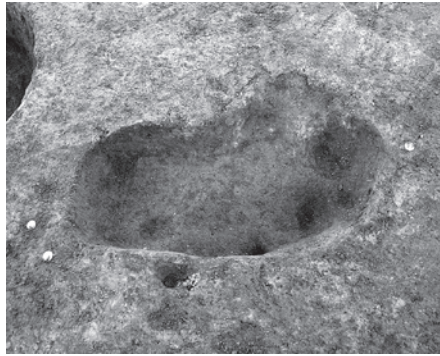

5. 5区4号土坑全景(南西から)



6. 5区4号土坑土層断面(南から)

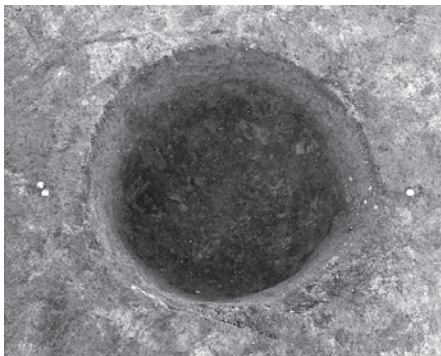

7. 5区6号土坑全景(東から)



8. 5区6号土坑土層断面(東から)



9. 5区7号土坑全景(南から)



10. 5区7号土坑土層断面(南から)



11. 5区8号土坑全景(南から)



12. 5区8号土坑土層断面(南から)



13. 5区7~9・18・19号土坑全景(北から)



14. 5区9号土坑土層断面(南から)

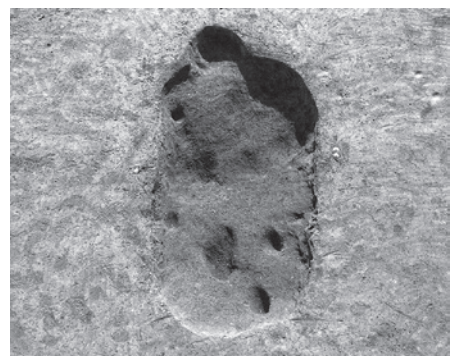

15. 5区10号土坑全景(北から)

上西根遺跡



1. 5区10号土坑土層断面(南から)

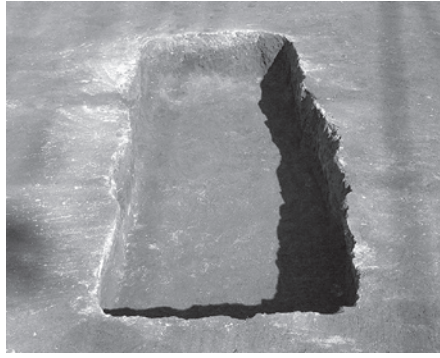

2. 5区11号土坑全景(南から)



3. 5区11号土坑土層断面(南から)

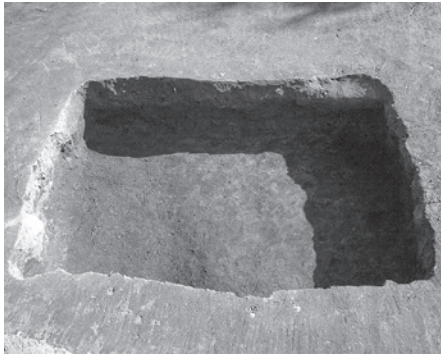

4. 5区12号土坑全景(西から)



5. 5区12号土坑土層断面(南から)



6. 5区13号土坑全景(北から)



7. 5区13号土坑土層断面(南から)

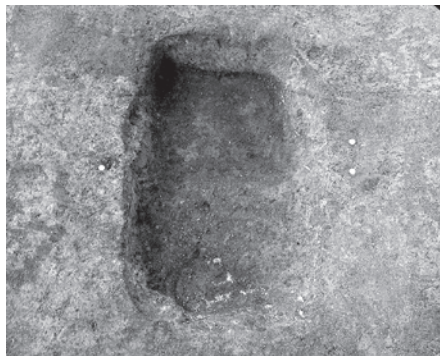

8. 5区14号土坑全景(東から)



9. 5区14号土坑土層断面(西から)

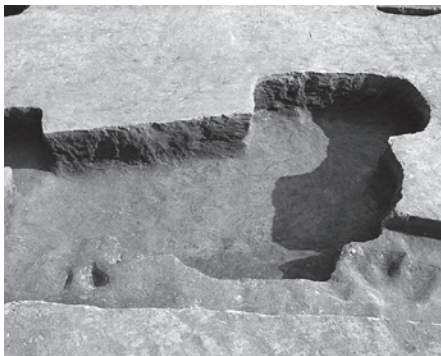

10. 5区15～17号土坑全景(西から)



11. 5区15～17号土坑土層断面(南から)



12. 5区18・19号土坑全景(北から)



13. 5区18・19号土坑土層断面(南から)

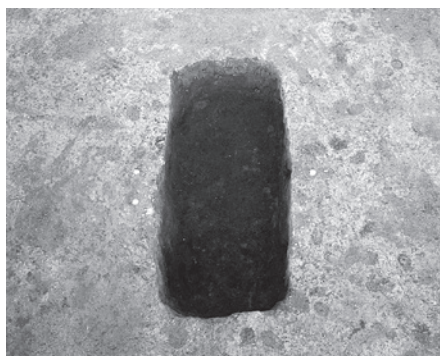

14. 5区20号土坑全景(南から)



15. 5区20号土坑土層断面(南から)



1. 5区21号土坑全景(東から)



2. 5区21号土坑土層断面(西から)

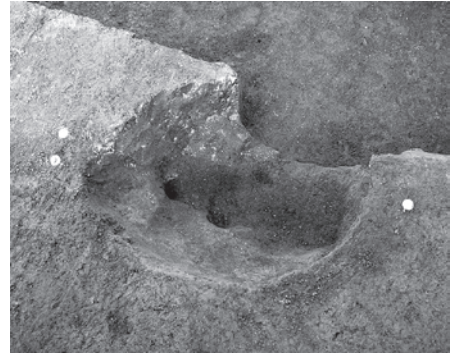

3. 5区22号土坑全景(南から)



4. 5区22号土坑土層断面(南から)

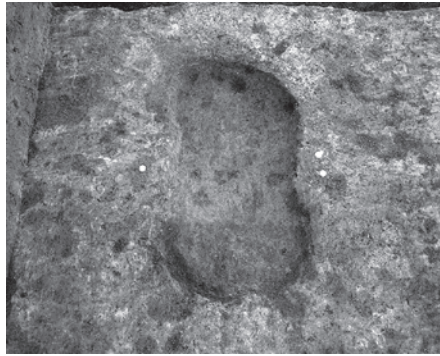

5. 5区23号土坑全景(北から)



6. 5区23号土坑土層断面(南から)



7. 5区24号土坑全景(西から)



8. 5区24号土坑土層断面(西から)



9. 5区25号土坑全景(西から)



10. 5区25号土坑土層断面(西から)



11. 5区26号土坑全景(西から)



12. 5区26・27号土坑土層断面(西から)



13. 5区27号土坑全景(西から)

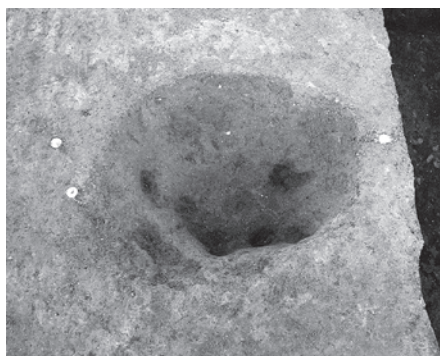

14. 5区29号土坑全景(南から)



15. 5区29号土坑土層断面(南から)

上西根遺跡



1. 5区30号土坑全景(南から)



2. 5区30号土坑土層断面(南から)

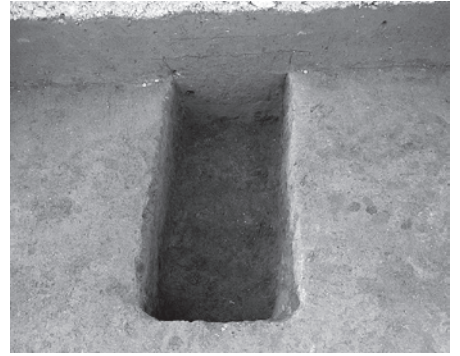

3. 5区31号土坑全景(東から)



4. 5区31号土坑土層断面(東から)



5. 5区32号土坑全景(南から)

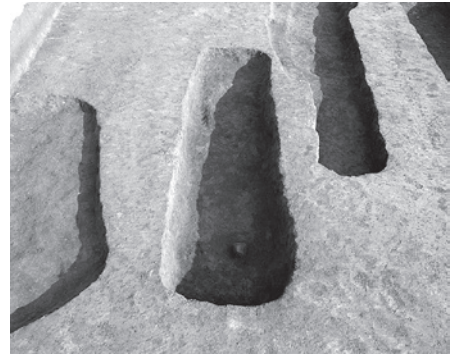

6. 5区33号土坑全景(南から)



7. 5区33号土坑土層断面(南から)



8. 5区33・34・80号土坑全景(南から)



9. 5区34号土坑土層断面(南から)



10. 5区35号土坑全景(南から)



11. 5区35号土坑土層断面(南から)



12. 5区36号土坑全景(南から)



13. 5区36号土坑土層断面(北から)

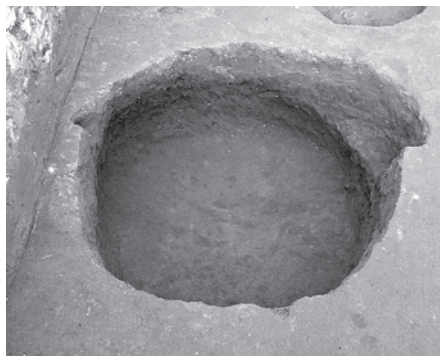

14. 5区37号土坑全景(南から)



15. 5区37号土坑土層断面(南から)

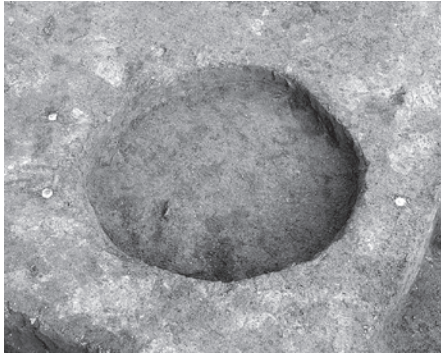

1. 5区38号土坑全景(南から)



2. 5区38号土坑土層断面(南から)



3. 5区39号土坑全景(南から)



4. 5区39号土坑土層断面(南から)



5. 5区40号土坑全景(南から)



6. 5区40号土坑土層断面(南から)



7. 5区41・42号土坑全景(南から)



8. 5区42号土坑土層断面(東から)



9. 5区43・45・47・61・62号土坑全景(東から)



10. 43号土坑土層断面(東から)



11. 5区44号土坑(南から)



12. 5区44号土坑土層断面(北から)



13. 5区43・45・47・61・62号土坑全景(東から)



14. 5区45号土坑土層断面(東から)



15. 5区46・81号土坑全景(東から)

上西根遺跡



1. 5区46号土坑土層断面(東から)



2. 5区47・61・62号土坑土層断面(東から)

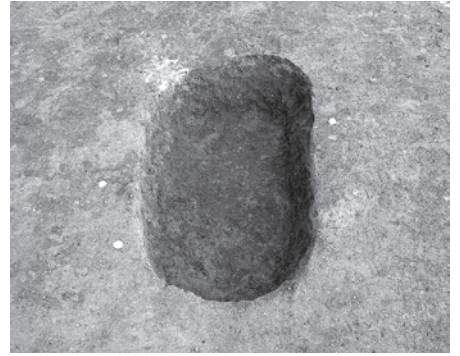

3. 5区48号土坑全景(南から)



4. 5区48号土坑土層断面(南から)



5. 5区49・50号土坑全景(南から)



6. 5区49・50号土坑土層断面(東から)

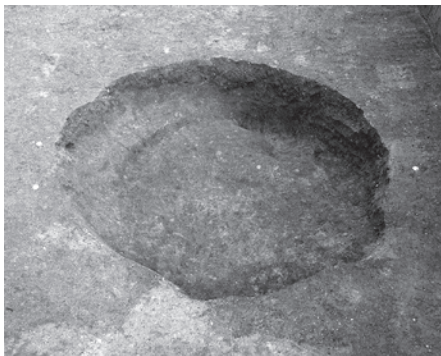

7. 5区51号土坑全景(南から)



8. 5区51号土坑土層断面(南から)

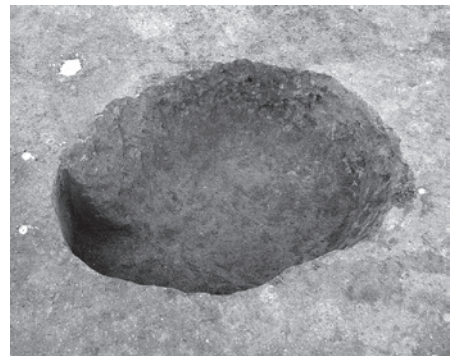

9. 5区52号土坑全景(南から)



10. 5区52号土坑土層断面(南から)



11. 5区53号土坑全景(南から)



12. 5区53号土坑土層断面(南から)

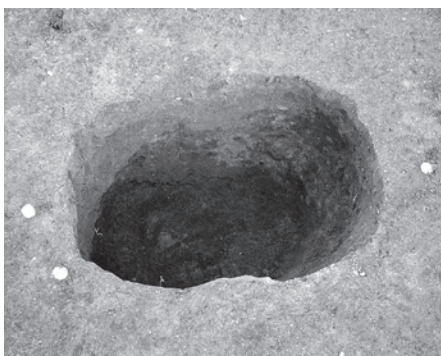

13. 5区54号土坑全景(南から)



14. 5区54号土坑土層断面(南から)



15. 5区55号土坑土層断面(西から)



1. 5区56号土坑全景(西から)



2. 5区56号土坑土層断面(南から)

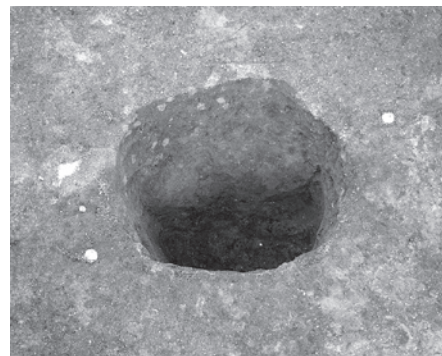

3. 5区57号土坑全景(南から)



4. 5区57号土坑土層断面(南から)



5. 5区58号土坑遺物出土状態(西から)



6. 5区58号土坑全景(西から)



7. 5区58号土坑土層断面(西から)

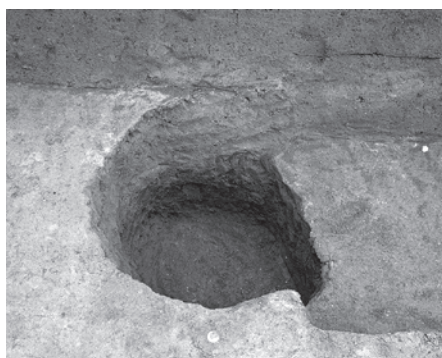

8. 5区59・60号土坑全景(西から)

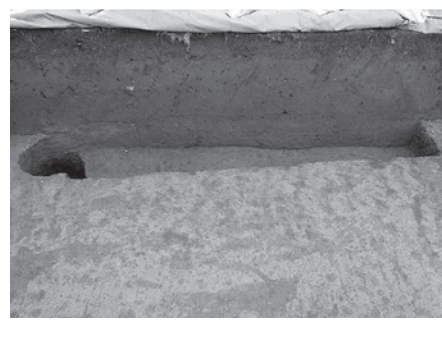

9. 5区59・60号土坑全景(西から)

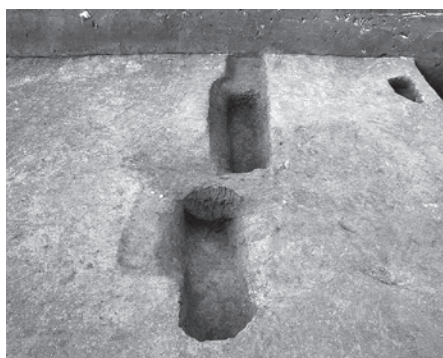

10. 5区63～65号土坑全景(東から)



11. 5区63号土坑土層断面(東から)



12. 5区64号土坑土層断面(西から)

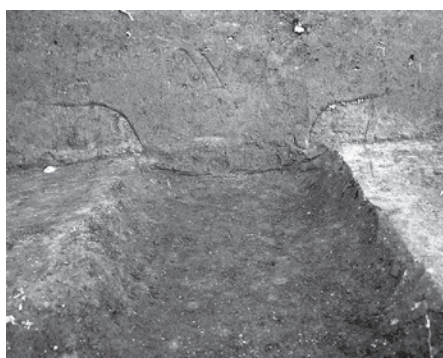

13. 5区65号土坑土層断面(東から)

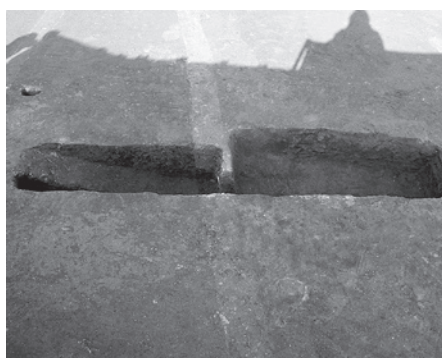

14. 5区66・67号土坑全景(南から)

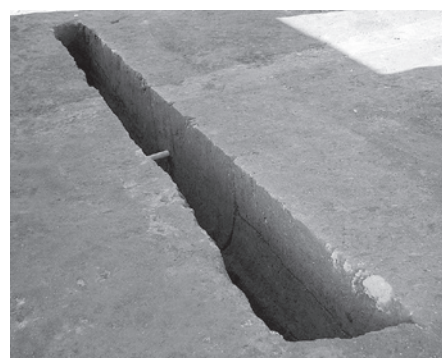

15. 5区66・67号土坑土層断面(南から)

上西根遺跡



1. 5区68・69号土坑全景(東から)



2. 5区70号土坑全景(南西から)



3. 5区71・72号土坑全景(北から)



4. 5区71・72号土坑土層断面(北から)

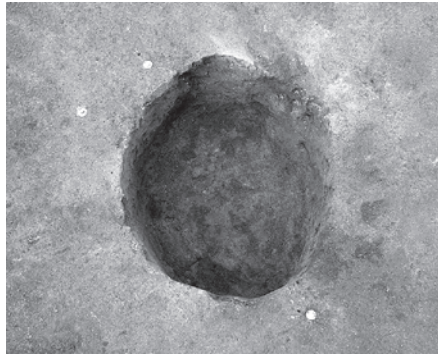

5. 5区73号土坑全景(南から)

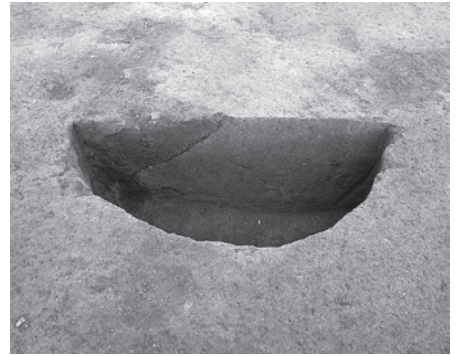

6. 5区73号土坑土層断面(南から)

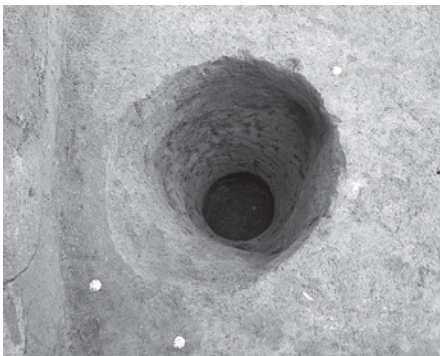

7. 5区74号土坑全景(南から)



8. 5区74号土坑土層断面(南から)

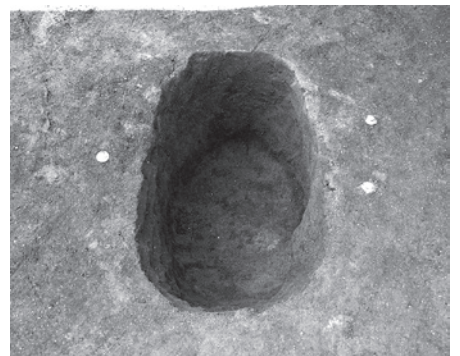

9. 5区76号土坑全景(北東から)



10. 5区76号土坑土層断面(西から)



11. 5区77号土坑土層断面(西から)



12. 5区78号土坑全景(西から)

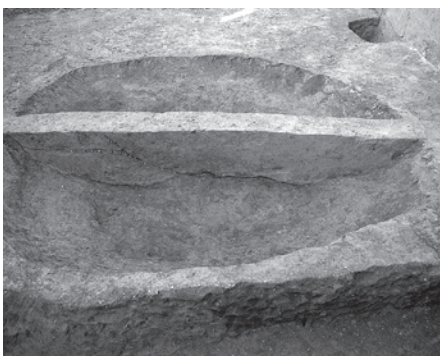

13. 5区78号土坑土層断面(南から)



14. 5区79号土坑全景(西から)



15. 5区79号土坑土層断面(西から)



1. 1区調査風景(北から)



2. 1区全景(北から)



3. 1区全景(南から)



4. 1区全景(南から)



5. 1区全景(北から)



6. 1区全景(南から)



7. 1区全景(北から)



8. 1区調査風景(南から)

新屋敷遺跡



1. 1区1号住居全景(北から)



2. 1区1号溝全景(東から)



3. 1区1号溝土層断面(東から)



4. 1区2～7号溝全景(北から)

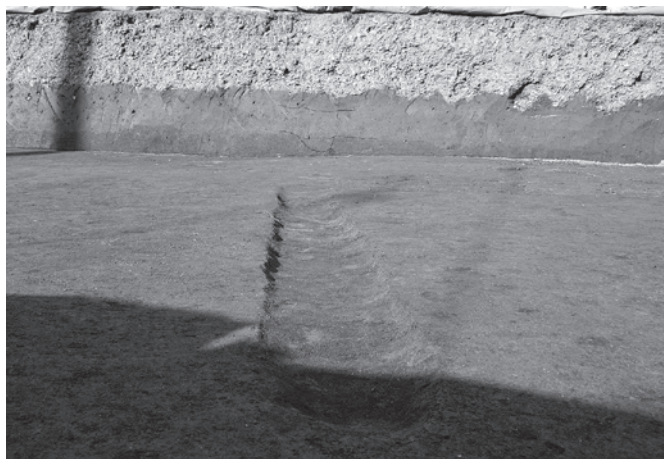

5. 1区3号溝土層断面(東から)



6. 1区3号溝土層断面(東から)



7. 1区4～7号溝土層断面(南から)



8. 1区8・15号溝全景(西から)

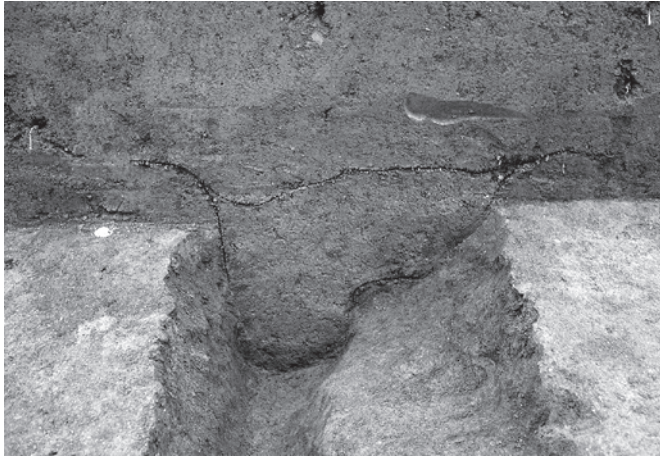

1. 1区8・15号溝土層断面(西から)



2. 1区9～11号溝、35号土坑土層断面(西から)



3. 1区11号溝土層断面(東から)



4. 1区12号溝全景(東から)



5. 1区12号溝土層断面(東から)



6. 1区13・14号溝全景(東から)

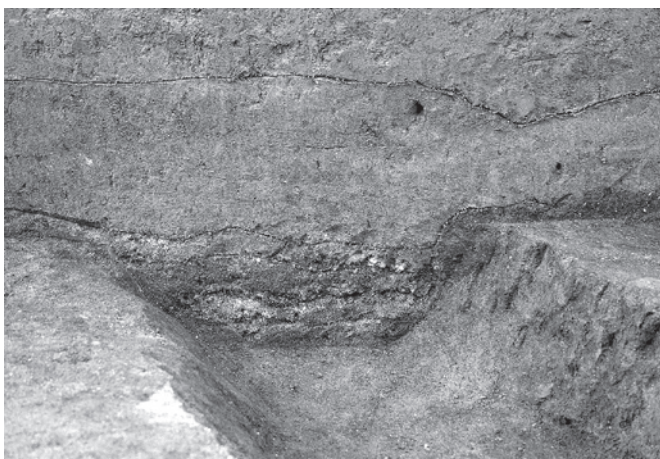

7. 1区13号溝土層断面(東から)



8. 1区14号溝土層断面(東から)

新屋敷遺跡



1. 1区1号土坑全景(北から)



2. 1区2号土坑全景(南から)



3. 1区2号土坑土層断面(南から)



4. 1区3号土坑全景(南から)



5. 1区3号土坑土層断面(西から)

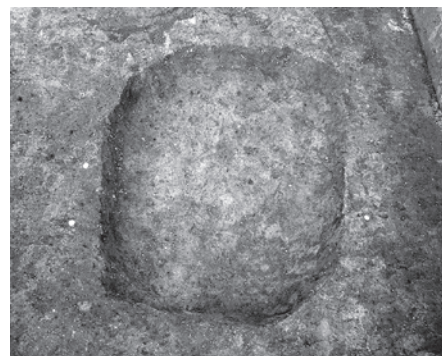

6. 1区4号土坑全景(南から)



7. 1区4号土坑土層断面(南から)

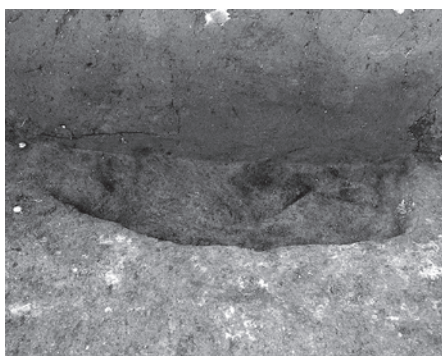

8. 1区5号土坑全景(東から)



9. 1区6・7号土坑全景(東から)



10. 1区6・7号土坑土層断面(南から)



11. 1区8号土坑全景(西から)

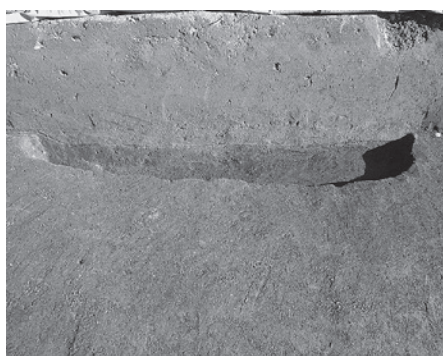

12. 1区10号土坑全景(西から)



13. 1区12・13号土坑全景(東から)



14. 1区12・13号土坑土層断面(東から)

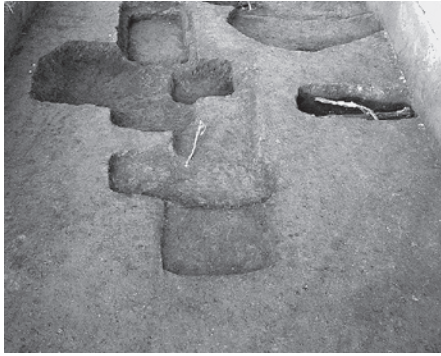

1. 1区14～16号土坑全景(南から)



2. 1区14～16号土坑土層断面(南から)

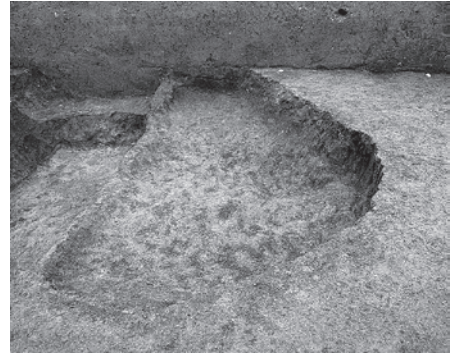

3. 1区17号土坑全景(西から)



4. 1区17号土坑土層断面(西から)



5. 1区17～20号土坑全景(南から)



6. 1区18号土坑土層断面(東から)



7. 1区19号土坑土層断面(東から)



8. 1区20号土坑土層断面(東から)



9. 1区21・22号土坑全景(東から)



10. 1区21・22号土坑土層断面(南から)



11. 1区25号土坑全景(東から)



12. 1区25号土坑土層断面(南から)



13. 1区26号土坑全景(東から)

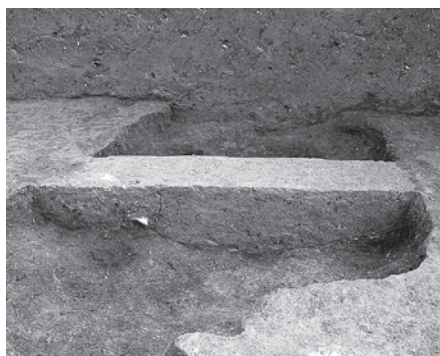

14. 1区26号土坑土層断面(西から)



15. 1区28号土坑全景(西から)



1. 1区28号土坑土層断面(東から)



2. 1区29・30号土坑全景(南から)



3. 1区29号土坑土層断面(東から)



4. 1区30号土坑土層断面(南から)



5. 1区31号土坑土層断面(西から)



6. 1区31号土坑土層断面(西から)



7. 1区32・38号土坑、9～11号溝全景(西から)



8. 1区32号土坑土層断面(西から)



9. 1区33号土坑全景(西から)



10. 1区33号土坑土層断面(西から)



11. 1区36号土坑全景(東から)



12. 1区36号土坑土層断面(東から)



13. 1区37号土坑全景(東から)



14. 1区37号土坑土層断面(西から)



15. 1区38号土坑土層断面(西から)



1. 1区39号土坑全景(北から)



2. 1区39号土坑土層断面(北から)

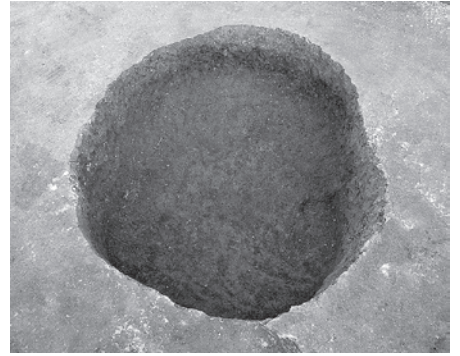

3. 1区40号土坑全景(南西から)



4. 1区40号土坑土層断面(南西から)



5. 1区40号土坑木桶底部検出状況(南西から)



6. 1区40号土坑木桶底部検出状況(南西から)

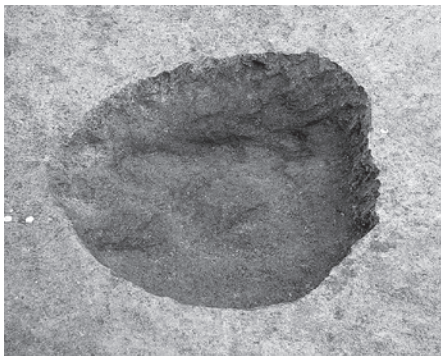

7. 1区41号土坑全景(南から)



8. 1区41号土坑土層断面(南から)



9. 1区42号土坑全景(南から)



10. 1区42号土坑土層断面(南から)



11. 1区43号土坑、12号溝全景(南から)



12. 1区43号土坑、12号溝土層断面(東から)



13. 1区44号土坑全景(南から)



14. 1区45・52号土坑全景(南から)



15. 1区45・52号土坑土層断面(南から)



1. 1区46・47号土坑全景(東から)



2. 1区46・47号土坑土層断面(東から)



3. 1区48・49号土坑全景(東から)



4. 1区48・49号土坑土層断面(東から)



5. 1区50号土坑全景(西から)



6. 1区51号土坑全景(北から)



7. 1区53号土坑土層断面(西から)



8. 1区53号土坑、49号ピット全景(西から)



9. 1区55・56号土坑全景(西から)



10. 1区54・59号土坑全景(東から)



11. 1区55号土坑土層断面(西から)



12. 1区56号土坑全景・土層断面(西から)

1号住居出土遺物



1住2



1住3



1住4



1住5



1住7

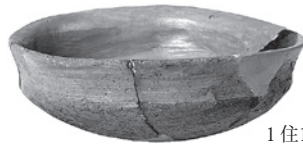

1住10



1住11



1住15



1住16



1住18



1住22

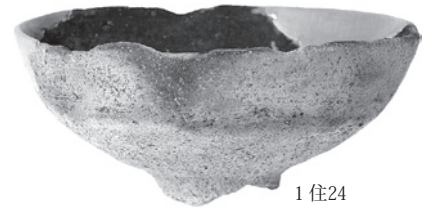

1住24



1住27



1住28



1住29



1住30



1住35

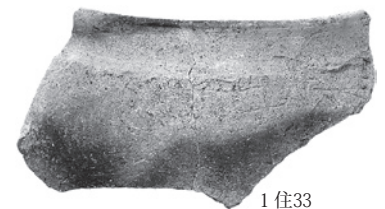

1住33



1住36

関遺跡

2号住居出土遺物



2住1



2住5



2住6



2住8



2住7

3号住居出土遺物



3住1



3住2



3住9



3住10

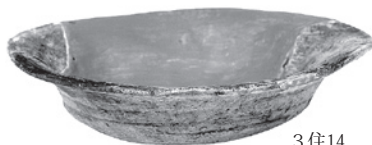

3住14



3住18



3住23



3住25



3住28



3住26



3住30

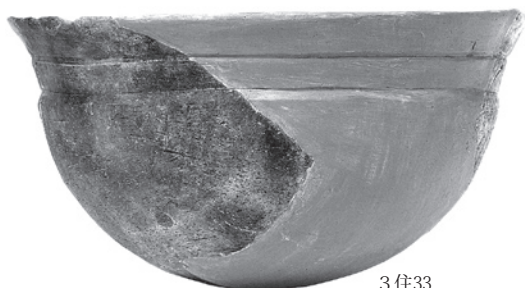

3住33



3住34



3住37



3住38



3住39



3住40



3住48



3住50



3住51



3住52



3住53



3住54



3住55



3住56



3住66



3住77



3住78



3住79



3住80



3住85



3住86



3住88



3住91

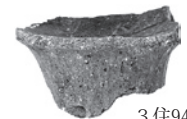
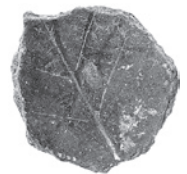

3住94



3住96



3住97



3住99



3住101



3住103



3住102



3住104



3住109

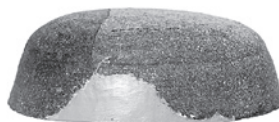

3住110



3住111



3住112

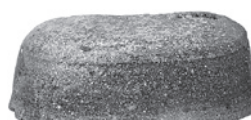

3住113

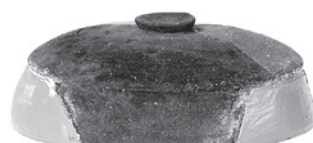

3住121



3住122



3住124



3住126



3住131

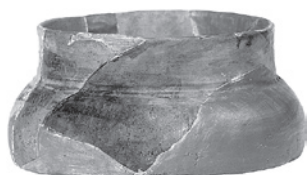

3住132



3住133

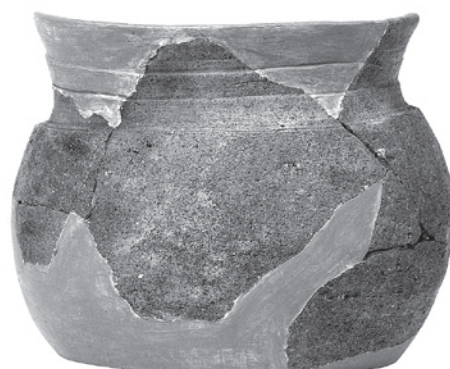

3住134



3住135



3住137



3住138



3住150

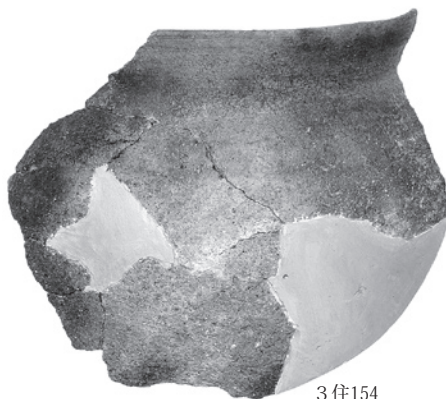

3住154



3住168



3住165

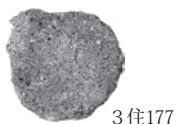

3住177

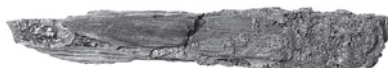

3住178



3住180



3住179

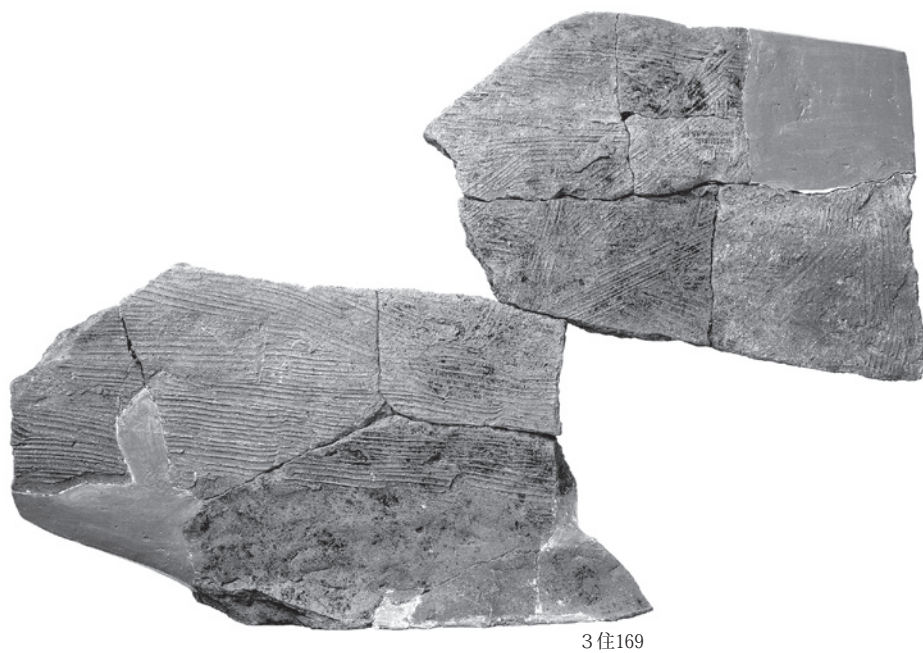

3住169



3住169



3住176

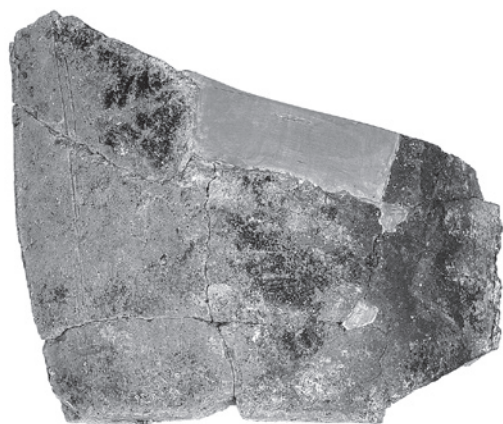

3住181

3住183

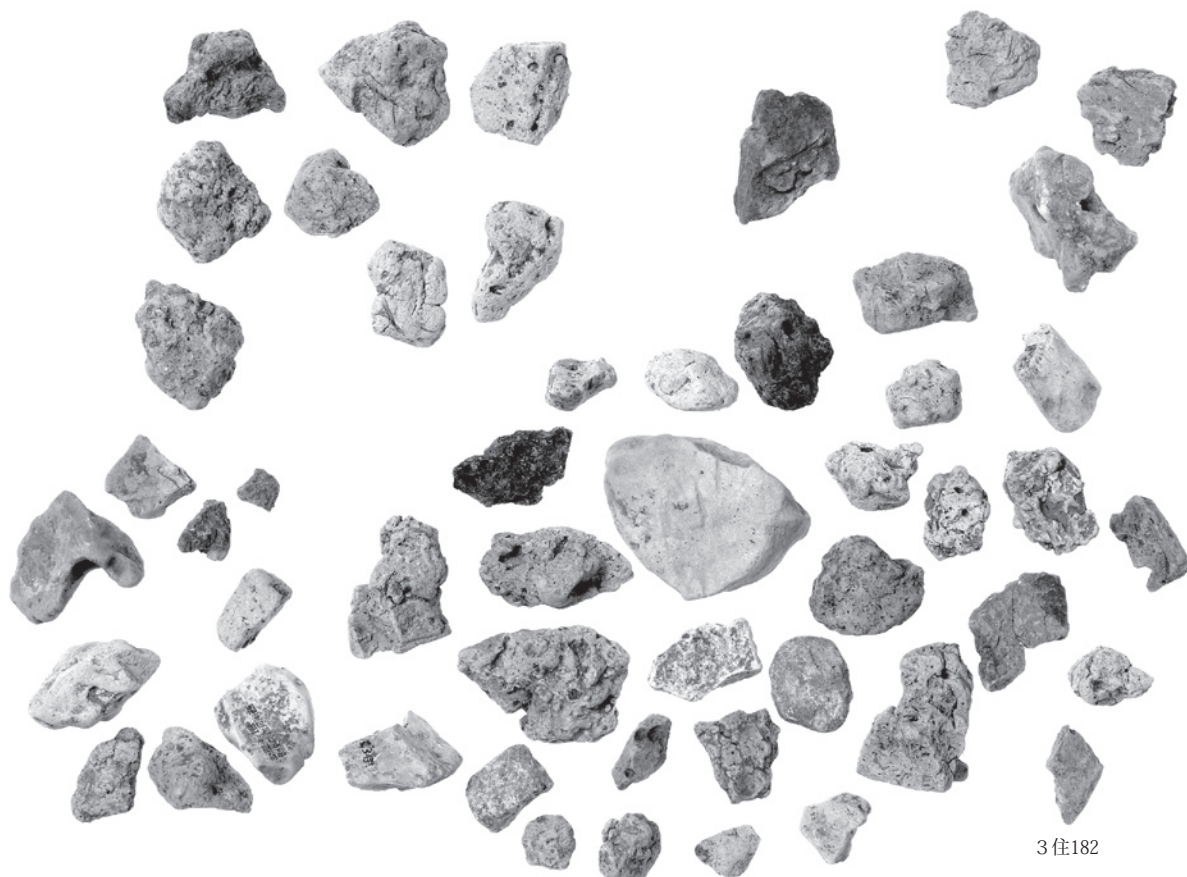

3住182

4号住居出土遺物



4住3

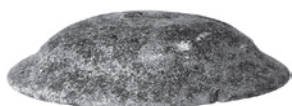

4住4



4住5



4住6

5号住居出土遺物



5住1

8号住居出土遺物



8住1



8住2

9号住居出土遺物



9住1



9住2



9住3



9住4



9住5



9住8



9住9



9住13



9住18



9住10

10号住居出土遺物

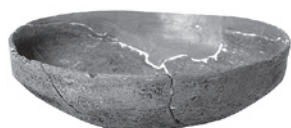

10住1



10住2



10住3



10住5

関遺跡



10住6



10住16



10住7



10住8



10住17



10住18



10住19

12号住居出土遺物



12住1



12住6



12住2



12住3

14号住居出土遺物



14住1



14住2



14住3



14住5



14住6



14住7

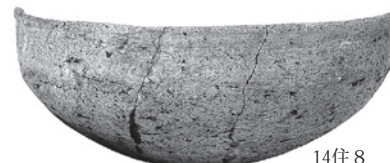

14住8



14住9



14住10



14住11



14住14



14住15



14住19



14住21



14住24



14住26



14住27



14住28



14住30



14住31



14住29

15号住居出土遺物

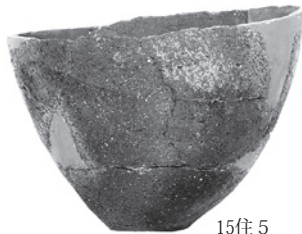

15住 5

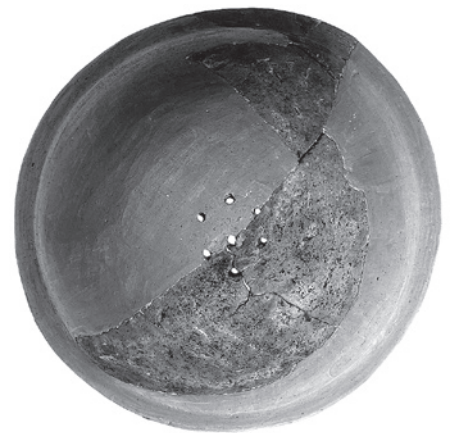

17号住居出土遺物



17住 1

18号住居出土遺物



18住 1



18住 6

19号住居出土遺物

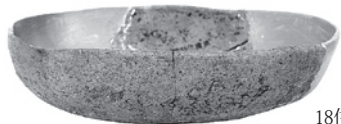

18住2



18住11



19住1



18住12



19住2



19住3



19住4



19住5



19住6

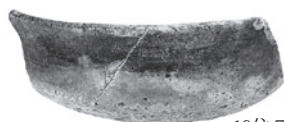

19住7



19住8



19住9



19住10

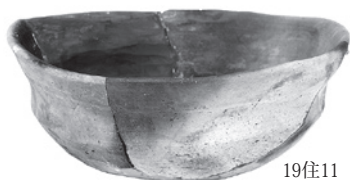

19住11



19住12



19住17



19住18



19住19



19住22



19住23



19住24



19住25



19住27



19住28



19住26



19住31



19住33



19住36



19住37

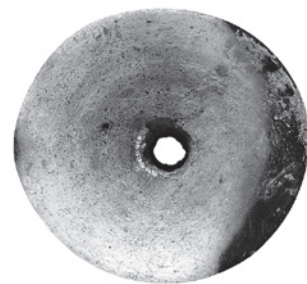

19住38



19住39

21号住居出土遺物



21住2



21住4

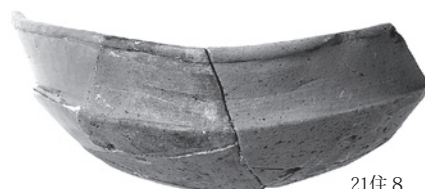

21住8

関遺跡



21住11



21住12



22住4

22号住居出土遺物



22住1



22住3

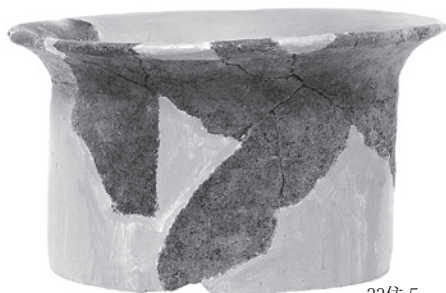

22住5



22住8

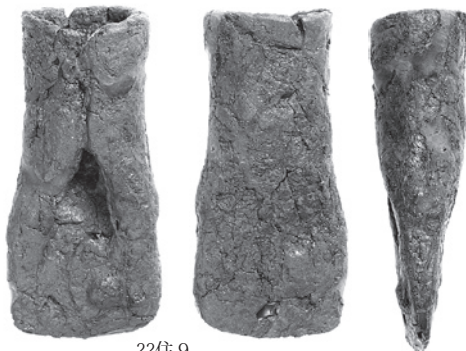

22住9

23号住居出土遺物



23住1



23住2

1号溝出土遺物



1溝1



1溝2



1溝3



1溝4



1溝5

3号溝出土遺物



3溝1

5号溝出土遺物



5溝1



5溝2



5溝3



5溝4



5溝5

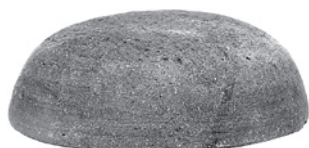

5溝6



5溝8



5溝7



5溝11



5溝9

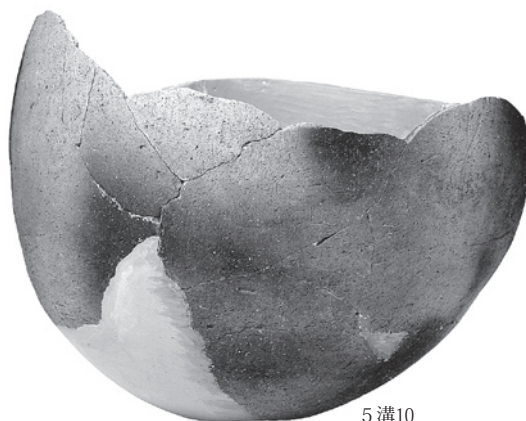

5溝10



5溝12

14号溝出土遺物

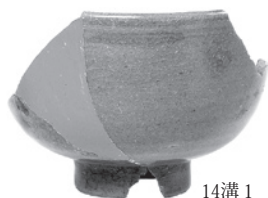

14溝1

1号井戸出土遺物



1井8



1井15



1井16



1井17



1井18



1井19



1井20

4号井戸出土遺物



4井1

2号井戸出土遺物



2井4

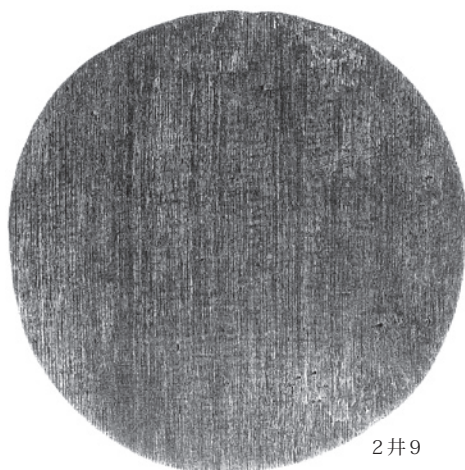

2井9



4井10

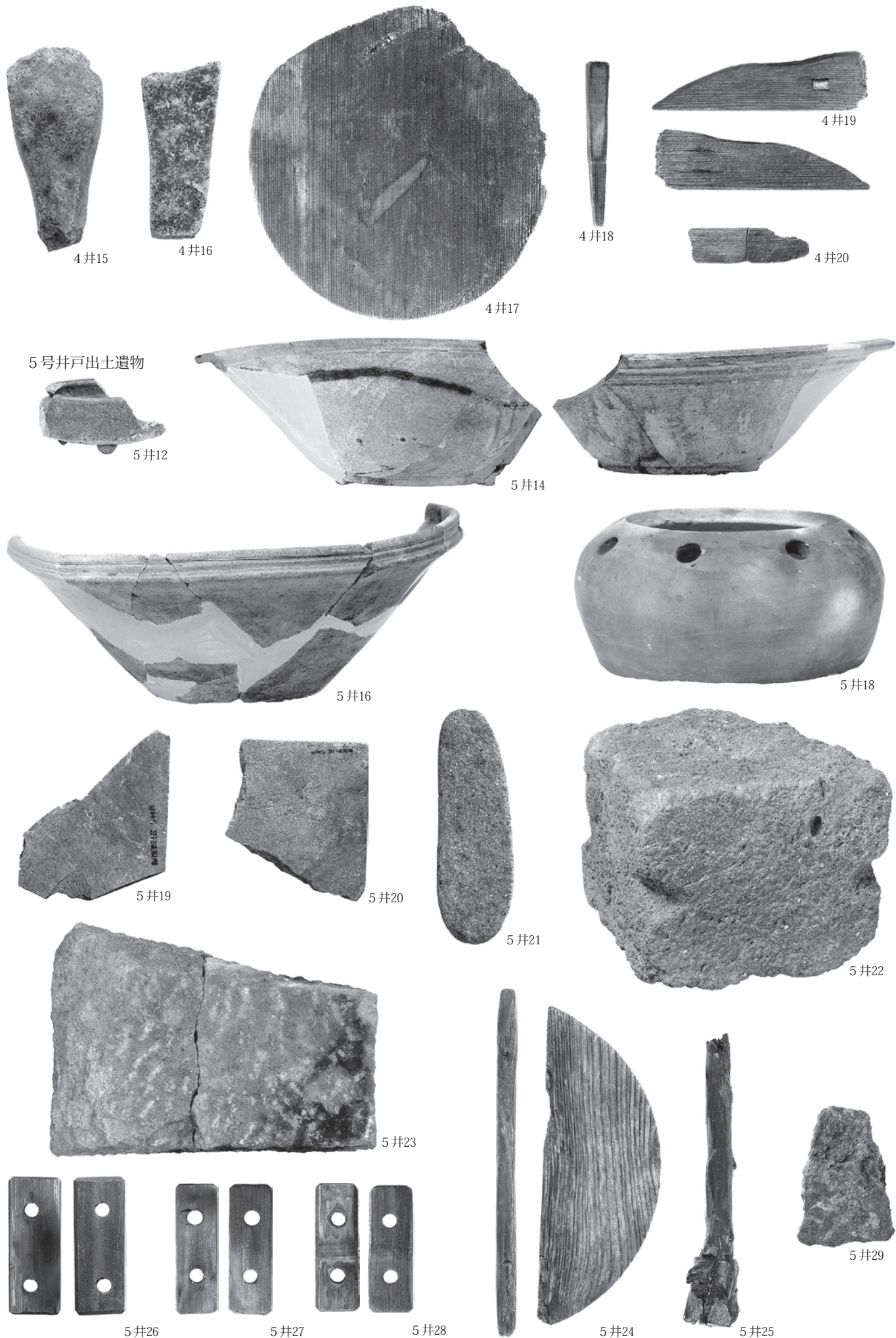

2号墓出土遺物



2墓1



2墓2



2墓3



2墓4



2墓5

3号墓出土遺物



3墓1



3墓2

3号土坑出土遺物

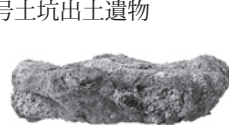

3土9



3土10

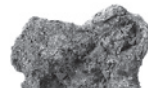

3土11

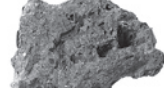
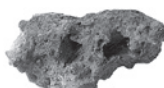
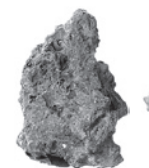

遺構外出土遺物



外15



外21



外22

7号土坑出土遺物



7土1



27号土坑出土遺物



27土1



外16

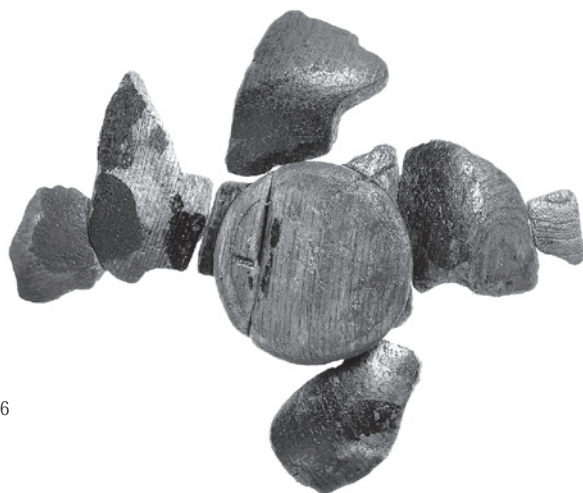

外17

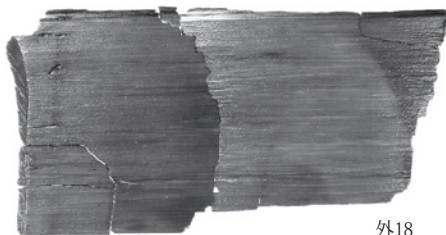

外18

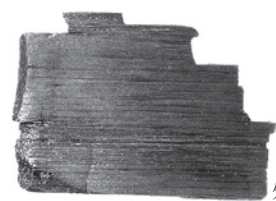

外19



外20

上西根遺跡

1区 1号住居出土遺物

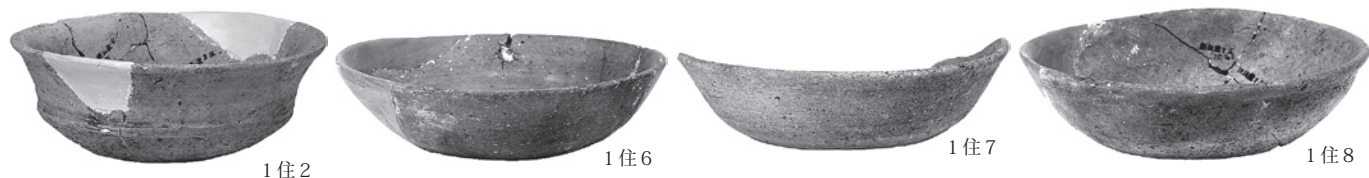

1区 2号住居出土遺物

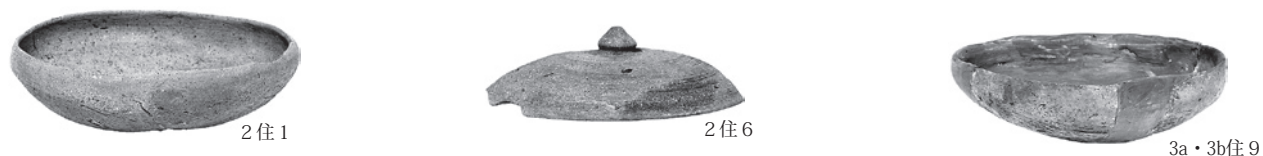

1区 3号住居出土遺物



1区 5号住居出土遺物



1区 7号住居出土遺物

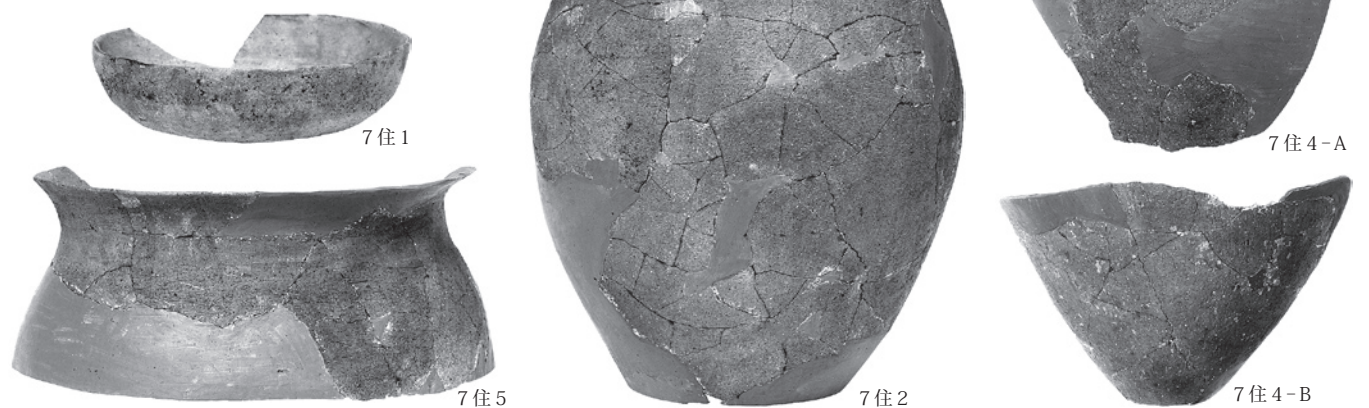

1区 6号住居出土遺物

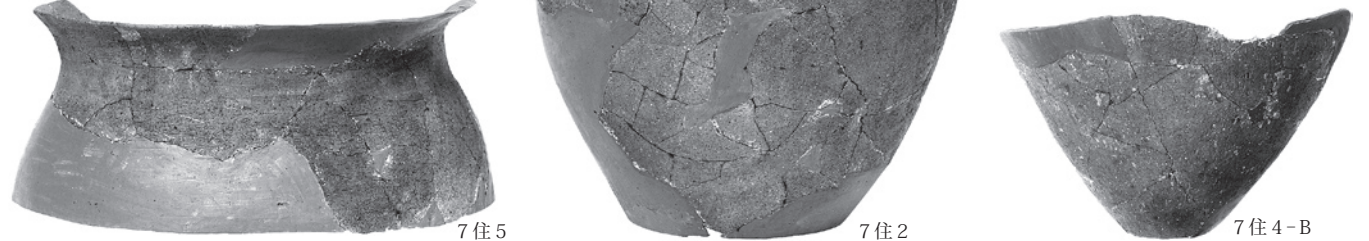

1区 8号住居出土遺物



8住5



8住7

1区 10号住居出土遺物



10住1



10住4



7住3

1区 9号住居出土遺物



9住1



9住4



9住5

1区 12号住居出土遺物



12住1

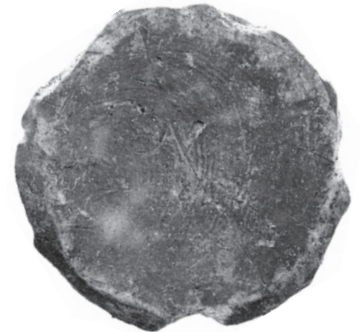

1区 13号住居出土遺物



13住1



13住8



13住9



13住12

上西根遺跡

1区 14号住居出土遺物

1区 15号住居出土遺物



1区 16号住居出土遺物

1区 17号住居出土遺物

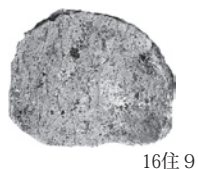

1区 18号住居出土遺物

1区 1号井戸出土遺物

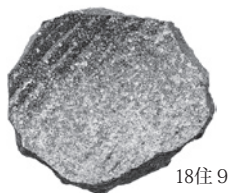

1区 3号土坑出土遺物

1区 遺構外出土遺物



2区 1号住居出土遺物

2区 2号住居出土遺物



2区 4号住居出土遺物



4住2



4住3



4住4



4住5



4住7

2区 5号住居出土遺物



5住1

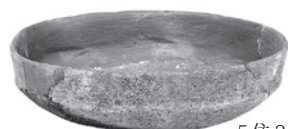

5住2



5住3



5住5



4住6



5住16



5住6



5住7



5住8



5住9

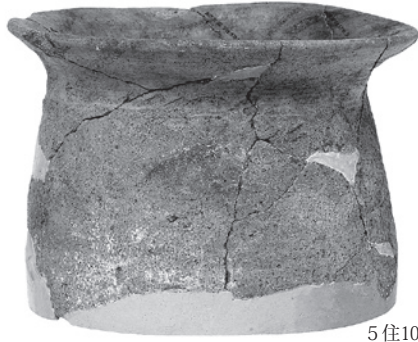

5住10



5住23



5住17



5住24



5住25

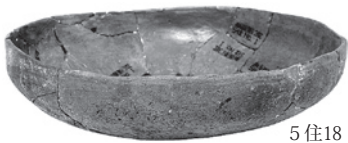

5住18



5住19



5住26



5住27

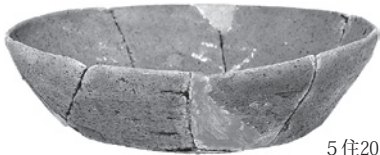

5住20

2区 7号住居出土遺物



7住4



7住3



5住28



7住6

2区 10号住居出土遺物

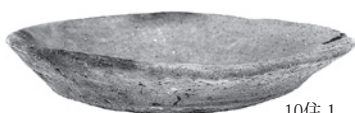

10住1



10住2



10住5



10住9



10住7



10住8



10住10



10住11

2区 11号住居出土遺物



11住1

2区 13号住居出土遺物

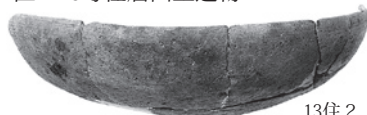

13住2

2区 15号住居出土遺物



15住6



15住7

2区 17号住居出土遺物



17住1



17住2



17住3



17住6



17住7

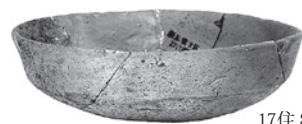

17住8



17住11



17住12



17住13



17住14

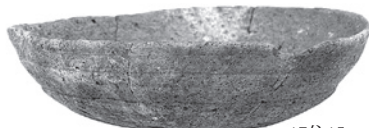

17住15



17住16

上西根遺跡



17住17



17住18



17住19



17住20



17住21

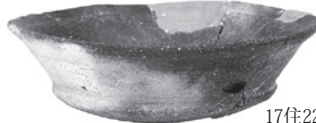

17住22



17住23



17住24



17住25



17住27



17住28



17住26



17住29



17住30



17住31



17住32



17住36



17住37

PL.130

上西根遺跡

2区 18号住居出土遺物

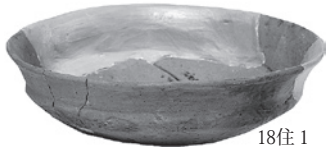

18住1



18住4



18住6



18住7

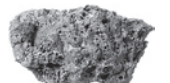

18住8

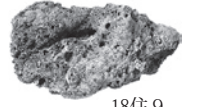

18住9

2区 28号住居出土遺物

2区 20号住居出土遺物



20住3

2区 22号住居出土遺物



22住4

2区 29号住居出土遺物



28住6



29住4

2区 30号住居出土遺物



30住1



30住2



30住3



30住4



30住5



30住6



30住7



30住14



30住8



30住9



30住13



30住19



30住20



30住23



30住24



30住21



2区 31号住居出土遺物

2区 32号住居出土遺物

2区 33号住居出土遺物

2区 35号住居出土遺物

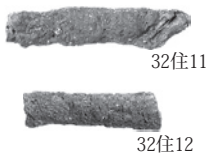
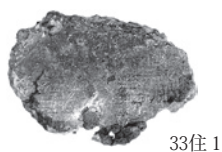

2区 37号住居出土遺物

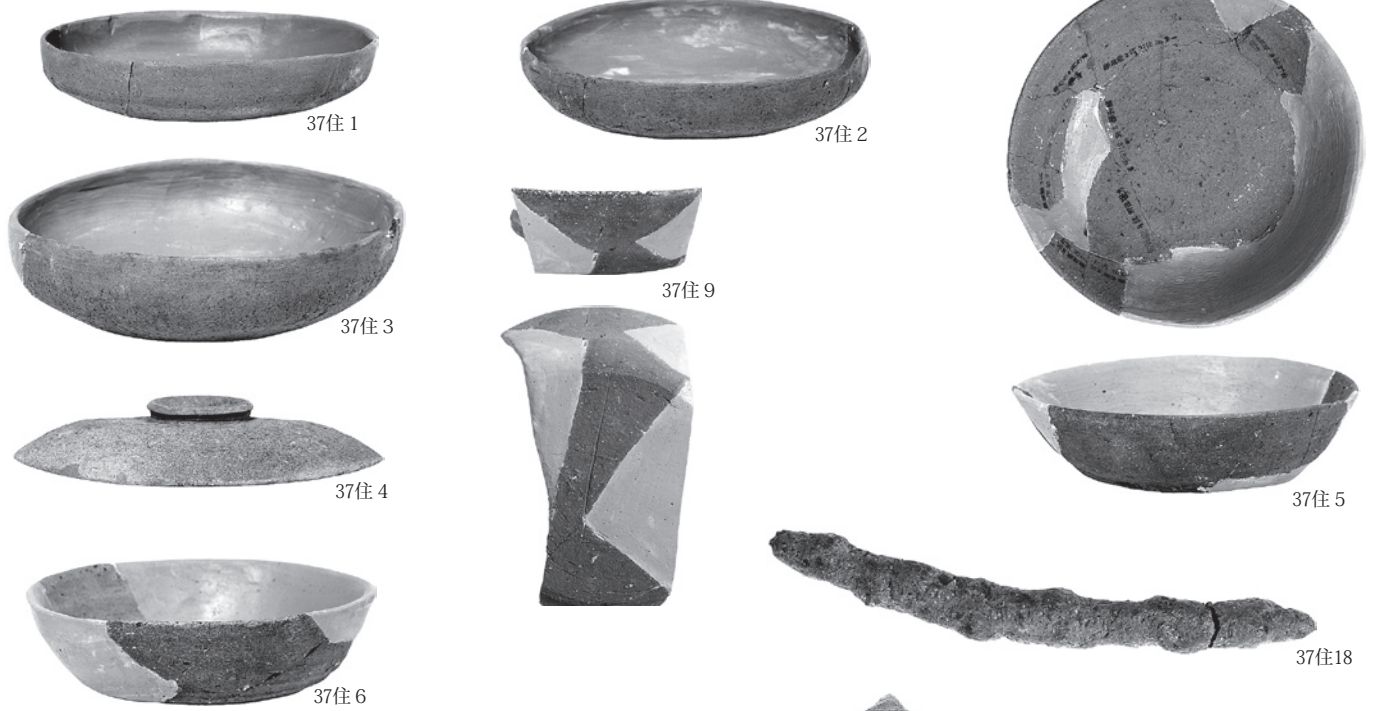

2区 38号住居出土遺物



2区 49号住居出土遺物



2区 1号竪穴状遺構出土遺物

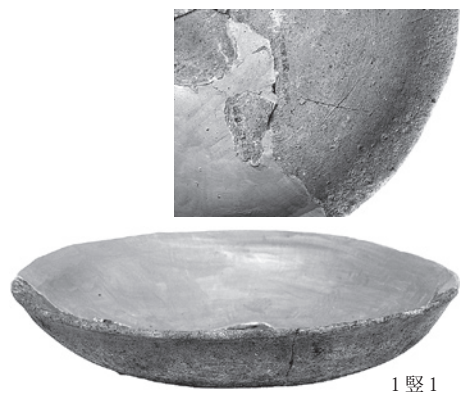

2区 2号竪穴状遺構出土遺物



2区 4号竪穴状遺構出土遺物



2区 6号竪穴状遺構出土遺物

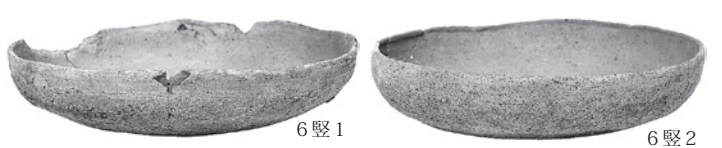

2区 7号竪穴状遺構出土遺物



上西根遺跡

2区 3号溝出土遺物



3溝1



3溝2

2区 4号溝出土遺物



4溝1

2区 遺構外出土遺物



外1



外2

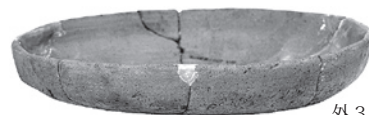

外3

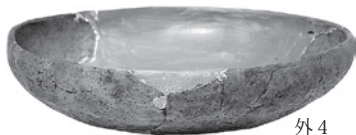

外4



外5

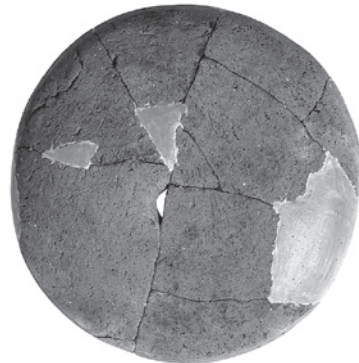

外6

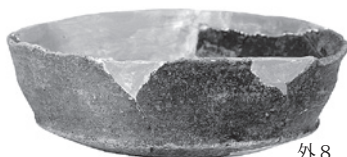

外8



外14



外16



外19

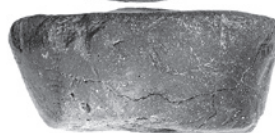

外20

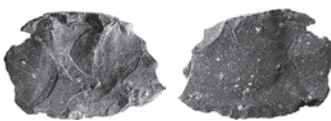

外21



外22



外23



外24



外25



外26



外28



外29



外27

PL.134

上西根遺跡

3区 2a号住居出土遺物



2a住1



2a住2

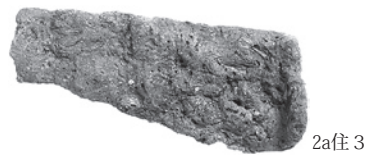

2a住3

3区 4号住居出土遺物



4住9

3区 22号土坑出土遺物



22土1

3区 48号土坑出土遺物



48土1

3区 41号土坑出土遺物

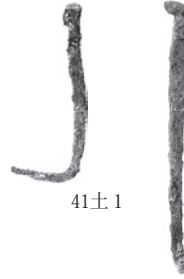

41土1



41土2



4住10

3区 32号土坑出土遺物



32土1

3区 遺構外出土遺物



外1

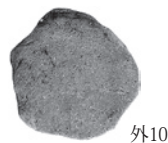

外10



外11



外13

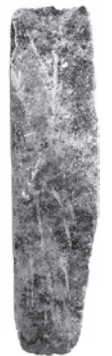

外15



外14



外16



外17



外18

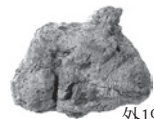

外19

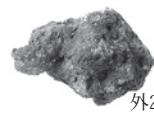

外20



外21

4区 2号住居出土遺物



2住1



2住3



2住4



2住10



2住11

4区 5号住居出土遺物



5住1

4区 6号住居出土遺物



6住1

4区 3号住居出土遺物



3住1



5住2



6住6



6住7

上西根遺跡

4区 1号竪穴状遺構出土遺物

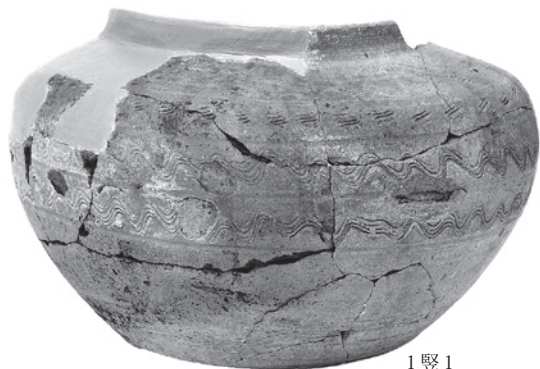

1 竪 1

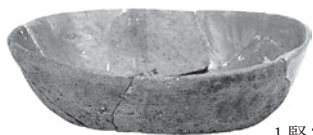

1 竪 2



1 竪 3

4区 1号溝出土遺物

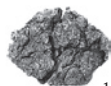

1 溝 8

4区 3号溝出土遺物



3 溝 1

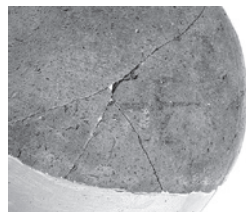

3 溝 2



3 溝 9



3 溝 10

4区 6号溝出土遺物



6 溝 2

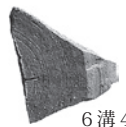

6 溝 4

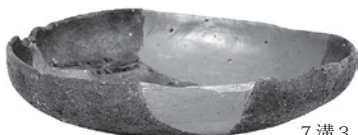

7 溝 3

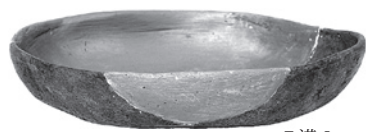

7 溝 6



7 溝 18

4区 7号溝出土遺物



7 溝 1



7 溝 4



7 溝 13



7 溝 19

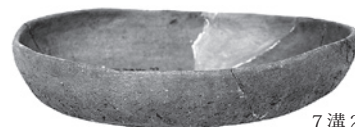

7 溝 2



7 溝 5

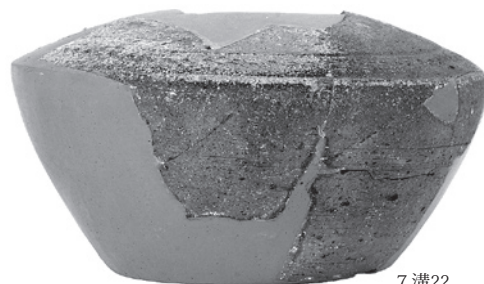

7 溝 22

4区 1号井戸出土遺物



1 井 1

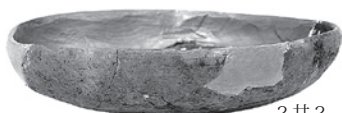

2 井 2

4区 2号井戸出土遺物

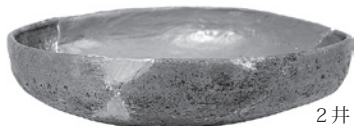

2 井 1

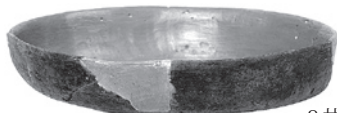

2 井 3

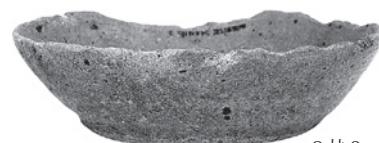

2 井 6



4区 9号土坑出土遺物



9土1

4区 11号土坑出土遺物

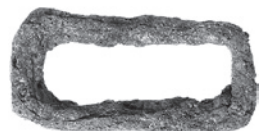

11土2

4区 15号土坑出土遺物



15土3



15土4



15土5

4区 14号土坑出土遺物



14土2



14土3

4区 26号土坑出土遺物



26土1



26土2

4区 27号土坑出土遺物



27土1



27土2

4区 26号ピット出土遺物

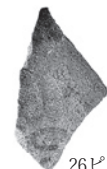

26ピット1

4区 遺構外出土遺物



外10

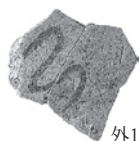

外12

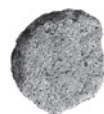

外22

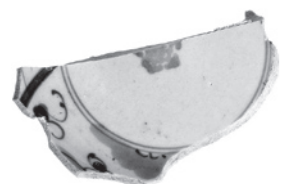

外24



外25



外27



外29



外28

5区 2号住居出土遺物



2住1

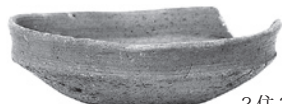

2住3



2住7



2住8



2住9



2住10



2住11



2住12



2住20



2住22



2住23



2住24



2住28



2住32



2住33



2住34



2住38

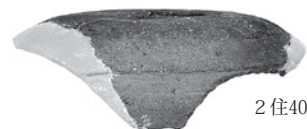

2住40



2住44



2住45



2住43

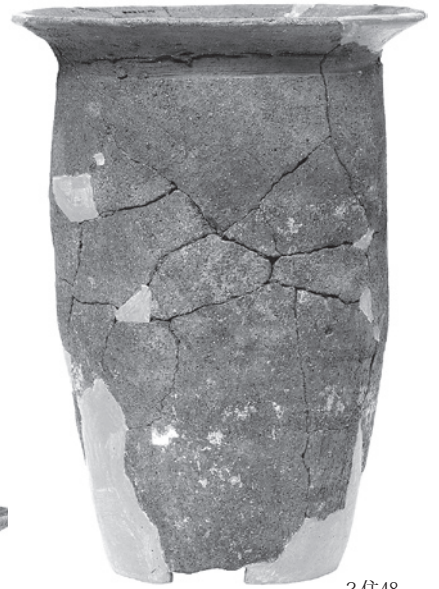

2住48



2住46



2住47



2住49



2住50



2住61



2住62



2住60

5区 1号溝出土遺物



1溝1

5区 1号井戸出土遺物

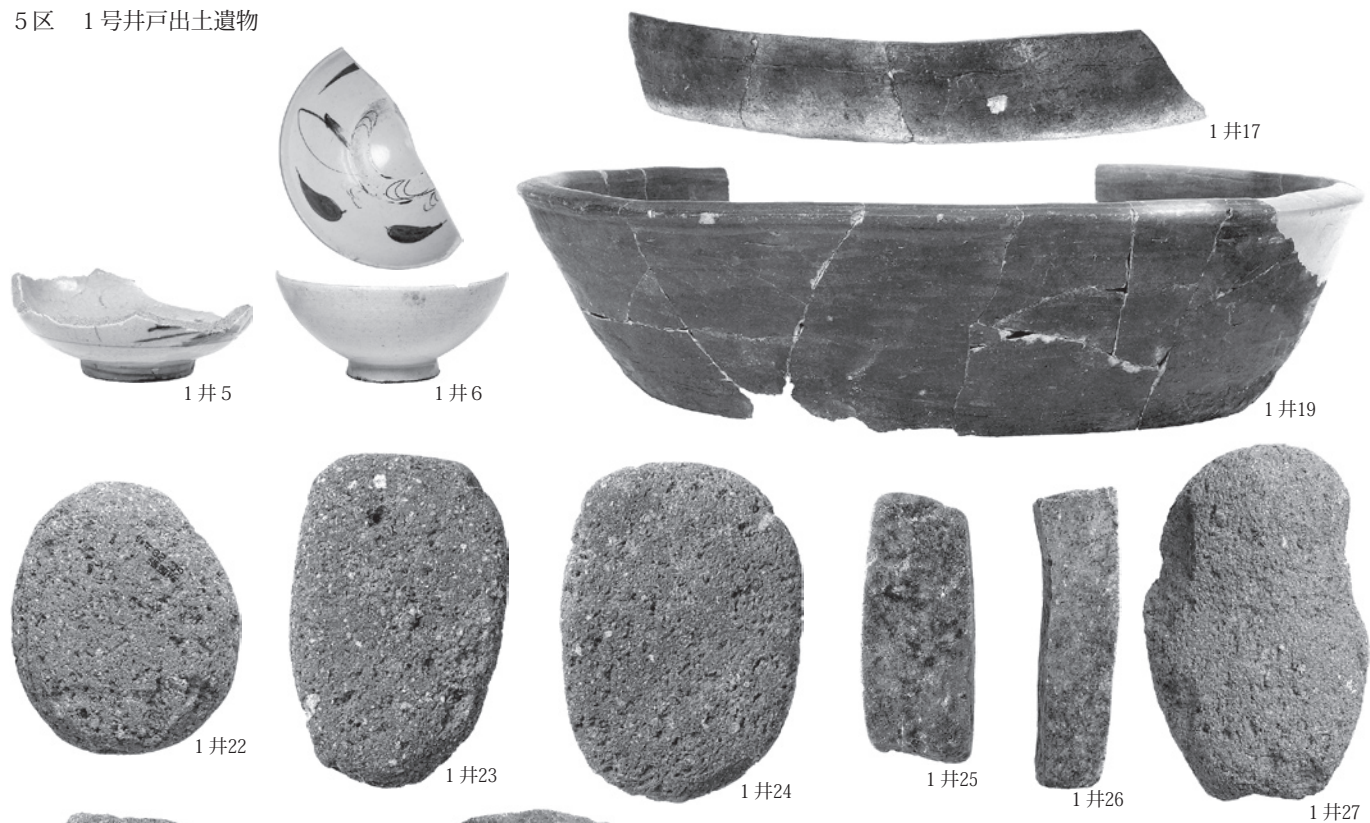

5区 31号土坑出土遺物

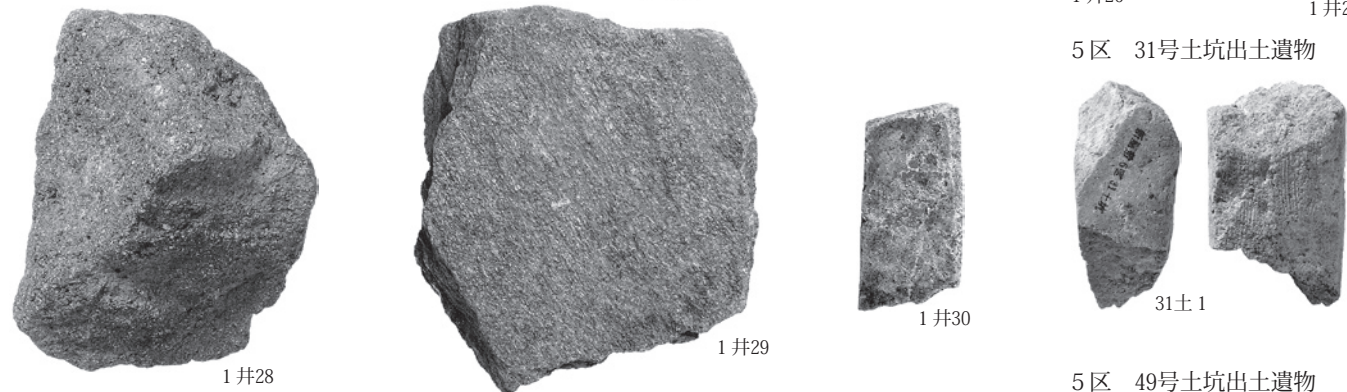

5区 49号土坑出土遺物



5区 12号土坑出土遺物

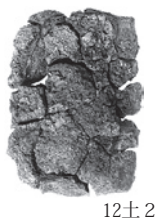

5区 17号土坑出土遺物

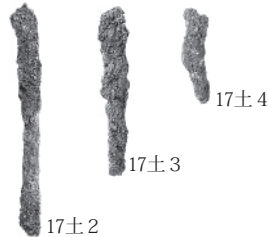

5区 70号土坑出土遺物



5区 遺構外出土遺物

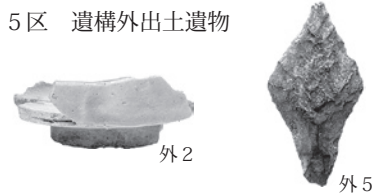

新屋敷遺跡

1区 38号土坑出土遺物



1区 40号土坑出土遺物

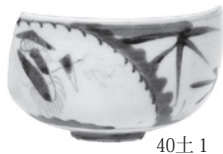

1区 43号土坑出土遺物



報告書抄録

書名ふりがな	あらかしきいせき・かみにしねいせき・せきいせき
書名	新屋敷遺跡・上西根遺跡・関遺跡(1)
副書名	社会資本整備総合交付金事業(活力創出基盤整備)国道462号(本関拡幅)に伴う埋蔵文化財発掘調査報告書
巻次	
シリーズ名	公益財団法人群馬県埋蔵文化財調査事業団調査報告書
シリーズ番号	第565集
編著者名	大西雅広／宮下寛／石田典子
編集機関	公益財団法人群馬県埋蔵文化財調査事業団
発行機関	公益財団法人群馬県埋蔵文化財調査事業団
発行年月日	2013年3月18日
作成法人ID	21005
郵便番号	377-8555
電話番号	0279-52-2511
住所	群馬県渋川市北橋町下箱田784番地2

遺跡名ふりがな	あらかしきいせき
遺跡名	新屋敷遺跡
所在地ふりがな	ぐんまけんいせきしほんせきちょう・かしまちょう
遺跡所在地	群馬県伊勢崎市本関町・鹿島町
市町村コード	10204
遺跡番号	IS084
北緯(世界測地系)	362032
東経(世界測地系)	1391221
調査期間	20090101-20090331
調査面積	1511.33
調査原因	道路建設
種別	集落
主な時代	奈良／中世／近世
遺跡概要	集落-奈良-竪穴住居1-土師器+須恵器／集落-中世・近世-土坑38+ピット50-陶磁器+石器+金属製品／その他-時期不明-溝15+土坑14-土師器+陶磁器+時期不明土器+礫
特記事項	奈良時代の竪穴住居
要約	本報告書は国道462号改築事業に伴い、平成20年度に発掘調査が行われた新屋敷遺跡の報告である。本遺跡からは奈良時代の竪穴住居および中近世と考えられるピットが多数検出された。

遺跡名ふりがな	かみにしねいせき
遺跡名	上西根遺跡
所在地ふりがな	ぐんまけんいせさきしかしまちょう
遺跡所在地	群馬県伊勢崎市鹿島町
市町村コード	10204
遺跡番号	IS093
北緯(世界測地系)	362037
東経(世界測地系)	1391223
調査期間	20080701-20080930 / 20090101-20090331
調査面積	5226.99
調査原因	道路建設
種別	集落
主な時代	古墳/奈良/平安/中世/近世
遺跡概要	集落-古墳-竪穴住居29+竪穴状遺構5+溝1-土師器+須恵器+石器+金属製品/集落-奈良・平安-竪穴住居31+竪穴状遺構7+溝2-土師器+須恵器+石器+金属製品/中世・近世-礎石建物1+柵2+溝2+井戸2+土坑105+ピット131-陶磁器+石器+金属製品/その他-時期不明-竪穴住居1+溝13+井戸4+土坑103-土師器+須恵器+陶磁器+石器+金属製品
特記事項	古墳時代から平安時代まで継続する集落遺跡。
要約	本報告書は国道462号改築事業に伴い、平成20年度に発掘調査が行われた上西根遺跡の報告である。本遺跡からは古墳時代から平安時代の竪穴住居が多数検出された。土師器・須恵器が多数出土したほか、表面に鍍金が施された丸軀裏金具も出土している。

遺跡名ふりがな	せきいせき
遺跡名	関遺跡
所在地ふりがな	ぐんまけんいせさきしほんせきちょう・かしまちょう
遺跡所在地	群馬県伊勢崎市本関町・鹿島町
市町村コード	10204
遺跡番号	IS081
北緯(世界測地系)	362046
東経(世界測地系)	1391228
調査期間	20080701-20080930
調査面積	1374.84
調査原因	道路建設
種別	集落
主な時代	古墳/奈良/平安/中世/近世
遺跡概要	集落-古墳-竪穴住居13+溝1-土師器+須恵器/集落-奈良・平安-竪穴住居8-土師器+須恵器+石器+金属製品/その他-中世・近世-墓坑3+柵1+溝5+井戸5+土坑24+ピット88-陶磁器+石器+木製品/その他-時期不明-溝8+井戸1+土坑6-土師器+須恵器+陶磁器+石器+金属製品
特記事項	古墳時代から平安時代まで継続する集落遺跡。
要約	本報告書は国道462号改築事業に伴い、平成20年度に発掘調査が行われた関遺跡の報告である。本遺跡からは古墳時代から平安時代の竪穴住居が多数検出された。洪水層が厚く堆積した竪穴住居が確認された。

公益財団法人群馬県埋蔵文化財調査事業団調査報告書第565集

新 屋 敷 遺 跡
上 西 根 遺 跡
関 遺 跡 (1)

社会資本整備総合交付金事業(活力創出基盤整備)
国道462号(本関拡幅)に伴う埋蔵文化財発掘調査報告書

平成25(2013)年3月11日 印刷

平成25(2013)年3月18日 発行

編集・発行／公益財団法人群馬県埋蔵文化財調査事業団

〒377-8555 群馬県渋川市北橘町下箱田784番地2

電話(0279)52-2511(代表)

ホームページアドレス <http://www.gunmaibun.org/>

印刷／上武印刷株式会社

新屋敷遺跡 上西根遺跡 関遺跡 (1)

社会資本整備総合交付金事業（活力創出基盤整備）
国道462号（本関拡幅）に伴う埋蔵文化財発掘調査報告書

付 図

付図1 関遺跡・上西根遺跡・新屋敷遺跡 全体図

2013

群馬県伊勢崎土木事務所
公益財団法人群馬県埋蔵文化財調査事業団

新屋敷 1 区

上西根 5 区

上西根 2 区

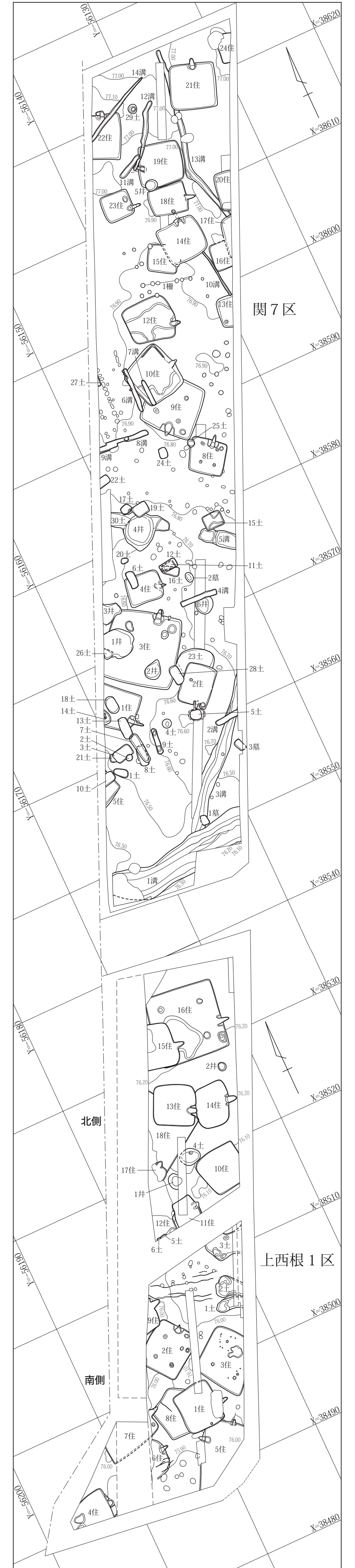
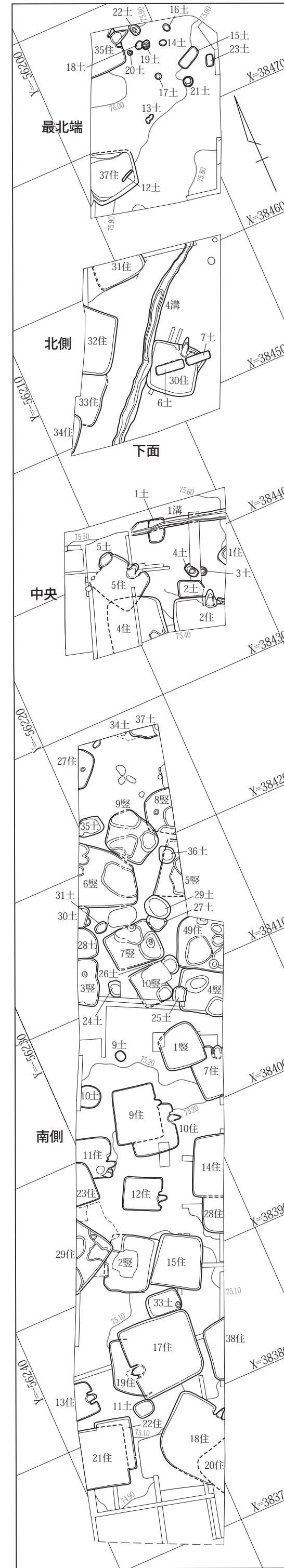
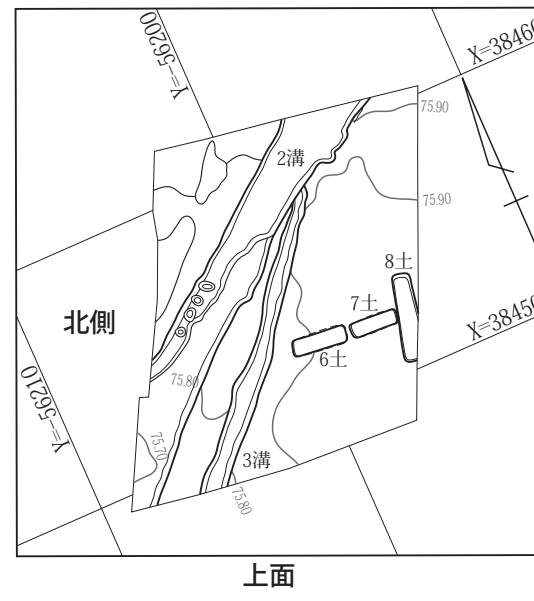
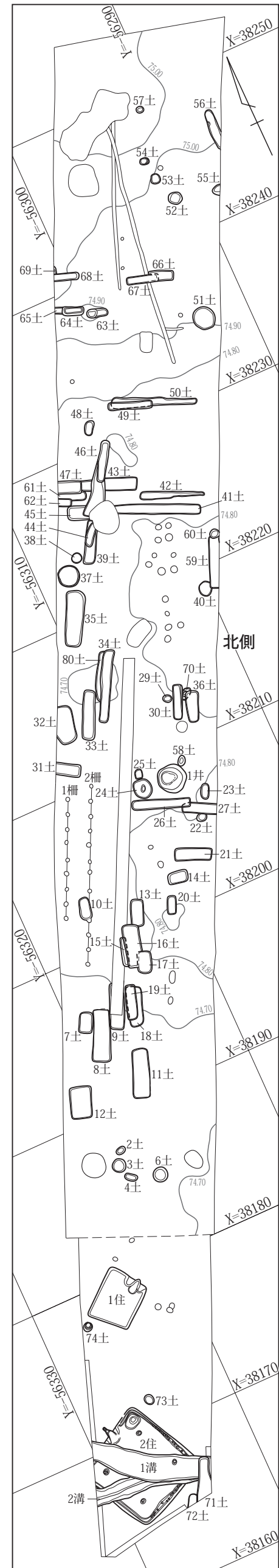
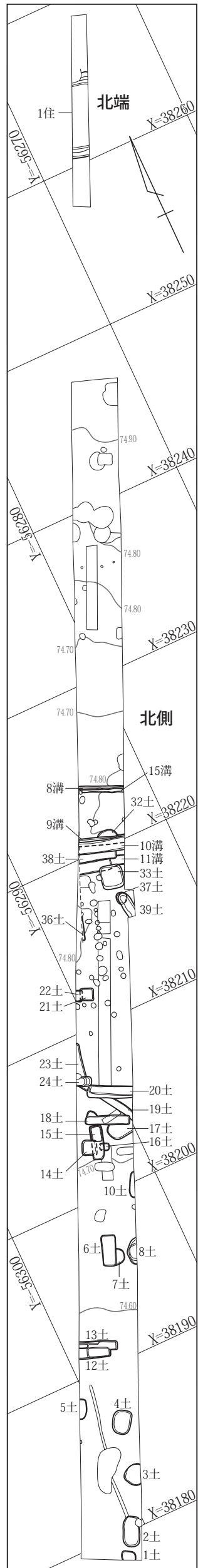
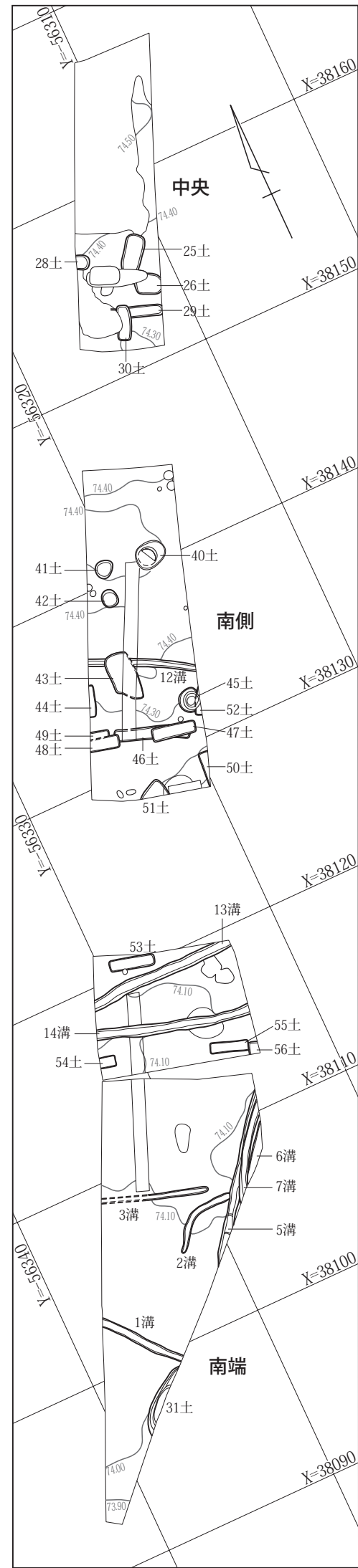

上西根 3 区

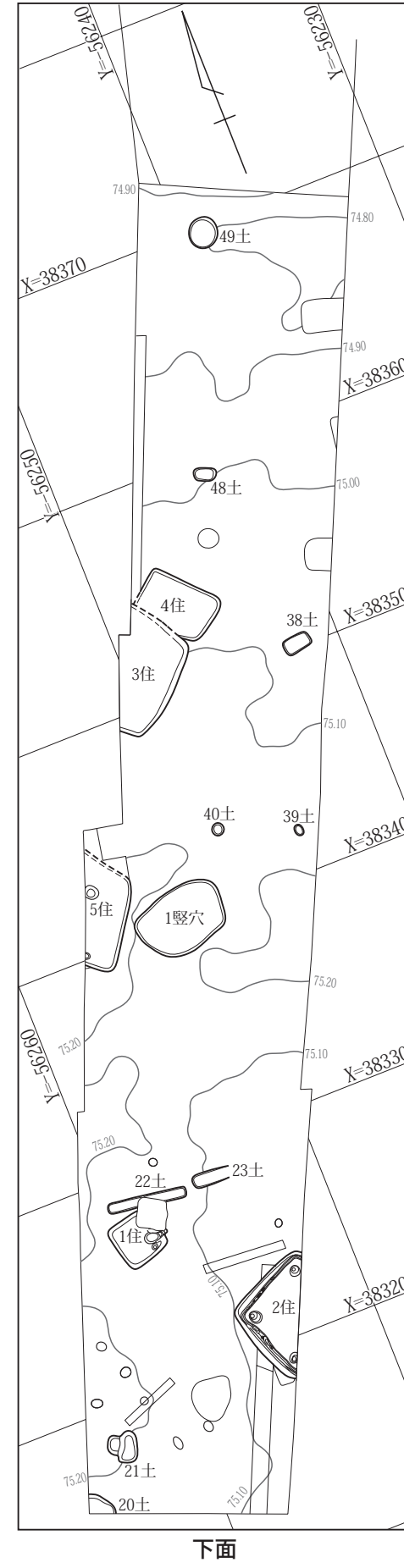
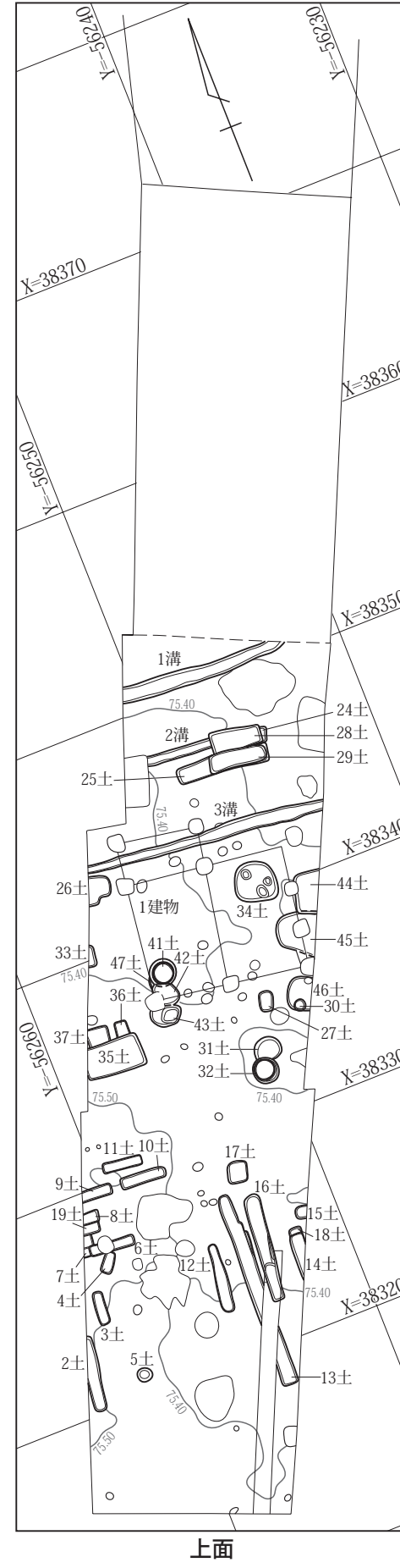

上西根 4 区

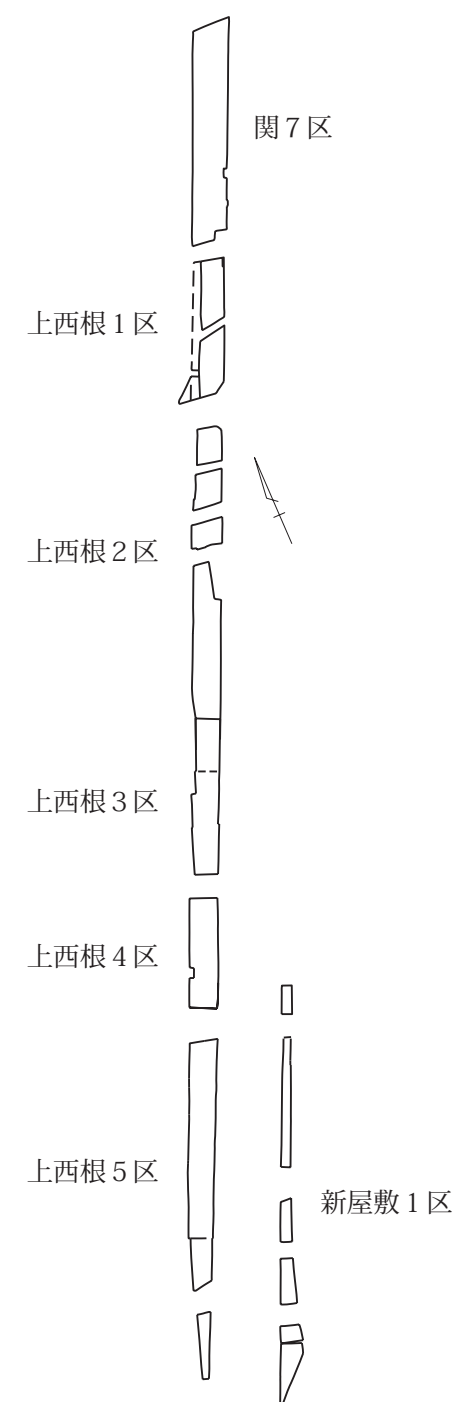
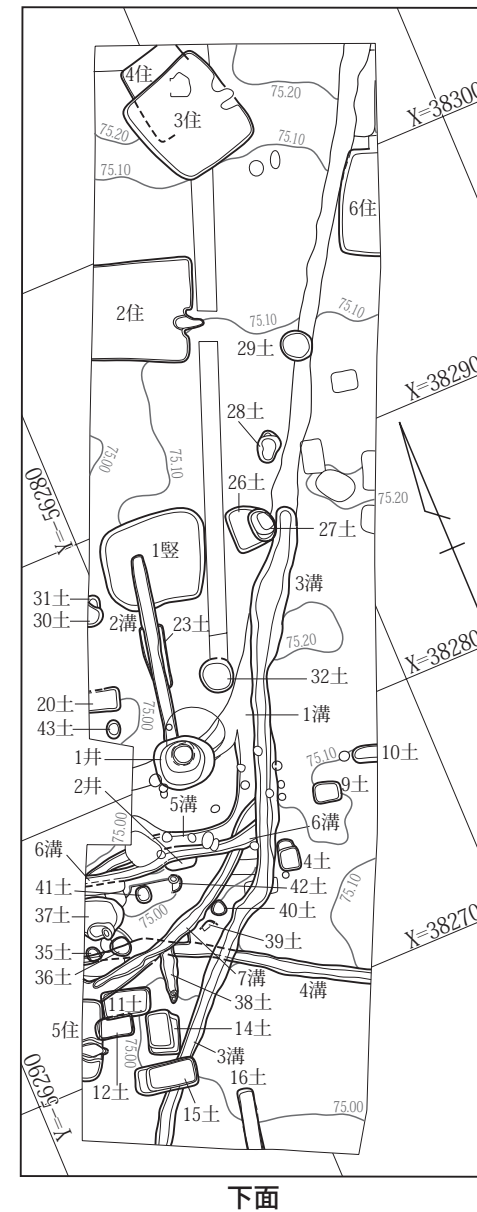
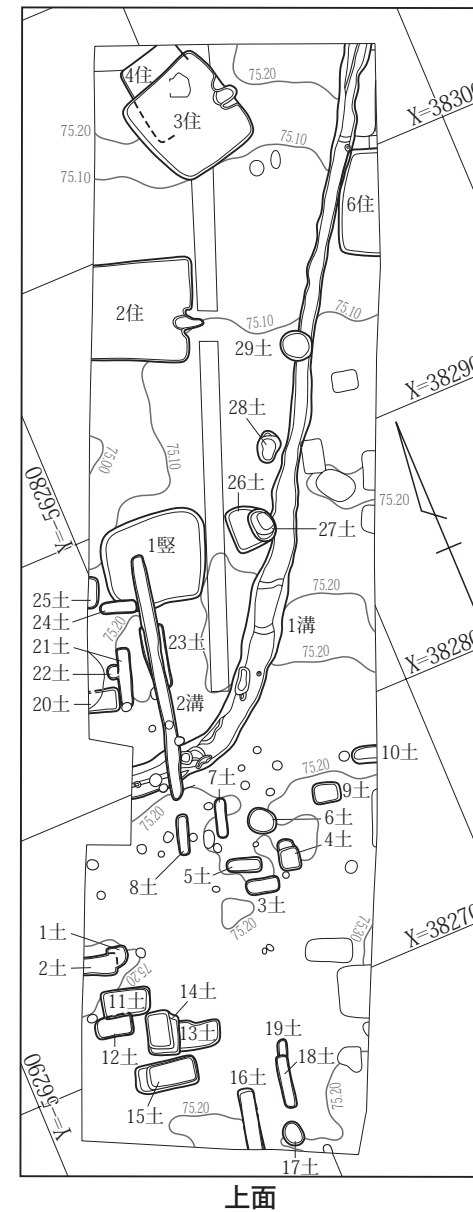

付図 1 関遺跡・上西根遺跡・新屋敷遺跡 全体図

0 1:300 10m

