

遺物一覧

No	資料番号	資料名称	数量	重量(g)	備考
7-315-850グリット					
734	11-004350	軟質陶器鉢口縁部	1	25	
7-315-855グリット					
735	11-004352	土師器壺体部	3	18	古墳時代前期中心
736	11-004353	土師器甕口縁部	4	144	古墳時代前期中心
737	11-004354	土師器甕体部	98	547	古墳時代前期中心
738	11-004355	土師器甕底部	2	19	古墳時代前期中心
739	11-004356	土師器高坏坏部	1	15	古墳時代前期中心
740	11-004357	土師器高坏脚部	2	21	古墳時代前期中心
741	11-004358	土師器甕口縁部	1	5	平安時代中心
742	11-004359	土師器甕体部	6	13	平安時代中心
743	11-004360	土師器坏口縁部	2	25	平安時代中心
744	11-004361	土師器坏体～底部	15	40	平安時代中心
745	11-004362	須恵器甕体部	6	19	平安時代中心
746	21-002127	砂岩?剥片	1	42	
747	11-004366	須恵器坏体～底部	4	38	
748	11-004367	灰釉陶器碗体～底部	1	8	
7-315-865グリット					
749	11-004368	須恵器碗体～底部	1	19	
7-315-895グリット					
750	11-004369	土師器甕口縁部	1	3	平安時代中心
751	11-004370	土師器甕体部	1	6	平安時代中心
752	11-004371	土師器高坏坏部	1	61	平安時代中心
753	11-004372	土師器坏口縁部	1	3	平安時代中心
7-315-900グリット					
754	11-004373	土師器甕口縁部	8	42	古墳時代前期中心
755	11-004374	土師器台付甕口縁部	2	16	古墳時代前期中心
756	11-004375	土師器台付甕体部	19	80	古墳時代前期中心
757	11-004376	土師器壺口縁部	1	2	古墳時代前期中心
758	11-004377	土師器壺体部	2	10	古墳時代前期中心
759	11-004378	土師器坏口縁部	6	31	平安時代中心
760	11-004379	土師器坏体～底部	6	25	平安時代中心
7-320-850グリット					
761	11-004382	土師器壺口縁部	1	30	古墳時代前期中心
762	11-004383	土師器甕口縁部	7	51	平安時代中心
763	11-004384	土師器甕体部	120	709	平安時代中心
764	11-004385	土師器甕底部	3	98	平安時代中心
765	11-004386	土師器高坏脚部	1	30	平安時代中心
766	11-004387	土師器甕口縁部	3	16	平安時代中心
767	11-004389	土師器坏口縁部	10	75	平安時代中心
768	11-004390	土師器坏体～底部	24	94	平安時代中心
769	11-004391	須恵器甕体部	6	128	
770	11-004392	須恵器坏体～底部	3	31	
771	11-004394	須恵器軟質陶器口縁部	1	30	
7-320-855グリット					
772	11-004395	土師器甕体部	12	78	古墳時代前期中心
773	11-004396	土師器甕底部	1	20	古墳時代前期中心
774	11-004397	土師器台付甕口縁部	2	60	古墳時代前期中心
775	11-004398	土師器台付甕脚部	1	45	古墳時代前期中心
776	11-004399	土師器壺体部	13	70	古墳時代前期中心
777	11-004400	土師器壺底部	2	50	古墳時代前期中心
778	11-004401	土師器高坏脚部	2	60	古墳時代前期中心
779	11-004402	土師器土錘	1	8	古墳時代前期中心
780	11-004403	土師器甕口縁部	13	386	平安時代中心
781	11-004404	土師器甕体部	158	1093	平安時代中心

No	資料番号	資料名称	数量	重量(g)	備考
7-320-855グリット					
782	11-004405	土師器甕底部	7	275	平安時代中心
783	11-004406	土師器高坏坏部	1	12	平安時代中心
784	11-004407	土師器高坏脚部	9	251	平安時代中心
785	11-004408	土師器甕口縁部	1	28	平安時代中心
786	11-004409	土師器甕口縁部	3	12	平安時代中心
787	11-004410	土師器甕体部	19	44	平安時代中心
788	11-004411	土師器坏口縁部	18	58	平安時代中心
789	11-004412	土師器坏体～底部	36	89	平安時代中心
790	11-004413	須恵器坏体～底部	1	56	
791	11-004414	須恵器碗口縁部	2	12	
792	11-004415	土師器坏口縁部	9	30	平安時代中心
793	11-004416	土師器坏体～底部	6	20	平安時代中心
794	11-004417	須恵器甕体部	2	70	
795	11-004418	須恵器甕体～底部	1	50	
796	11-004419	女瓦	2	70	
7-320-855グリットC混下					
797	11-004420	土師器甕口縁部	3	33	平安時代中心
798	11-004421	土師器甕体部	74	494	平安時代中心
799	11-004422	土師器甕底部	3	44	平安時代中心
800	11-004423	土師器高坏脚部	3	16	平安時代中心
801	11-004424	土師器甕体部	4	10	平安時代中心
802	11-004425	土師器坏口縁部	3	18	平安時代中心
803	11-004426	土師器坏体～底部	2	4	平安時代中心
804	11-004427	須恵器甕口縁部	1	22	
805	11-004428	須恵器甕体部	9	225	
806	11-004429	須恵器坏口縁部	1	10	
807	11-004430	須恵器坏体～底部	4	24	
7-320-860グリット					
808	11-004431	土師器甕口縁部	1	2	古墳時代前期中心
809	11-004432	土師器甕体部	20	80	古墳時代前期中心
810	11-004433	土師器壺体部	11	62	古墳時代前期中心
811	11-004434	土師器台付甕体部	1	2	古墳時代前期中心
7-320-860グリット					
812	11-004435	土師器高坏器台脚部	1	10	古墳時代前期中心
813	11-004436	土師器鉢体～底部	1	10	古墳時代前期中心
814	11-004437	土師器甕口縁部	2	48	平安時代中心
815	11-004438	土師器甕体部	9	95	平安時代中心
816	11-004439	土師器高坏脚部	1	55	平安時代中心
817	11-004440	土師器坏体～底部	2	7	平安時代中心
818	11-004441	土師器甕体部	2	2	平安時代中心
819	11-004442	土師器坏口縁部	7	20	平安時代中心
820	11-004443	土師器坏体～底部	4	10	平安時代中心
821	11-004444	須恵器坏底部	1	2	
822	11-004445	施釉陶器	1	3	
7-320-860グリットC混上					
823	11-004446	土師器甕口縁部	18	136	平安時代中心
824	11-004447	土師器甕体部	232	1189	平安時代中心
825	11-004448	土師器甕底部	6	87	平安時代中心
826	11-004449	土師器高坏坏部	2	12	平安時代中心
827	11-004450	土師器高坏脚部	2	38	平安時代中心
828	11-004451	土師器甕体部	11	19	平安時代中心
829	11-004452	土師器坏口縁部	3	9	平安時代中心
830	11-004453	土師器坏体～底部	6	20	平安時代中心

## 遺物一覧

No	資料番号	資料名称	数量	重量(g)	備考
7-320-860グリットC混上					
831	11-004454	須恵器甕体部	1	8	
7-320-865グリット					
832	11-004455	土師器坏口縁部	1	3	平安時代中心
833	11-004456	土師器坏体～底部	2	5	平安時代中心
7-320-880グリット					
834	11-004457	土師器甕口縁部	2	6	平安時代中心
835	11-004458	土師器甕体部	25	87	平安時代中心
836	11-004459	土師器甕底部	2	13	平安時代中心
837	11-004460	土師器高坏脚部	1	9	平安時代中心
838	11-004461	須恵器坏体～底部	1	27	
839	11-004462	磁器碗	1	3	
7-320-880グリットB下					
840	11-004463	土師器甕体部	4	22	平安時代中心
7-320-900グリット					
841	11-004464	土師器甕口縁部	2	9	平安時代中心
842	11-004465	土師器甕体部	45	263	平安時代中心
843	11-004466	土師器甕底部	4	102	平安時代中心
844	11-004467	土師器高坏脚部	5	82	平安時代中心
7-320-910グリット					
845	11-004468	土師器坏口縁部	4	14	平安時代中心
7-320-920グリットB下					
846	11-004469	土師器甕体部	1	5	平安時代中心
847	11-004470	土師器甕底部	1	9	平安時代中心
848	11-004471	土師器坏口縁部	2	11	平安時代中心
849	11-004472	土師器坏体～底部	3	8	平安時代中心
7-320-940グリット					
850	11-004473	土師器坏体～底部	2	6	平安時代中心
851	11-004474	須恵器坏口縁部	1	11	
7-325-550グリット					
852	11-004475	土師器甕口縁部	9	70	古墳時代前期中心
853	11-004476	土師器甕体部	104	520	古墳時代前期中心
854	11-004477	土師器甕体～底部	1	3	古墳時代前期中心
855	11-004478	土師器甕口縁部	1	10	古墳時代前期中心
856	11-004479	土師器甕体部	35	246	古墳時代前期中心
857	11-004480	土師器甕底部	1	20	古墳時代前期中心
858	11-004481	土師器台付甕口縁部	2	4	古墳時代前期中心
859	11-004482	土師器台付甕体部	13	45	古墳時代前期中心
860	11-004483	土師器台付甕脚部	2	60	古墳時代前期中心
861	11-004484	土師器高坏脚部	1	5	古墳時代前期中心
7-325-550グリット					
862	11-004485	土師器甕底部	1	4	平安時代中心
863	11-004486	土師器坏口縁部	4	8	平安時代中心
864	11-004487	土師器坏体～底部	5	25	平安時代中心
865	11-004488	土師器坏底部	15	20	平安時代中心
866	11-004489	土師器甕口縁部	1	2	平安時代中心
867	11-004490	須恵器甕体部	2	60	
868	11-004491	須恵器甕口縁部	1	2	
869	11-004492	須恵器甕体部	1	1	
870	11-004493	須恵器甕体～底部	2	25	
871	21-002128	黒色頁岩剥片	1	1	
7-325-850グリット					
872	11-004495	土師器甕口縁部	18	100	古墳時代前期中心
873	11-004496	土師器甕体部	242	736	古墳時代前期中心
874	11-004497	土師器甕口縁部	4	60	古墳時代前期中心

No	資料番号	資料名称	数量	重量(g)	備考
7-325-850グリット					
875	11-004498	土師器甕体部	89	533	古墳時代前期中心
876	11-004499	土師器台付甕体部	3	5	古墳時代前期中心
877	11-004500	土師器台付甕脚部	3	18	古墳時代前期中心
878	11-004502	土師器甕台脚部	3	50	古墳時代前期中心
879	11-004503	土師器高坏脚部	3	95	平安時代中心
880	11-004504	灰釉陶器碗口縁部	1	4	
881	11-004505	土師器甕口縁部	2	10	平安時代中心
882	11-004506	土師器甕体部	4	5	平安時代中心
883	11-004507	土師器坏口縁部	2	3	平安時代中心
884	11-004508	土師器坏体～底部	3	3	平安時代中心
885	11-004509	土師器坏底部	1	1	平安時代中心
886	11-004510	土師器甕口縁部	1	20	平安時代中心
887	11-004511	須恵器甕体部	1	2	
888	11-004512	須恵器甕体～底部	2	4	
889	11-004513	施釉陶器	1	2	
7-300-855グリット					
890	11-004515	土師器甕底部	5	79	平安時代中心
891	11-004516	土師器高坏坏部	10	175	平安時代中心
892	11-004517	土師器高坏脚部	12	252	平安時代中心
893	11-004518	土師器甕体部	320	1349	平安時代中心
894	11-004519	土師器坏口縁部	46	145	平安時代中心
895	11-004520	土師器坏体～底部	95	191	平安時代中心
896	11-004521	羽釜	1	35	
897	11-004522	須恵器甕体部	4	222	
898	11-004523	須恵器坏口縁部	1	10	
899	11-004524	須恵器坏体～底部	2	12	
900	11-004525	灰釉陶器碗口縁部	1	2	
901	11-004526	灰釉陶器甕体～底部	1	3	
902	11-004527	須恵器甕体部	1	2	
7-330-860グリット					
903	11-004528	土師器甕口縁部	2	4	古墳時代前期中心
904	11-004529	土師器甕体部	43	190	古墳時代前期中心
905	11-004530	土師器甕口縁部	3	20	古墳時代前期中心
906	11-004531	土師器甕体部	18	80	古墳時代前期中心
907	11-004532	土師器台付甕口縁部	4	60	古墳時代前期中心
908	11-004533	土師器甕口縁部	19	226	平安時代中心
909	11-004534	土師器甕体部	386	1957	平安時代中心
910	11-004535	土師器甕底部	8	187	平安時代中心
911	11-004536	土師器高坏坏部	13	139	平安時代中心
912	11-004537	土師器高坏脚部	6	109	平安時代中心
913	11-004539	土師器坏口縁部	26	67	平安時代中心
914	11-004540	土師器坏体～底部	50	120	平安時代中心
915	11-004541	須恵器坏体～底部	2	7	
916	11-004544	女瓦	2	60	
7-330-865グリット					
917	11-004545	土師器甕口縁部	23	190	平安時代中心
918	11-004546	土師器甕体部	341	1642	平安時代中心
919	11-004547	土師器甕底部	16	138	平安時代中心
920	11-004548	土師器高坏坏部	6	39	平安時代中心
921	11-004549	土師器高坏脚部	7	63	平安時代中心
922	11-004552	土師器坏口縁部	2	7	平安時代中心
923	11-004553	土師器坏体～底部	11	33	平安時代中心
924	11-004554	須恵器坏体～底部	1	24	
925	11-004555	須恵器甕口縁部	2	5	

遺物一覧

No	資料番号	資料名称	数量	重量(g)	備考
7-330-870グリット					
926	11-004556	土師器壺体部	1	3	古墳時代前期中心
927	11-004557	土師器甕口縁部	6	61	平安時代中心
928	11-004558	土師器甕体部	62	258	平安時代中心
929	11-004559	土師器甕底部	2	18	平安時代中心
930	11-004560	土師器高坏坏部	1	14	平安時代中心
931	11-004561	土師器高坏脚部	4	22	平安時代中心
7-330-875グリットB下					
932	11-004563	土師器甕体部	2	9	平安時代中心
933	11-004564	土師器坏体～底部	1	4	平安時代中心
7-330-880グリット					
934	11-004565	土師器甕体部	5	19	平安時代中心
935	11-004566	土師器高坏坏部	1	33	平安時代中心
7-330-885グリット					
936	11-004567	土師器甕口縁部	1	40	平安時代中心
937	11-004568	土師器甕体部	7	88	平安時代中心
938	11-004569	土師器甕底部	3	143	平安時代中心
939	11-004570	土師器高坏坏部	2	27	平安時代中心
940	11-004571	土師器高坏脚部	2	64	平安時代中心
7-330-895グリット					
941	11-004572	須恵器碗体～底部	1	3	
7-330-900グリット					
942	11-004573	土師器甕体部	1	14	平安時代中心
7-330-900グリットB下					
943	11-004574	土師器甕体部	4	14	平安時代中心
7-330-910グリット					
944	11-004575	土師器甕体部	2	8	平安時代中心
7-330-990グリット					
945	11-004577	土師器甕体部	3	10	平安時代中心
946	11-004578	灰釉陶器碗口縁部	1	4	
7-335-850グリット					
947	11-004579	灰釉陶器碗?	1	2	
7-335-850グリットAs-C混上					
948	11-004580	土師器甕口縁部	17	134	平安時代中心
949	11-004581	土師器甕体部	93	570	平安時代中心
950	11-004582	土師器甕底部	25	241	平安時代中心
951	11-004583	土師器高坏坏部	3	15	平安時代中心
952	11-004584	土師器高坏脚部	3	27	平安時代中心
953	11-004587	土師器坏口縁部	22	55	平安時代中心
954	11-004588	土師器坏体～底部	28	77	平安時代中心
7-335-855グリット					
955	11-004589	土師器甕口縁部	2	3	古墳時代前期中心
956	11-004590	土師器甕体部	31	159	古墳時代前期中心
957	11-004591	土師器碗口縁部	1	3	古墳時代前期中心
958	11-004592	土師器壺口縁部	2	3	古墳時代前期中心
959	11-004593	土師器壺体部	17	60	古墳時代前期中心
960	11-004594	土師器台付甕体部	1	2	古墳時代前期中心
961	11-004595	土師器台付甕脚部	1	10	古墳時代前期中心
962	11-004596	土師器高台付埴体部	4	15	古墳時代前期中心
963	11-004597	土師器甕底部	3	45	平安時代中心
964	11-004598	土師器高坏脚部	2	74	平安時代中心
965	11-004599	土師器甕口縁部	2	9	平安時代中心
966	11-004600	土師器甕体部	15	46	平安時代中心

No	資料番号	資料名称	数量	重量(g)	備考
7-340-860グリット					
967	11-004601	土師器高坏坏部	12	86	平安時代中心
968	11-004602	土師器高脚坏部	7	142	平安時代中心
969	11-004603	土師器甕体部	328	1975	平安時代中心
970	11-004604	土師器甕口縁部	6	56	平安時代中心
971	11-004605	土師器甕体～底部	69	208	平安時代中心
972	11-004606	須恵器坏口縁部	1	12	
973	11-004607	須恵器坏体～底部	6	39	
7-340-855グリット					
974	11-004609	土師器高坏坏部	5	22	平安時代中心
975	11-004610	土師器高脚坏部	10	88	平安時代中心
976	11-004611	土師器甕口縁部	4	32	平安時代中心
977	11-004612	土師器甕体部	15	51	平安時代中心
978	11-004613	土師器甕底部	2	10	平安時代中心
979	11-004614	土師器坏口縁部	21	75	平安時代中心
980	11-004615	土師器坏体～底部	55	142	平安時代中心
981	11-004616	灰釉陶器碗口縁部	1	12	
982	11-004617	灰釉陶器碗体～底部	1	6	
7-350-855グリット					
983	11-004618	土師器甕口縁部	7	92	古墳時代前期中心
984	11-004619	土師器甕体部	108	610	古墳時代前期中心
985	11-004620	土師器甕底部	3	98	古墳時代前期中心
986	11-004621	土師器高坏坏部	7	90	古墳時代前期中心
987	11-004623	土師器甕体部	31	101	平安時代中心
988	11-004624	土師器甕体部	23	60	平安時代中心
989	11-004625	土師器坏口縁部	6	10	平安時代中心
990	11-004626	土師器坏底部	18	50	平安時代中心
7-340-860グリット					
991	21-002129	礫	1	7	
7-335-855グリットC混上					
992	11-004627	土師器坏口縁部	20	69	平安時代中心
993	11-004628	土師器坏底部	24	60	平安時代中心
994	11-004629	須恵器甕口縁部	1	10	
995	11-004630	須恵器甕体部	3	102	
996	11-004631	須恵器碗口縁部	2	3	
997	11-004632	須恵器碗体～底部	4	10	
998	11-004633	土師器甕底部	3	10	平安時代中心
999	11-004634	土師器高坏坏部	2	15	平安時代中心
1000	11-004635	土師器高脚坏部	1	9	平安時代中心
1001	11-004636	土師器甕口縁部	4	32	平安時代中心
1002	11-004637	土師器甕体部	11	53	平安時代中心
1003	11-004639	土師器坏体～底部	39	117	平安時代中心
1004	11-004640	須恵器蓋	1	6	
1005	11-004641	須恵器坏口縁部	1	7	
1006	11-004642	須恵器坏体～底部	2	16	
7-335-855グリットC混下					
1007	11-004643	土師器甕口縁部	4	90	平安時代中心
1008	11-004644	土師器甕体部	157	743	平安時代中心
1009	11-004646	土師器高坏坏部	2	15	平安時代中心
1010	11-004647	土師器高脚坏部	9	66	平安時代中心
1011	11-004649	土師器甕底部	6	65	平安時代中心
1012	11-004650	土師器坏口縁部	14	46	平安時代中心
1013	11-004651	土師器坏体～底部	32	92	平安時代中心
1014	11-004652	須恵器碗口縁部	1	4	
1015	11-004653	須恵器碗体～底部	1	3	

## 遺物一覽

No	資料番号	資料名称	数量	重量(g)	備考
7-335-865グリット					
1016	11-004654	土師器甕体部	392	1636	平安時代中心
1017	11-004655	土師器甕底部	8	216	平安時代中心
1018	11-004656	土師器高坏坏部	15	146	平安時代中心
1019	11-004657	土師器高脚坏部	4	85	平安時代中心
1020	11-004658	土師器甕口縁部	3	21	平安時代中心
1021	11-004659	土師器甕体部	12	30	平安時代中心
1022	11-004660	土師器甕底部	1	7	平安時代中心
1023	11-004661	土師器坏口縁部	31	137	平安時代中心
1024	11-004662	土師器坏体～底部	55	127	平安時代中心
1025	11-004663	須恵器甕口縁部	1	19	
1026	11-004664	須恵器甕体部	3	46	
1027	11-004665	須恵器坏体～底部	1	6	
1028	11-004666	須恵器碗体～底部	2	23	
1029	11-004667	須恵器蓋摘部	1	10	
1030	11-004668	女瓦	1	25	
7-335-860グリット					
1031	11-004669	土師器甕口縁部	3	20	古墳時代前期中心
1032	11-004670	土師器甕体部	44	212	古墳時代前期中心
1033	11-004671	土師器碗口縁部	1	3	古墳時代前期中心
1034	11-004672	土師器壺口縁部	5	28	古墳時代前期中心
1035	11-004673	土師器壺体部	19	112	古墳時代前期中心
1036	11-004674	土師器台付甕体部	7	28	古墳時代前期中心
1037	11-004675	土師器高坏脚部	1	18	古墳時代前期中心
1038	11-004676	土師器器台脚部	1	10	古墳時代前期中心
1039	11-004677	土師器甕口縁部	27	246	平安時代中心
1040	11-004678	土師器甕体部	478	2686	平安時代中心
1041	11-004679	土師器甕底部	14	238	平安時代中心
1042	11-004680	土師器高坏坏部	8	97	平安時代中心
1043	11-004681	土師器高脚坏部	13	184	平安時代中心
1044	11-004682	土師器甕口縁部	4	48	平安時代中心
1045	11-004683	土師器甕体部	20	104	平安時代中心
1046	11-004684	土師器坏口縁部	38	102	平安時代中心
7-335-865グリットAs-C混下					
1047	11-004687	土師器坏体～底部	1	28	平安時代中心
7-335-865グリットC黒下					
1048	11-004688	土師器甕口縁部	1	41	平安時代中心
1049	11-004689	土師器甕体部	13	41	平安時代中心
1050	11-004690	土師器甕底部	1	4	平安時代中心
1051	11-004692	土師器坏口縁部	2	6	平安時代中心
1052	11-004693	土師器坏体～底部	15	42	平安時代中心
7-335-870グリット					
1053	11-004694	土師器甕口縁部	11	147	平安時代中心
1054	11-004695	土師器甕体部	318	1485	平安時代中心
1055	11-004696	土師器甕底部	20	257	平安時代中心
1056	11-004697	土師器高坏坏部	3	29	平安時代中心
1057	11-004698	土師器高脚坏部	4	122	平安時代中心
1058	11-004702	土師器坏口縁部	4	9	平安時代中心
1059	11-004703	土師器坏体～底部	8	22	平安時代中心
1060	11-004704	須恵器甕体部	2	11	
1061	11-004705	須恵器坏体～底部	1	35	
7-335-885グリット					
1062	11-004706	土師器甕体部	1	14	平安時代中心
1063	11-004707	土師器甕底部	1	46	平安時代中心
1064	11-004708	須恵器碗体～底部	1	15	

No	資料番号	資料名称	数量	重量(g)	備考
7-340-750グリット					
1065	11-004709	土師器甕体部	5	25	平安時代中心
1066	11-004710	土師器高坏坏部	1	8	平安時代中心
7-340-780グリット					
1067	11-004711	土師器高坏坏部	1	3	平安時代中心
7-340-840グリット					
1068	11-004712	土師器甕体部	1	3	平安時代中心
7-340-850グリット					
1069	11-004713	土師器甕口縁部	6	50	古墳時代前期中心
1070	11-004714	土師器甕体部	38	194	古墳時代前期中心
1071	11-004715	土師器台付甕体部	1	3	古墳時代前期中心
1072	11-004716	土師器壺体部	33	400	古墳時代前期中心
1073	11-004717	土師器壺底部	1	32	古墳時代前期中心
1074	11-004718	土師器甕体部	4	22	平安時代中心
1075	11-004719	土師器甕底部	1	9	平安時代中心
7-340-855グリットC混下					
1076	11-004720	土師器甕体部	100	328	平安時代中心
1077	11-004721	土師器甕底部	2	72	平安時代中心
1078	11-004722	土師器高脚坏部	2	17	平安時代中心
1079	11-004723	土師器甕口縁部	3	15	平安時代中心
7-340-860グリット					
1080	11-004724	土師器台付甕体部	2	2	古墳時代前期中心
1081	11-004725	土師器壺体部	3	48	古墳時代前期中心
1082	11-004726	土師器甕口縁部	3	15	平安時代中心
1083	11-004727	土師器甕体部	7	10	平安時代中心
1084	11-004728	須恵器甕体部	2	95	
1085	11-004729	須恵器坏口縁部	1	12	
1086	11-004730	土師器坏体～底部	1	2	平安時代中心
1087	21-002130	礫	1	26	
7-340-865グリット					
1088	11-004731	土師器甕体部	29	106	古墳時代前期中心
1089	11-004732	土師器台付甕口縁部	3	32	古墳時代前期中心
1090	11-004733	土師器台付甕体部	9	26	古墳時代前期中心
1091	11-004734	土師器台付甕脚部	2	18	古墳時代前期中心
1092	11-004735	土師器壺口縁部	1	10	古墳時代前期中心
1093	11-004736	土師器壺体部	11	70	古墳時代前期中心
1094	11-004737	土師器高坏脚部	2	10	古墳時代前期中心
1095	11-004738	土師器甕口縁部	5	32	平安時代中心
1096	11-004739	土師器甕体部	190	998	平安時代中心
1097	11-004740	土師器甕底部	6	85	平安時代中心
1098	11-004741	土師器高坏坏部	3	78	平安時代中心
1099	11-004742	土師器高坏脚部	6	72	平安時代中心
1100	11-004743	土師器甕口縁部	2	16	平安時代中心
1101	11-004745	土師器坏口縁部	54	287	平安時代中心
1102	11-004746	土師器坏体～底部	86	324	平安時代中心
1103	11-004747	須恵器甕体部	1	98	
1104	11-004748	須恵器坏口縁部	1	7	
1105	11-004749	須恵器坏体～底部	3	24	
1106	11-004754	須恵器碗口縁部	1	2	
7-340-865グリットAs-C混下					
1107	11-004755	土師器甕体部	10	46	平安時代中心
1108	11-004756	土師器甕口縁部	1	5	平安時代中心
1109	11-004758	土師器坏口縁部	2	33	平安時代中心

遺物一覧

No	資料番号	資料名称	数量	重量(g)	備考
7-340-865グリットAs-C混下					
1110	11-004759	土師器坏体~底部	5	27	平安時代中心
7-340-870グリット					
1111	11-004760	土師器甕口縁部	62	694	古墳時代前期中心
1112	11-004761	土師器甕体部	765	4408	古墳時代前期中心
1113	11-004762	土師器甕底部	39	569	古墳時代前期中心
1114	11-004763	土師器壙口縁部	6	16	古墳時代前期中心
1115	11-004764	土師器台付甕口縁部	3	50	古墳時代前期中心
1116	11-004765	土師器台付甕体部	24	102	古墳時代前期中心
1117	11-004766	土師器台付甕脚部	4	20	古墳時代前期中心
1118	11-004767	土師器壺口縁部	11	142	古墳時代前期中心
1119	11-004768	土師器壺体部	104	506	古墳時代前期中心
1120	11-004769	土師器壺底部	2	12	古墳時代前期中心
1121	11-004770	土師器高坏脚部	29	292	古墳時代前期中心
1122	11-004771	土師器甕口縁部	6	12	平安時代中心
1123	11-004772	須恵器碗体部	1	1	
1124	11-004773	土師器坏底部	28	95	平安時代中心
1125	11-004774	土師器高坏坏部	19	209	平安時代中心
1126	11-004775	須恵器碗底部	2	28	平安時代中心
1127	11-004777	土師器甕体部	16	34	平安時代中心
1128	11-004778	土師器甕底部	1	13	平安時代中心
1129	11-004779	土師器坏口縁部	26	127	平安時代中心
1130	11-004780	土師器坏体~底部	18	49	平安時代中心
1131	11-004781	須恵器甕体部	4	85	
1132	11-004782	須恵器坏口縁部	1	7	
1133	11-004783	須恵器坏体~底部	2	12	
1134	11-004784	灰軸陶器	1	14	
7-340-875グリット					
1135	11-004787	土師器甕体部	1	6	平安時代中心
7-340-875グリットC混下					
1136	11-004788	土師器甕口縁部	10	86	平安時代中心
1137	11-004789	土師器甕体部	119	623	平安時代中心
1138	11-004790	土師器甕底部	8	156	平安時代中心
1139	11-004791	土師器高坏脚部	1	13	平安時代中心
1140	11-004794	土師器坏口縁部	2	3	平安時代中心
1141	11-004795	土師器坏体~底部	2	7	平安時代中心
1142	11-004796	羽釜	1	9	
7-340-880グリット					
1143	11-004797	土師器甕口縁部	1	11	平安時代中心
1144	11-004798	土師器甕体部	13	65	平安時代中心
1145	11-004799	土師器甕底部	2	69	平安時代中心
7-340-885グリット					
1146	11-004800	土師器甕体部	1	7	平安時代中心
7-340-900グリット					
1147	11-004801	土師器高坏脚部	1	8	平安時代中心
1148	11-004802	土師器甕体部	4	23	平安時代中心
7-345-465グリット					
1149	11-004803	土師器甕体部	1	7	平安時代中心
7-345-850グリット					
1150	11-004804	土師器甕口縁部	3	9	古墳時代前期中心
1151	11-004805	土師器甕体部	67	340	古墳時代前期中心
1152	11-004806	土師器台付甕体部	7	20	古墳時代前期中心
1153	11-004807	土師器台付甕脚部	3	40	古墳時代前期中心
1154	11-004808	土師器壺体部	17	200	古墳時代前期中心

No	資料番号	資料名称	数量	重量(g)	備考
7-345-850グリット					
1155	11-004809	土師器甕口縁部	11	123	平安時代中心
1156	11-004810	土師器甕体部	106	729	平安時代中心
1157	11-004811	土師器甕底部	3	15	平安時代中心
1158	11-004812	土師器高坏坏部	4	62	平安時代中心
1159	11-004813	土師器高坏脚部	3	13	平安時代中心
7-345-855グリット					
1160	11-004814	土師器甕底部	17	524	平安時代中心
1161	11-004815	土師器高坏坏部	9	118	平安時代中心
1162	11-004816	土師器高坏脚部	17	226	平安時代中心
1163	11-004817	土師器甕口縁部	11	49	平安時代中心
1164	11-004818	土師器甕体部	40	108	平安時代中心
1165	11-004819	土師器甕底部	1	6	平安時代中心
1166	11-004820	土師器坏口縁部	45	144	平安時代中心
1167	11-004821	土師器坏体~底部	120	328	平安時代中心
1168	11-004822	須恵器甕体部	2	90	
1169	11-004823	須恵器坏口縁部	4	13	
1170	11-004824	須恵器坏体~底部	3	16	
1171	11-004825	須恵器蓋	2	25	
7-345-860グリットAs-C混上					
1172	11-004829	土師器甕口縁部	8	27	平安時代中心
1173	11-004830	土師器甕体部	127	639	平安時代中心
1174	11-004831	土師器甕底部	4	34	平安時代中心
1175	11-004832	土師器高坏坏部	7	40	平安時代中心
1176	11-004833	土師器高坏脚部	5	44	平安時代中心
1177	11-004836	土師器坏口縁部	34	112	平安時代中心
1178	11-004837	土師器坏体~底部	48	252	平安時代中心
1179	11-004838	須恵器甕体部	1	14	
1180	11-004839	須恵器坏口縁部	1	8	
1181	11-004840	須恵器碗甕口縁部	1	6	
7-345-860グリットAs-C混下					
1182	11-004841	土師器甕口縁部	7	56	平安時代中心
1183	11-004842	土師器甕体部	183	918	平安時代中心
1184	11-004843	土師器甕底部	1	7	平安時代中心
1185	11-004844	土師器高坏坏部	6	67	平安時代中心
1186	11-004845	土師器高坏脚部	4	34	平安時代中心
1187	11-004847	土師器坏口縁部	8	40	平安時代中心
1188	11-004848	土師器坏体~底部	25	90	平安時代中心
7-345-865グリット					
1189	11-004849	土師器甕口縁部	17	95	古墳時代前期中心
1190	11-004850	土師器甕体部	116	640	古墳時代前期中心
1191	11-004851	土師器壙口縁部	3	20	古墳時代前期中心
1192	11-004852	土師器高坏脚部	1	30	古墳時代前期中心
1193	11-004853	土師器器台脚部	1	16	古墳時代前期中心
1194	11-004854	土師器甕口縁部	5	41	平安時代中心
1195	11-004855	土師器甕体部	190	1110	平安時代中心
1196	11-004856	土師器坏底部	20	80	平安時代中心
1197	11-004857	土師器甕底部	8	162	平安時代中心
1198	11-004858	土師器高坏坏部	8	69	平安時代中心
1199	11-004859	土師器甕体部	8	27	平安時代中心
1200	11-004861	土師器坏口縁部	12	38	平安時代中心

## 遺物一覧

No	資料番号	資料名称	数量	重量(g)	備考
7-345-865グリット					
1201	11-004862	土師器坏体~底部	17	64	平安時代中心
1202	11-004863	須恵器坏口縁部	1	4	
1203	11-004864	須恵器坏体~底部	3	40	
1204	11-004865	灰釉陶器	1	10	
1205	11-004866	土師器高坏脚部	6	43	古墳時代前期中心
7-350-855グリット					
1206	11-004875	土師器甕体部	23	60	平安時代中心
1207	11-004876	土師器甕底部	1	4	平安時代中心
1208	11-004877	土師器坏口縁部	6	10	平安時代中心
1209	11-004878	土師器坏体~底部	18	50	平安時代中心
1210	11-004879	土師器壺体部	15	50	平安時代中心
1211	11-004880	土師器壺底部	1	10	平安時代中心
1212	11-004881	須恵器碗口縁部	2	5	
1213	11-004882	土師器台付甕脚部	1	4	古墳時代前期中心
1214	11-004883	土師器高坏脚部	1	5	古墳時代前期中心
1215	11-004884	土師器甕口縁部	3	6	平安時代中心
1216	11-004885	土師器台付甕体部	4	6	古墳時代前期中心
1217	11-004886	土師器台付甕口縁部	7	70	古墳時代前期中心
7-330-855グリット					
1218	11-004891	女瓦	1	10	律令
1219	11-004892	スレート	1	4	
1220	11-004893	土師器壺口縁部	2	22	古墳時代前期中心
1221	11-004894	土師器壺体部	5	20	古墳時代前期中心
1222	11-004895	土師器壺底部口縁部	1	18	古墳時代前期中心

No	資料番号	資料名称	数量	重量(g)	備考
7-295-805グリット					
1243	11-004887	土師器甕口縁部	1	8	古墳時代前期中心
1244	11-004888	土師器甕体部	17	93	古墳時代前期中心
1245	11-004889	土師器高坏脚部	1	8	古墳時代前期中心
1246	11-004890	土師器坏体~底部	1	4	平安時代中心

No	資料番号	資料名称	数量	重量(g)	備考
7-一括					
1251	11-004917	土師器台付甕体部	1	25	古墳時代前期(4世紀)

No	資料番号	資料名称	数量	重量(g)	備考
7-345-870グリット					
1223	11-004867	土師器甕口縁部	11	189	平安時代中心
1224	11-004868	土師器甕体部	176	1060	平安時代中心
1225	11-004869	土師器甕底部	17	252	平安時代中心
1226	11-004870	土師器高坏坏部	10	170	平安時代中心
1227	11-004871	土師器高坏脚部	14	84	平安時代中心
1228	11-004873	土師器甕体部	2	5	平安時代中心
1229	11-004874	土師器坏口縁部	1	3	平安時代中心
1230	11-004896	土師器坏体~底部	5	17	平安時代中心
1231	11-004897	須恵器碗体~底部	2	31	
1232	11-004898	土師器甕口縁部	7	54	平安時代中心
1233	11-004900	土師器甕体部	112	523	平安時代中心
1234	11-004901	土師器甕底部	2	11	平安時代中心
1235	11-004902	土師器高坏坏部	2	22	平安時代中心
1236	11-004905	土師器坏口縁部	1	5	平安時代中心
1237	11-004906	土師器坏体~底部	1	3	平安時代中心
7-345-875グリット					
1238	11-004907	土師器甕口縁部	4	30	平安時代中心
1239	11-004908	土師器甕体部	54	221	平安時代中心
1240	11-004909	土師器甕底部	3	74	平安時代中心
1241	11-004910	土師器高坏坏部	1	6	平安時代中心
1242	11-004911	土師器甕体~底部	13	28	平安時代中心

No	資料番号	資料名称	数量	重量(g)	備考
7-295-840グリット					
1247	11-004913	土師器甕体部	4	22	古墳時代前期中心
1248	11-004914	土師器高坏坏部	1	8	古墳時代前期中心
1249	11-004915	土師器坏体~底部	2	6	平安時代中心
1250	11-004916	須恵器甕体部	1	13	平安時代中心

No	資料番号	資料名称	数量	重量(g)	備考
7-As-C混下					
1252	11-004918	土師器壺体部	1	400	古墳時代前期中心



# 写 真 图 版





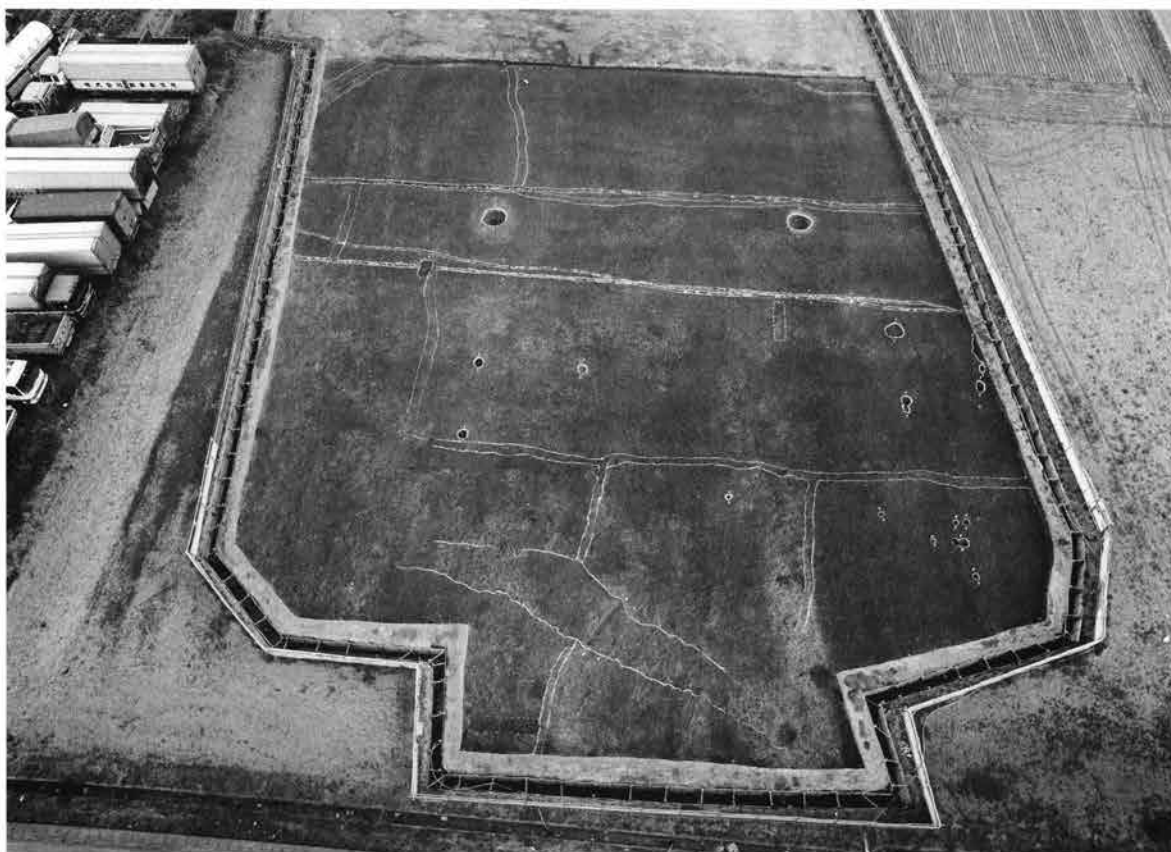

5区1面全景（西より）

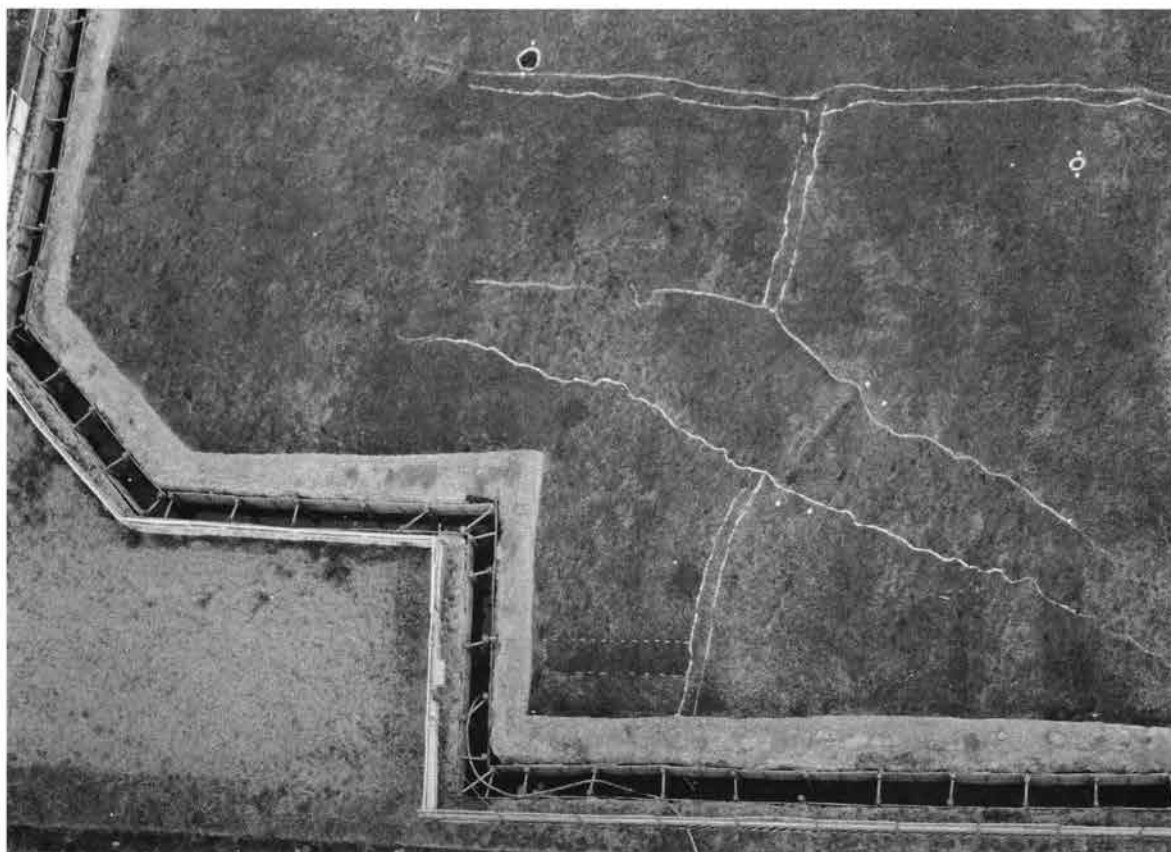

5区1面西部全景（西より）

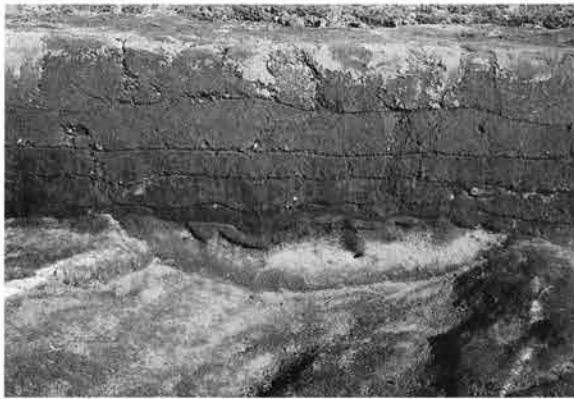

5-1-5号溝土層（西より）



5-1-5号溝全景（東より）



5-1-5号溝全景（北西より）

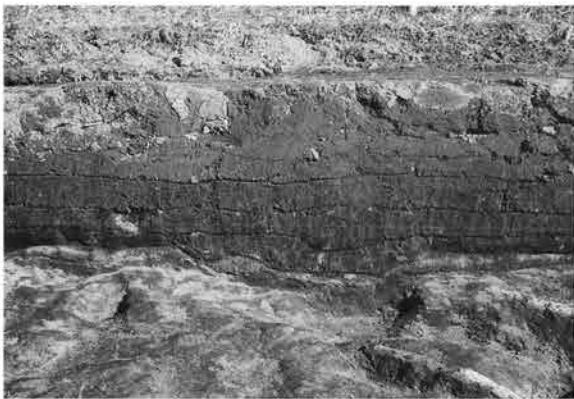

5-1-7号溝土層（南より）



5-1-7号溝全景（南西より）



5-1-9・10号溝全景（東より）



5-1-9・10号溝全景（東より）

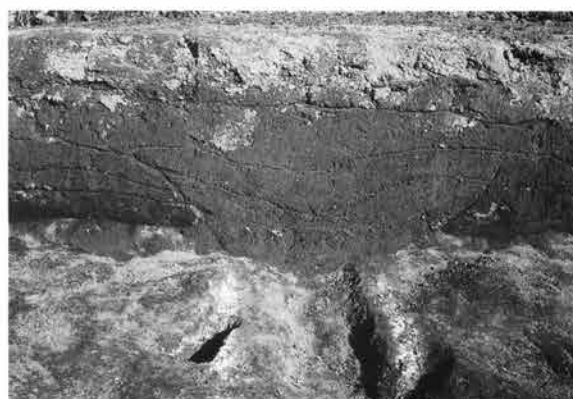

5-1-11号溝土層（西より）



5-1-11号溝全景（北より）



5-1-12号溝全景（西より）



5-1-11号土坑全景（南より）



5-1-12号土坑全景（南より）



5-1-14号土坑全景（南より）



5-1-15号土坑全景（南より）



5-1-16号土坑全景（南より）



5-1-17号土坑全景（南より）



5-1-1号爆裂坑全景（北より）



5区2面東部全景（東より）

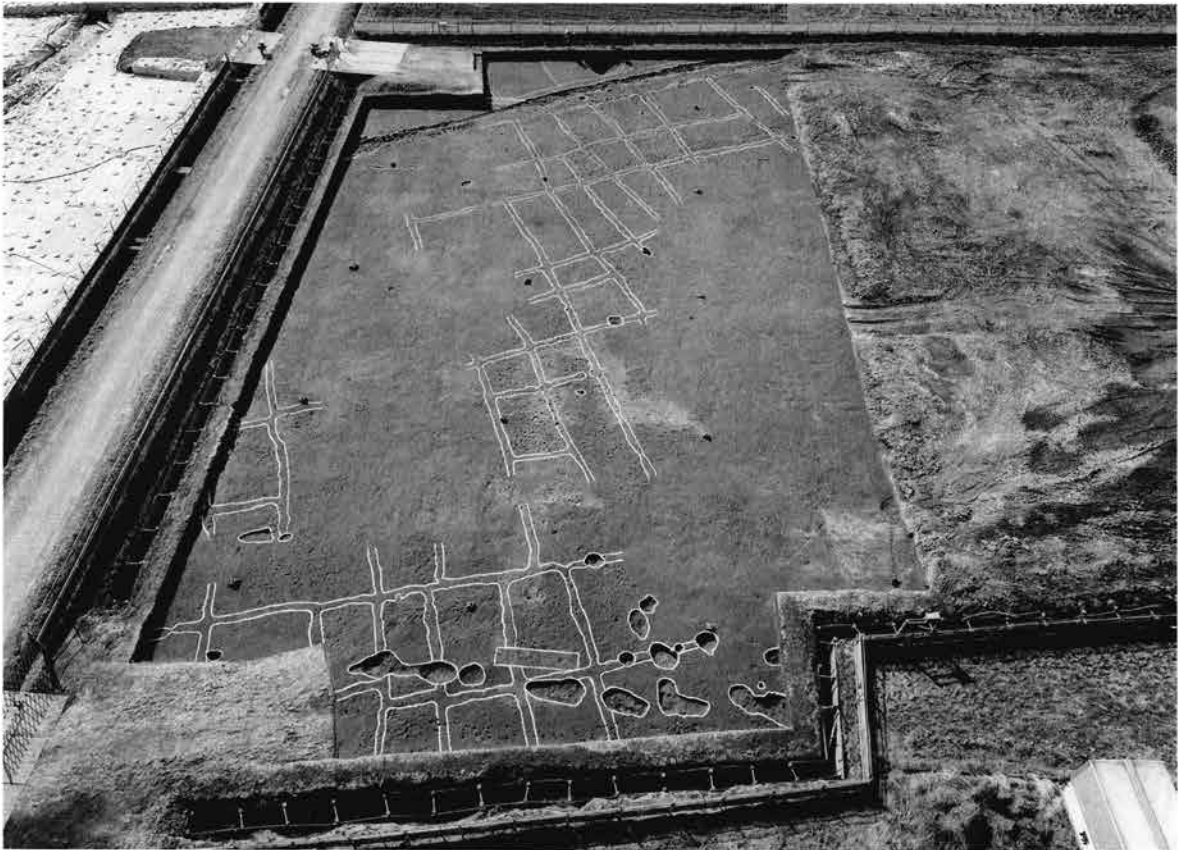

5区2面東部全景（北より）



5-2-1・2号溝全景 (南西より)



5-2-Hr-FA下水田 (東より)



5-2-北部全景 (西より)



5-2-Hr-FA水田北部 (東より)



5-2-Hr-FA下水田東部 (南より)



5-2-Hr-FA下水田南部 (南より)



5-2-Hr-FA下水田南部 (東より)



5-2-1号井戸 (北より)

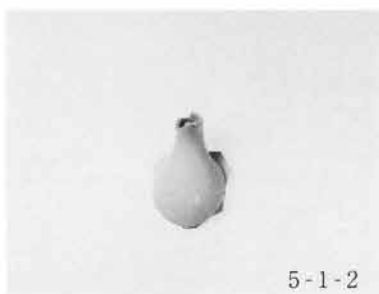





6区1面西半部全景（南より）



6区1面西半部土坑群（北より）

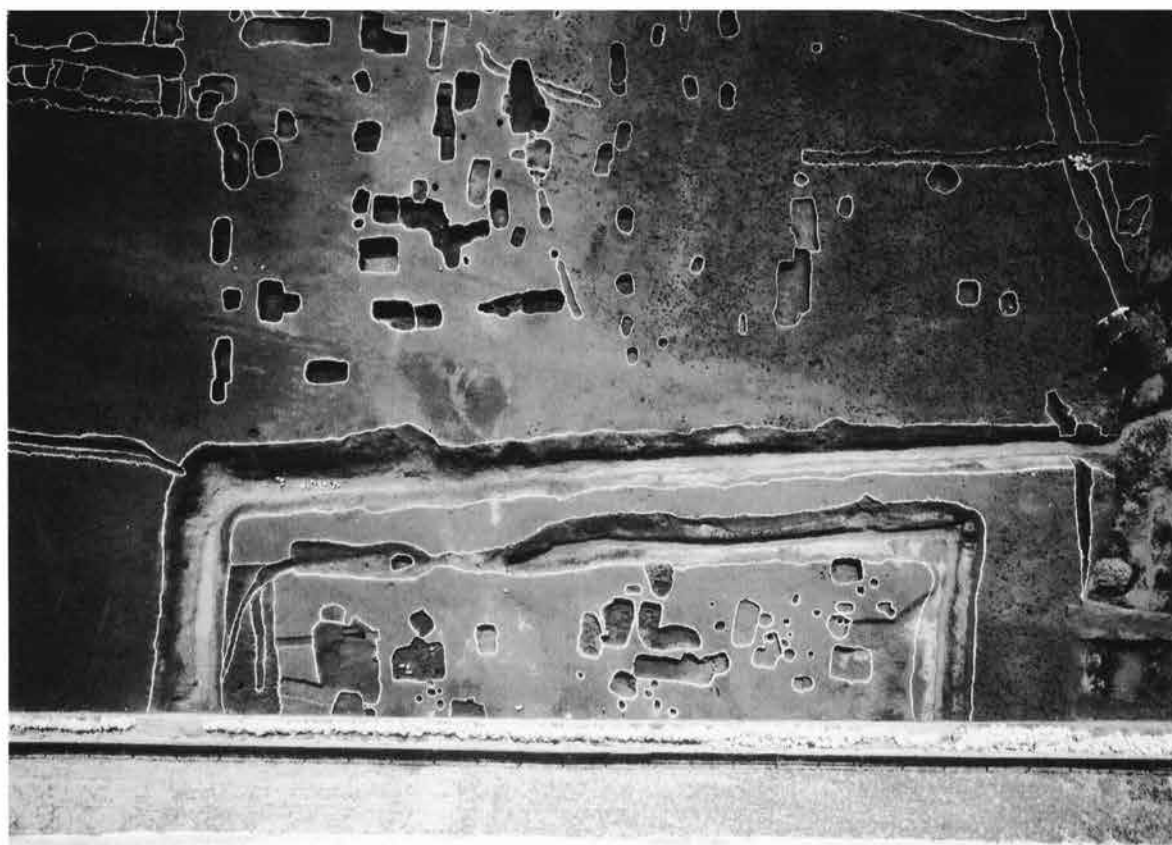

6-1-1号屋敷全景（上が南）



6-1-1号屋敷全景（西より）



6区1面西南部全景（西より）



6-1-2号屋敷内東部溝・土坑群（南より）



6-1-2号屋敷内西部溝・土坑群（南より）

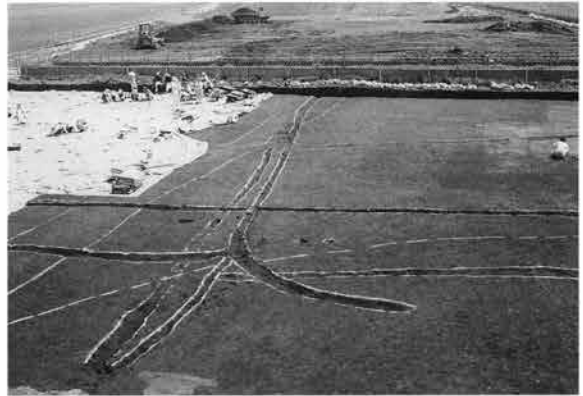

6区1面東部溝群（西より）



6区1面西半部中部土坑群（東より）



6-1-1号屋敷と6-1-32号溝（手前）



6-1-1号屋敷内土坑群（西より）



6区1面中部土坑群（北より）



6区1面西端部溝群 (南より)



6区1面As-B下水田面 (南より)



6-1-3号溝全景 (北西より)

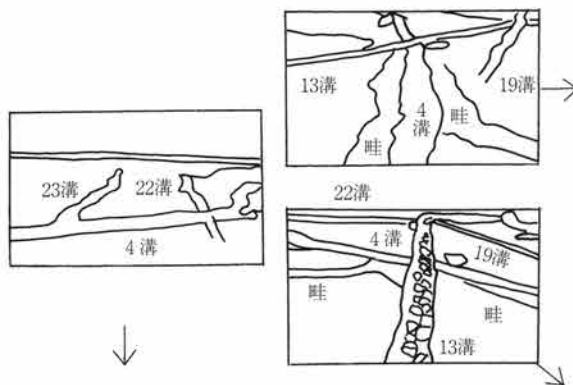
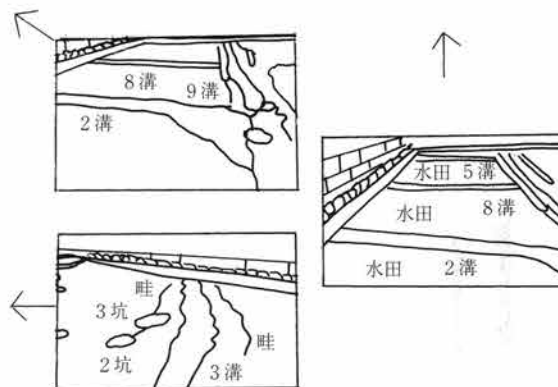

6-1-4・13・19号溝全景 (南東より)



6-1-4・22・23号溝全景 (西より)



6-1-4・13・19号溝、6-1-5号土坑全景 (南より)



6-1-14~16・38号溝全景（南より）

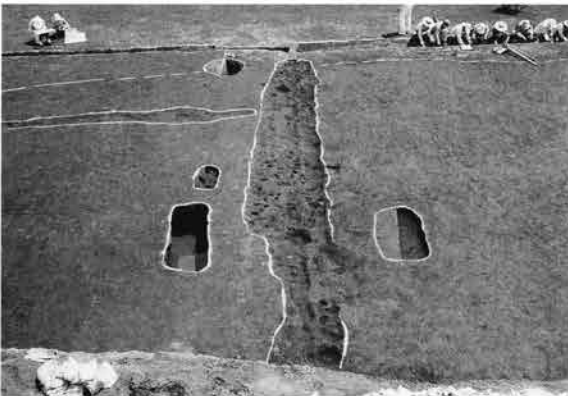
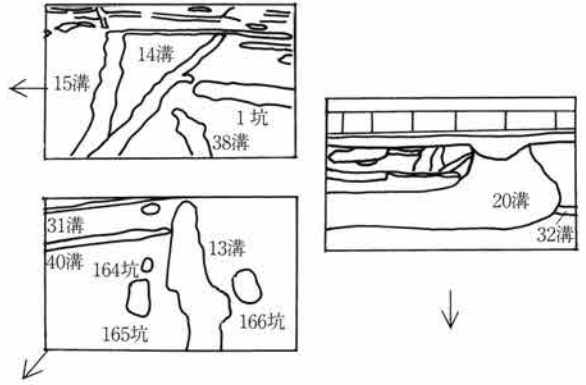

6-1-13号溝全景（西より）



6-1-20・32号溝全景（南より）



6-1-20・21・32号溝全景（東より）



6-1-20・21号溝全景（南より）

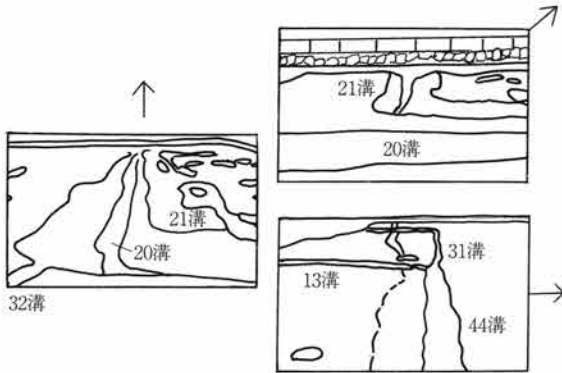

6-1-13・31・44号溝全景（南より）



6-1-31・32・38号溝全景（北より）

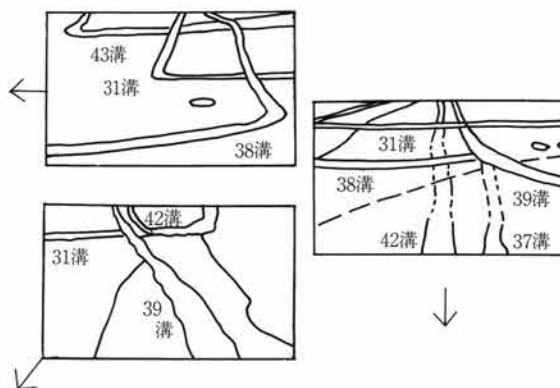

6-1-39・42号溝全景（東より）



6-1-31・37~39・42号溝全景（西より）



6-1-38・41号溝全景（東より）



6-1-40号溝全景（南より）



6-1-39・42号溝全景（東より）



6-1-43号溝全景（南東より）



6-1-41号溝全景（北西より）



6-1-37~40・42号溝全景（北より）



6-1-31・37・39・42号溝全景（西より）

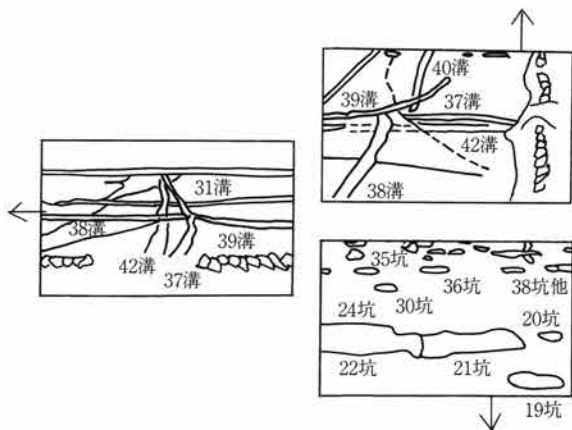

6区1面西半北部土坑群（西より）



6区1面西半北部土坑群（西より）



6-1-16号土坑全景（南より）



6-1-147号土坑全景（東より）



6-1-164号土坑全景 (南より)



6-1-165号土坑全景 (南より)



6-1-180号土坑全景 (南より)



6-1-147号土坑全景 (東より)



6-1-164号土坑全景 (南より)



6-1-165号土坑全景 (西より)



6-1-166号土坑全景 (南より)



6-1-167号土坑全景 (北より)





6-1-168号土坑全景（南より）



6-1-169号土坑全景（南より）



6-1-179号土坑全景（東より）



6-2-182号土坑全景（南より）



6-1-1号井戸全景（東より）

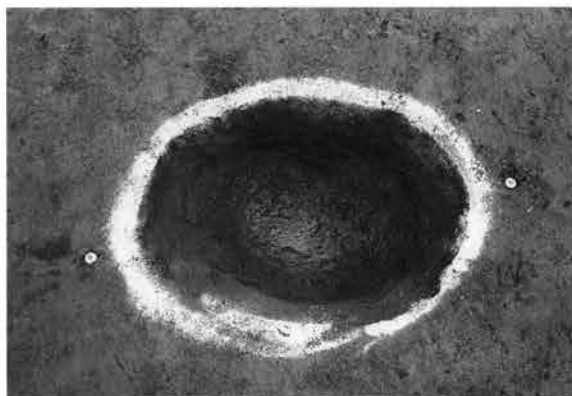

6-1-8号ピット全景（南より）



6区1面五輪塔等出土状況（西より）

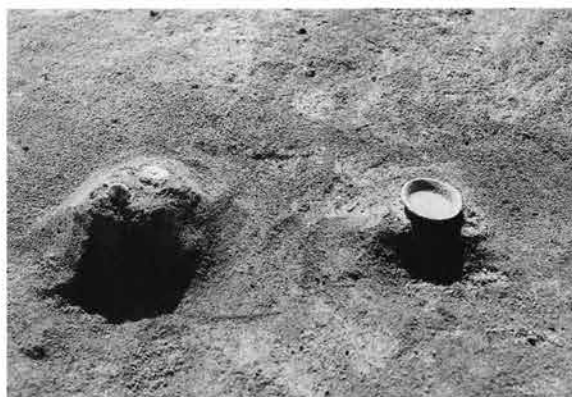

6区1面銅銭等出土状況（南より）

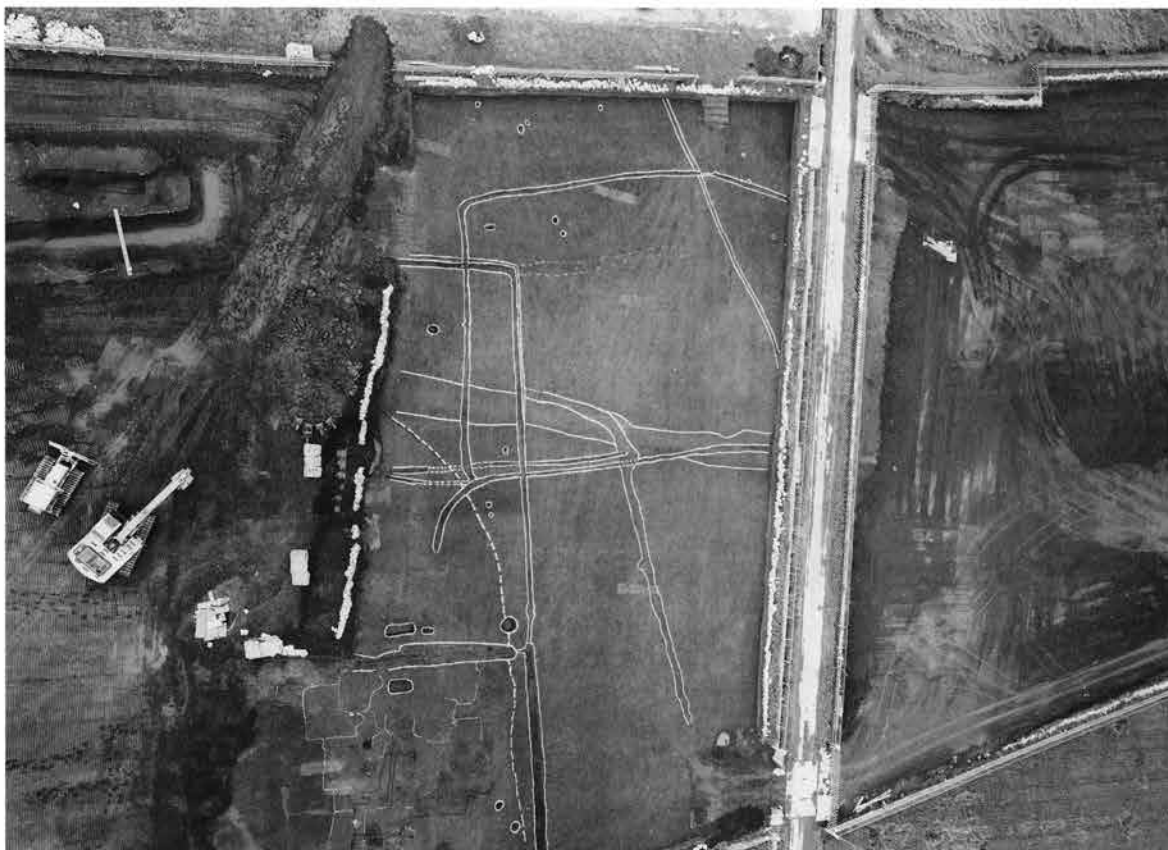

6区1面東部As-B下水田面



6区1面東部As-B下水田面全景



6区1面西端部As-B下水田面



6区1面西端部As-B下水田面



6区1面西端部As-B下水田面



6区2面竪穴住居分布状況



6-2-1号住居全景（西より）



6-2-1号住居掘り方全景（西より）

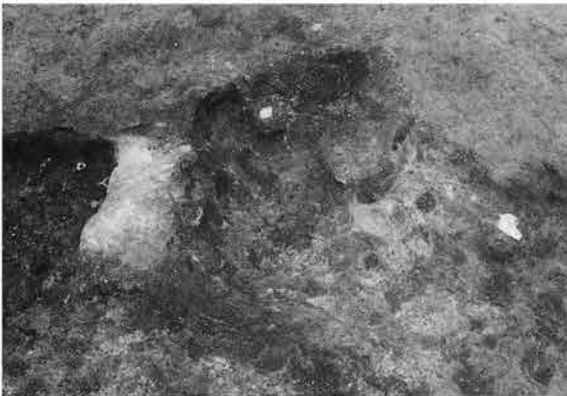

6-2-2号住居竈全景（西より）



6-2-2号住居全景（西より）



6-2-2号住居掘り方全景（西より）

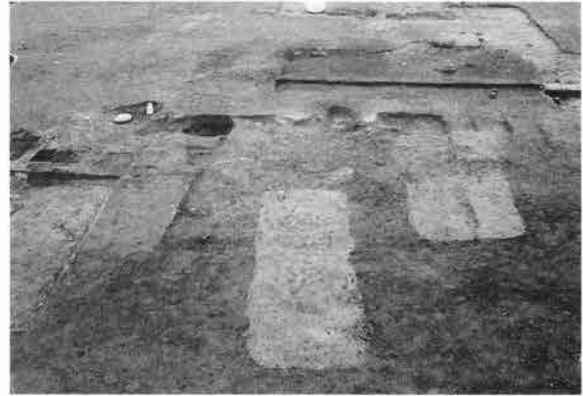

6-2-3号住居全景（西より）



6-2-4号住居全景（西より）



6-2-3号住居竈全景（西より）



6-2-4号住居掘り方全景（西より）



6-2-4号住居竈全景（西より）



6-2-5号住居全景（西より）



6-2-5号住居掘り方全景（西より）



6-2-5号住居竈掘り方(南より)

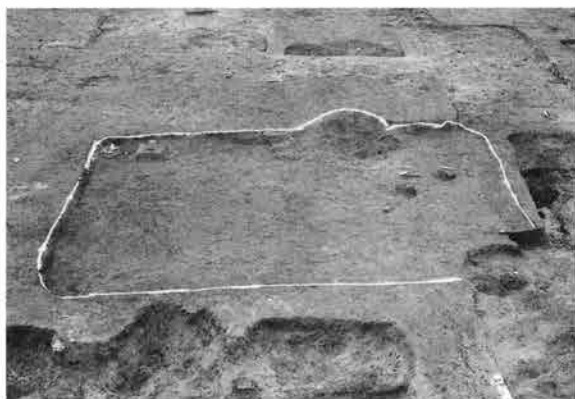

6-2-6号住居全景(西より)



6-2-6号住居竈全景(西より)



6-2-6号住居掘り方全景(西より)

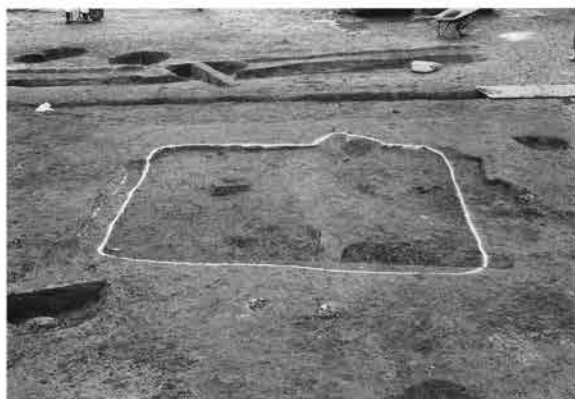

6-2-8号住居全景(西より)



6-2-7・8号住居全景(西より)

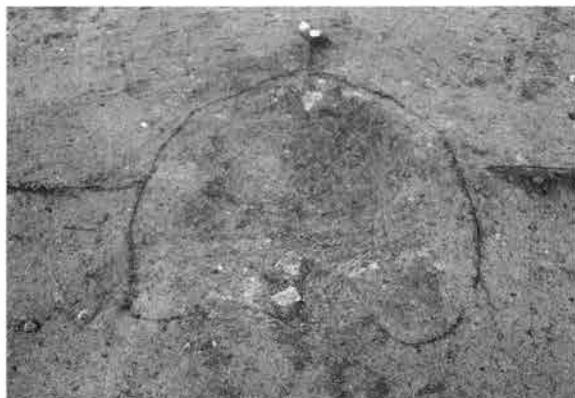

6-2-8号住居竈(西より)

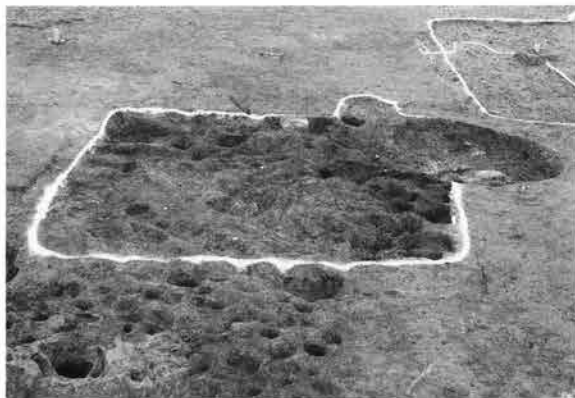

6-2-9号住居掘り方全景(西より)



6-2-9号住居竈（西より）



6-2-10号住居全景（西より）



6-2-10号住居掘り方全景（西より）



6-2-10号住居竈（西より）



6-2-12・21号住居全景（西より）



6-2-12号住居竈（西より）



6-2-13号住居全景（西より）



6-2-13号住居掘り方全景（西より）



6-2-16・18号住居全景（西より）



6-2-16号住居竈全景（遺物出土状況）



6-2-16号住居遺物出土状況（竈前）

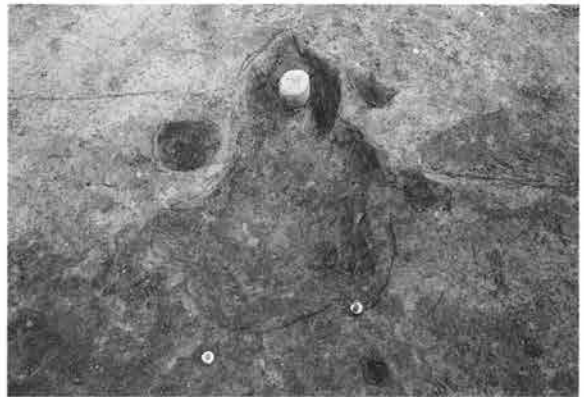

6-2-16号住居竈掘り方全景（西より）

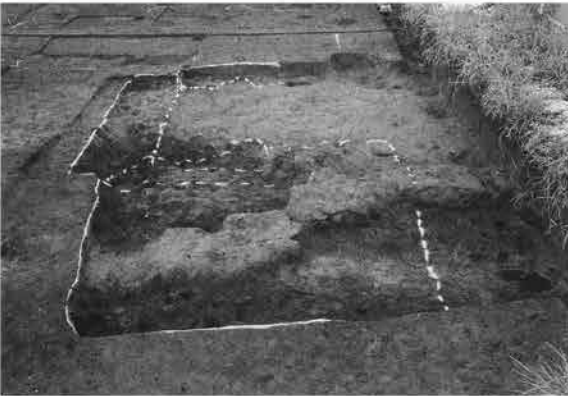

6-2-1・17・22号住居全景（西より）

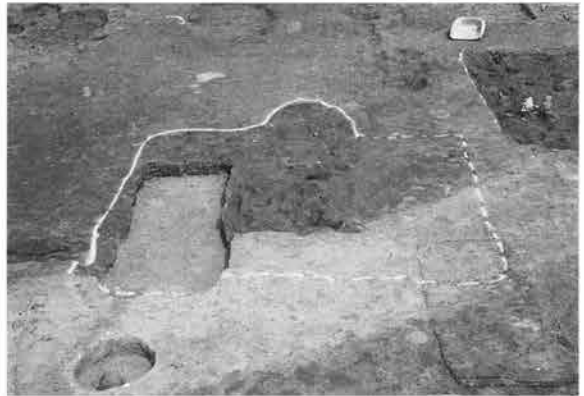

6-2-18号住居全景（西より）

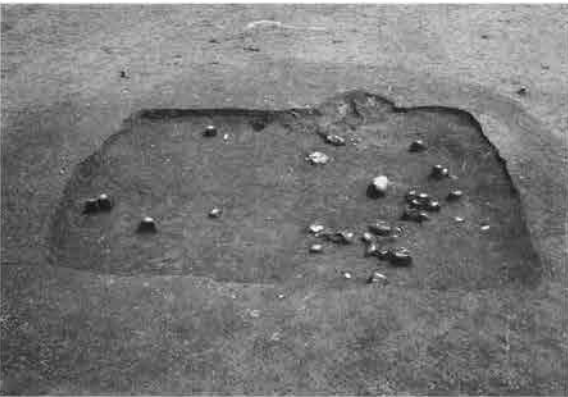

6-2-19号住居全景（遺物出土状況）

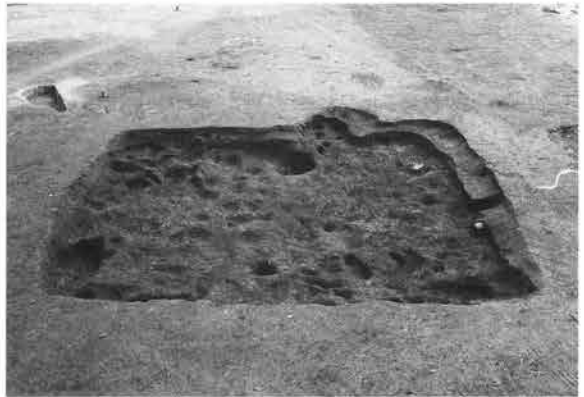

6-2-19号住居掘り方全景（西より）



6区2面19号住居竈全景（西より）



6-2-19・20号住居掘り方全景（西より）

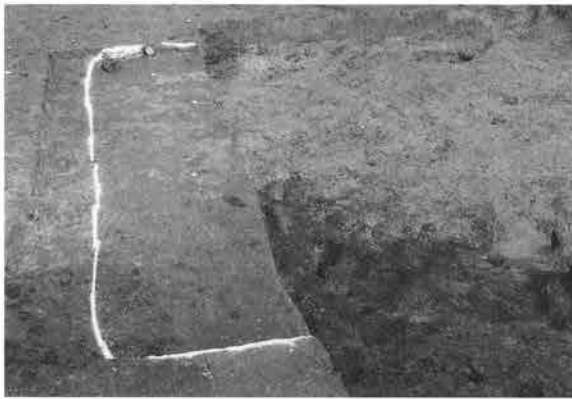

6-2-22号住居全景（西より）



6-2-20号住居竈全景（西より）

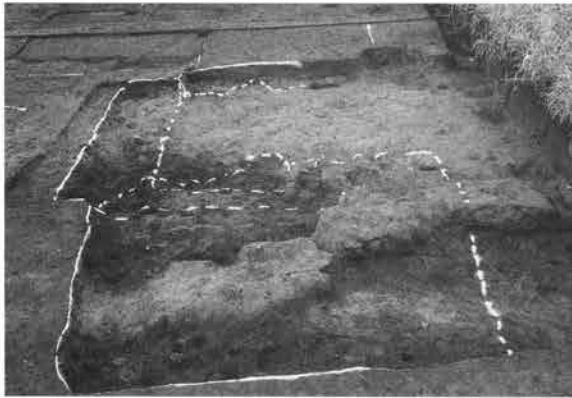

6-2-17・22号住居掘り方全景（西より）

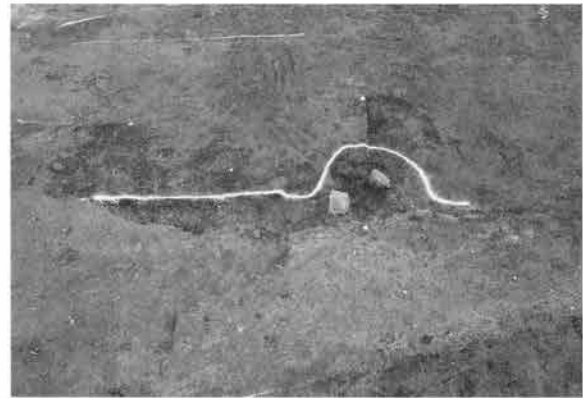

6-2-23号住居竈全景（西より）



6-2-24号住居竈掘り方全景（西より）

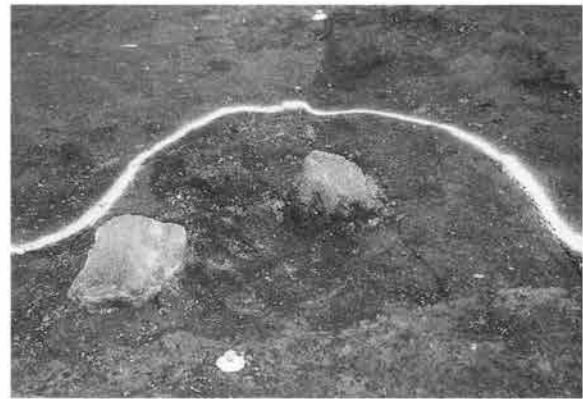

6-2-23号住居竈全景（西より）





6-2-25号住居全景 (西より)

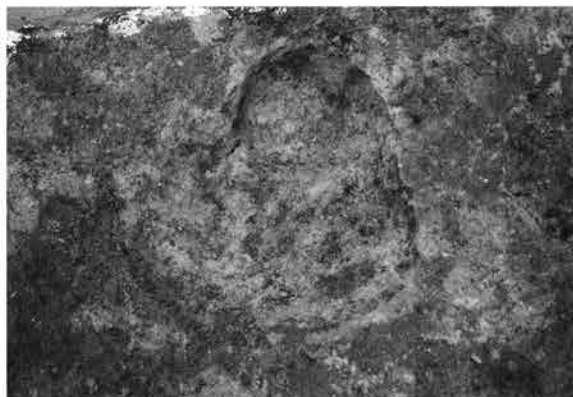

6-2-25号住居竈全景 (西より)



6-2-26号住居全景 (西より)

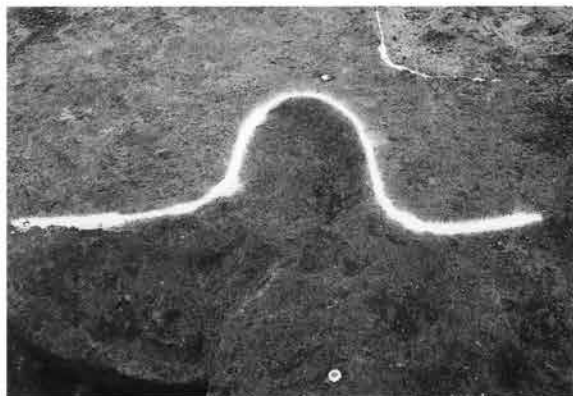

6-2-26号住居竈全景 (西より)

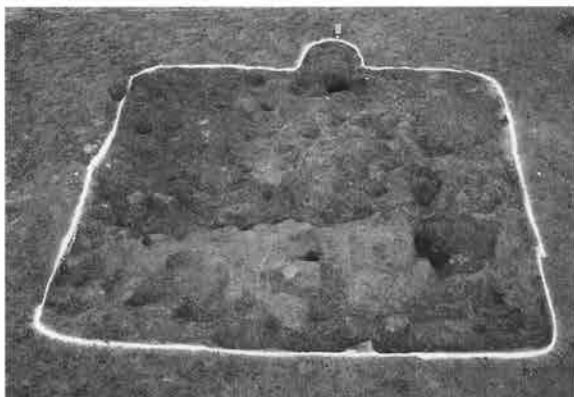

6-2-27号住居全景 (西より)



6-2-27号住居竈全景 (西より)

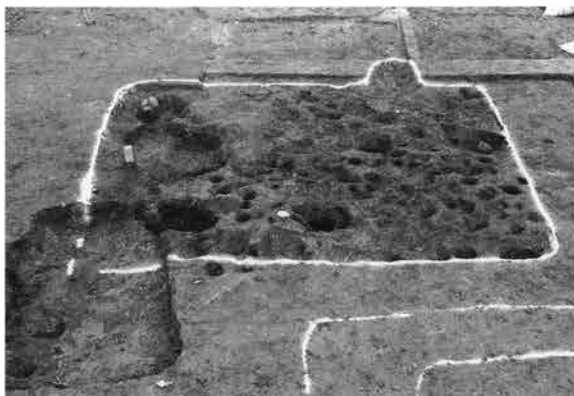

6-2-28号住居掘り方全景 (西より)



6-2-28号住居竈全景 (西より)



6-2-29号住居全景（西より）



6-2-29号住居竈（西より）



6-2-30・31号住居全景（西より）



6-2-30・31号住居掘り方全景（西より）



6-2-30号住居竈覆土断面（南より）



6-2-30号住居掘り方覆土断面（南より）



6-2-32号住居全景（西より）

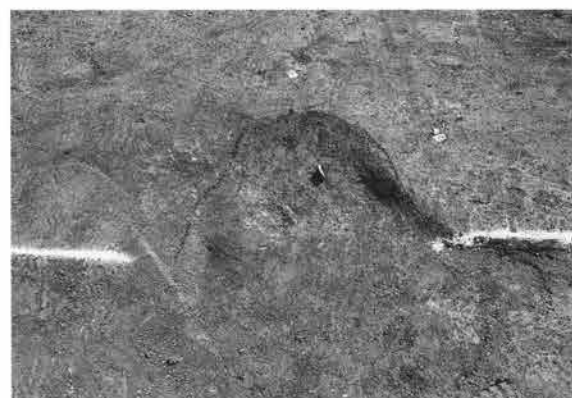

6-2-32号住居竈全景（西より）

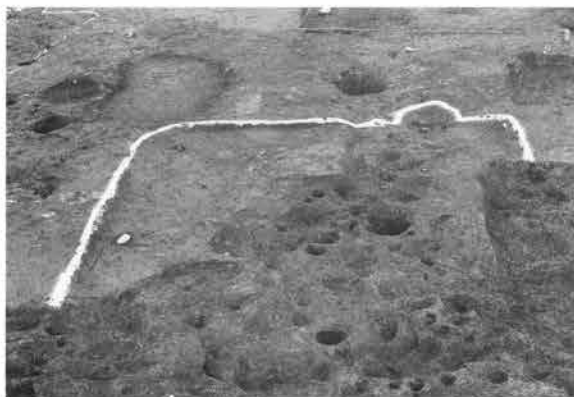

6-2-33号住居全景（西より）



6-2-33号住居掘り方全景（西より）



6-2-33号住居竈全景（西より）



6-2-33号住居竈掘り方全景（西より）



6-2-34号住居竈全景（西より）



6-2-34号住居竈掘り方全景（西より）

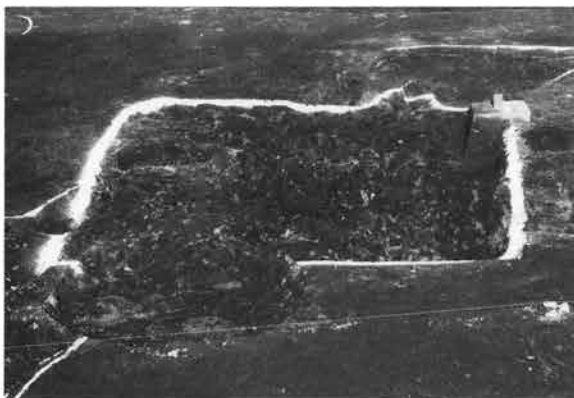

6-2-35号住居全景（西より）



6-2-35号住居掘り方全景（西より）

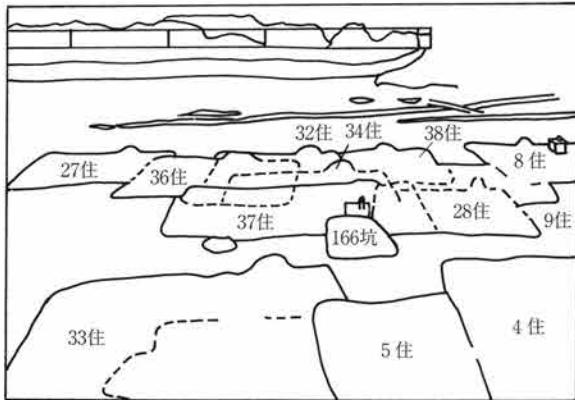

6-2-36号住居竈セクション (南より)



6-2-32・34・36・37・38号住居 (西より)



6-2-37号住居竈掘り方全景 (西より)



6-2-39号住居全景 (西より)



6-2-39号住居全景（西より）



6-2-30・39・40号住居全景（西より）

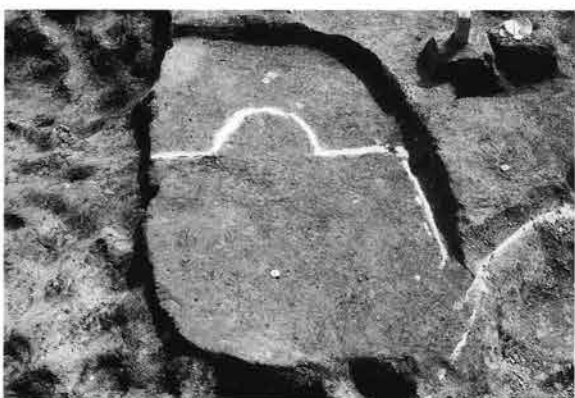

6-2-40号住居全景（西より）



6-2-39・40号住居掘り方全景（西より）



6-2-40号住居竈全景（西より）



6-2-40号住居竈掘り方全景（西より）



6-2-41号住居全景（西より）



6-2-41号住居竈全景（西より）



6-2-42号住居掘り方全景（西より）



6-2-42号住居竈全景（西より）



6-2-43号住居全景（西より）



6-2-44号住居全景（西より）



6-2-44号住居竈全景（西より）



6-2-44号住居竈掘り方全景（西より）



6-2-45号住居掘り方覆土（西より）



6-2-46号住居掘り方覆土（西より）



6-2-46号住居竈全景（西より）



6-2-47号住居竈全景（西より）



6-2-47号住居掘り方全景（西より）

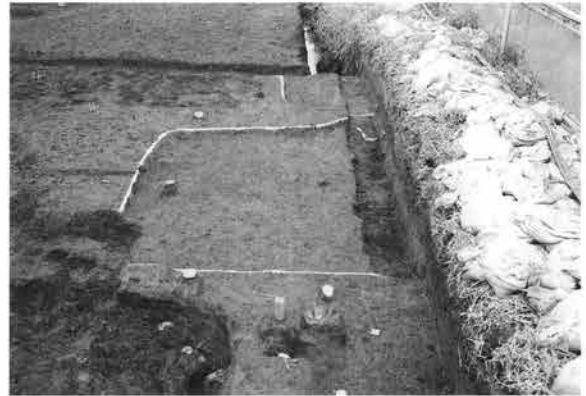

6-2-48号住居全景（西より）



6-2-48号住居竈覆土断面（南より）



6-2-48号住居全景（西より）

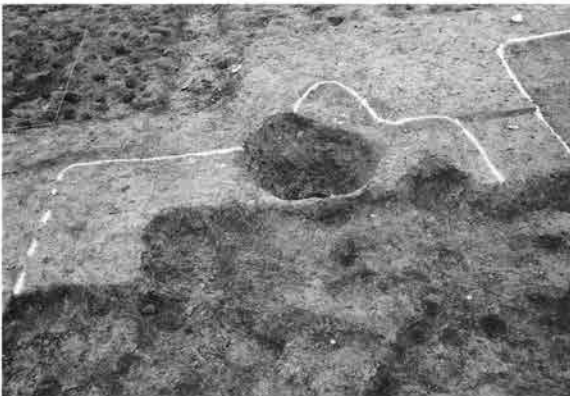

6-2-49号住居全景（西より）

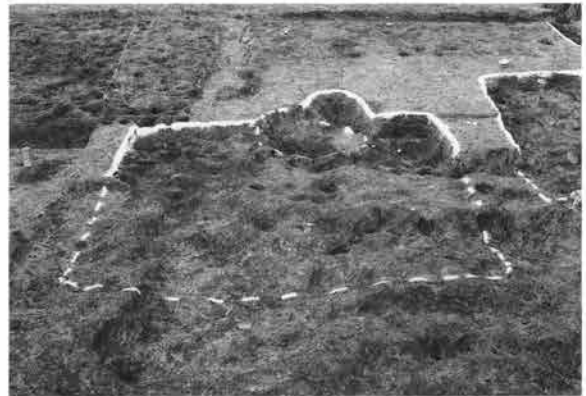

6-2-49号住居掘り方全景（西より）



6-2-50号住居全景 (西より)



6-2-50号住居竈全景 (西より)



6-2-51号住居全景 (西より)



6-2-51号住居竈全景 (西より)

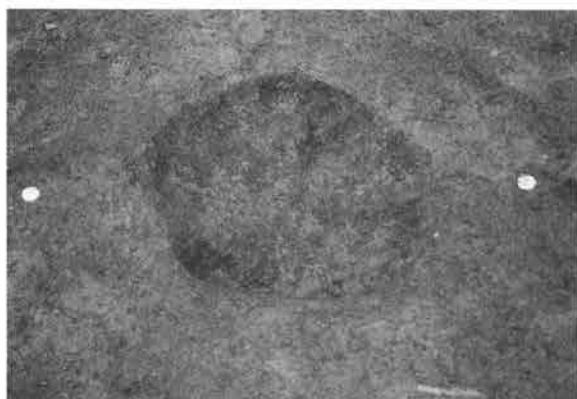

6-2-51号住居貯蔵穴 (西より)

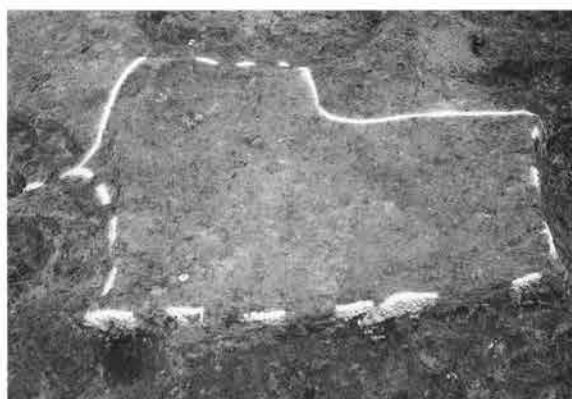

6-2-52号住居全景 (西より)



6-2-52号住居竈掘り方全景 (西より)

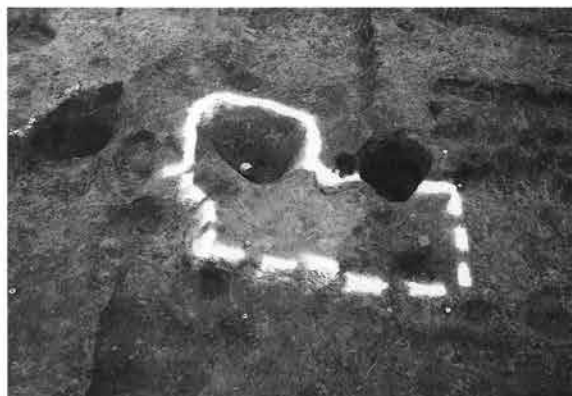

6-2-52号住居全景 (西より)



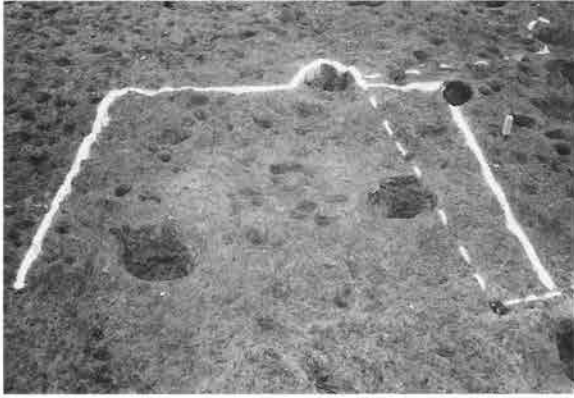

6-2-53号住居全景（西より）

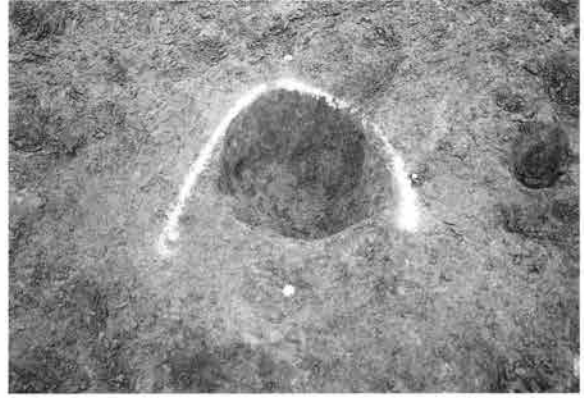

6-2-53号住居竈全景（西より）



6-2-54号住居竈全景（西より）



6-2-48・55号住居掘り方全景（西より）

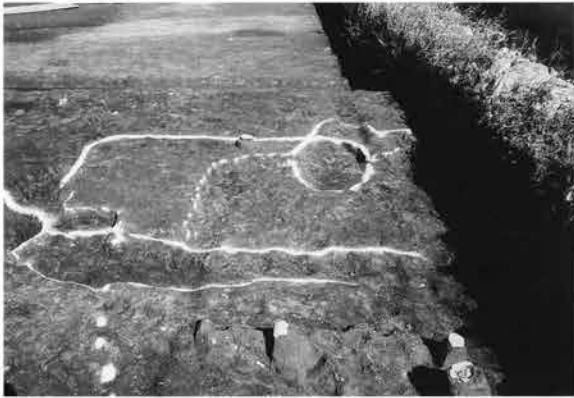

6-2-48・56号住居全景（西より）



6-2-55号住居覆土断面（北より）



6-2-56号住居竈全景（西より）



6-2-56号住居竈掘り方全景（南より）



6-2-57号住居全景（西より）



6-2-57号住居竈全景（西より）



6-2-59号住居掘り方全景（西より）



6-2-60号住居全景（西より）



6-2-62号住居全景（西より）



6-2-61号住居全景（西より）



6-2-62号住居竈全景（西より）



6-2-61号住居掘り方全景（西より）



6-2-65号住居全景（南東より）



6-2-65号住居周溝（南東より）



6-2-65号住居周溝遺物出土状況（東より）



6-2-65号住居遺物出土状況（東より）



6-2-65号住居遺物出土状況（南より）



6-2-65号住居周溝遺物出土状況（東より）



6-2-66号住居遺物出土状況（南西より）



6-2-66号住居全景（西南より）



6-2-66号住居周溝遺物出土状況（北より）



6-2-66号住居覆土断面（西より）

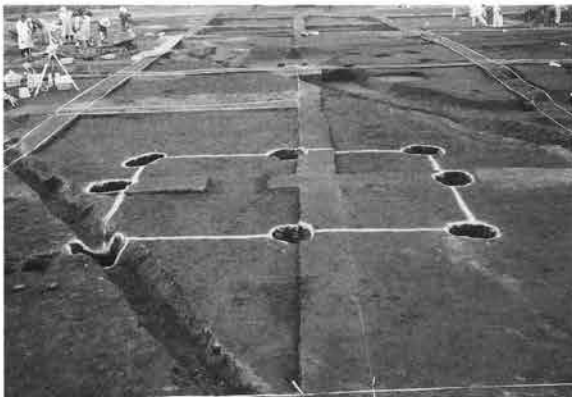

6-2-1号掘立柱建物全景（南より）



6-2-1号道全景（北西より）



6区2面航空写真



6区2面全景



6-2-45・54号溝切り合い断面（北西より）



6-2-46・47号溝切り合い断面（西より）



6-2-45・49号溝切り合い断面（西より）



6-2-48・49・53号溝切り合い断面（南より）



6-2-4号道・51号溝切り合い断面（南より）



6-2-51号溝・176号土坑切り合い断面（南より）



6-2-62号溝・210号土坑切り合い断面（南東より）



6-2-62・63号溝切り合い断面（南より）



6-2-71号溝覆土断面（北より）



6-2-170号土坑全景（南より）



6-2-171号土坑全景（南東より）



6-2-172号土坑覆土断面（南より）



6-2-173号土坑全景（西より）



6-2-174号土坑覆土断面（南より）



6-2-49・54号溝切り合い断面（南西より）



6-2-54号溝・178号土坑切り合い断面（南より）



6-2-171号土坑覆土断面（南より）



6-1-175号土坑全景（南東より）

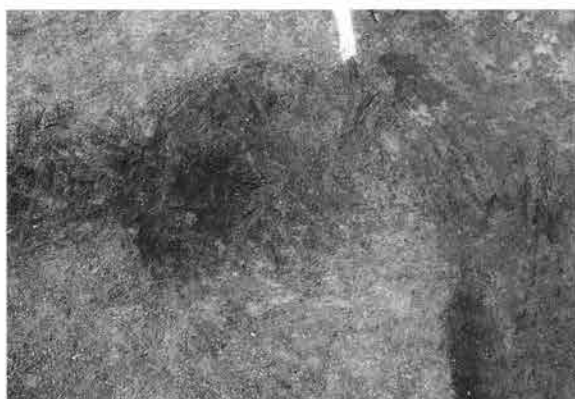

6-2-176号土坑全景（南より）



6-2-177号土坑全景（南より）



6-1-179号土坑全景（東より）



6-1-180号土坑覆土断面（南より）



6-2-181号土坑全景（北より）



6-2-182号土坑全景（北より）



6-2-183号土坑全景（北東より）



6-2-184号土坑全景（南より）



6-2-185号土坑全景（南より）



6-2-186号土坑全景（南より）



6-2-187号土坑全景（南より）



6-2-189号土坑全景（南より）





6-2-200号土坑全景（北より）

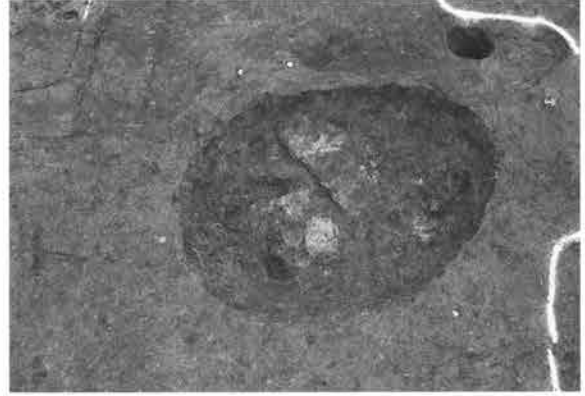

6-2-202号土坑全景（南より）

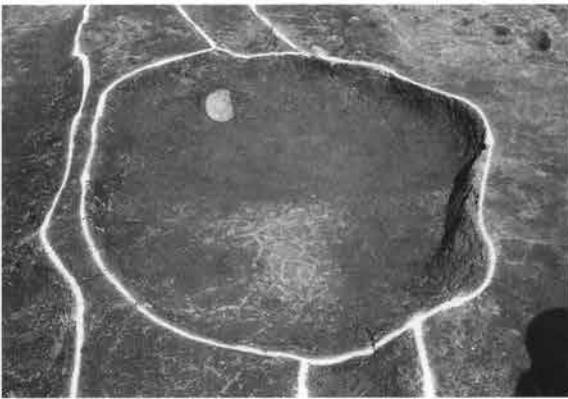

6-2-205号土坑全景（南より）

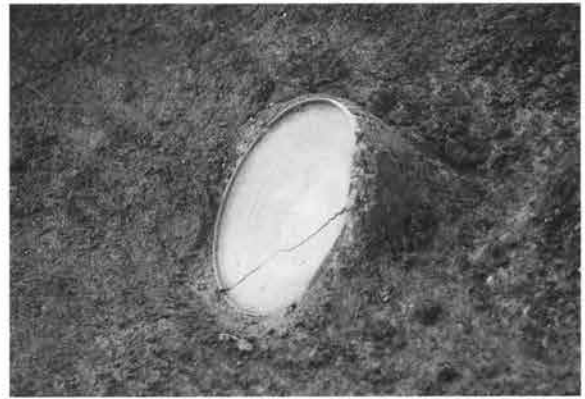

6-2-205号土坑出土遺物（東より）

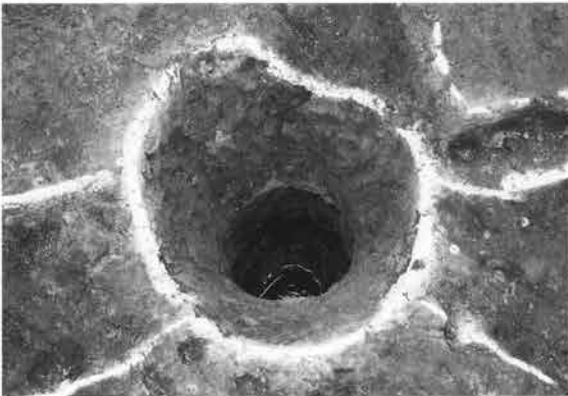

6-2-208号土坑全景（西より）



6-2-208号土坑出土遺物（西より）



6-2-213号土坑全景（北より）



6-2-214号土坑全景（南より）



6-2-191号土坑全景（南より）



6-2-192号土坑全景（南より）



6-2-193号土坑全景（南より）



6-2-191～196号土坑全景（北より）



6-2-196号土坑全景（南より）



6-2-198号土坑全景（南より）



6-2-190・197号土坑（西より）



6区2面Hr-FA・FP泥流下水田全景（北東より）



6-2-1号Hr-FA・FP泥流下水田全景（東より）



6-2-46号溝と1号Hr-FA・FP泥流下水田（北東より）



6-2-2号Hr-FA・FP泥流下水田全景（北より）



6-2-1号Hr-FA・FP泥流下水田航空写真（北西より）

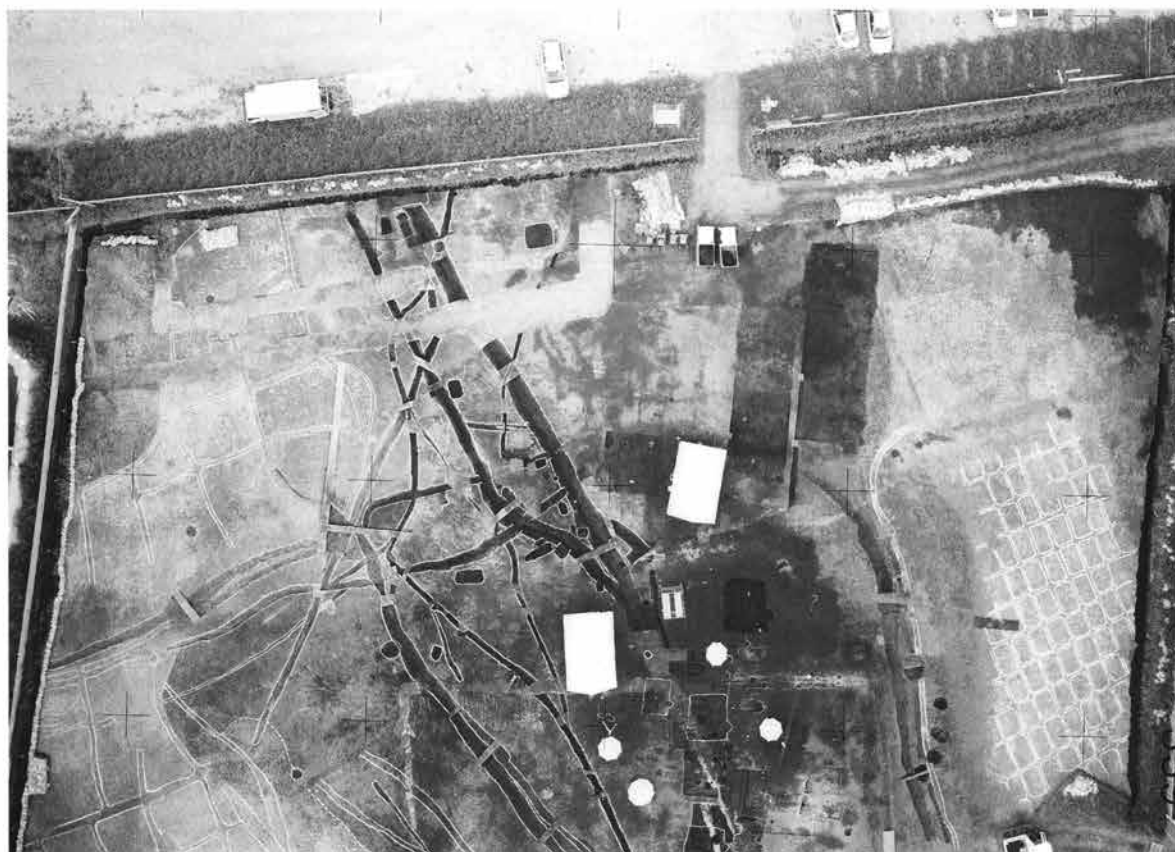

6-2-2号Hr-FA・FP泥流下水田航空写真



6区2面Hr-FA下水田航空写真

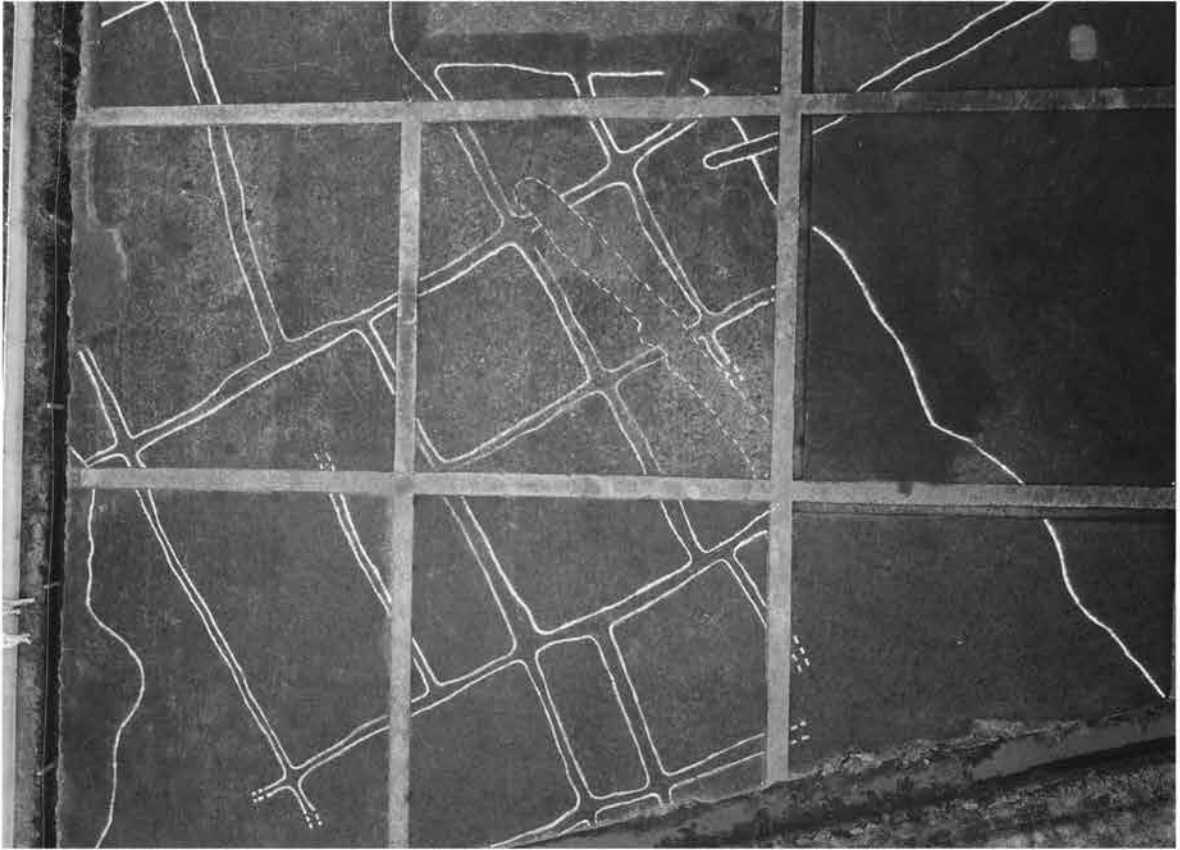

6-2-1号Hr-FA下水田全景

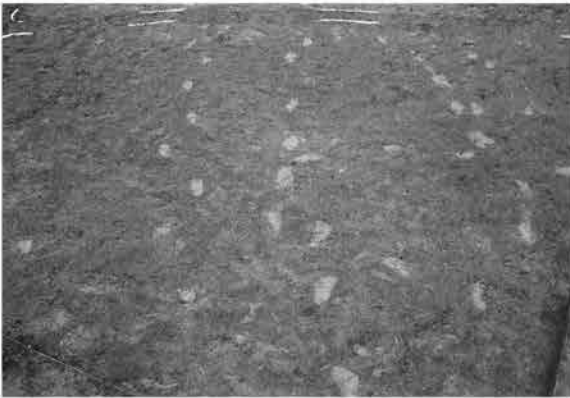

6-2-1号Hr-FA下水田面足跡（東より）



6-2-1号Hr-FA下水田面足跡（東より）

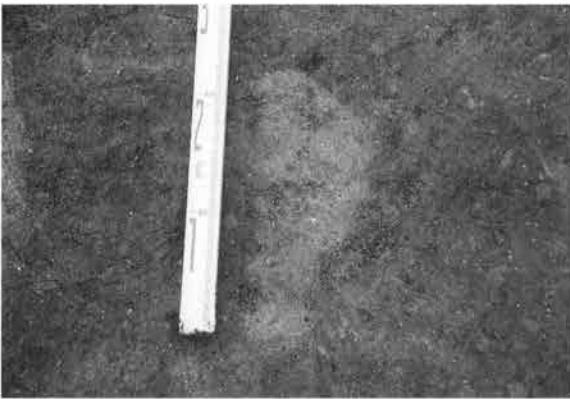

6-2-1号Hr-FA下水田面足跡（接写）東より



6-2-1号Hr-FA下水田面足跡（東より）



6-2-2号Hr-FA下水田全景



6-2-2号Hr-FA下水田面（北東より）



6-2-2号Hr-FA下水田面（北西より）



6-2-2号Hr-FA下水田面（北西より）



6-2-2号Hr-FA下水田面（北西より）

PL46



6-2-3号Hr-FA下水田面（北西より）



6区2面全景



6区2面遺構外出土遺物出土状況（西より）



6区2面確認状況（南より）



6区3面試掘状況（西南より）



6区3面風倒木確認状況（南より）



6区3面下位層確認調査状況（南東より）



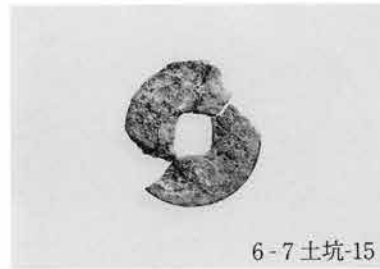
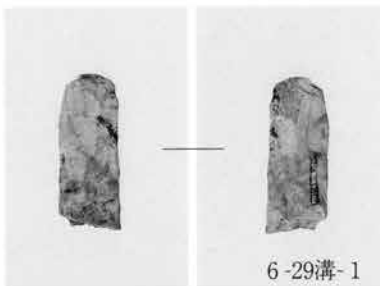



6-7 土坑-16



6-56~  
59 土坑-1



6-150 土坑-1



6-60·76 土坑-1

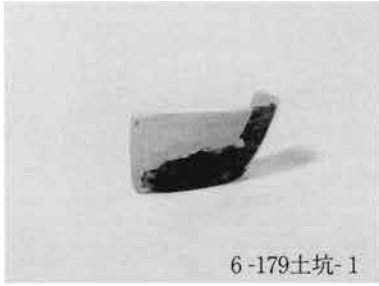

6-179 土坑-1

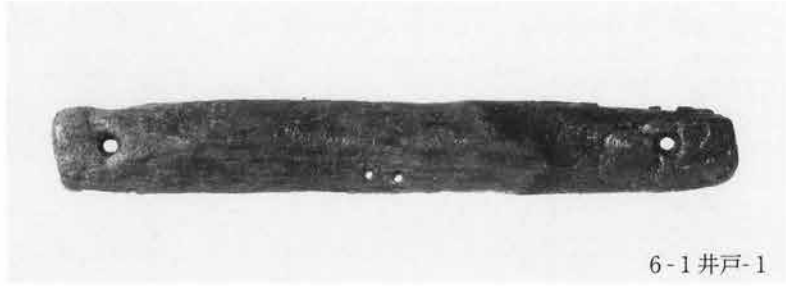

6-1 井戸-1



6-1-1



6-1-2



6-1-石塔-1

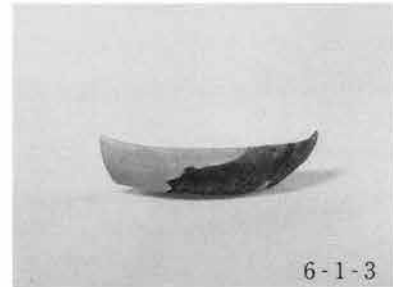

6-1-3



6-1-4

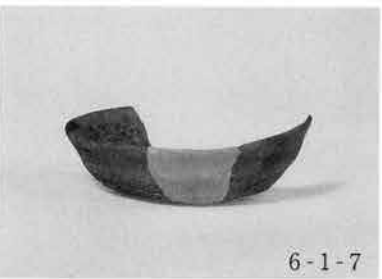
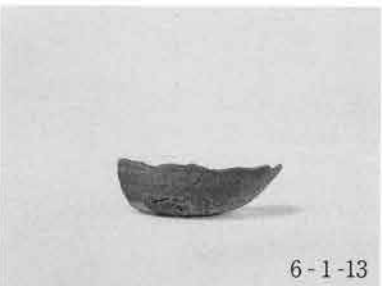
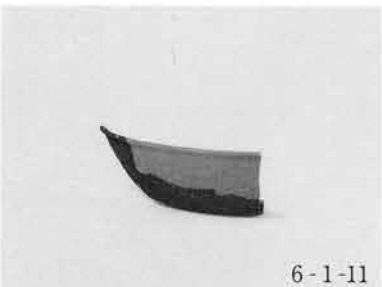



6-1-22



6-1-5



6-1-19



6-1-20



6-1-14



6-1-15



6-1-16



6-1-17



6-1-21



6-1-13



6-1-9



6-1-31



6-1-12

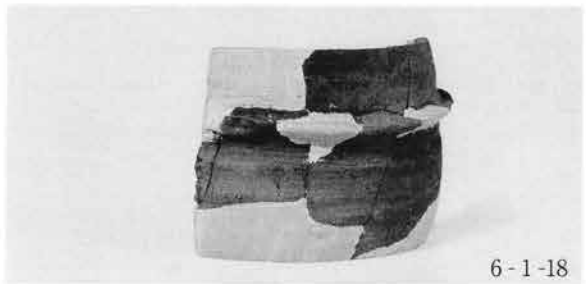

6-1-18

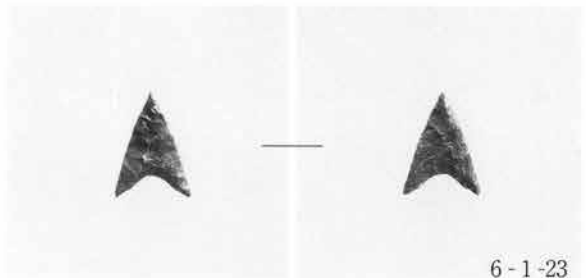

6-1-23

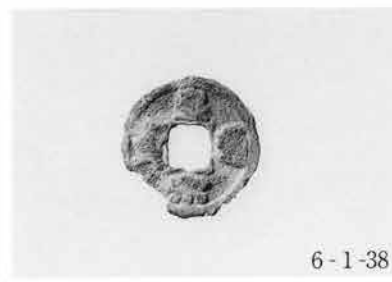
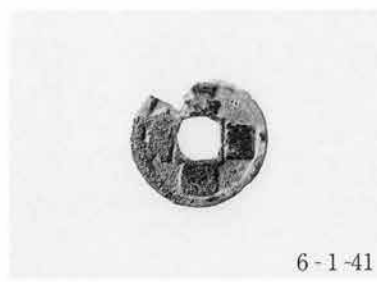
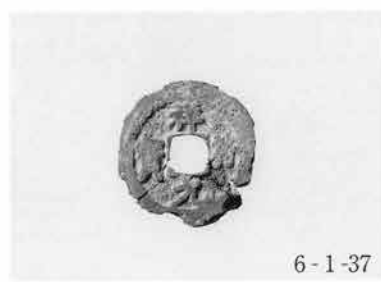
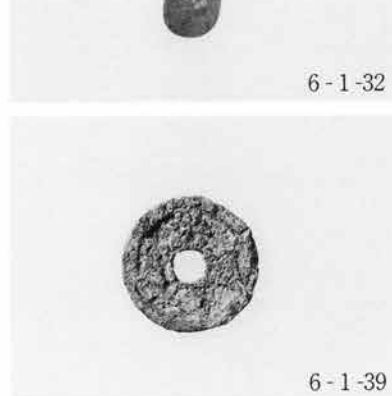
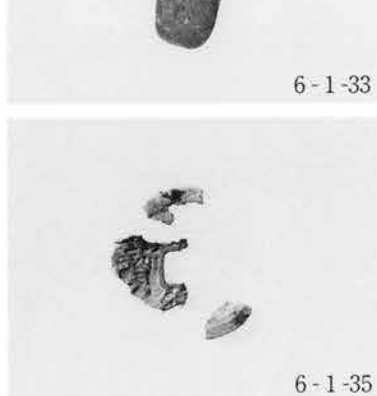

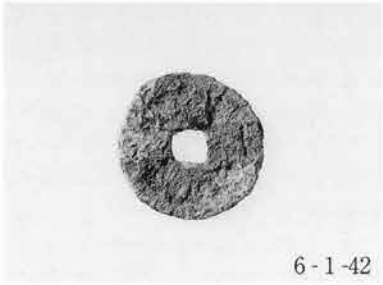

6-1-42

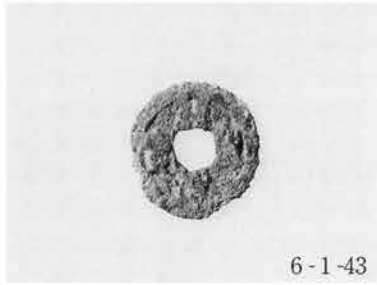

6-1-43

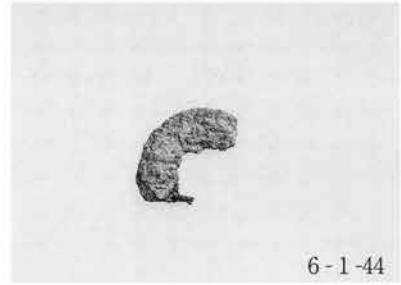

6-1-44



6-1-45



6-1-46

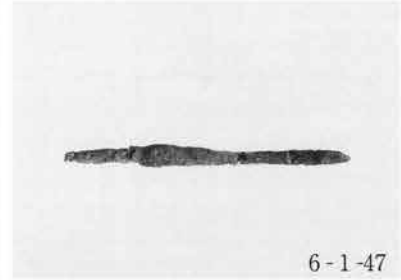

6-1-47



6-1-48



6-1-49



6-20溝-1

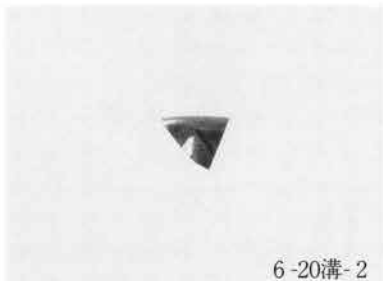

6-20溝-2

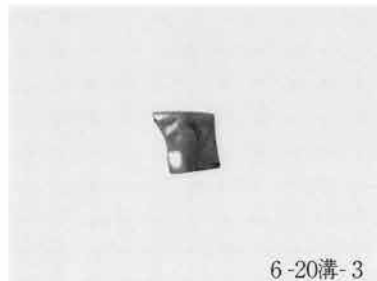

6-20溝-3

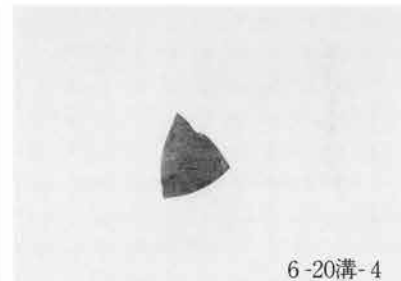

6-20溝-4



6-20溝-5



6-20溝-6



6-20溝-7



6-20溝-8



6-20溝-9



6-20溝-10



6-20溝-12



6-20溝-11



6-20溝-13

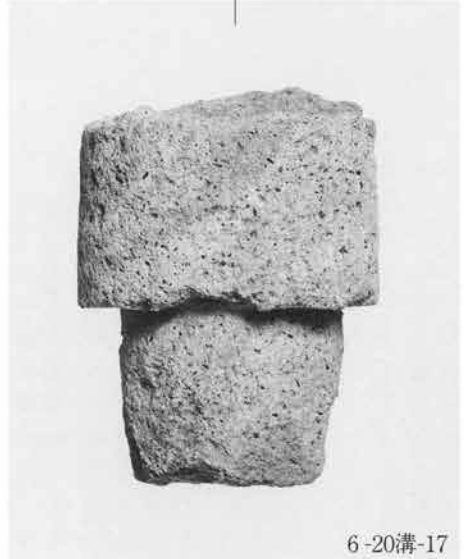

6-20溝-17



6-20溝-20



6-20溝-23

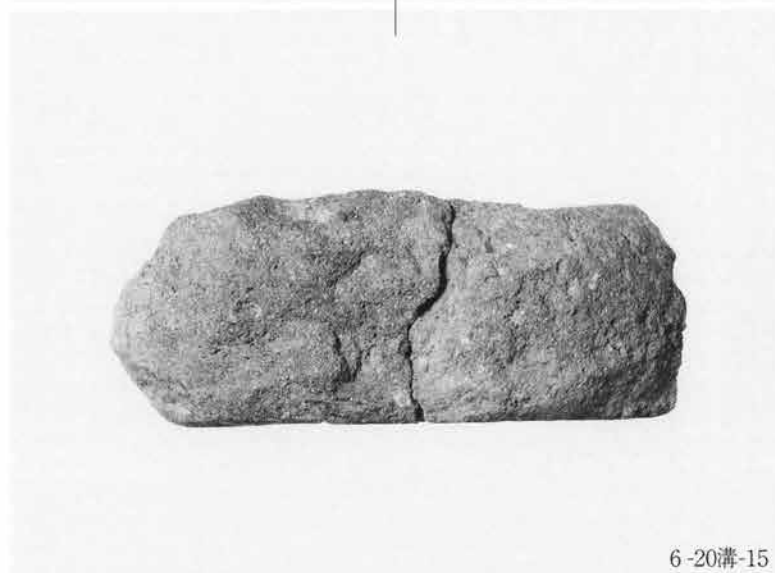

6-20溝-15



6-20溝-16



6-20溝-18



6-20溝-21

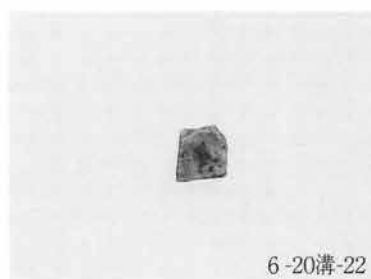

6-20溝-22



6-20溝-26



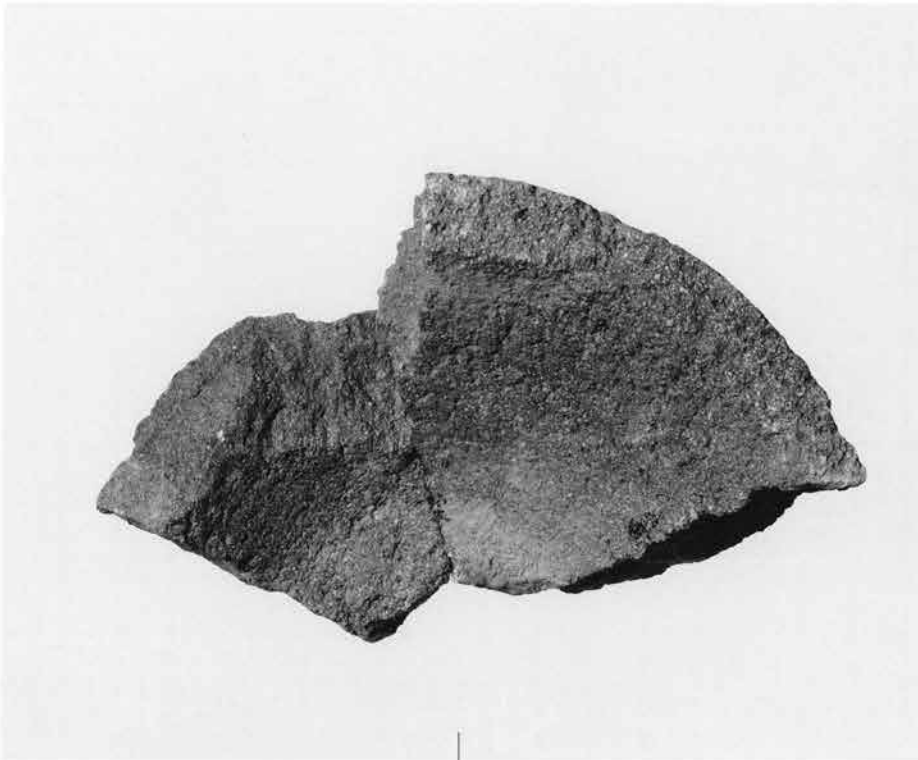

6-20溝-25



6-20溝-19

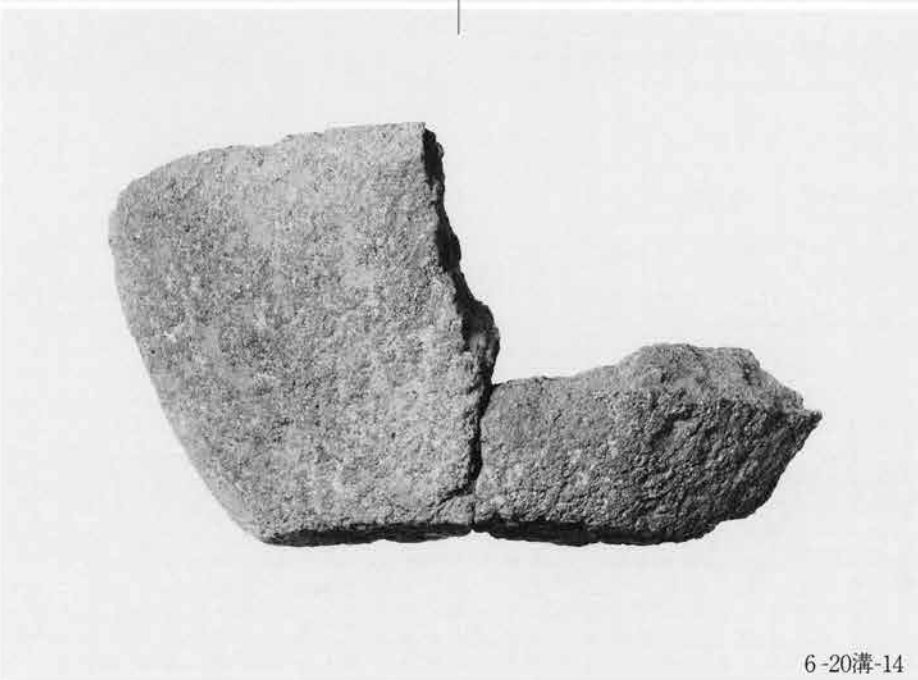

6-20溝-24



6-21溝-1

6-20溝-14



6-21溝-4



6-21溝-3

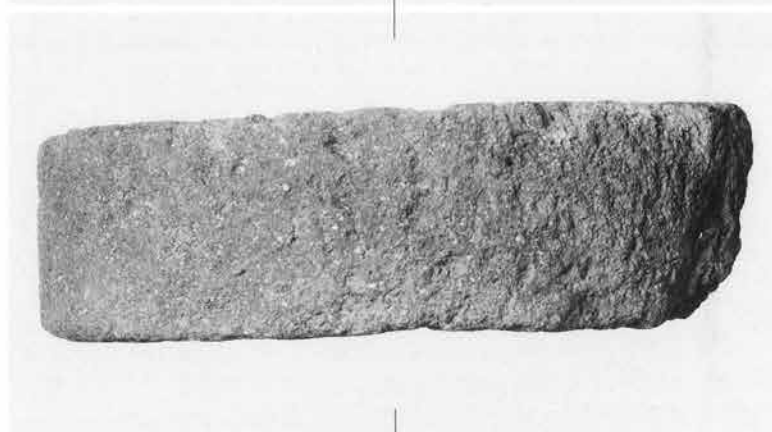
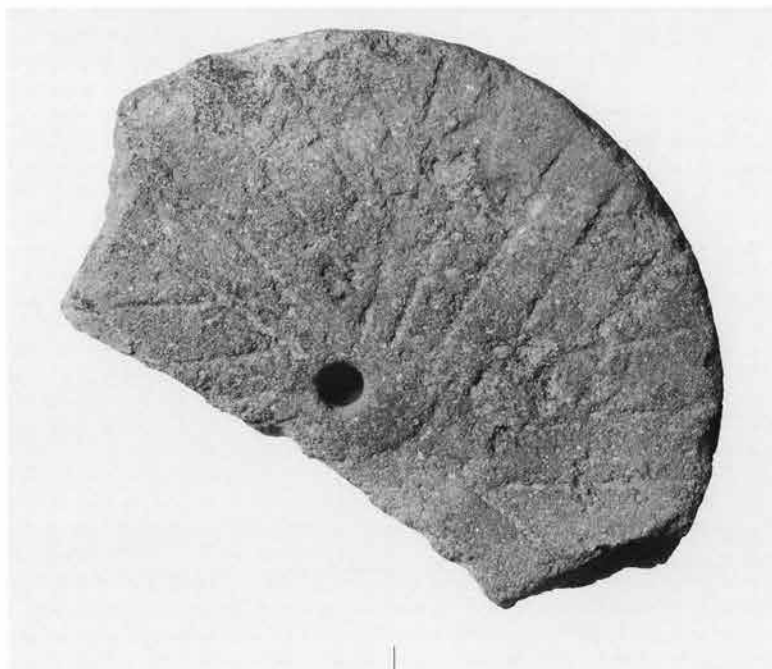

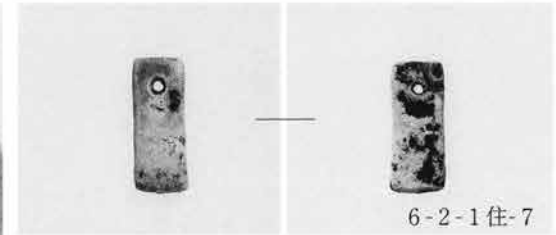
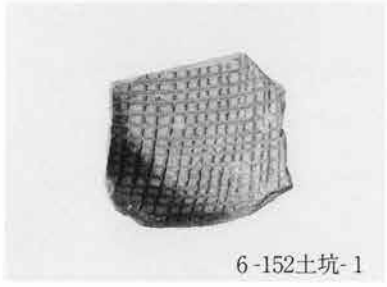

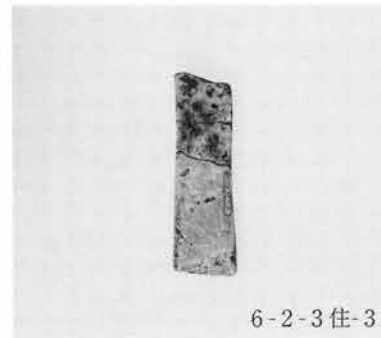
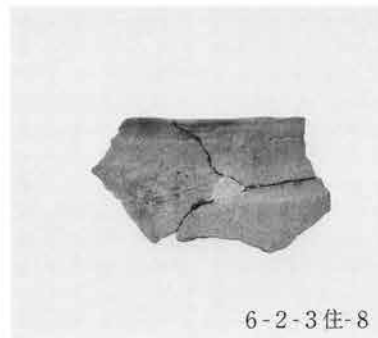
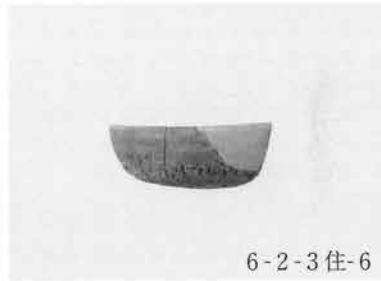
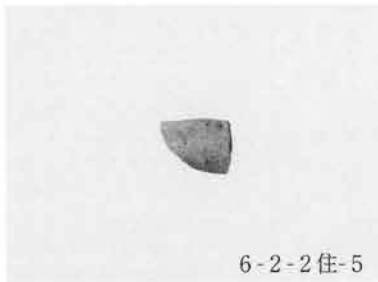
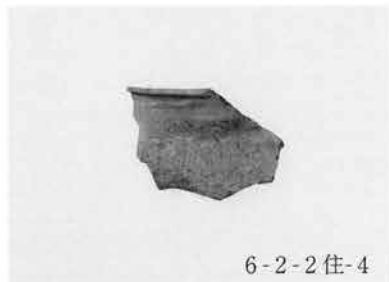
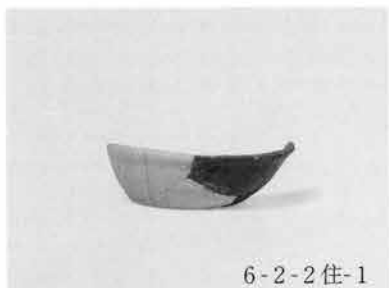

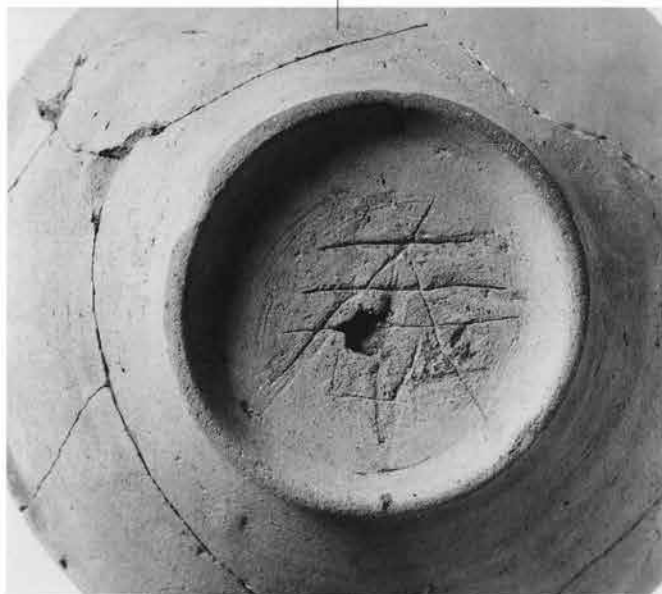
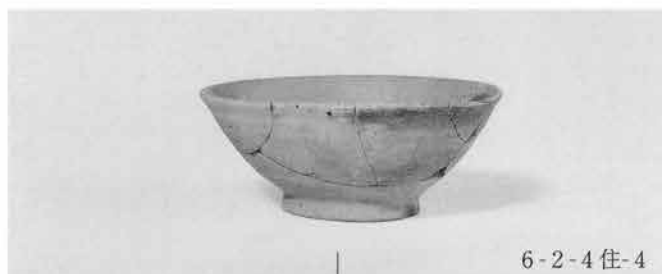

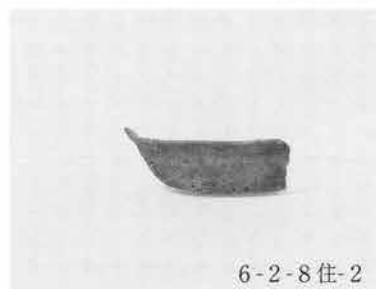
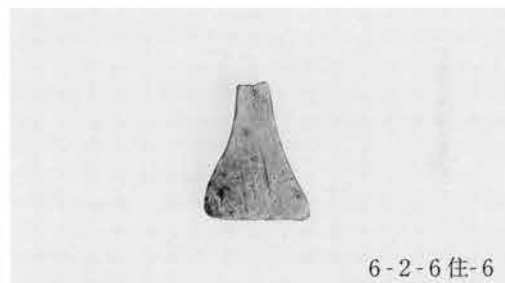
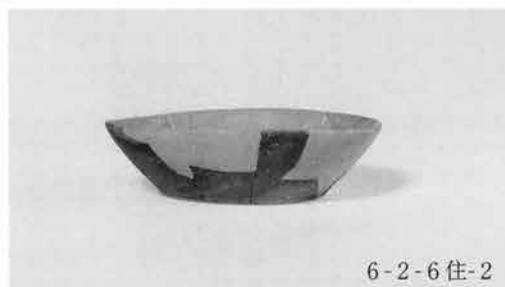



6-2-8住-4



6-2-8住-5



6-2-8住-7



6-2-8住-9



6-2-8住-8



6-2-9住-1



6-2-8住-10



6-2-10住-1



6-2-10住-3



6-2-10住-5



6-2-10住-4

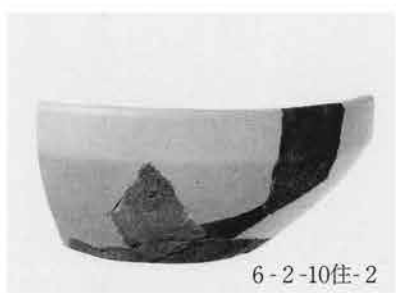

6-2-10住-2



6-2-13住-1



6-2-13住-2



6-2-13住-3



6-2-13住-4



6-2-16住-5



6-2-16住-4



6-2-16住-1



6-2-16住-2

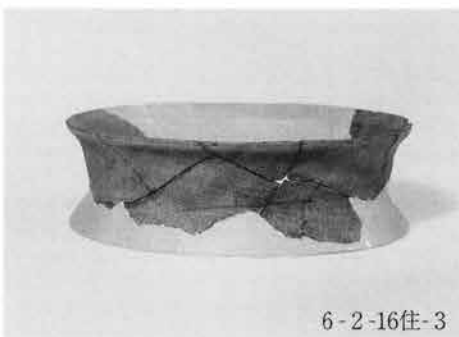

6-2-16住-3



6-2-16住-6



6-2-16住-7



6-2-17住-1



6-2-19住-1



6-2-19住-2



6-2-19住-3

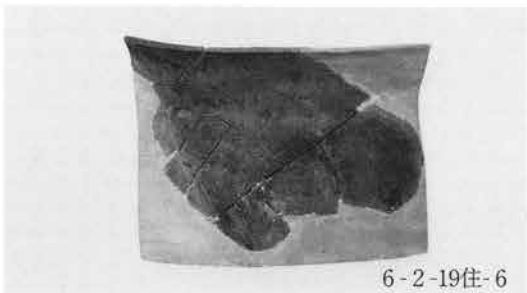

6-2-19住-6

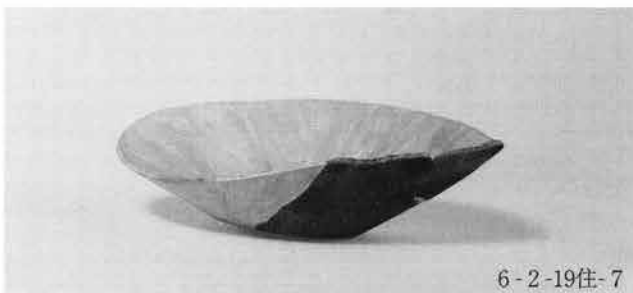

6-2-19住-7





6-2-19住-5



6-2-19住-10



6-2-19住-4



6-2-19住-9



6-2-20住-1

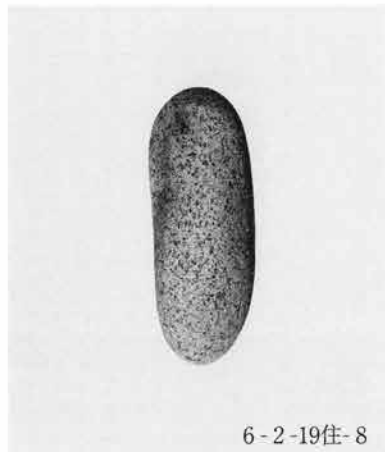

6-2-19住-8



6-2-21住-1



6-2-22住-1



6-2-28住-1



6-2-28住-2



6-2-19住-11



6-2-28住-3

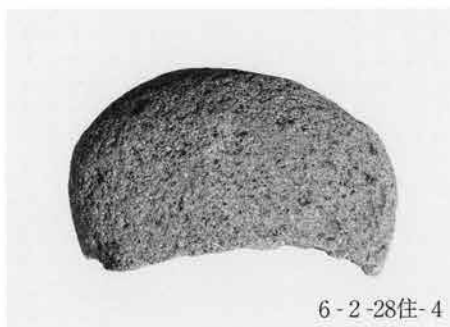

6-2-28住-4

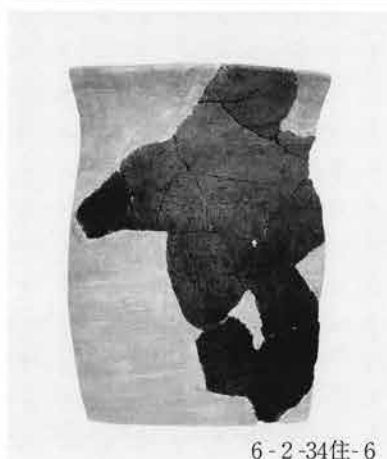
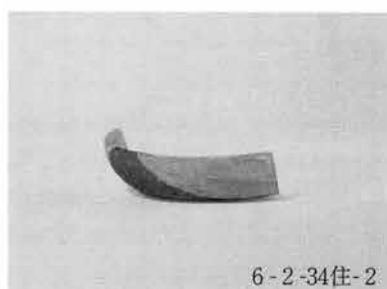
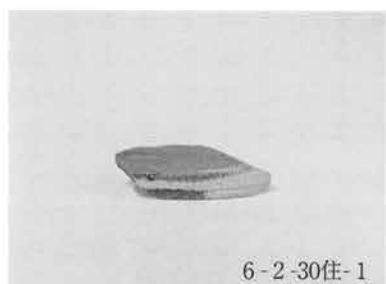

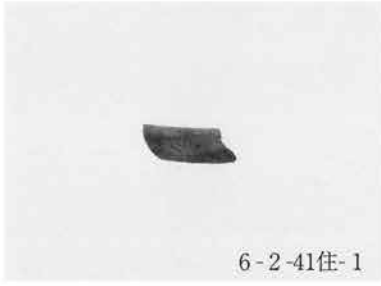
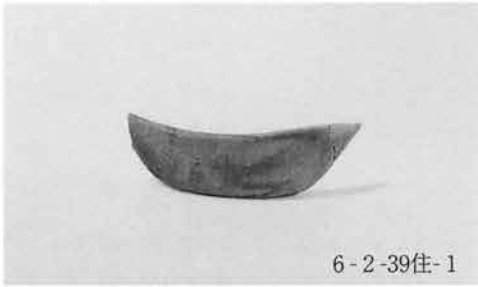
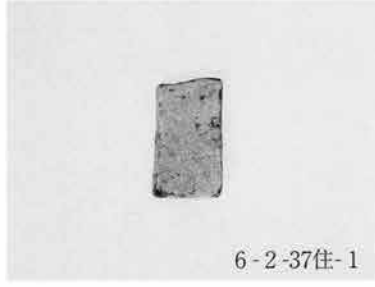



6-2-48住-1



6-2-51住-1



6-2-52住-1



6-2-52住-2



6-2-56住-1



6-2-57住-1



6-2-59住-1



6-2-62住-1



6-2-63住-2



6-2-63住-3



6-2-63住-1



6-2-64住-1



6-2-65住-1



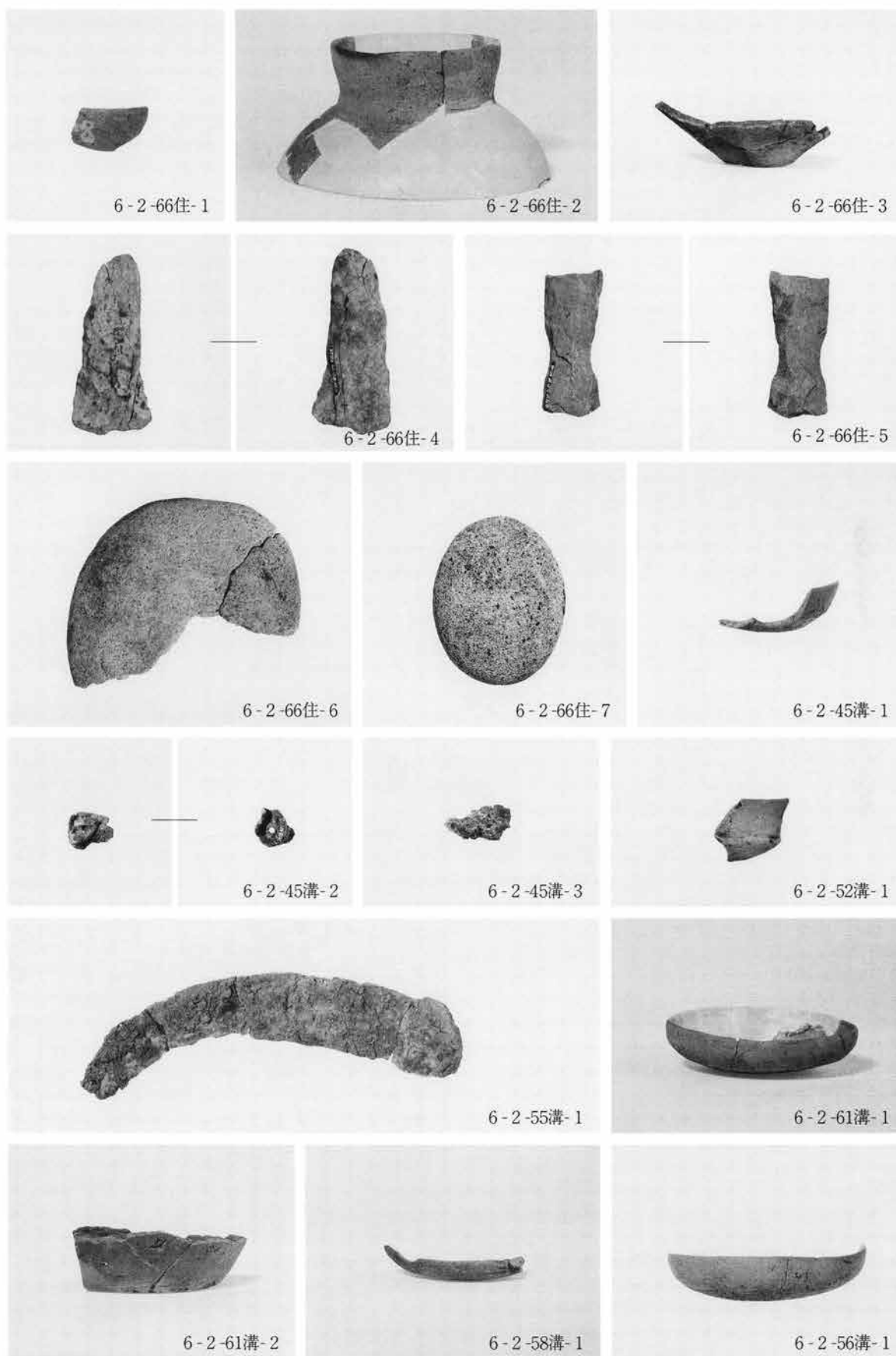

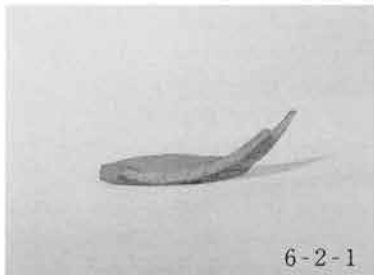
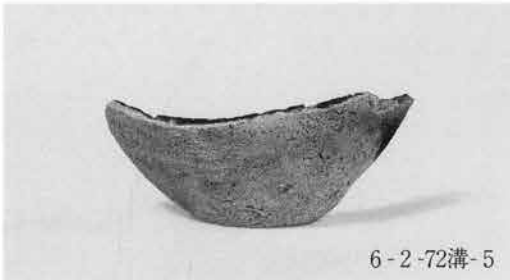
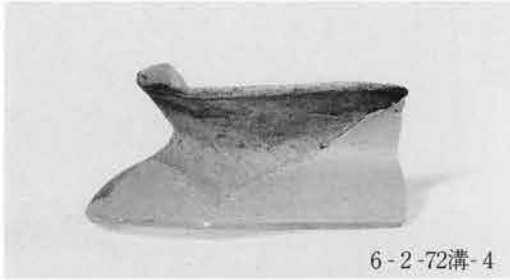



6-1-As-B下-1



6-1-As-B下-2



6-1-As-B下-3



6-グリッド-1



6-グリッド-2



6-グリッド-3



6-グリッド-5



6-グリッド-12



6-グリッド-4



6-グリッド-7



6-グリッド-6



6-グリッド-10



6-グリッド-13



6-グリッド-17



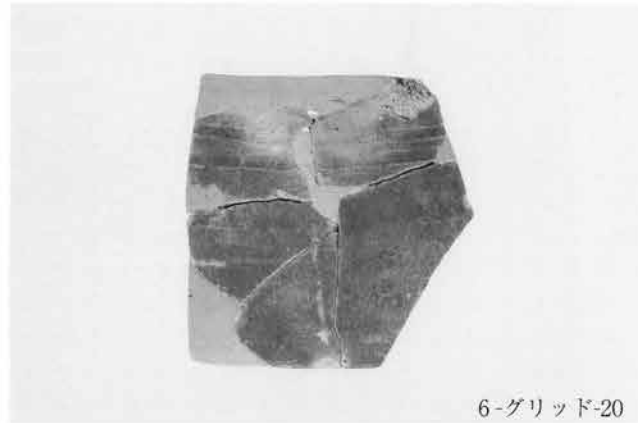
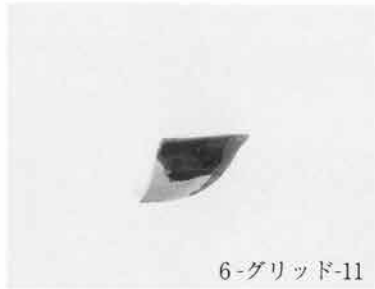

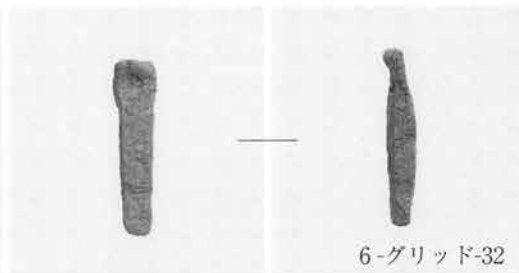
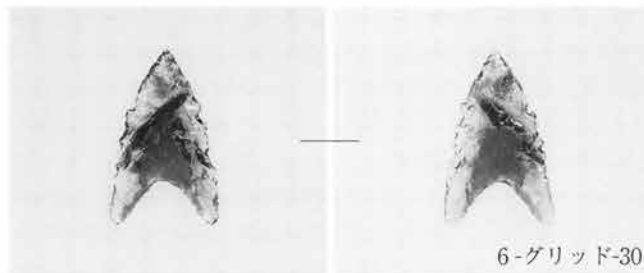
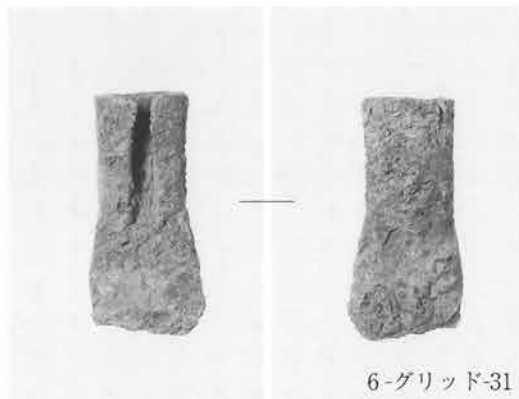
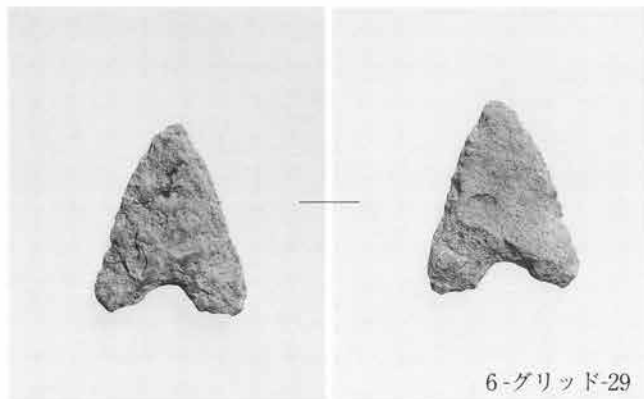
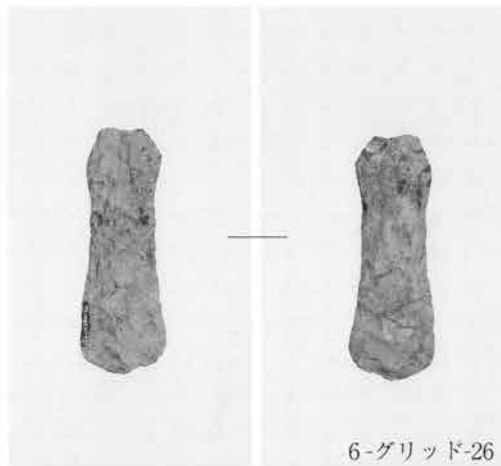
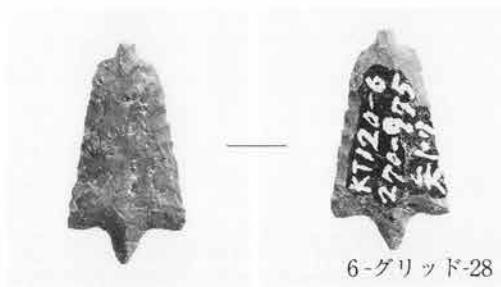



7区1面道群 (南より)



7-1-1号溝全景 (西より)



7-1-2～4号溝全景 (南より)



7-1-2号溝全景 (南東より)



7-1-4号溝全景 (南東より)



7-1-5号溝全景 (南東より)



7-1-8号溝全景 (南より)



7-1-9号溝全景 (南西より)



7-1-13・14・25号溝全景（東より）



7-1-16・17・18号溝全景（南より）



7-1-1号土坑全景（西より）



7-1-2号土坑全景（南東より）



7-1-3号土坑全景（南東より）



7-1-4号土坑全景（東より）



7-1-5号土坑全景（東より）

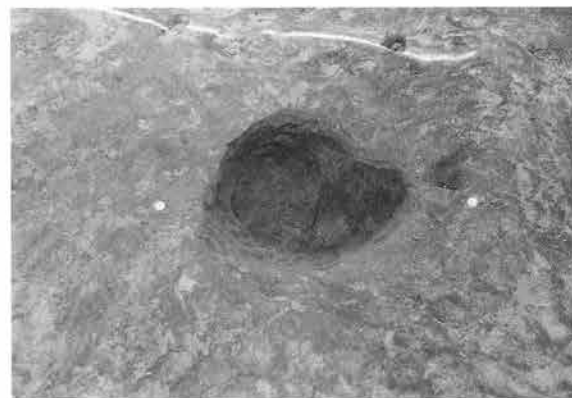

7-1-6号土坑全景（南より）



7-1-7号土坑全景 (南より)



7-1-8・9号土坑全景 (南より)



7-1-10号土坑全景 (南より)



7区1面中世耕作痕 (南より)



7区1面中世耕作痕



7区1面中世耕作痕



7区1面中世水田面 (南西より)



7区1面中世水田面 (南より)

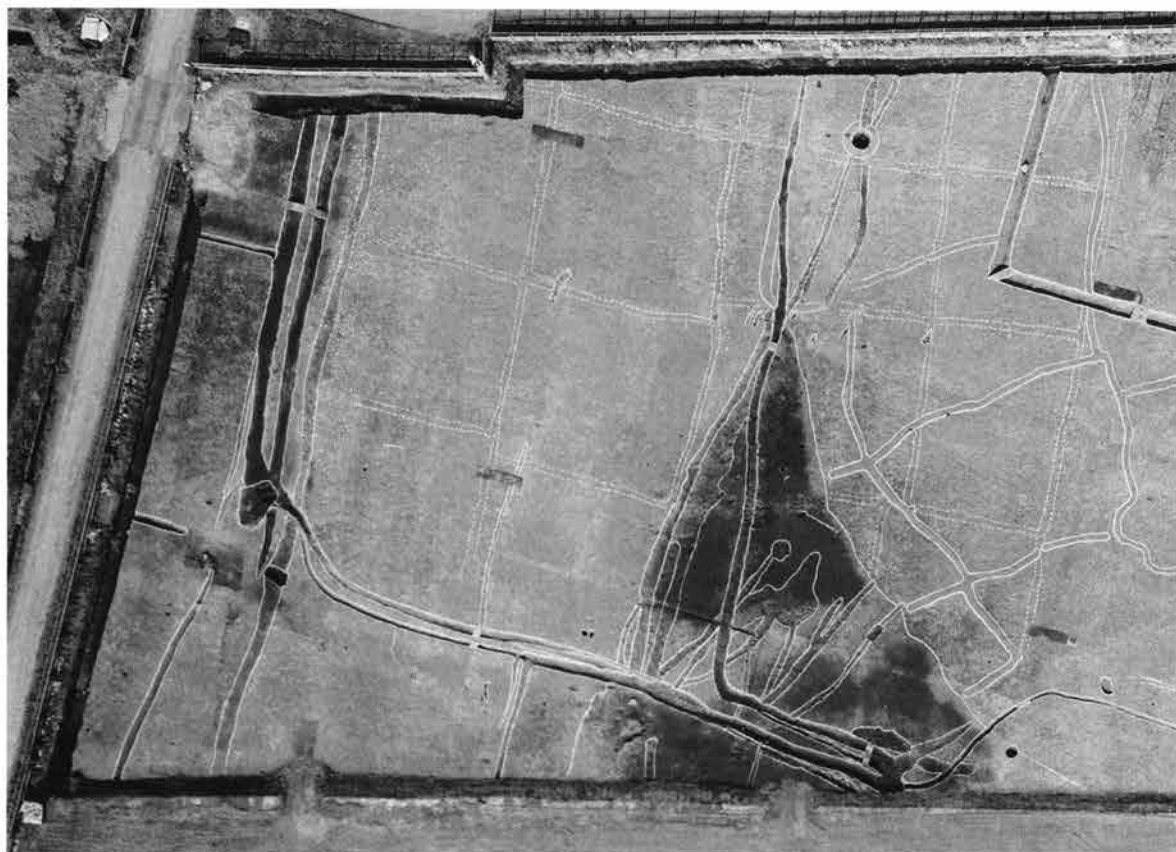

7区1面中世水田

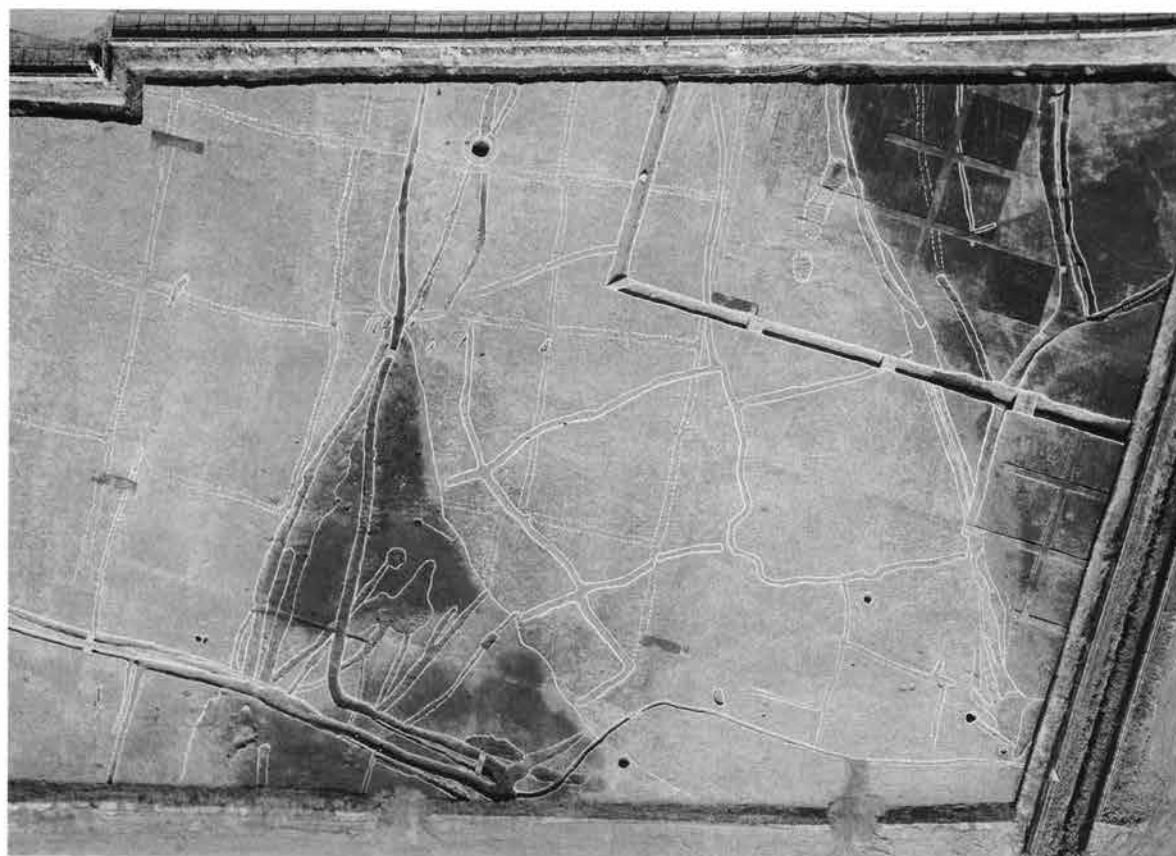

7区1面As-B下水田

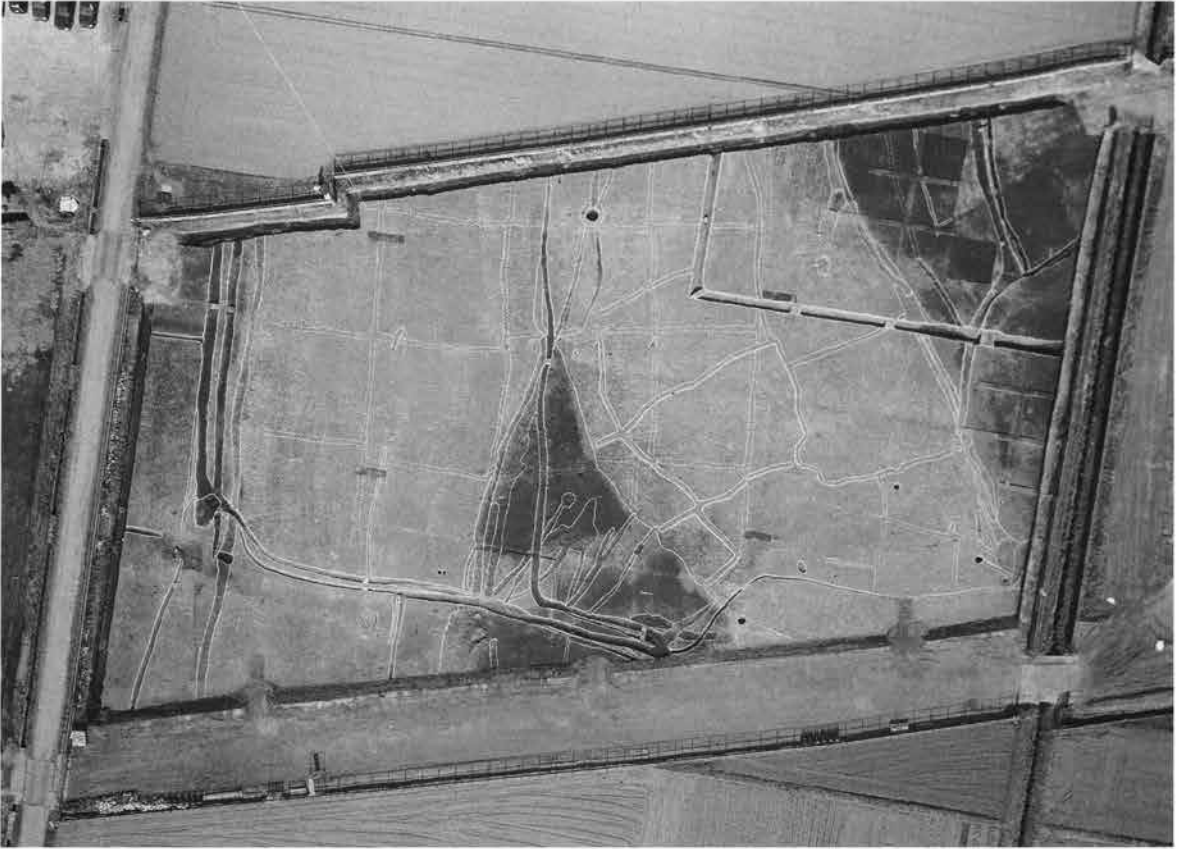

7区2面全景



7区2面全景（東より）

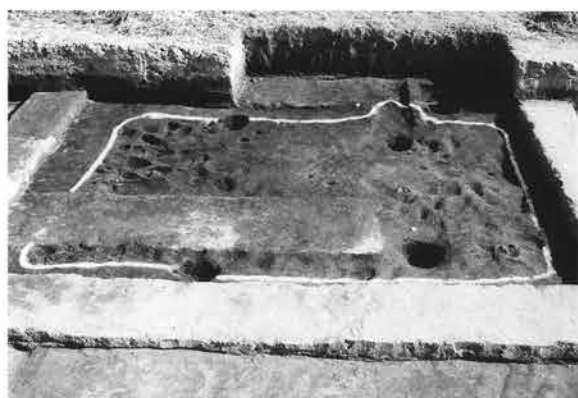

7-2-1号住居全景（西より）



7-2-1号住居竈全景（西より）



7-2-2号住居全景（西より）



7-2-2号住居竈全景（西より）



7-2-5号住居全景（西より）



7-2-5号住居竈全景（西より）



7-2-12号住居竈掘り方全景（西より）



7-2-5号住居竈掘り方全景（西より）





7-2-13号住居（北より）



7-2-14号住居焼土（竈？）検出状況（西より）



7-2-26~30号溝全景

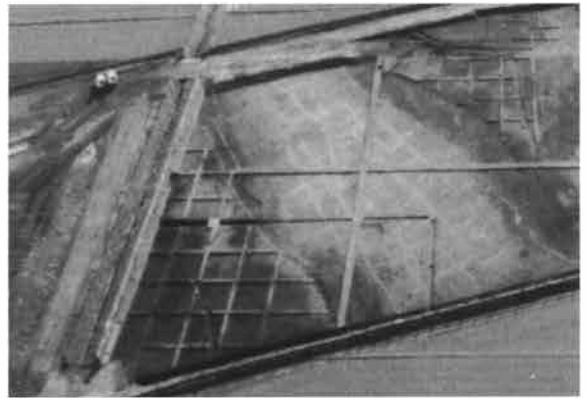

7-2-32号溝全景



7区2面Hr-FA・FPT下水田全景



7区2面Hr-FA・FP泥流下水田及びHr-FA下水田（北より）

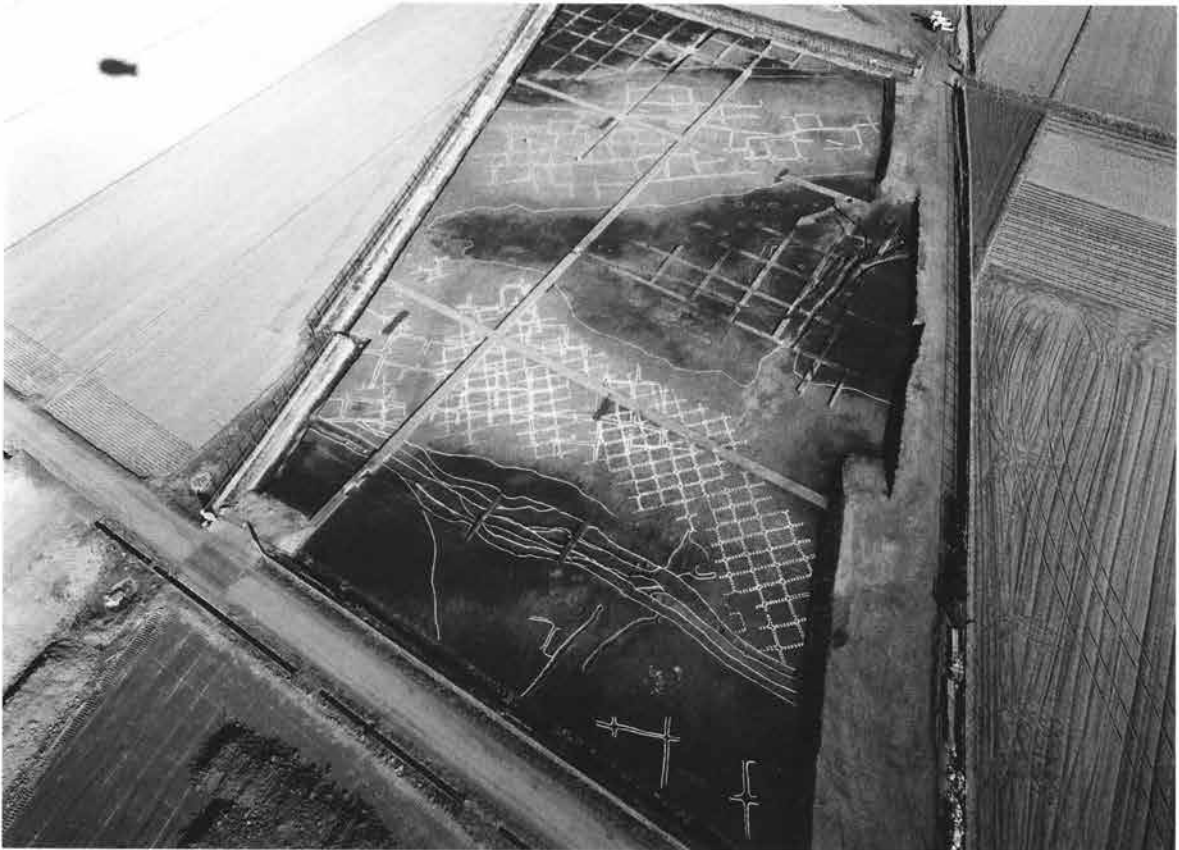

7区2面Hr-FA・FP泥流下水田及びHr-FA下水田（西より）



7区2面Hr-FA下水田



7-3号住居全景（南東より）



7-3-3号住居周溝遺物出土状況（南東より）



7-3-3号住居周溝遺物出土状況（北東より）



7-3-3号住居周溝土層断面（南西より）



7-3-4号住居全景（西より）



7-3-6号住居全景（北西より）



7-3-6号住居遺物出土状況（北西より）



7-3-6・11号住居附近遺物出土状況（北西より）



7-3-7号住居全景（南東より）



7-3-7号住居周溝遺物出土状況（南東より）



7-3-7号住居周溝遺物出土状況（西より）



7-3-7号住居周溝遺物出土状況（南東より）



7-3-8号住居全景（西より）



7-3-9号住居全景（西より）



7-3-10号住居全景（南東より）



7-3-11号住居全景（南東より）

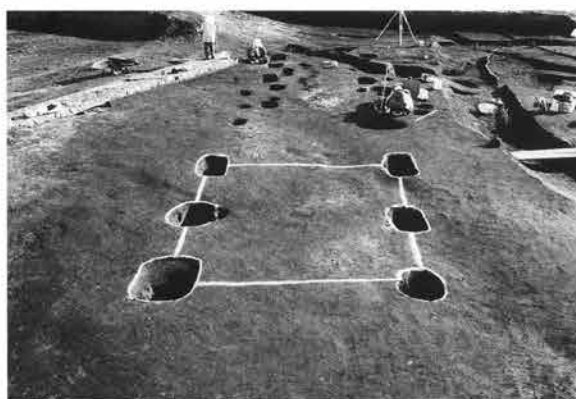

7-3-1号掘立柱建物全景（北西より）



7-3-2号掘立柱建物全景（北西より）



7-3-5号掘立柱建物全景（南東より）



7-3-6号掘立柱建物全景（南より）



7-3-7号掘立柱建物全景（南より）

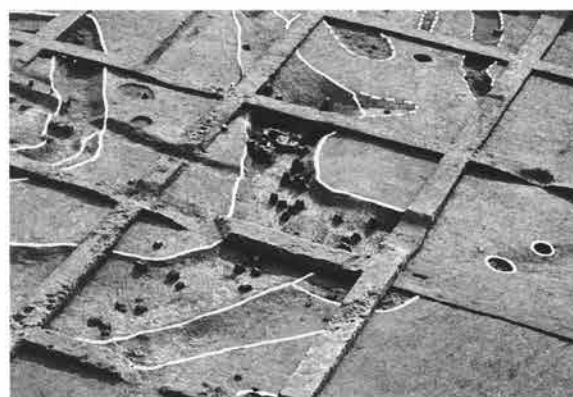

7-3-35号溝全景（北西より）



7-3-3号掘立柱建物全景（北西より）



7-3-1号竪穴住居全景（東より）

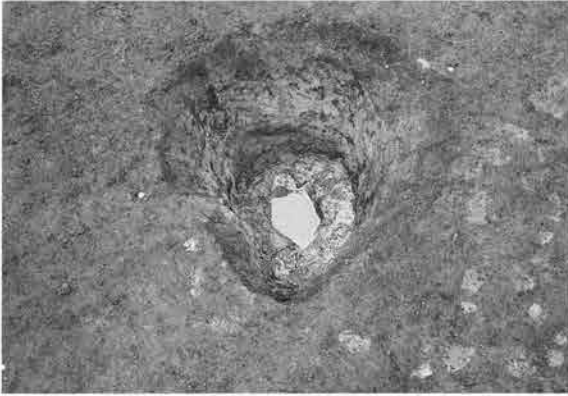

7-3-14号土坑全景（南西より）



7-3-12号土坑全景（北より）



7-3-23号土坑全景（東より）



7-3-24号土坑全景（南より）



7-3-25b号土坑全景（南東より）



7-3-2号井戸覆土断面全景（南より）



7-3-1号井戸全景（西より）



7-3-3号井戸全景（南東より）



7-1-2溝-1



7-1-2溝-3

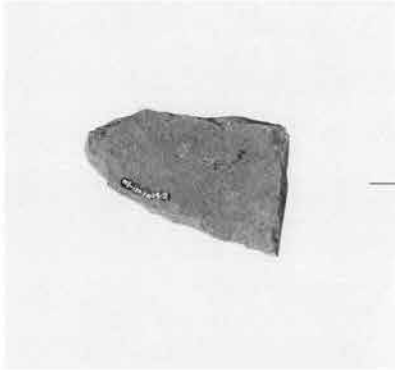

7-1-2溝-2



7-1-8溝-1



7-1-8溝-2



7-1-2溝-4

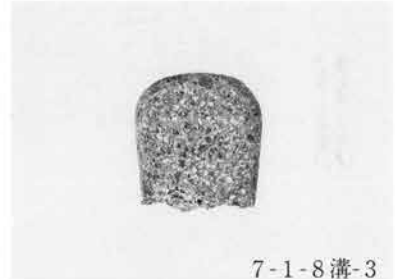

7-1-8溝-3



7-1-12溝-1



7-1-25溝-1

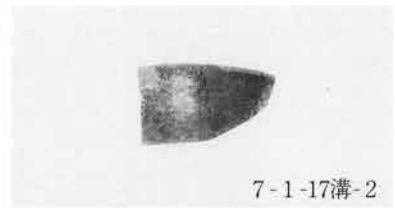

7-1-17溝-2



7-1-17溝-1



7-1-23溝-1



7-1-3土坑-1





7-1-表土-3



7-1-表土-4

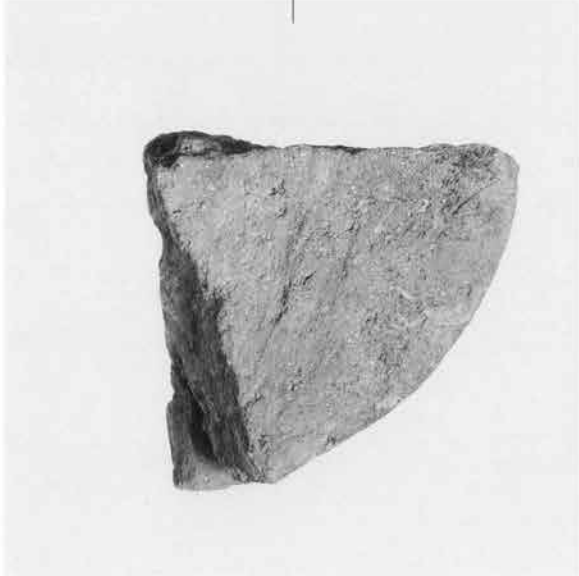

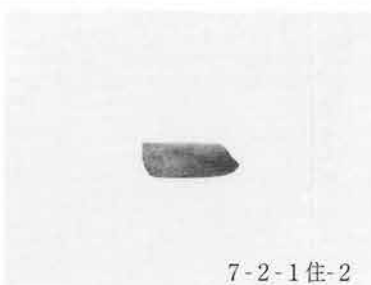
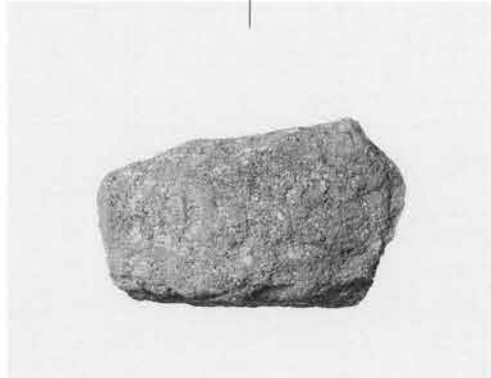
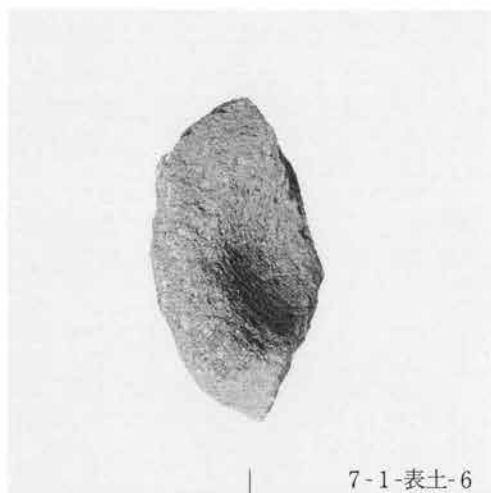
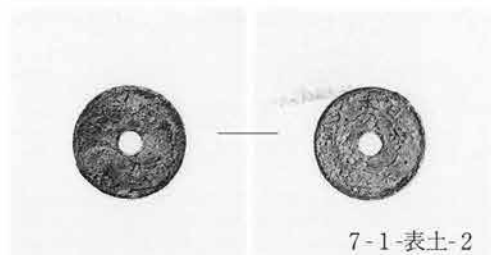

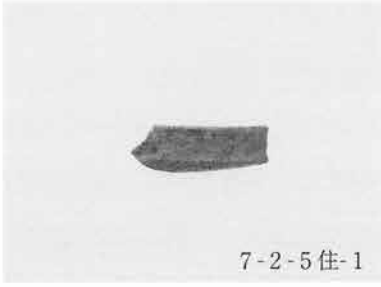



7-2-5住-12



7-2-5住-11



7-2-29溝-1



7-2-26溝-1



7-2-26溝-2

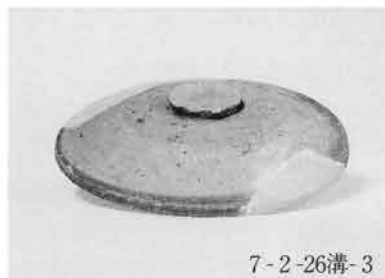

7-2-26溝-3



7-2-26溝-4



7-2-26溝-5



7-2-26溝-6



7-2-26溝-7



7-2-27溝-1



7-2-27溝-2



7-2-27溝-3



7-2-34溝-1



7-2-FA上-1



7-3-3住-1



7-3-3住-2



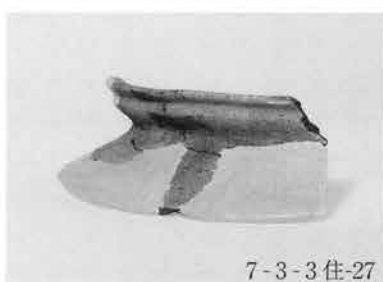
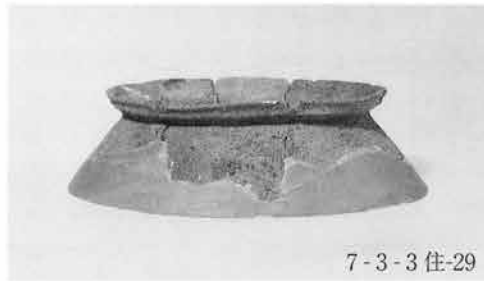
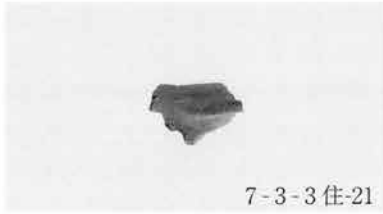

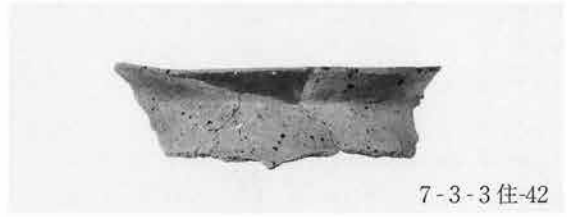
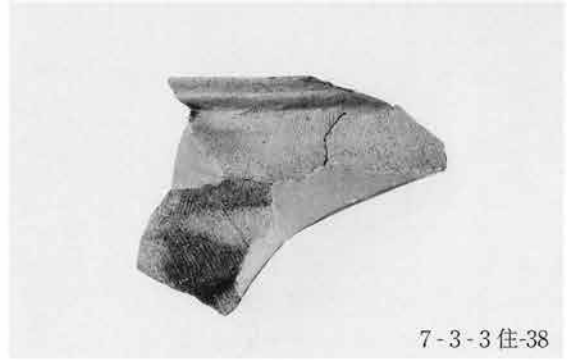







7-3-3住-62



7-3-3住-63



7-3-3住-69



7-3-3住-70



7-3-3住-73



7-3-3住-71



7-3-3住-67

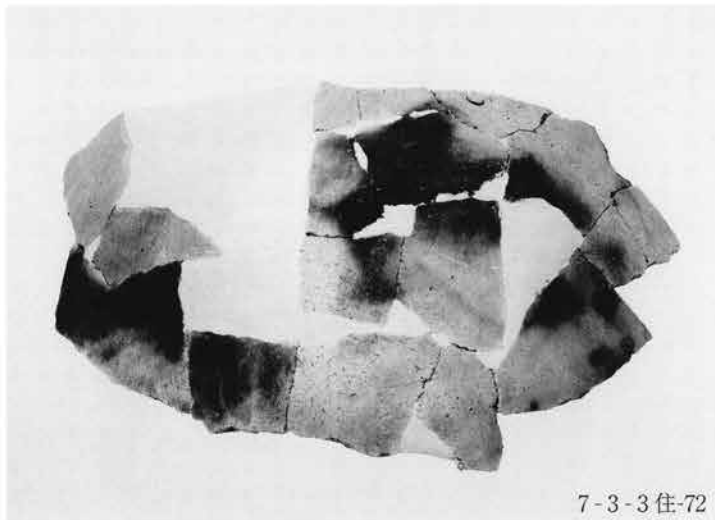

7-3-3住-72



7-3-3住-68



7-3-3住-74



7-3-3住-75



7-3-3住-78



7-3-3住-77



7-3-3住-76



7-3-3住-79



7-3-3住-82



7-3-3住-80



7-3-3住-81



7-3-3住-85



7-3-3住-83



7-3-3住-84



7-3-3住-91



7-3-3住-87



7-3-3住-89



7-3-3住-95



7-3-3住-86



7-3-3住-88



7-3-3住-90



7-3-3住-93



7-3-3住-94



7-3-3住-96



7-3-3住-92



7-3-3住-97



7-3-3住-98



7-3-4住-1

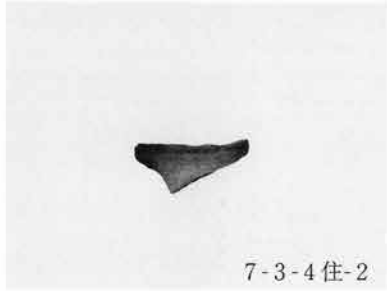

7-3-4住-2



7-3-4住-3



7-3-6住-1



7-3-6住-2



7-3-6住-3



7-3-6住-4



7-3-6住-5



7-3-6住-6

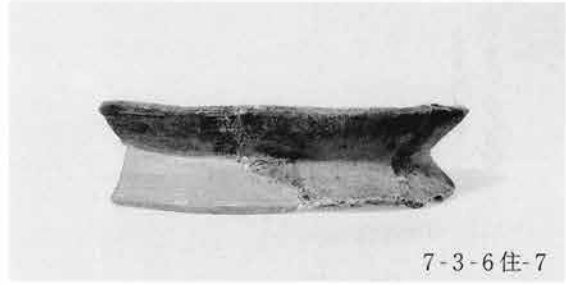

7-3-6住-7



7-3-6住-8



7-3-6住-11



7-3-6住-10



7-3-6住-9



7-3-6住-12

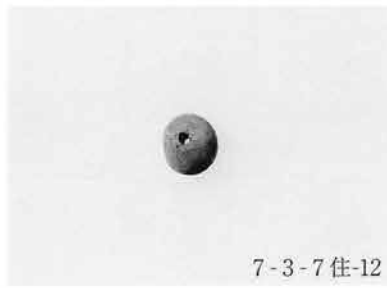





7-3-8住-2



7-3-8住-3



7-3-9住-1



7-3-9住-2



7-3-9住-3



7-3-11住-1



7-3-2掘立-1



7-3-3掘立-1



7-3-35溝-2



7-3-35溝-1



7-3-36溝-2



7-3-36溝-1



7-3-12土坑-1



7-3-13土坑-1



7-3-14土坑-1



7-3-14土坑-2



7-3-14土坑-3





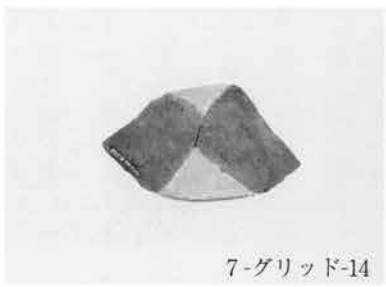



7-グリッド-17



7-グリッド-19



7-グリッド-18



7-グリッド-21



7-グリッド-22



7-グリッド-20



7-グリッド-23



7-グリッド-24



7-グリッド-25



7-グリッド-26



7-グリッド-27

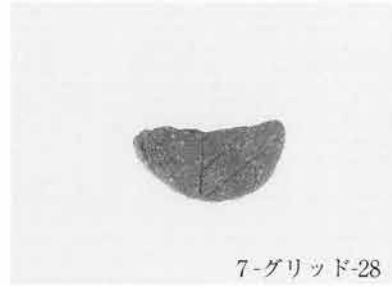

7-グリッド-28



7-グリッド-29



7-グリッド-30



7-グリッド-31



7-グリッド-32

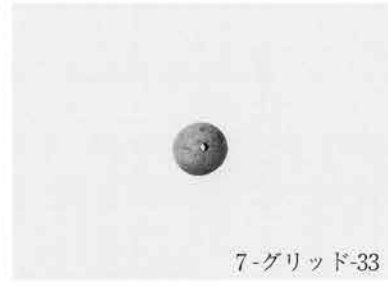

7-グリッド-33

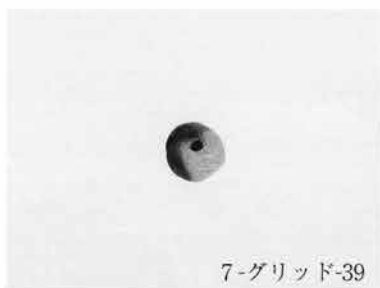

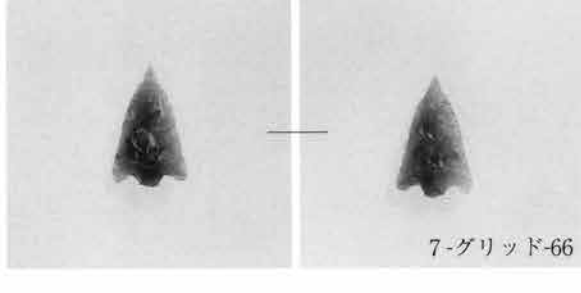
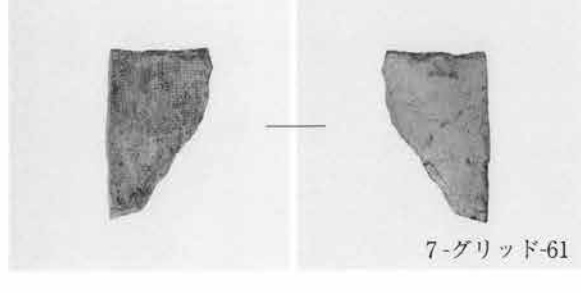
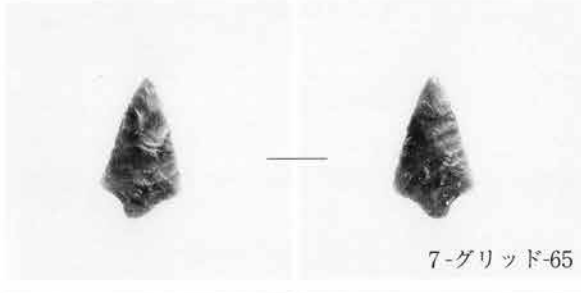
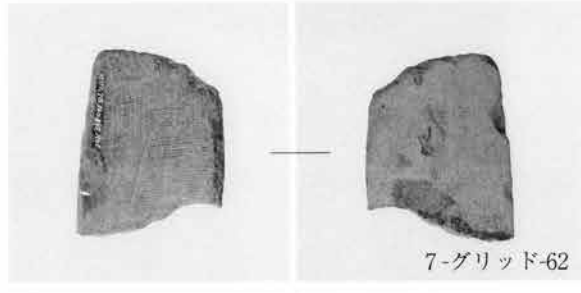
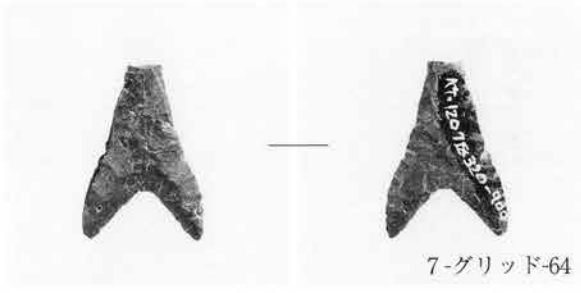
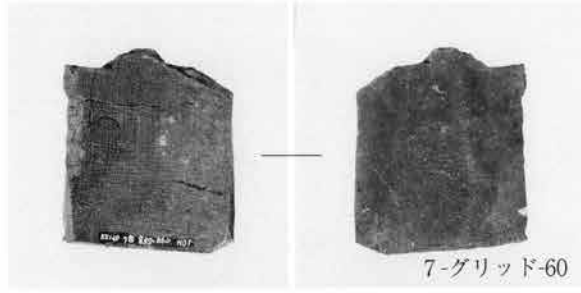
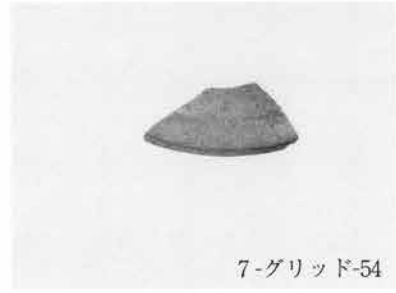





7-グリッド-88



7-グリッド-91

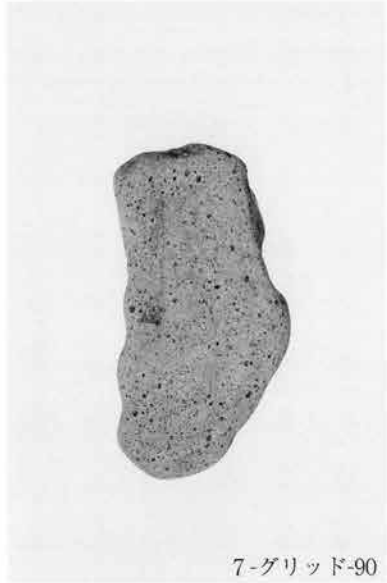

7-グリッド-90



7-グリッド-93



7-グリッド-92



7-グリッド-94



7-グリッド-95



7-グリッド-96



7-グリッド-97



7-グリッド-98



7-グリッド-99



7-グリッド-100



7-グリッド-101



7-グリッド-102



7-グリッド-103

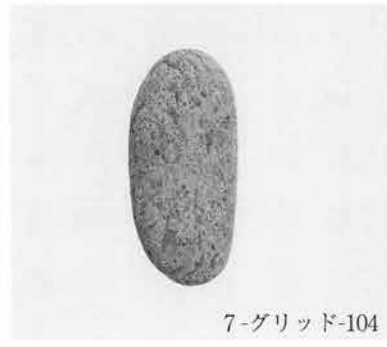

7-グリッド-104



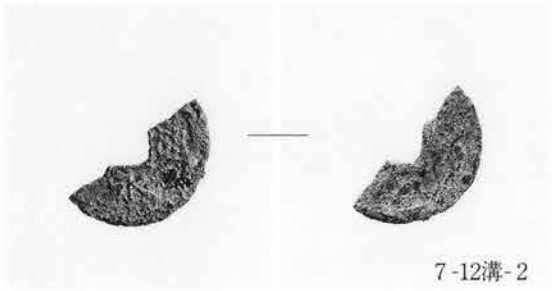

7-12溝-2



7-グリッド-112



7-グリッド-113



7-グリッド-114



7-グリッド-115



7-グリッド-116



7-グリッド-117



7-グリッド-118



7-B下水田-1



7-グリッド-119



PL112 植物珪酸体の顕微鏡写真

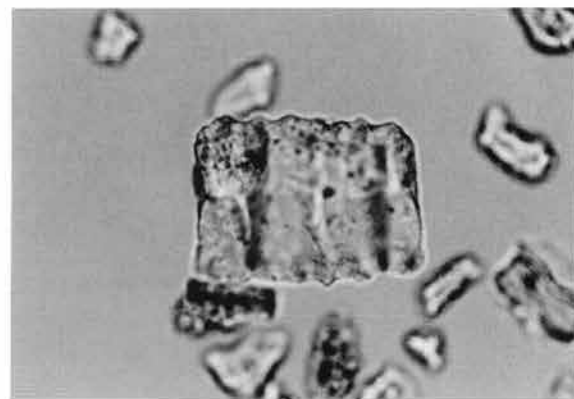
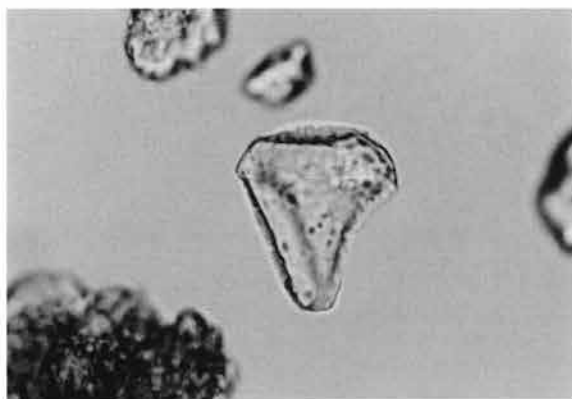
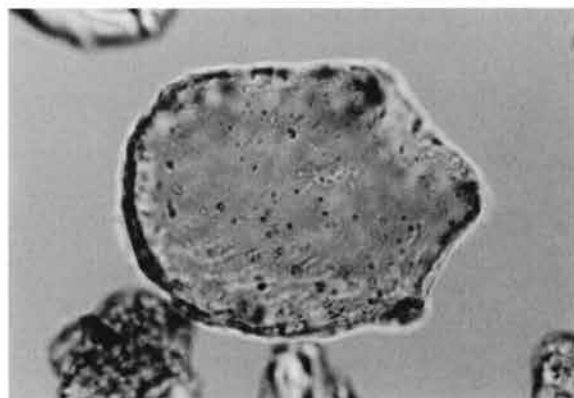
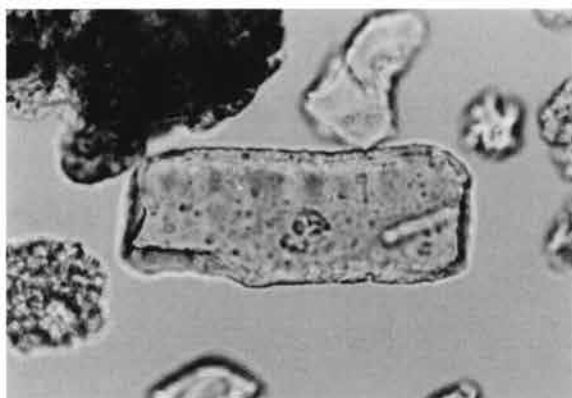
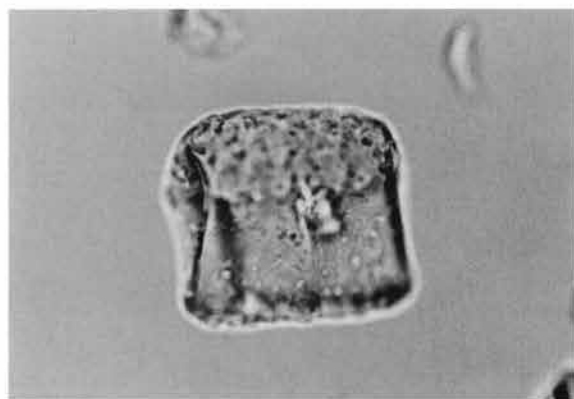
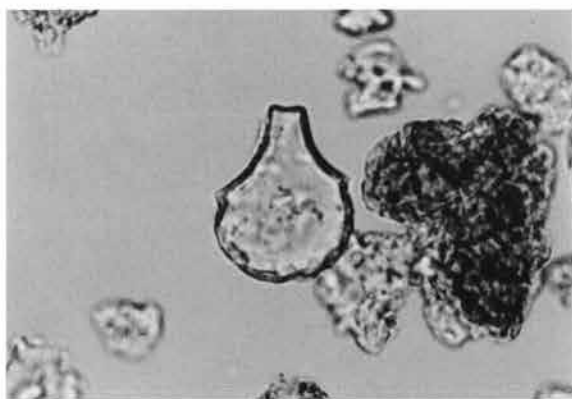

0 50 100  $\mu$ m

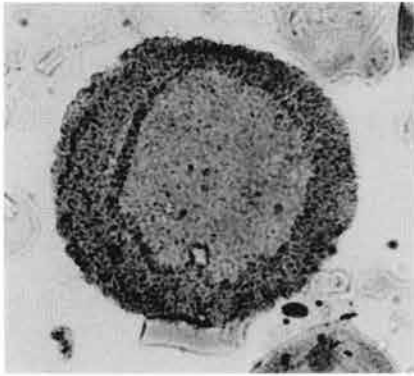

1 ツガ属

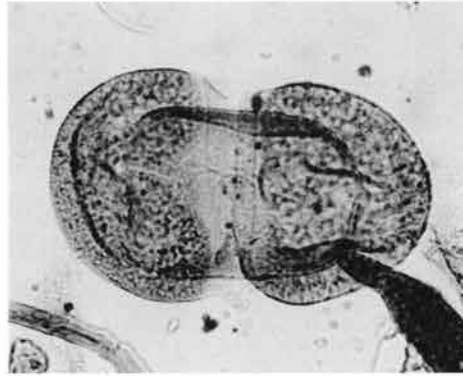

2 トウヒ属

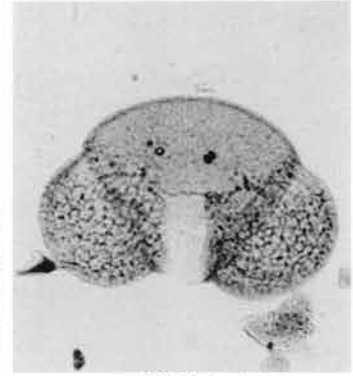

3 マツ属単維管束亜属

— 10 $\mu$ m

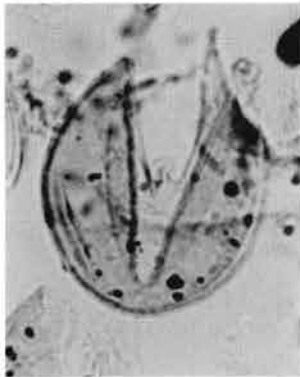

4 スギ

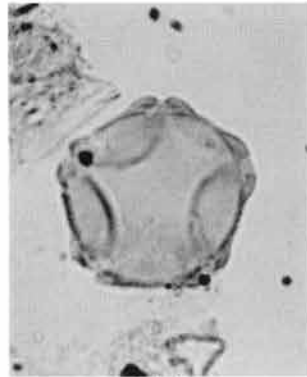

5 ハンノキ属



6 カバノキ属

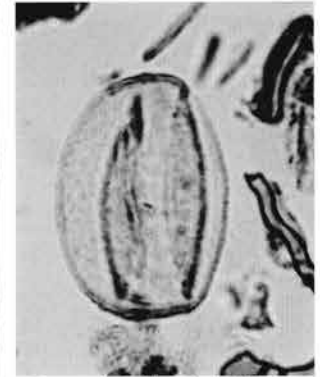

7 コナラ属コナラ亜属



8 ニレ属—ケヤキ



9 シナノキ属



10 イネ科



11 カヤツリグサ科

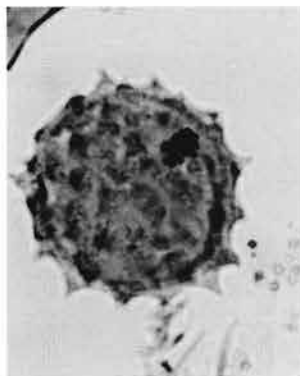

12 キク亜科



13 ヨモギ属

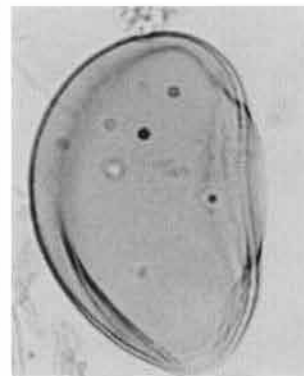

14 シダ植物単条溝孢子

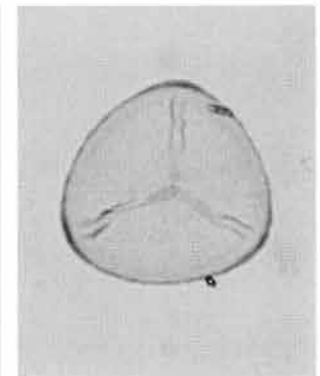

15 シダ植物三条溝孢子

— 10 $\mu$ m

PL114 中内村前遺跡出土木材の顕微鏡写真



横断面 ————— : 0.5mm  
1. 材2 トウヒ属

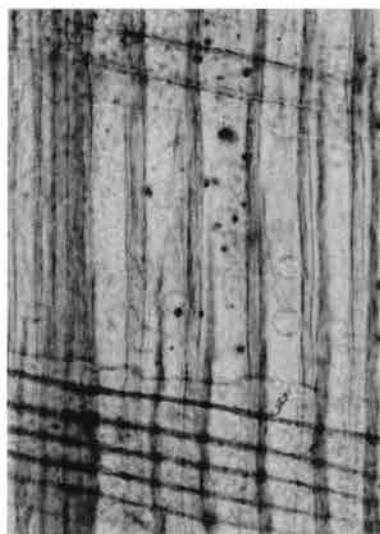

放射断面 ————— : 0.1mm

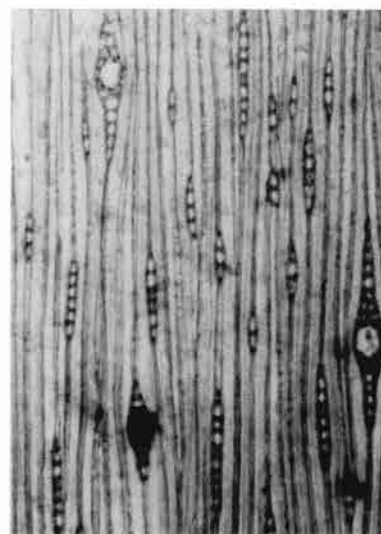

接線断面 ————— : 0.2mm

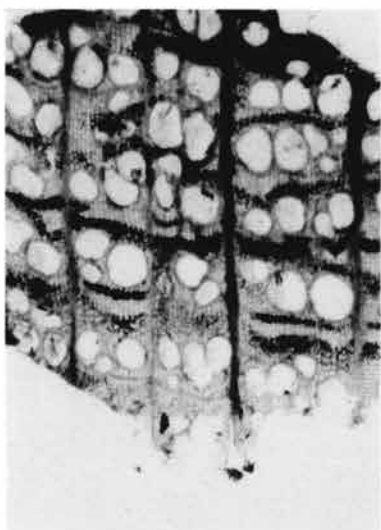

横断面 ————— : 0.5mm  
2. 材1 フジ



放射断面 ————— : 0.2mm



接線断面 ————— : 0.5mm



## 発掘調査報告書抄録

ふりがな	なかうちむらまえいせき (に) —ごからななく—						
書名	中内村前遺跡 (2) —5～7区—						
副書名	北関東自動車道 (高崎—伊勢崎) 地域埋蔵文化財発掘調査報告書						
巻次	第21集						
シリーズ名	財団法人 群馬県埋蔵文化財調査事業団						
シリーズ番号	第322集						
編集者名	石守 晃						
編集機関	財団法人 群馬県埋蔵文化財調査事業団						
所在地	〒377-8555 群馬県勢多郡北橋村大字下箱田784-2 TEL 0279-52-2511						
発行年月日	2003年10月28日						
ふりがな	ふりがな	コード		北緯	調査期間	調査面積	調査原因
所収遺跡名	所在地	市町村	遺跡番号	東経		m <sup>2</sup>	
なかうちむらまえいせき 中内村前遺跡 5～7区	ぐんまけんまえはしし 群馬県前橋市 なかうちまち 中内町	10201	10005 — 00466	36°20'00"  139°07'44"	1997.04.01  }	17,680  5～7区	北関東自動車建設 工事に伴う事前調査
所収遺跡名	種別	主な時代		主な遺構	主な遺物	特記事項	
なかうちむらまえ 中内村前 いせき 遺跡 5～7区	包蔵地	古墳時代	前期	竪穴住居、井戸、 As-C復旧水田	土師器	周溝をもつ建物、 東海・北陸系土器	
			後期	Hr-FA下水田、 Hr-FA・FP泥流下水田		小区画水田、 極小区画水田	
		平安時代		竪穴住居、溝、道路、 掘立柱建物、井戸、 As-B下水田、土坑	土師器、須恵器 灰釉陶器	南武蔵系の須恵器 小型双耳壺	
		中世		屋敷、溝、道路、 土坑、水田	軟質陶器、陶器、 かわらけ、板碑 台座、模鑄銭	15世紀後半頃の屋敷遺 構2箇所	
		近世		溝、土坑	陶磁器		

(財)群馬県埋蔵文化財調査事業団  
発掘調査報告書第322集

## 中内村前遺跡(2) 北関東自動車道(高崎～伊勢崎)地域 埋蔵文化財発掘調査報告書第21集

---

平成15年10月22日 印刷

平成15年10月28日 発行

編集・発行／財団法人 群馬県埋蔵文化財調査事業団

〒377-8555 群馬県勢多郡北橋村大字下箱田784番地の2

電話(0279)52-2511 (代表)

ホームページアドレス <http://www.gunmaibun.org/>

印刷／上毛新聞社出版局

---