

0 1 : 4 10cm

0 1 : 2 5 cm

0 1 : 3 10cm

18号住居

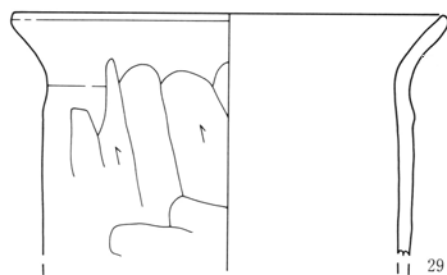
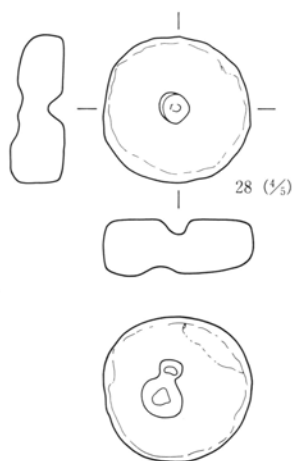

18号住居

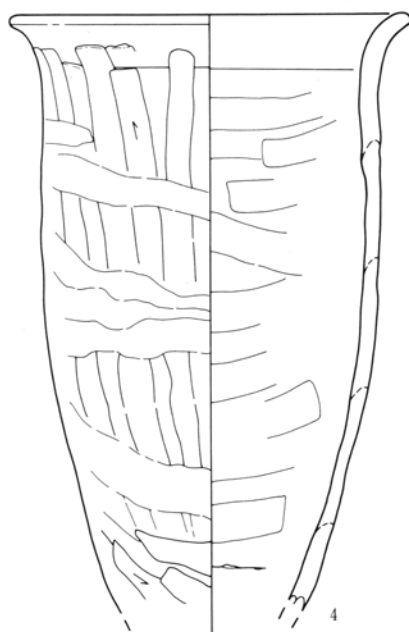
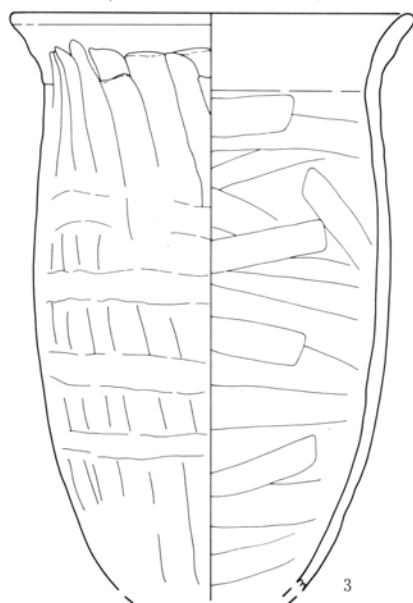
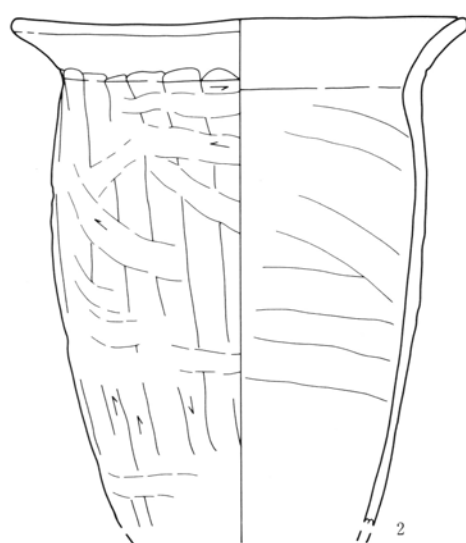
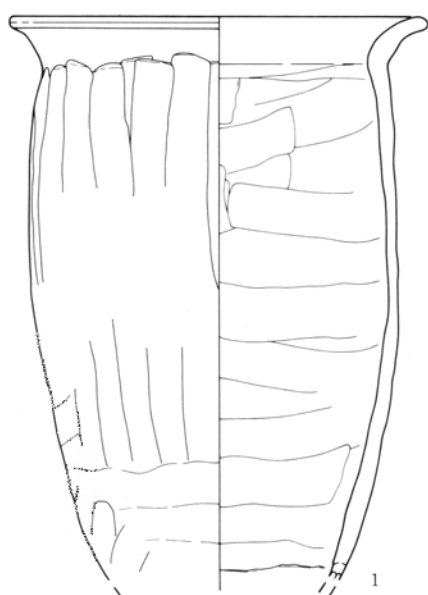

19号住居

0 1 : 4 10cm

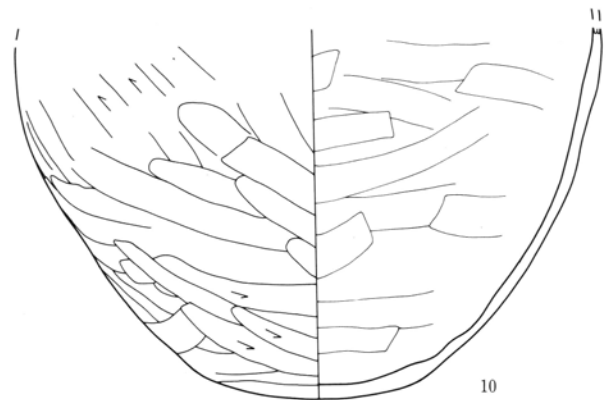
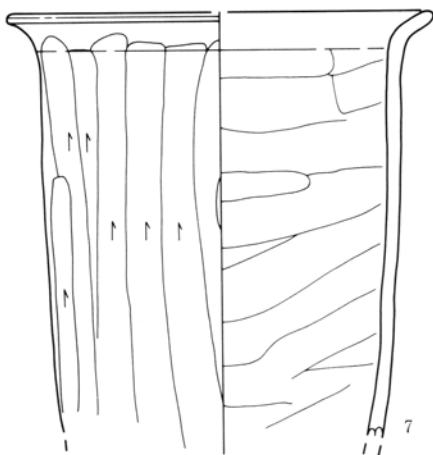
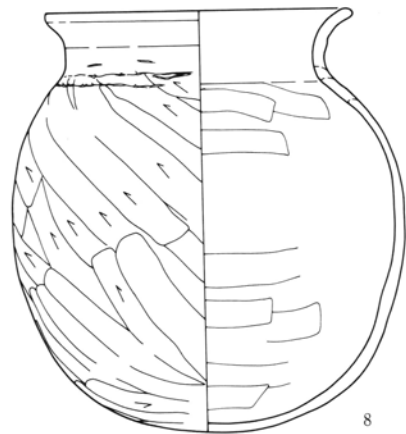
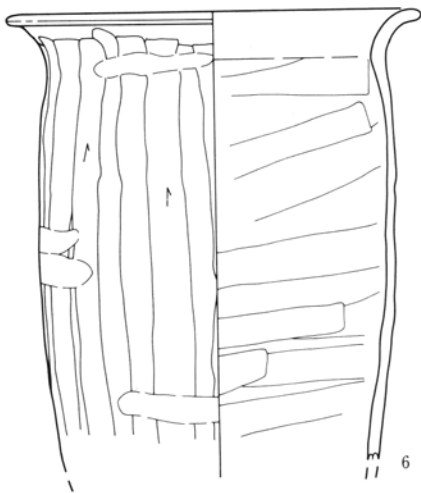
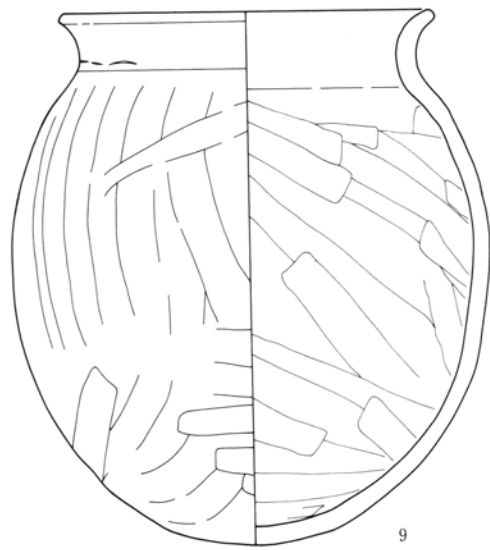
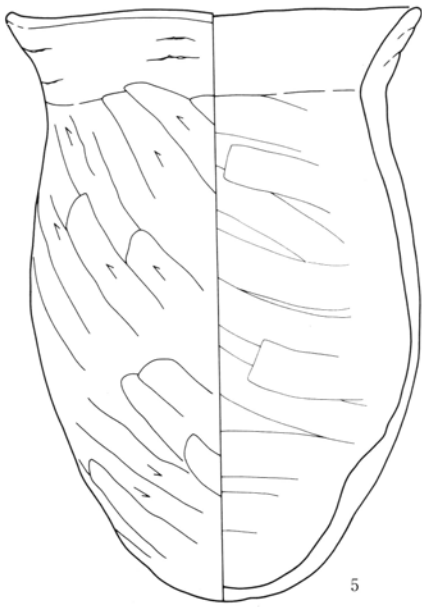

19号住居

0 1 : 4 10cm

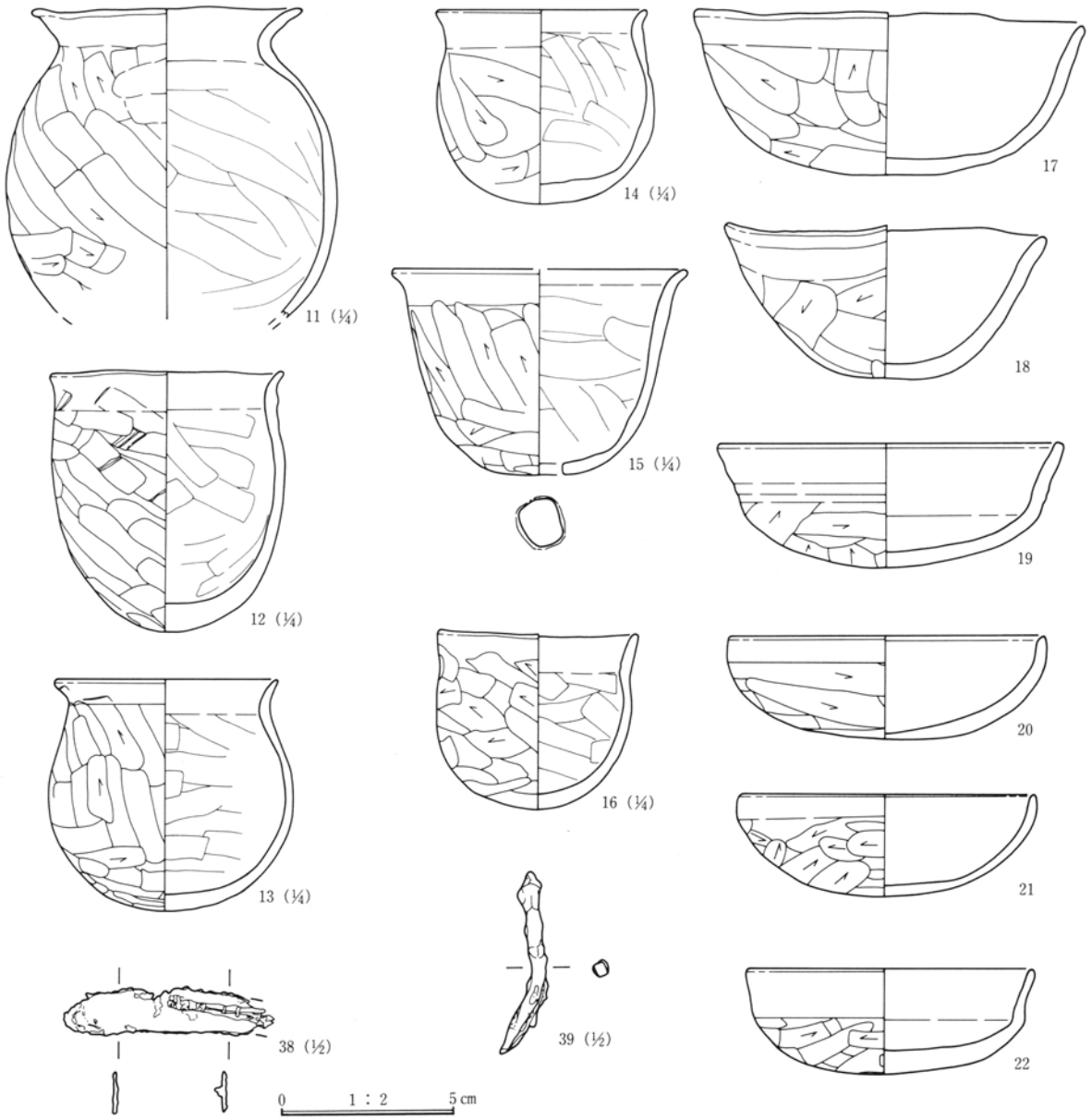

19号住居

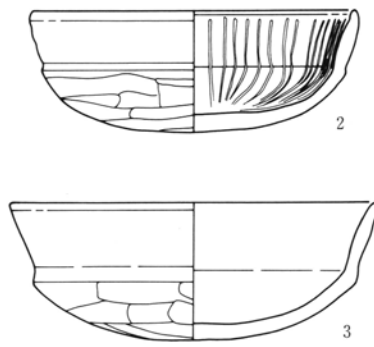
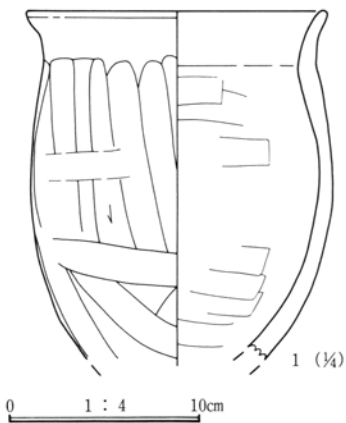

21号住居

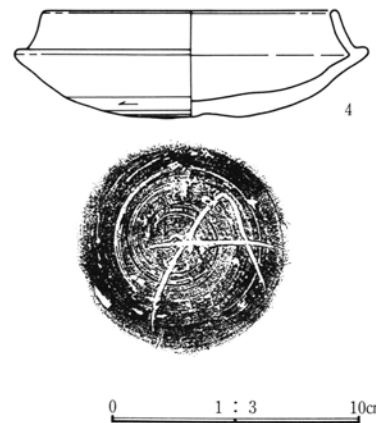

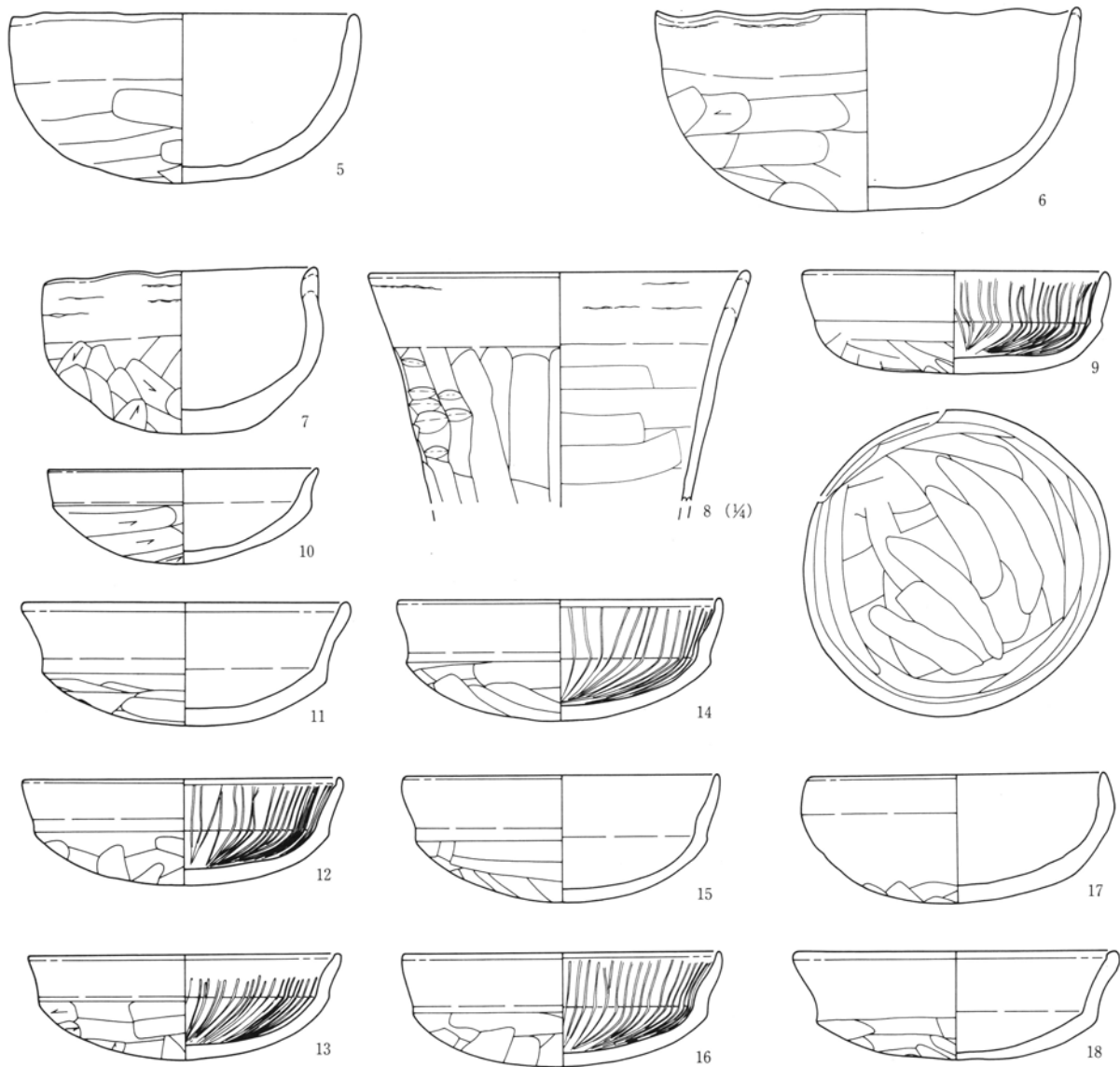

21号住居

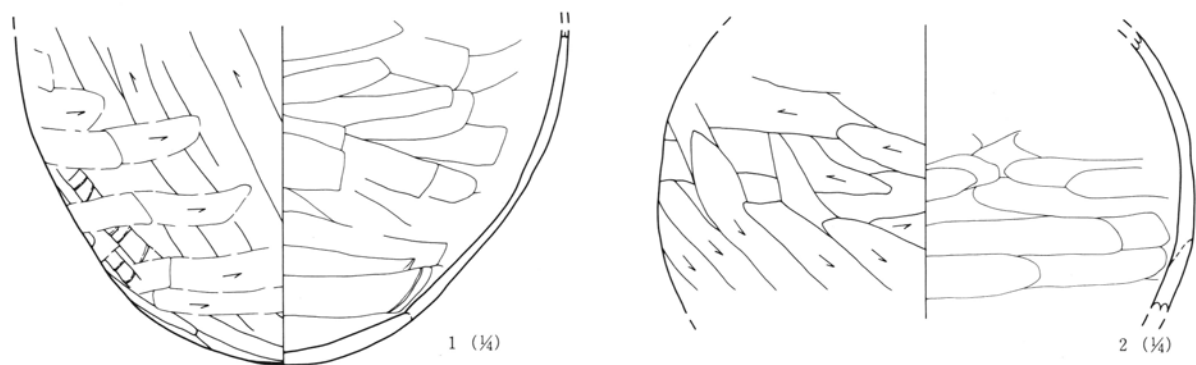

25号住居

0 1 : 4 10cm

0 1 : 3 10cm

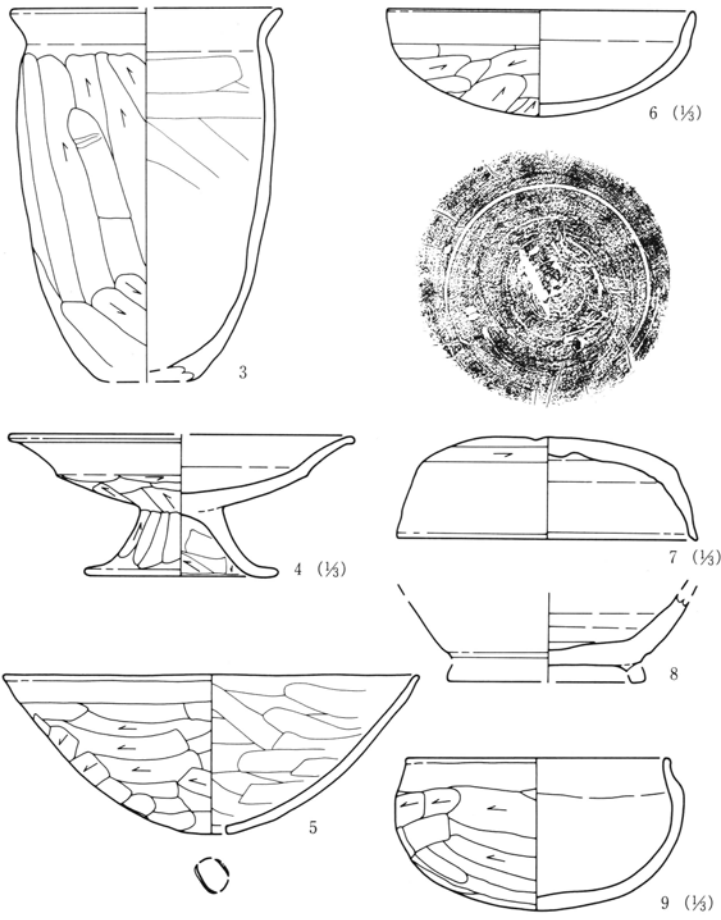

25号住居

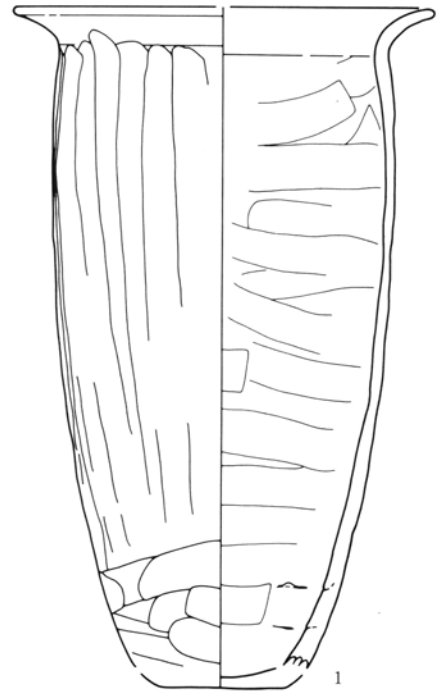

28号住居

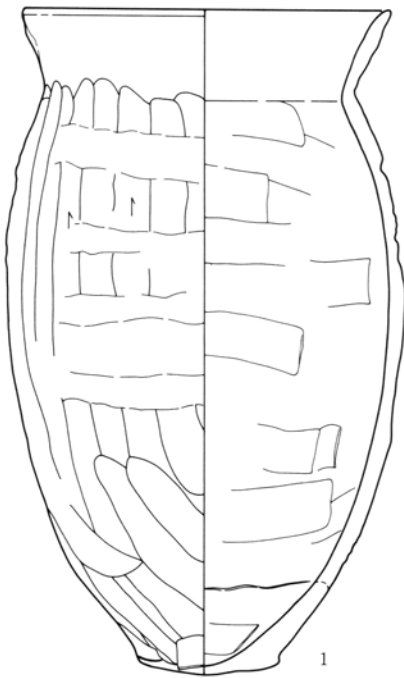

33号住居

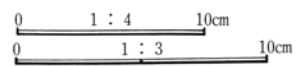
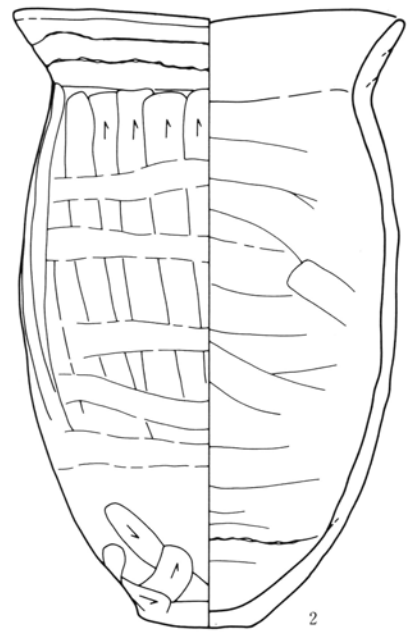

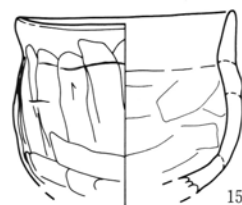
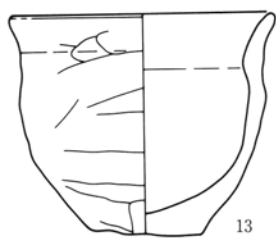
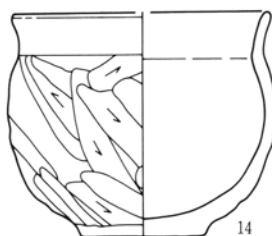
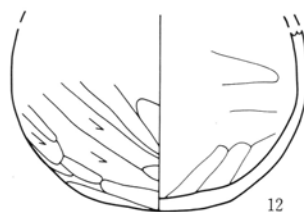
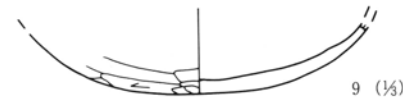
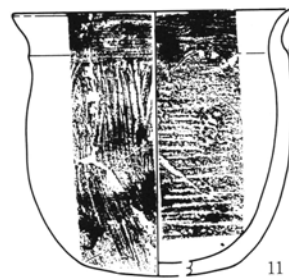
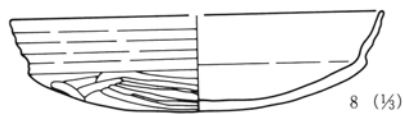
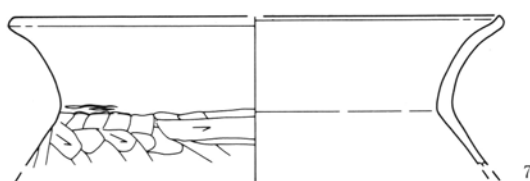
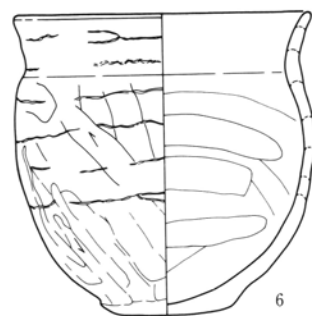
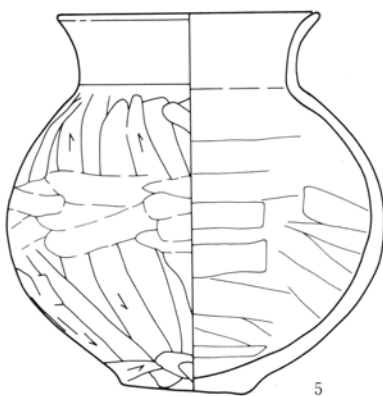
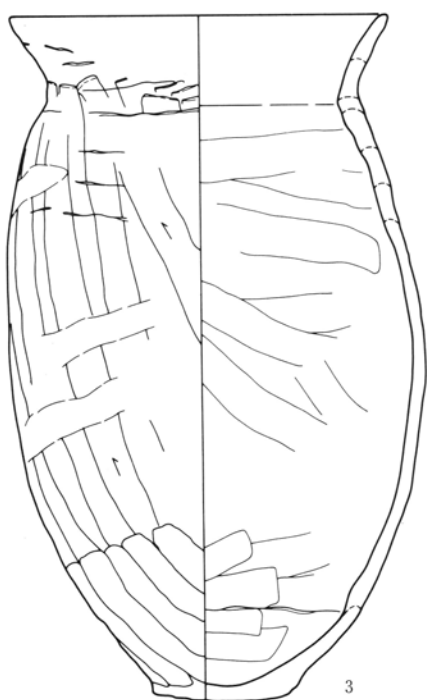

0 1 : 4 10cm

0 1 : 3 10cm

33号住居

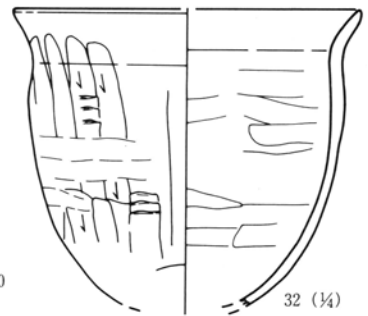
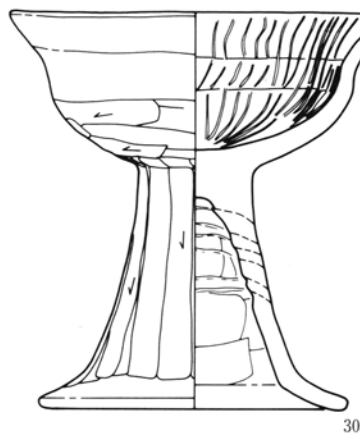
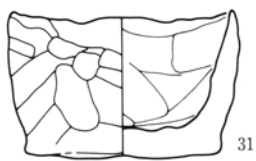
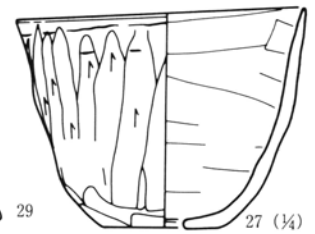
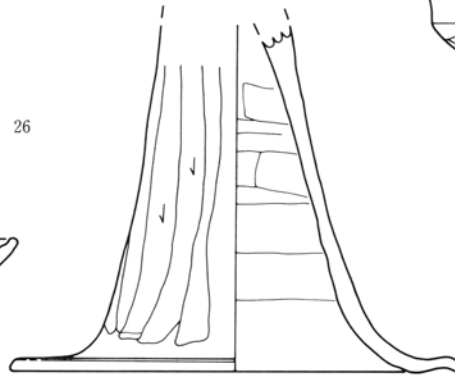
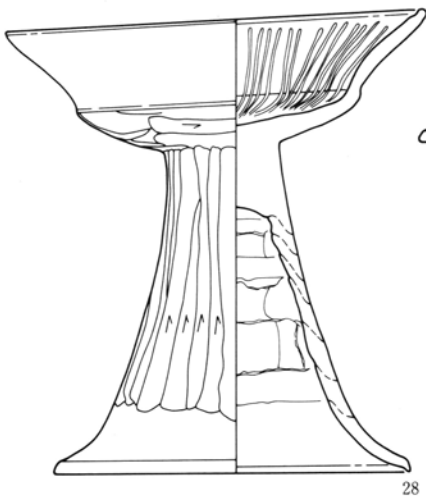
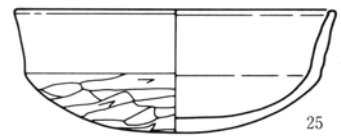
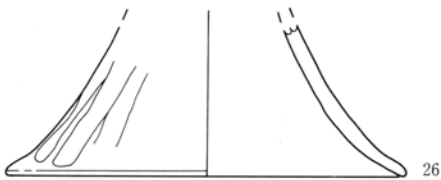
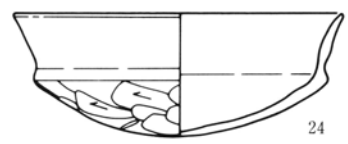
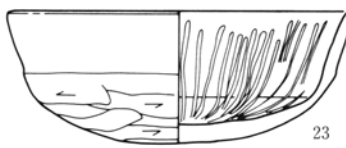
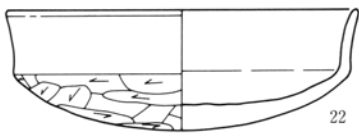
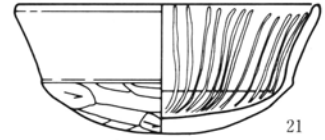
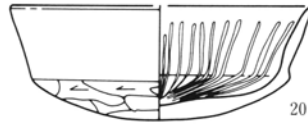
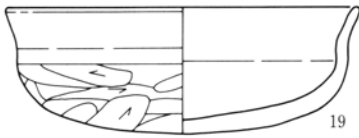
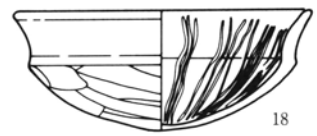
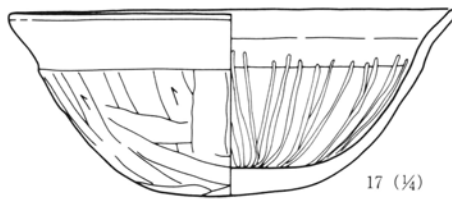
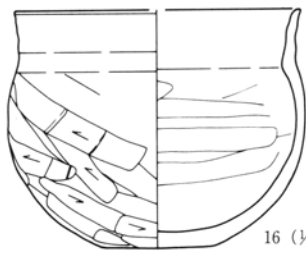

0 1 : 4 10cm

0 1 : 3 10cm

33号住居

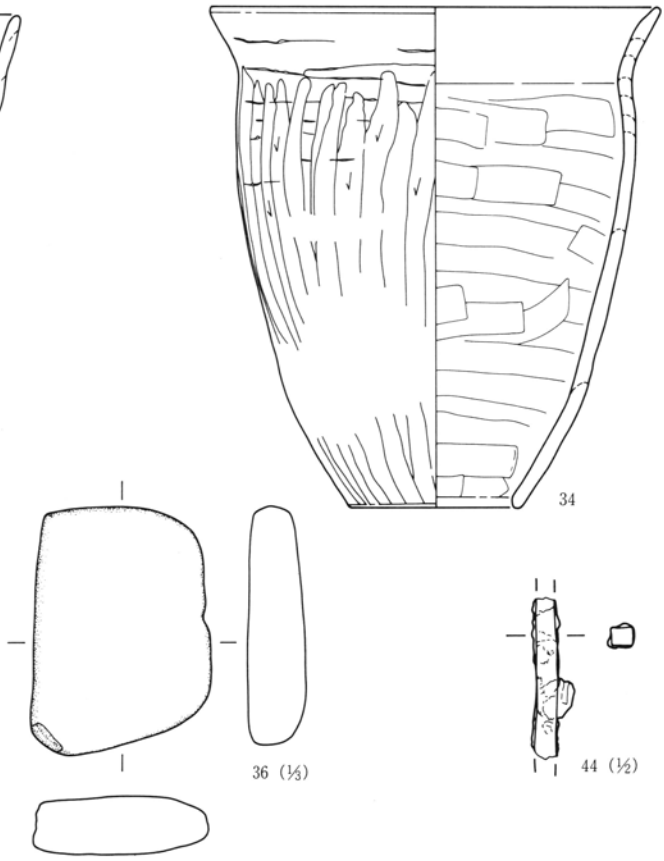
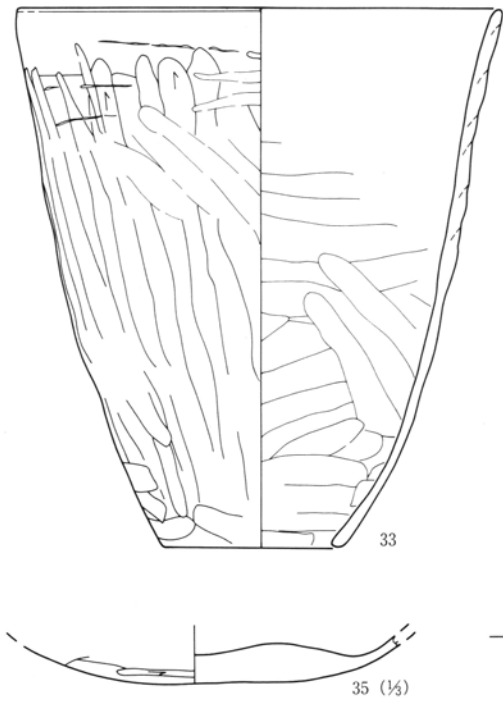

33号住居

0 1 : 3 10cm

0 1 : 2 5 cm

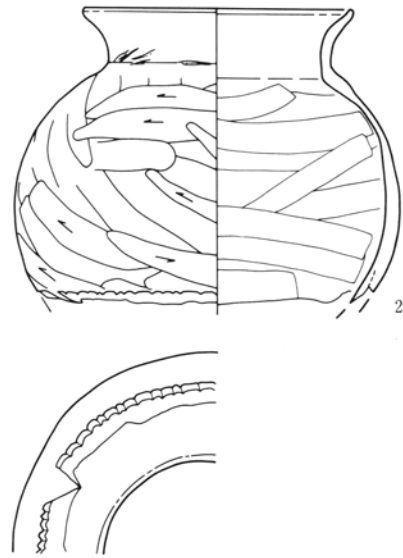
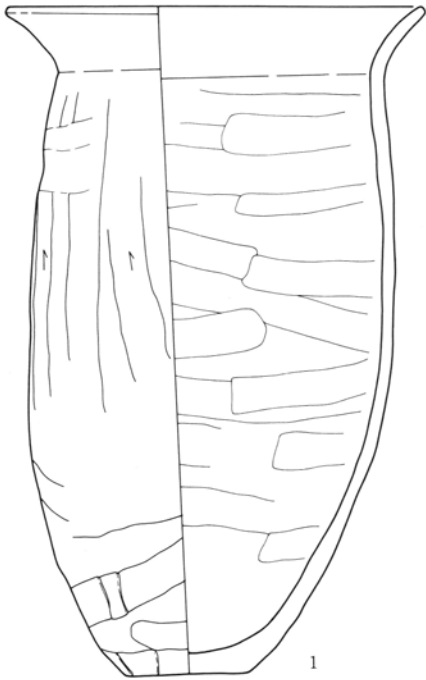

36号住居

0 1 : 4 10cm

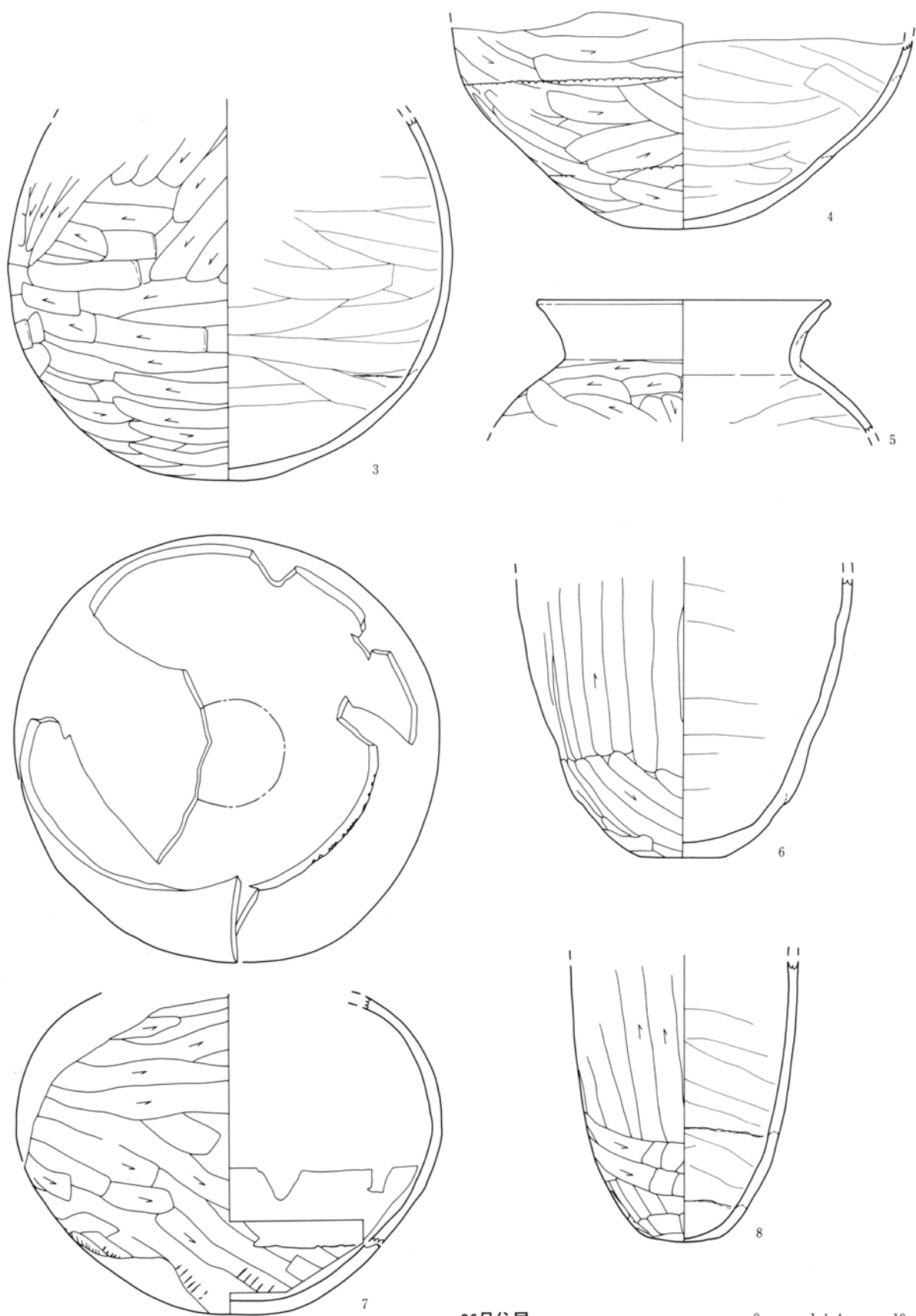

36号住居

0 1 : 4 10cm

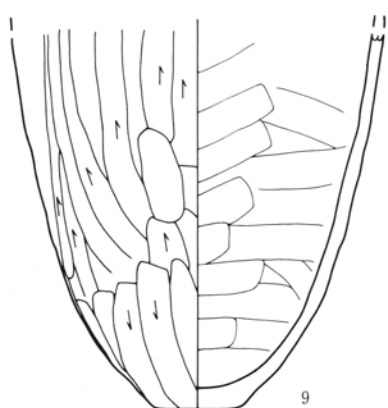

9



10 (1/2)



11 (1/2)

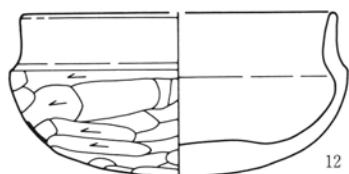
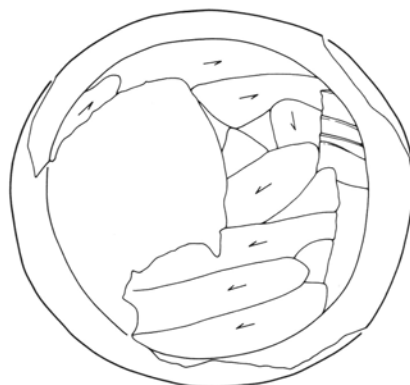

12 (1/2)



13 (1/2)

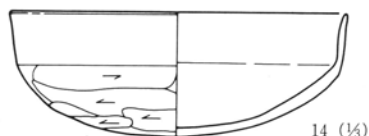

14 (1/2)

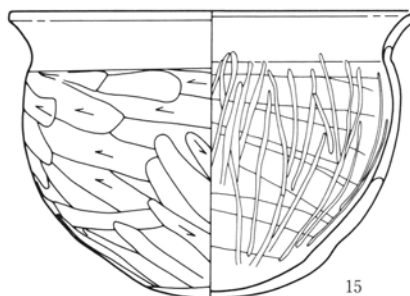

15

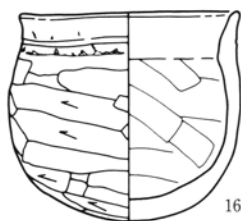

16

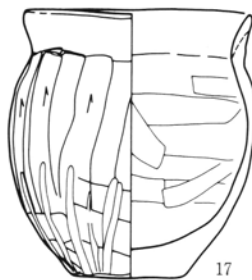

17

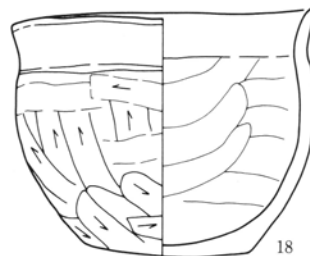

18

0 1 : 4 10cm

0 1 : 3 10cm

36号住居

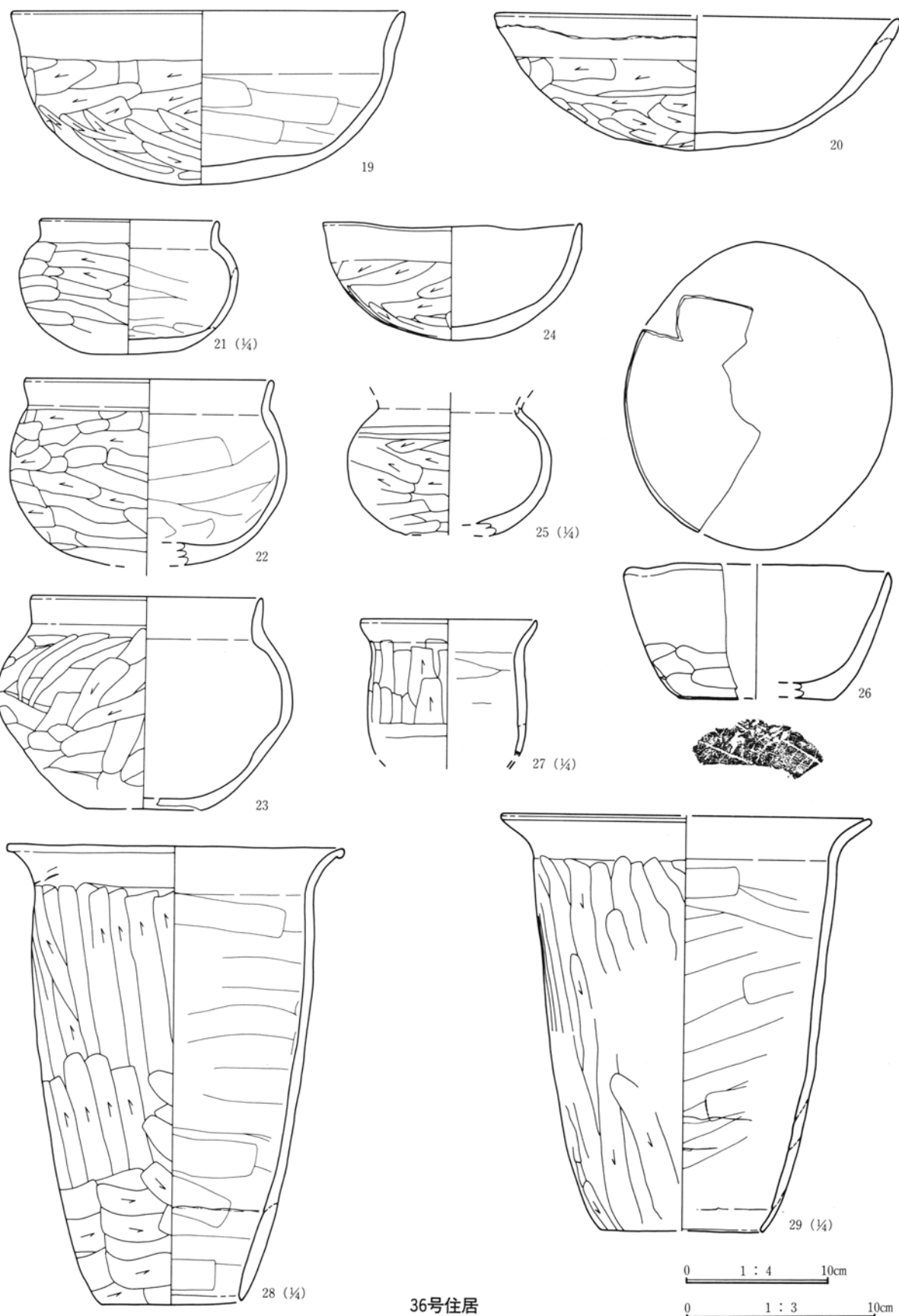

36号住居

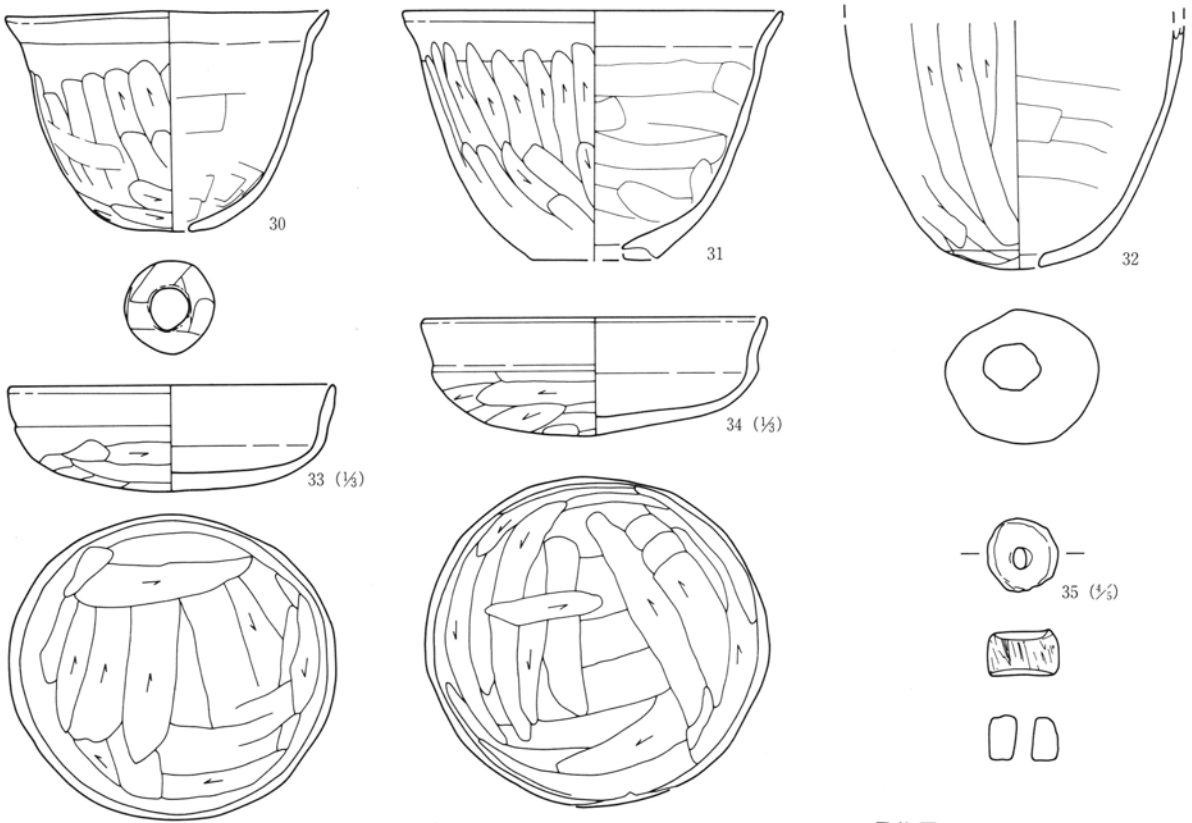

36号住居

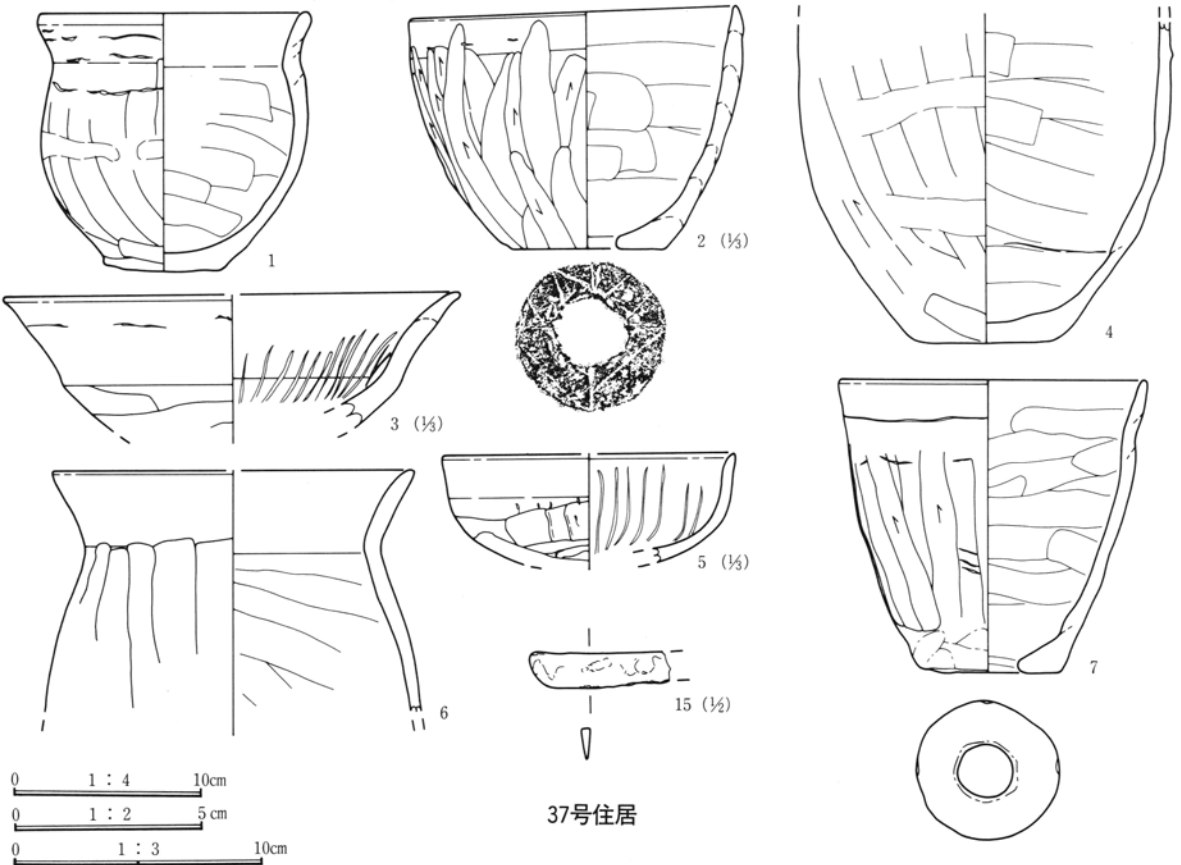

37号住居

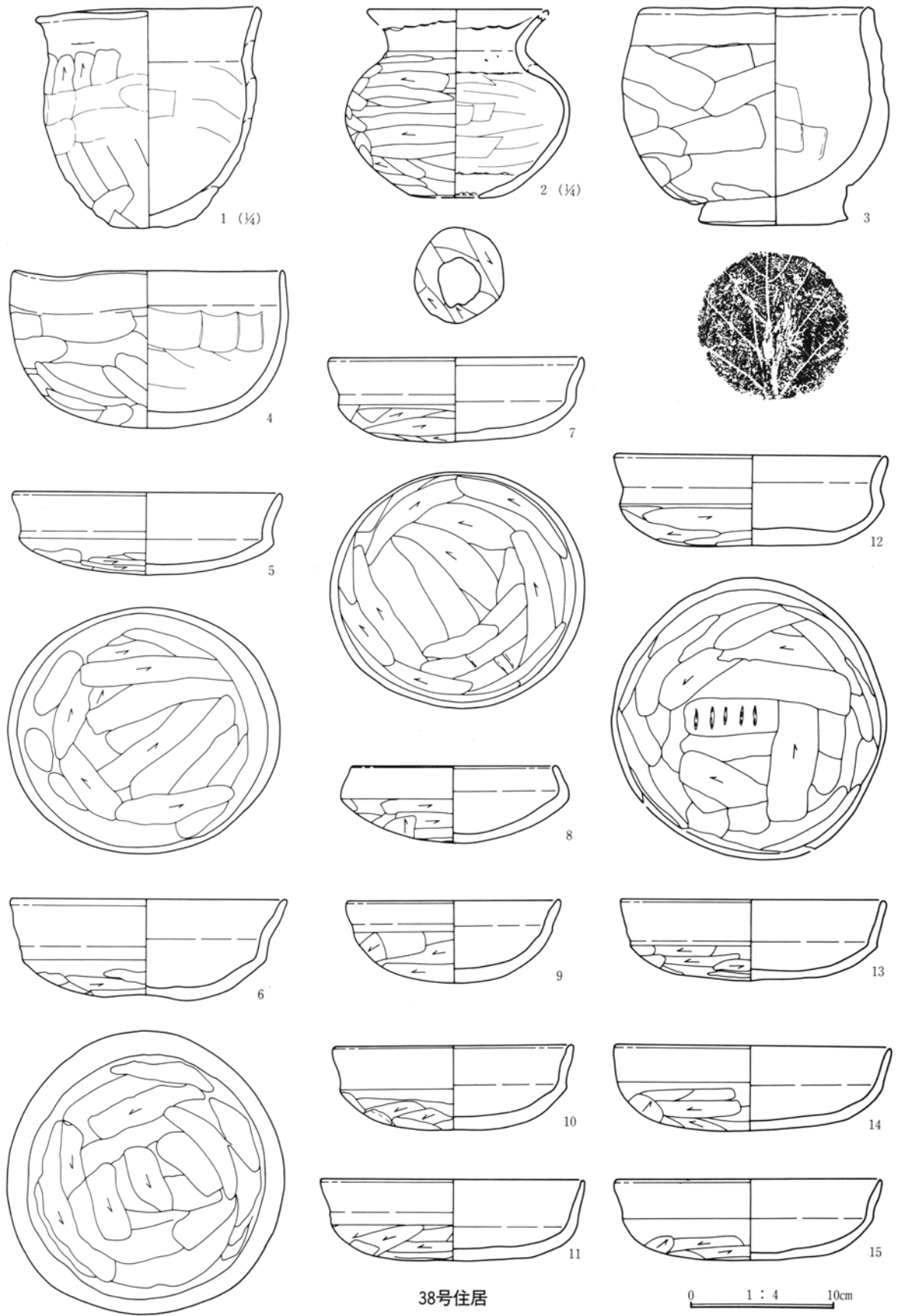

38号住居

0 1 : 4 10cm

0 1 : 3 10cm

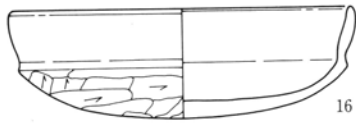

16

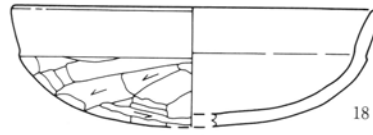

18

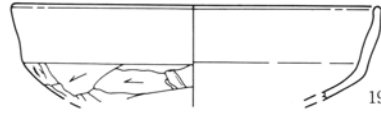

19

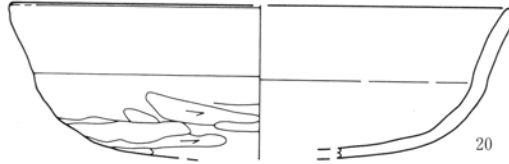

20

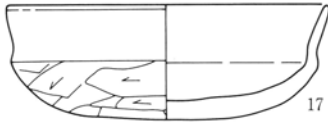

17

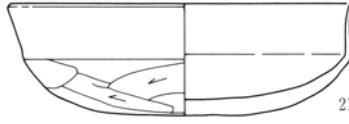

21

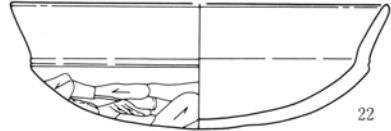

22

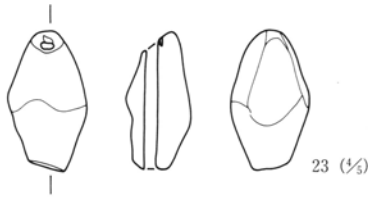

23 (1/3)

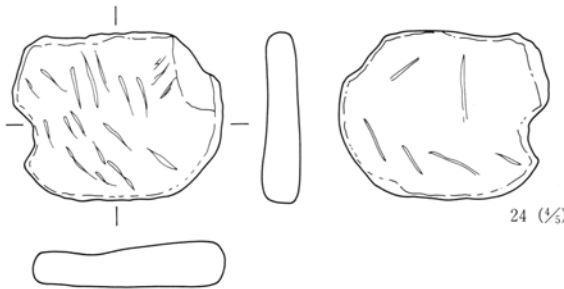

24 (1/2)

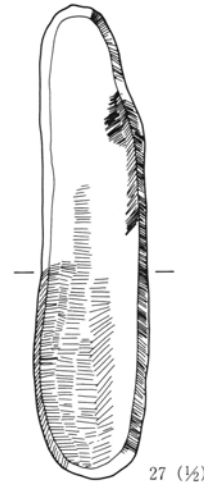

27 (1/2)

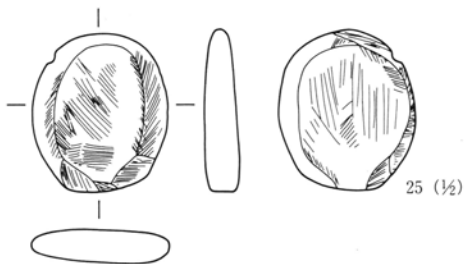

25 (1/2)



28 (1/3)

0 1 : 2 5 cm

0 1 : 3 10cm

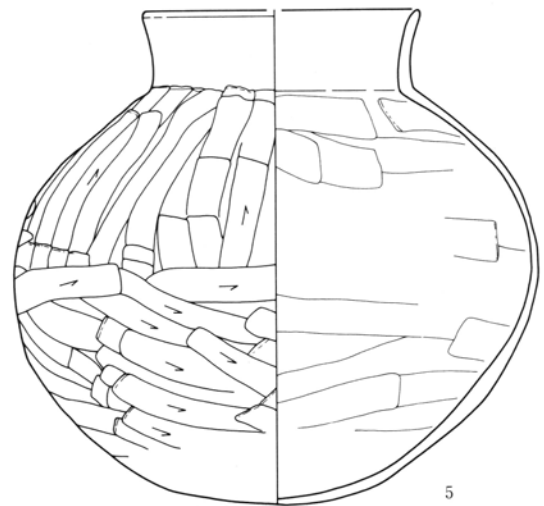
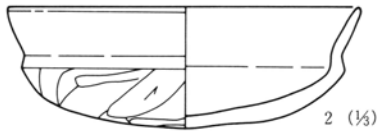
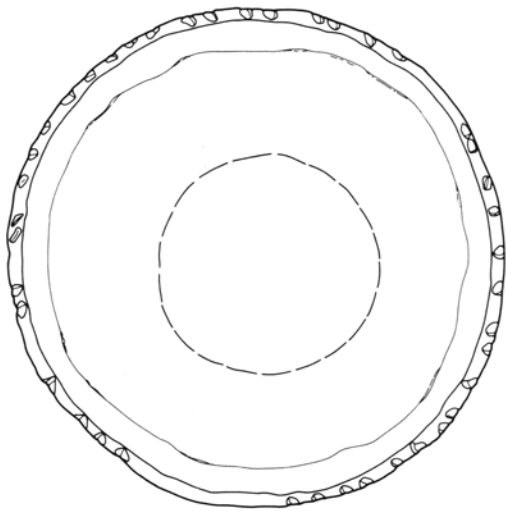
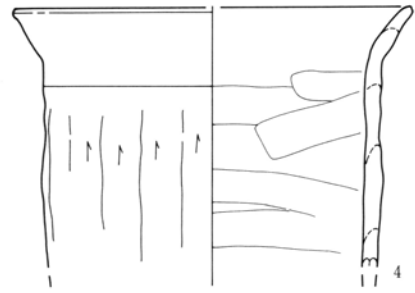
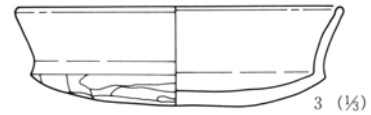
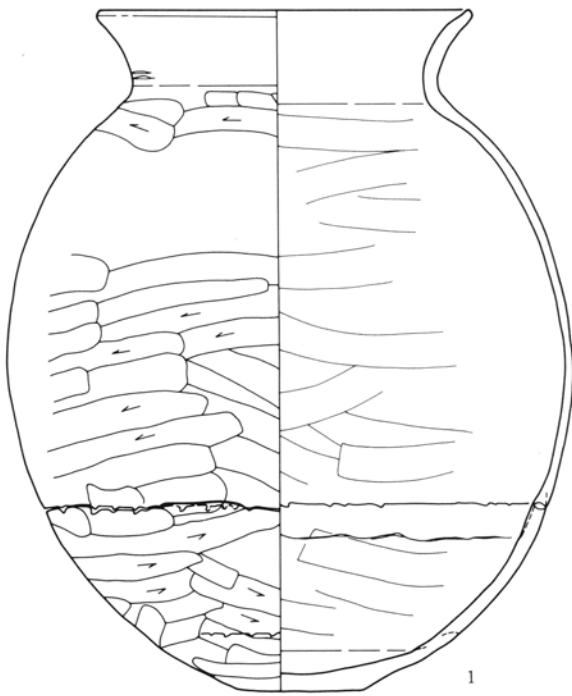

0 1 : 4 10cm

0 1 : 3 10cm

42号住居

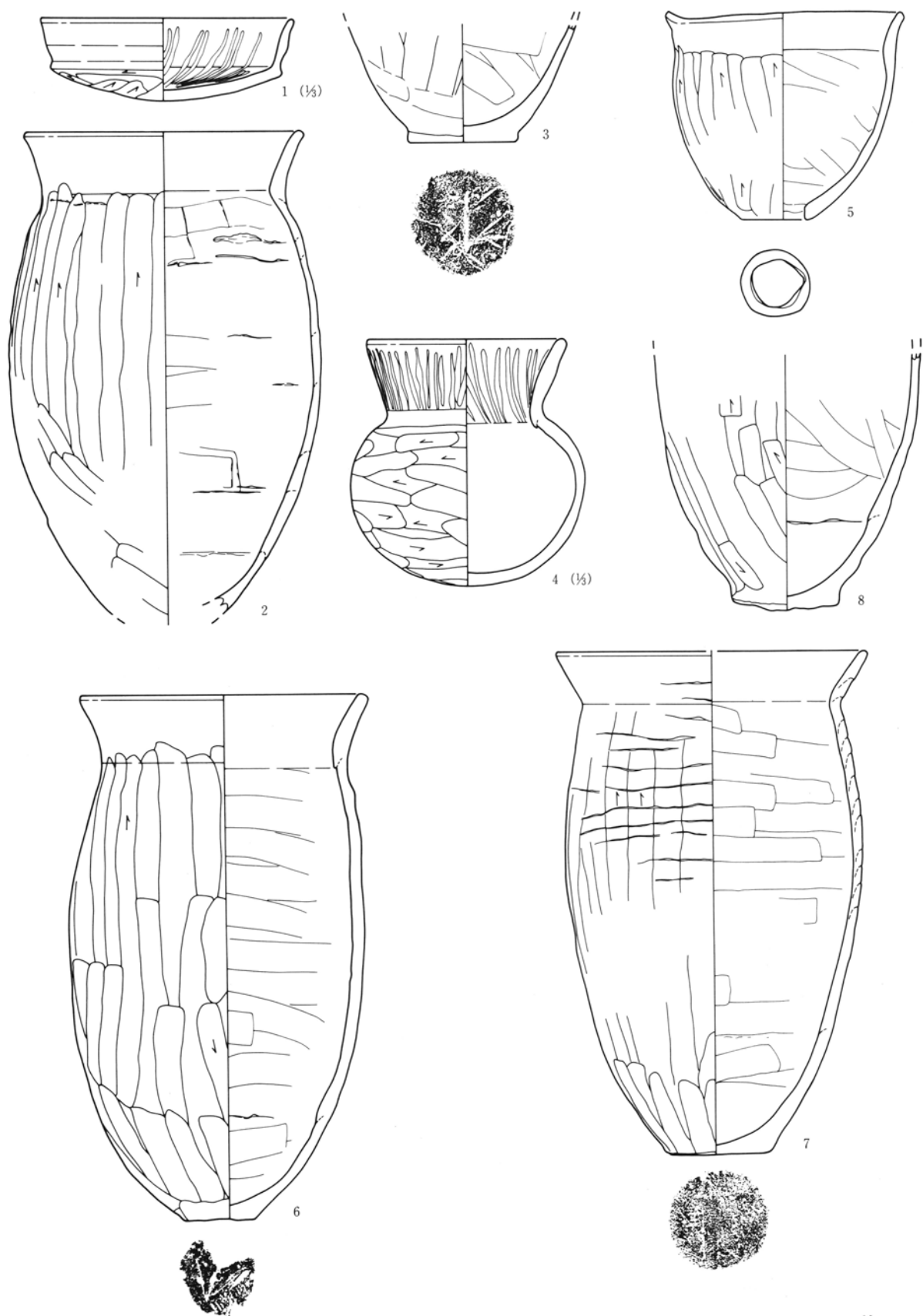

48号住居

0 1 : 4 10cm
0 1 : 3 10cm

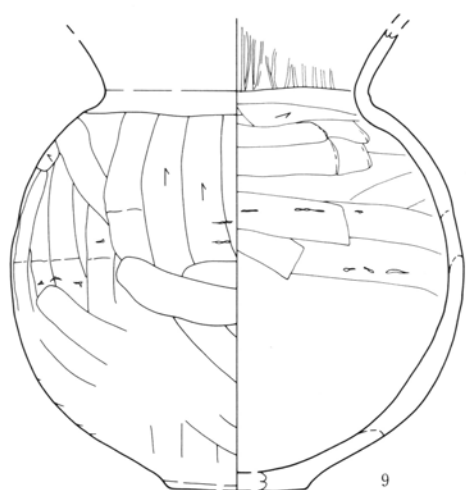

9

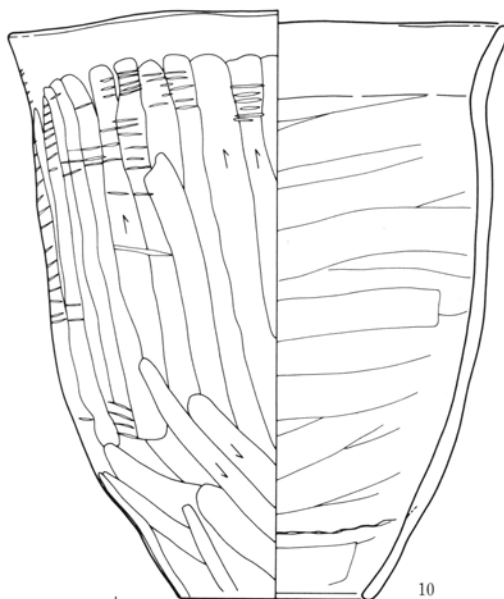

10

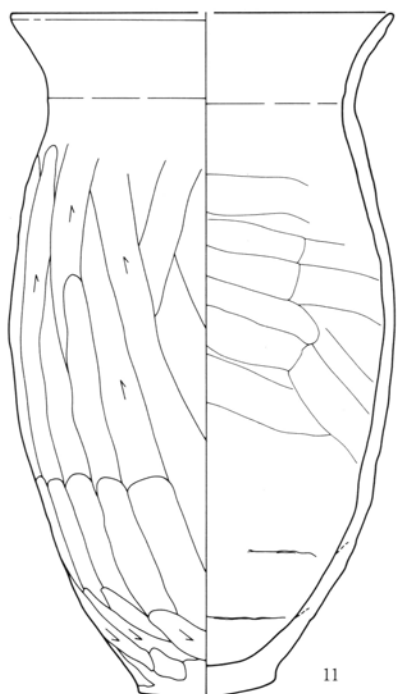

11



26 (1/2)

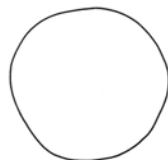

48号住居

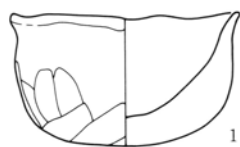

1 (1/2)

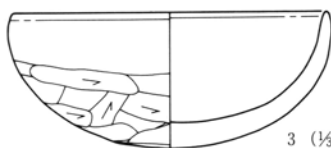

3 (1/2)

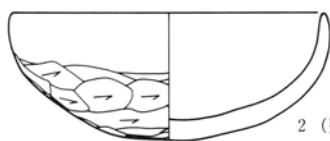

2 (1/2)

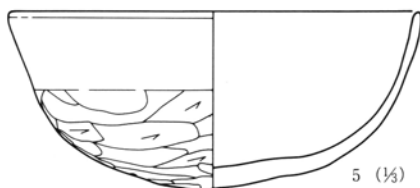

5 (1/2)

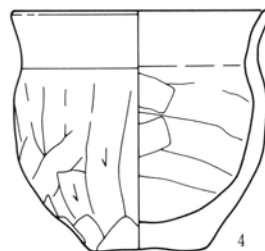

4

49号住居

0 1 : 2 5 cm

0 1 : 4 10cm

0 1 : 3 10cm

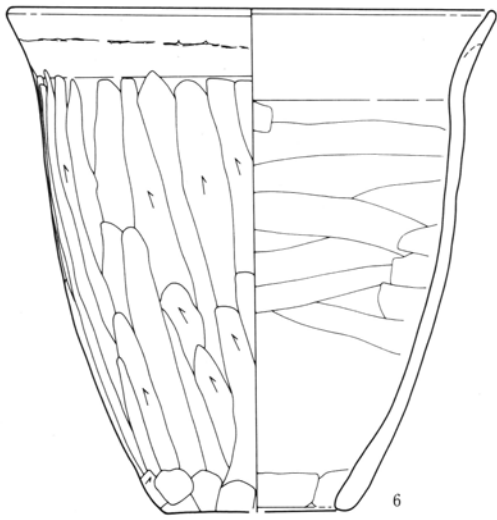

6

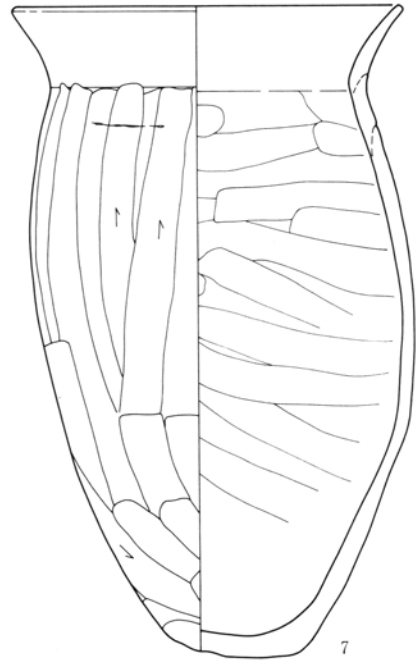

7

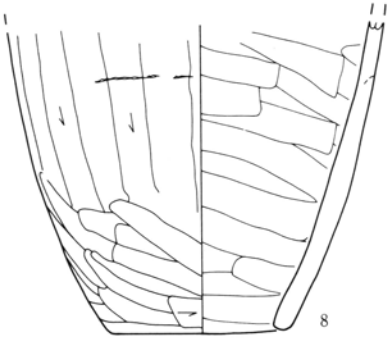

8

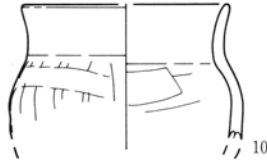

10

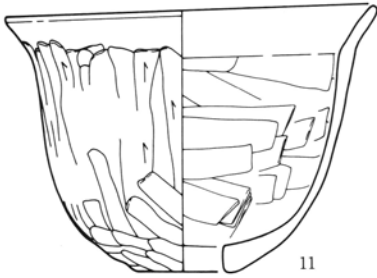

11

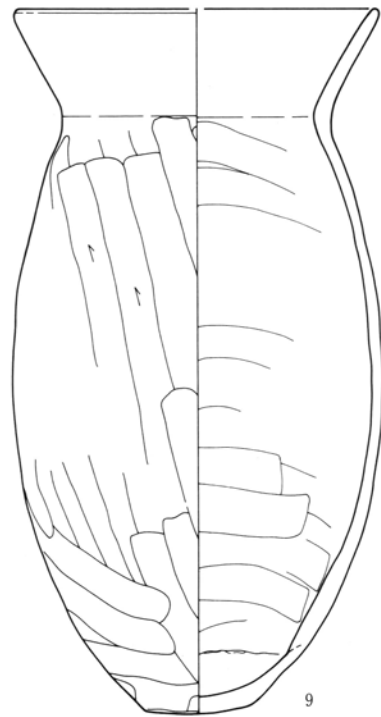

9

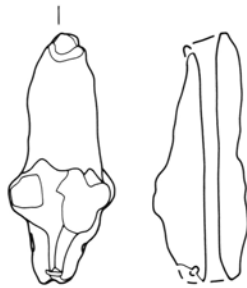

12 (1/2)

0 1 : 2 5 cm

0 1 : 4 10cm

49号住居

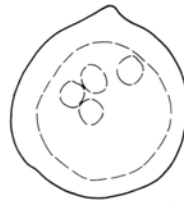
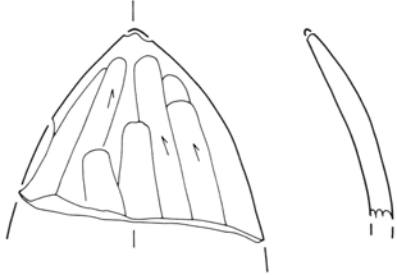

14 (1/2)

49号住居

0 1 : 2 5 cm

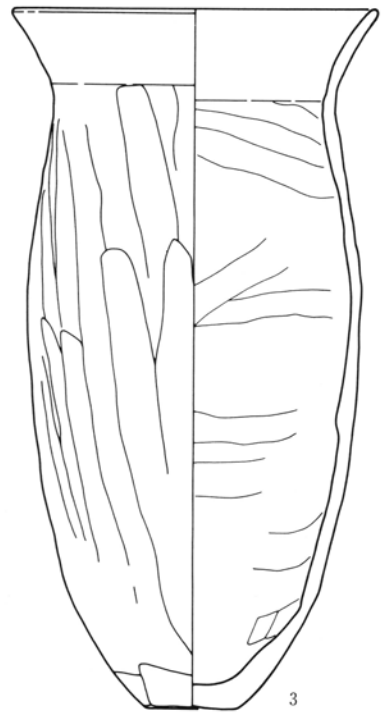
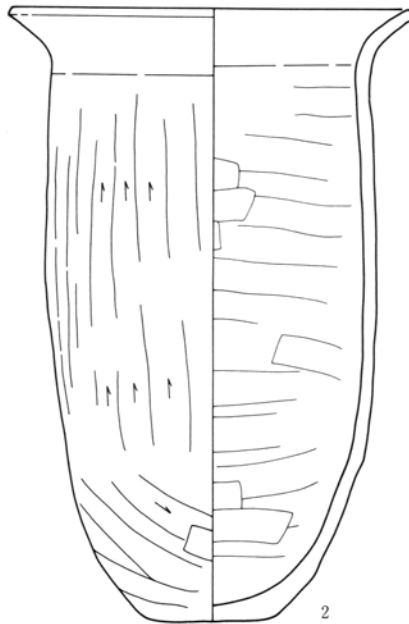
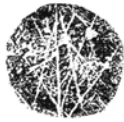
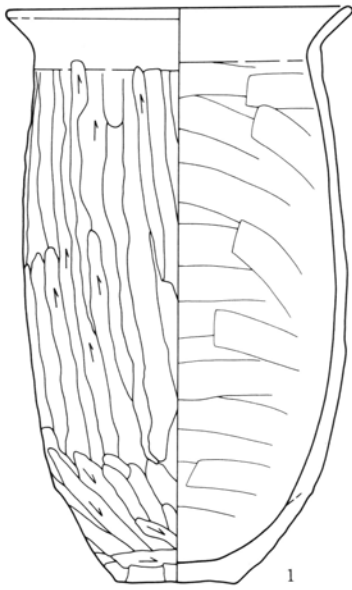

50号住居

0 1 : 4 10cm

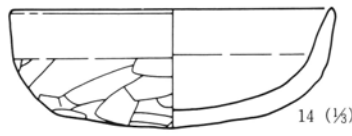
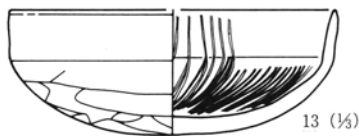
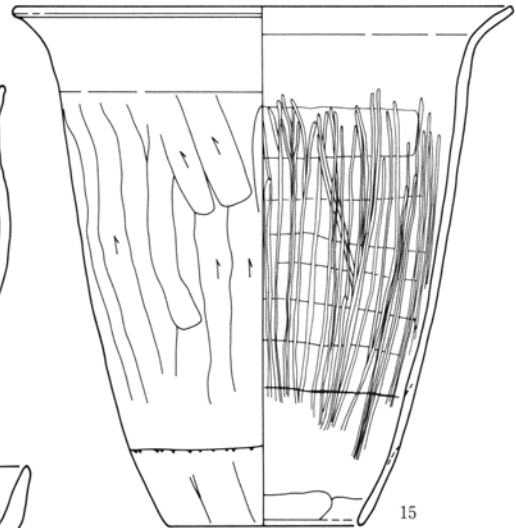
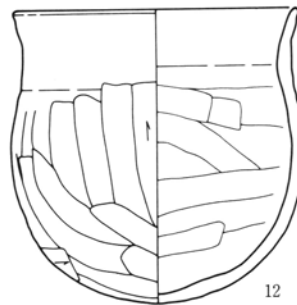
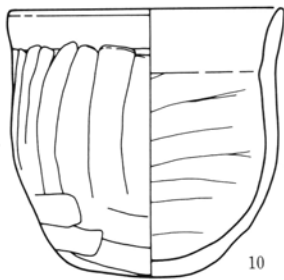
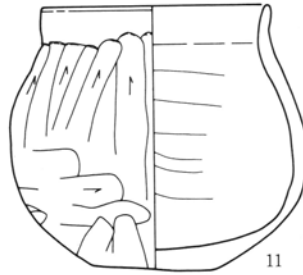
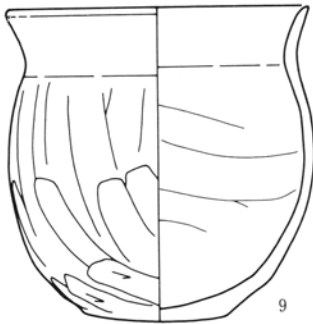
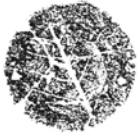
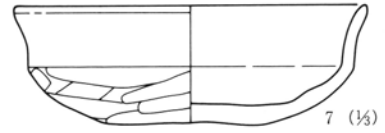
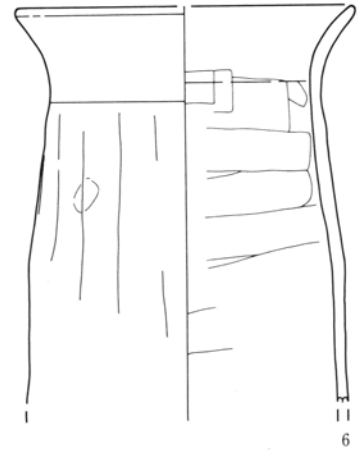
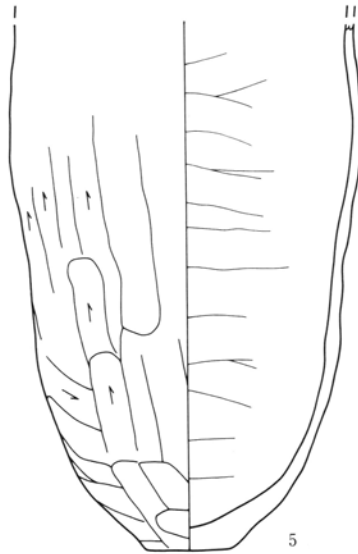
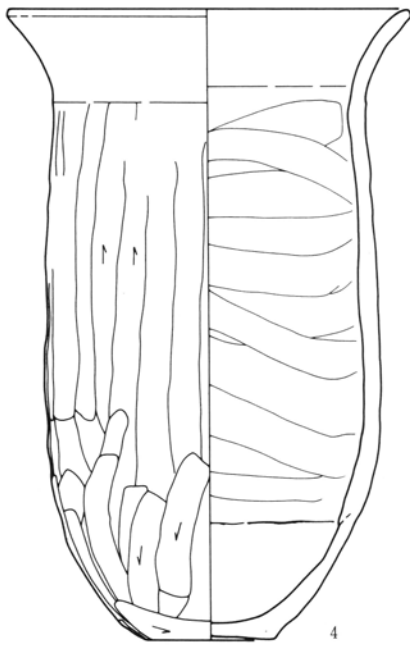

50号住居

0 1 : 4 10cm

0 1 : 3 10cm

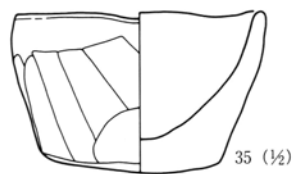
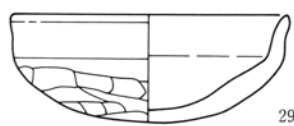
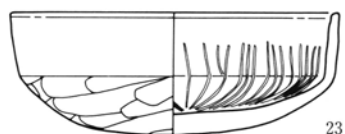
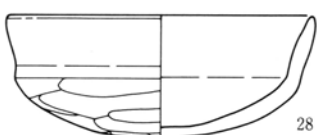
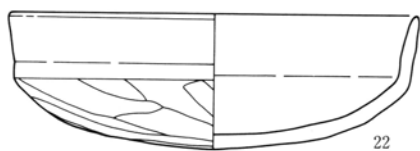
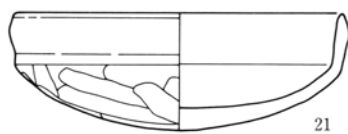
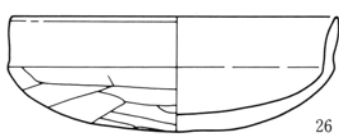
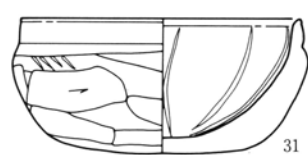
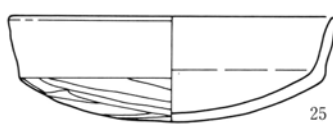
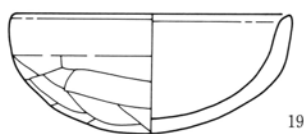
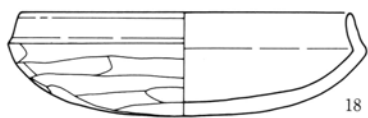
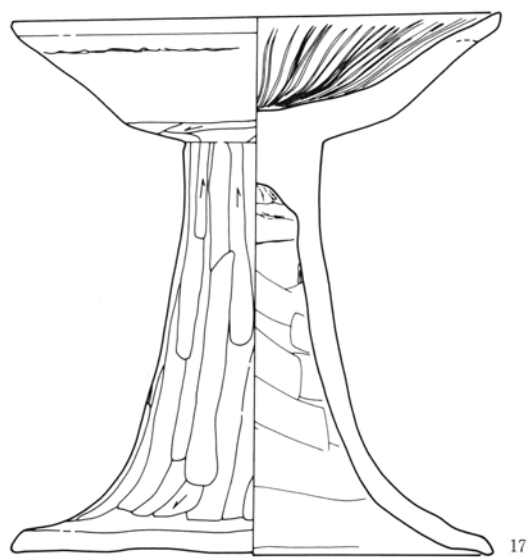
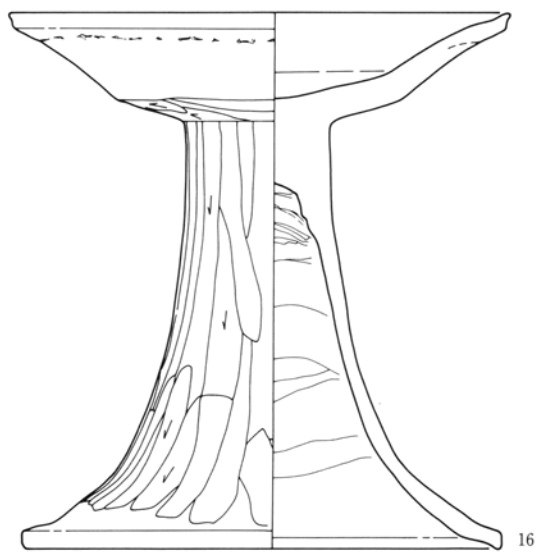

50号住居

0 1 : 2 5 cm

0 1 : 3 10cm

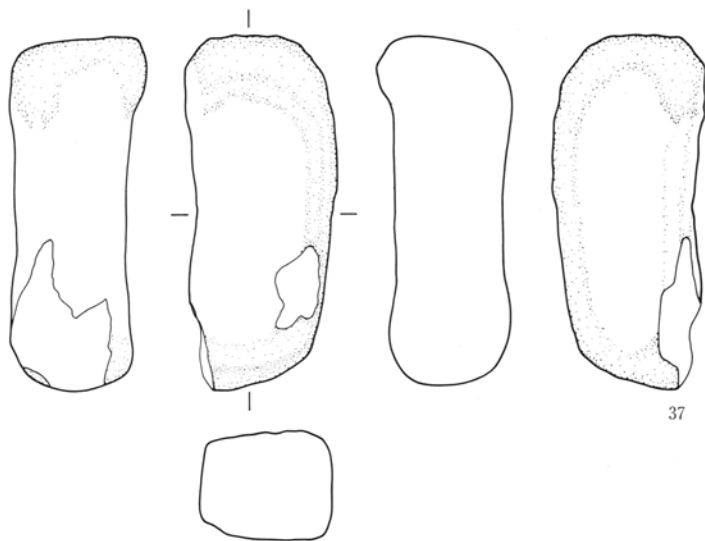

50号住居

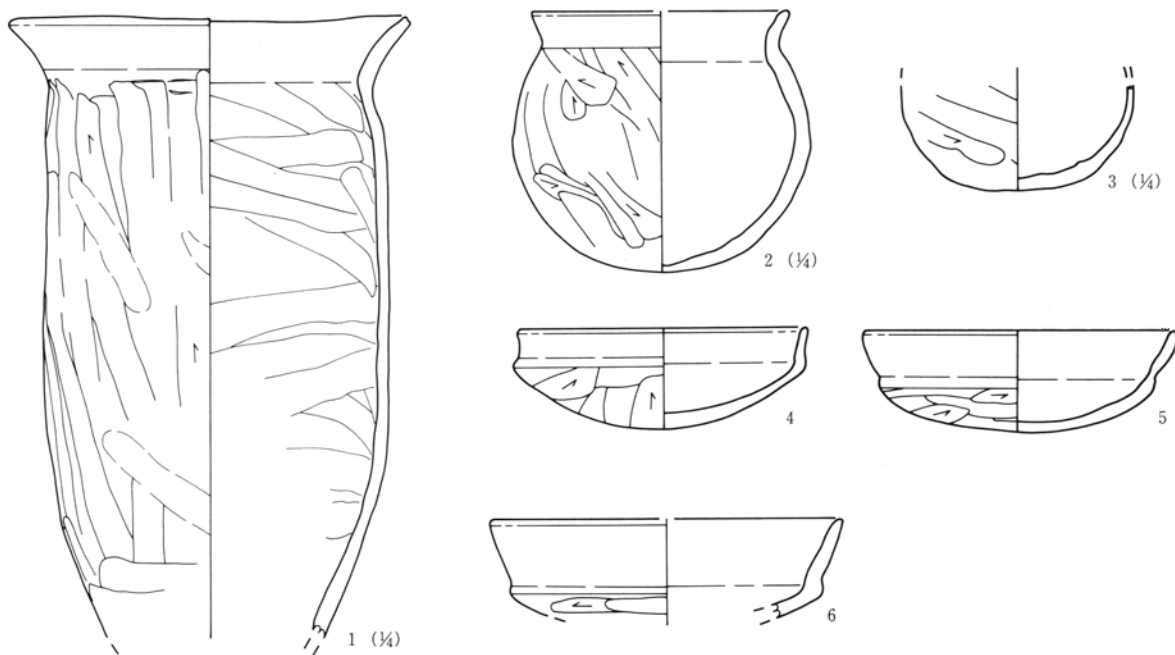

52号住居

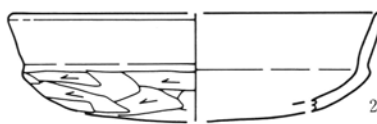
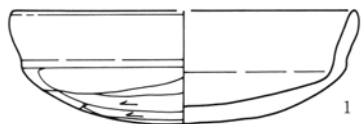

58号住居

0 1 : 4 10cm

0 1 : 3 10cm

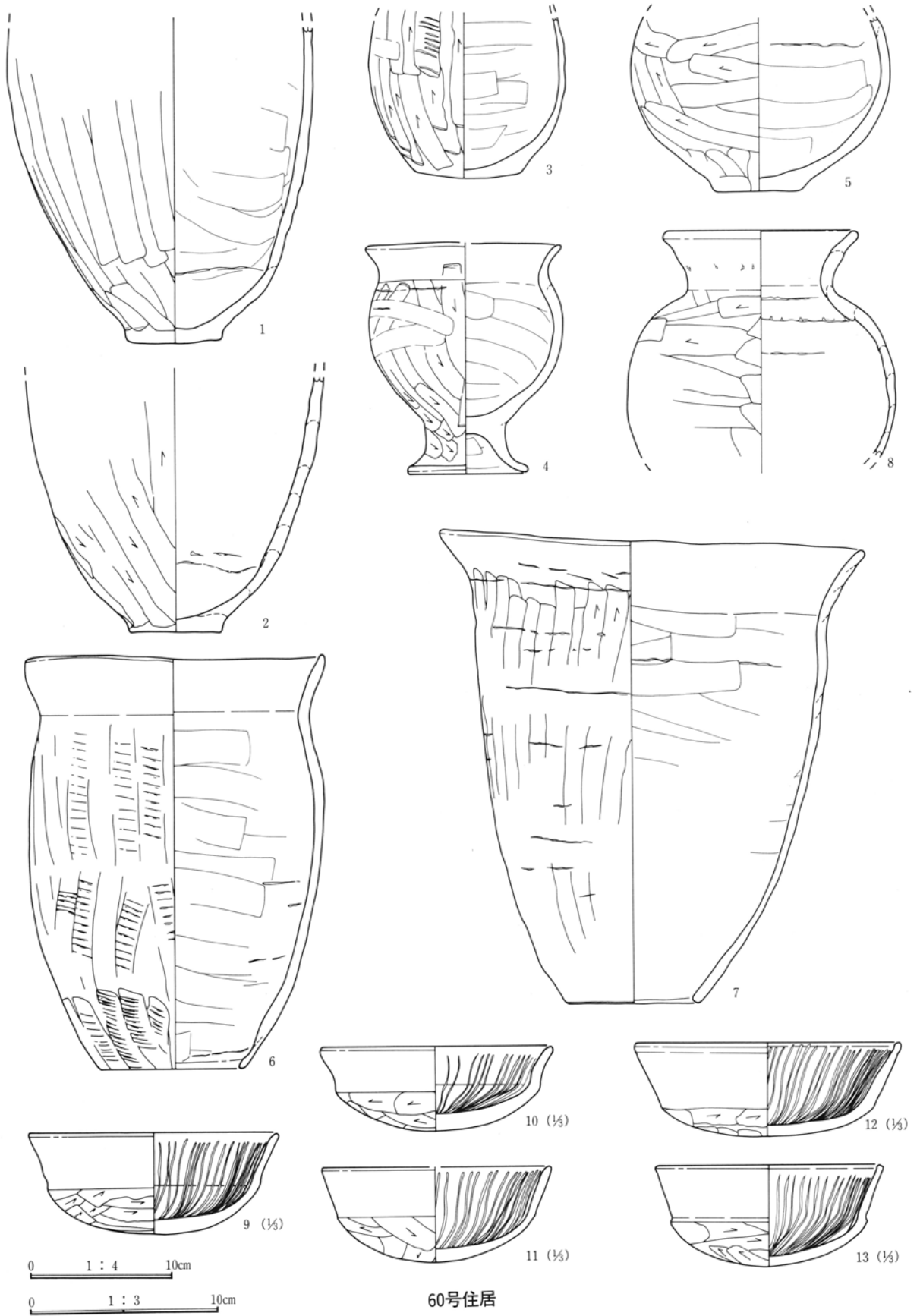

60号住居

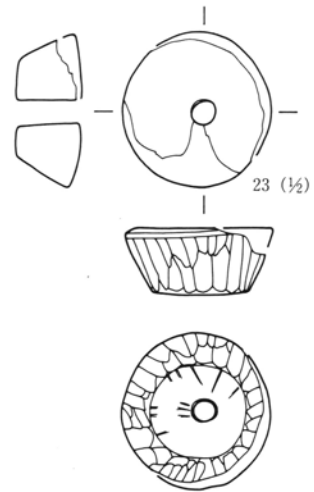
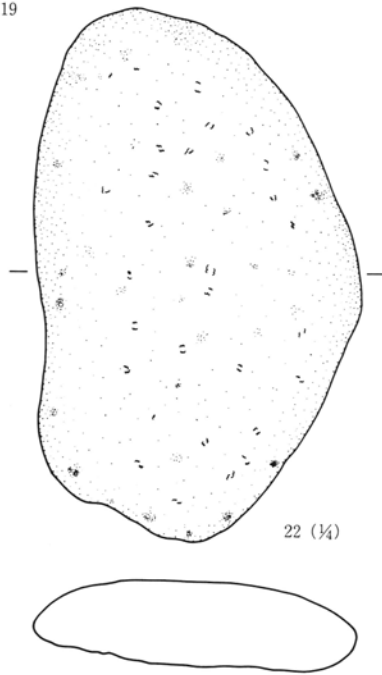
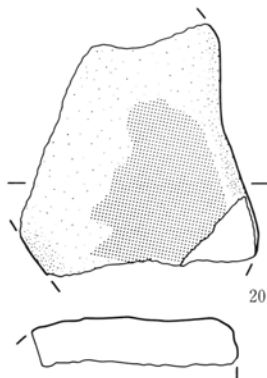
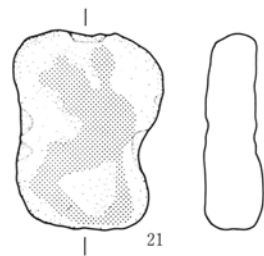
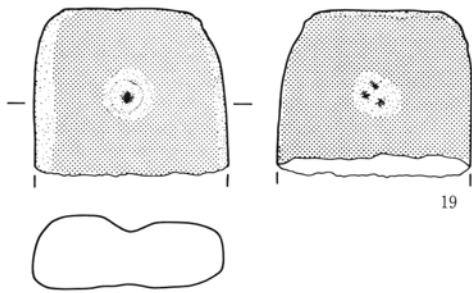
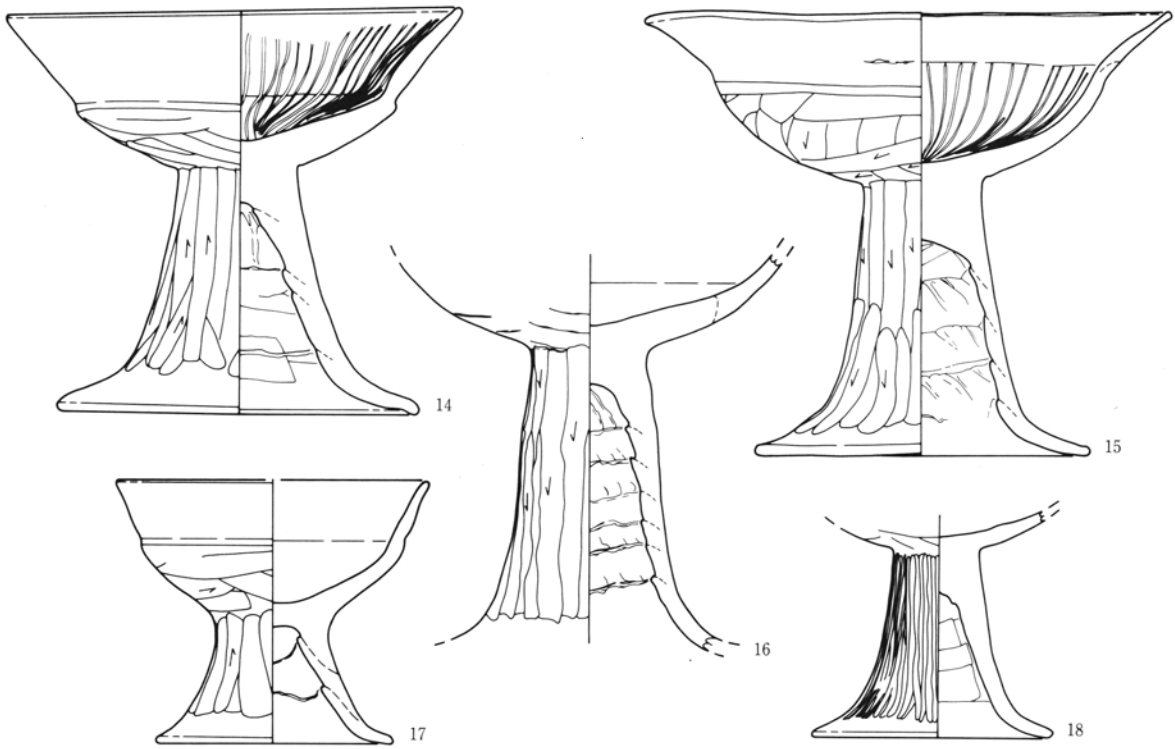

60号住居

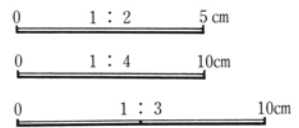

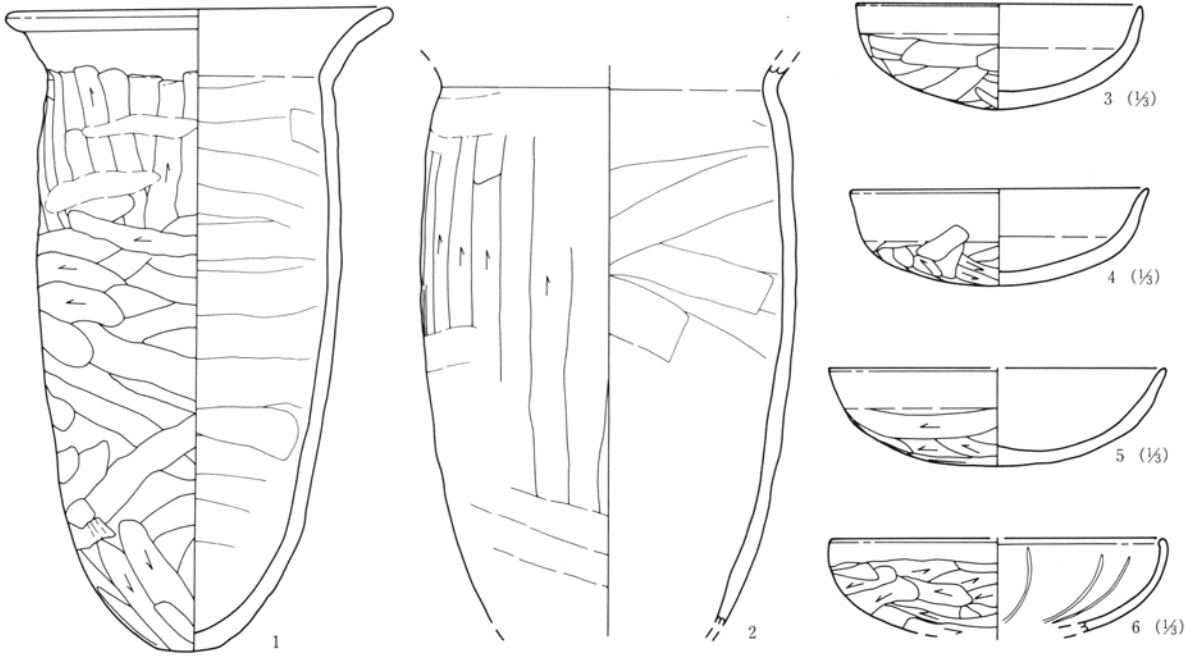

61号住居

0 1 : 3 10cm

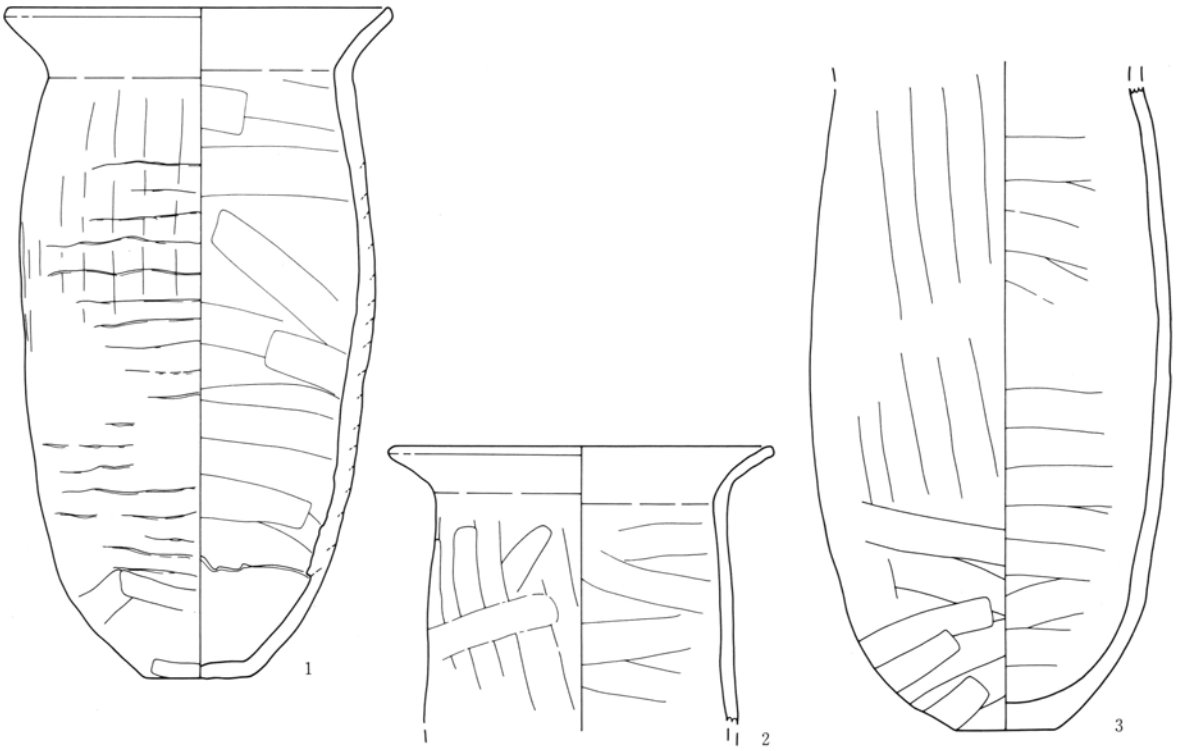

62号住居

0 1 : 4 10cm

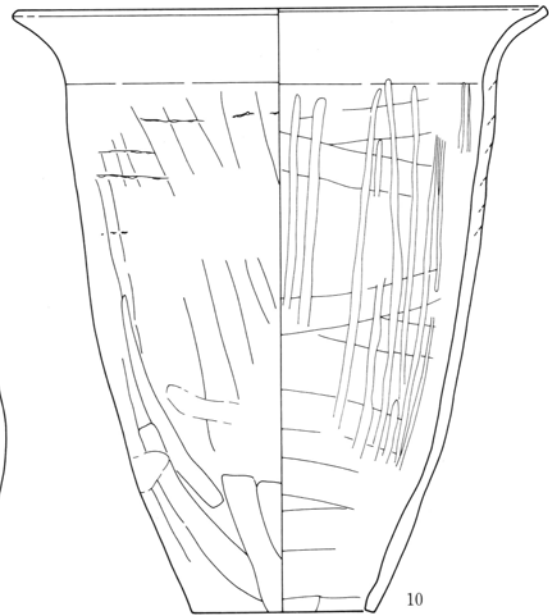
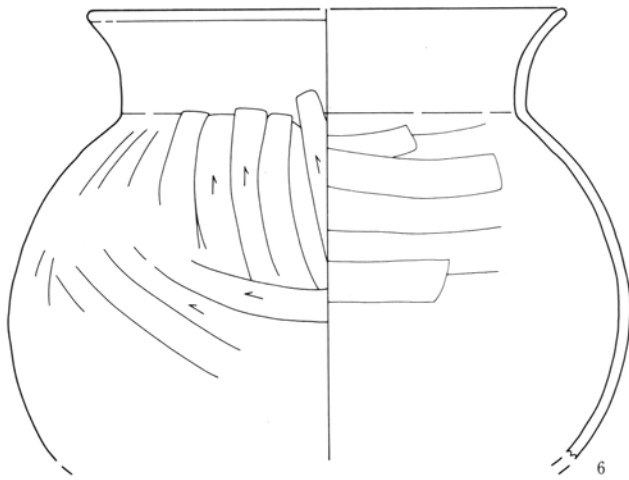
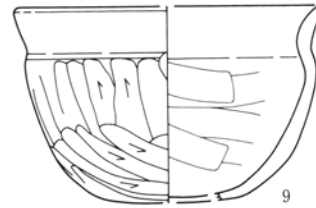
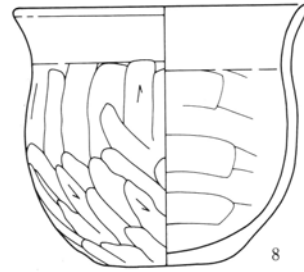
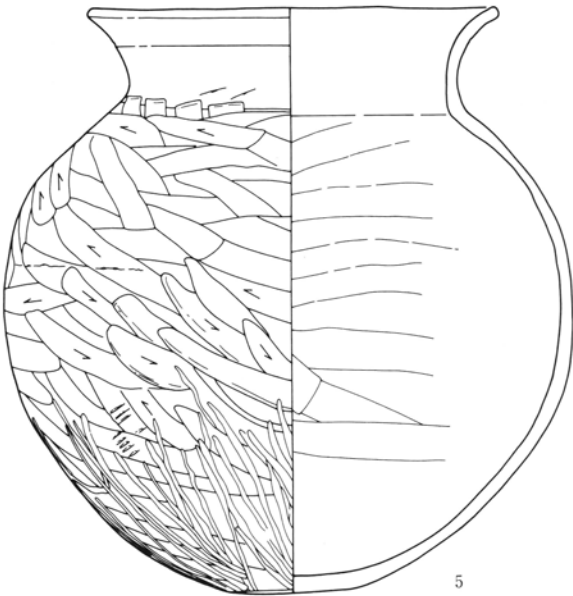
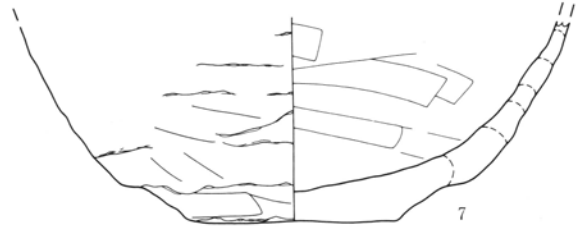
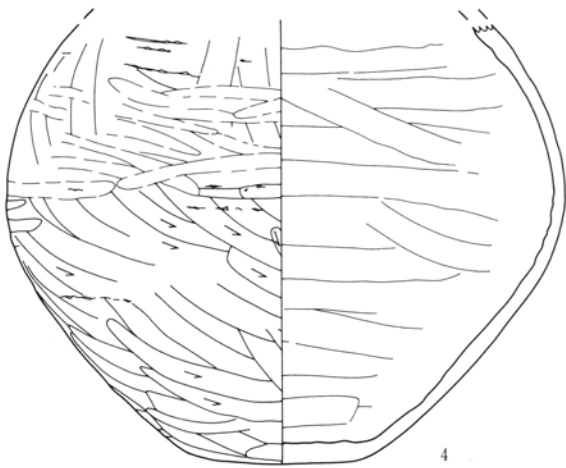

62号住居

0 1 : 4 10cm

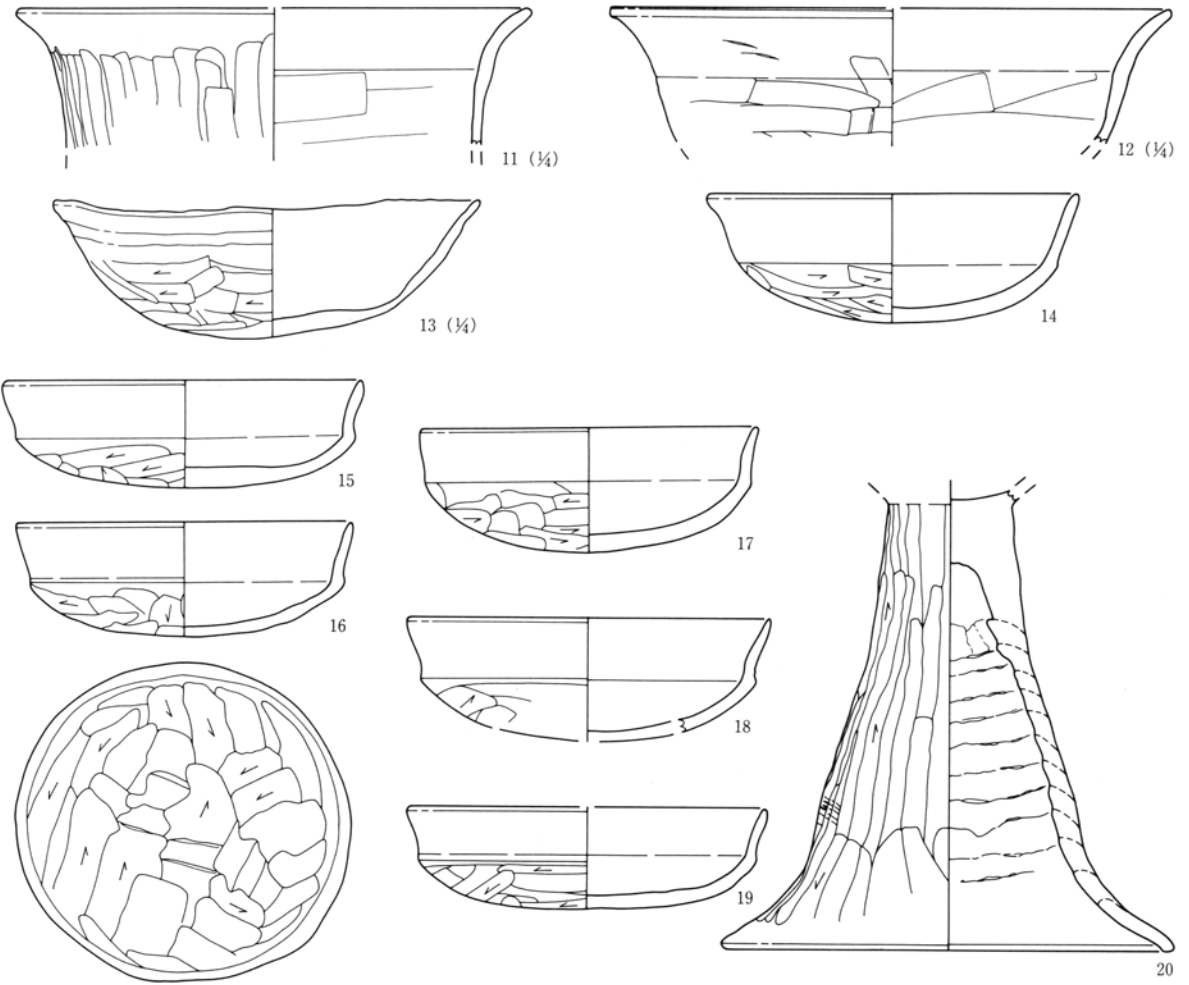

62号住居

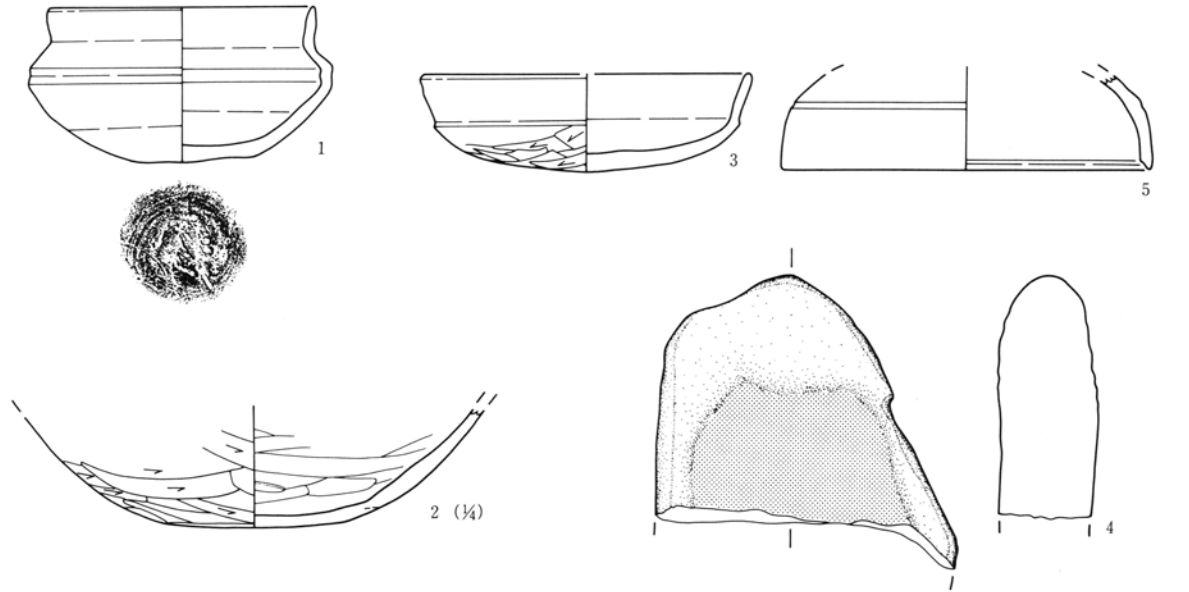

0 1 : 3 10cm

65号住居

0 1 : 4 10cm

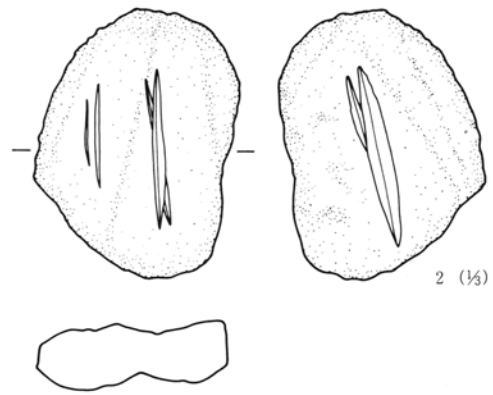
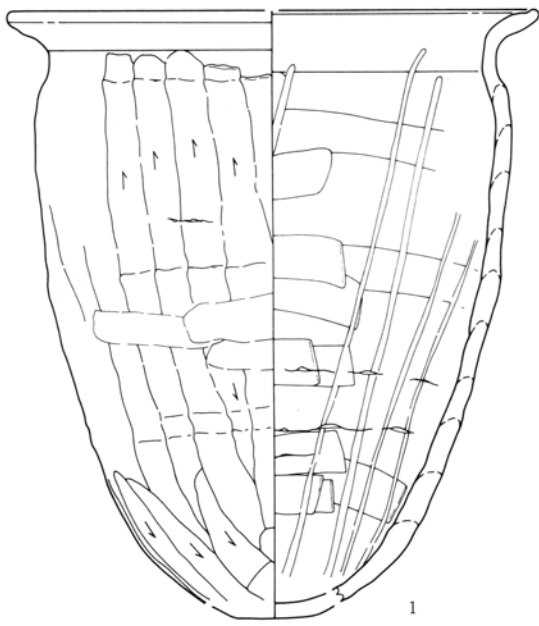

0 1 : 3 10cm

74号住居

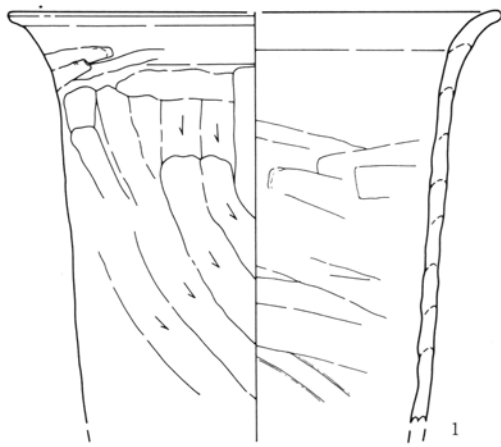

79号住居

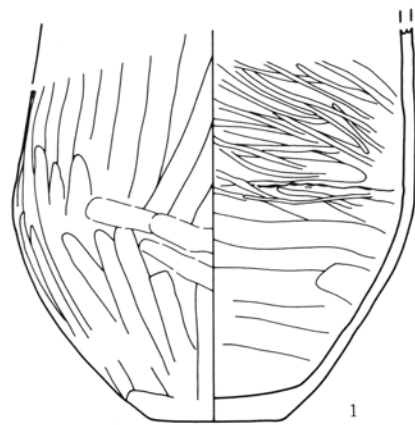

88号住居

0 1 : 4 10cm

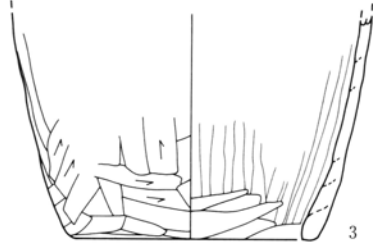
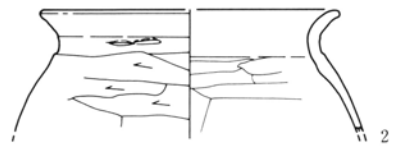
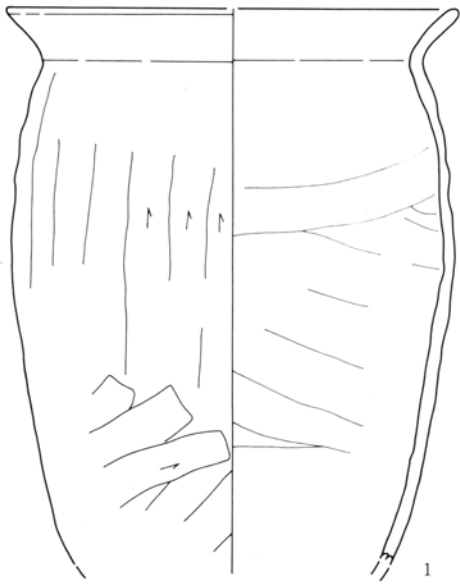

7号住居

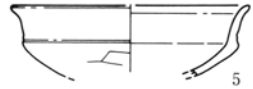
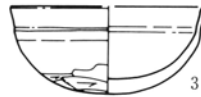
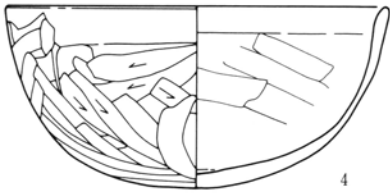
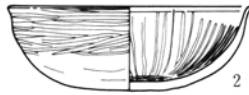
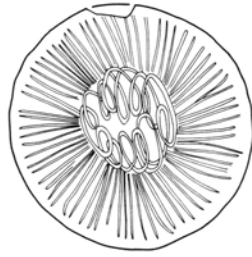
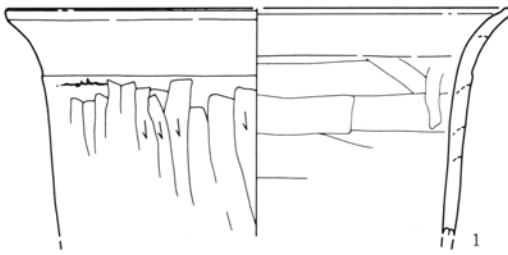

44号住居

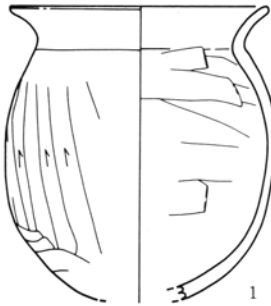

50号住居

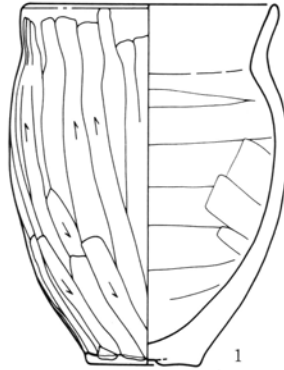

52号住居

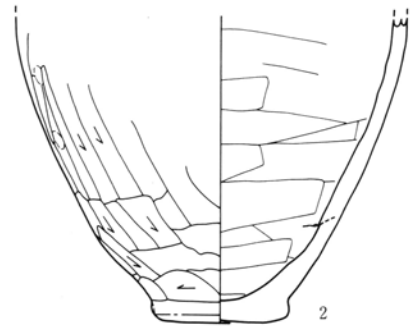

0 1 : 4 10cm

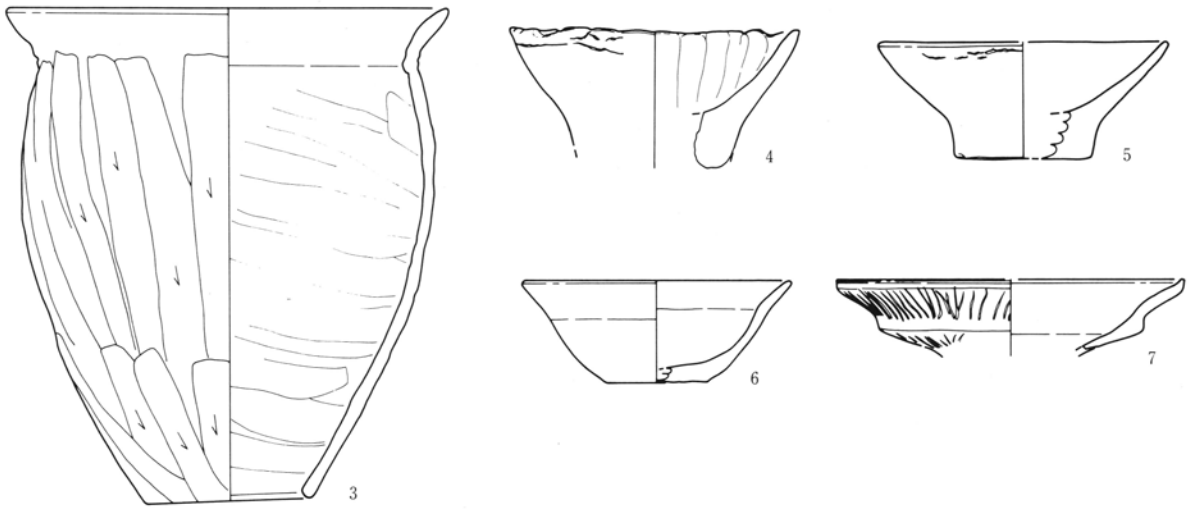

52号住居

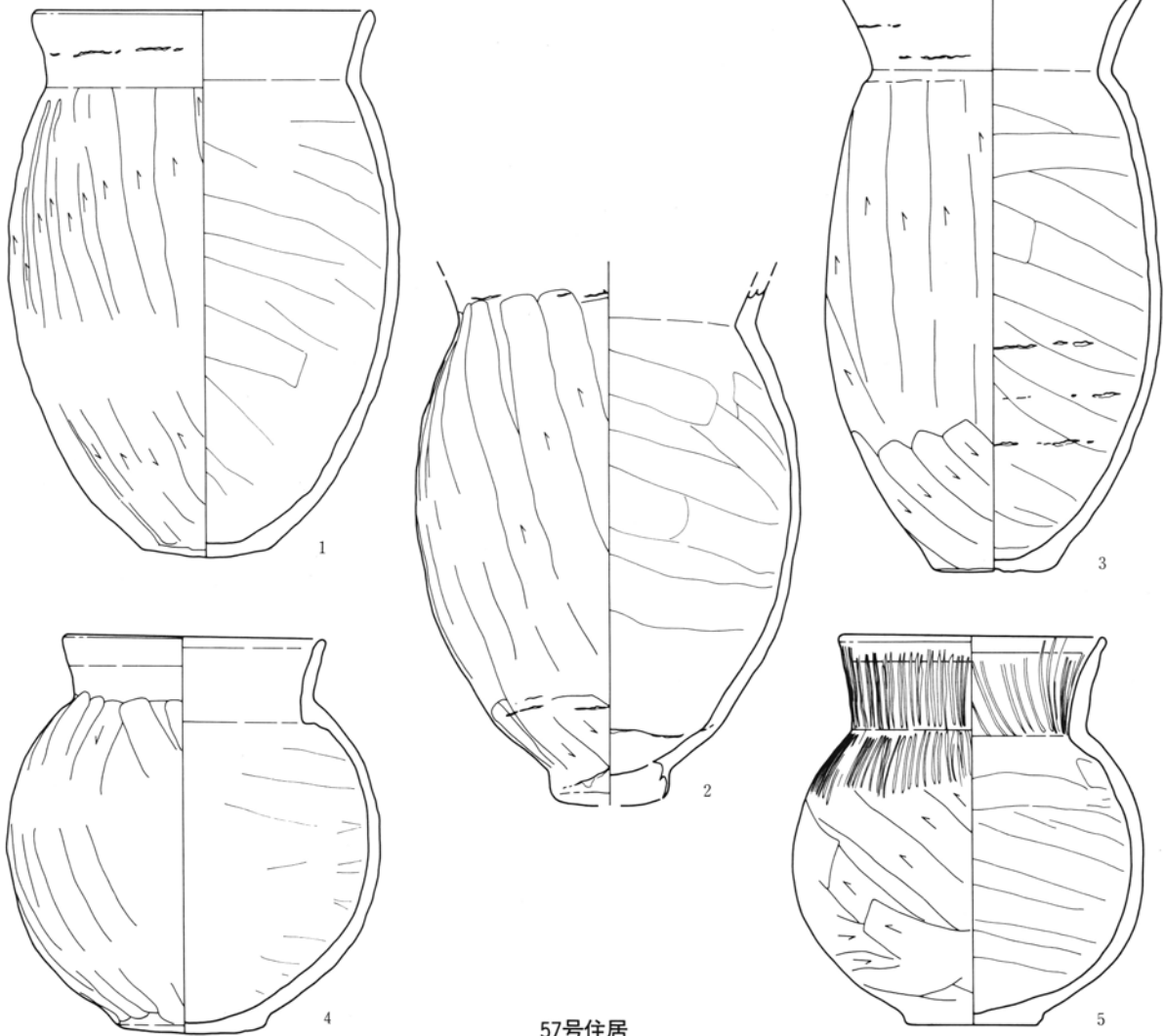

57号住居

0 1 : 4 10cm

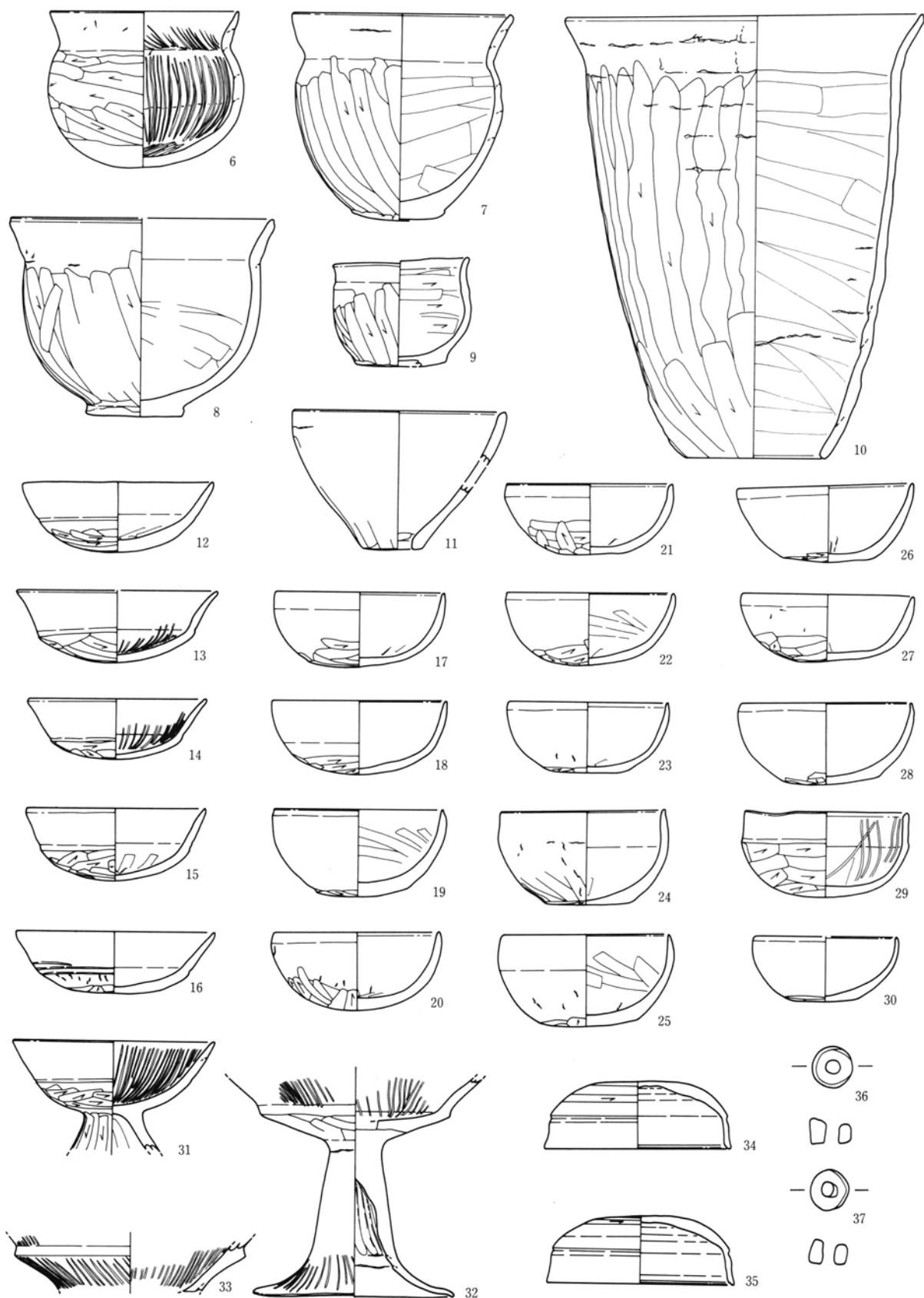

57号住居

0 1 : 4 10cm

36 · 37 0 1 : 1 1cm

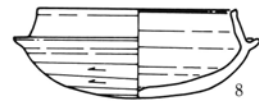
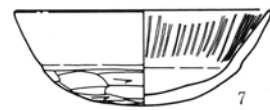
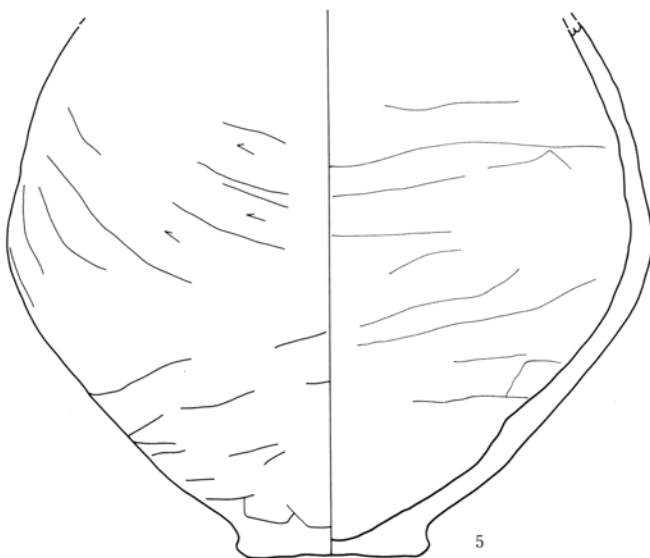
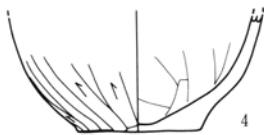
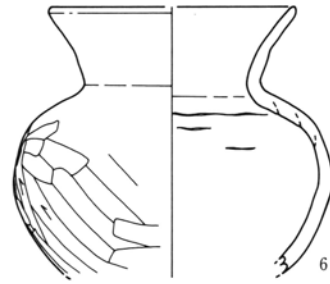
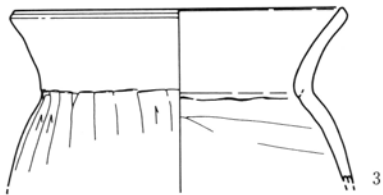
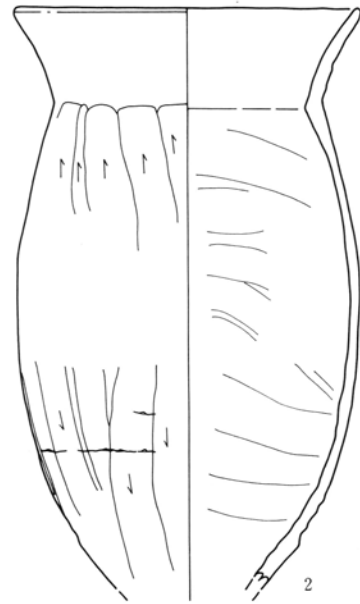
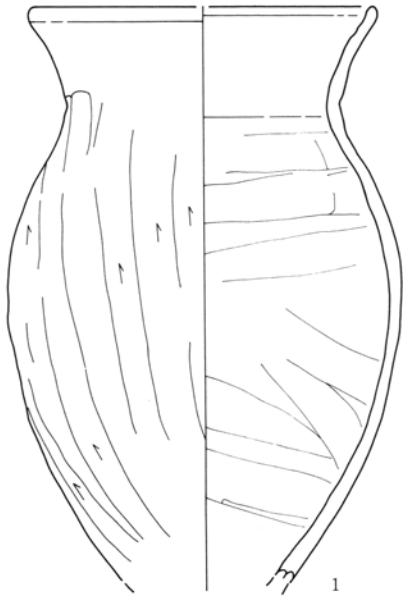

71号住居

0 1 : 4 10cm

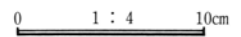
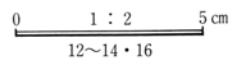
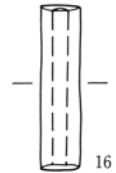
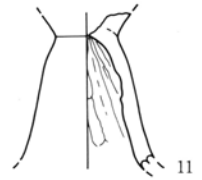
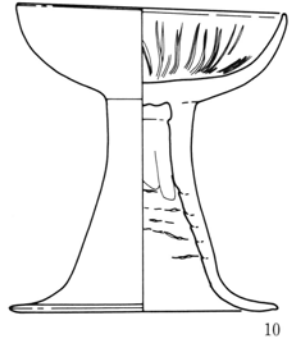
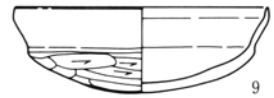
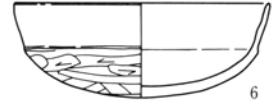
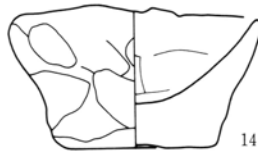
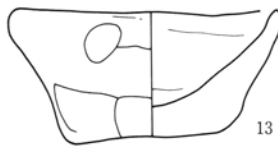
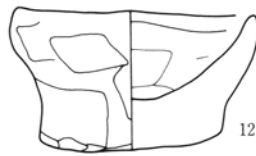
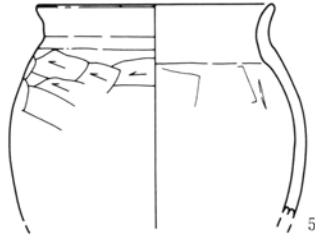
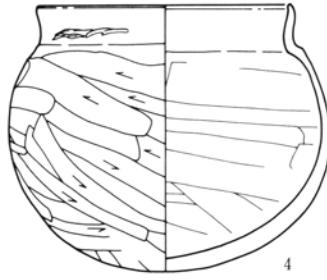
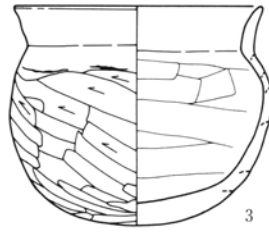
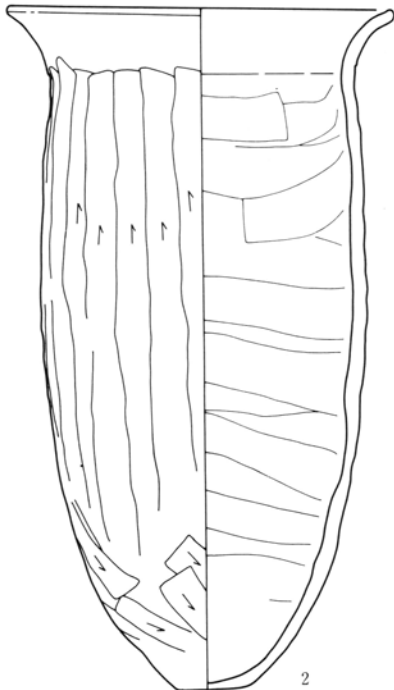
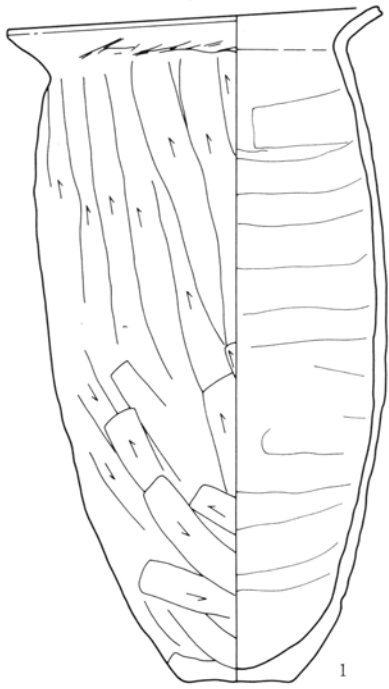

73号住居

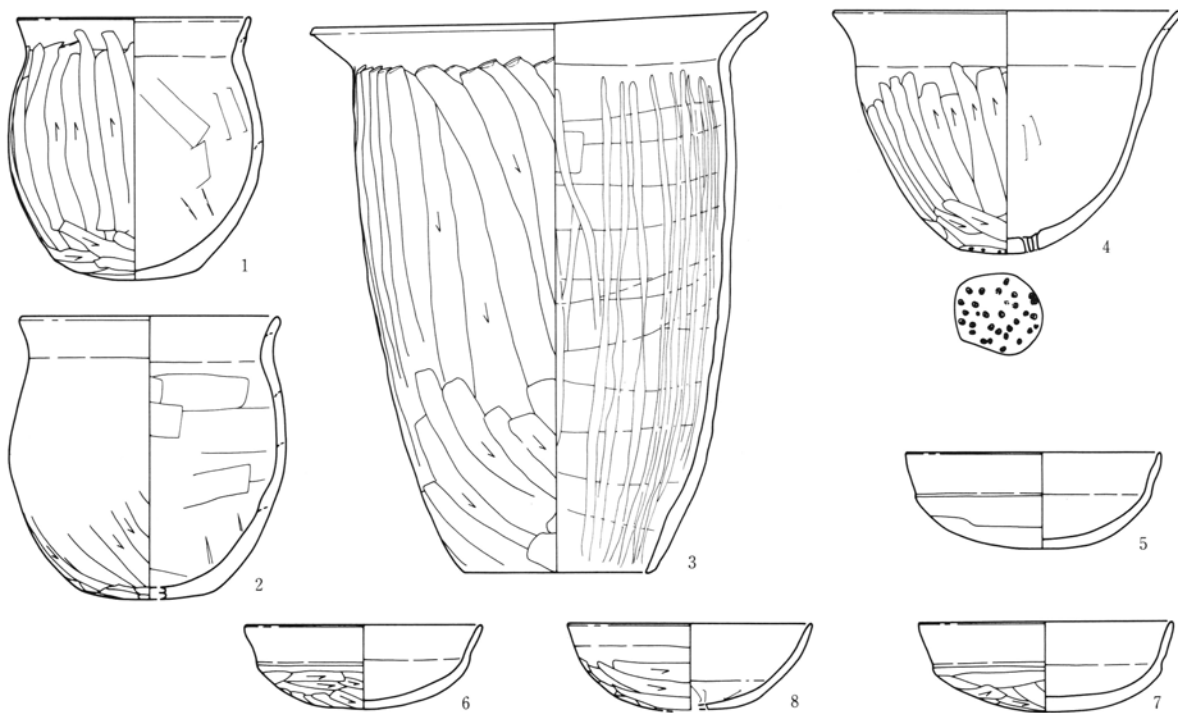

87号住居

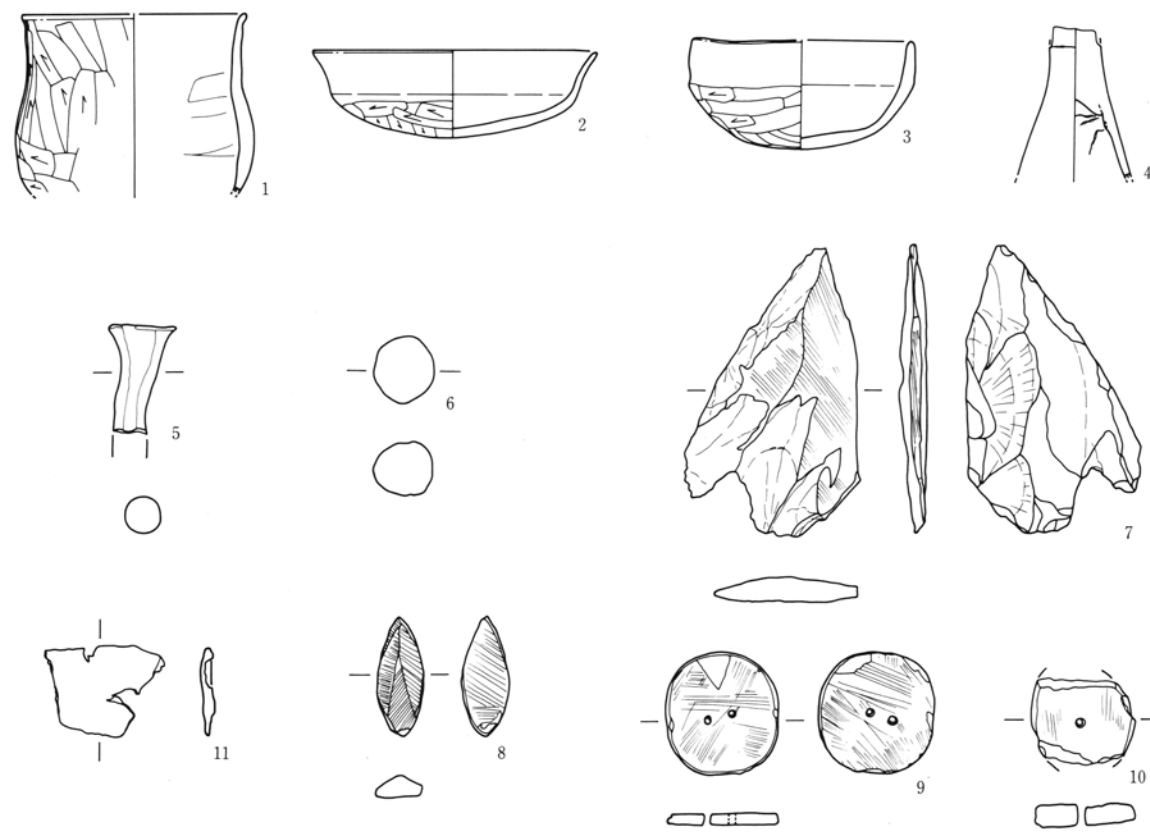

115号住居

0 1 : 2 5 cm
5 ~ 11

0 1 : 4 10 cm

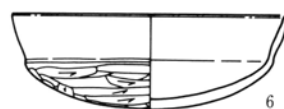
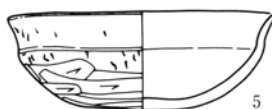
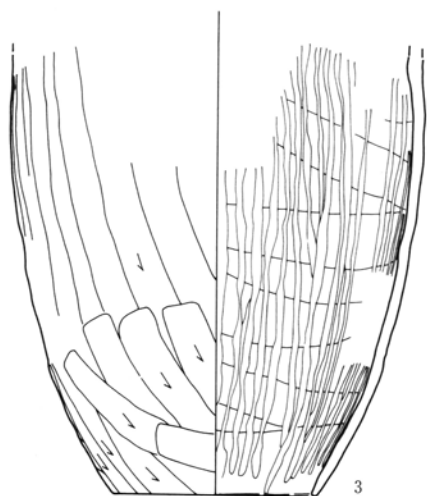
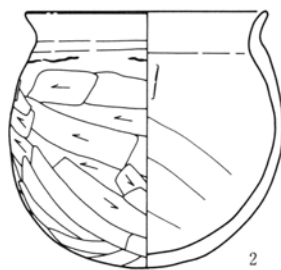
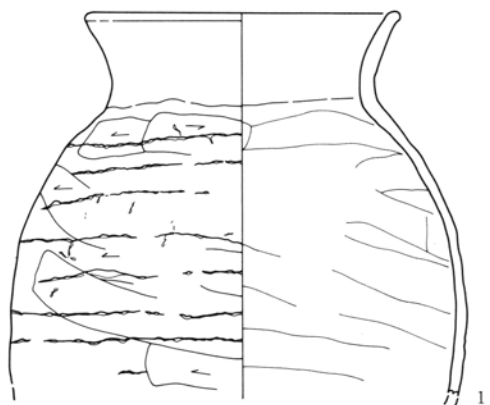

124号住居

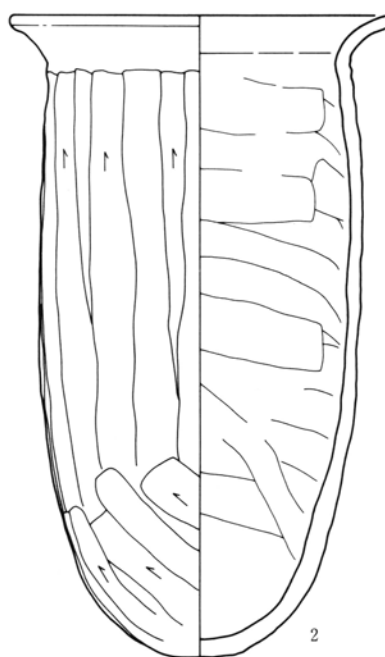
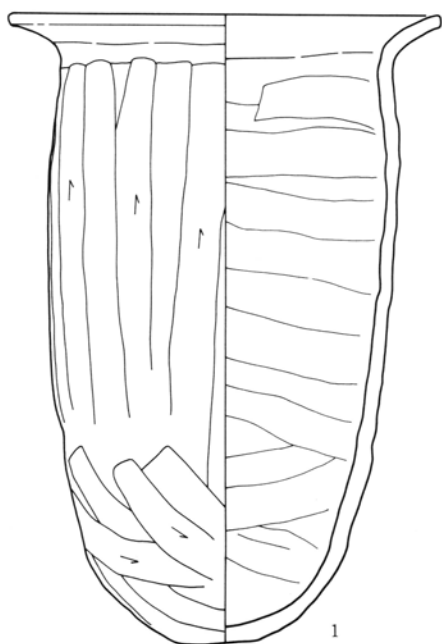

141号住居

0 1 : 4 10cm

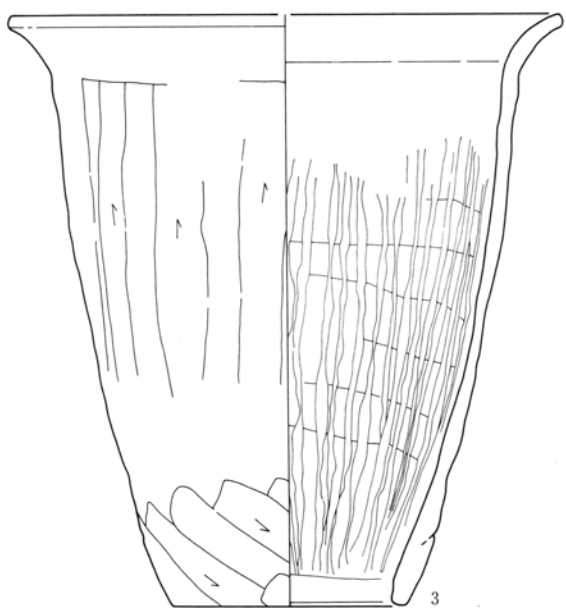

3

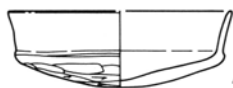

4

141号住居

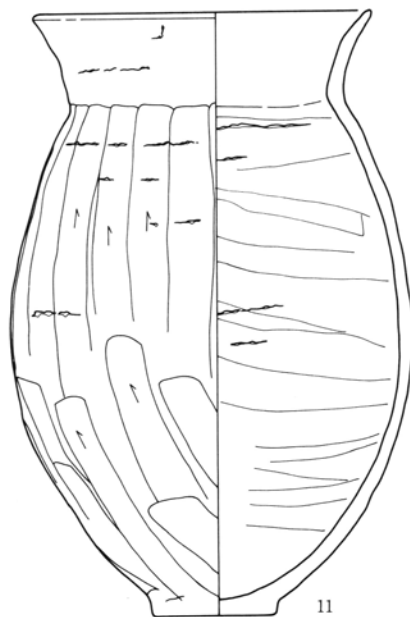

11

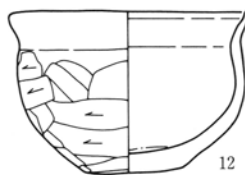

12



13

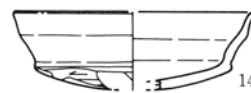

14

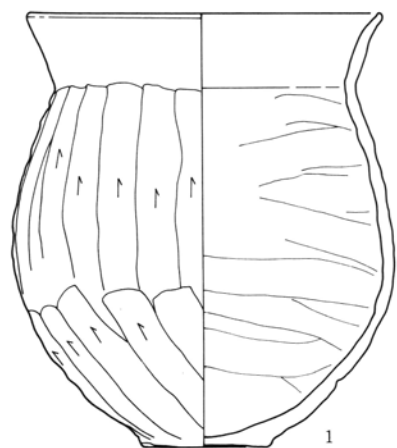

1

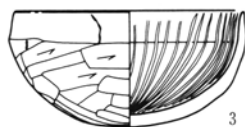

3

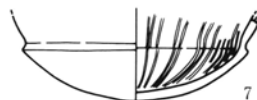

7



4



8

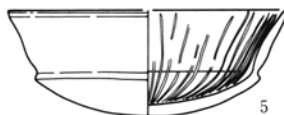

5

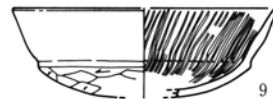

9

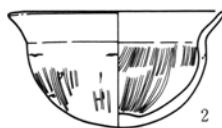

2

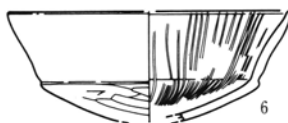

6



10

149号住居

0 1 : 4 10cm

6坑

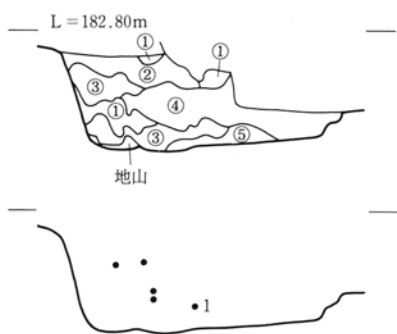
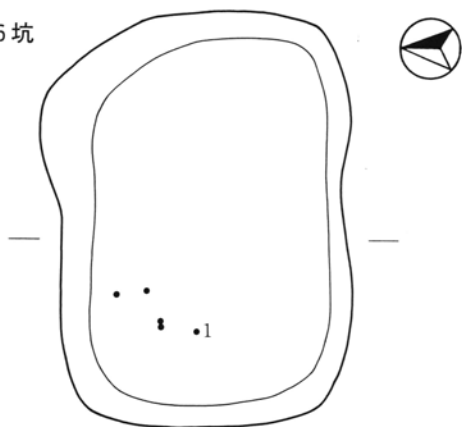

18坑

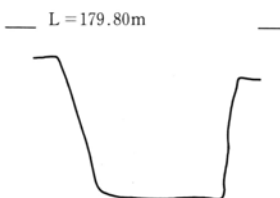

- 1、黒色土。
- 2、黄褐色土。ロームを含む。
- 3、黄褐色土。
- 4、黄褐色土。ロームを含む。
- 5、灰黄褐色土。

43坑

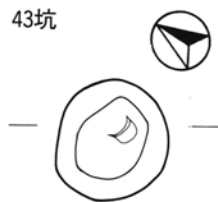

- 1、暗褐色土。軟質。
- 2、暗褐色土。ロームを含む。
- 3、ロームブロック混土。

46坑

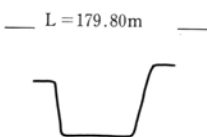
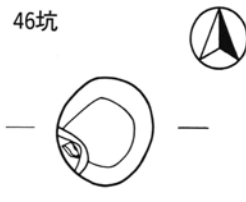

64坑

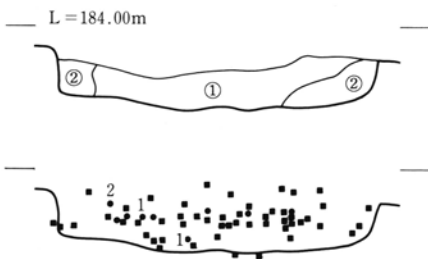
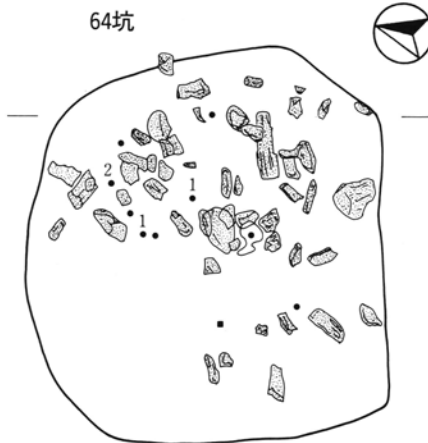

47坑

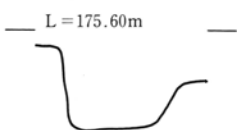
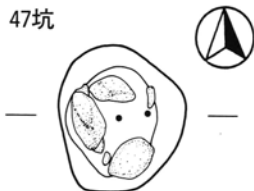

68坑

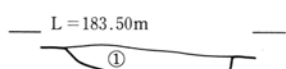
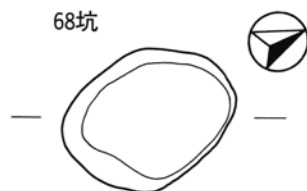

- 1、暗褐色砂混じり土。
焼土・炭化物を含む。

- 1、黒色砂混じり土。
- 2、暗黄褐色土。

0 1 : 40 1 m

71坑

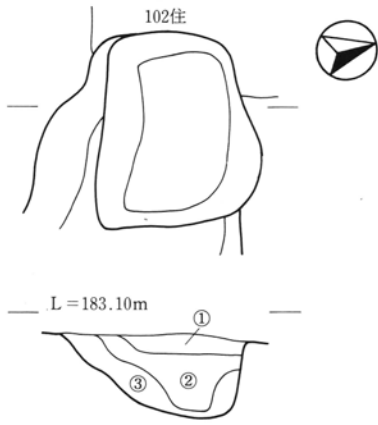

- 1、黒褐色砂混じり土。
- 2、黒褐色砂混じり土。ロームを含む。
- 3、2とロームの混土。

4坑

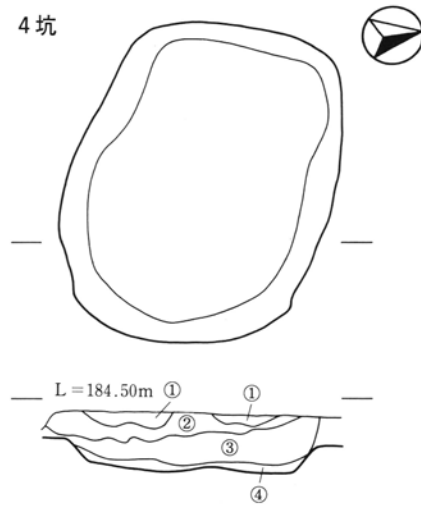

- 1、ローム混土。
- 2、褐色土。
- 3、褐色土。ロームを含む。
- 4、暗褐色土。

白倉A区

白倉B区

5坑

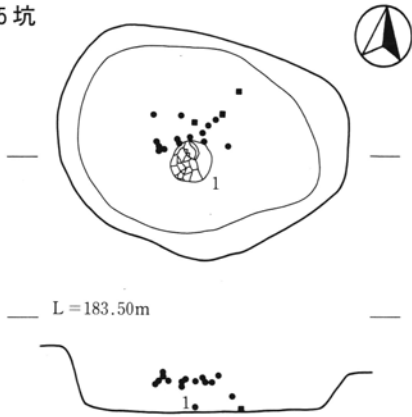

14坑

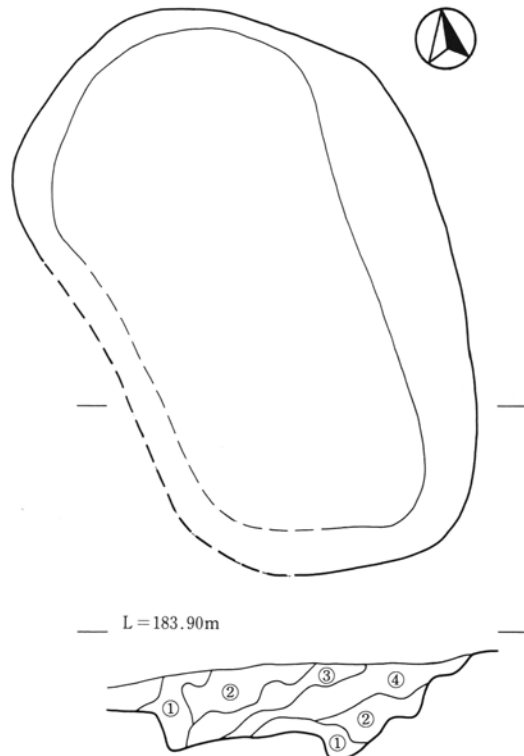

- 1、ロームブロック。
- 2、褐色土とロームの混土。
- 3、暗褐色土。
- 4、黒褐色土。

9坑

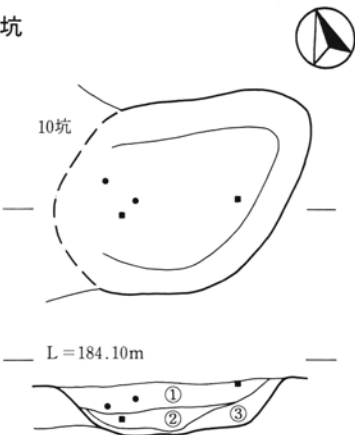

- 1、暗褐色土。
- 2、褐色土。
- 3、褐色土とロームの混土。

0 1 : 40 1 m

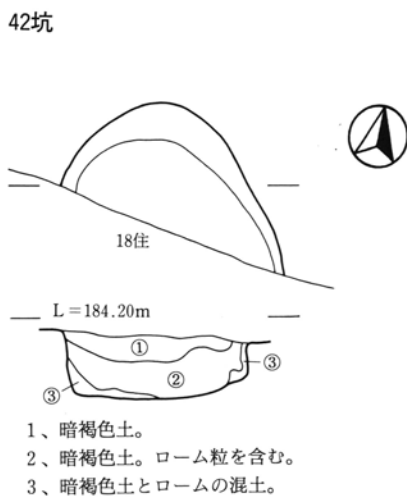
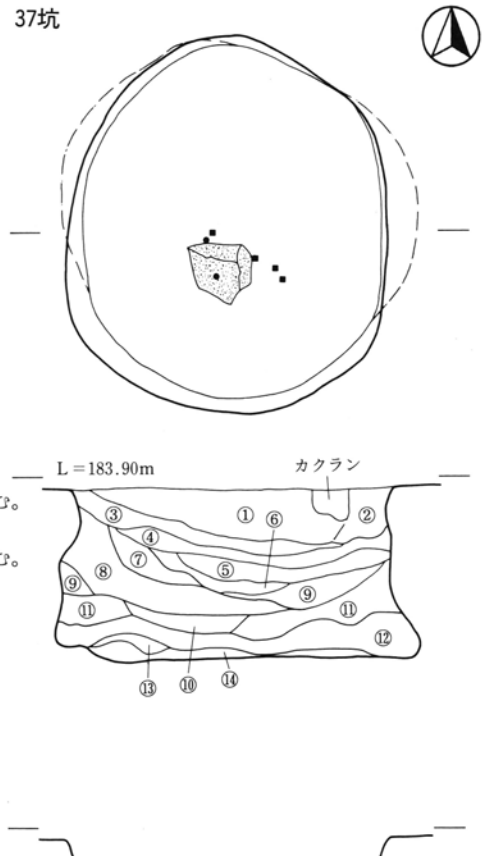
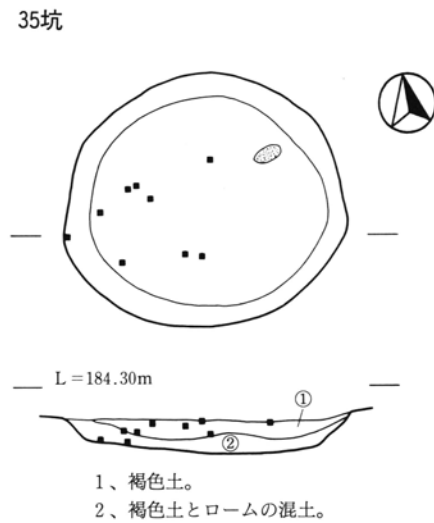
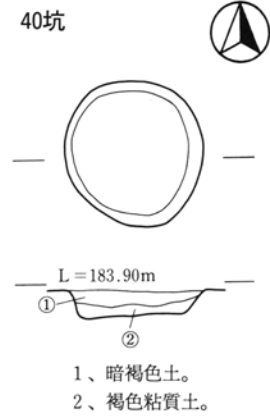
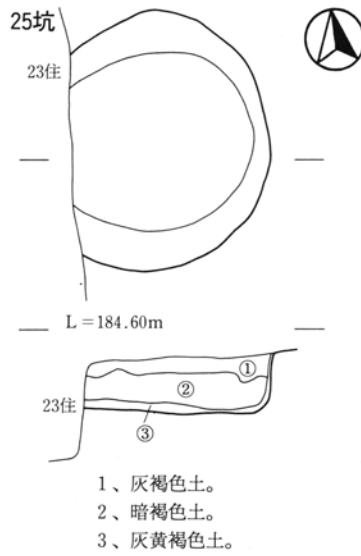
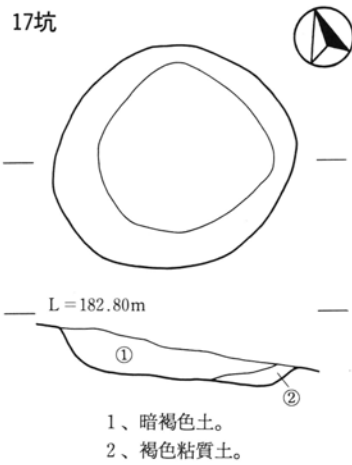

45坑

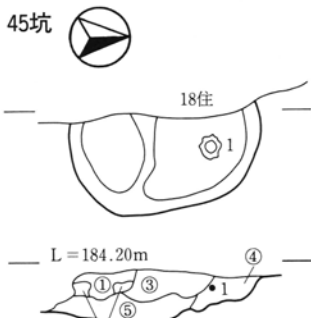

- 1、暗褐色土。
- 2、褐色土。ロームを含む。
- 3、褐色土。焼土粒を含む。
- 4、暗褐色土。
- 5、明褐色土。ロームを含む。

46坑

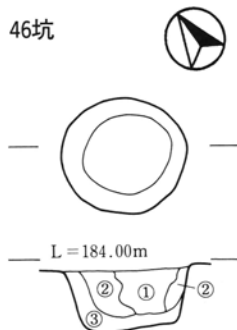

- 1、暗褐色土。
- 2、褐色ブロック土。
- 3、褐色土とロームの混土。

60坑

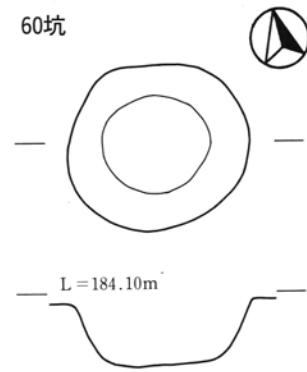

61坑

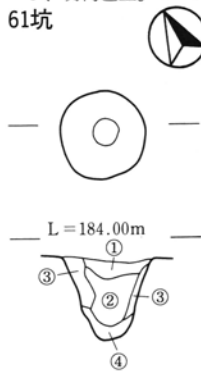

- 1、暗褐色土。
- 2、黒褐色土。ロームを含む。
- 3、黒褐色土。
- 4、暗褐色土。

70坑

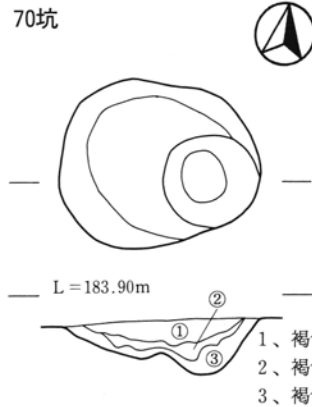

- 1、褐色土。
- 2、褐色ローム混土。
- 3、褐色土。

71坑

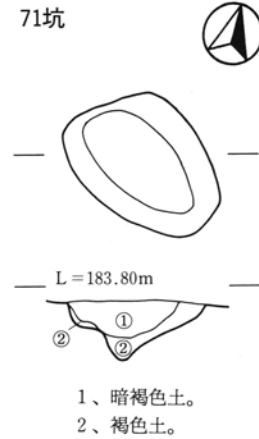

- 1、暗褐色土。
- 2、褐色土。

74坑

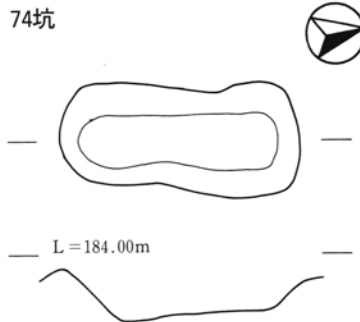

72坑

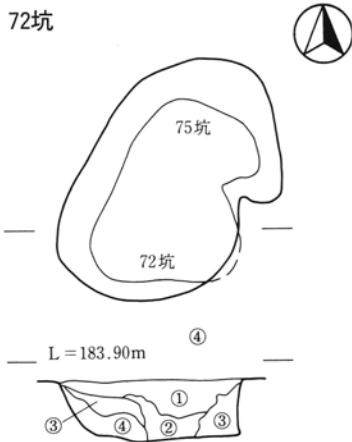

- 1、褐色土。
- 2、褐色土。軟質。
- 3、褐色土とロームの混土。
- 4、ローム混土。

76坑

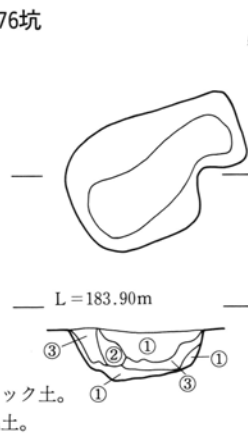

- 1、褐色土。
- 2、褐色ブロック土。
- 3、ローム混土。

91坑

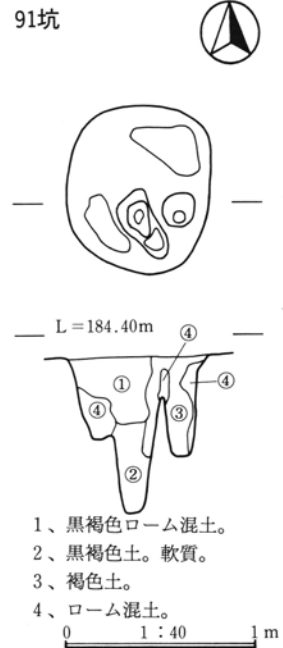

- 1、黒褐色ローム混土。
- 2、黒褐色土。軟質。
- 3、褐色土。
- 4、ローム混土。

0 1:40 1 m

111坑

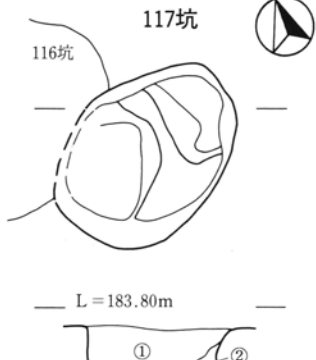
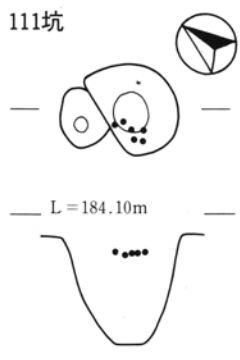

- 1、褐色土。
- 2、褐色ローム混土。
- 3、ローム混土。

138坑

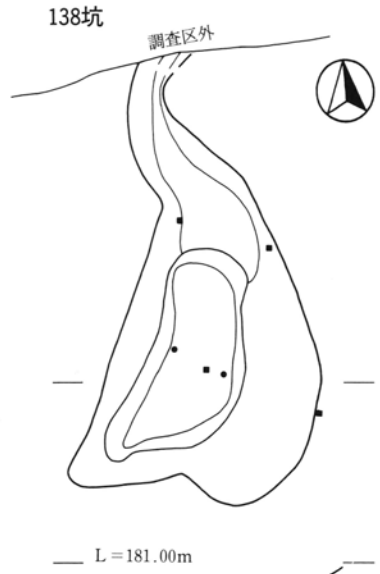

146坑

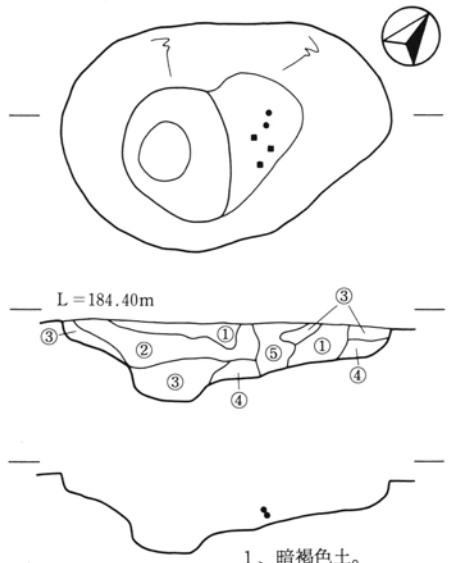

- 1、暗褐色土。
- 2、褐色土。
- 3、黄褐色土。
- 4、ローム混土。
- 5、黒褐色土。

203坑

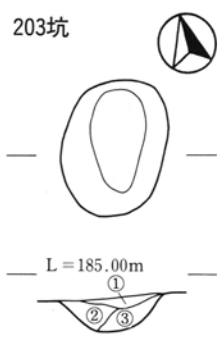

- 1、暗褐色土。
- 2、褐色土とロームの混土。
- 3、暗褐色土。

- 1、暗茶褐色土。
- 2、暗褐色土。
- 3、黒褐色土。

154坑

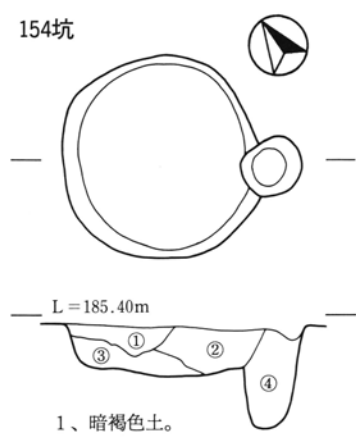

- 1、暗褐色土。
- 2、暗褐色土。ロームを含む。
- 3、褐色土。
- 4、褐色土。硬質。

177坑

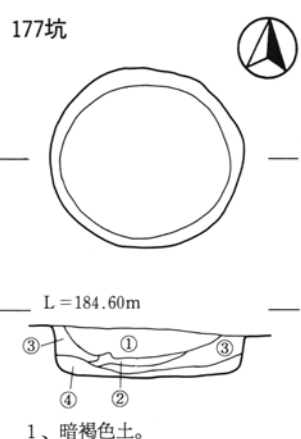

- 1、暗褐色土。
- 2、黒色土。
- 3、褐色土。
- 4、黒色土。ロームを含む。

178坑

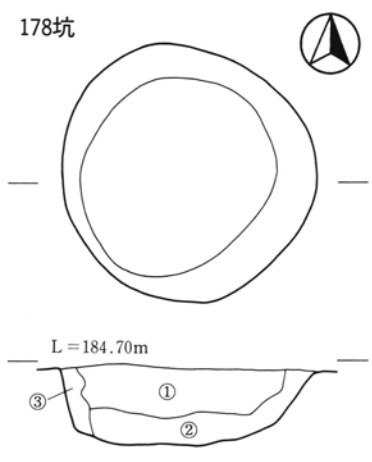

- 1、黒褐色土。
- 2、暗褐色土。
- 3、黒褐色土。ロームを含む。

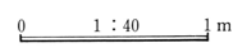

221坑

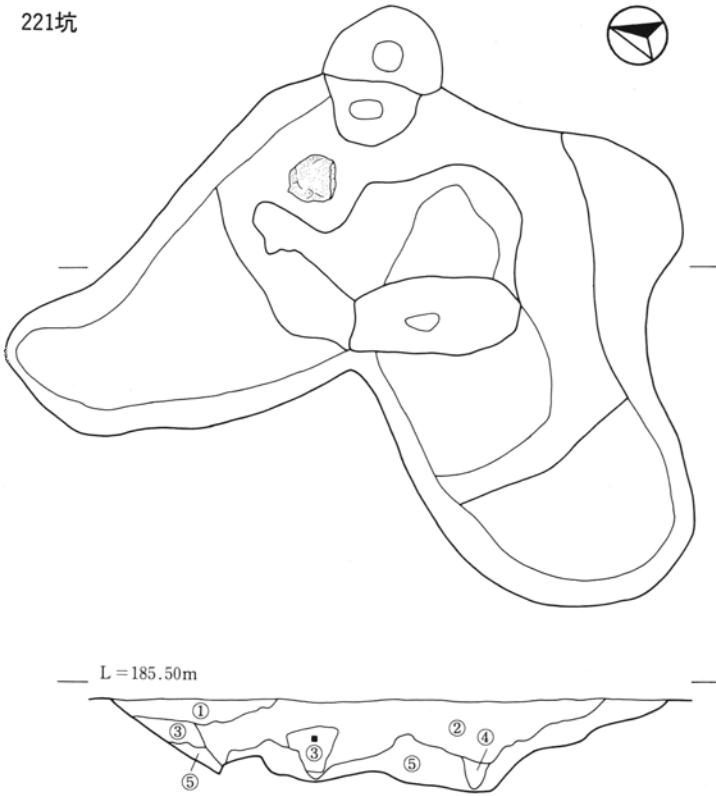

- 1、茶褐色土。ロームを含む。
- 2、暗褐色土。
- 3、褐色土とロームの混土。
- 4、茶褐色土。
- 5、1と同質。

229坑

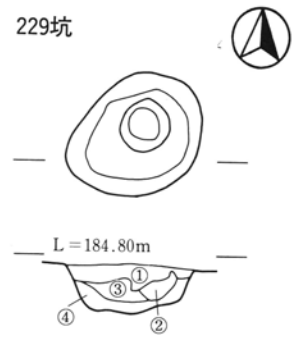

- 1、暗褐色土。
- 2、褐色土。
- 3、ローム混土。
- 4、暗褐色土。ロームを含む。

252坑

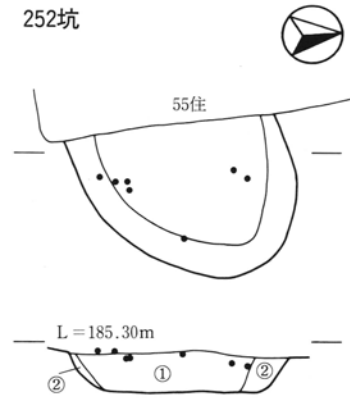

- 1、黒褐色土。ロームを含む。
- 2、暗褐色土。

206坑

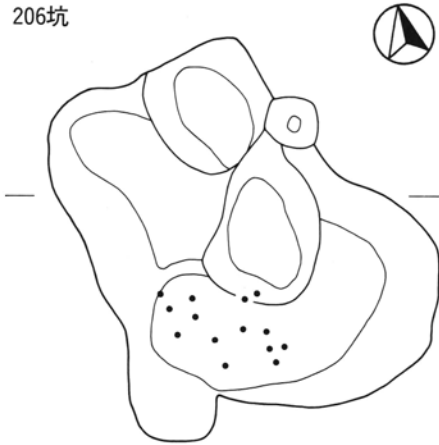

- 1、暗褐色土。
- 2、暗褐色土。ロームを含む。
- 3、黄褐色土。
- 4、黄褐色土。ロームを含む。

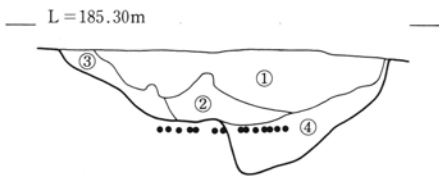

254坑

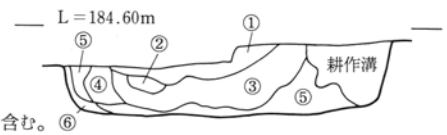
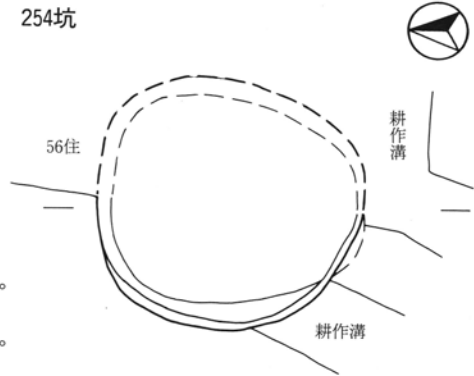

- 1、黒褐色土。
- 2、茶褐色土。
- 3、黒褐色土。ロームを含む。
- 4、暗褐色土。
- 5、暗褐色土。ロームを含む。
- 6、黄褐色土。

0 1 : 40 1 m

図312 白倉B区271号・275号・293号土坑 白倉C区4号・10号・12号・22号土坑 24号・25号・33号土坑

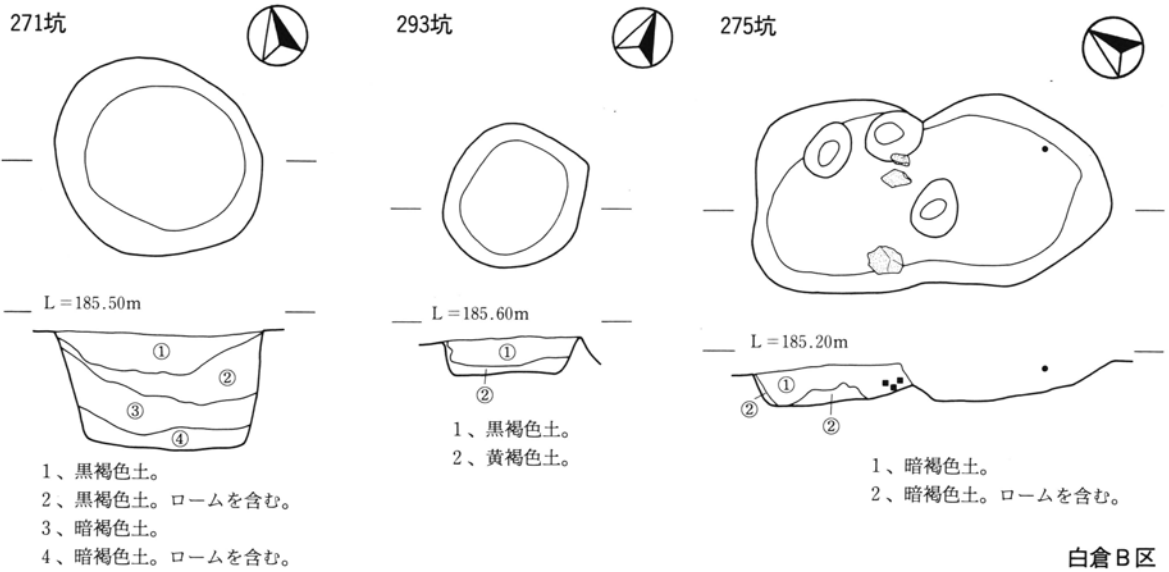

白倉B区

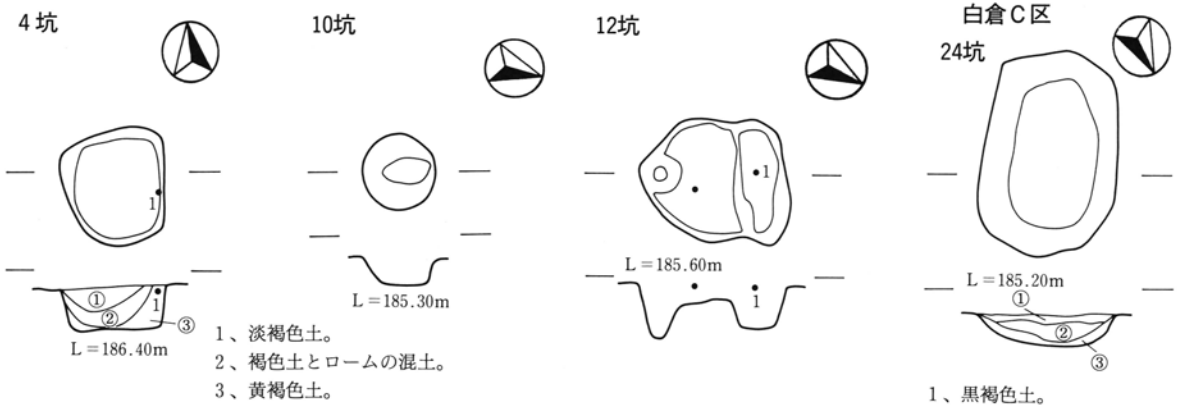

白倉C区

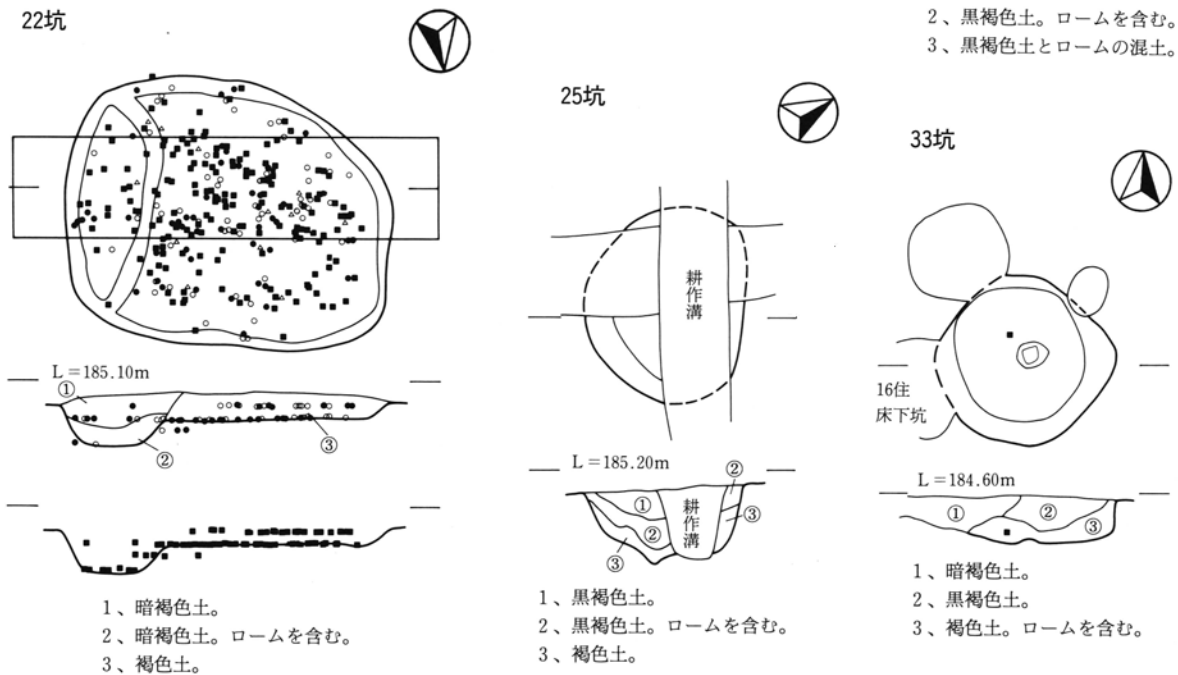

0 1 : 40 1m

図313 白倉C区54号・65号・66号土坑 83号・93号・111号土坑 天引C区34号・41号土坑

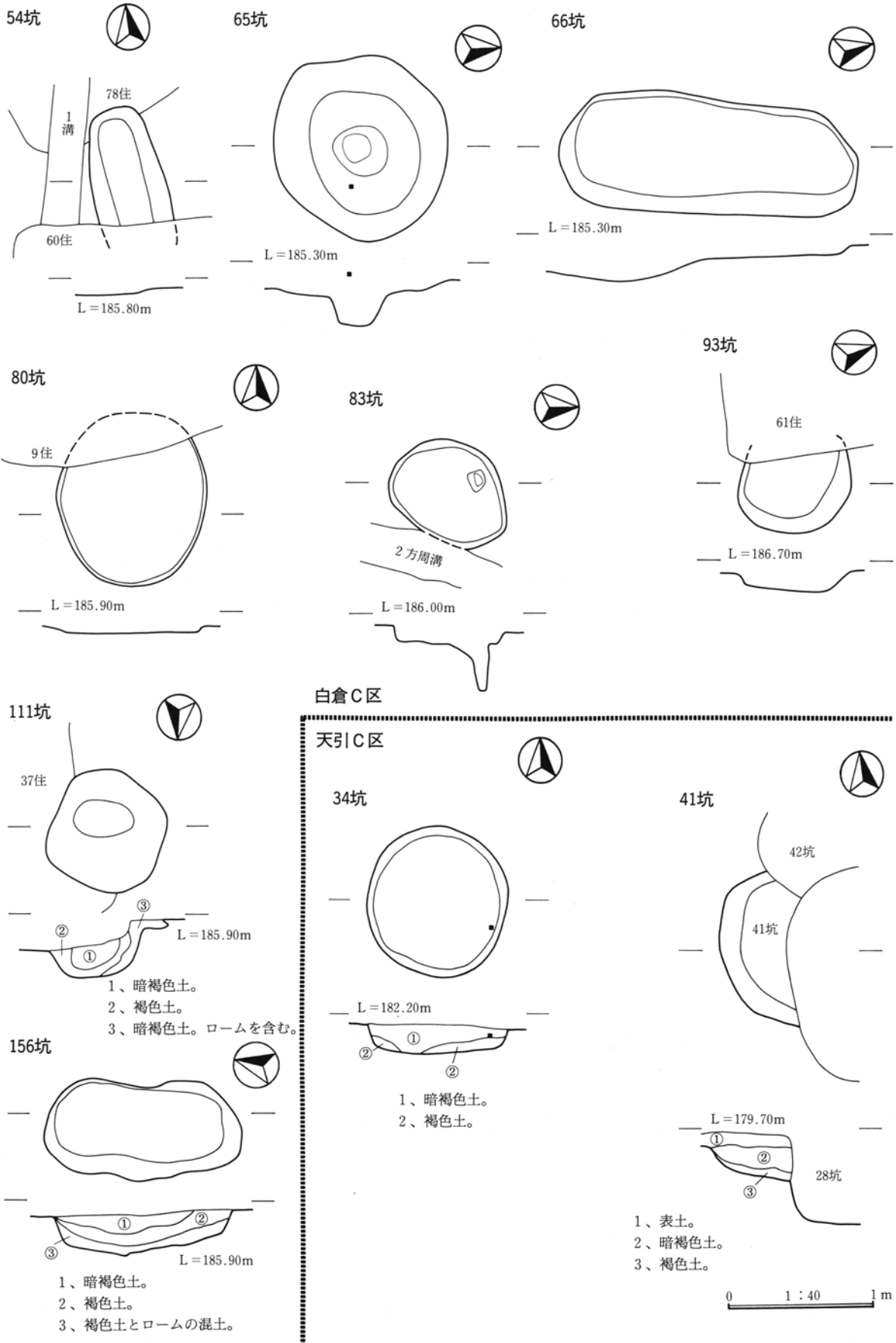

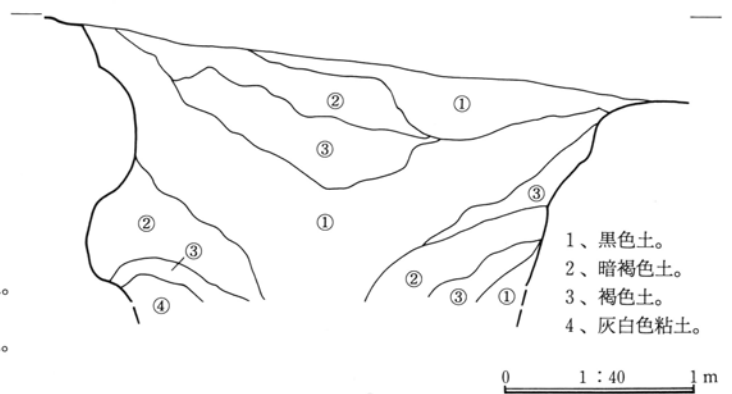
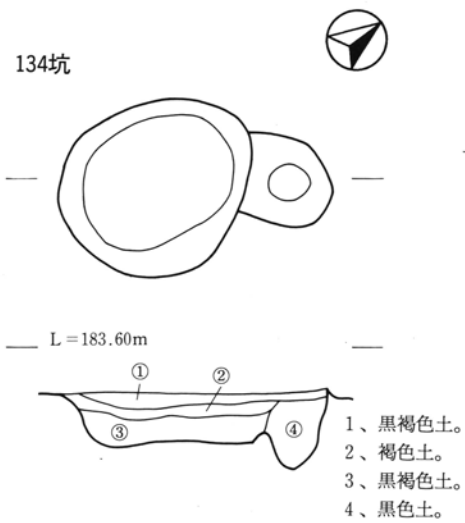
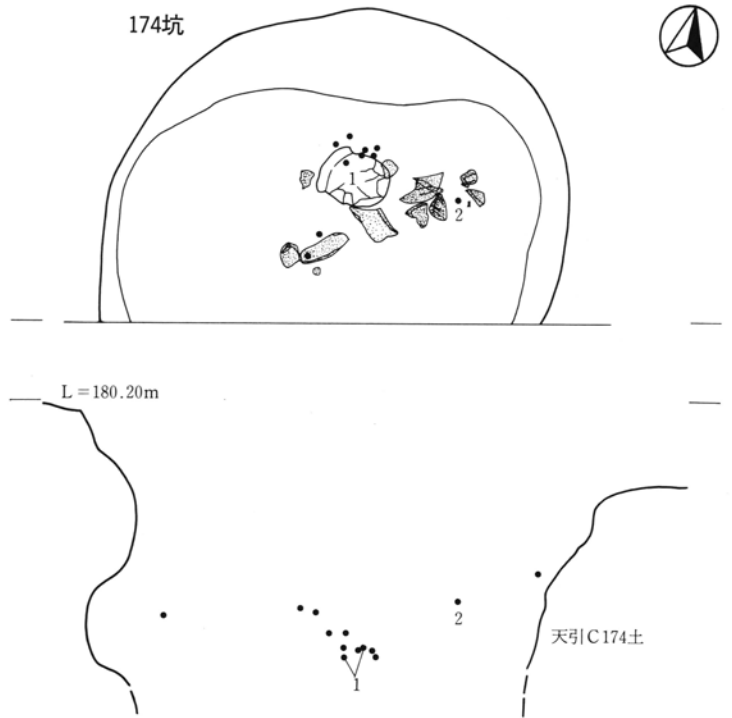
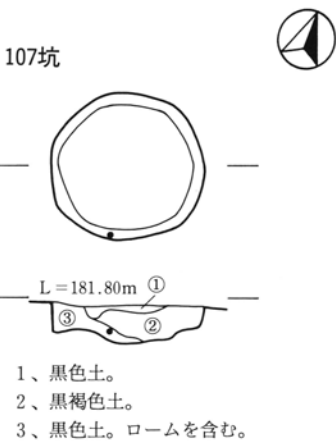
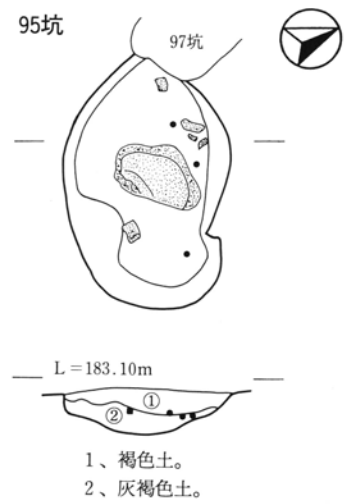
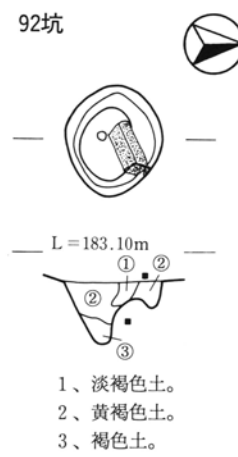
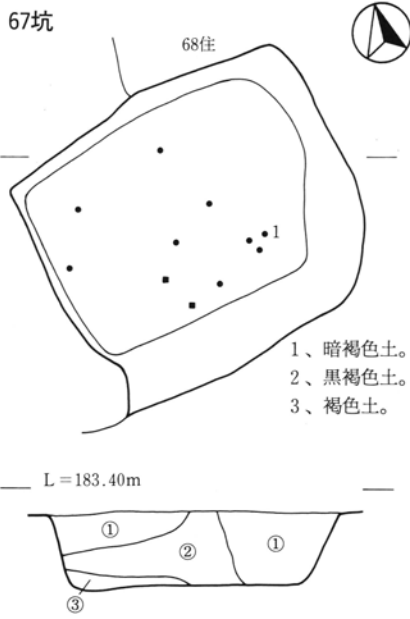

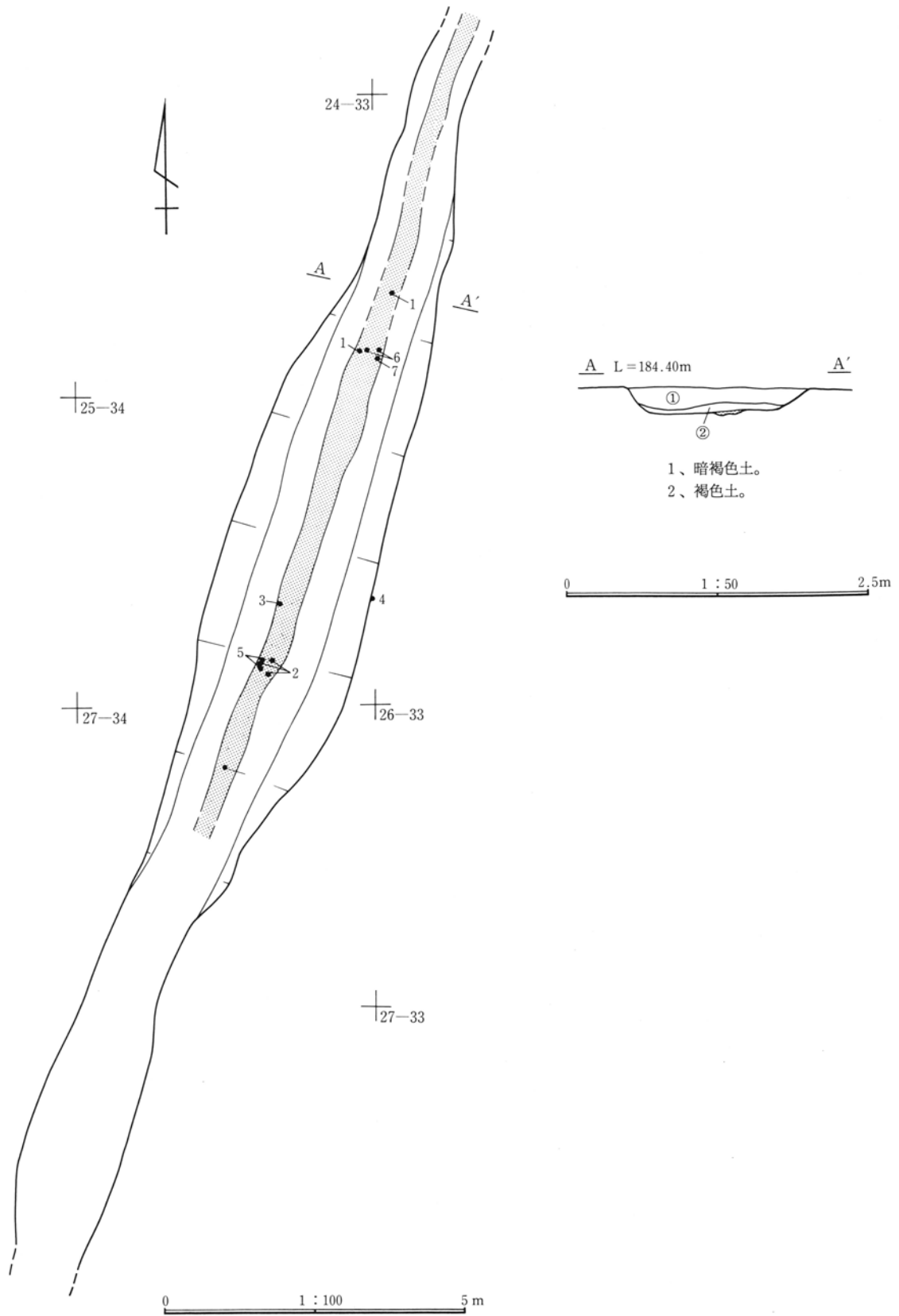

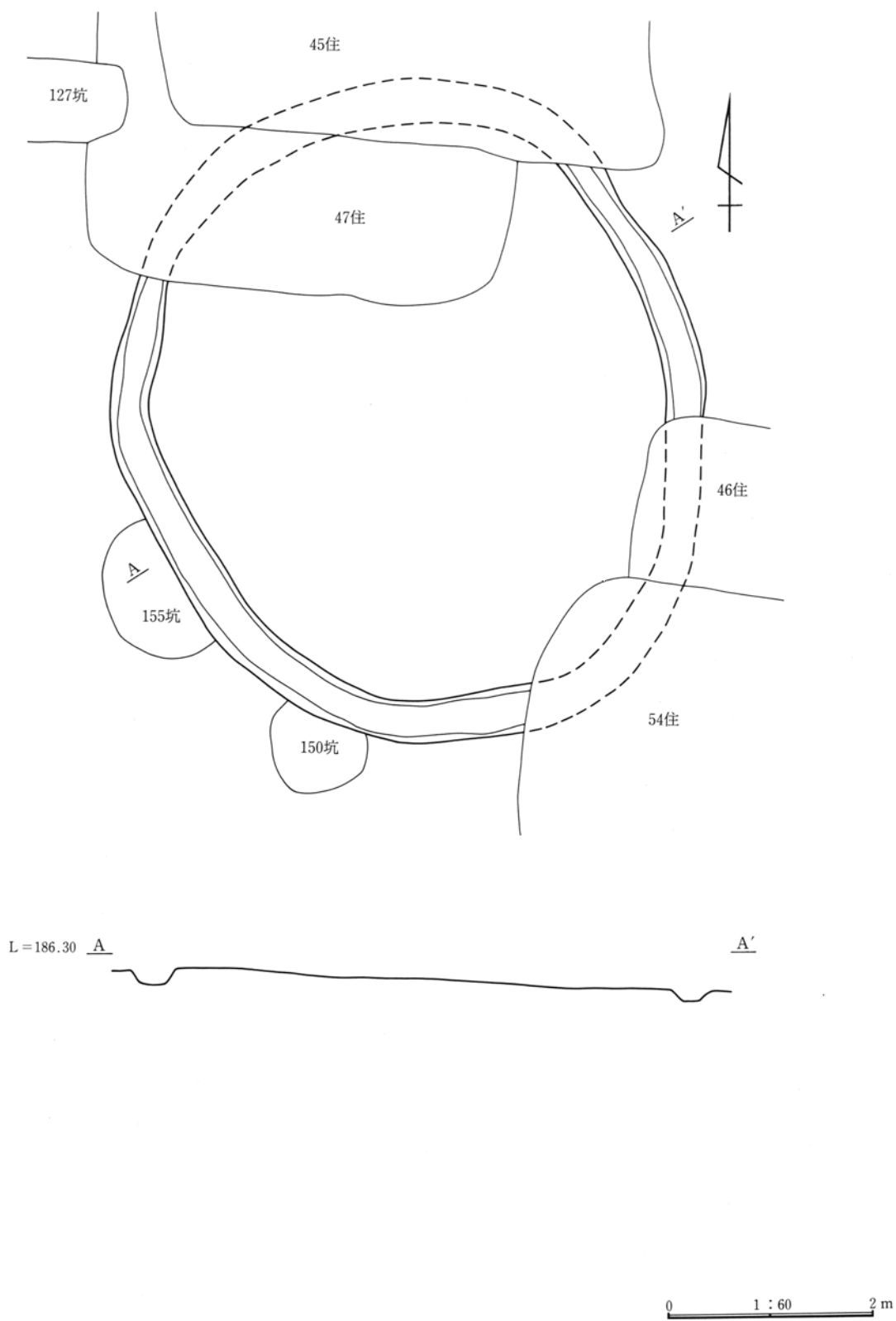

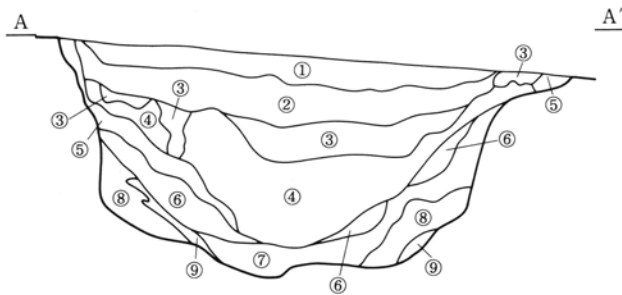
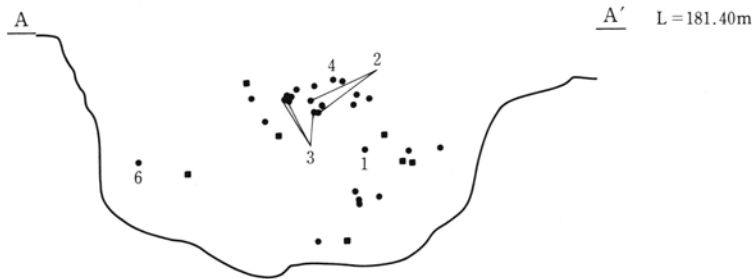
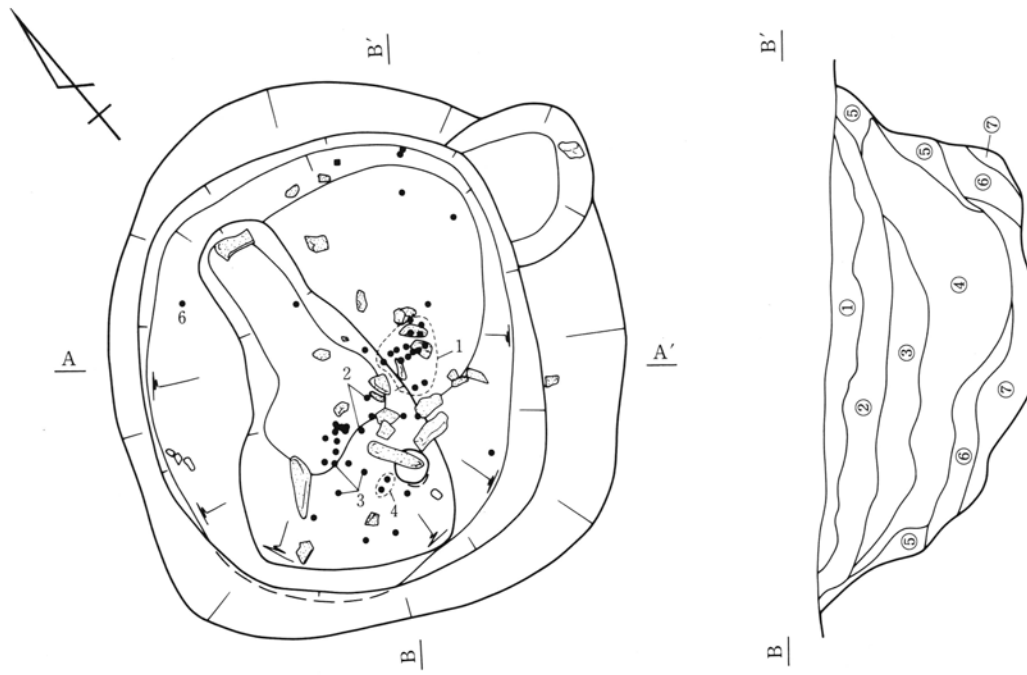

- 1、暗褐色土。
- 2、暗褐色土。ロームを含む。
- 3、暗褐色土。黒褐色土を含む。
- 4、明褐色土。
- 5、明褐色土。ローム粒を多く含む。
- 6、褐色土とロームのブロック状混土。
- 7、暗褐色土。ロームブロックを含む。
- 8、黄褐色土。
- 9、灰白色粘土。

0 1 : 60 2 m

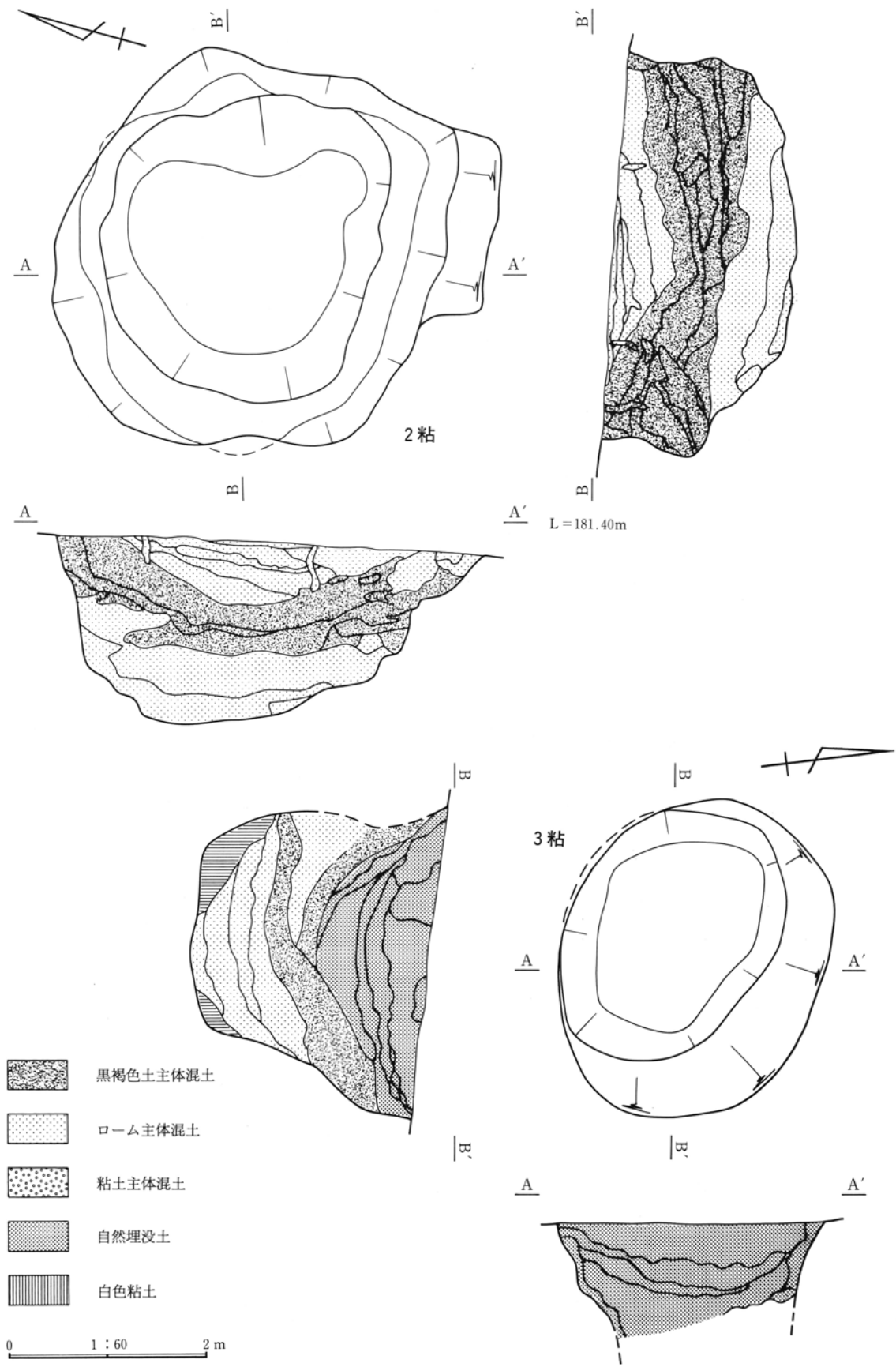

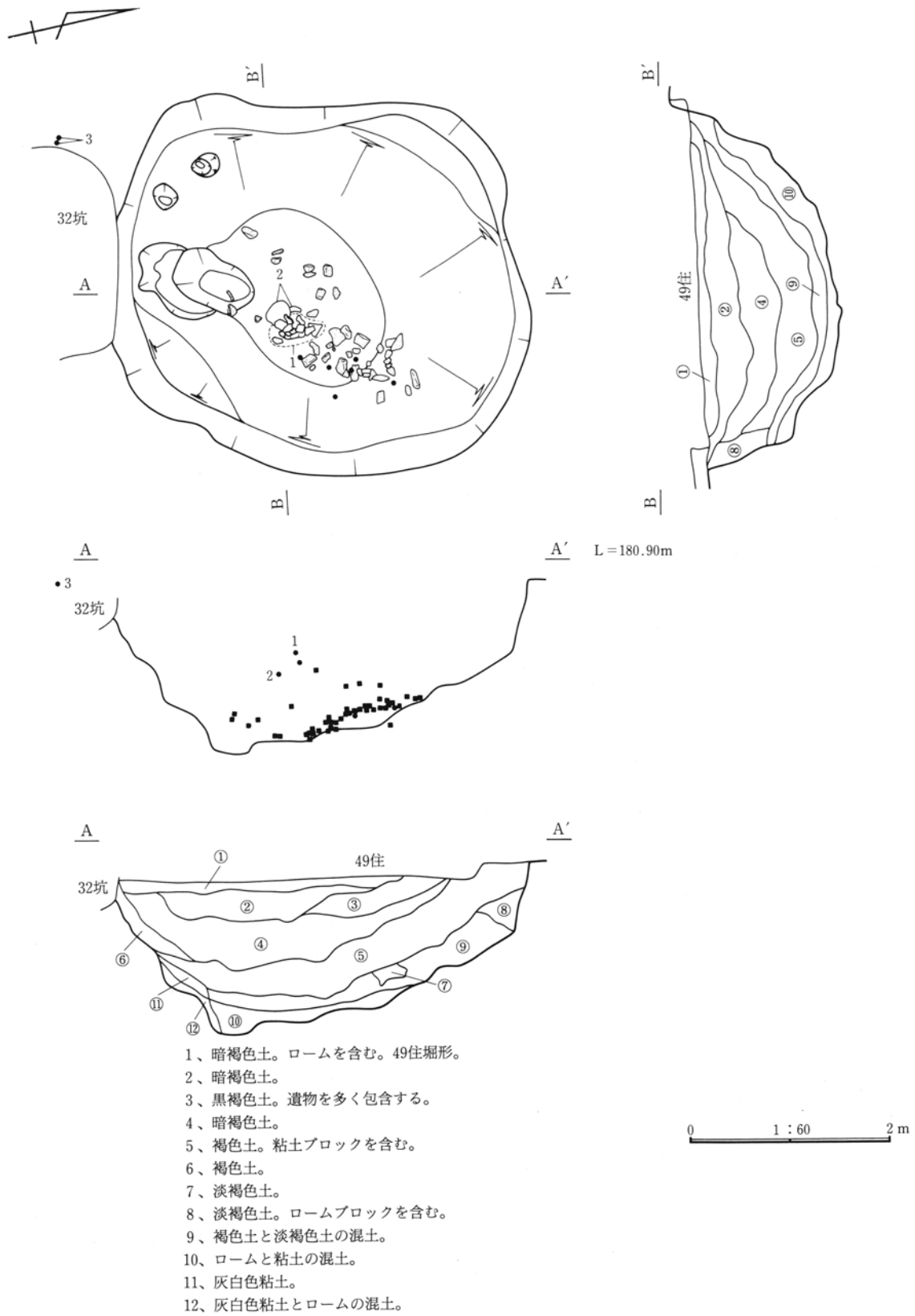

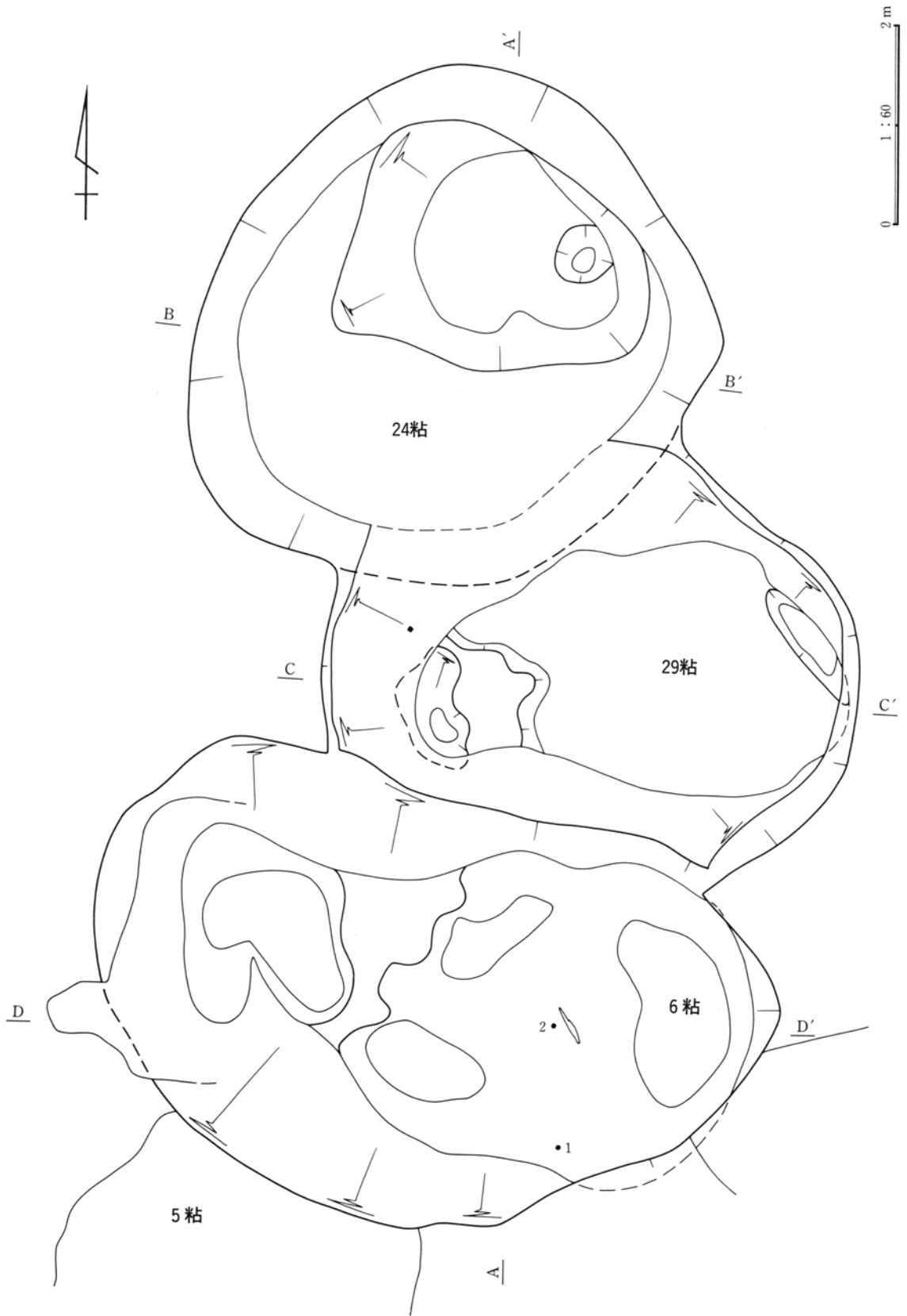

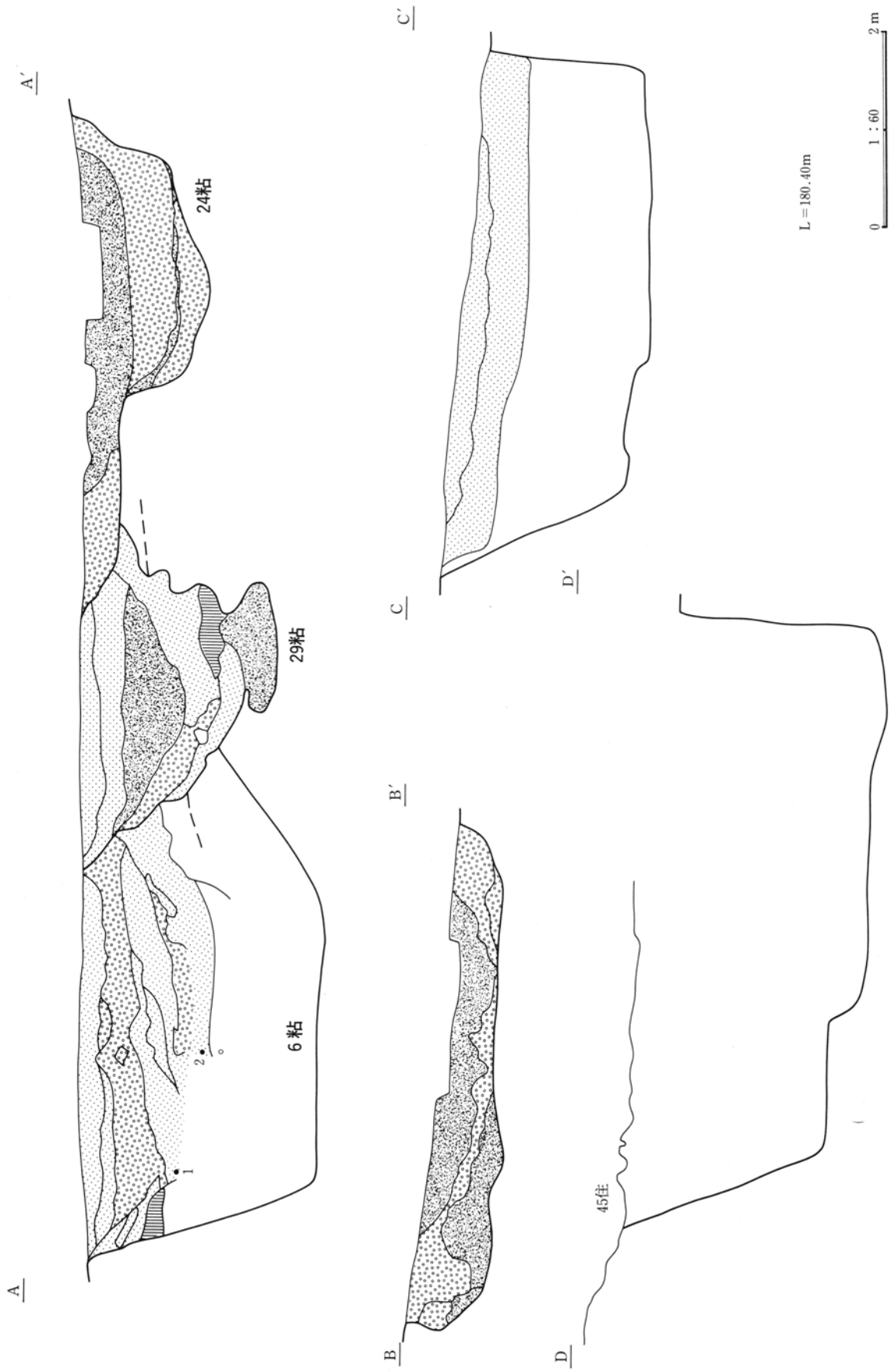

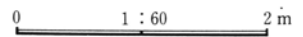
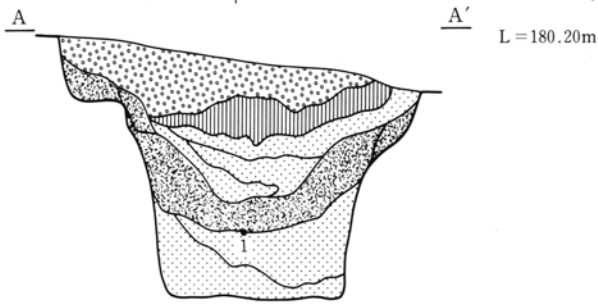
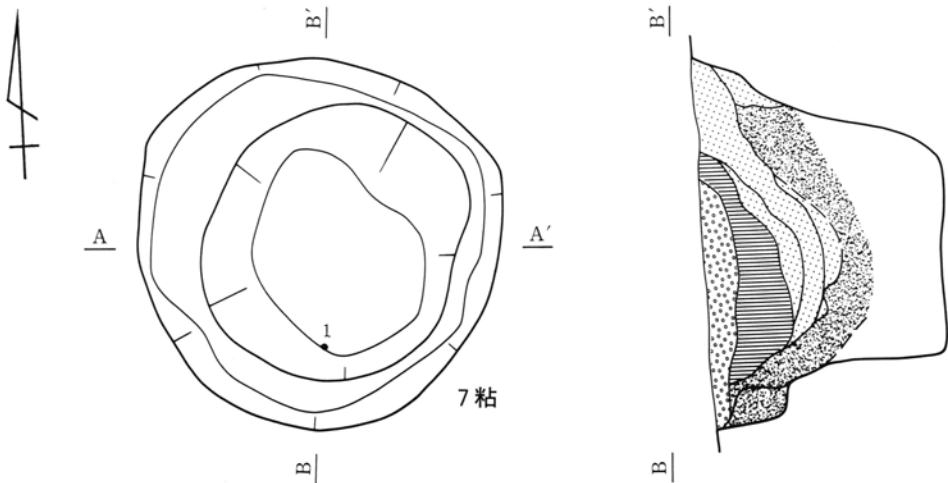
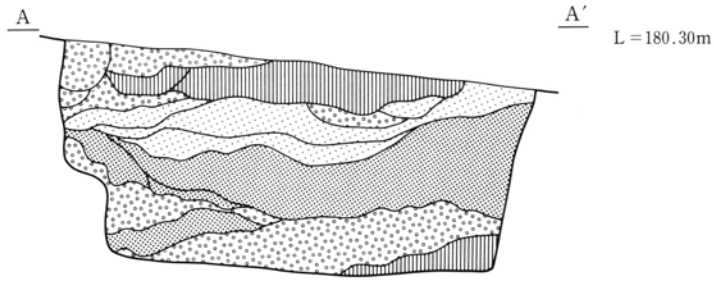
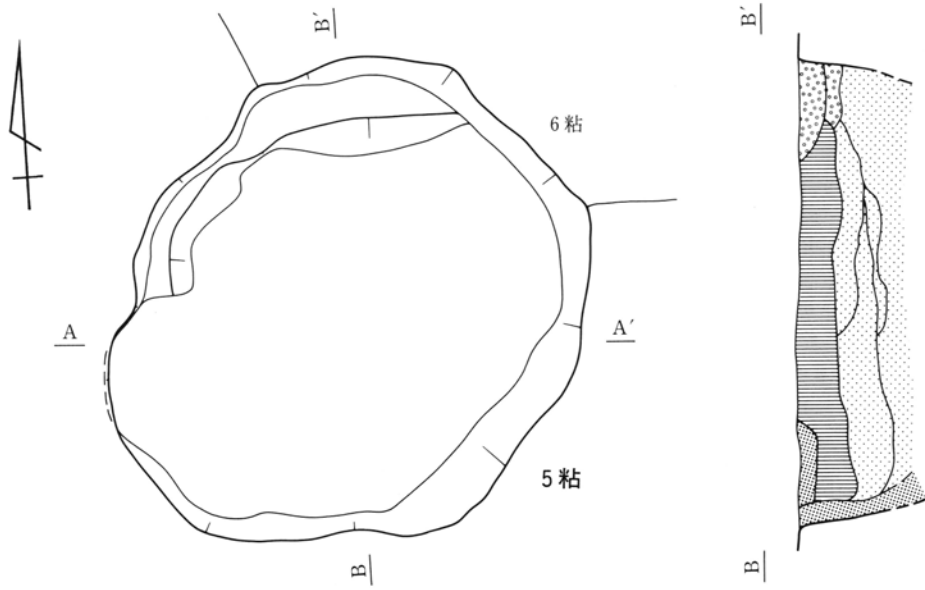

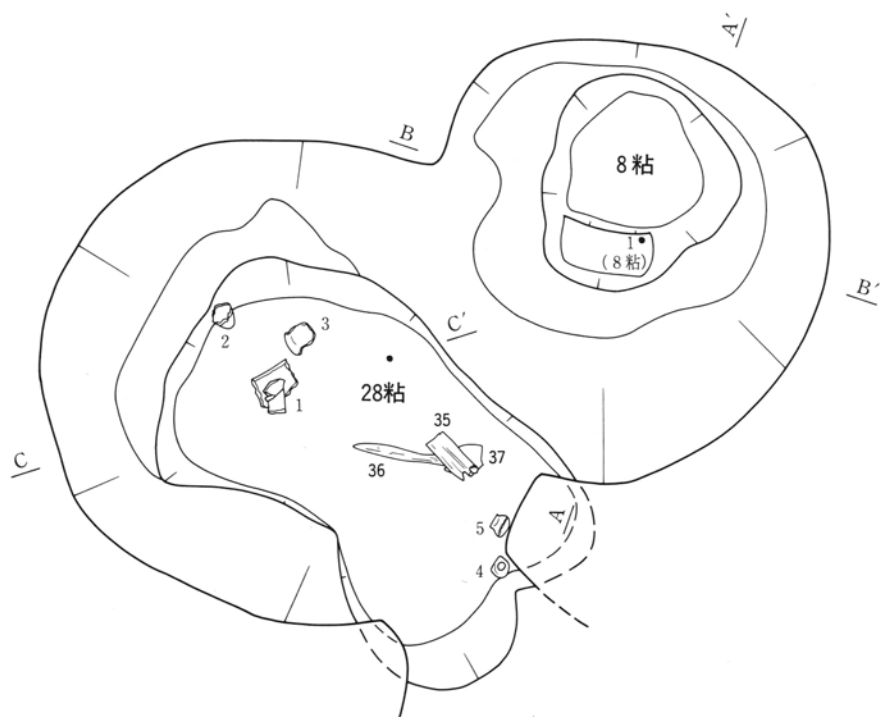

A L=180.40m

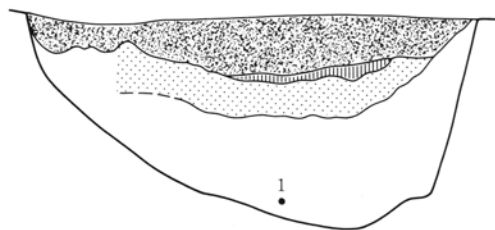

A'

B L=180.40m

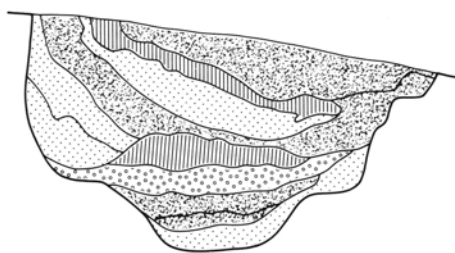

B'

C L=180.40m

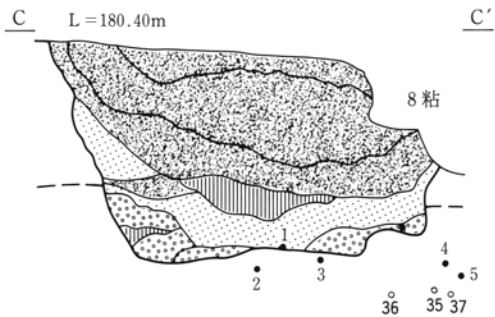

C'

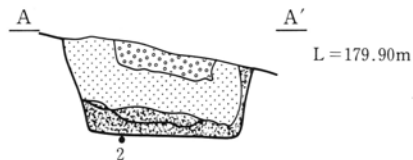
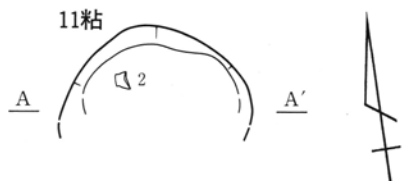

0 1:60 2m

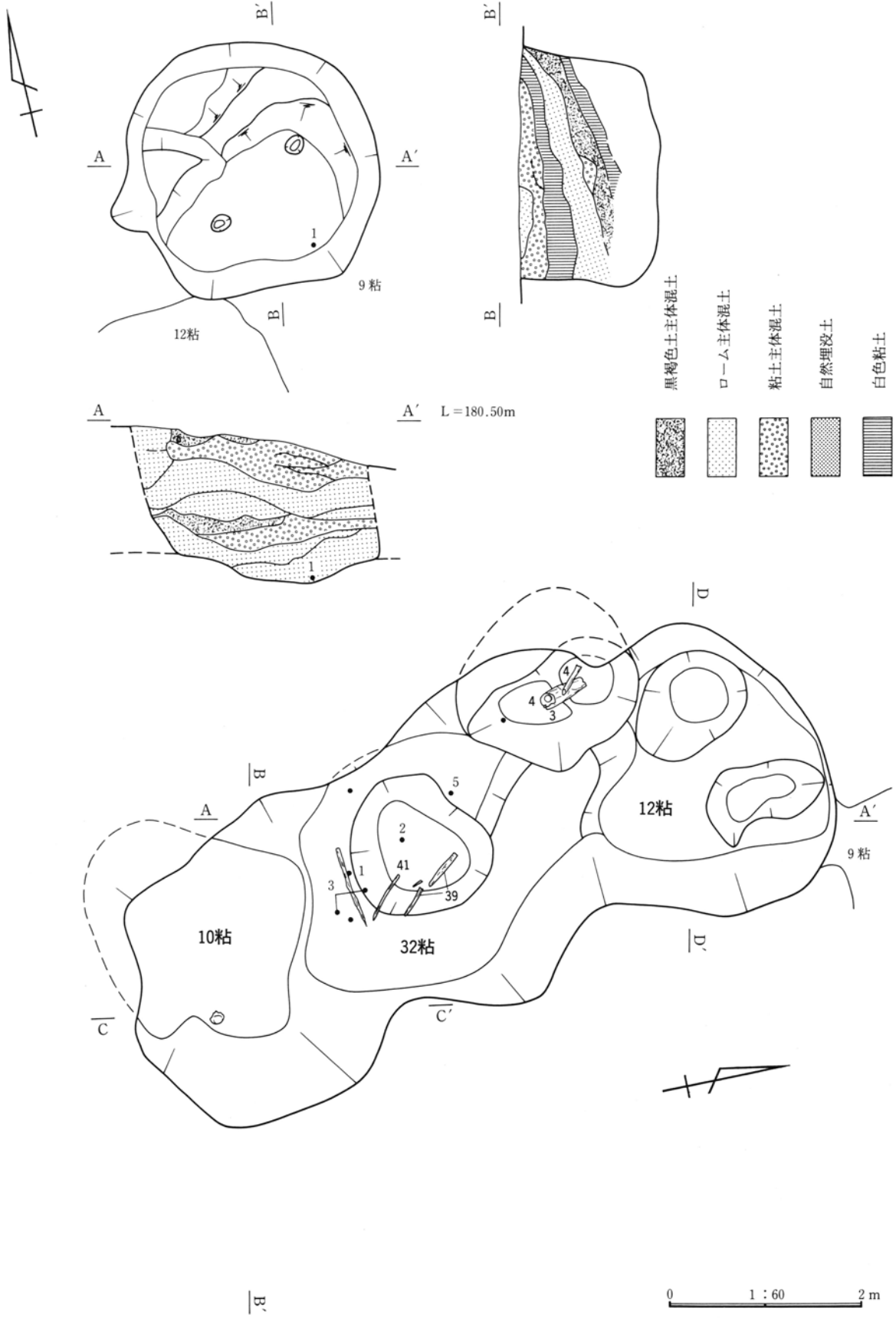

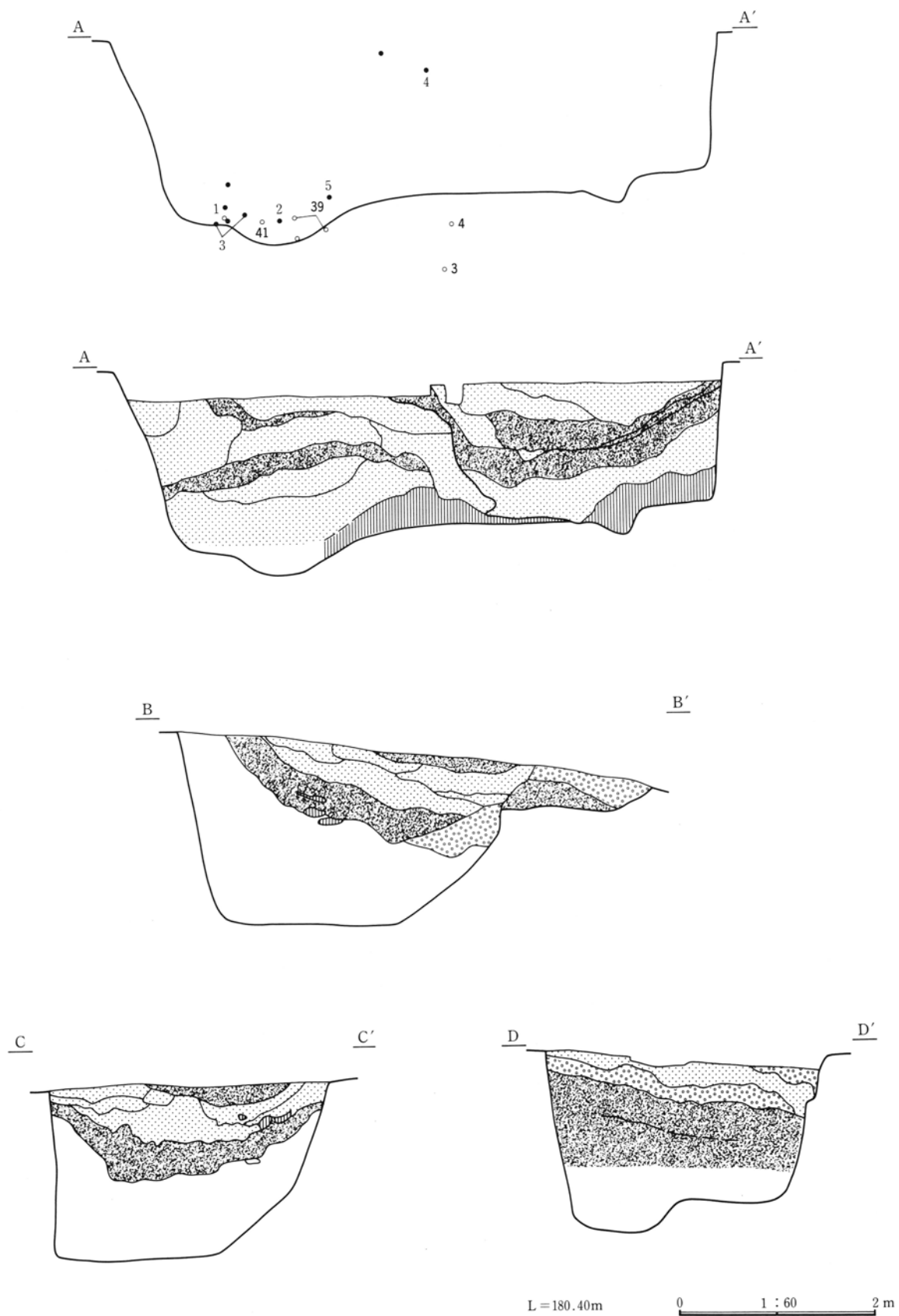



图327

天引C区14号·15号·52号粘土採掘坑





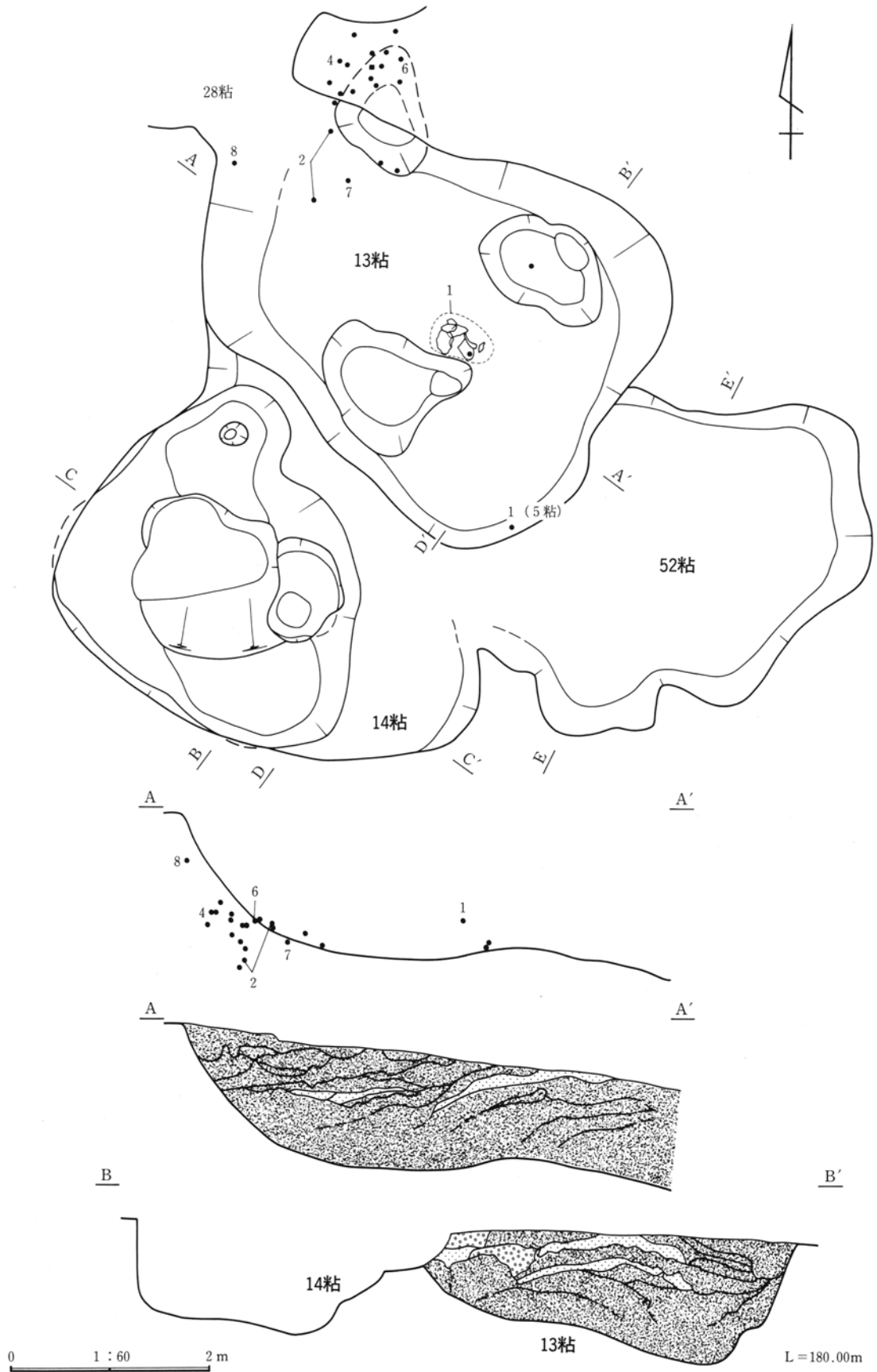
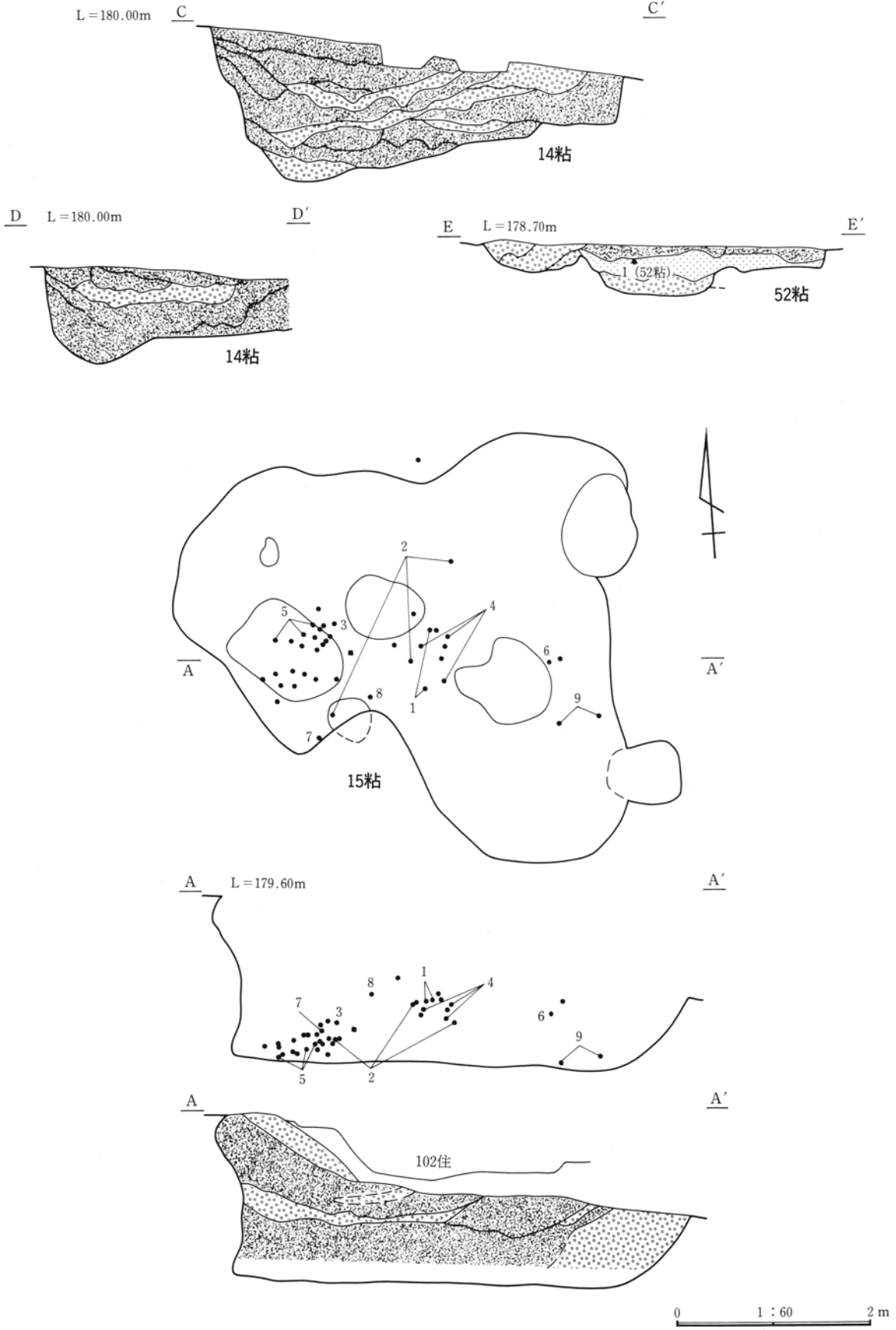
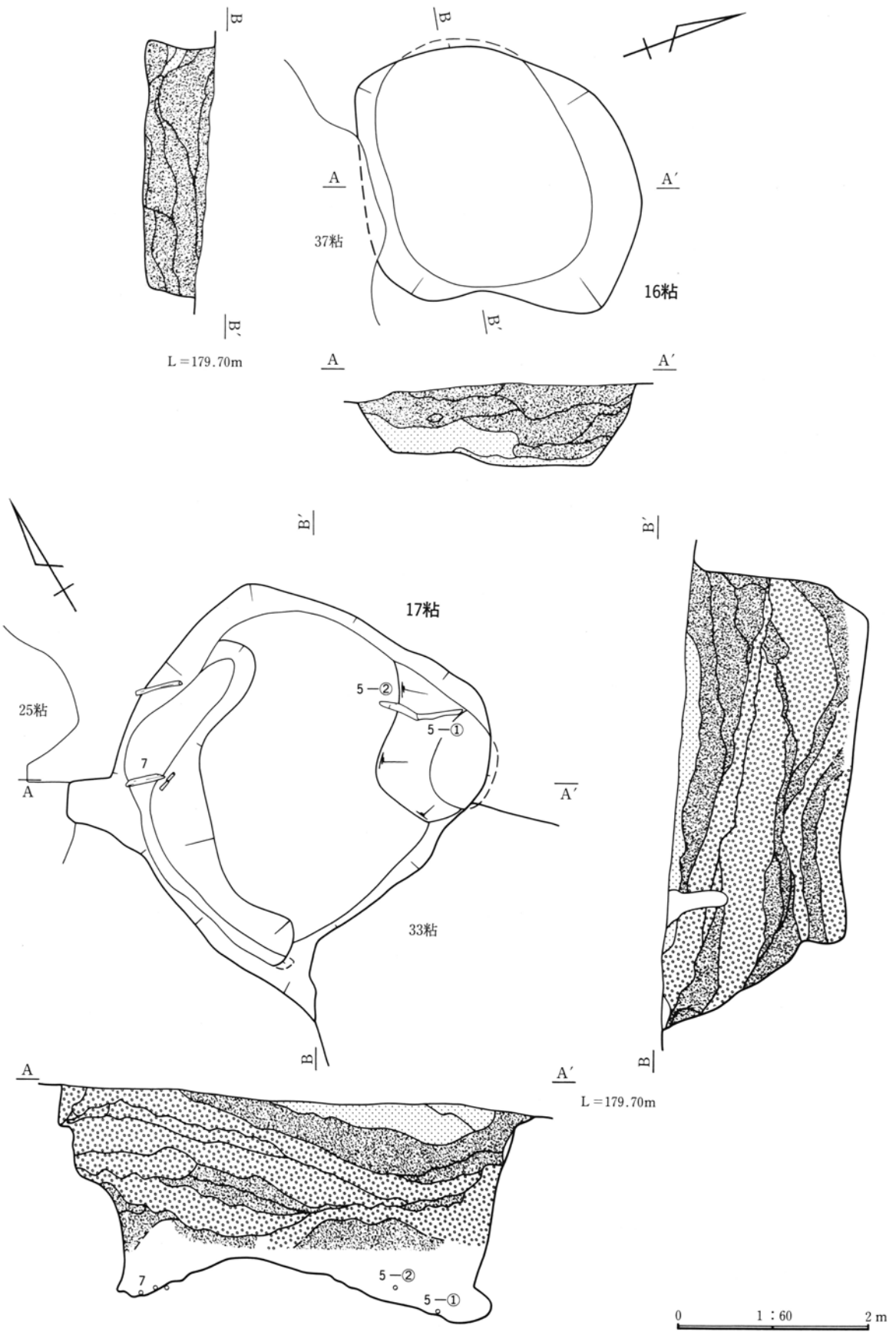
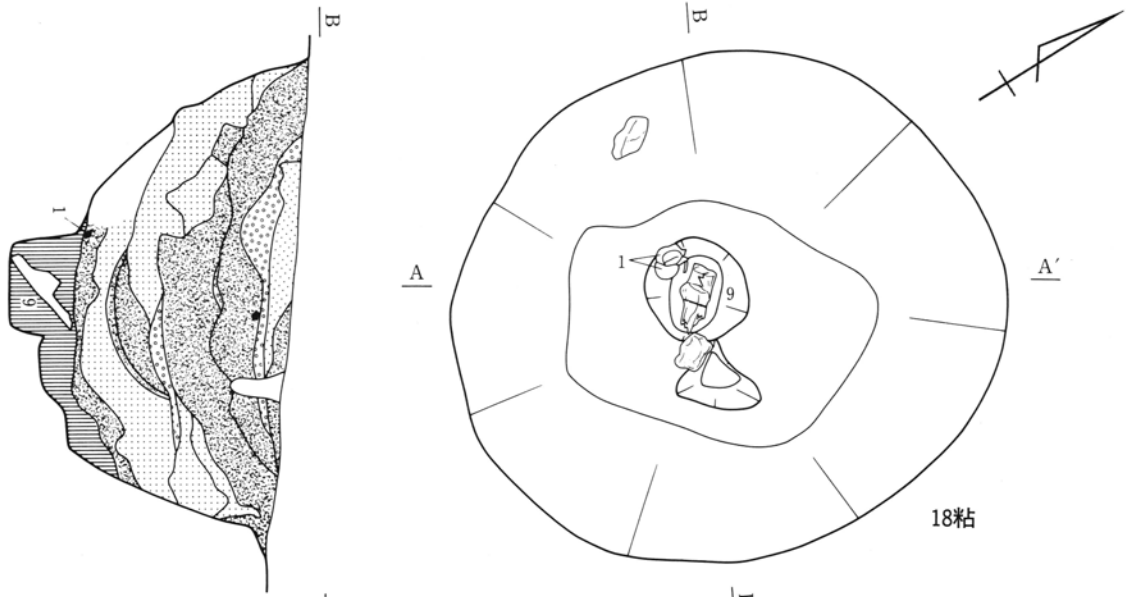

L = 179.70m

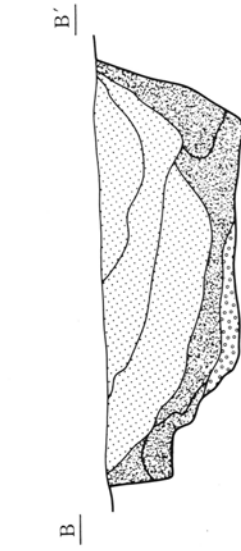
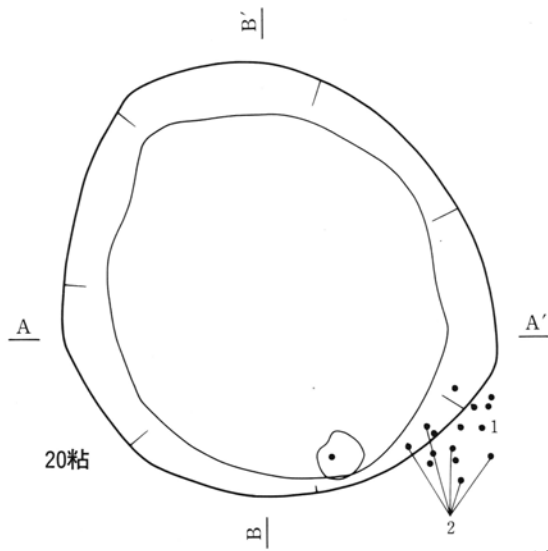
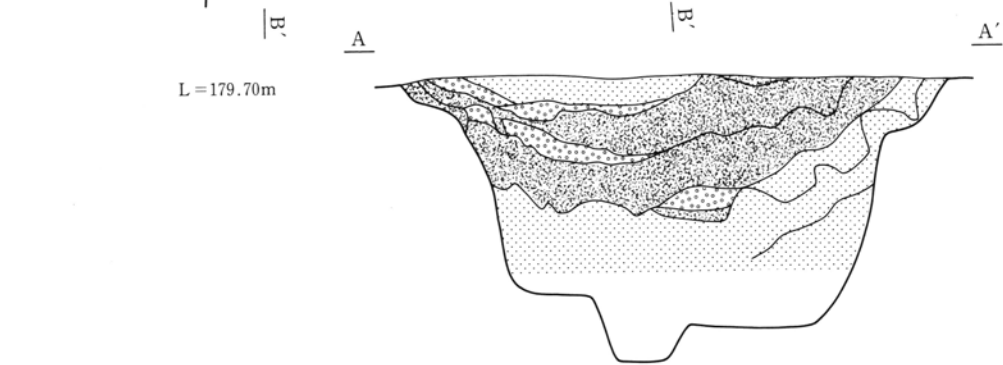



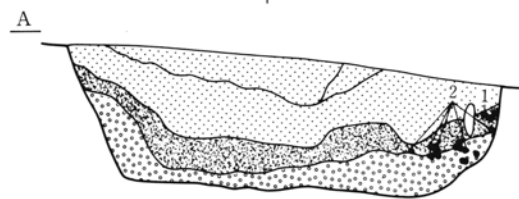

L = 179.70m

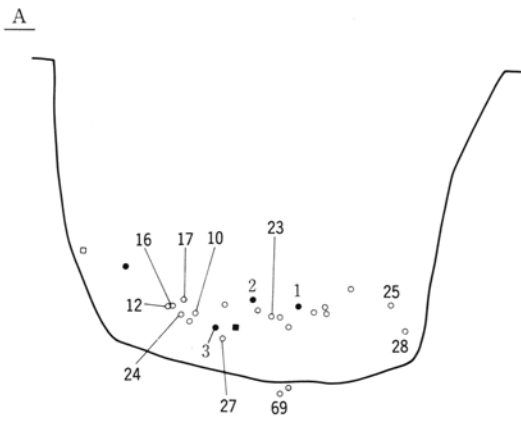
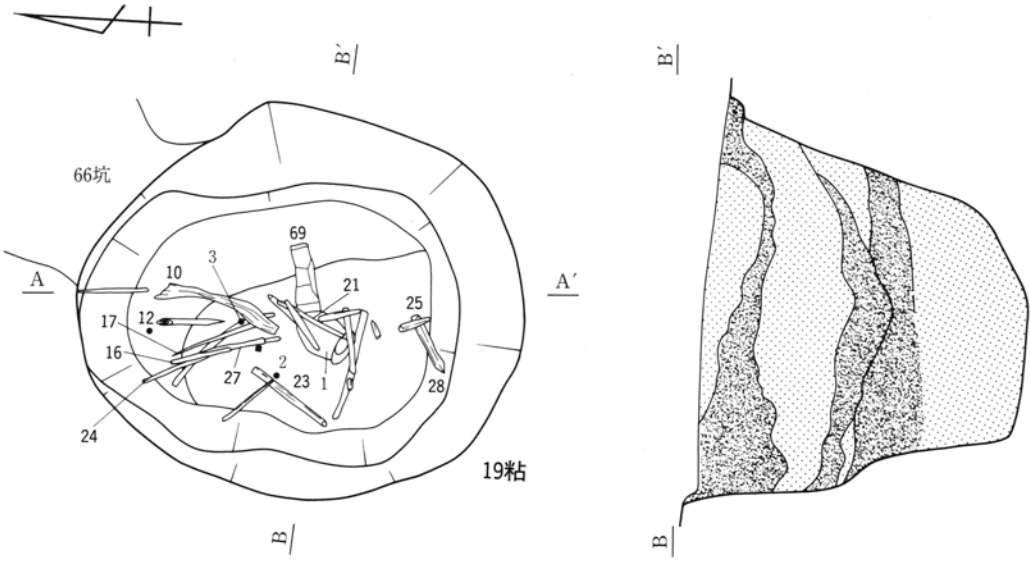

0 1 : 60 2 m



- L = 181.00m
-  黑褐色土主体混土
 -  ローム主体混土
 -  粘土主体混土
 -  自然埋没土
 -  白色粘土

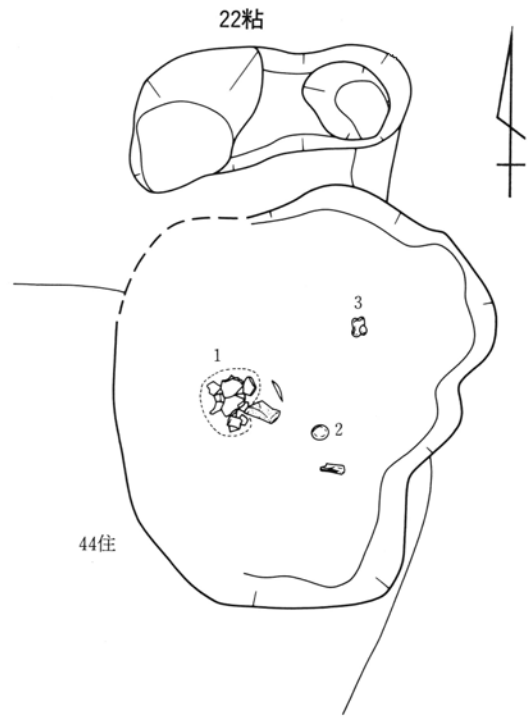
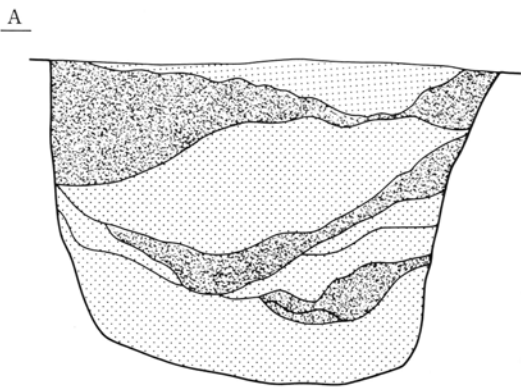

0 1 : 60 2 m

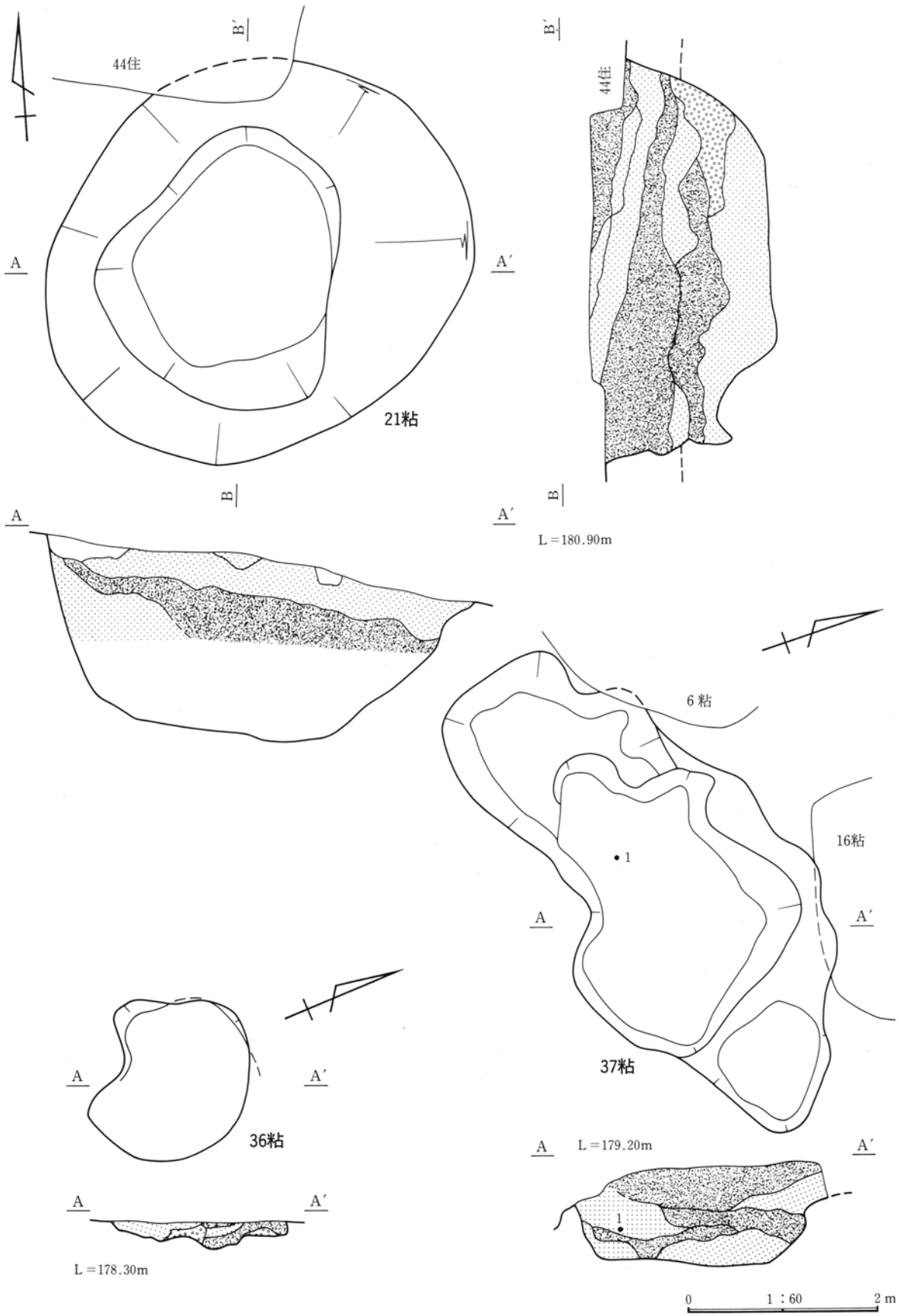



图333





天引C区25号·26号·67号粘土探掘坑

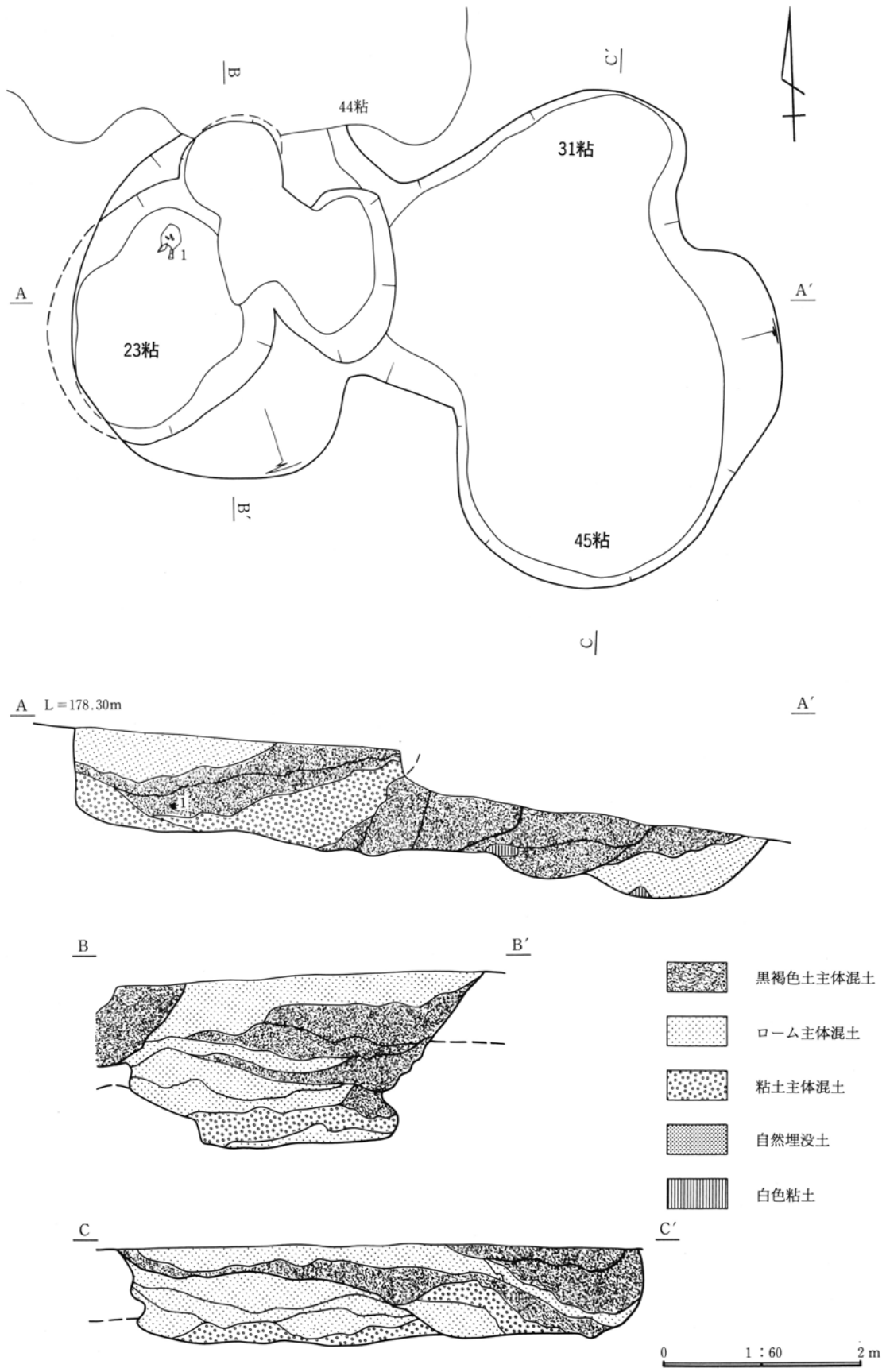
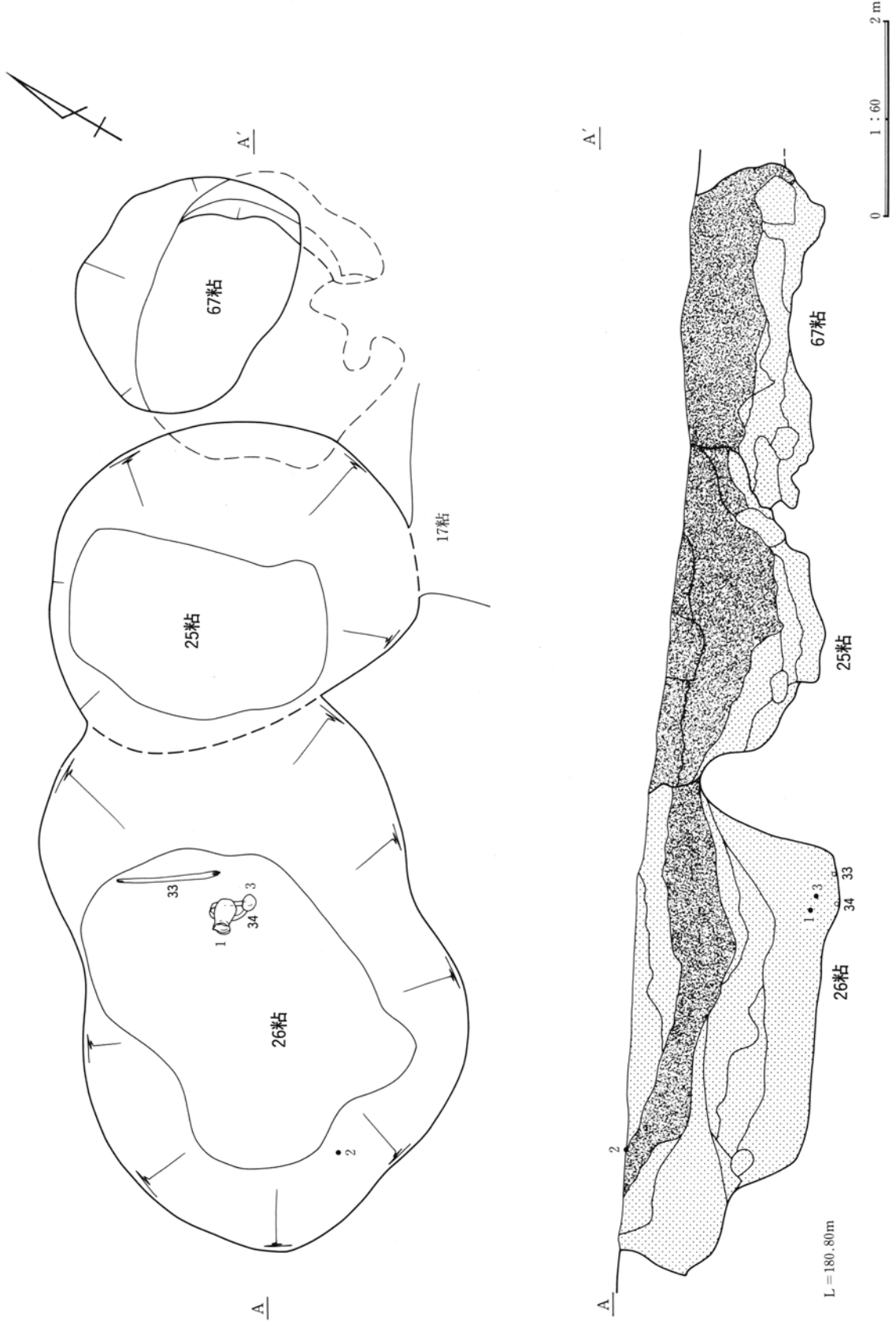
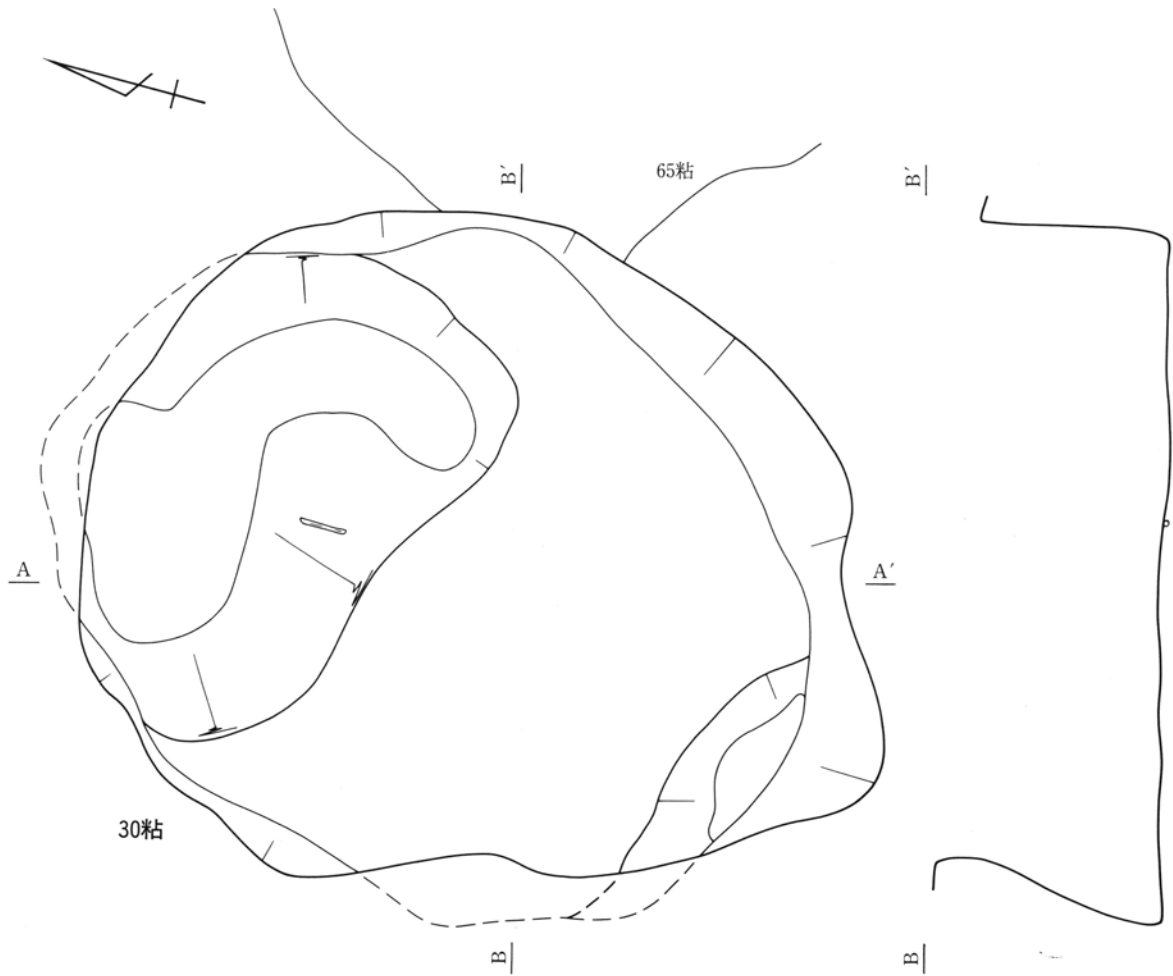

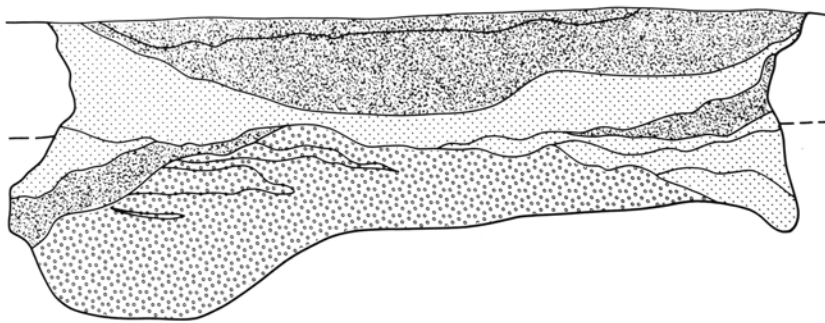

A A' L=179.90m



-  黑褐色土主体混土
-  ローム主体混土
-  粘土主体混土
-  自然埋没土
-  白色粘土

0 1 : 60 2 m

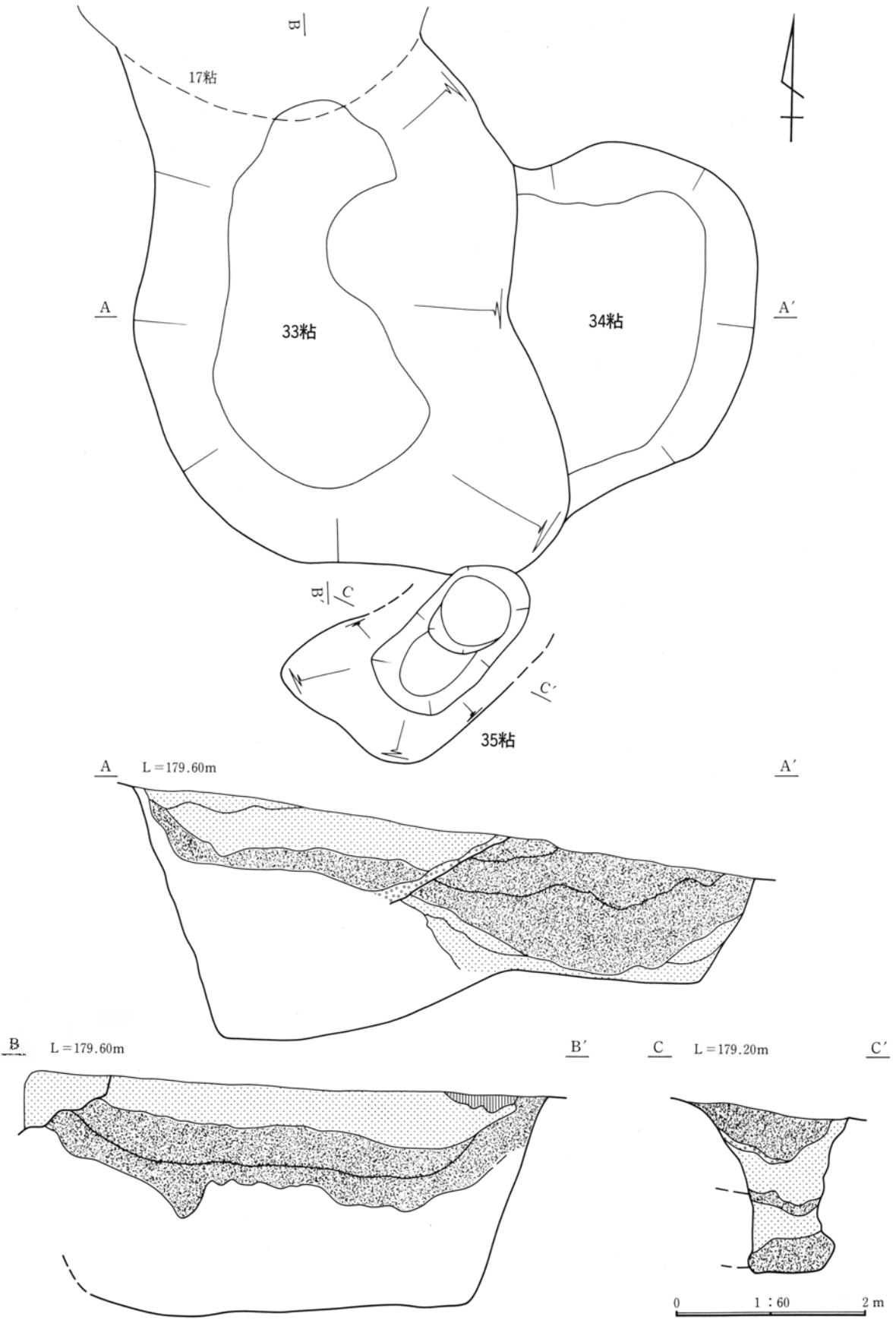

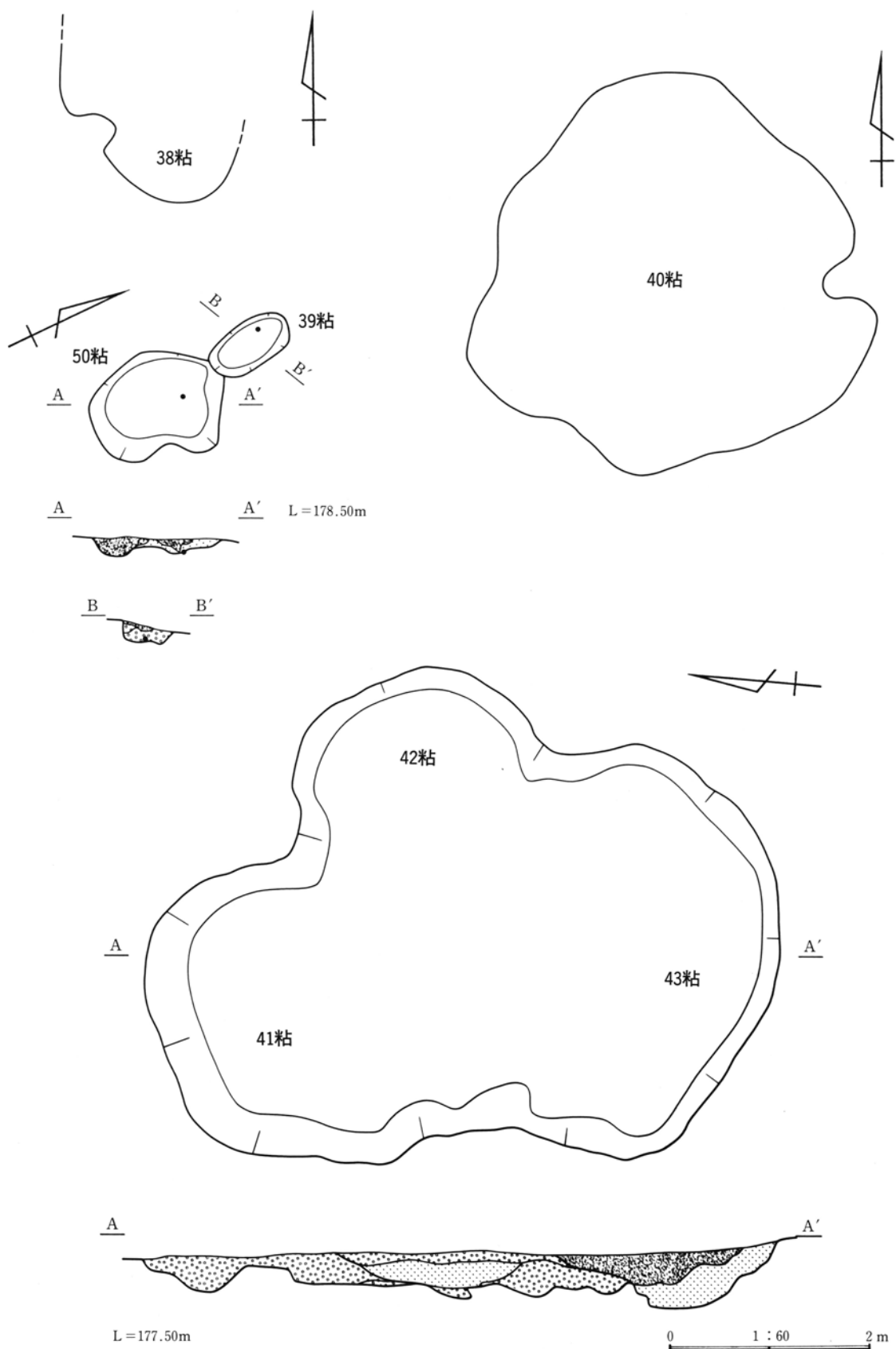

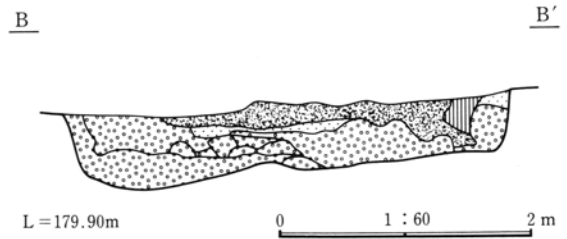
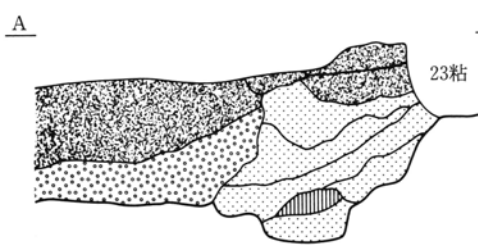
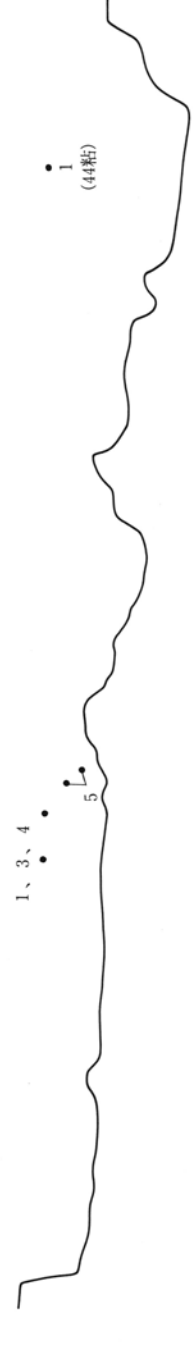
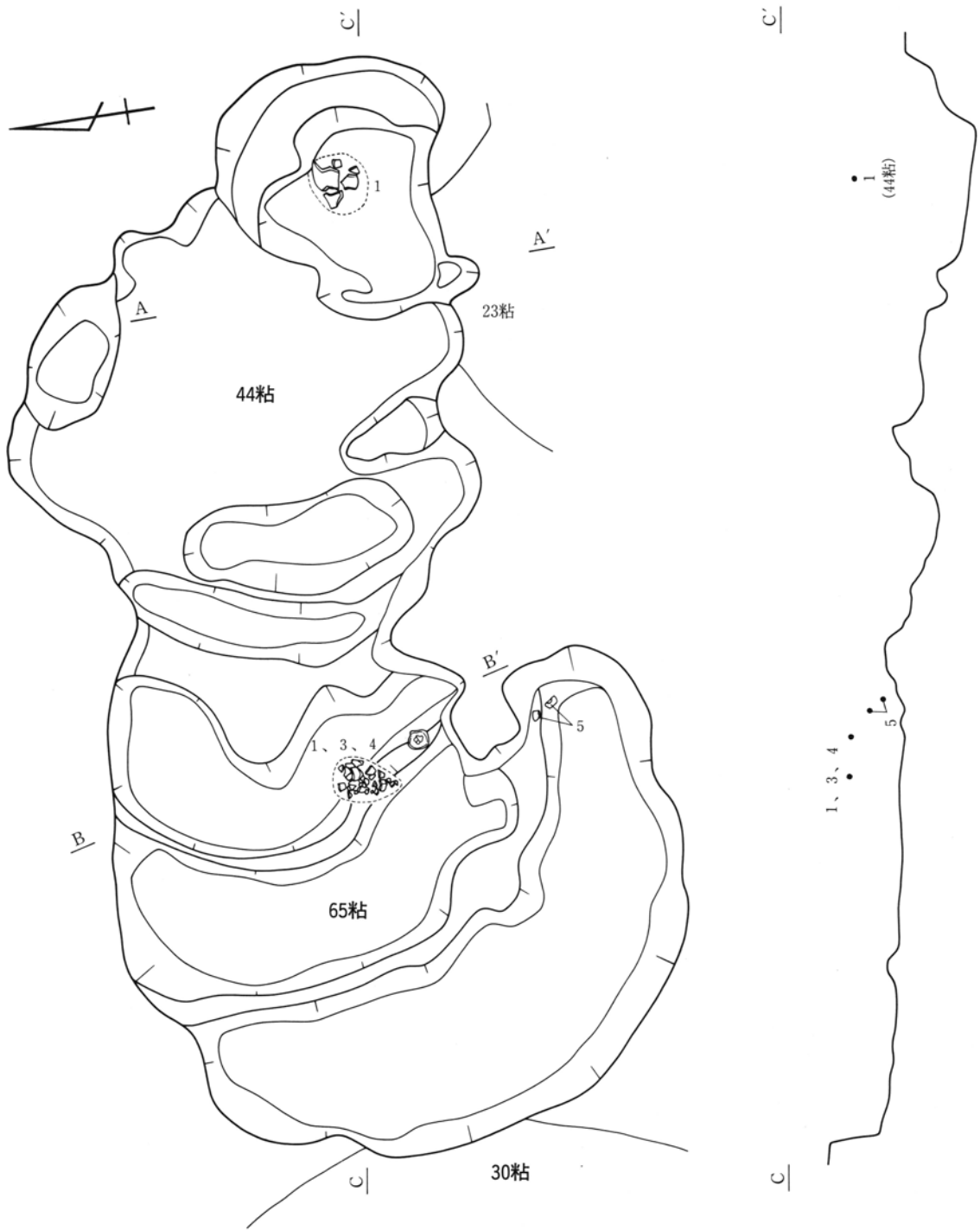

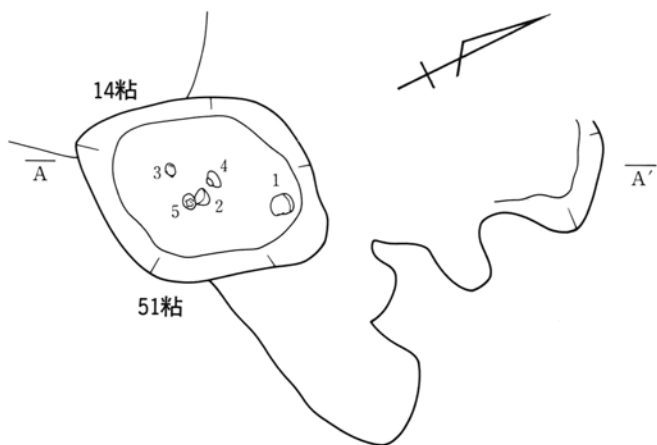
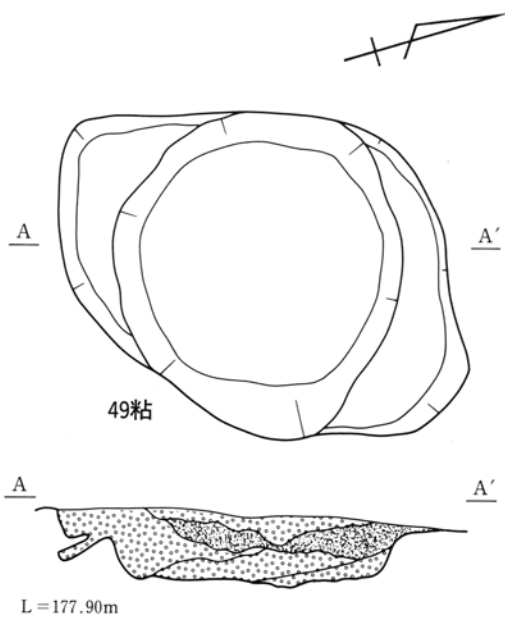
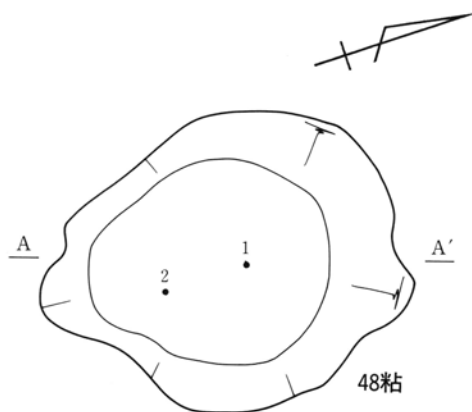
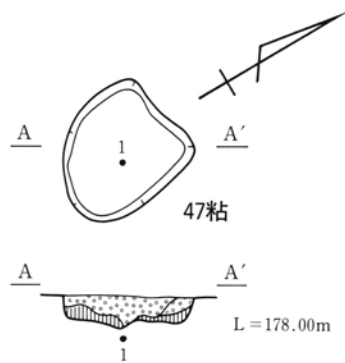
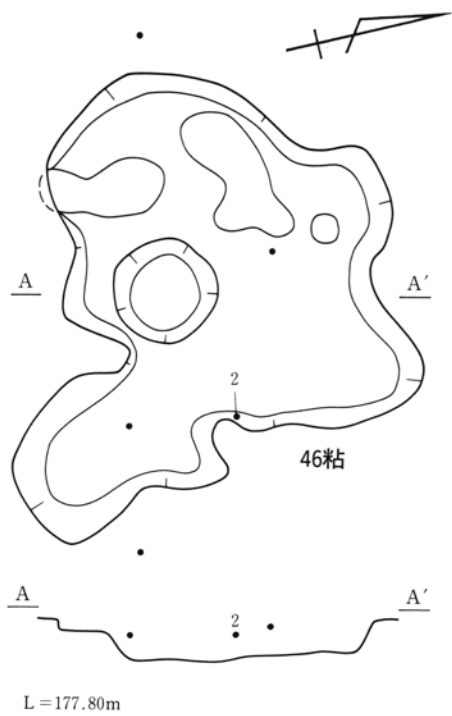



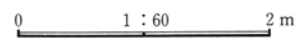
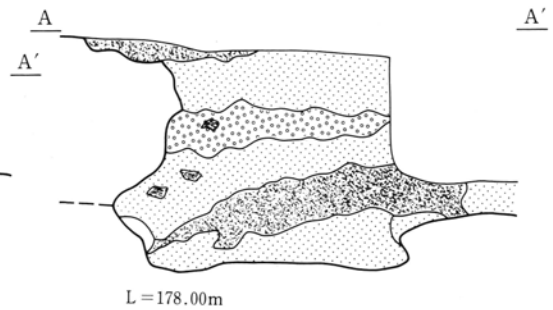
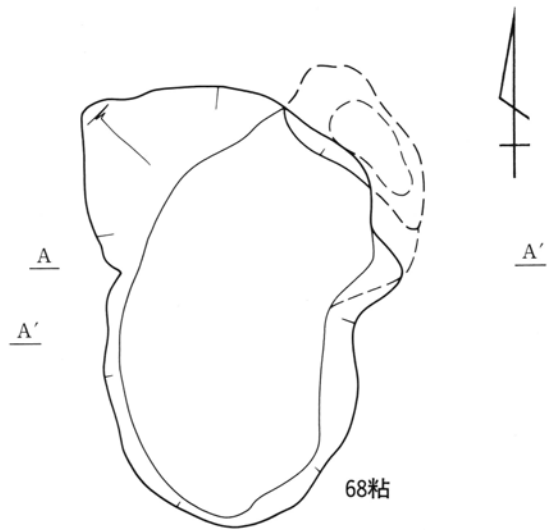
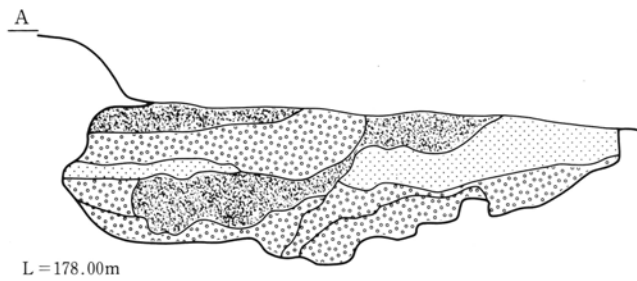
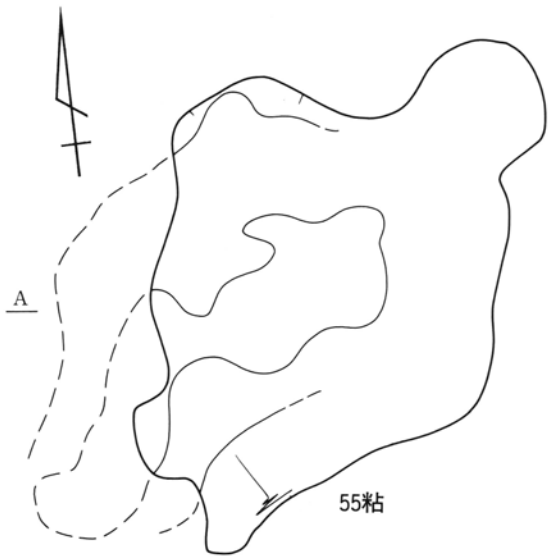
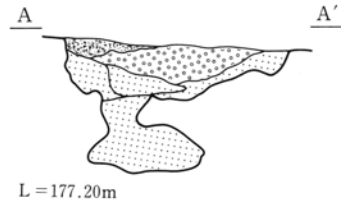
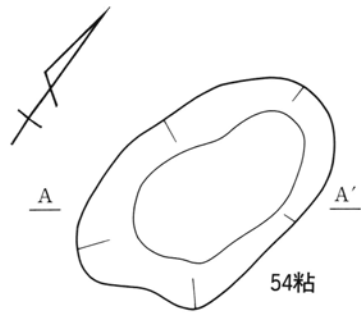
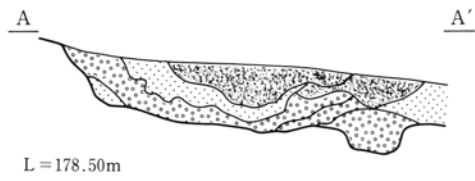

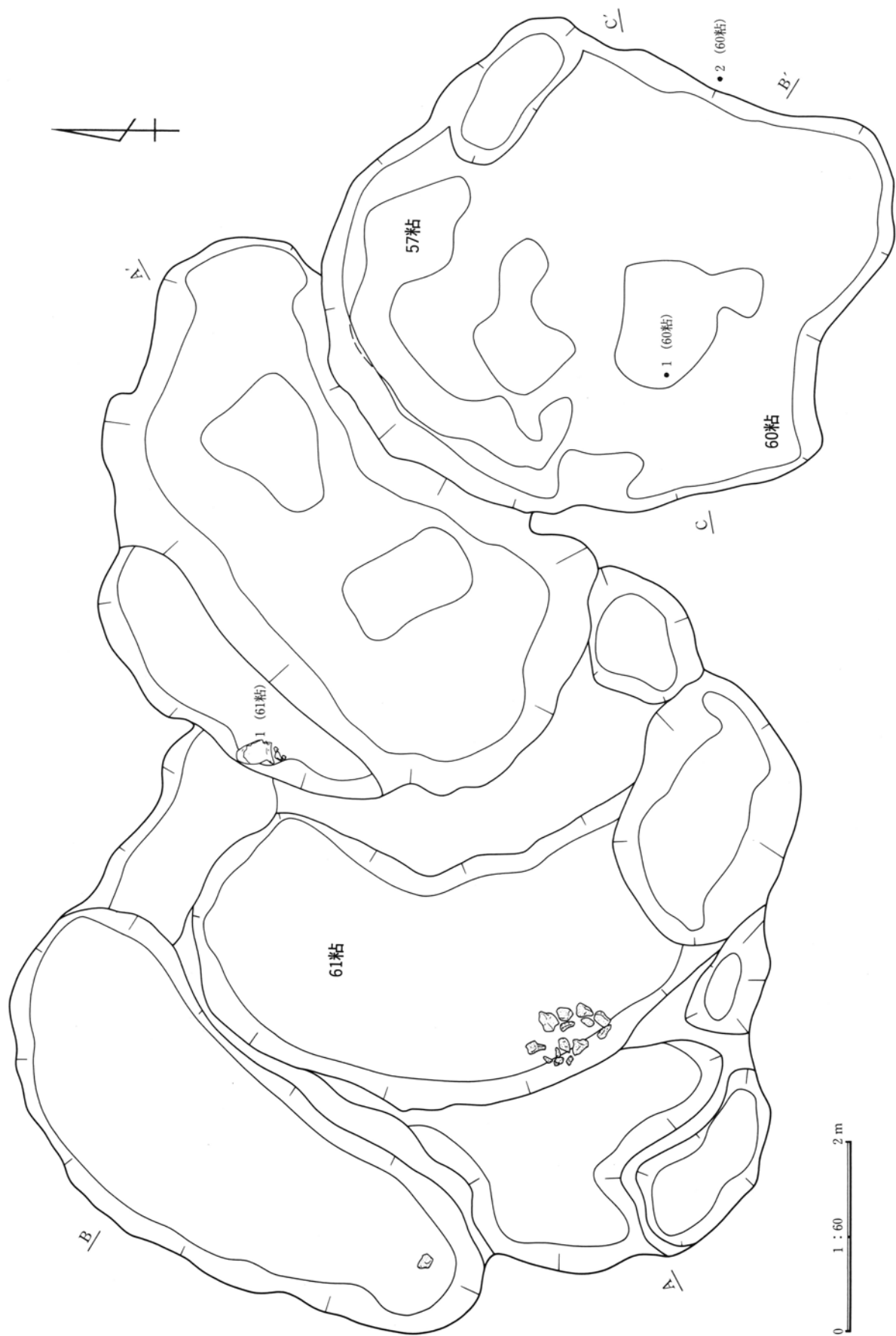

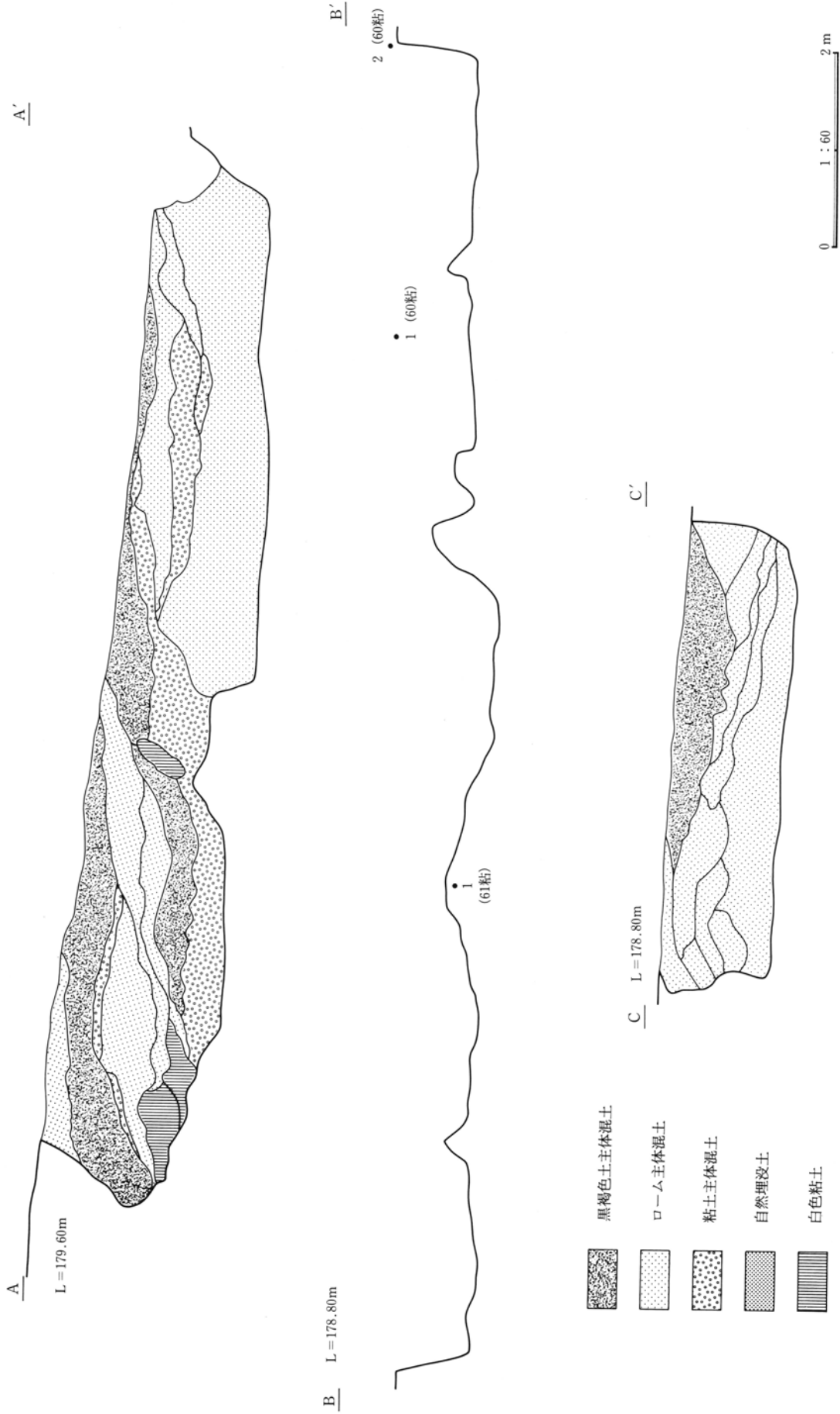
0 1 : 60 2 m

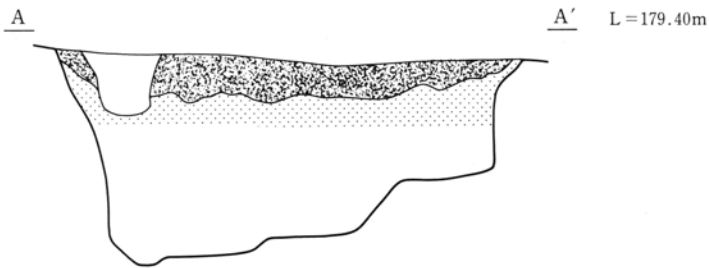
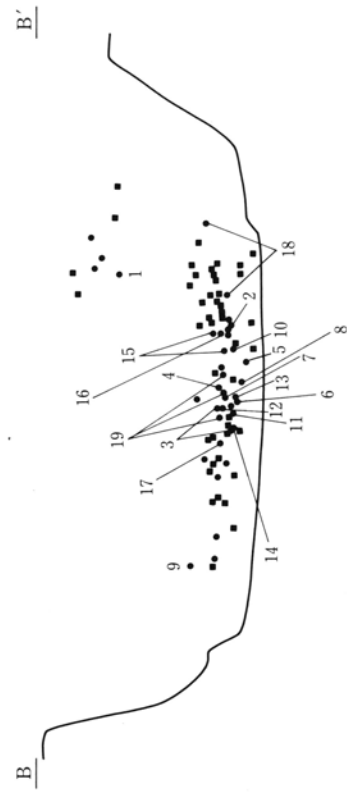
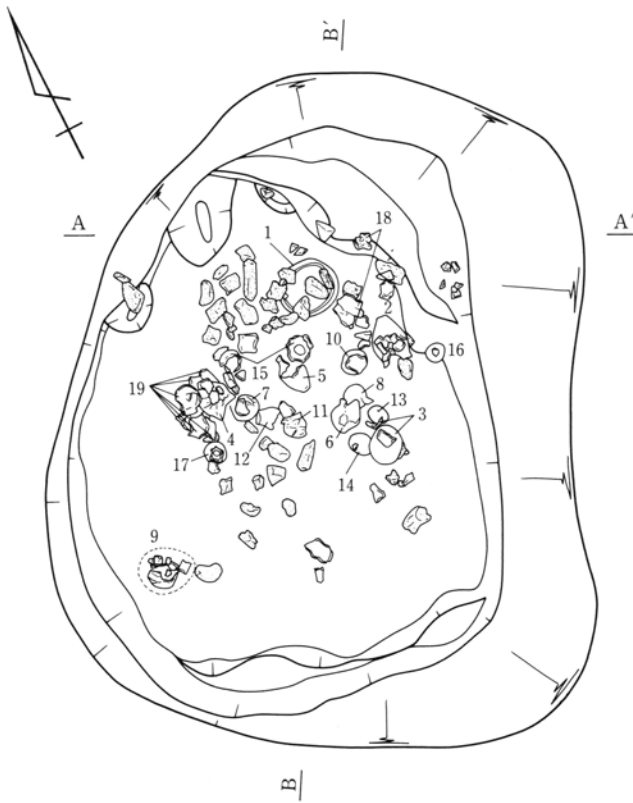







-  黒褐色土主体混土
-  ローム主体混土
-  粘土主体混土
-  自然埋没土
-  白色粘土

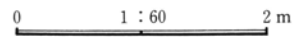

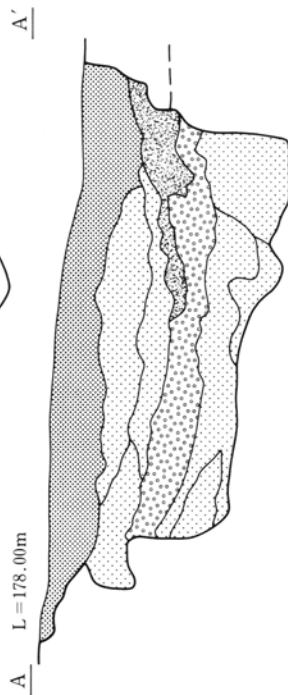
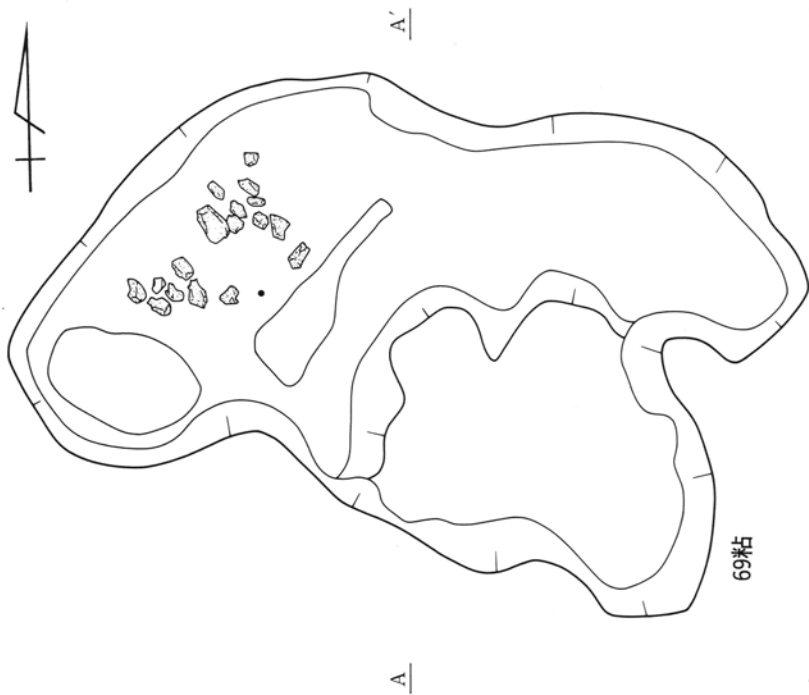
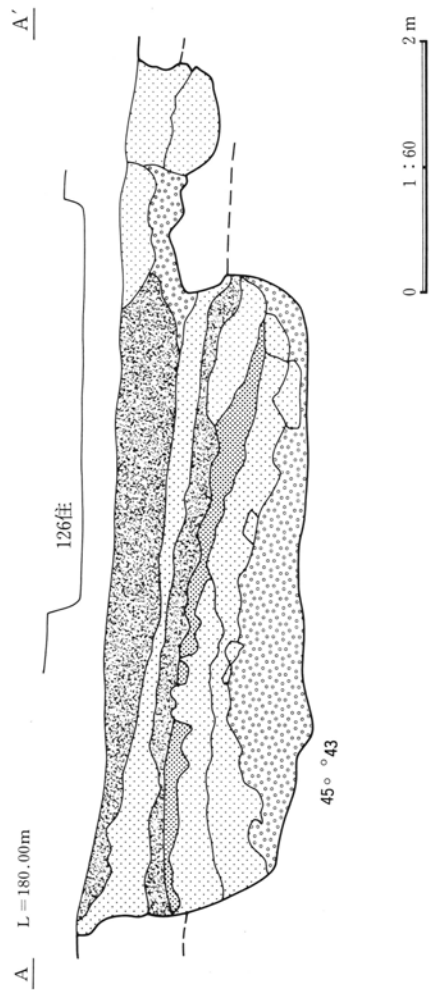
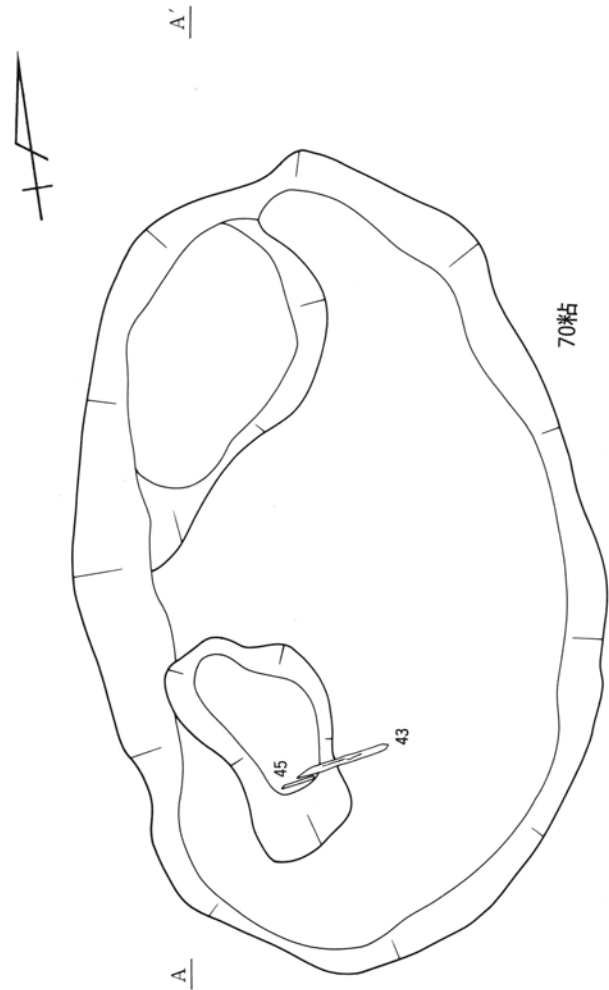

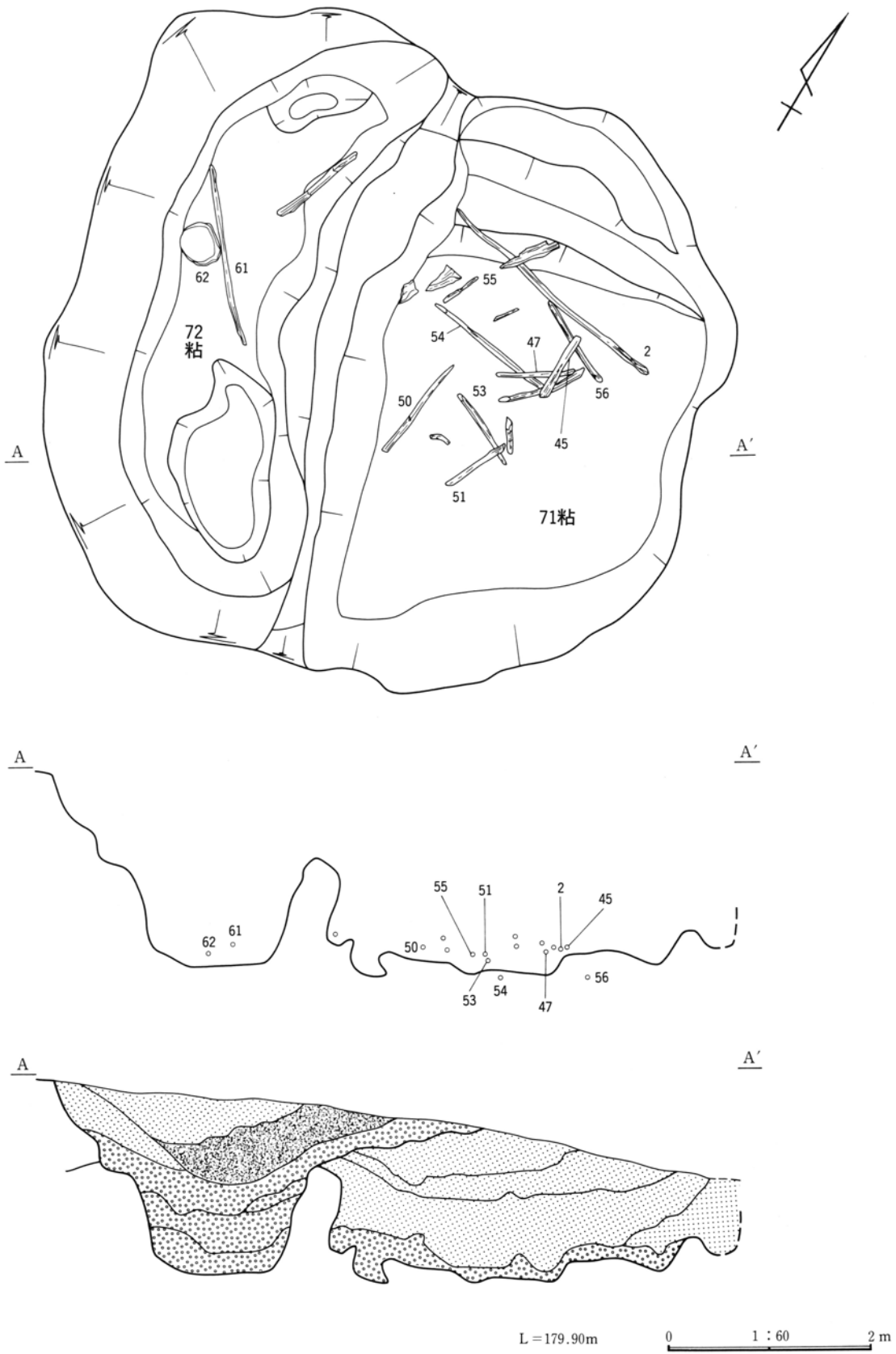

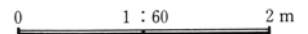
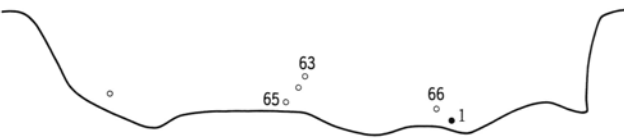
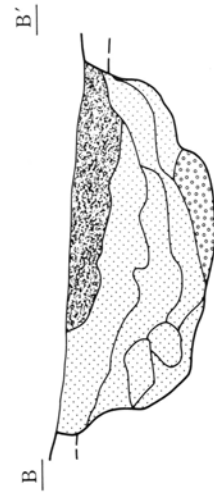
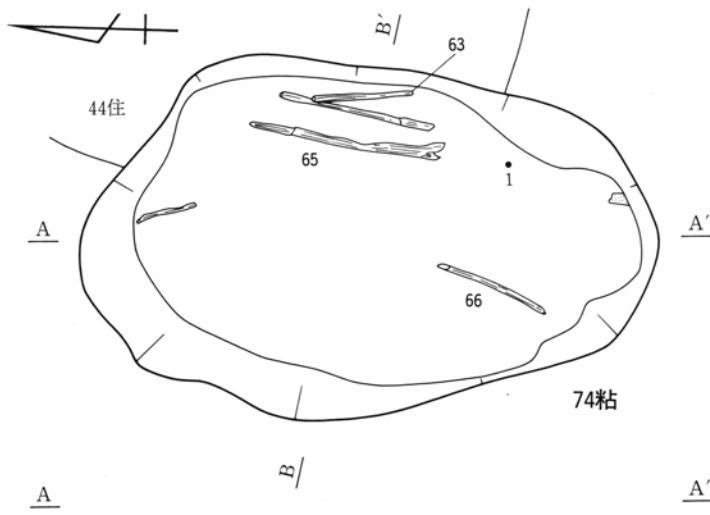
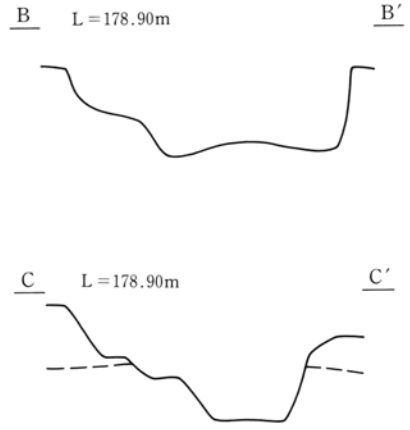
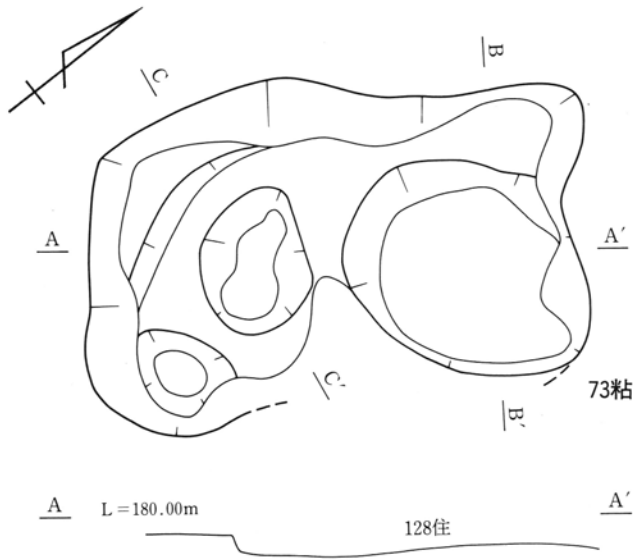

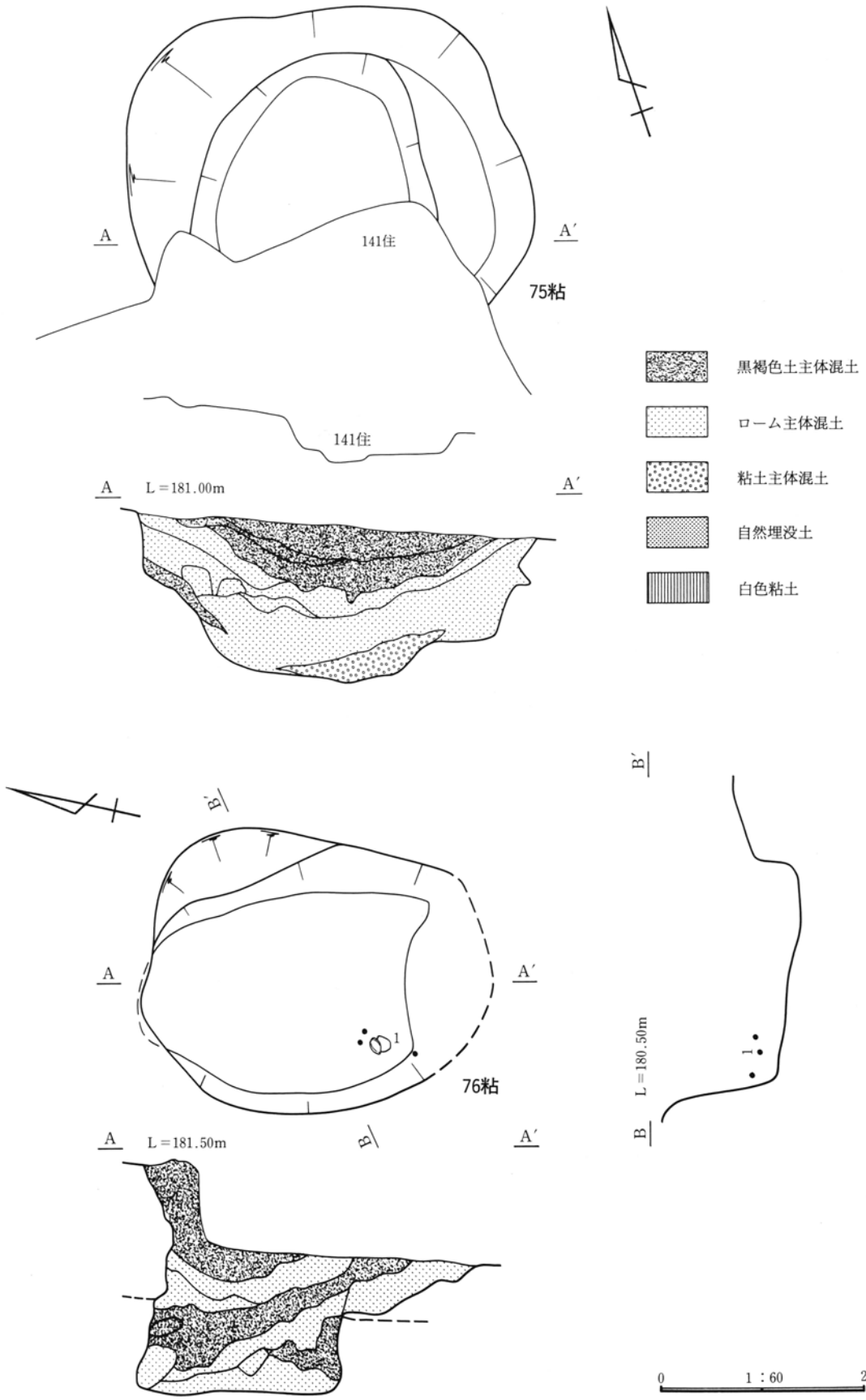

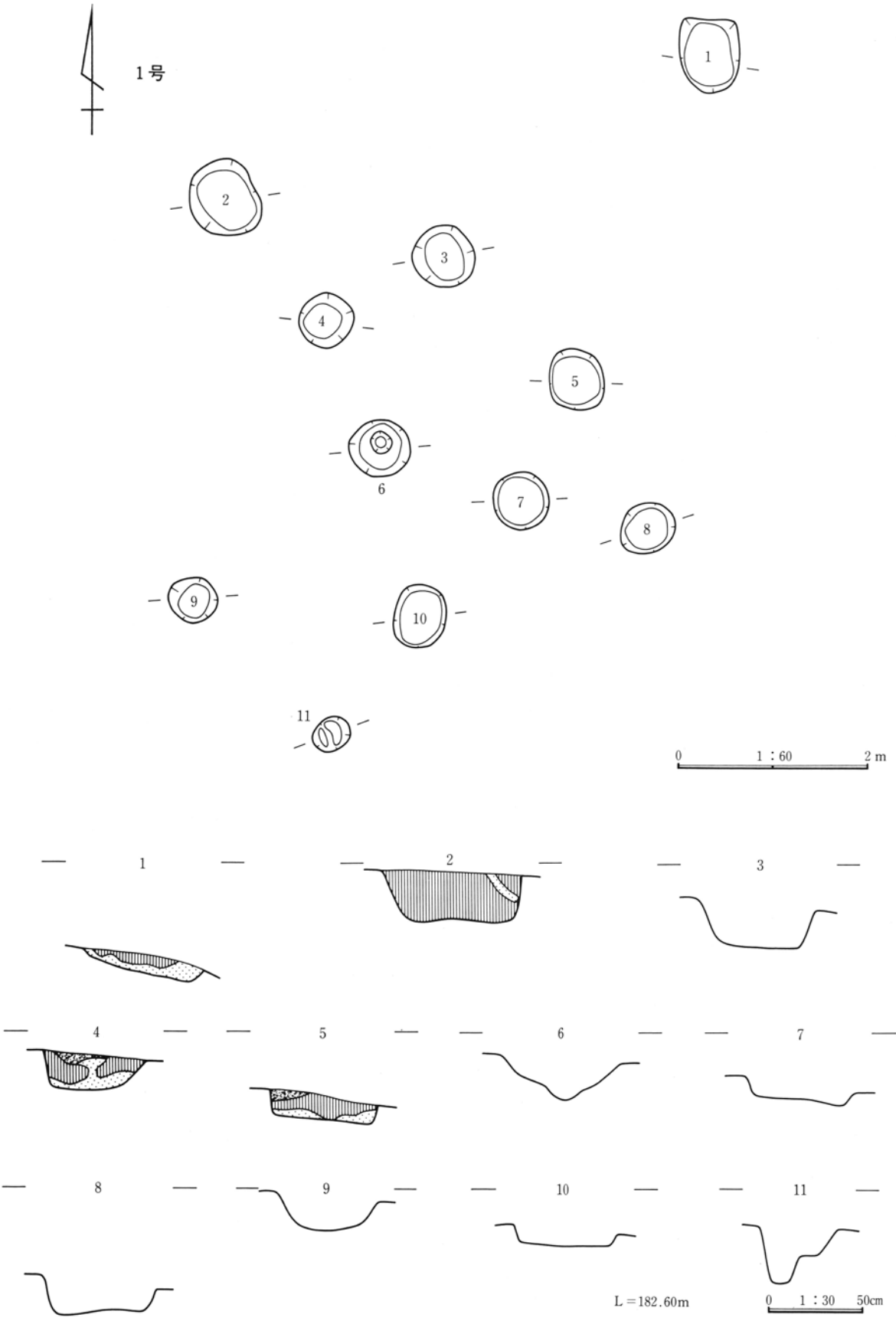

2号

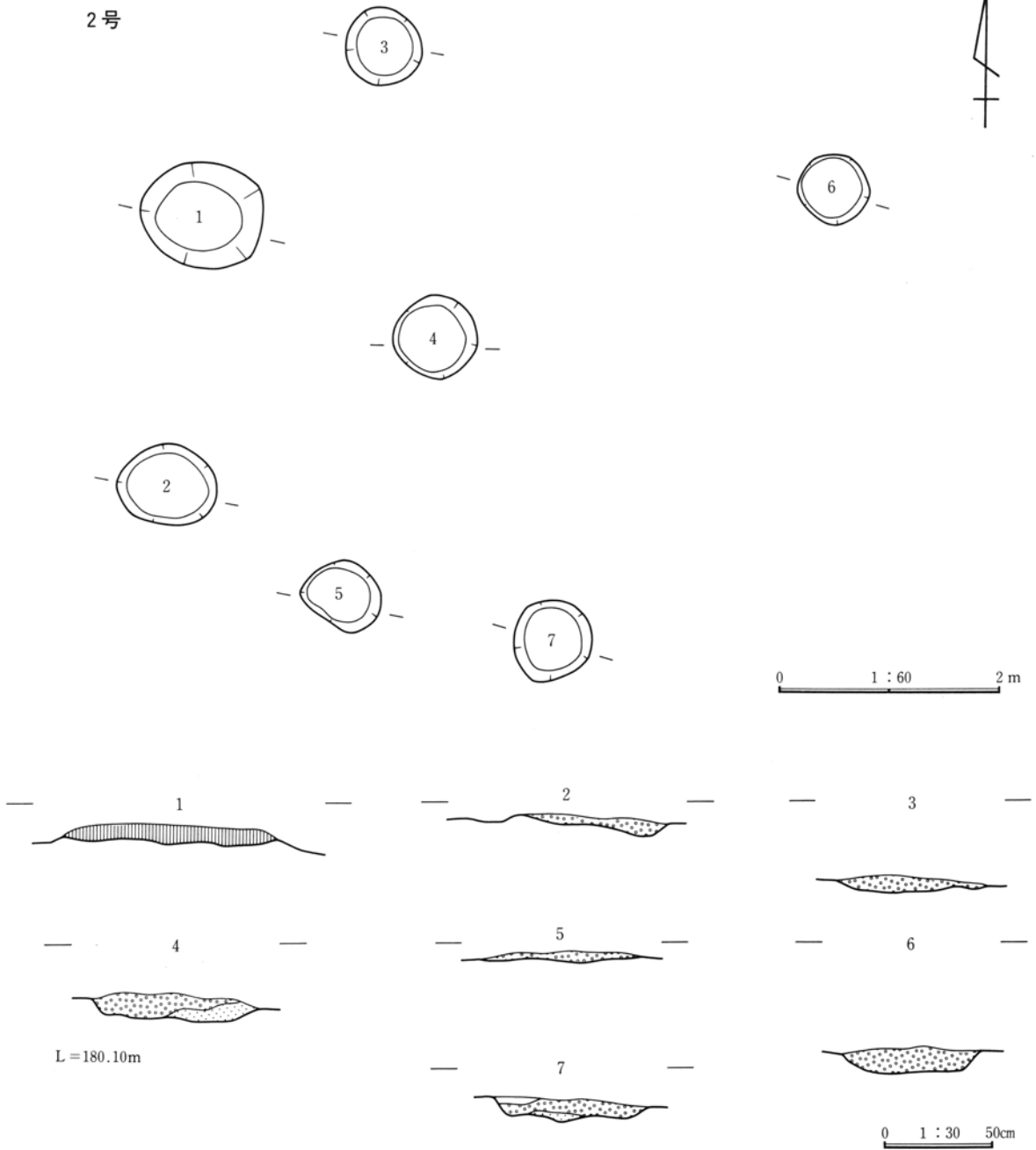

3号

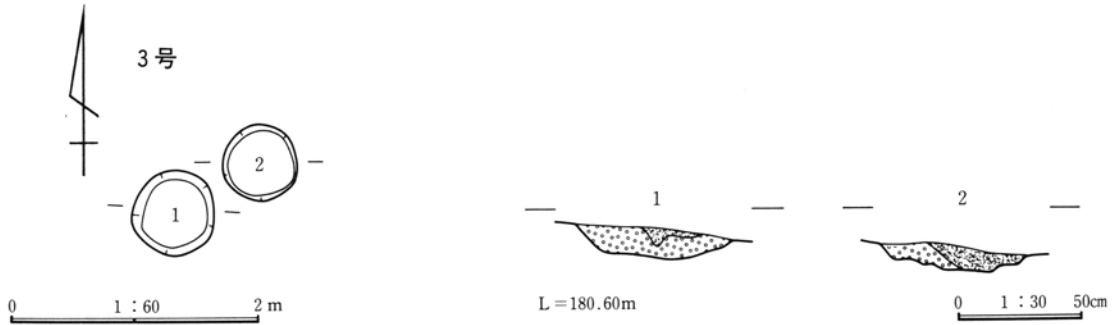

白倉A区

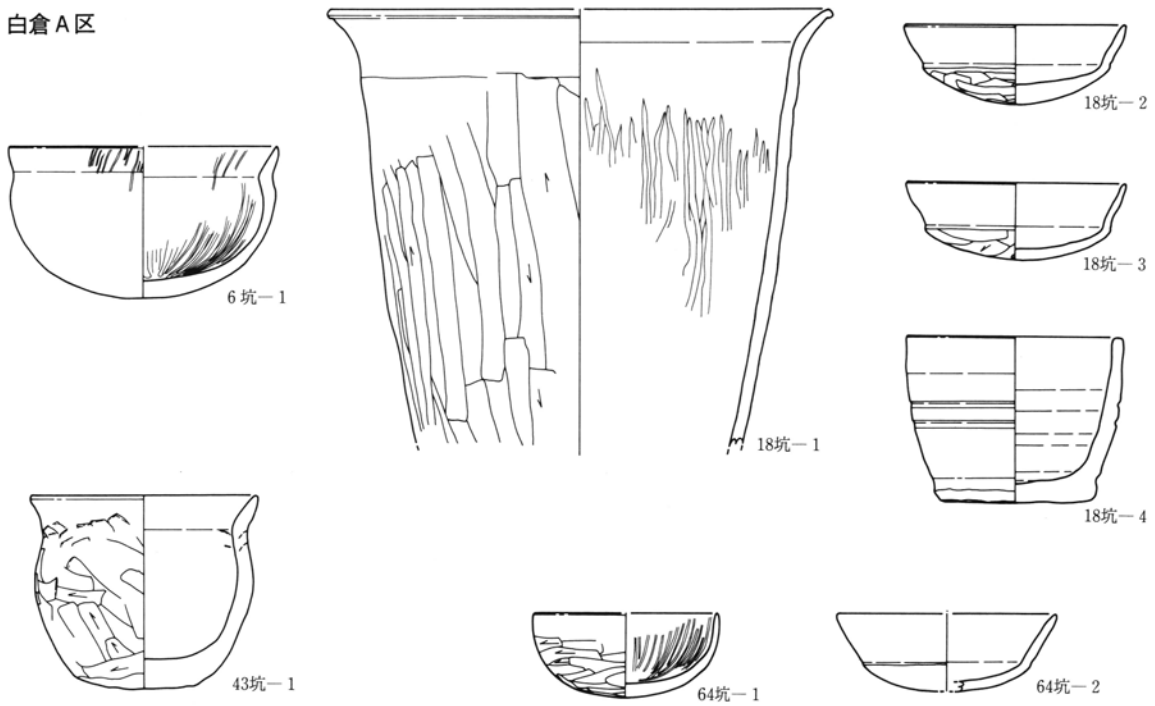

白倉B区

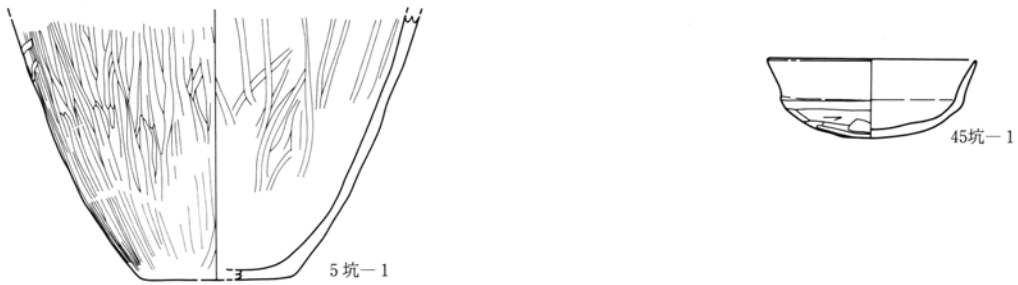

白倉C区

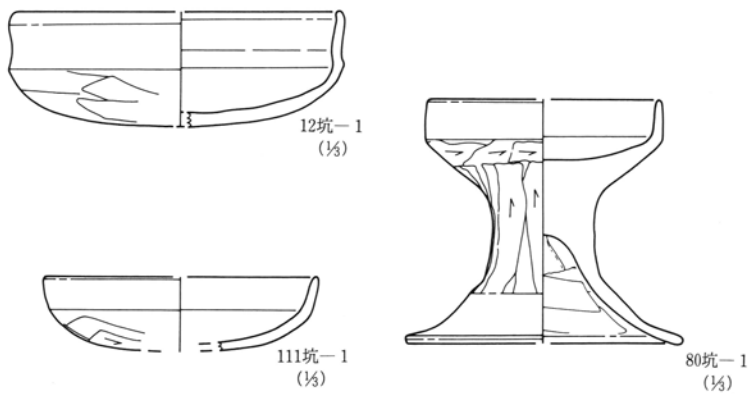

0 1 : 3 10cm

天引C区

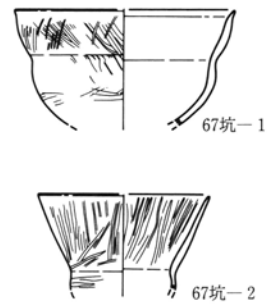

0 1 : 4 10cm

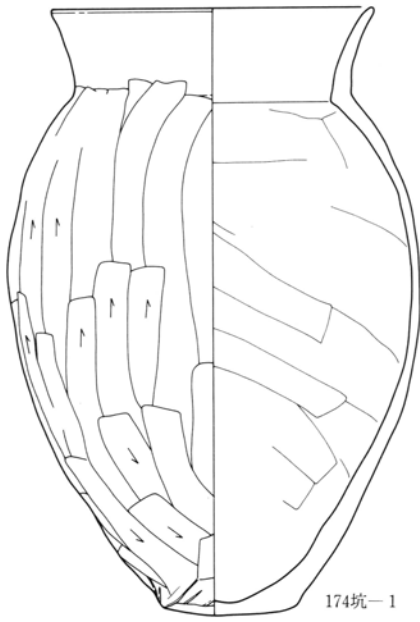

174坑-1



174坑-2

天引C区



遺構外

白倉A区

白倉B区

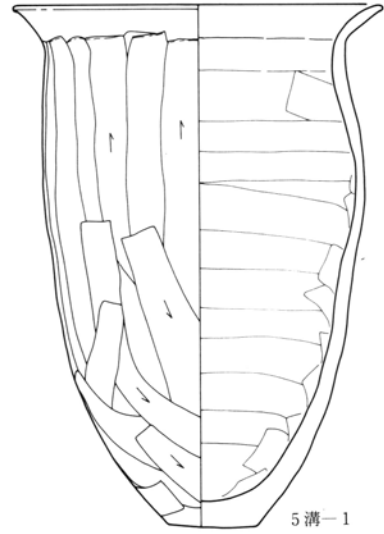

5溝-1

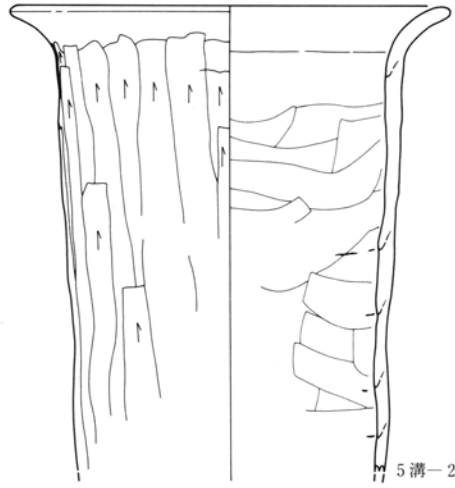

5溝-2



5溝-3

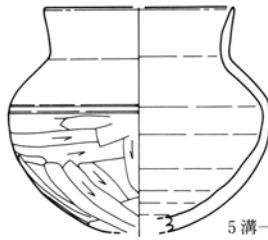

5溝-5

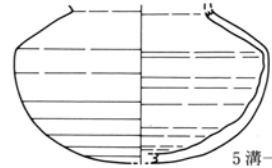

5溝-6



5溝-4



5溝-7

0 1 : 4 10cm

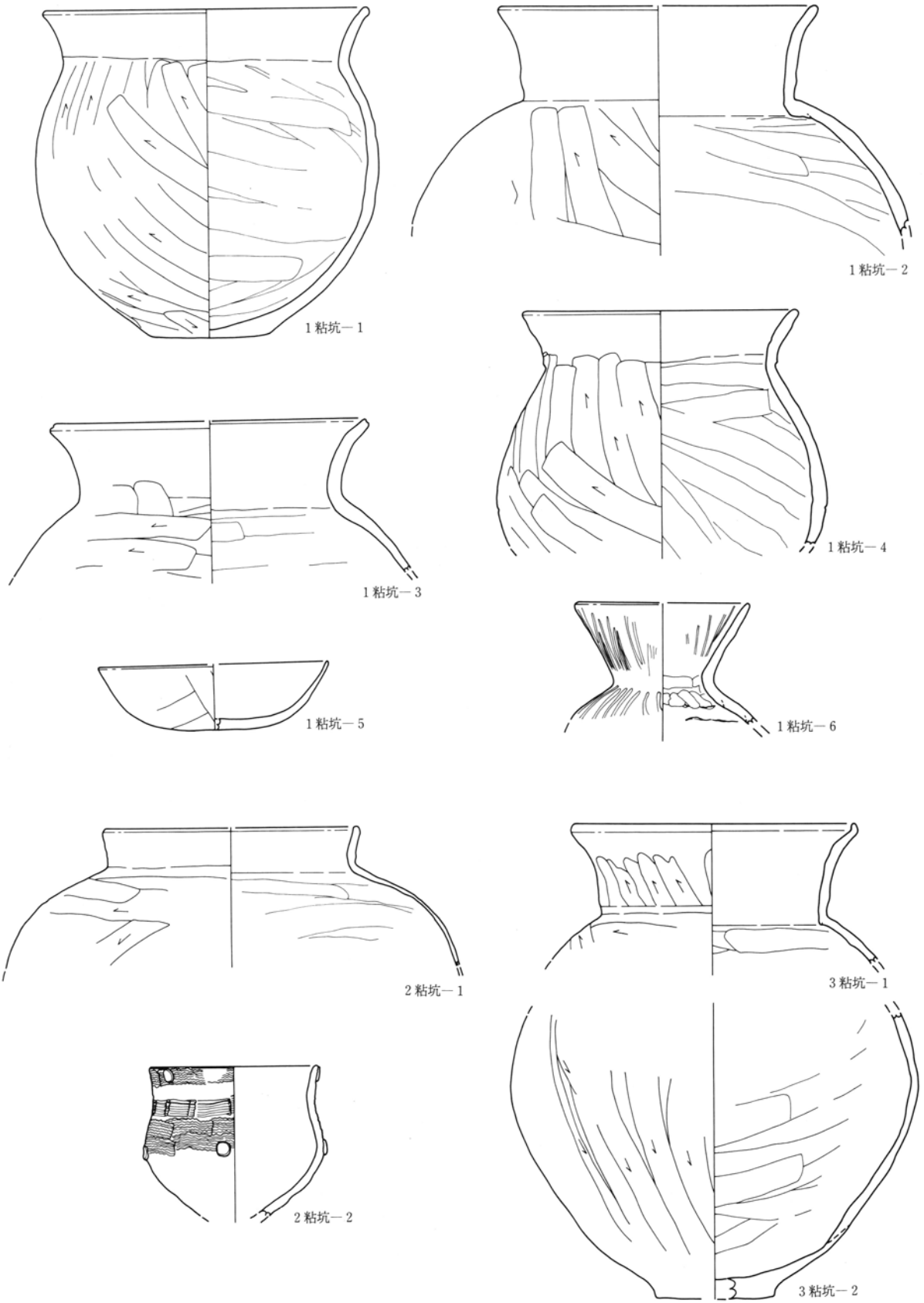

0 1 : 4 10cm

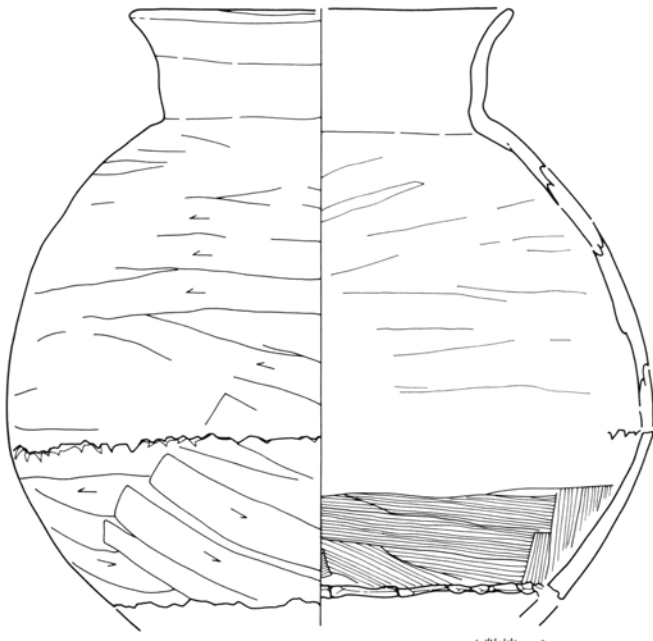

4粘坑-1

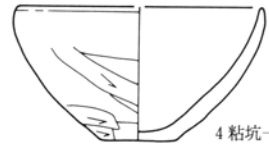

4粘坑-3

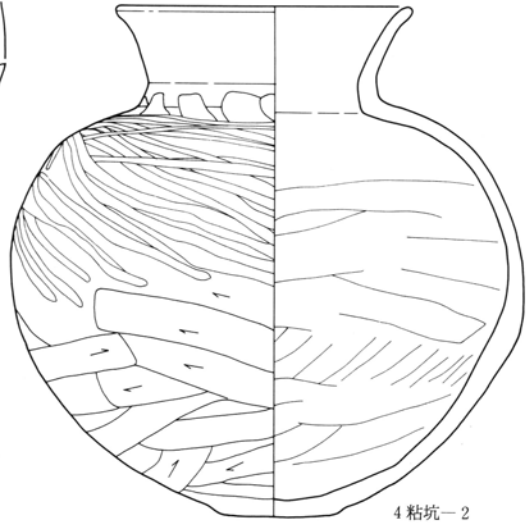

4粘坑-2



6粘坑-1

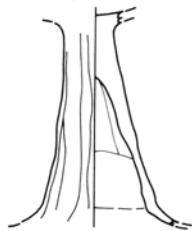

6粘坑-2

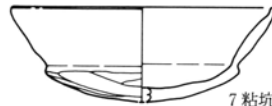

7粘坑-1



8粘坑-1

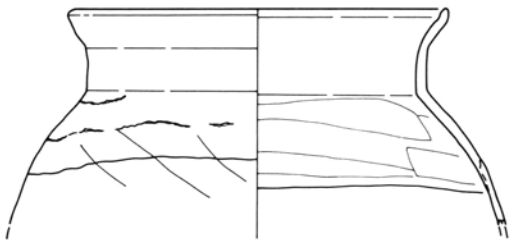

9粘坑-1

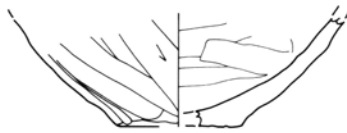

9粘坑-2

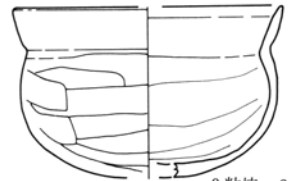

9粘坑-3

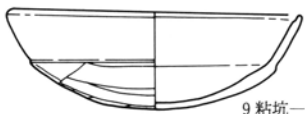

9粘坑-4

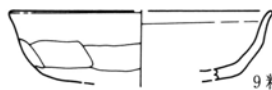

9粘坑-5

0 1 : 4 10cm

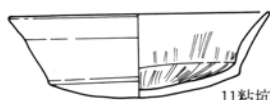

11粘坑-1



11粘坑-2



12粘坑-1

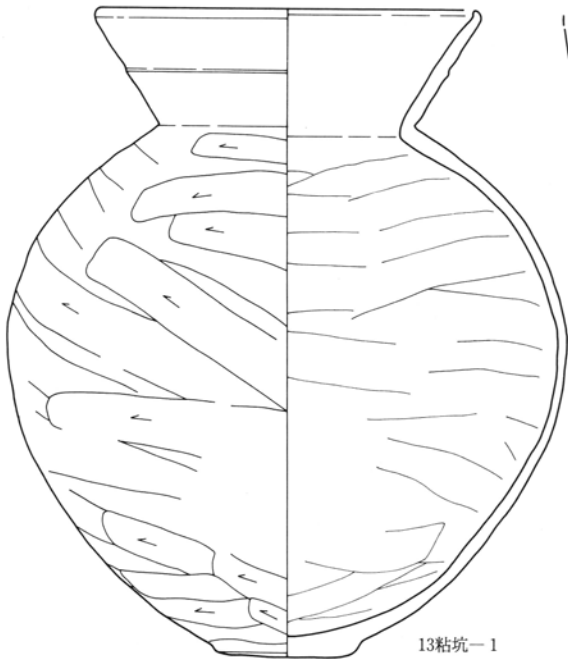

13粘坑-1

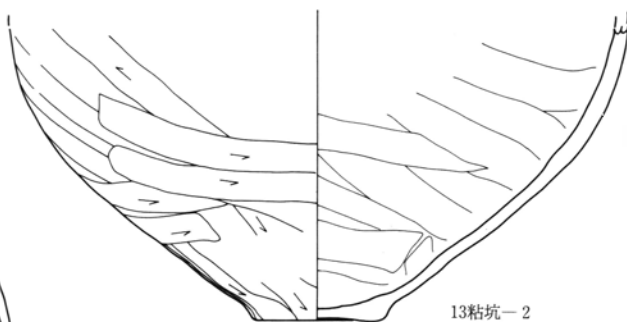

13粘坑-2

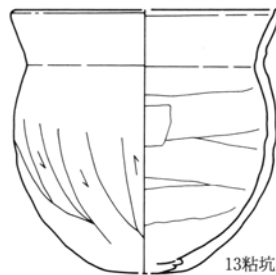

13粘坑-3

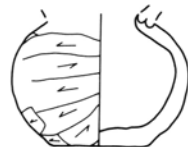

13粘坑-4

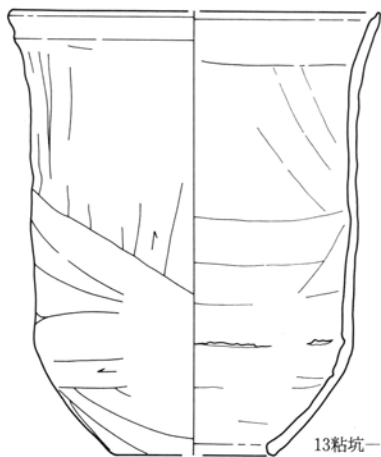

13粘坑-5

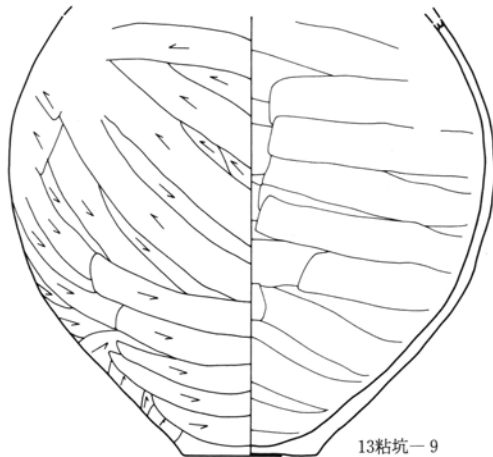

13粘坑-9

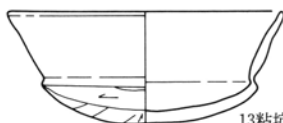

13粘坑-6

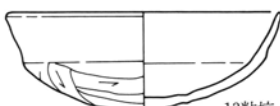

13粘坑-7

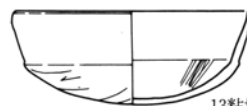

13粘坑-8

0 1 : 4 10cm

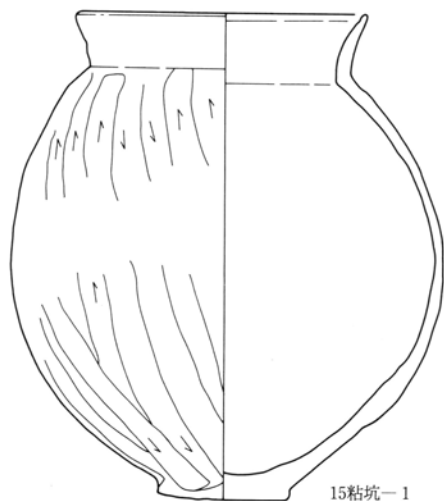

15粘坑-1

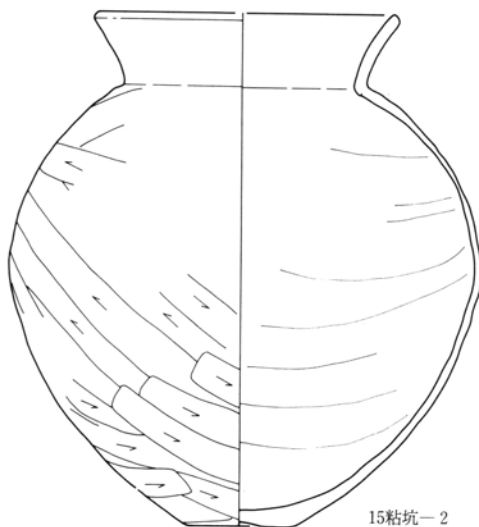

15粘坑-2

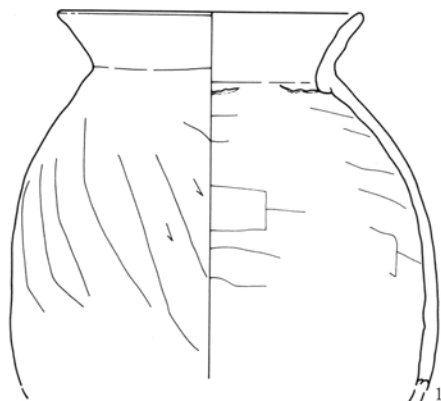

15粘坑-3

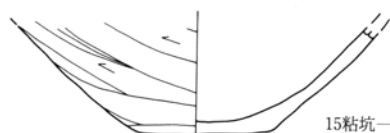

15粘坑-6

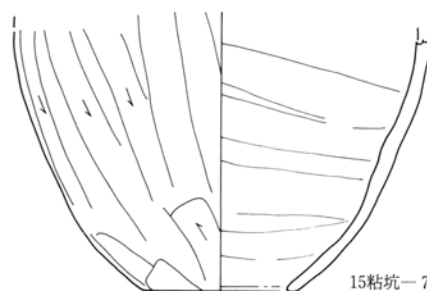

15粘坑-7

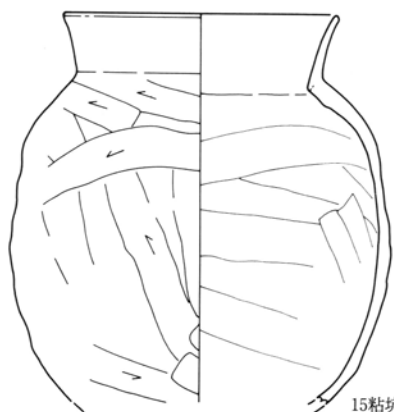

15粘坑-4

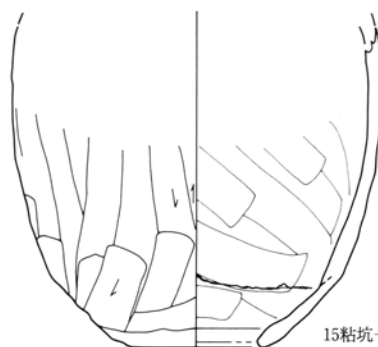

15粘坑-8

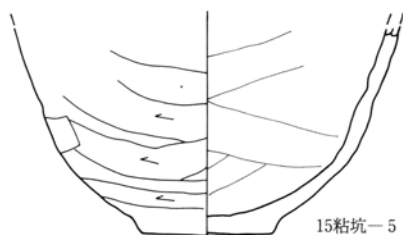

15粘坑-5



15粘坑-9

0 1 : 4 10cm

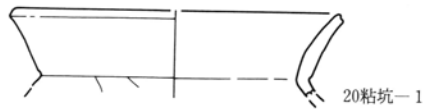
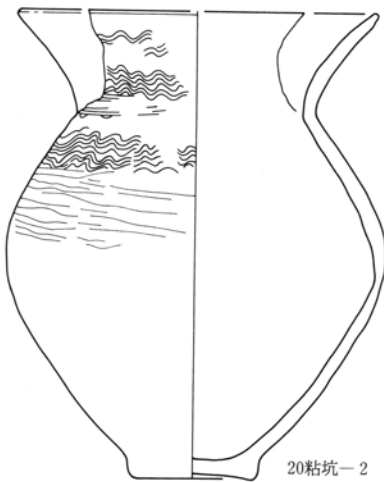
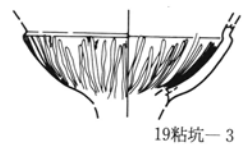
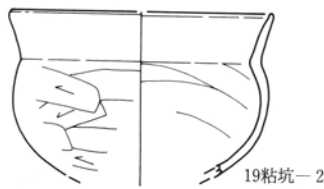
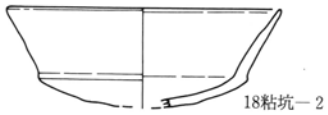
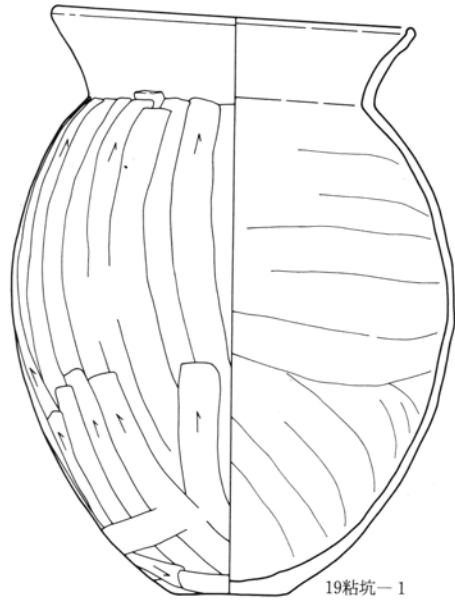
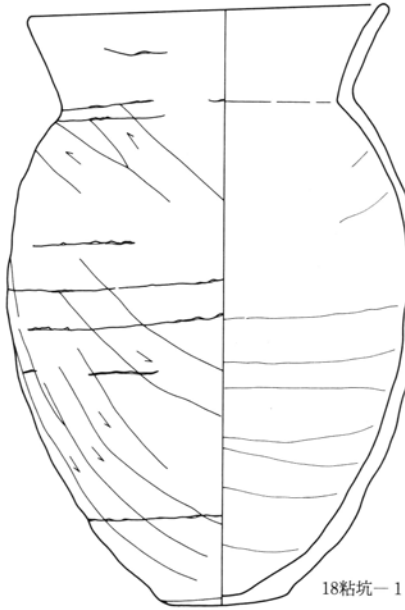
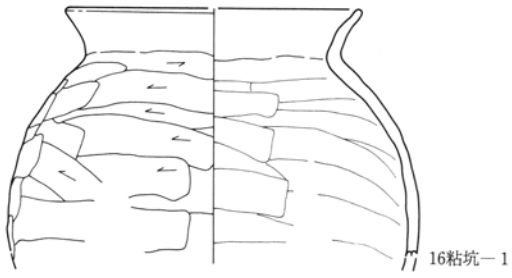

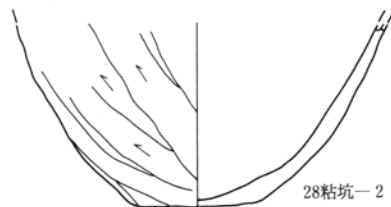
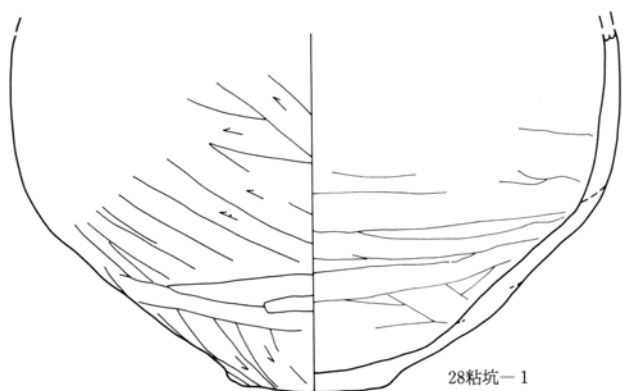
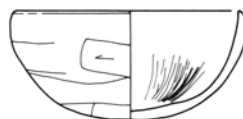
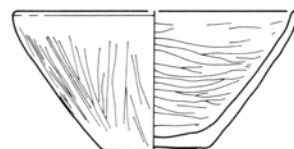
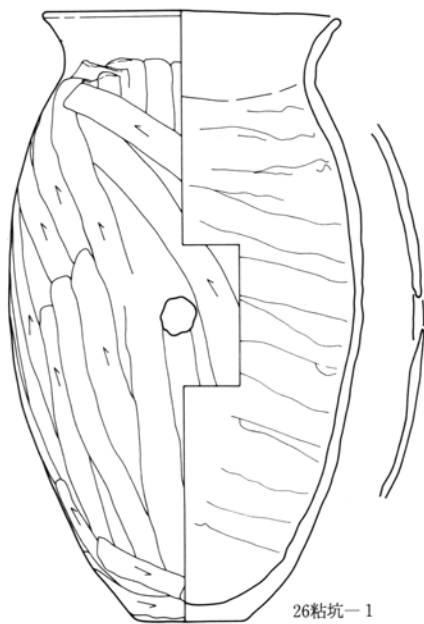
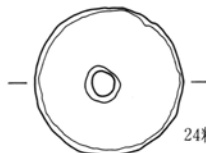
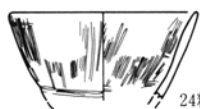
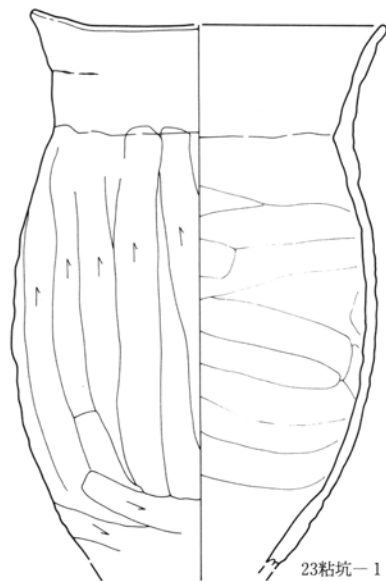
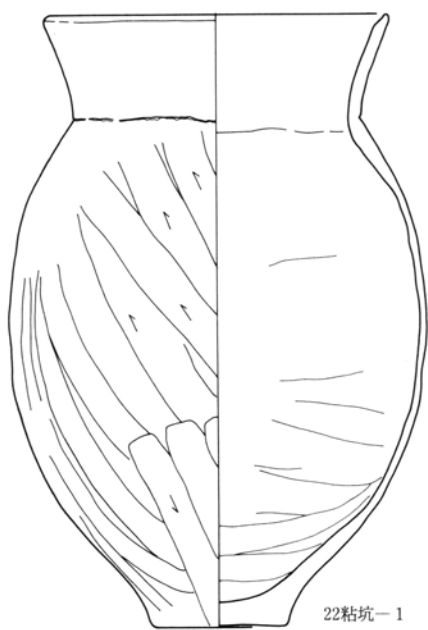

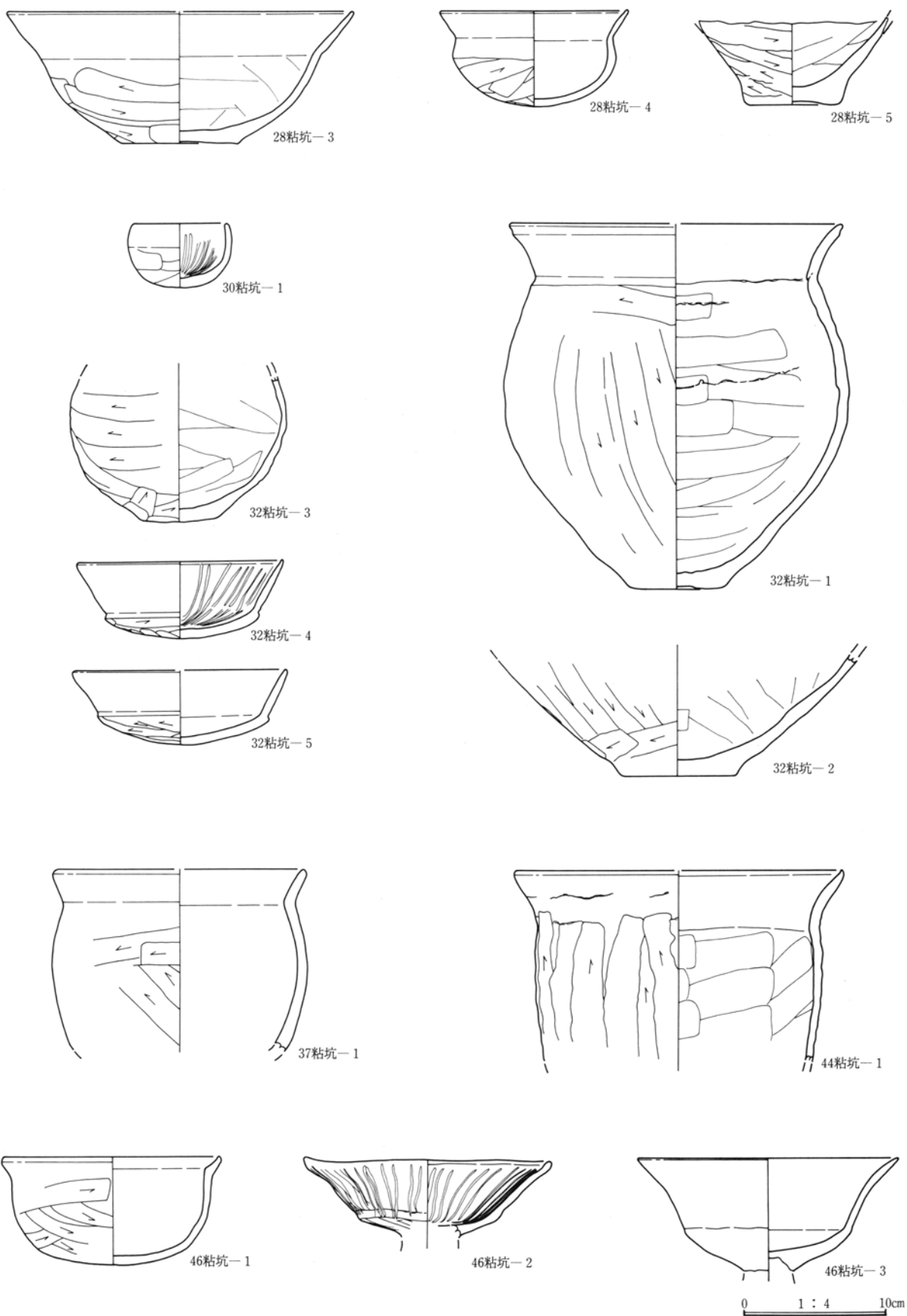

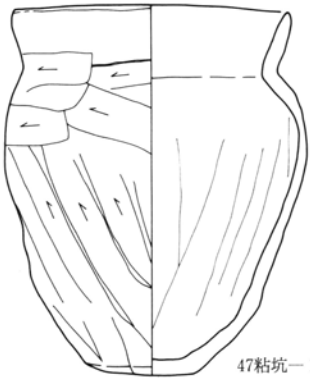

47粘坑-1

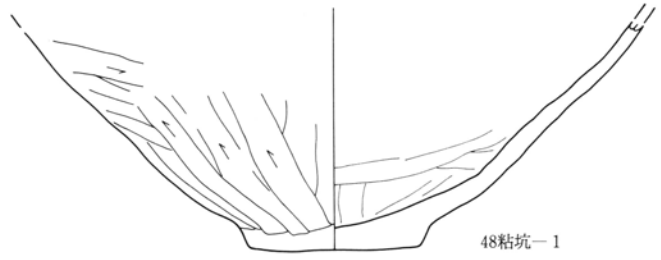

48粘坑-1

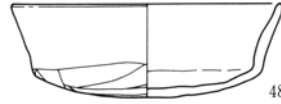

48粘坑-2

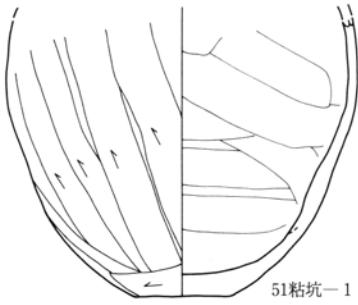

51粘坑-1

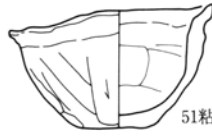

51粘坑-2



51粘坑-3

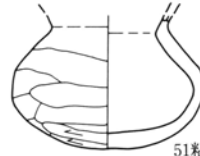

51粘坑-4

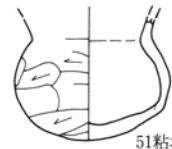

51粘坑-5

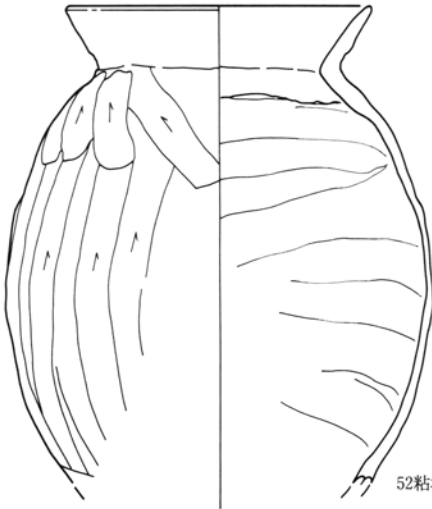

52粘坑-1

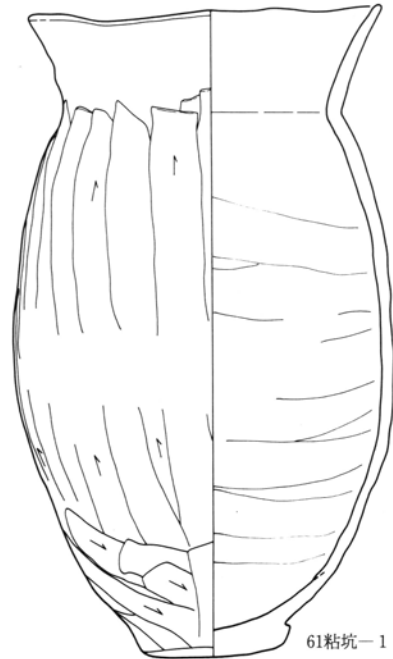

61粘坑-1

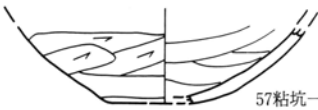

57粘坑-1

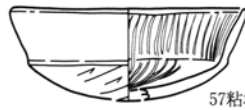

57粘坑-2

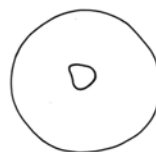
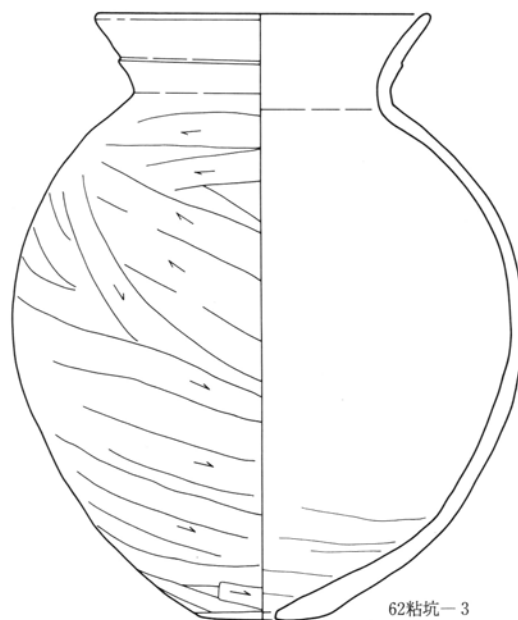
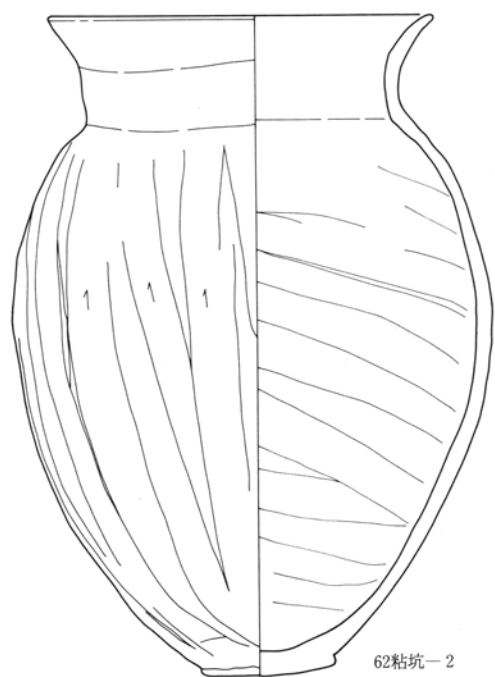
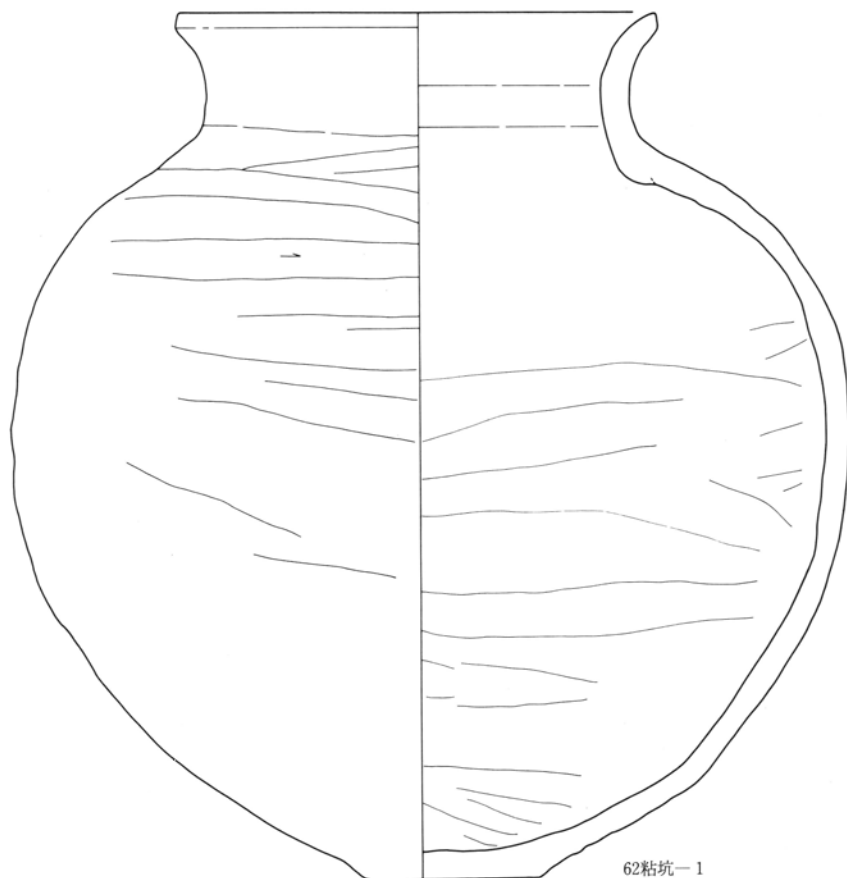

0 1 : 4 10cm

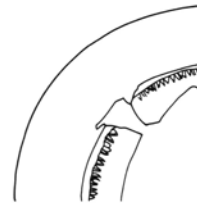
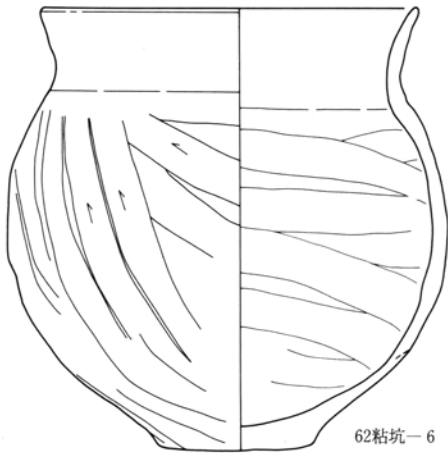
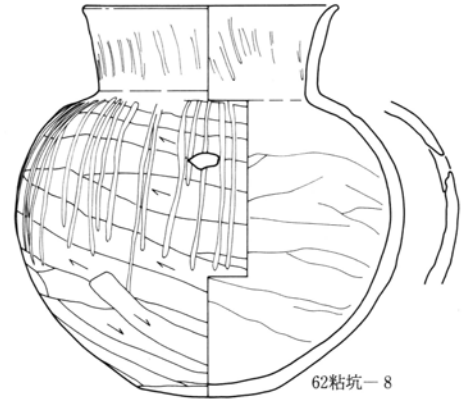
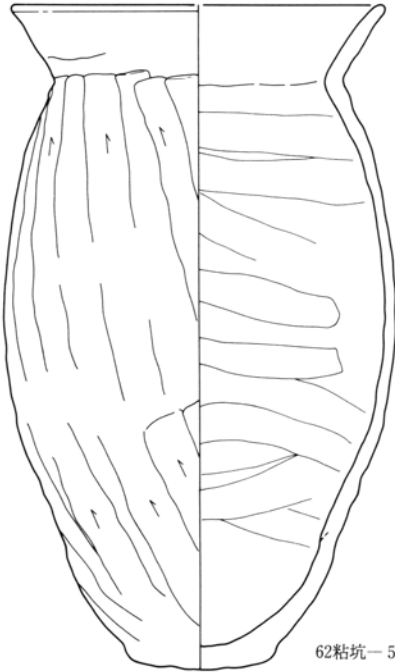
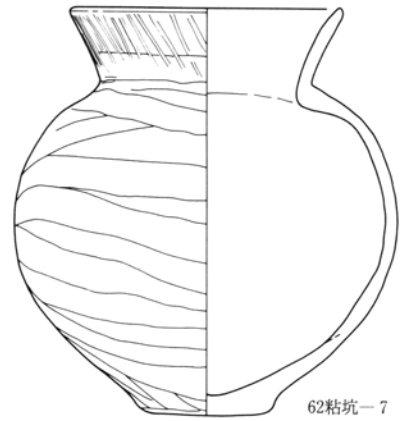
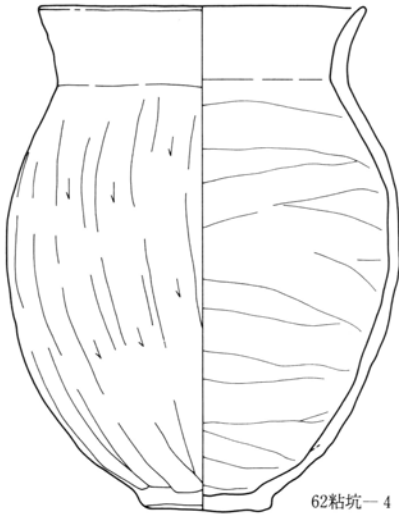

0 1 : 4 10cm

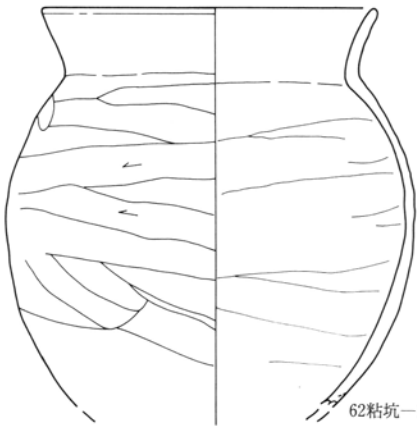

62粘坑-10

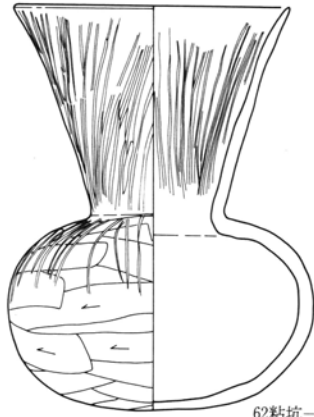

62粘坑-13

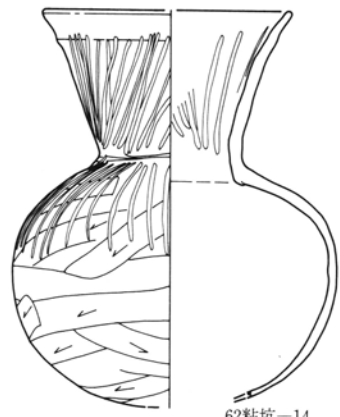

62粘坑-14



62粘坑-11



62粘坑-15

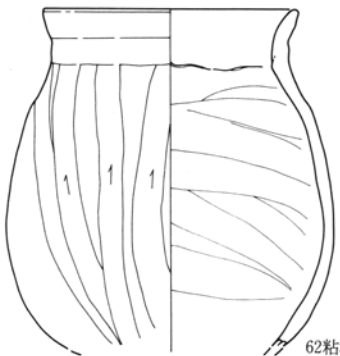
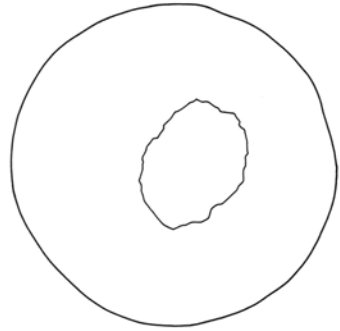

62粘坑-12

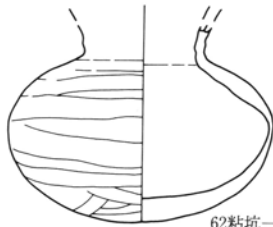

62粘坑-16

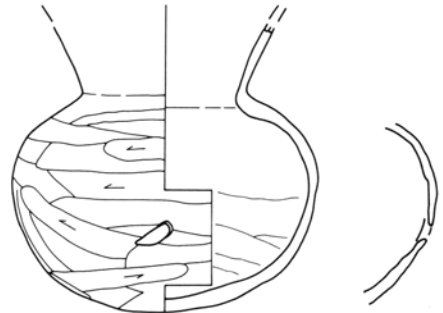

62粘坑-17

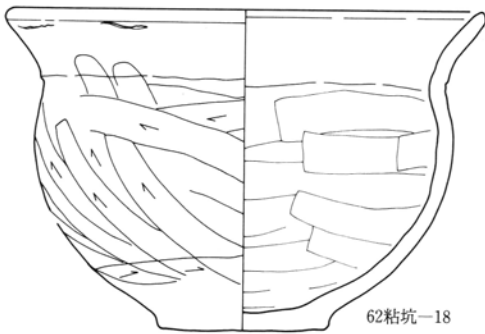

62粘坑-18

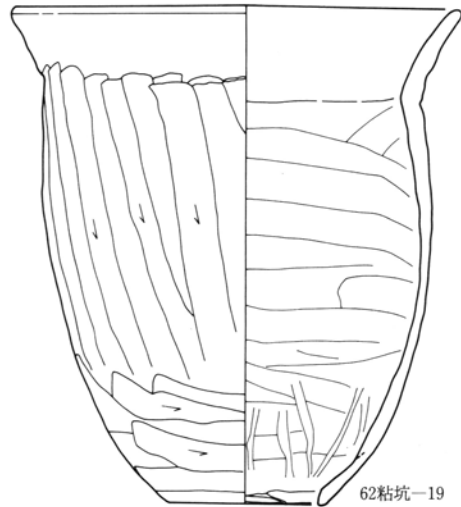

62粘坑-19

0 1 : 4 10cm

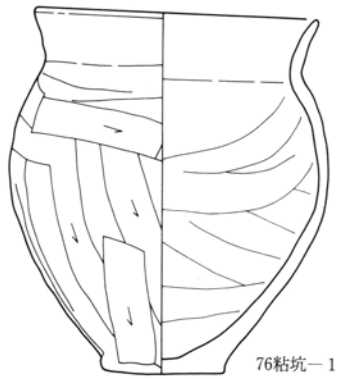
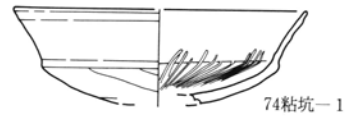
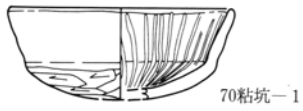
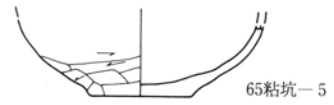
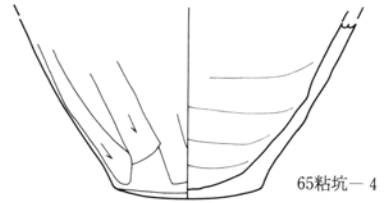
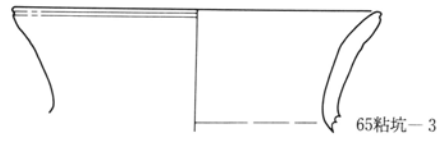
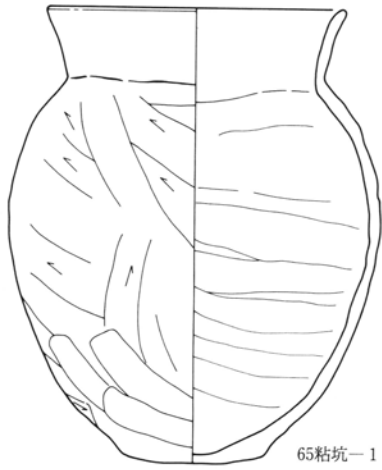

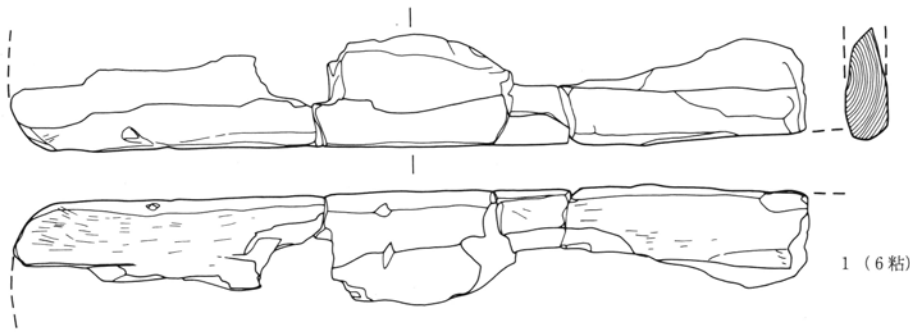

1 (6粘)

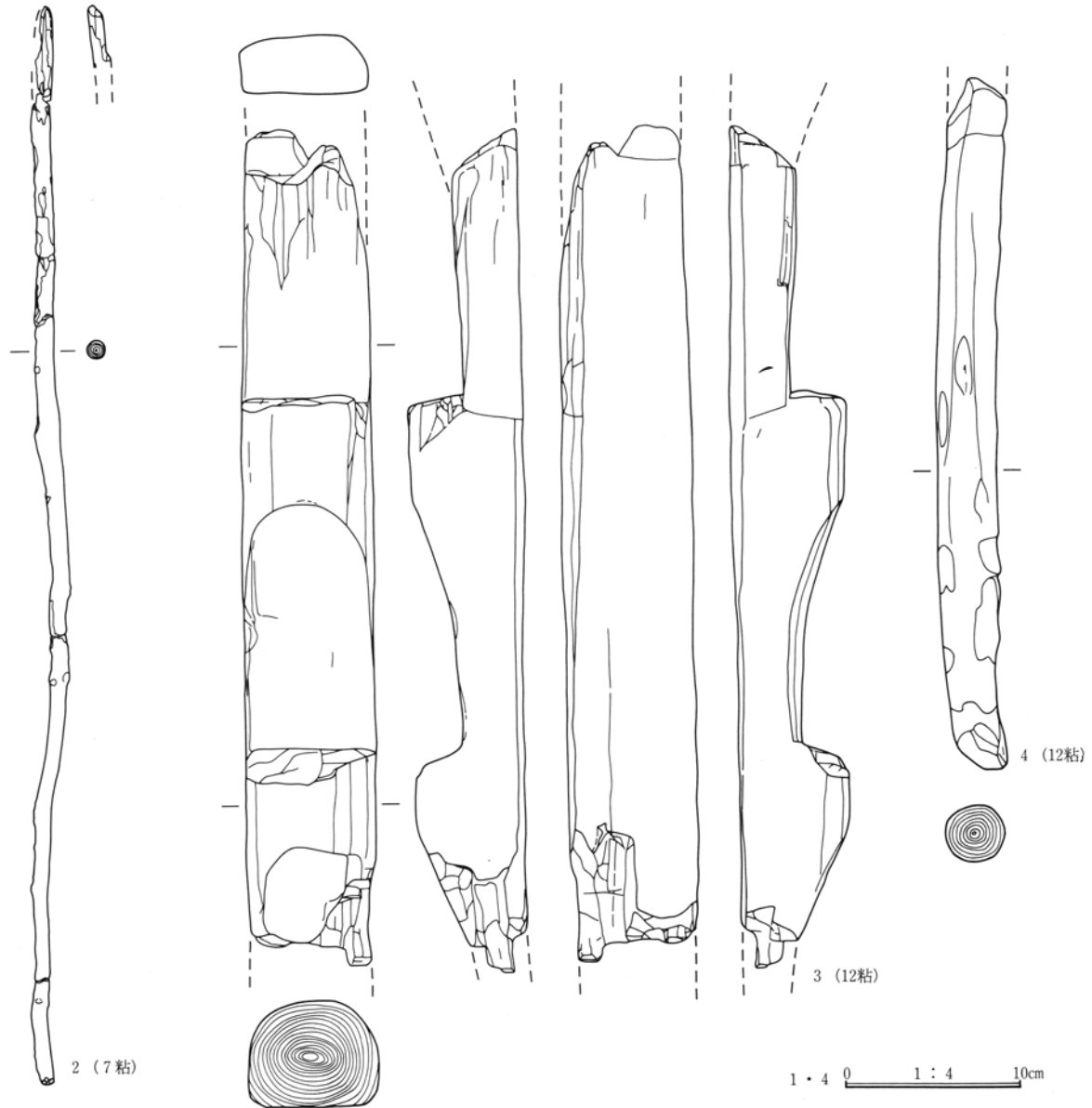

2 (7粘)

3 (12粘)

4 (12粘)

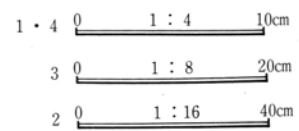

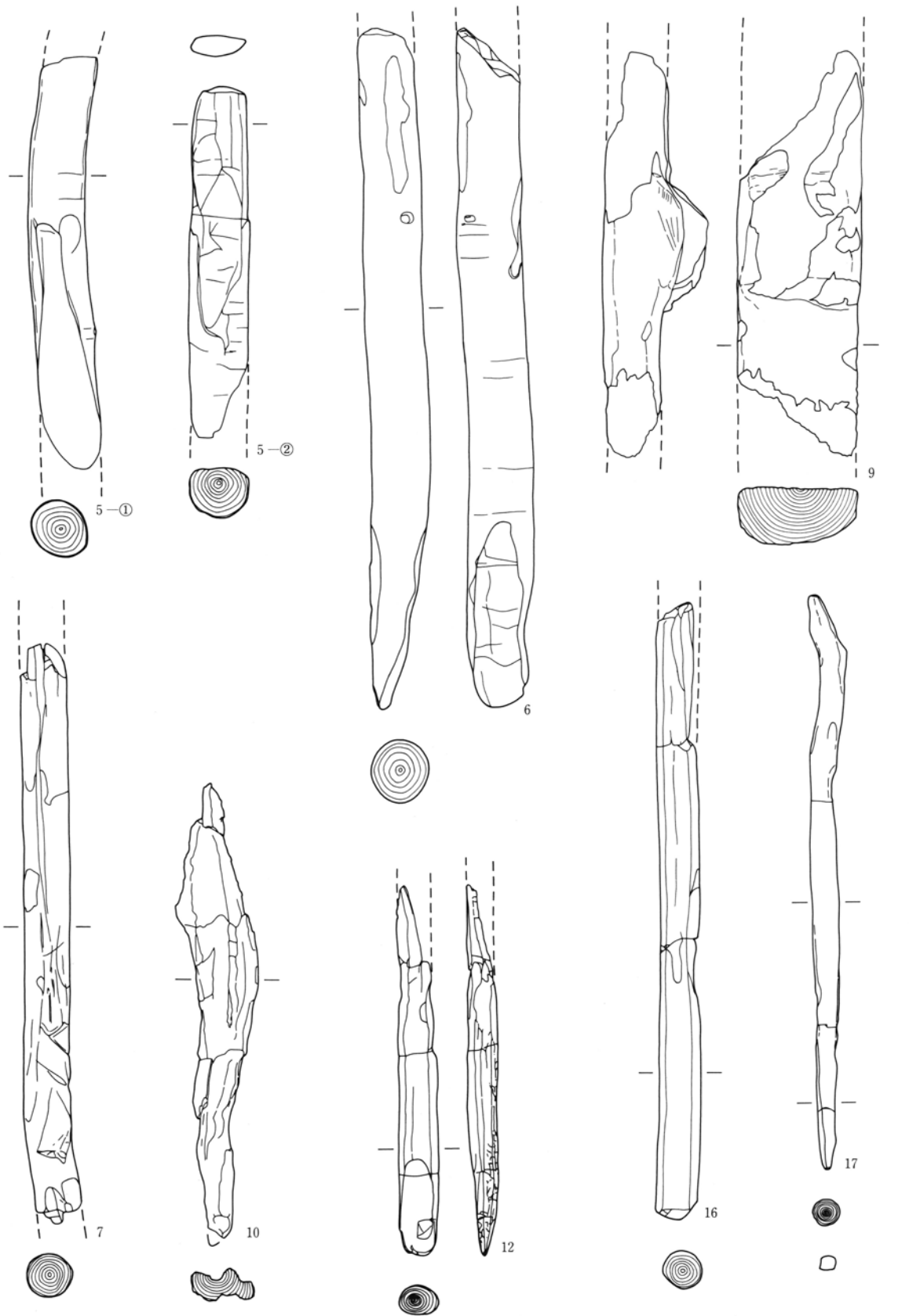

5-①·5-②·6·7 (17粘) 9 (18粘) 10·11·12·16·17 (19粘)

0 1 : 4 10cm

0 1 : 8 20cm

9·10·12

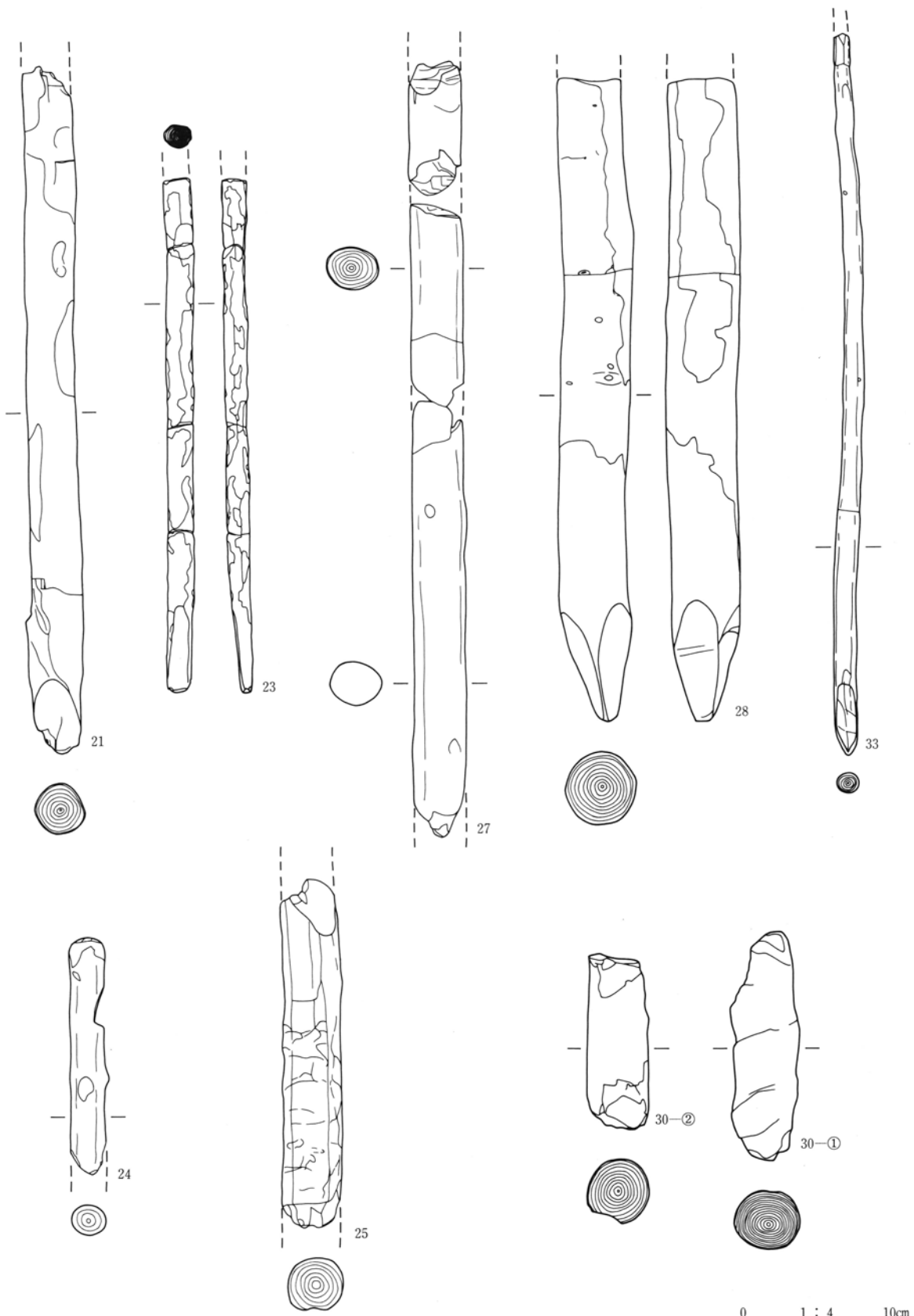

21 · 23 · 24 · 25 · 27 · 28 · 30—① · 30—② (19粘) 33 (26粘)

0 1 : 4 10cm

0 1 : 8 20cm
23 · 33

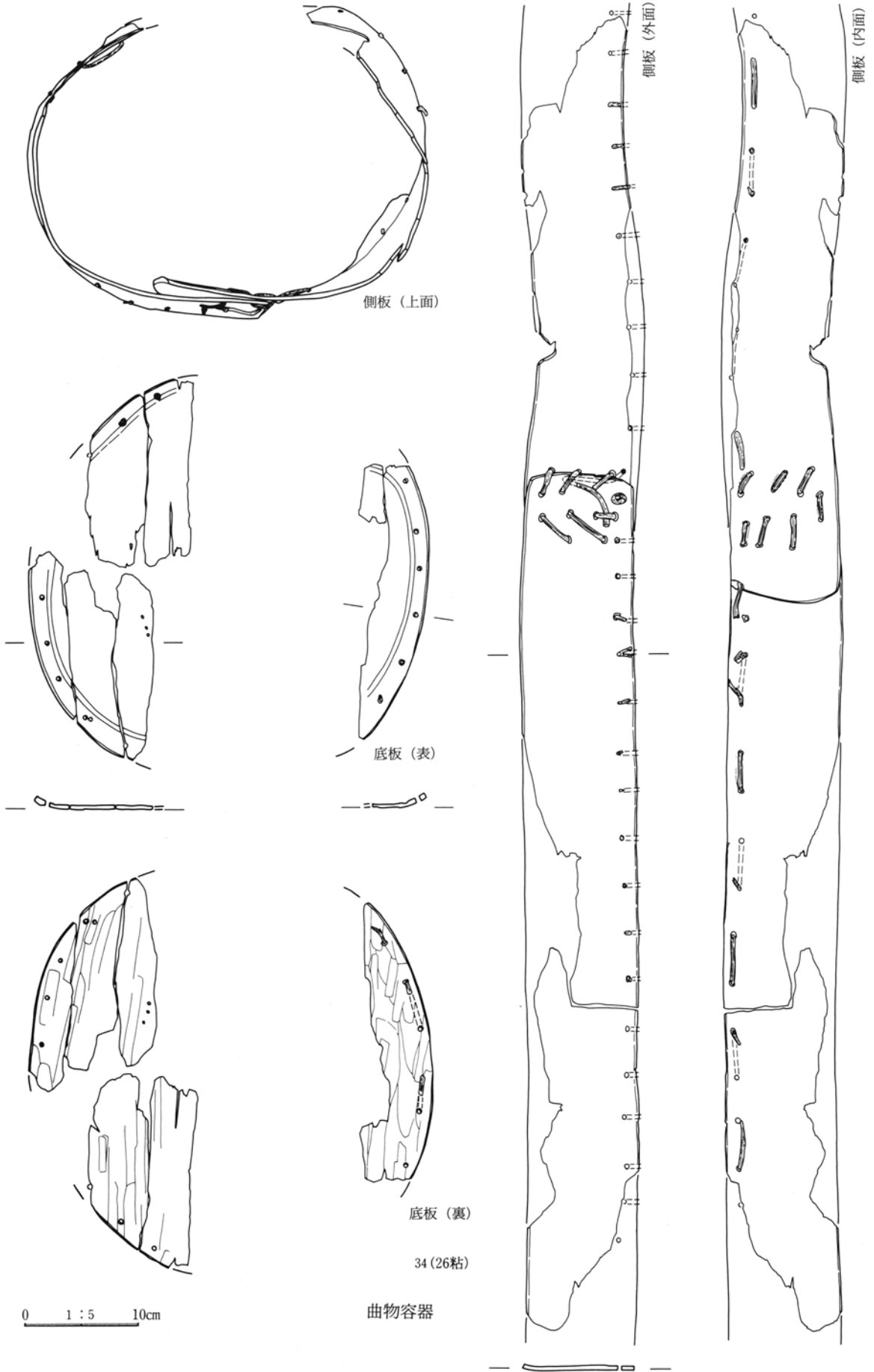

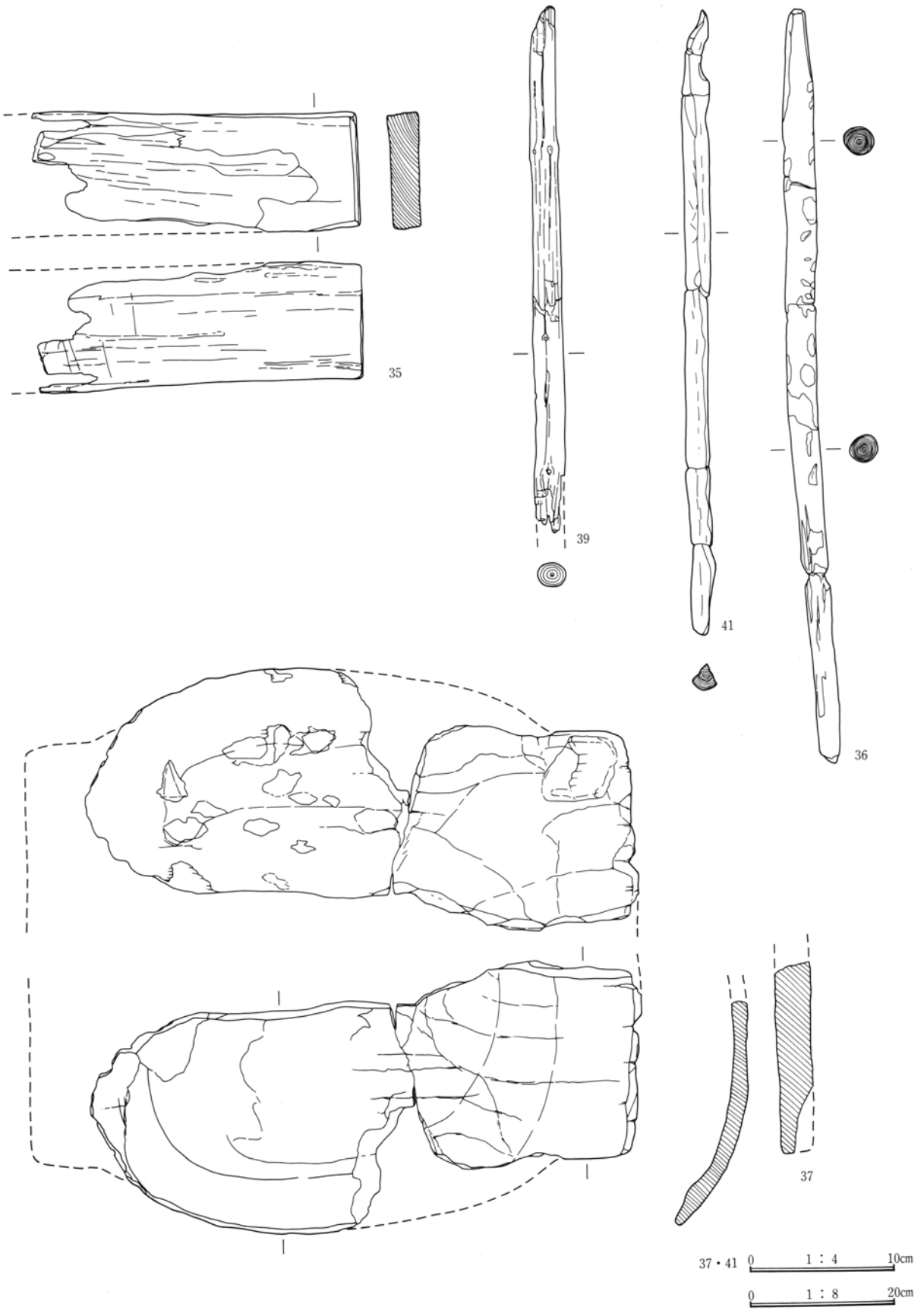

35・36・37 (28粘) 39・41 (32粘)

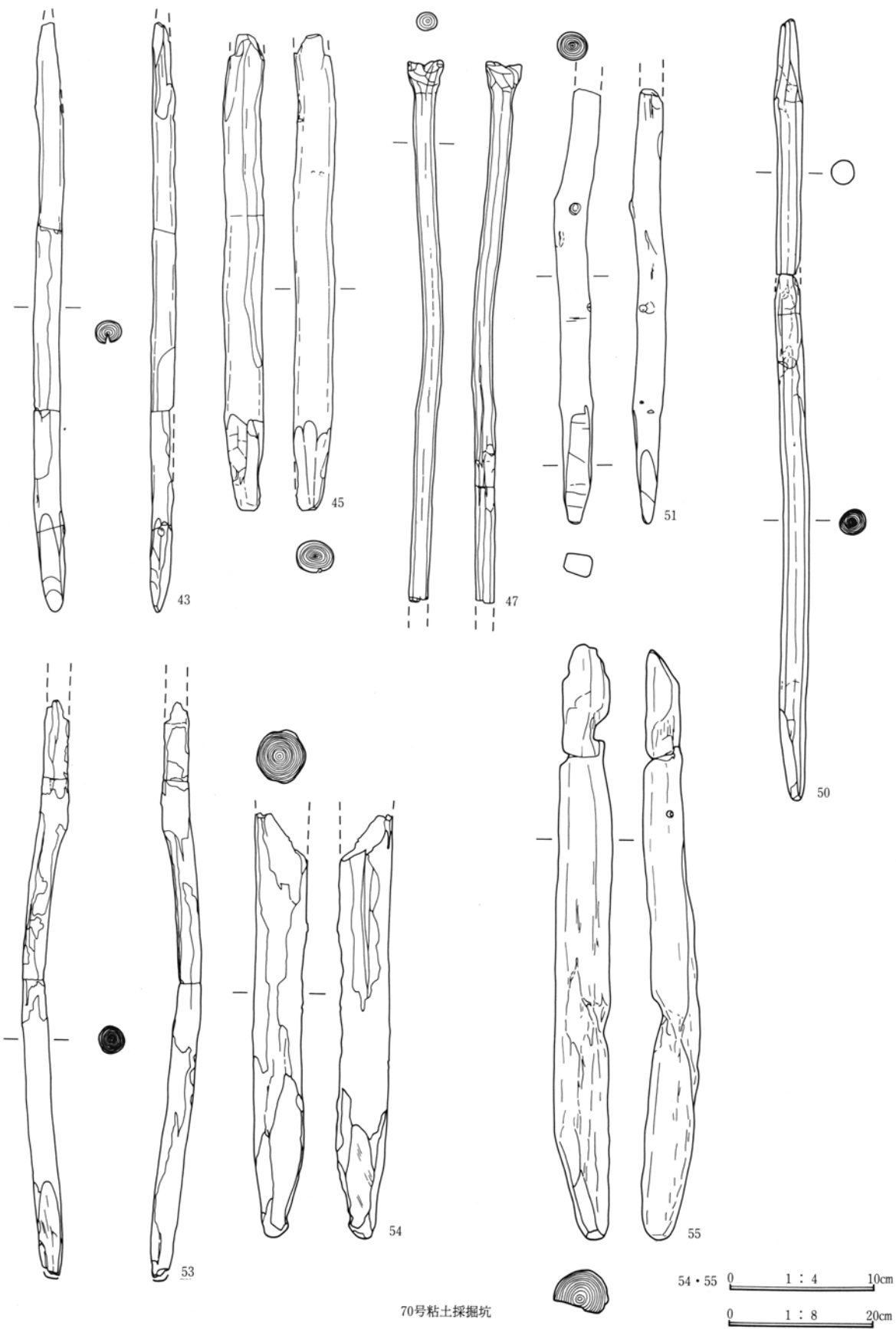

70号粘土探掘坑

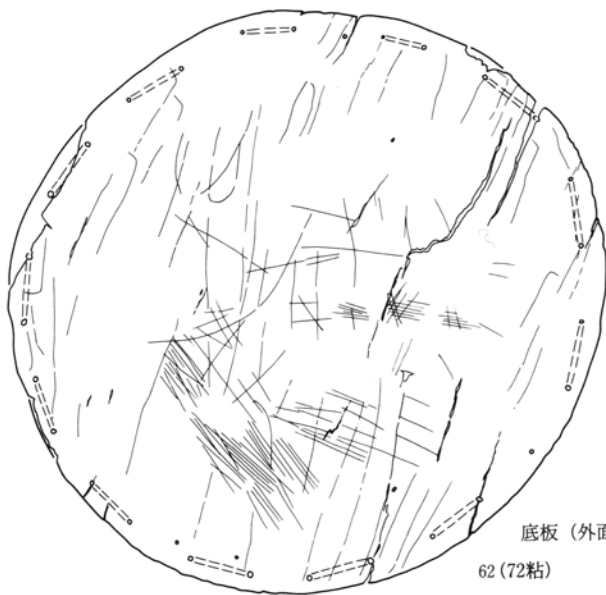
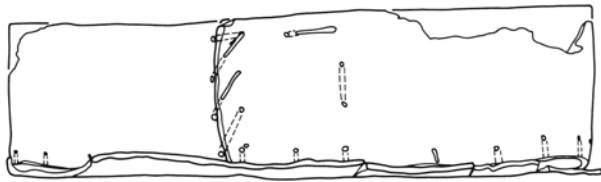
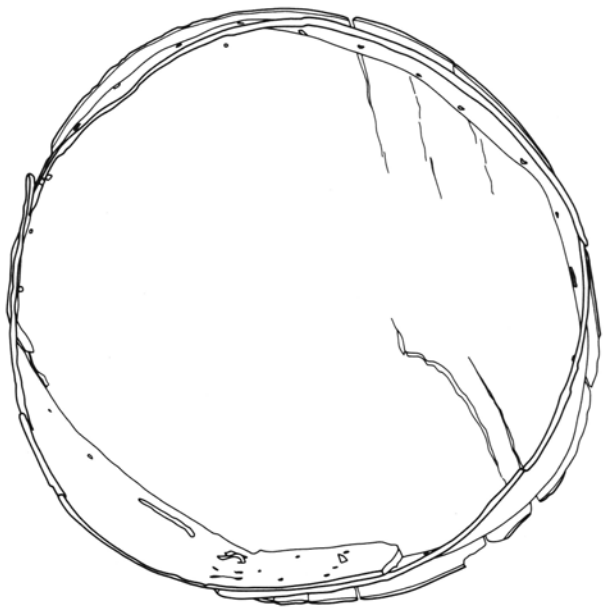

底板 (外面)

62 (72粘)

曲物容器

0 1 : 5 10cm

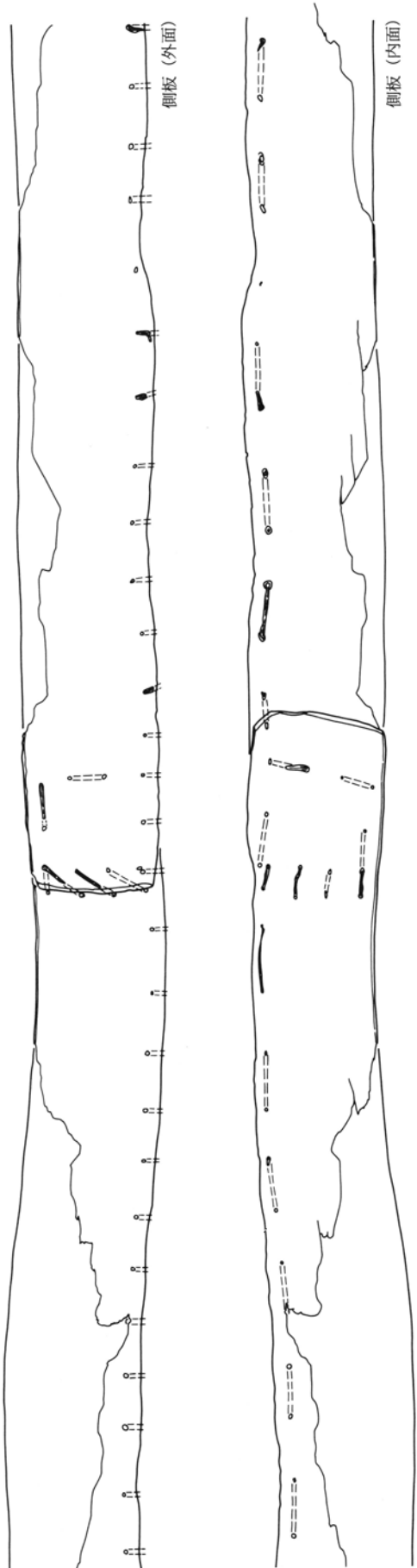

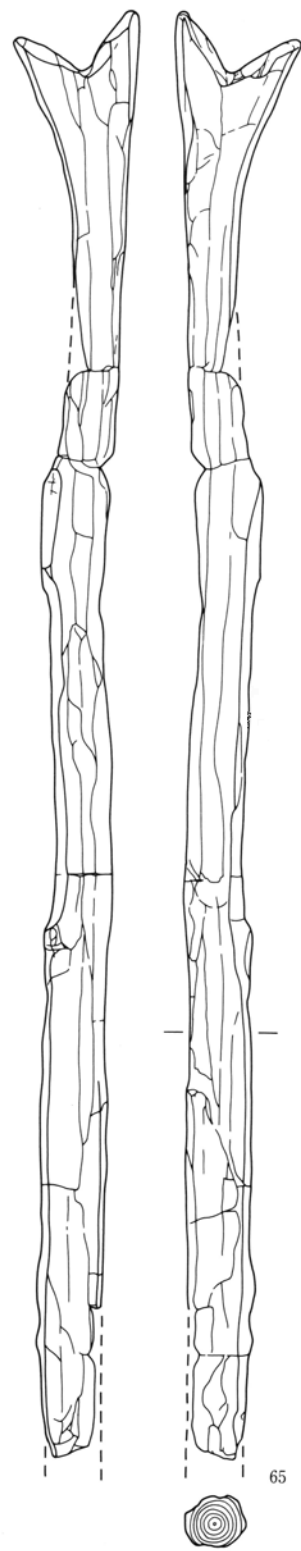
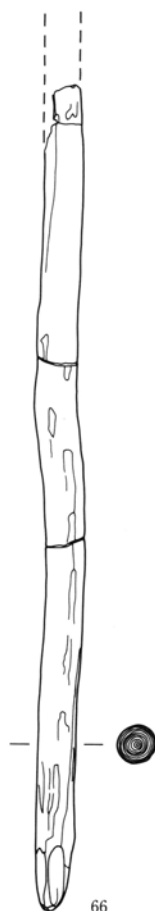
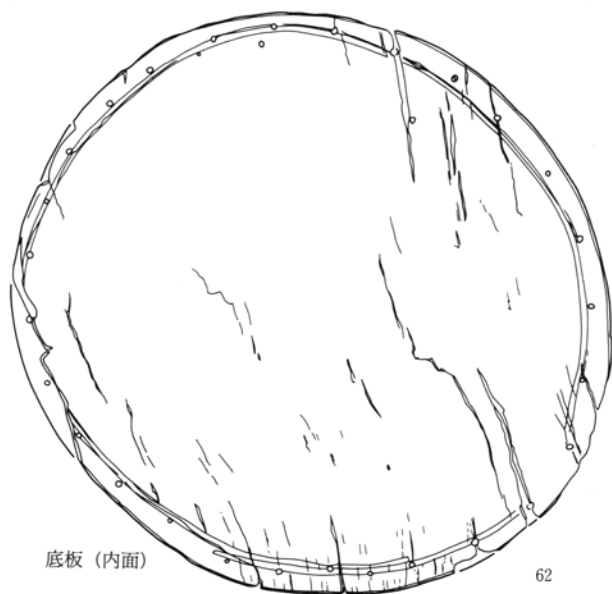

56 (71粘) 61·62 (72粘) 63·65·66 (74粘)

0 1 : 5 10cm

0 1 : 8 20cm

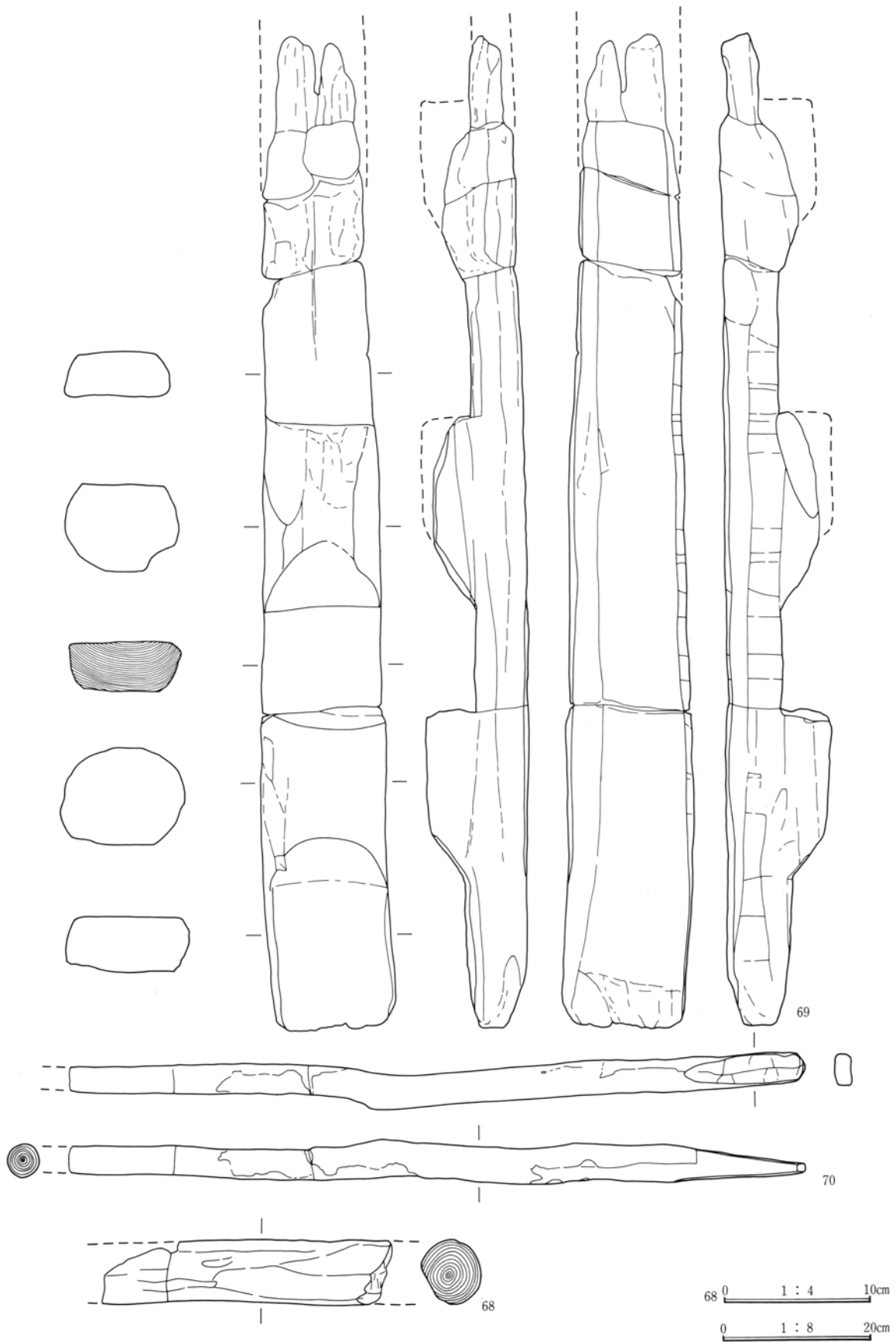

68 (74粘) 69·70 (19粘)

報 告 書 抄 録

フリガナ	シラクラシモハラ・アマビキムカイハライセキ
書名	白倉下原・天引向原遺跡IV
副書名	関越自動車道（上越線）地域埋蔵文化財発掘調査報告書
巻次	第221集
シリーズ名	（財）群馬県埋蔵文化財調査事業団調査報告
シリーズ番号	第46集
編集者名	木村 收 藤巻幸男
編集機関	（財）群馬県埋蔵文化財調査事業団
所在地	〒377 群馬県勢多郡北橘村大字下箱田784-2
発行年月日	西暦1997年3月25日

フリガナ 所収遺跡	フリガナ 所在地	コード		北緯 ° ' "	東経 ° ' "	調査期間	調査面積 ㎡	調査原因
		市町村	遺跡番号					
シラクラシモハラ 白倉下原 ・ アマビキムカイハラ 天引向原	カンラ郡 甘楽町 オオアザシラクラ 大字白倉 オオアザアマビキ 大字天引	103845	10005— 00294	36°14'14" }	138°56'23" }	19890401— 19910820	白倉下原 26,978	道路建設
		103845	10005— 00293	36°14'21" }	138°56'35" 138°56'36" } 138°56'55"	天引向原 38,465 計 65,443		

所収遺跡名	種別	主な時代	主な遺構		主な遺物	特記事項
白倉下原 ・ 天引向原	集落遺跡	5世紀後半以降7世紀まで 古墳時代後期から飛鳥時代	竪穴住居跡 粘土採掘坑 粘土土坑 溝 円形 周溝遺構 白玉工房跡	163軒 67基 20基 1条 1基	当該期の土器群 多数 樹皮製曲物 2点 はしご 3点 土鈴 1点 木の葉形坏 5点 手鏡形土製品 3点 魚形（動物） 意匠土製品 1点 佐波理破片 1点	各時代にわたる集落遺跡。 粘土採掘坑や白玉工房跡など他の遺構も豊富。 希少性のある遺物も多く出土。

群馬県埋蔵文化財調査事業団
調査報告第221集

白倉下原・
天引向原遺跡IV
(本文編)

関越自動車道(上越線)地域埋蔵
文化財発掘調査報告書第46集

平成9年3月20日 印刷
平成9年3月25日 発行

編集/群馬県埋蔵文化財調査事業団
勢多郡北橋村大字下箱田784-2
電話(0279)52-2511(代表)

発行/群馬県考古資料普及会
勢多郡北橋村大字下箱田784-2
電話(0279)52-2511(代表)

印刷/朝日印刷工業株式会社