

443~450

SK2159

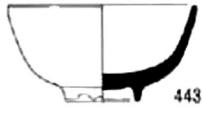

443

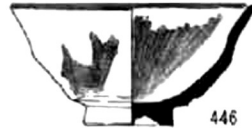

446



448

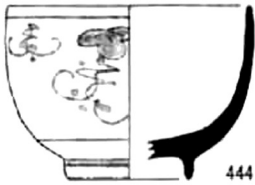

444



445



447

SK2172



449

SK2179

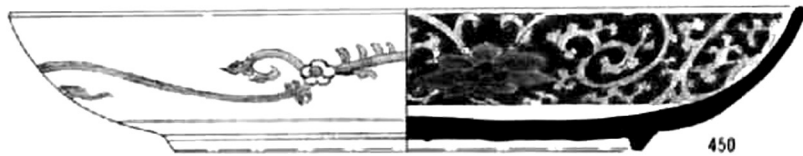

450

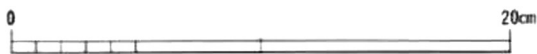
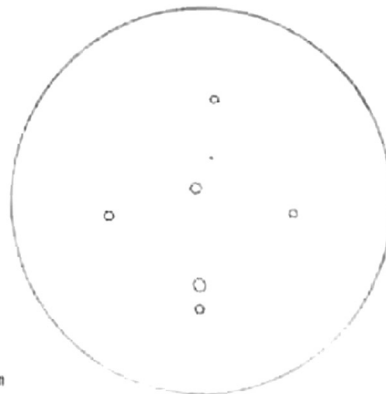

452~460

SD2201



452

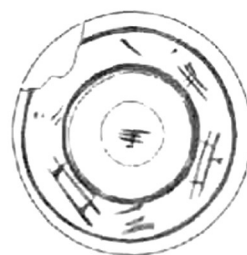

453



454

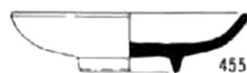

455

SD3201



456



458



459

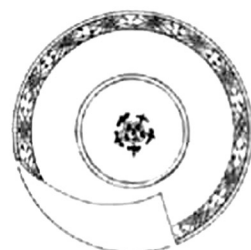

457

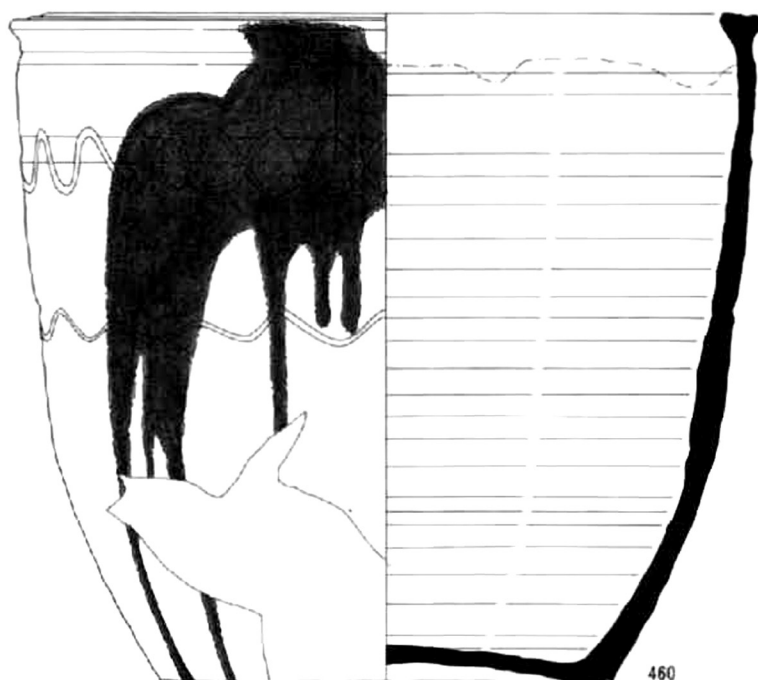

460

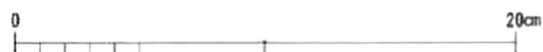

461~478

SD3202

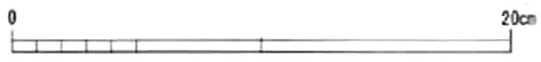
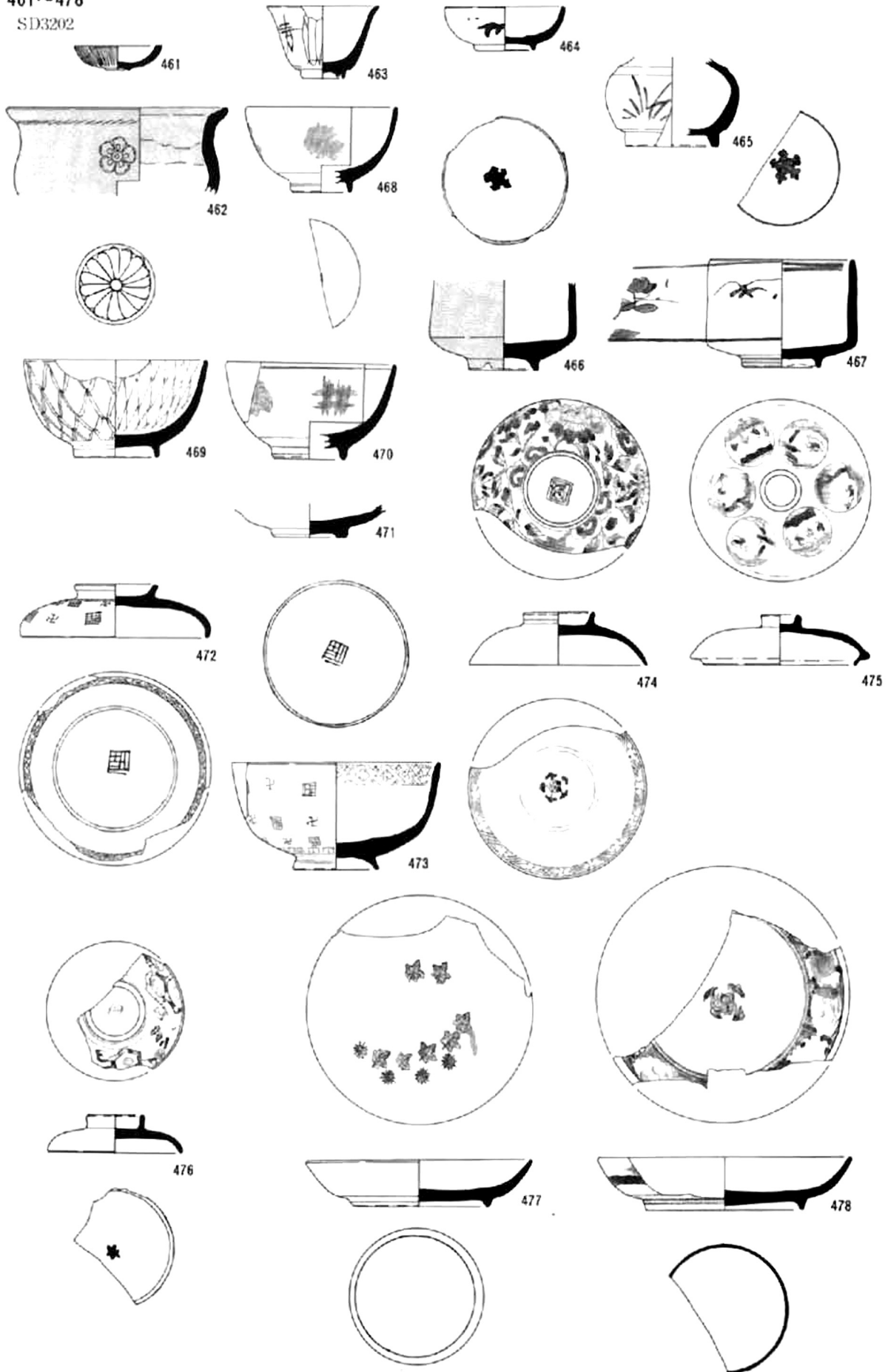

SD3202

479~497

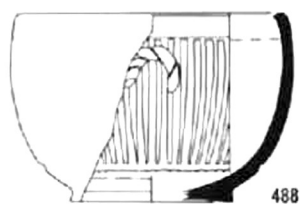
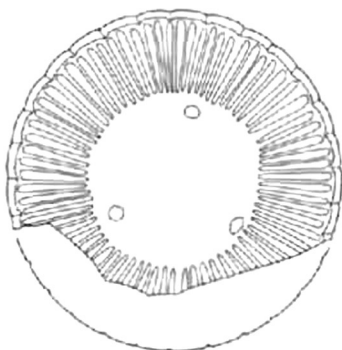
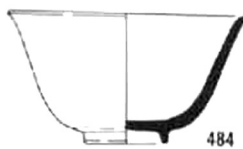
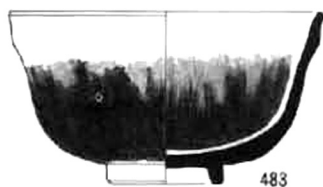
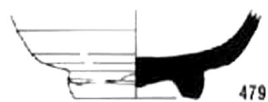

石野山

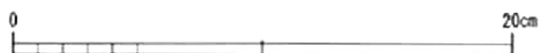
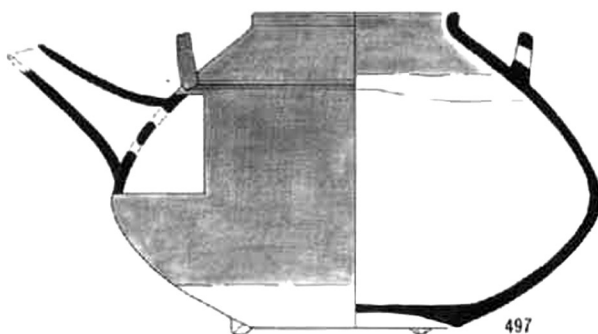
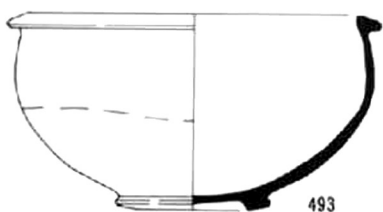
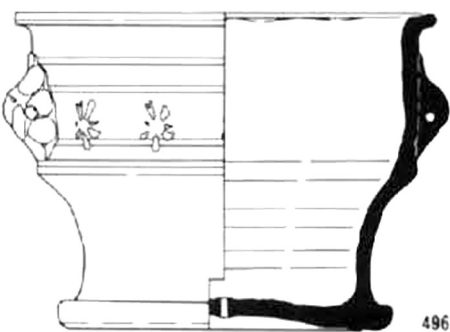
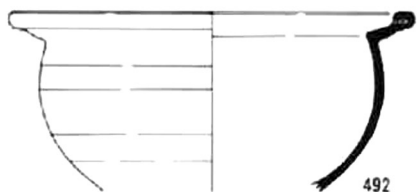
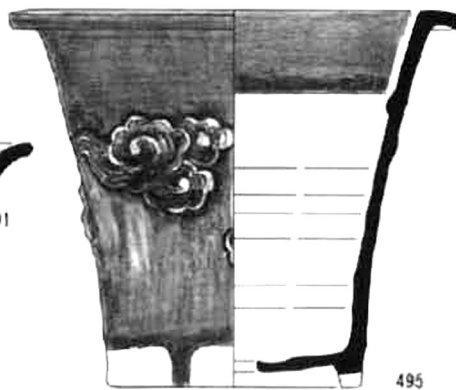
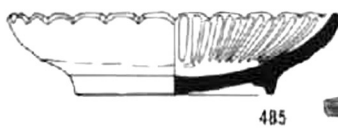

498~504  
SD3202

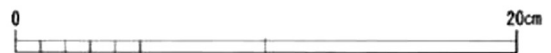
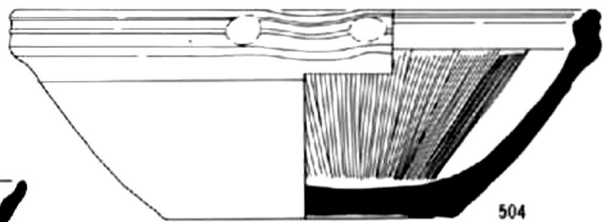
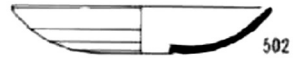
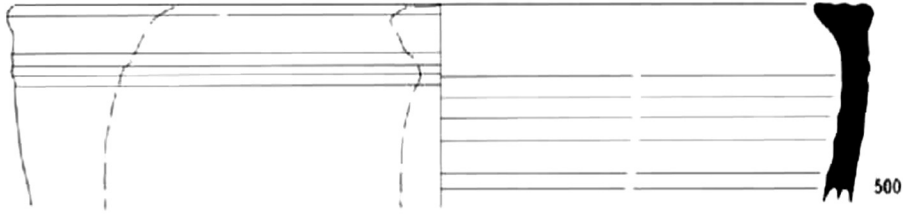
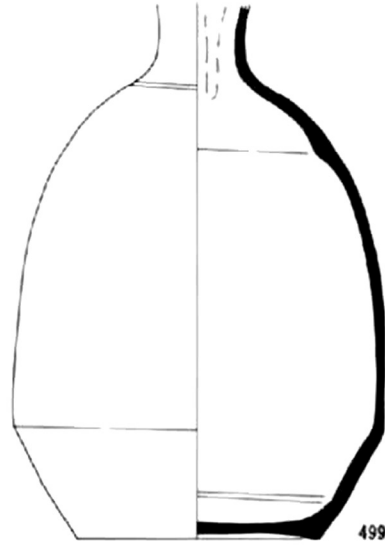
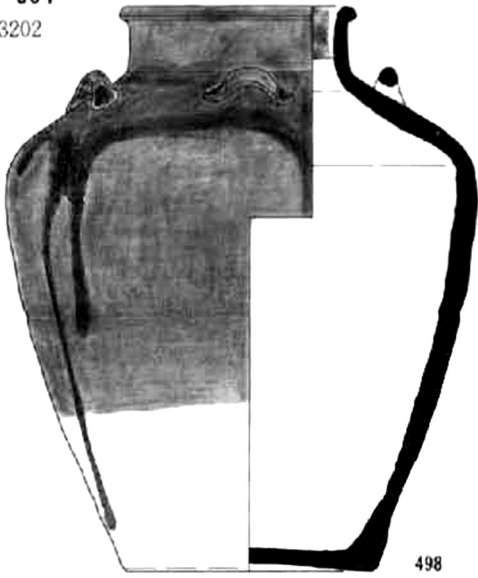

SD3202

505~514

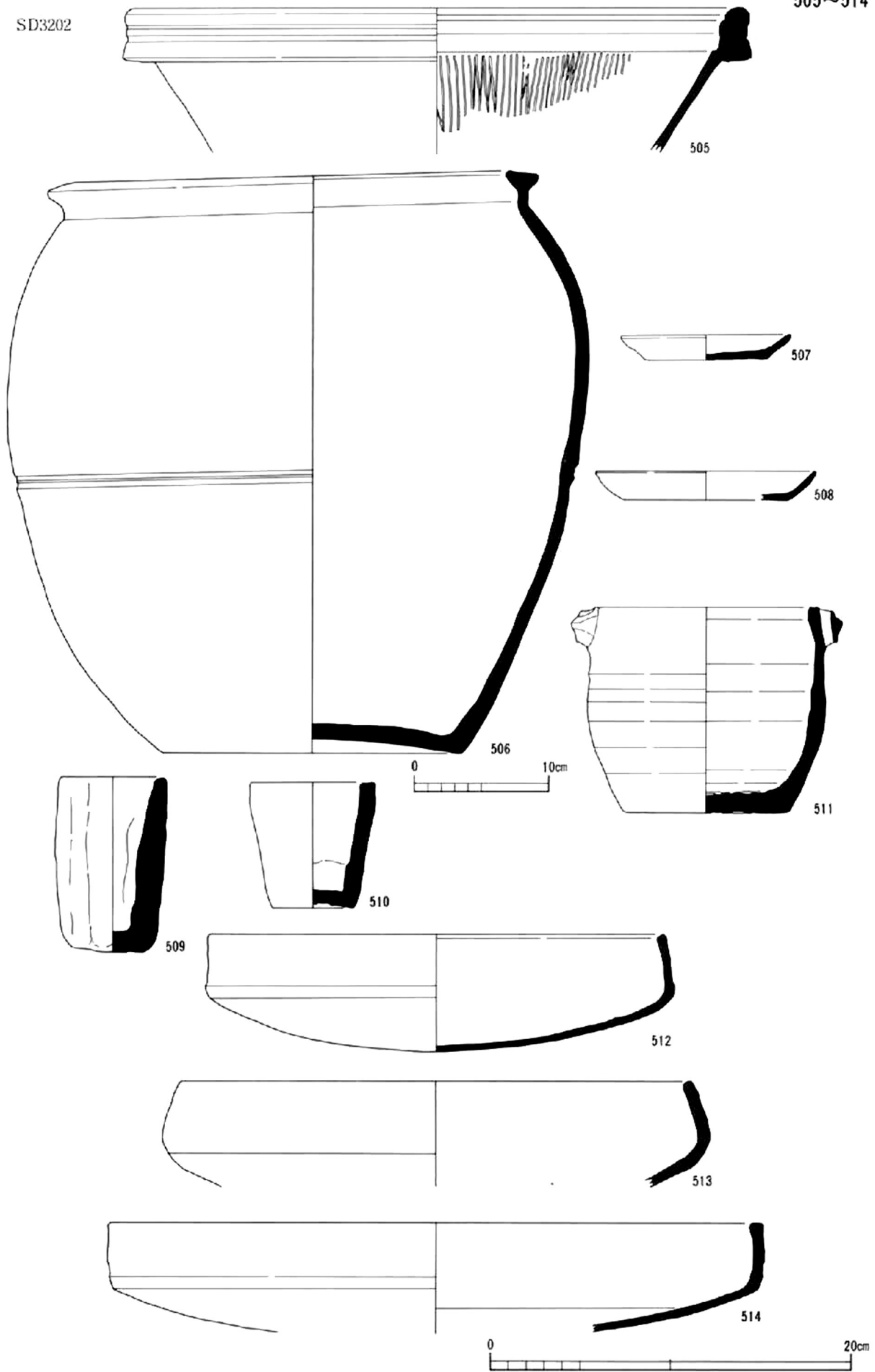

515~530

SK3208



515



516



517



518



519

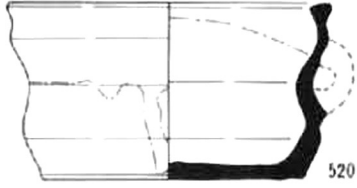

520

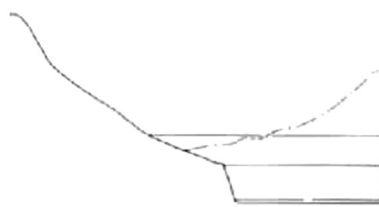

521



522

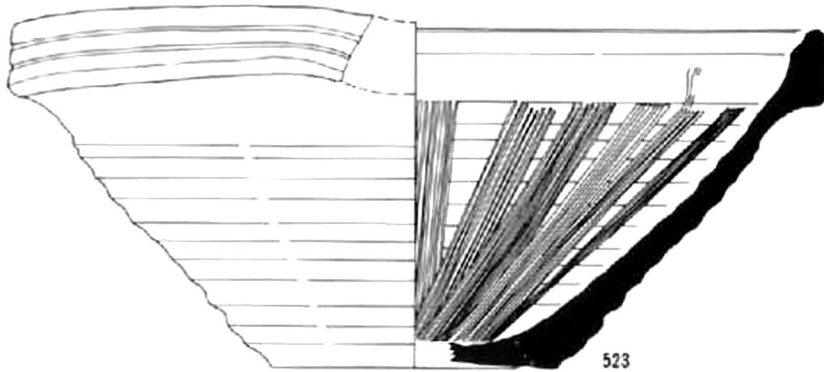

523



524



527



529

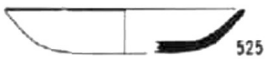

525



528



530



526

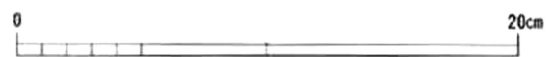

20cm

531~552

SG3201

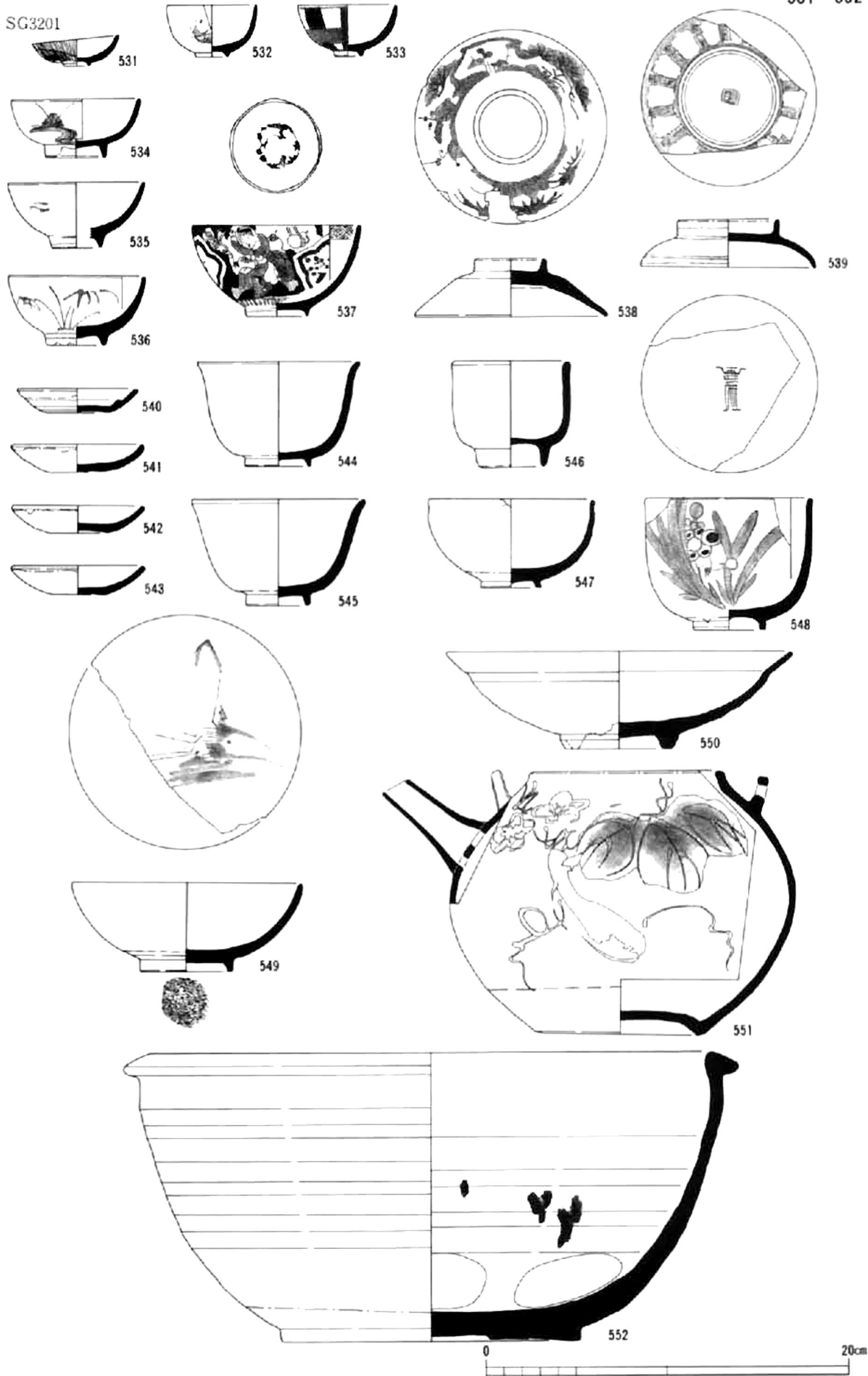



553~556

SG3201

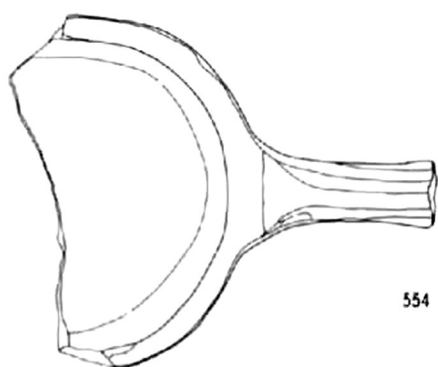
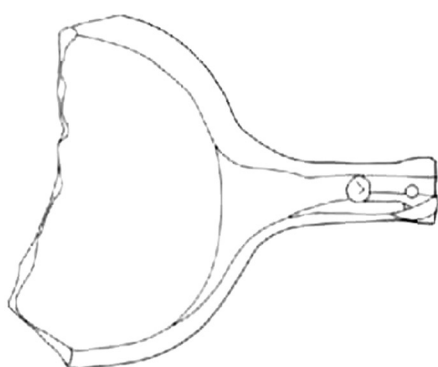
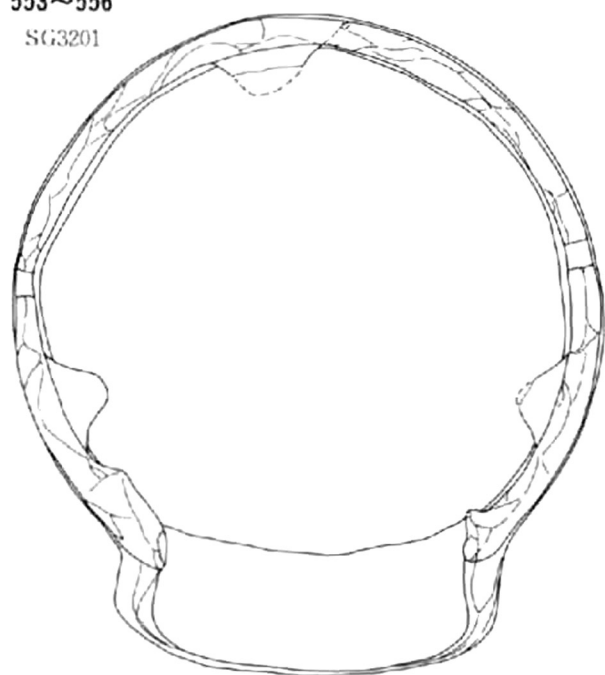

554

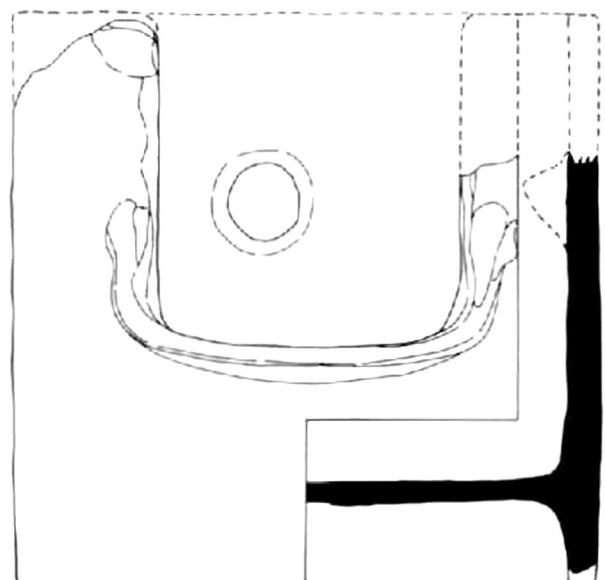

553

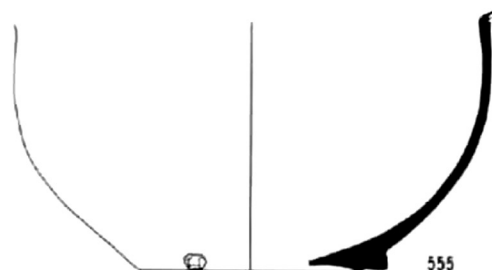

555

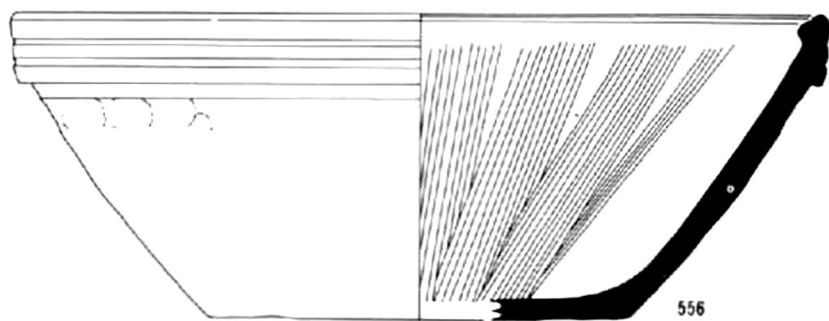

556



SG3201

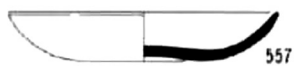

557~565

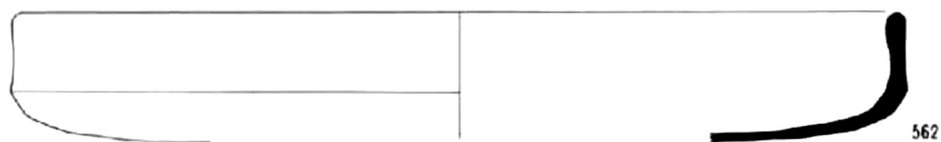
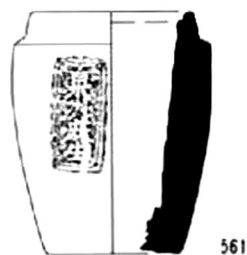

SX4002

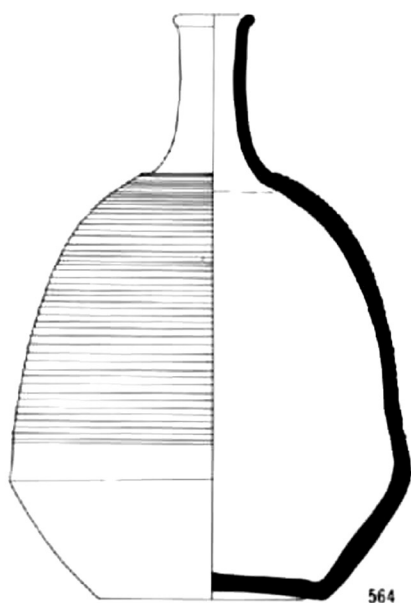
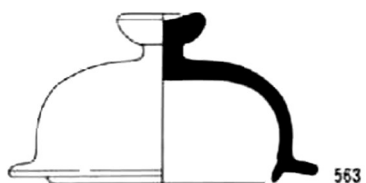

SK3201

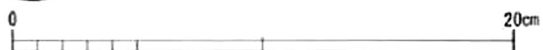
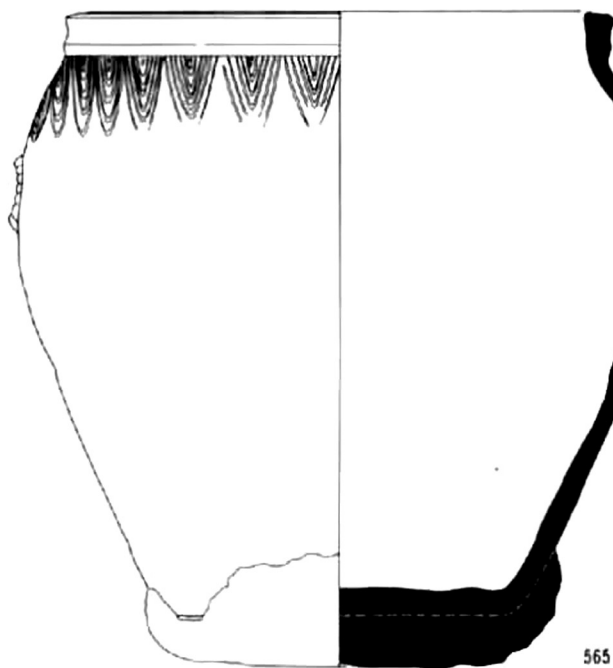

556~581

SD2321

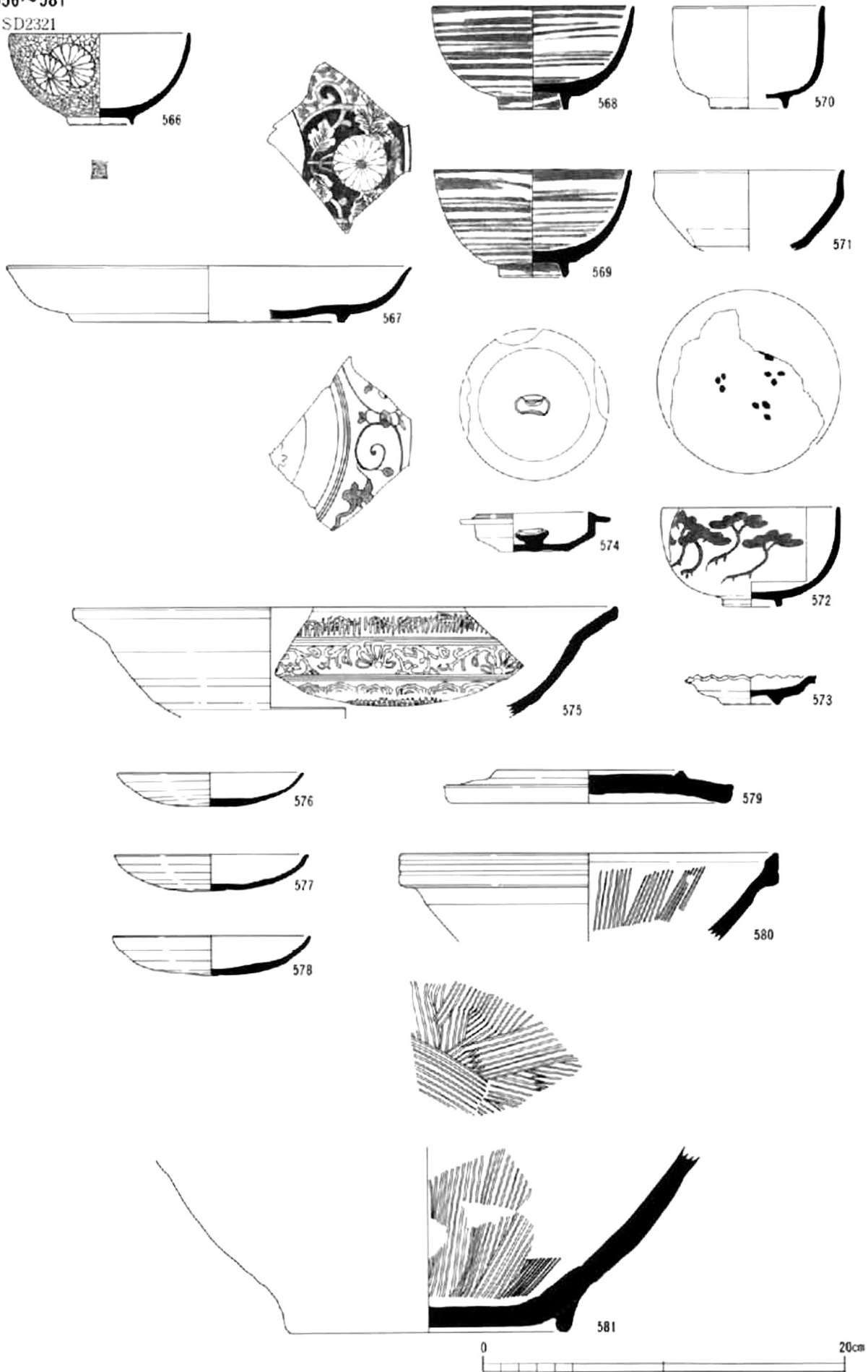

582~590

SD2321

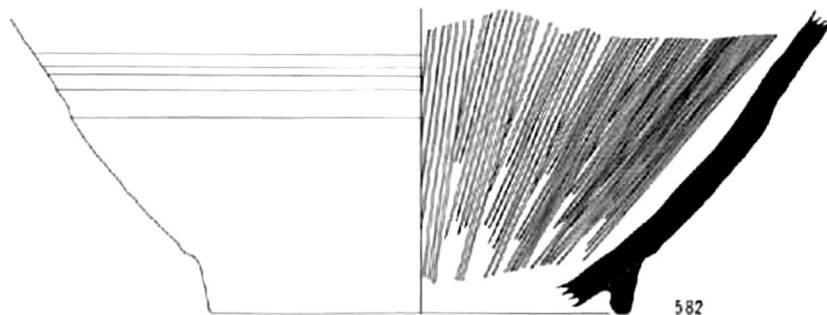

582



583



584



585

SD2301



586

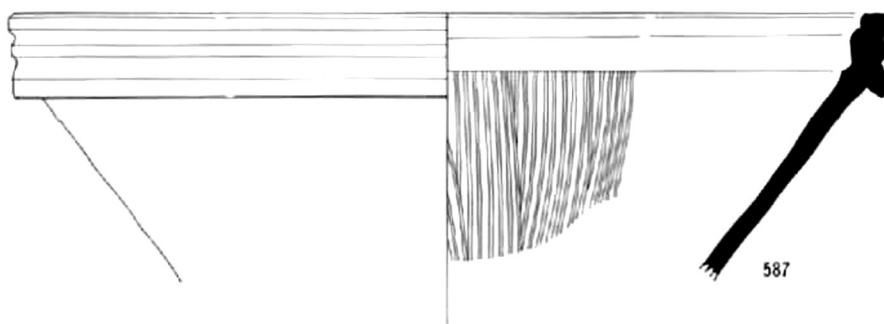
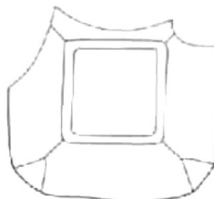

587

SD2304

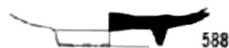

588



589

SD2303

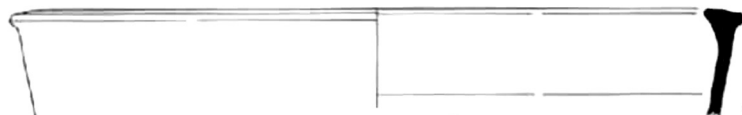

590

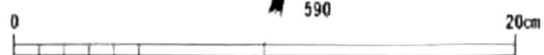

591~606

SD2310

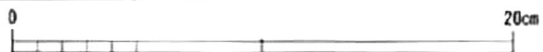
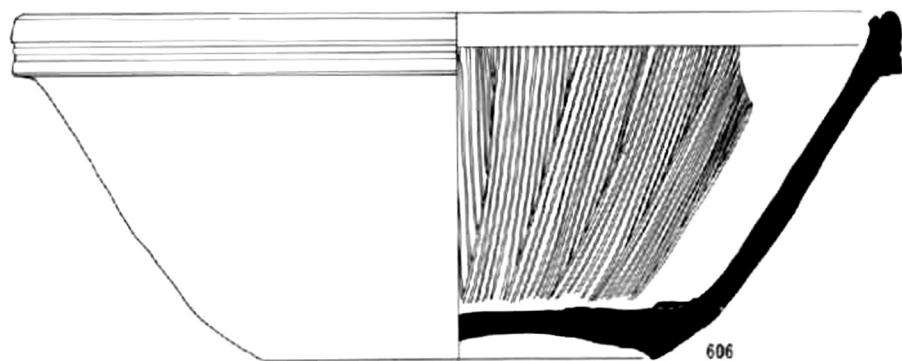
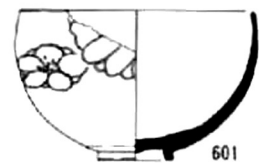
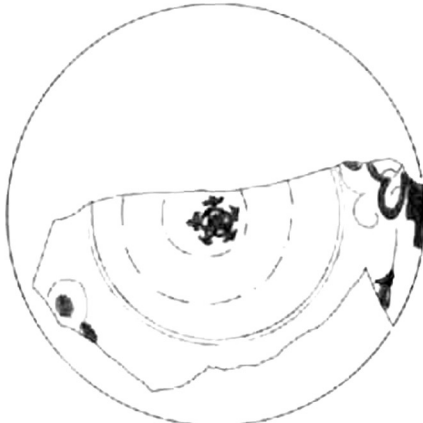
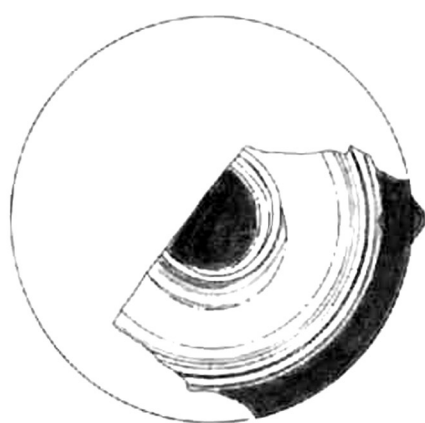
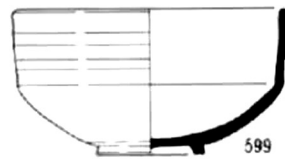
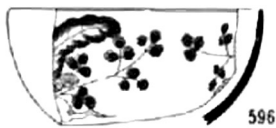
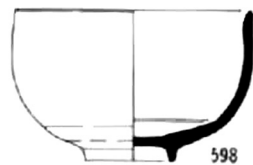

607~613

SD2310

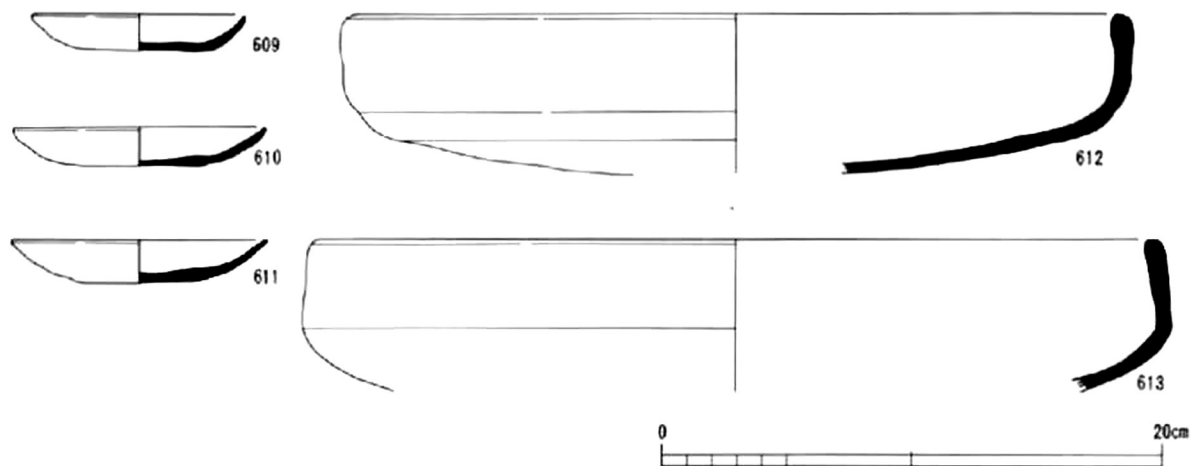
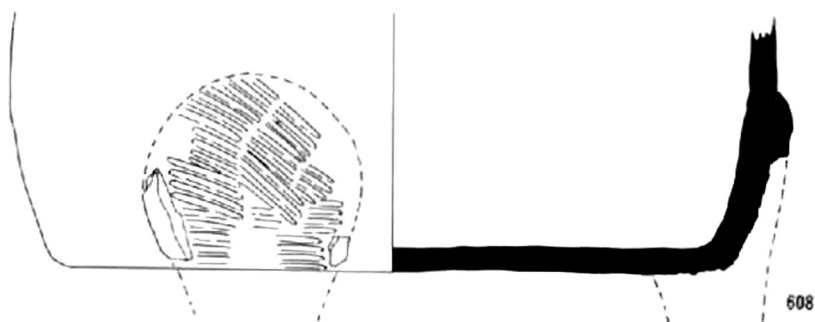
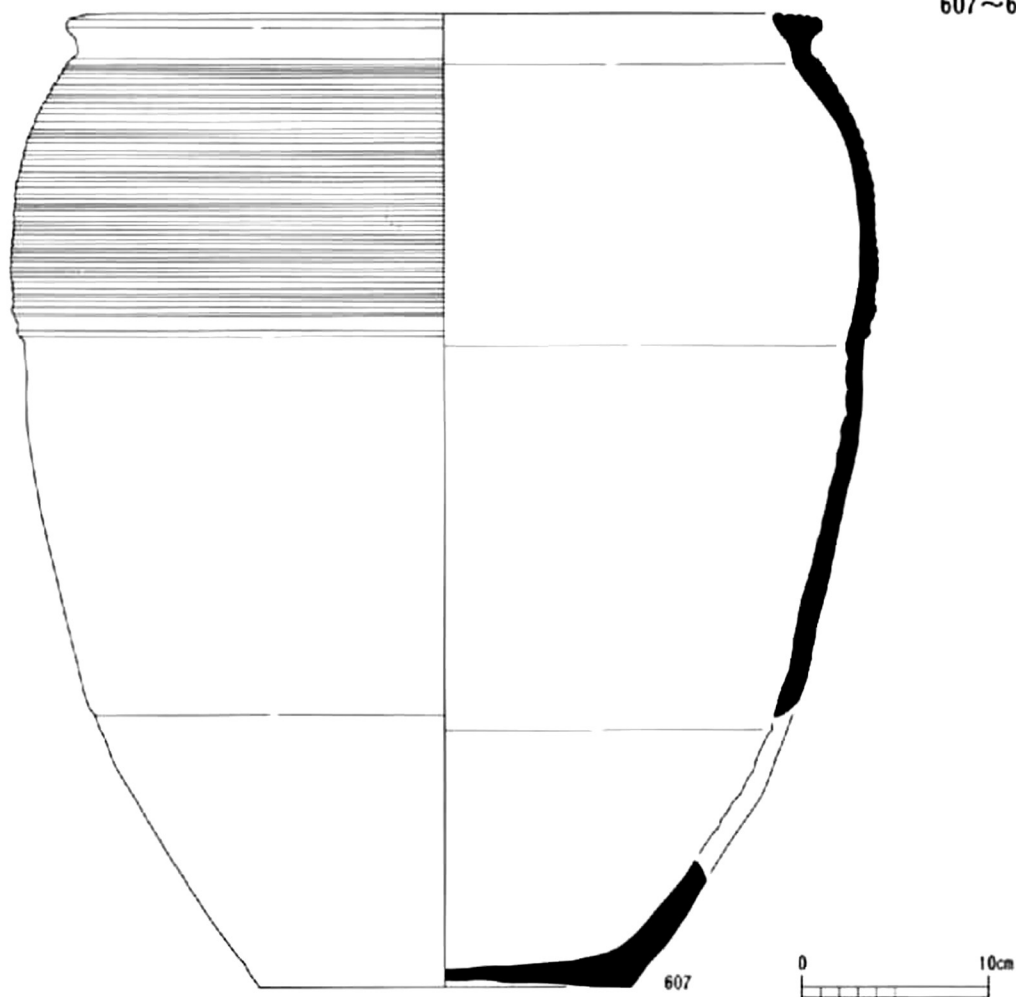

614~619  
SD2305

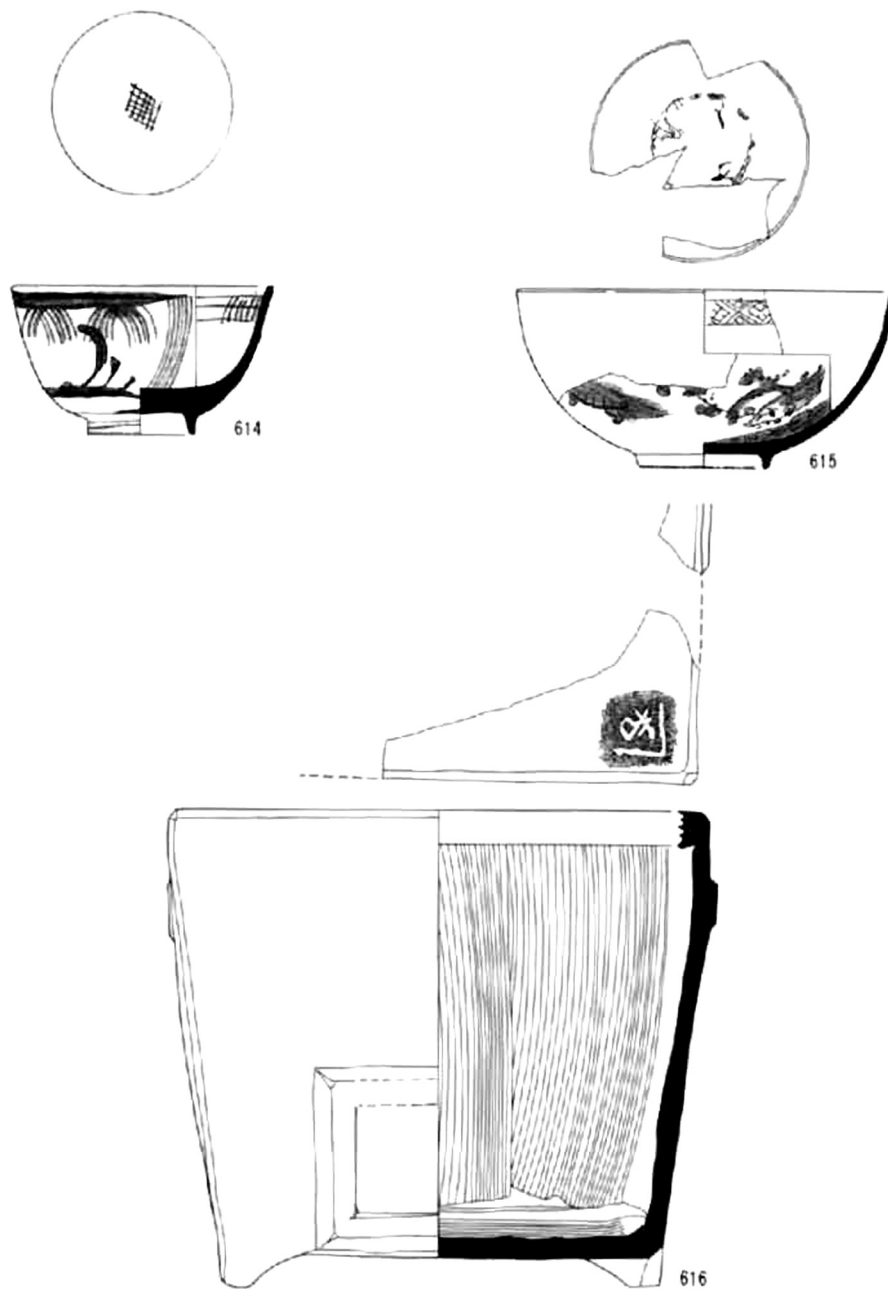

SD2306



SK2315

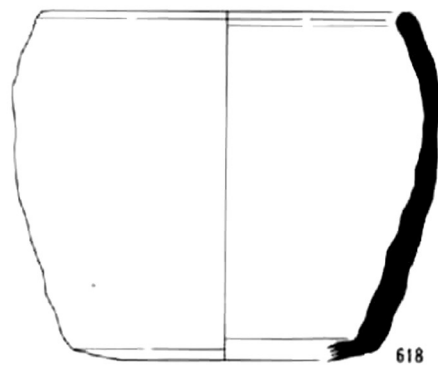

622~642

SD2403



620



621

SD2401



622

SD2402



624



SD2404



625



626



628

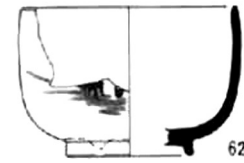

629



630



627



631



633

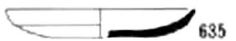

635

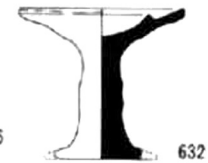

632

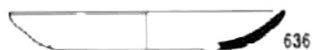

636



637

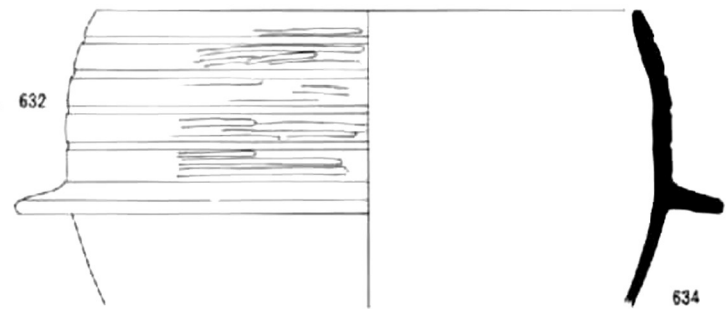

634

SK2417



638



639

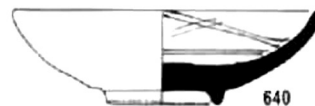

640



641

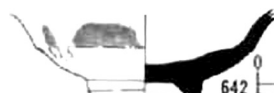

642

20cm



643~665

SD3501

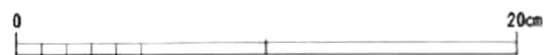
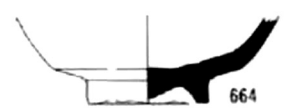
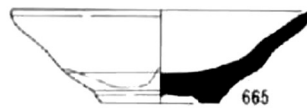
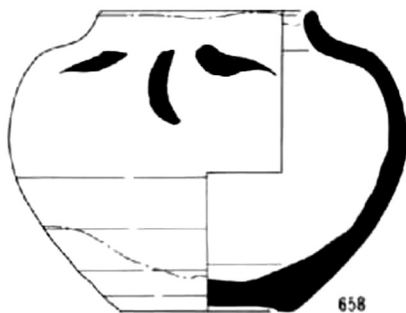
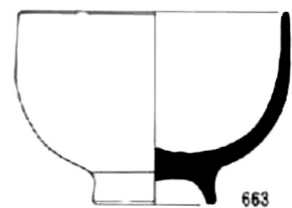
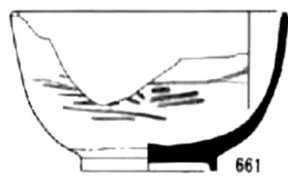
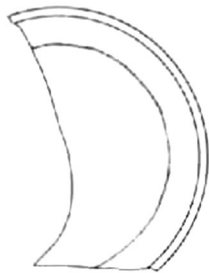
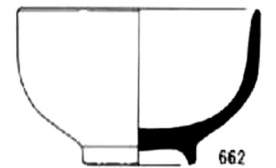
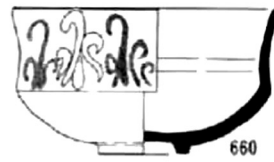
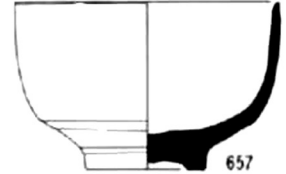
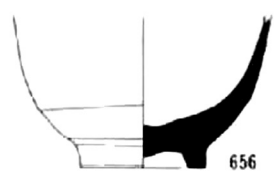
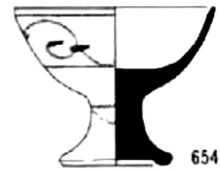
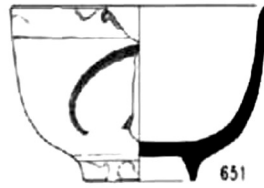
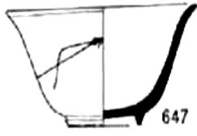
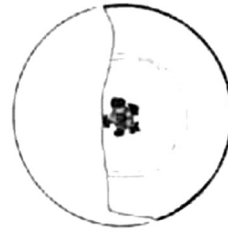
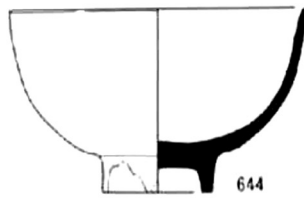
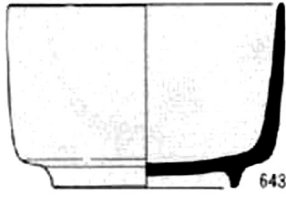

666~670

SD3501

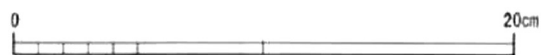
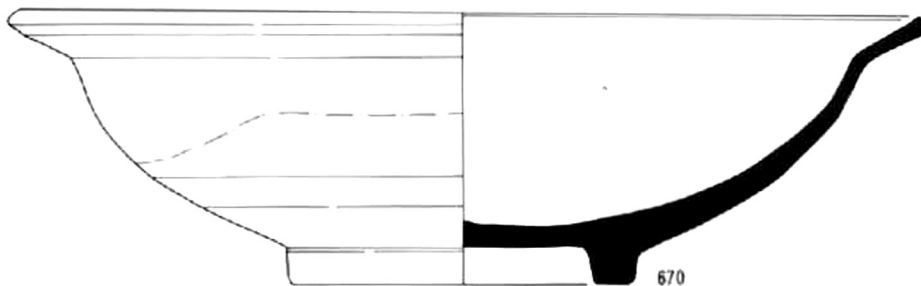
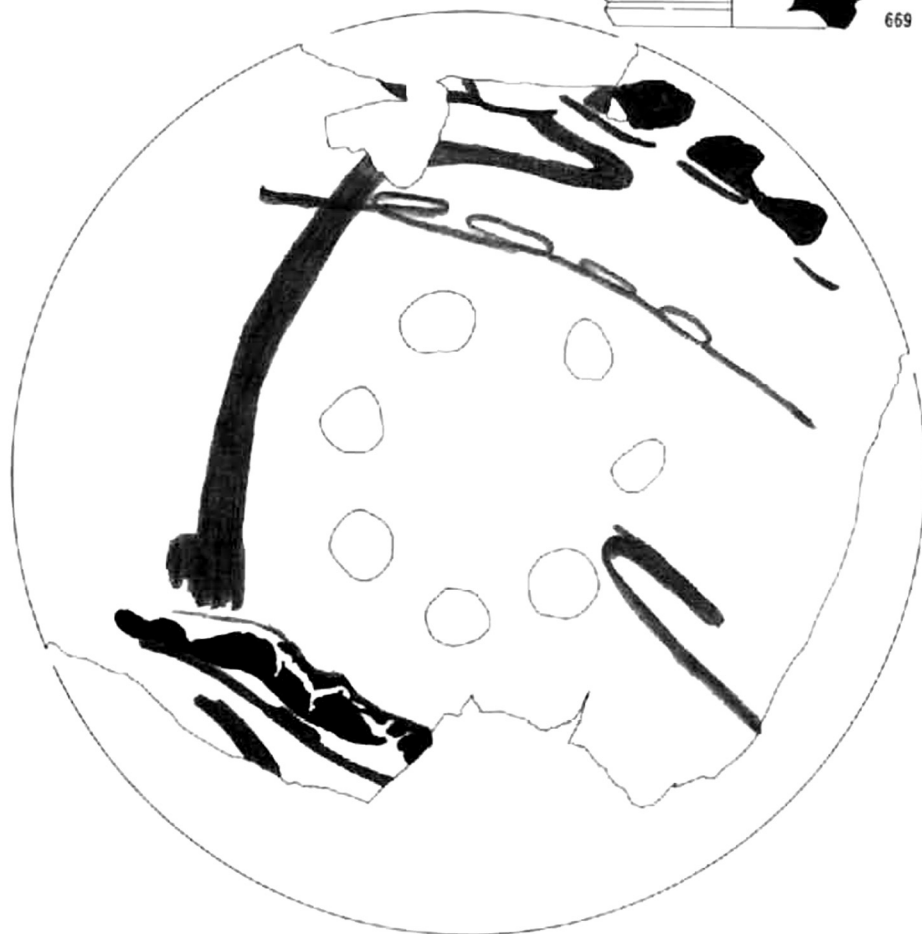
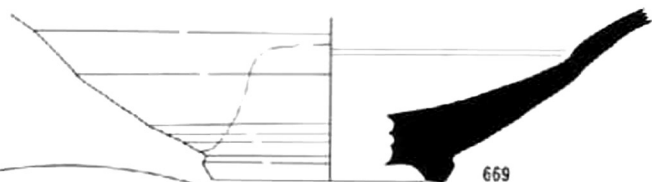

671~673  
SD3501

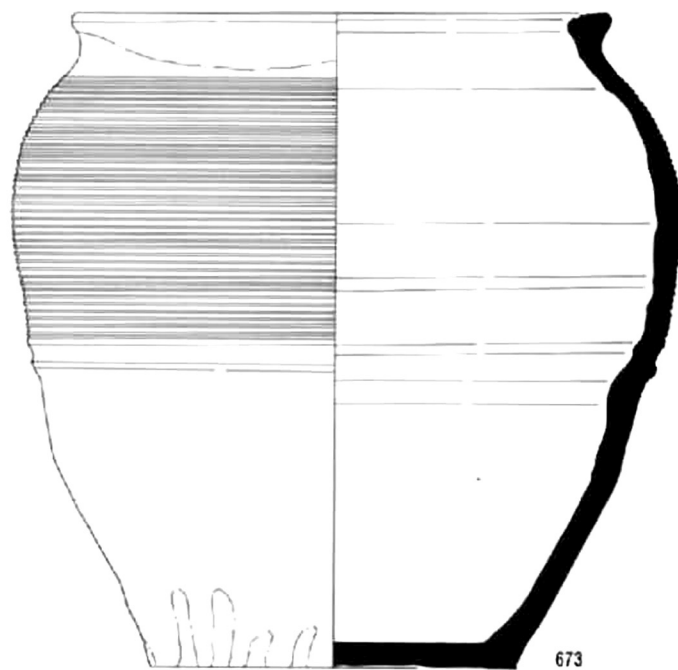
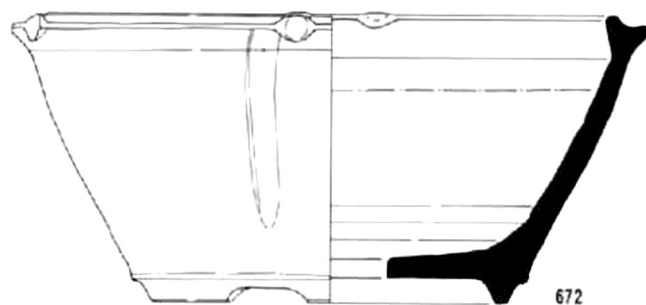

0 20cm

SD3501

674~678

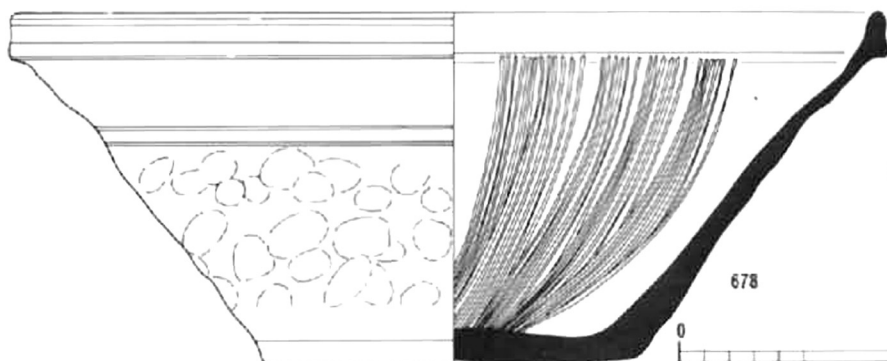
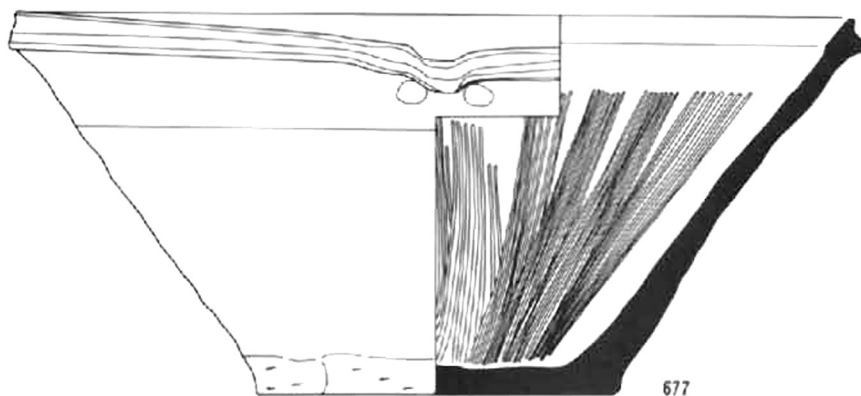
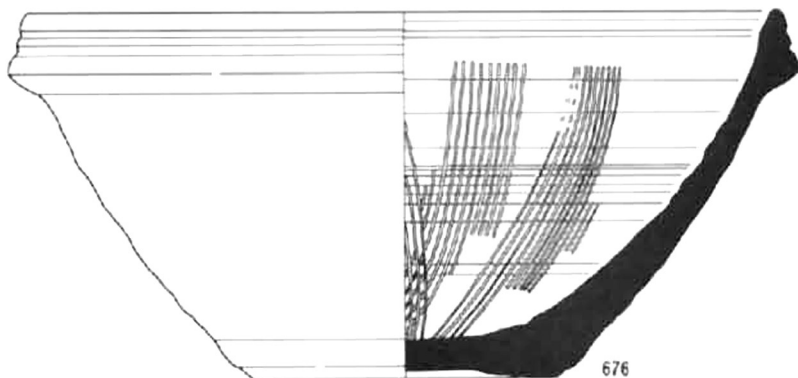
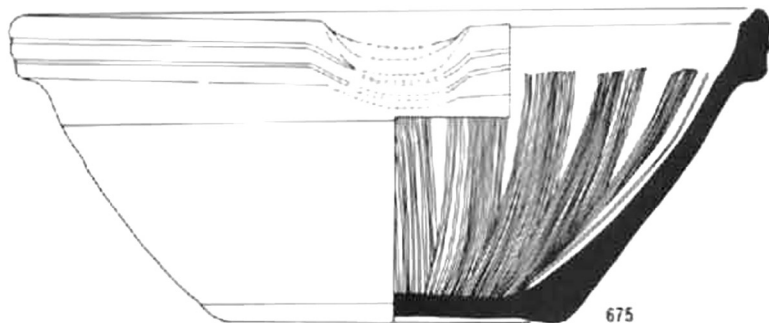
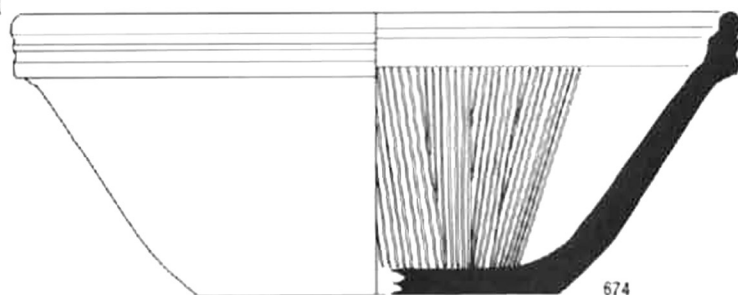

679~704

SD3501

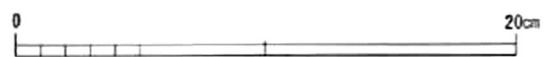
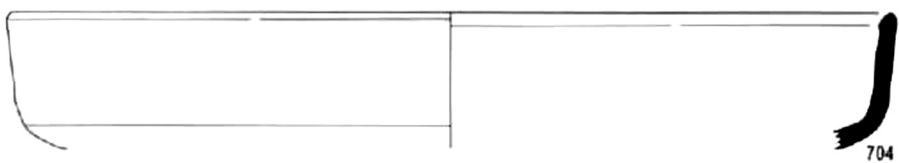
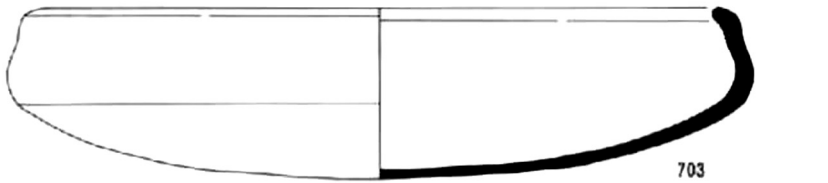
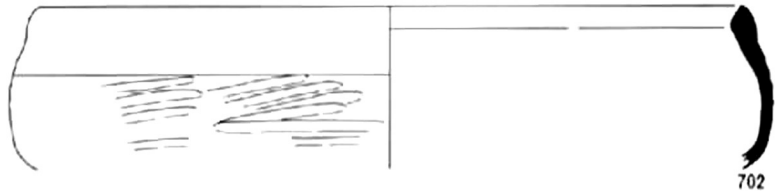
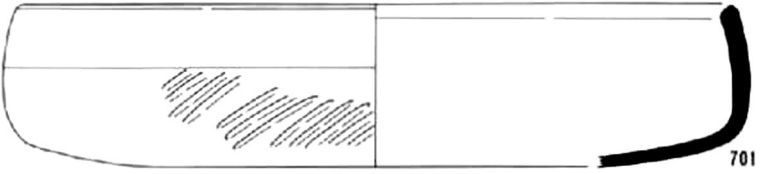
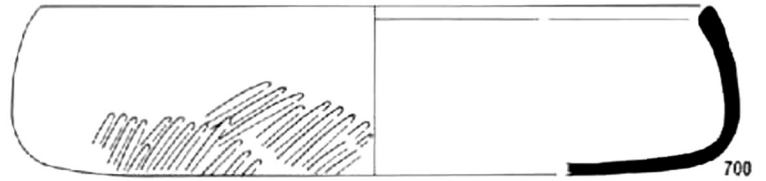
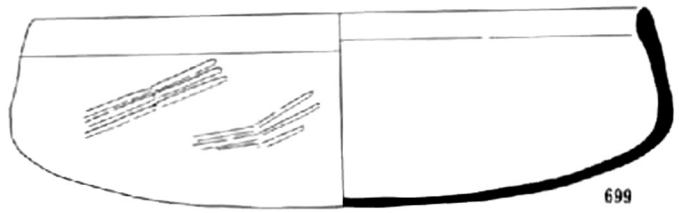
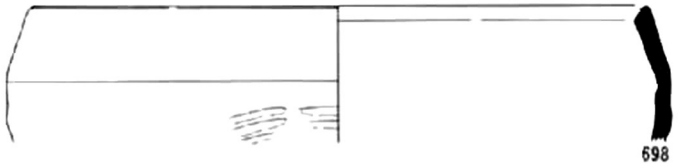
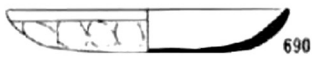
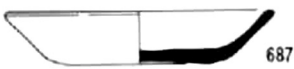
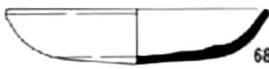
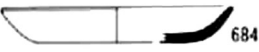
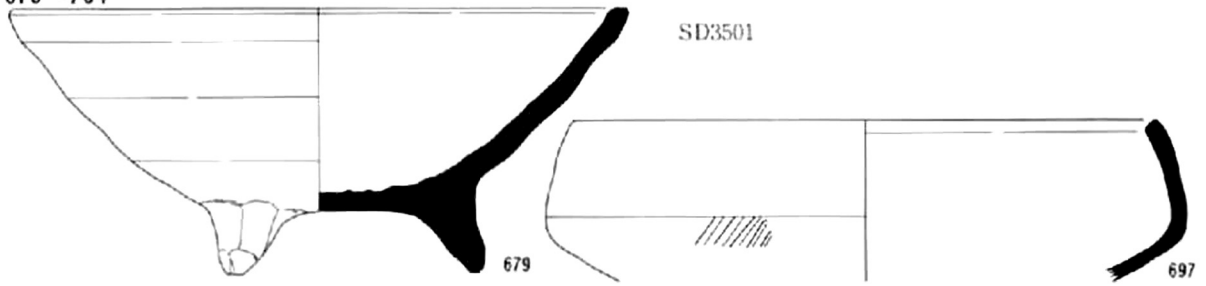

705~714

SD2501

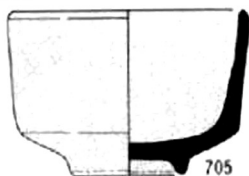

705

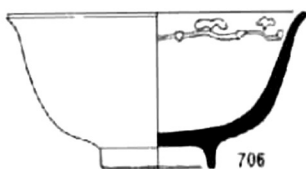
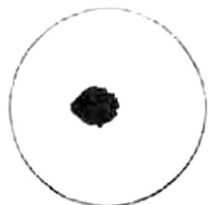

706

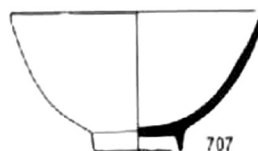

707

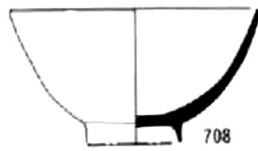

708



709

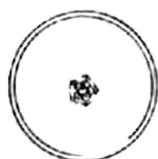

711

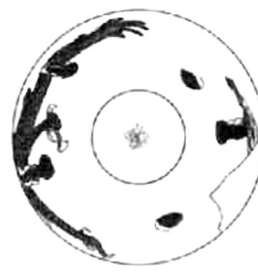

710



712



713



714

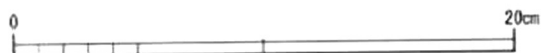

20cm

715~719

SD2501

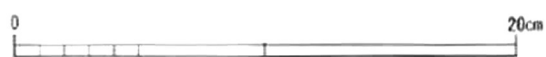
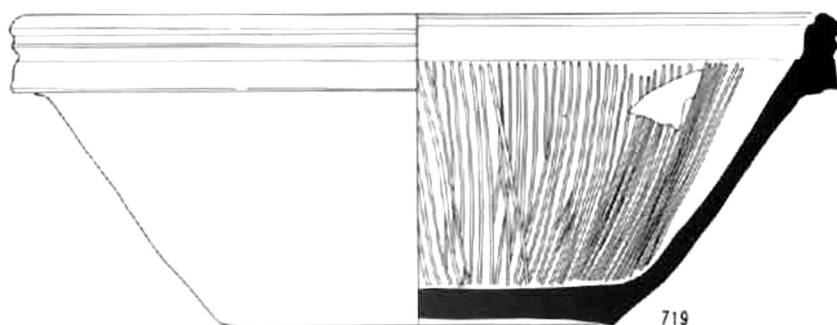
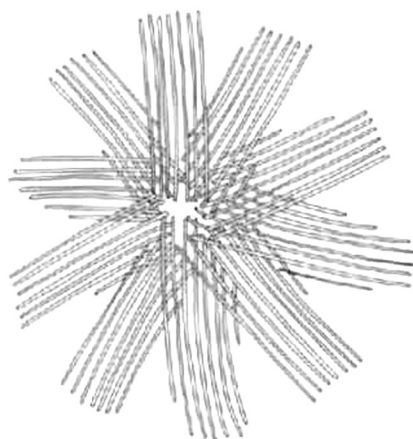
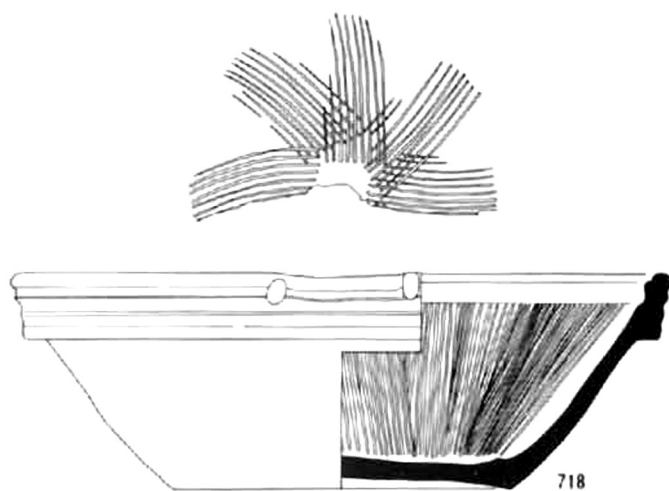
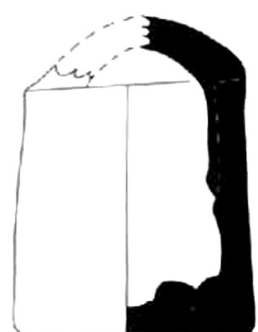
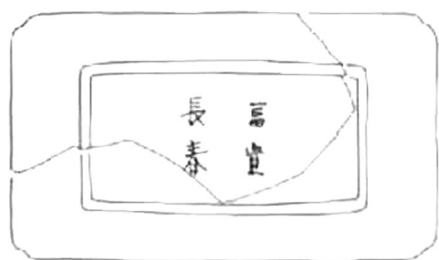
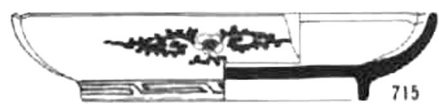
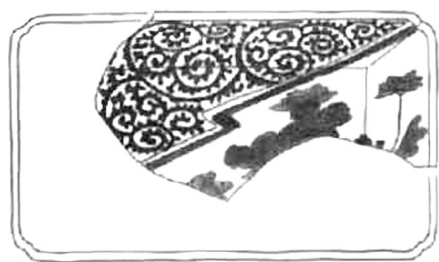

720~728

SD2502



721



720

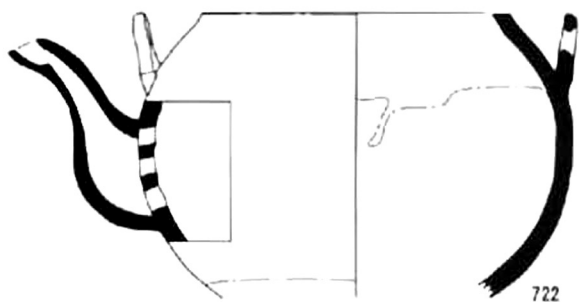

722

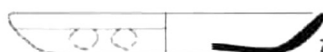

723

SD2503



724



725

SF2501



726



727

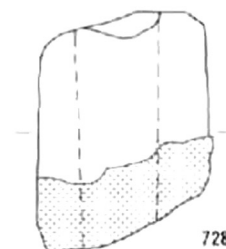

728

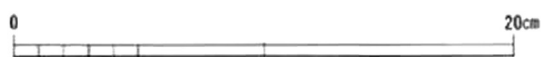



729~743

SK2501

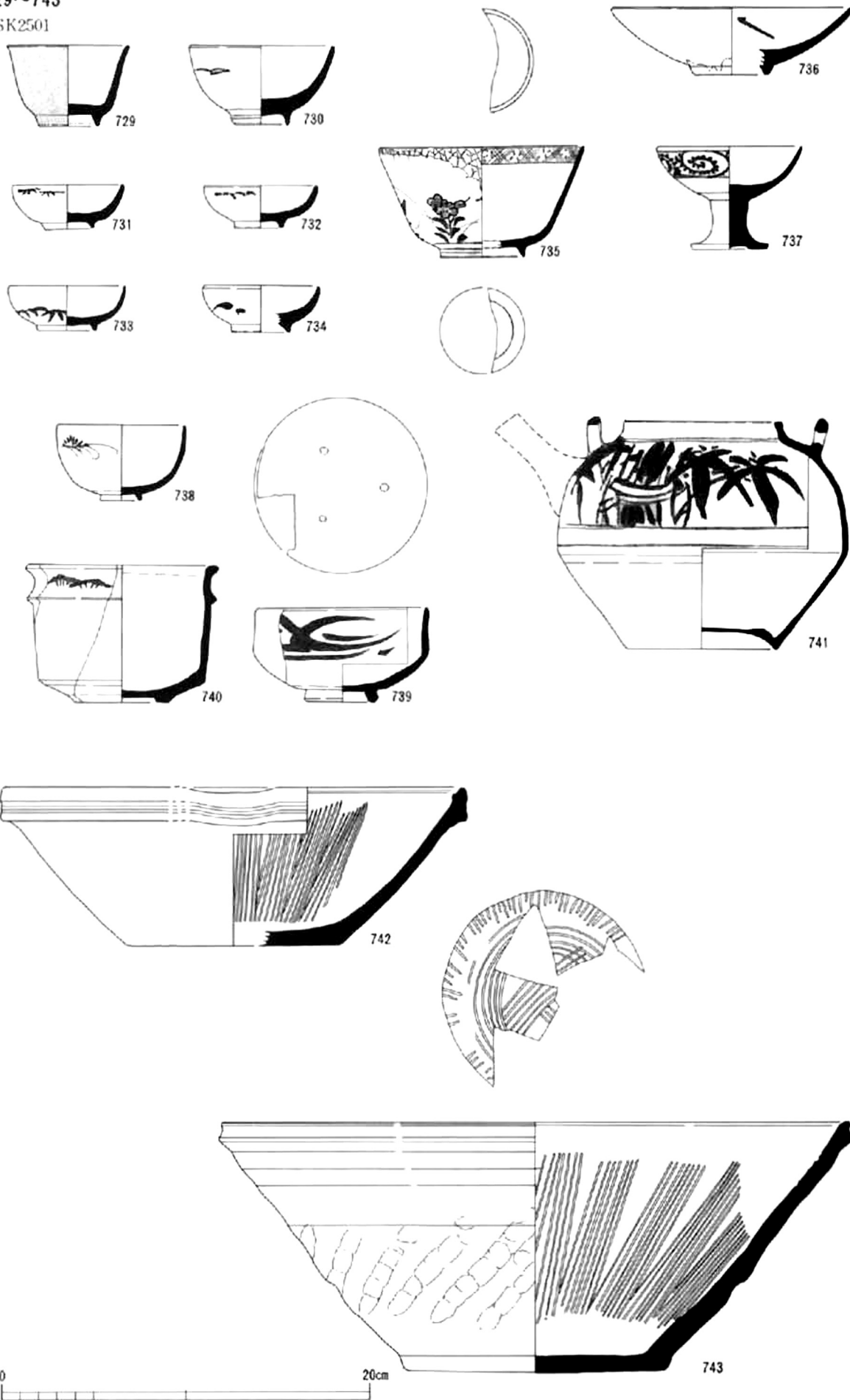

744~760

SK2501

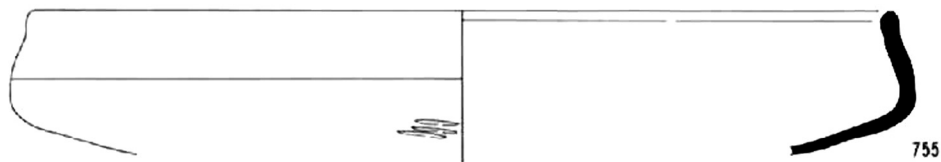
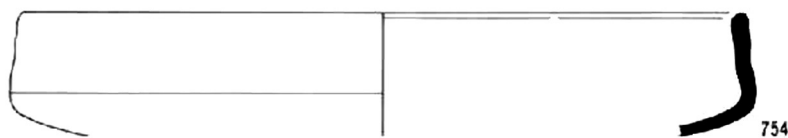
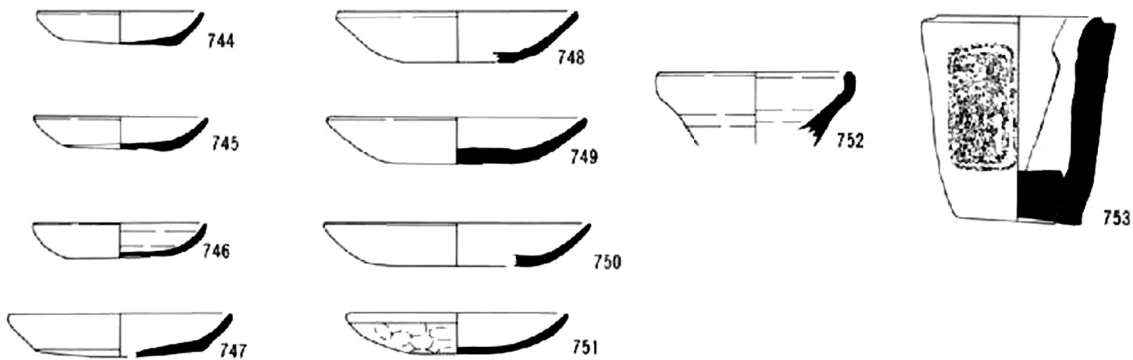

SG3501

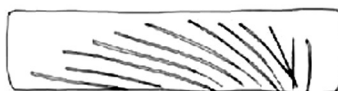
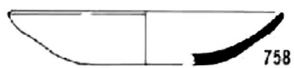
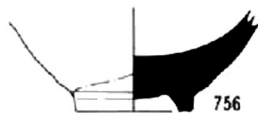

SD2506

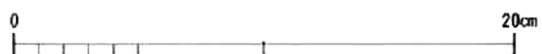
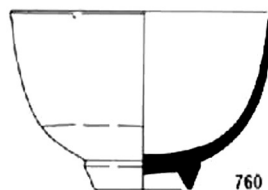

761~767  
SK2503

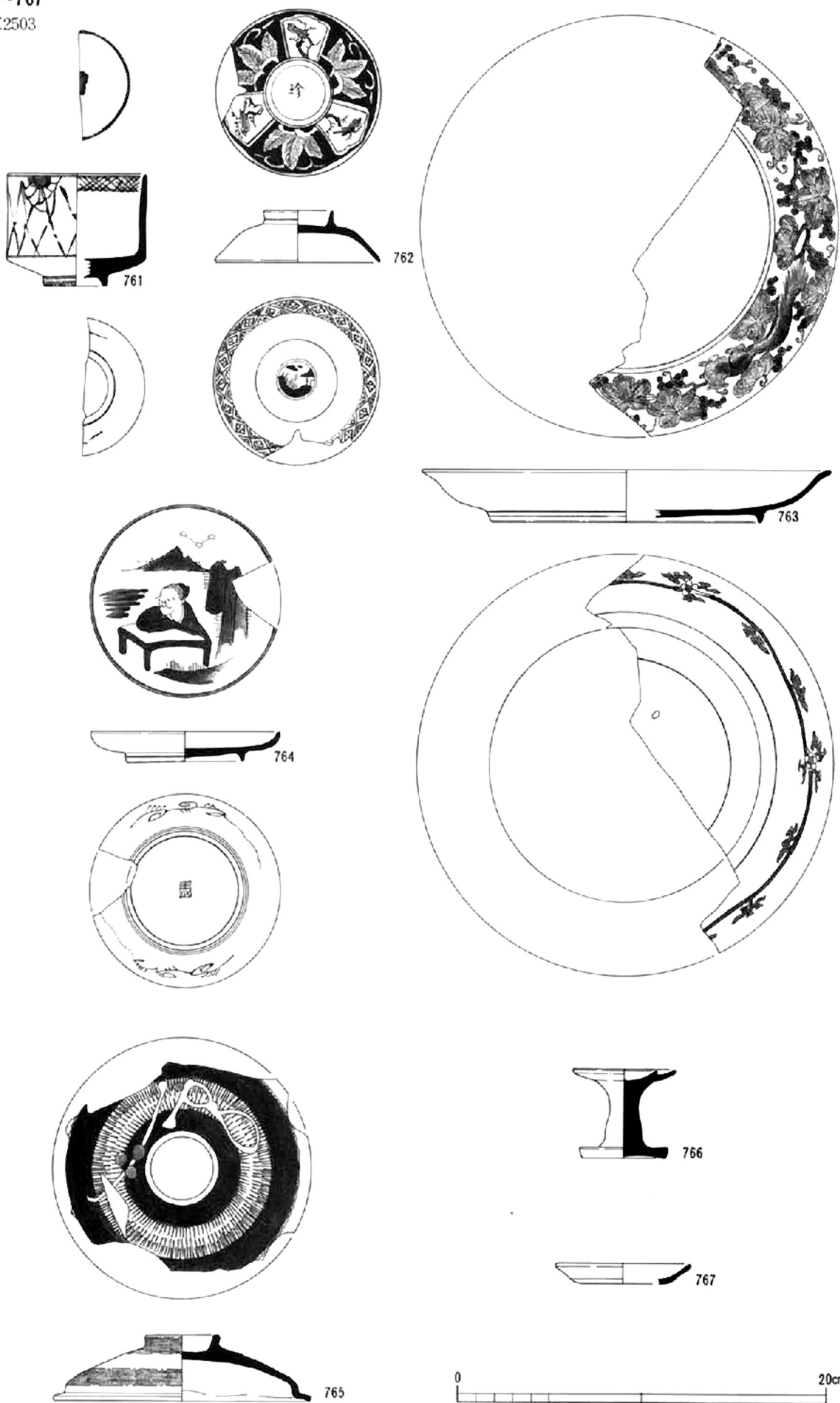

SK2502

768~796

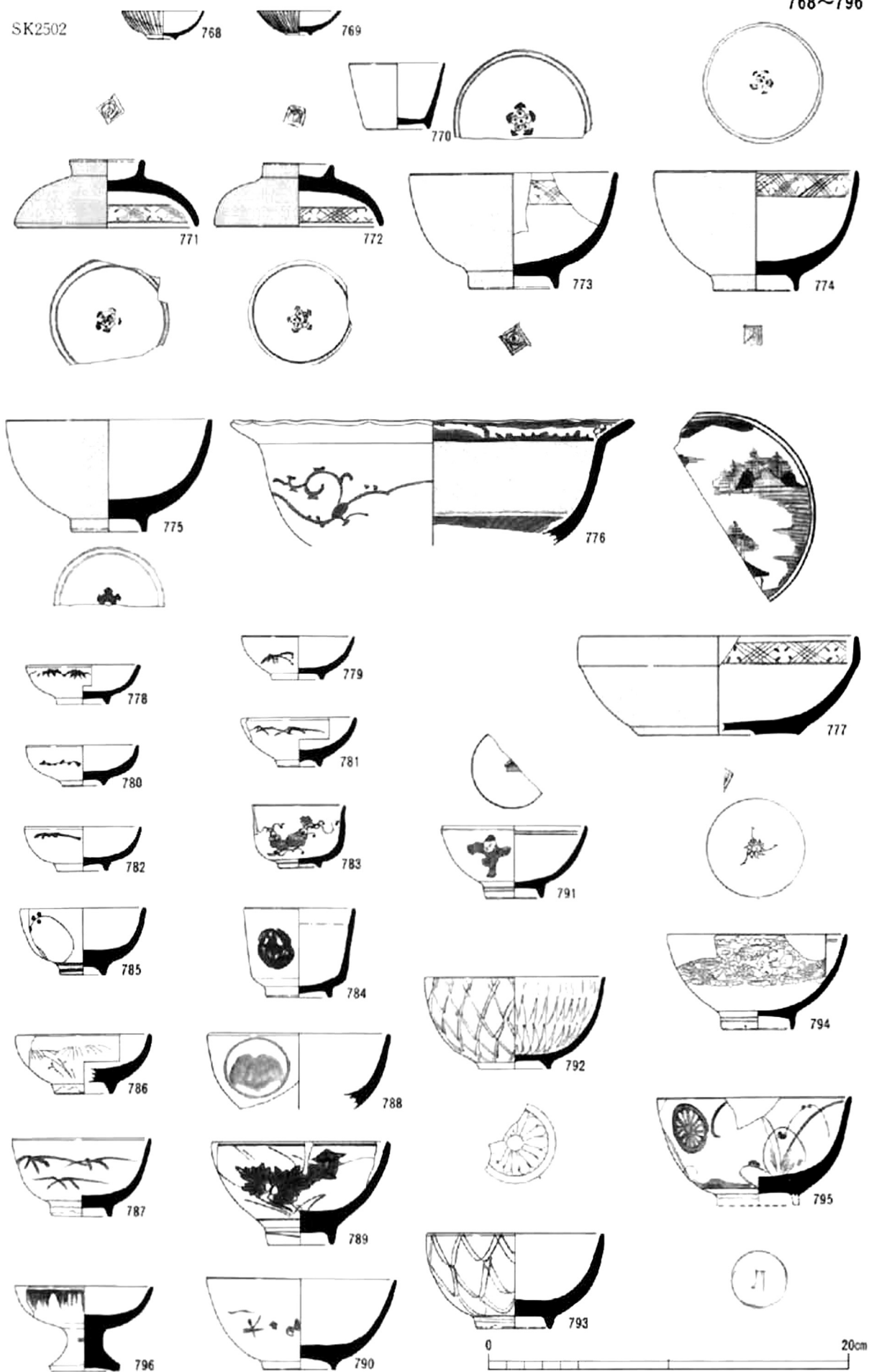

797~809

SK2502

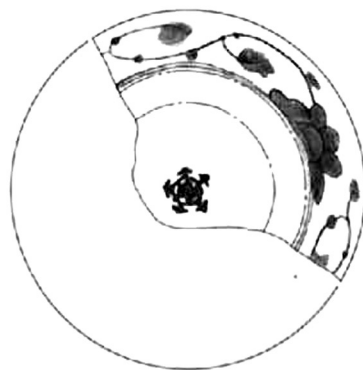
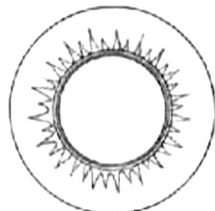
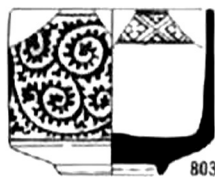
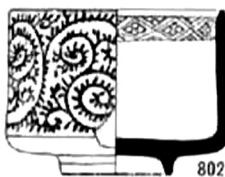
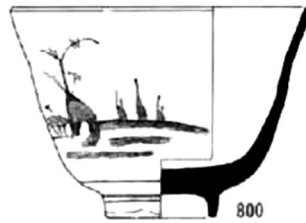
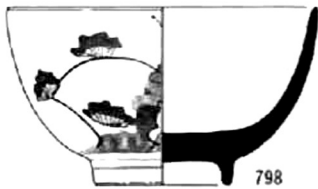
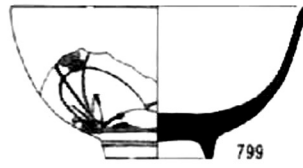

810~823

SK2502

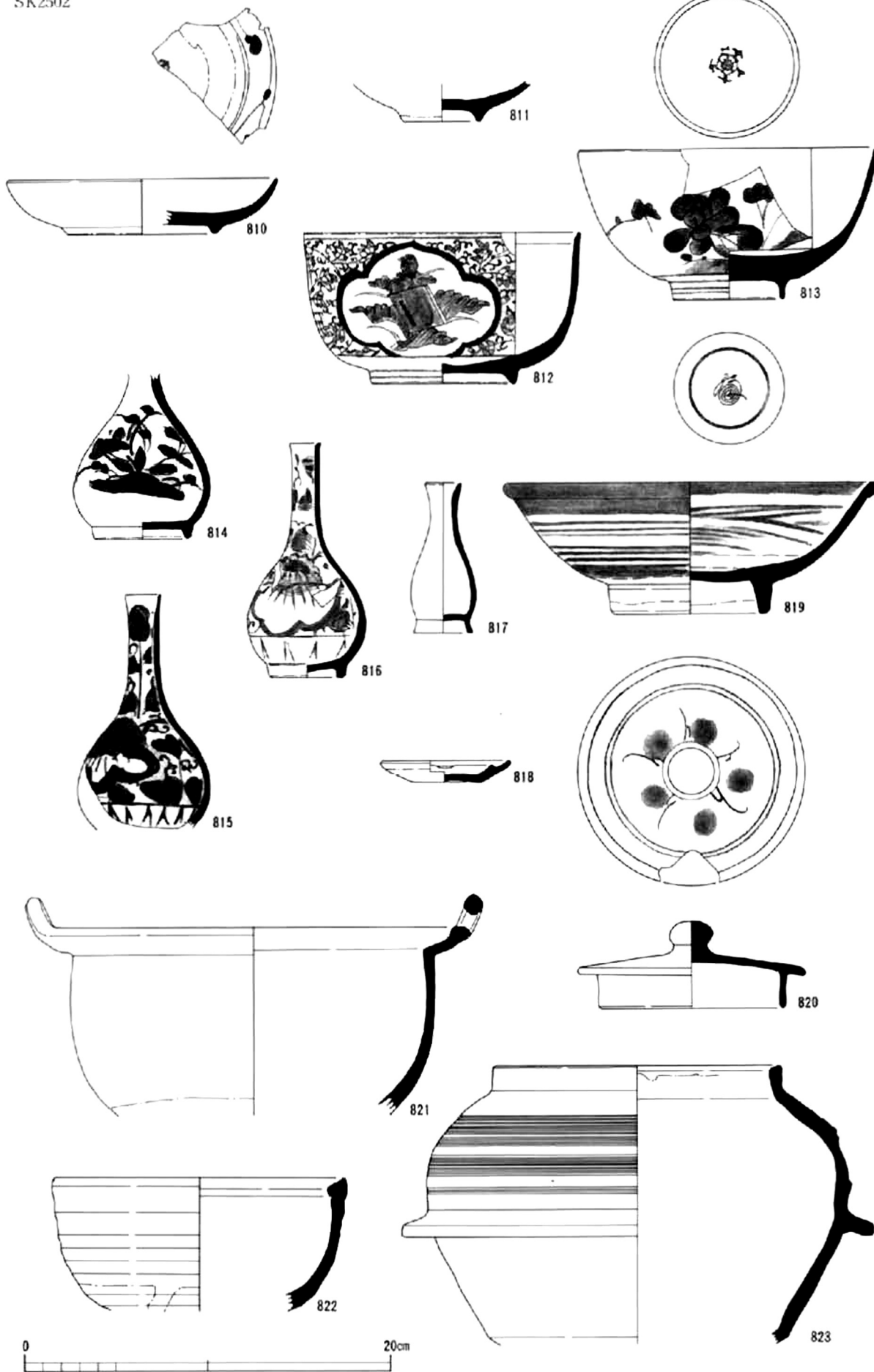

824 · 825

SK2502

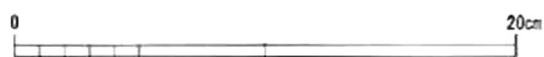
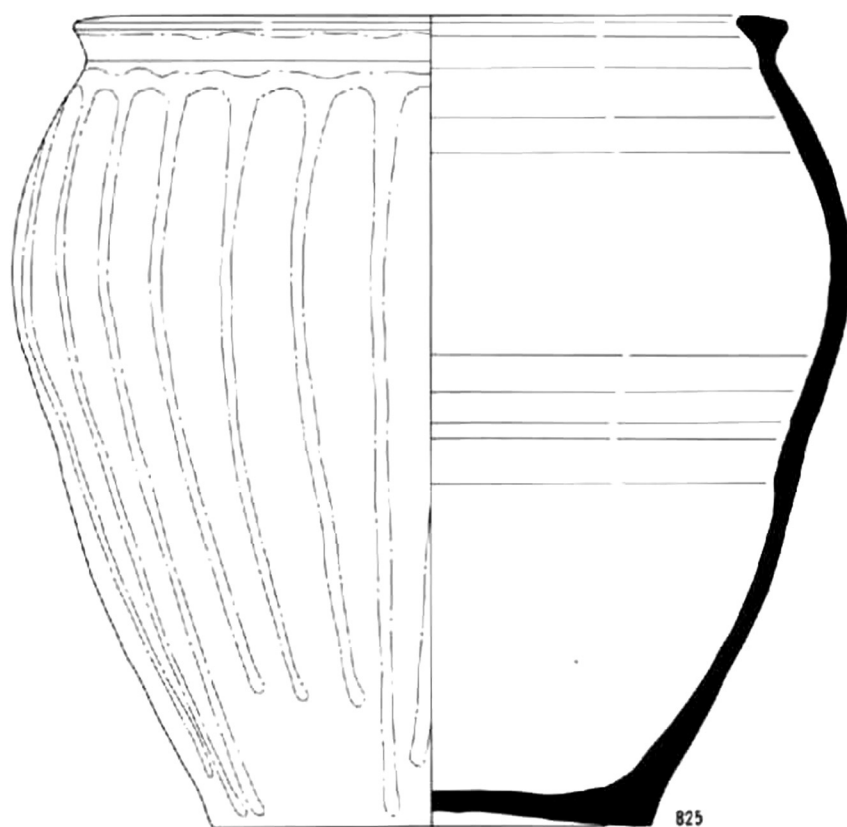
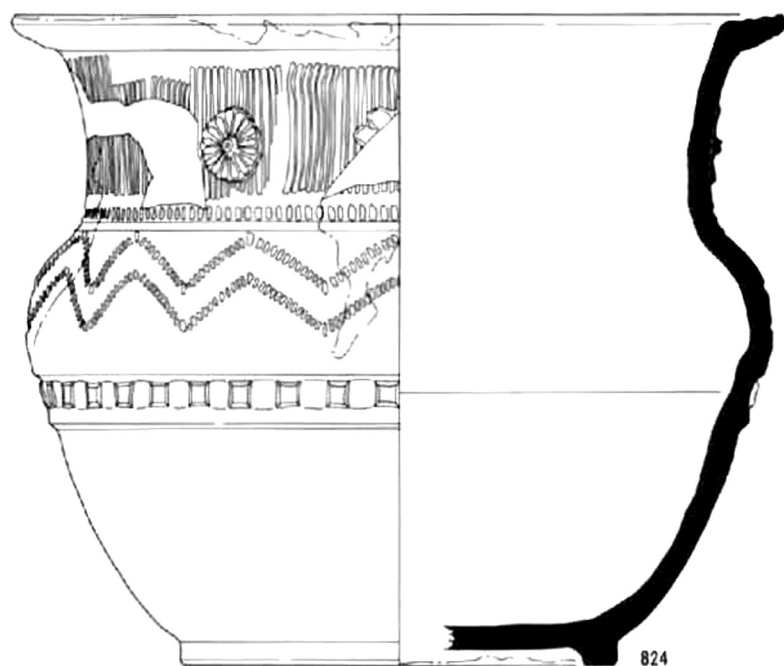

826~828

SK2502

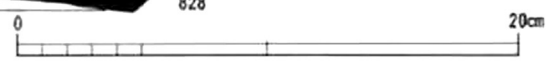
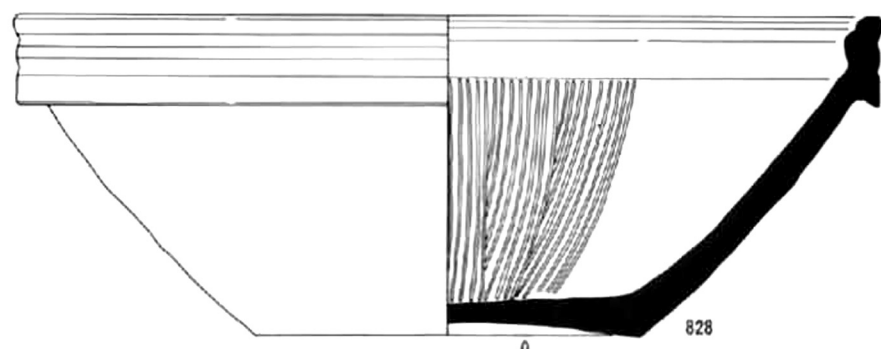
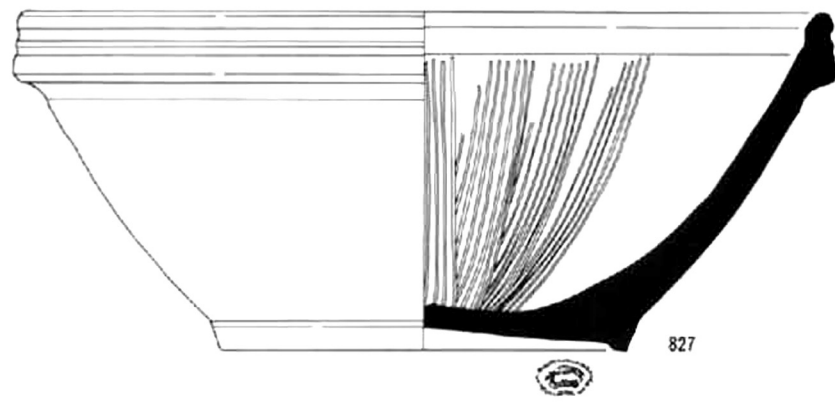
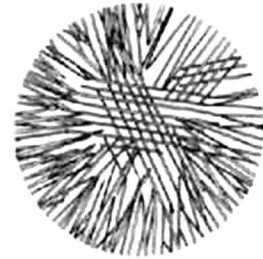
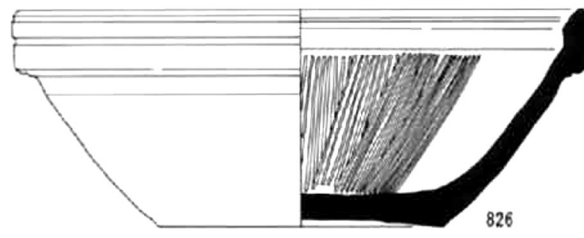
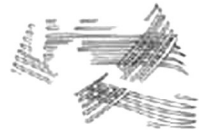



829~851

SK2502

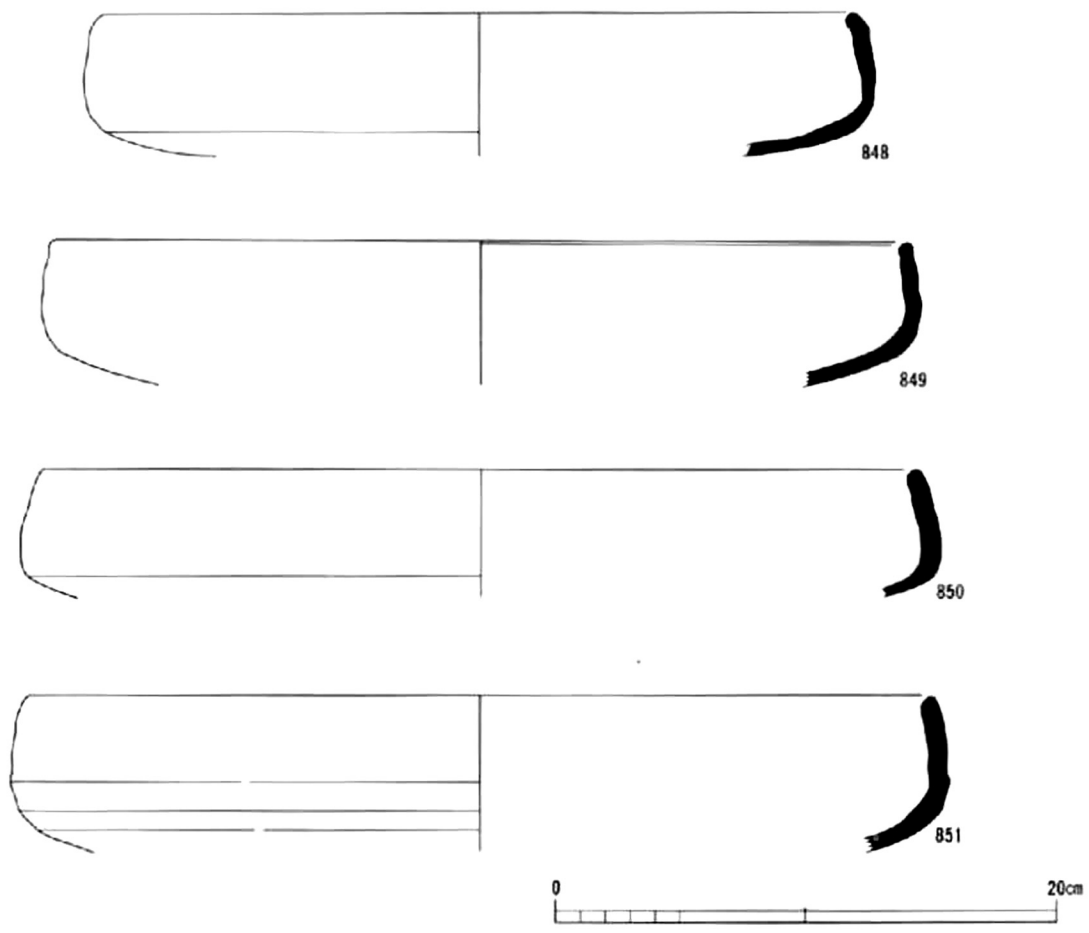
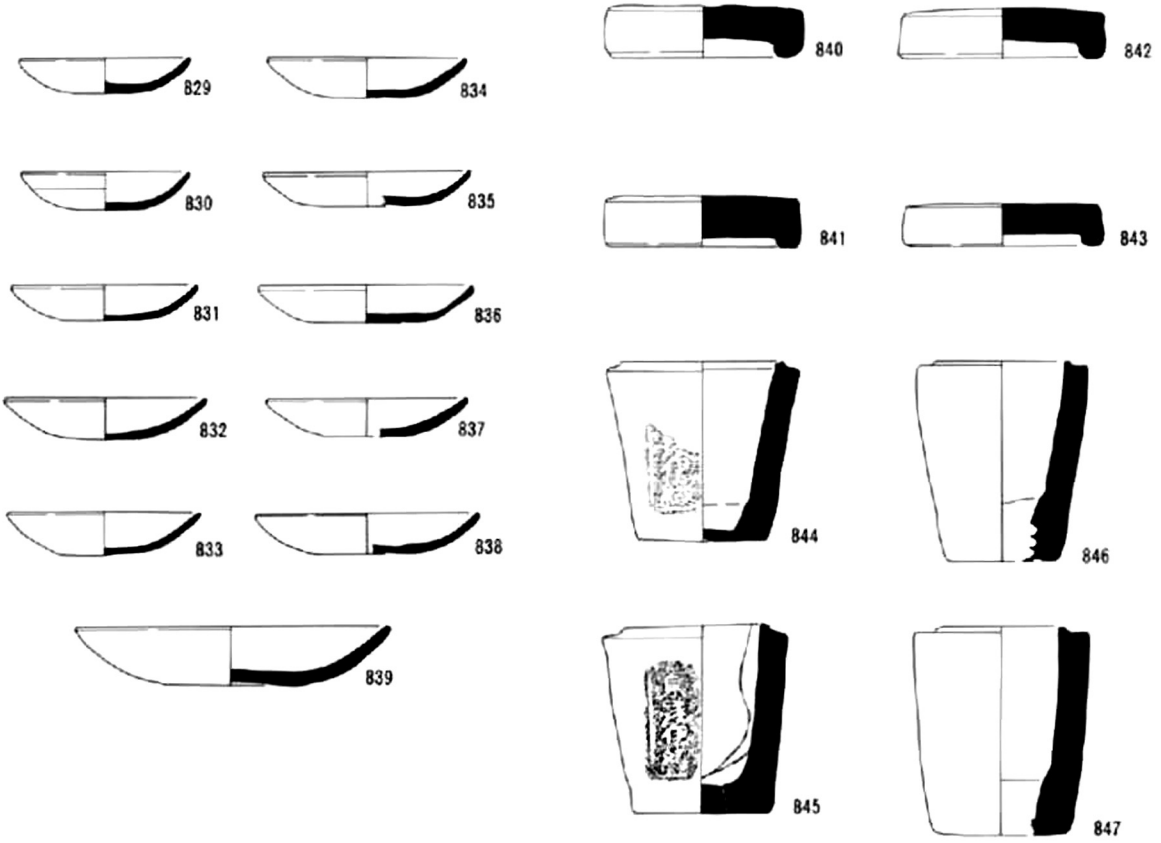

852~863

SD2505

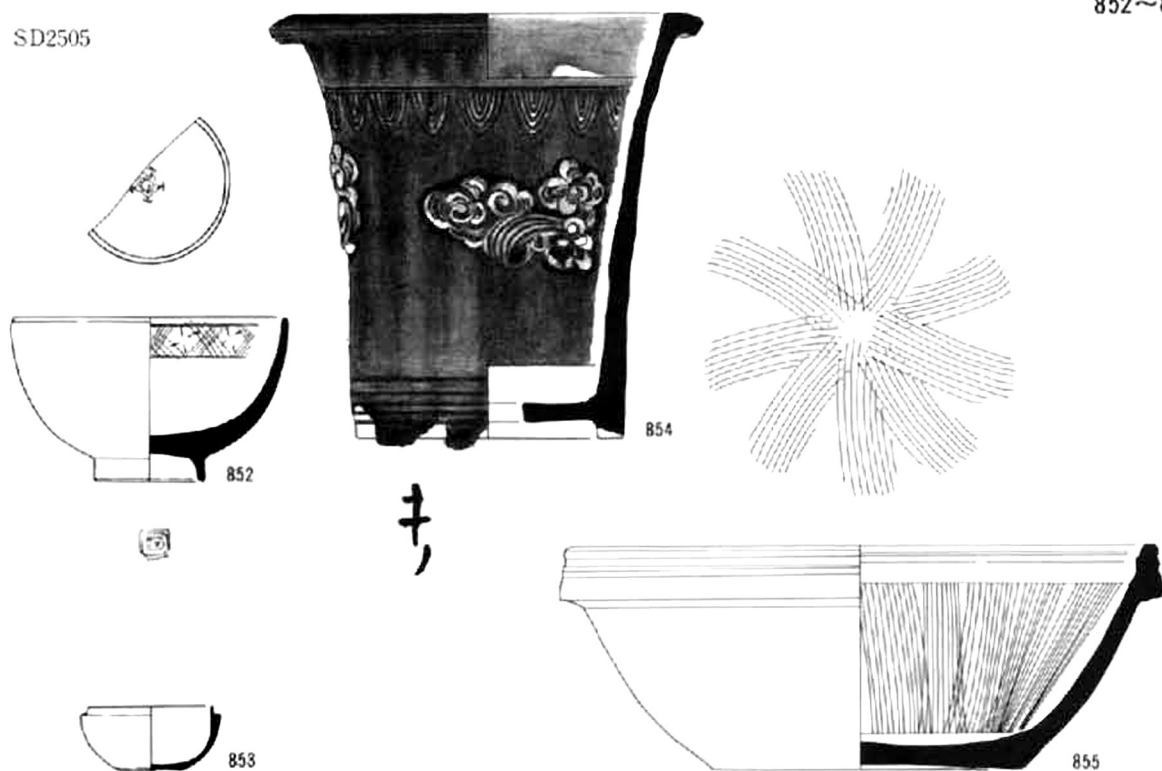

SG2501

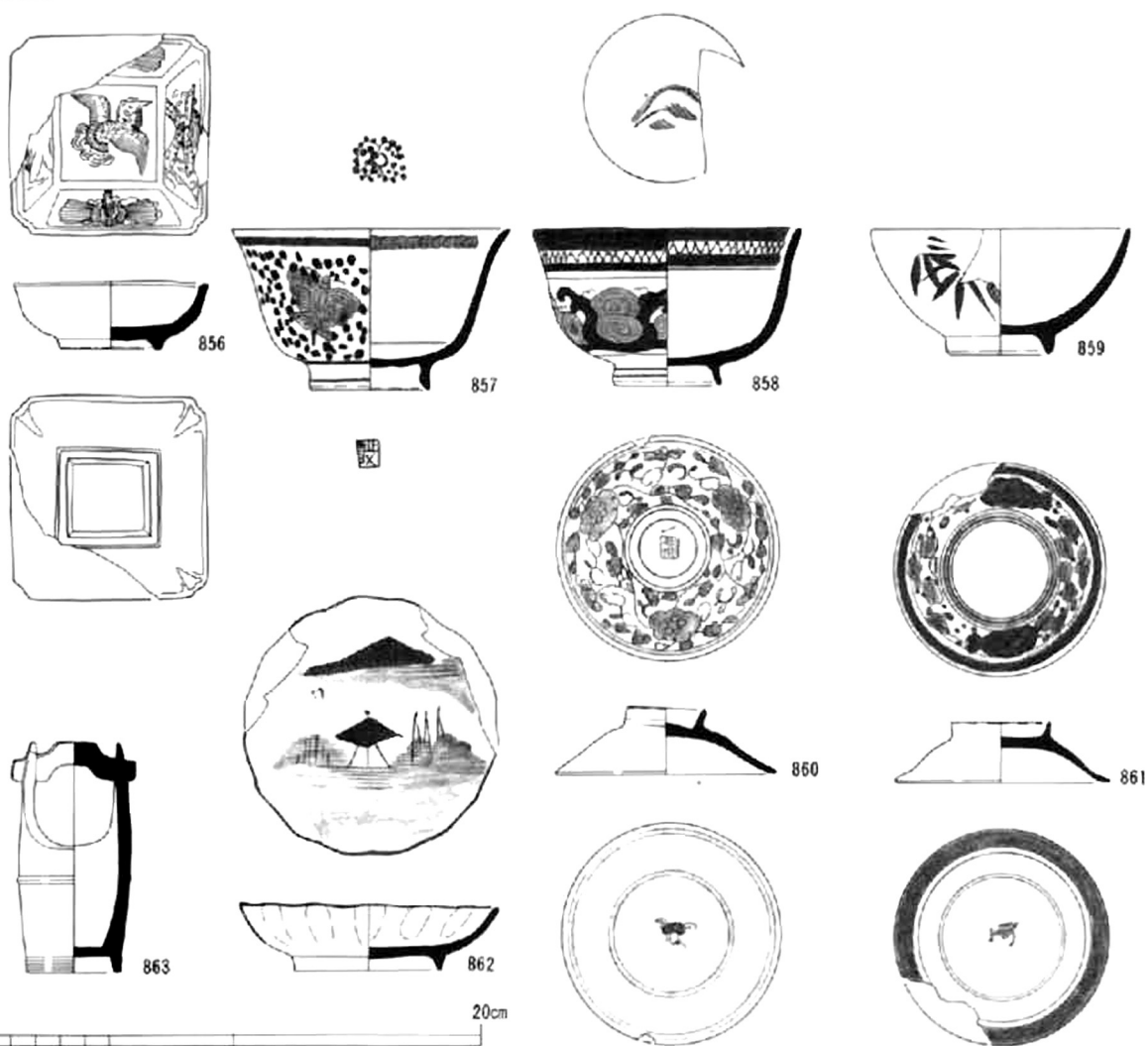

864~875

SD3505

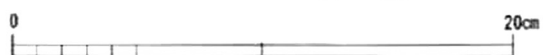
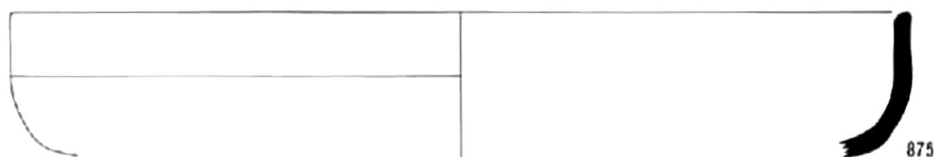
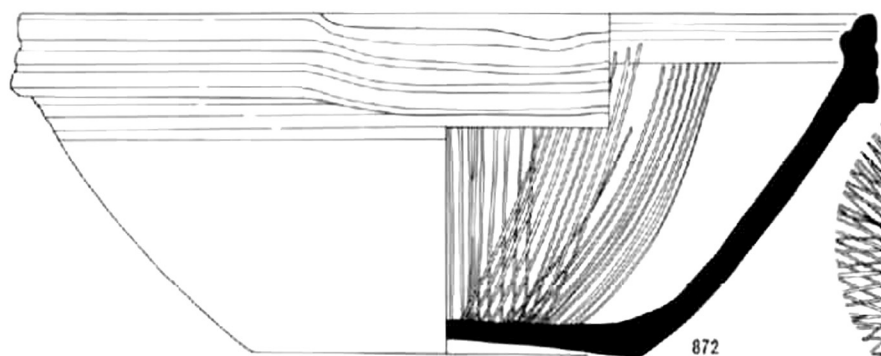
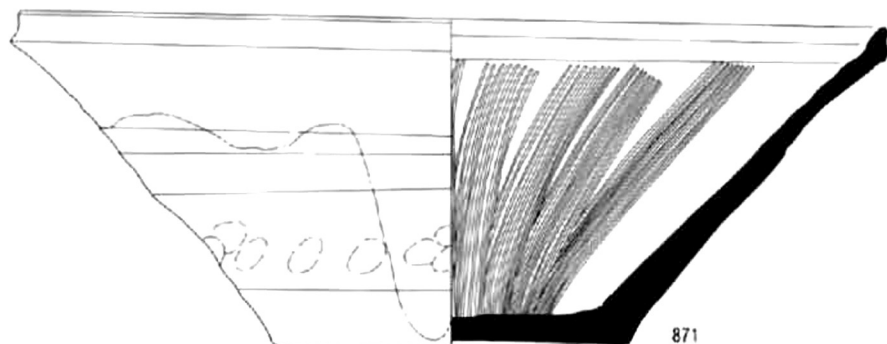
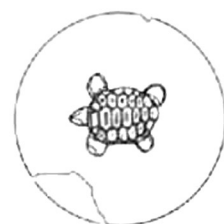

876~899

SK3506

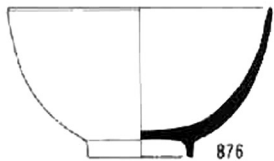

876



877



882

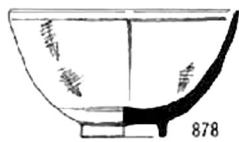

878



883

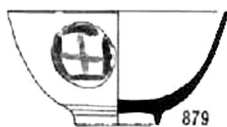

879



881



884



880

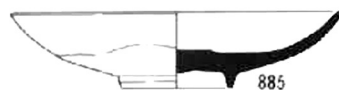

885

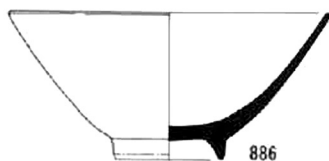

886



887



888

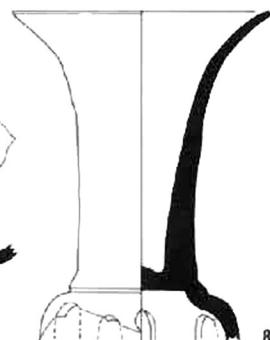

889

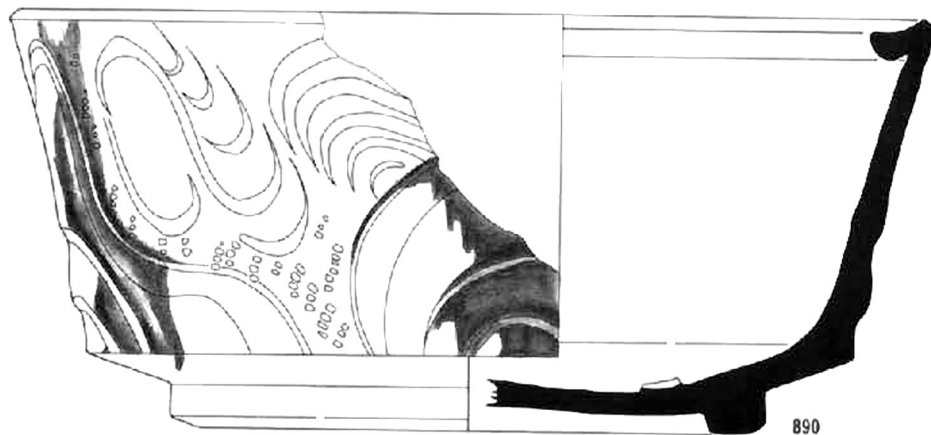

890



891



894



897

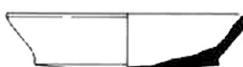

892



895

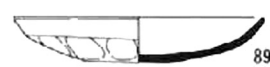

898



893



896



899



900~909  
SK3506

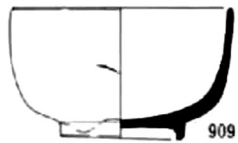
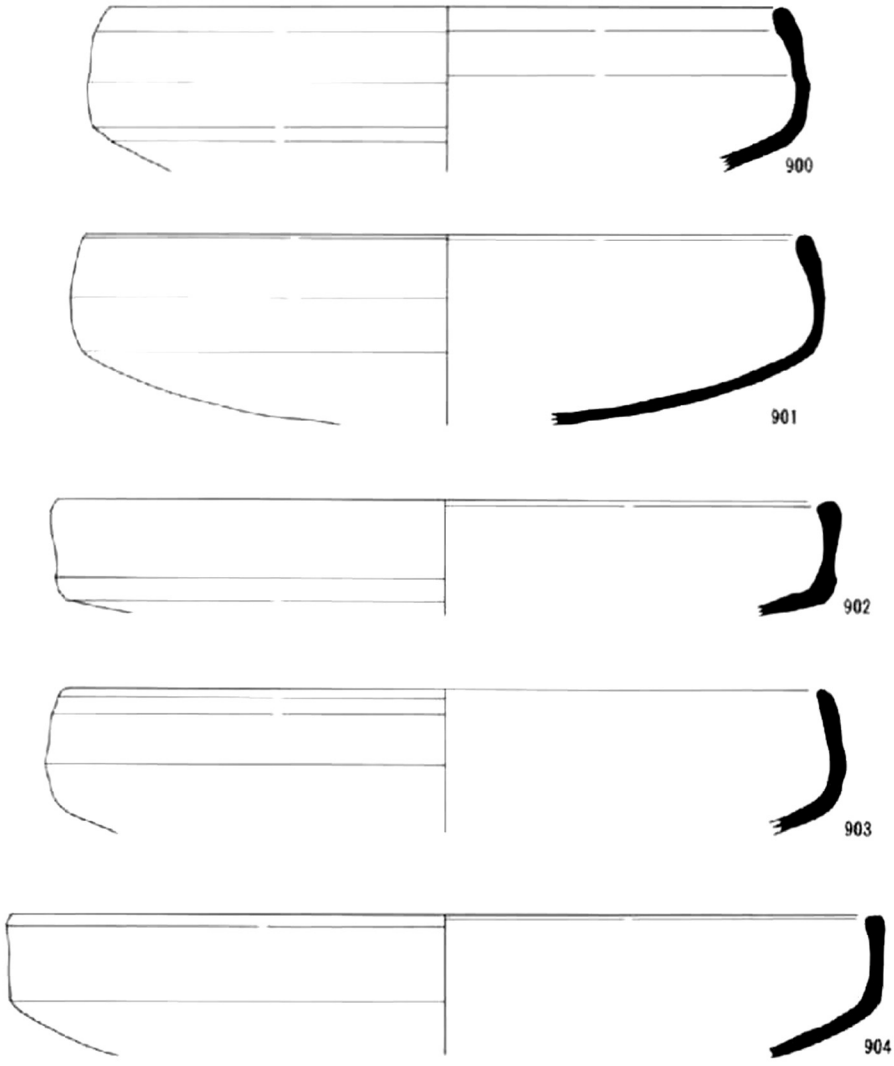

SK3518

910~923

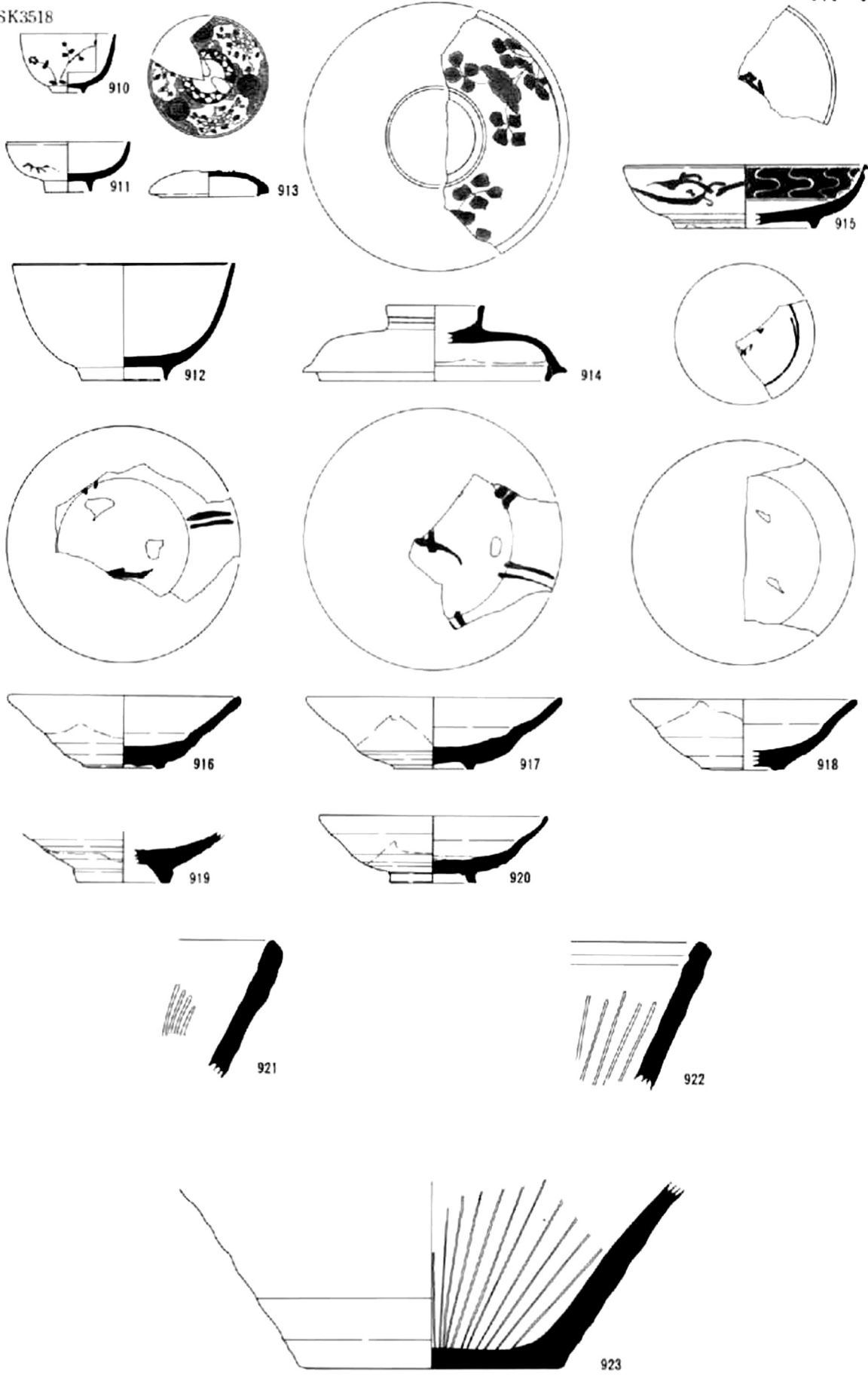

924~930  
SK3518

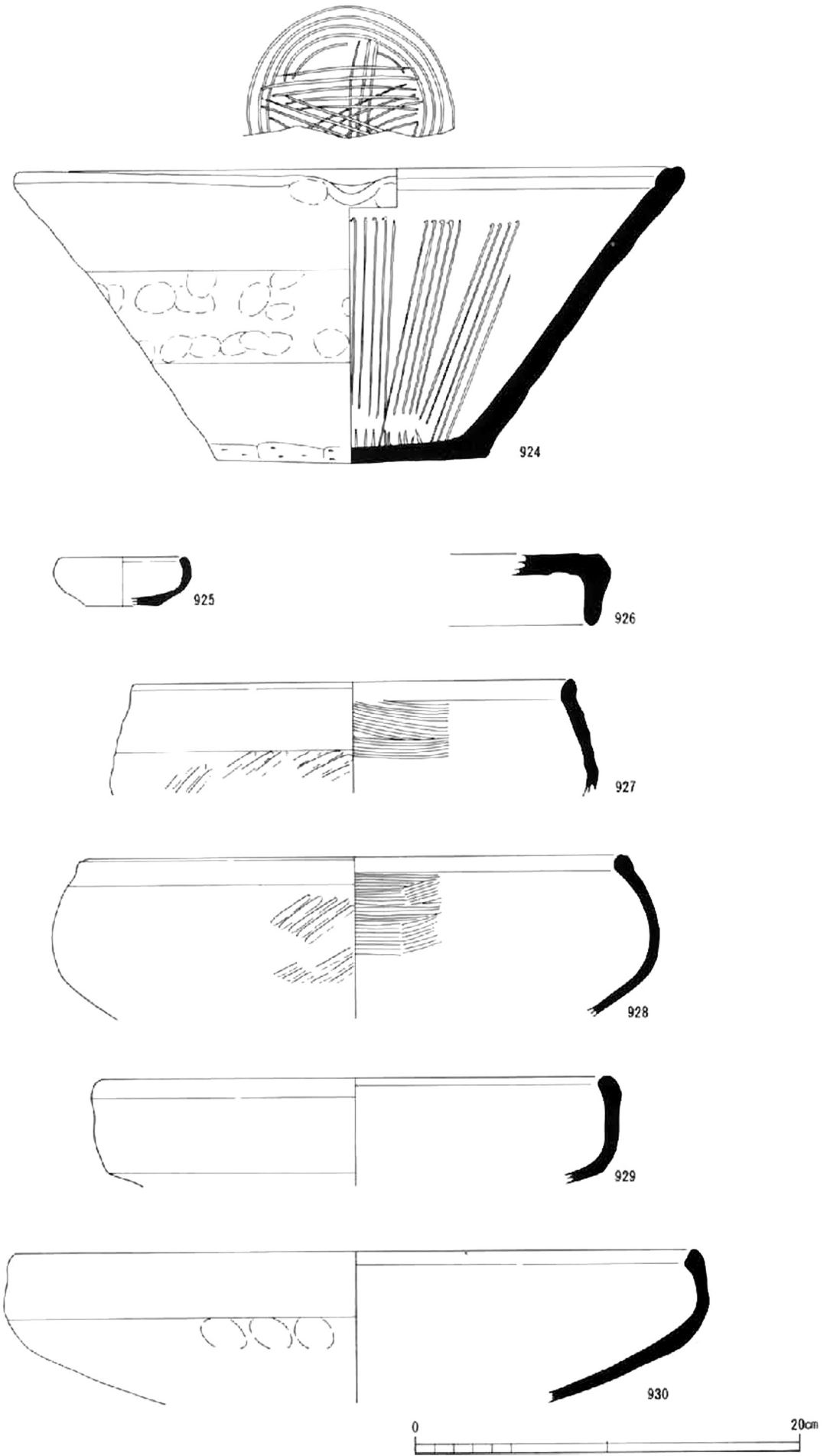

931~939

SK3523



SK3528



SK3533

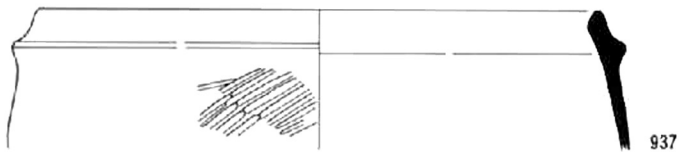
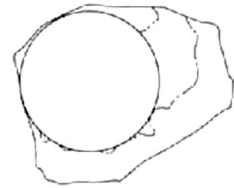
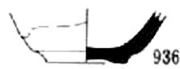
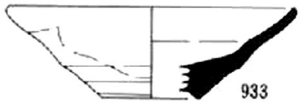
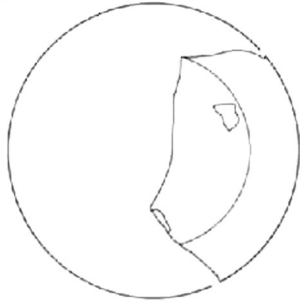

SK3534

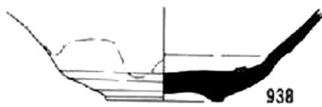

SK3536

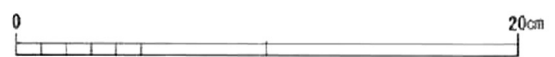
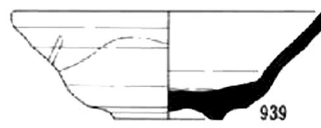



940~943  
SK2505



940

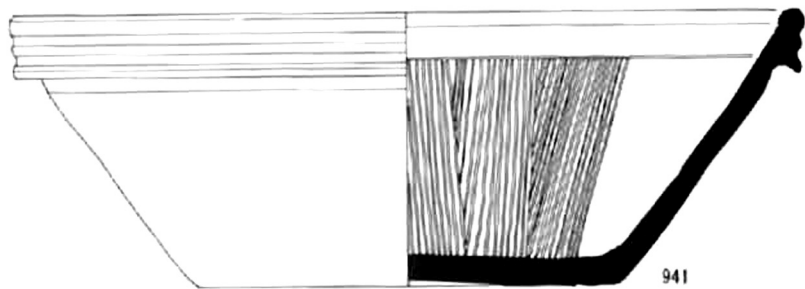

941

その他



942

SK2506

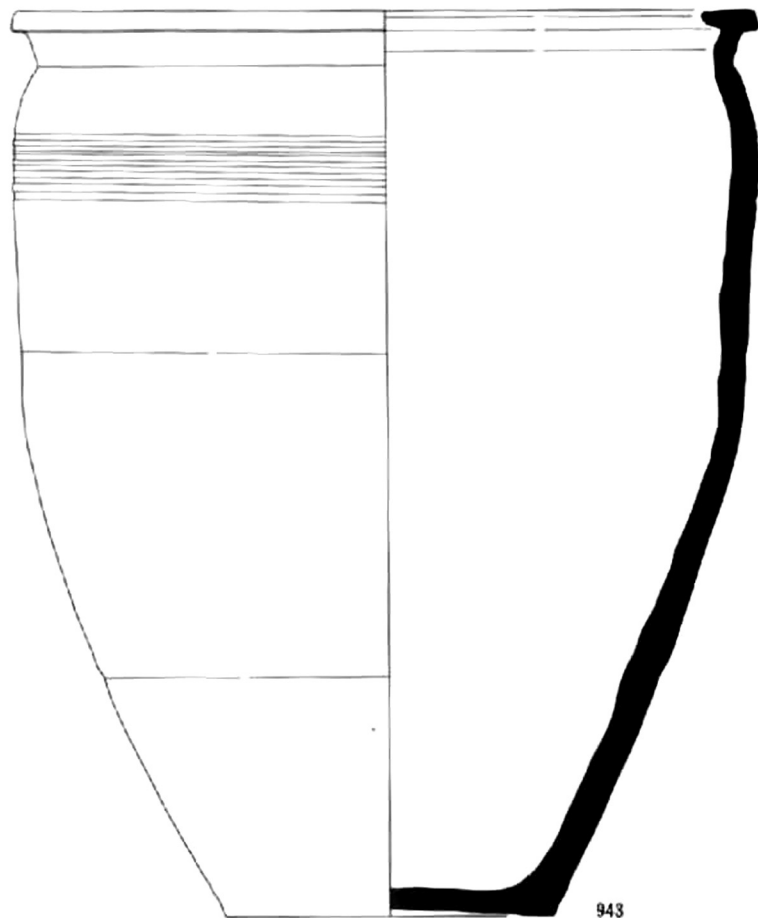

943

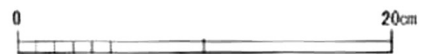
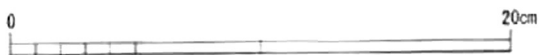

944・945

SK2504(水琴窟)

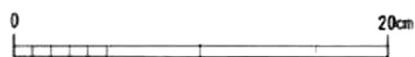
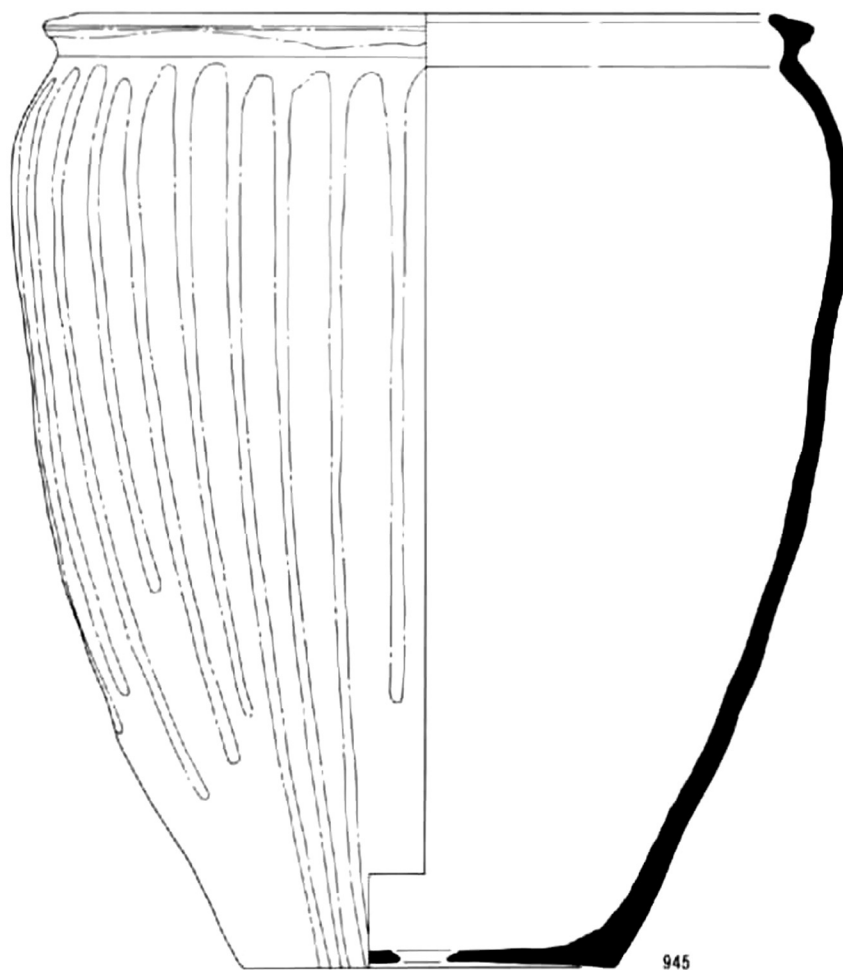
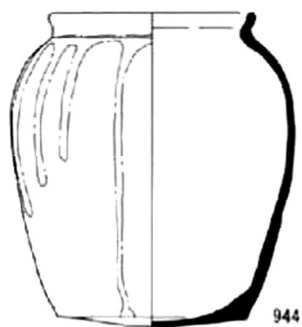

946~957

土製品



958~963

土製品



958

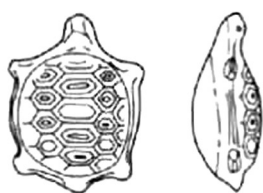

959

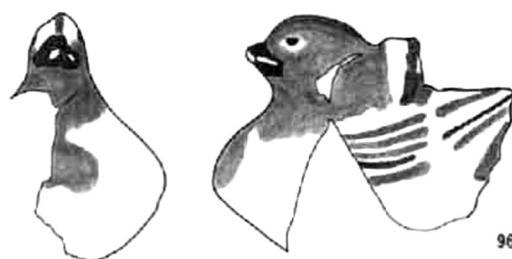

960

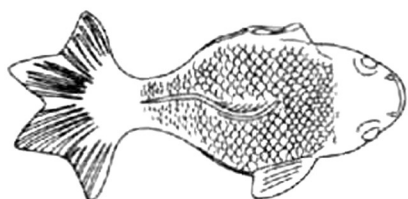

961



962



963

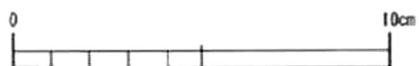

964~985

土製品



965

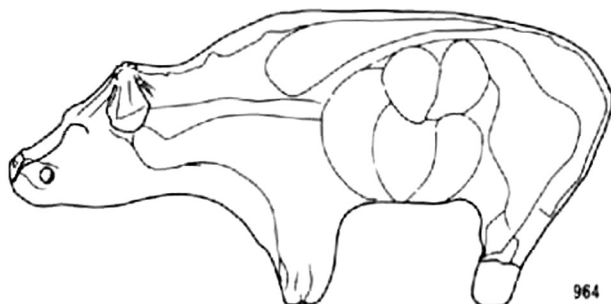
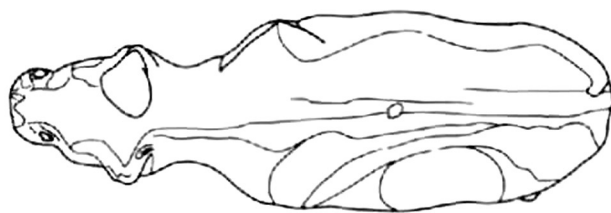

964



966



967



968



969



971



970



972



973



974



975



976



977



978



979

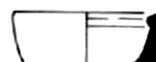

980



981

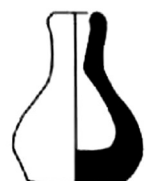

982



983



984



985

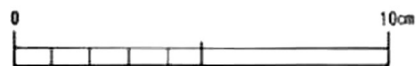

上製品

986~996

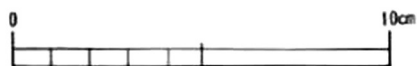
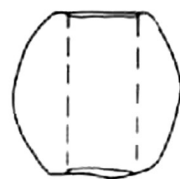
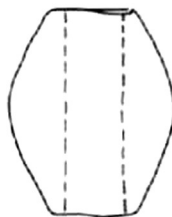
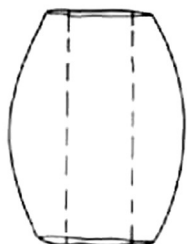
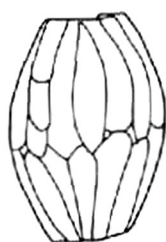
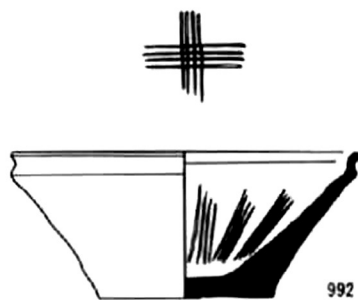
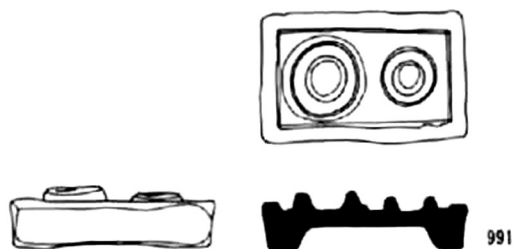
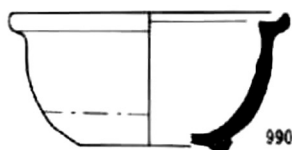
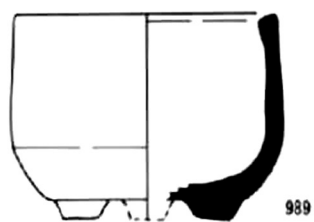
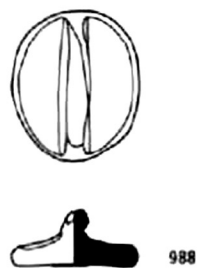

997~1004

軒九瓦



997



998



999



1000



1001



1002

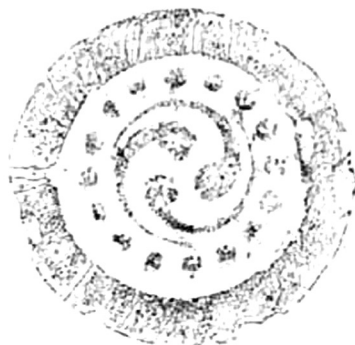

1003



1004

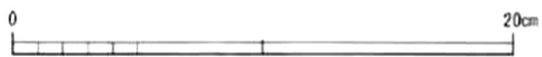

1005~1012

軒九瓦

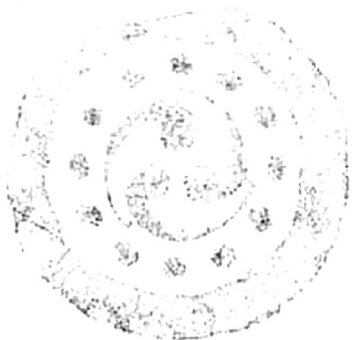

1005



1006



1007



1008



1009



1010



1011

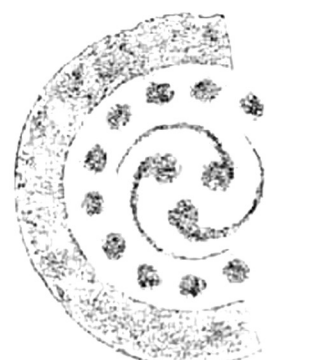

1012





1013~1020

軒丸瓦

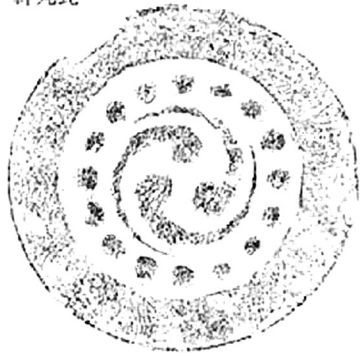

1013

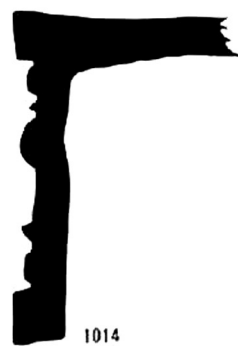

1014

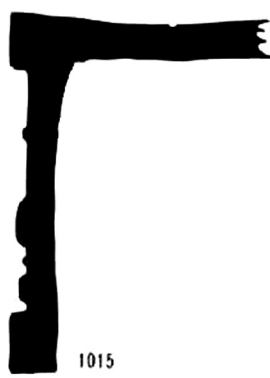

1015



1016



1017



1018



1019



1020

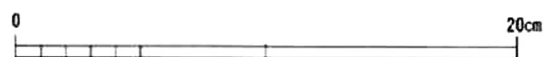

軒丸瓦

1021~1026

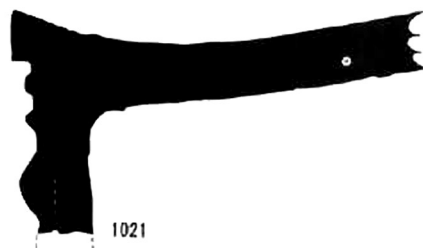
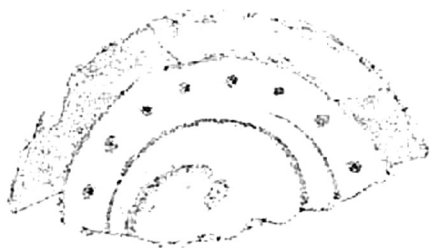

1021



1022



1023



1024



1025



1026

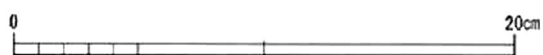

1027~1032

軒平瓦

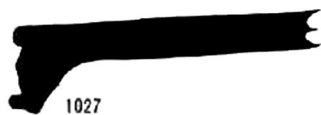
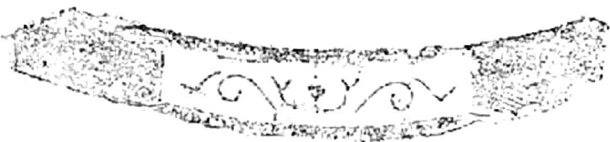

1027



1028



1029



1030



1031



1032

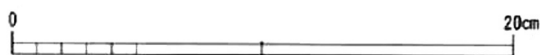

1033~1038

軒平瓦



1033



1034



1035



1036



1037



1038

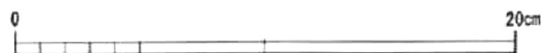

1039~1060

汽車土瓶

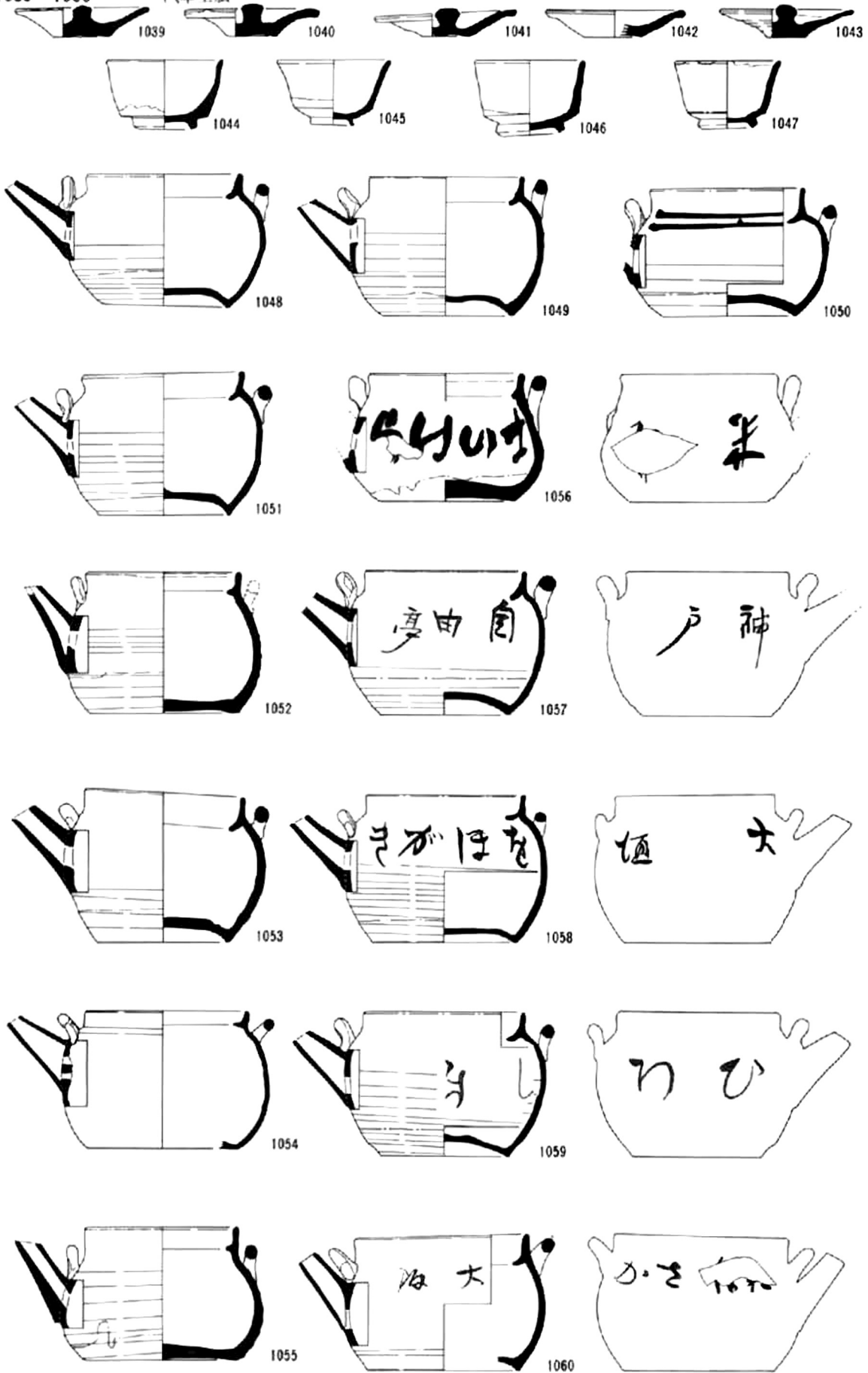

0 20cm

1061~1076

ガラス製品



弥生土器

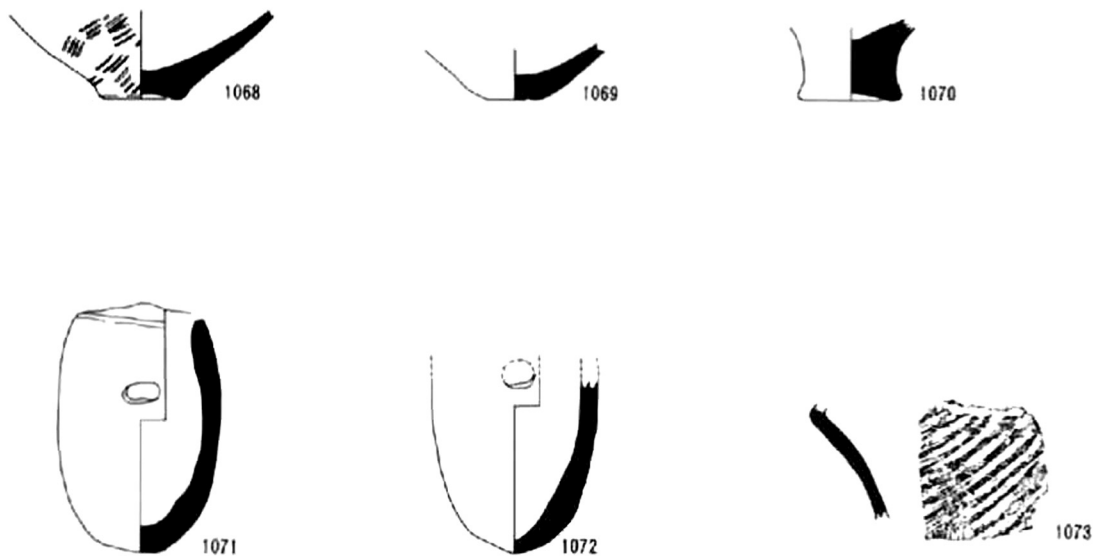

須恵器

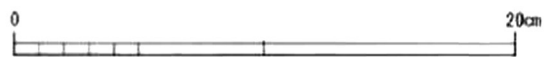

W1~W21

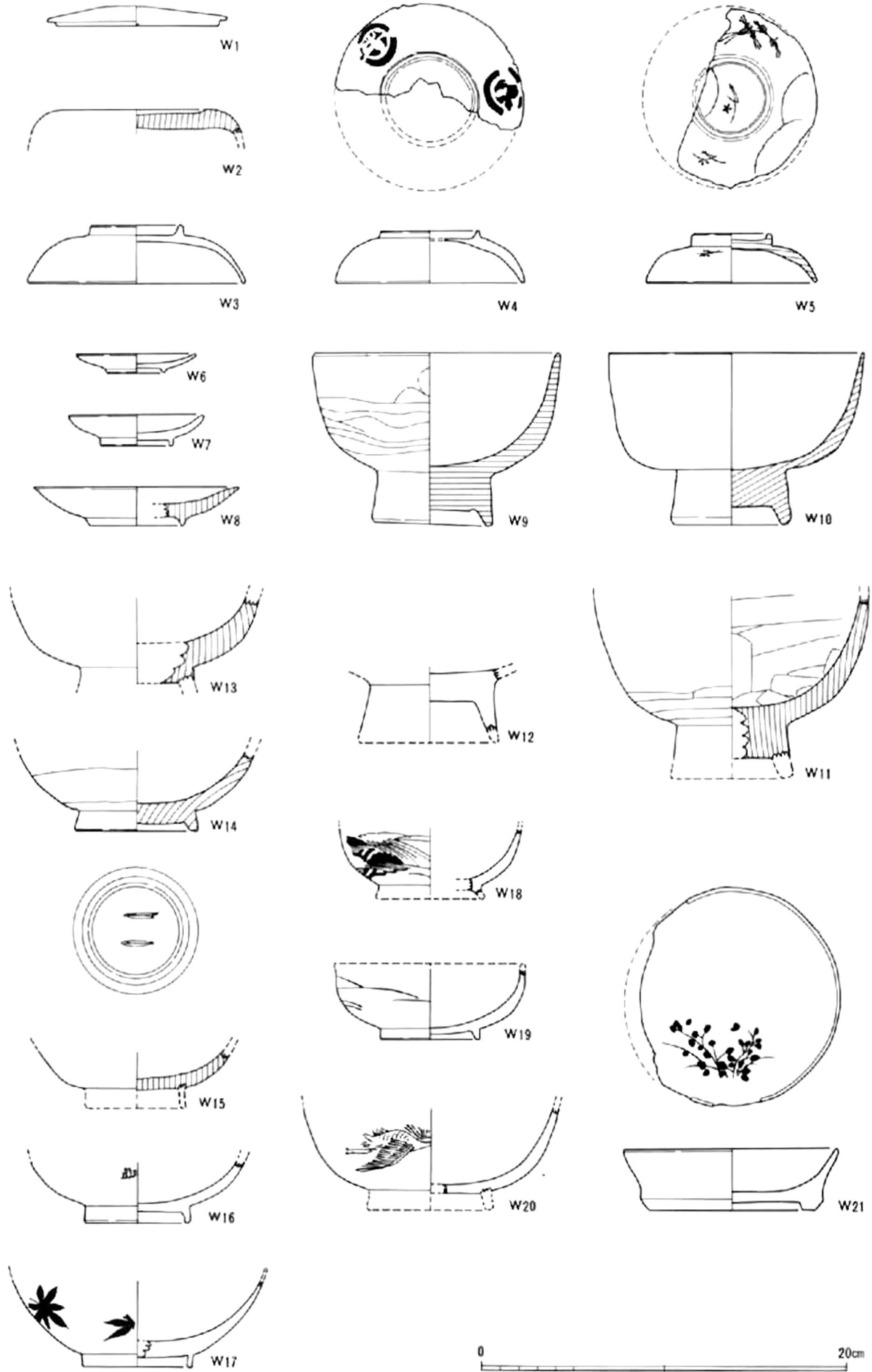

0 20cm

W22~W28

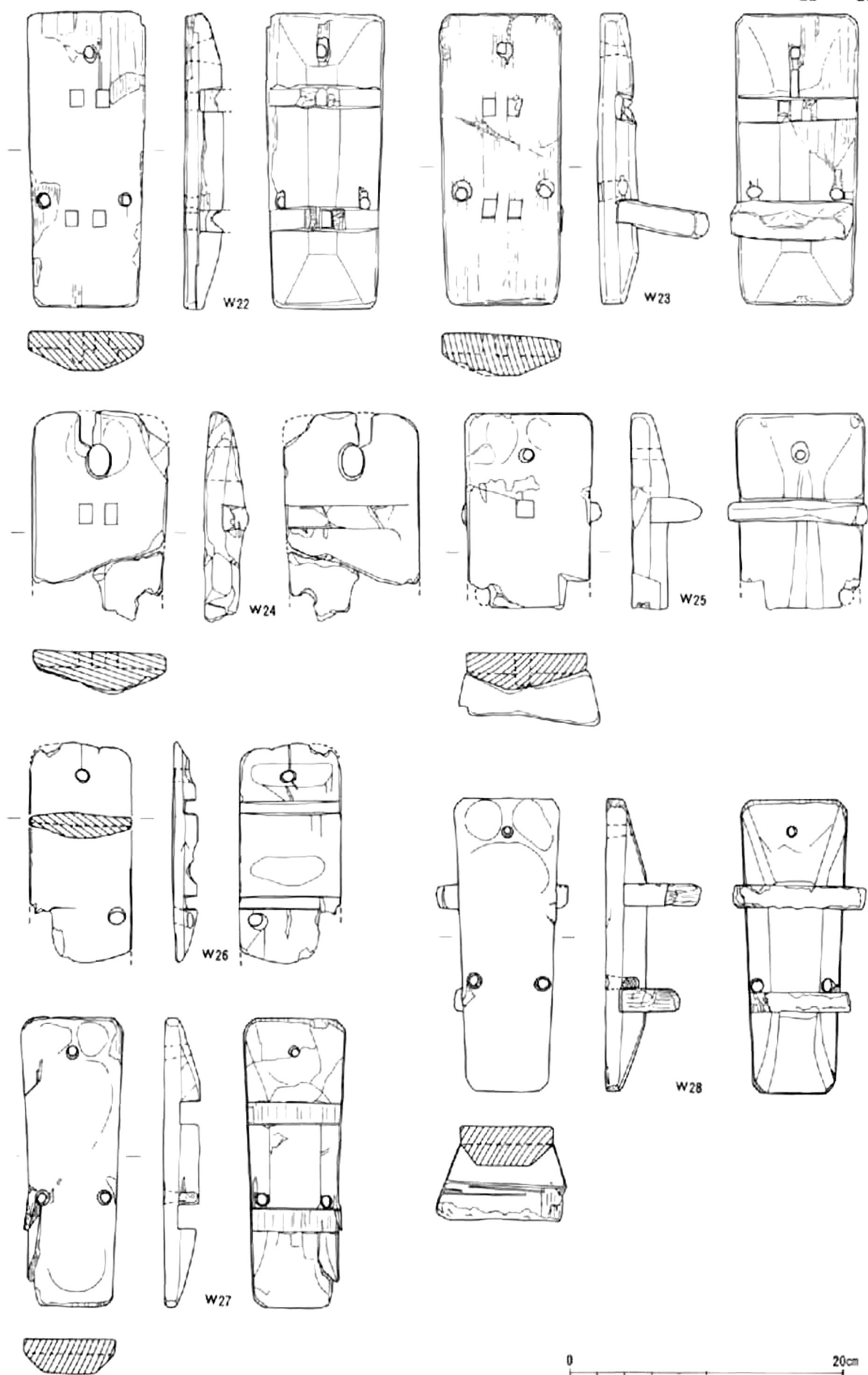



W29~W35

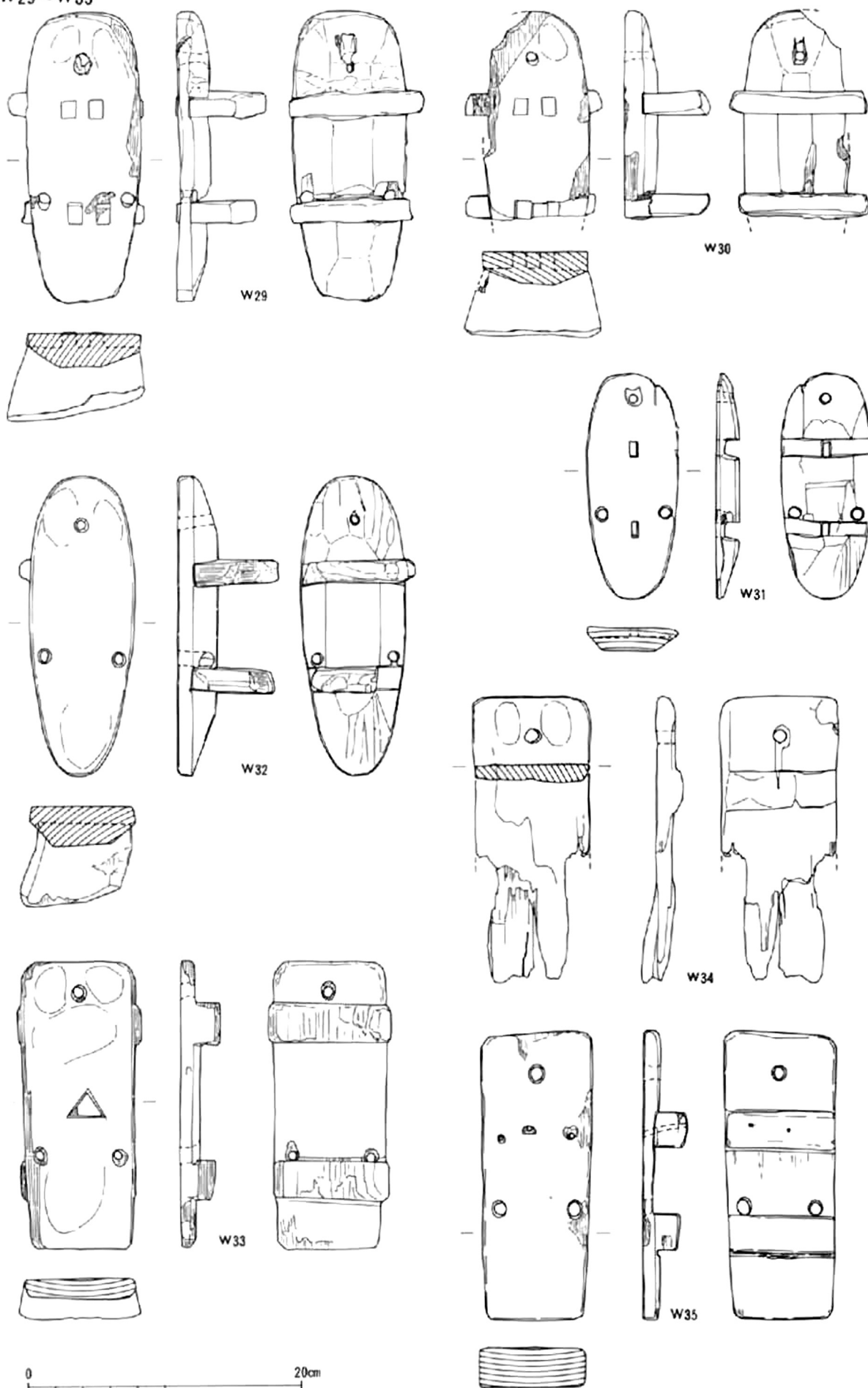

0 20cm

W36~W41

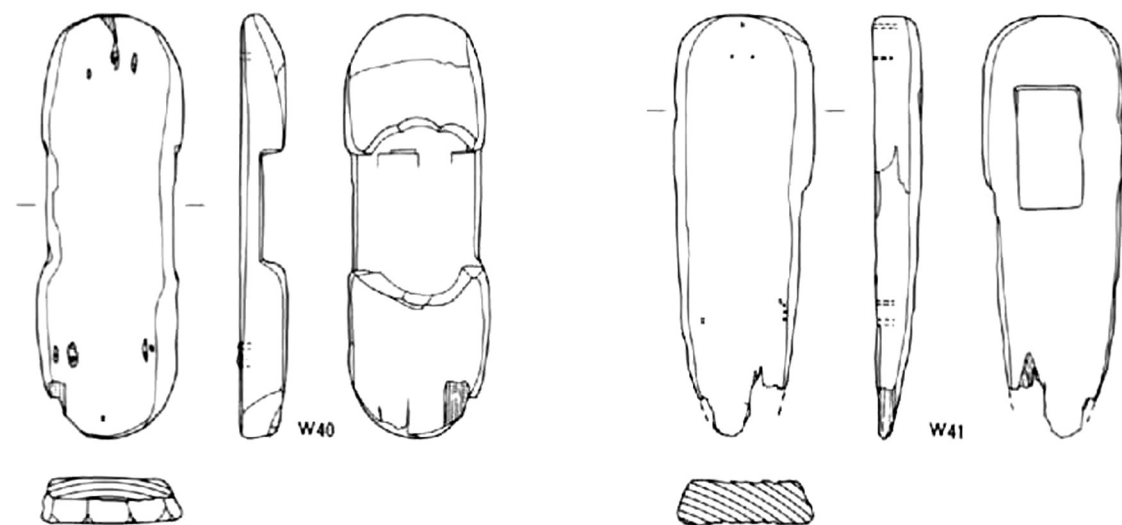
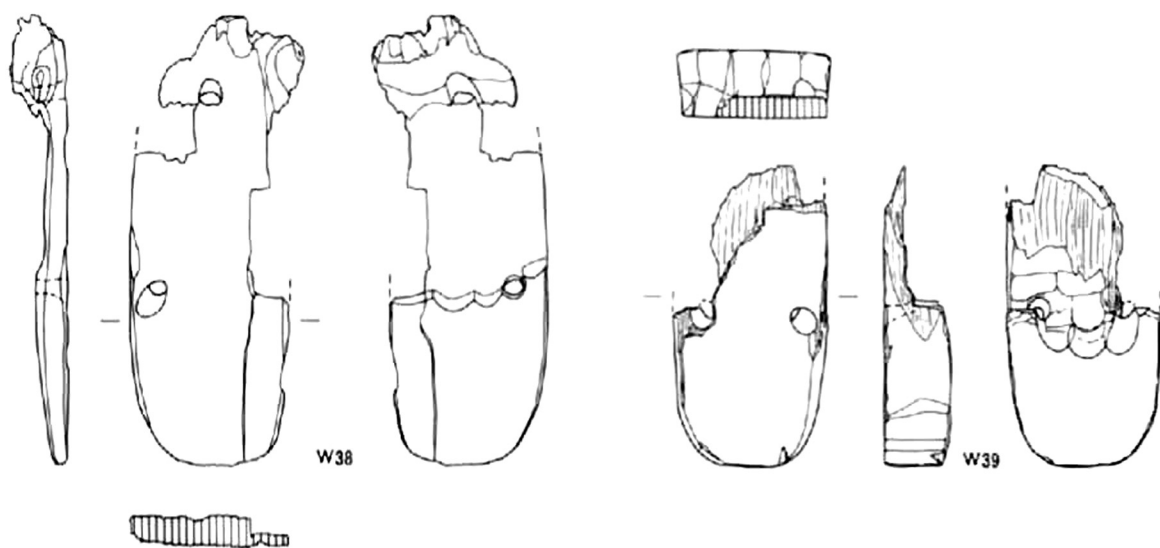
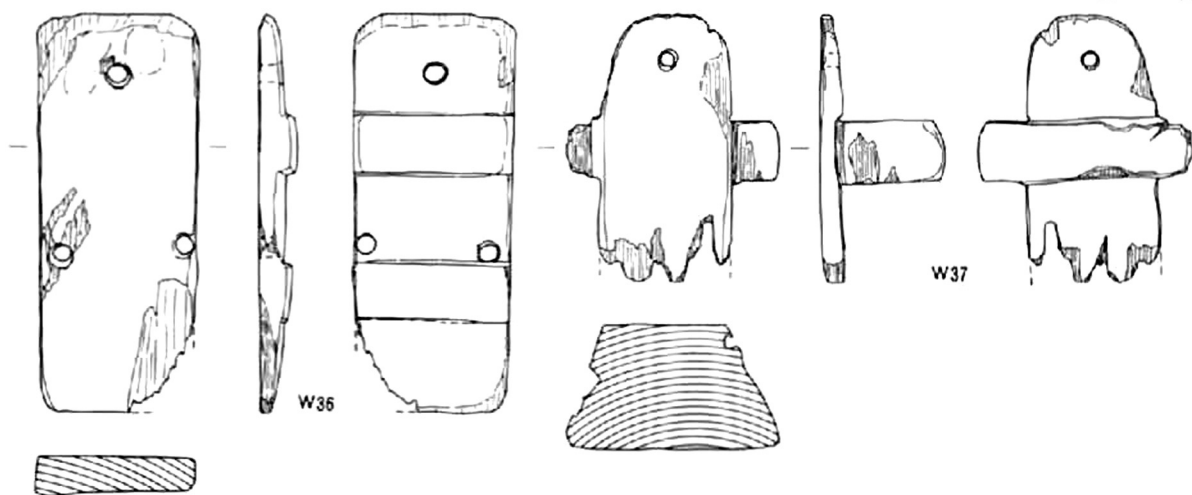

0 20cm

W42~W56

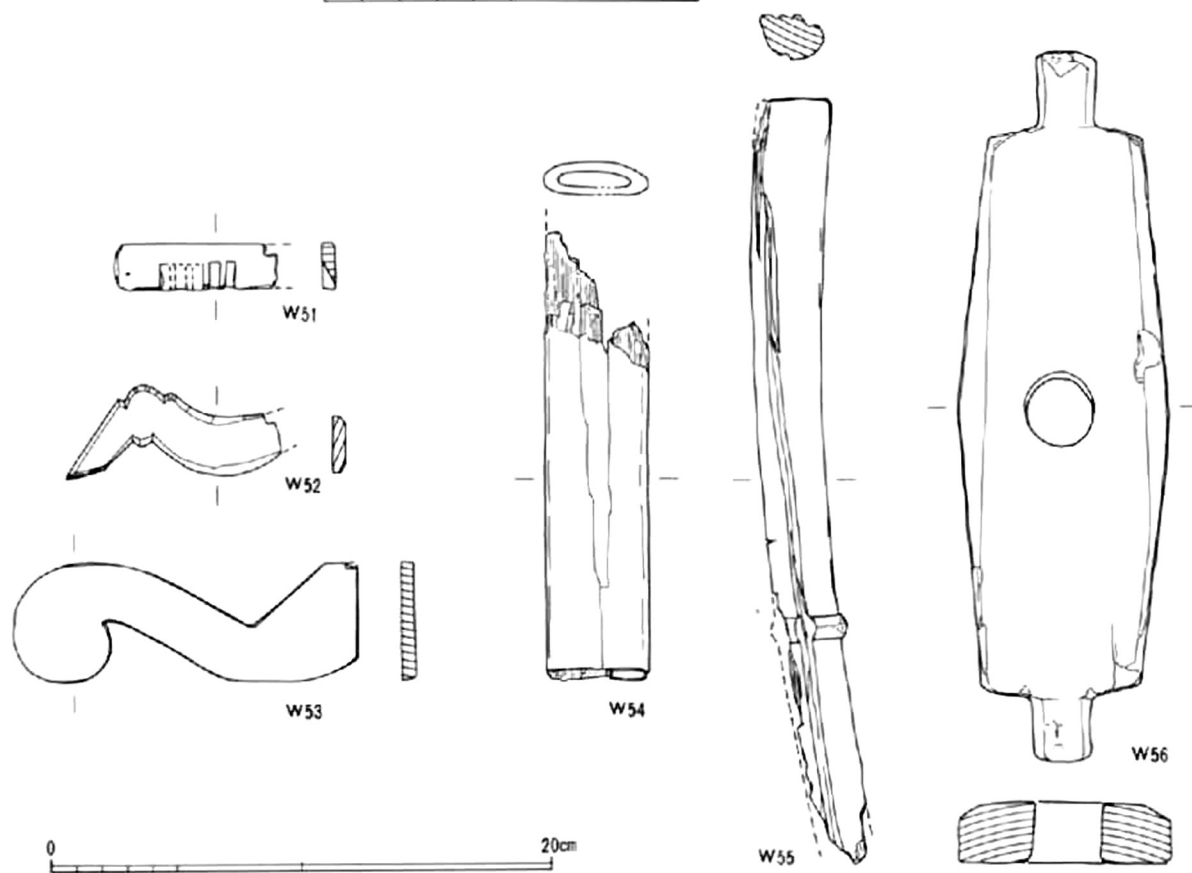
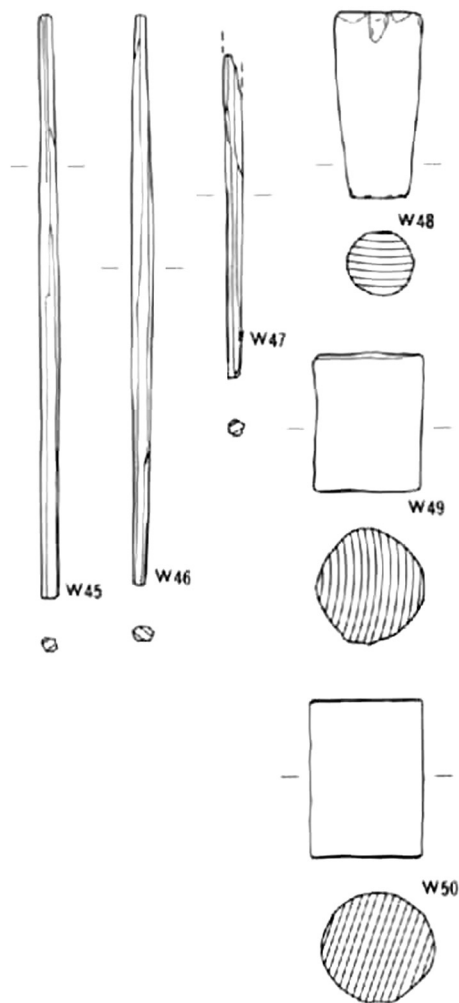
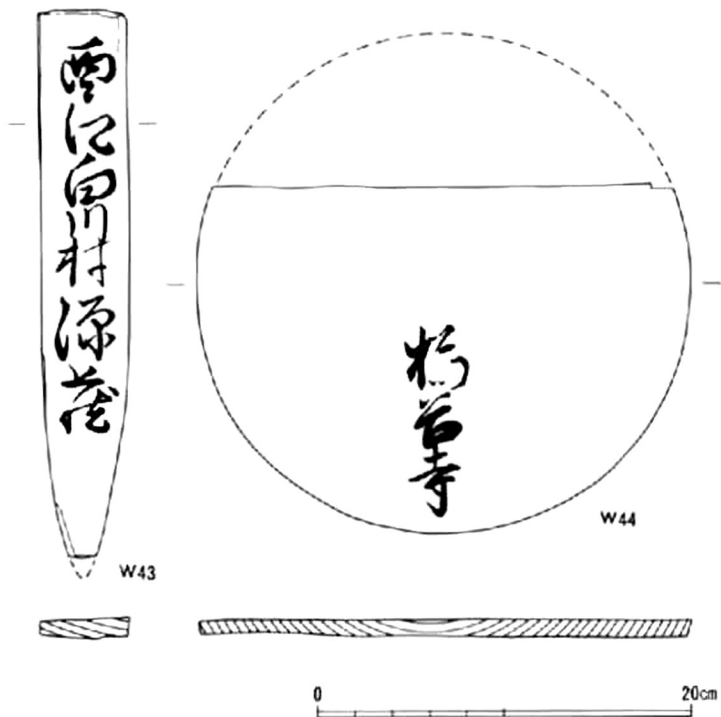
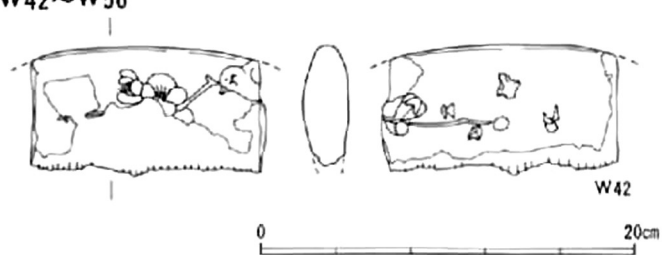

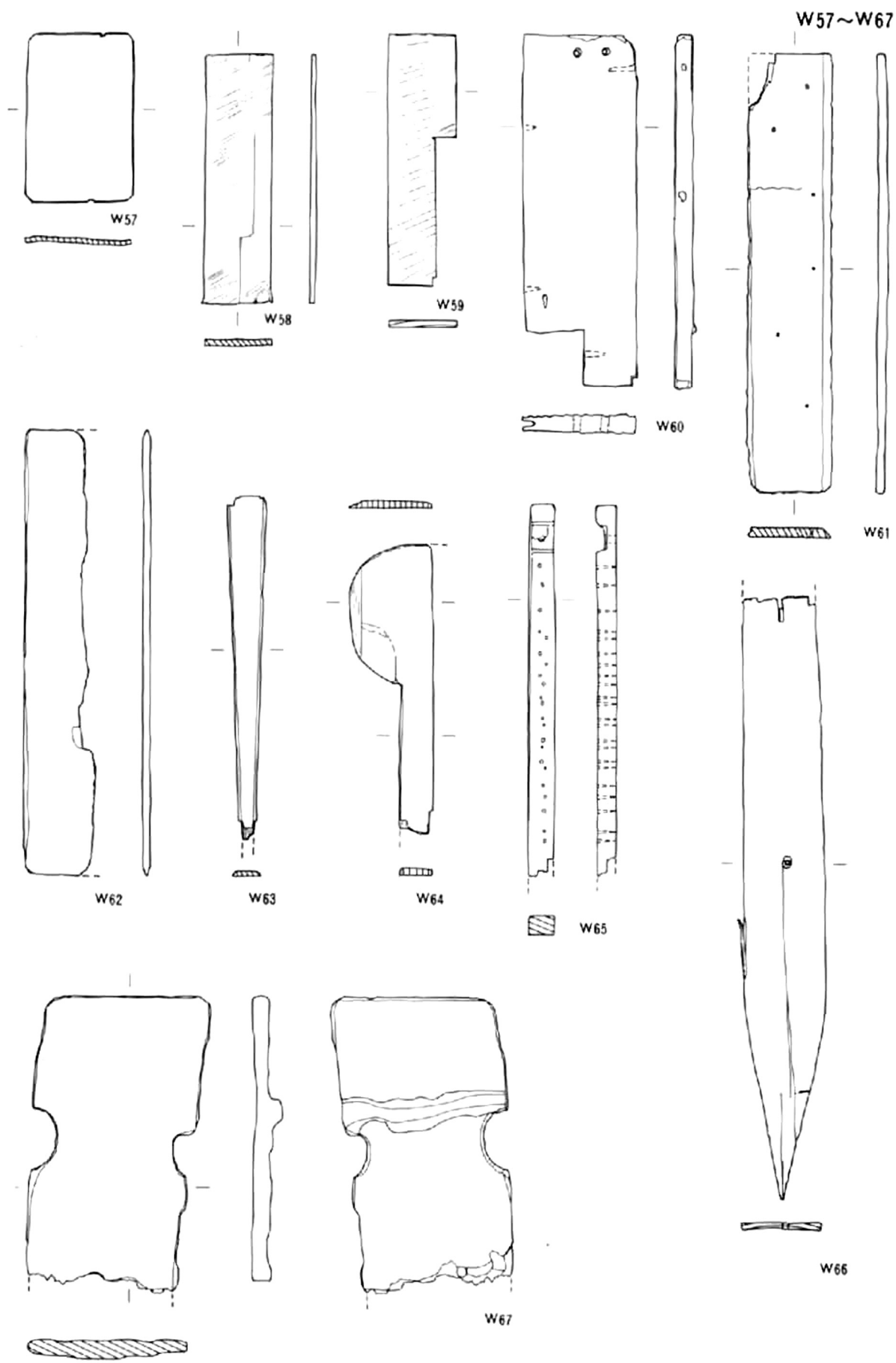

0 20cm

W69~W73

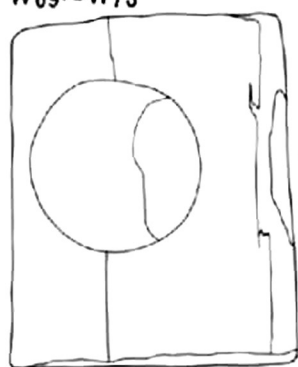

W69

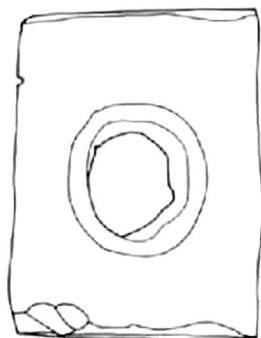
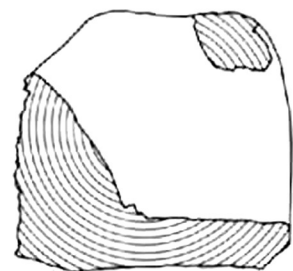
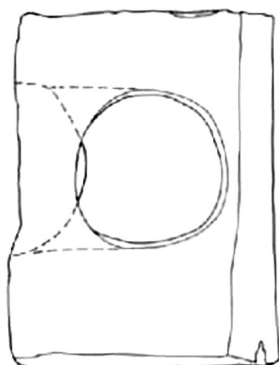

W70

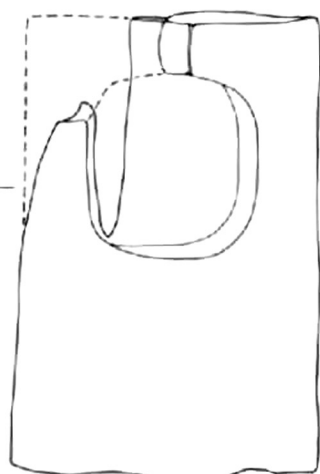
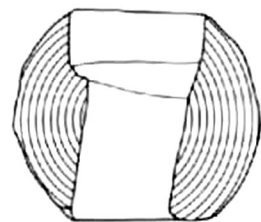

W71

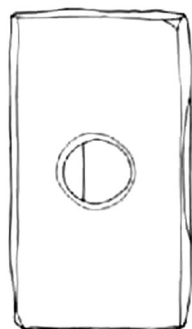
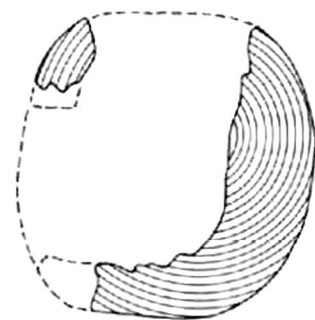

W72

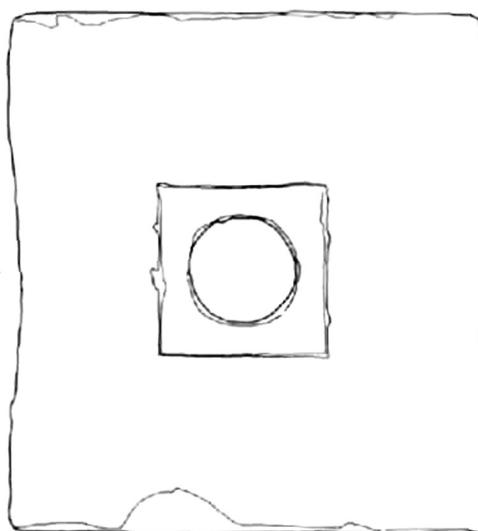
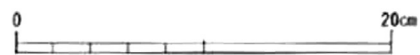
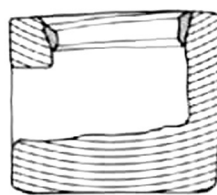
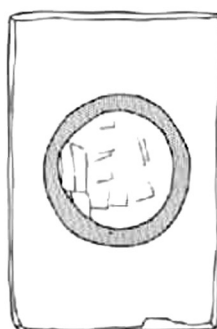

W73

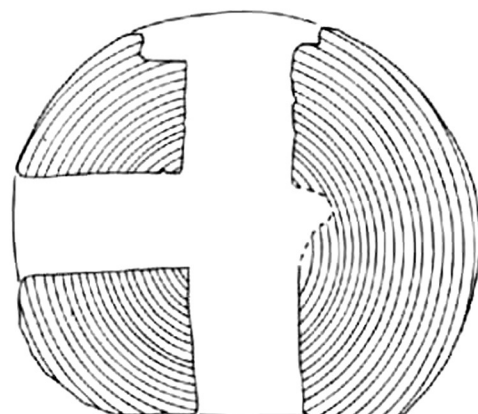
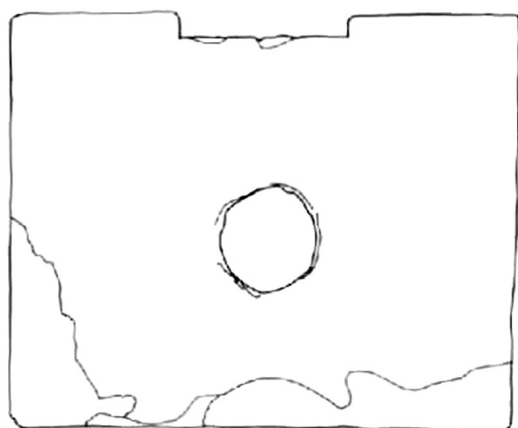

B1·B2 M1~M13

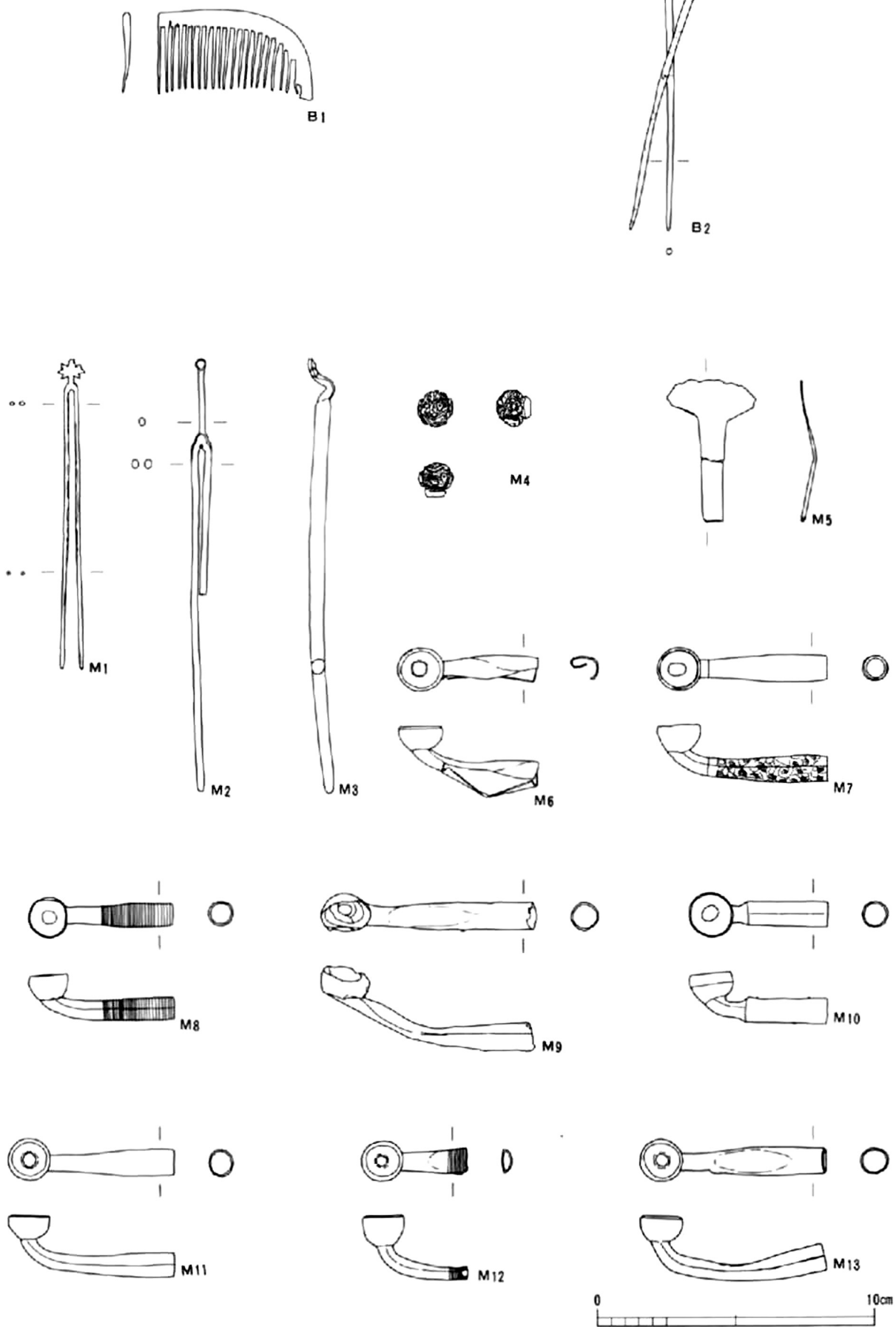

M14~M29

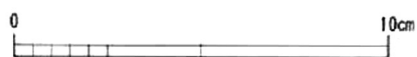
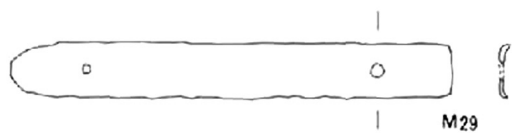
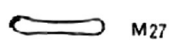
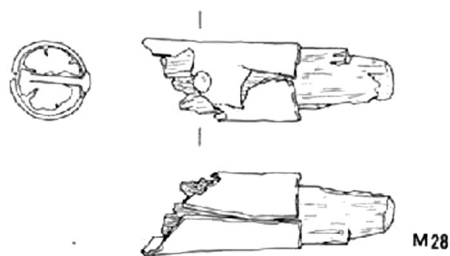
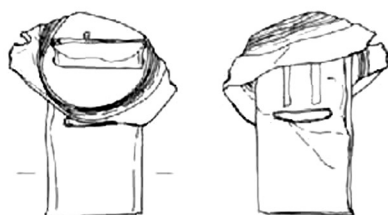
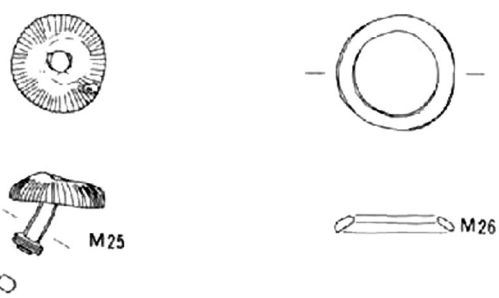
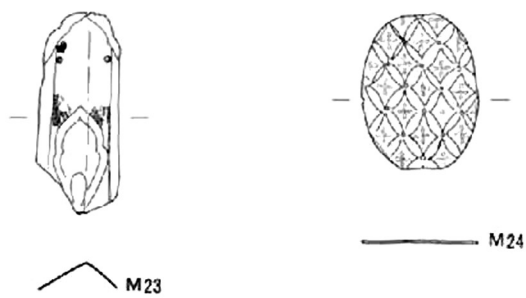
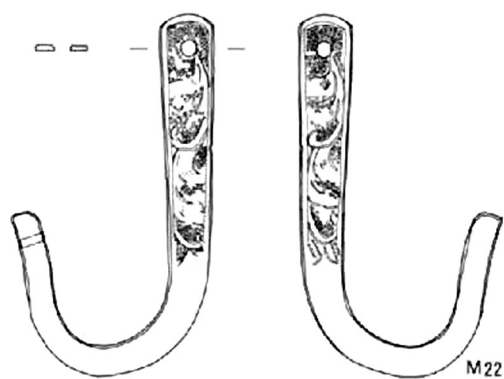
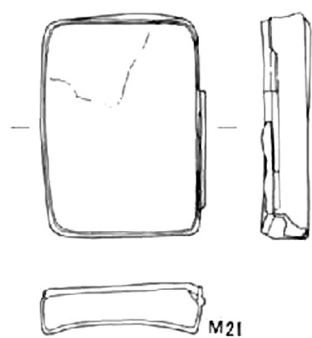
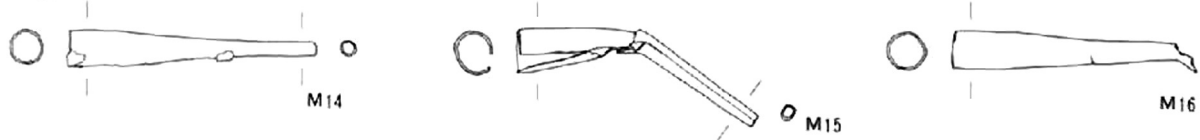

M30~M36

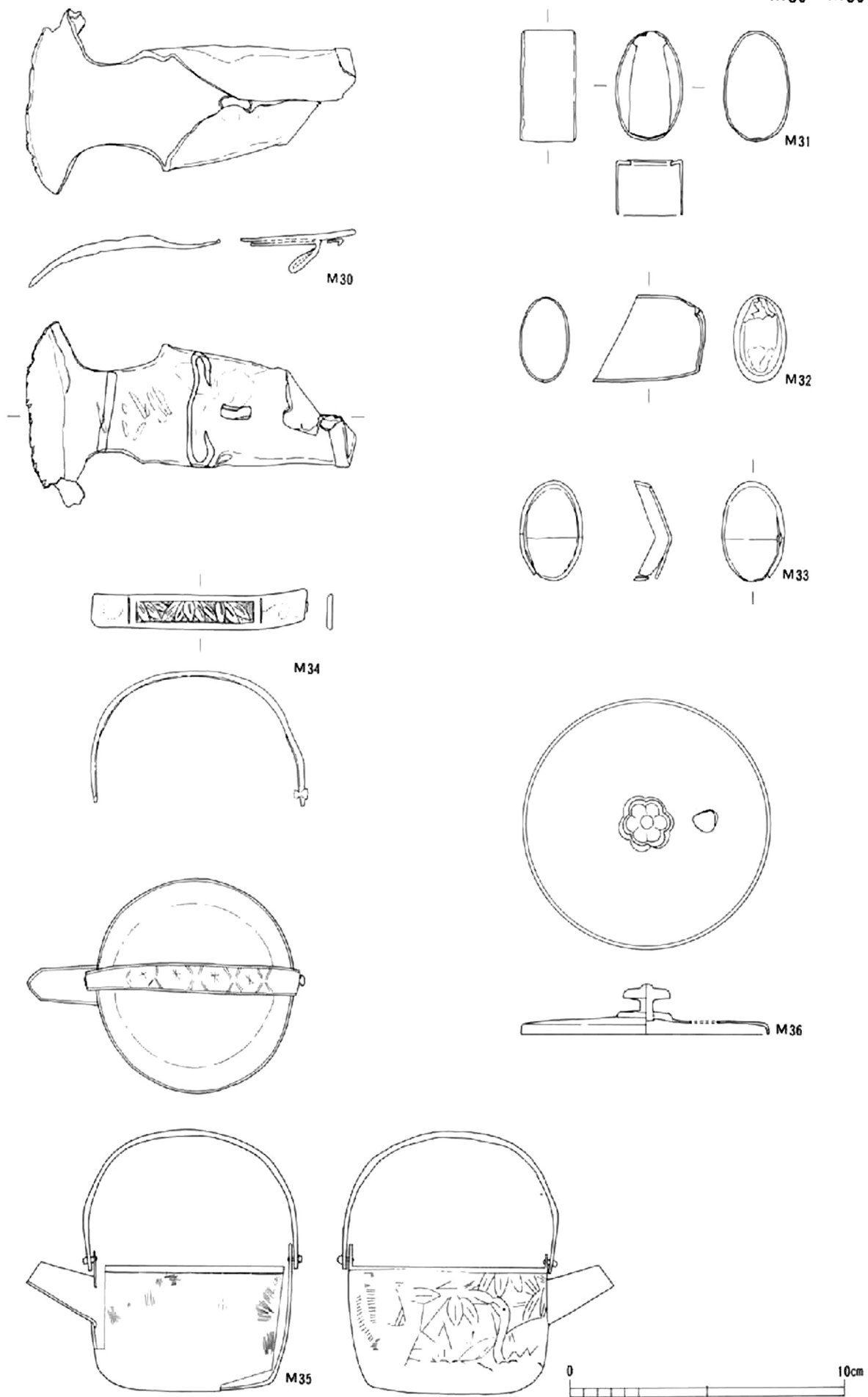



M37~M44

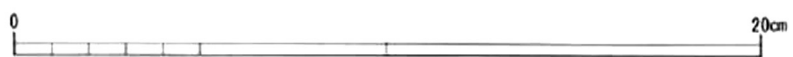
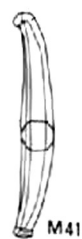
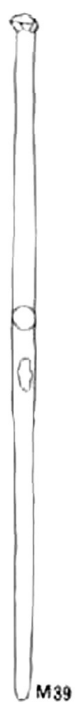

M45~M51

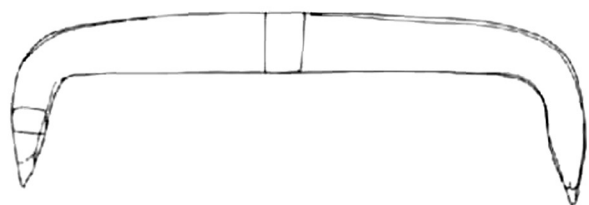
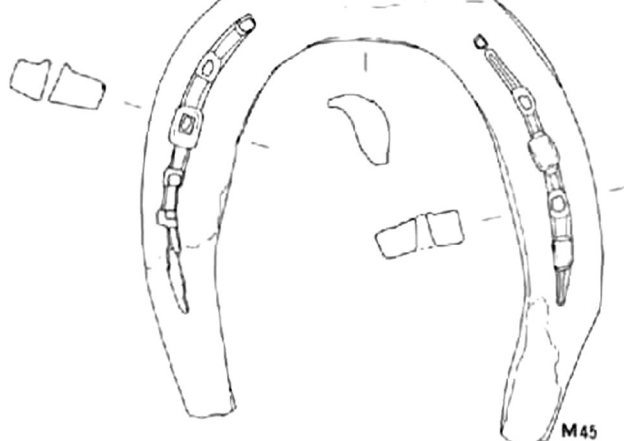
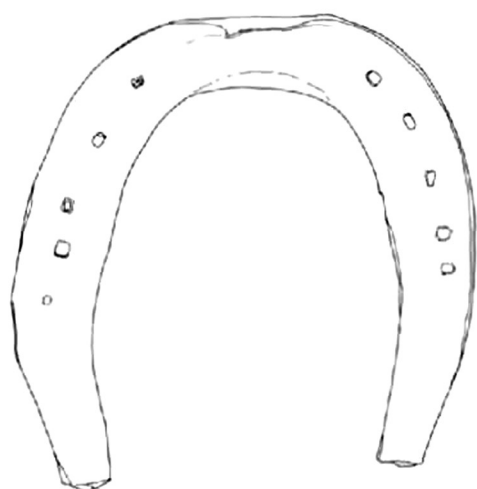

M46

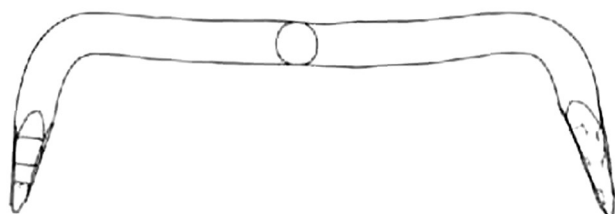

M47



M48



M49



M50



M51

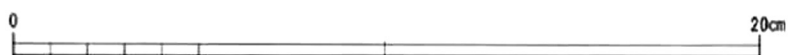

M52~M82

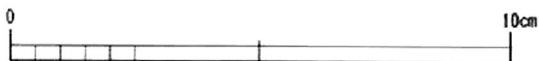
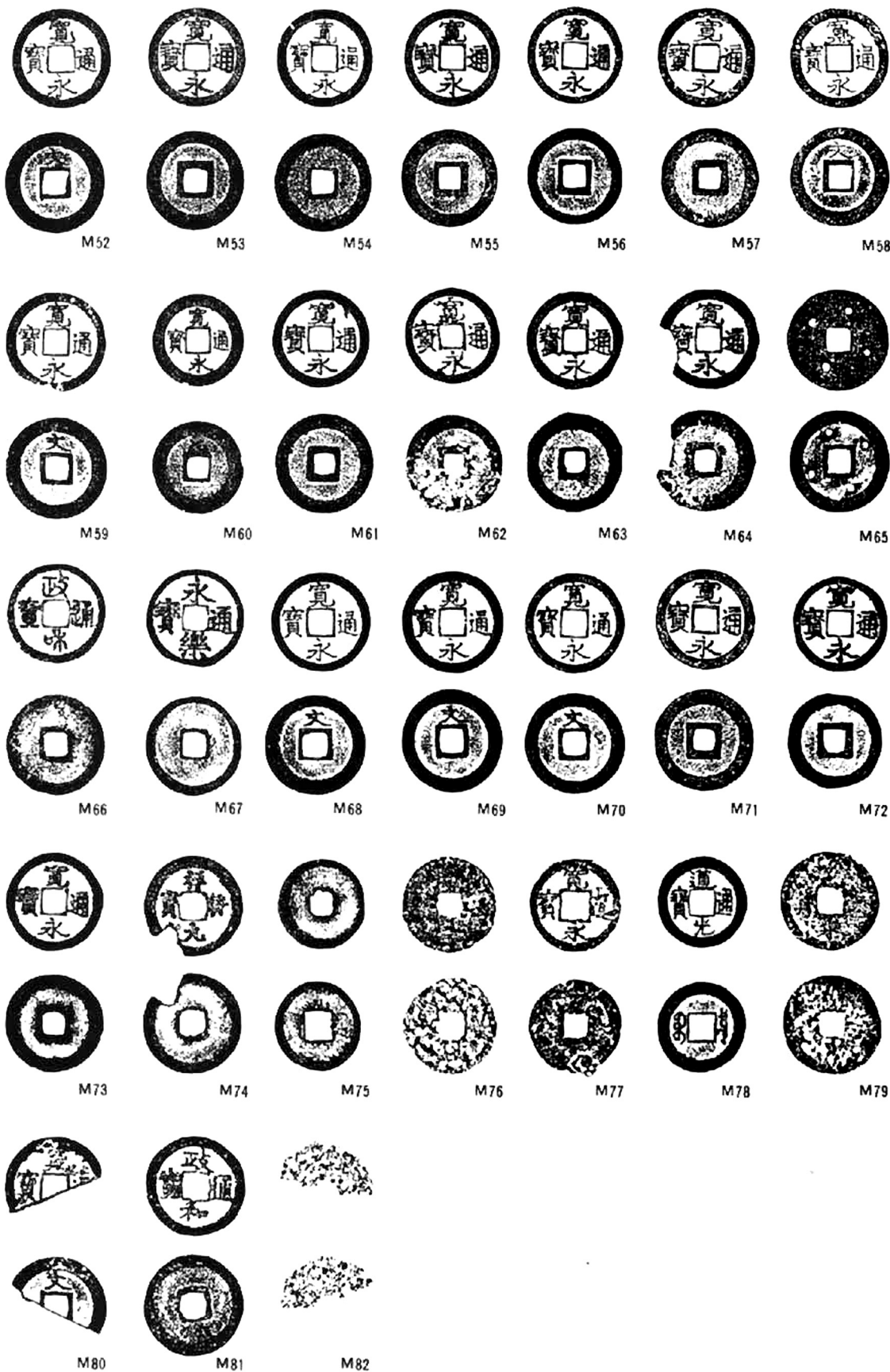

S1~S10

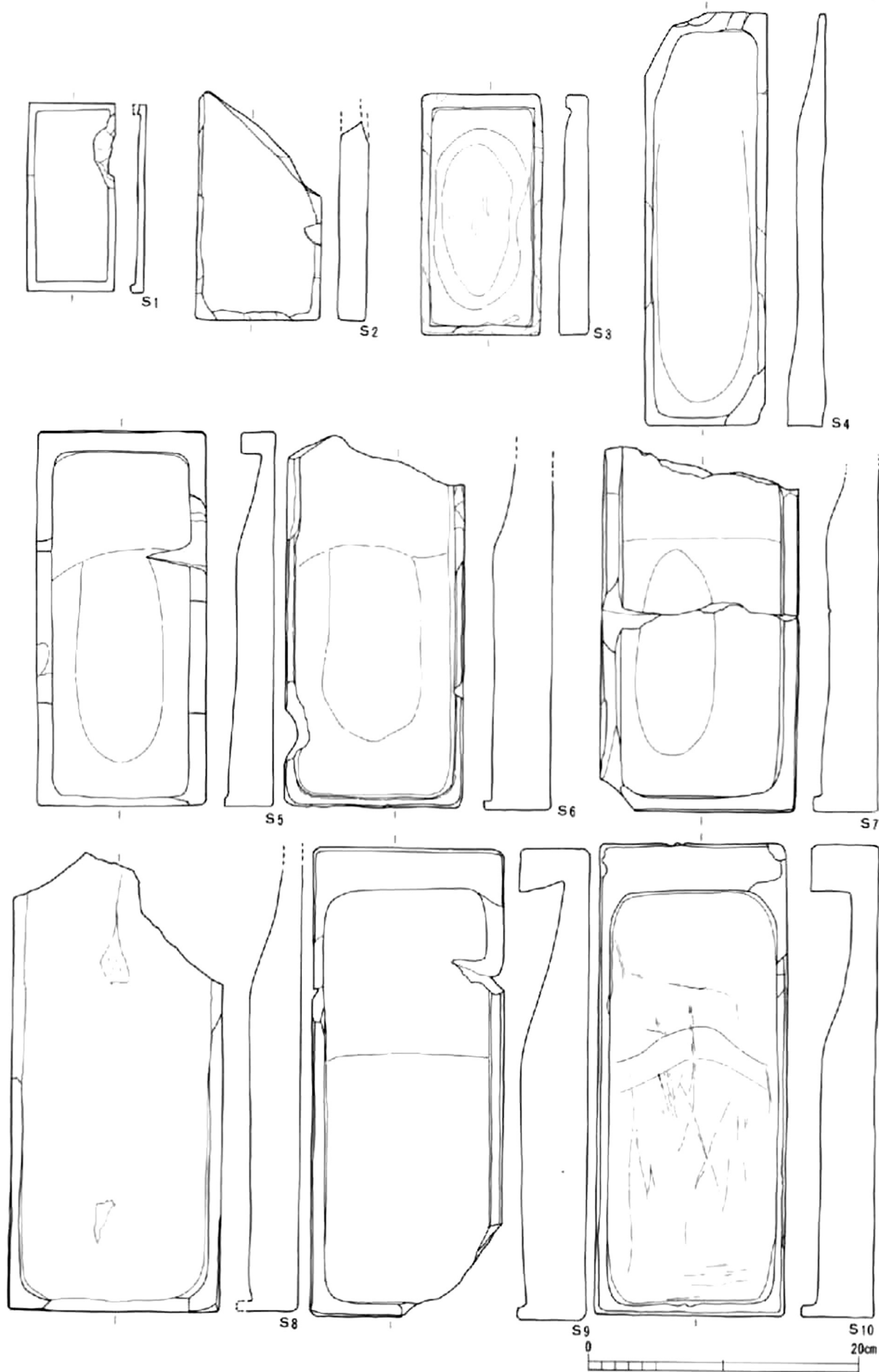

S11~S14

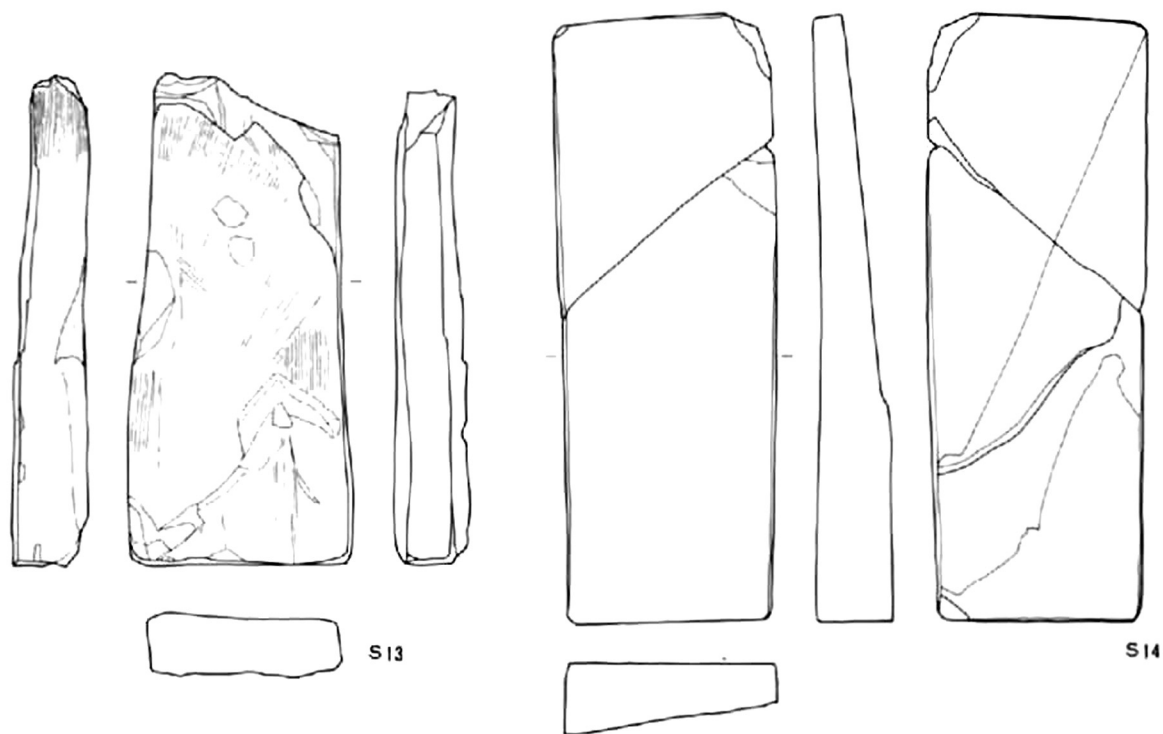
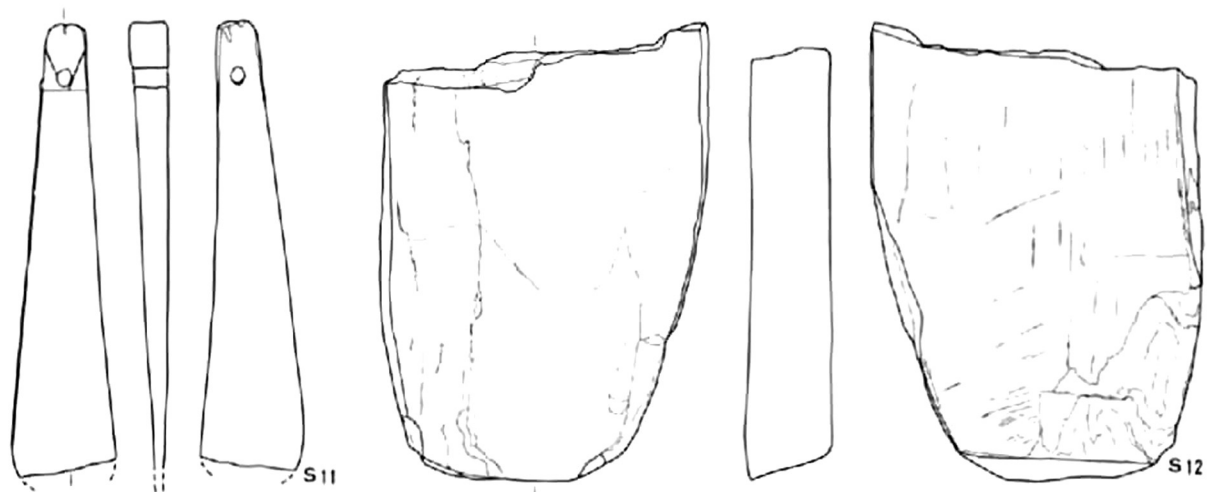

0 20cm

S15·S16

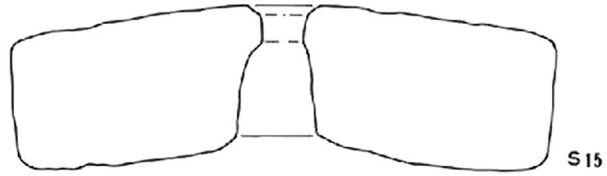
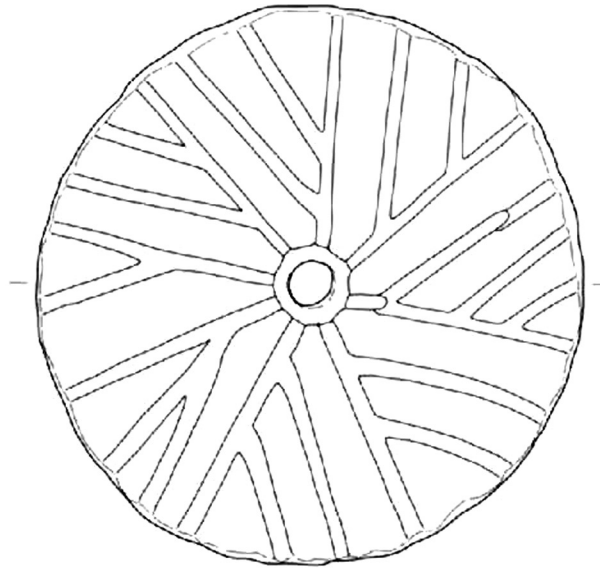

S15

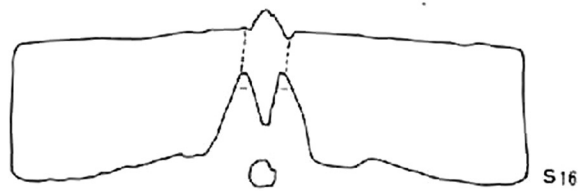
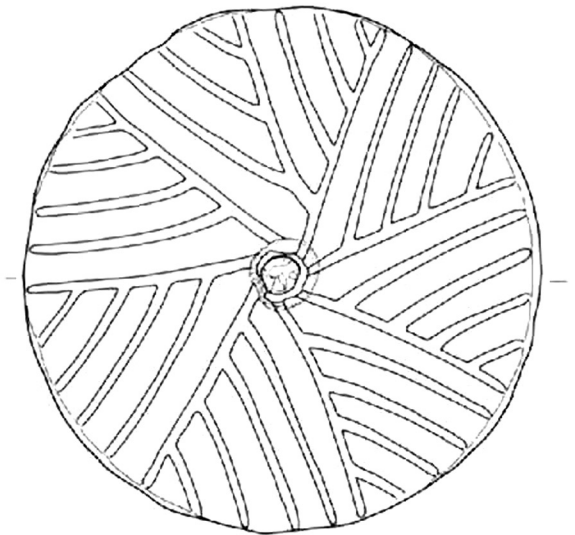

S16

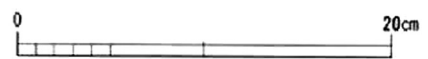

# 遺構図版



明石城跡航空写真（1980年撮影）





1. 発掘調査前の東中ノ町地区  
(駅前駐車場 東から)



2. 東中ノ町地区全景と中ノ町地区を望む



1. 東中ノ町地区全景（東から）

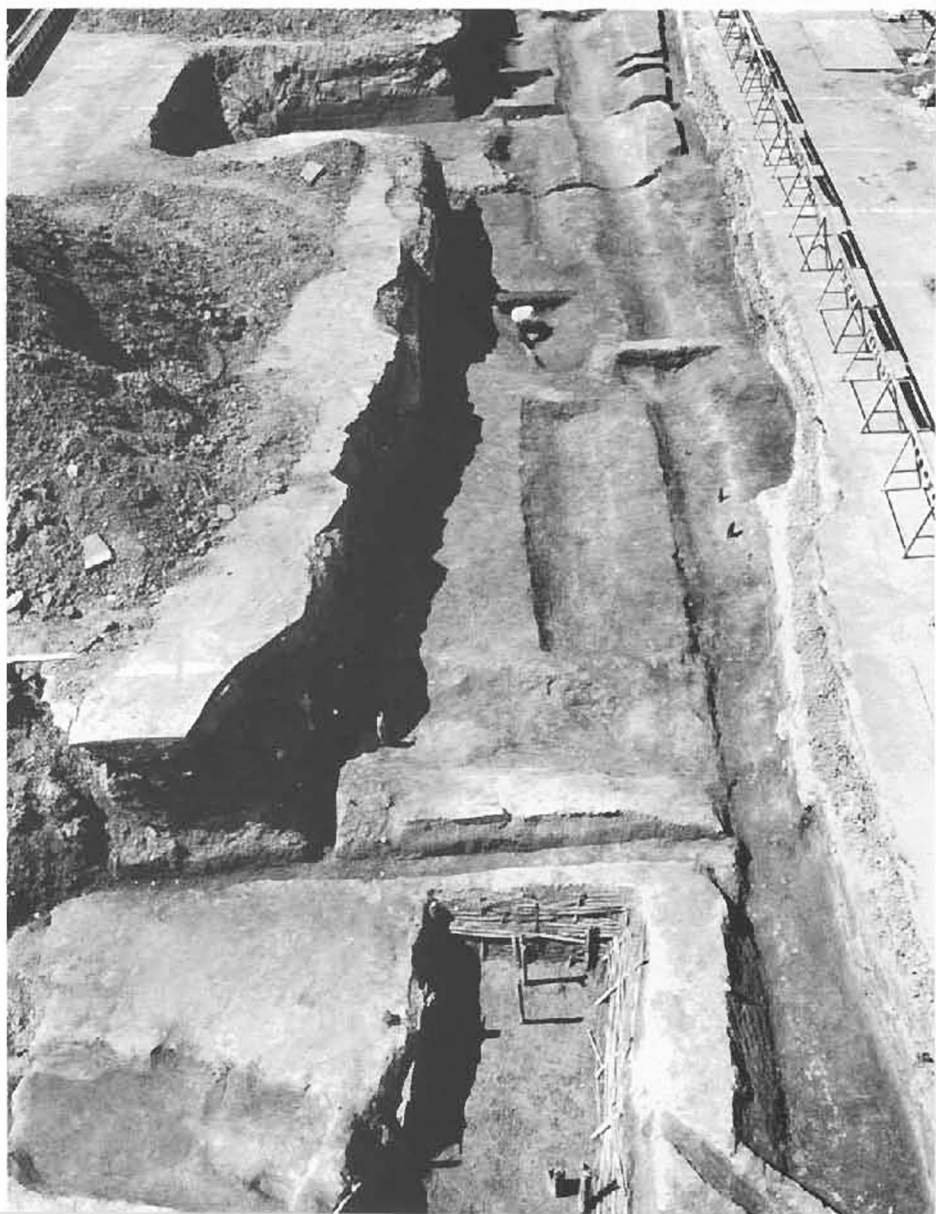

2. 東中ノ町地区全景（東から）



1. SB3001 (建物跡)



2. SD2012 (石組溝) と  
SD2013

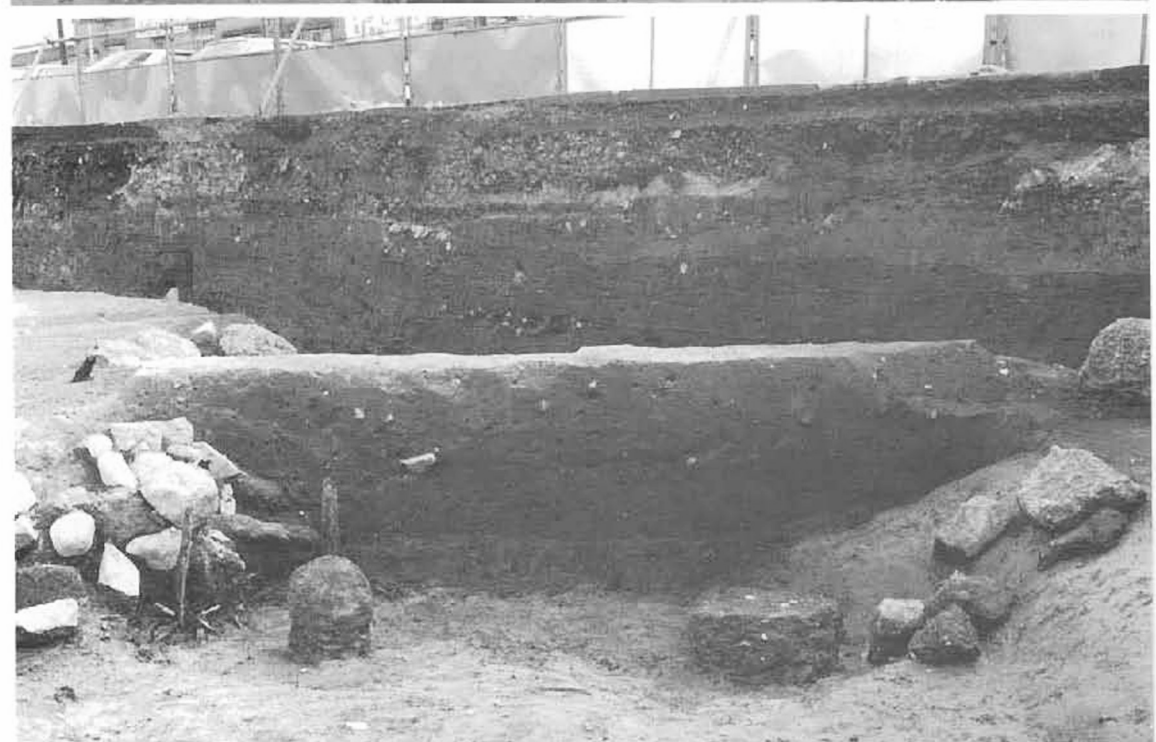

3. SD2013 土層断面



1. SE3001 検出状態  
2. SE3001 断面



1. SG2001  
(池状遺構) 全景



2. SG2001



3. SG2001の水位調整施設



1. SW1001 (水道)



2. SW2001 (水道)



3. SW2001の樹

1. SK2001 (漆喰土坑)と  
SK2002 (焼土坑)



2. SK2002 埋土断面

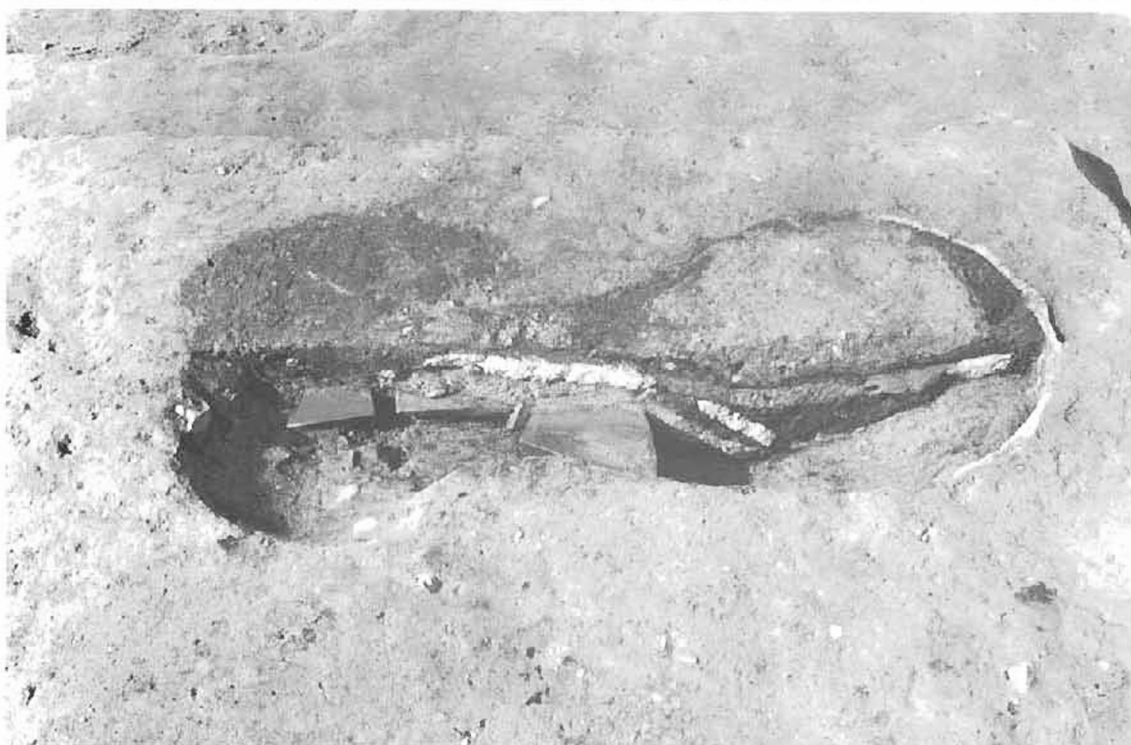

3. SK2002

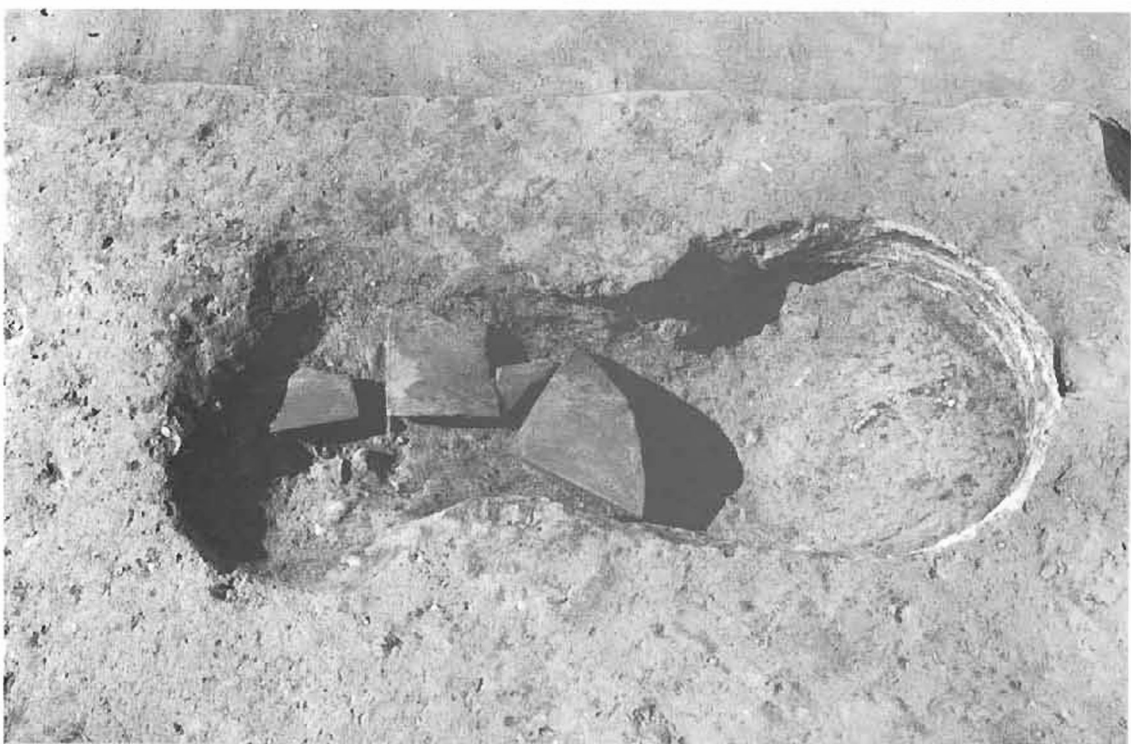

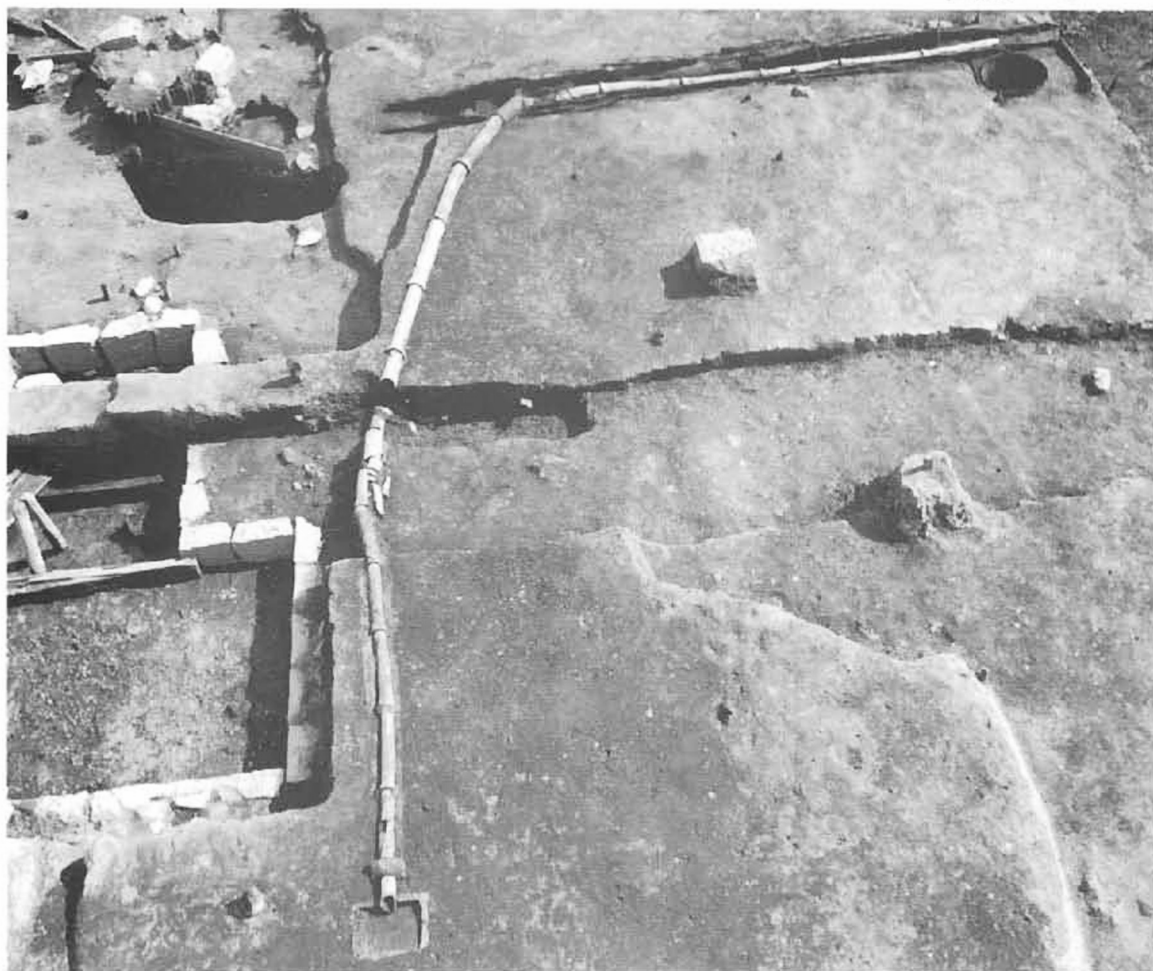

1. SP2001 (排水用土管)
2. SP2001の漆喰塗り集水樹





1. SG2002 (池状遺構)



2. SK3001 (埋桶)



3. SK2011



1. SD2002 と土層断面  
鉄道のバラス敷きがみえる



2. 7トレンチ付近地層断面



3. 下層の地層  
(D 2-D 4間)



1. 中ノ町A地区から東中ノ町地区を望む

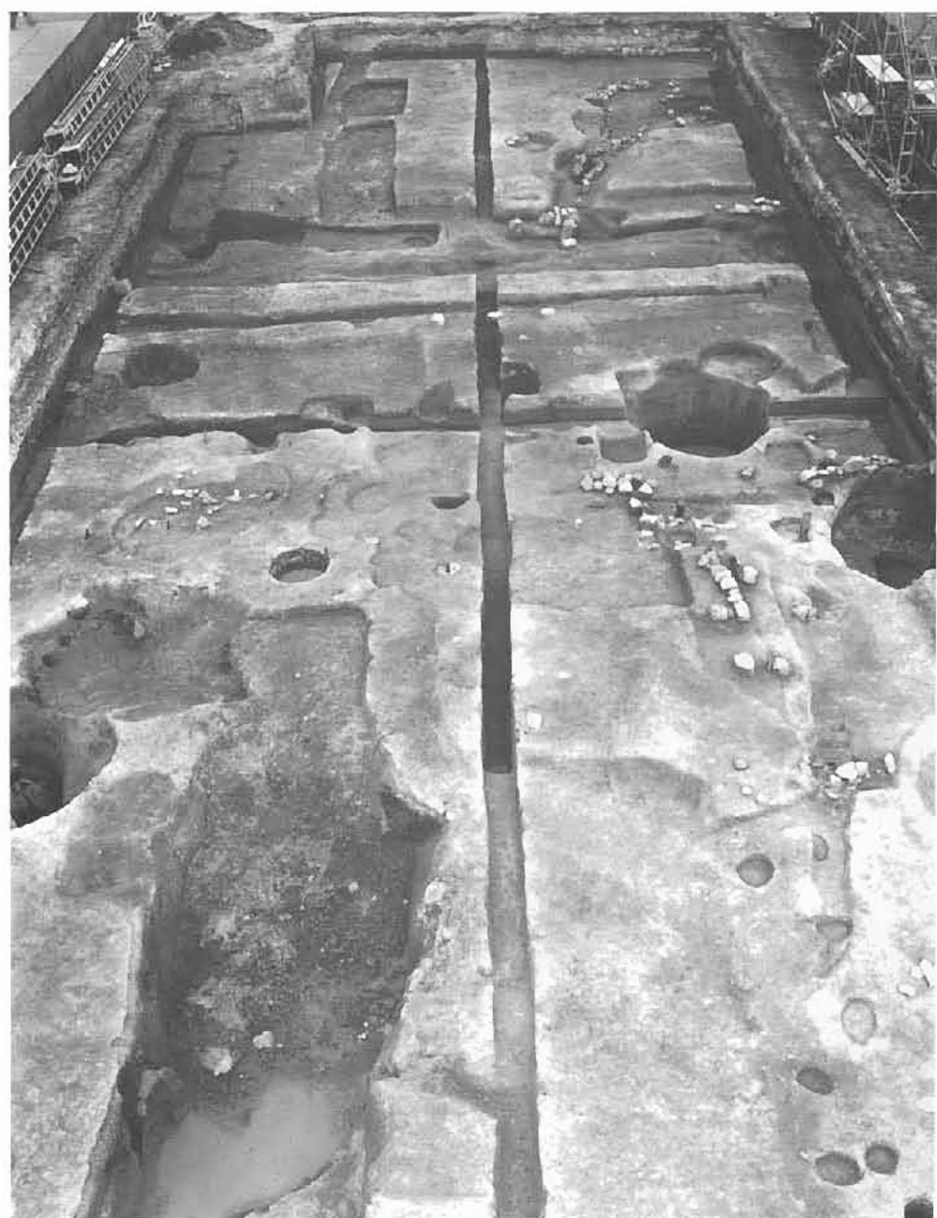

2. A地区全景（西から）



1. A地区屋敷境溝と築地跡

2. SA3102 (築地の基礎)





1. A地区西半部（南東から）  
2. SX2101（石敷遺構）



1. SE2101 (井戸)



2. SE2102 (井戸)



3. SK2124 (土坑)



1. SG2101 (池) (南西から)

2. SG2101 (池) (南東から)



1. B地区上層全景（西から）
2. B地区下層全景（西から）





1. SD2201 (水路)



2. SD2201



3. SD2201の堰

1. SA2201 (石列)



2. SD3202



3. 下層遺構面 (北から)

