

畠4出土土器

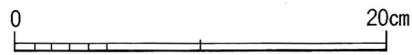

畠4出土瓦

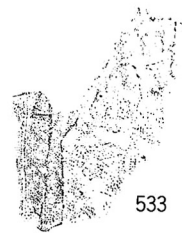
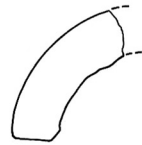
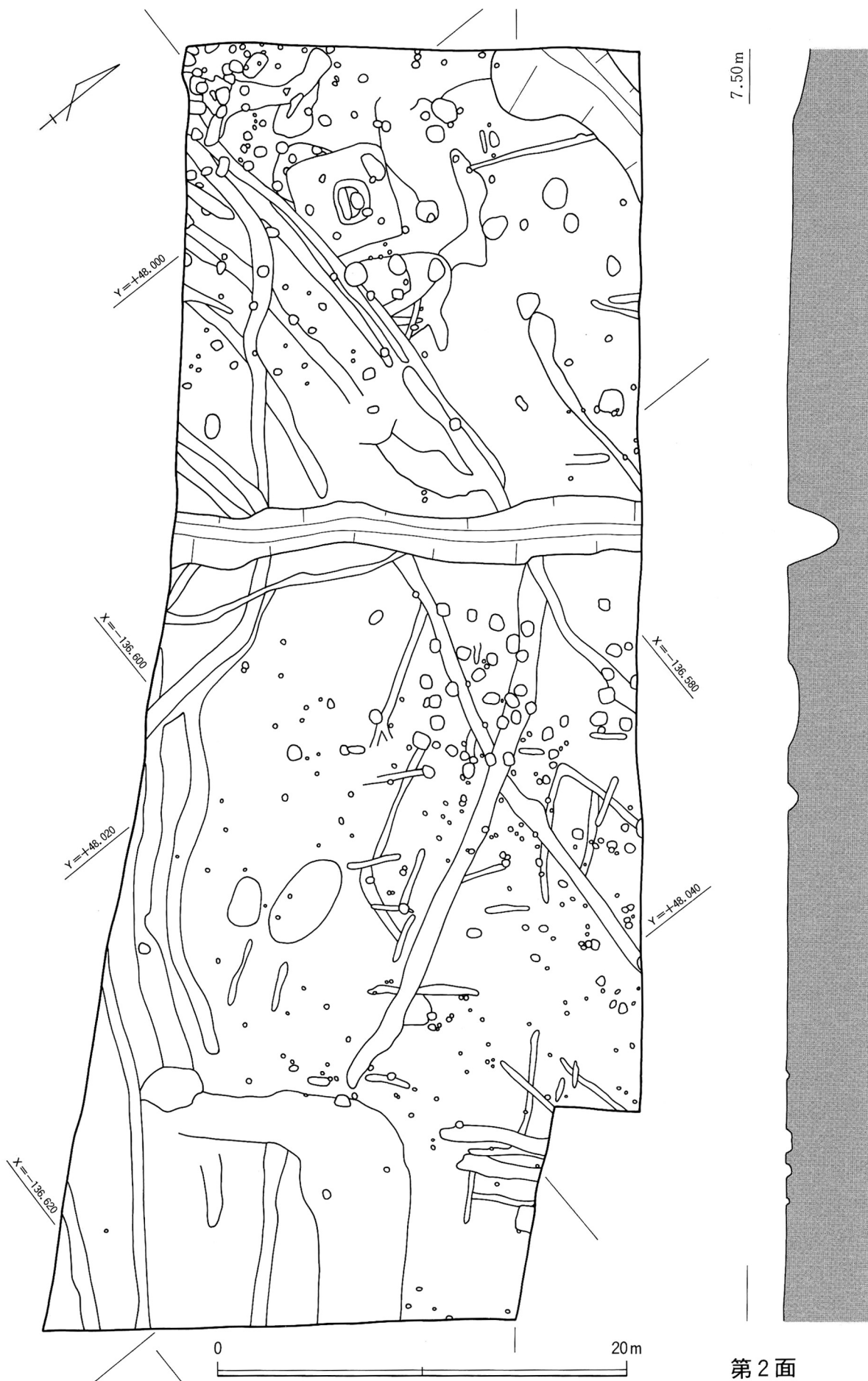

第2面

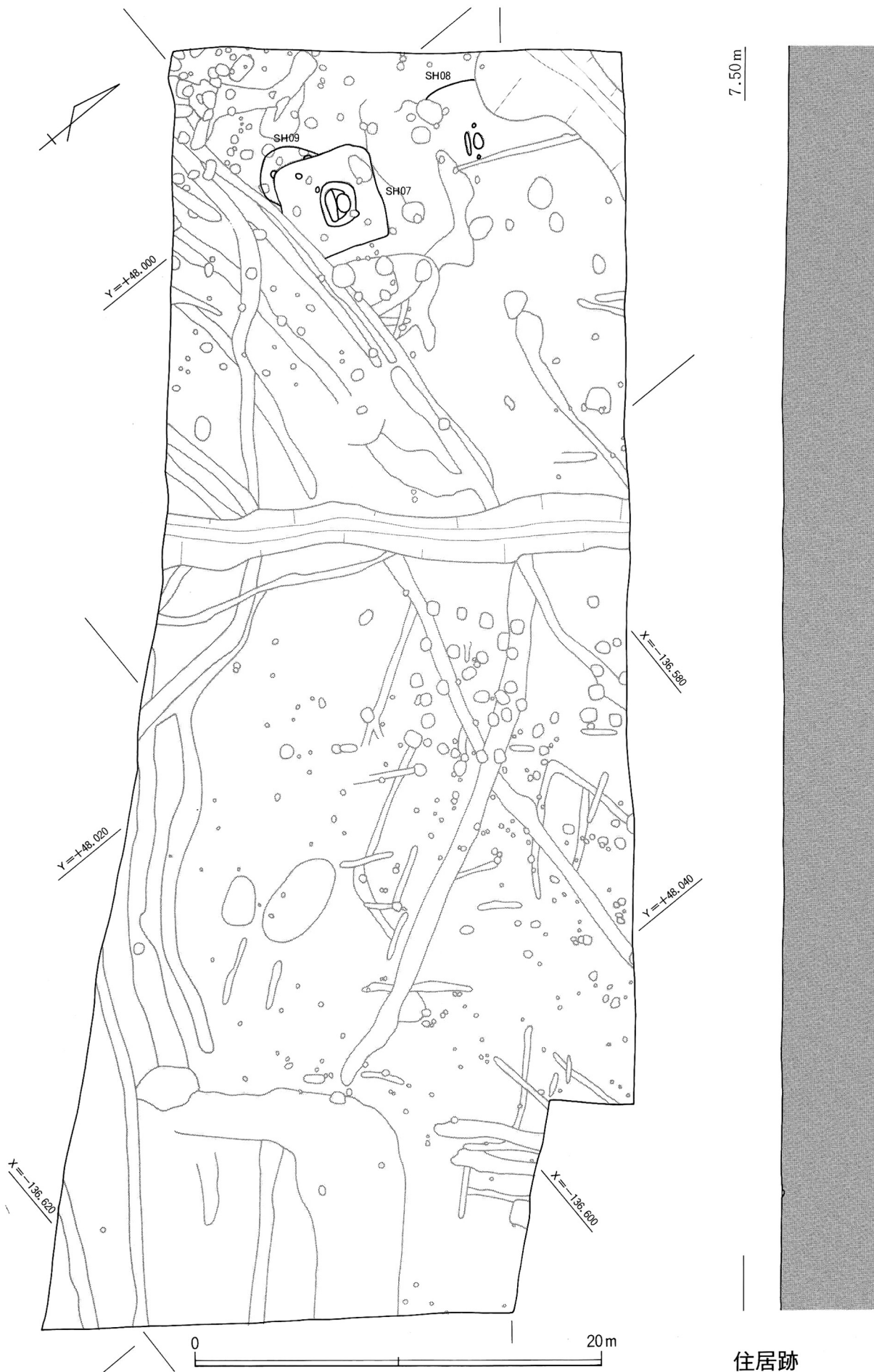

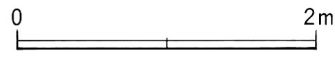
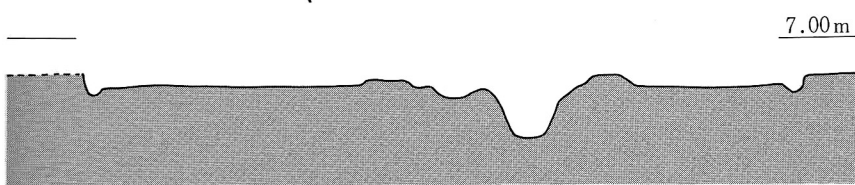
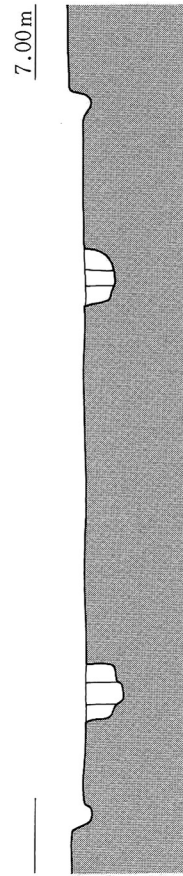
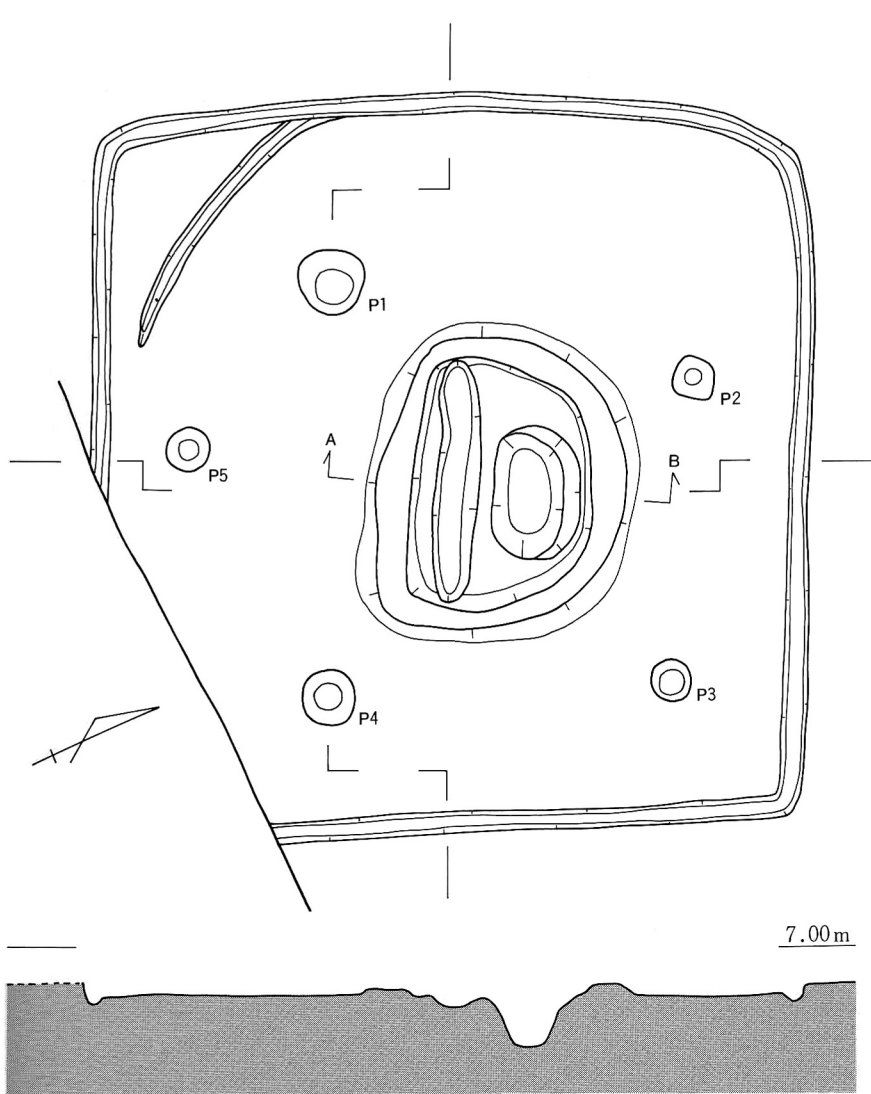

SH07

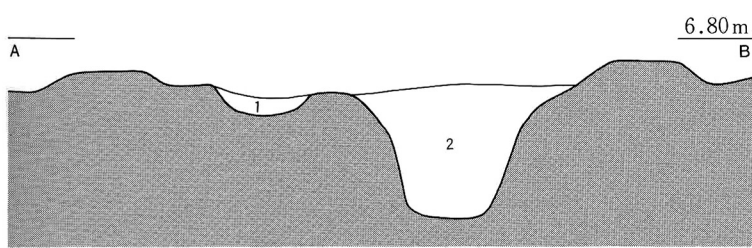

- 1. 7.5YR 2/1 黒 砂質シルト 炭多い 土器含む
- 2. 7.5YR 3/1 黒褐 砂質シルト 炭・土器含む

SH07中央土坑

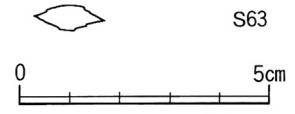
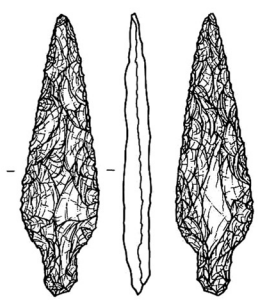
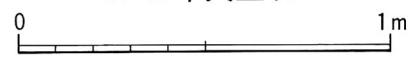

SH07出土石器

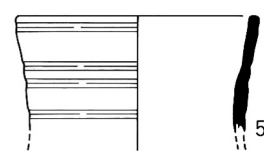

SH07出土土器

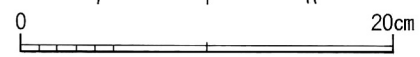

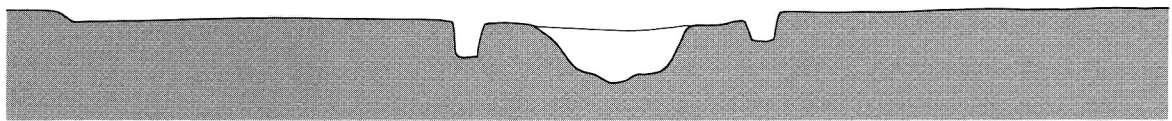
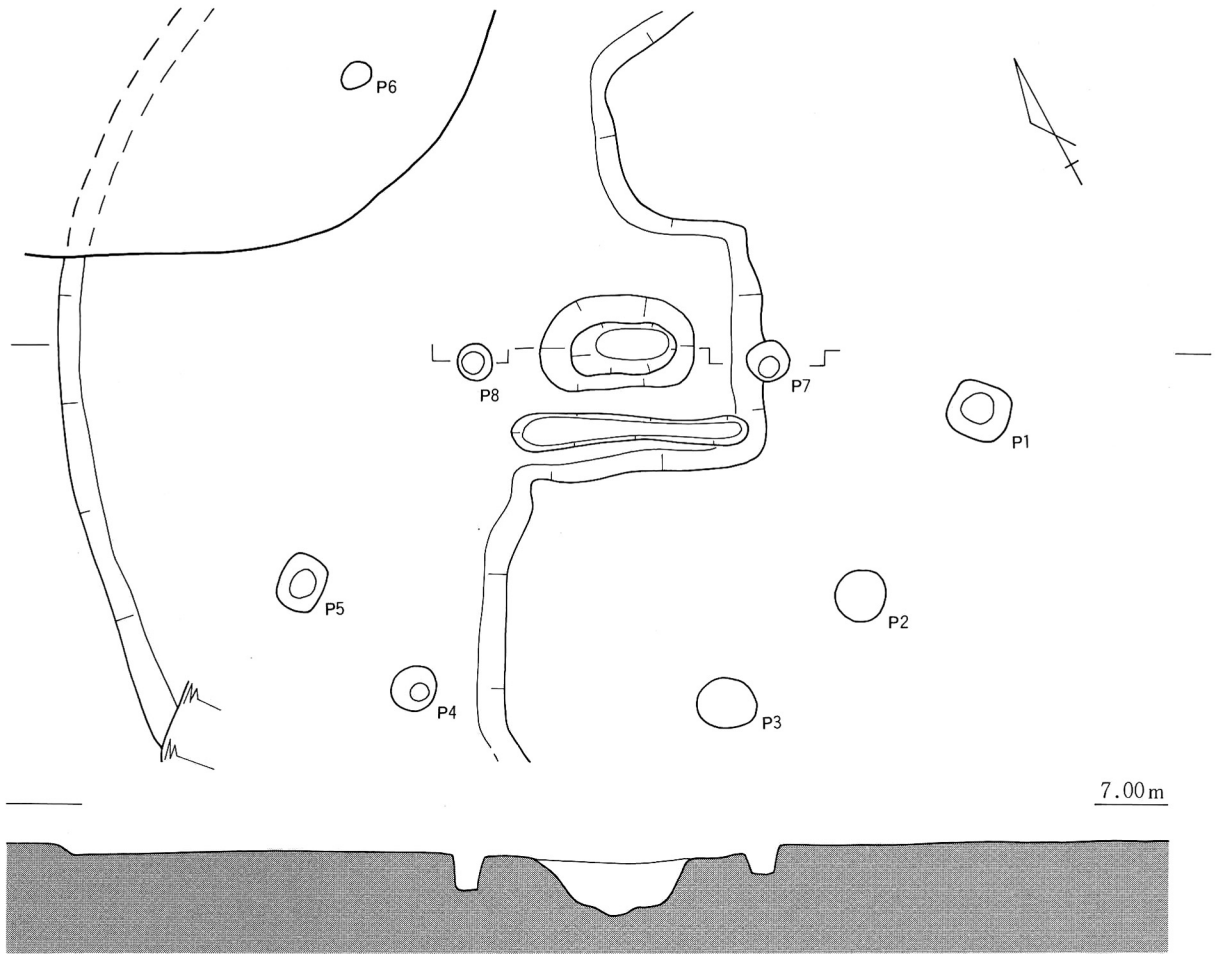

SH08

0 2m

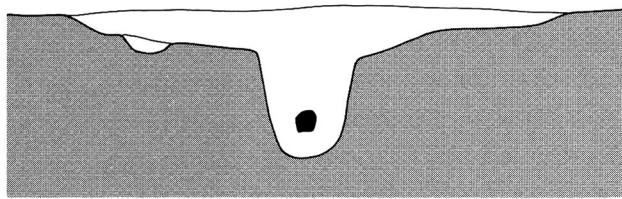
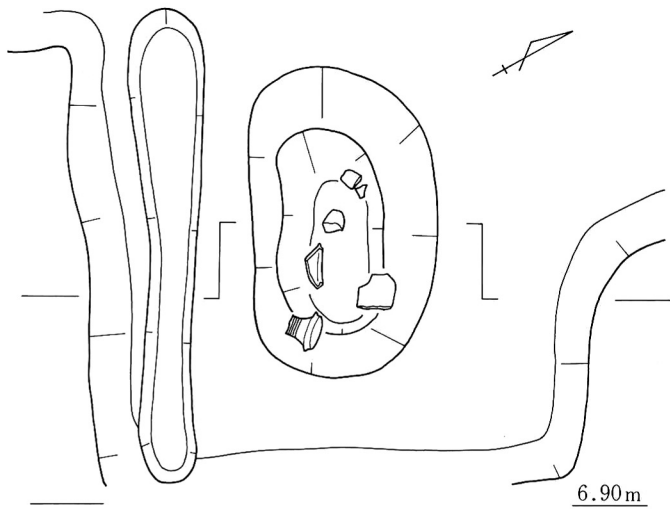

SH08中央土坑

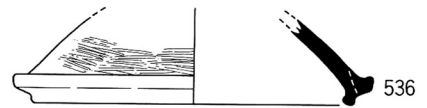
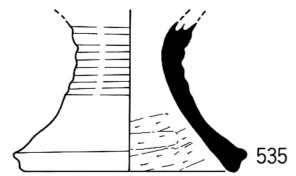

0 20cm

SH08出土土器

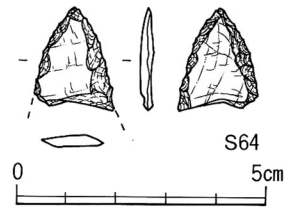

0 5cm

SH08出土石器

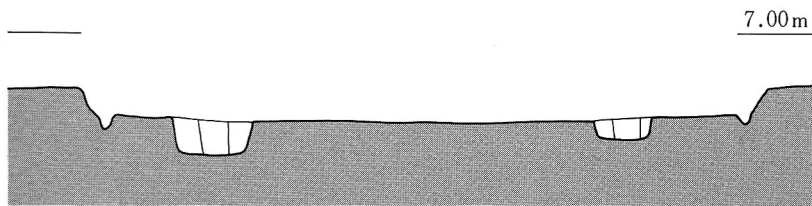
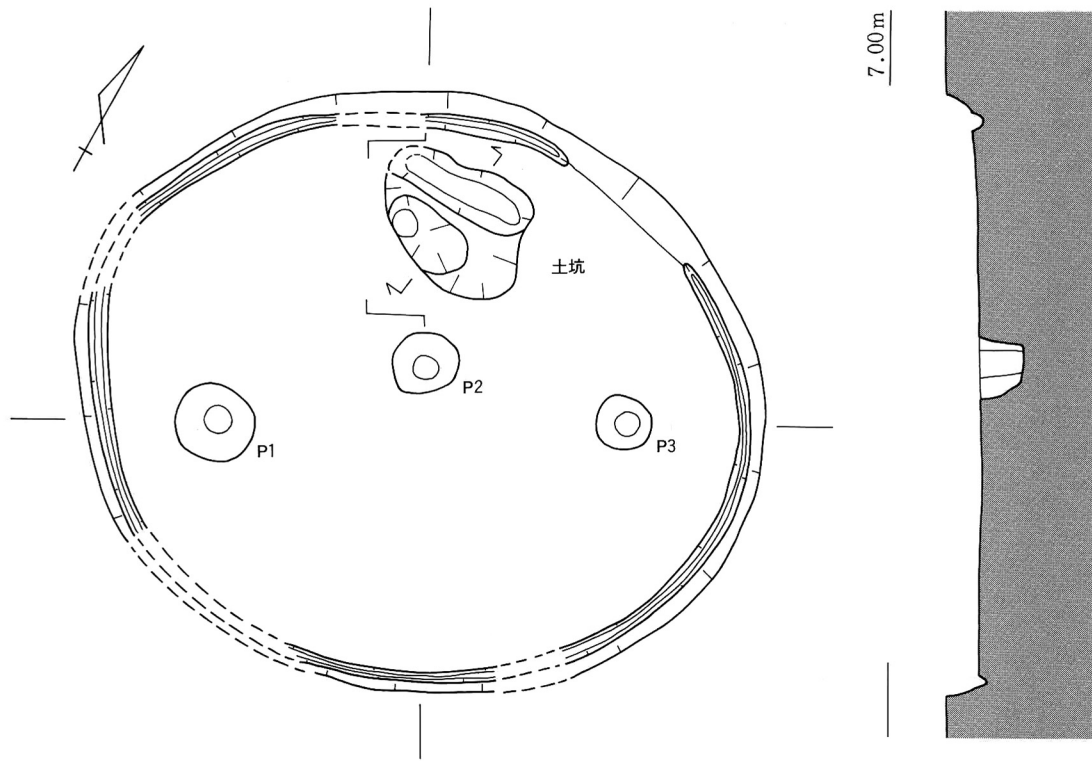

SH09

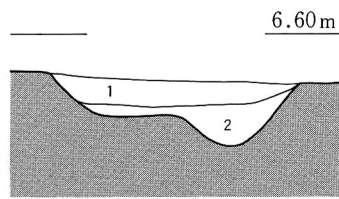
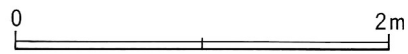

- 1. 灰色 シルト質極細砂 (炭混じり)
- 2. 褐灰色 シルト質極細砂 (炭混じり)

SH09土坑

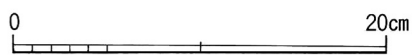
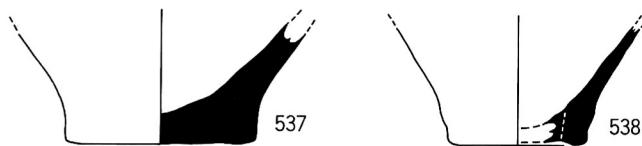
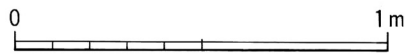

SH09出土土器

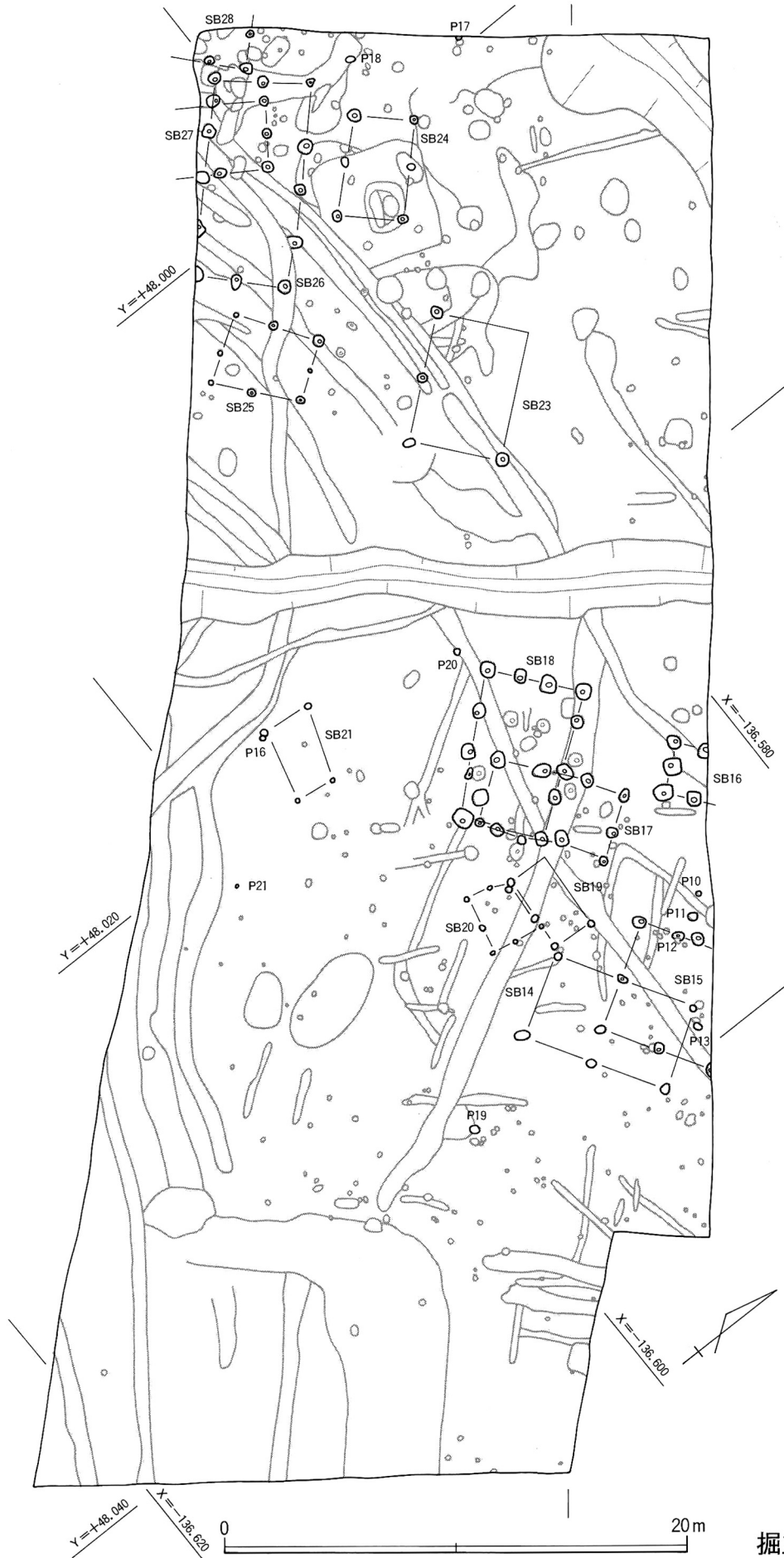

7.50m

掘立柱建物跡

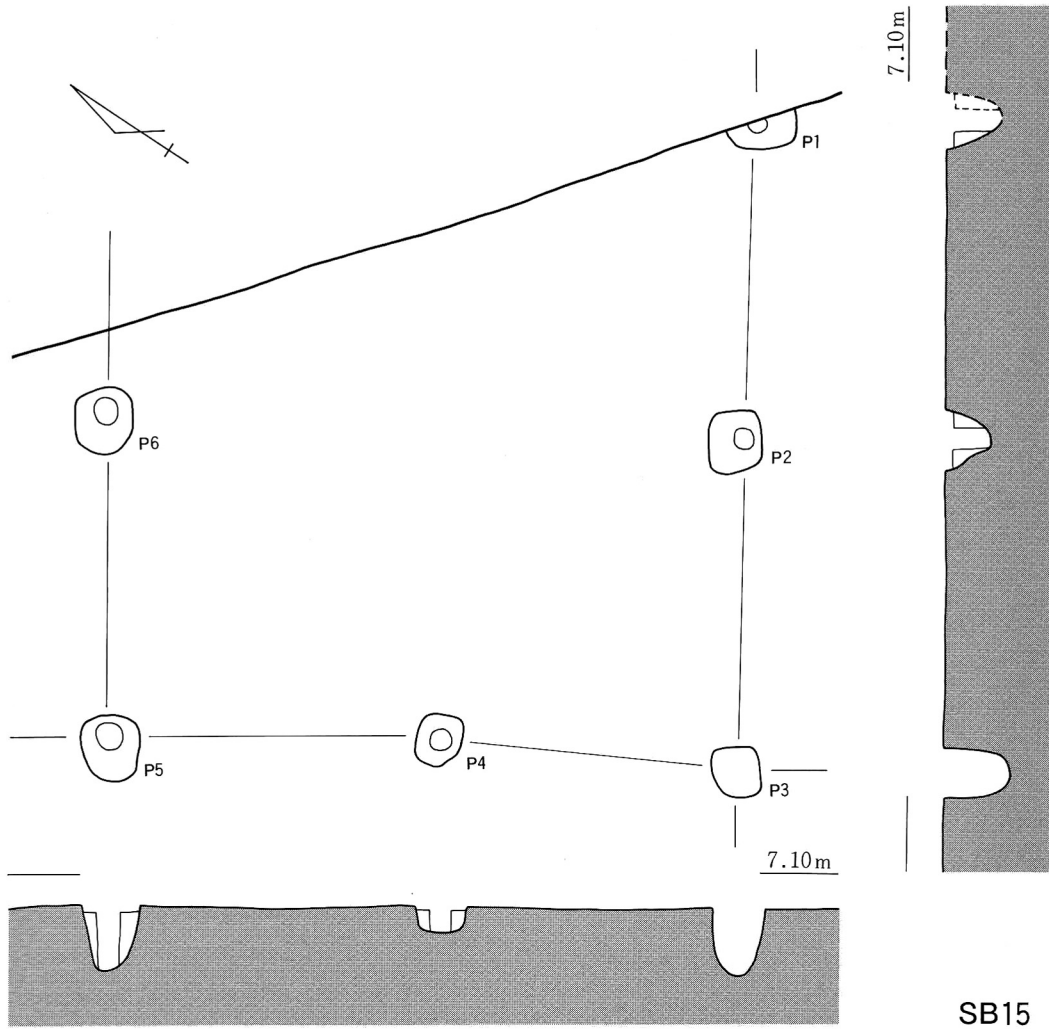

SB15

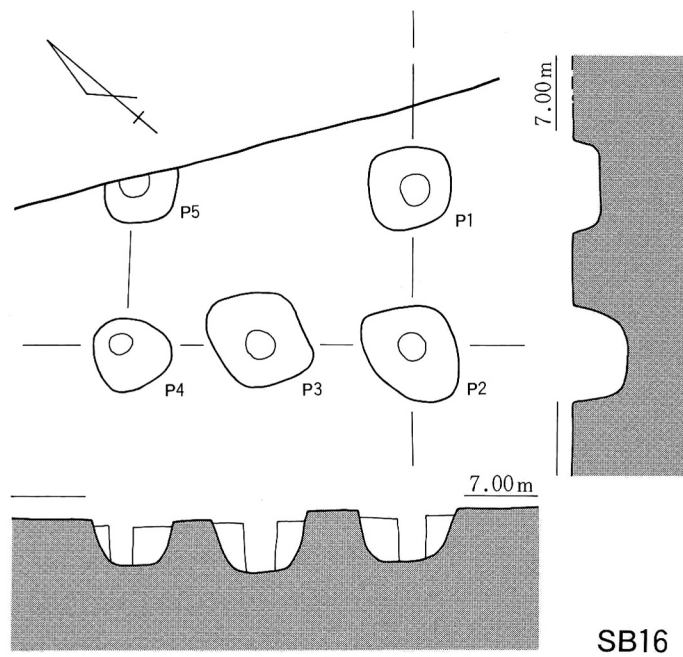

SB16

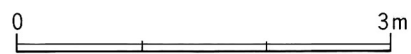

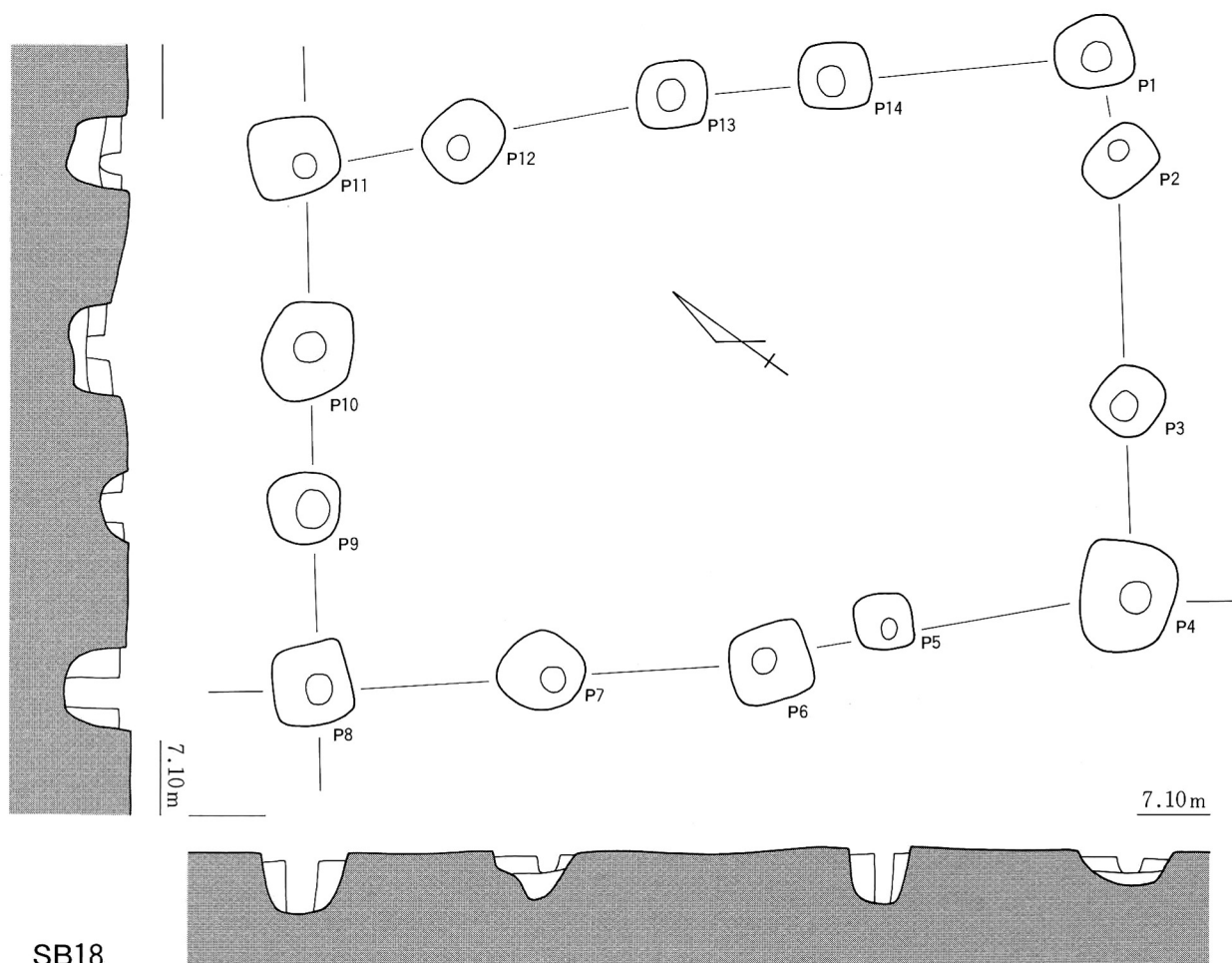
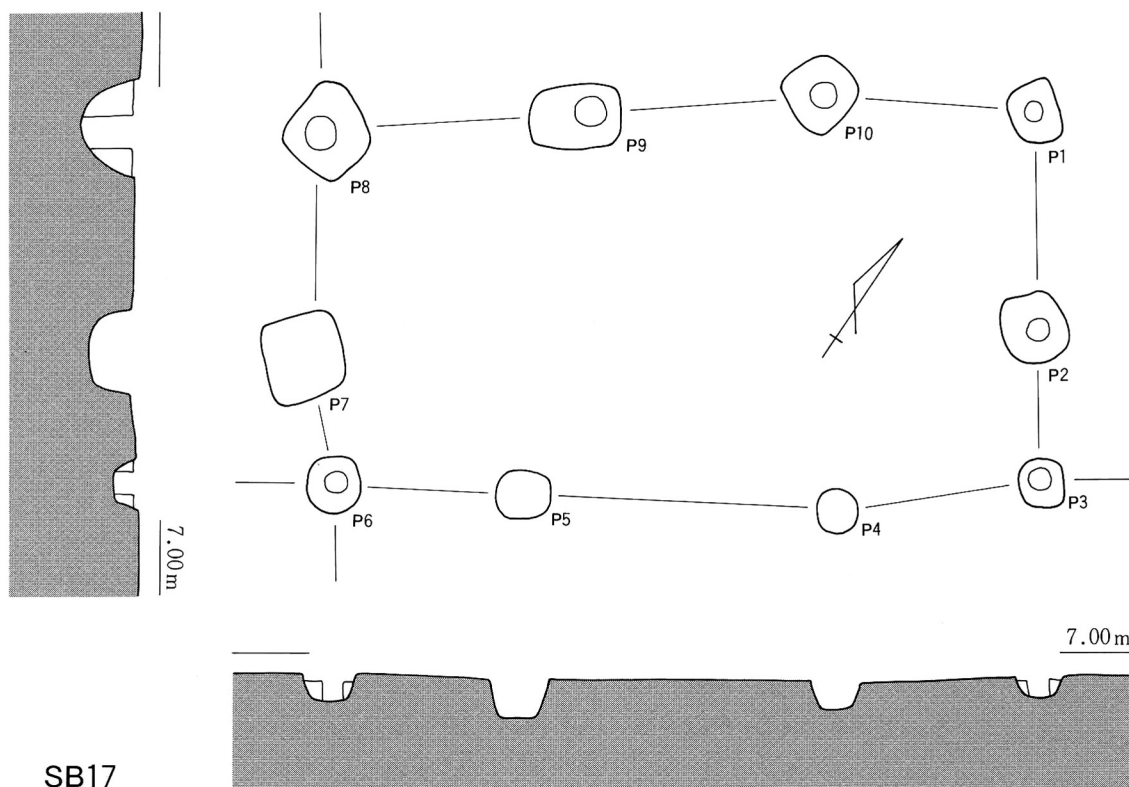

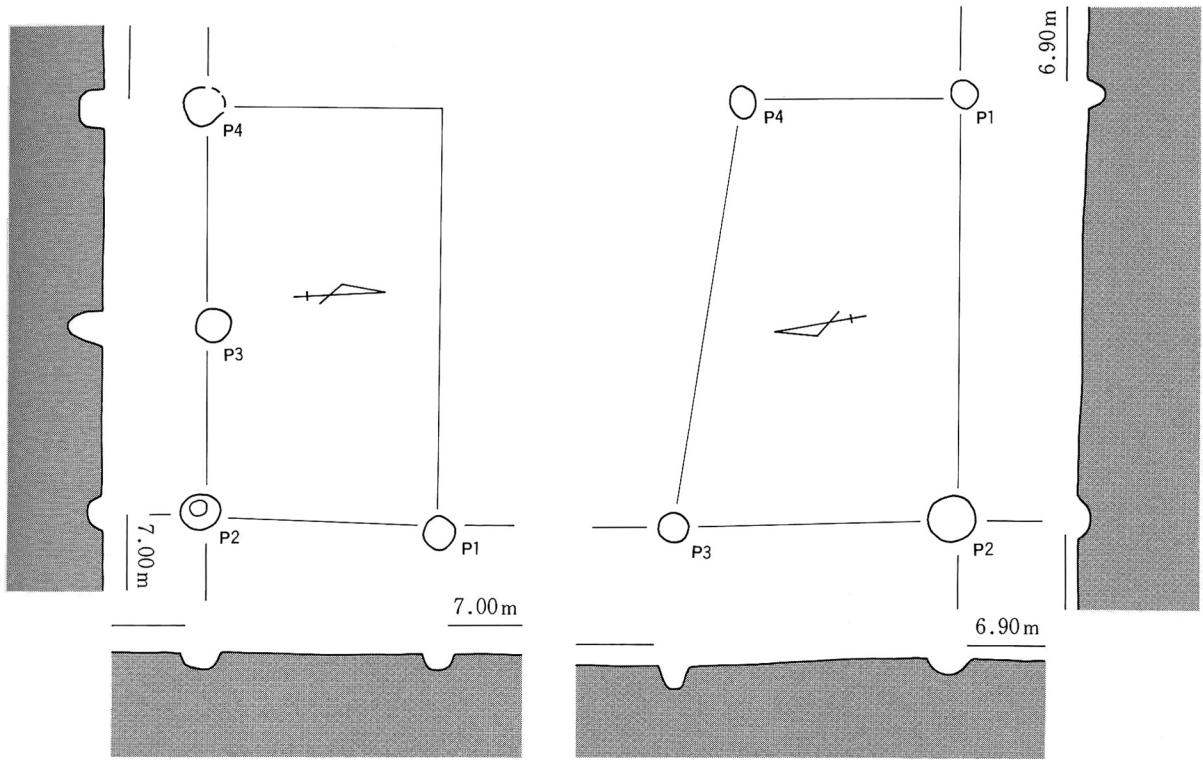

SB19

SB21

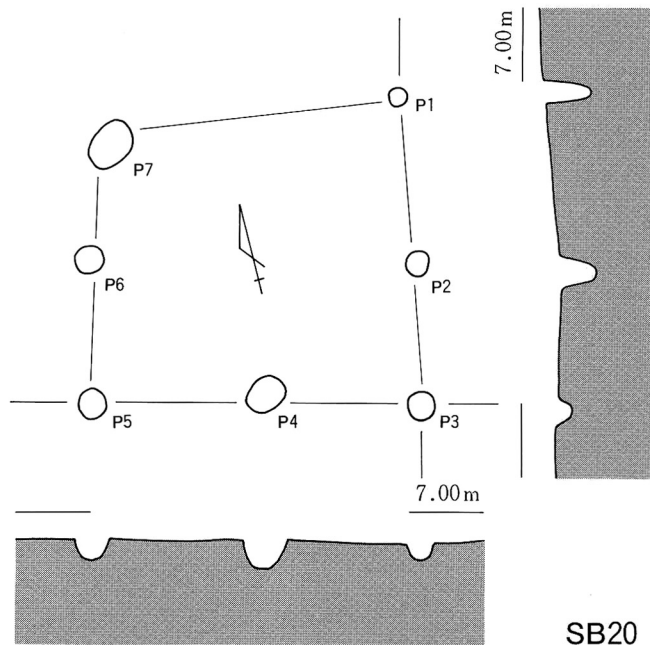

SB20



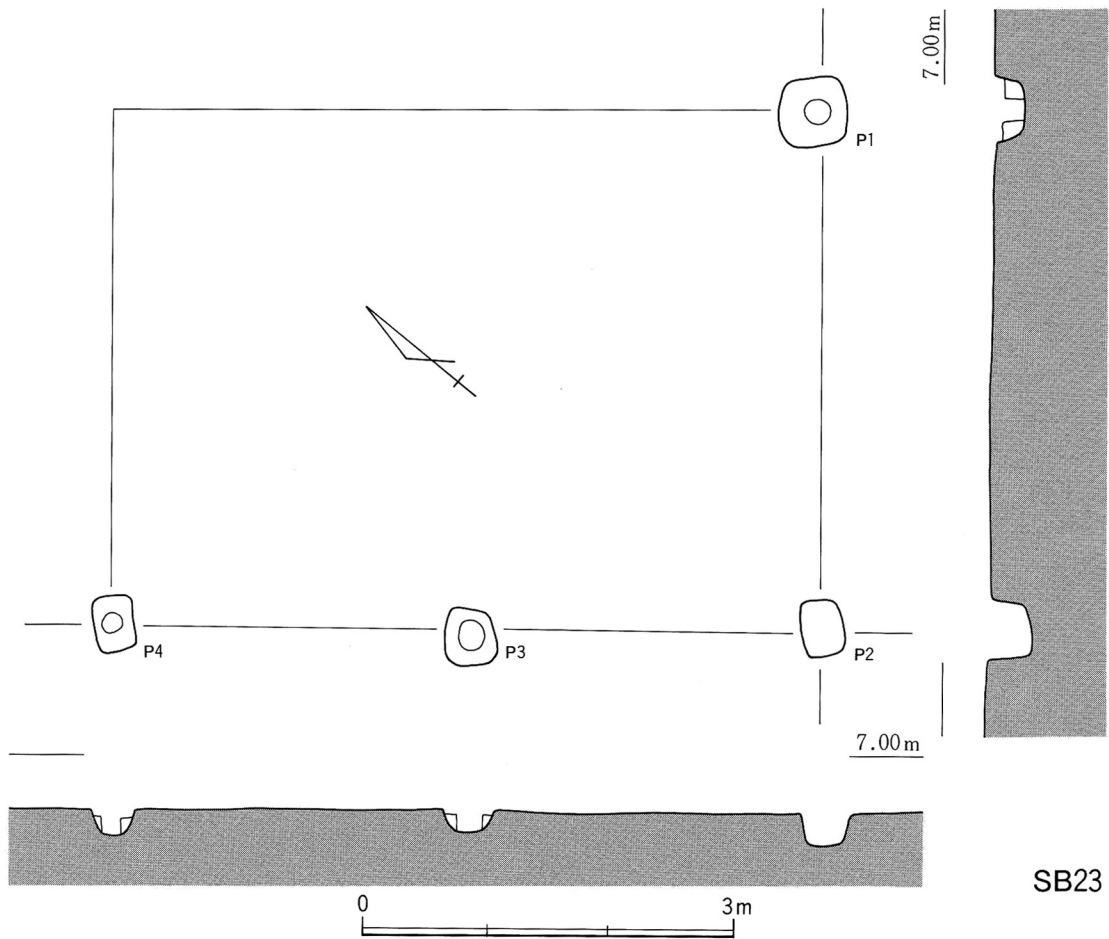
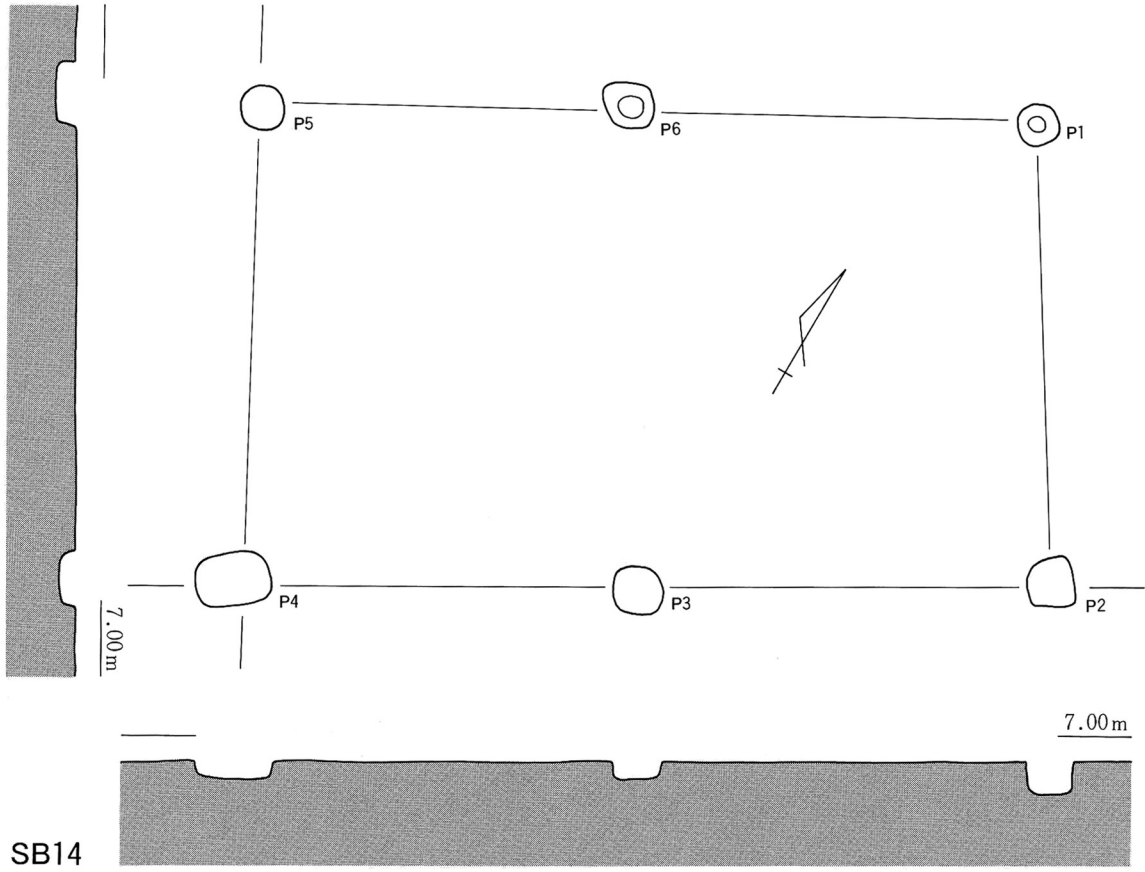

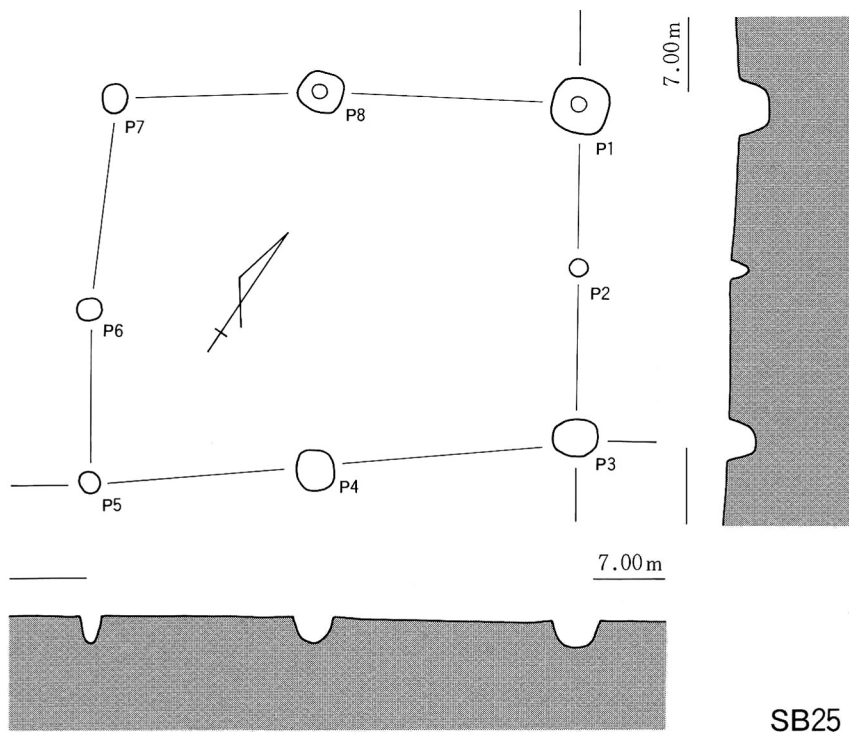
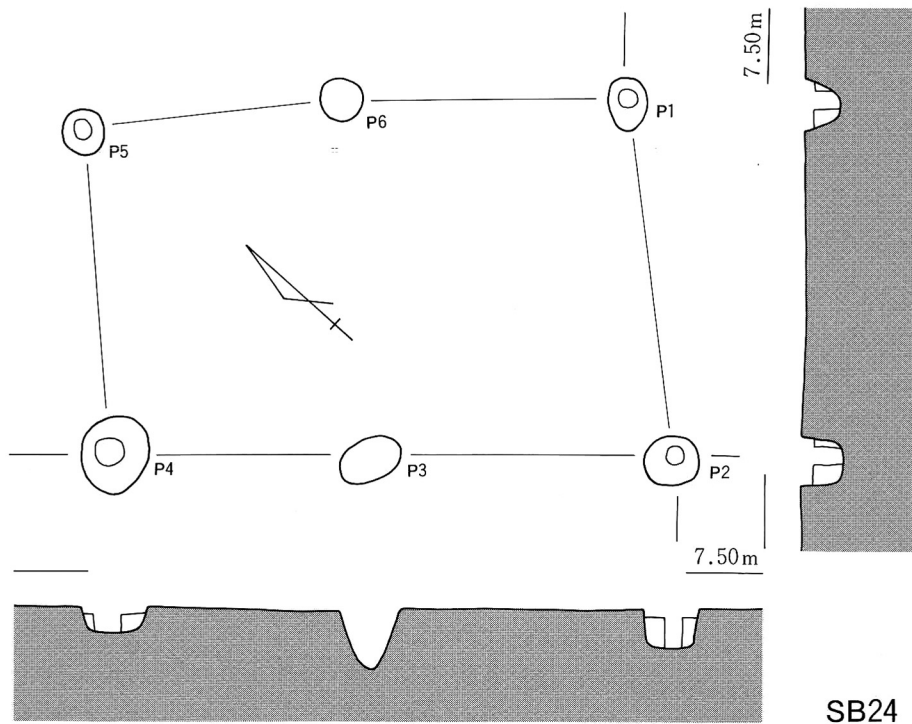

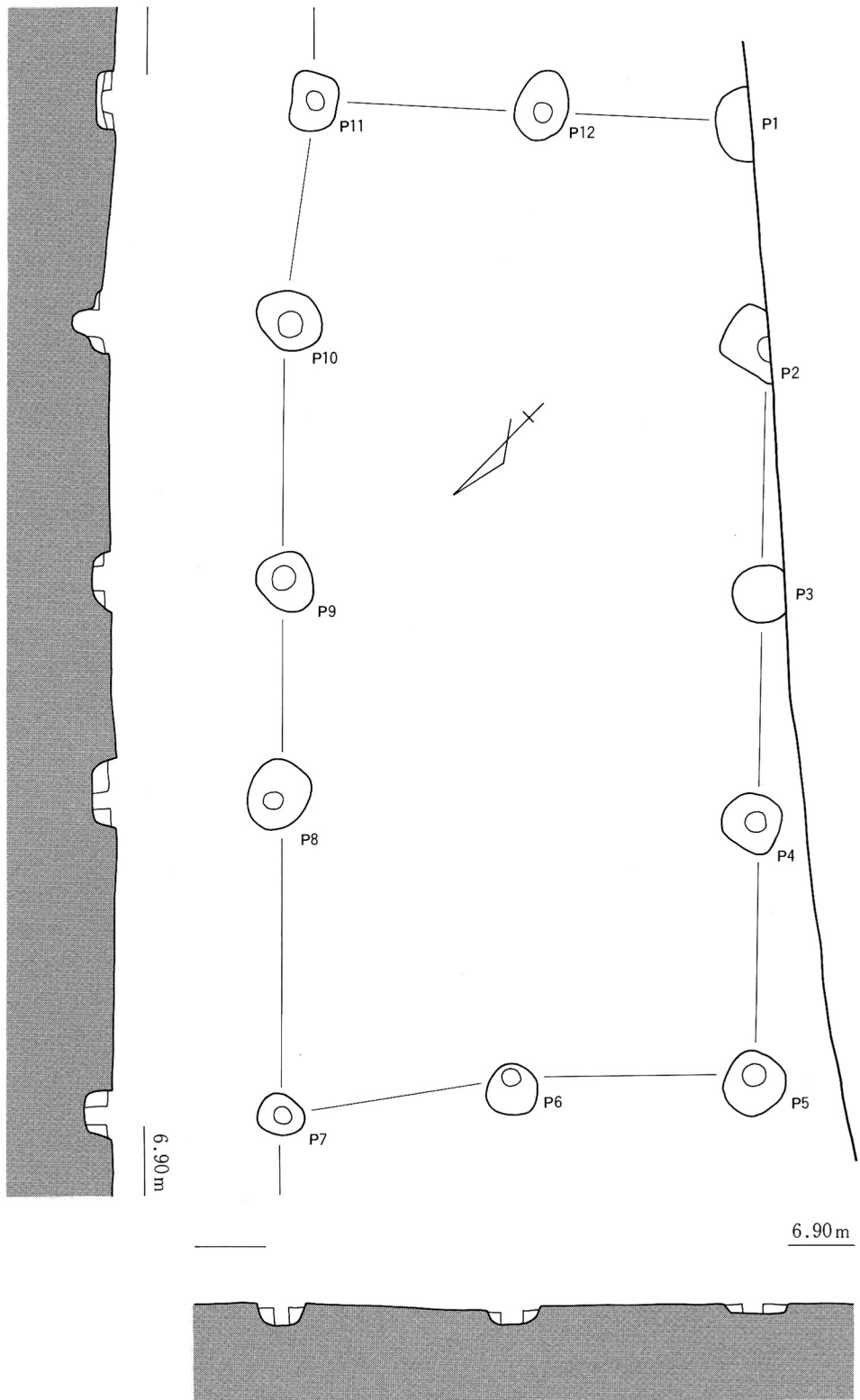

SB26

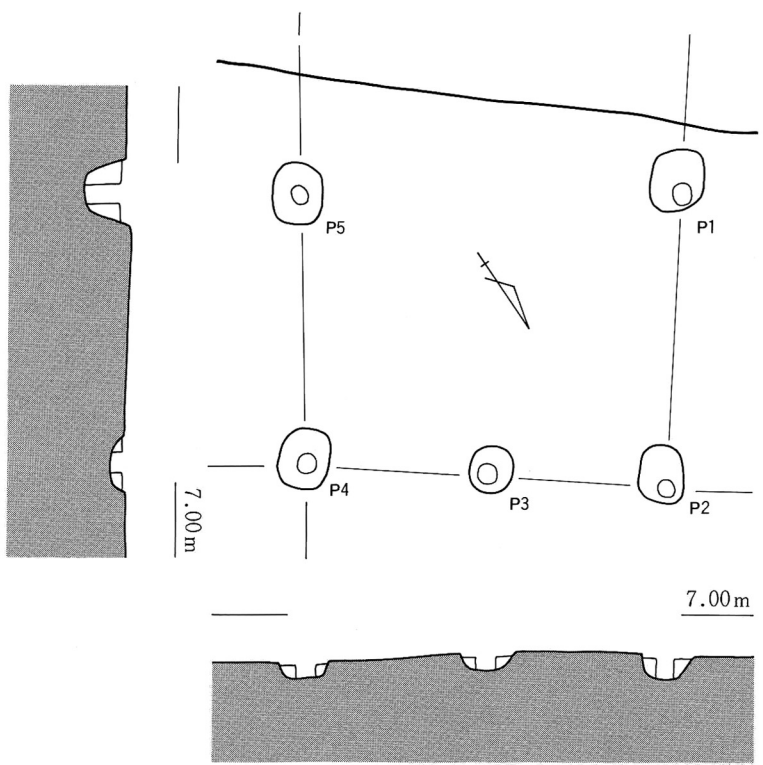

SB27

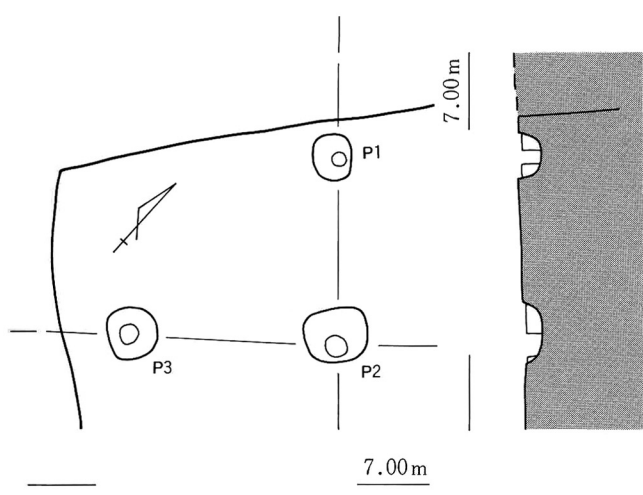

SB28

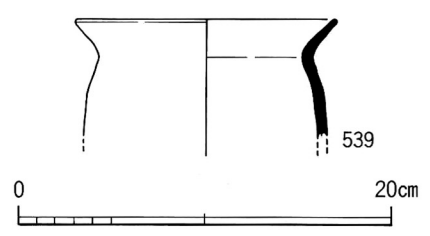
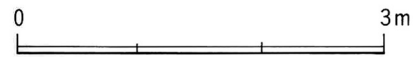

SB28出土土器

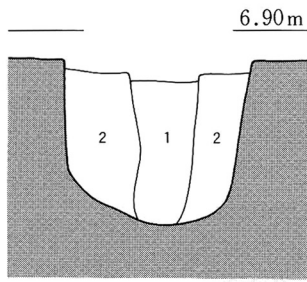

- 1. 暗褐シルト混じり極細砂 (黄灰シルトブロック含む)
- 2. 褐灰シルト混じり極細砂 (黄灰シルトブロック含む)

P5

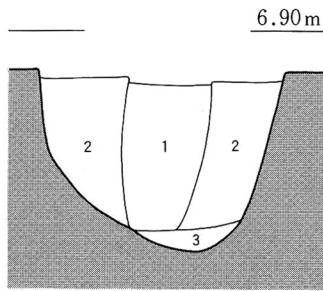

- 1. 褐灰シルト混じり極細砂 (黄灰砂ブロック含む)
- 2. 暗褐灰シルト混じり極細砂
- 3. 褐灰シルト混じり極細砂 (黄灰砂ブロック含む)

P8

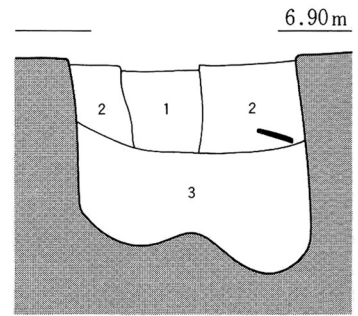

- 1. 褐灰シルト混じり極細砂 (黄灰砂ブロック・炭含む)
- 2. 褐灰シルト混じり極細砂 (炭・土器含む)
- 3. 褐灰シルト混じり極細砂 (黄灰砂ブロック多く含む)

P11

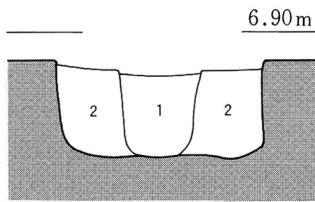

- 1. 淡褐灰シルト混じり極細砂
- 2. 褐灰シルト混じり極細砂

P13

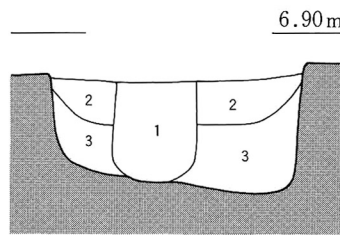

- 1. 暗褐灰シルト混じり極細砂 (炭含む)
- 2. 褐灰シルト混じり極細砂
- 3. 黄灰極細砂

P6

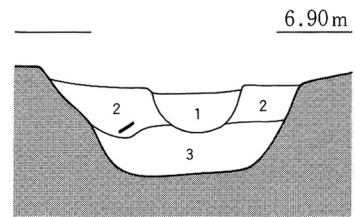

- 1. 褐灰シルト混じり極細砂
- 2. 明褐灰シルト混じり極細砂 (土器含む)
- 3. 黄灰極細砂 (シルトブロック混じる)

P4

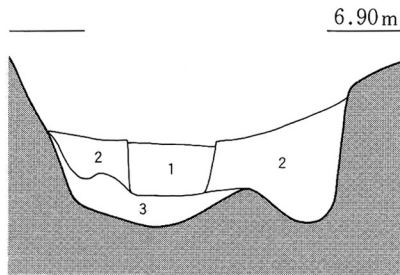

- 1. 黒褐シルト混じり極細砂 (黄灰砂ブロック含む)
- 2. 褐灰シルト混じり極細砂
- 3. 淡褐灰シルト混じり極細砂

P10

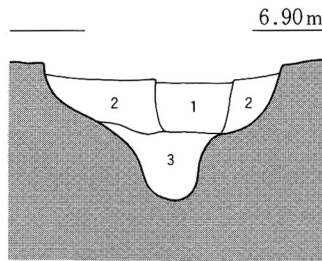

- 1. 褐灰シルト混じり極細砂
- 2. 黄灰シルト混じり極細砂 (土器シルトブロック含む)
- 3. 暗褐シルト質極細砂 (下底にシルトたまる)

P7

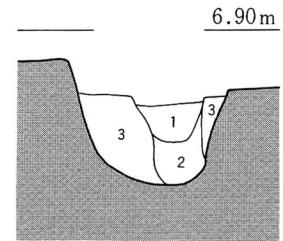

- 1. 明黄褐シルト混じり極細砂
- 2. 褐灰シルト混じり極細砂 (炭・土器含む)
- 3. 黄灰極細砂 (炭含む)

P3



SB18柱穴断面

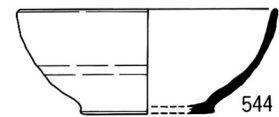
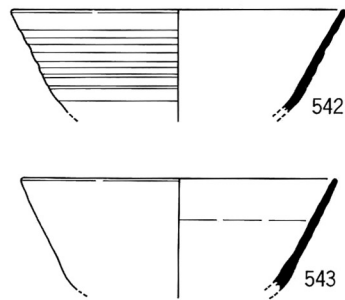
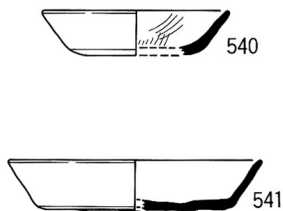

- 540 SB16出土土器
- 541 SB17出土土器
- 542~544 SB18出土土器

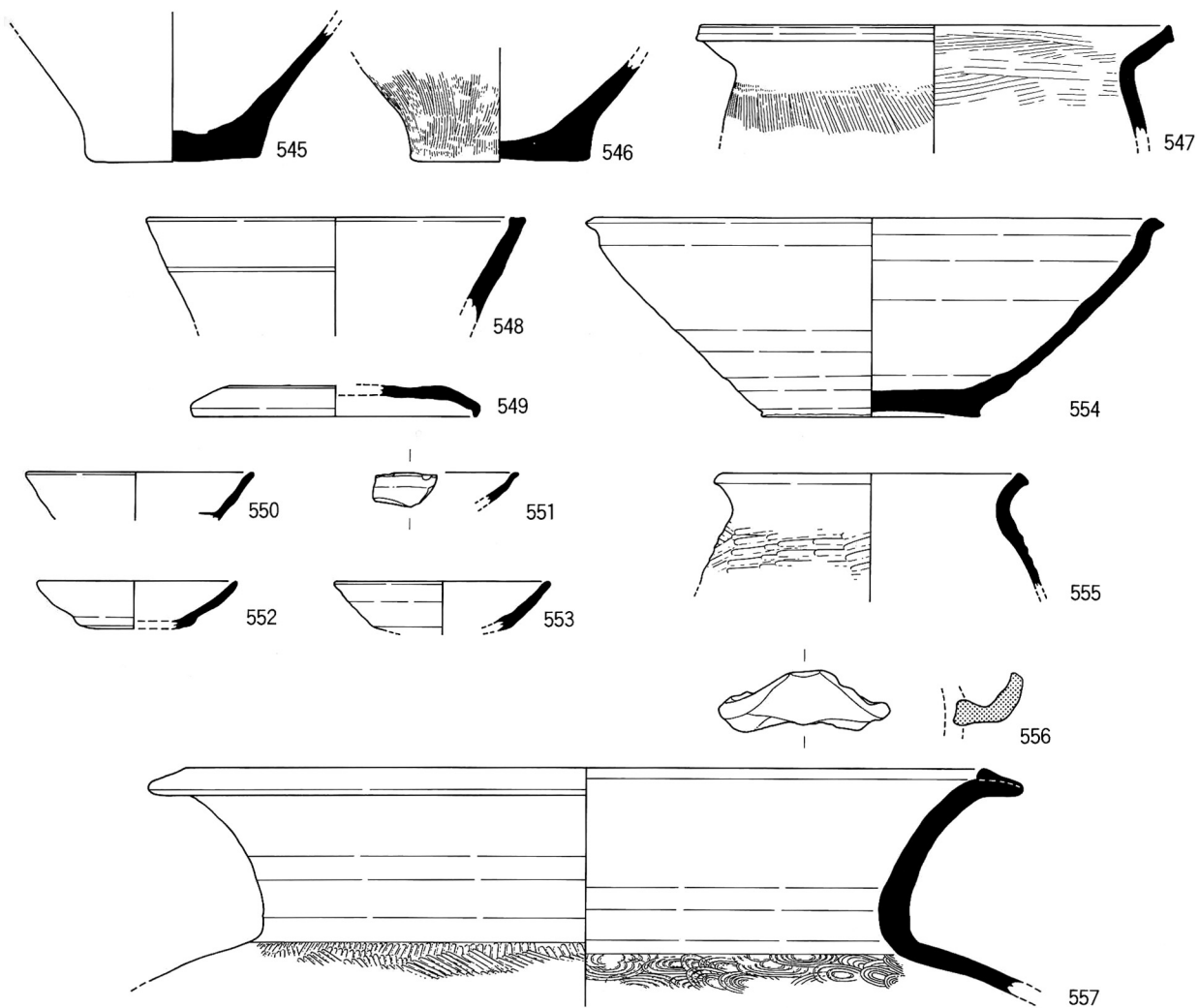

- | | | | | | |
|---------|---------|---------|---------|-----|---------|
| 545·546 | P17出土土器 | 547 | P14出土土器 | 548 | P20出土土器 |
| 549 | P18出土土器 | 550 | P19出土土器 | 551 | P11出土土器 |
| 552 | P15出土土器 | 553·557 | P13出土土器 | 554 | P16出土土器 |
| 555 | P21出土土器 | 556 | P12出土土器 | | |

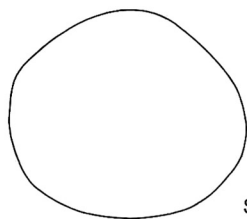
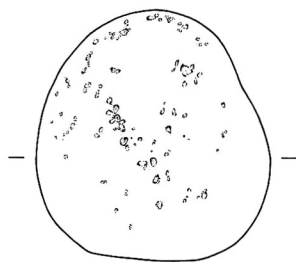

S65



P17出土石器

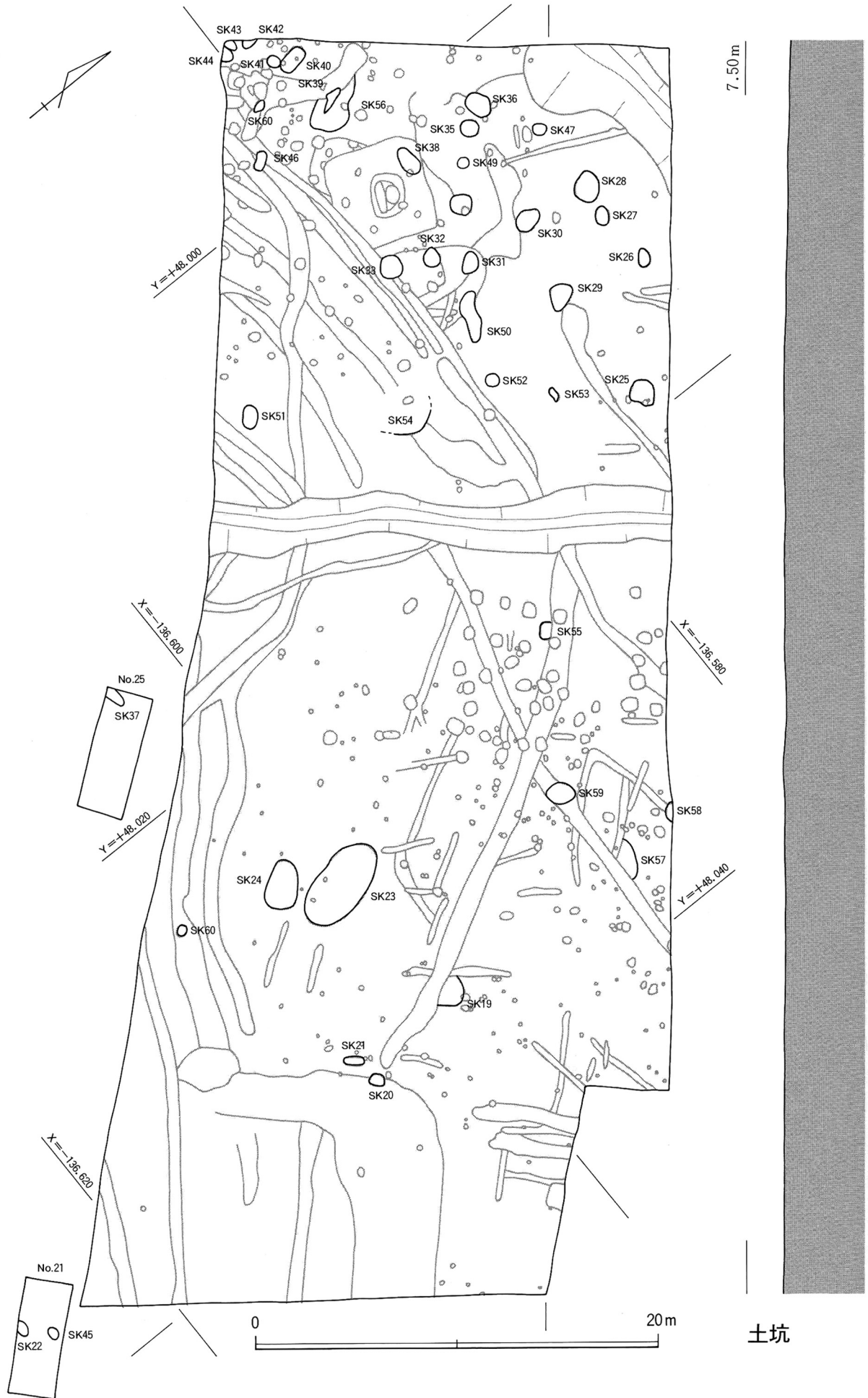

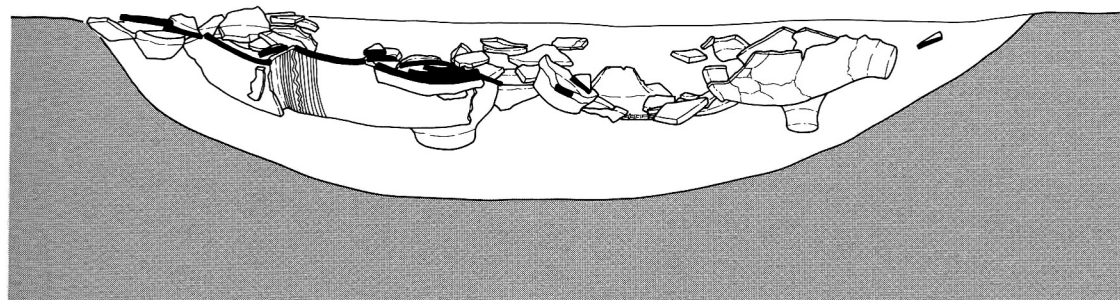
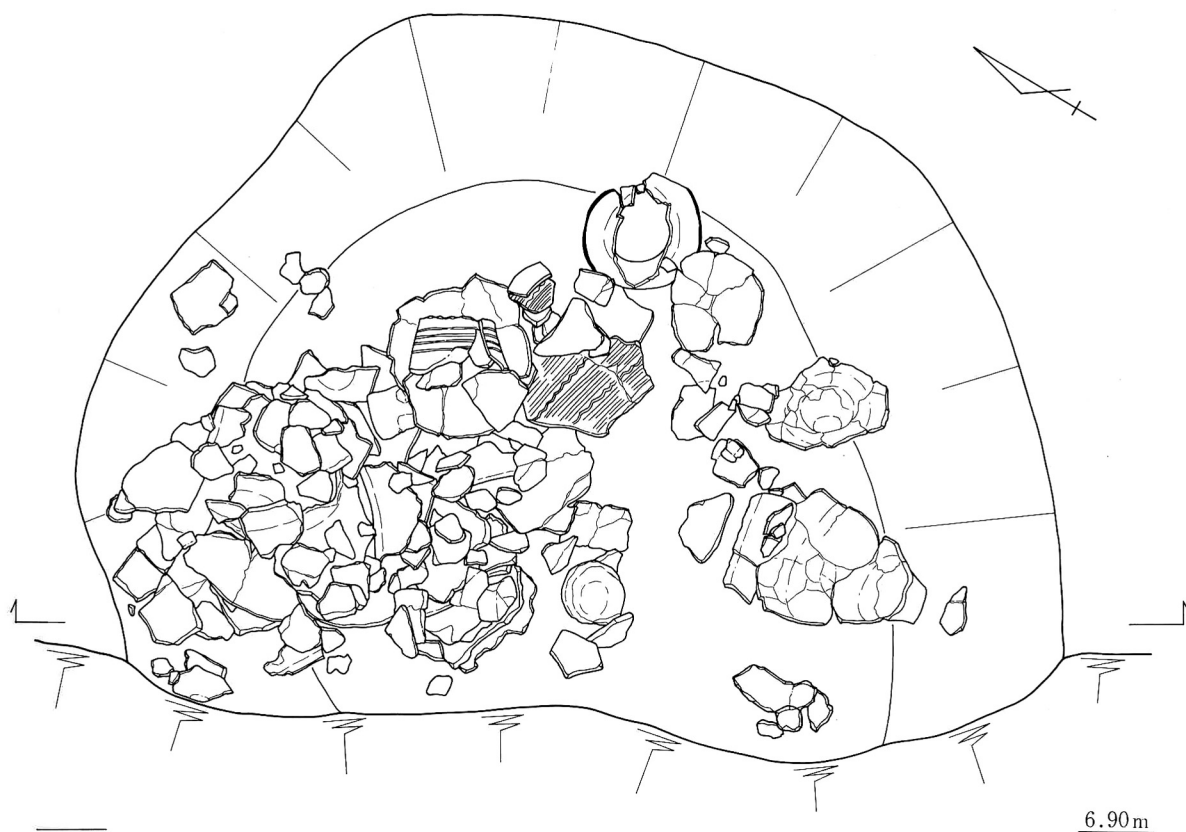

SK19

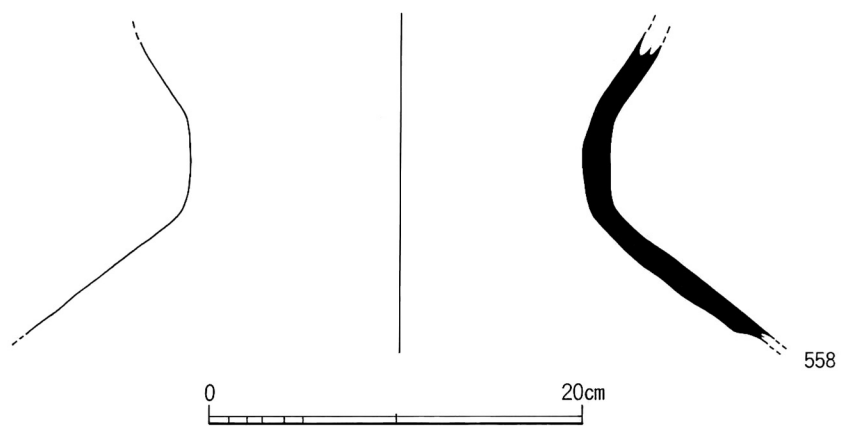

SK19出土土器 (1)

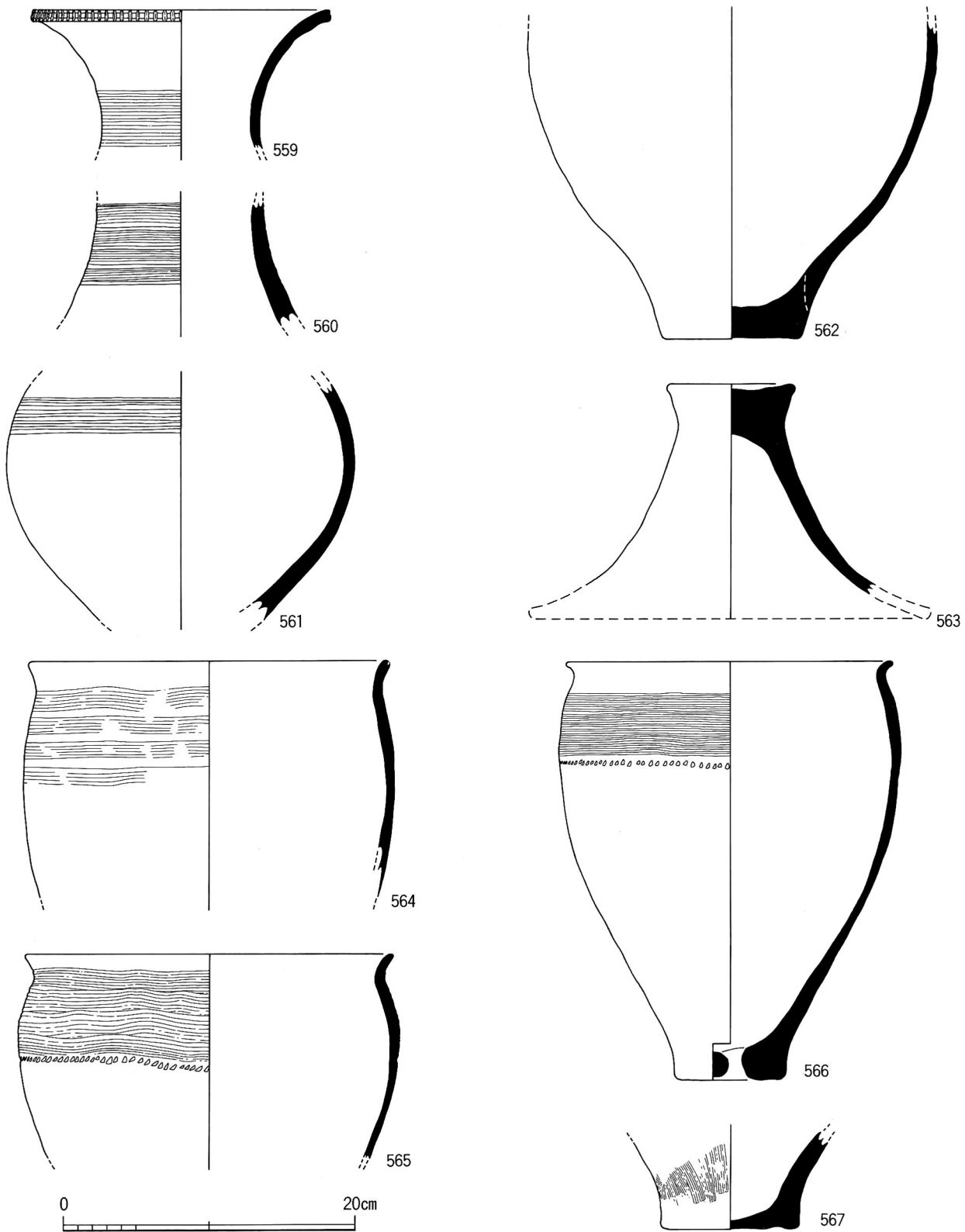

SK19出土土器 (2)

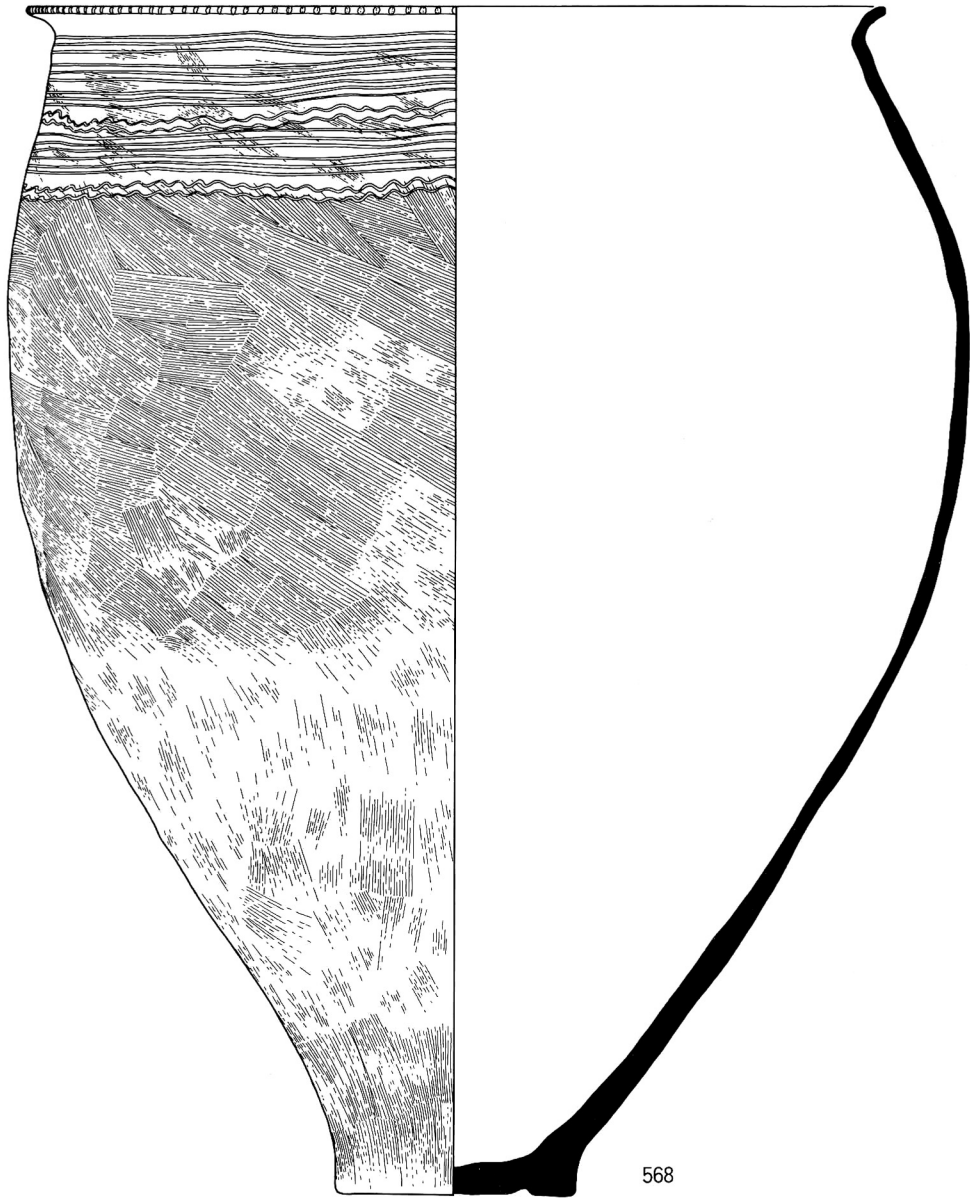

568

SK19出土土器 (3)

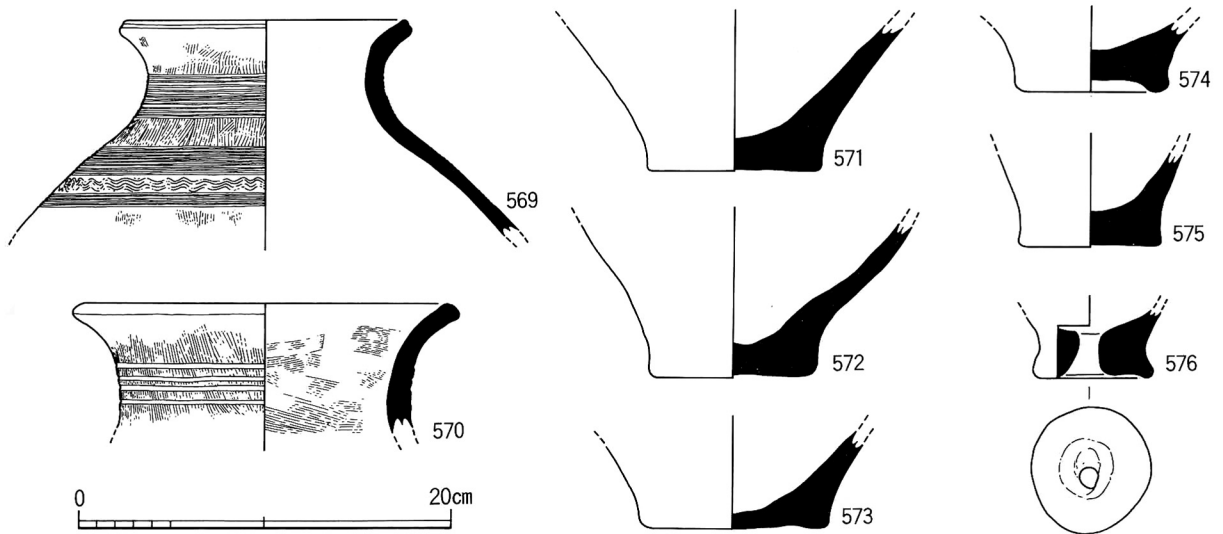

SK22出土土器

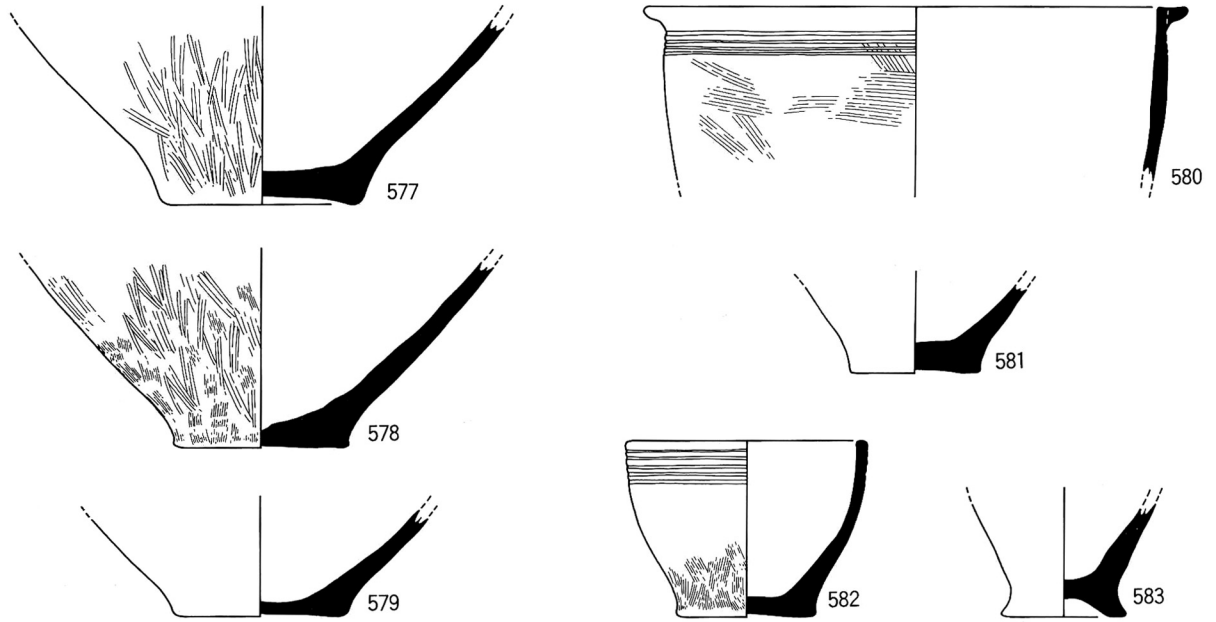

SK23出土土器

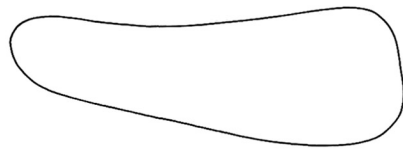
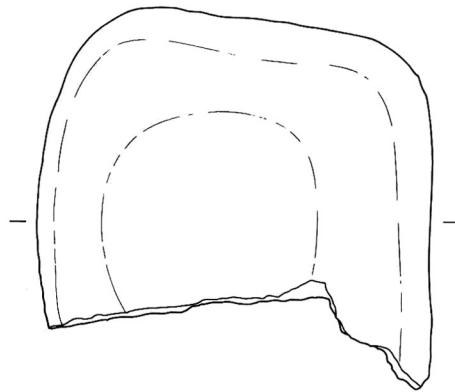

SK23出土石器

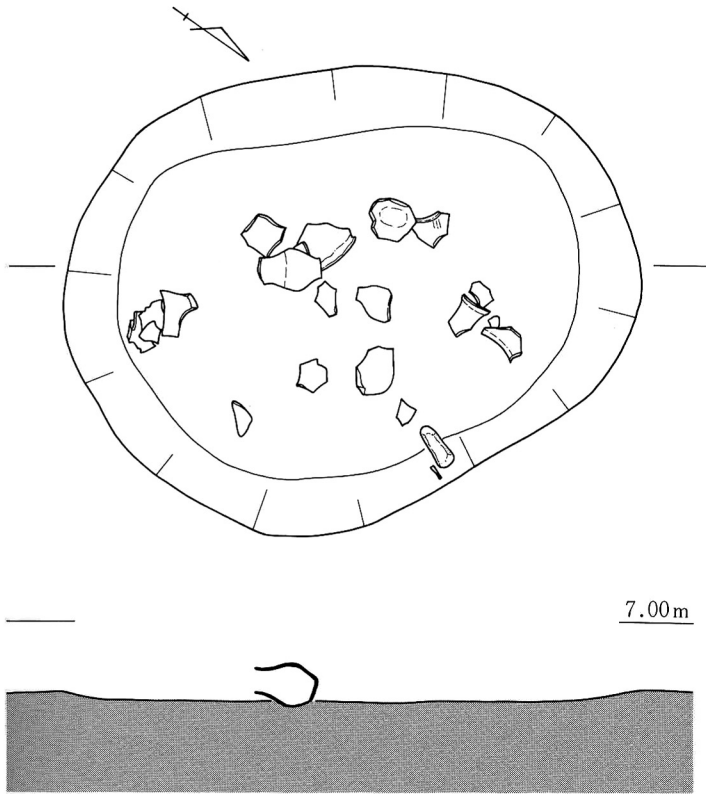

SK28

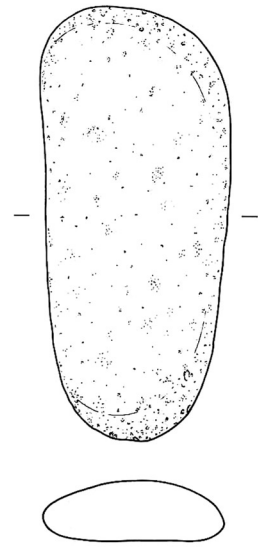

S67



SK28出土石器

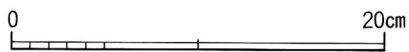
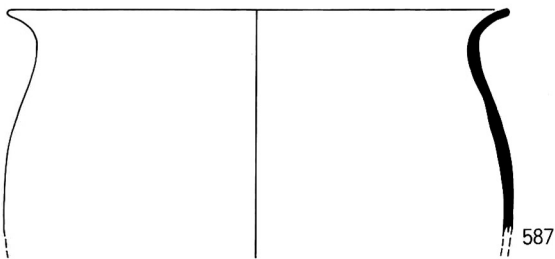
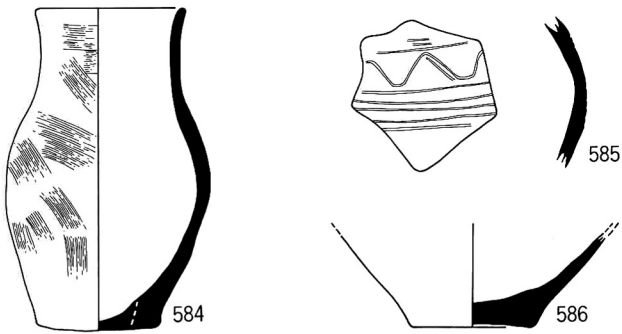

SK28出土土器

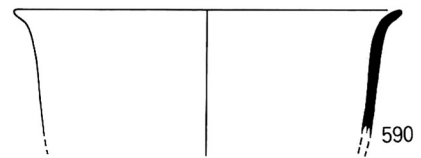
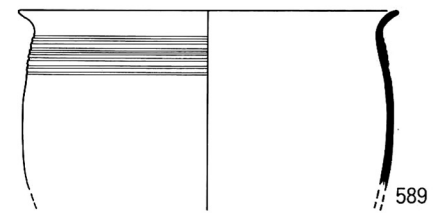
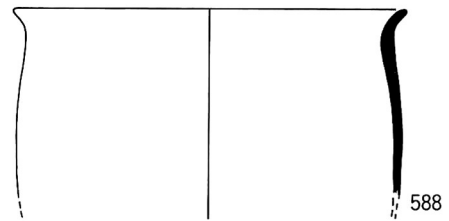

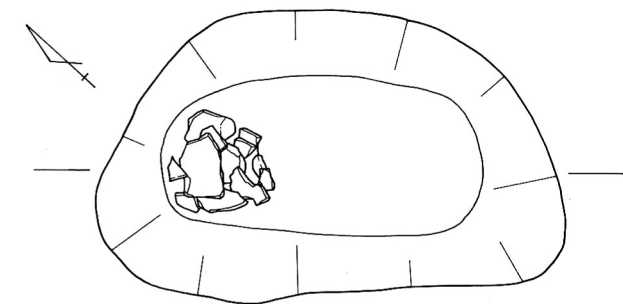

6.80m

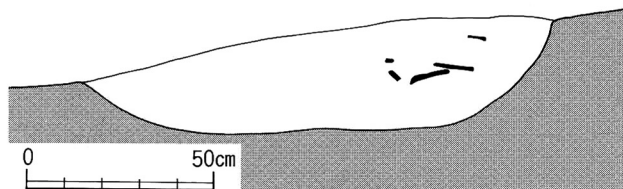

0 50cm

SK31

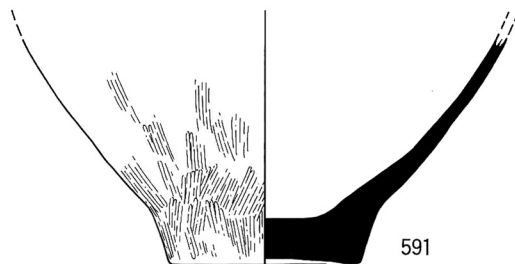

591

0 20cm

SK31出土土器

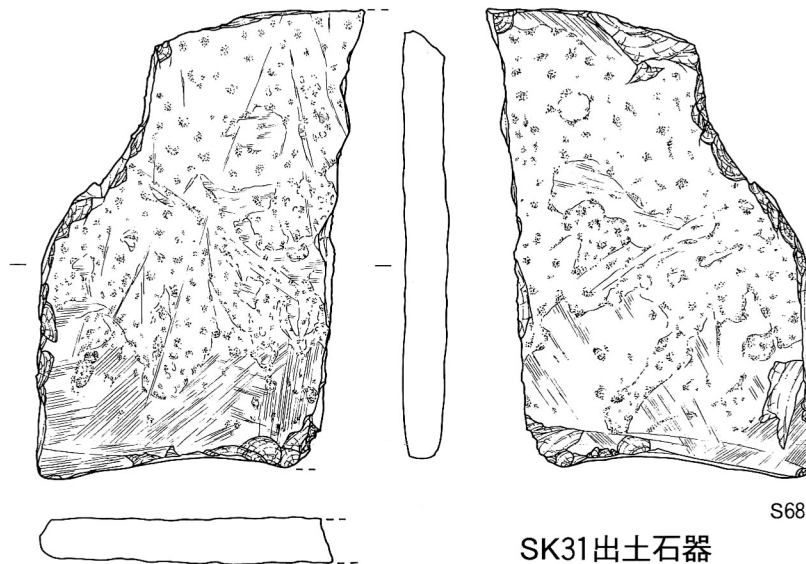

S68

SK31出土石器

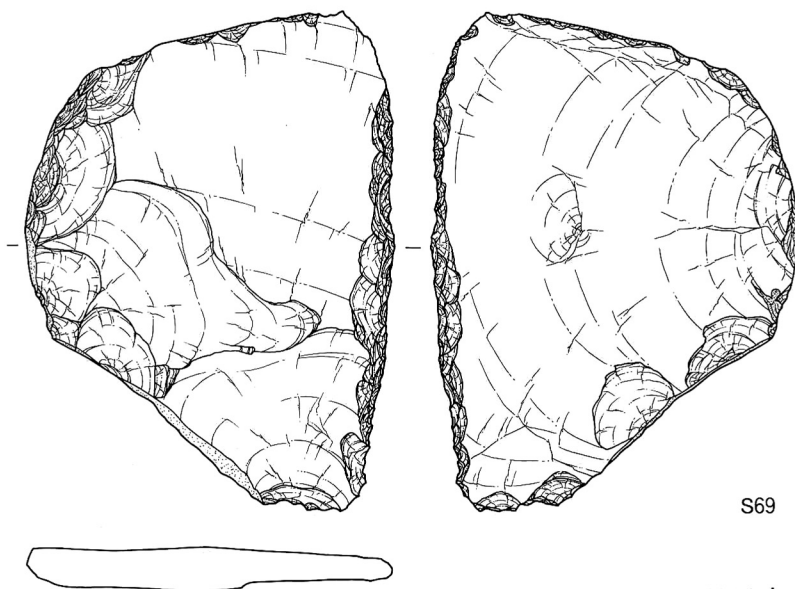

S69

SK32出土石器

0 10cm

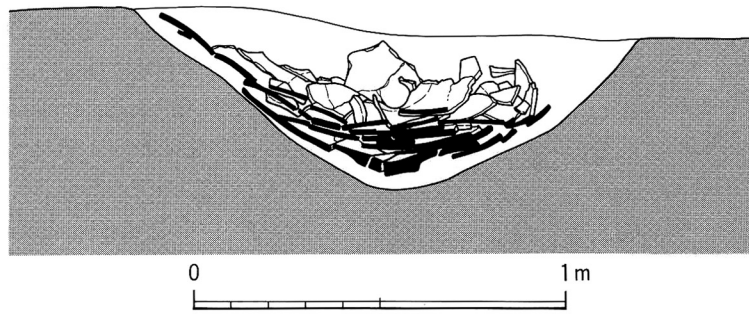
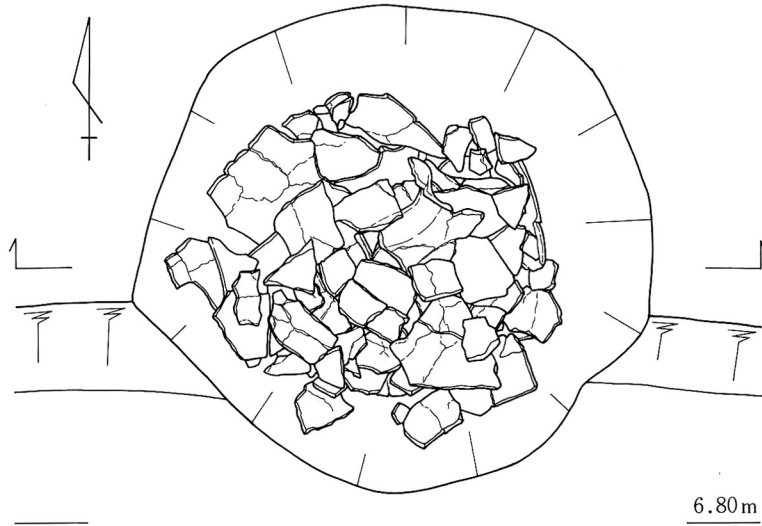

上面

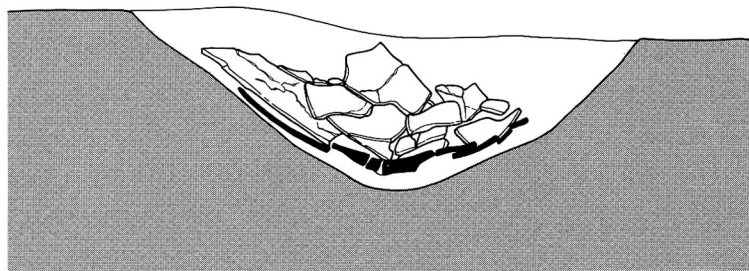
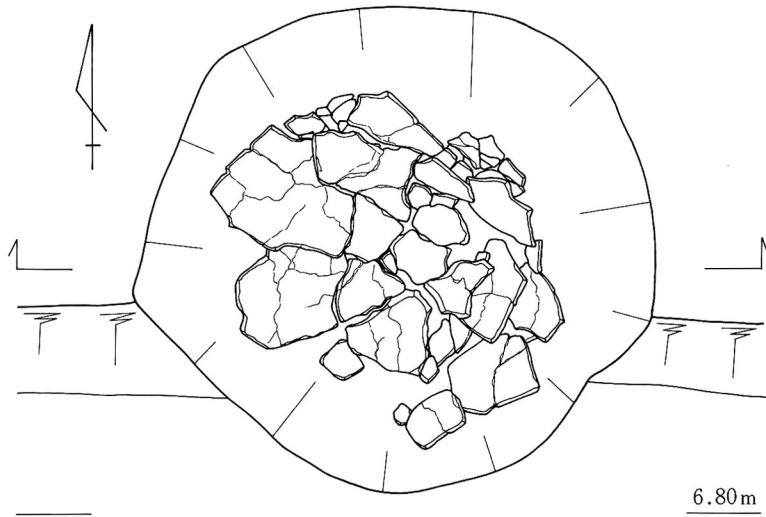

下面



SK33

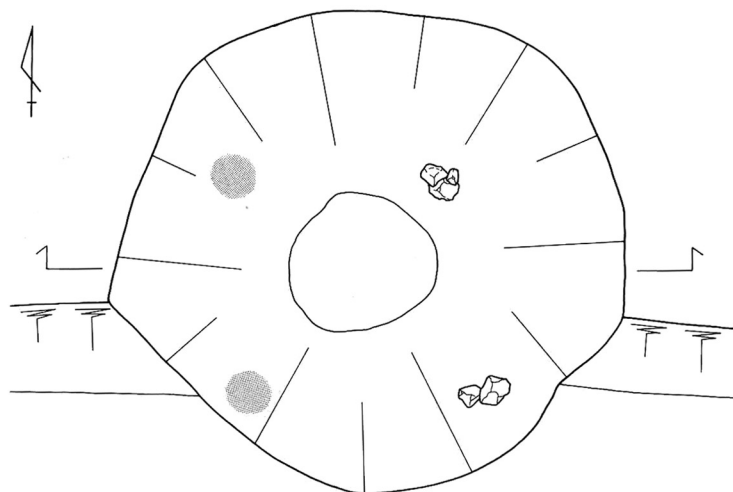

土器取り上げ後

6.80m

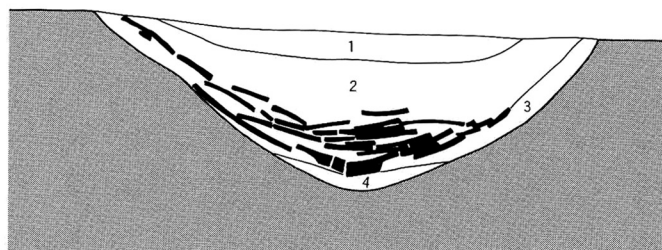

1. 暗灰色シルト質極細砂 (炭含む)
2. 黄灰褐色極細砂混じりシルト (炭含む)
3. 黒灰色シルト質極細砂 (炭含む)
黄白色粒混じる
4. 暗灰色シルト質極細砂 (炭含む)

0 1m

SK33

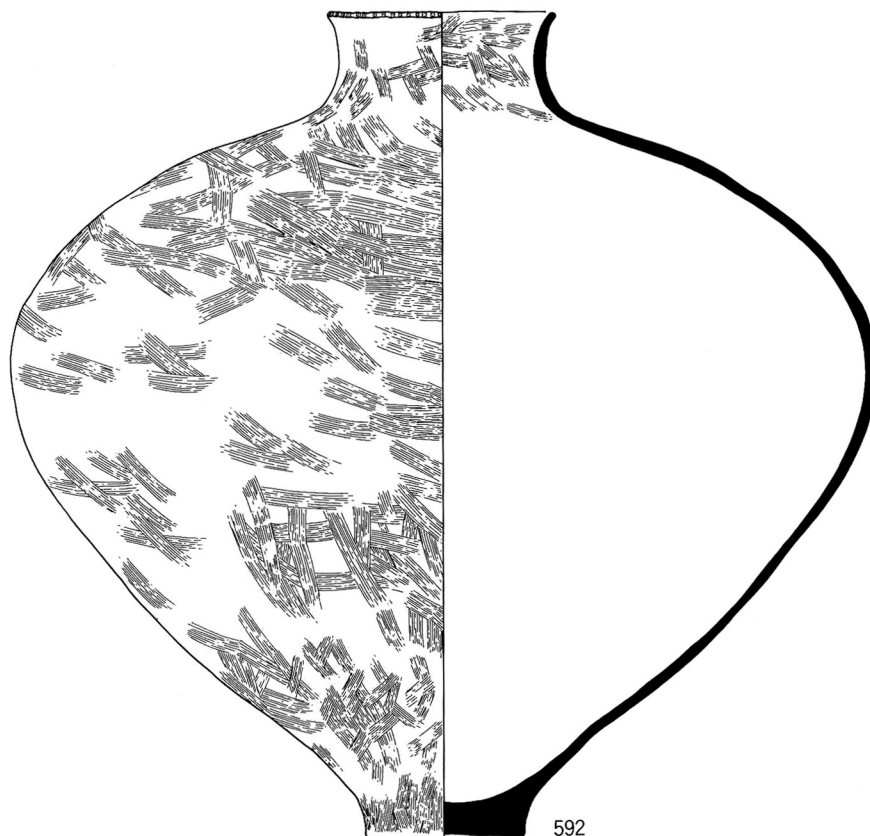

592

0 40cm

SK33出土土器

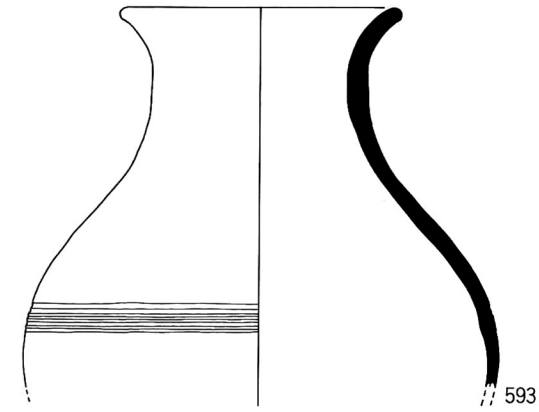

593



594

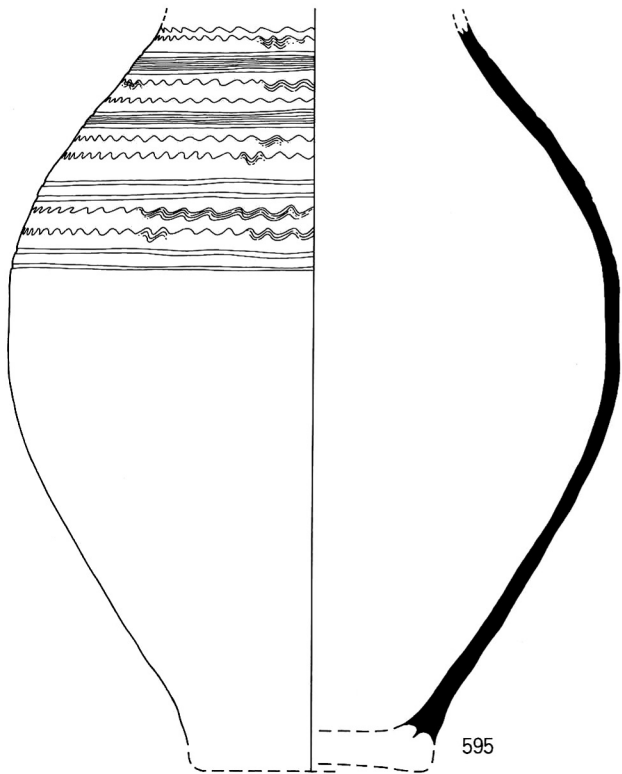

595

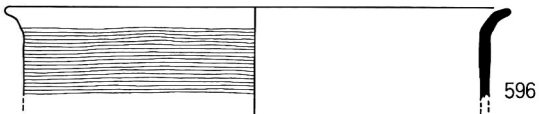

596

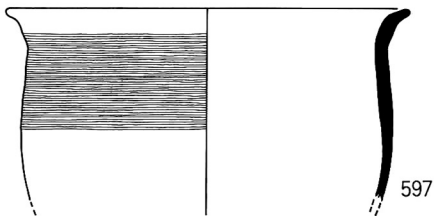

597

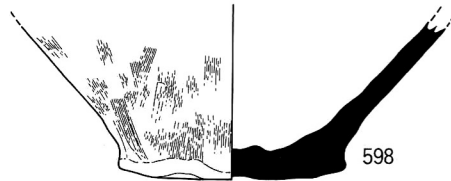

598

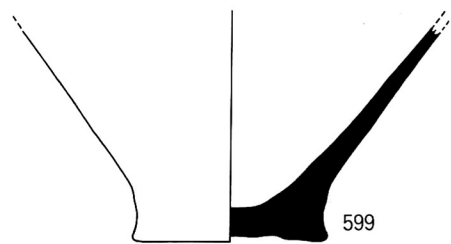

599

593~599 SK37出土土器

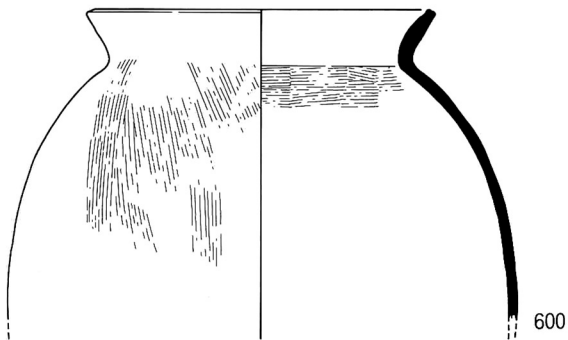

600

SK45出土土器

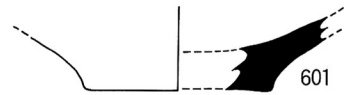

601

SK40出土土器

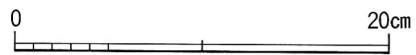

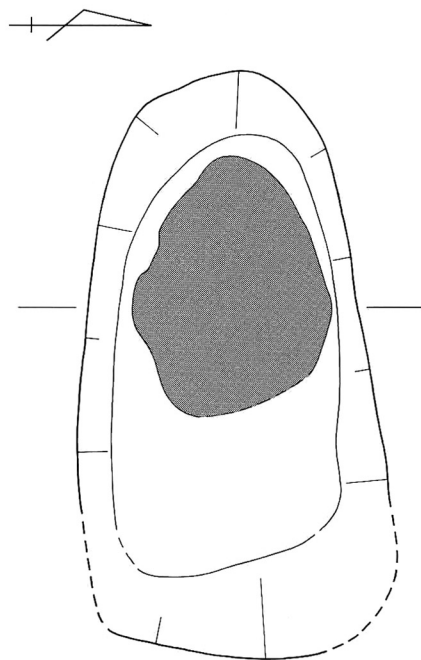

6.80m

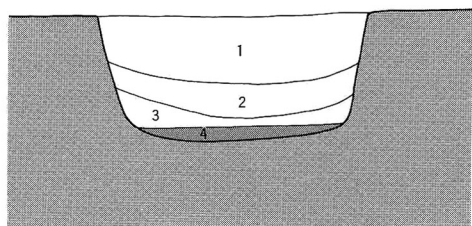

- 1. 灰色シルト混じり極細砂
- 2. 灰褐色シルト質極細砂
- 3. 黒灰色シルト
- 4. 白色粘土

SK38

0 1m

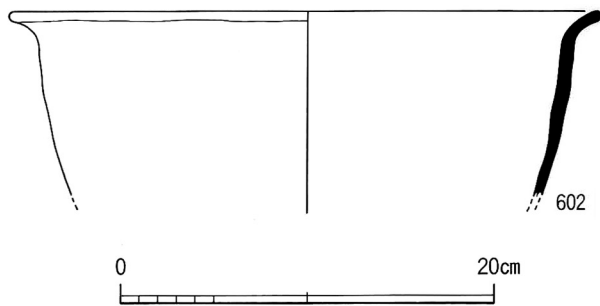

SK38出土土器

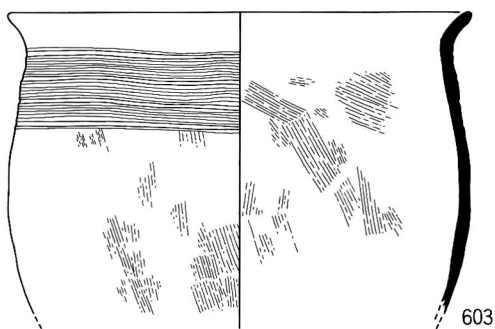

0 20cm

SK50出土土器

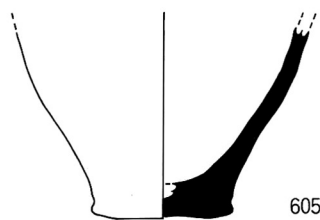
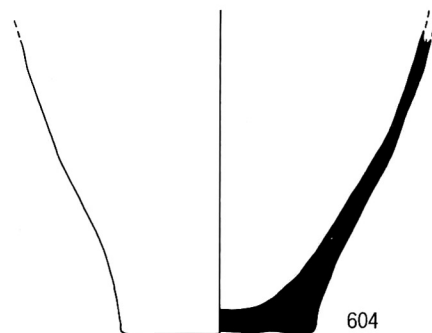

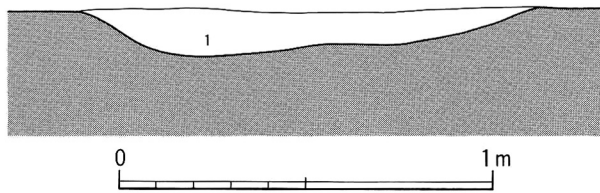
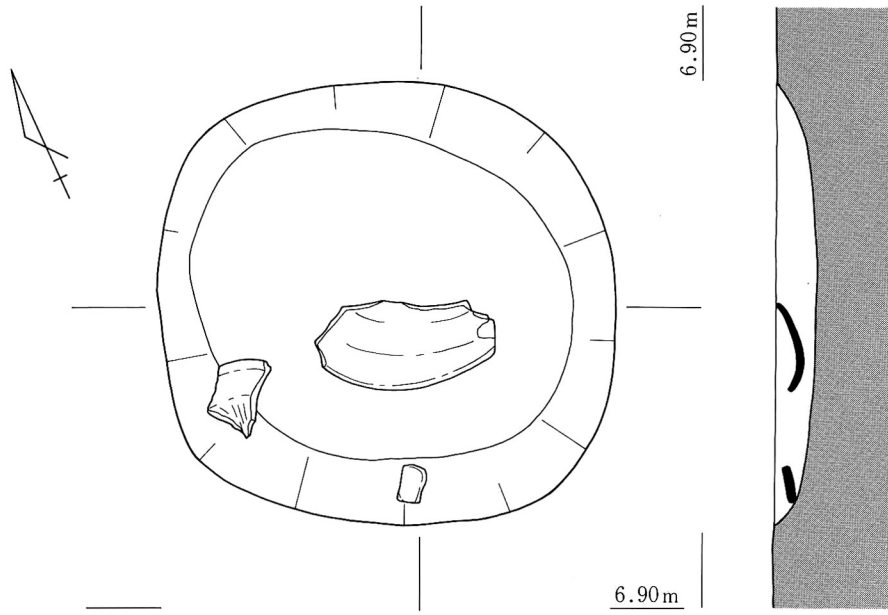

1. 黒褐色シルト質極細砂

SK47

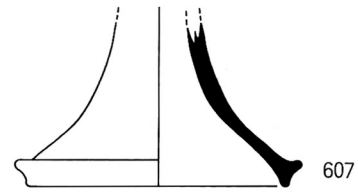
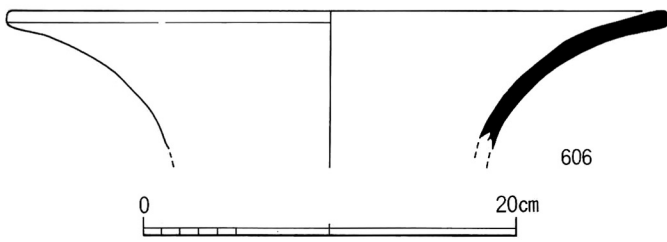

SK47出土土器

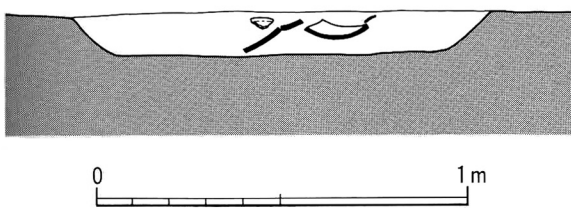
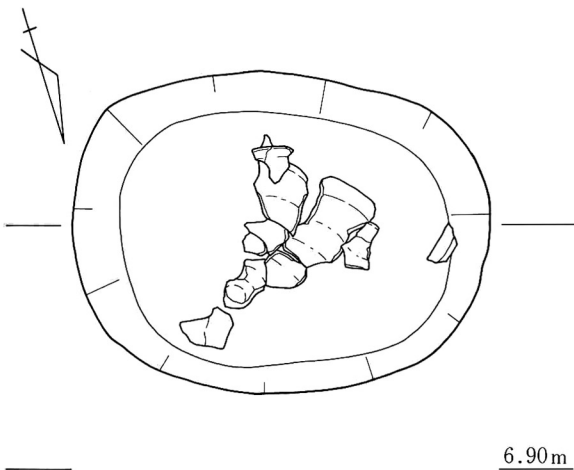

SK48

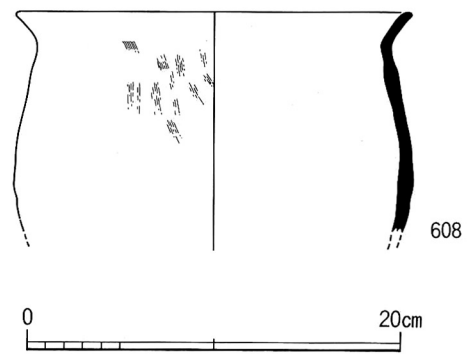

SK48出土土器

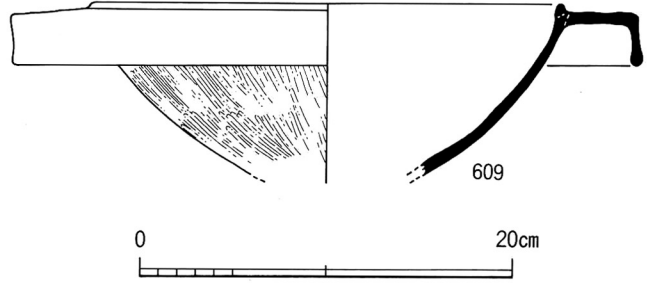
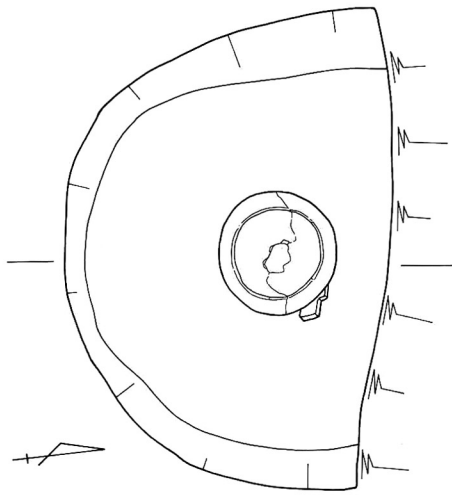

SK49出土土器

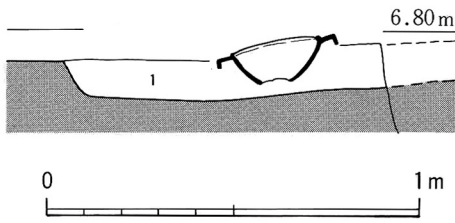

1. 10YR 3/1 砂質シルト

SK49

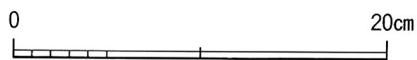
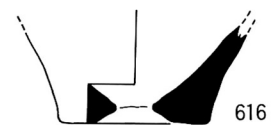
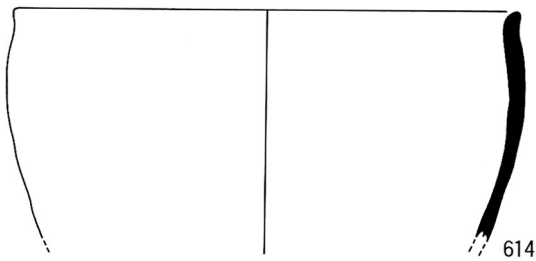
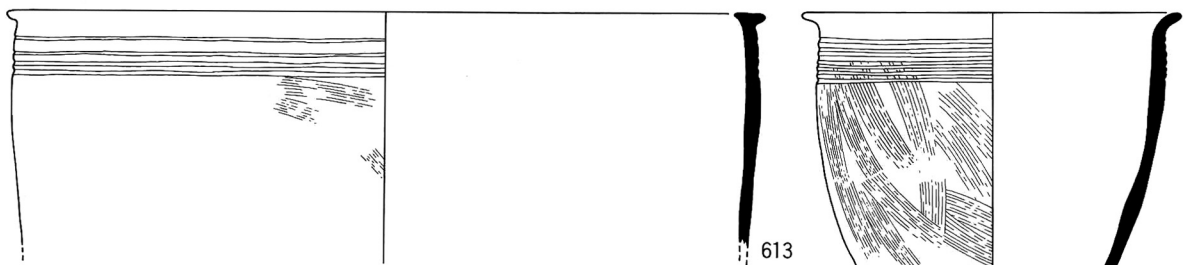
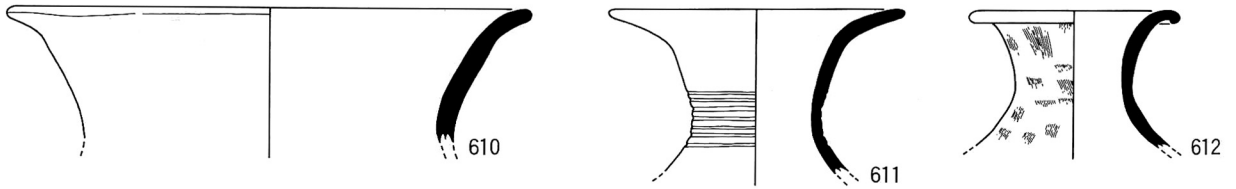

SK56出土土器 (1)

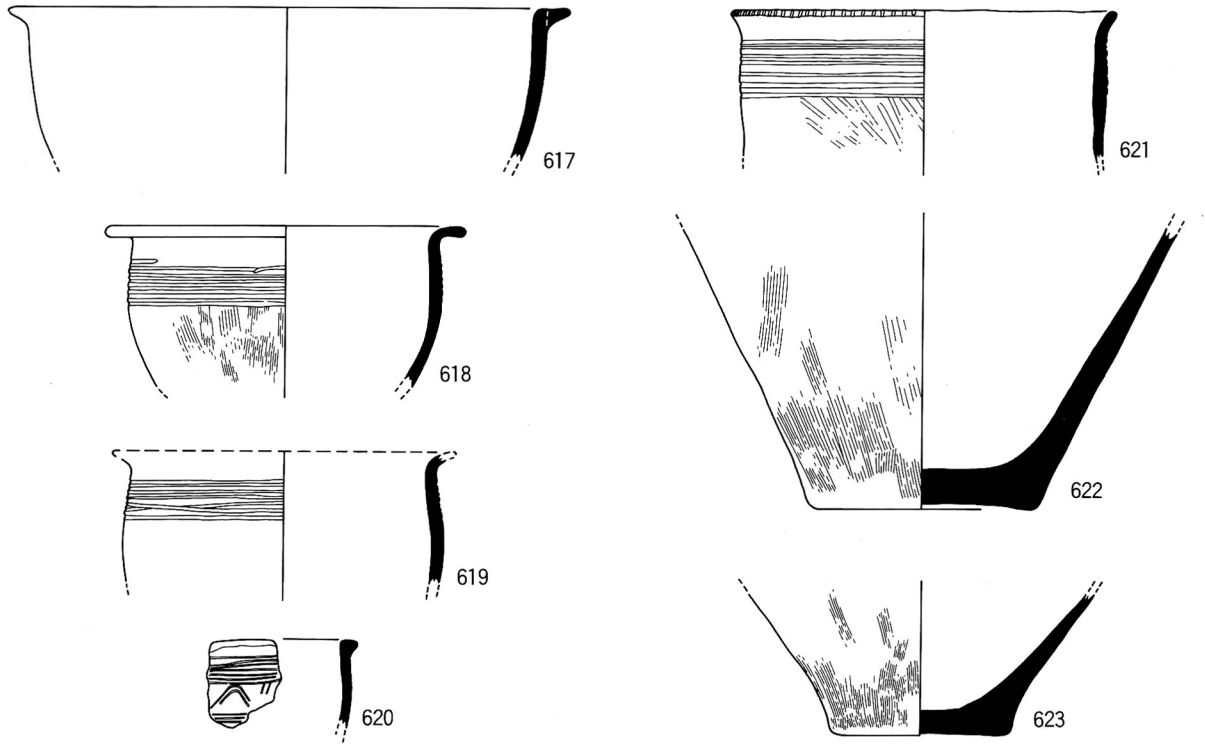

SK56出土土器 (2)

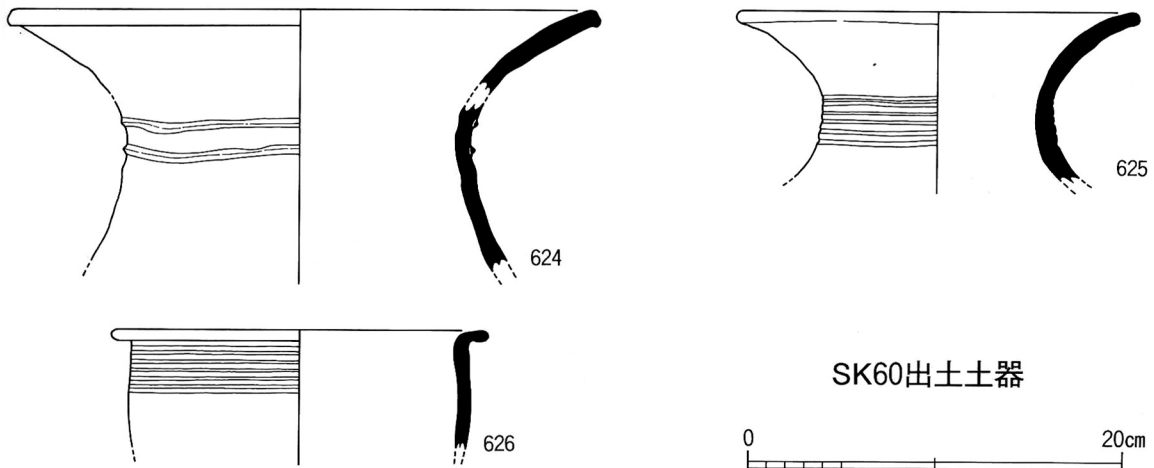

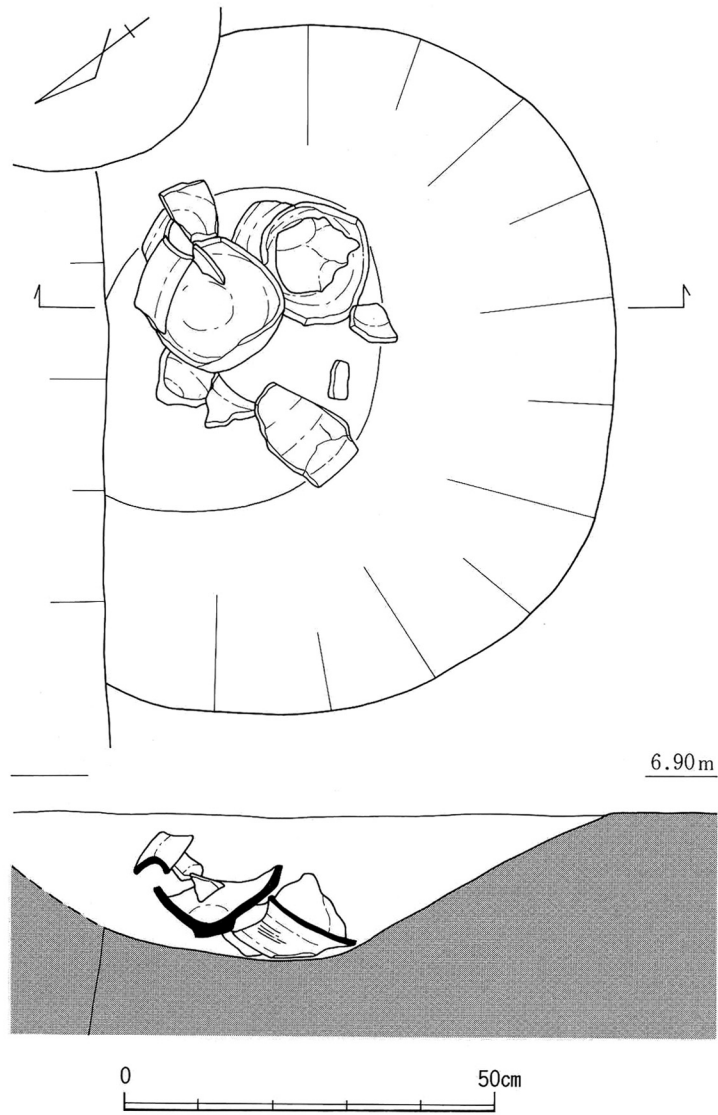

SK55

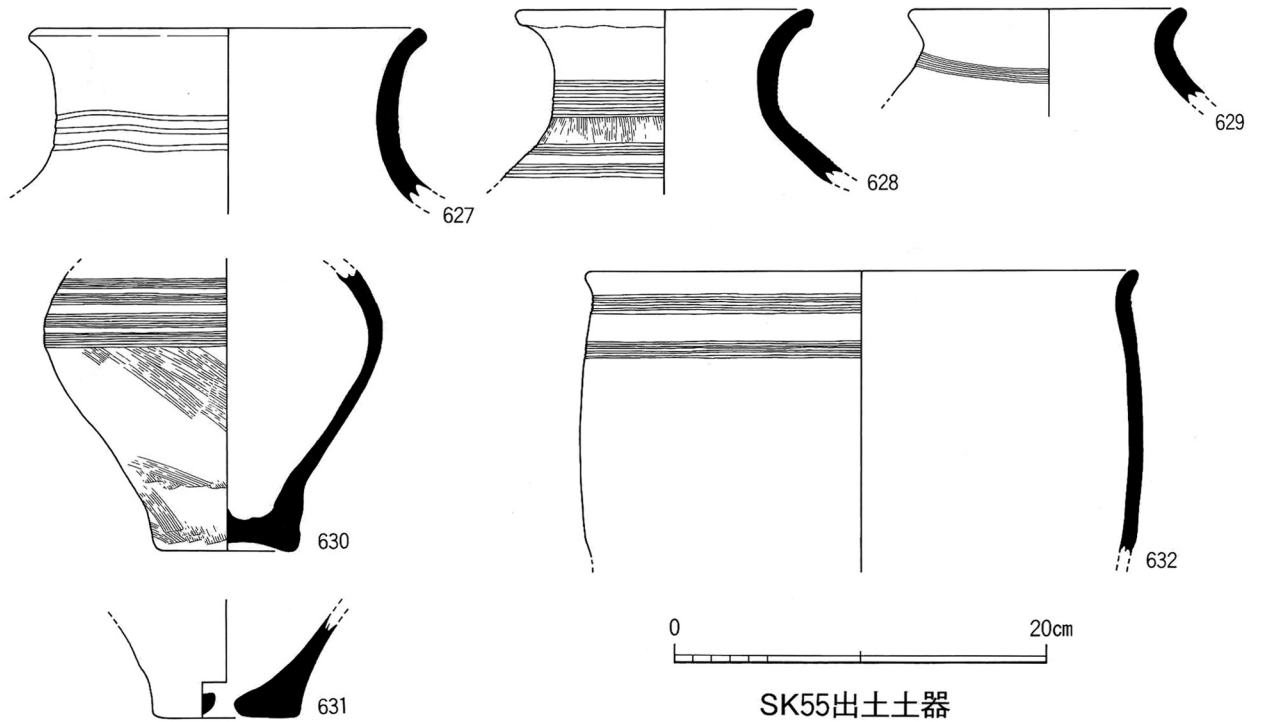

SK55出土土器

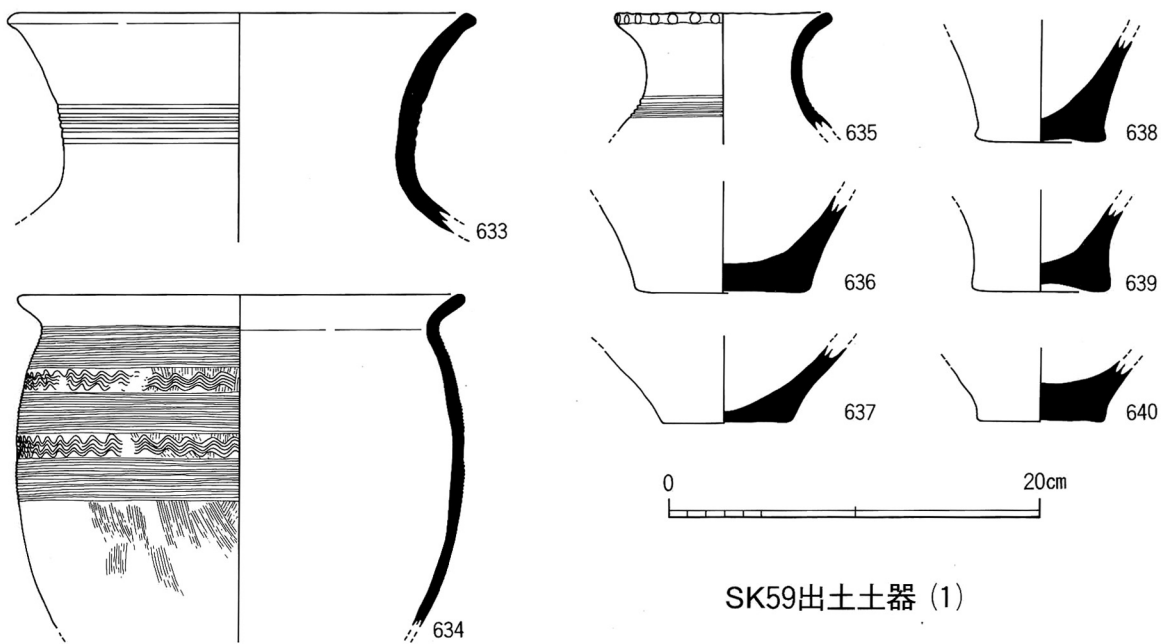
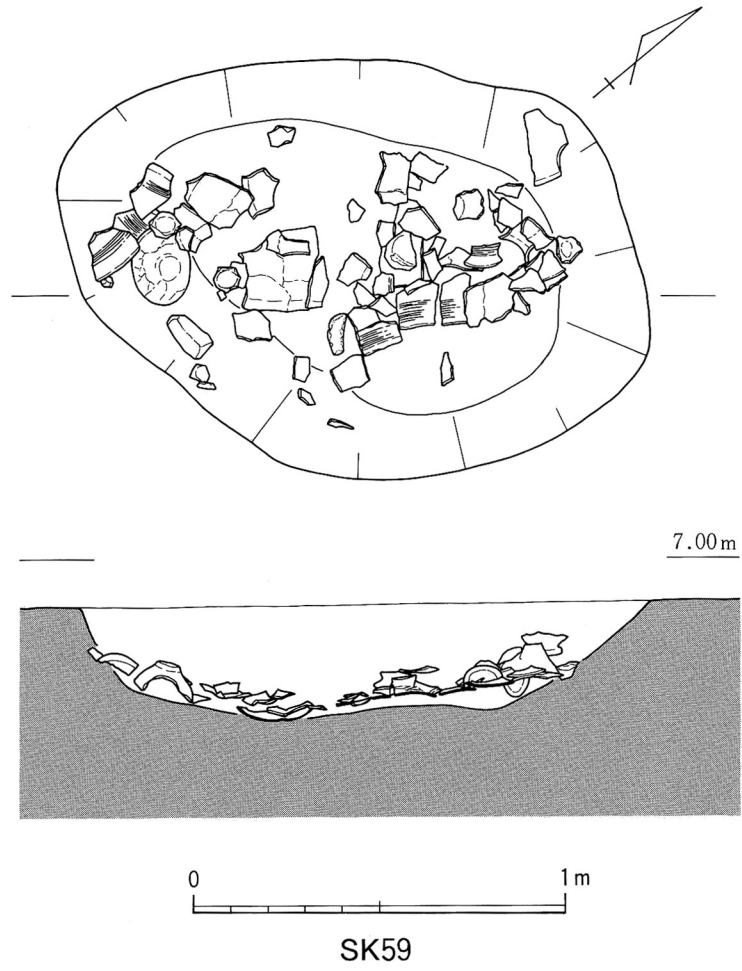

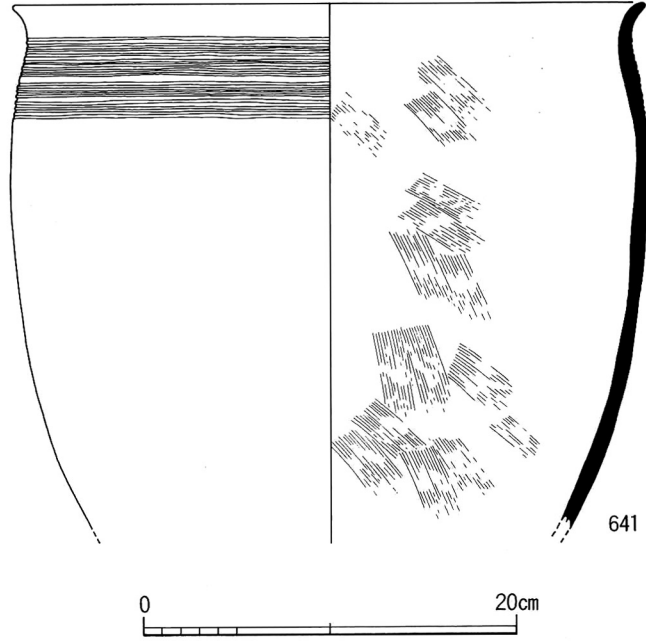

SK59出土土器 (2)

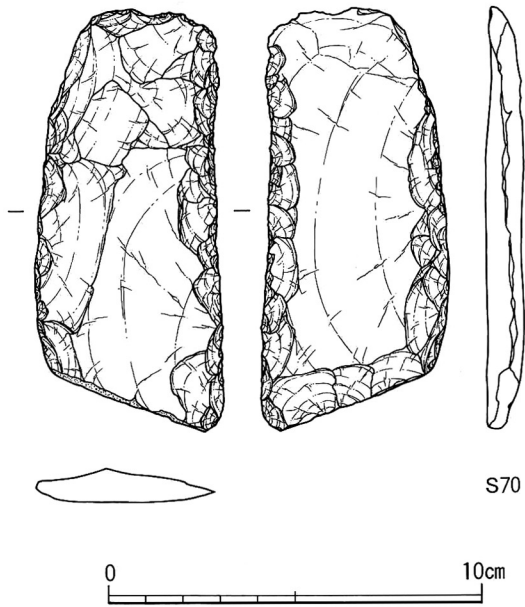

SK59出土石器

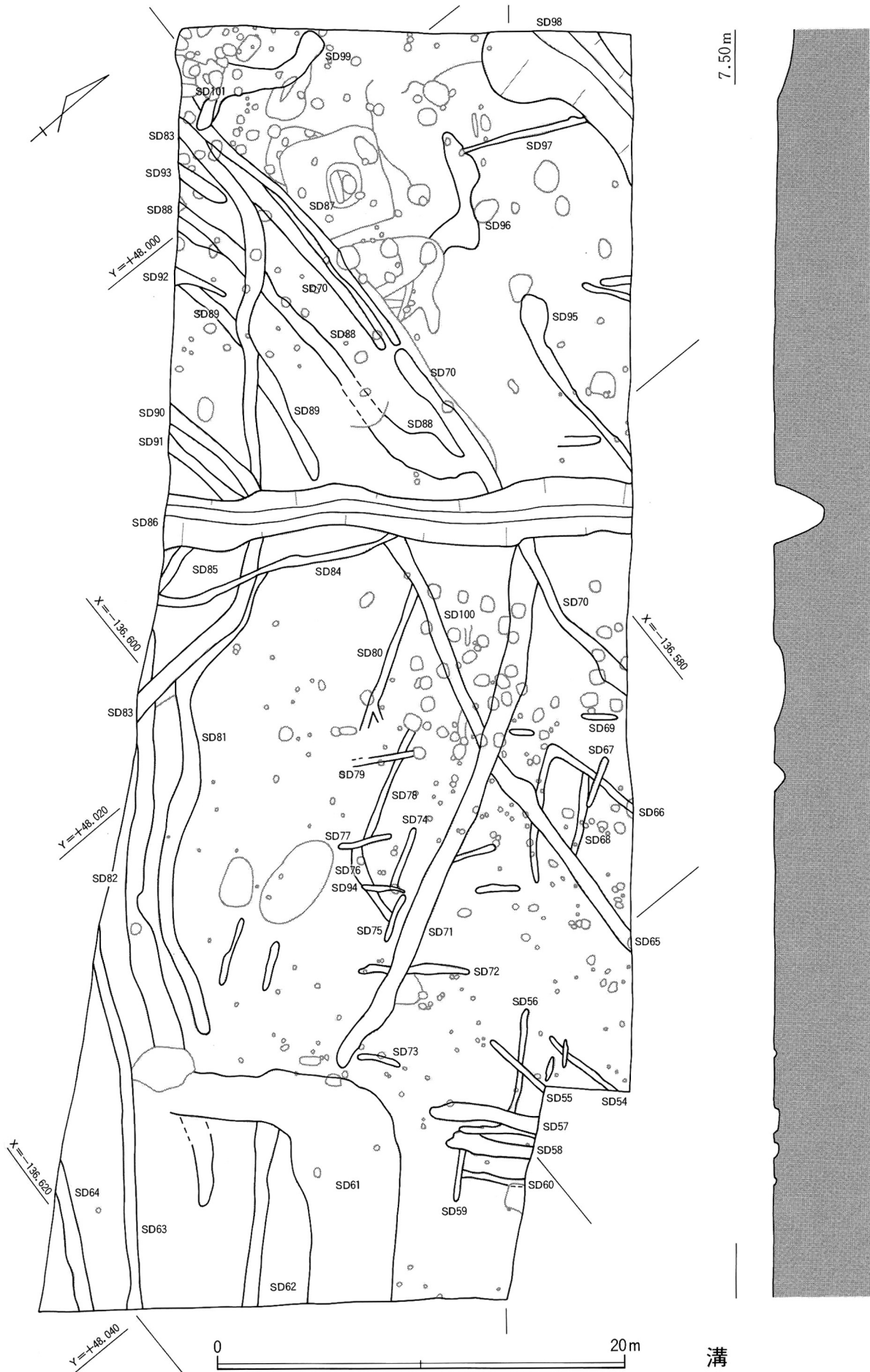

溝

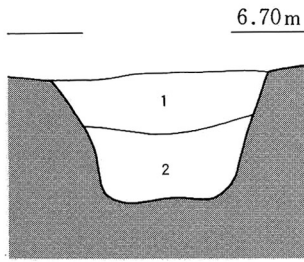

1. 10YR 4/2 灰黄褐
シルト質極細砂
2. 10YR 2/2 黒褐
シルト 土器含む

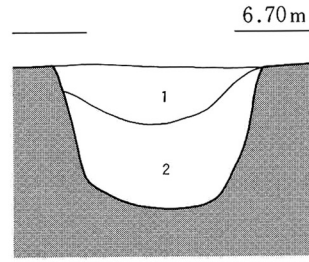

1. 10YR 4/2 灰黄褐
シルト 土器含む
2. 2.5Y 5/2 暗灰黄
砂質シルト



SD63

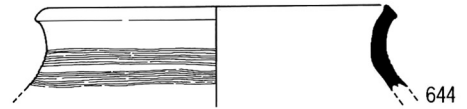
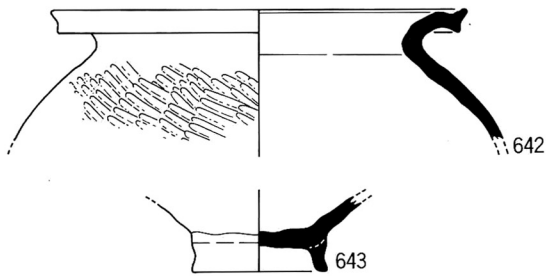

SD55出土土器

SD63出土土器

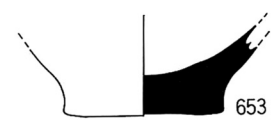
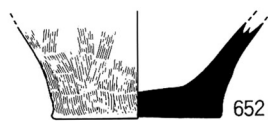
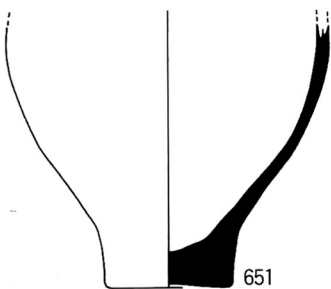
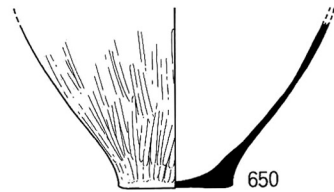
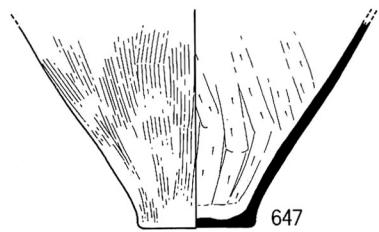
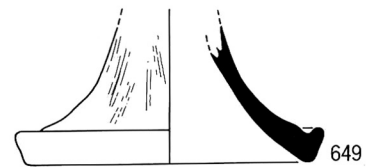
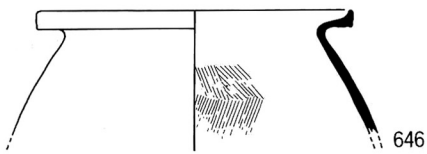
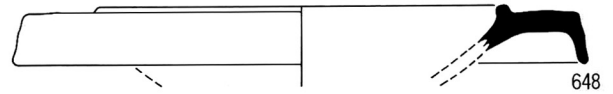
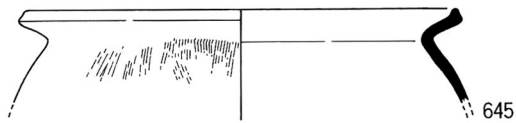

645~649 SD66出土土器

650 SD82出土土器

651~653 SD71出土土器

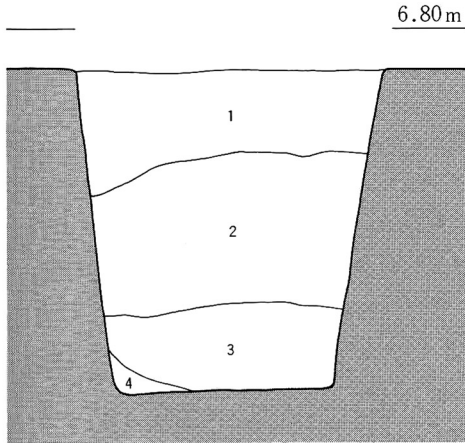

1. 褐色極細砂と灰色極細砂の混じり
2. 黄褐色シルト質極細砂と黒灰色極細砂質シルトの混じり
3. 黄灰褐色シルト質極細砂と黒灰色極細砂質シルトの混じり
4. 灰色極細砂～細砂

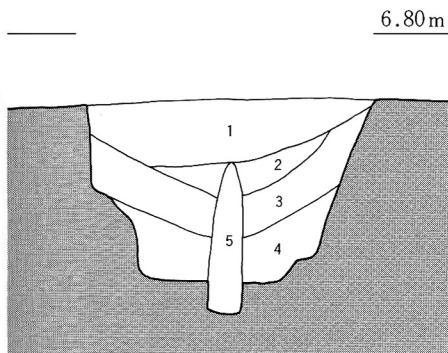

1. 灰色極細砂
2. 暗灰色極細砂（灰色極細砂がブロックで混ざる）
3. 灰色シルト混じり極細砂（ラミナ）
4. 暗灰色シルト混じり極細砂（ラミナ）
5. 暗灰色シルト混じり極細砂（下側はグライ化）



SD83

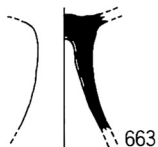
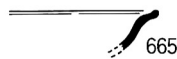
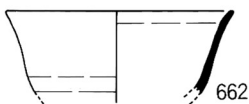
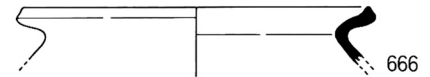
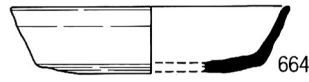
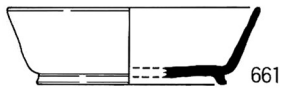
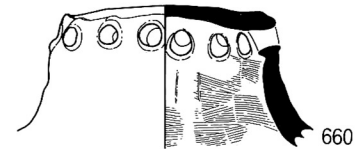
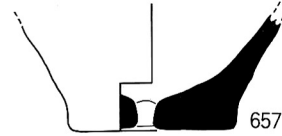
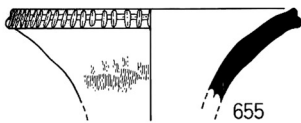
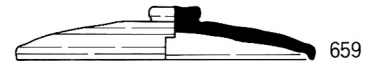
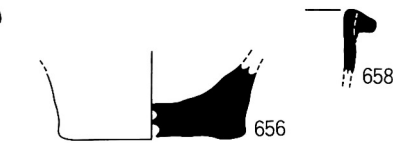
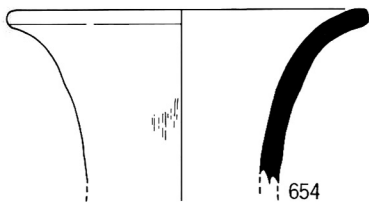

- | | |
|---------|----------|
| 654~658 | SD83出土土器 |
| 659・660 | SD84出土土器 |
| 661~663 | SD61出土土器 |
| 664 | SD71出土土器 |
| 665 | SD85出土土器 |
| 666 | SD94出土土器 |

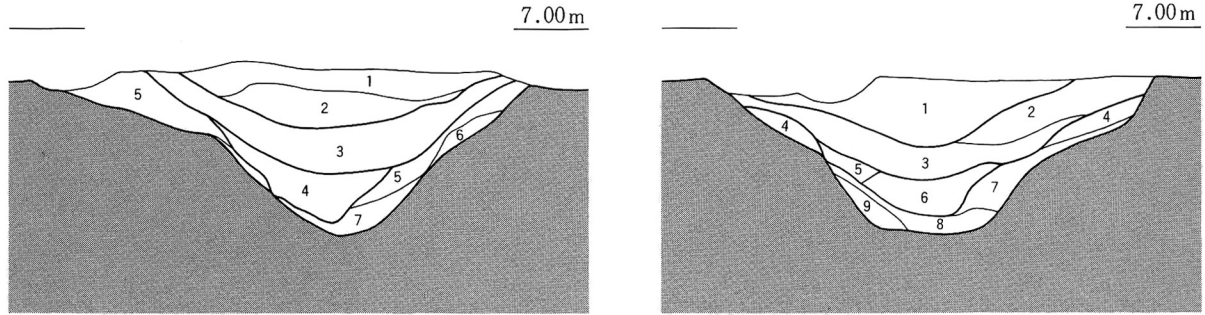

- | | | | |
|-----------------|----------|-----------|------|
| 1. 10YR 3/2 黒褐 | 極細砂 | シルトブロック含む | } 上層 |
| 2. 10YR 4/2 灰黄褐 | 極細砂 | 炭含む | |
| 3. 10YR 3/2 黒褐 | シルト質極細砂 | 炭含む | } 中層 |
| 4. 2.5Y 3/2 黒褐 | シルト | ラミナ 炭含む | |
| 5. 10YR 4/2 灰黄褐 | シルト混じり細砂 | | } 下層 |
| 6. 10YR 5/2 灰黄褐 | 細砂混じりシルト | | |
| 7. 2.5Y 5/2 暗灰黄 | 細砂 | 上方シルト ラミナ | |

- | | | |
|------------------|-------------|------|
| 1. 7.5YR 4/2 灰褐 | 極細砂 | } 上層 |
| 2. 7.5YR 3/2 黒褐 | シルト質極細砂 | |
| 3. 10YR 3/2 黒褐 | 細砂混じりシルト | } 中層 |
| 4. 2.5Y 5/1 黄灰 | シルト混じり細砂 | |
| 5. 10YR 4/2 灰黄褐 | 細砂混じりシルト | } 下層 |
| 6. 5YR 3/1 オリーブ黒 | シルト ラミナ 炭含む | |
| 7. 10YR 4/2 灰黄褐 | シルト混じり細砂 | |
| 8. 5YR 4/2 灰オリーブ | 細砂 | |
| 9. 10YR 4/2 灰黄褐 | シルト | |

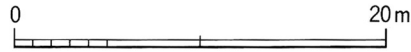

SD86

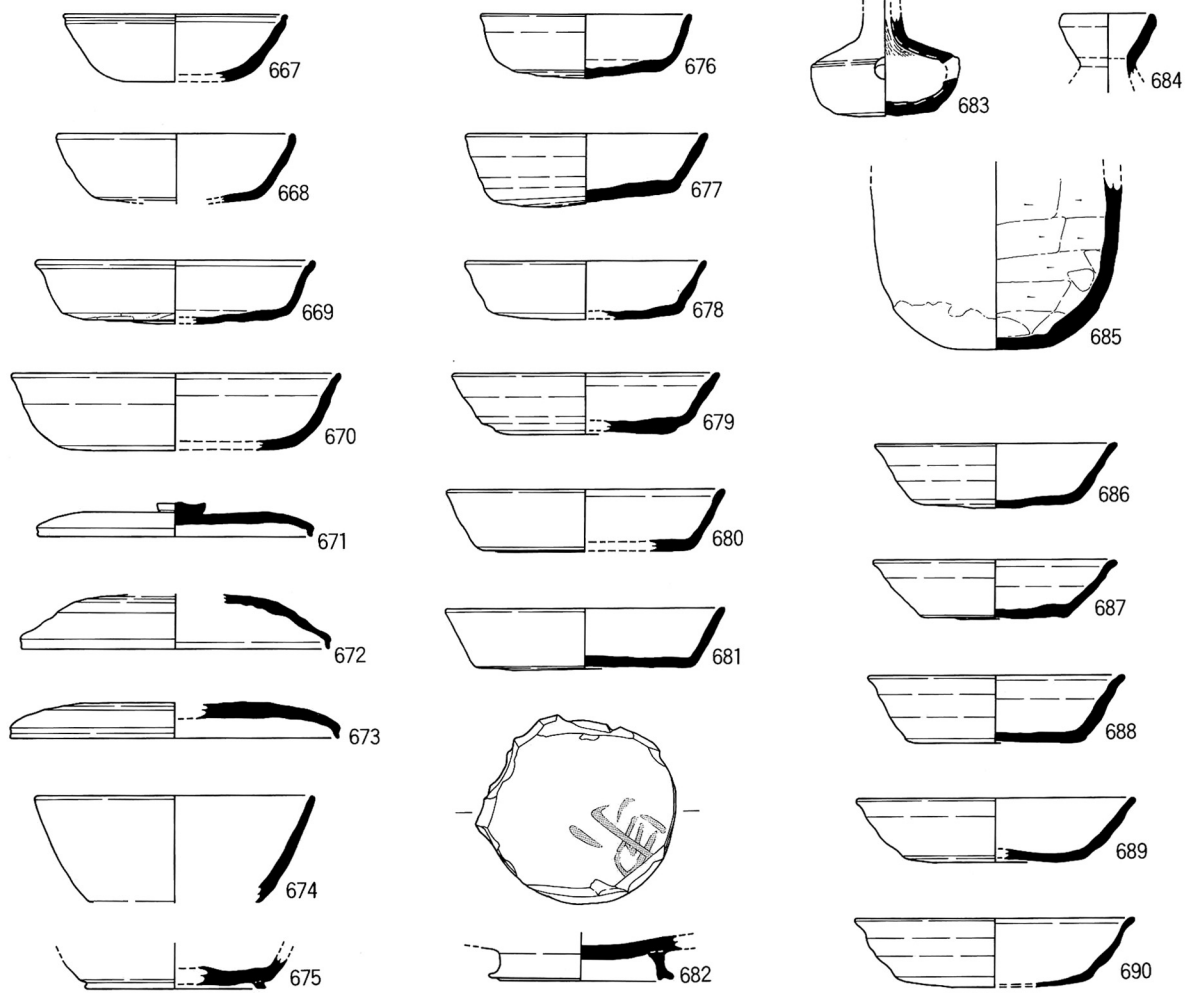

SD86出土土器 (1)

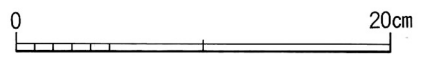
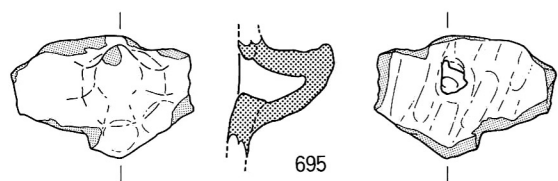
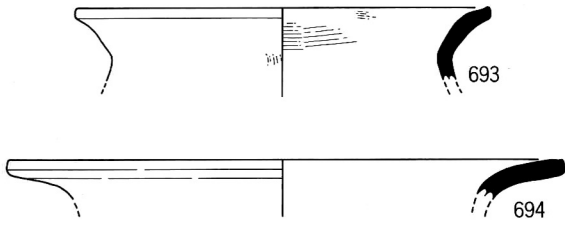
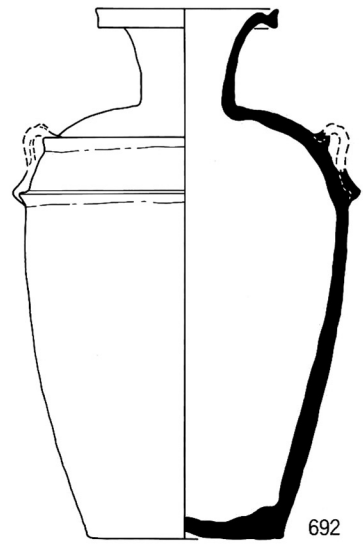
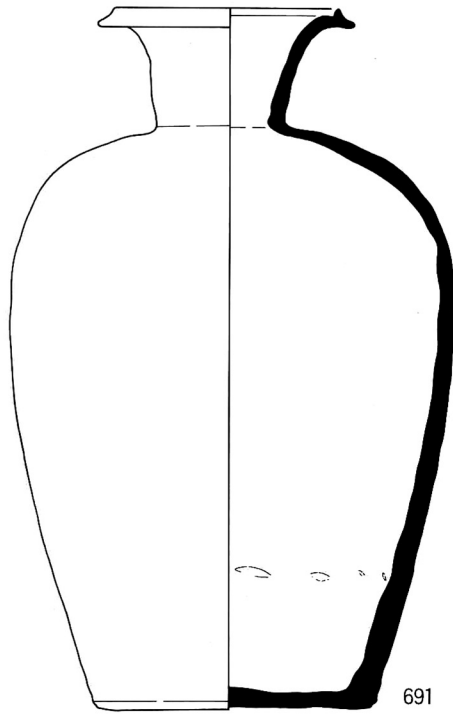

SD86出土土器 (2)

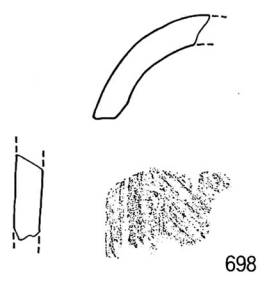
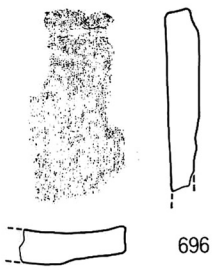

SD86出土瓦

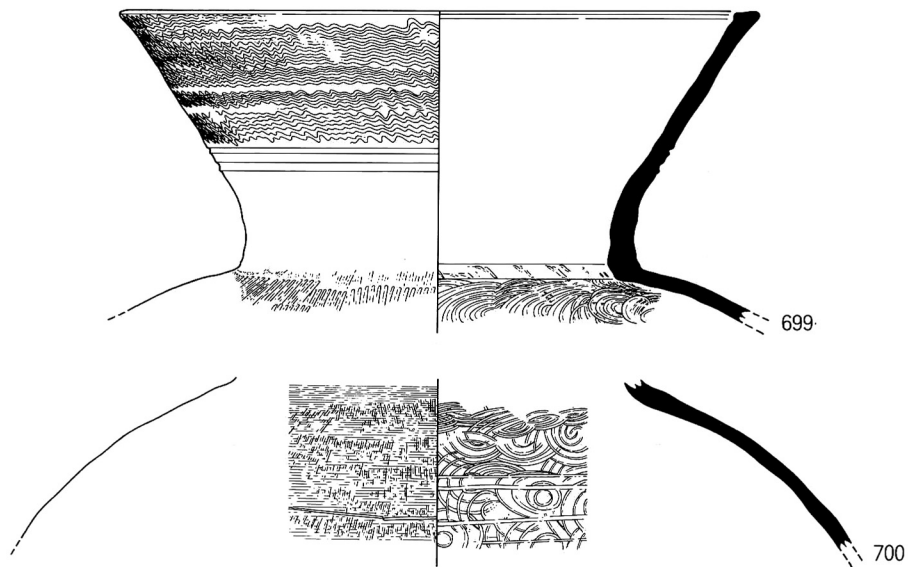

SD90出土土器

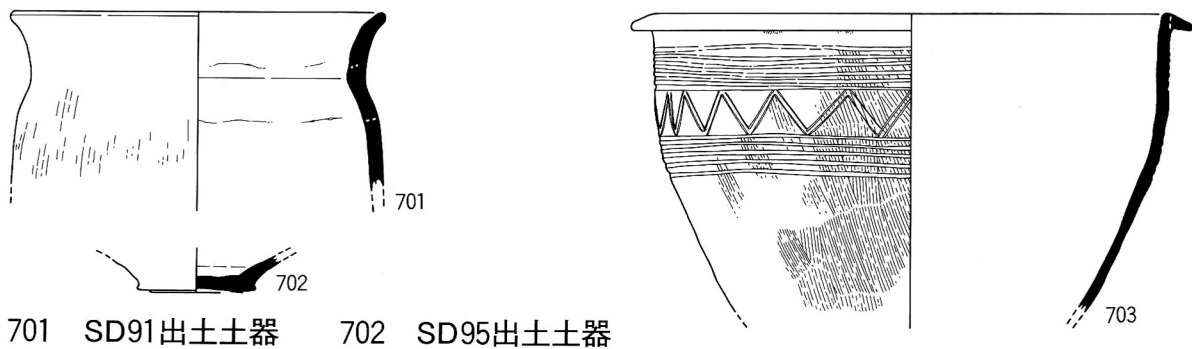

701 SD91出土土器 702 SD95出土土器

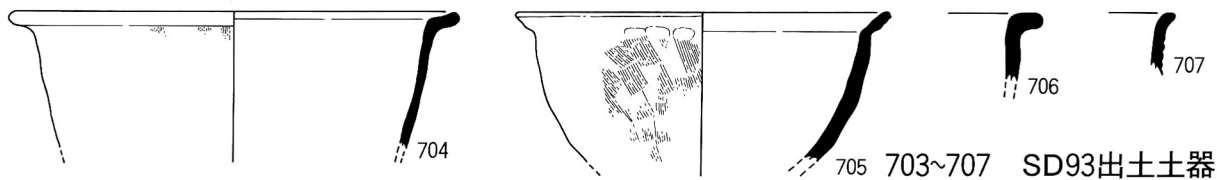

705 703~707 SD93出土土器

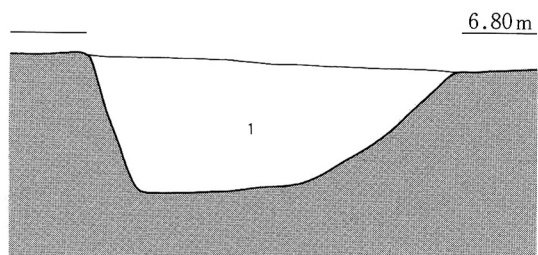

1. にぶい黄褐色 シルト質極細砂



SD99

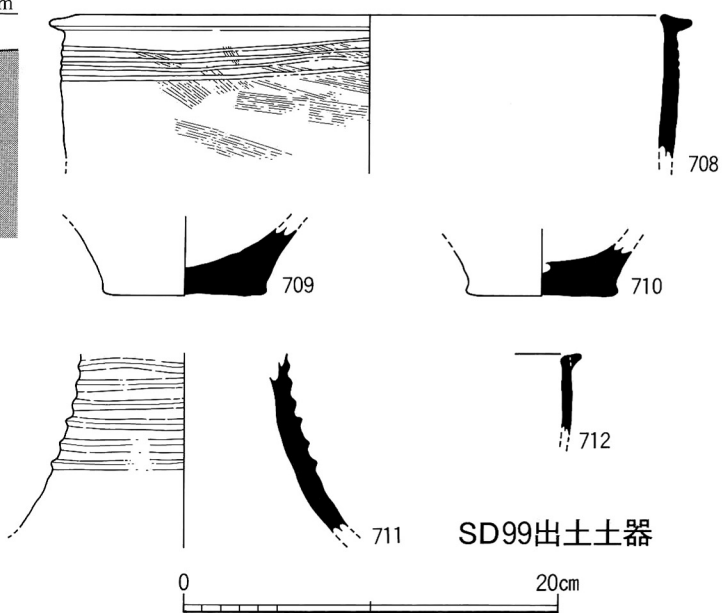

SD99出土土器



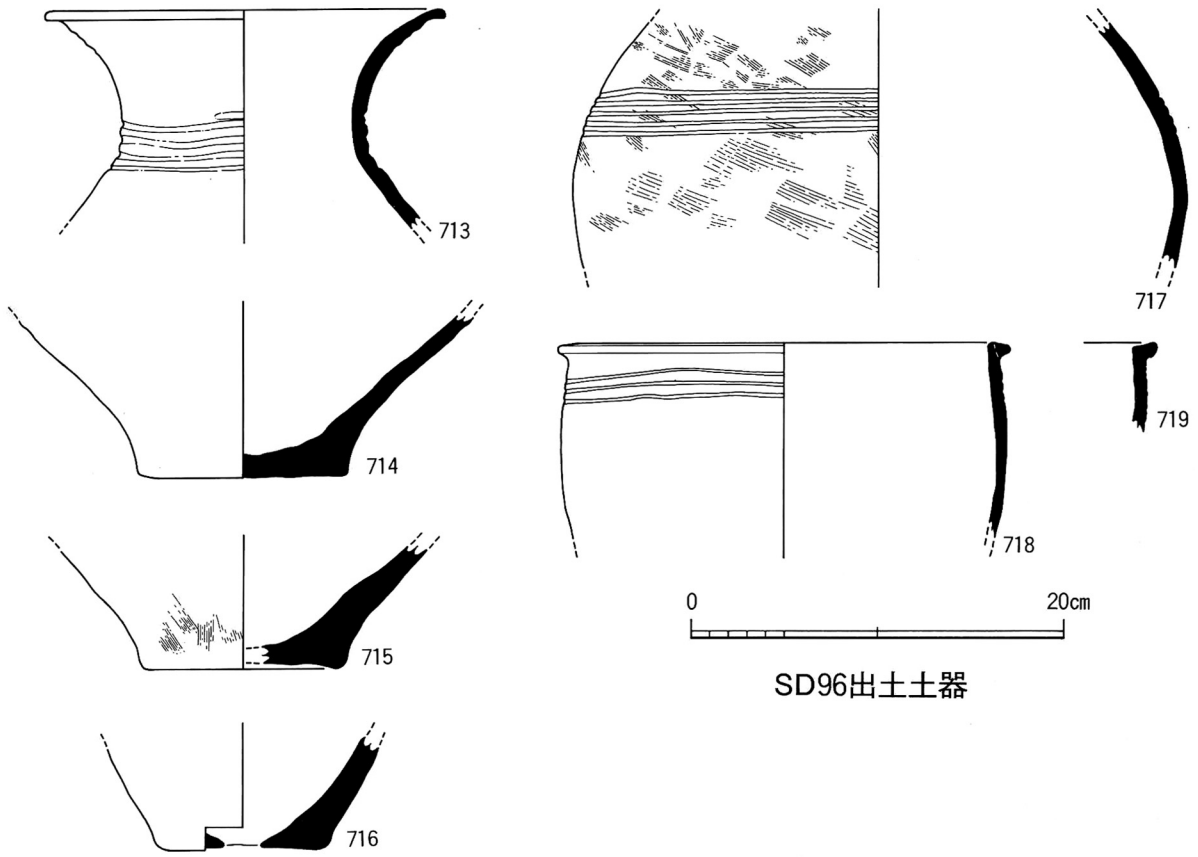

SD96出土土器

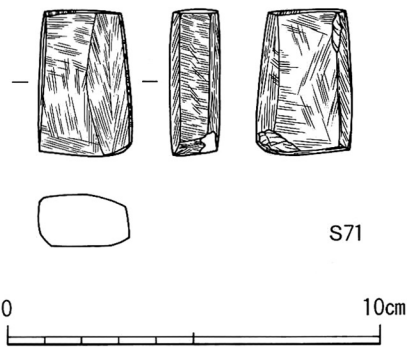

SD100出土石器

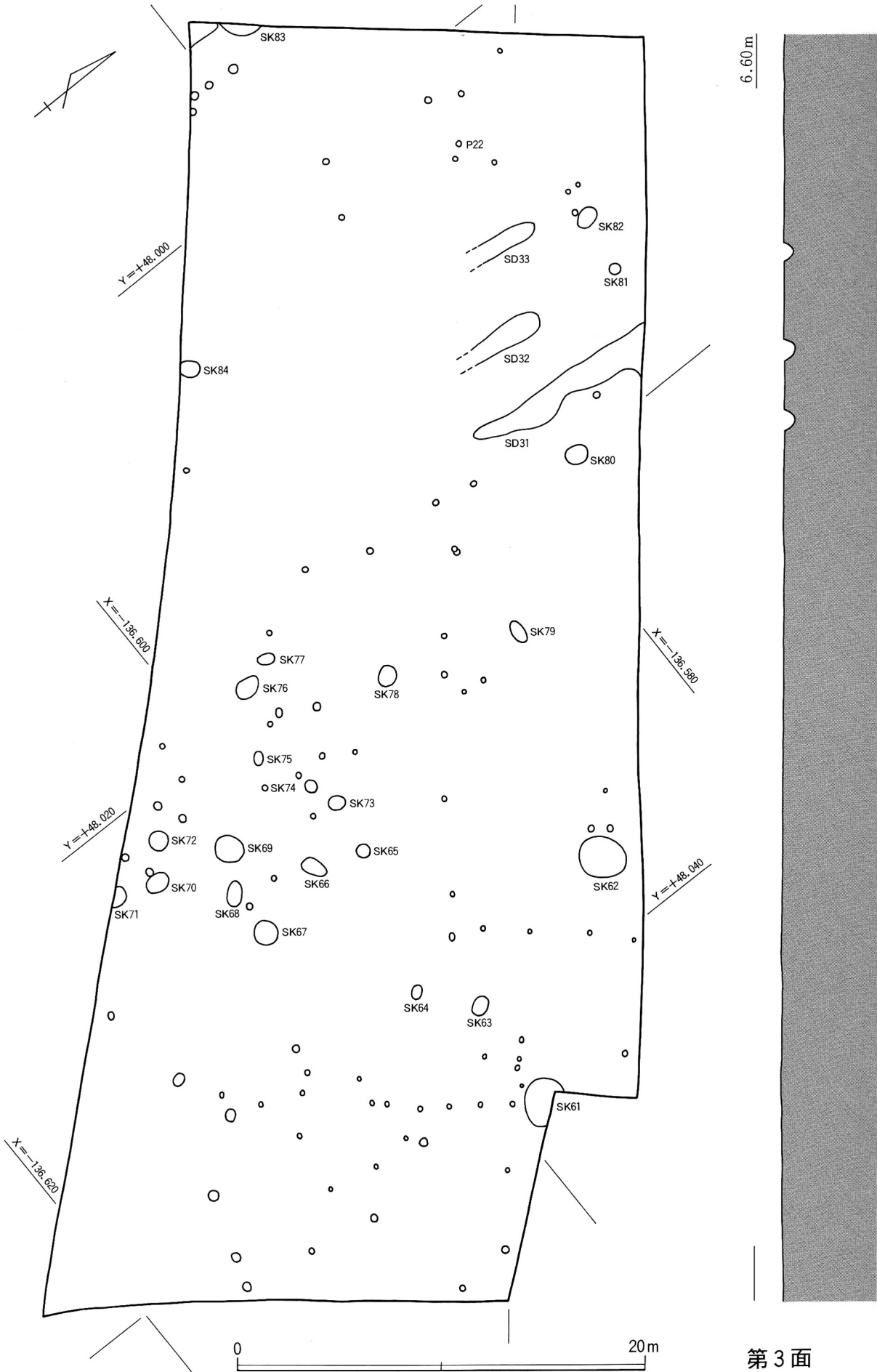

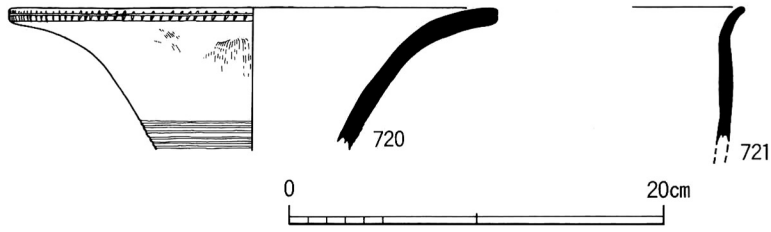

P22出土土器

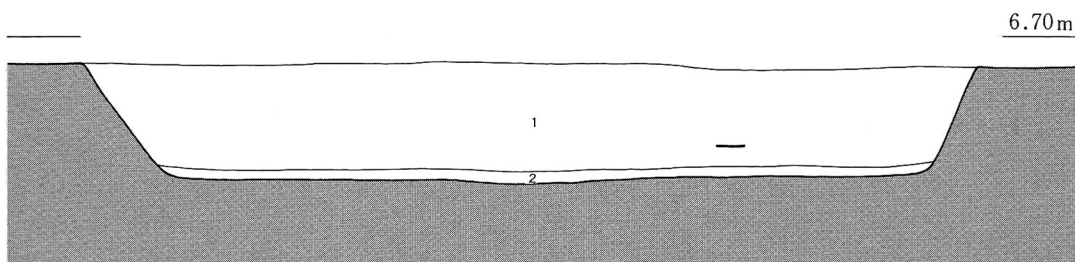
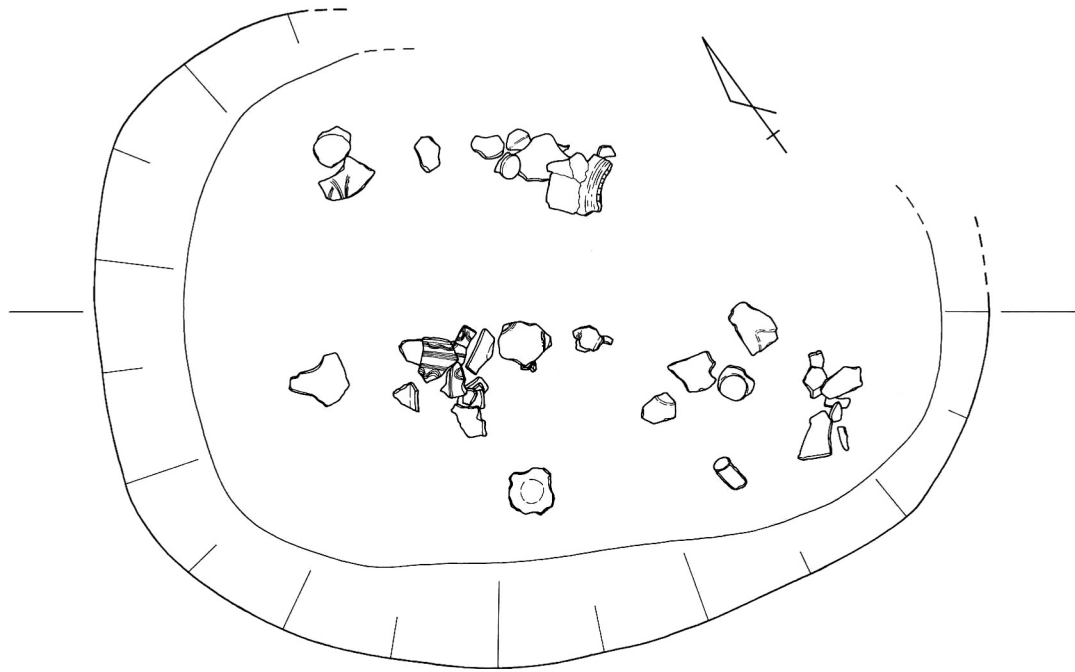

- 1. 暗灰色シルト質極細砂 (炭混じり)
- 2. 黒色 炭層



SK61

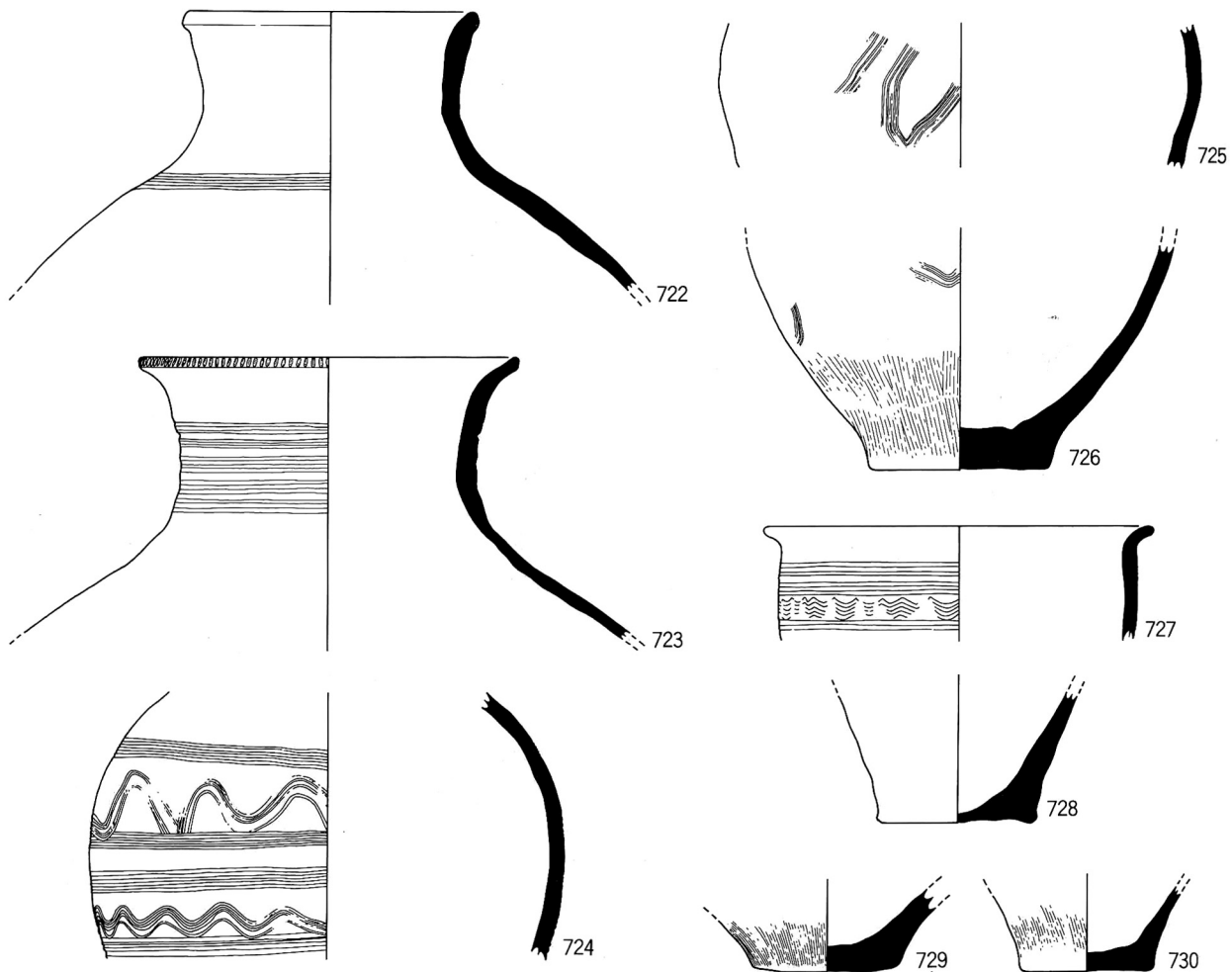

SK61出土土器

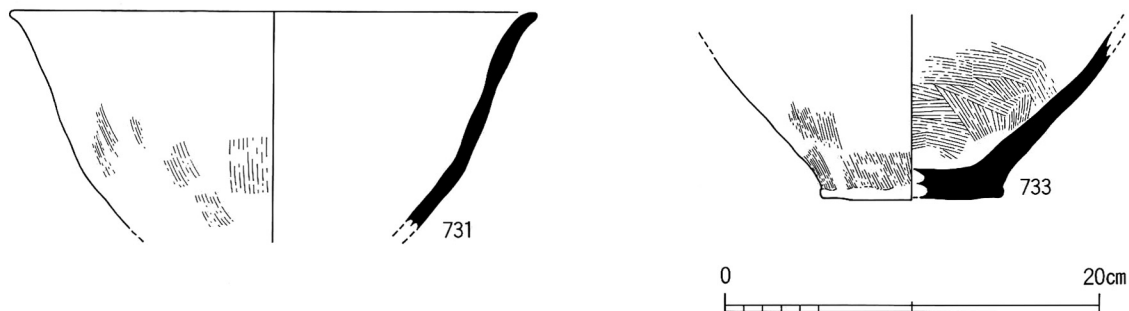

731·732 SK62出土土器
733 SK79出土土器

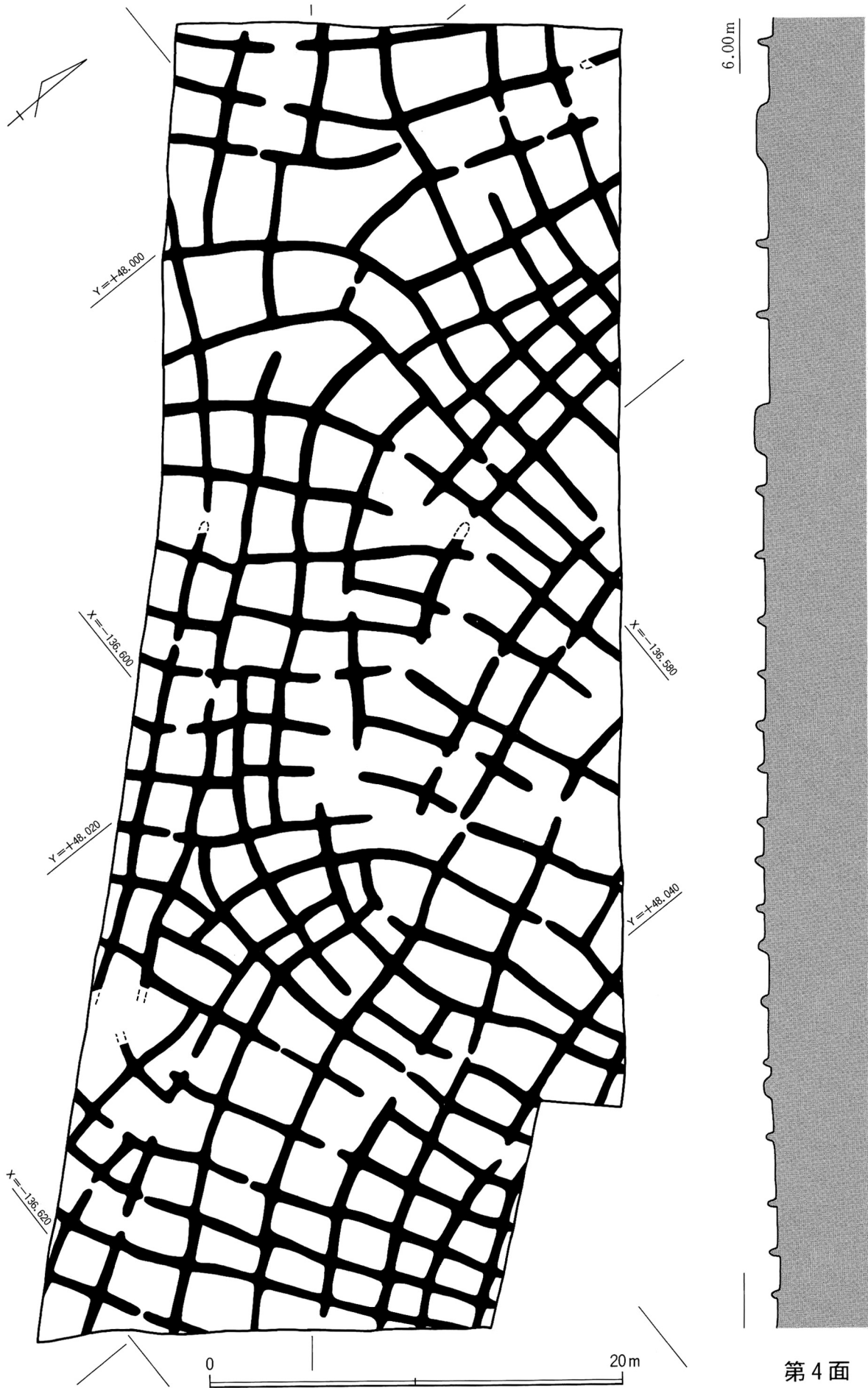

第4面

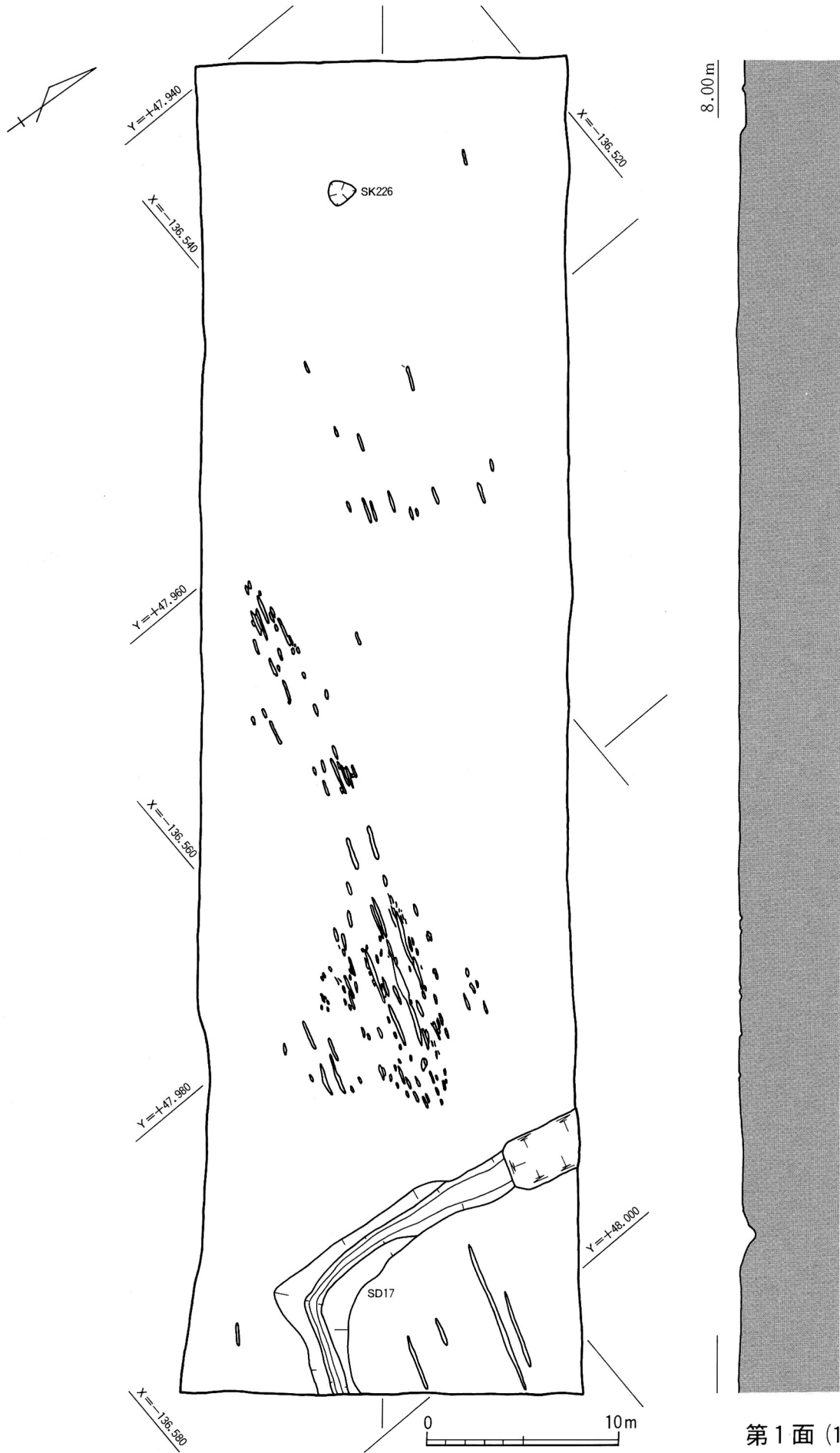

第1面(1)

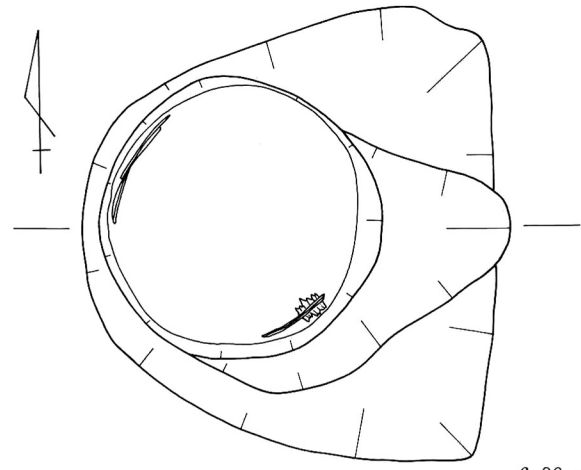

6.90m

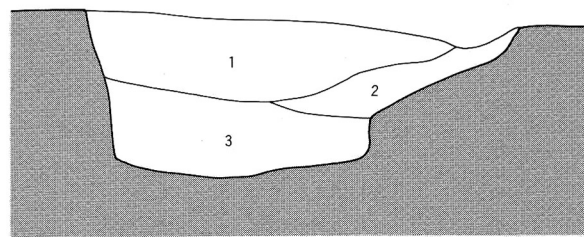

- 1. 明灰白色シルト混じり極細砂
- 2. 1層に灰褐色極細砂
(ベースの層)が混ざる
- 3. 灰白色シルト質極細砂

SK226

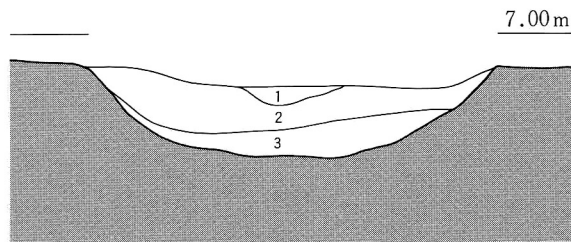

7.00m

- 1. 極細砂混じりシルト 赤灰色
- 2. 極細砂混じりシルト 暗灰色
- 3. 極細砂混じりシルト 灰白色

SD17

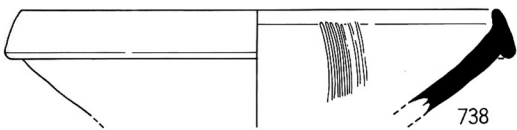
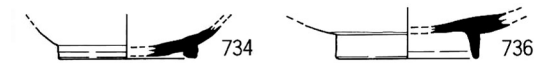

SD17出土土器・瓦



739

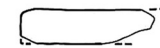
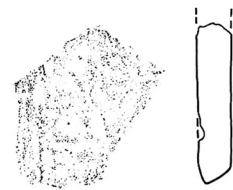

740

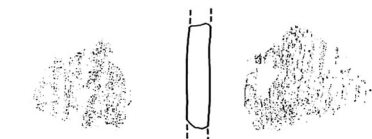

741

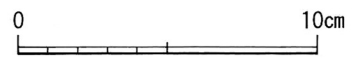

SD18出土瓦

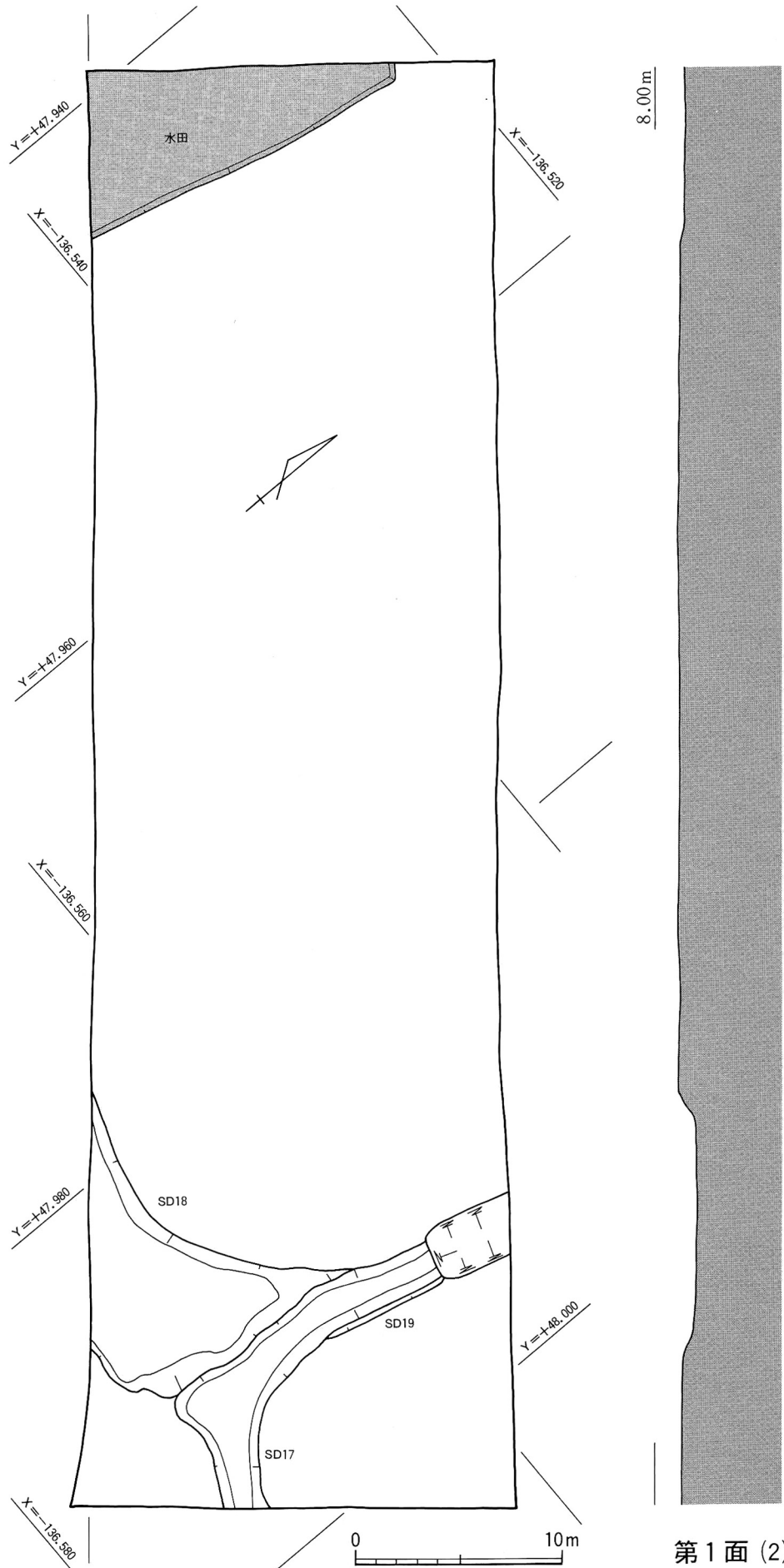

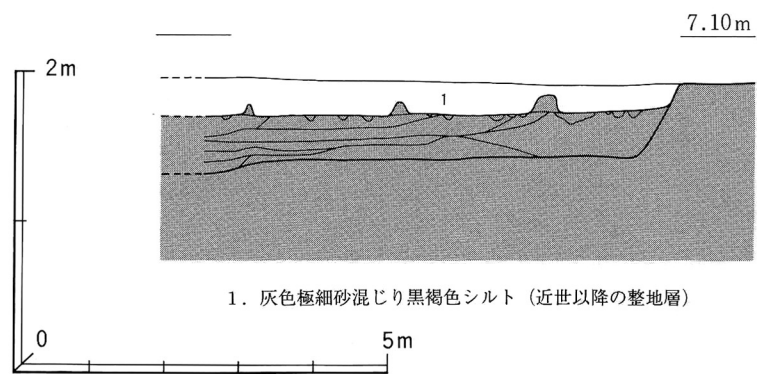
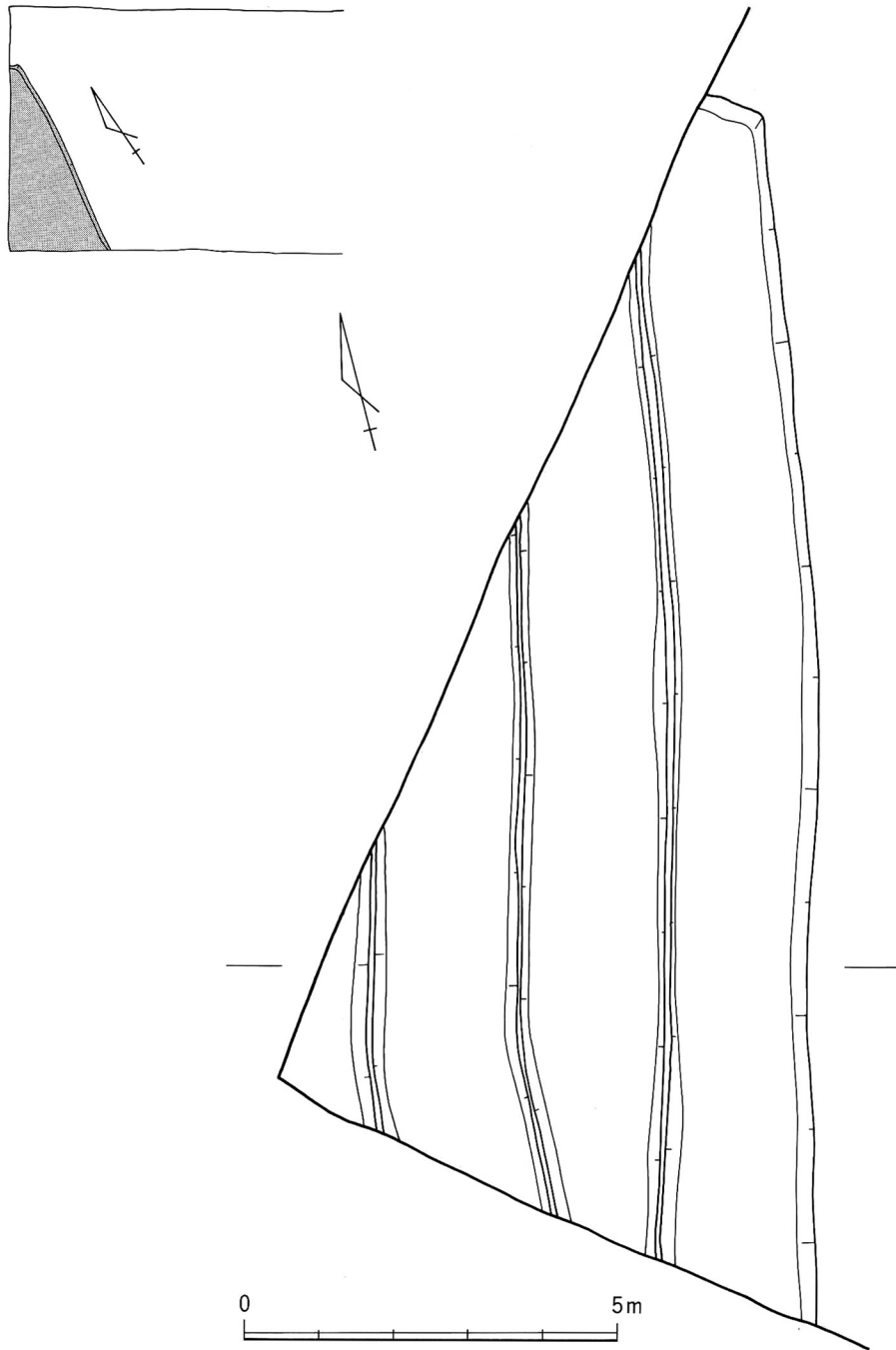

水田(上層)

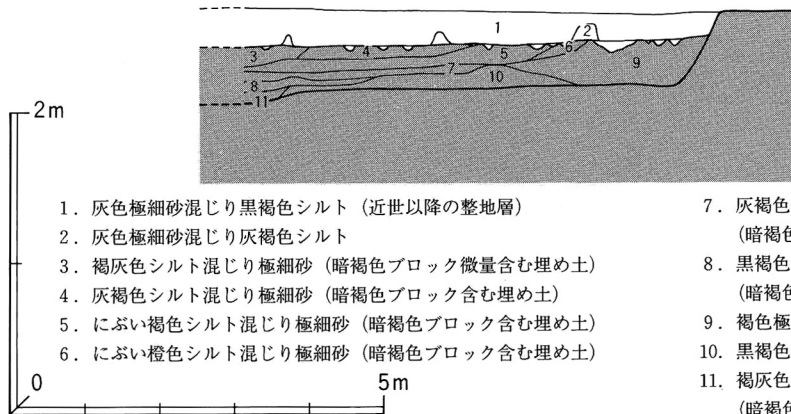
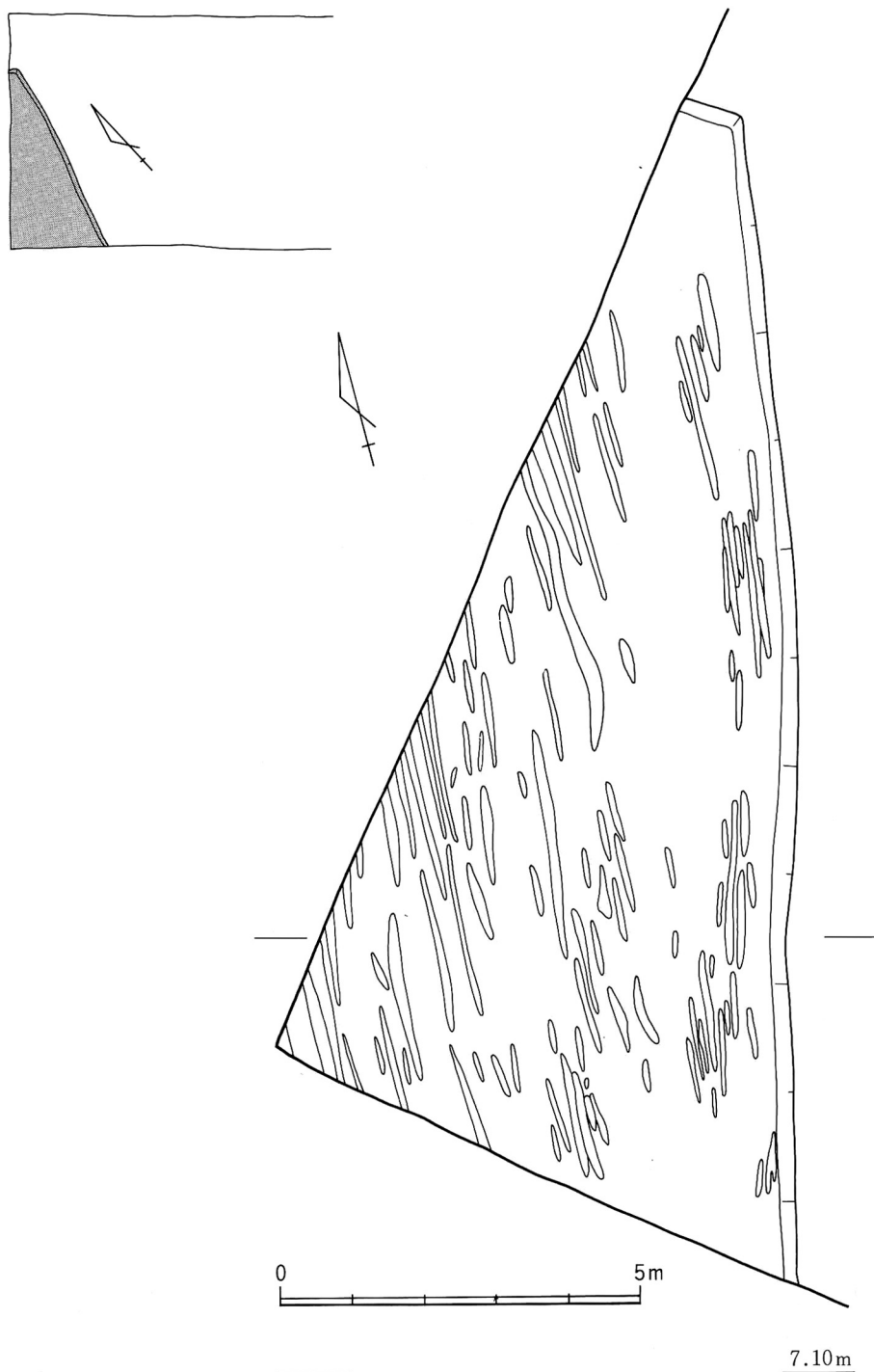

- | | |
|---|--|
| <p>1. 灰色極細砂混じり黒褐色シルト (近世以降の整地層)</p> <p>2. 灰色極細砂混じり灰褐色シルト</p> <p>3. 褐色シルト混じり極細砂 (暗褐色ブロック微量含む埋め土)</p> <p>4. 灰褐色シルト混じり極細砂 (暗褐色ブロック含む埋め土)</p> <p>5. にぶい褐色シルト混じり極細砂 (暗褐色ブロック含む埋め土)</p> <p>6. にぶい橙色シルト混じり極細砂 (暗褐色ブロック含む埋め土)</p> | <p>7. 灰褐色極細砂混じりシルト (暗褐色ブロック含む埋め土)</p> <p>8. 黒褐色極細砂混じりシルト (暗褐色ブロック含む埋め土)</p> <p>9. 褐色極細砂混じりシルト</p> <p>10. 黒褐色極細砂混じりシルト</p> <p>11. 褐灰色極細砂混じりシルト (暗褐色ブロック微量含む埋め土)</p> |
|---|--|

水田(下層)

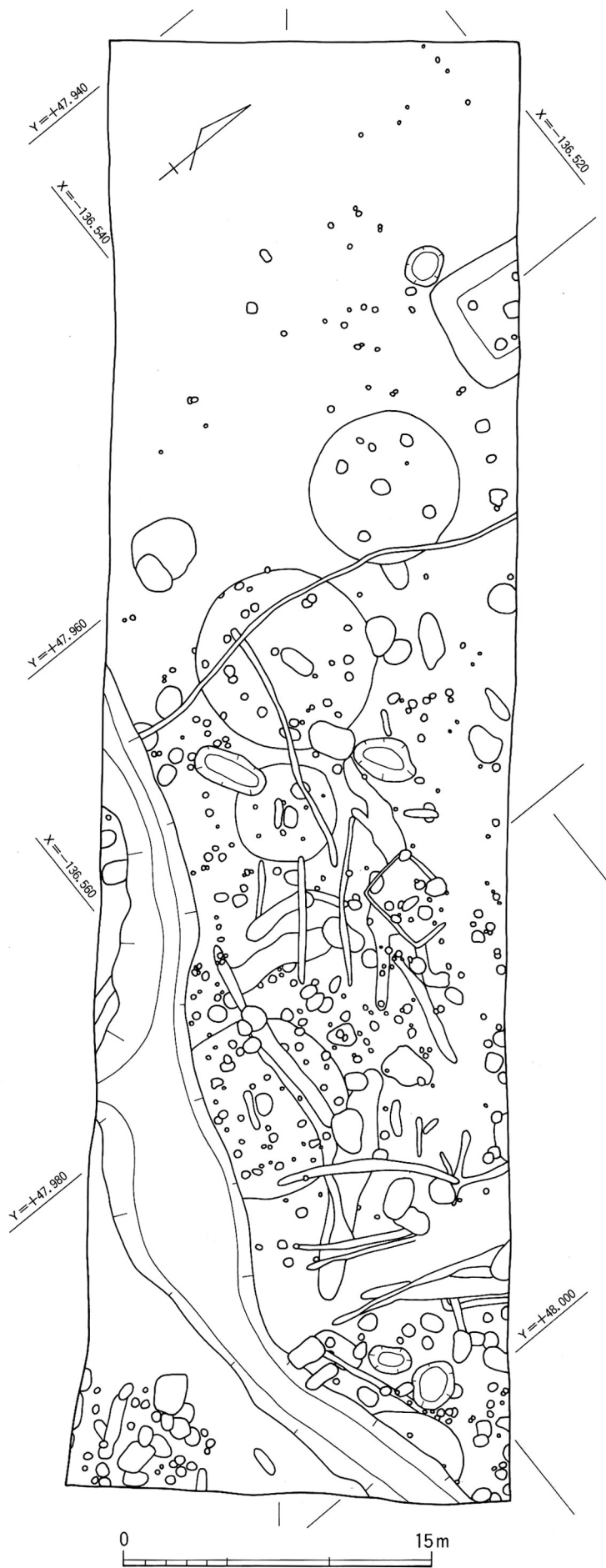

7.20m

第2面

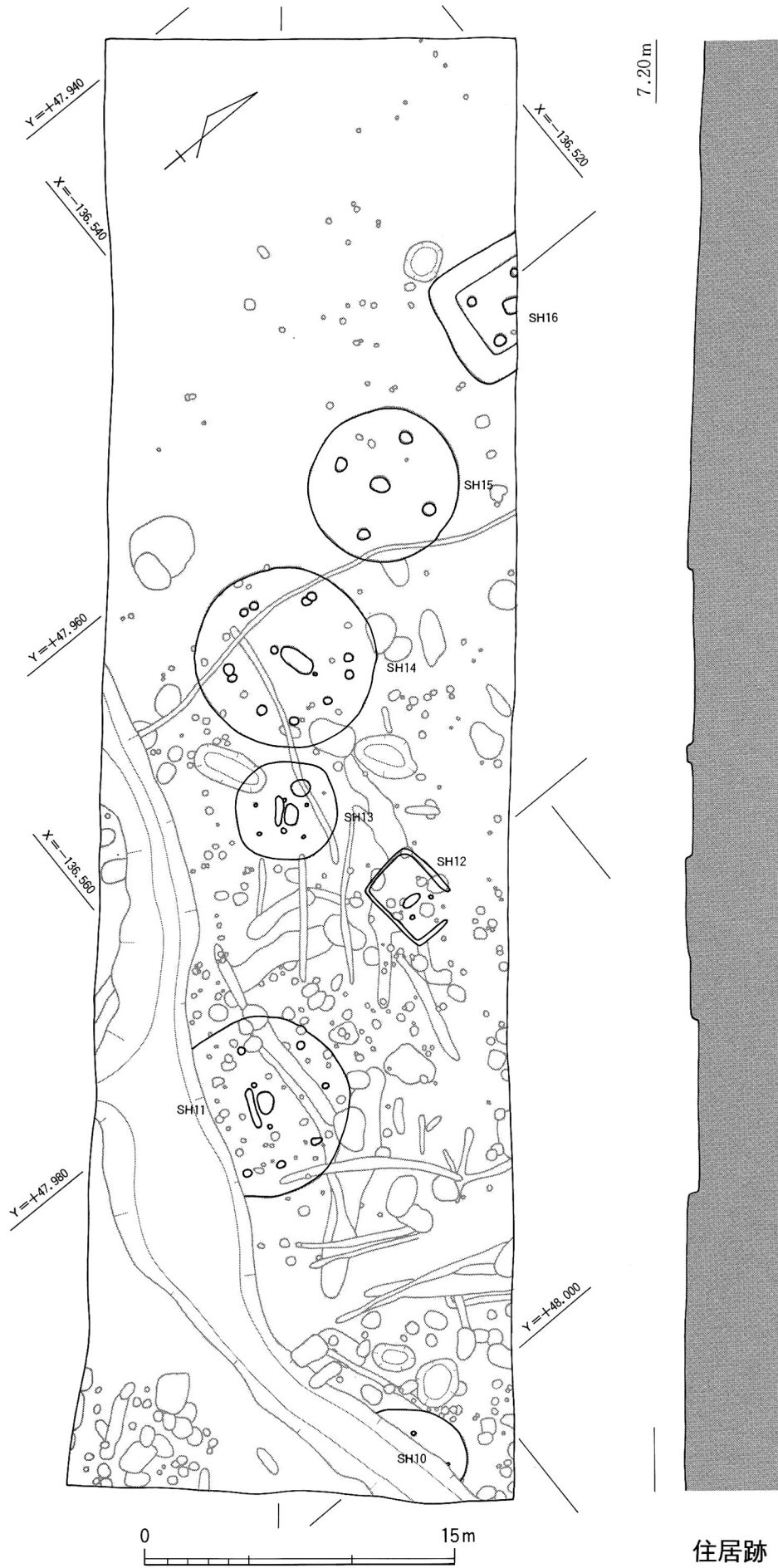

住居跡

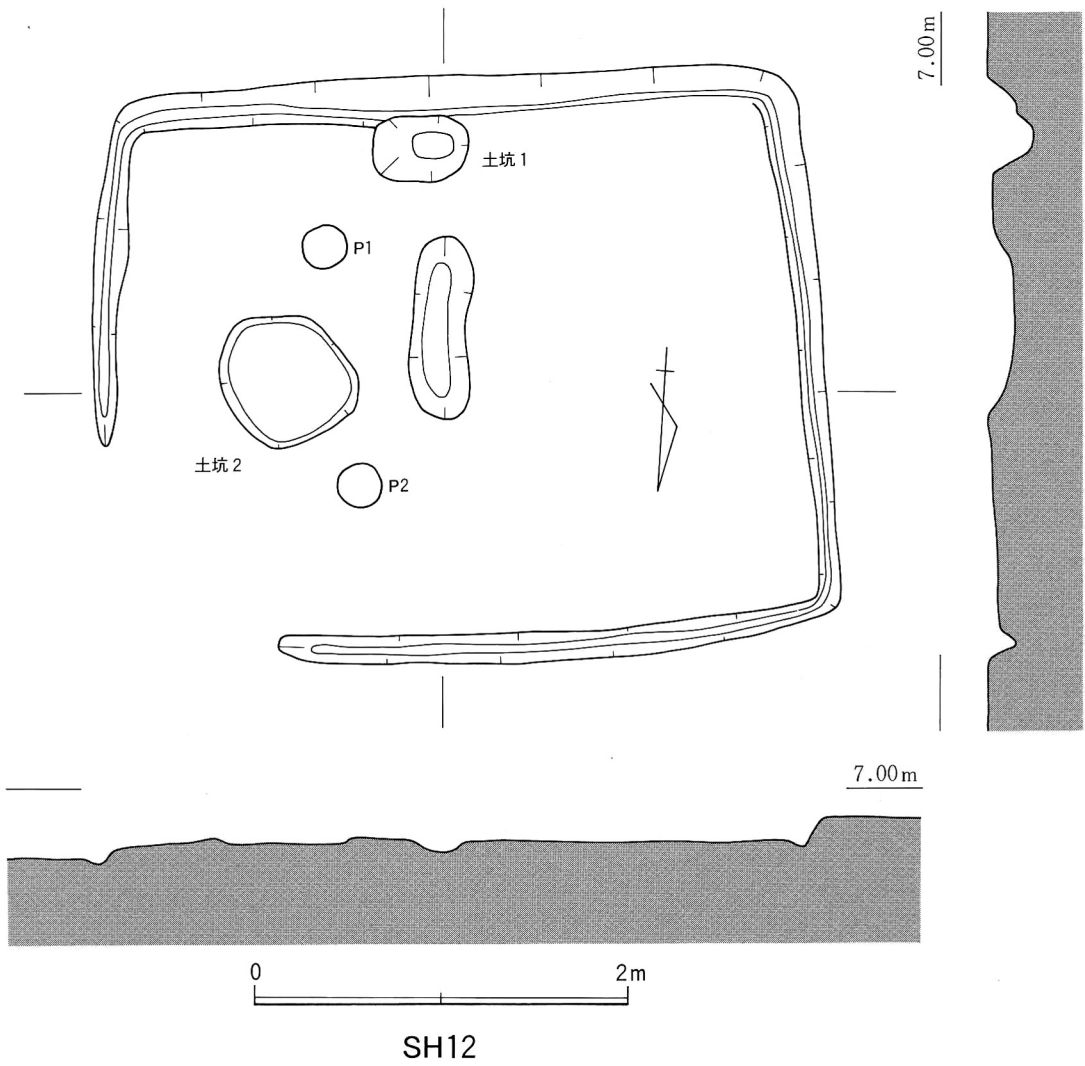
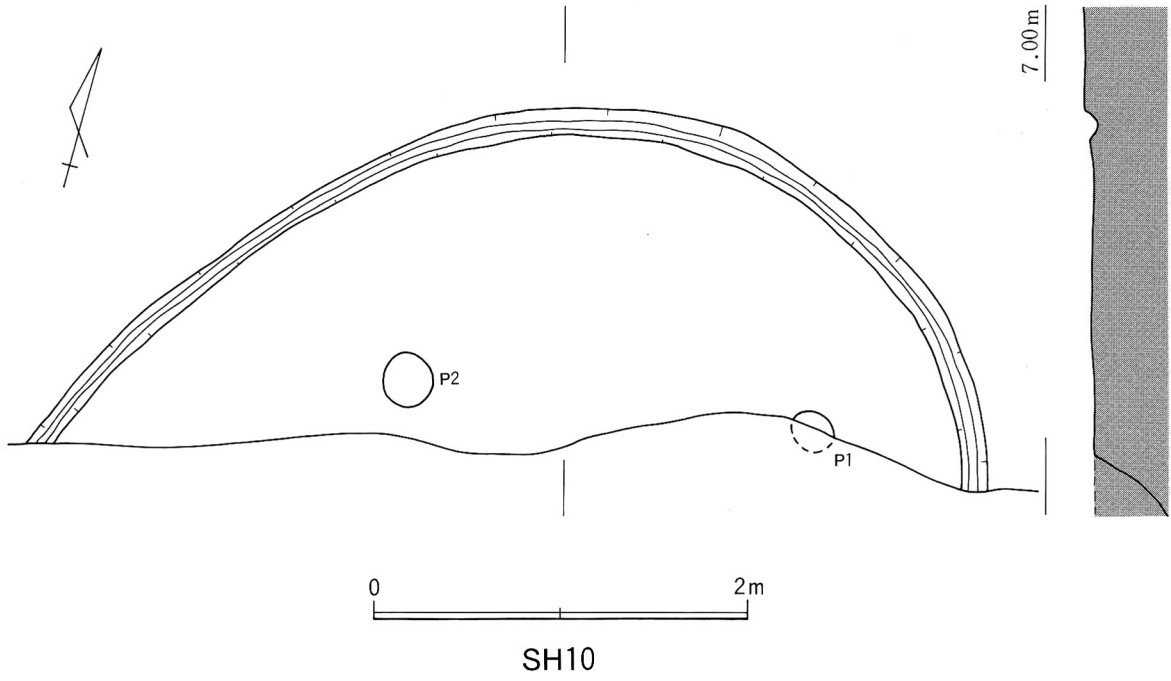

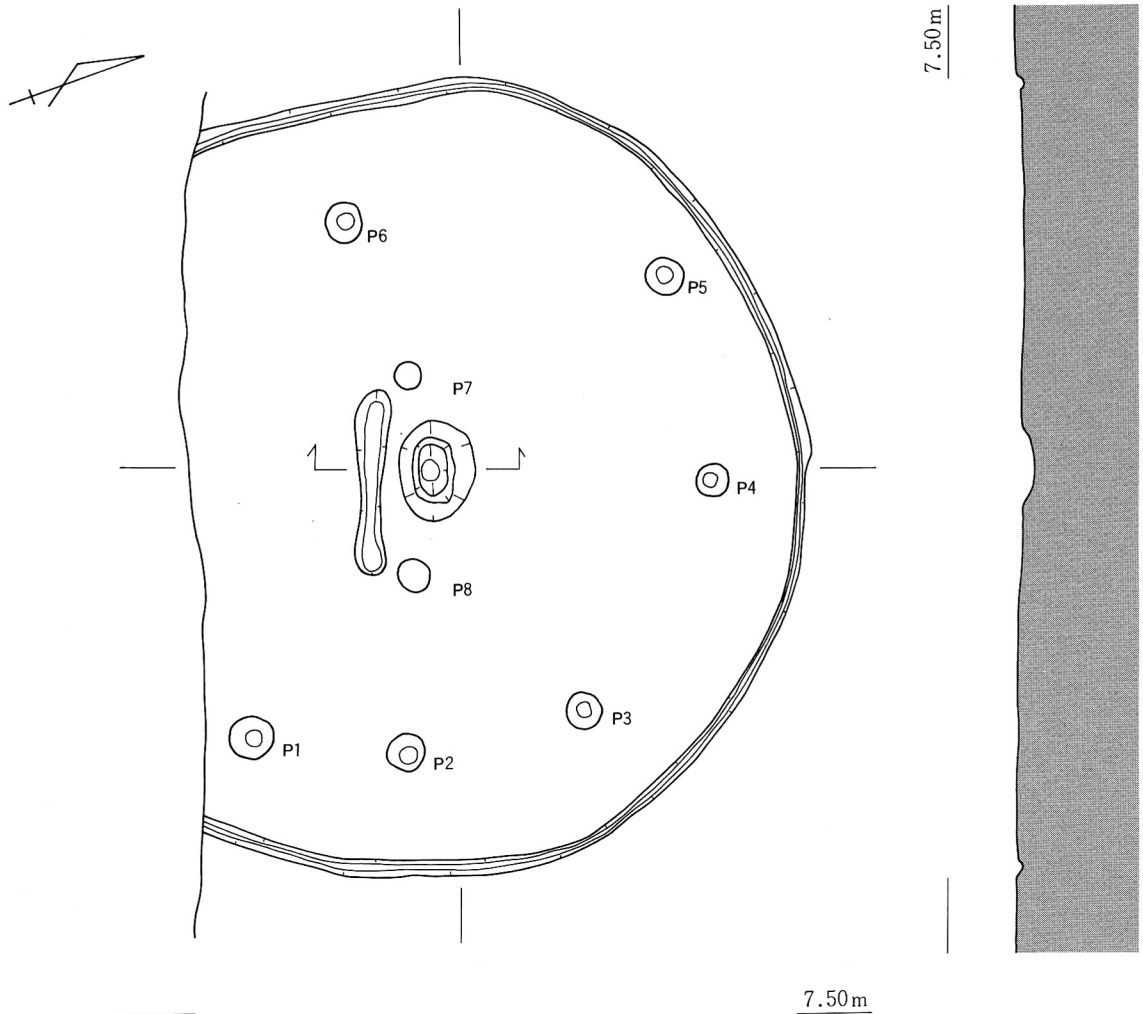

SH11



6.80m

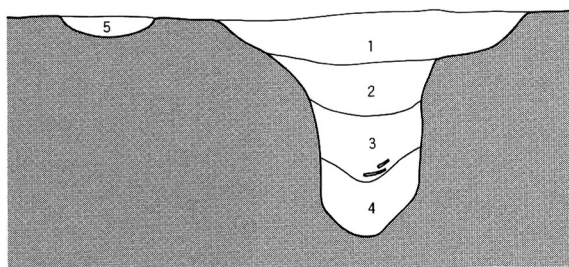

SH11中央土坑

- 1. 黒褐色 極細砂 (シルト・土器含む)
- 2. 黒褐色 シルト (炭少量含む)
- 3. 黒褐色 極細砂～細砂 (シルト・土器含む)
- 4. 黒色 シルト (炭含む)
- 5. 褐灰色 極細砂

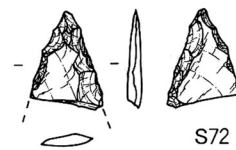

SH11出土石器

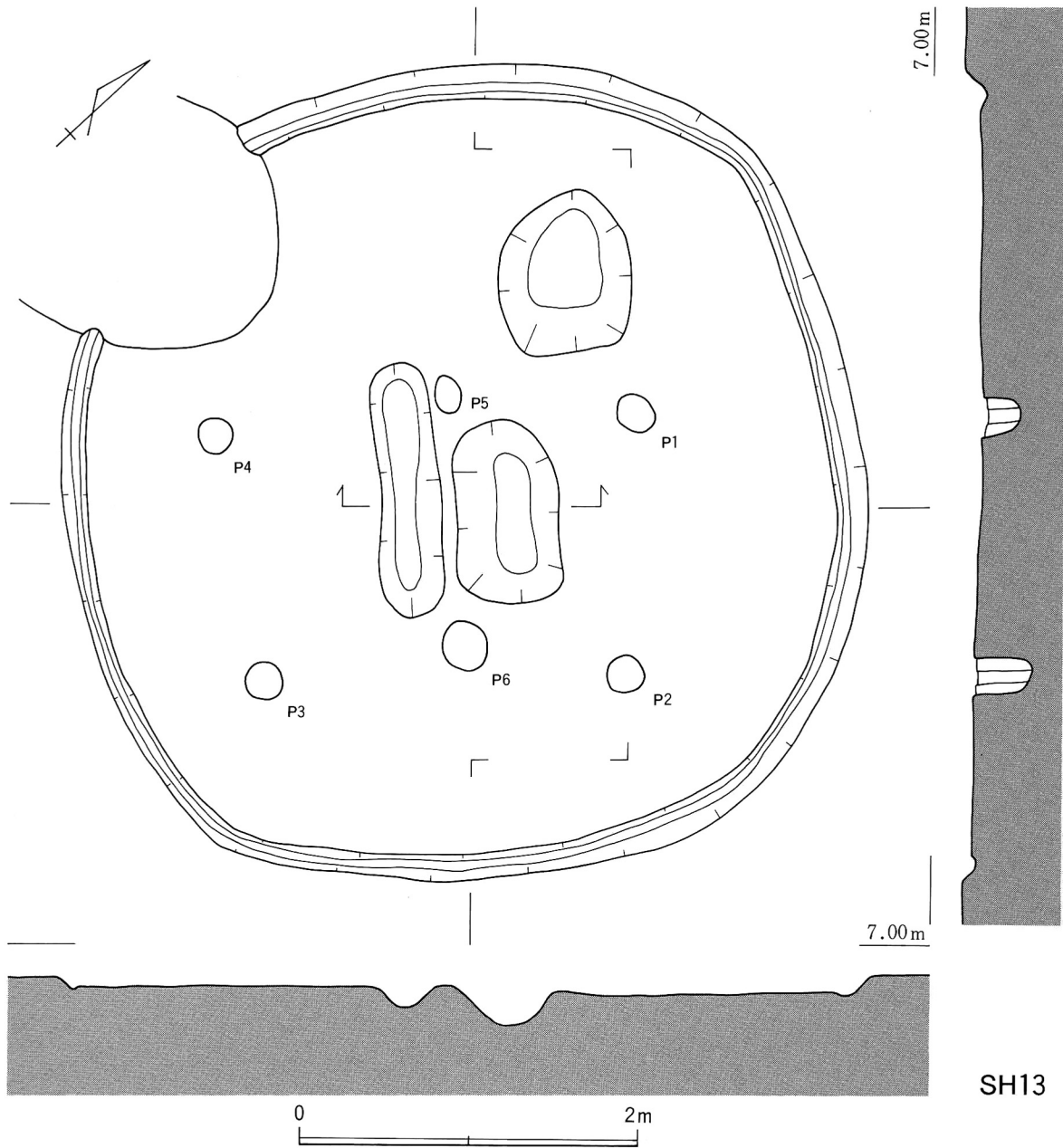

SH13

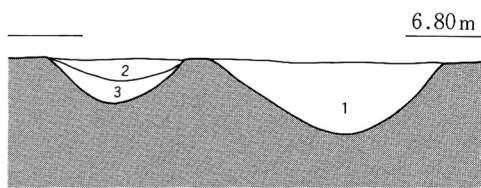

- 1. 灰色 極細砂混じりシルト質極細砂
- 2. 灰色 シルト質極細砂 (土器多く含む・下層に炭含む)
- 3. 灰色 極細砂質シルト

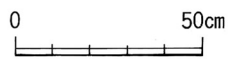

SH13中央土坑

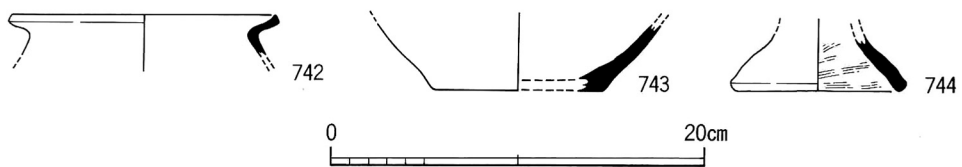

SH13出土土器

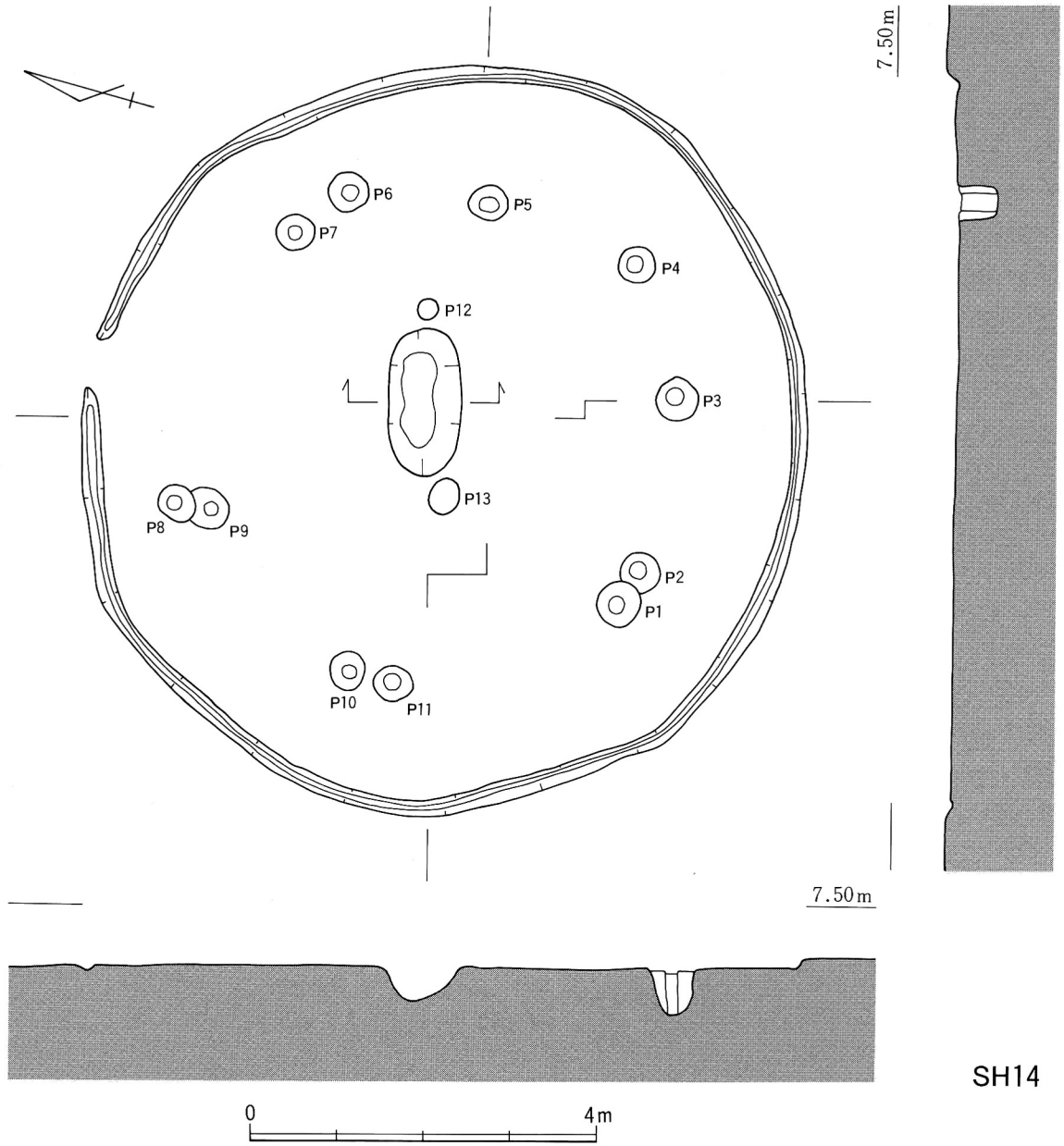

SH14

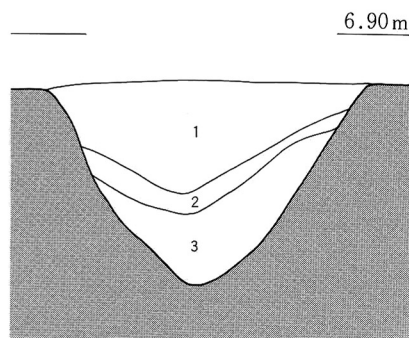

- 1. 灰色 シルト質極細砂 (土器・炭若干含む)
- 2. 暗灰色 シルト質極細砂 (炭多く含む)
- 3. 黄灰色 極細砂質シルト (土器含む)

0 50cm

SH14中央土坑

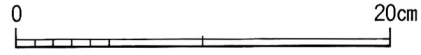
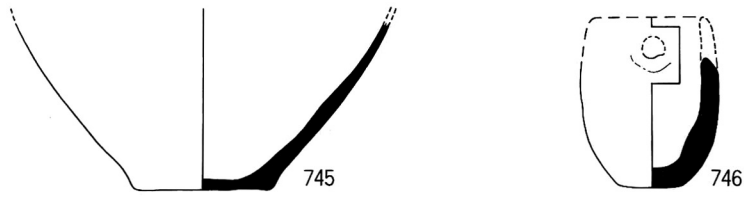

SH14出土土器

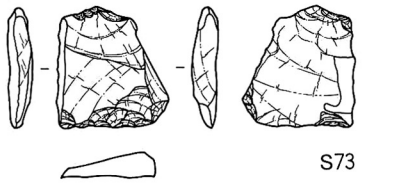

S73

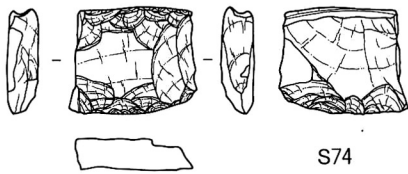

S74

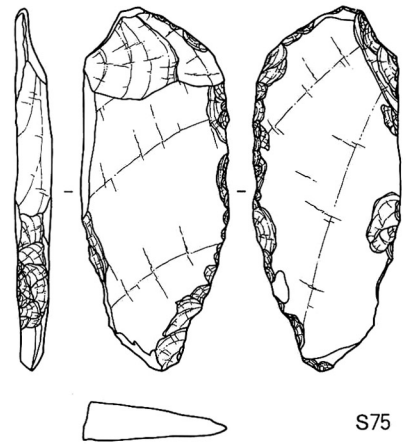

S75

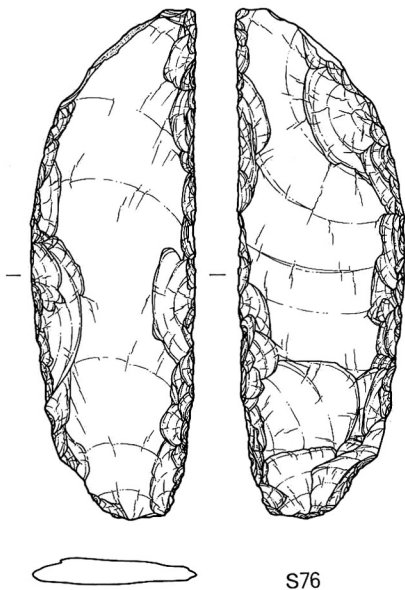

S76

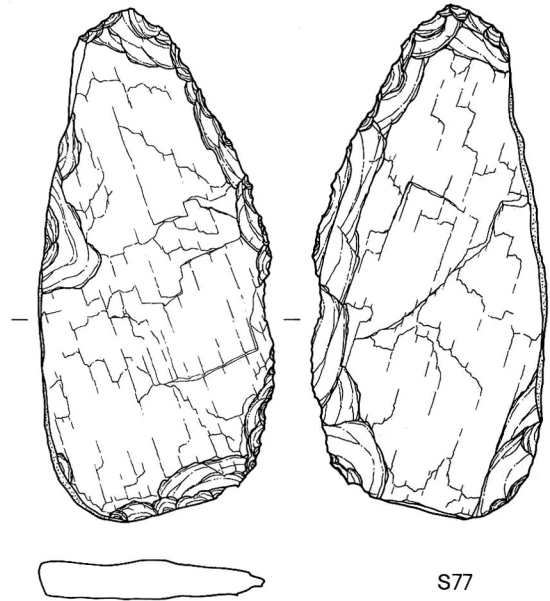

S77



SH14出土石器

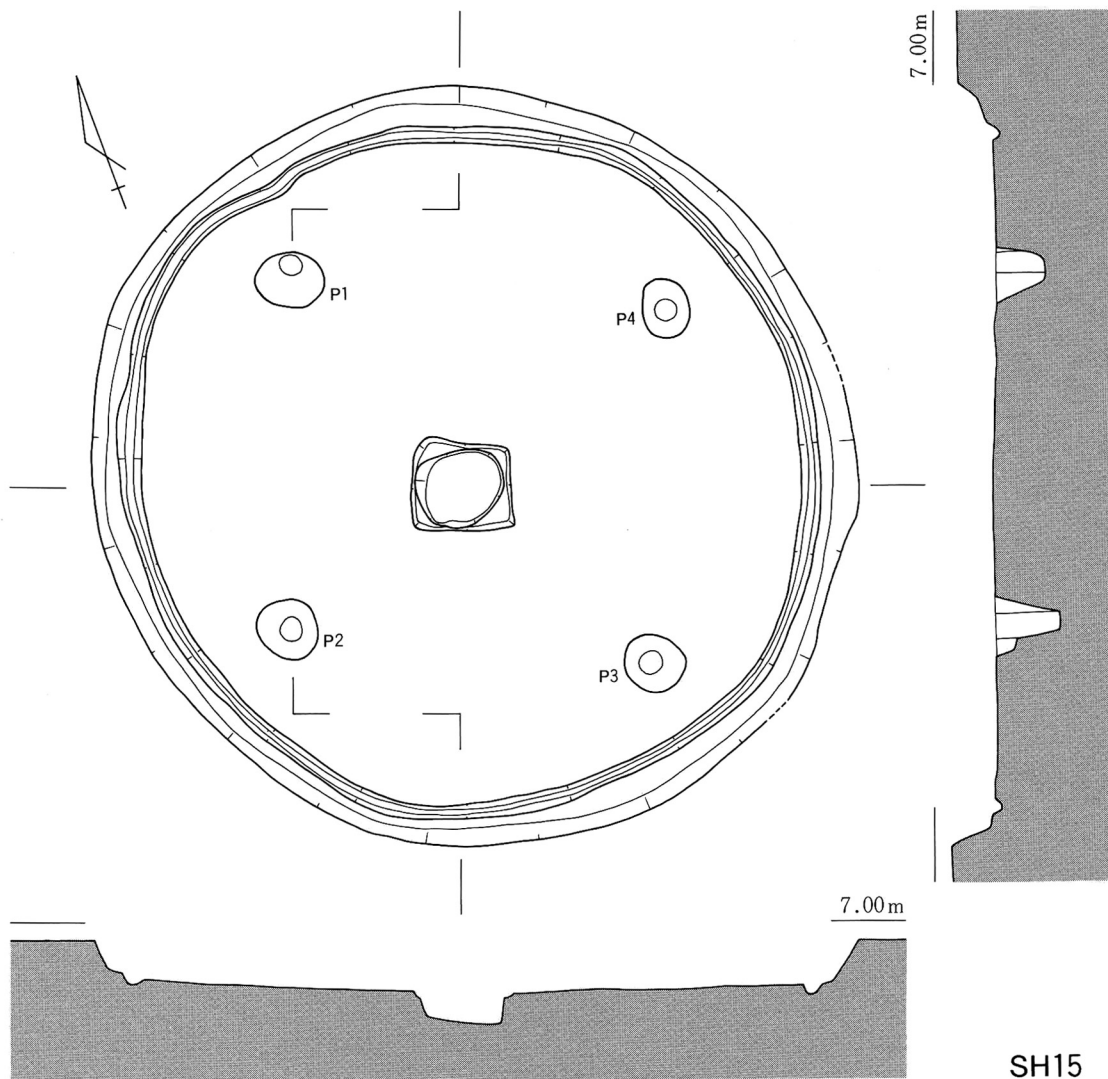

SH15

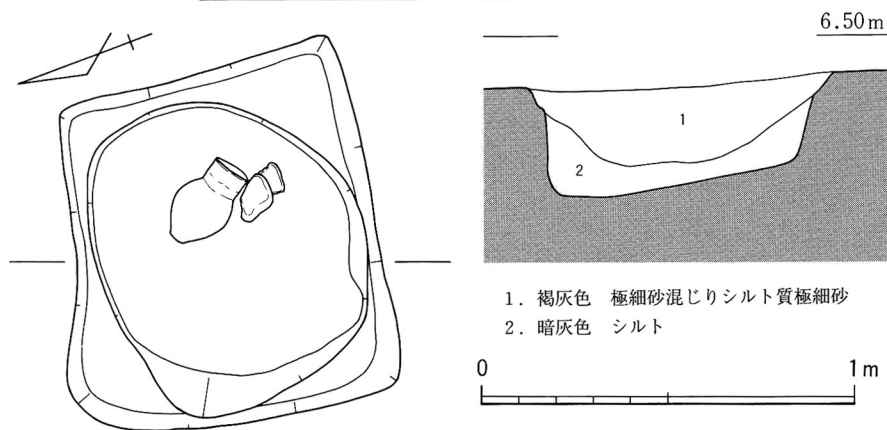

- 1. 褐灰色 極細砂混じりシルト質極細砂
- 2. 暗灰色 シルト

SH15中央土坑

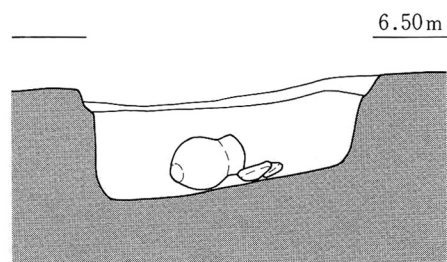

SH15中央土坑

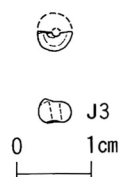

中央土坑出土玉

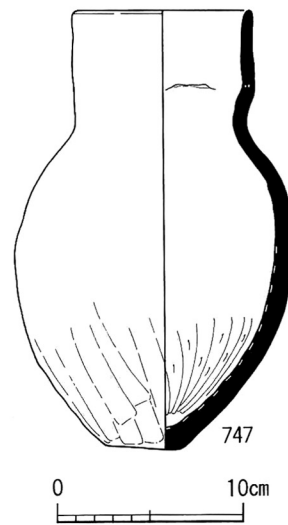

中央土坑出土土器

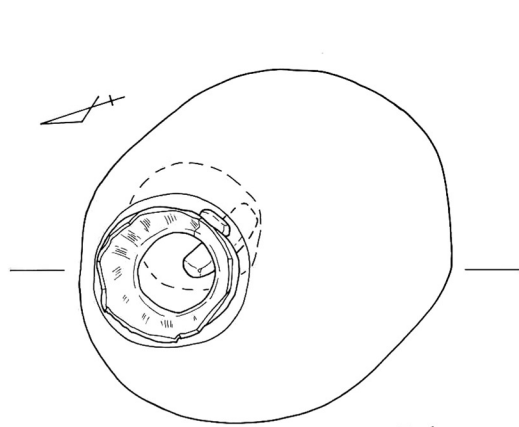

P 1

6.50m

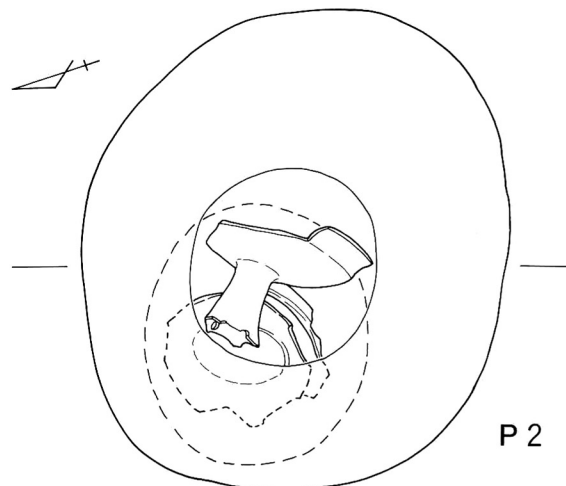

P 2

6.50m

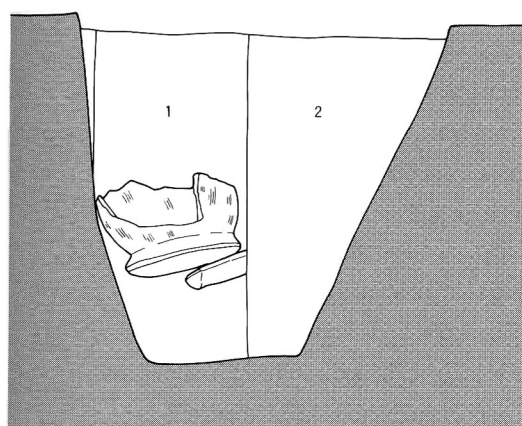

SH15柱穴 (1)

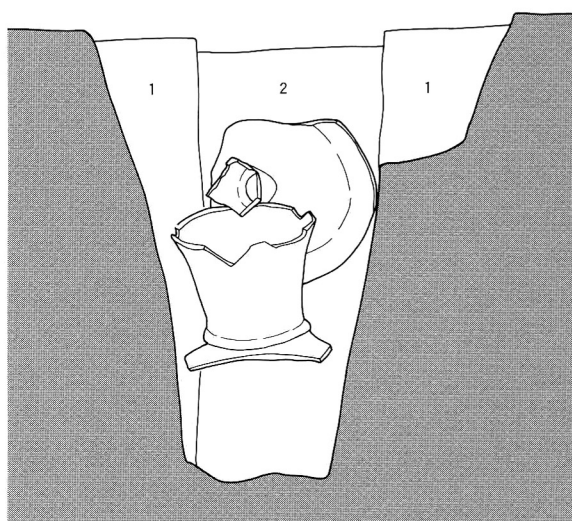

P 1

- 1. 褐灰色 シルト質極細砂 (小礫混じり)
- 2. 褐灰色 シルト質極細砂

P 2

- 1. 灰黄褐色 極細砂混じりシルト質極細砂
- 2. 褐灰色 シルト質極細砂

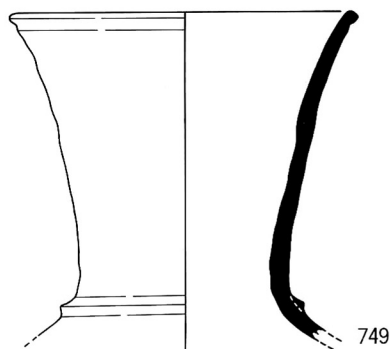

749

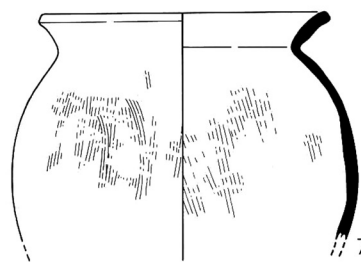

748

P 1 出土土器

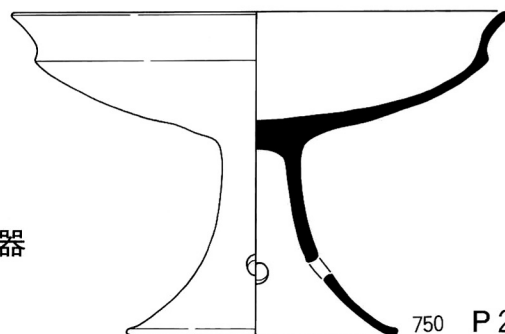
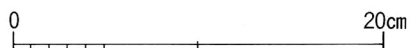

750

P 2 出土土器

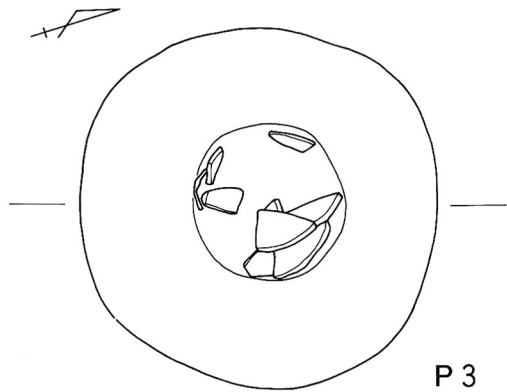

P 3

6.50m

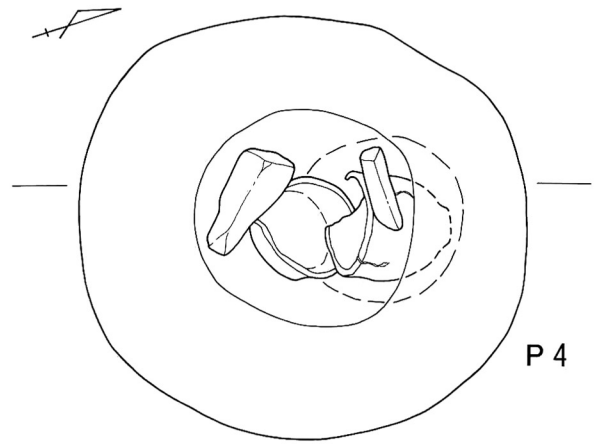

P 4

6.50m

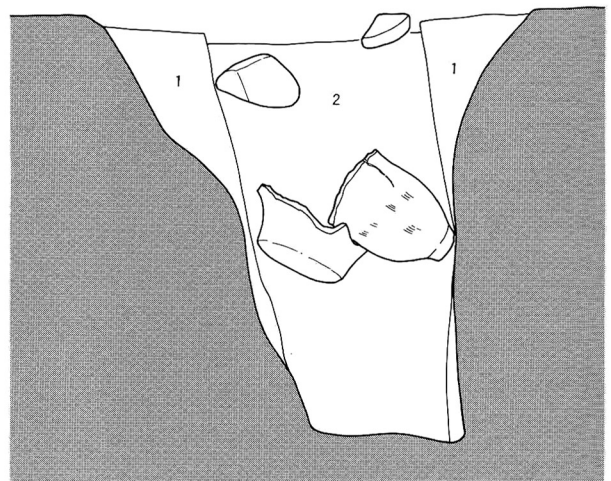
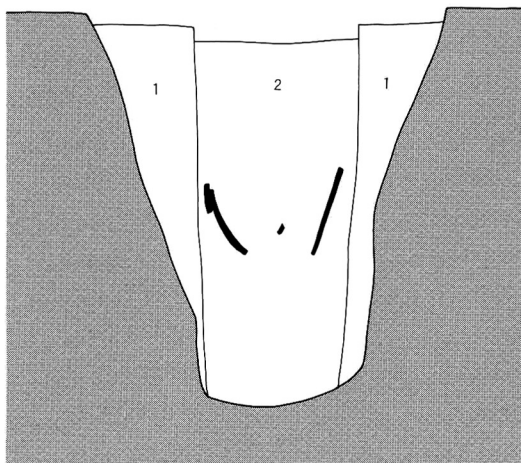

- 1. 灰黄褐色 極細砂混じりシルト質極細砂
- 2. 褐灰色 シルト質極細砂

- 1. 黄灰色 シルト質極細砂
- 2. 灰色 シルト質極細砂



SH15柱穴 (2)



751

751 P 3 出土土器
752・753 P 4 出土土器

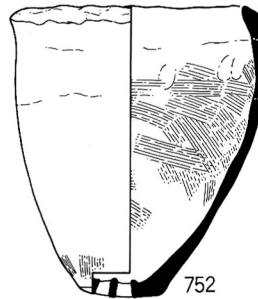

752



753

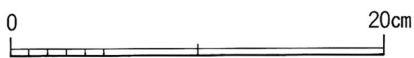

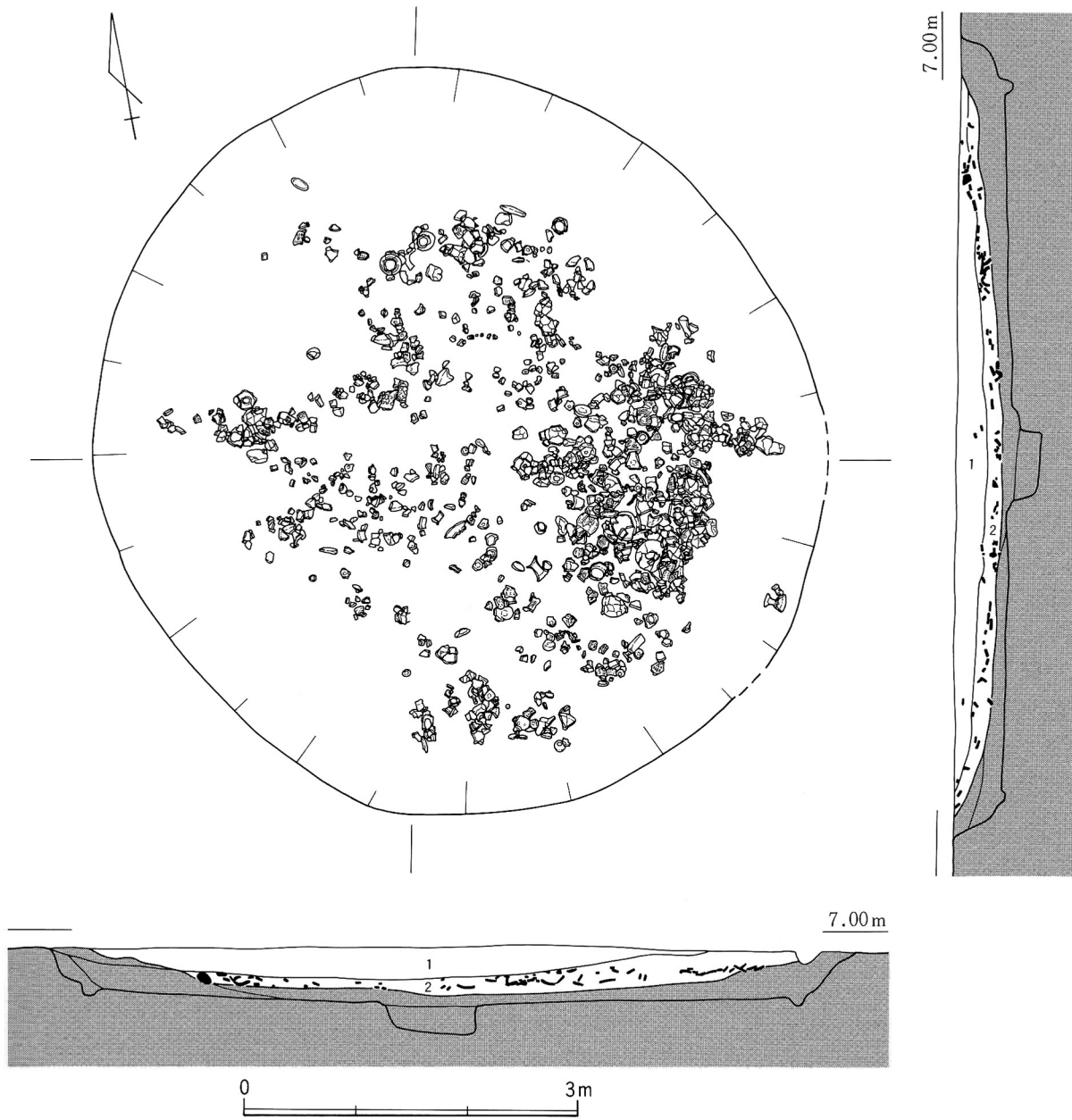

- 1. 黒色 シルト質極細砂 (土器若干含む)
- 2. 褐灰色 シルト混じりシルト質極細砂 (土器多量に含む)

SH15上層

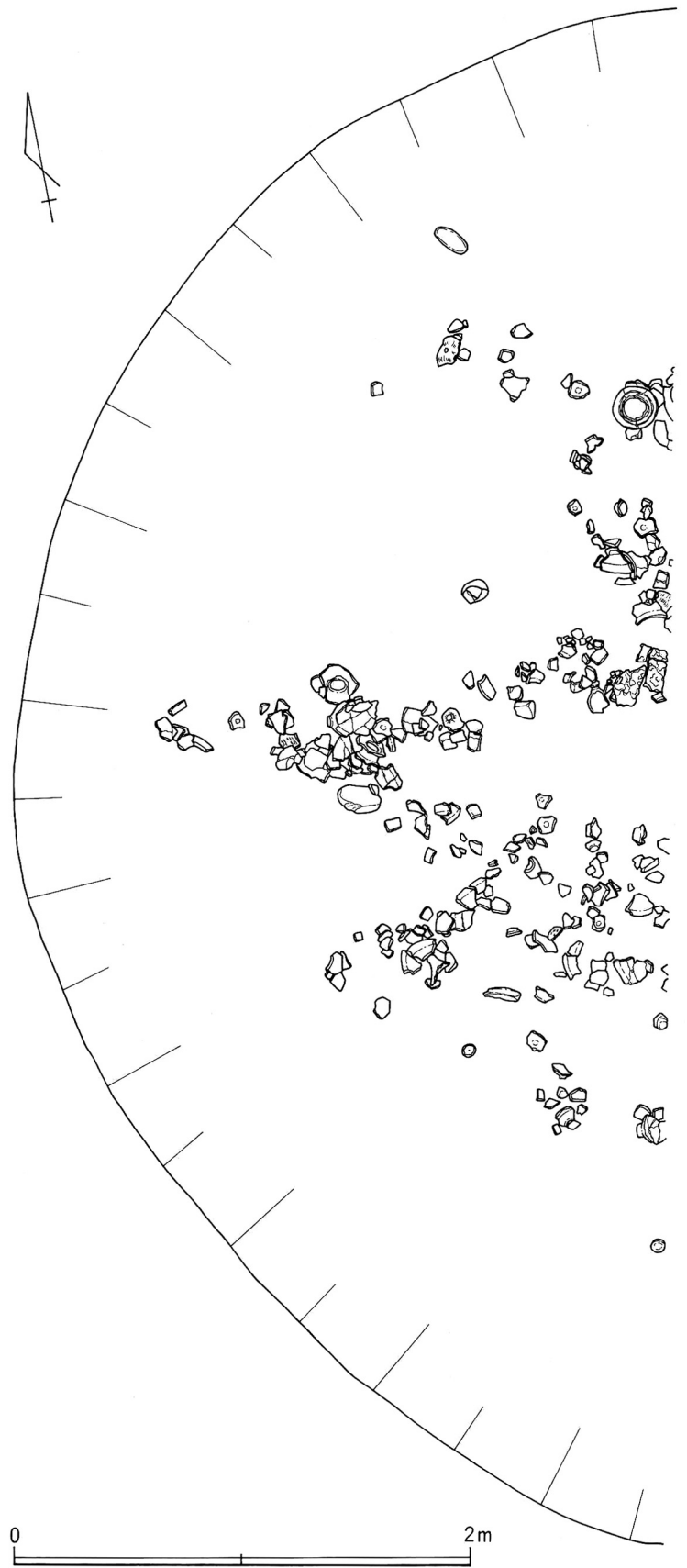

SH15上層 (1)

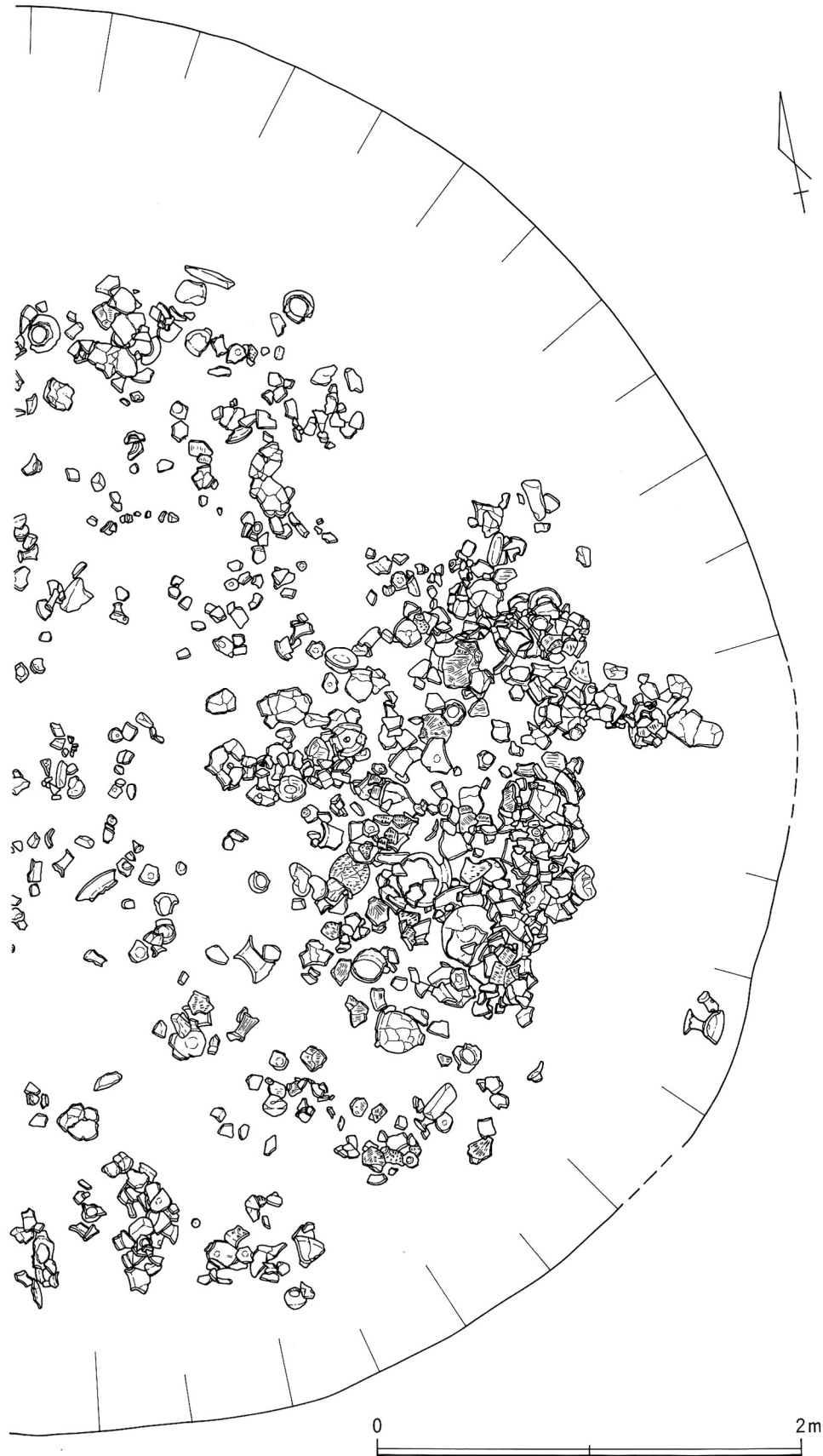

SH15上層 (2)

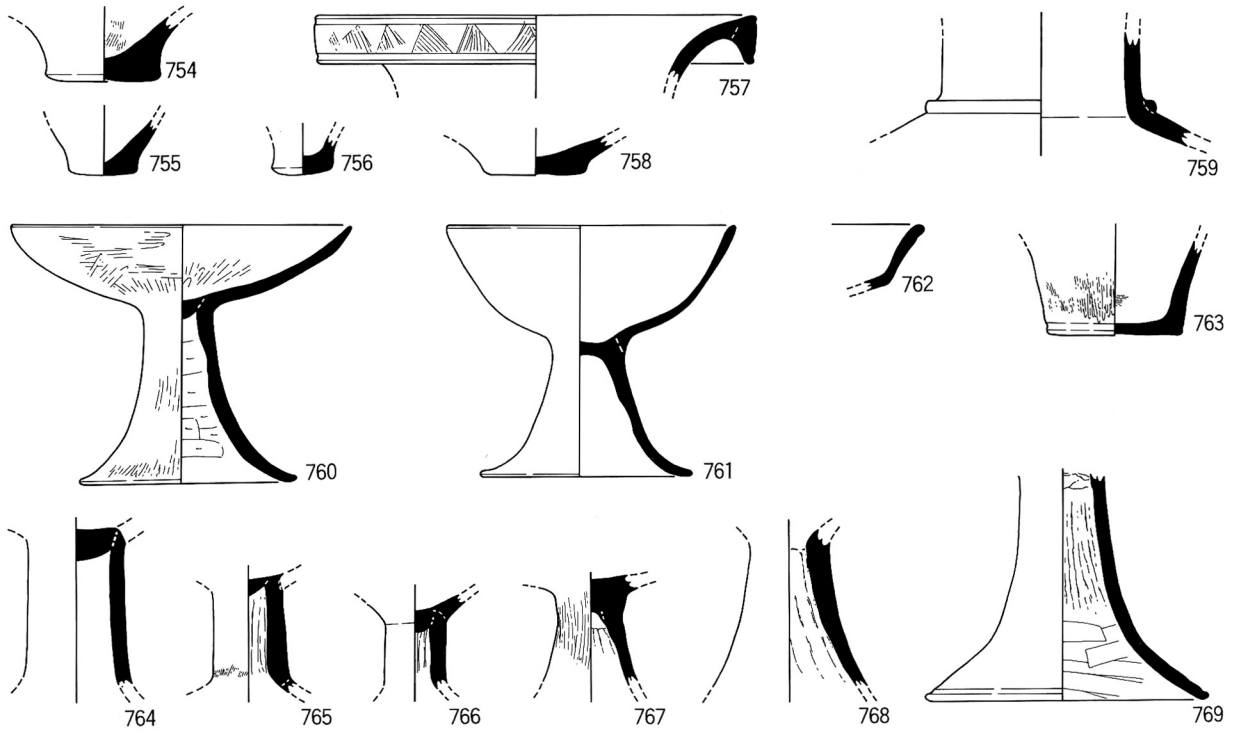

754~769 SH15下層出土土器

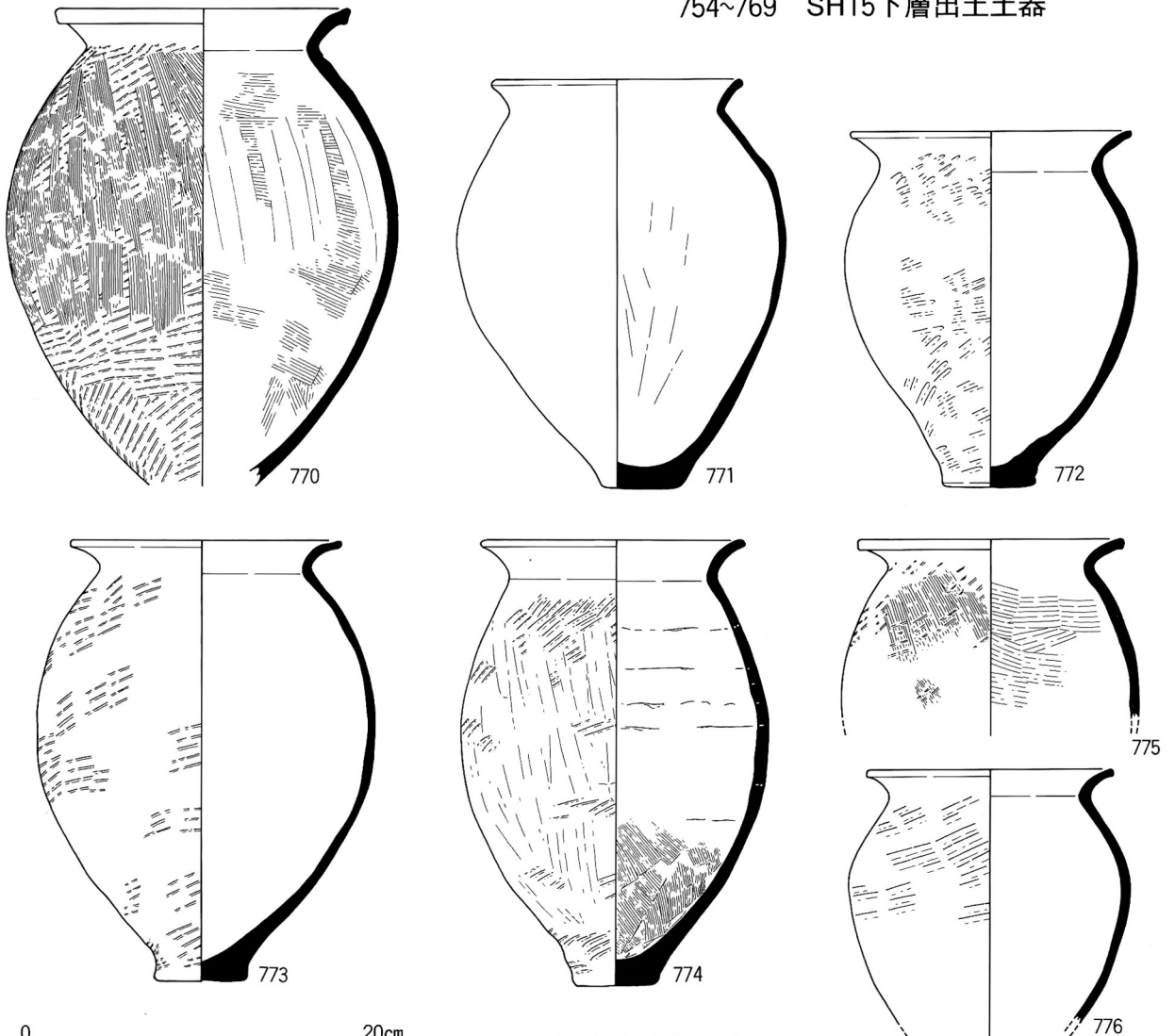

SH15上層出土土器 (1)



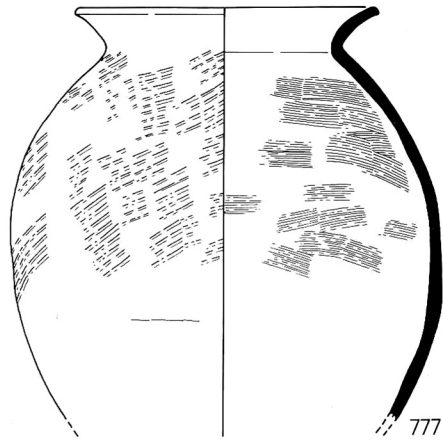

777

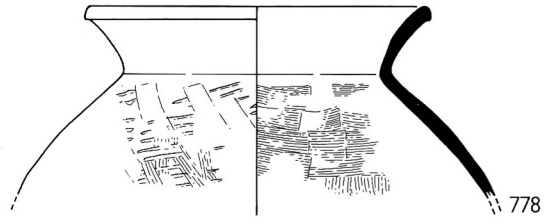

778

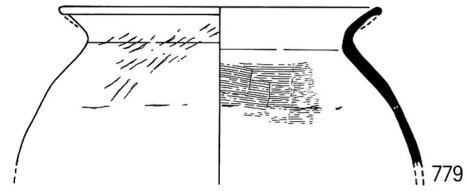

779

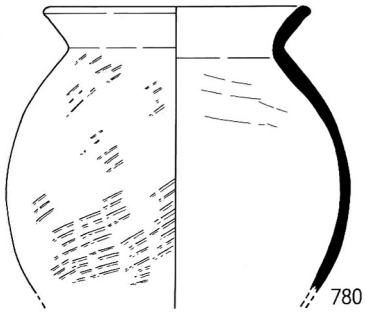

780

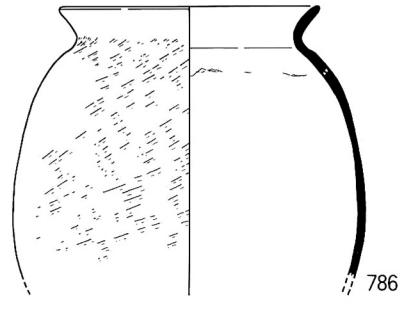

786

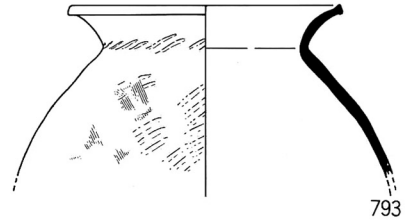

793

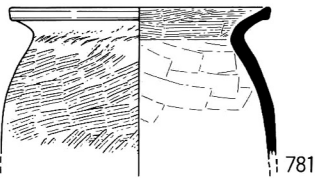

781

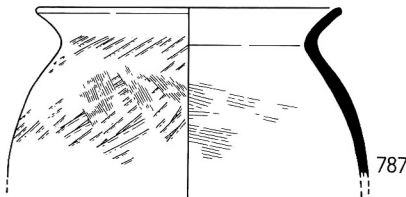

787

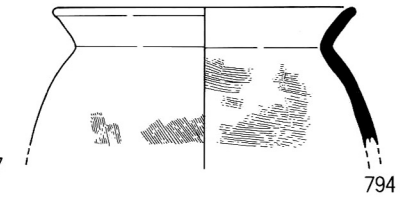

794

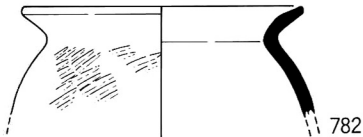

782

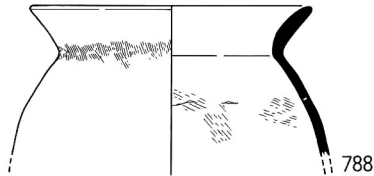

788

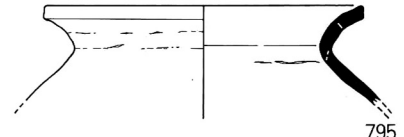

795

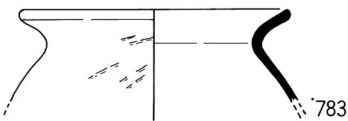

783

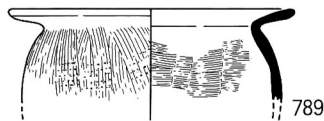

789

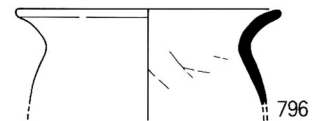

796

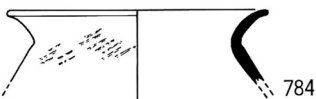

784

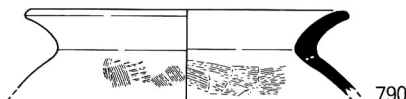

790

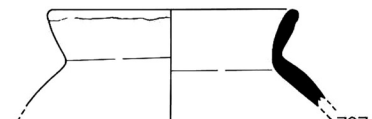

797

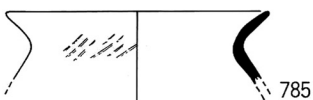

785

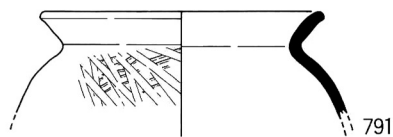

791

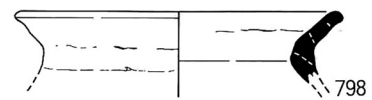

798

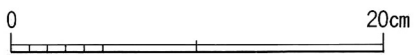

SH15上層出土土器 (2)

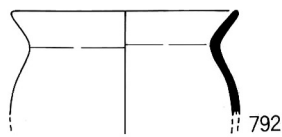

792

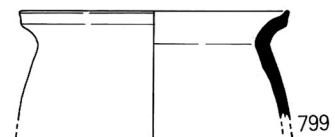

799

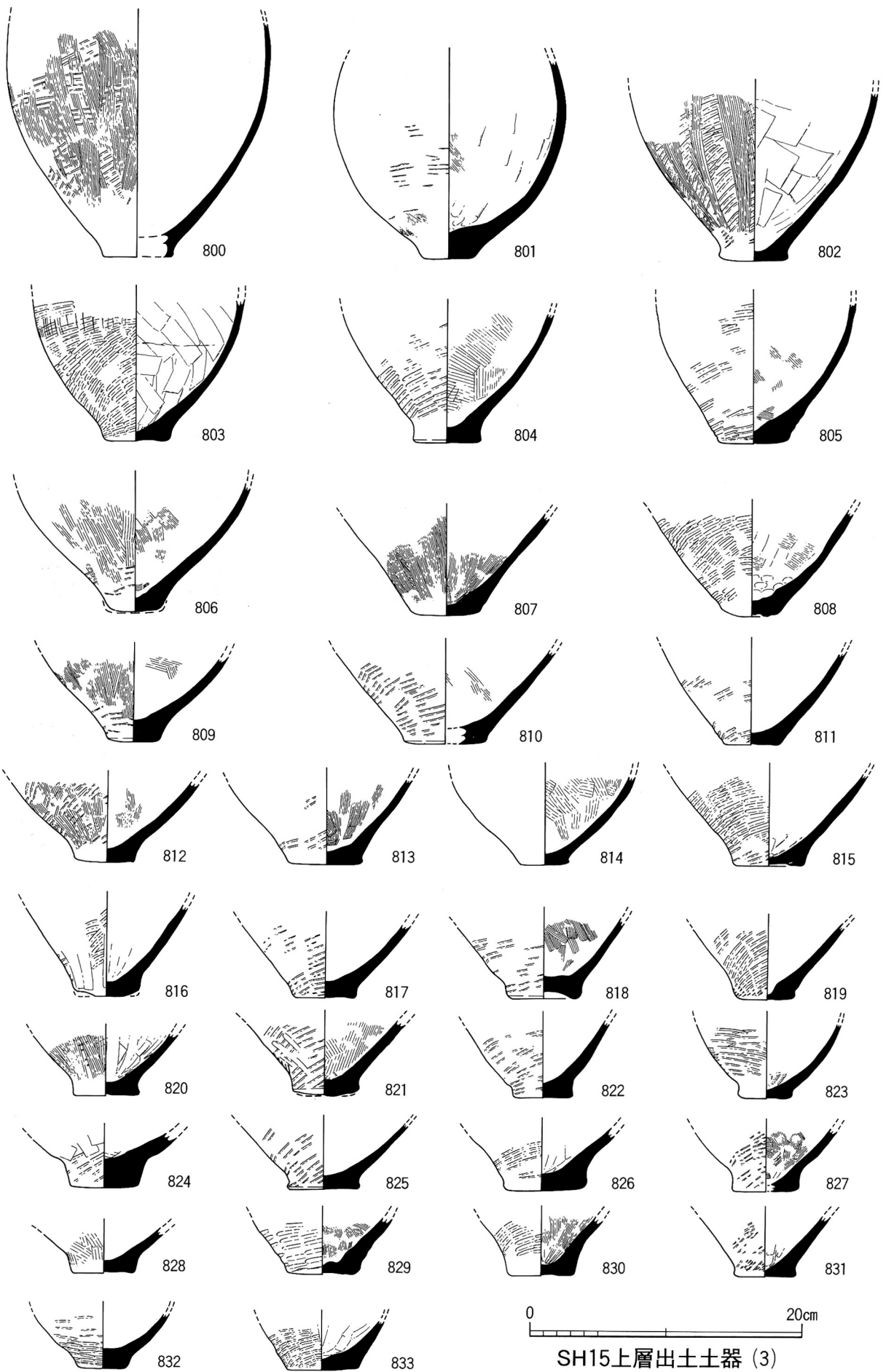

0 20cm

SH15上層出土土器 (3)

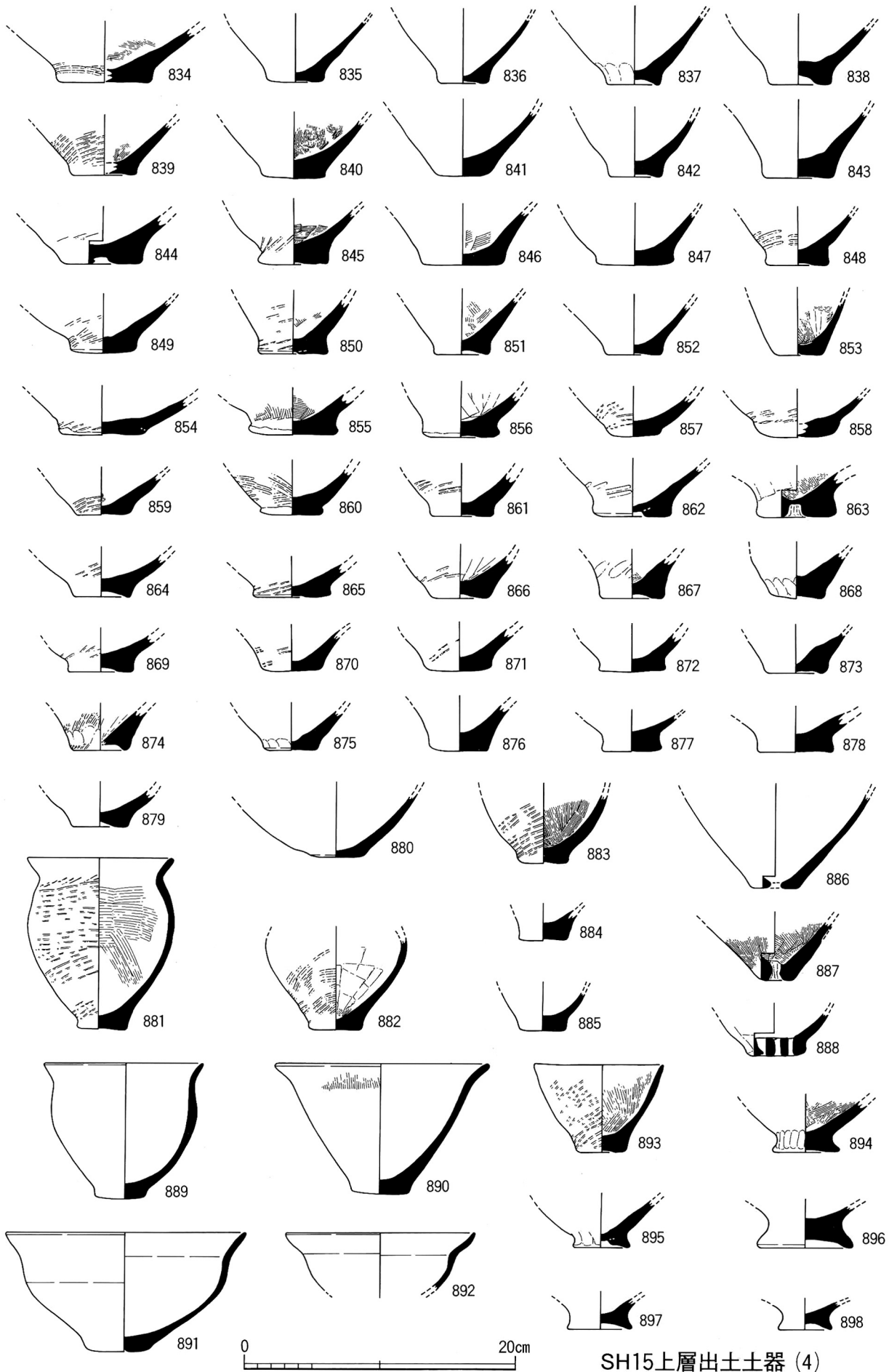

SH15上层出土土器(4)

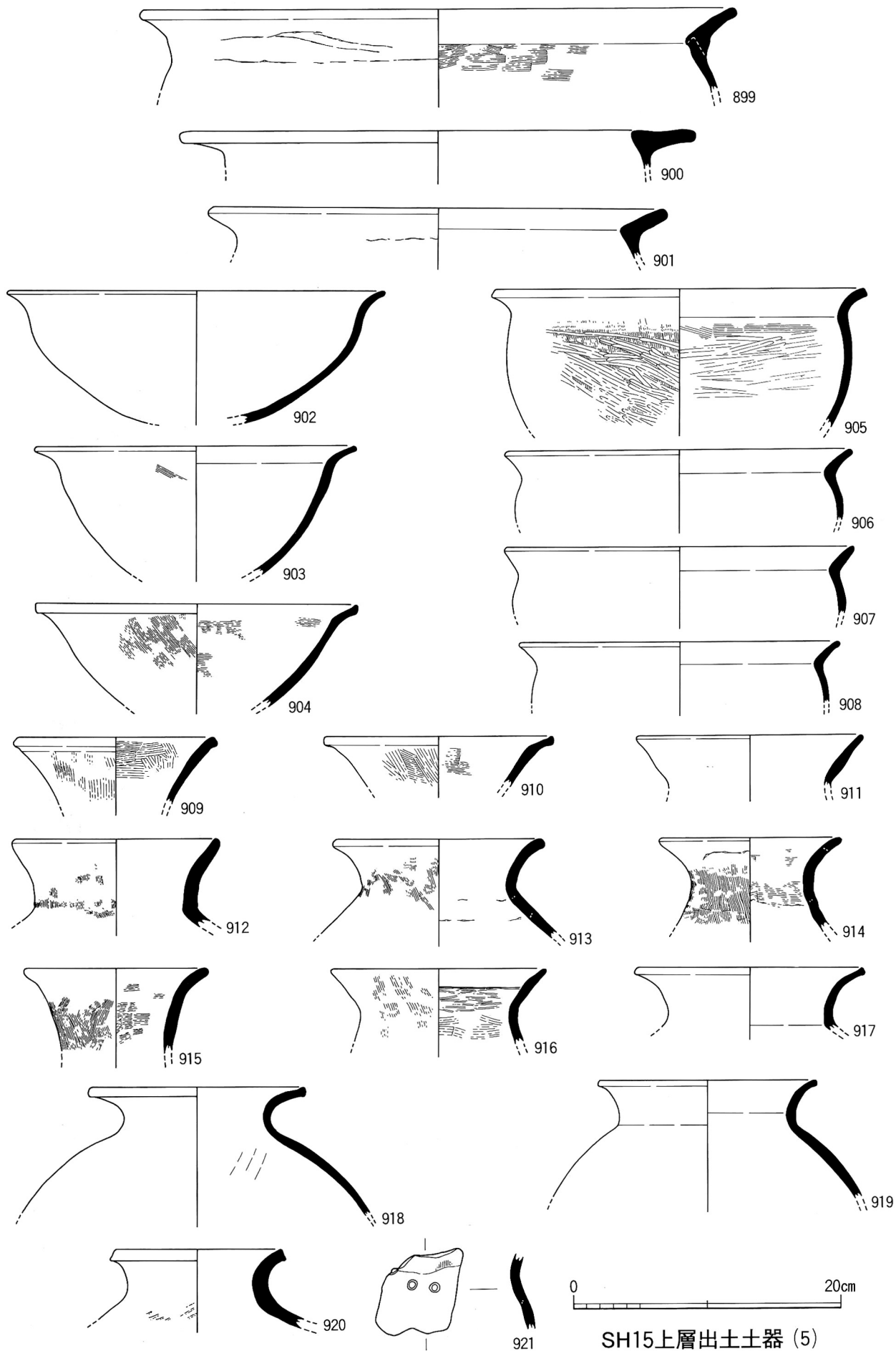

SH15上層出土土器 (5)

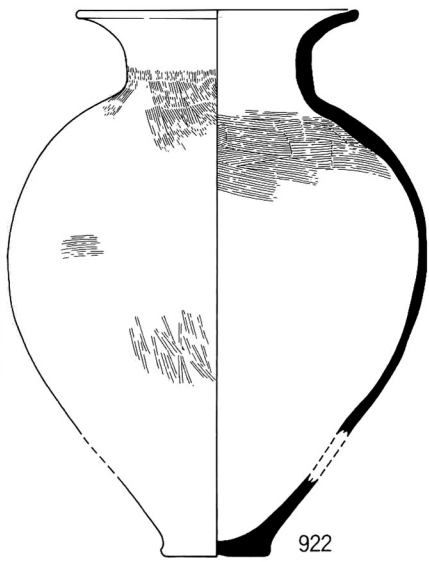

922

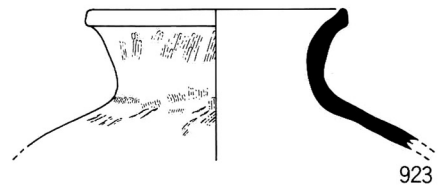

923

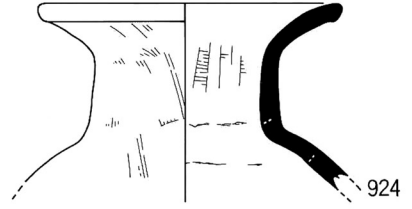

924

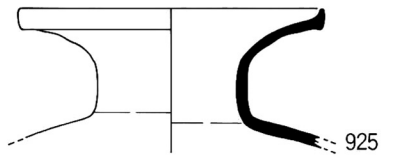

925

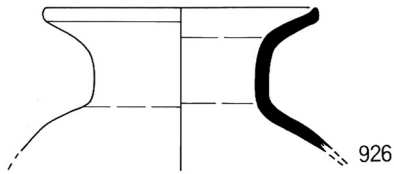

926

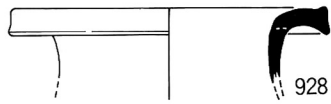

928

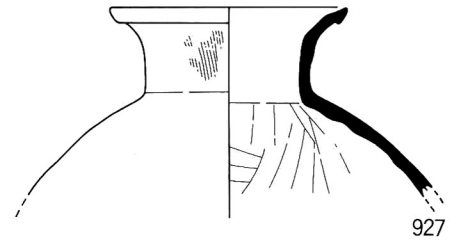

927

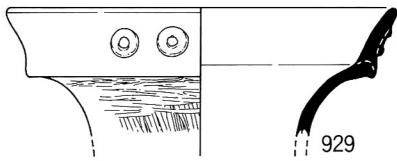

929

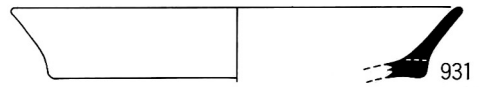

931

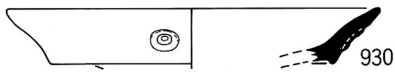

930

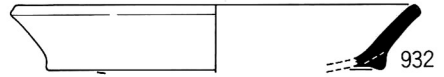

932

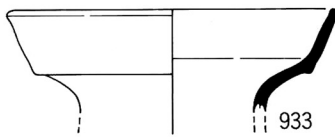

933

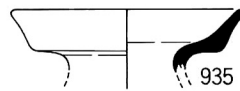

935

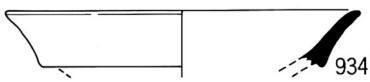

934



936

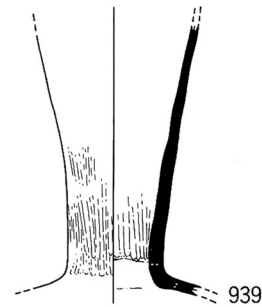

939

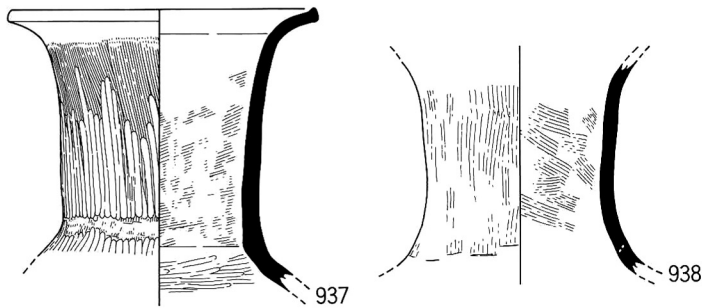

937

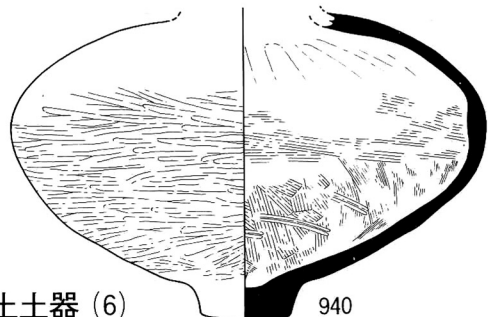

938



SH15上層出土土器 (6)

940

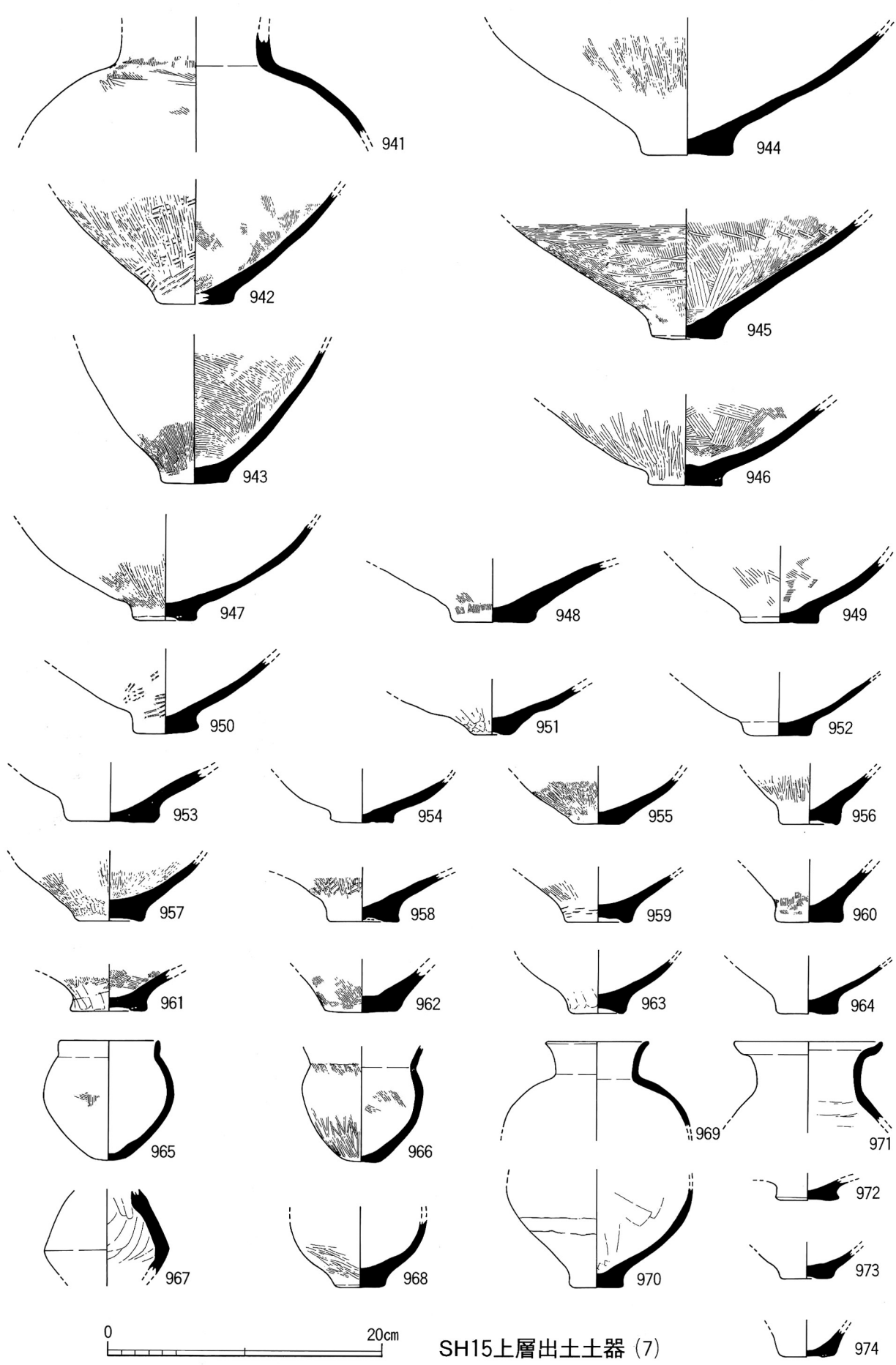

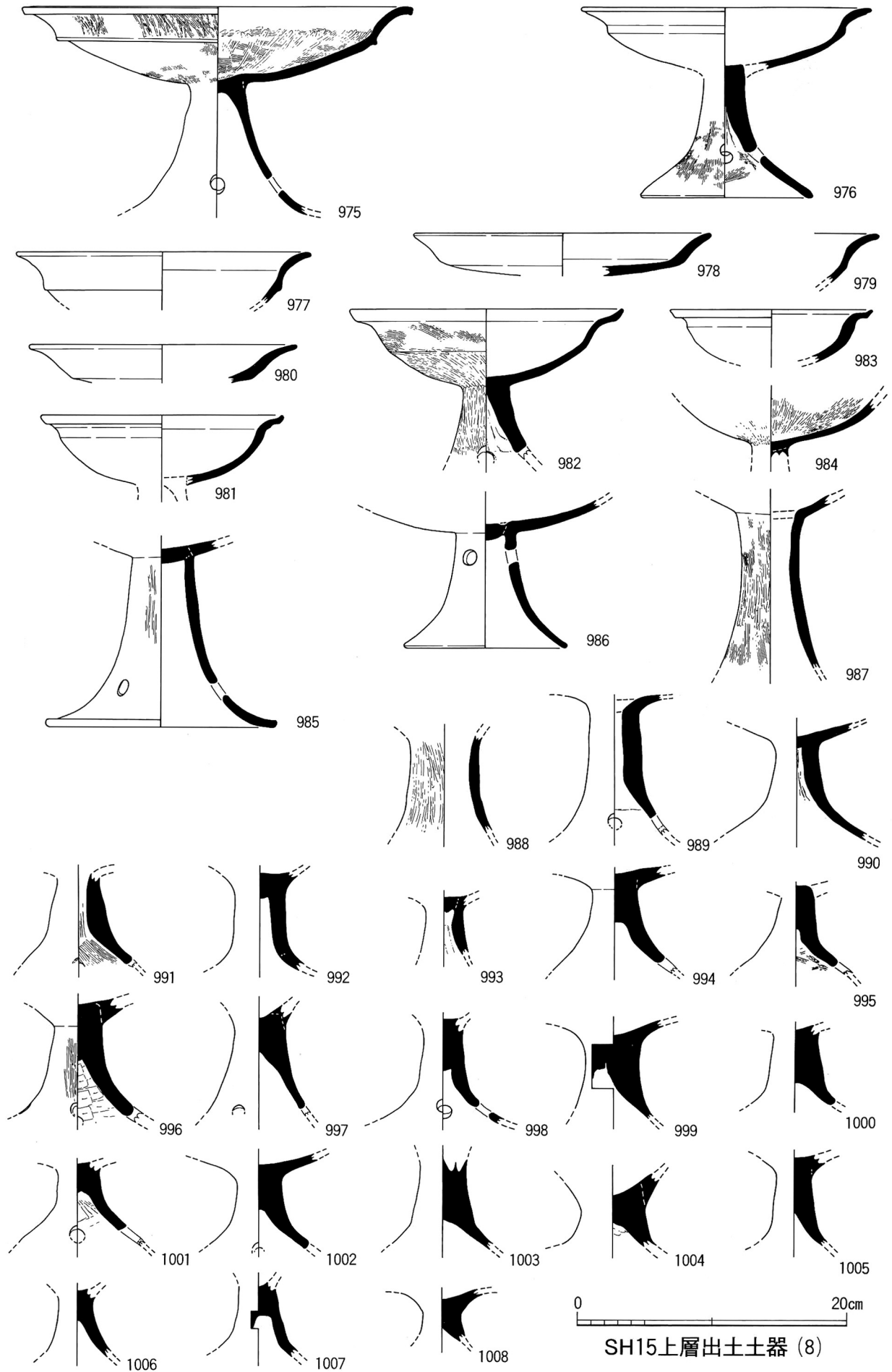

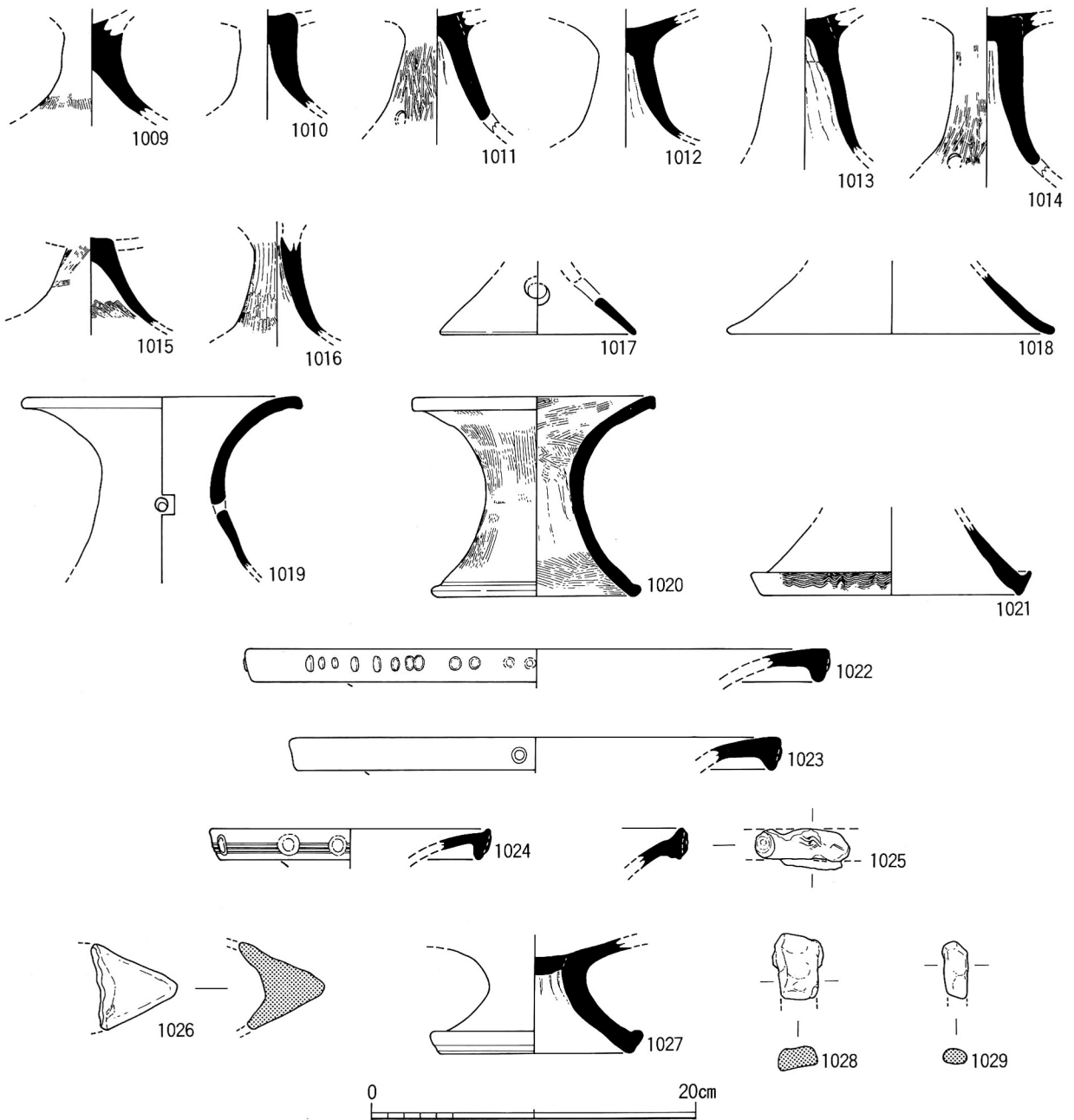

SH15上層出土土器 (9)

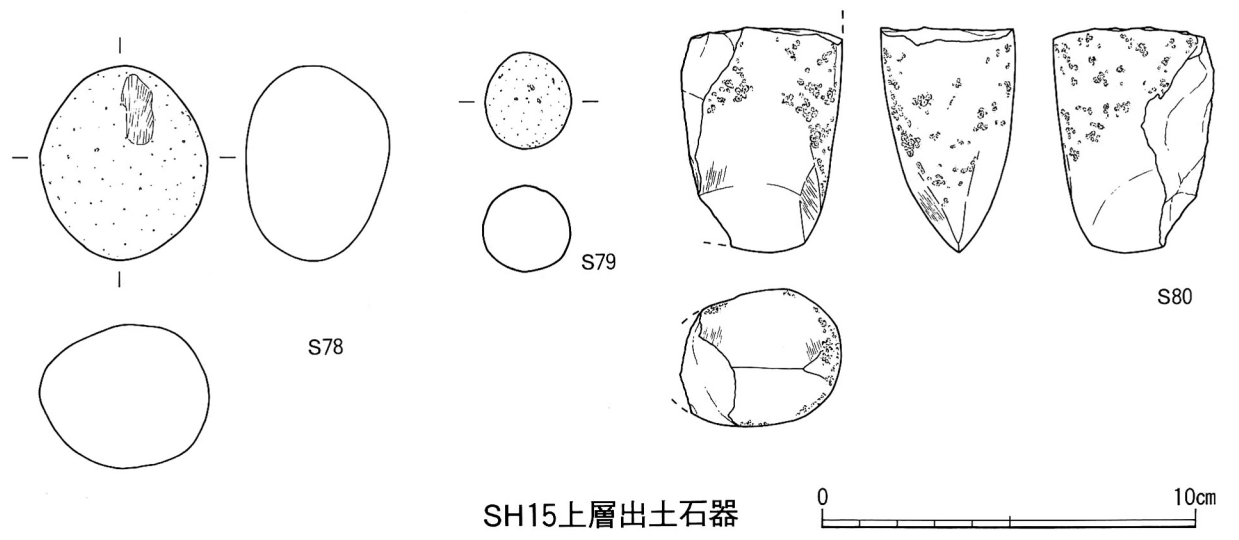

SH15上層出土石器

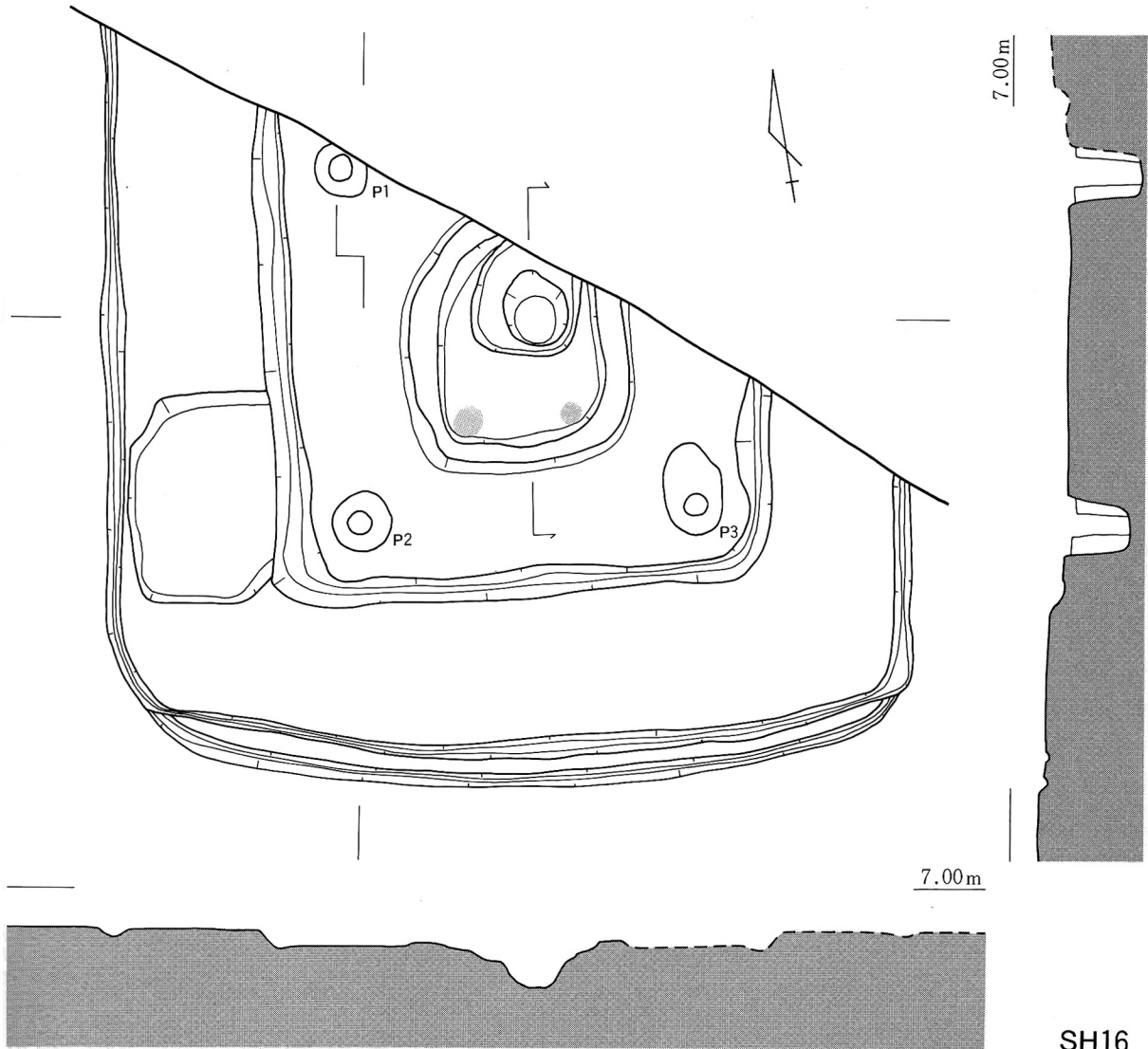

SH16

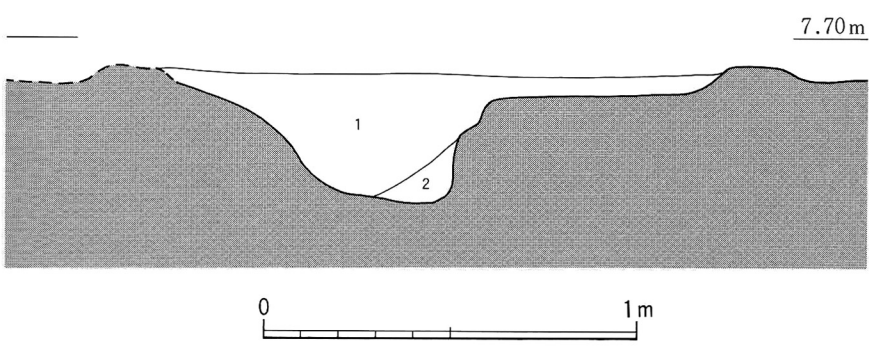

- 1. 緑黒色 シルト質極細砂
(径2~3cmの焼土混じる)
- 2. 明黄褐色 シルト質極細砂

SH16中央土坑

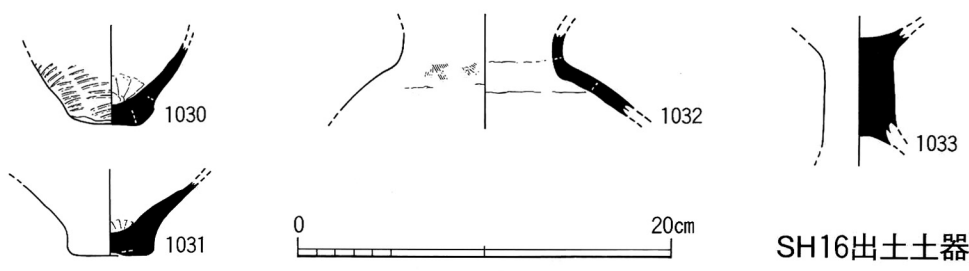

SH16出土土器

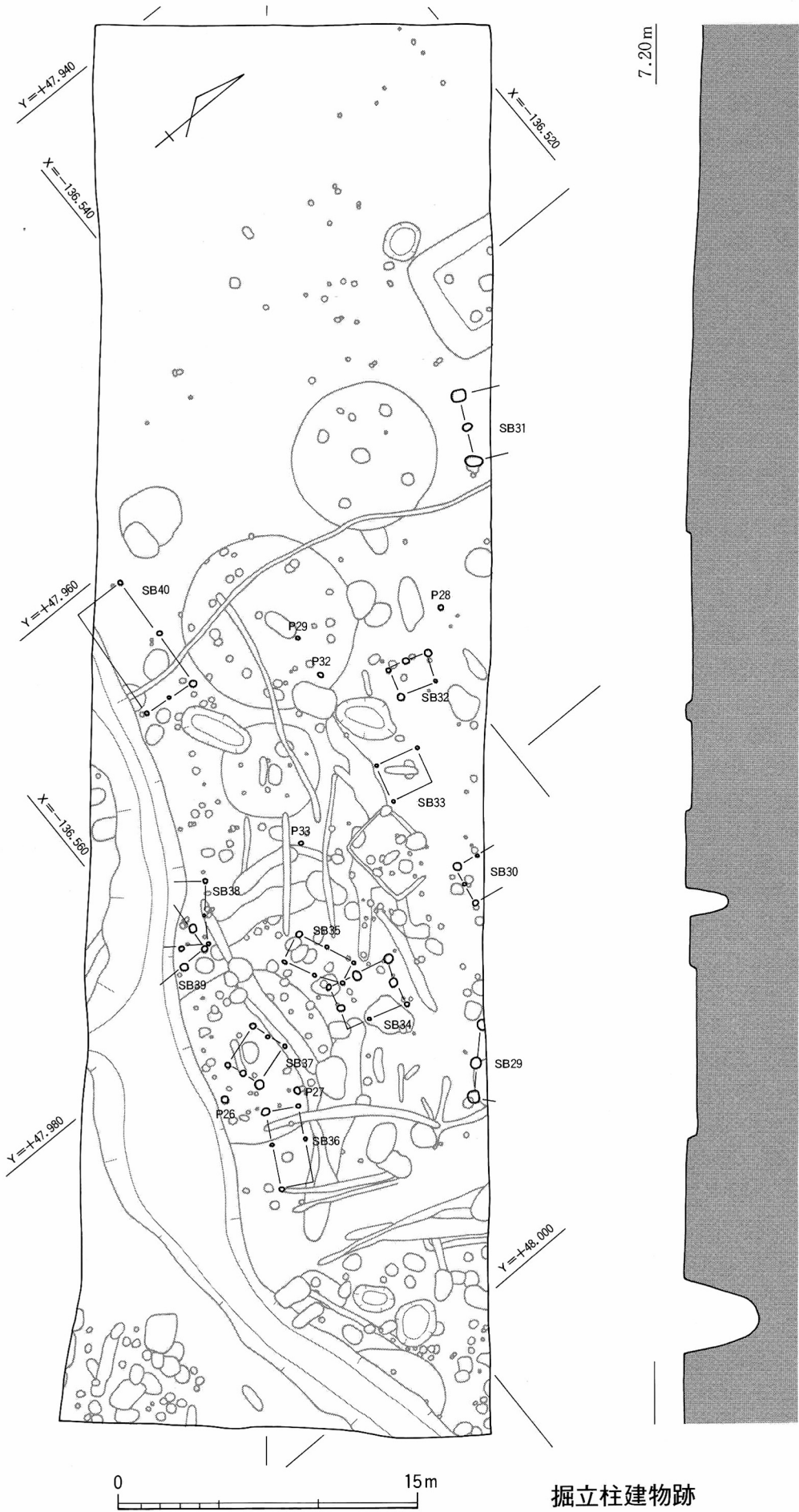

掘立柱建物跡

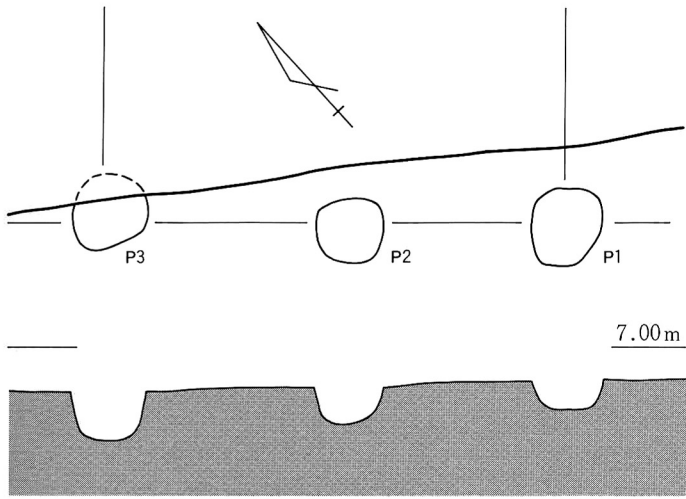

SB29

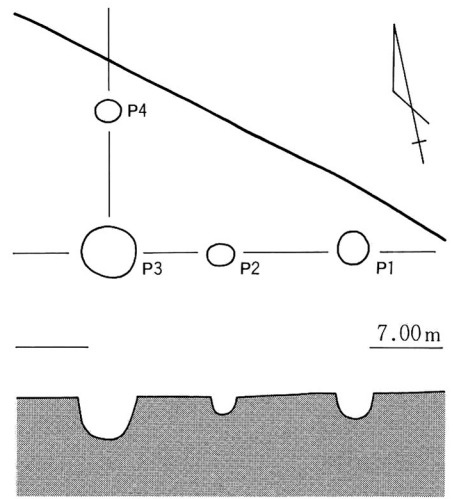

SB30

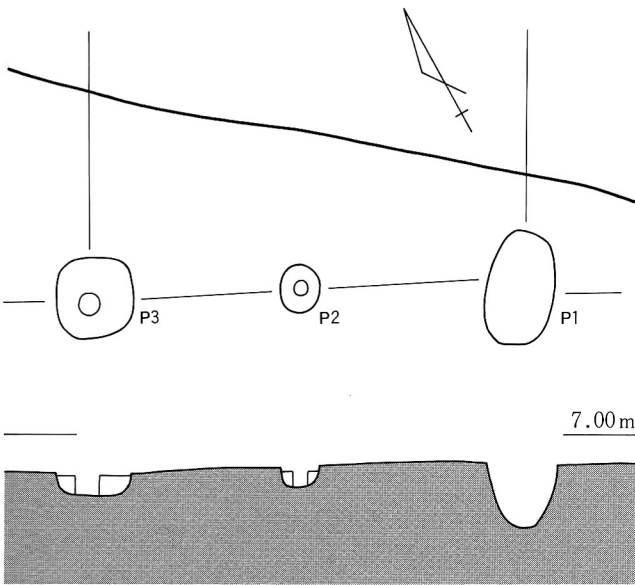

SB31

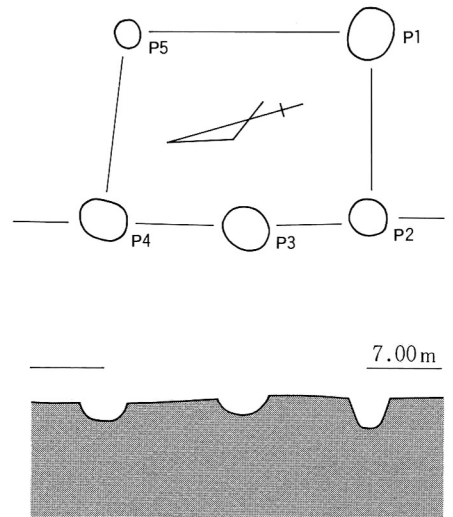

SB32

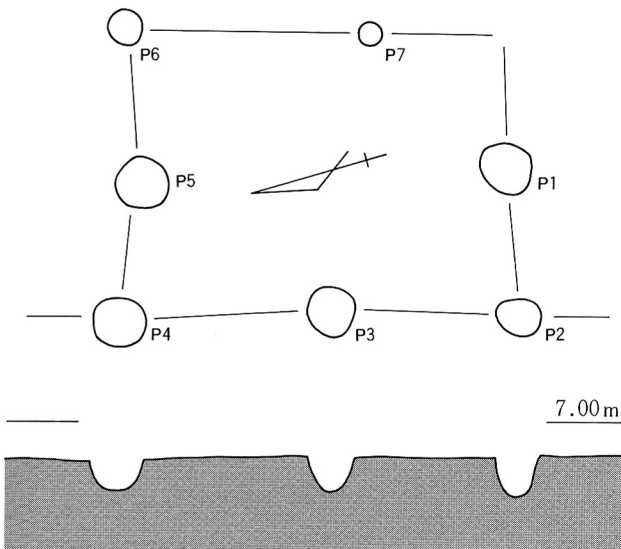

SB34

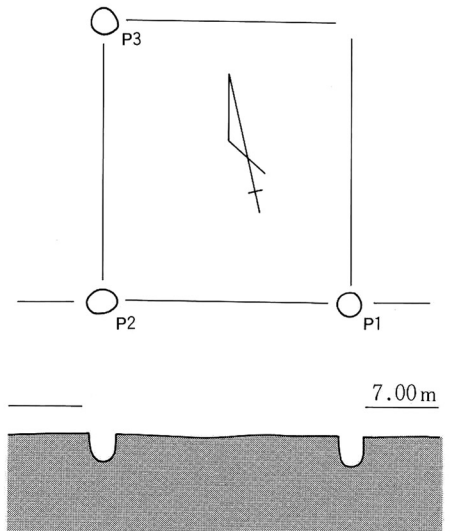

SB33



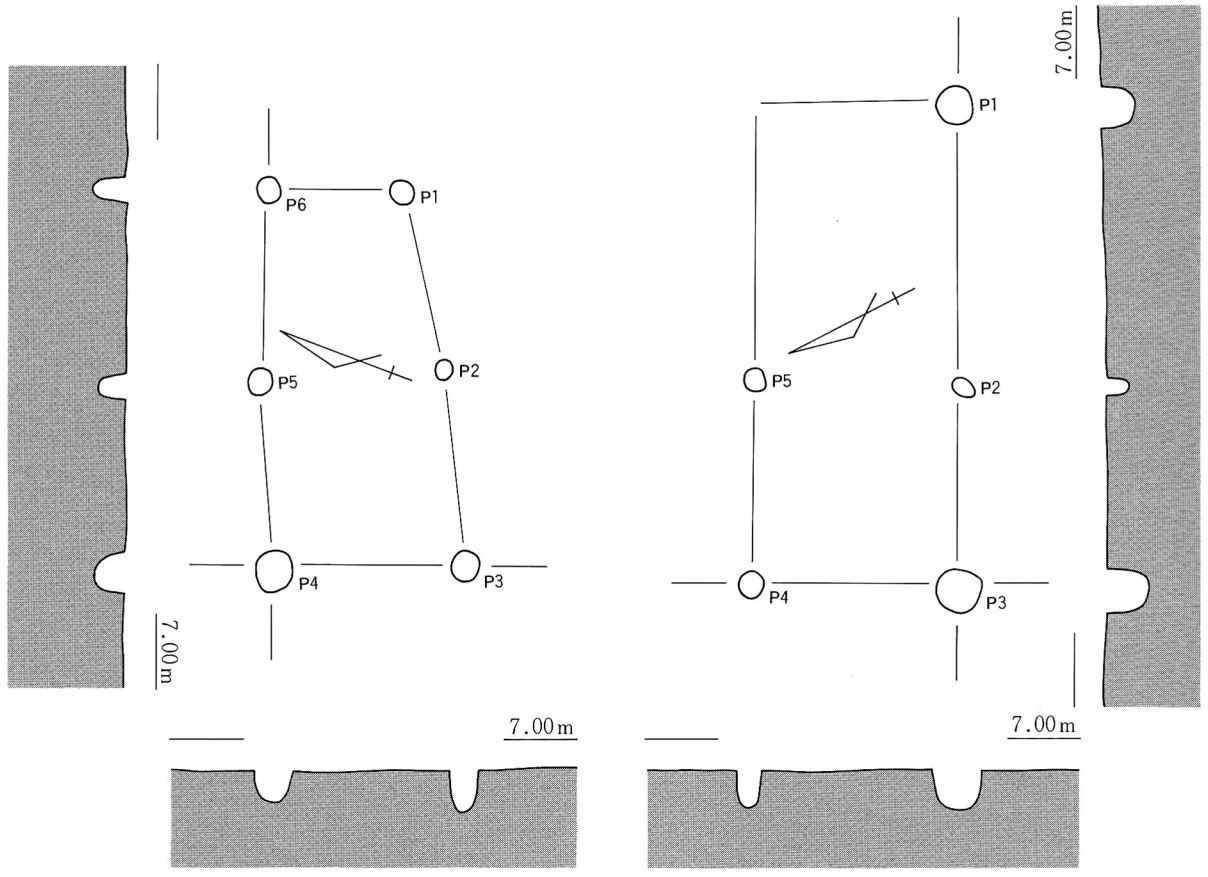

SB35

SB36

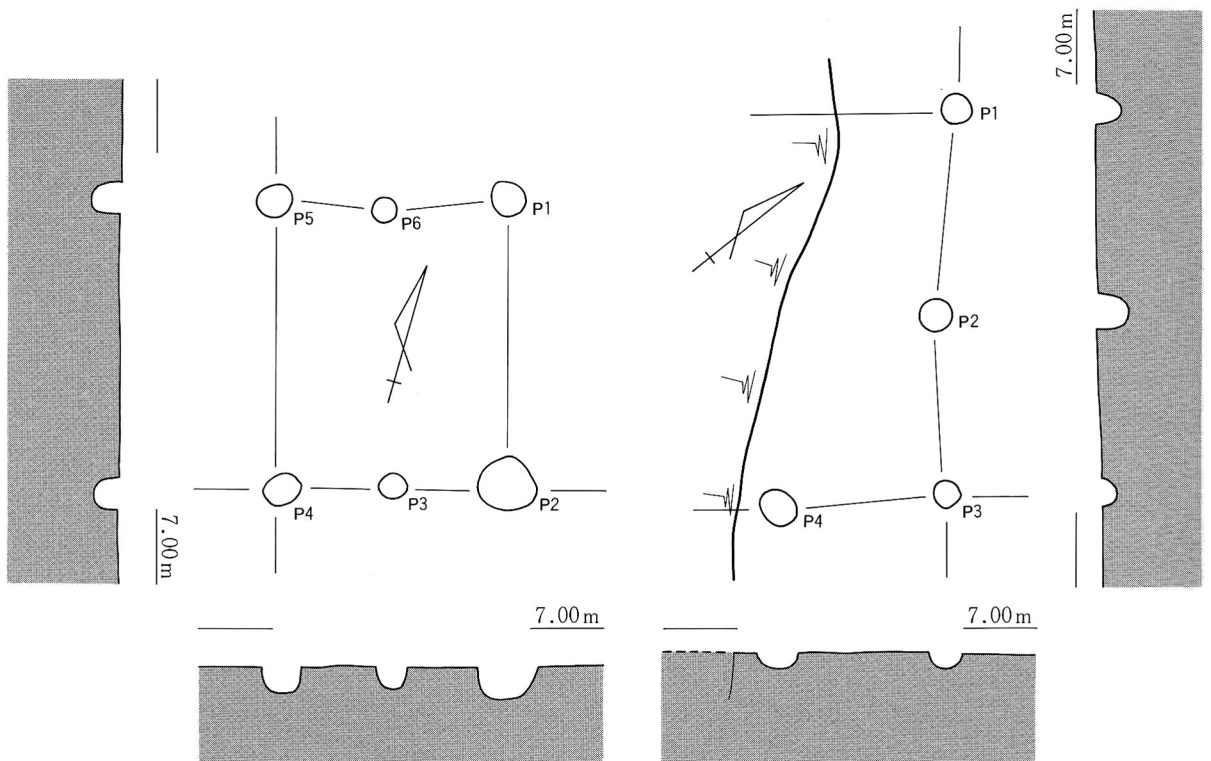

SB37

SB38



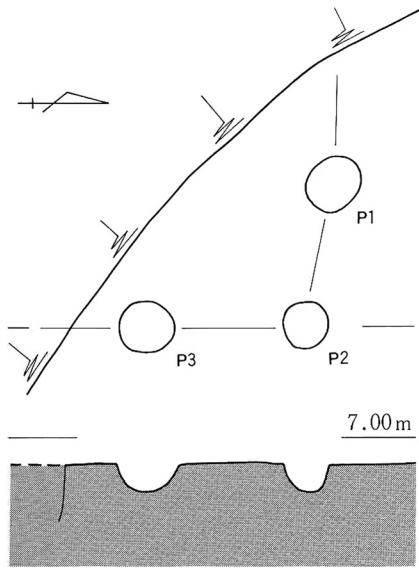

SB39

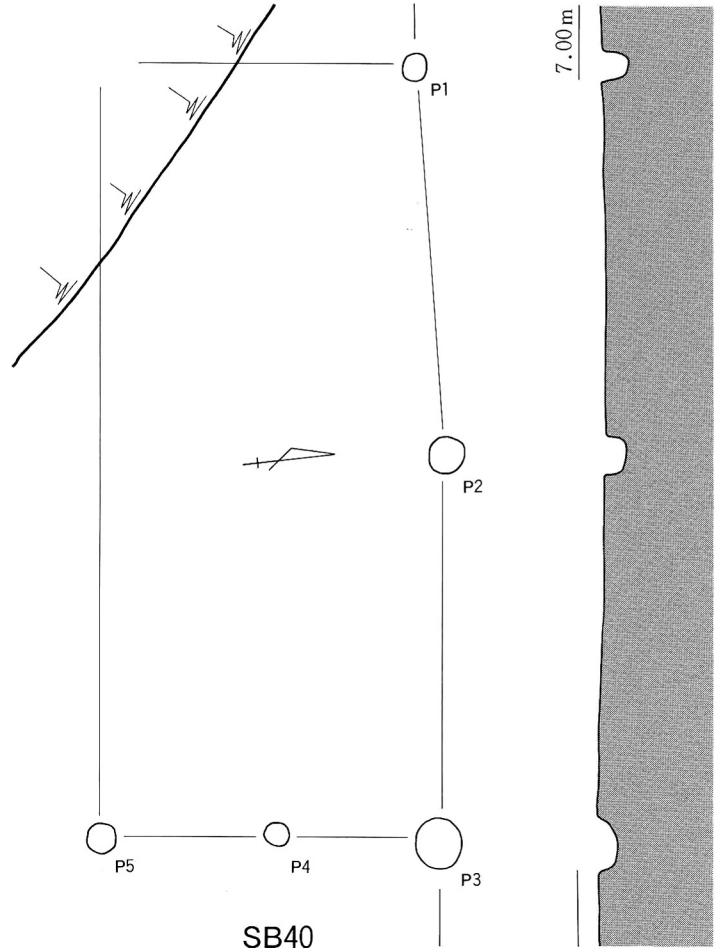

SB40

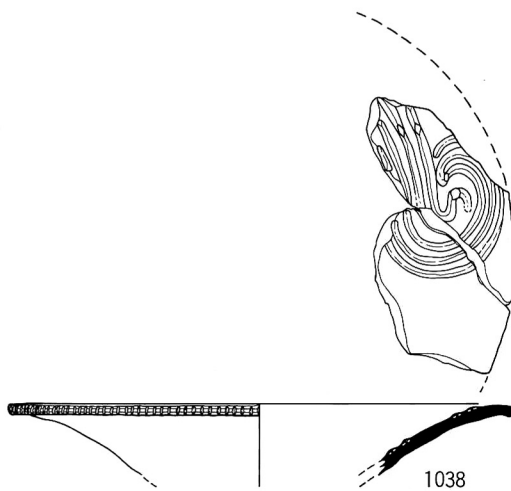
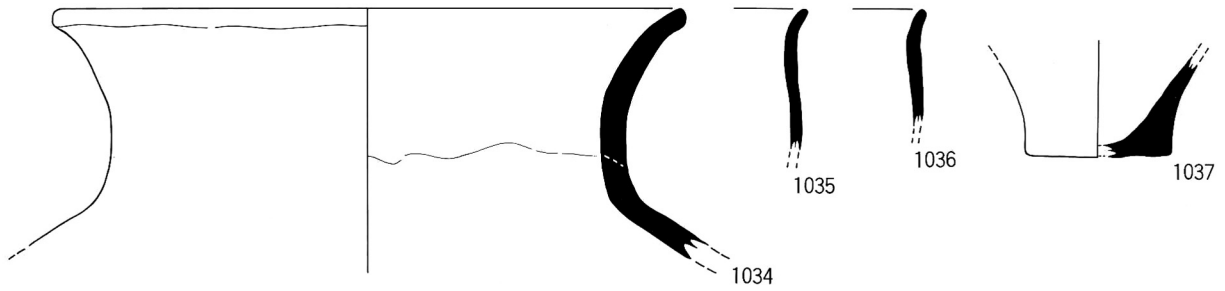
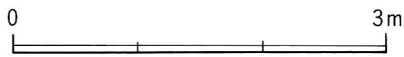

1034~1037 SB31 P 1 出土土器
1038 SB34 P 5 出土土器



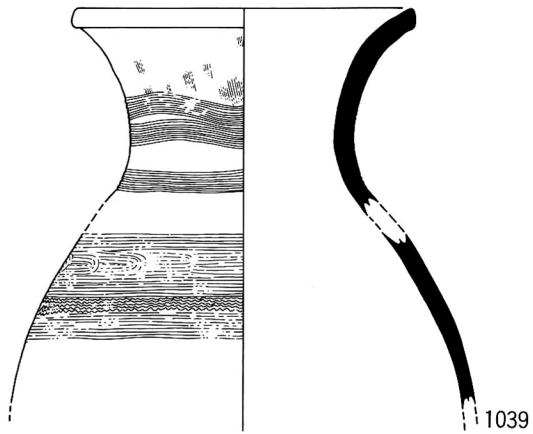

1039

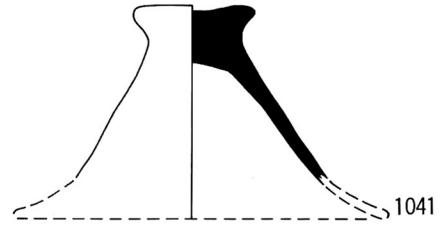

1041

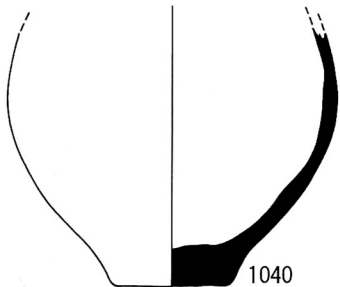

1040

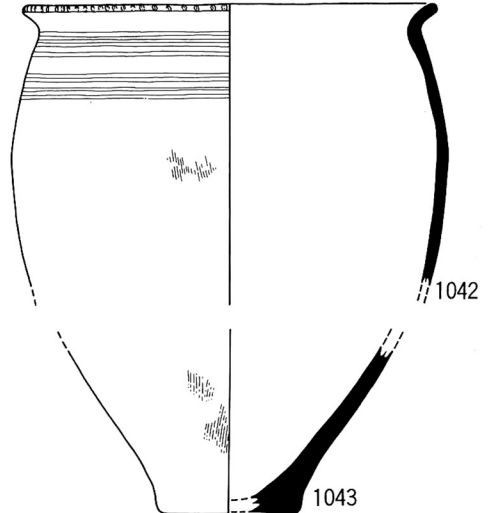

1042

1043

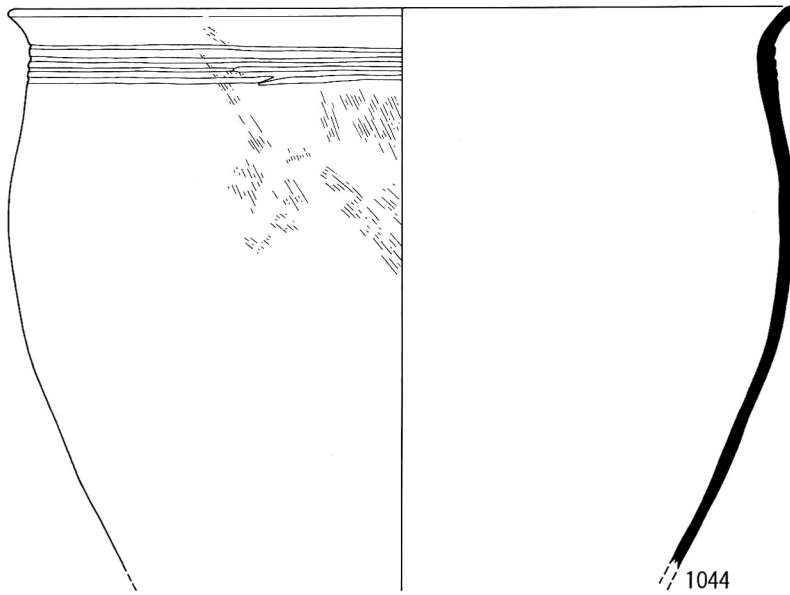

1044



1045

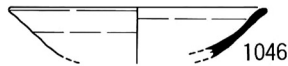

1046



1047

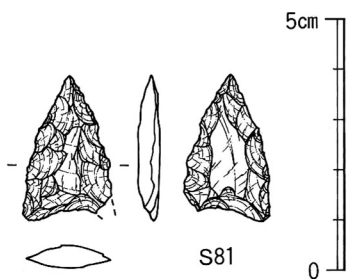

S81



- | | | | |
|-----------|---------|------|---------|
| 1039 | P31出土土器 | 1045 | P25出土土器 |
| 1040·1044 | P28出土土器 | 1046 | P33出土土器 |
| 1041 | P26出土土器 | 1047 | P27出土土器 |
| 1042·1043 | P32出土土器 | S81 | P30出土石器 |

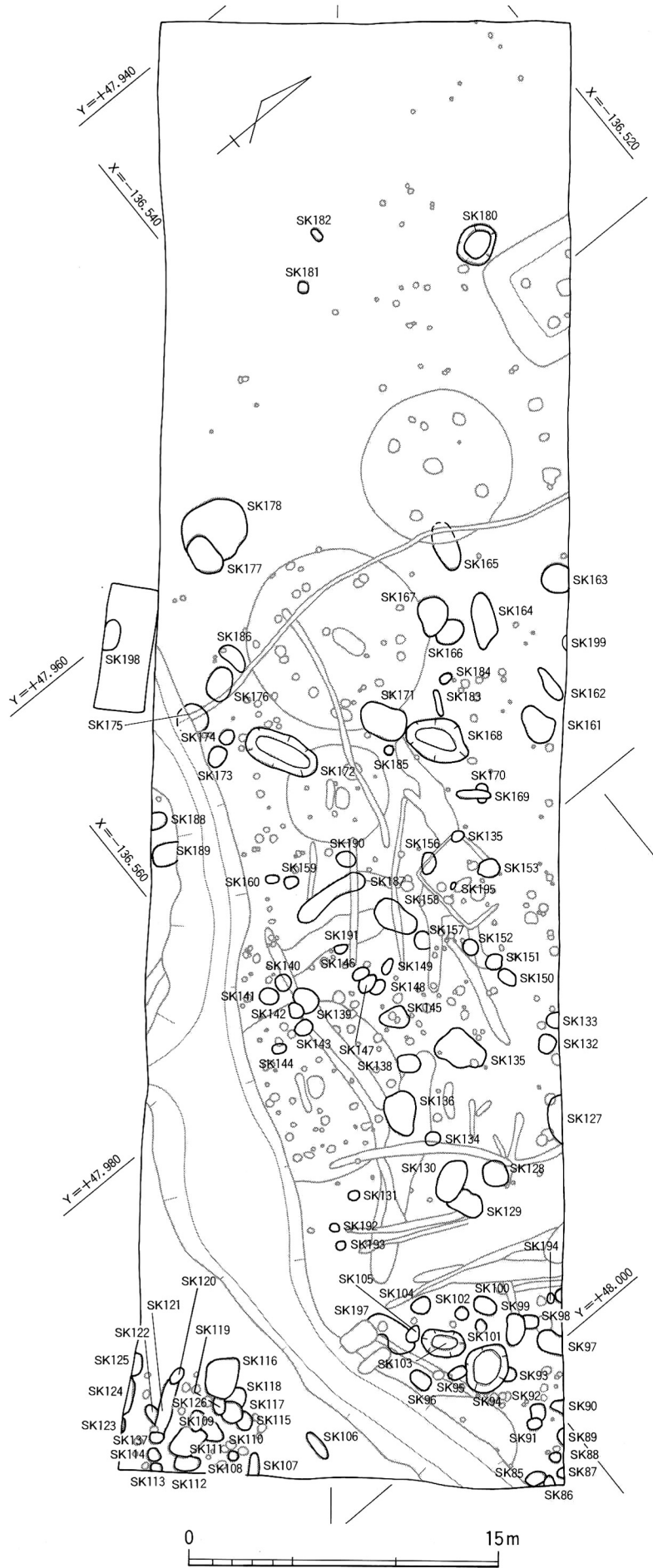

7.20 m

土坑

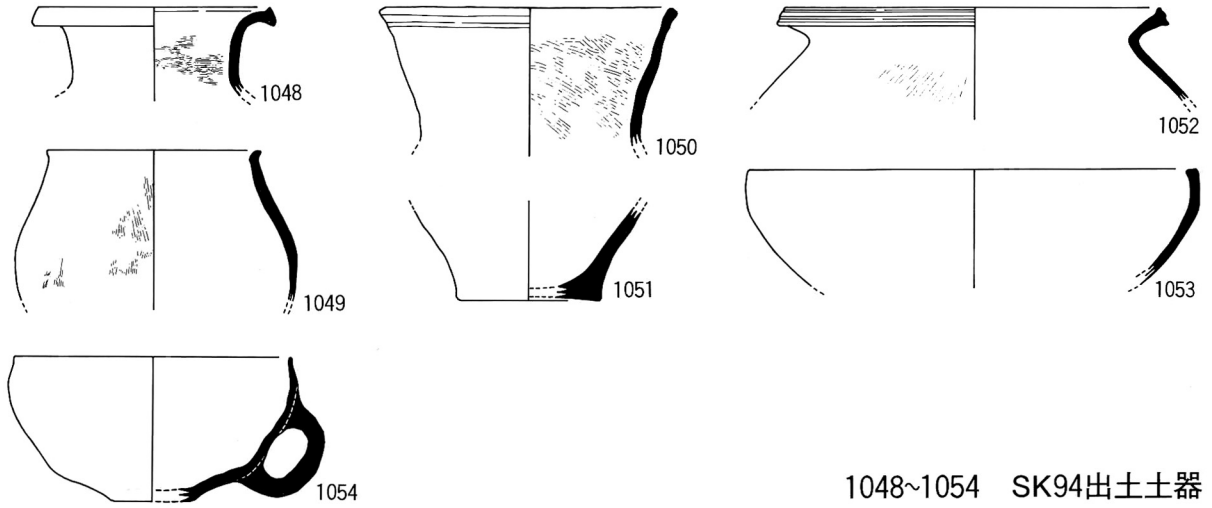

1048~1054 SK94出土土器

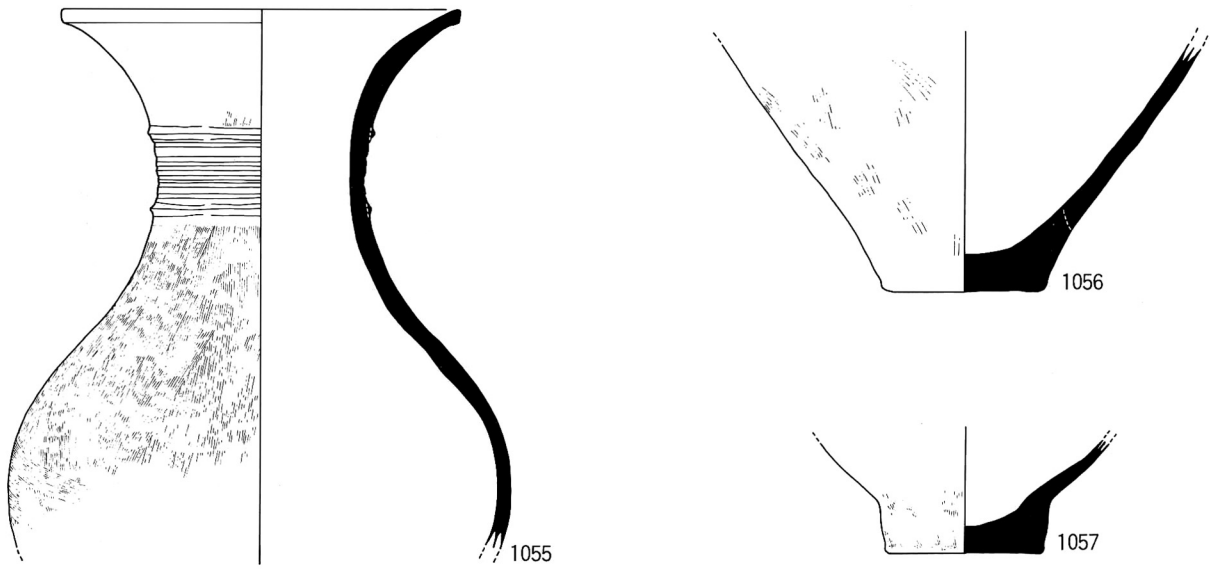

1055~1059 SK99出土土器

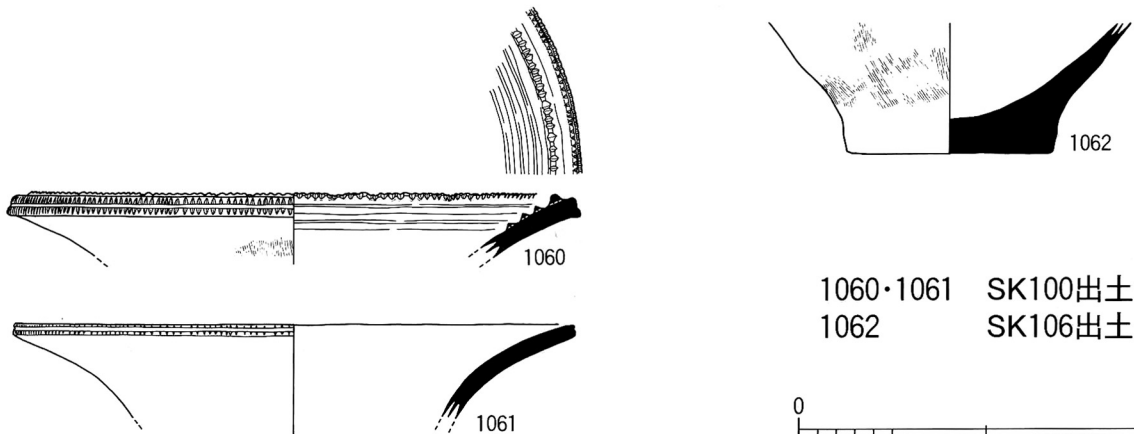

1060·1061 SK100出土土器
1062 SK106出土土器

0 20cm

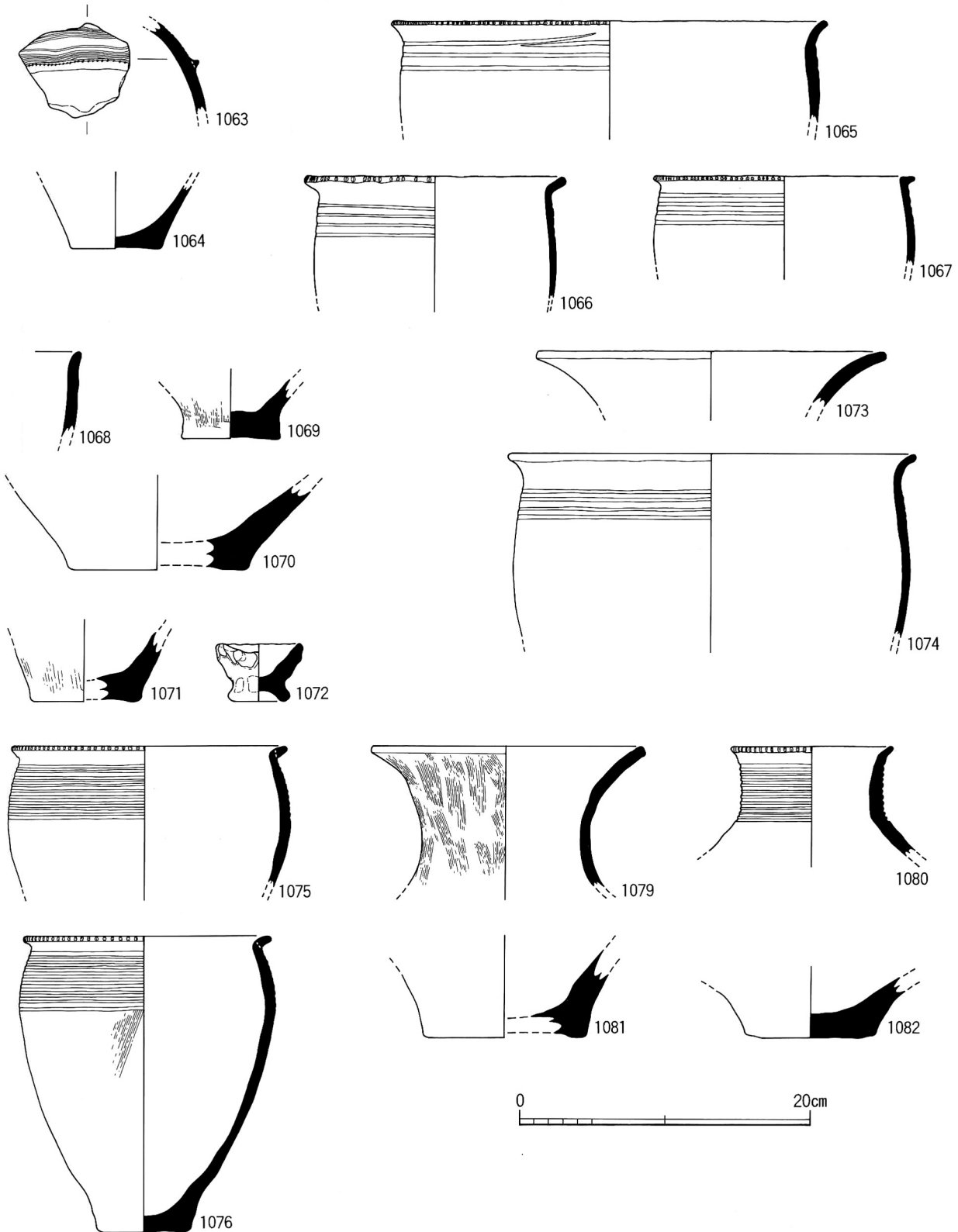

1063~1067 SK108出土土器
 1068·1069 SK115出土土器
 1070~1072 SK116出土土器

1073·1074 SK125出土土器
 1075~1078 SK117出土土器
 1079~1082 SK127出土土器