

1. 灰 極細砂質シルト
2. 暗褐色 シルト
3. 灰 シルト質極細砂
4. 明灰 極細砂質シルト (炭混)
5. 灰 シルト (炭混)
6. 明灰褐色 極細砂混シルト (炭混)
7. 明灰 極細砂質シルト
8. 灰 シルト
9. 明青灰 シルト
10. 明灰 極細砂

方形周溝墓4 (SX40005)

図版 44
弥生中期上層

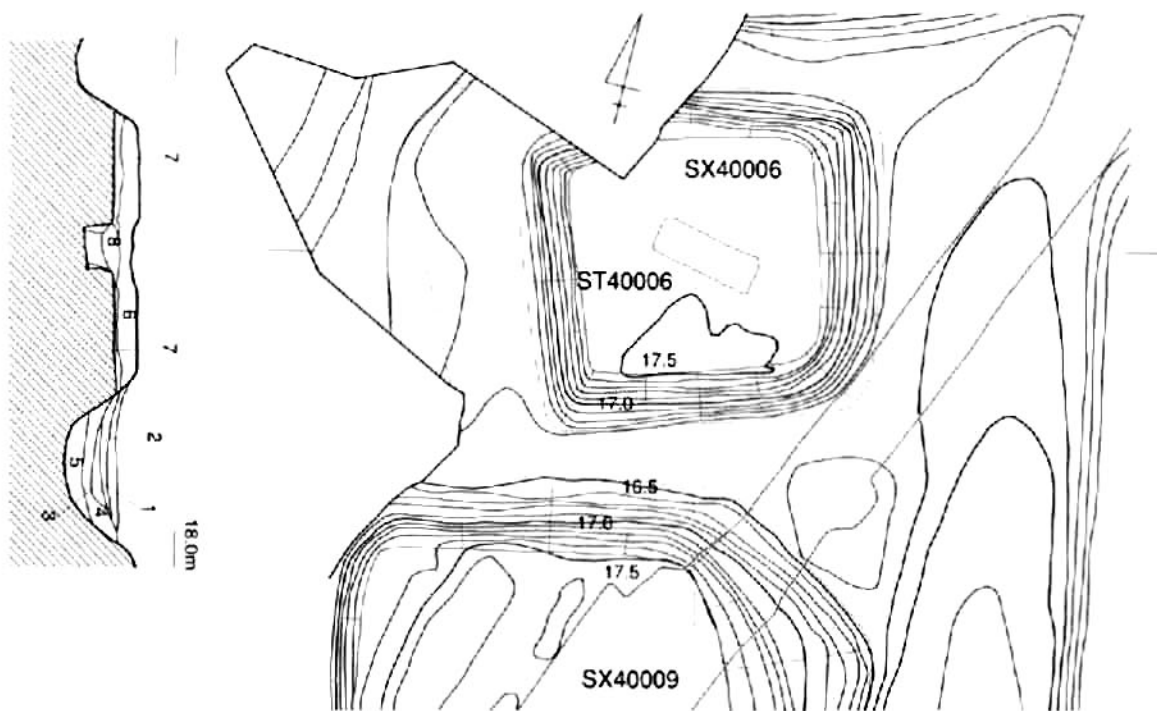

- 1 暗灰膏 シルト質極細砂 (Fe₂O₃含)
- 2 灰 シルト質極細砂 (Fe₂O₃含)
- 3 灰 シルト質極細砂 (Fe₂O₃含)
- 4 灰 シルト
- 5 灰 シルト
- 6 黄灰 極細砂
- 7 灰 極細砂
- 8 灰 シルト質極細砂

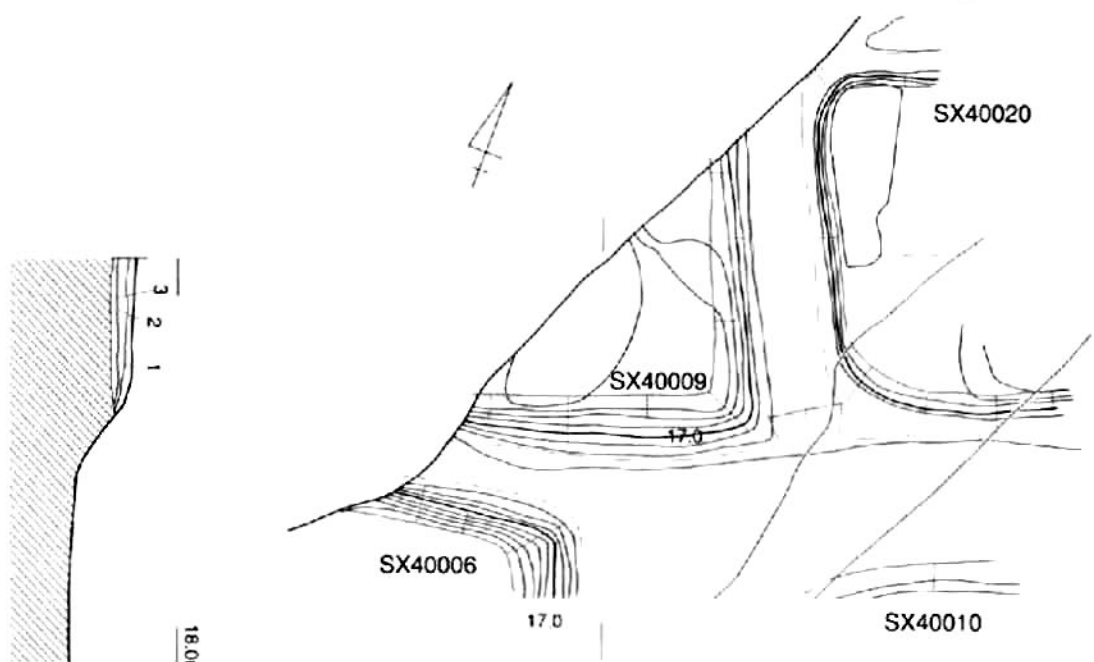
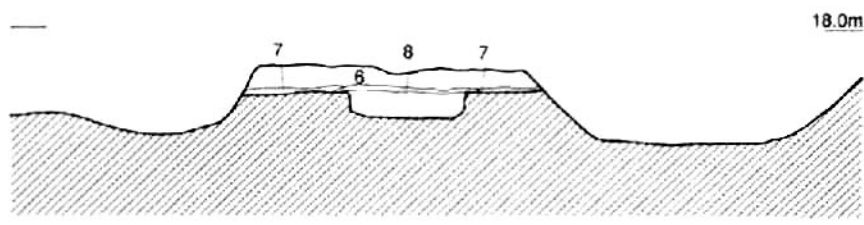

- 1 黄灰 極細砂
- 2 灰オリーブ 極細砂
- 3 灰 シルト質極細砂

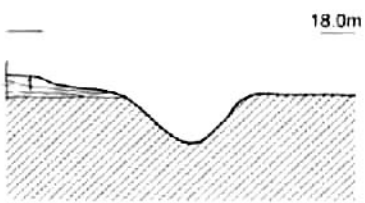

方形周溝墓5 (SX40006・40019)

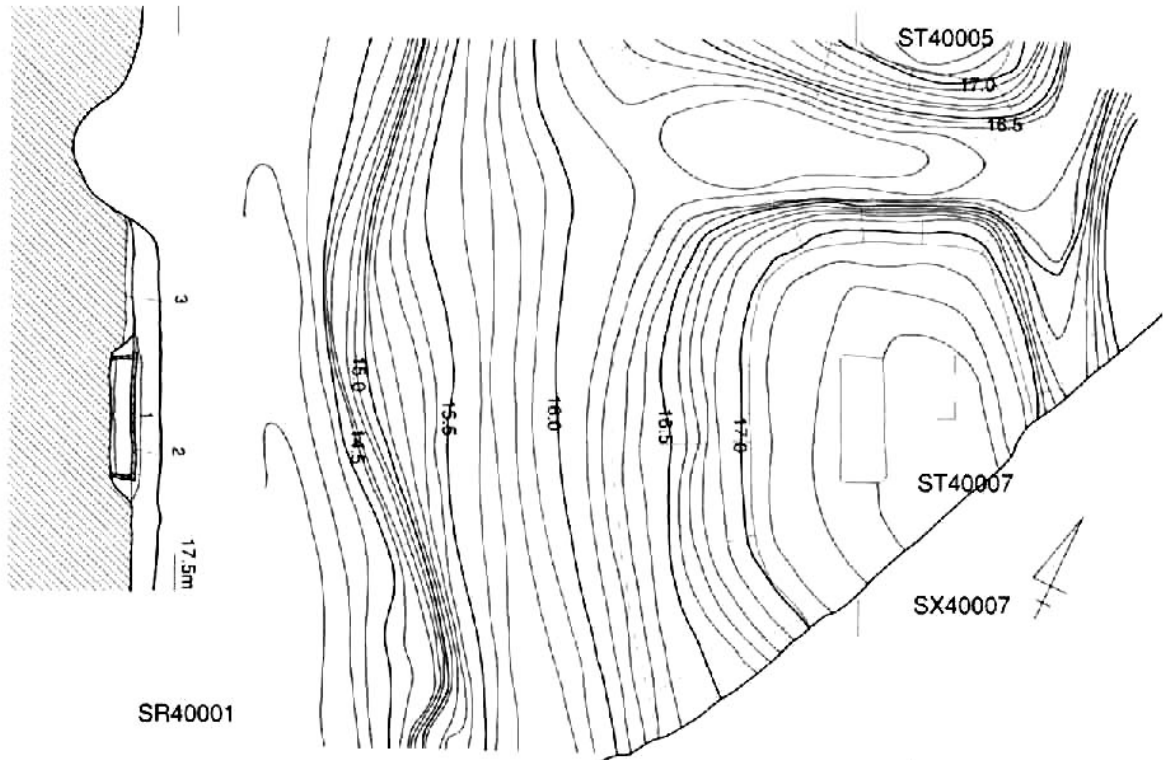

1. 暗灰黄 極細砂 (Fe₂O₃・Mn含)
2. 灰黄褐 極細砂 (Fe₂O₃・Mn含)
3. 灰 極細砂質シルト

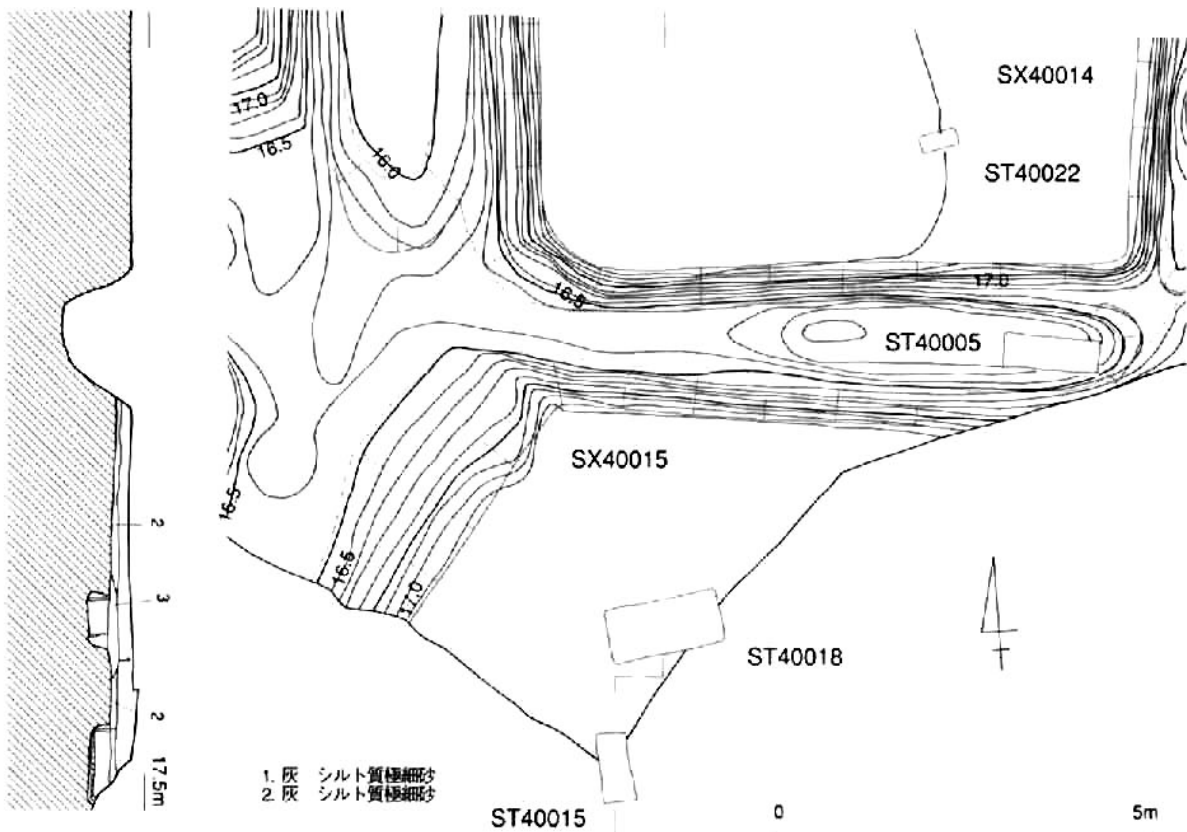
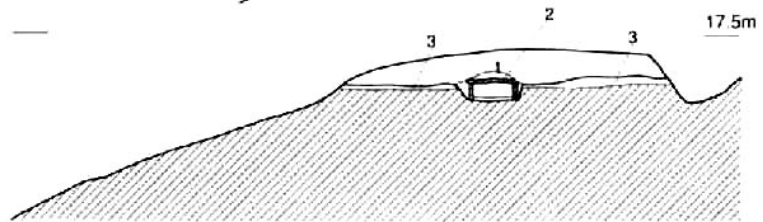

1. 灰 シルト質極細砂
2. 灰 シルト質極細砂



方形周溝墓6 (SX40007・40015)

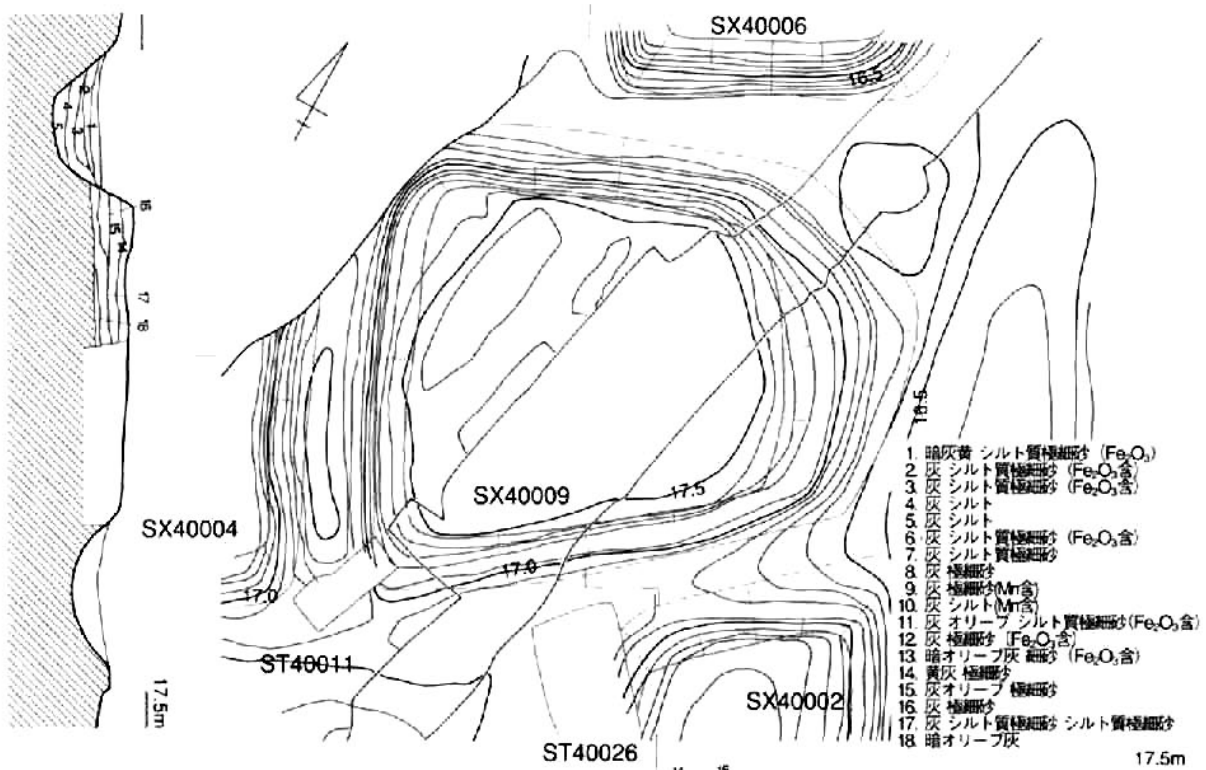

- 1 暗灰 シルト質極細砂 (Fe₂O₃含)
- 2 灰シルト質極細砂 (Fe₂O₃含)
- 3 灰シルト質極細砂 (Fe₂O₃含)
- 4 シルト
- 5 灰シルト
- 6 灰シルト質極細砂 (Fe₂O₃含)
- 7 シルト質極細砂
- 8 極細砂
- 9 灰極細砂 (Mn含)
- 10 灰シルト (Mn含)
- 11 灰オリブシルト質極細砂 (Fe₂O₃含)
- 12 灰極細砂 (Fe₂O₃含)
- 13 暗オリブ灰 極細砂 (Fe₂O₃含)
- 14 黄灰 極細砂
- 15 灰オリブ 極細砂
- 16 灰 極細砂
- 17 灰シルト質極細砂 シルト質極細砂
- 18 暗オリブ灰

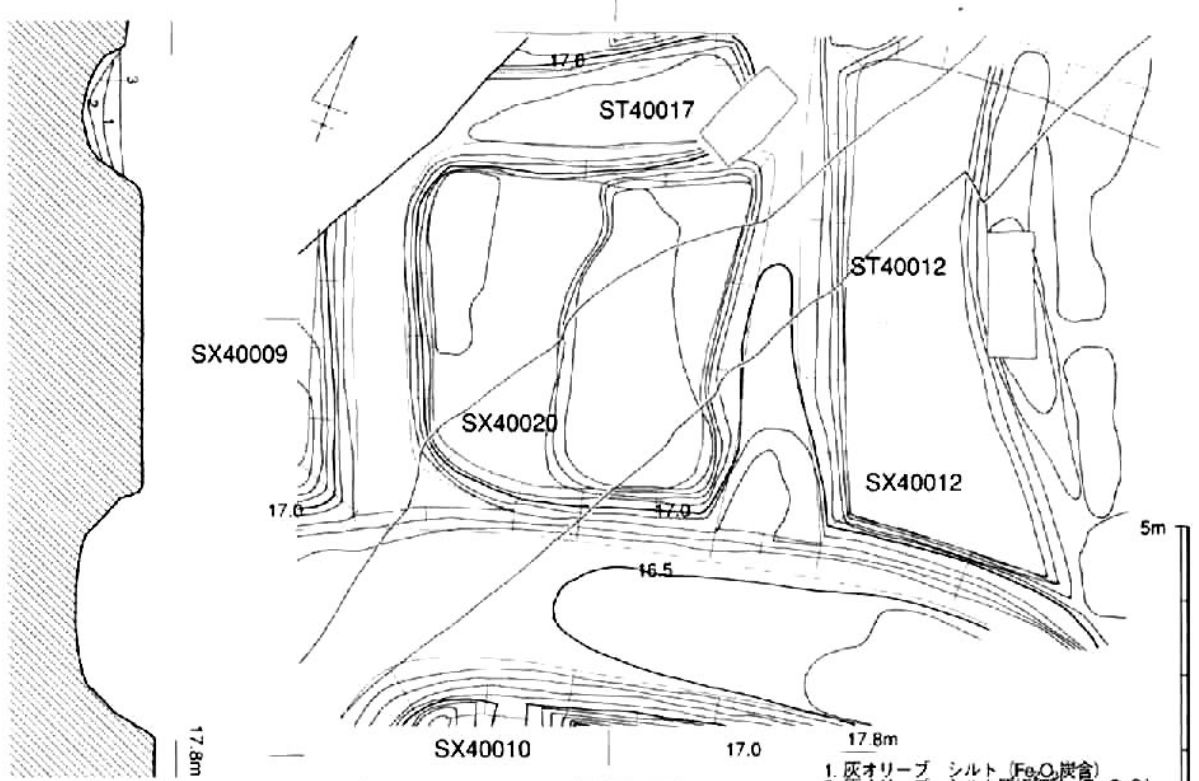
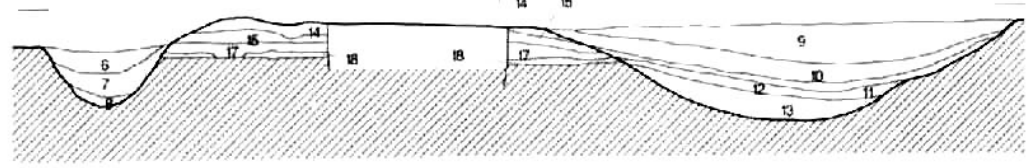

- 1 灰オリブシルト (Fe₂O₃炭含)
- 2 灰オリブシルト質極細砂 (Fe₂O₃炭含)
- 3 灰シルト質極細砂
- 4 暗灰シルト質極細砂 (Fe₂O₃炭含)
- 5 黄灰シルト質極細砂 (Fe₂O₃炭含)
- 6 灰シルト質極細砂 (Fe₂O₃炭含)
- 7 灰シルト質極細砂 (Fe₂O₃炭含)
- 8 黄灰 極細砂



方形周溝墓7 (SX40009・40020)

図版 47 弥生中期上層

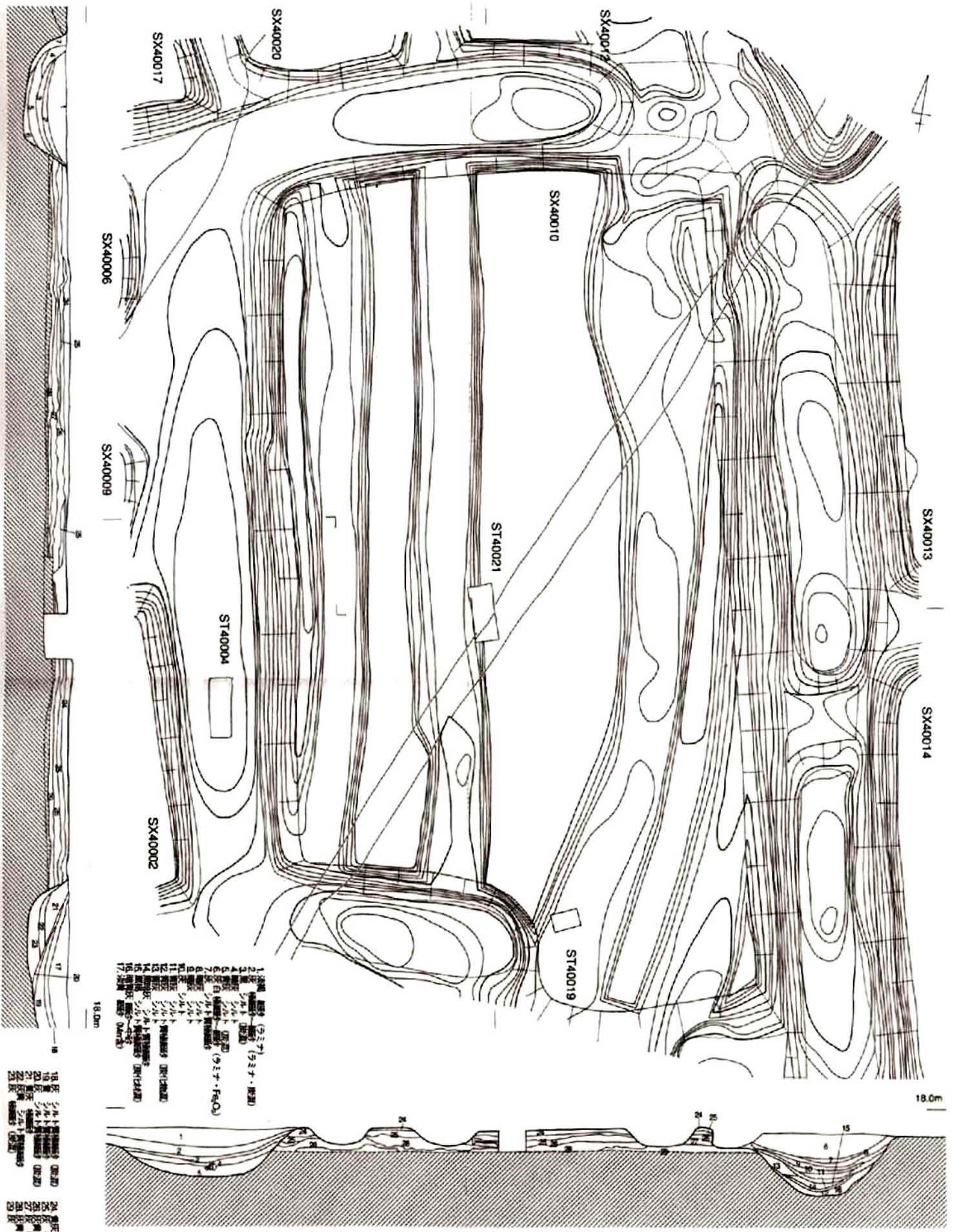

- 1. 土坑 (9.37)
- 2. 土坑 (9.37)
- 3. 土坑 (9.37)
- 4. 土坑 (9.37)
- 5. 土坑 (9.37)
- 6. 土坑 (9.37)
- 7. 土坑 (9.37)
- 8. 土坑 (9.37)
- 9. 土坑 (9.37)
- 10. 土坑 (9.37)
- 11. 土坑 (9.37)
- 12. 土坑 (9.37)
- 13. 土坑 (9.37)
- 14. 土坑 (9.37)
- 15. 土坑 (9.37)
- 16. 土坑 (9.37)
- 17. 土坑 (9.37)

18. 土坑 (9.37) 19. 土坑 (9.37) 20. 土坑 (9.37)

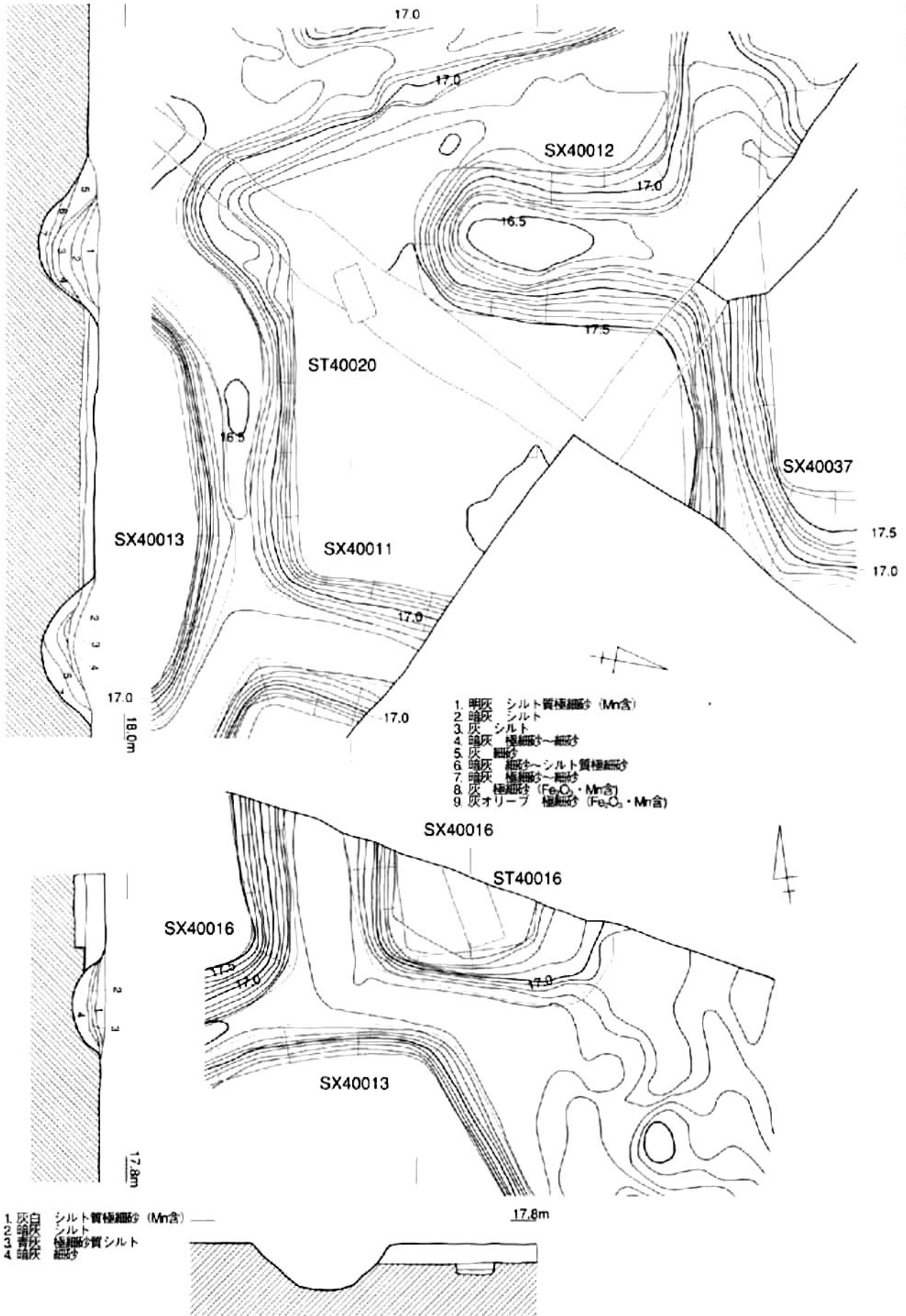

1. 明灰 シルト質極細砂 (Mn含)
2. 暗灰 シルト
3. 灰 シルト
4. 暗灰 極細砂-細砂
5. 灰 細砂
6. 暗灰 細砂-シルト質極細砂
7. 暗灰 極細砂-細砂
8. 灰 極細砂 (Fe₂O₃・Mn含)
9. 灰オリーブ 極細砂 (Fe₂O₃・Mn含)

1. 灰白 シルト質極細砂 (Mn含)
2. 暗灰 シルト
3. 青灰 極細砂質シルト
4. 暗灰 細砂

方形周溝墓9 (SX40011・40016)

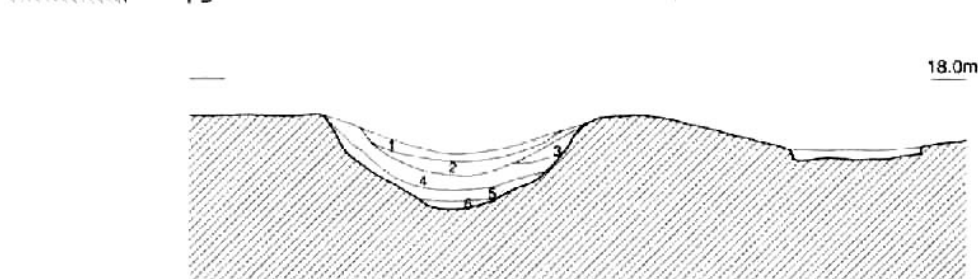
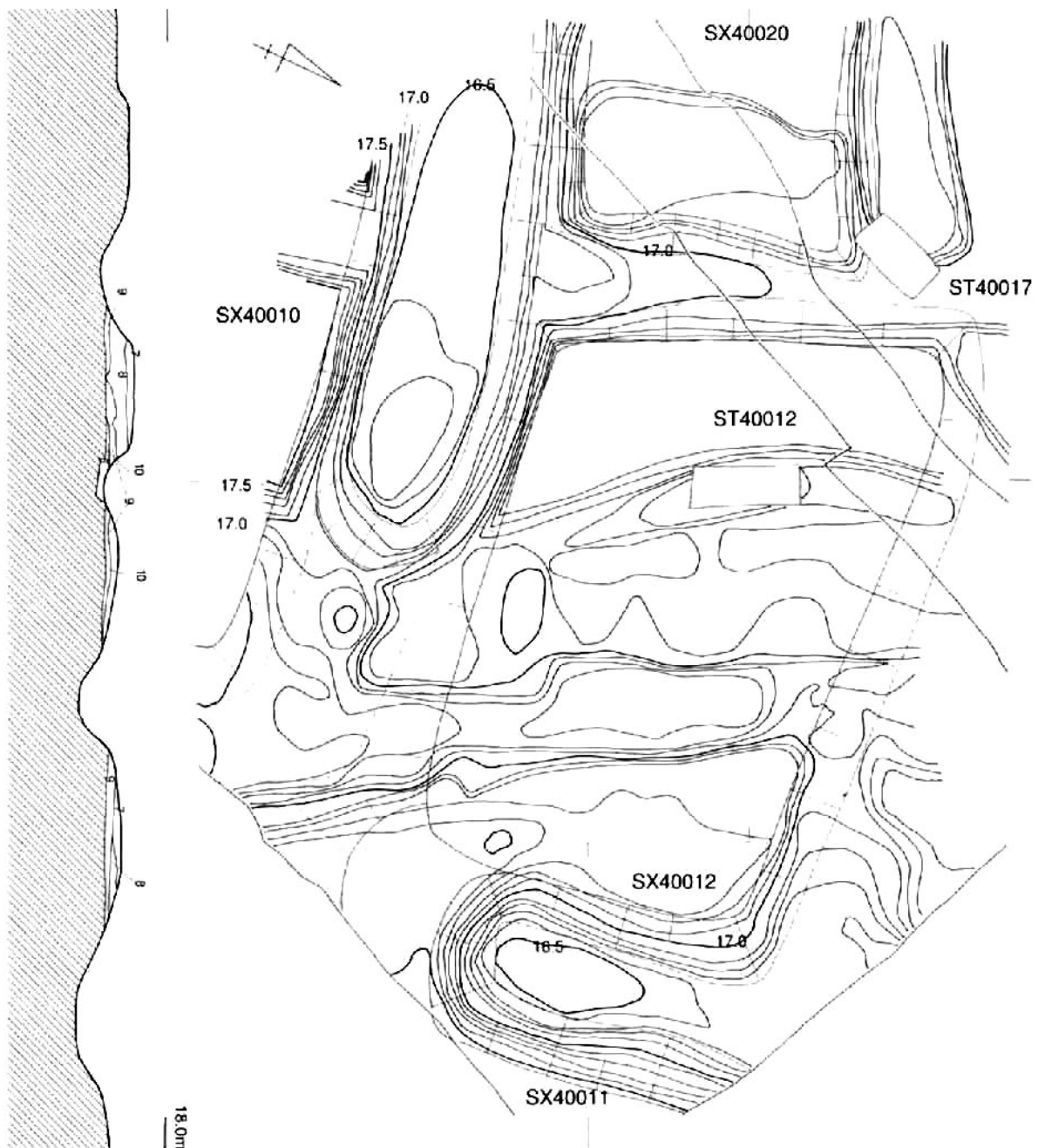

- 1. 灰 極細砂～細砂 (ラミナ・炭混)
- 2. 黒 シルト (炭混)
- 3. 暗灰 シルト
- 4. 青灰 シルト (炭混)
- 5. 灰白 極細砂～細砂 (ラミナ・Fe₂O₃)
- 6. 灰 シルト質極細砂
- 7. 灰黄 極細砂 (Fe₂O₃・Mn含)
- 8. 黄灰 シルト (Fe₂O₃・Mn含)
- 9. 暗灰黄 シルト質極細砂 (Fe₂O₃含)
- 10. 灰 シルト

方形周溝墓10 (SX40012)

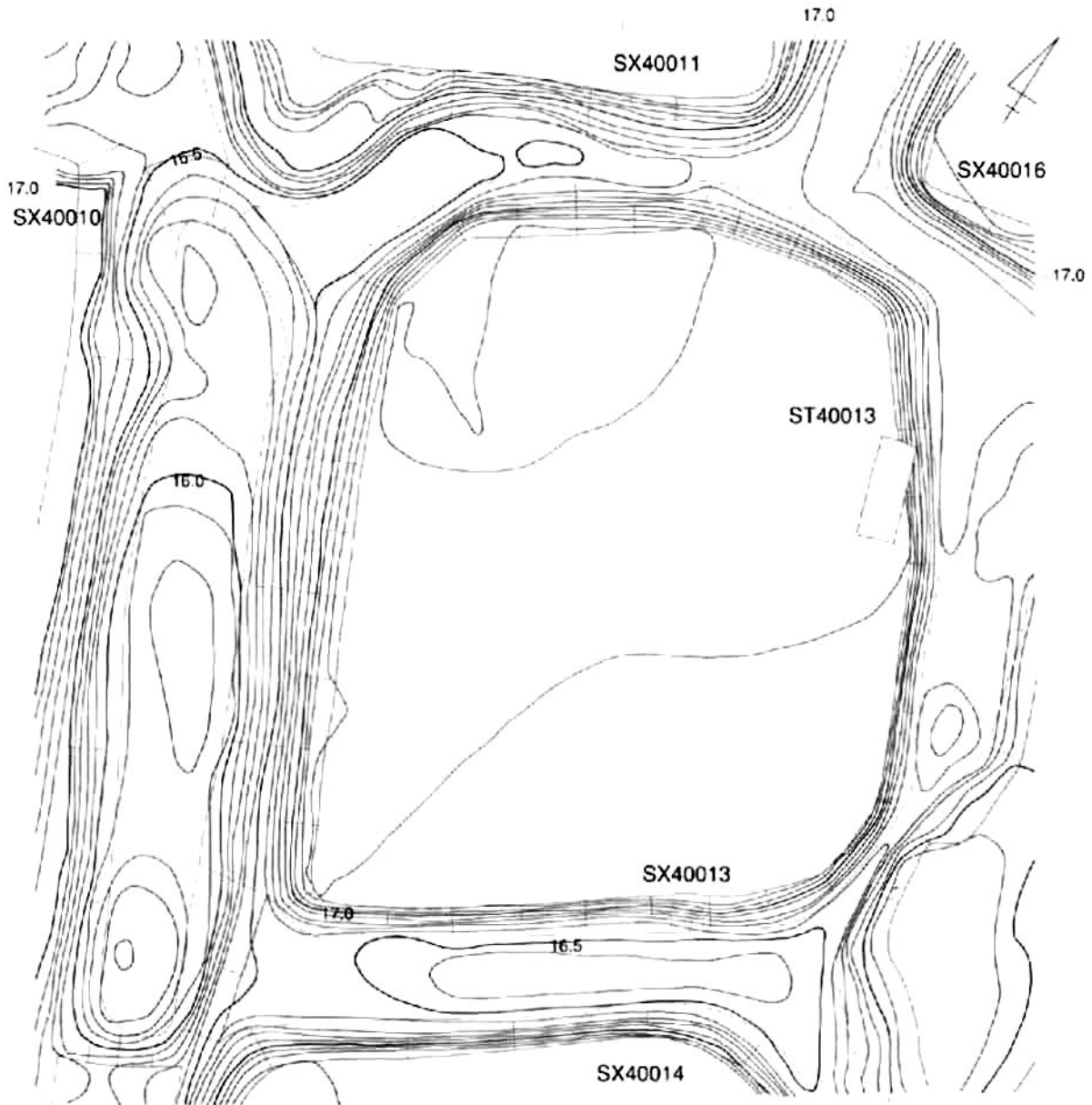

- | | | | | |
|------|---|---|------|------|
| 17.0 | 1. 灰 シルト質極細砂 | 9. 相灰 シルト質極細砂 | 17.0 | 17.0 |
| | 2. 灰 シルト質極細砂 (Fe ₂ O ₃ 含) | 10. 暗灰 シルト | | |
| | 3. 灰 極細砂 | 11. 灰 極細砂 (Fe ₂ O ₃ ・Mn含) | | |
| | 4. にぶい黄 極細砂 (Fe ₂ O ₃ 含) | 12. 灰 シルト質極細砂 (Fe ₂ O ₃ ・Mn含) | | |
| | 5. 灰黄 極細砂 (Fe ₂ O ₃ 含) | 13. 灰 シルト質極細砂 | | |
| | 6. 暗灰黄 細砂 | 14. 暗緑灰 シルト質極細砂 | | |
| | 7. 灰 シルト質極細砂 (Mn含) | 15. 灰 極細砂 | | |
| | 8. 暗灰 シルト | | | |

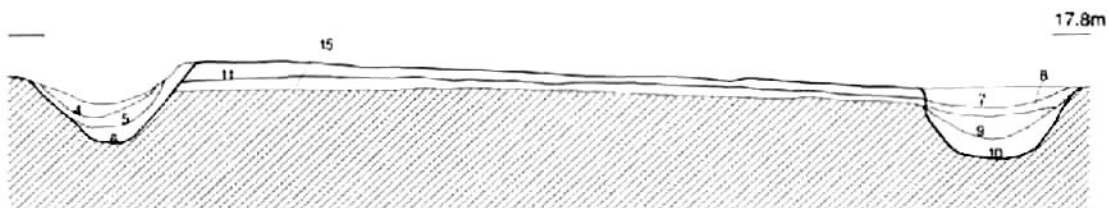
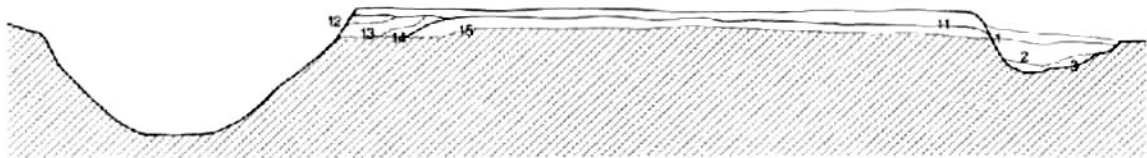

方形周溝墓11 (SX40013)

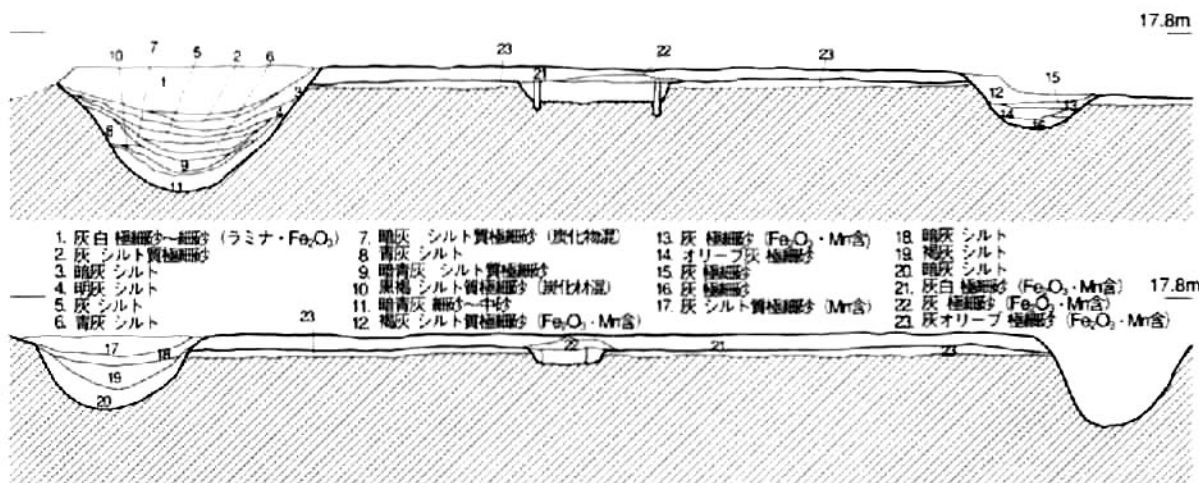
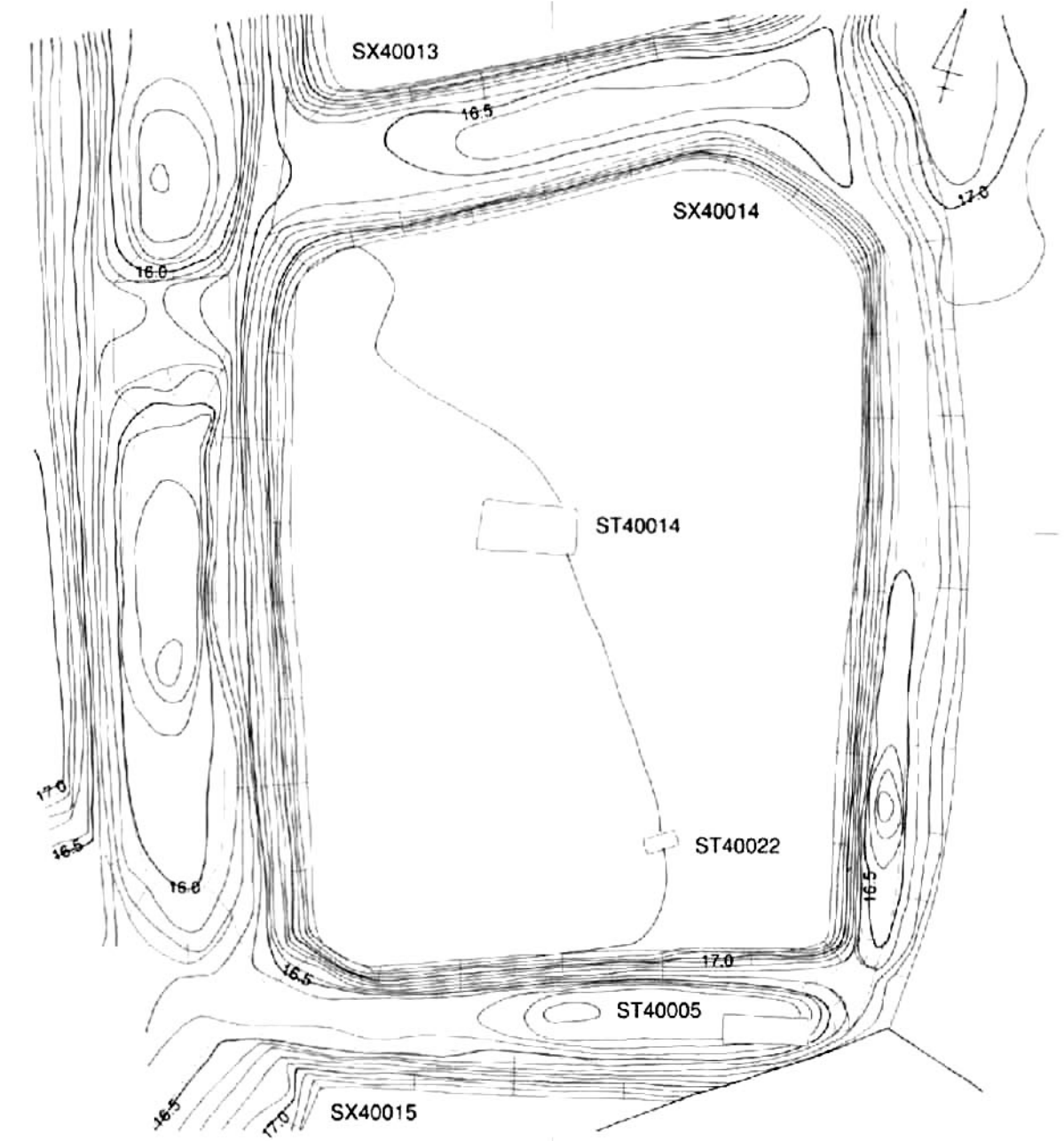

方形周溝墓12 (SX40014)

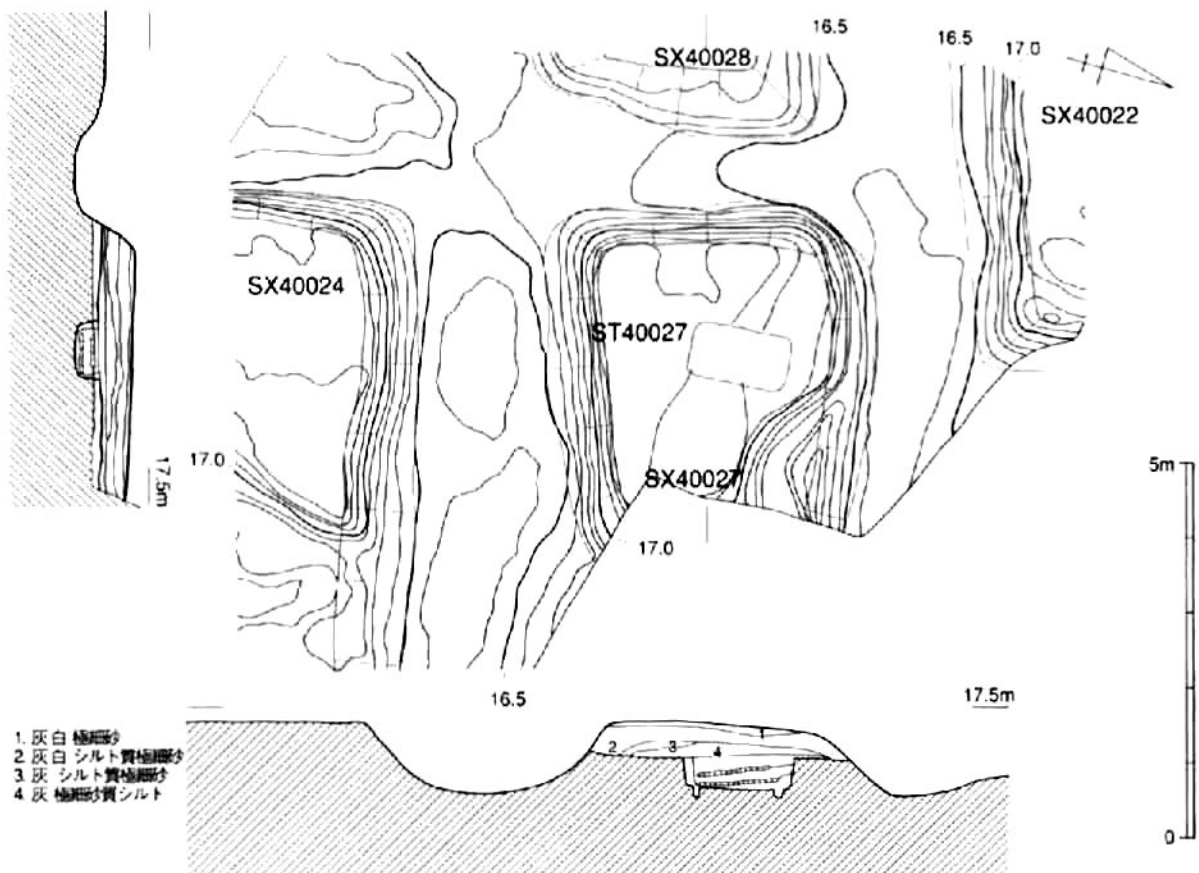
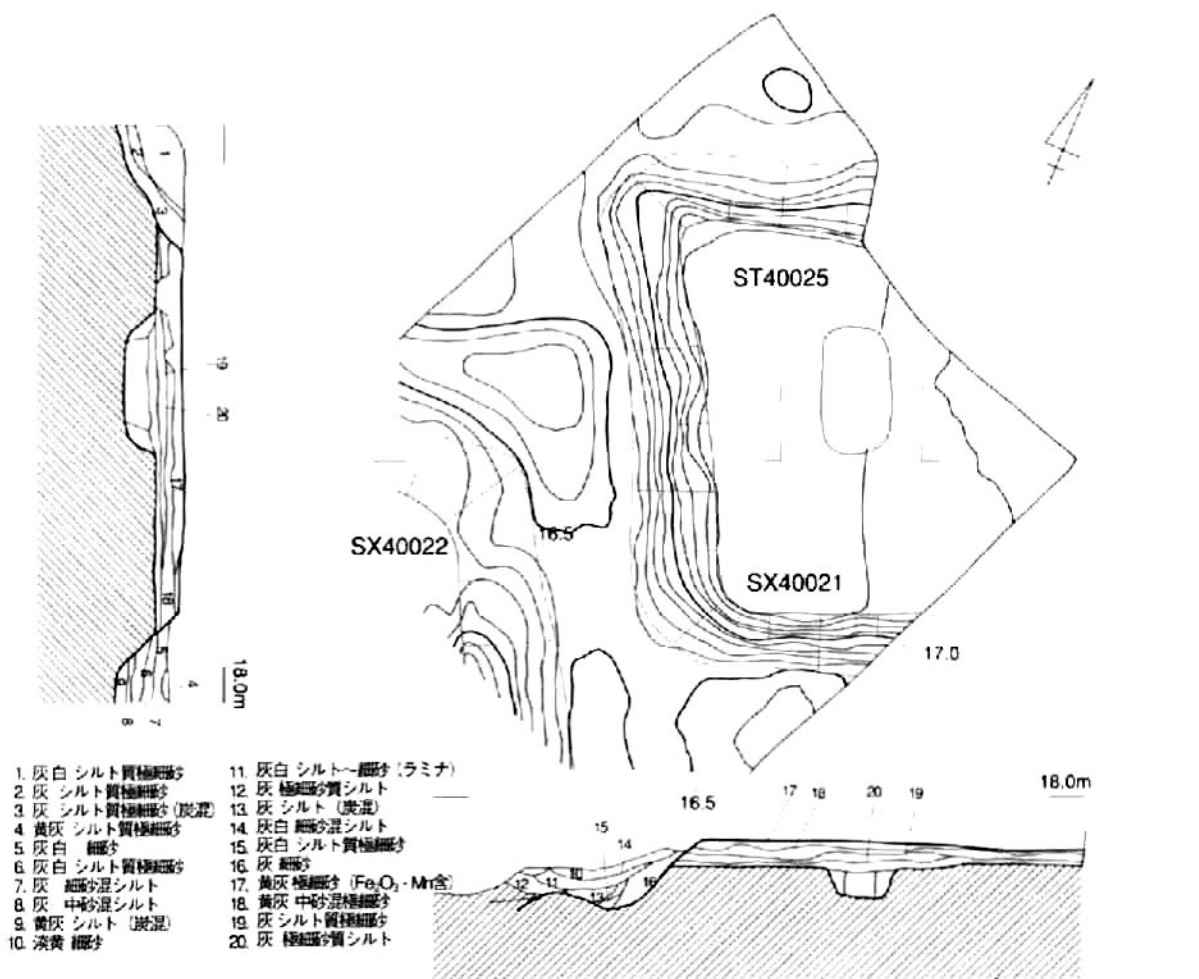

方形周溝墓13 (SX40021・40027)

図版 54 弥生中期上層

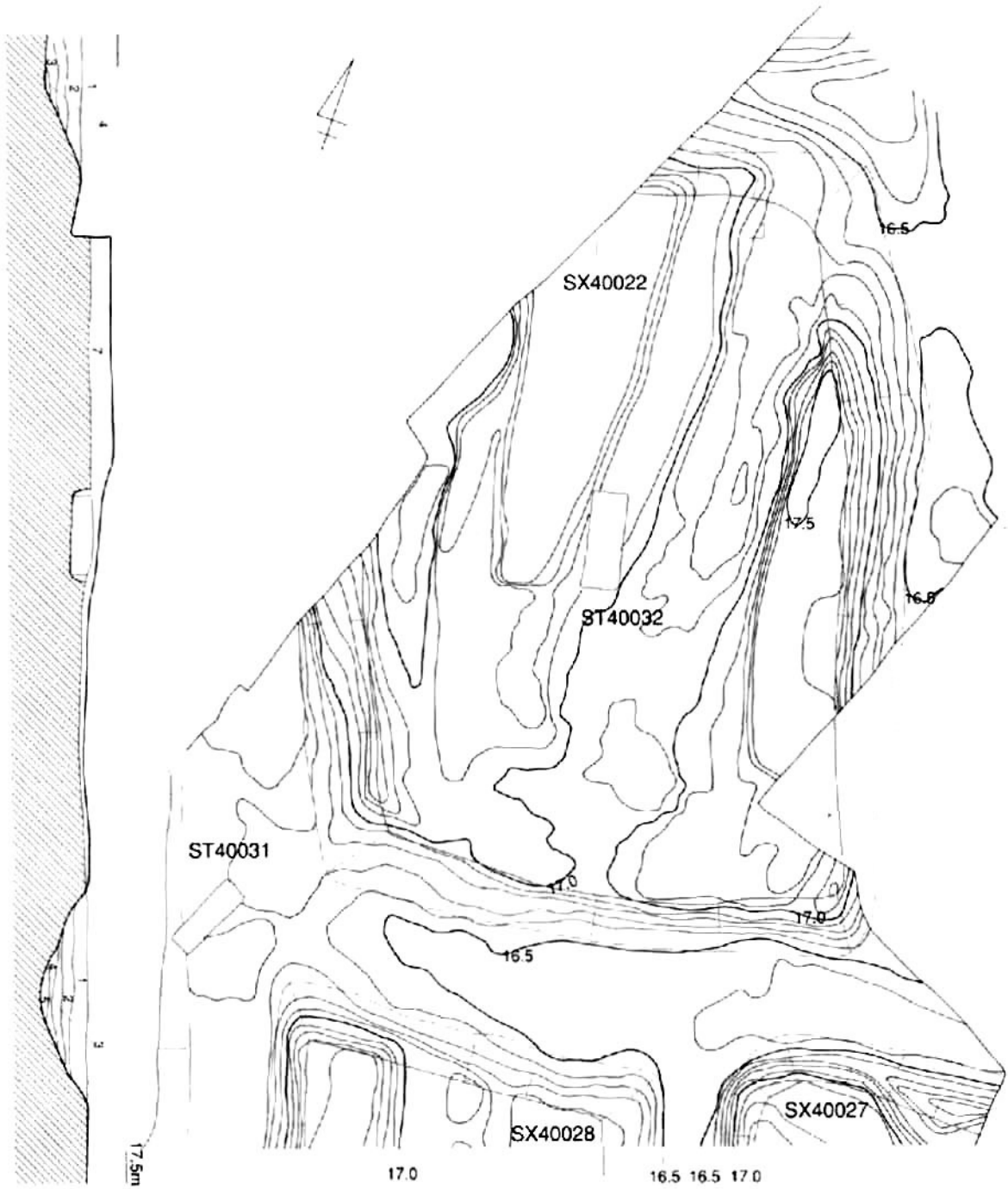

- 1 暗灰黄 細砂-極細砂
- 2 暗灰黄 シルト質極細砂 (ラミナ)
- 3 灰 シルト
- 4 灰 シルト質極細砂
- 5 灰 シルト
- 6 黄灰 極細砂質シルト (Fe₂O₃・Mn含)
- 7 灰 極細砂質シルト

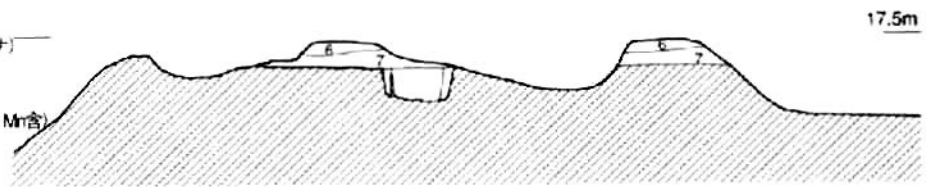

方形周溝墓14 (SX40022)

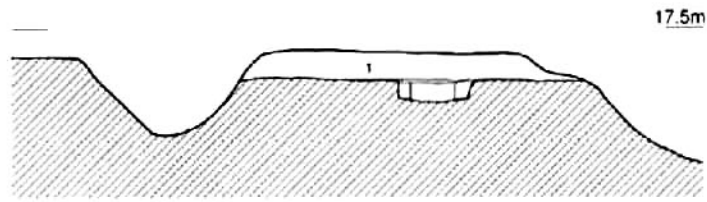
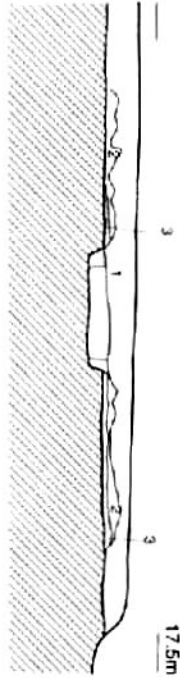
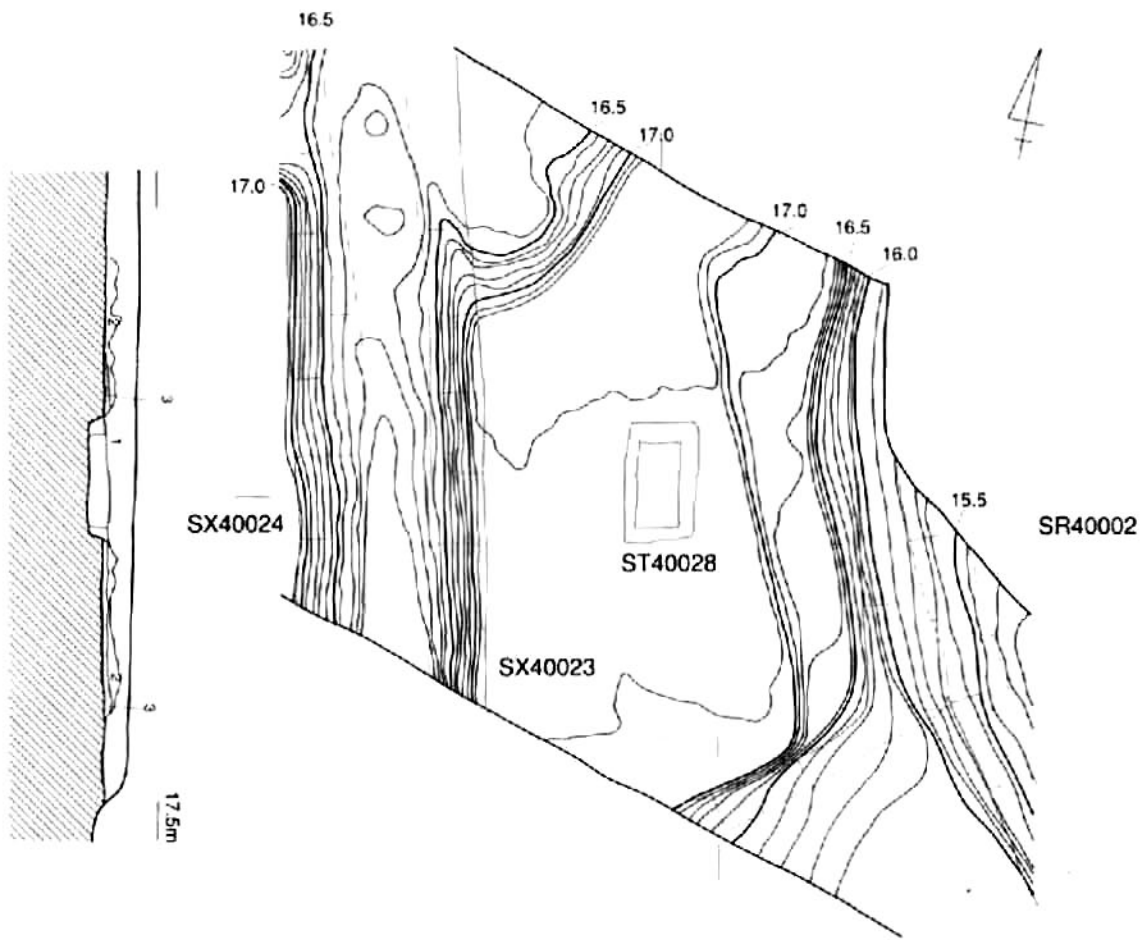

- 1. 暗灰黄 シルト混粗砂～極細砂
- 2. 暗灰黄 中砂～粗砂 (Fe₂O₃含)
- 3. 暗灰黄 中砂～粗砂



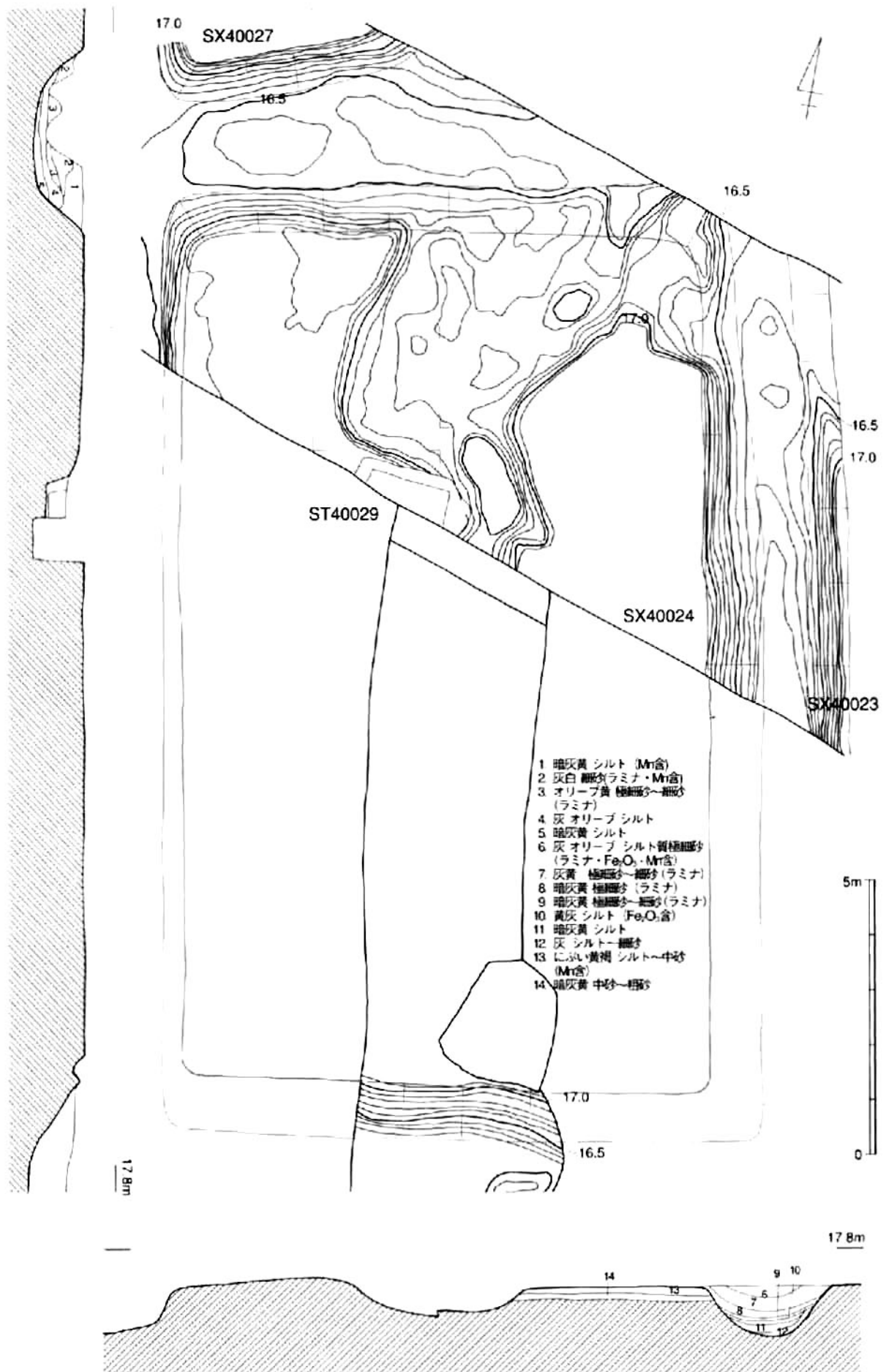

方形周溝墓16 (SX40024)

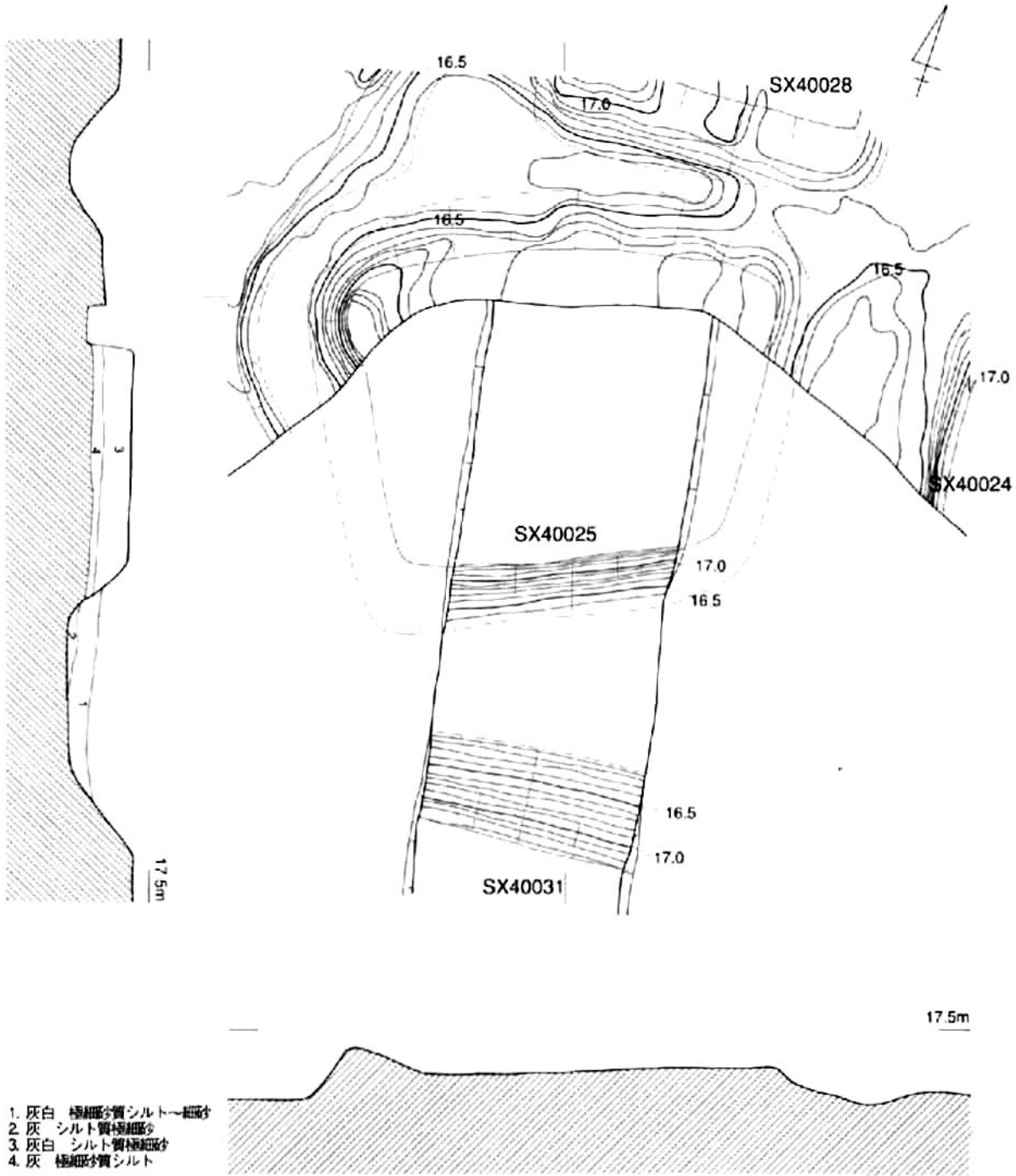

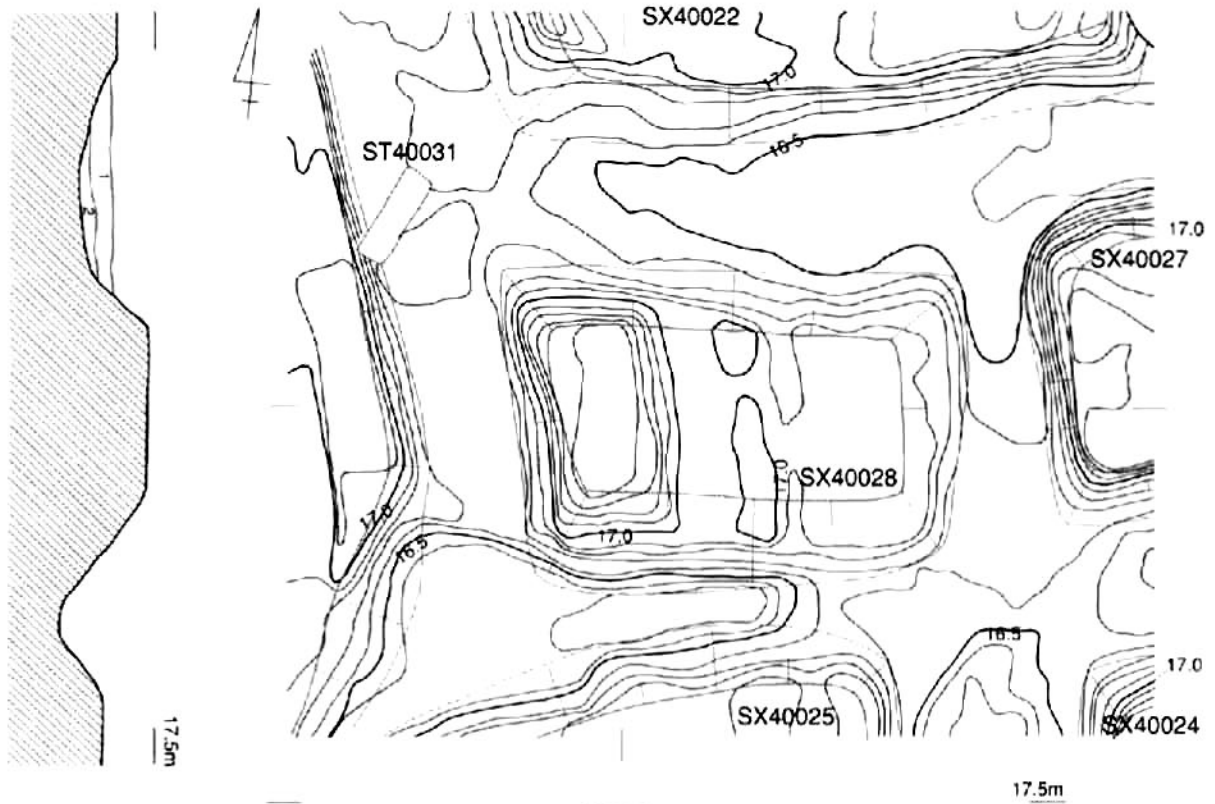

- 1. 暗灰黄 シルト
- 2. 灰 シルト質極細砂

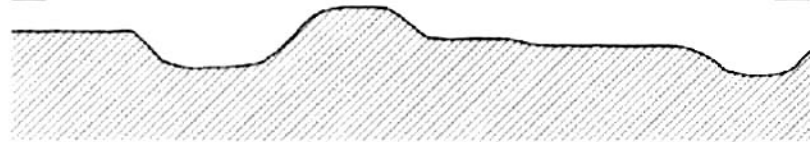

SR40001

0 5m

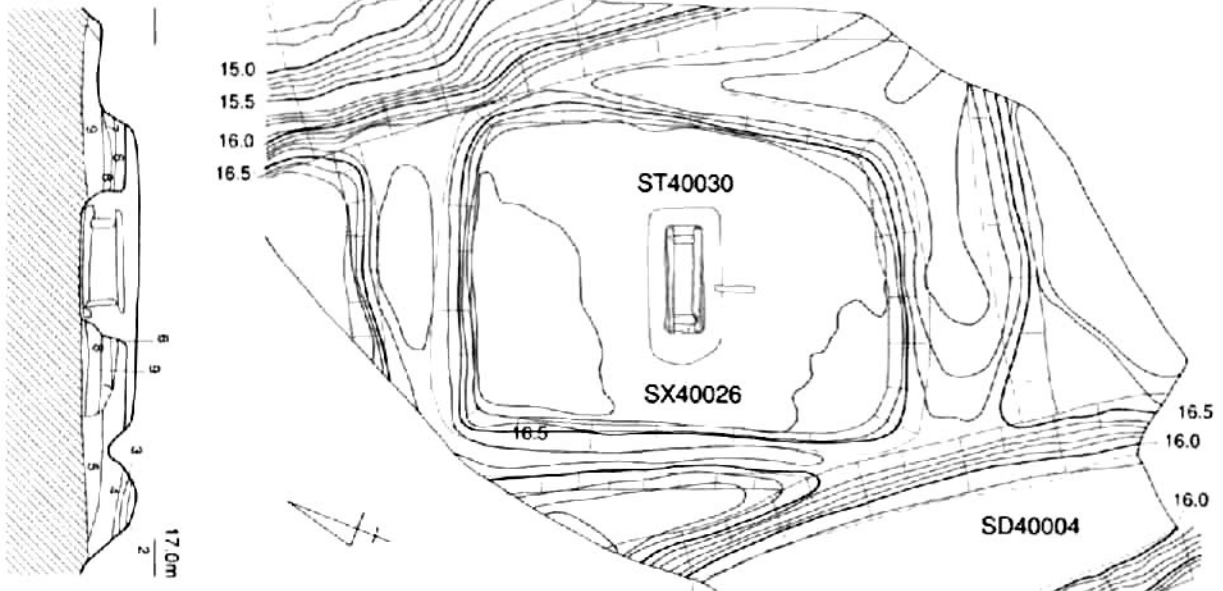

- 1. 暗オリブ灰 シルト質極細砂
- 2. オリブ灰 極細砂
- 3. 暗オリブ灰 極細砂
- 4. 暗オリブ灰 極細砂 (Fe₂O₃含)
- 5. 暗オリブ灰 シルト質極細砂
- 6. 暗オリブ灰 シルト質極細砂
- 7. 暗オリブ灰 シルト (Fe₂O₃含)
- 8. 暗オリブ灰 シルト (Fe₂O₃含)
- 9. 黒シルト (Fe₂O₃含)
- 10. 暗オリブ灰 シルト (Fe₂O₃含)

方形周溝墓18 (SX40028・40026)



- 1 灰白 極細分質シルト～細砂
- 2 灰 シルト質極細砂
- 3 灰白 極細砂
- 4 灰白 シルト質極細砂
- 5 灰 極細分質シルト

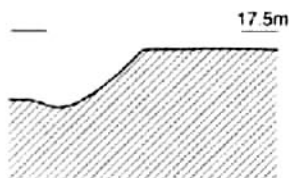
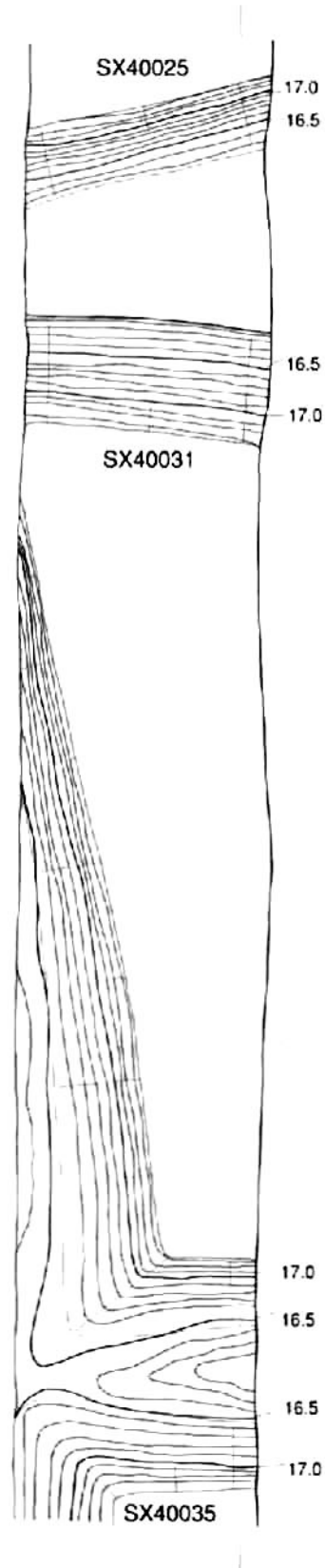

方形周溝墓19 (SX40031)

図版 60 弥生中期上層

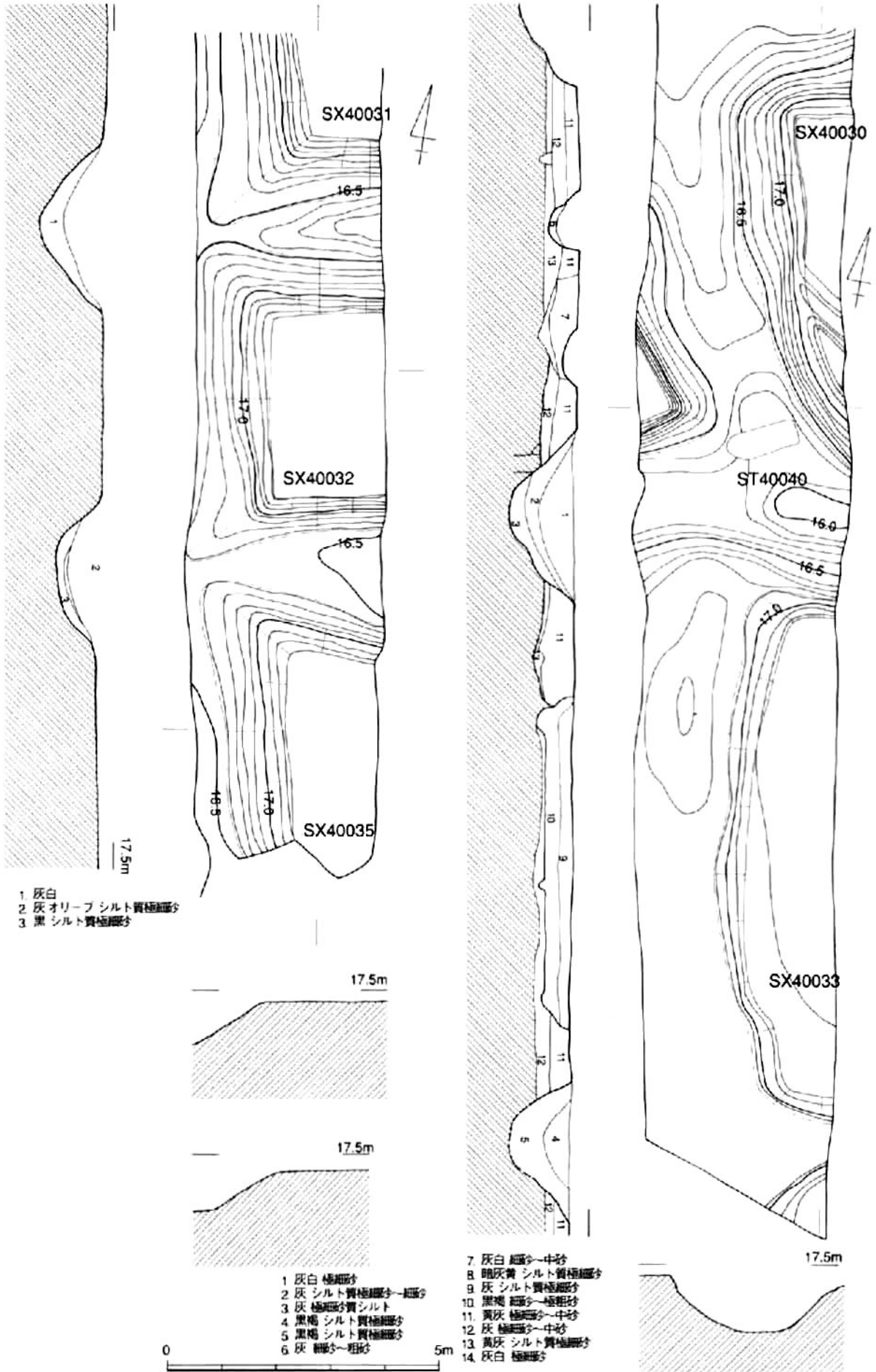

方形周溝墓20 (SX40032・40030・40035・40033)

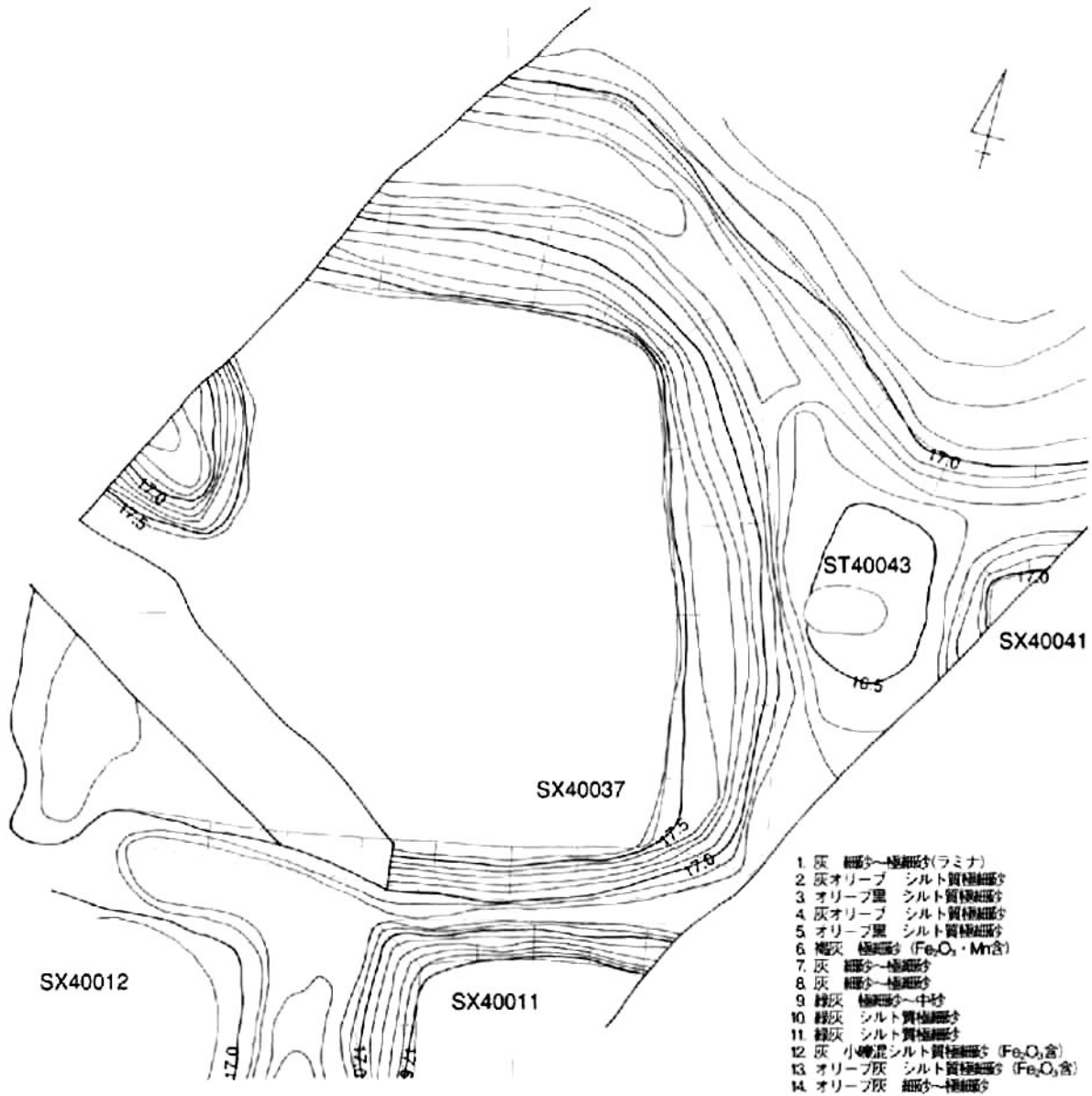

- 1 灰 細砂〜極細砂(ラミナ)
- 2 灰オリブ シルト質極細砂
- 3 オリブ黒 シルト質極細砂
- 4 灰オリブ シルト質極細砂
- 5 オリブ黒 シルト質極細砂
- 6 焼灰 極細砂 (Fe₂O₃・Mn含)
- 7 灰 細砂〜極細砂
- 8 灰 細砂〜極細砂
- 9 緑灰 極細砂〜中砂
- 10 緑灰 シルト質極細砂
- 11 緑灰 シルト質極細砂
- 12 灰 小礫混シルト質極細砂 (Fe₂O₃含)
- 13 オリブ灰 シルト質極細砂 (Fe₂O₃含)
- 14 オリブ灰 細砂〜極細砂

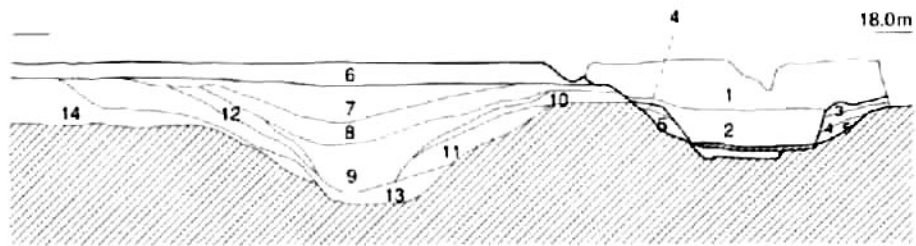

方形周溝墓21 (SX40037)

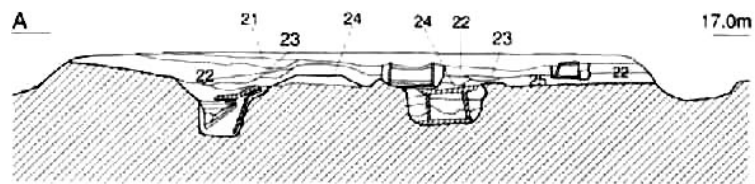
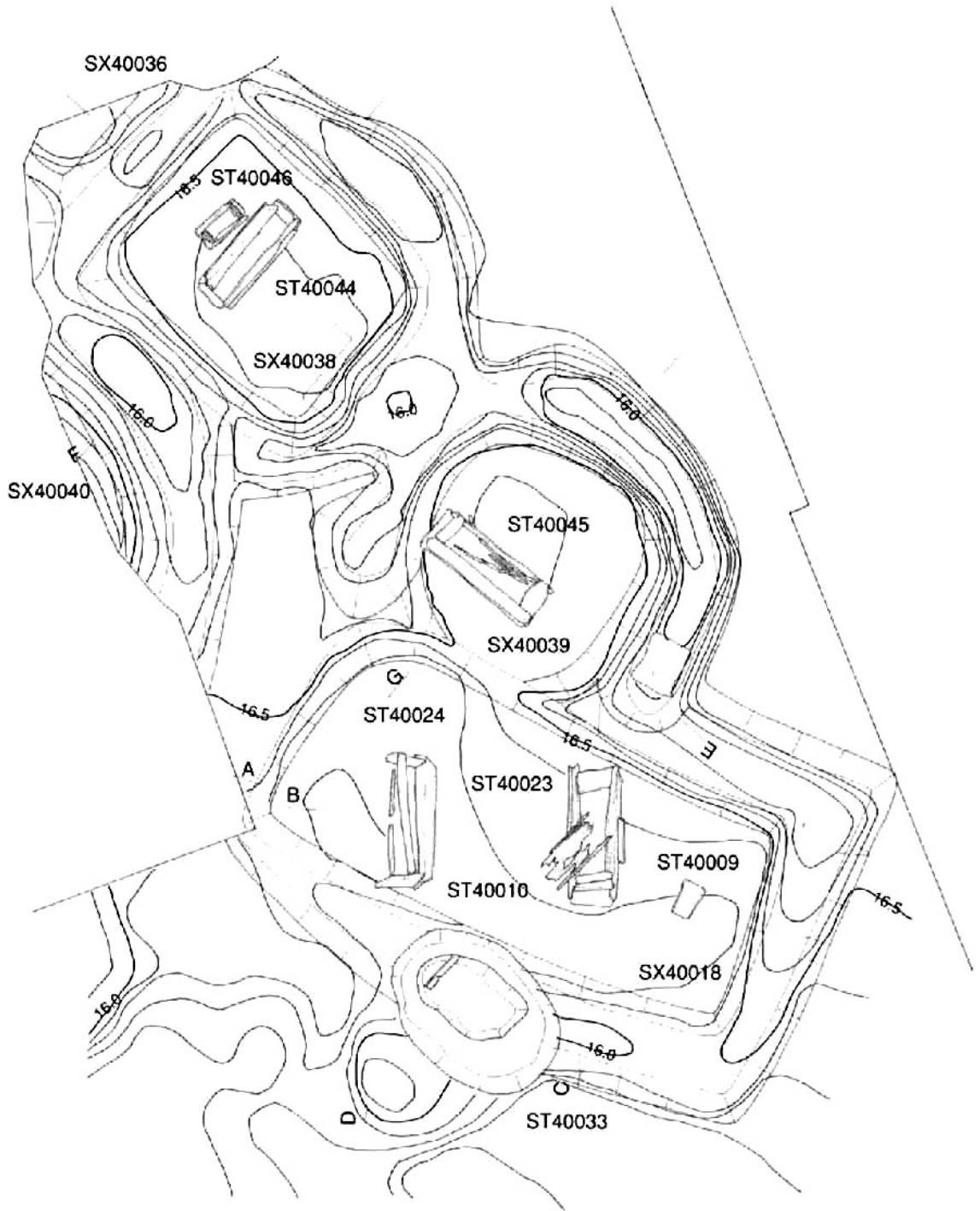

方形周溝墓22 (SX40018・40038・40039・40040平面)

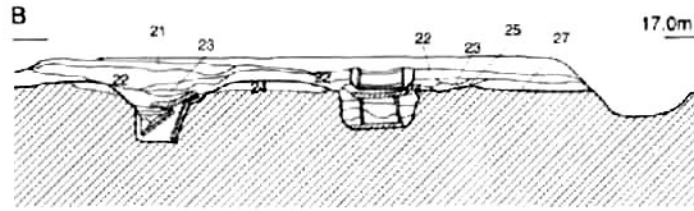

- 21. 暗灰黄 細砂
- 22. 灰 オリーブ シルト質極細砂
- 23. 灰 オリーブ シルト質極細砂
- 24. 灰 細砂
- 25. 灰 シルト質極細砂
- 26. オリーブ黒 シルト質極細砂
- 27. 暗オリーブ灰 シルト質極細砂
- a. 灰 シルト質極細砂 (灰)
- b. 灰 オリーブ 細砂
- c. オリーブ黄 シルト質極細砂
- d. 灰 オリーブ シルト質極細砂
- e. オリーブ黄 極細砂
- f. 灰 オリーブ シルト質極細砂

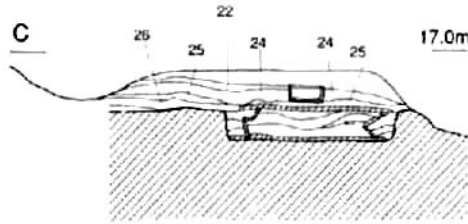

- 1. 黄灰 細砂～極細砂 (ラミナ)
- 2. 黒 シルト質極細砂 (ラミナ)
- 3. オリーブ灰 細砂～極細砂 (ラミナ)
- 4. オリーブ黒 シルト～細砂 (炭化物多量)
- 5. 暗オリーブ灰 シルト～細砂 (ラミナ)
- 6. 灰 細砂～極細砂
- 7. オリーブ灰 極細砂
- 8. オリーブ黒 シルト質極細砂
- 9. 灰 細砂～中砂
- 10. 暗オリーブ灰 極細砂
- 11. 緑灰 極細砂
- 12. 灰白 シルト質極細砂
- 13. 灰オリーブ シルト質極細砂
- 14. オリーブ黒 小粒～細砂
- 15. 黒褐 シルト～細砂
- 16. 黒 細砂
- 17. 暗オリーブ灰 細砂
- 18. 暗オリーブ灰 シルト～細砂
- 19. 黒 シルト質極細砂
- 20. 暗緑灰 シルト～細砂

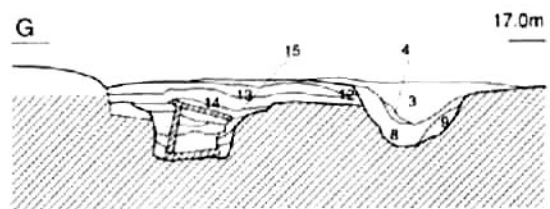
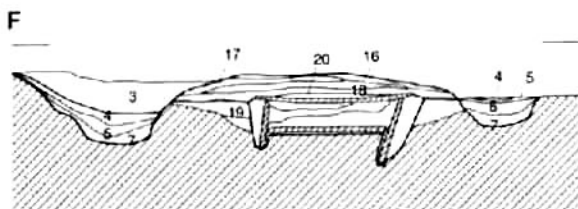
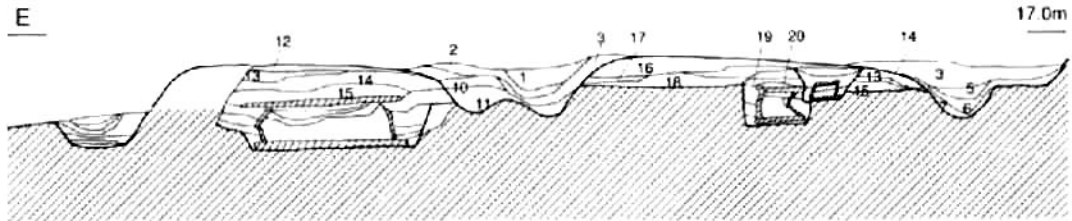
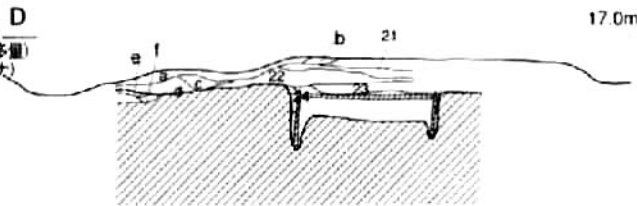

方形周溝墓23 (SX40018・40038・40039・40040断面)

图版 64 弥生中期上層

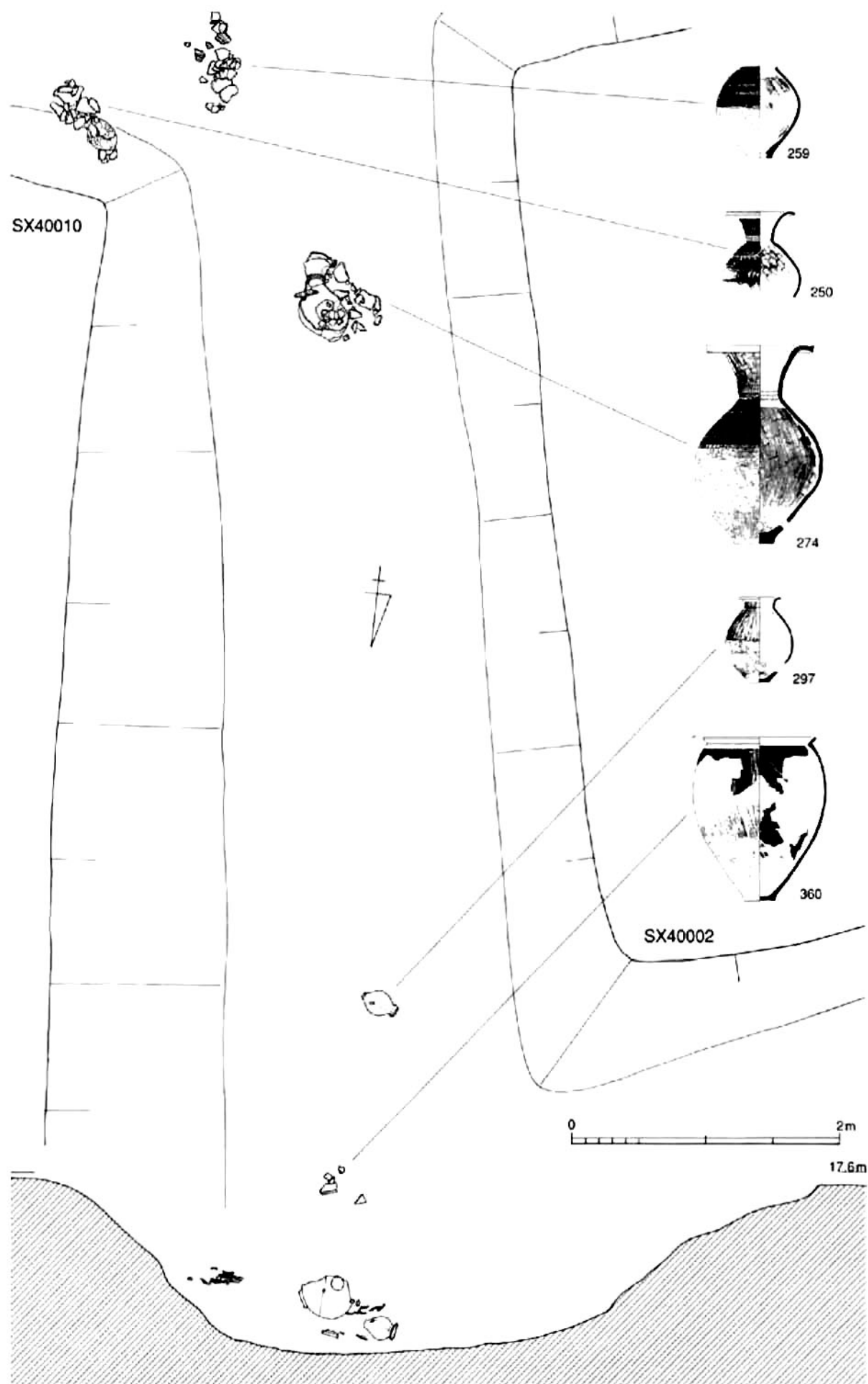

方形周溝墓土器出土状況1 (SX40002-40010)

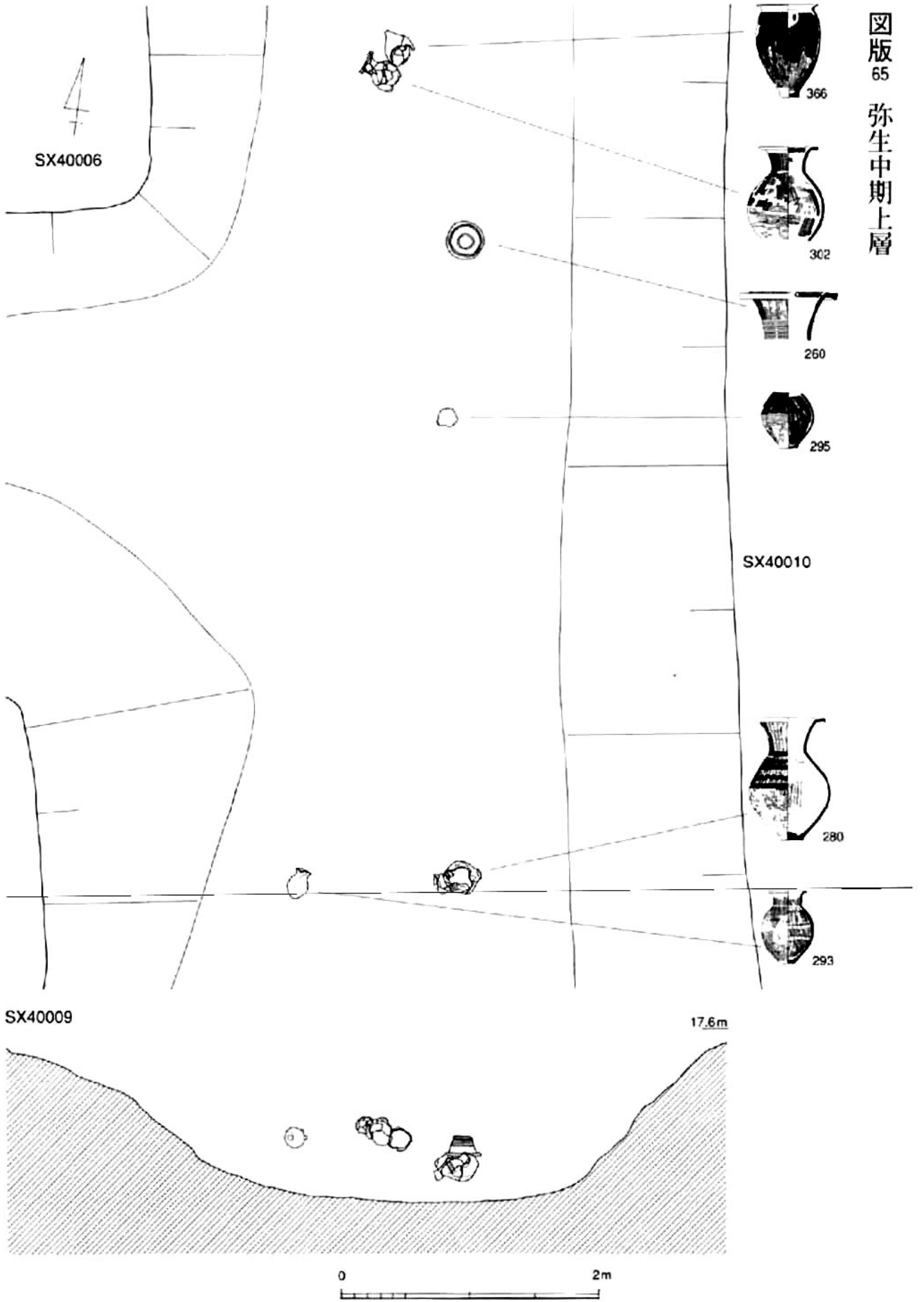

方形周溝墓土器出土状況2 (SX40006・40009-40010)

图版 66
弥生中期上層

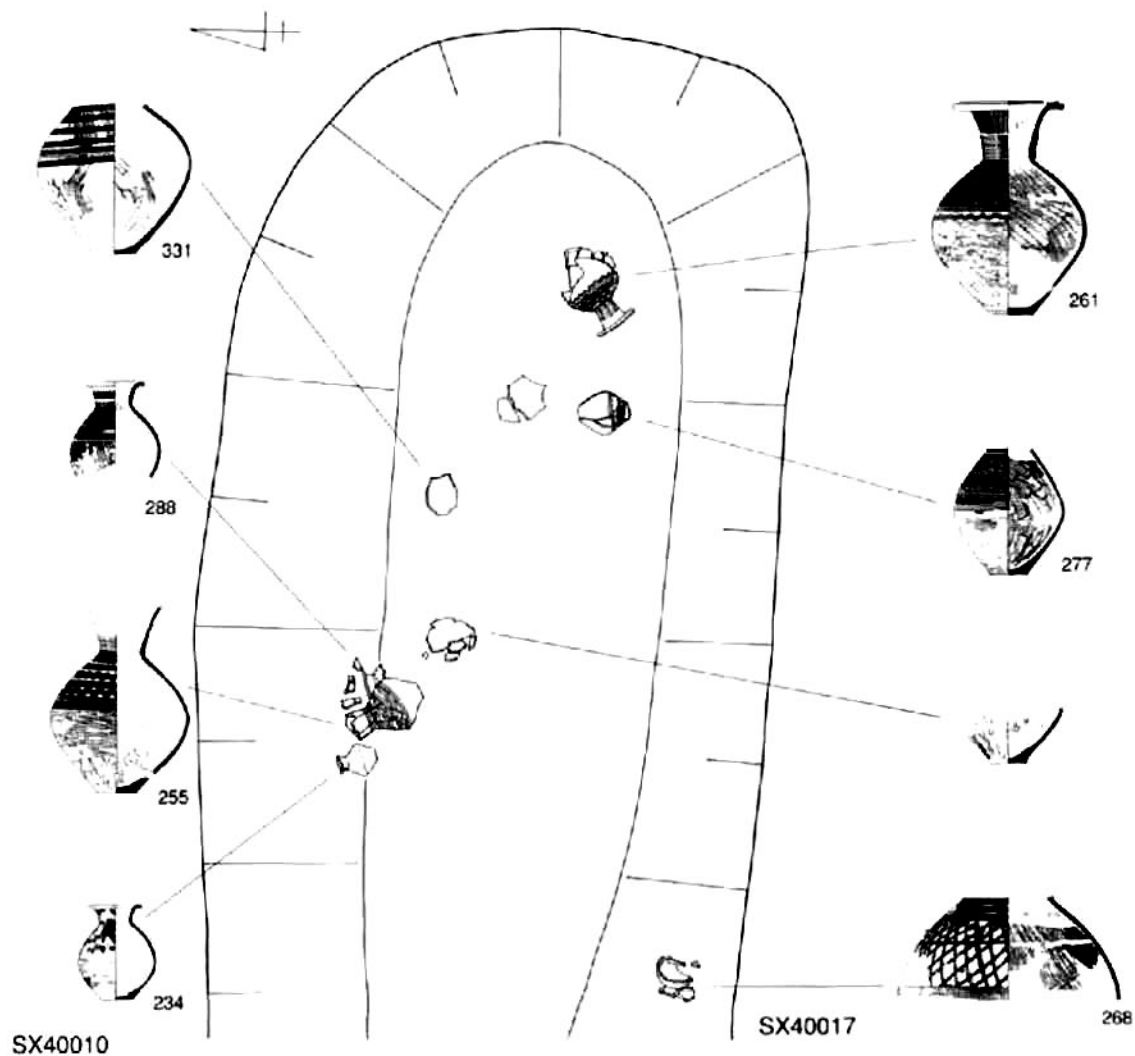

方形周溝墓土器出土状況3 (SX40010-40017西)

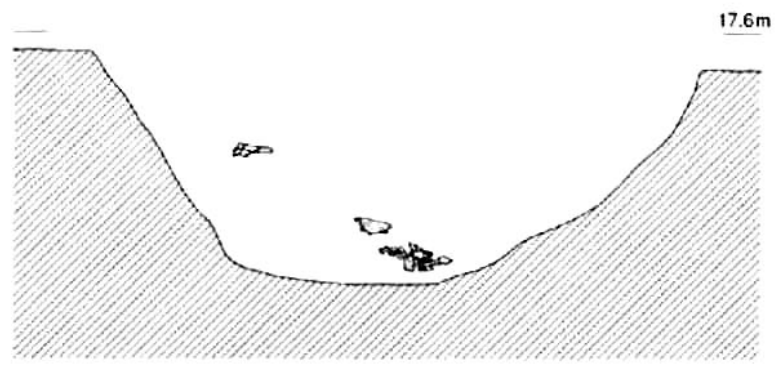
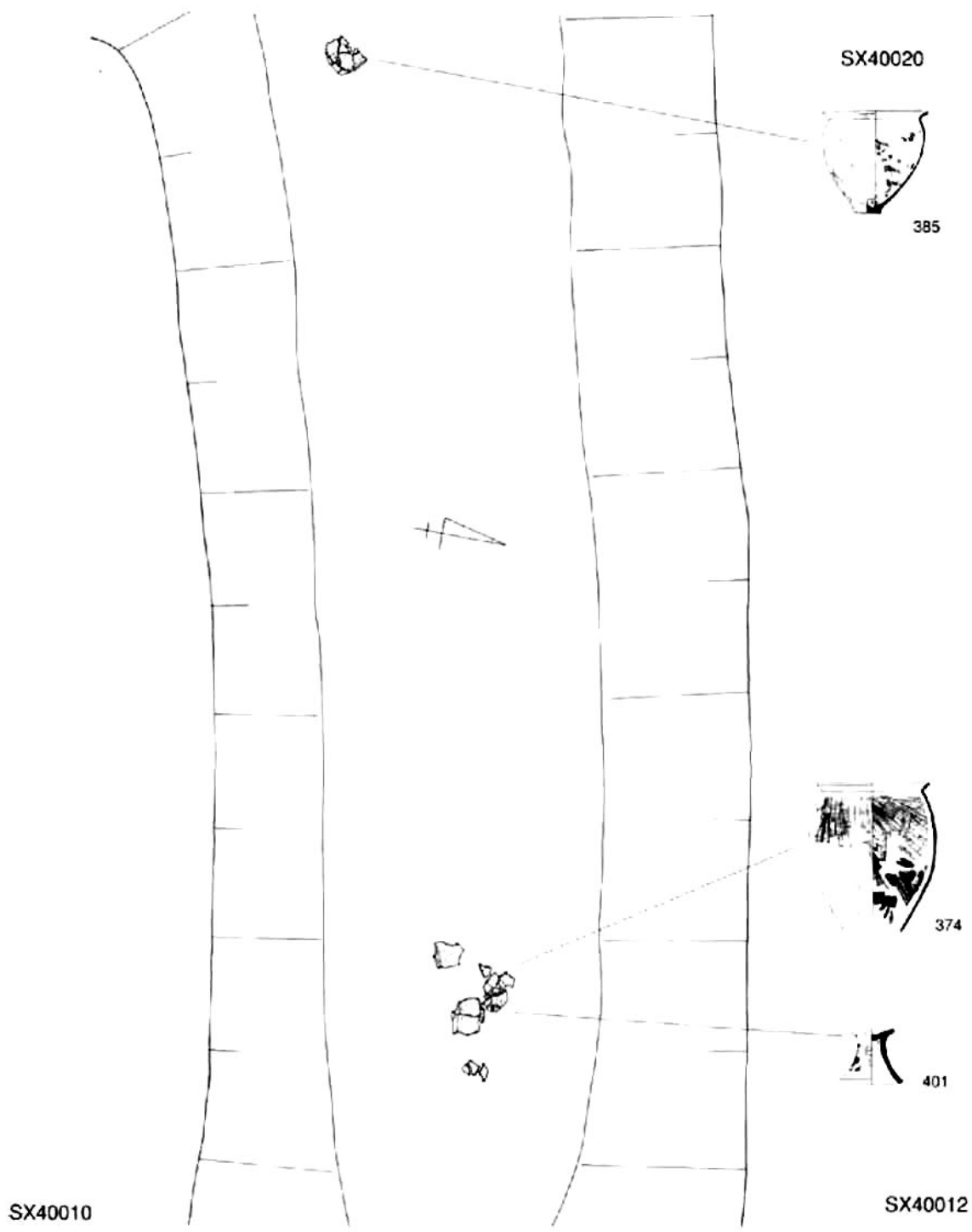

方形周溝墓土器出土状況4 (SX40010-40012・40020)

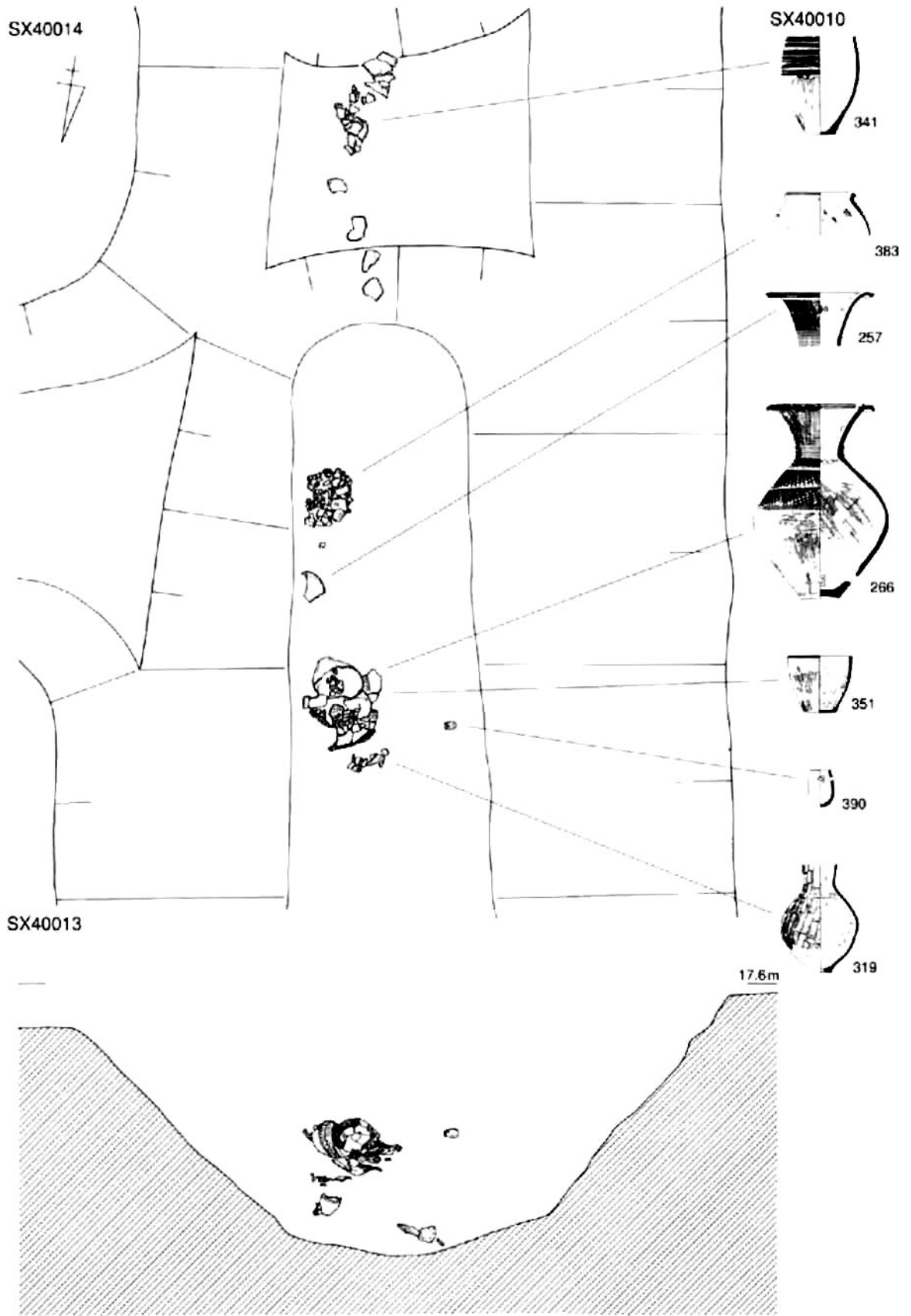

方形周溝墓土器出土状況5 (SX40010-40013・40014)

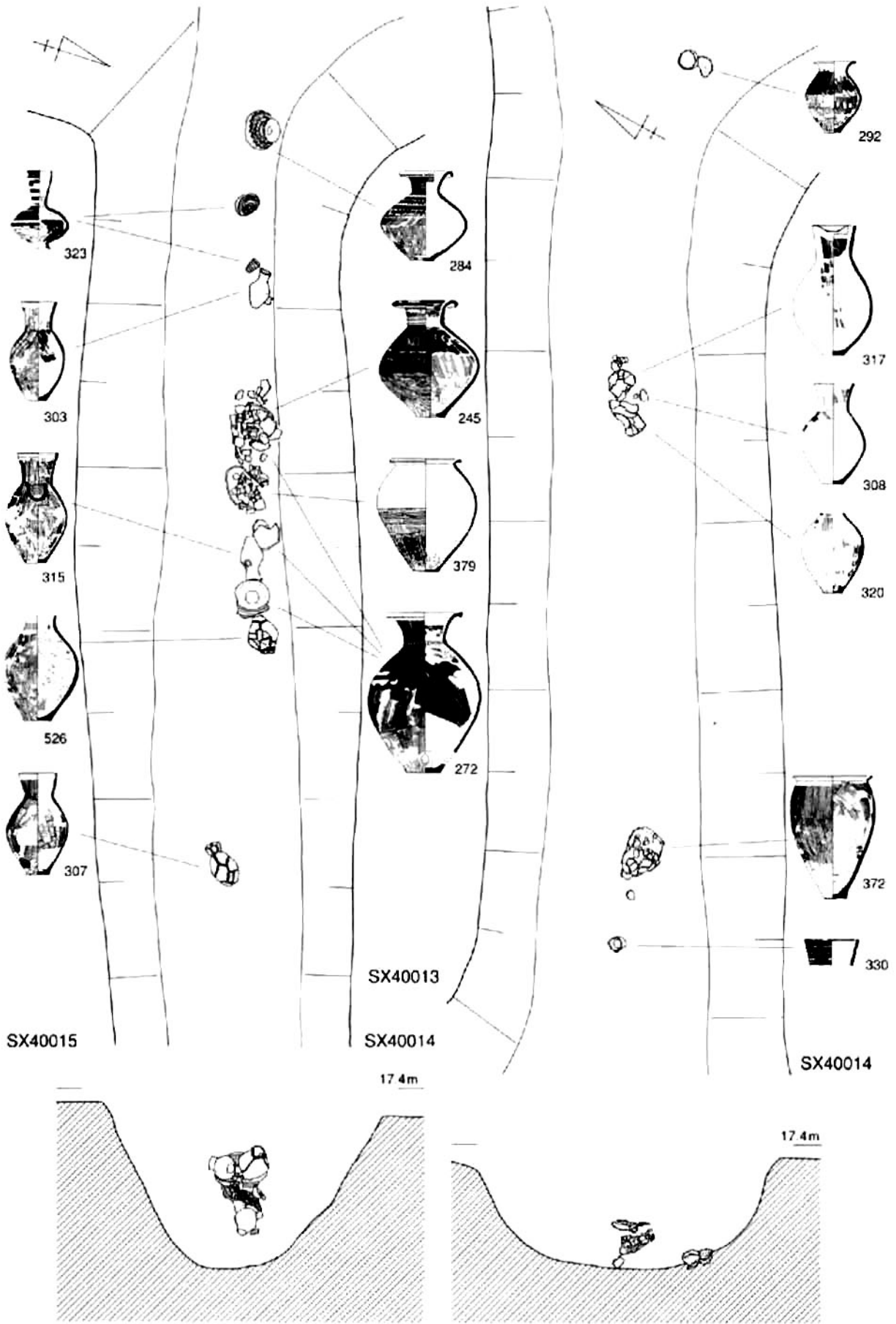

方形周溝墓土器出土状況6 (SX40014-40015 · SX40013-40014)

图版 70
弥生中期上層

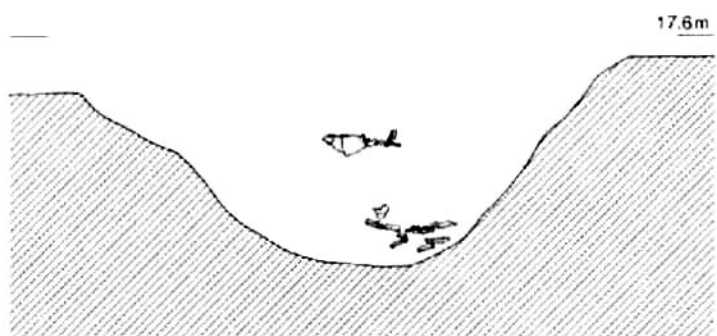
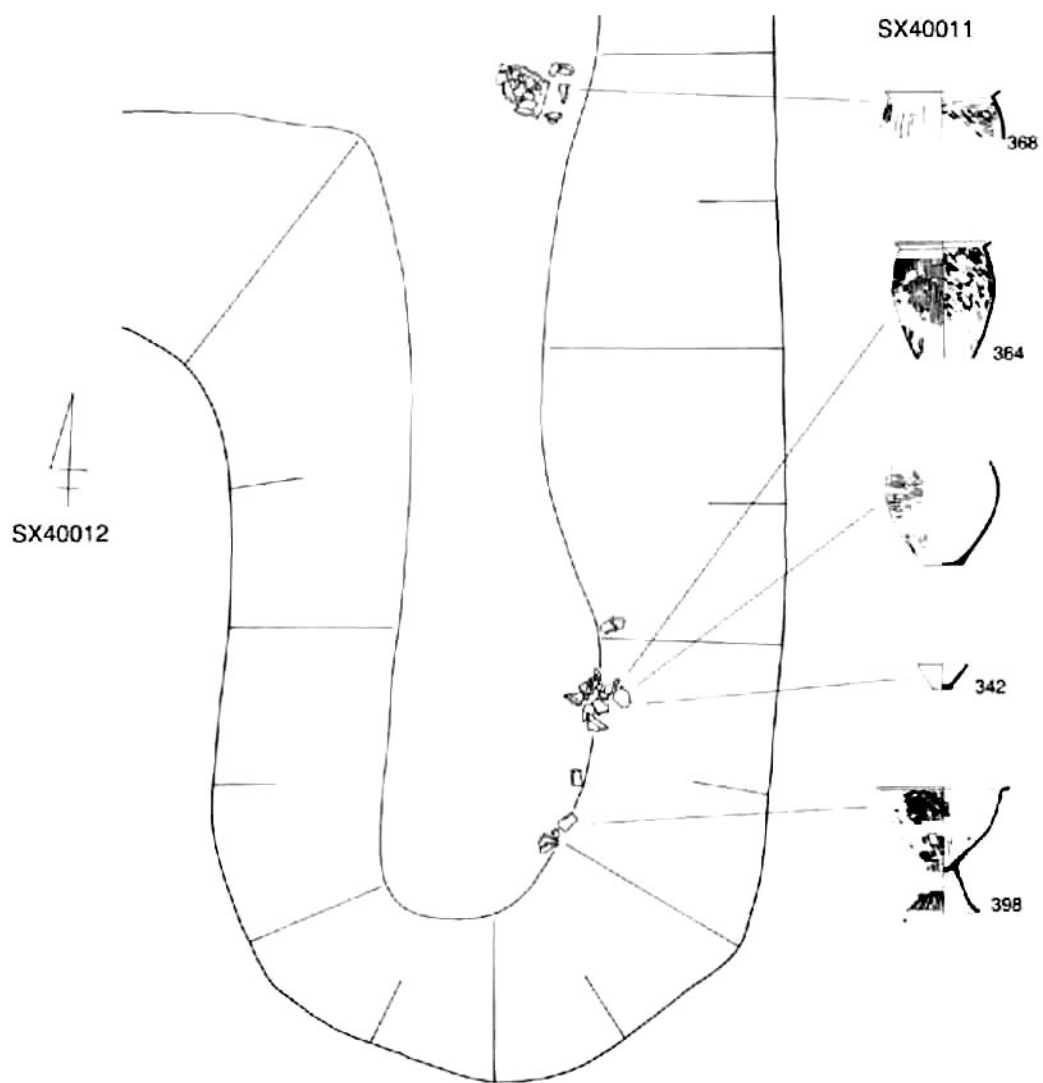

方形周溝墓土器出土状況7 (SX40011-40012)

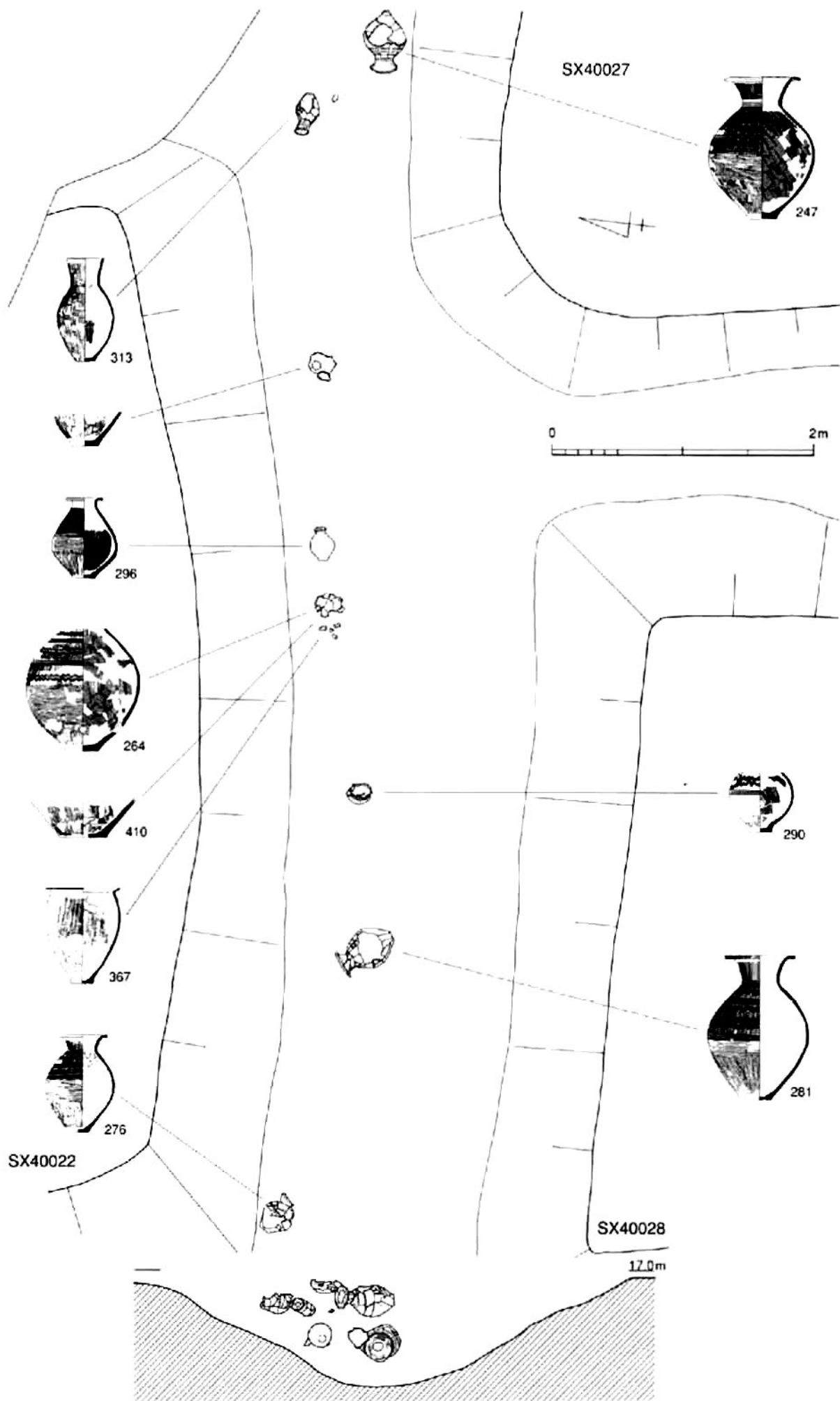

方形周溝墓土器出土状況8 (SX40022-40027・40028)

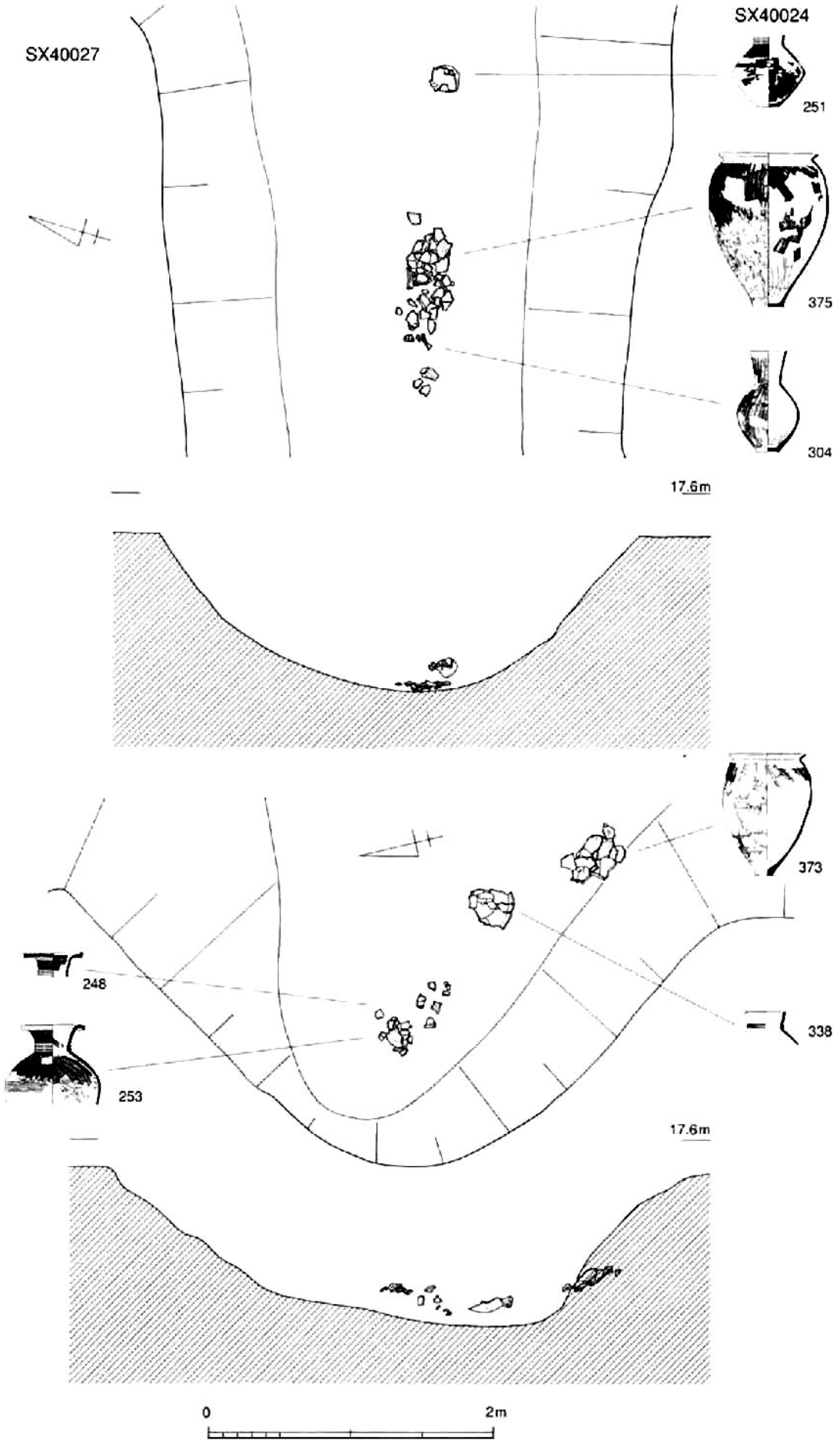

方形周溝墓土器出土状況9 (SX40024-40027・SX40010-40017東)

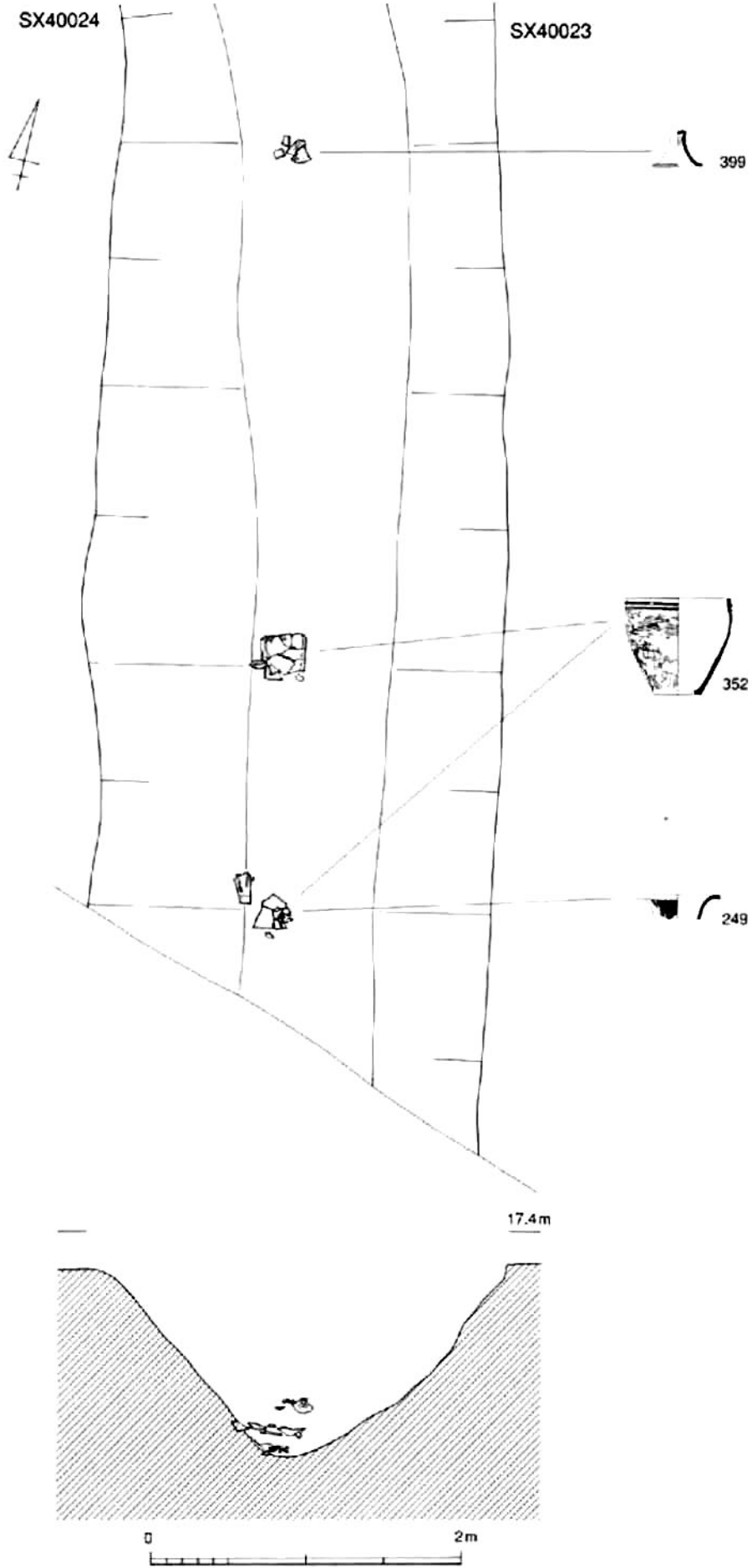

方形周溝墓土器出土状況10 (SX40023-40024)

図版 74
弥生中期上層

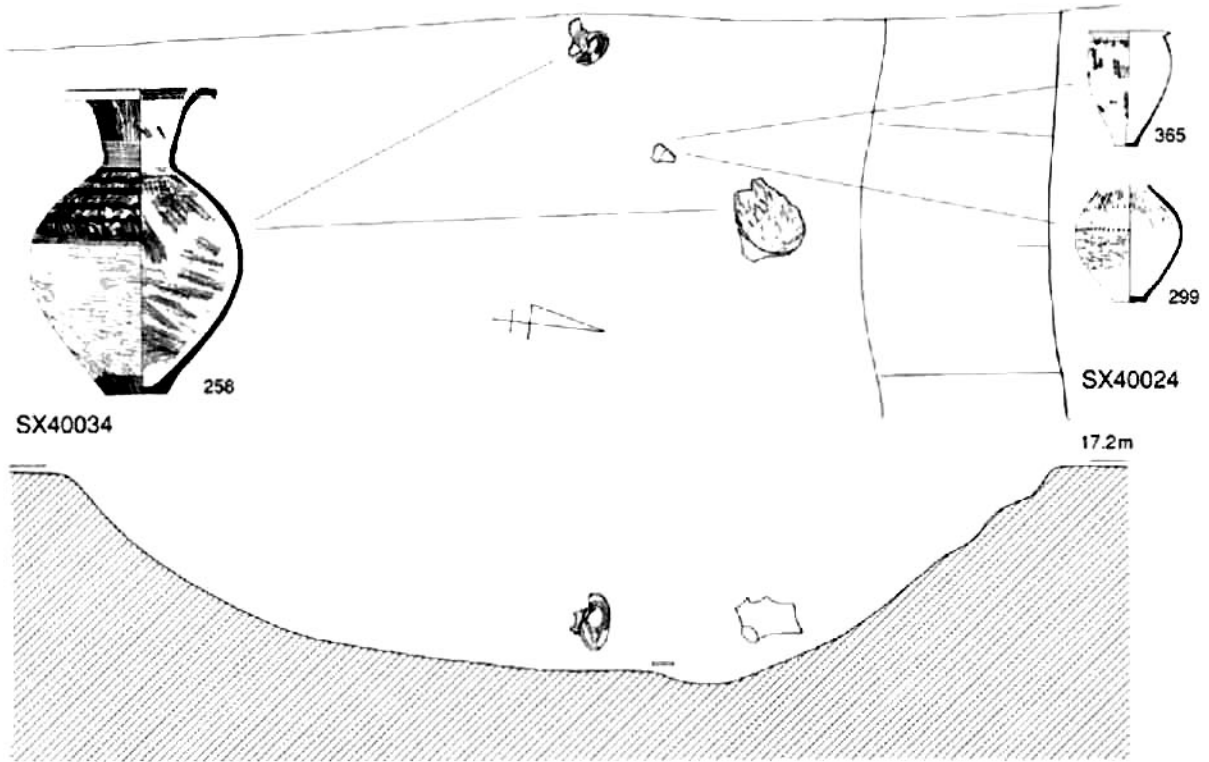

SX40034

SX40024

17.2m

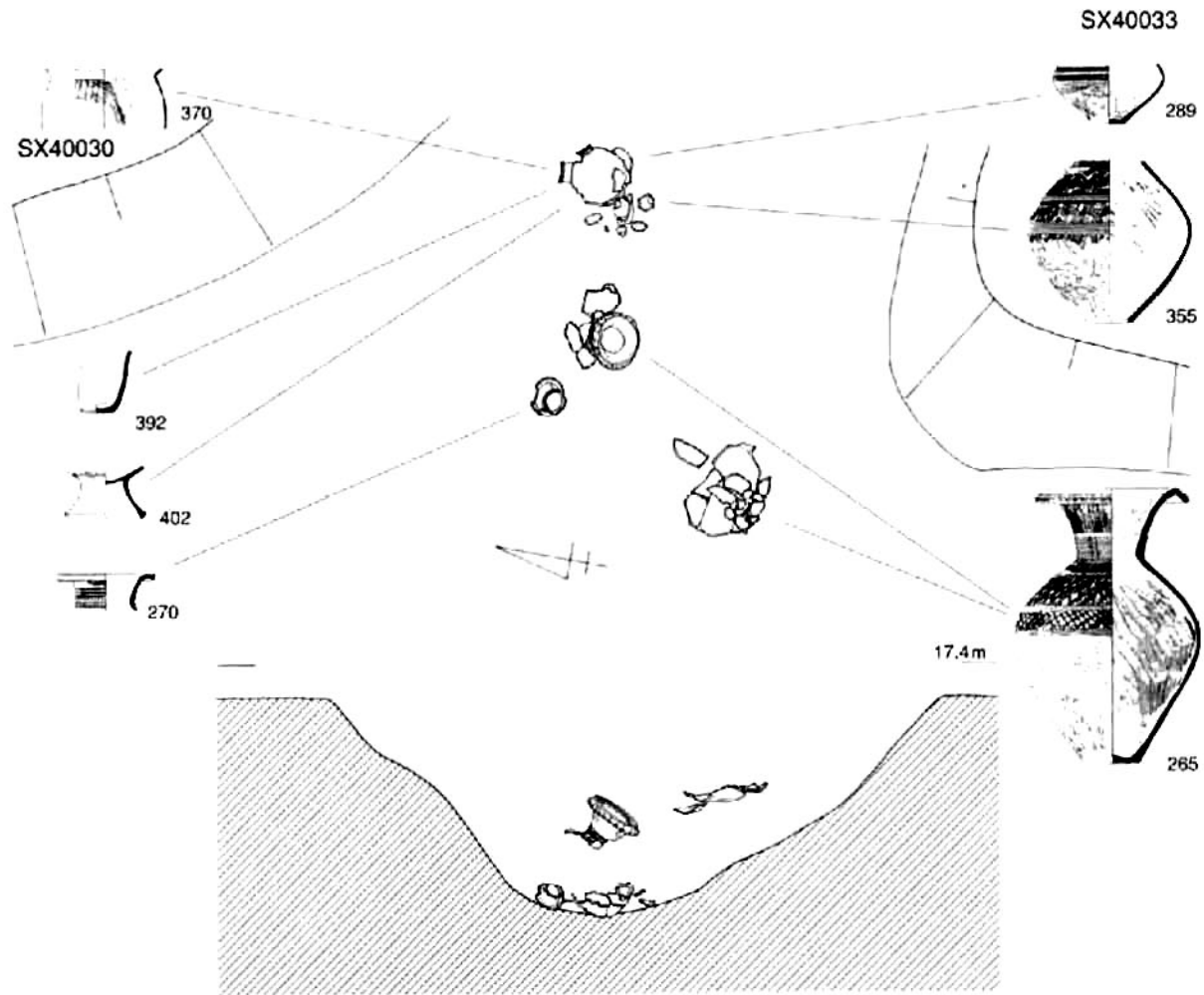

SX40033

SX40030

17.4m

0 2m

方形周溝墓土器出土状況11 (SX40024-40034・SX40030-40033)

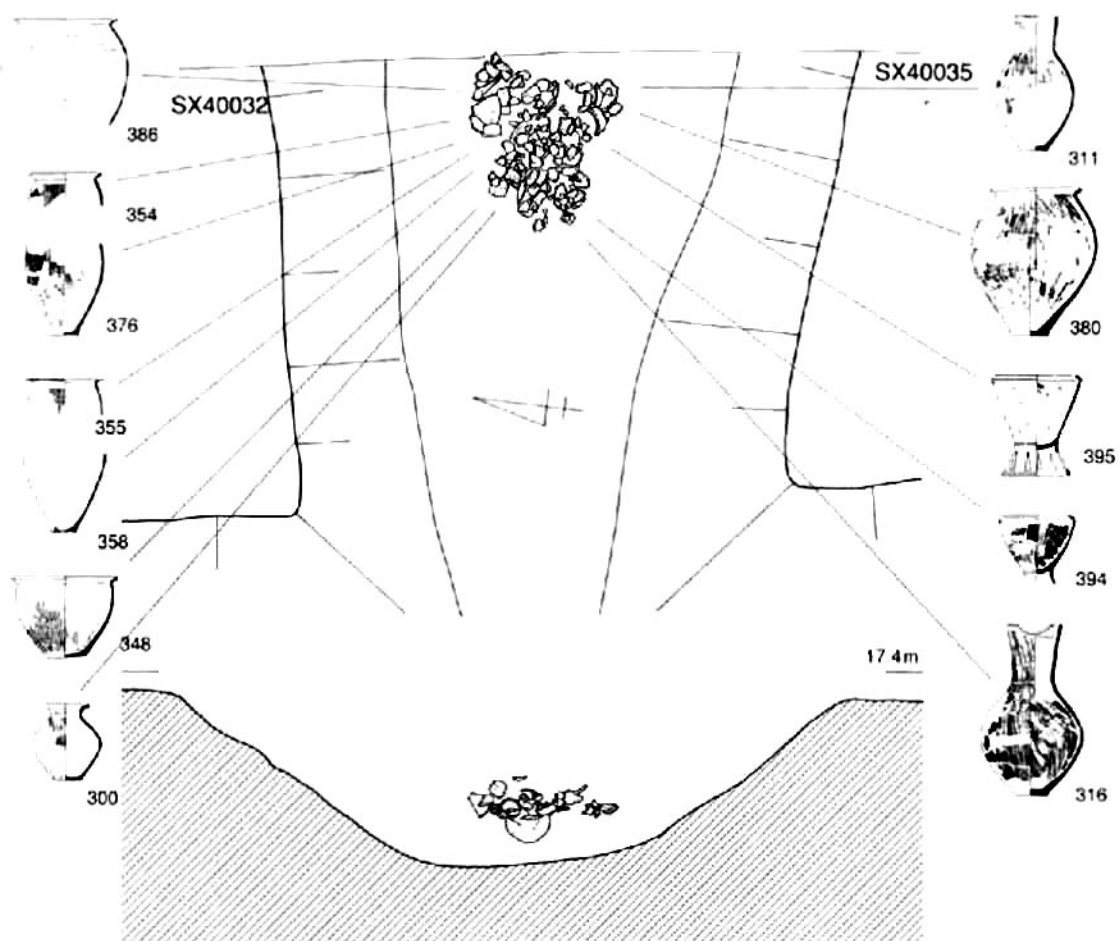
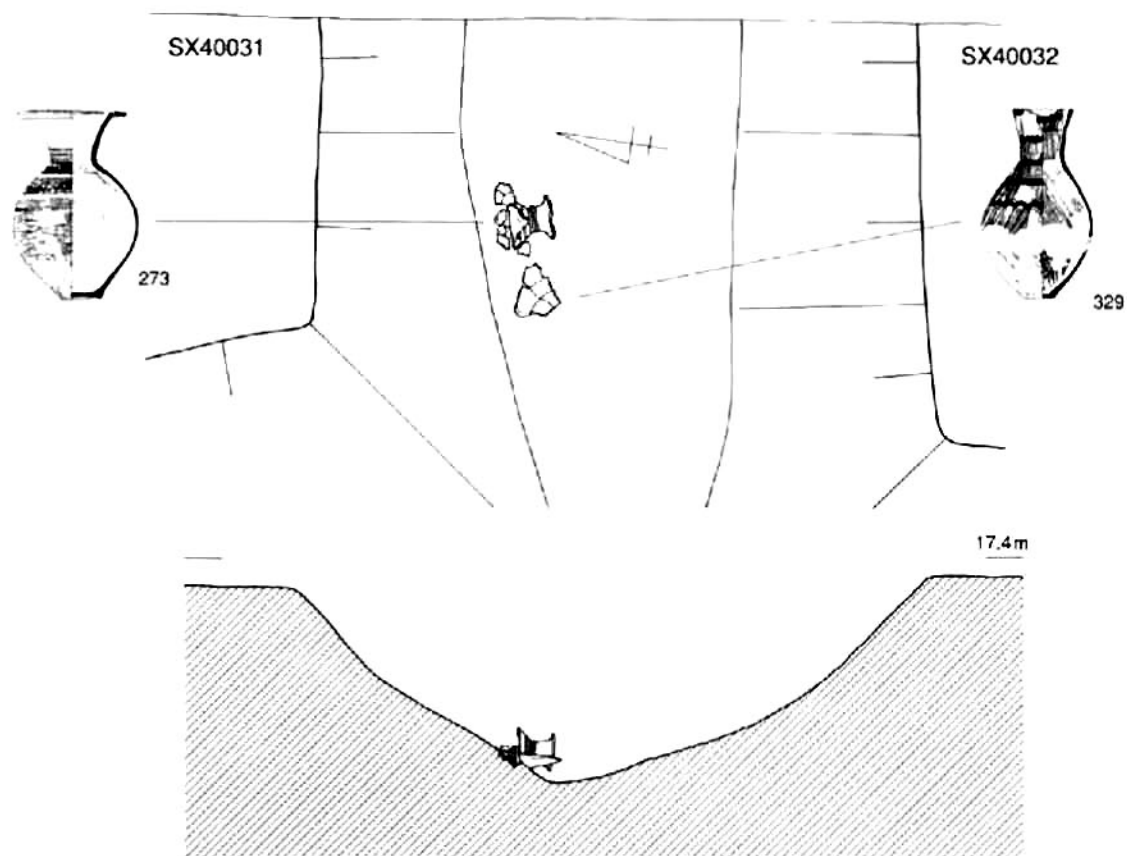

方形周溝墓土器出土状況12 (SX40031-40032・SX40032-40035)

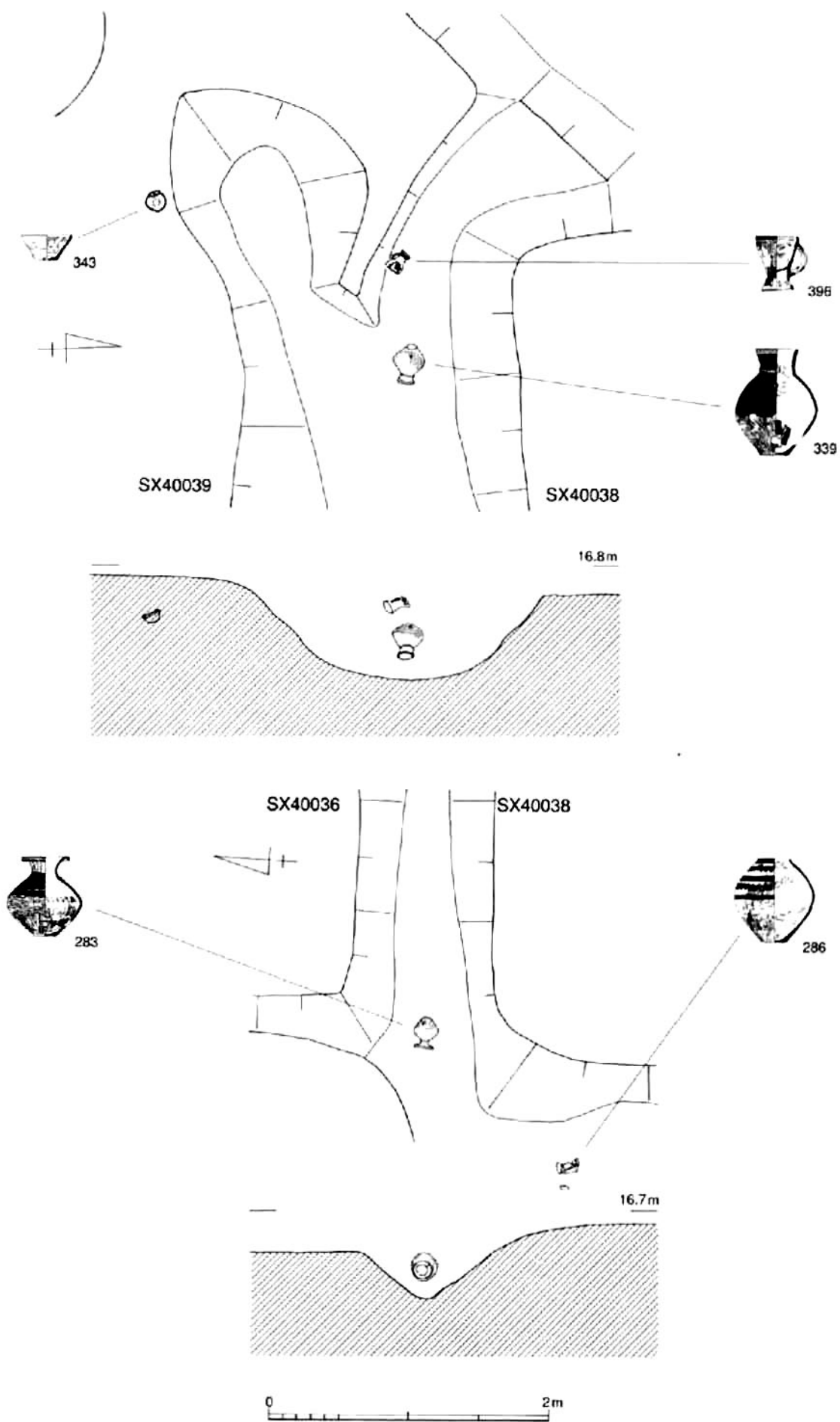

方形周溝墓土器出土状況13 (SX40038-40039・SX40036-40038)

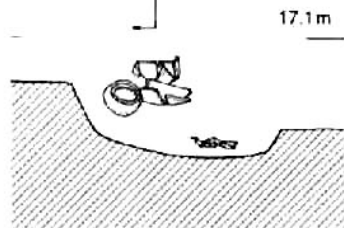
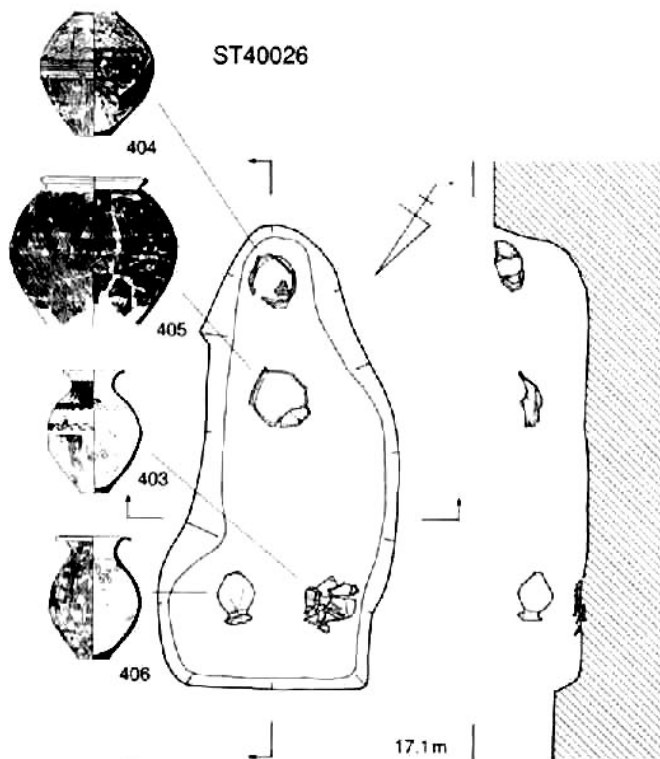
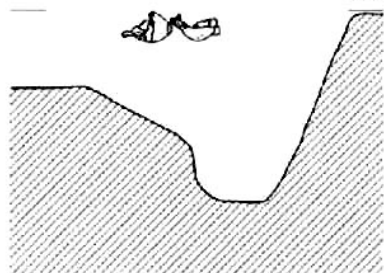
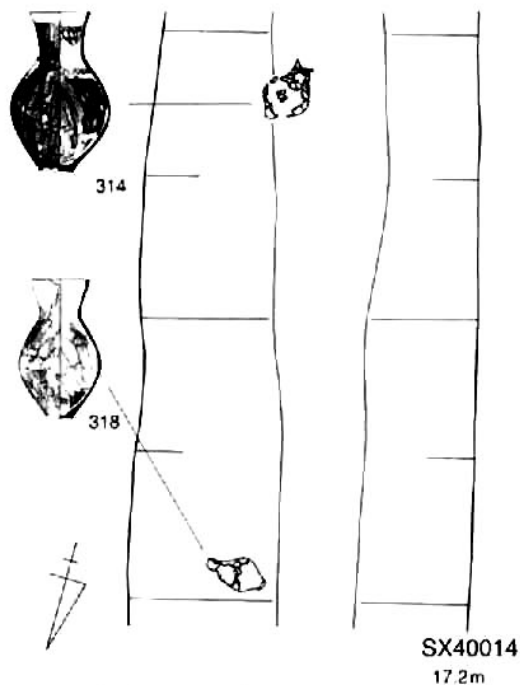
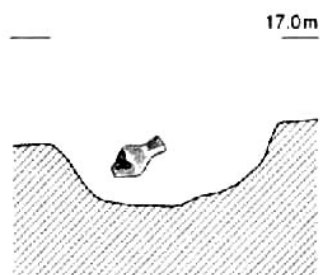
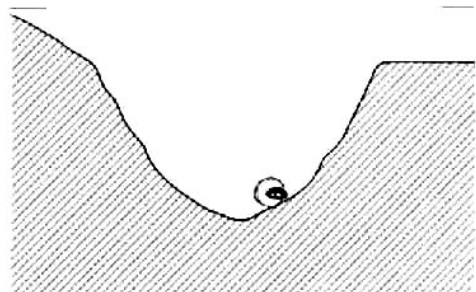
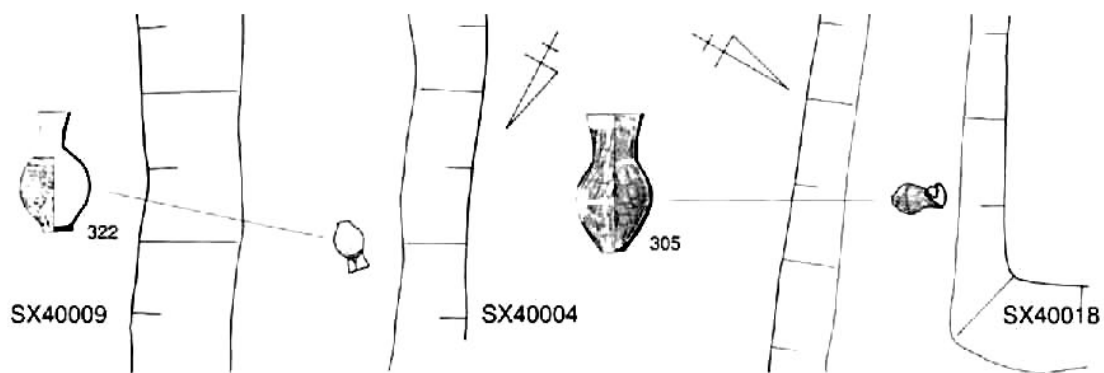

0 2m

方形周溝墓土器出土状況13 (SX40004-40009・SX40018南・SX40014東・ST40026)

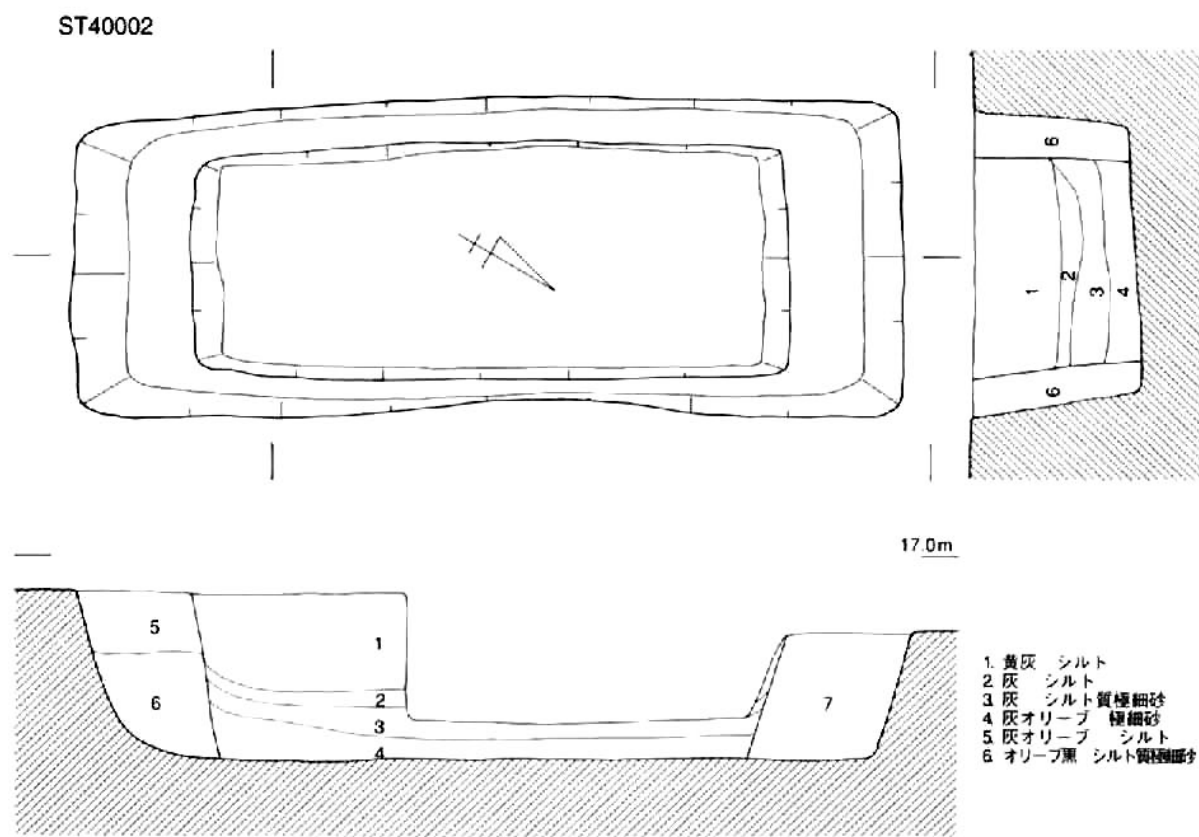
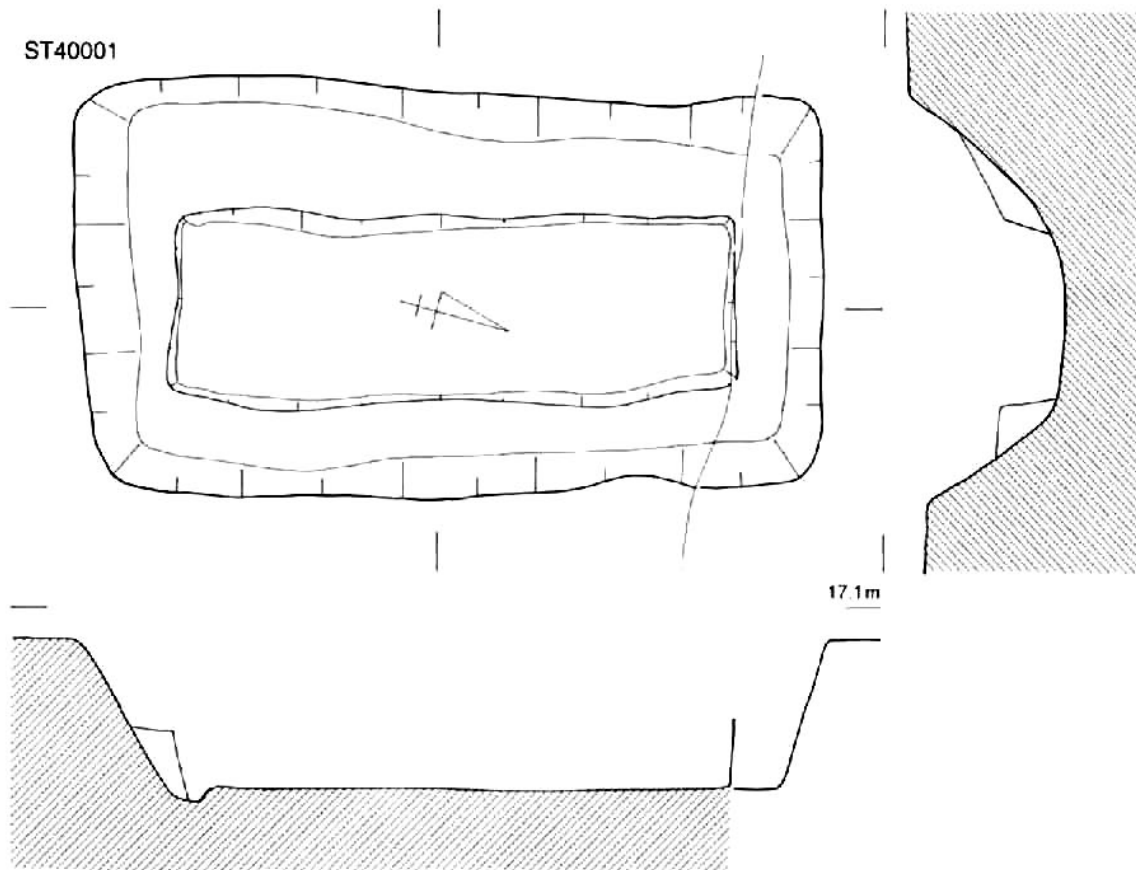

- 1. 黄灰 シルト
- 2. 灰 シルト
- 3. 灰 シルト 黄極細砂
- 4. 灰オリーブ 極細砂
- 5. 灰オリーブ シルト
- 6. オリーブ黒 シルト黄極細砂



方形周溝墓埋葬施設1 (ST40001・40002)

ST40010

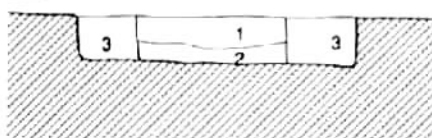
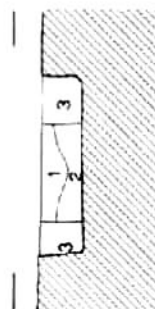
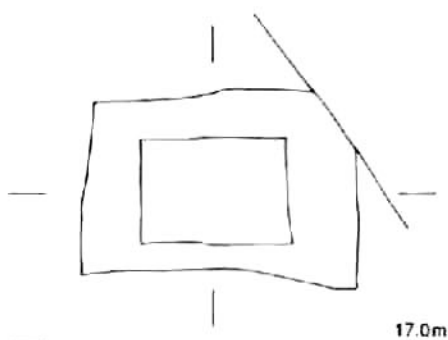

- 1 灰 シルト質極細砂
- 2 灰 オリーブ シルト
- 3 オリーブ黄 シルト

ST40003

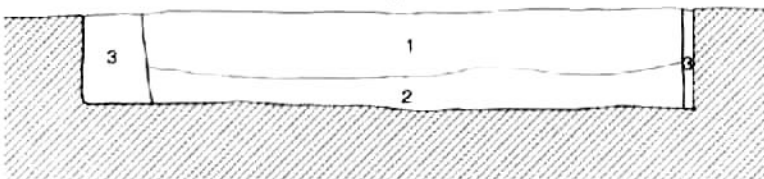
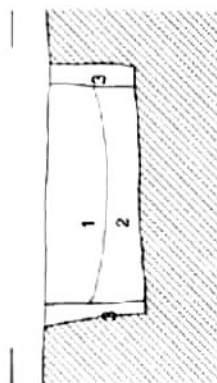
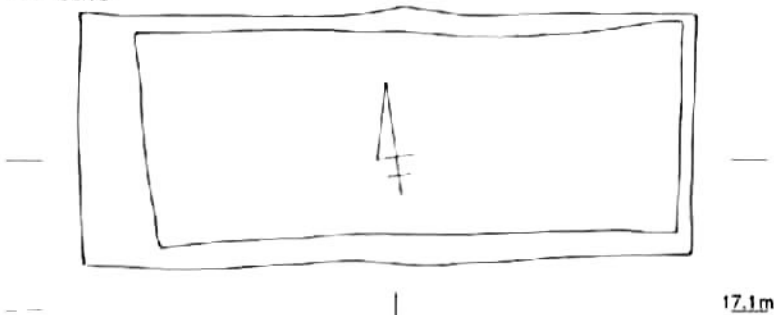

- 1 灰 オリーブ シルト
- 2 灰 オリーブ シルト
- 3 灰 シルト

ST40007

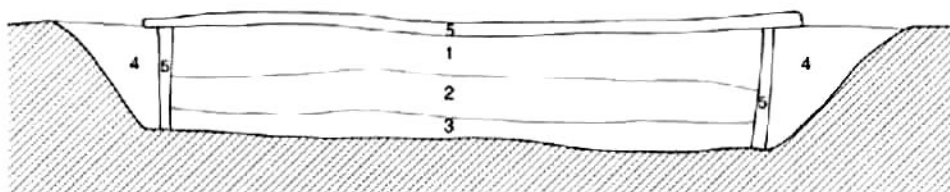
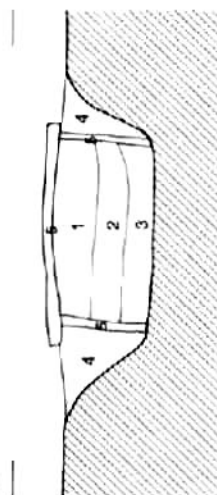
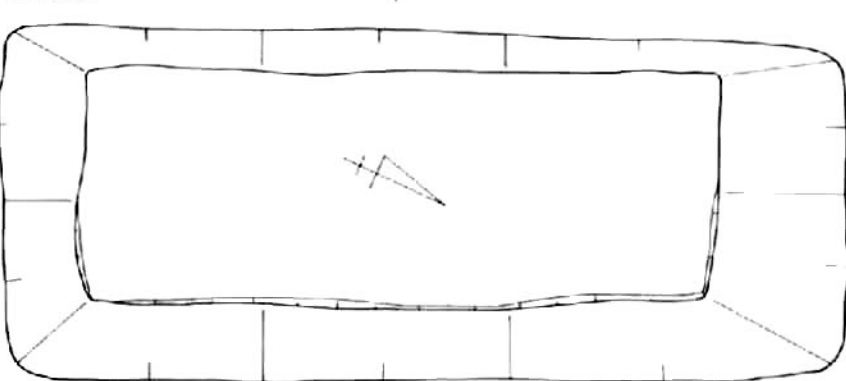

- 1 黄灰 シルト質極細砂
- 2 灰黄 極細砂
- 3 暗灰黄 シルト
- 4 灰 極細砂
- 5 黄灰 シルト



方形周溝墓埋葬施設2 (ST40010・40003・40007)

ST40009

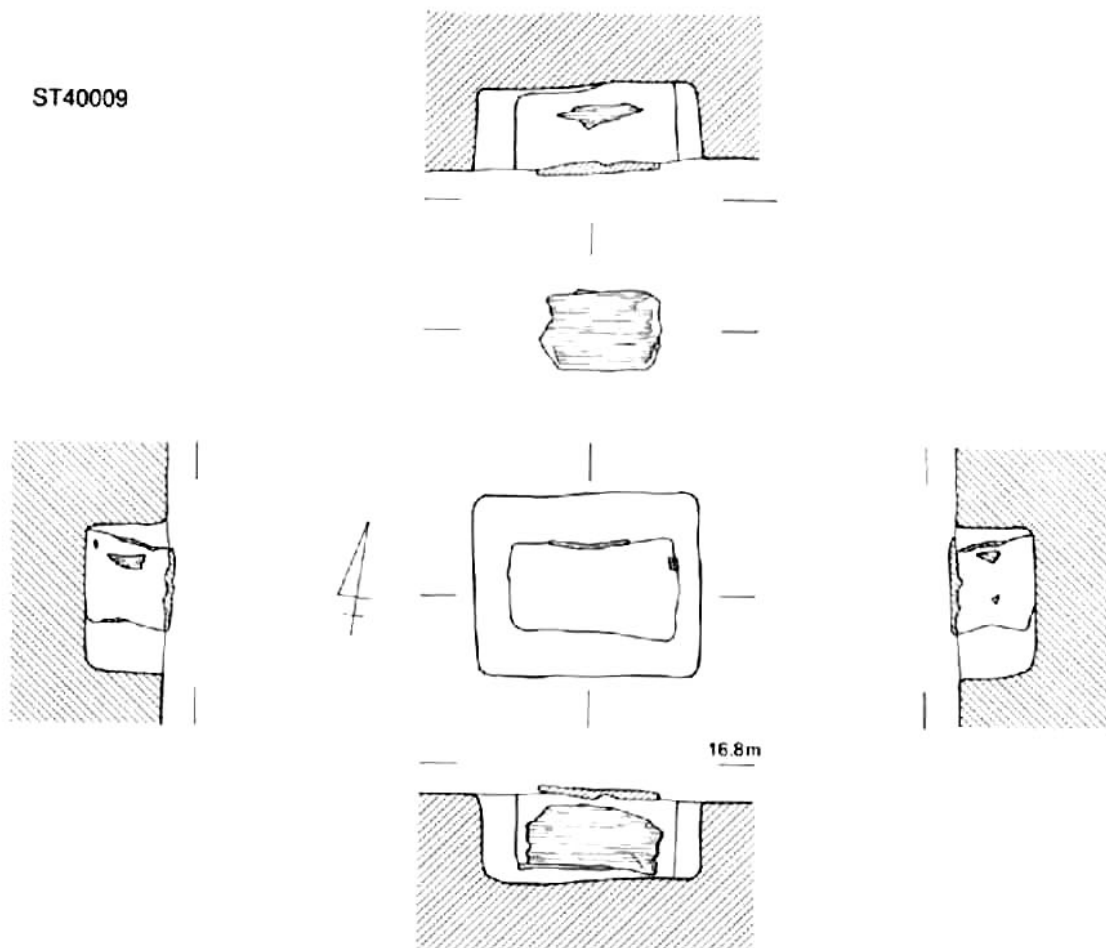

ST40008

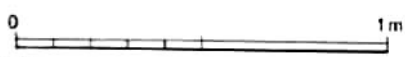
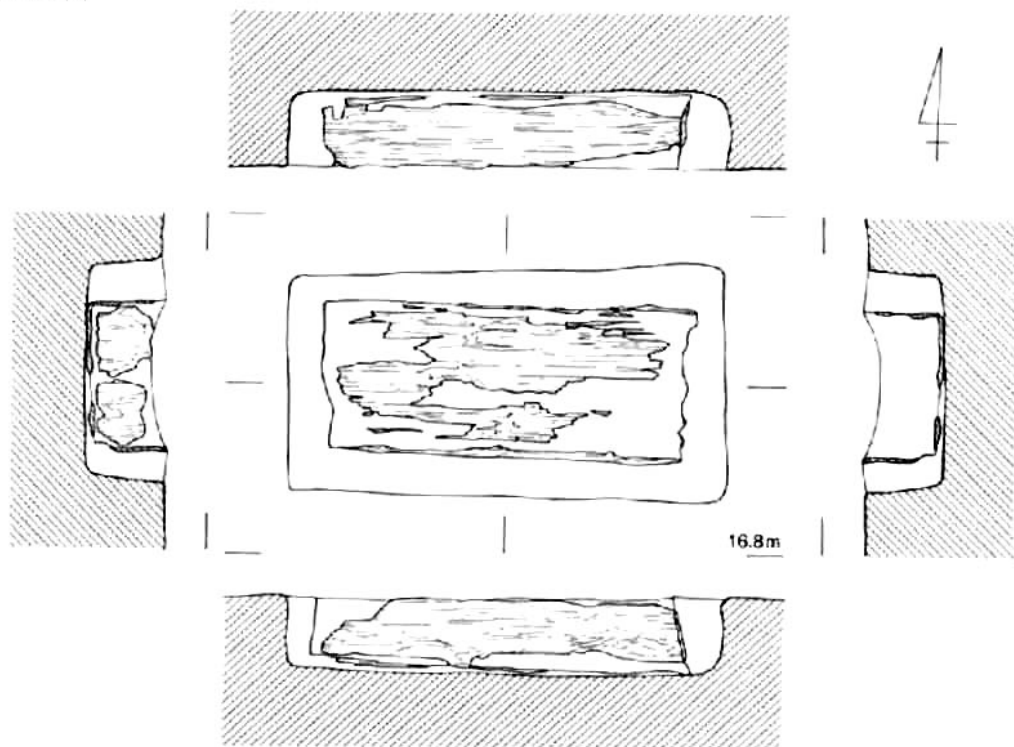

ST40011

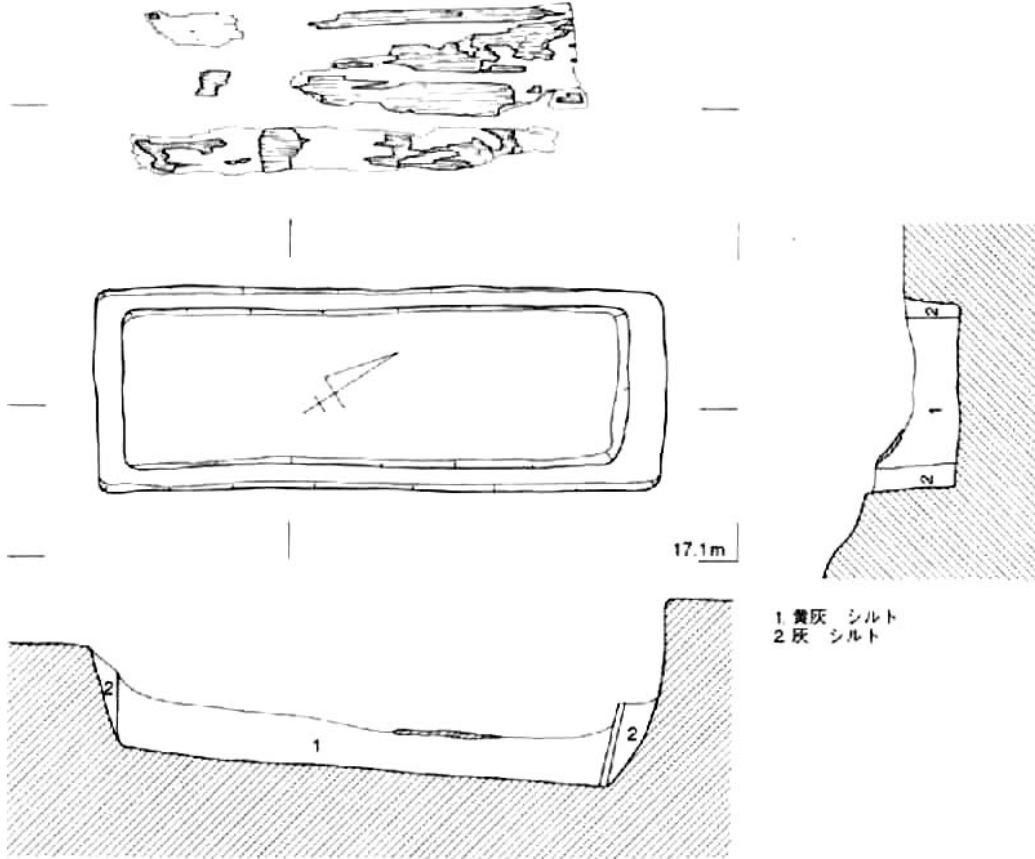

ST40006

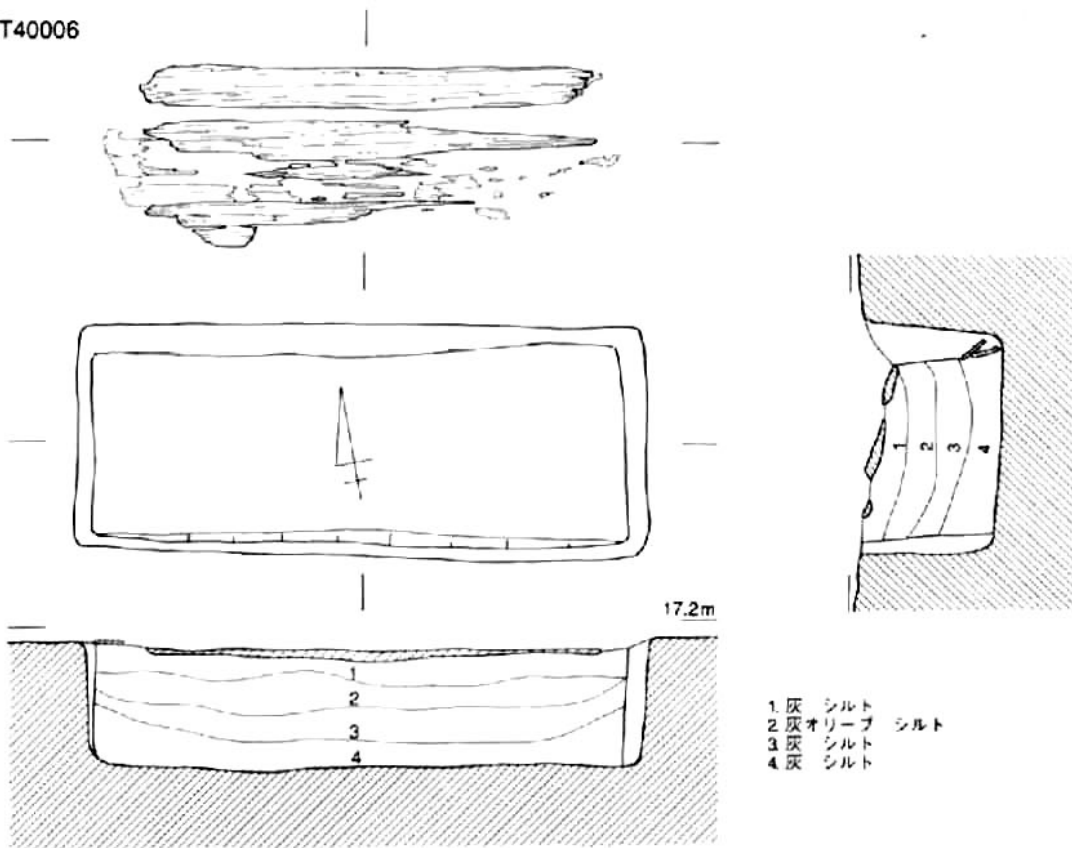

0 1m

ST40013

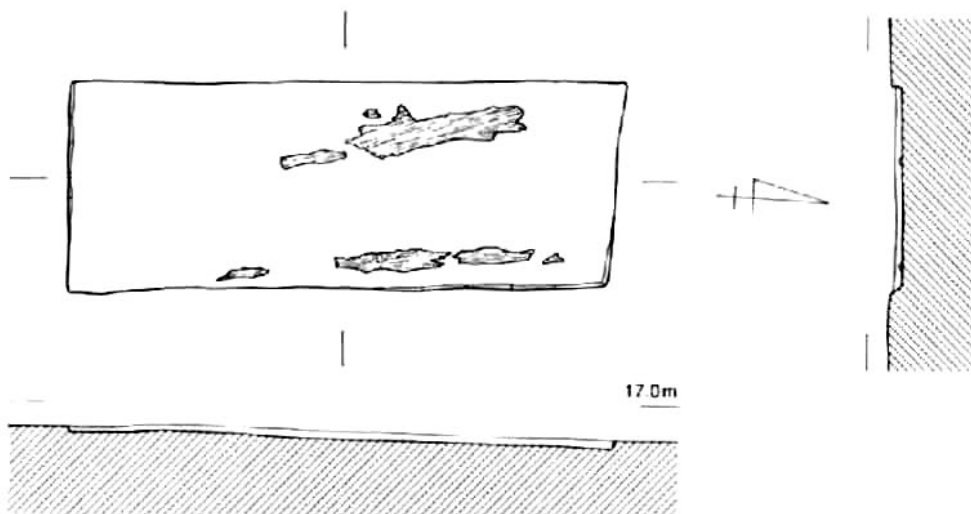

ST40022

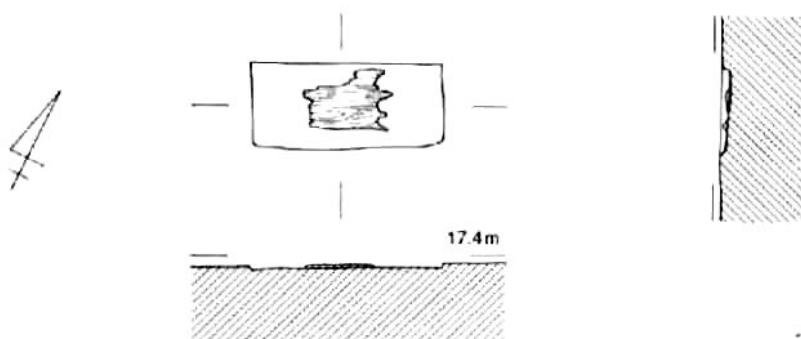

ST40014

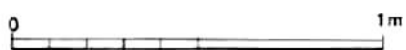
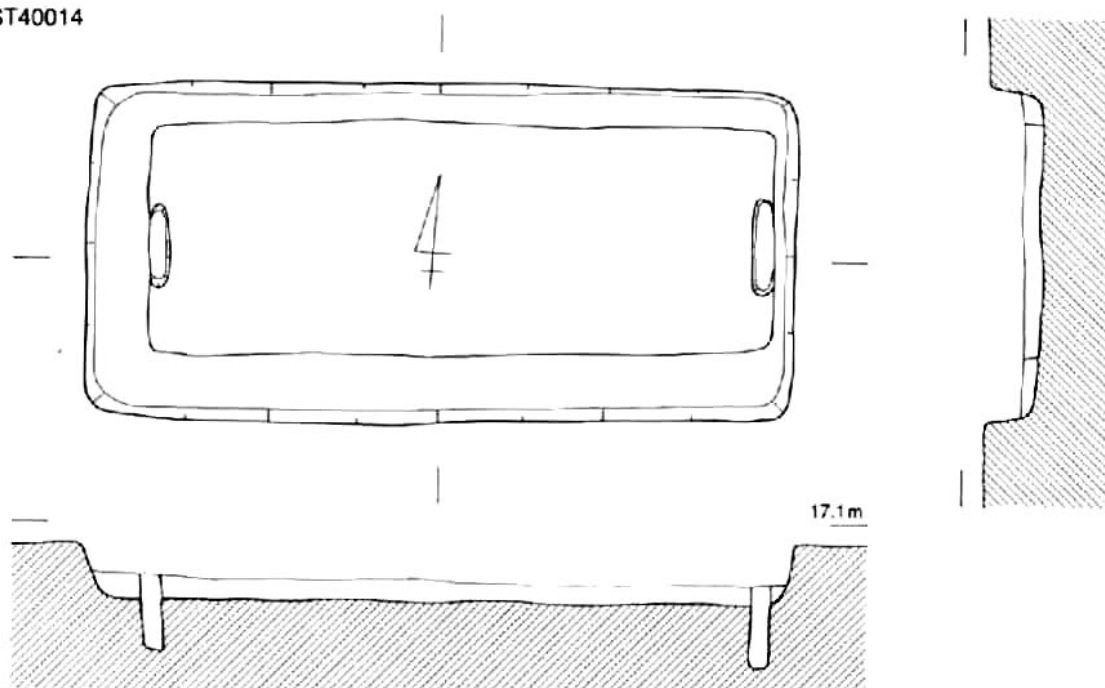

方形周溝墓埋葬施設5 (ST40013・40022・40014)

ST40017

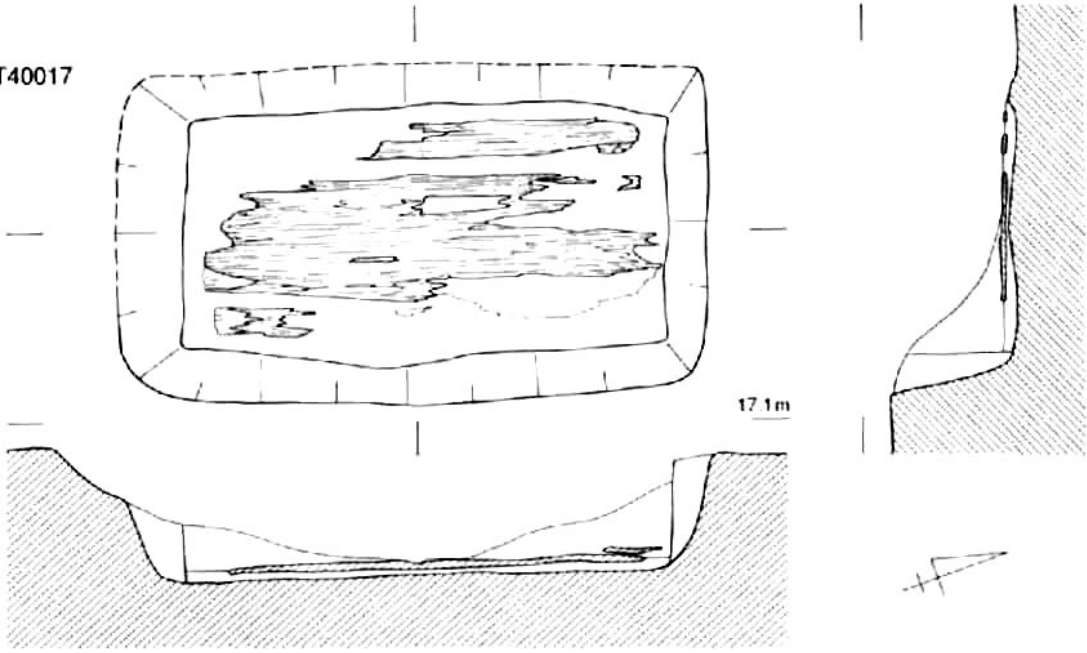

ST40005

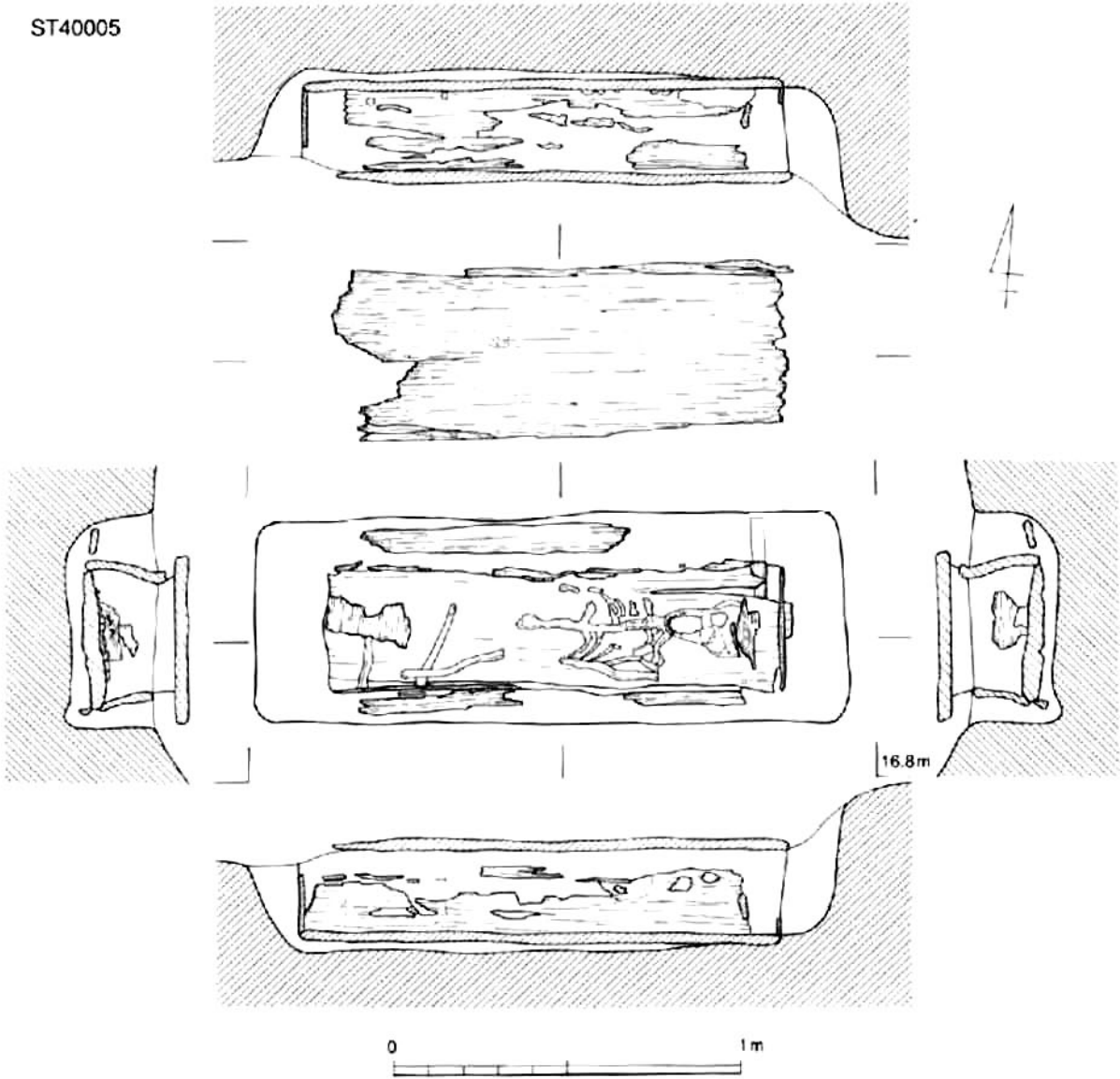

方形周溝墓埋葬施設6 (ST40017・40005)

ST40018

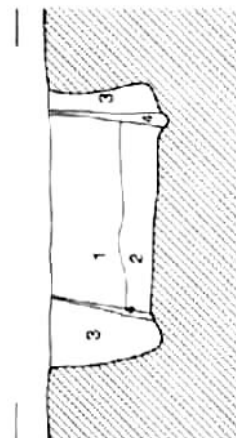
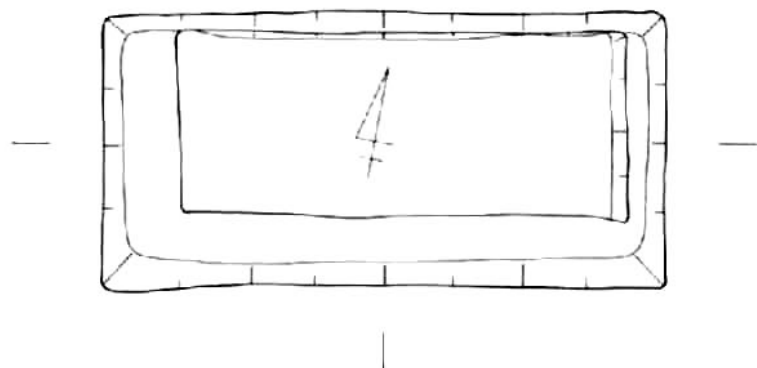

17.1m

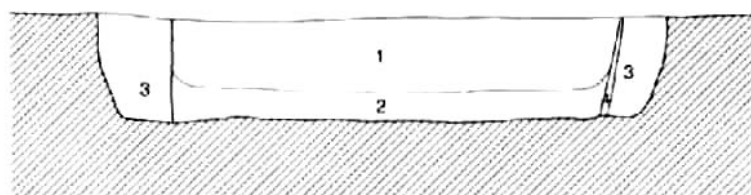

- 1 暗灰黄 シルト
- 2 にぶい黄橙 極細砂
- 3 暗灰黄 シルト質極細砂
- 4 灰 シルト

ST40015

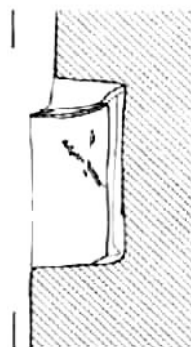
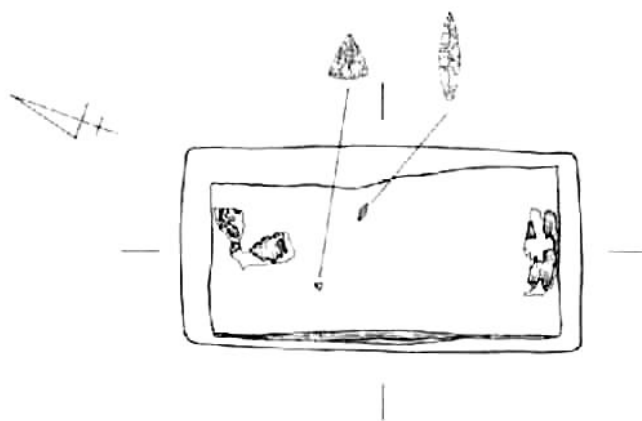
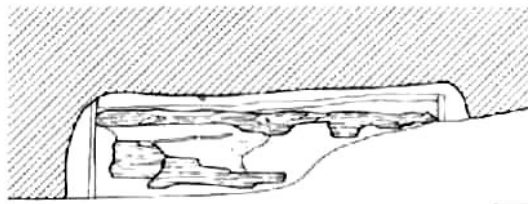

17.1m

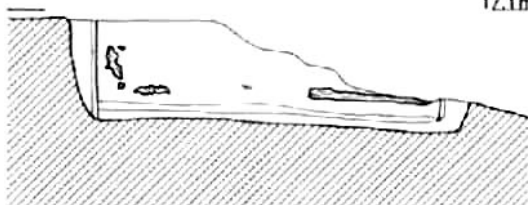

ST40016

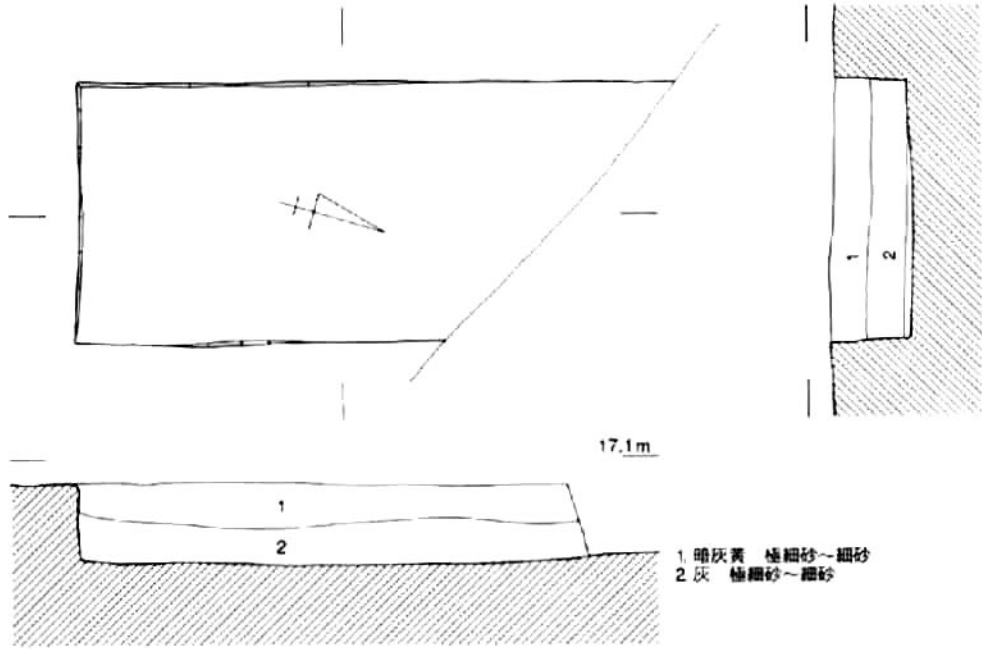

ST40020

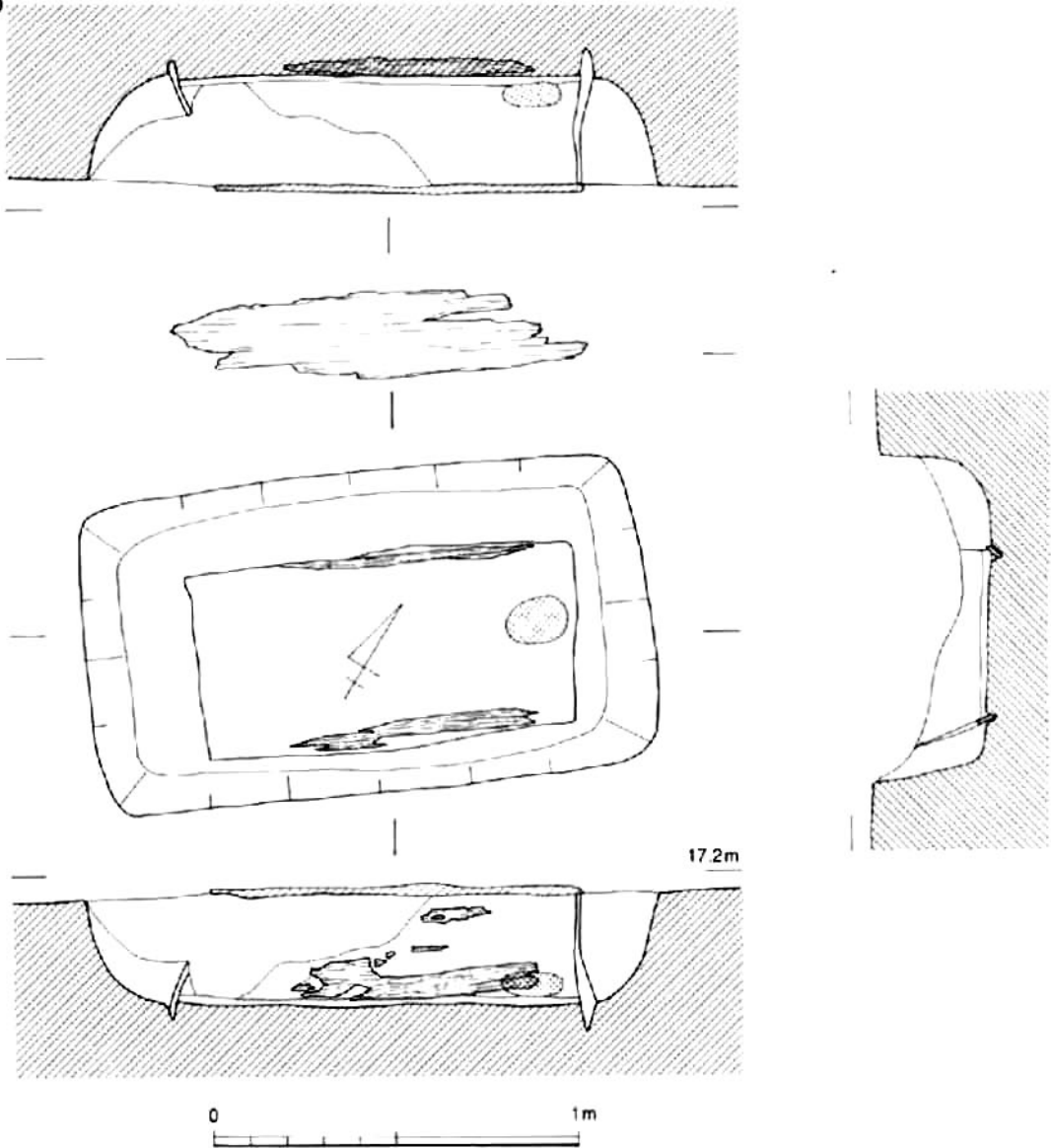

ST40019

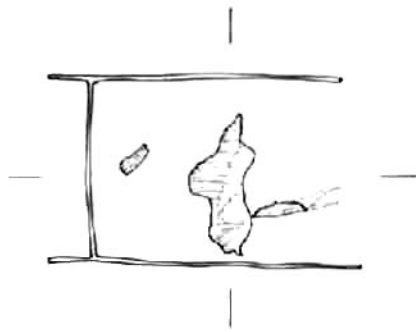

17.1m



17.1m

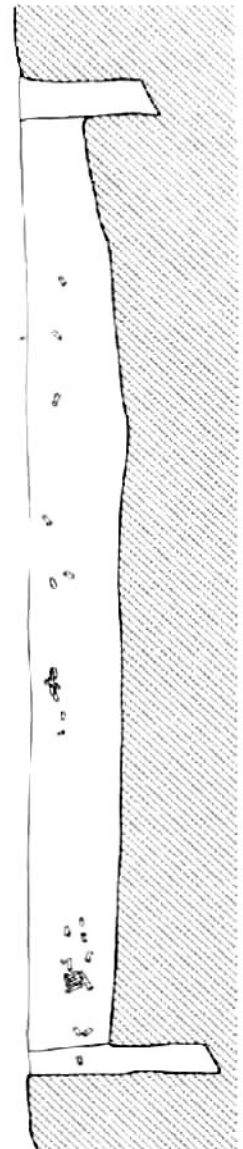

方形周溝葬埋葬施設9 (ST40019)

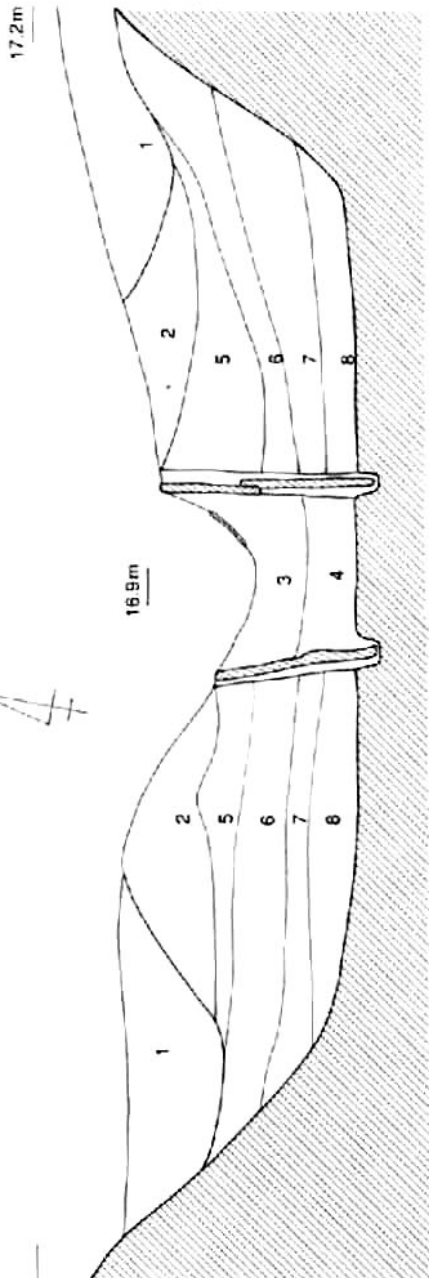
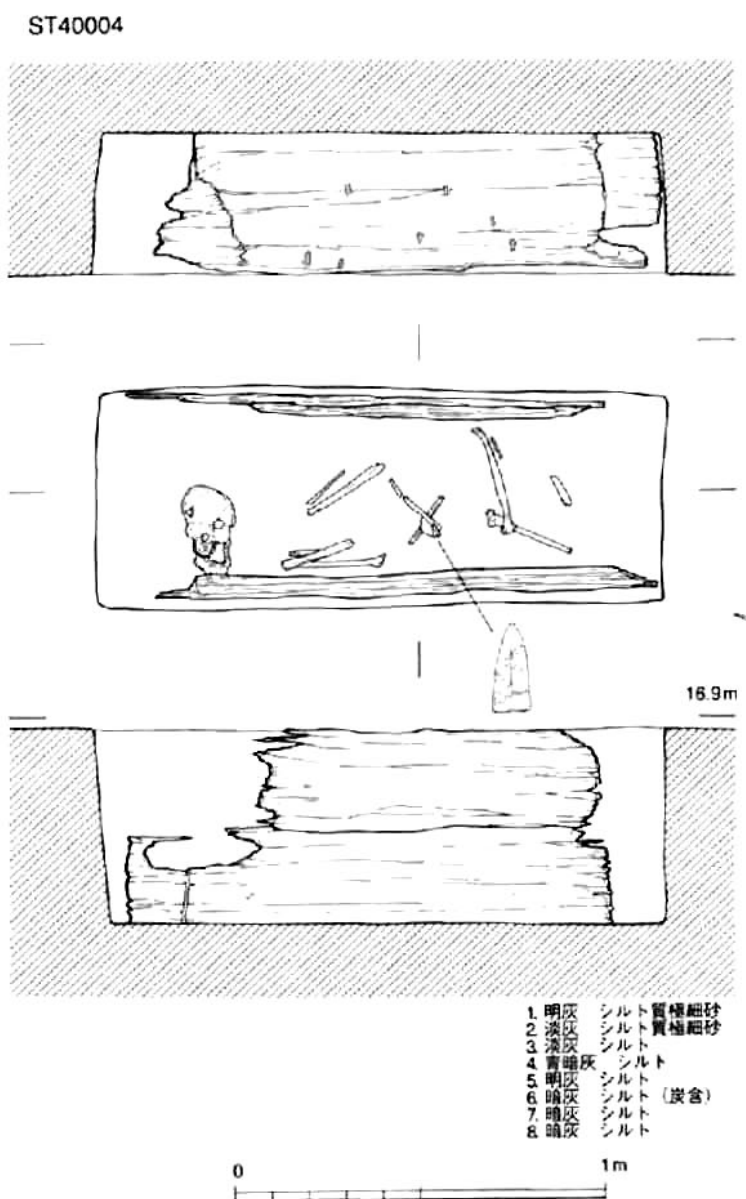
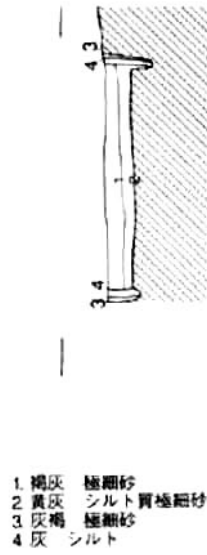
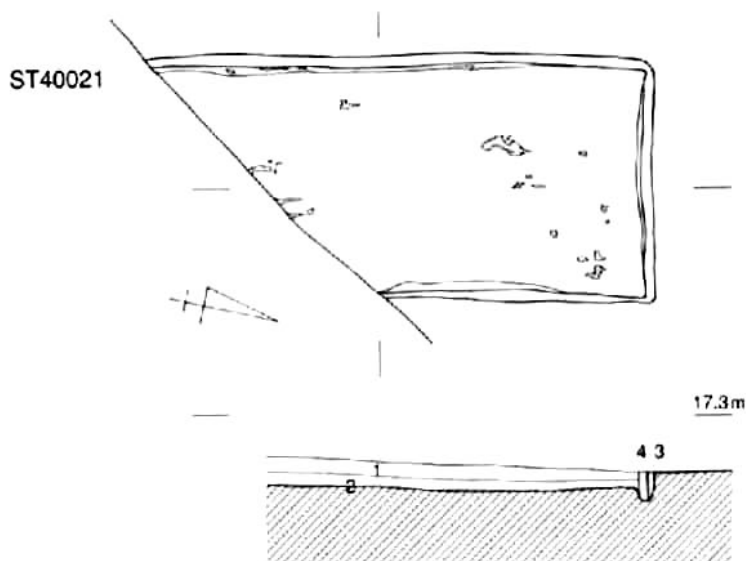

- 1 明灰 シルト質極細砂
2 淡灰 シルト質極細砂
3 淡灰 シルト
4 青暗灰 シルト
5 明暗灰 シルト (炭含)
6 暗灰 シルト
7 暗灰 シルト
8 暗灰 シルト



方形周溝埋葬施設10 (ST40021・40004)

ST40023

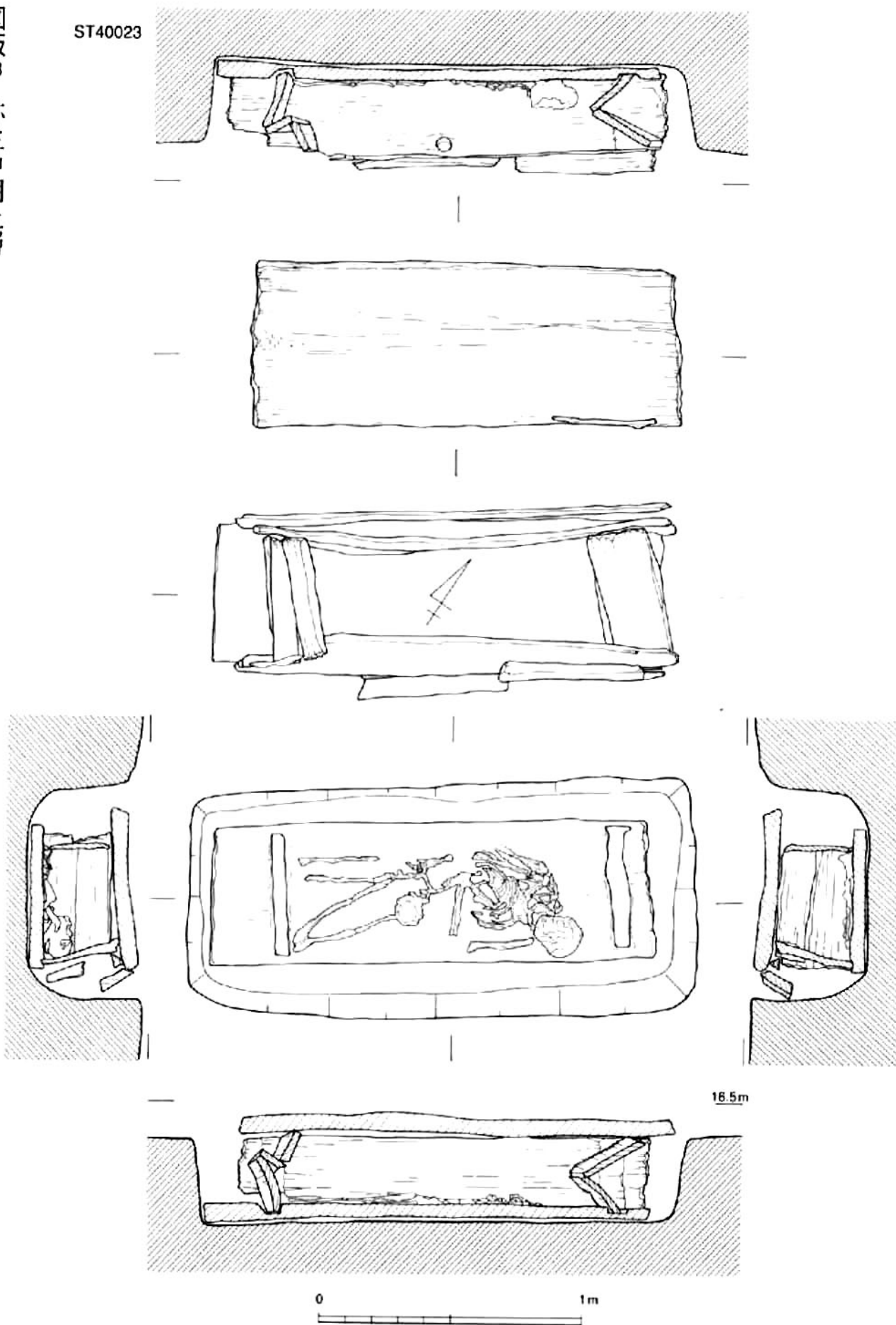

方形周溝埋葬葬施設11 (ST40023)

ST40024

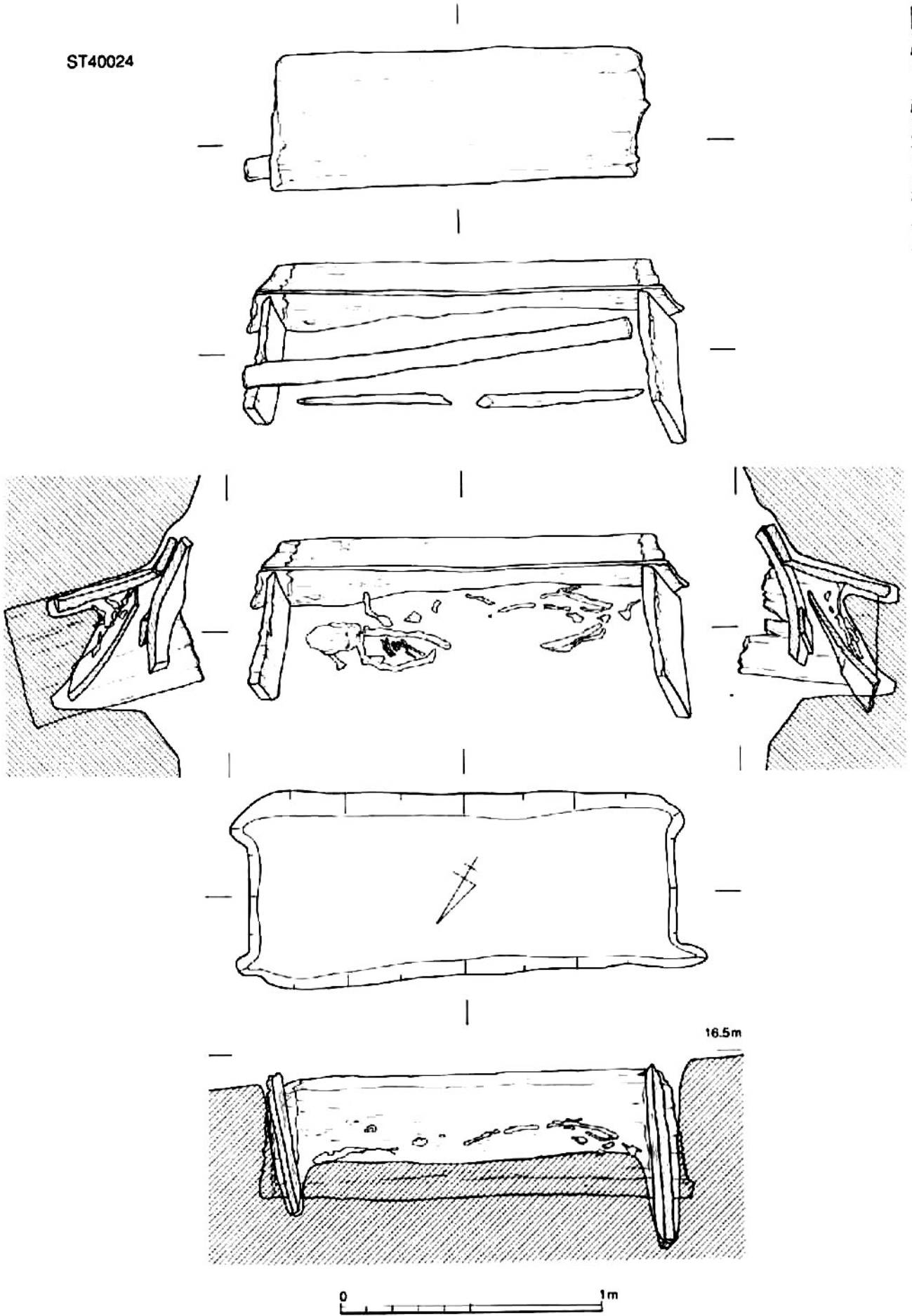

方形周溝埋葬施設12 (ST40024)

ST40027

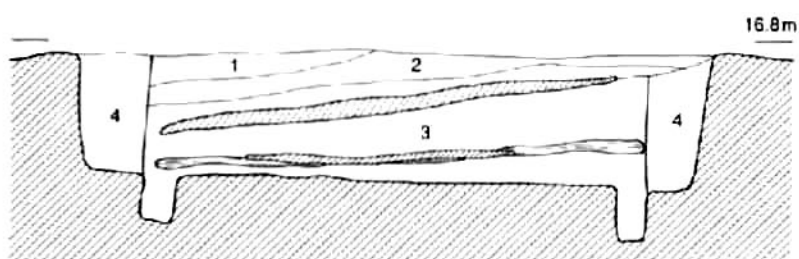
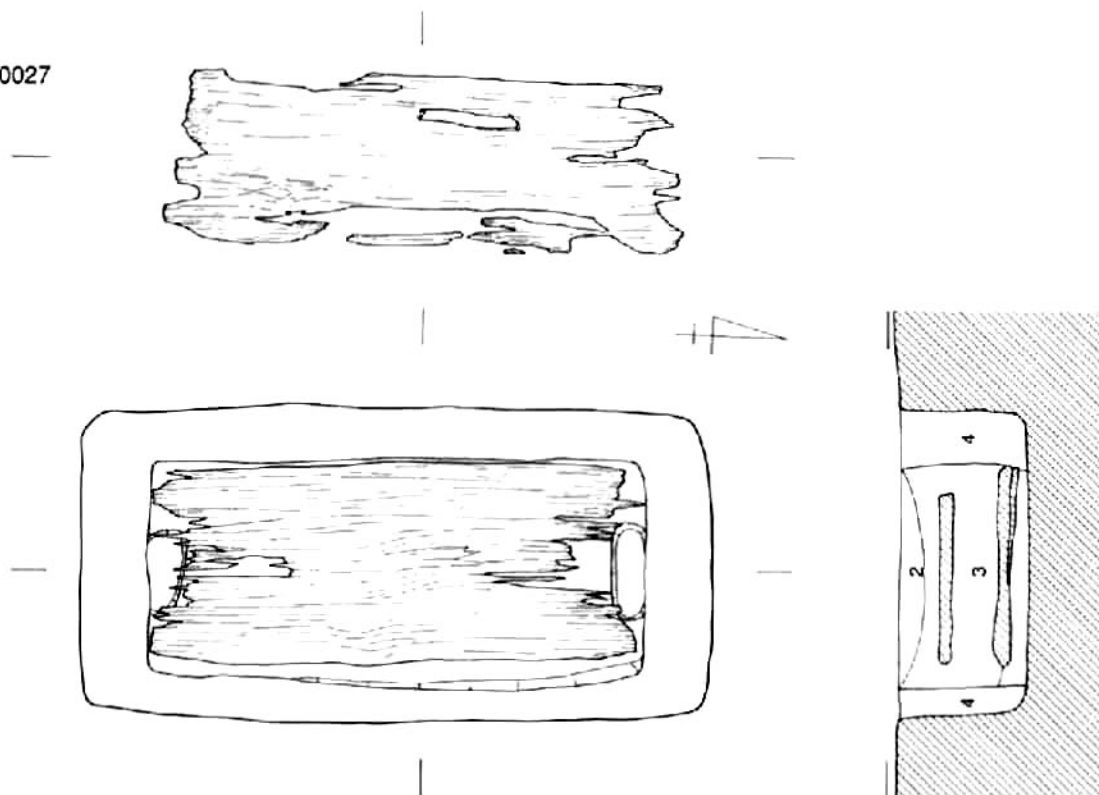

- 1 灰オリブ 細砂～極細砂混シルト
- 2 灰 シルト質極細砂
- 3 灰 極細砂質シルト
- 4 黄灰 シルト質極細砂

ST40031

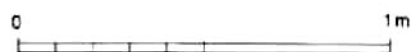
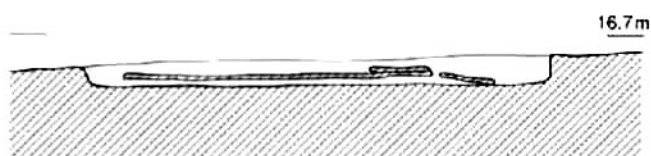
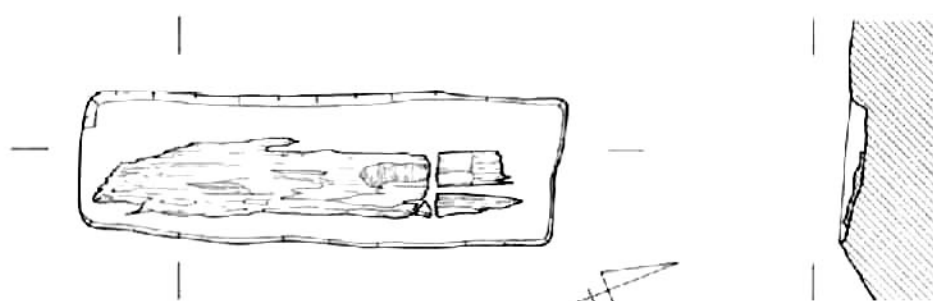

方形周溝墓埋葬施設13 (ST40027・40031)

ST40028

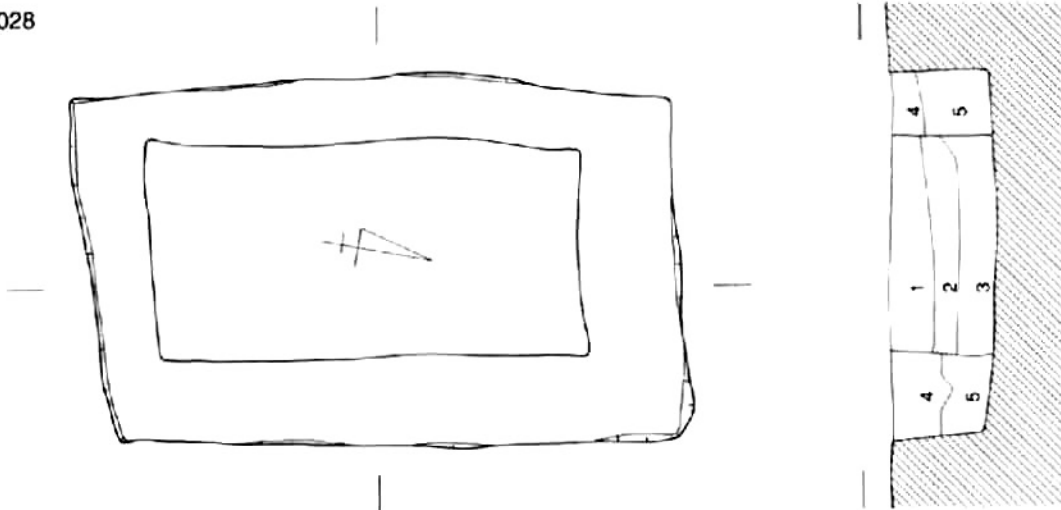

16.9m

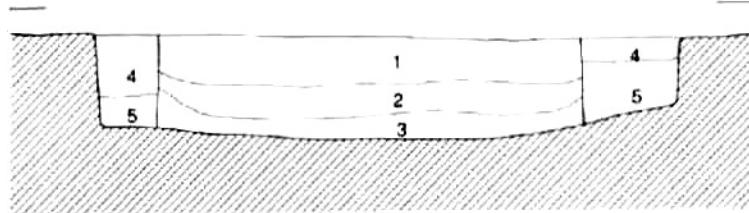

- 1. オリーブ灰 粗砂
- 2. 灰 シルト質極細砂
- 3. 灰 シルト
- 4. 灰黄 極細砂
- 5. 黄灰 極細砂

ST40029

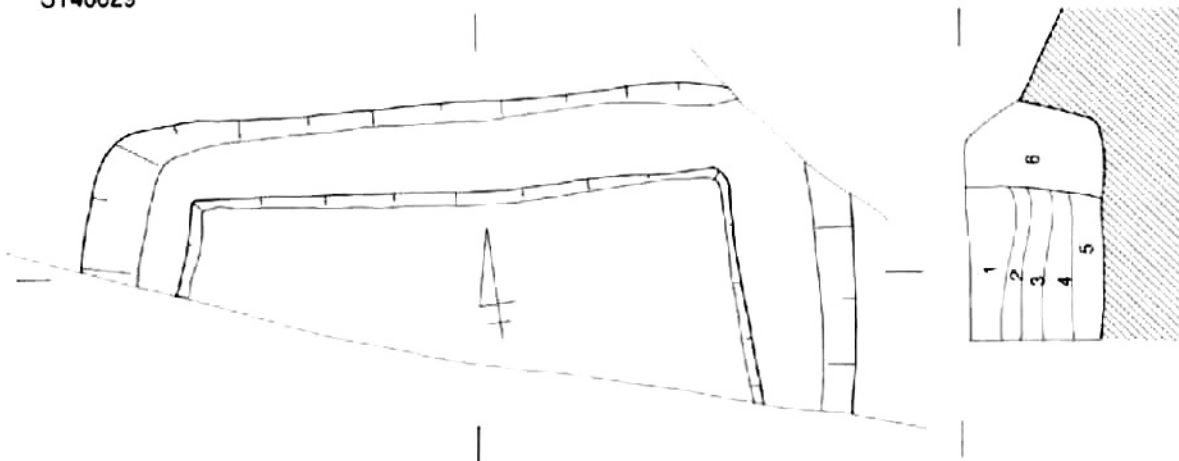

17.0m

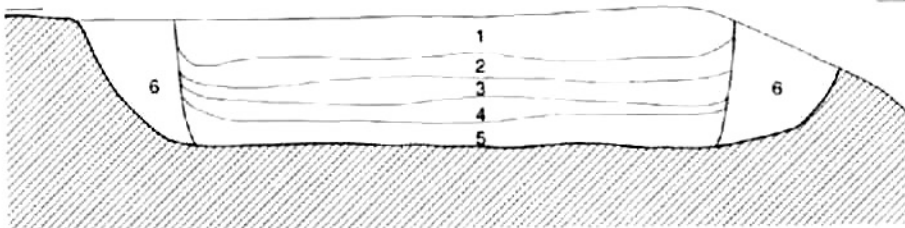

- 1. 灰オリーブ シルト質極細砂
- 2. 灰 細砂 (Mn含)
- 3. 灰 シルト質極細砂(Fe₂O₃・Mn含)
- 4. 灰 極細砂質シルト(Fe₂O₃・Mn含)
- 5. オリーブ黒 中砂混シルト
- 6. 黒褐 シルト質極細砂



ST40030

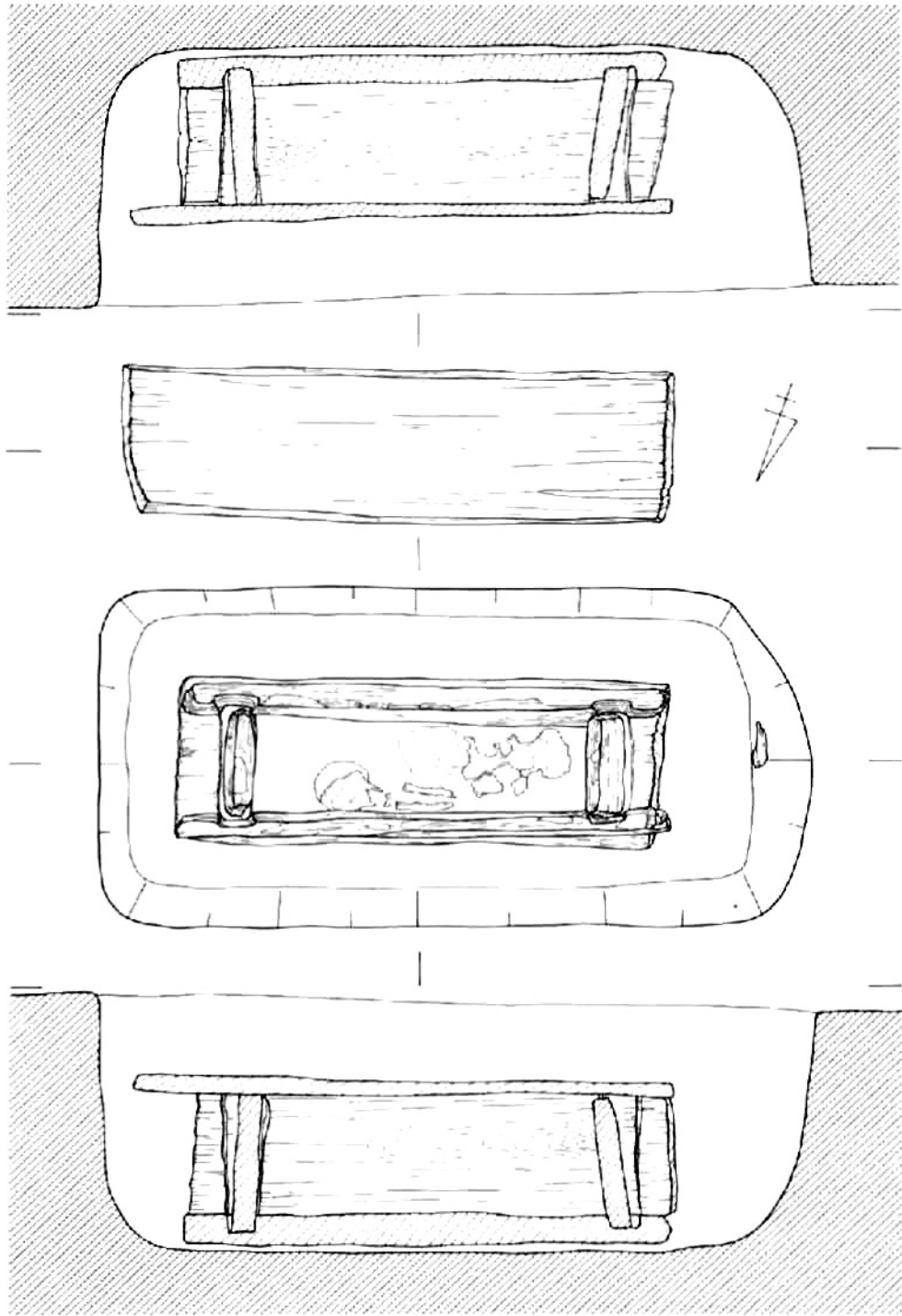

16.8m

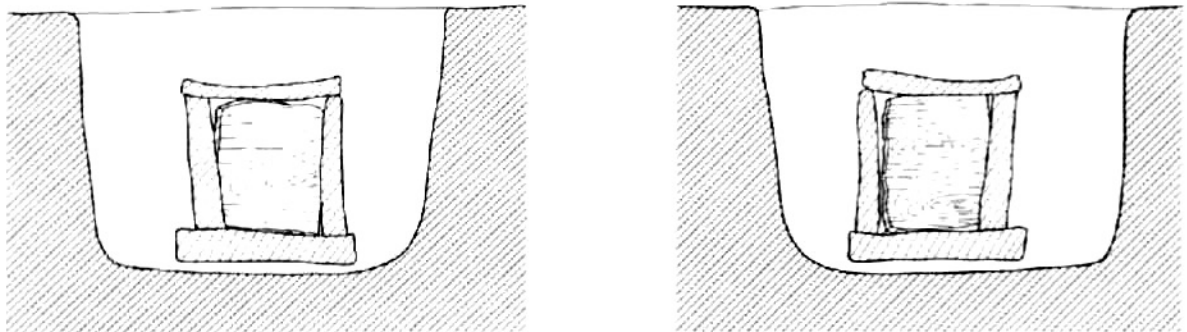

0 1 m

方形周溝墓埋葬施設15 (ST40030)

ST40030

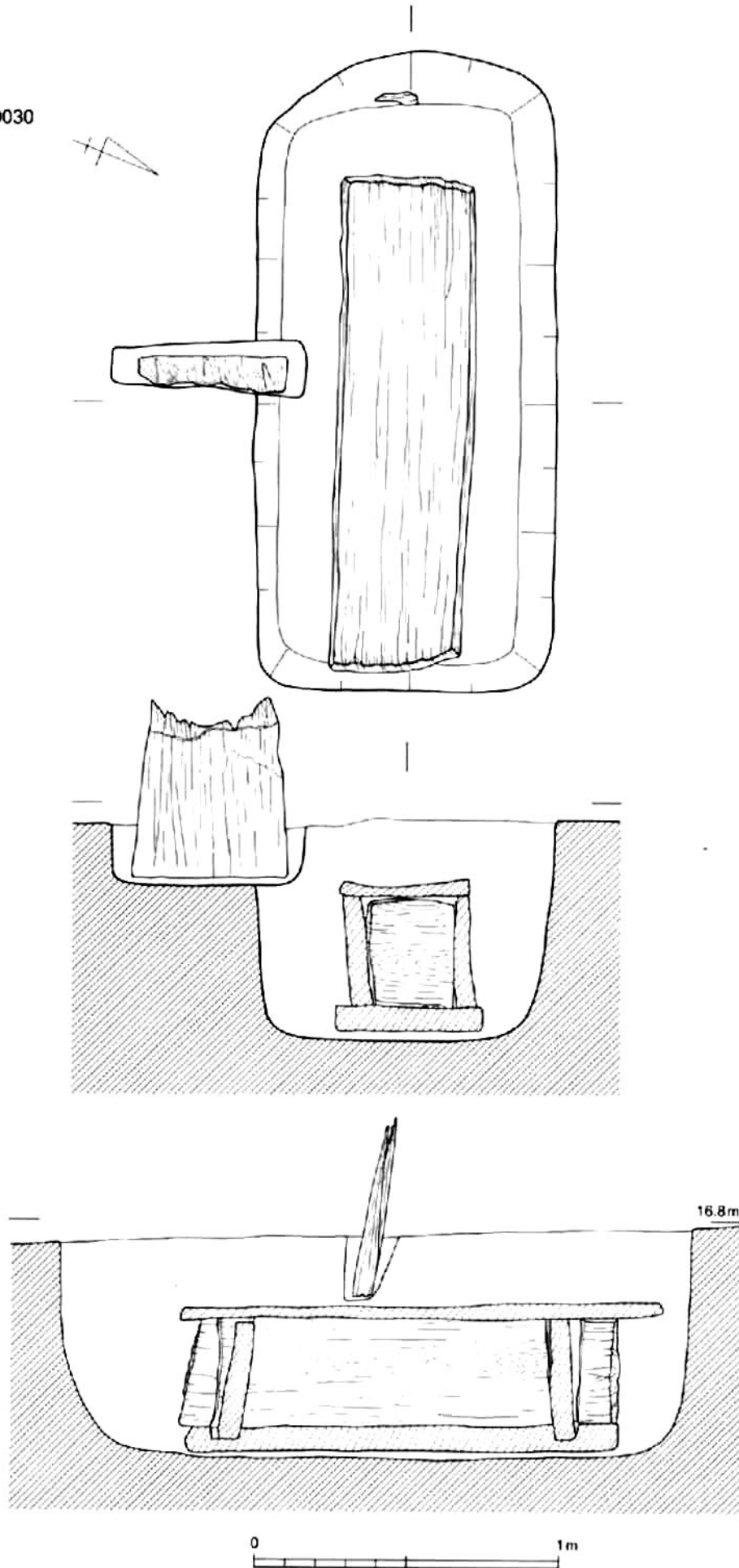

方形周溝墓埋葬施設16 (ST40030)

ST40032

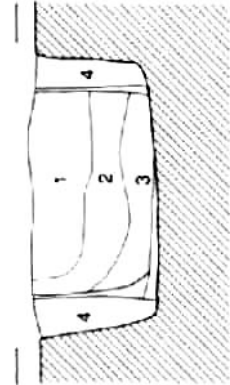
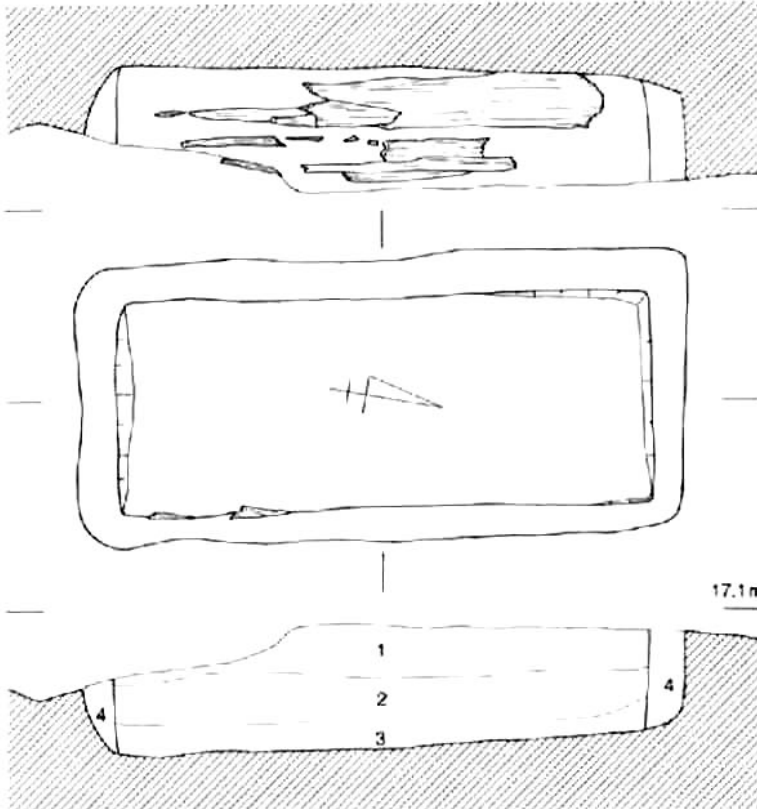

- 1 灰 シルト質極細砂 (Fe₂O₃Mn含)
- 2 灰 シルト質極細砂
- 3 灰 極細砂
- 4 灰 シルト質極細砂

ST40025

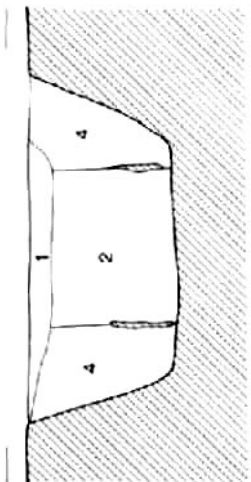
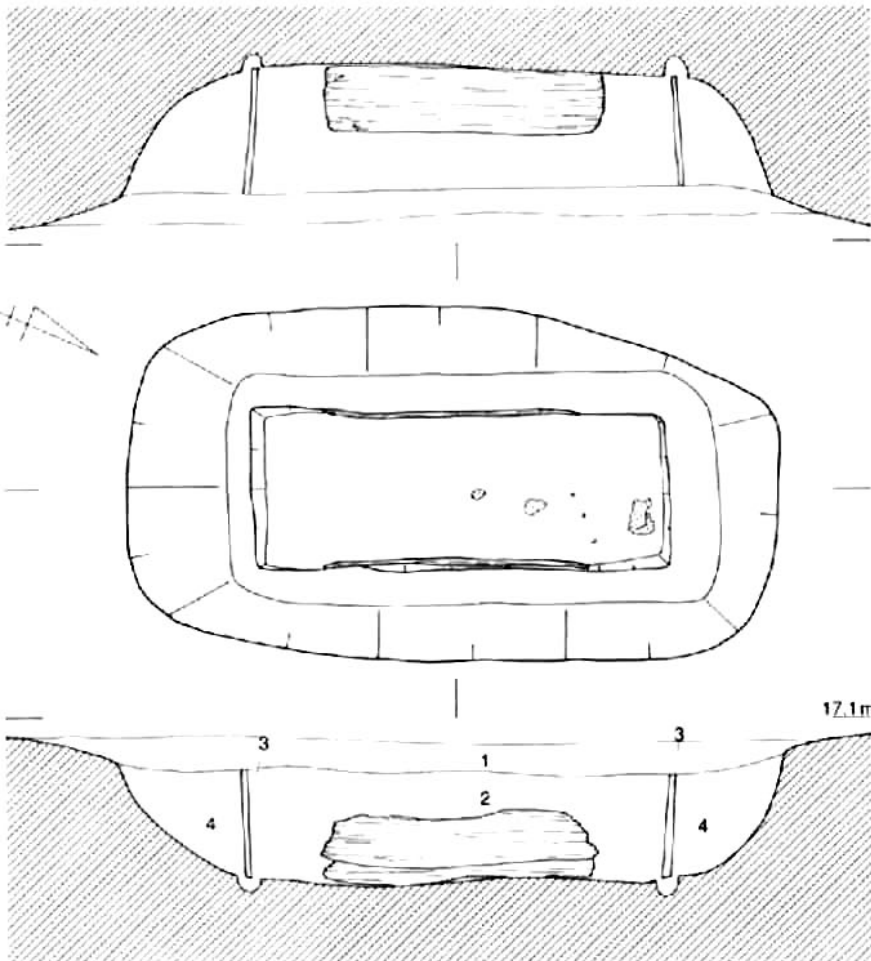

- 1 灰白 細砂
- 2 灰 シルト質細砂
- 3 灰 シルト
- 4 灰 極細砂

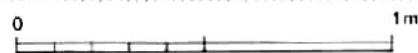

方形周溝墓施設17 (ST40032・40025)

ST40033

図版 95
弥生中期上層

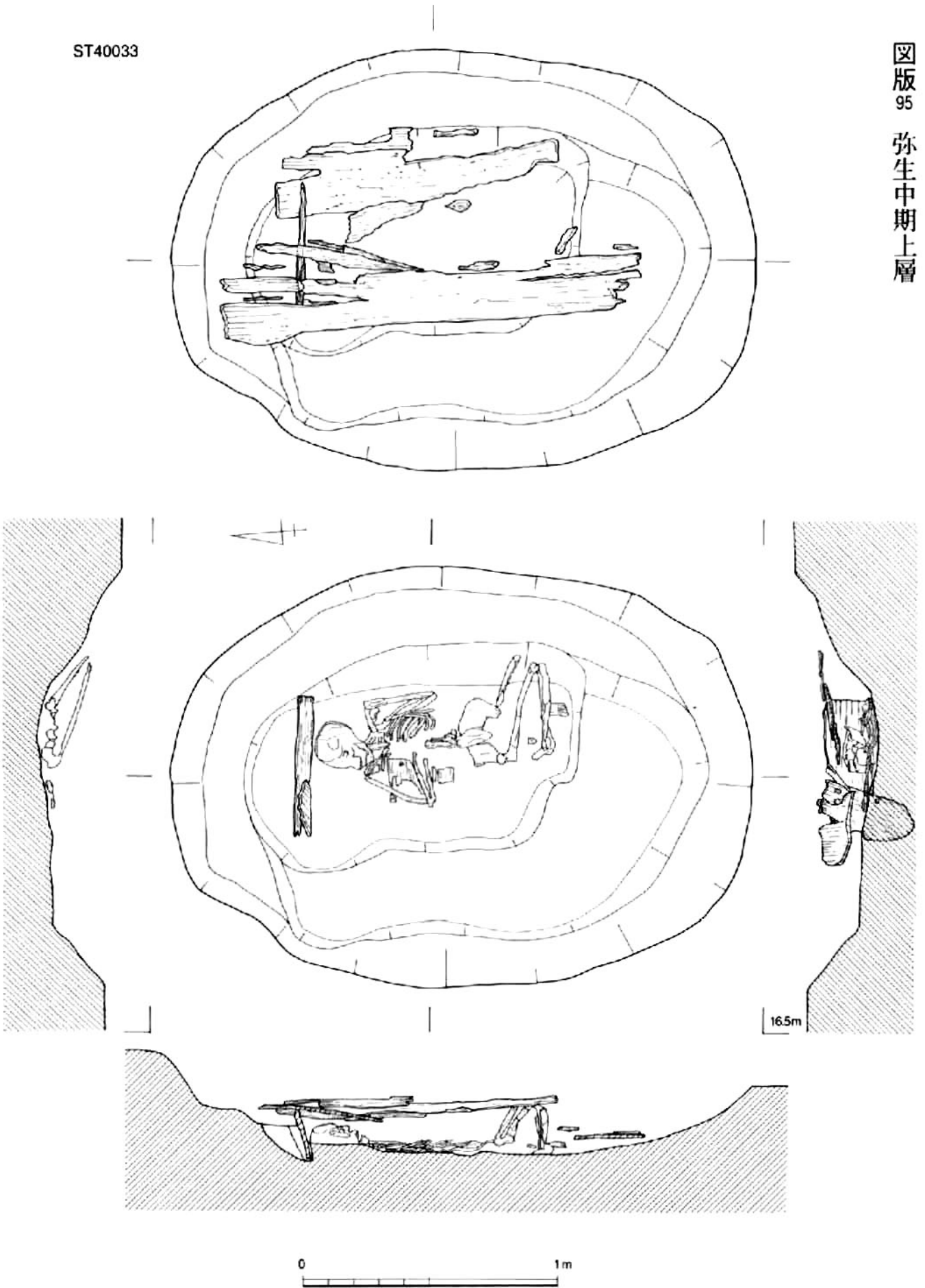

方形周溝埋葬葬施設18 (ST40033)

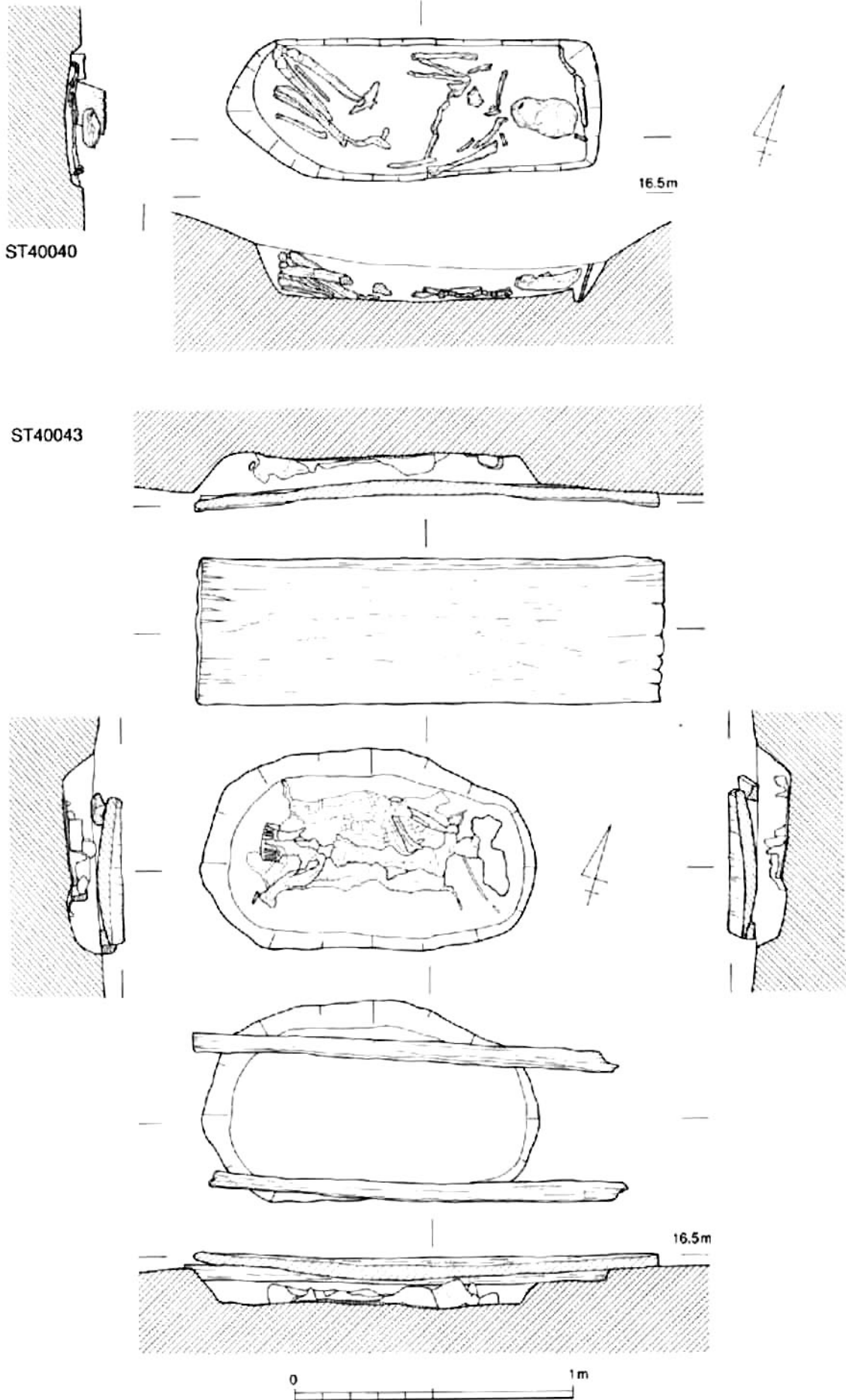

方形周溝墓埋葬施設19 (ST40040・40043)

ST40044

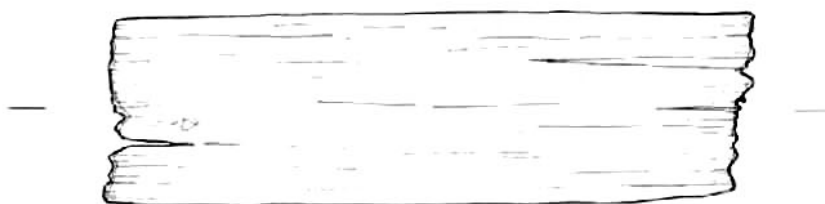
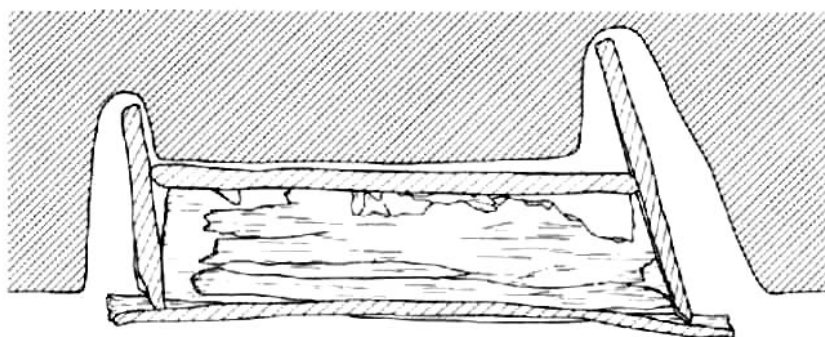

4

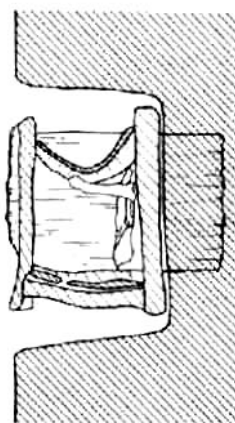
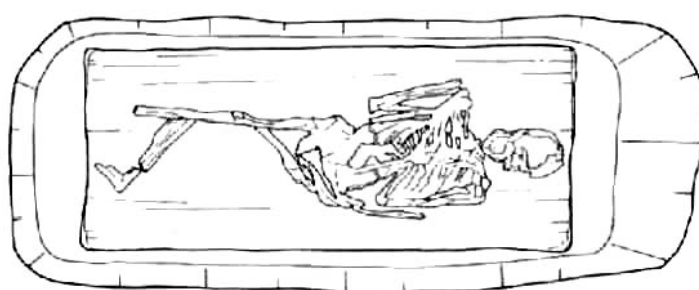
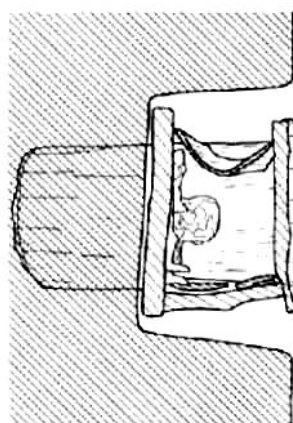

16.5m

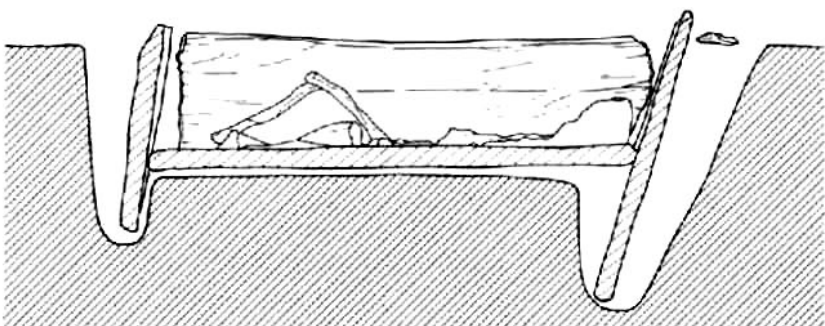

0 1m

方形周溝墓埋葬施設20 (ST40044)

図版 98
弥生中期上層

ST40045

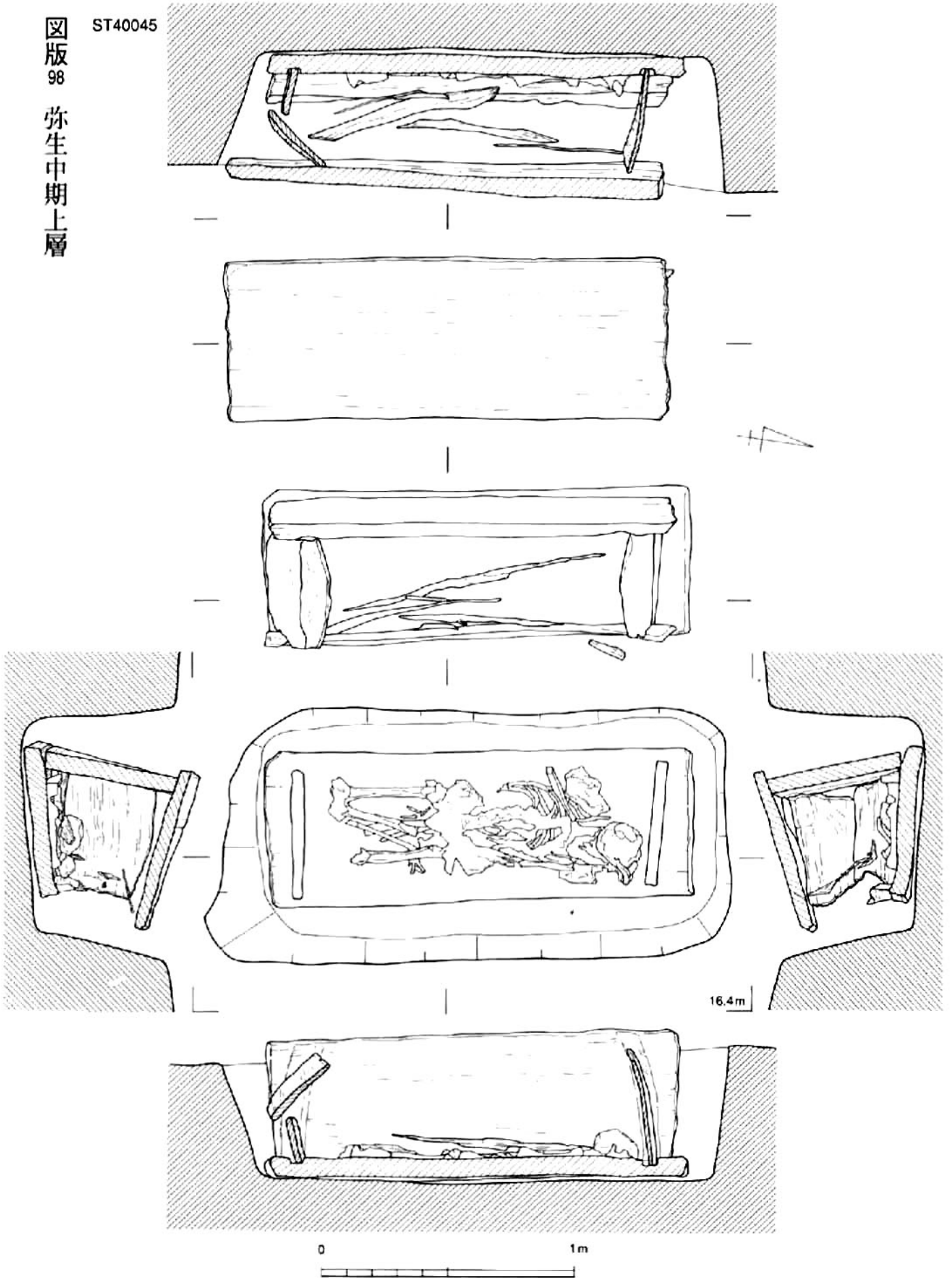

方形周溝墓埋葬施設21 (ST40045)

ST40046

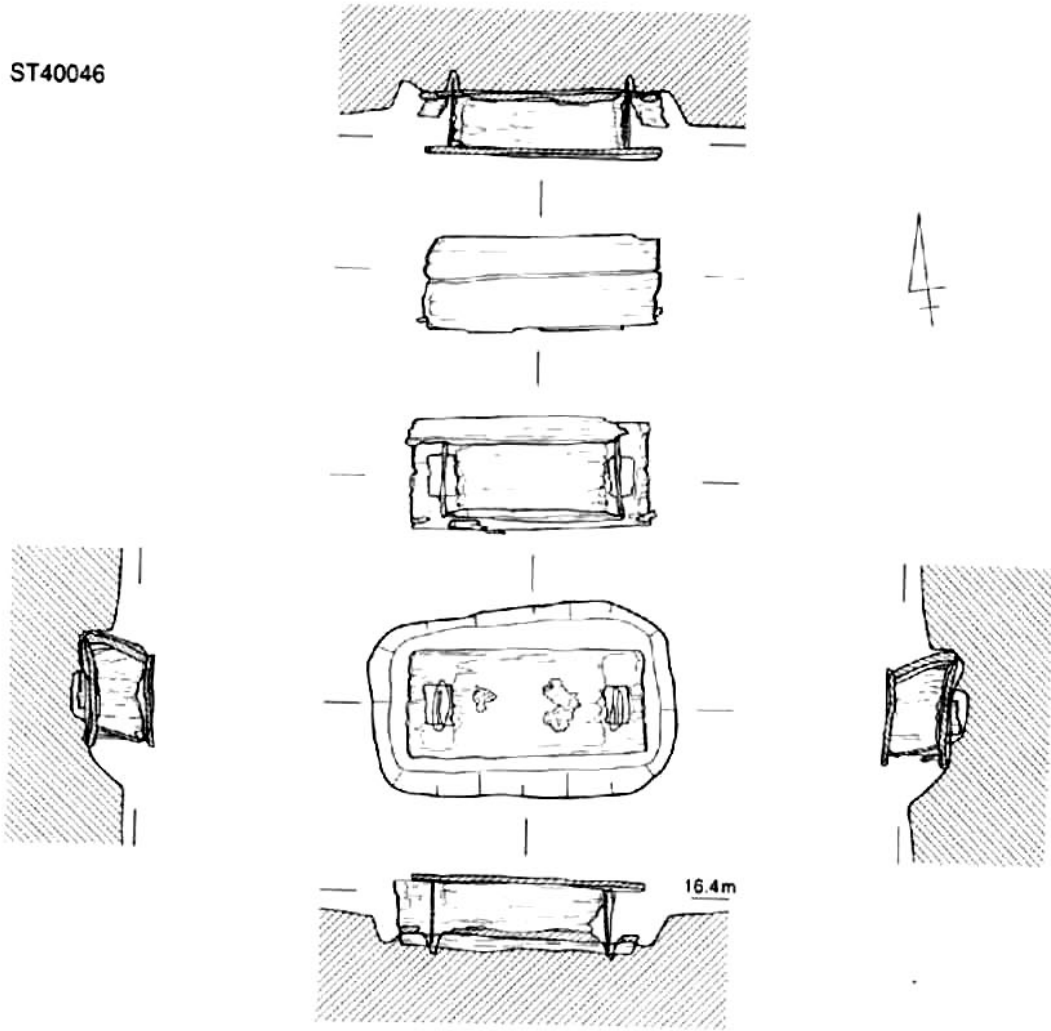

ST40012

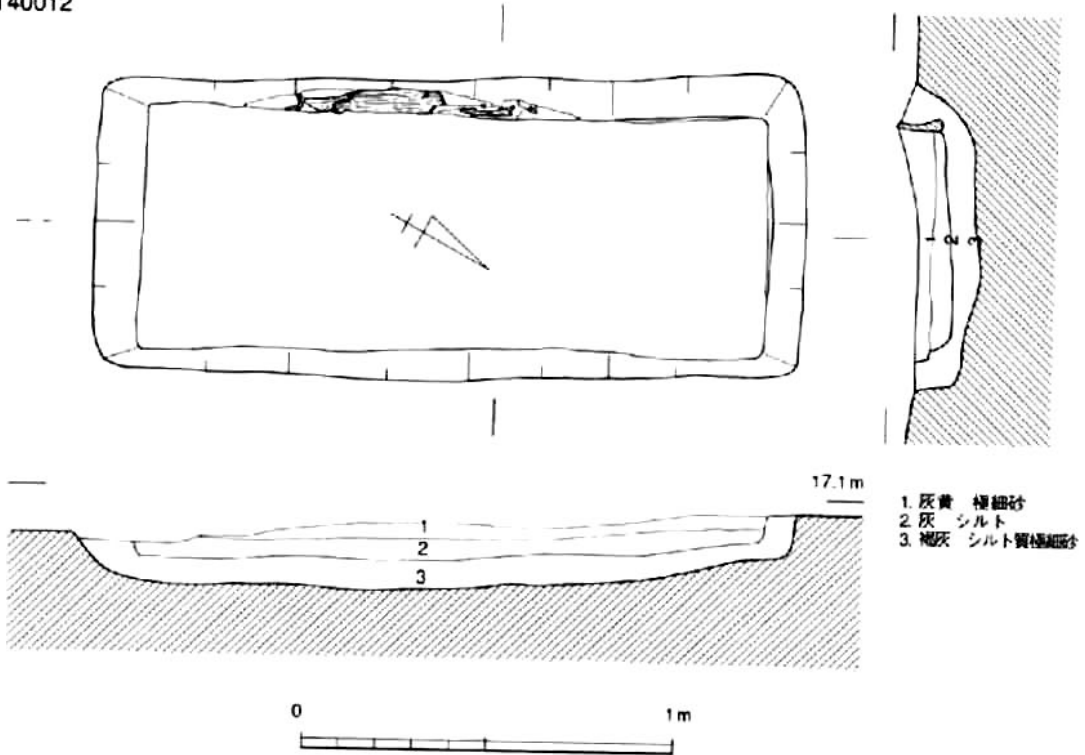

方形周溝墓埋葬施設22 (ST40046・40012)

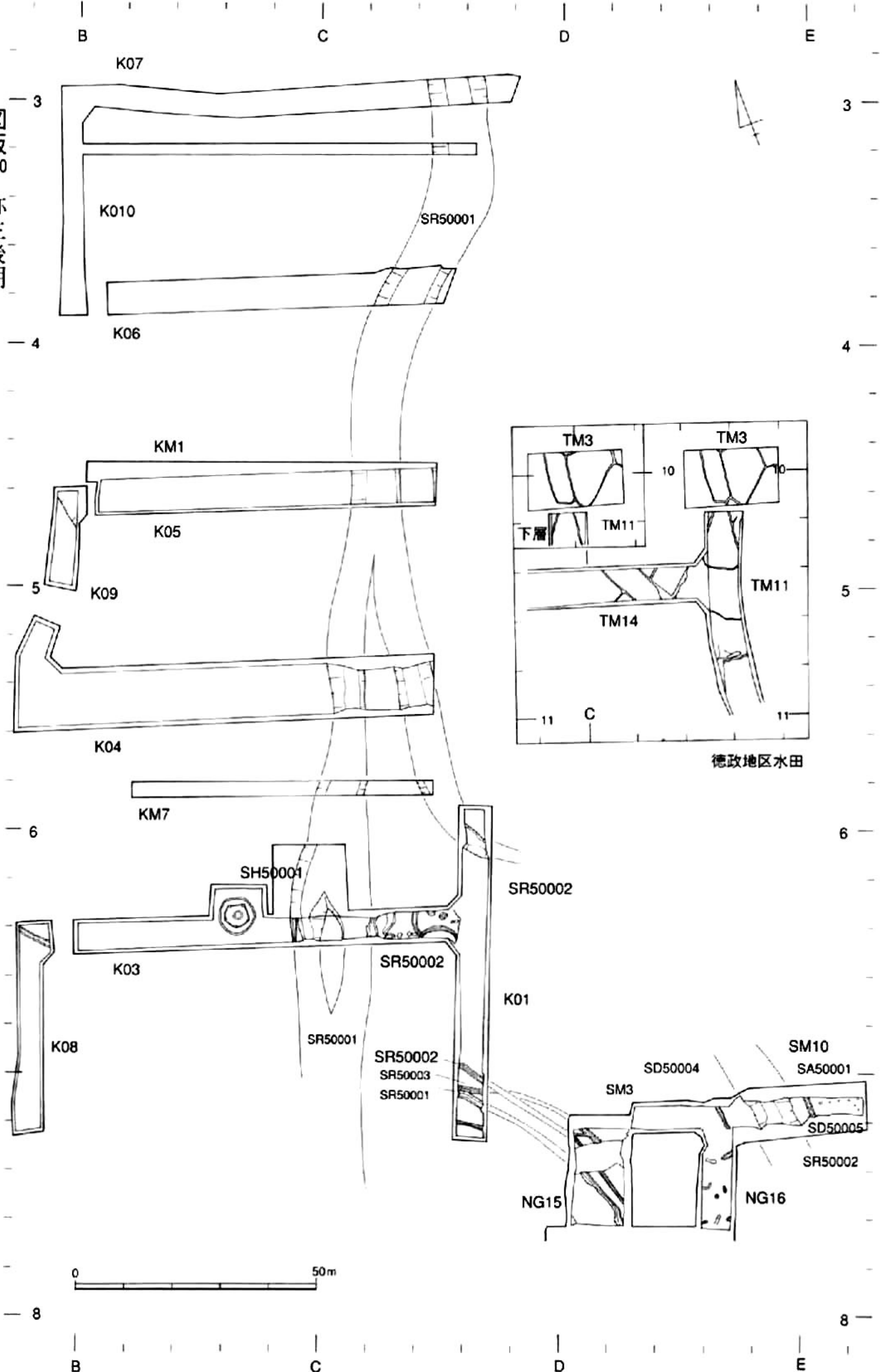

遺構全体 (黒岡・一部徳政)

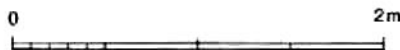
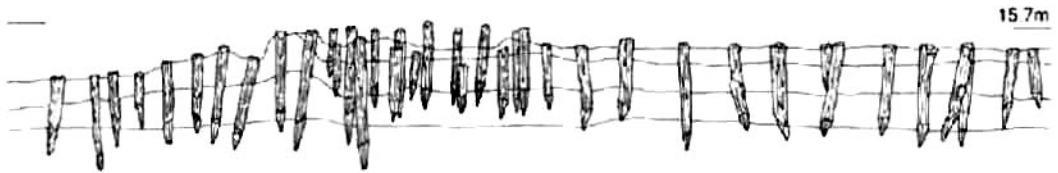
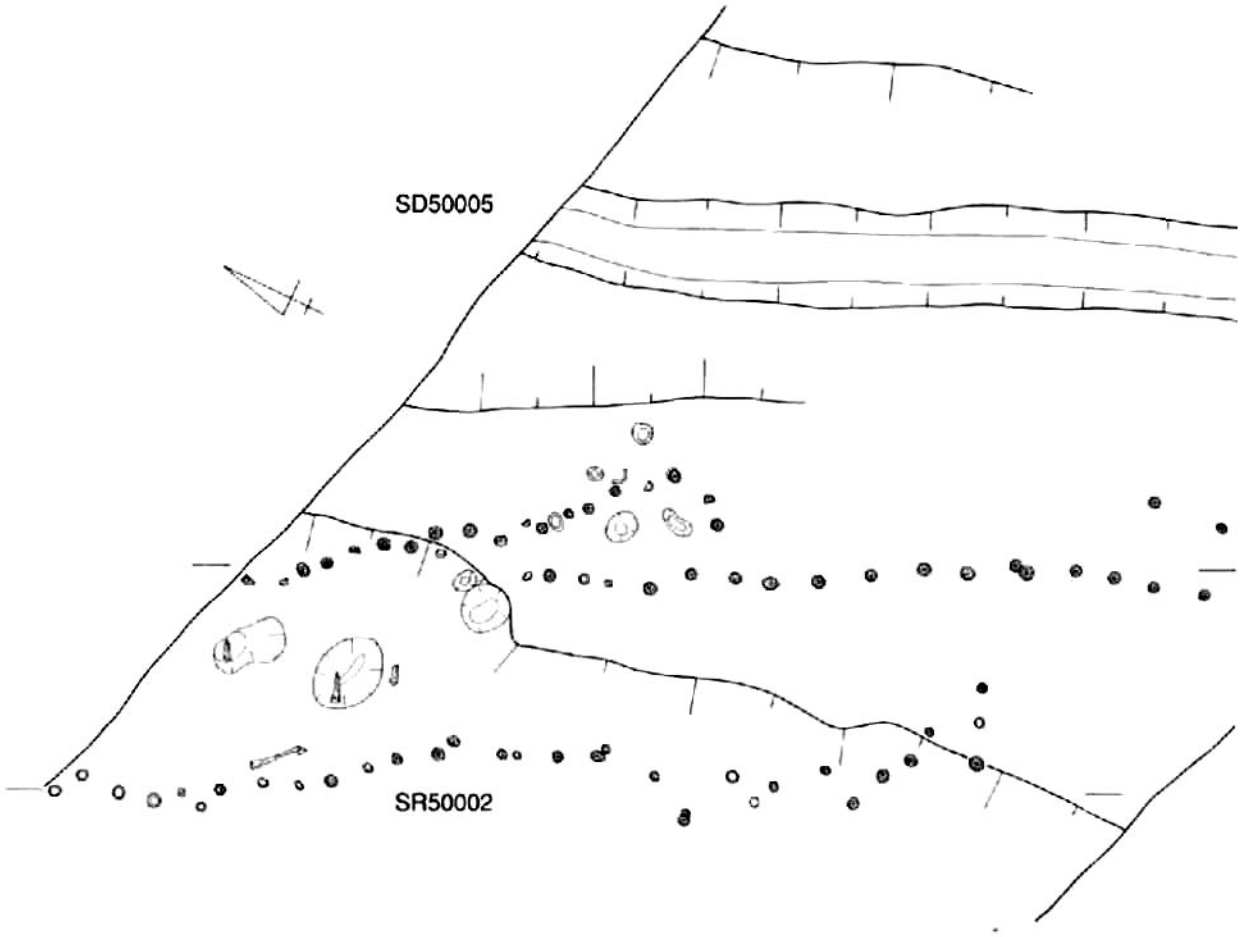

河道杭列 (SR50002) ・溝 (SD50005)

SH50001

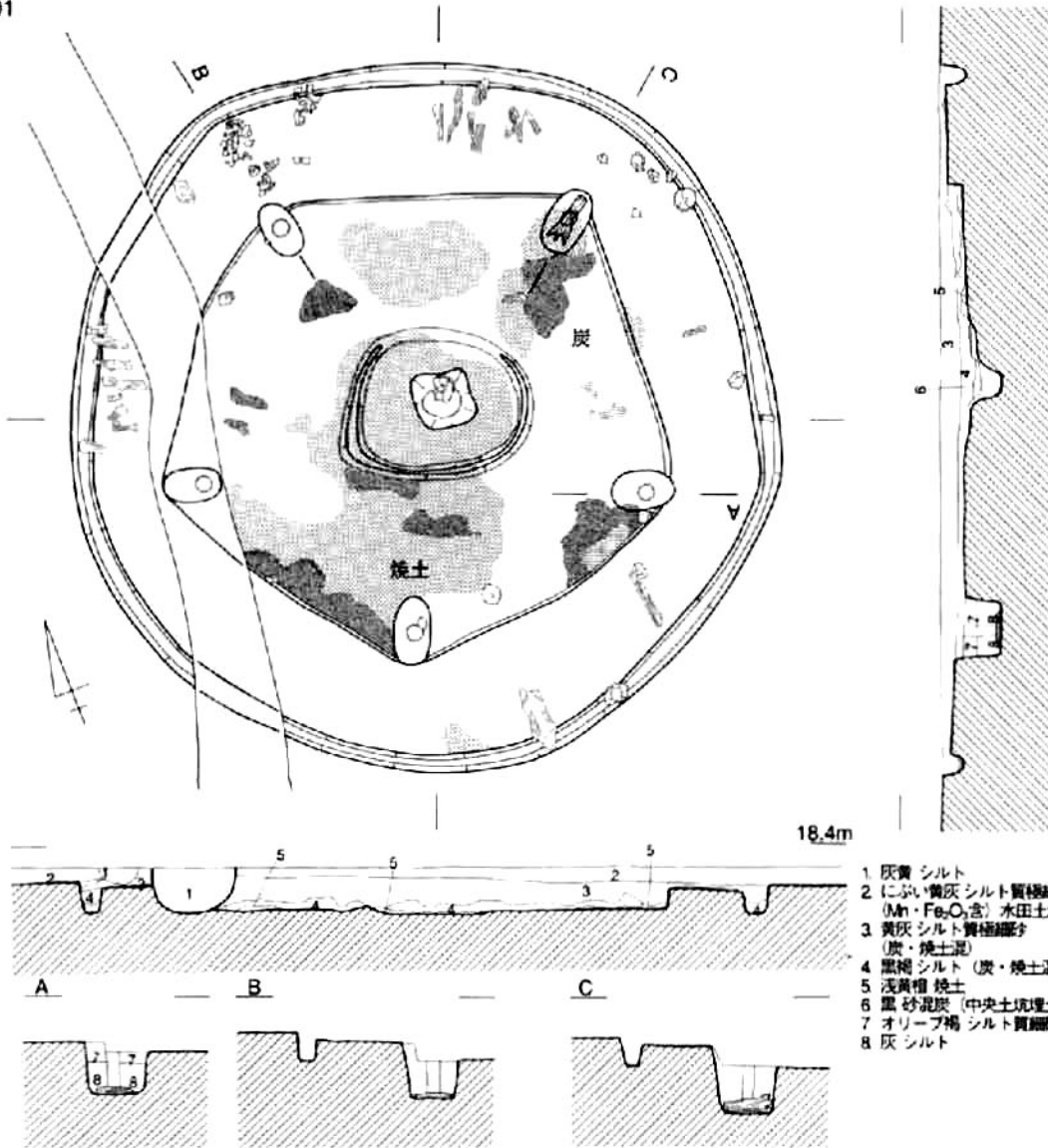

SH50002

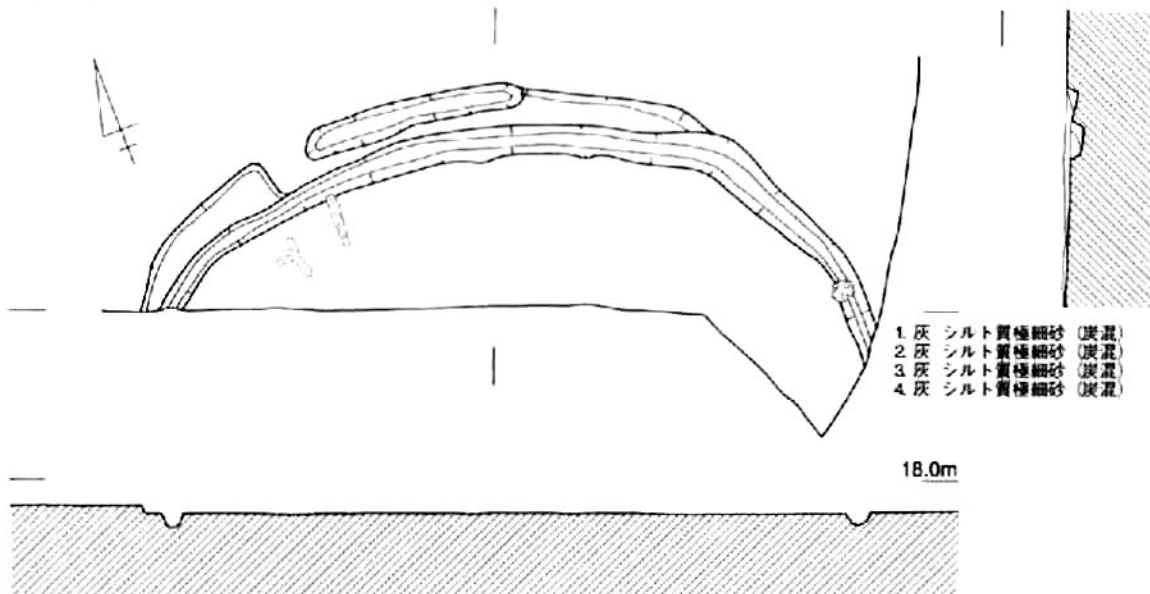

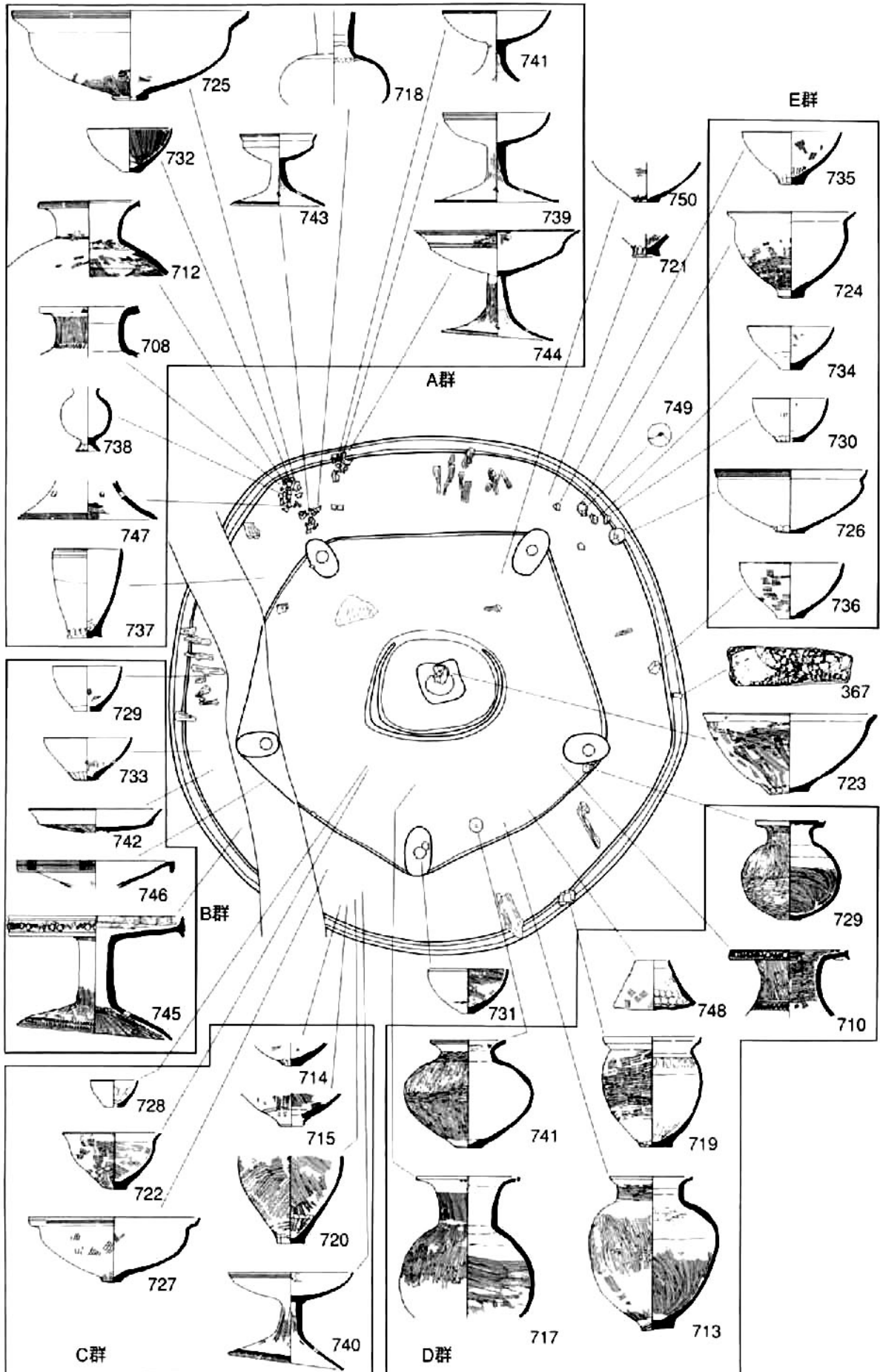

竪穴住居2 (SH50001)遺物出土状況

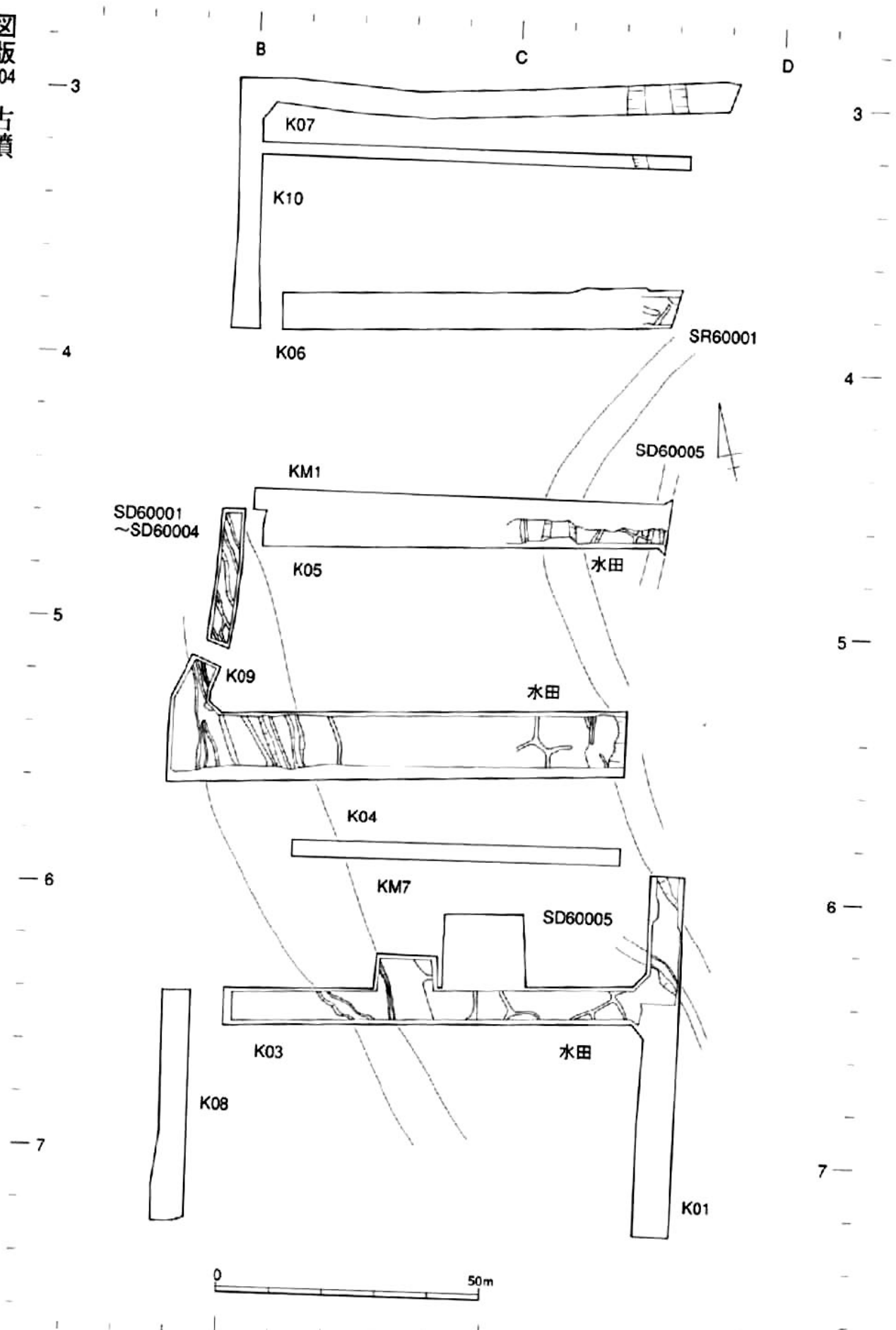

遺構全体1 (黒岡)

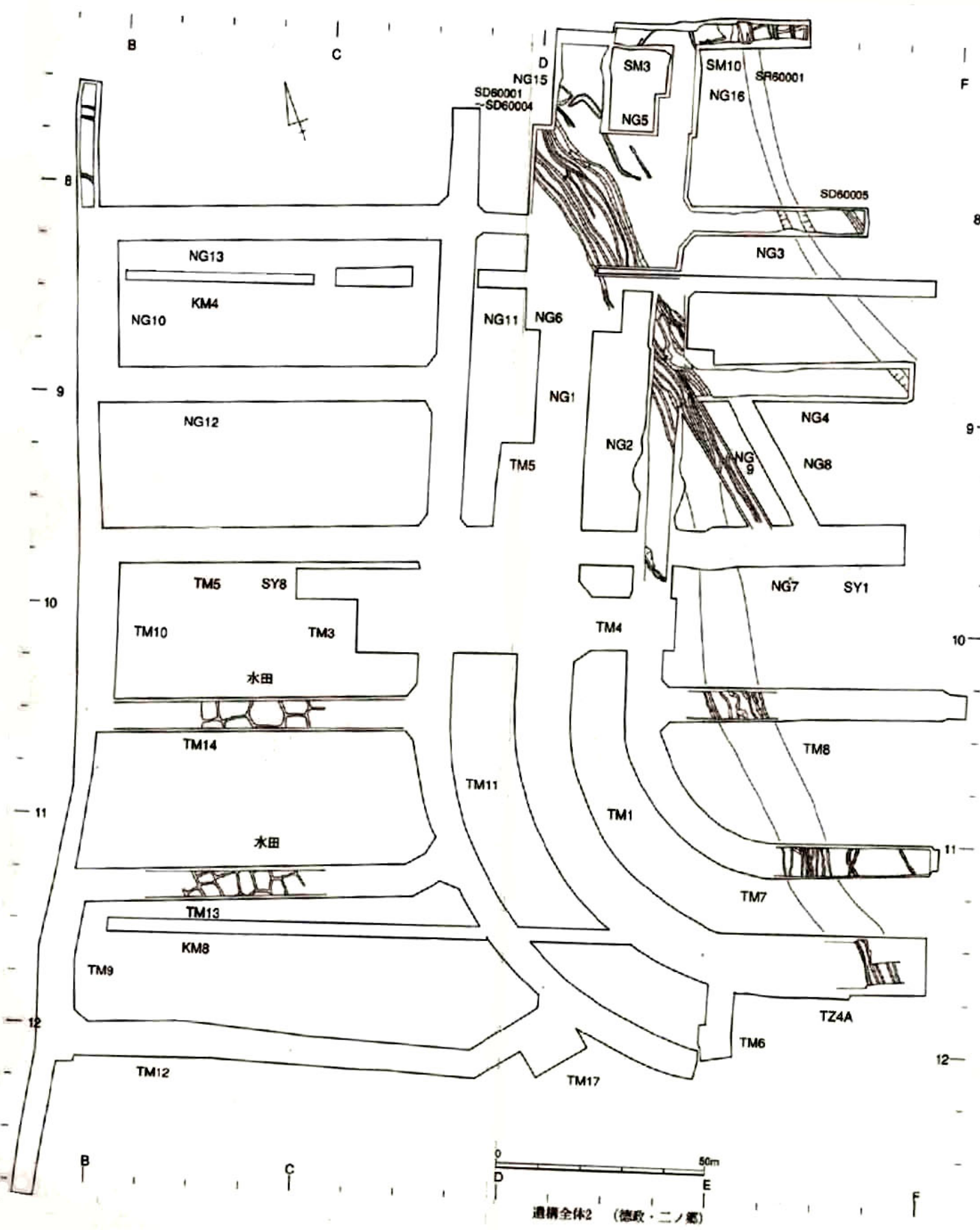

遺構全体2 (徳政・二ノ墓)

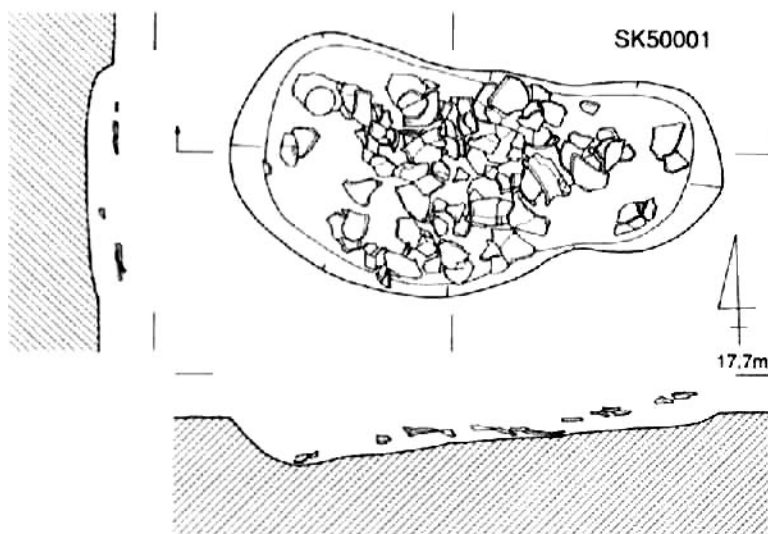

SD60001

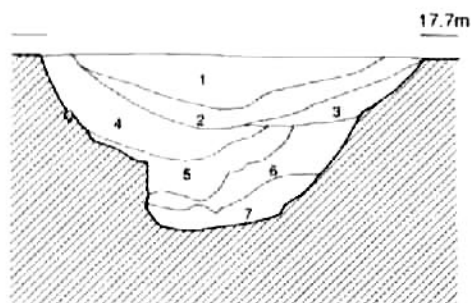

1. 淡灰 細砂～粗砂(Fe₂O₃含)
2. 灰 シルト～細砂
3. 淡灰 細砂～極細砂(ラミナ)
4. 淡灰 細砂～中砂(ラミナ・一部植物遺体含)
5. 暗灰 シルト～細砂(上面Fe₂O₃含)
6. 褐 中砂～粗砂(下面小礫・Fe₂O₃沈着)
7. 淡灰 粗砂～細砂(ラミナ)



SD60002

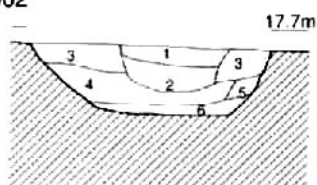

1. 灰 細砂(Fe₂O₃含)
2. 灰白 細砂～粗砂
3. 暗灰 粗砂
4. 淡灰 中砂～粗砂(Fe₂O₃沈着)
5. 暗灰 細砂(Fe₂O₃含)
6. 暗灰 細砂(Fe₂O₃含)

SD60003

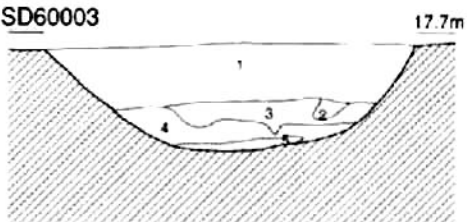

1. 茶褐 粗砂～極細砂
2. 暗灰 極細砂～シルト
3. 淡灰 細砂～極細砂
4. 淡灰 中砂～小礫
5. 明黄褐 細砂～極細砂

SD60004

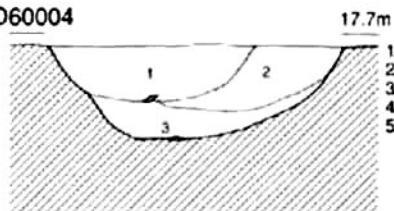

1. 灰白 極細砂～細砂
2. 暗灰 細砂～シルト
3. 暗灰 細砂～小礫(ラミナ・Fe₂O₃含)
4. 灰 細砂～シルト(Mn・Fe₂O₃含)
5. 灰 細砂～シルト(Mn・Fe₂O₃含)

SD60005

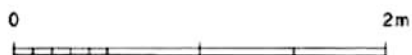
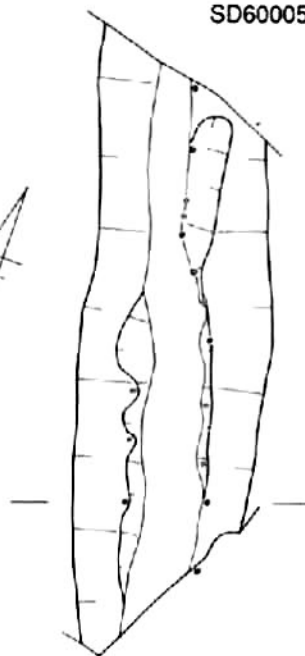

弥生後期土坑(SK50001)、古墳 溝(SD60001～60005)

SB80001

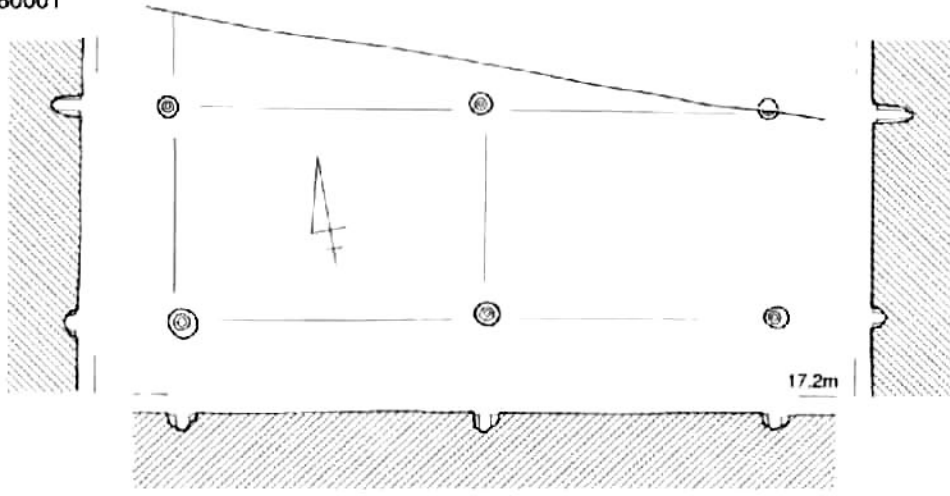

SB80002

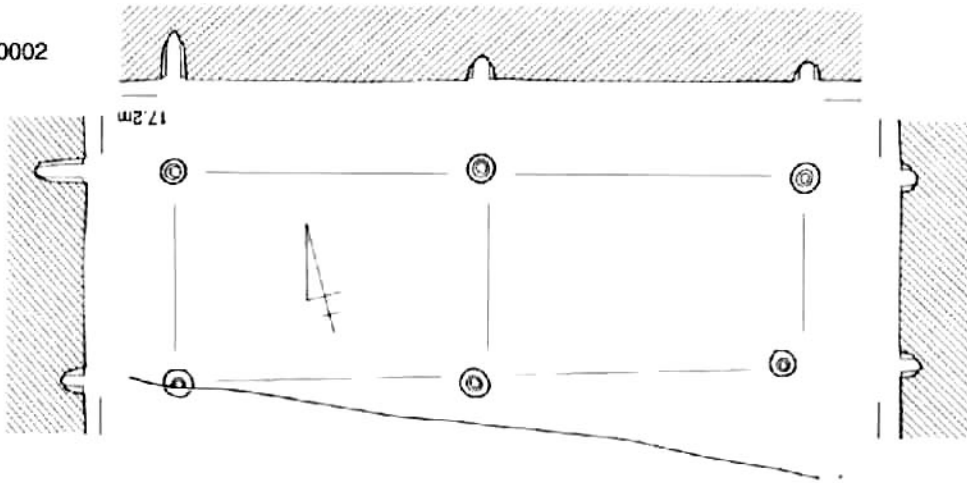

SB80003

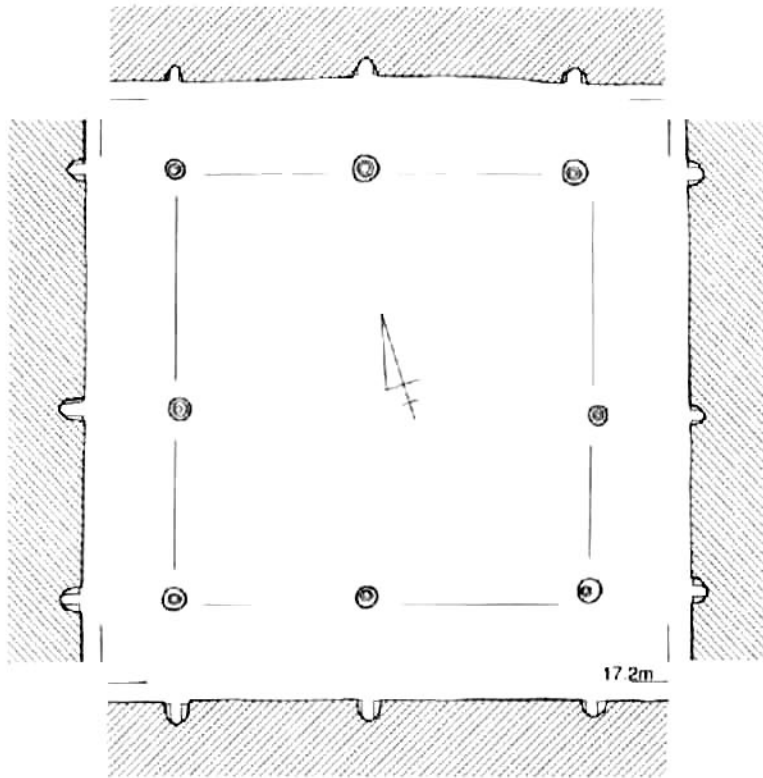

0 4m

掘立柱建物1 (SB80001~80003)

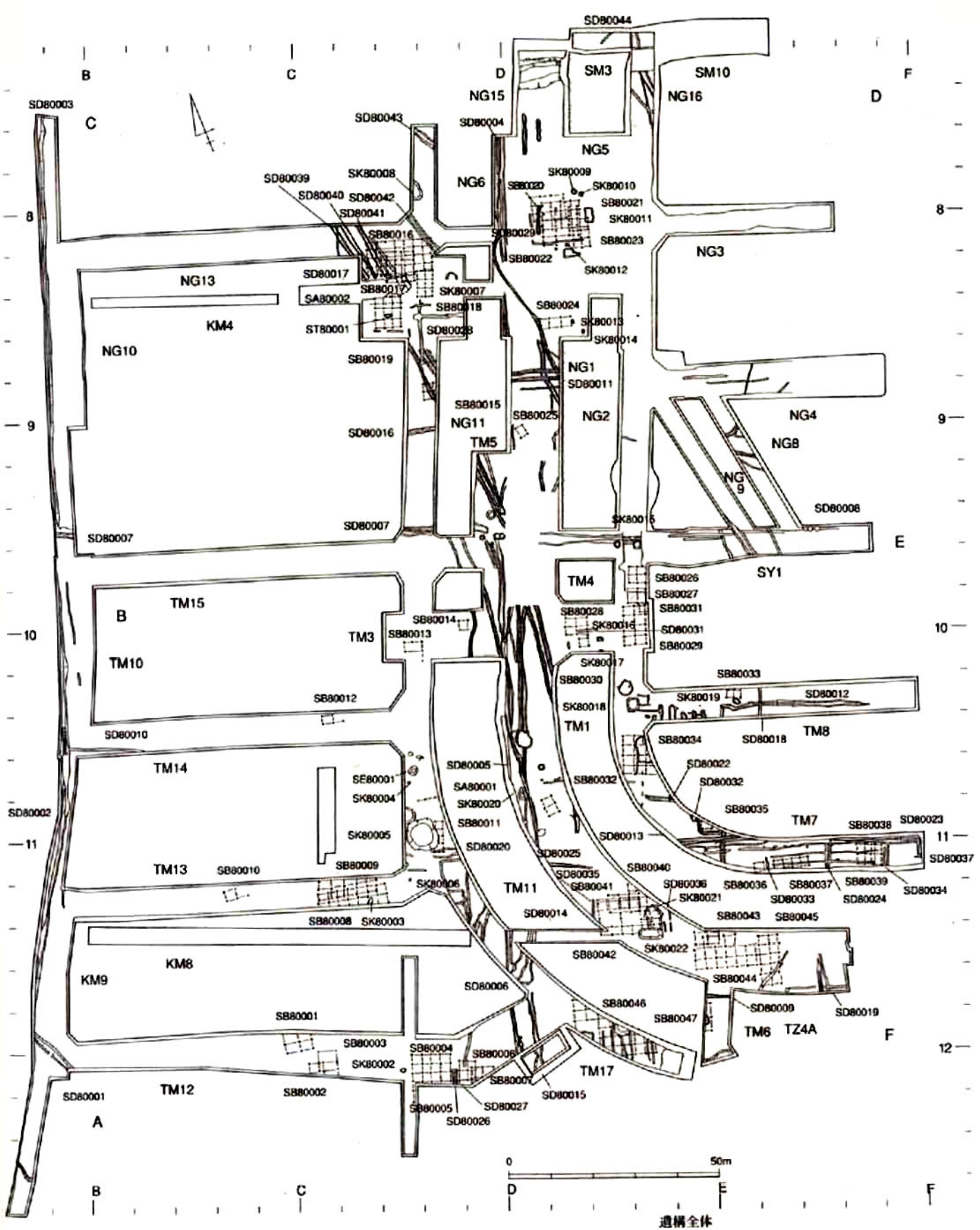

遺構全体

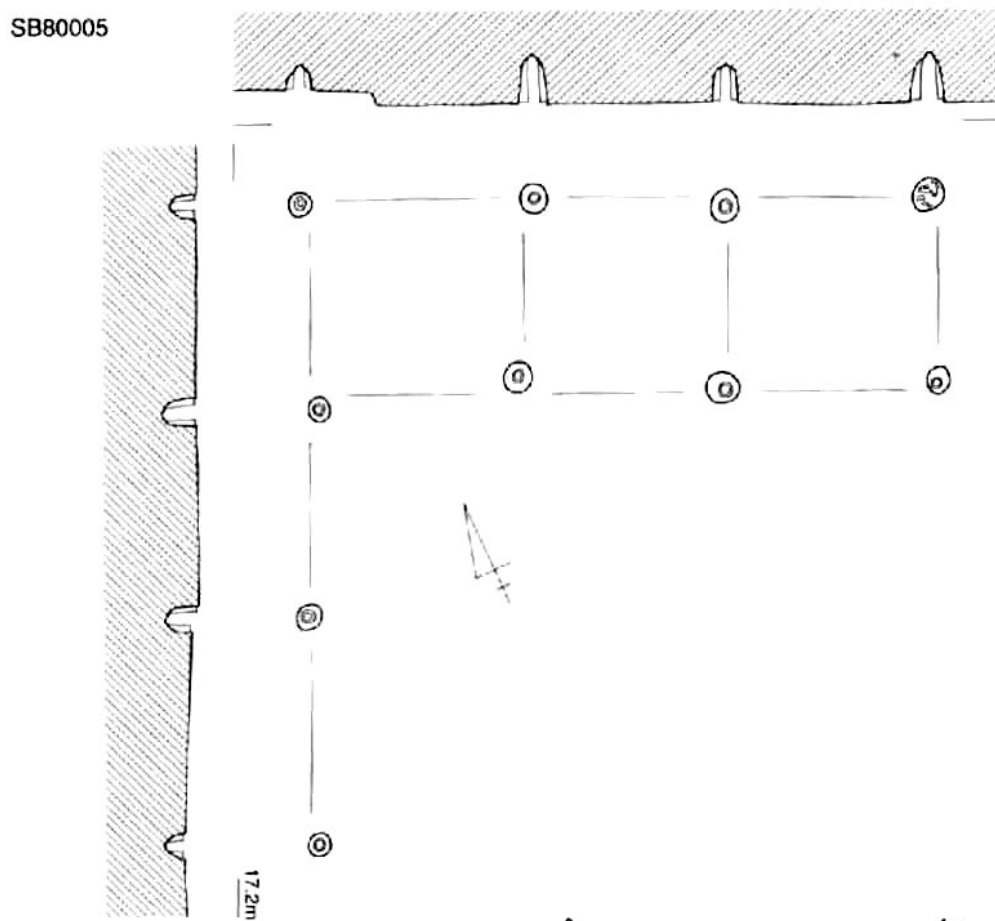
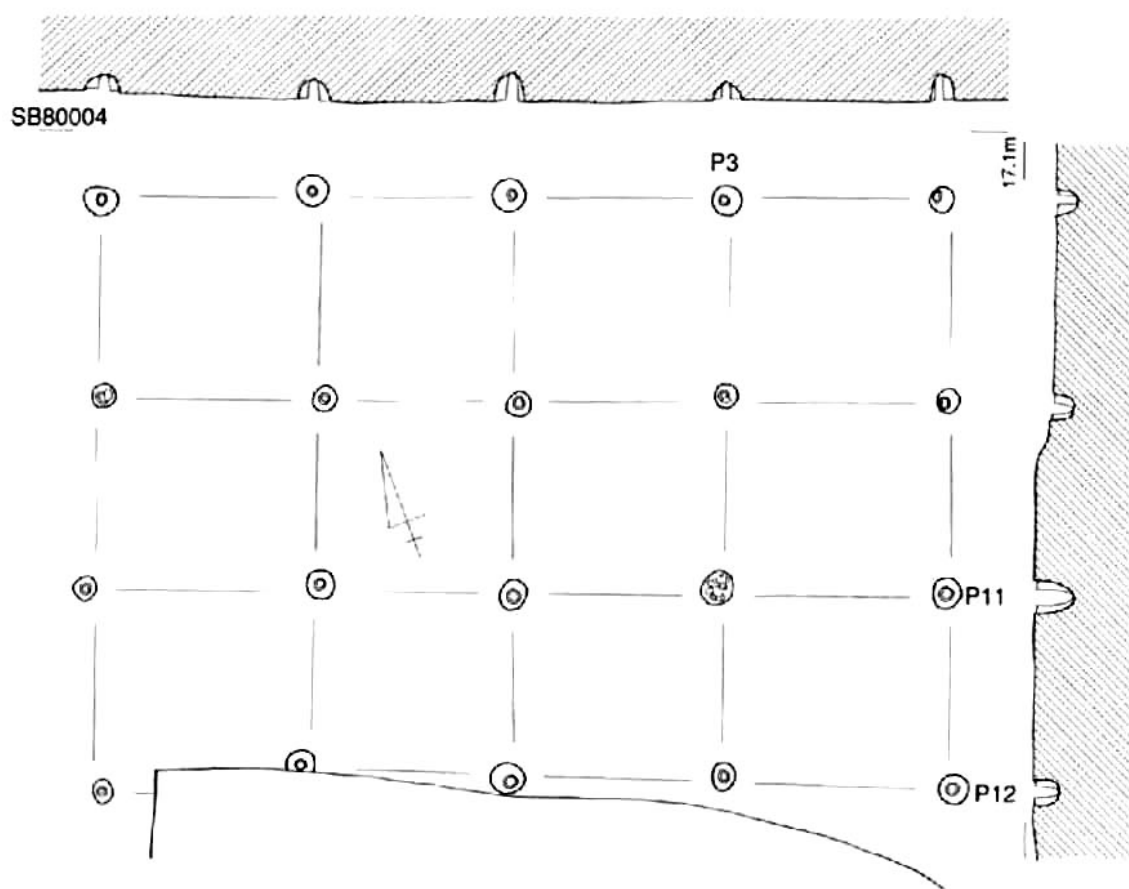

掘立柱建物2 (SB80004・80005)

SB80006

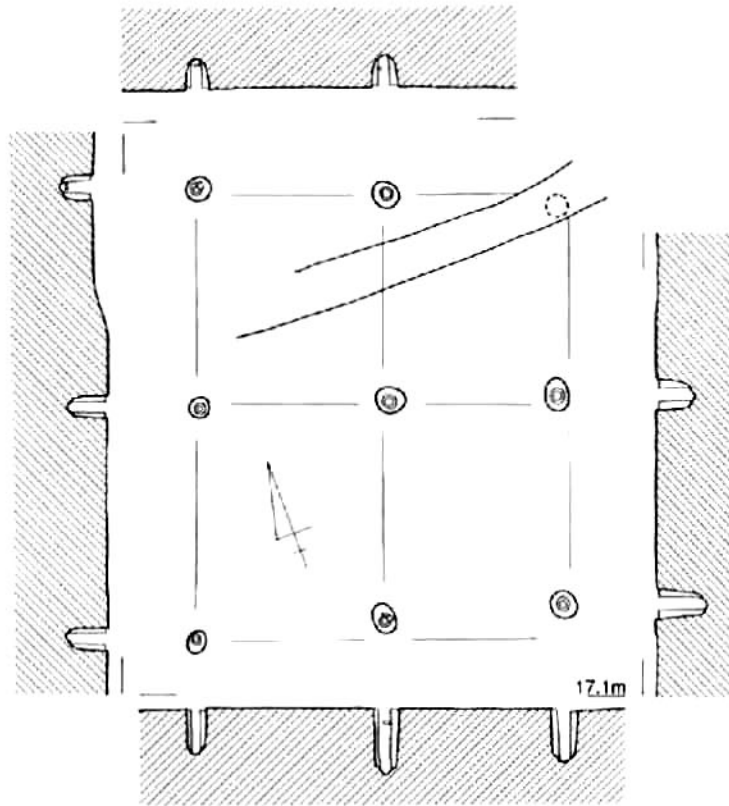

SB80007

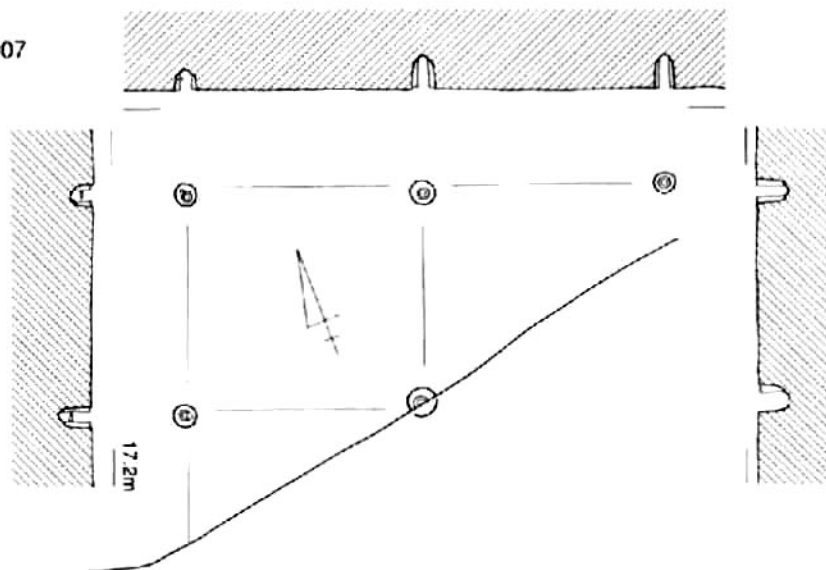

SB80008

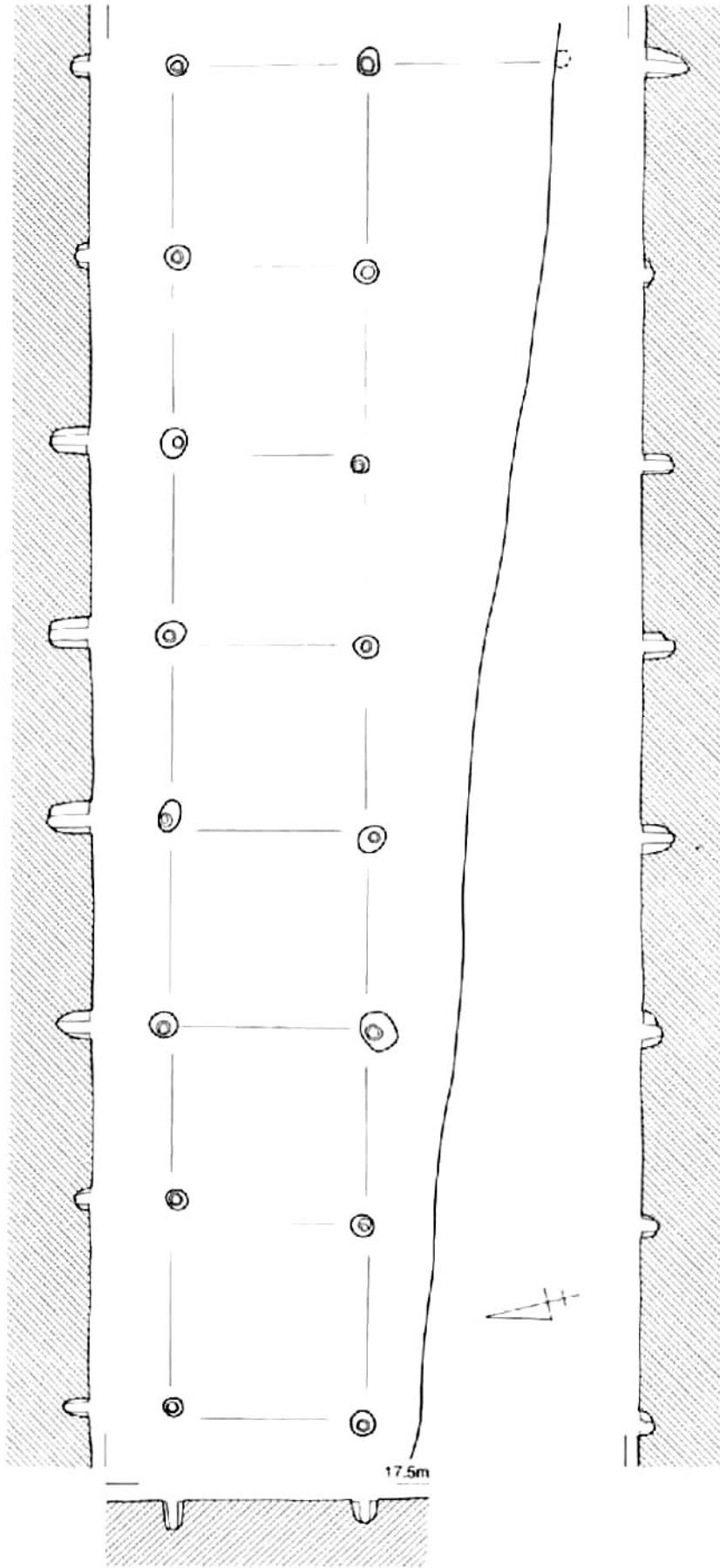

0 4m

掘立柱建物4 (SB80008)

SB80009

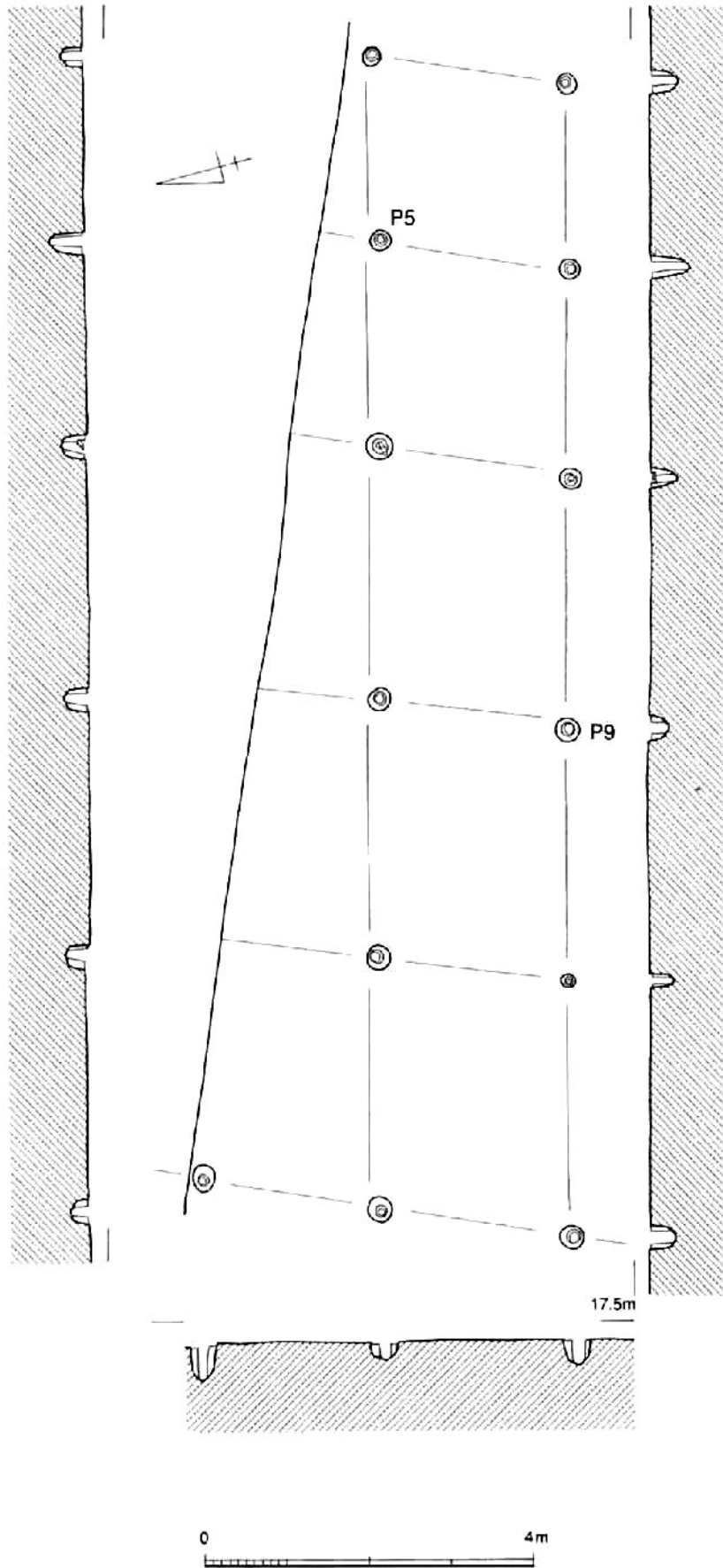

掘立柱建物5 (SB80009)

SB80010

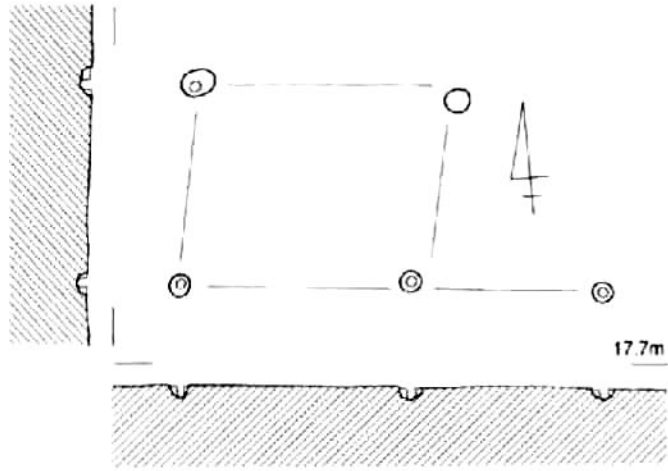

SB80011

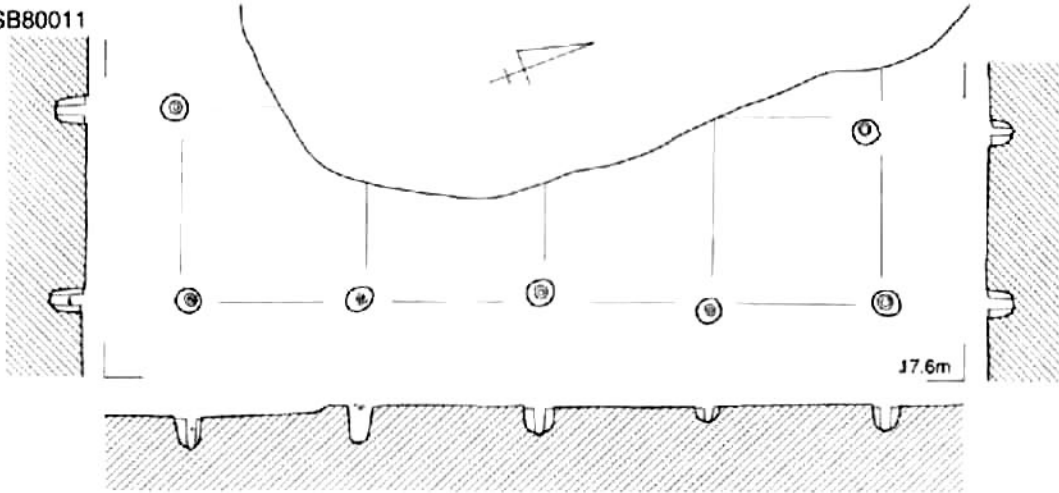

SB80012

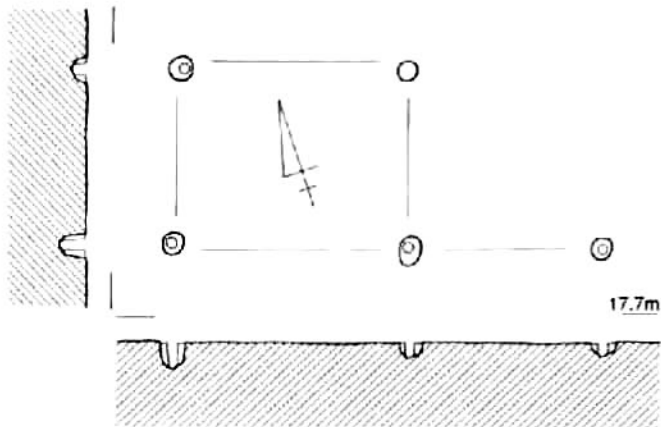

0 4m

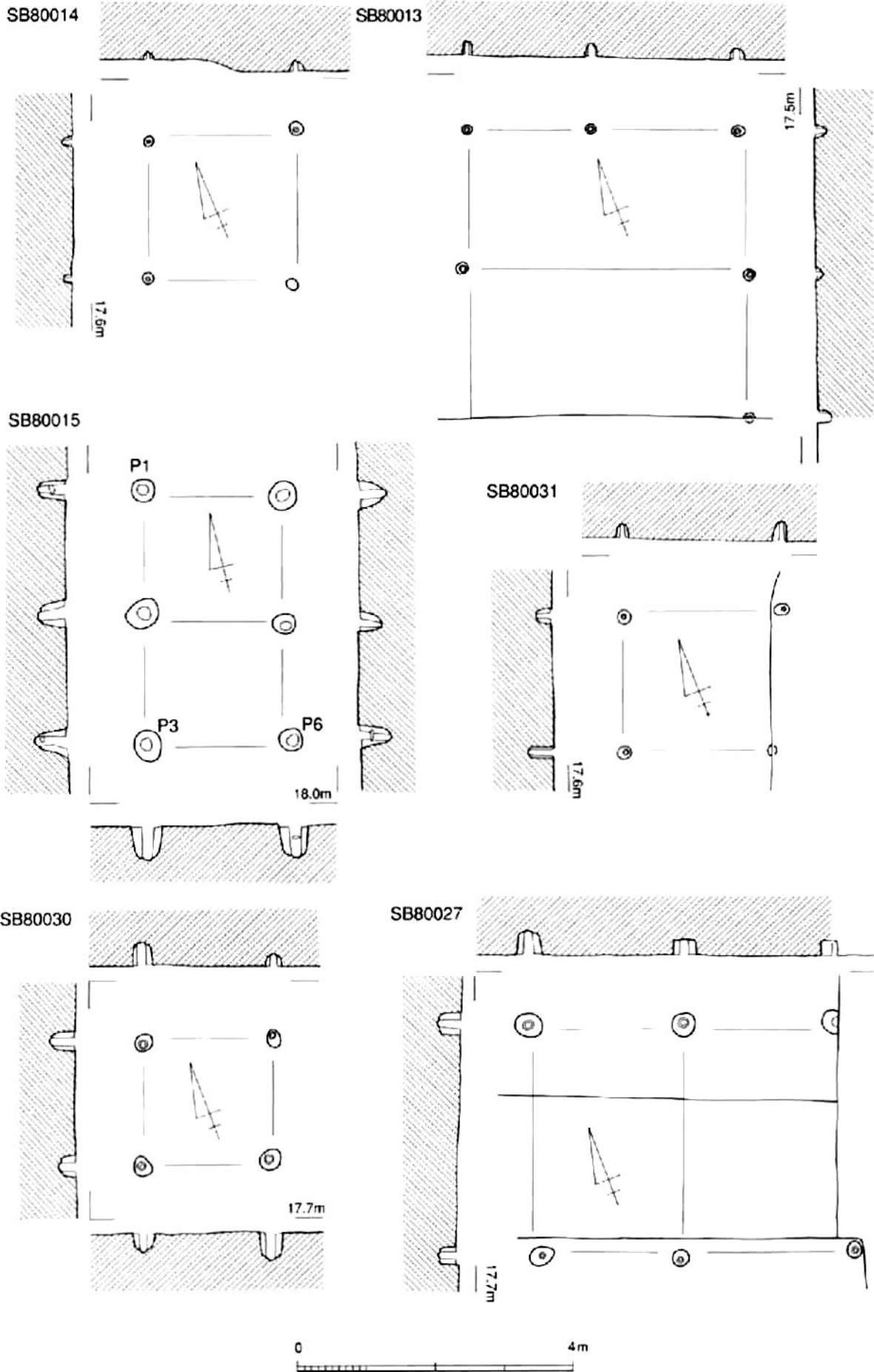

掘立柱建物7 (SB80013~80015・80027・80030・80031)

SB80016

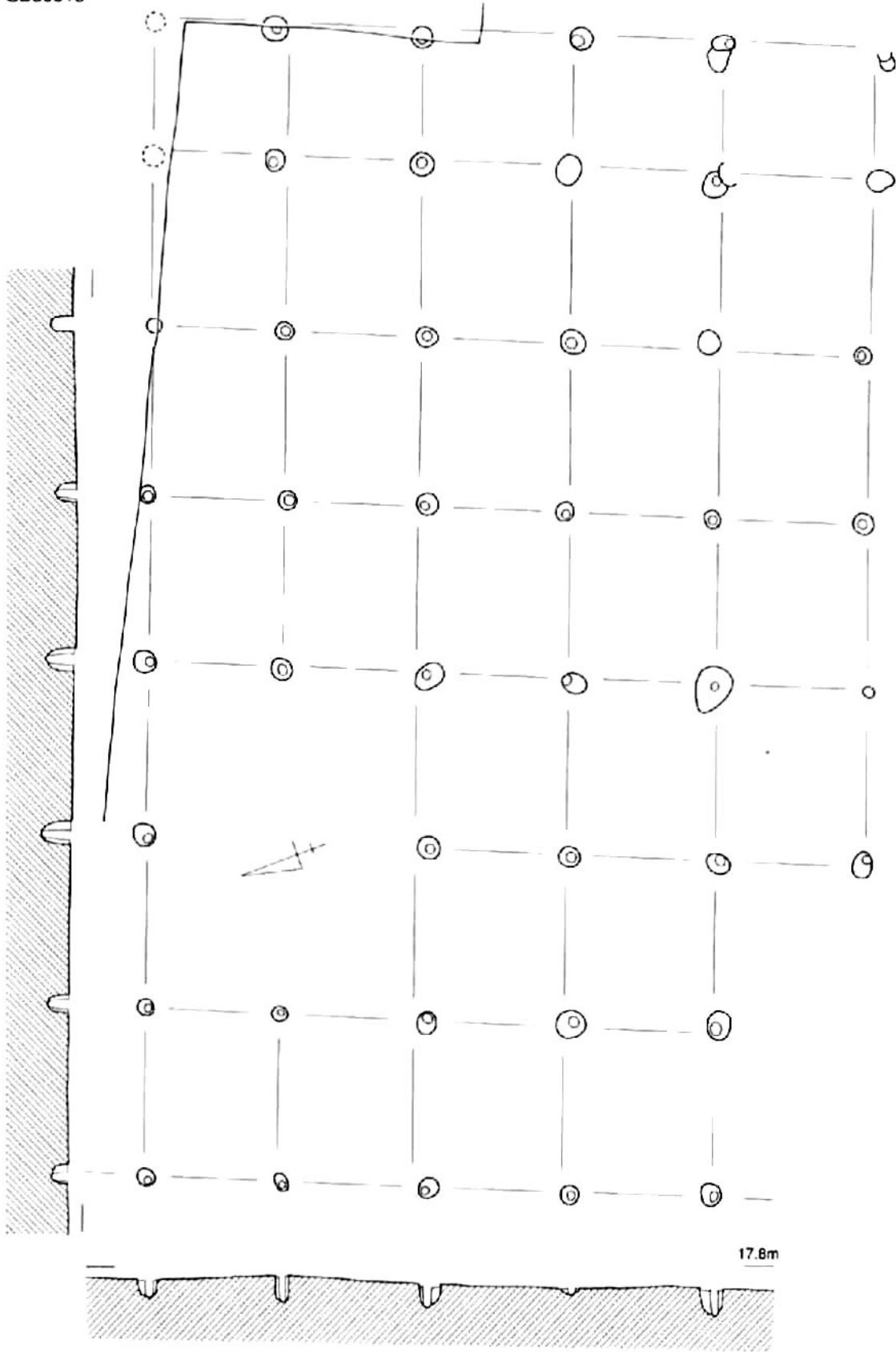

掘立柱建物8 (SB80016)

SB80018

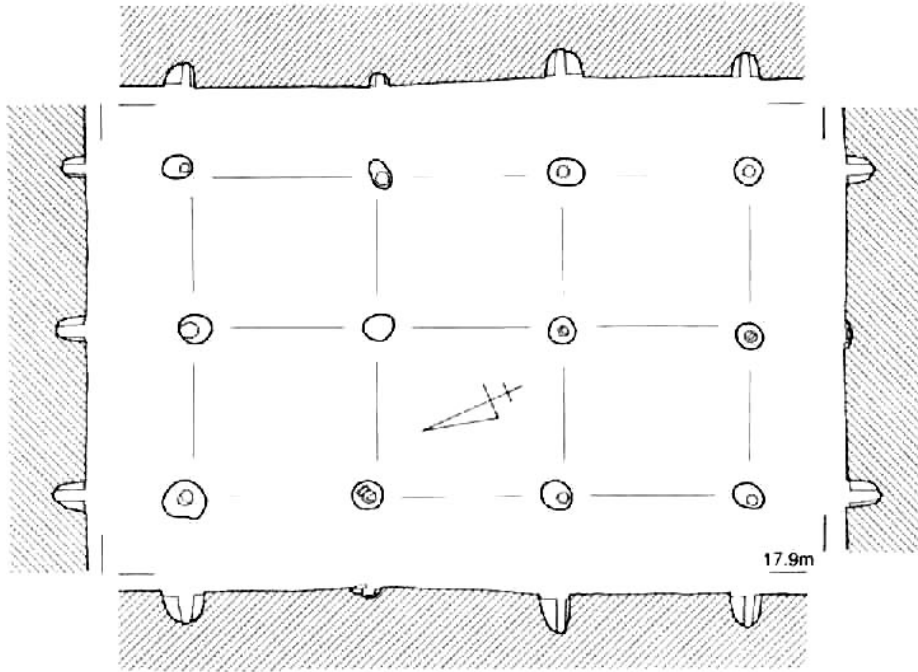

SB80019

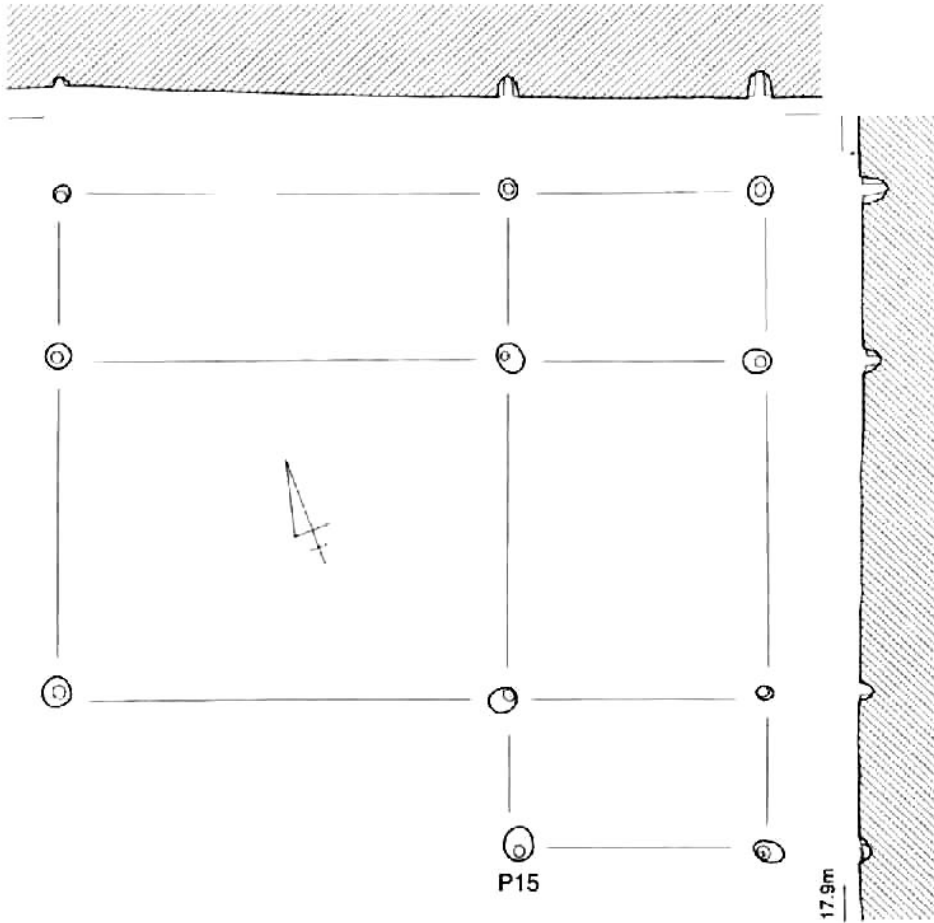

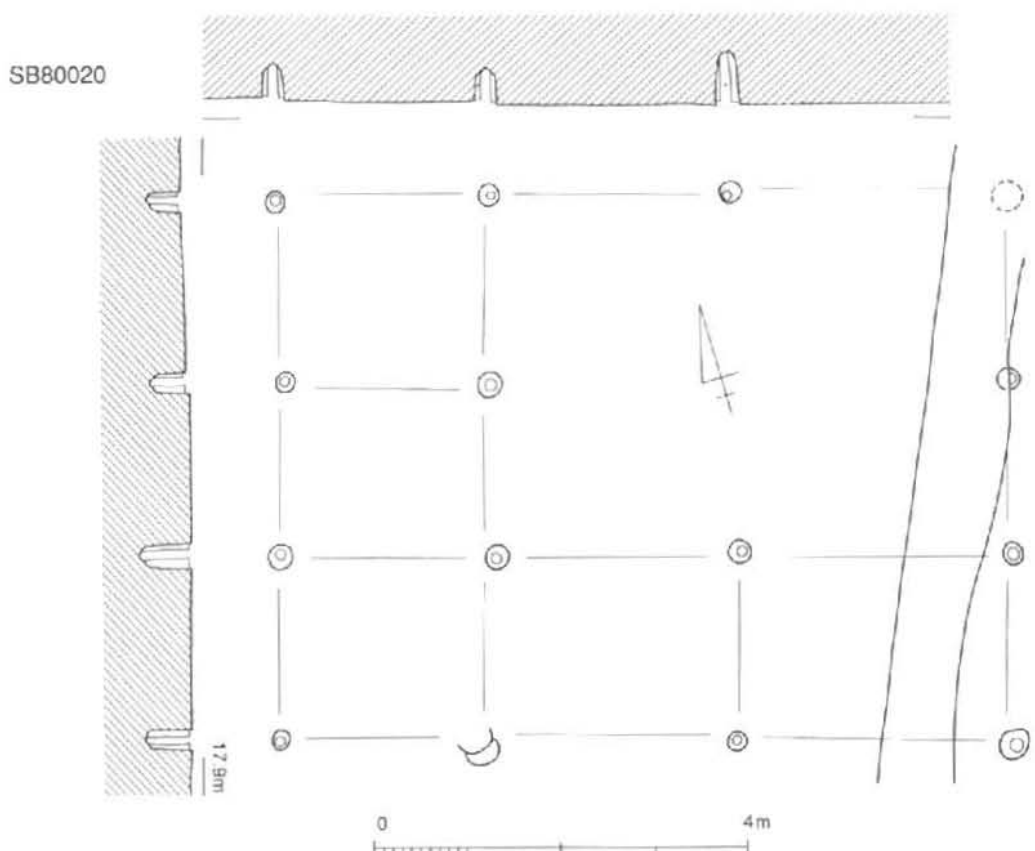
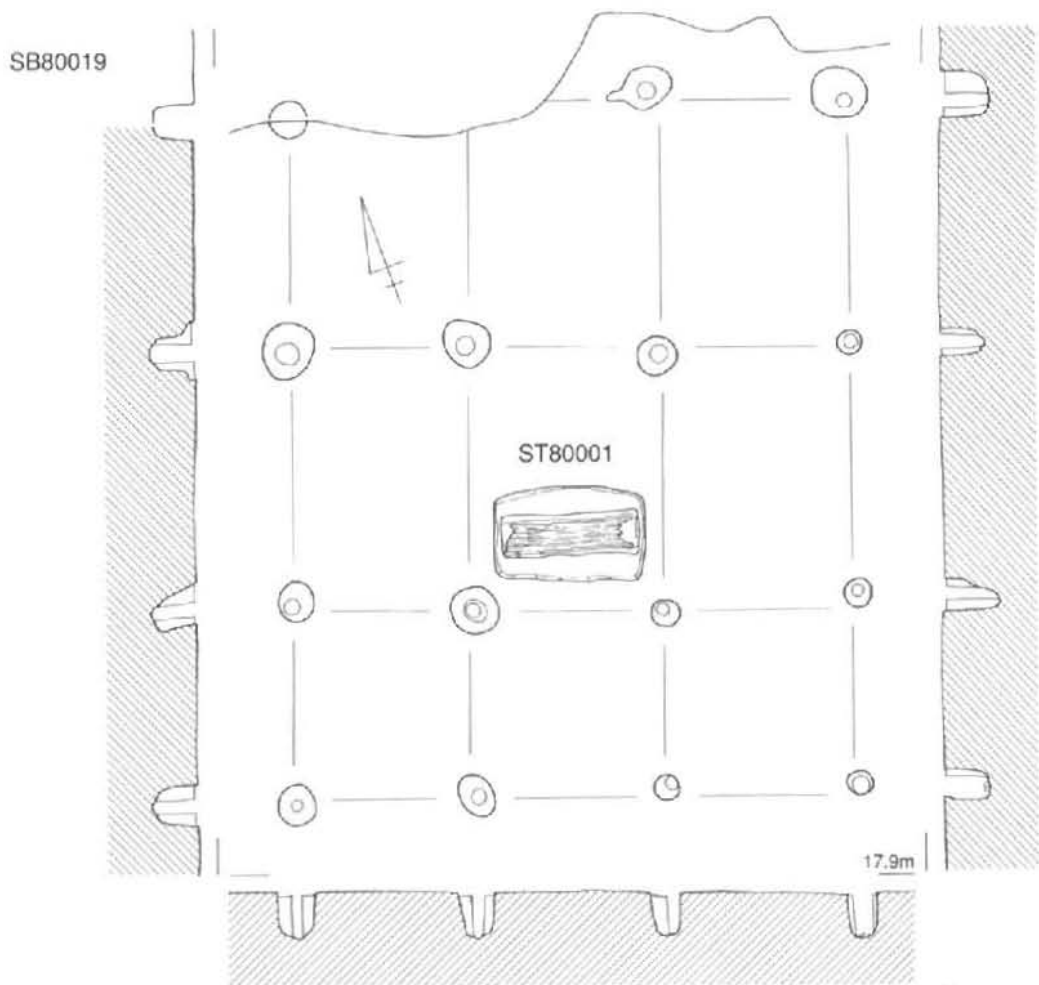

掘立柱建物10 (SB80019・80020)

図版
120
中世

SB80021

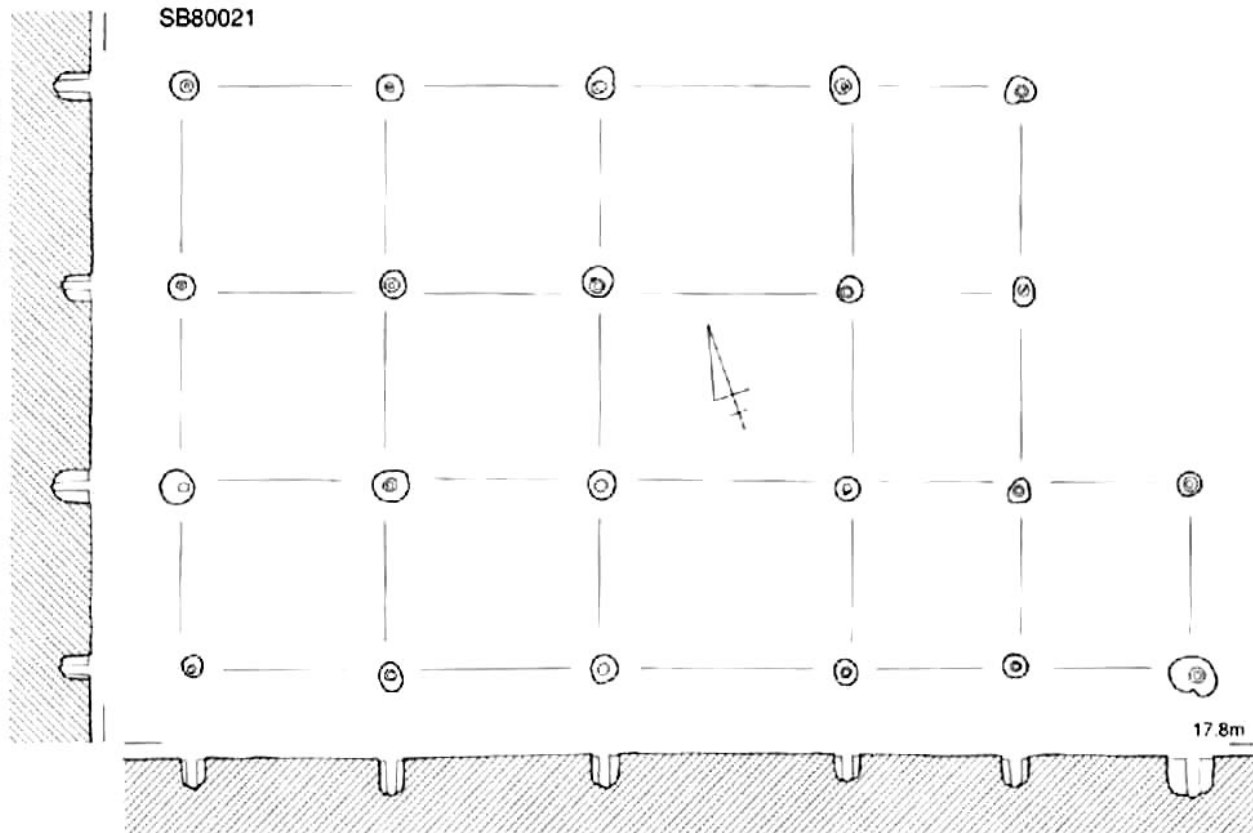

SB80022

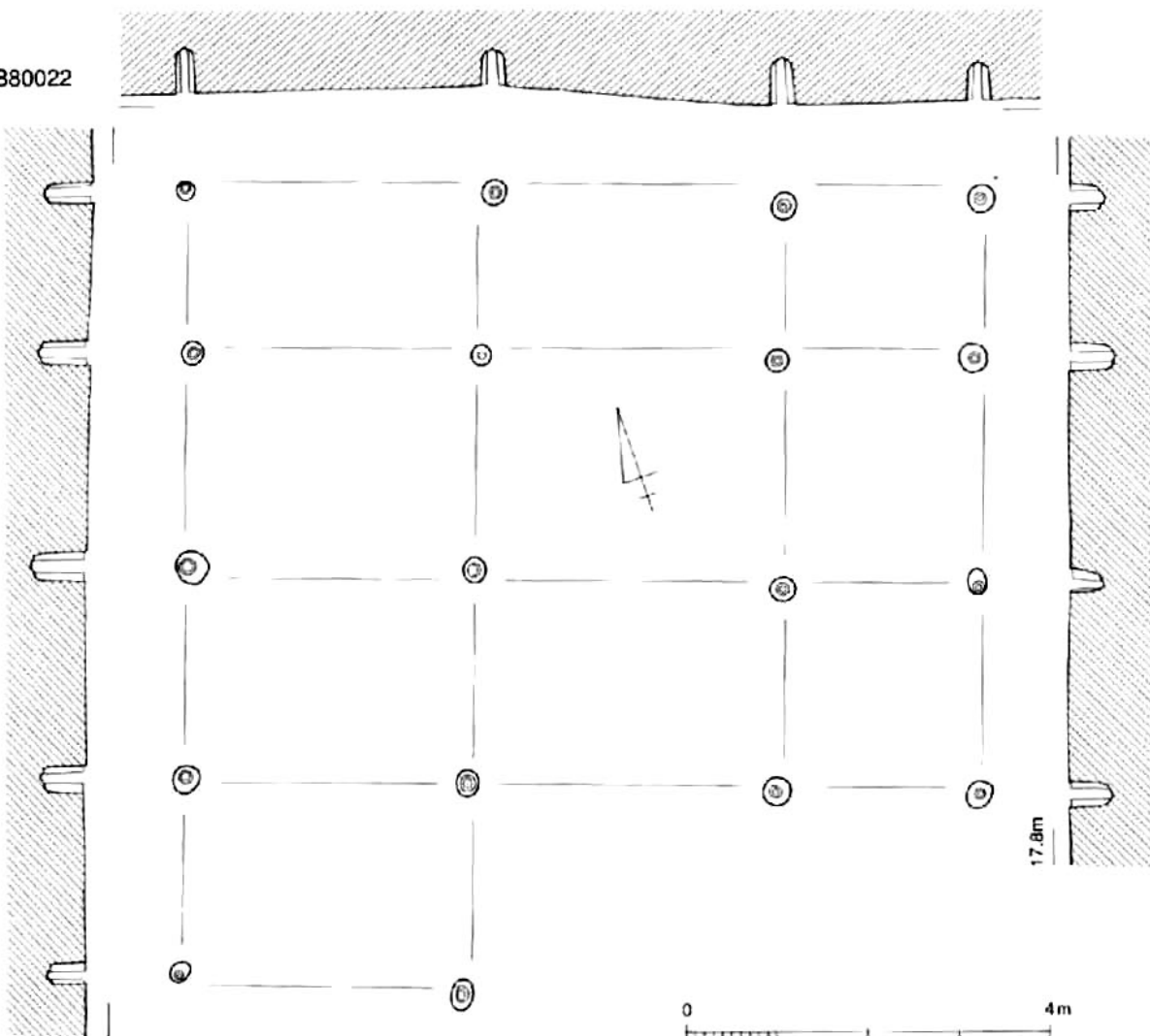

掘立柱建物11 (SB80021・80022)

SB80023

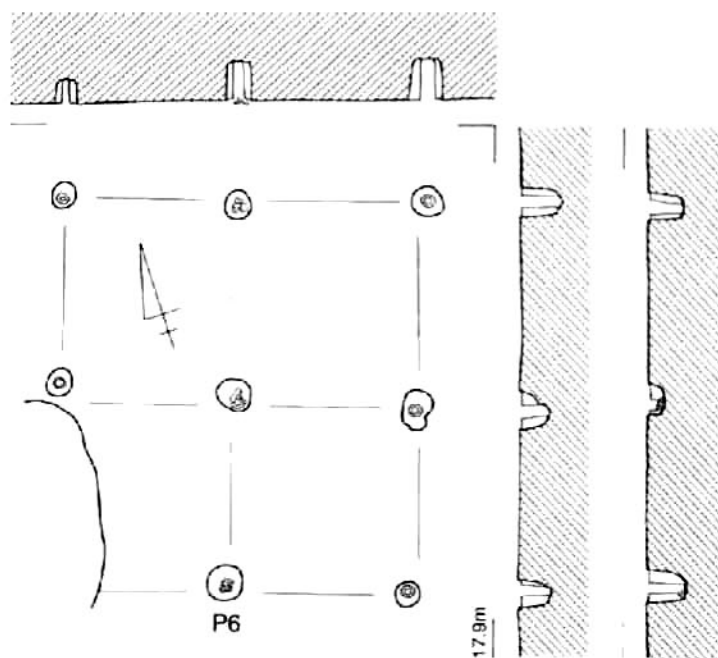

SB80024

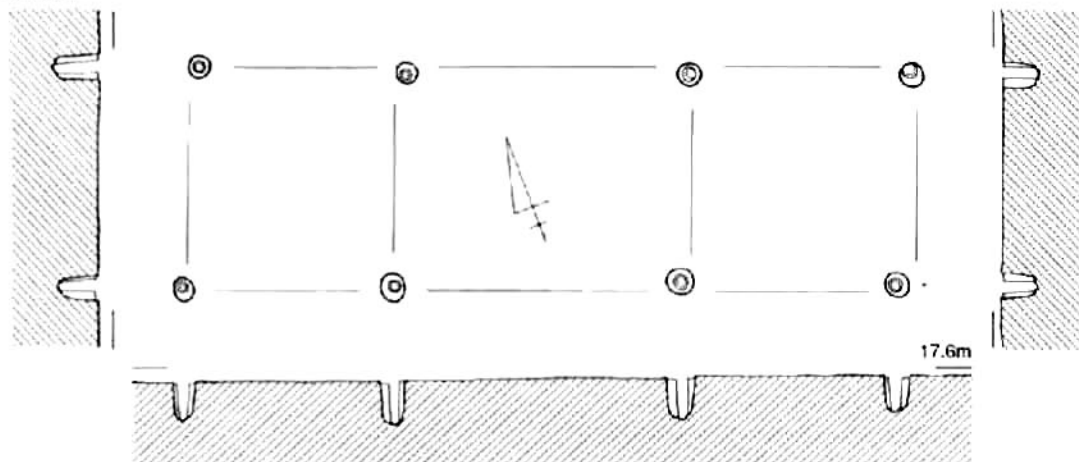

SB80025

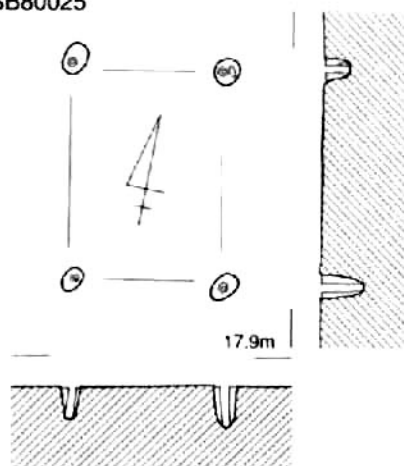

SB80026

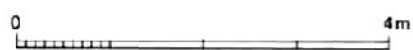
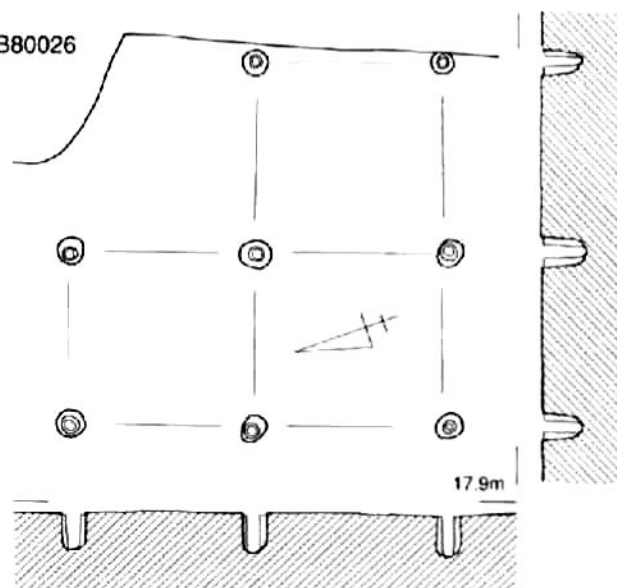

SB80028

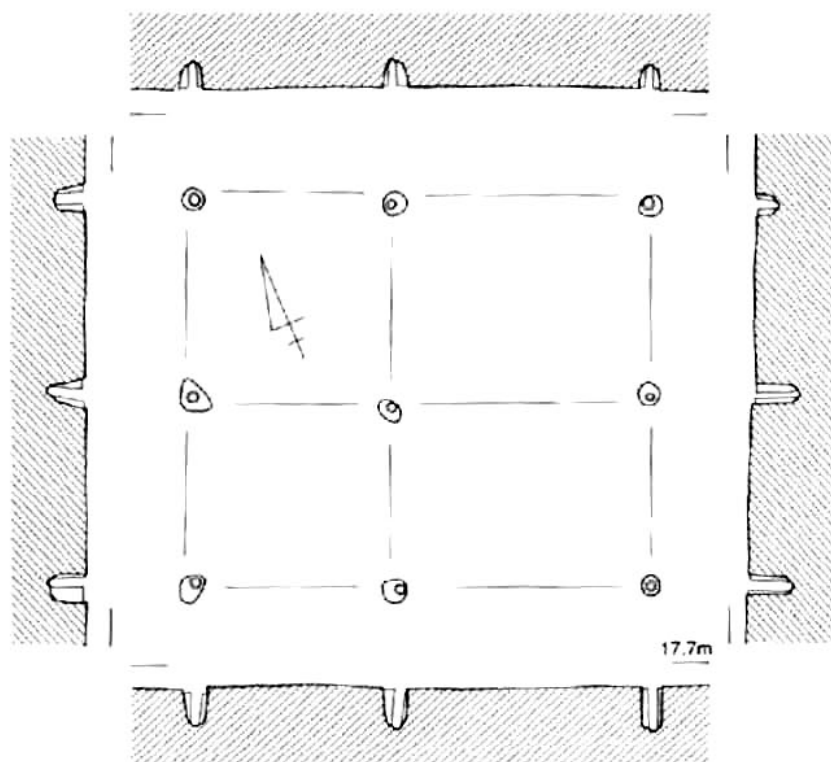

SB80029

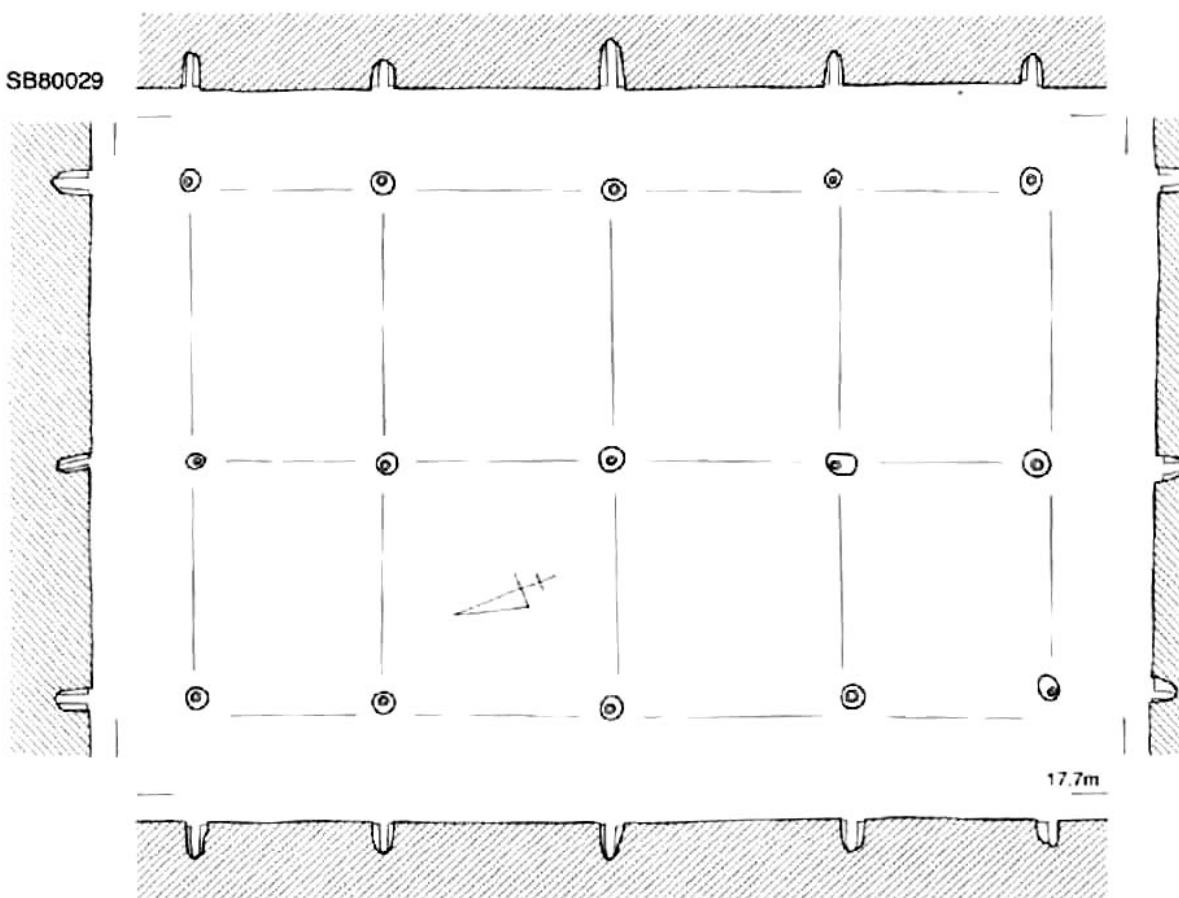

SB80032

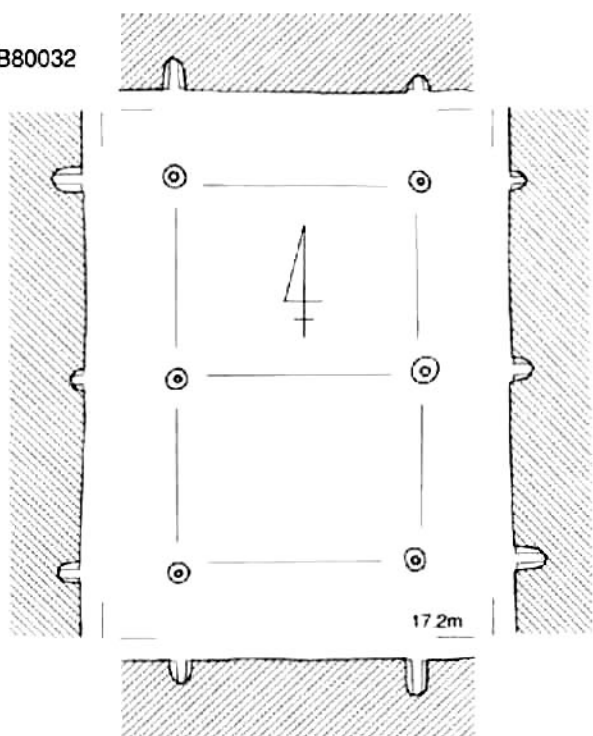

SB80033

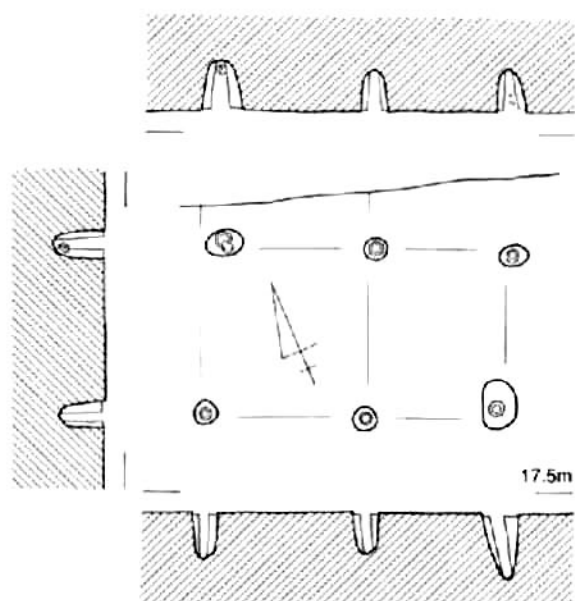

SB80034

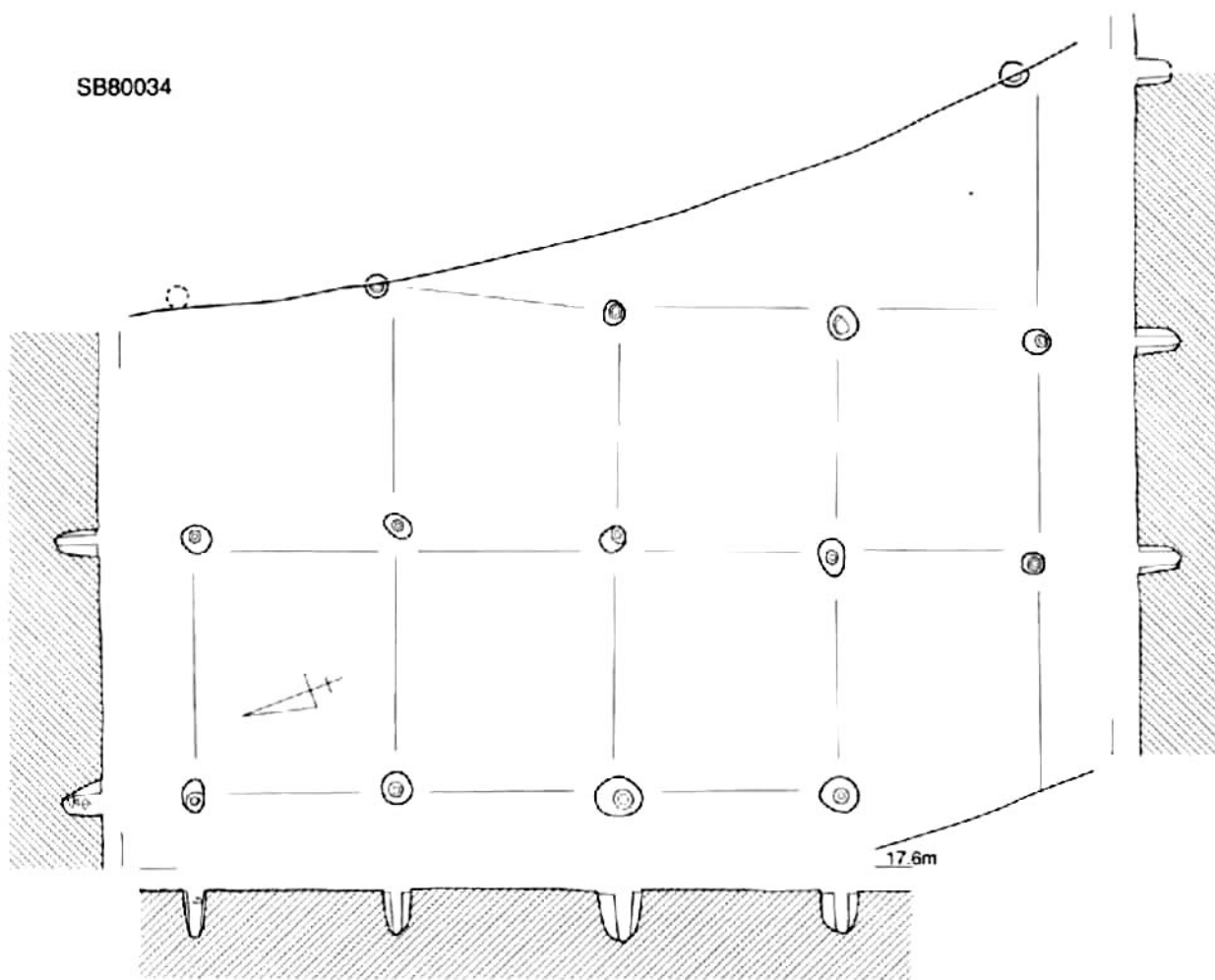

0 4m

掘立柱建物14 (SB80032~80034)

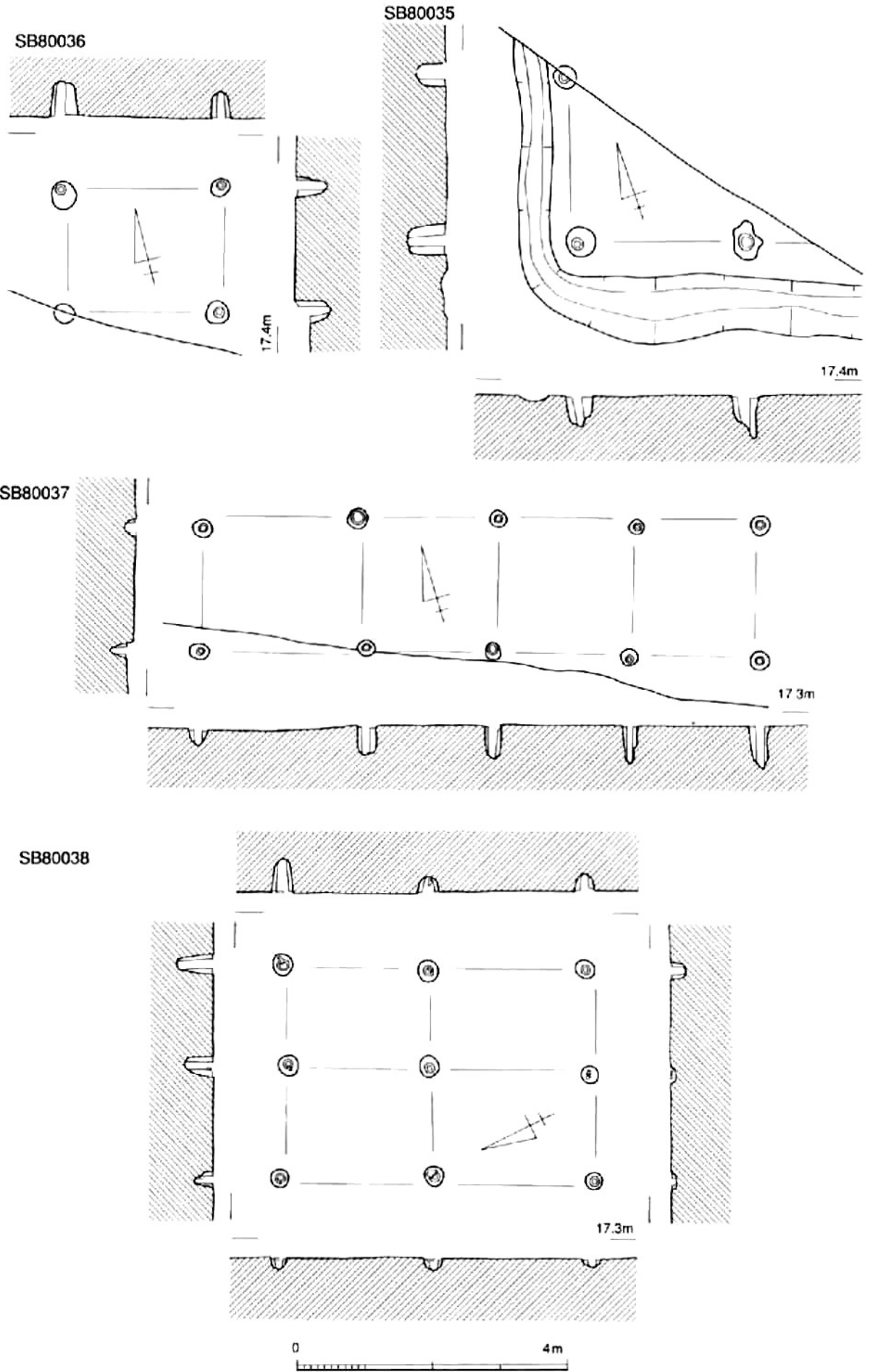

掘立柱建物15 (SB80035~80038)

SB80039

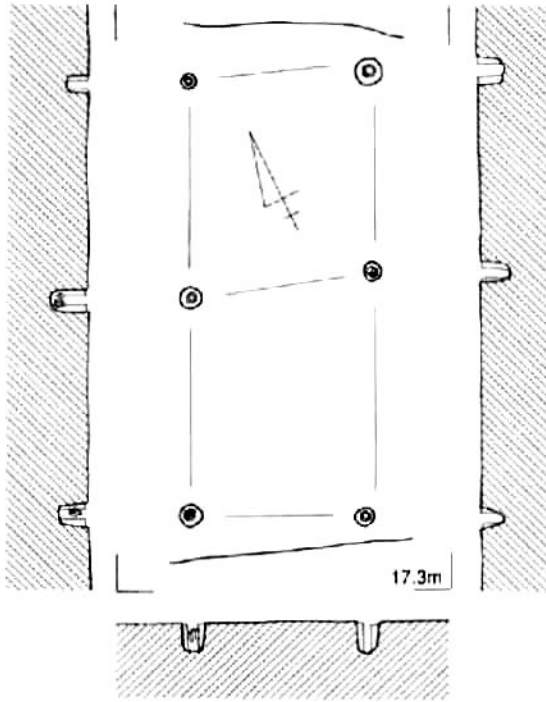

SB80047

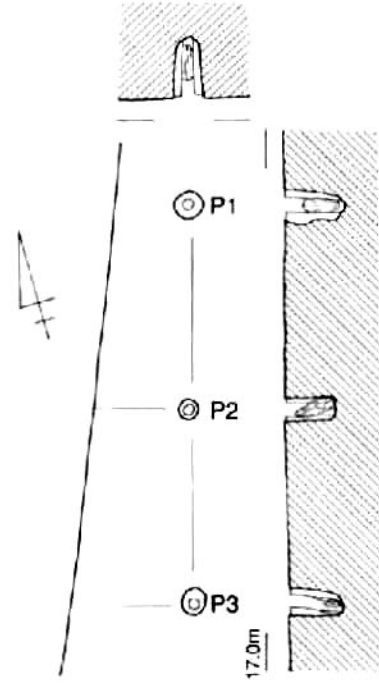

SB80041

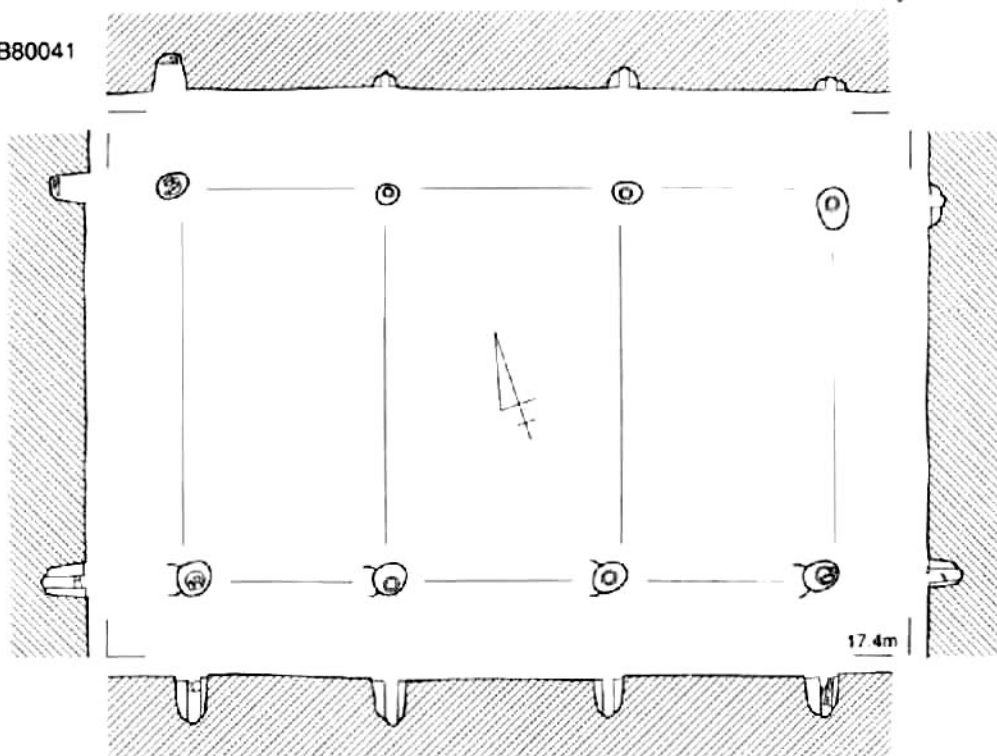

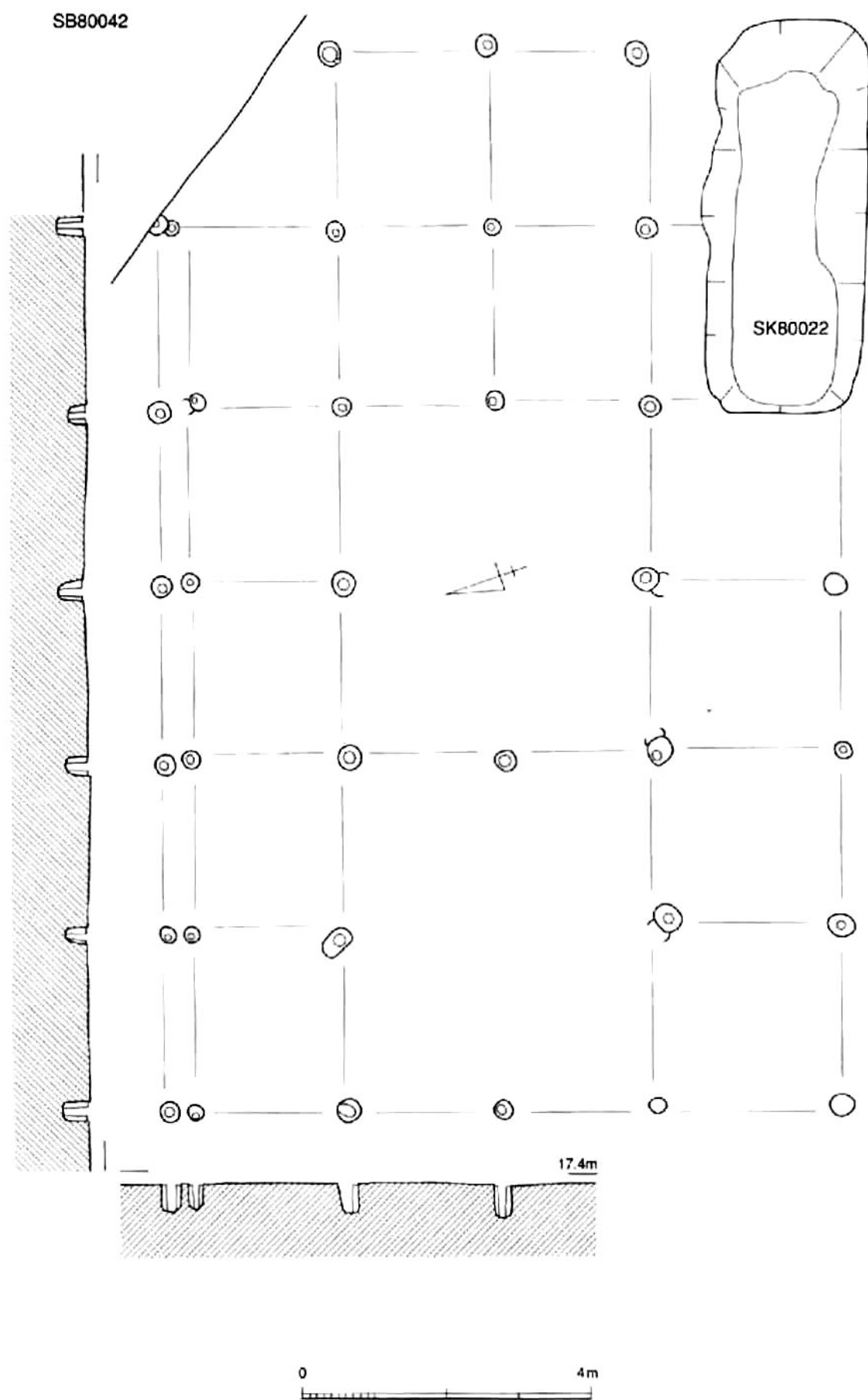

掘立柱建物17 (SB80042)

SB80043

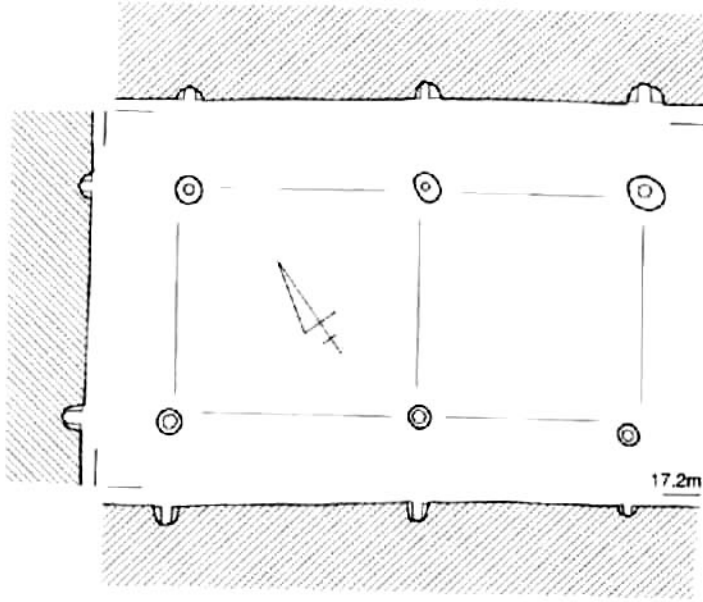

SB80040

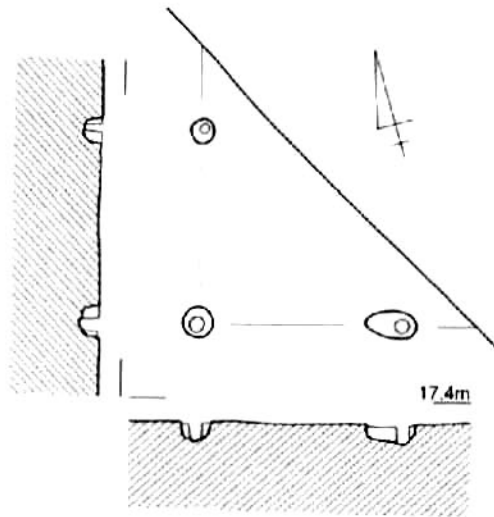

SB80044

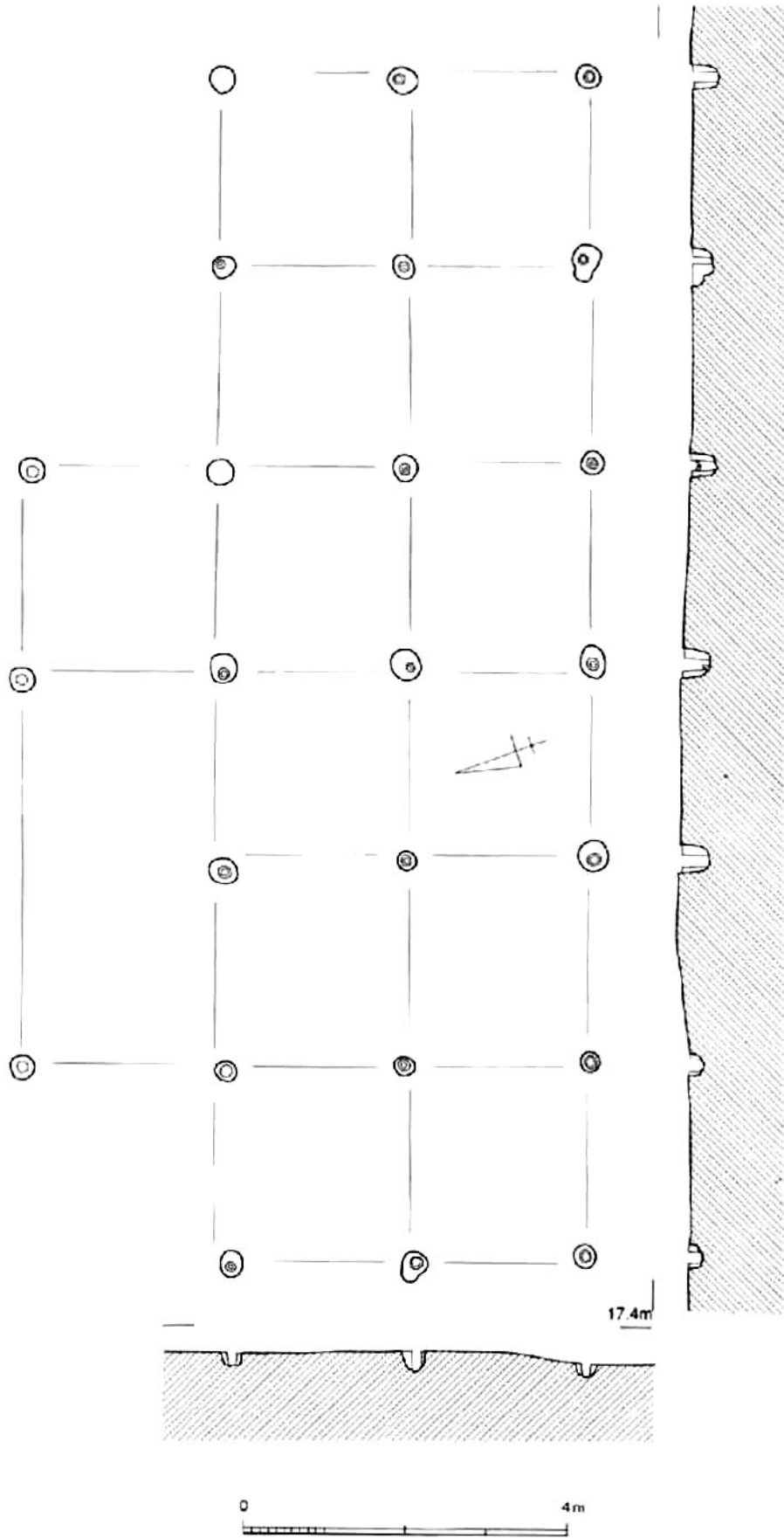

掘立柱建物19 (SB80044)

SB80045

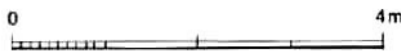
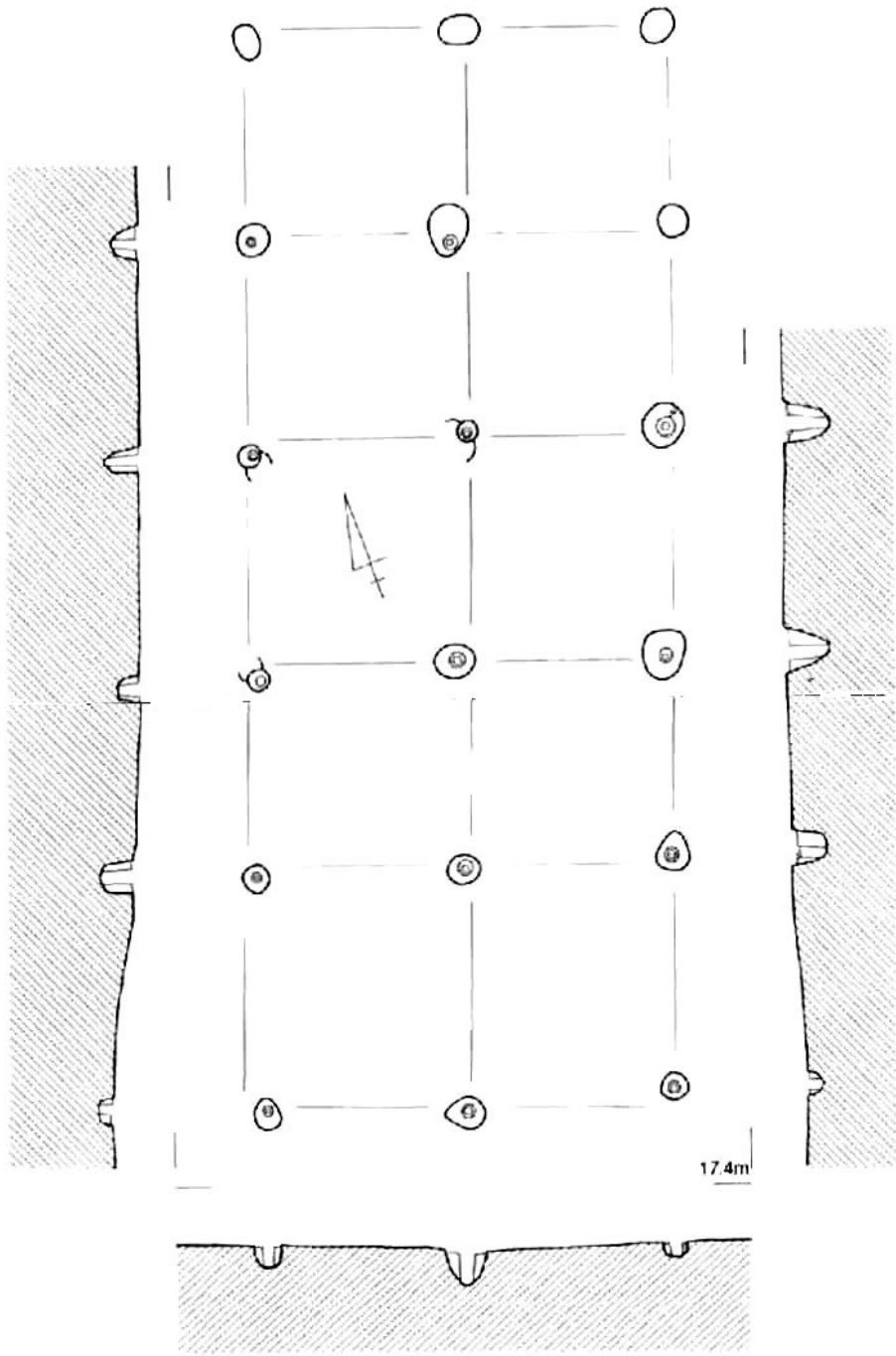

掘立柱建物20 (SB80045)

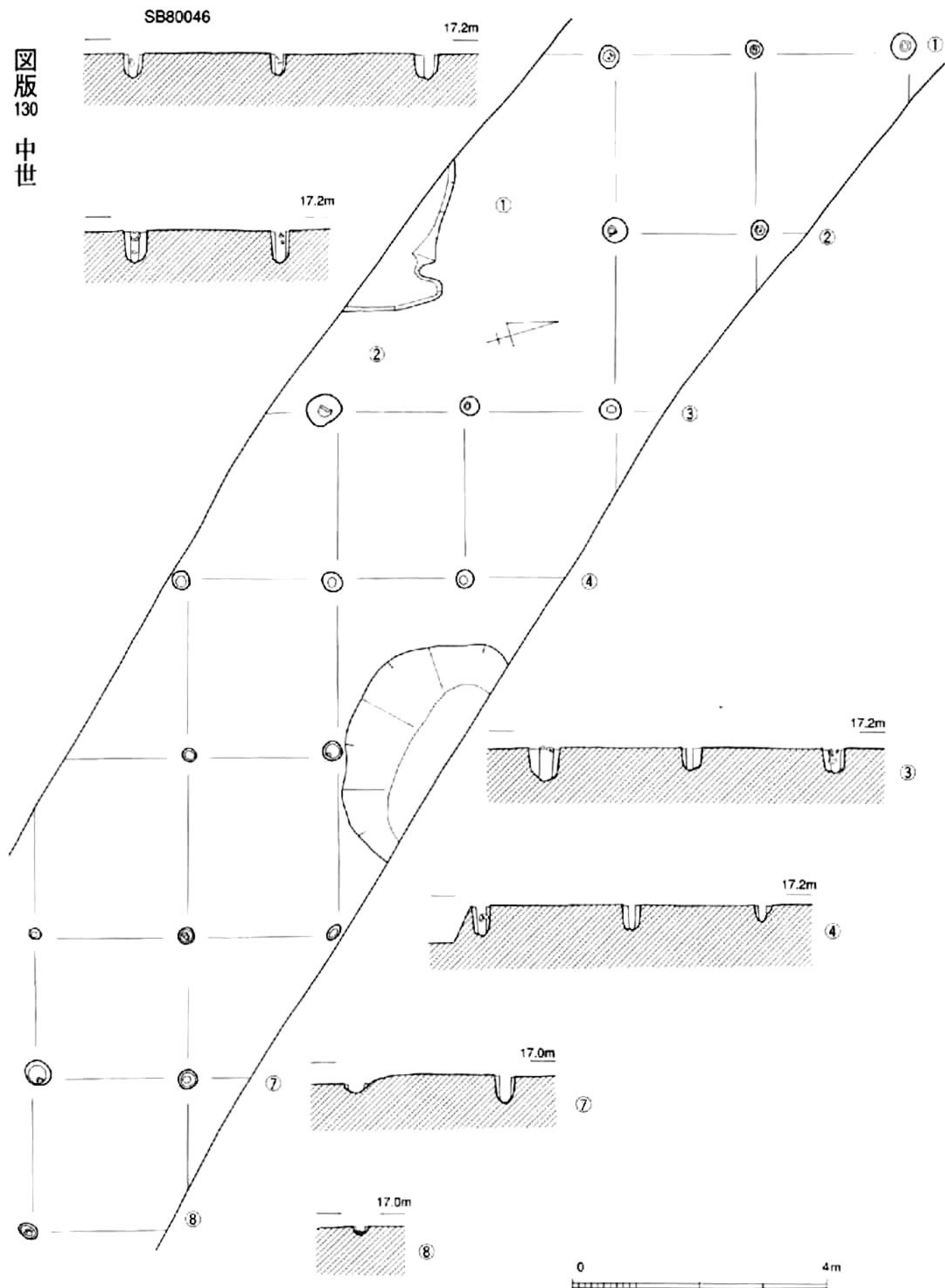

掘立柱建物21 (SB80046)

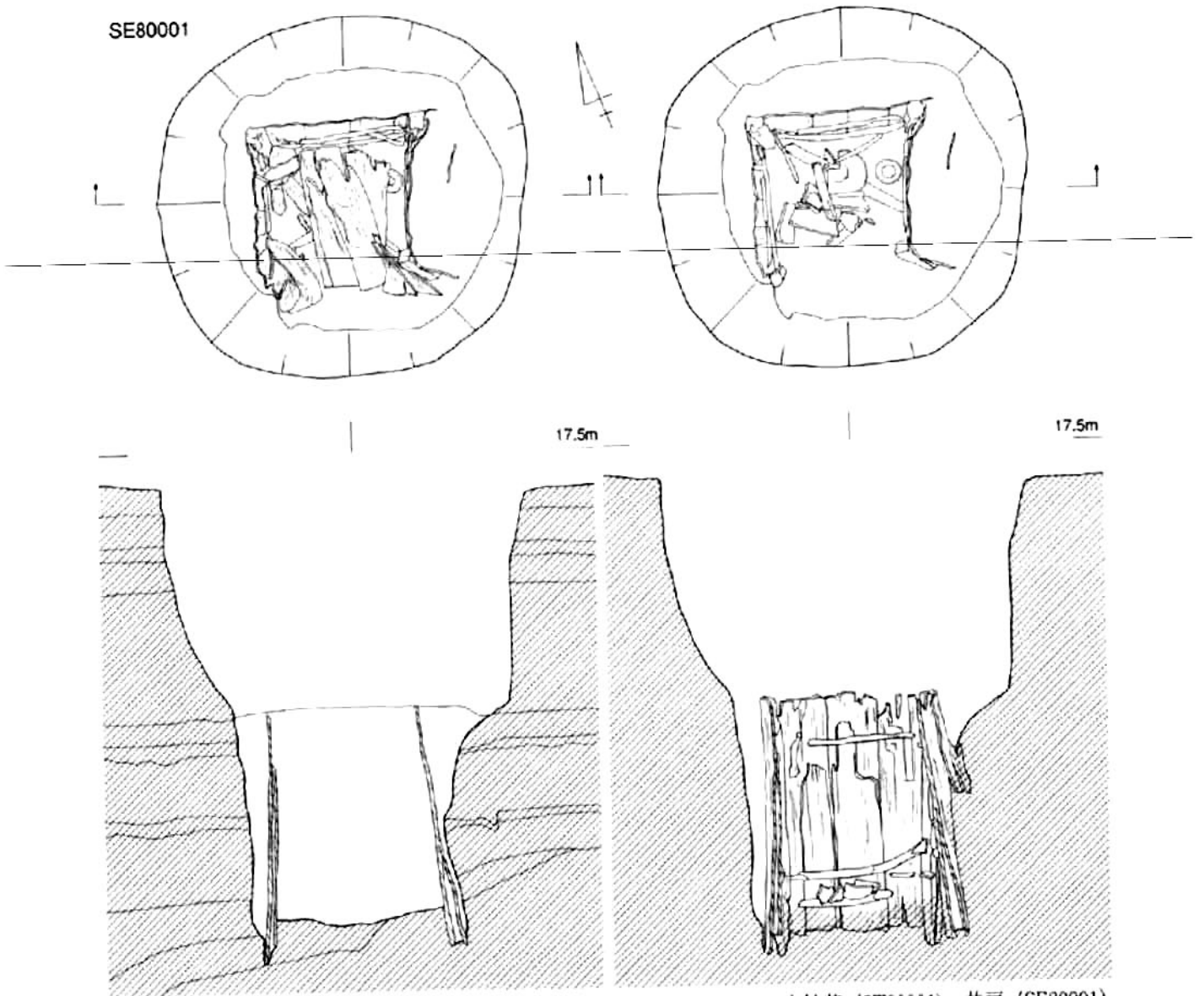
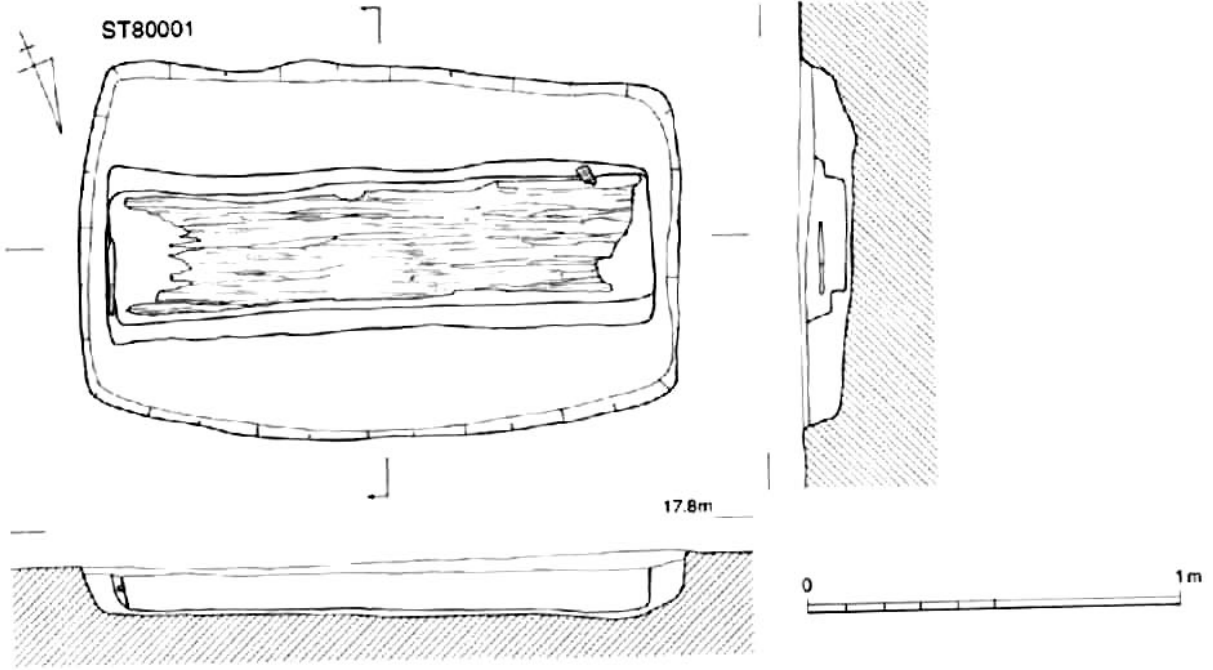

木棺墓 (ST80001)、井戸 (SE80001)

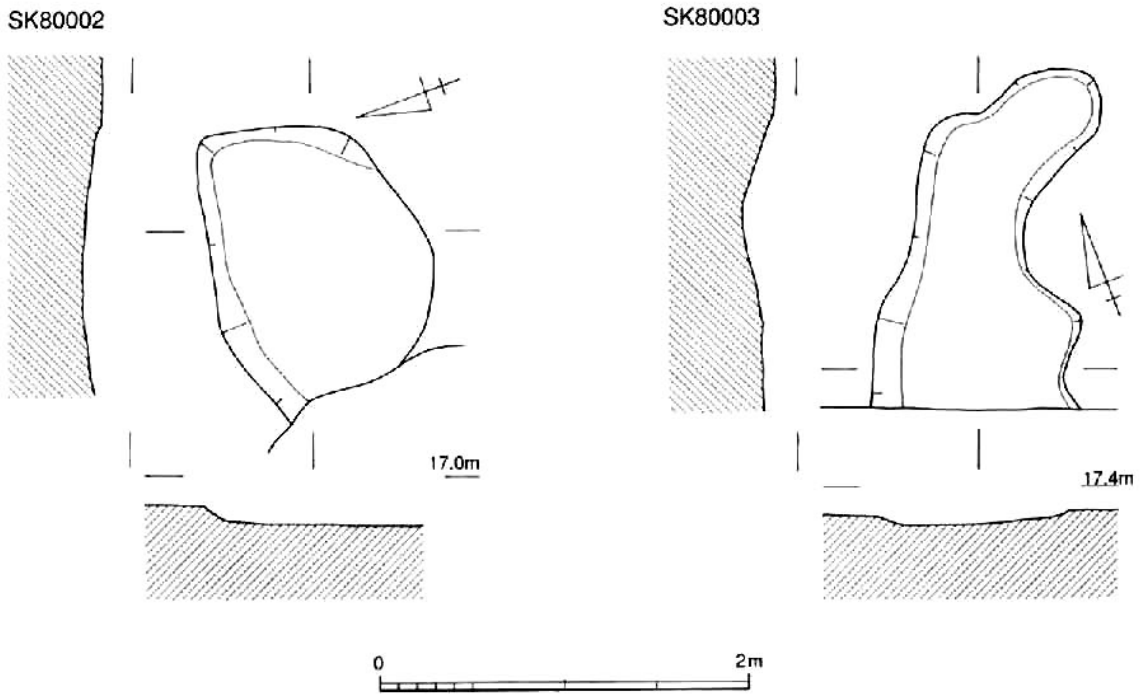
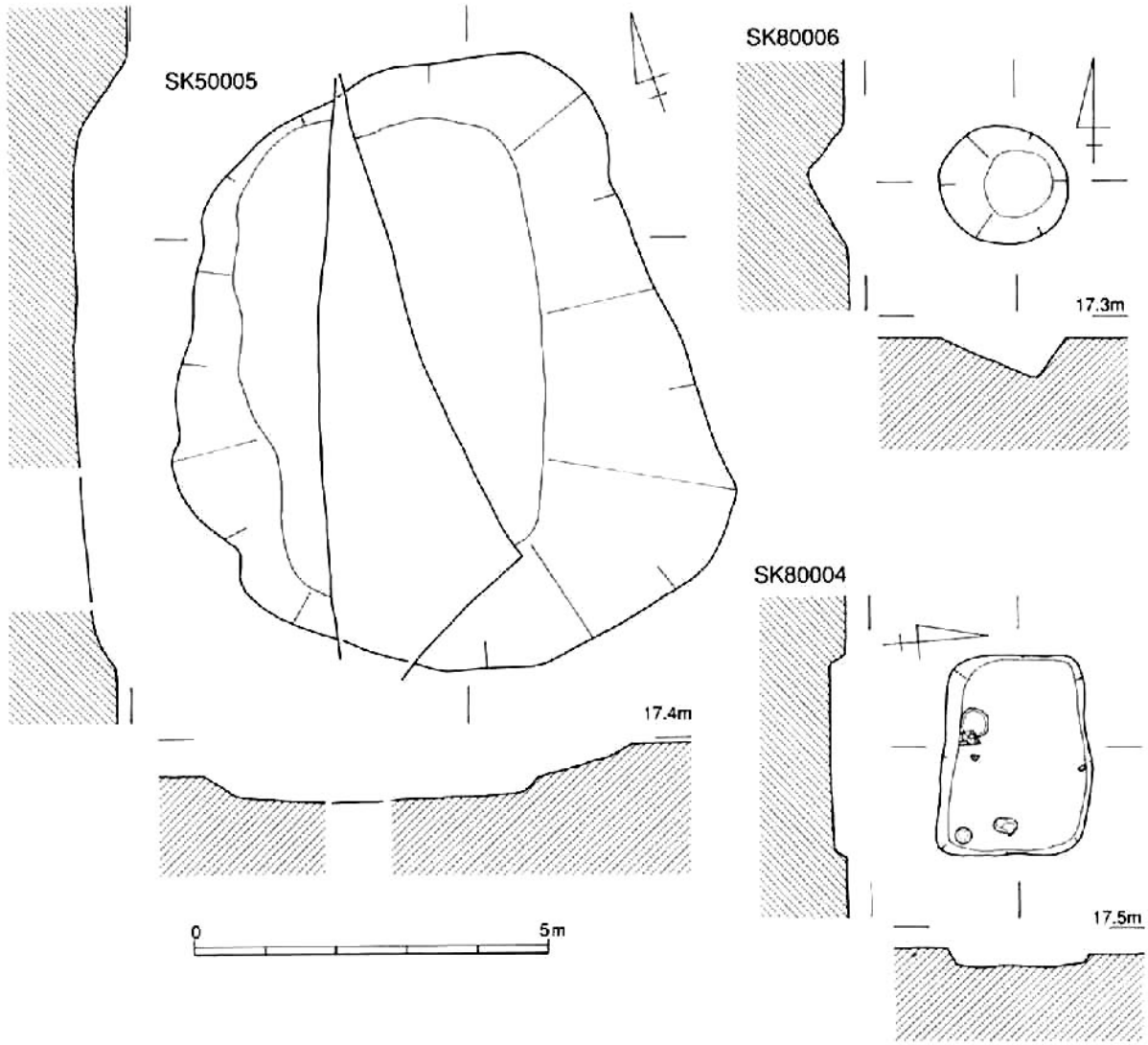

土坑1 (SK80002~80006)

SK80008

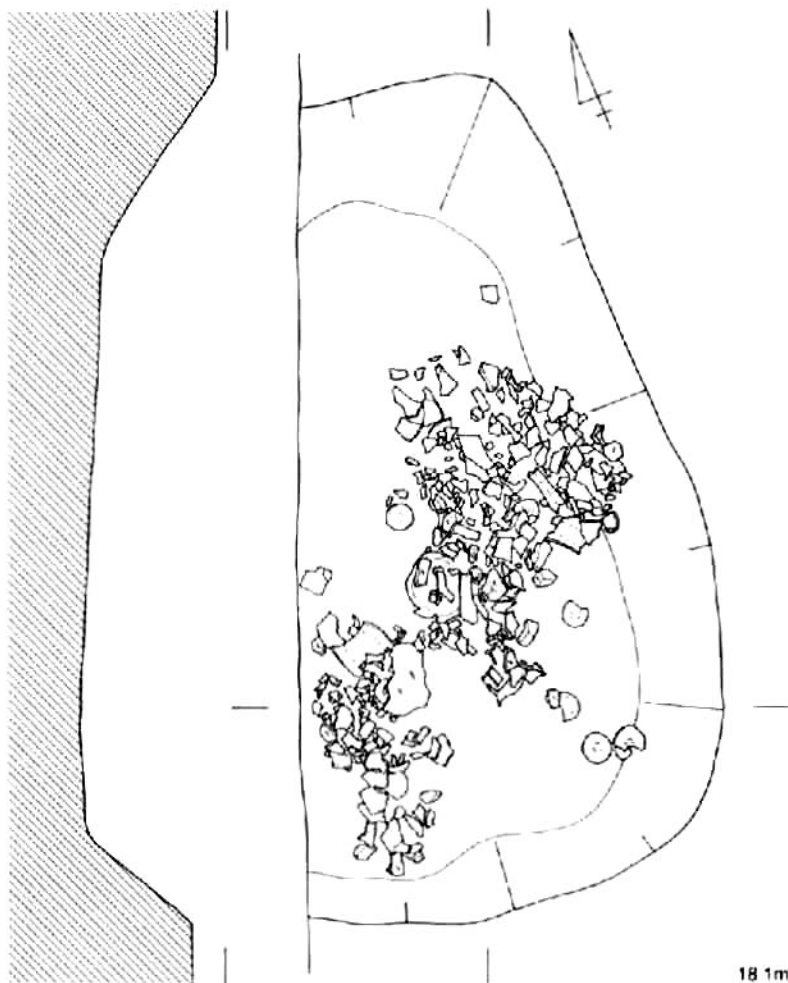

18.1m

- 1. 灰黄 極細砂(Mn・Fe₂O₃含む)
- 2. 暗灰黄 シルト質極細砂ラミナ(Mn・Fe₂O₃含む)
- 3. 黄灰 シルト(Mn・Fe₂O₃含む)

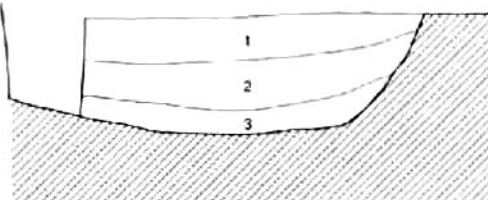

SK80009

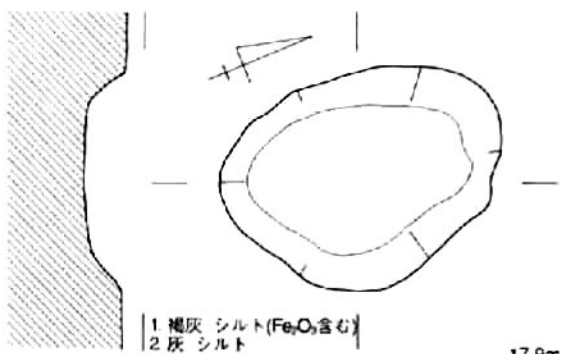
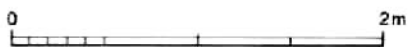

17.9m

- 1. 褐灰 シルト(Fe₂O₃含む)
- 2. 灰 シルト

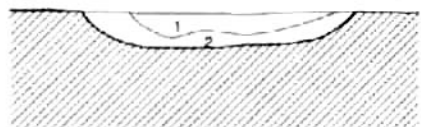

SK80007

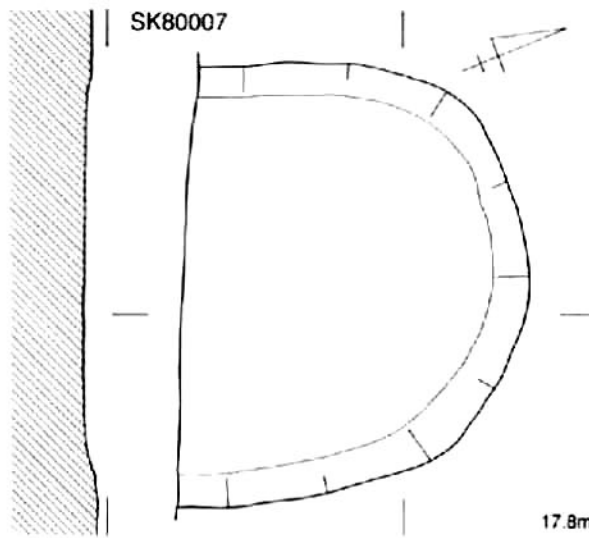

17.8m



土坑2 (SK80007~80009)

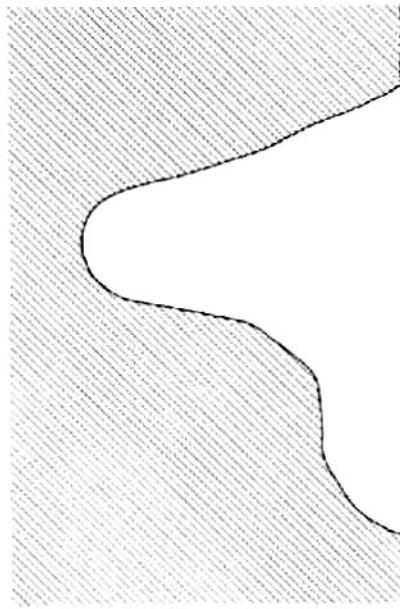

SK80010

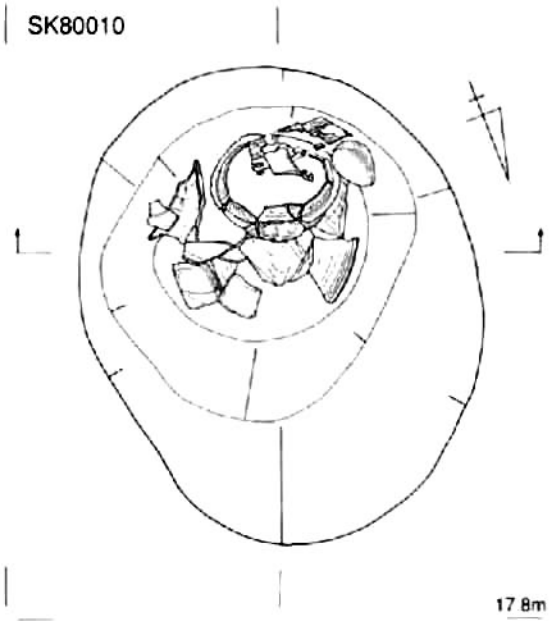

SK80014

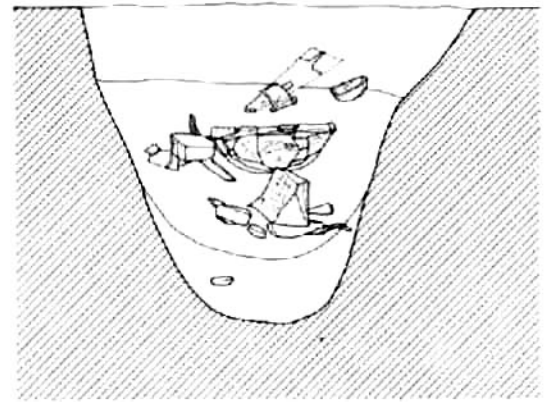
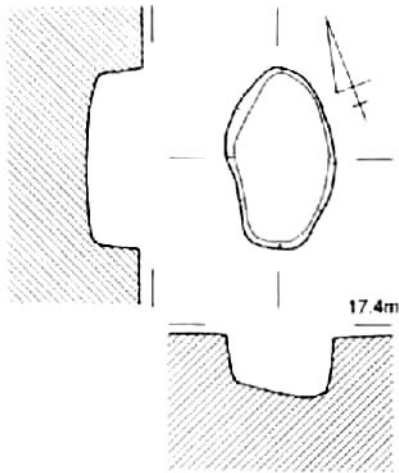

SK80015

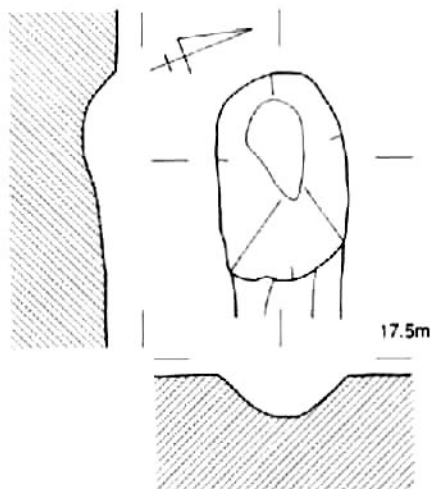

SK80013

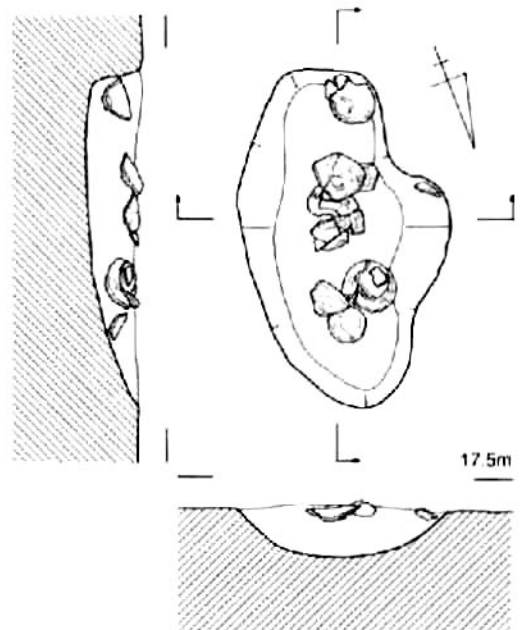

土坑3 (SK800010・80013~80015)

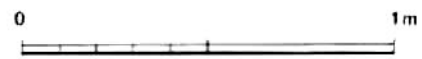

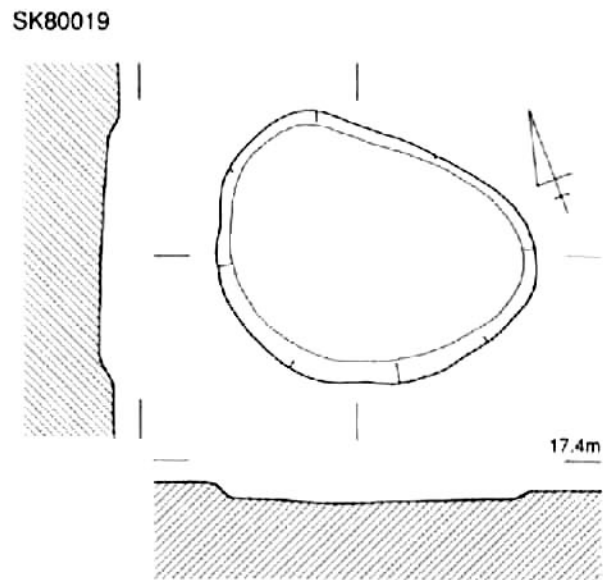
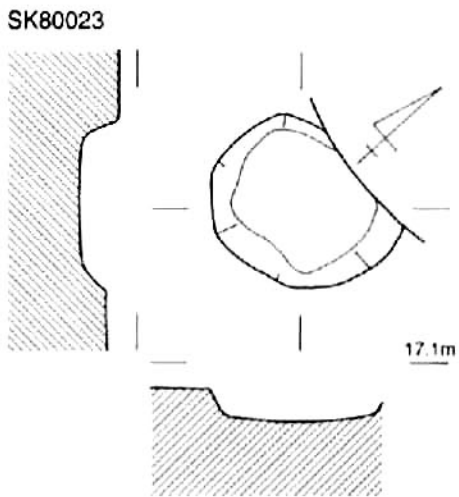
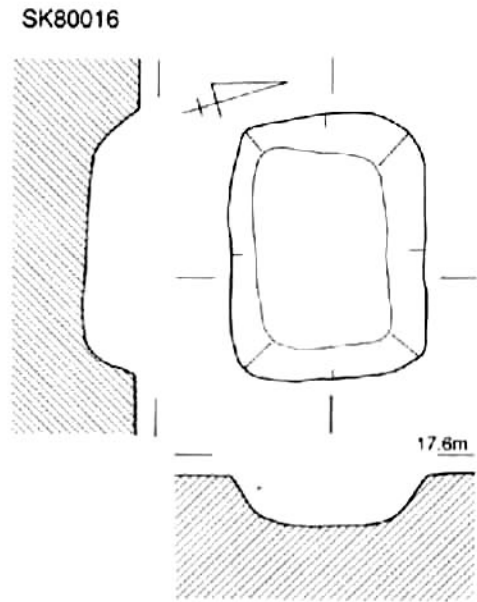
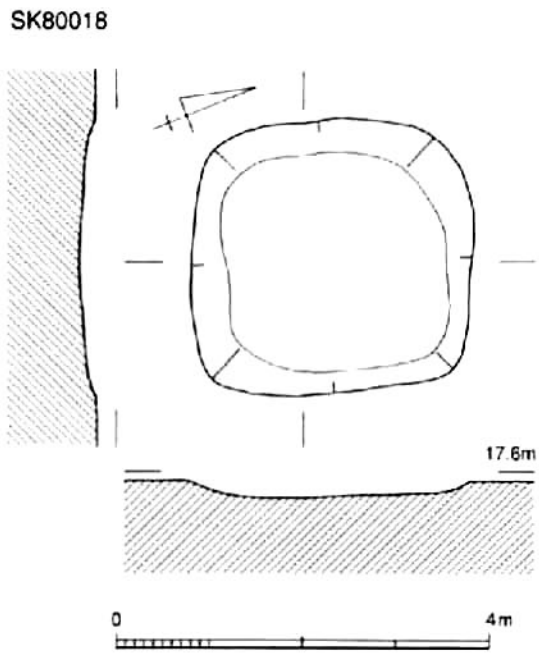
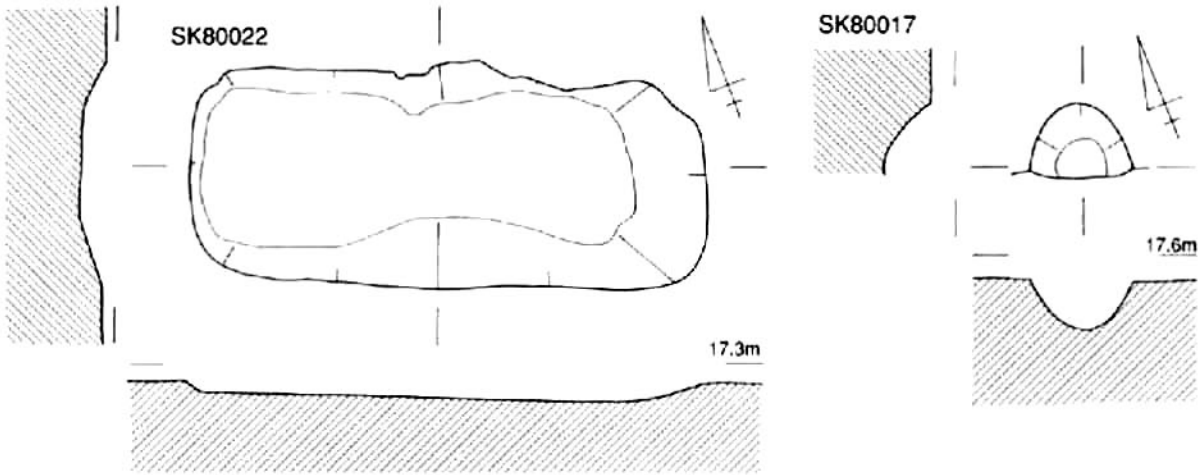

土坑4 (SK80016~80019・80022・80023)

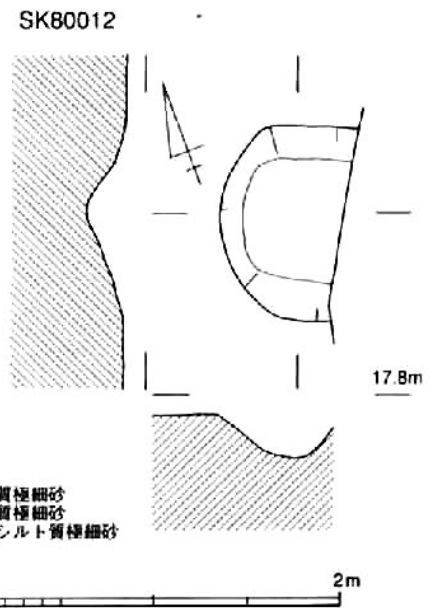
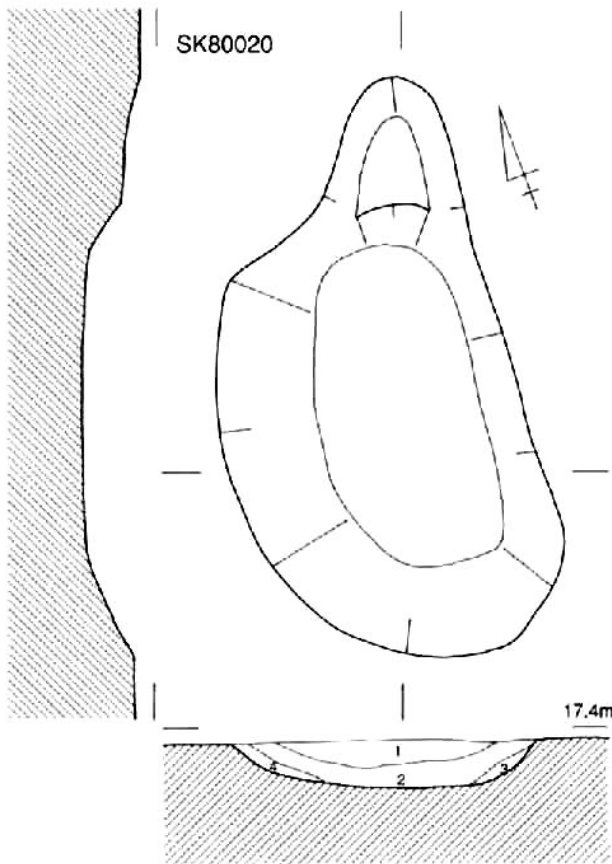
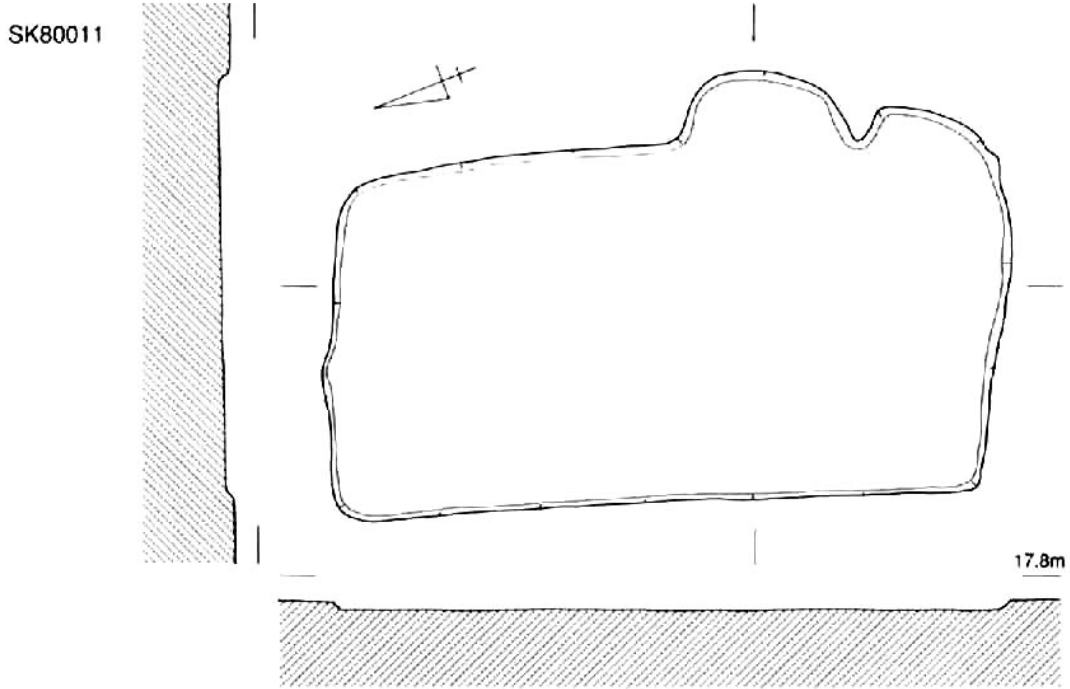

- 1. 灰白 シルト質極細砂
- 2. 灰白 シルト質極細砂
- 3. 灰黄 細砂混シルト質極細砂

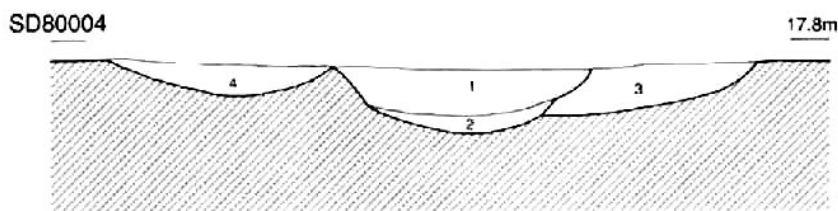
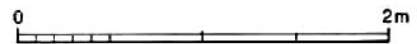

- 1. 暗灰 シルト質極細砂
- 2. 灰 中砂
- 3. 灰褐 極細砂
- 4. 灰 シルト質極細砂

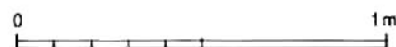

土坑5 (SK80011・80012・80020)、溝 (SD80004)

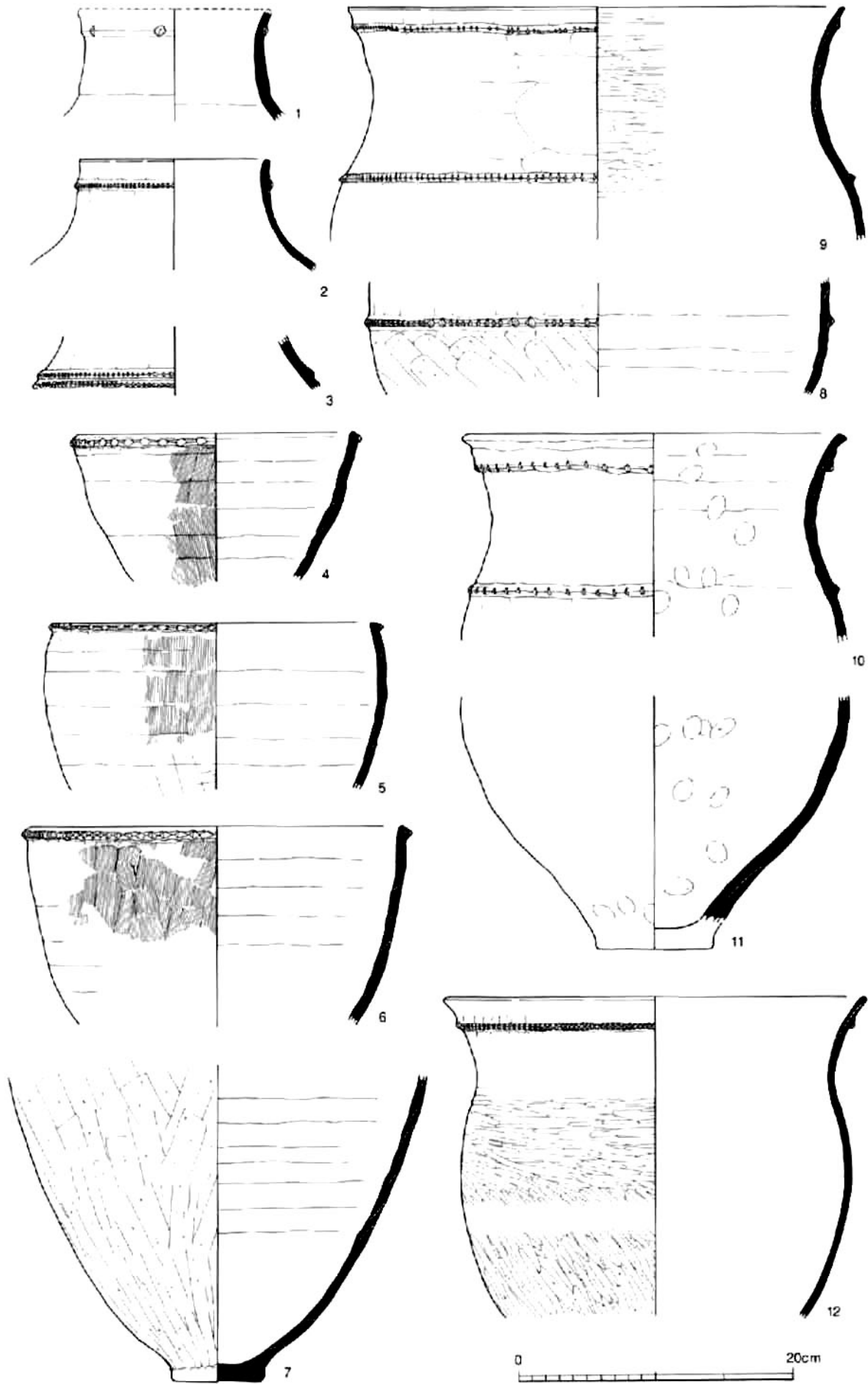

土器1 (河道/1~12)



土器2 (河道/13~25)

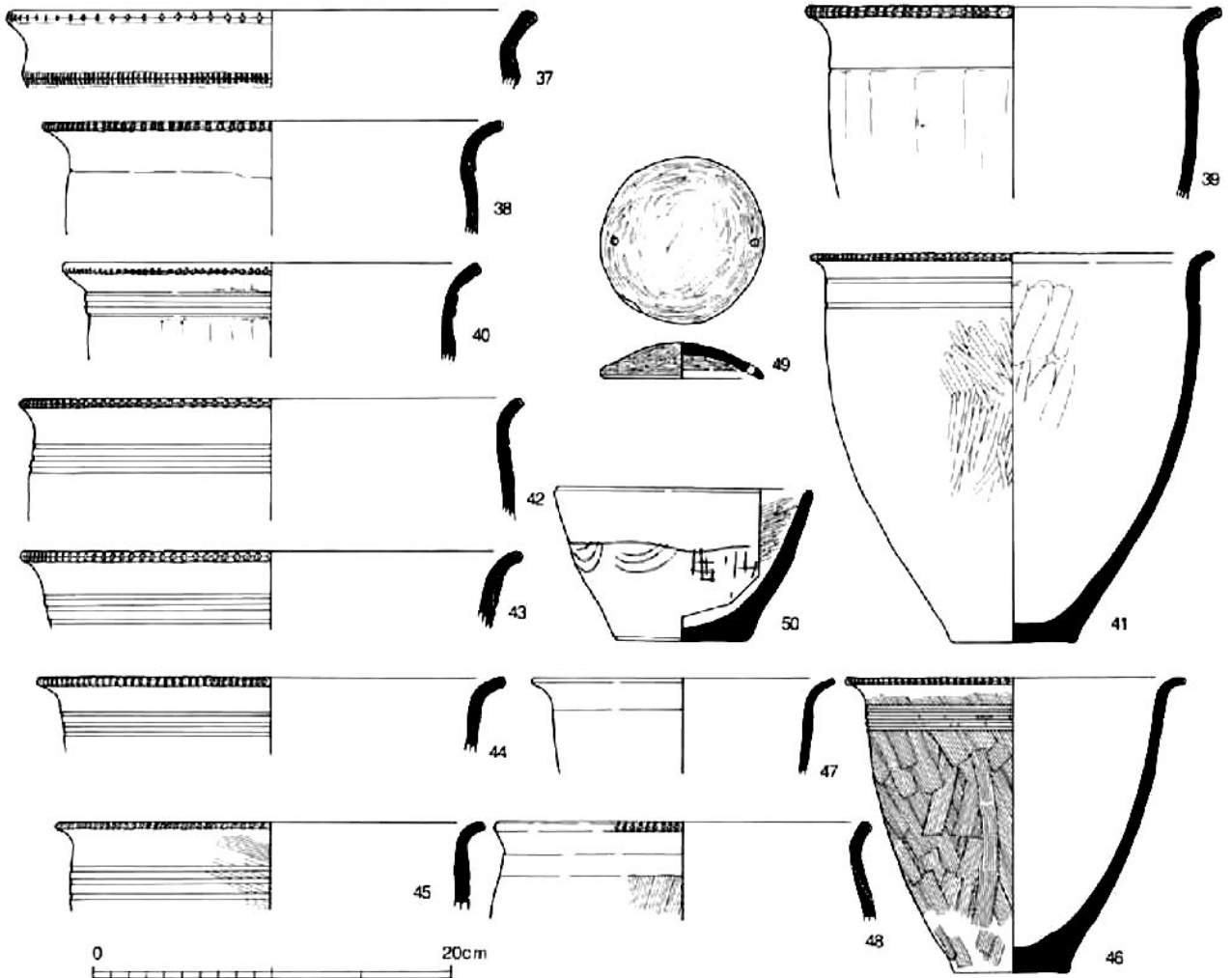
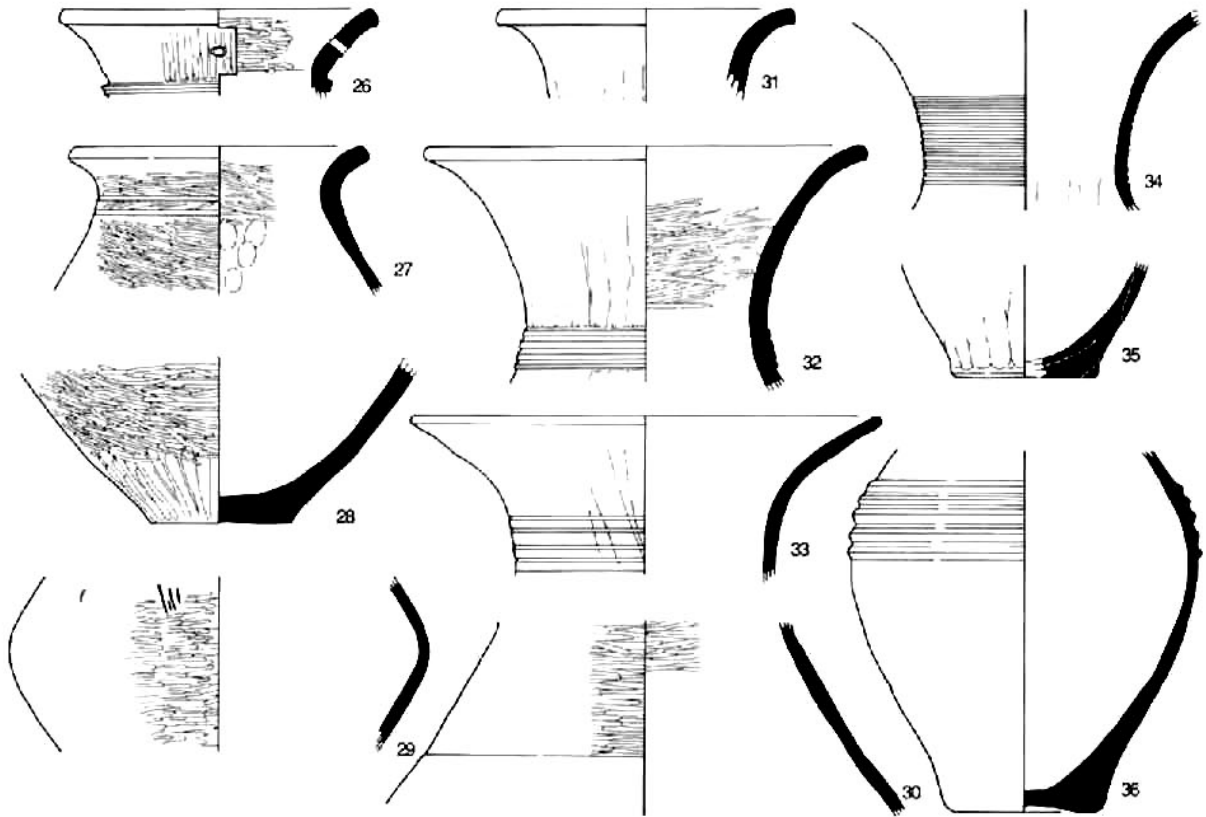

土器1 (26~50)



51

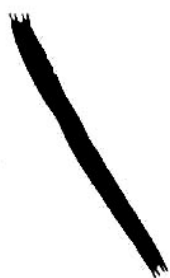

58



52



59



53



60



54



61



55



56



57



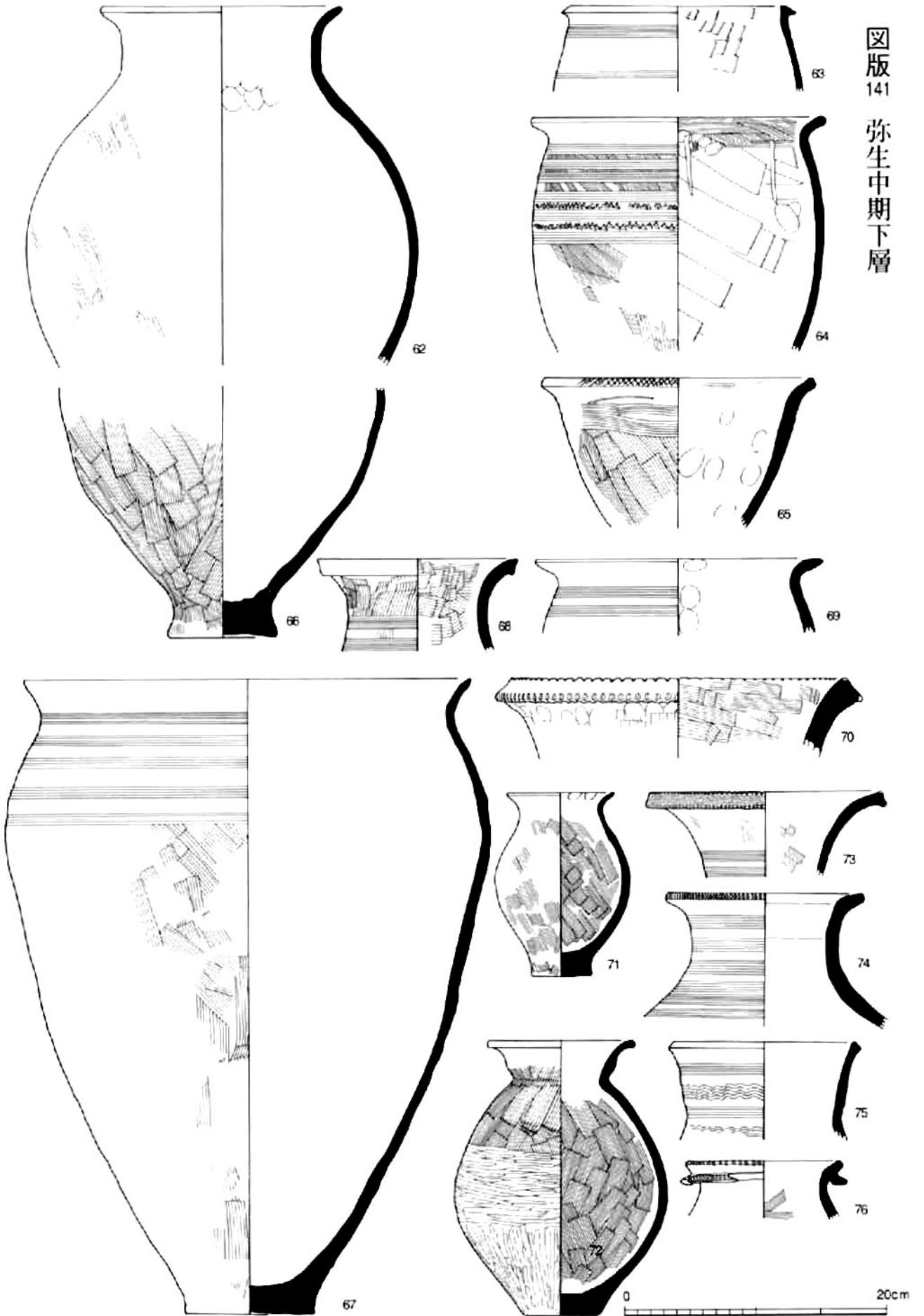

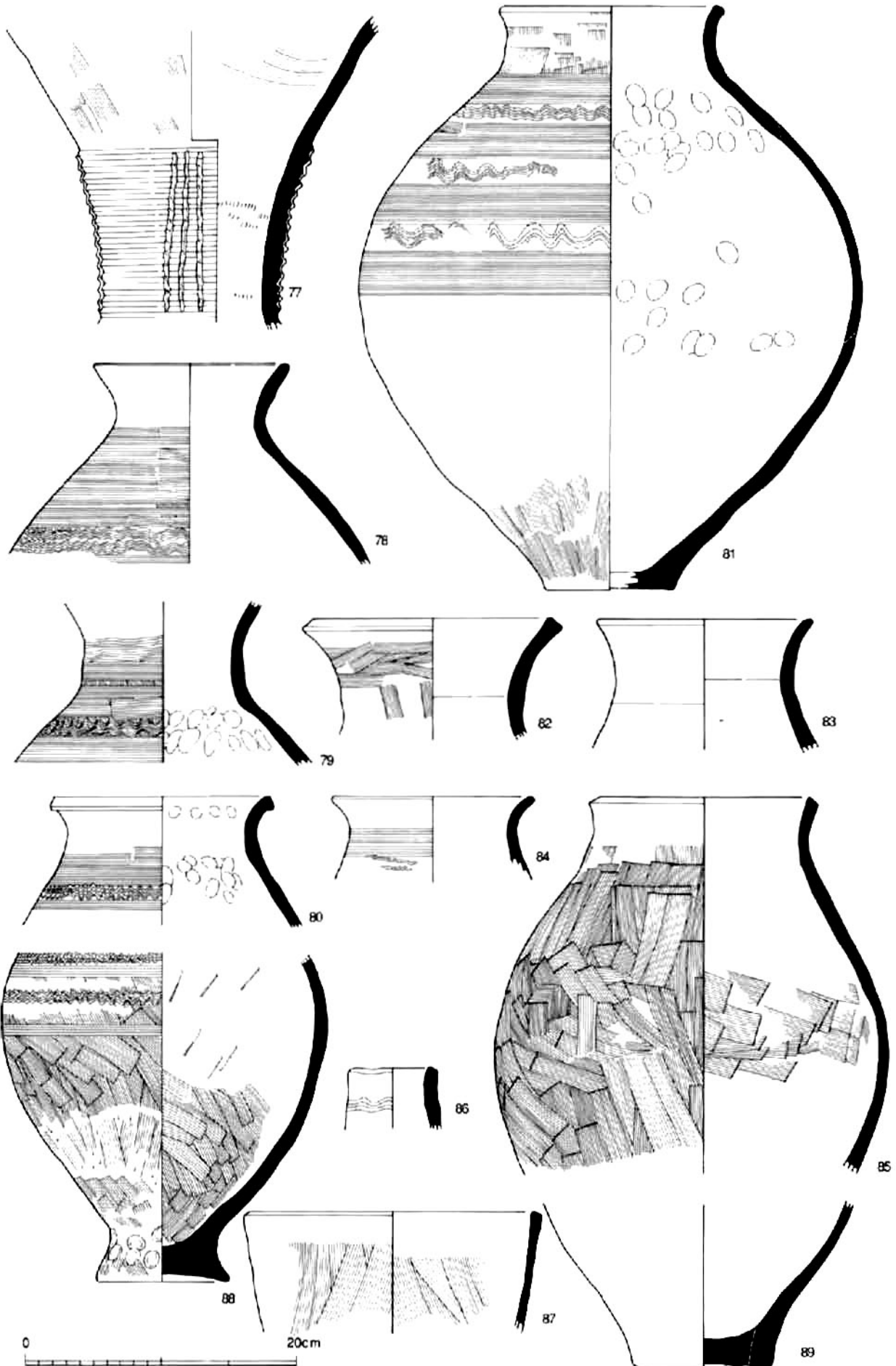

土器2 (溝・土坑・竪穴住居/77-89)

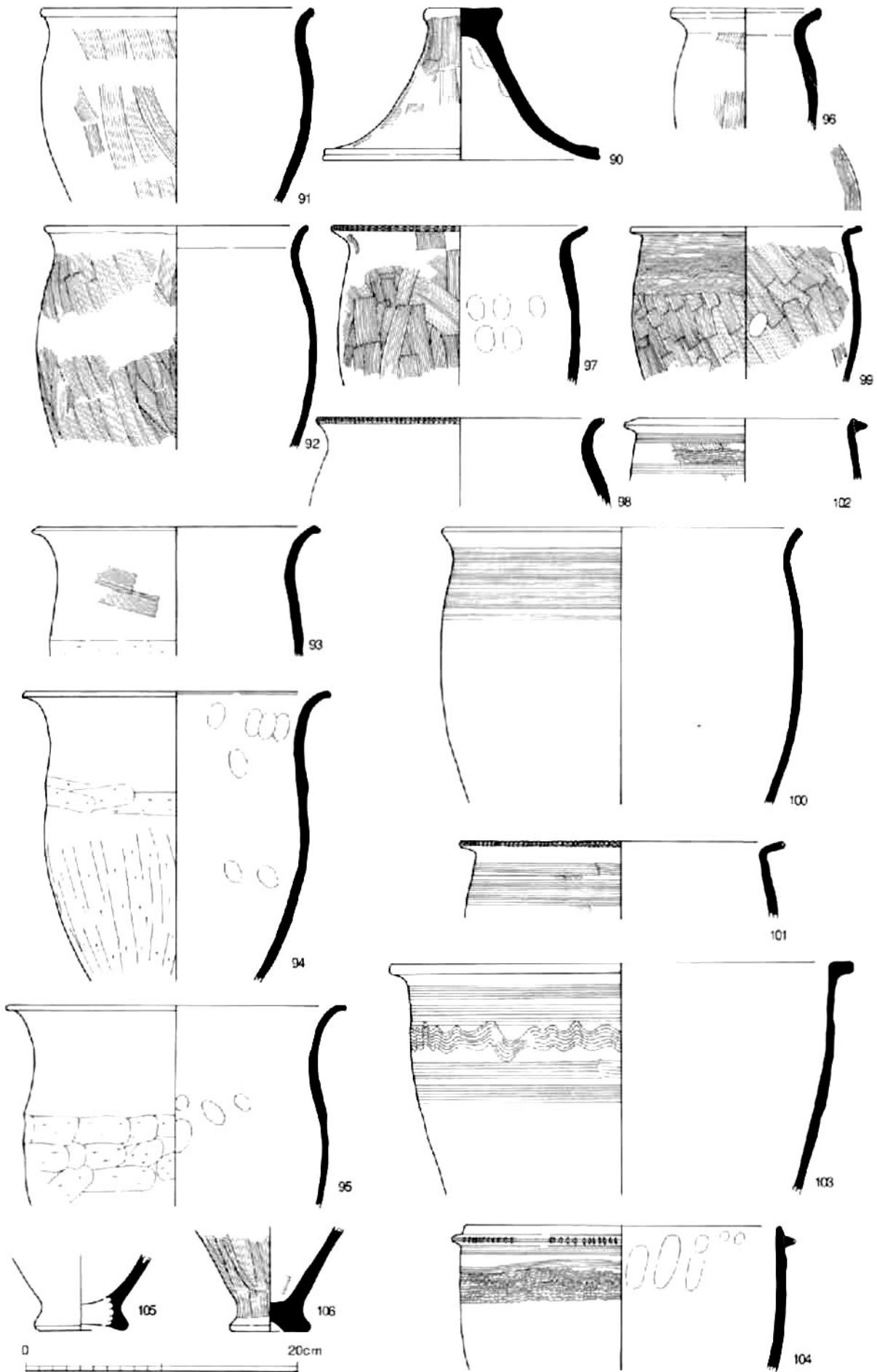

土器3 (溝/90~106)

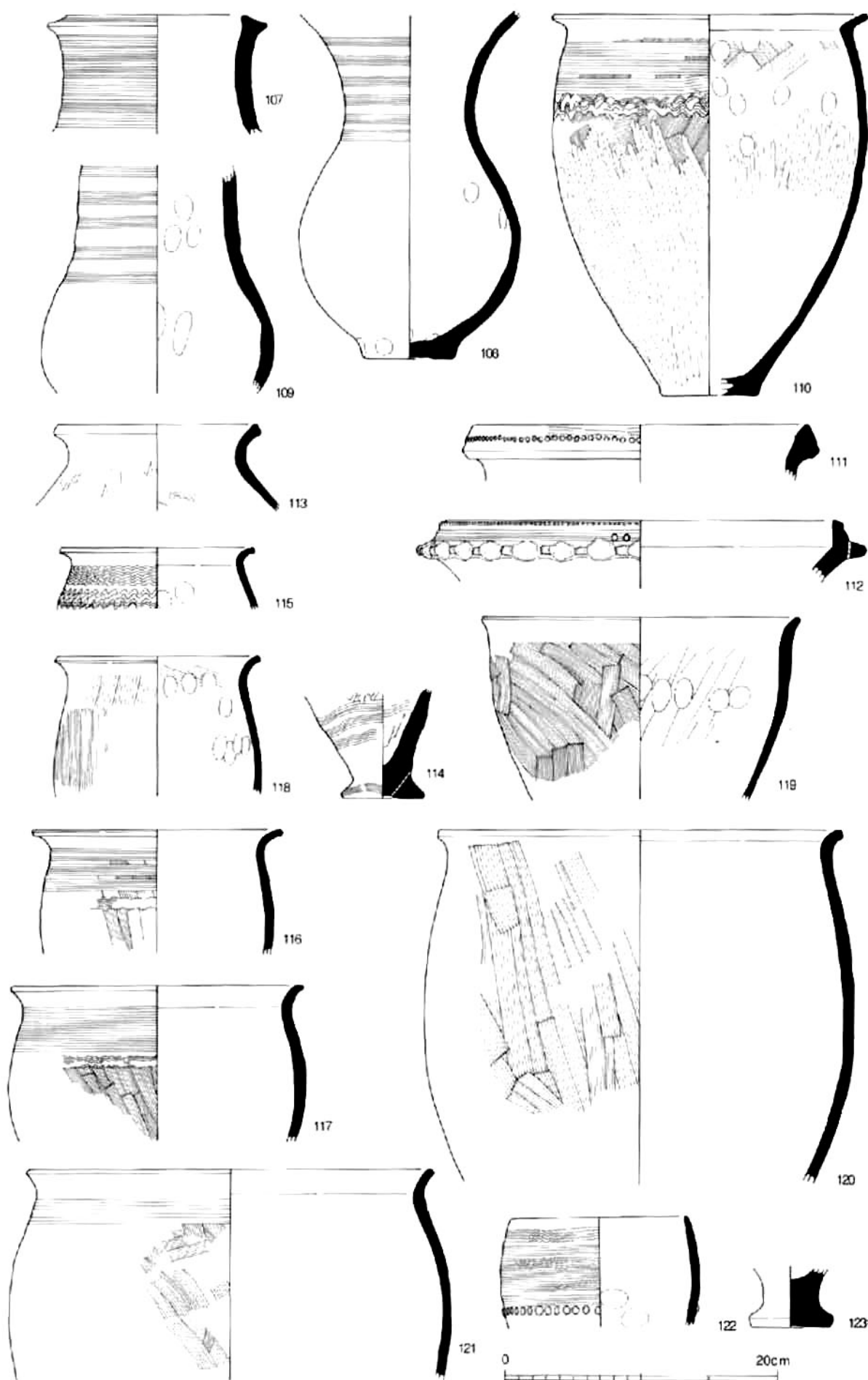

土器4 (土坑・竪穴住居/107~123)

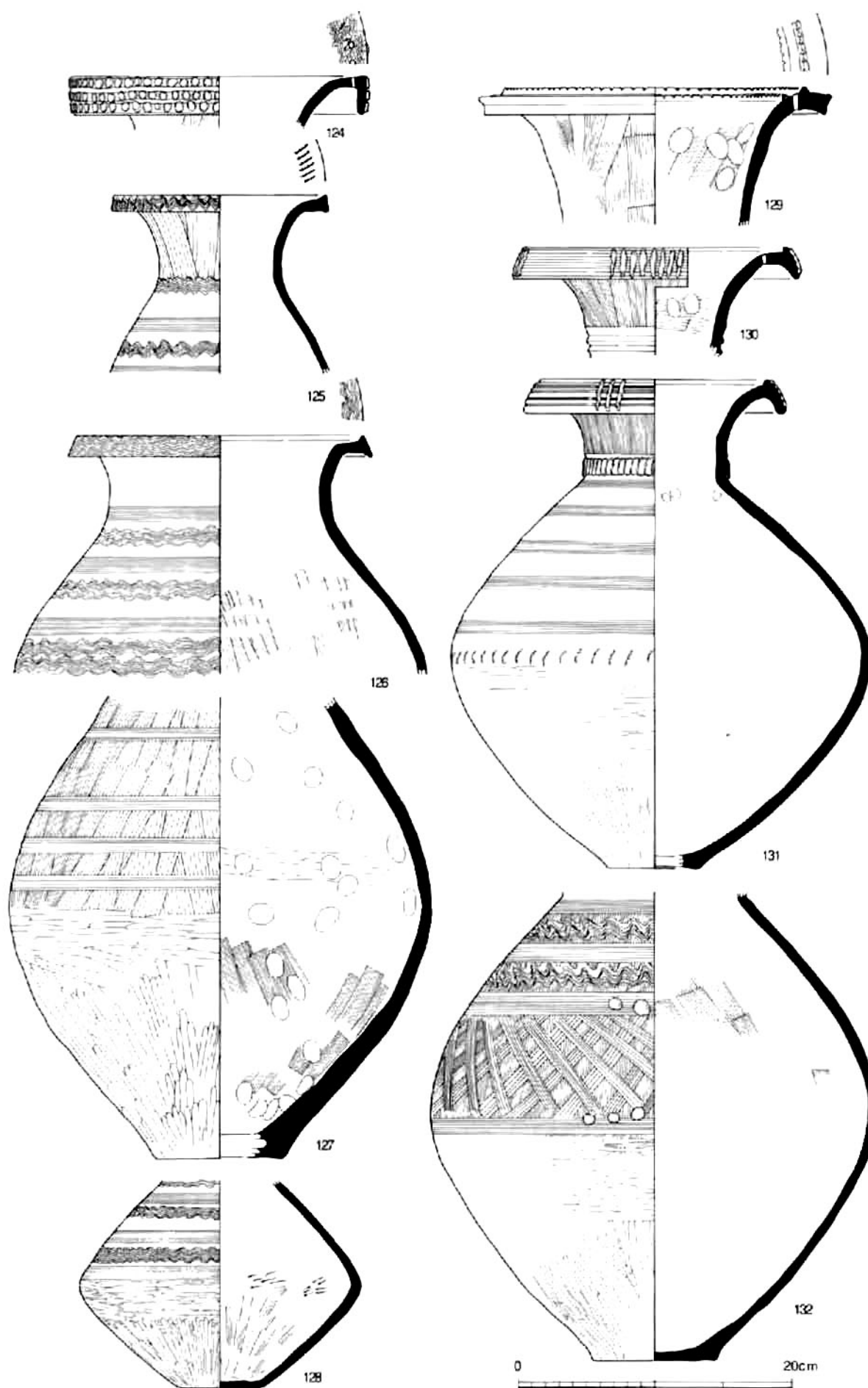

土器1 (河道/124~132)

图版 146
弥生中期上層

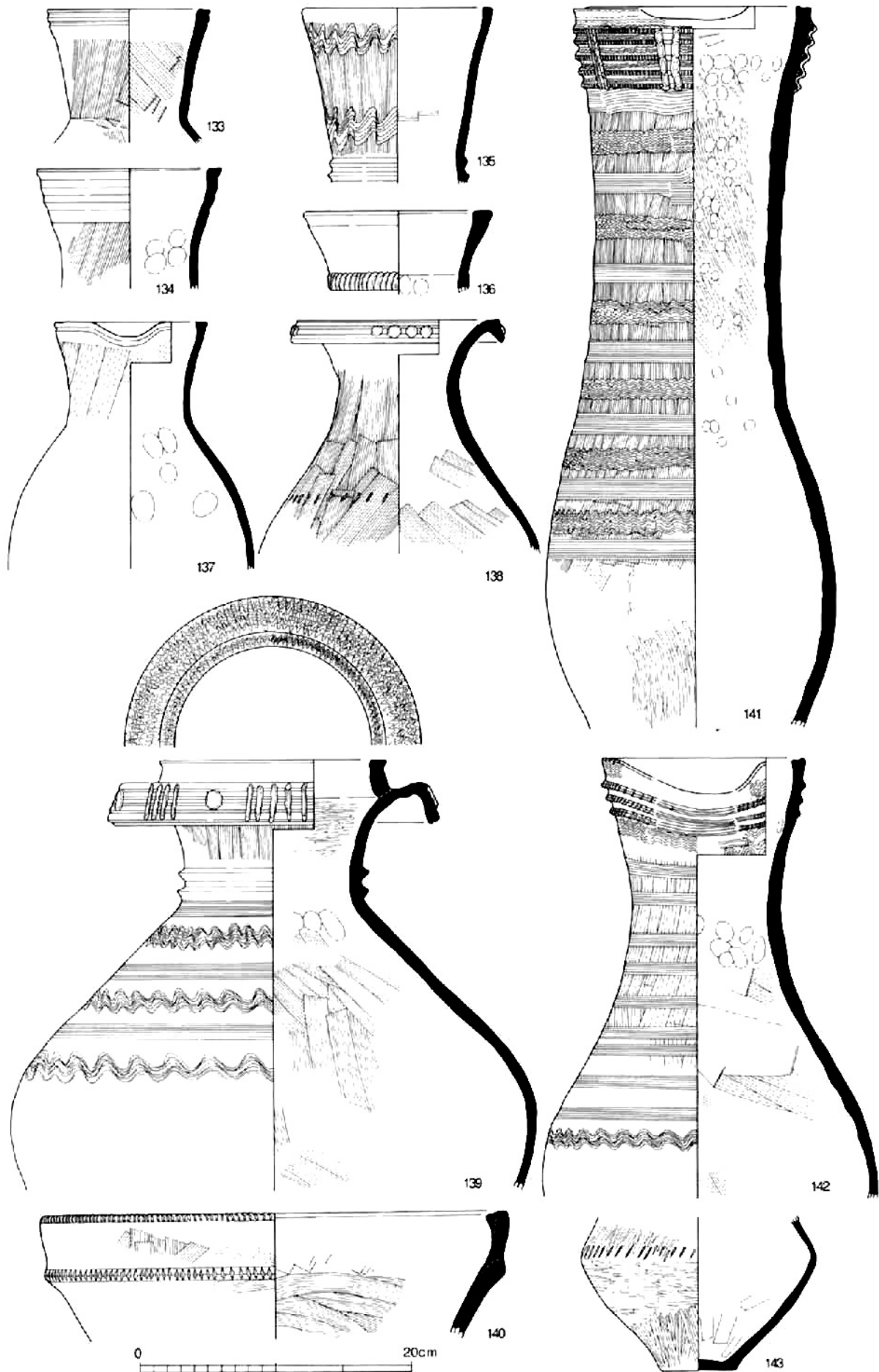

土器2 (河道/133~143)

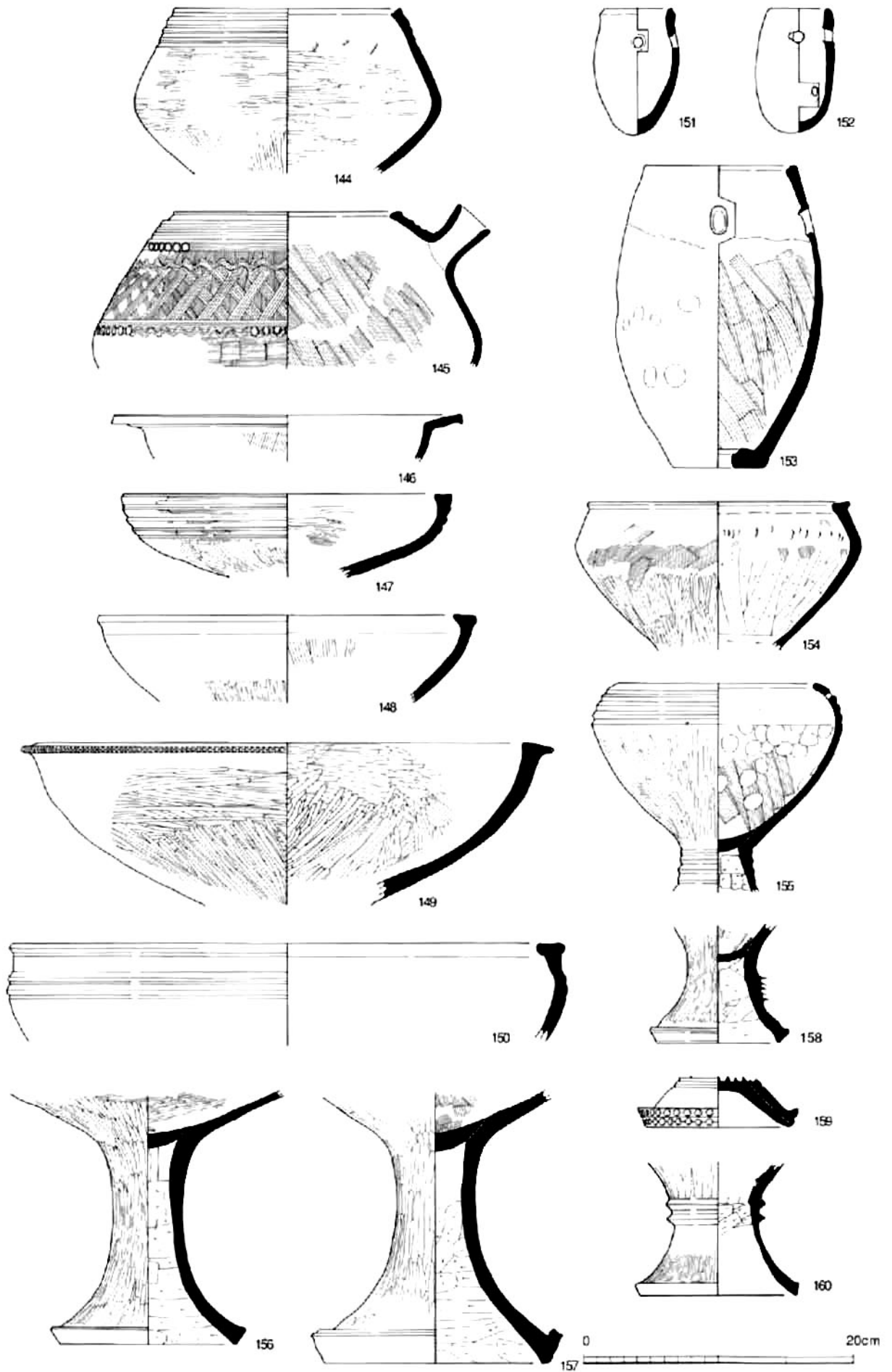

土器3 (河道/144~160)

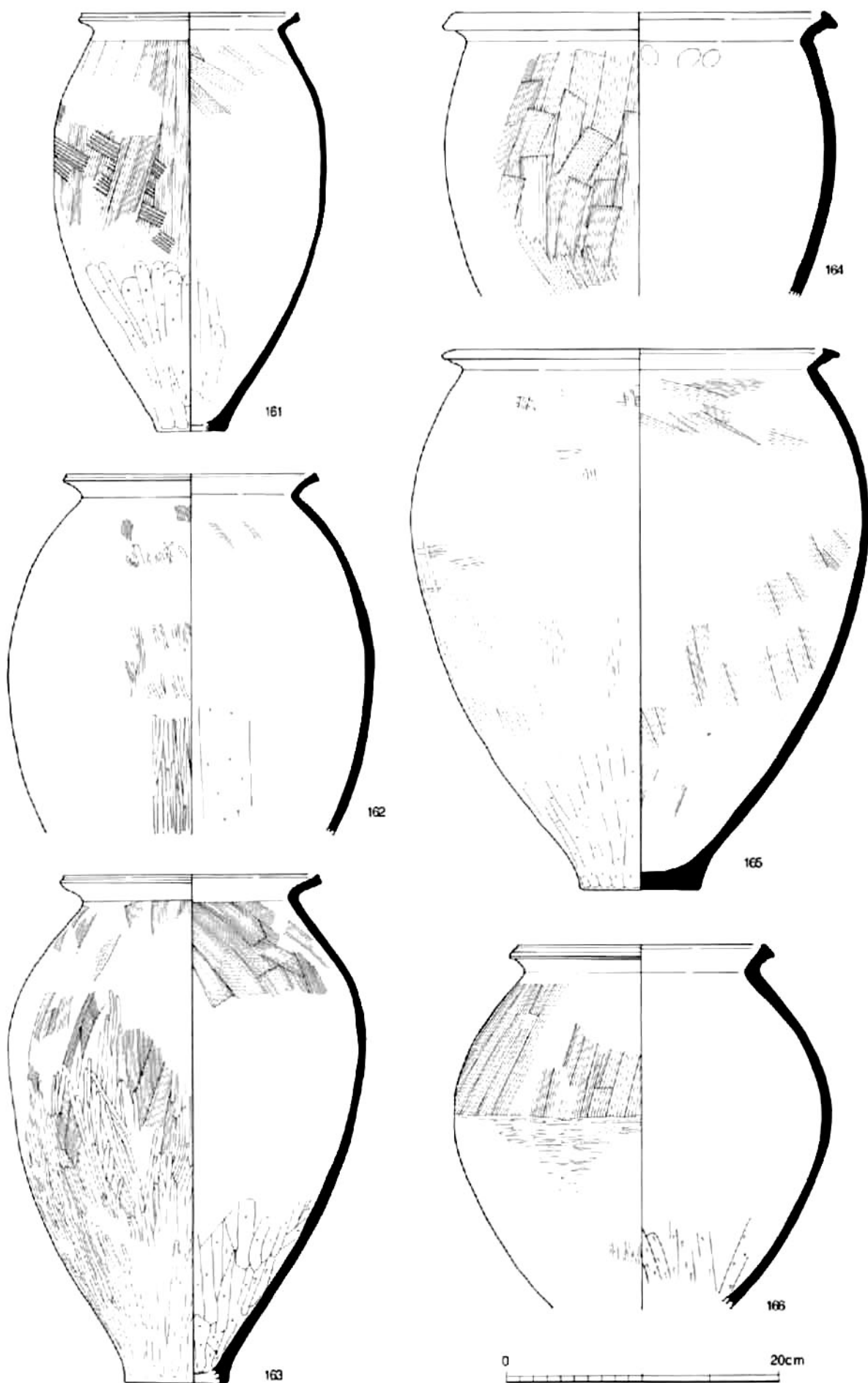

土器4 (河道/161~166)

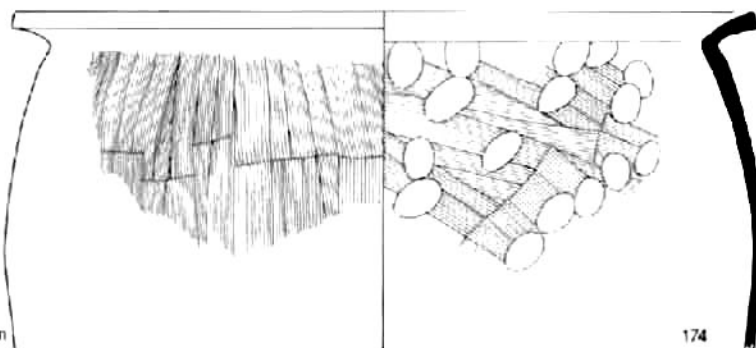
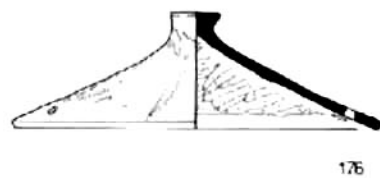
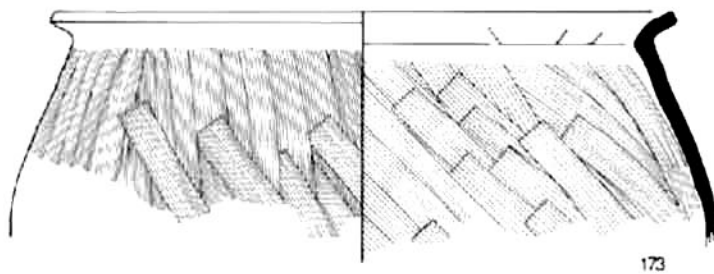
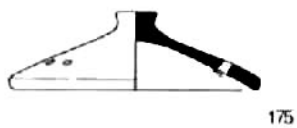
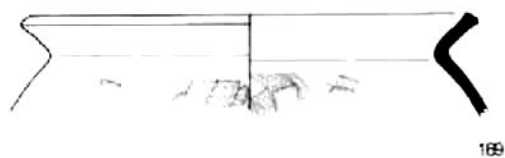
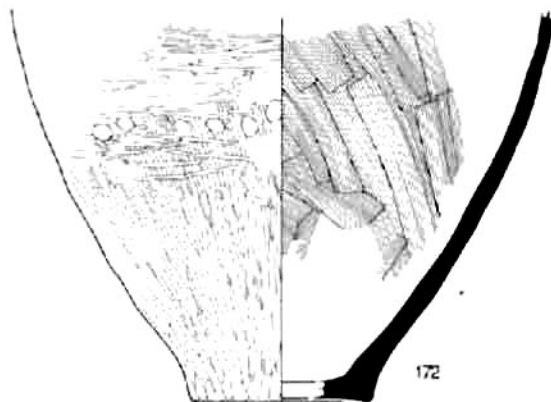
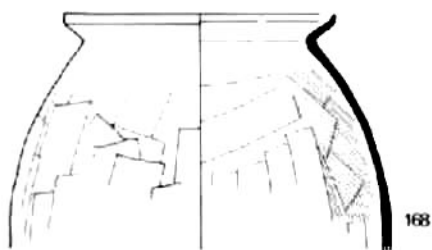
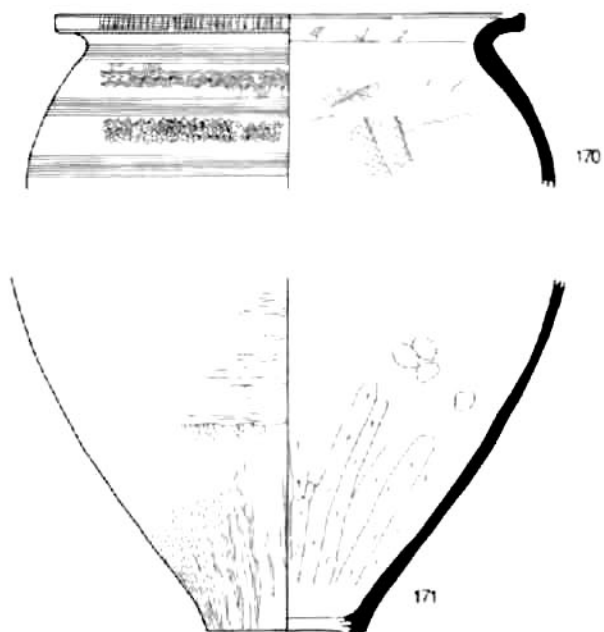
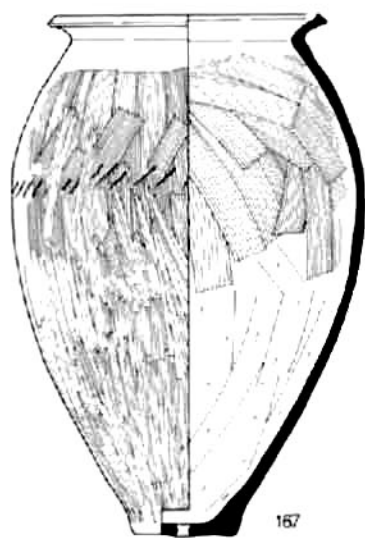

0 20cm

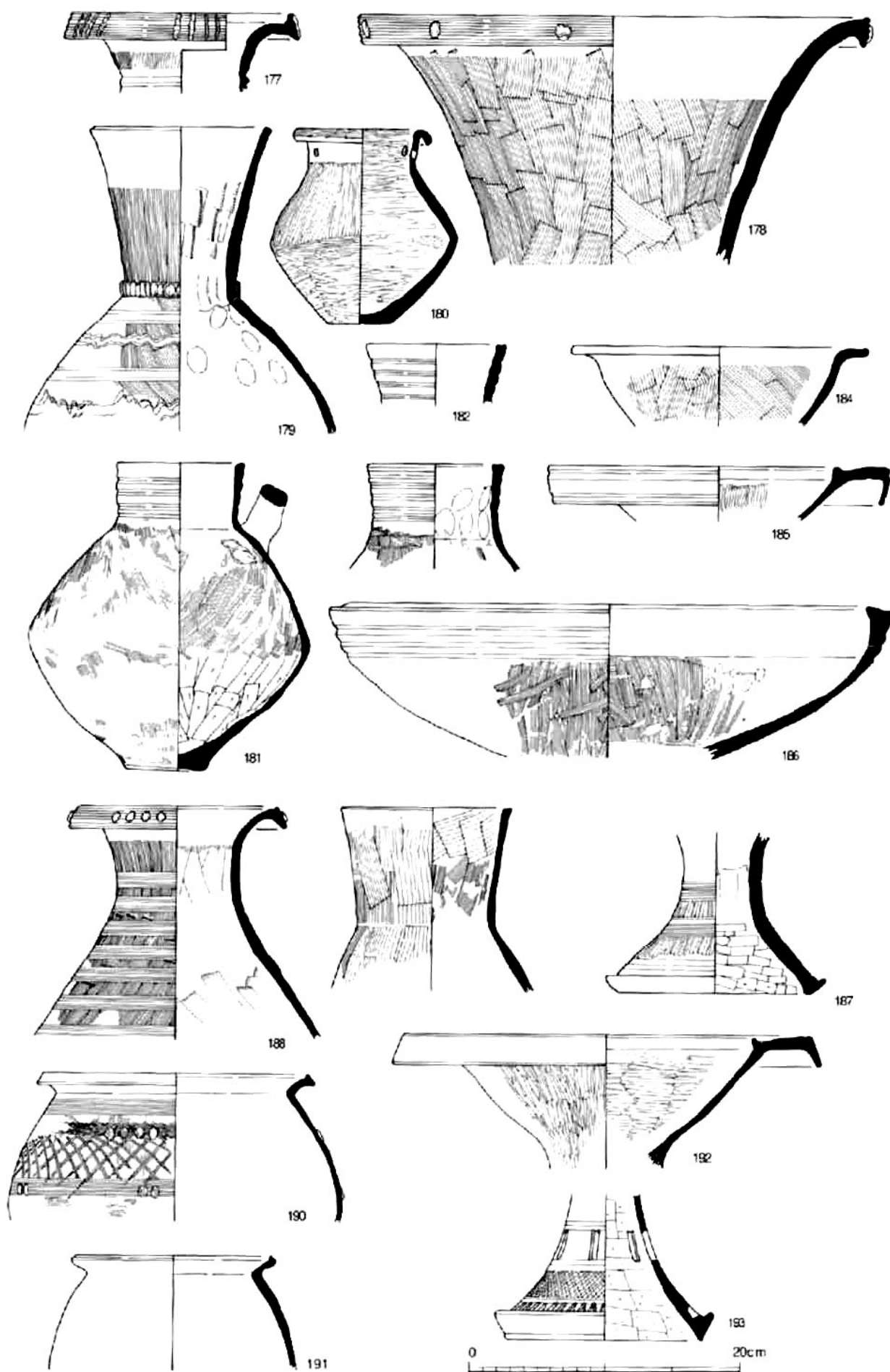

土器6 (河道・溝/177~193)

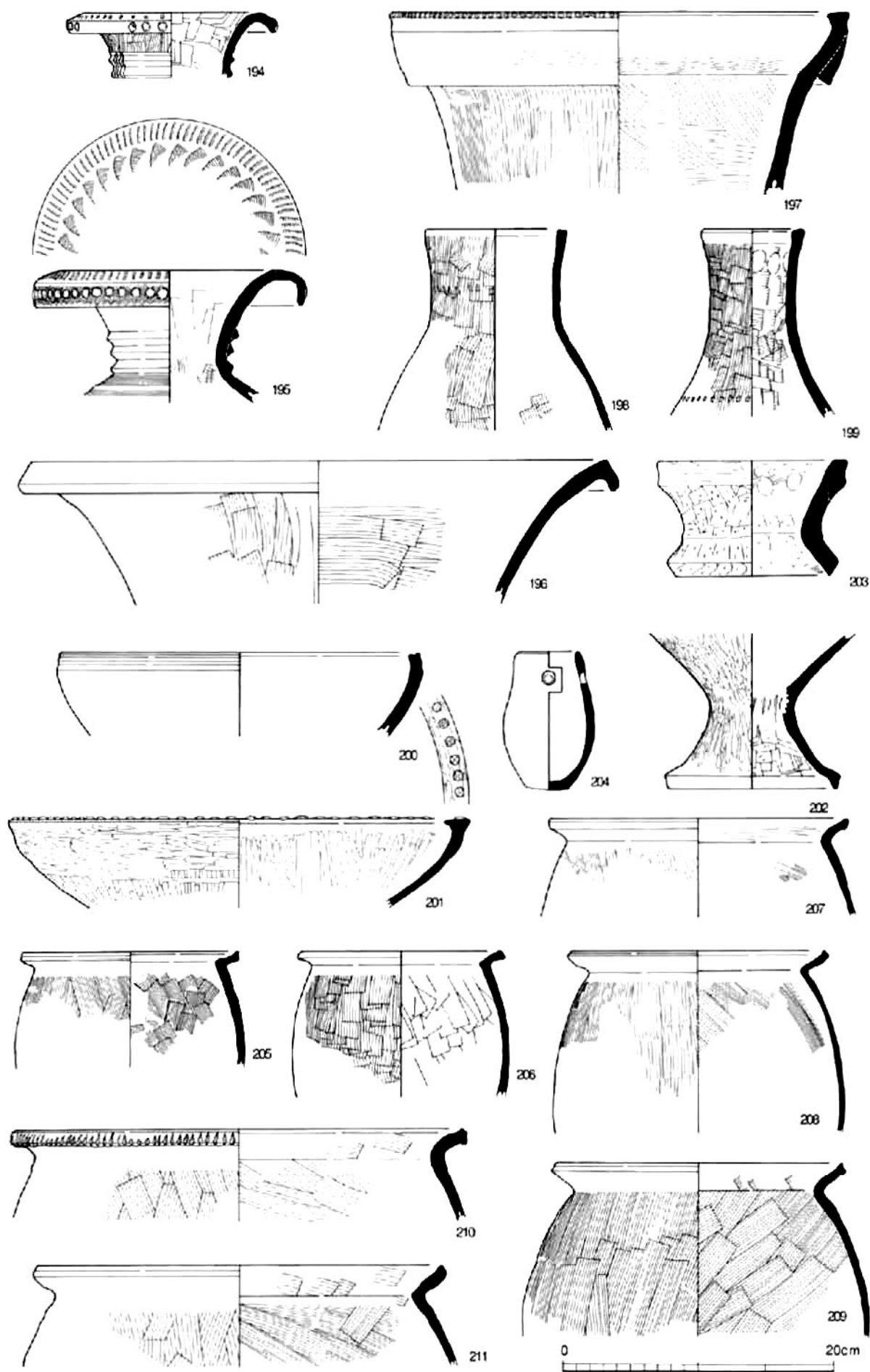

土器7 (溝/194~211)

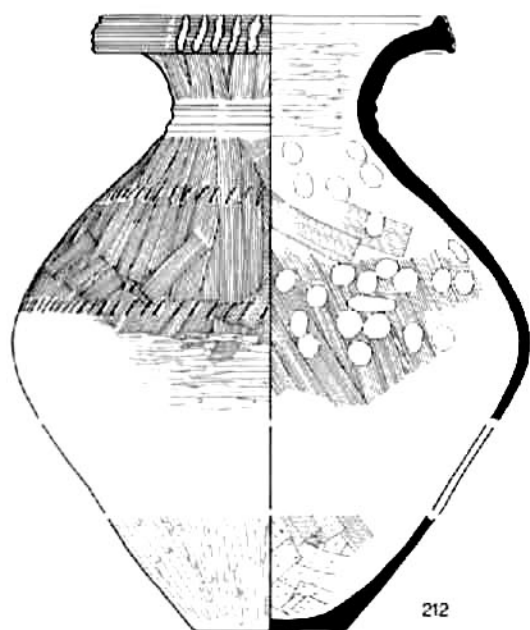

212

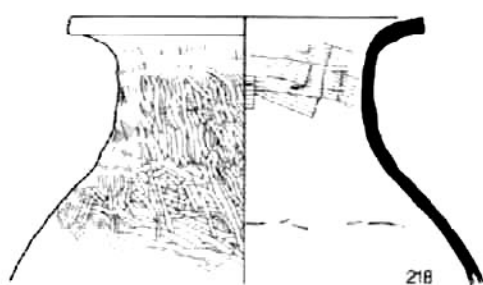

218

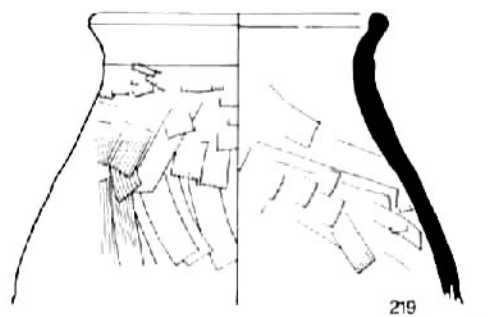

219

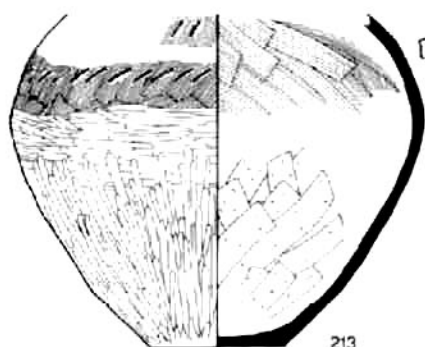

213

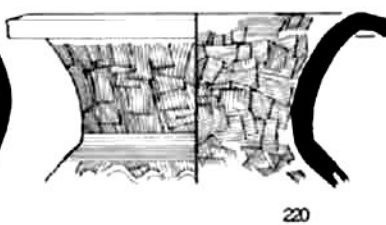

220

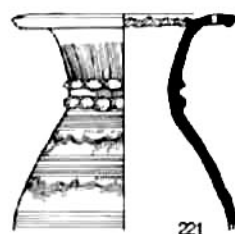

221

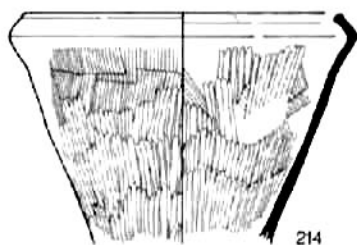

214

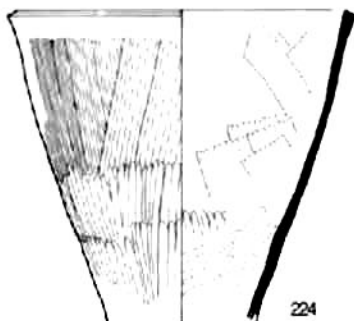

224

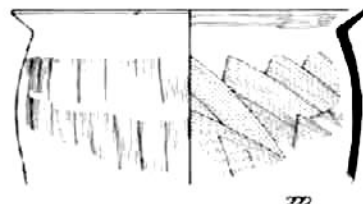

222

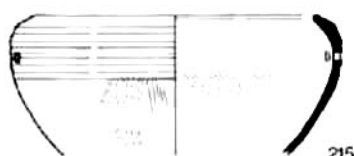

215



225

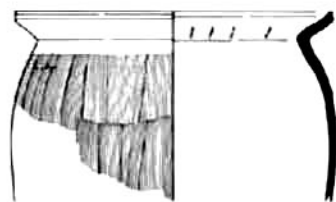

223

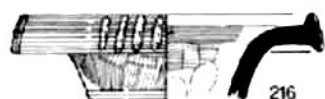

216

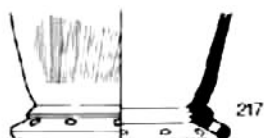

217

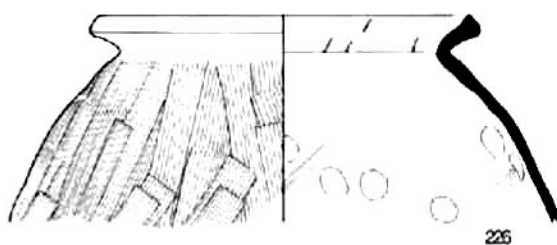

226



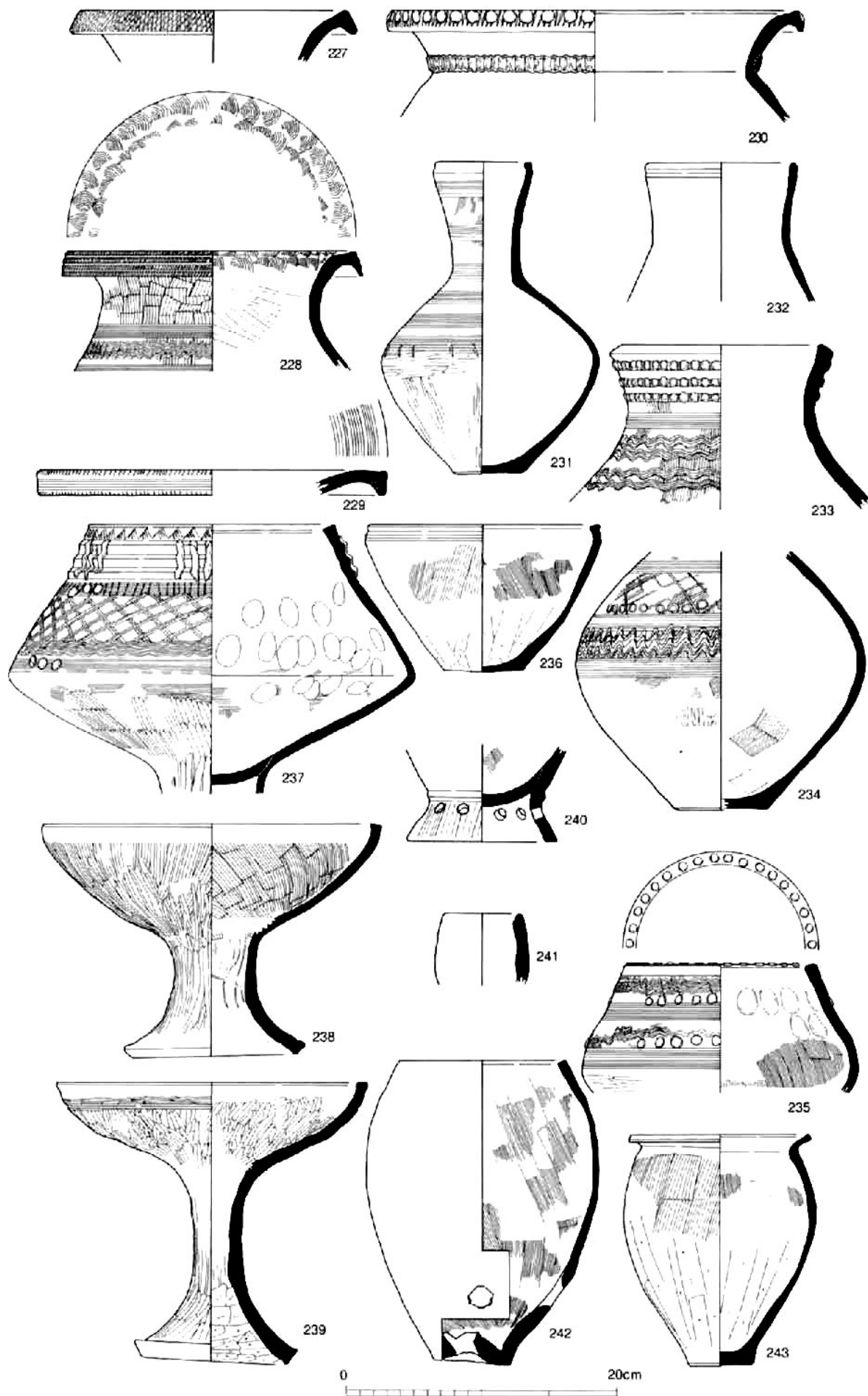

土器9 (溝・水田/227~243)

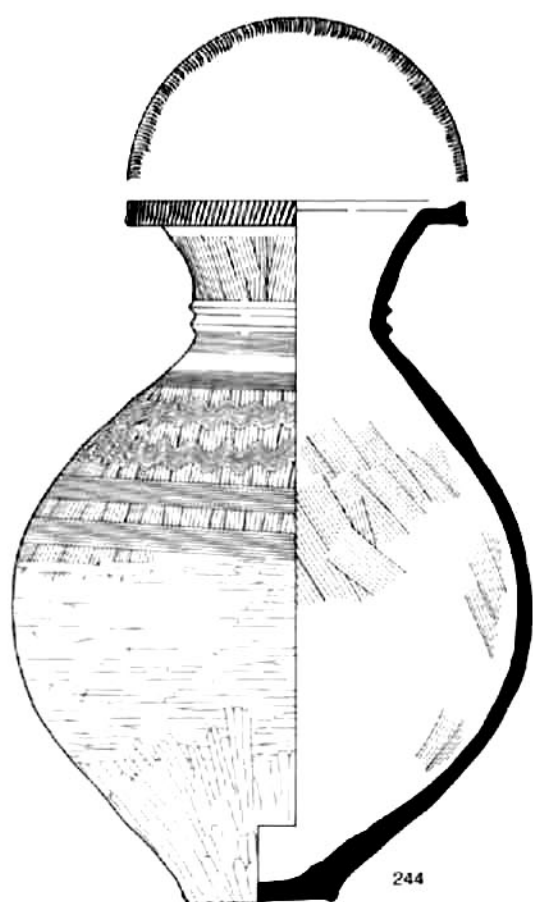

244

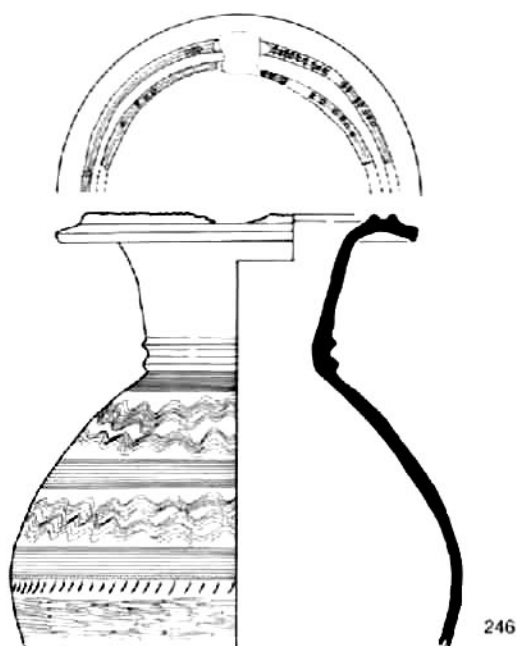

246



245

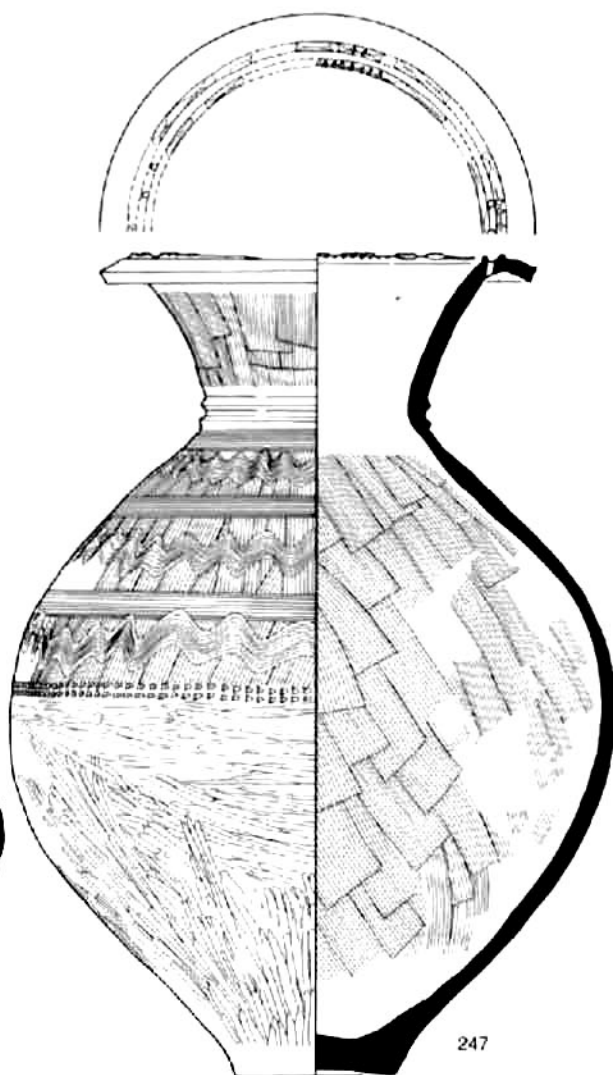

247



土器10 (方形周溝墓/244~247)

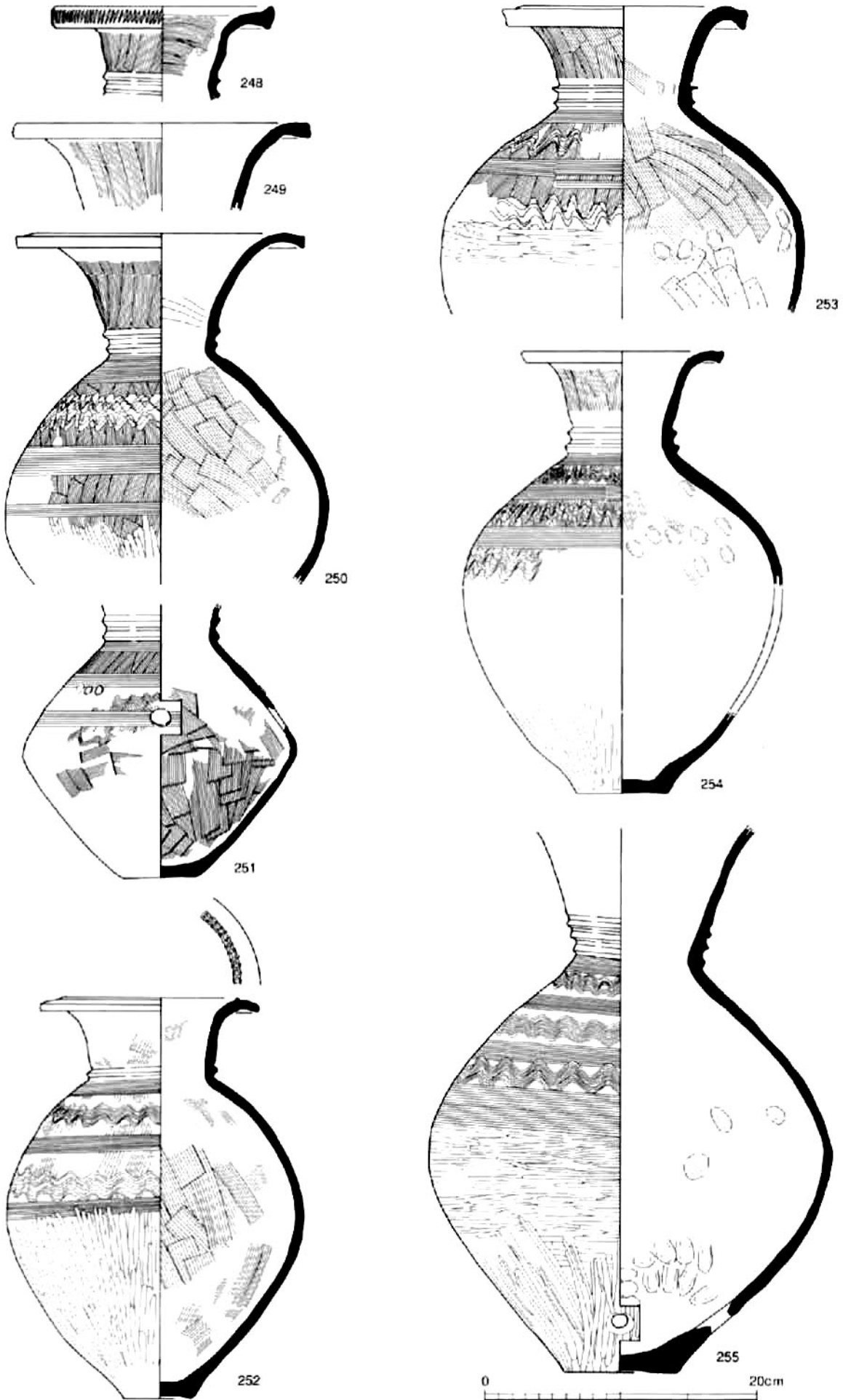

土器11 (方形周溝埴輪/248~255)

図版
156
弥生中期上層

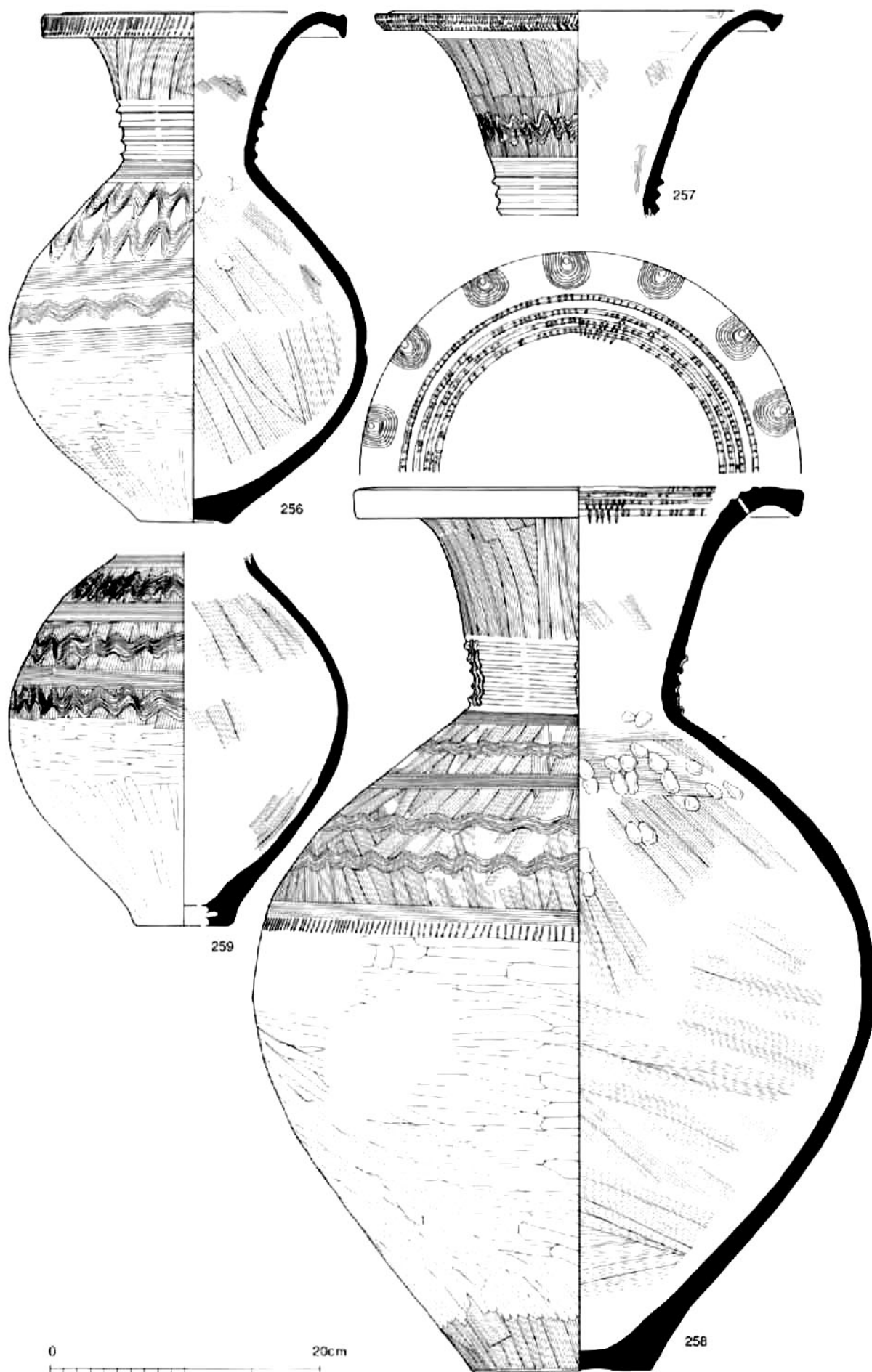

土器12 (方形周溝墓/256~259)

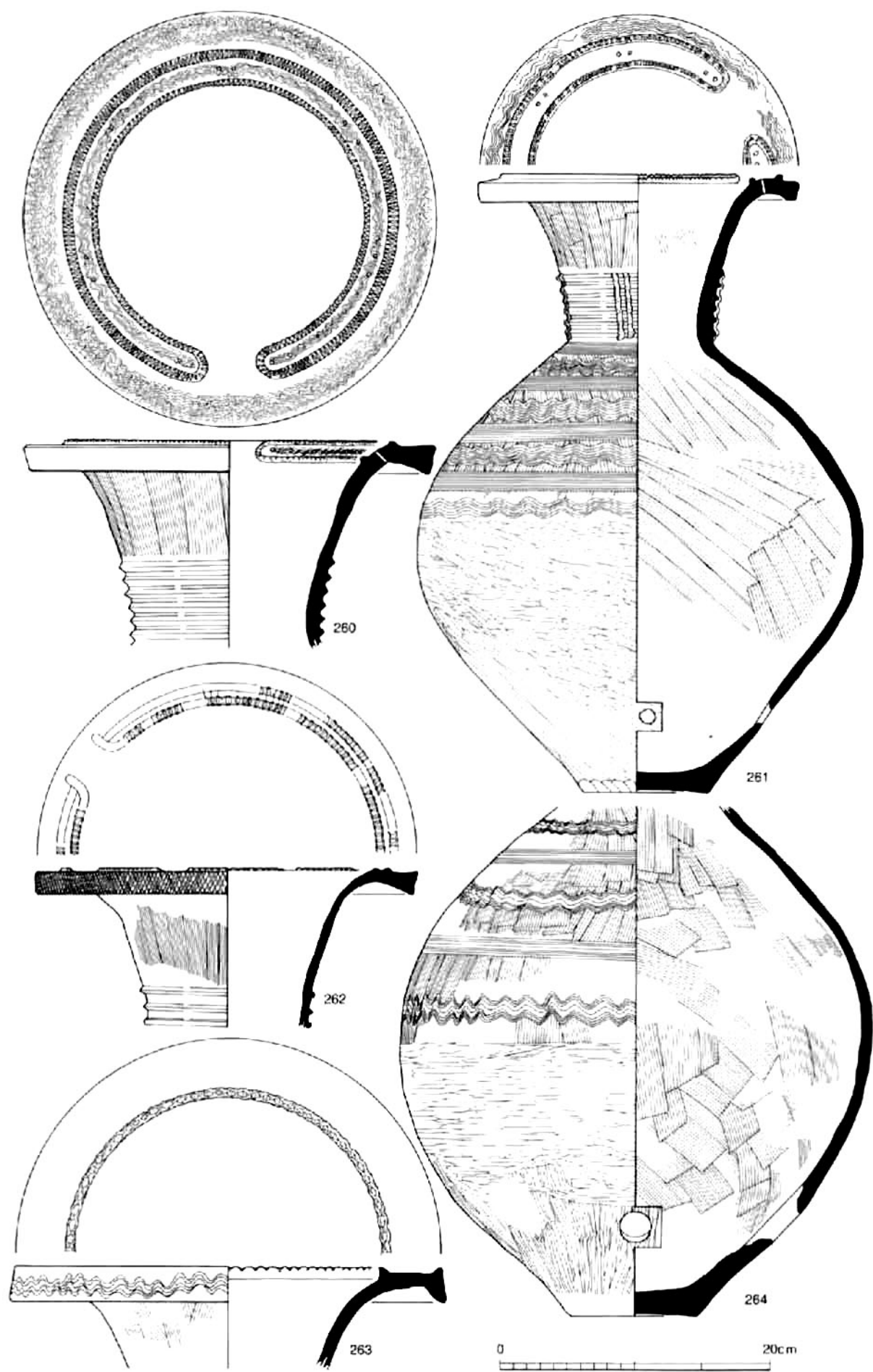

土器13 (方形周溝墓/260~264)

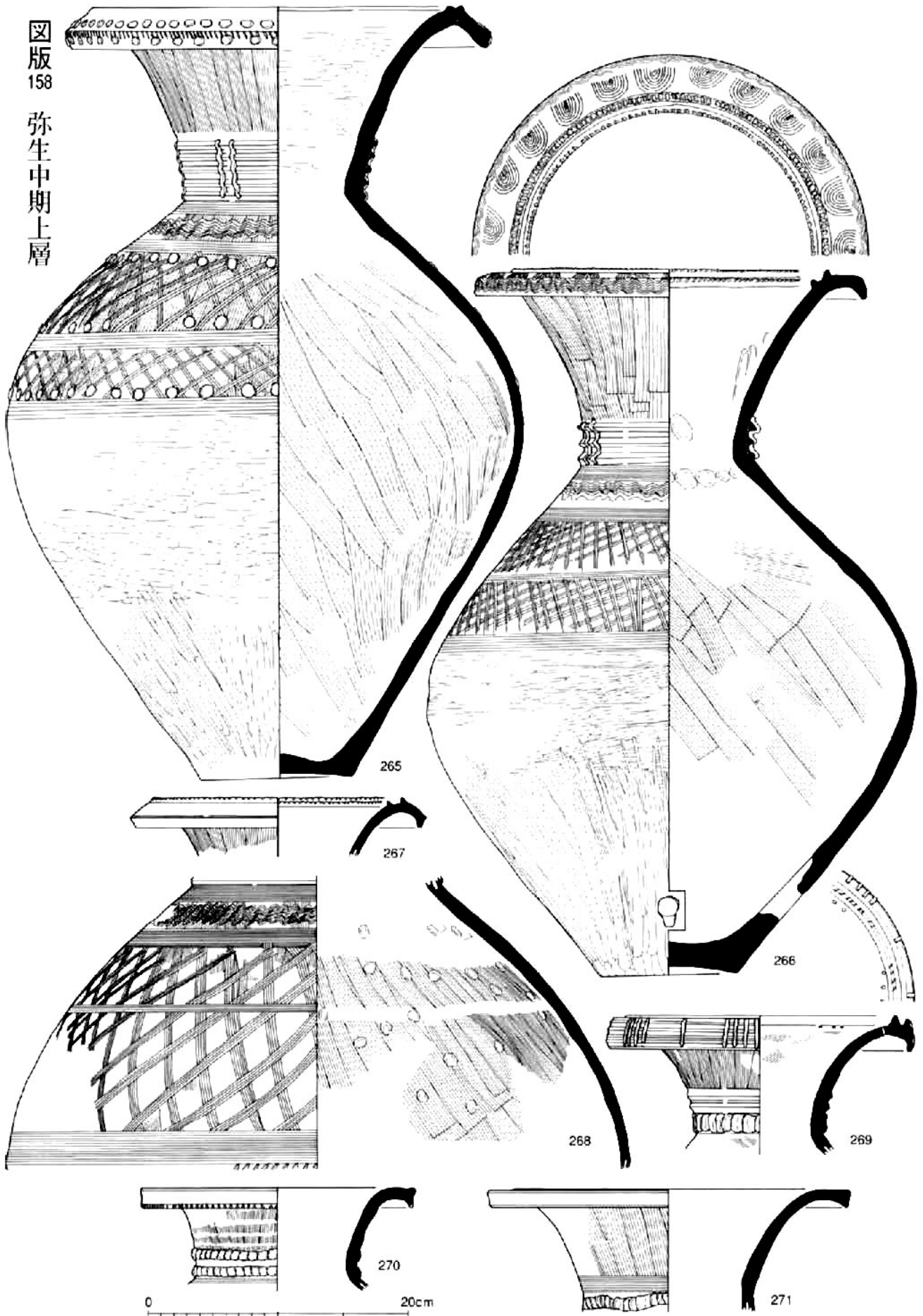

土器14 (方形周溝墓/265~271)

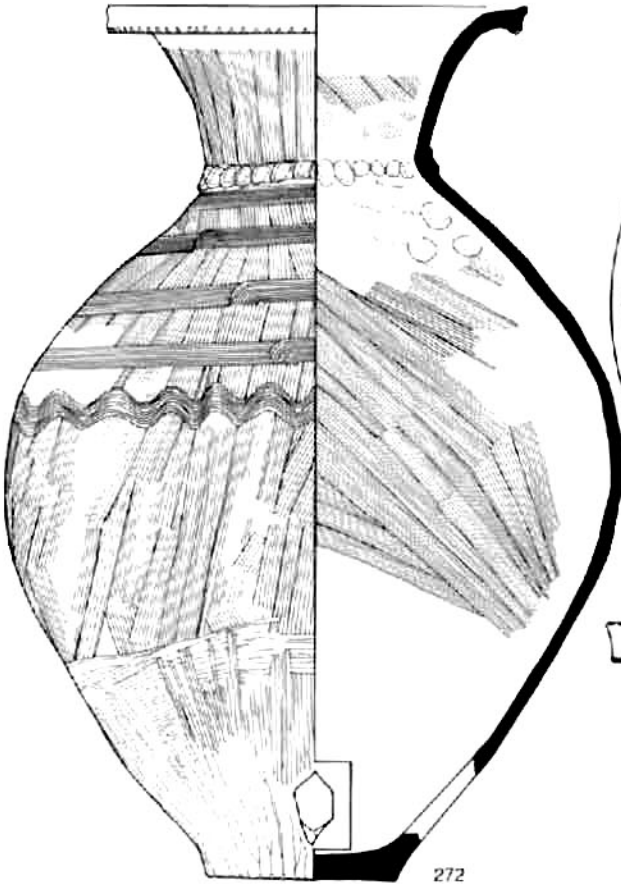

272

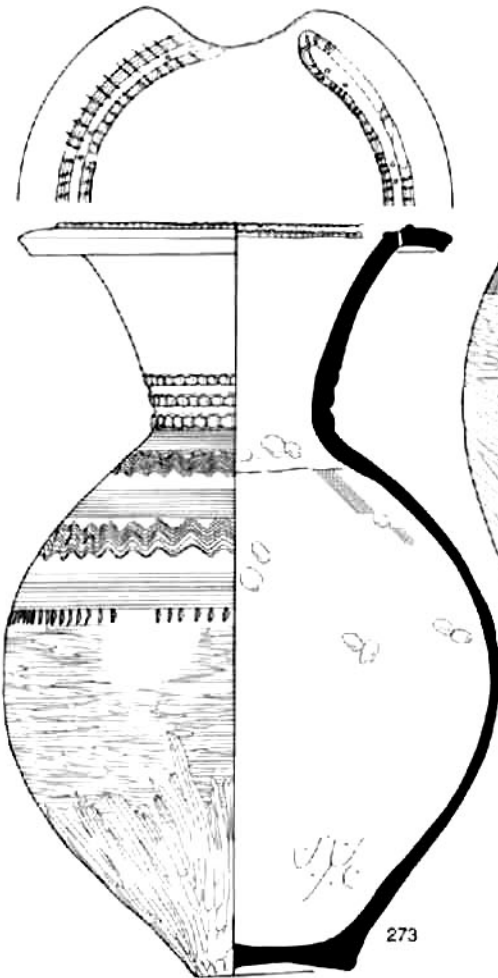
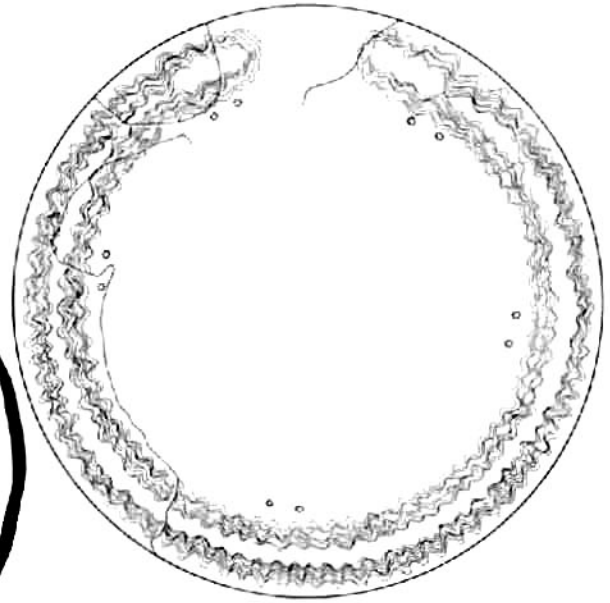

273

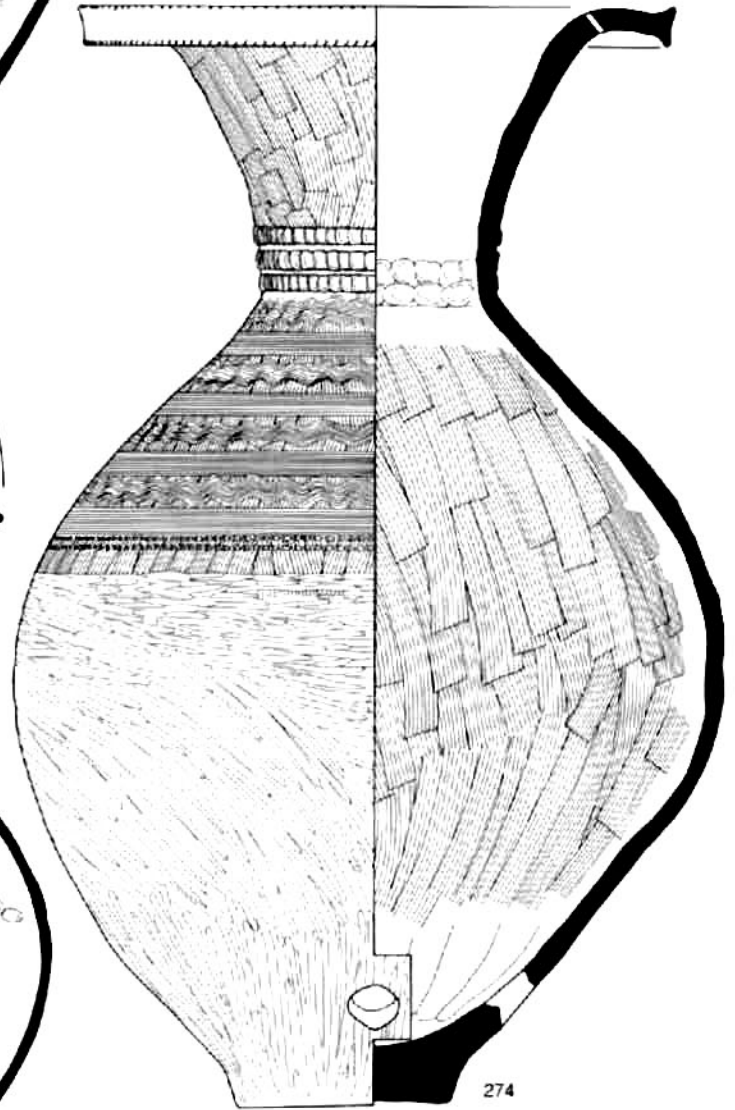

274

0 20cm

土器15 (方形周溝墓/272~274)

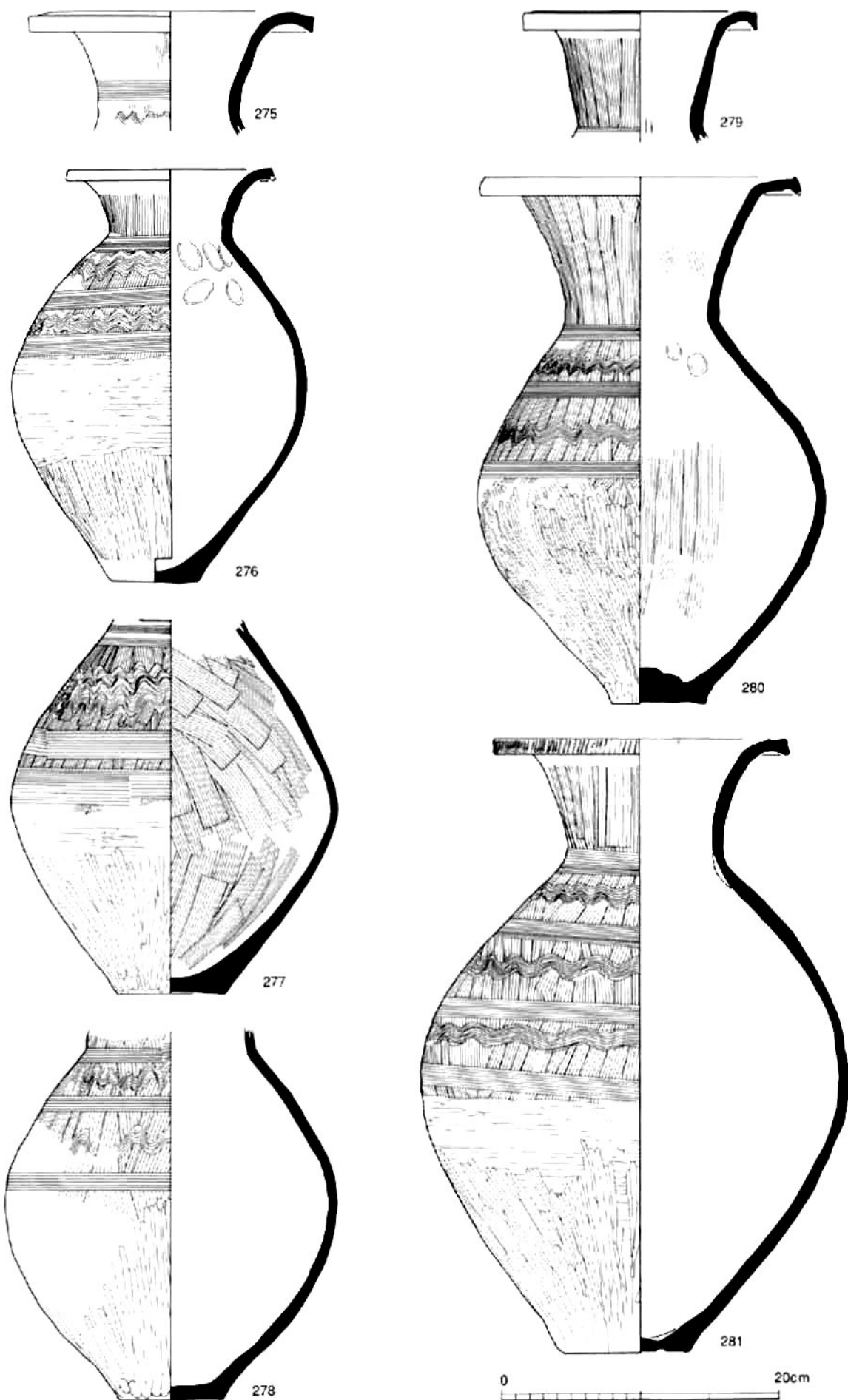

土器16 (方形刷清墓/275~281)

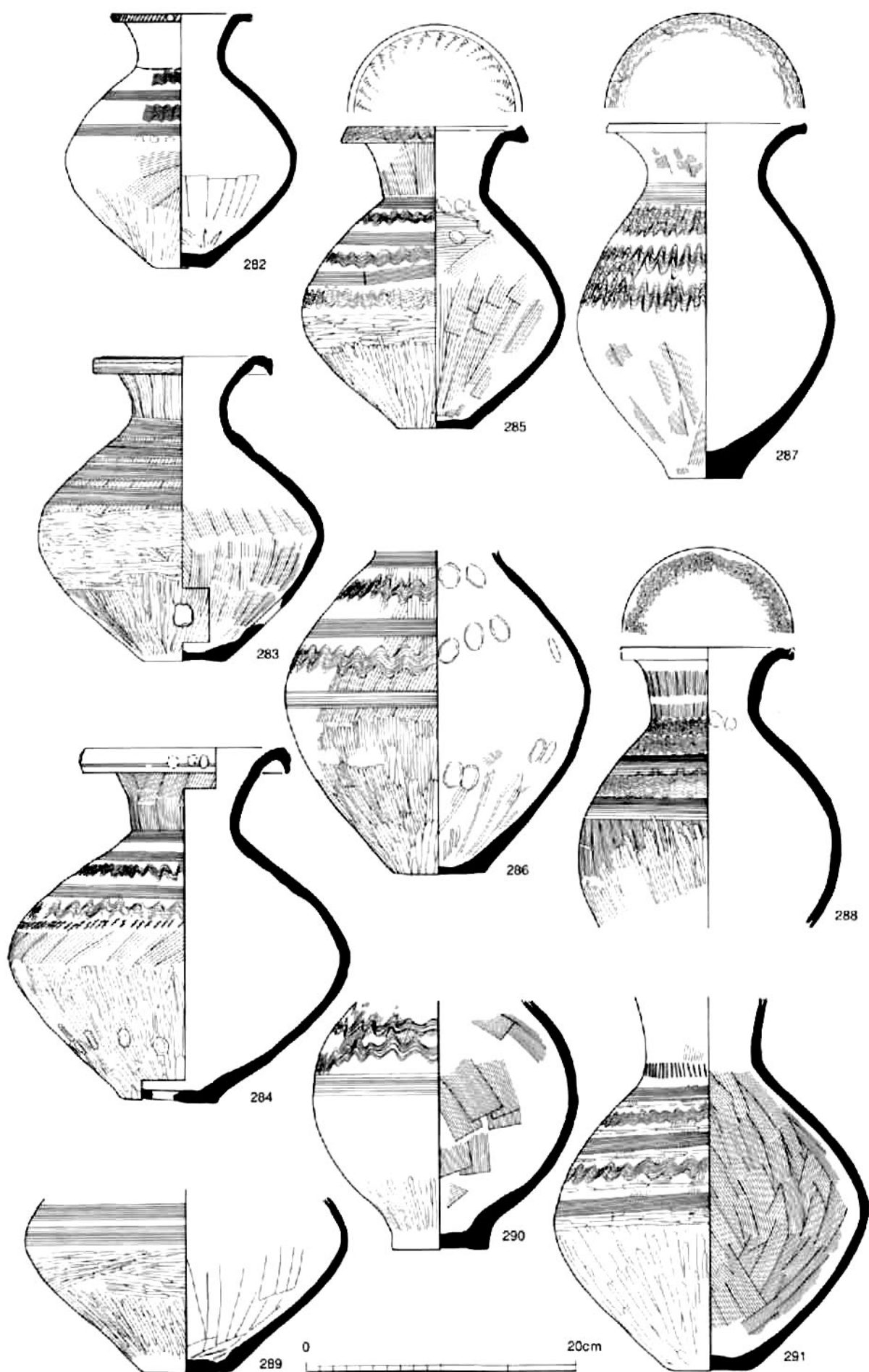

土器17 (方形周溝墓/282~291)

图版 162
弥生中期上層

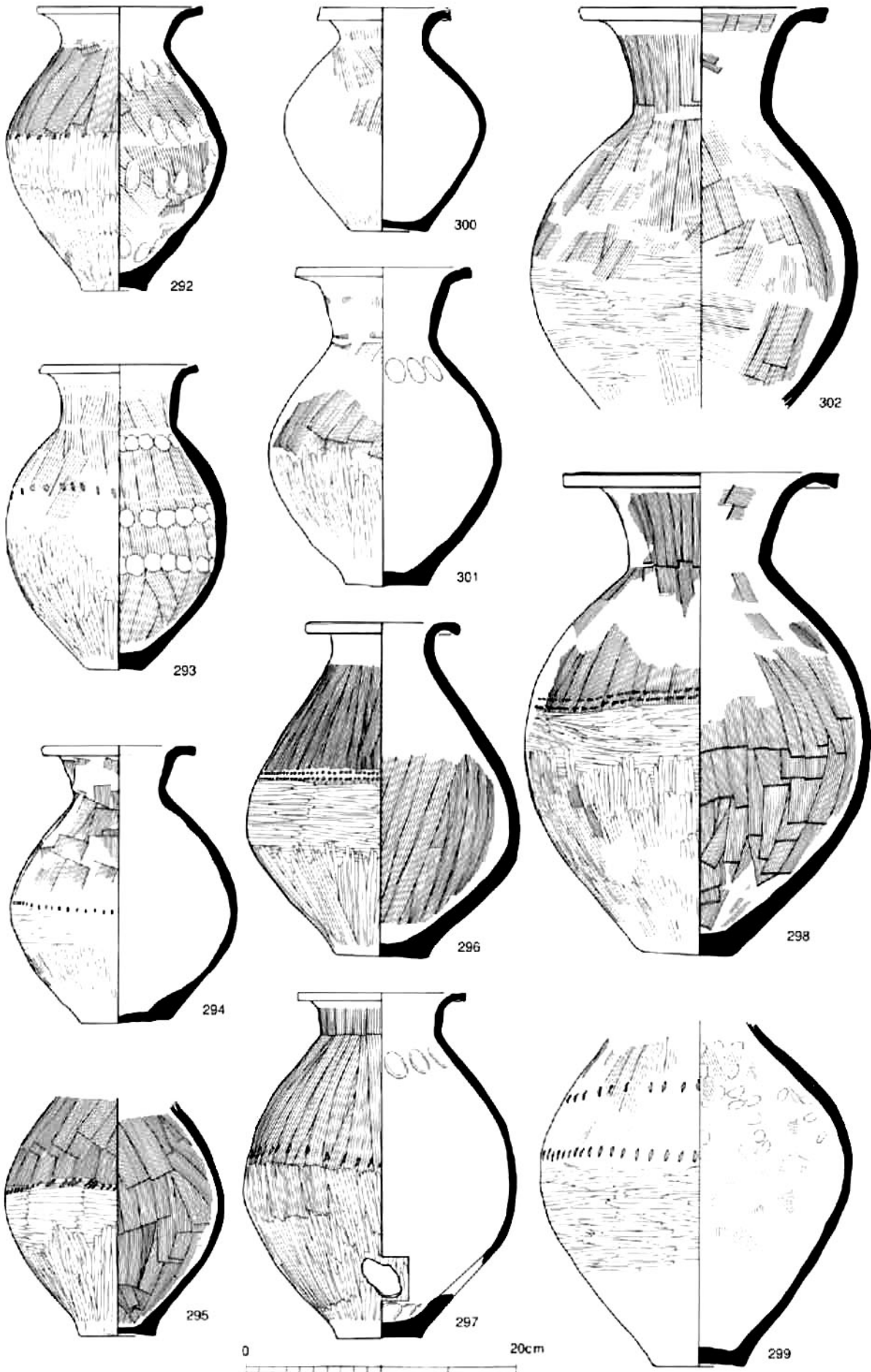

土器18 (方形周溝墓/292~302)

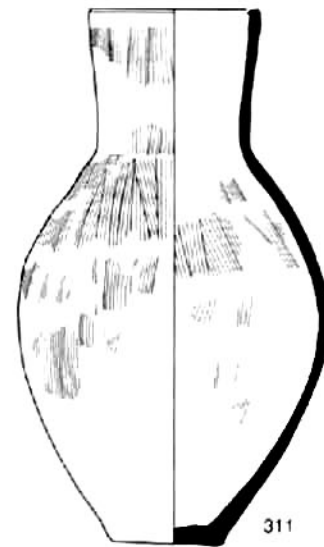
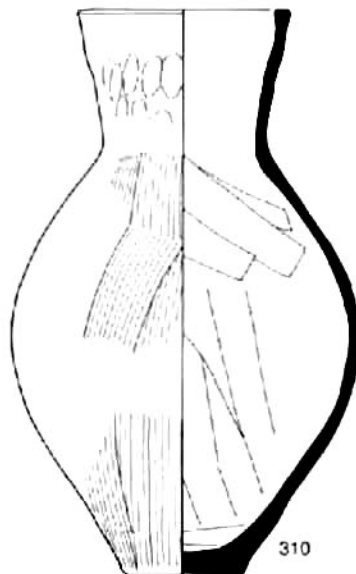
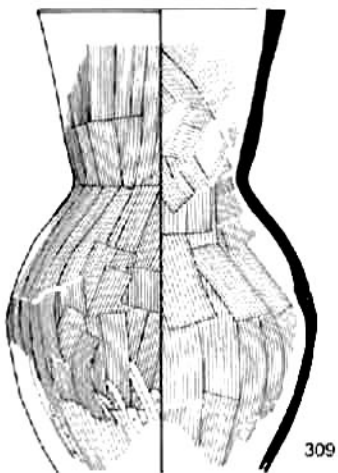
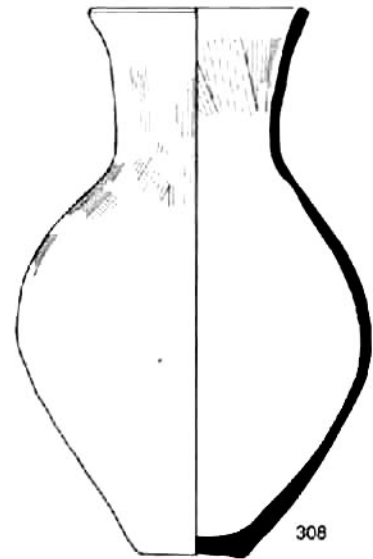
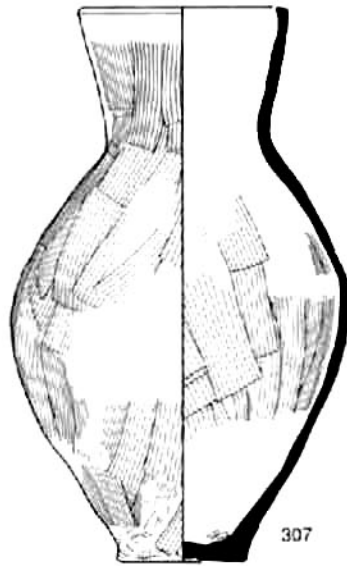
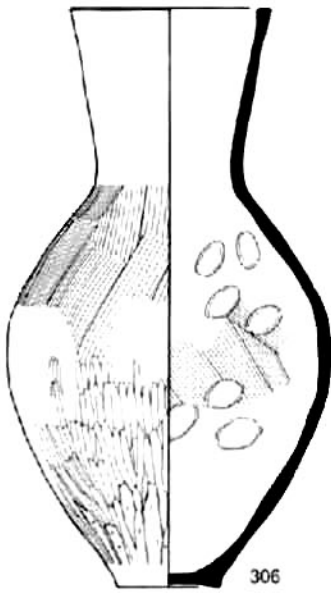
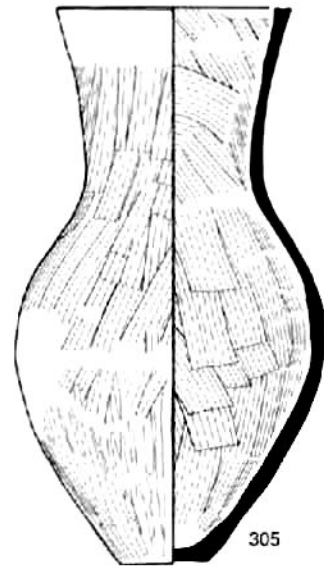
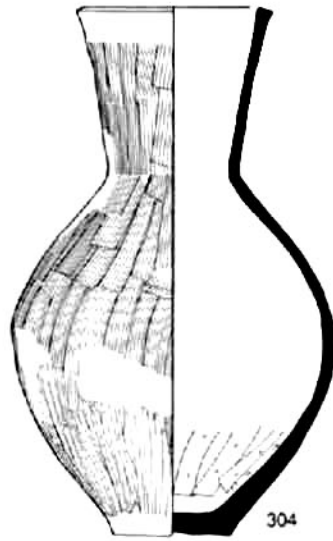
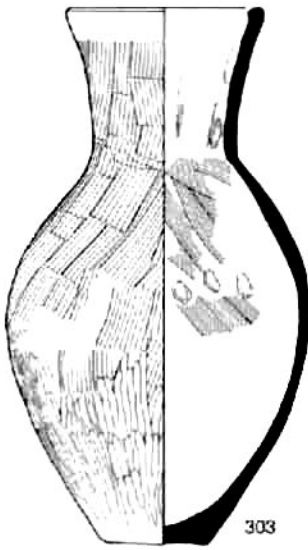

0 20cm

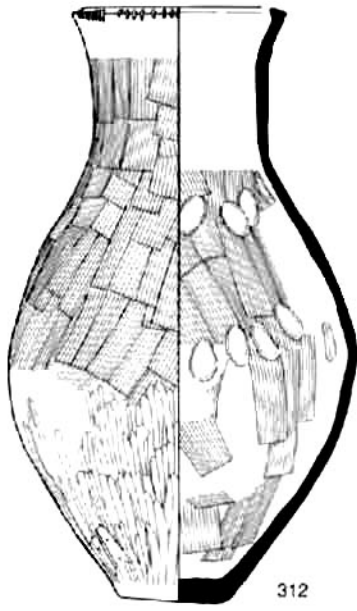

312

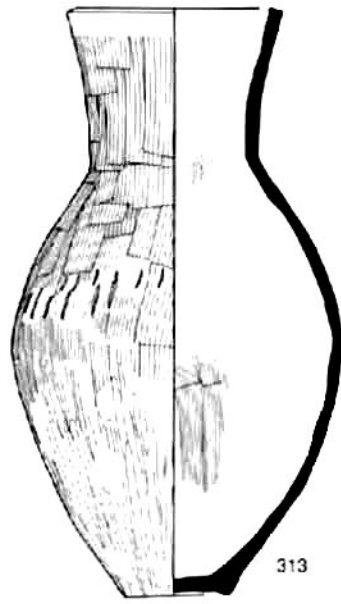

313

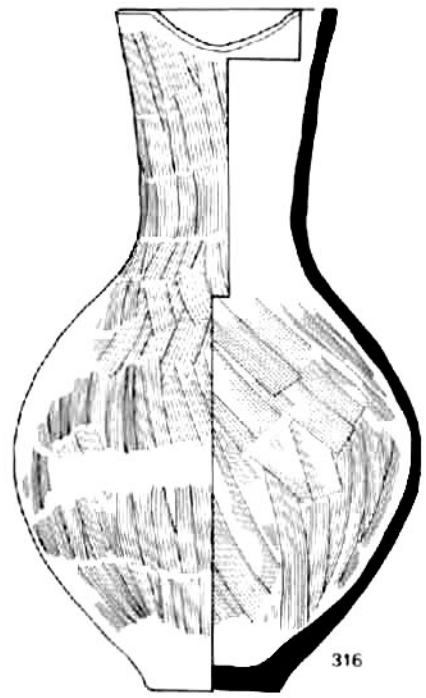

316

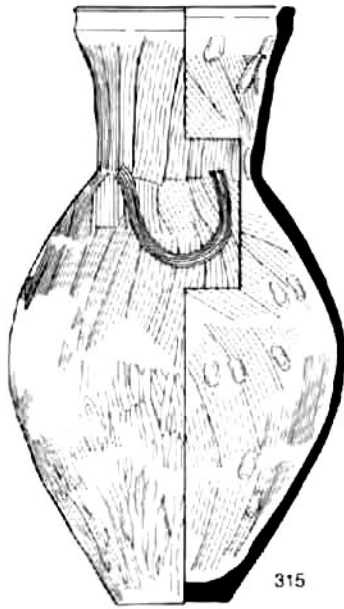

315

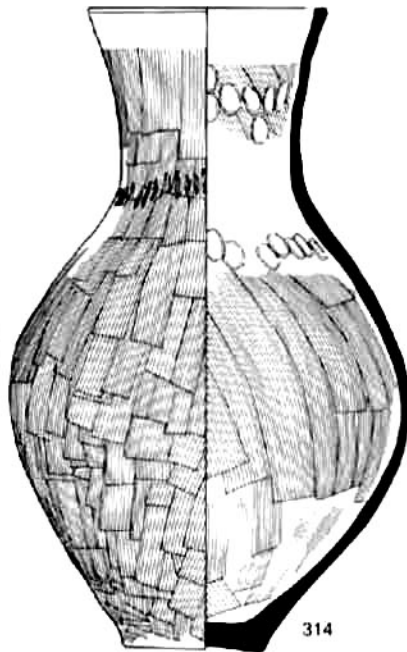

314



317

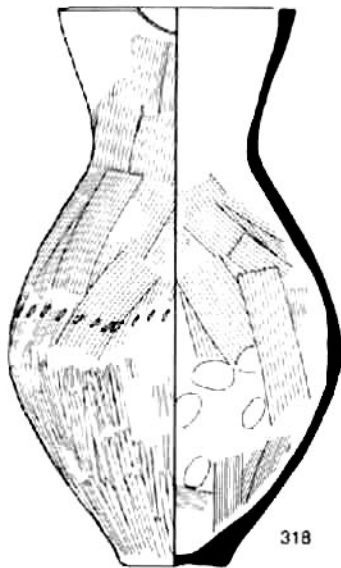

318

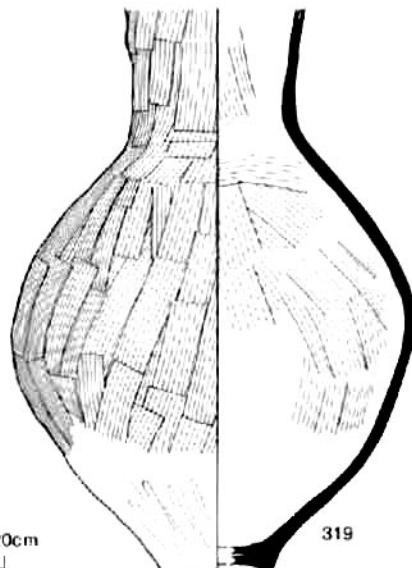

319

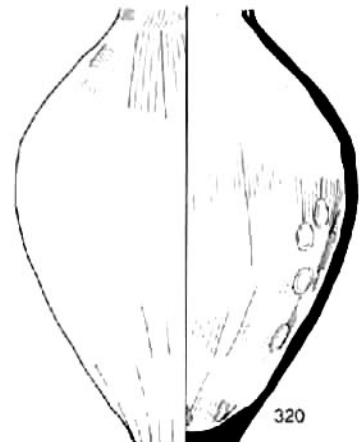

320

0 20cm

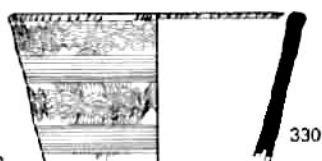
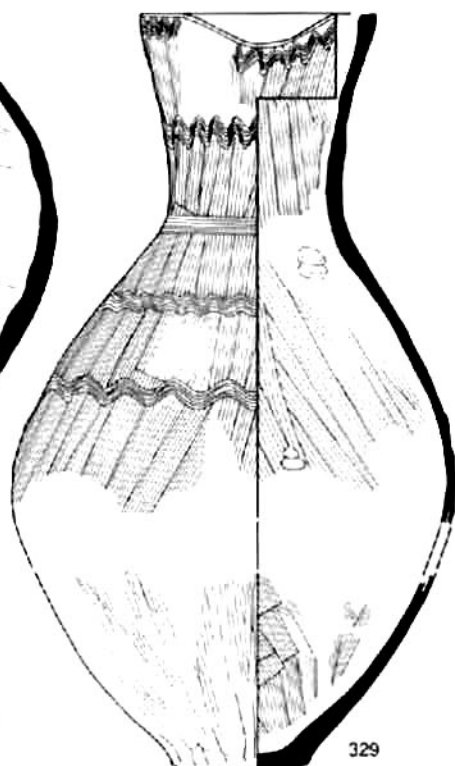
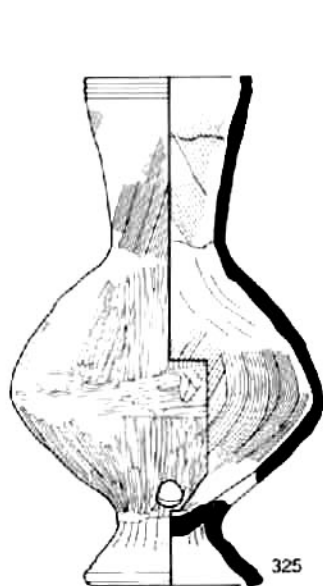
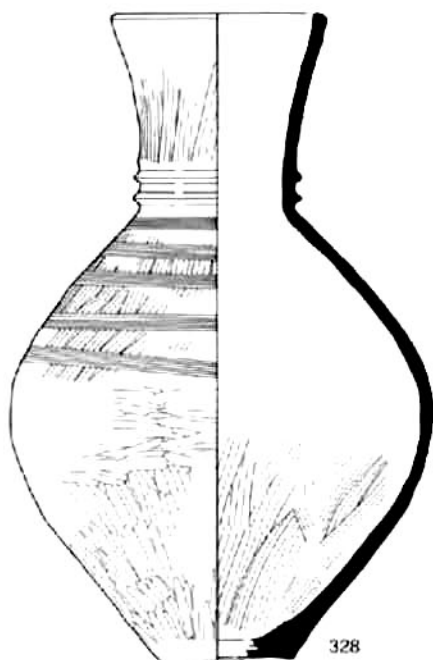
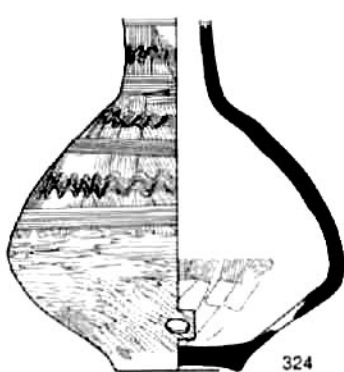
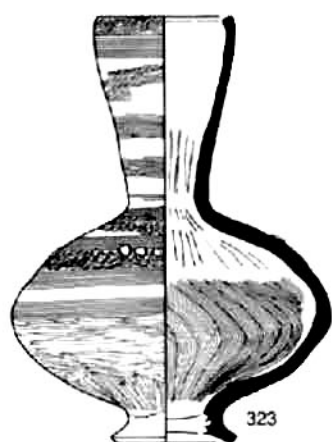
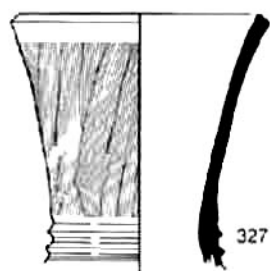
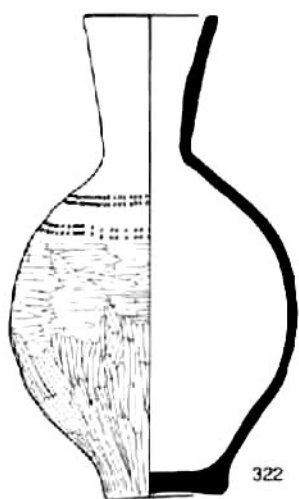
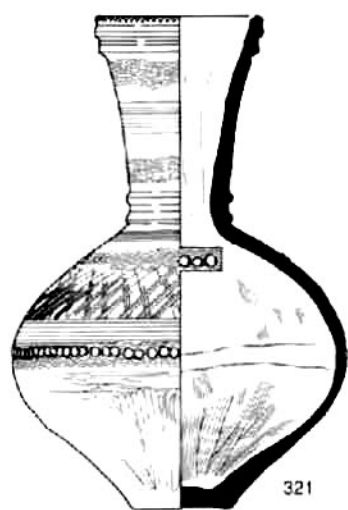

0 20cm

土器21 (方形周溝墓/321~330)

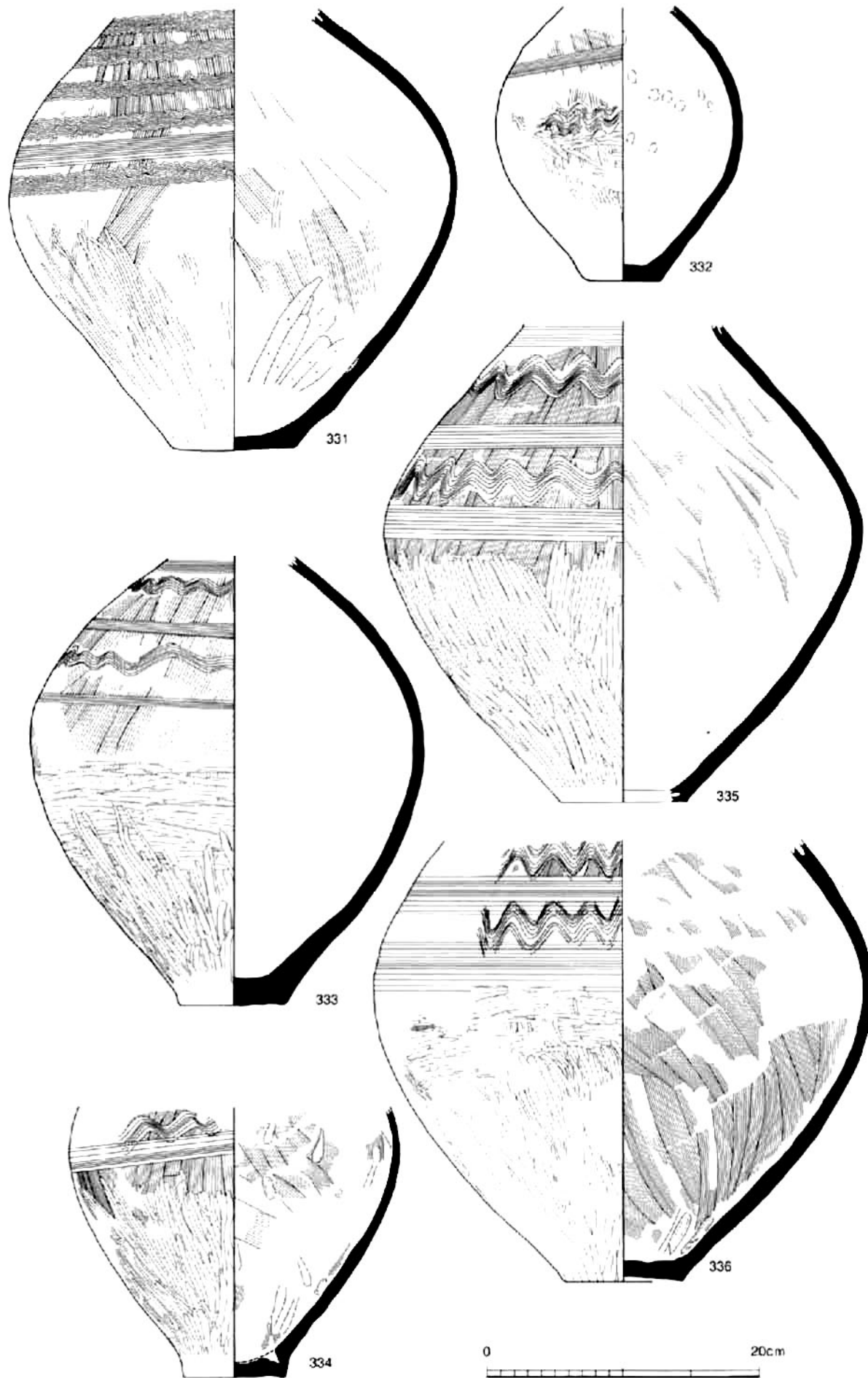

上器22 (方形周溝墓/331~336)

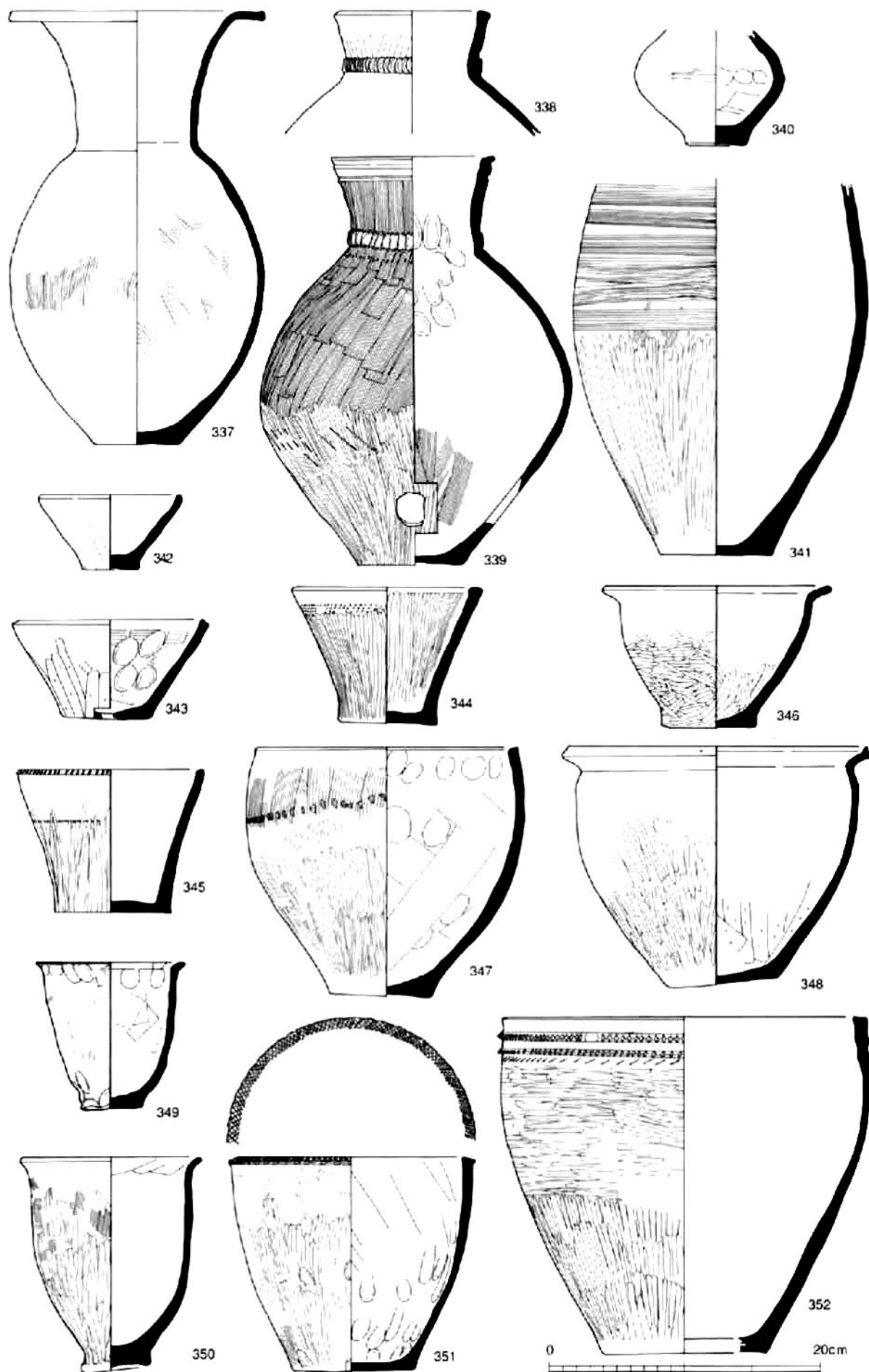

土器23 (方形周溝墓/337~352)

图版 168
弥生中期上層

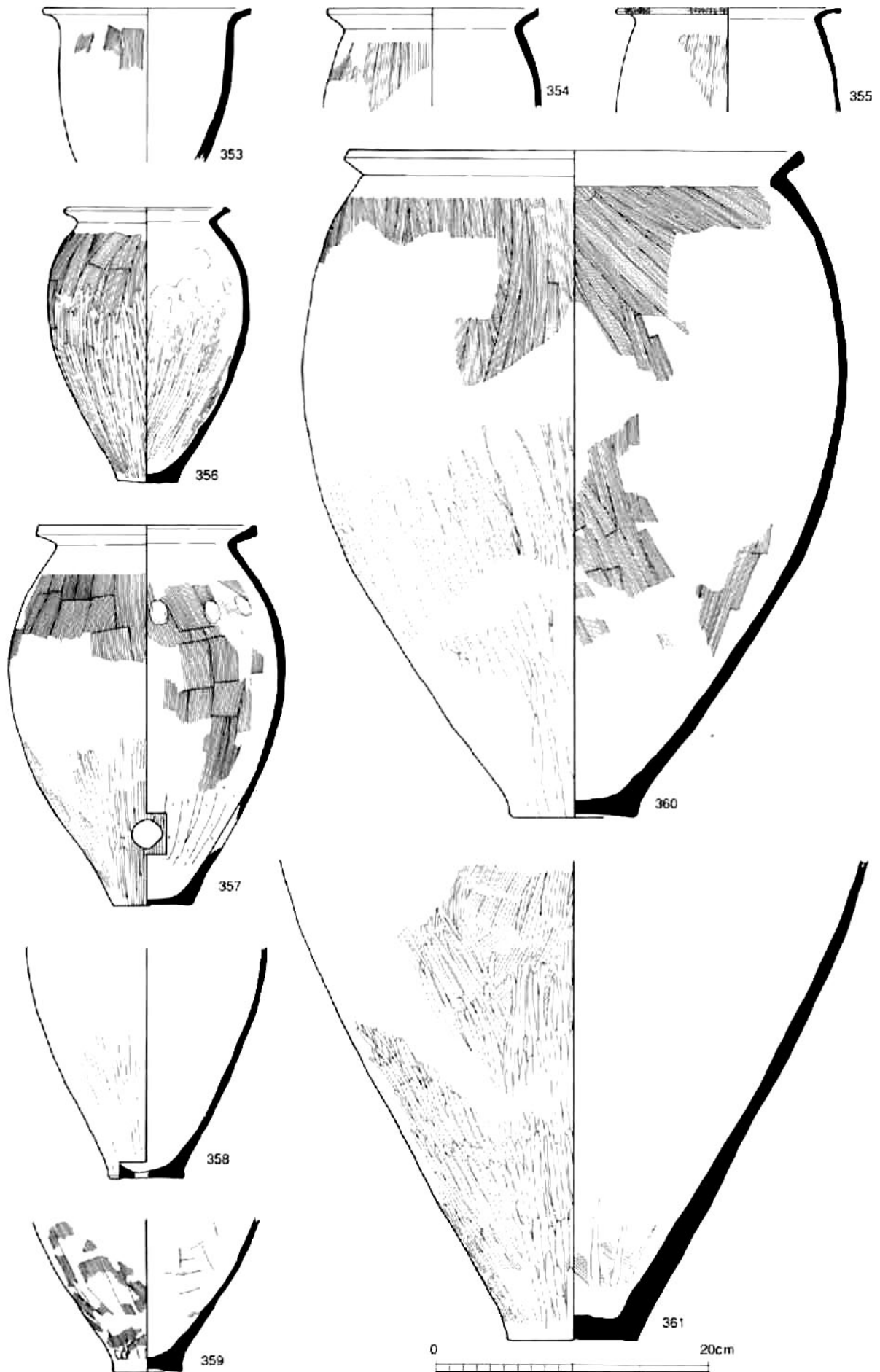

土器24 (方形周溝埴/353~361)

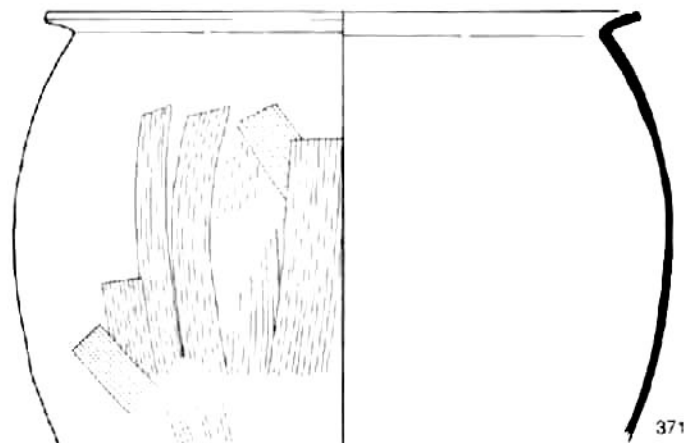
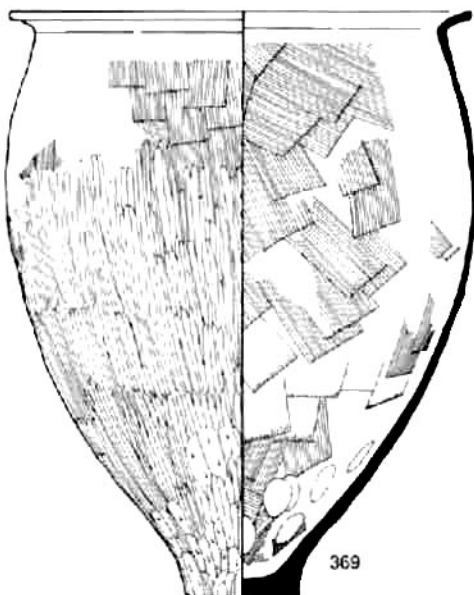
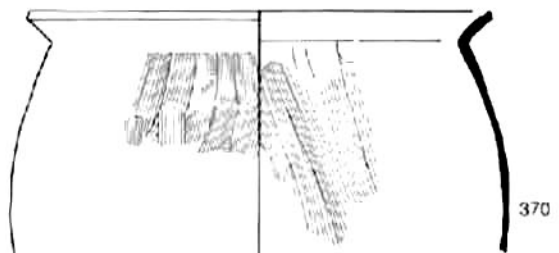
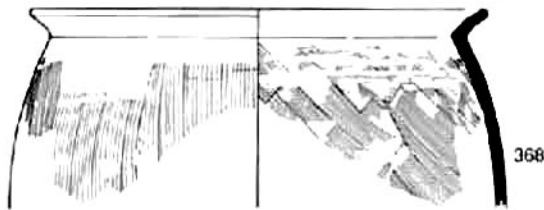
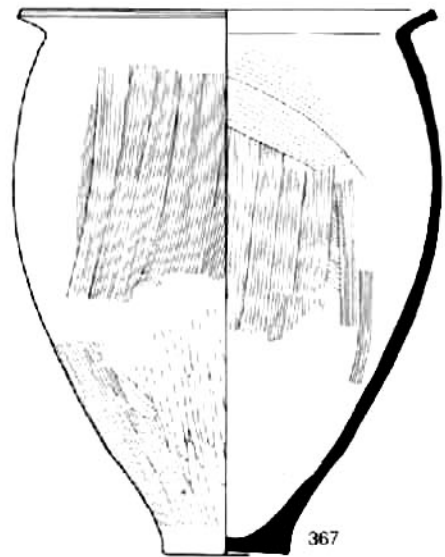
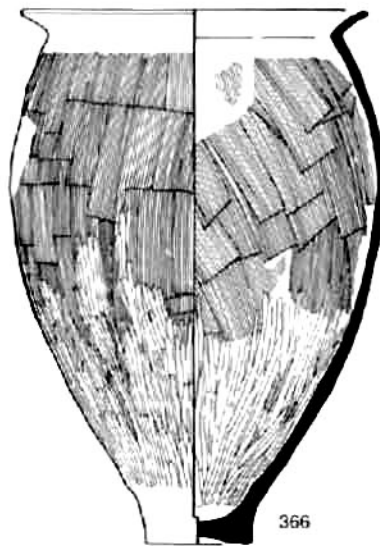
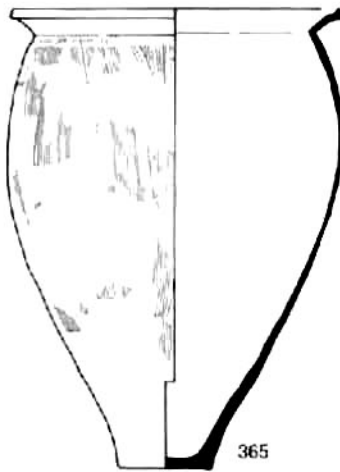
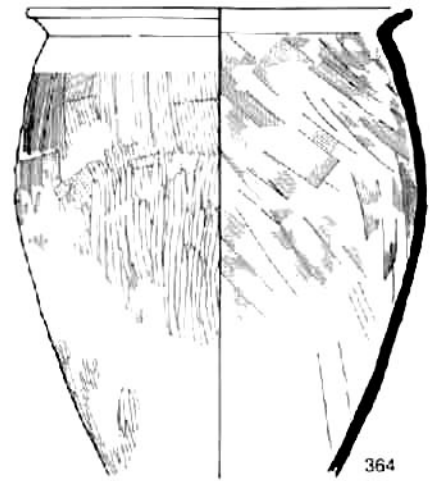
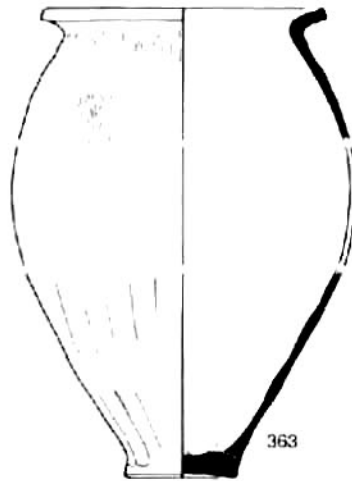

0 20cm

土器25 (方形周溝墓/362~371)

図版
170
弥生中期上層

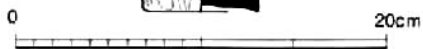
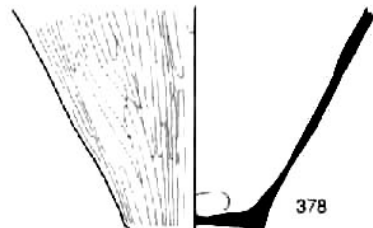
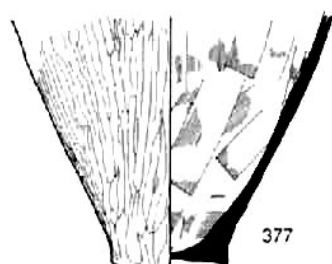
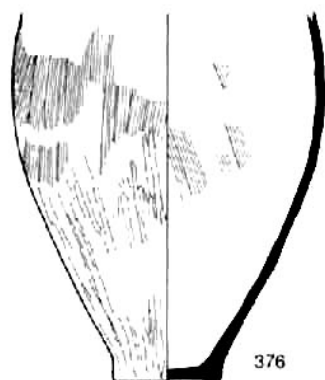
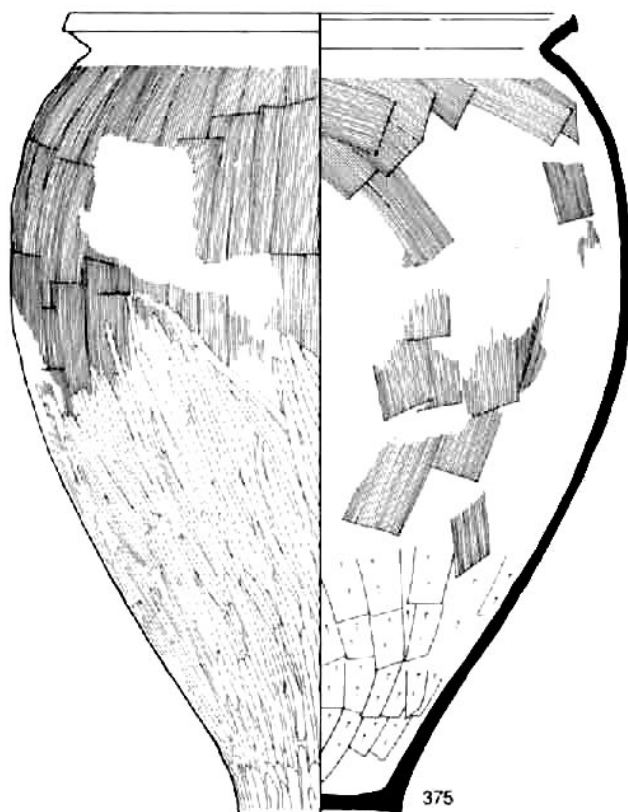
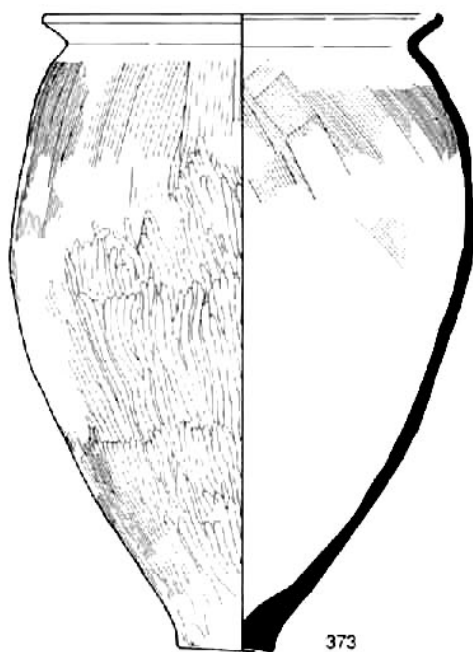
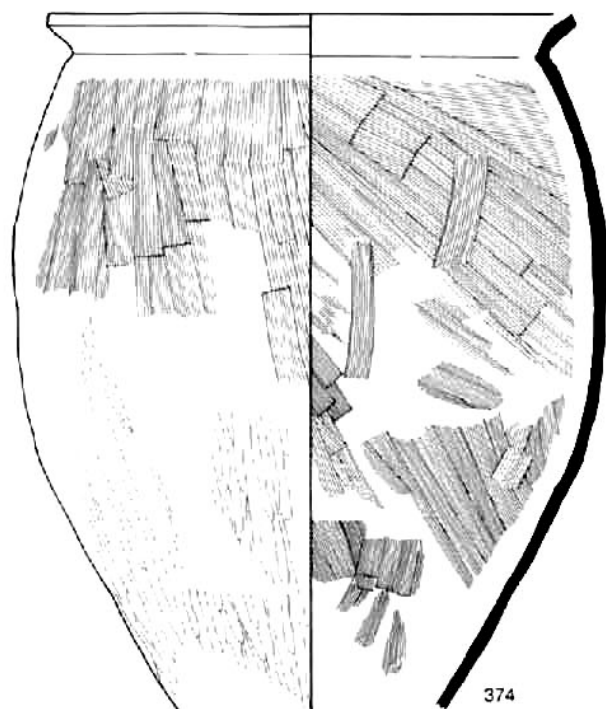
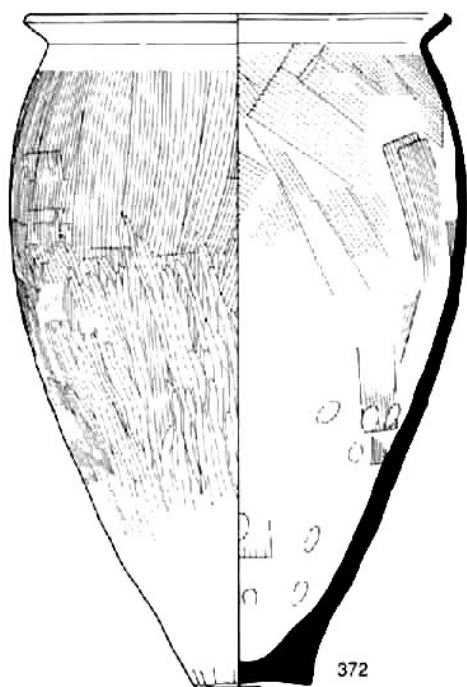

土器26 (方形周溝墓/372~378)

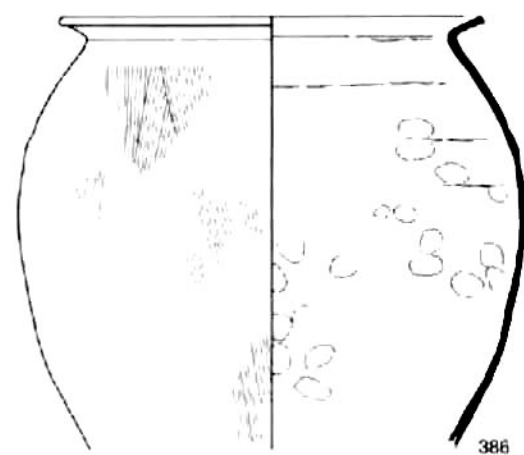
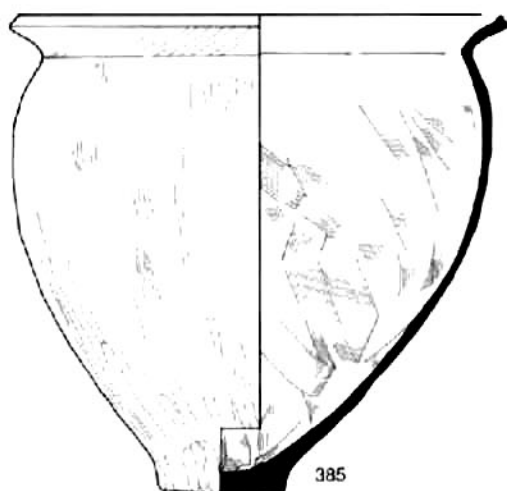
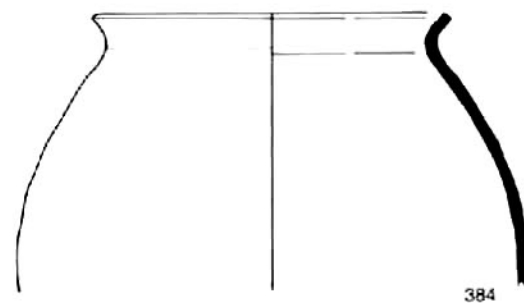
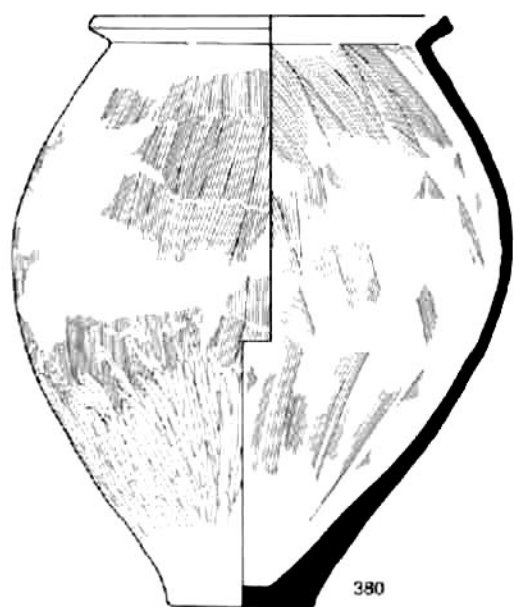
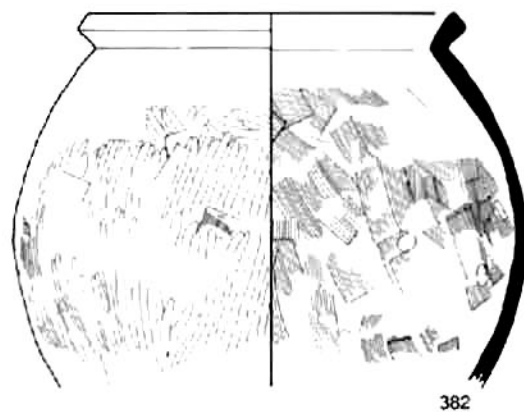
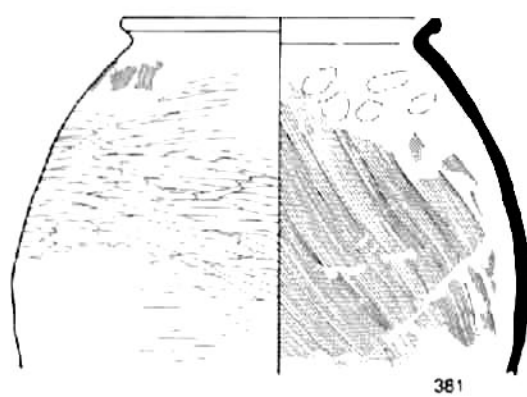
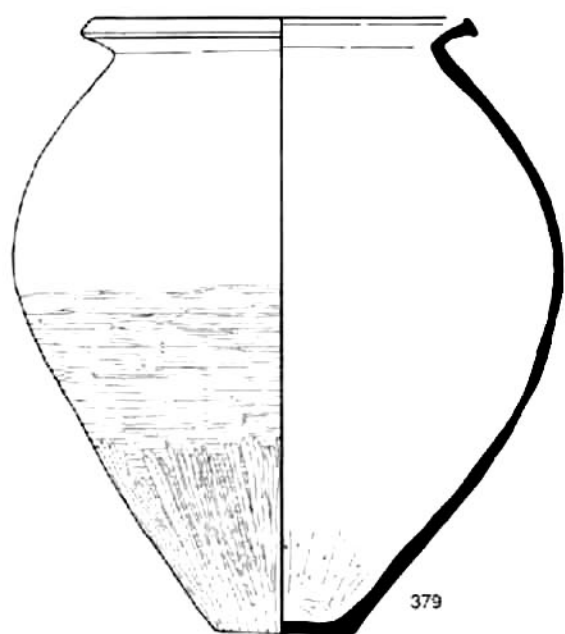

上器27 (方形周溝釜/379~386)

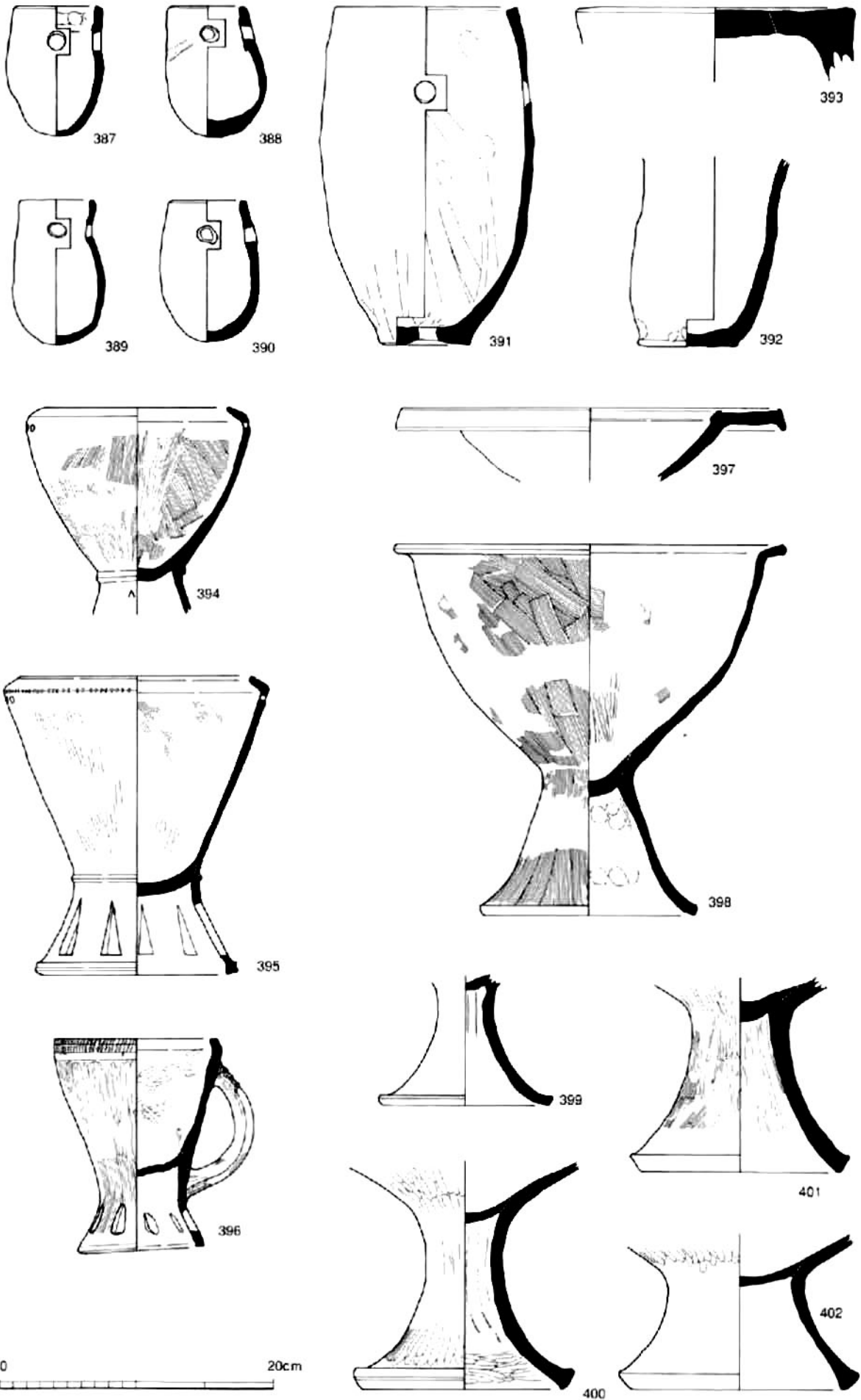

土器28 (方形周溝墓/387~402)

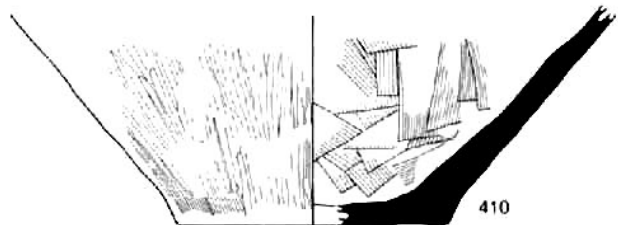
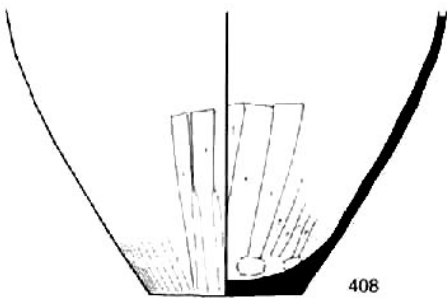
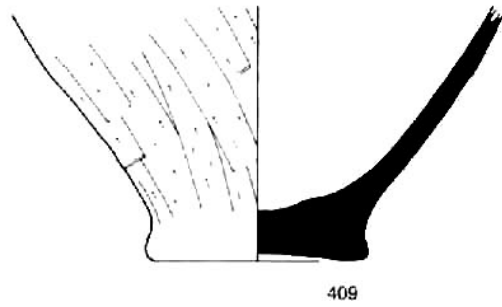
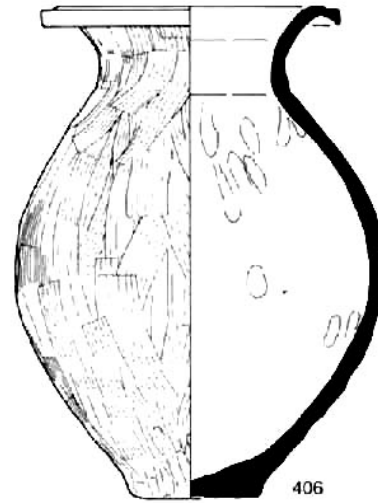
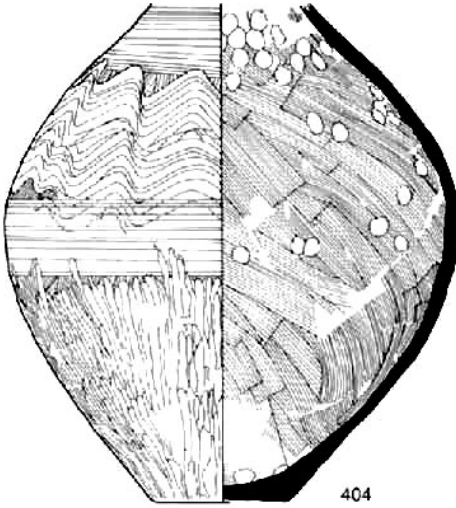
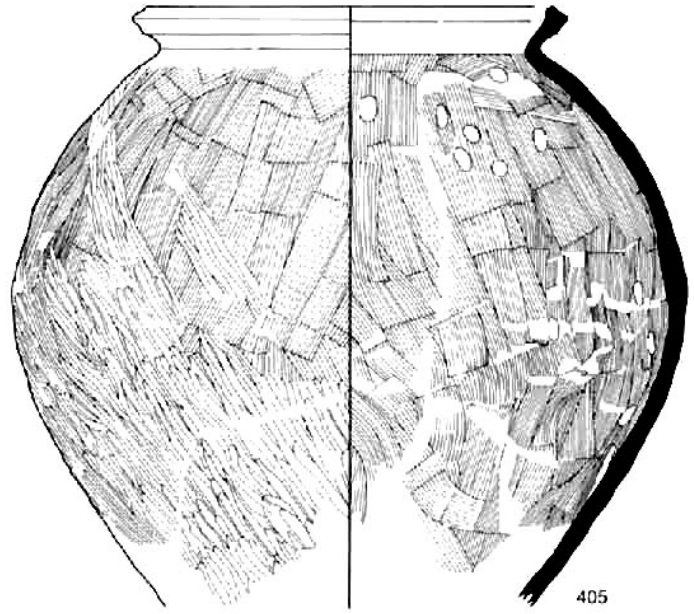
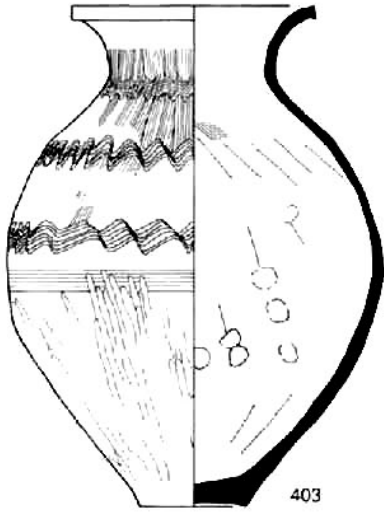

土器29 (方形周溝墓/403~410)

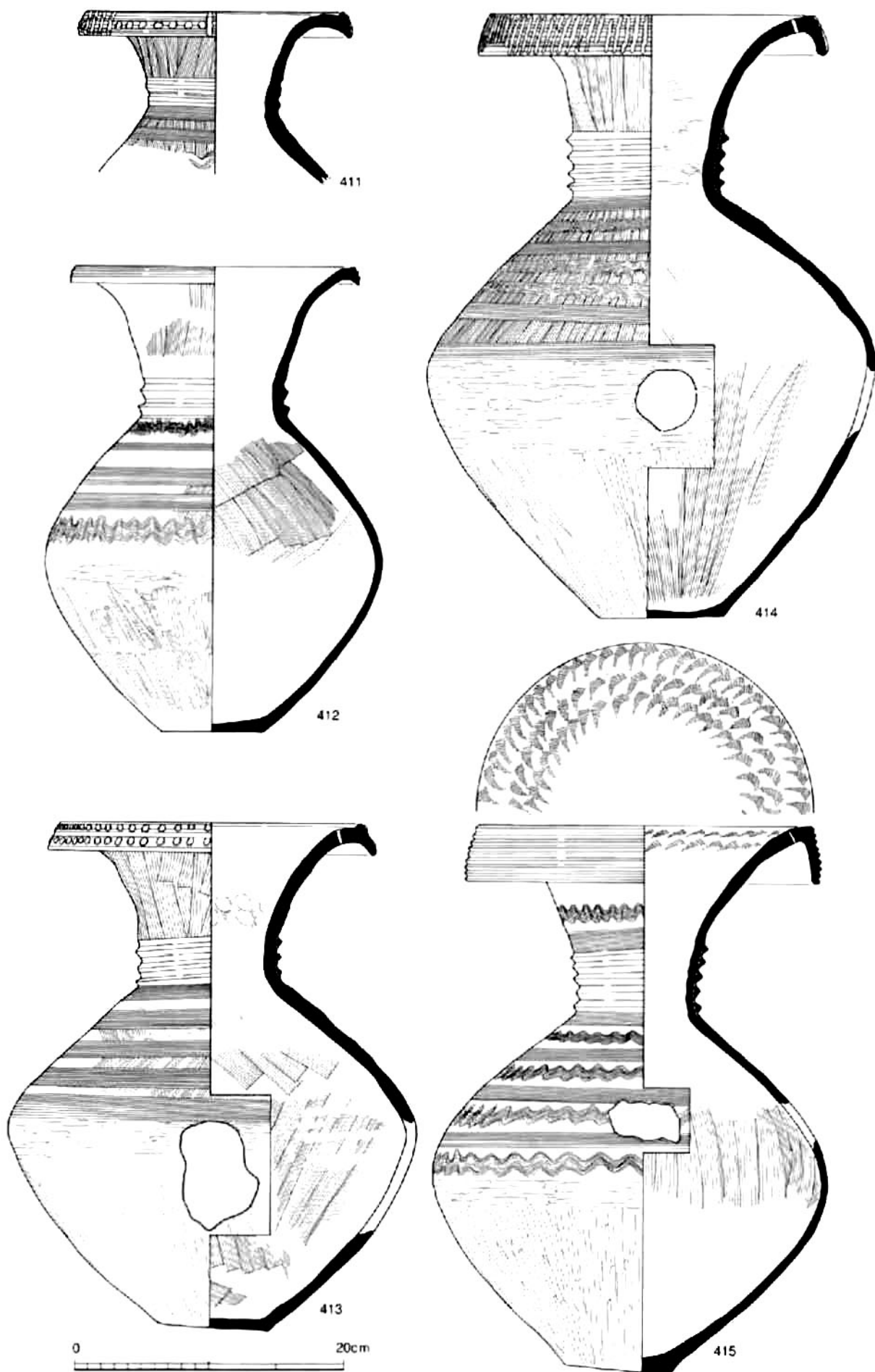

上器30 (平地住居SB40001/411~415)

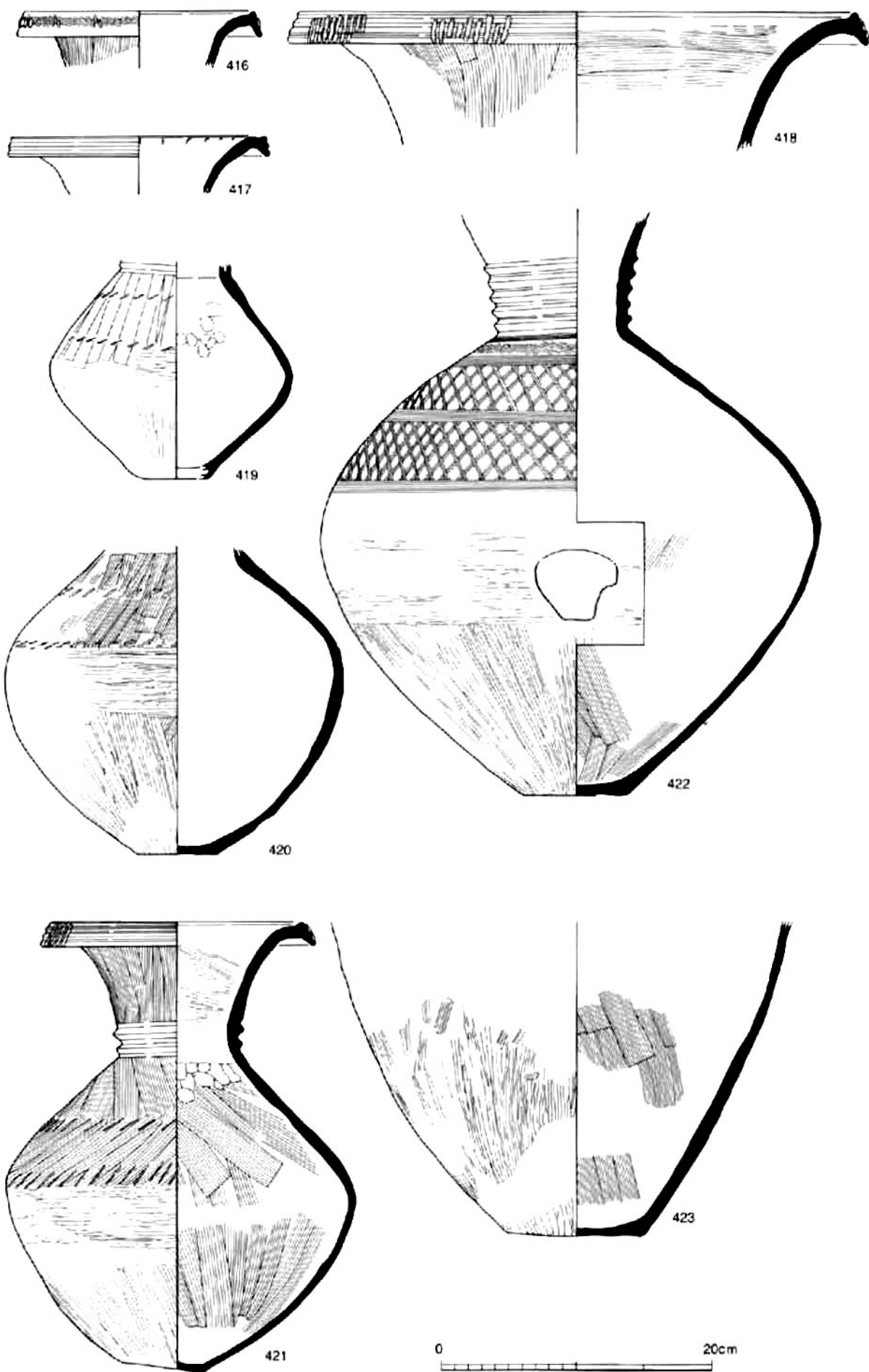

土器31 (平地住居SB40001/416~423)

図版
176
弥生中期上層

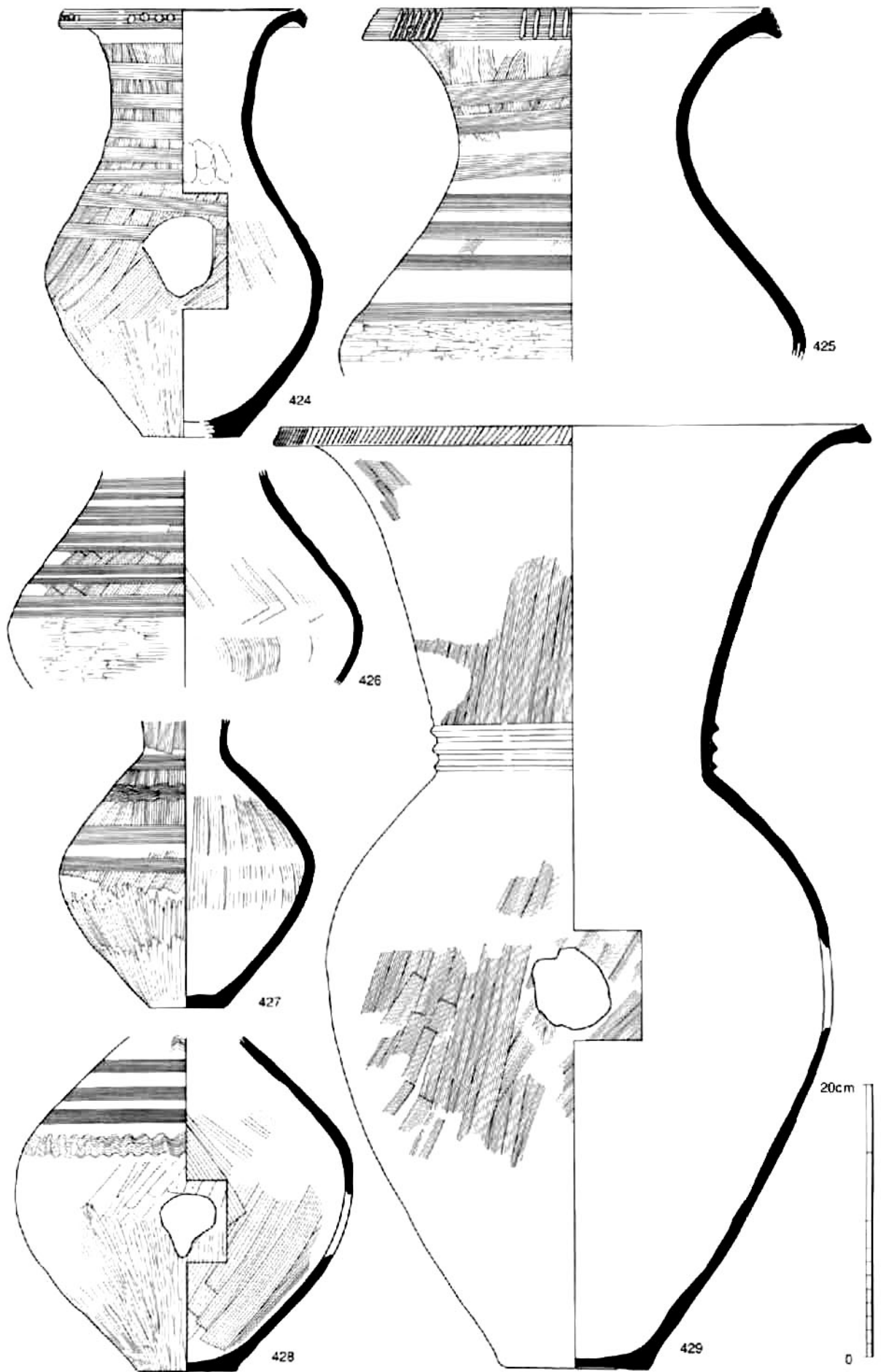

土器32 (平地住居SB40001/424-429)

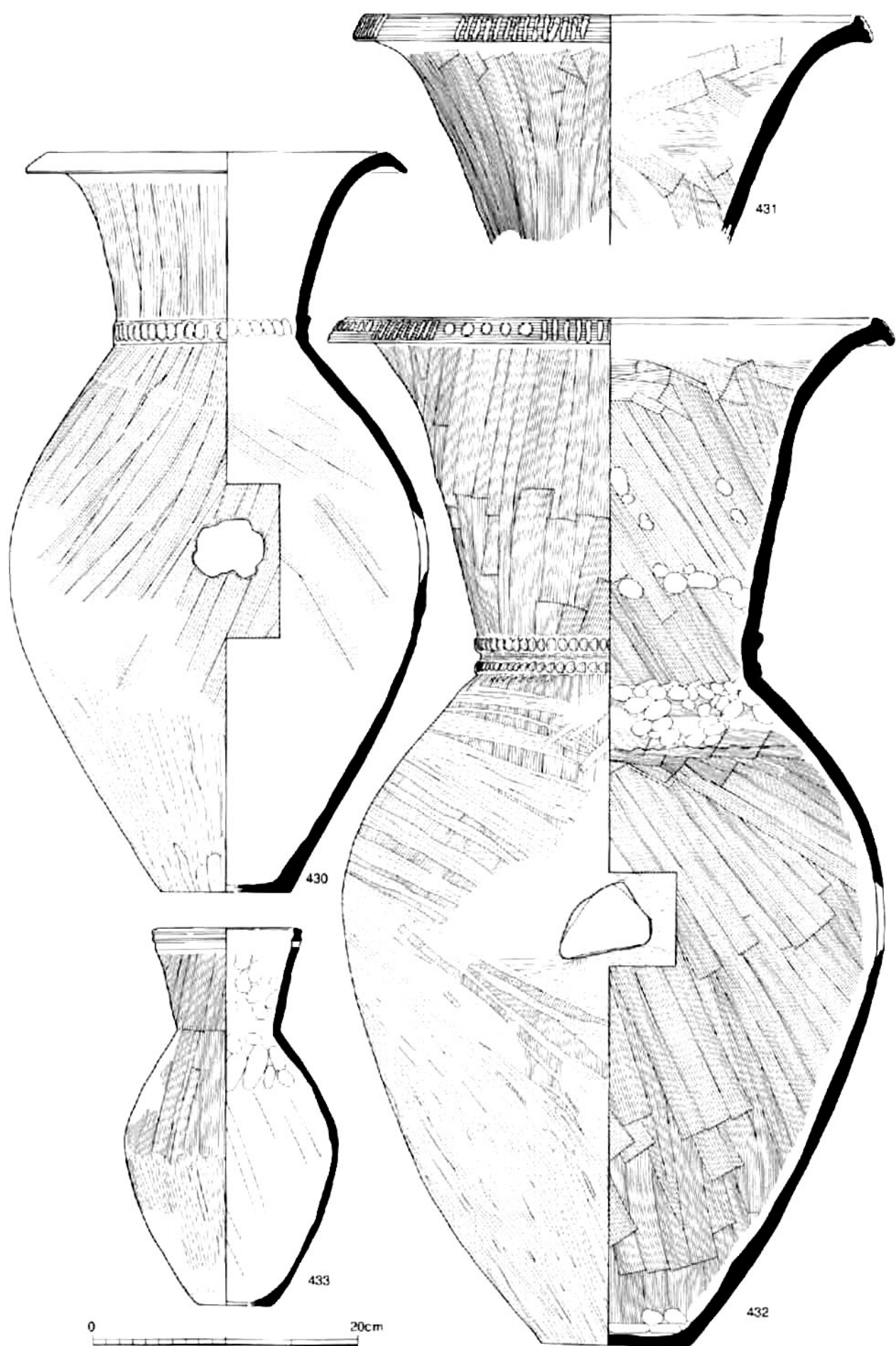

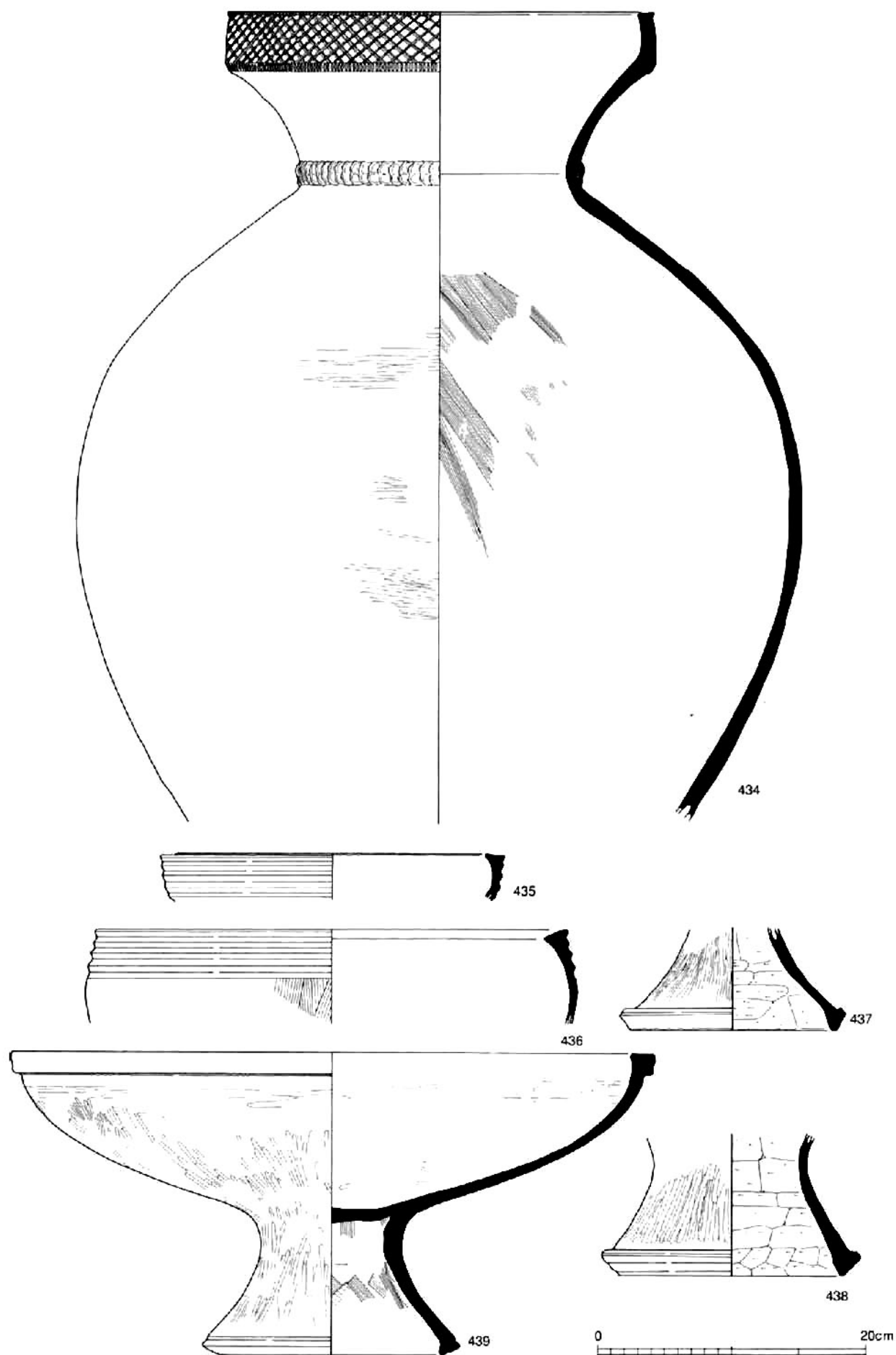

土器34 (平地住居SB40001/434~439)

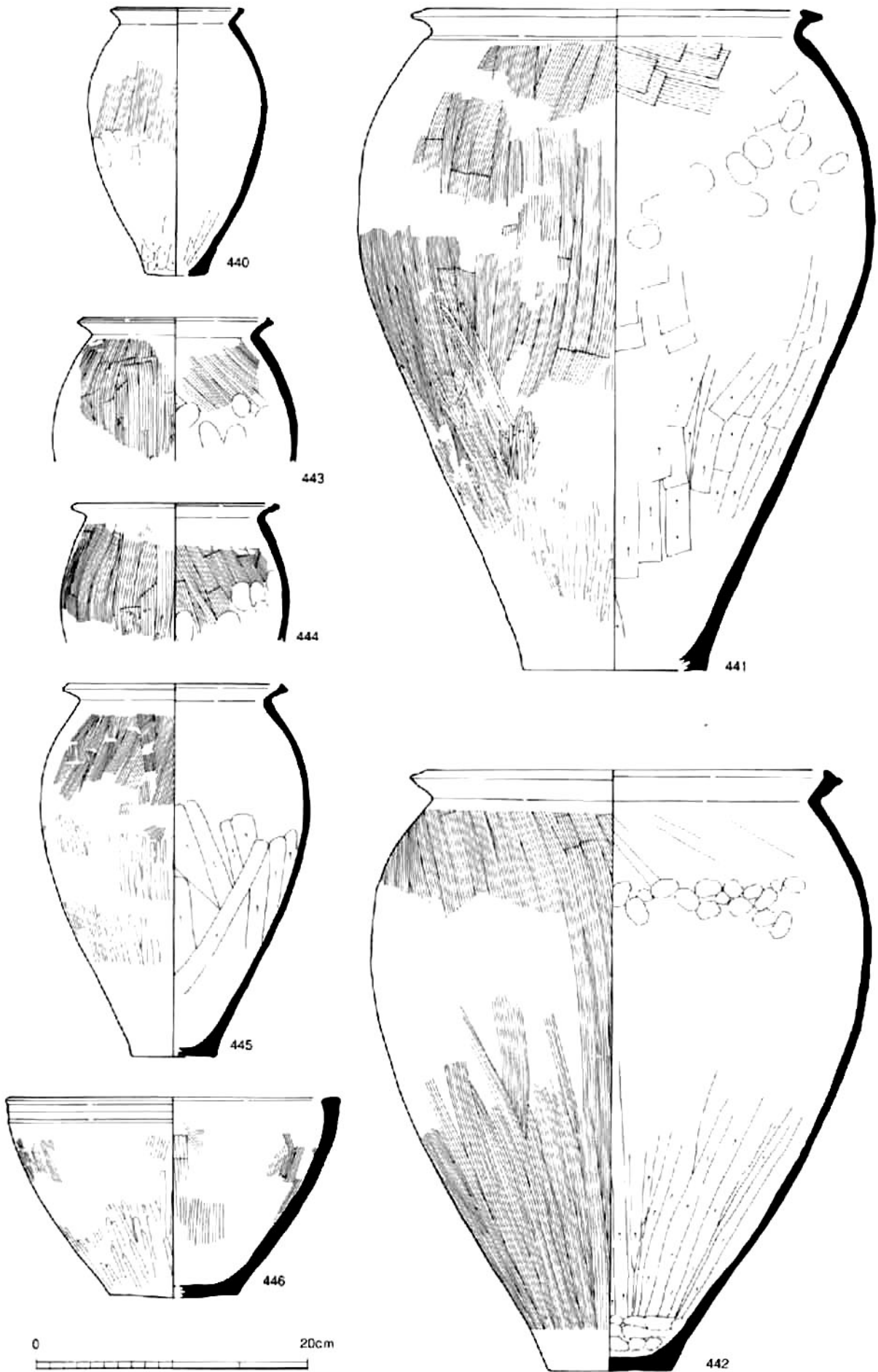

土器35 (平地住居SB40001/440~446)

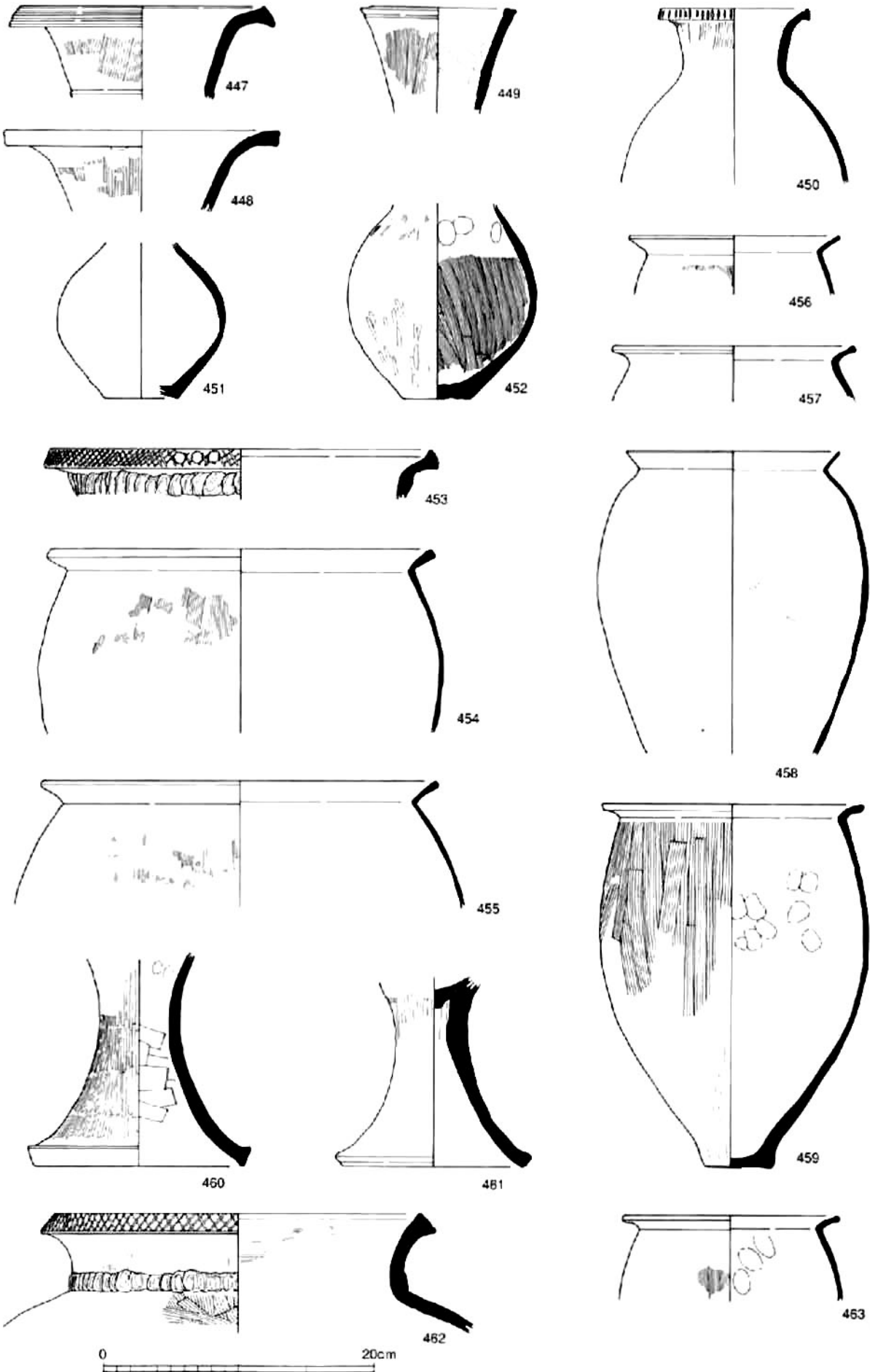

上器36 (竪穴住居 / 447~463)

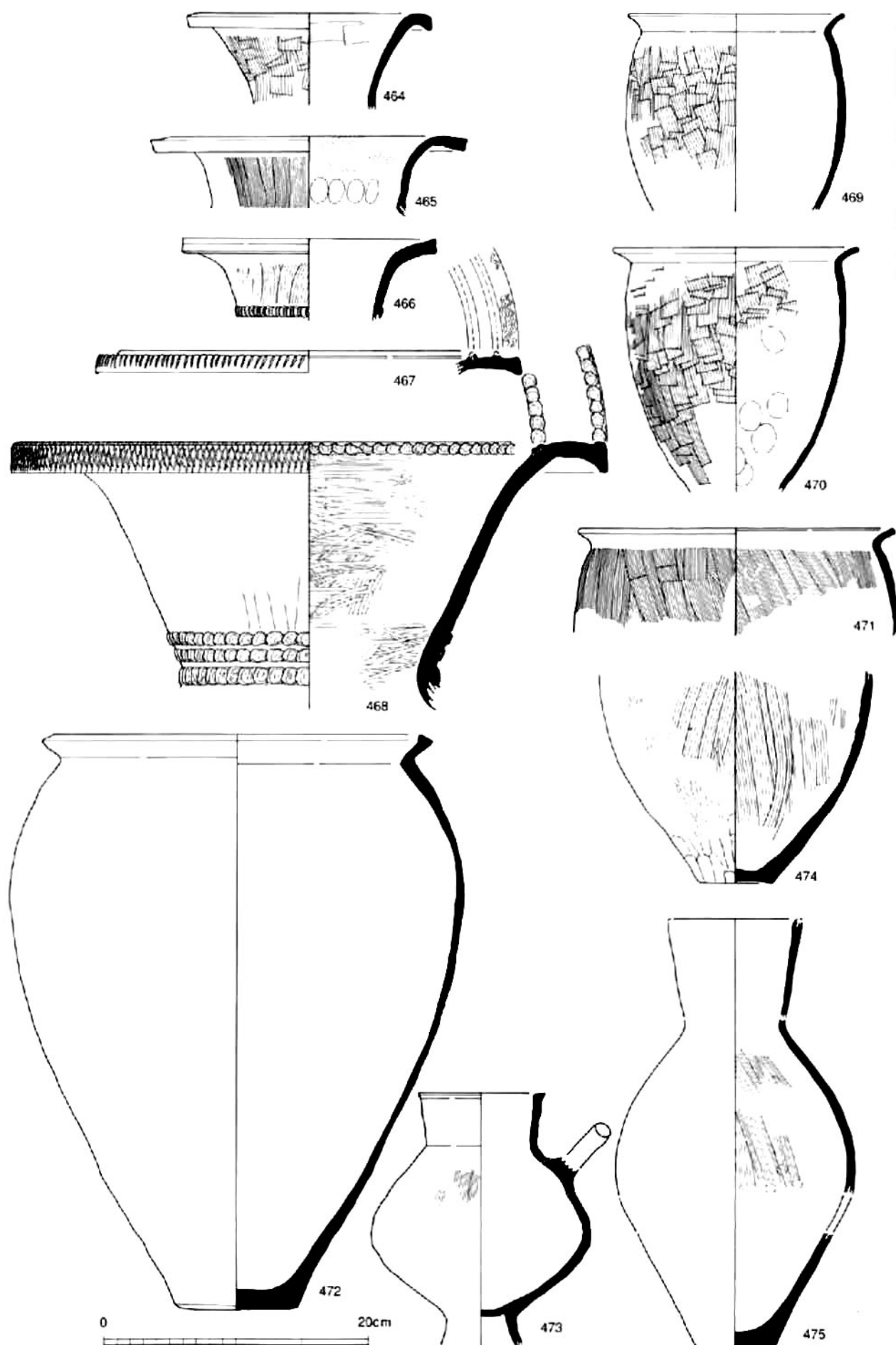

土器37 (竖穴住居・土坑/464~475)

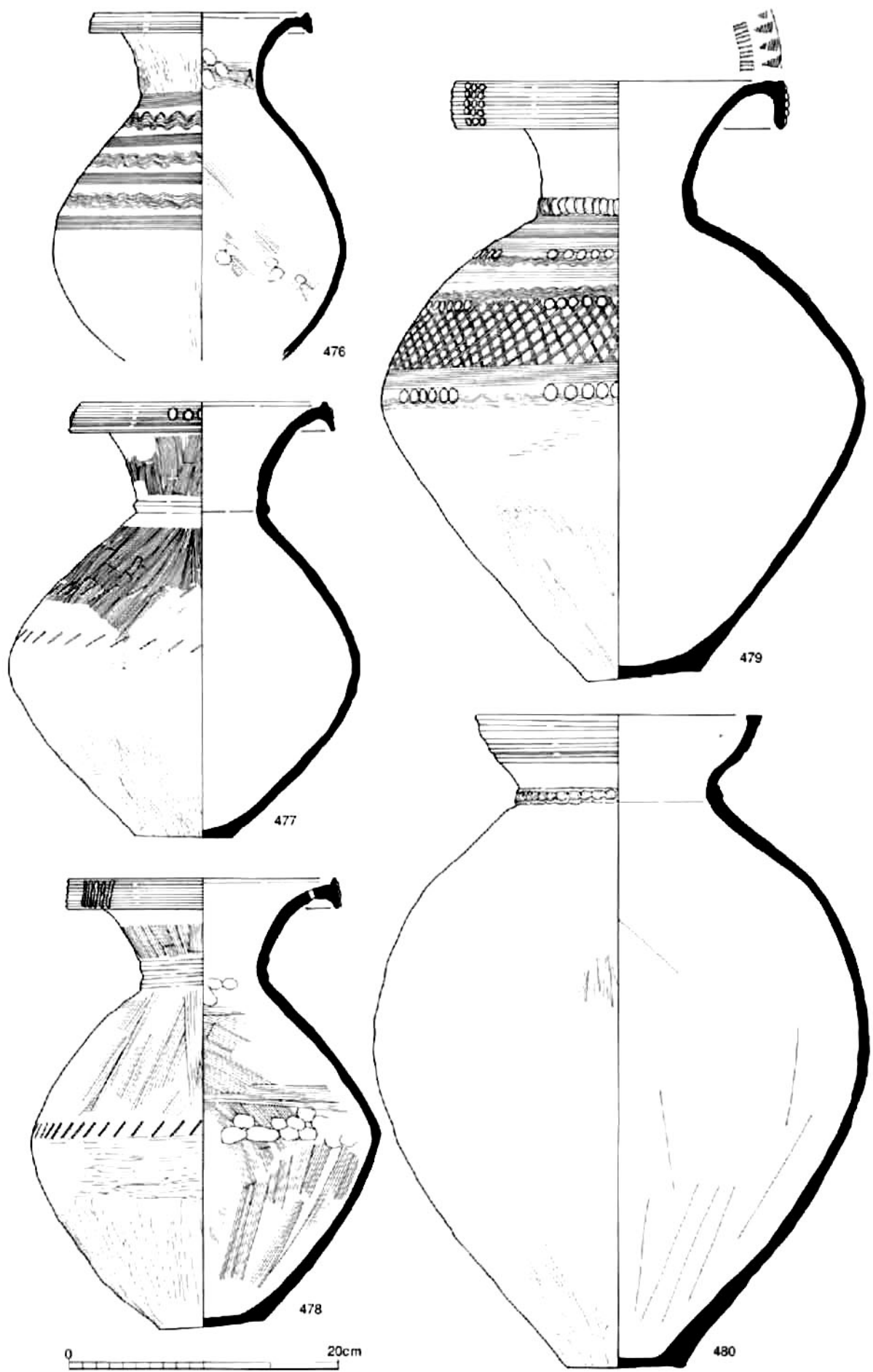

土器38 (土坑/476~480)

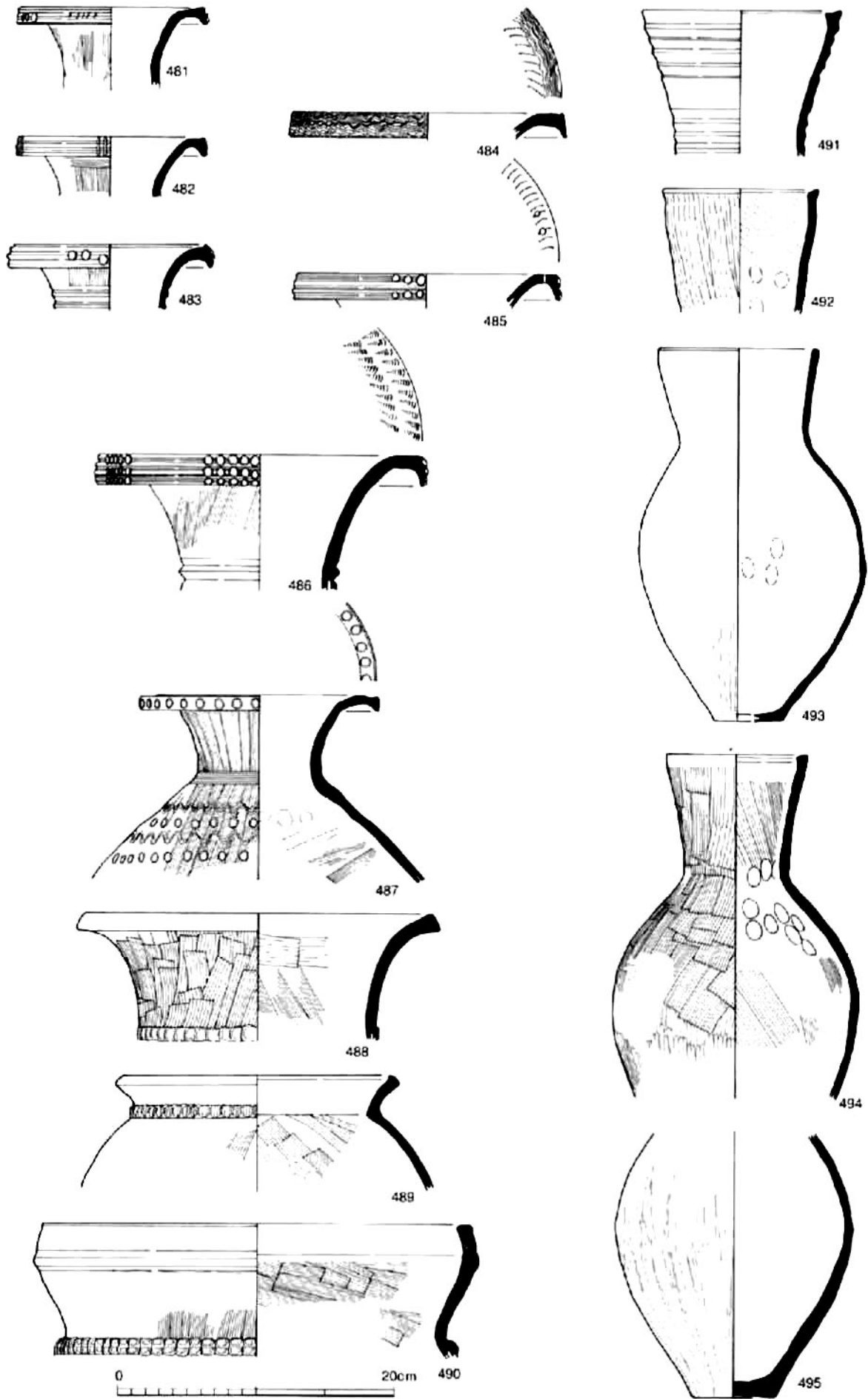

土器39 (整穴住居・土坑/481~495)

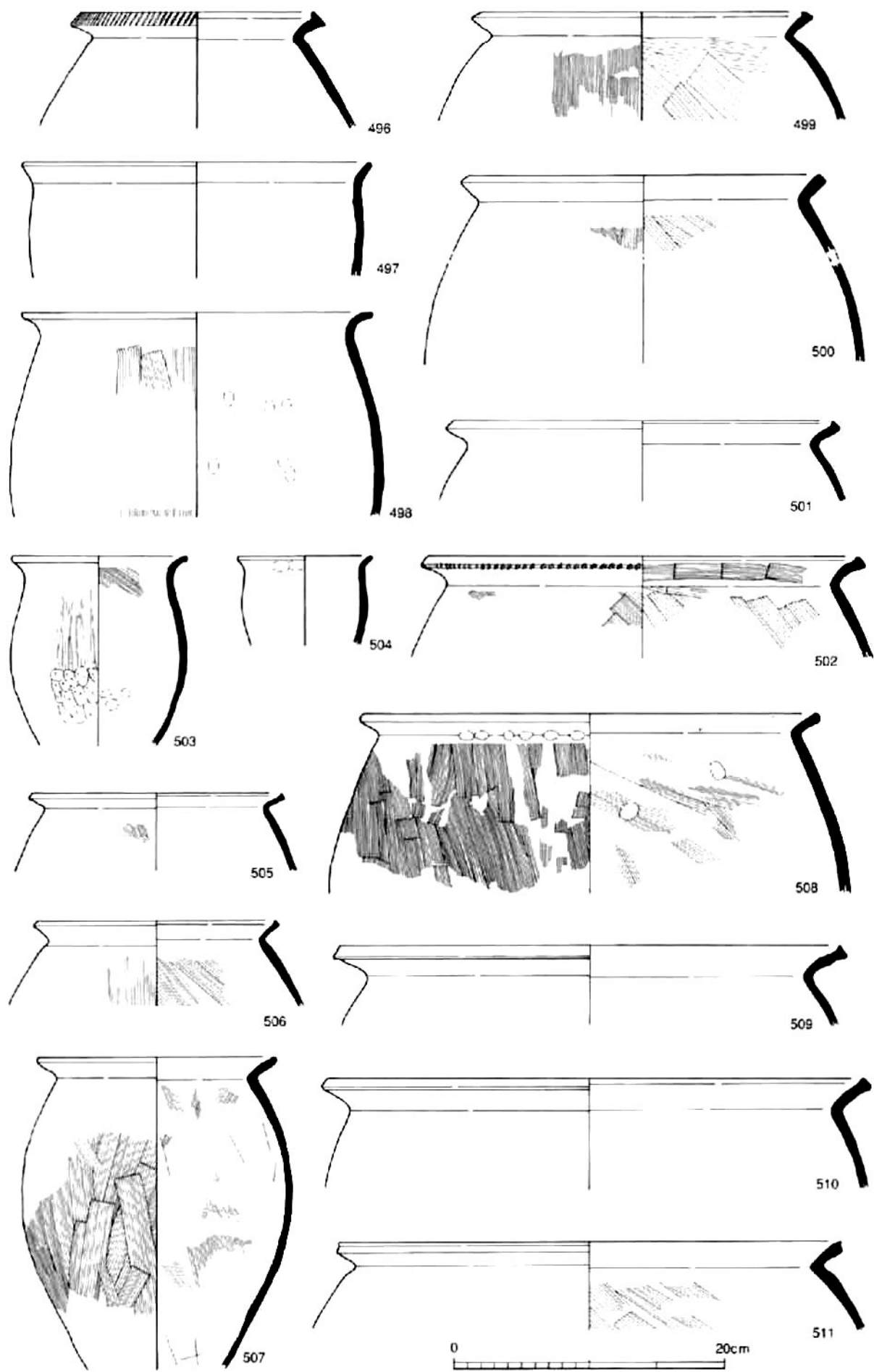

土器40 (土坑/496~511)

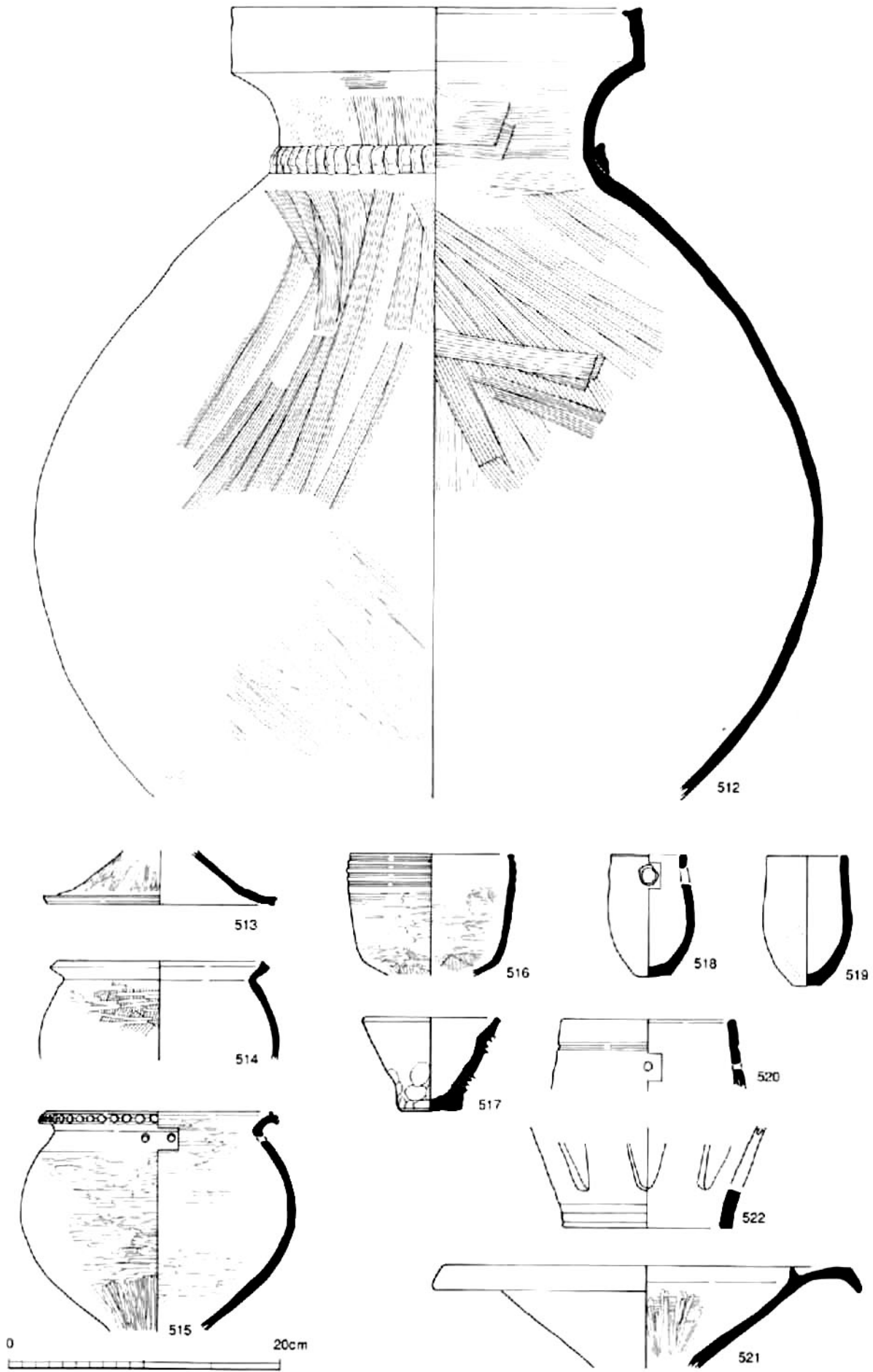

土器41 (土坑/512~522)

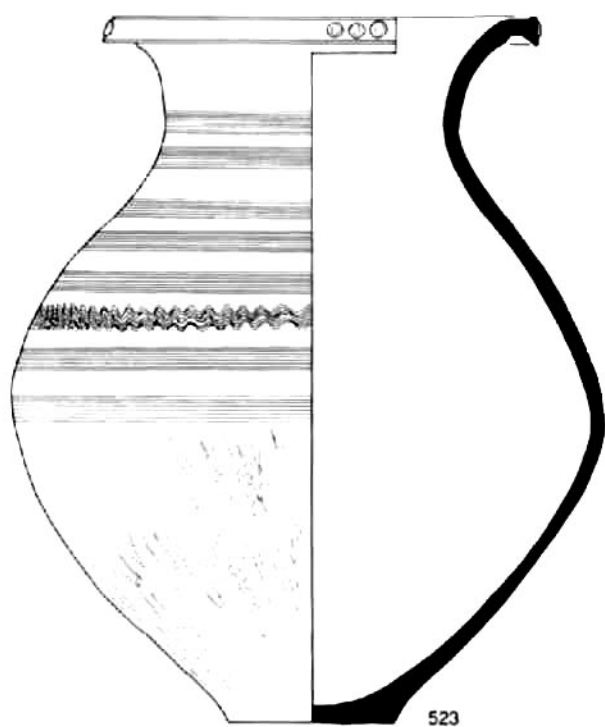

523

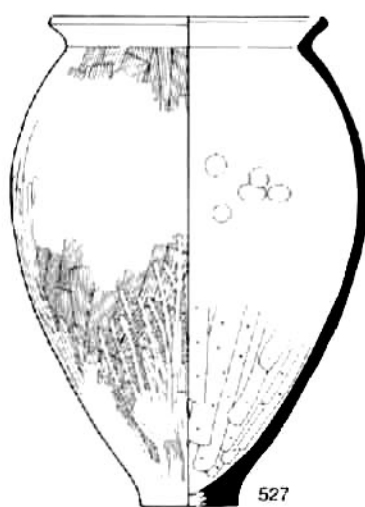

527

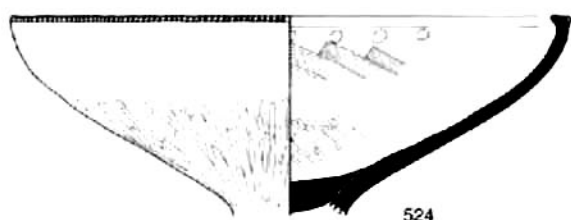

524

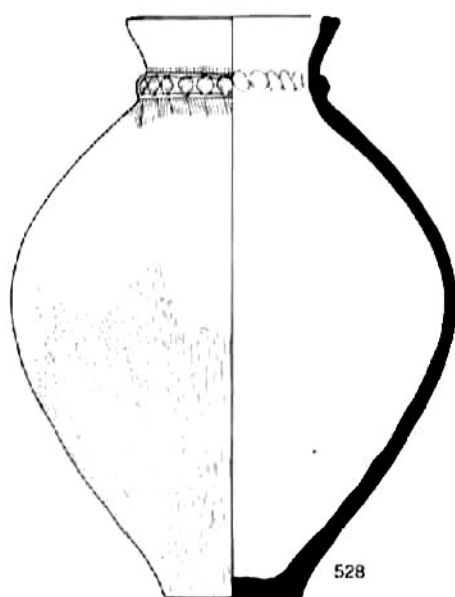

528

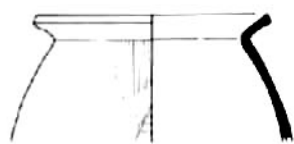

525

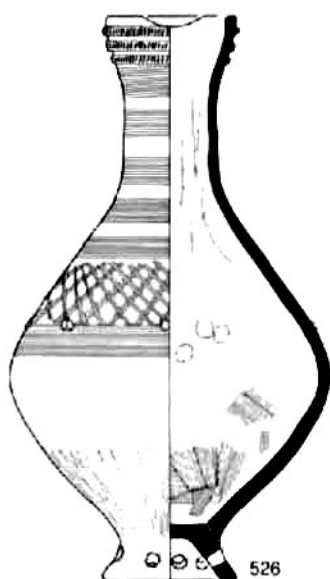

526

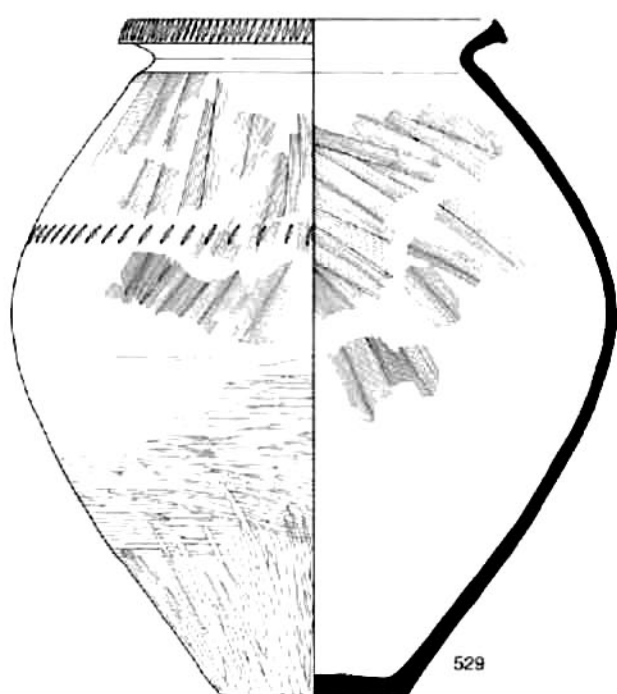

529



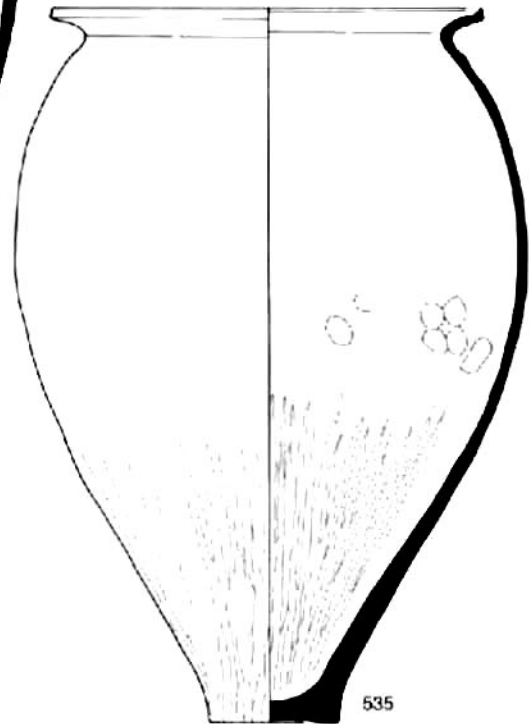
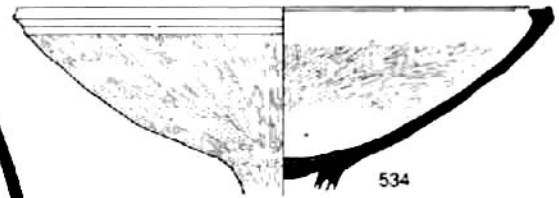
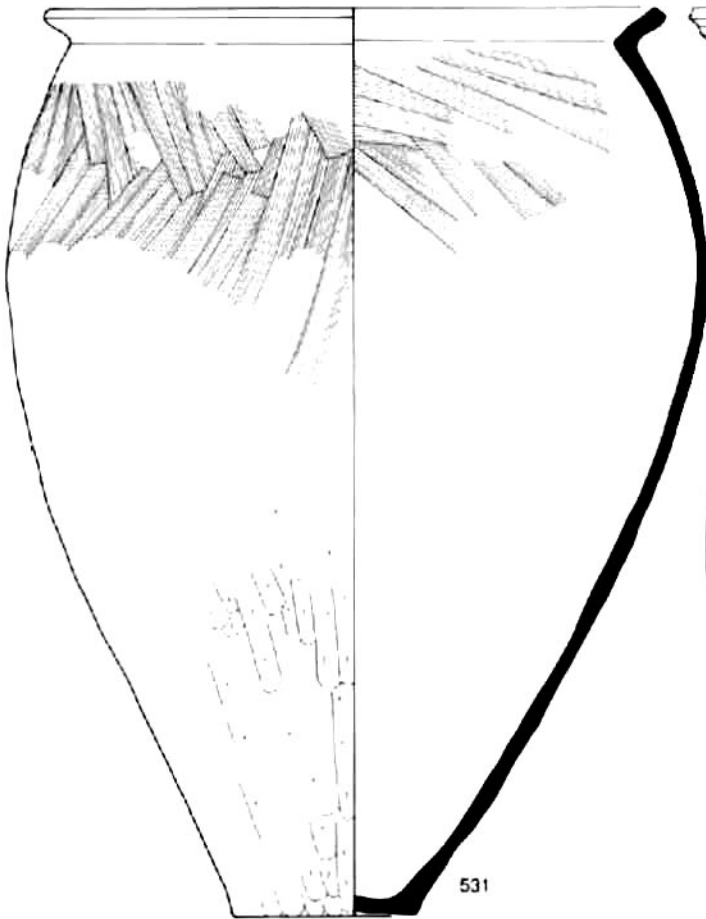
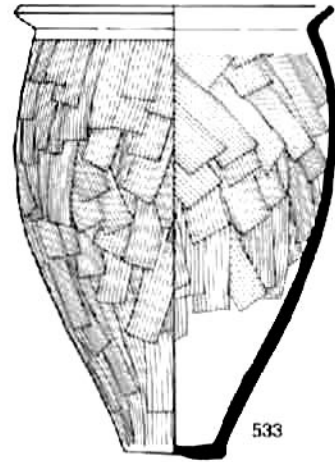
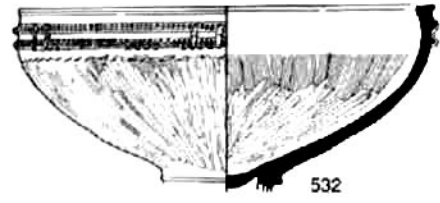
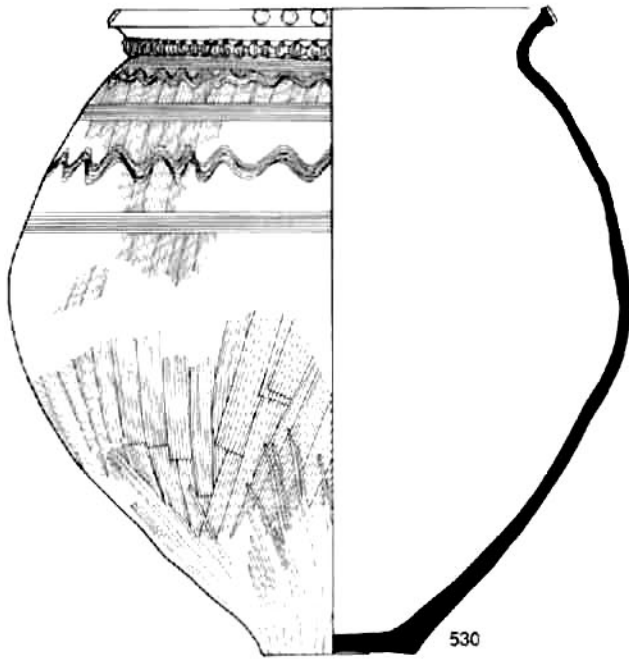

0 20cm

土器43 (土器棺/530~535)

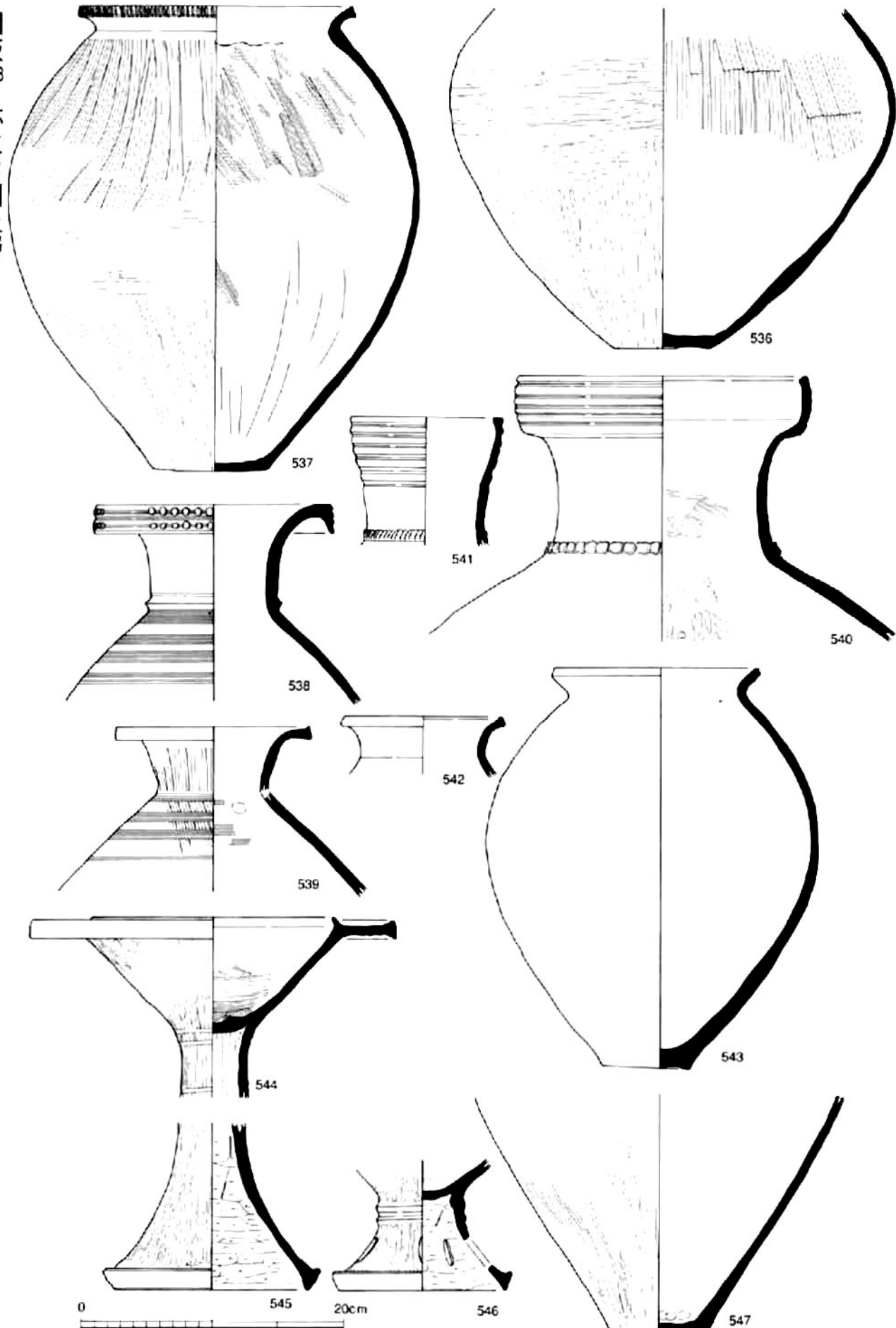

土器44 (土器棺・ビット/536~547)

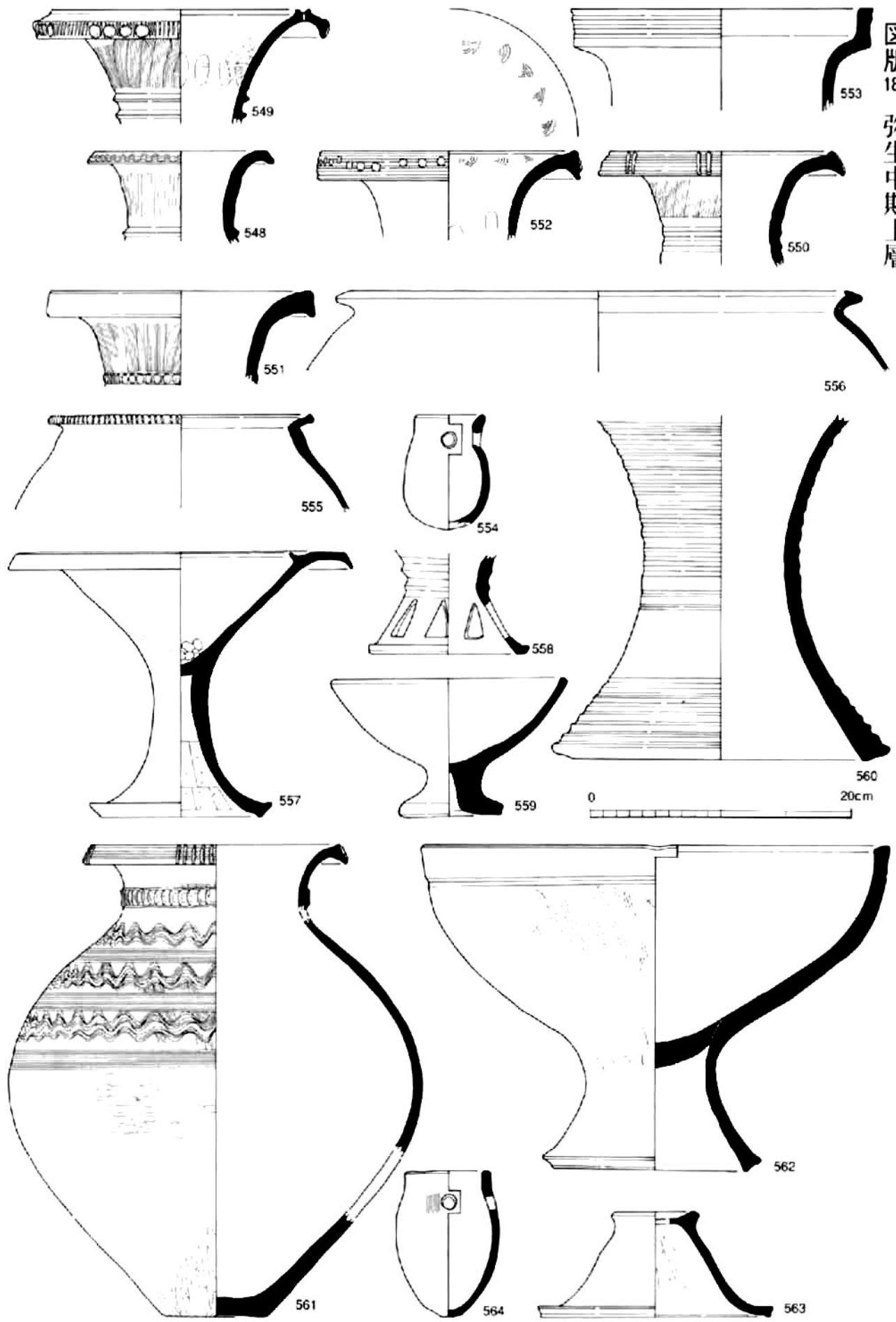

土器45 (包含層/548~564)

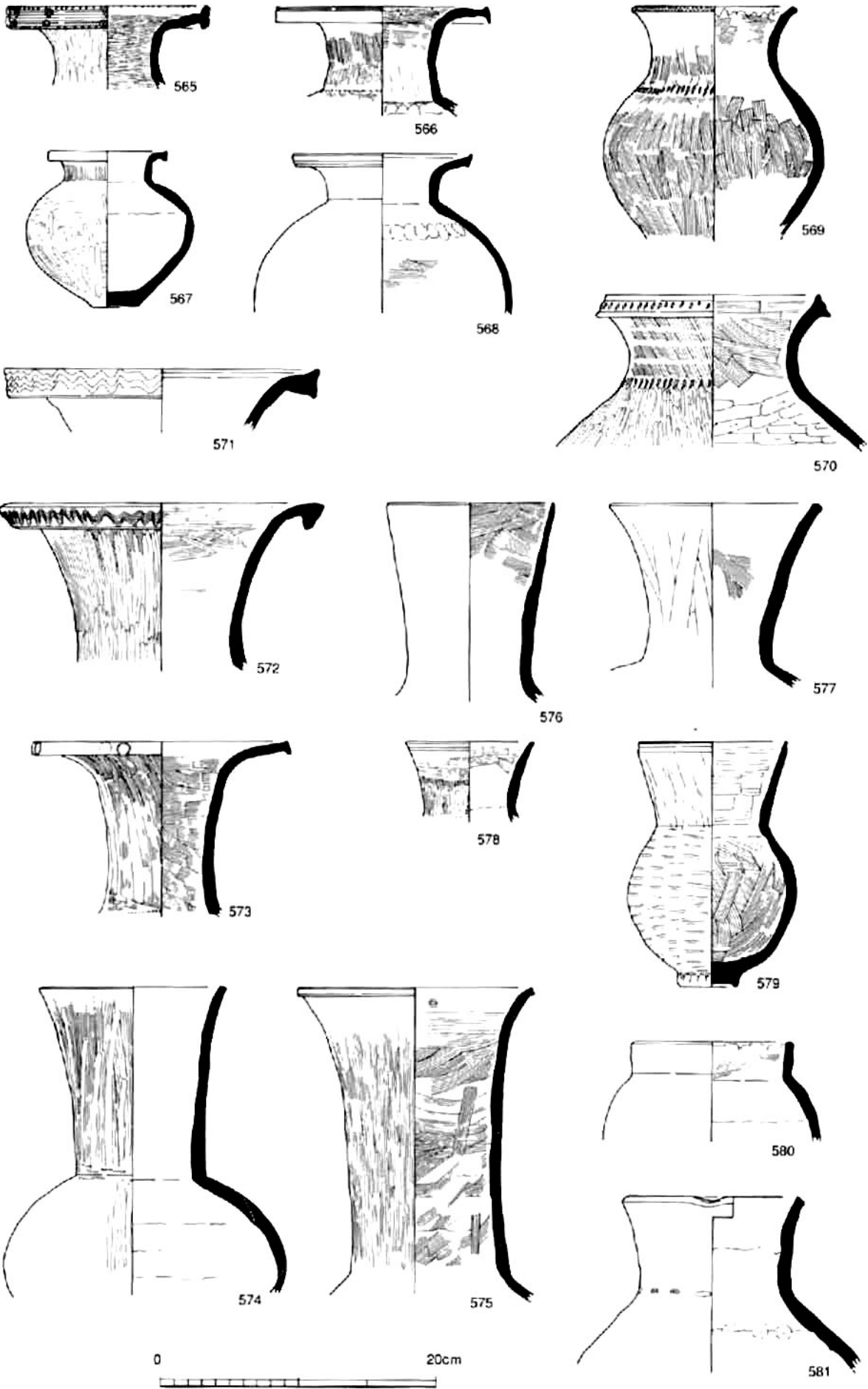

土器1 (河道/565~581)

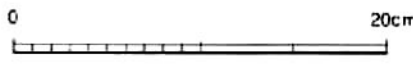
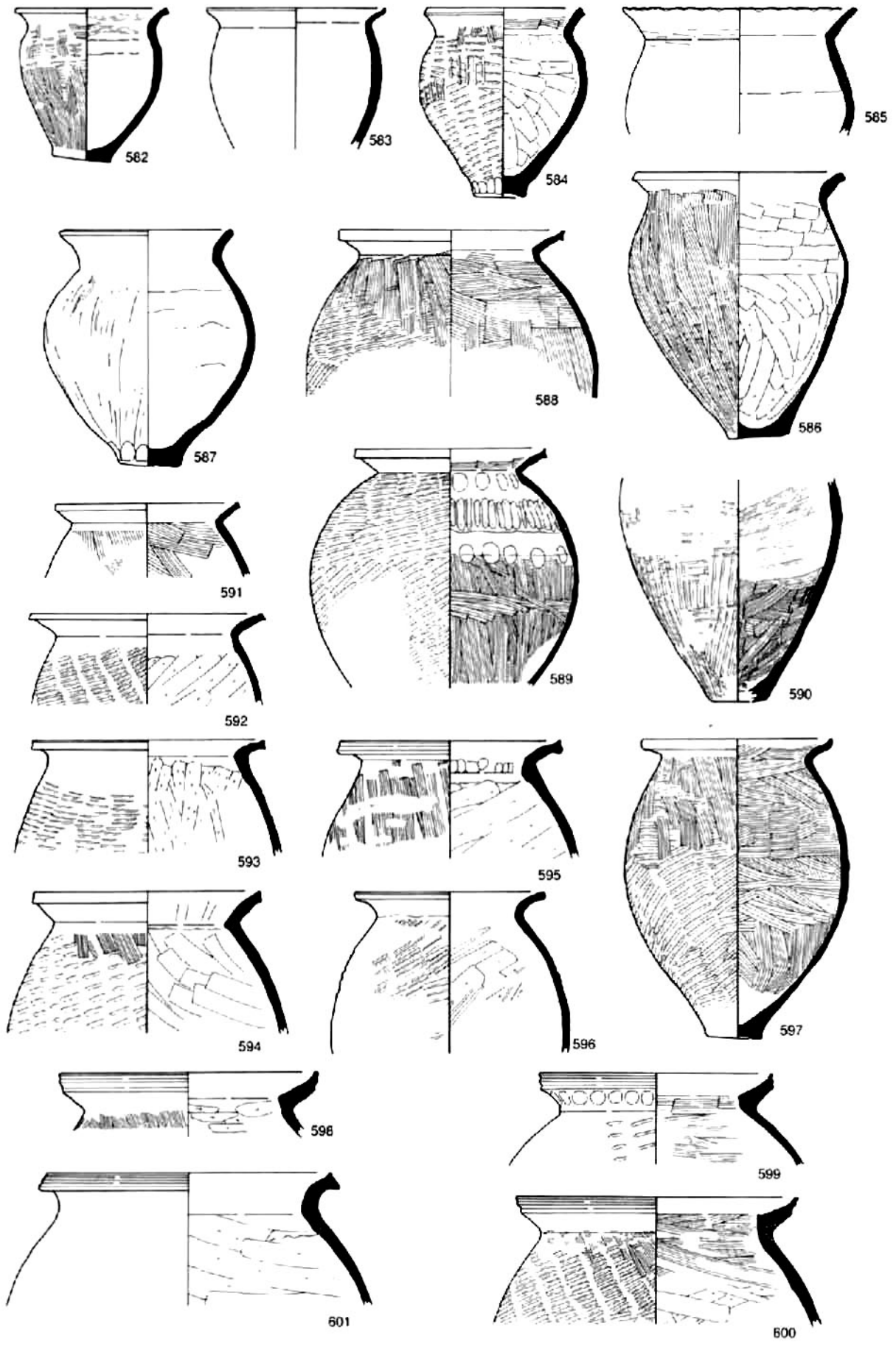

土器2 (河道/582~601)

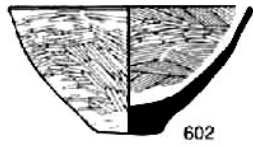

602

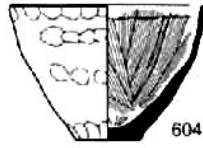

604



606



603



605

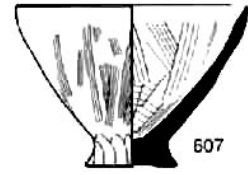

607

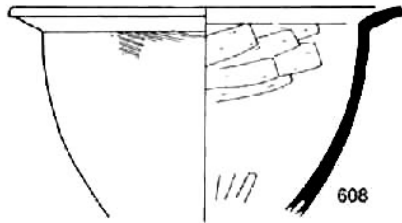

608



609

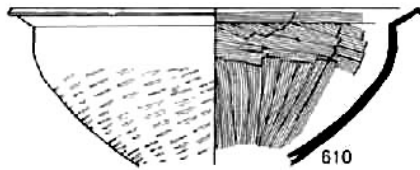

610

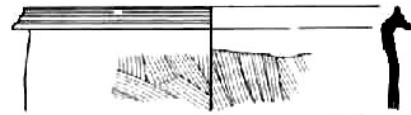

612

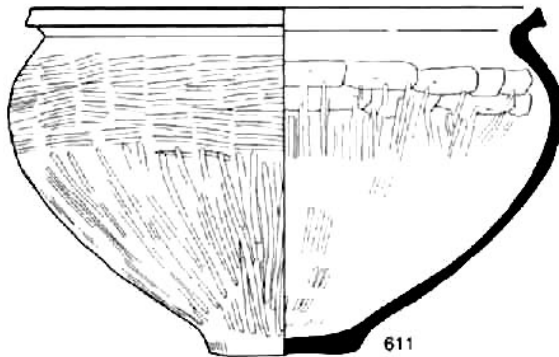

611

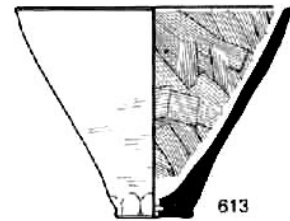

613



615

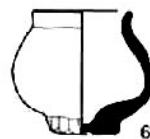

616

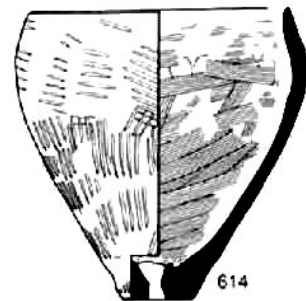

614

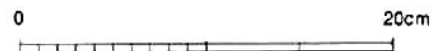

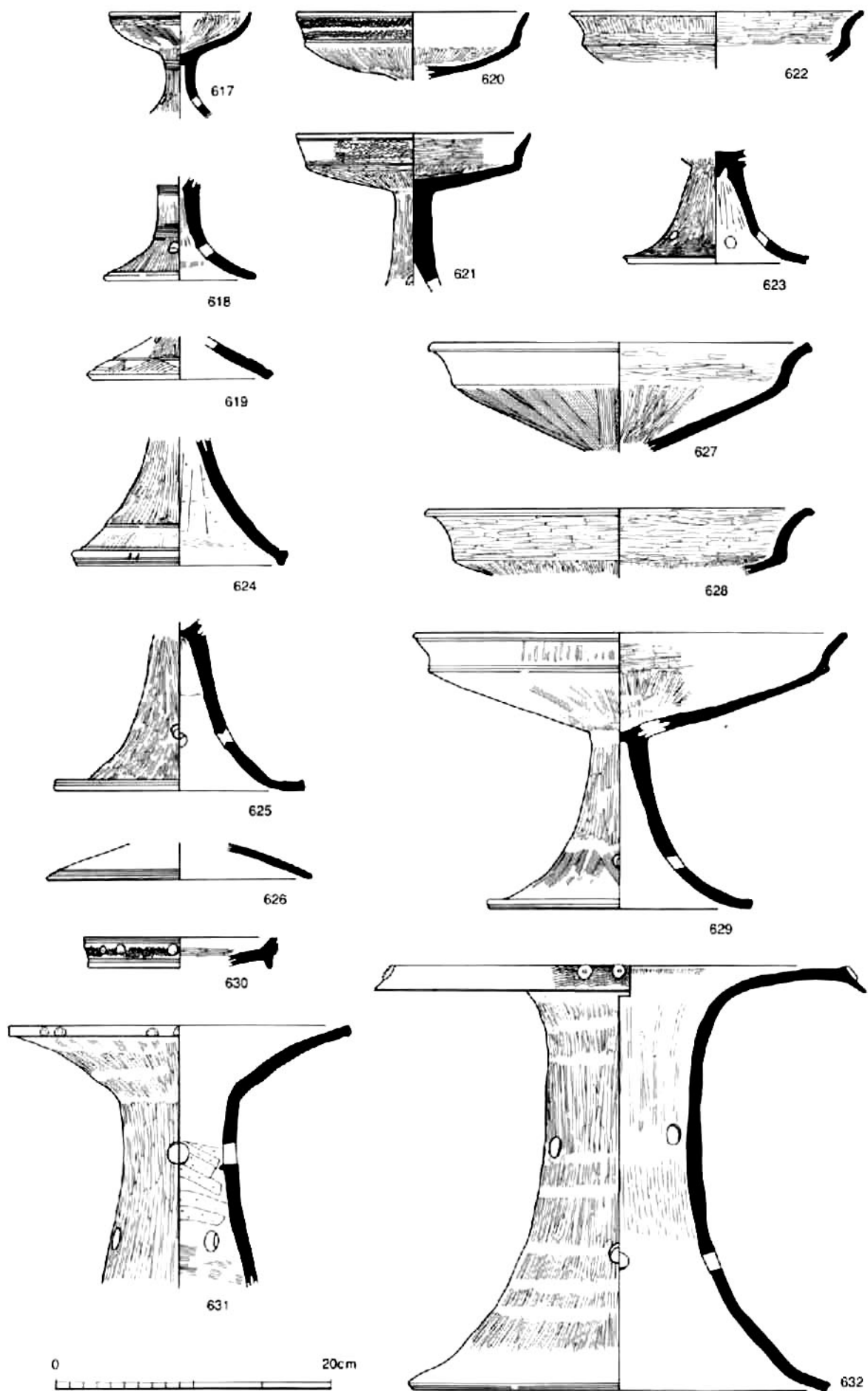

土器4 (河道/617~632)

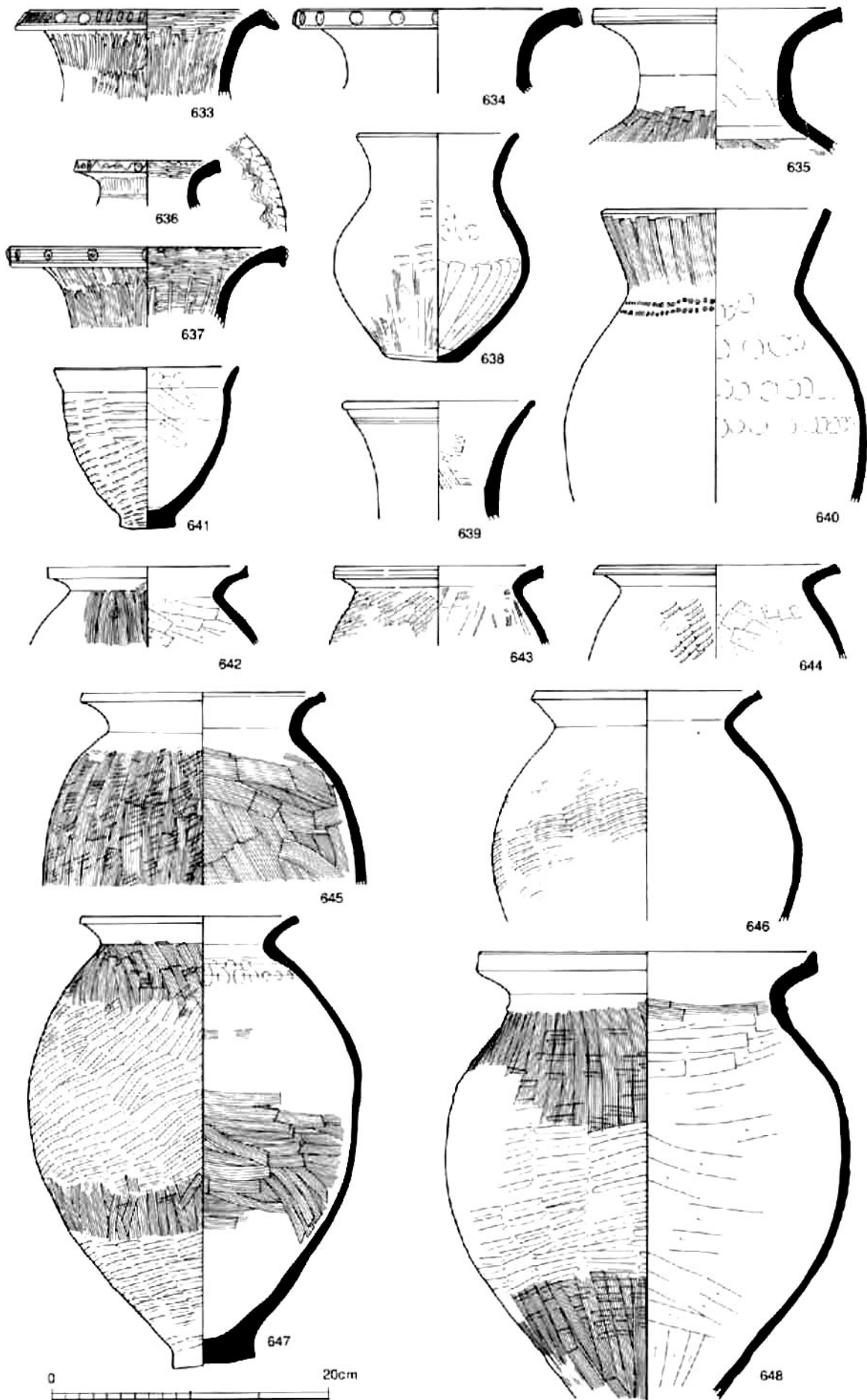

土器5 (河道/633~648)

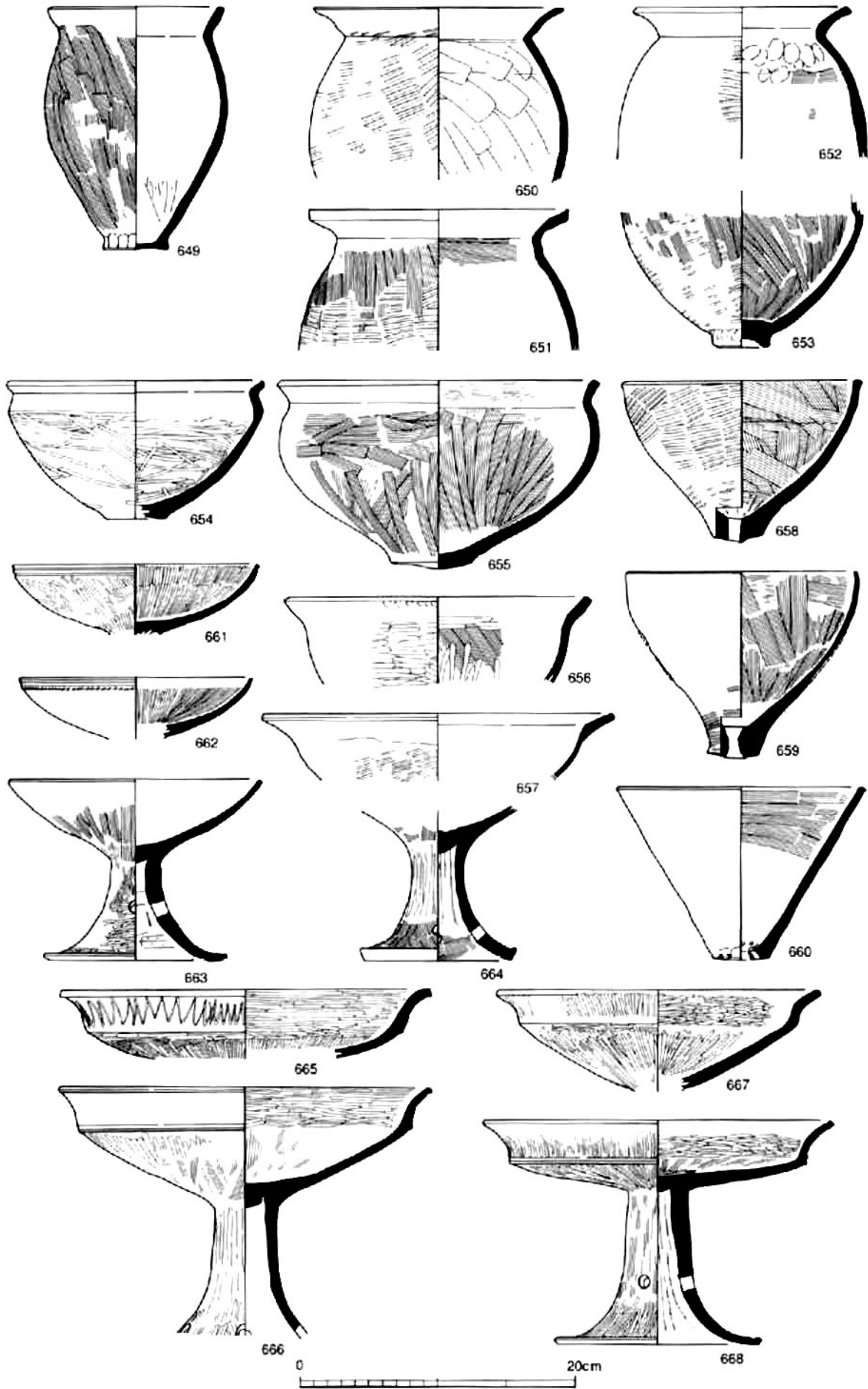

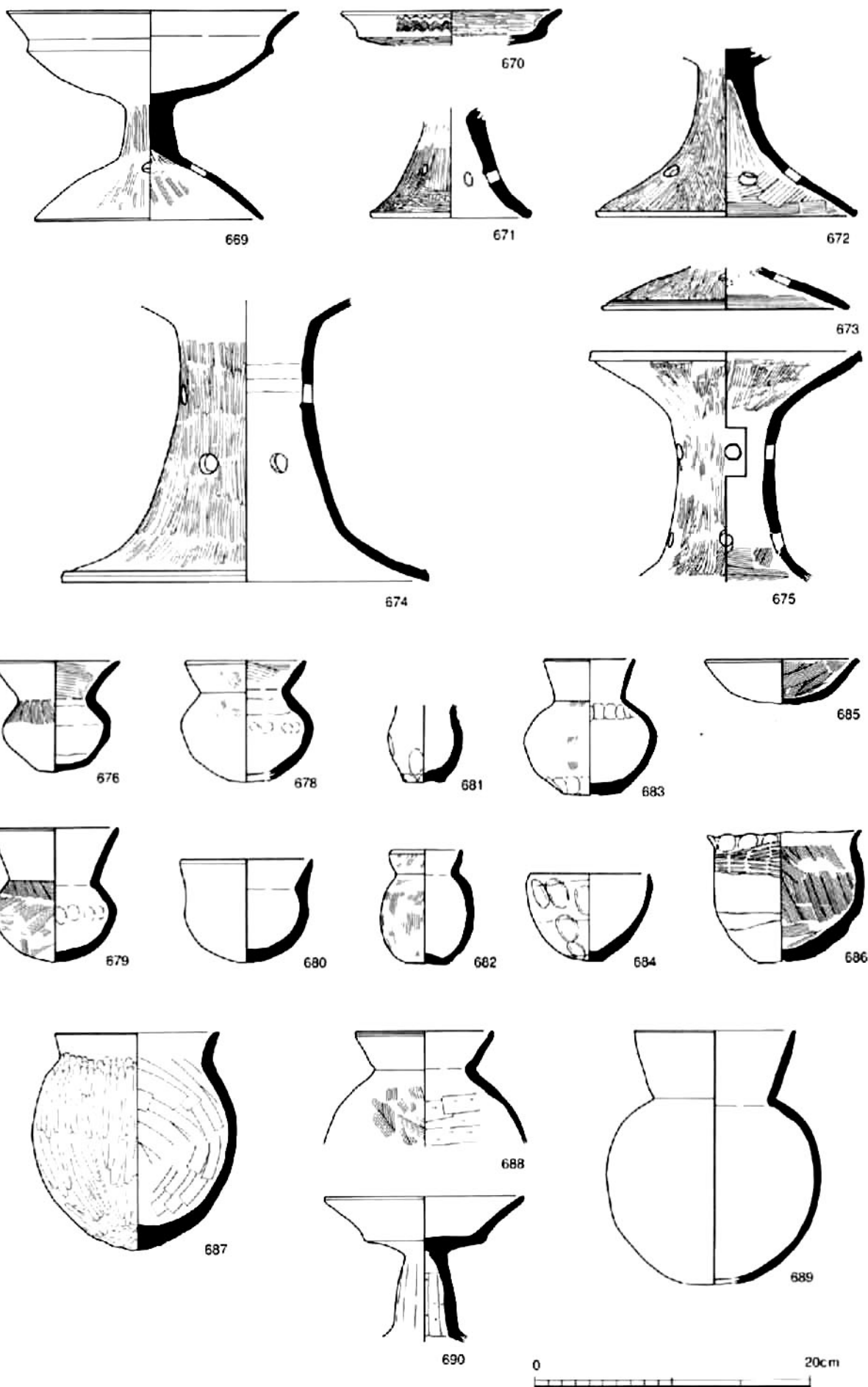

土器7 (河道/669~690)

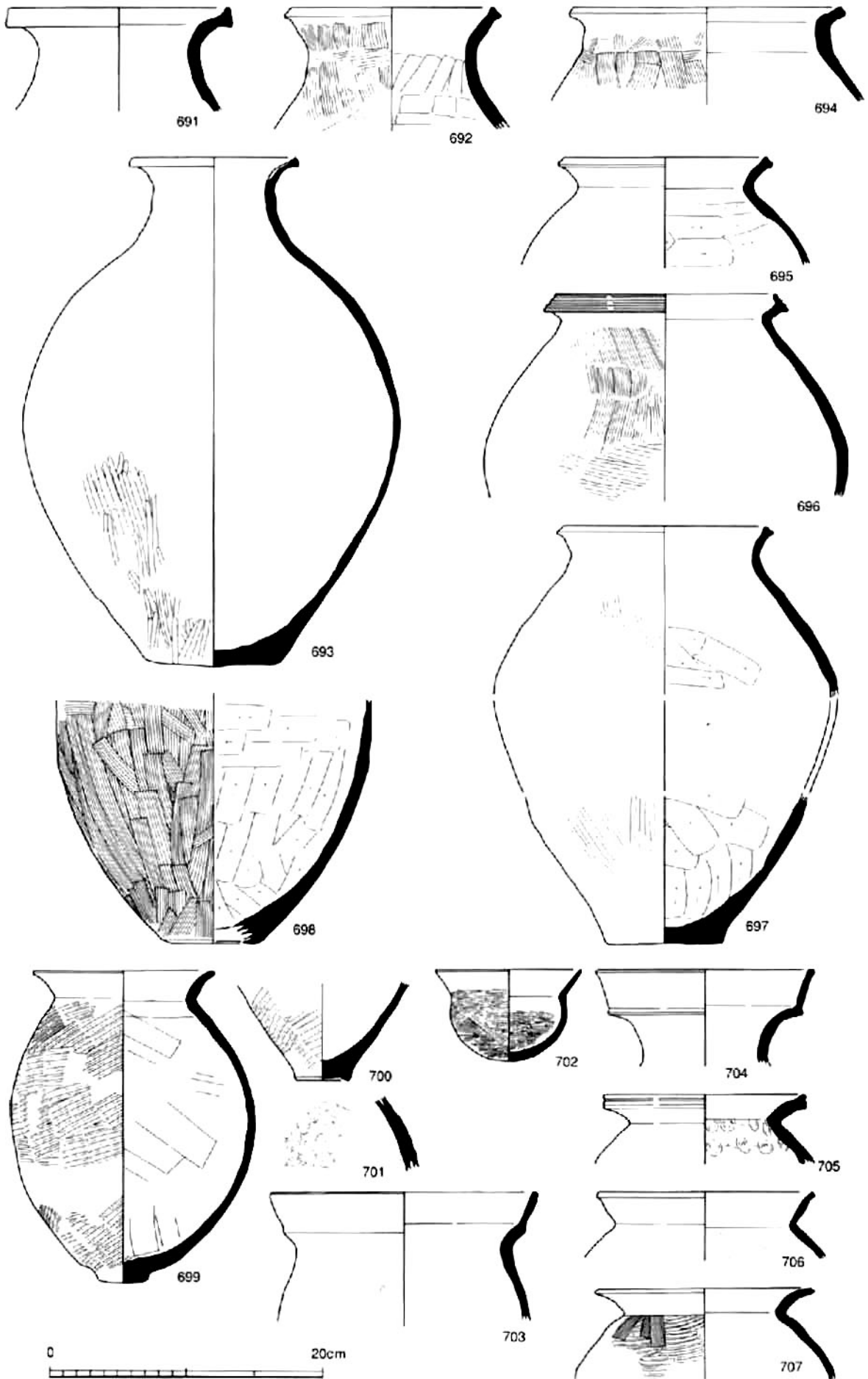

土器8 (土坑・溝/691~707)

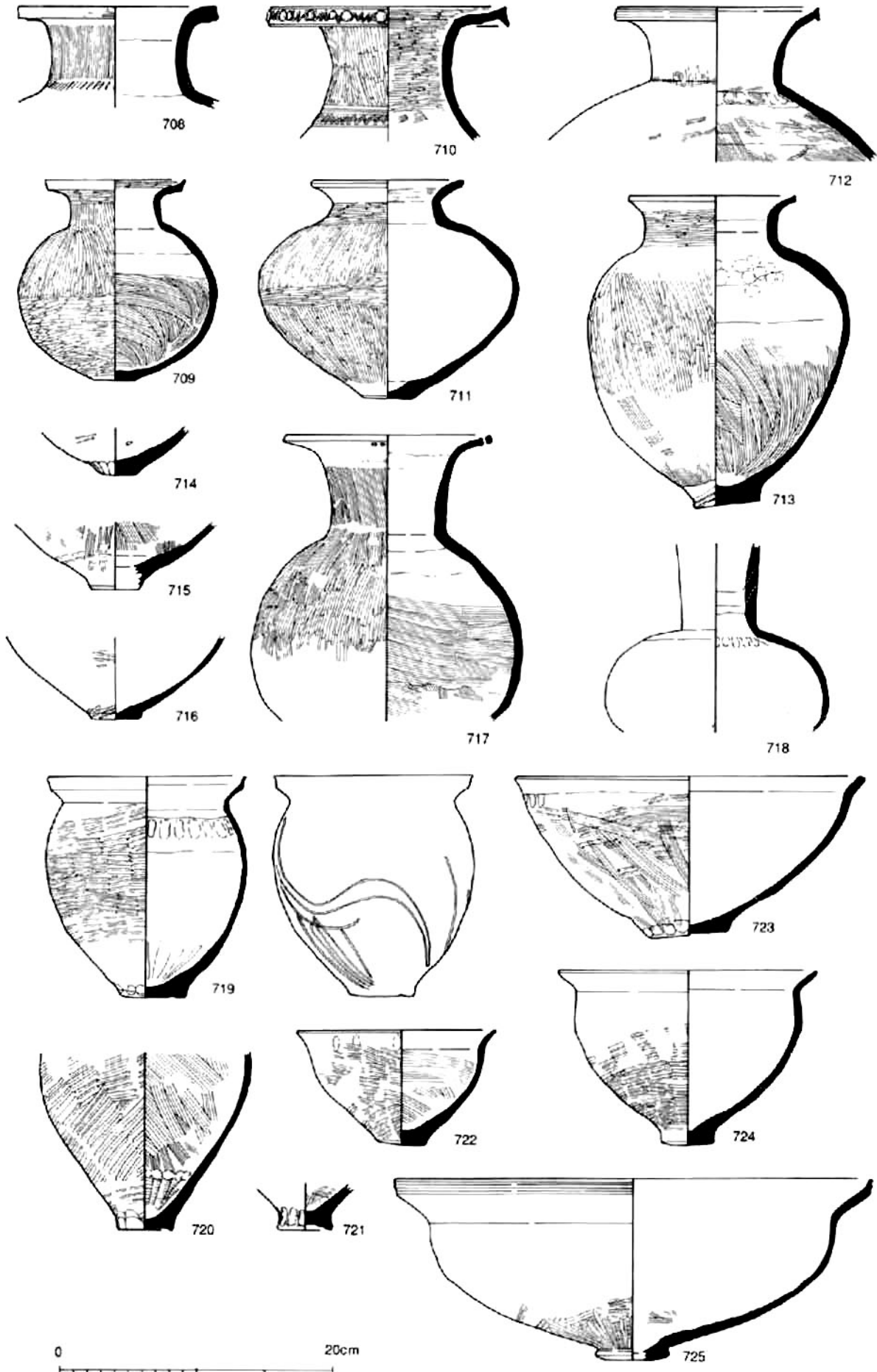

0 20cm

土器9 (豎穴住居/708~725)

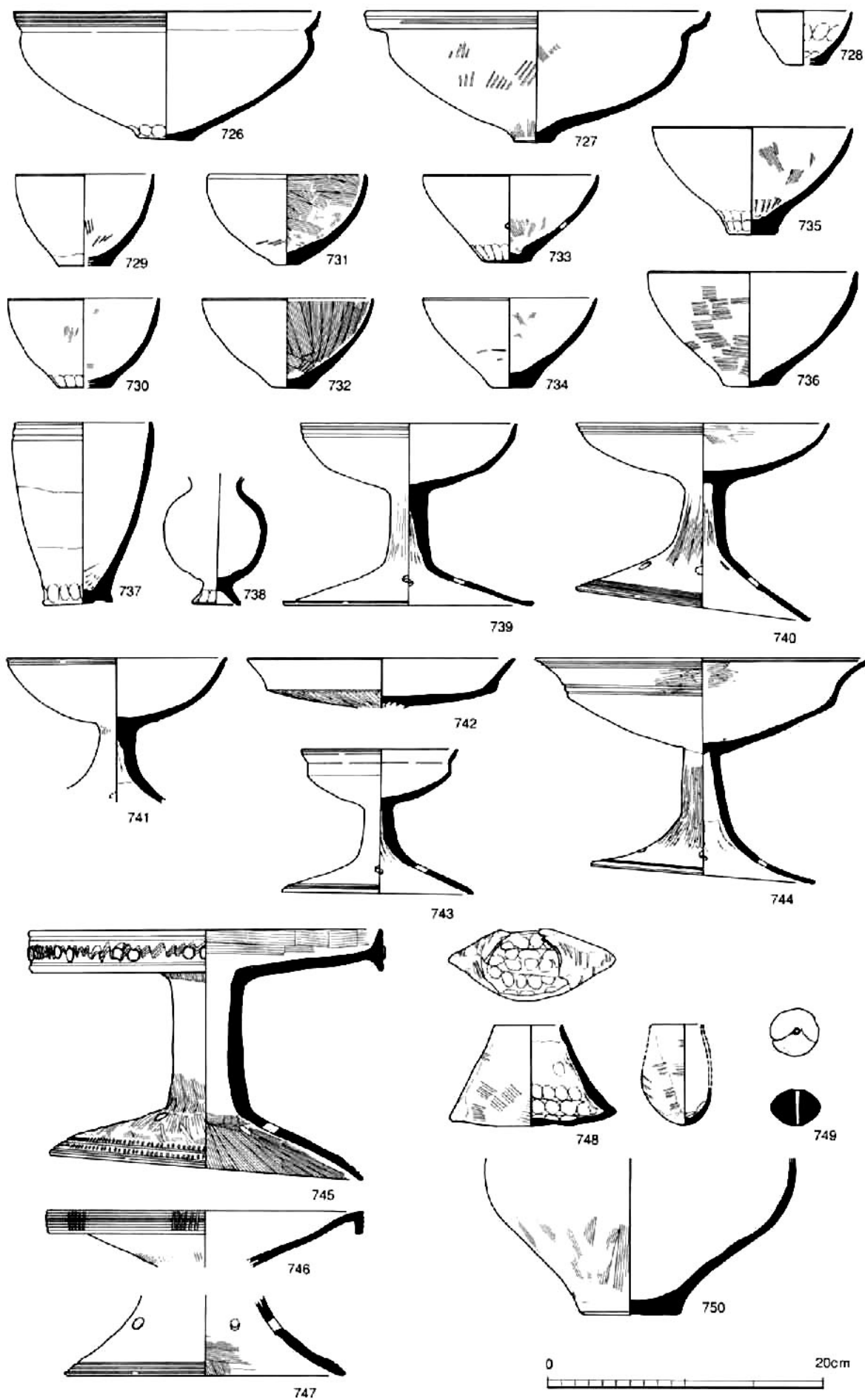

土器10 (竪穴住居/726~750)

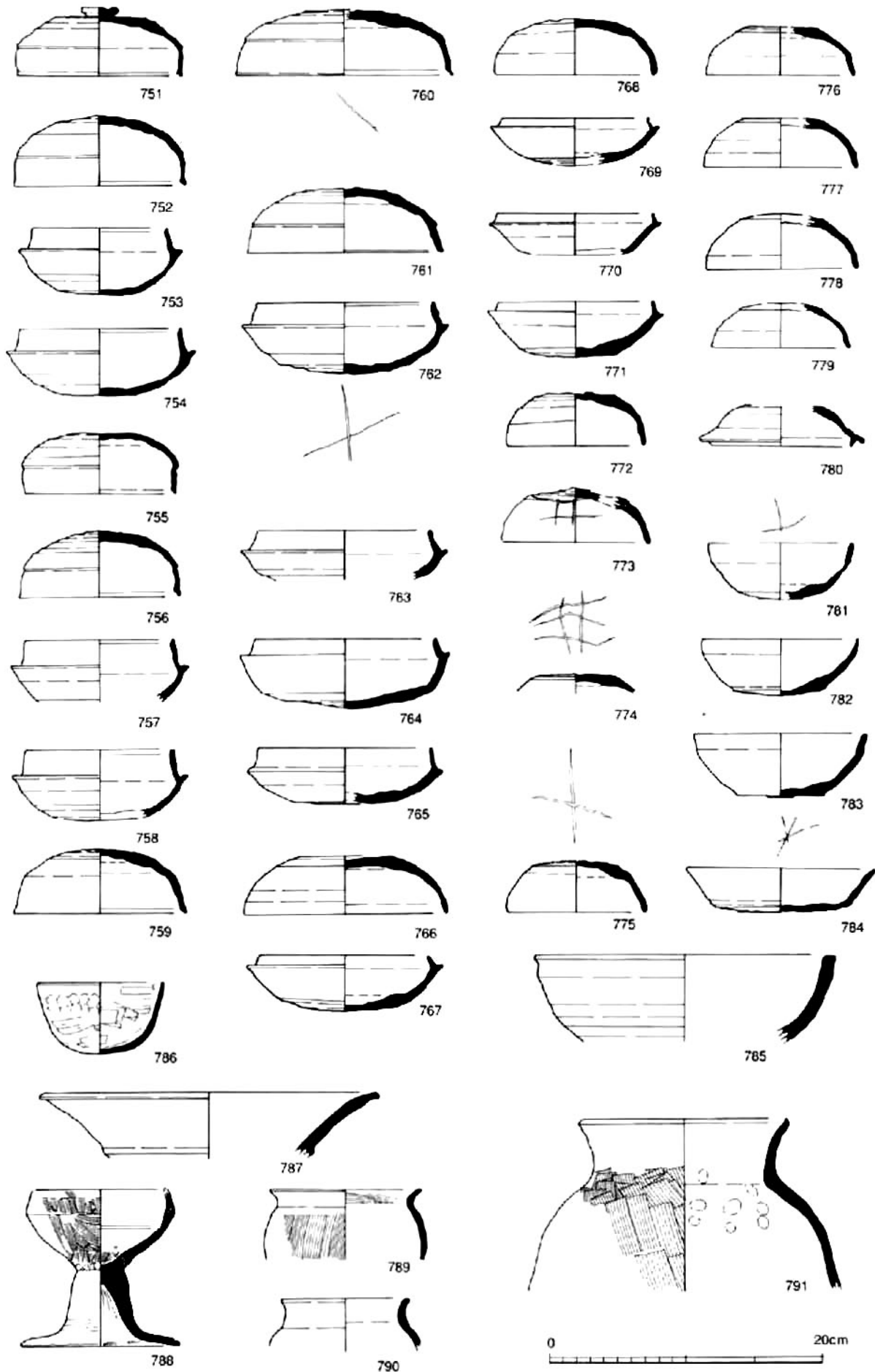

土器 (751-791)

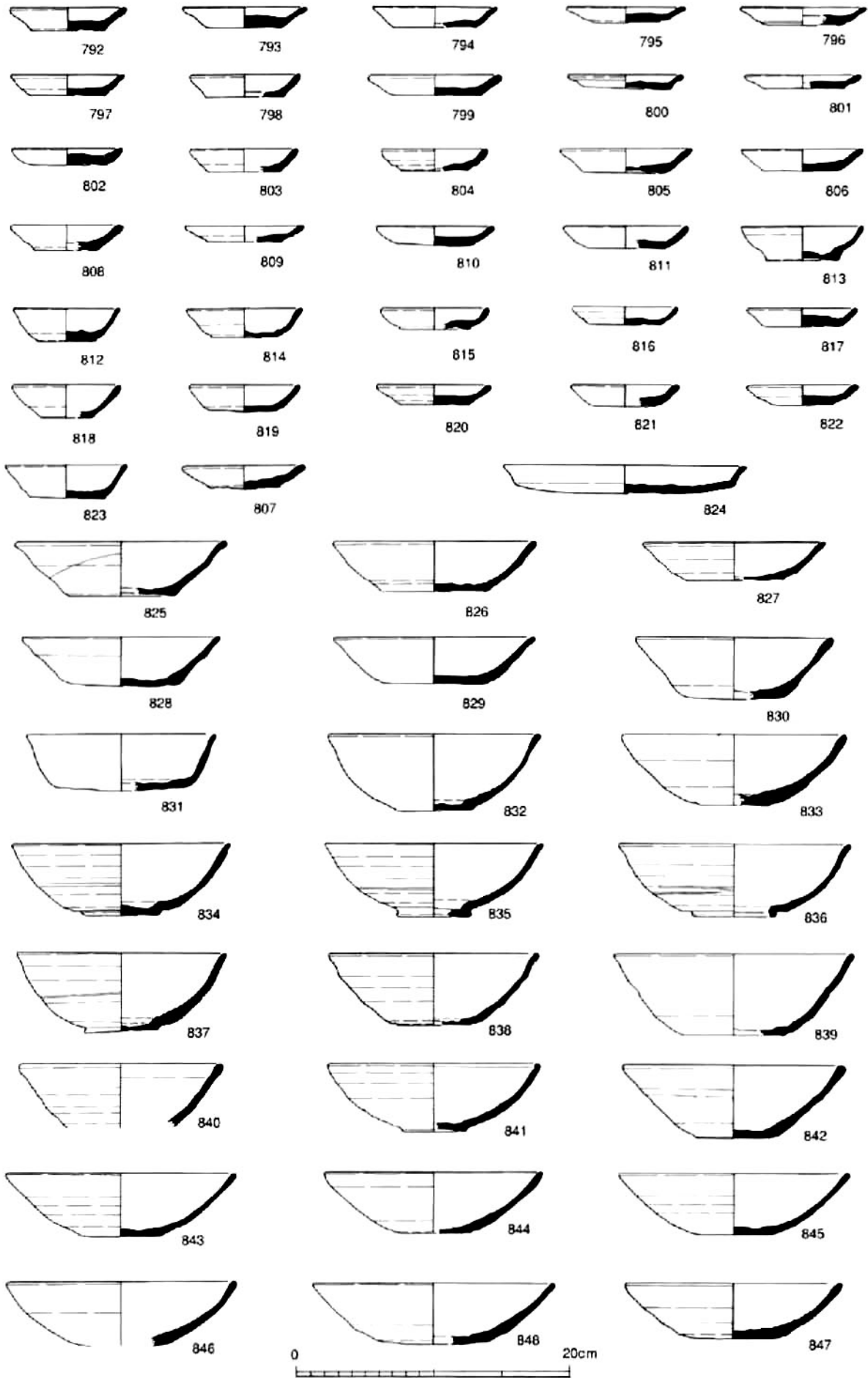

土器1 (溝/792~848)

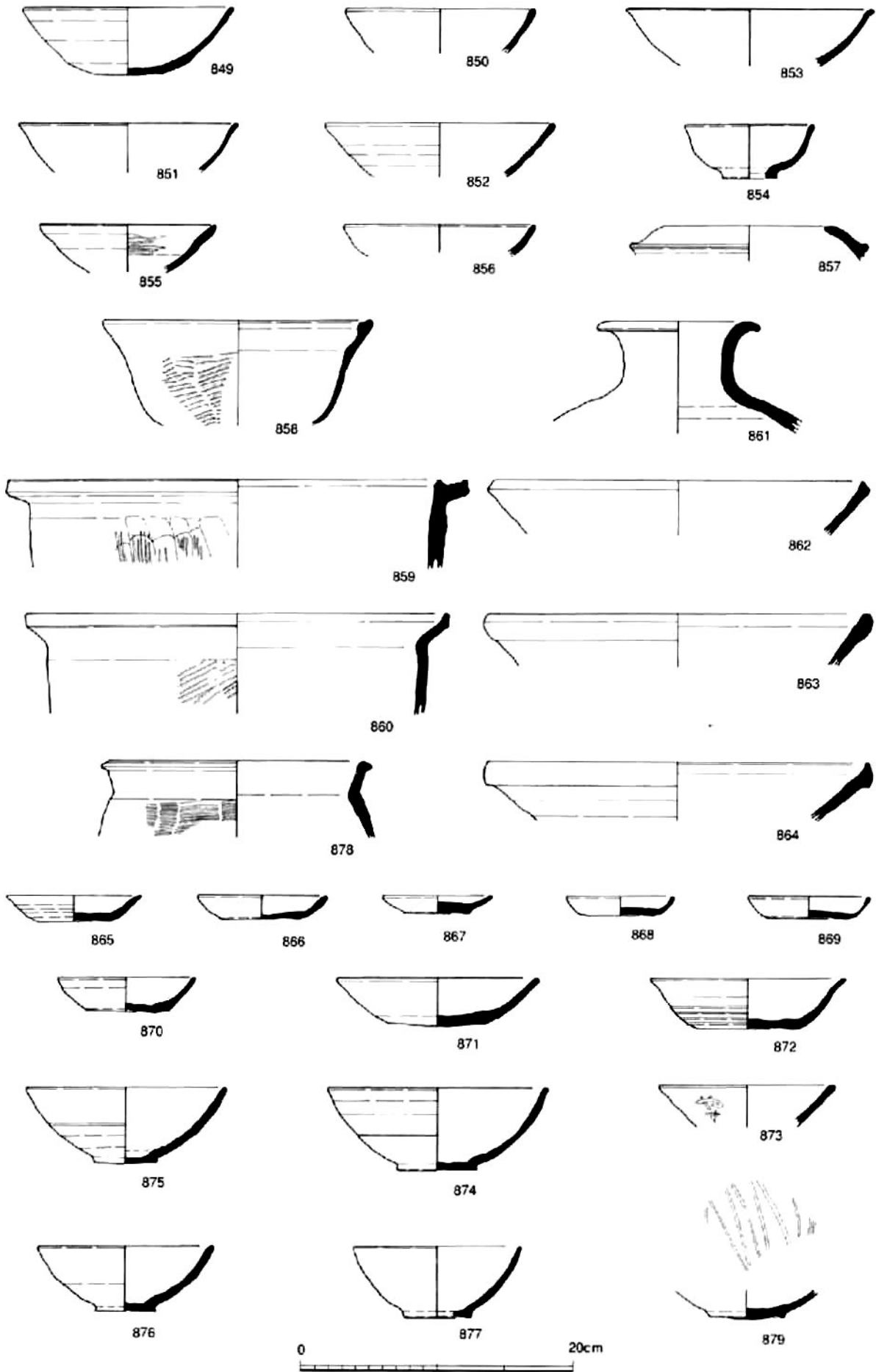

土器2 (溝・包含層/849~879)

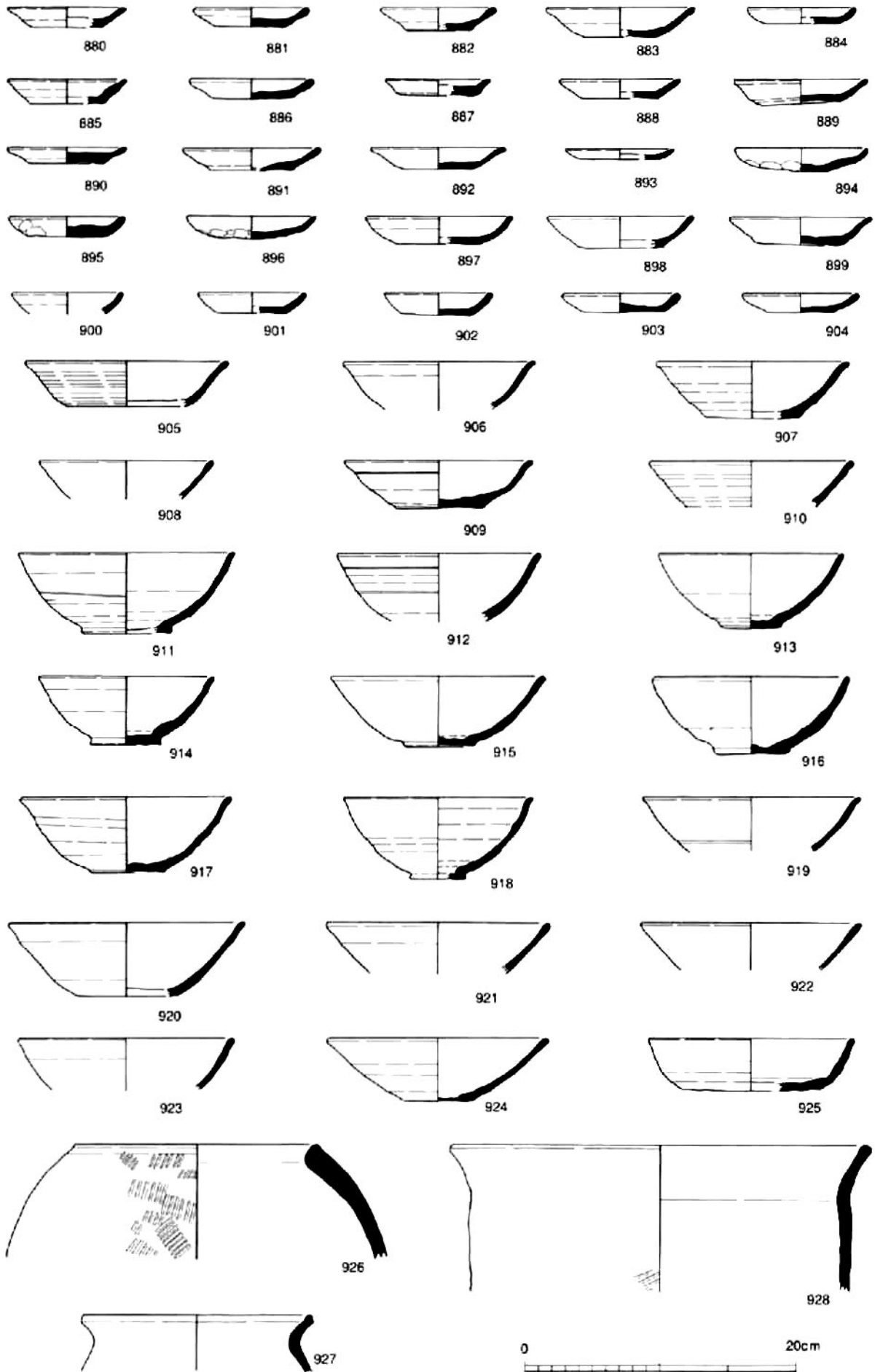

土器3 (掘立柱建物・柵/880~928)

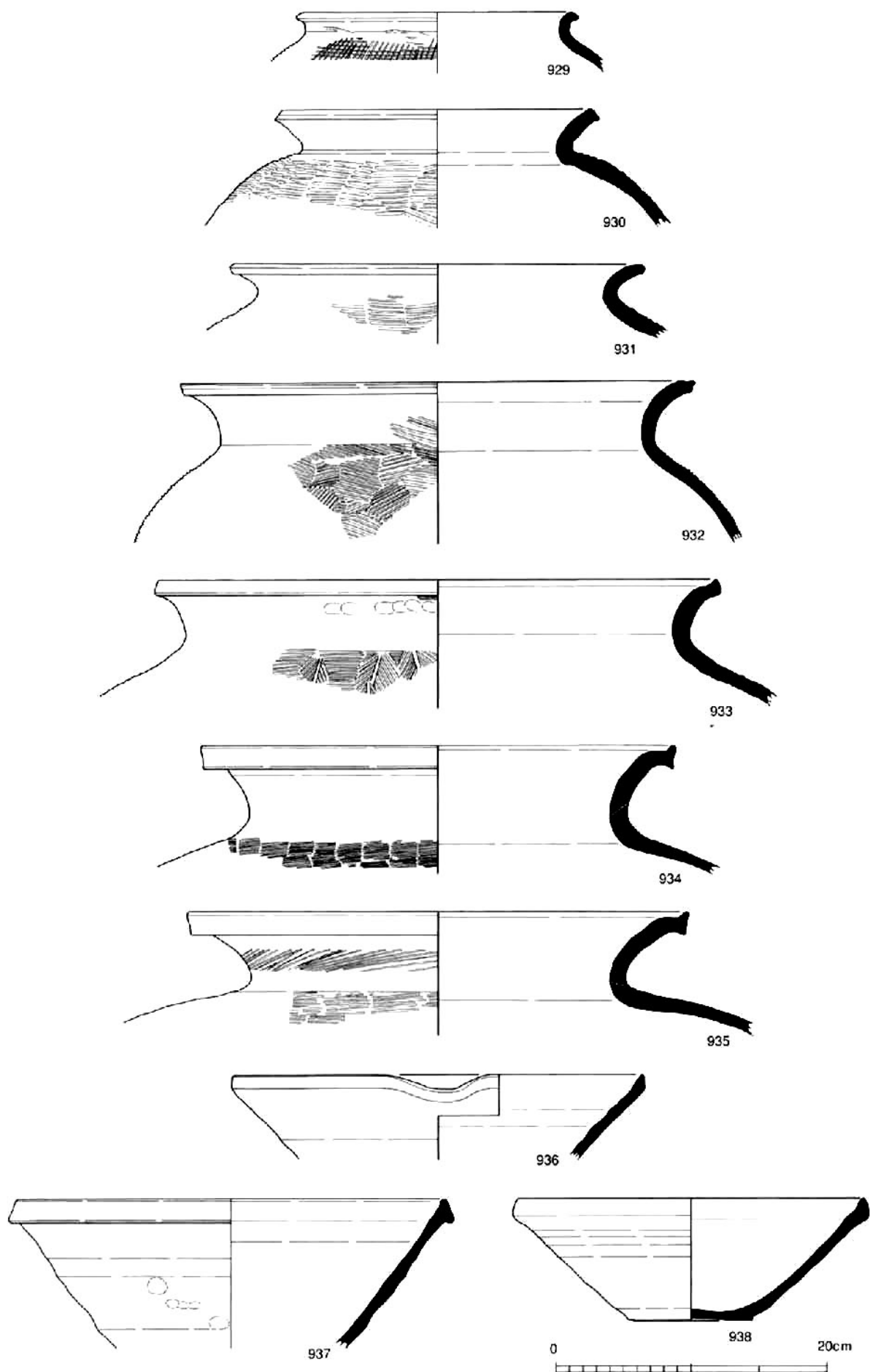

土器4 (掘立柱建物・ピット/929~938)

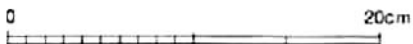
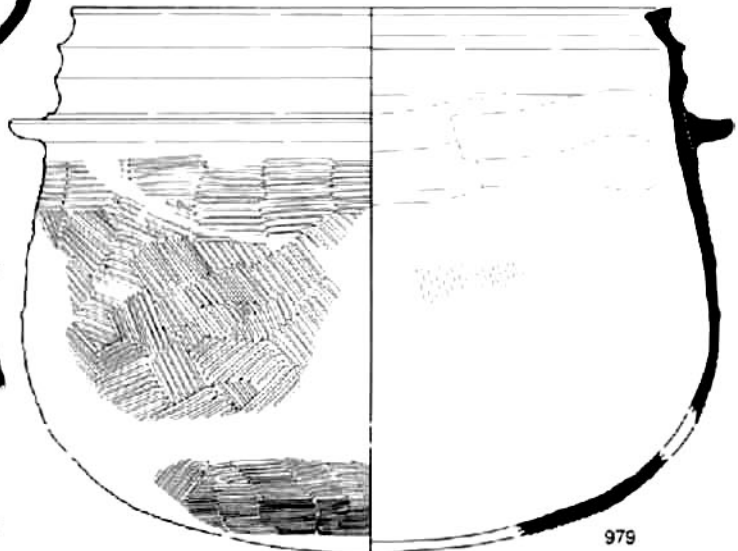
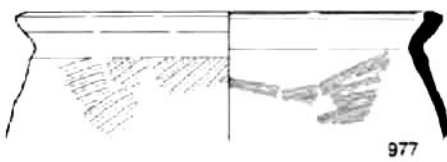
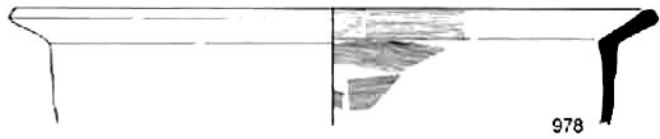
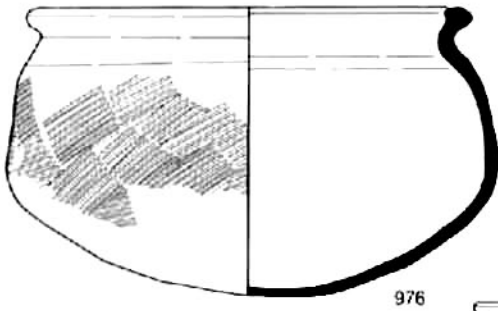
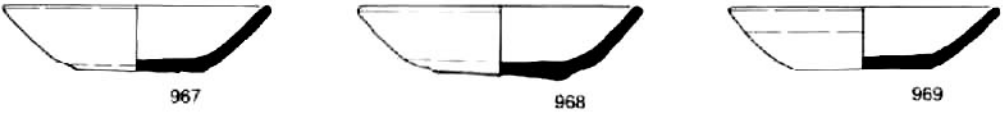
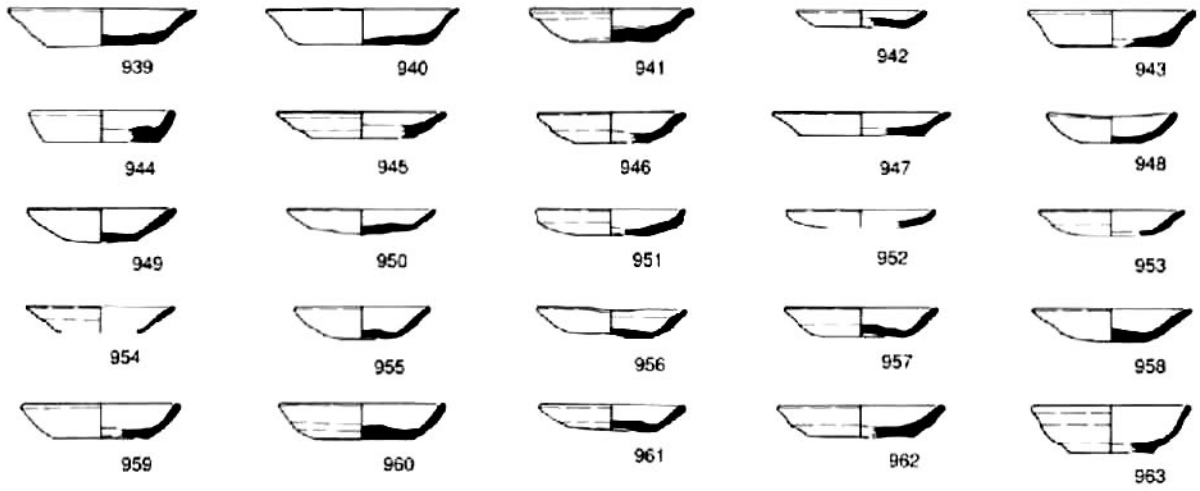

上器5 (掘立柱建物・ピット/939-979)

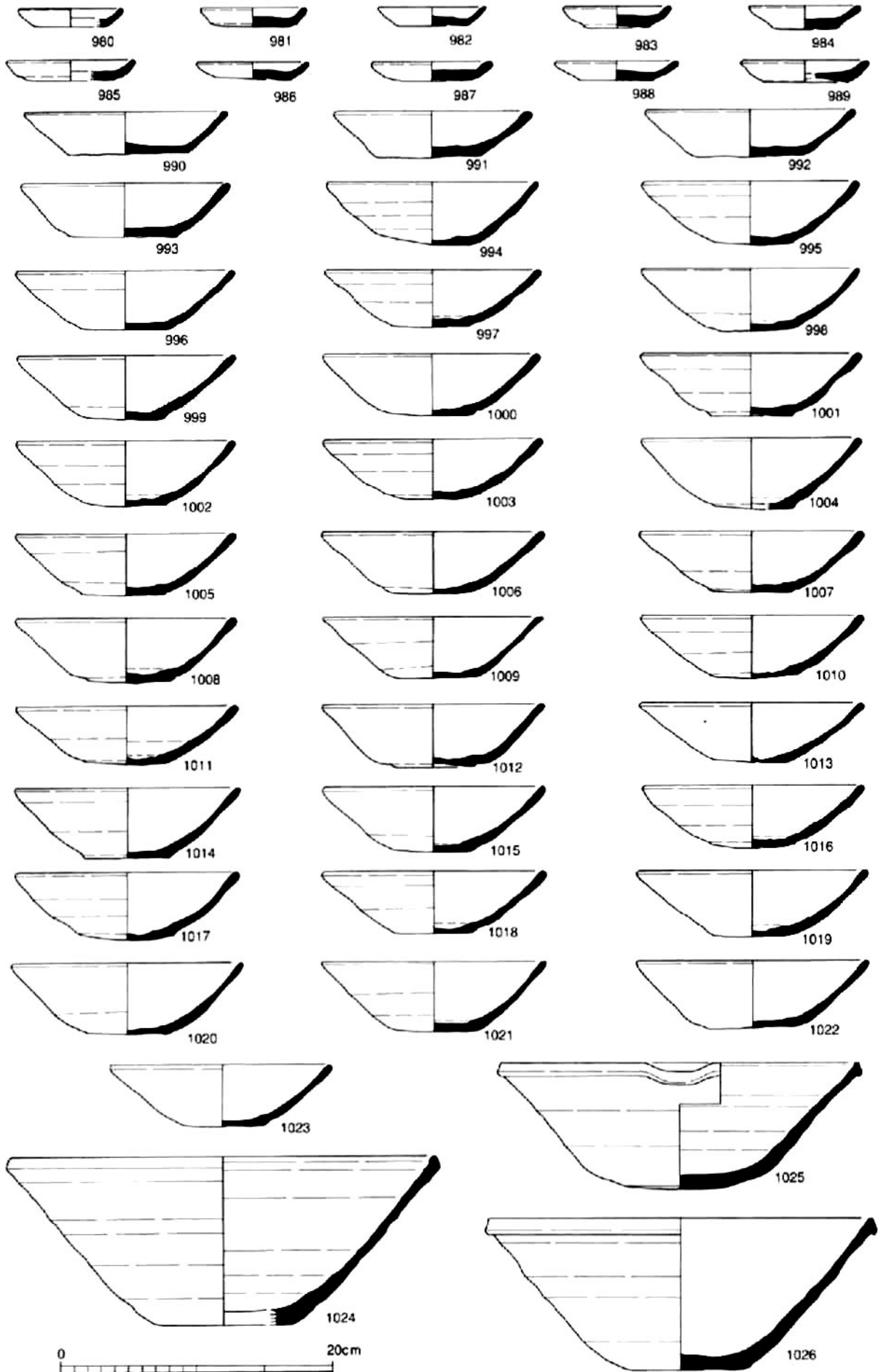

土器6 (土坑/980~1026)

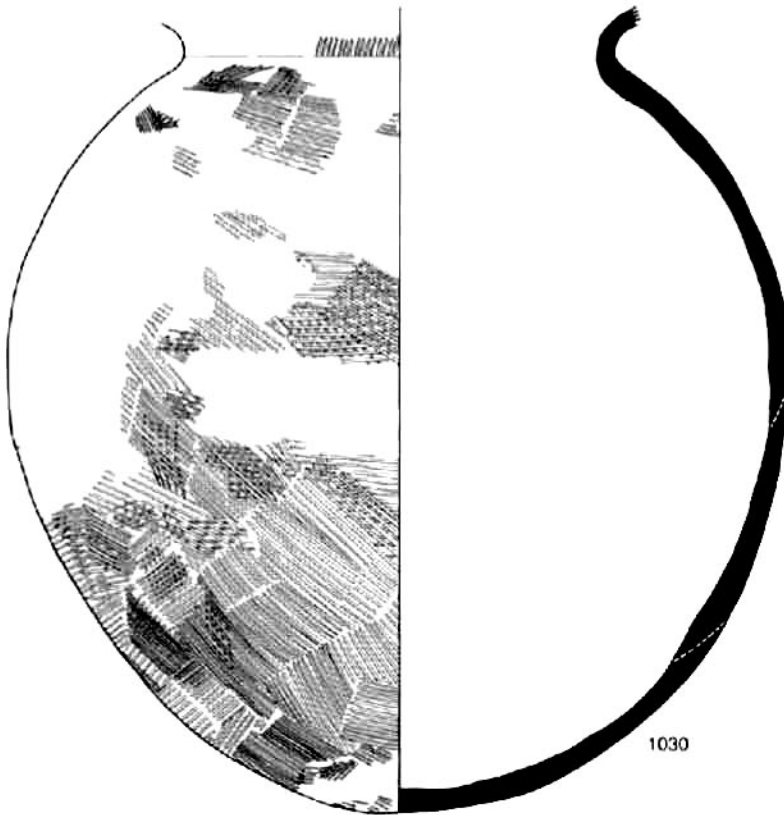
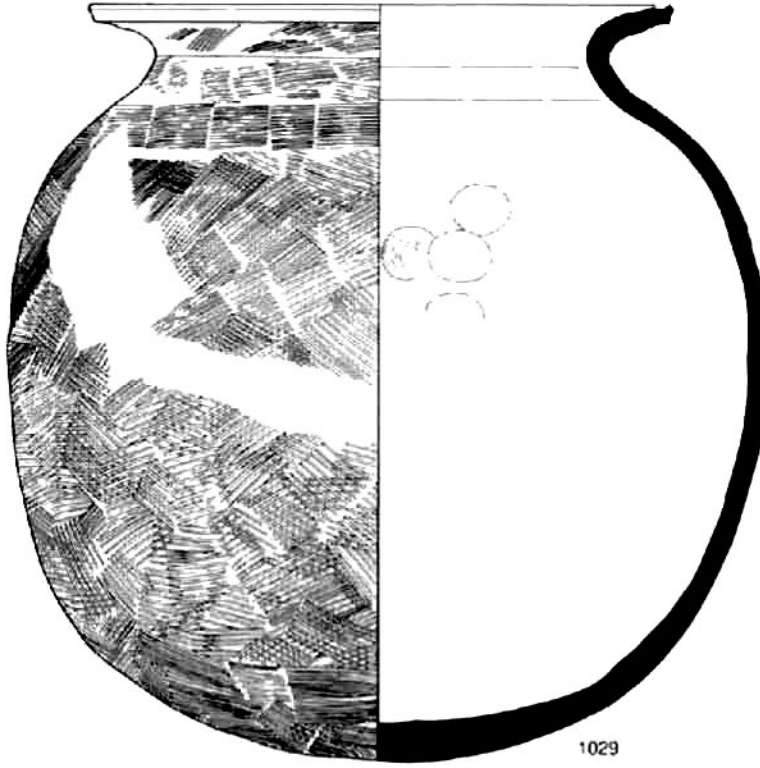

土器7 (土坑/1027~1030)

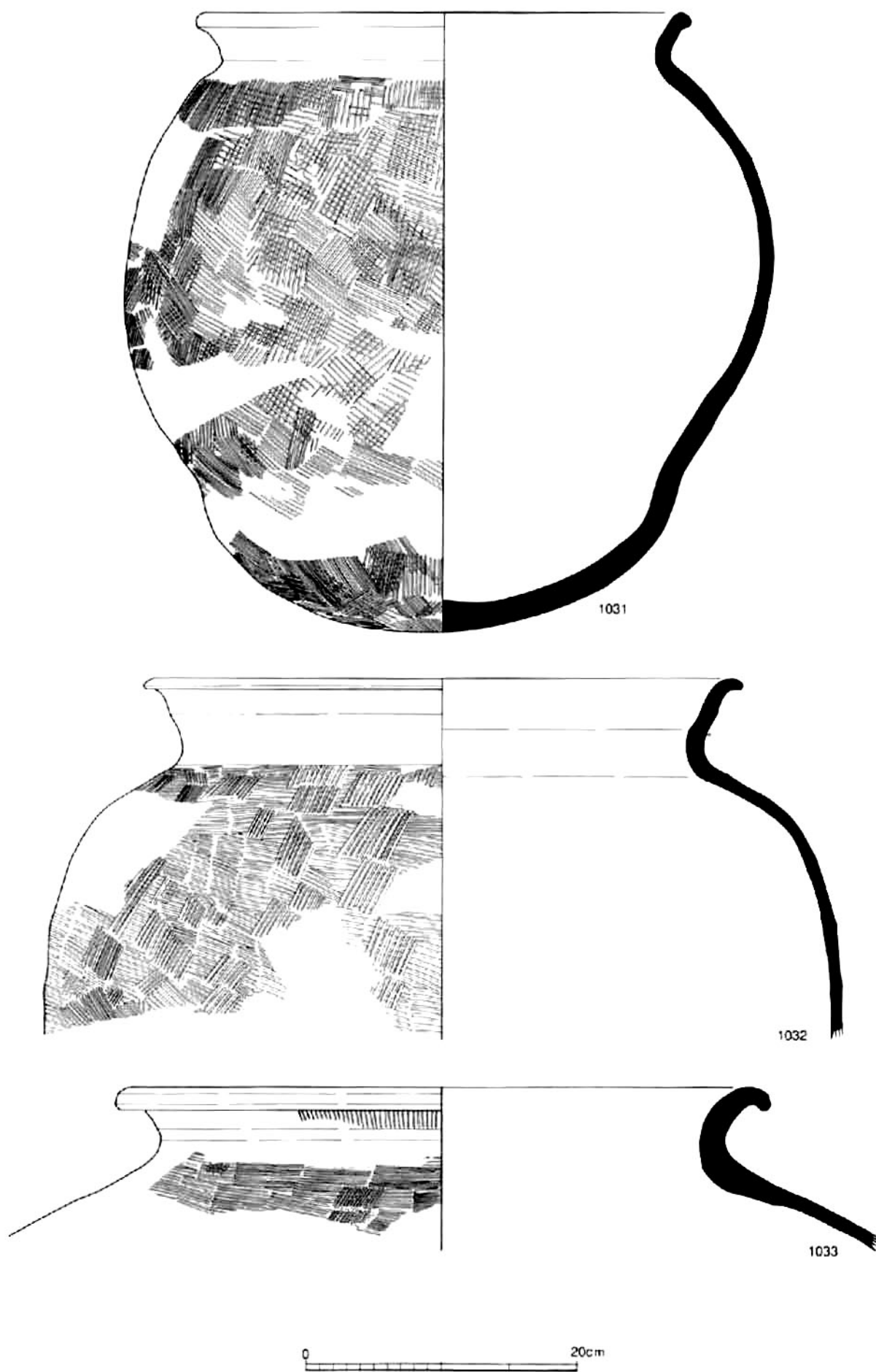

土器8 (土坑/1031~1033)



0 60cm

土器9 (土坑/1034・1035)

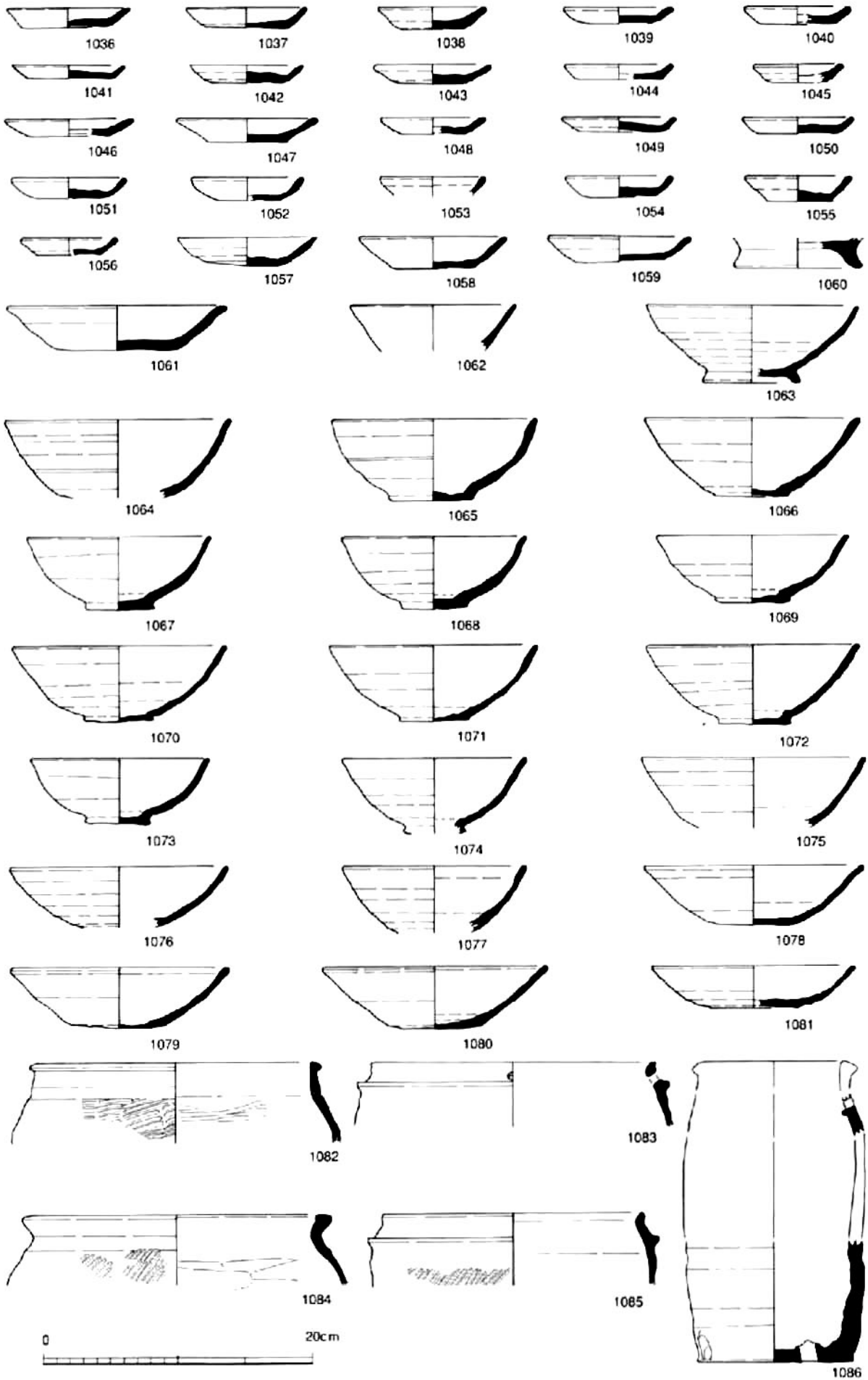

土器10 (土坑/1036~1086)

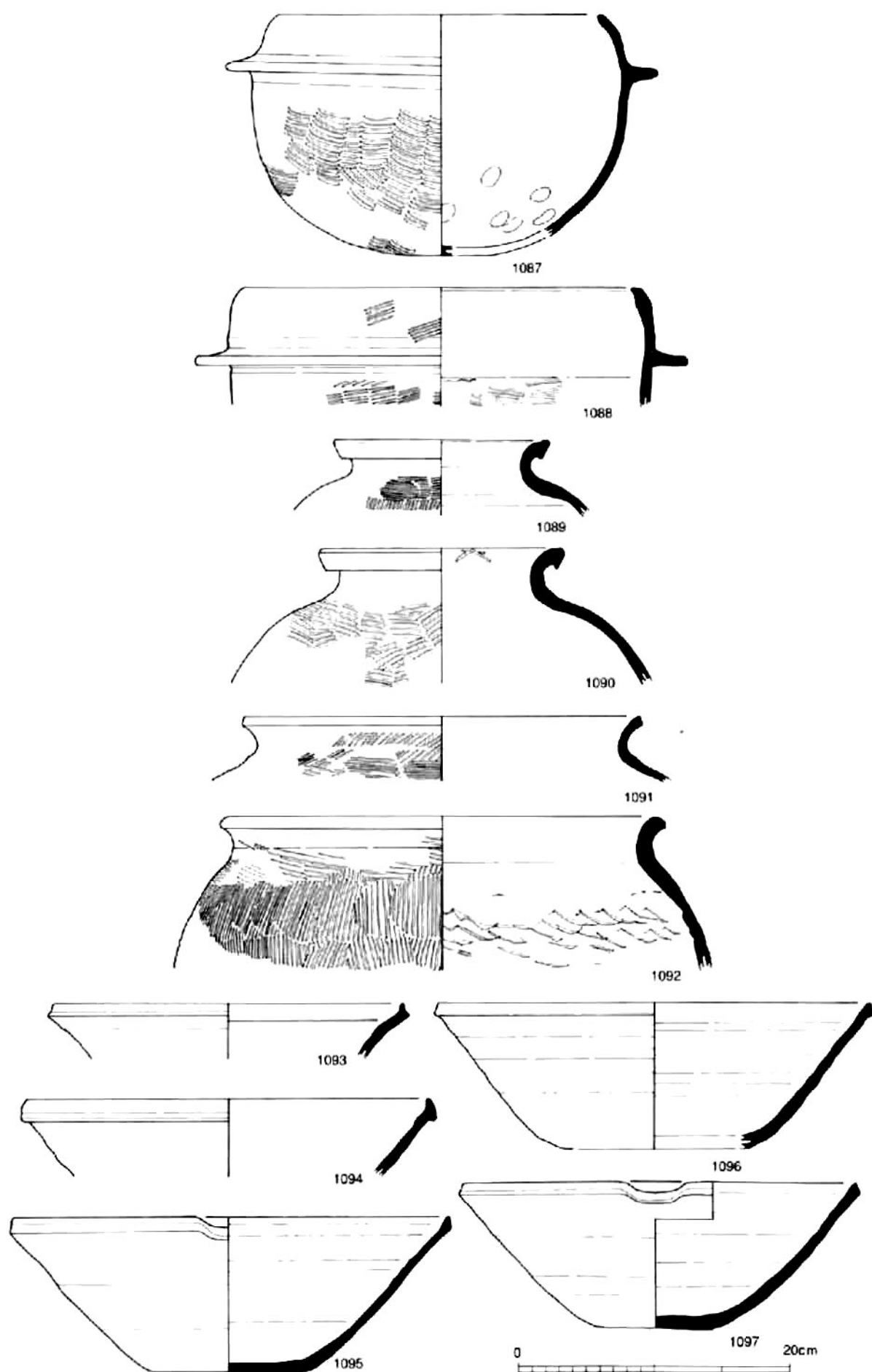

土器11 (土坑/1087~1097)

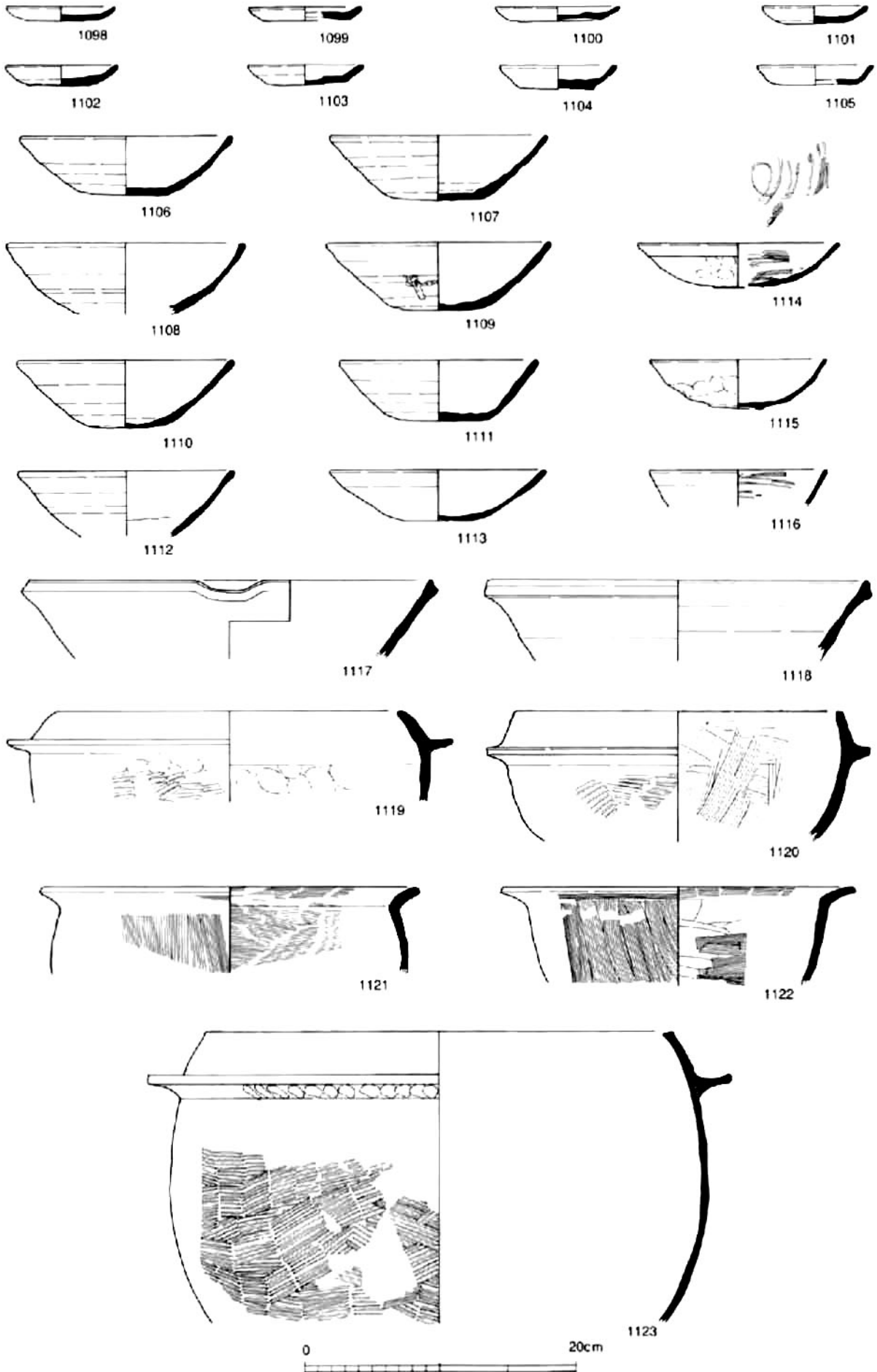

土器12 (井戸/1098~1123)

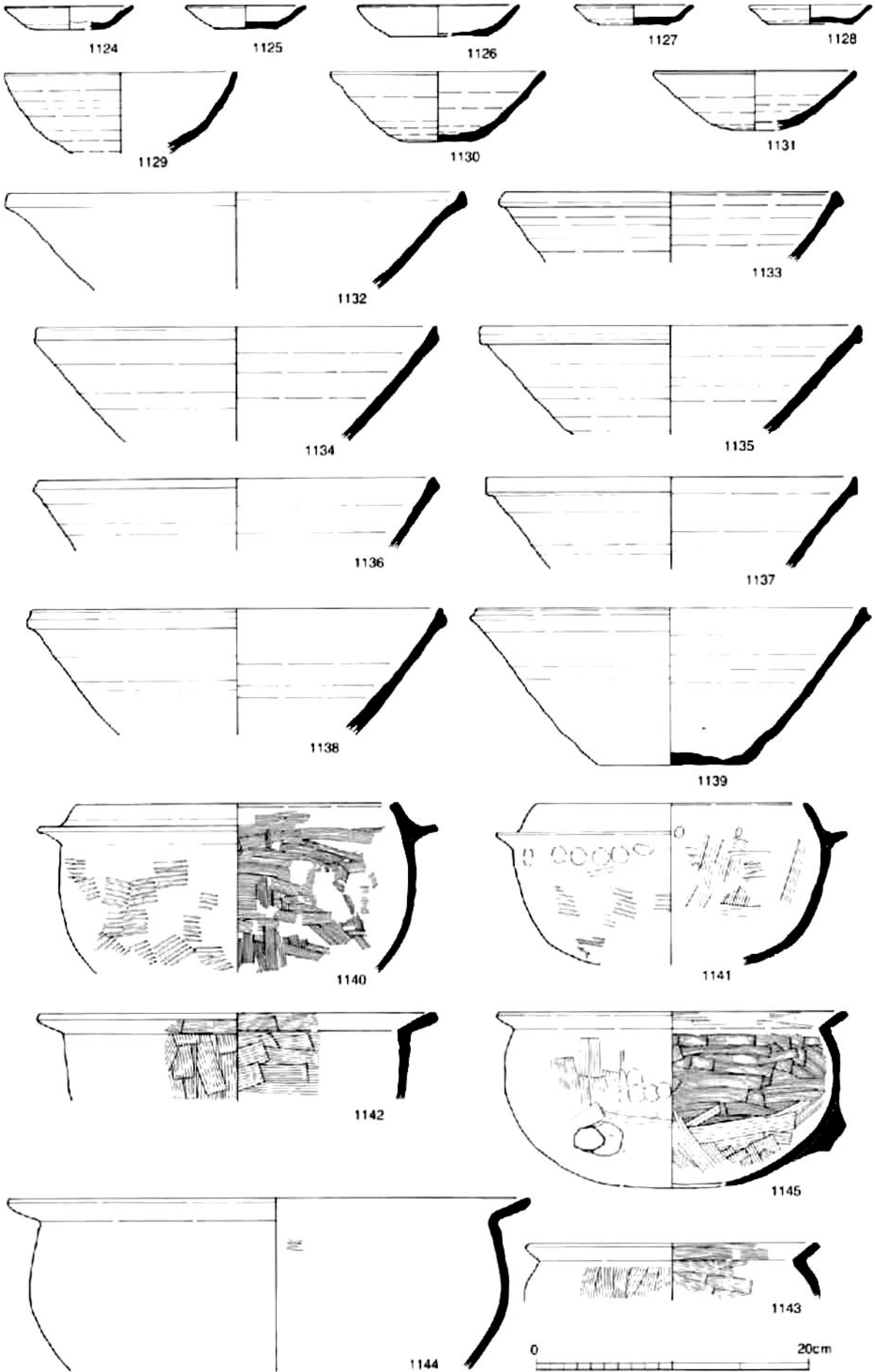

土器13 (土器群/1124~1145)

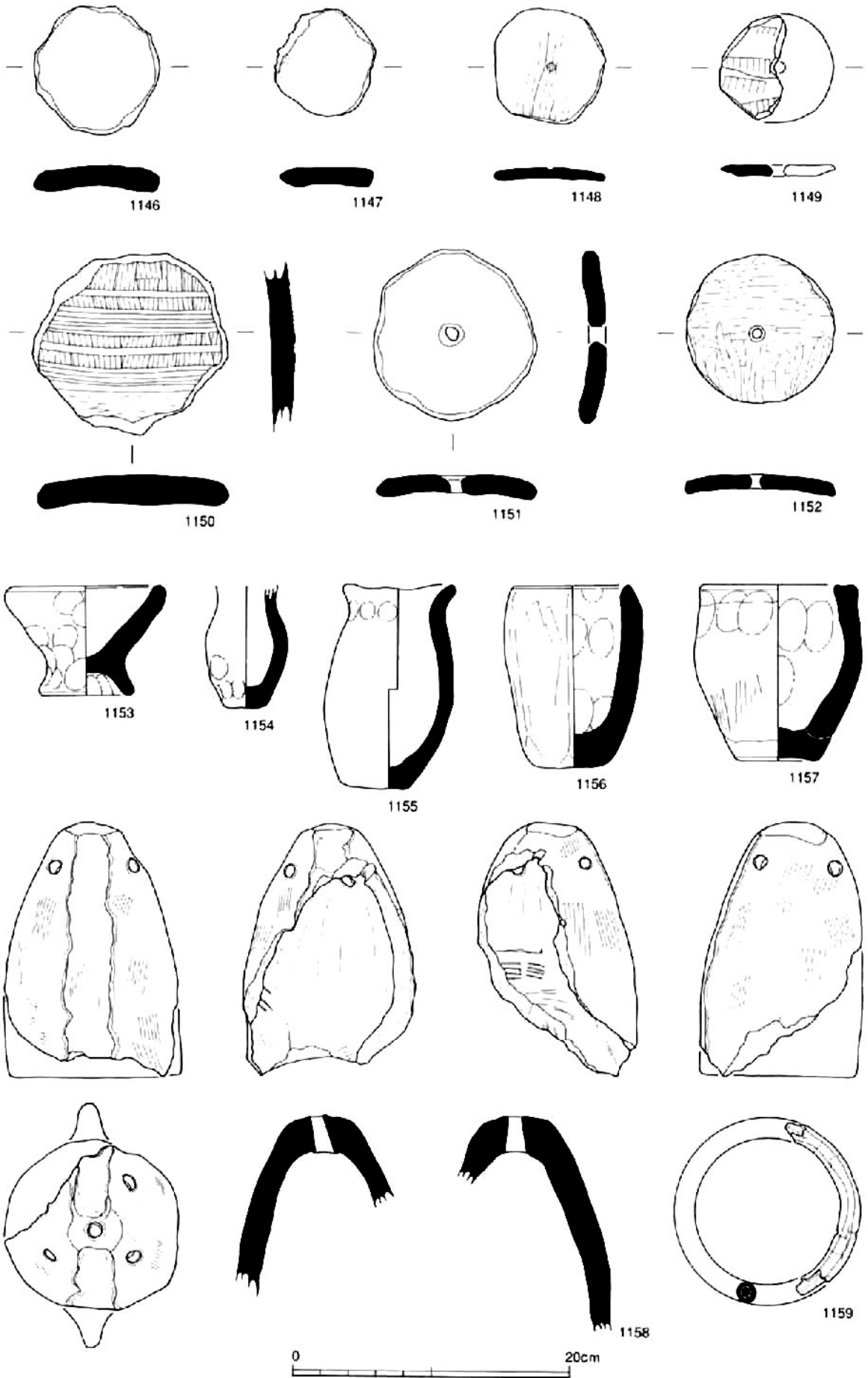

土製品 (1146-1159)

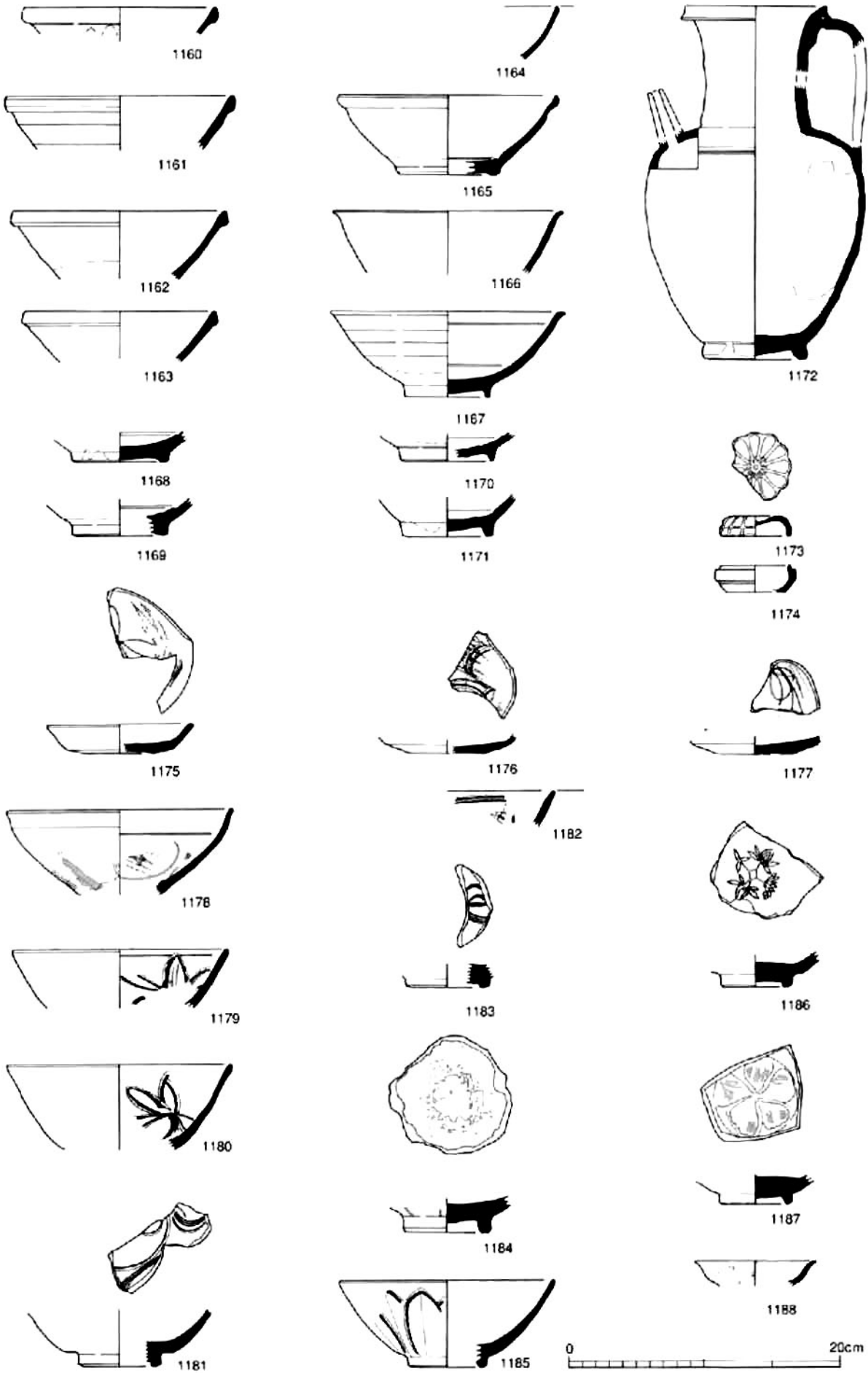

輸入磁器 (1160~1188)

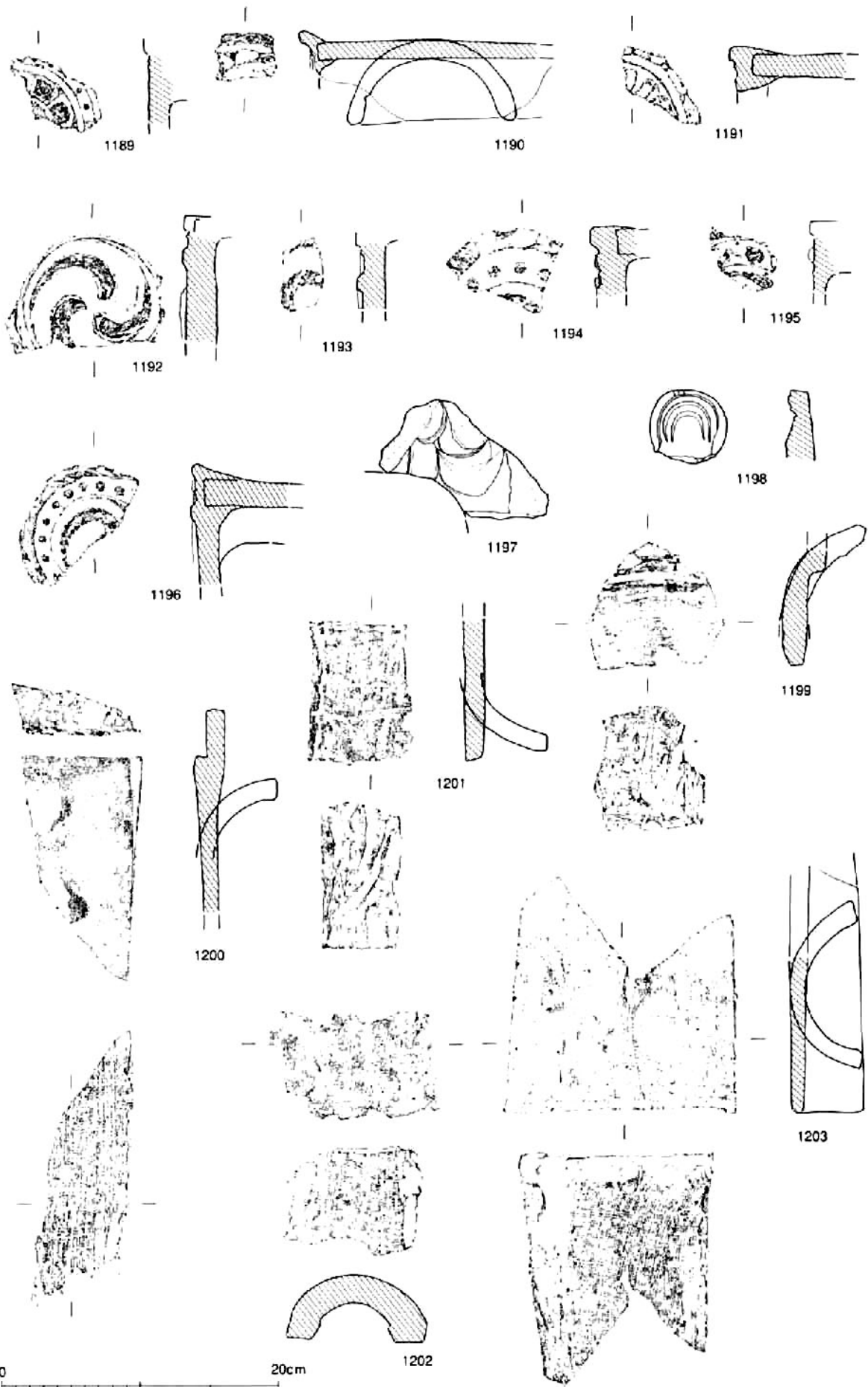

瓦1 (丸瓦・鬼瓦/1189~1203)

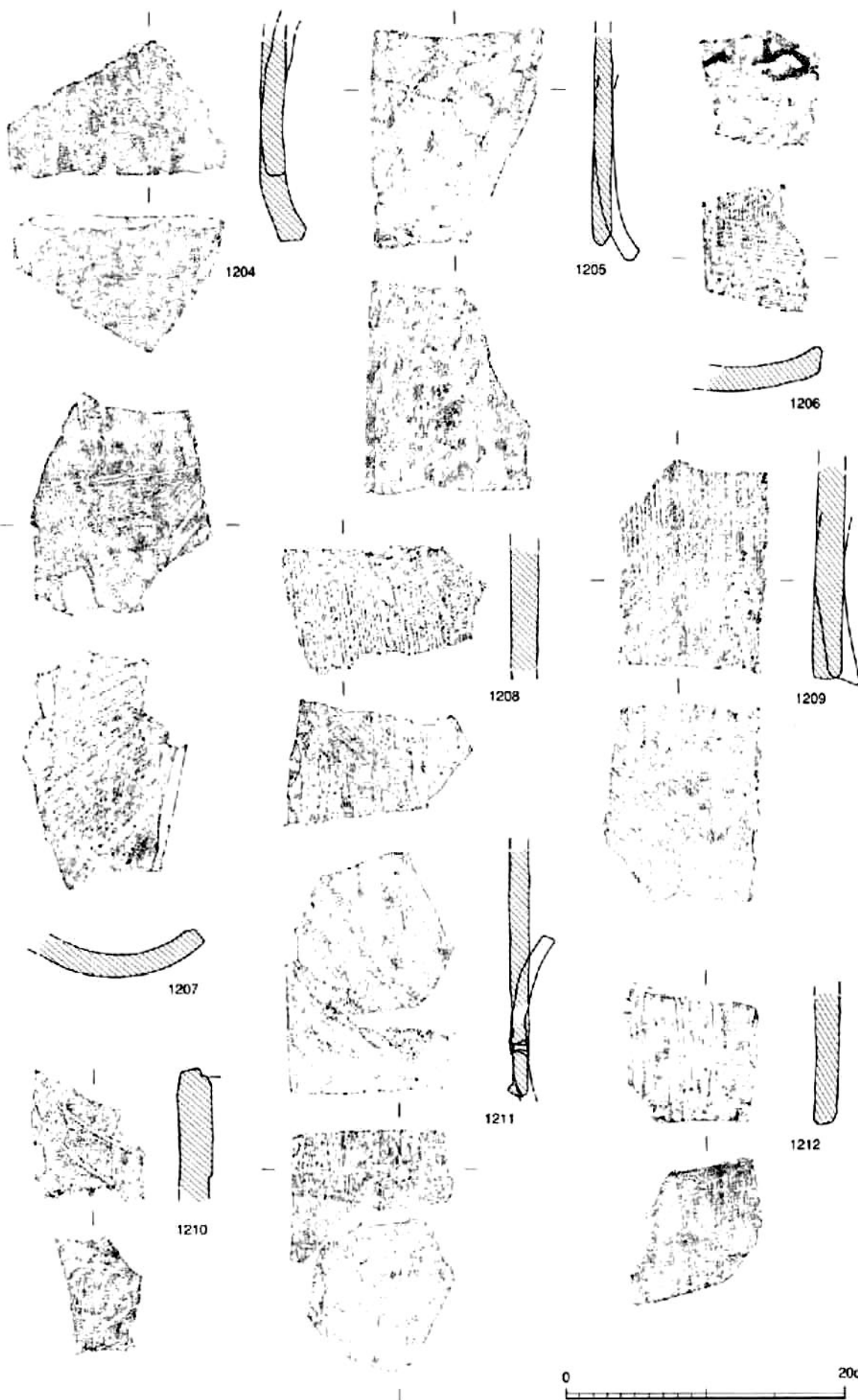

瓦2 (平瓦/1204~1212)

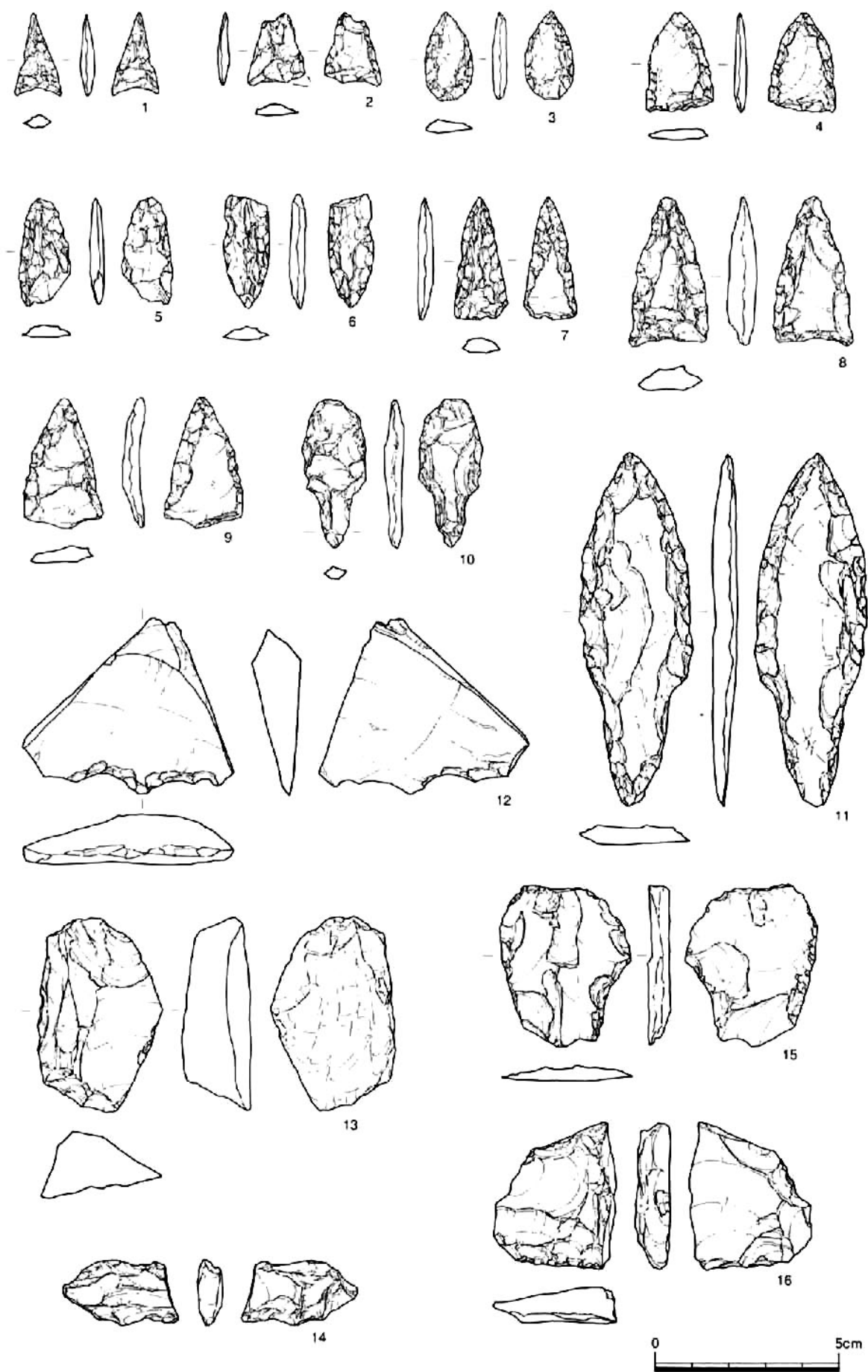

石器1 (1~16) [上層: 3・8・9・13・14・15]

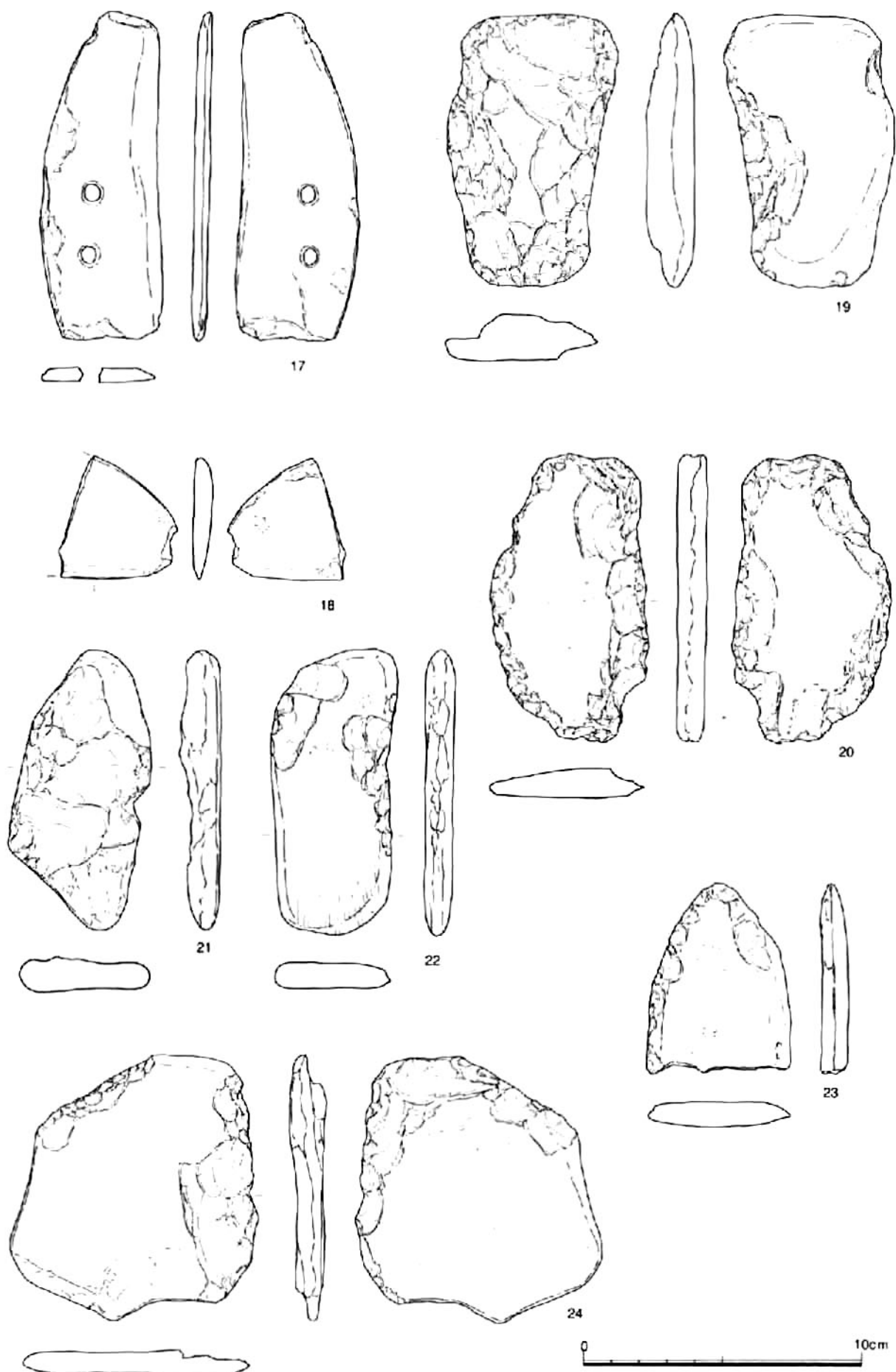

石器2 (17~24) (上層: 19)

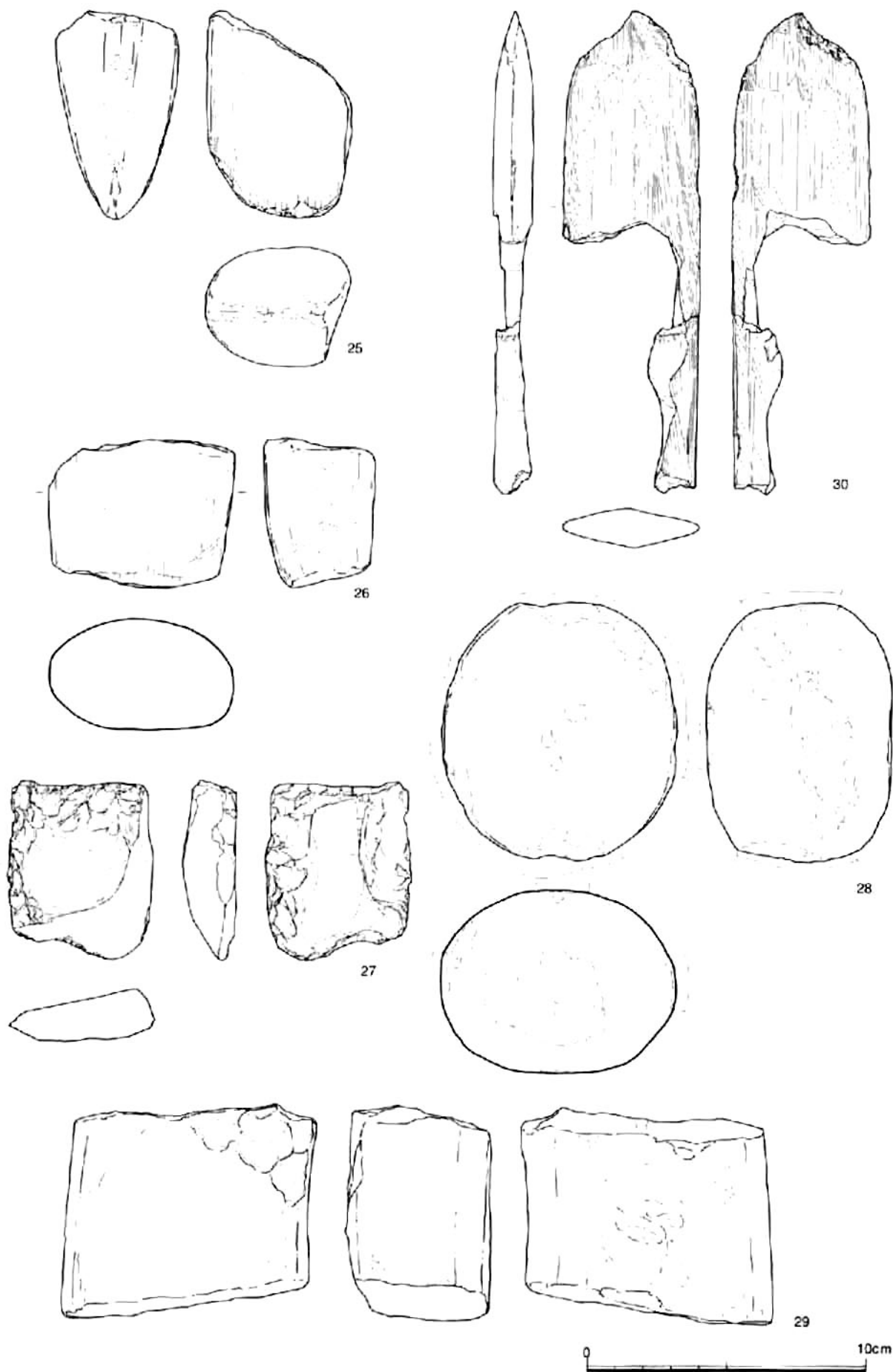

石器3 (25~30)

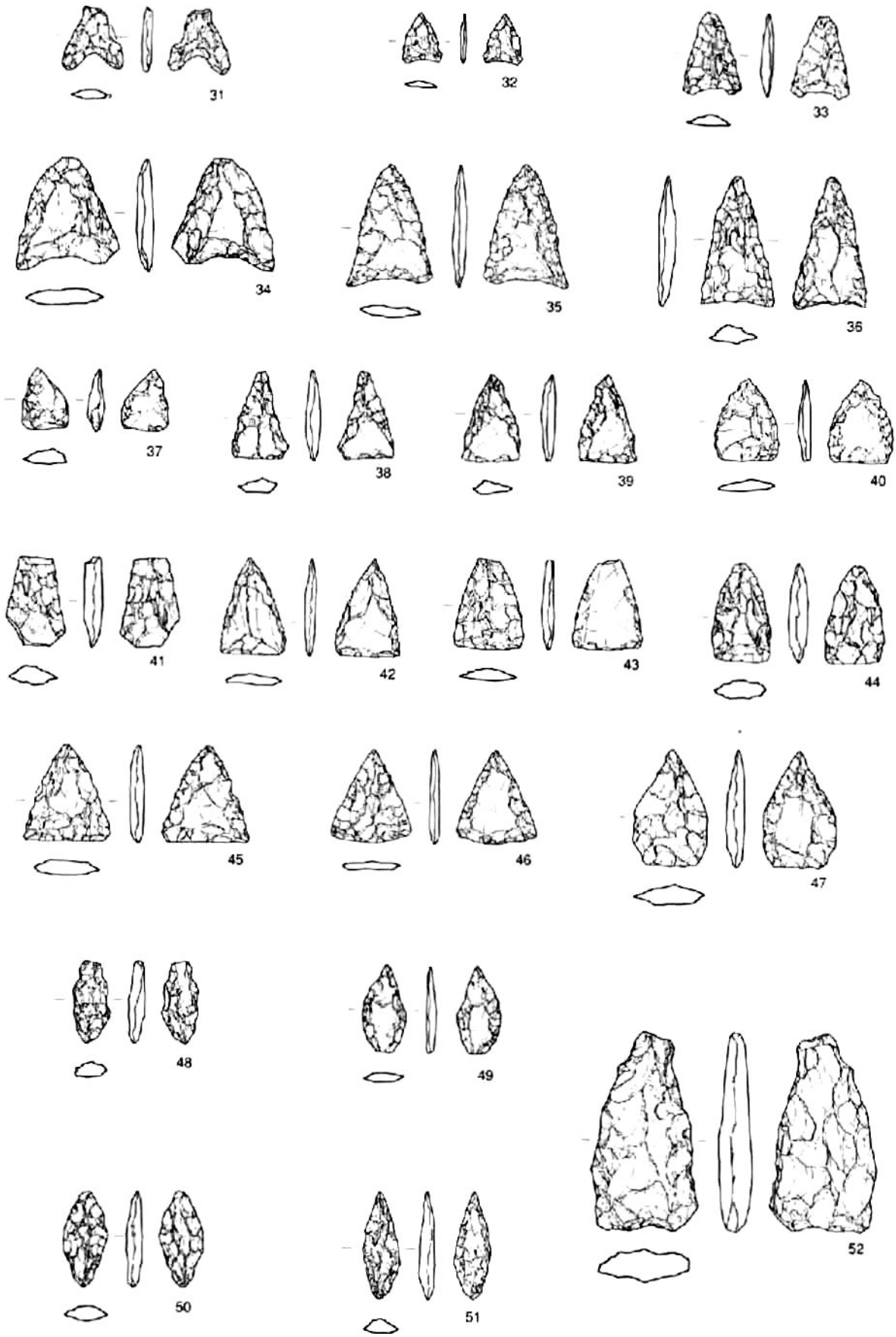

石器4 (31~52)〔下層:37〕

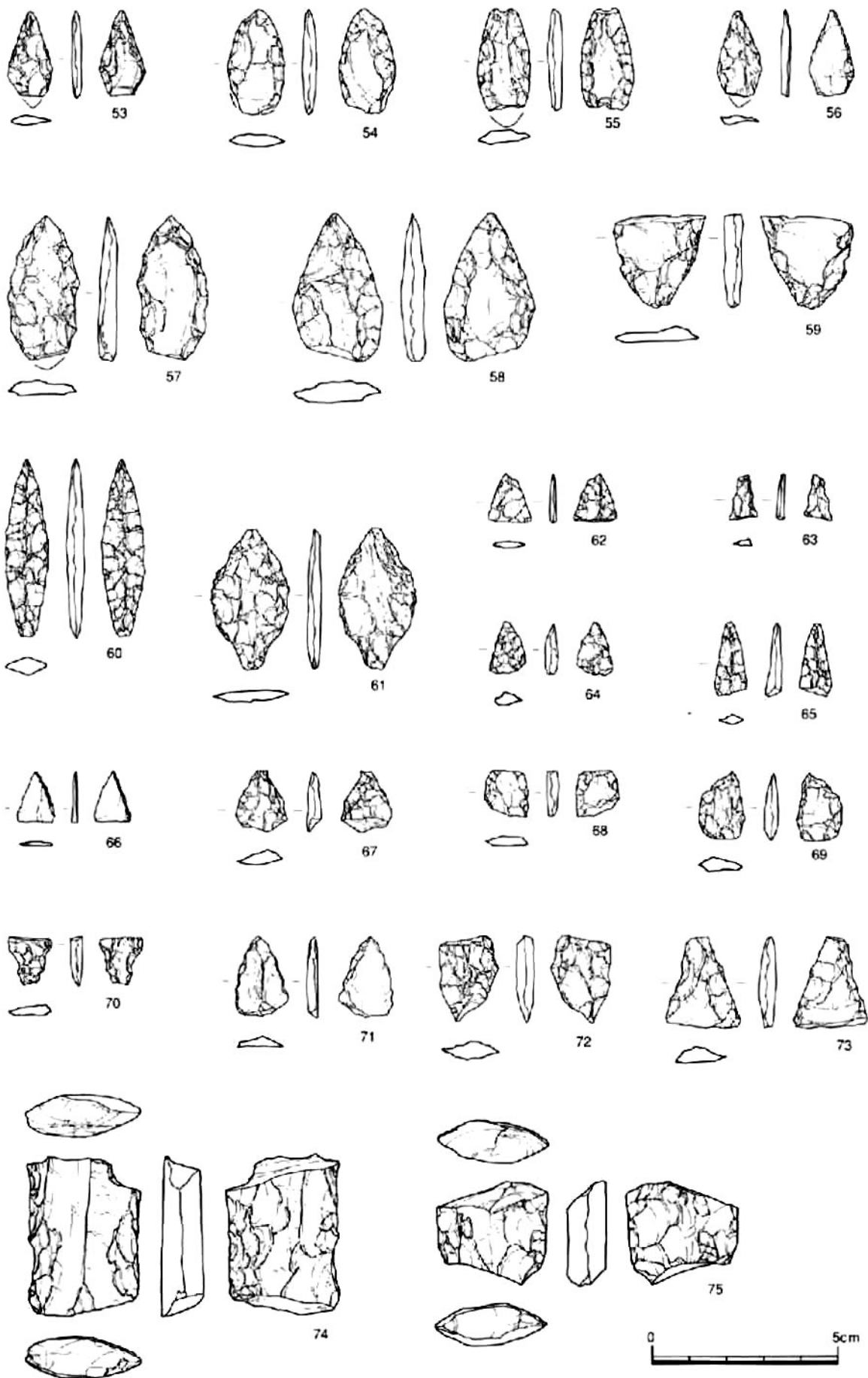

石器5 (53~75) [下層: 62・72]

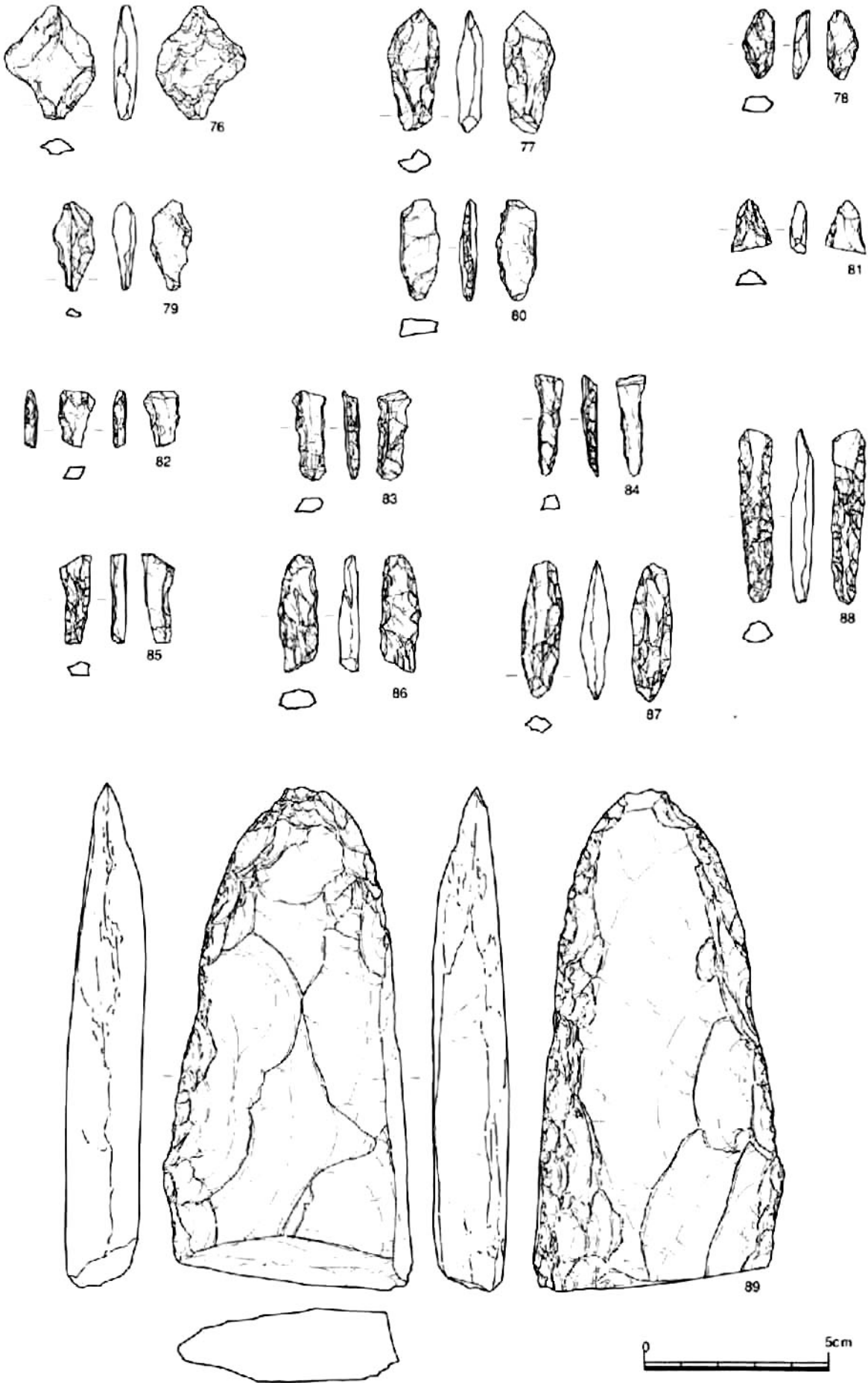

石器6 (76~89)

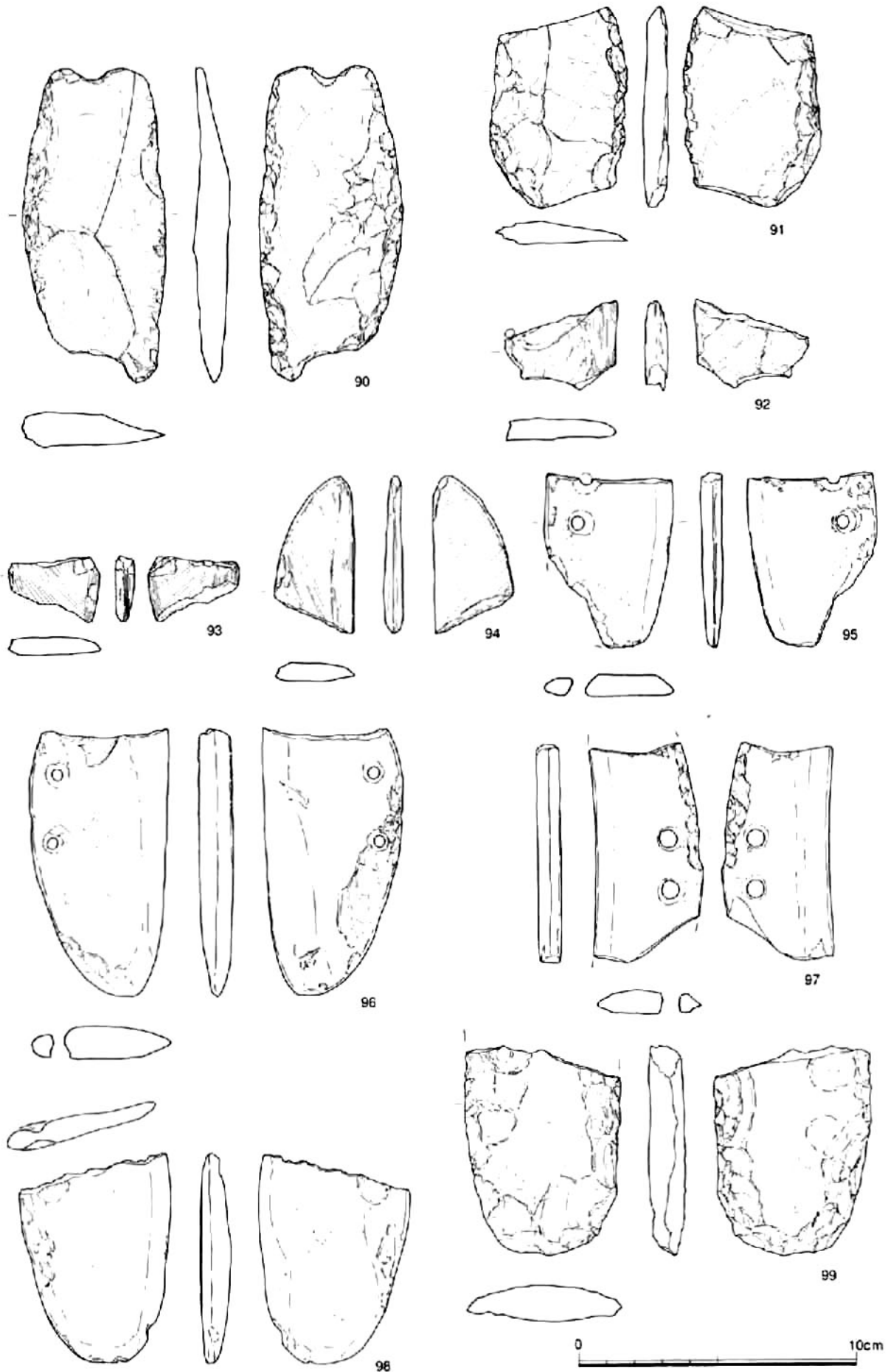

石器7 (90~99) [下層:92]

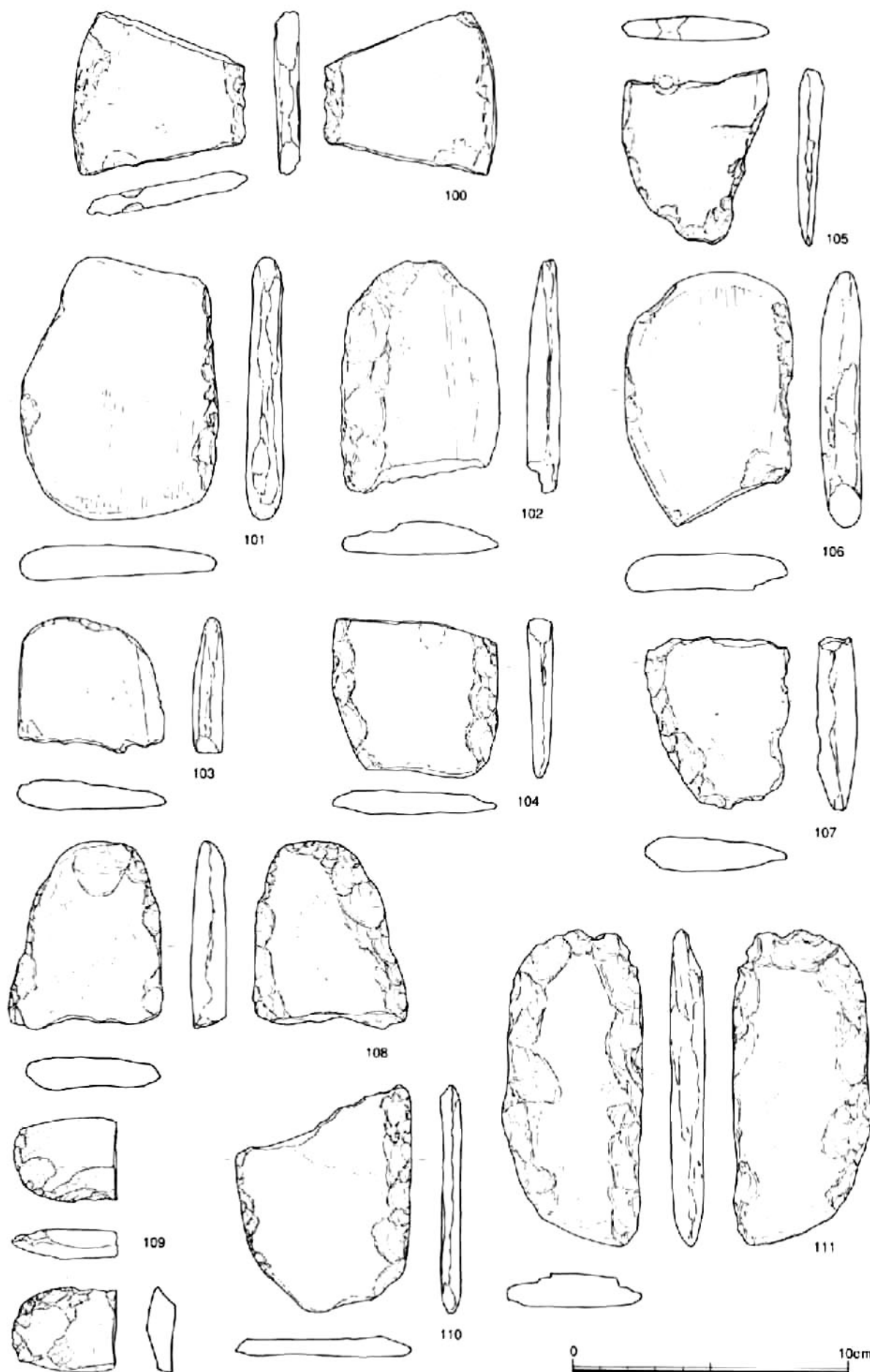

石器8 (100~111) [下層: 100・102]

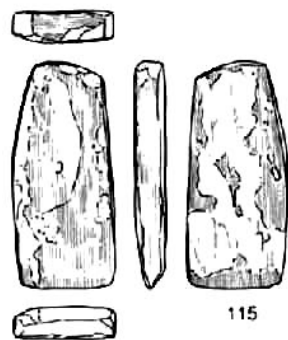
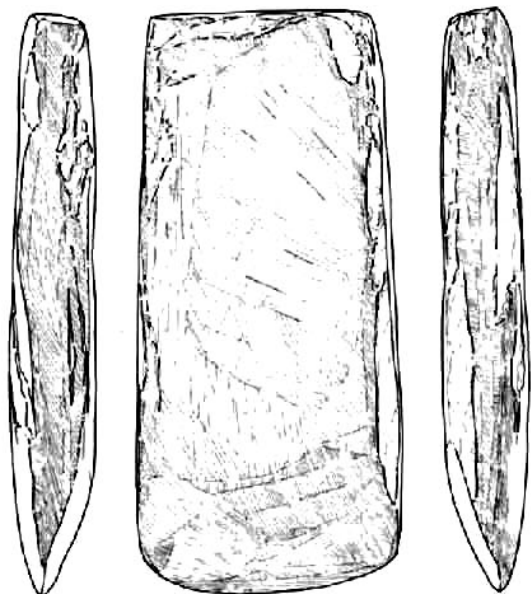
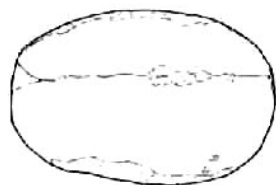
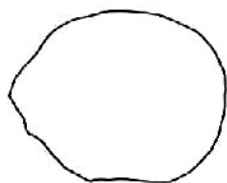
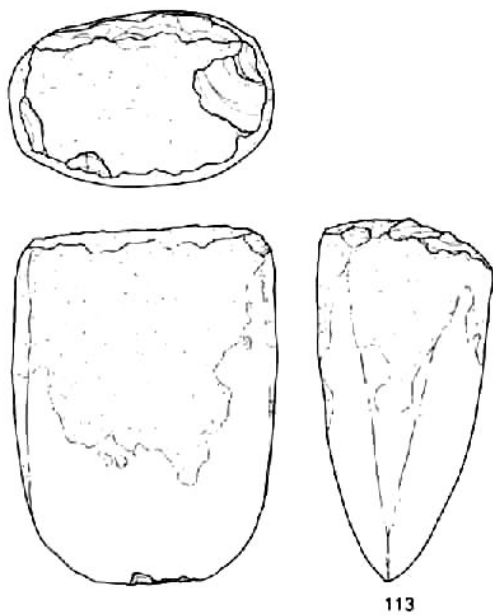
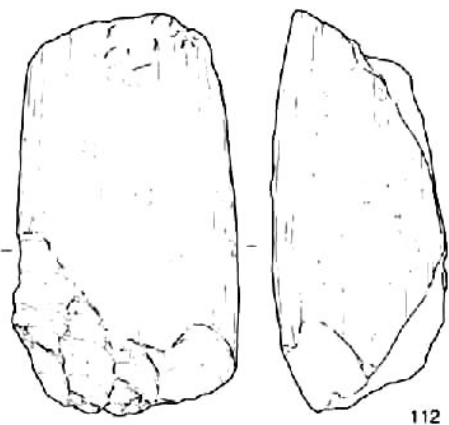

石器9 (112~116) [下層: 112]

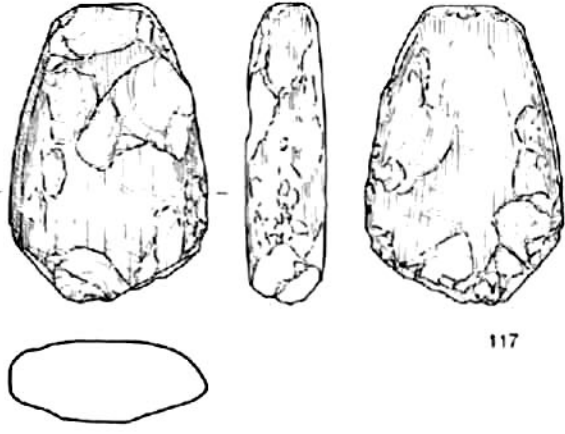

117

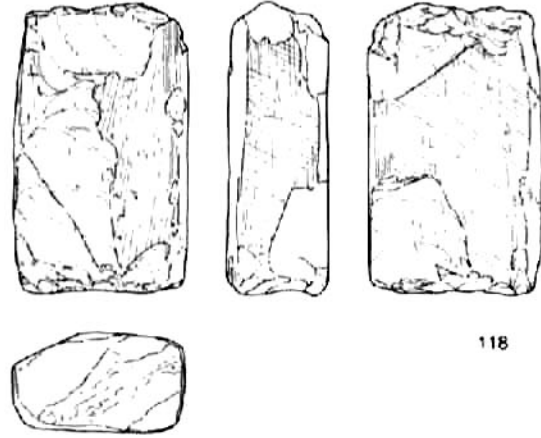

118



119

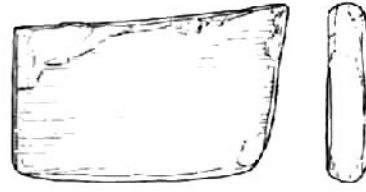

120

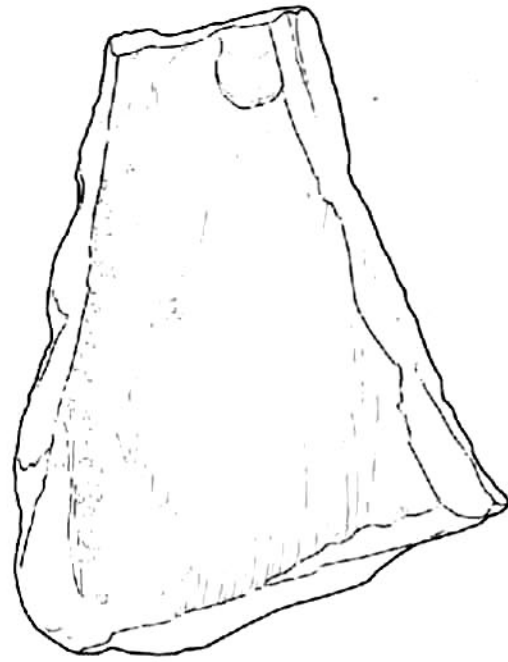

122

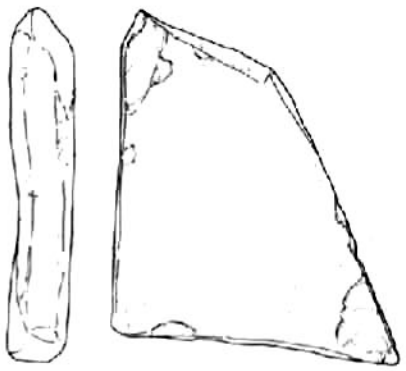

121



石器10 (117~122) [下層: 121]

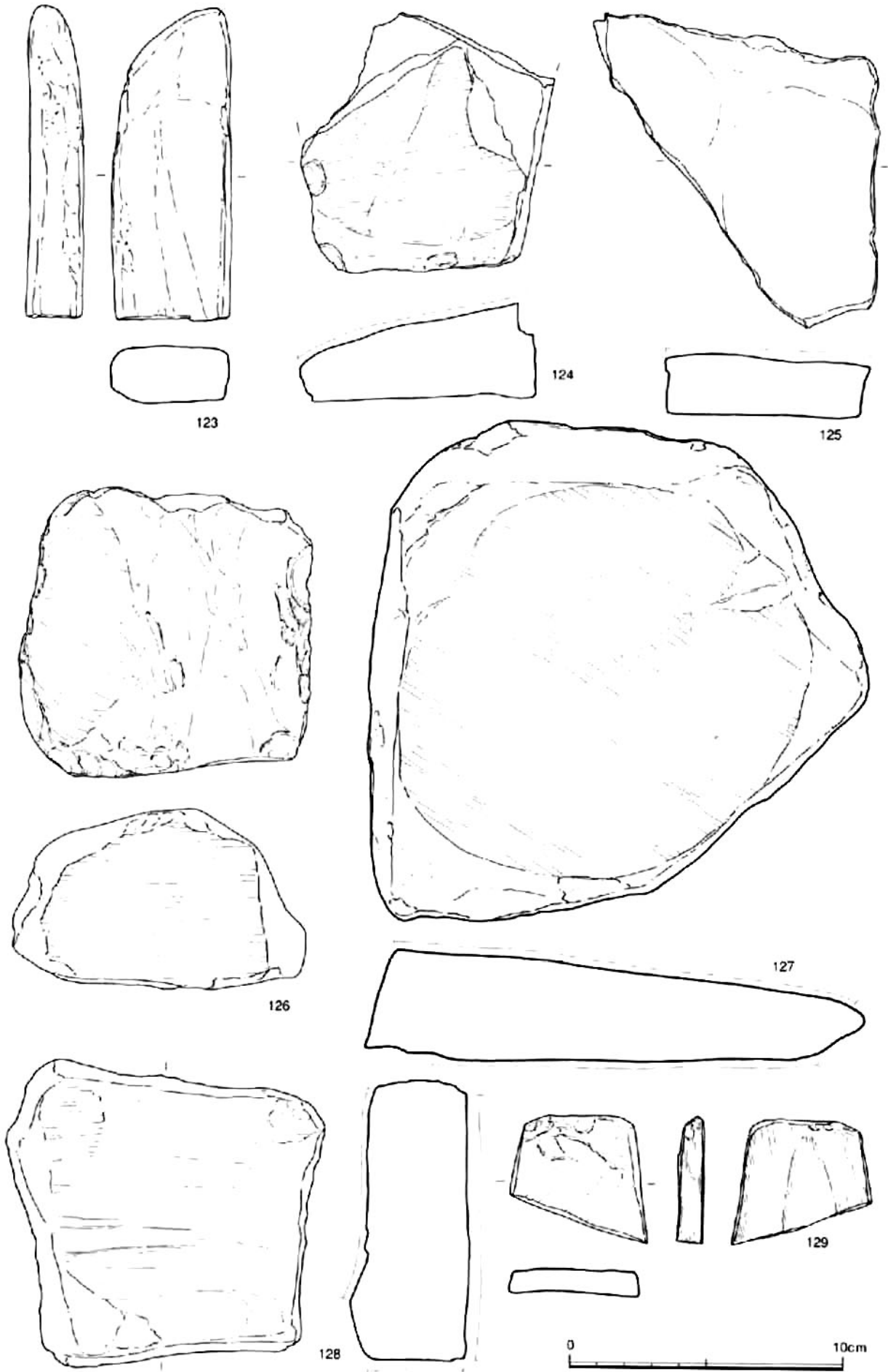

石器11 (123~129)

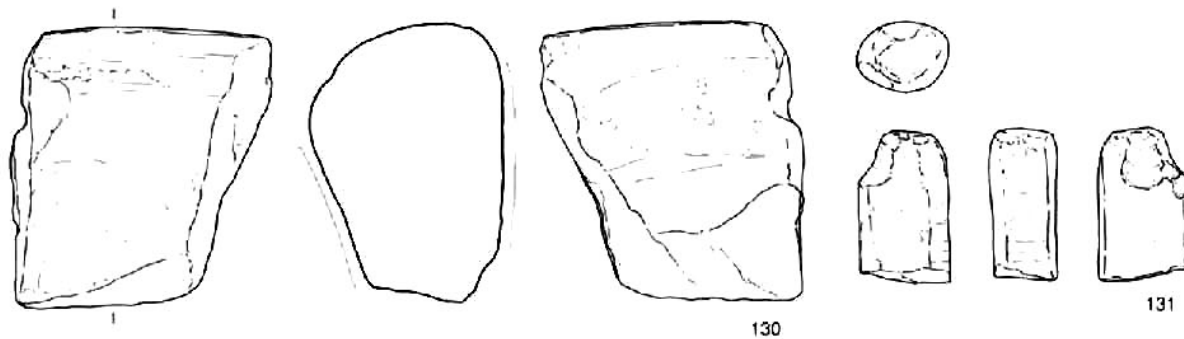

130

131

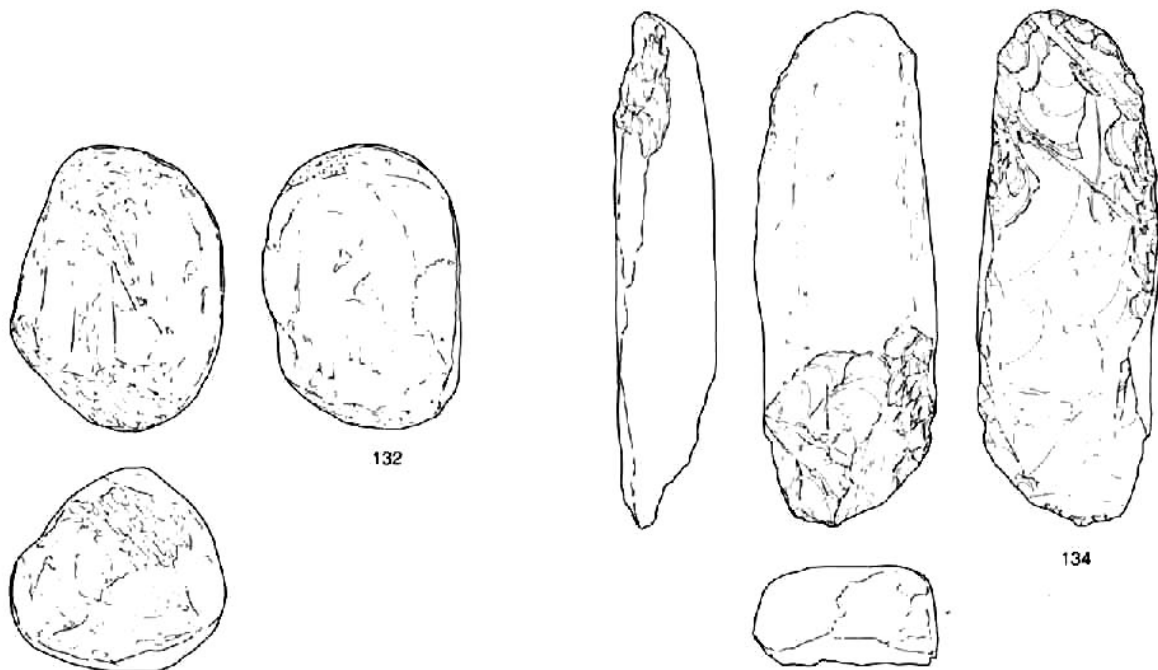

132

134

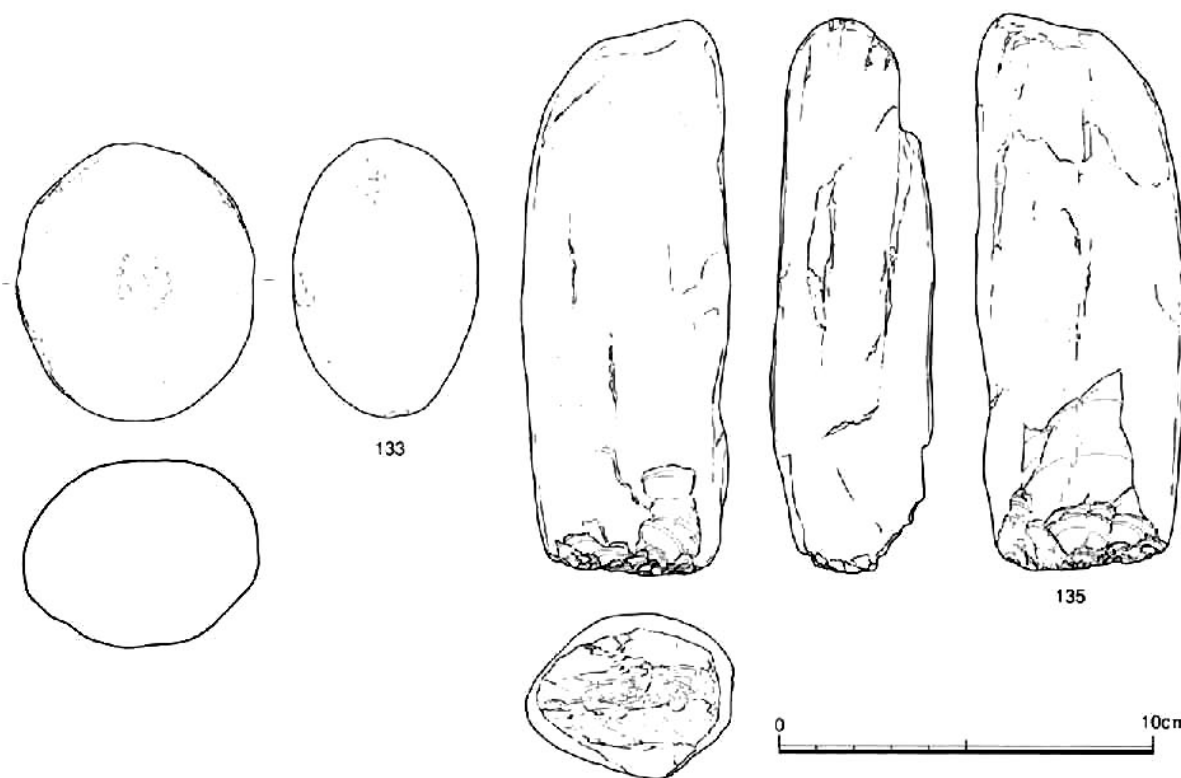

133

135

0 10cm

石器12 (130~135) [下層:132]

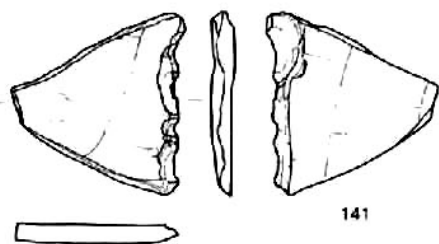
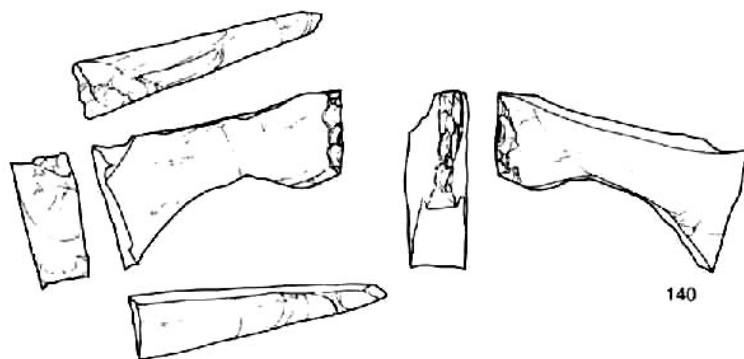
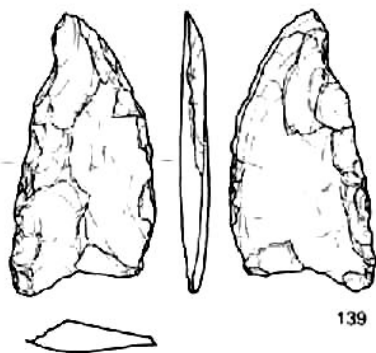
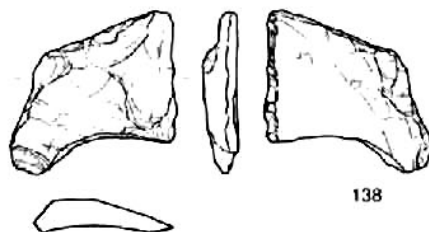
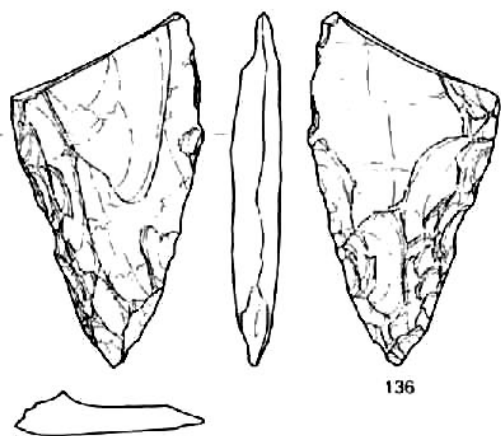

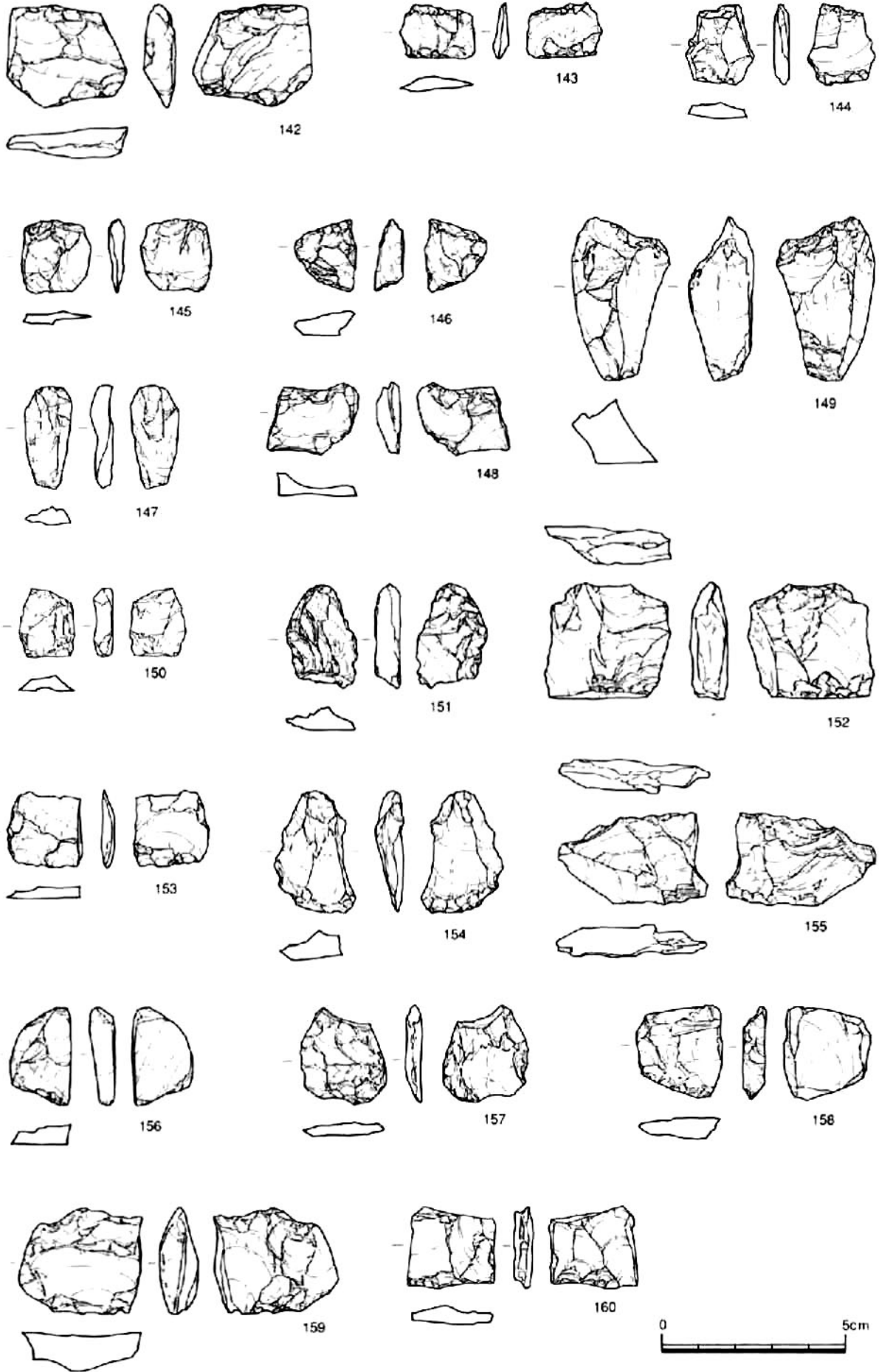

石器14 (142~160)

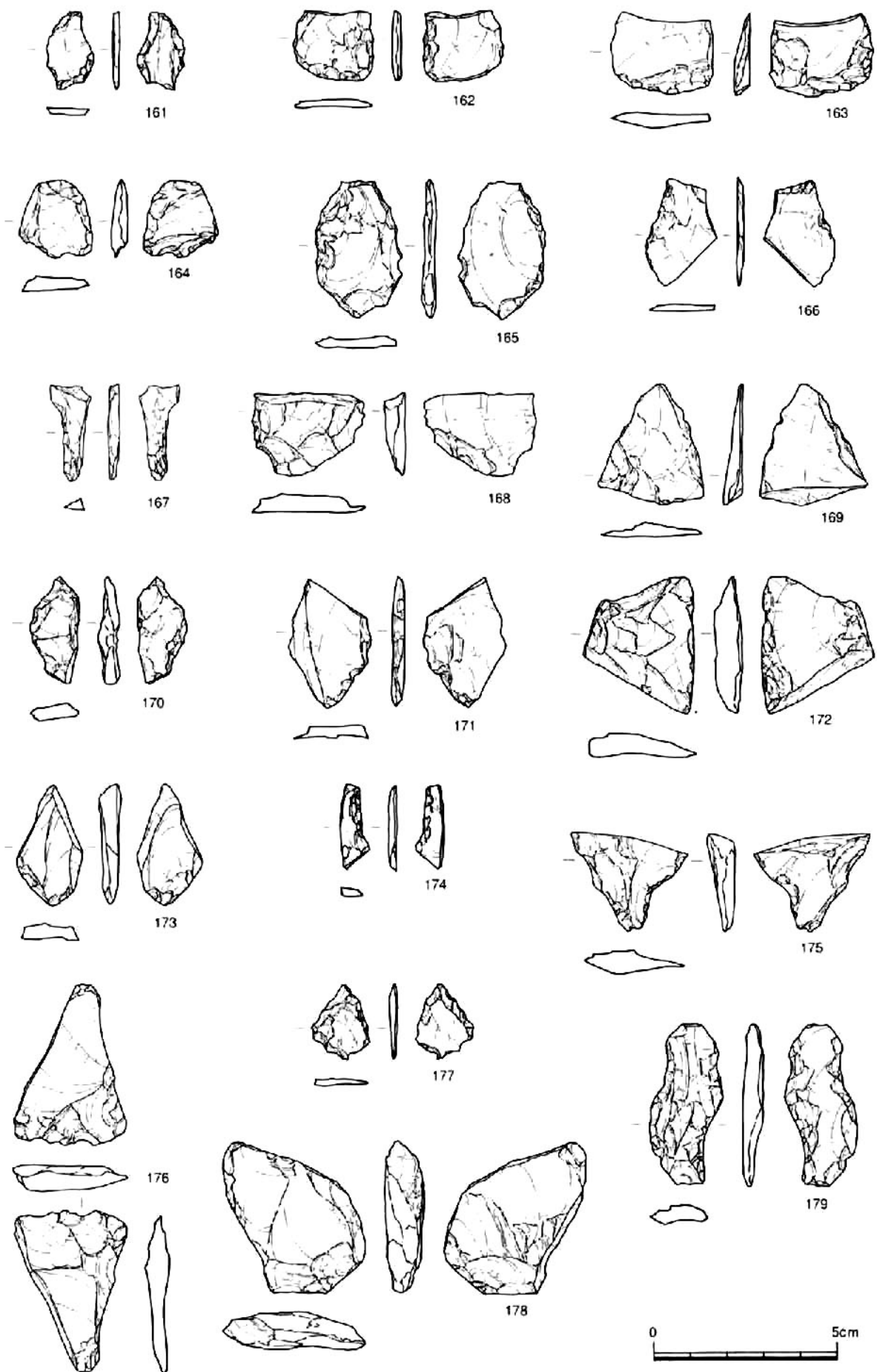

石器15 (161~179) [下層: 167・174]

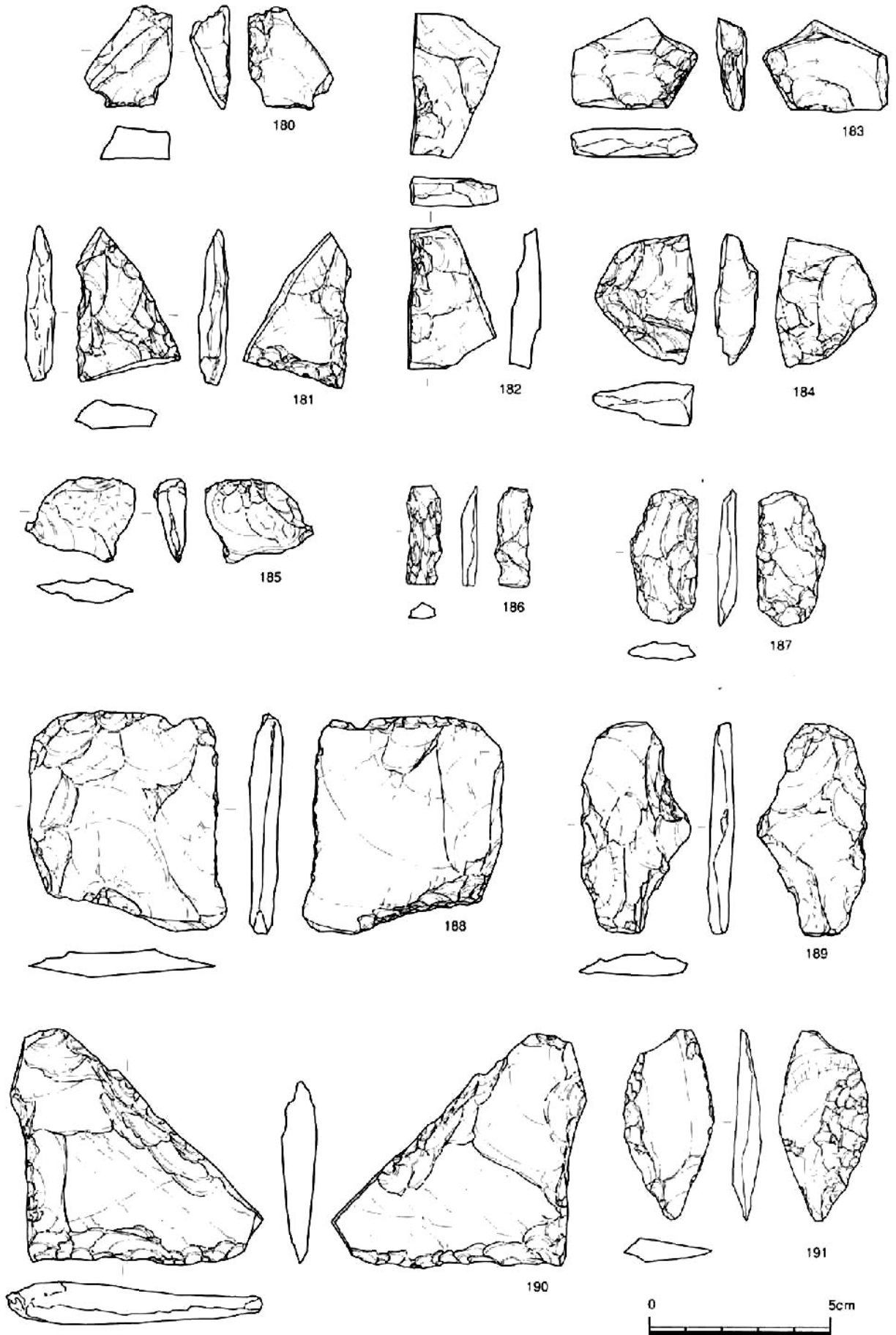

石器16 (180~191) [下層: 185]

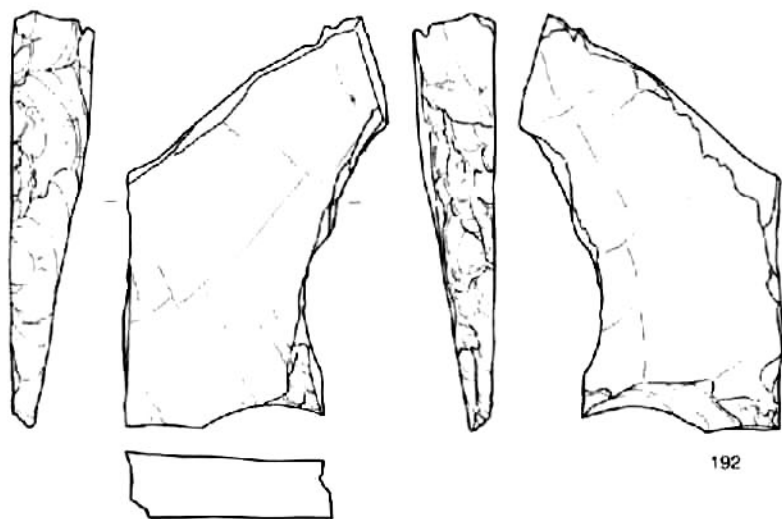

192

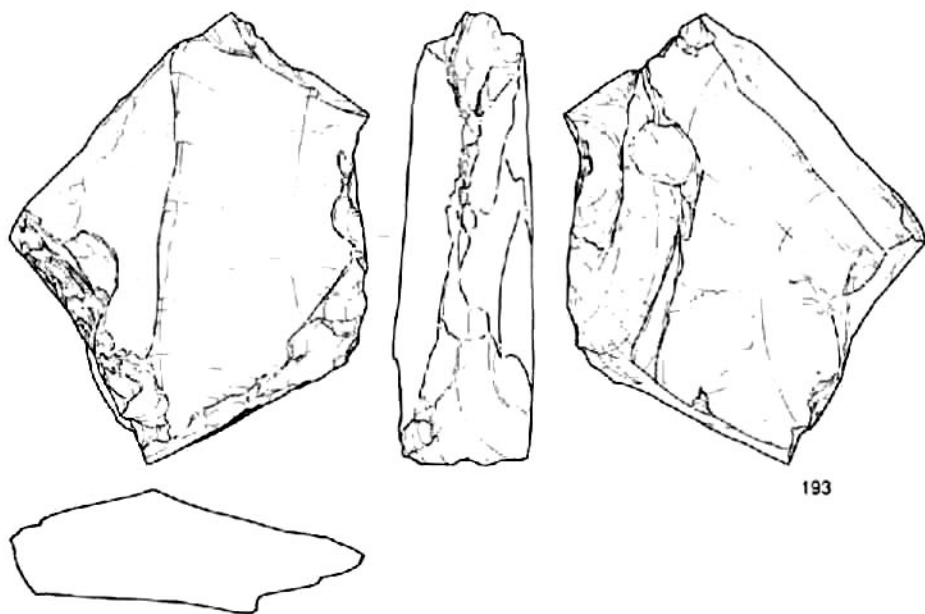

193

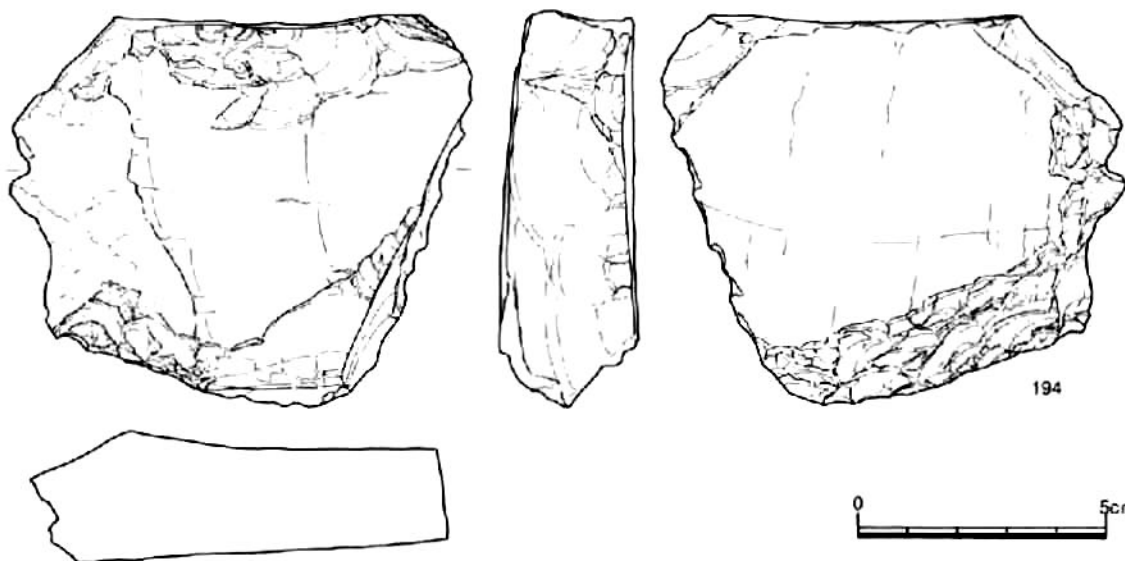

194



石器17 (192~194)

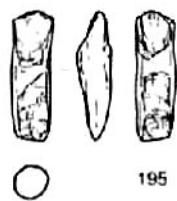

195



196

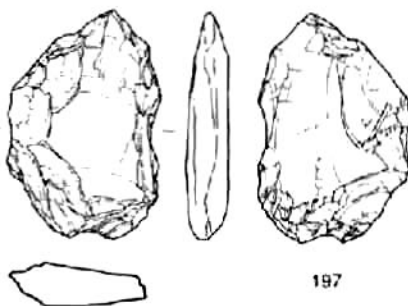

197

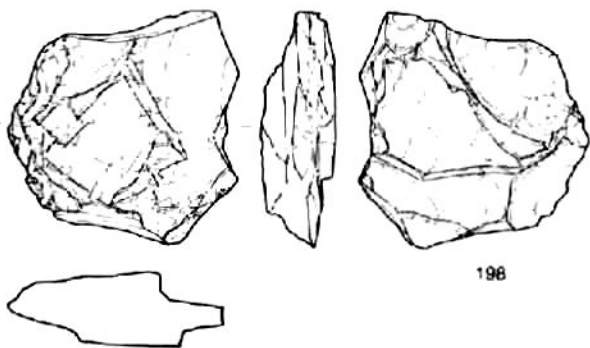

198

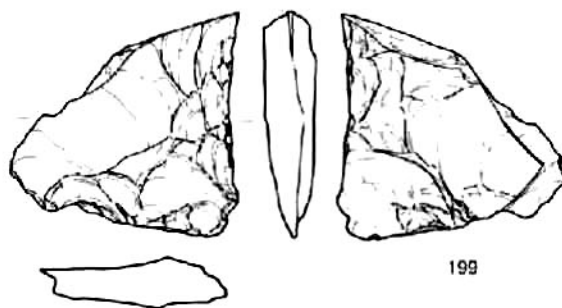

199

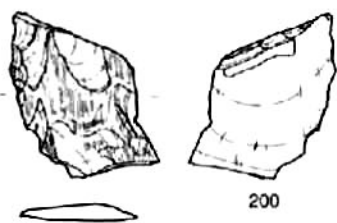

200



201

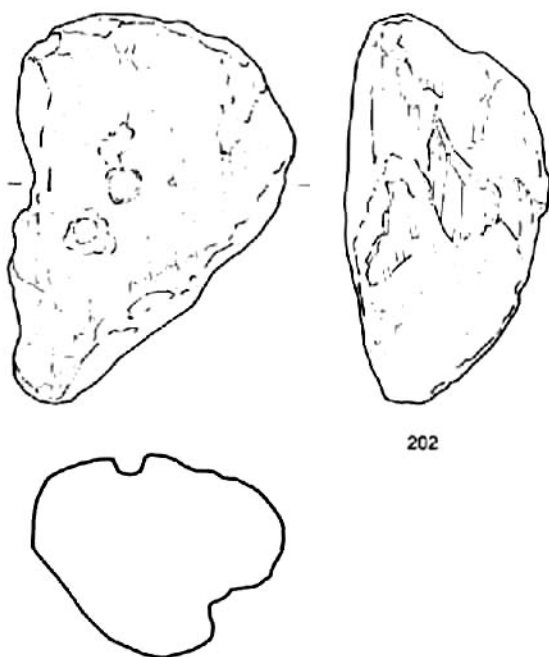

202

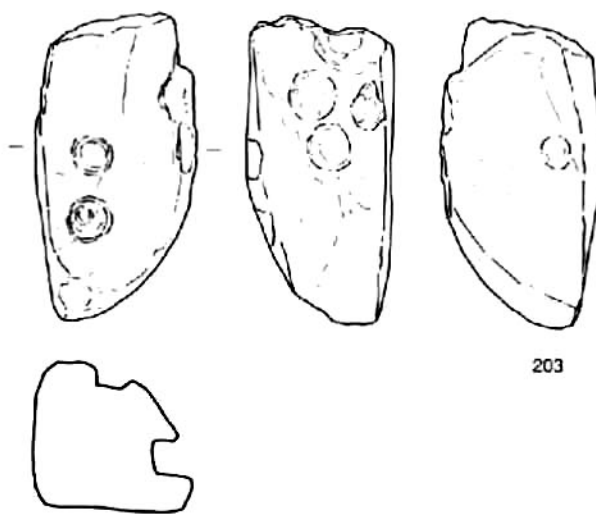

203



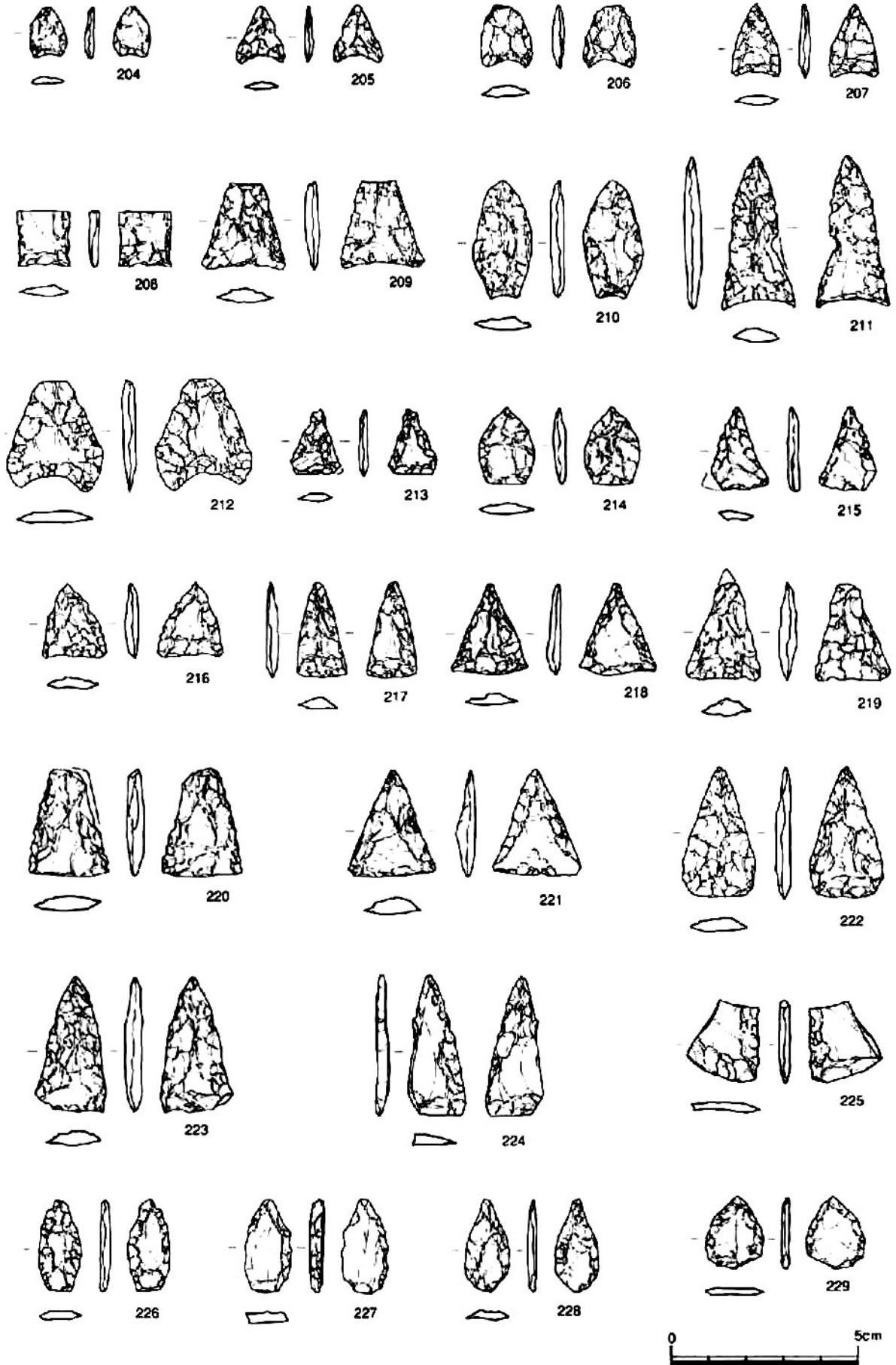

石器19 (主に包含層/204~229) [下層: 205]

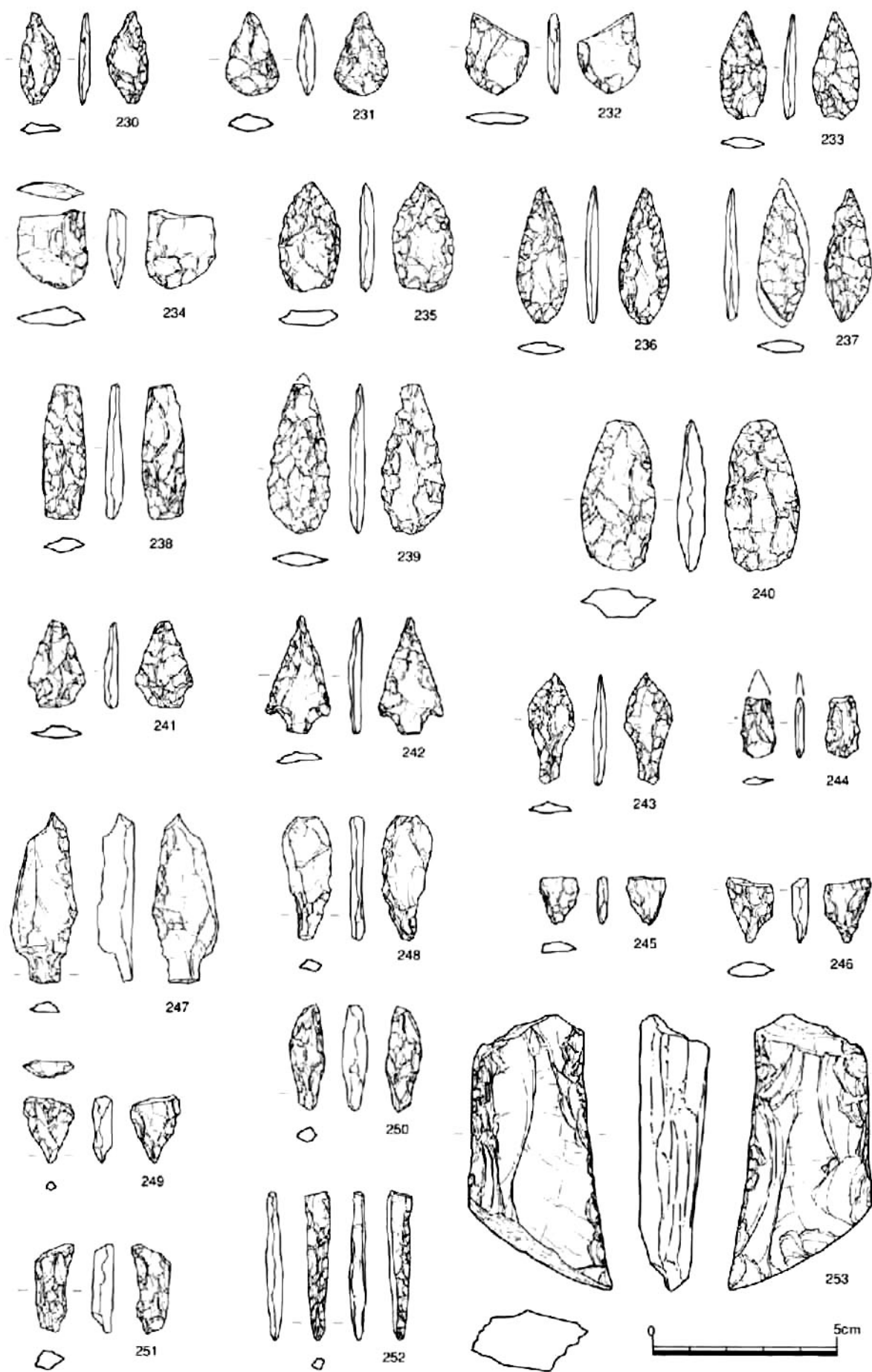

石器20 (主に包含層/230~253)

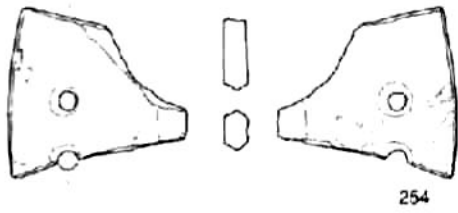

254

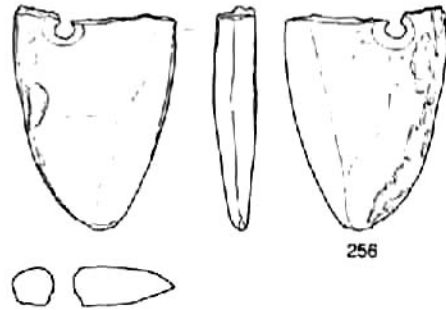

256

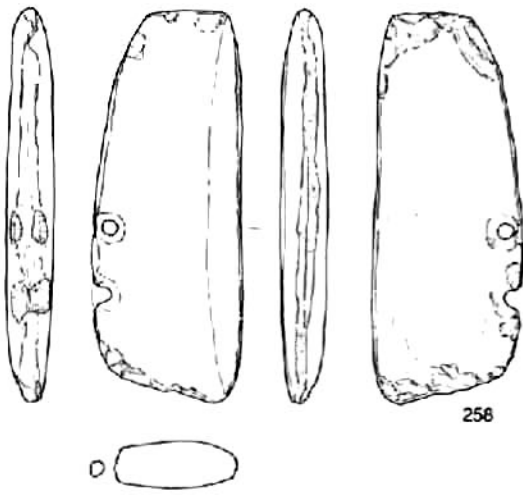

258

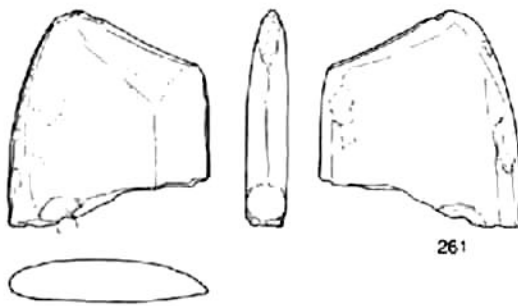

261

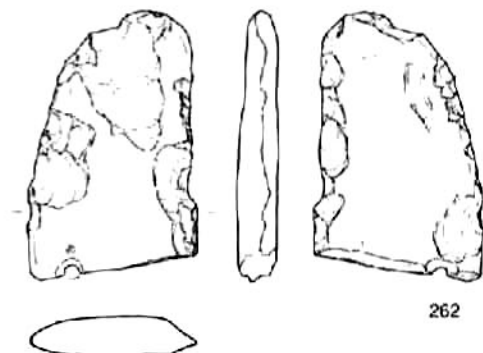

262

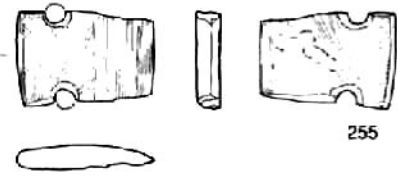

255



257

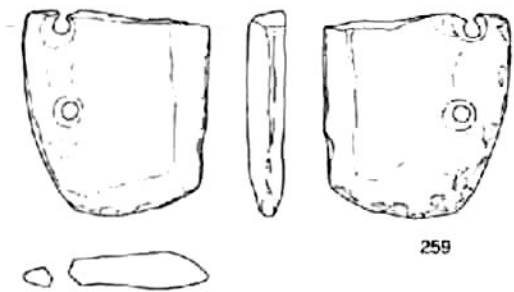

259

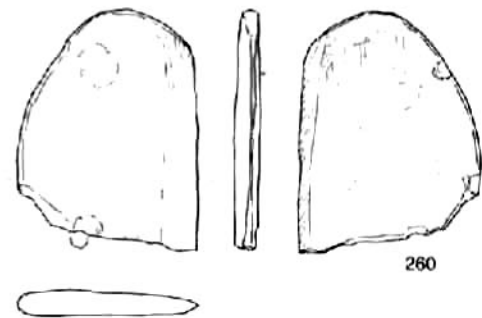

260

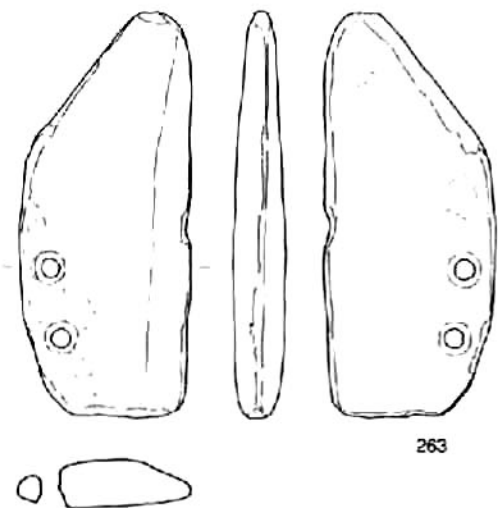

263



石器21 (主に包含層/254~263)

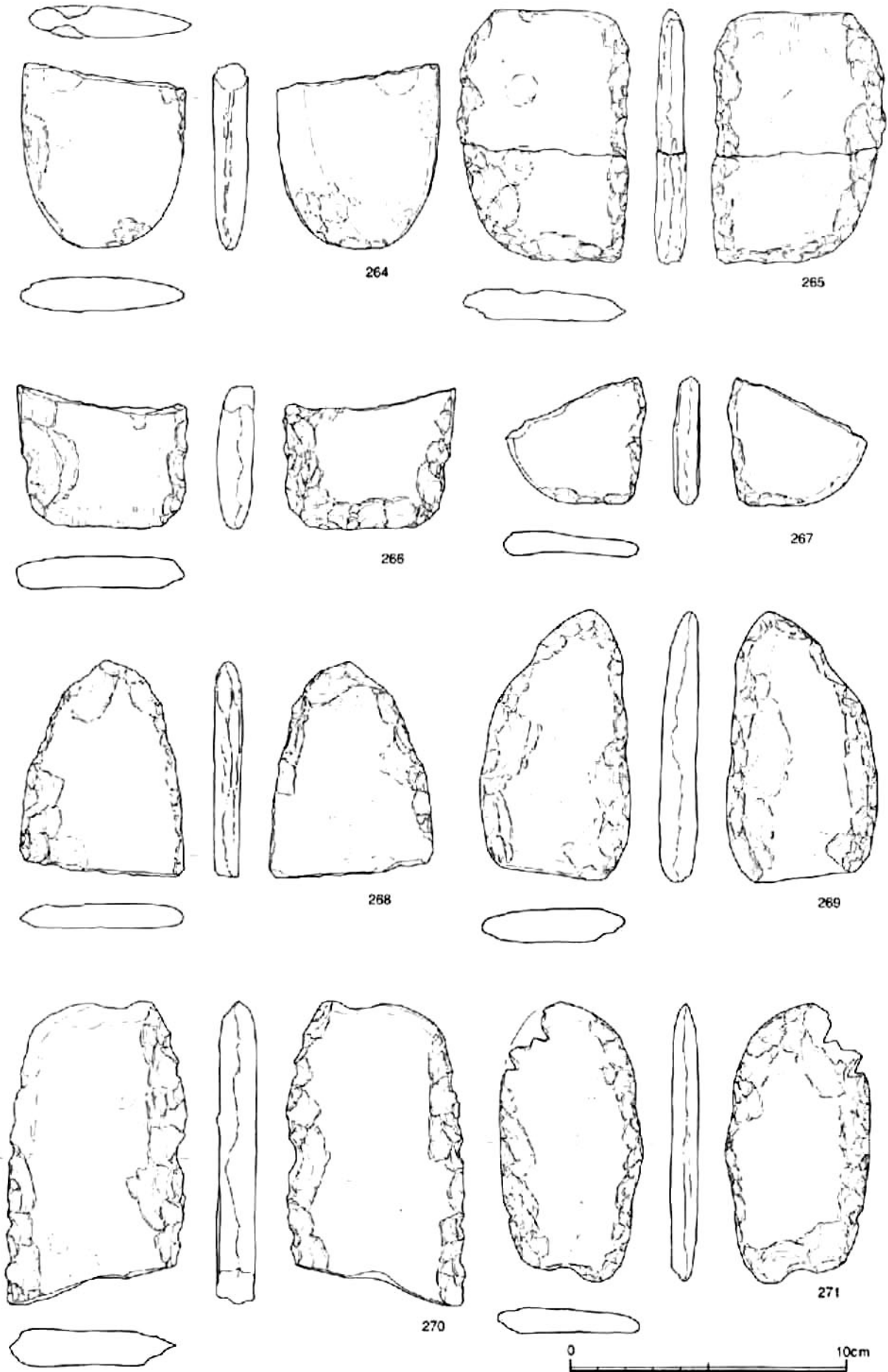

石器22 (主に包含層/264~271)

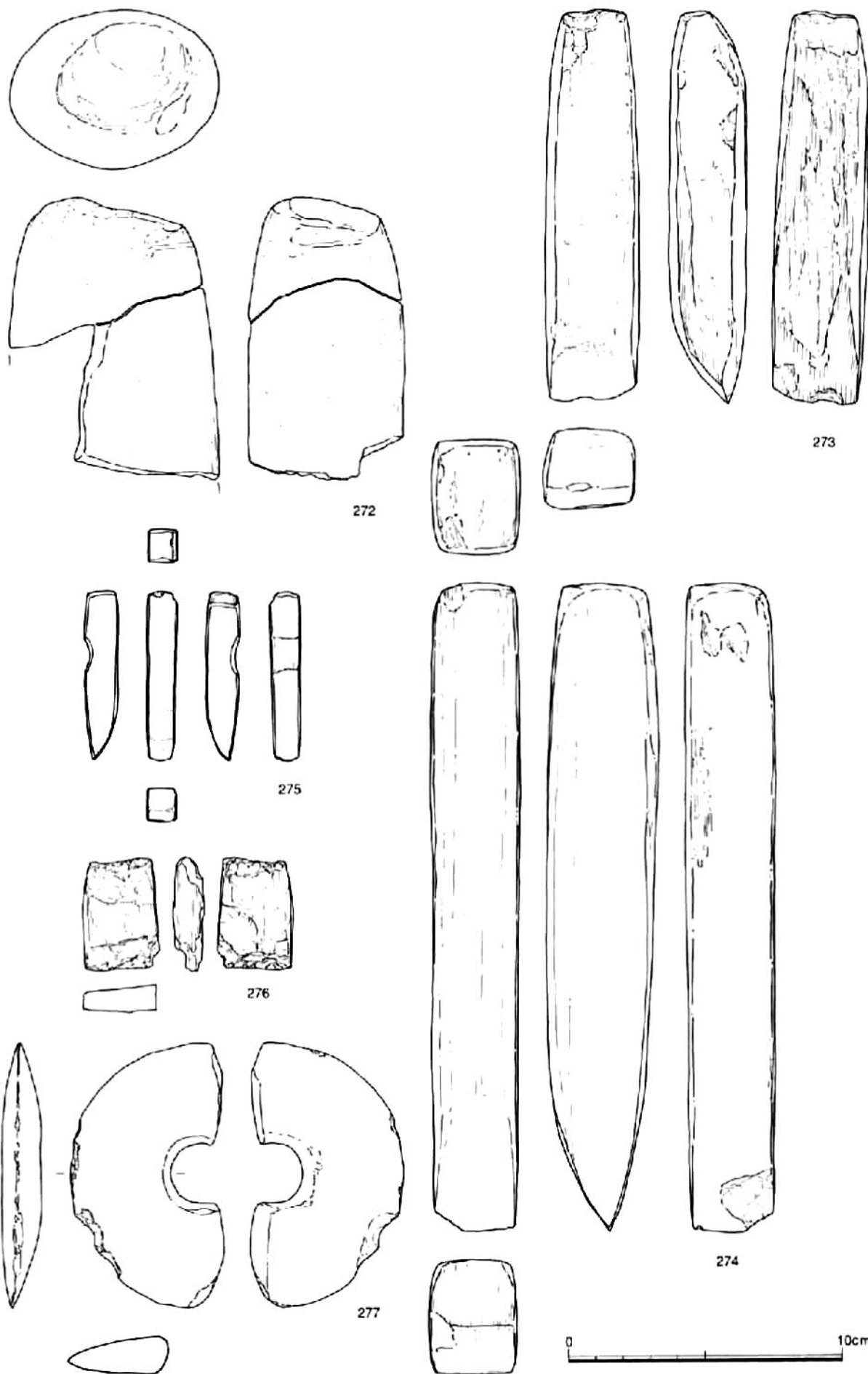

石器23 (主に包含層/272~277)

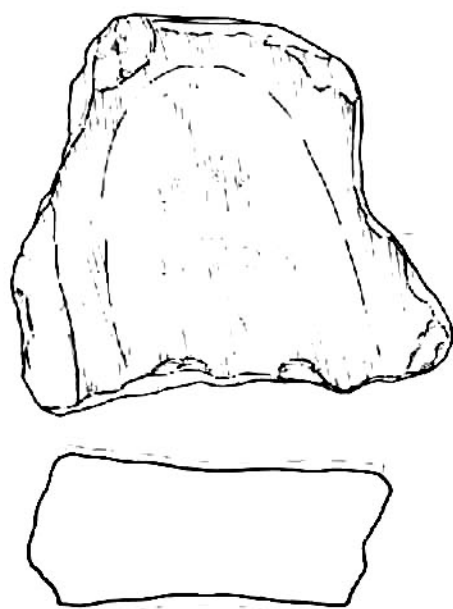

278

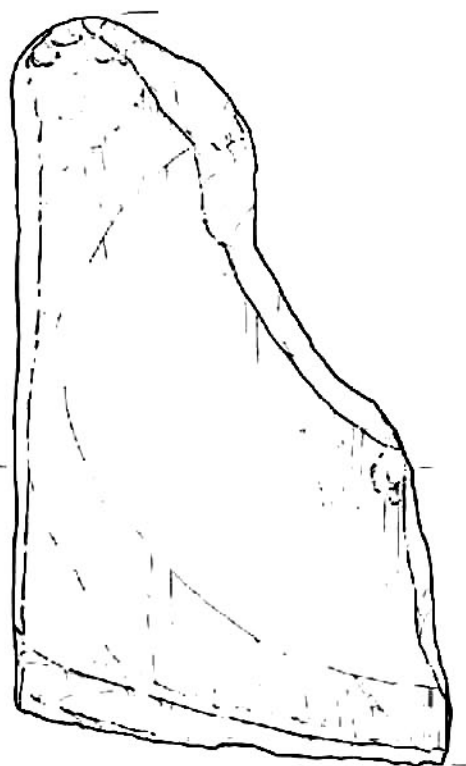

279

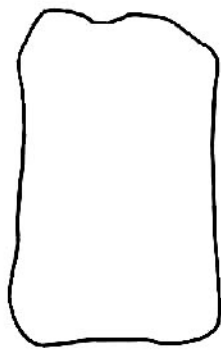
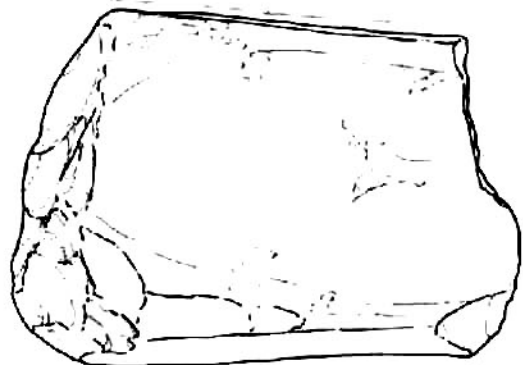

280

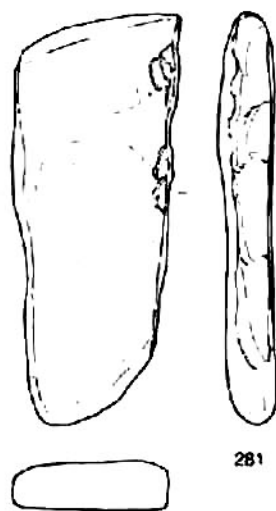

281



石器24 (主に包含層/278-281)

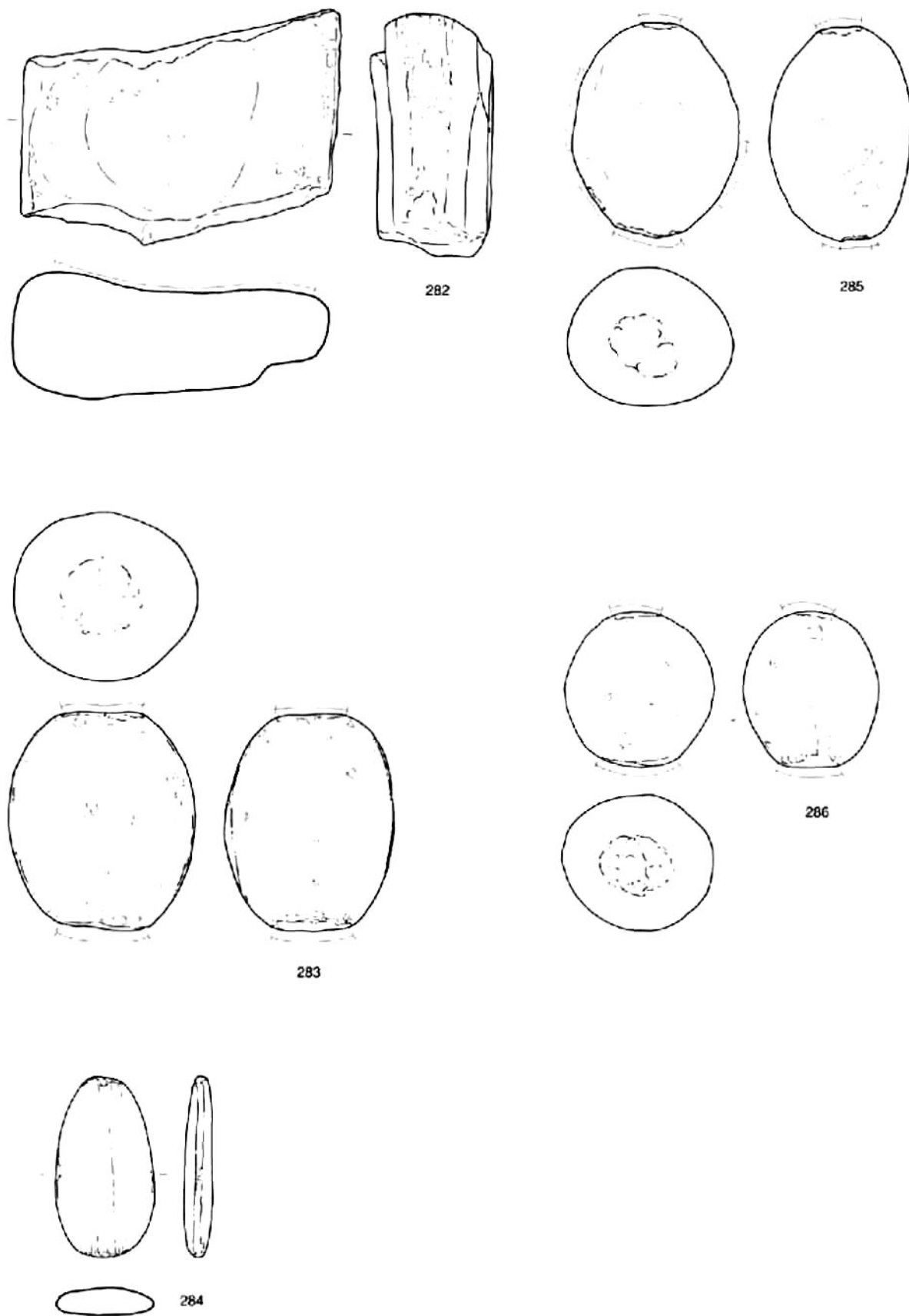

石器25 (主に包含層/282~286)

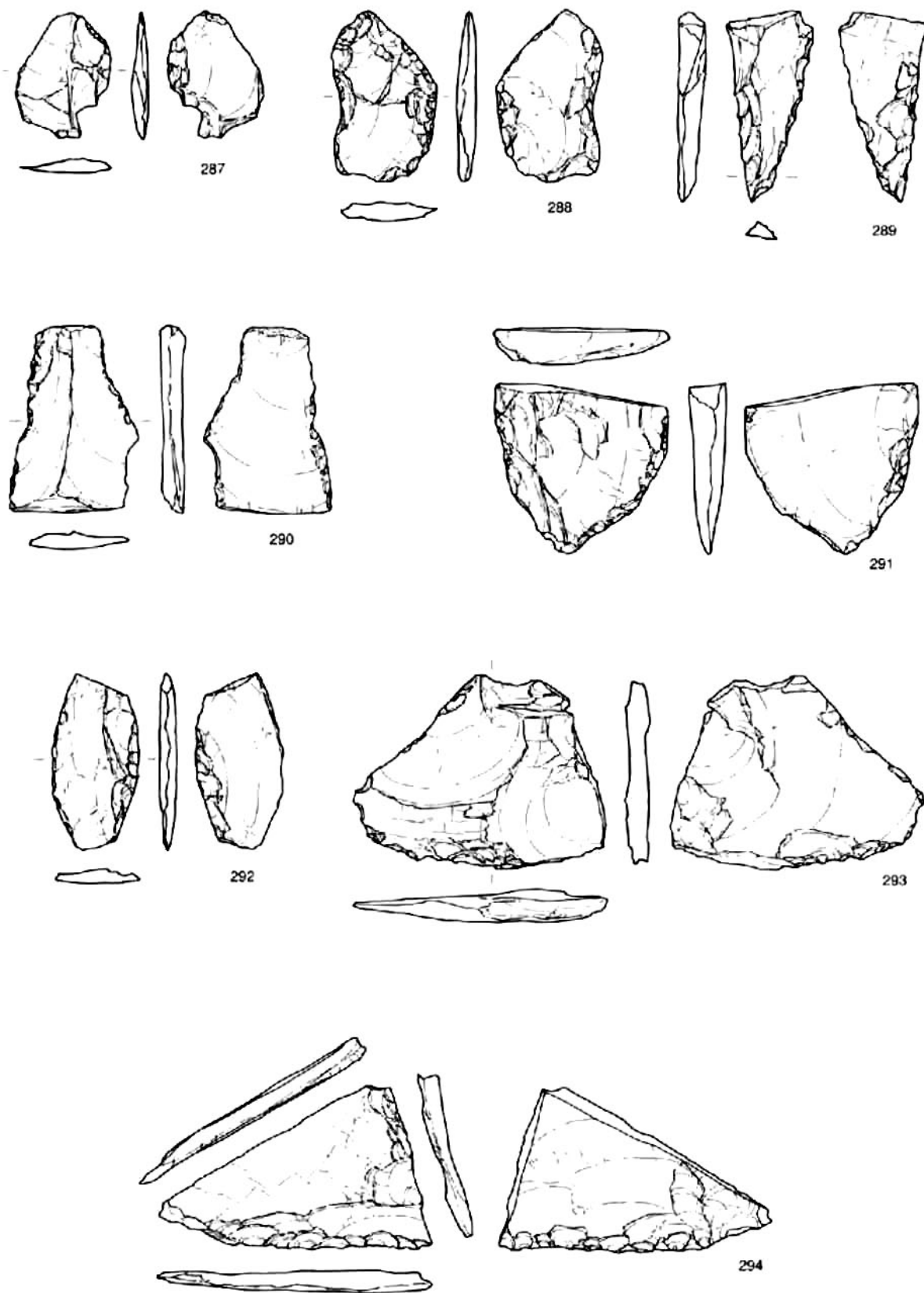

0 5cm
石器26 (主に包含層/287~294)

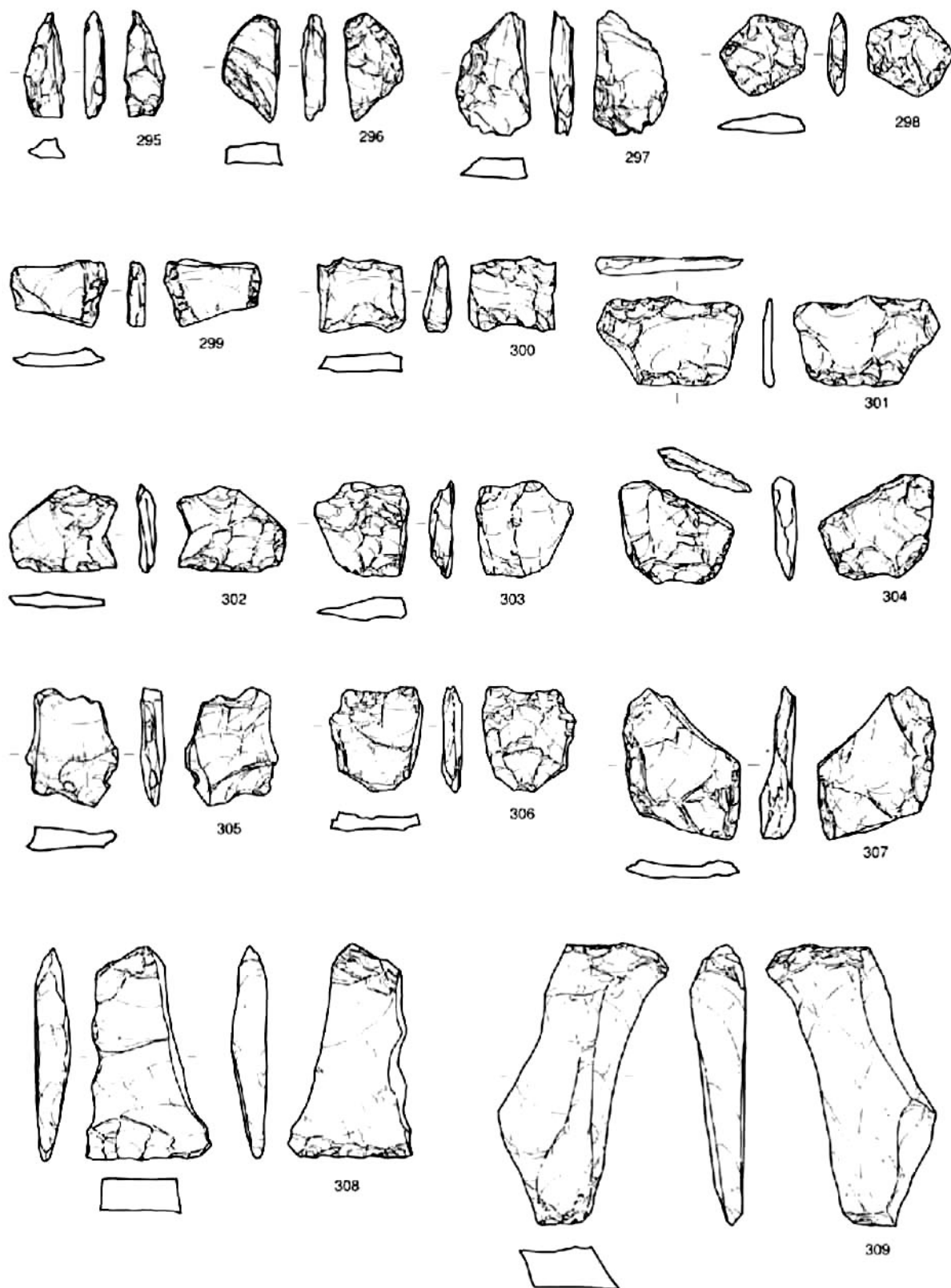

石器27 (主に包含層/295~309)

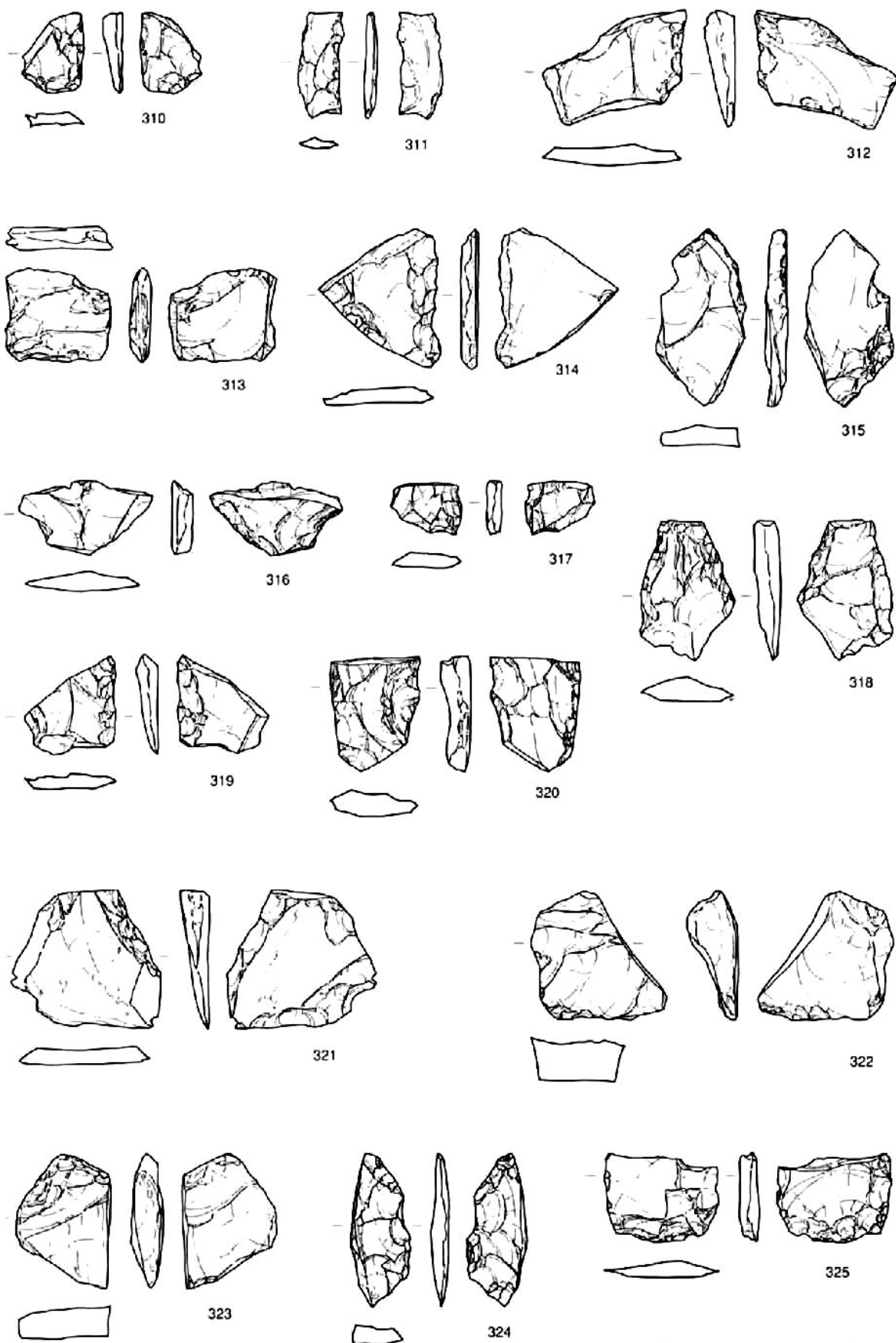

石器28 (主に包含層/310~325)