

PL. Ⅱ-153 1号土壌 炭化物・焼土面の図

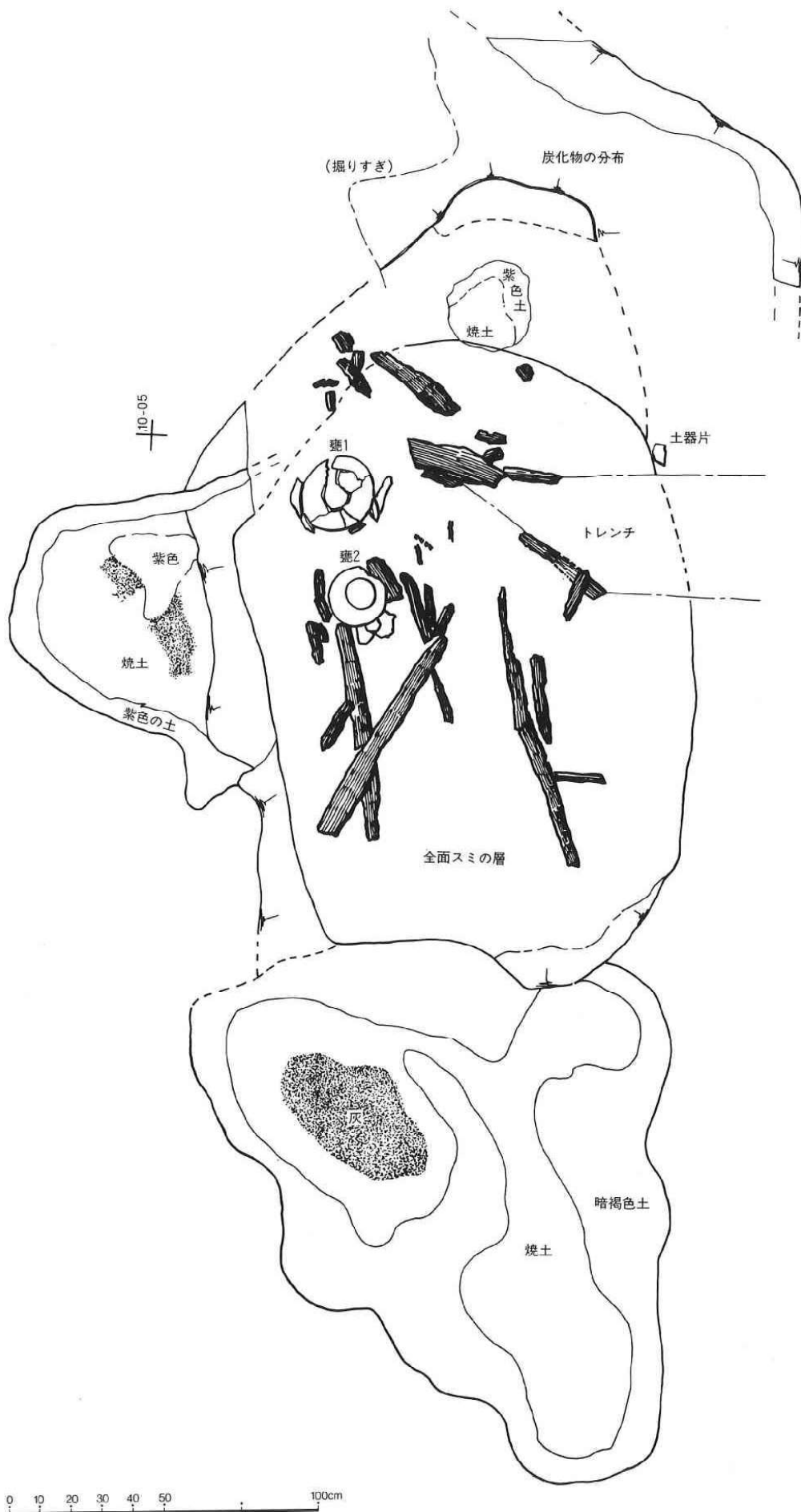

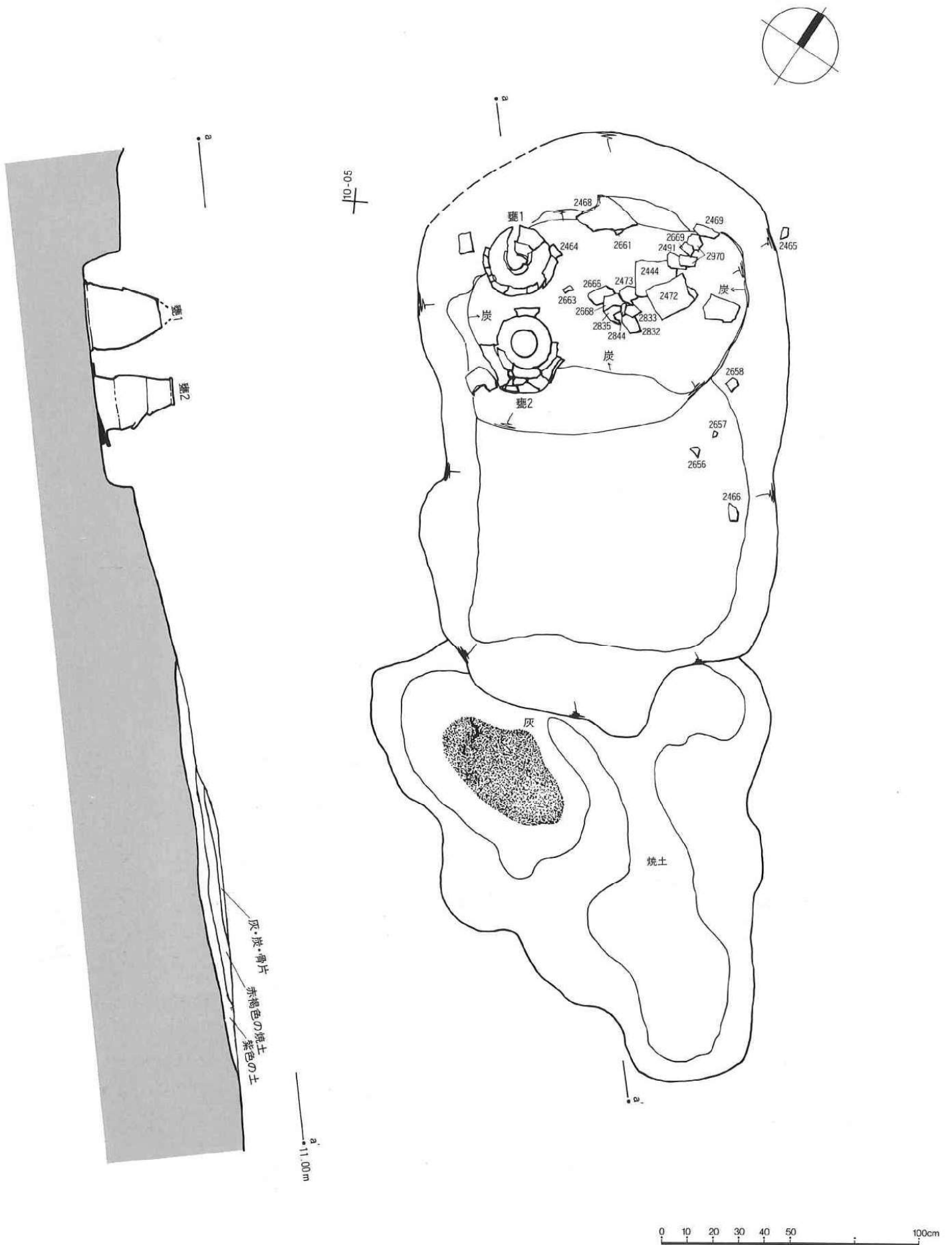



PL. 図-155 1号土壙 最終平面図と土層断面図

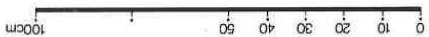
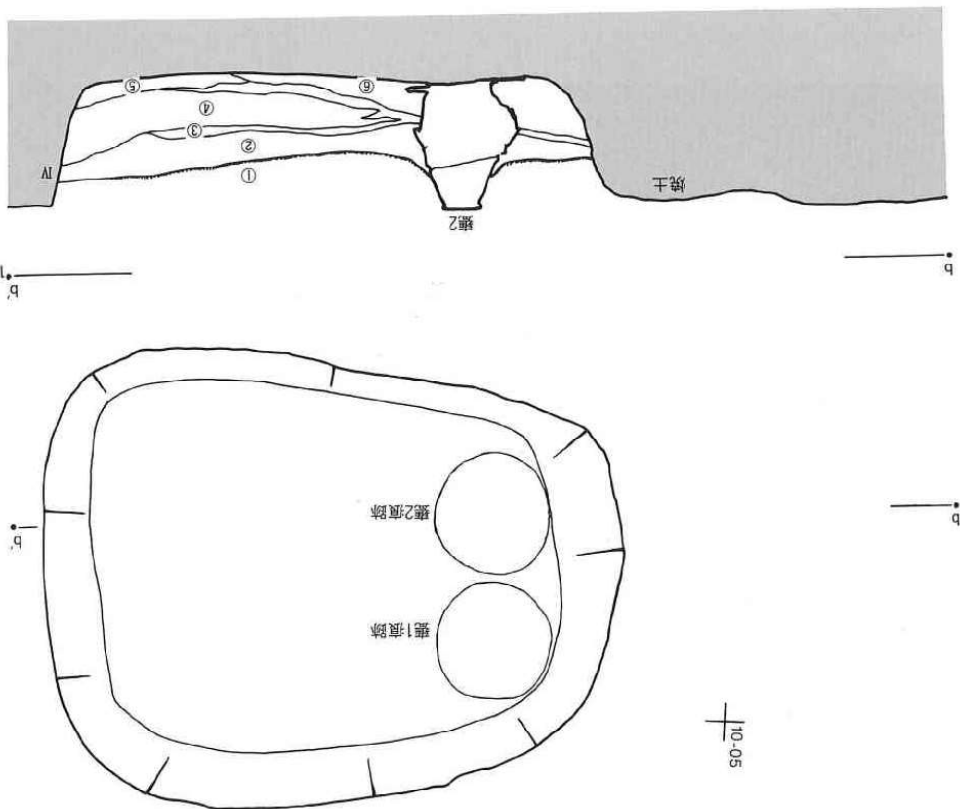

PL. 図-156 1号土壙



東からみる

南東からみる



PL. 図-157 1号土壙およびその周辺の焼土・炭化物層などからの出土土器 ① (( )内は個体番号)

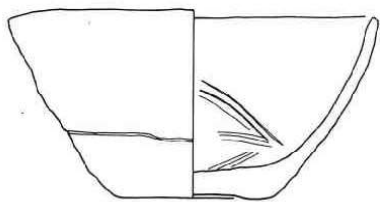

1 (坏19)

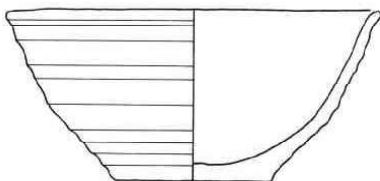

2 (坏2)

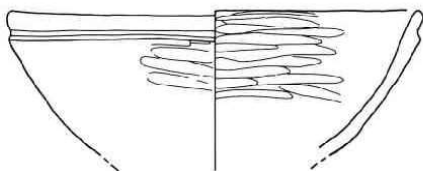

3 (坏62)

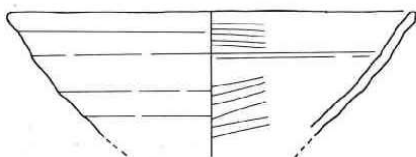

4 (坏66)

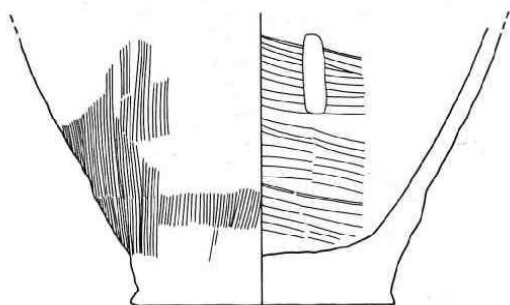

5 (甕149)

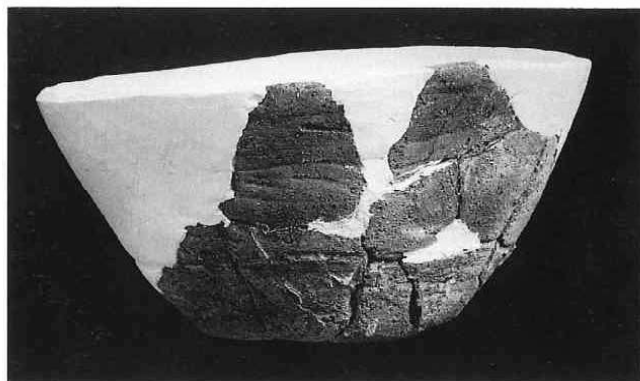

1



2

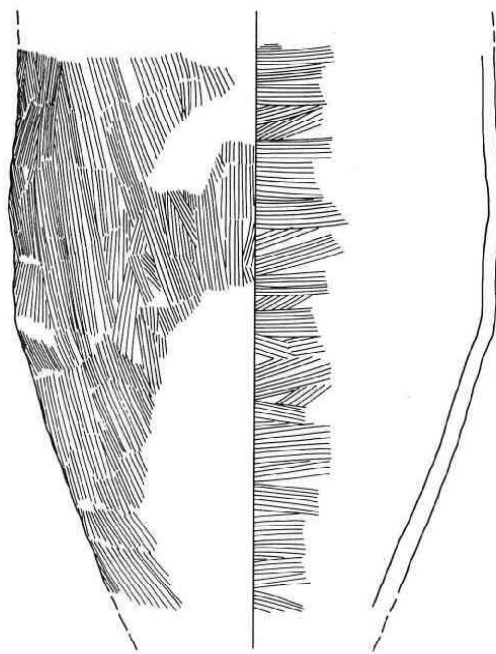

6 (甕80)

PL. ②-158 1号土壙およびその周辺の焼土・炭化物層などからの出土土器 ② [( )内は個体番号]

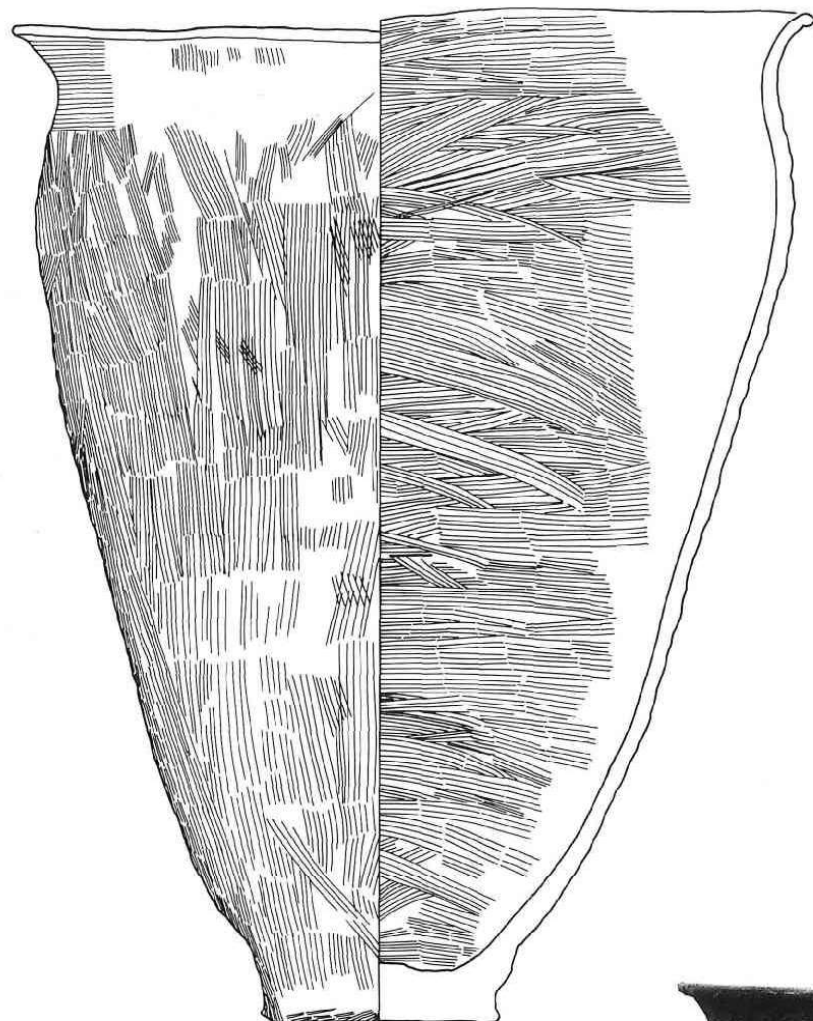

1 (壺1)

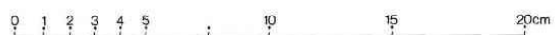

1

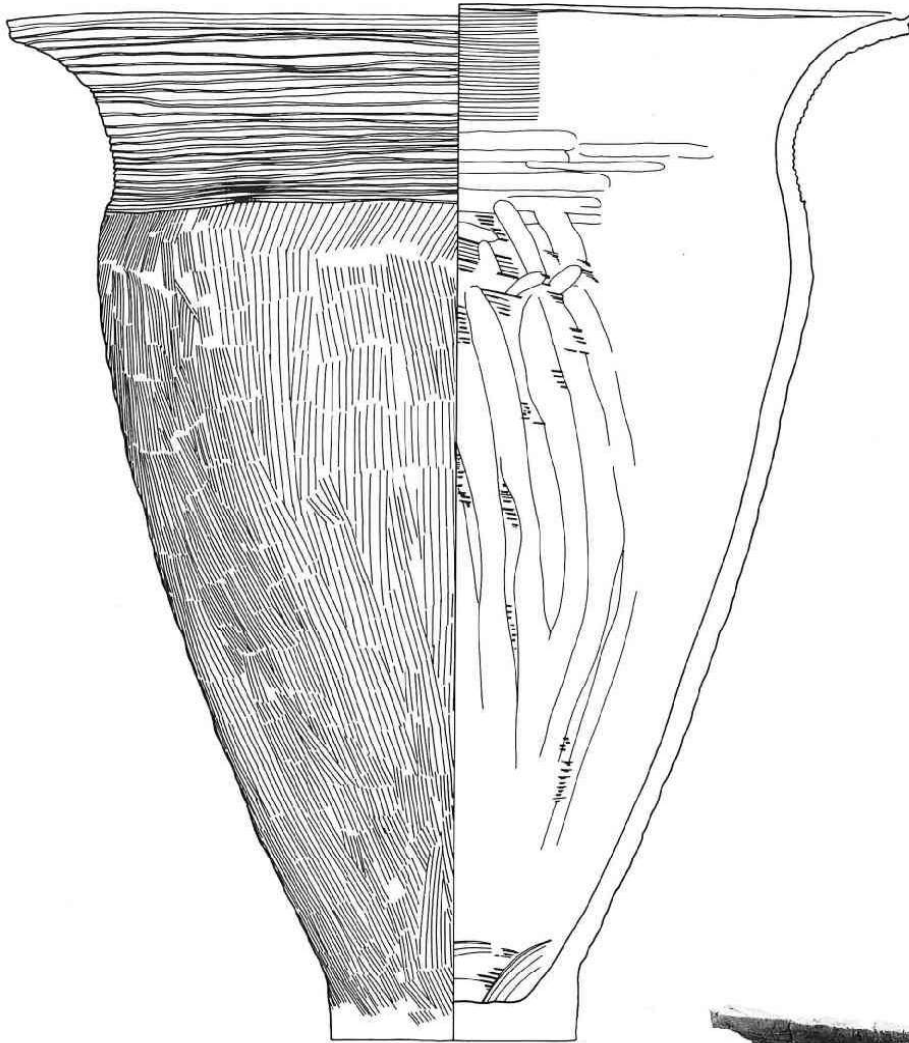

1 (猪2)

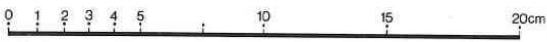

1

PL. ②-160 2号土壇 平面図と土層断面図(上)

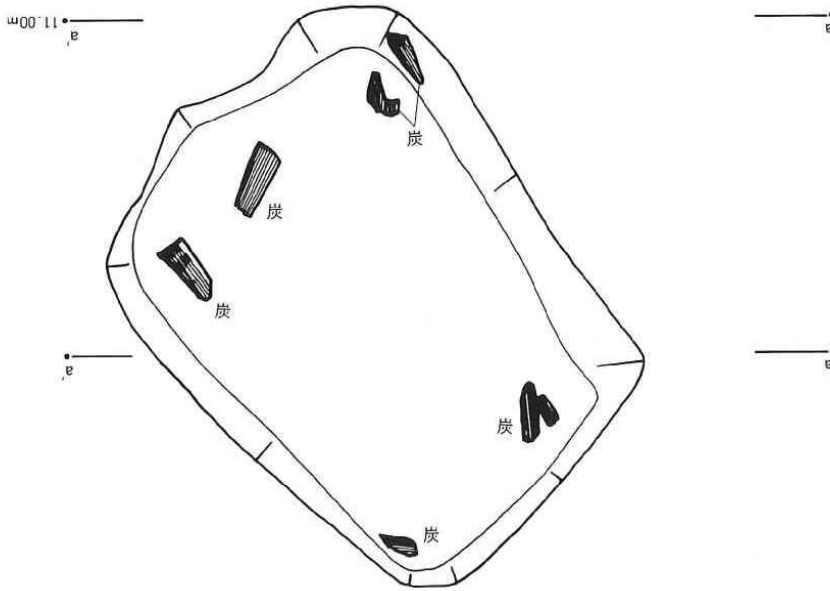
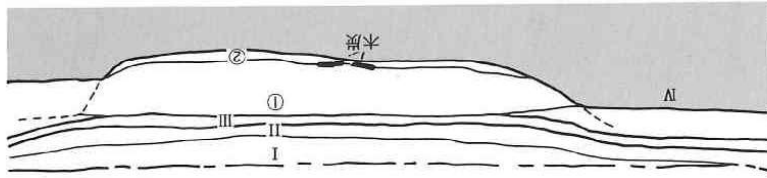

0 10 20 30 40 50 100cm

19-08

PL. ②-161 2号土壇



南西からみる

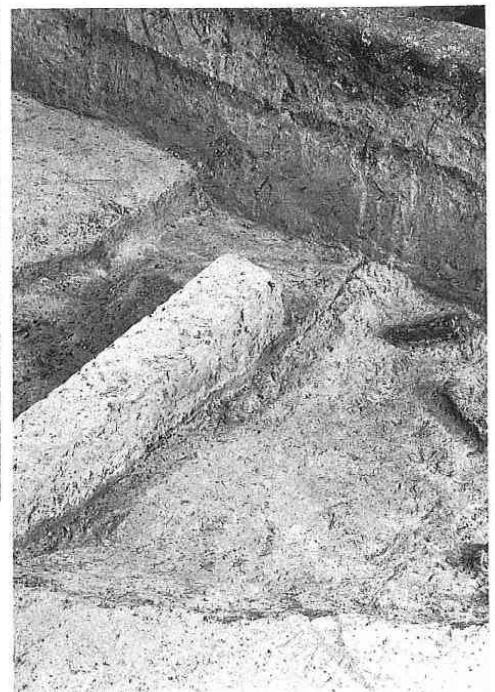

南からみる



PL. ②-162 3号土壌の平面・土層・断面図と出土した礫の重量ヒストグラム

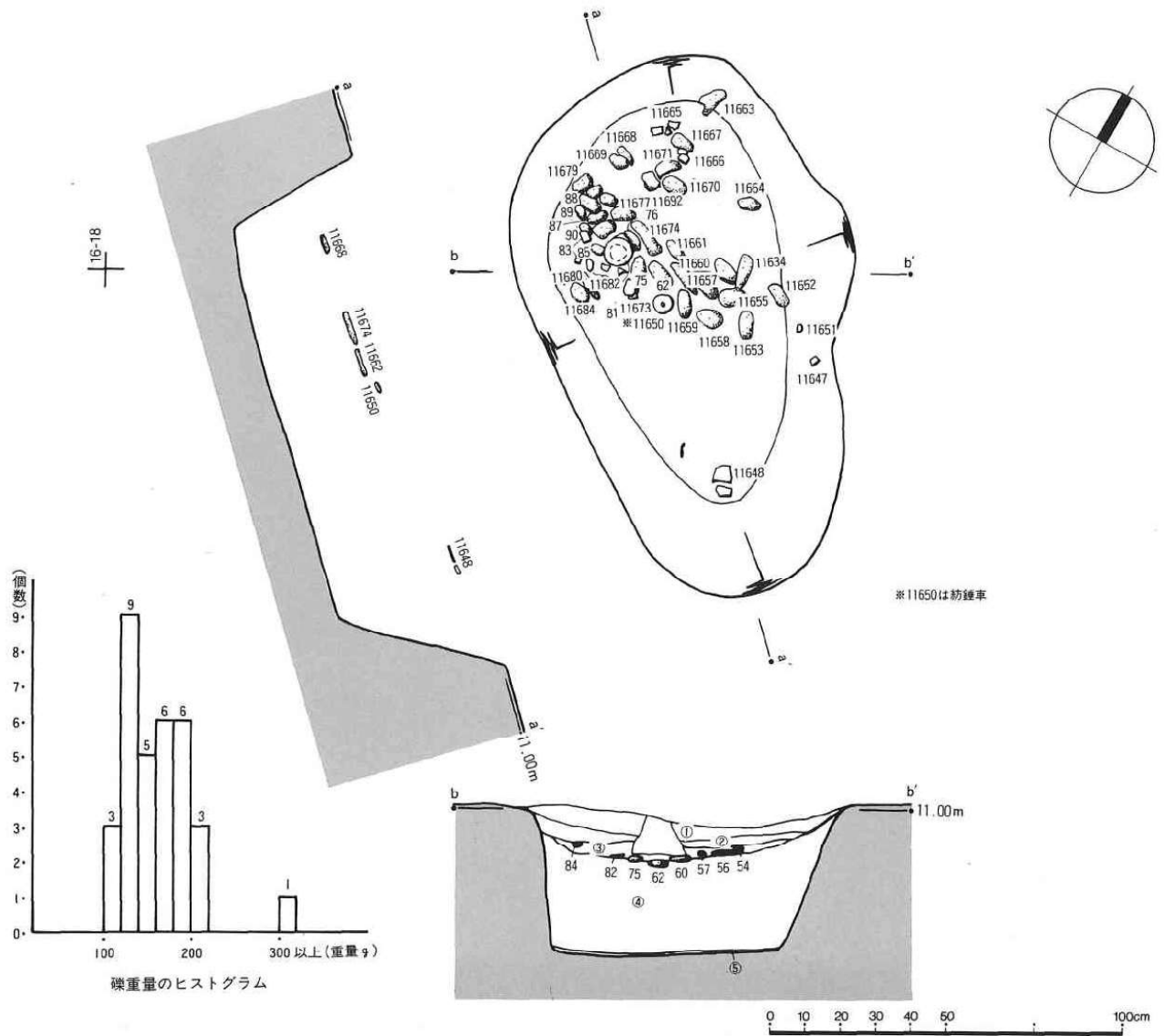

PL. ②-163 3号土壌



④層の遺物出土状況：東南からみる

PL. 図-164 4号土壌上面の炭化物・焼土の分布と土層断面図

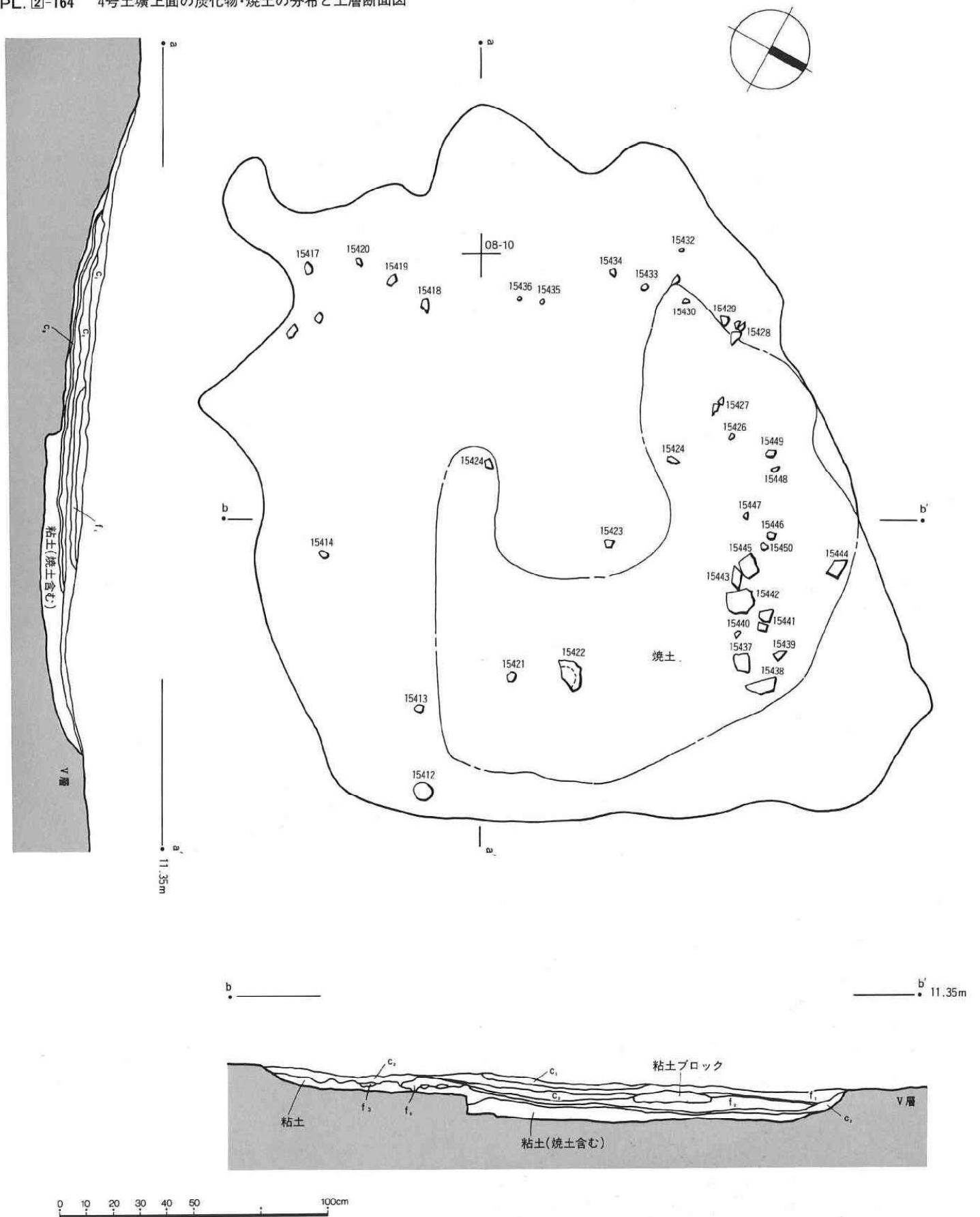

PL. 2-165 4号土壙 最終平面図と断面図

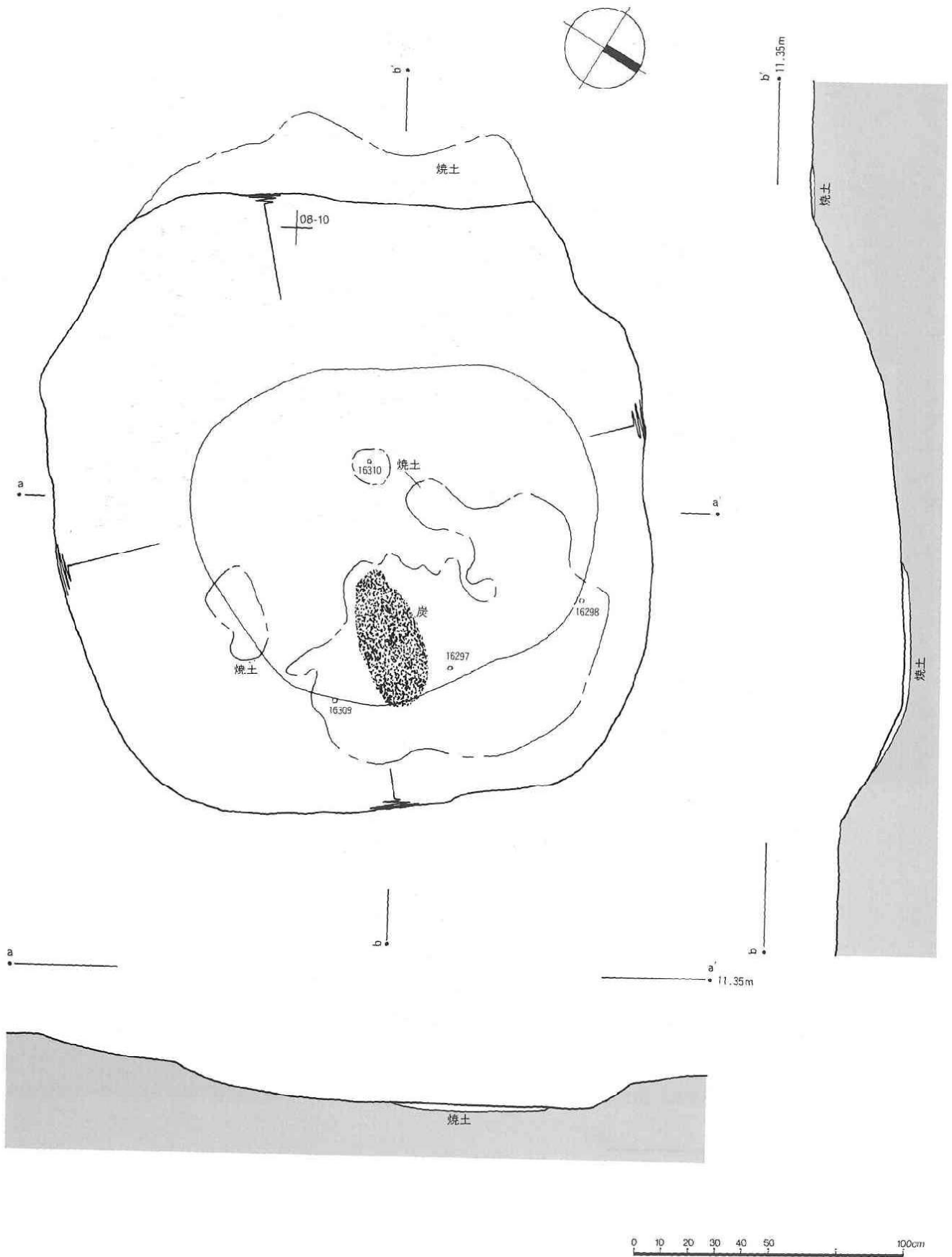



PL. ②-166 4号土壌



炭化物層のひろがり：西からみる

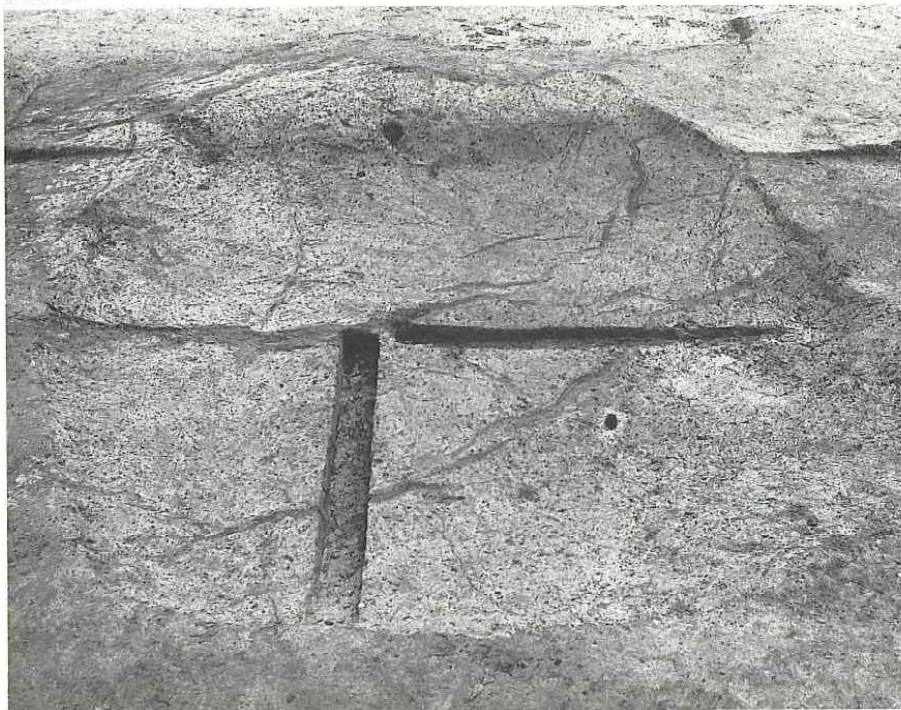

西からみる

PL. 2-167 个体番号坏26の破片分布图

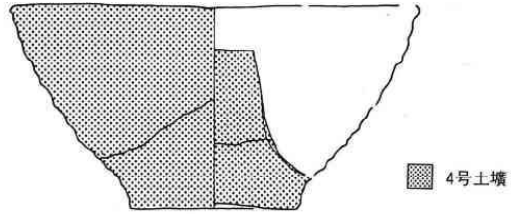
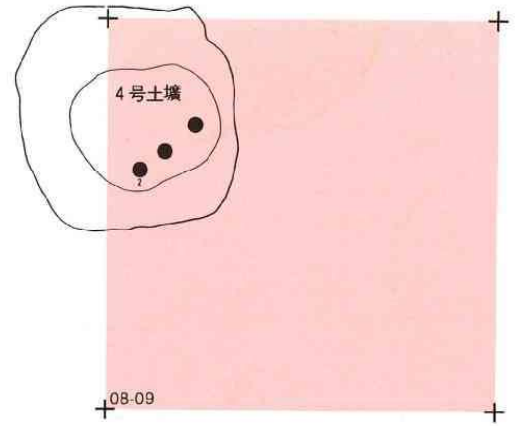
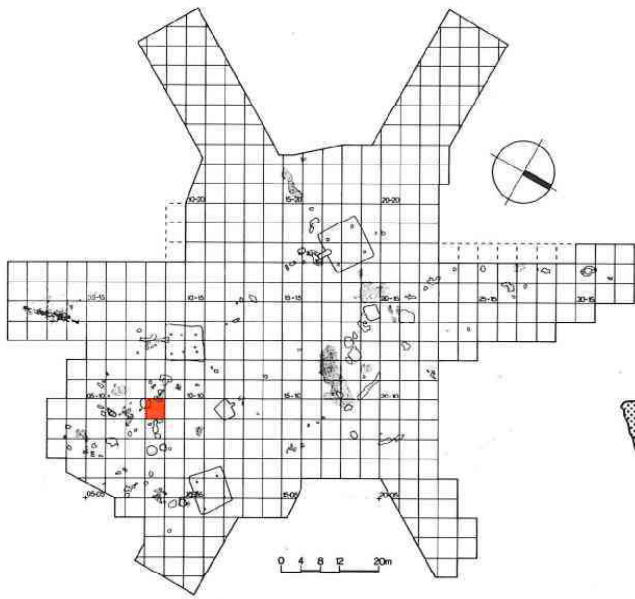

PL. 2-168 个体番号坏32の破片分布图

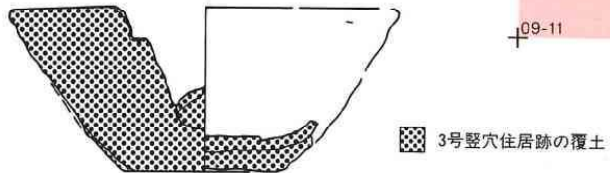
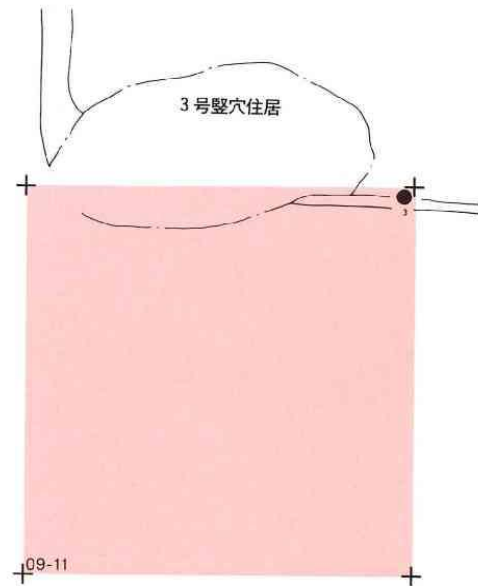
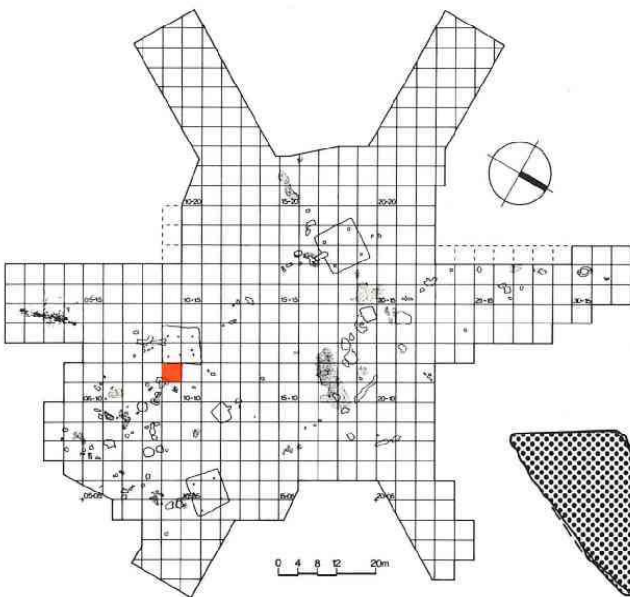



PL. ②-169 個体番号 坏66の破片分布図

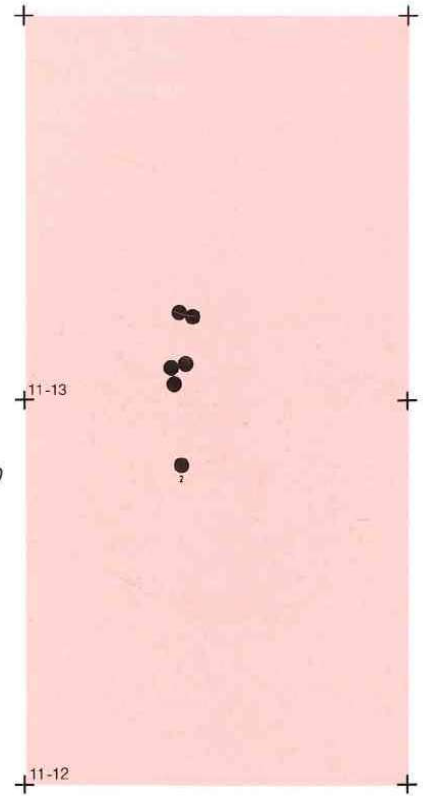
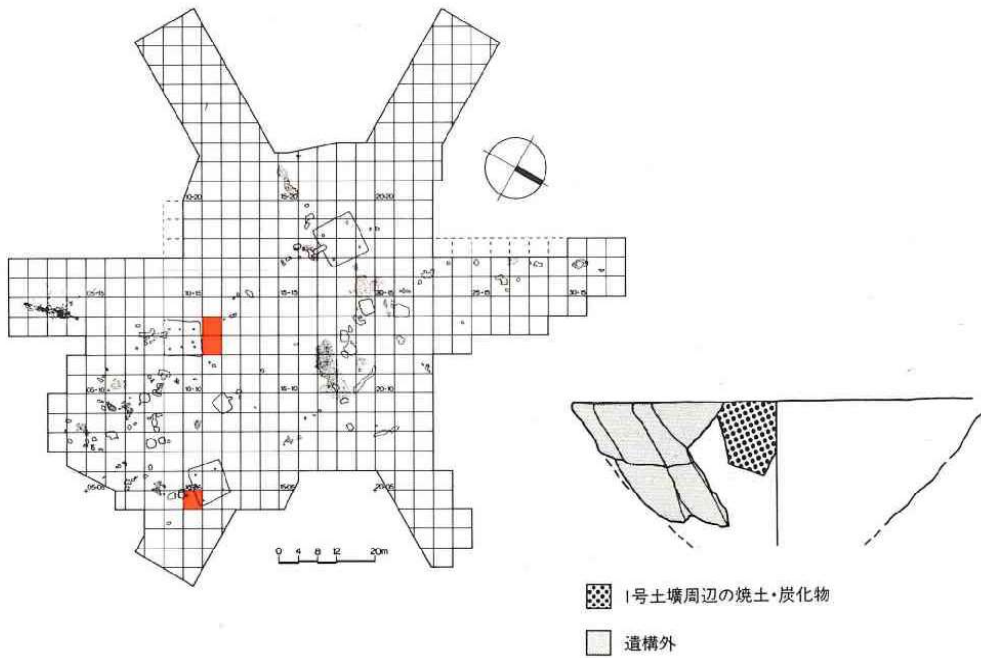

PL. ②-170 個体番号 坏68の破片分布図

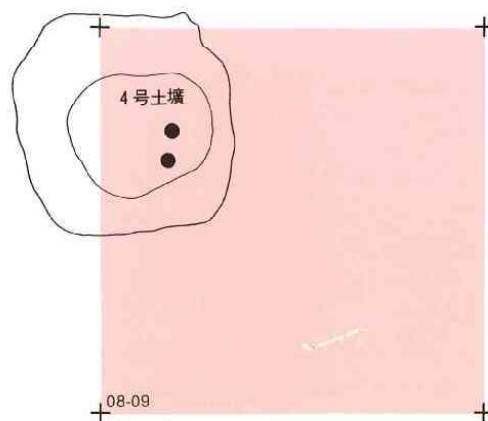
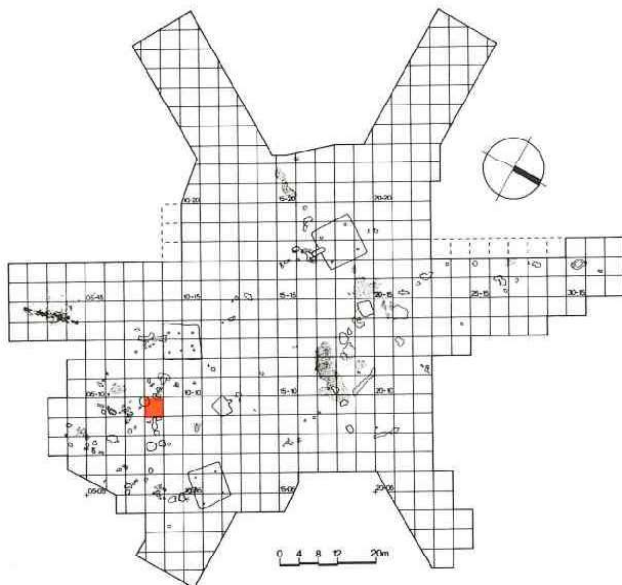

PL. ②-171 个体番号 坏73の破片分布図

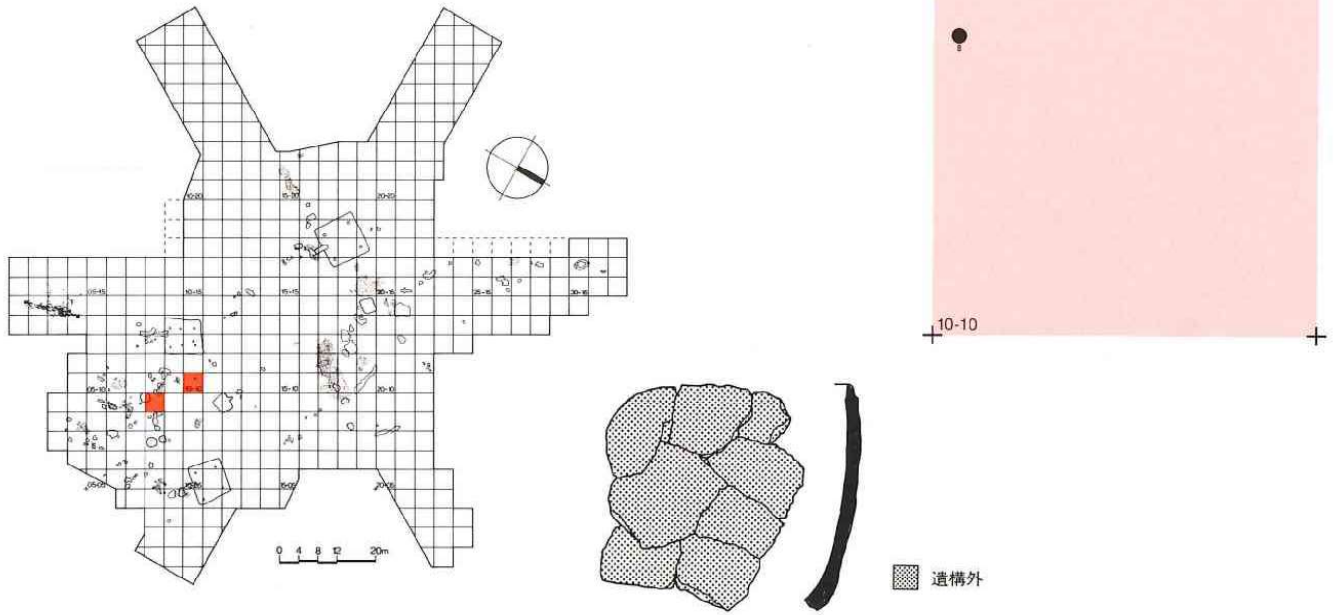

PL. ②-172 个体番号 坏75の破片分布図

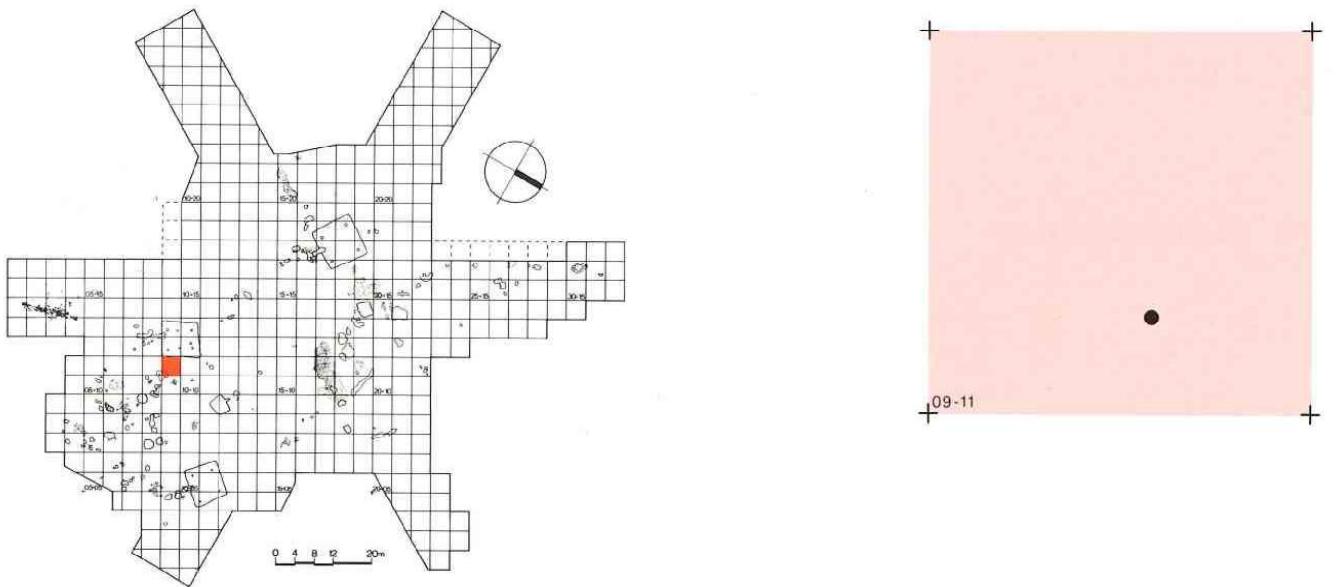

PL. ②-173 個体番号壺14の破片分布図

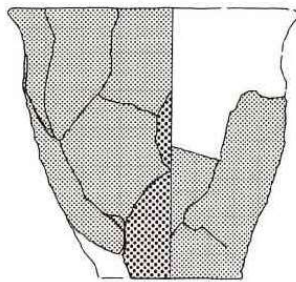
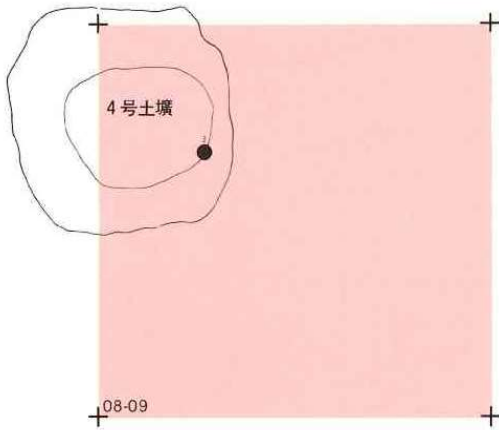
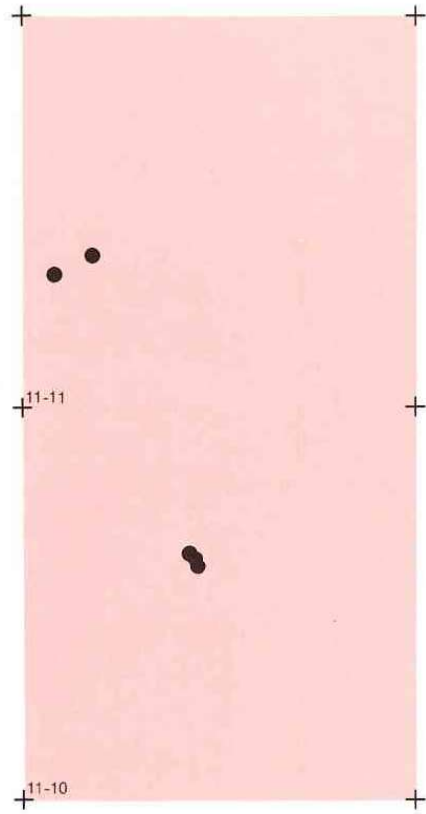
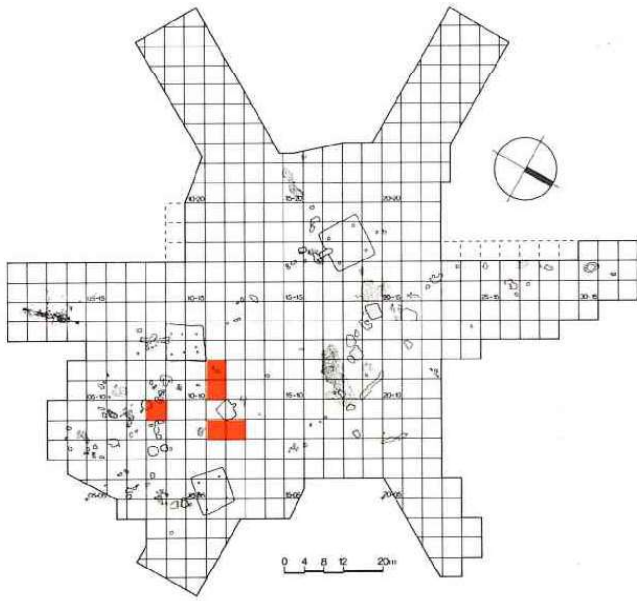

4号竪穴住居跡の東側  
 焼土32

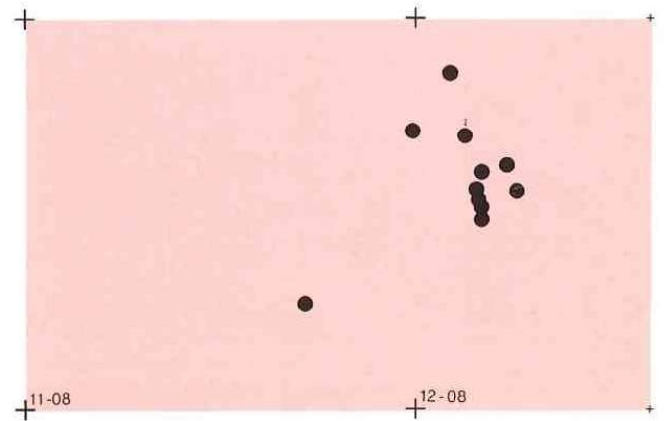

PL. 図 174 個体番号壺51の破片分布図

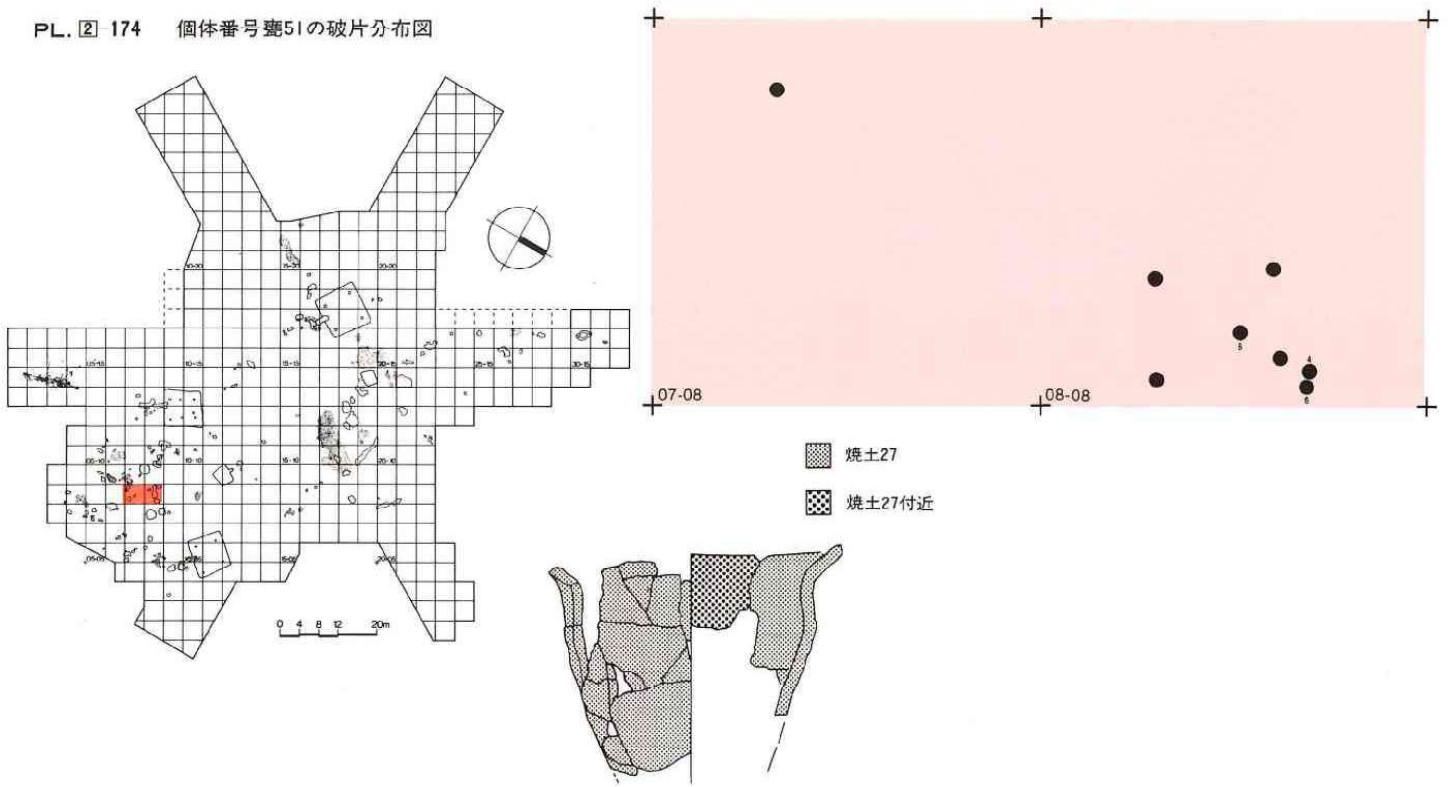

PL. 図-175 個体番号壺89の破片分布図



PL. ②-176 個体番号73の破片分布図

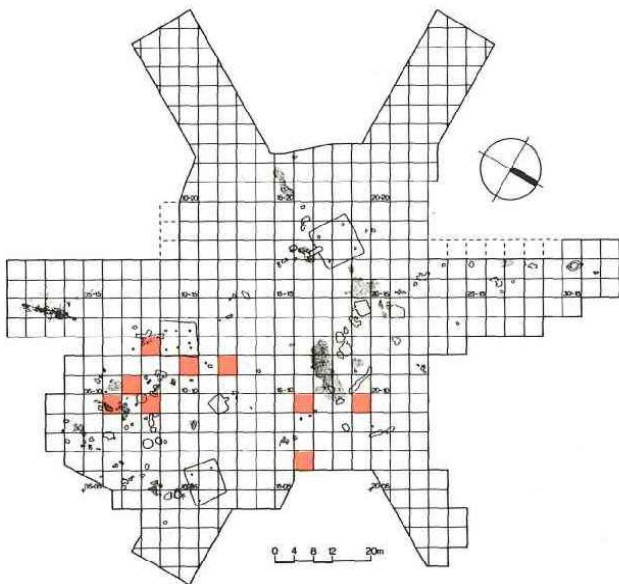
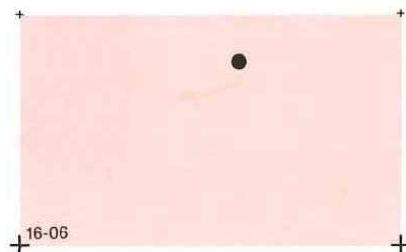
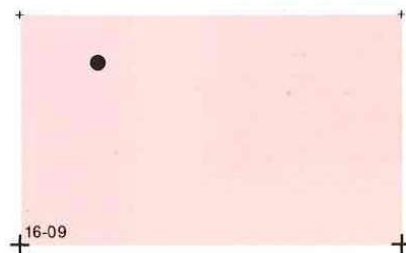
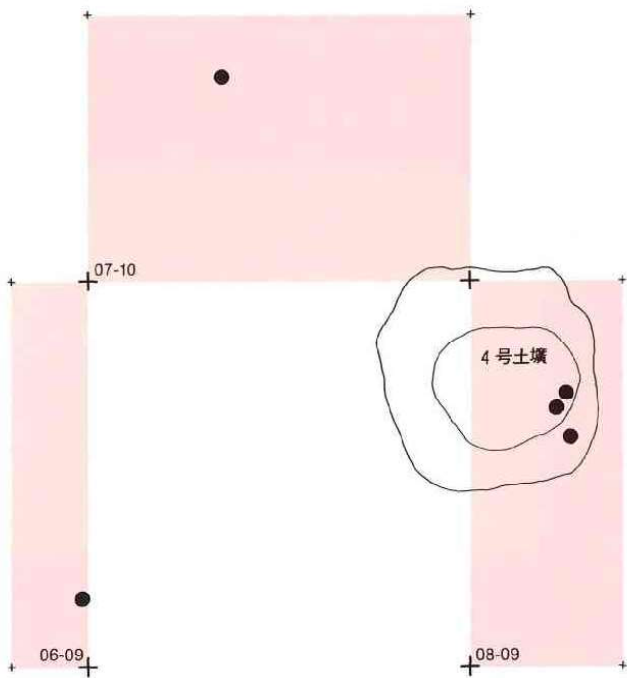
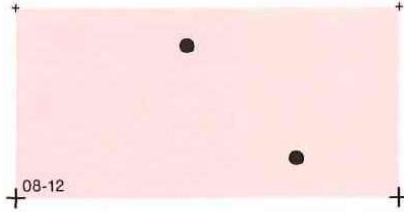



PL. ②-177 个体番号壺76の破片分布図

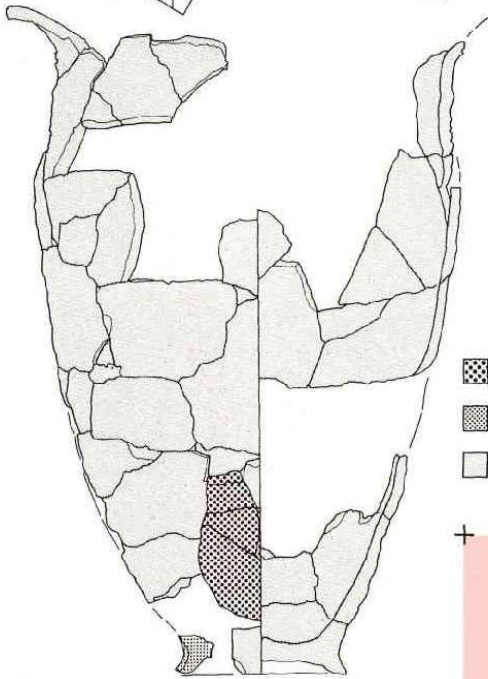
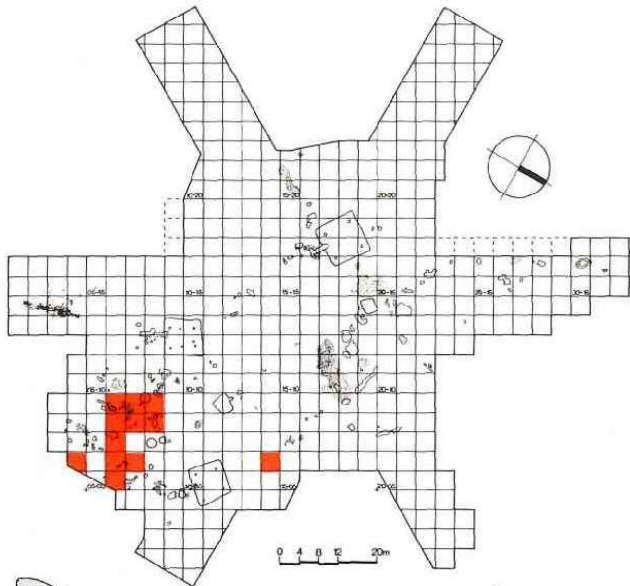

-  4号土坑
-  炭化物14
-  遺構外

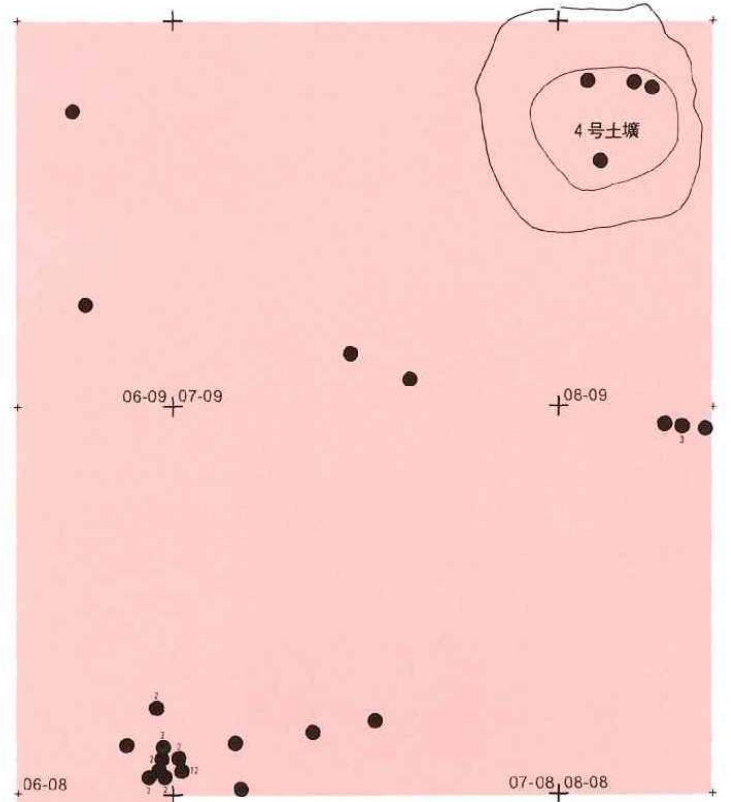
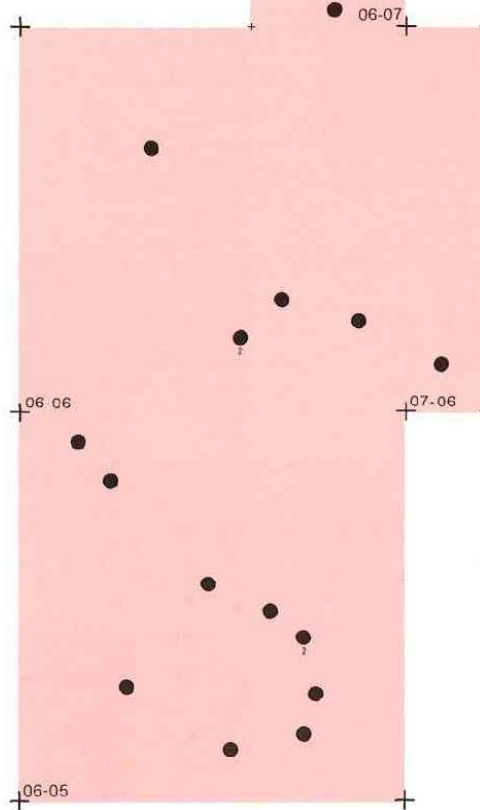
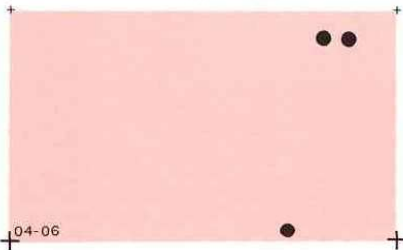



PL. ②-178 個体番号壺98の破片分布図

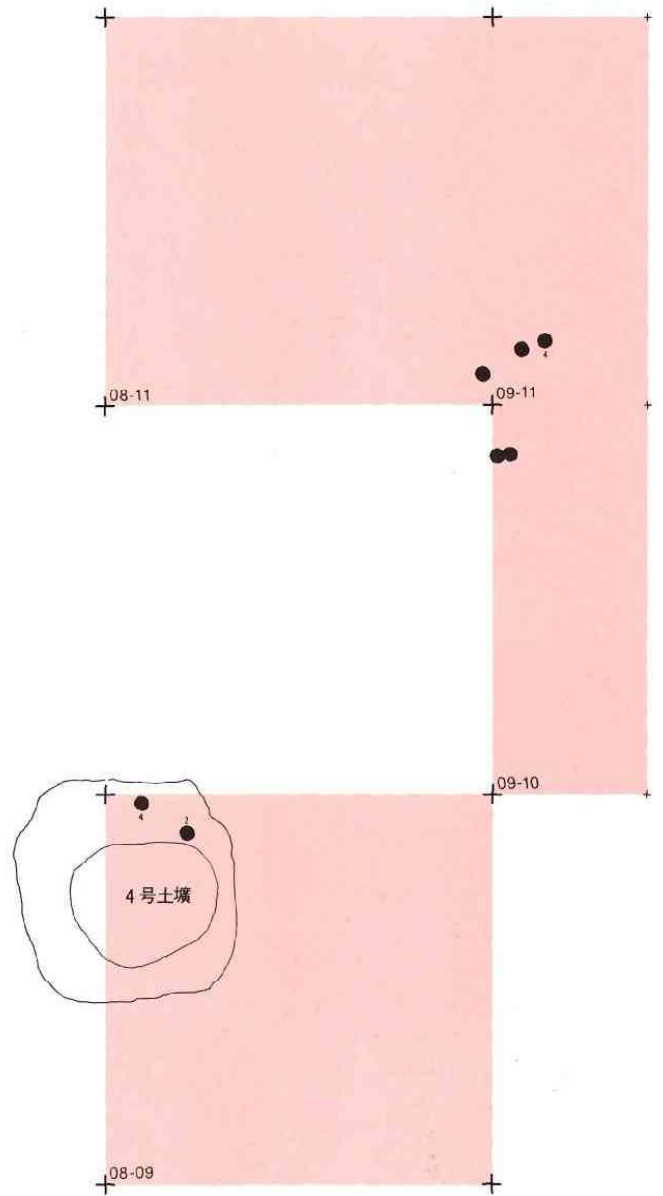
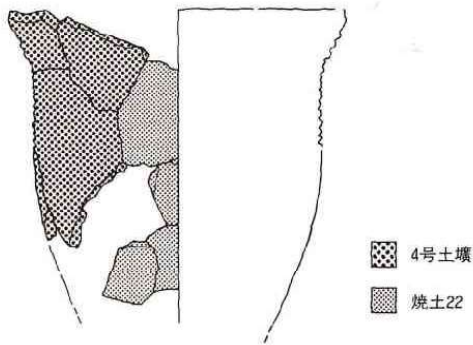
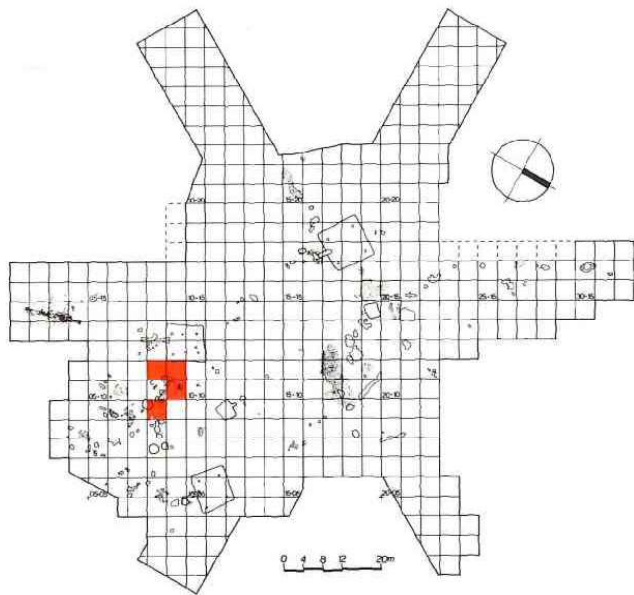

PL. ②-179 個体番号壺100の破片分布図

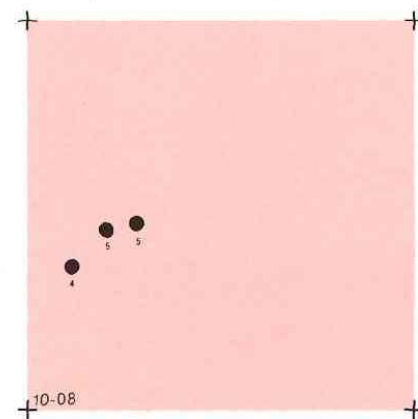
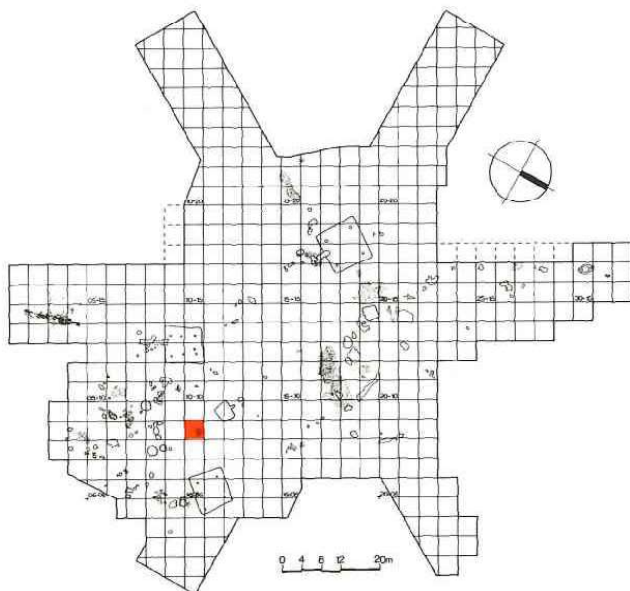

PL. 図-180 個体番号壺152の破片分布図

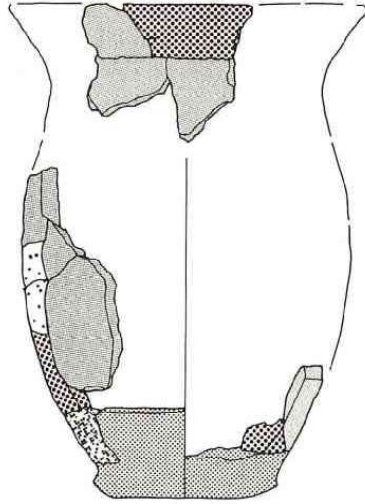
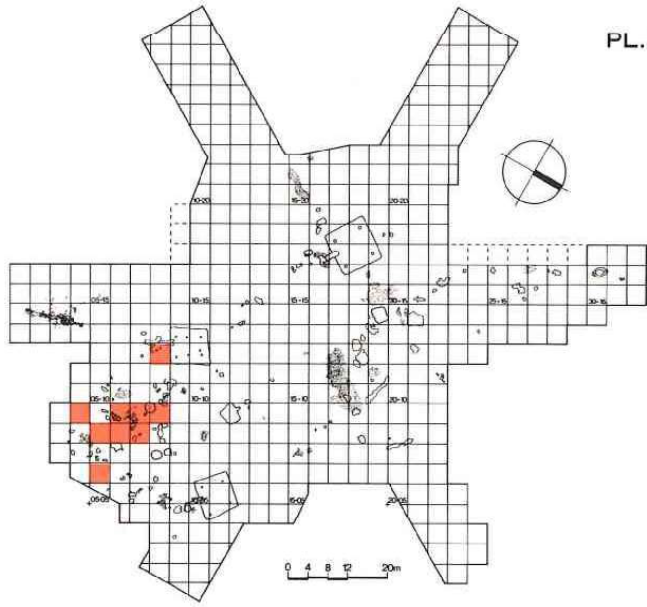

-  4号土壌
-  焼土24
-  炭化物19
-  炭化物14
-  遺構外

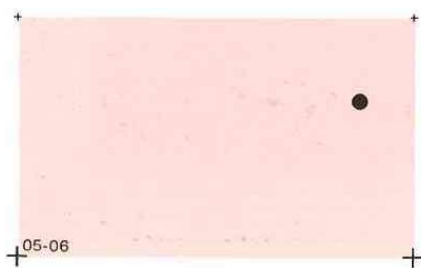
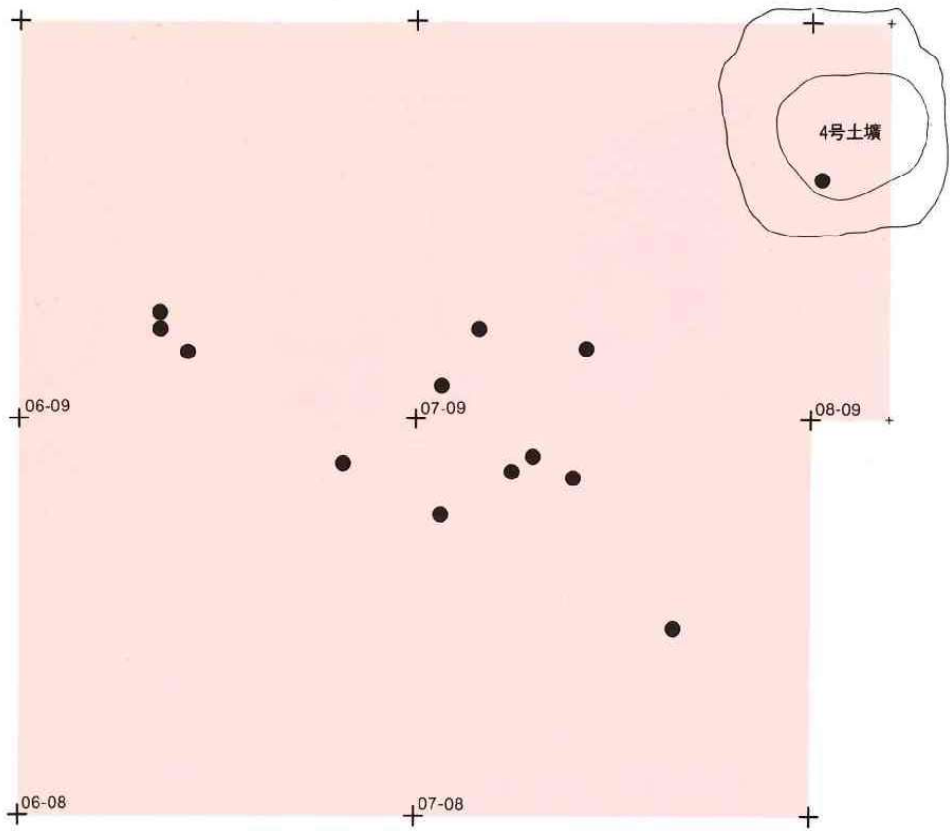
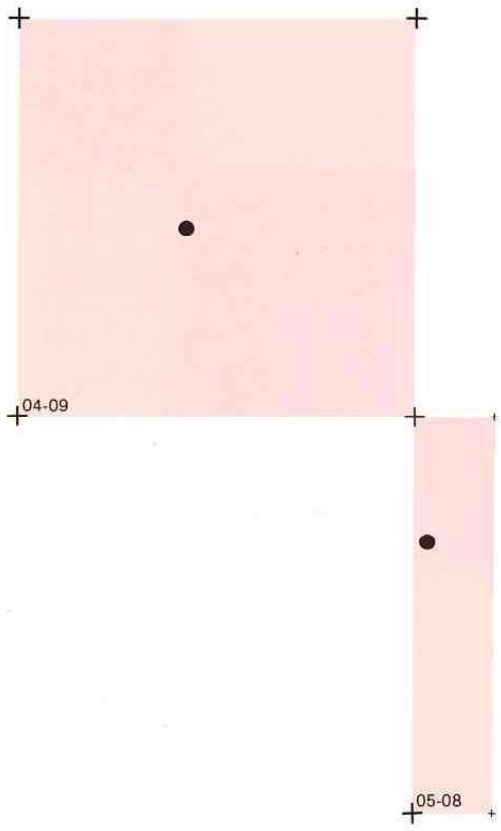





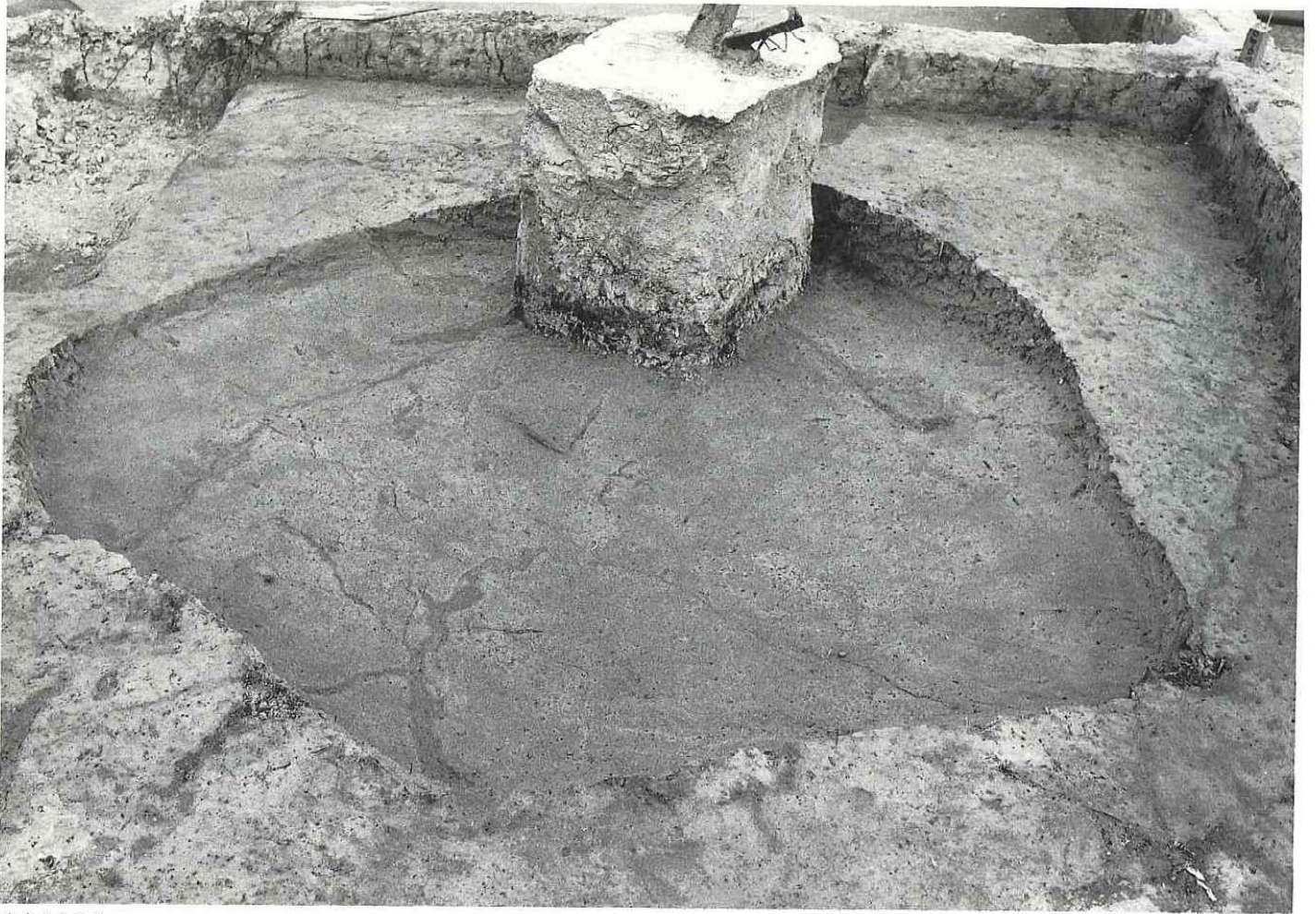

東南からみる

PL. ②-183 個体番号環48の破片分布図

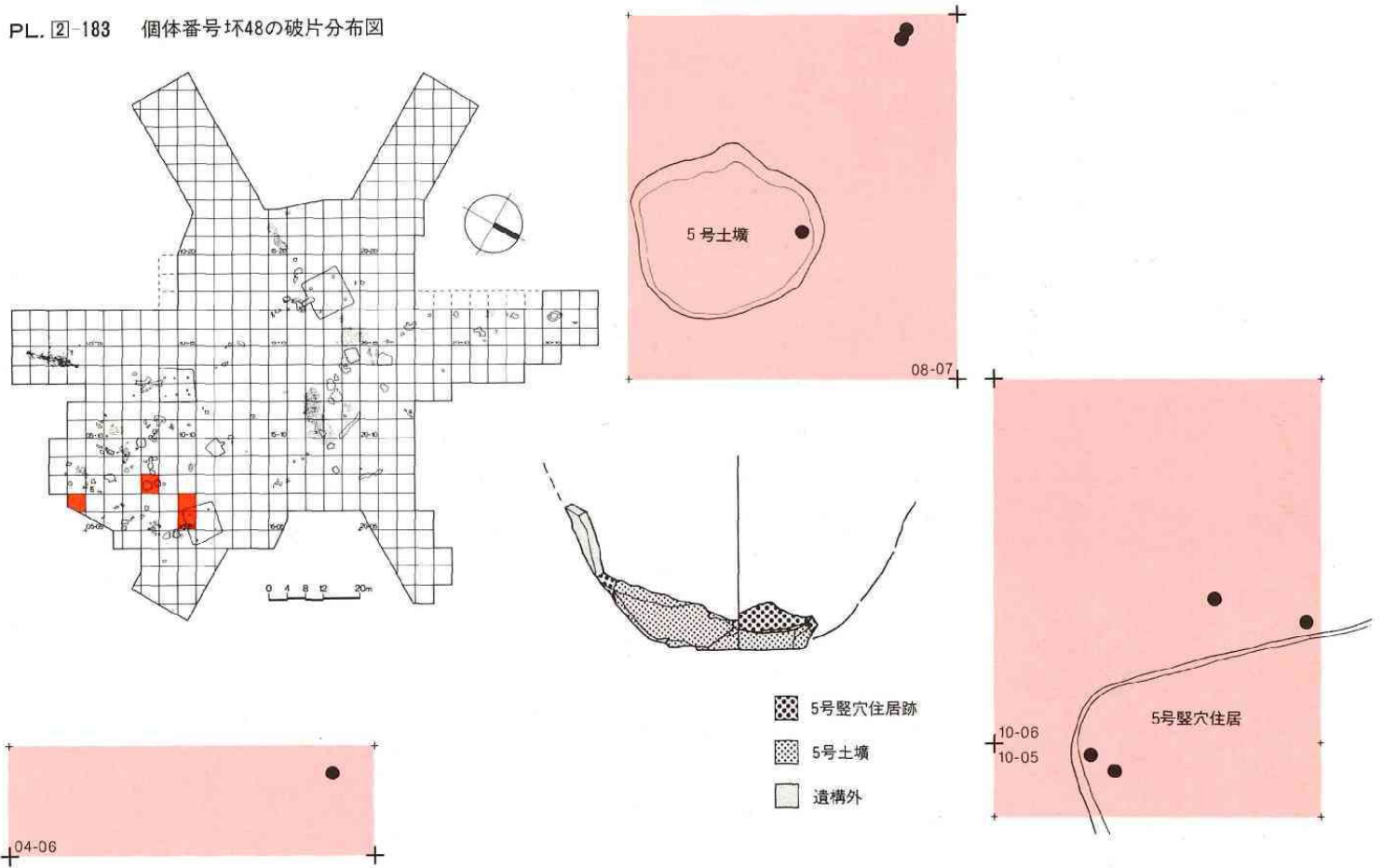

PL. ②-184 個体番号環63の破片分布図

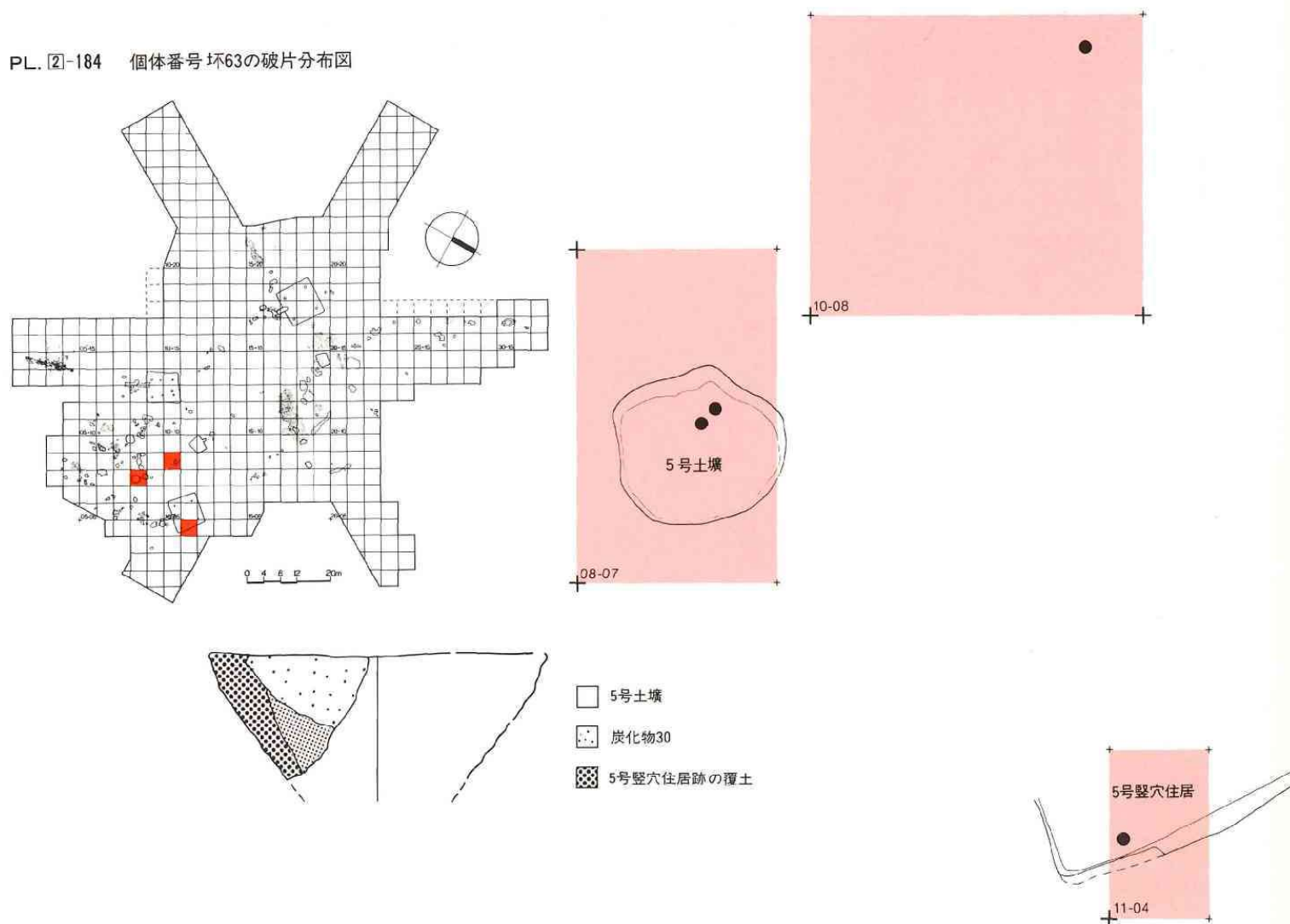

PL. 図-185 個体番号 坏7Iの破片分布図

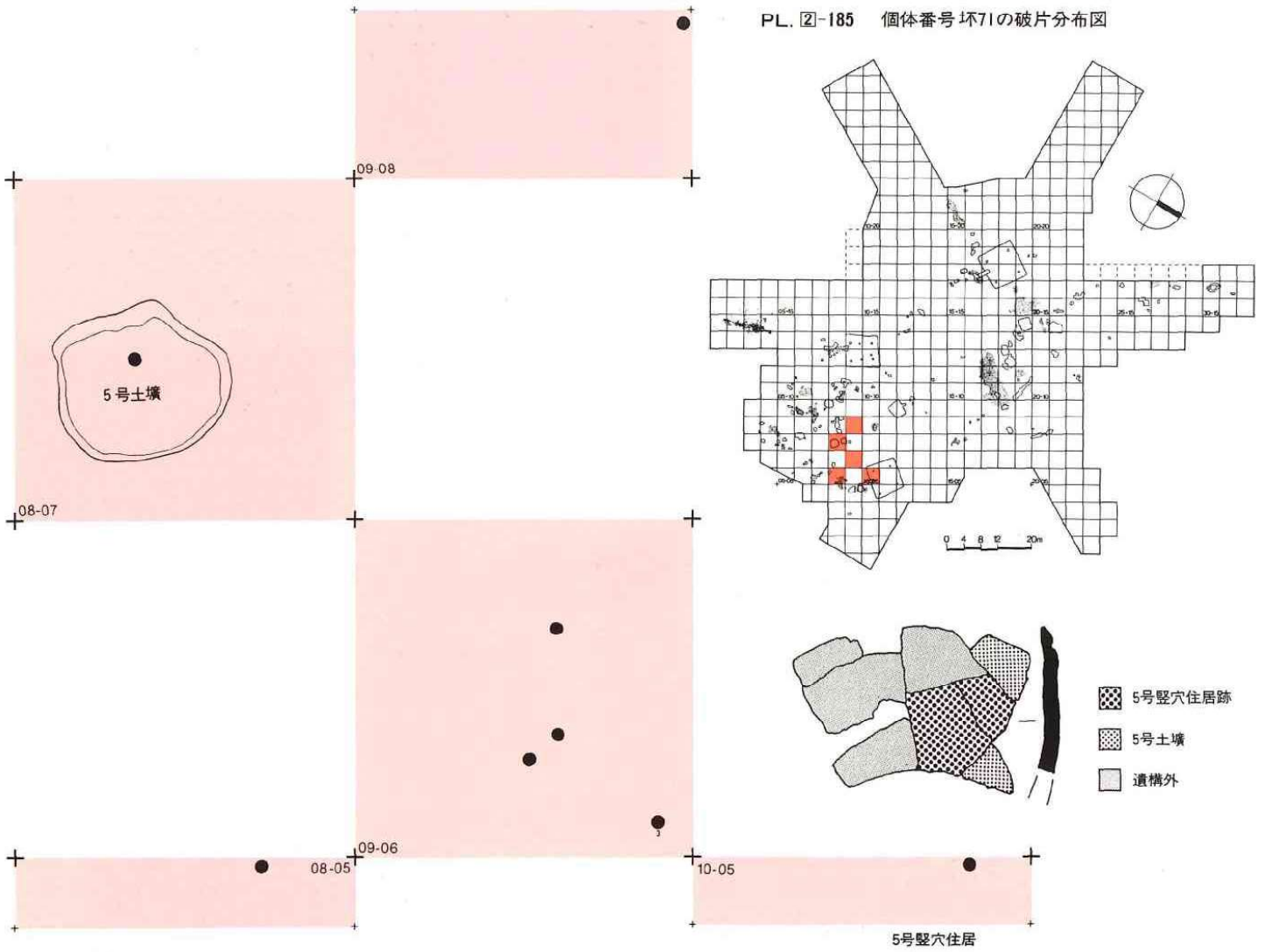

PL. 図-186 個体番号 坏I08の破片分布図

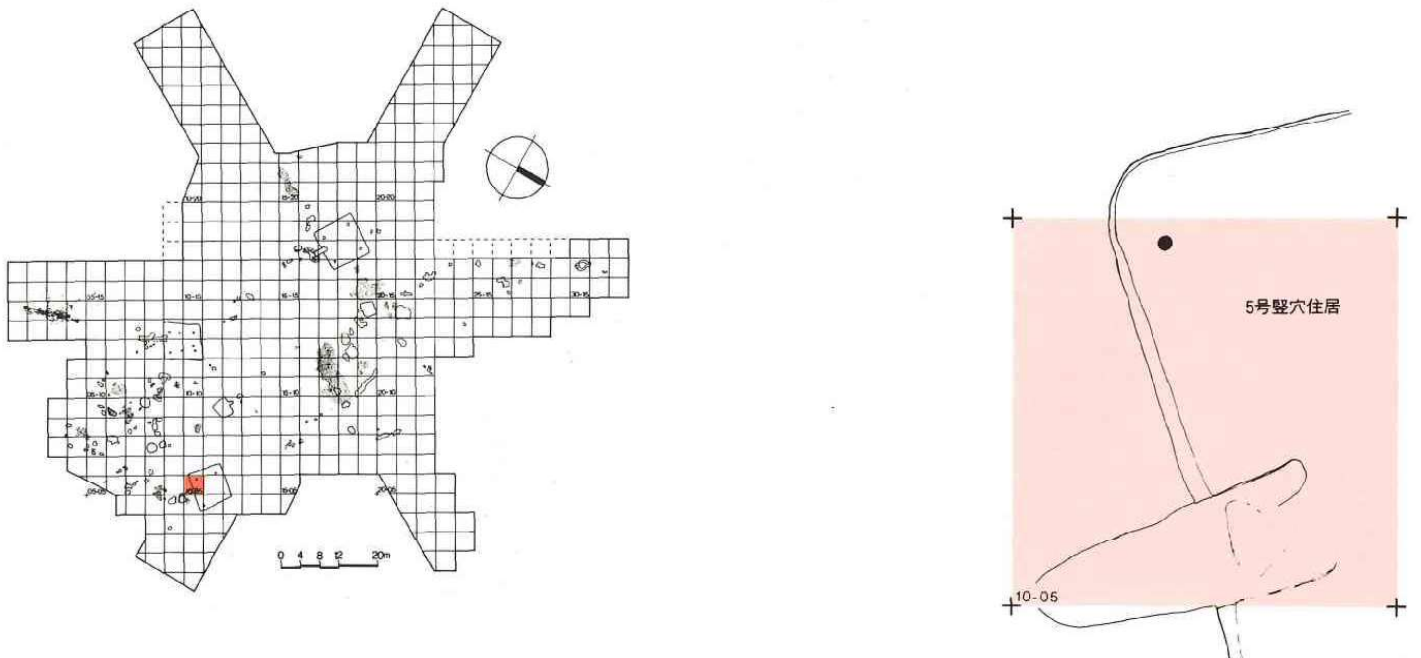



PL. ②-187 個体番号環100の破片分布図

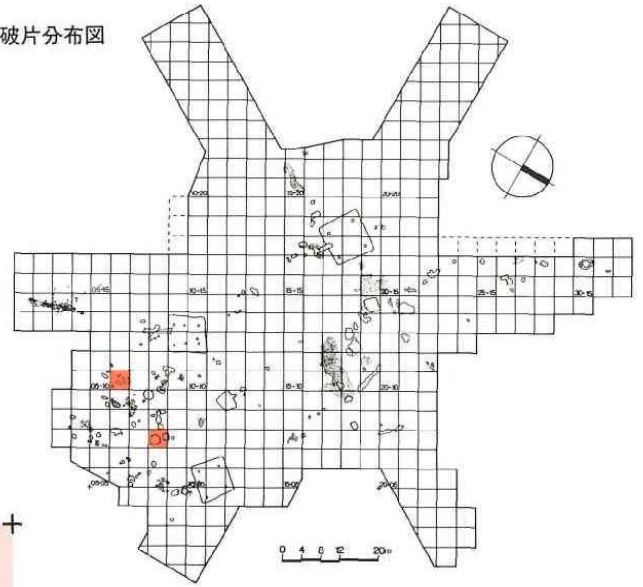
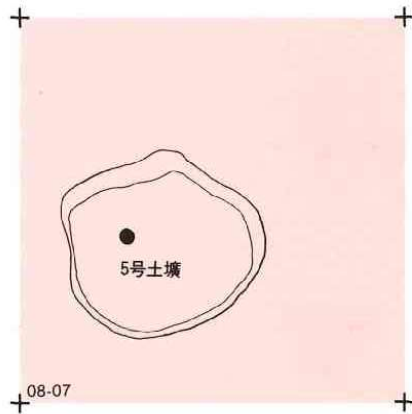
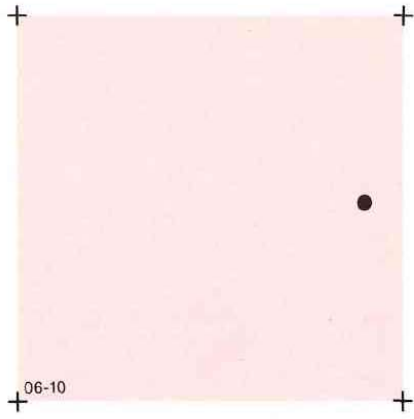

PL. ②-188 個体番号甕79の破片分布図

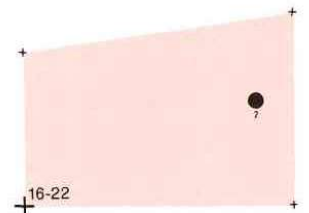
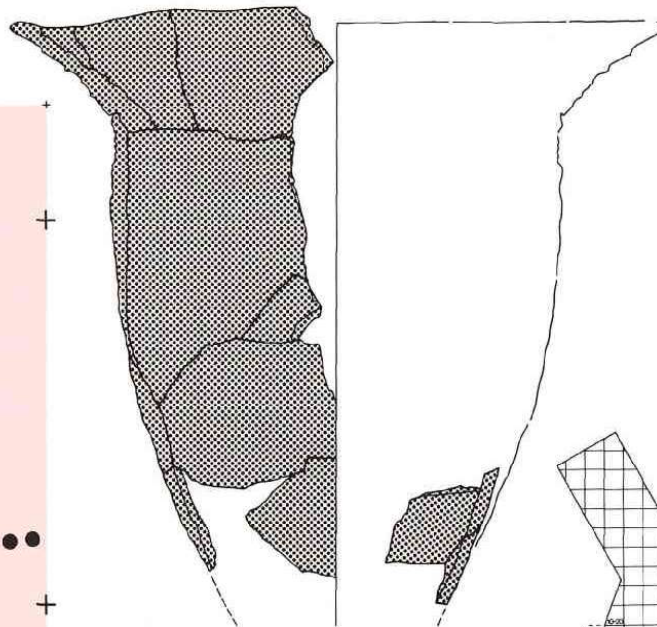
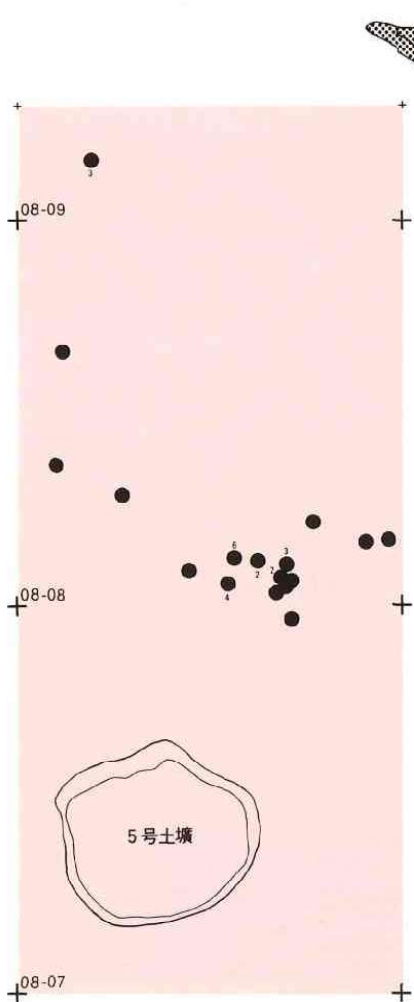

5号土坑の周辺

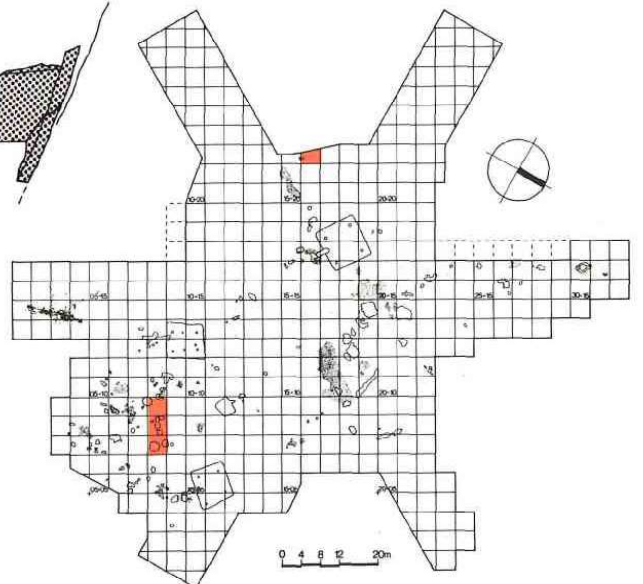

PL. 図-189 6号土壇 炭化物層(④層)上面(上), 最終平面図(中)と土層断面図(下)

109-08

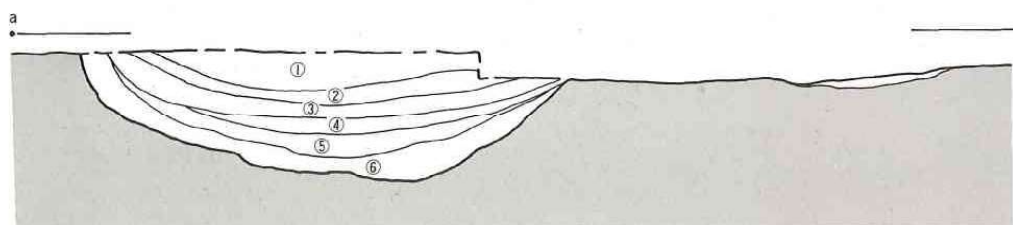
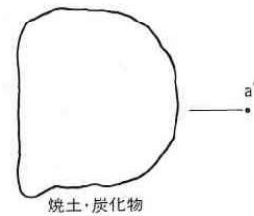
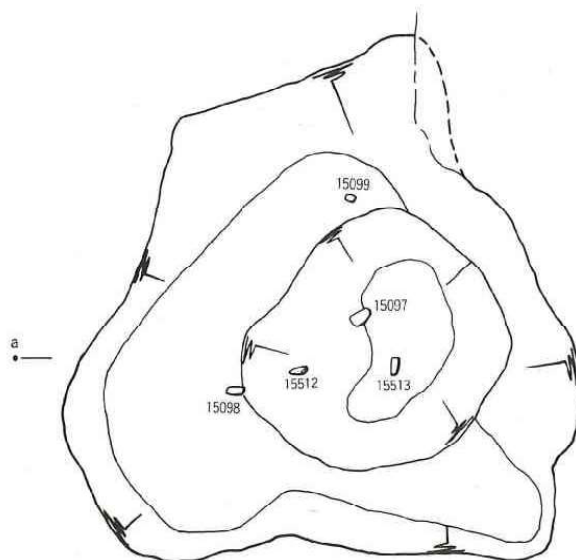
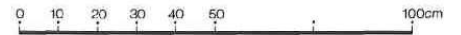
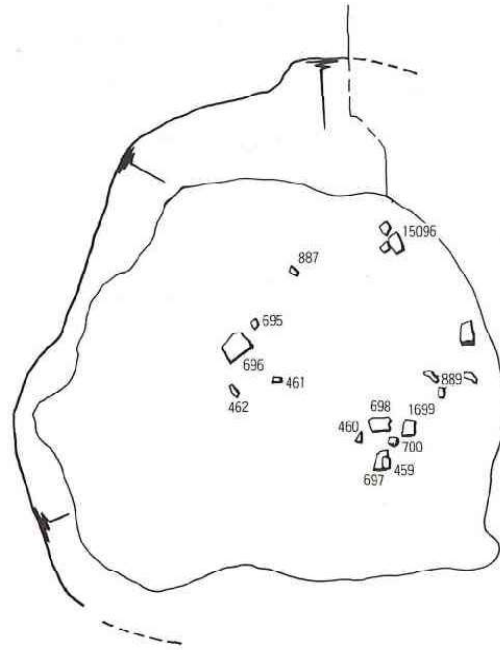



PL. 図-190 6号土壌

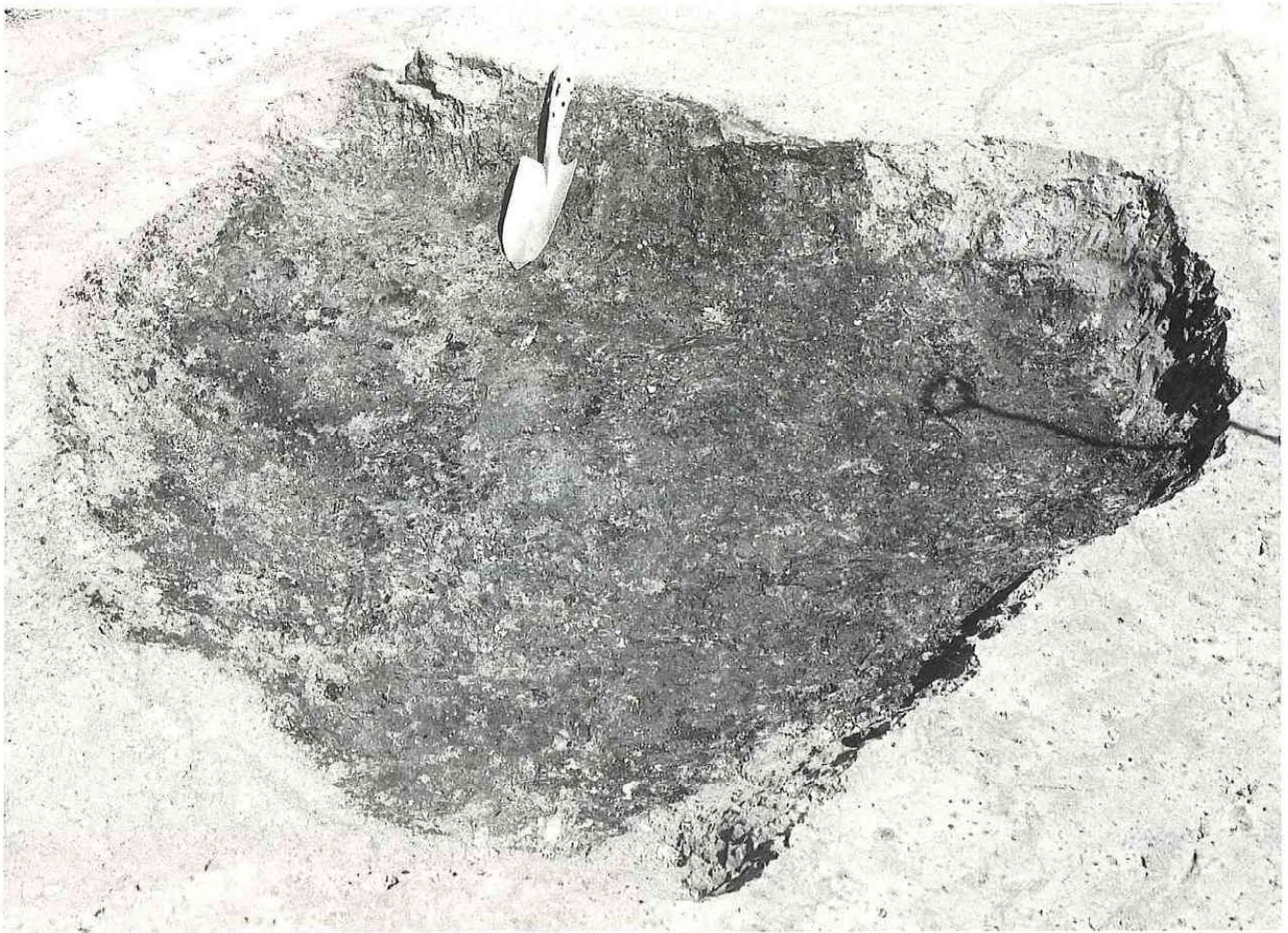

炭化物層のひろがり：東南からみる

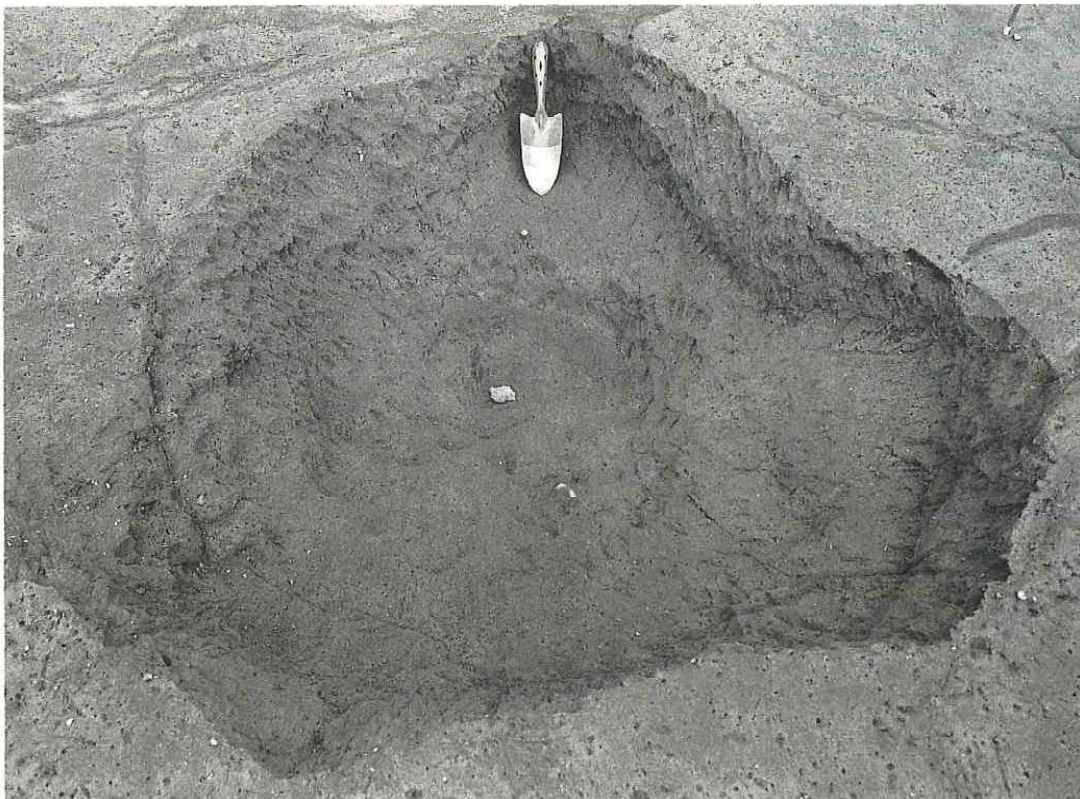

東南からみる



PL. ②-191 坏15の破片分布図

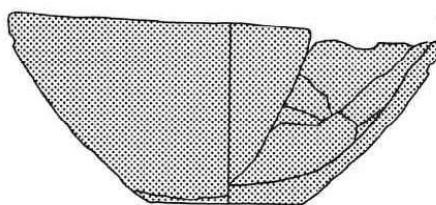
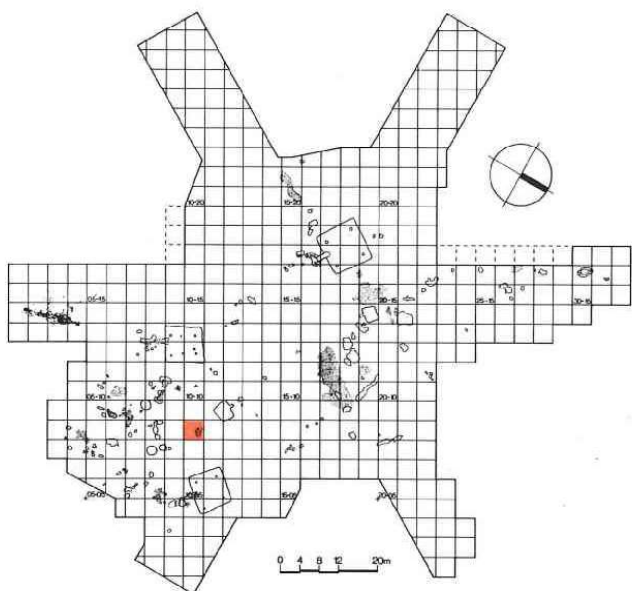

遺構外

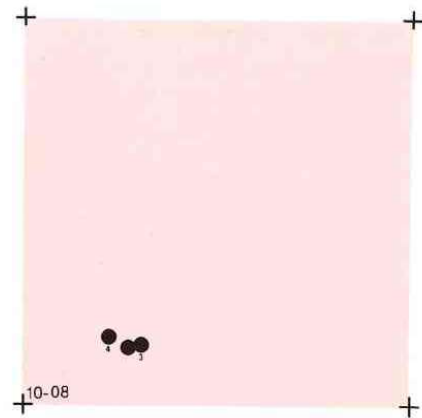

PL. ②-192 坏47の破片分布図

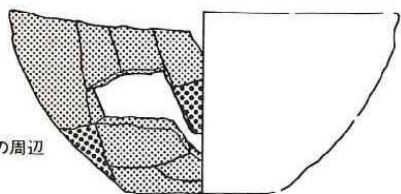
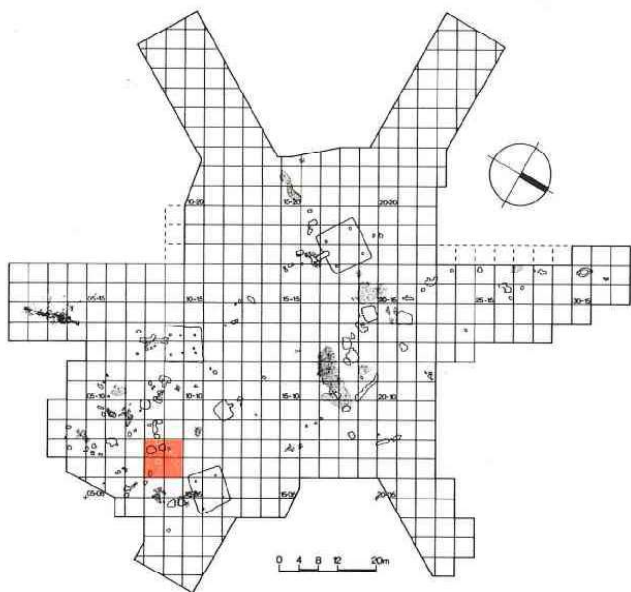

6号土壌  
6号土壌の周辺

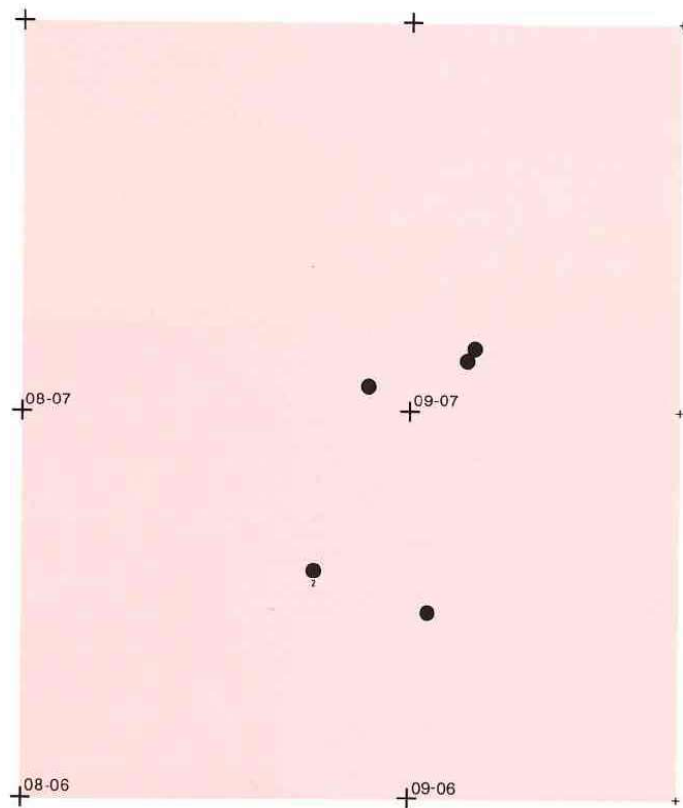

PL. ②-193 須志器10の破片分布図

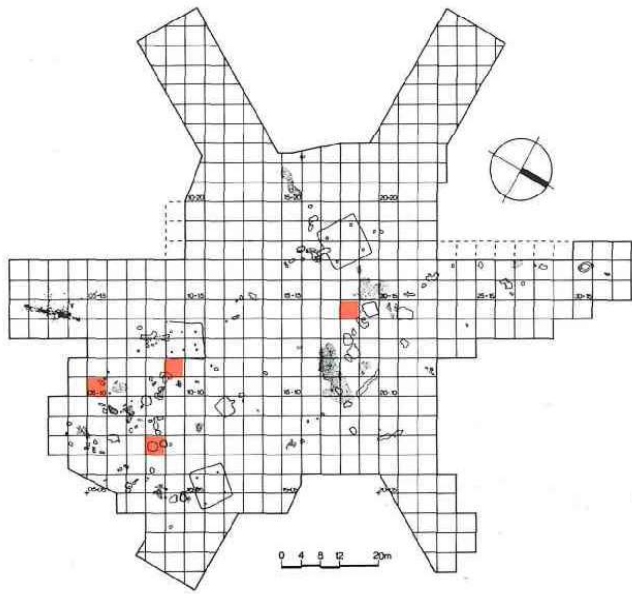

-  6号土壇
-  焼土II
-  1号竪穴住居跡の南側
-  遺構外

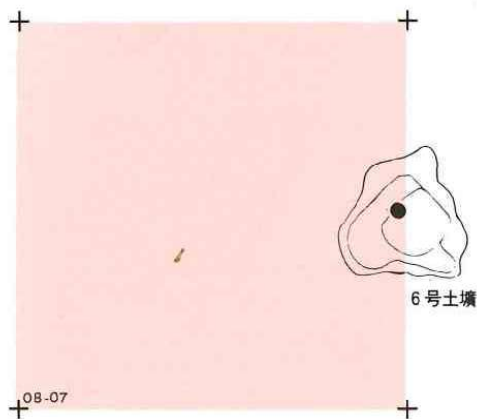
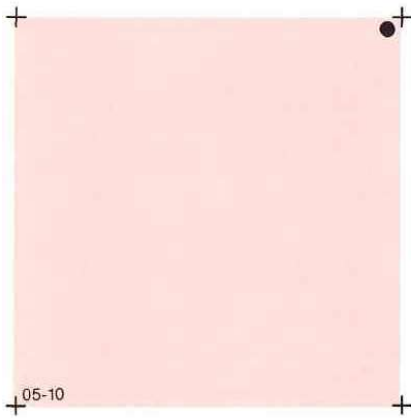
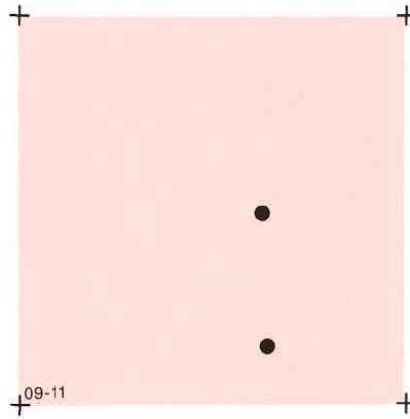
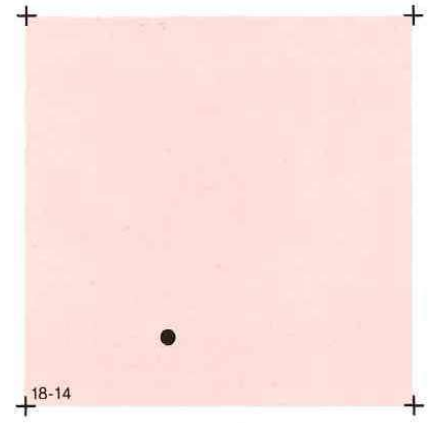
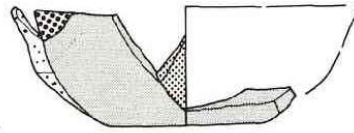

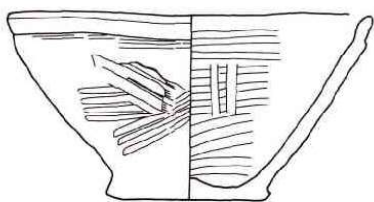

1 (坏16)

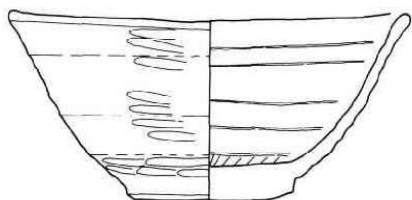

2 (坏31)

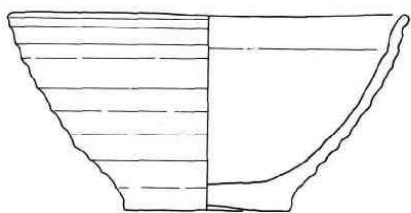

3 (坏26)



4 (坏47)

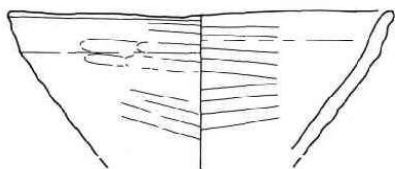

5 (坏63)



6 (須恵器10)

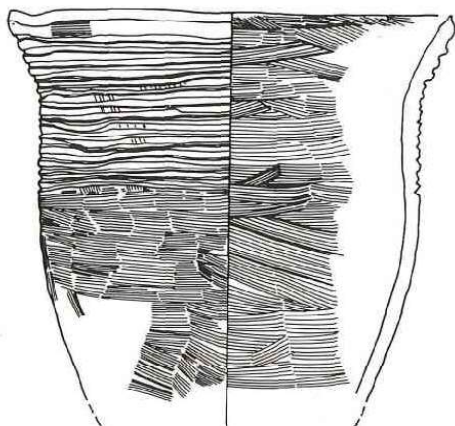

7 (甕98)



1



2



3

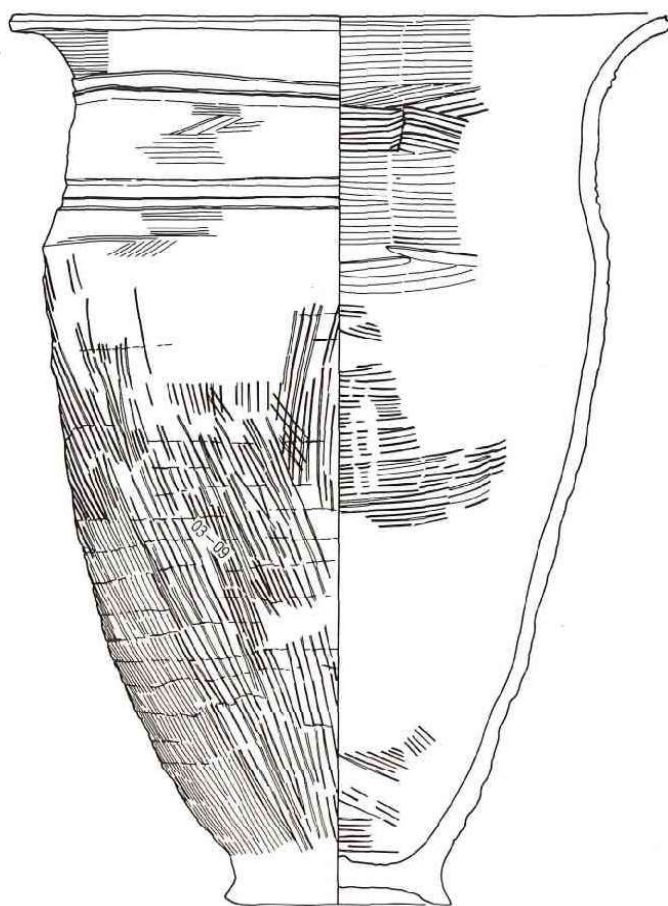

8 (甕76)

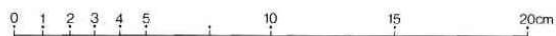



PL. ②-195 集石の図(a)と礫重量ヒストグラム(b)

a 礫の分布

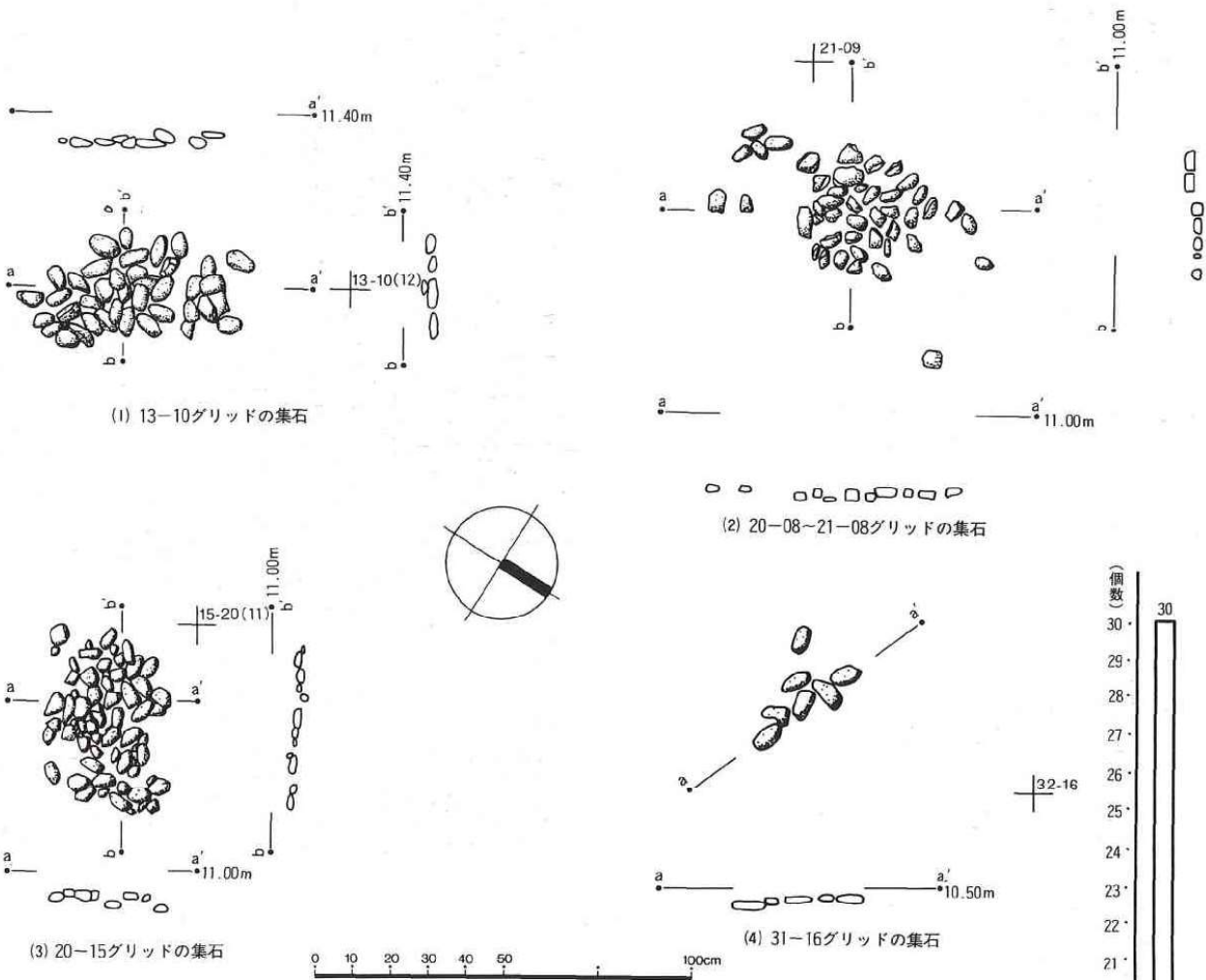

- (1) 13-10グリッドIV層の礫群-aと重量ヒストグラム-b
- (2) 20-08~21-08グリッドIV層の礫群-aと重量ヒストグラム-b
- (3) 20-15グリッドIV層の礫群-aと重量ヒストグラム-b
- (4) 31-16グリッドIV層の礫群

b 重量ヒストグラム

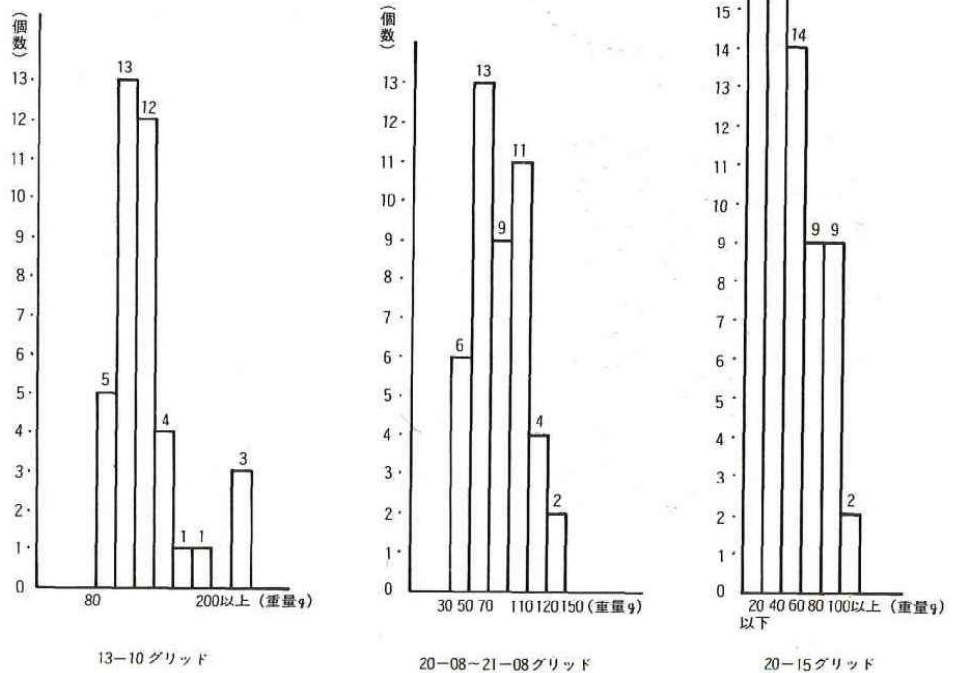

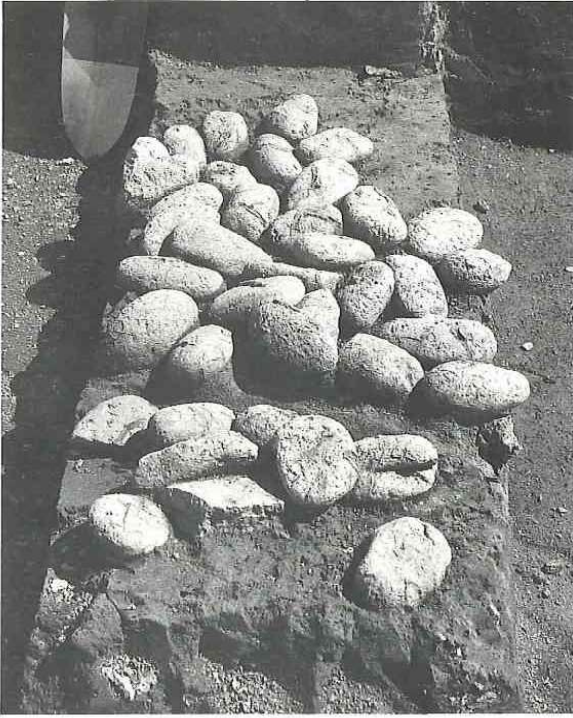

13-10グリッドの集石：北からみる



20-15グリッドの集石：東からみる



20-08～21-08グリッドの集石：北からみる

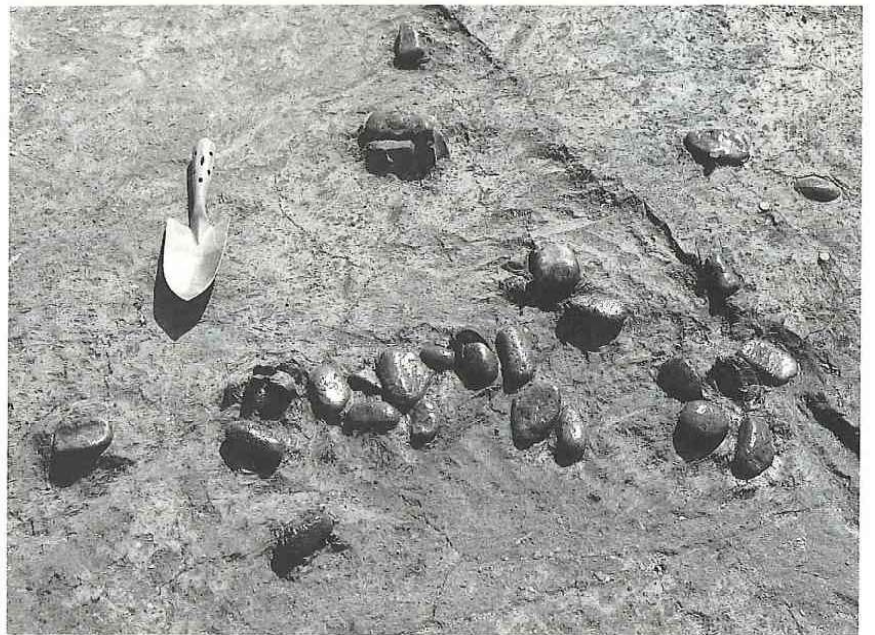

21-15グリッドの集石：北からみる



PL. ②-197 炭化物マウンド平面図



PL. 2-198 炭化物マウンドにおける  
遺物の出土状況

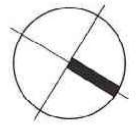

- 土器
- 礫
- ▲種子や炭
- △剥片
- ✦土製玉
- ★鉄製環





PL. ②-199 炭化物マウンドの土層断面図

①18-10・18-11グリッド

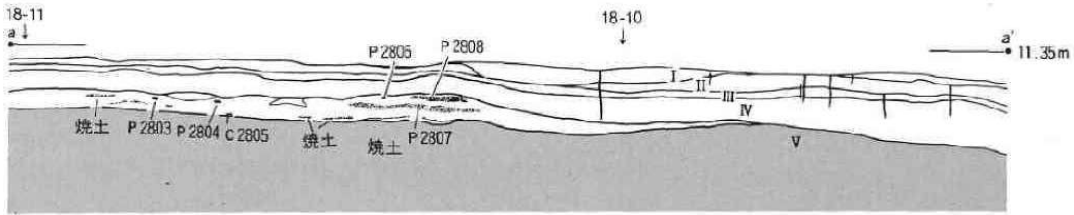

②17-10-19-10グリッド

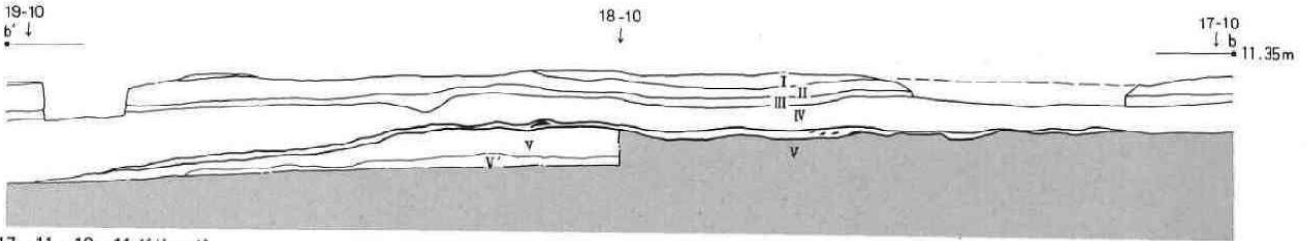

③17-11・18-11グリッド

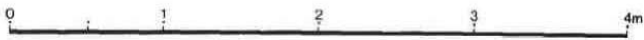
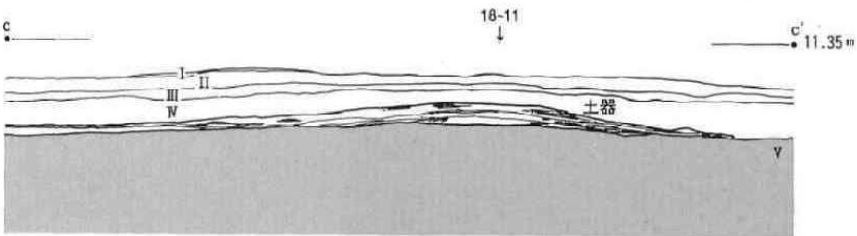

PL. ②-200 炭化物マウンド ①



炭化物マウンドの全景：南からみる



南からみる



環状鉄製品の出土状況

PL. ②-201 炭化物マウンド ②

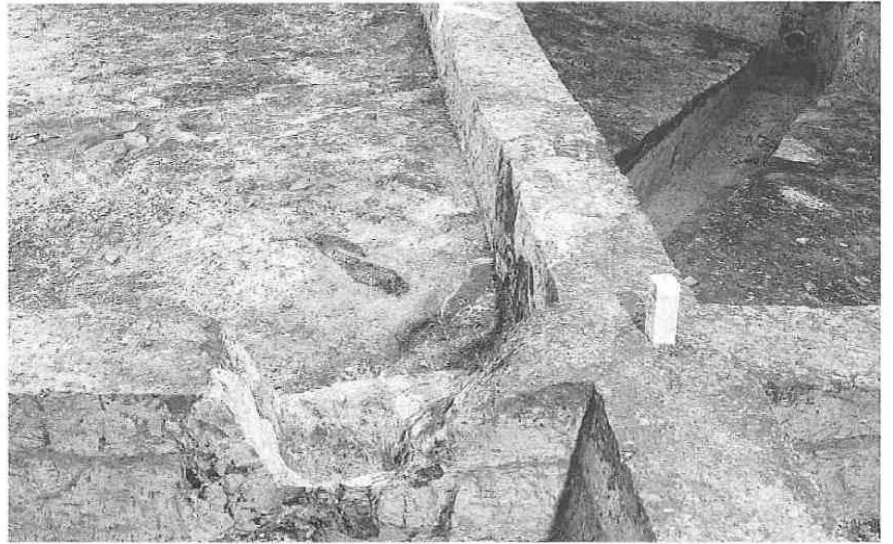

南北ベルト東面の土層堆積と炭化物マウンド上面



東西ベルト南面の土層堆積と炭化物マウンド上面



炭化物マウンド上面の土器出土状況。右手前が個体番号壺36の破片：東からみる

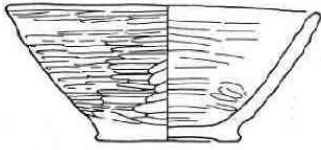

1 (坏6)

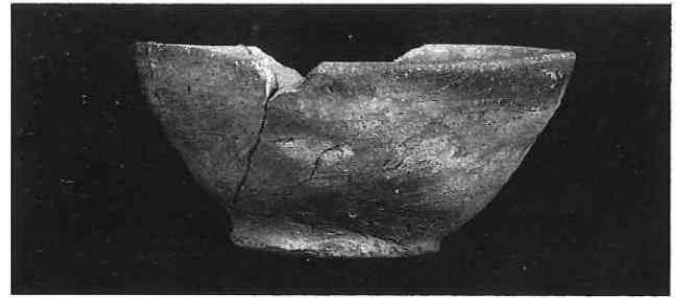

1

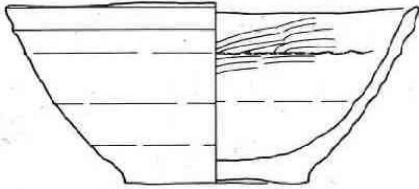

2 (坏10)



2

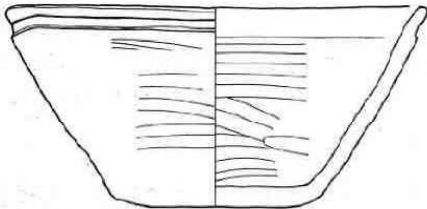

3 (坏21)



4

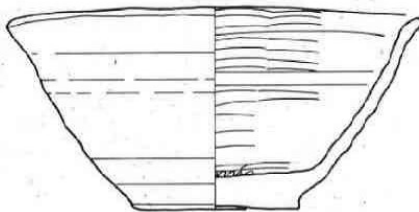

4 (坏22)



5

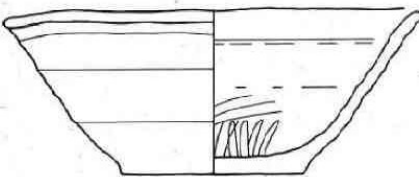

5 (坏24)

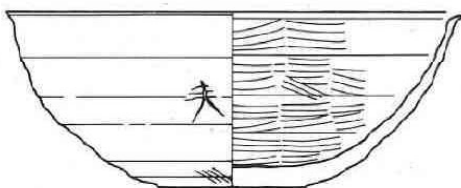

6 (坏17)

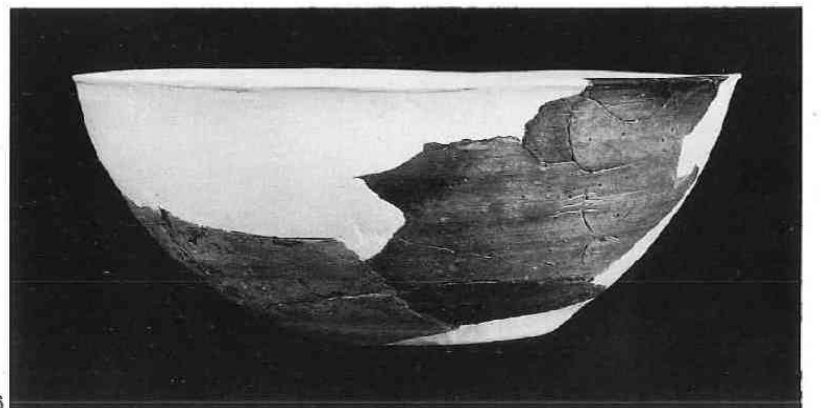

6





PL. ②-203 炭化物マウンドなどからの出土土器 ② (( )は個体番号)

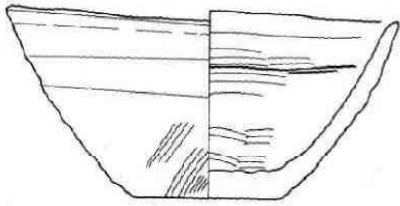

1 (杯28)

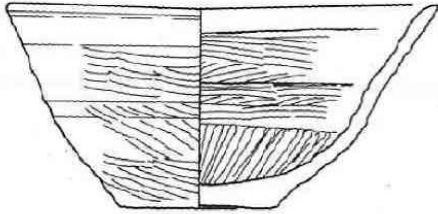

2 (杯30)

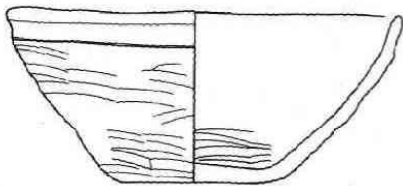

3 (杯35)

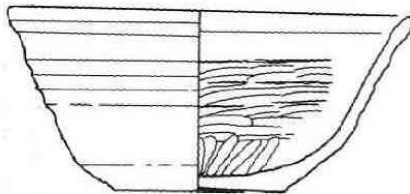

4 (杯36)

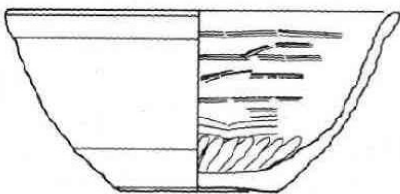

5 (杯37)

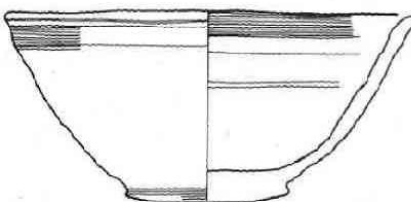

6 (杯41)

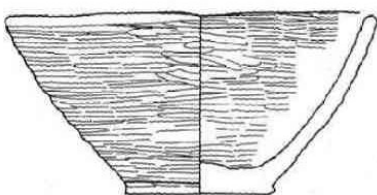

7 (杯42)



1

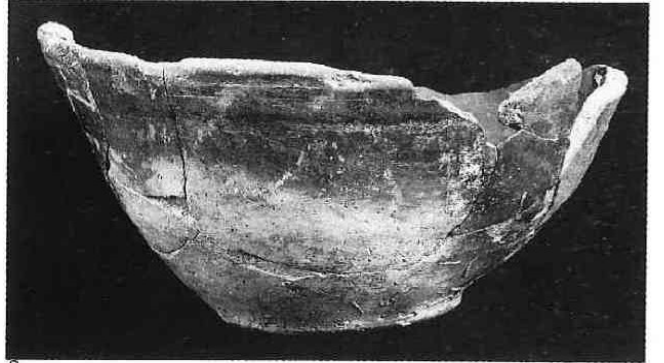

2



3



4

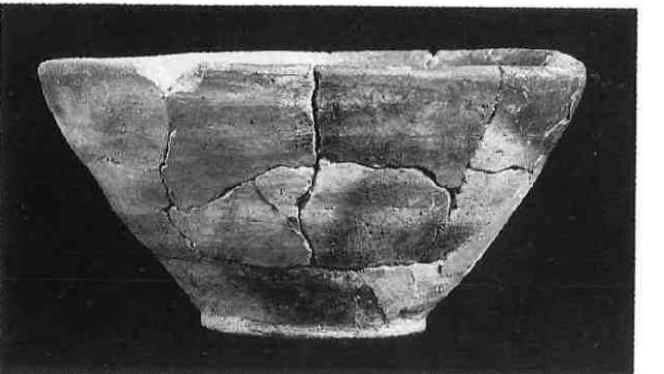

7

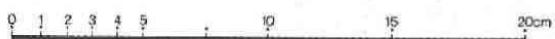

PL. ②-204 炭化物マウンドなどからの出土土器 ③ [( )内は個体番号]

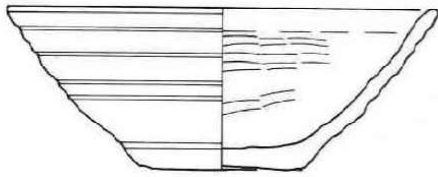

1 (杯51)

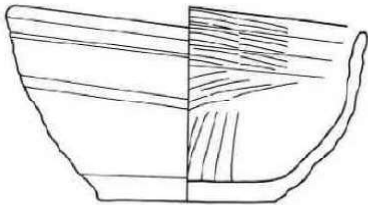

2 (杯53)

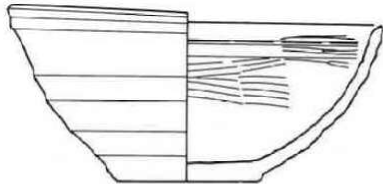

3 (杯54)

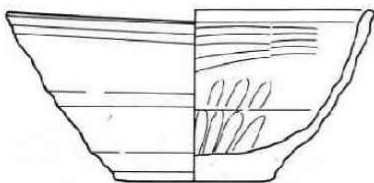

4 (杯55)

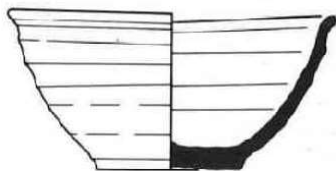

5 (須恵器2)



6 (須恵器7)



2



4



5



6



6

PL. ②-205 炭化物マウンドなどからの出土土器 ④ (( )内は個体番号)

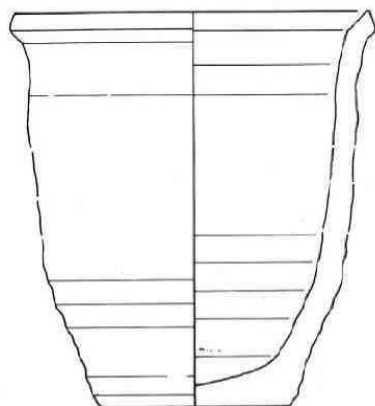

1 (壺90)

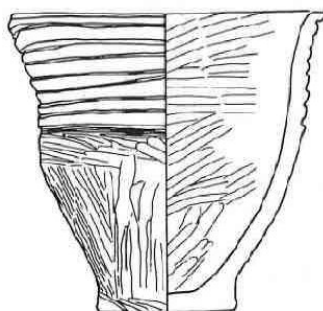

2 (壺11)

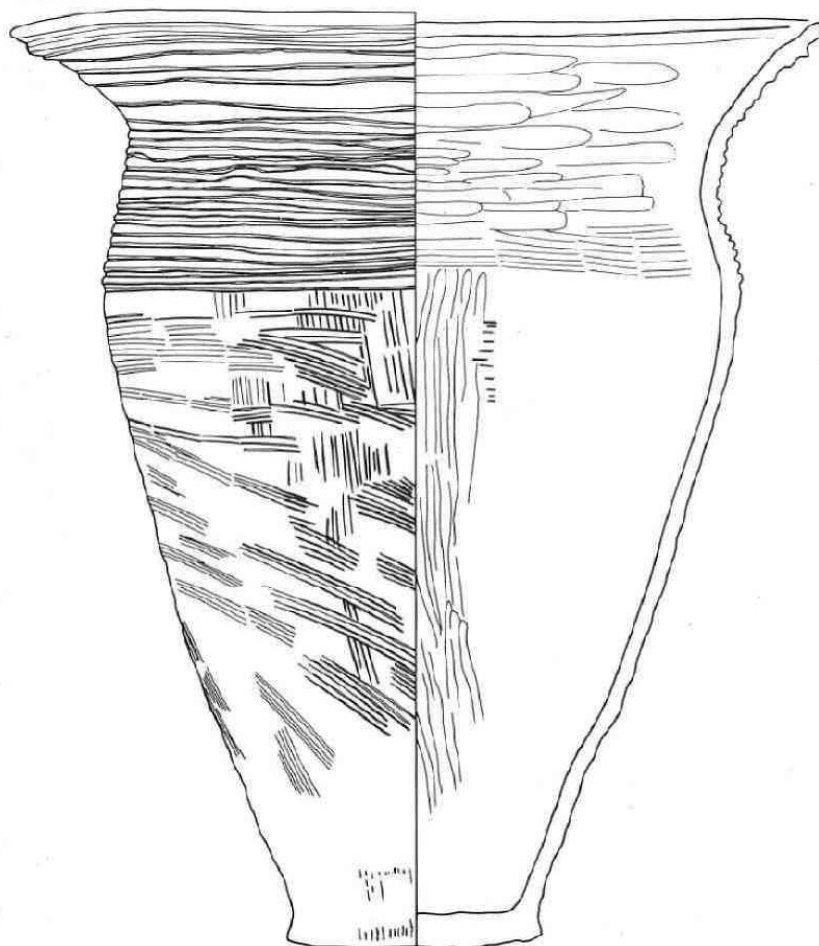

3 (壺29)

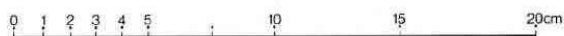

2



3



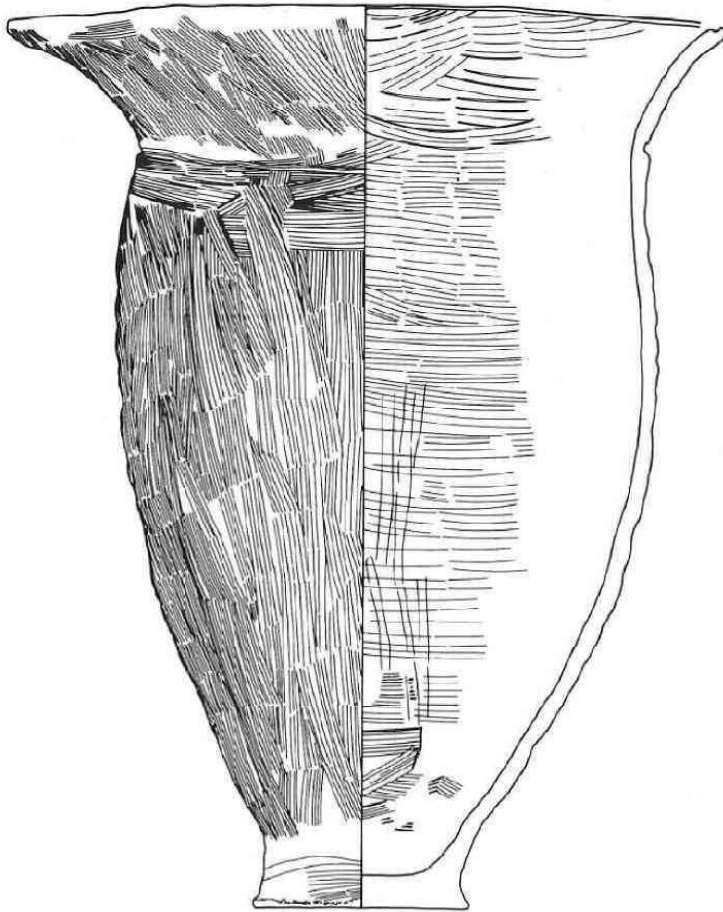

1 (壺64)



1



2 (壺43)

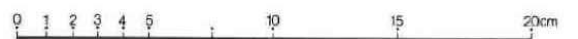

PL. ②-207 炭化物マウンドなどからの出土土器 ⑦ (( )内は個体番号)

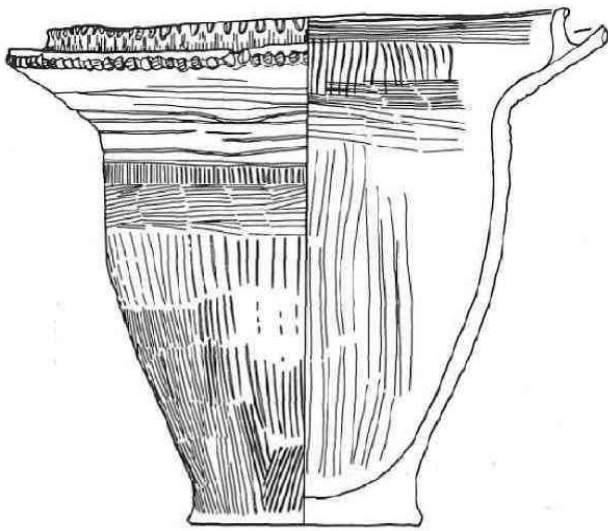

1 (壺10)

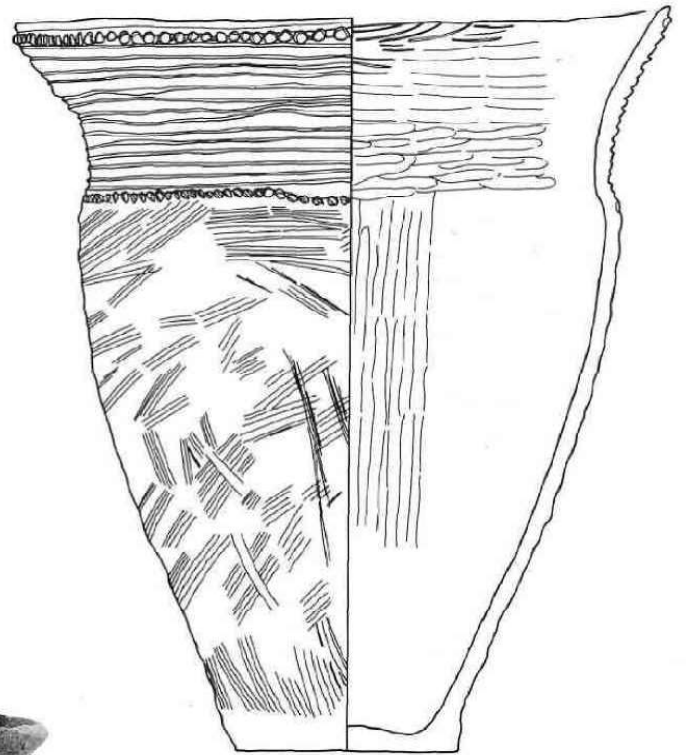

3 (壺20)

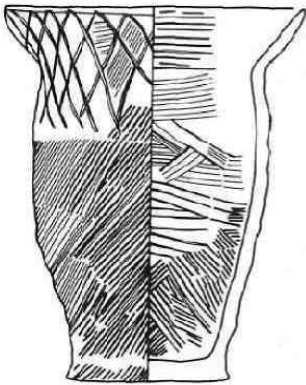

2 (壺12)



2

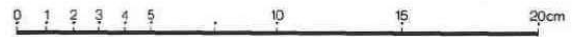

1



3

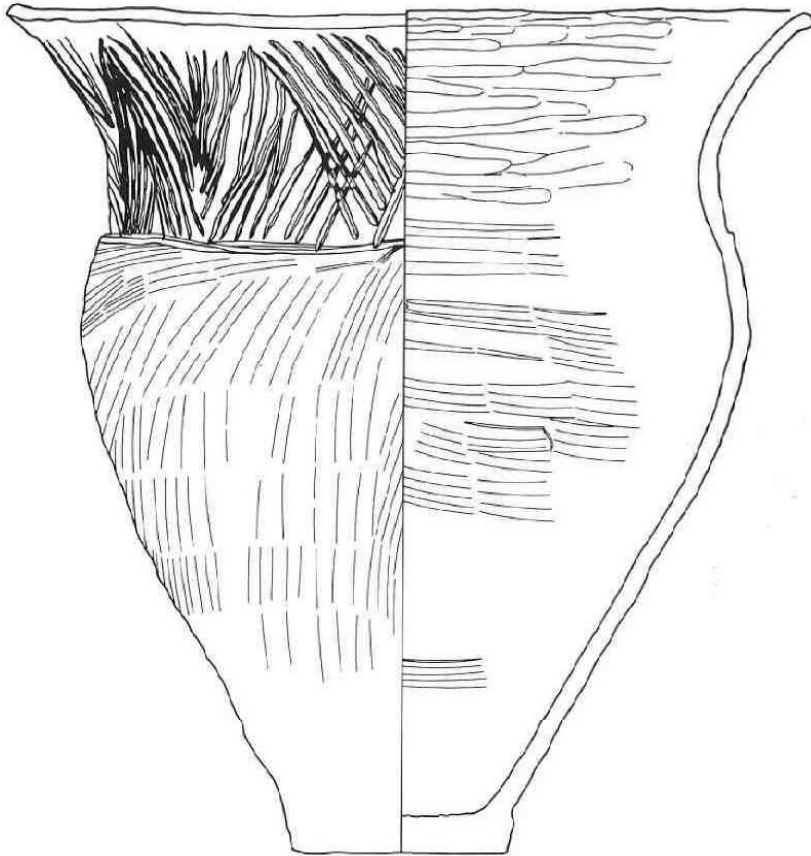

1 (號36)

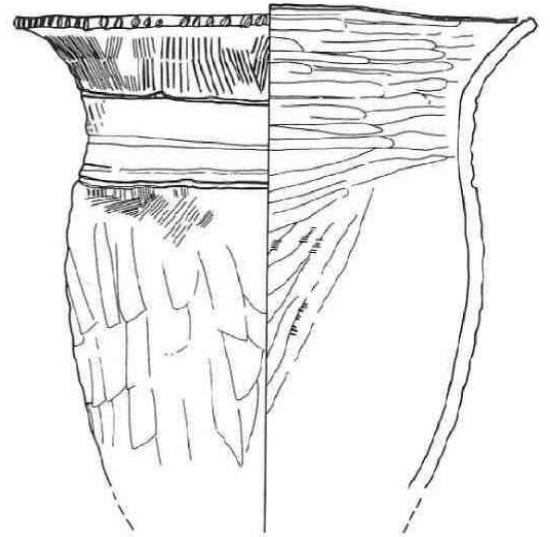

2 (號48)

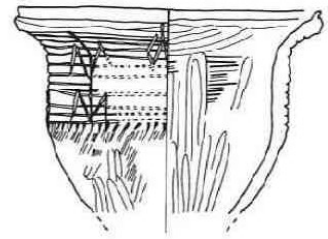

3 (號99)

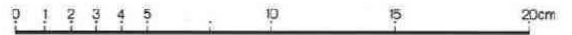

1

PL. ②-209 個体番号環3の破片分布図

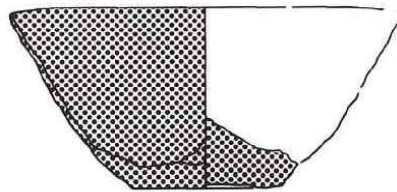
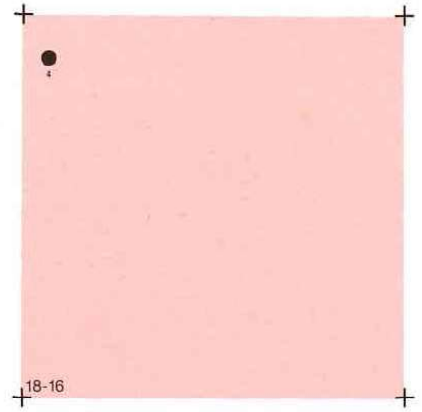
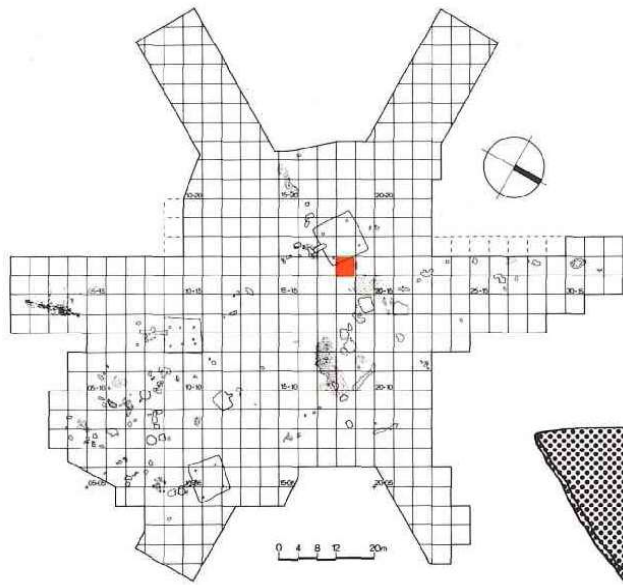

遺構外

PL. ②-210 個体番号環6の破片分布図

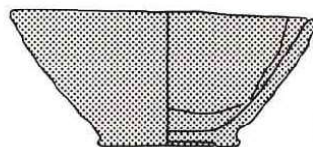
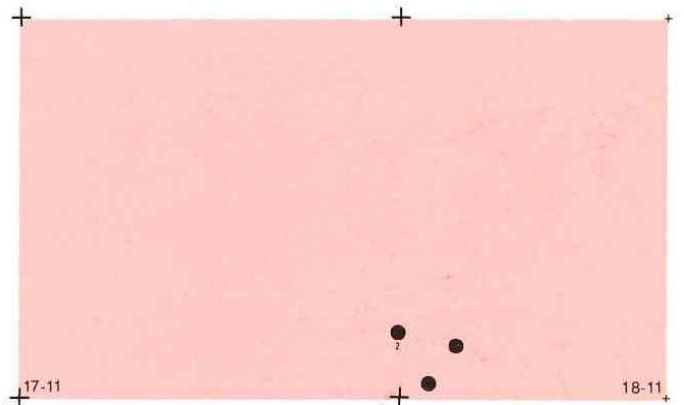
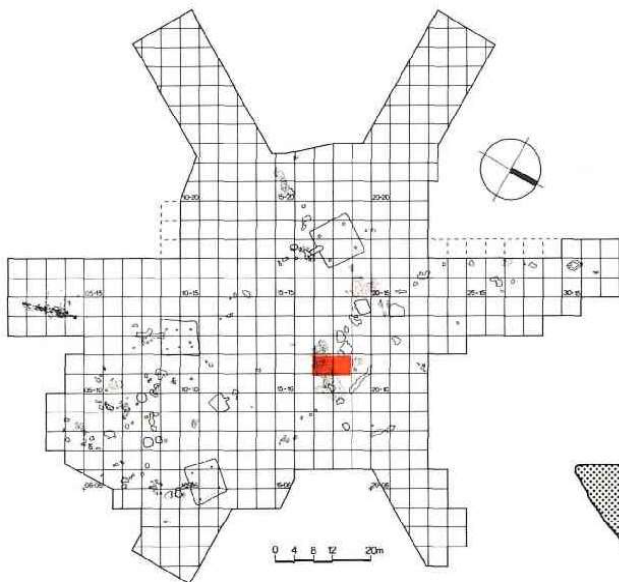

炭化物マウンド



PL. 2-211 個体番号環10の破片分布図

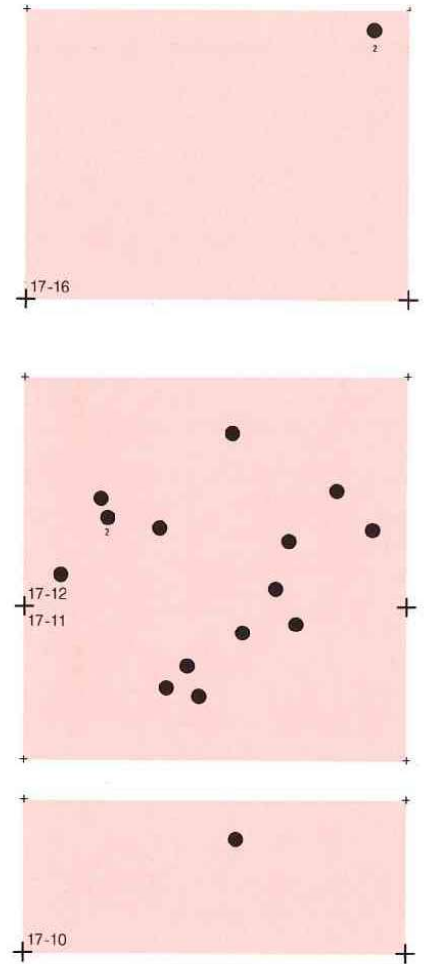
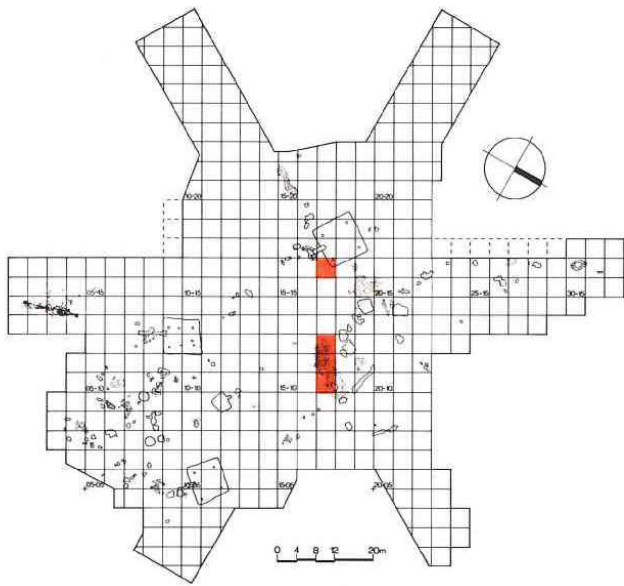

PL. 2-212 個体番号環16の破片分布図

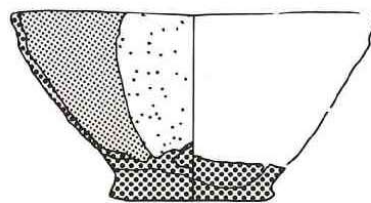
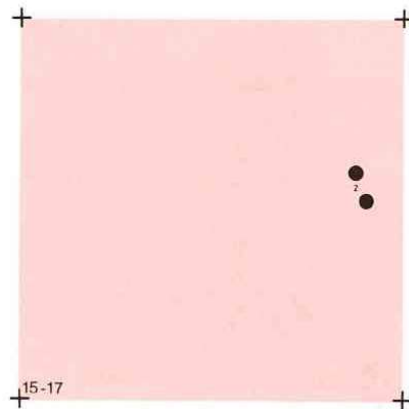
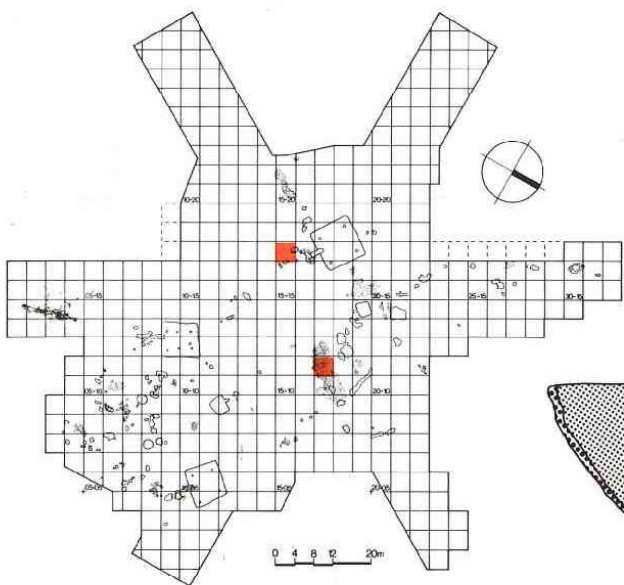

-  3号土壌
-  焼土41
-  炭化物マウンド

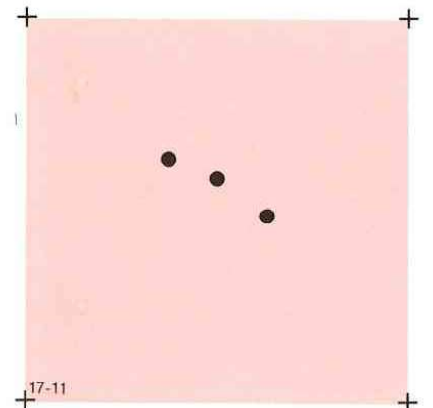

PL. ②-213 個体番号環17の破片分布図

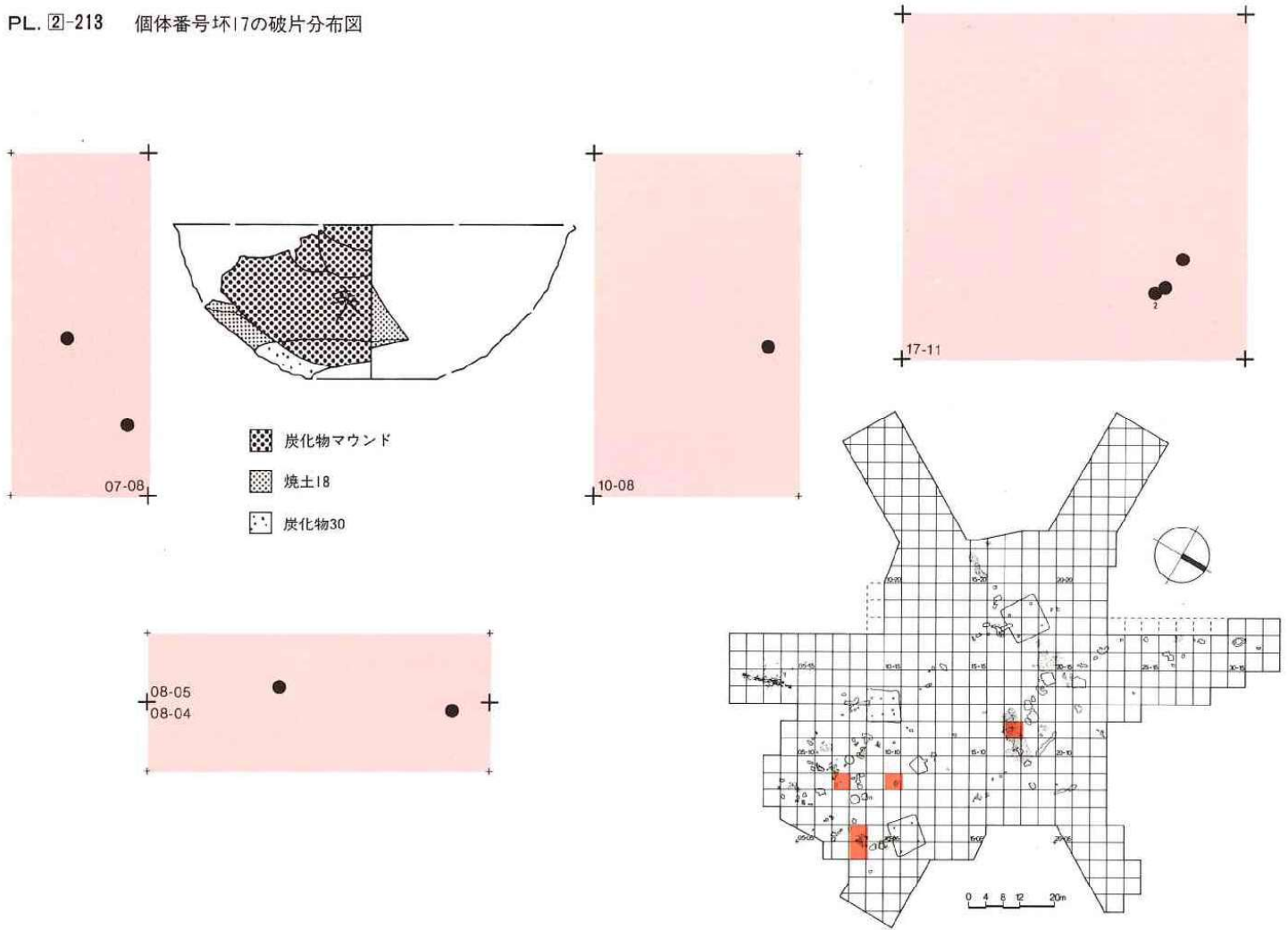

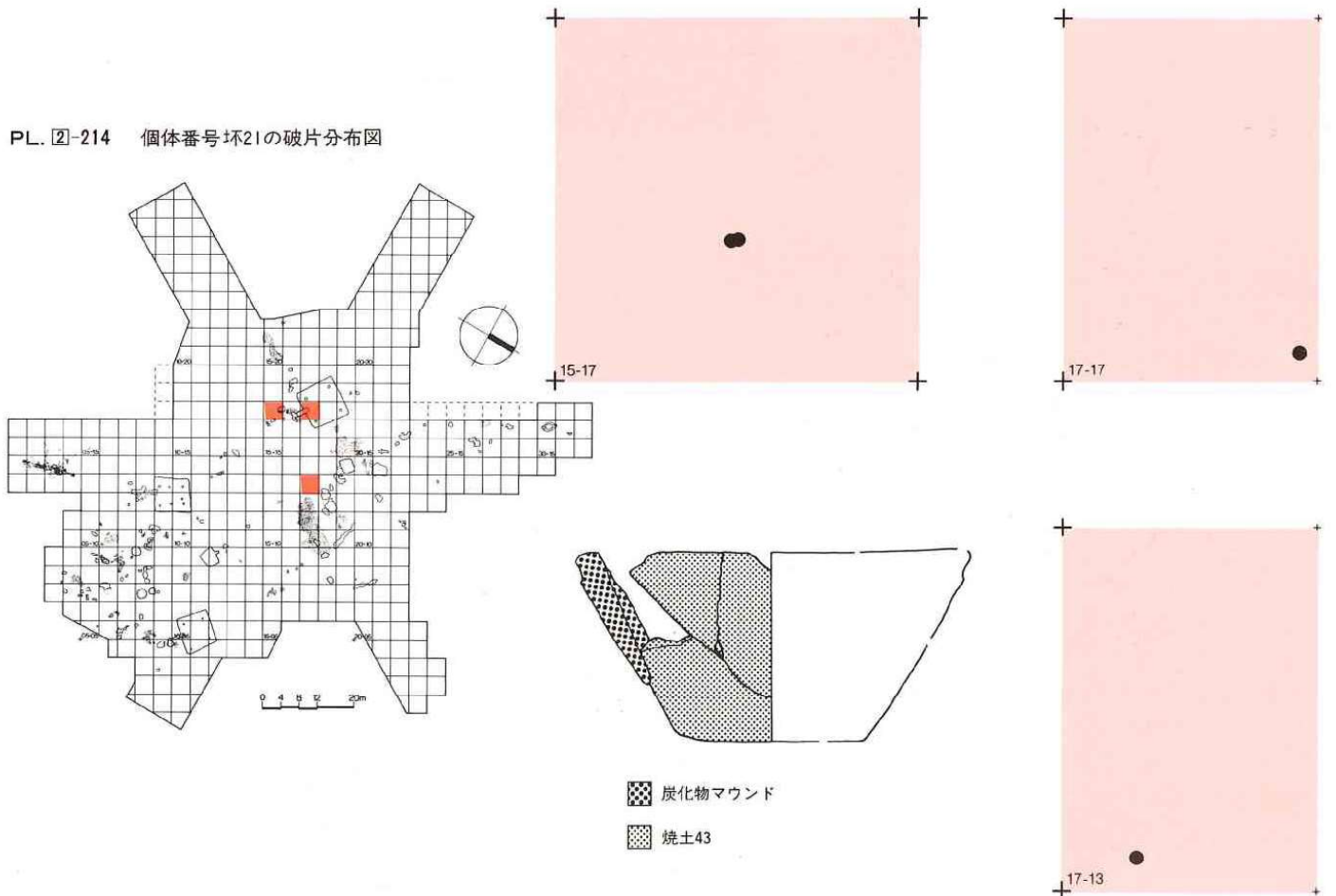

PL. ②-214 個体番号環21の破片分布図

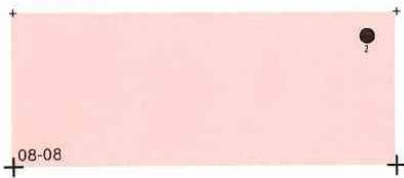
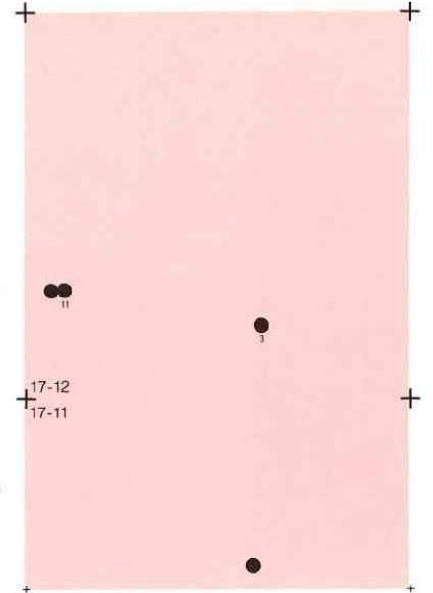
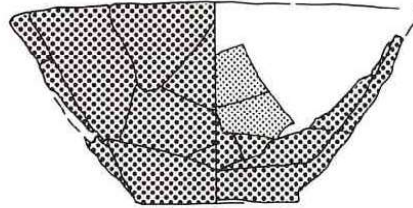
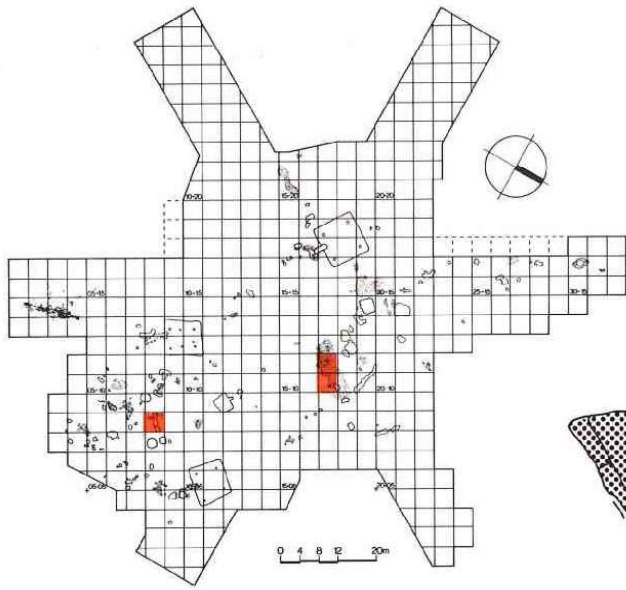

PL. 2-215 個体番号 坏22の破片分布図



-  炭化物マウンド
-  焼土27

PL. 2-216 個体番号 坏24の破片分布図

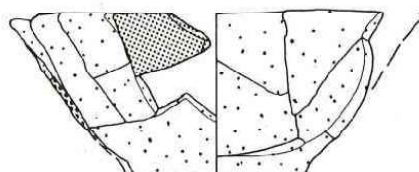
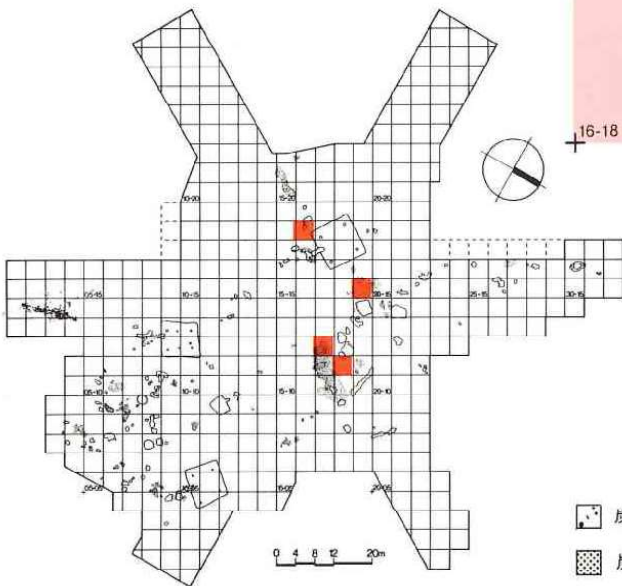

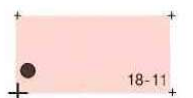
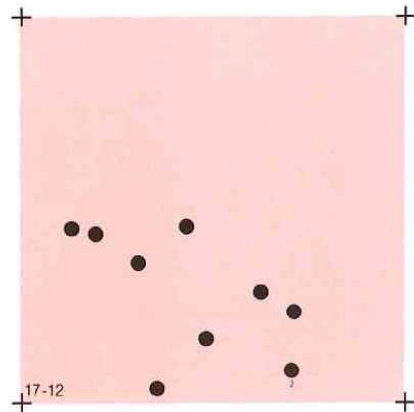
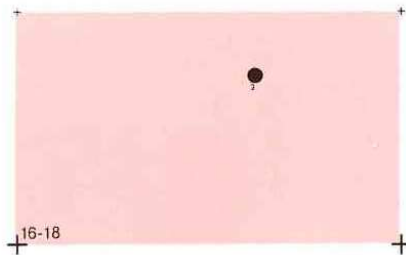

-  炭化物マウンド
-  炭化物52
-  焼土44

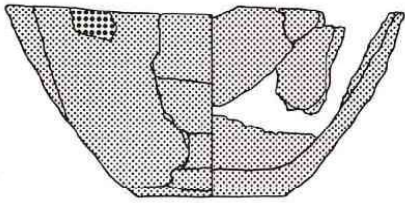
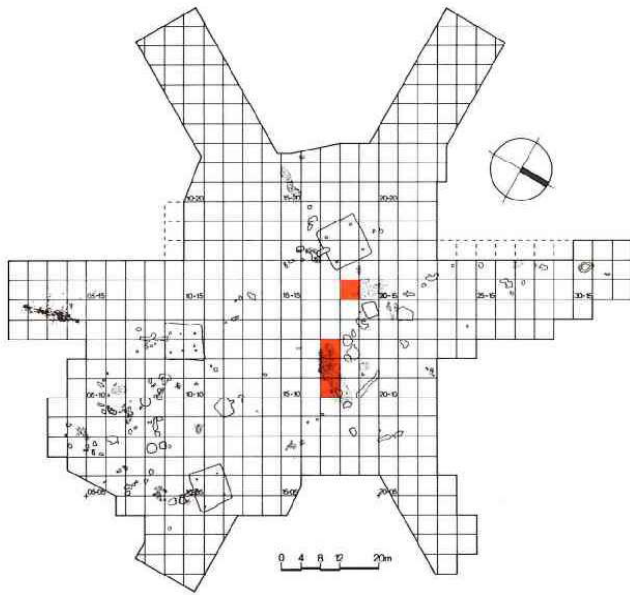

PL. ②-217 個体番号環28の破片分布図



 炭化物52  
 炭化物マウンド

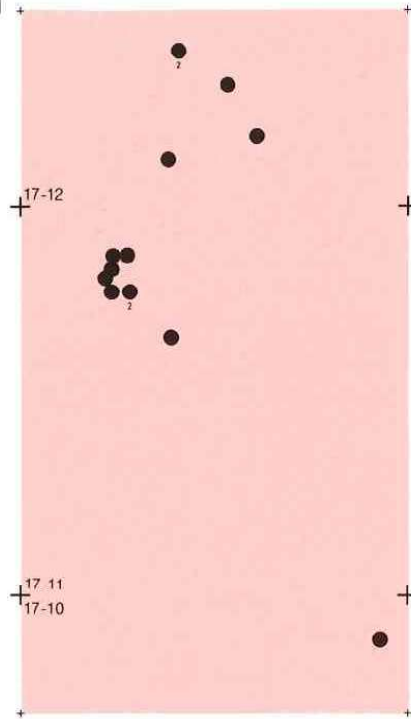
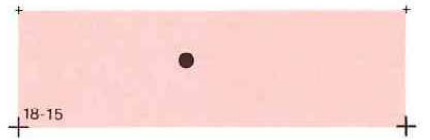

PL. ②-218 個体番号環30の破片分布図

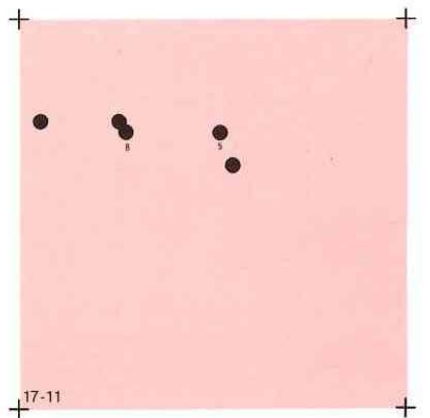
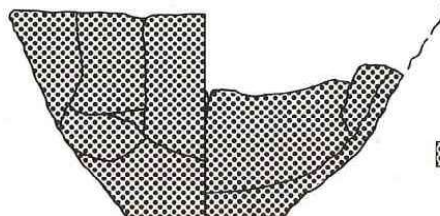
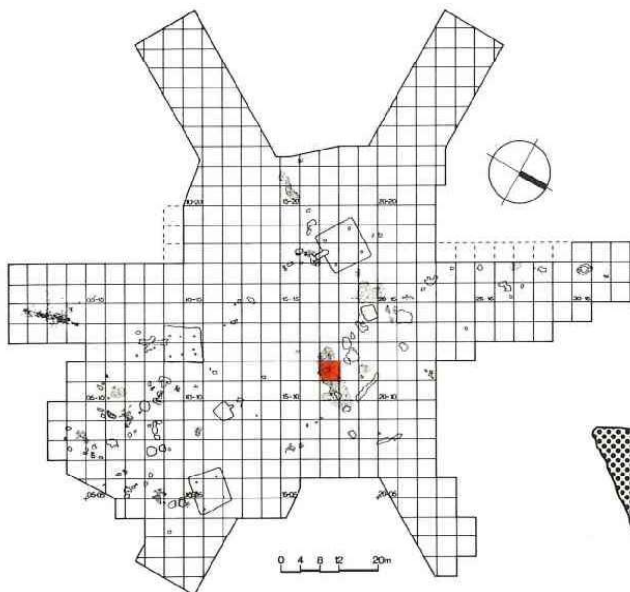

 炭化物マウンド



PL. 2-219 个体番号坏31の破片分布図

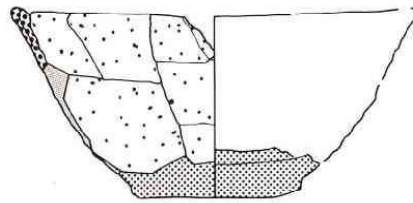
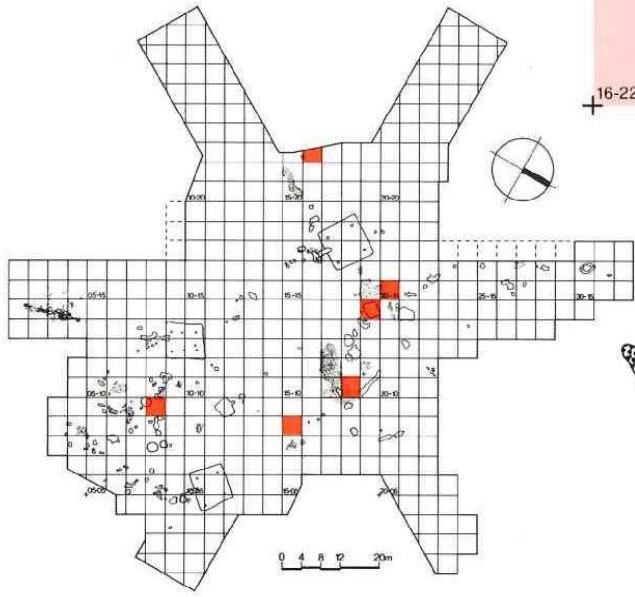

-  4号土壌
-  炭化物マウンドの攪乱
-  炭化物52
-  遺構外

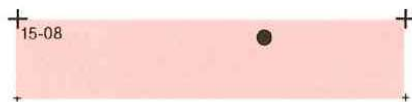
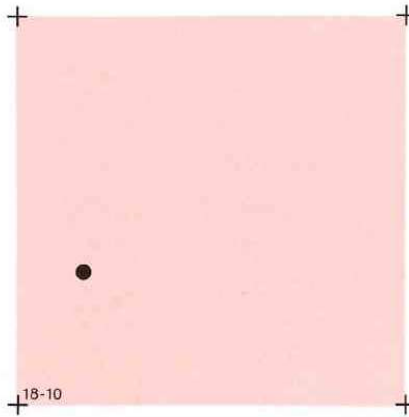

PL. 図-220 個体番号坏35の破片分布図

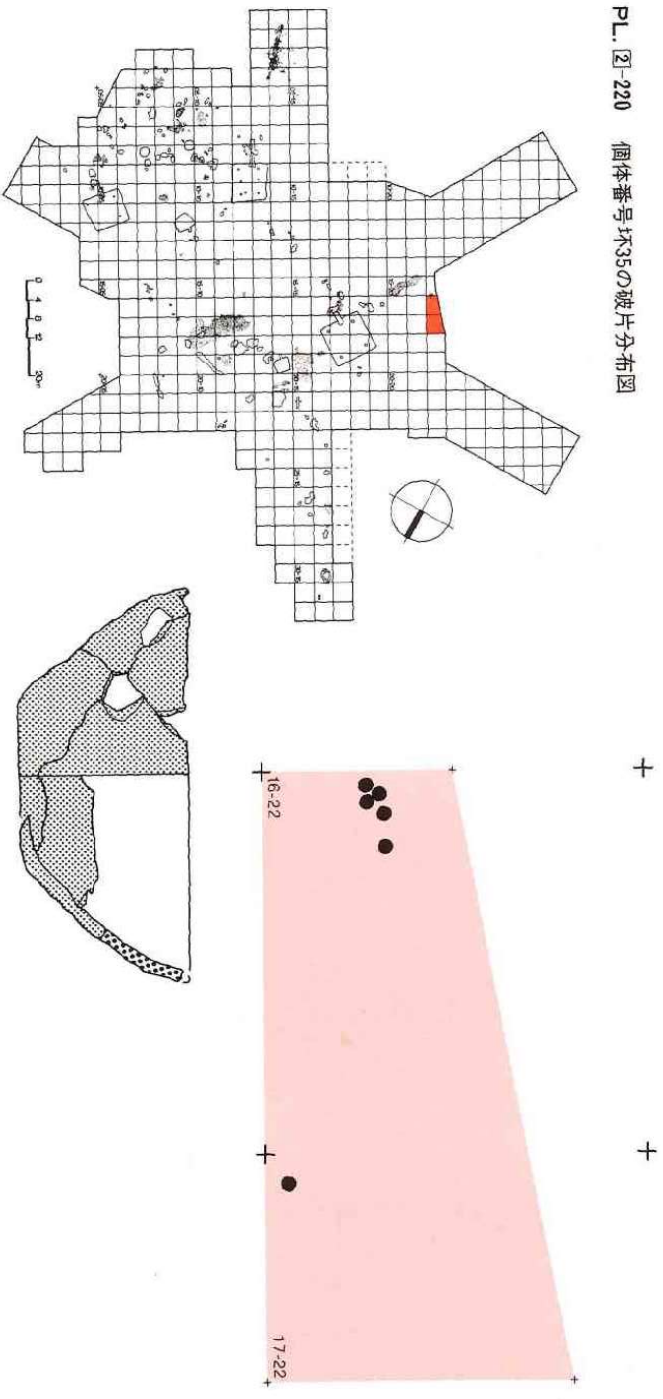

PL. 図-221 個体番号坏36の破片分布図

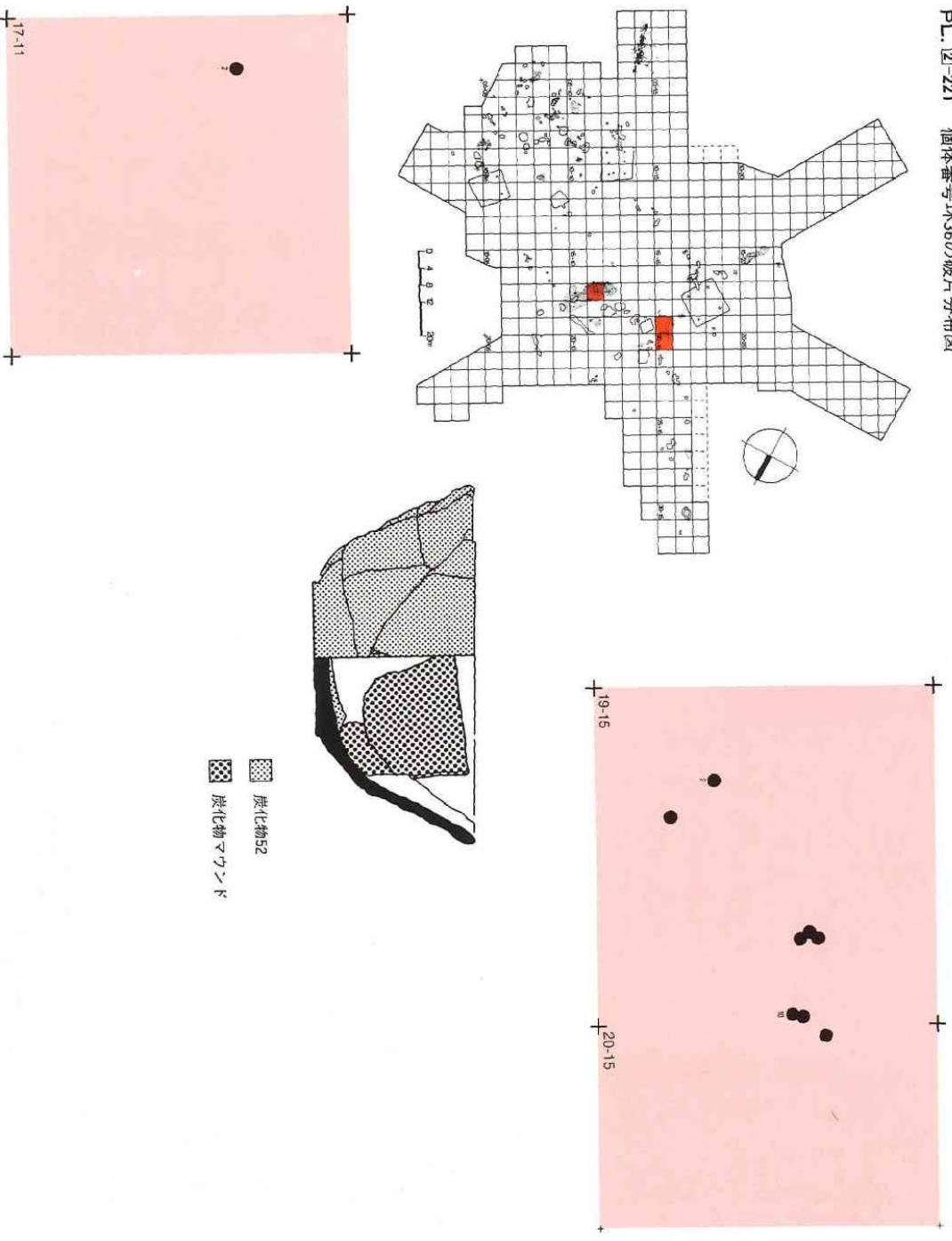

PL. 2-222 個体番号環37の破片分布図

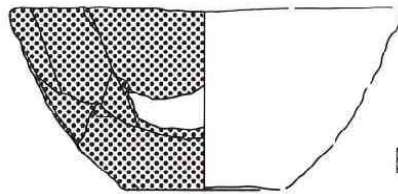
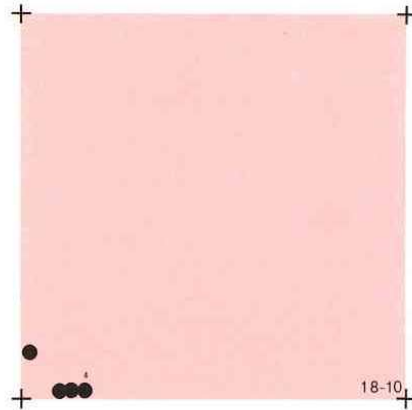
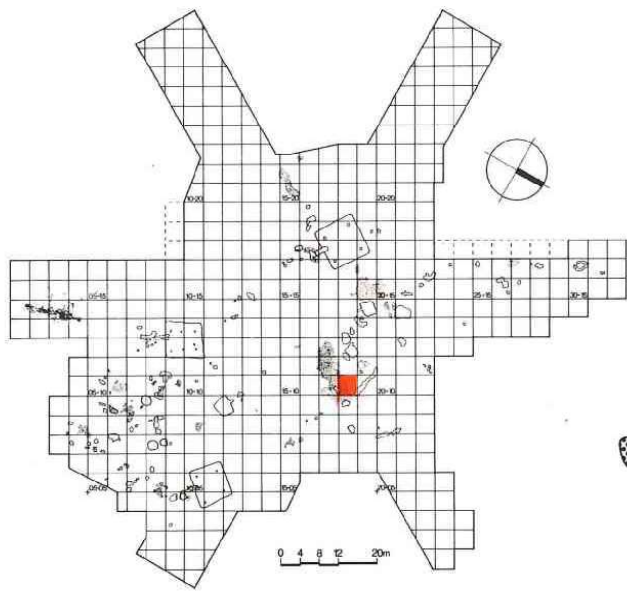

炭化物マウンド

PL. 2-223 個体番号環41の破片分布図

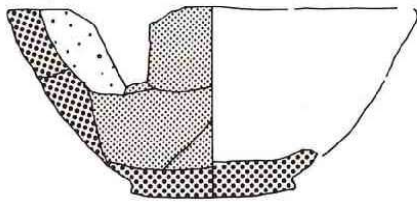

炭化物マウンド

炭化物52

焼土62

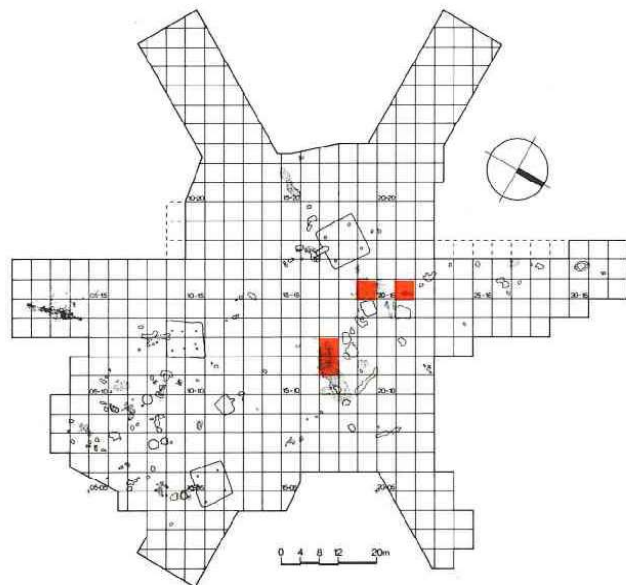
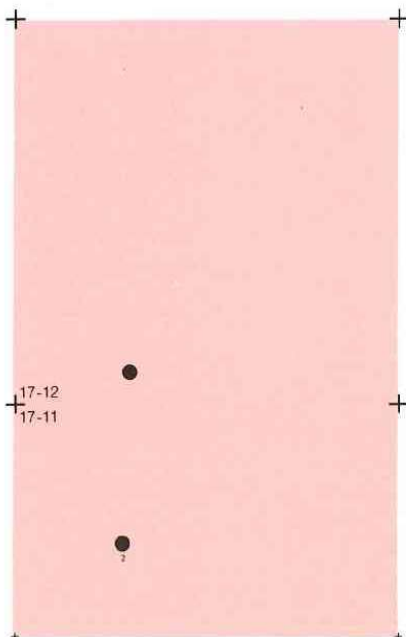
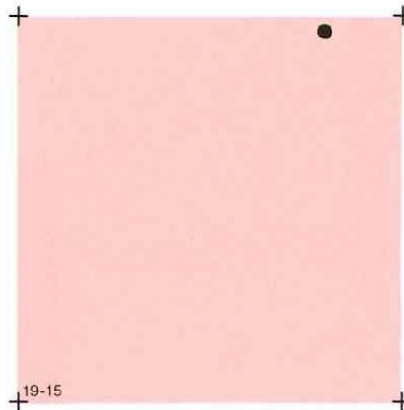



PL. 2-224 個体番号42の破片分布図

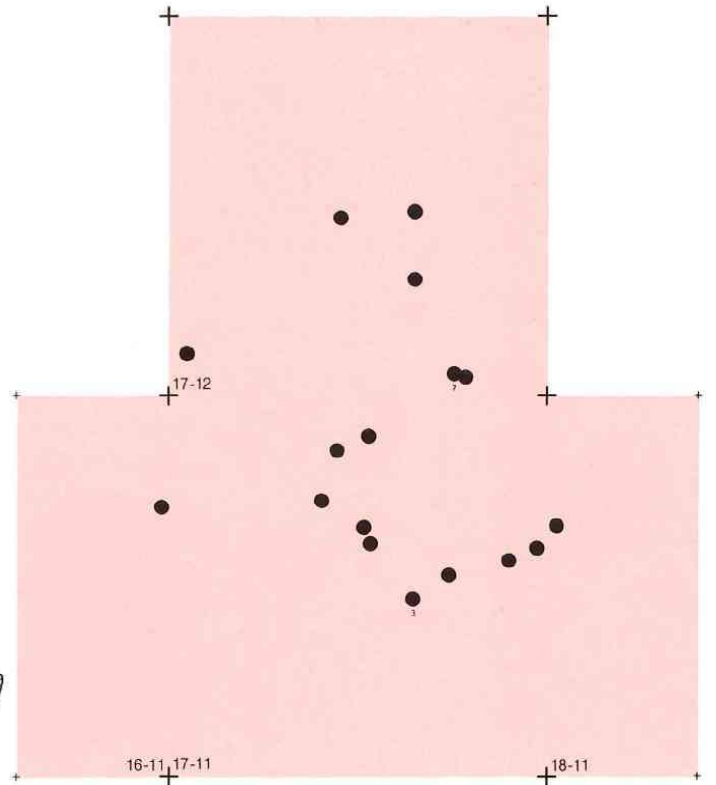
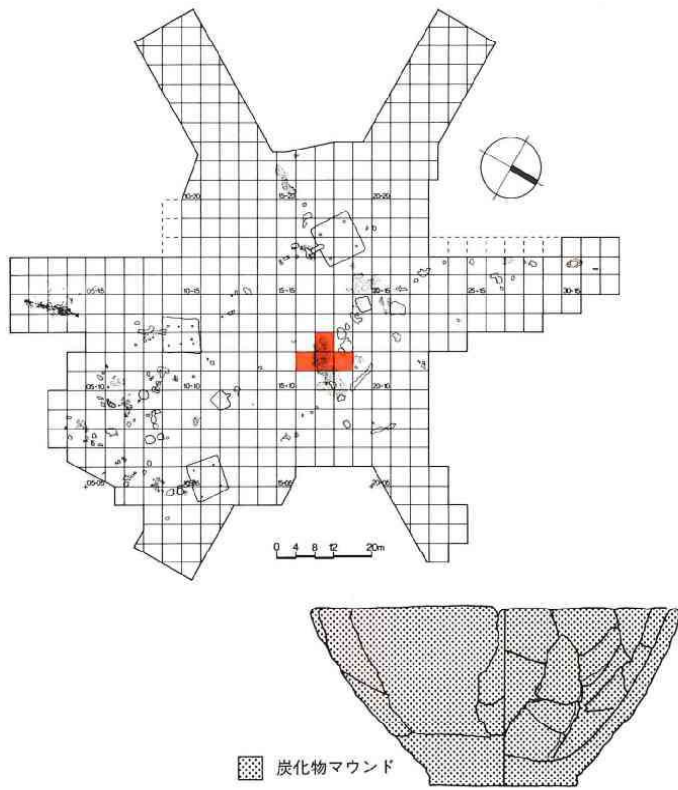

PL. 2-225 個体番号43の破片分布図

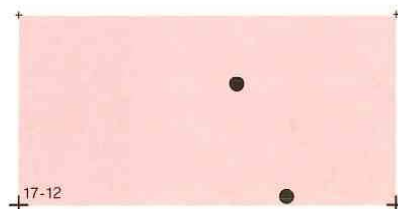
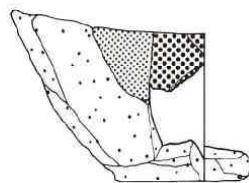
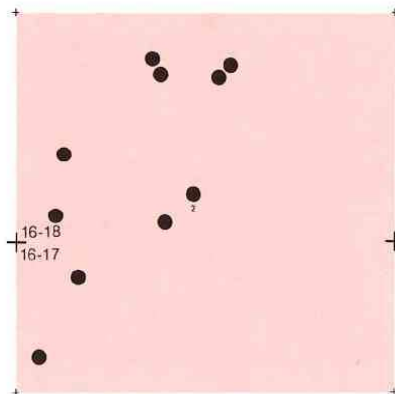
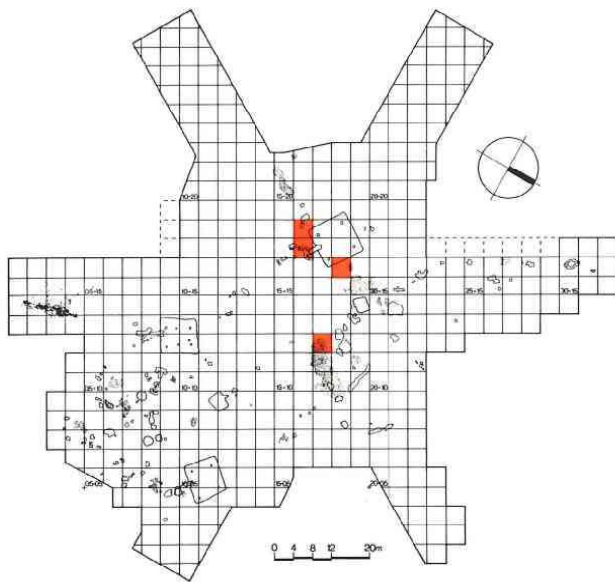

PL. ②-226 個体番号 坏51の破片分布図

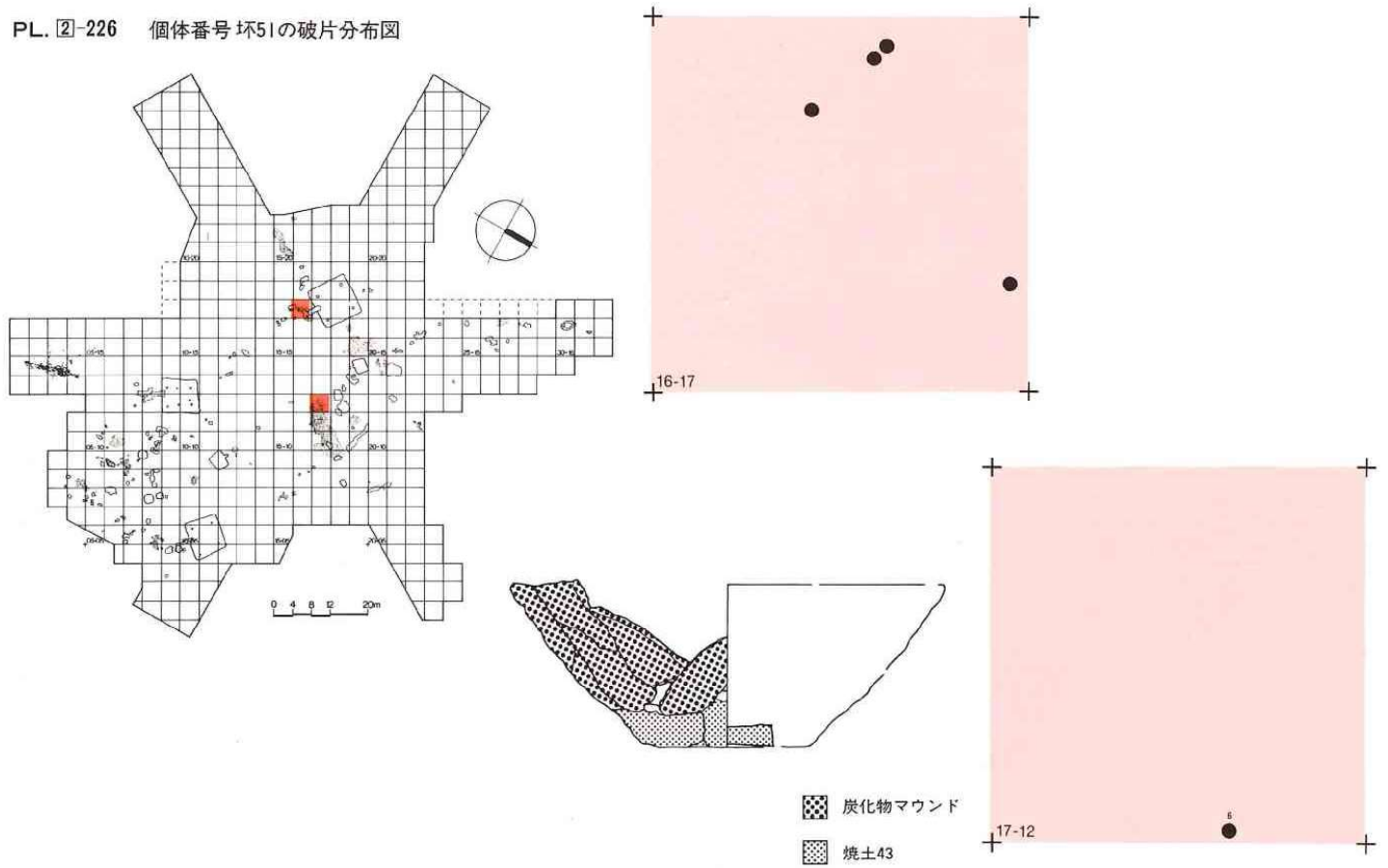

PL. ②-227 個体番号 坏53の破片分布図

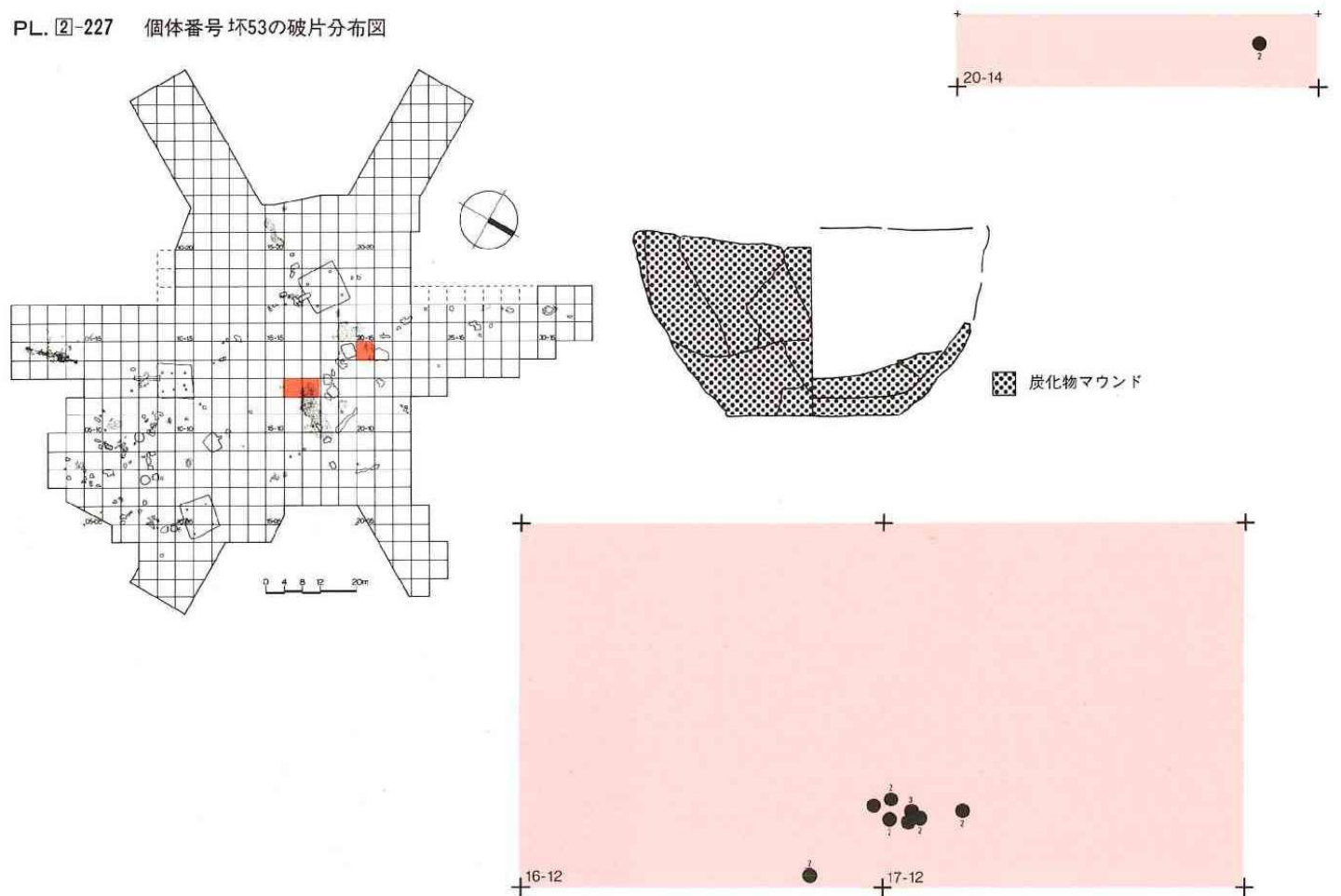

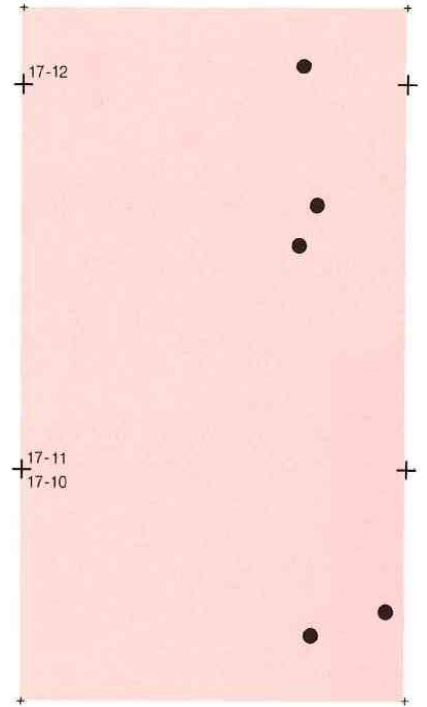
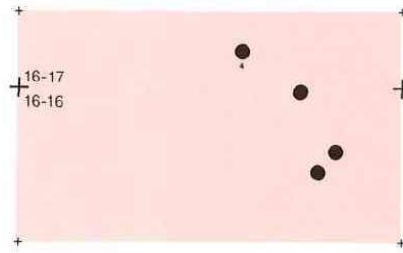
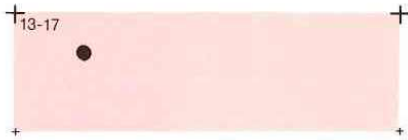

PL. 228 个体番号 坏54の破片分布図

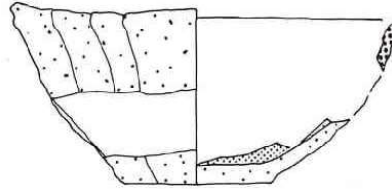
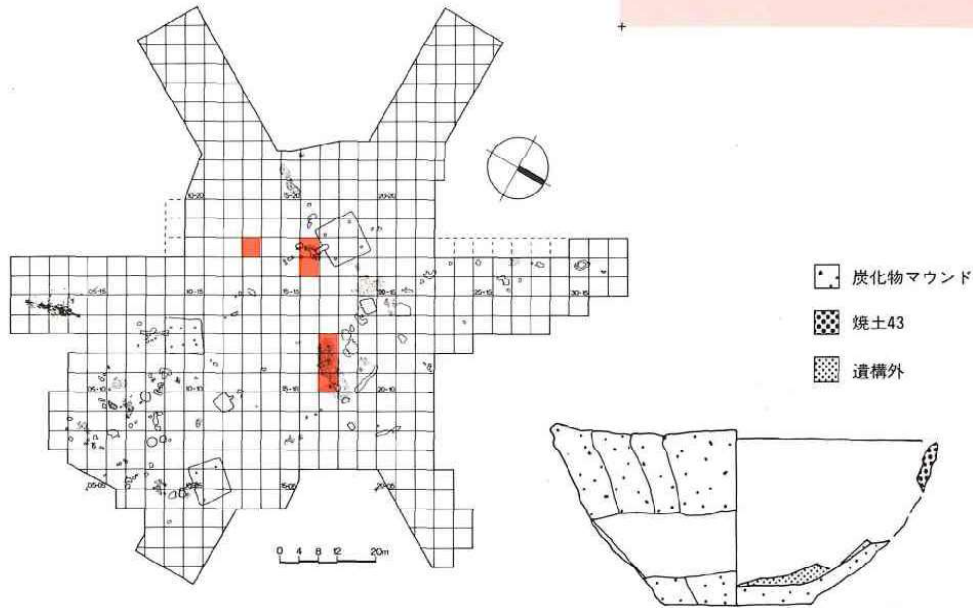

PL. 229 个体番号 坏57の破片分布図

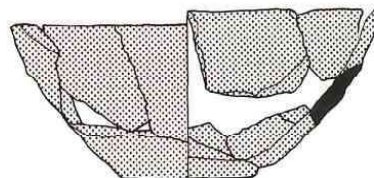
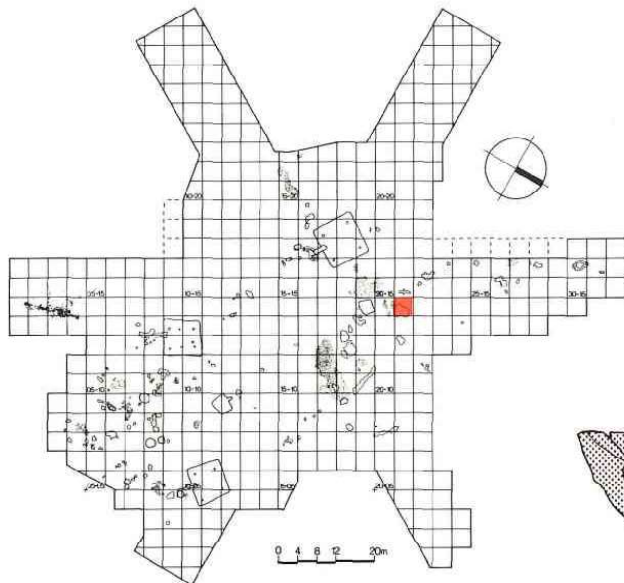

遺構外

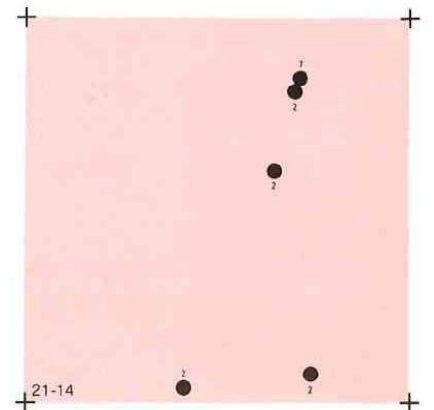

PL. ②-230 個体番号 坏55の破片分布図

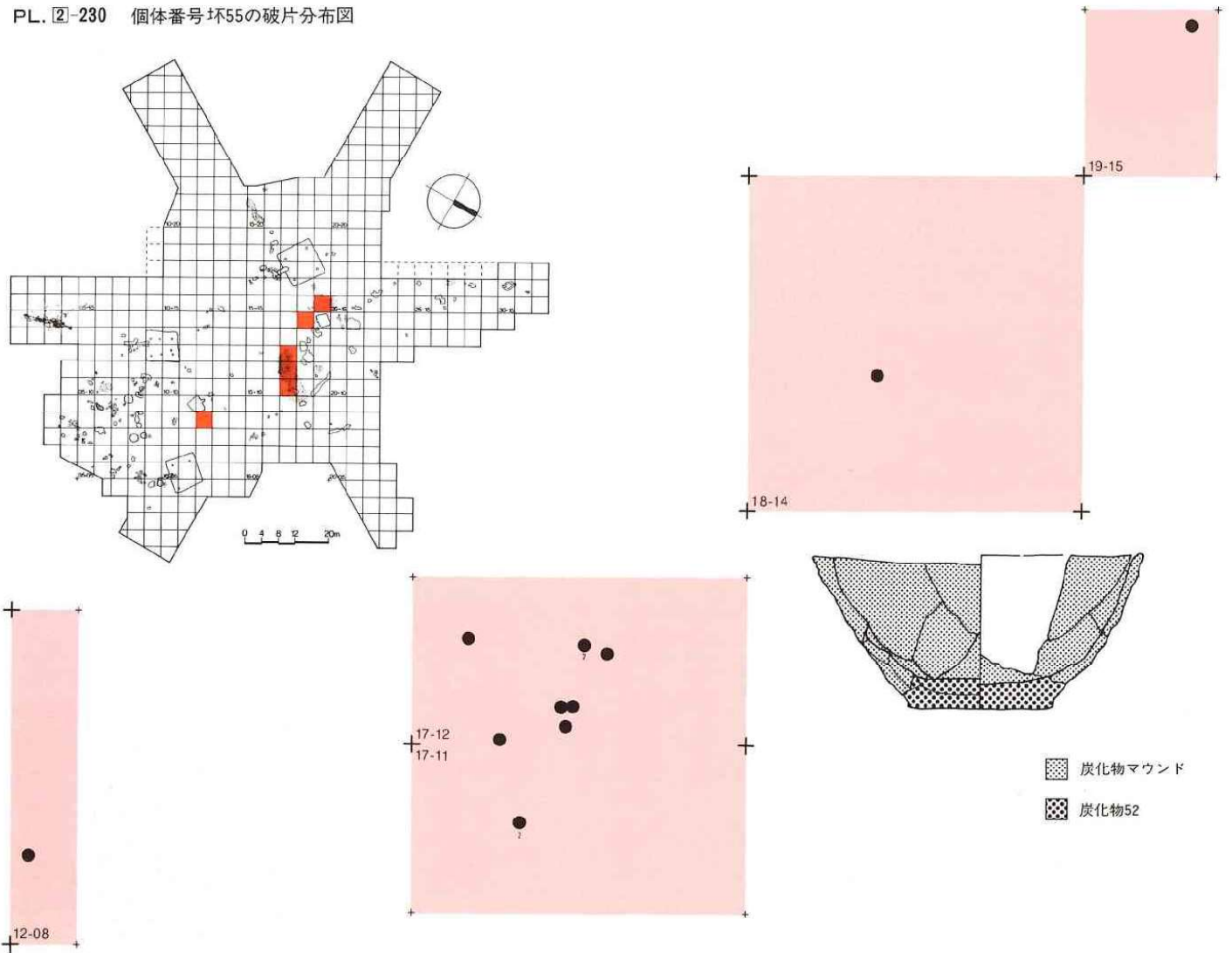

PL. ②-231 個体番号 坏58の破片分布図

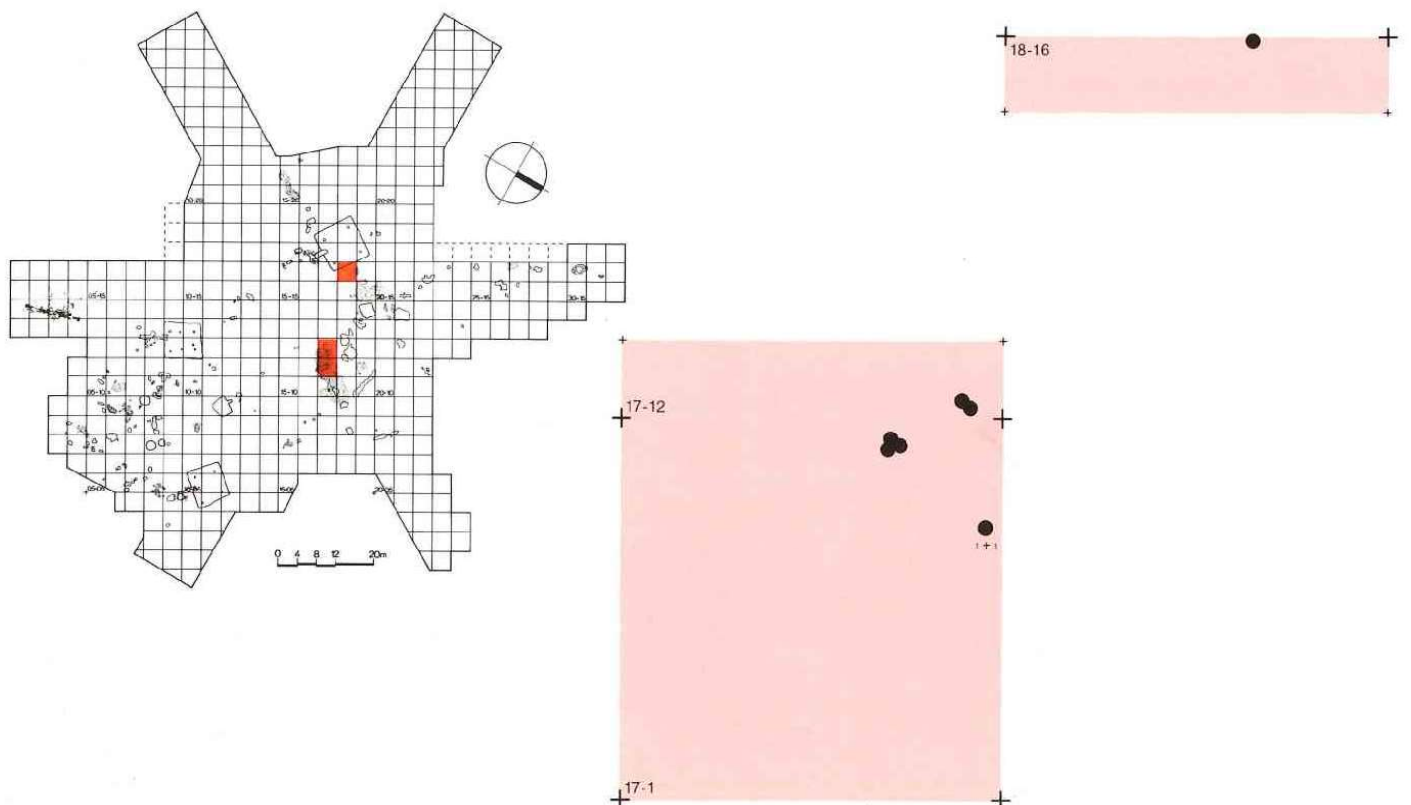





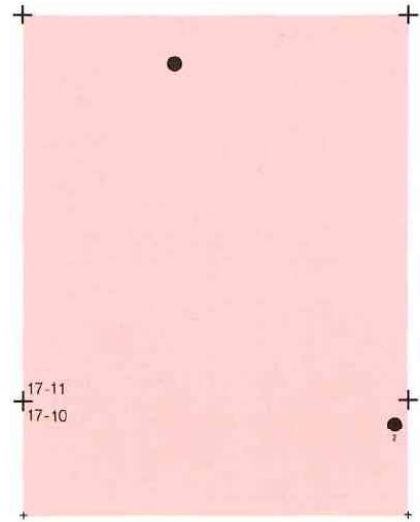
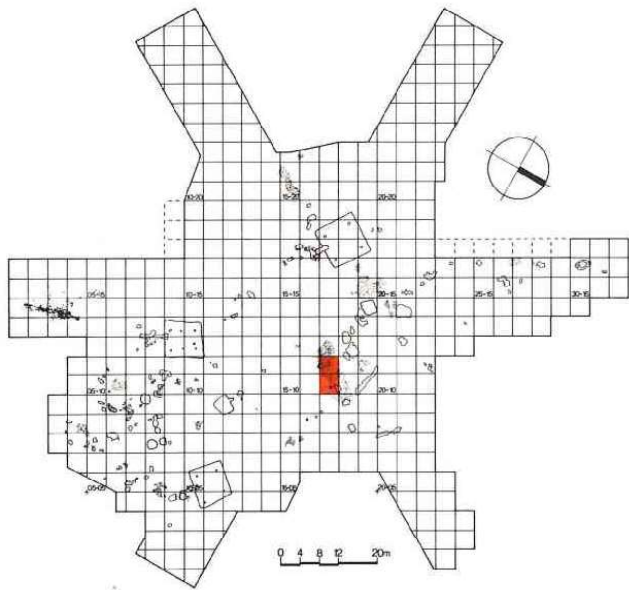

PL. 図-232 個体番号環61の破片分布図

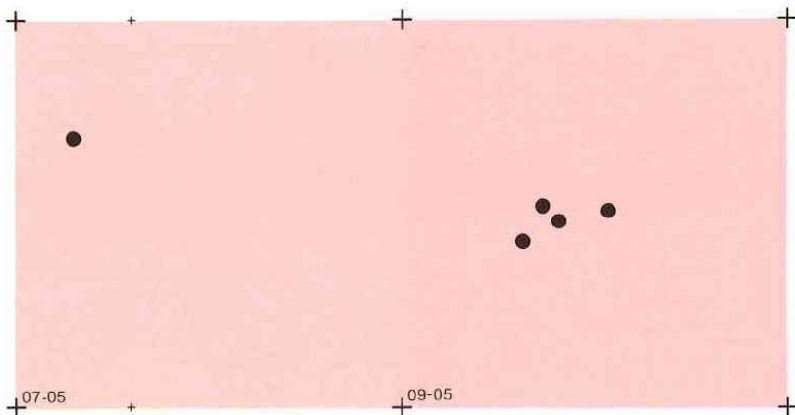
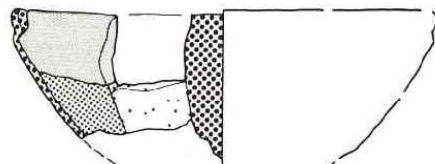
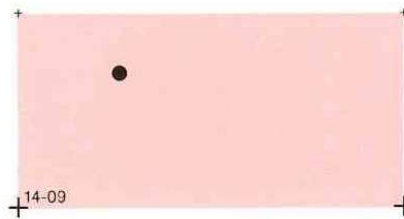
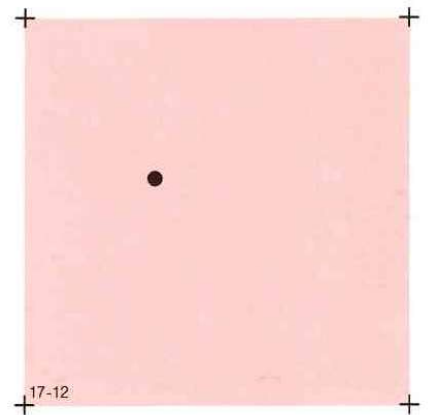
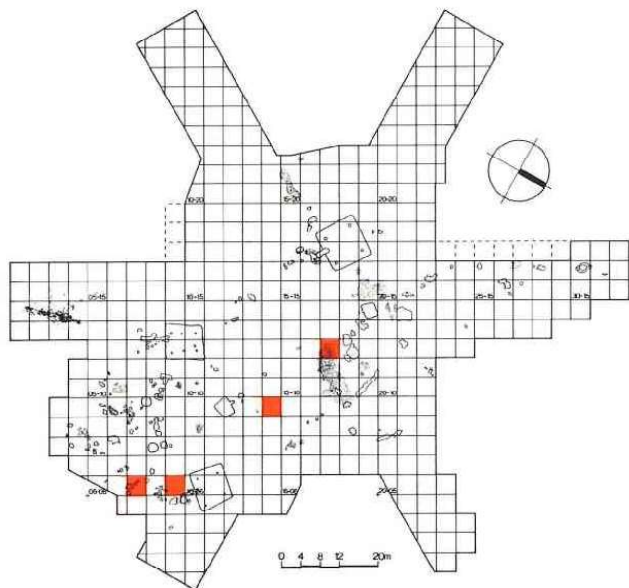



PL. 図-233 個体番号環62の破片分布図

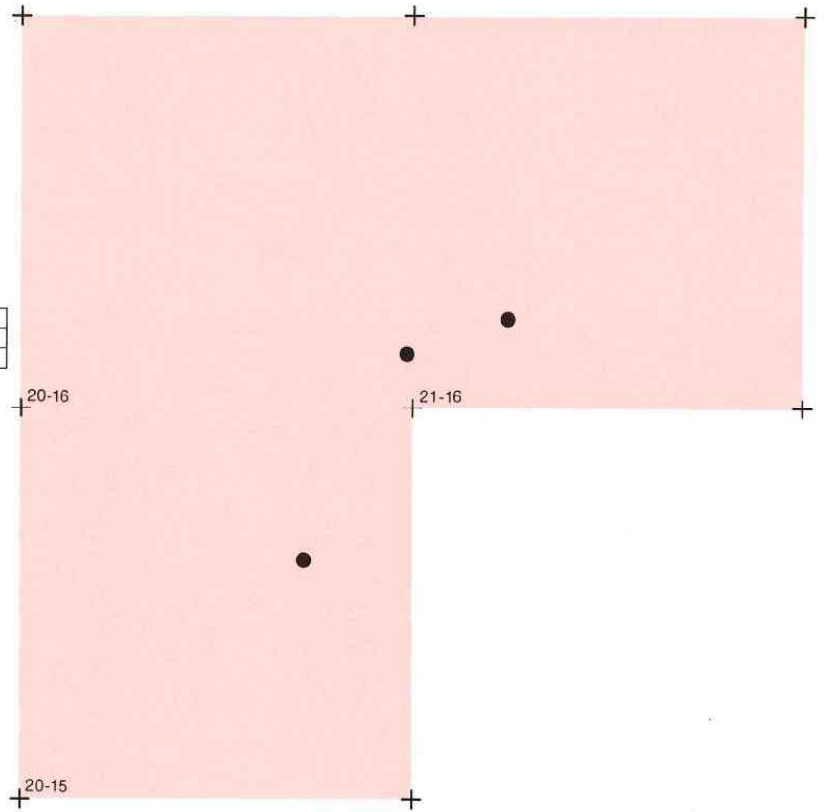
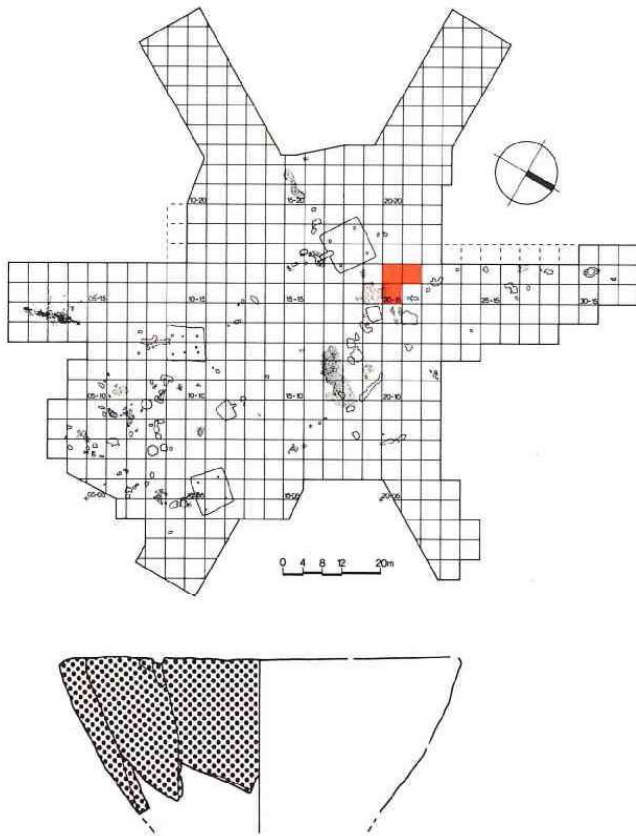

-  1号土壇周辺の焼土・炭化物
-  炭化物マウンド
-  焼土17
-  遺構外

PL. 2-234 個体番号 坏64の破片分布図



 炭化物52の周辺

PL. 2-235 個体番号 坏70の破片分布図

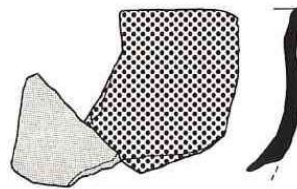
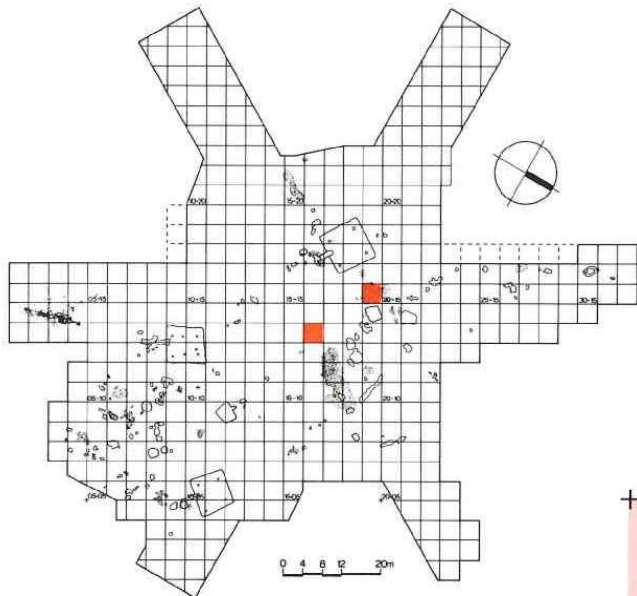

 炭化物52  
 遺構外

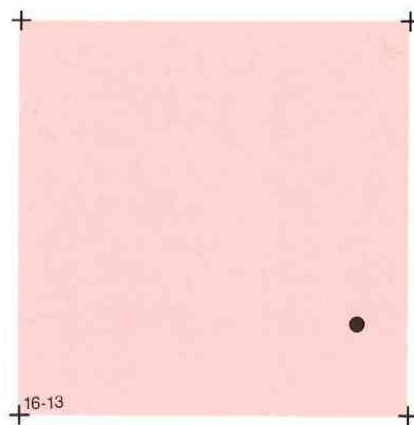
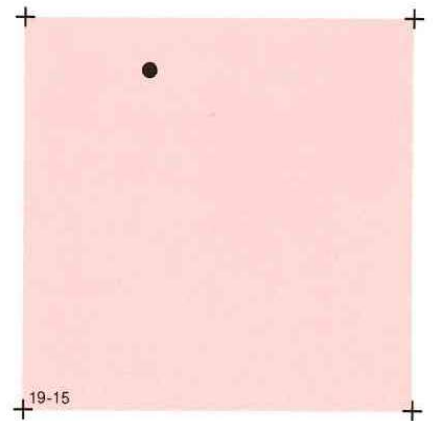

PL. 2-236 個体番号 106 の破片分布図

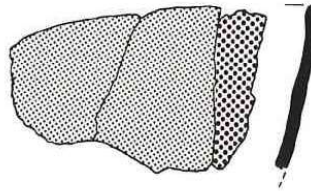
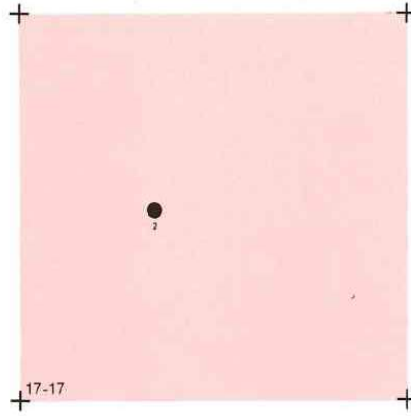
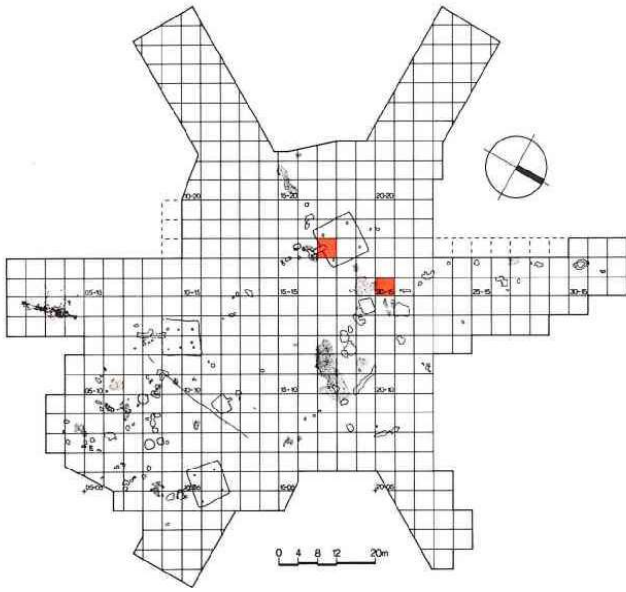

- 2号竪穴住居跡の床面
- 炭化物52

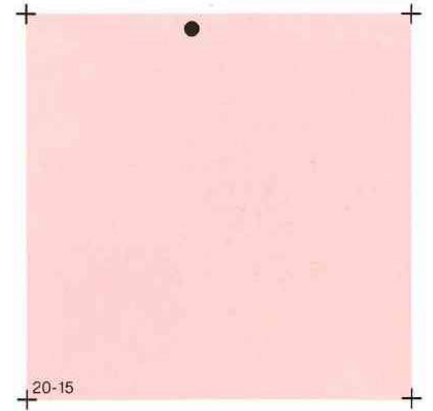

PL. 2-237 個体番号 110 の破片分布図

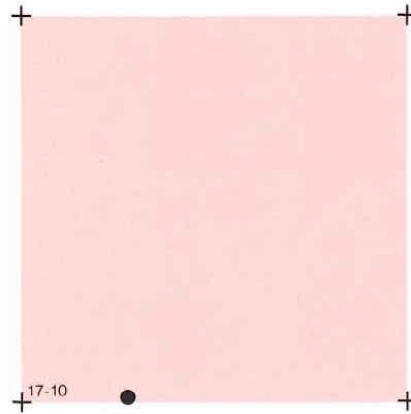
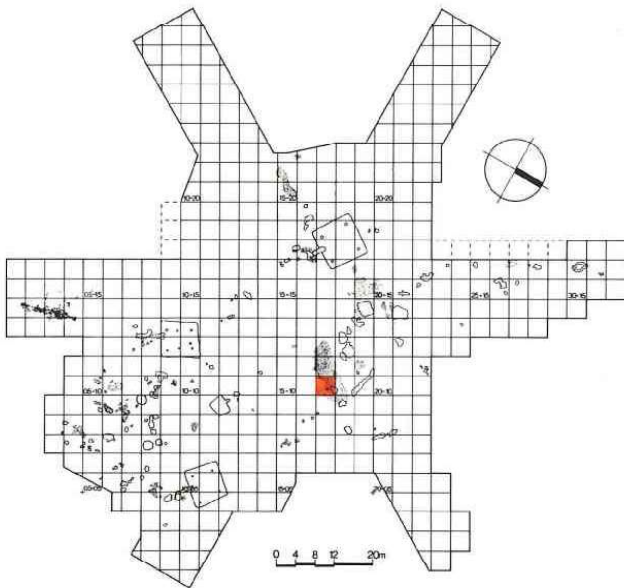

PL. 2-238 個体番号須志器2の破片分布図

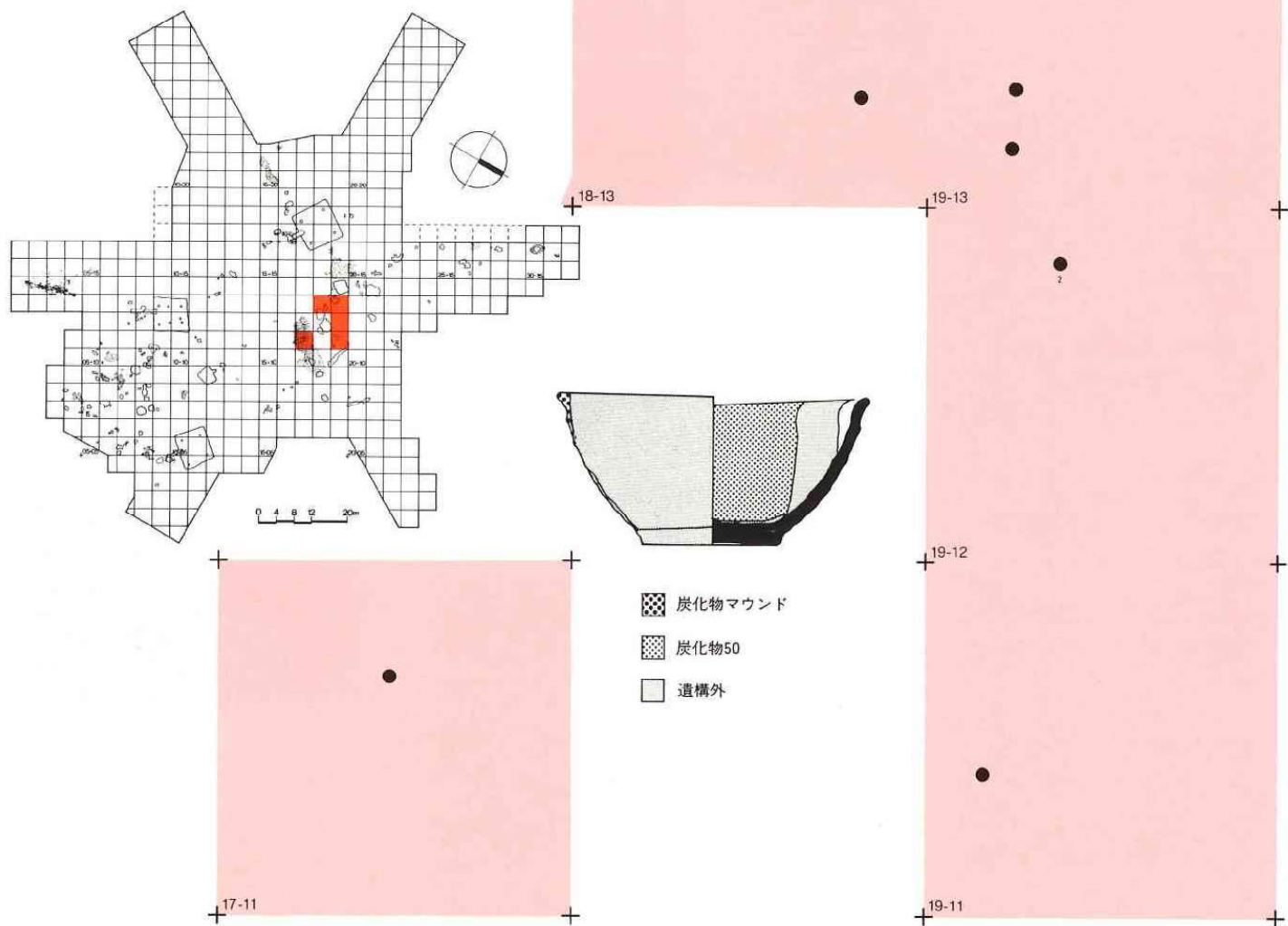





PL. 2-239 個体番号須恵器(瓶)8の破片分布図

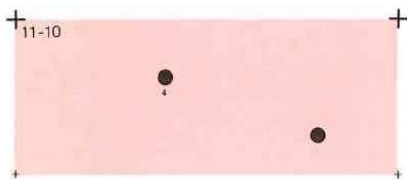
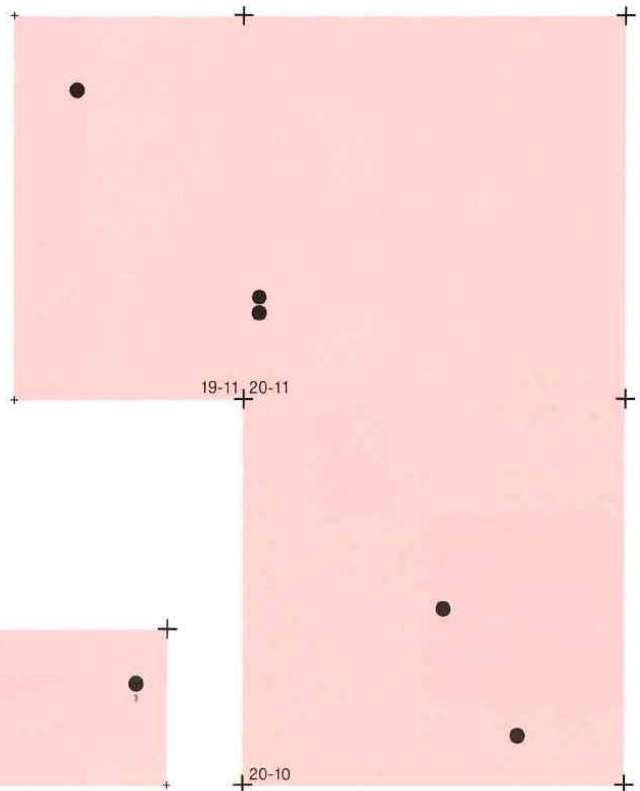
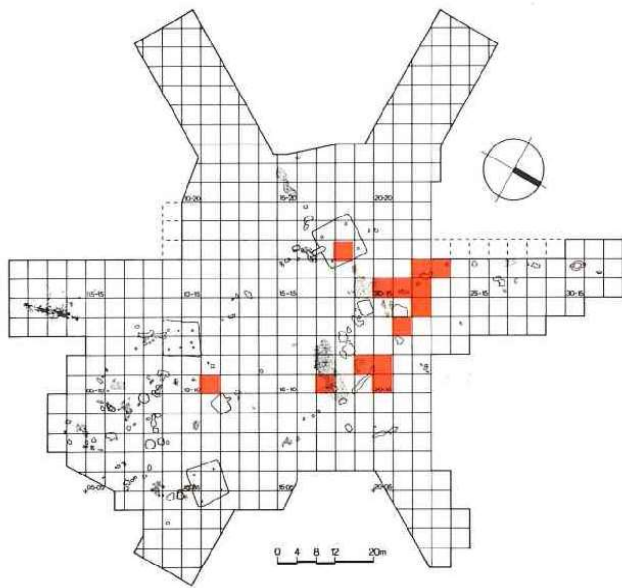

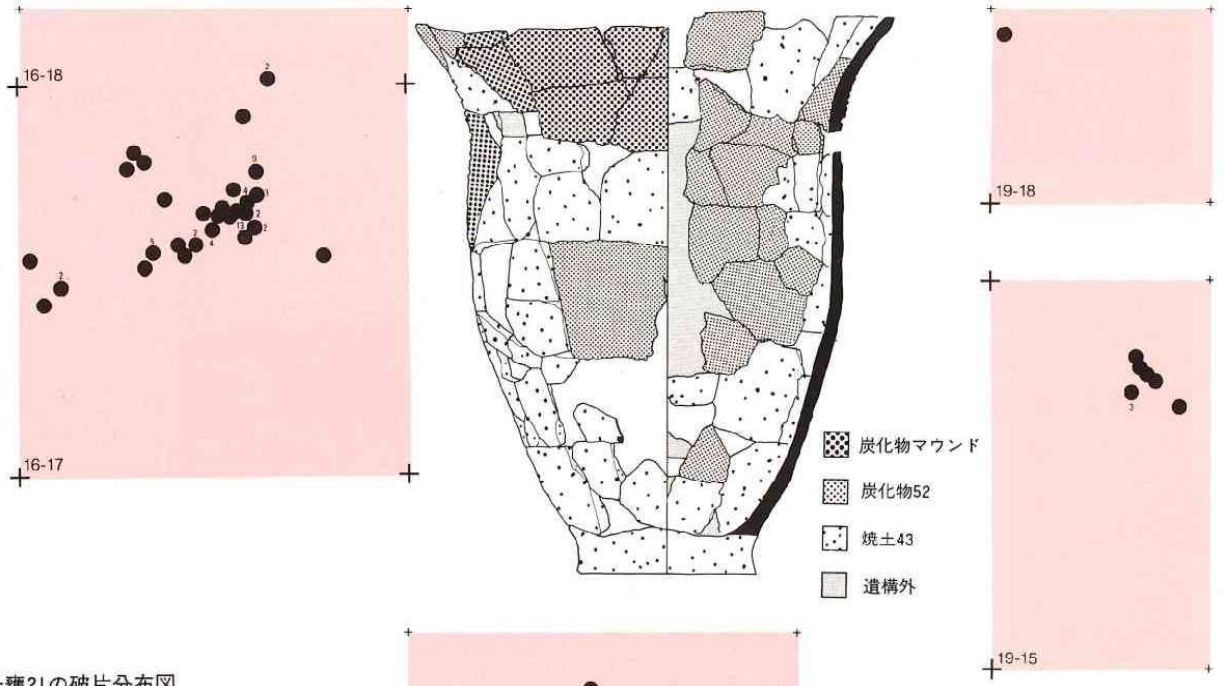

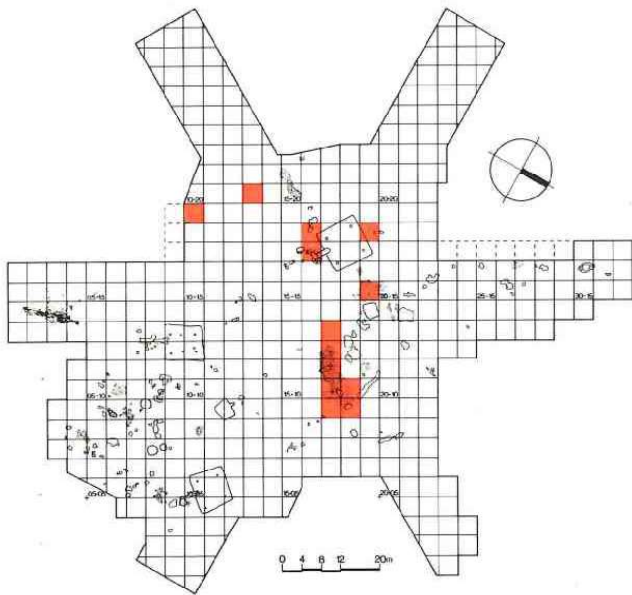

PL. 2-240 個体番号21の破片分布図

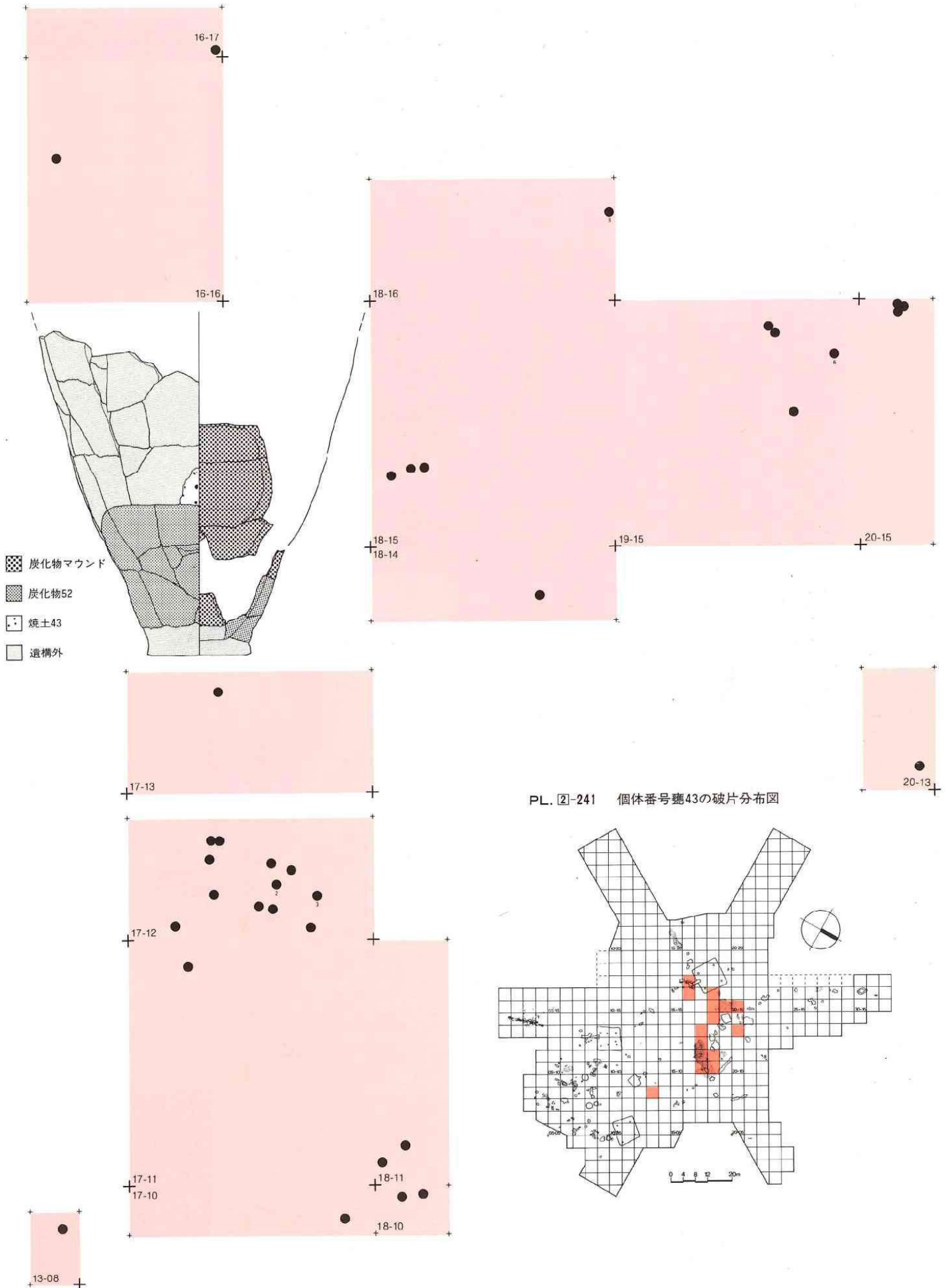

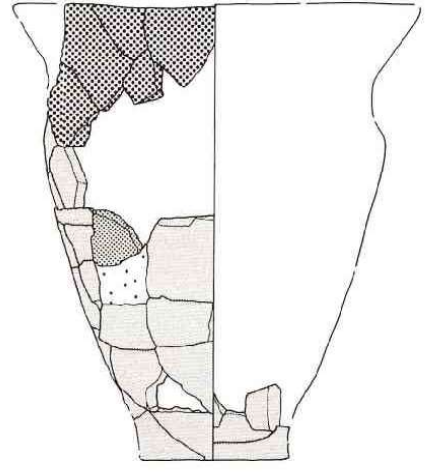

PL. 2-242 個体番号壺57の破片分布図



-  焼土43
-  焼土41
-  炭化物52
-  遺構外

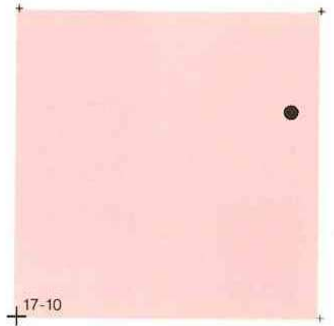



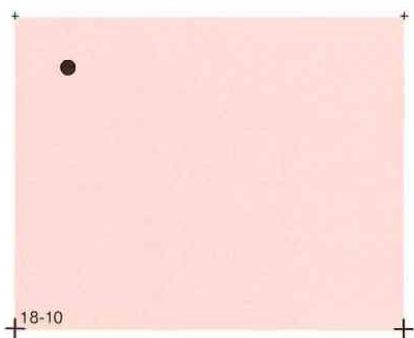
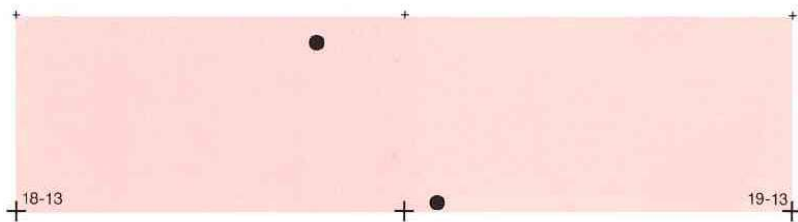
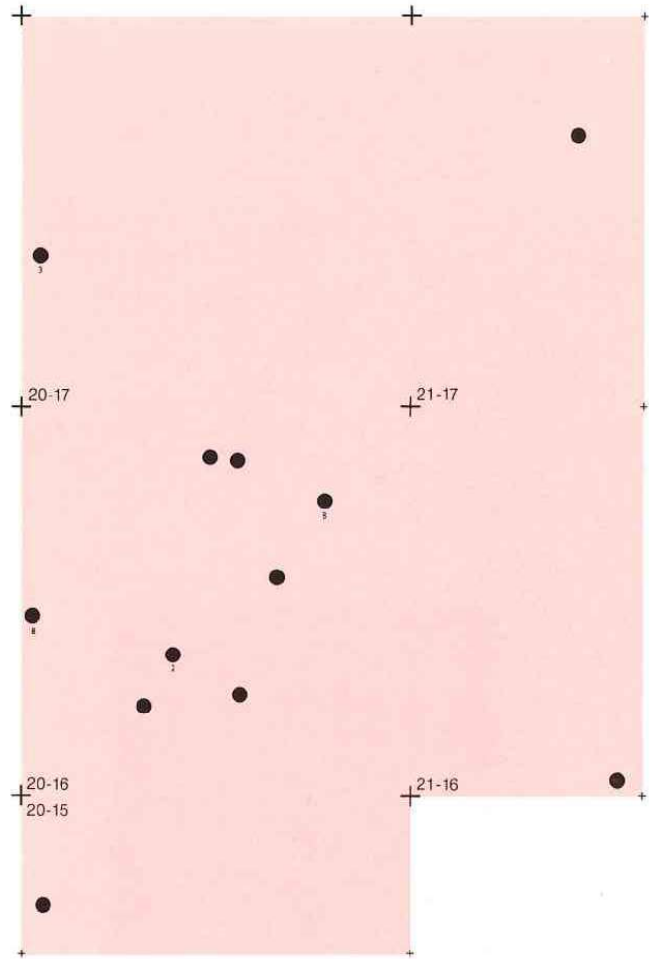
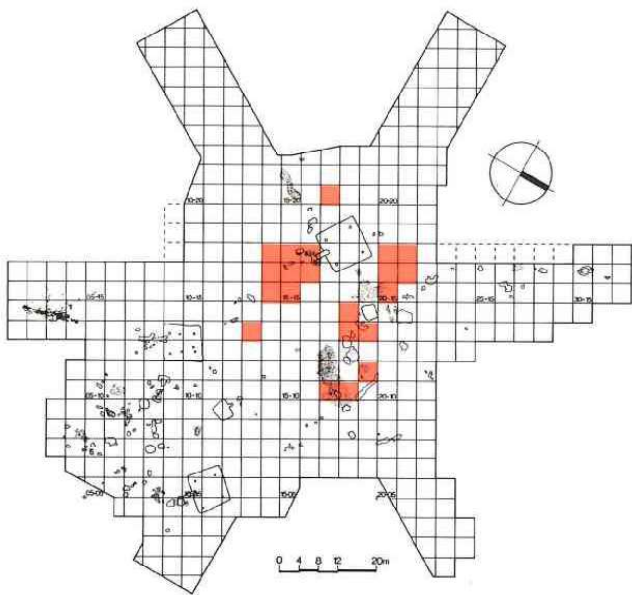

PL. 2-243 个体番号壺48の破片分布図

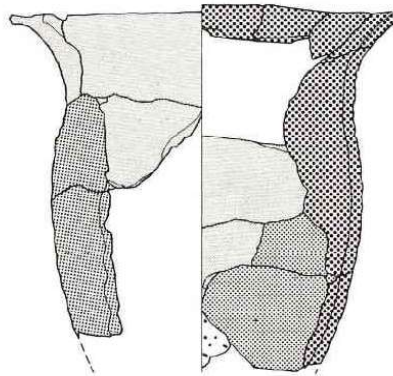
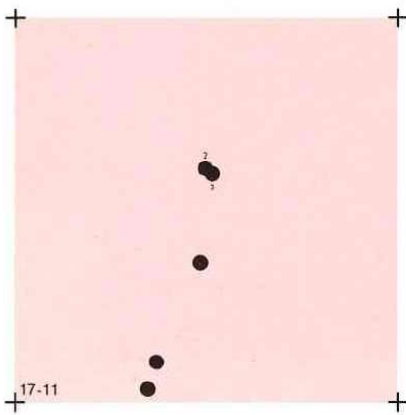
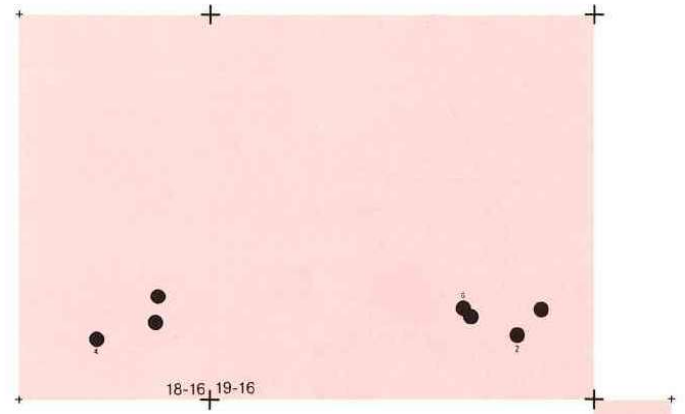
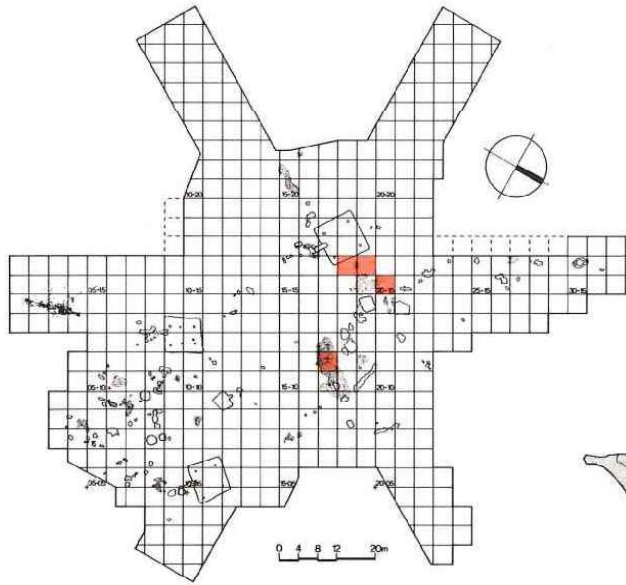



-  炭化物マウンド
-  炭化物52
-  炭化物53
-  遺構外

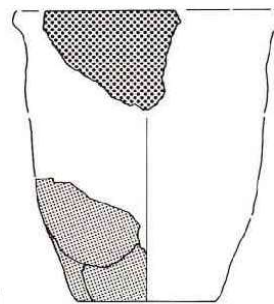
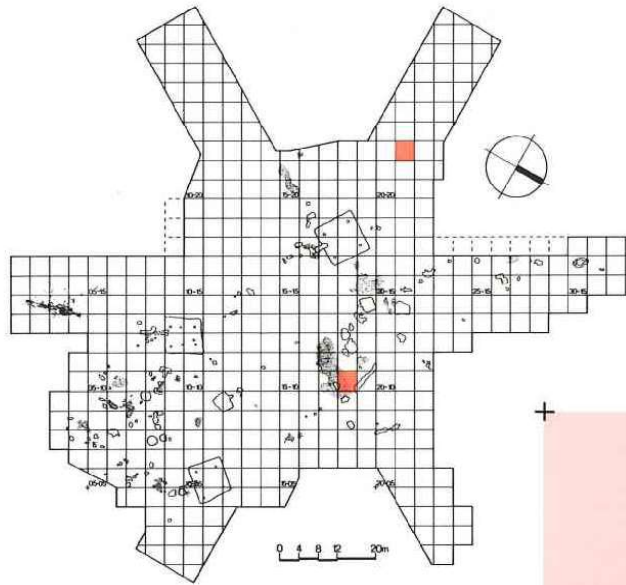

PL. 2-244 个体番号壺90の破片分布図



-  炭化物マウンド
-  遺構外

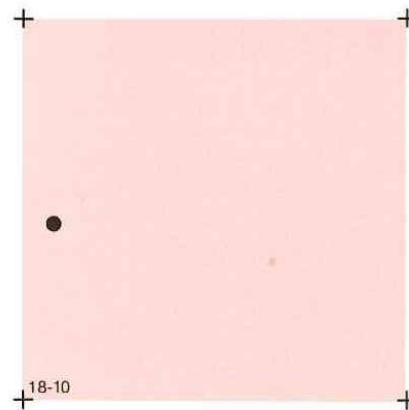
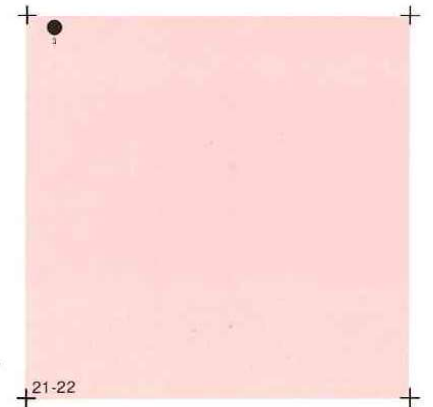

PL. 2-245 個体番号96の破片分布図

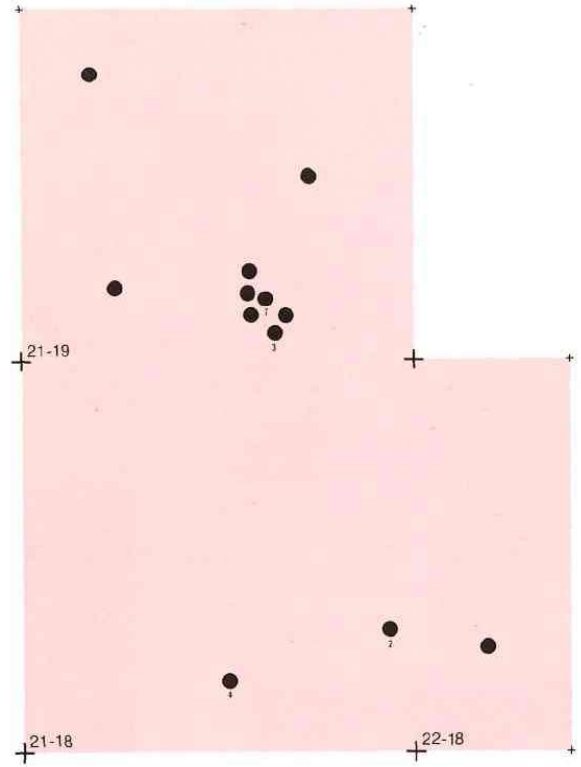
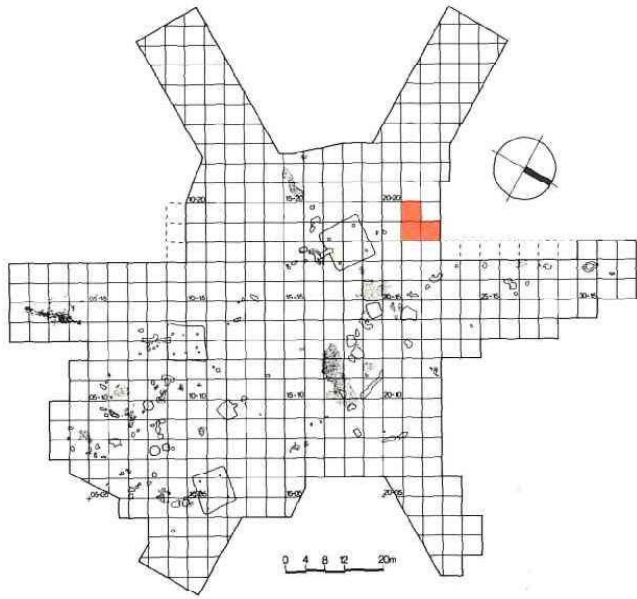

PL. 2-246 個体番号99の破片分布図

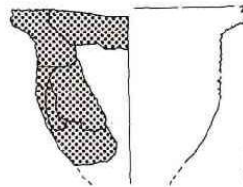
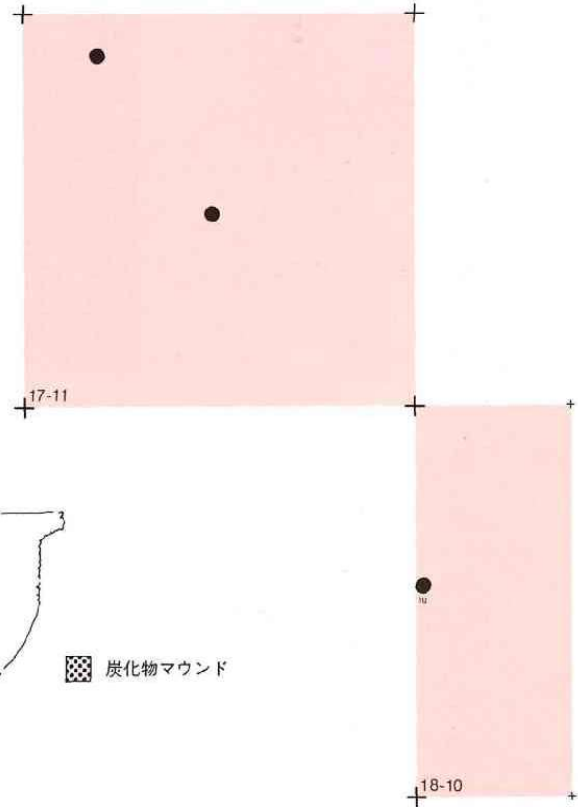
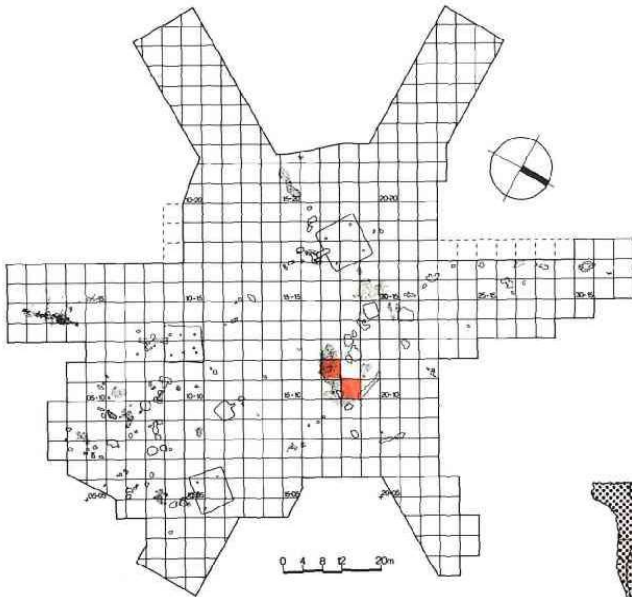

炭化物マウンド

PL. ②-247 個体番号壺102の破片分布図

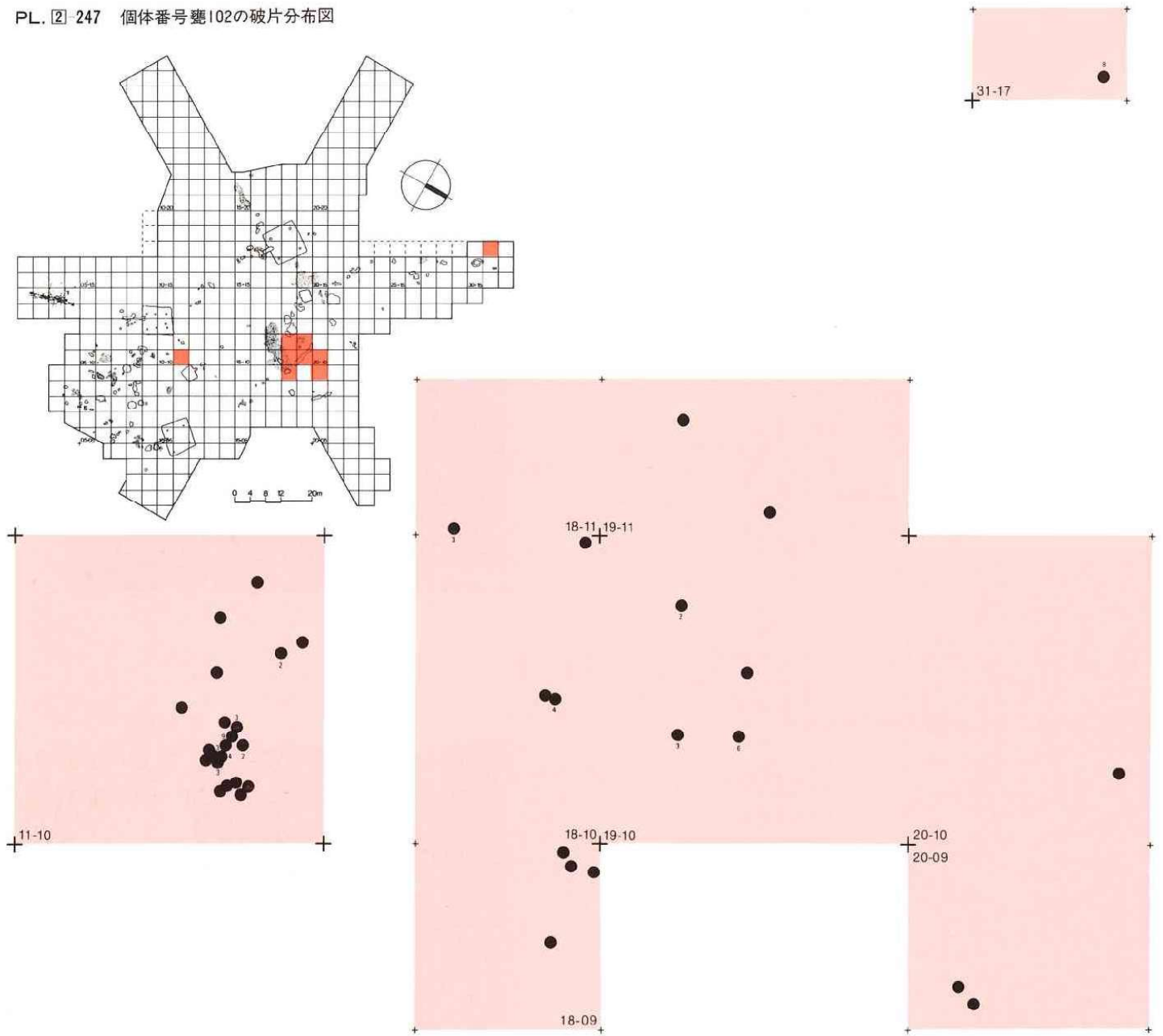

PL. ②-248 個体番号壺161の破片分布図

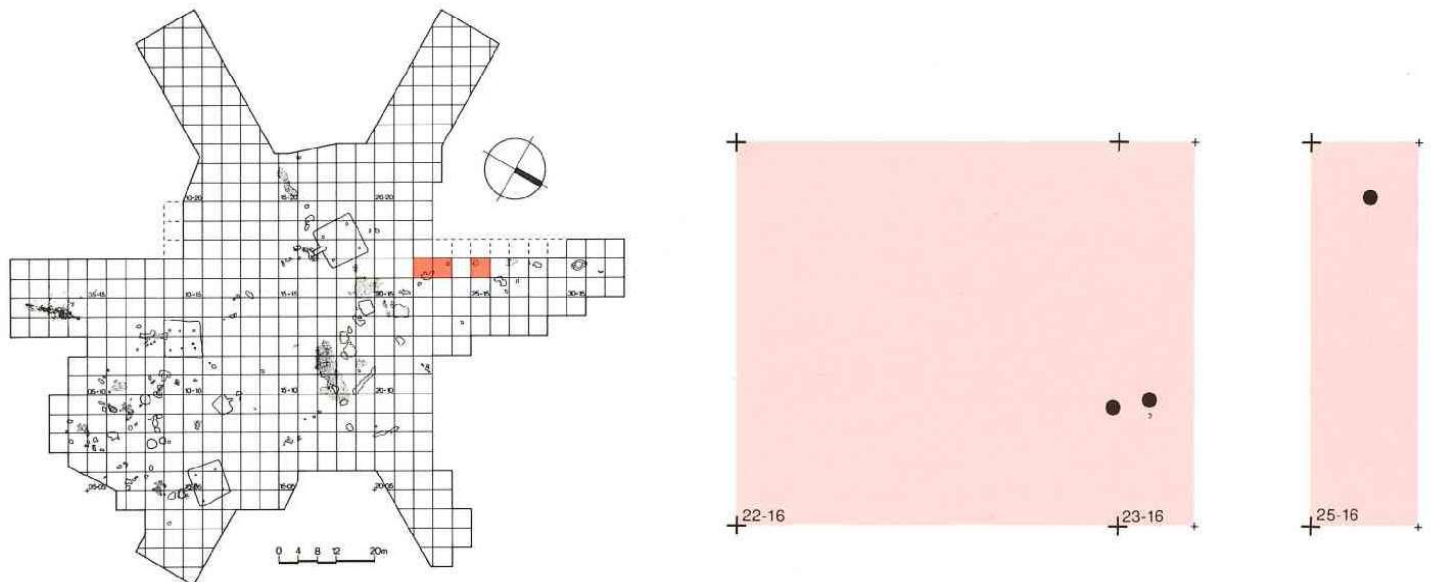



PL. ②-249 個体番号壺113の破片分布図

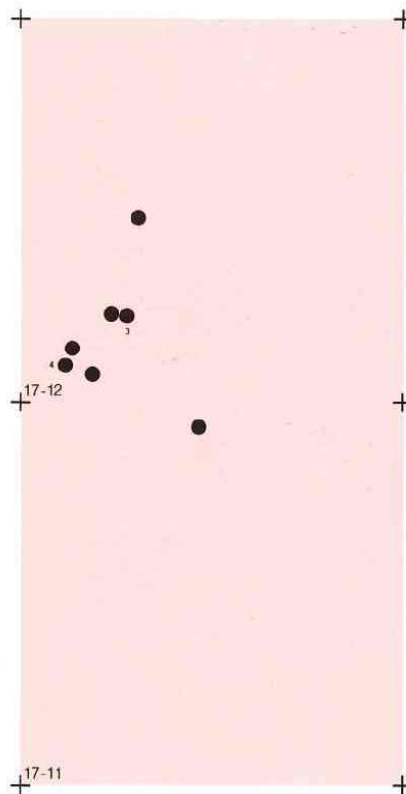
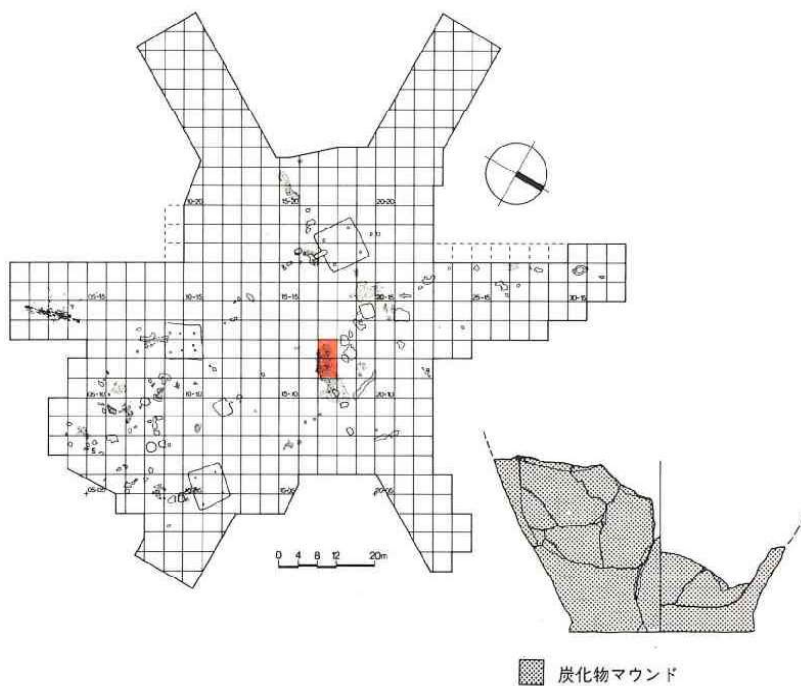

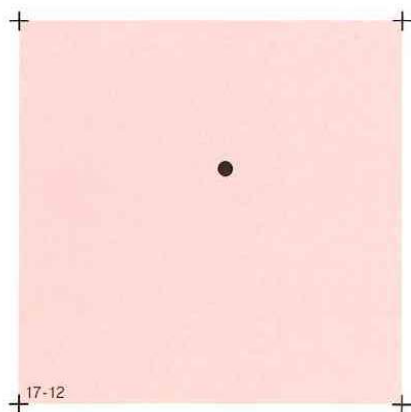
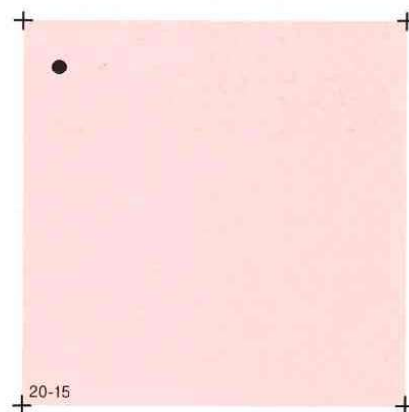
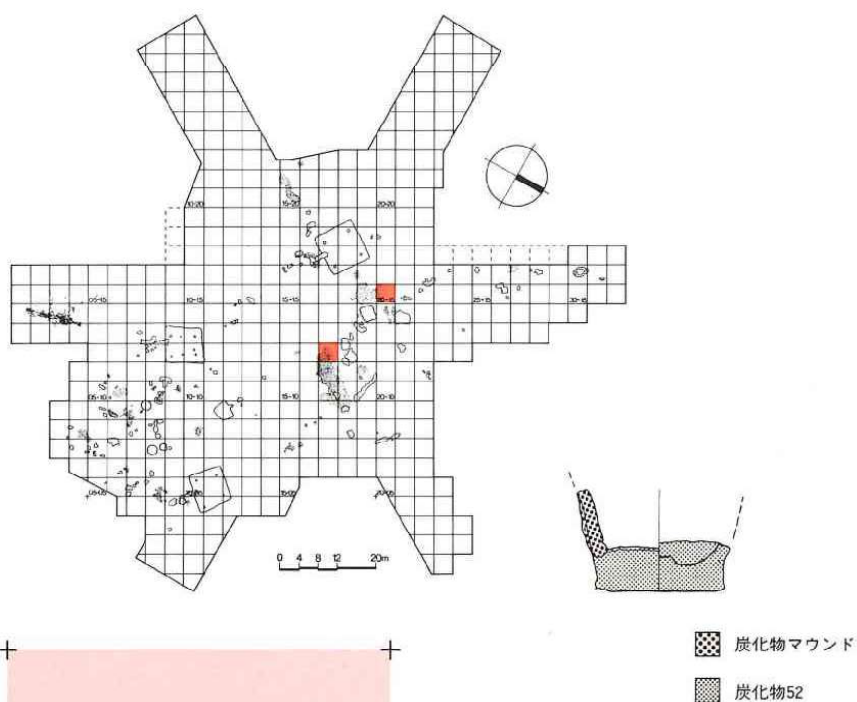

PL. ②-250 個体番号壺119の破片分布図

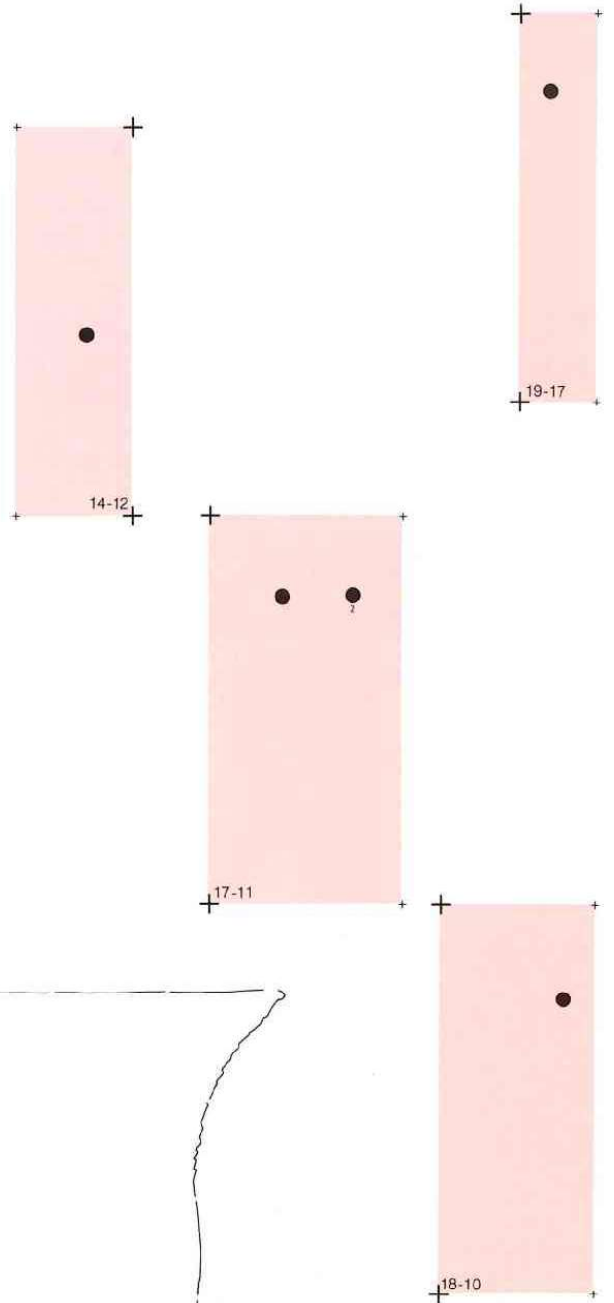
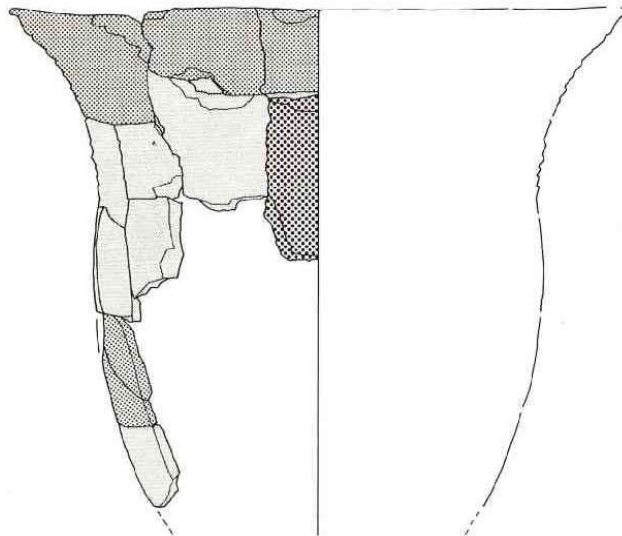
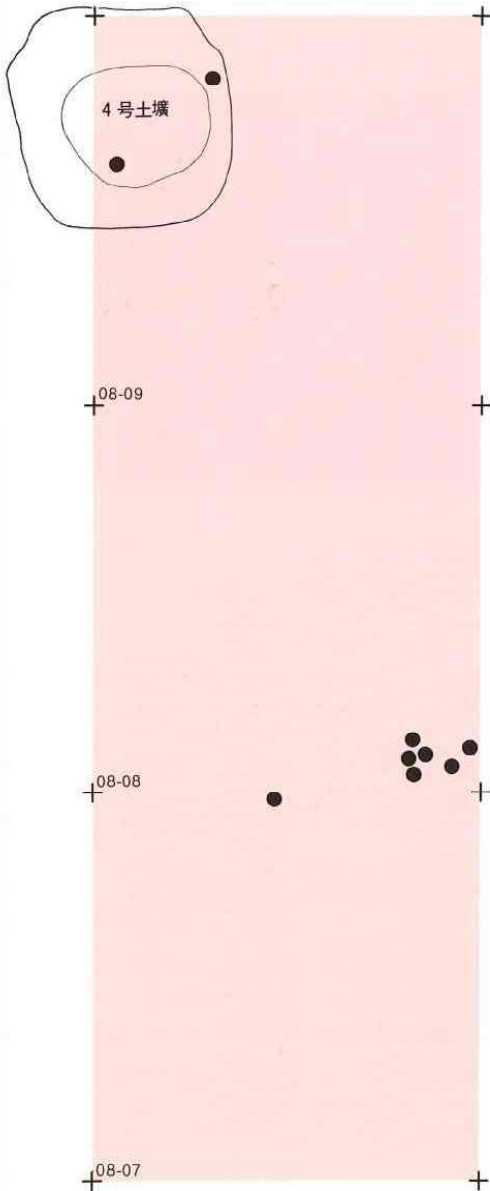
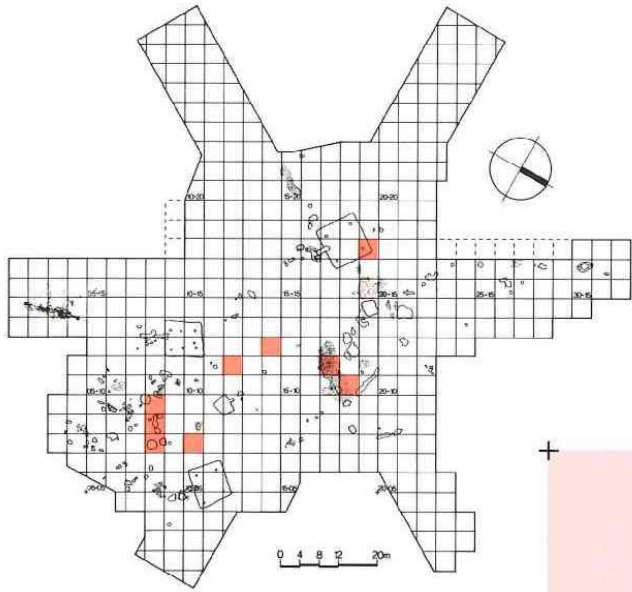

PL. 2-251 個体番号 179 の破片分布図



-  2号竖穴住居跡の覆土
-  4号土壌
-  遺構外

PL. ②-252 焼土・炭化物分布図 ①

(1) 炭化物16

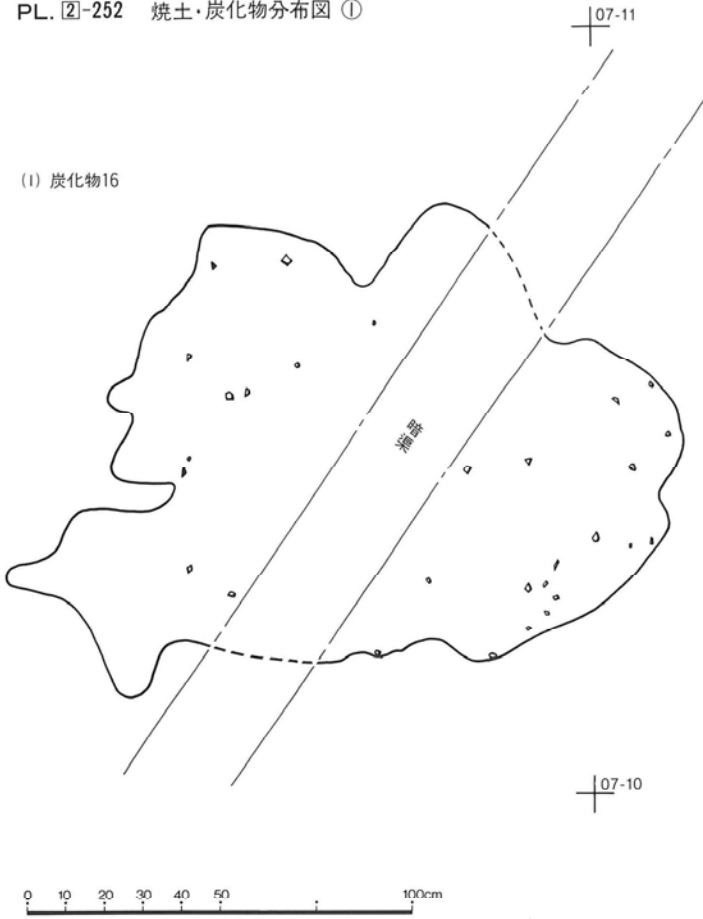

(2) 焼土・炭化物22

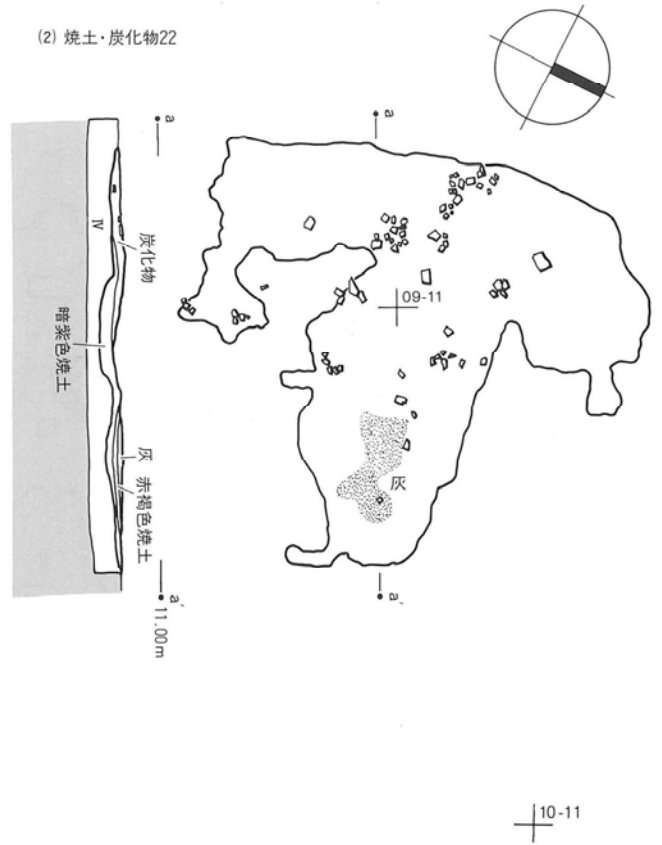

(3) 炭化物19



(4) 焼土33

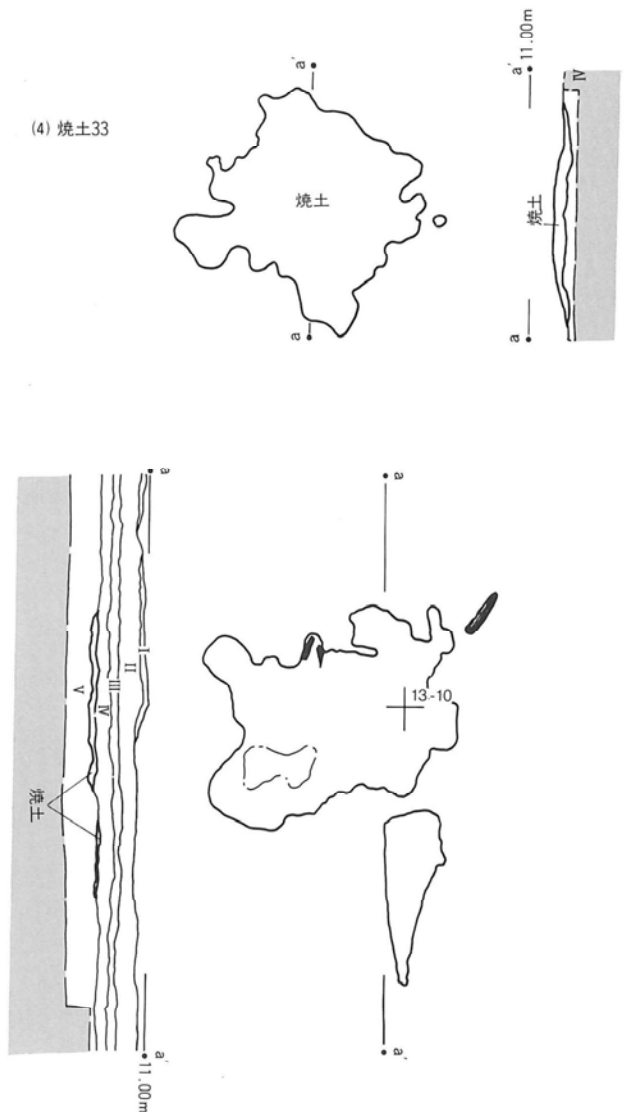

(1) 焼土27

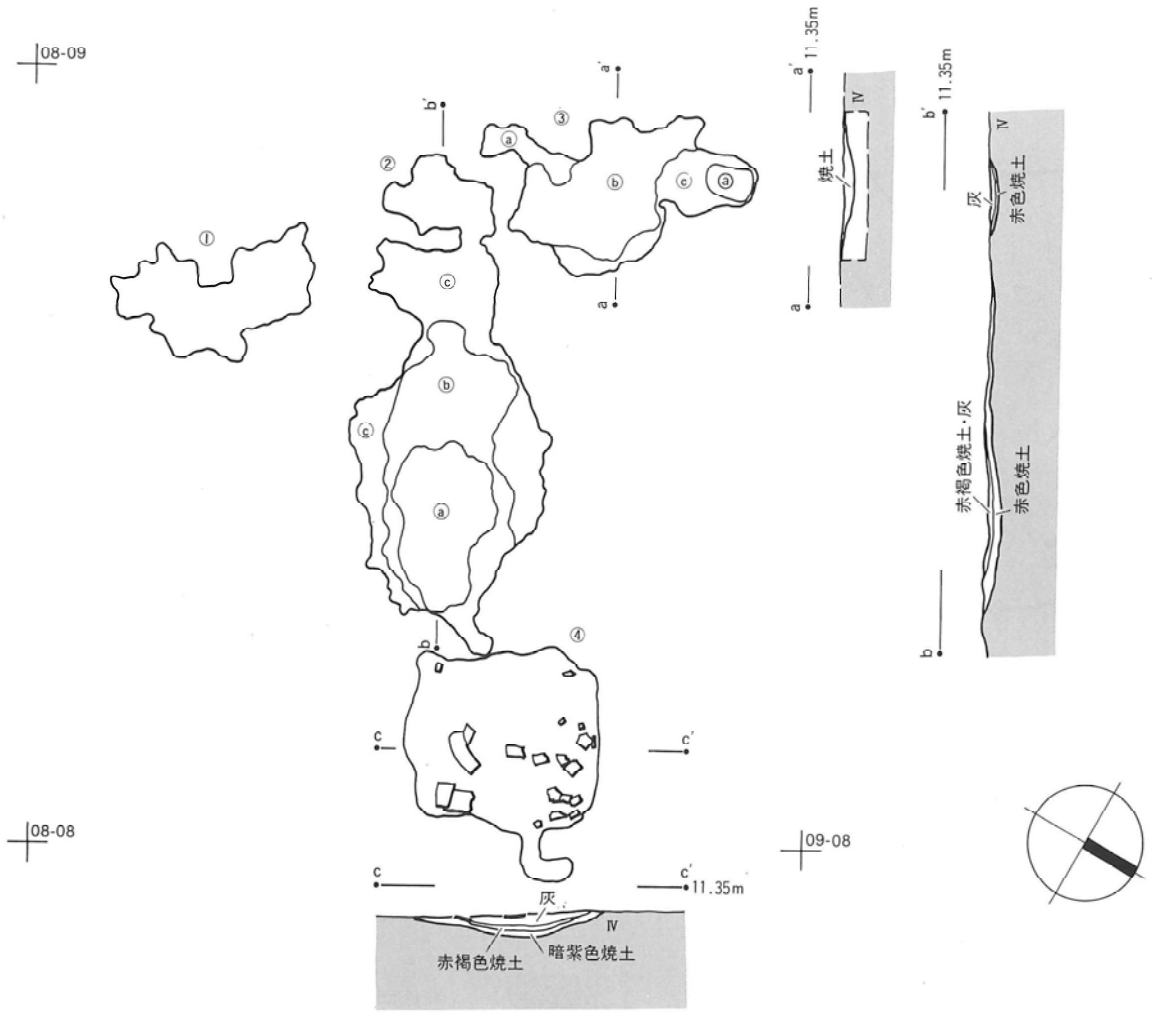

(2) 焼土34

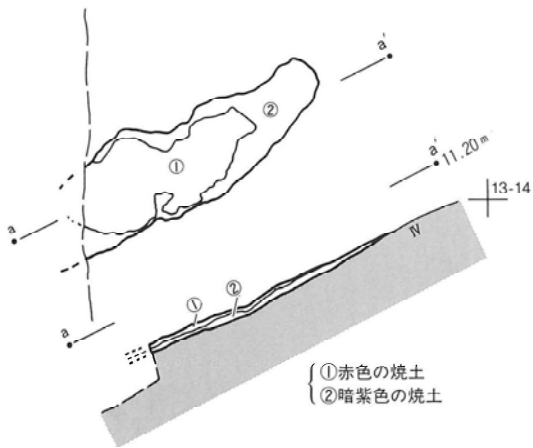

(3) 焼土41

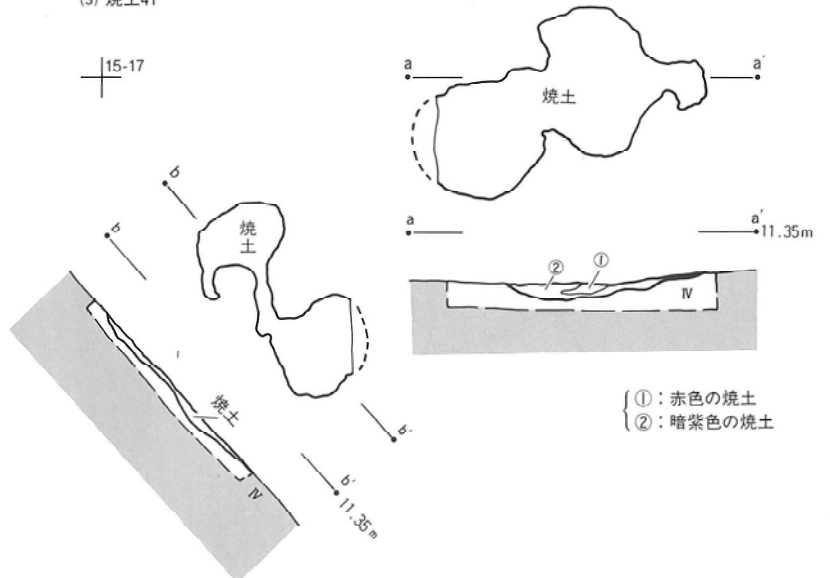



PL. ②-254 焼土分布図 ③

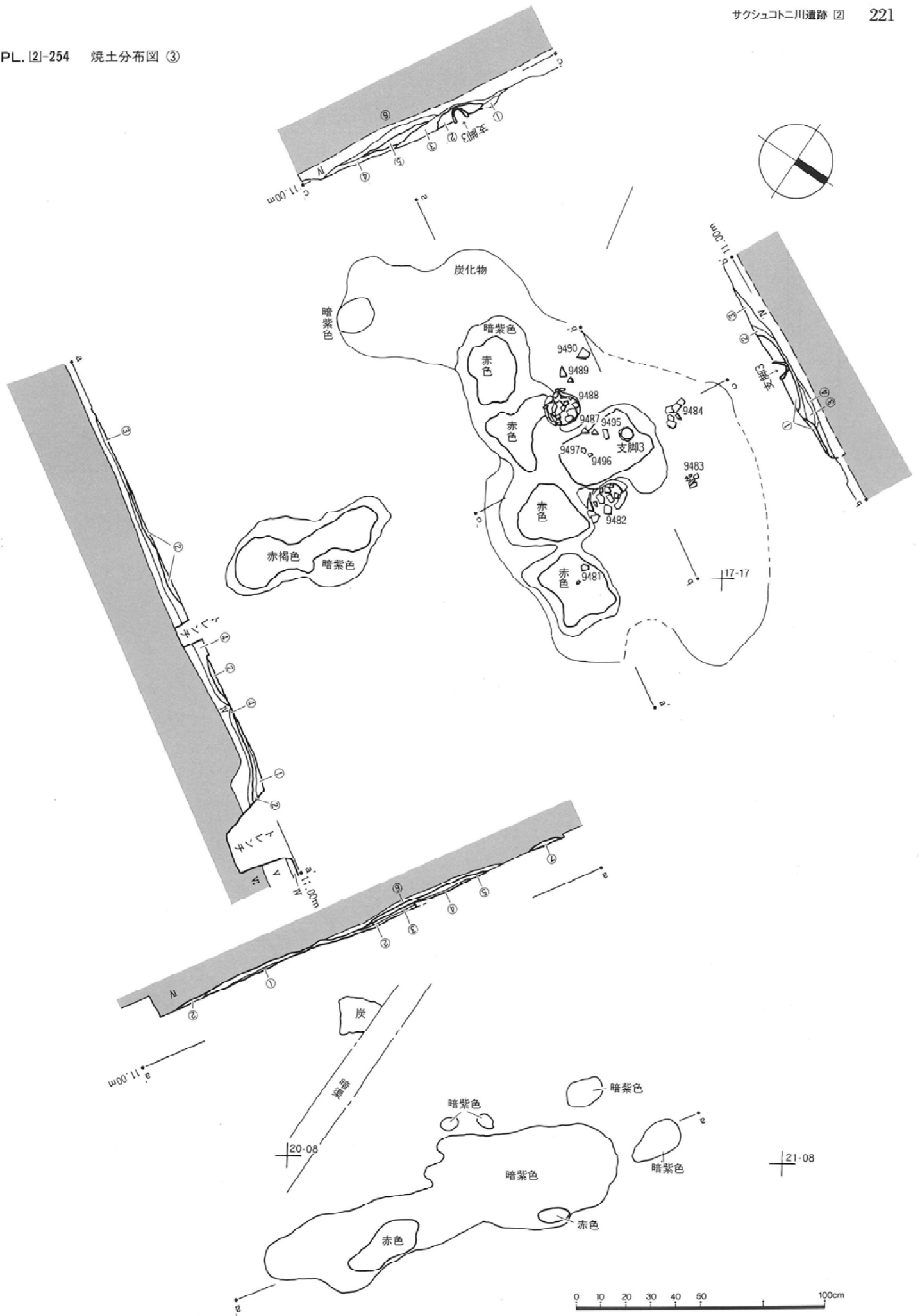

PL. ②-255 焼土分布図 ④ と礫の重量ヒストグラム

(1) 焼土62

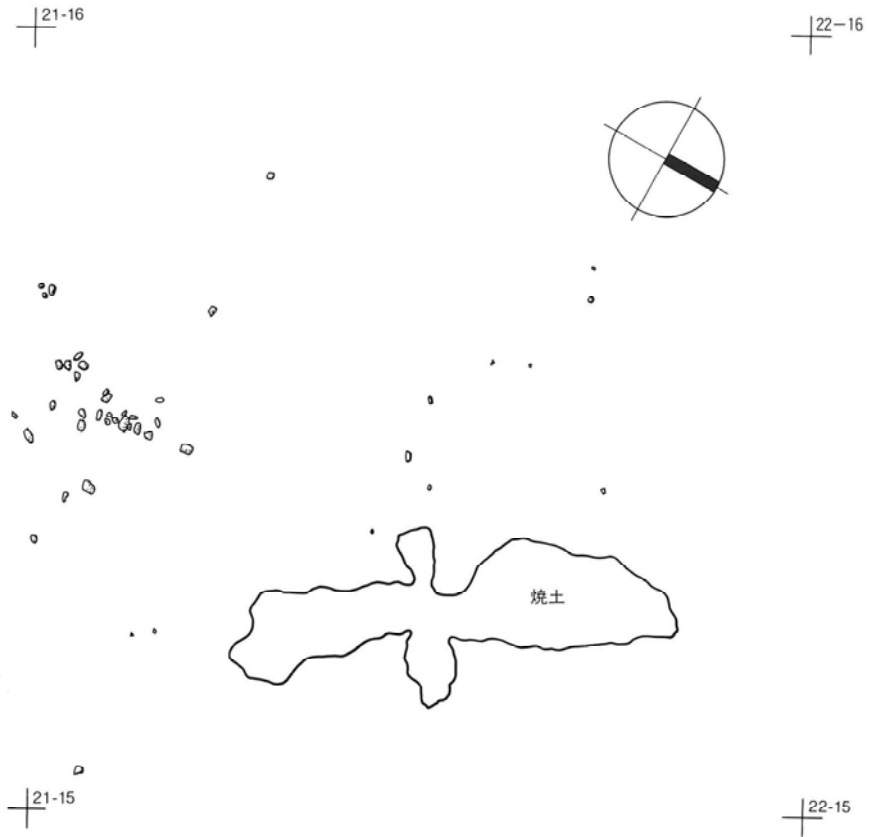
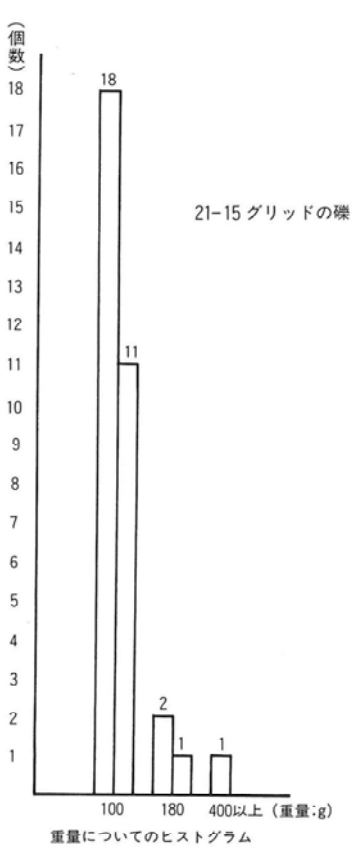

(2) 焼土64

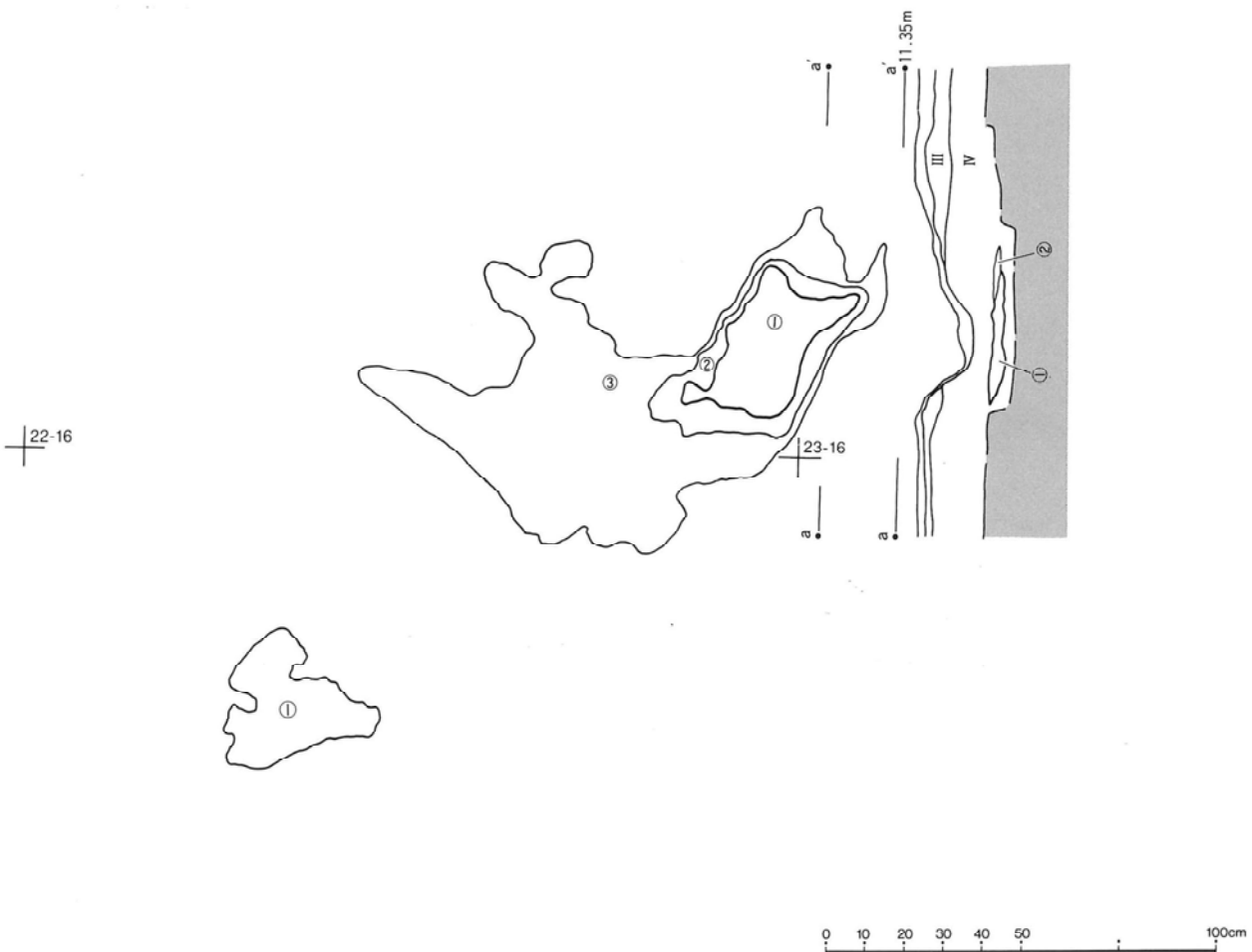

PL. ②-256 焼土・炭化物分布図 ⑤



(1) 焼土68

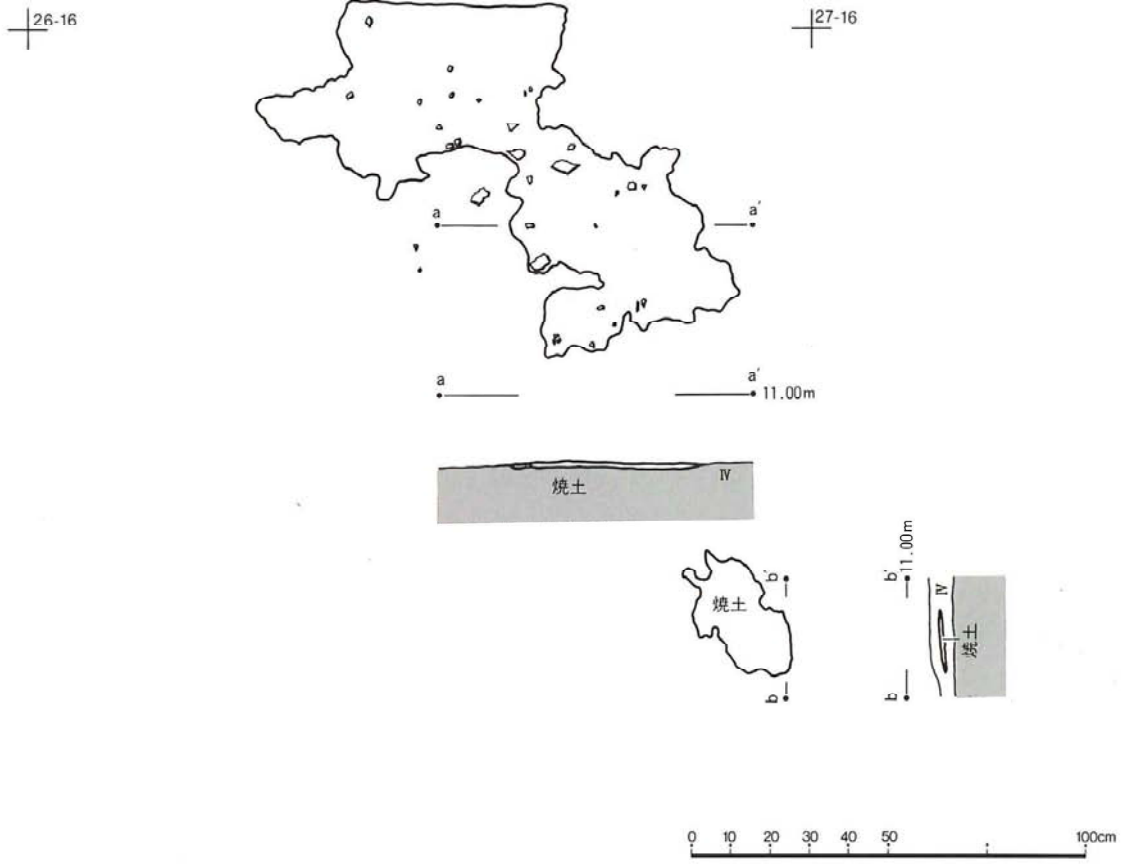

(2) 炭化物・焼土70

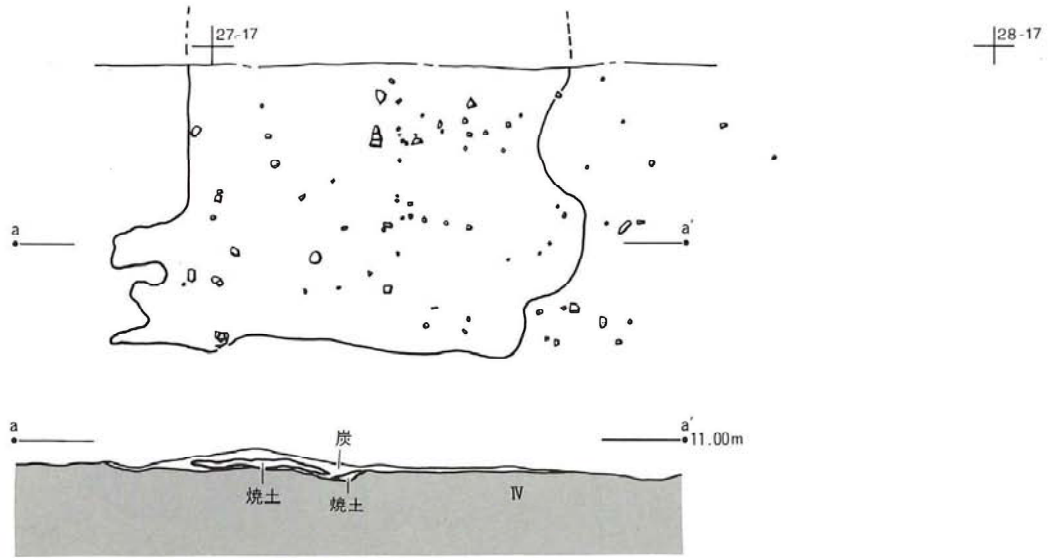

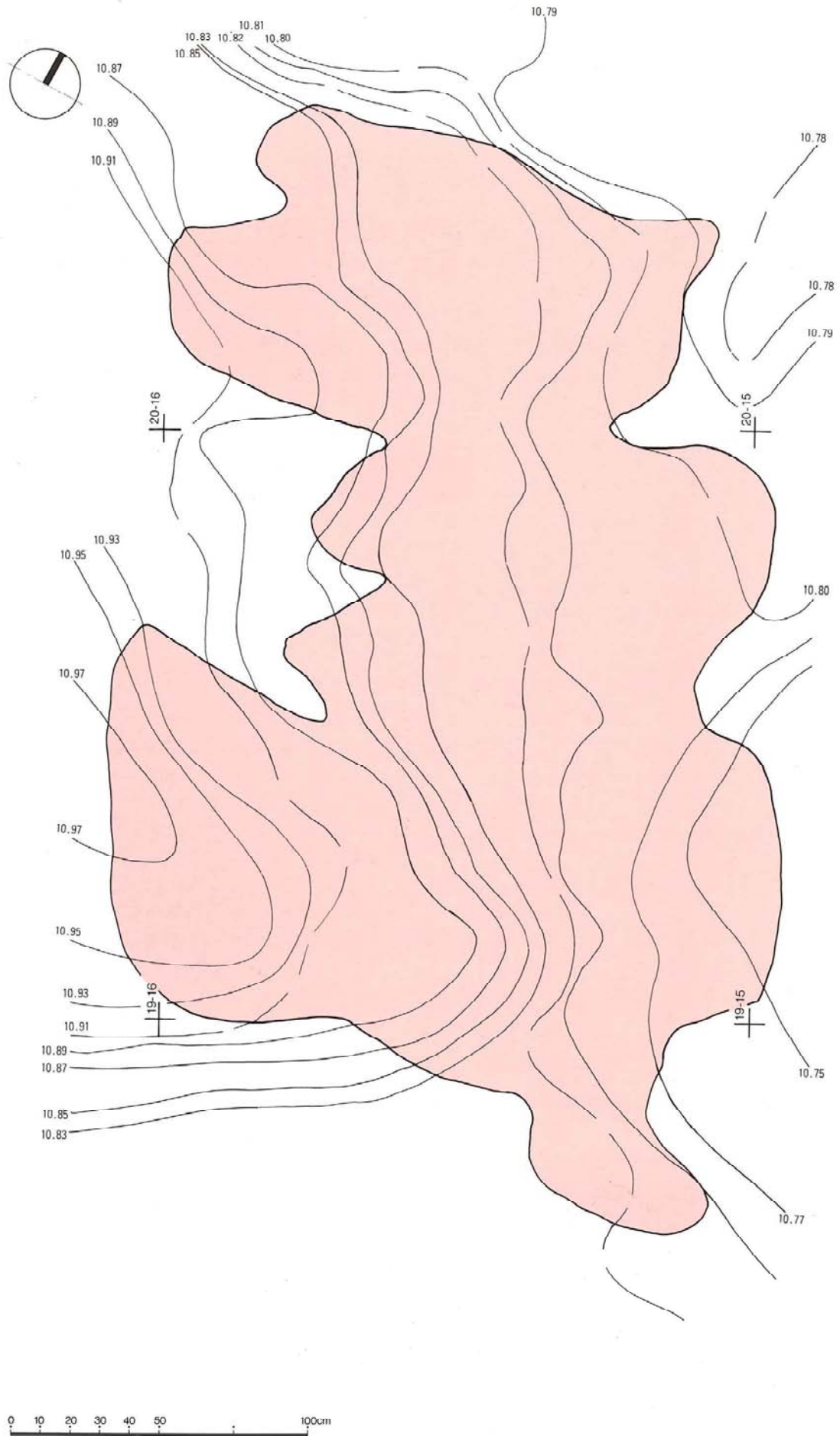



PL. ②-258 焼土・炭化物 ①



焼土10：南からみる

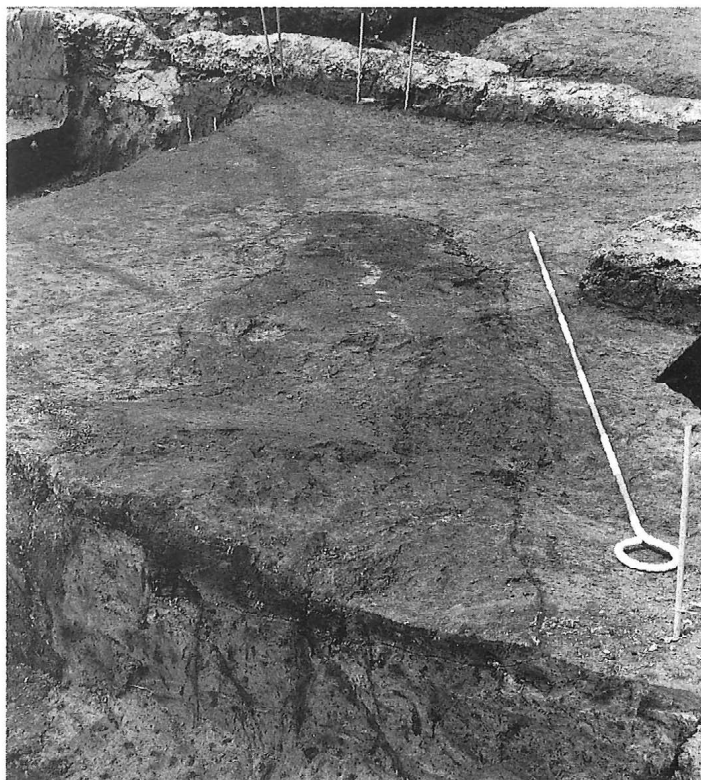

焼土34：北からみる

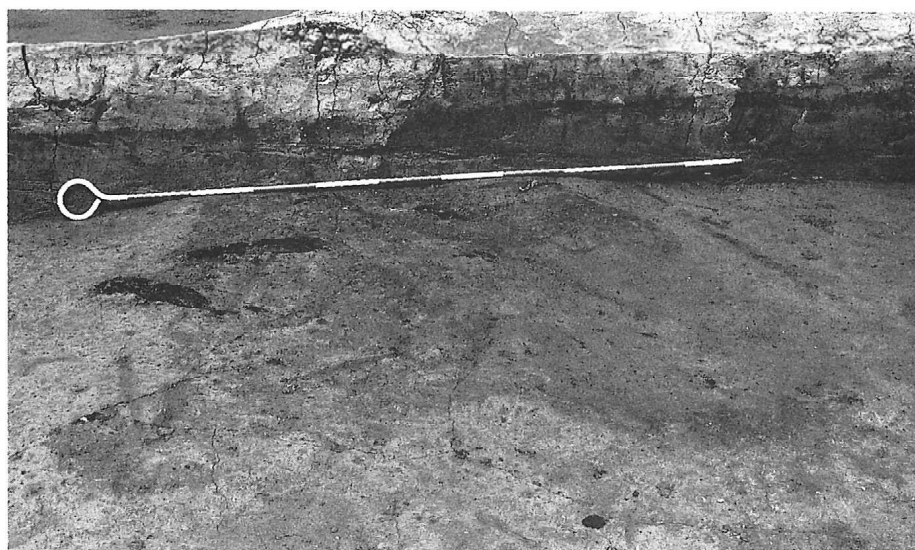

焼土33：北からみる



炭化物39：東からみる



炭化物52の遺物出土状況：南からみる

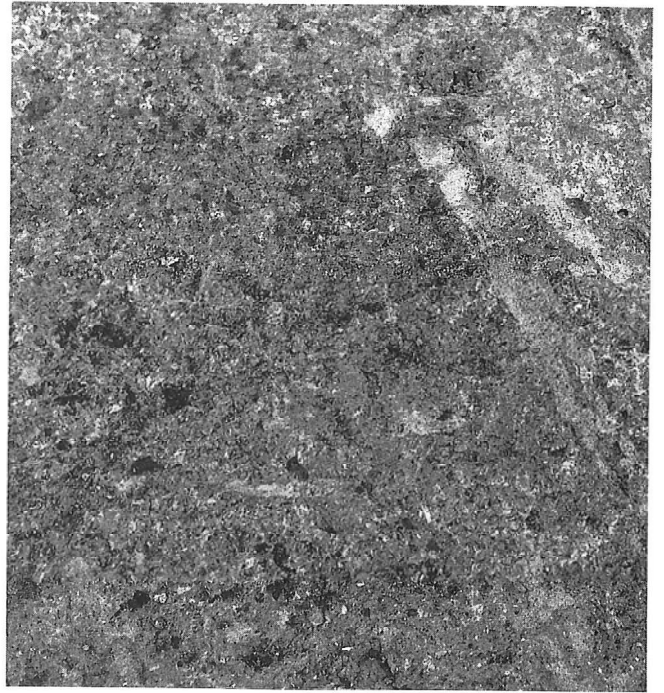

炭化物52の骨片出土状況：南からみる

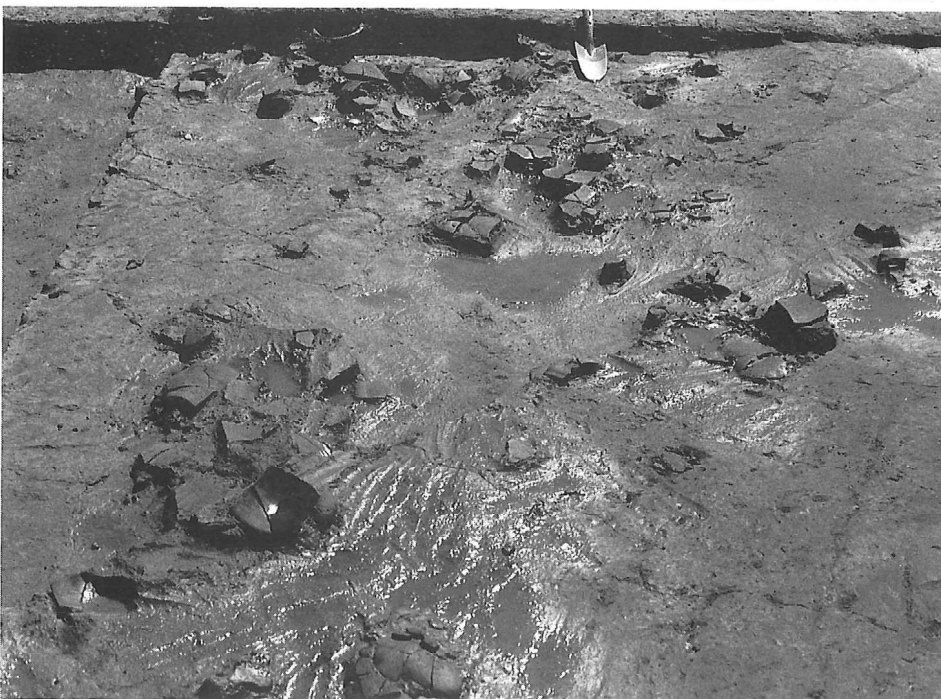

炭化物52の遺物出土状況：南からみる



PL. ②-260 焼土・炭化物 ③



炭化物42：北東からみる



焼土43の遺物出土状況, 中央が支脚3：南からみる



焼土62：北からみる



炭化物・焼土70の遺物出土状況：南からみる

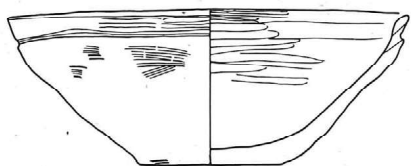

1 (坏11)

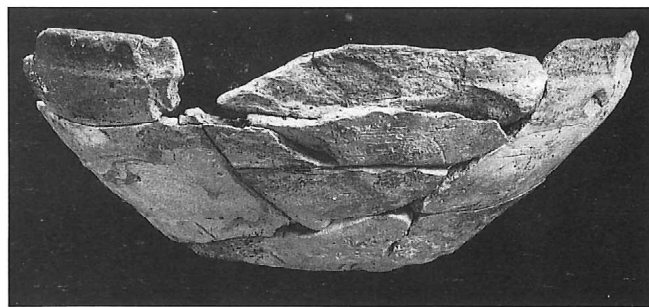

1

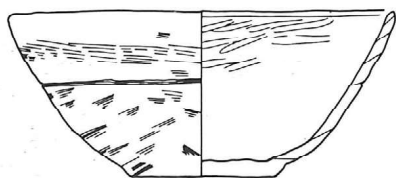

2 (坏27)

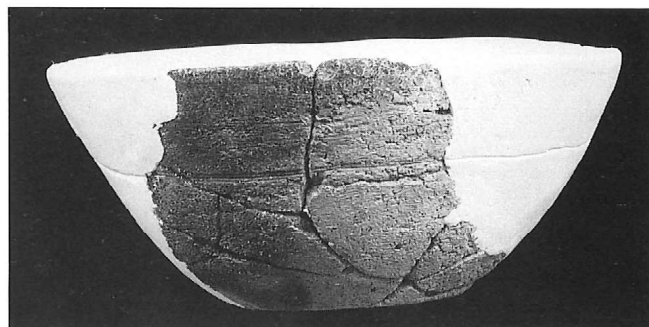

2

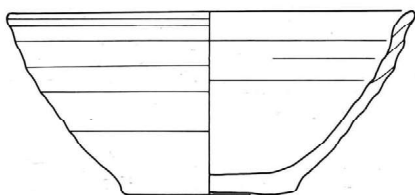

3 (坏38)

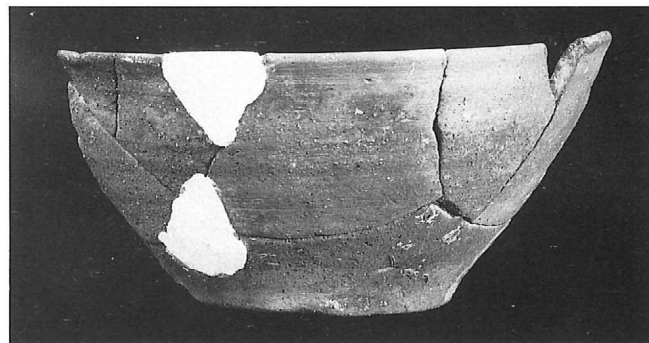

3

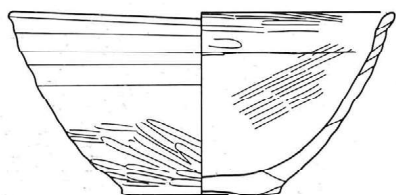

4 (坏40)



5

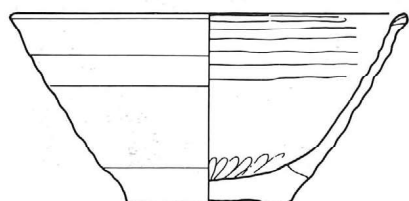

5 (坏44)



6 (坏46)

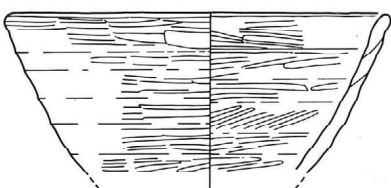

7 (坏65)

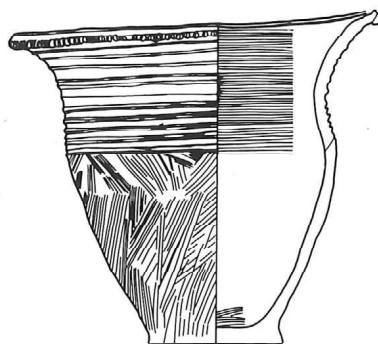

8 (甕3)



8

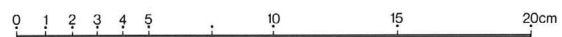



PL. ②-262 焼土・炭化物遺構などからの出土土器 ② [( )内は個体番号]

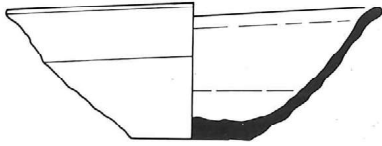

1 (須恵器1)

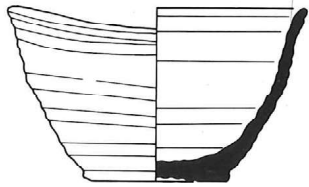

2 (須恵器4)



3 (須恵器5)

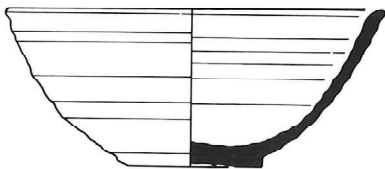

4 (須恵器6)

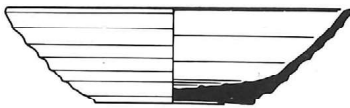

5 (須恵器9)

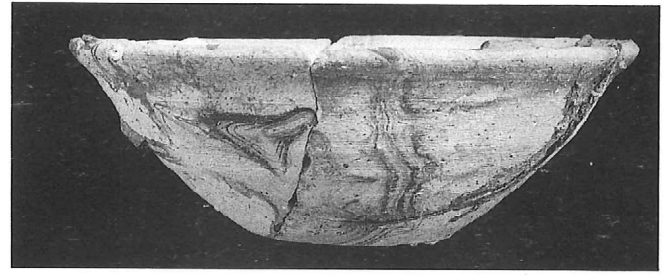

1

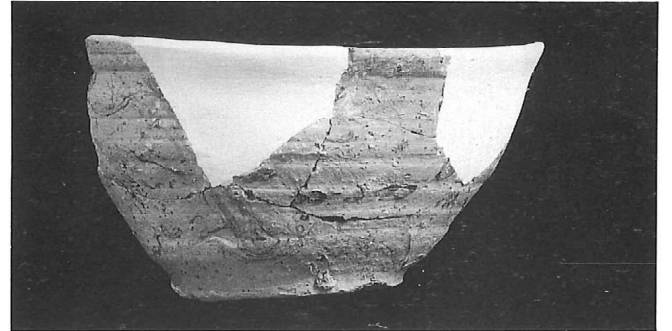

2

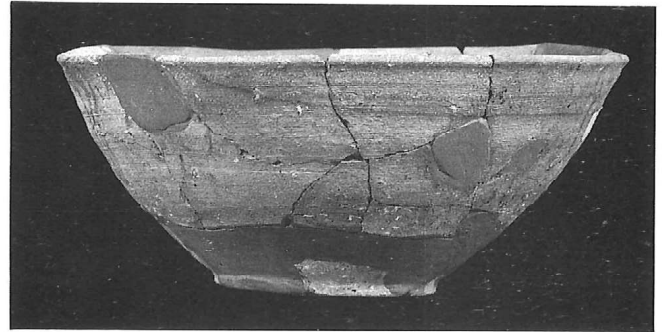

4

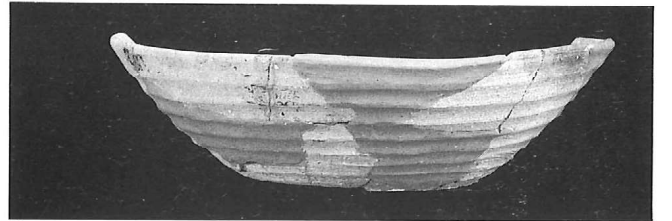

5

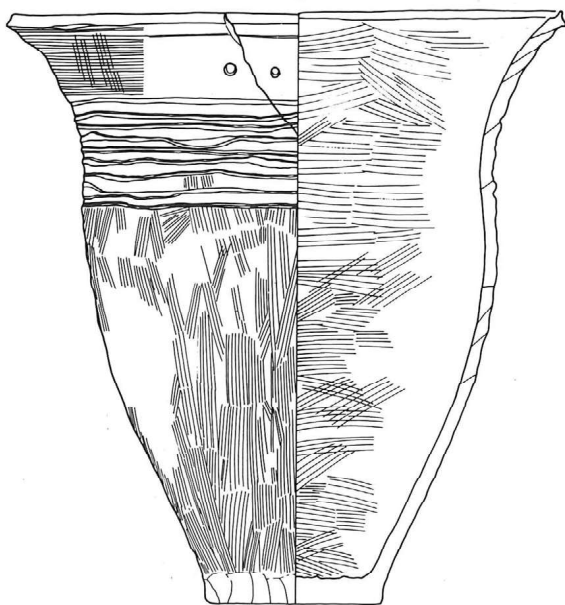
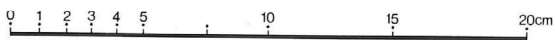

6 (甕19)



6

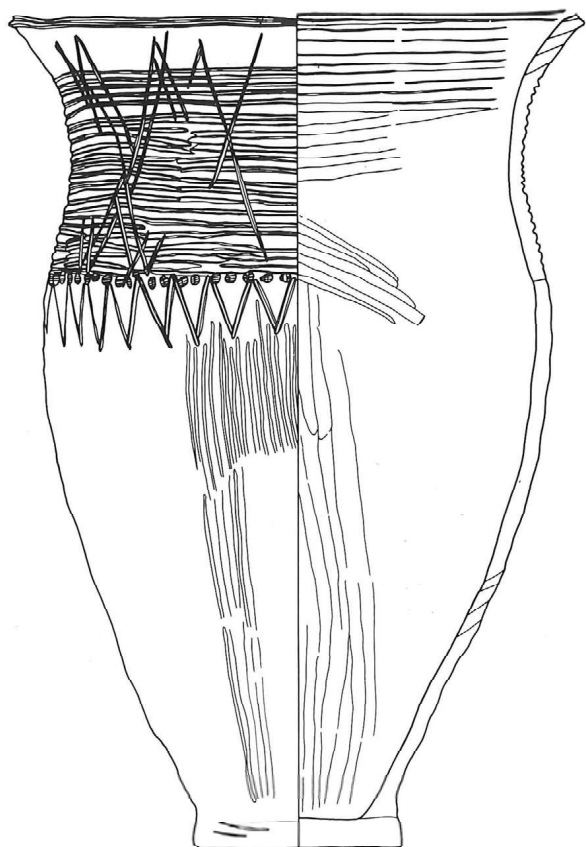

1 (壺25)



1

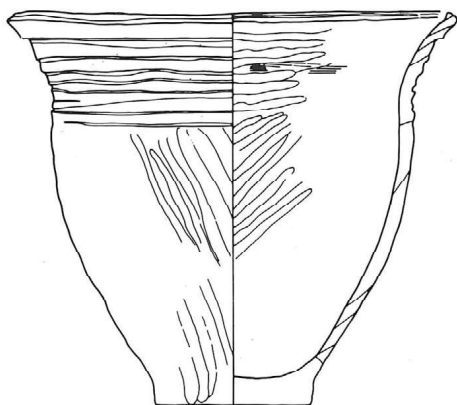

2 (壺155)

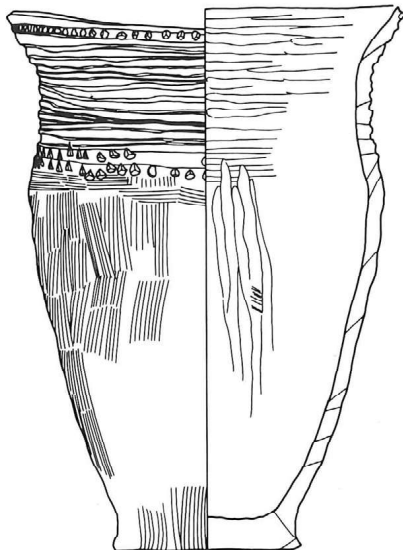

4 (壺153)

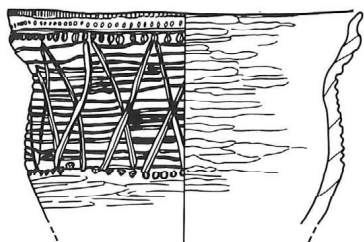

3 (壺84)



4

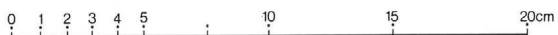

PL. ②-264 焼土・炭化物遺構などからの出土土器 ④ [( )内は個体番号]

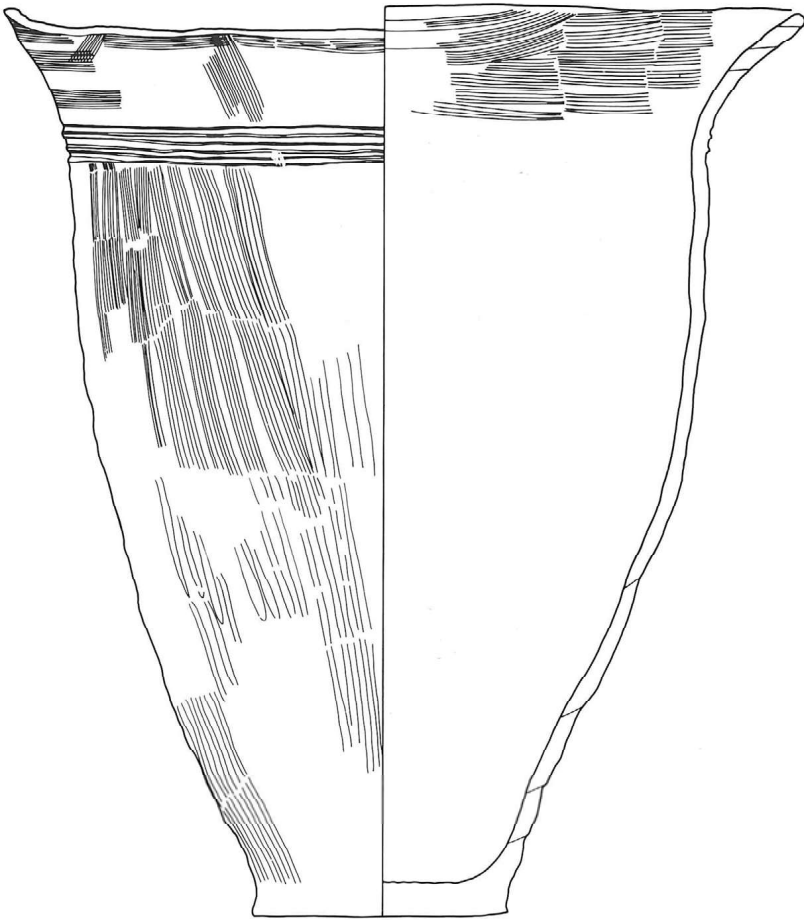

1 (壺11)

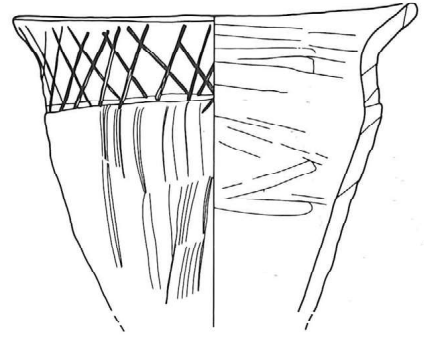

2 (壺51)

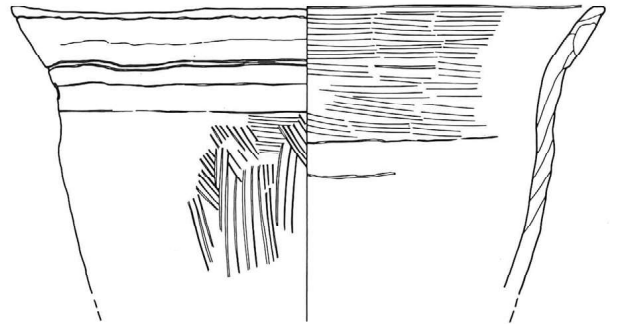

3 (壺182)

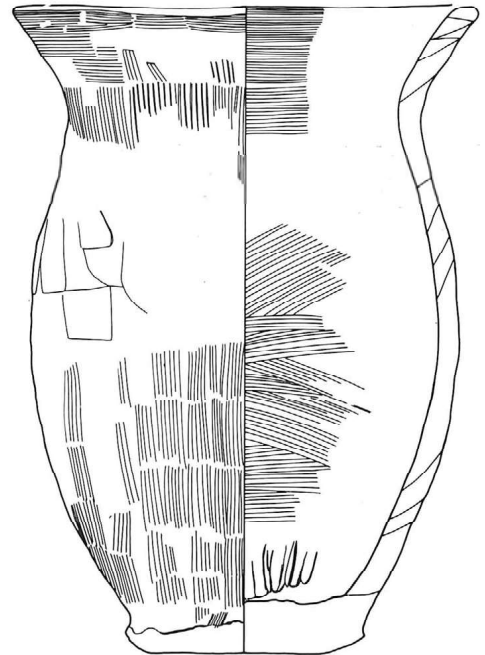

4 (壺152)



1

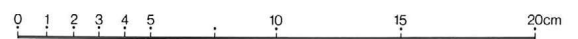

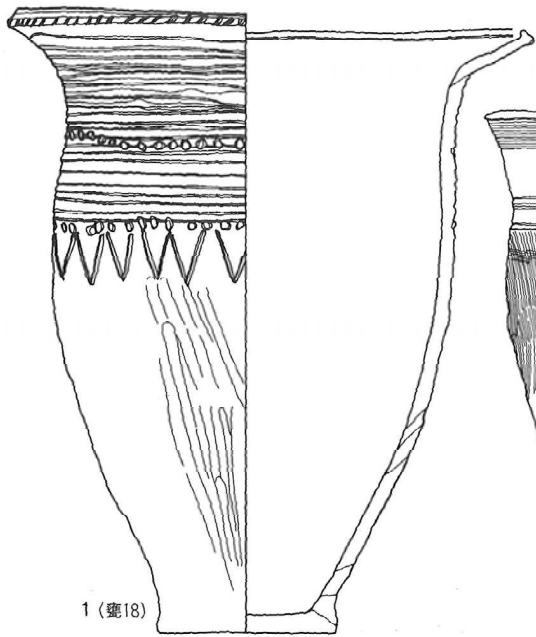

1 (壺18)

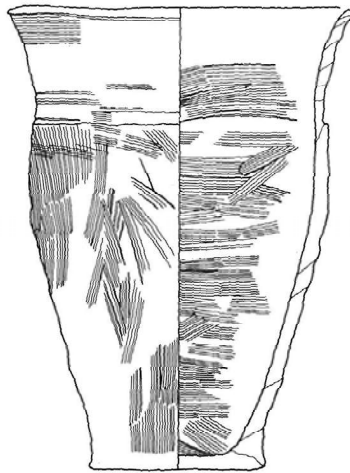

2 (壺169)

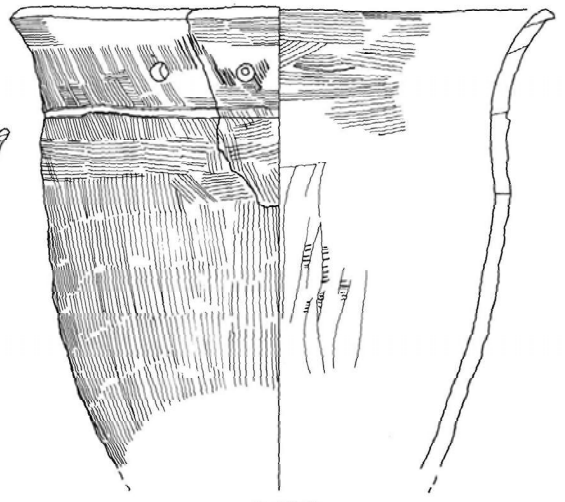

3 (壺47)

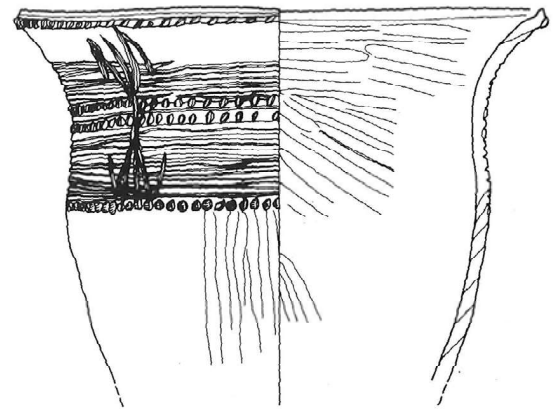

6 (壺50)

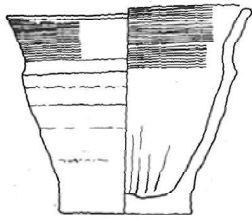

4 (壺5)

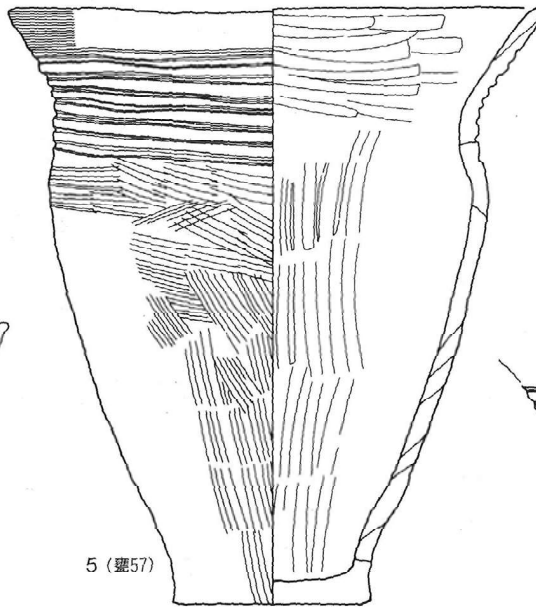

5 (壺57)

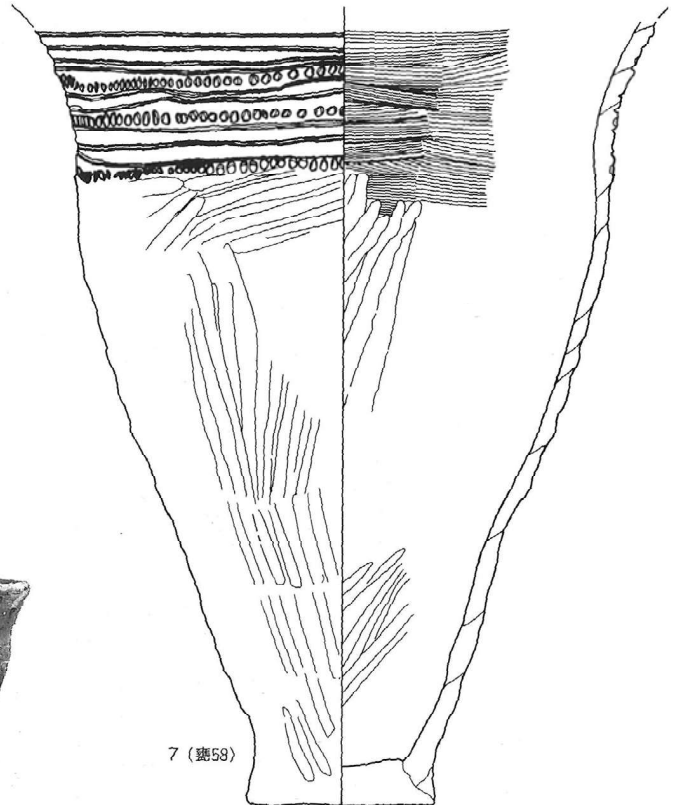

7 (壺58)



1



4

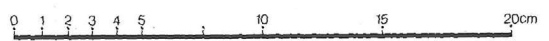



PL. ②-266 炭化物52などからの出土土器 ① [( )内は個体番号]

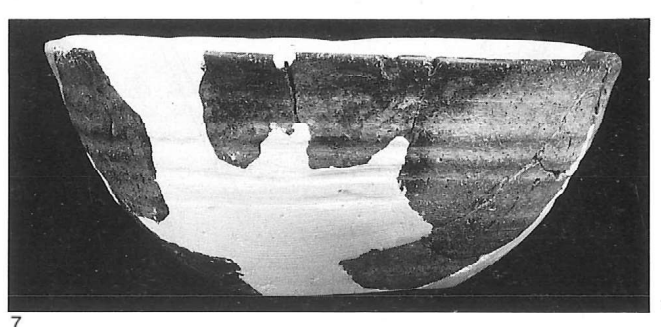
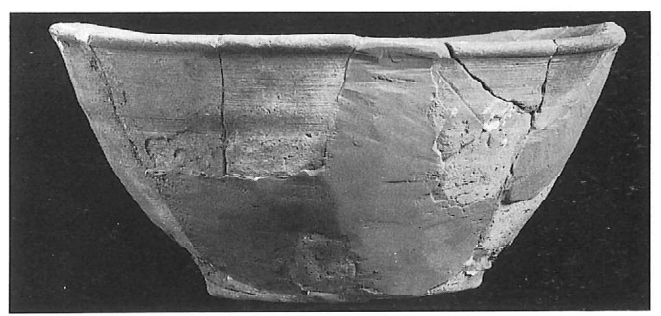
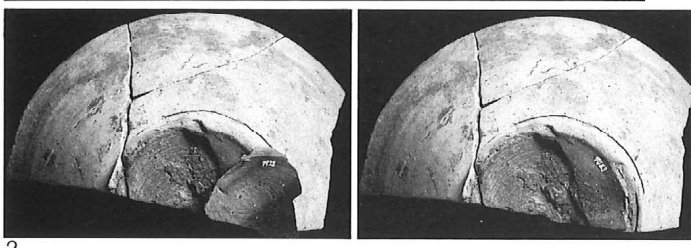
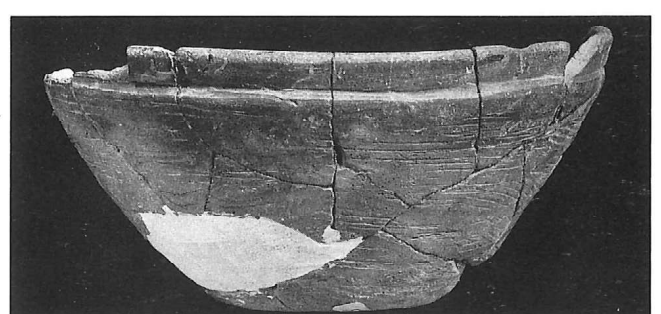
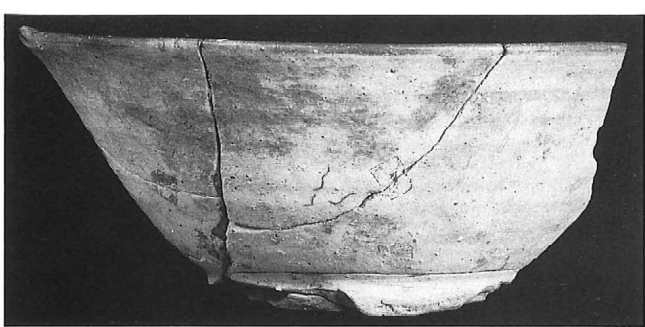
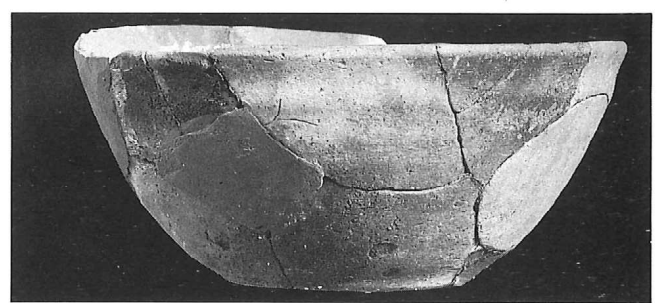
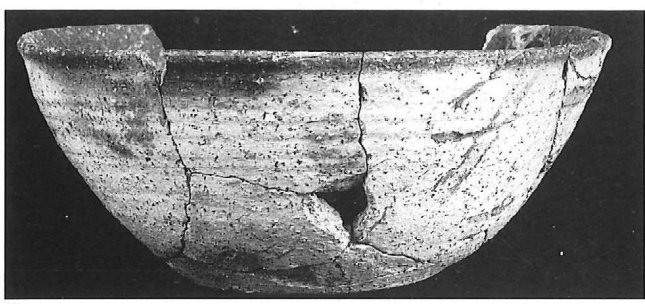
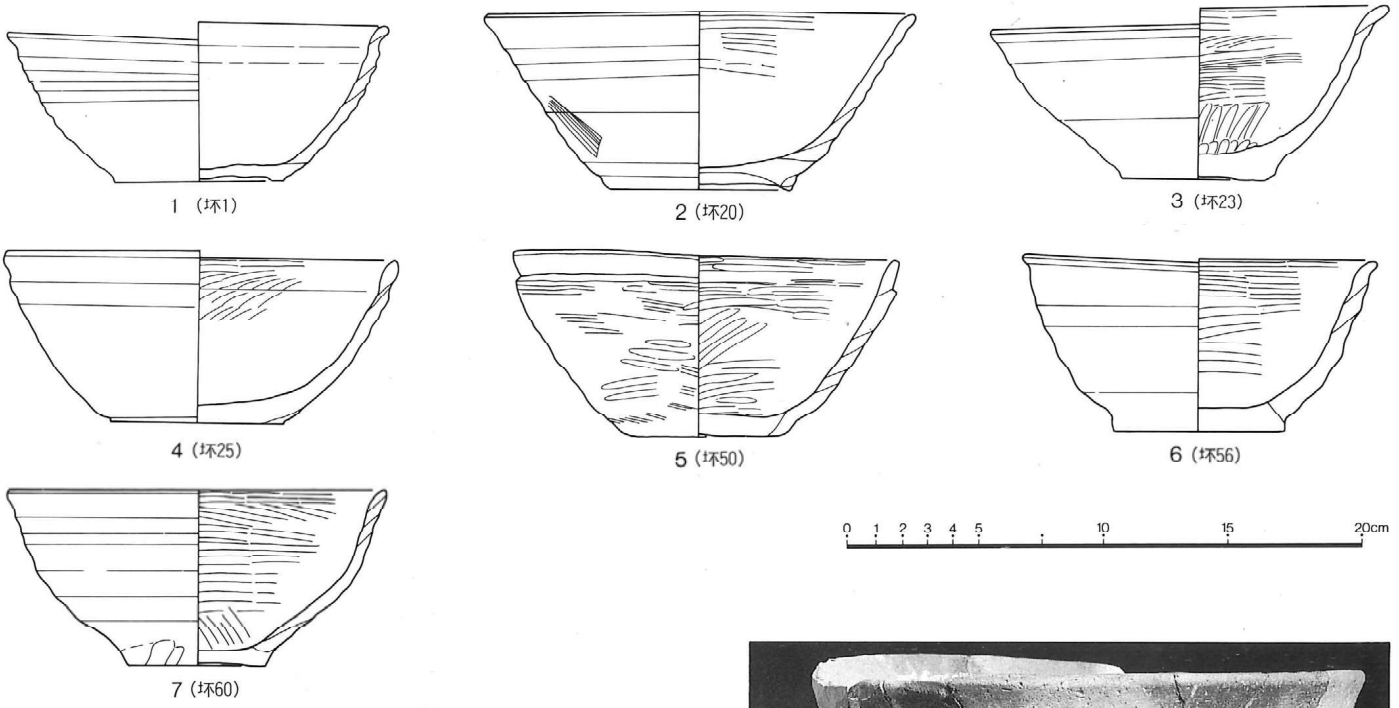

PL. ②-267 炭化物52などからの出土土器 ② [( )内は個体番号]

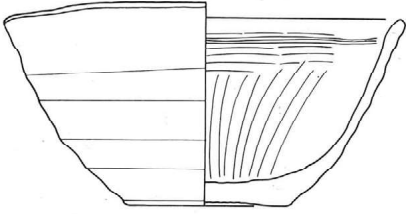

1 (坏34)

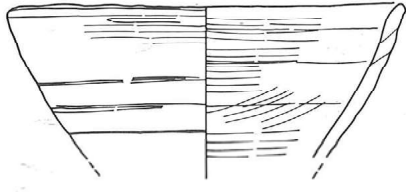

2 (坏64)

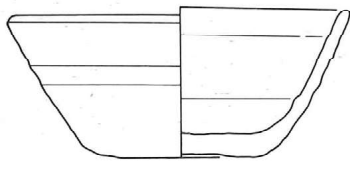

3 (坏113)

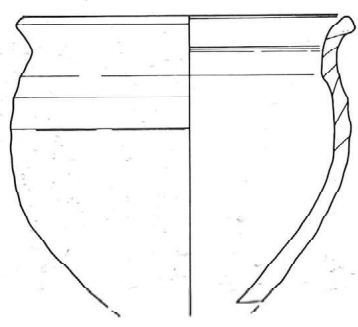

4 (甕88)



5

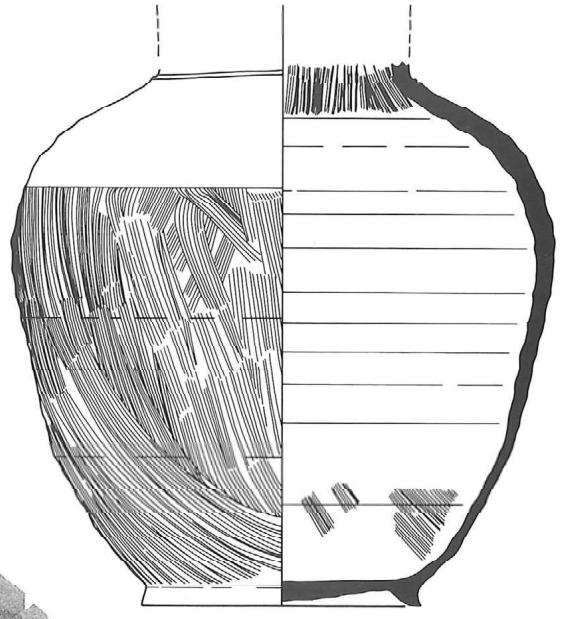

5 (須恵器8)



4

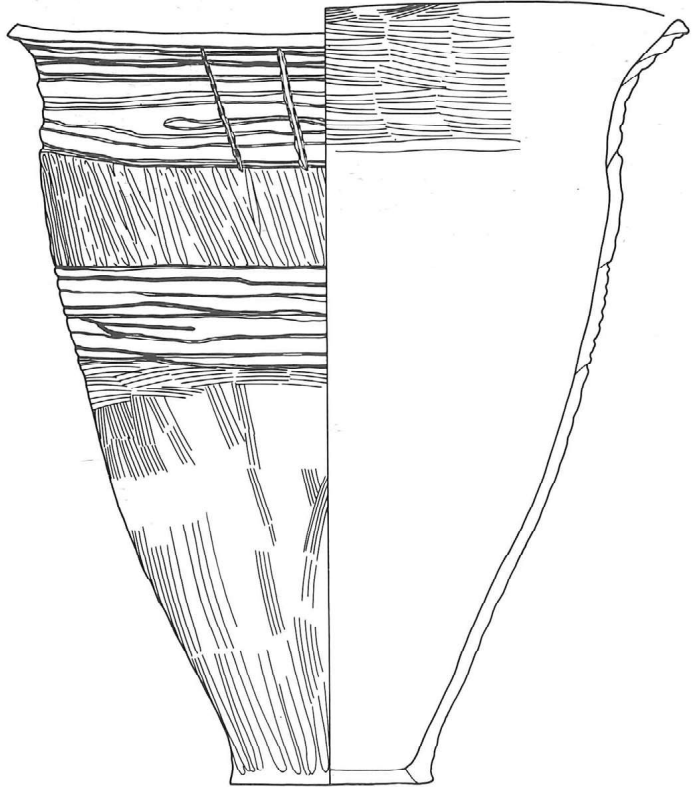

6 (甕26)



6

PL. ②-268 遺構外からの出土土器 ① [( )内は個体番号]

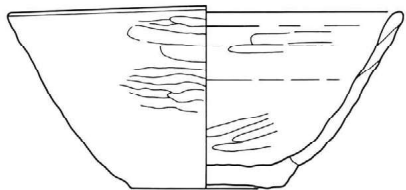

1 (坏3)



1

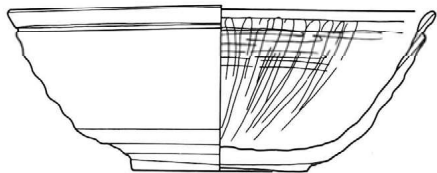

2 (坏7)



3

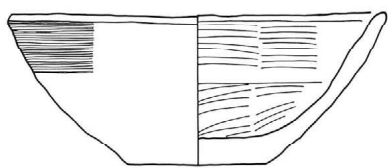

3 (坏14)



4

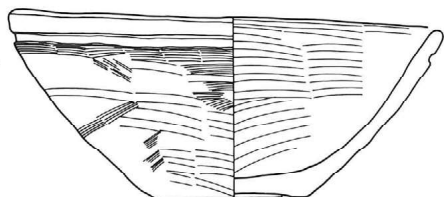

4 (坏15)

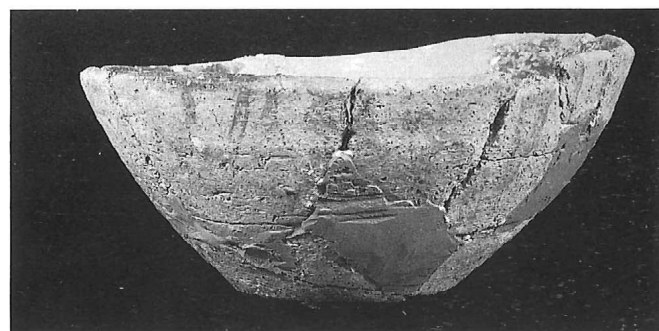

7

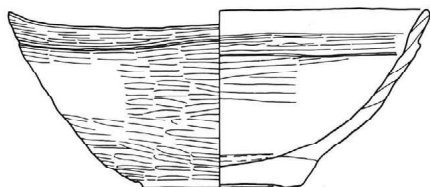

5 (坏39)

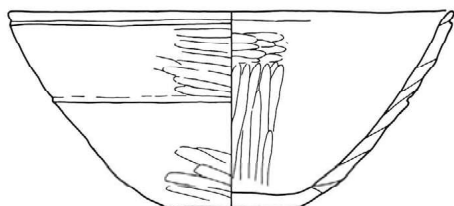

6 (坏52)

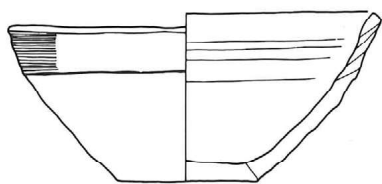

7 (坏57)

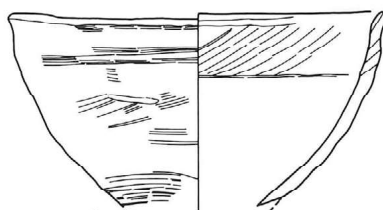

8 (坏59)

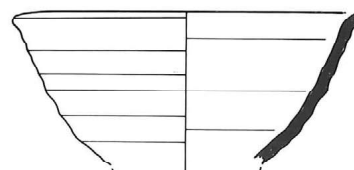

9 (須恵器12)



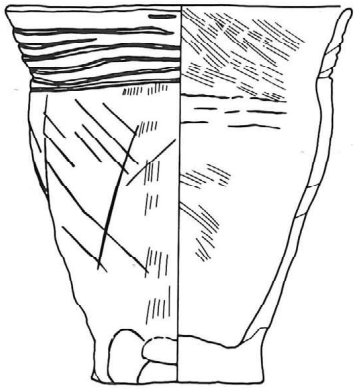

1 (甕13)



1

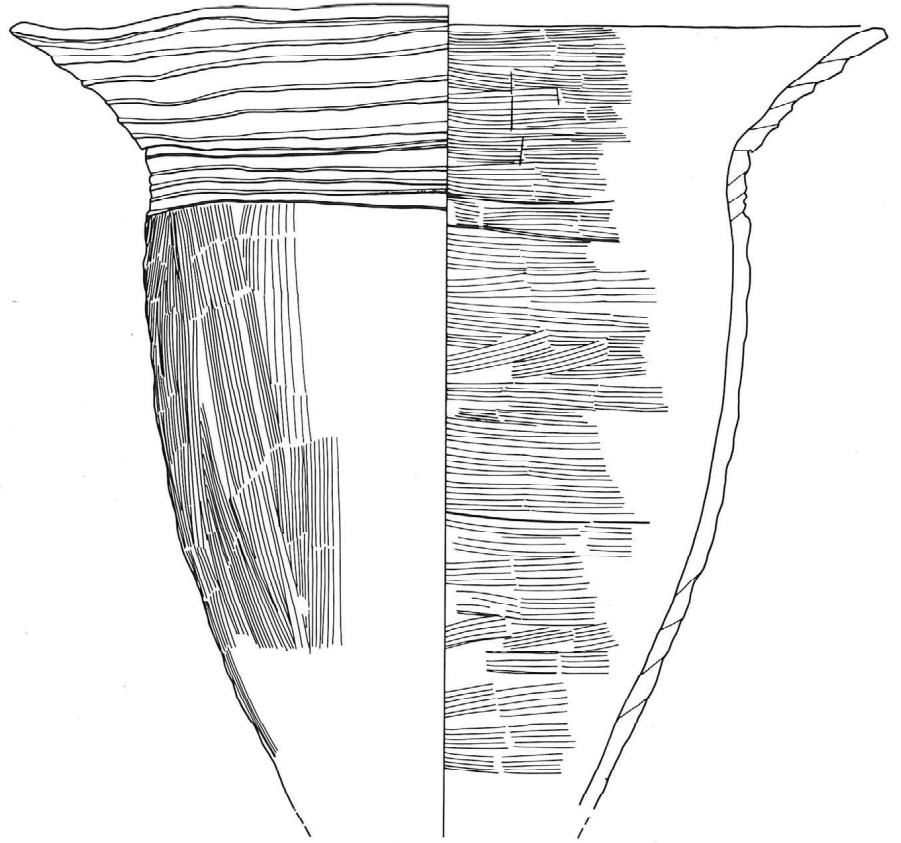

2 (甕79)

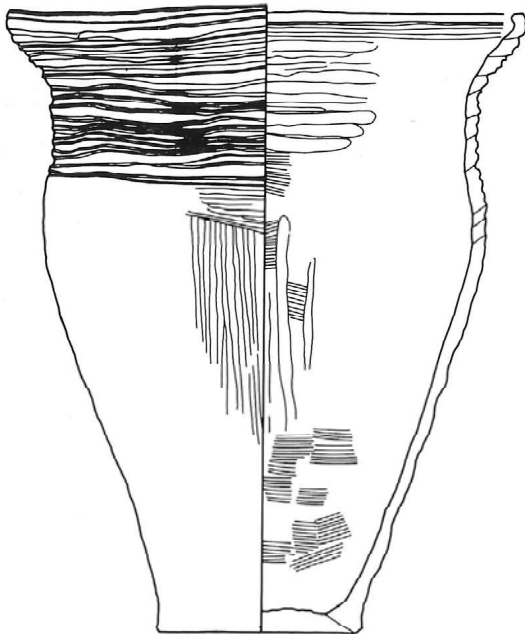

3 (甕154)





PL. ②-270 個体番号9の破片分布図

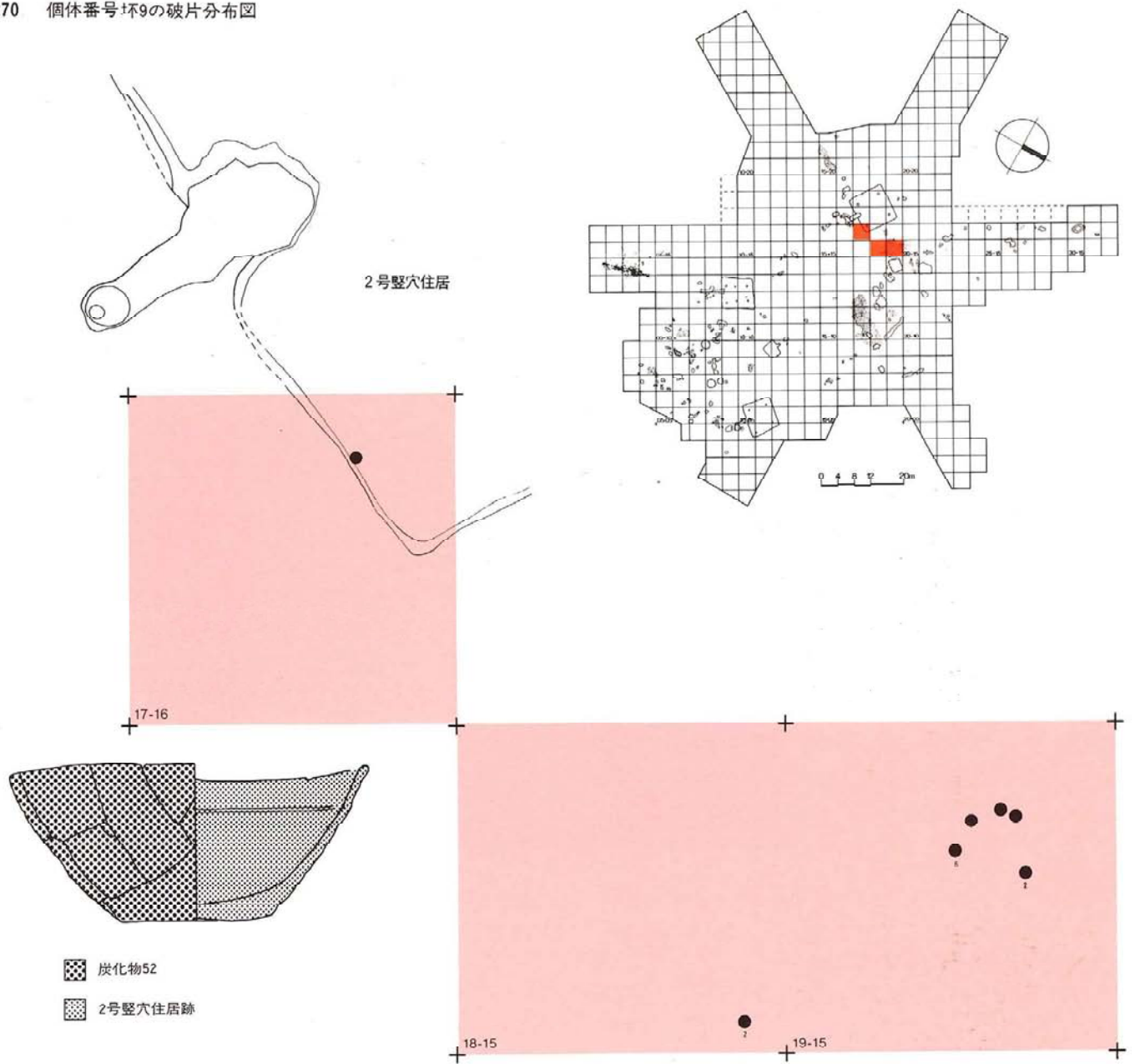

PL. 2-271 個体番号坏IIの破片分布図

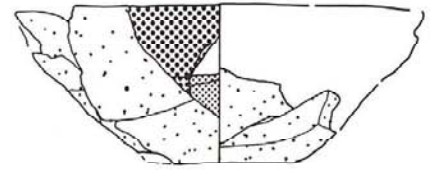
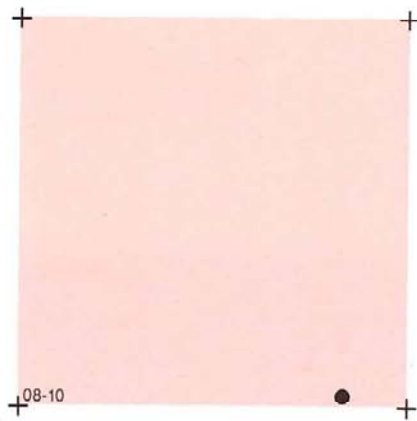
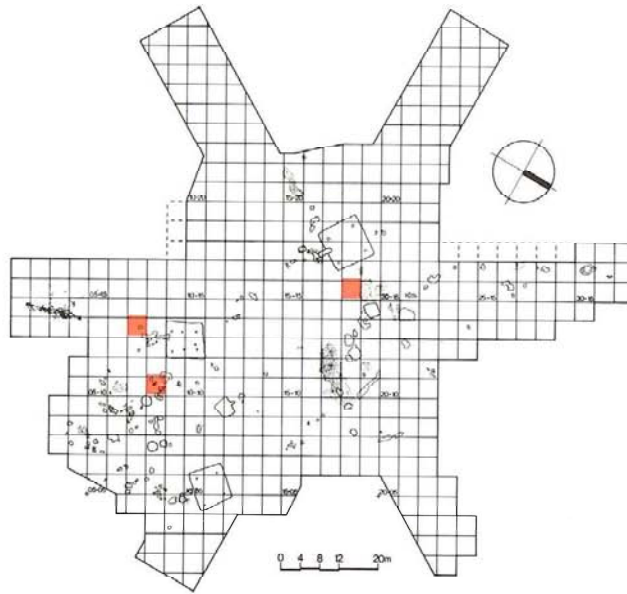

-  焼土24
-  焼土20・21
-  遺構外

PL. 2-272 個体番号坏46の破片分布図

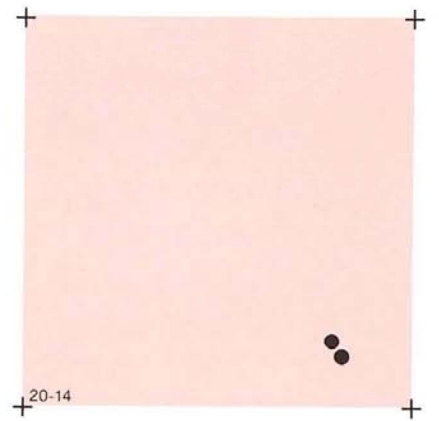
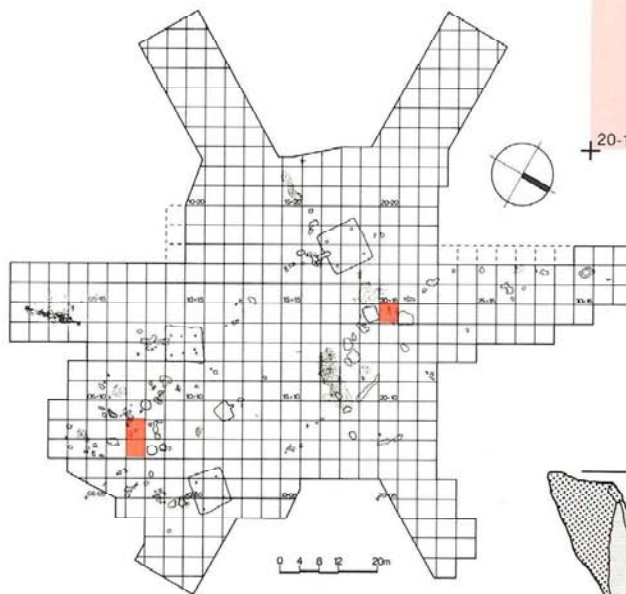
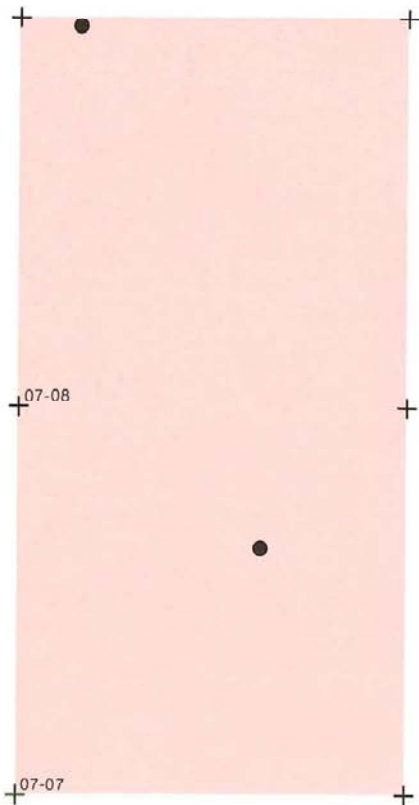

-  炭化物19
-  焼土61
-  遺構外

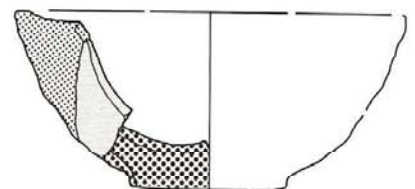

PL. ②-273 個体番号25の破片分布図

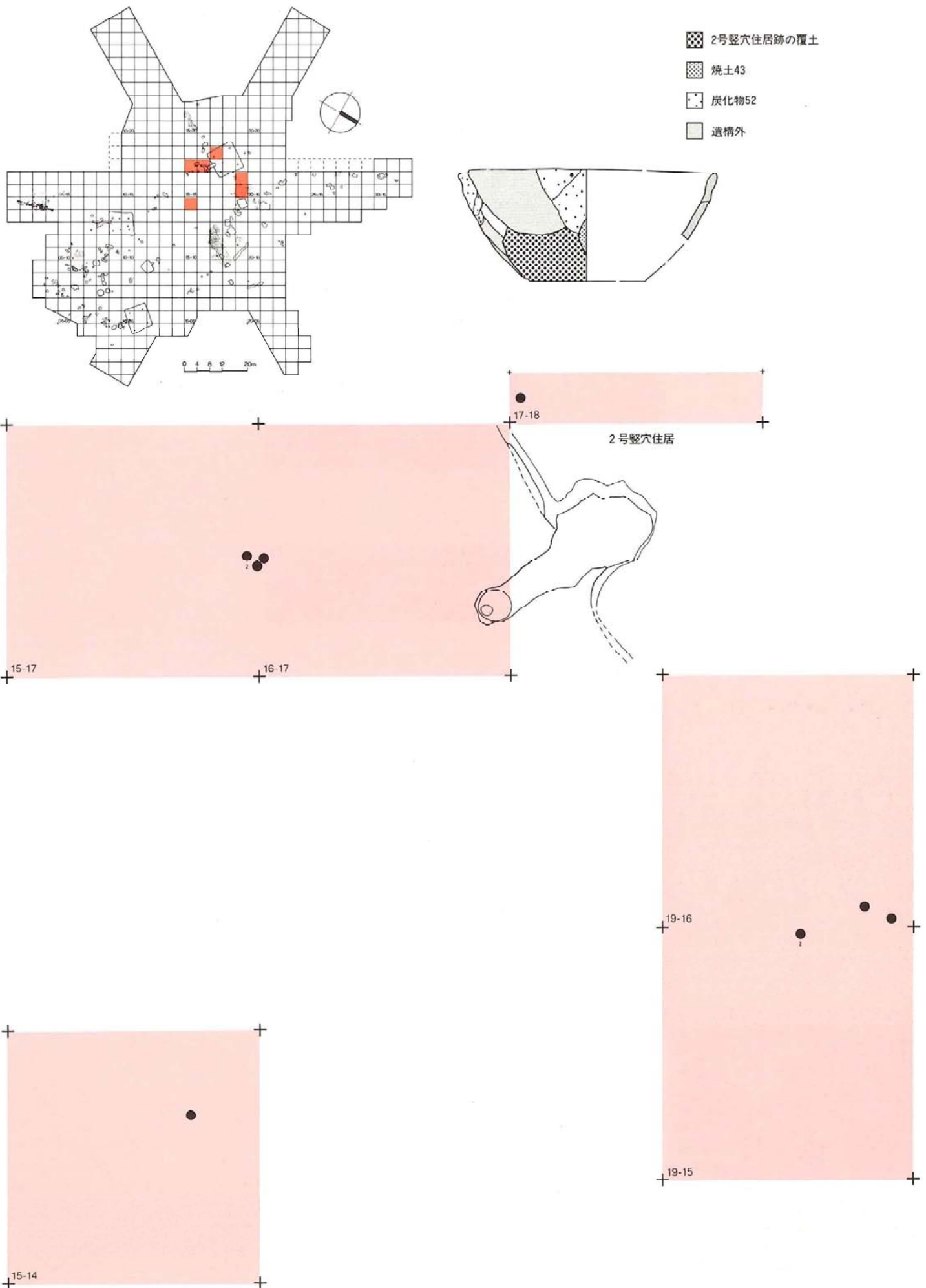

PL. 274 个体番号 坏38の破片分布图

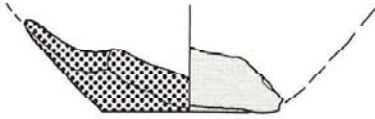
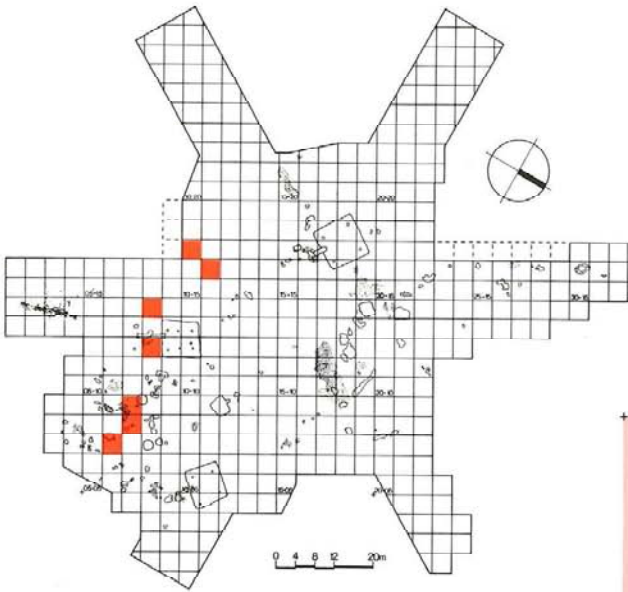

黄土27  
遺構外

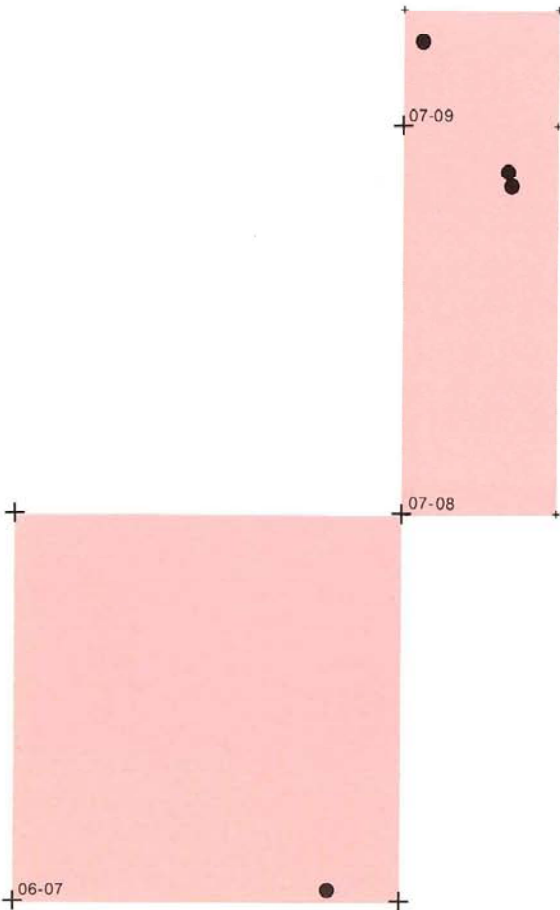
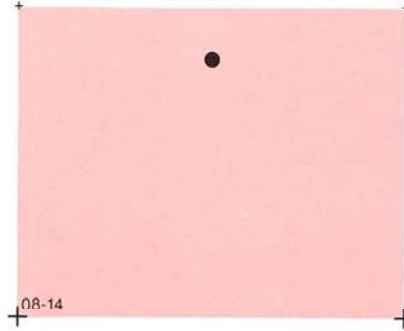
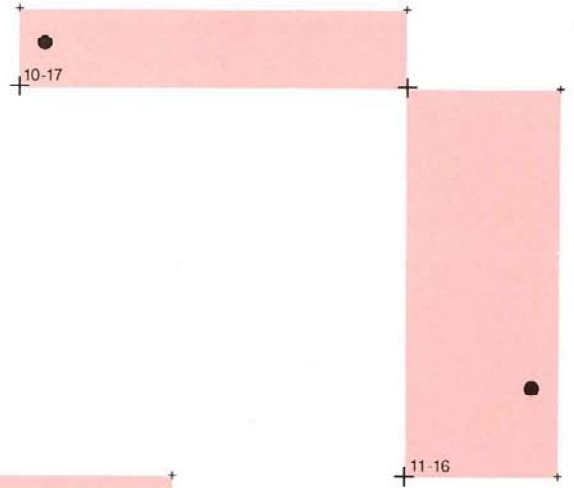



PL. 2-275 個体番号49の破片分布図

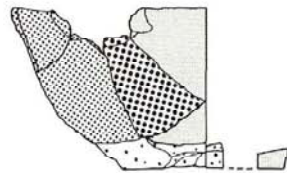
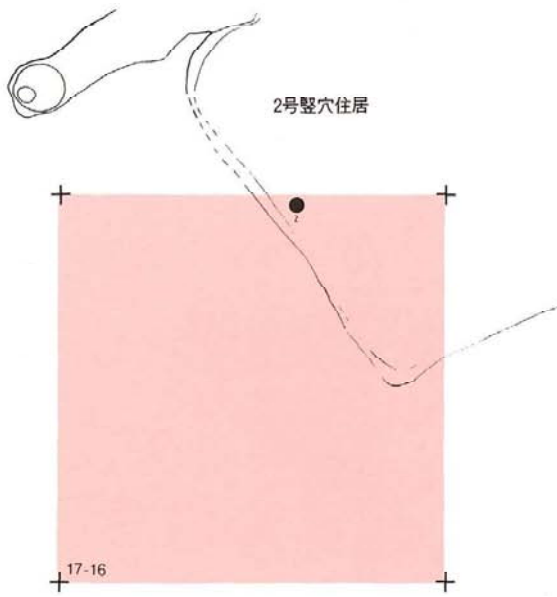

-  2号竪穴住居跡
-  炭化物52
-  焼土30
-  遺構外

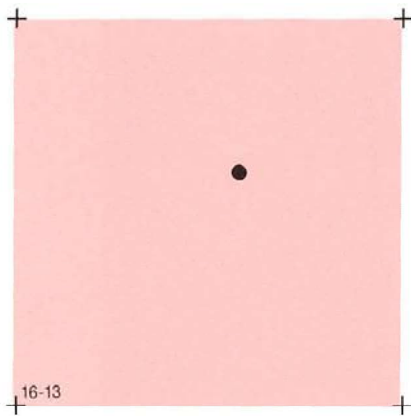
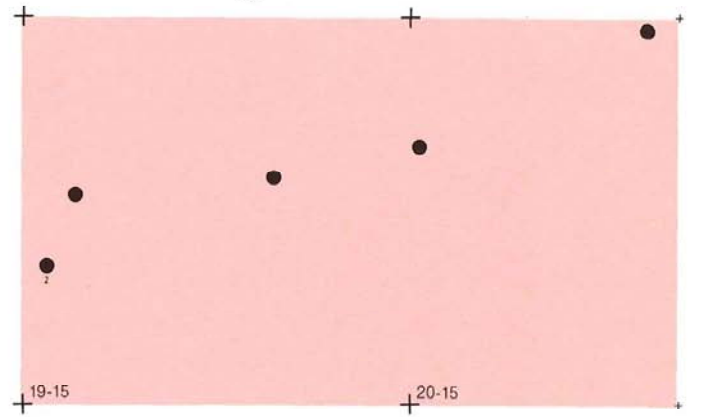
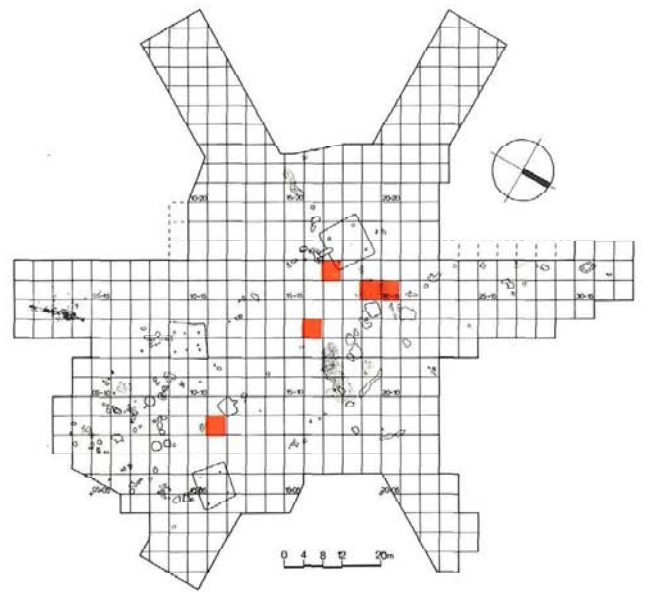

PL. 276 个体番号 60 の破片分布図

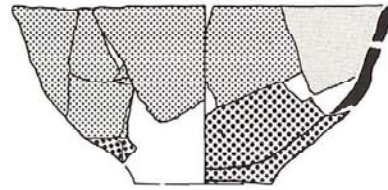
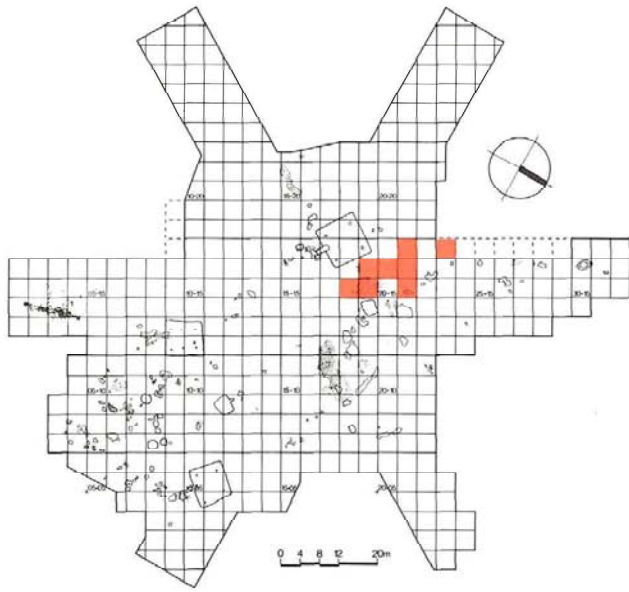

- 炭化物52
- 焼土62
- 遺構外

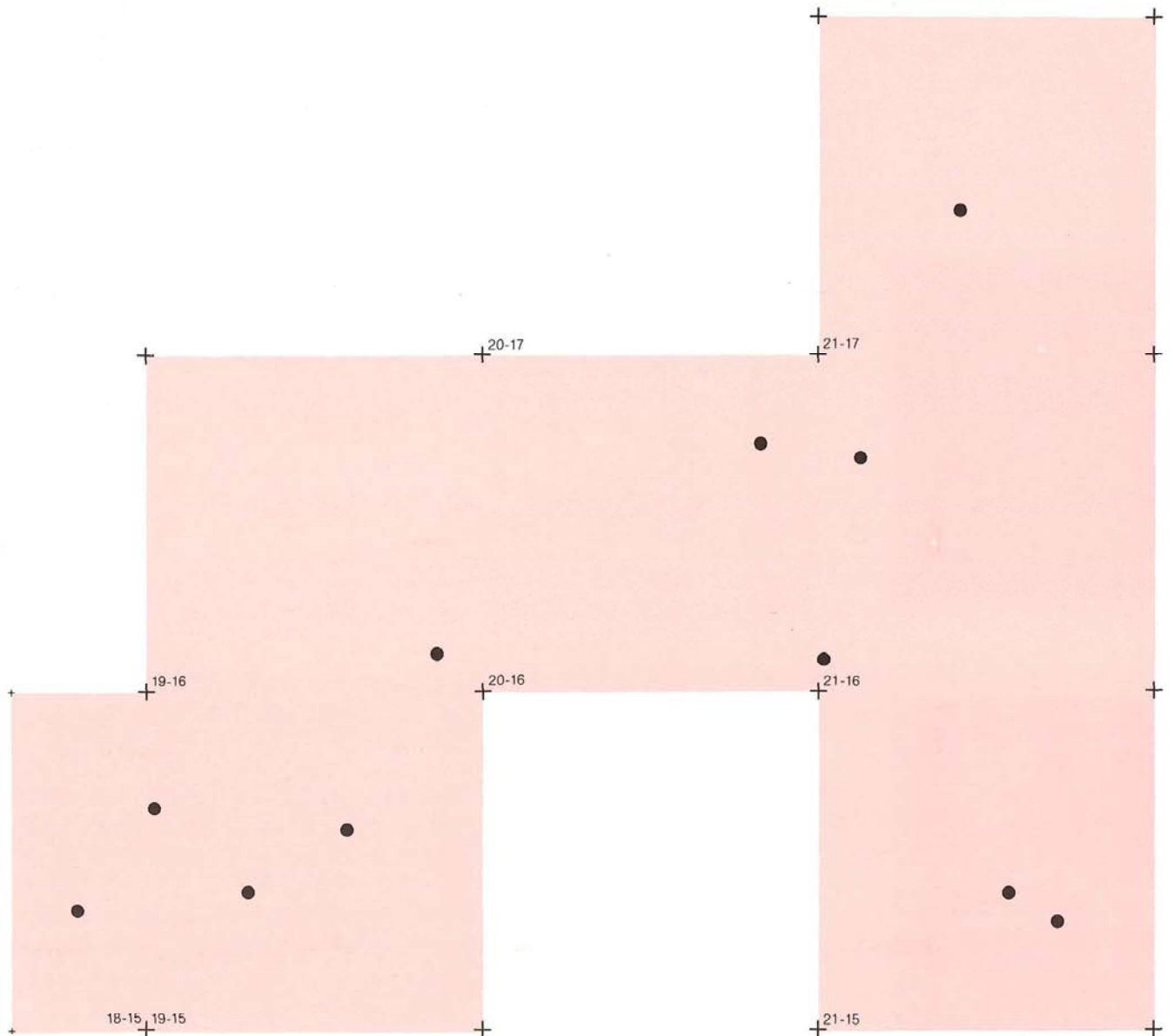

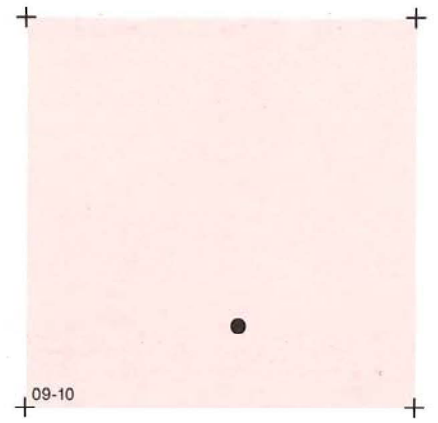
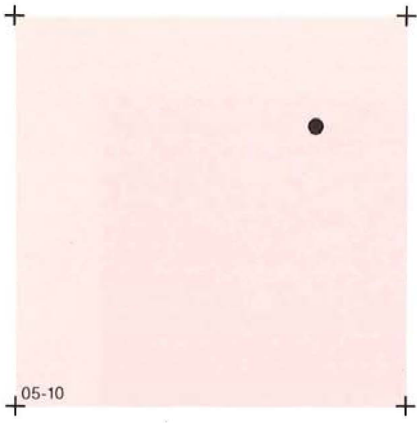

PL. 277 个体番号 76 の破片分布図

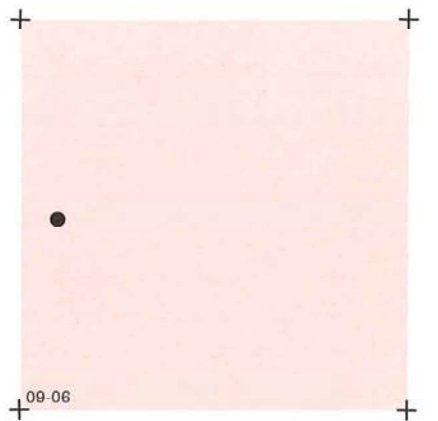
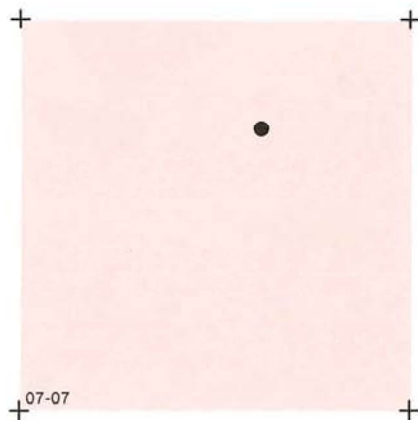
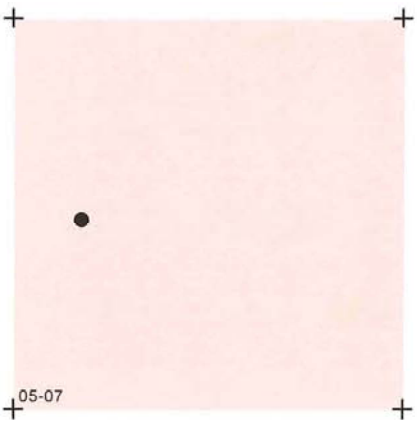
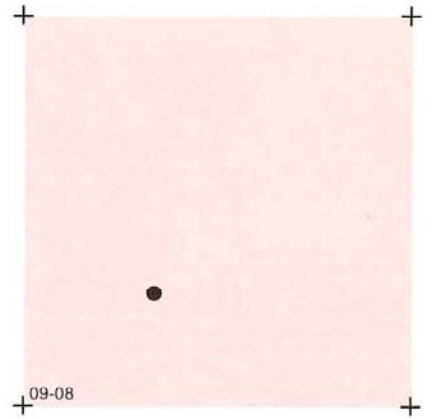
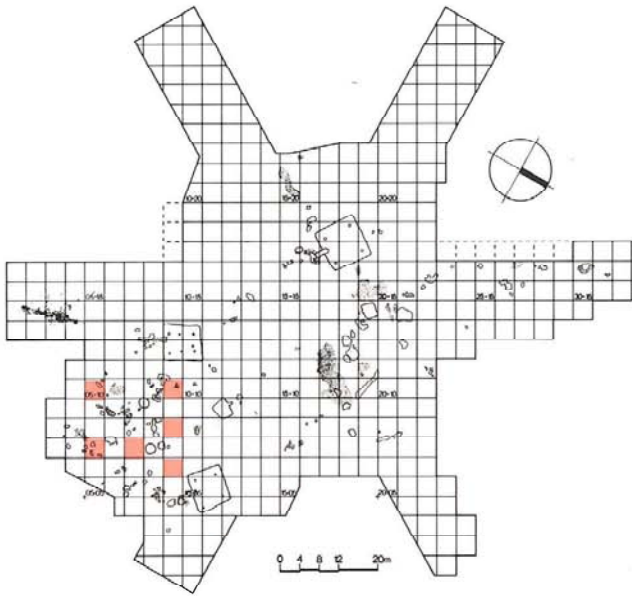

PL. 278 个体番号环78の破片分布図

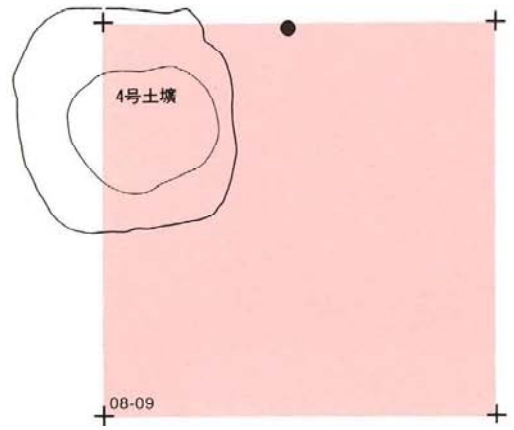
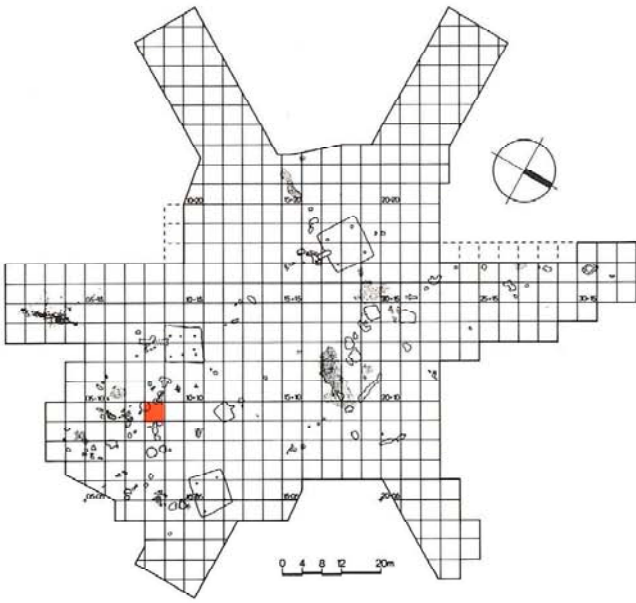

PL. 279 个体番号环84の破片分布図

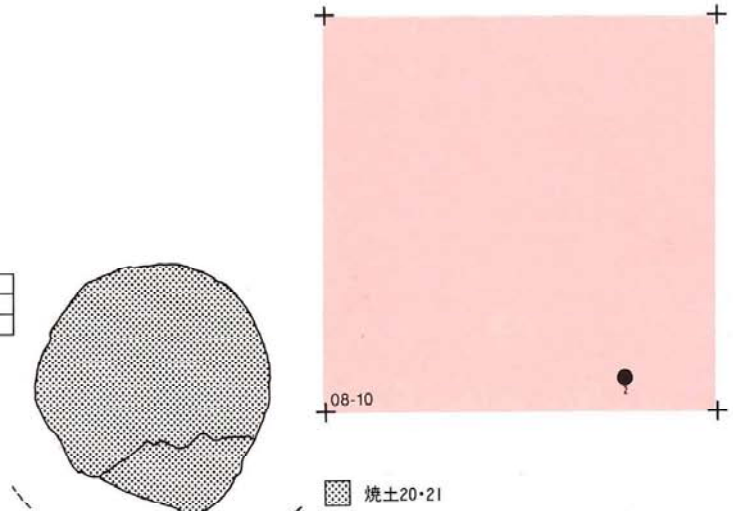
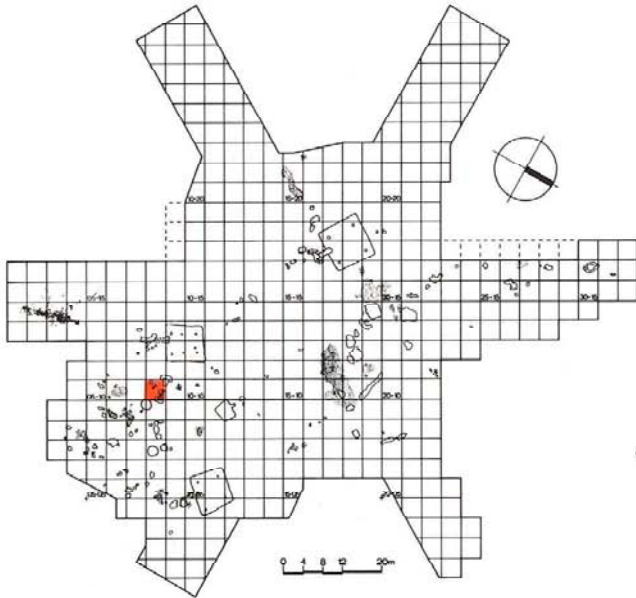

PL. 280 个体番号环93の破片分布図

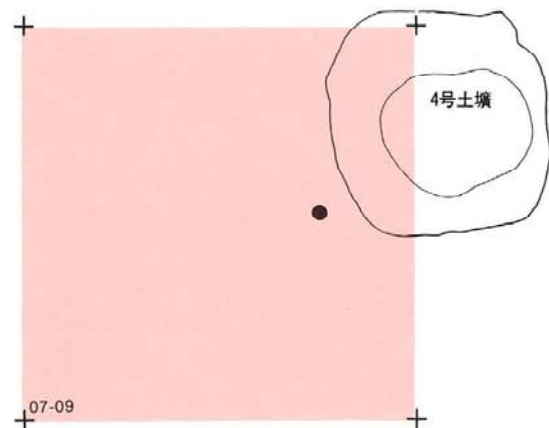
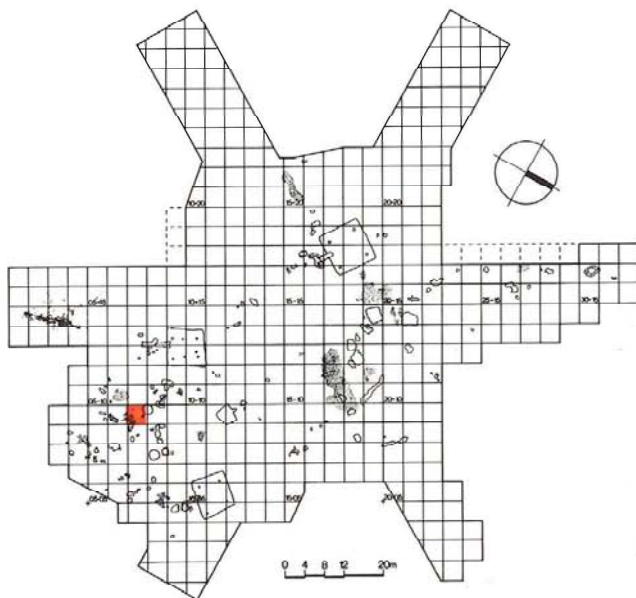



PL. 図-281 個体番号環90の破片分布図

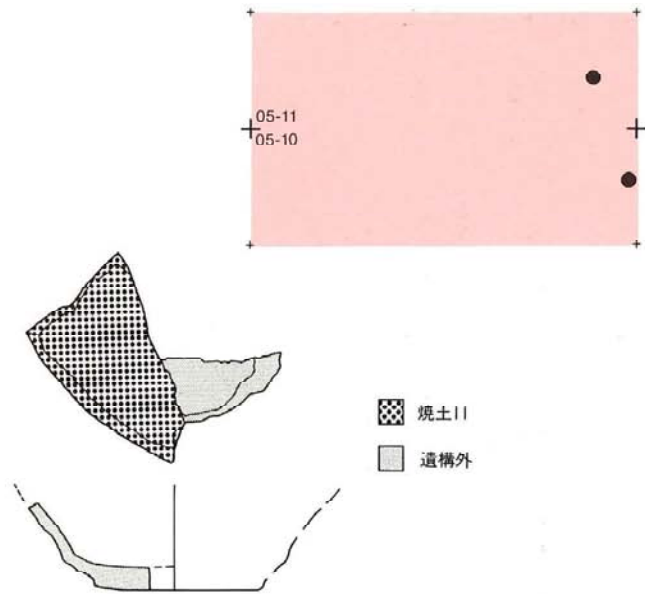
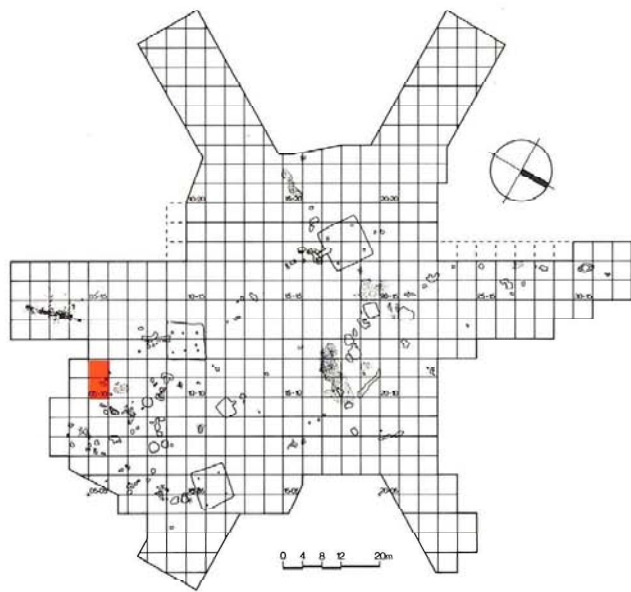

PL. 図-282 個体番号環94の破片分布図

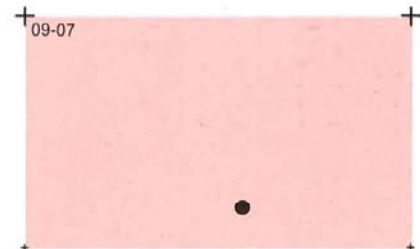
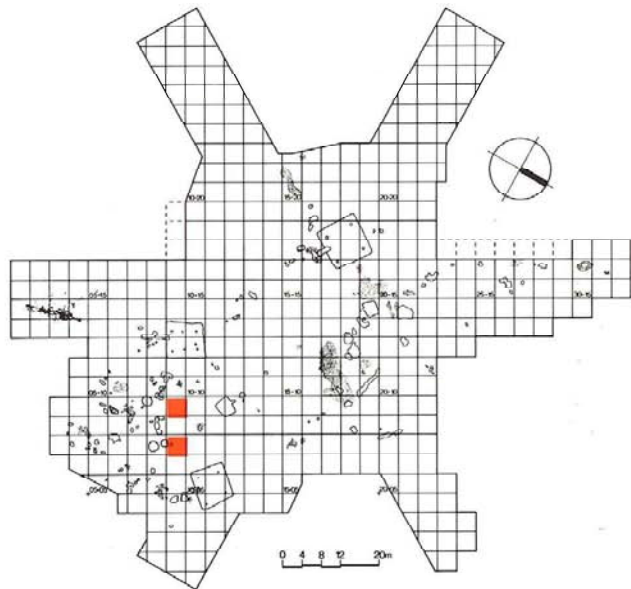

PL. 図-283 個体番号環99の破片分布図

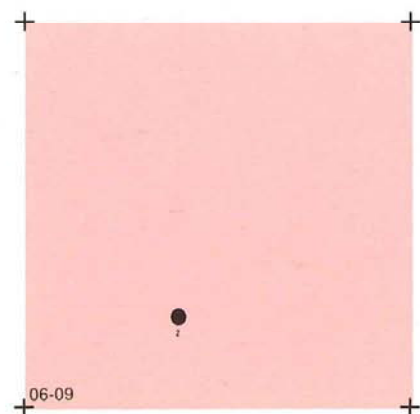
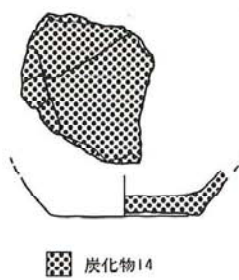
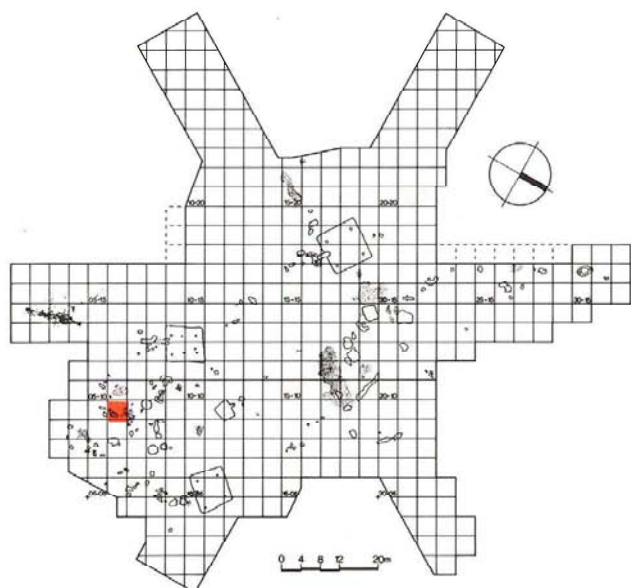

PL. 2-284 個体番号 98の破片分布図

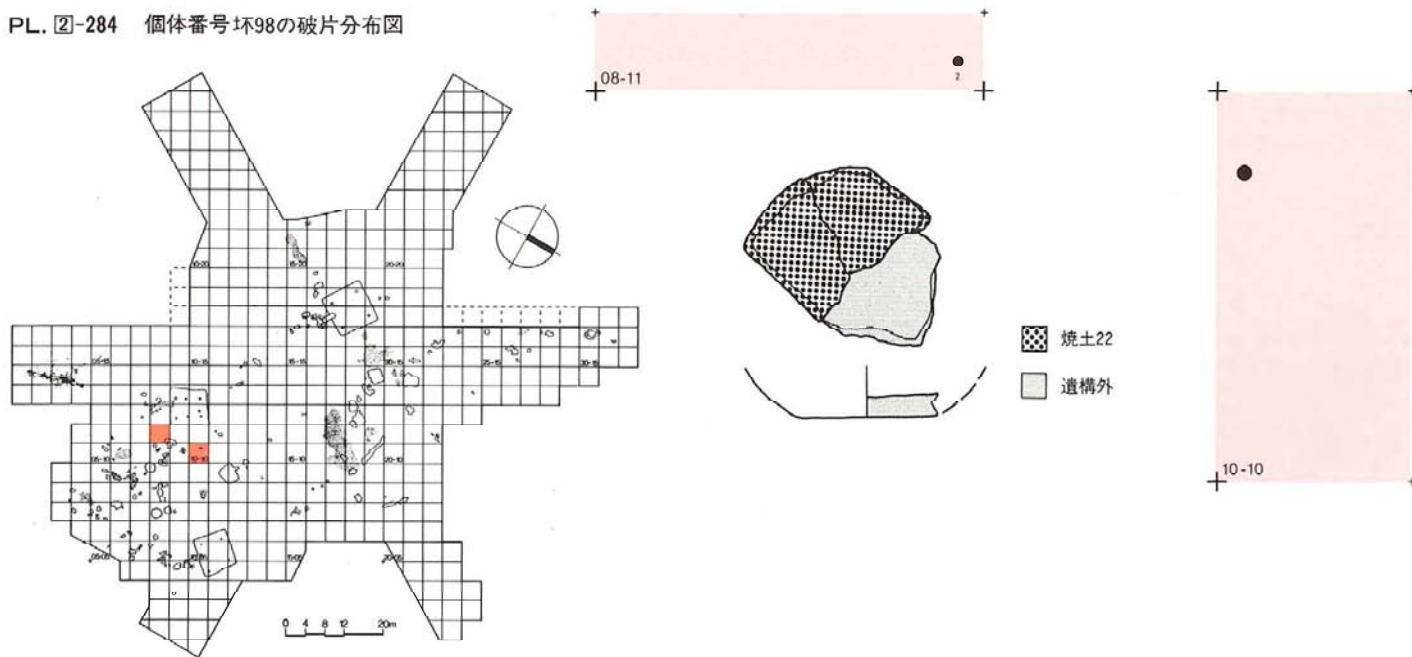

PL. 2-285 個体番号 104の破片分布図

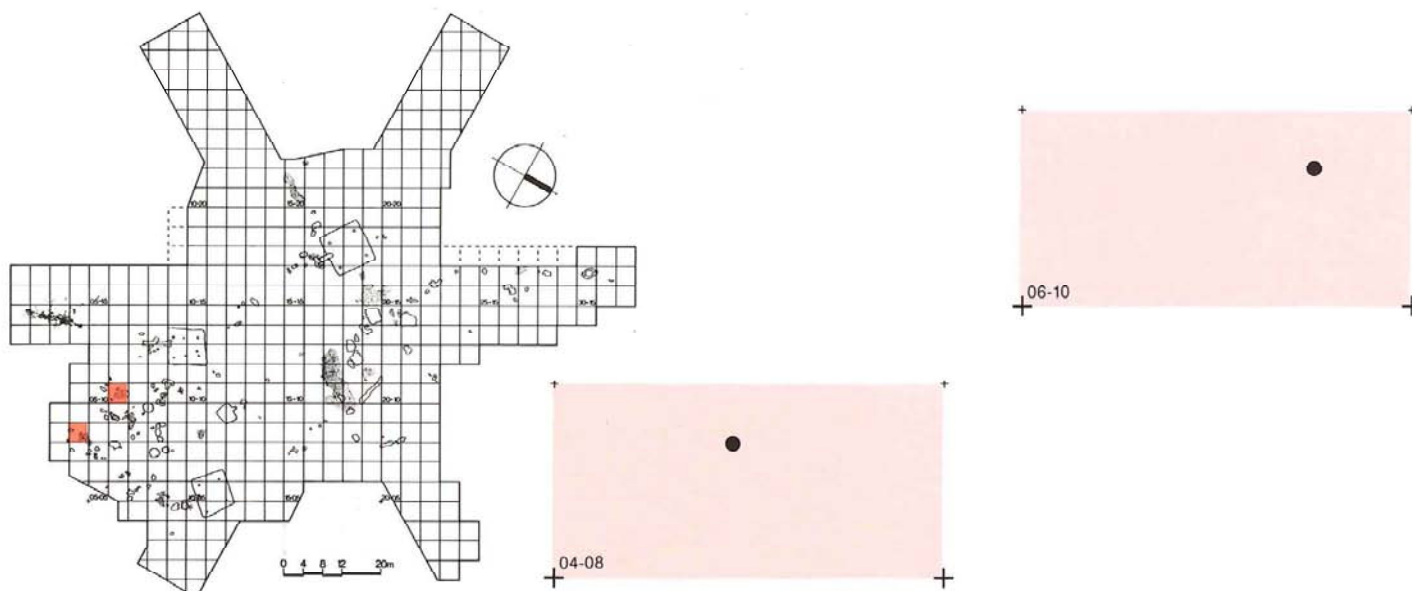

PL. 2-286 個体番号 113の破片分布図

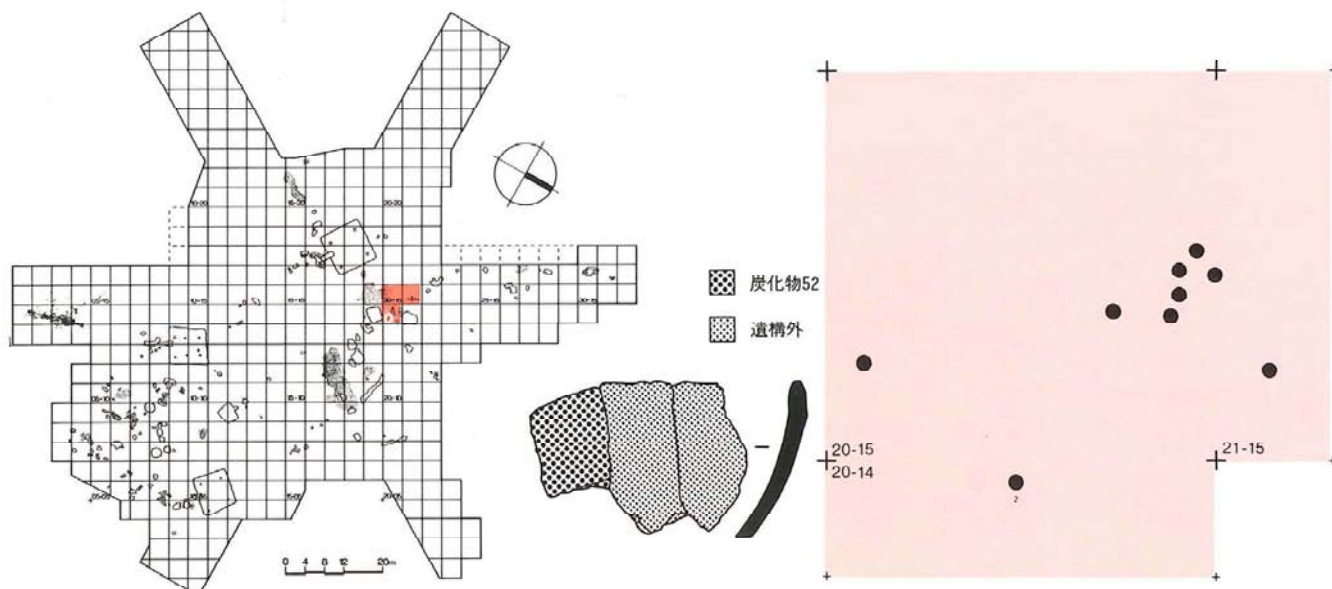

PL. ②-287 个体番号須恵器7の破片分布図

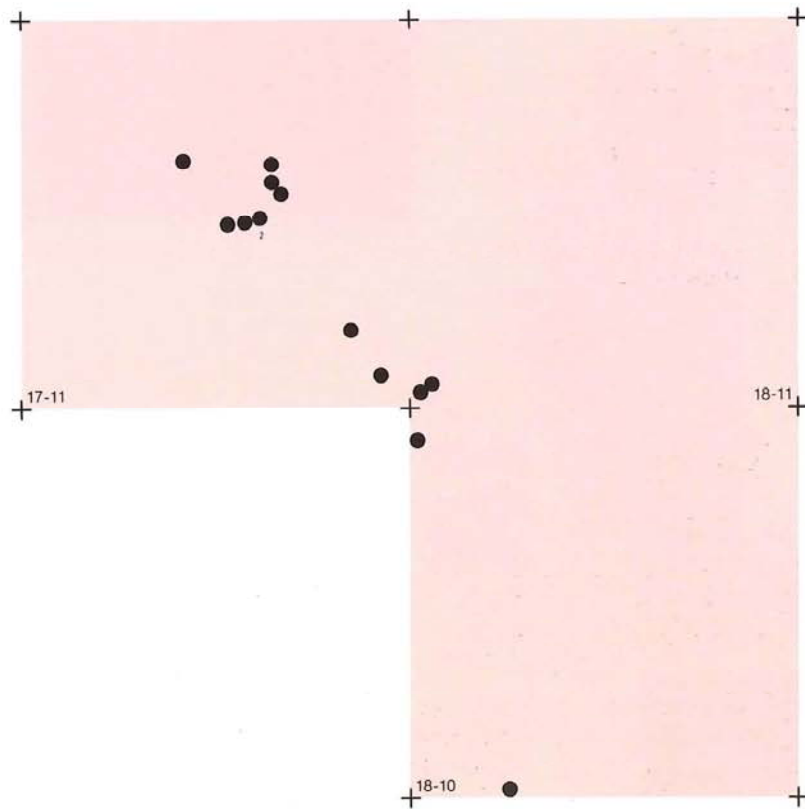
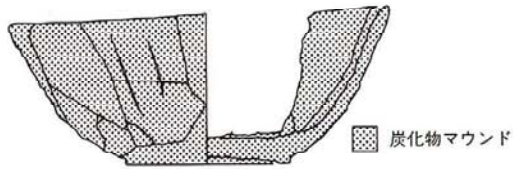
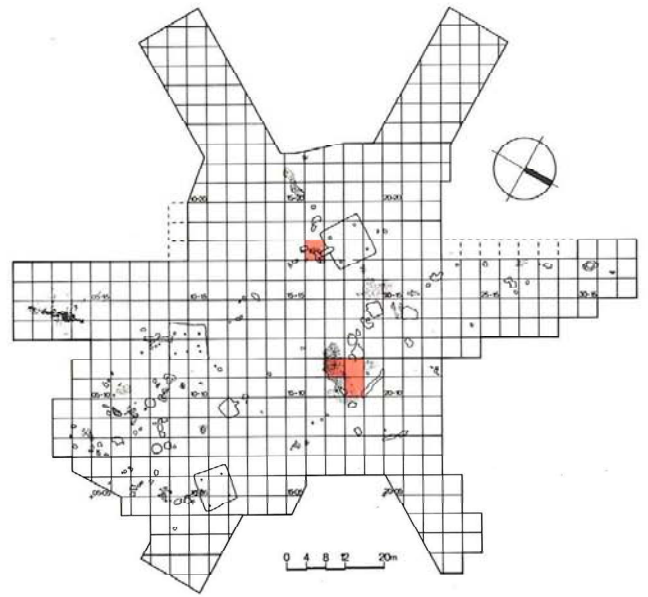
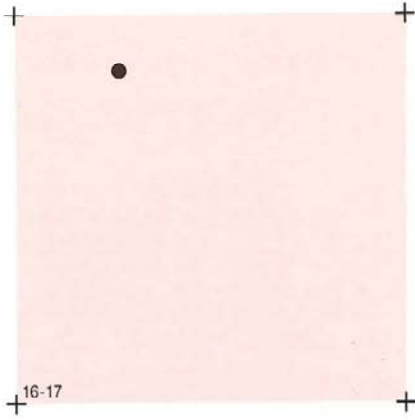

PL. 図-288 個体番号64の破片分布図

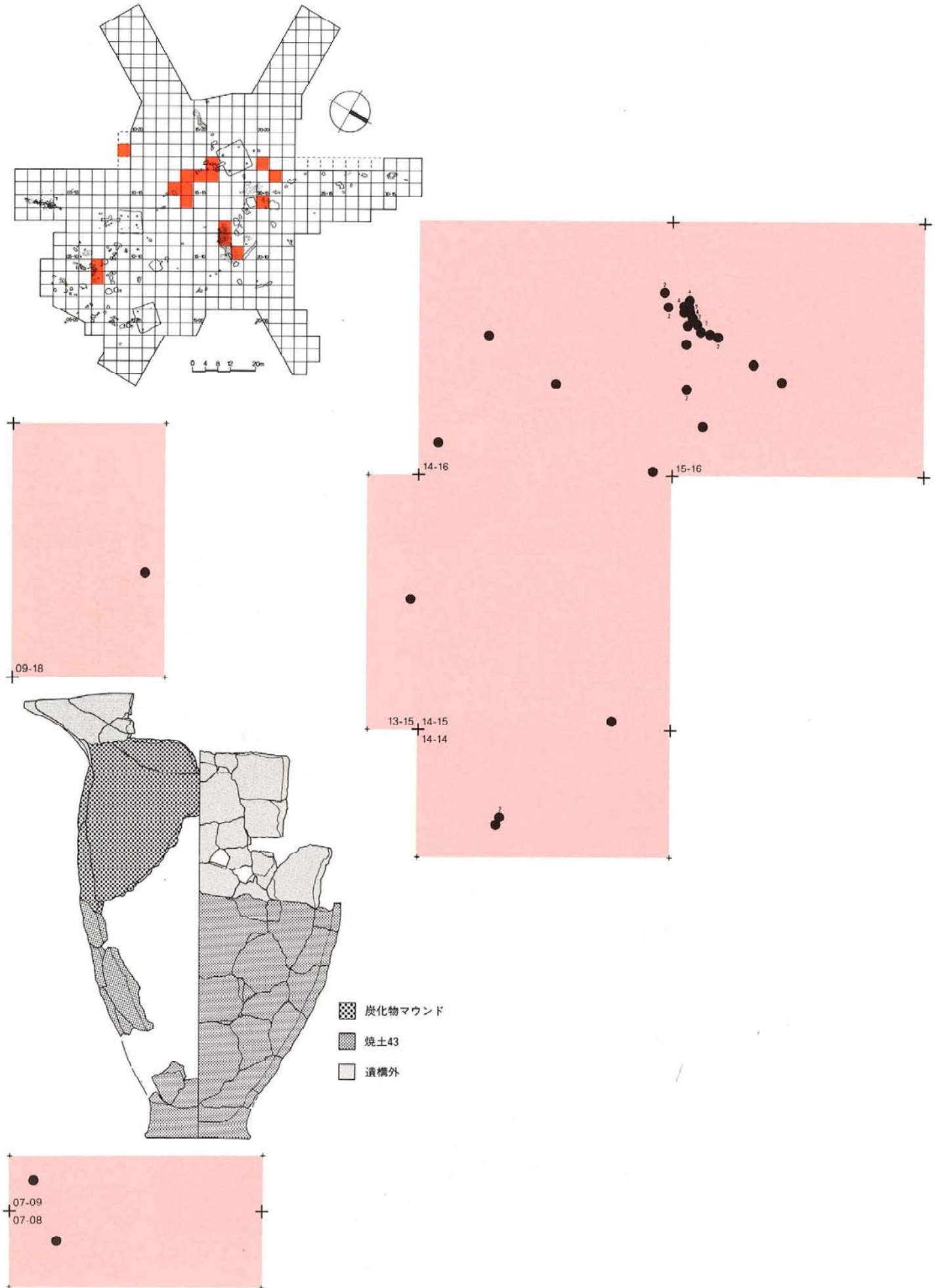



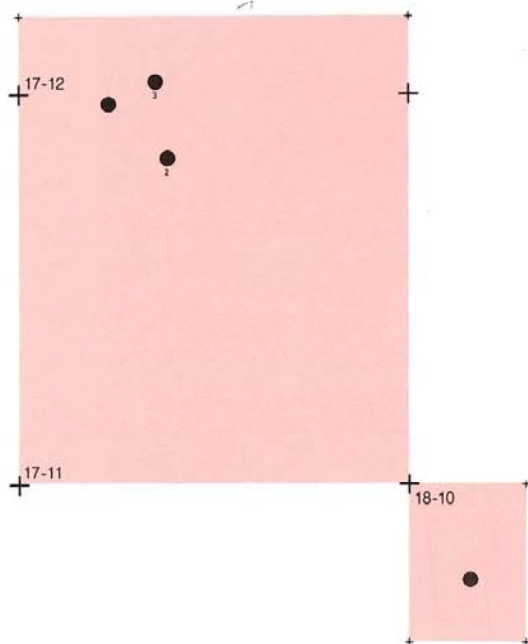
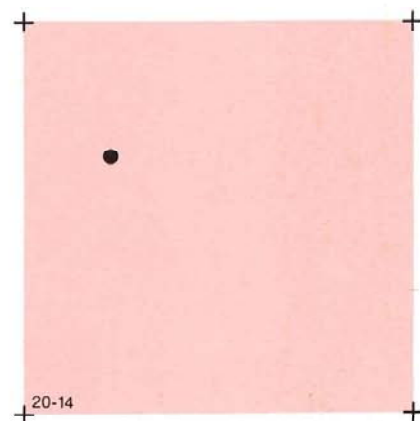
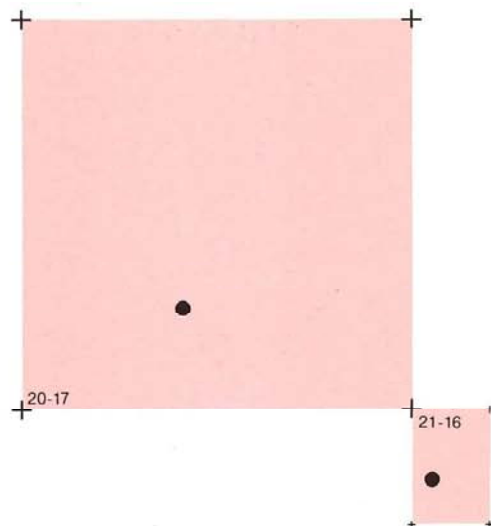
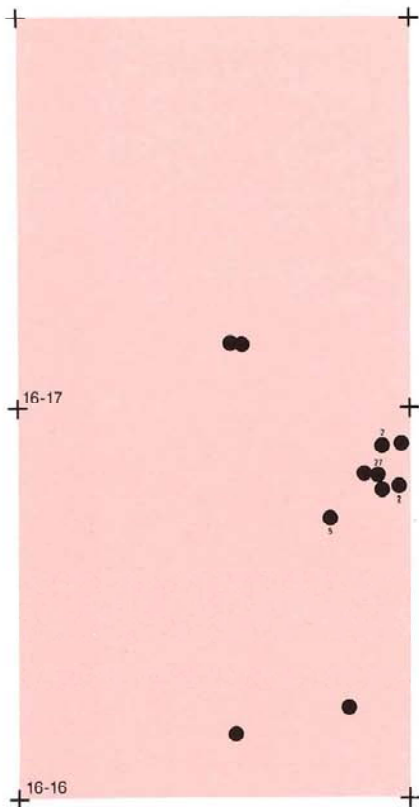

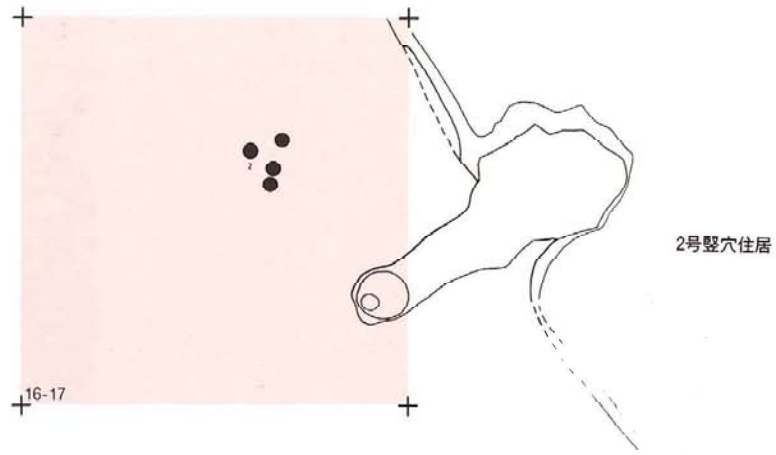

PL. 2-289 个体番号壺61の破片分布図

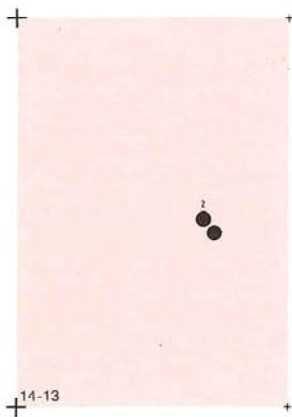
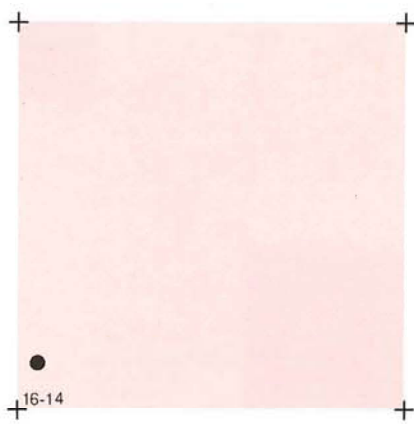
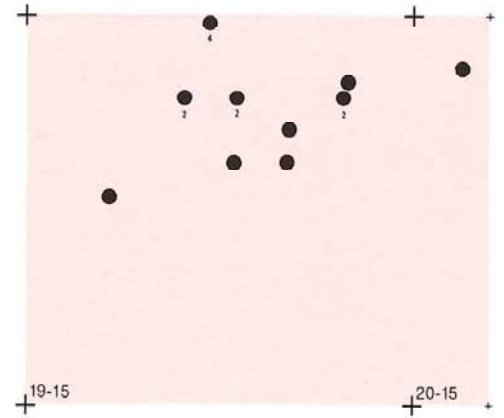
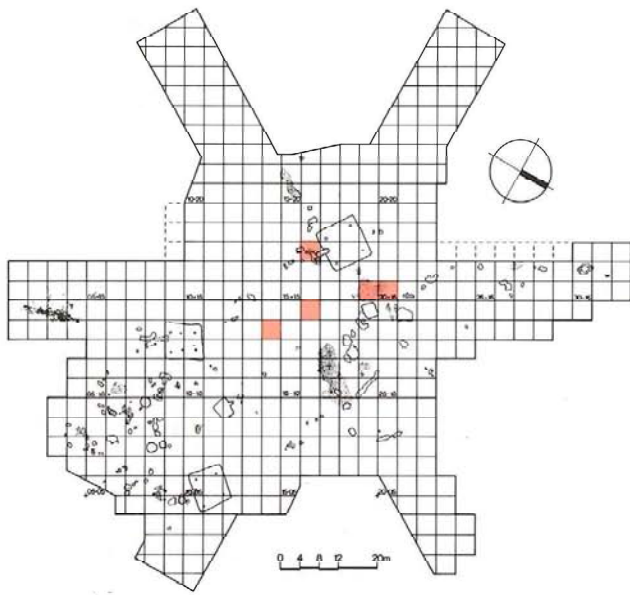

PL. 290 個体番号77の破片分布図

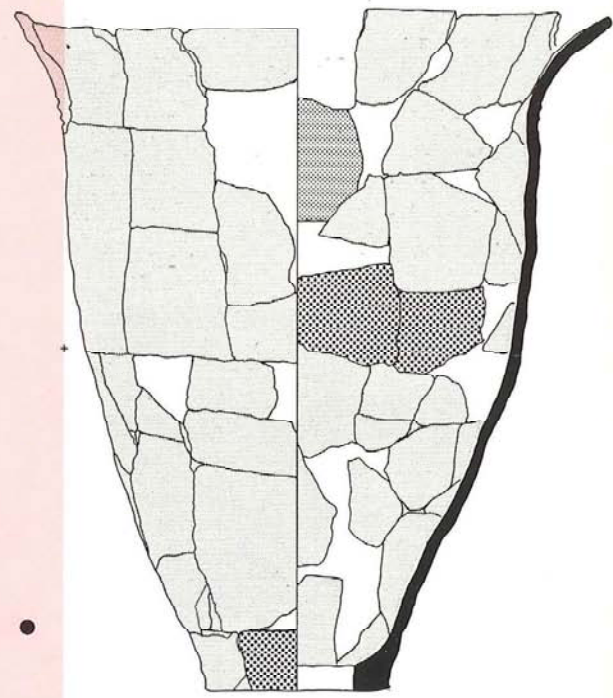
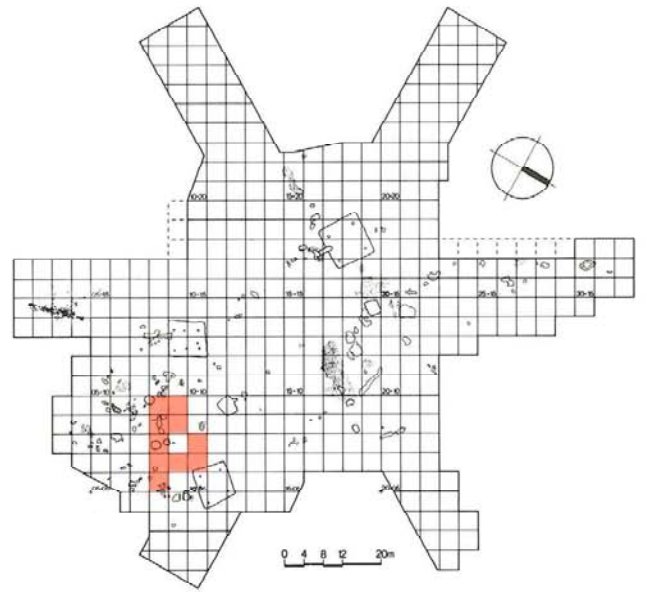

-  焼土27
-  炭化物28
-  遺構外

PL. 291 个体番号壺158の破片分布図

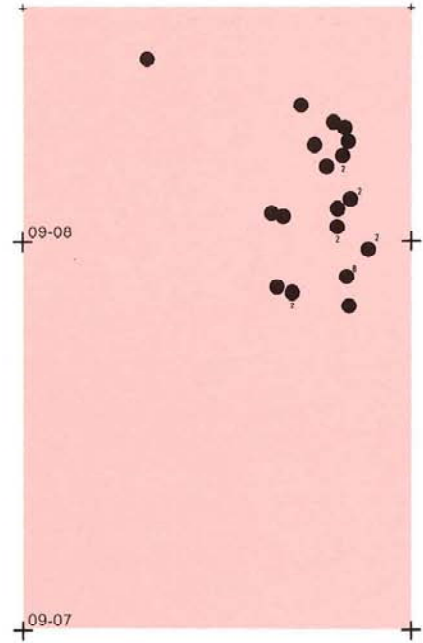
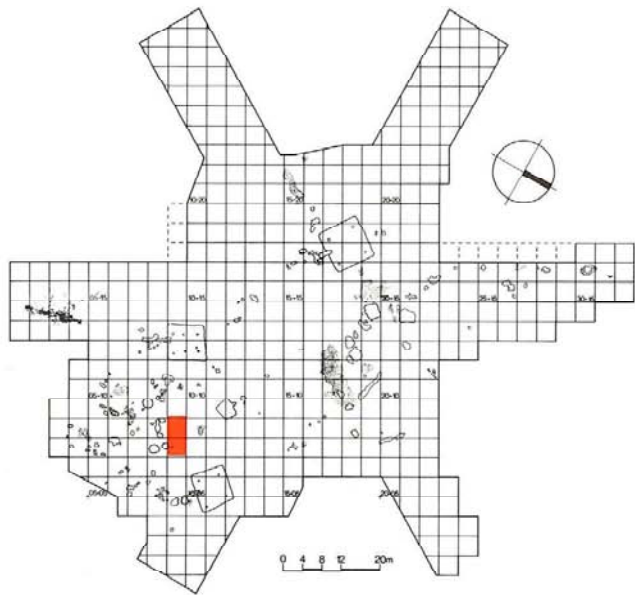

PL. 292 个体番号壺162の破片分布図

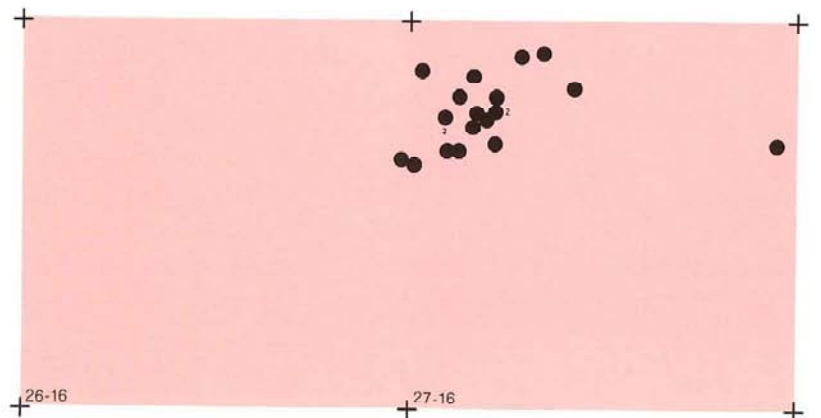
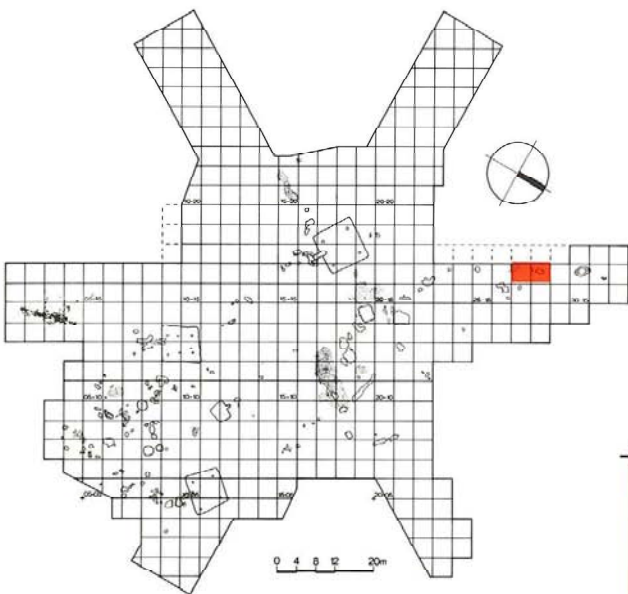



PL. ②-293 個体番号壺159の破片分布図

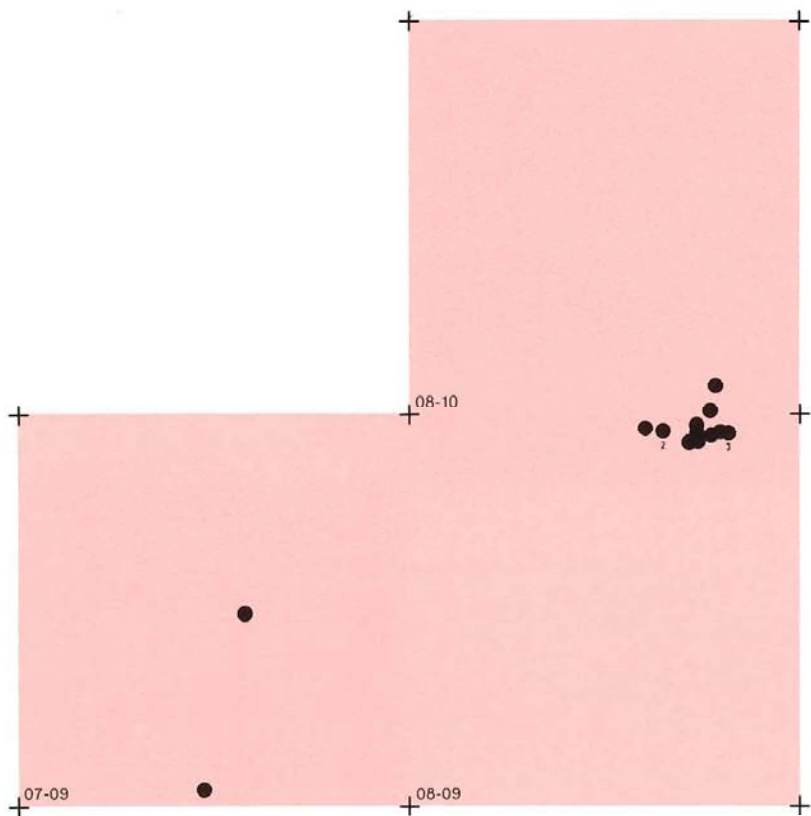
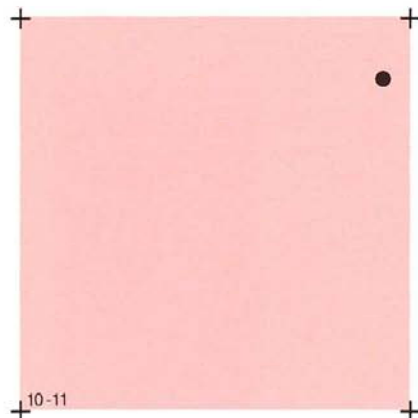
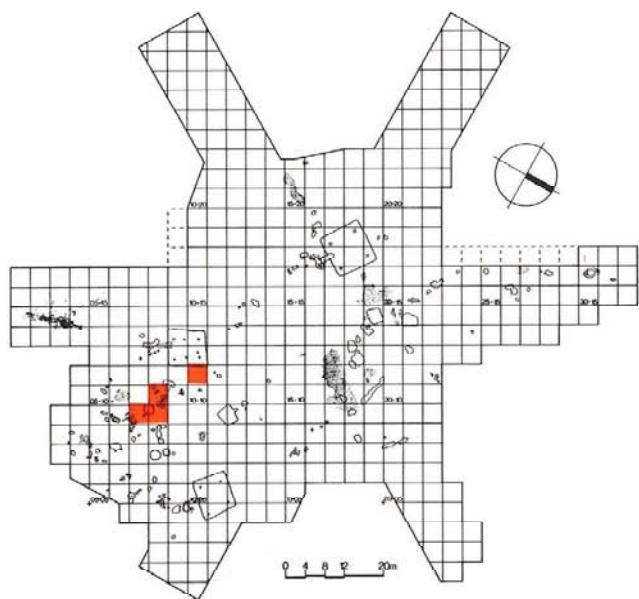

PL. 図-294 個体番号180の破片分布図

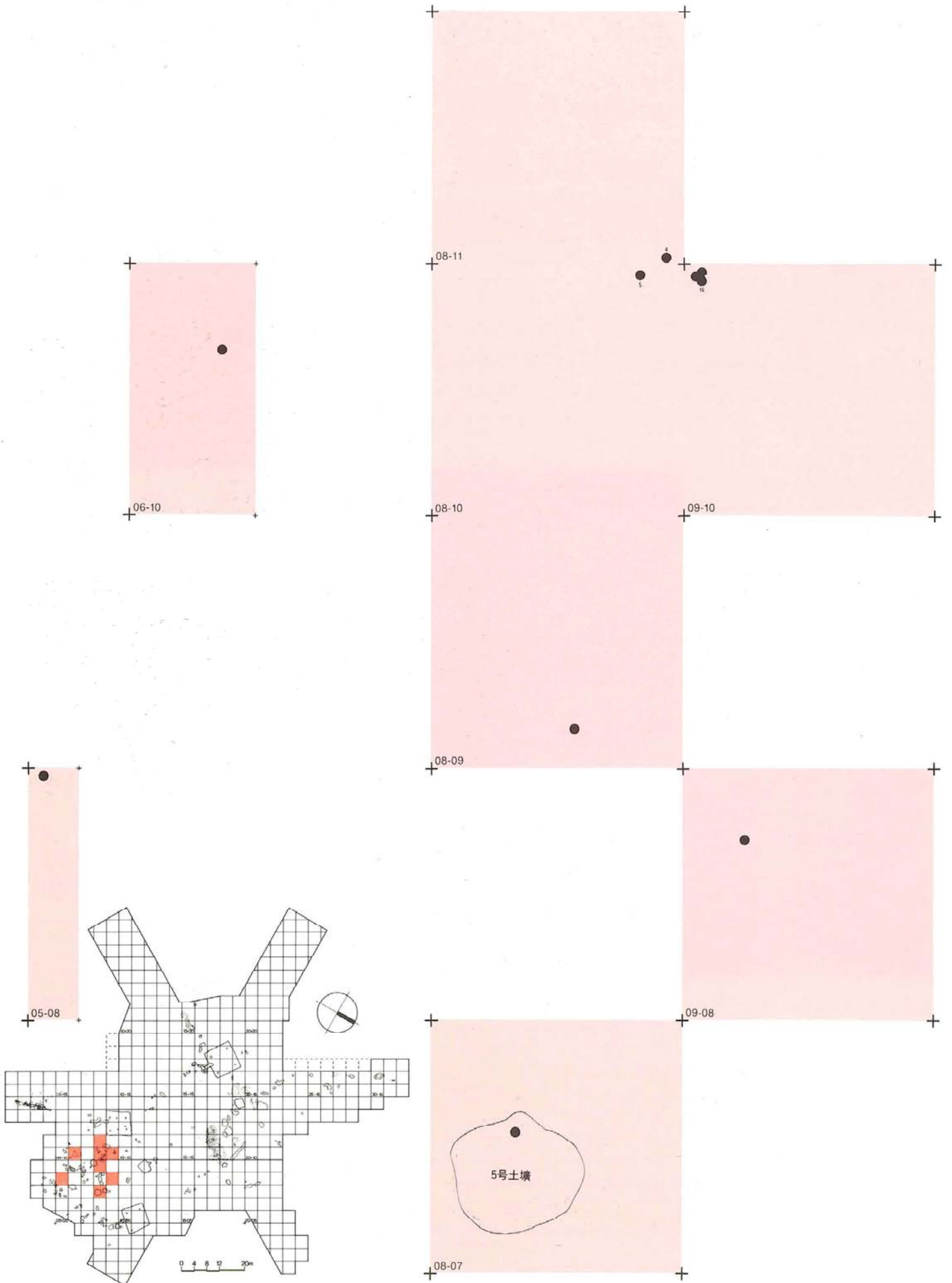



PL. ②-295 サクシュコトニ川遺跡 第2文化層出土土器の文様および整形痕



横走沈線文：個体番号壺28



横走沈線文：個体番号壺30



横走沈線文：個体番号壺2



刻み目文と横走沈線文  
：個体番号壺20

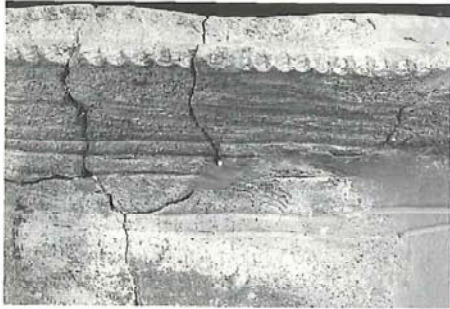

刻み目文と横走沈線文：個体番号壺10



刻み目文と横走沈線文：個体番号壺15

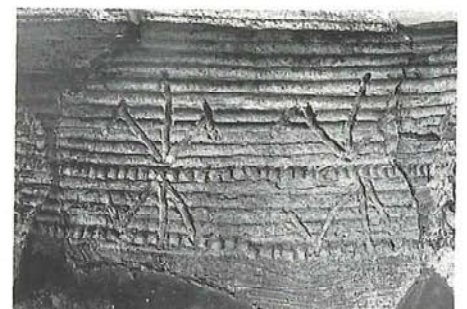

横走沈線文・刺突文・沈線文：個体番号壺17



斜行沈線文：個体番号壺36



横走沈線文・沈線文：個体番号壺49

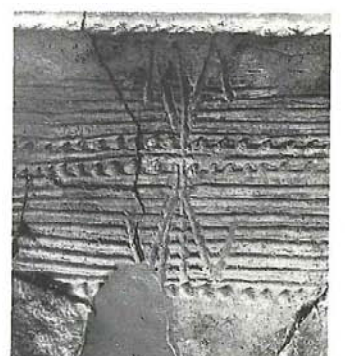

刻み目文・横走沈線文・刺突文・沈線文  
：個体番号壺50



斜行沈線文：個体番号壺51



器外面のハケ目：個体番号壺28



器内面のハケ目：個体番号壺9

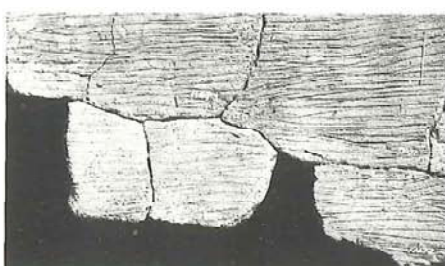

器内面のハケ目：個体番号壺62



器外面のヘラミガキ  
：個体番号壺41



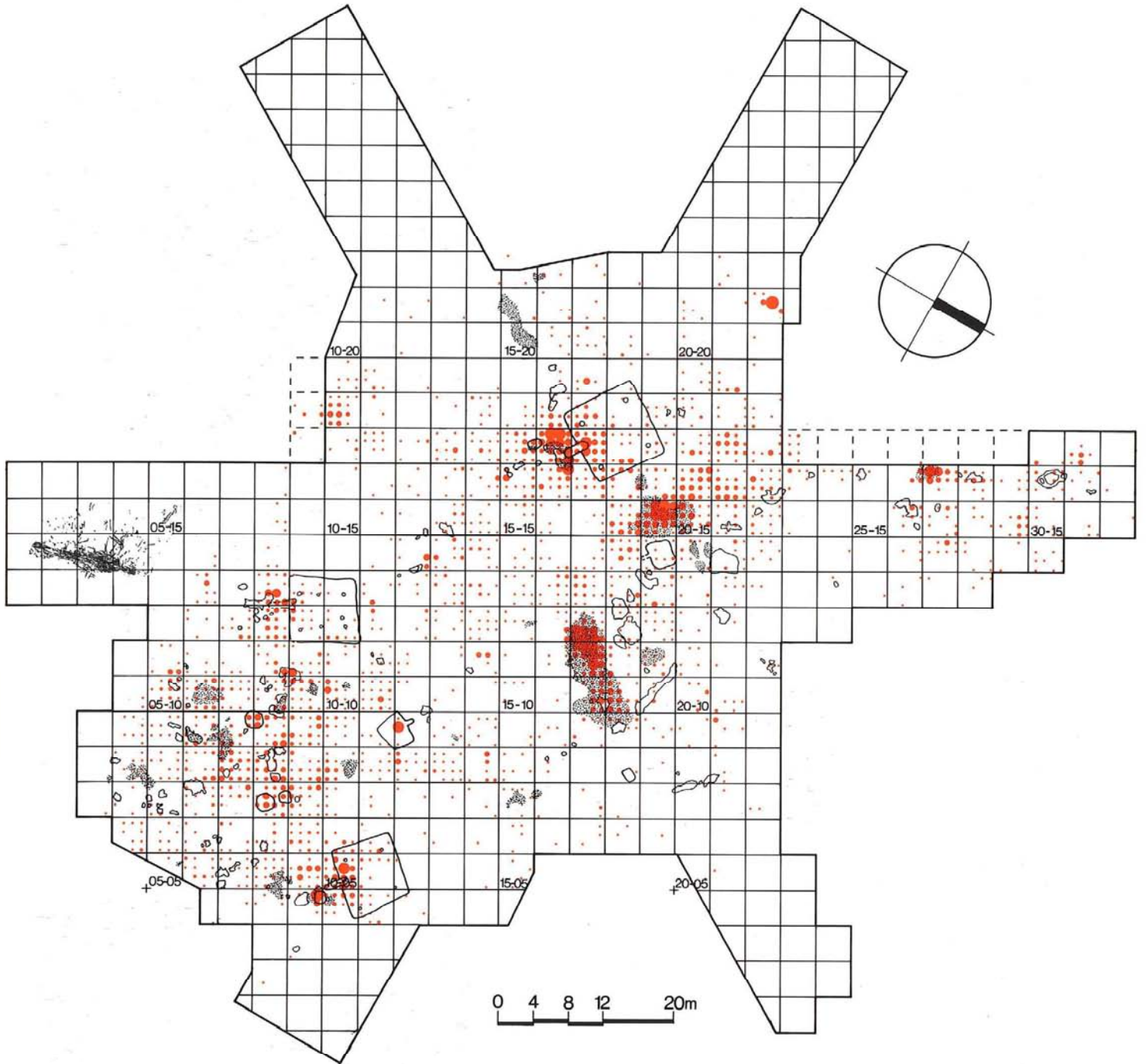

## ▼破片数

- 1 ~ 3
- 4 ~ 6
- 7 ~ 10
- 11 ~ 20
- 21 ~ 30
- 31 ~ 50
- 51 ~ 70
- 71 ~ 100
- 101 ~

※小グリッド単位で、各小グリッドの中心に表示した。



PL. ②-297 土製支脚 ① [( )内は個体番号]

支脚1：5号住居床面出土

支脚2：5号住居床面-1号土壇-6号土壇出土

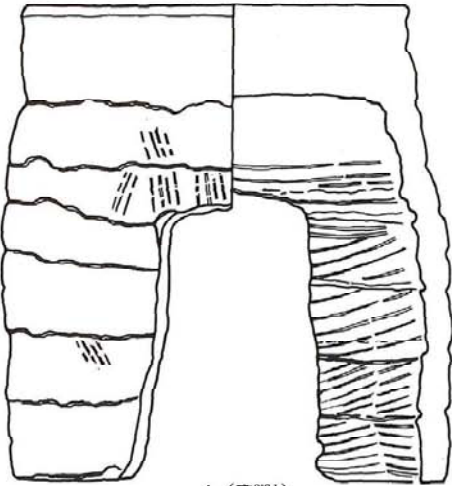

1 (支脚1)

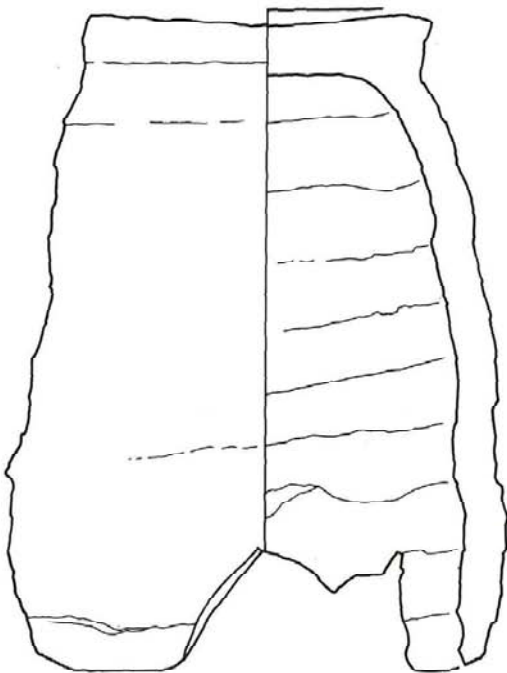
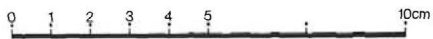
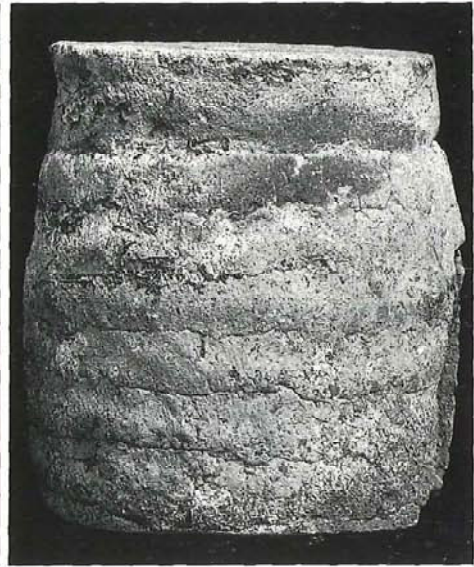

2 (支脚2)

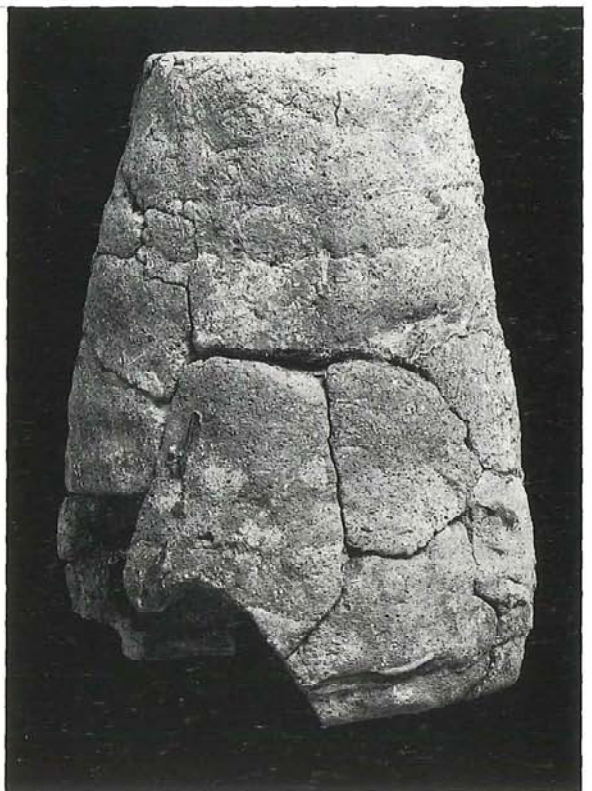

2

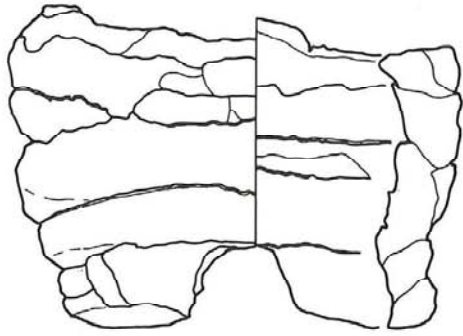

1 (支脚3)

支脚 3 : 焼土43出土  
 支脚 4 : 5号住居床面-1号土壇出土  
 支脚 6 : 2号住居カマド-炭化物52出土



1

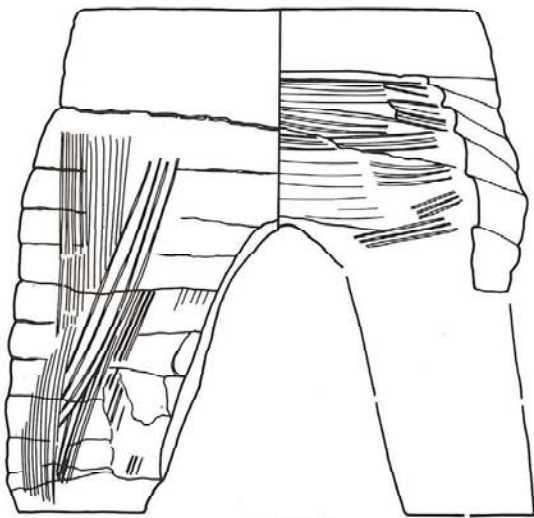

2 (支脚4)

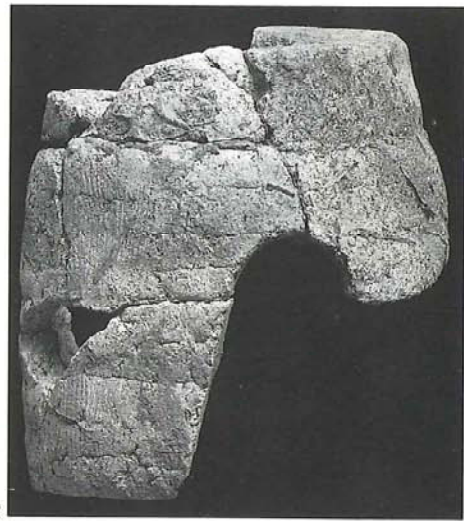

2

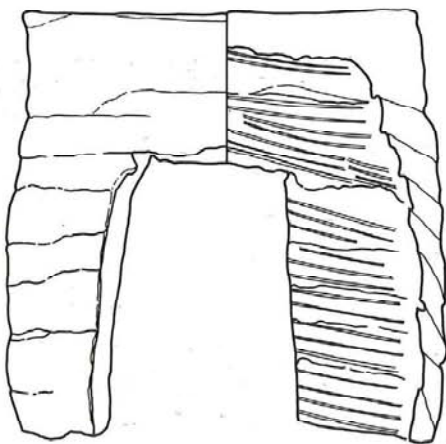

3 (支脚6)



3



PL. ②-299 土製紡錘車 ①

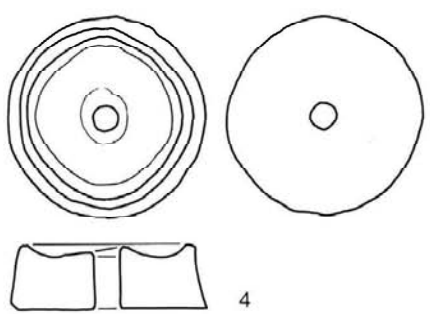
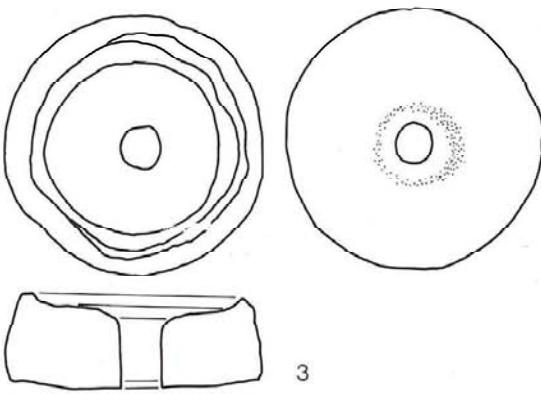
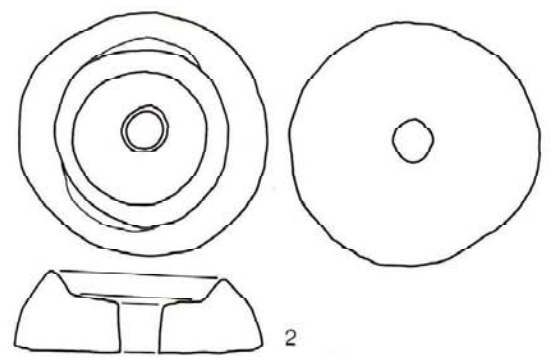
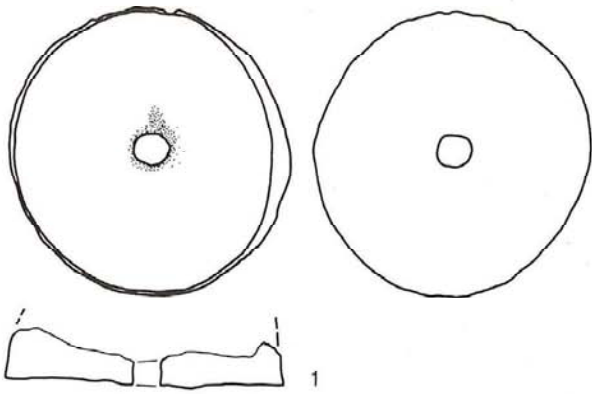

- 1 : 3号竖穴住居覆土中
- 2 : 3号土城
- 3 : 2号竖穴住居床面
- 4 : 5号竖穴住居床面
- 5 : 13-10グリッド

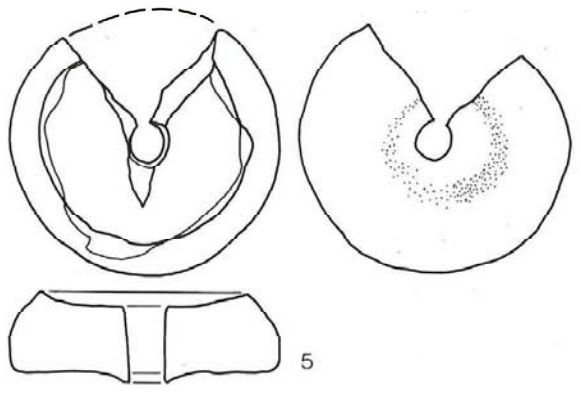

1



2



3

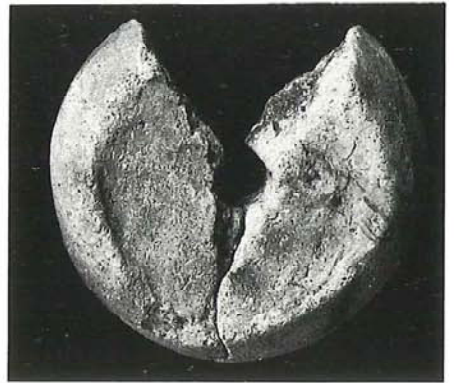

5

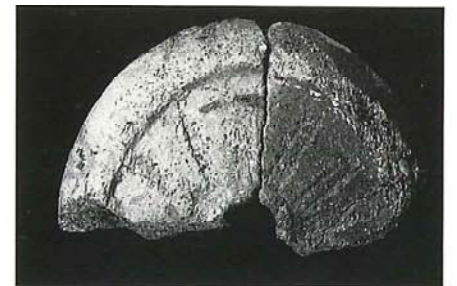
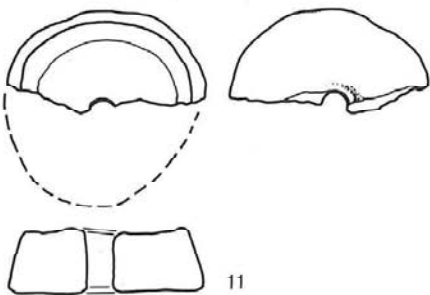
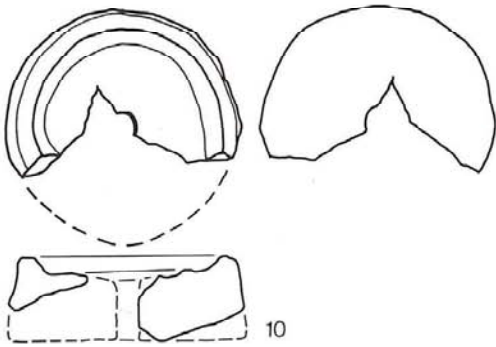
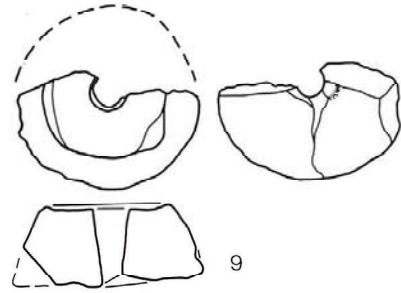
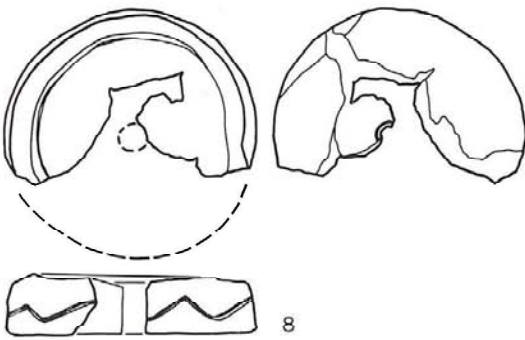
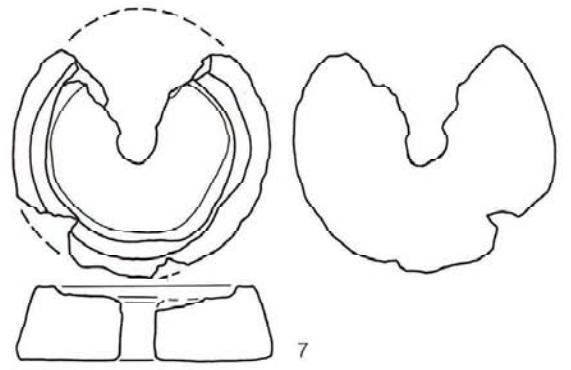
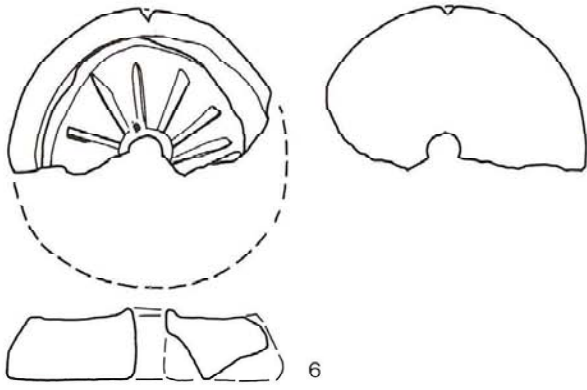

6

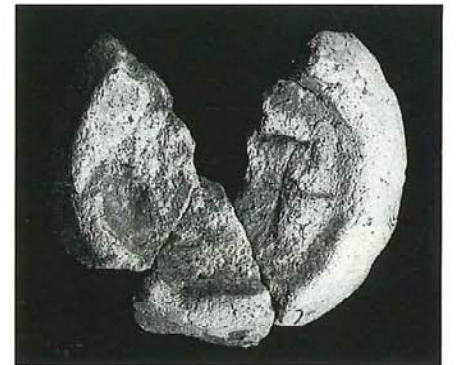

7

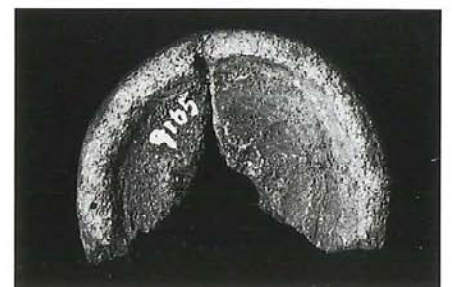

10

- 6 : 炭化物52
- 7 : 09-08~09-09グリッド
- 8 : 炭化物マウンド
- 9 : 炭化物マウンド-焼土43
- 10 : 炭化物52
- 11 : 13-21グリッド

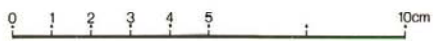



PL. ②-301 個体番号支脚1の破片分布図

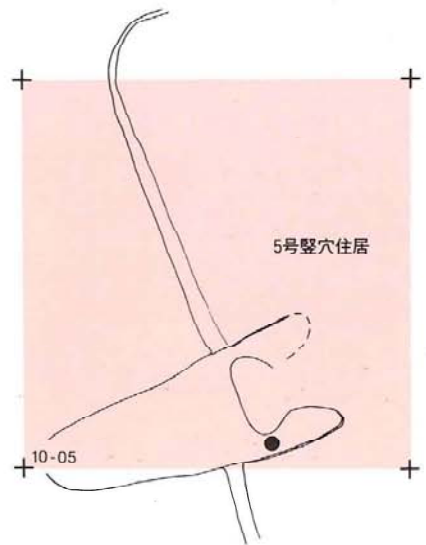
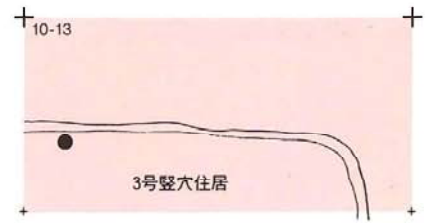
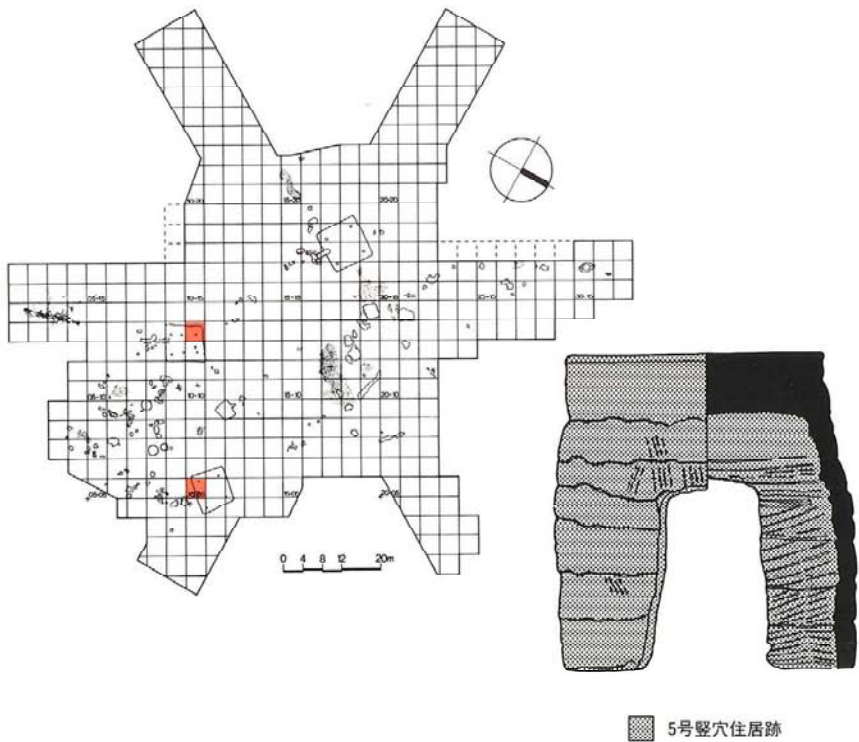

PL. ②-302 個体番号支脚2の破片分布図

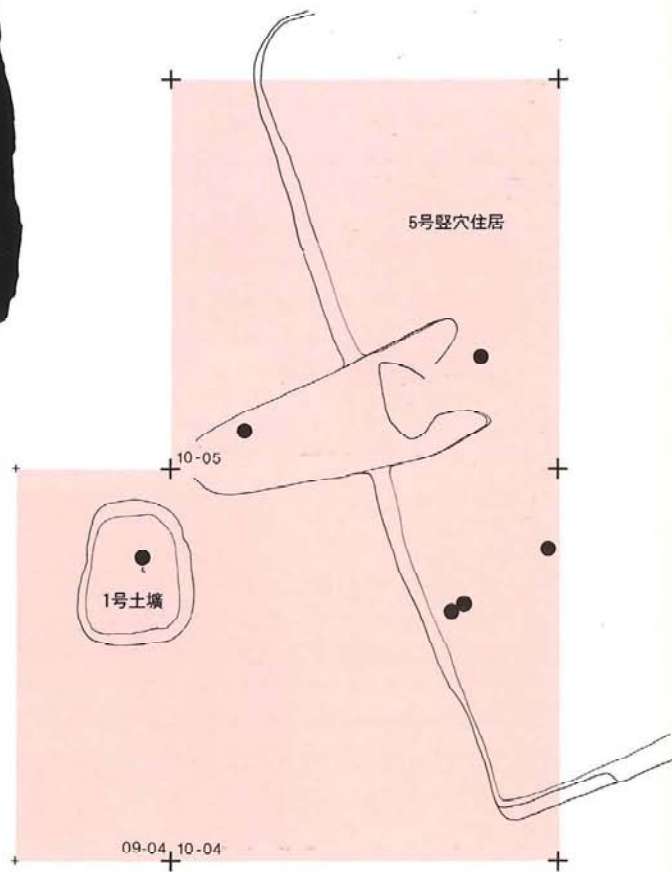
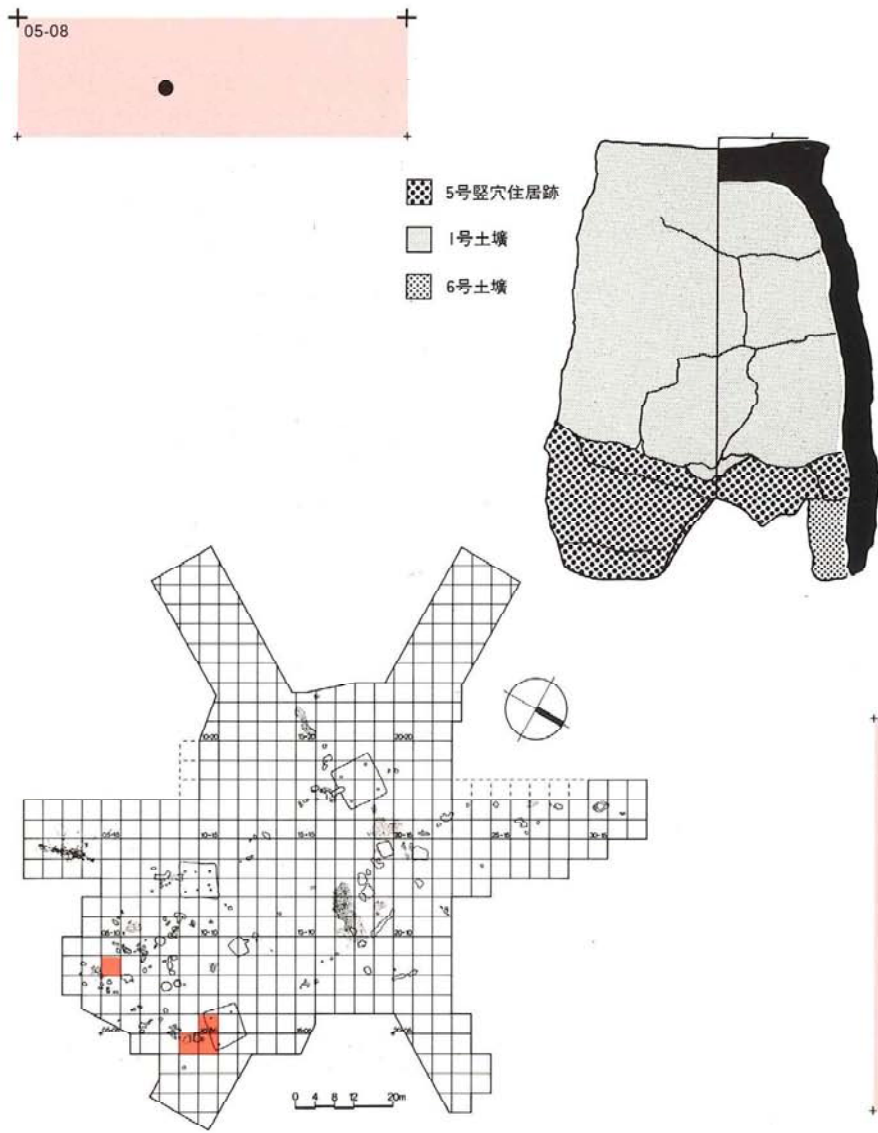

PL. 2-303 个体番号支脚3の破片分布図

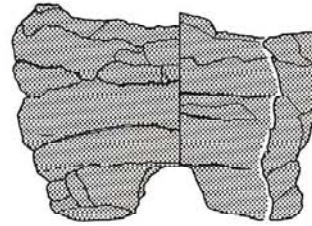
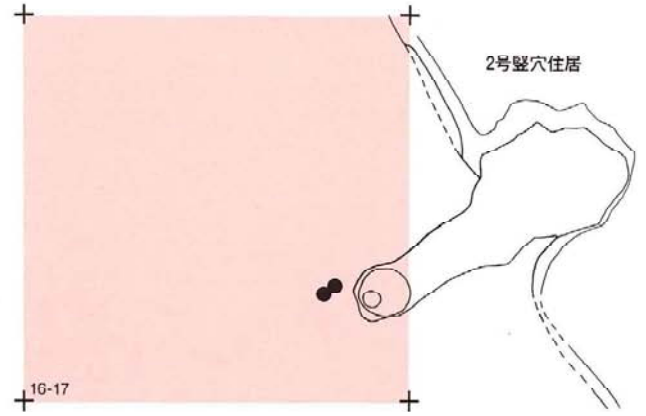
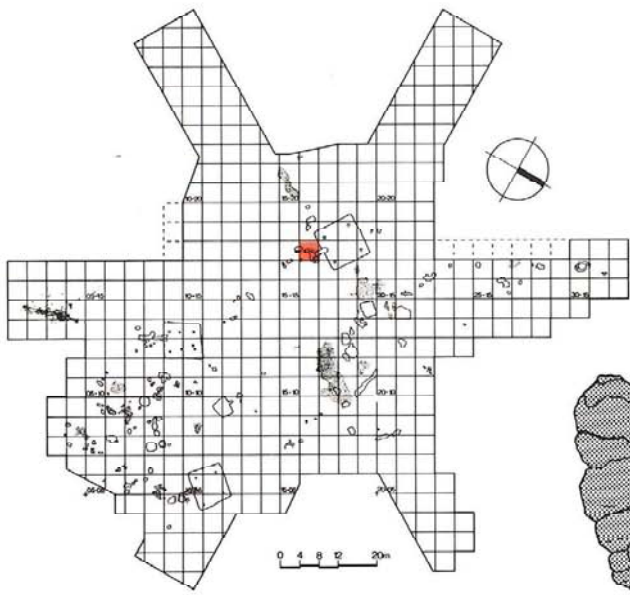

焼土43

PL. 2-304 个体番号支脚4の破片分布図

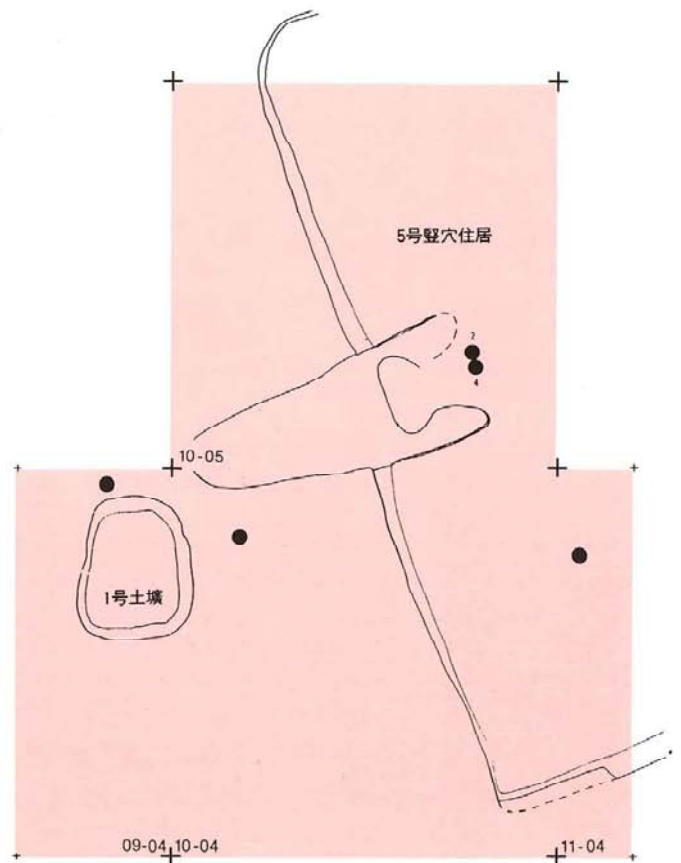
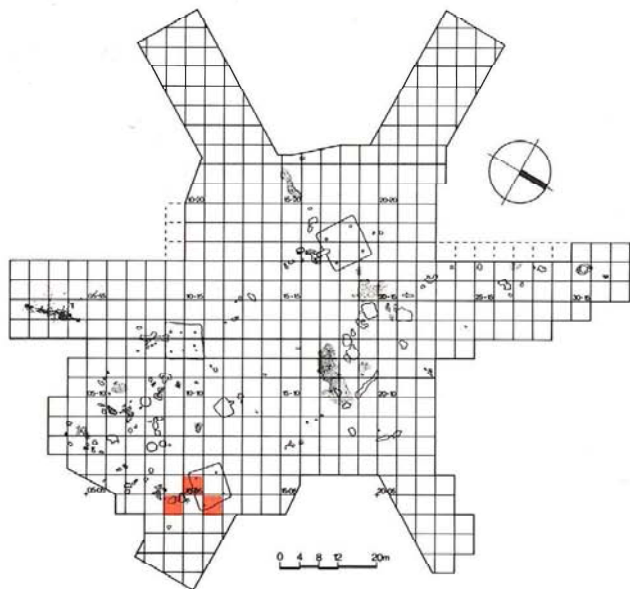

5号竪穴住居跡  
1号土坑周辺の焼土・炭化物

PL. ②-305 個体番号支脚5の破片分布図

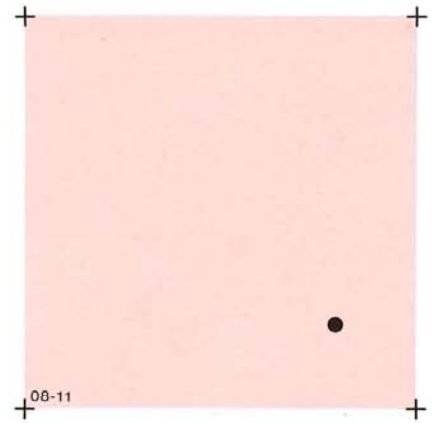
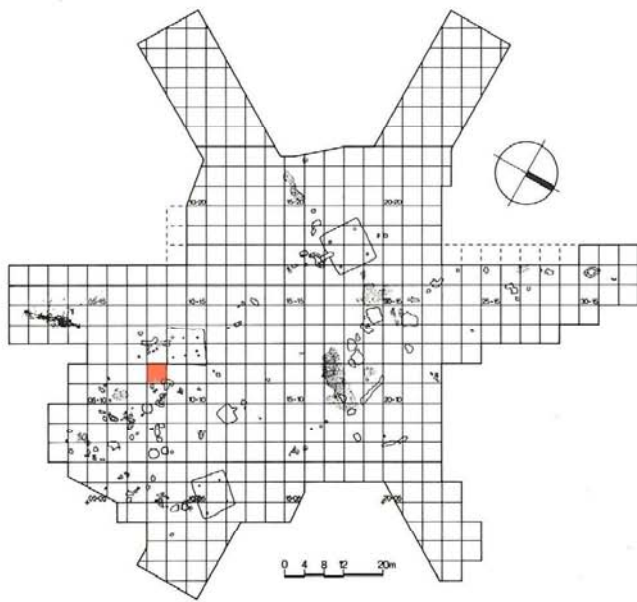

PL. ②-306 個体番号支脚6の破片分布図

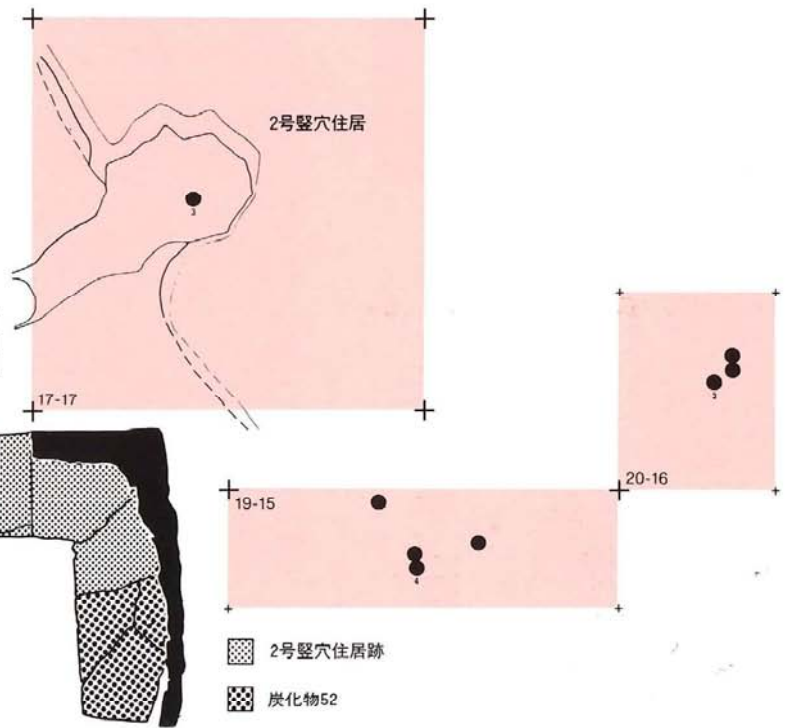
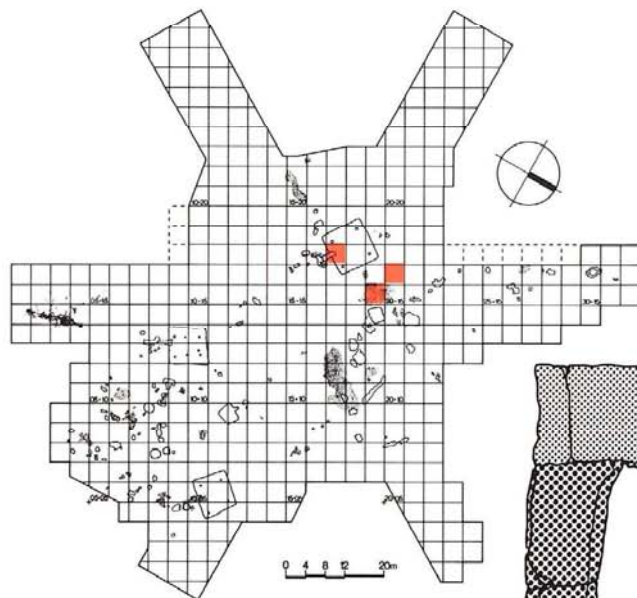

PL. ②-307 個体番号支脚7の破片分布図

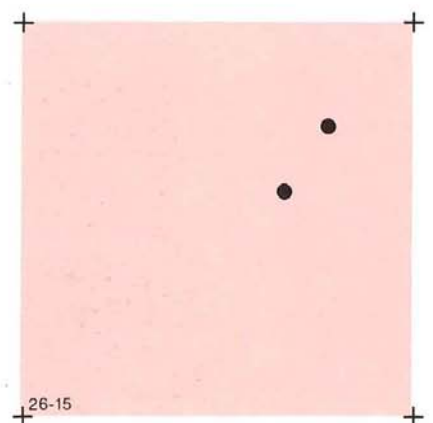
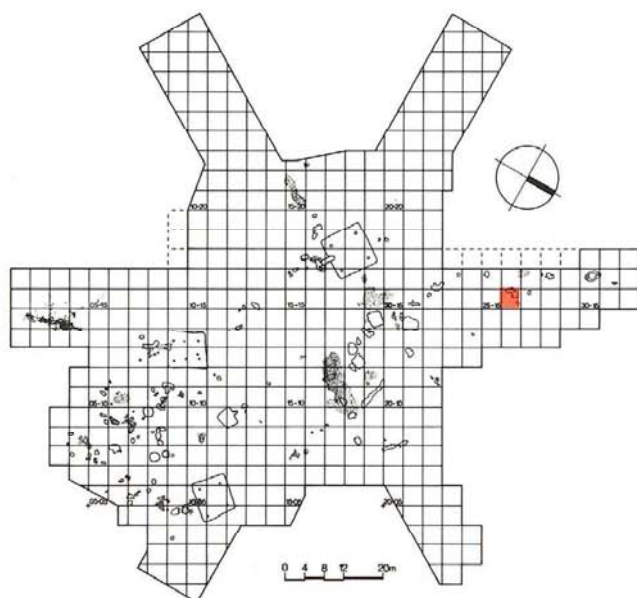



PL. 図-308 個体番号紡錘車1~14の破片分布図

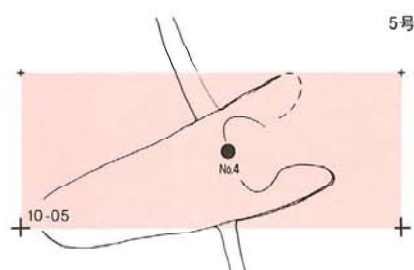
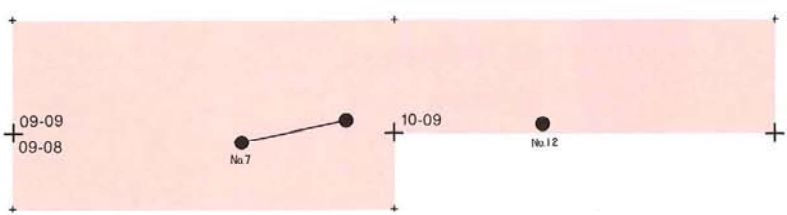
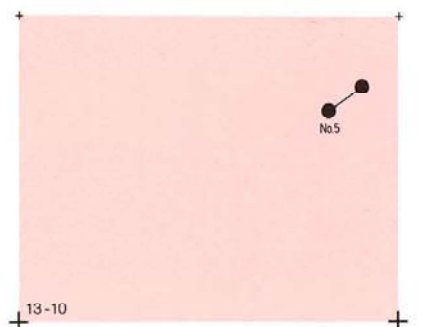
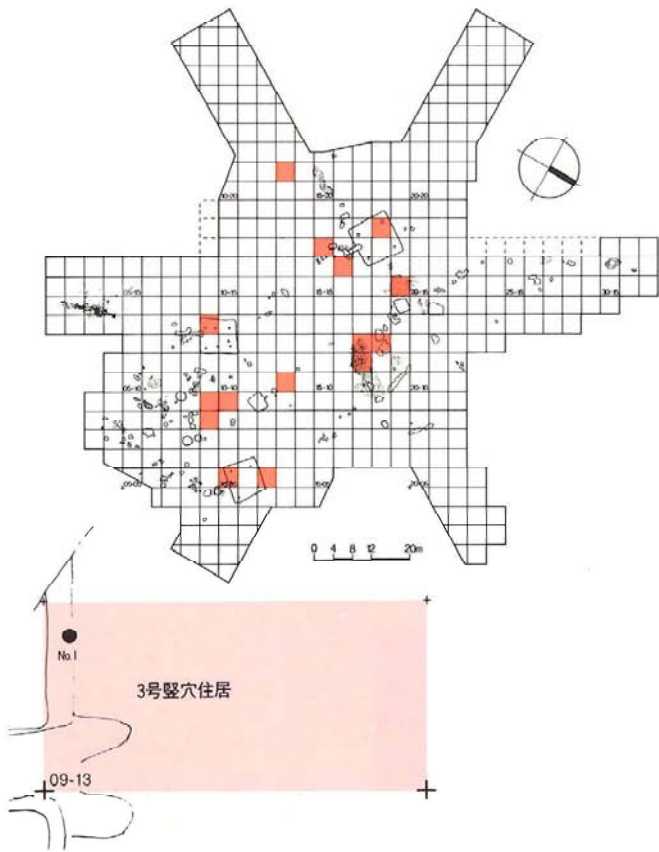

5号竪穴住居

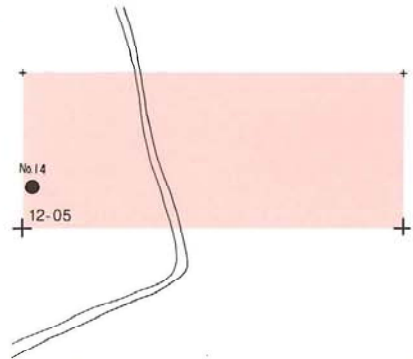



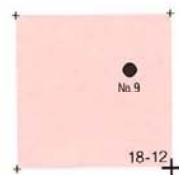
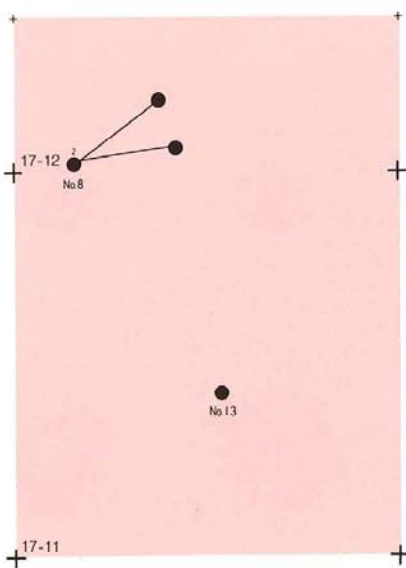
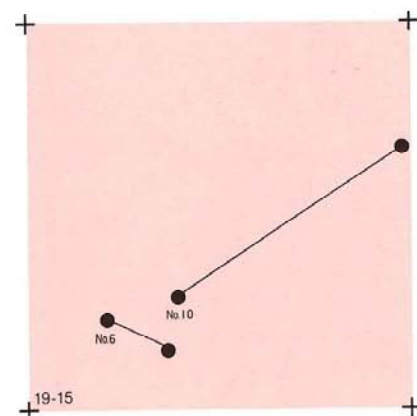
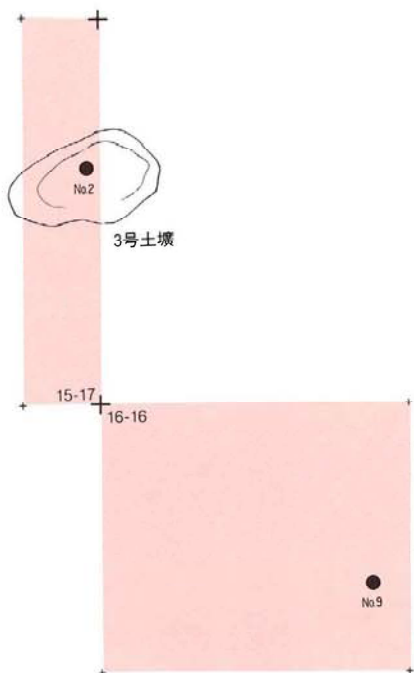

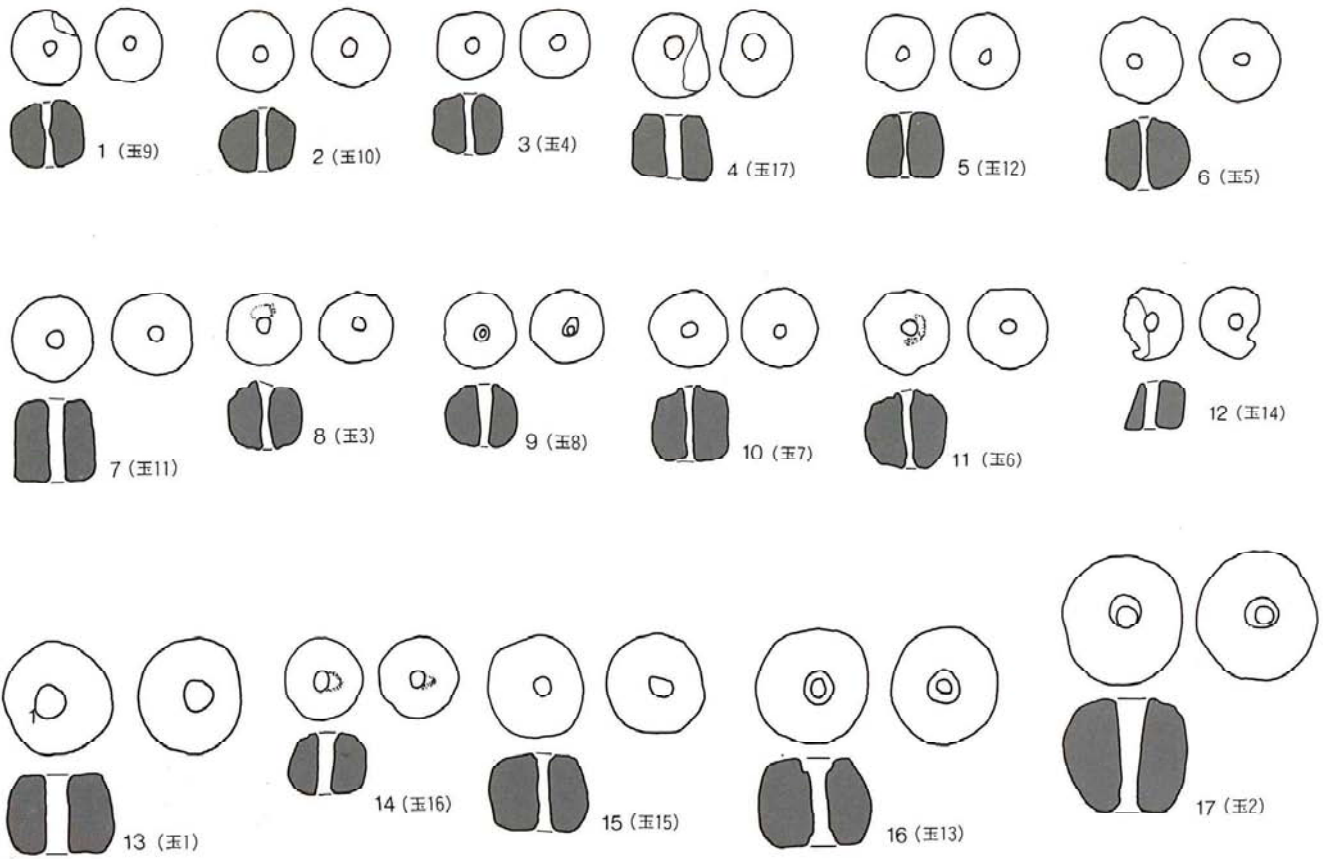

1-4, 6-15, 17: 炭化物マウンドから出土  
 5: 炭化物・焼土50から出土  
 16: 炭化物52から出土

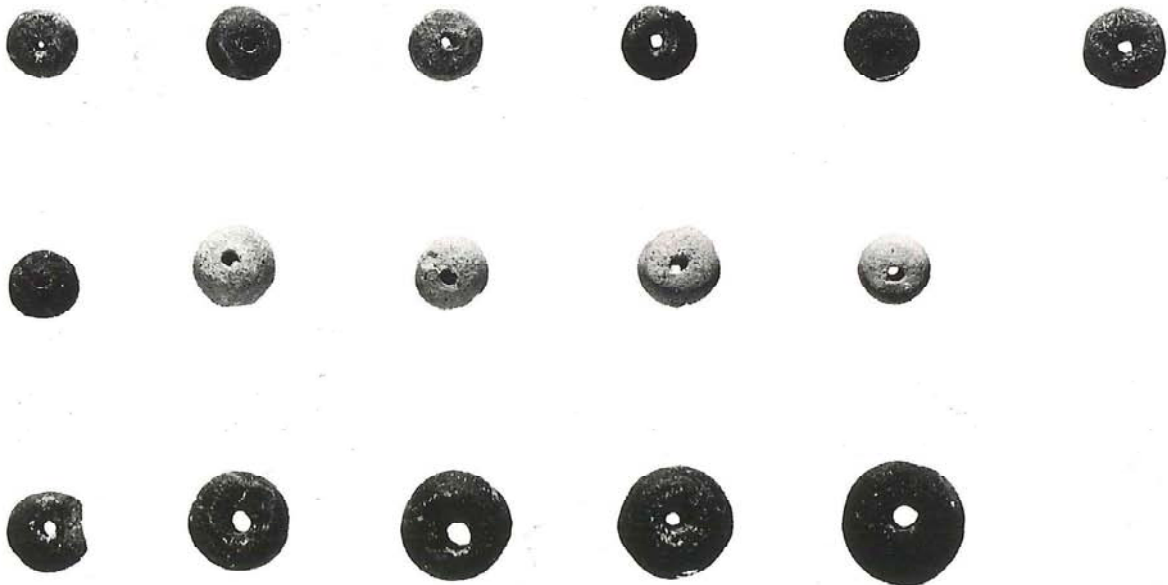

PL. 2-310 土製羽口, 金属製品, 石製品 (( )内は個体番号)

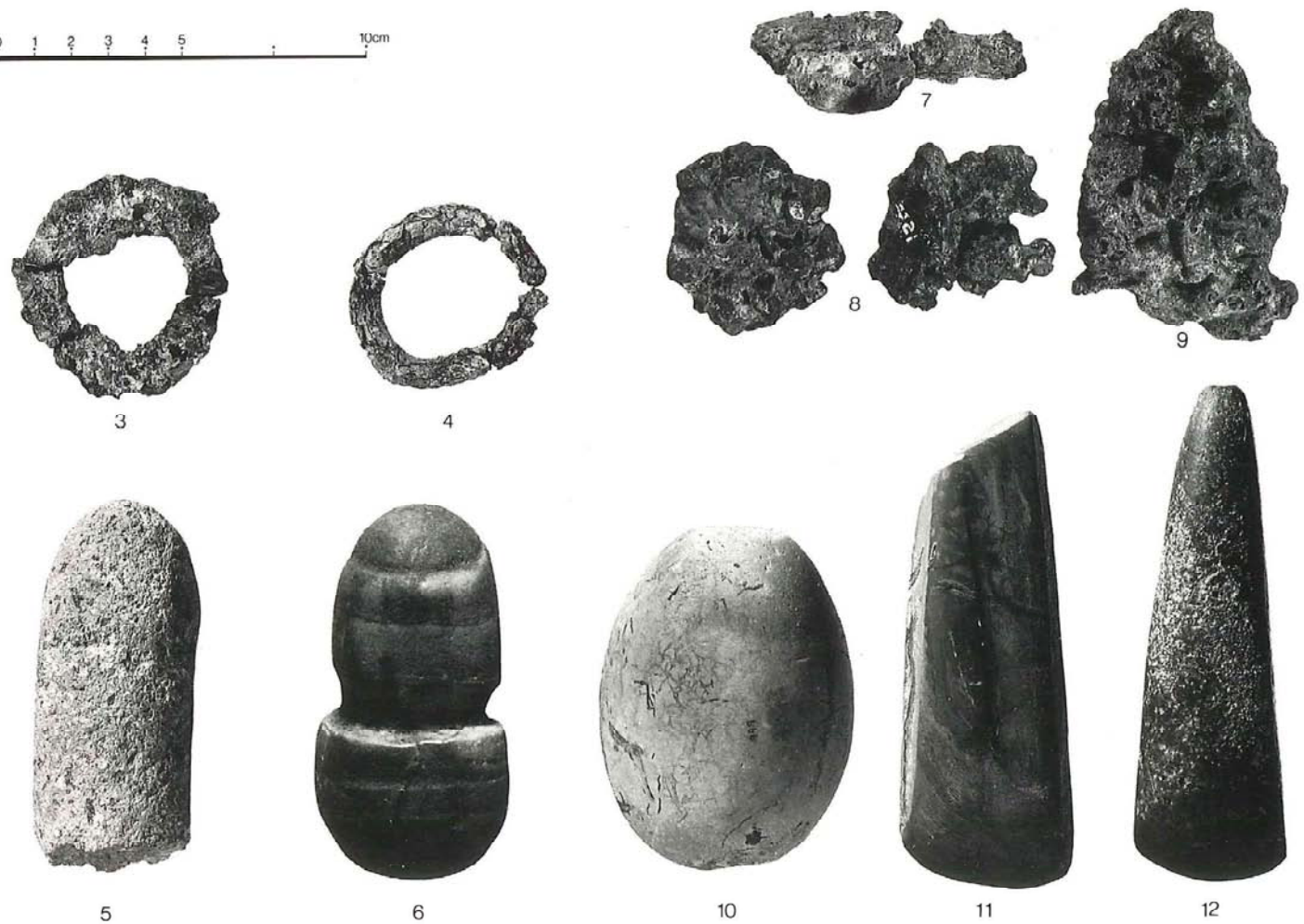
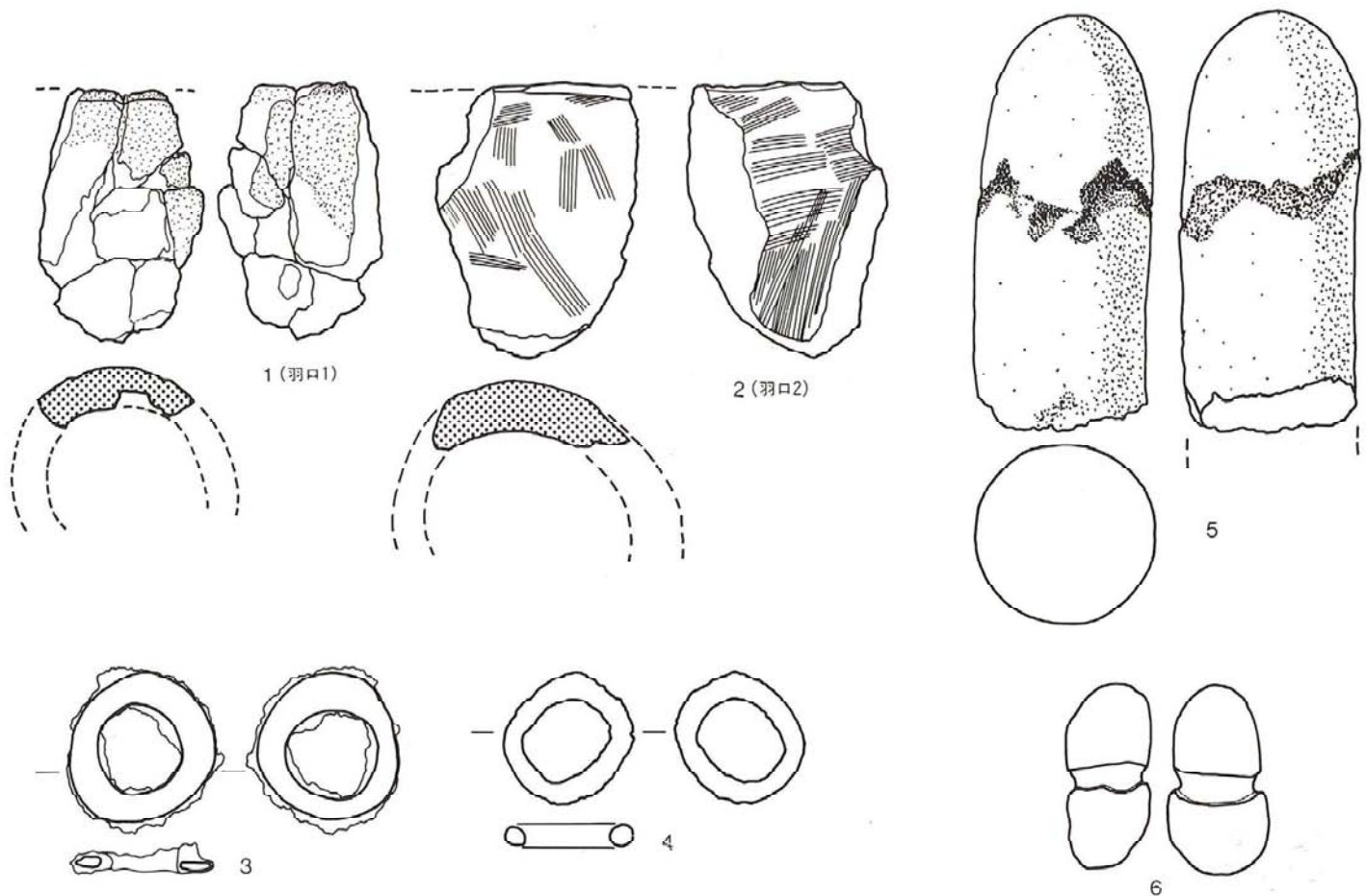

PL. ②-311 鉄製品・鉄滓の破片分布図

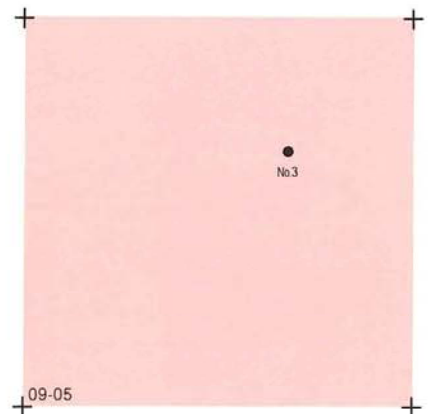
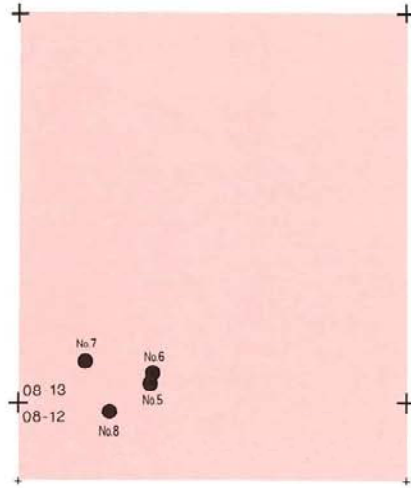
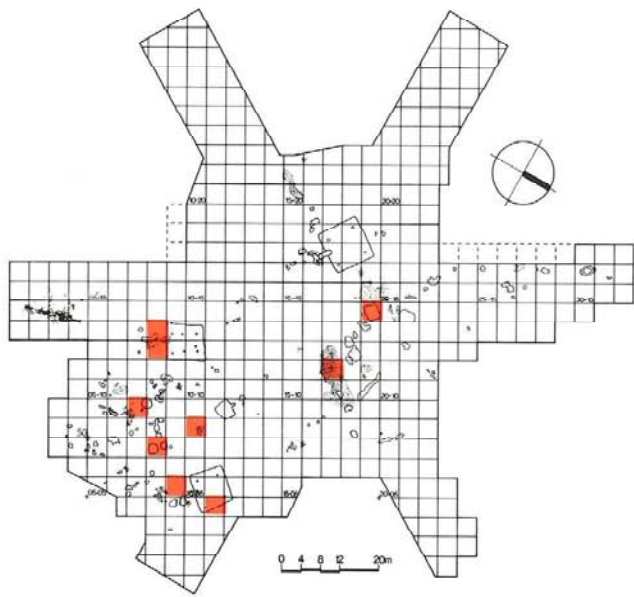



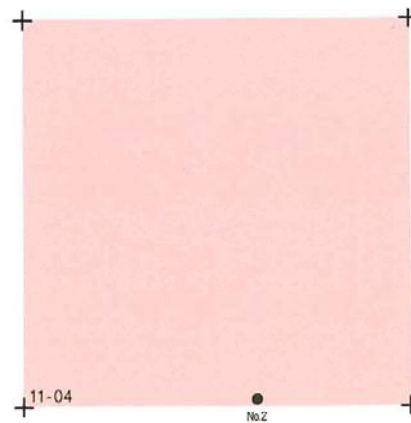
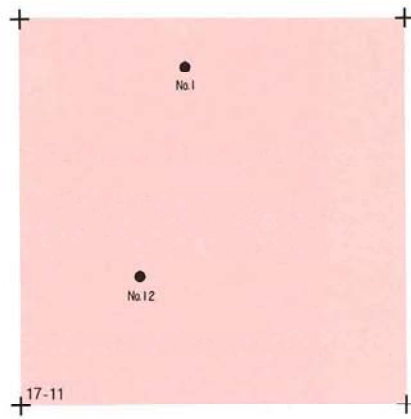

PL. 図-312 土製玉の破片分布図



PL. 図-313 羽口の破片分布図

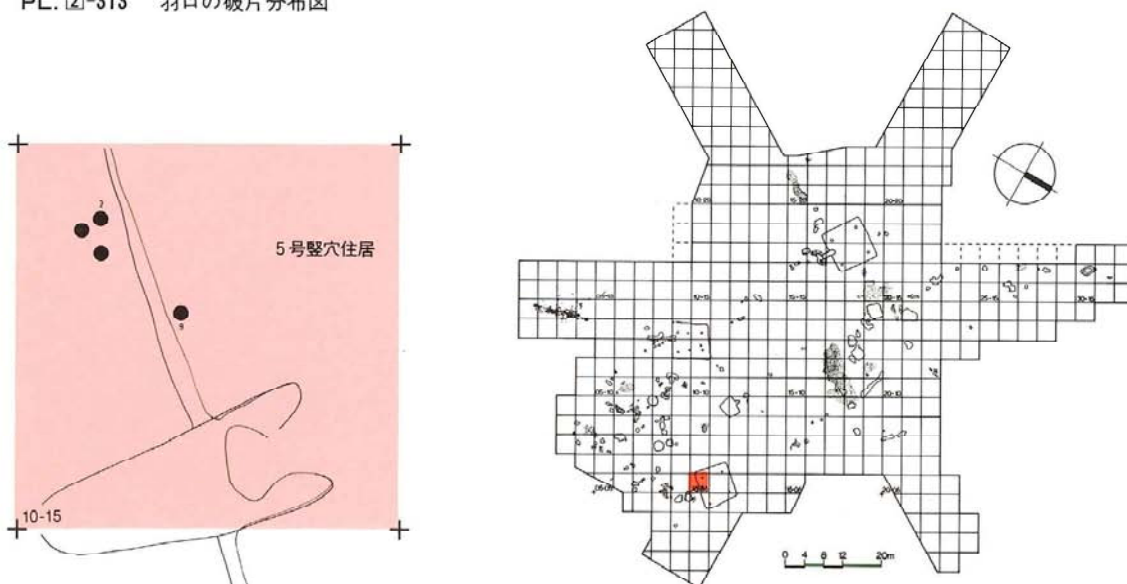



PL. ②-315 石器の分布と接合関係の図 ②

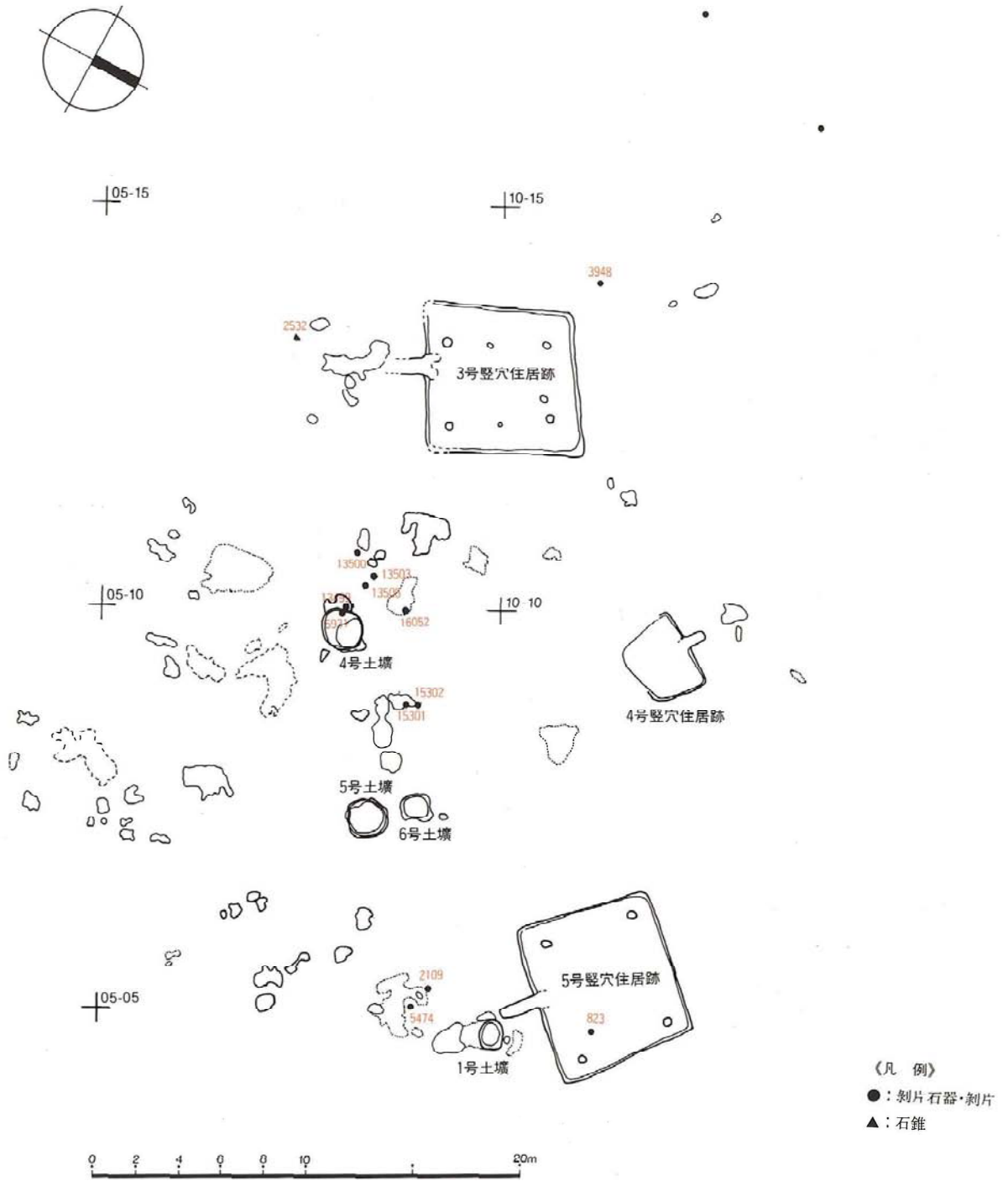



PL. ②-316 石器, 石核, 剥片と接合図 ① [( )内は個体番号]

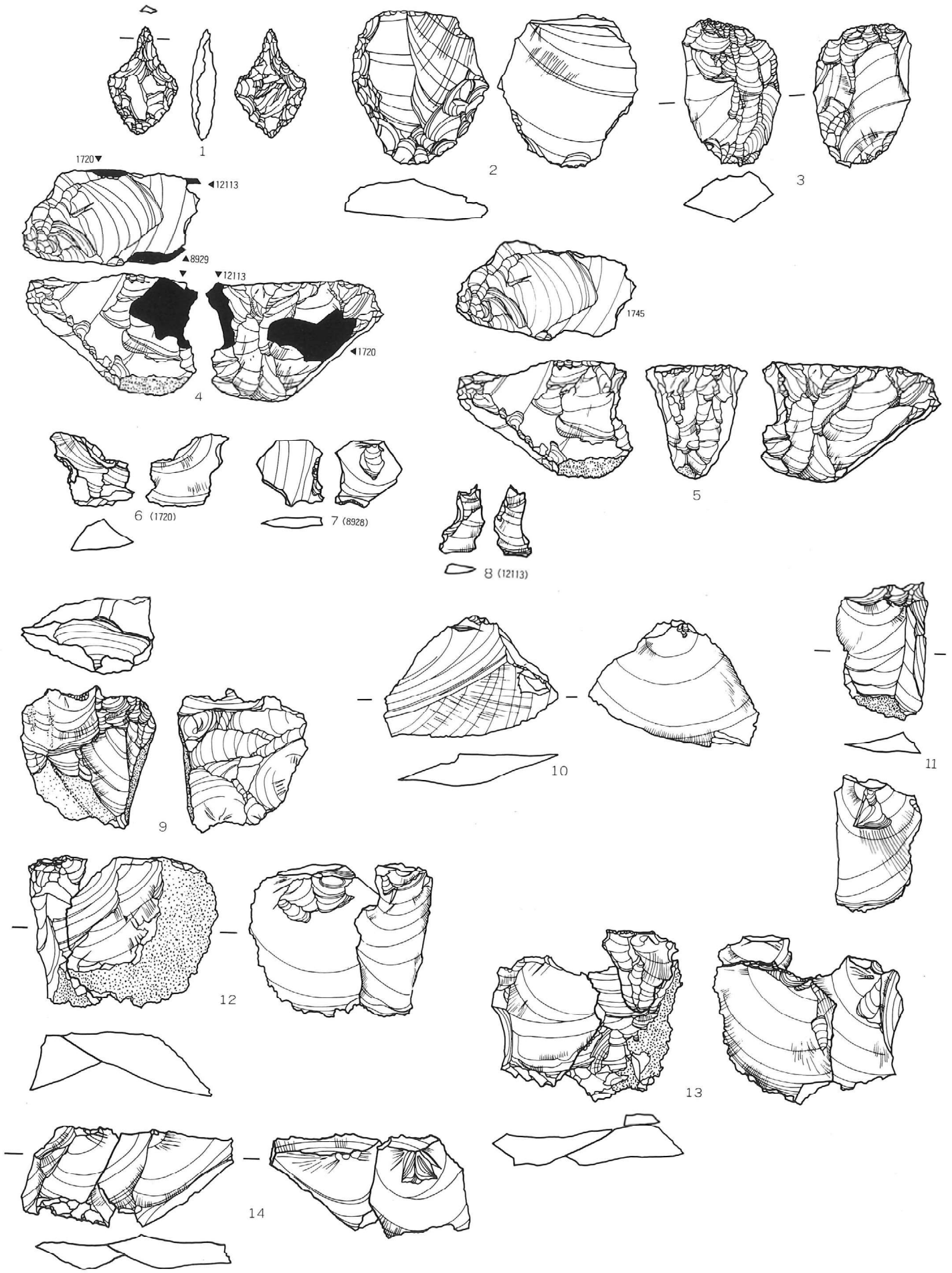

PL. ②-317 石器, 剥片の接合図 ② (( )内は個体番号)

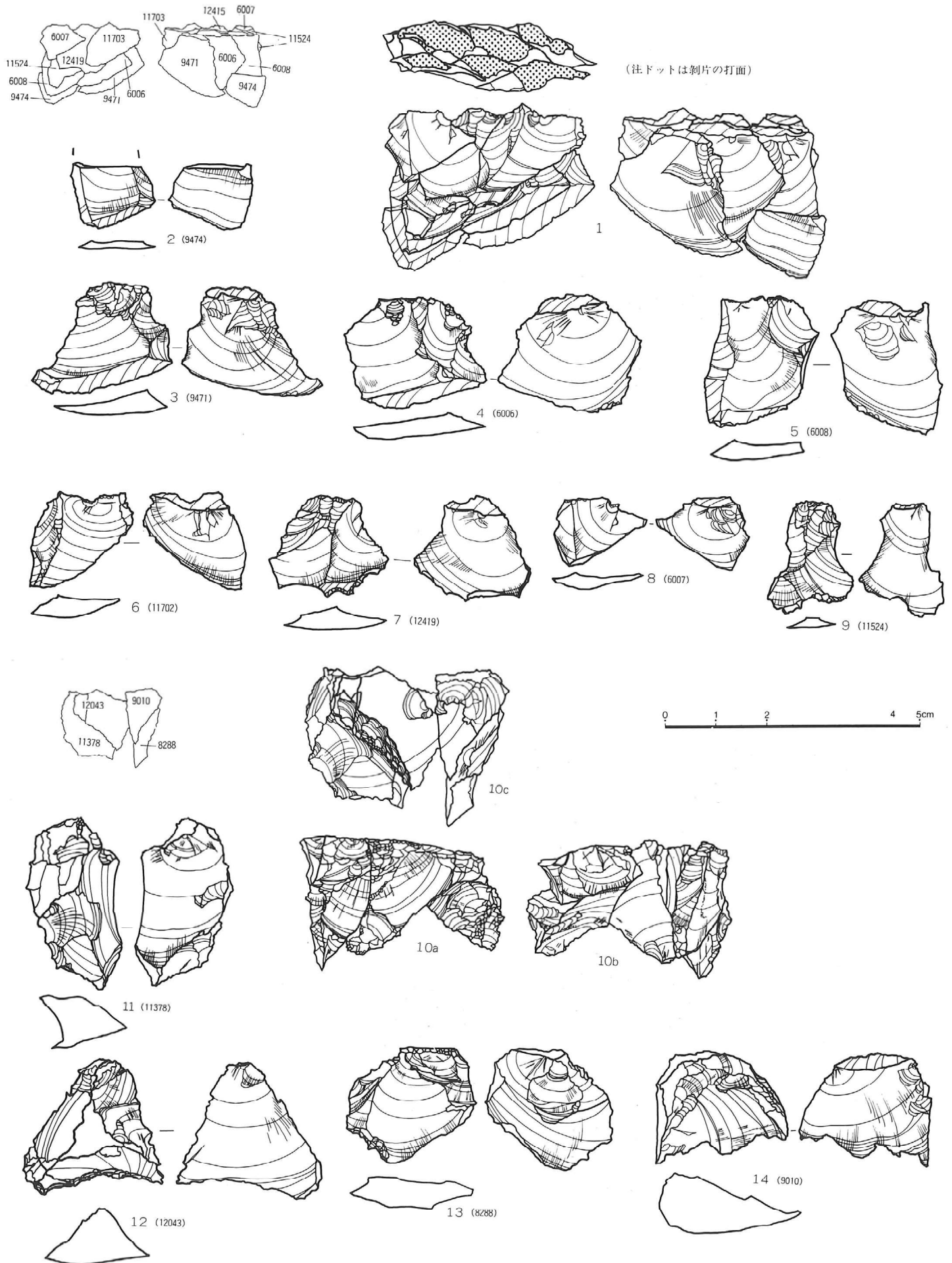

PL. ②-318 石器, 石核, 剥片と接合図 ①

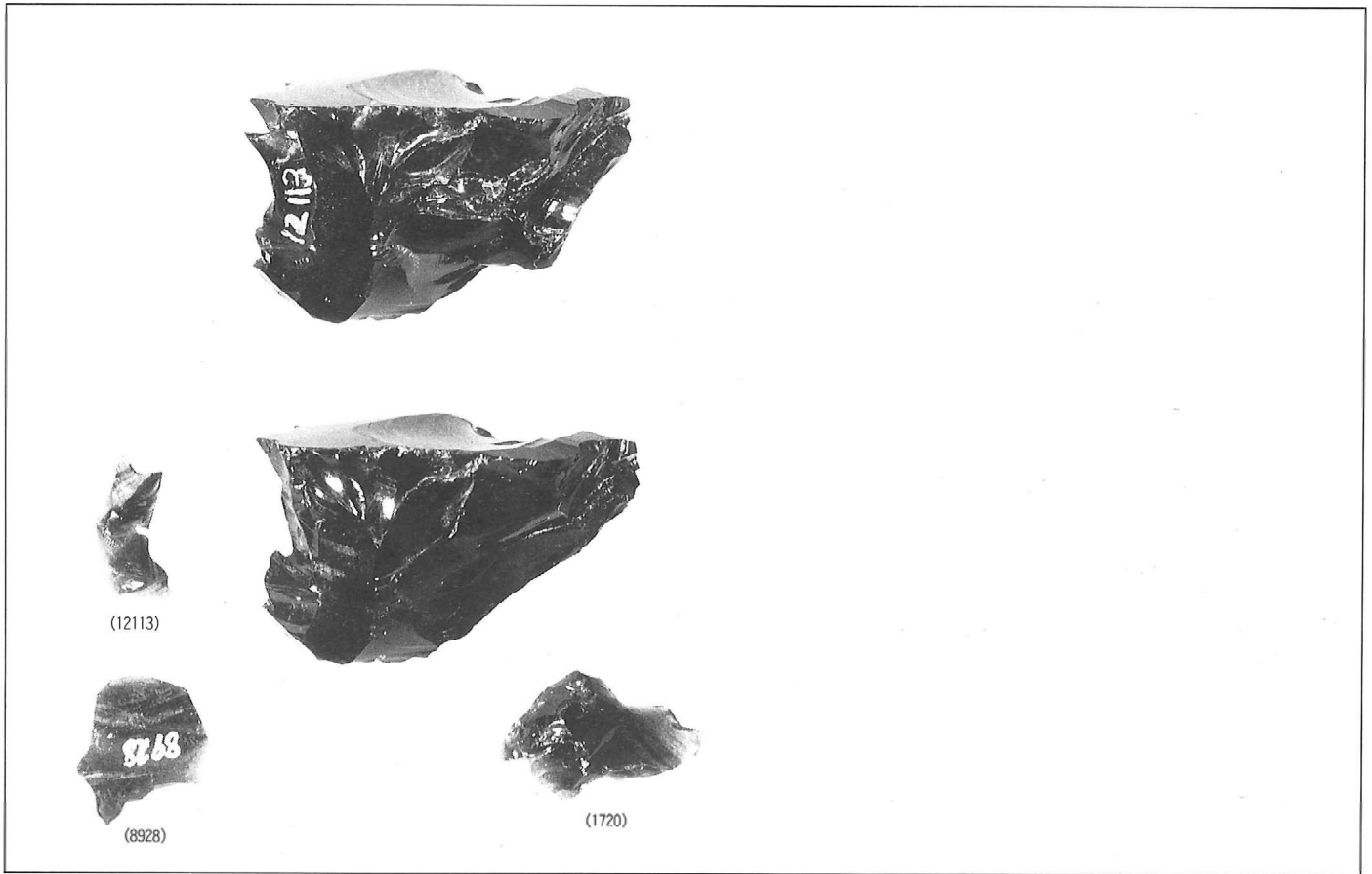

(接合資料4)

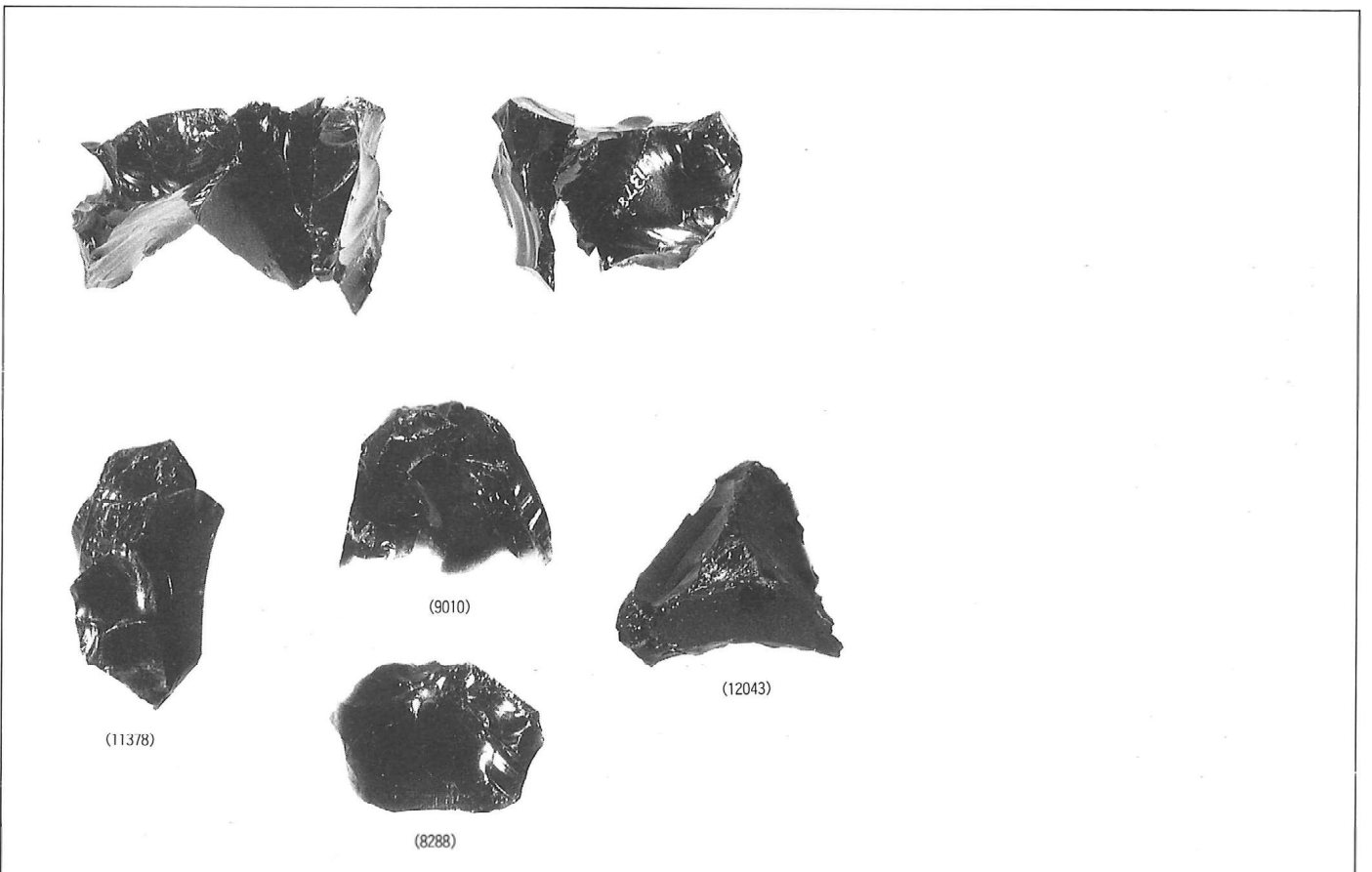

(接合資料6)

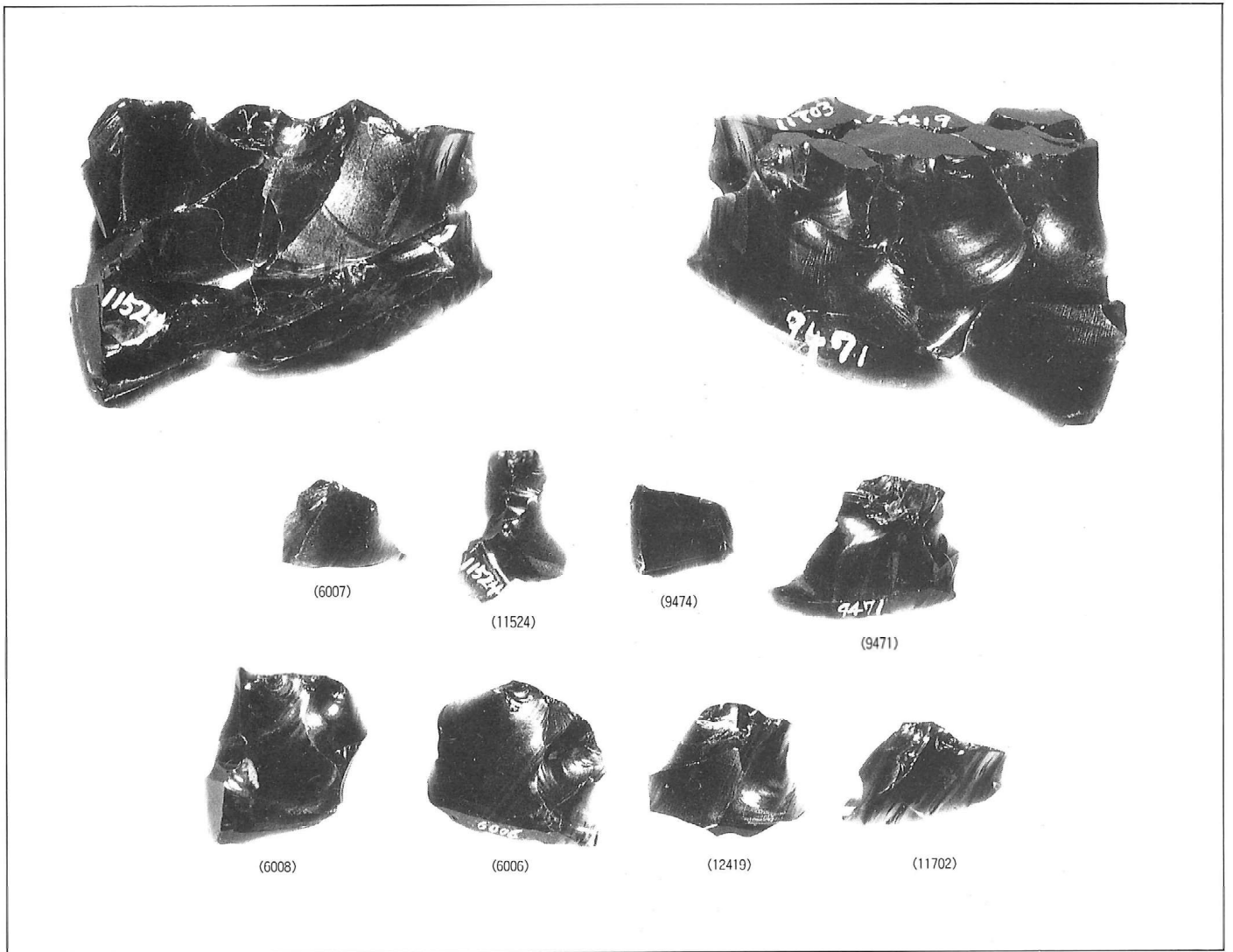

(接合資料5)



PL. ②-320 埋没河川(00-15↔08-15グリッド)の地層図

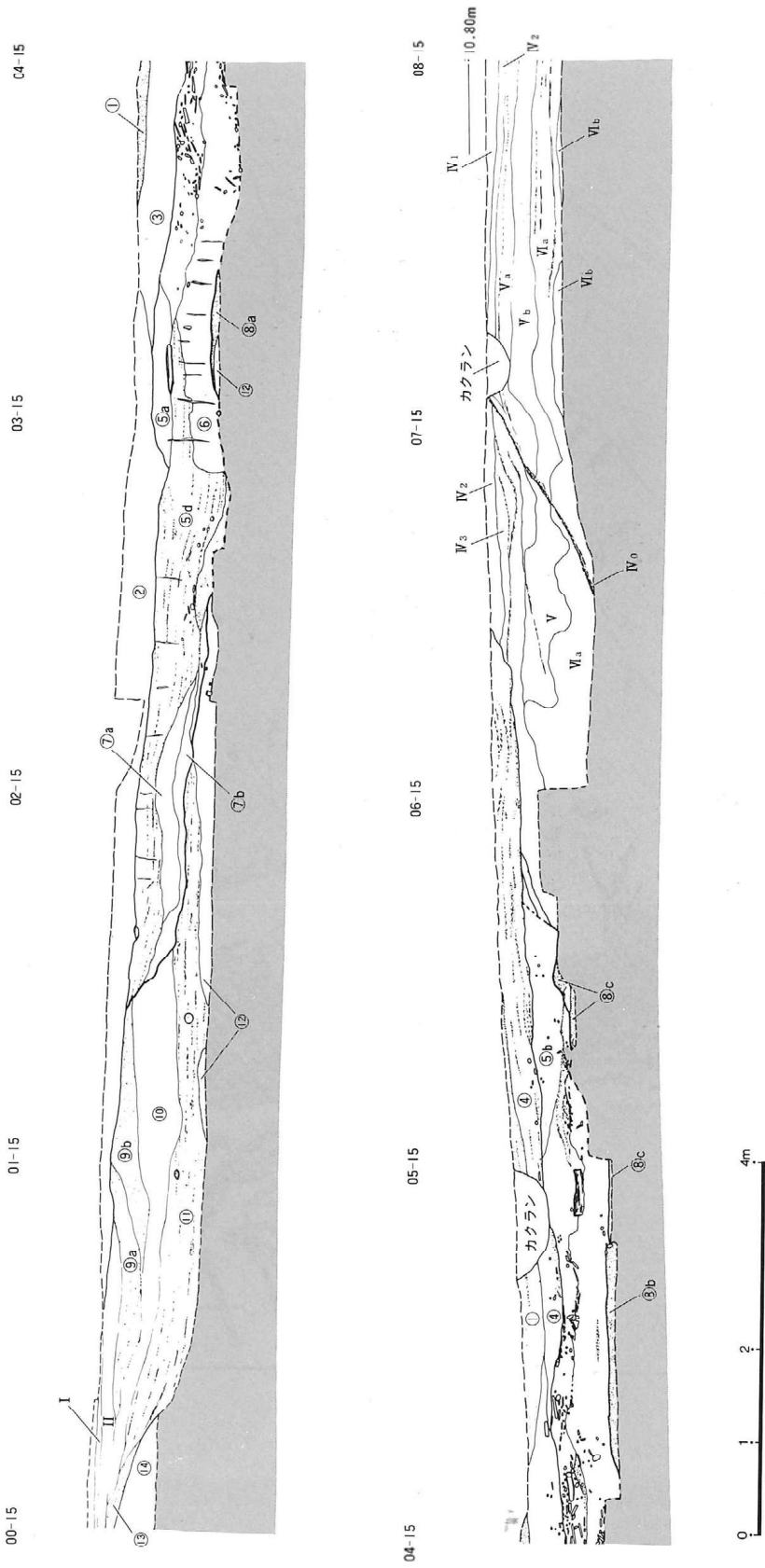

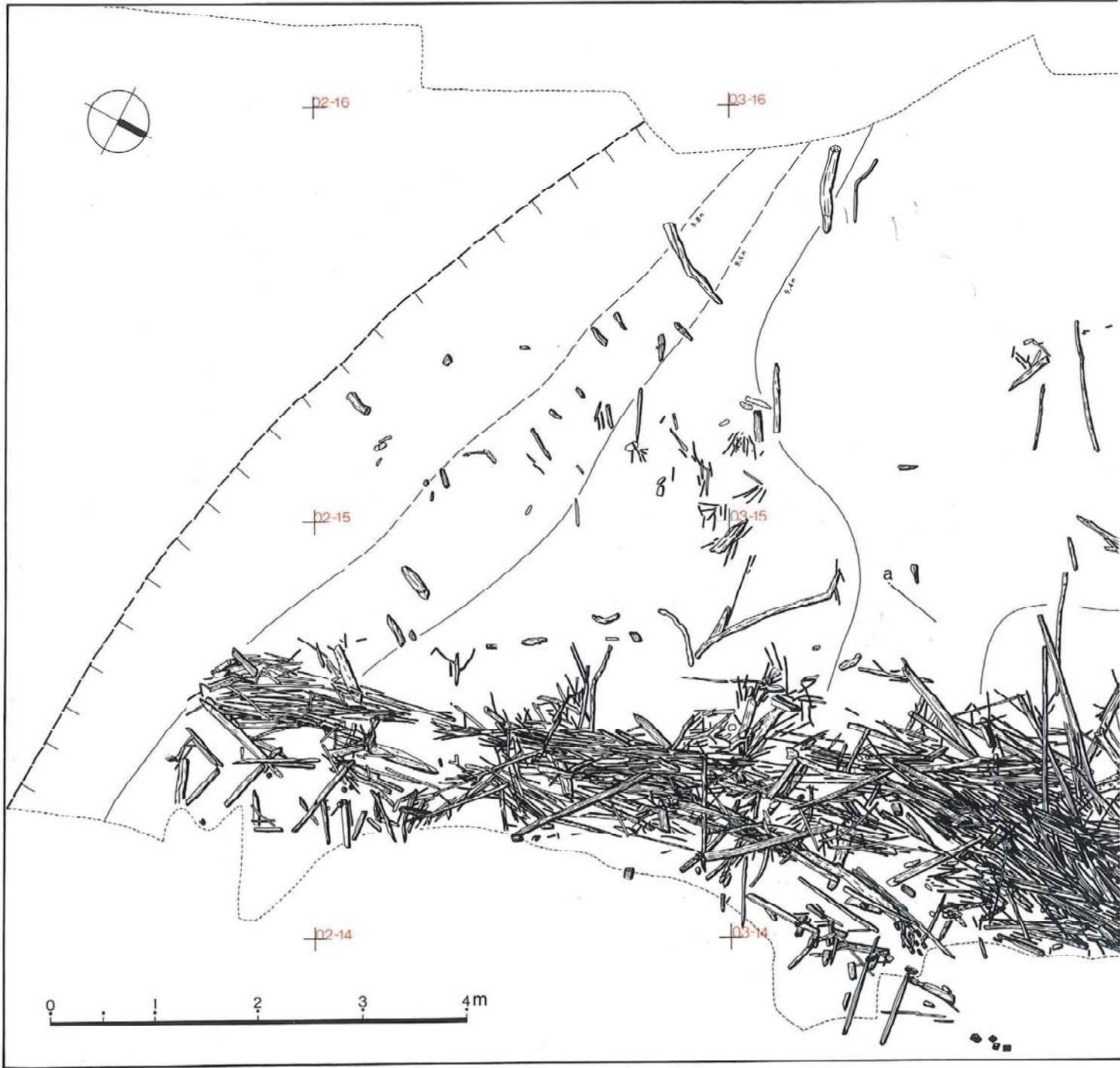



PL. 図-322 テシの杭立面図

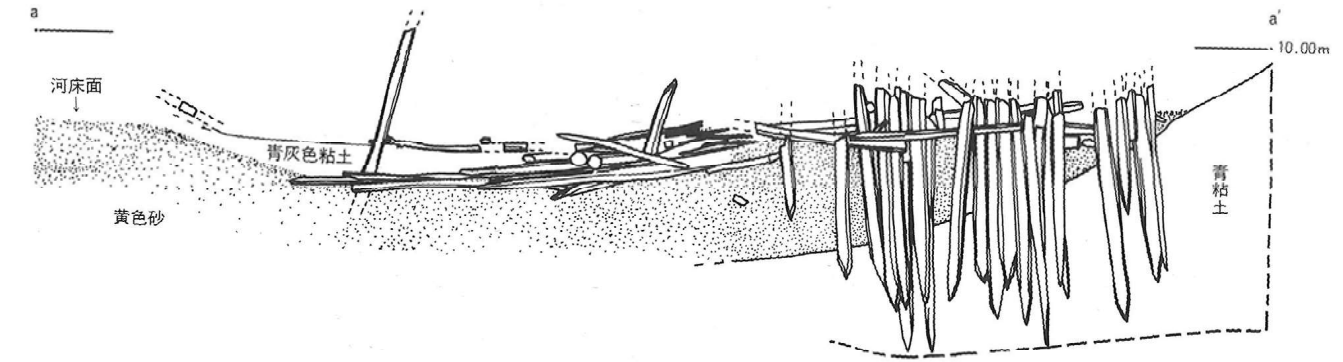

0 10 20 30 40 50 100cm

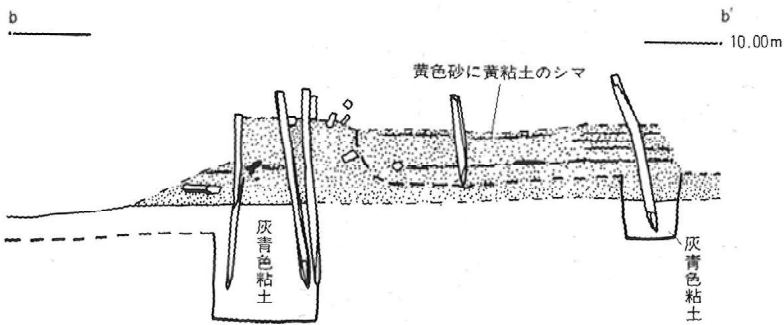



PL. ②-323 テシ ①



左岸からみる

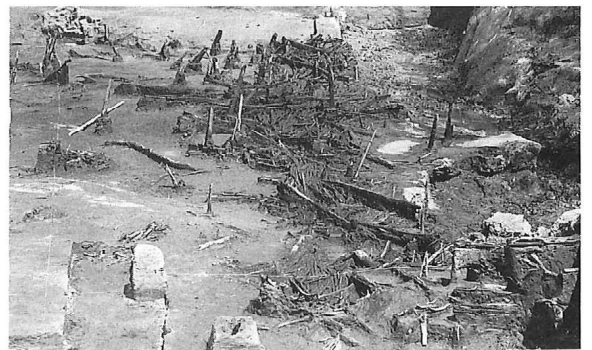

右岸からみる



左岸の上流からみる



右岸の上流からみる



埋没河川の土層堆積-1



埋没河川の土層堆積 2

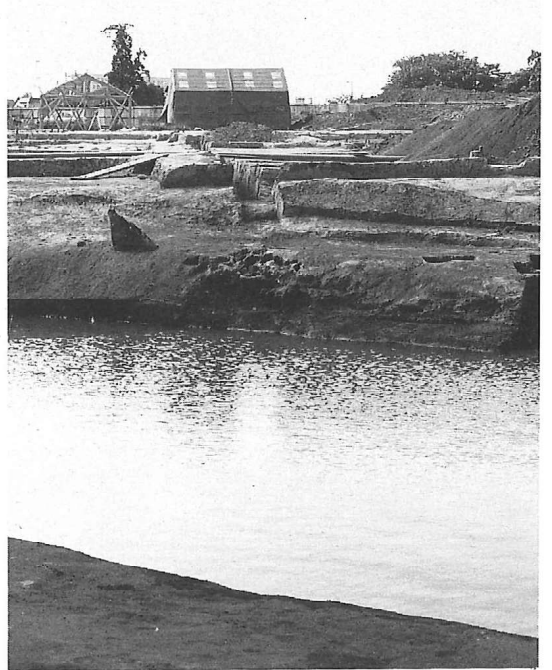

水をたたえた旧河川：右岸からみる



左岸の杭列と横材：上流からみる



左岸の杭列と横材の組み合わせ



PL. ②-325 テシ ③

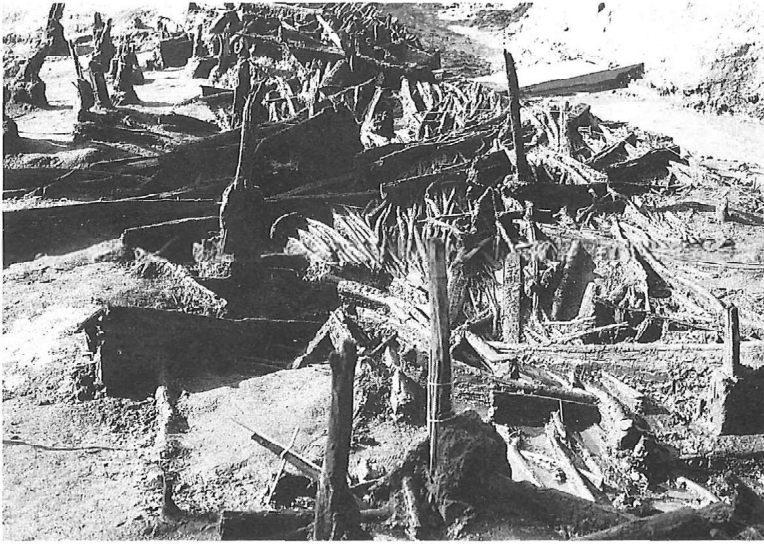

旧河川の中から左岸側をみる

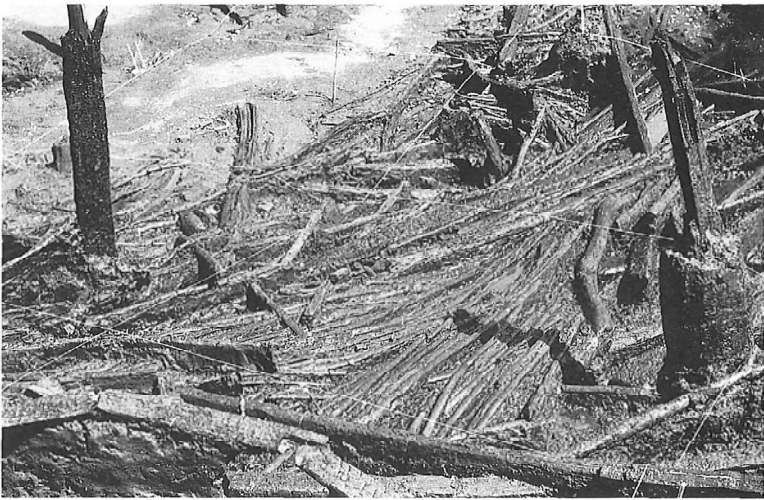

中央部分の状況：上流からみる



中央部分の状況：上流からみる

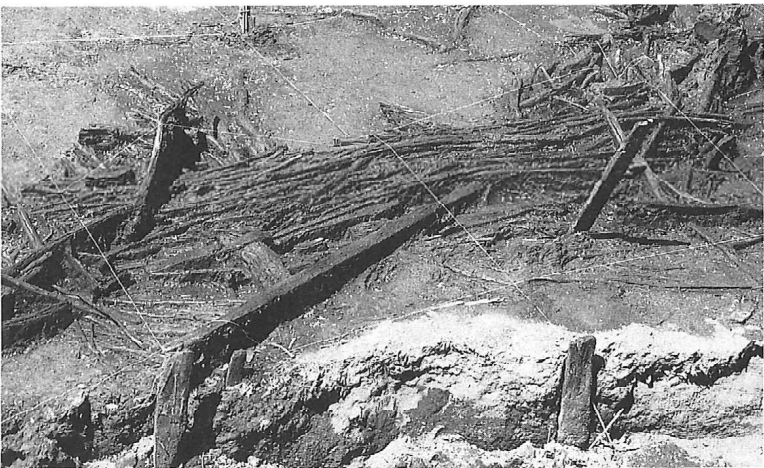

中央部分の状況：上流からみる



横材とヤナギの小枝

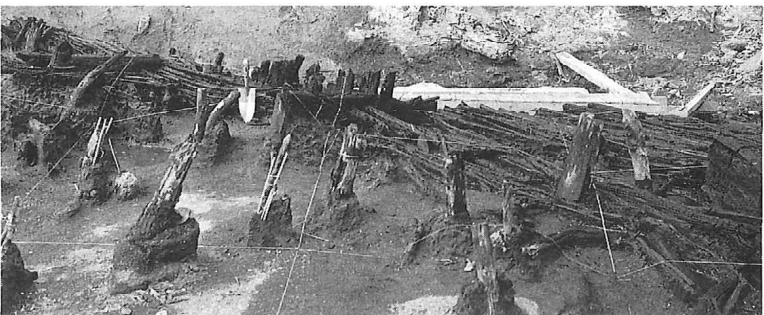

左岸部分の状況：上流からみる



左岸の杭列：下流からみる



横材の出土状況



横材の出土状況



ヤナギの小枝の出土状況

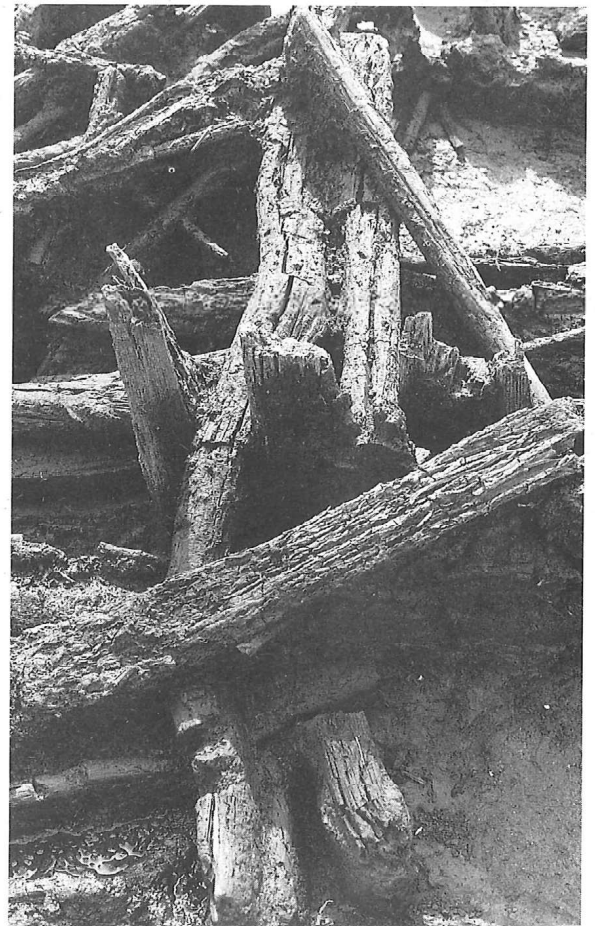

左岸の木組み状況



PL. ②-327 テシ ⑤ 遺物の出土状況



粘土層深く打ち込まれたえぐり込みのある丸杭



えぐり込みのある横材

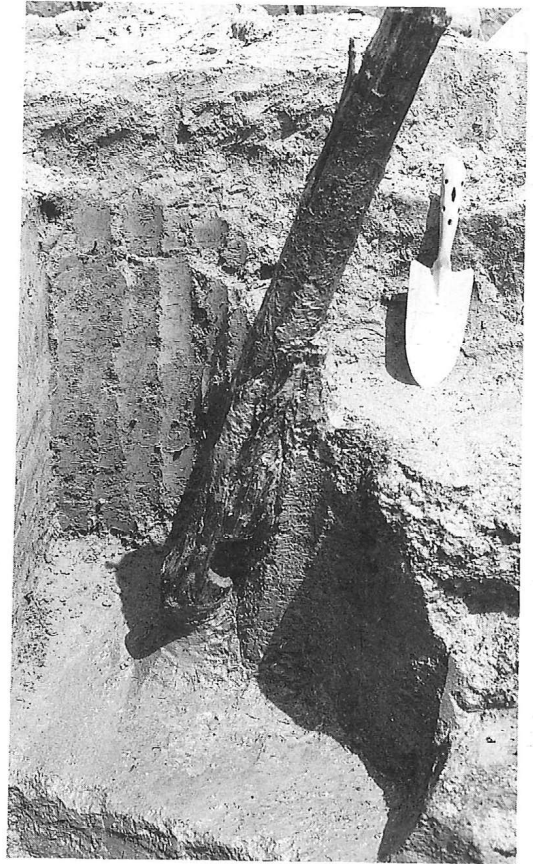

粘土層深く打ち込まれたえぐり込みのある割杭

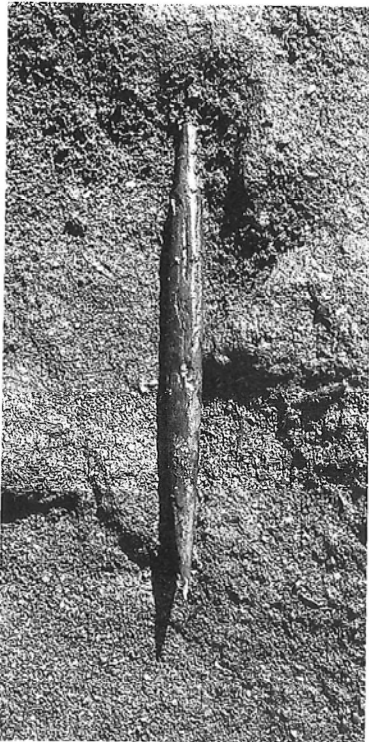

川砂から出土した木製漁具

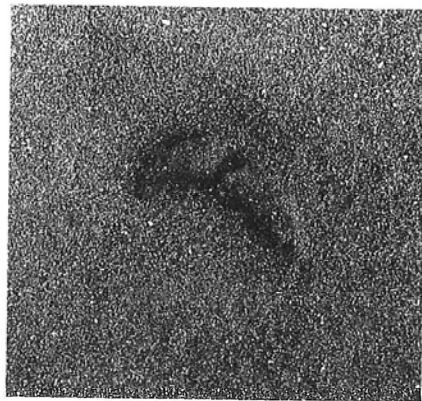

川砂から出土したマレク



川砂から出土した擦文土器の破片

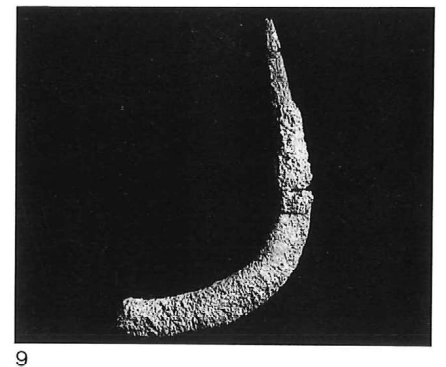
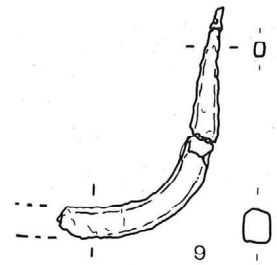
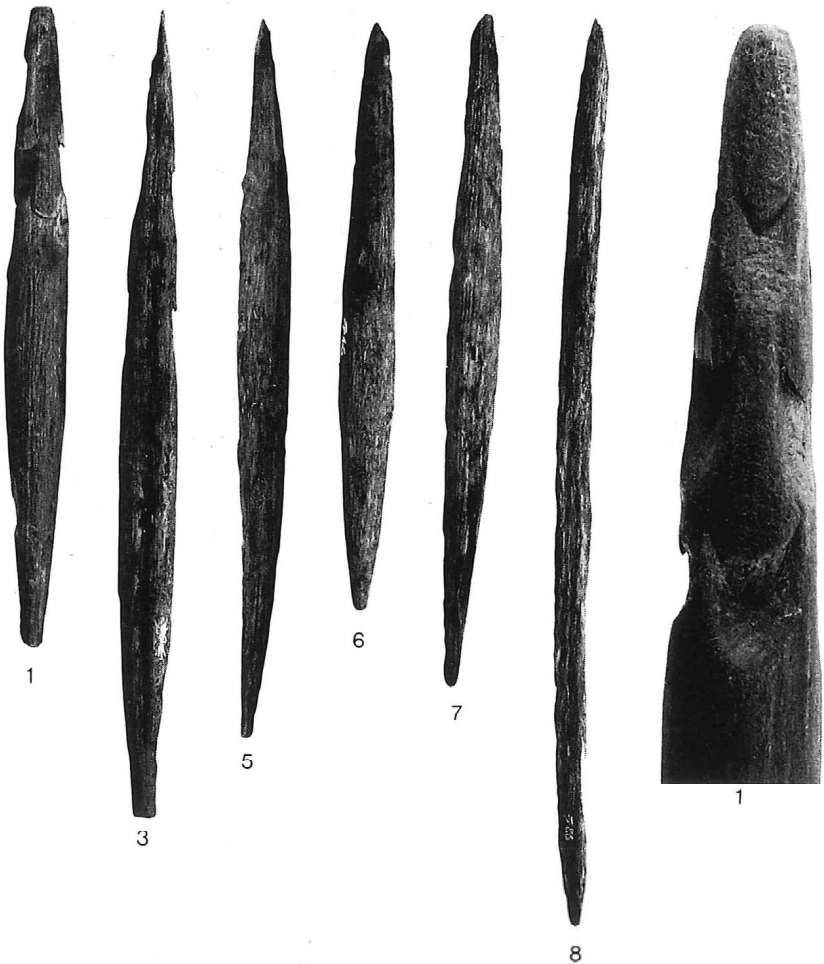
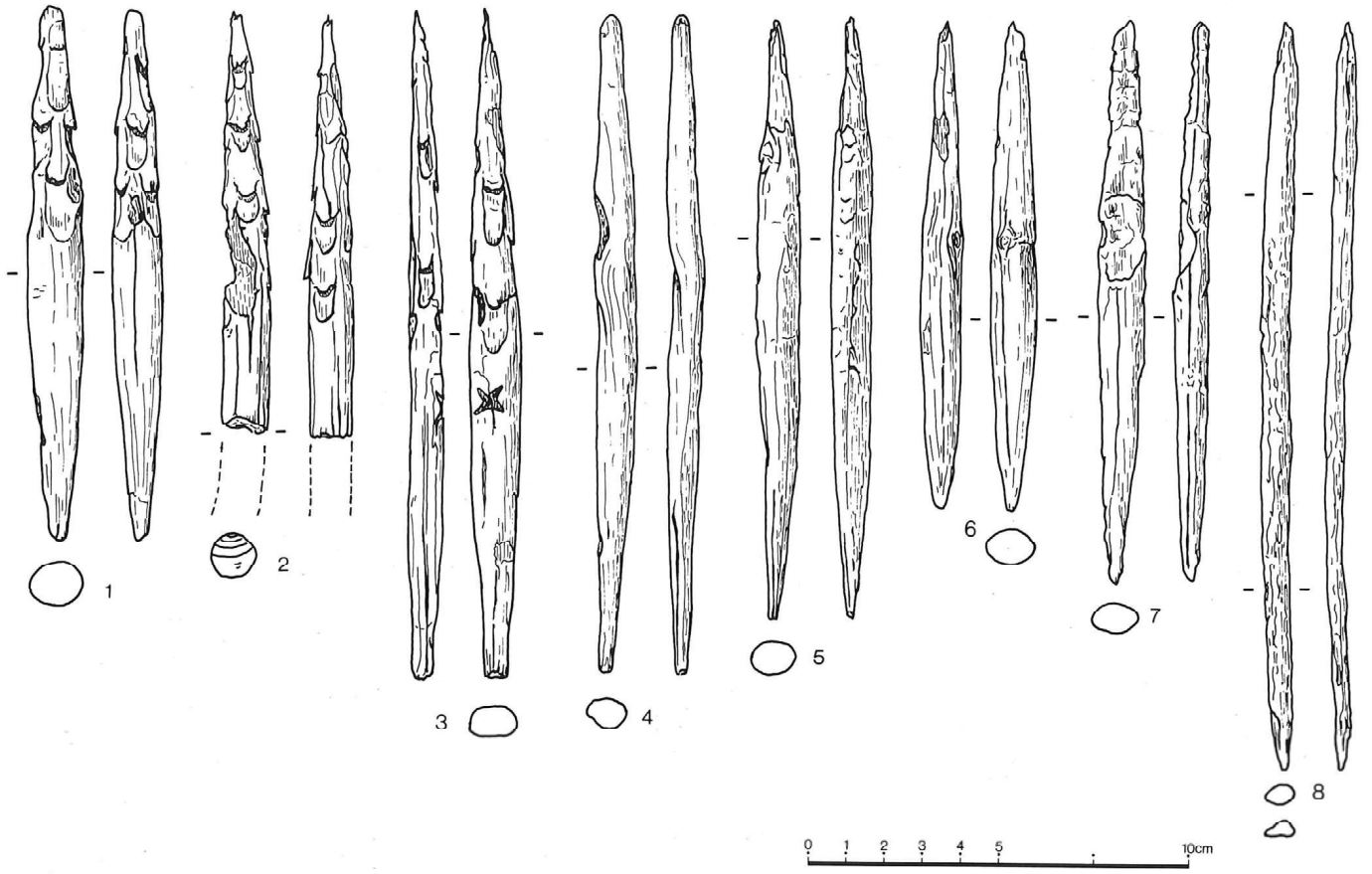

PL. ②-329 木製品 ①

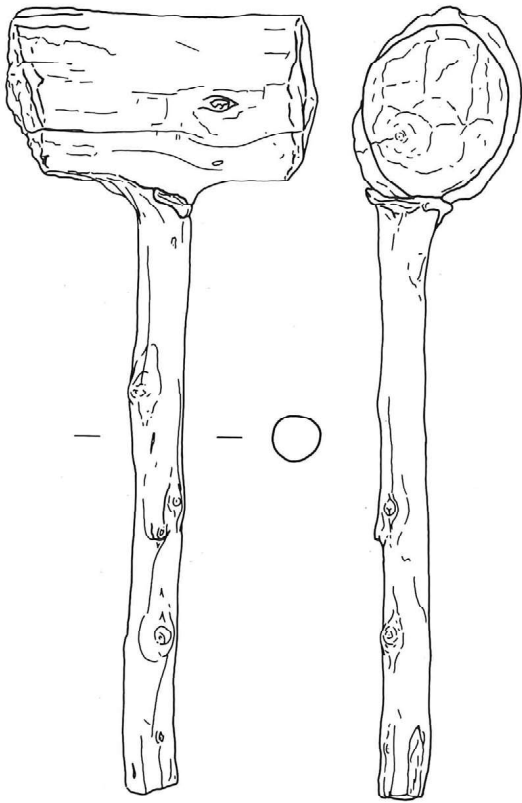

1 木槌

0 1 2 3 4 5 ; 10cm

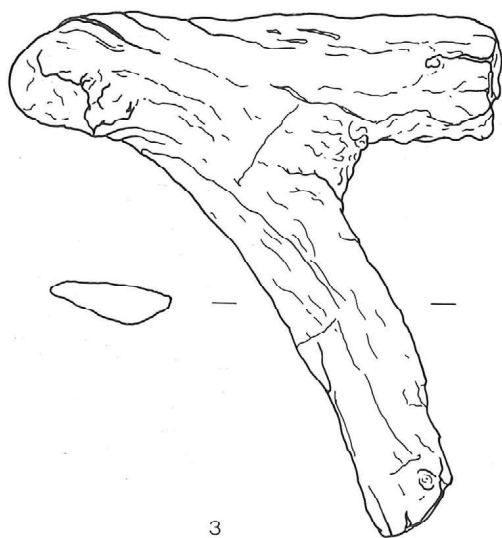
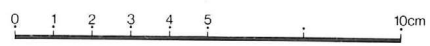
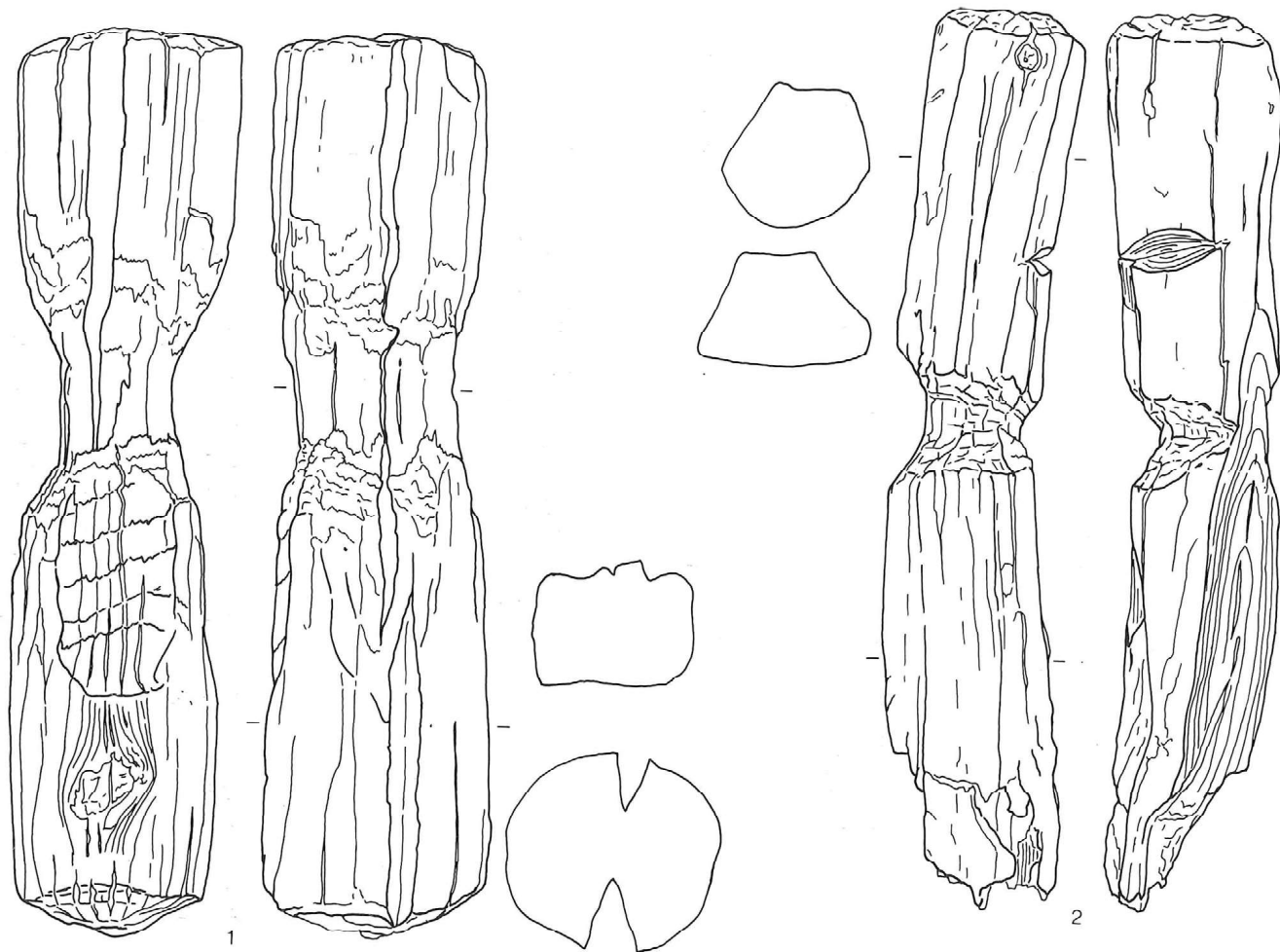



PL. ②-331 木製品 ③ と割杭および土器片



1 木樋



2



3



4



5



6



7

木杭



8



9

えぐり込みのある木器

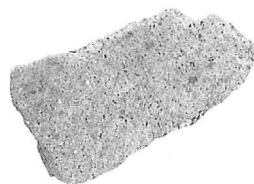

10

擦文土器の破片

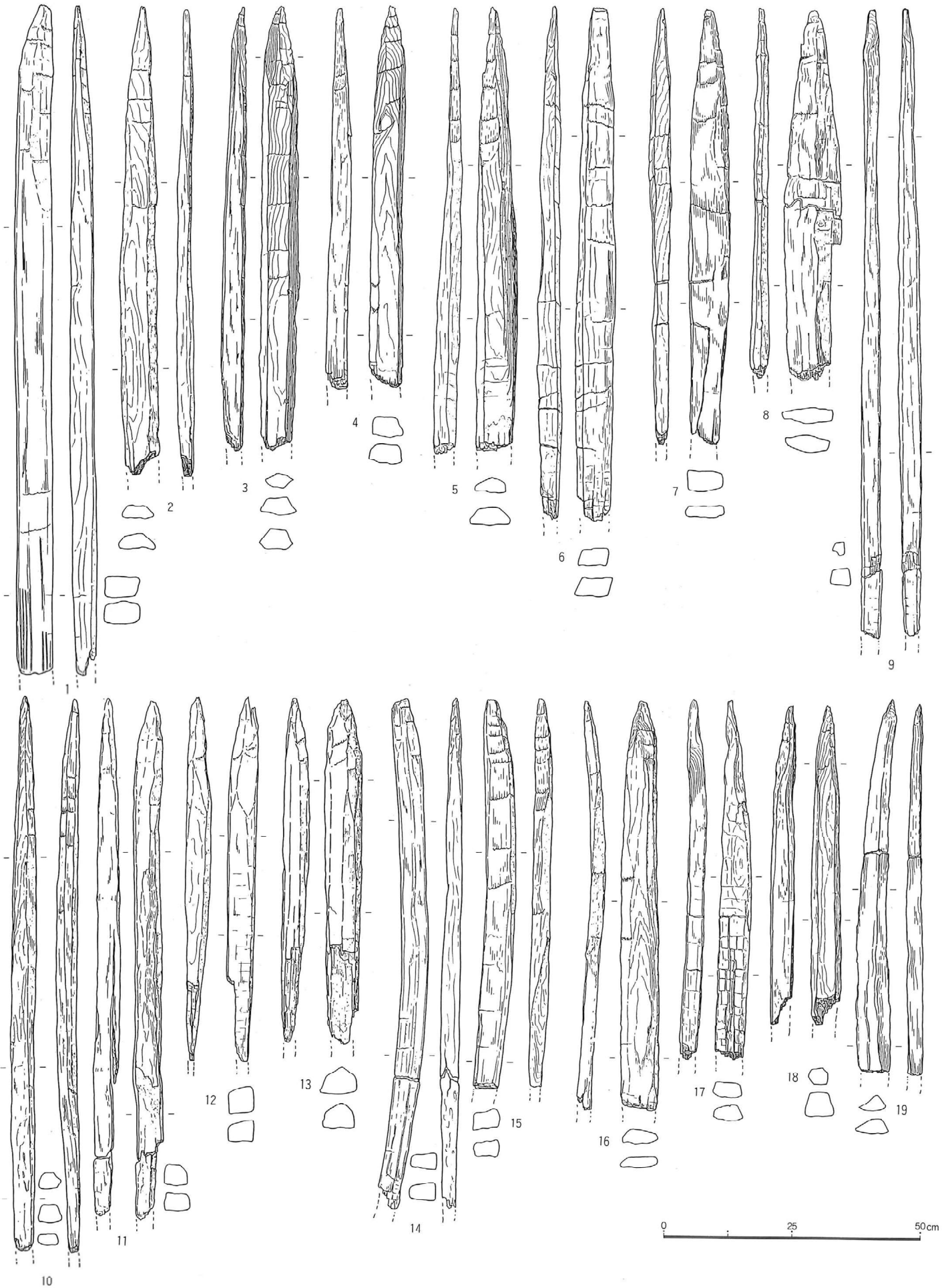

PL. 2-333 丸杭(1~9)と横材(10~13)

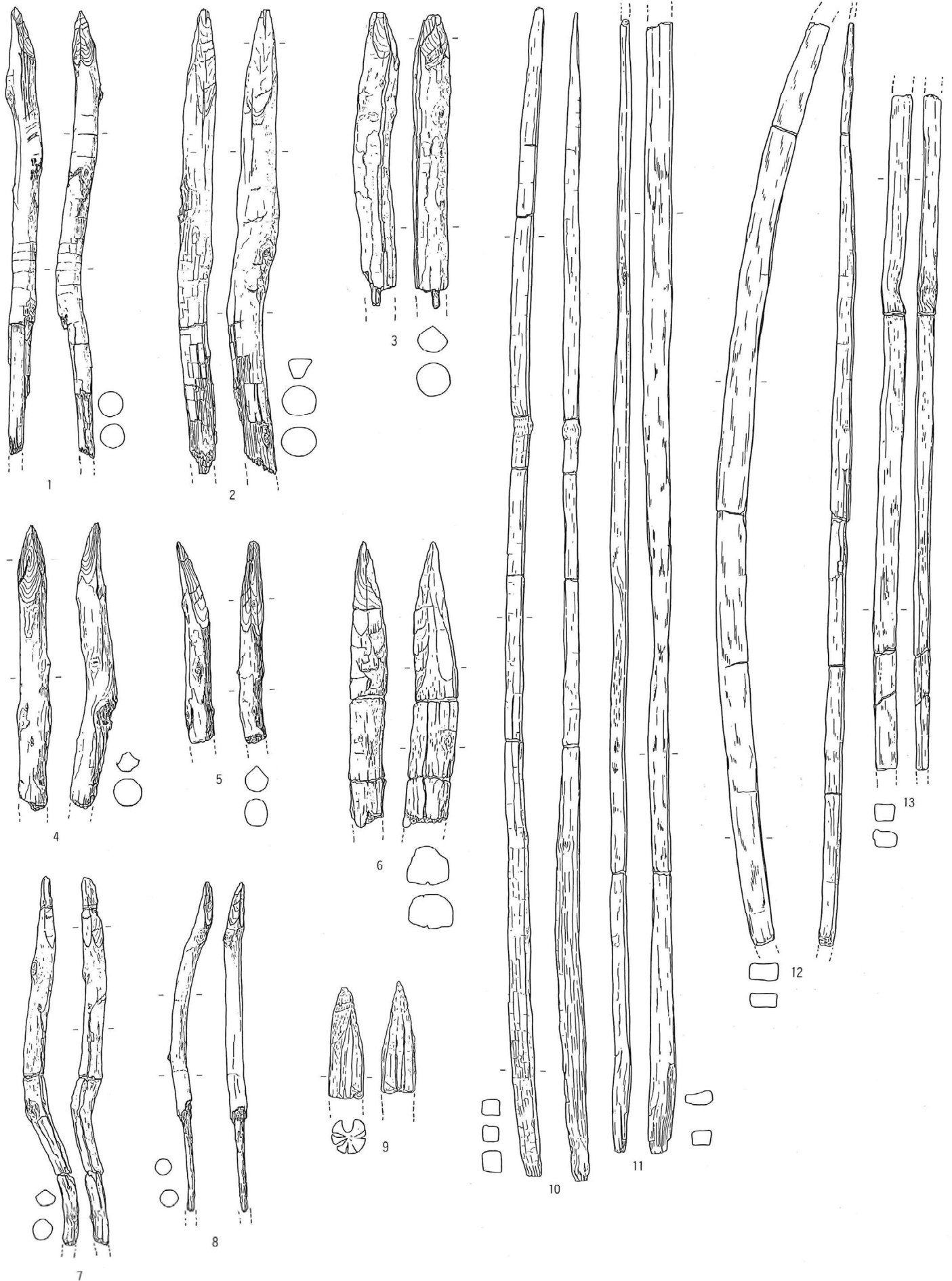

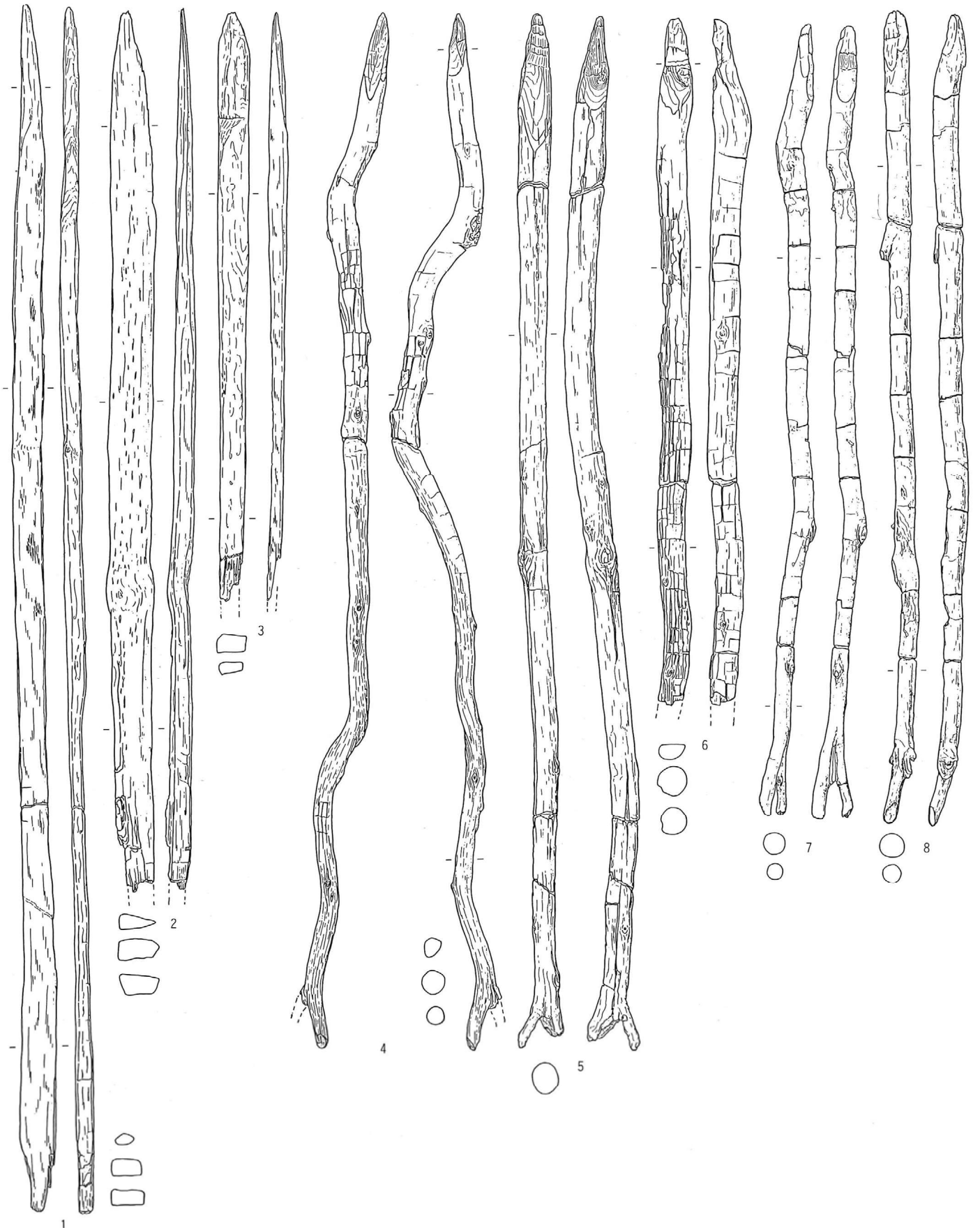



PL. 2-335 横木・杭などに転用された廃材(1~6, 13), 補助材に用いたヤナギ(7~12), 丸太(14)

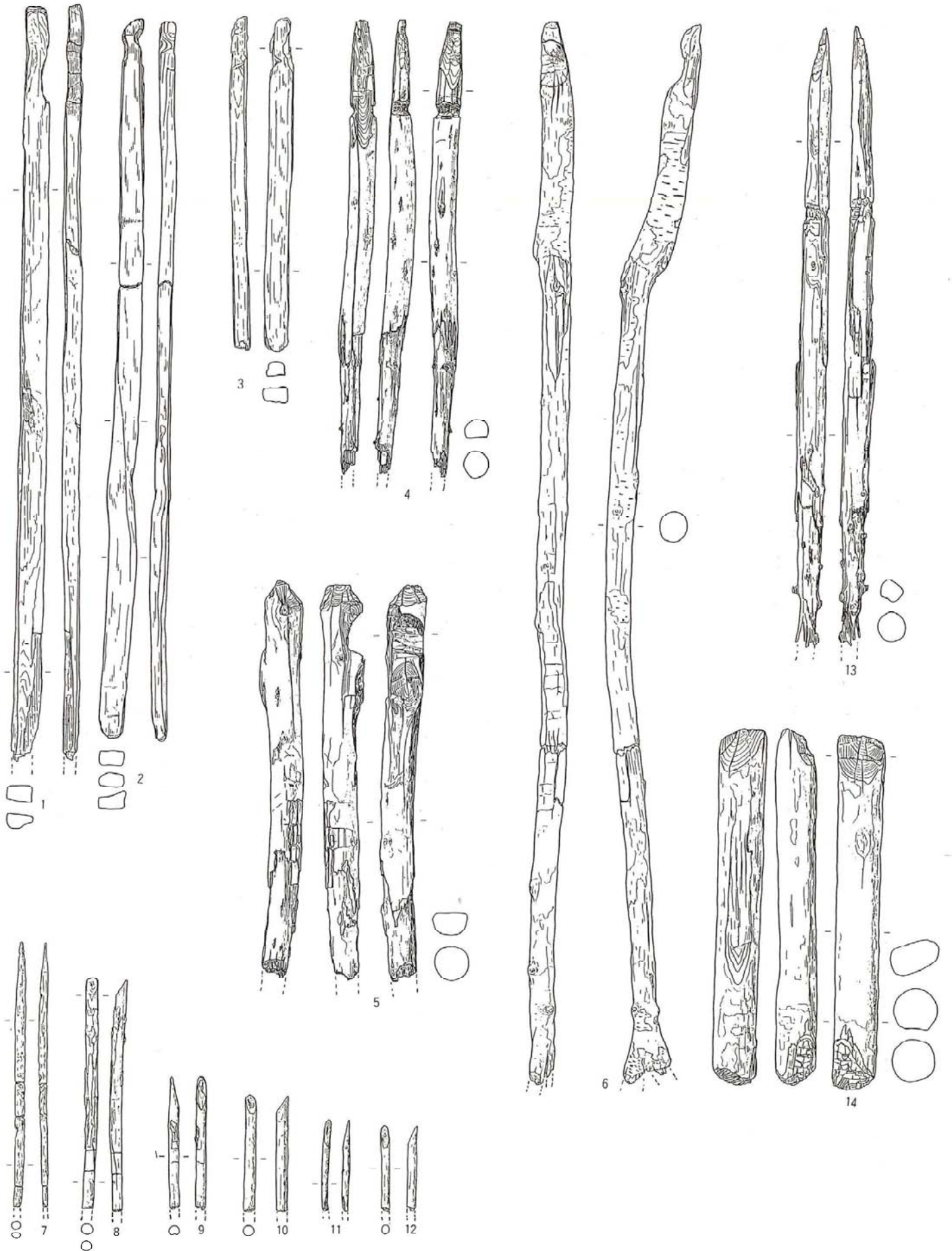

PL. 2-336 テシの割杭と丸杭の分布図

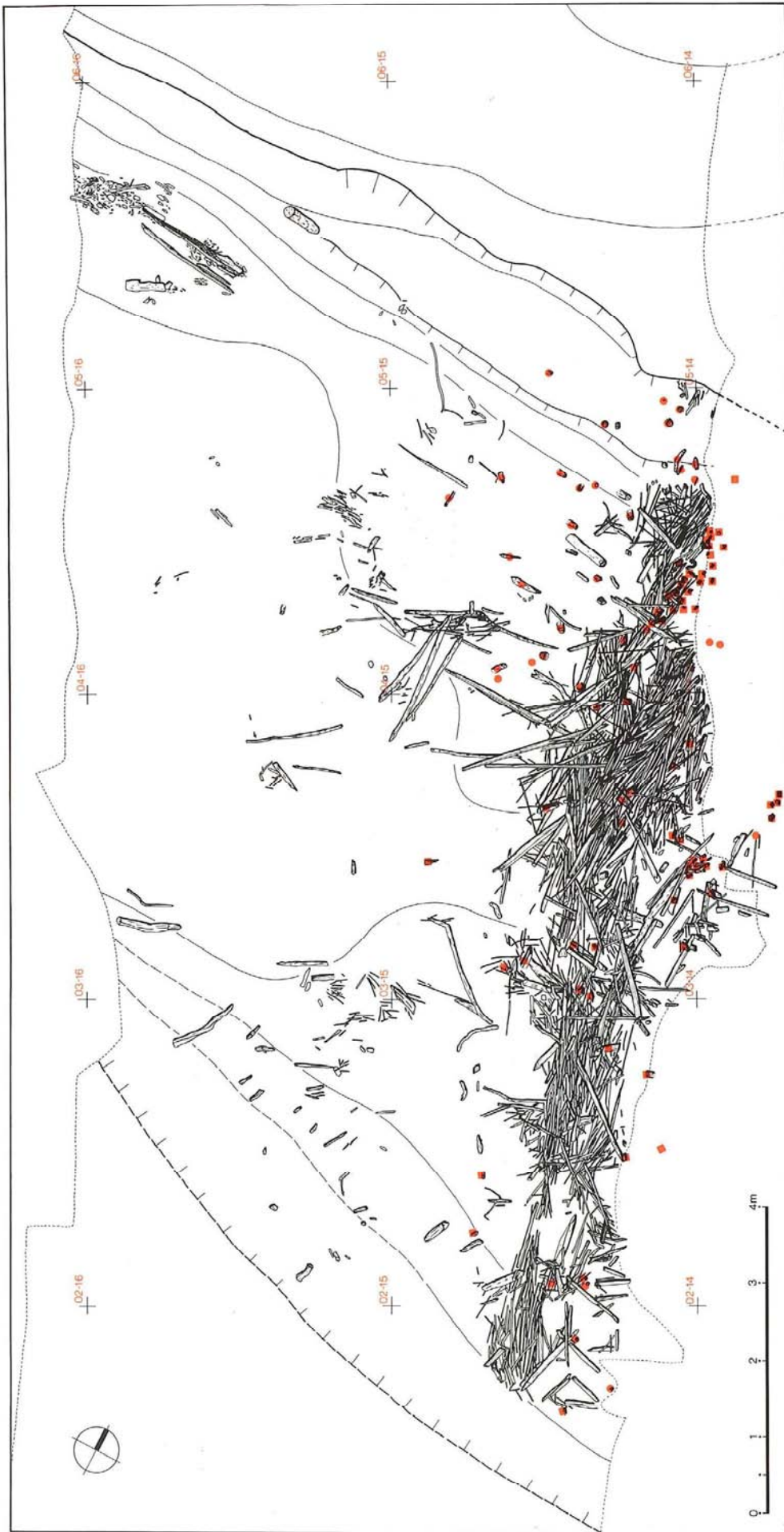

PL. ②-337 テシ出土の遺物分布図

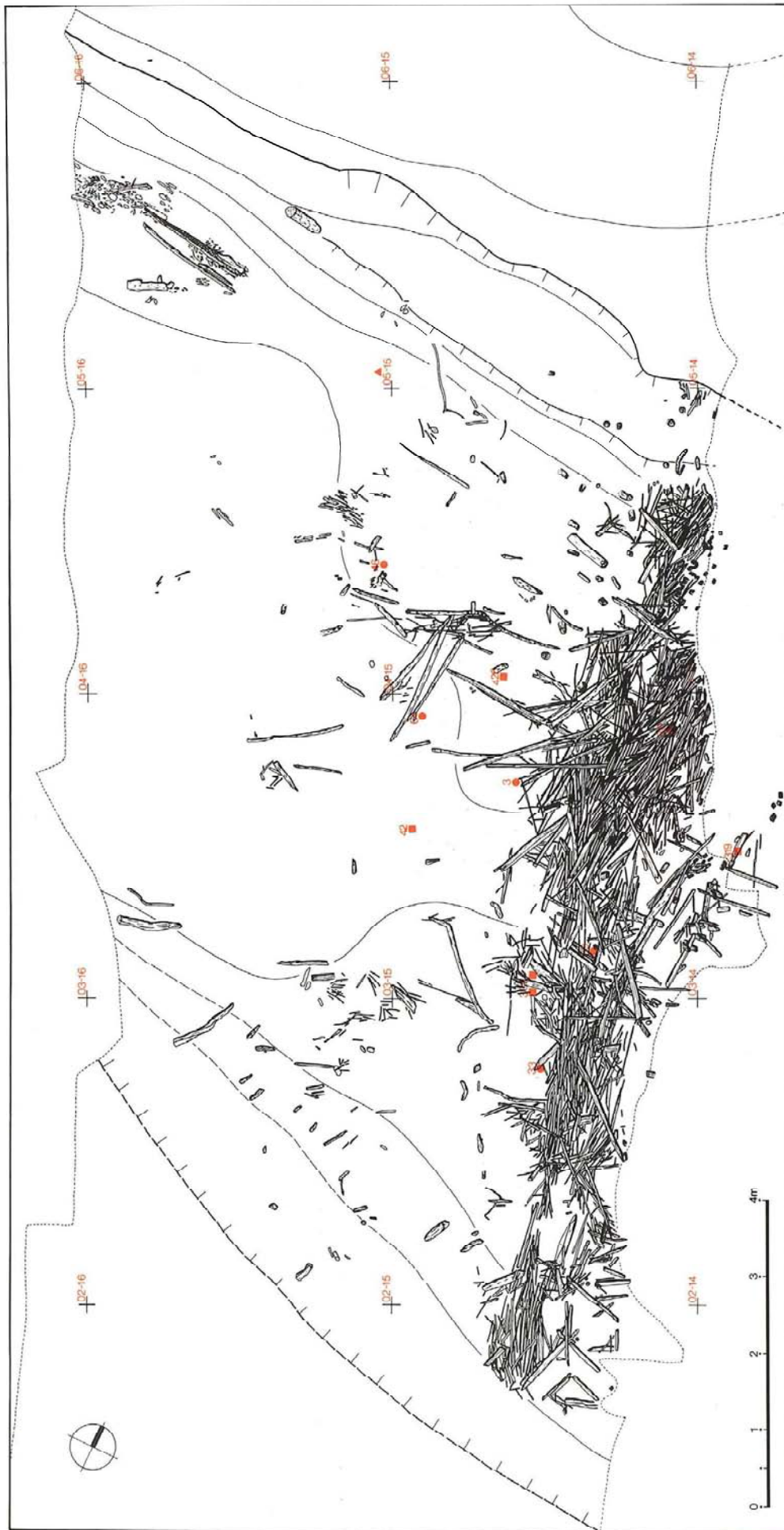

- 魚具
- 木製道具
- ▲ 弥文土器片



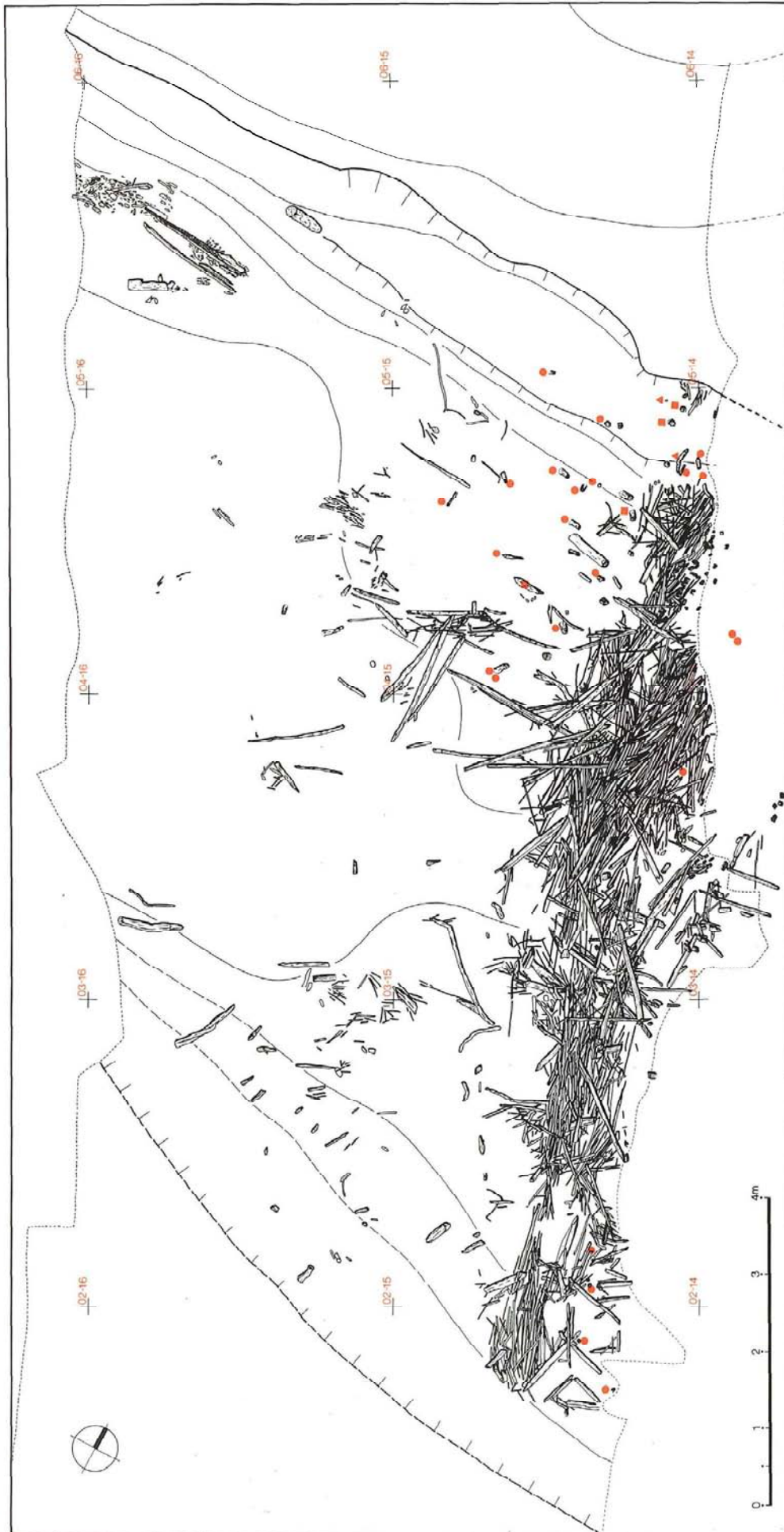

- ▲ モミ属 (代表樹種: トドマツ) 2点
- ニレ属 (代表樹種: ハルニレ) 4点
- トネリコ属 (代表樹種: ヤチダモ)・(ヤナギ属: 代表樹種: エゾノカワヤナギ) 23点







PL. 2-339 横木割材の形状別分布図



PL. 図-340 横木割材の樹種別分布図



-  ニレ属(代表樹種:ハルニレ) 5点
-  トネリコ属(代表樹種:ヤチダモ) 6点
-  ヤナギ属(代表樹種:エゾノカワヤナギ) 4点
-  ハシドイ属(代表樹種:ハシドイ) 1点
- 杭状の材には矢印 9点

PL. ②-341 廃材の樹種別分布図

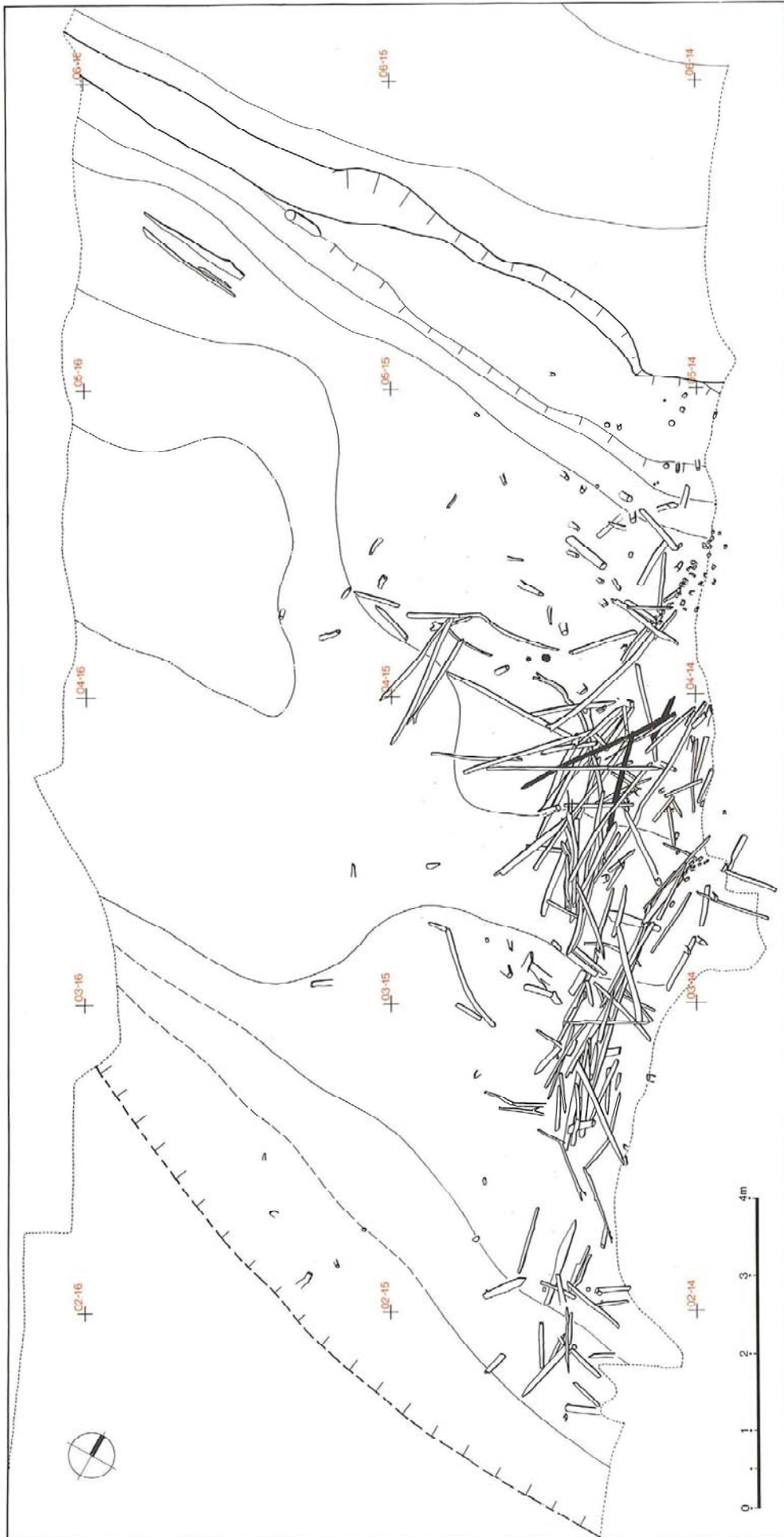

- モミ属(代表樹種:トドマツ) 1点
- ニレ属(代表樹種:ハルニレ) 1点
- トネリコ属(代表樹種:ヤチダモ) 4点
- ハンシドイ属(代表樹種:ハンシドイ) 1点



PL. 2-342 針葉樹加工材流木の分布図

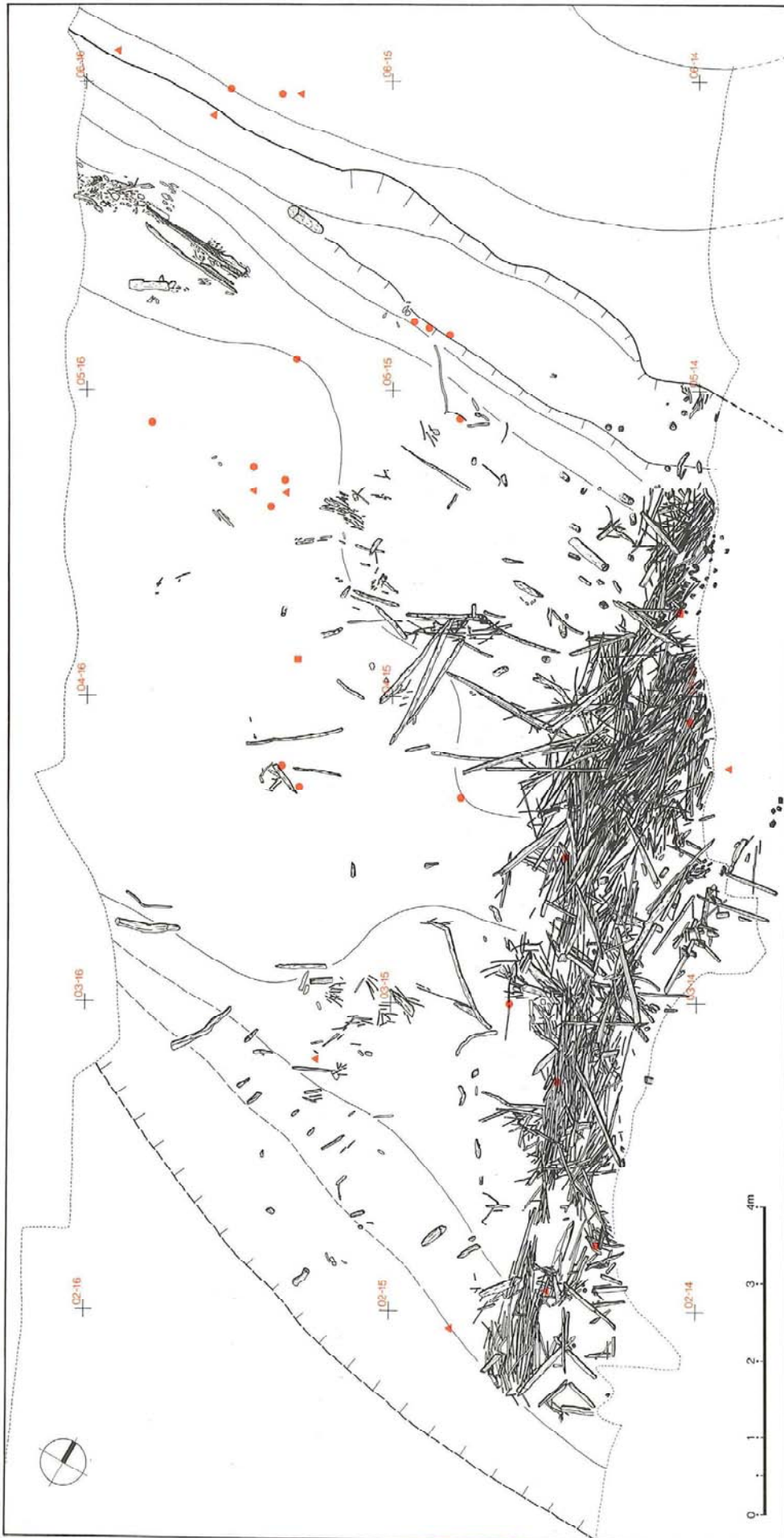

- イチイ属 20点
- モミ属 2点
- ▲ トウヒ属 9点



PL. 図-343 割材の木取り分布図

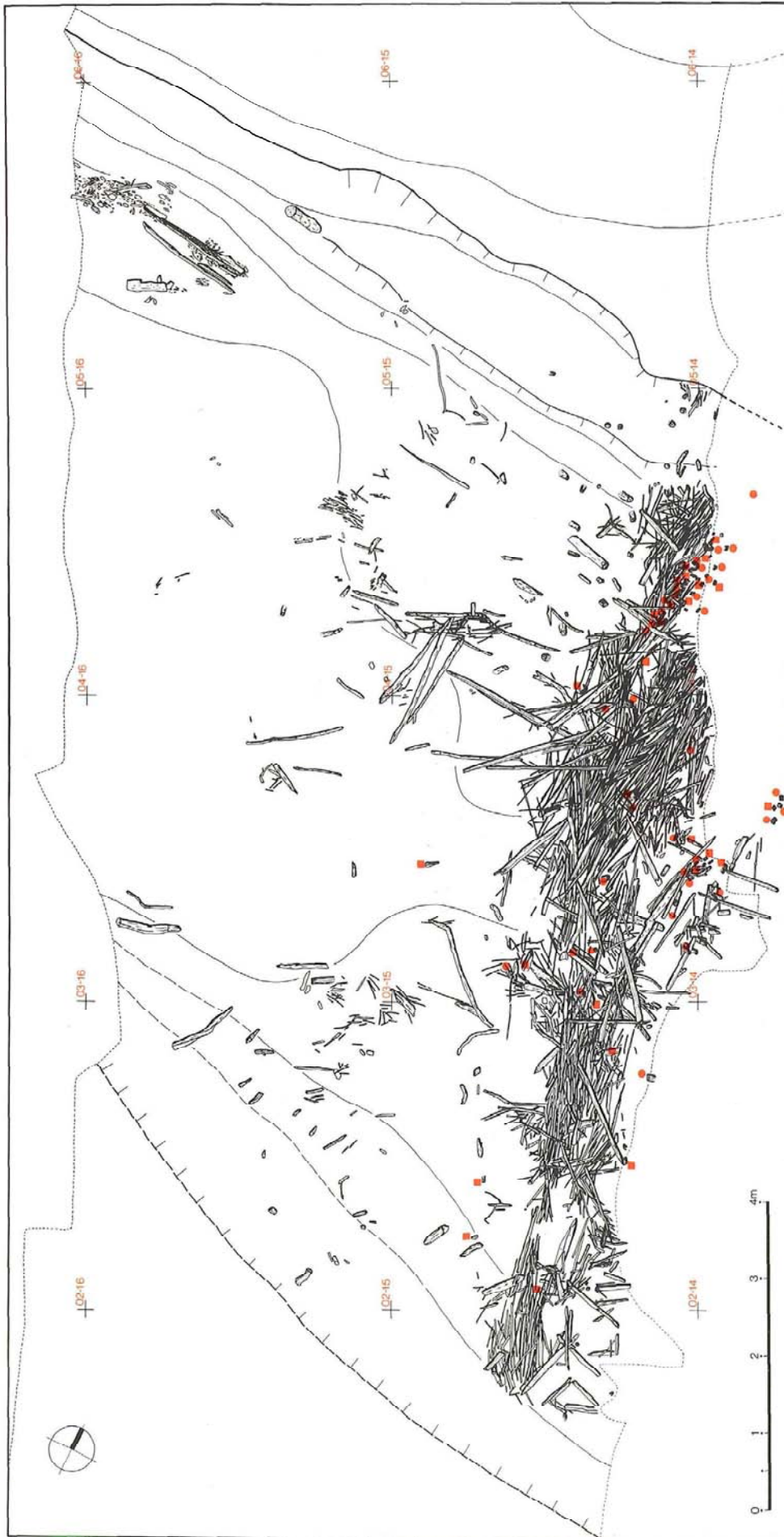

- 板目木取り
- 柱目木取り

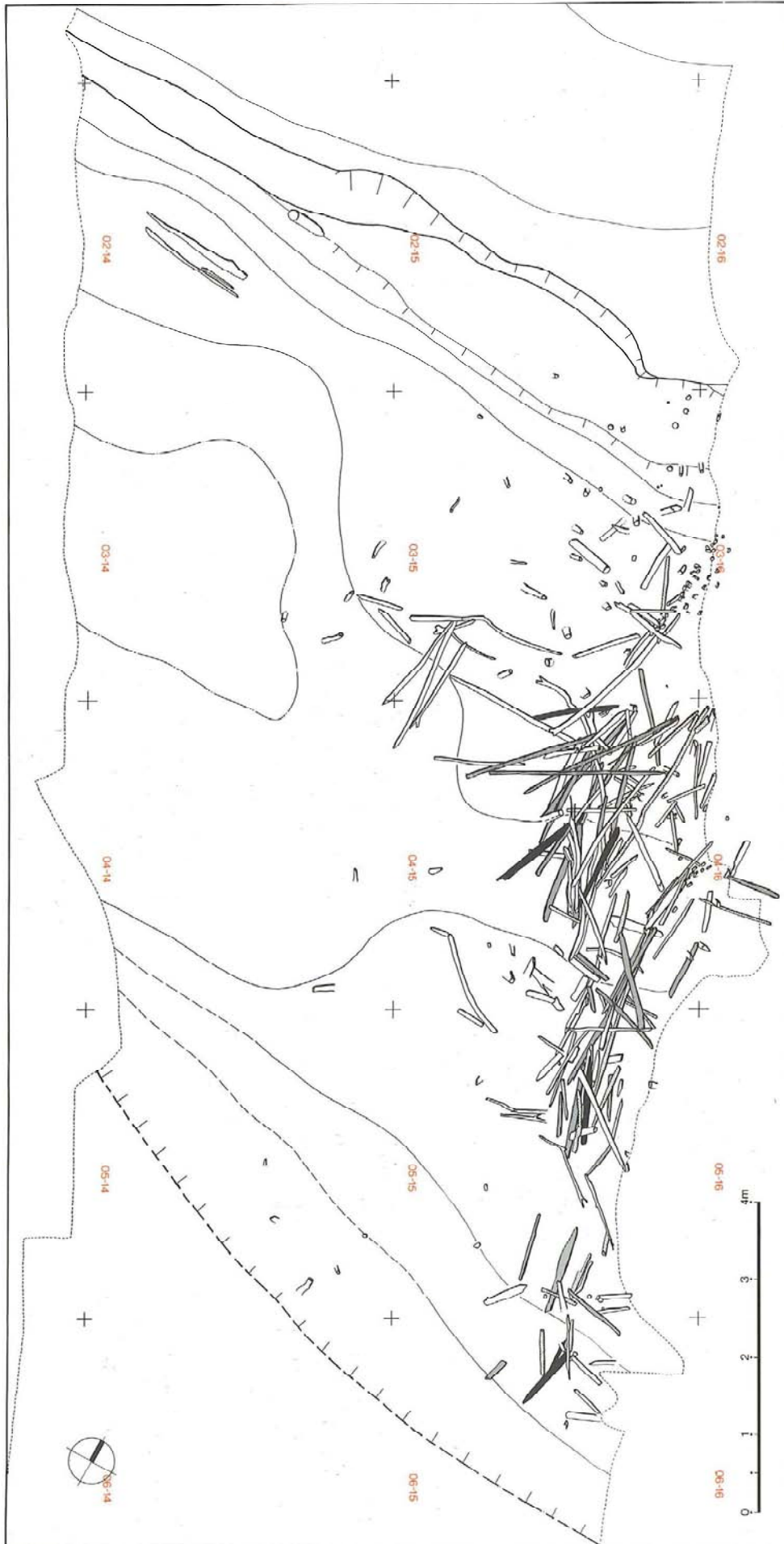

- 柱目木取り 25点
- 板目木取り 6点
- 角材 18点

PL. 2-345 動物遺存体

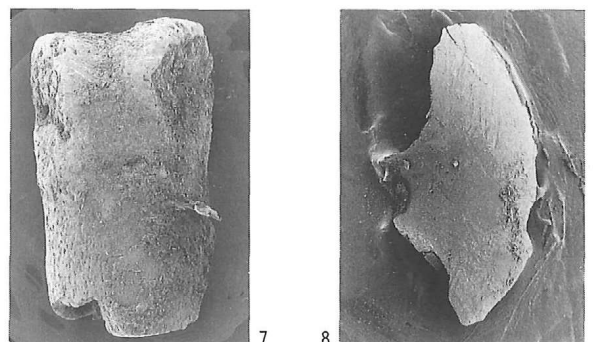
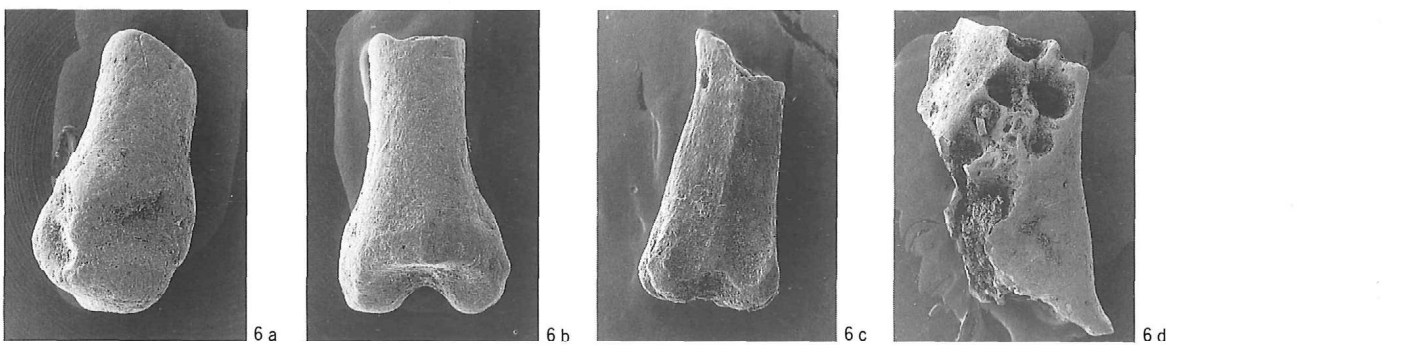
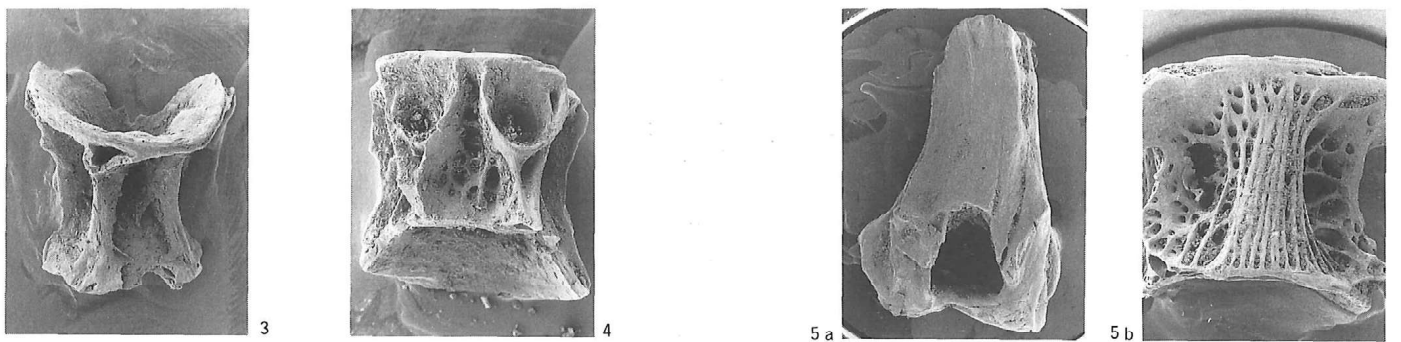
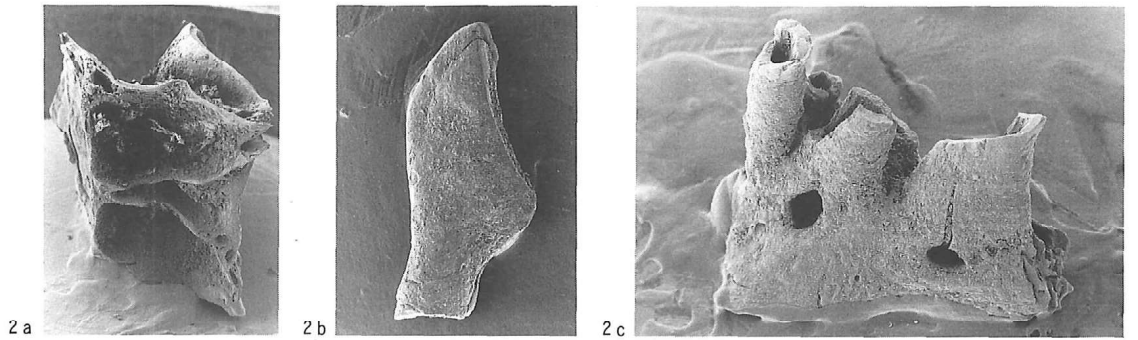
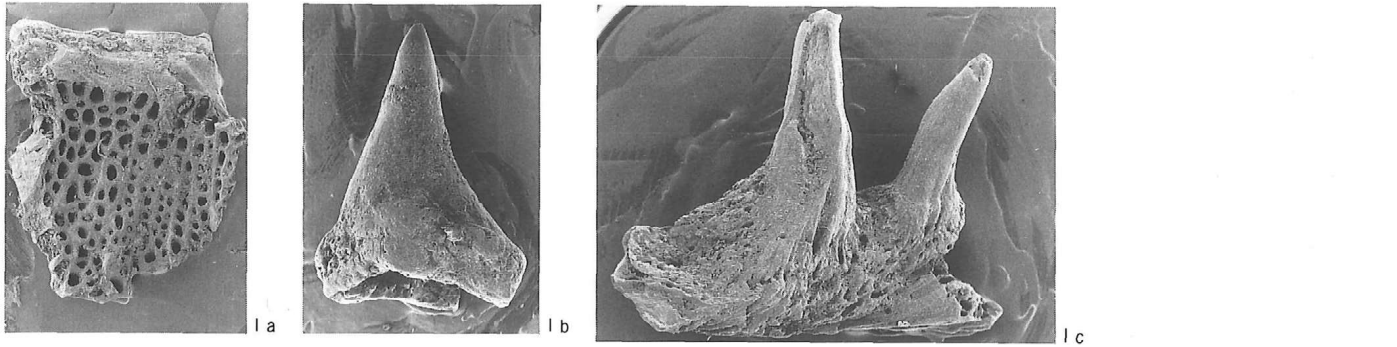

- 1 サケ科魚類 a;椎骨(×7) b;歯(×7) c;歯骨および歯(×9)
- 2 ウグイ a;椎骨(×8) b;咽頭歯(×12) c;咽頭骨(×12)
- 3 コイ科魚類椎骨(×9)
- 4 ニシン科魚類<マイワシ>椎骨(×10)
- 5 カサゴ科魚類 a;背棘(×7) b;椎骨(×7)
- 6 ネズミ類 a;中手骨<中足骨>(×15) b;中節骨<基節骨?>(×14) c;尾椎(×10) d;左上顎骨基部(×9)
- 7 ウサギ中節骨<基節骨?>(×7)
- 8 陸性貝類(×8)



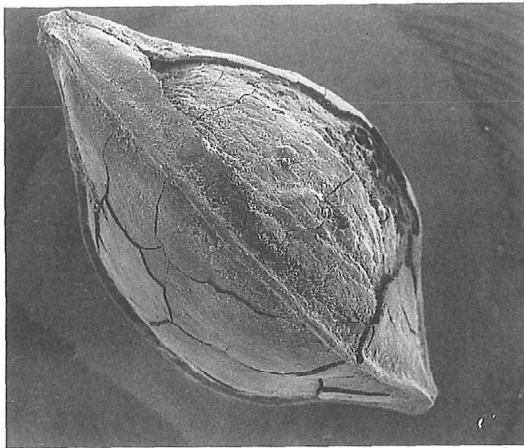

a

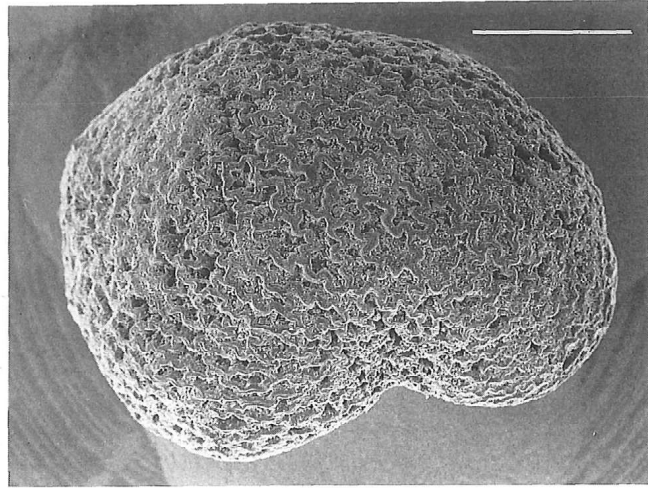

b

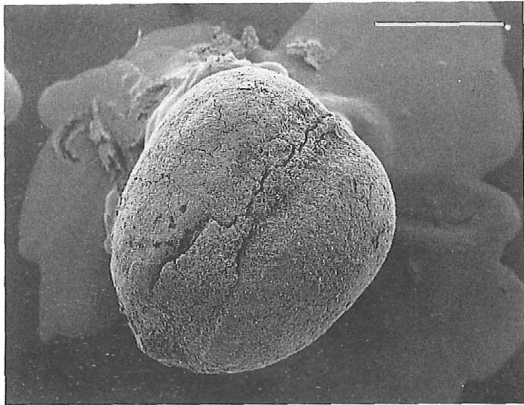

c

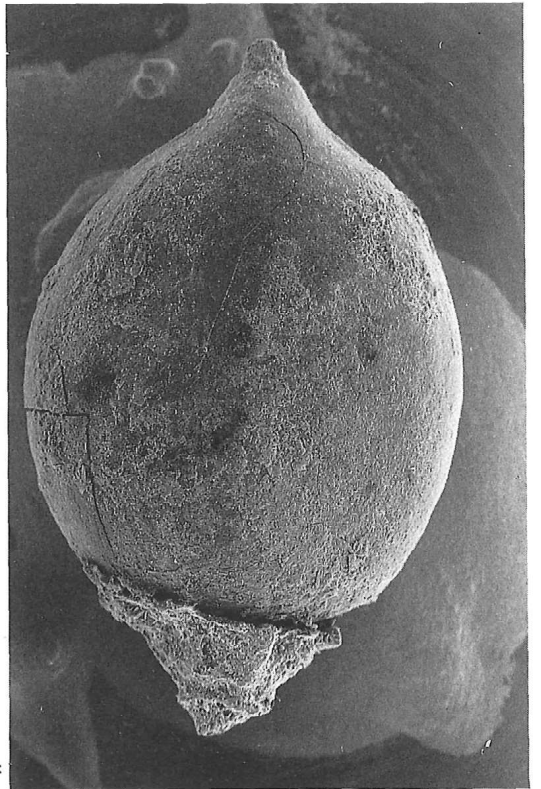

f

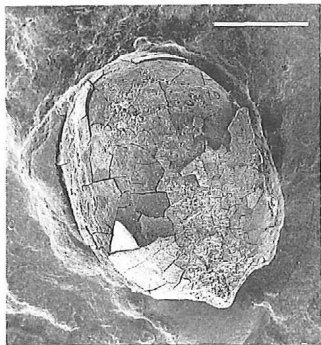

d

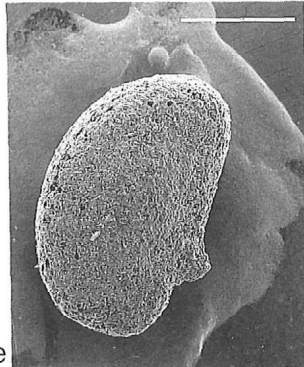

e

Selected Wild and Weedy Plant Seeds: a) *Rumex*, b) *Physalis*, c) *Lathyrus*, d) *Echinochloa*, e) *Empetrum*, f) *Polygonum*.  
Scale: a, b, f same, bar = 1/2 mm, d, e, bar = 1/2 mm, c, bar = 1 mm.

g

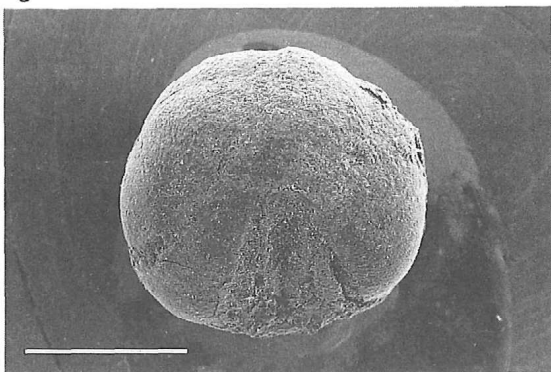

h1

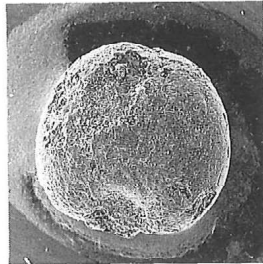

h2



Millets: a) Broomcorn (*Kibi*), b) Foxtail, Dorsal (L) and Ventral (R) Views.  
Scale = 1 mm.



PL. ②-347 植物遺存体 ②

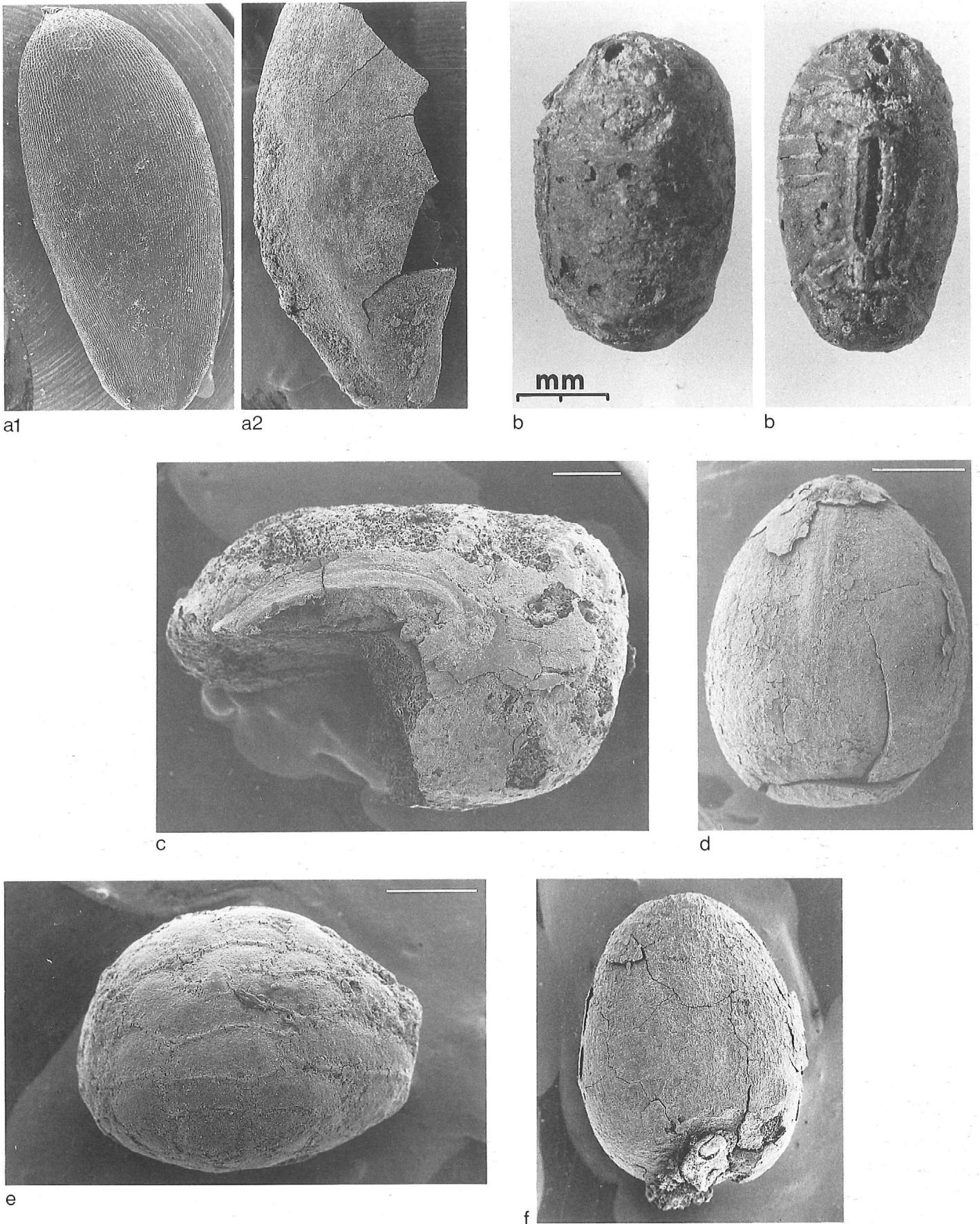

Other Cultigens: a1) Modern Melon, a2) Archaeological Melon, b) Rice, c) Adzuki, d) Hemp, e) *Shiso* or Beefsteak Plant, f) Wheat.  
 Scale: a, b, c, f same — bar = 1 mm, d — bar = 1 mm, e — bar = 1/2 mm.

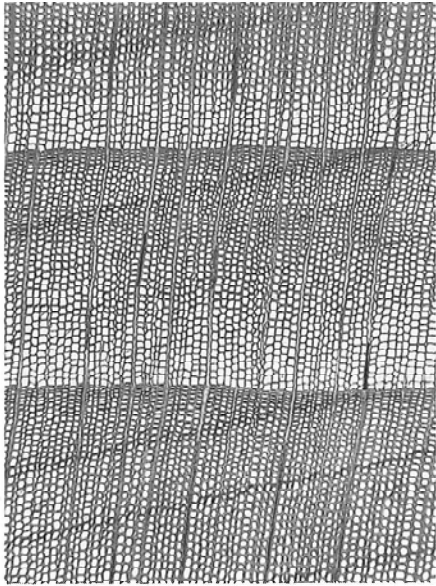

イチイ Ia(×50)

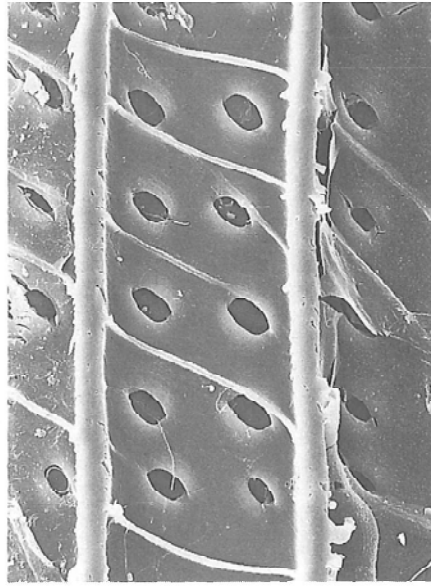

Ib(×780)

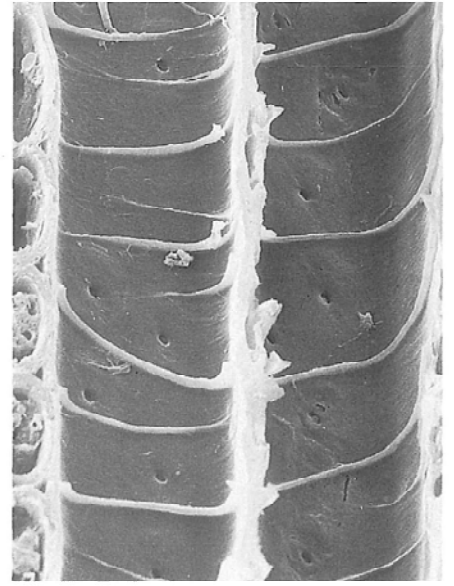

Ic(×1,040)

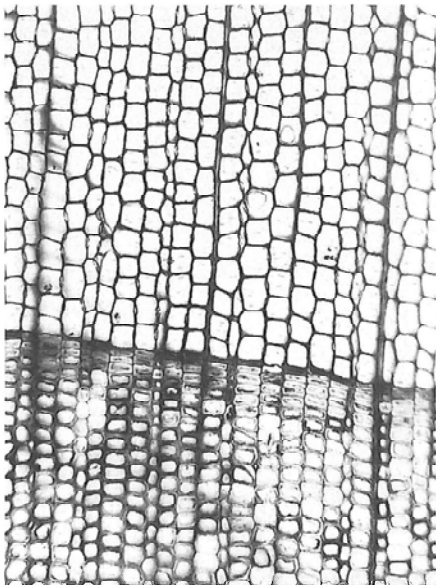

モミ属 IIa(×85)

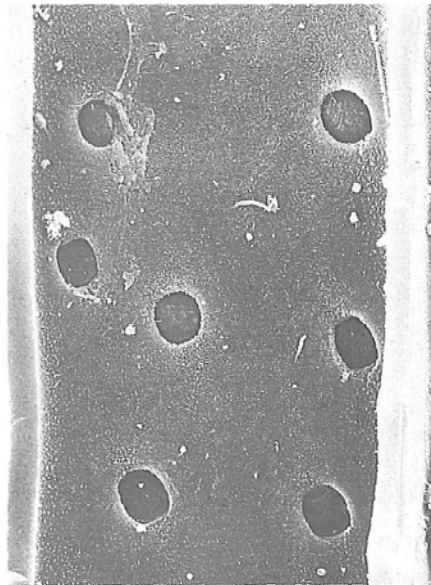

IIb(×1,770)

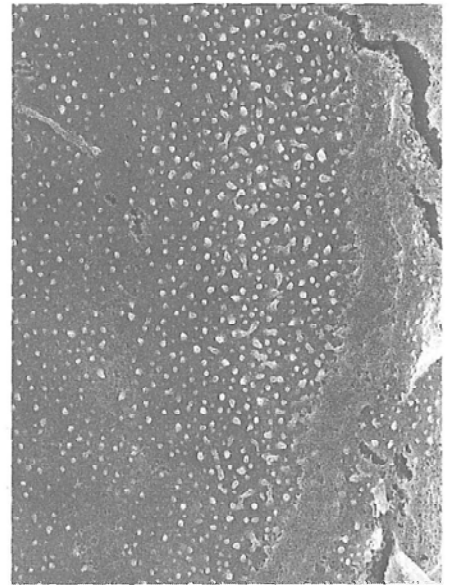

IIc(×6,700)

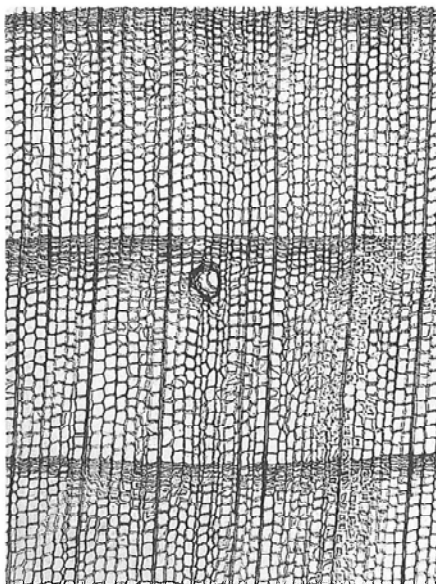

トウヒ属 IIIa(×40)

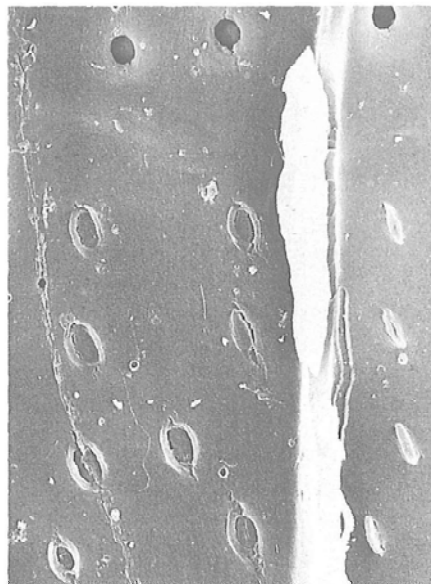

IIIb(×1,925)

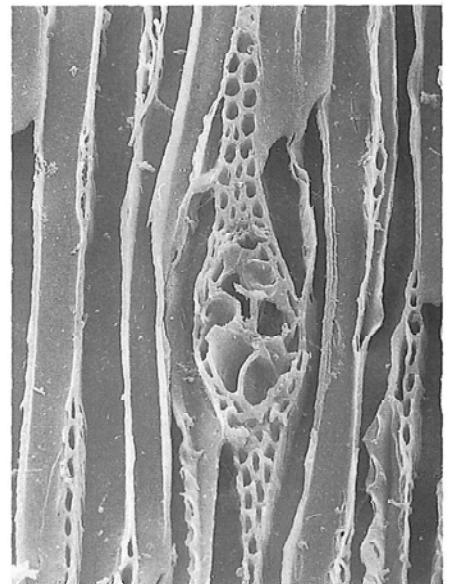

IIIc(×260)



PL. ②-349 テン木材の組織・構造 ②

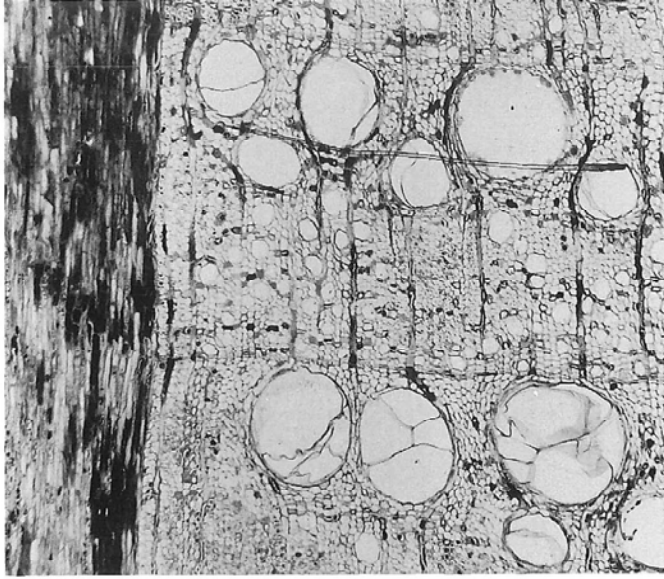

コナラ属

IVa(×45)

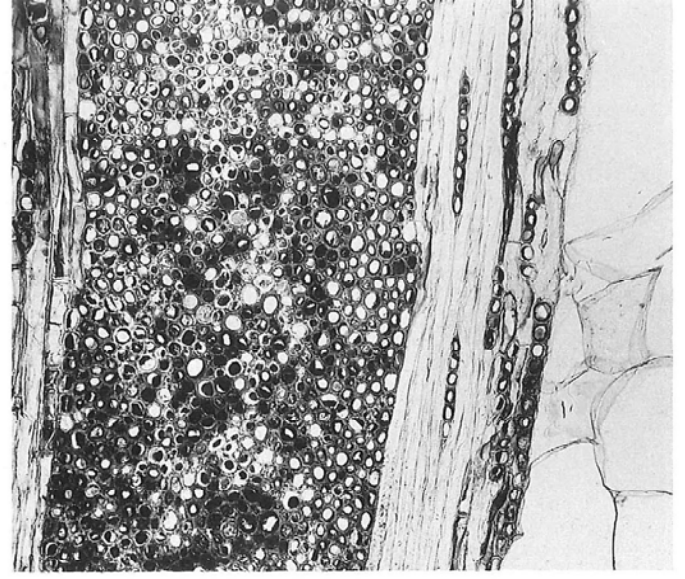

IVb(×42)

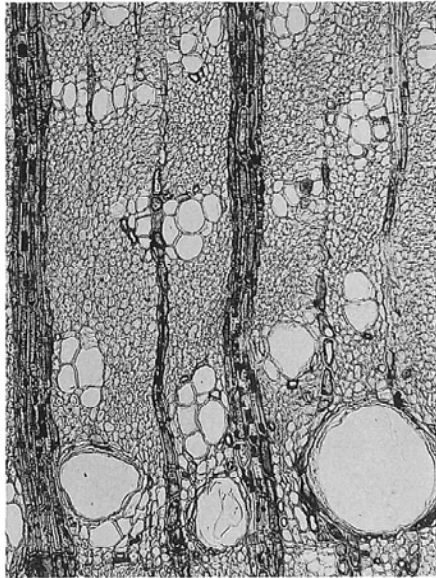

ニレ属

Va(×85)



Vb(×110)

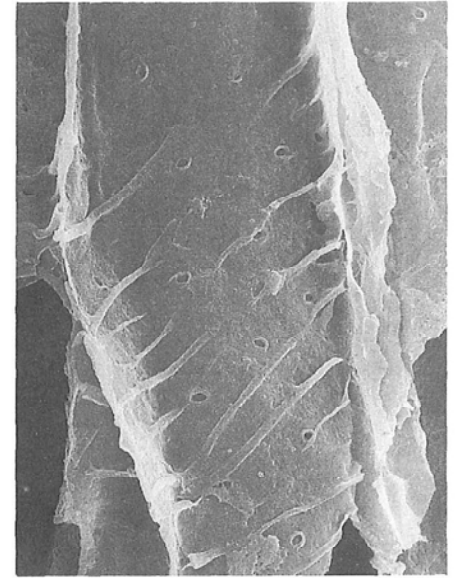

Vc(×1,780)

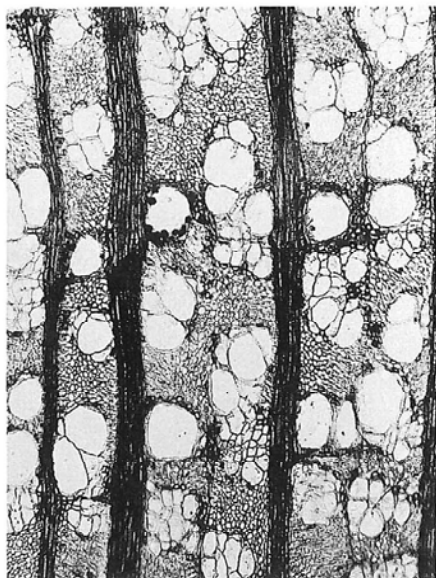

エノキ属

VIa(×45)



VIb(×120)

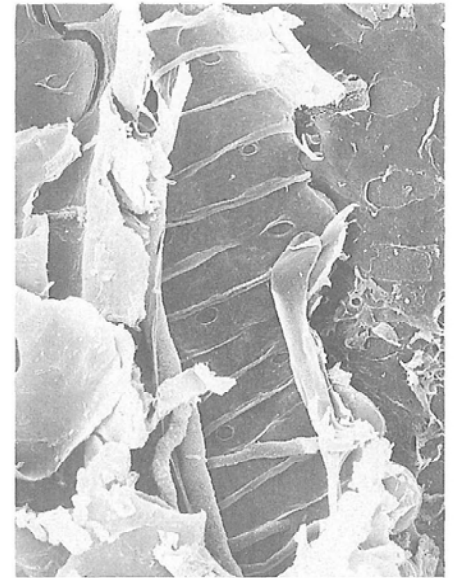

VIc(×1,350)

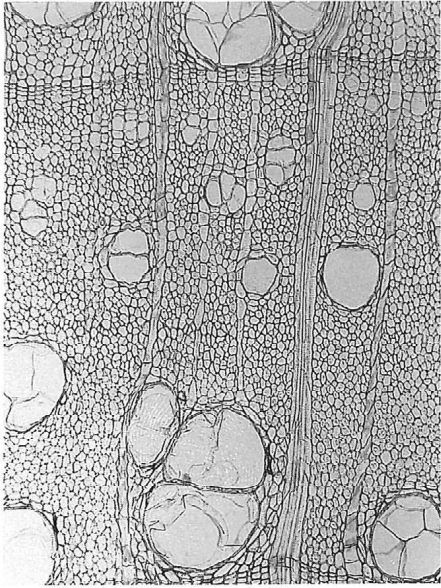

クワ属 VIIa(×70)

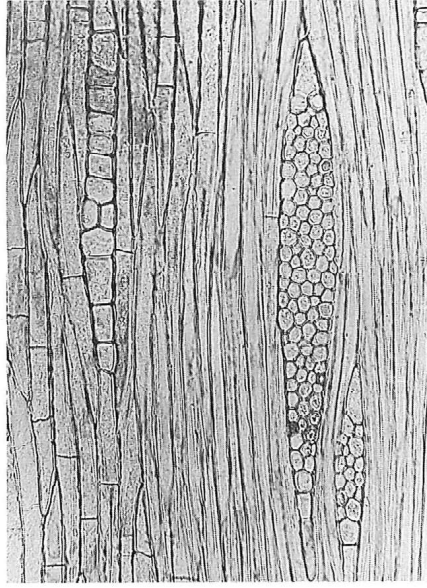

VIIb(×150)

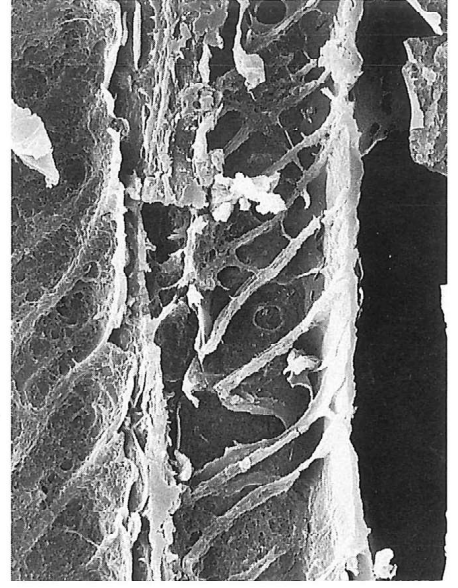

VIIc(×2,500)

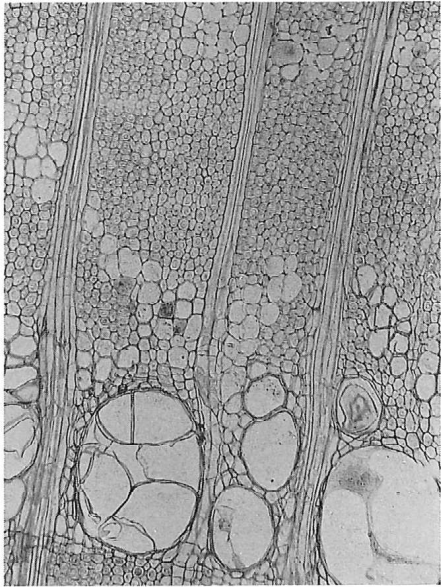

イヌエンジュ属 VIIIa(×75)



VIIIb(×100)

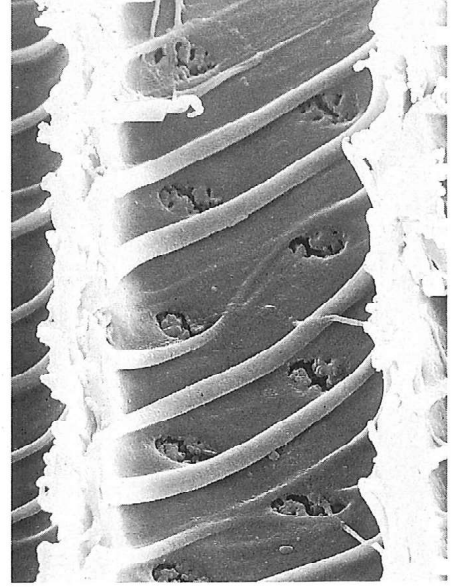

VIIIc(×2,600)

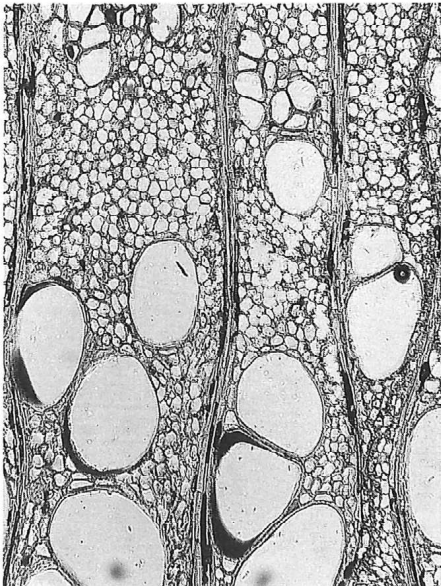

キハダ属 IXa(×80)



IXb(×95)

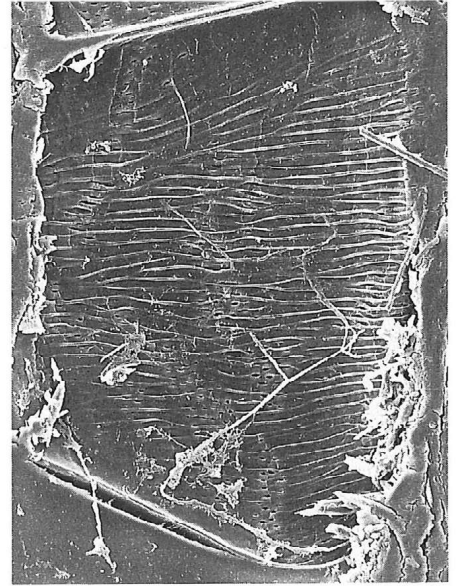

IXc(×220)



PL. ②-351 テシ木材の組織・構造 ④

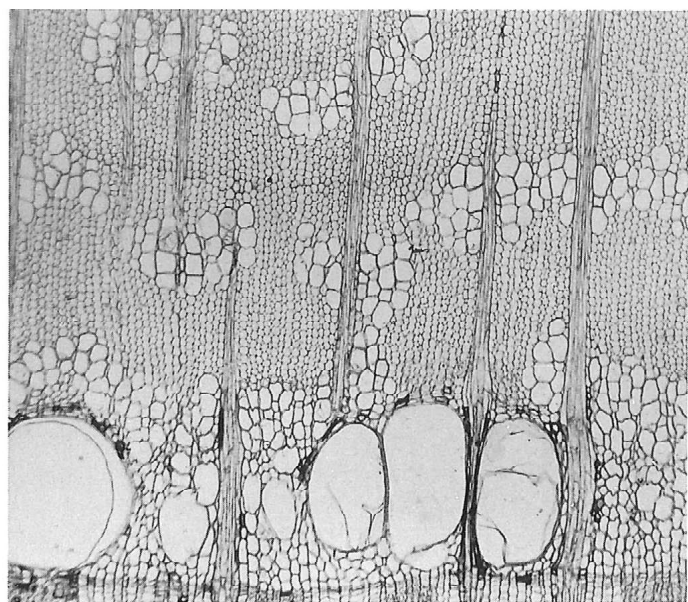

ハリギリ

Xa(×40)

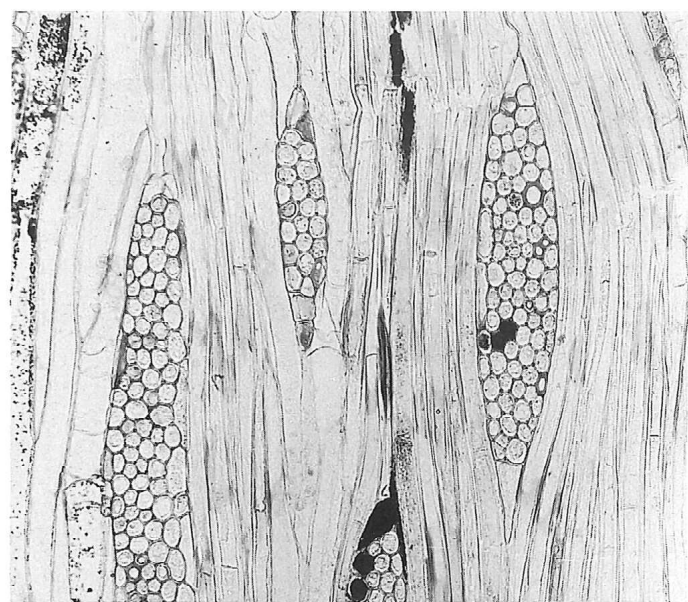

Xb(×110)

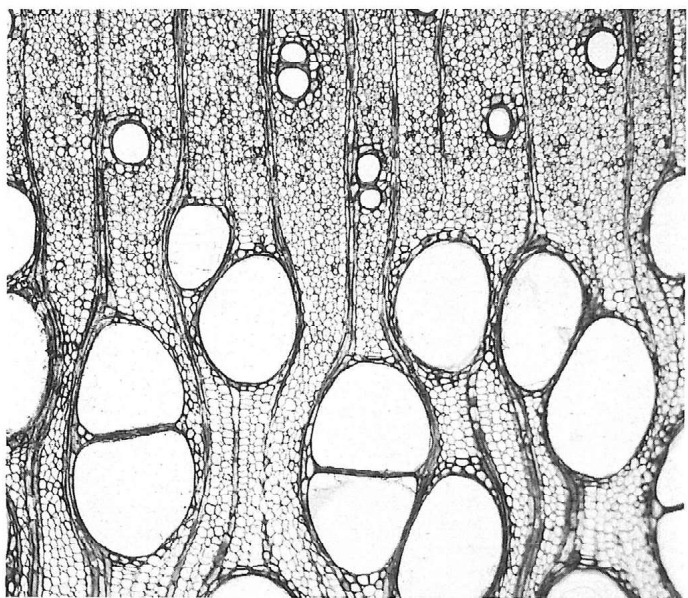

トネリコ属

XIa(×40)

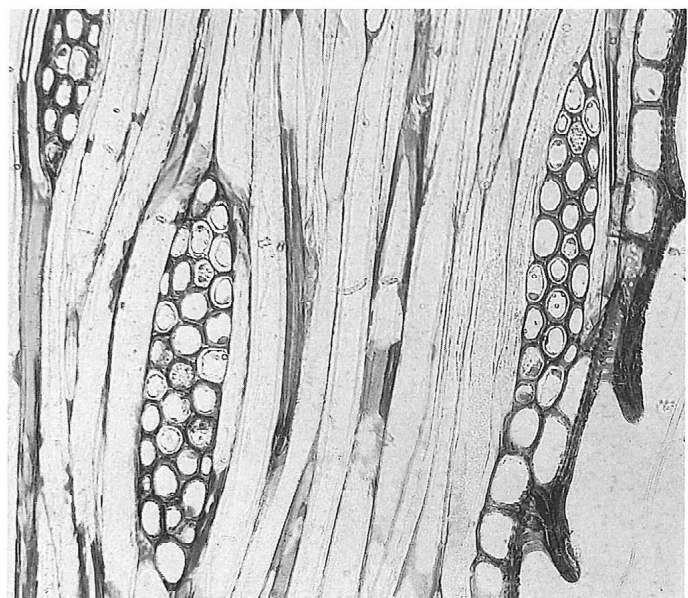

XIb(×200)

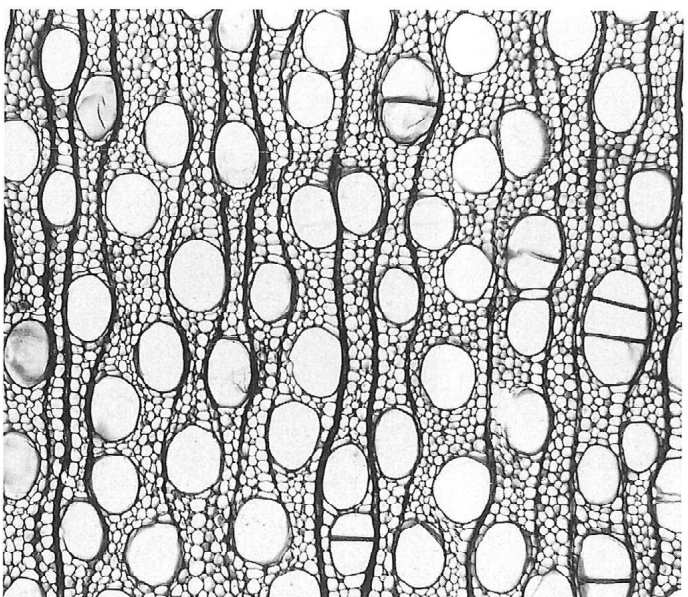

ハコヤナギ属

XIIa(×125)

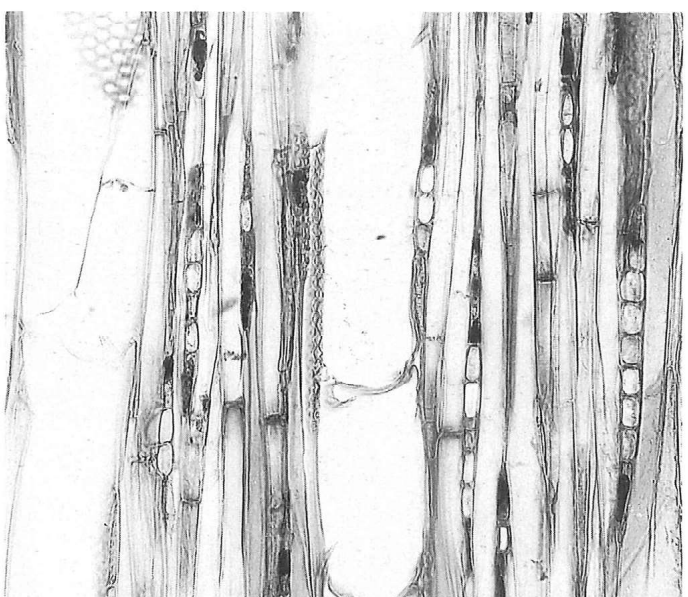

XIIb(×250)

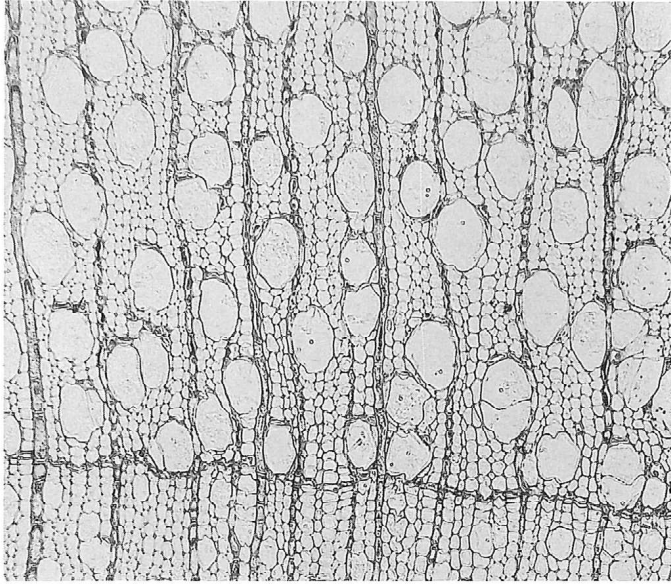

ヤナギ属

XIII a (×105)

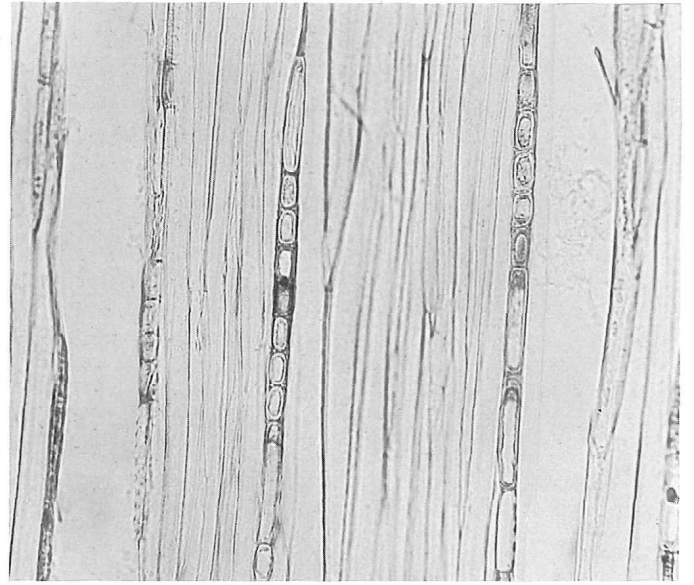

XIII b (×225)

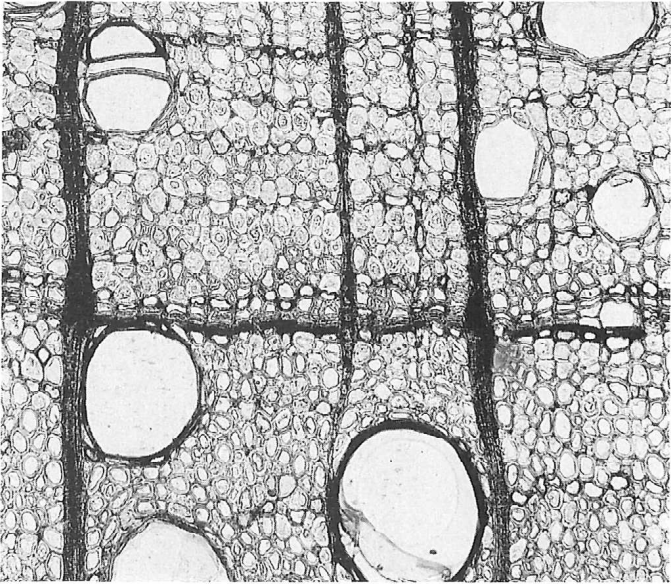

オニグルミ

XIV a (×105)

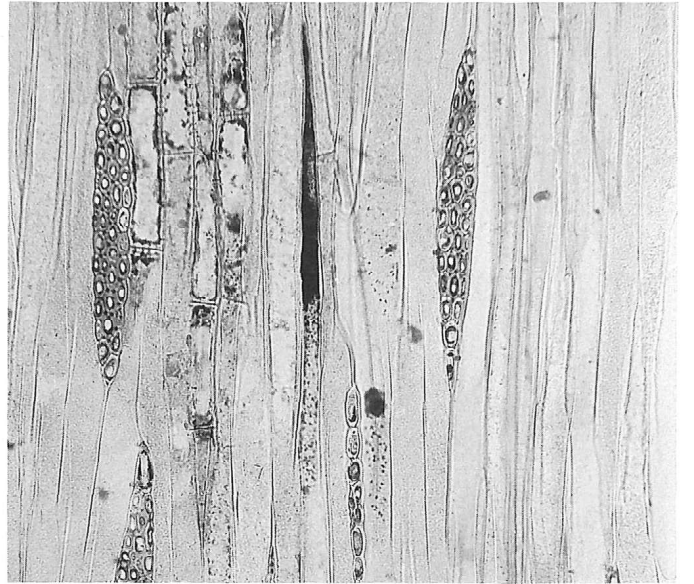

XIV b (×250)

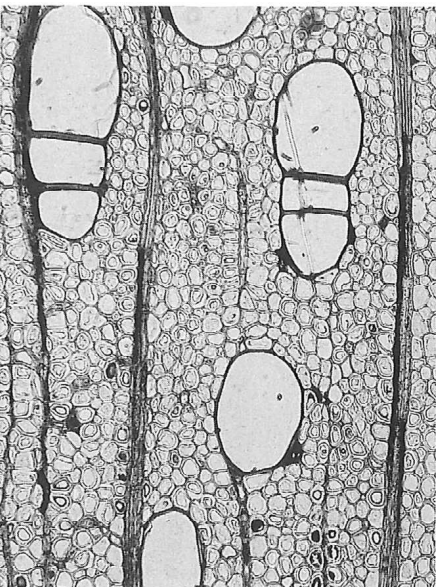

カバノキ属

XV a (×100)

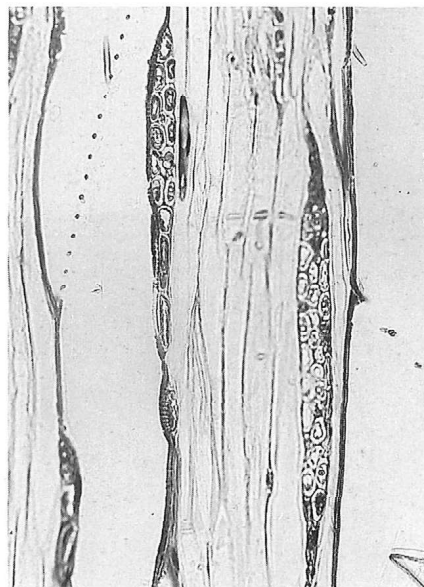

XV b (×185)

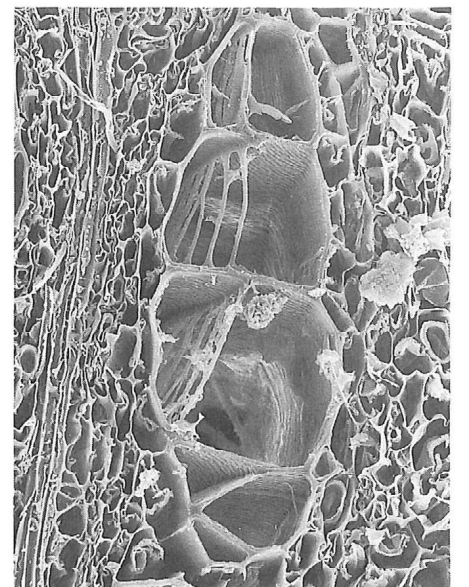

XV c (×315)



PL. ②-353 テシ木材の組織・構造 ⑥

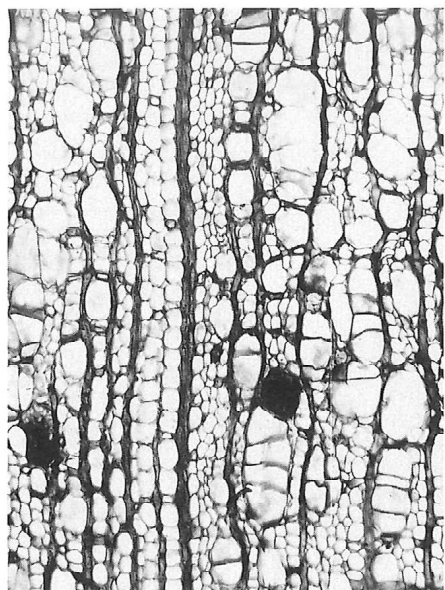

ハンノキ属

XVIIa(×110)

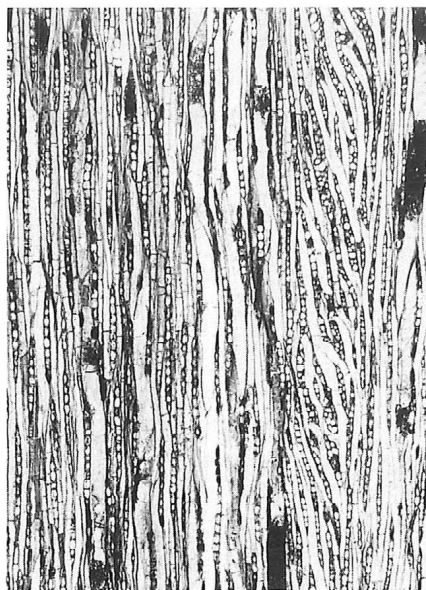

XVIIb(×70)

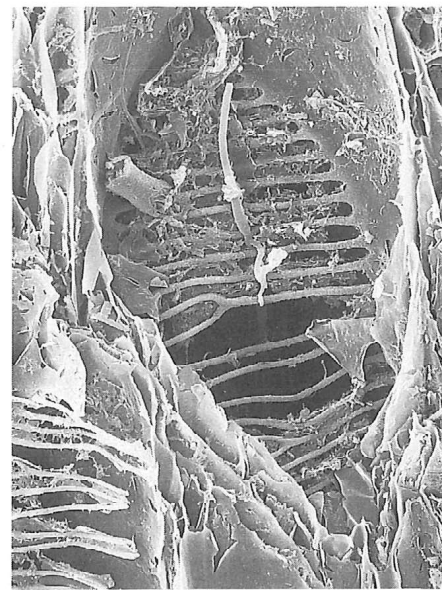

XVIIc(×360)

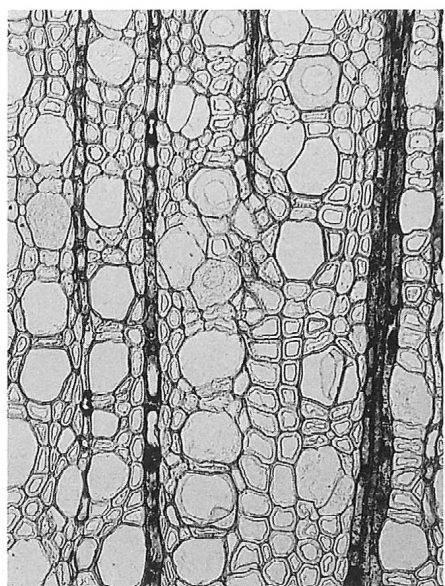

カツラ

XVIIa(×100)

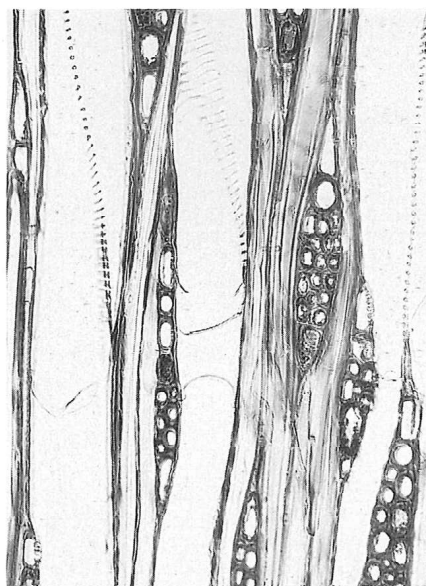

XVIIb(×165)

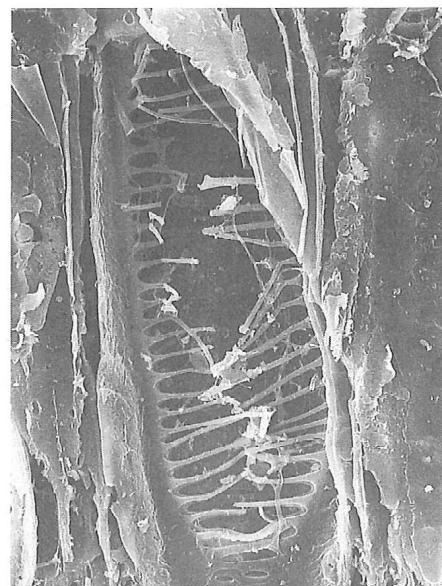

XVIIc(×535)

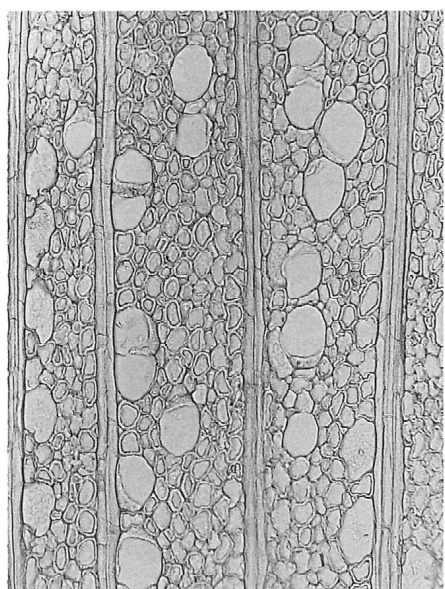

モクレン属

XVIIIa(×80)



XVIIIb(×100)



XVIIIc(×410)

ツシノキ属 (XXa × 165)

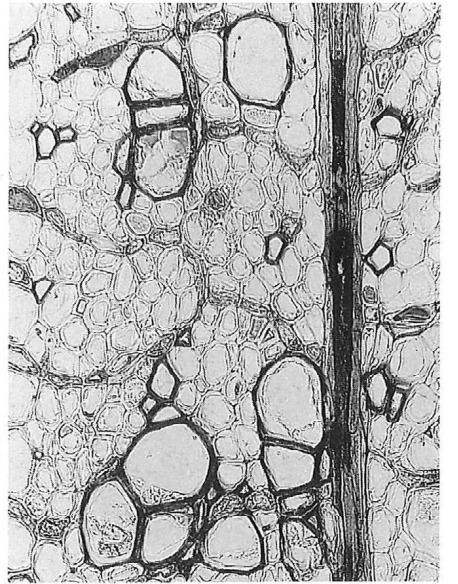

カエデ属 (XXa × 90)

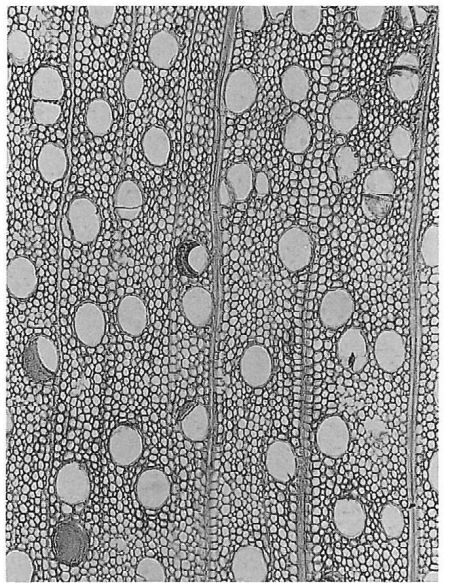

アサキ属 (XIXa × 110)

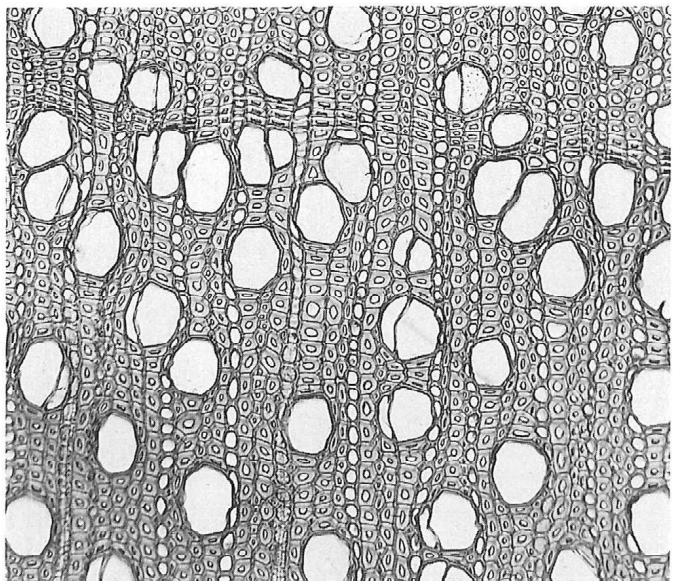

XXb (× 160)

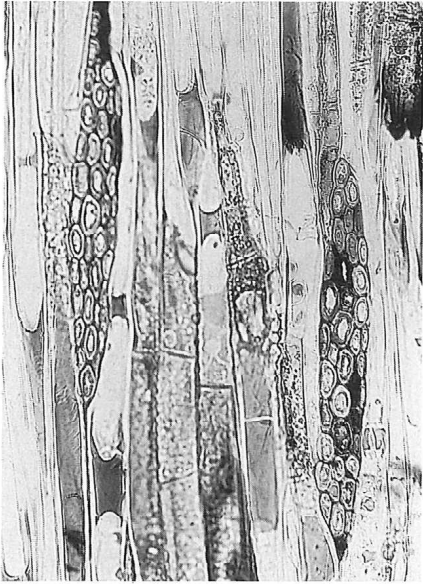

XXb (× 110)

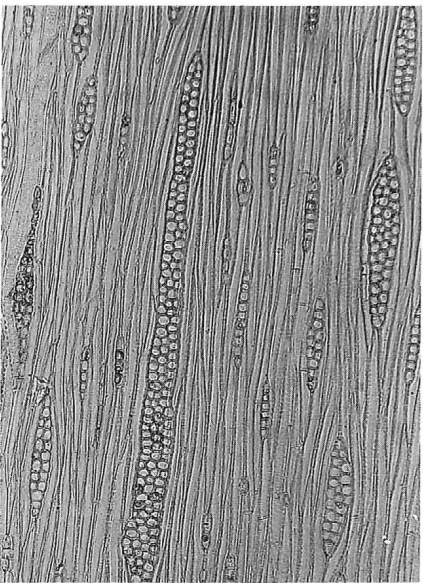

XXc (× 660)

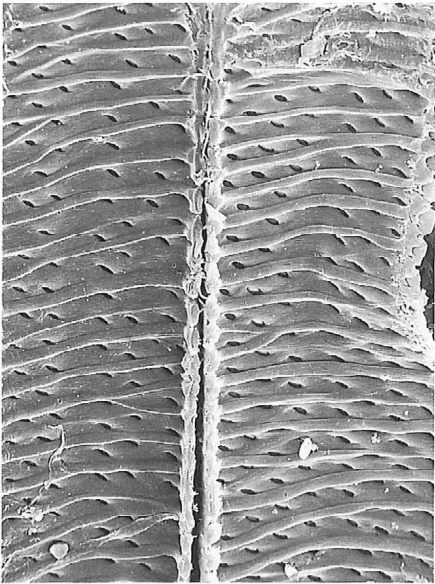

XXc (× 490)

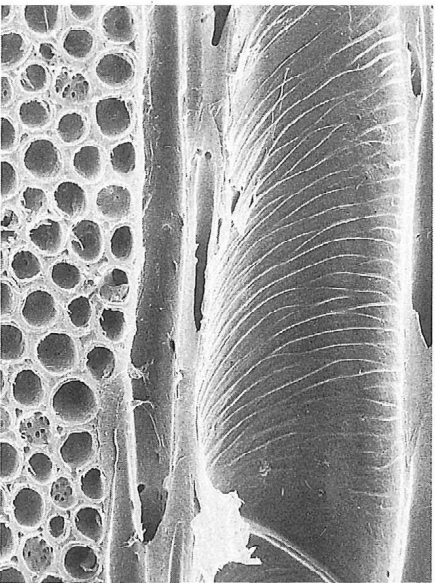

XIXb (× 120)

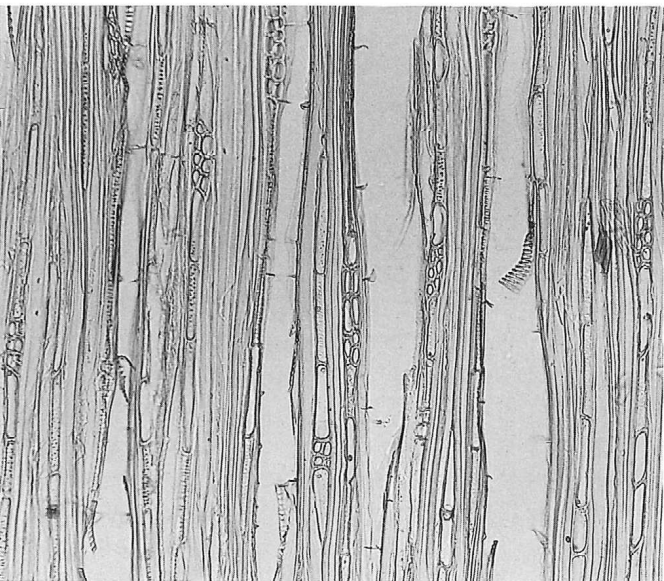



PL. ②-355 テン木材の組織・構造 ⑧

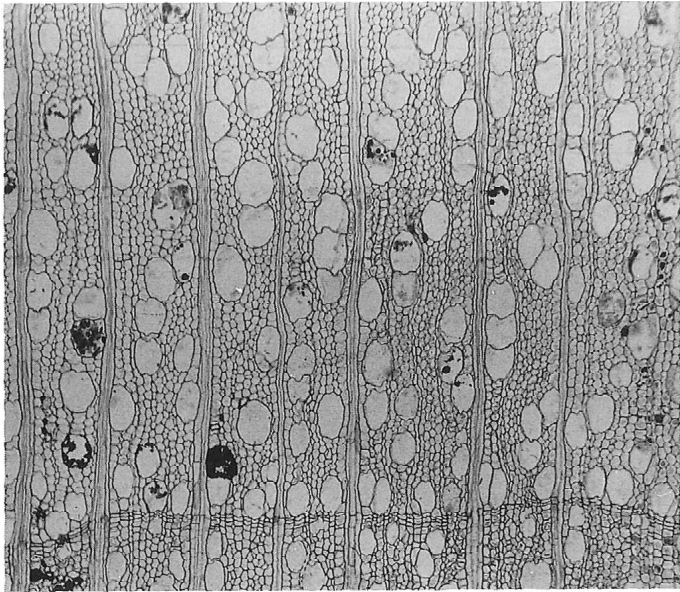

ミズギ属

XXII a (×65)

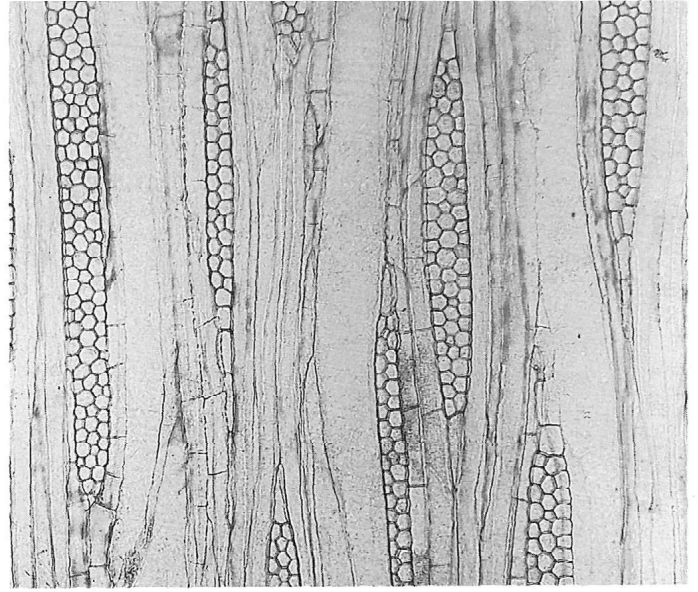

XXII b (×105)

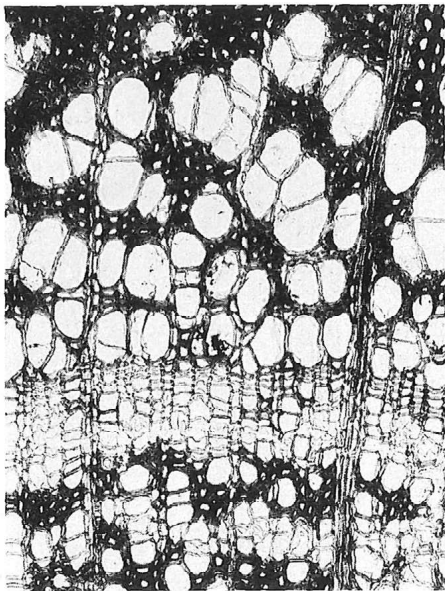

ハシドイ属

XXIII a (×75)

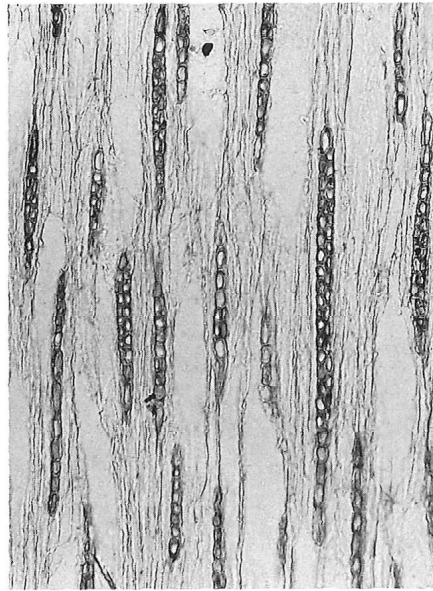

XXIII b (×100)

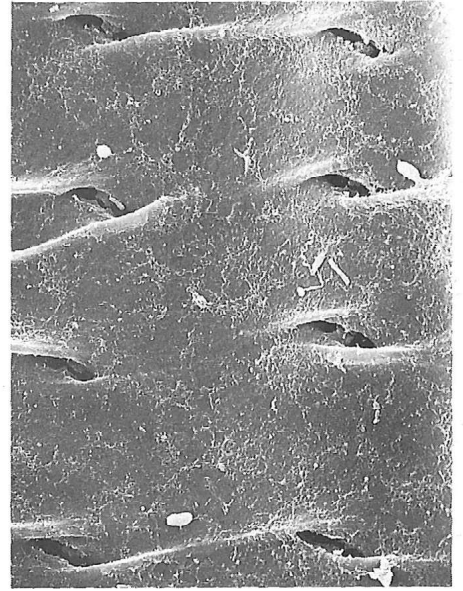

XXIII c (×2,700)

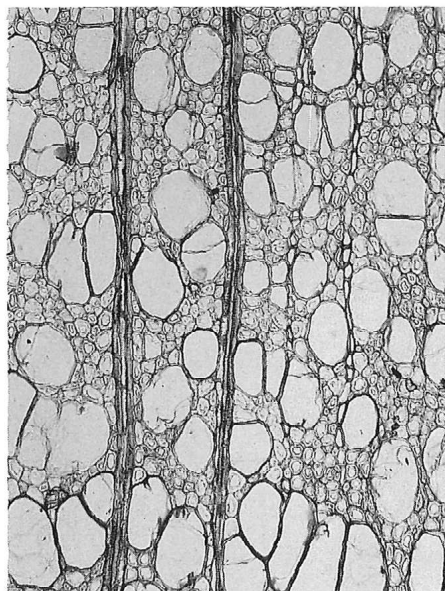

ニワトコ属

XXIV a (×85)

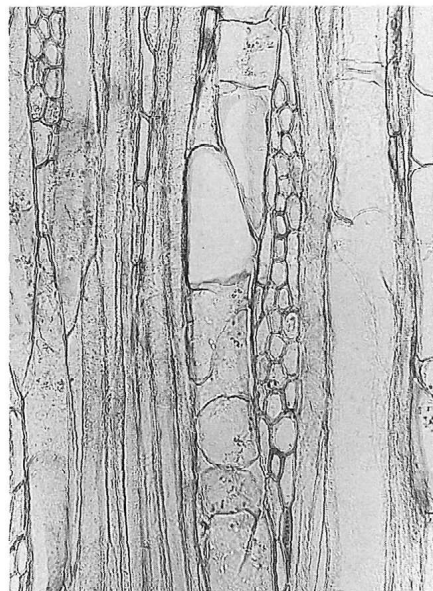

XXIV b (×140)

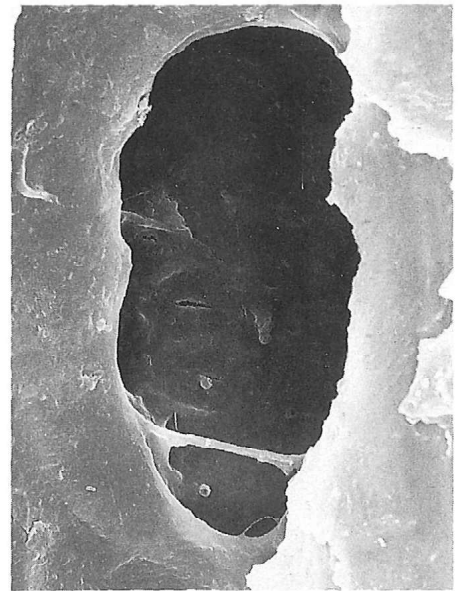

XXIV c (×1,480)

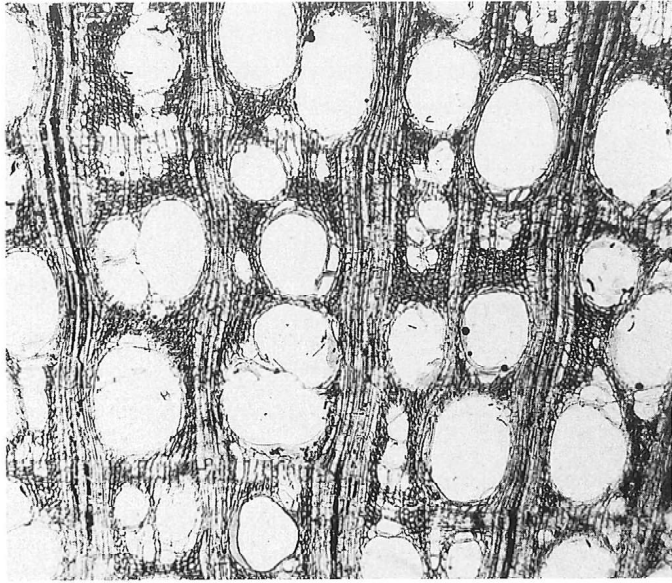

ツル性植物

XXVa(×85)

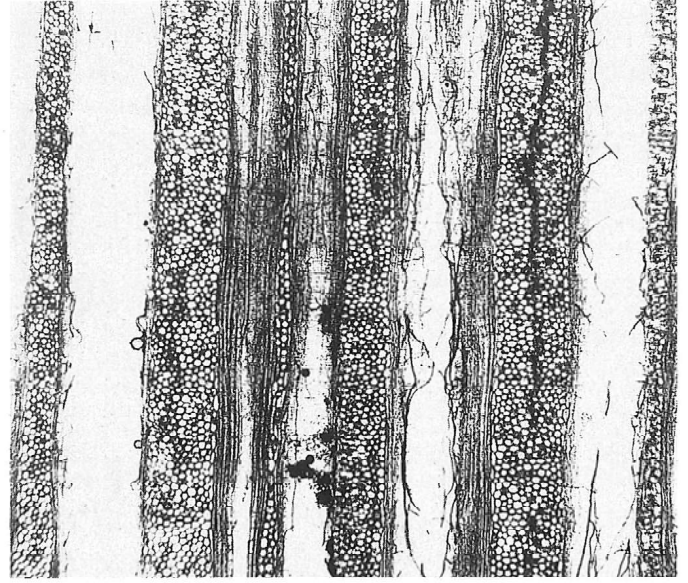

XXVb(×50)

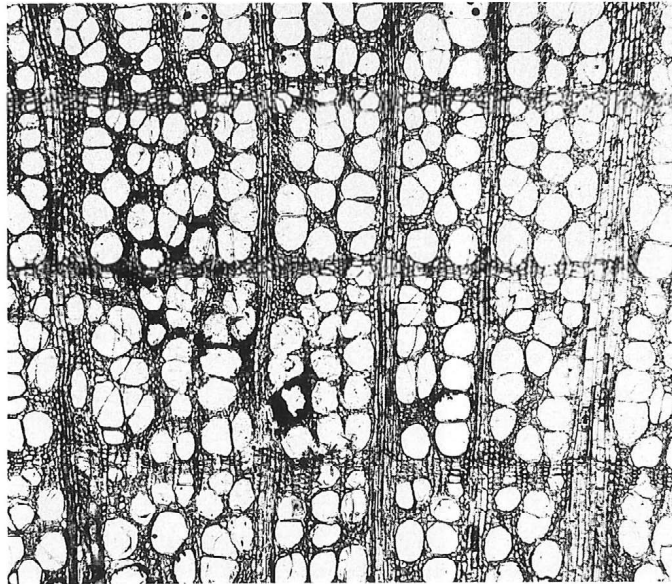

ツル性植物

XXVa(×55)

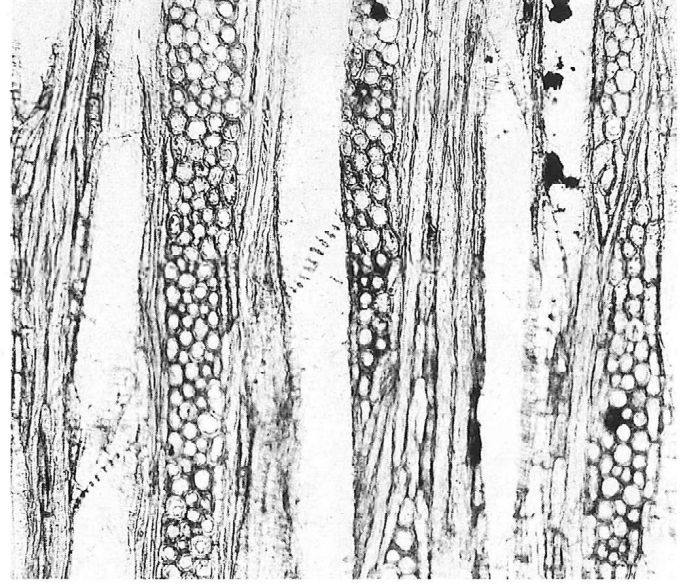

XXVb(×155)

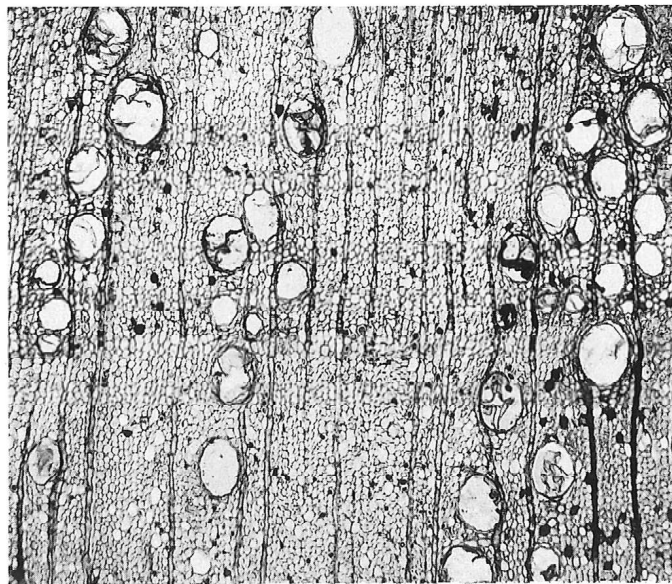

ブナ科?

XXVa(×40)

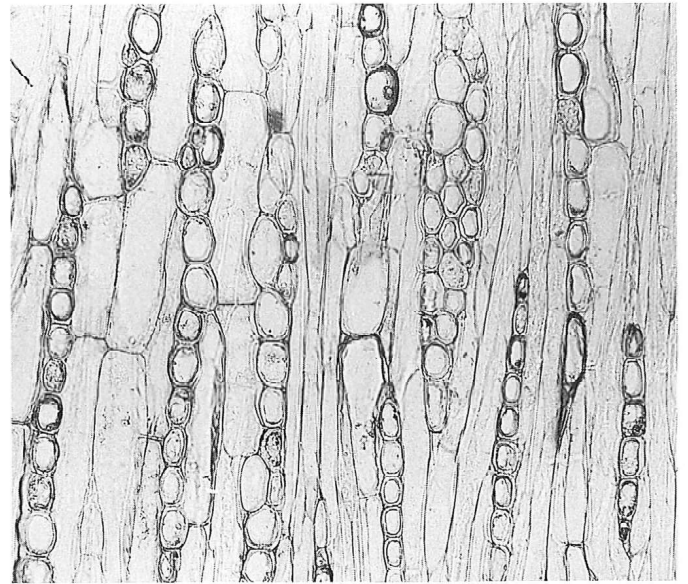

XXVb(×200)



PL. ②-357 テシ木材の組織・構造 ⑩

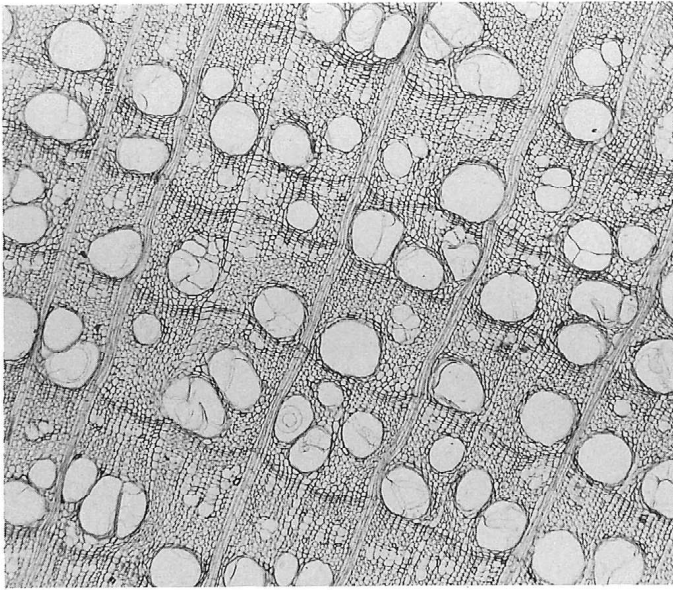

ウルシ属?

XXVIII a (×40)



XXVIII b (×125)

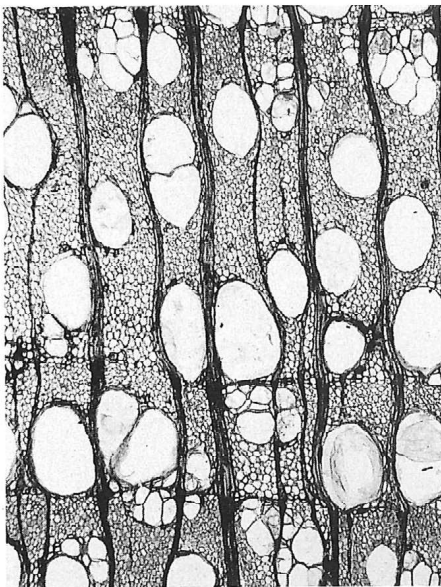

?

XXIX a (×45)



XXIX b (×165)

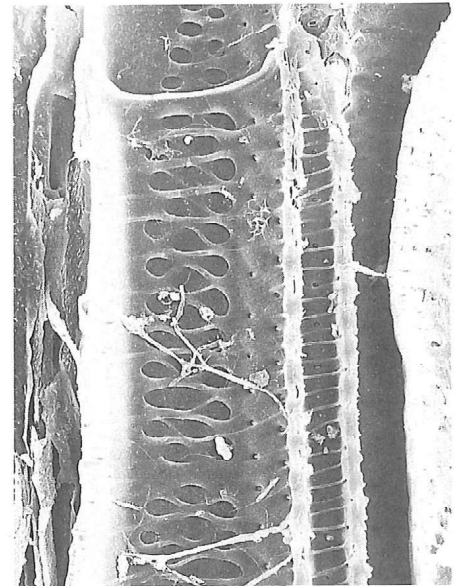

XXIX c (×575)

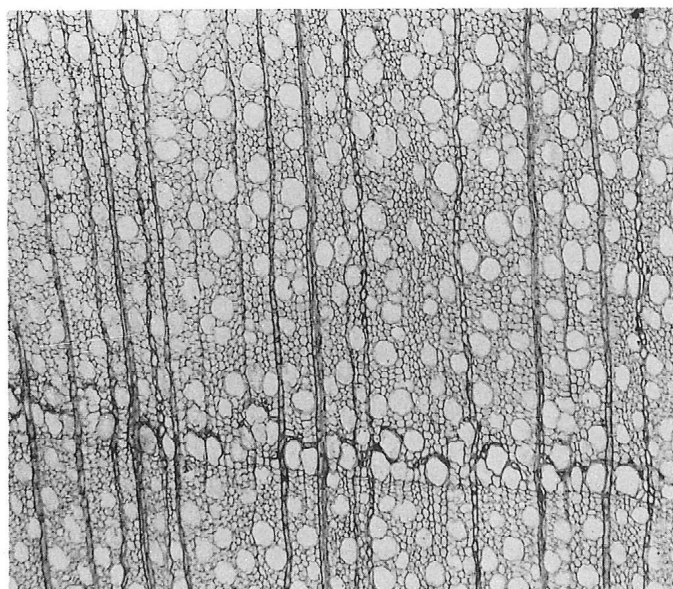

コシアブラ?

XXX a (×65)

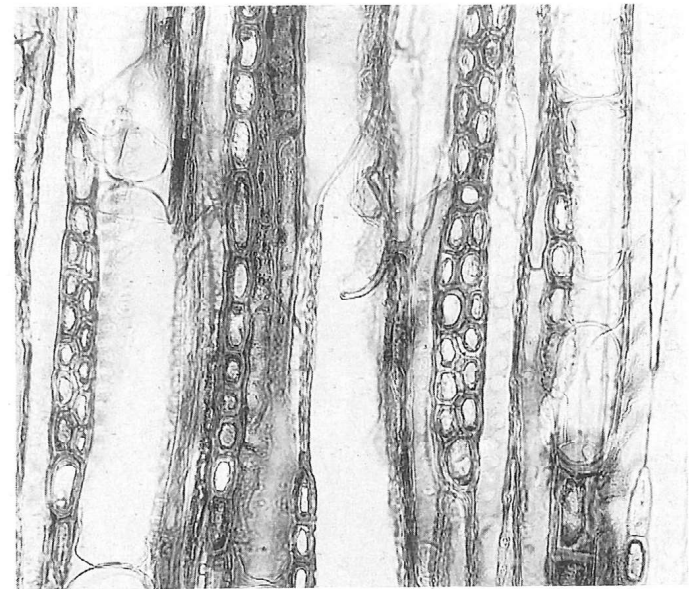

XXX b (×235)

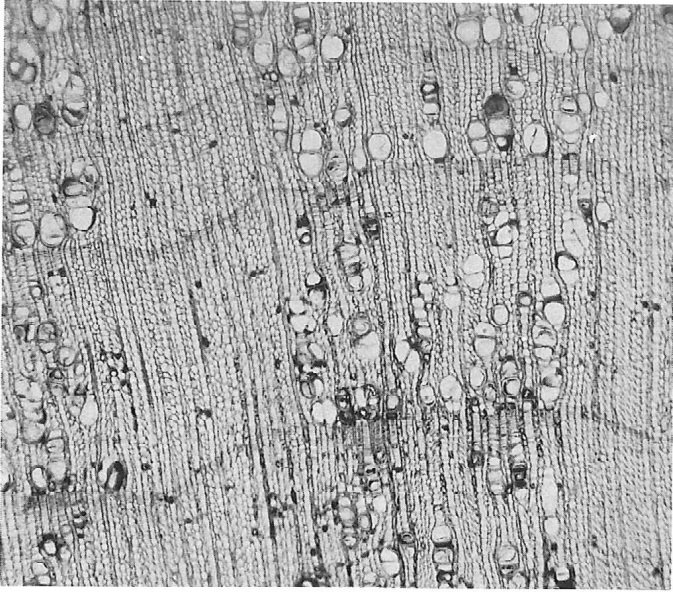

クマシデ属?

XXXIa(×60)

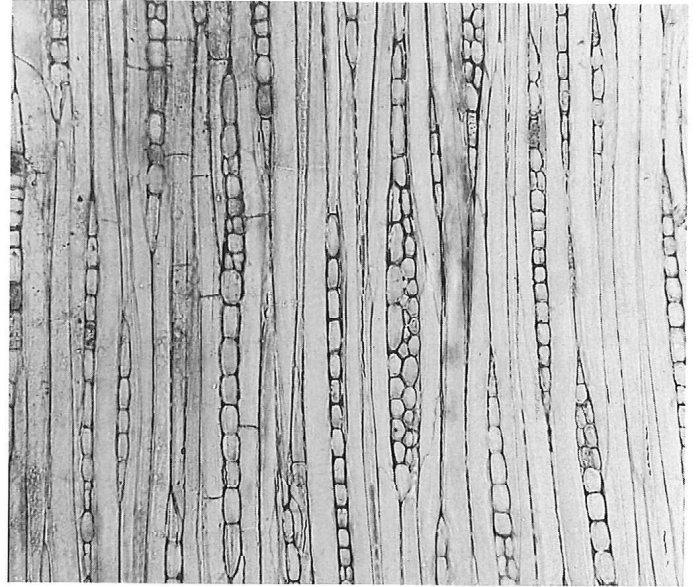

XXXIb(×245)

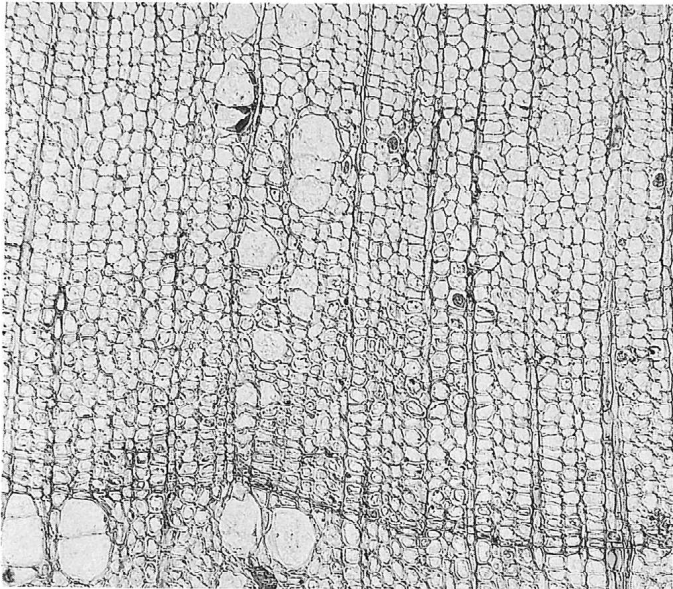

クマシデ属?

XXXIIa(×105)



XXXIIb(×110)

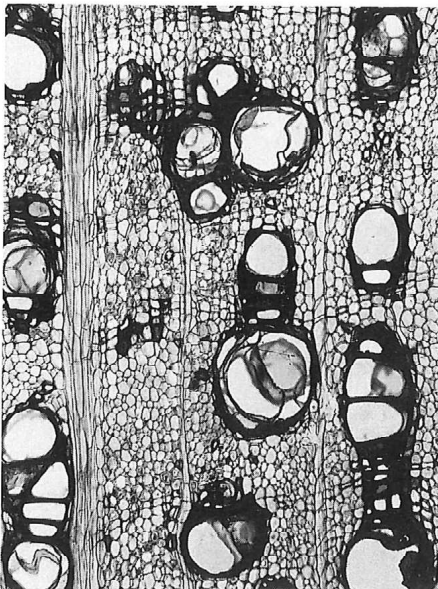

ニレ科?

XXXIIIa(×85)

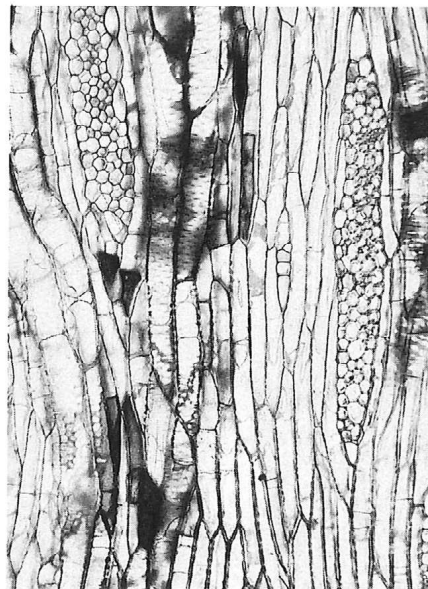

XXXIIIb(×140)

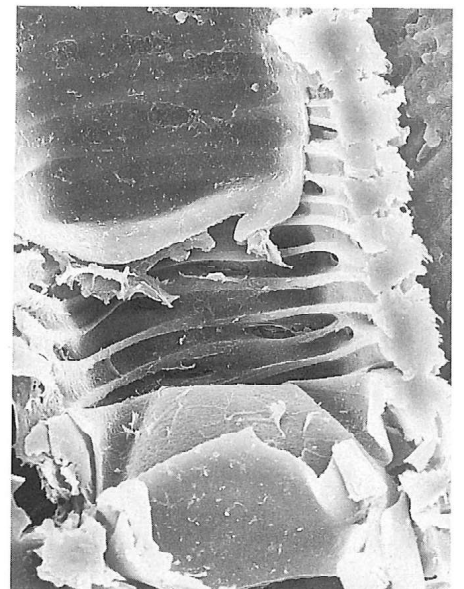

XXXIIIc(×1,300)



PL. ②-359 テシ木材の組織・構造 ②

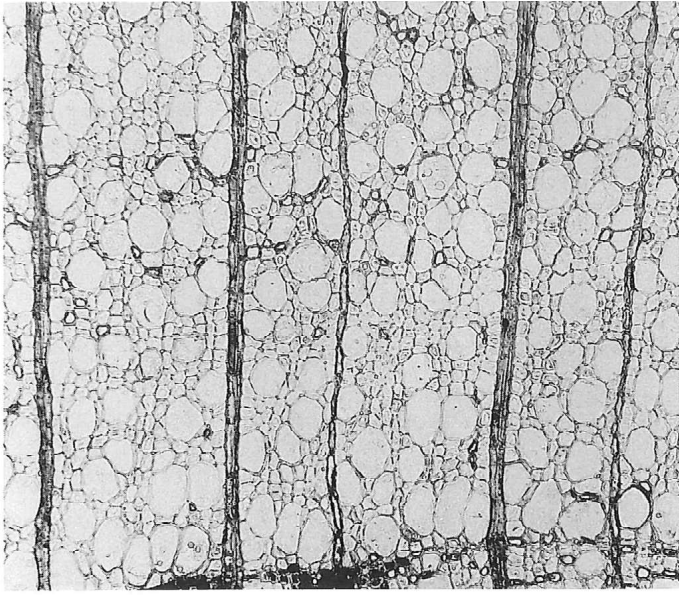

ナナカマド属?, リンゴ属?

XXXVa(×105)



XXXVb(×95)

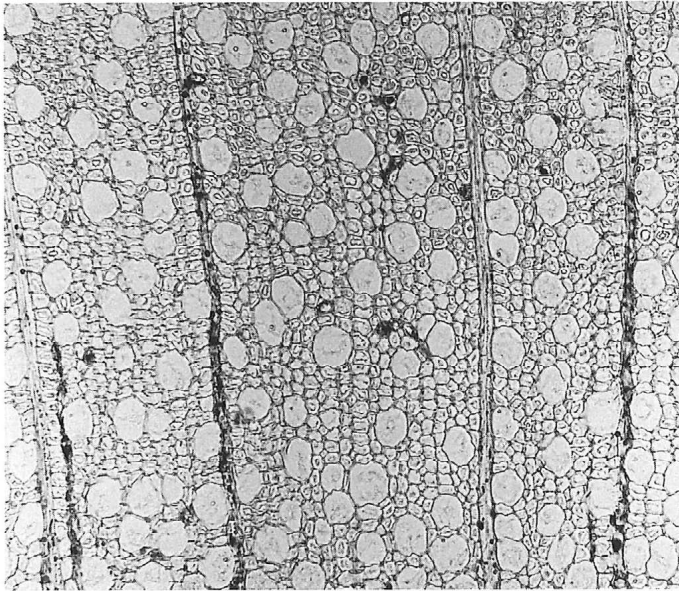

ナナカマド属?, リンゴ属?

XXXVa(×125)

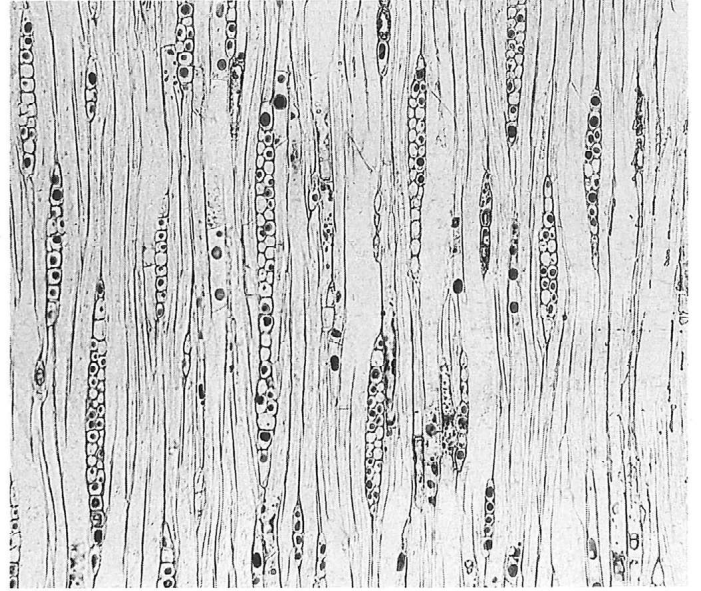

XXXVb(×120)

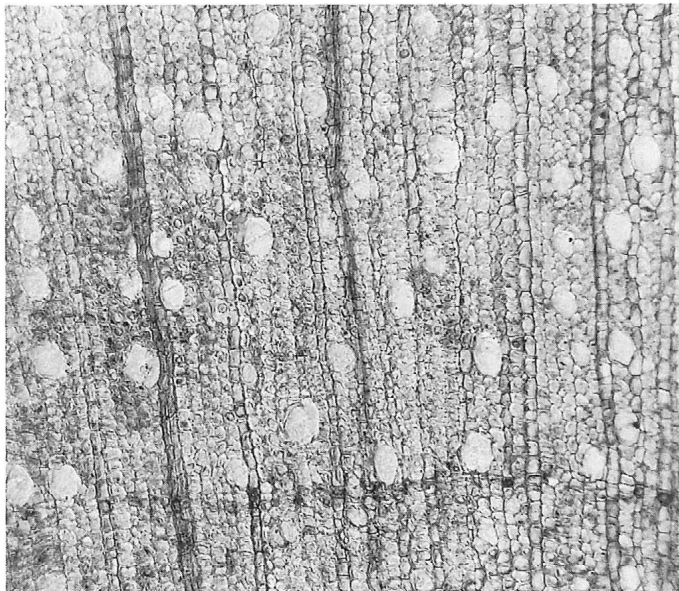

?

XXXVa(×125)



XXXVb(×280)

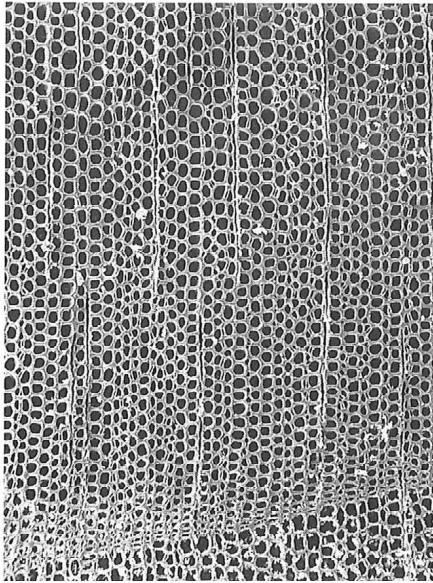

イチイ 1a(×100)

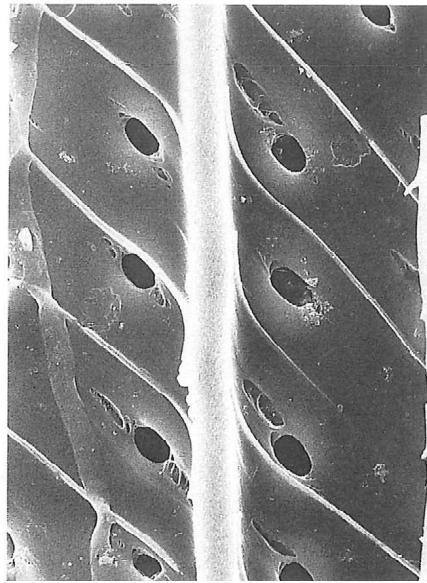

1b(×1,175)

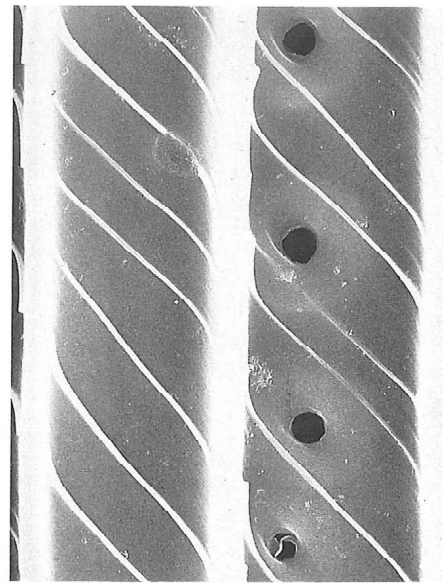

1c(×1,270)

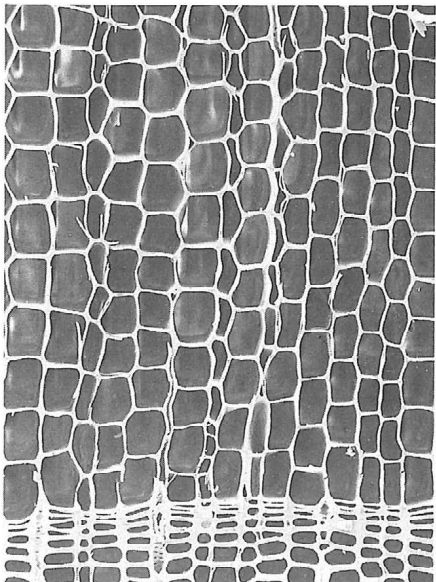

モミ属 2a(×230)

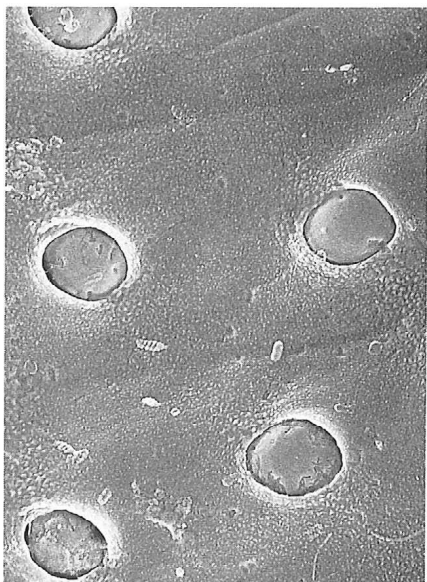

2b(×2,370)

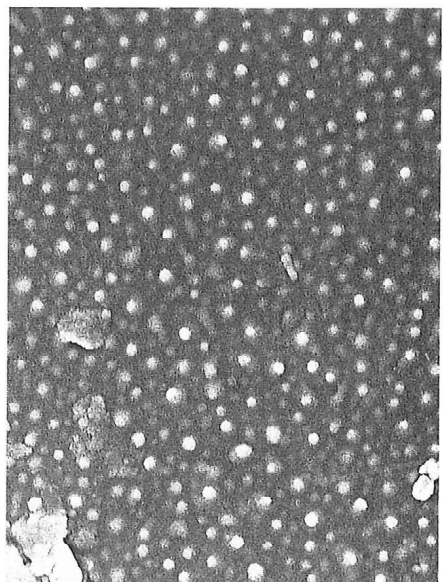

2c(×10,030)

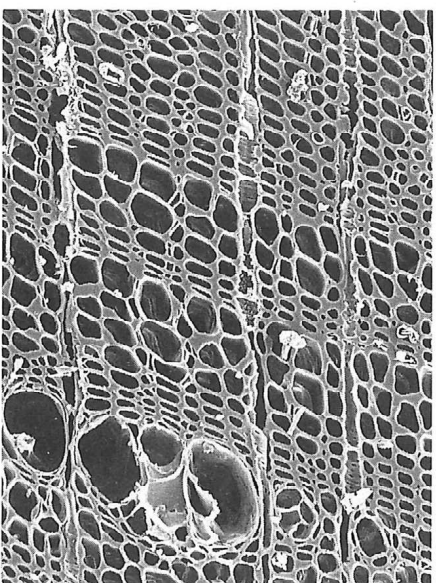

トウヒ属 3a(×180)

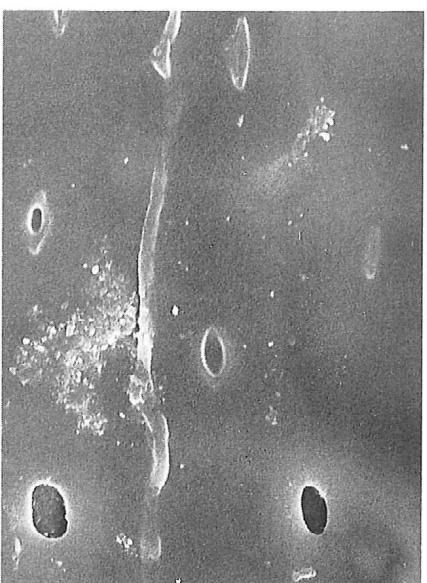

3b(×2,400)

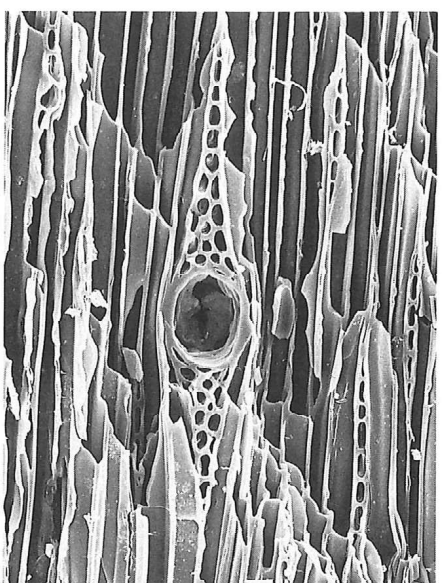

3c(×2,260)



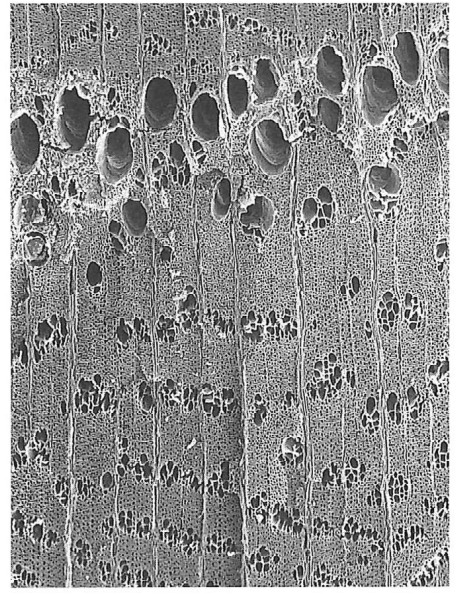
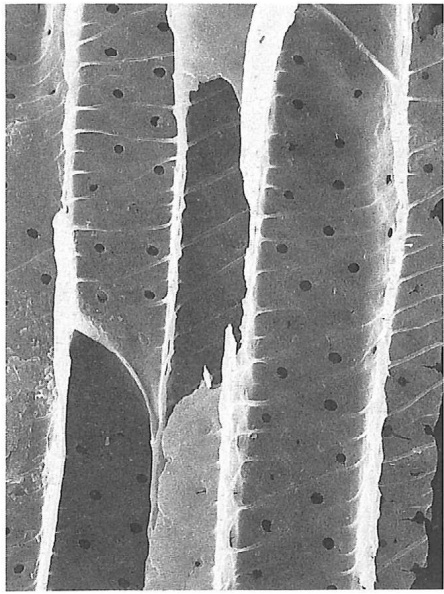
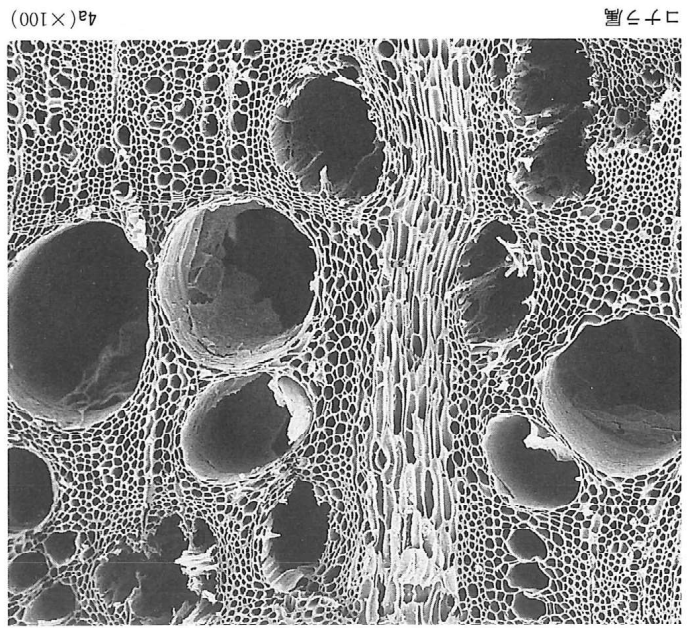
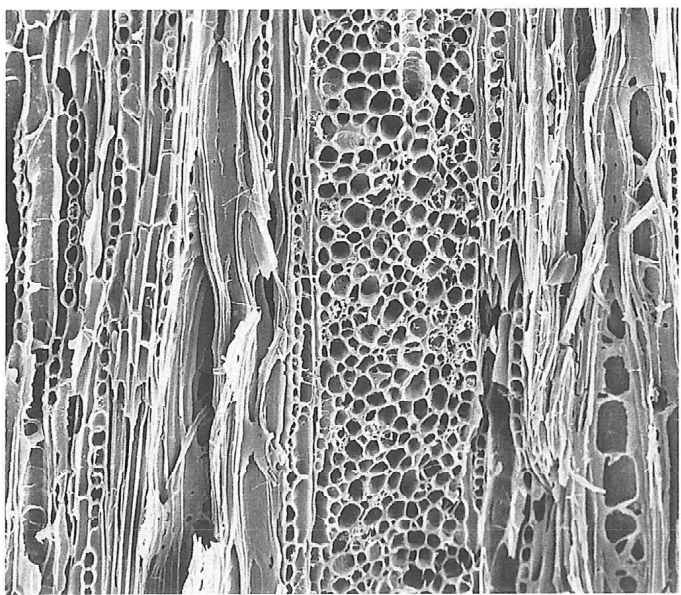

ニシ属

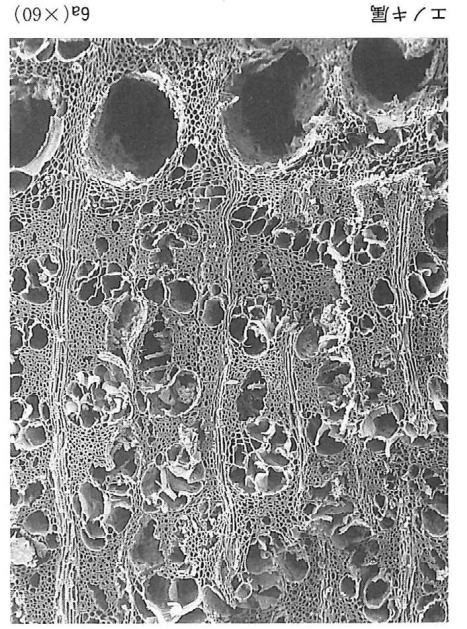
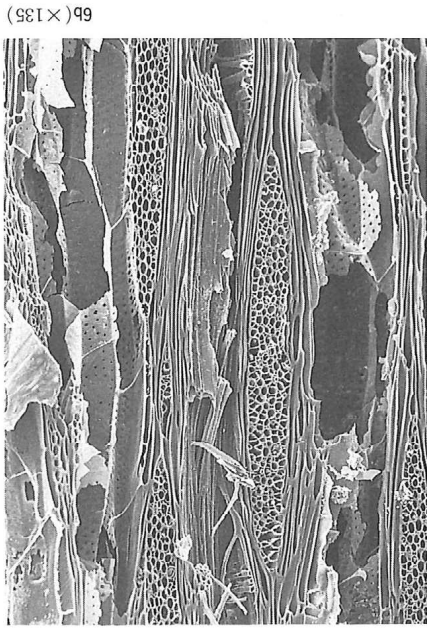

エノキ属

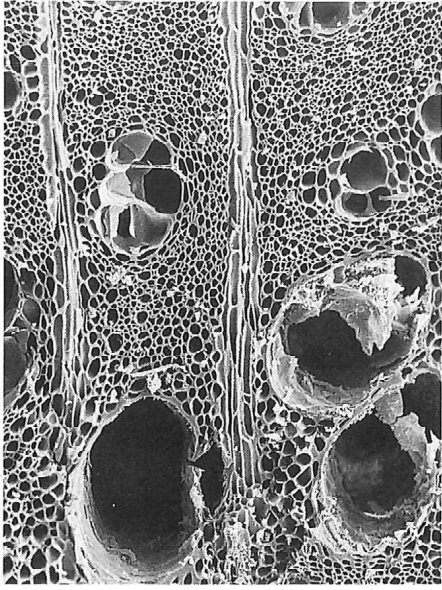

クワ属 7a(140)

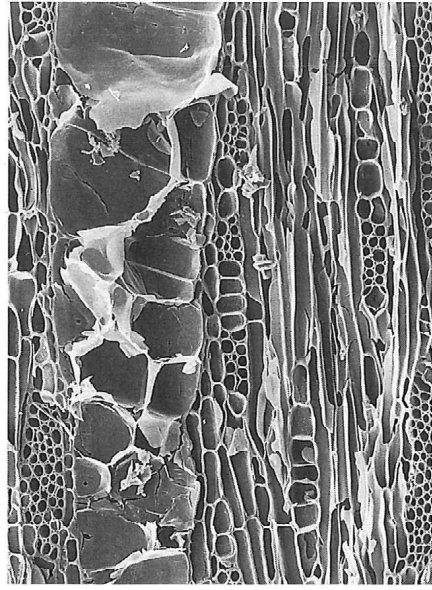

7b(×275)

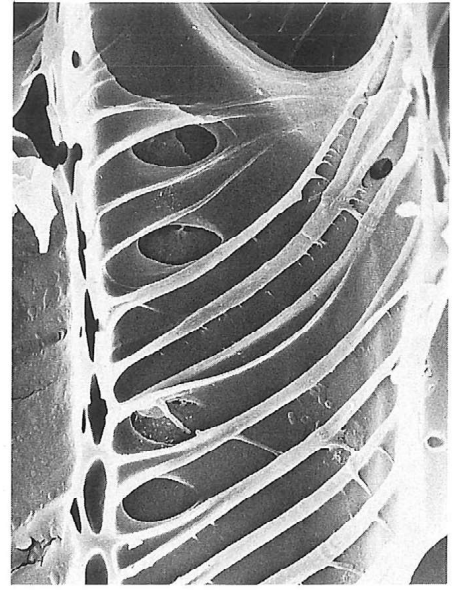

7c(×1,710)

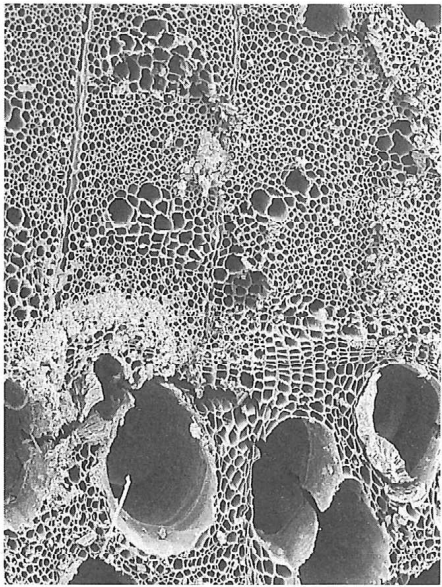

イヌエンジュ属 8a(×105)

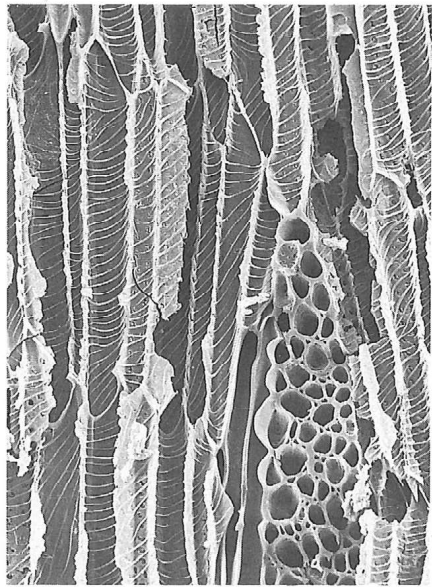

8b(×340)



8c(×5,380)

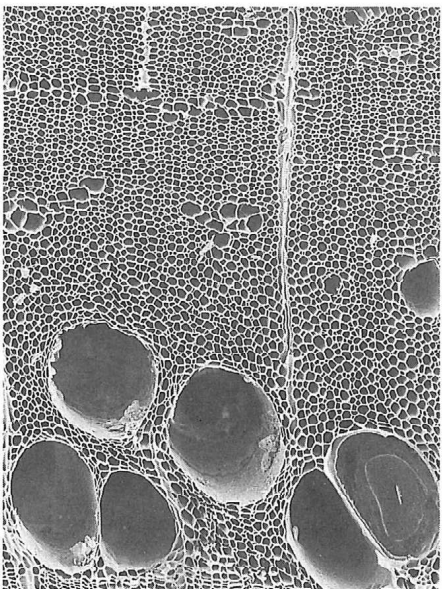

キハダ属 9a(×70)

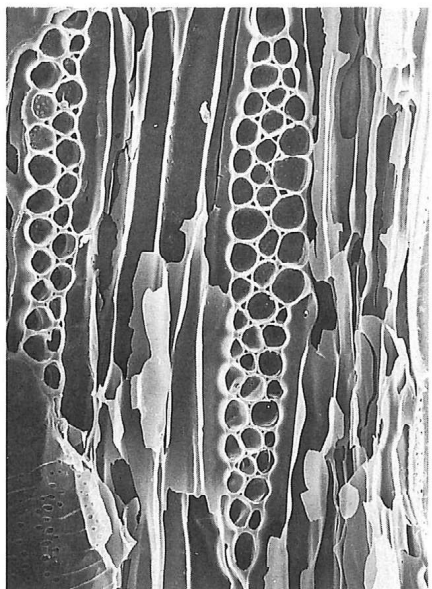

9b(×245)

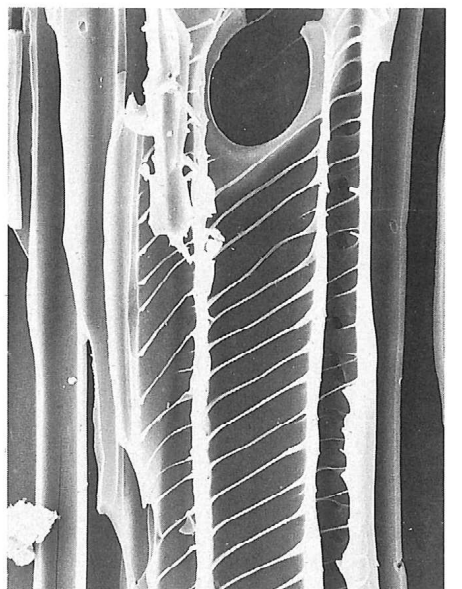

9c(×810)



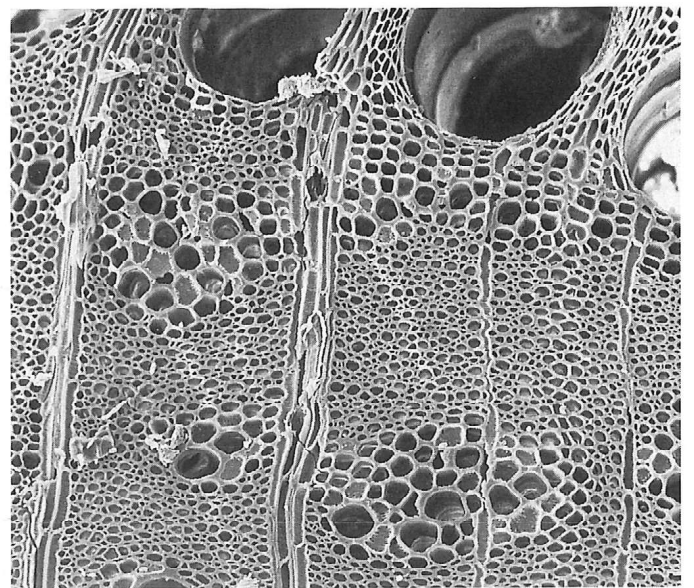

10a (×175)

ニガキ

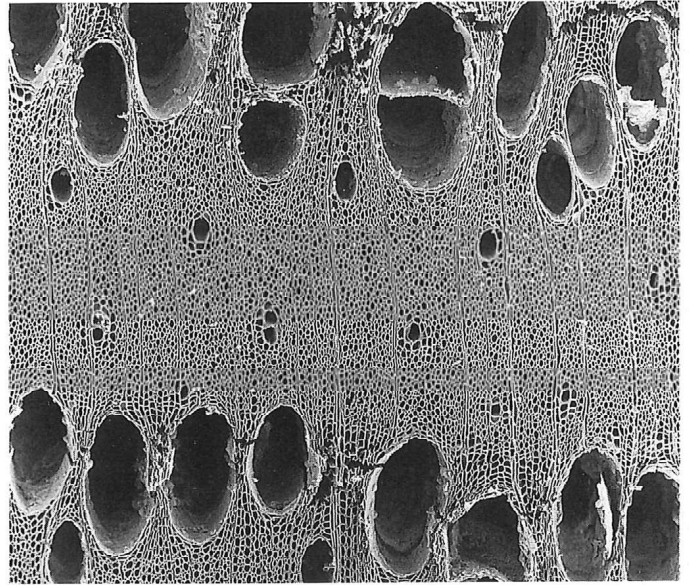

11a (×60)

トナリコ属

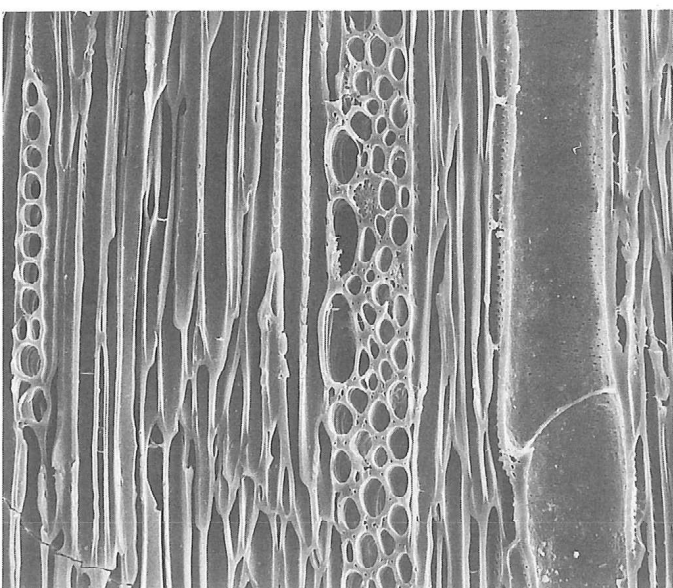

10b (×350)

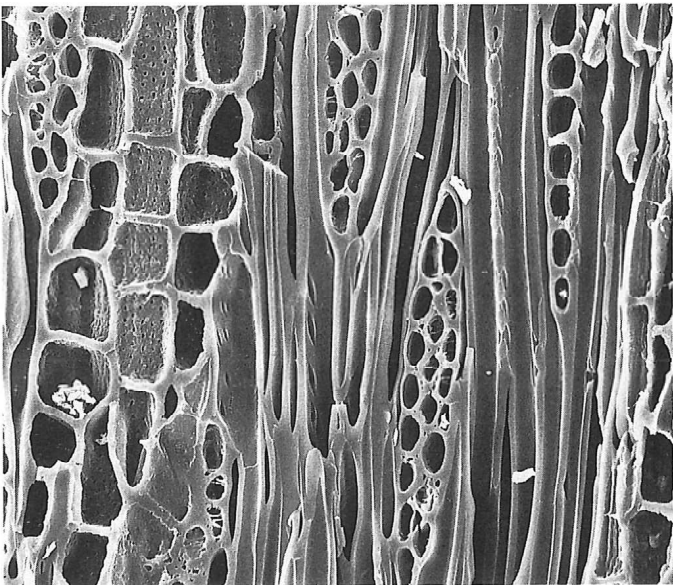

11b (×375)

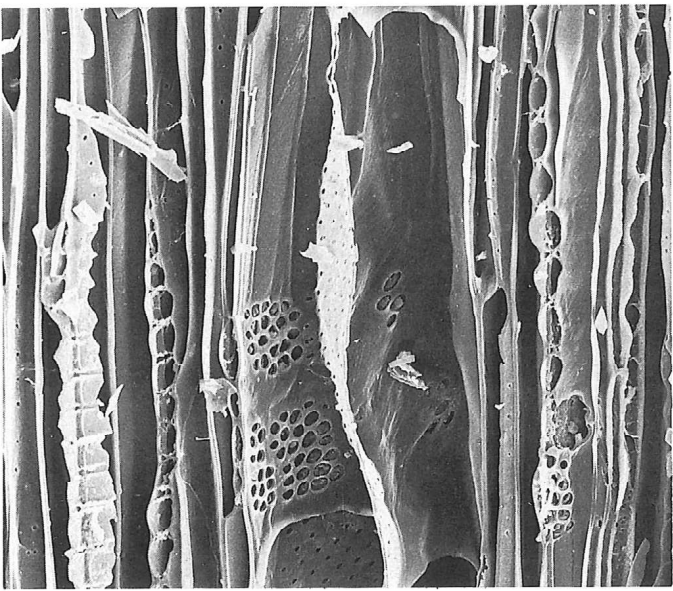

12b (×400)

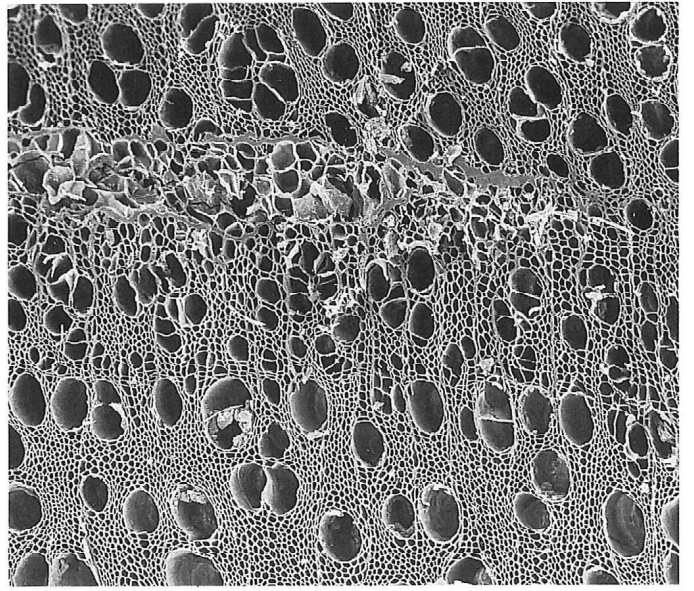

12a (×95)

ハコヤナギ属

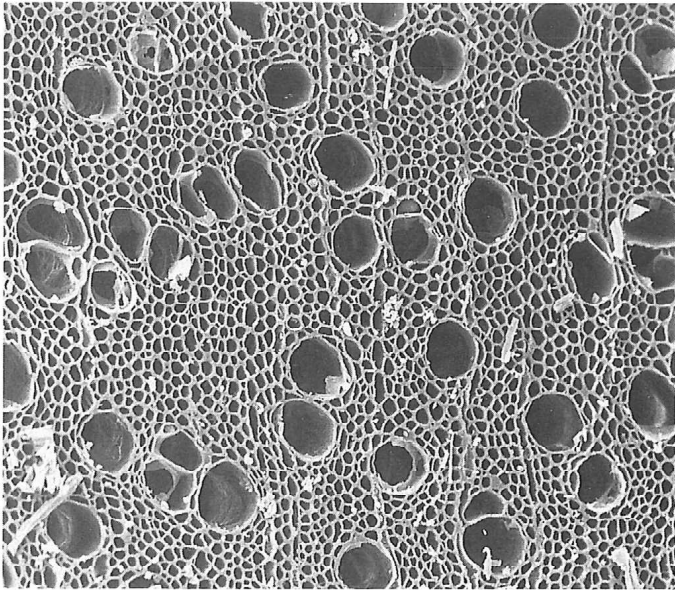

ヤナギ属

13a(×220)

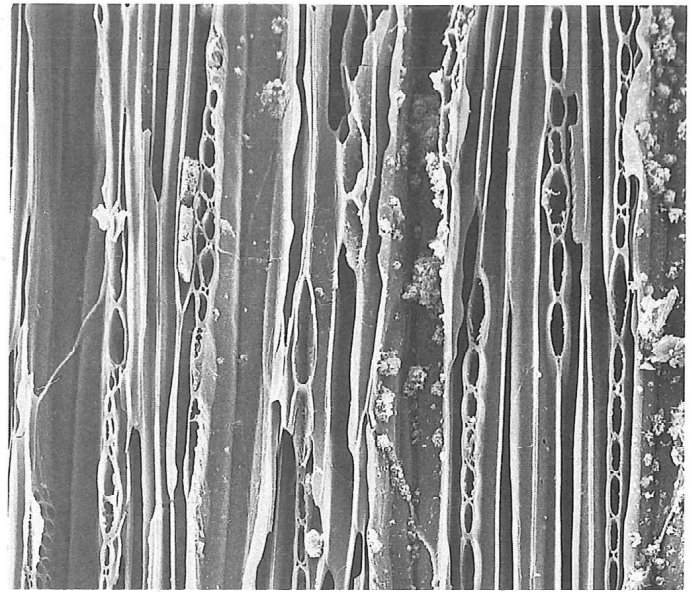

13b(×450)

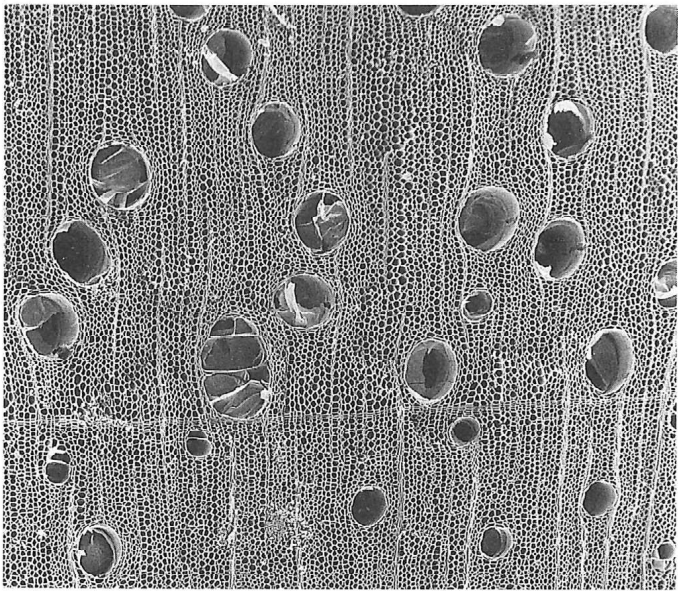

オニグルミ

14a(×40)

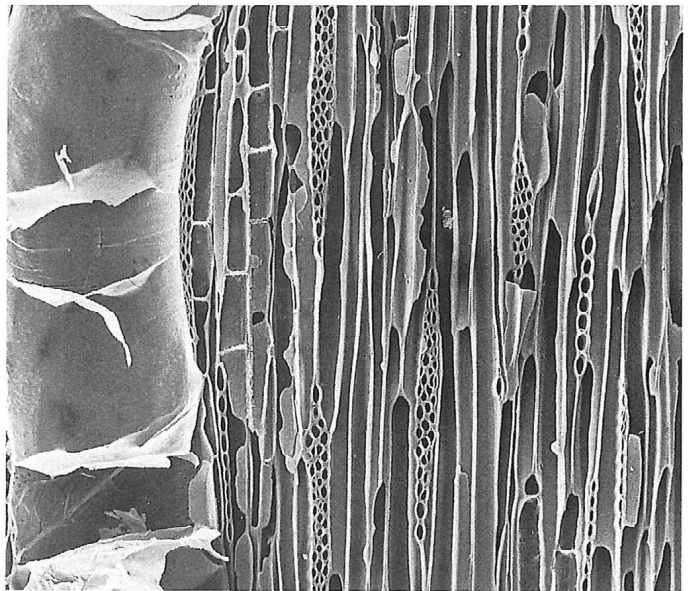

14b(×165)

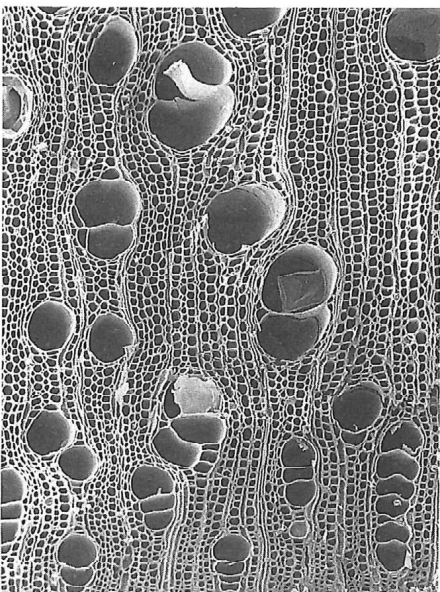

アサダ

15a(×90)



15b(×220)

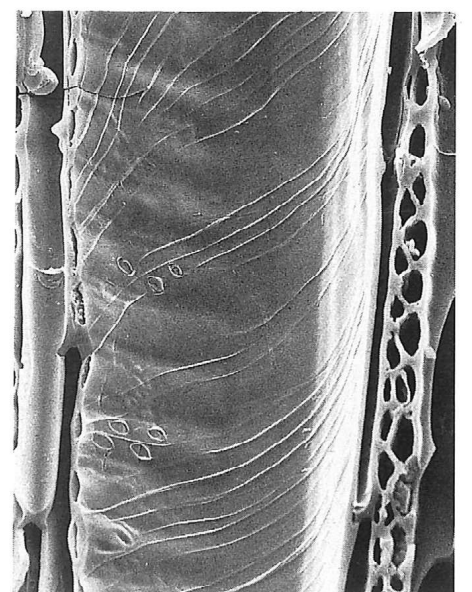

15c(×590)



PL. ②-365 炭化材の組織・構造 ⑥

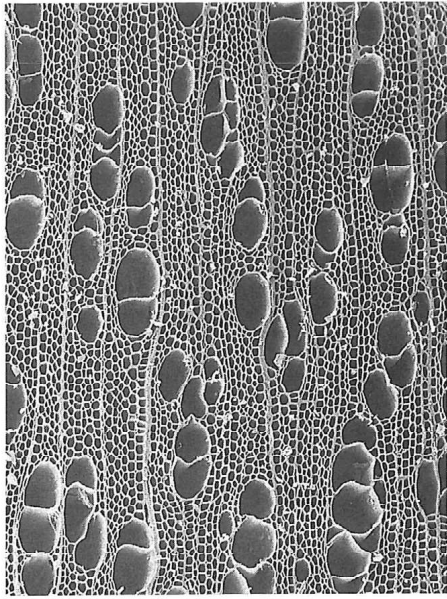

カバノキ属

16a(×90)

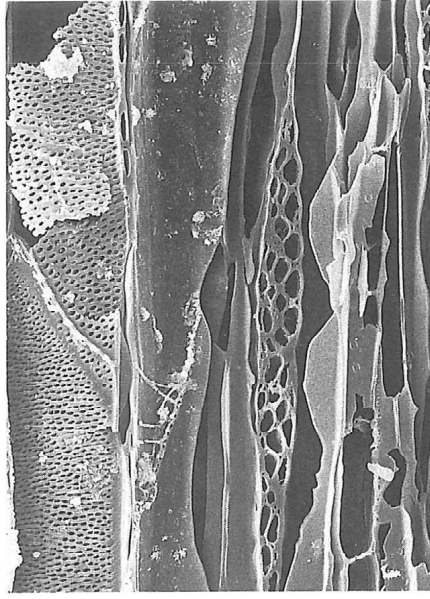

16b(×400)

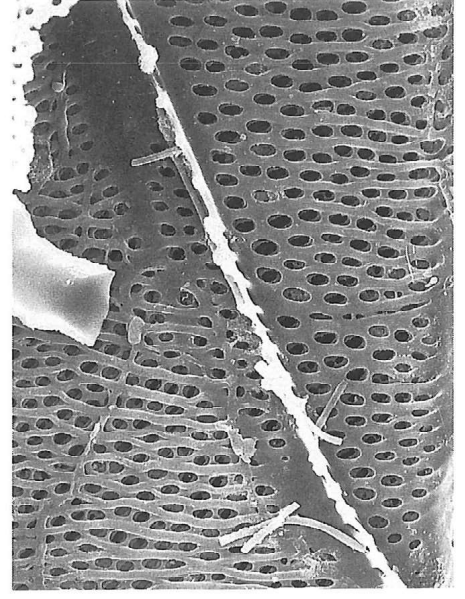

16c(×1,130)

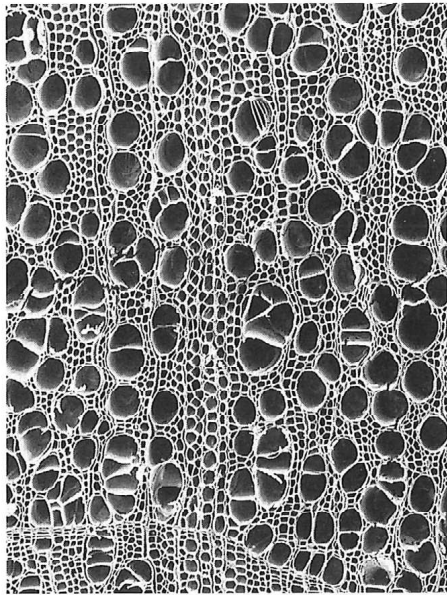

ハンノキ属

17a(×60)



17b(×180)

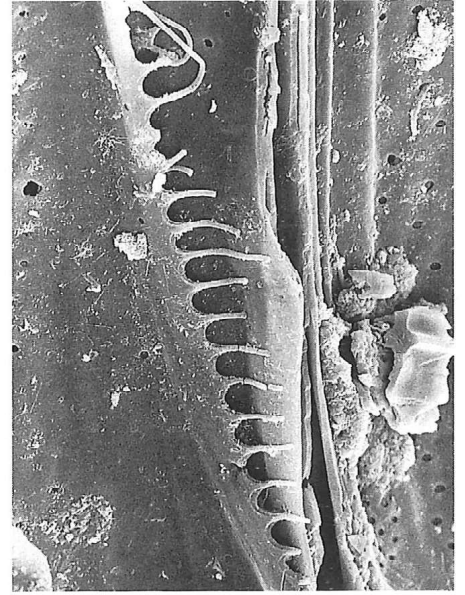

17c(×860)

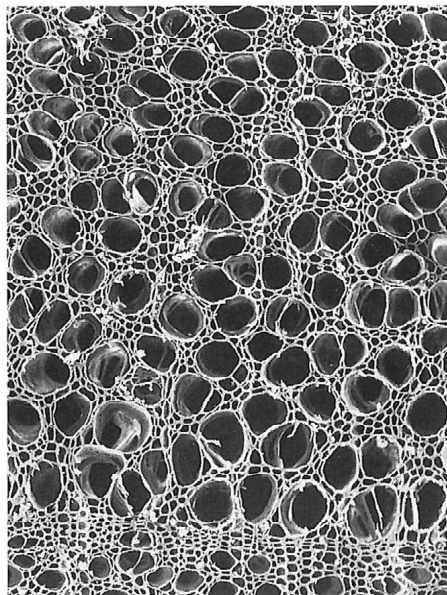

カツラ

18a(×70)

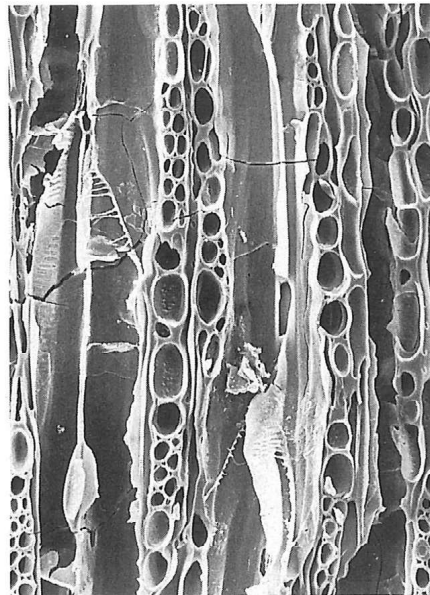

18b(×150)

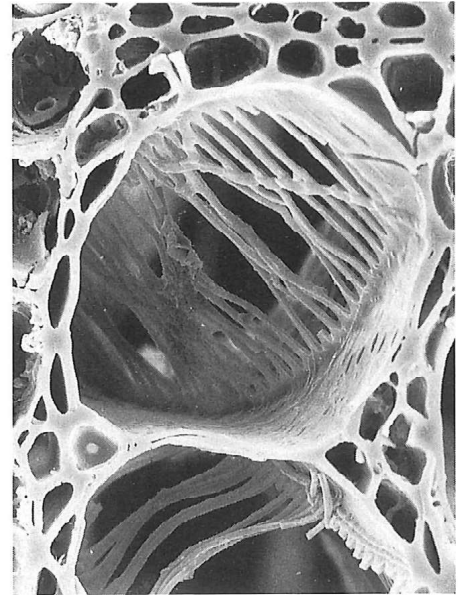

18c(×500)

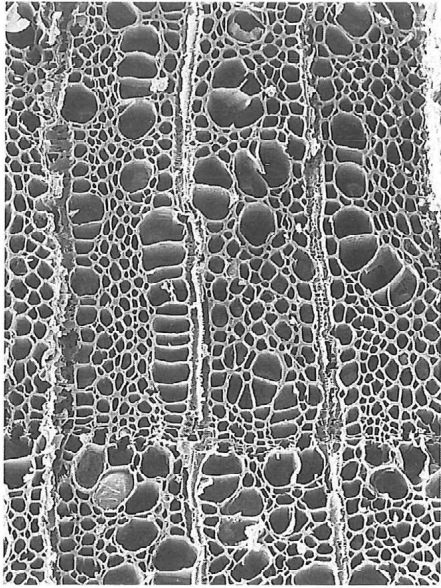

モクレン属

19a(×145)

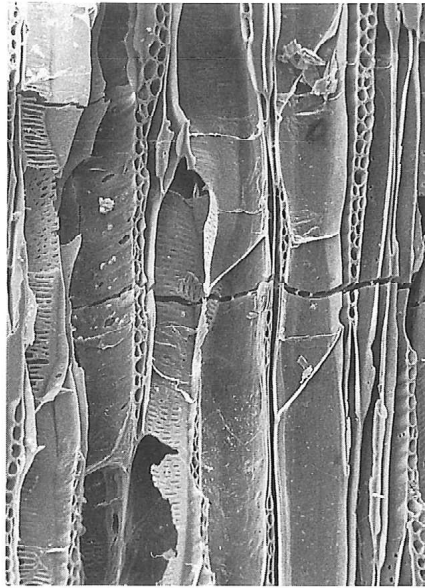

19b(×130)

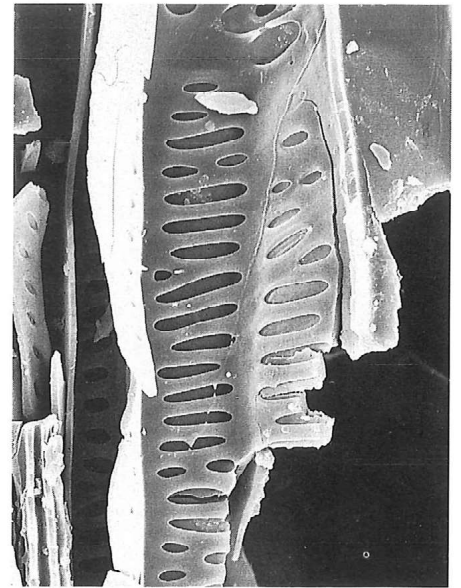

19c(×790)

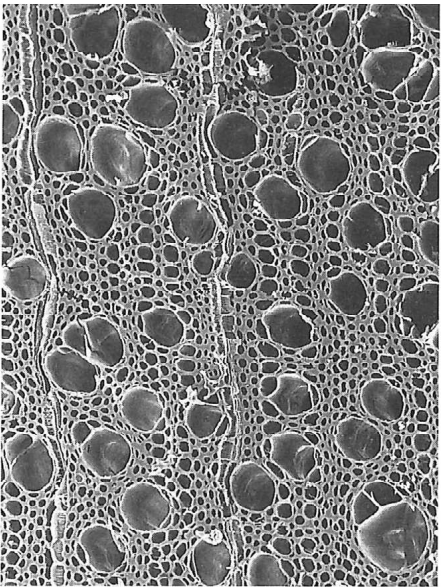

アジサイ属

20a(×145)

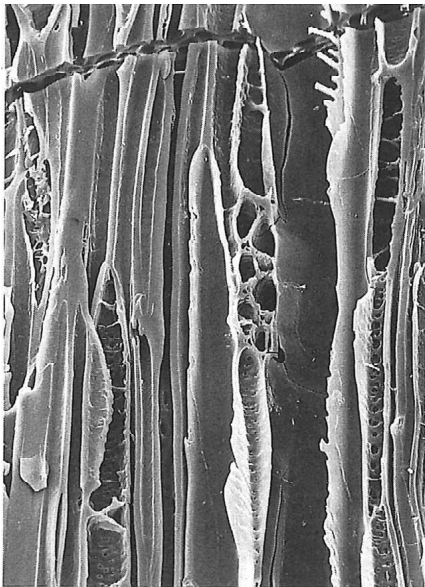

20b(×405)

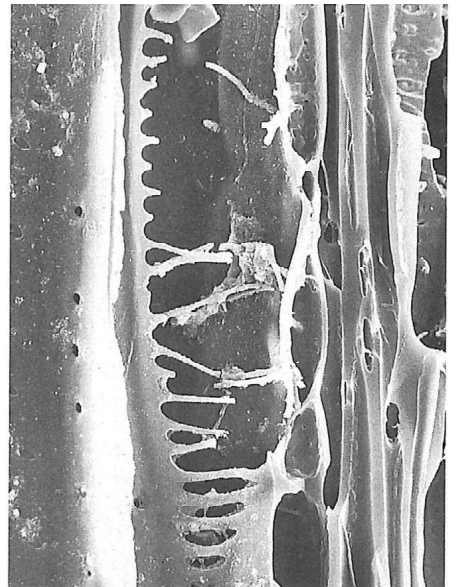

20c(×540)

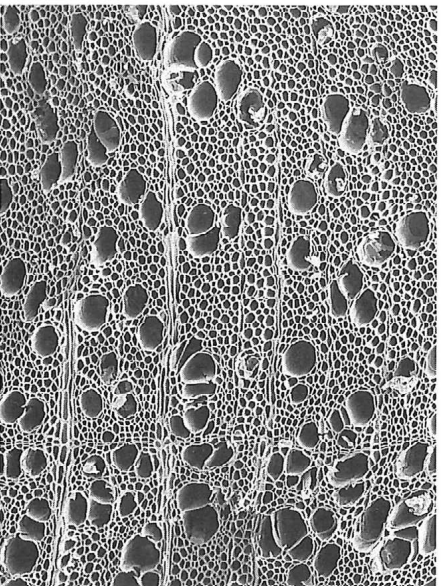

サクラ属

21a(×110)

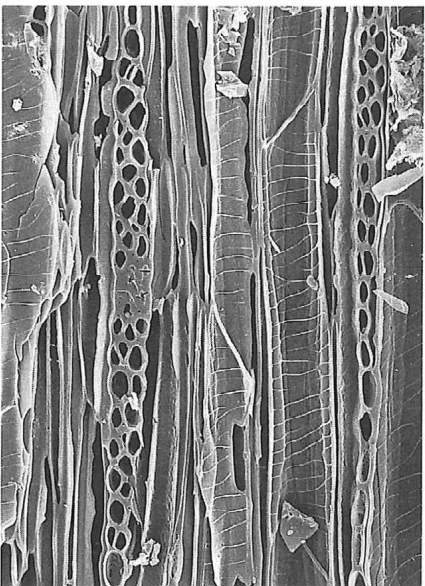

21b(×350)

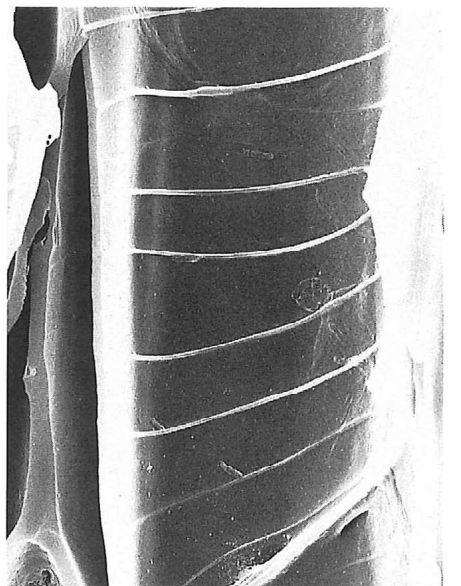

21c(×1,760)



PL. ②-367 炭化材の組織・構造 ⑧

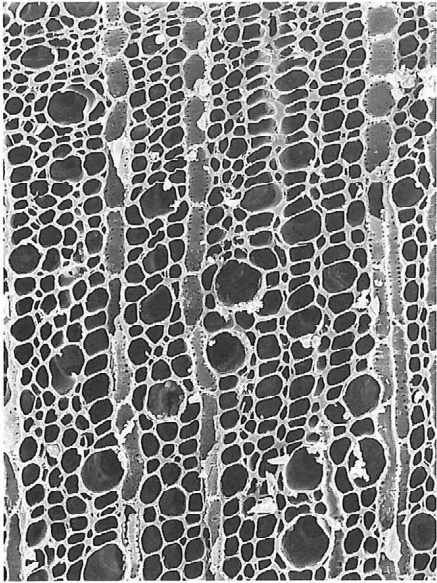

ニシギギ属 22a(×280)

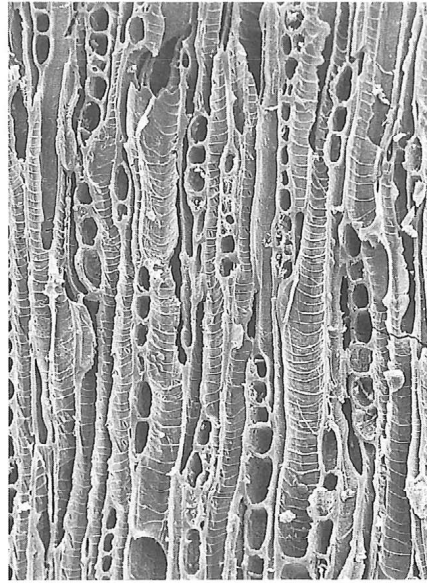

22b(×300)

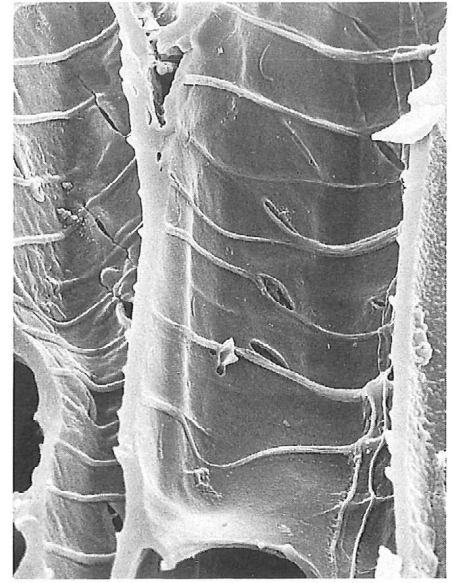

22c(×1,880)

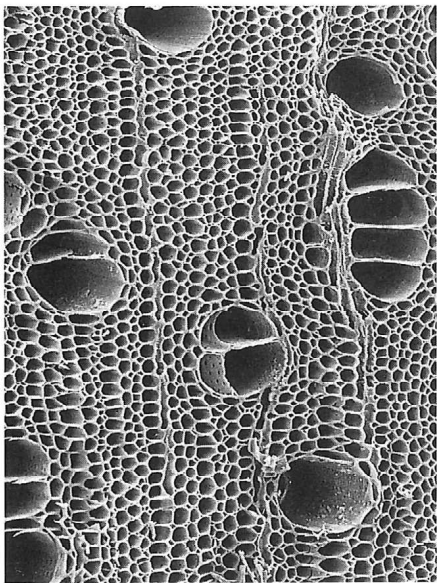

カエデ属 23a(×165)

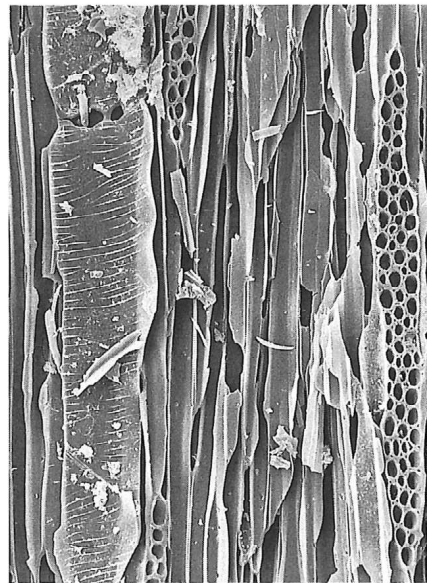

23b(×160)

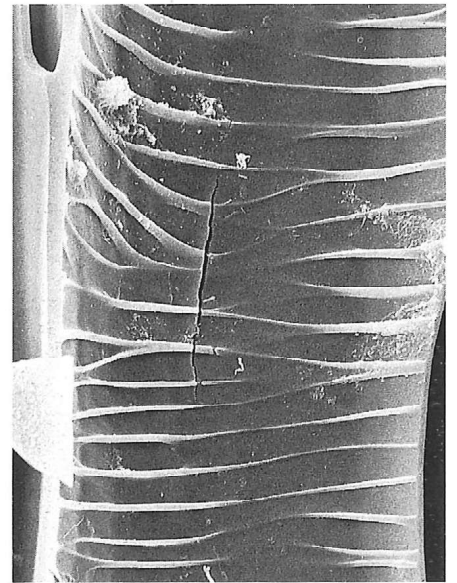

23c(×1,650)

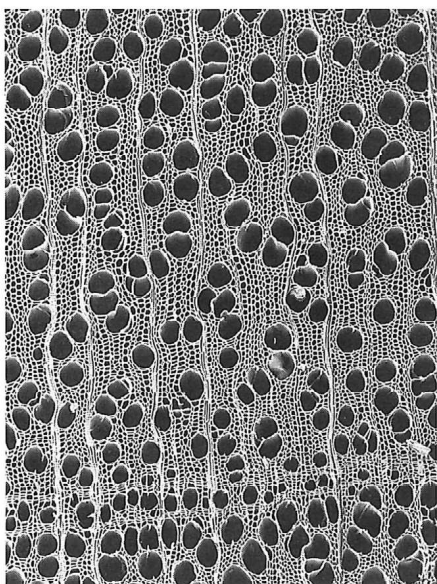

ミズキ属 24a(×50)

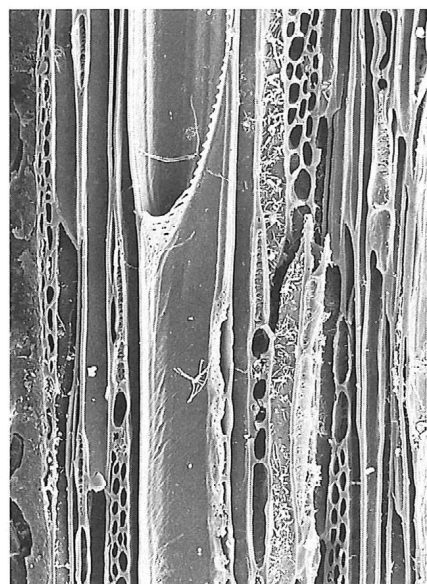

24b(×245)

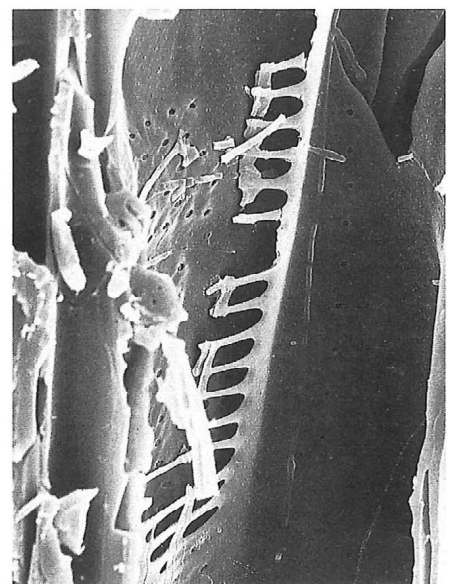

24c(×660)

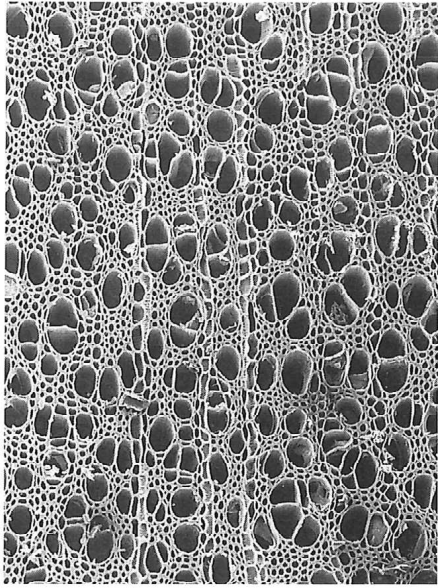

ニワトコ属

25a(×110)

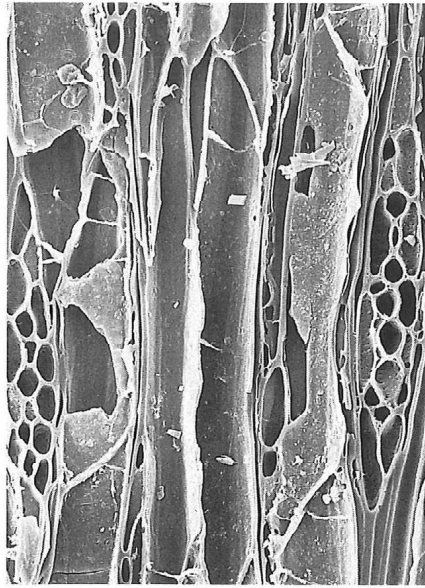

25b(×1,190)

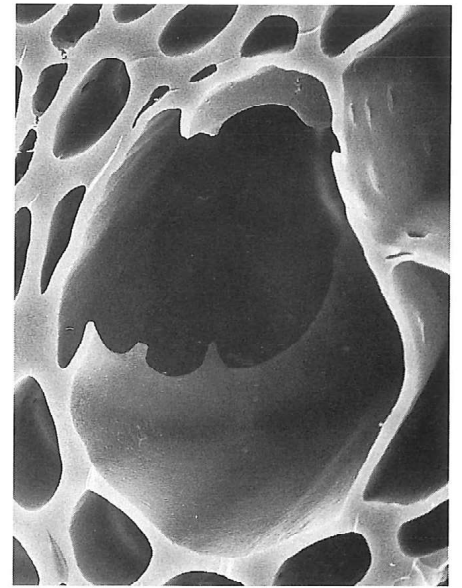

25c(×1,190)

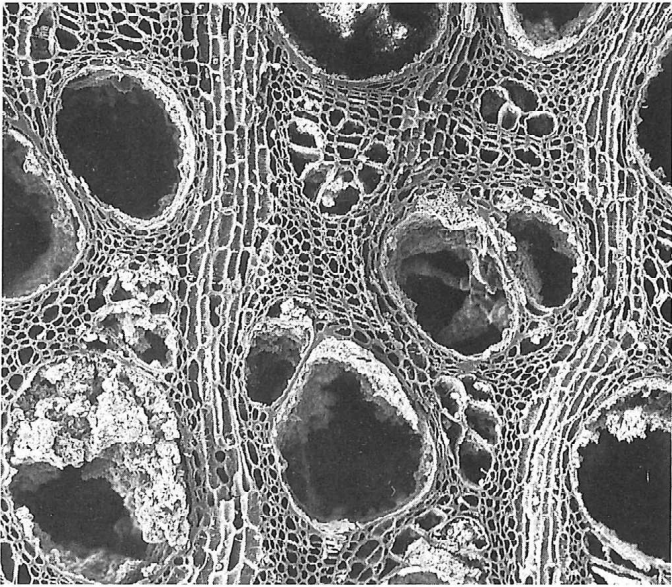

ツル性植物

26a(×130)

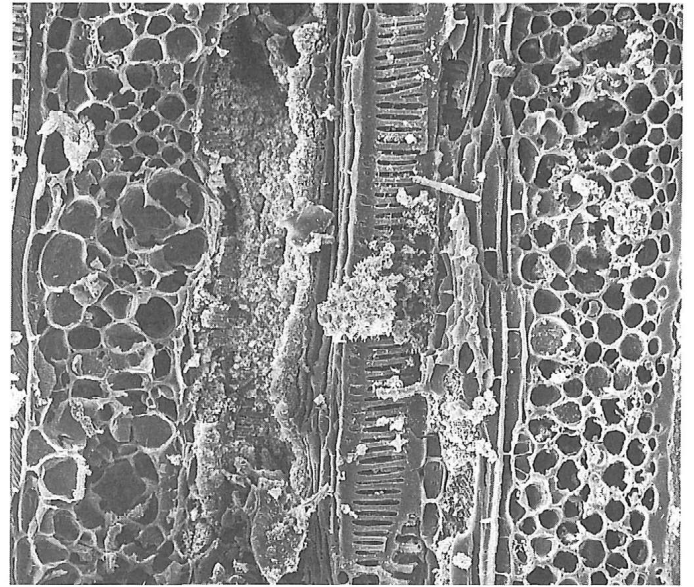

26b(×260)

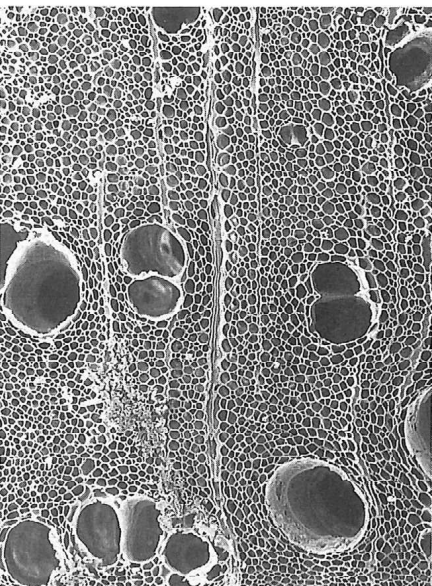

ウルシ属

27a(×105)

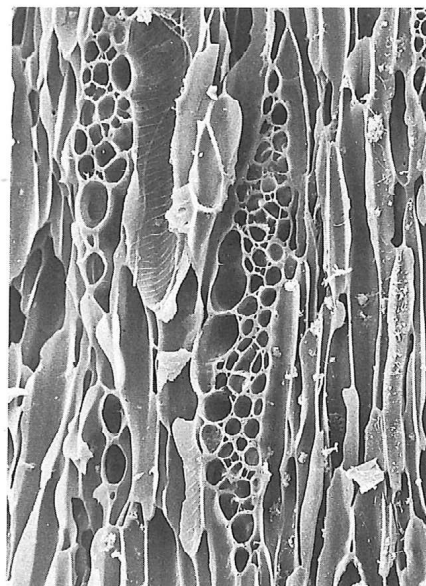

27b(×320)

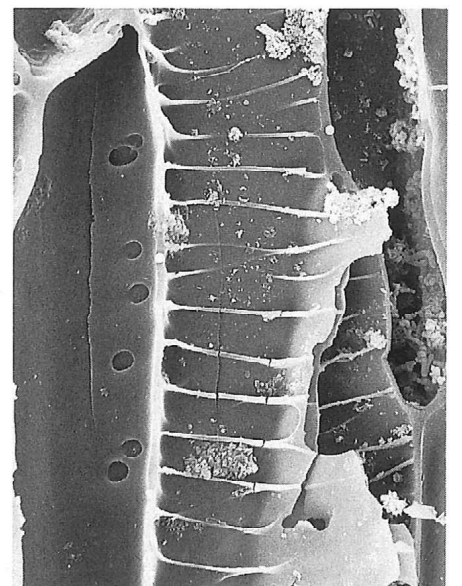

27c(×1,560)



PL. ②-369 炭化材の組織・構造 ⑩



? 28a(×20)

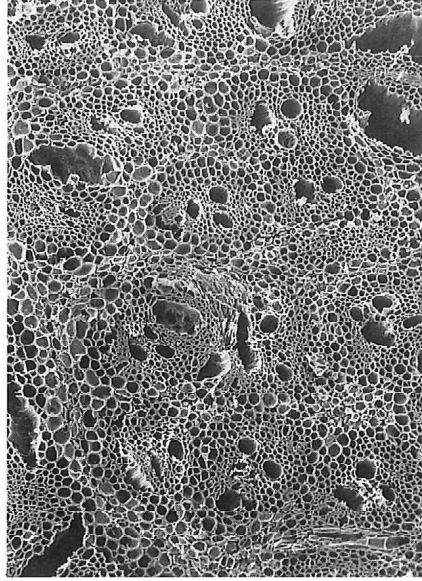

28b(×50)

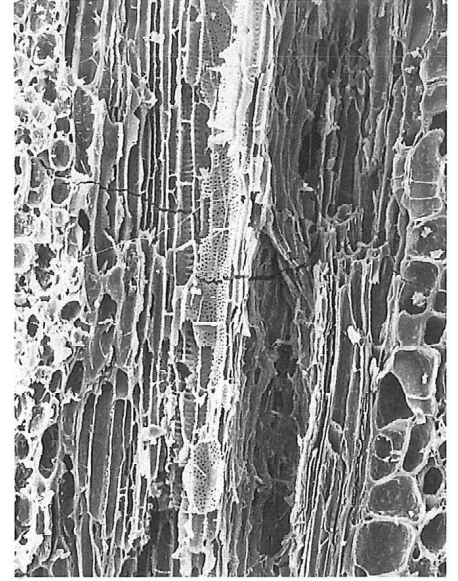

28c(×160)

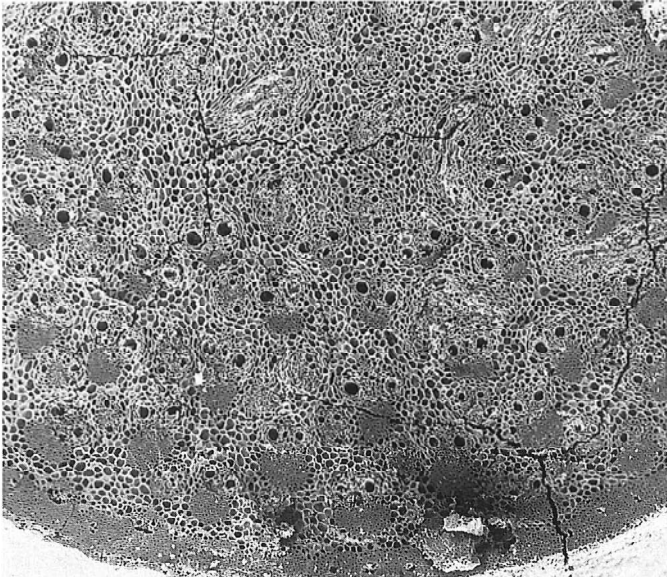

? 29a(40)

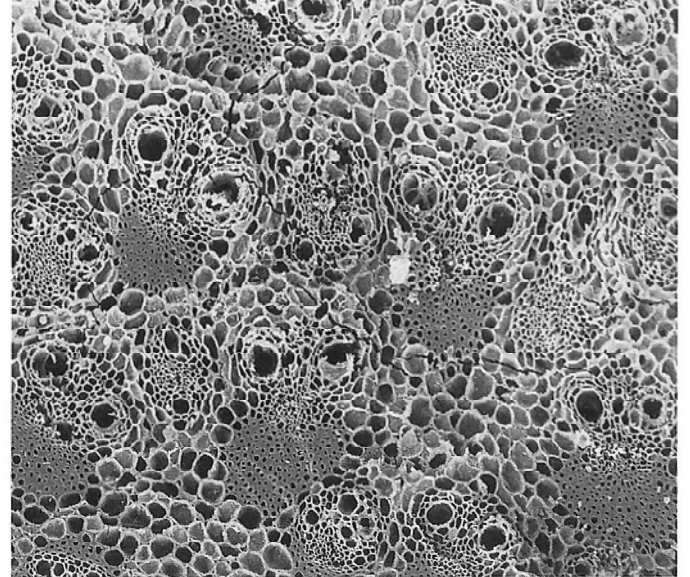

29b(×300)

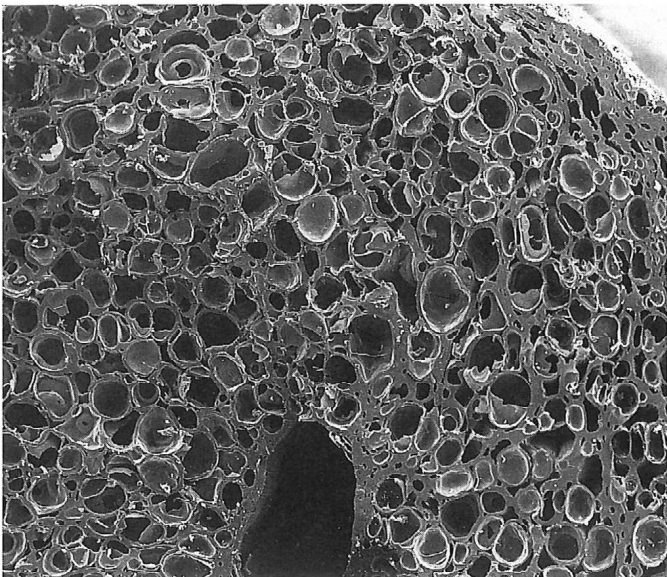

? 30a(×70)

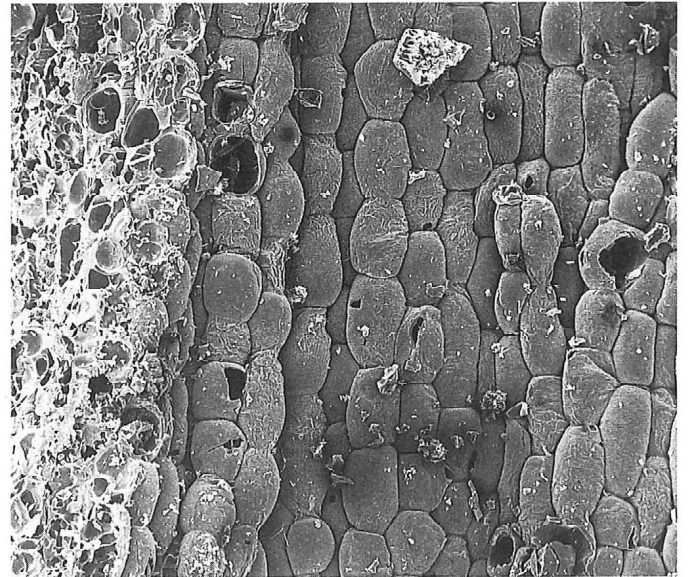

30b(×80)

## PL. 図-370 主な花粉・孢子化石

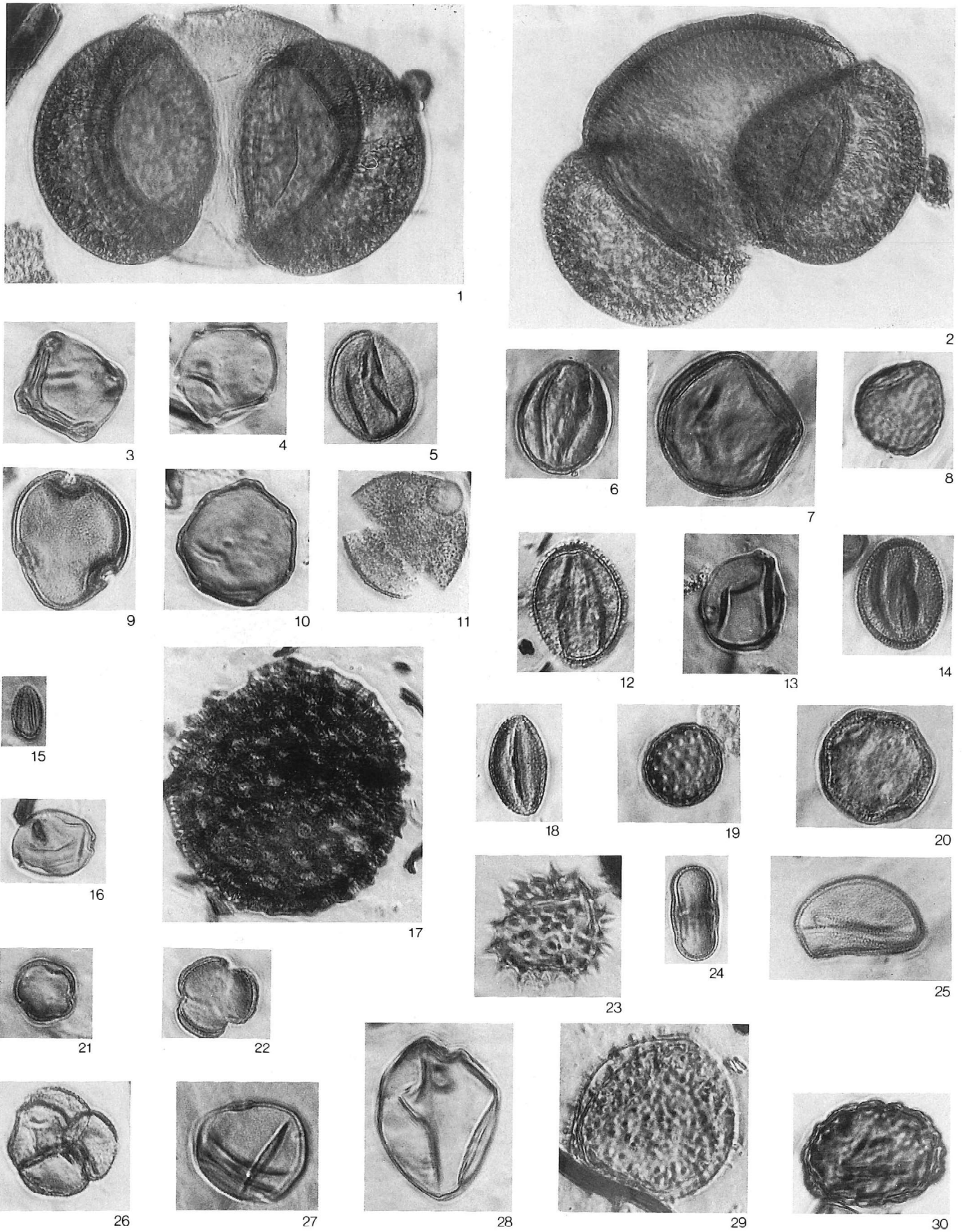

主な花粉・孢子化石 (1~30は約640倍)

- 1 *Picea*, 焼土11, 2 *Abies*, 炭化物16, 3 *Alnus*, 炭化物16, 4 *Alnus*, 炭化物52, 5 *Quercus*, 炭化物16, 6 *Quercus*, 焼土11, 7 *Fagus*, 炭化物16, 8 *Ulmus*, 2号住居址床面, 9 *Tilia*, 炭化物16, 10 *Juglans*, 炭化物40, 11 *Acer*, 炭化物40, 12 *Phellodendron*, 炭化物16, 13 *Betula*, 焼土40, 14 *Fraxinus*, 炭化物16, 15 *Salix-Populus*, 焼土11, 16 *Moraceae*, 炭化物16, 17 *Polygonaceae*, 2号住居址床面, 18 *Polygonaceae*, 炭化物16, 19 *Chenopodiaceae*, 炭化物16, 20 *Caryophyllaceae*, 炭化物16, 21 *Ranunculaceae*, 焼土11, 22 *Artemisia*, 焼土44, 23 *Carduoideae*, 2号住居址床面, 24 *Umbelliferae*, 焼土11, 25 *Lysichiton*, 2号住居址床面, 26 *Typhaceae*, 2号住居址床面, 27 *Gramineae*, 炭化物16, 28 *Gramineae*, 焼土11, 29 *Osmundaceae*, 2号住居址床面, 30 *Monolate type spore*, 炭化物16



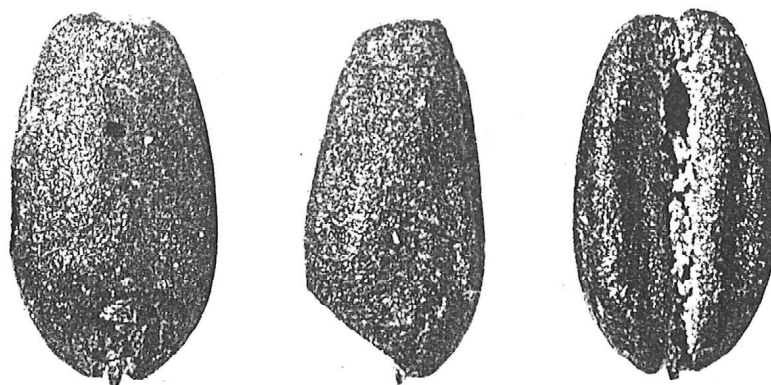

mm

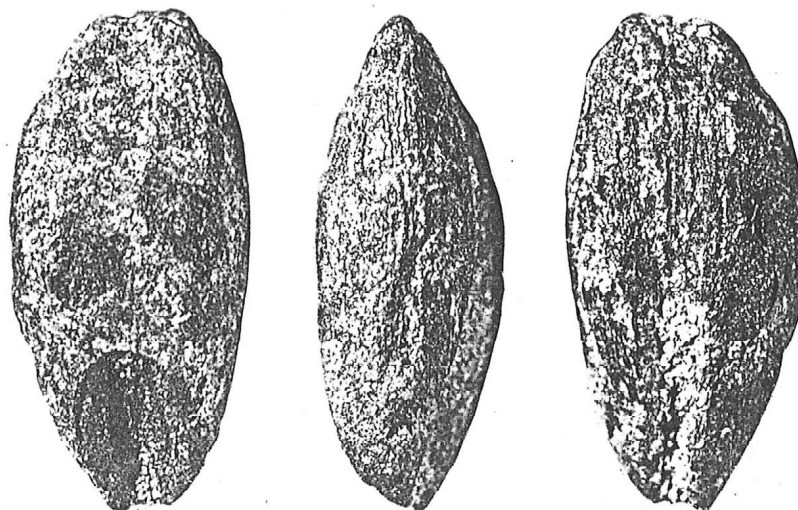

mm

Top:Wheat Dorsal,Lateral,and  
Ventral Views.

Bottom:Barley Dorsal,Lateral,and  
Ventral Views.

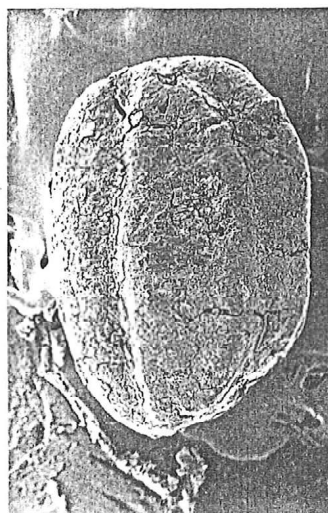

Rice.

[図版編]

2

## サクシュコトニ川遺跡

北海道大学構内で発掘された西暦9世紀代の原初的農耕集落

昭和61年3月20日発行

発行所— 北海道大学  
札幌市北区北8条西5丁目

編集——北海道大学埋蔵文化財調査室

デザイン—桜井雅章

印刷所—(株)北海道機関紙印刷所  
札幌市北区北6条西7丁目

[図版編]

## サクシュコトニ川遺跡

北海道大学構内で発掘された西暦9世紀代の原初的農耕集落

1986

2

北海道大学