

名古屋市緑区鳴海町

徳重西部土地区画整理事業予定地内所在
埋蔵文化財発掘調査報告

[図録編]

1976

名古屋市教育委員会

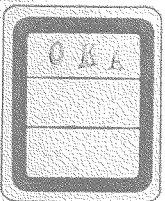

名古屋市緑区鳴海町

徳重西部土地区画整理事業予定地内所在

埋蔵文化財発掘調査報告

〔図録編〕

1976

名古屋市教育委員会



卷頭図版1 NJA-2号窯全景



卷頭図版2 NK1-1群C窯

例 言



- 1 本書は、名古屋市緑区鳴海町徳重西部土地区画整理事業予定地区に所在した古窯跡7基の発掘調査報告〔図録編〕である。
- 2 本調査は、1974年4月から1976年3月までの2カ年間で費し、日本住宅公団から委託を受けた名古屋市教育委員会が調査主体者となり実施した。
- 3 実測図版のうち遺構に関するものは $\frac{1}{40}$ 、遺物関係は特殊なものを除いて $\frac{1}{4}$ の縮尺に統一してある。
- 4 遺物写真は縮尺不統一である。
- 5 遺構実測図のうち、朱線で表示してある個所は、窯体断面で観察された熱量の変化による地山の焼け具合を表現してある。同じく、は地山を、は、最終床面下に充填された土層を示してある。
- 6 現況測量図等で用いてある海拔絶対高は名古屋港工事用基本水準面(N. P.)である。
- 7 現況測量図の方位Nは、真北(磁北 $6^{\circ}20'E$)である。
- 8 調査した7基古窯の真北に対する中軸線の傾きは、本文記述中に数値をもって示したので図中ではこれを省略した。
- 9 NK I-1群遺物実測図中のアルファベットは窯名を表わしており、二文字、例えばABとなっている遺物はA窯とB窯のあいだで得たものである。尚C'はC窯床面下で出土したものである。

図 版 目 次

- 卷頭図版 I N J A-2号窯全景
II N K I-1群C窯
- 実測図 I N J A-2号窯付近現況測量図 1 : 200
II N J A-2号窯遺物実測図 1 : 4
杯 蓋
III 高台付杯
IV 糸切杯
V 盤・碗・硯・浄瓶・高盤等
VI 鉢・短頸壺
VII 壺蓋・双耳瓶
VIII 長頸瓶1 口頸部
IX 2 口頸部 胴部
X 3 胴部 底部
XI 小型長頸瓶・平瓶・土錘・特殊品・窯道具等
XII 鉢・甕
XIII 魚・獸足・窯印拓影
XIV N K I-1群付近現況測量図 1 : 300
XV N K I-1群遺物実測図
A 窯灰原・A B窯間下
XVI B 窯窯内・B C窯間下
XVII C 窯窯内
XVIII C 窯窯内・C 窯床面下
XIX C 窯床面下・C D窯間下・D 窯窯内・同灰原
XX D E 窯間下・E 窯灰原・F 窯下・4225

- 写真図版 I N J A -2号窯付近航空写真
- II N J A -2号窯 発掘前遠景及び近景
- III 発掘途中風景
- IV 発掘後遠景西より
- V 発掘後近景西より
- VI 発掘後窯体各部
 左上・煙道部 右上・燃焼室補修壁
 下・焚口、燃焼室内ピット
- VII 出土遺物写真 杯・盤
- VIII 杯蓋
- IX 長頸瓶
- X 小型長頸瓶・鉢・平瓶等
- XI 双耳瓶
- XII 壺、瓶蓋・短頸壺
- XIII 碗・硯・窯道具・魚
- XIV 魚
- XV 陰刻花文片・窯印
- XVI 浄瓶・高盤脚・水瓶・甕
- XVII N K I -1群付近航空写真
- XVIII N K I -1群 上・発掘前遠景南より
 下・東北より
- XIX 発掘前近景上・B、C窯付近
 下・C、D窯付近
- XX A窯窯体 上・焼成室上方より焚口を望む
 下・焚口より上方を望む
- XXI B窯窯体 上・焚口より上方を望む
 下・焼成室上部西壁中の第1次床面推定線

XXII	B 窯窯体	上・西側補修壁及び床 下・焚口より上方、床面下状況
XXIII	C 窯窯体	上・焚口より上方を望む(床面撤去前) 下・ 同 (床面撤去後)
XXIV		上・焚口より上方を望む 下・上方より焚口を望む
XXV		上・分焰柱断ち割り 下・窯内より焚口方向西側をみる
XXVI		上・分焰柱断ち割り 下・東壁面
XXVII	D 窯窯体	上・焚口より上方を望む 下・ 同
XXVIII		上・分焰柱及び床断ち割り 下・上方より天井残存部を望む
XXIX		上・上方より天井残存部西側を望む 下・西壁面
XXX	E 窯窯体	下方より上方を望む
XXXI	F 窯窯体	下方より上方を望む
XXXII		出土遺物写真 碗
XXXIII		小皿・子持器台
XXXIV		片口鉢

卷末折込図版 I	N J A -2号窯
II	N K I -1 群A窯
III	B 窯
IV	C 窯
V	D 窯
VI	E・F 窯

実 測 図

図版 I NJA-2 号窠付近現況測量図 1 : 200



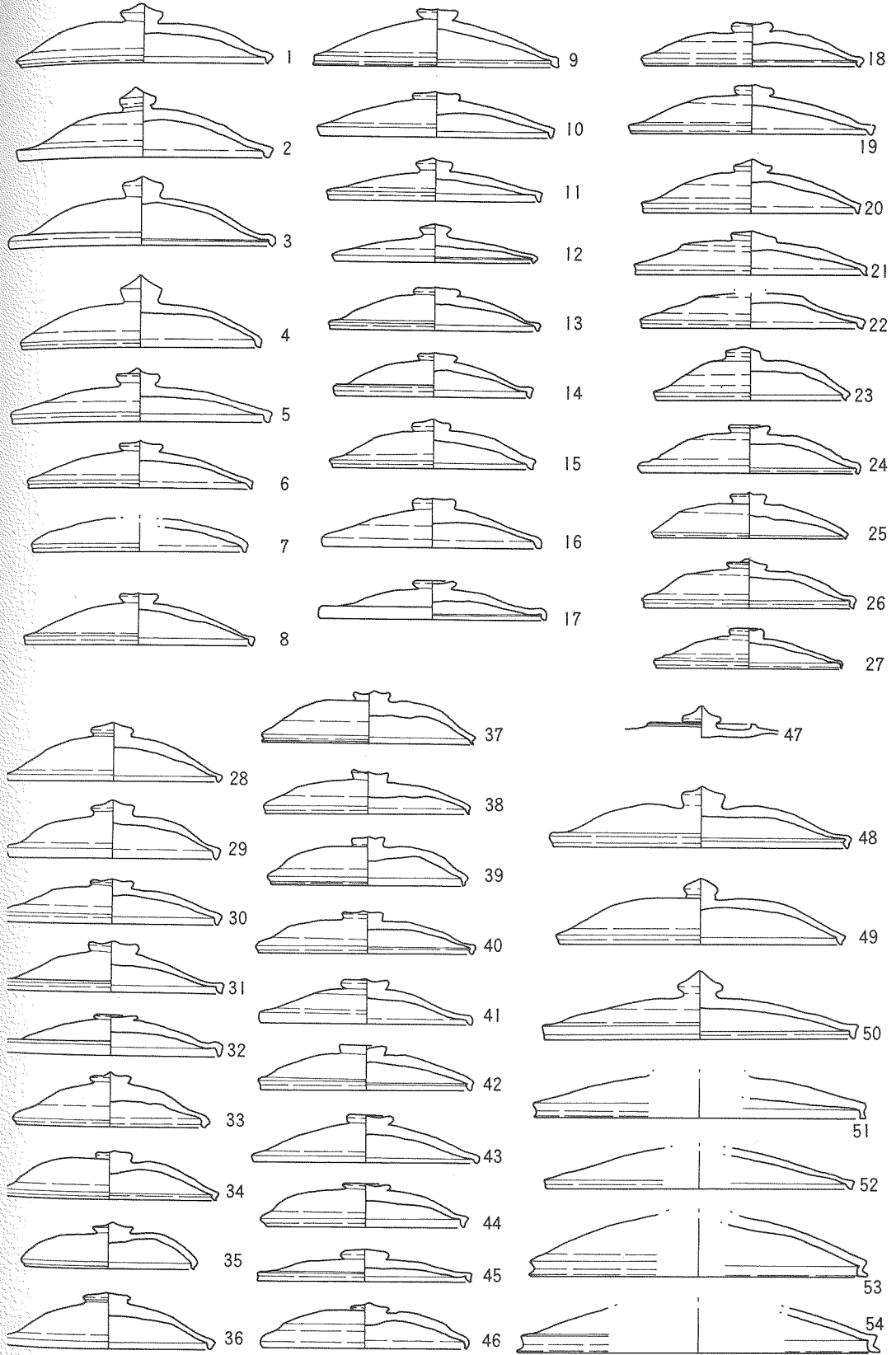

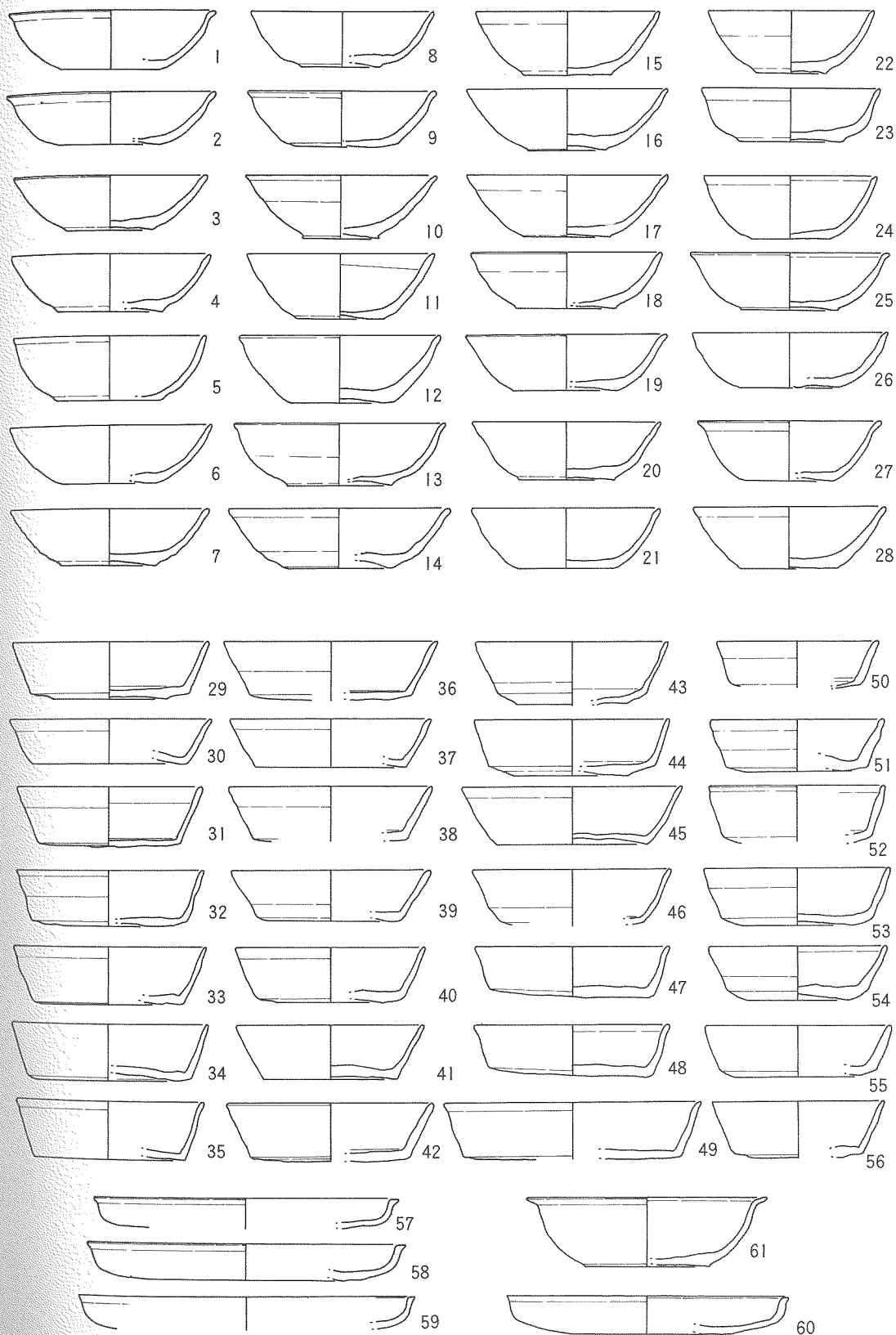

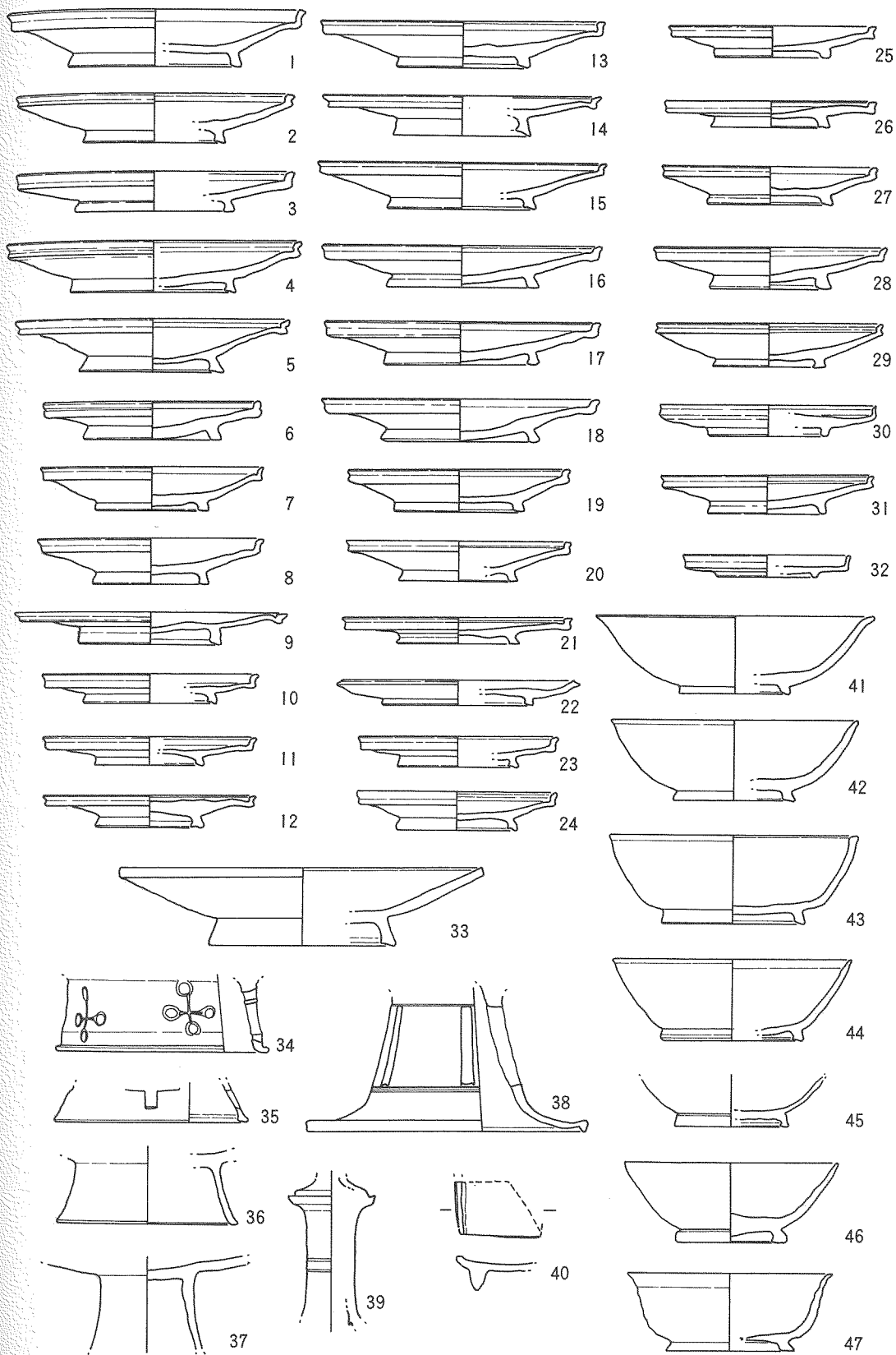

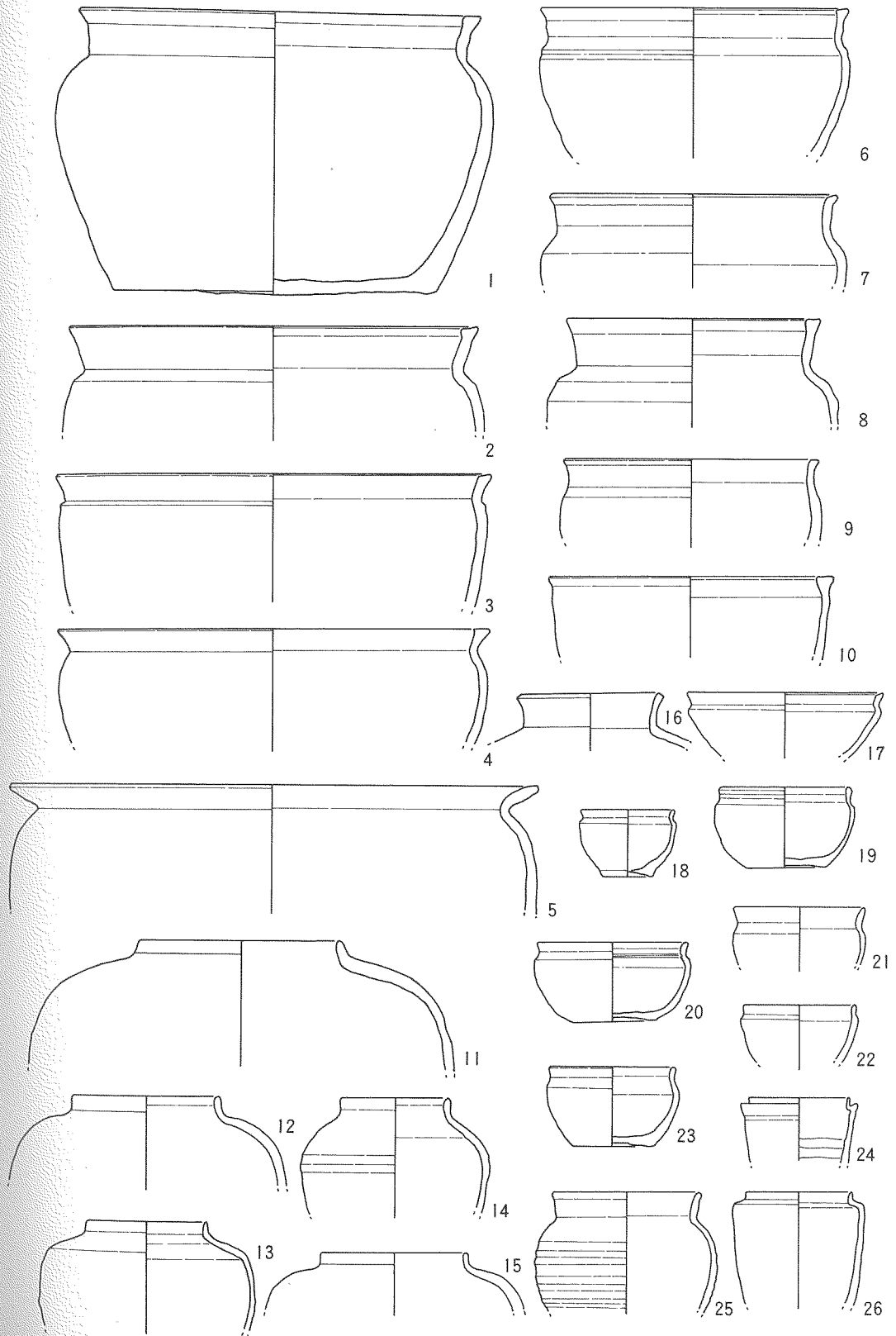

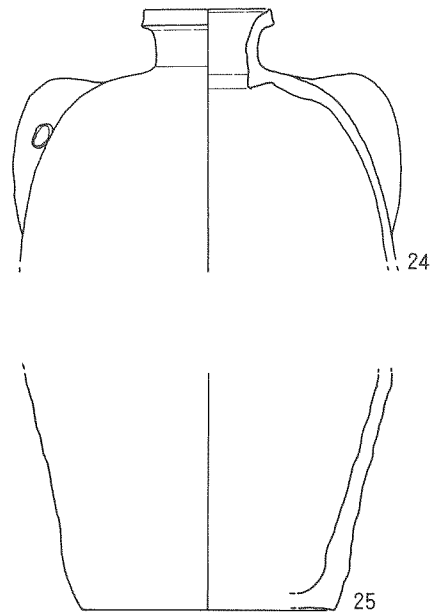
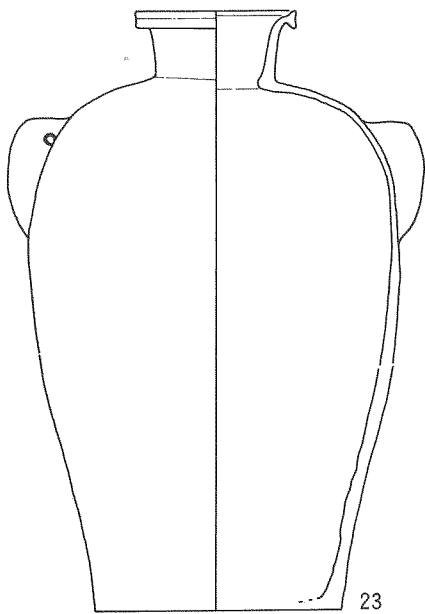
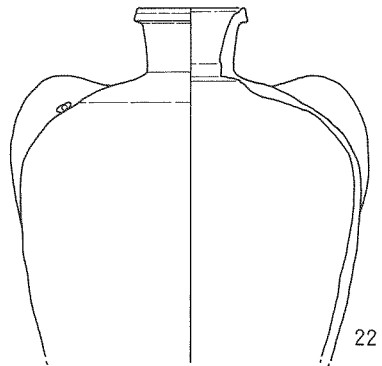
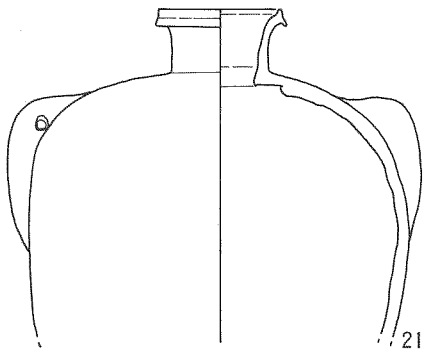
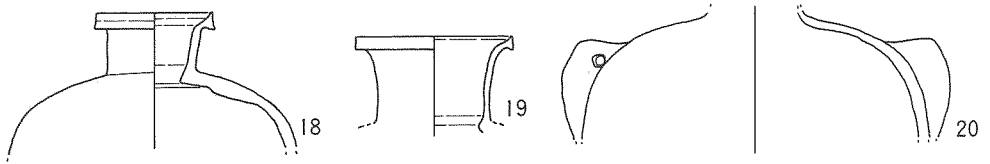
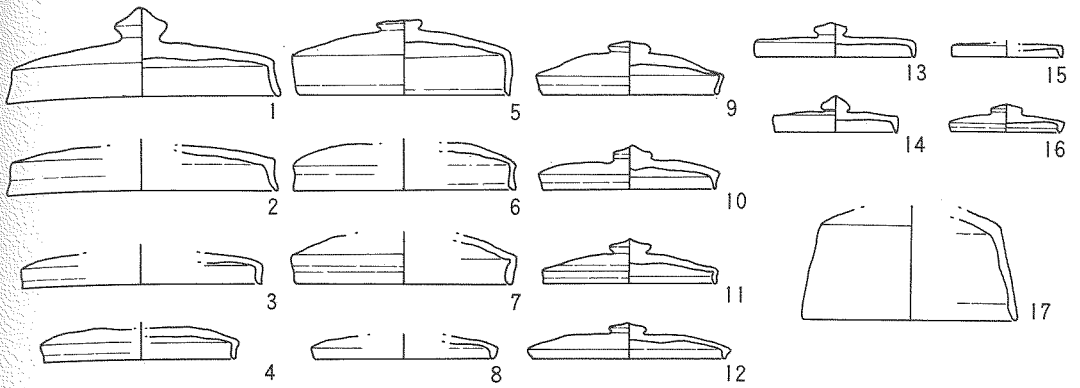

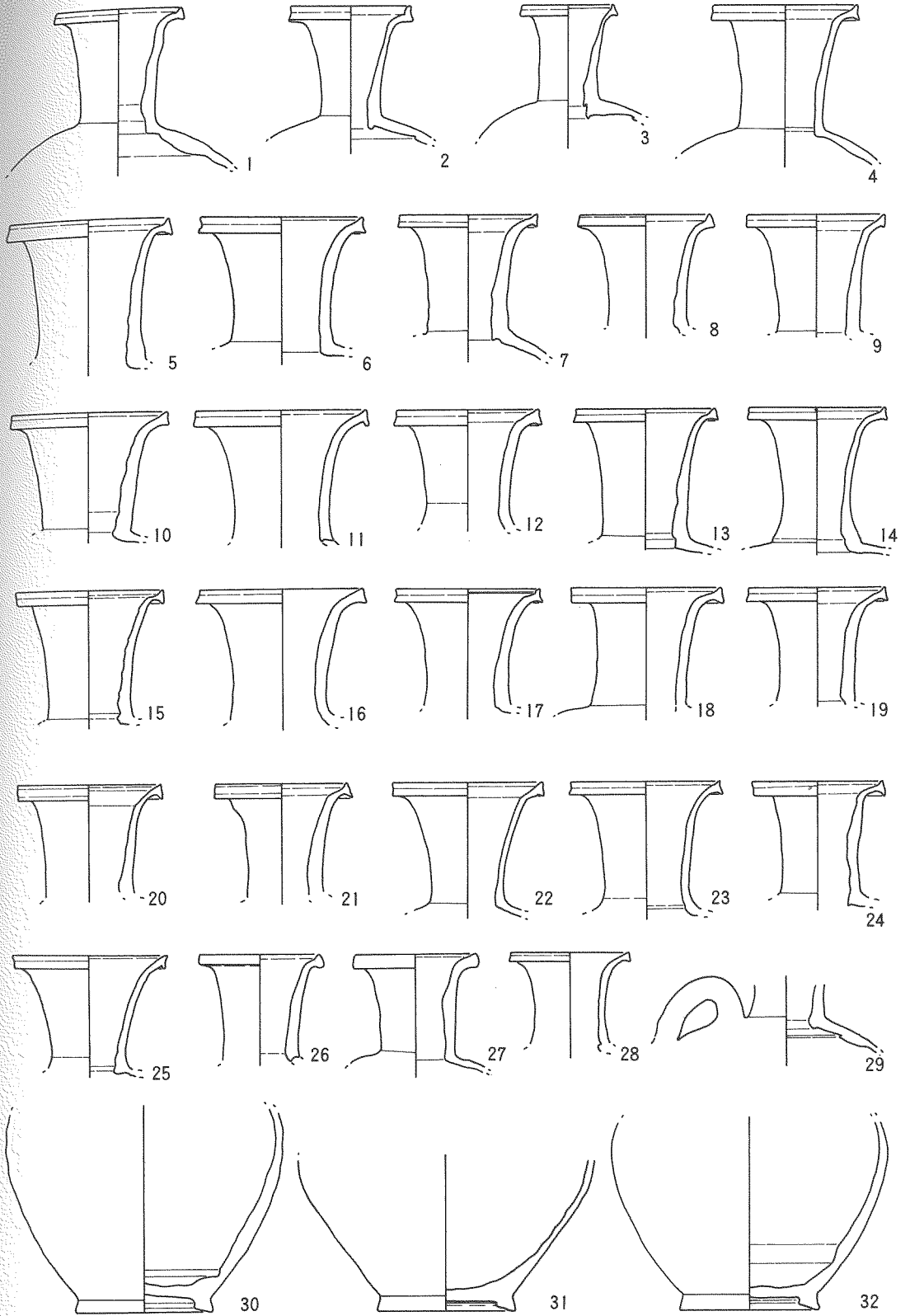

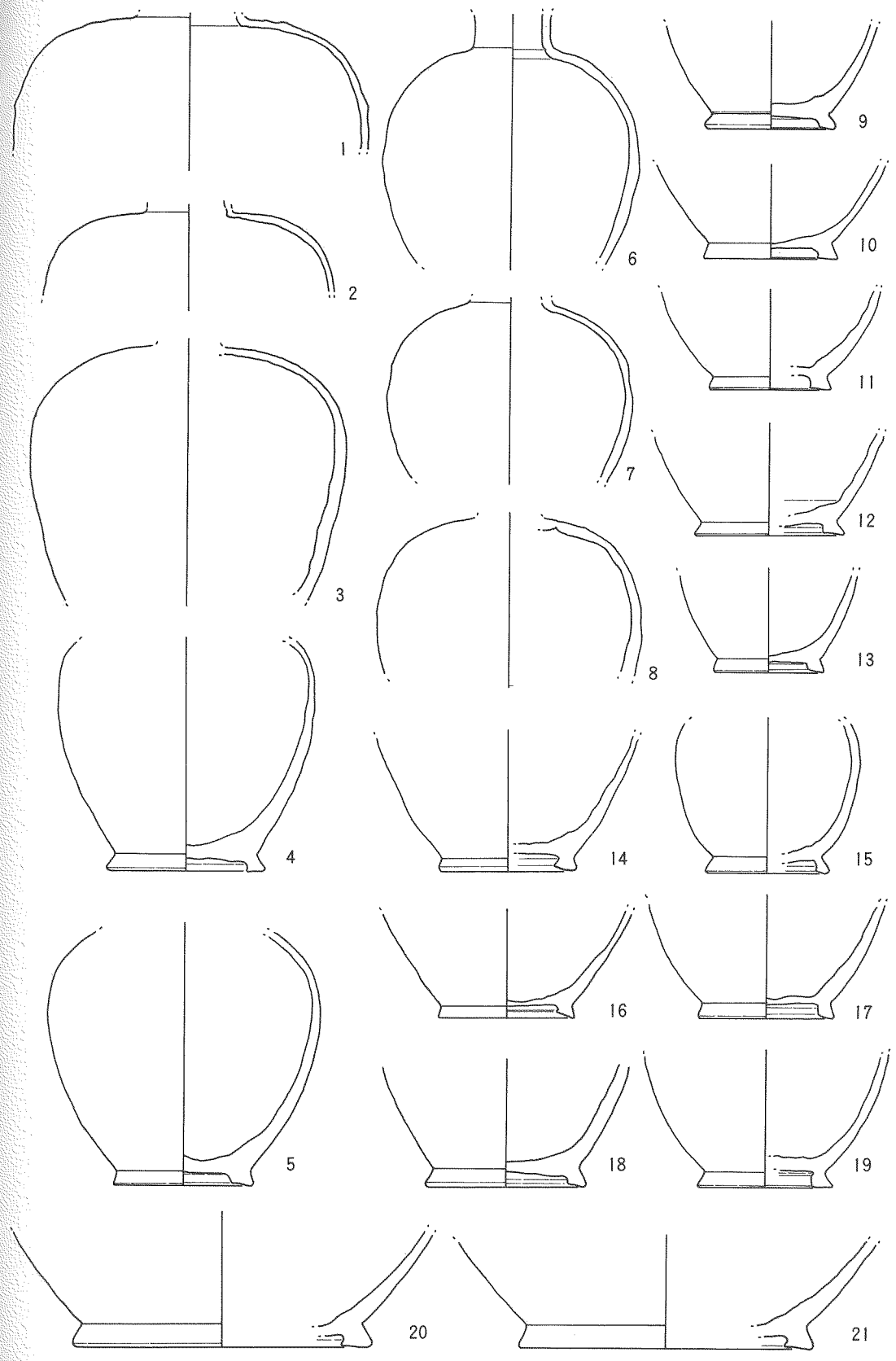

圖版 XI 小型長頸瓶・平瓶・土鍾・特殊品・窯道具等 (33~35 1/2・36~38 1/3) 1 : 4

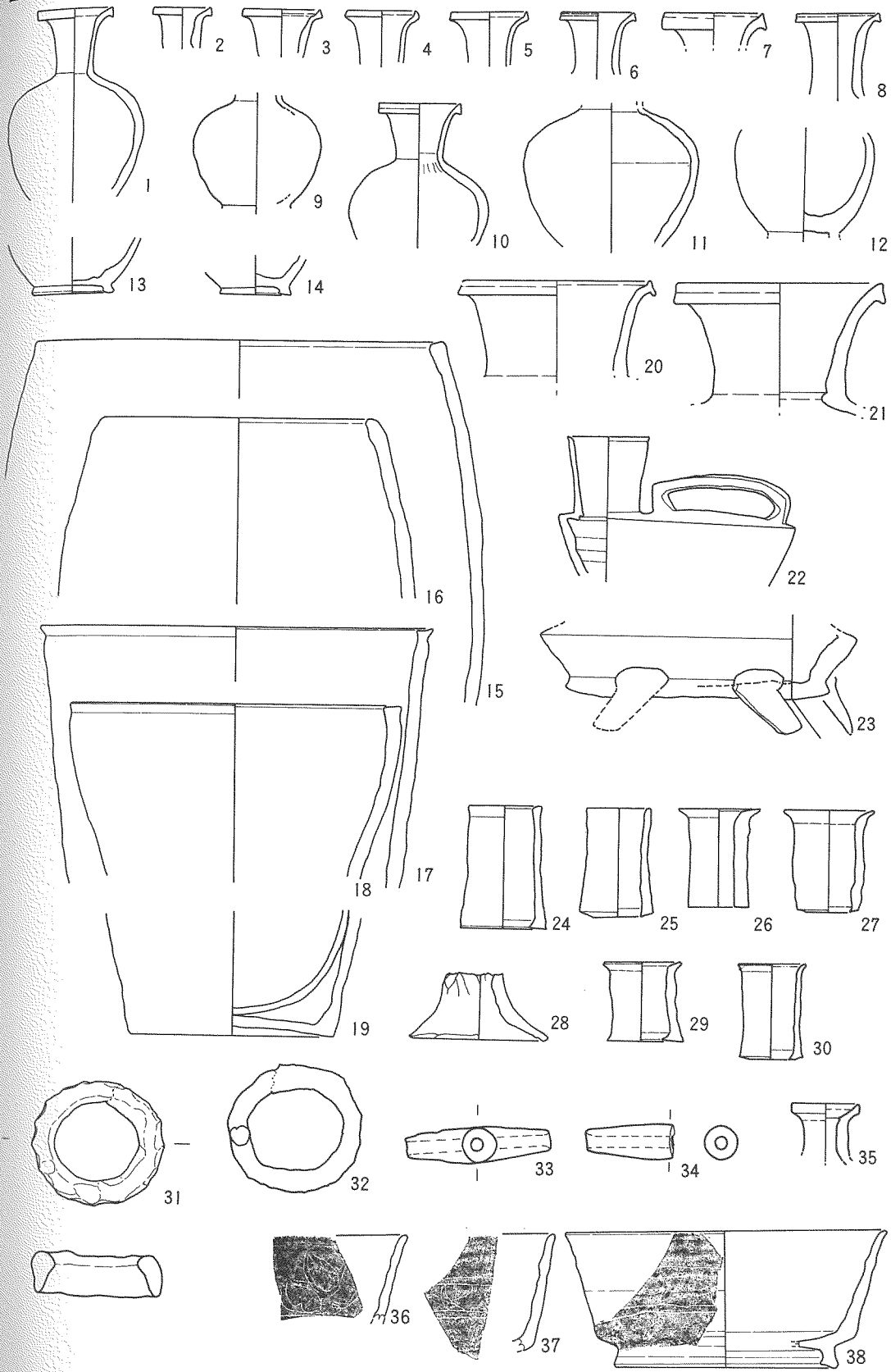

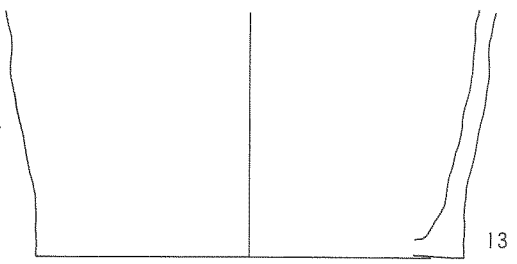
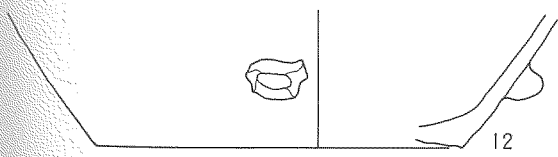
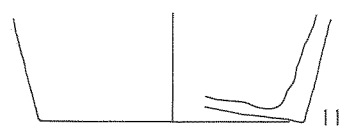
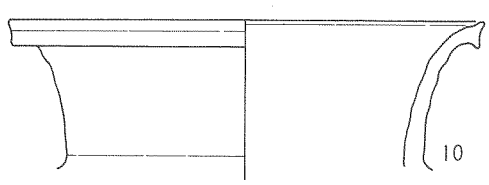
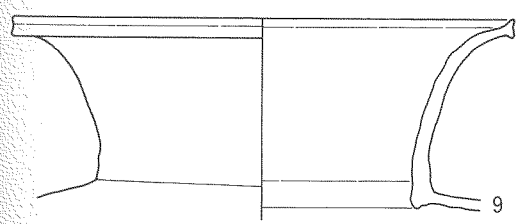
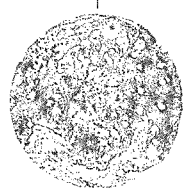
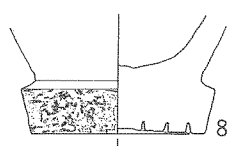
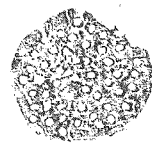
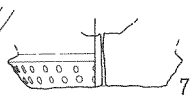
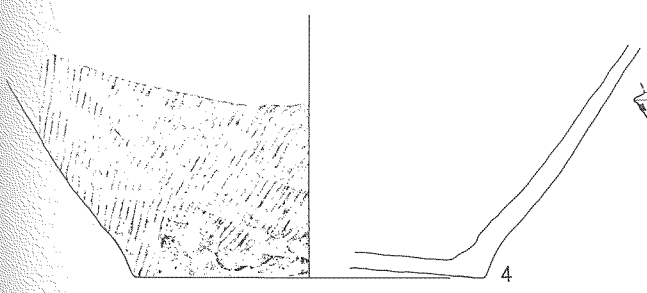
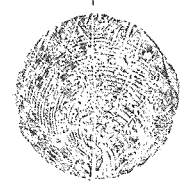
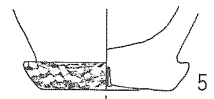
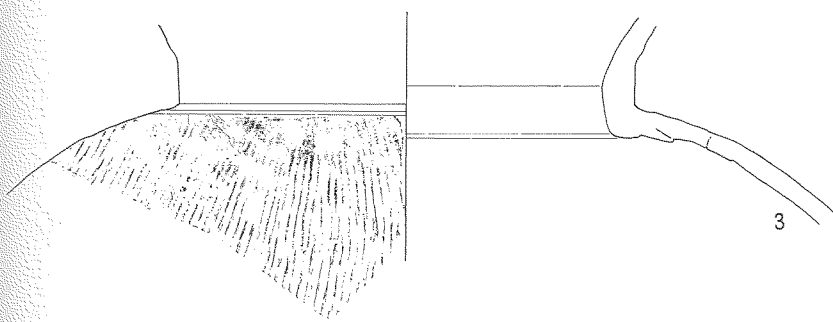
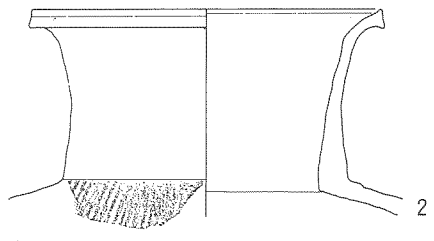
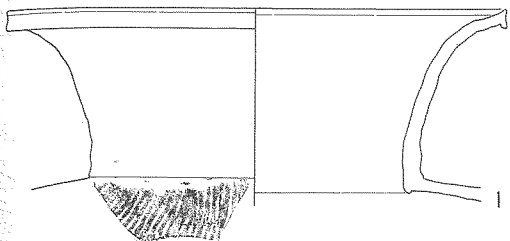

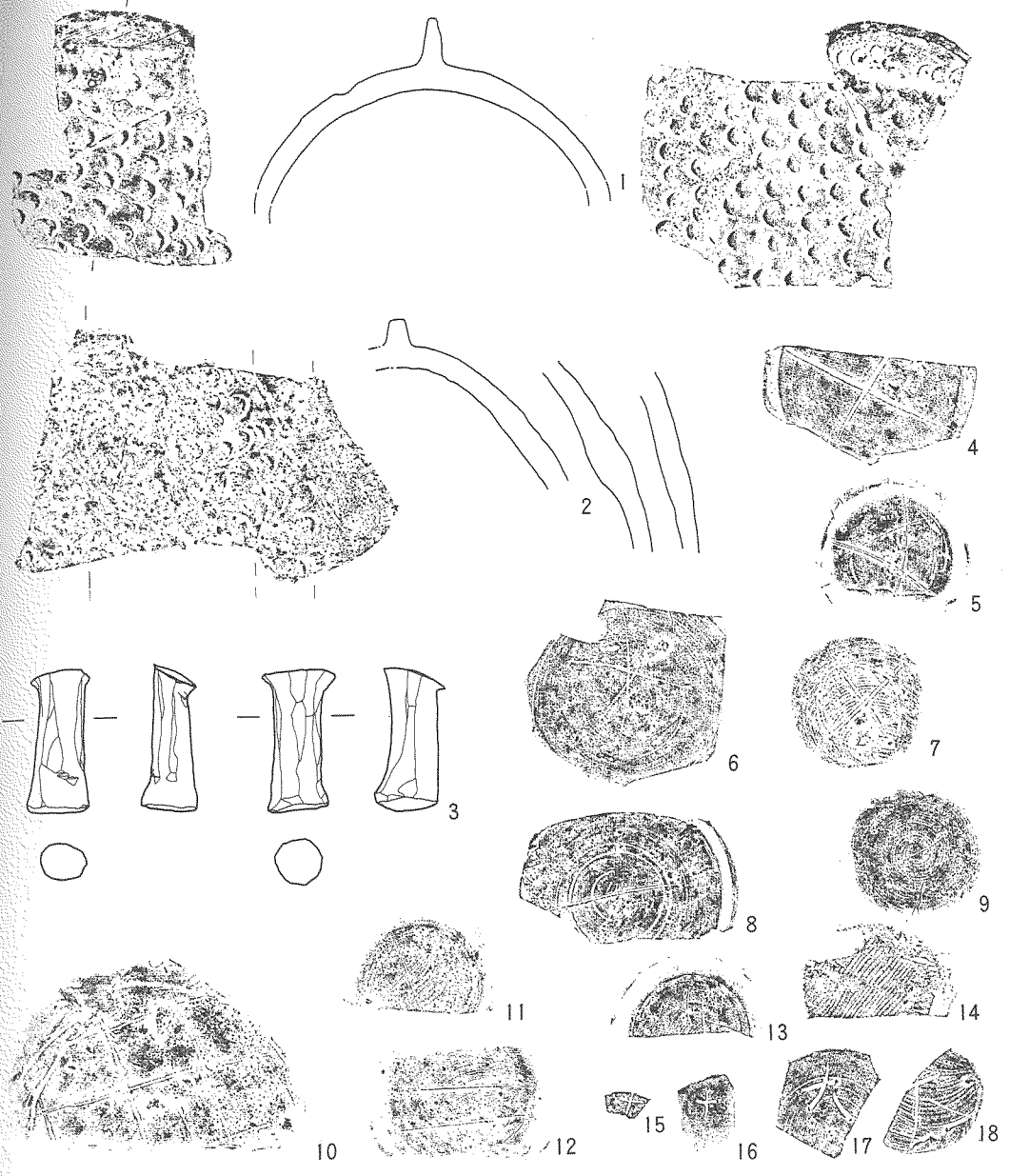

图版XIV NK I-1 群付近現況測量図 1:300

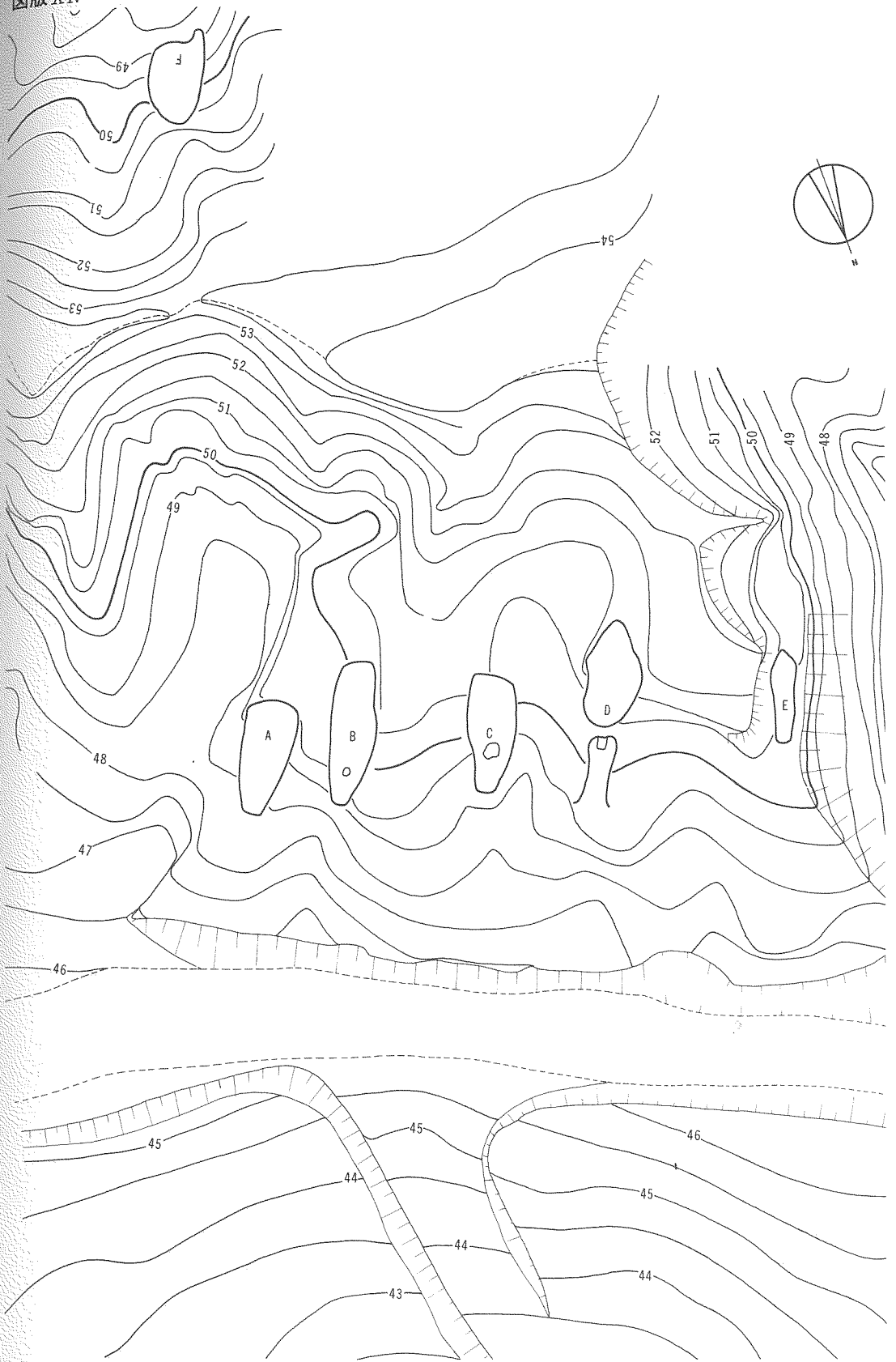

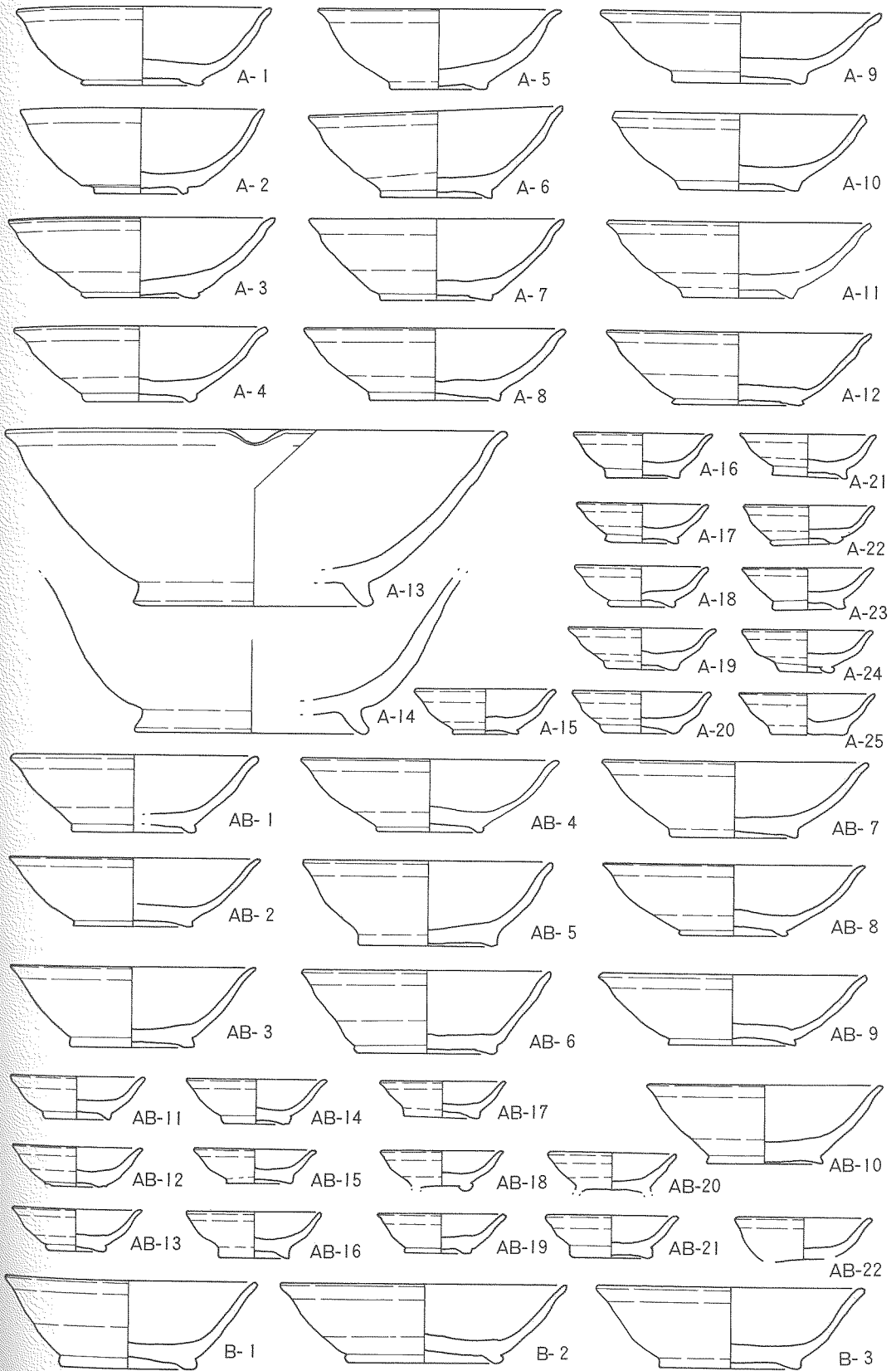

図版 XVI B窯窯内・BC間

1 : 4

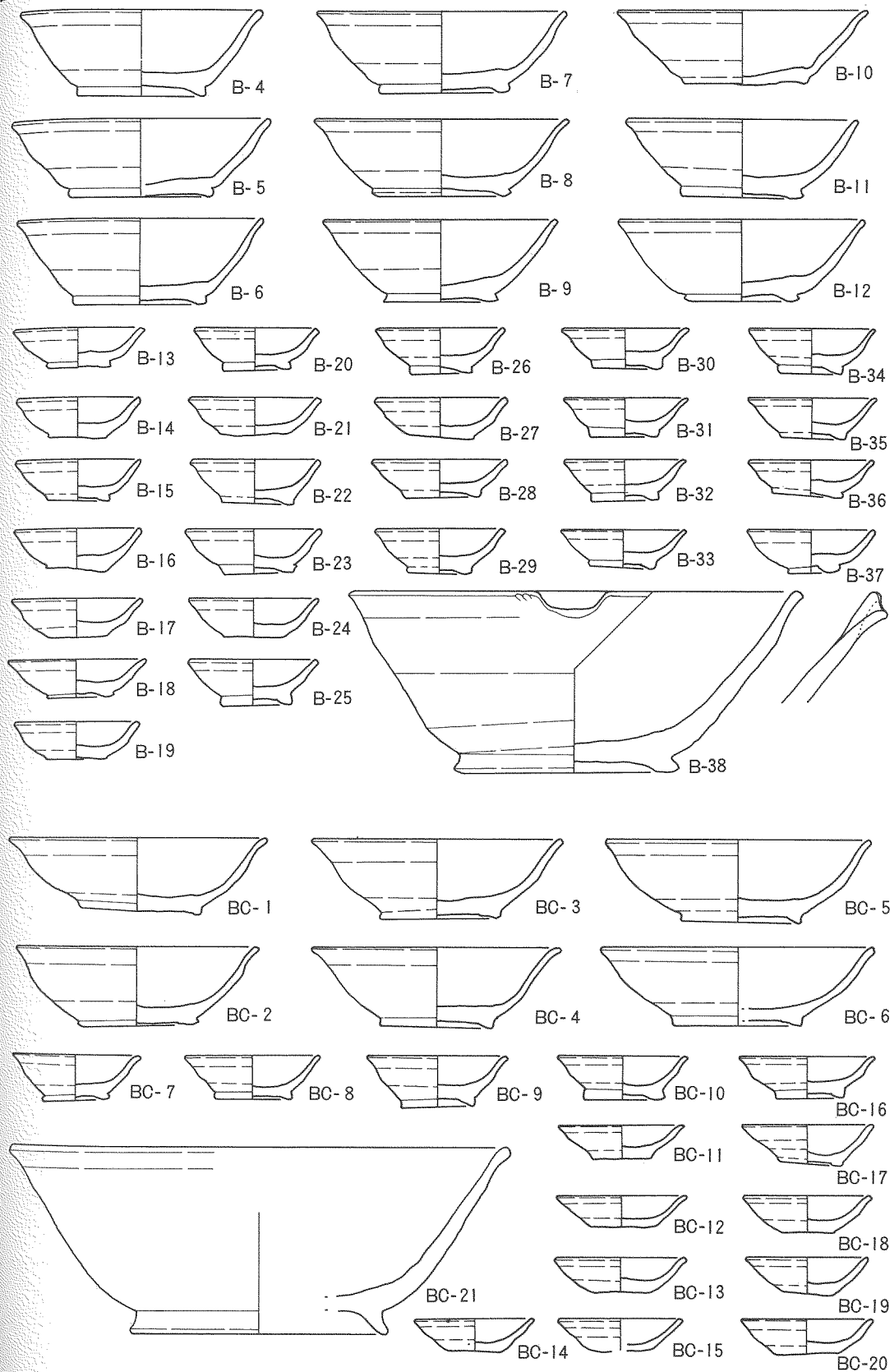

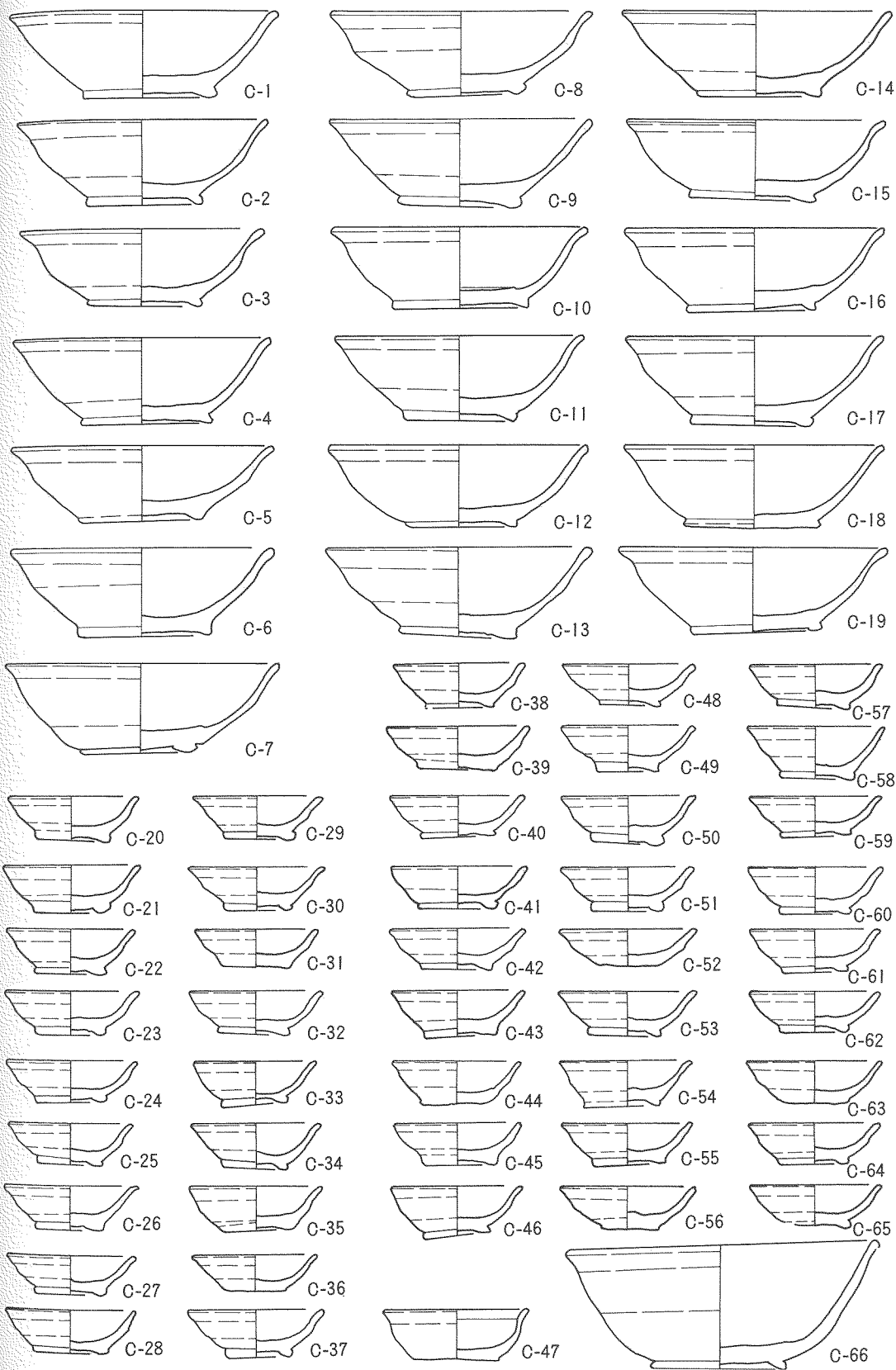

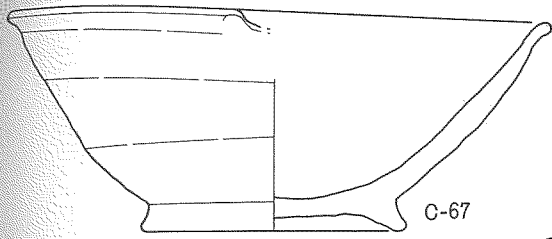

C-67

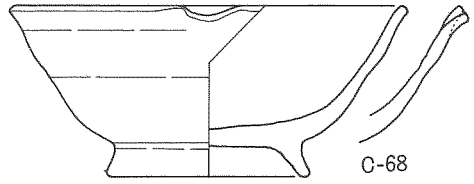

C-68

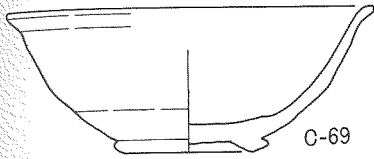

C-69

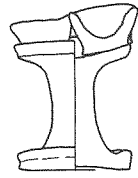

C-70

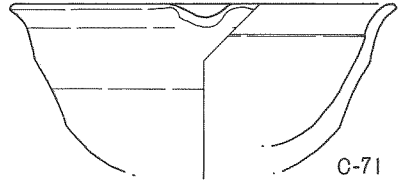

C-71

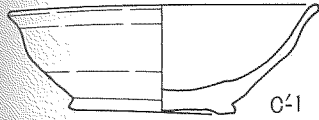

C-1

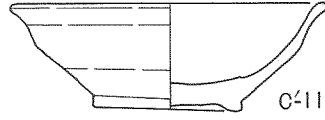

C-11

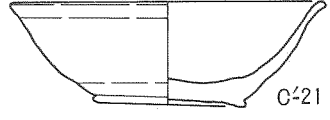

C-21

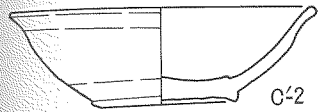

C-2

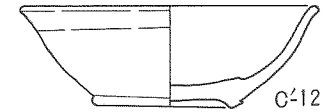

C-12

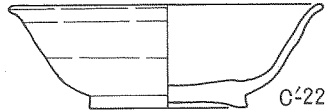

C-22

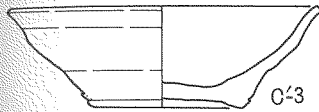

C-3

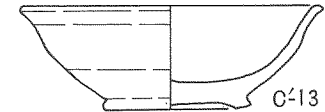

C-13

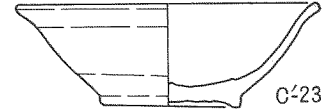

C-23

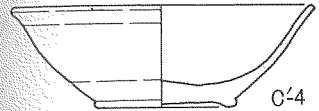

C-4

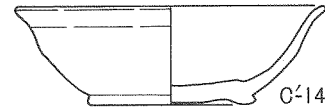

C-14

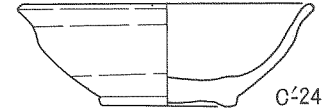

C-24

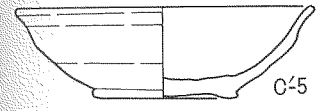

C-5

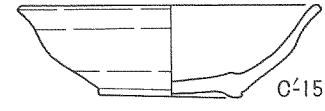

C-15

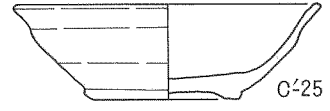

C-25

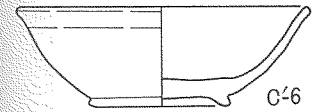

C-6

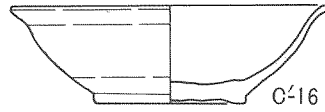

C-16

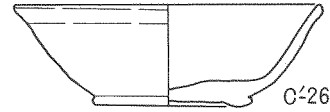

C-26

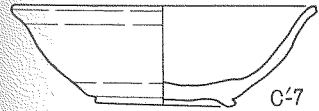

C-7

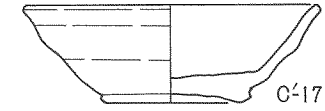

C-17

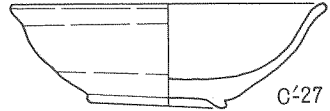

C-27

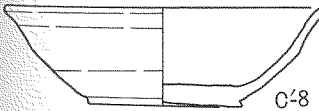

C-8

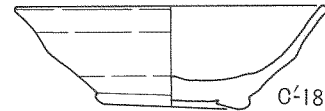

C-18

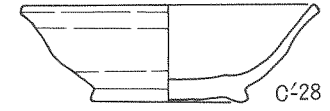

C-28



C-9

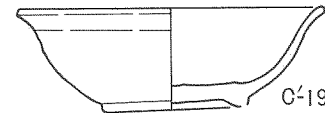

C-19



C-29



C-10

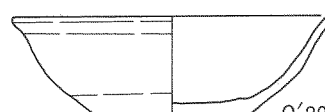

C-20

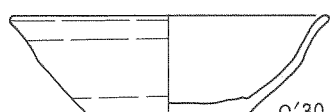

C-30

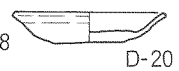
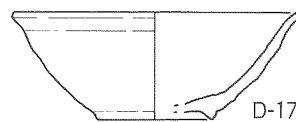
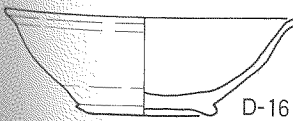
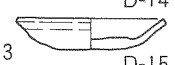
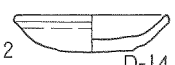
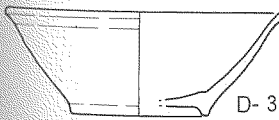
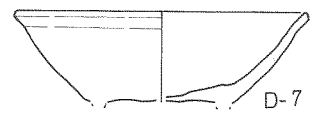
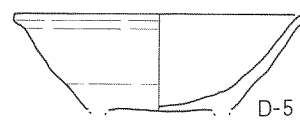
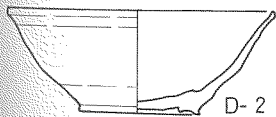
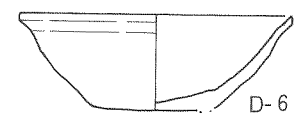
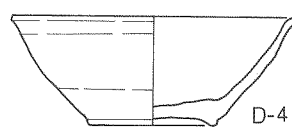
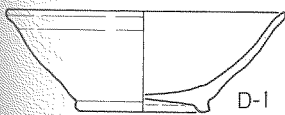
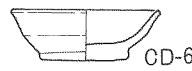
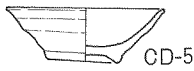
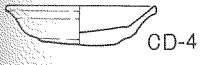
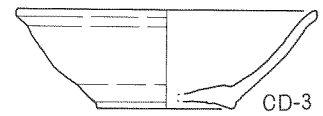
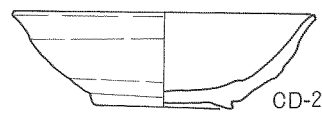
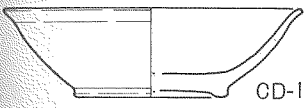
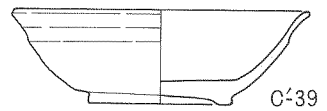
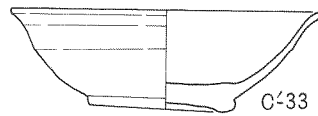
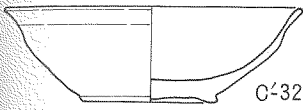
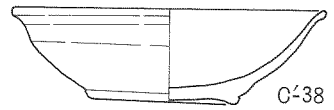
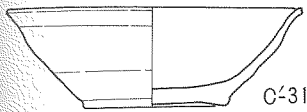
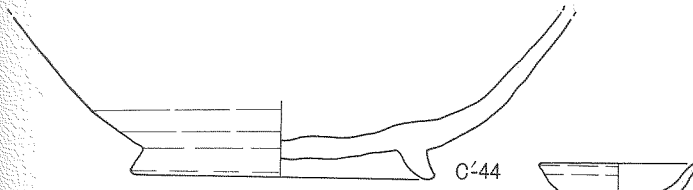
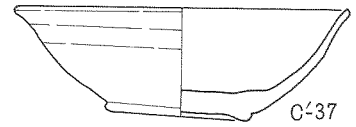
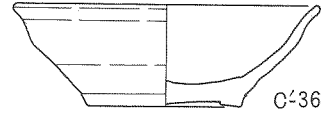
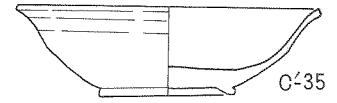
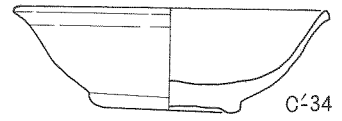
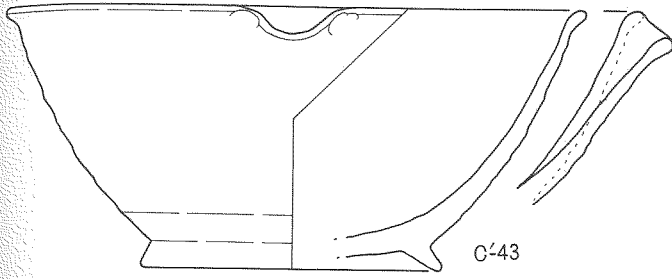

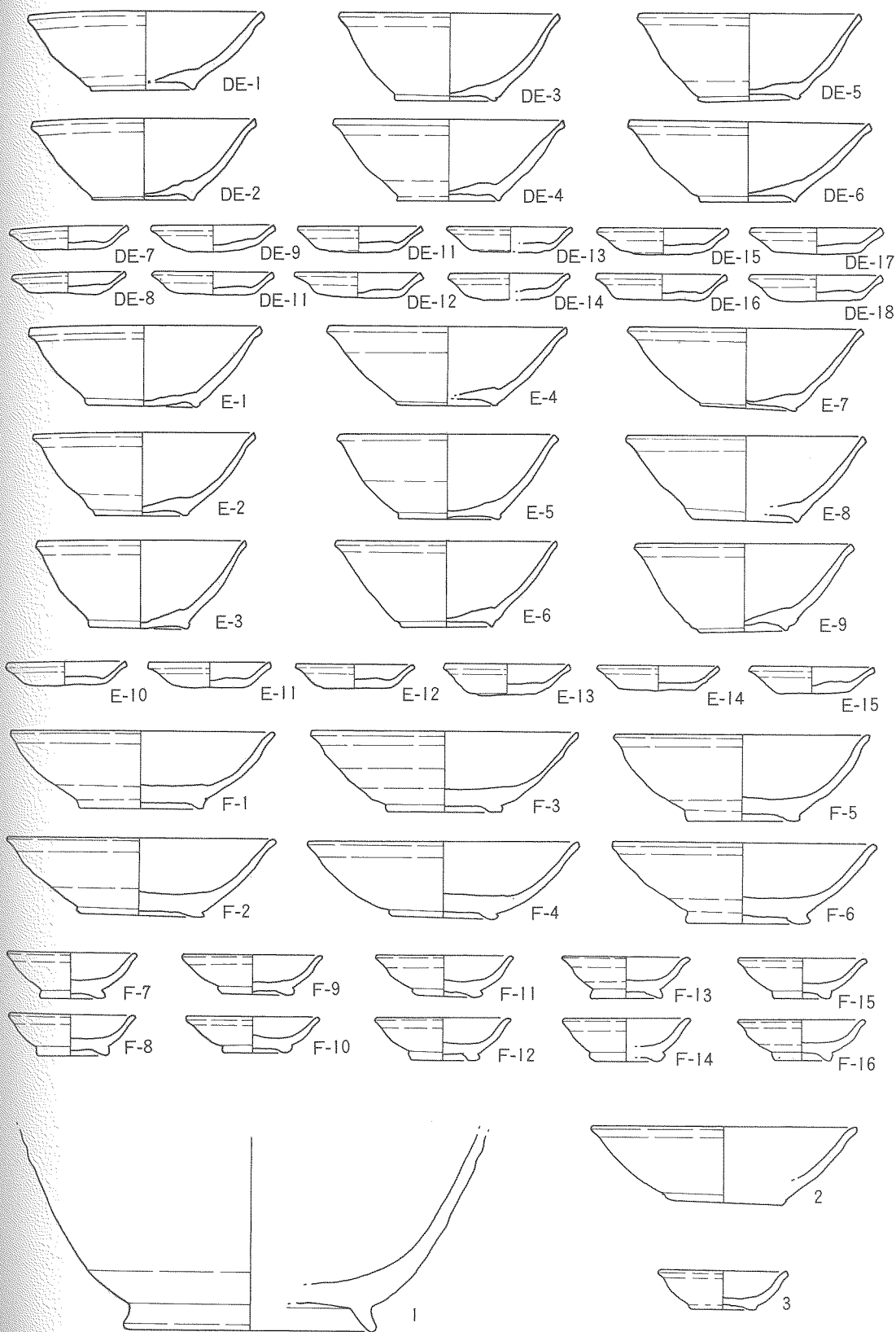

写 真 图 版

写真図版Ⅰ NJA-2号窯付近航空写真



写真図版Ⅱ 発掘前遠景及び近景



写真図版Ⅲ 発掘途中風景



写真図版Ⅳ 発掘後遠景



写真図版V 発掘後近景



写真図版Ⅵ 発掘後窯体各部

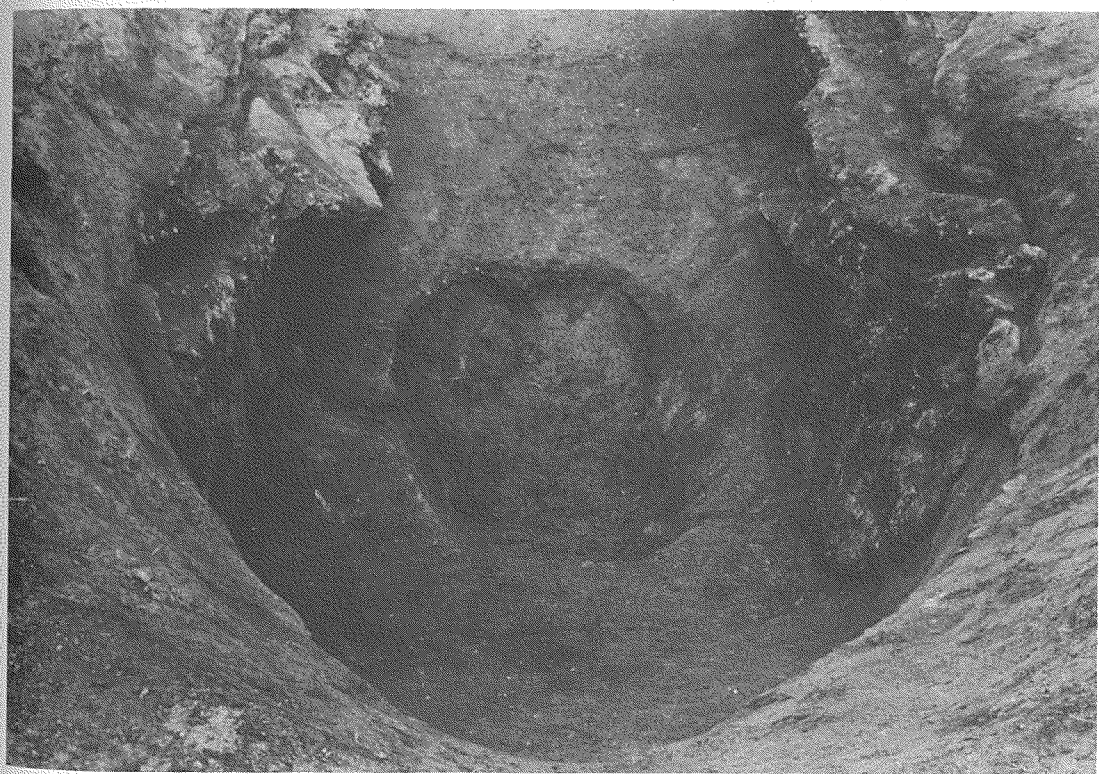
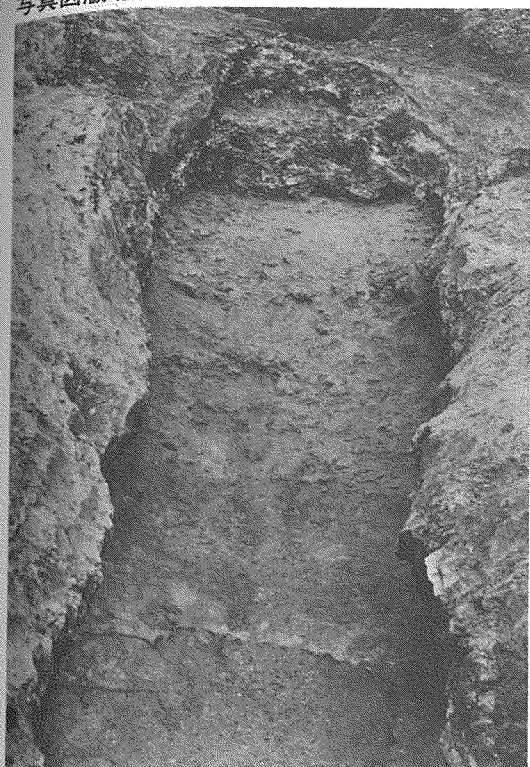

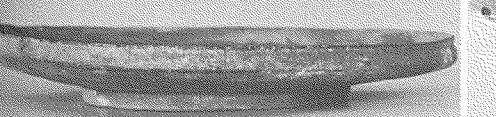
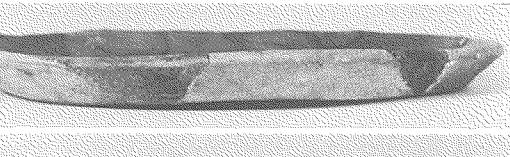
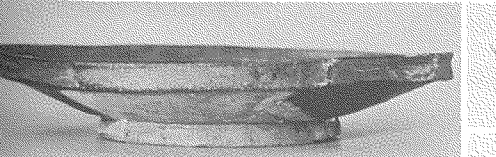
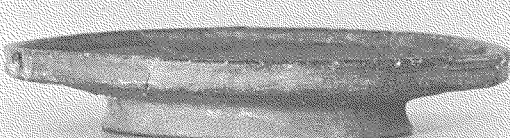
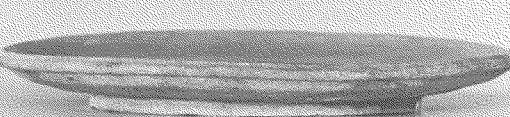
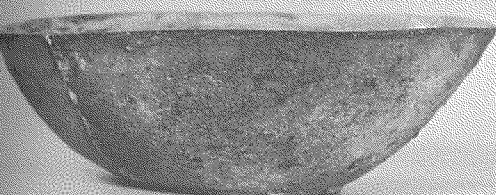
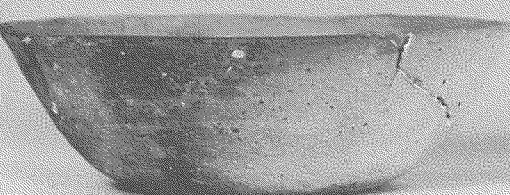
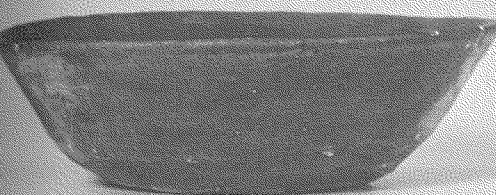
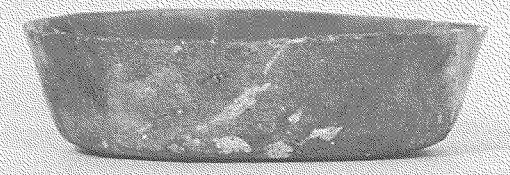
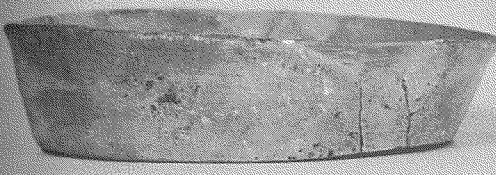
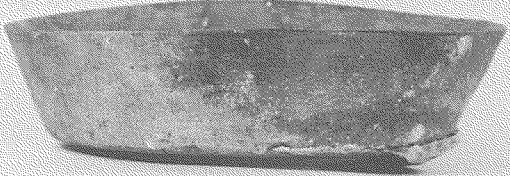
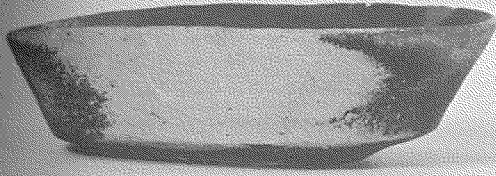

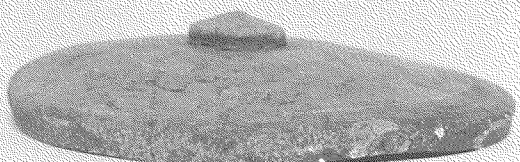
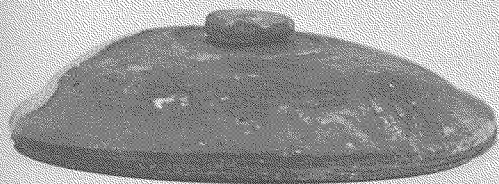
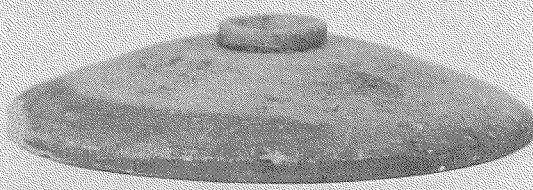
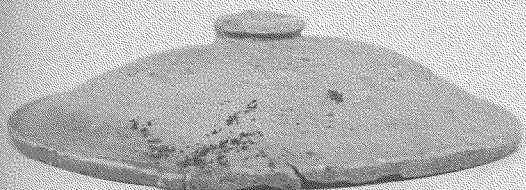
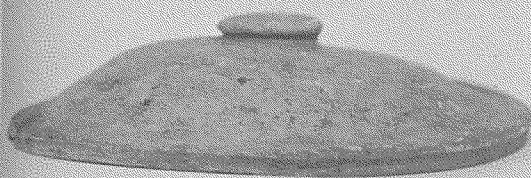
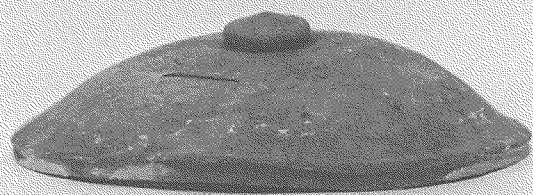
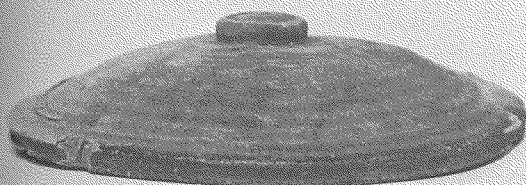
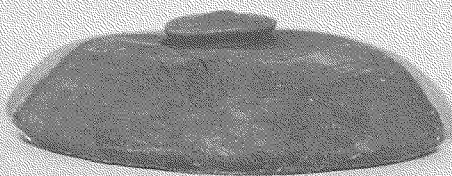

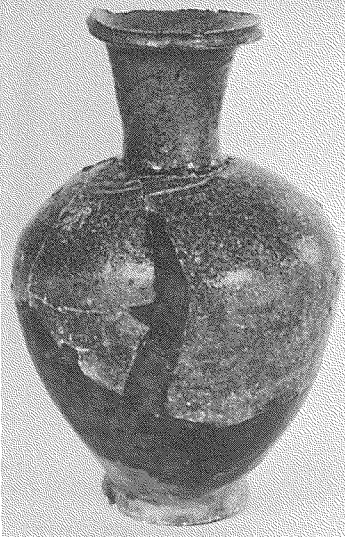

写真図版X 小型長頸瓶・鉢・平瓶等

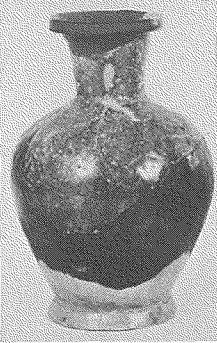
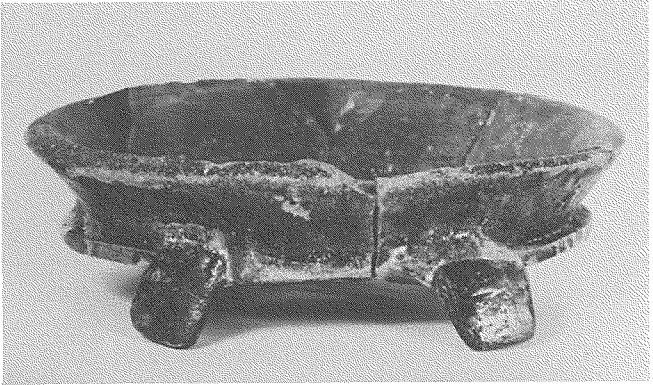

写真图版XI 双耳瓶

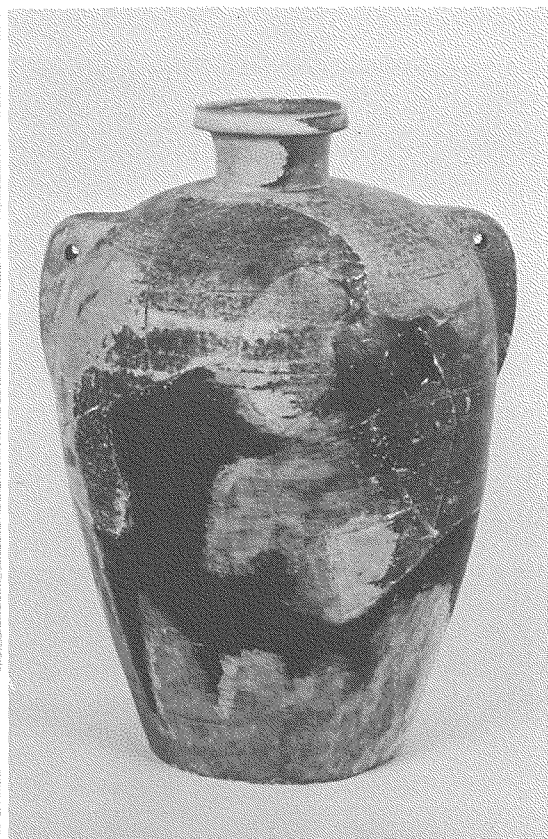

写真図版XII 壺・瓶蓋・短頸壺

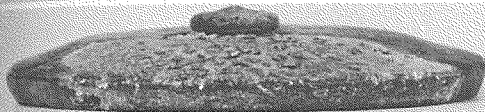
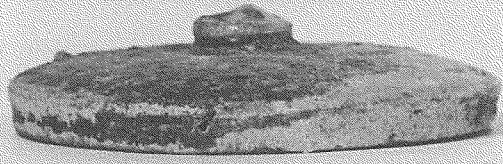
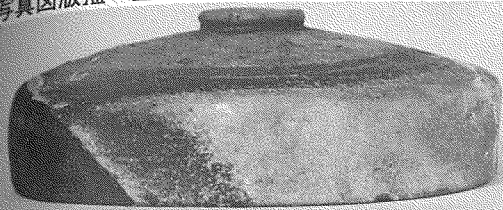

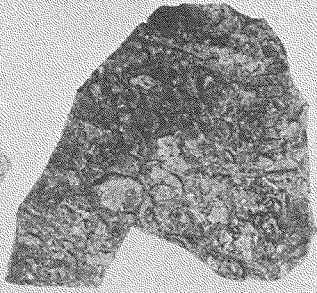
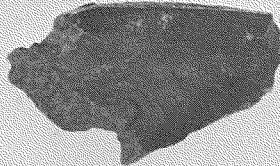
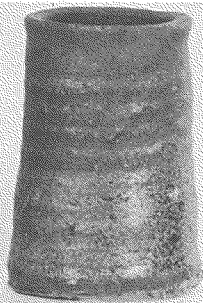
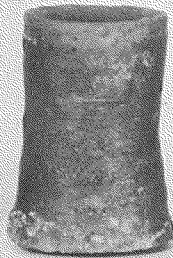
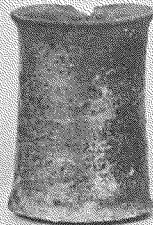
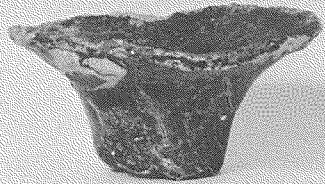
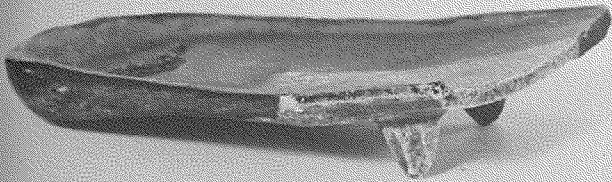
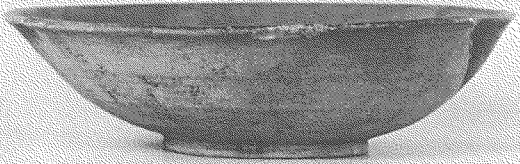

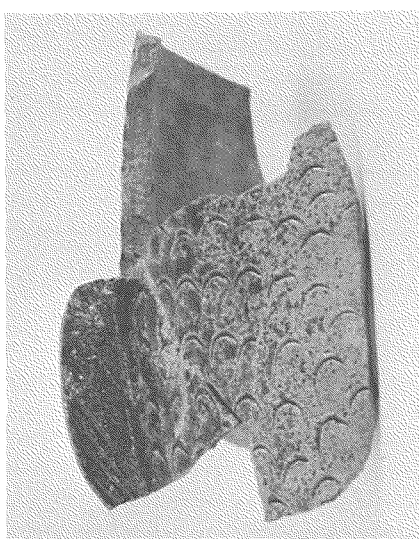
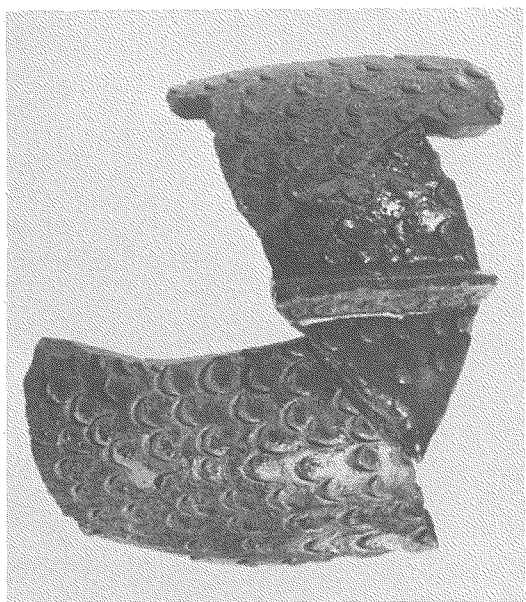

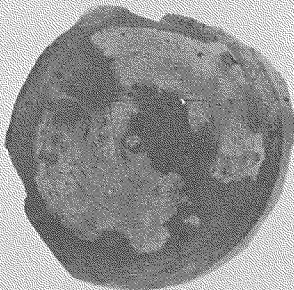
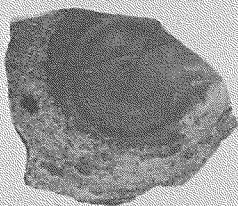
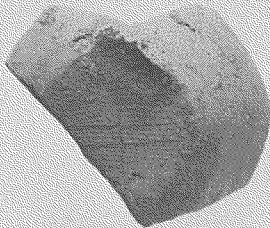
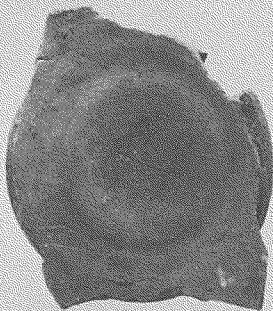
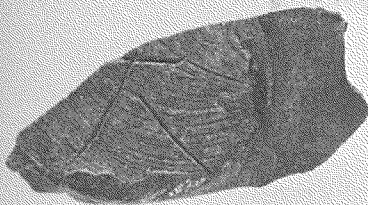
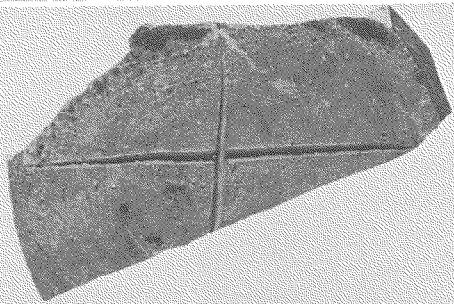
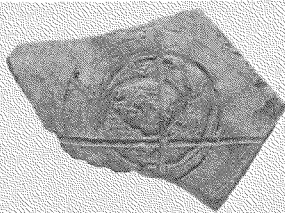
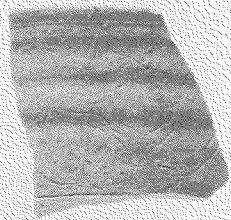

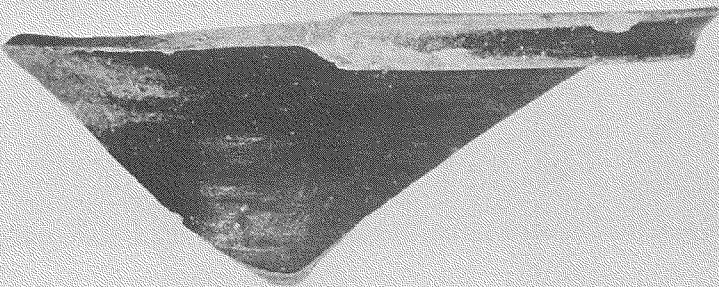
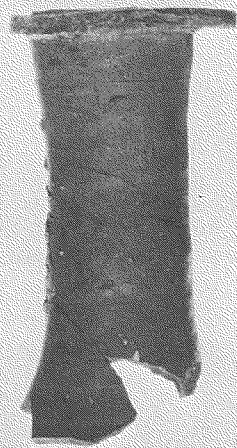
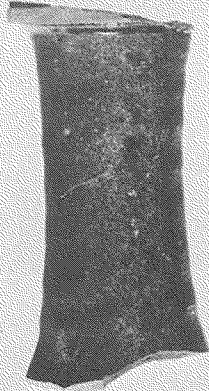
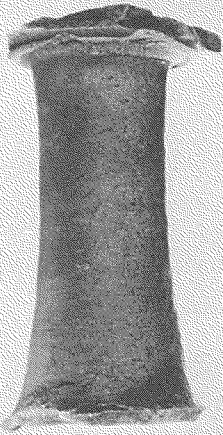
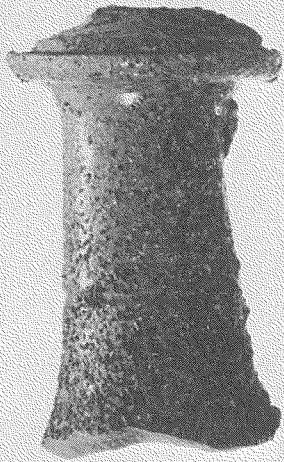

写真図版XVII NK I-1群付近航空写真

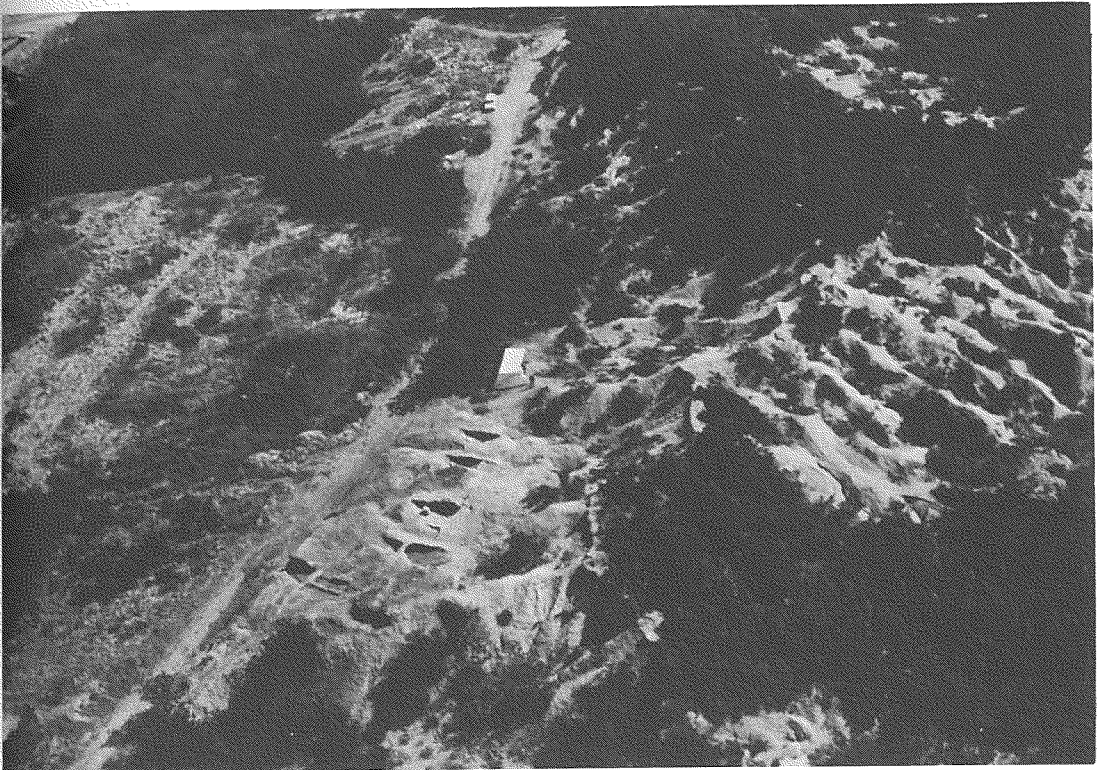
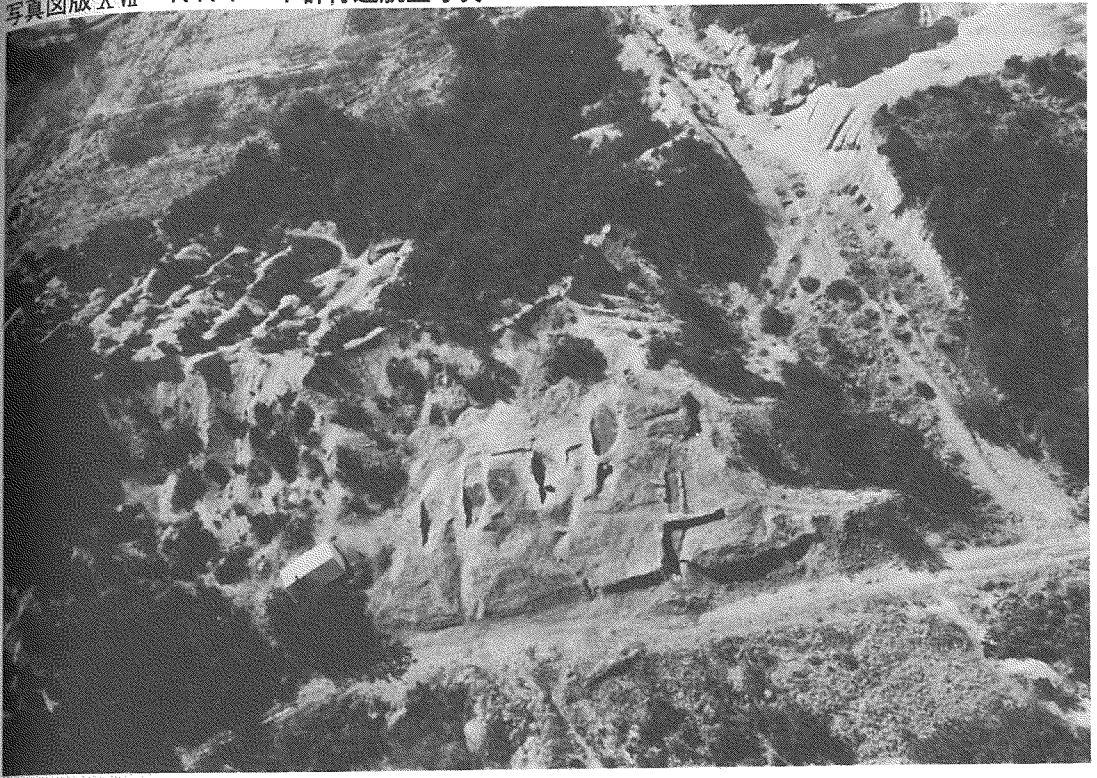

写真図版XVII 発掘前遠景



写真図版XIX 発掘前近景



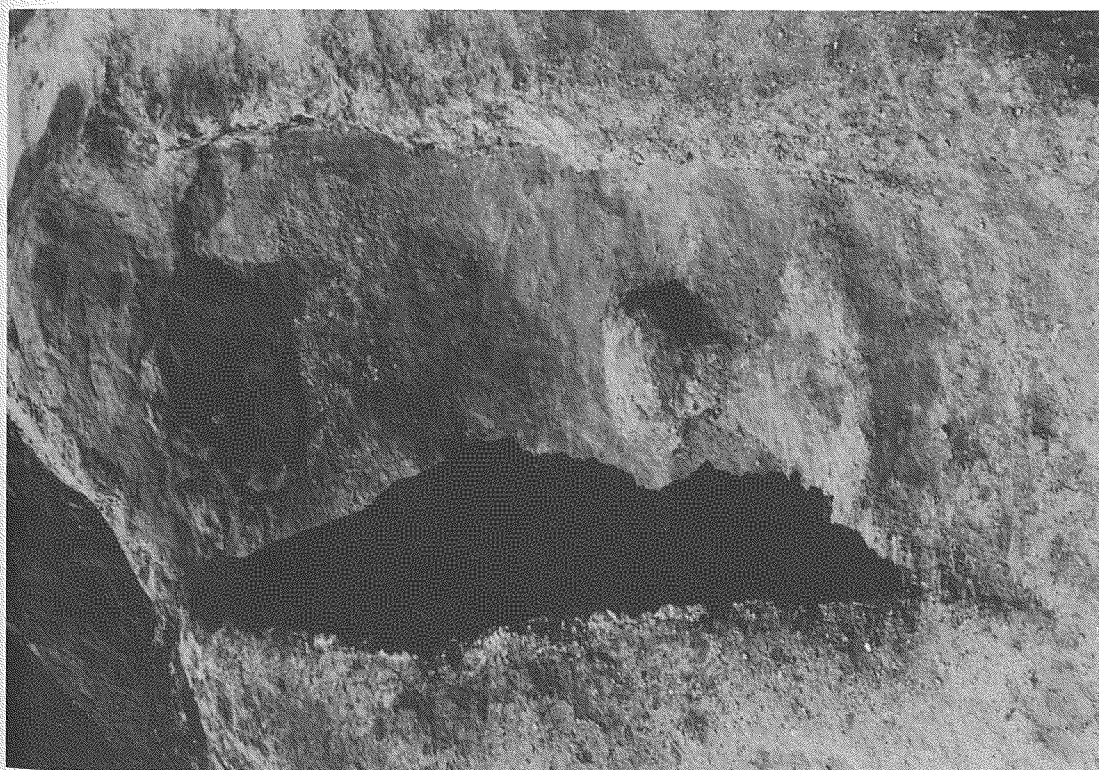
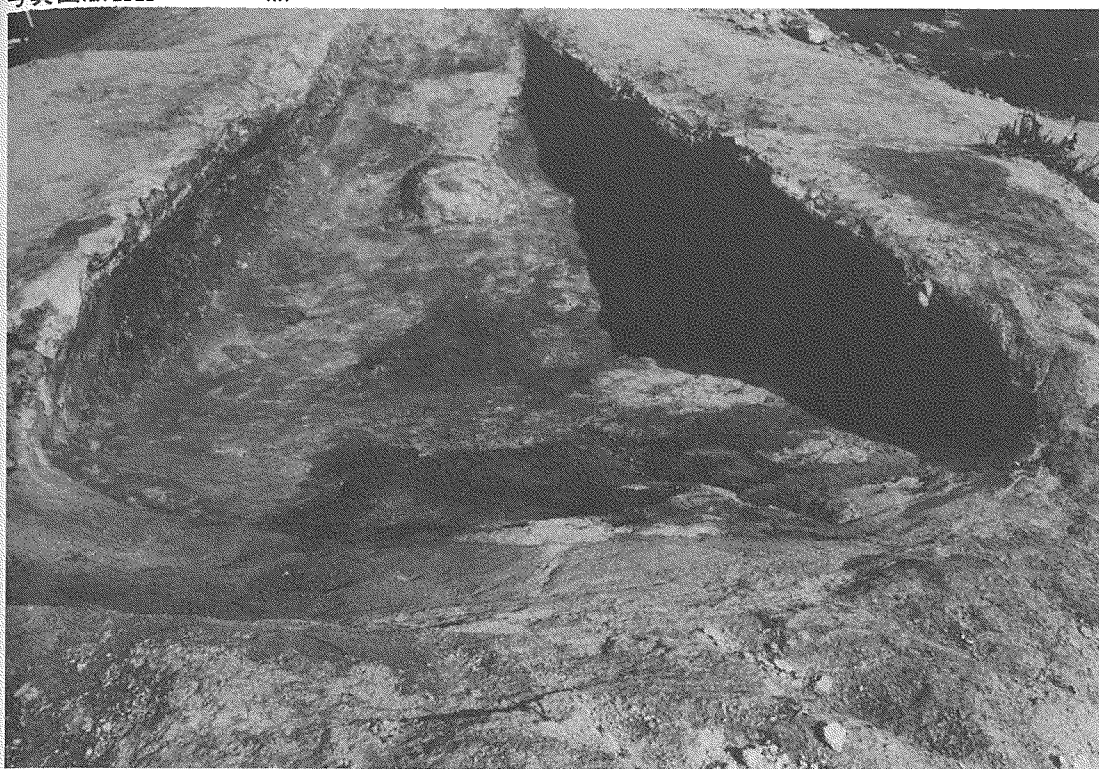





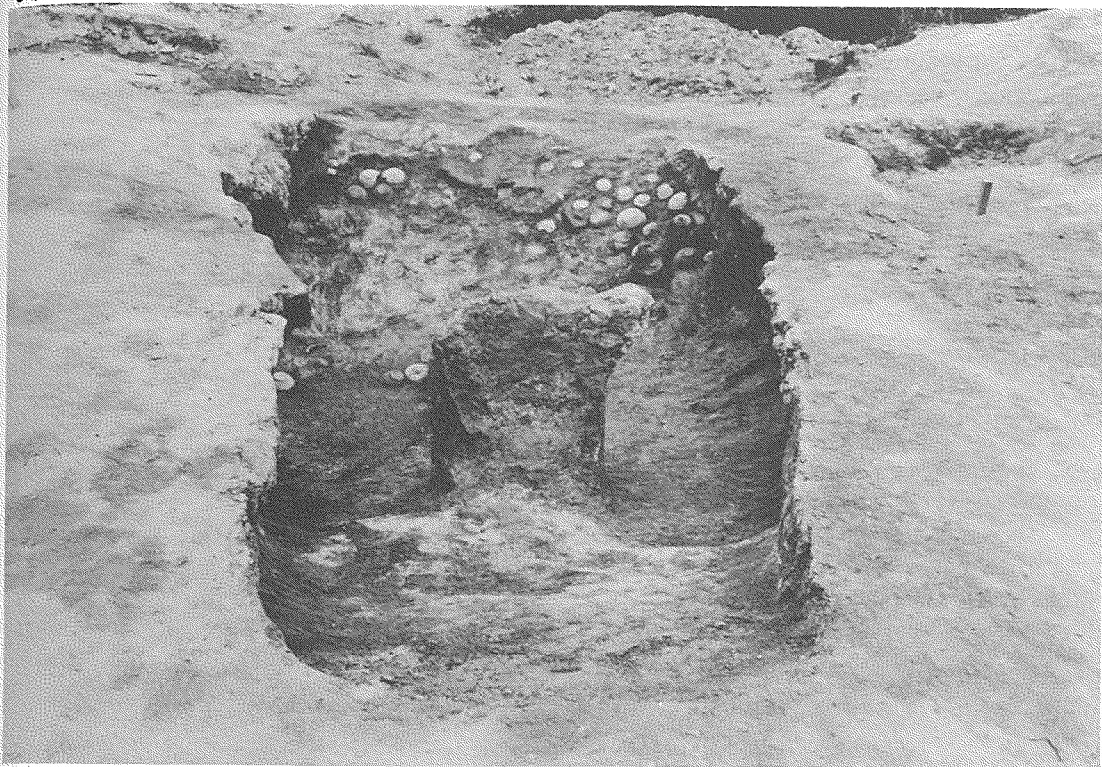

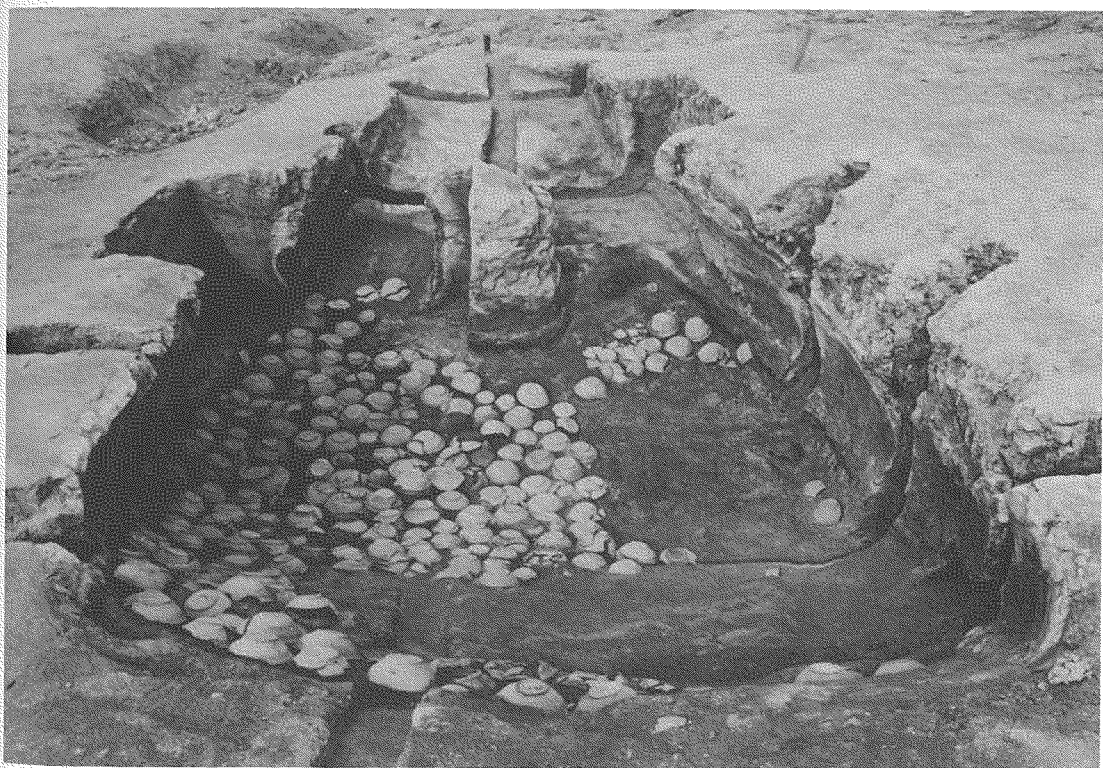
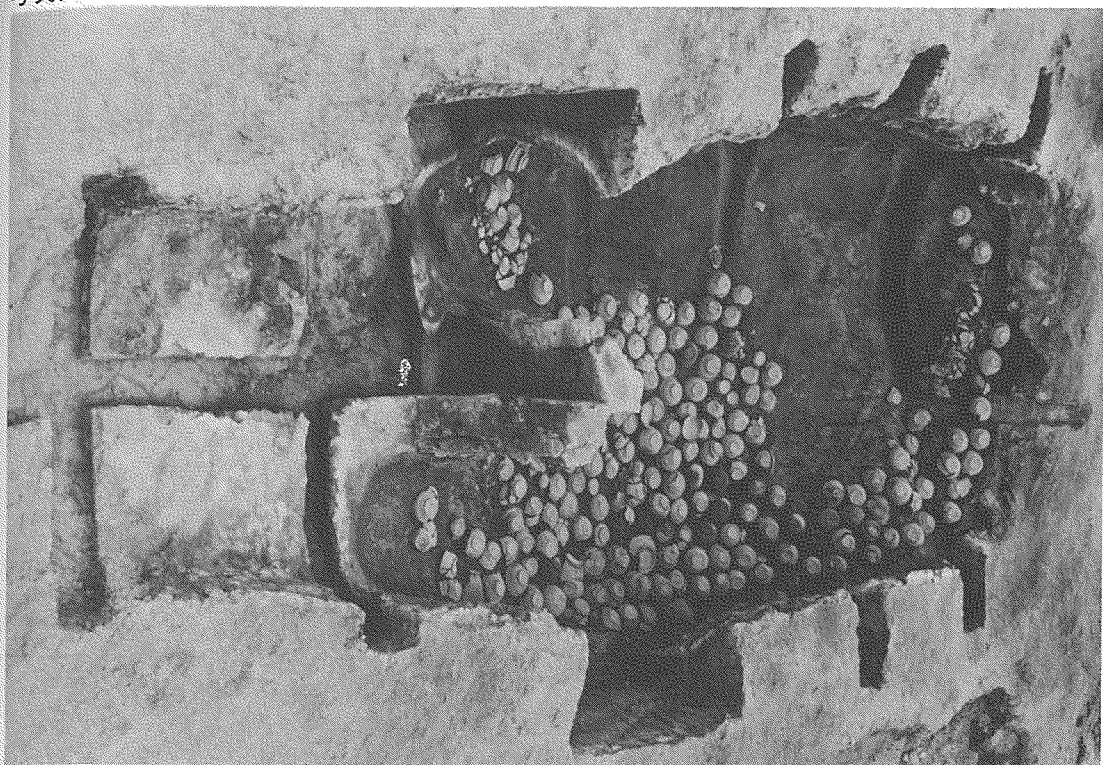







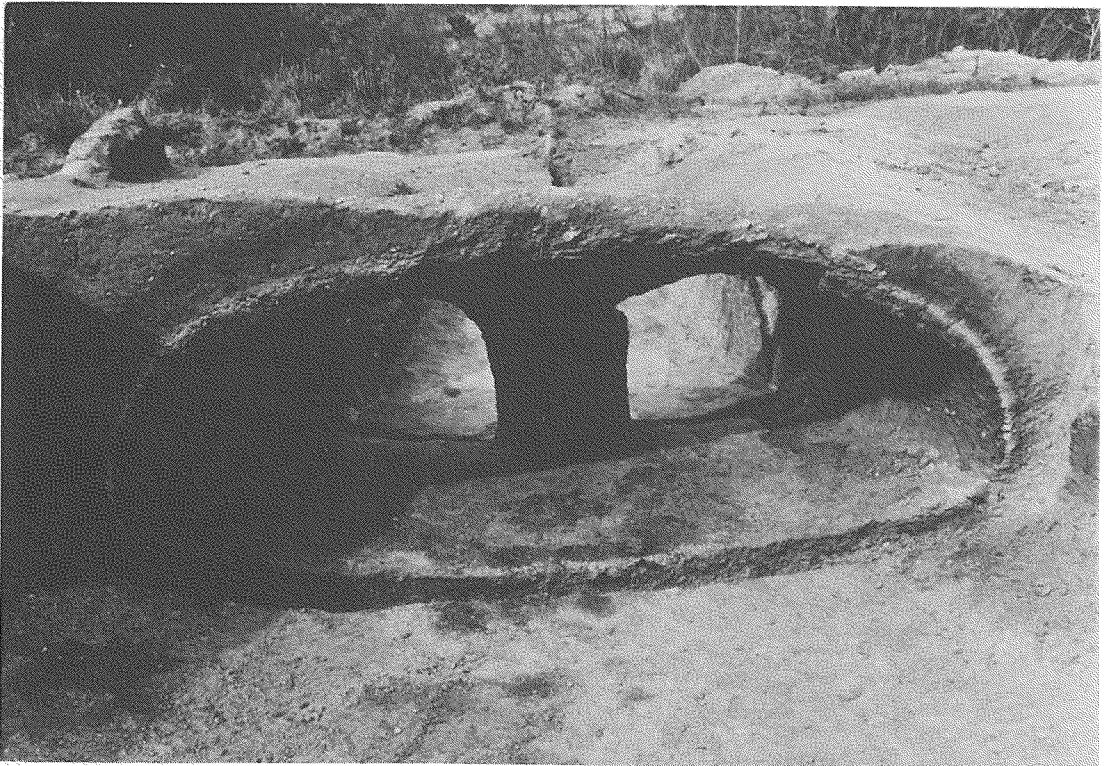

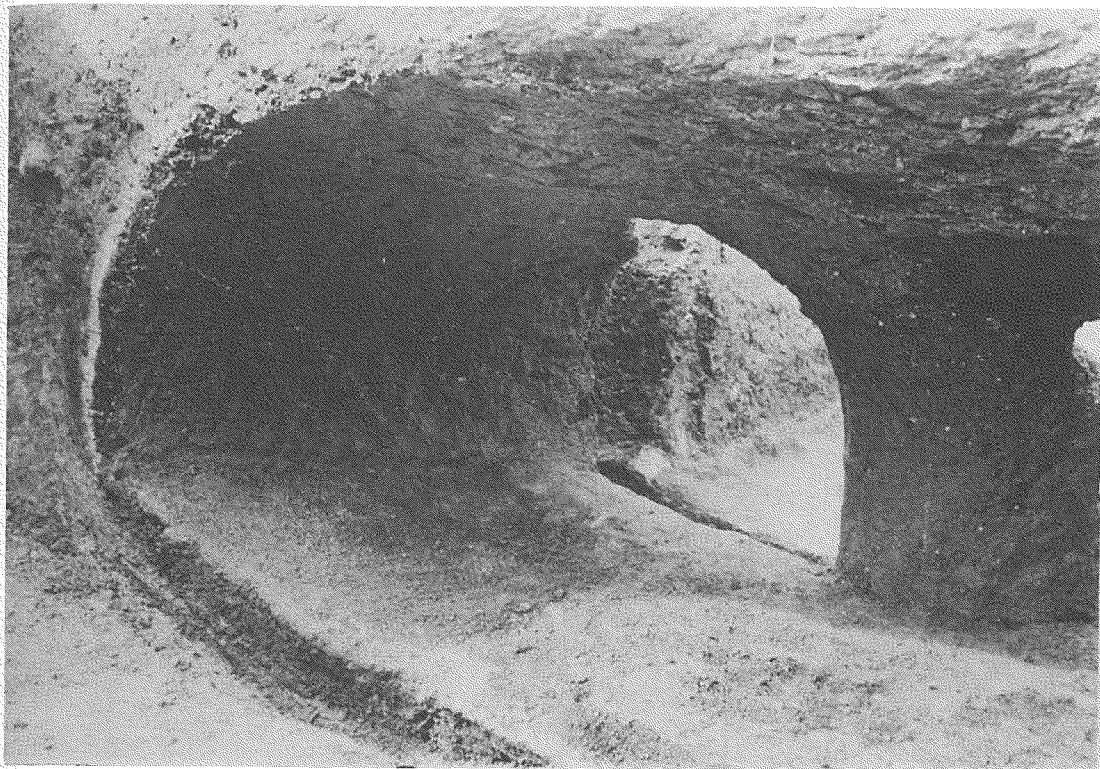

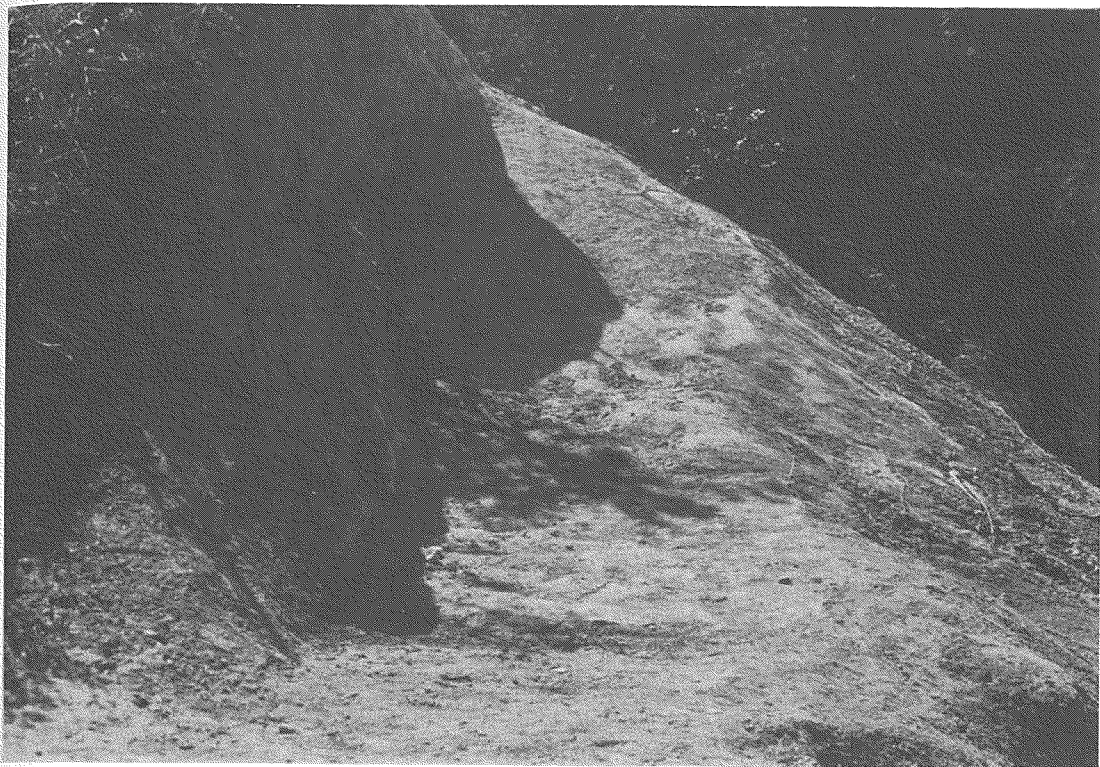



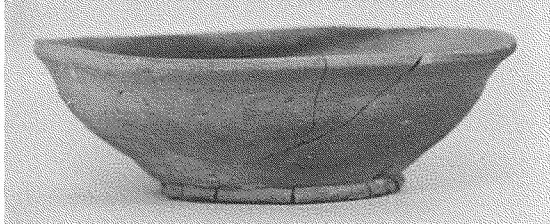
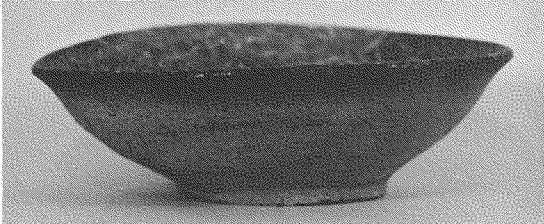
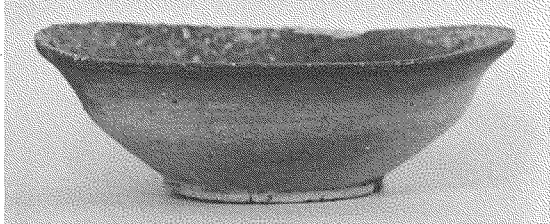
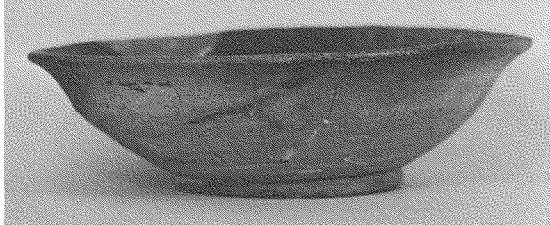
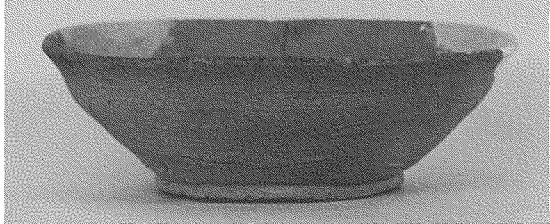
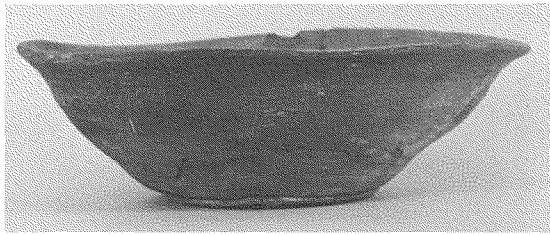

写真図版XXXIII 小皿・小持器台

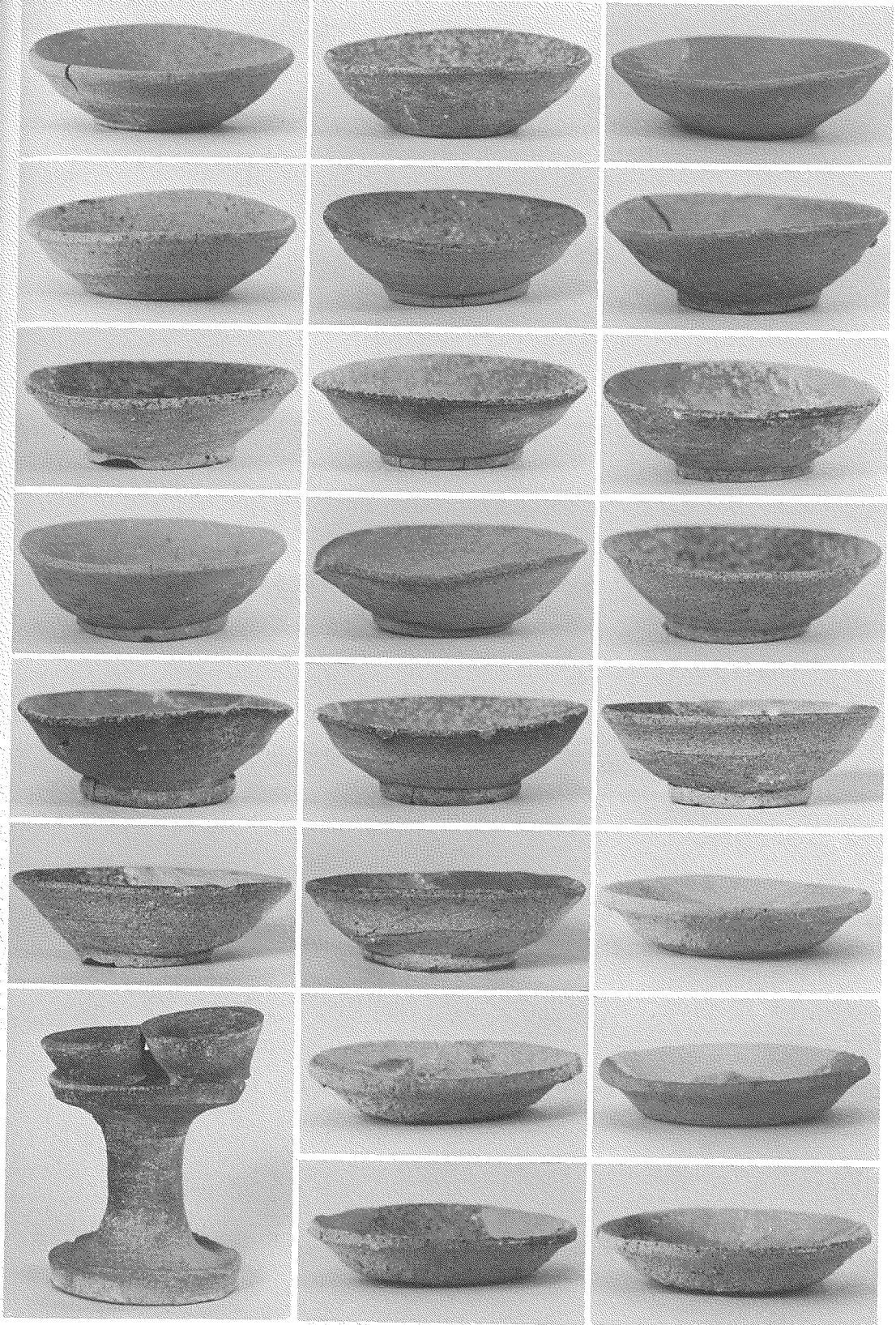



折 込 図 版

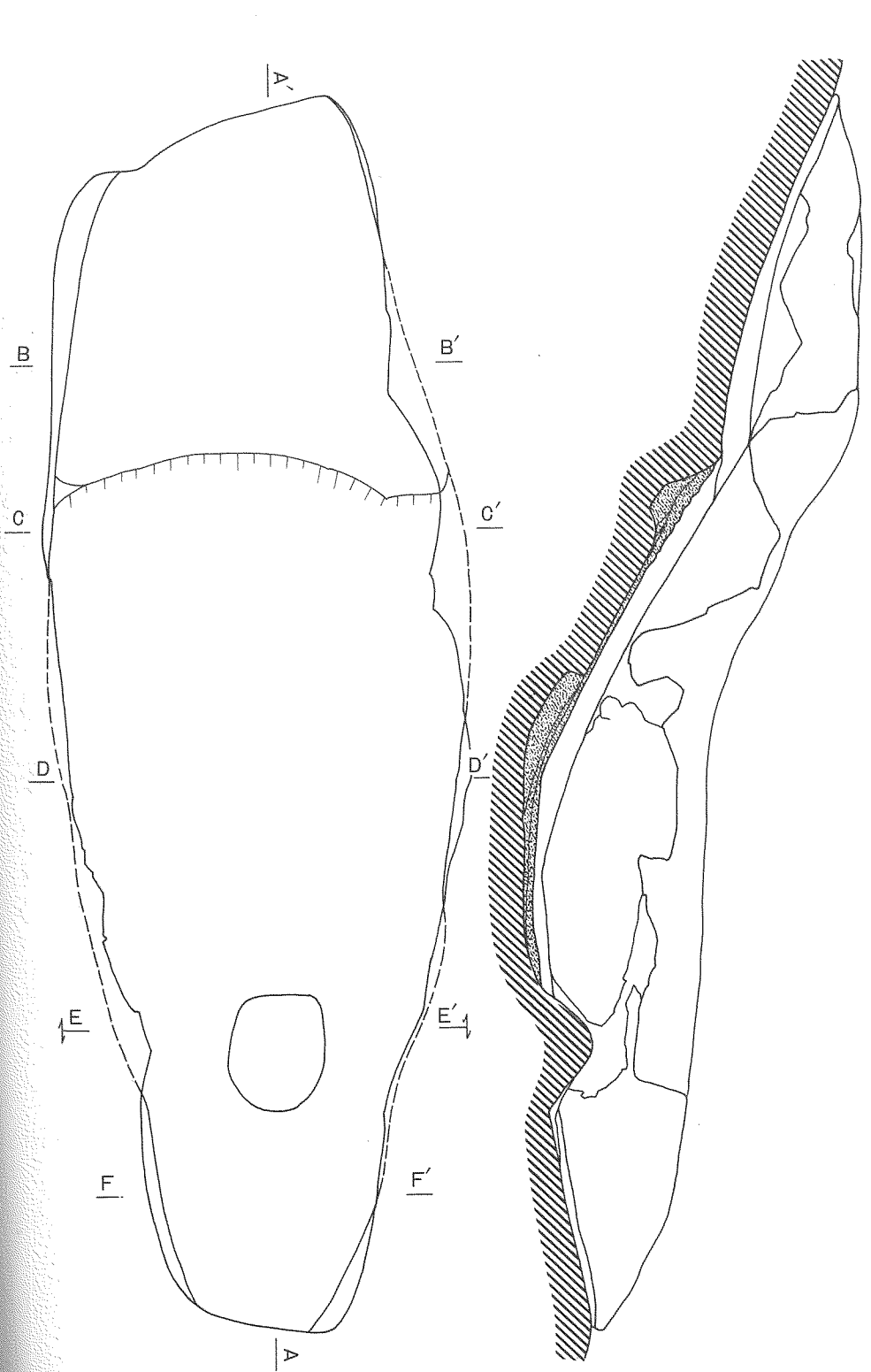

A' L. 50.5m

+

+

+

+

+

A

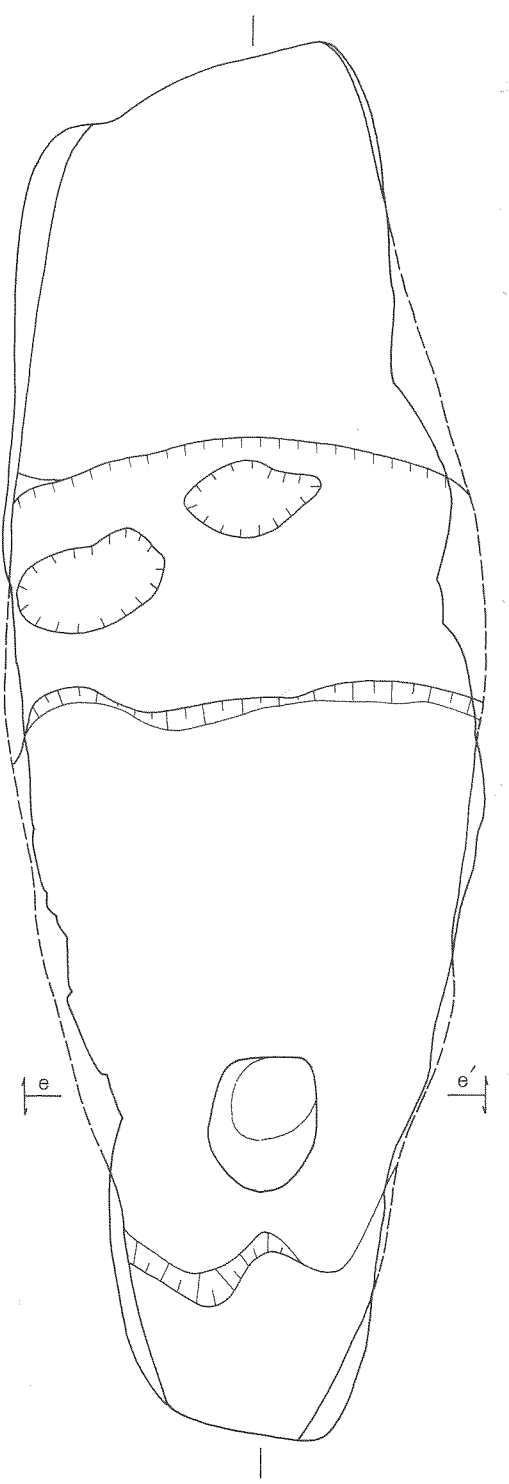
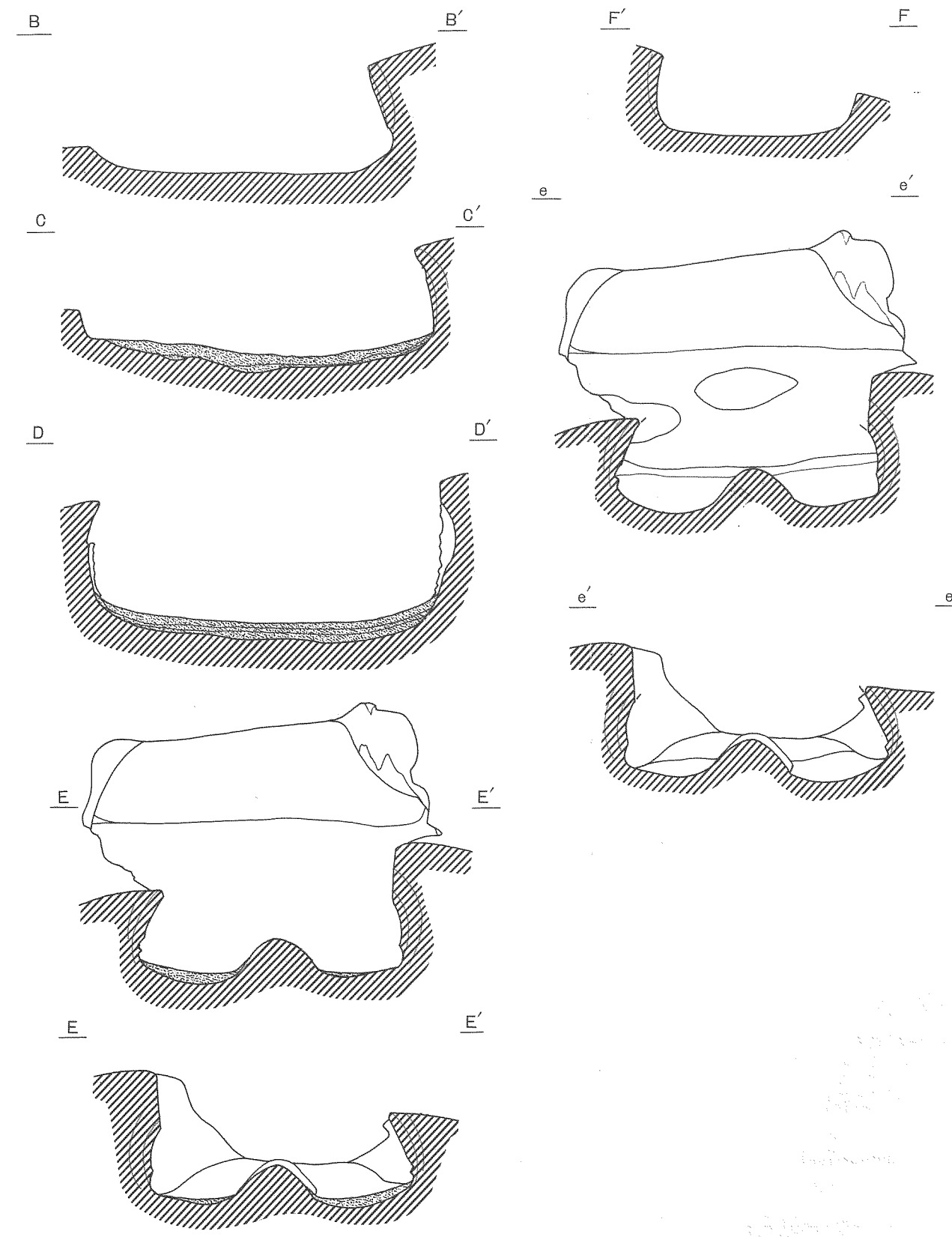

折込图版Ⅲ B案

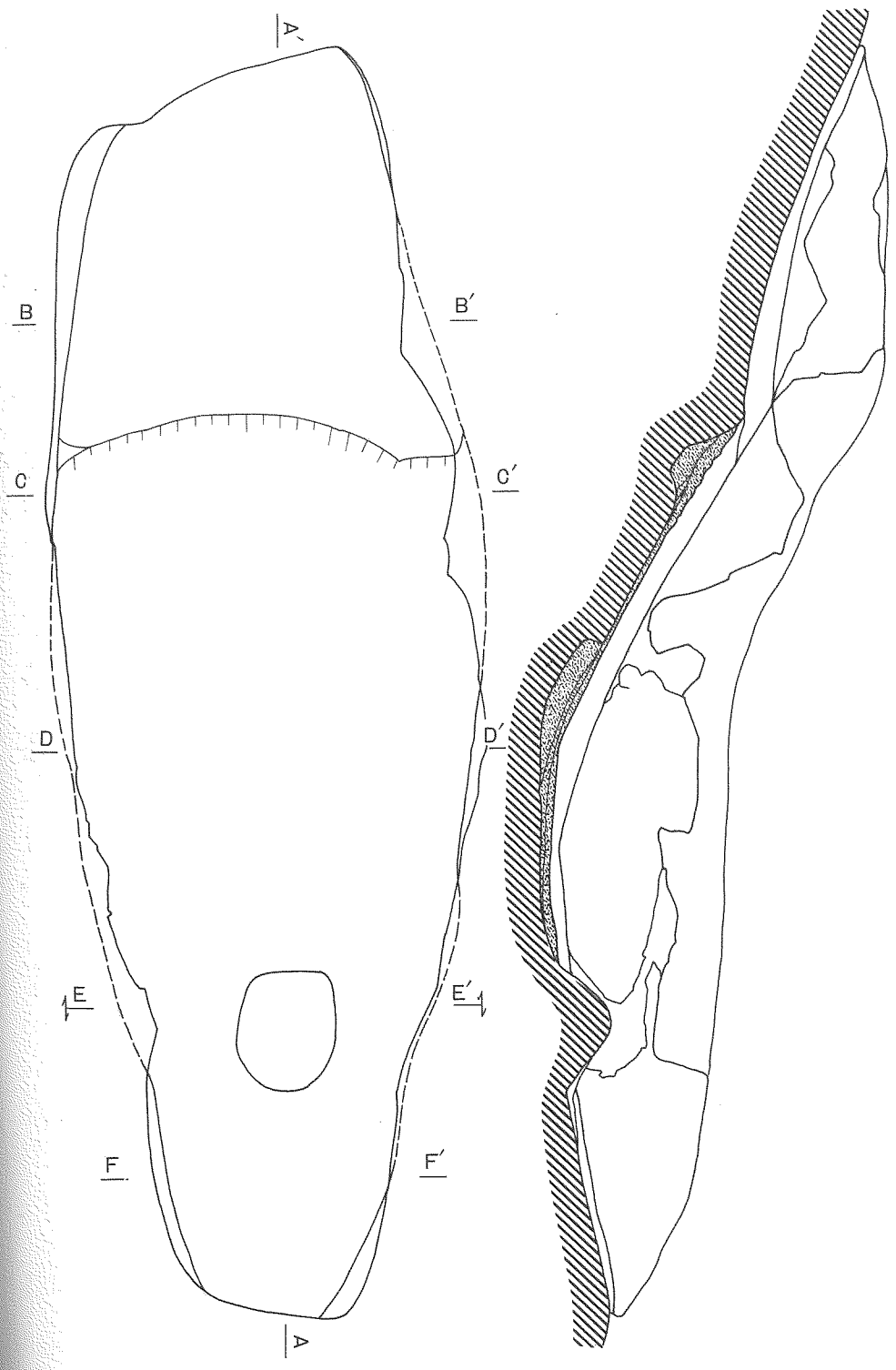

A' L. 50.5m

+

+

+

+

+

A

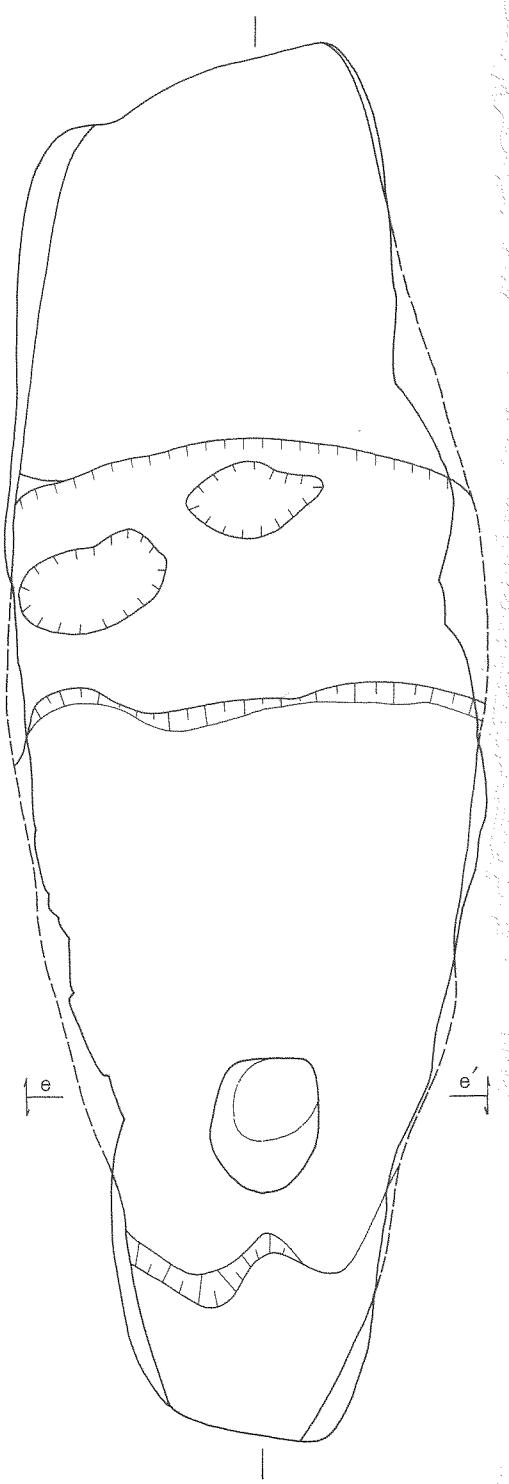
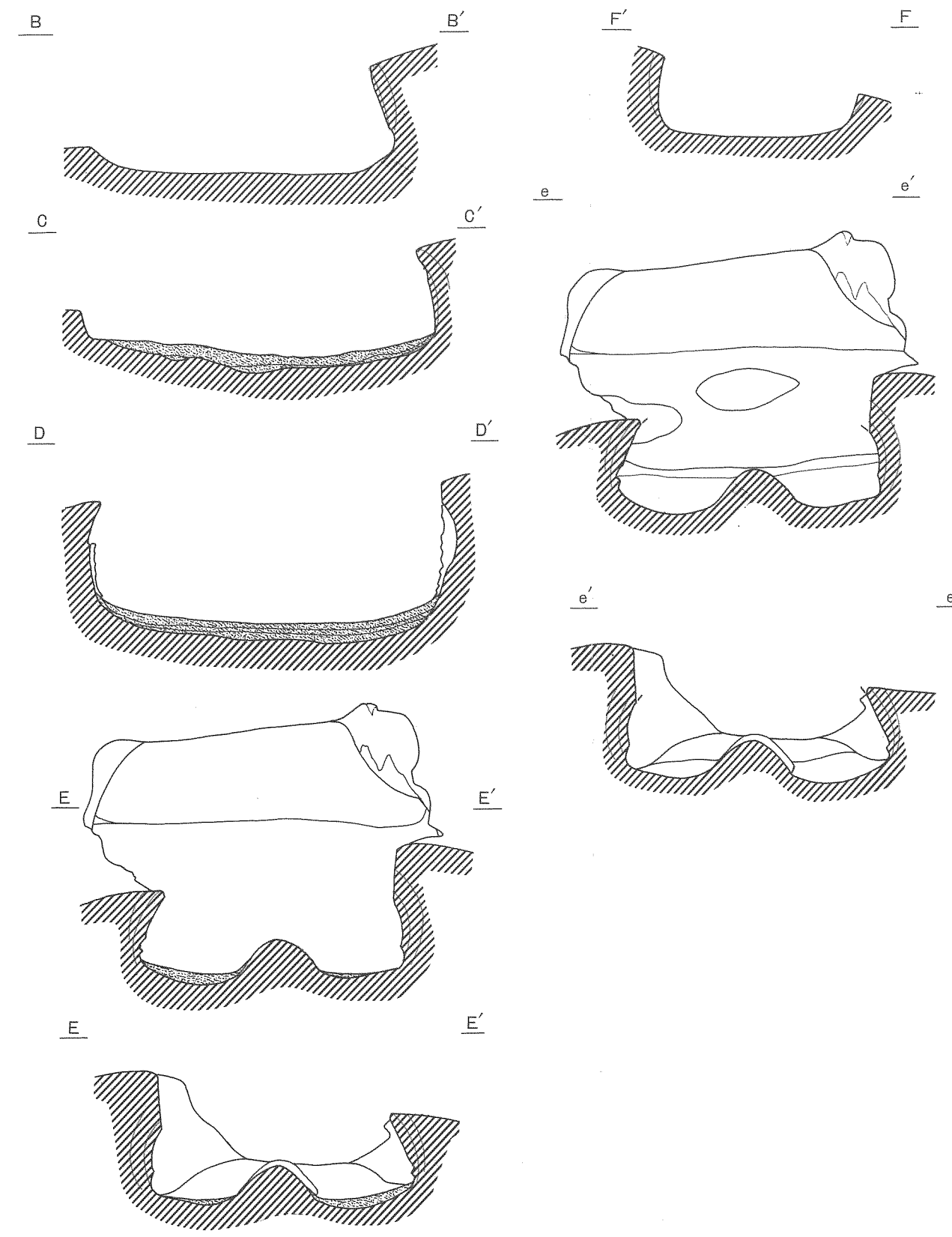

折込图版Ⅲ B案

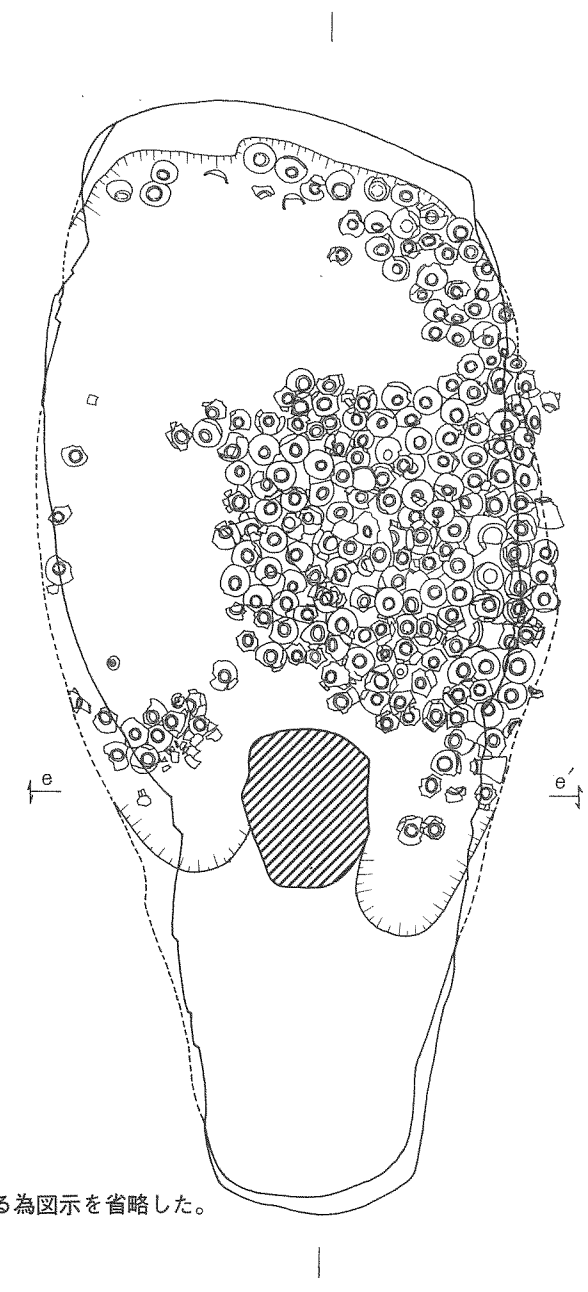
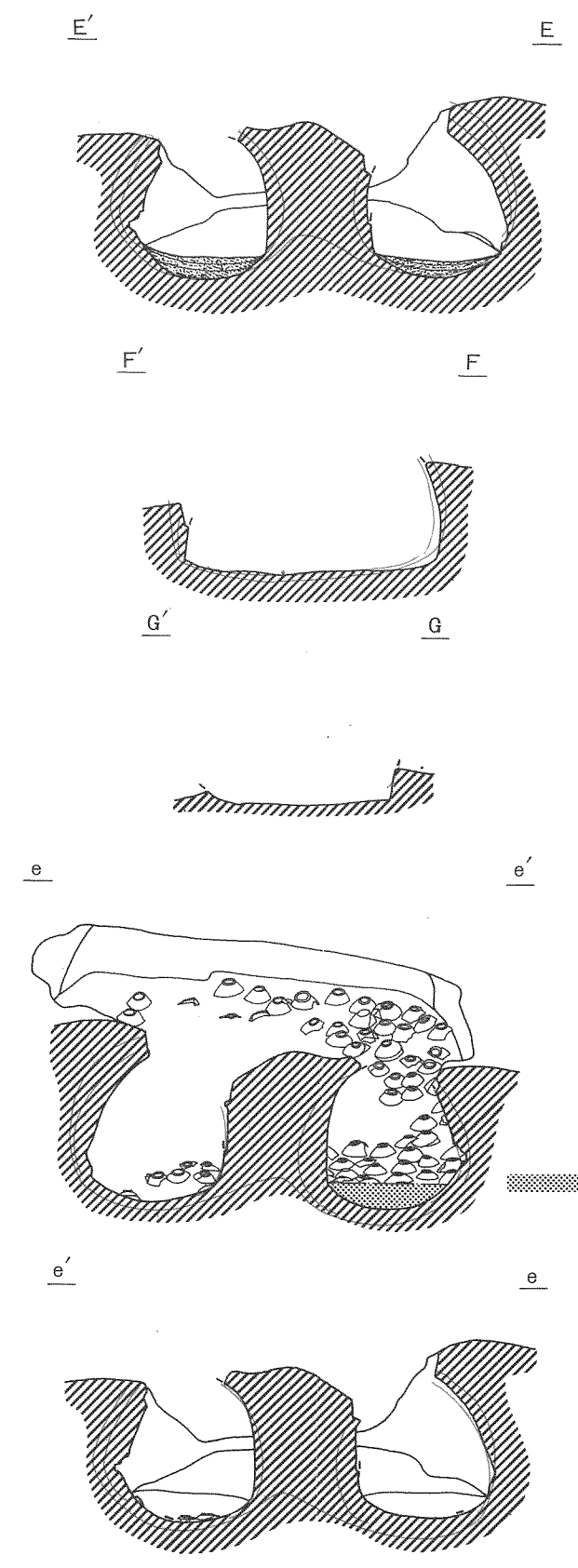
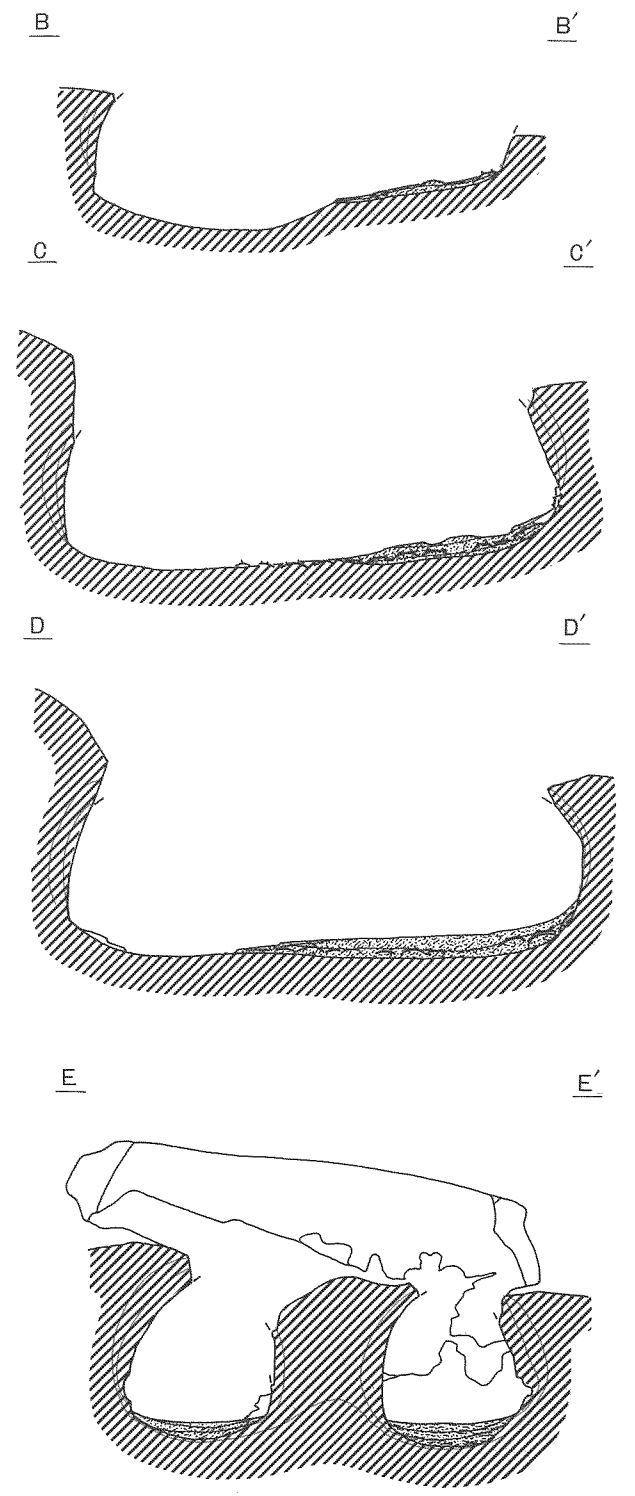
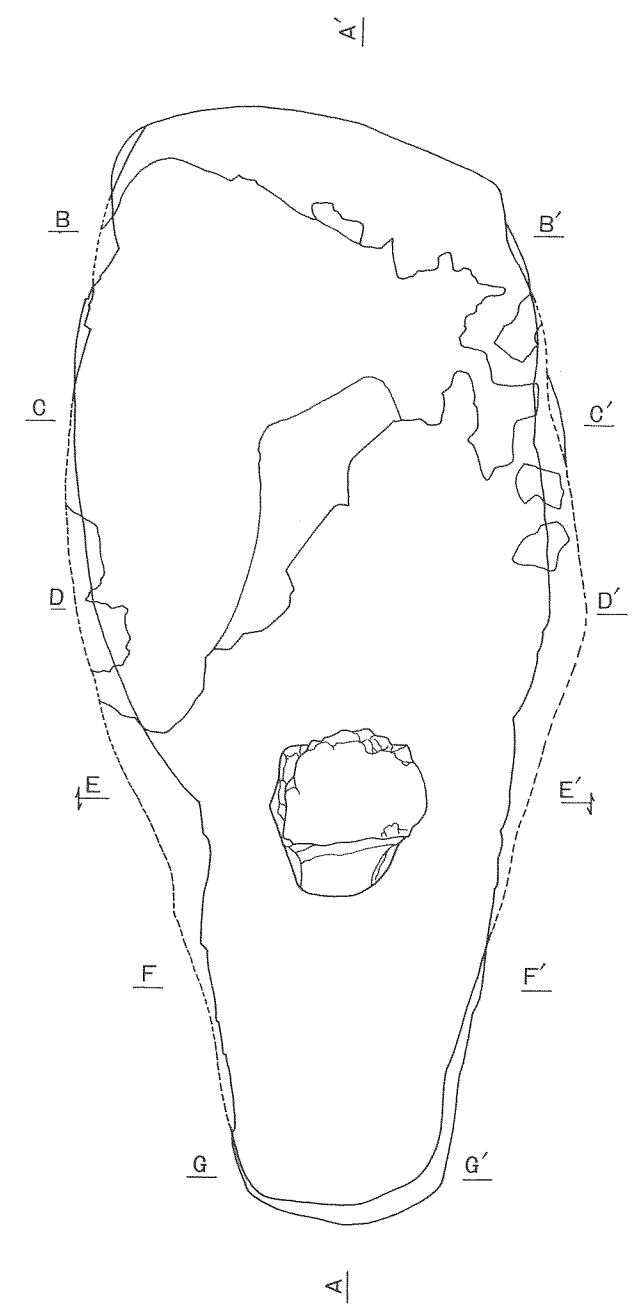
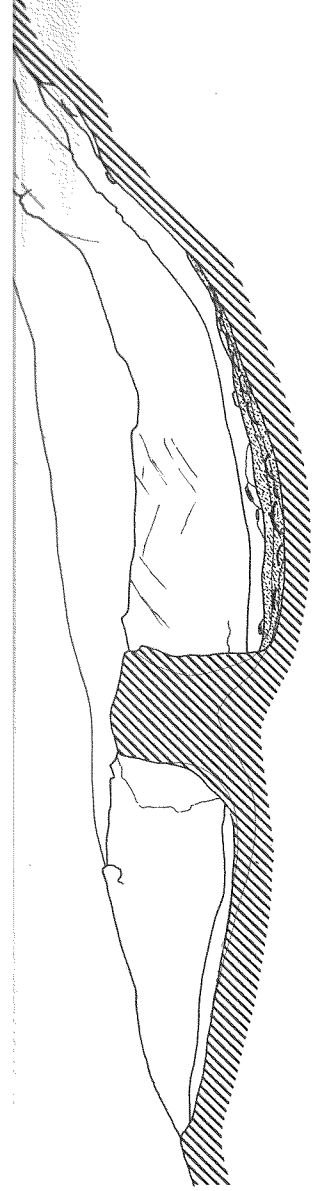

は煩を避ける為図示を省略した。

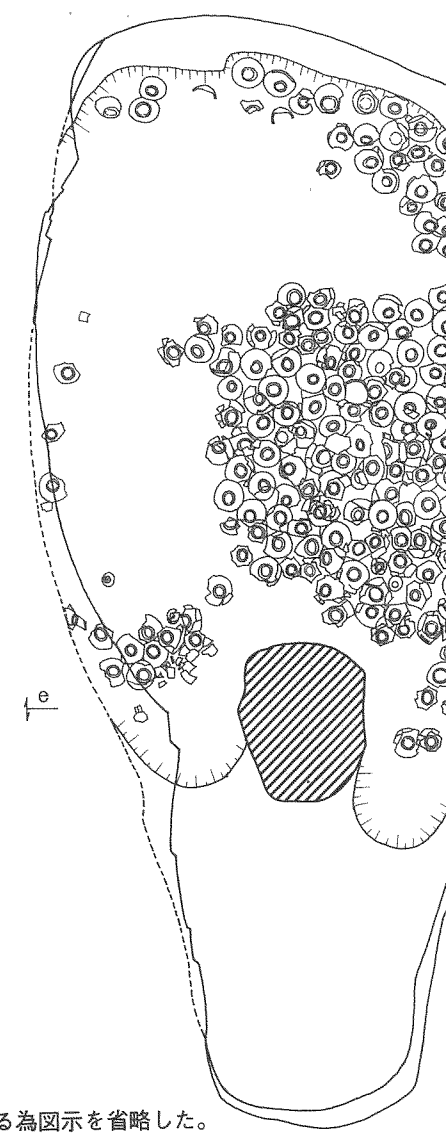
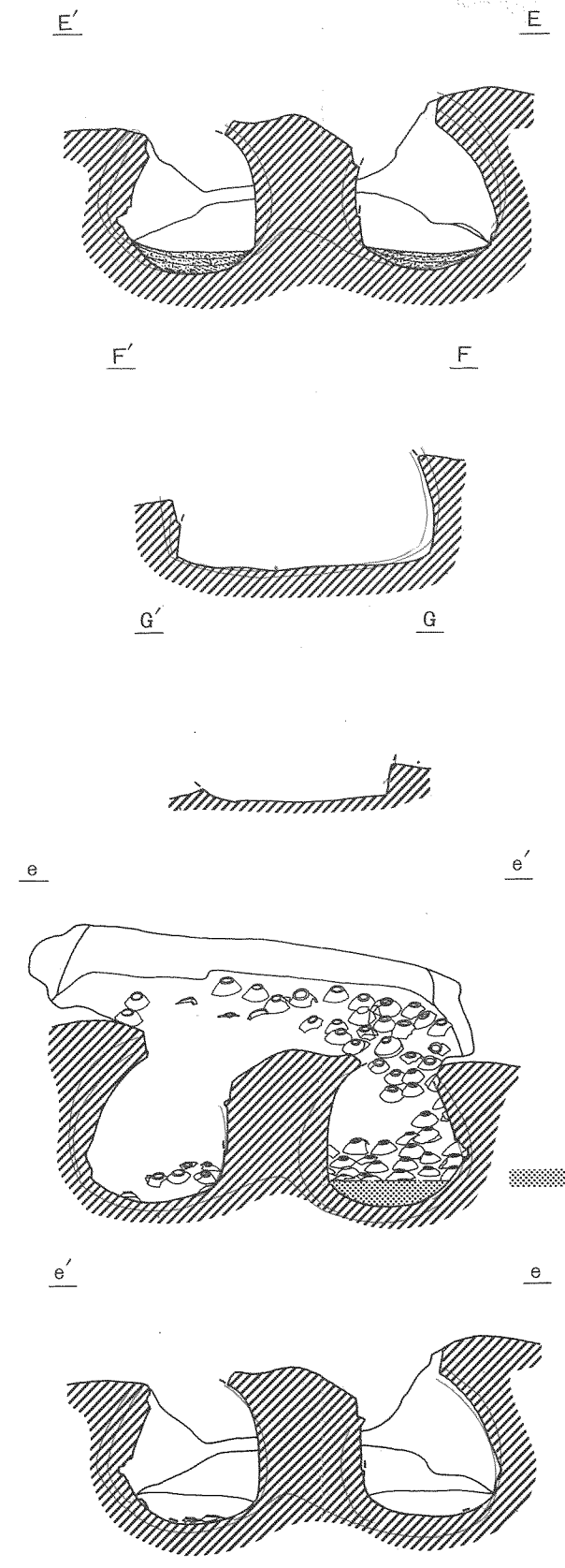
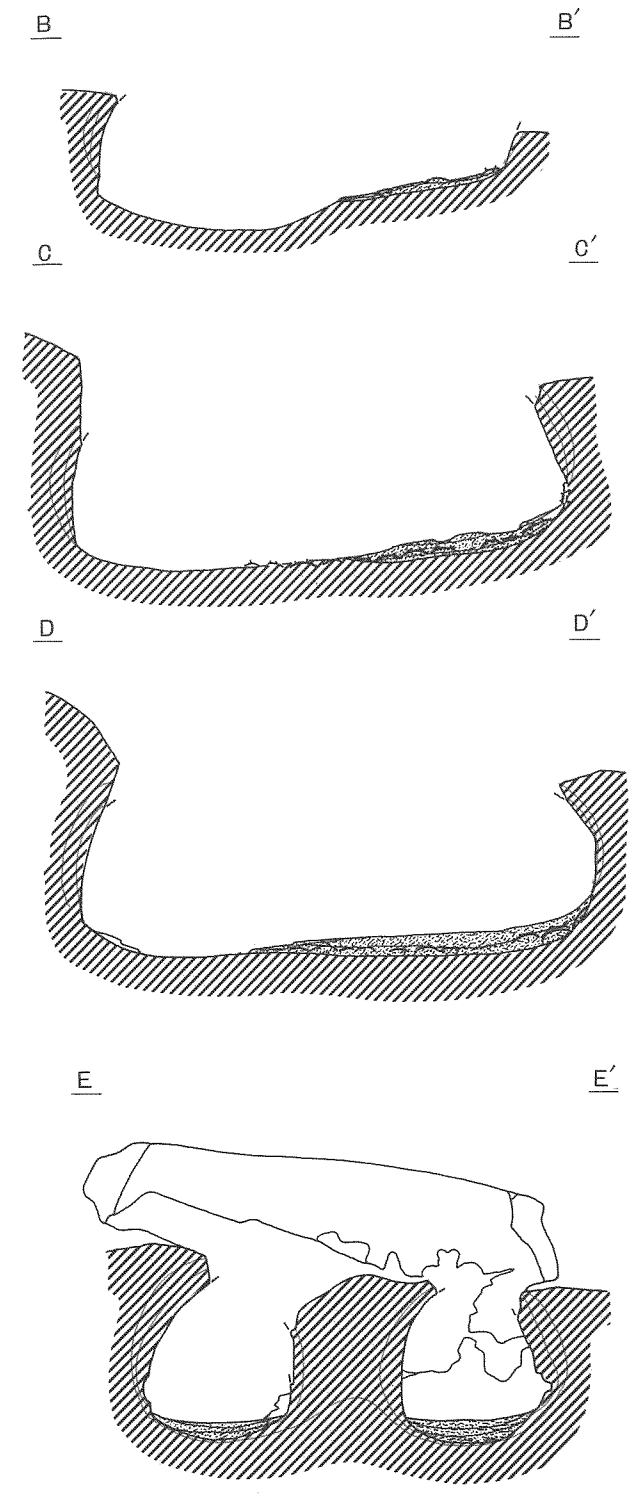
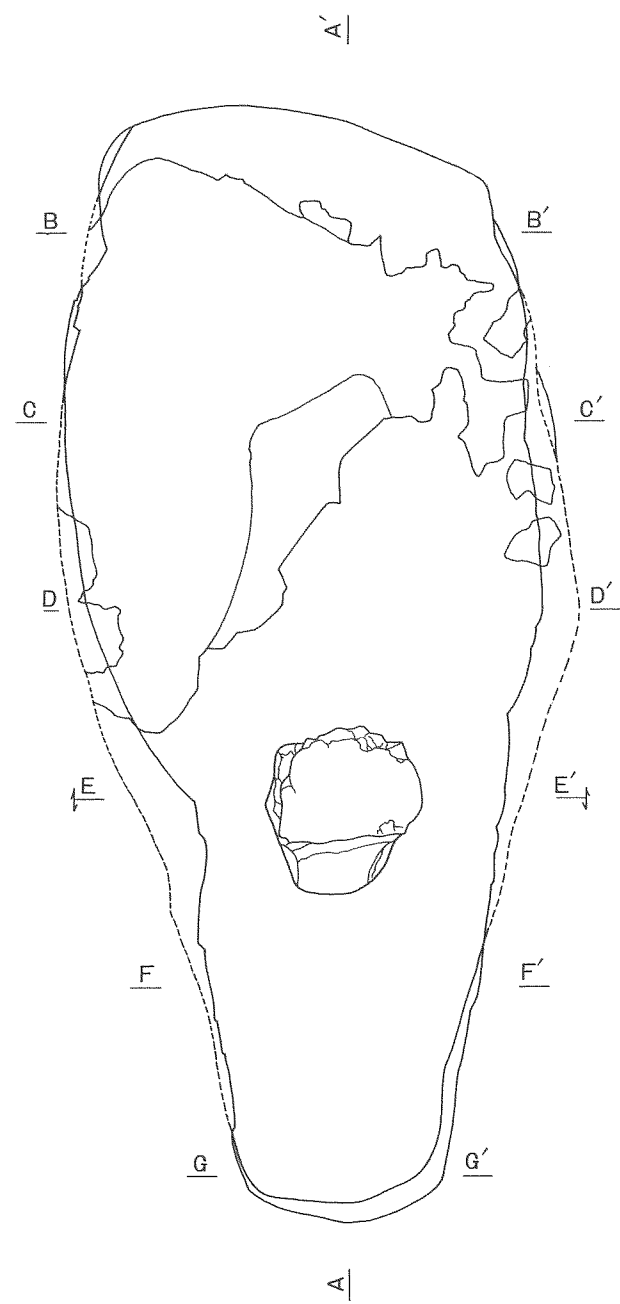
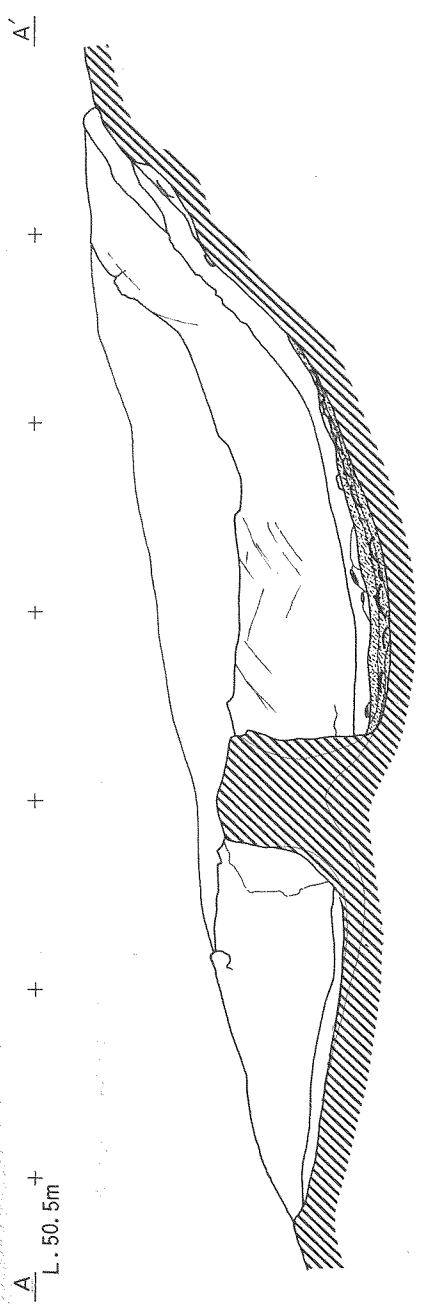

は煩を避ける為図示を省略した。

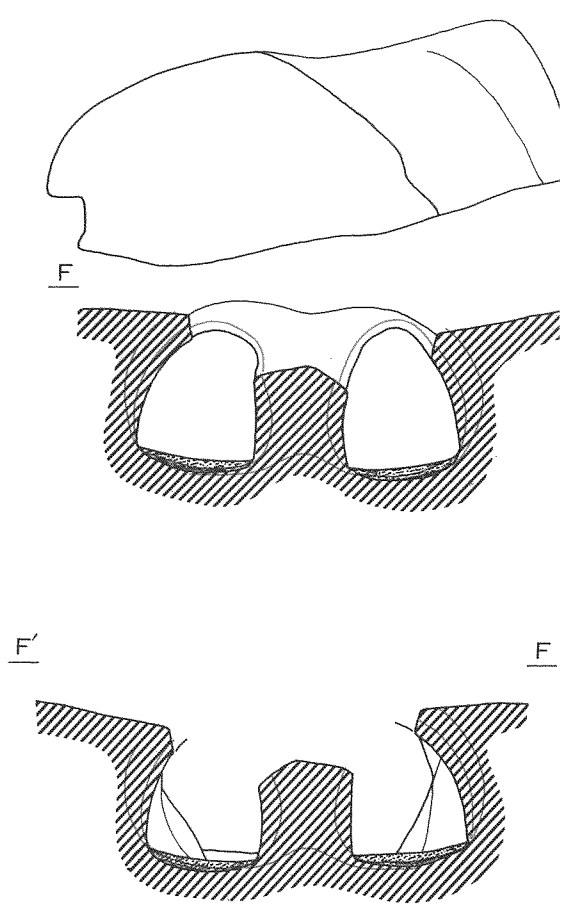
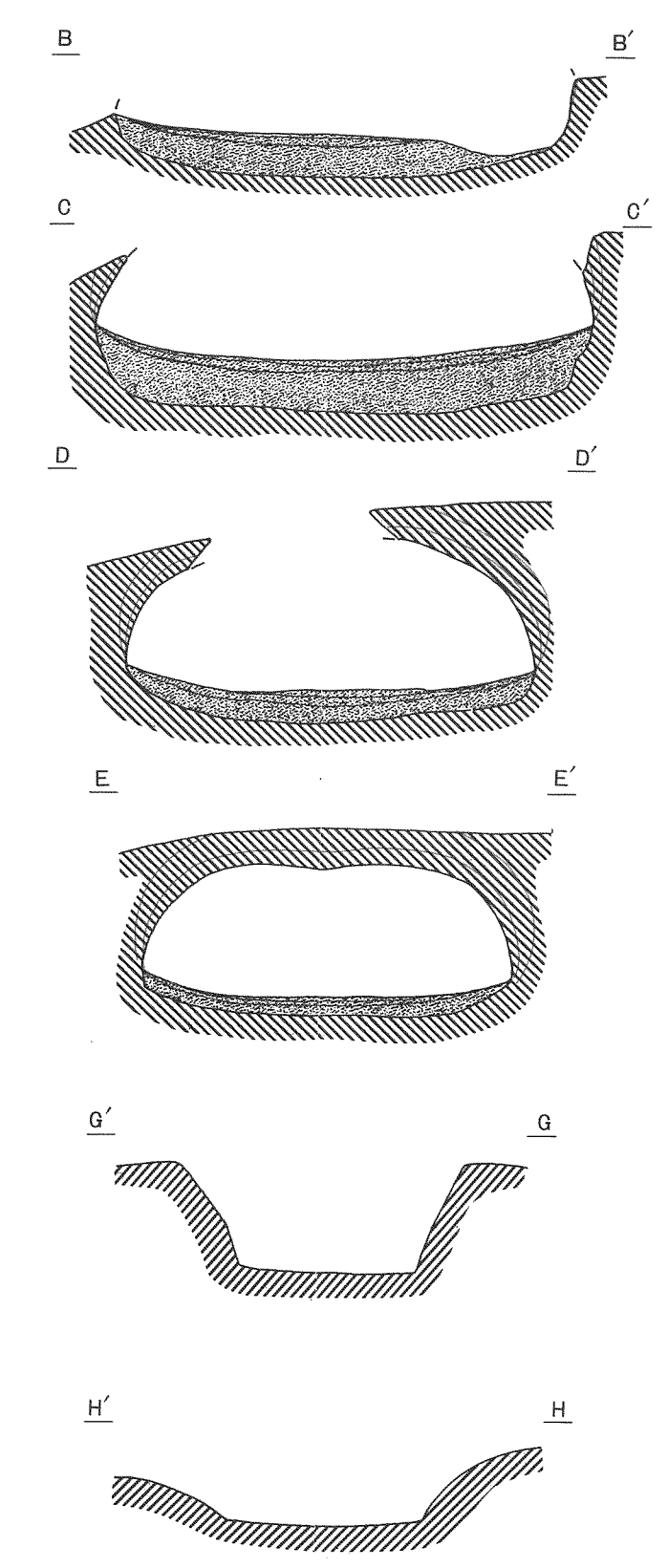
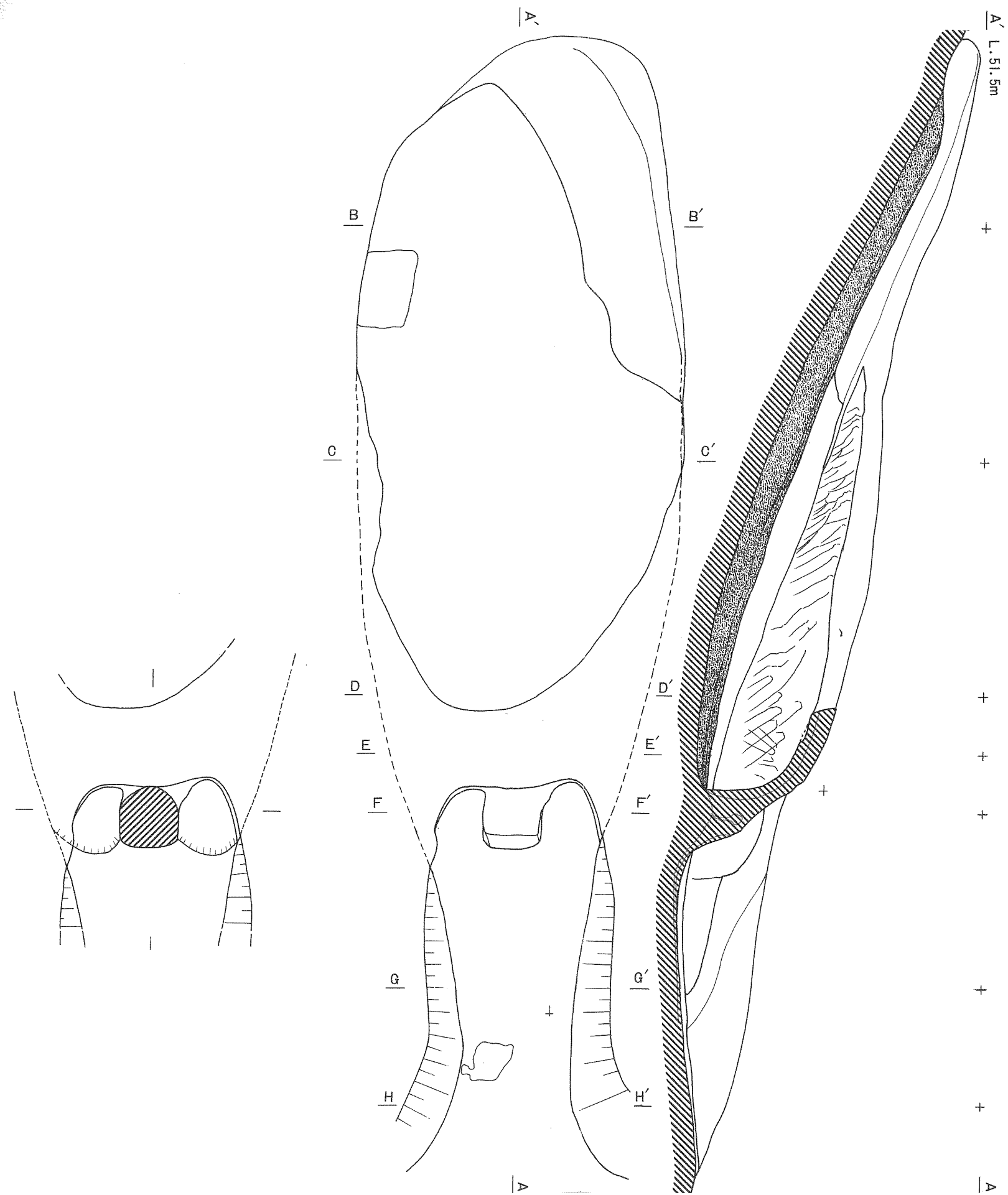

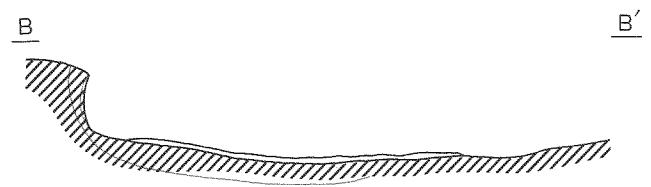
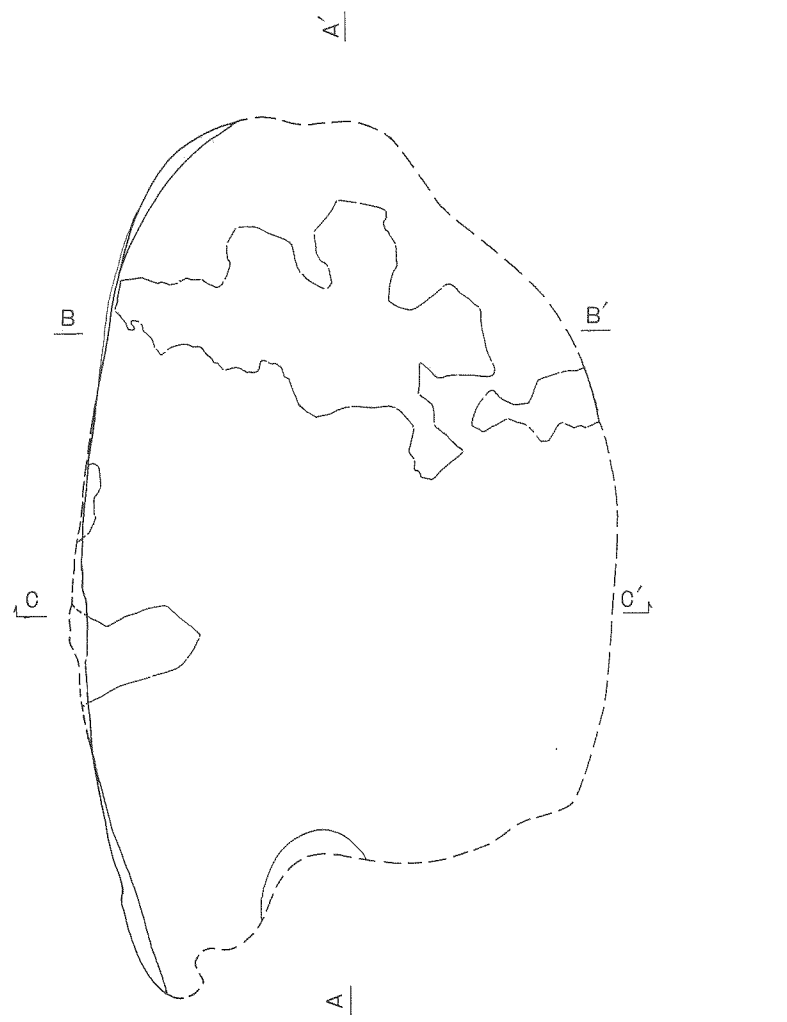
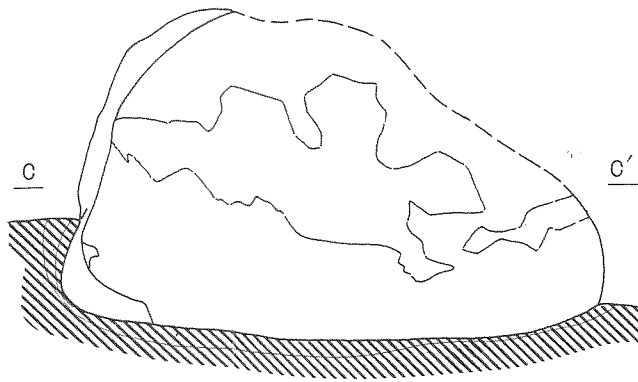
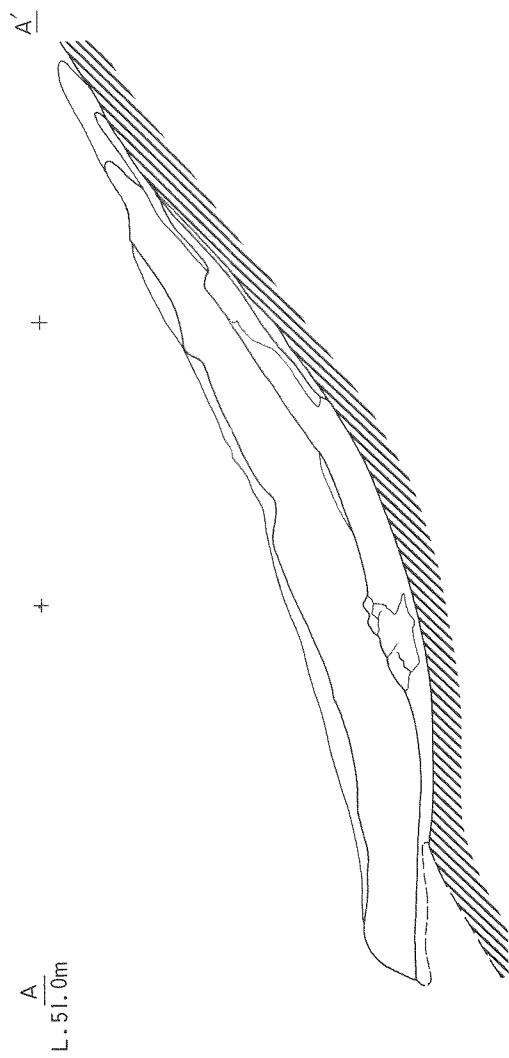
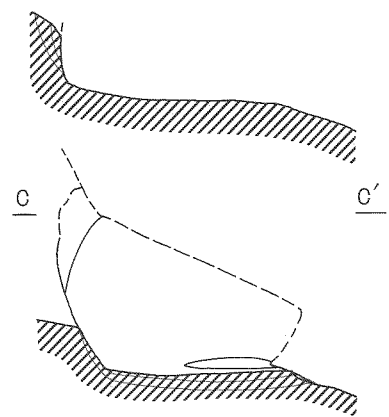
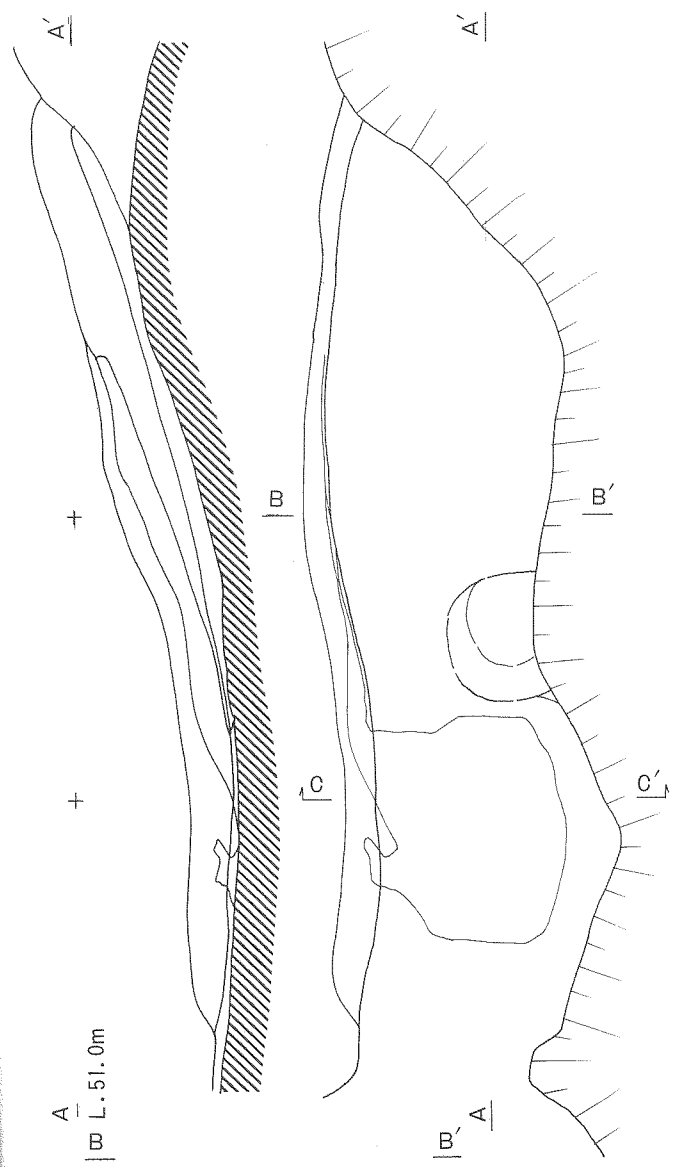

折込图版VI E·F窠

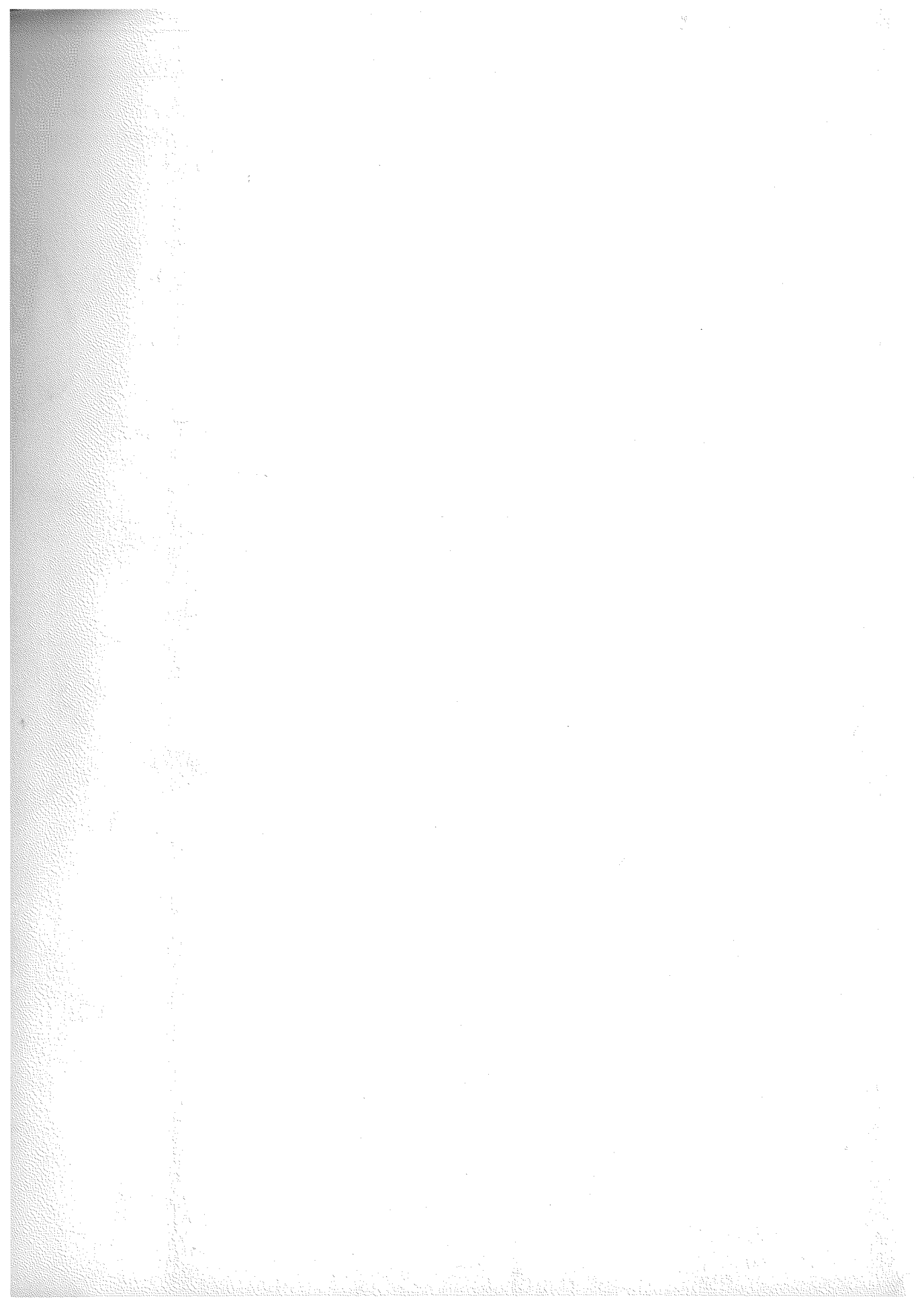

A' L. 33.0m +

A

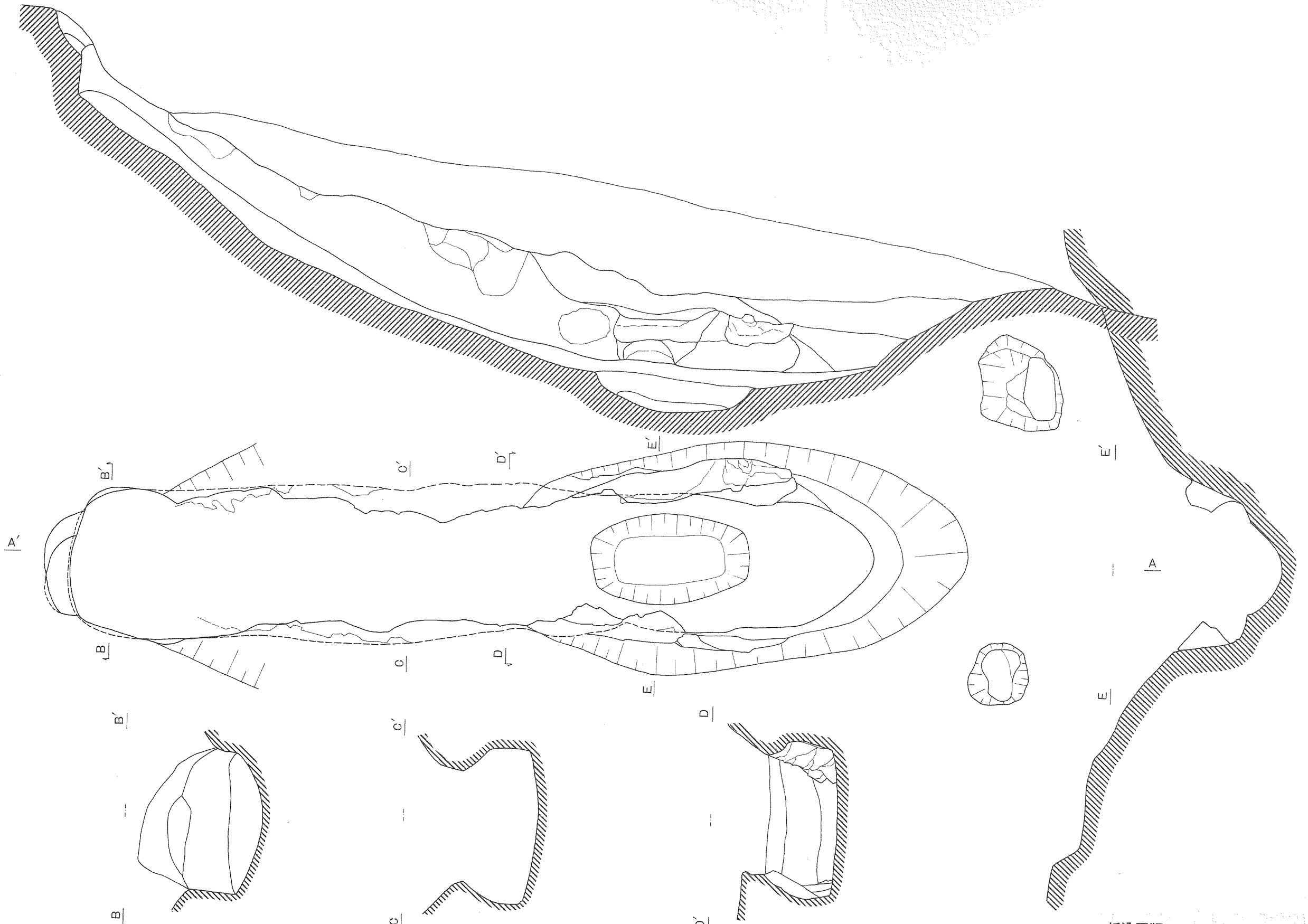

折込图版I NJA-2号窟

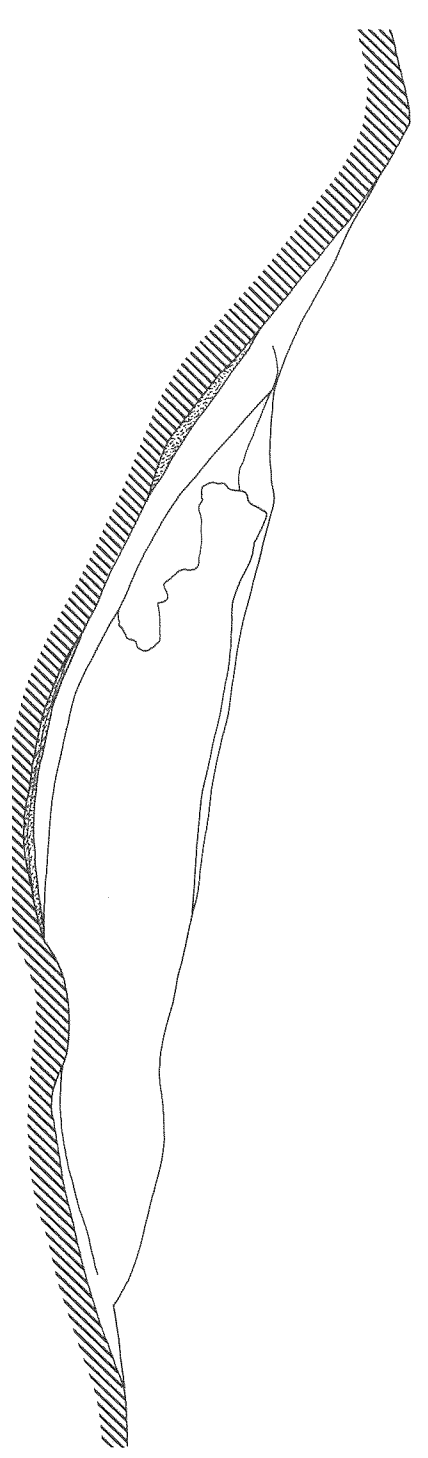
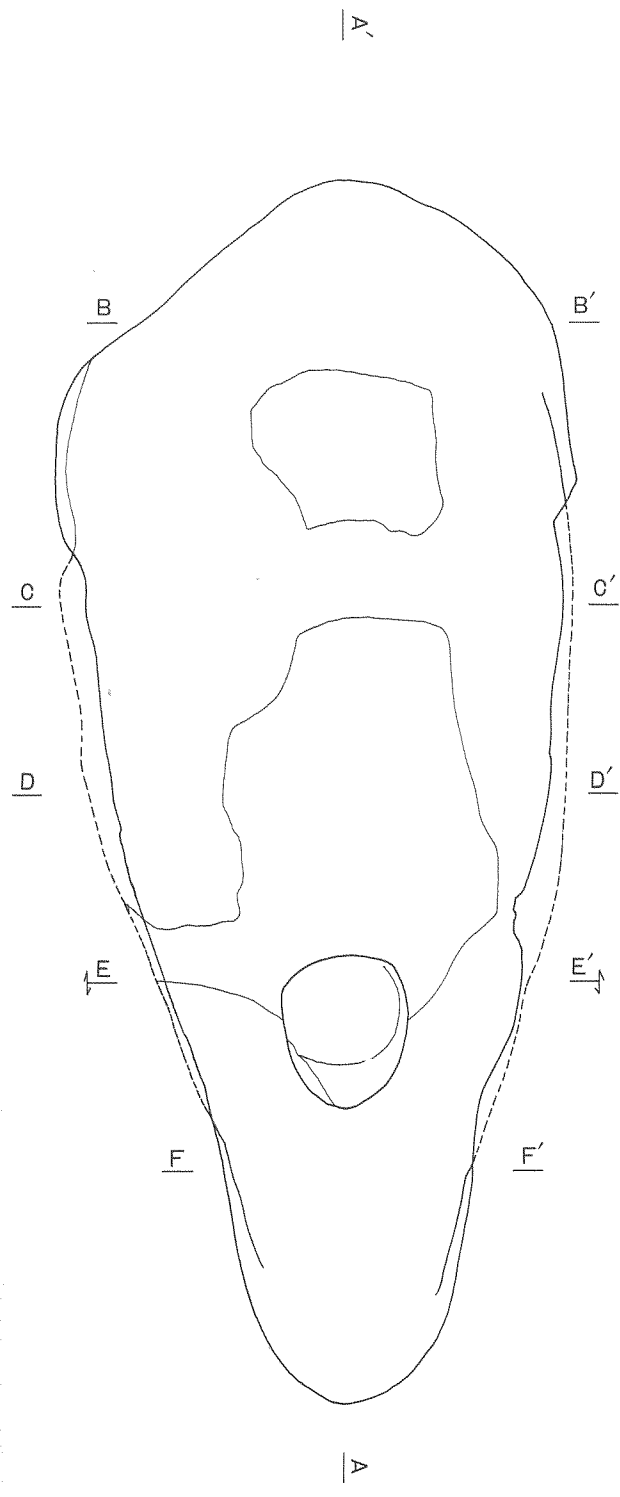

A' L. 50.00mm

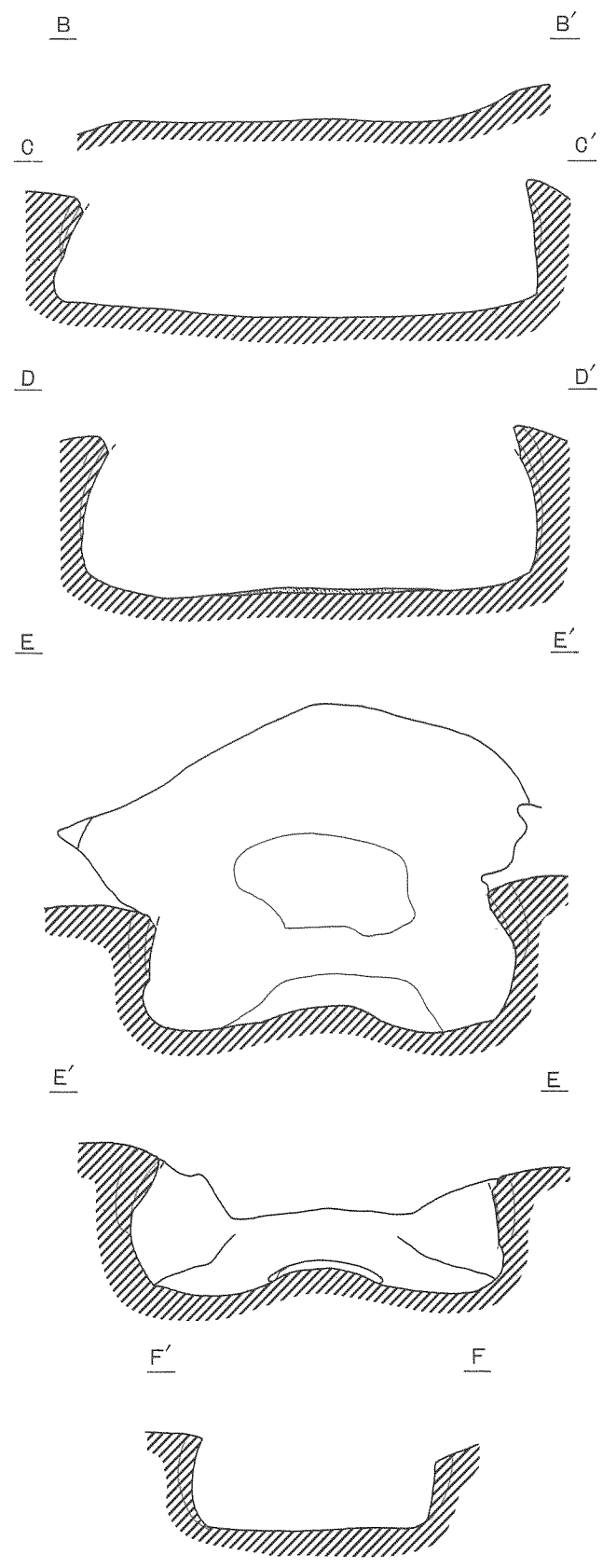

折込图版II A窠