

第26図 RA002竪穴建物跡(1)

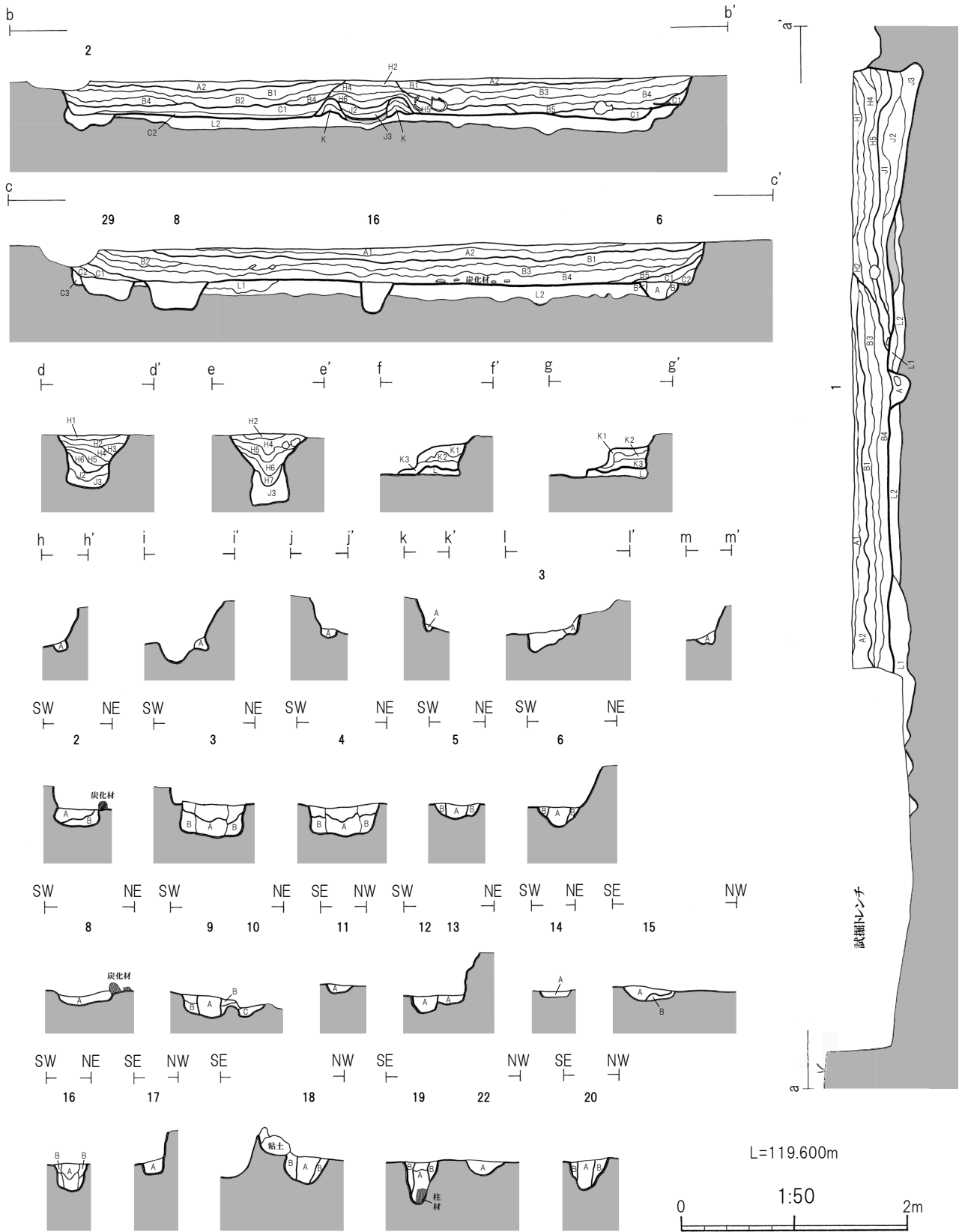

第27図 RA002竪穴建物跡(2)

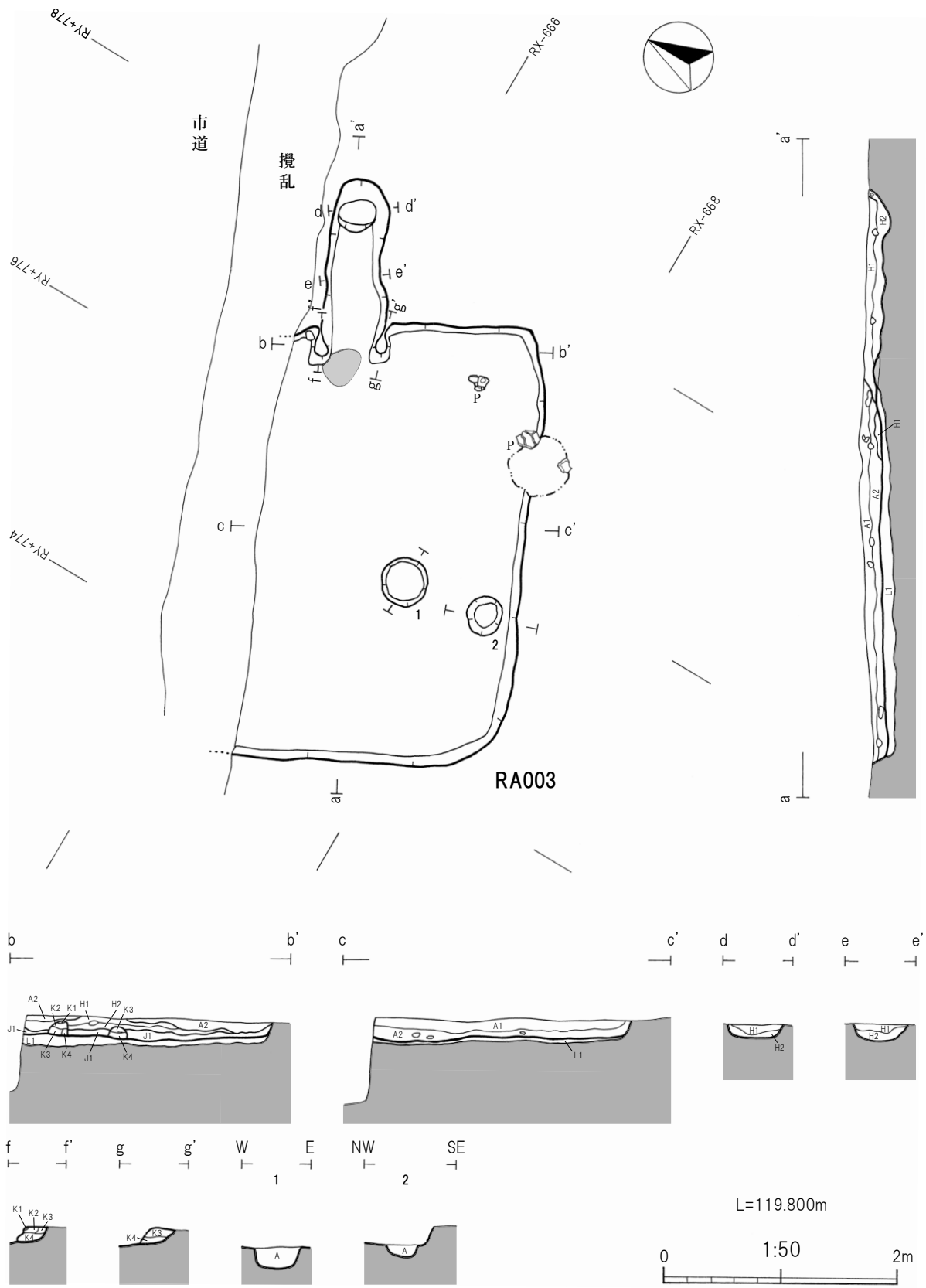

第28図 RA003竪穴建物跡

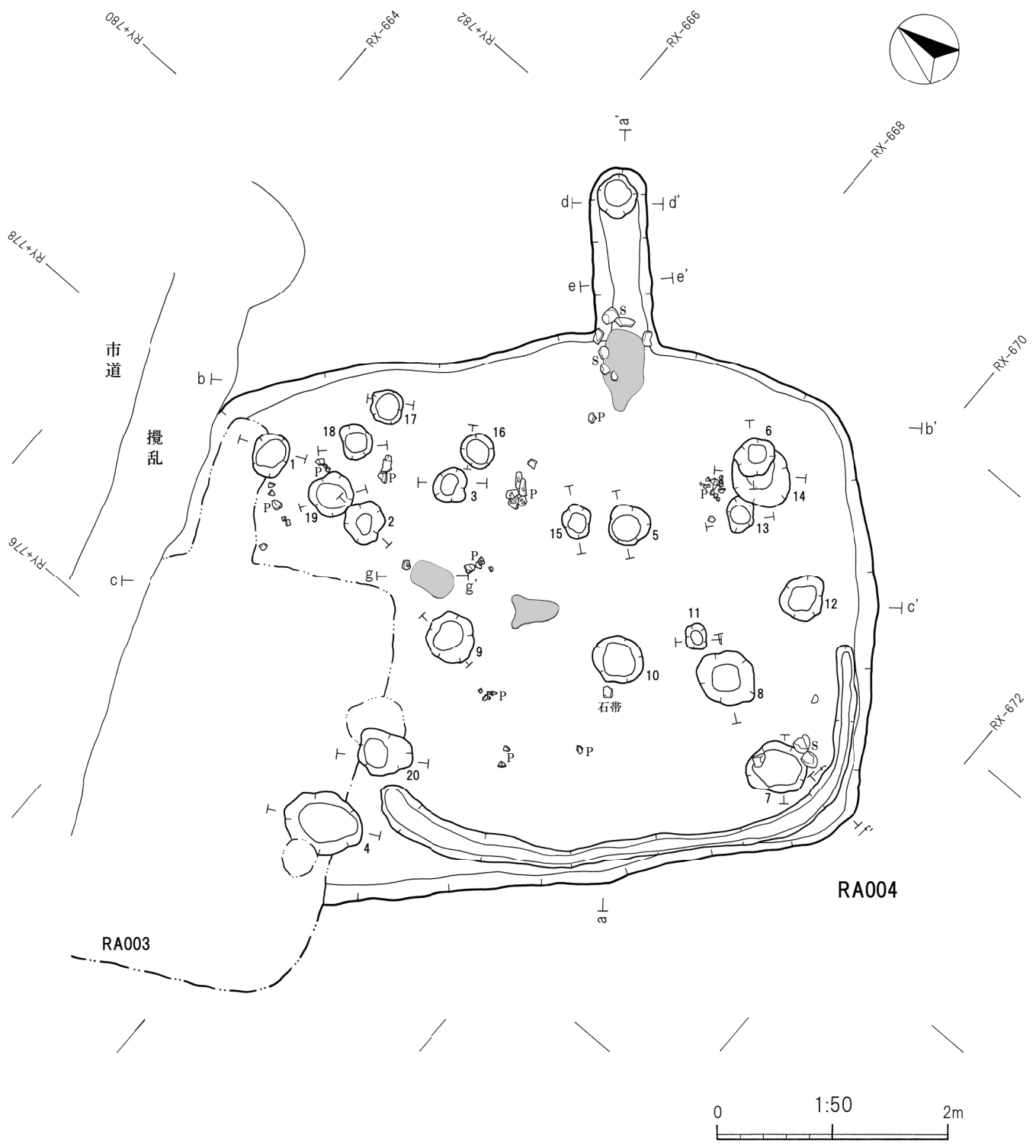

第29図 RA004竪穴建物跡(1)

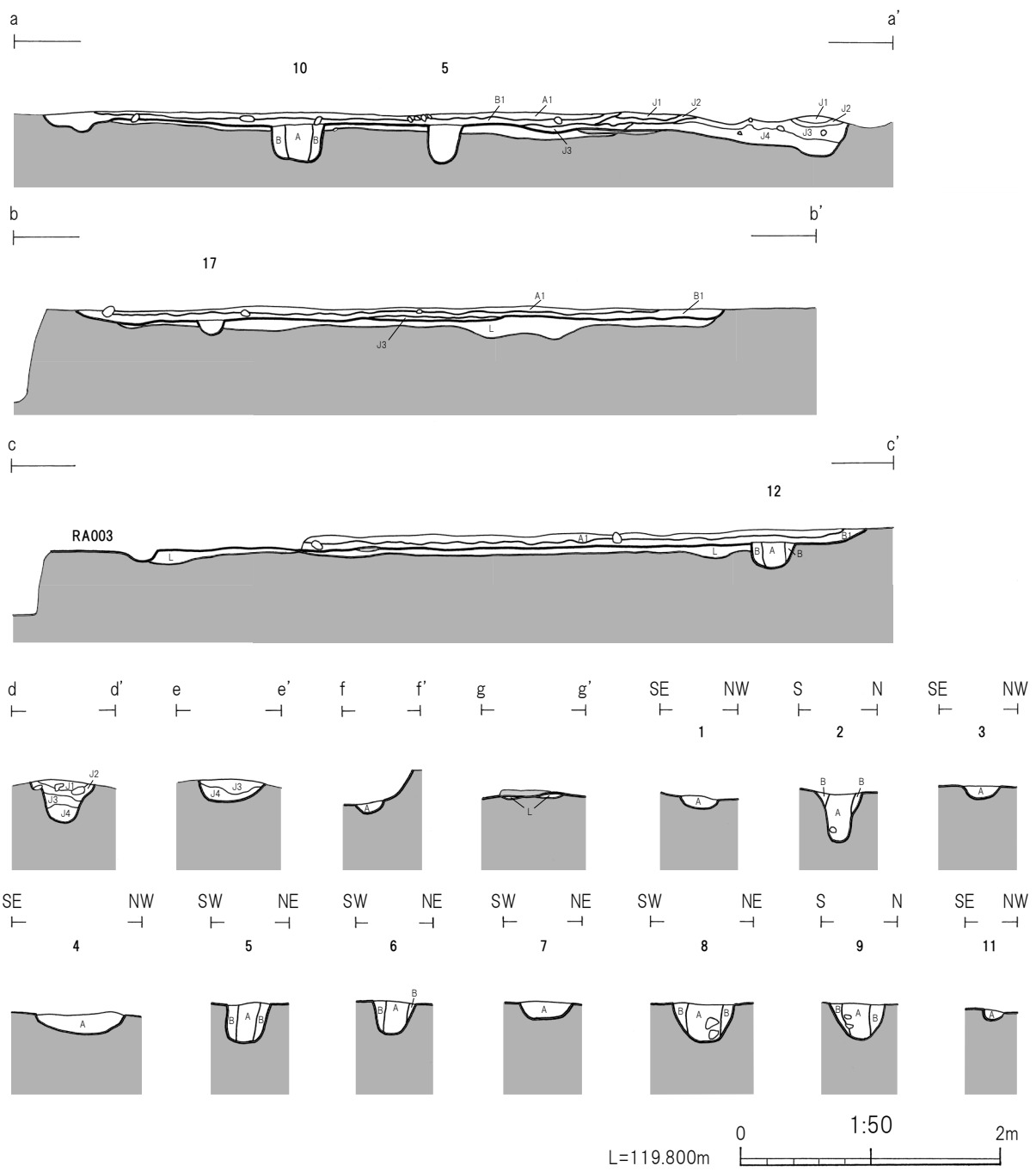

第30图 RA004竖穴建物跡(2)

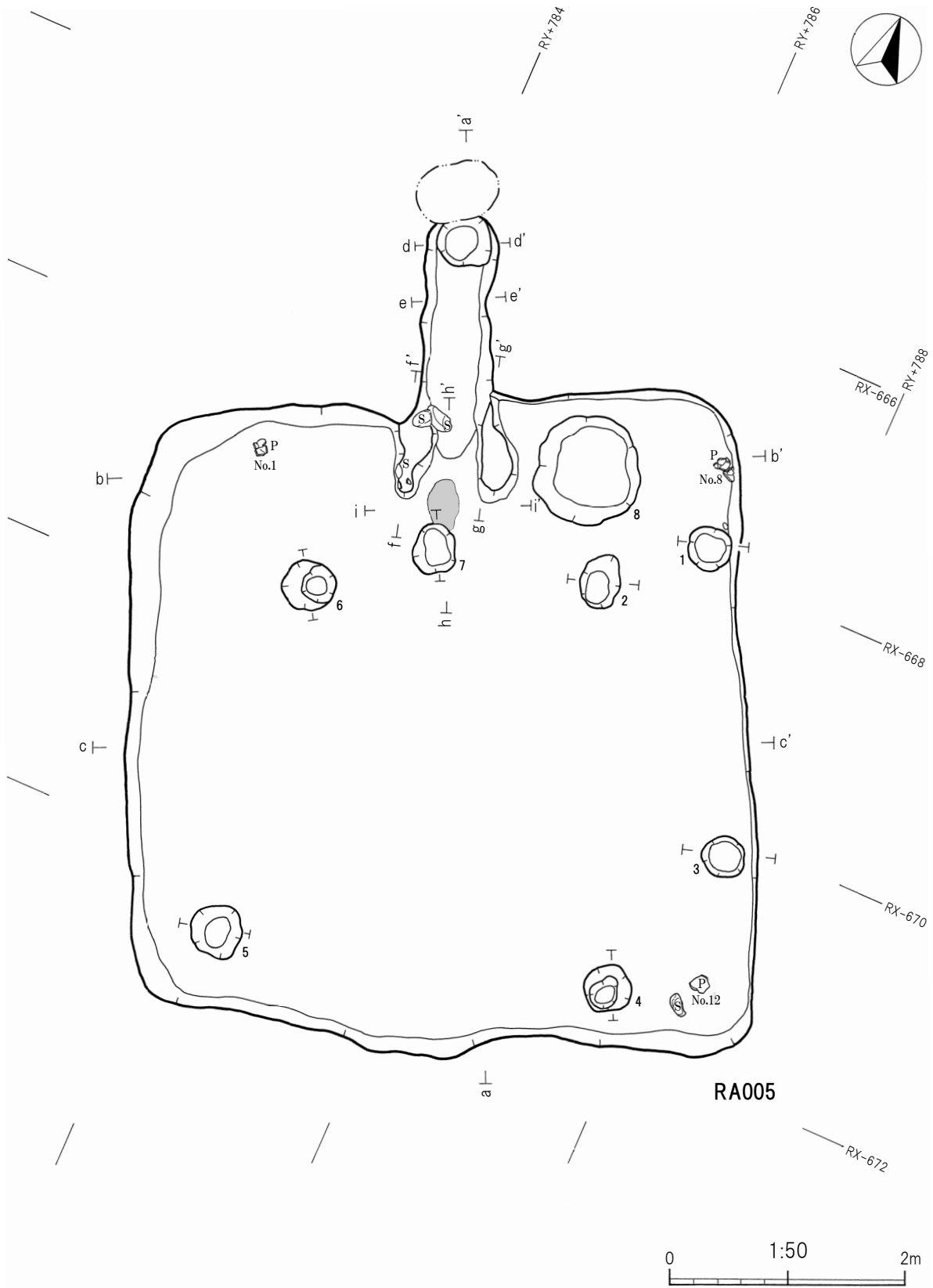

第31図 RA005竪穴建物跡(1)

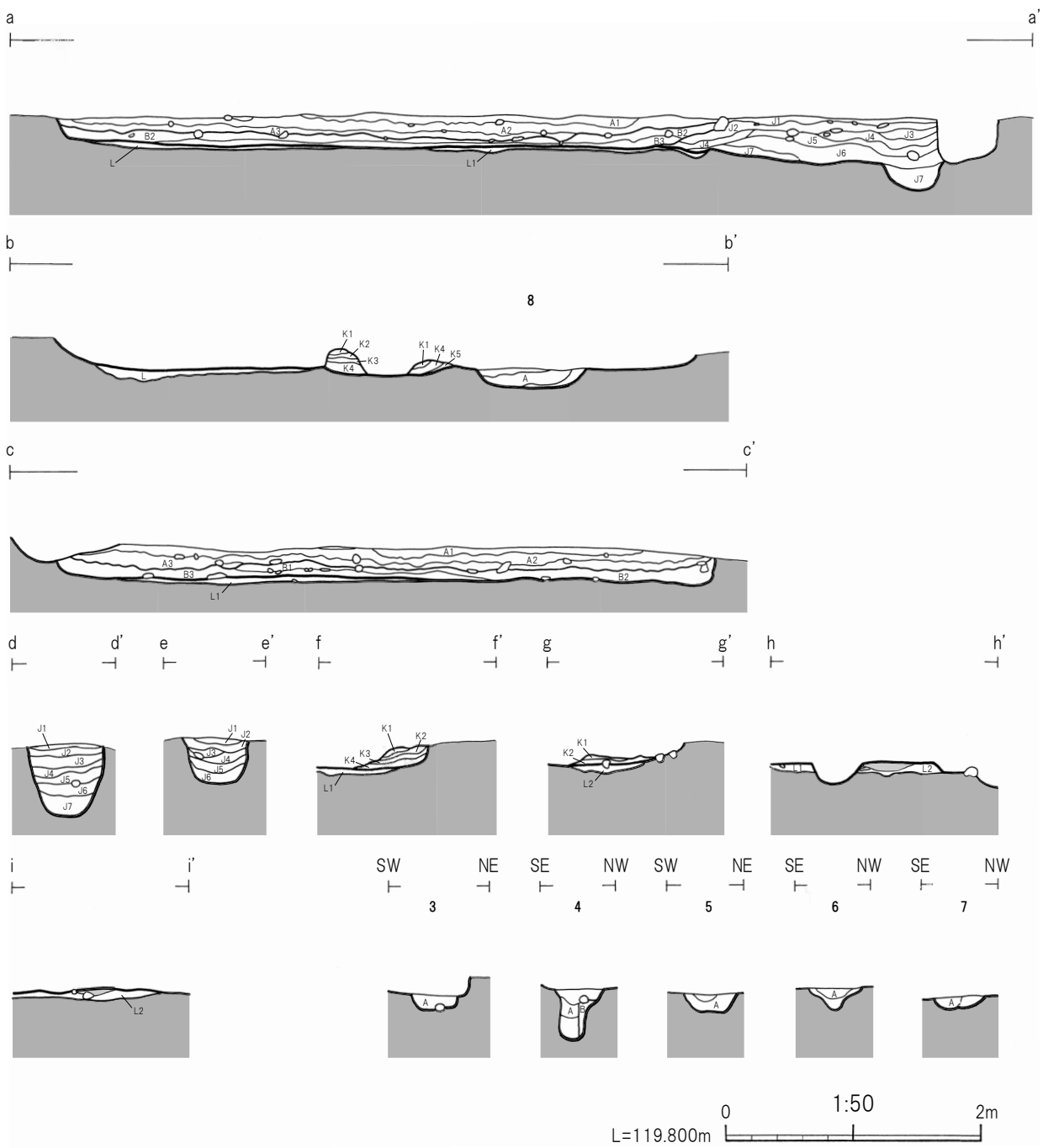

第32図 RA005竪穴建物跡(2)

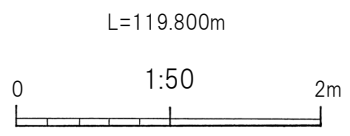
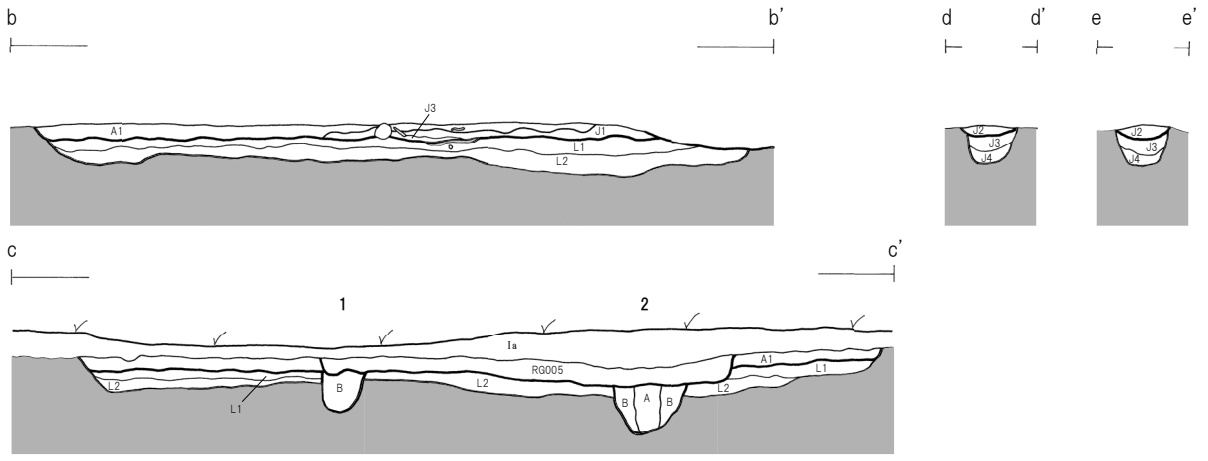
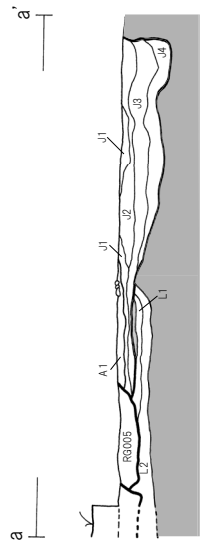
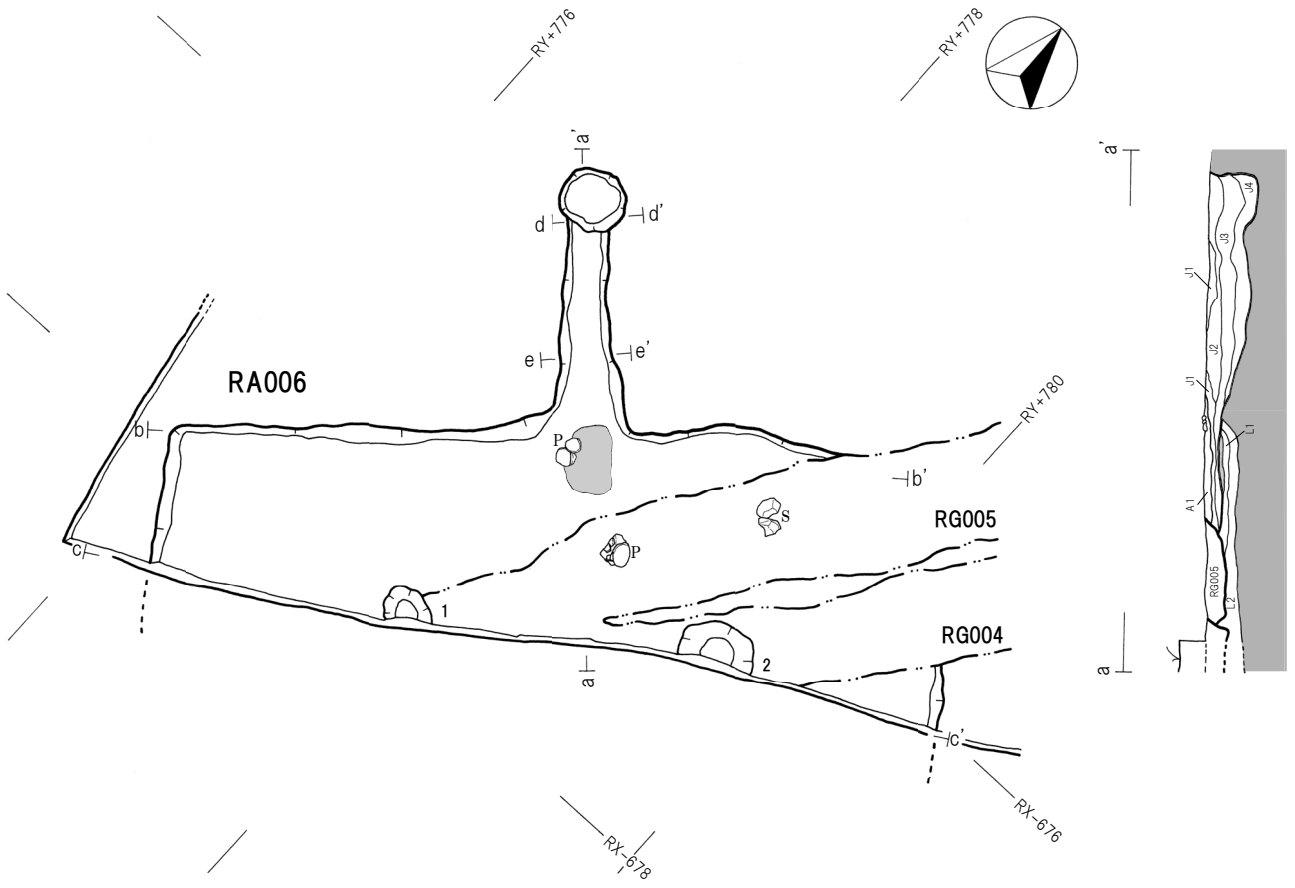

第33図 RA006竪穴建物跡

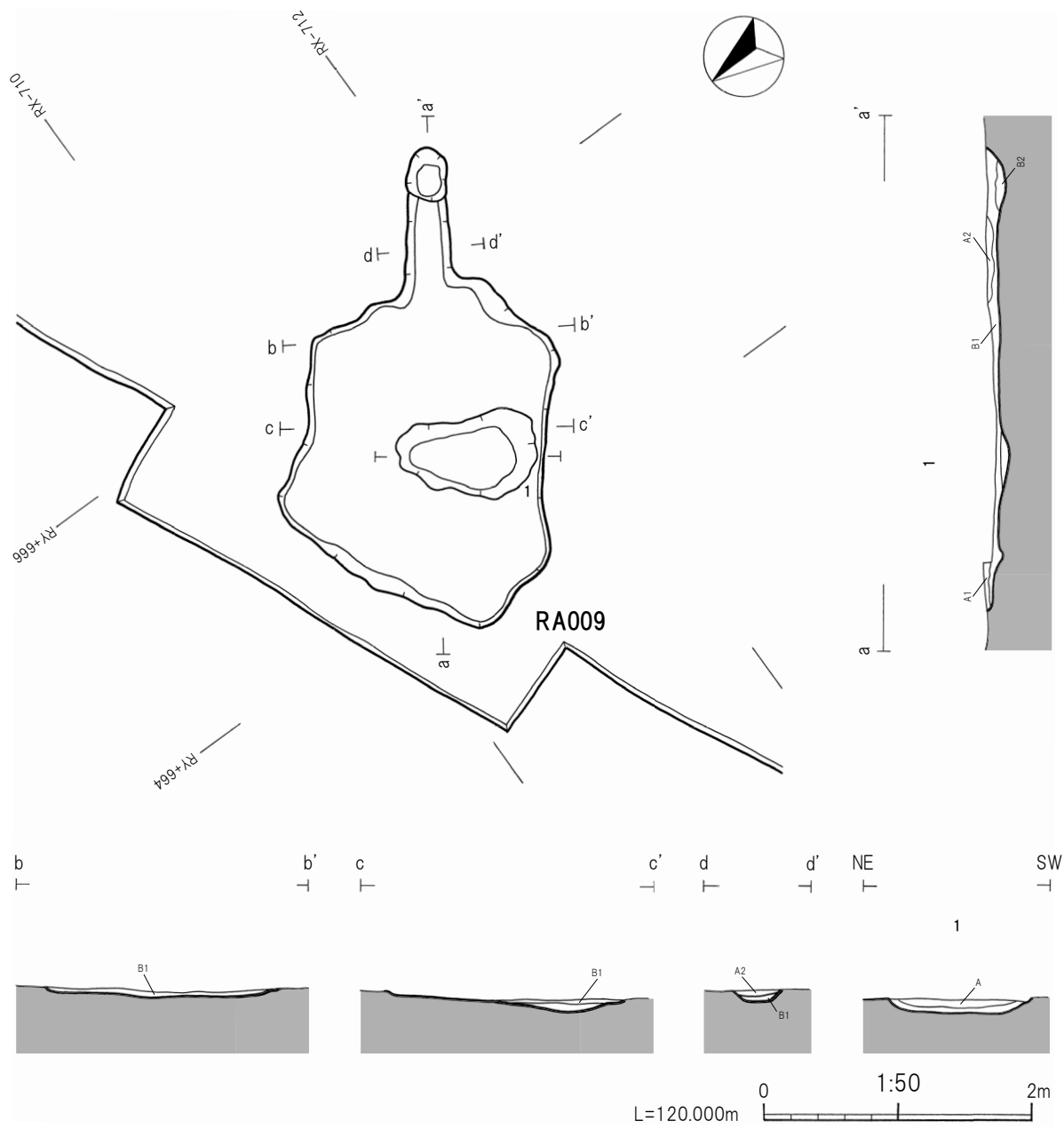

第34図 RA009竪穴建物跡

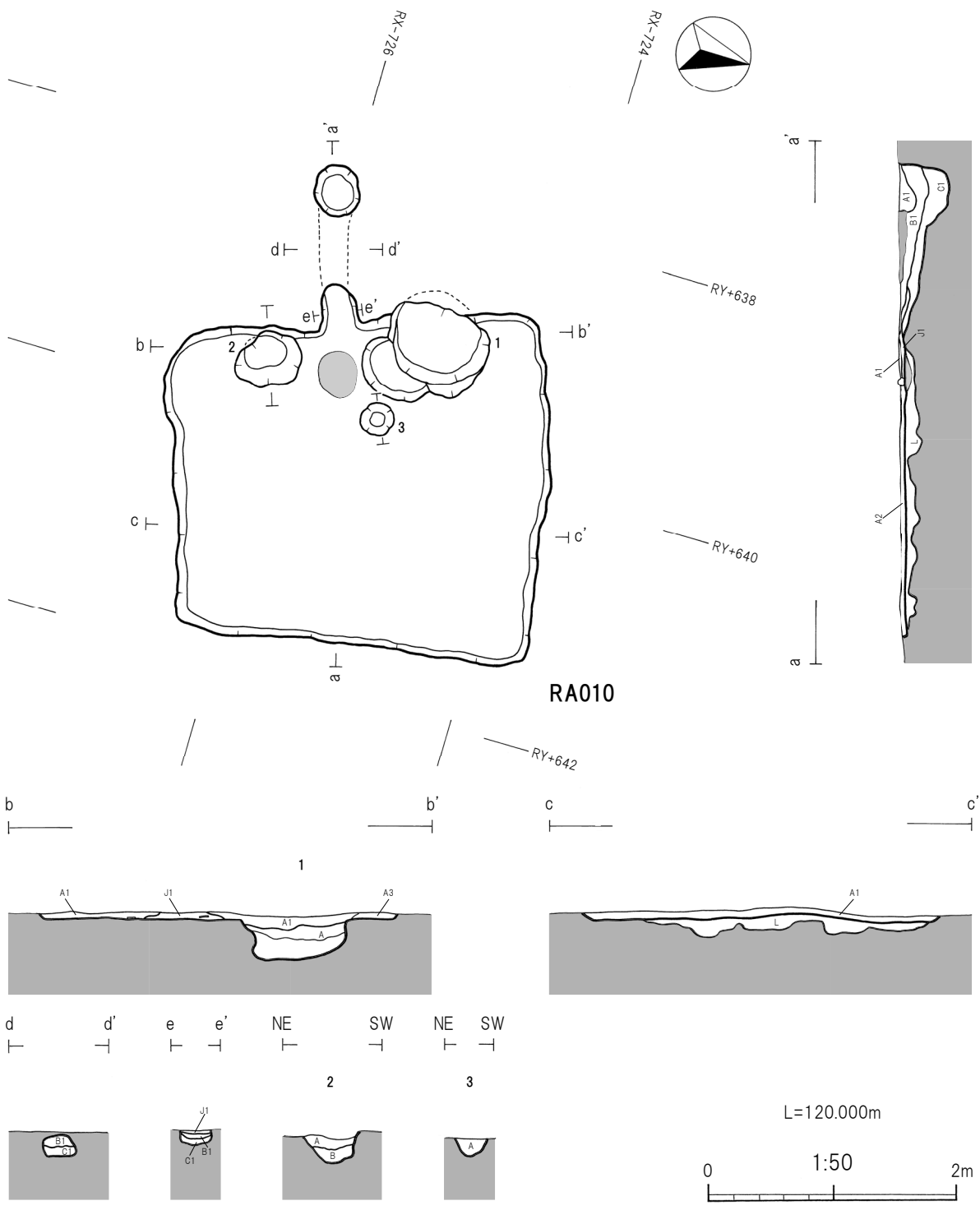

第35图 RA010竖穴建物跡

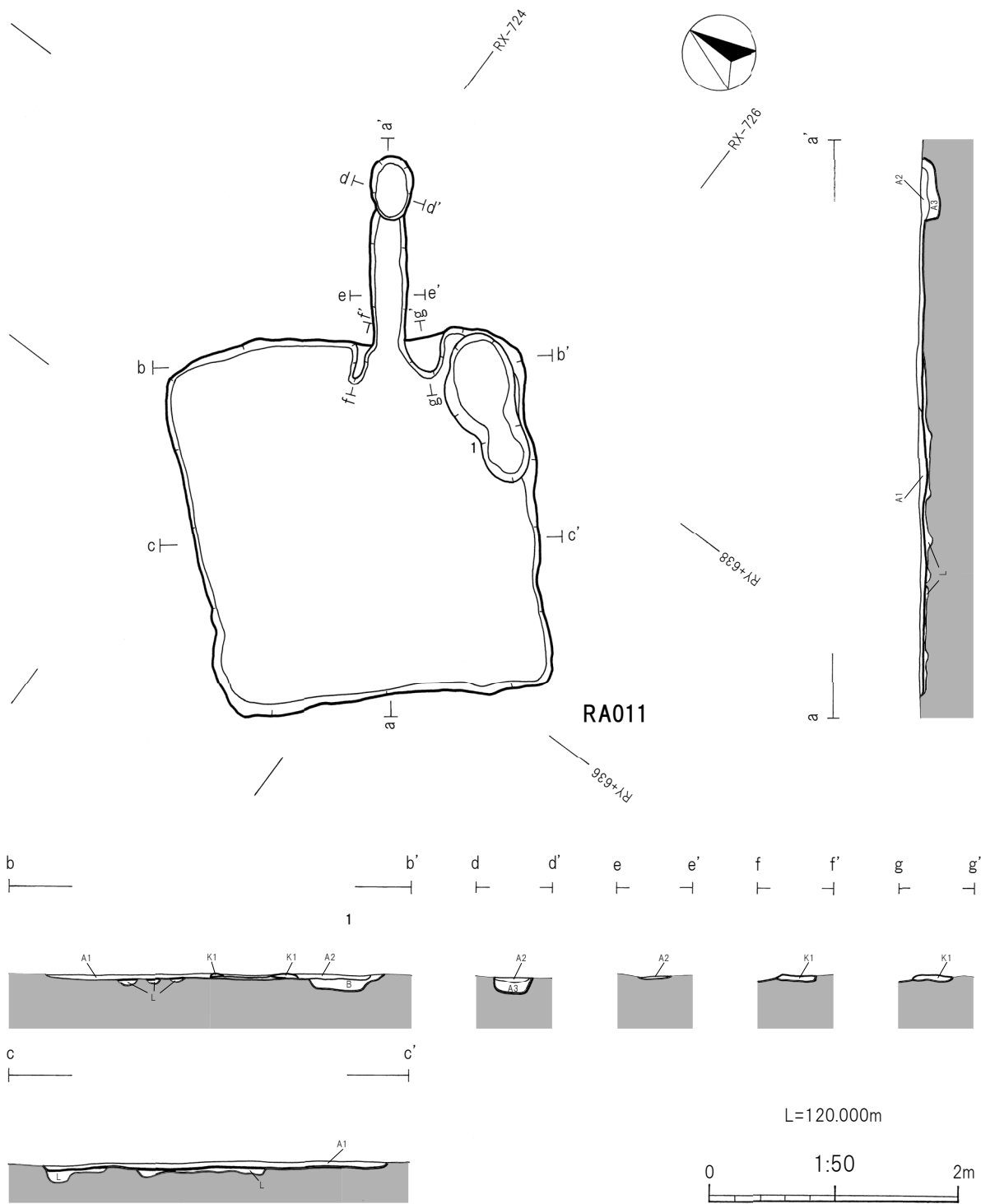

第36図 RA011豎穴建物跡

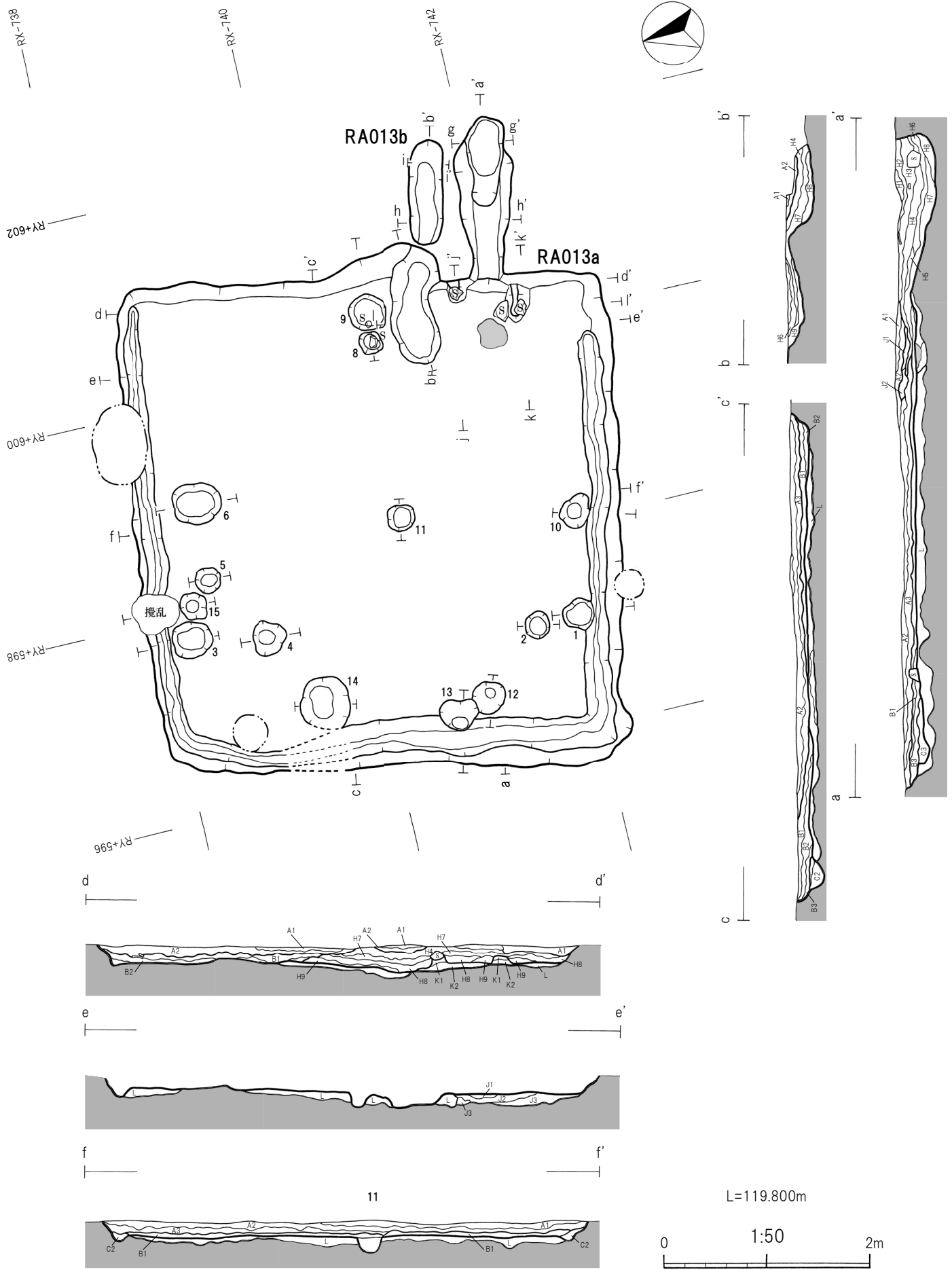

第38図 RA013竖穴建物跡(1)

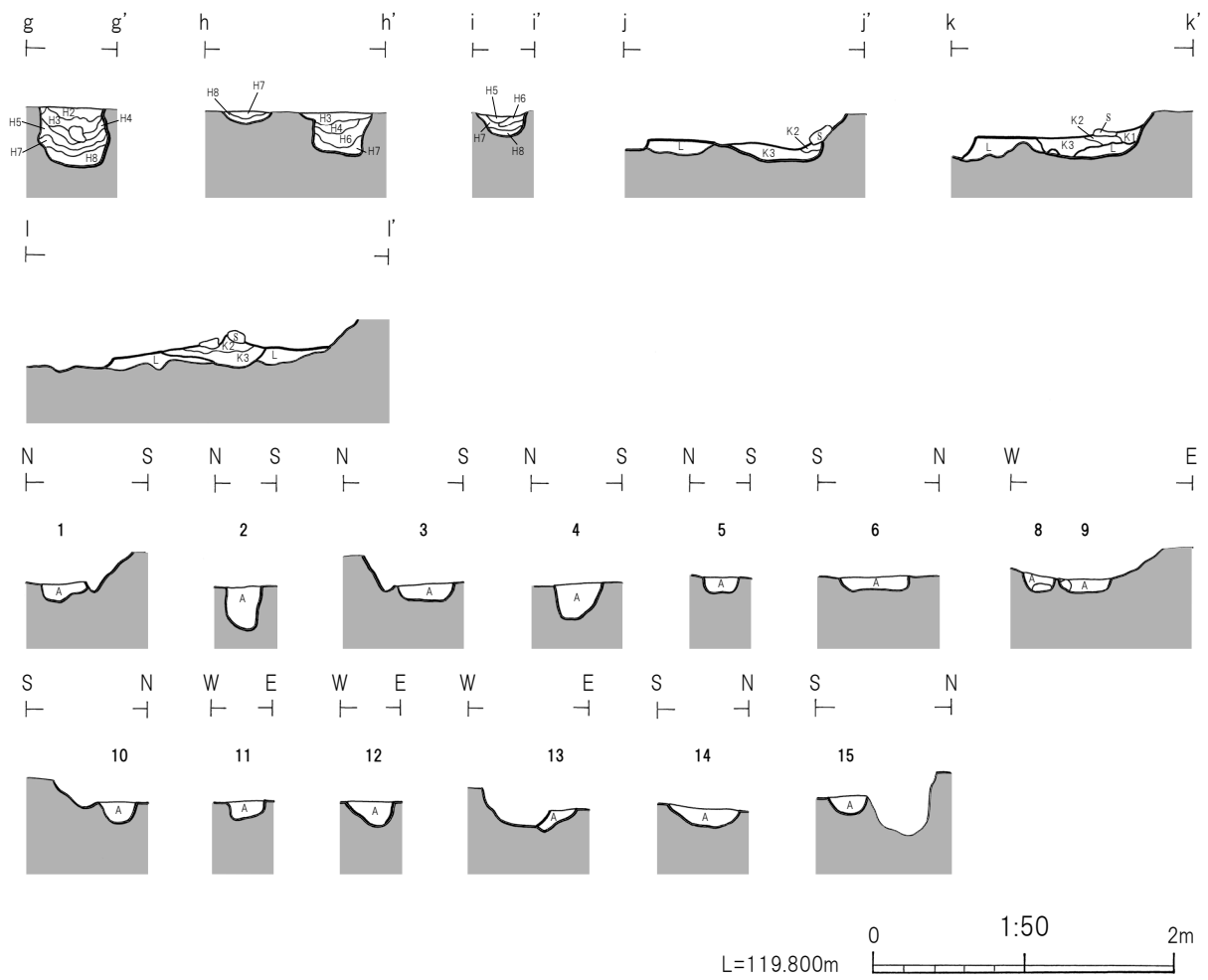

第39図 RA013竪穴建物跡(2)

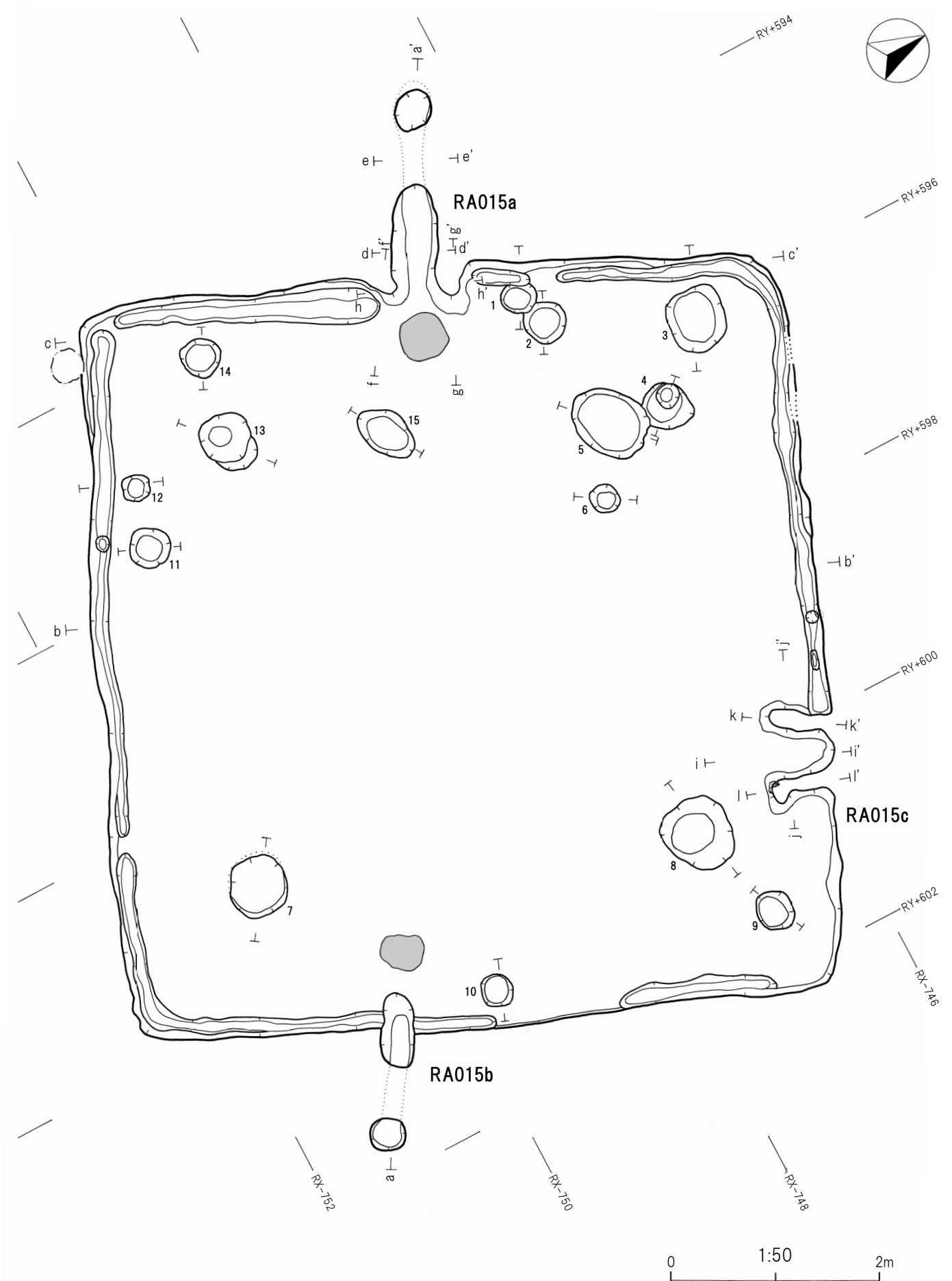

第41图 RA015竖穴建物跡(1)

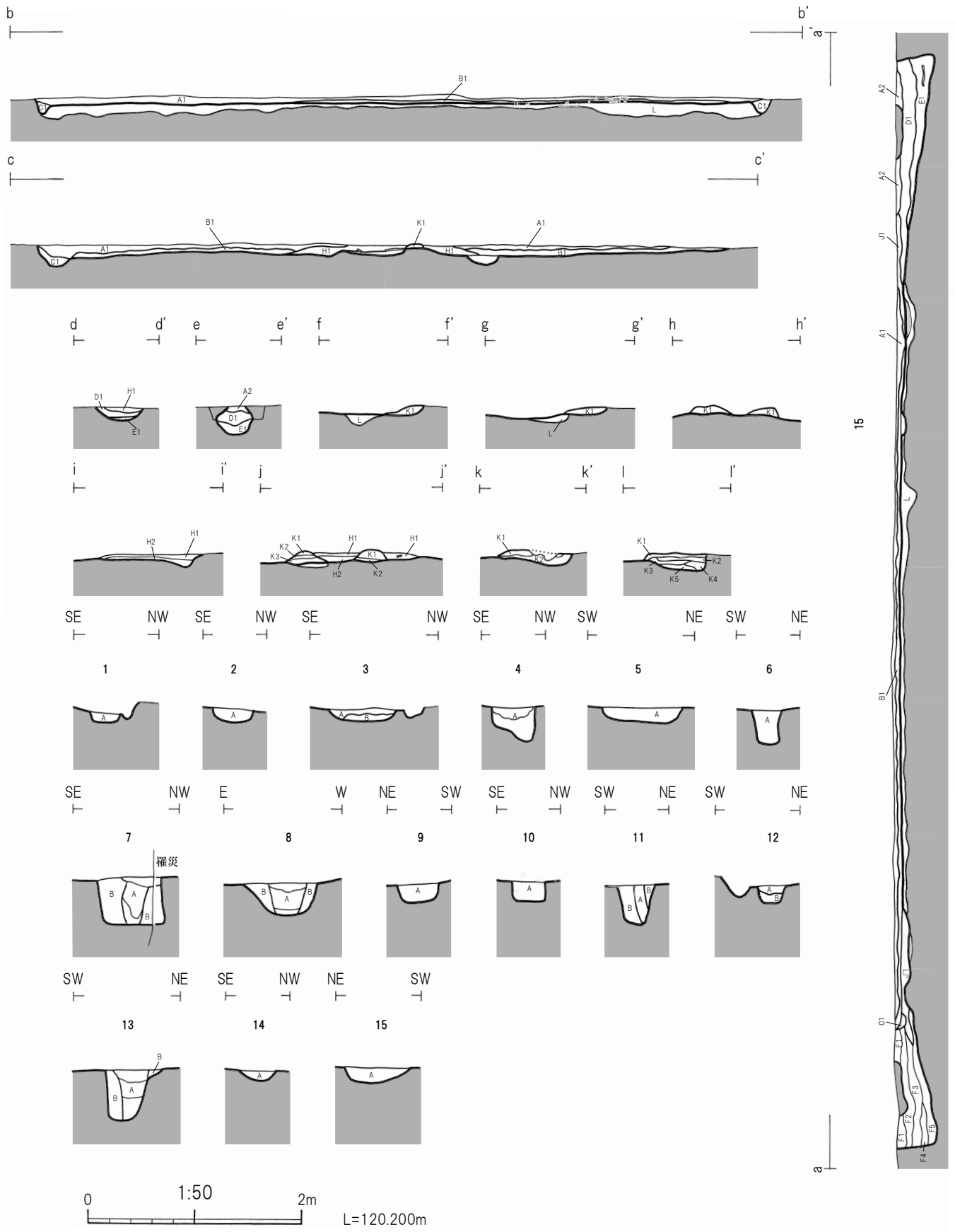

第42図 RA015竖穴建物跡(2)

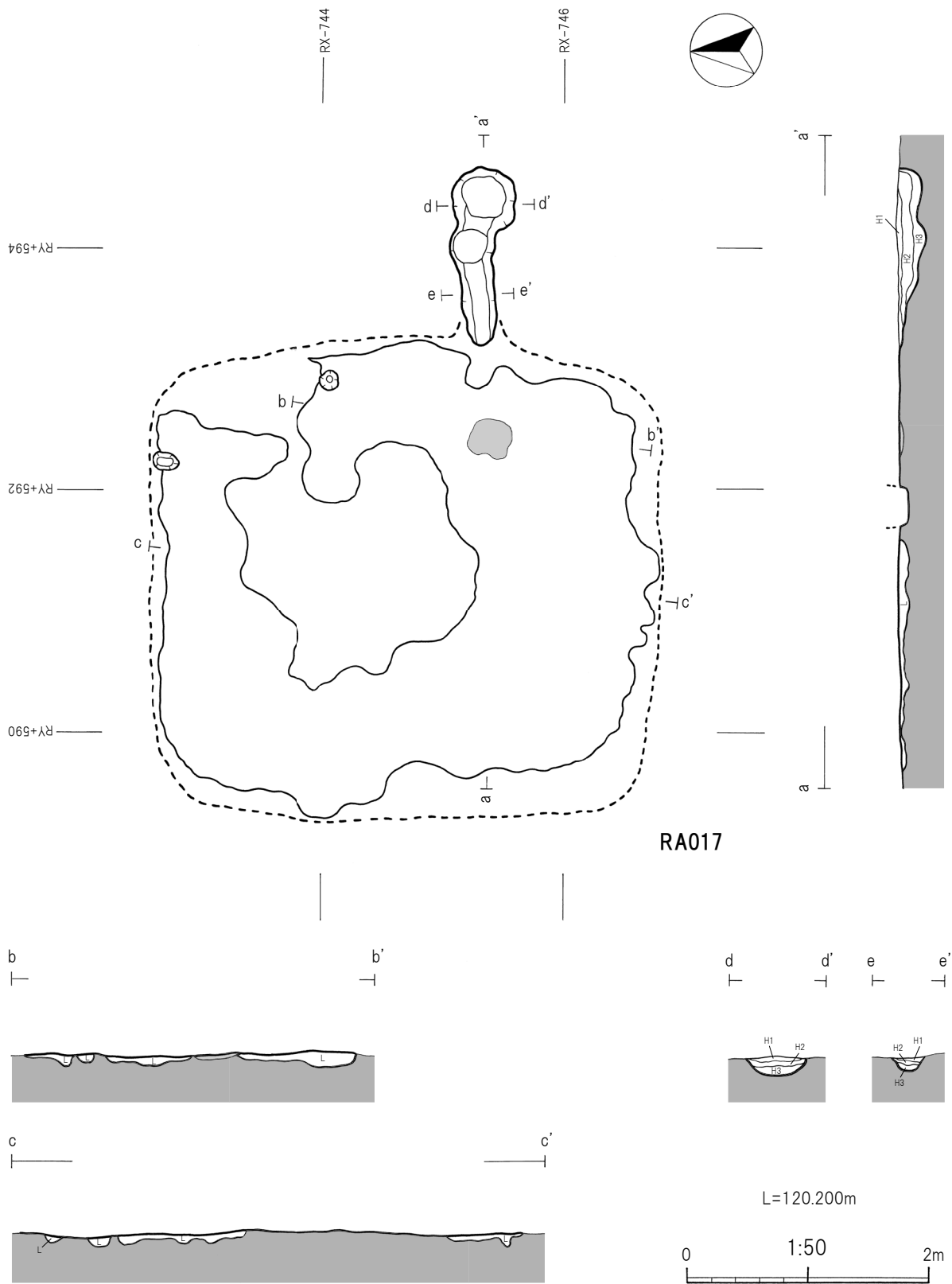

第43図 RA017竪穴建物跡

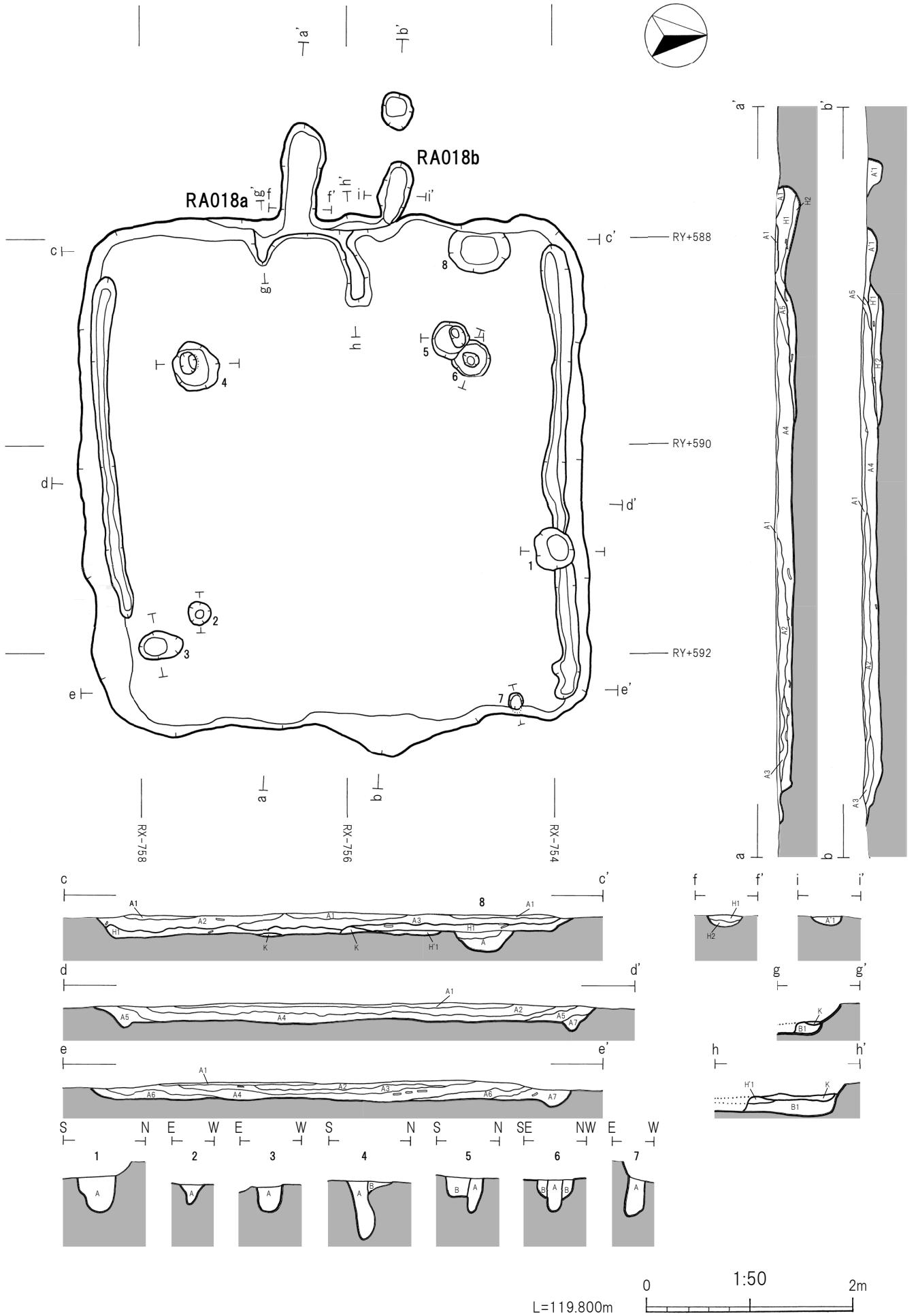

第44図 RA018竖穴建物跡(1)

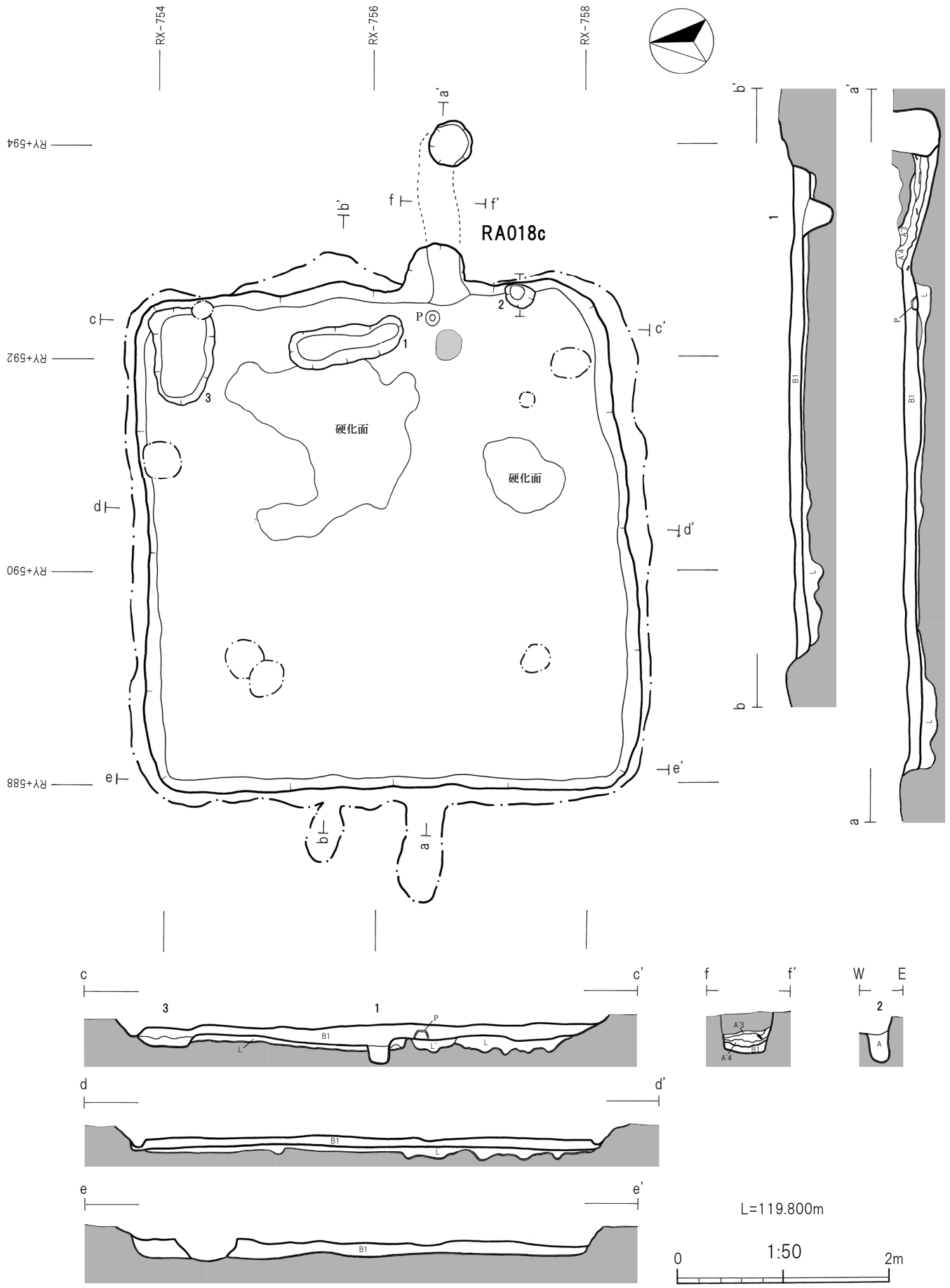

第45図 RA018竪穴建物跡(2)

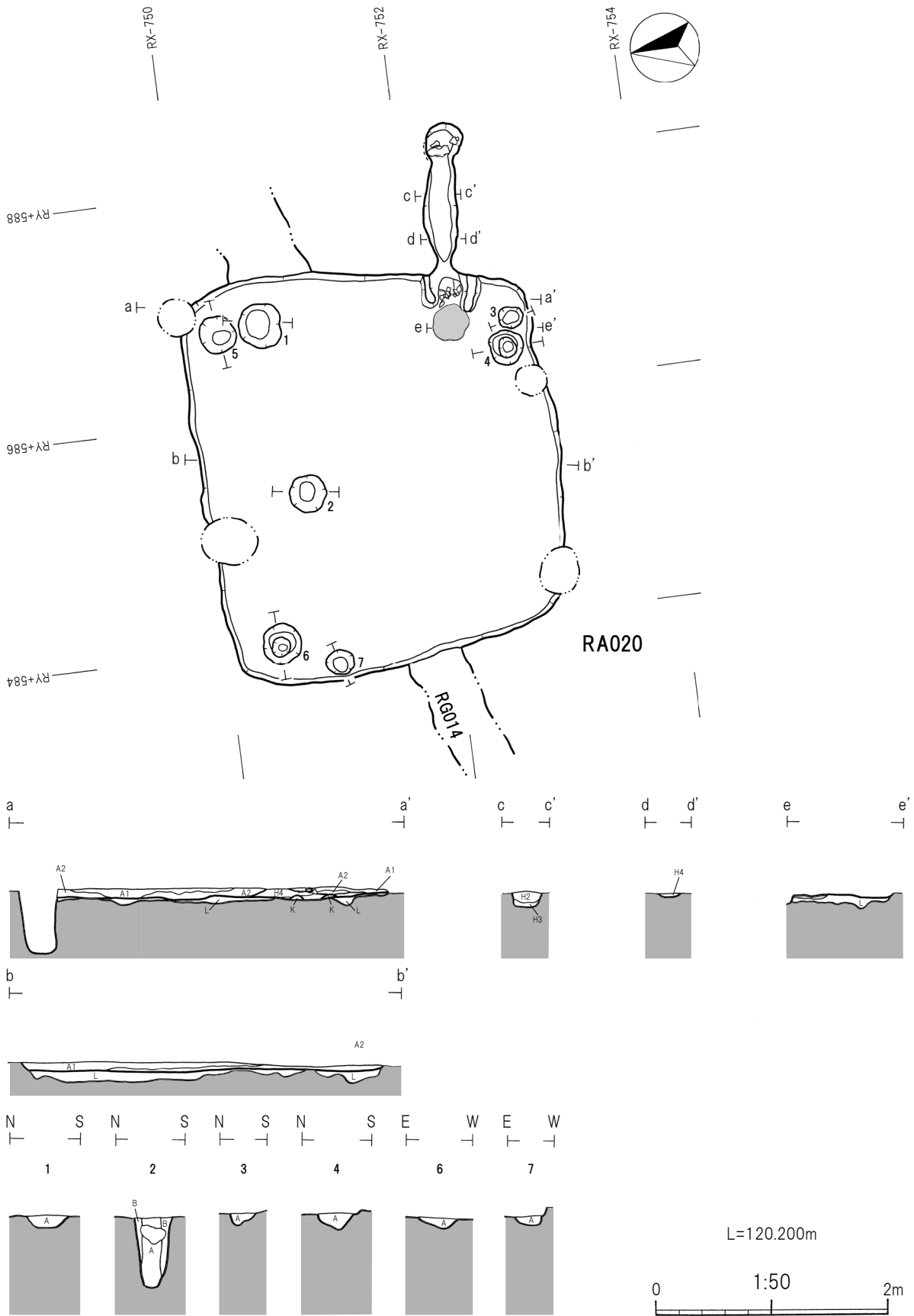

第46図 RA020竪穴建物跡

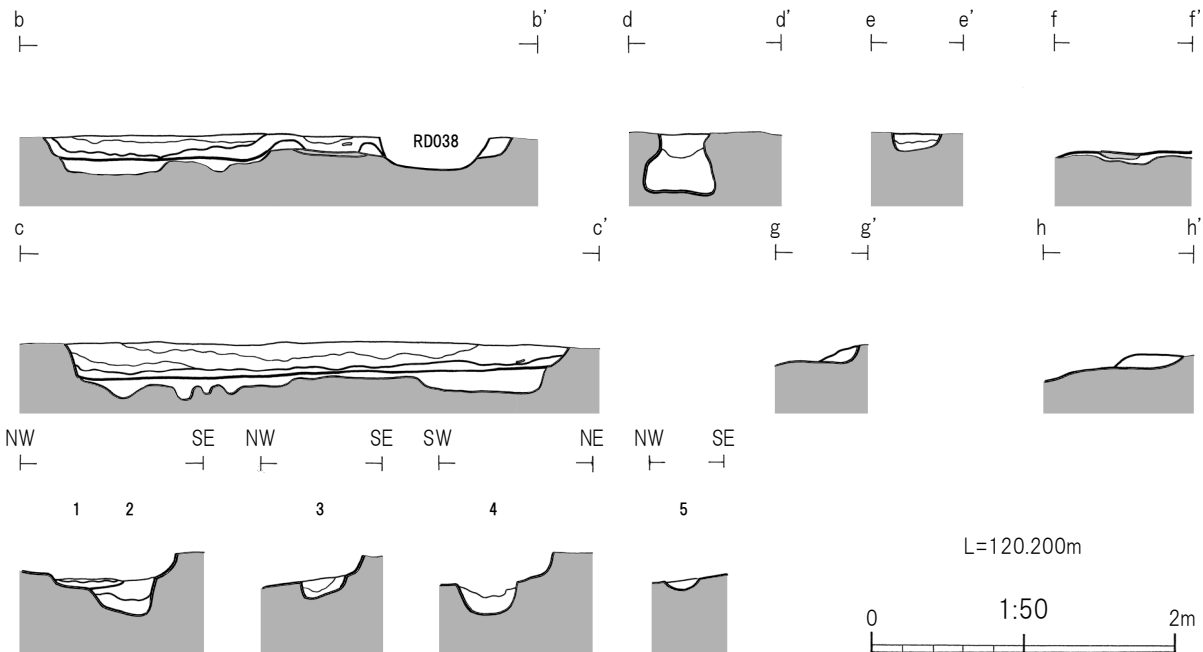
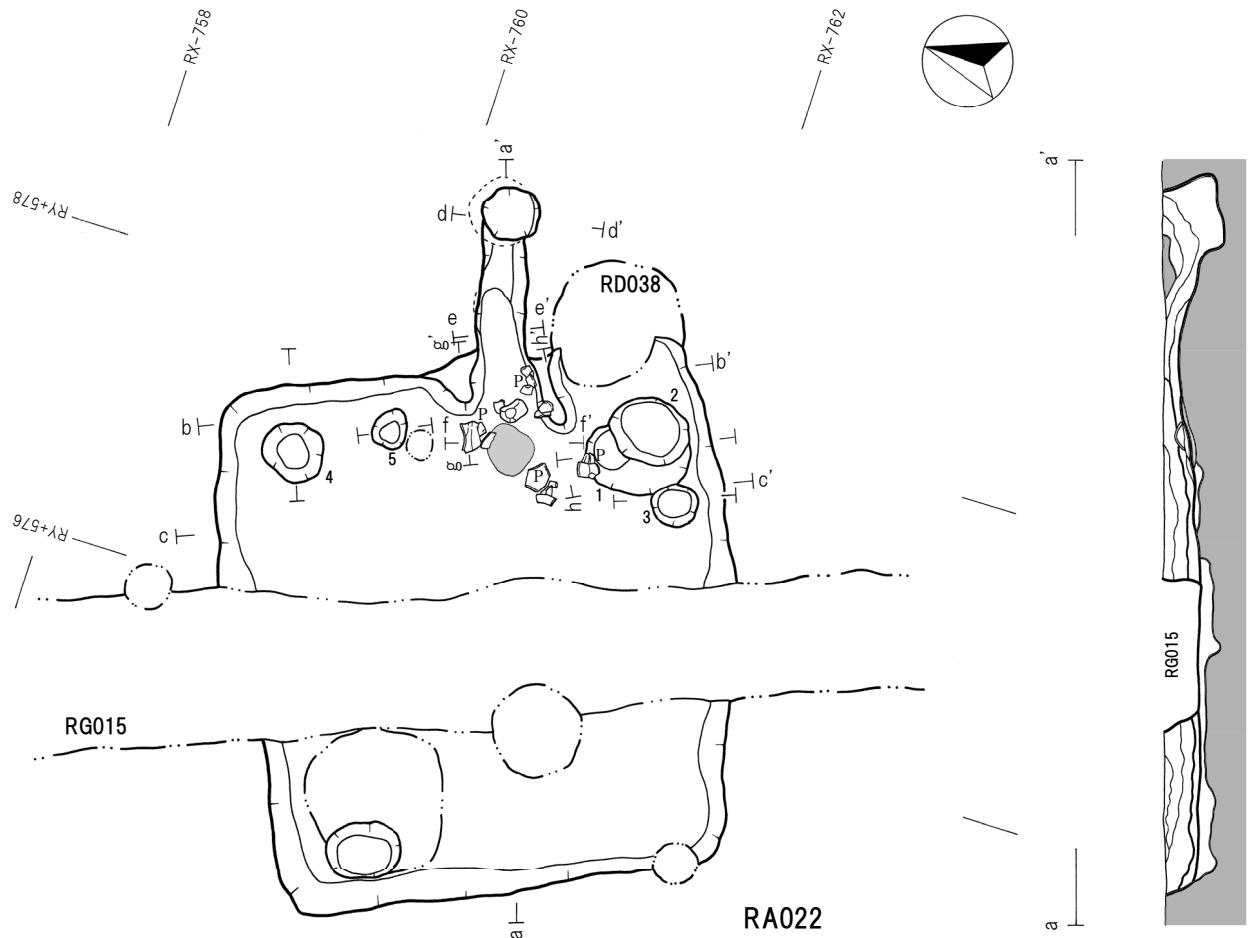

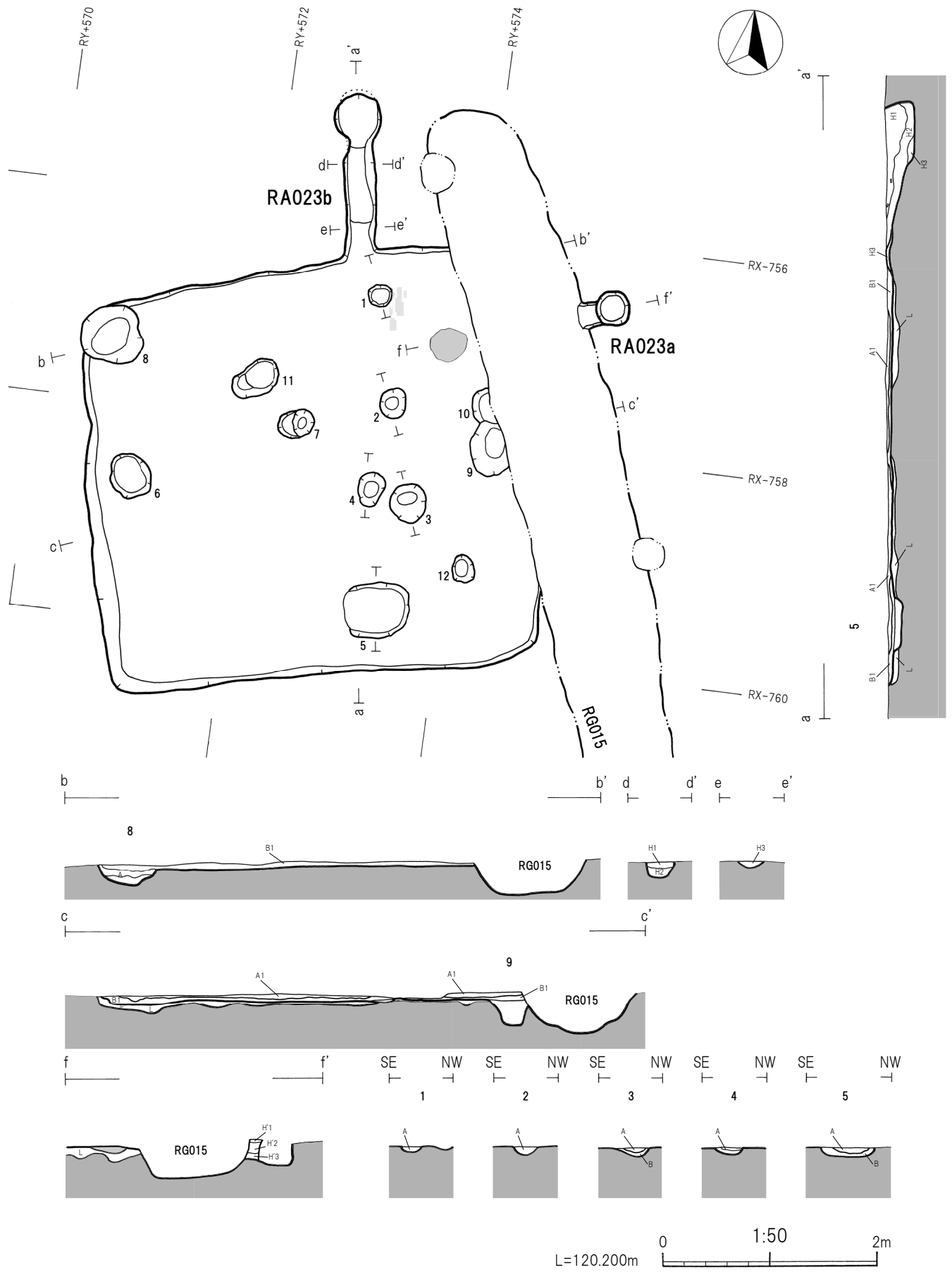

第48図 RA023竖穴建物跡

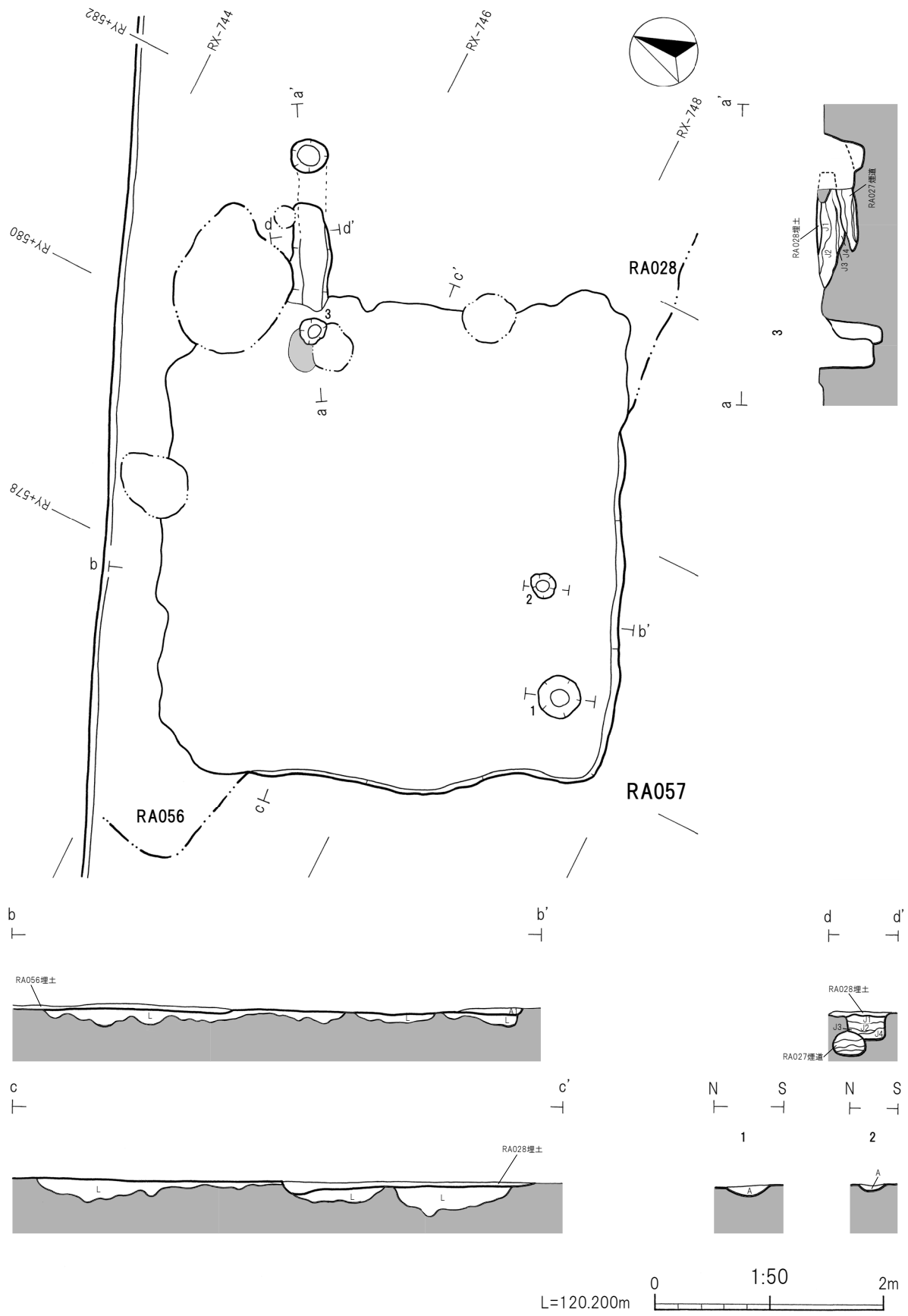

第49図 RA057竪穴建物跡

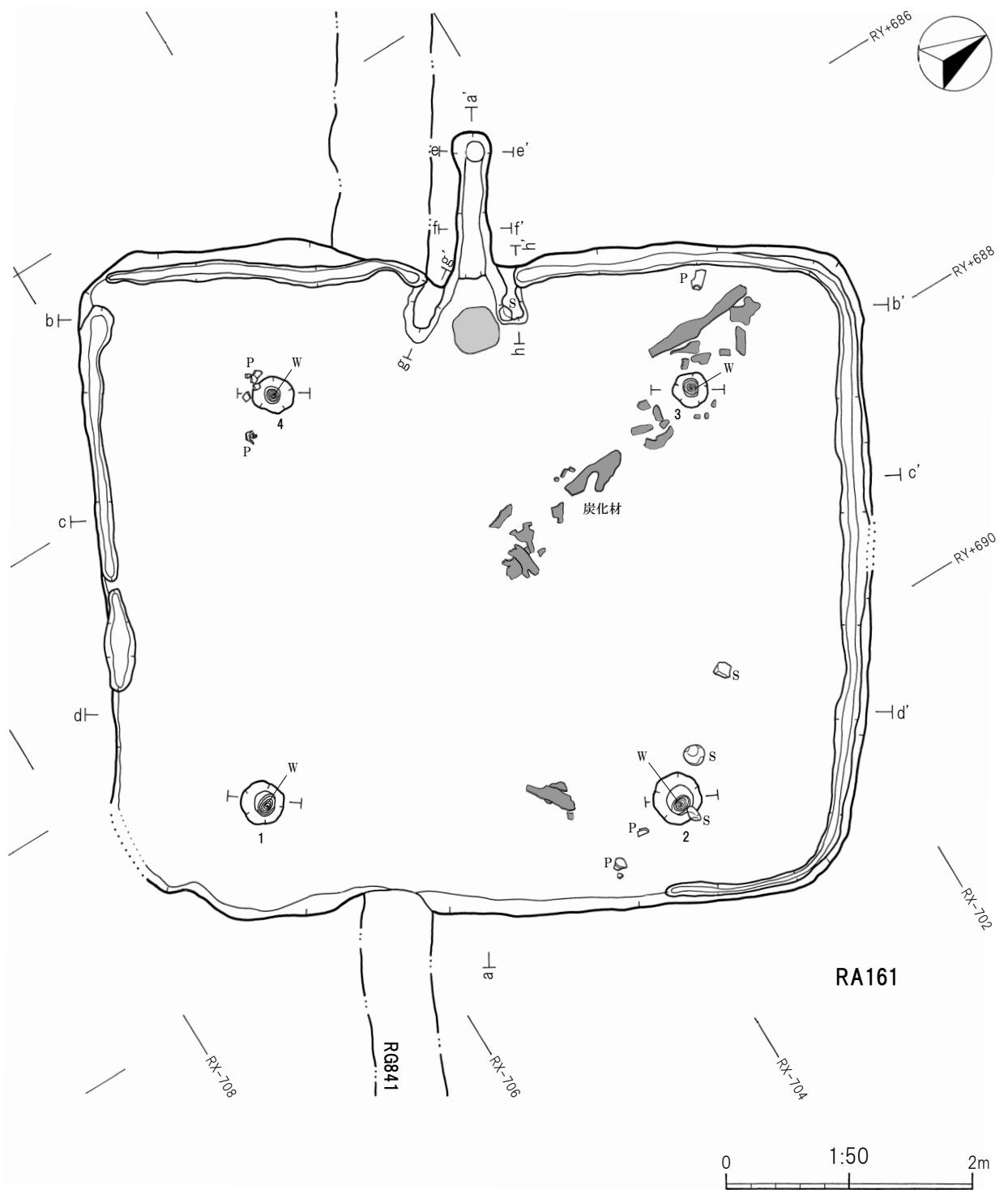

第50図 RA161竪穴建物跡(1)

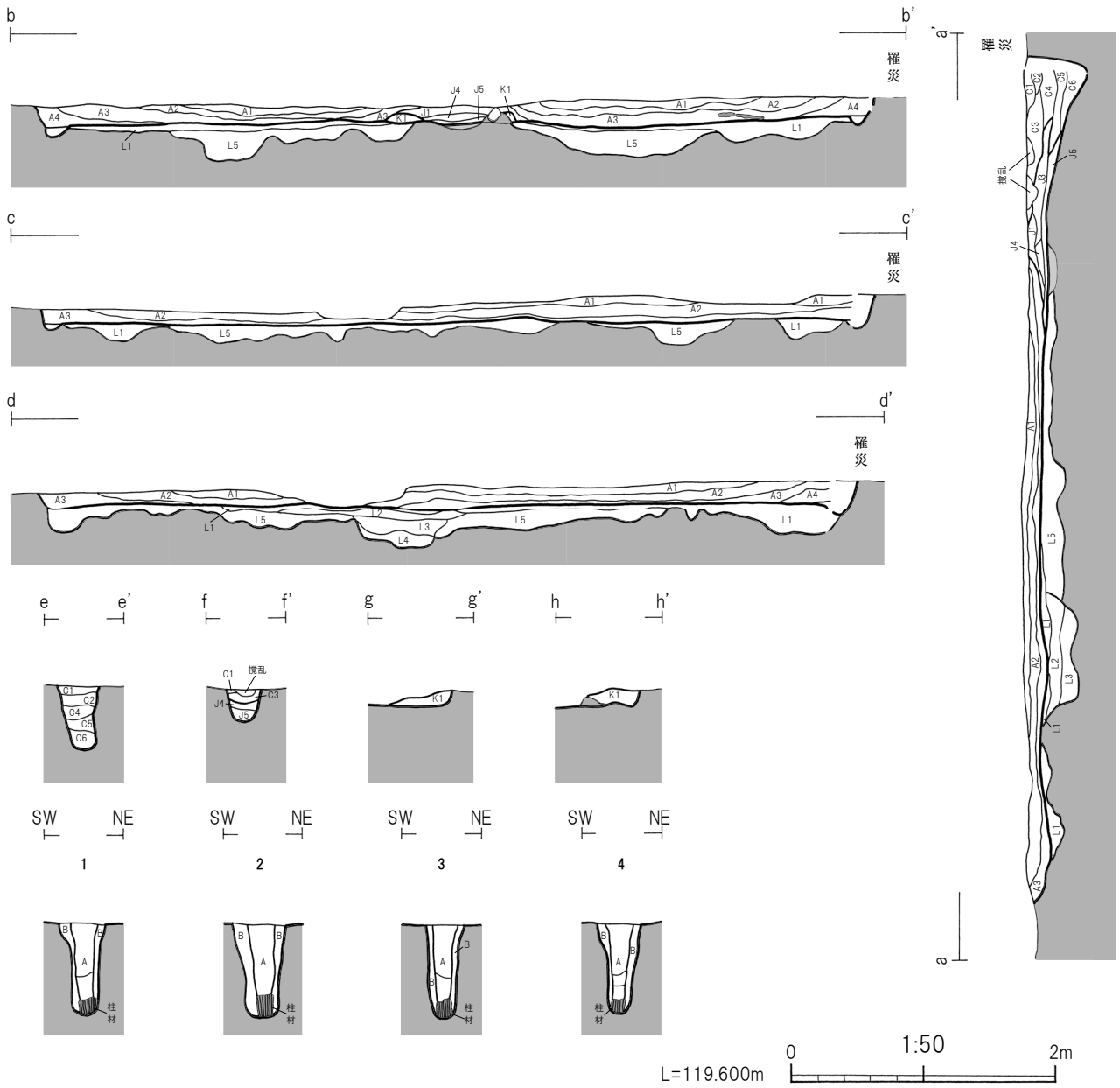

第51図 RA161竪穴建物跡(2)

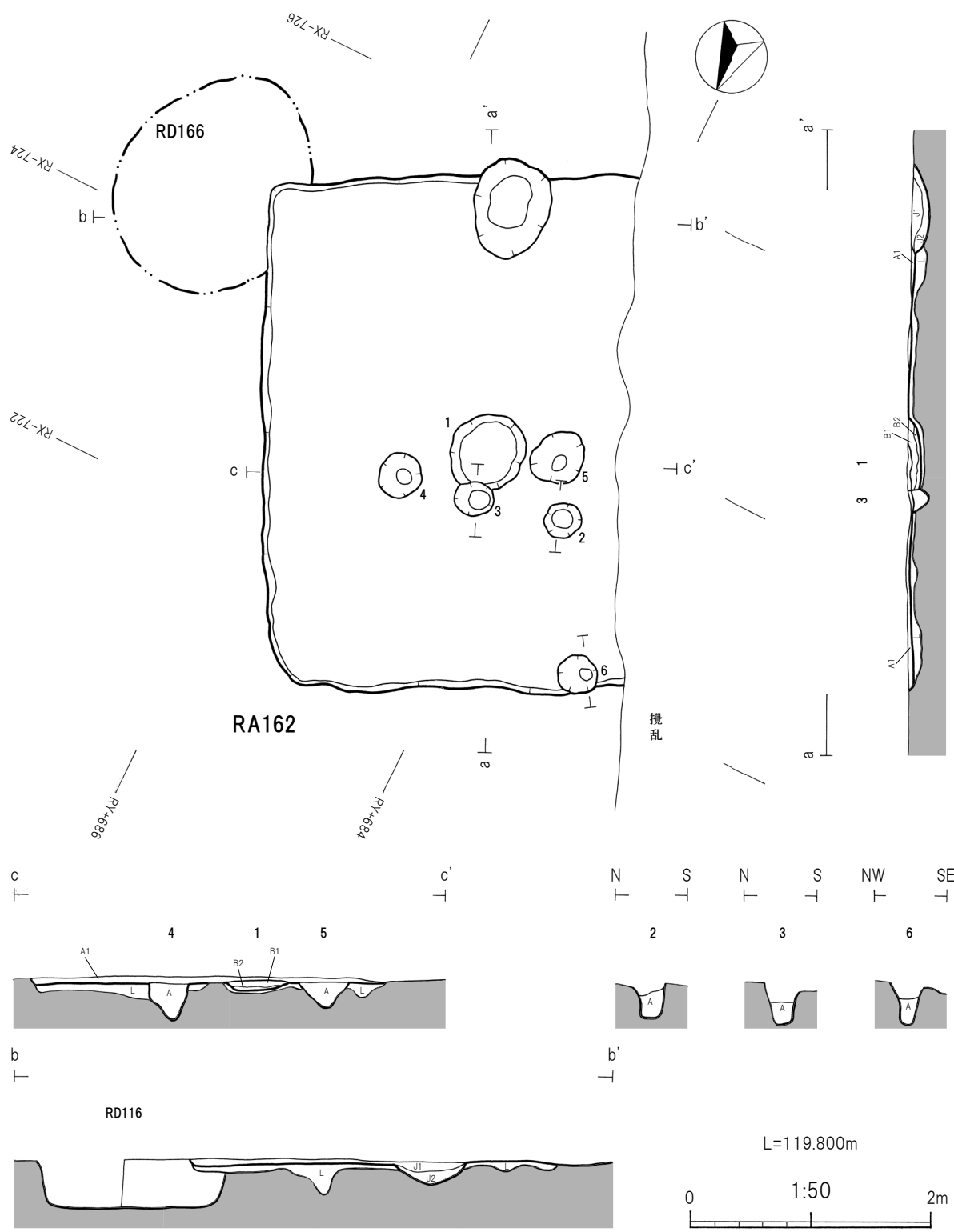

第52図 RA162竪穴建物跡

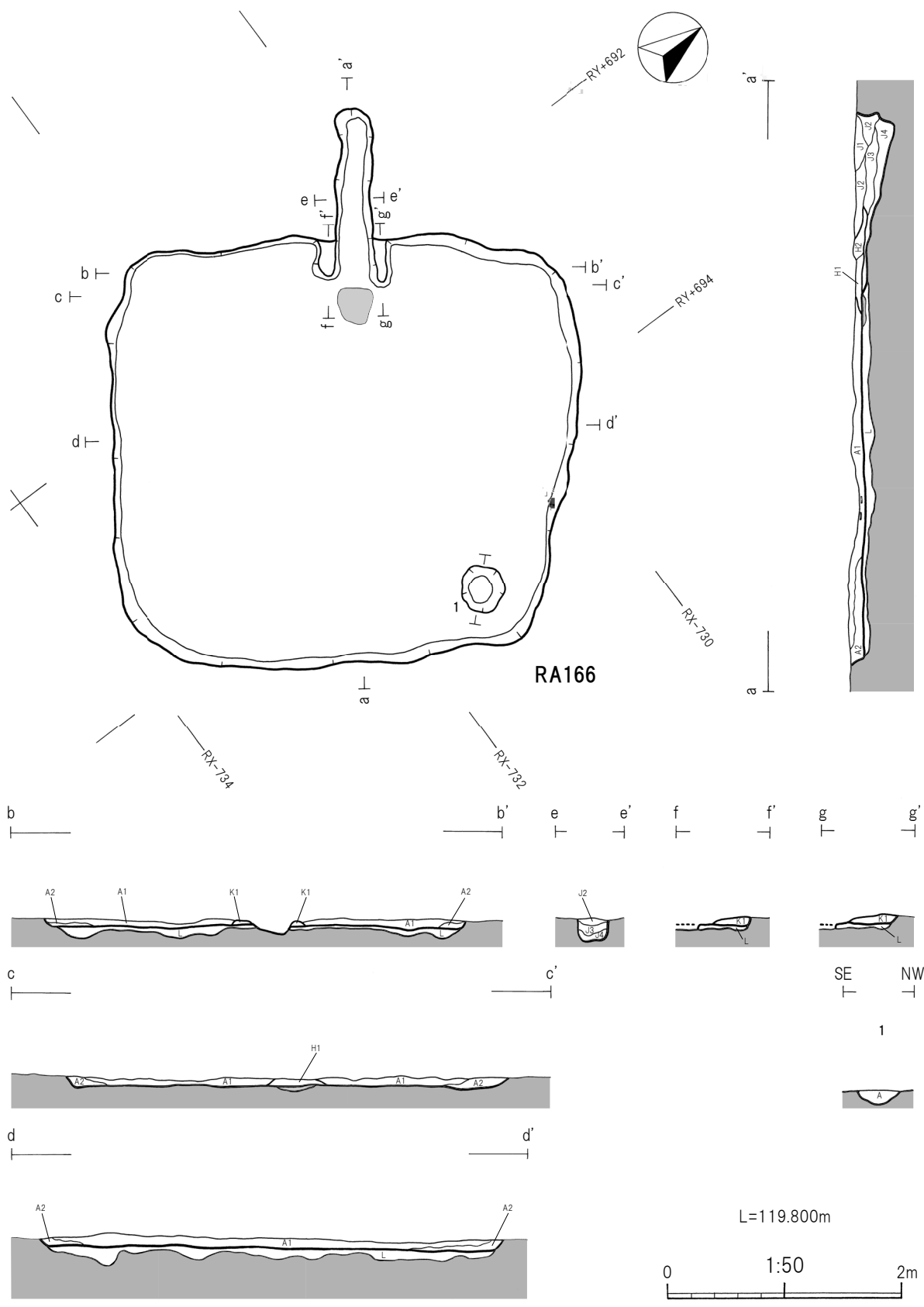

第54図 RA166竪穴建物跡

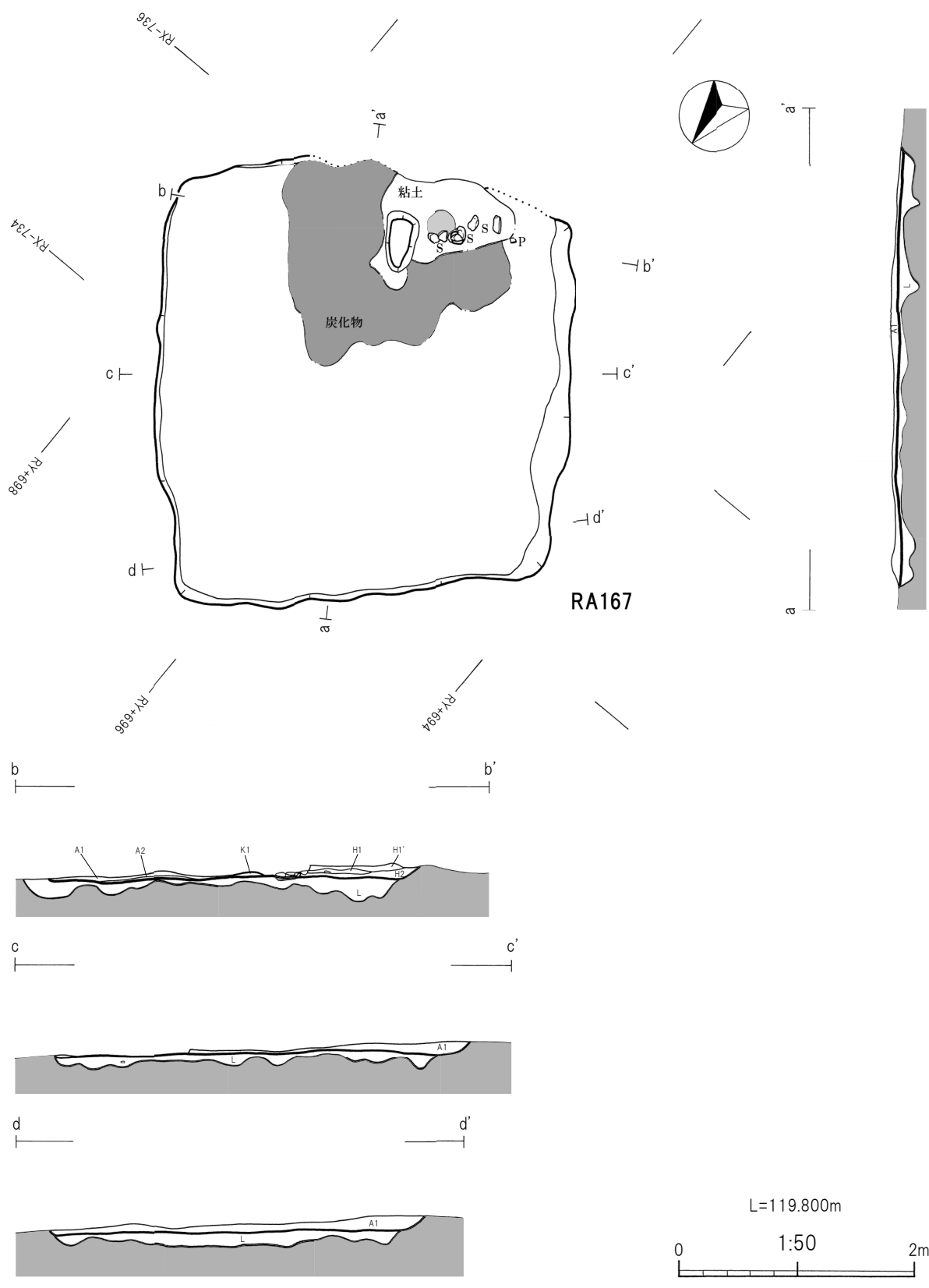

第55図 RA167竪穴建物跡

RX-694

RX-698

ba

RX-736



ba

RA168b

RA168a

RX-738

RX-740

RX-694

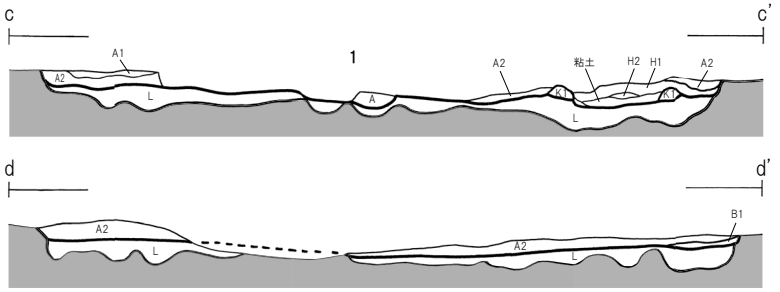
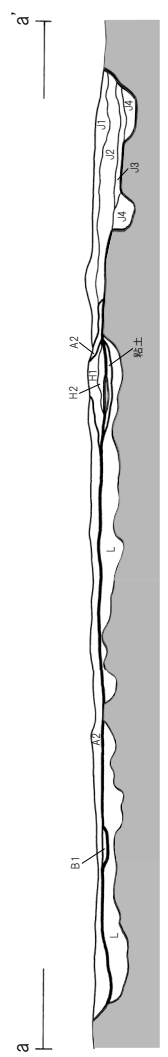
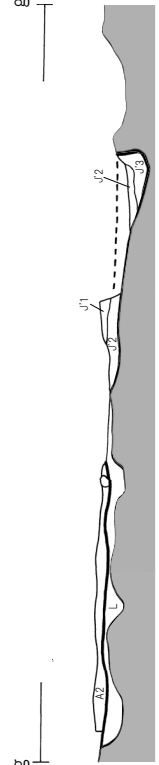
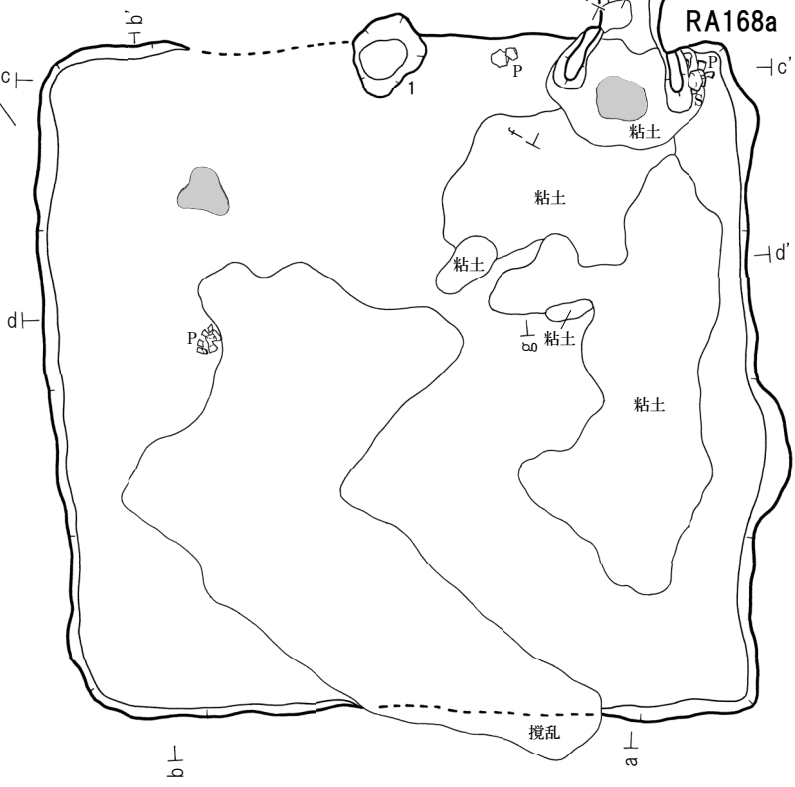

e e' f f' h h'

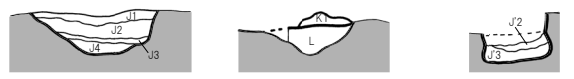

L=119.400m

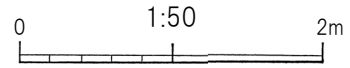

第56图 RA168竖穴建物跡

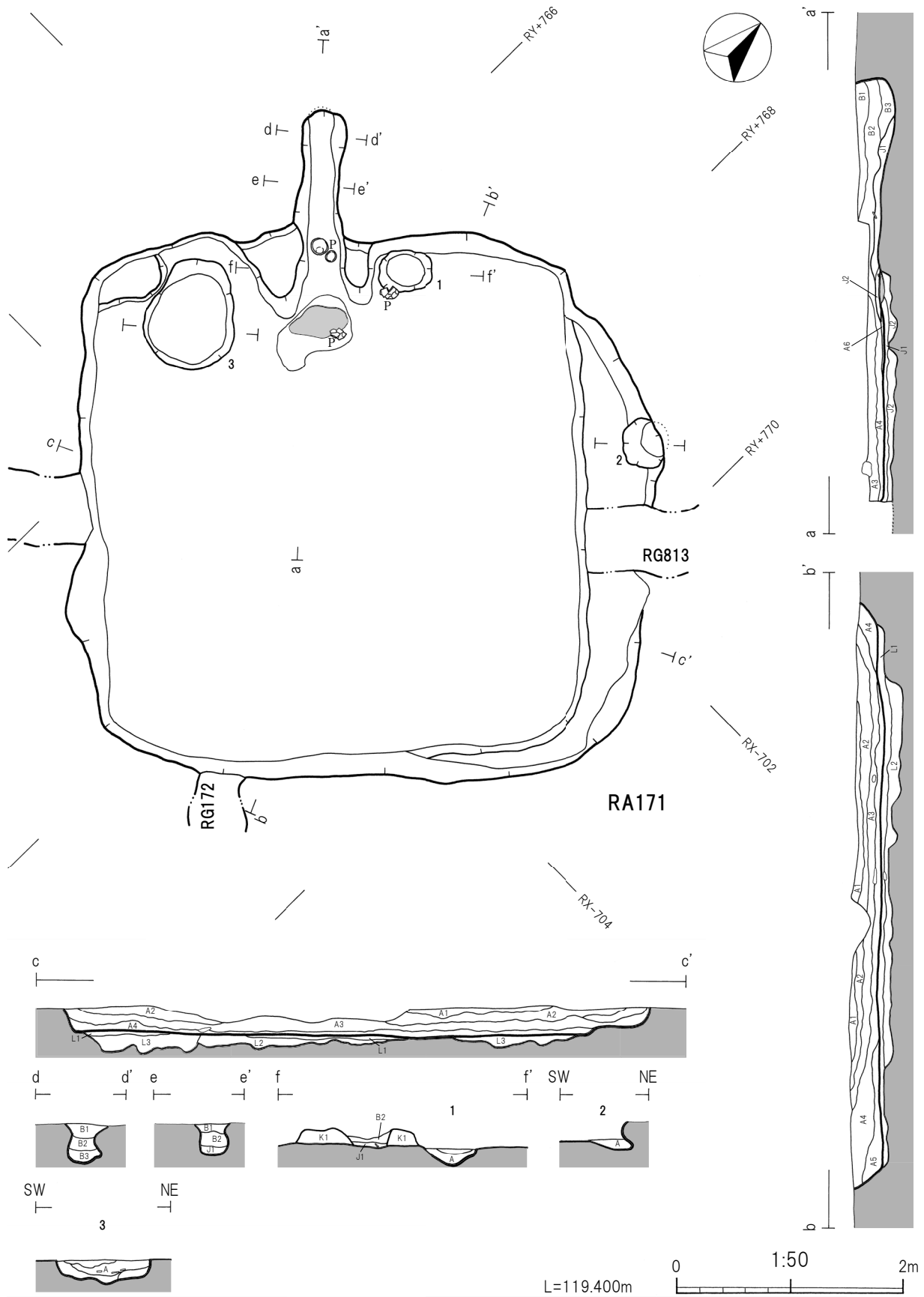

第57図 RA171豎穴建物跡

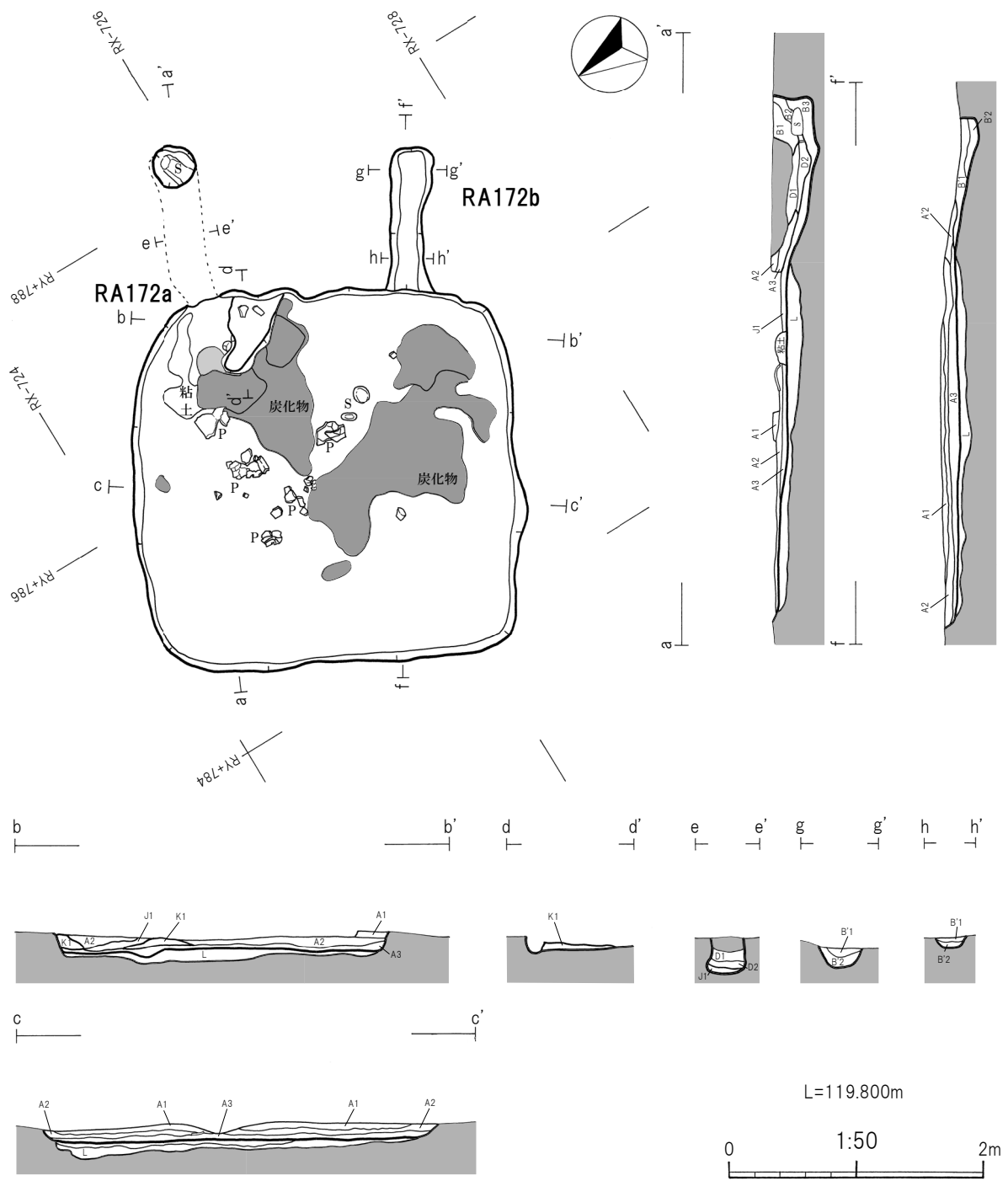

第58図 RA172竖穴建物跡

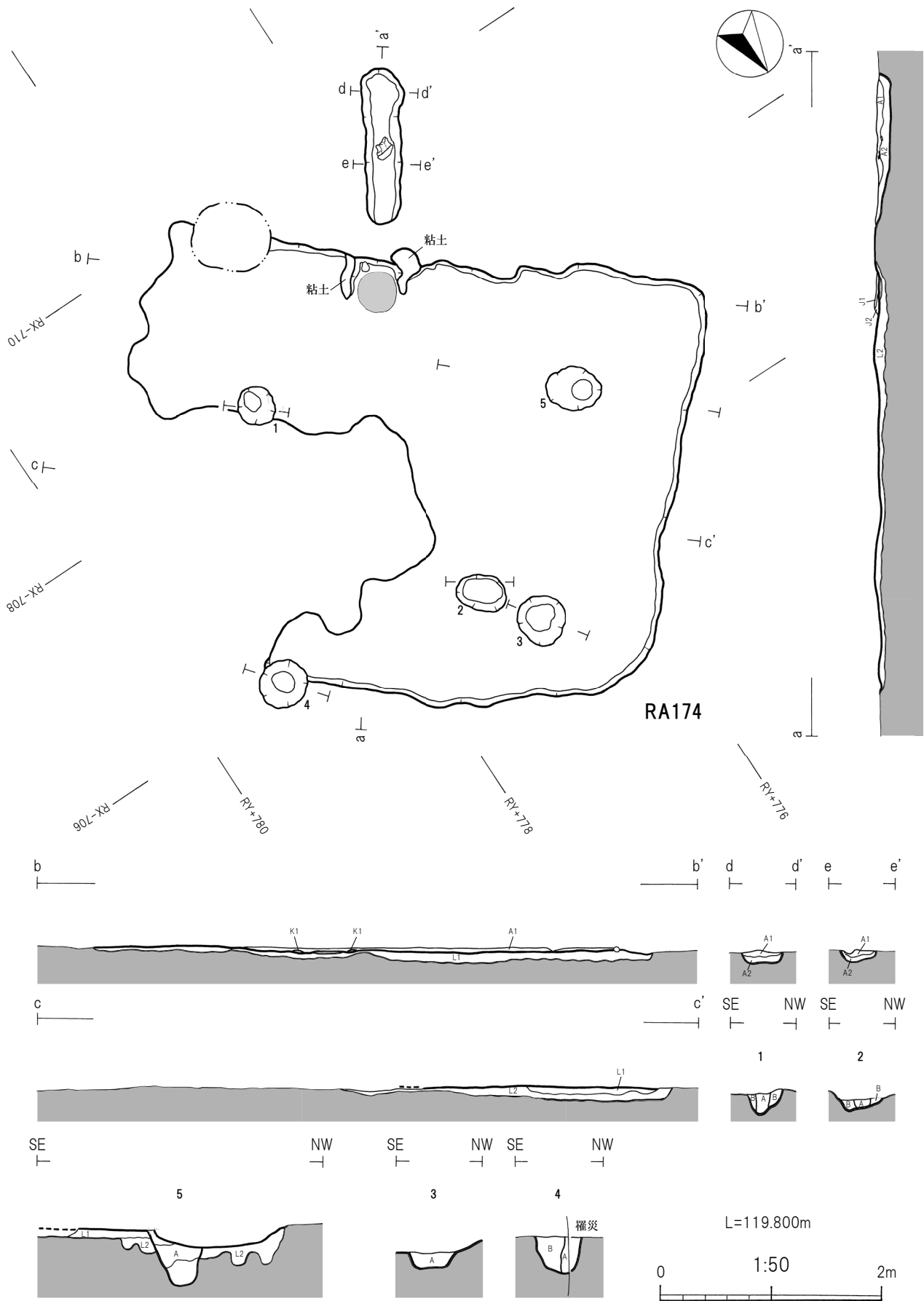

第59図 RA174竪穴建物跡

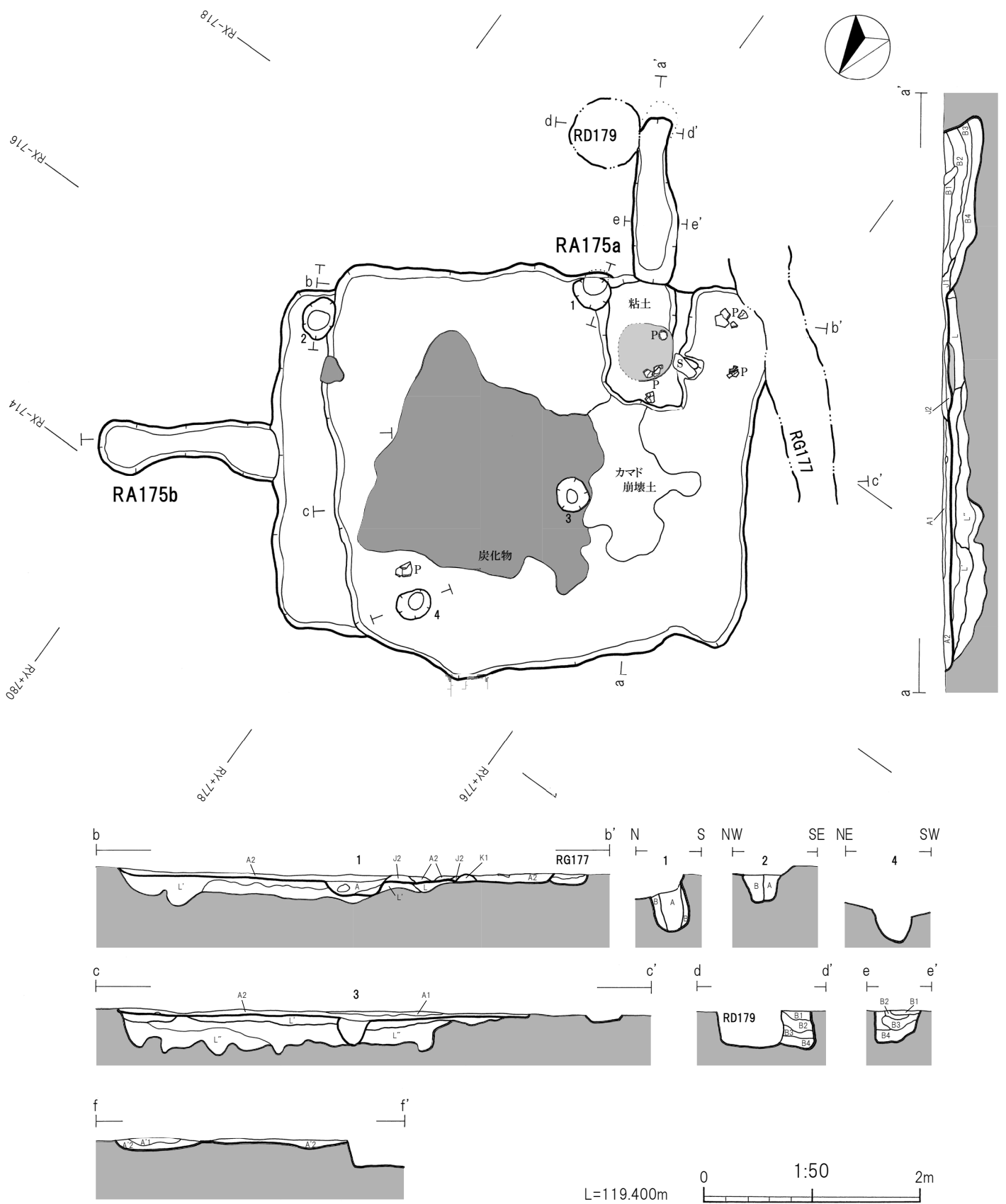

第60図 RA175竪穴建物跡

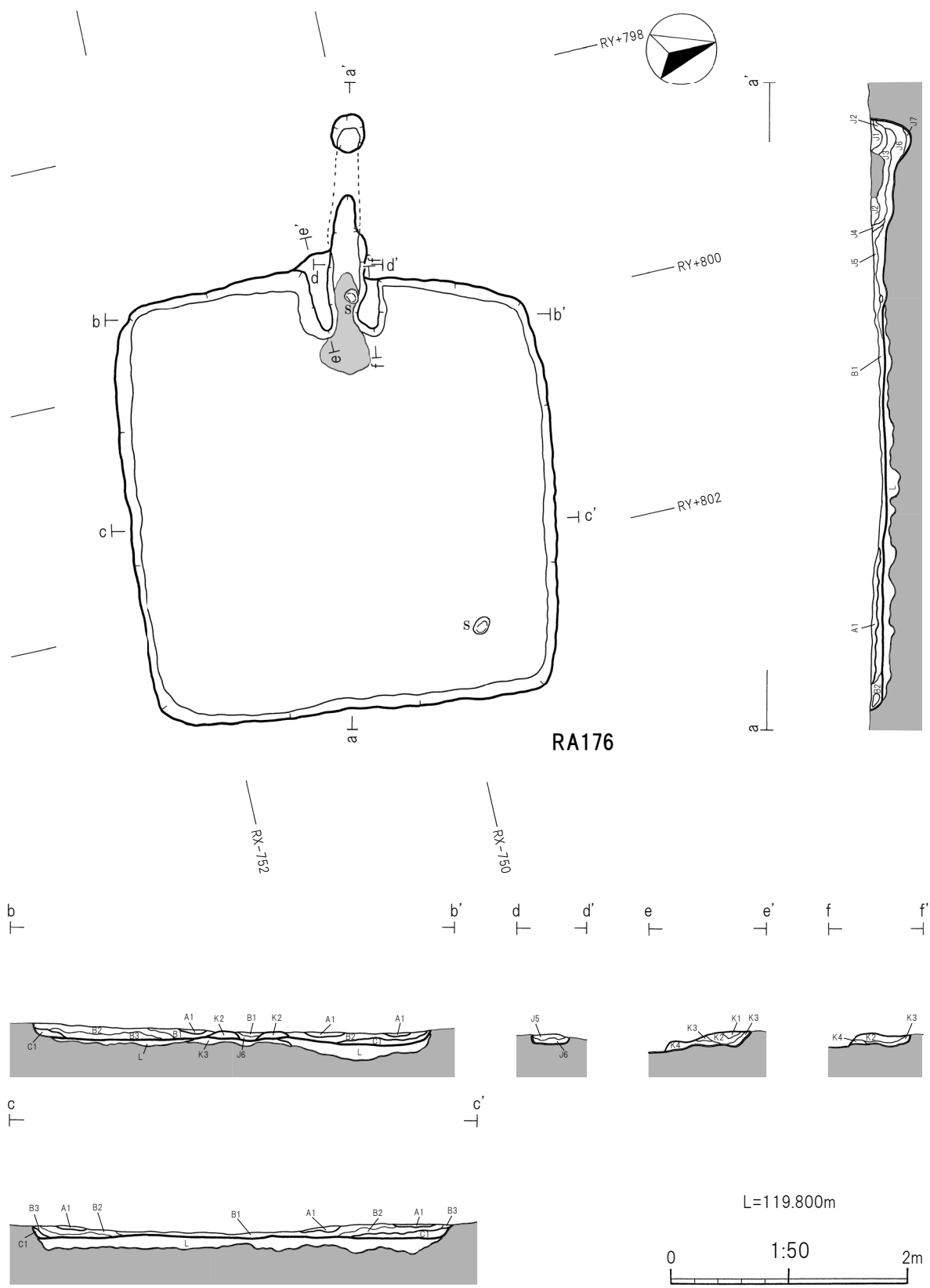

第61図 RA176竪穴建物跡

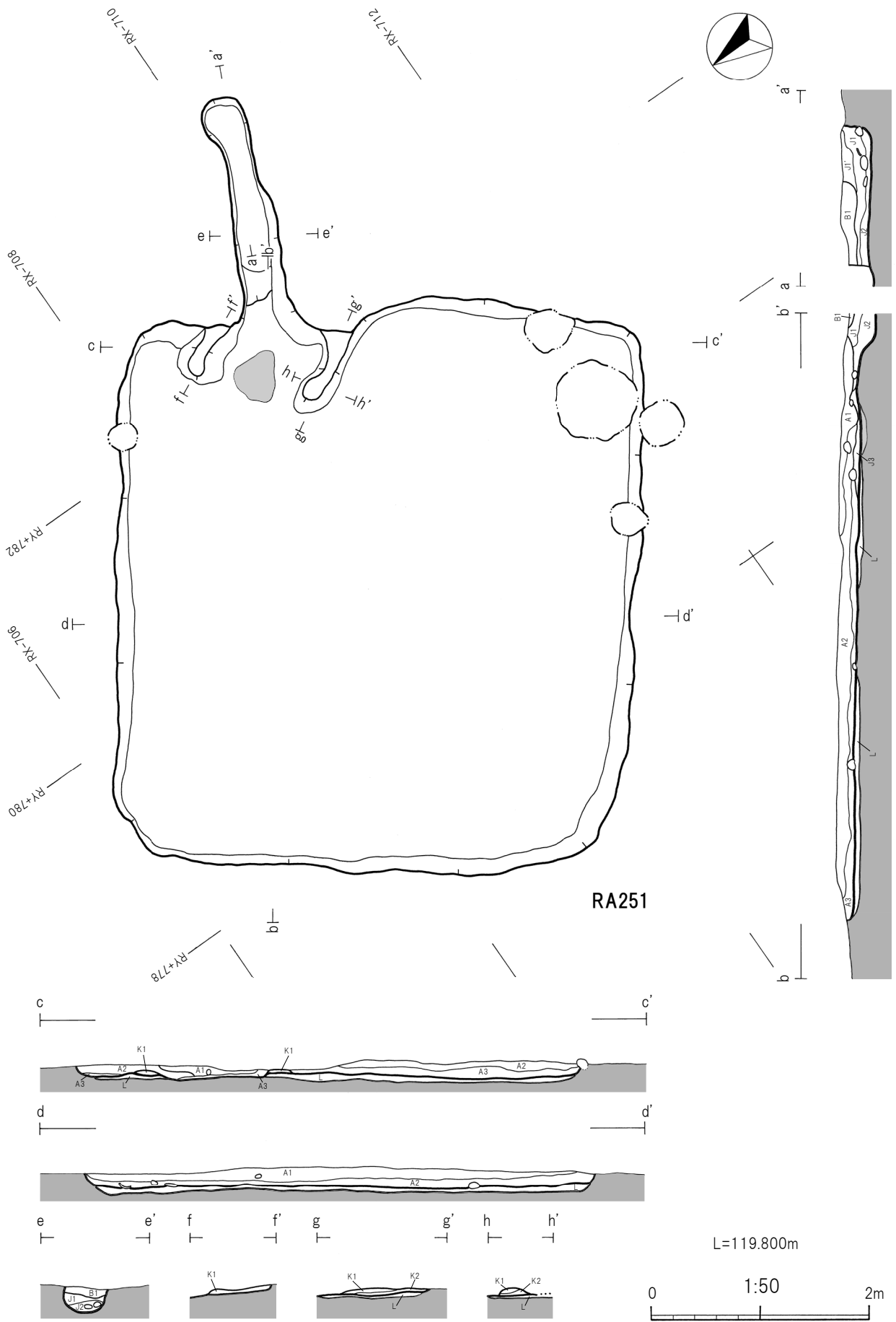

第62図 RA251竖穴建物跡

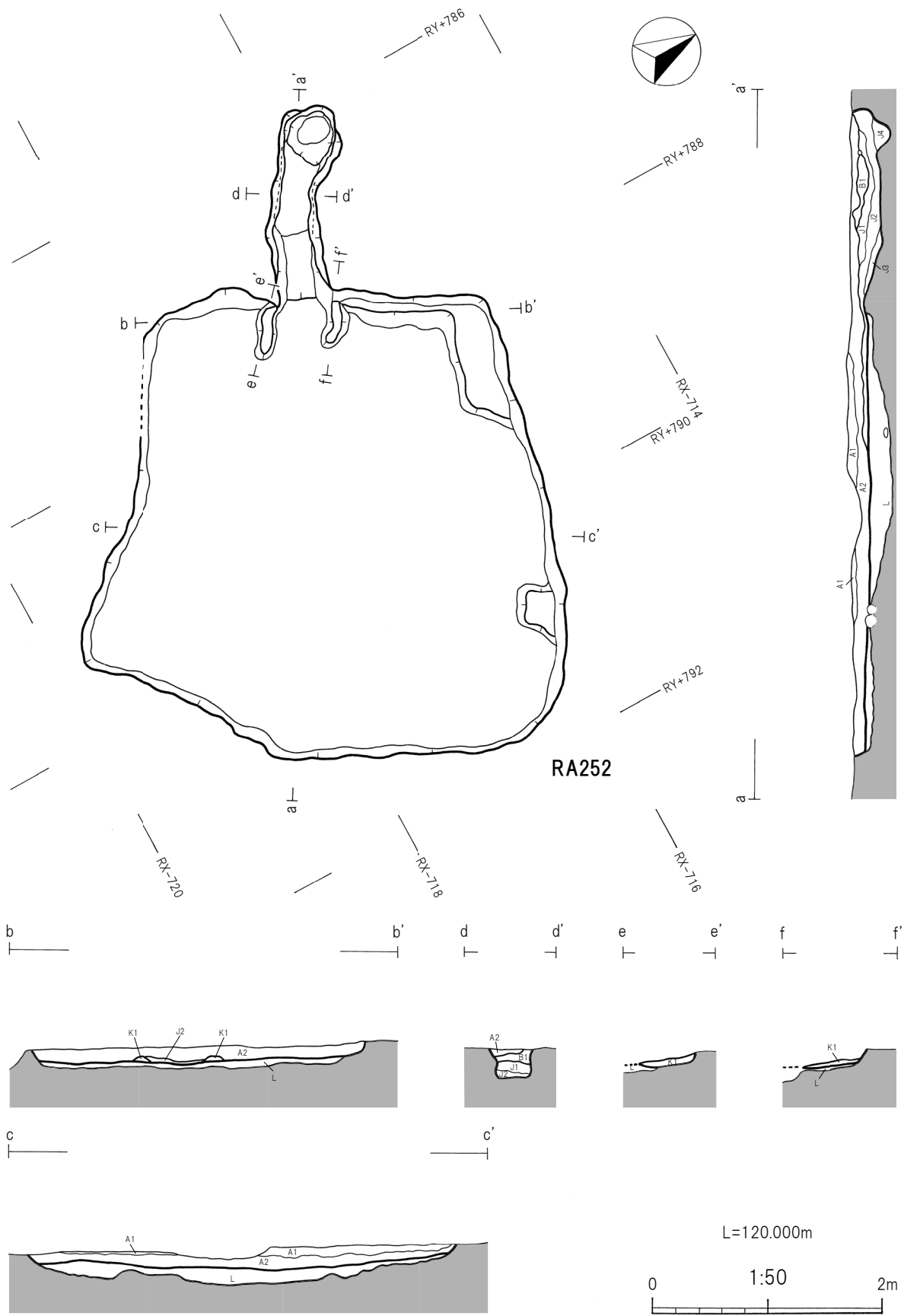

第63图 RA252竖穴建物跡

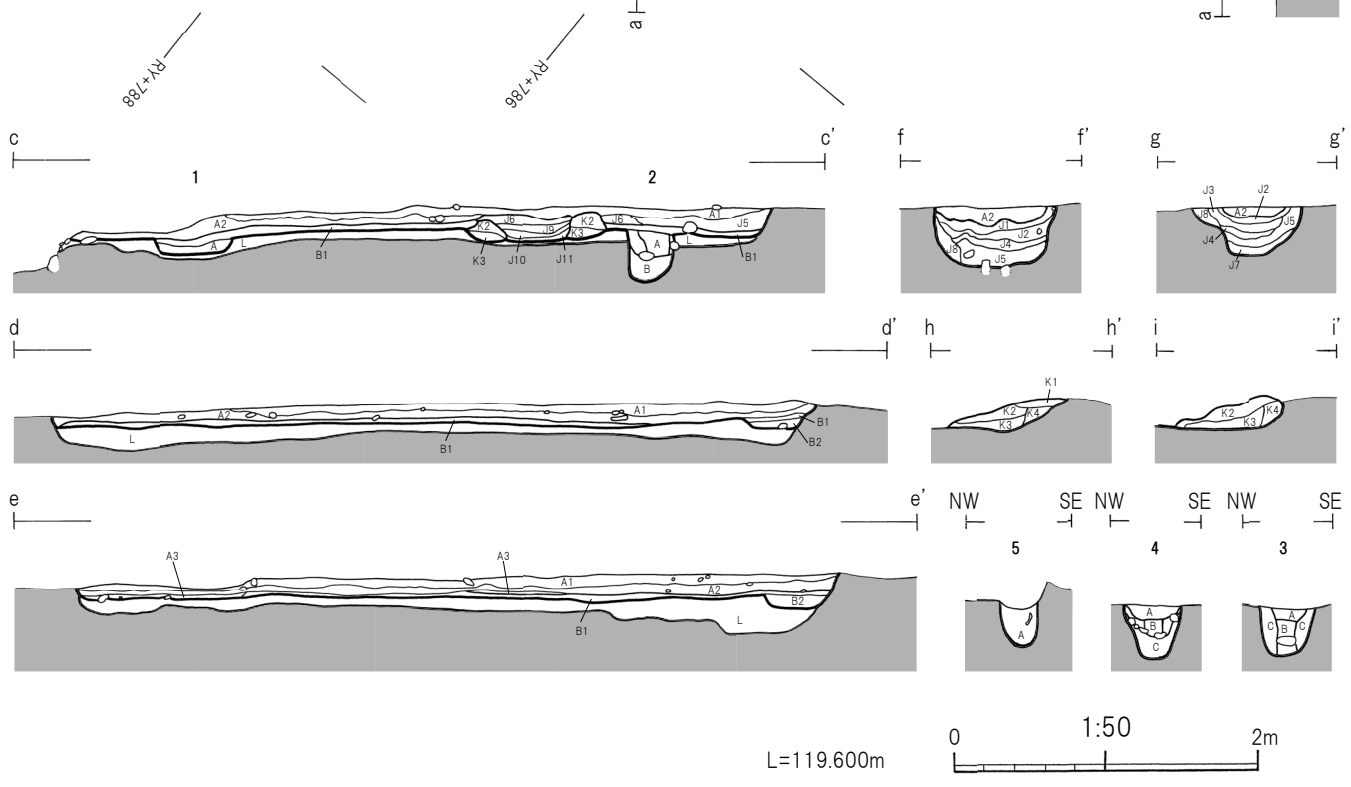
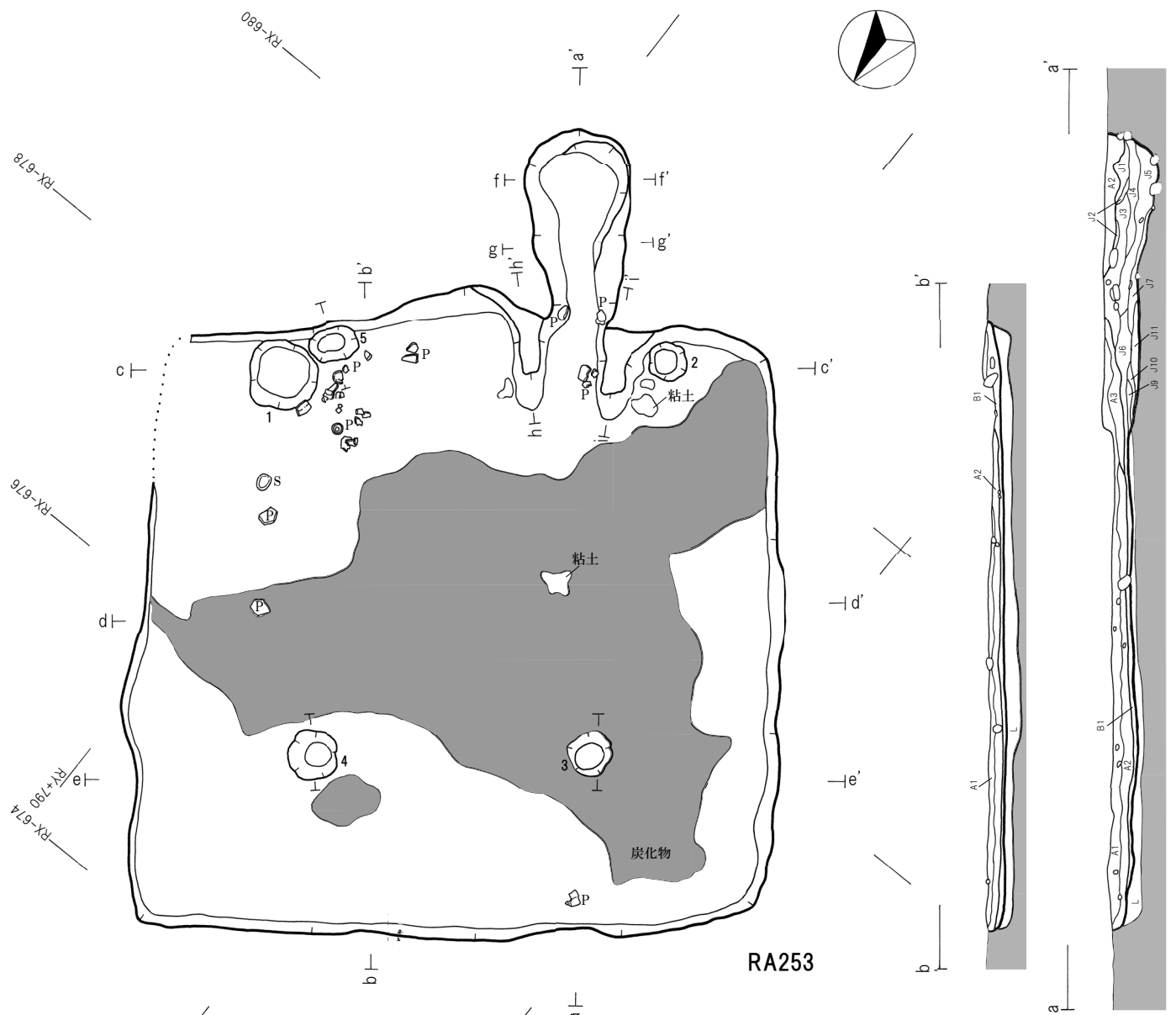

第64図 RA253竪穴建物跡

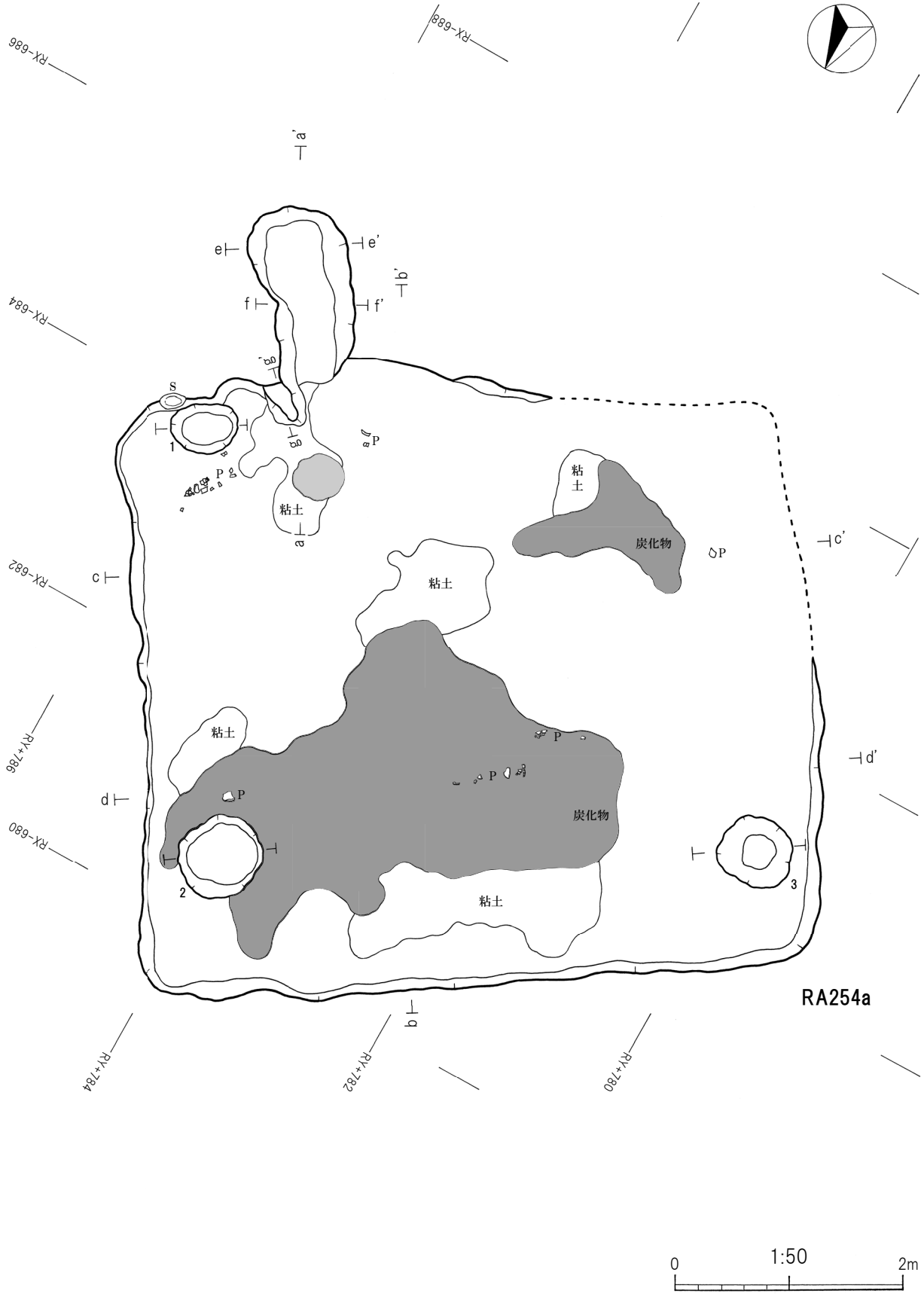

第65図 RA254竖穴建物跡

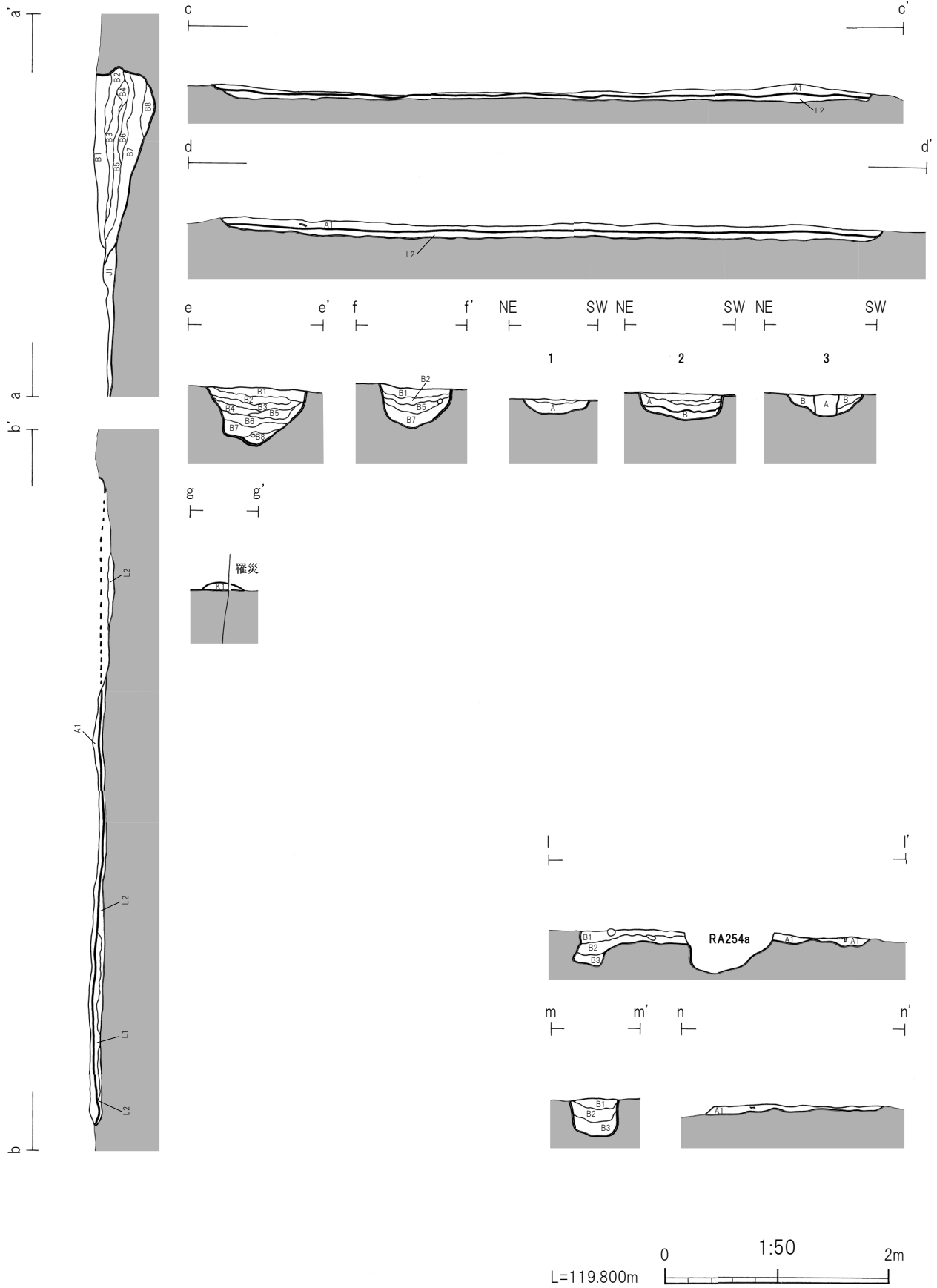

第66図 RA254・258竪穴建物跡

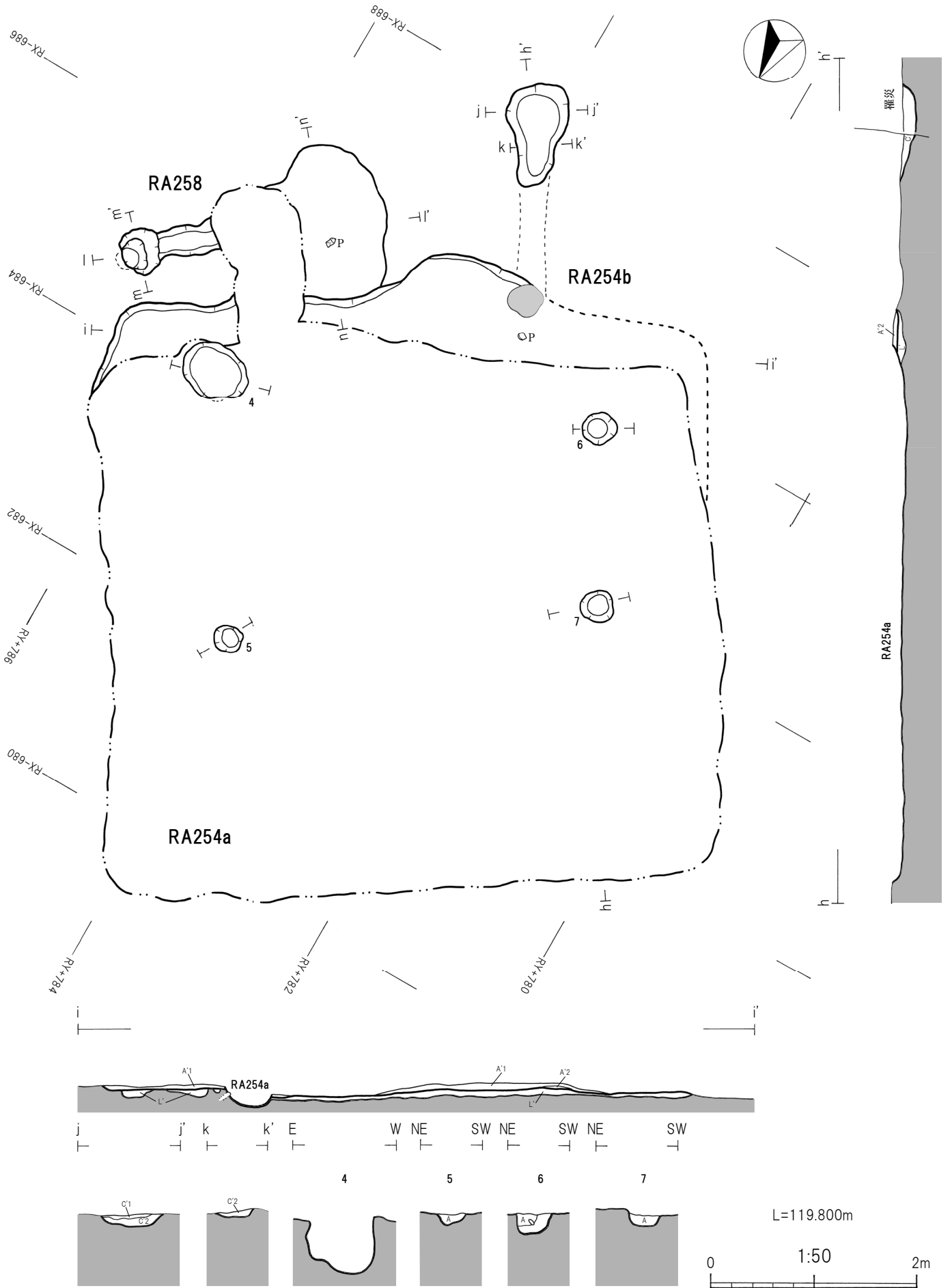

第67図 RA254・258竪穴建物跡(2)

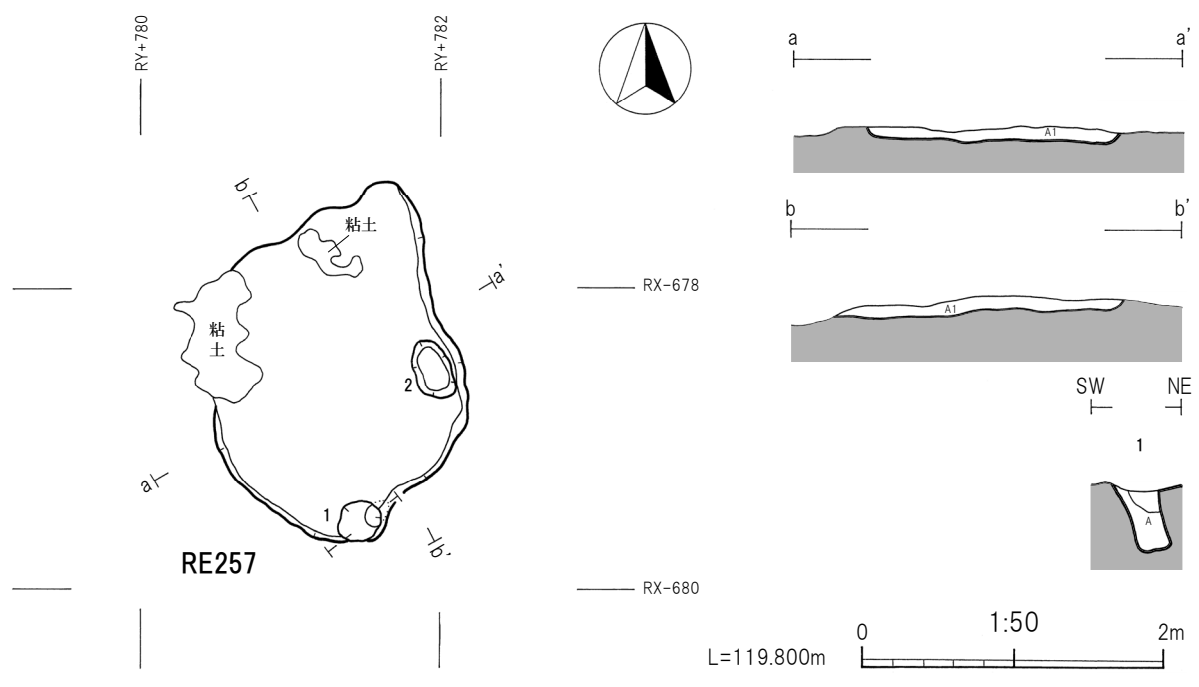
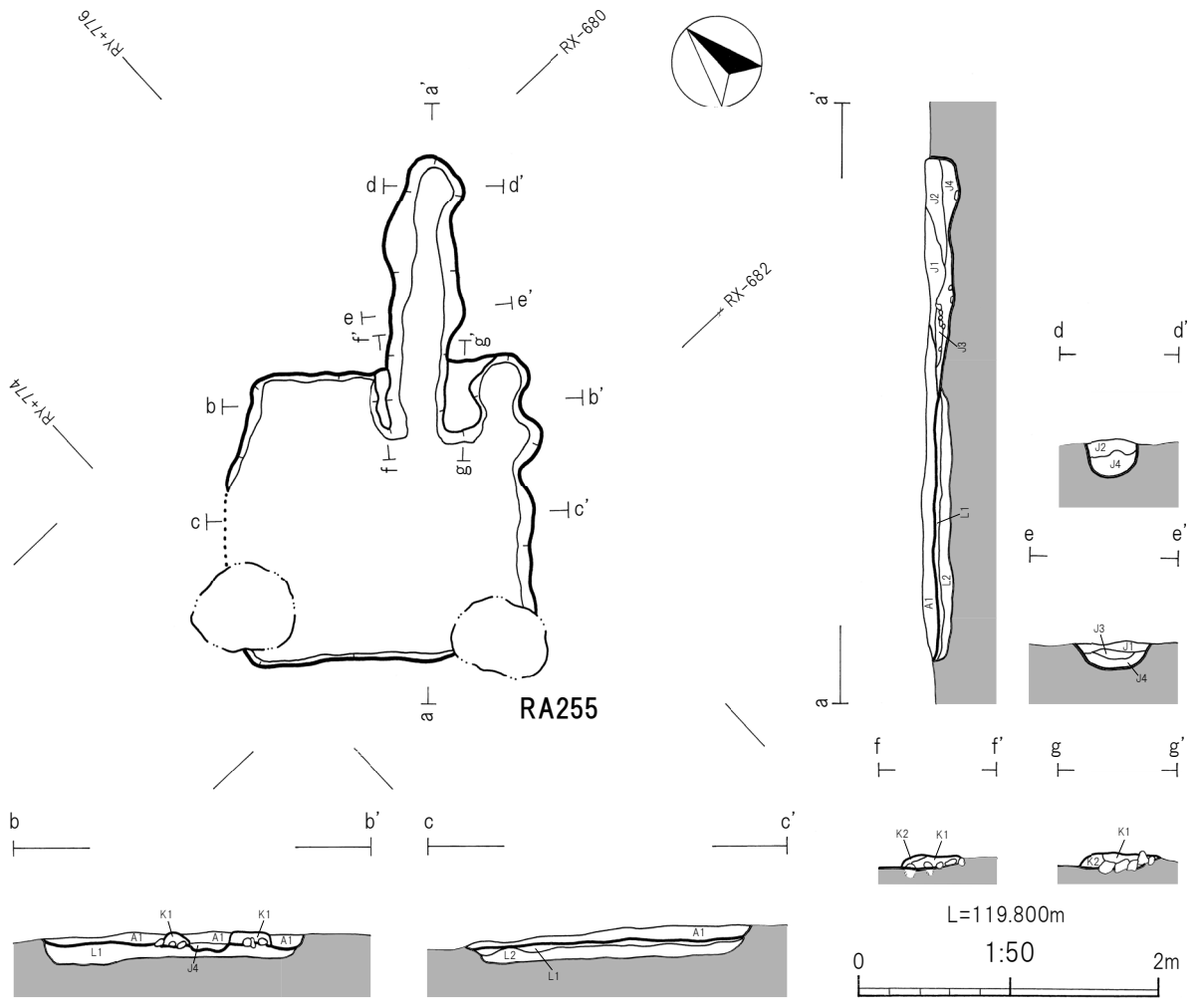

第68圖 RA255豎穴建物跡, RE257豎穴状遺構

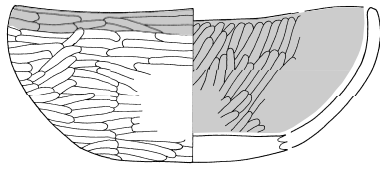

002 土師器坏-RA001-6区西ベルトB1層

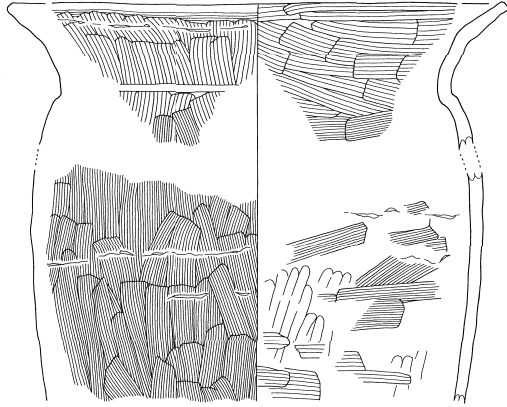

003 土師器甕-RA001-3区B層

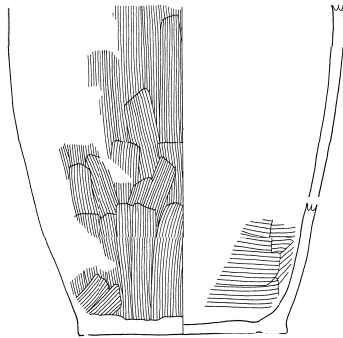

004 土師器甕-RA001-3区A層

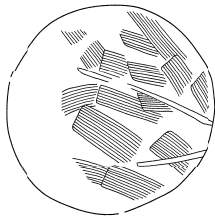

004 土師器甕-RA001-3区A層

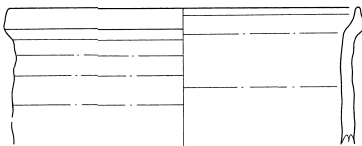

010 あかやき土器甕-RA055-pit1

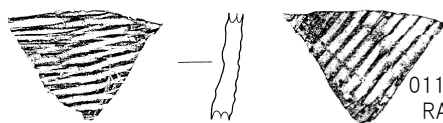

011 須恵器大甕-
RA055-SW区床面

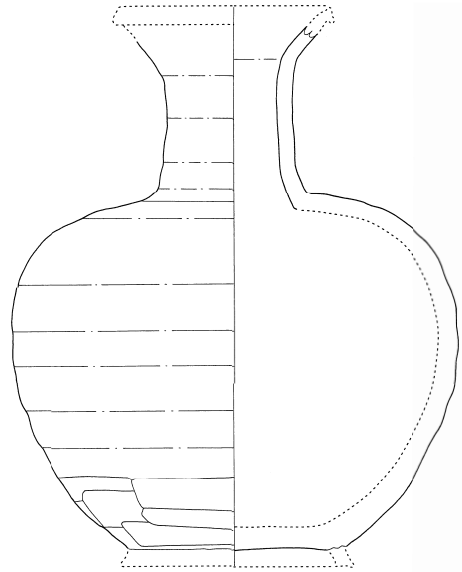

001 須恵器長頸瓶-RA002(1次)

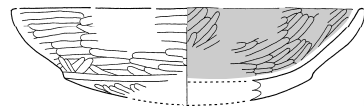

005 土師器坏-RA051-NW区埋土

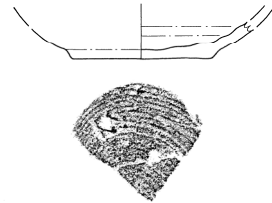

006 須恵器坏-RA056-検出面



007 あかやき土器坏-
RA057-カマド煙道入口

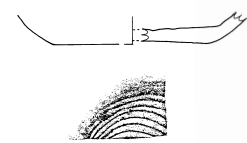

008 須恵器坏-RA057-SW区L層

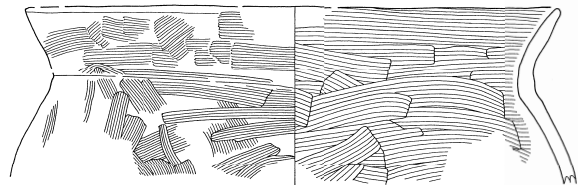

009 土師器甕-RA057-カマド煙道入口

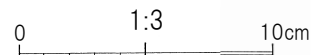

第69図 RA001・002・051・055・056・057出土土器

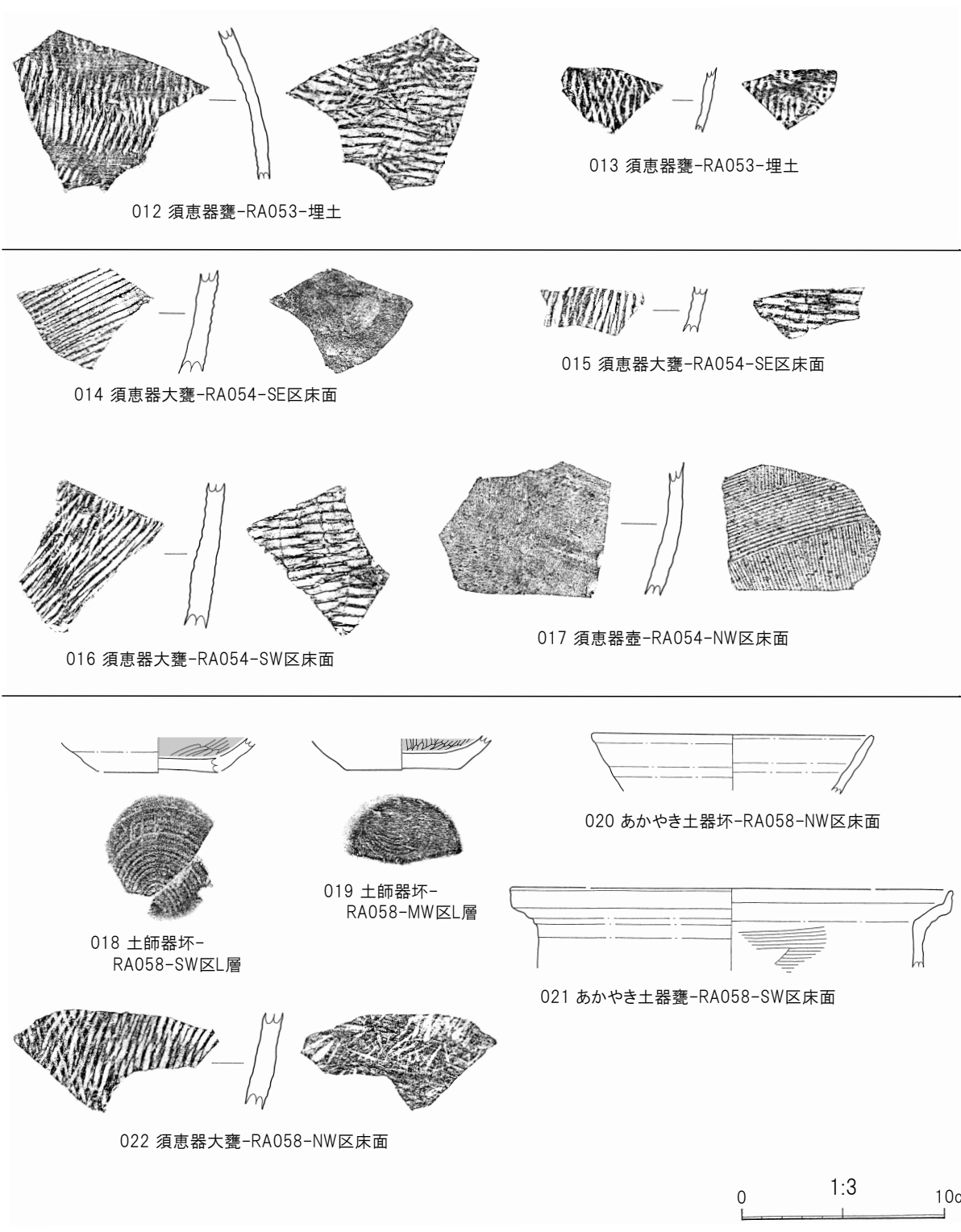

第70図 RA053・054・058出土土器

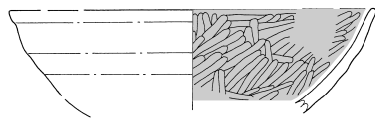

023 土師器坏-RA059-NW区床面

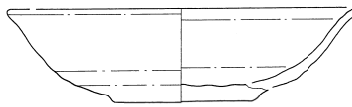

026 あかやき土器坏-RA059-NE区床面



024 土師器坏-RA059-L層



025 あかやき土器坏-RA059-SW区床面



027 あかやき土器坏-RA059-カマド左pit

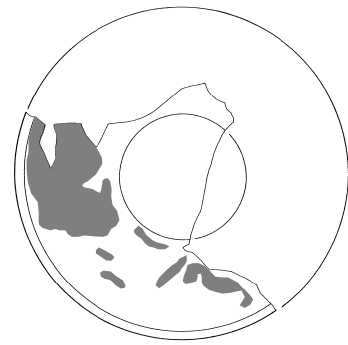

028 あかやき土器坏-RA059-床面-灯明皿

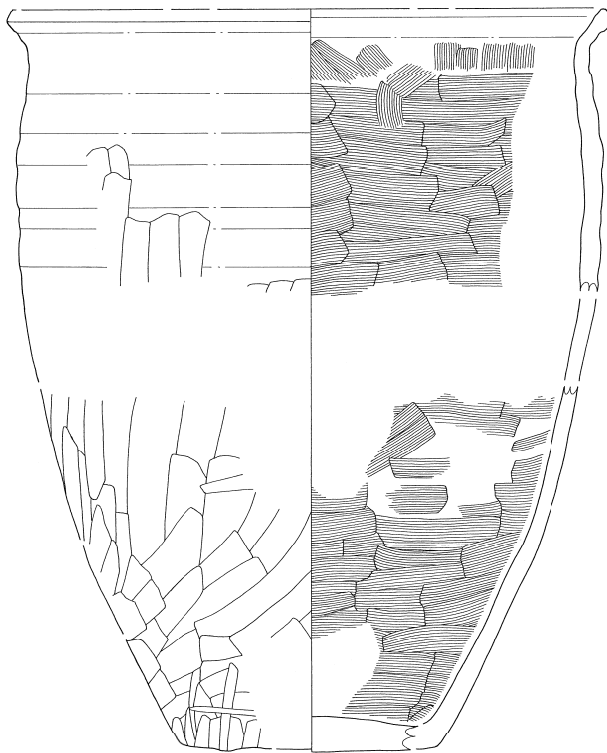
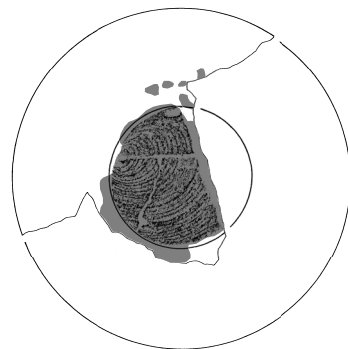
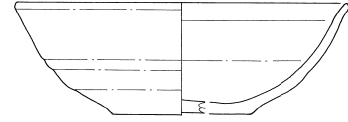

030 あかやき土器甕-RA059-カマド床面

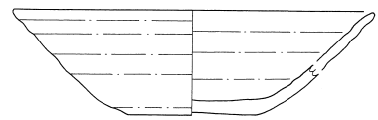

029 あかやき土器坏-RA059-カマド袖K層

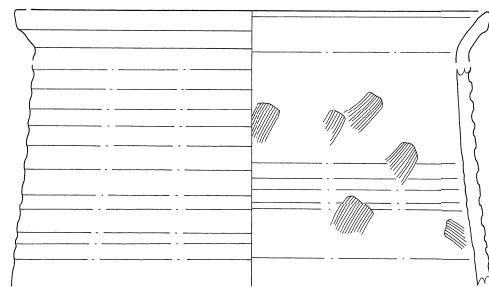

031 あかやき土器甕-RA059-カマド焼土面

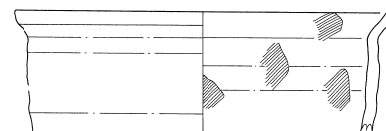

032 あかやき土器甕-RA059-カマド焼土面

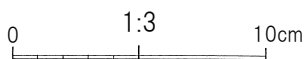
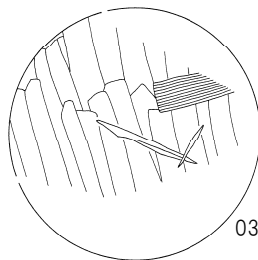

第71図 RA059出土土器(1)

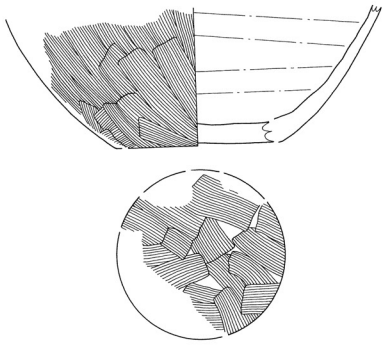

033 あかやき土器甕-RA059-カマド右床面

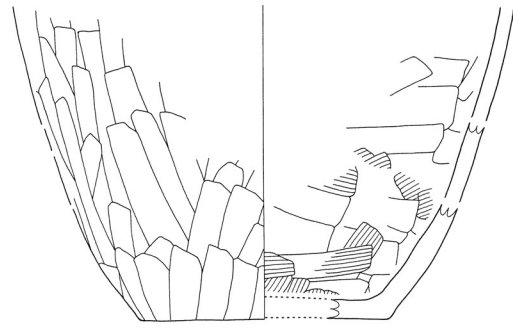

035 土師器甕-RA059-カマド右床面

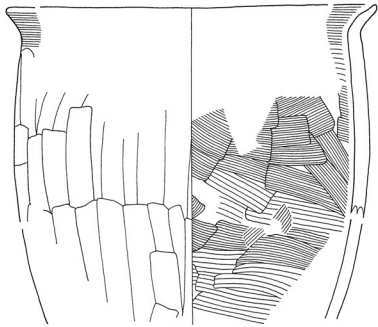

034 土師器甕-RA059-カマド焼土面

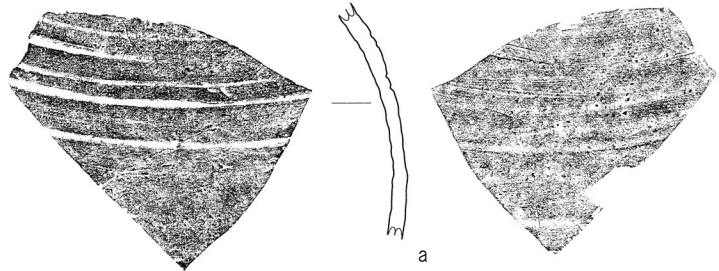

036 須恵器壺-RA059-カマド右床面

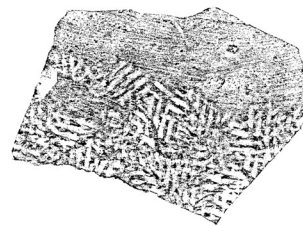
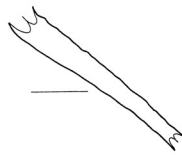
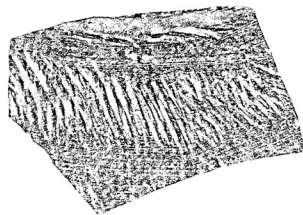
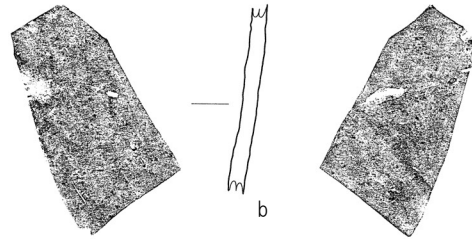

037 須恵器大甕-RA059-SW区床面

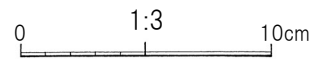

第72図 RA059出土土器(2)

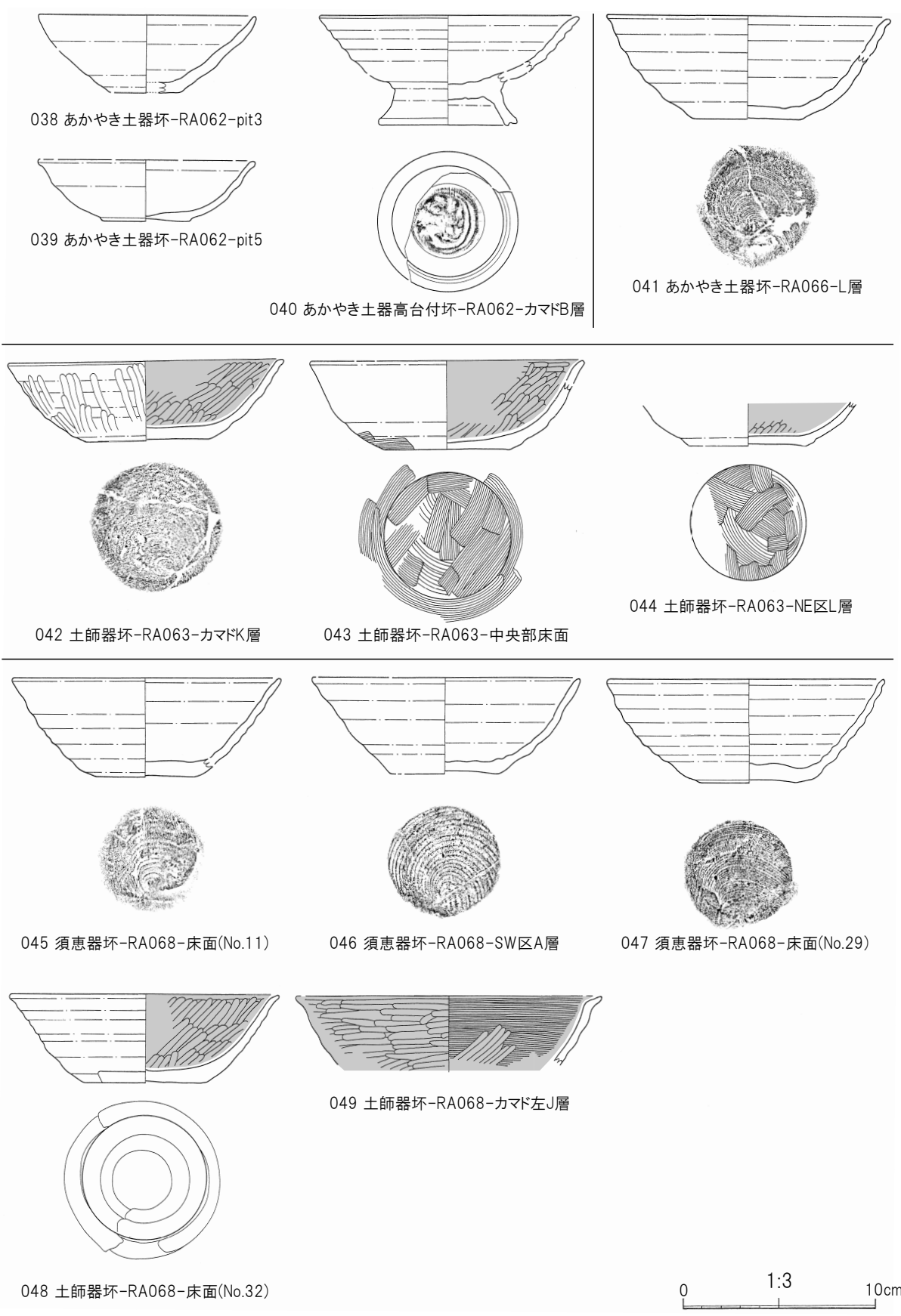

第73図 RA062・063・066出土土器, RA068出土土器(1)

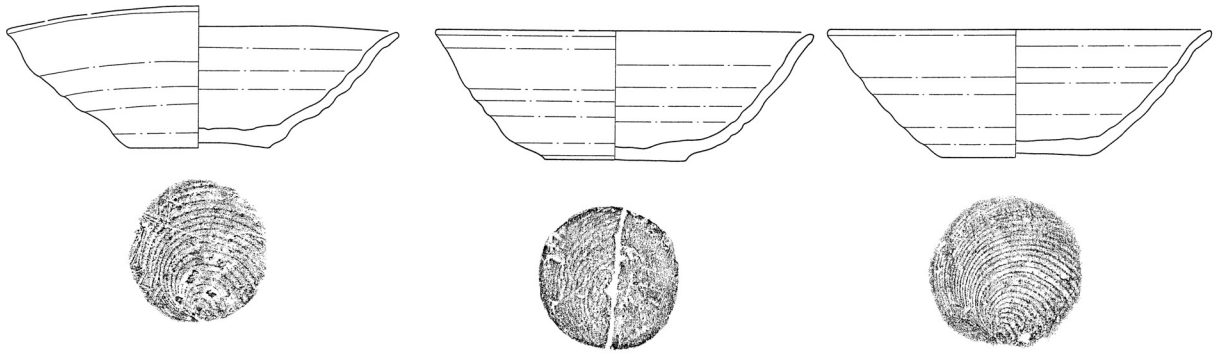

050 あかやき土器坏-RA068-カマド支脚2段目 051 あかやき土器坏-RA068-A4層(No.9) 052 あかやき土器坏-RA068-カマド支脚3段目

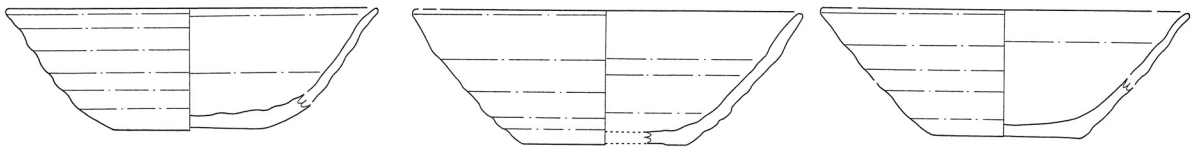

055 あかやき土器坏-RA068-A4層(No.5)



054 あかやき土器坏-RA068-カマドJ層(No.21)



053 あかやき土器坏-RA068-A4層(No.16)

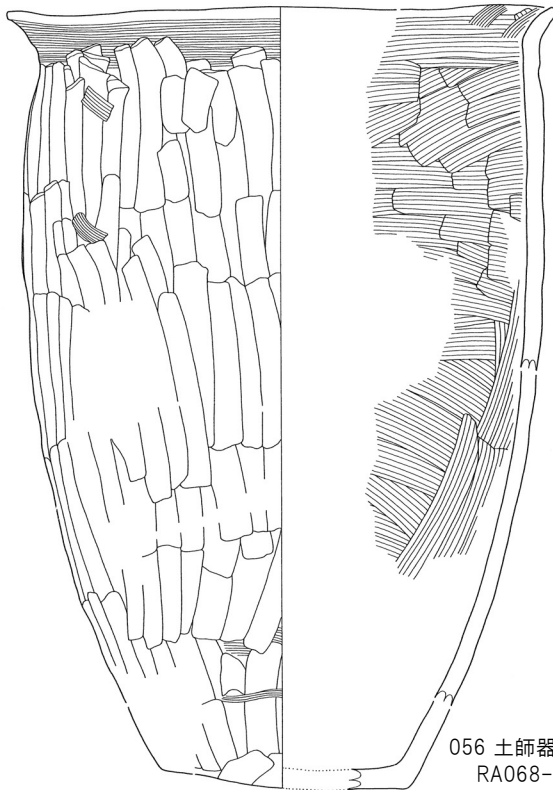

056 土師器甕-
RA068-床面(No.18)

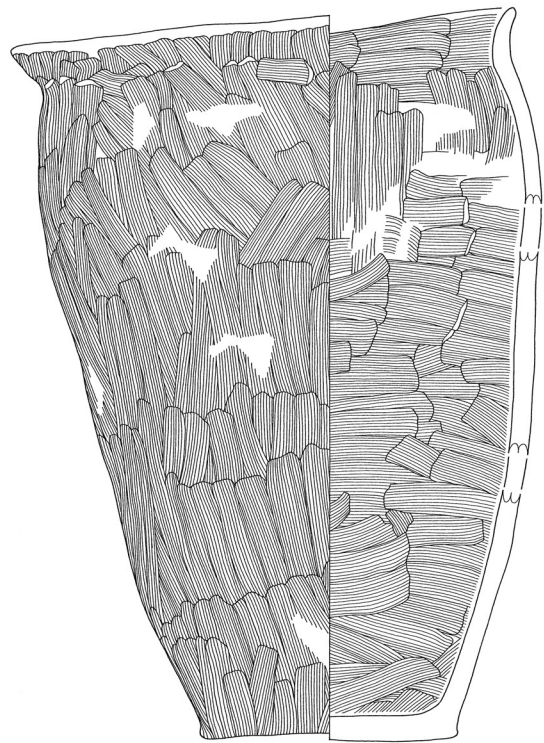

057 土師器甕-
RA068-カマドJ層(No.24)

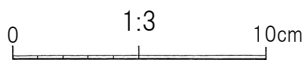
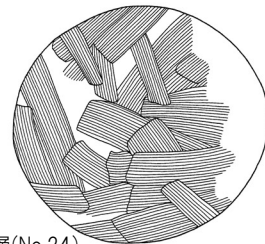

第74図 RA068出土土器(2)

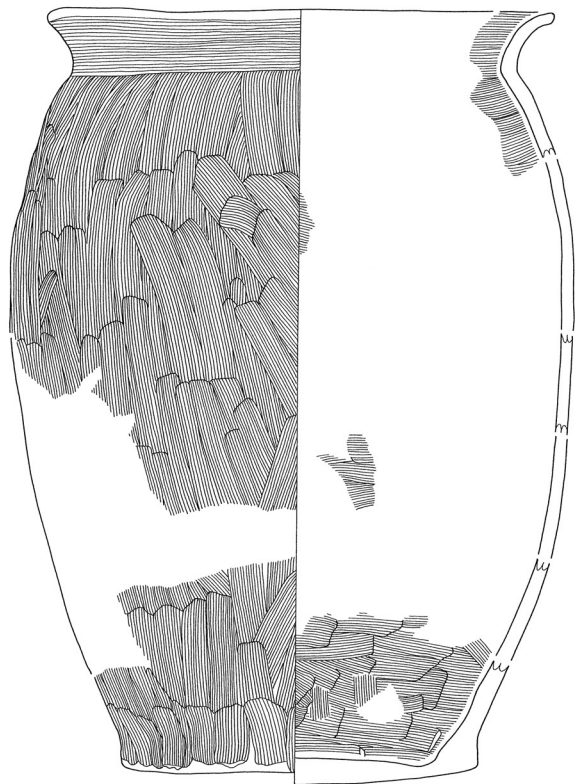

058 土師器甕-RA068-床面(No.30)

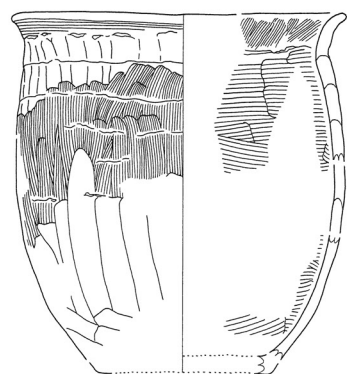
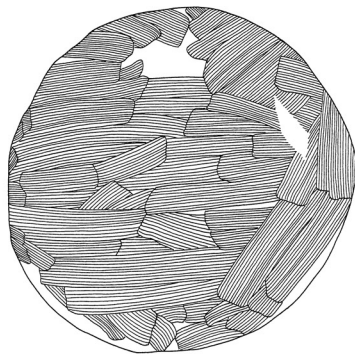

059 土師器甕-RA068-MN区A層

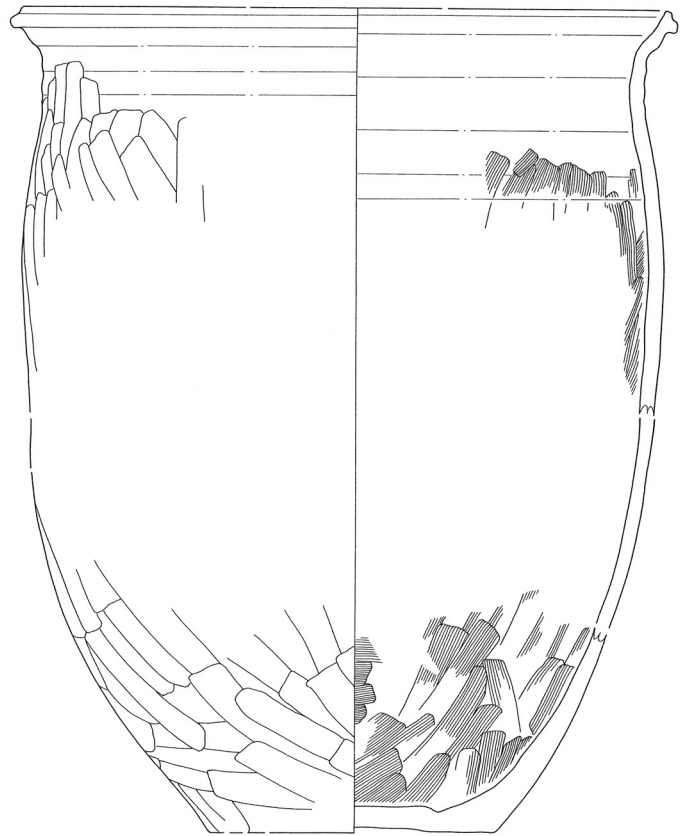

060 あかやき土器甕-RA068-床面(No.37)

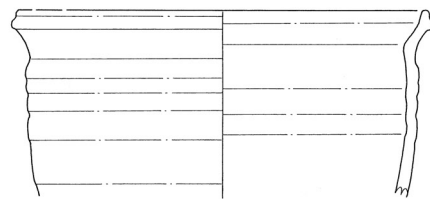

061 あかやき土器甕-RA068-カマドJ層(No.26)

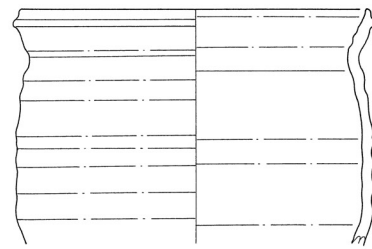

062 あかやき土器甕-RA068-カマドJ層(No.28)

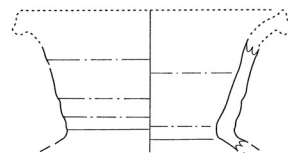

063 須恵器壺-RA068-NW区A層

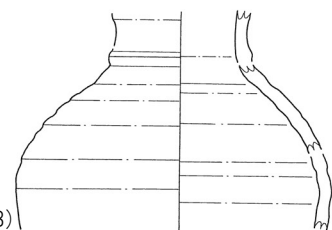

064 須恵器長頸瓶-RA068-カマドJ層(No.23)

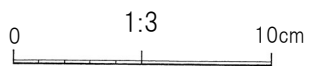

第75図 RA068出土土器(3)

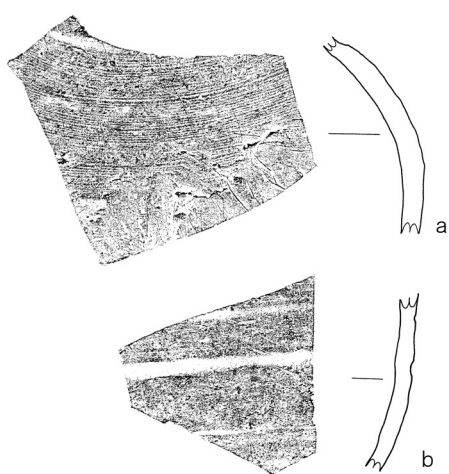

065 須恵器壺-RA068-NE区A層

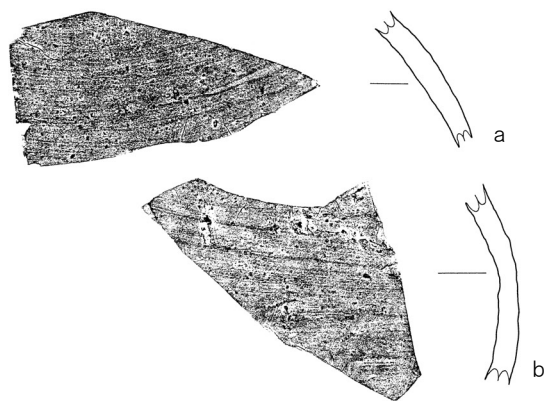

066 須恵器壺-RA068-MN区A層

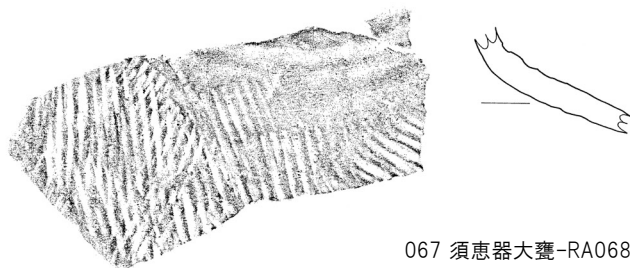

067 須恵器大甕-RA068-A4層(No.3)

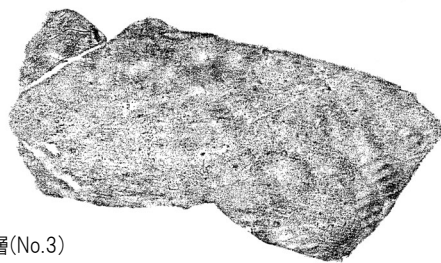

068 須恵器大甕-RA068-カマド焼土面

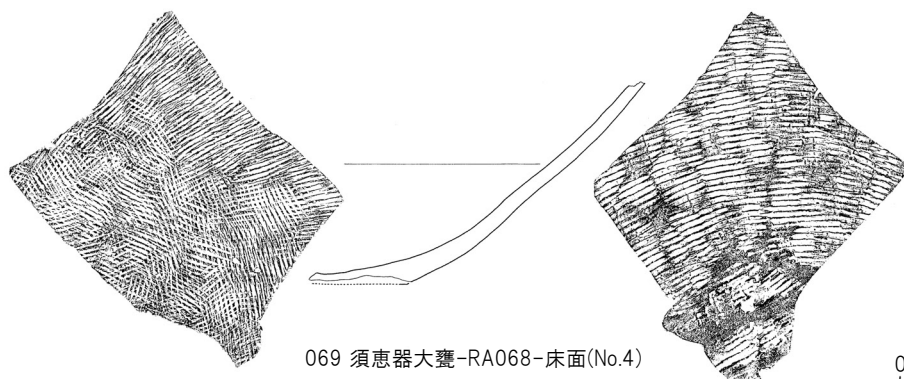
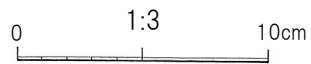
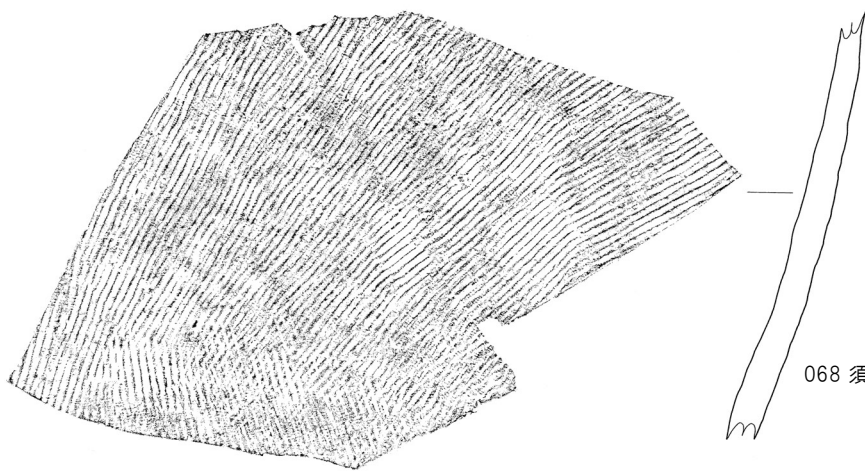

069 須恵器大甕-RA068-床面(No.4)

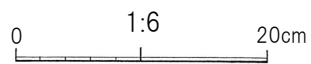

第76図 RA068出土土器(4)

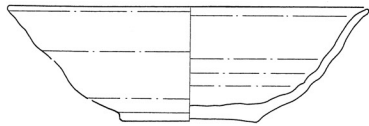

070 あかやき土器坏-RA069-床面(No.2)

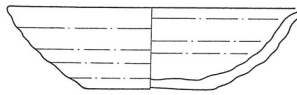

071 あかやき土器小型坏-
RA070-NW区床面

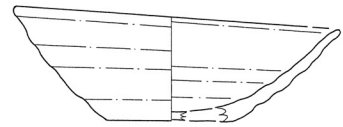

072 あかやき土器坏-RA070-pit2

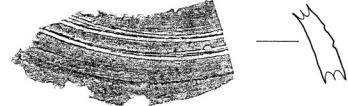

073 須恵器壺-RA070-SW区L層

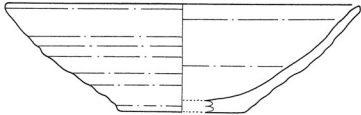

074 あかやき土器坏-RA071-pit2

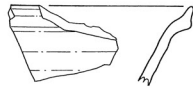

075 須恵器壺-
RA071-検出面

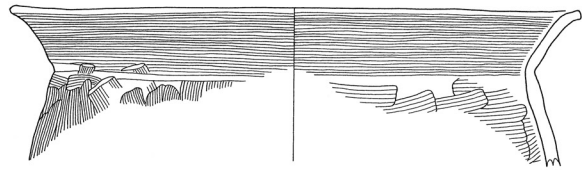

079 土師器甕-RA079-カマド右袖芯材

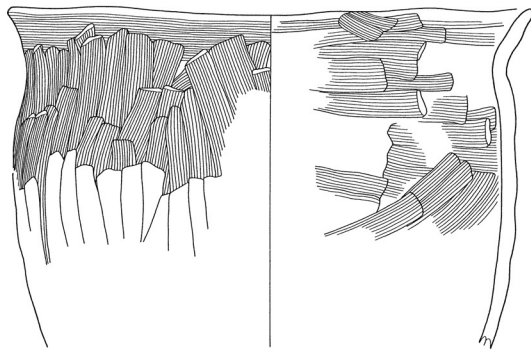

076 土師器甕-RA071-煙出上部



080 土師器甕-RA079-
カマド右袖芯材

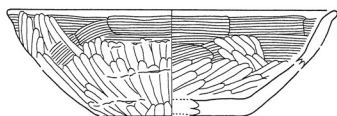

077 土師器坏-RA072-A層

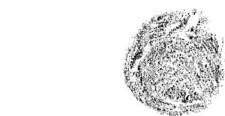
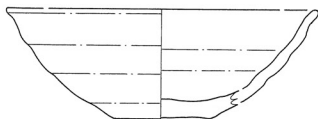

078 あかやき土器坏-RA072-検出面

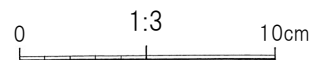

第77図 RA069-070-071-072-079出土土器

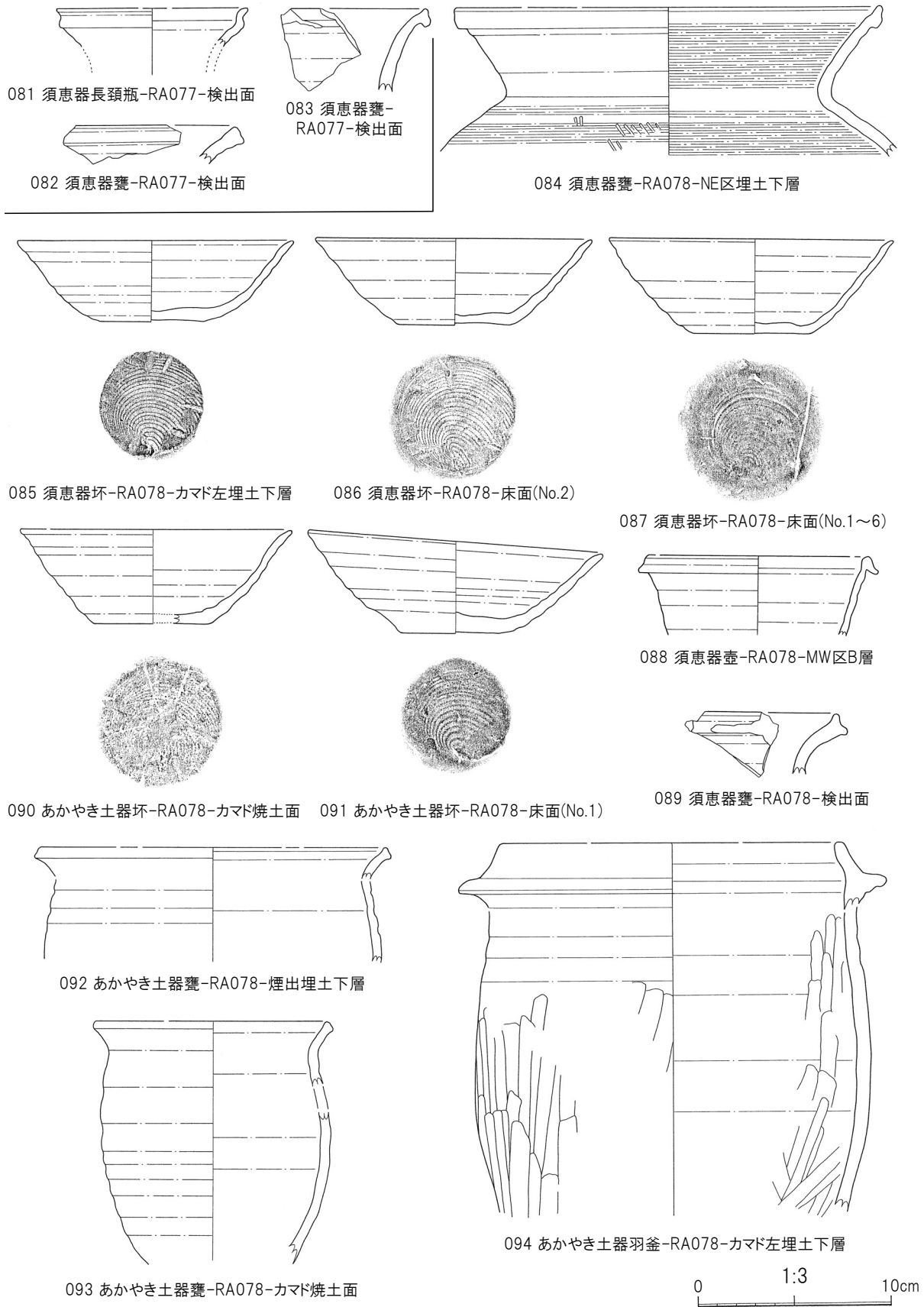

第78図 RA077・078出土土器

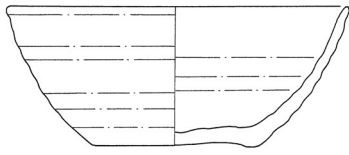

095 あかやき土器杯-RA080-床面(No.1)

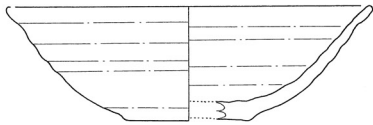

096 須恵器杯-RA081a-MW区B層

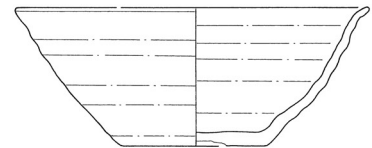
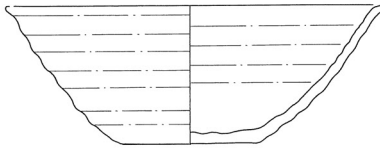

098 あかやき土器杯-RA081a-床面(No.4)

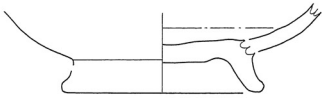

100 あかやき土器高台付杯-RA081a-検出面



097 あかやき土器杯-RA081a-NW区B層

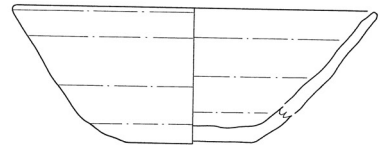

099 あかやき土器杯-RA081a-床面(No.1)

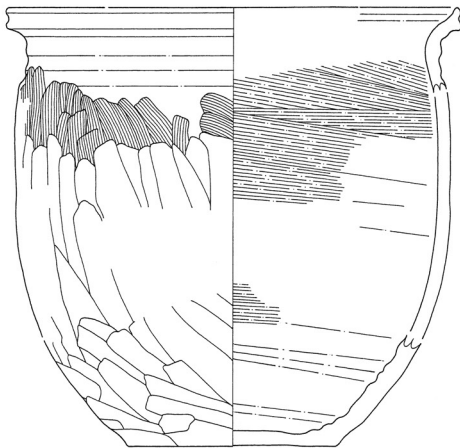

101 あかやき土器甕-RA081a-NW区床面



103 須恵器甕-RA081a-貼床



104 須恵器甕-RA081a-L層



105 須恵器長頸瓶-RA081a-SW区A層

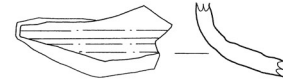

106 須恵器壺-RA081a-SW区A層

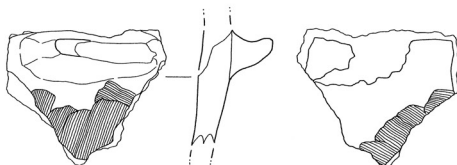

102 あかやき土器甕(把手)-RA081a-検出面

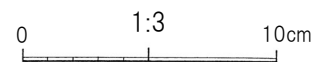

第79図 RA080-081a出土土器

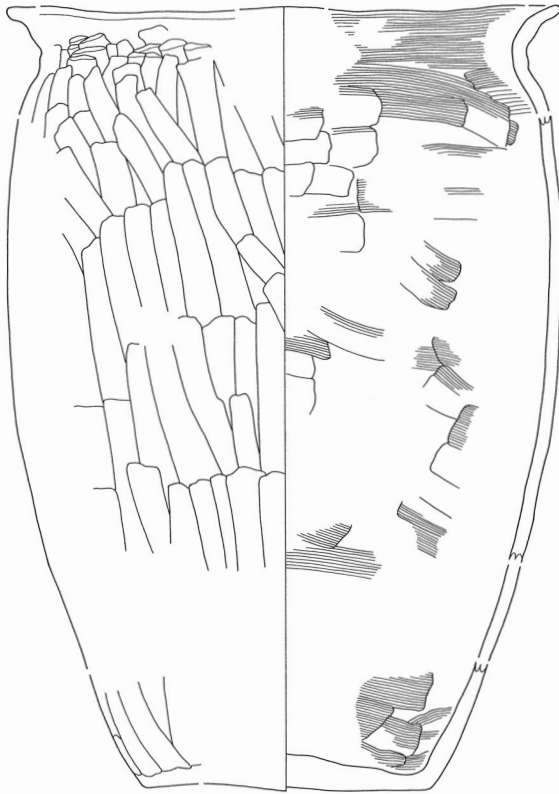

107 土師器甕-RA081b-北カマド煙道埋土



108 須恵器短頸壺-RA081b-L層

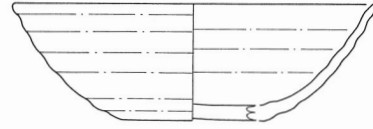

109 あかやき土器杯-RA083-NE区A1層

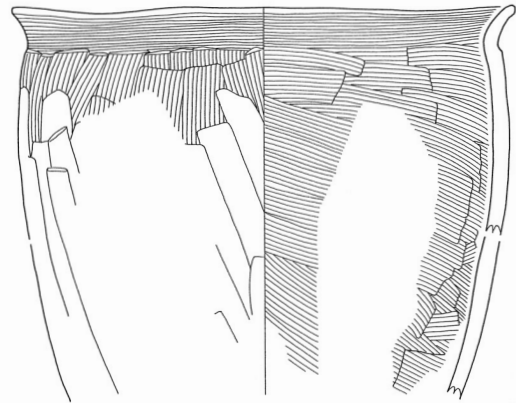

110 土師器甕-RA083-NW区A1層



111 須恵器甕-RA083-SE区A1層

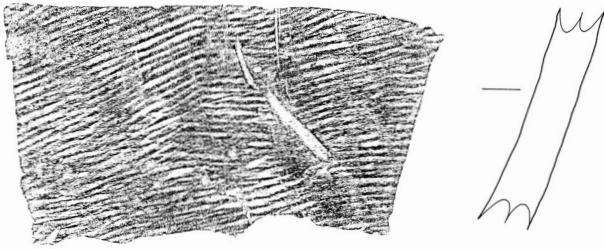

112 須恵器大甕-RA085-SE区L層

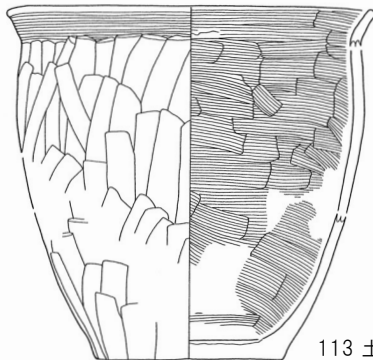

113 土師器甕-RA085-床面(No.1)



114 須恵器長頸瓶-RA085-SE区A3層



第80図 RA081b・083・085出土土器

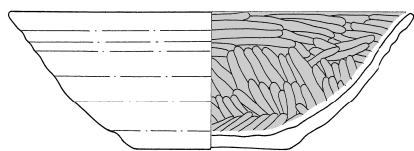

115 土師器坏-RA082-東西ベルト東A層

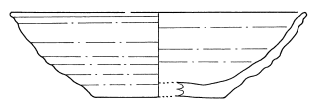

116 あかやき土器小型坏-RA082-カマドJ層

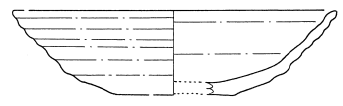

117 あかやき土器小型坏-RA082-カマドJ層

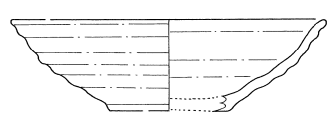

118 あかやき土器小型坏-RA082-pit1

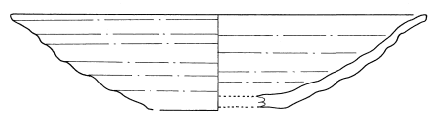

119 あかやき土器坏-RA082-床面

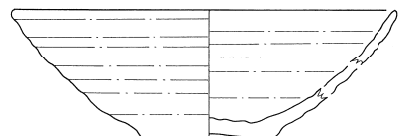

120 あかやき土器坏-RA082-東壁際A層

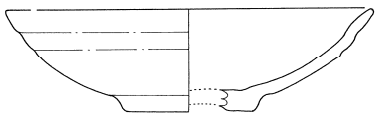
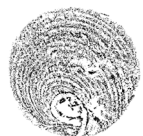

121 あかやき土器坏-RA082-カマドJ層

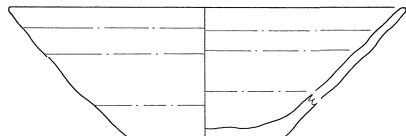

122 あかやき土器坏-RA082-L層

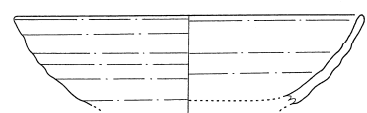

123 あかやき土器坏-RA082-カマドJ層

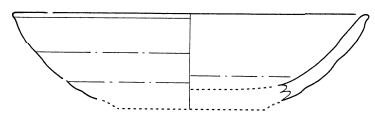

124 あかやき土器坏-RA082-pit2

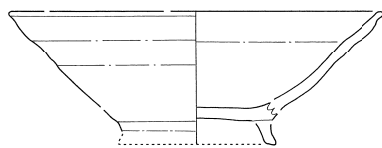

125 あかやき土器高台付坏-RA082-カマド支脚

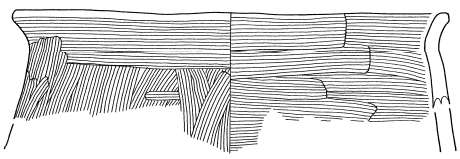

126 土師器甕-RA082-カマド支脚

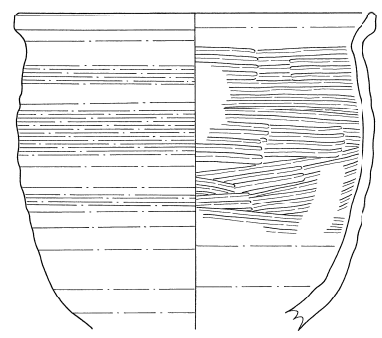

127 あかやき土器甕-RA082-pit2

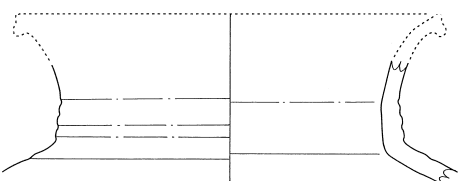

128 須恵器壺-RA082-南北ベルト南A層

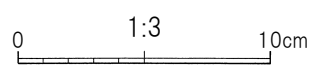

第81図 RA082出土土器

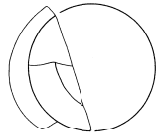
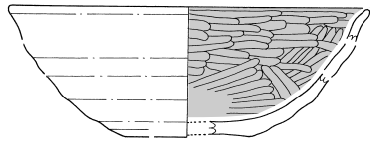

129 土師器坏-RA084-A3層(No.3)

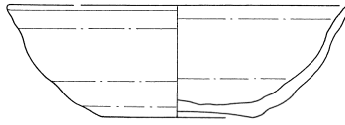

131 須恵器坏-RA084-埋土(No.33)

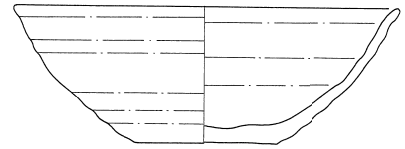

133 あかやき土器坏-RA084-SE区ベルト

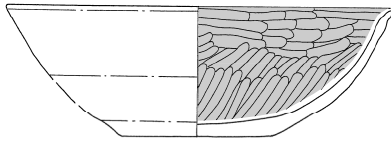

130 土師器坏-RA084-A3層(No.8)

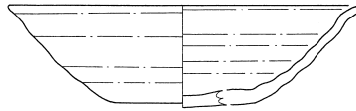

132 須恵器坏-RA084-床面(No.4)

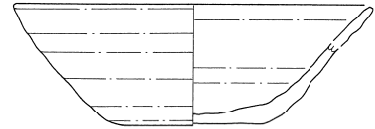

134 あかやき土器坏-RA084-床面(No.5)

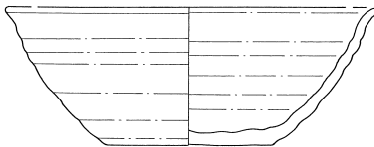

135 あかやき土器坏-RA084-床面(No.1)

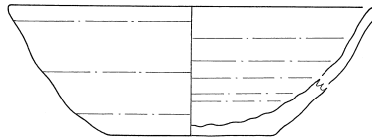

136 あかやき土器坏-RA084-カマド袖(No.2)

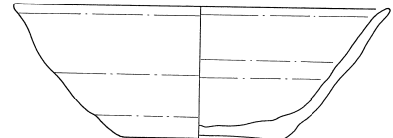

137 あかやき土器坏-RA084-カマド袖J4層

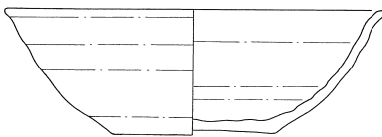

138 あかやき土器坏-RA084-NW区A1層

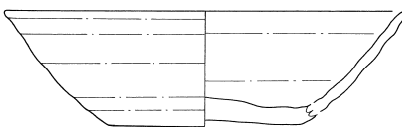

139 あかやき土器坏-RA084-A3層(No.7)

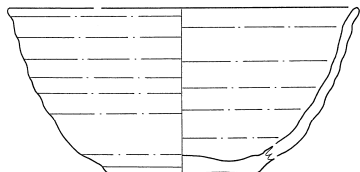

140 あかやき土器碗-RA084-NW区A3層

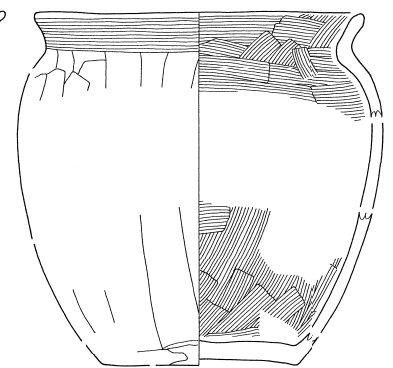

141 土師器甕-RA084-埋土(No.13)

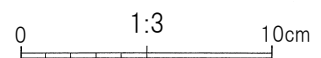

第82図 RA084出土土器(1)

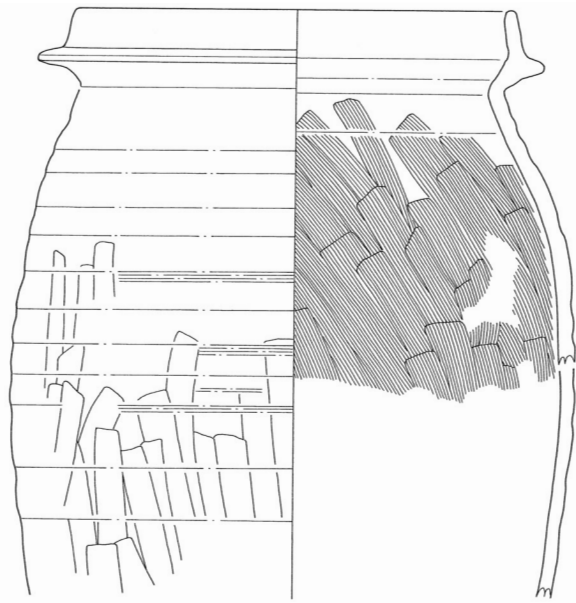

142 あかやき土器羽釜-RA084-MS区L層

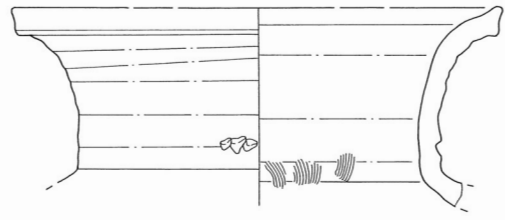

143 須恵器甕-RA084-煙出(No.5)

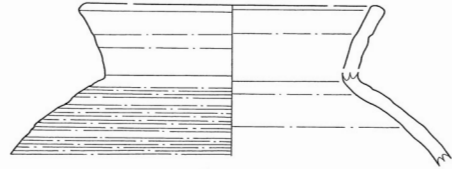

144 須恵器壺-RA084-pit14

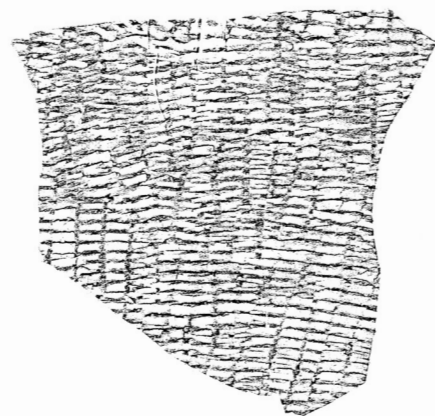
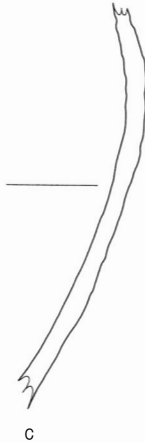
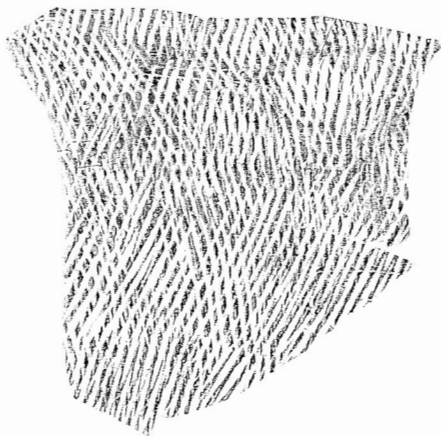
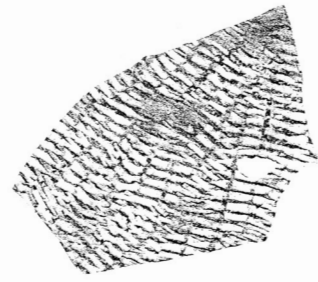
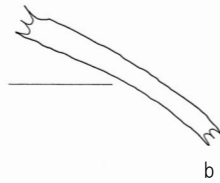
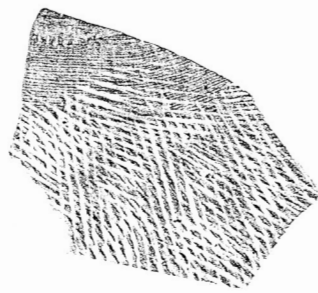
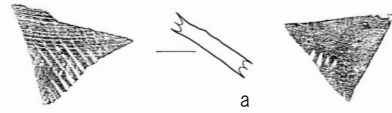

145-1 須恵器大甕-RA084-NW区A2層

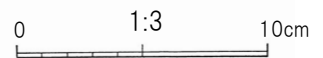

第83図 RA084出土土器(2)

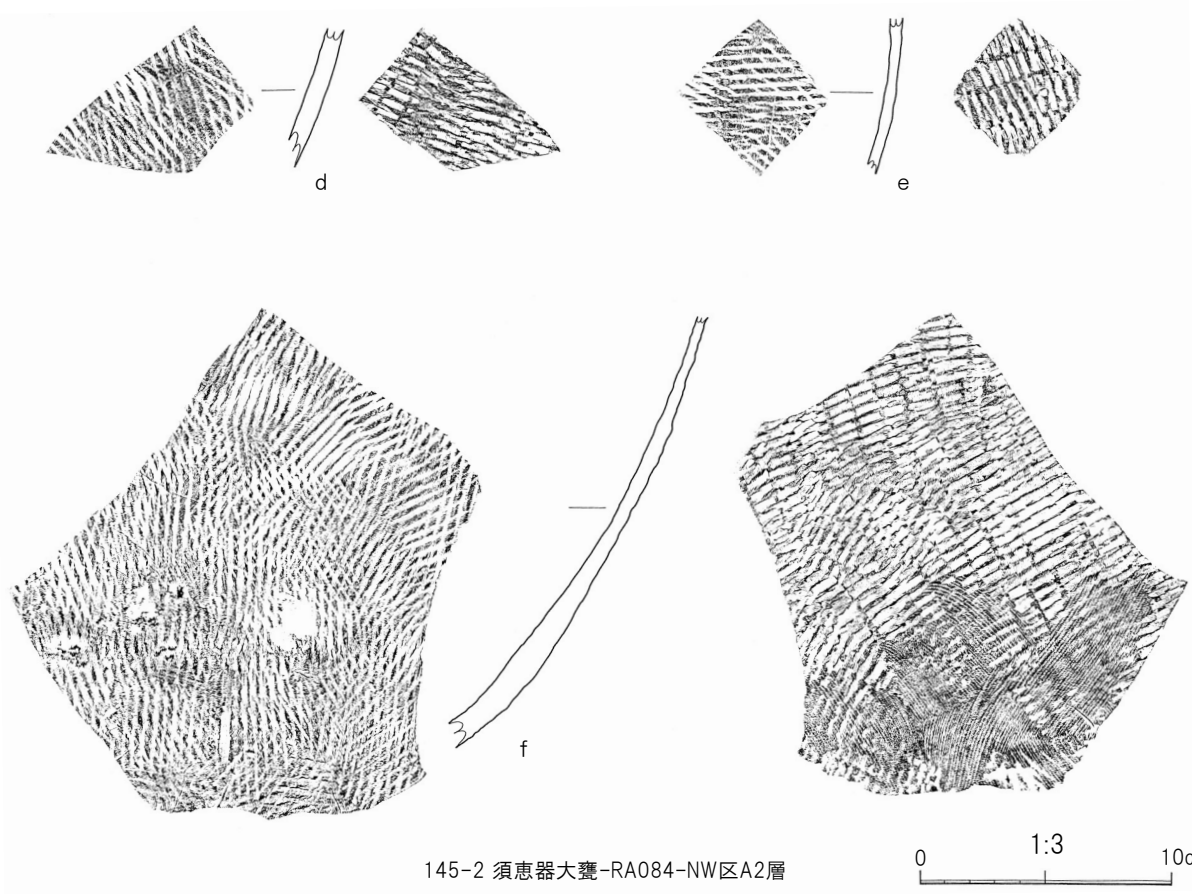

第84図 RA084出土土器(3)

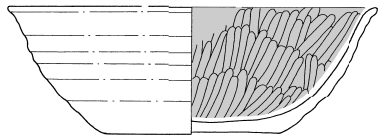

146 土師器坏-RA088-pit

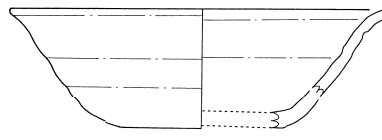

148 あかやき土器坏-RA088-カマド(No.5)

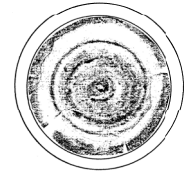
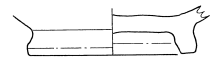

150 あかやき土器高台付坏-
RA088-MN区A3層

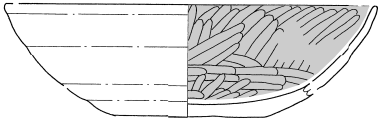

147 土師器坏-RA088-A4層(No.8)

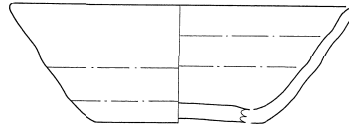

149 あかやき土器坏-RA088-煙出C3層

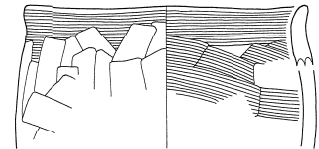
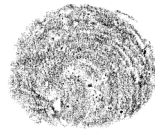

151 土師器小型甕-
RA088-カマド左袖K1層

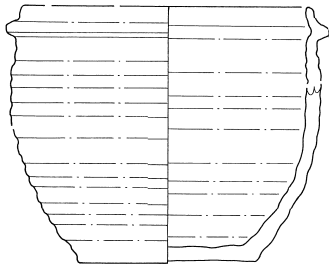

152 あかやき土器小型羽釜-RA088-床面

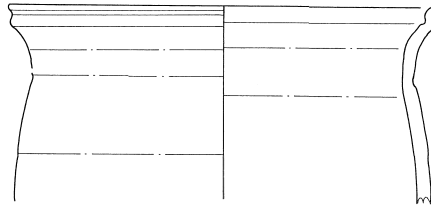
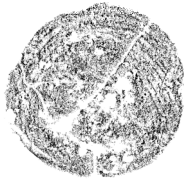

153 あかやき土器甕-RA088-NW区A4層

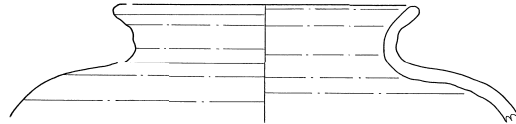

154 須恵器壺-RA088-MS区A2層

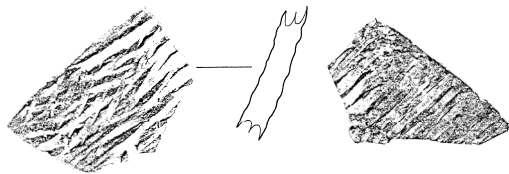

155 須恵器大甕-RA088-NW区L層

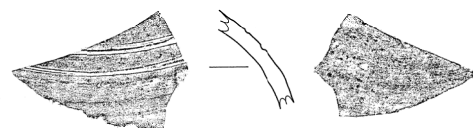

157 須恵器壺-RA088-NW区A1層

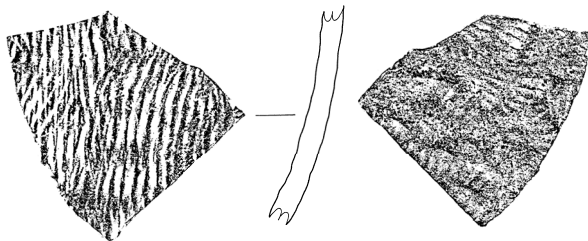

156 須恵器大甕-RA088-pit1

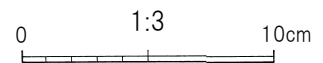

第85図 RA088出土土器

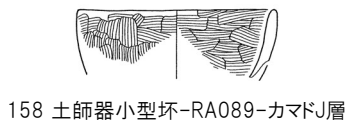

158 土師器小型杯-RA089-カマドJ層

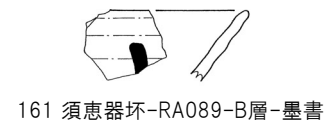
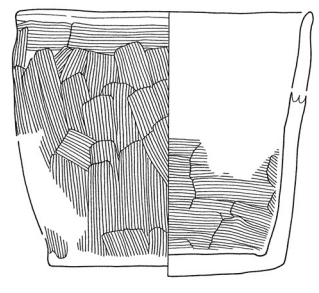

161 須恵器杯-RA089-B層-墨書

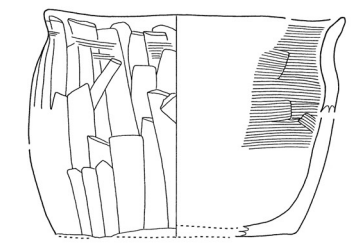

159 土師器小型甕-RA089-NW区A層

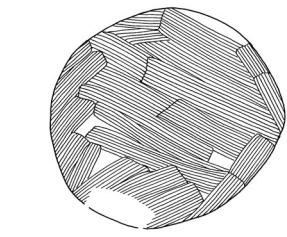

160 土師器小型甕-RA089-NW区A層

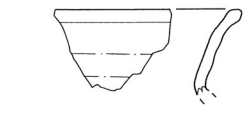

162 須恵器壺-RA089-検出面



163 須恵器壺-RA089-NE区A層

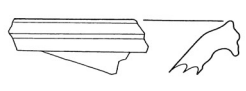

166 須恵器甕-RA089-検出面

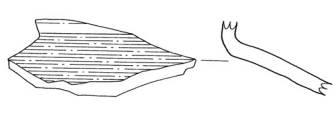

164 須恵器壺-RA089-SW区B層

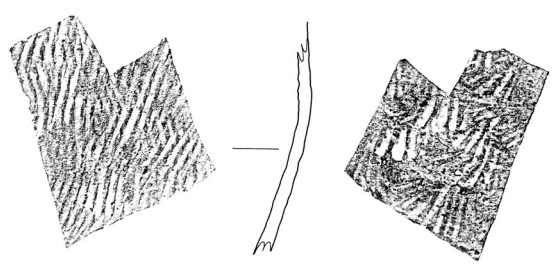

167 須恵器甕-RA089-L層

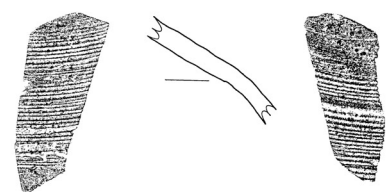

165 須恵器壺-RA089-pit 1



168 須恵器甕-RA089-床面(No.6)

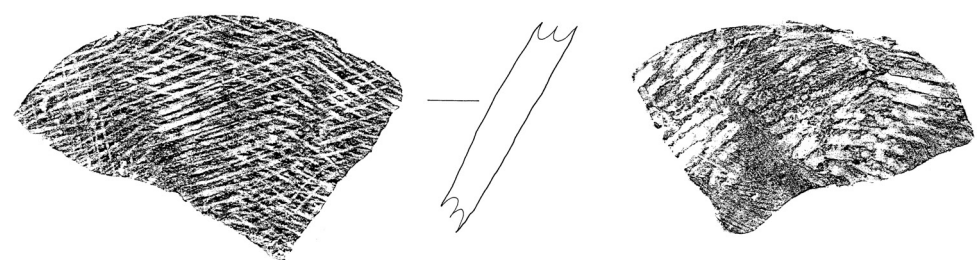

169 須恵器甕-RA089-床面(No.4)

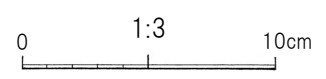

第86図 RA089出土土器

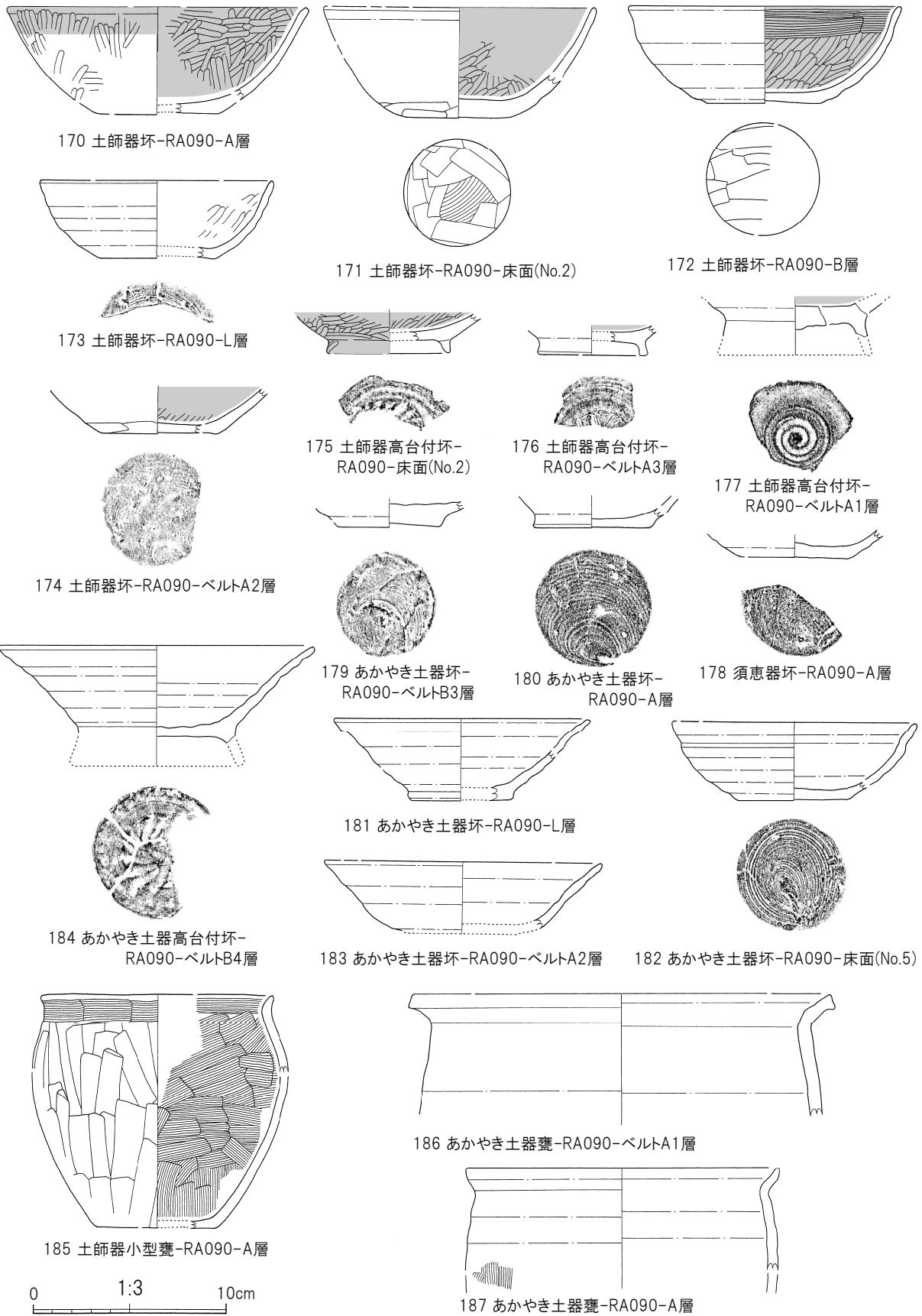

第87図 RA090出土土器(1)

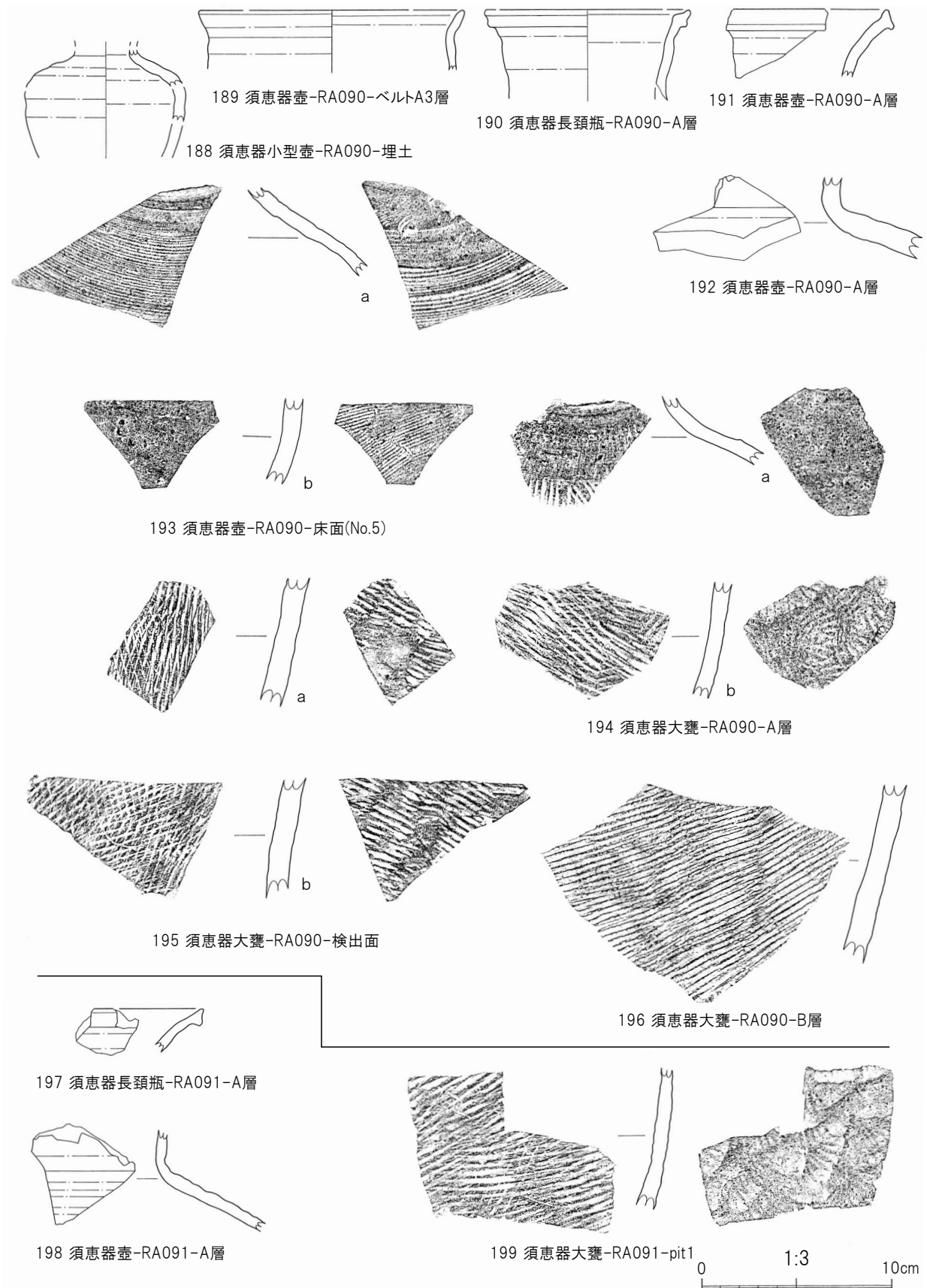

第88図 RA090出土土器(2), RA091出土土器

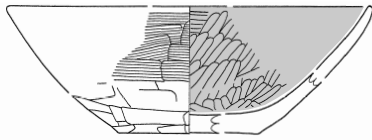

200 土師器坏-RA092-煙道J層

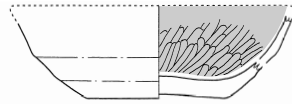

201 土師器坏-RA092-カマドJ層

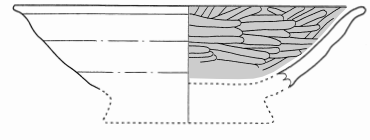
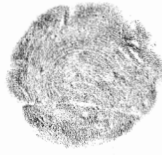

202 土師器高台付坏-RA092-B層

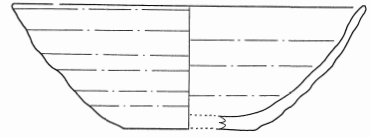

203 須恵器坏-RA092-北壁際B2層

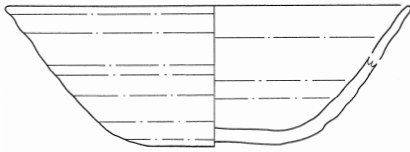

204 須恵器坏-RA092-床面(No.1)

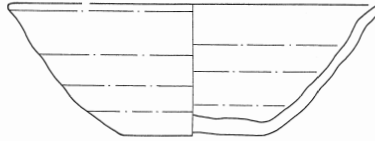

205 須恵器坏-RA092-煙出(No.3・5~11)



206 須恵器坏-RA092-B層-灯明皿



207 あかやき土器坏-RA092-東壁際B2層



208 あかやき土器坏-RA092-B層

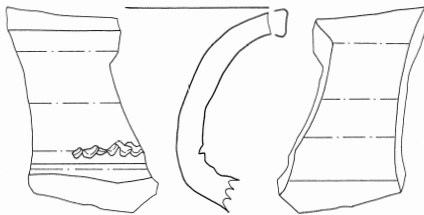

211 須恵器大甕-RA092-B層

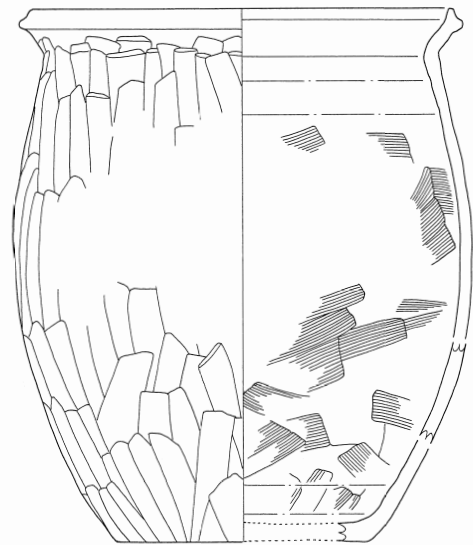

209 あかやき土器甕-RA092-B層

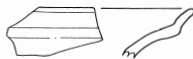

212 須恵器長頸瓶-RA092-B層



213 須恵器壺-RA092-A層

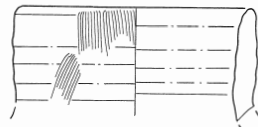

210 あかやき土器壺-RA092-B層



214 須恵器壺-RA092-A層

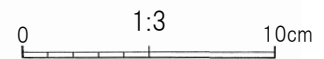

第89図 RA092出土土器(1)

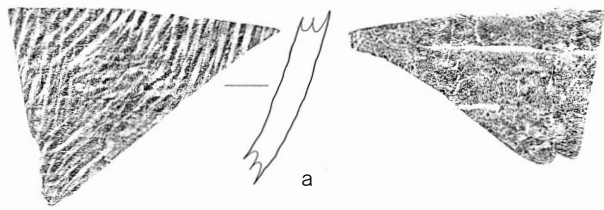

216 須恵器大甕-RA092-北壁際J層

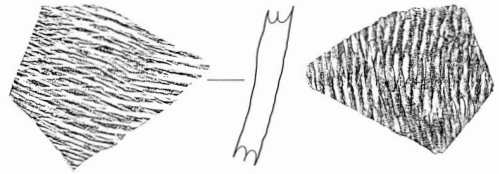

217 須恵器大甕-RA092-A層

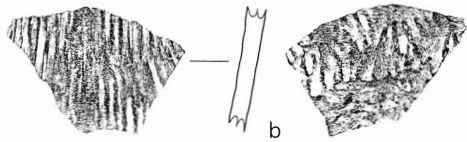

215 須恵器大甕-RA092-B層

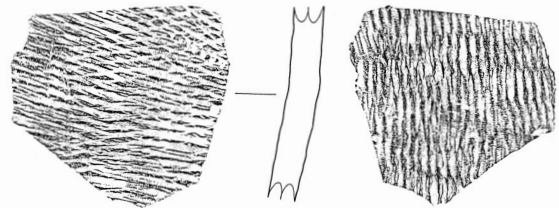

218 須恵器壺-RA092-B層

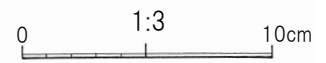
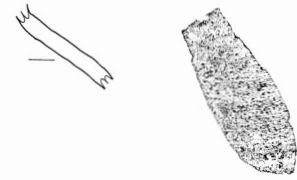
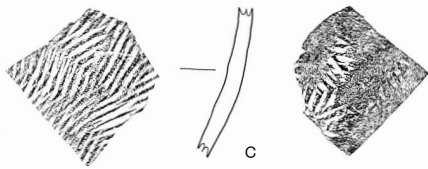

219 須恵器大甕-RA092-煙出(No.3・5~11)

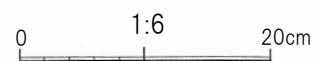
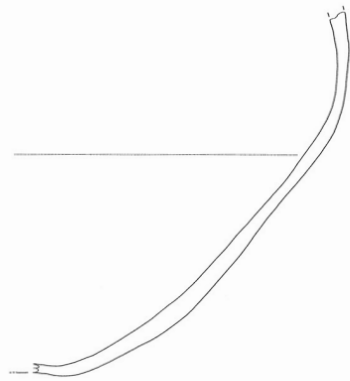

第90図 RA092出土土器(2)

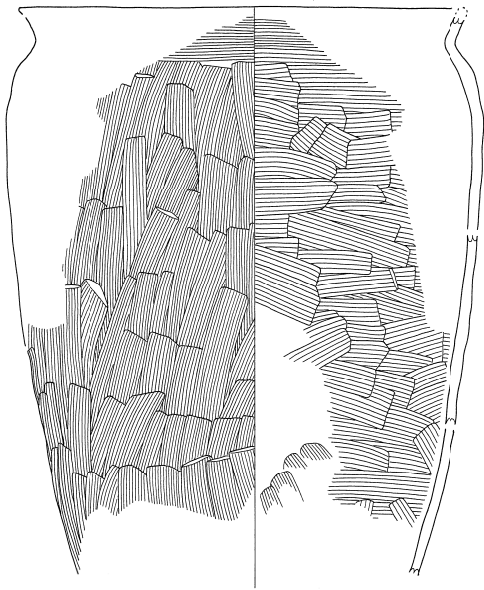

220 土師器甕-RA093-煙道(No.7)

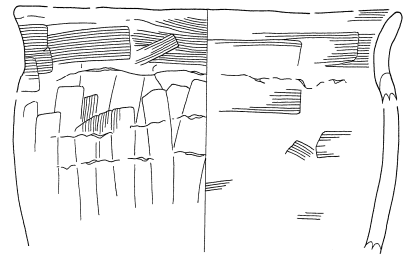

221 土師器甕-RA095-煙出J層

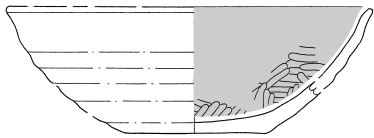

222 土師器坏-RA095-B層

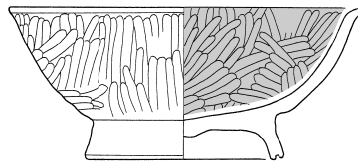

224 土師器高台付坏-RA095-B層

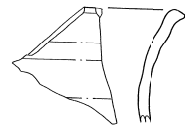

225 須恵器壺-RA095-SE区B層

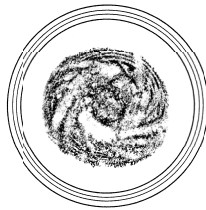

226 須恵器壺-RA095-NE区L層

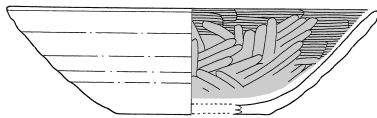

223 土師器坏-RA095-NE区B層

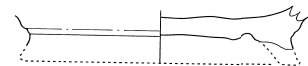

227 須恵器長頸瓶-RA095-MN区B層



228 須恵器大甕-RA095-B層

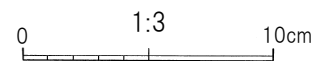

第91図 RA093-095出土土器

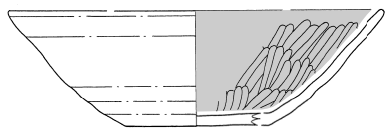

229 土師器坏-RA098-2区L層

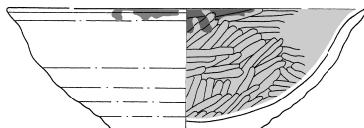

230 土師器坏-RA098-pit2-灯明皿

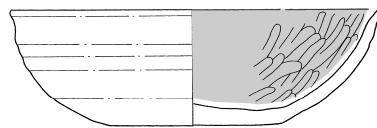

231 土師器坏-RA098-7区床面(No.1)

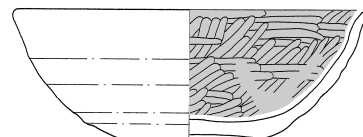

232 土師器坏-RA098-pit1

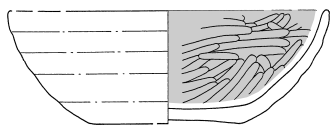

233 土師器坏-RA098-11区L層



235 須恵器坏-RA098-床面(No.2)-墨書

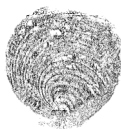

236 須恵器坏-RA098-2区L層-墨書「七」



234 須恵器盖-RA098-11区西ベルトA2層

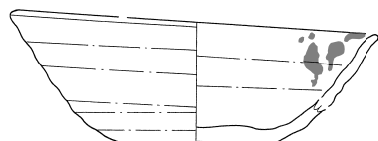

238 須恵器坏-RA098-床面(No.1)-灯明皿

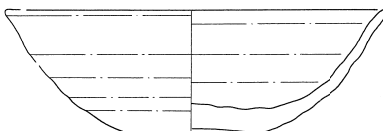

239 須恵器坏-RA098-2区カマド左袖下L層



237 須恵器坏-RA098-15区A層-墨書「メ」



241 須恵器坏-RA098-16区L層



242 須恵器坏-RA098-3区B層

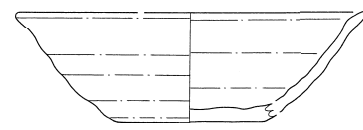

240 須恵器坏-RA098-12区周溝

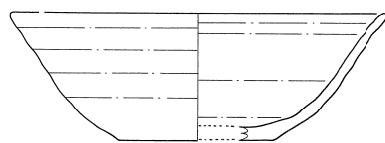

244 須恵器坏-RA098-3区カマドJ層

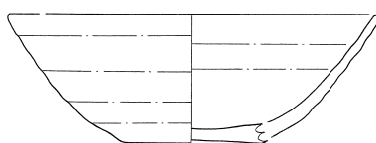

245 あかやき土器坏-RA098-床面(No.5)

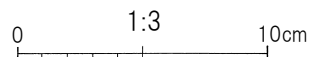

第92図 RA098出土土器(1)

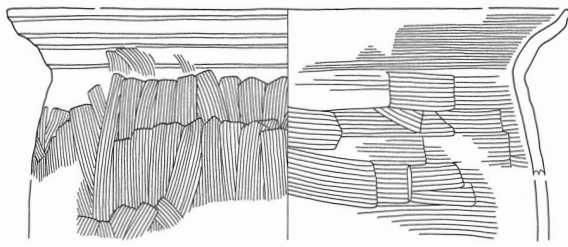

246 土師器甕-RA098-煙道J3層

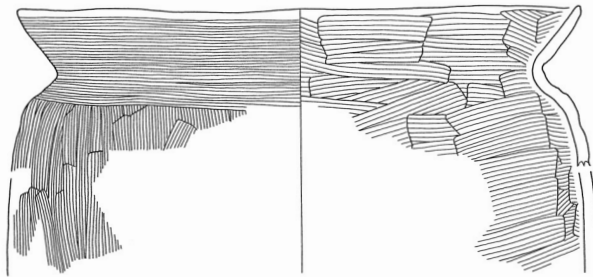

247 土師器甕-RA098-2区カマド左袖K層

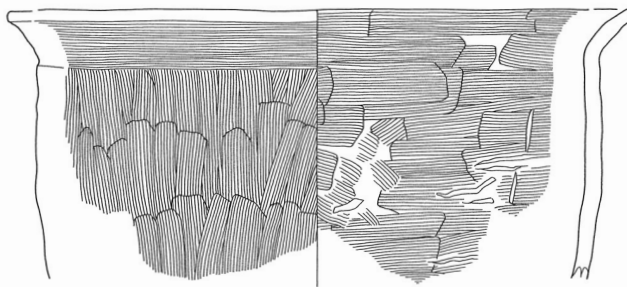

248 土師器甕-RA098-12区A層

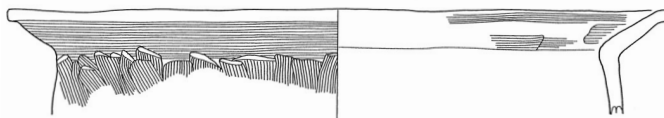

249 土師器甕-RA098-14区周溝

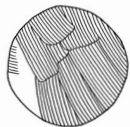
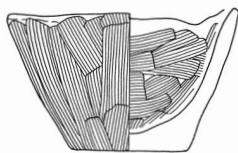

254 土師器小型鉢-
RA098-pit5

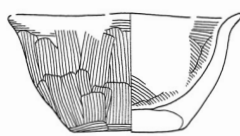

255 土師器小型鉢-
RA098-1区B層

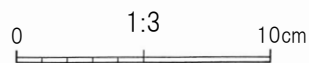

253 土師器甕-RA098-
床面(No.2)



250 土師器甕-RA098-pit5

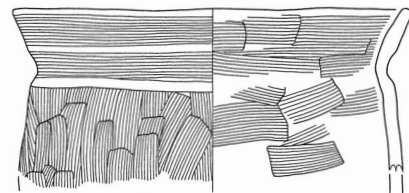

251 土師器甕-RA098-10区北ベルトL層

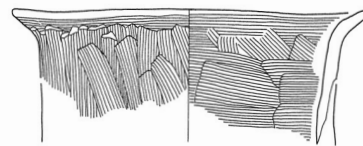

252 土師器甕-RA098-2区B層

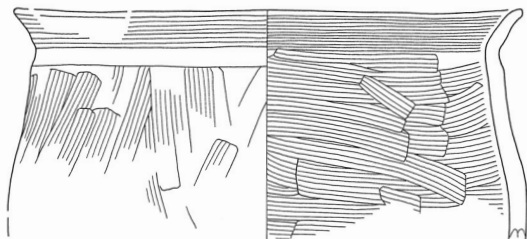

第93図 RA098出土土器(2)

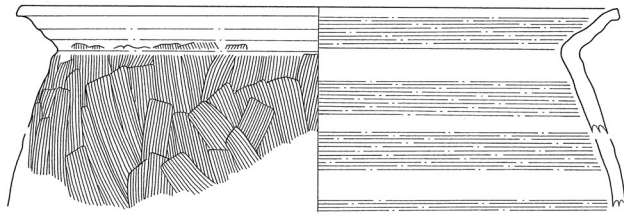

256 あかやき土器甕-RA098-2区周溝C層

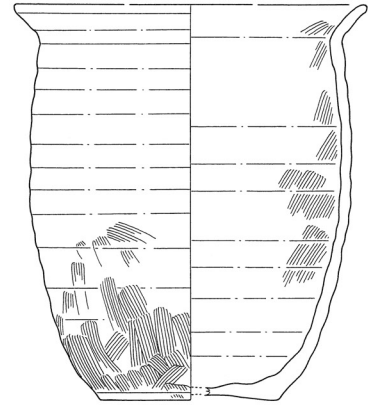

258 あかやき土器甕-RA098-pit7(No.5)

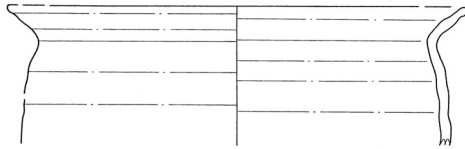

257 あかやき土器甕-RA098-1区周溝

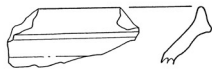

260 あかやき土器長頸瓶-RA098-11区A層

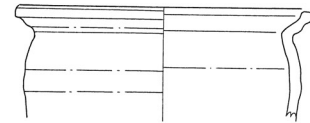

259 あかやき土器甕-RA098-pit1

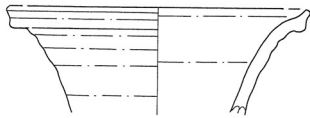

261 須恵器長頸瓶-RA098-11区A層



262 須恵器長頸瓶-RA098-12区L層

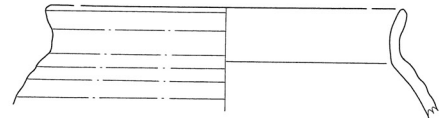

263 須恵器壺-RA098-5区L層

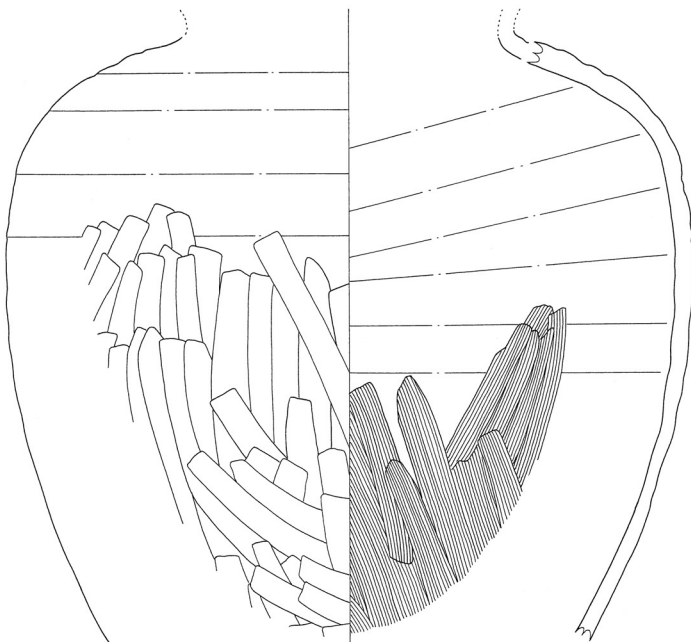

265 須恵器壺-RA098-床面(No.5)

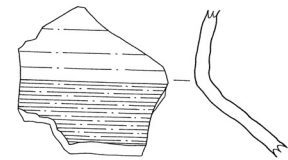

264 須恵器壺-RA098-12区A層

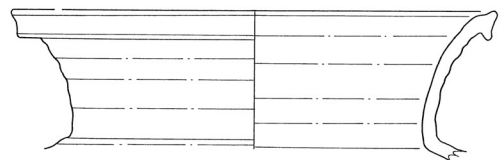

266 須恵器甕-RA098-11区A層最下部

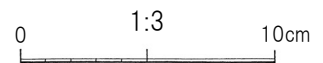

第94図 RA098出土土器(3)

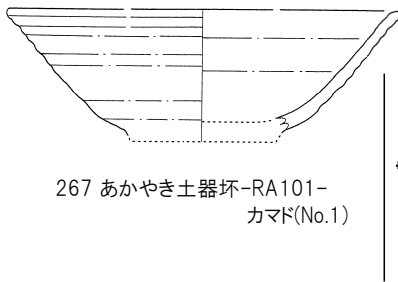

267 あかやき土器坏-RA101-カマド(No.1)

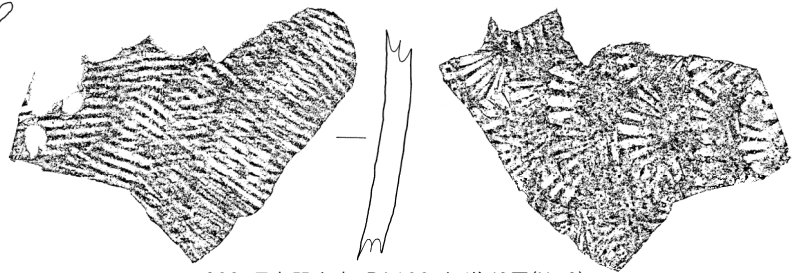

268 須恵器大甕-RA103-煙道J2層(No.2)

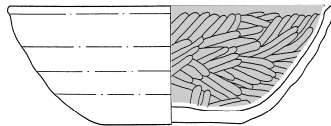

269 土師器坏-RA104-A1層(No.1)

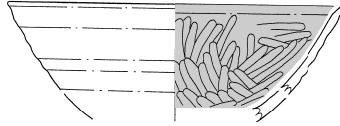

270 土師器坏-RA104-カマド床面(No.2)

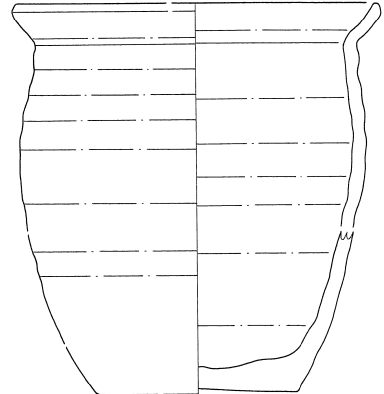

271 あかやき土器甕-RA104-SW区A2層

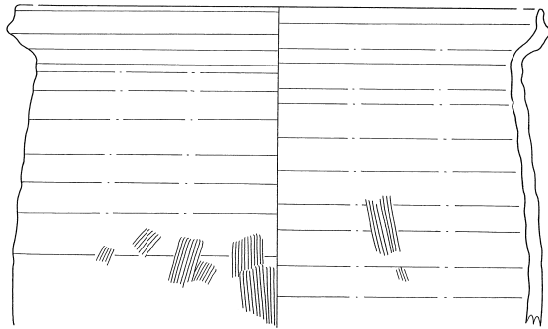

272 あかやき土器甕-RA104-NE区A2層

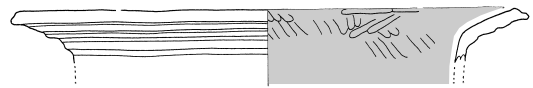

273 土師器甕-RA104-SW区A1層

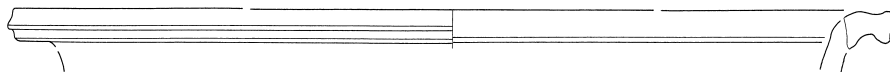

274 須恵器大甕-RA105-SE区A1層

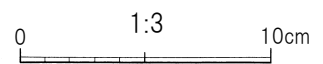

第95図 RA101・103・104・105出土土器

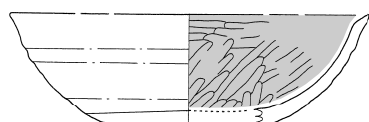

275 土師器坏-RA152a-8区西ベルトA3層



277 土師器坏-RA152a-10区西ベルトB層

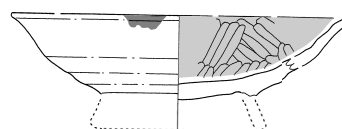

278 土師器高台付坏-RA152a-東カマド煙出埋土上層-灯明皿

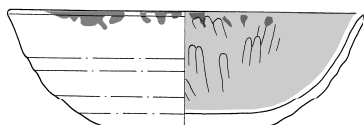

276 土師器坏-RA152a-15区西ベルトB層-灯明皿

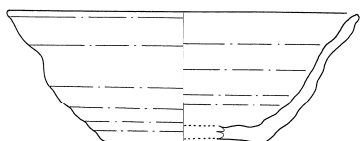
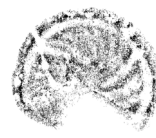

279 須恵器坏-RA152a-東カマド煙道

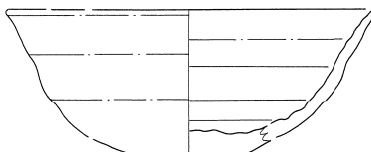

281 あかやき土器坏-RA152a-3区西ベルトL1層

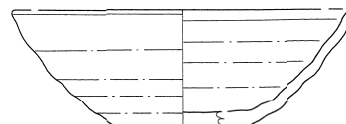

282 あかやき土器坏-RA152a-1区A3層

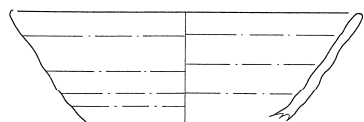

280 須恵器坏-RA152a-2区A1層

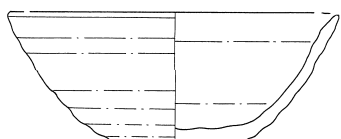

283 あかやき土器坏-RA152a-1区L層

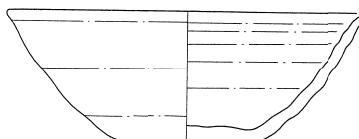

284 あかやき土器坏-RA152a-6区L層

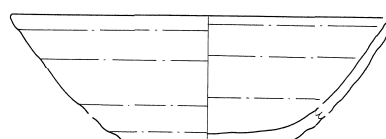

285 あかやき土器坏-RA152a-7区L層



286 あかやき土器坏-RA152a-13区B層-墨書「寿」

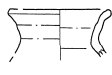

288 あかやき土器小型壺-RA152a-5区B層-赤彩

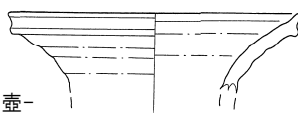

289 須恵器長頸瓶-RA152a-13区A2層

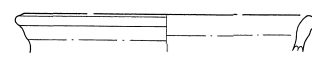

291 須恵器甕-RA152a-16区L層

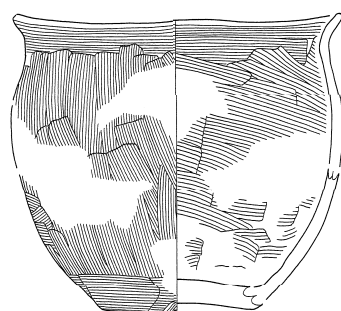

287 土師器小型壺-RA152a-3区L層

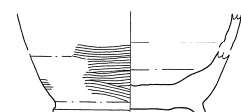

290 須恵器長頸瓶-RA152a-7区北ベルトA3層

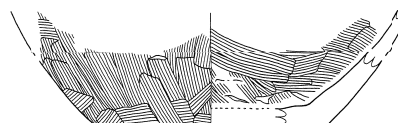

292 須恵器甕-RA152a-16区北ベルトB層

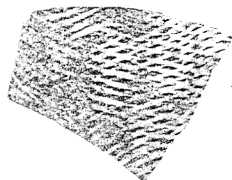

293 須恵器大甕-RA152a-16区

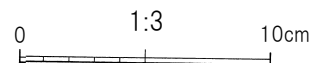
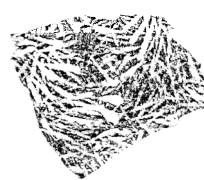

第96図 RA152a出土土器

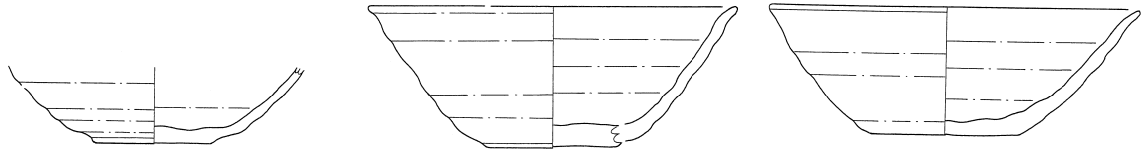

296 あかやき土器杯-RA152'-床面(No.28)

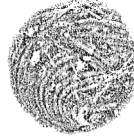

294 須恵器杯-RA152'-6区西ベルトL2層

295 あかやき土器杯-RA152'-床面(No.30)

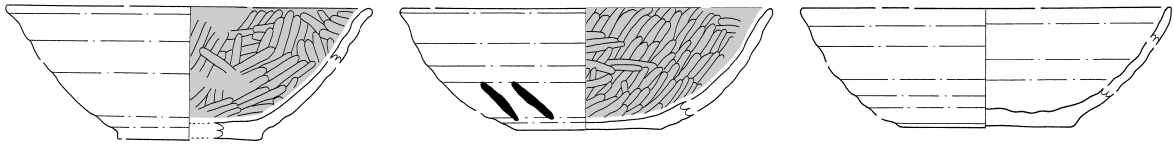

297 土師器杯-RA152''-ベルトL3層

298 土師器杯-RA152''-L3層(No.31)-墨書



299 あかやき土器杯-RA152''-L4層

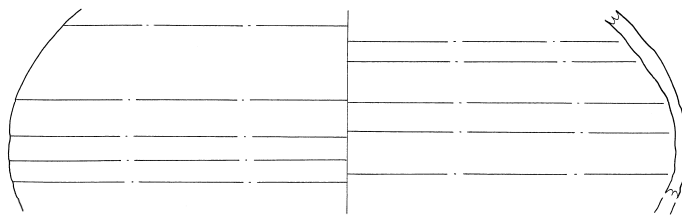

300 須恵器壺-RA152''-L3層(No.31)

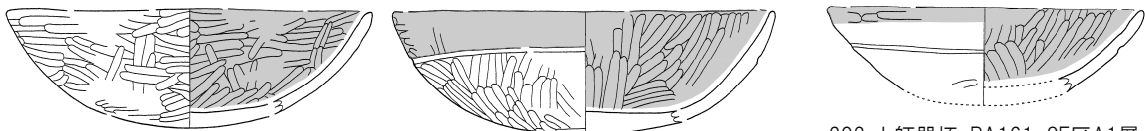

301 土師器杯-RA161-NW区L層

302 土師器杯-RA161-NE区床面

303 土師器杯-RA161-SE区A1層

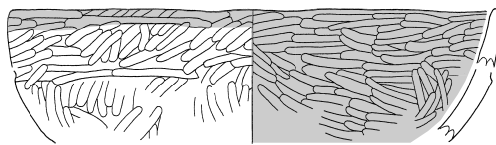

304 土師器杯-RA161-SE区L層

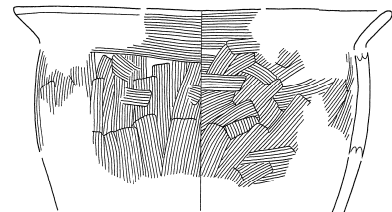

306 土師器甕-RA161-SE区L層

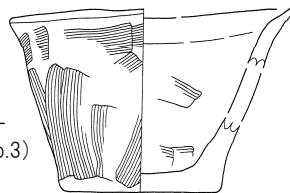

305 土師器小型鉢-RA161-A3層(No.3)

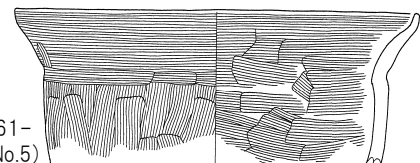
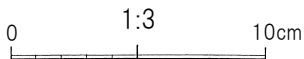

307 土師器甕-RA161-床面(No.5)

第97図 RA152'・152''・161出土土器

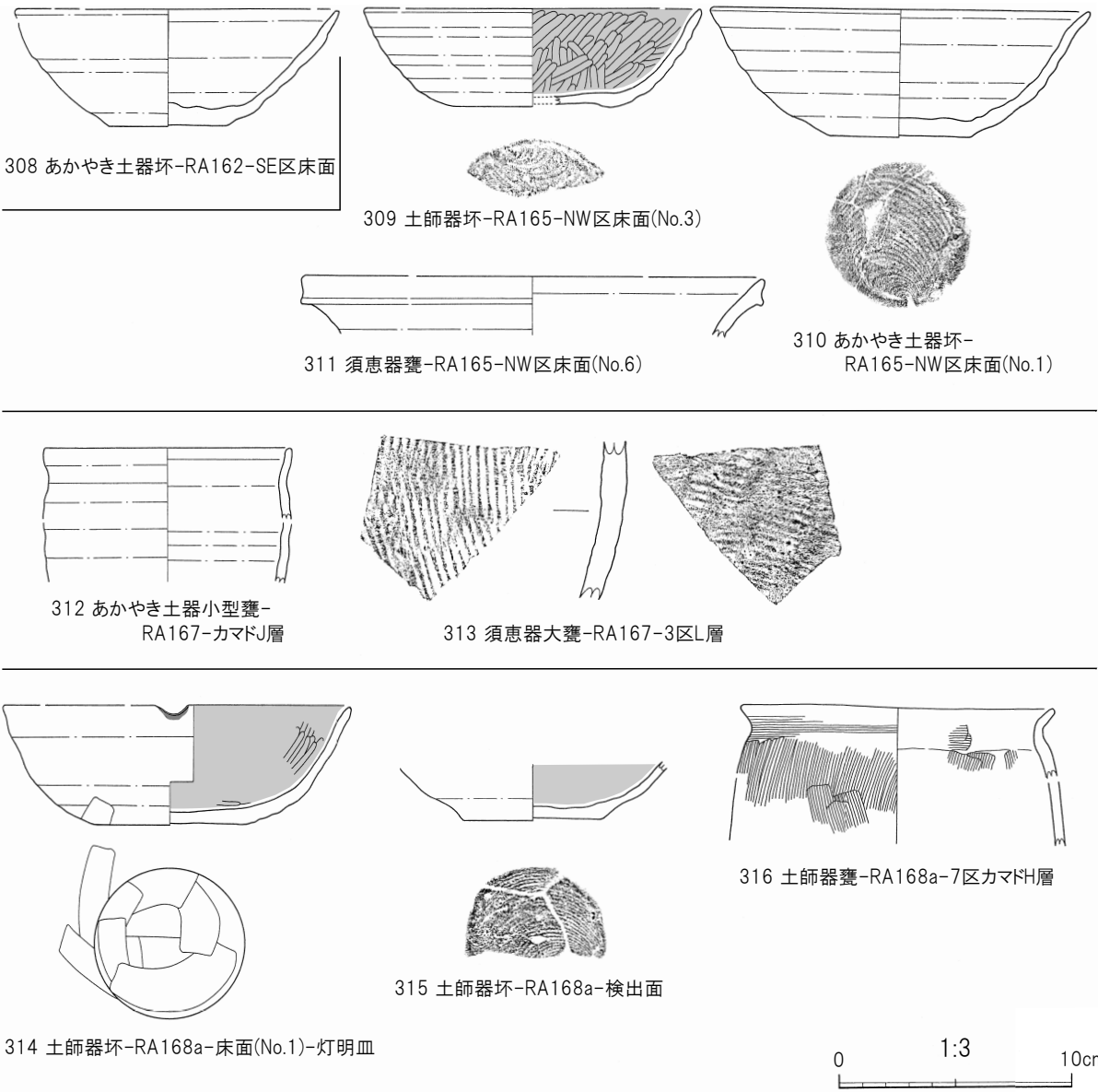

第98図 RA162・165・167・168a出土土器

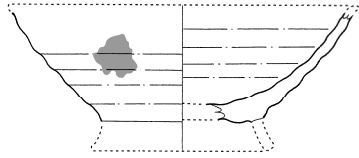

317 あかやき土器高台付坏-RA171-NW区A3層



318 須恵器大甕-RA171-SW区A層

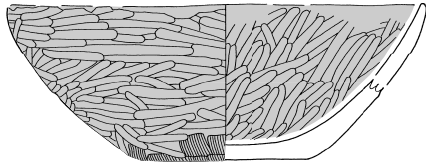

319 土師器坏-RA171-煙道(No.3)

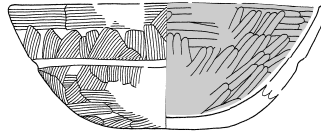

323 土師器坏-RA171-貯蔵穴A4層

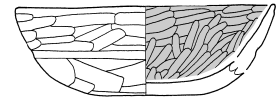

326 土師器坏-RA171-貯蔵穴A4層

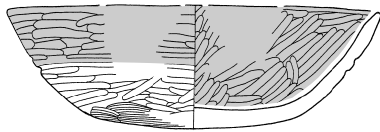

320 土師器坏-RA171-貯蔵穴A4層

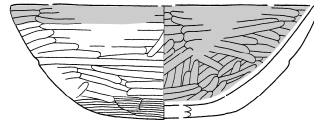

324 土師器坏-RA171-貯蔵穴A4層

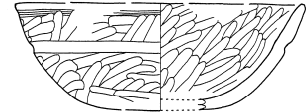

327 土師器坏-RA171-pit1

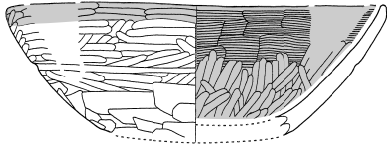

321 土師器坏-RA171-貯蔵穴A4層

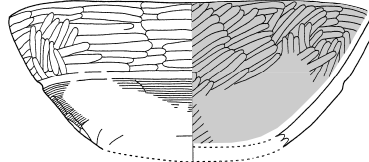

325 土師器坏-RA171-貯蔵穴A4層

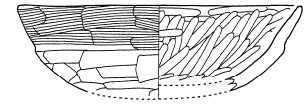

328 土師器坏-RA171-貯蔵穴A4層

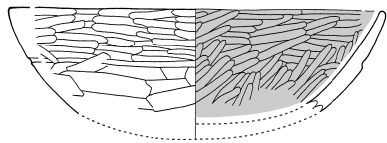

322 土師器坏-RA171-貯蔵穴A4層

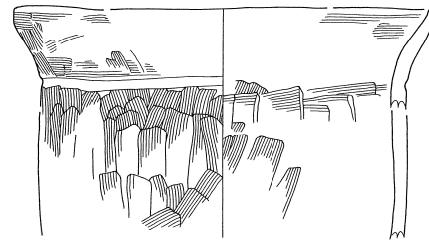

329 土師器甕-RA171-床面(No.4)

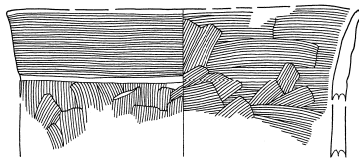

330 土師器甕-RA171-貯蔵穴埋土

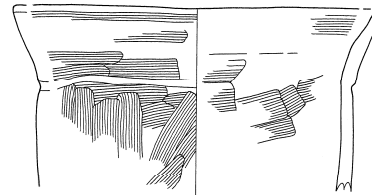

331 土師器甕-RA171-SW区A3層

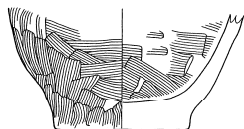

332 土師器甕-RA171-煙道

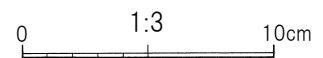

第99図 RA171出土土器

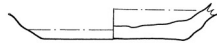

333 須恵器坏-RA172-ベルトA1層

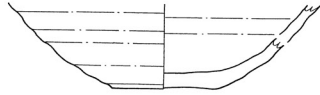

334 あかやき土器坏-RA172-2区A2層

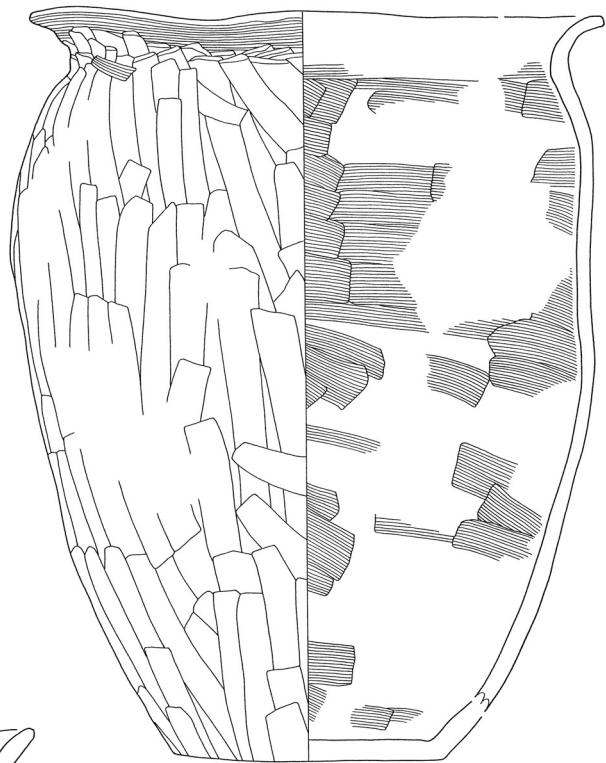

335 土師器甕-RA172-床面(No.1)



336 土師器甕-RA172b-煙道底面

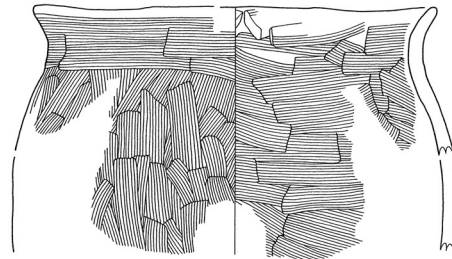

337 土師器甕-RA172b-カマドJ層

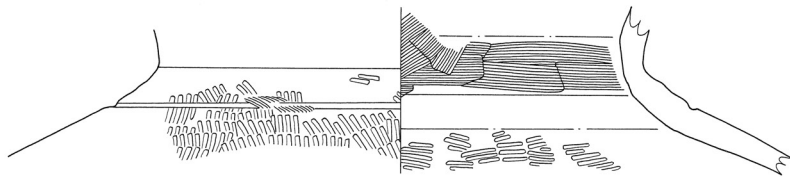

338 須恵器大甕-RA172-床面(No.6)

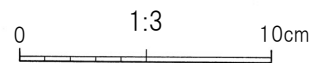

第100図 RA172出土土器

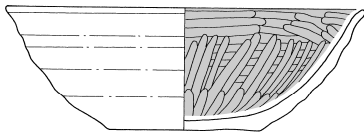

339 土師器坏-RA173-床面(No.11)

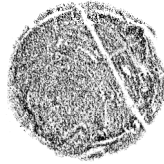
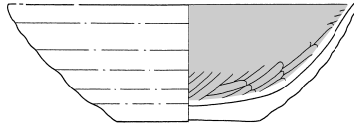

340 土師器坏-RA173-C層



341 土師器坏-RA173-ベルトC1層

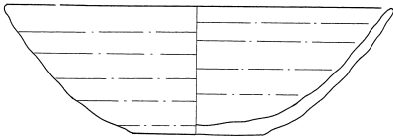

343 須恵器坏-RA173-煙道5

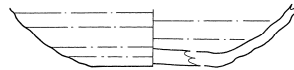

344 須恵器坏-RA173-床面

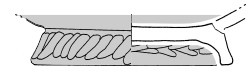

342 土師器高台付坏-RA173-床面(No.20)

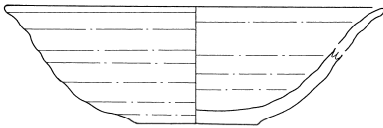

345 あかやき土器坏-RA173-3区A2層

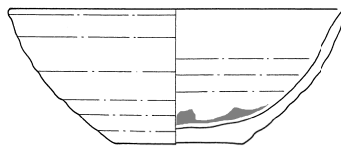

346 あかやき土器坏-RA173-6区A層

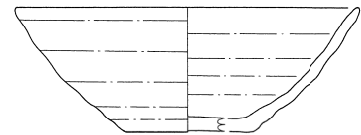

347 あかやき土器坏-RA173-床面

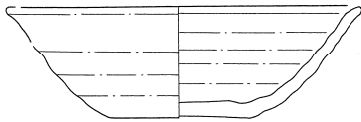

348 あかやき土器坏-RA173-床面

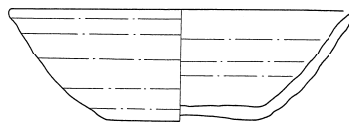

349 あかやき土器坏-RA173-床面

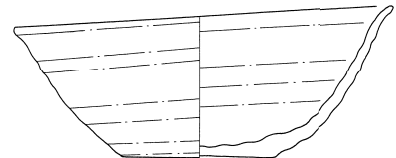

350 あかやき土器坏-RA173-pit6

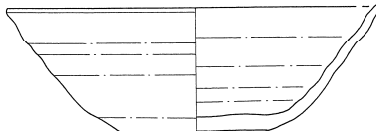

351 あかやき土器坏-RA173-床面(No.27)

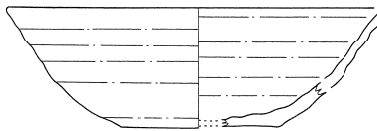

352 あかやき土器坏-RA173-床面(No.23)

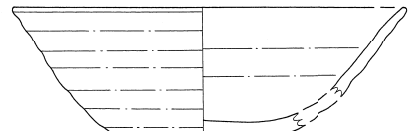

353 あかやき土器坏-RA173-貯蔵穴

0 1:3 10cm

第101図 RA173出土土器(1)

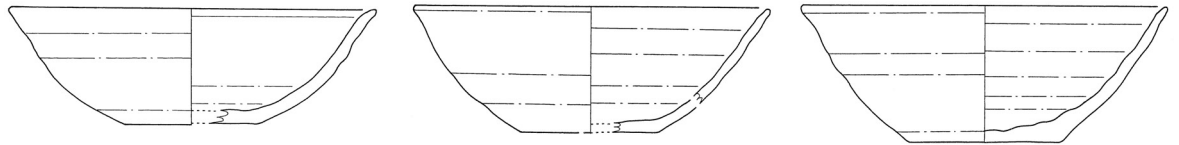

354 あかやき土器杯-RA173-5区A層

355 あかやき土器杯-RA173-床面(No.13)

356 あかやき土器杯-RA173-煙道2 B2層

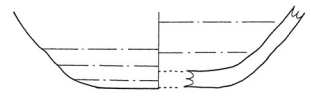
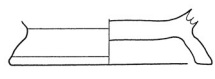

357 あかやき土器杯-RA173-張り出し



360 あかやき土器高台付杯-RA173-6区D層



358 あかやき土器高台付杯-RA173-床面(No.10)

359 あかやき土器高台付杯-RA173-ベルトD2層

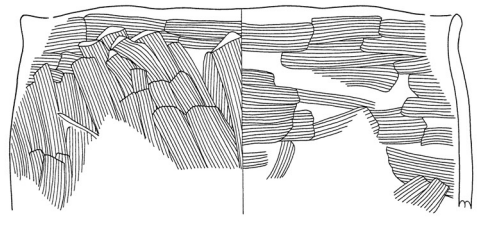

361 土師器甕-RA173-ベルトD2層

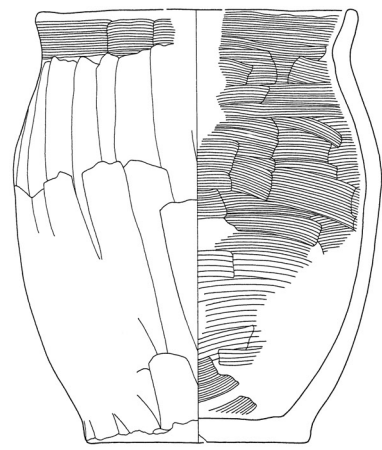

366 土師器小型甕-RA173-ベルトD2層

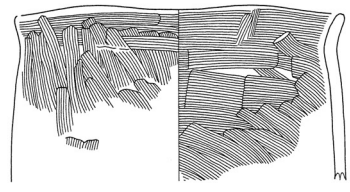

362 土師器小型甕-RA173-pit10

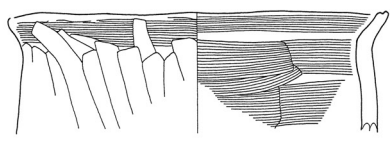

363 土師器小型甕-RA173-6区A2層

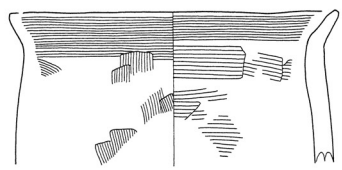

364 土師器小型甕-RA173-ベルト(カマド内)

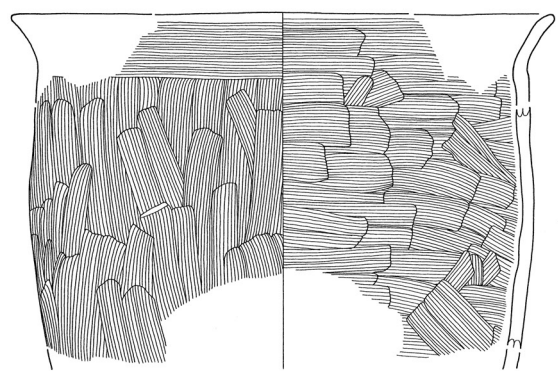

367 土師器甕-RA173-煙道4 C2層

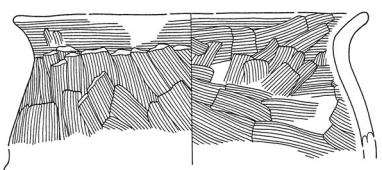

365 土師器小型甕-RA173-1区A2層

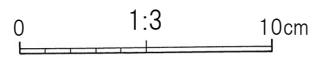

第102図 RA173出土土器(2)

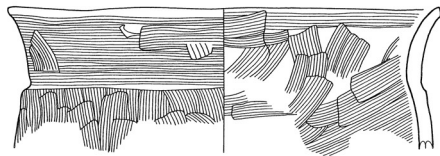

368 土師器甕-RA173-床面(No.9)

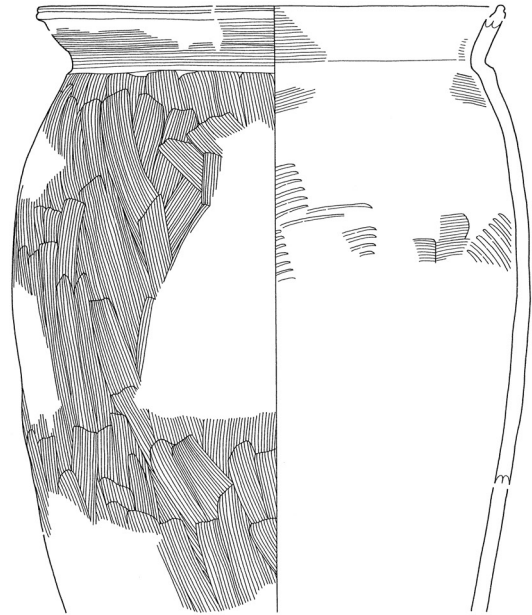

370 土師器甕-RA173-床面(No.4)

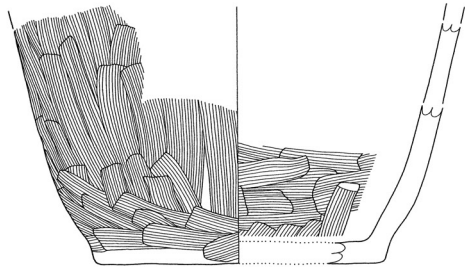

369 土師器甕-RA173-5区A層

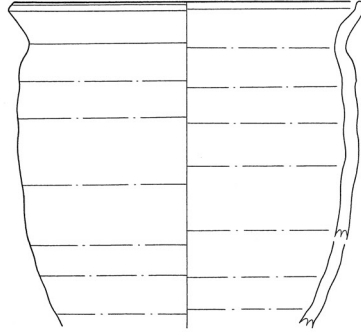
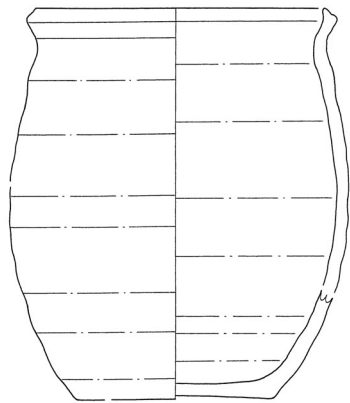

372 あかやき土器甕-
RA173-床面(No.26)



374 あかやき土器小型甕-
RA173-5区A層



371 あかやき土器甕-RA173-床面(No.21)

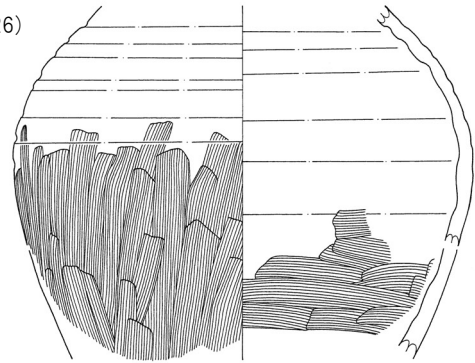

375 須恵器壺-RA173-床面(No.19)

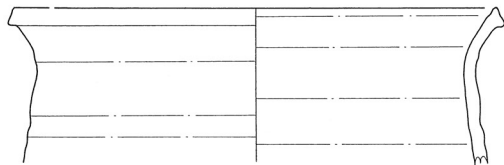

373 あかやき土器甕-RA173-ベルトD1層

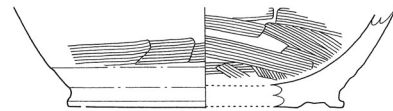

376 須恵器長頸瓶-RA173-4区A層

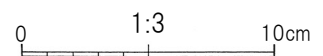

第103図 RA173出土土器(3)

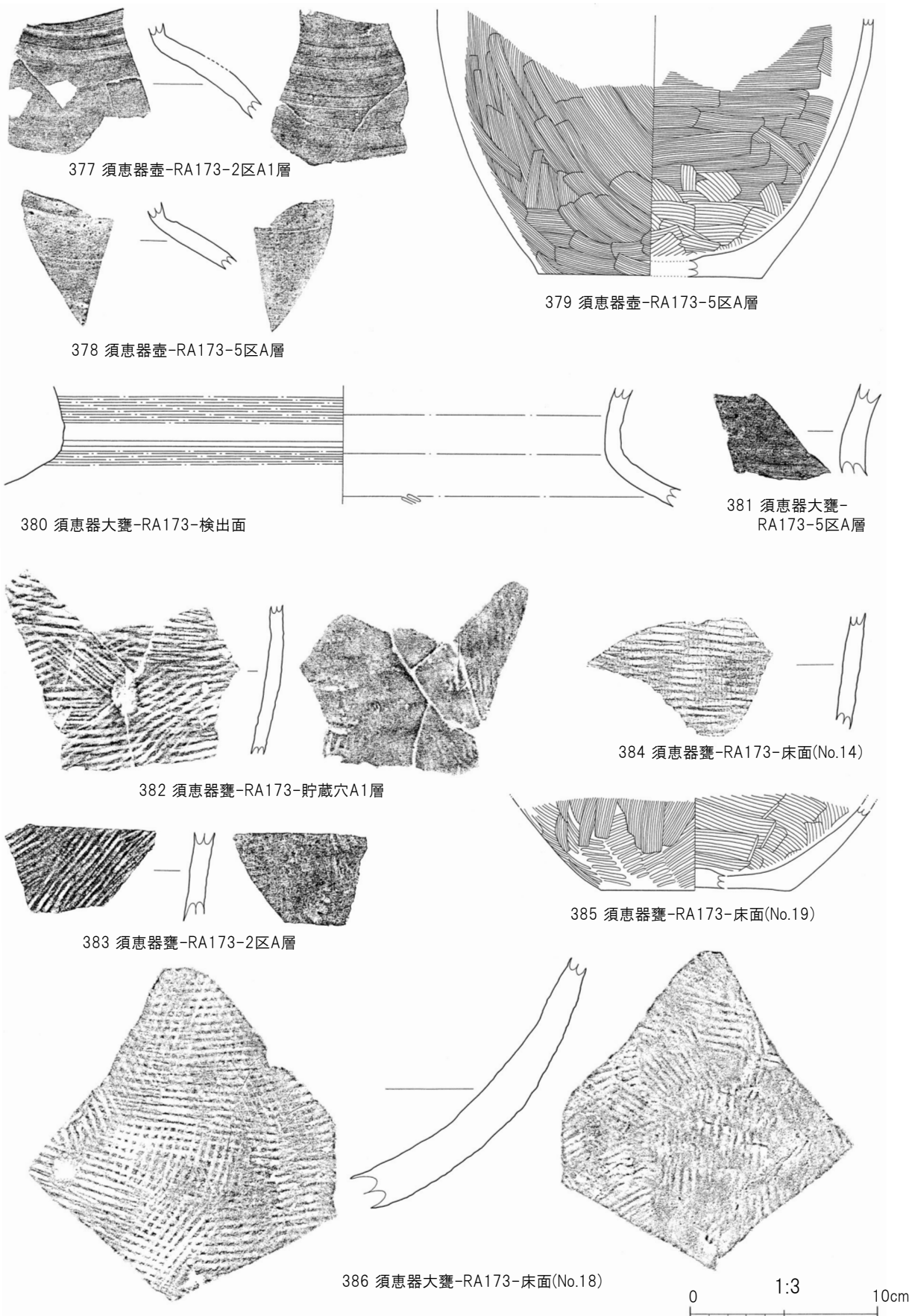

377 須恵器壺-RA173-2区A1層

378 須恵器壺-RA173-5区A層

379 須恵器壺-RA173-5区A層

380 須恵器大甕-RA173-検出面

381 須恵器大甕-RA173-5区A層

382 須恵器甕-RA173-貯蔵穴A1層

384 須恵器甕-RA173-床面(No.14)

383 須恵器甕-RA173-2区A層

385 須恵器甕-RA173-床面(No.19)

386 須恵器大甕-RA173-床面(No.18)

0 1:3 10cm

第104図 RA173出土土器(4)

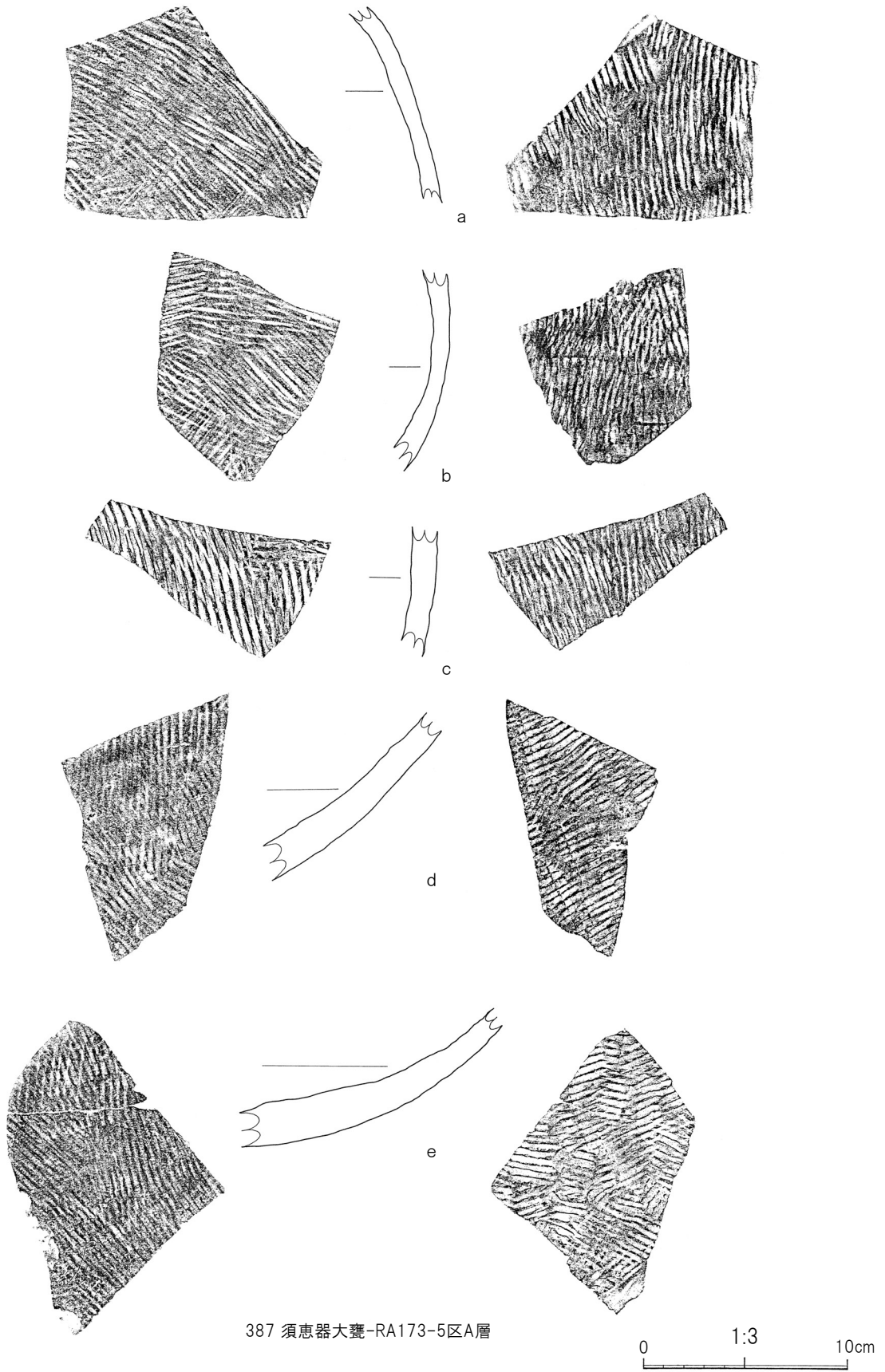

387 須恵器大甕-RA173-5区A層

第105図 RA173出土土器(5)

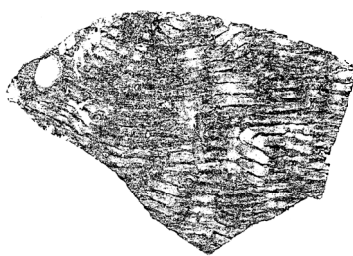
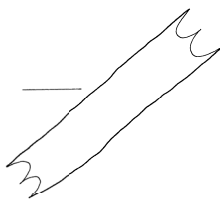
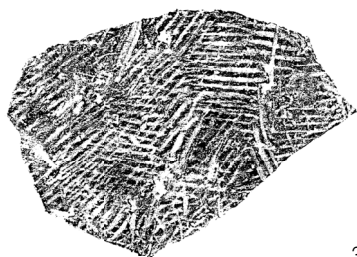

388 須恵器大甕-RA173-2区A2層

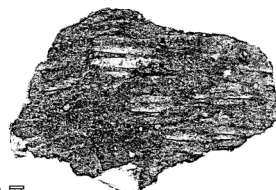
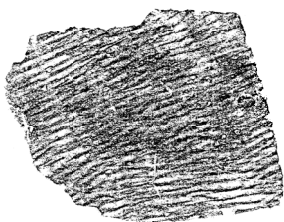

389 須恵器大甕-RA173-2区A層

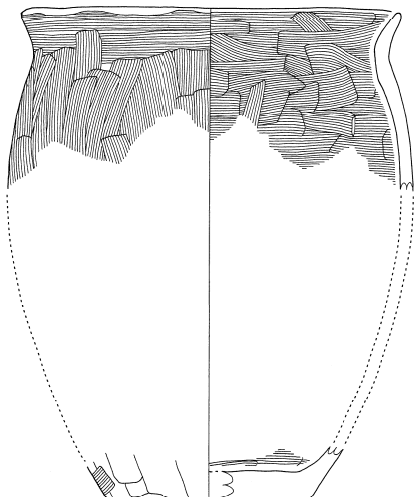

390 土師器甕-RA174-SE区検出面

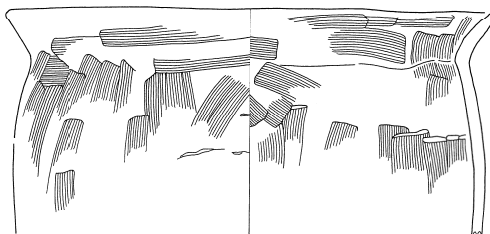

391 土師器甕-RA174-煙道(No.1)

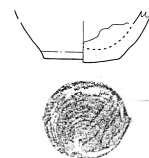

392 須恵器小型壺-RA174-NW区L層

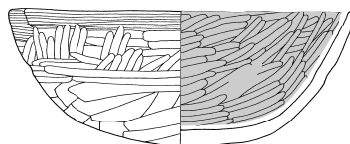

393 土師器甕-RA177-NE区A4層

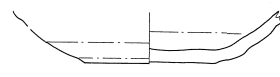

394 須恵器坏-RA177-NE区A4層

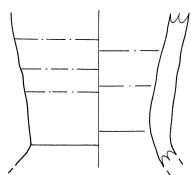

396 須恵器長頸瓶-RA179-検出面

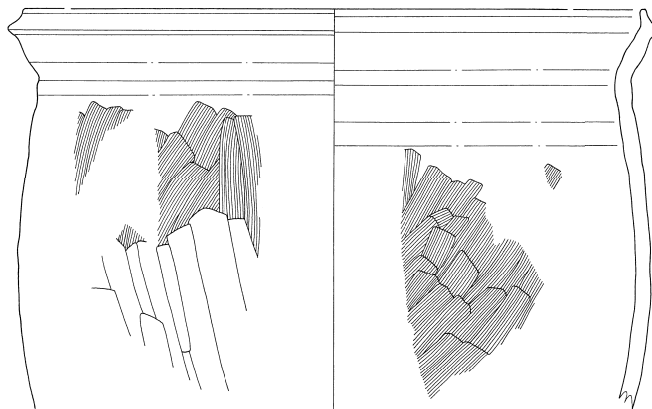

395 あかやき土器甕-RA177-検出面

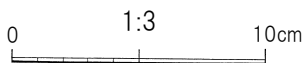

第106図 RA173出土土器(6), RA174・177・179出土土器

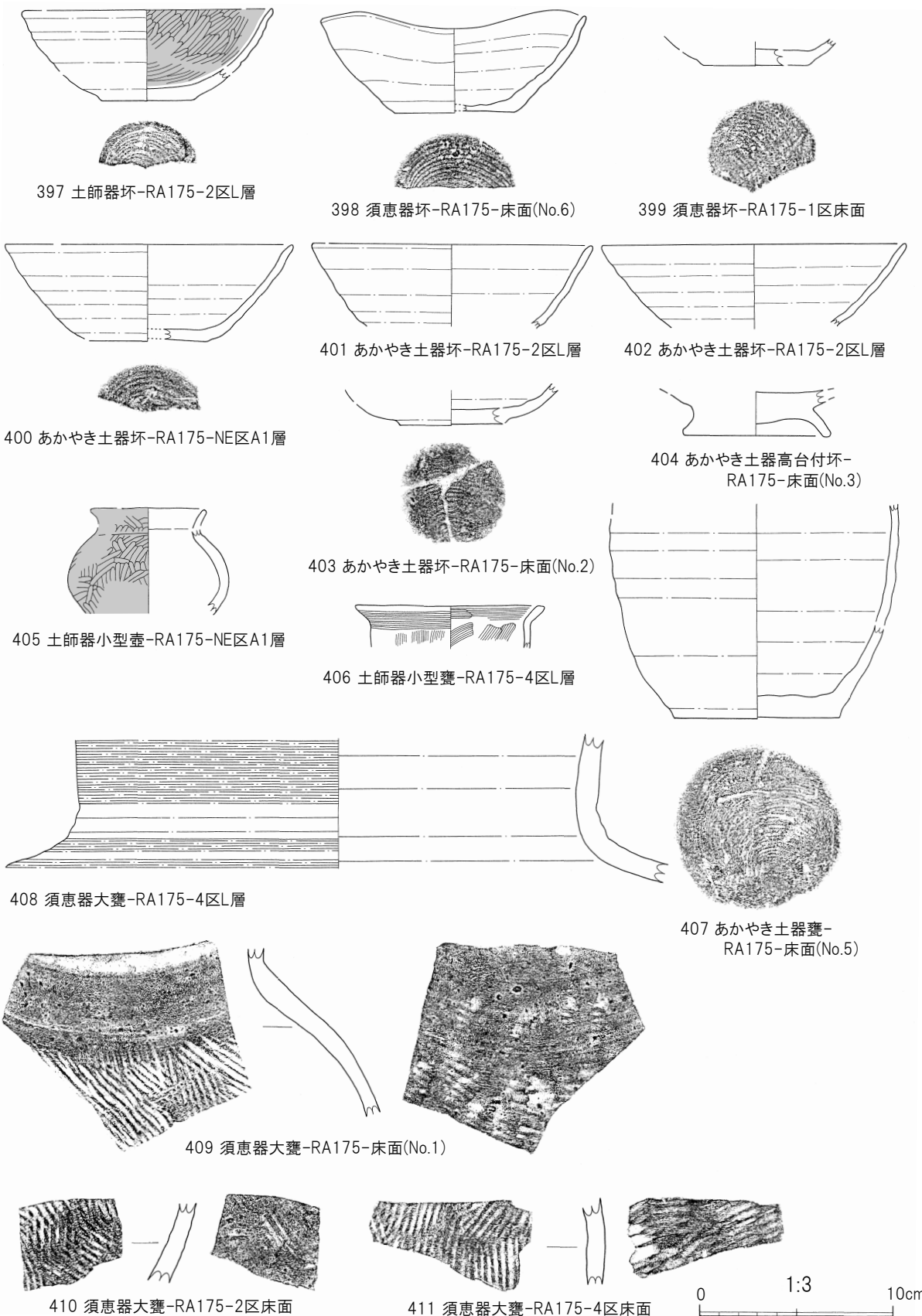

第107図 RA175出土土器(1)

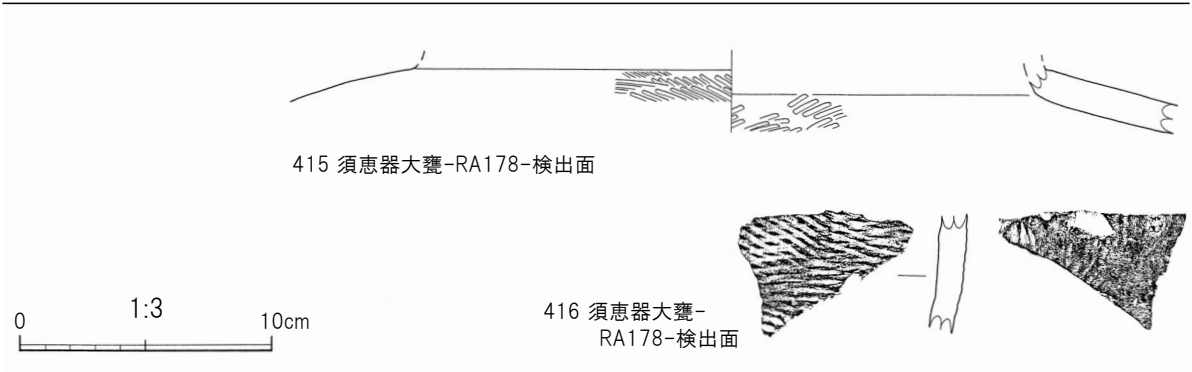
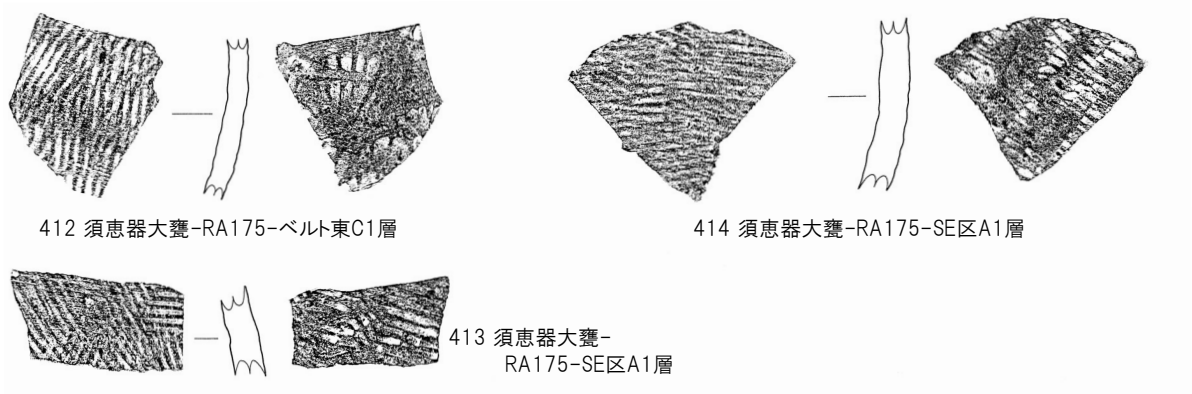

第108図 RA175出土土器(2)-RA178出土土器

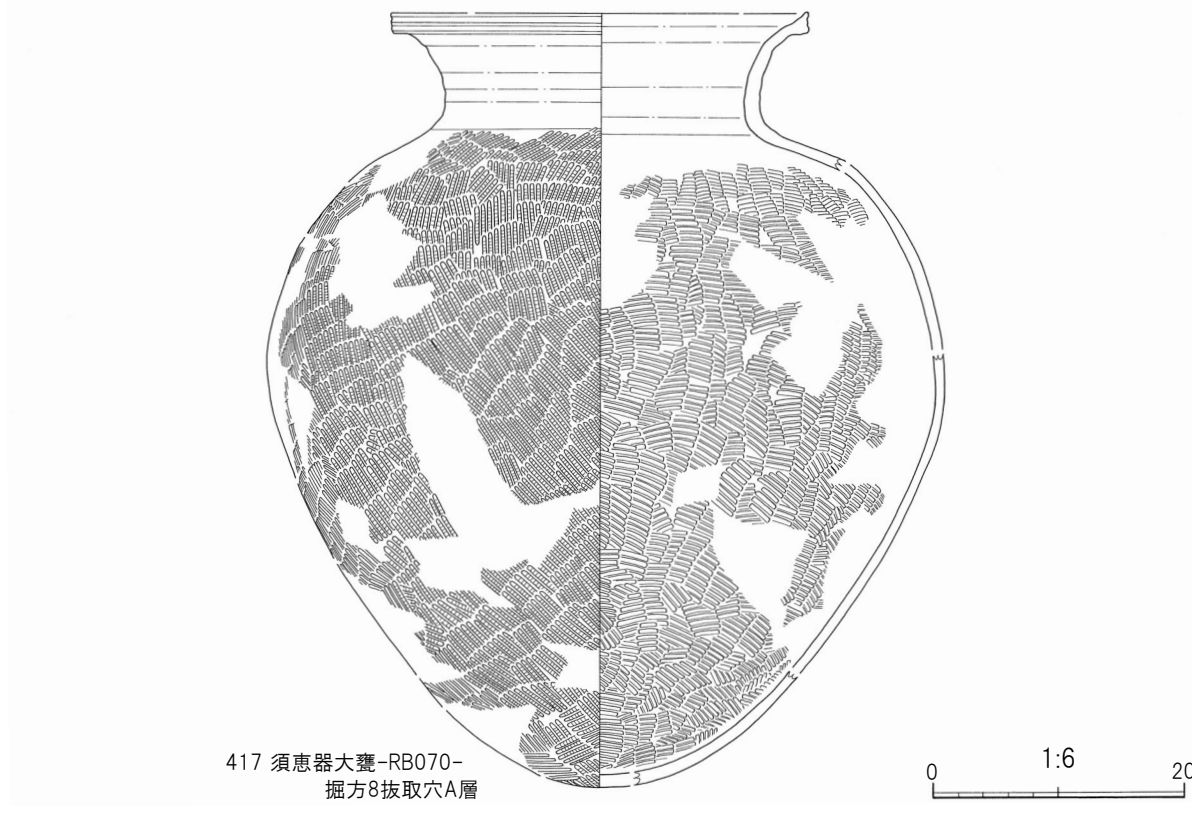

第109図 RB070出土土器(1)

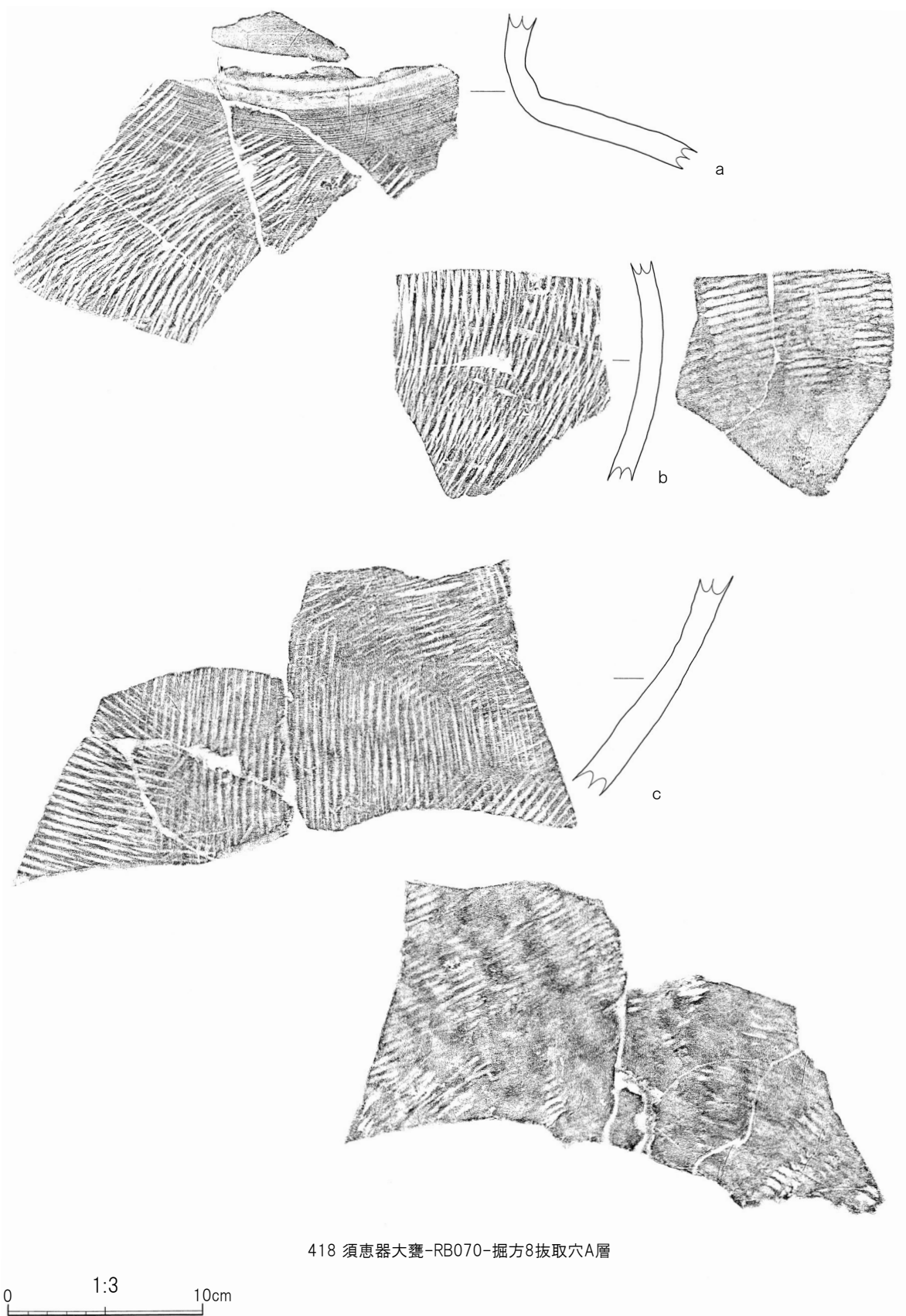

418 須恵器大甕-RB070-掘方8抜取穴A層

第110図 RB070出土土器(2)

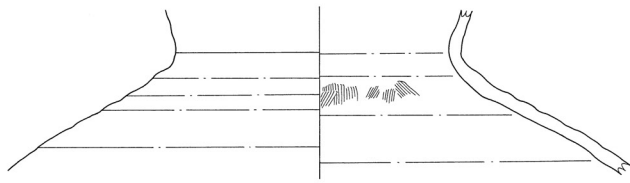

419 須恵器壺-RB070-掘方4 C層

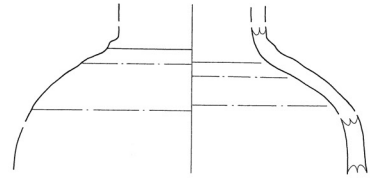

420 須恵器長頸瓶-RB070-掘方5柱痕跡

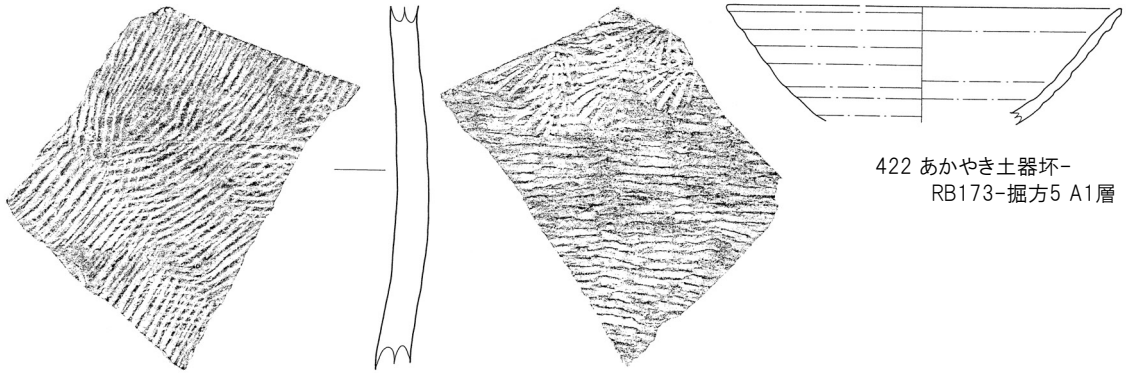

421 須恵器大甕-RB172-掘方5 B層

422 あかやき土器坏-
RB173-掘方5 A1層

第111図 RB070出土土器(3), RB172・173出土土器

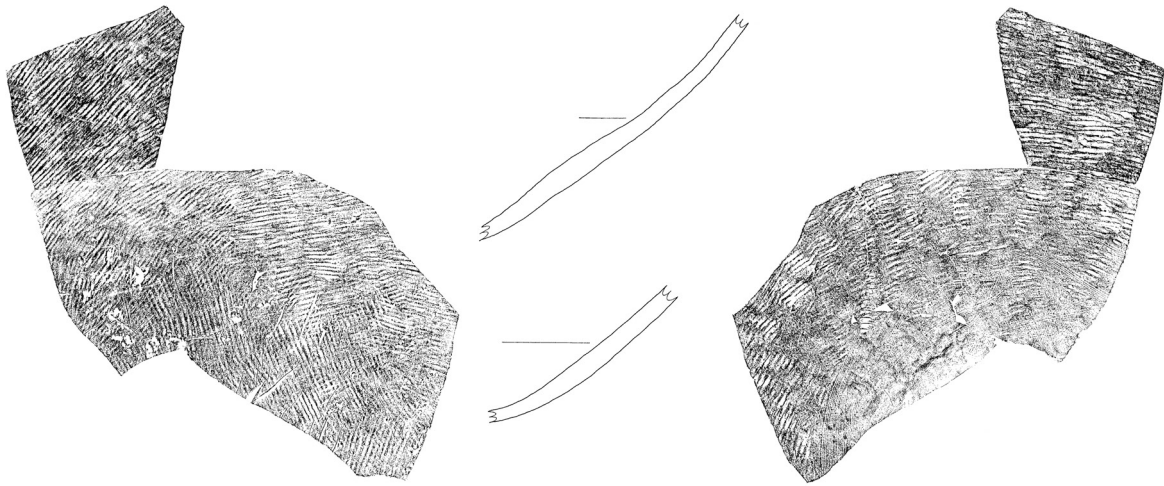

423 須恵器大甕-RD080-B層

第112図 RD080出土土器

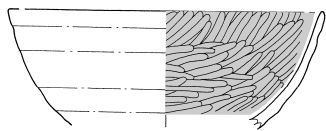

424 土師器坏-RD055-NE区A層

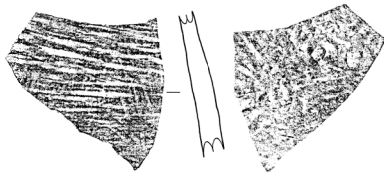

425 須恵器大甕-RD055-NE区A層



426 須恵器大甕-RD055-A3層

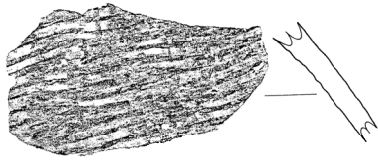

427 須恵器大甕-RD055-NW区A層

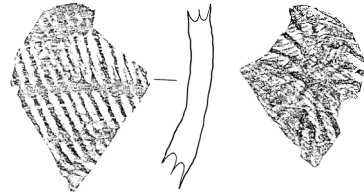

428 須恵器大甕-RD055-NW区A1層

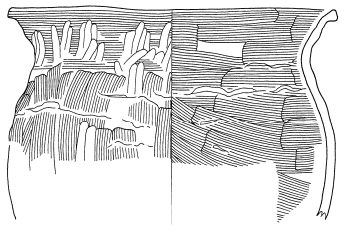

429 土師器甕-RD054-B層

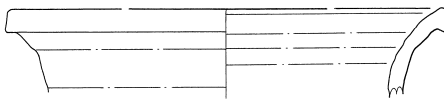

430 須恵器甕-RD056-SE区埋土

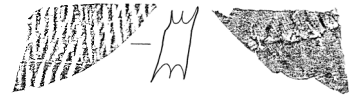

431 須恵器大甕-RD059-底面



432 須恵器大甕-RD065-A5層



433 土師器坏-RD065-A5層

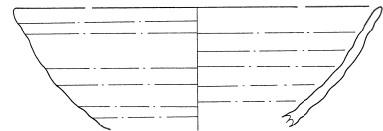

434 須恵器坏-RD069-埋土中層

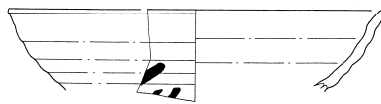
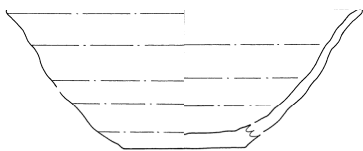

436 須恵器坏-RD067-A3層-墨書

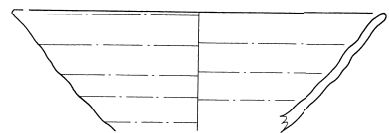

437 須恵器坏-RD067-埋土



435 須恵器坏-RD067-埋土中層

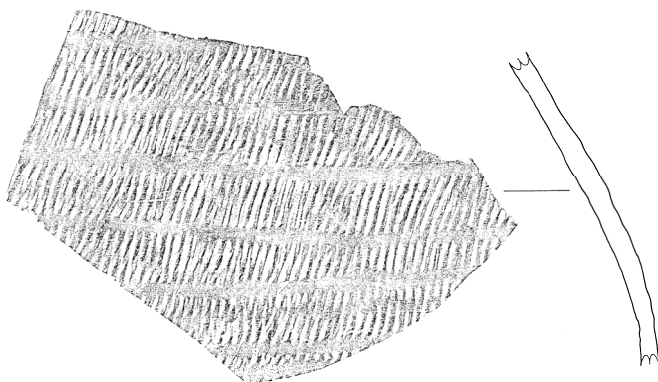

438 須恵器大甕-RD067-A3層(No.2)

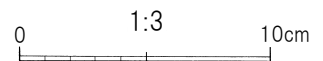

第113図 RD054・055・056・059・065・067・069出土土器

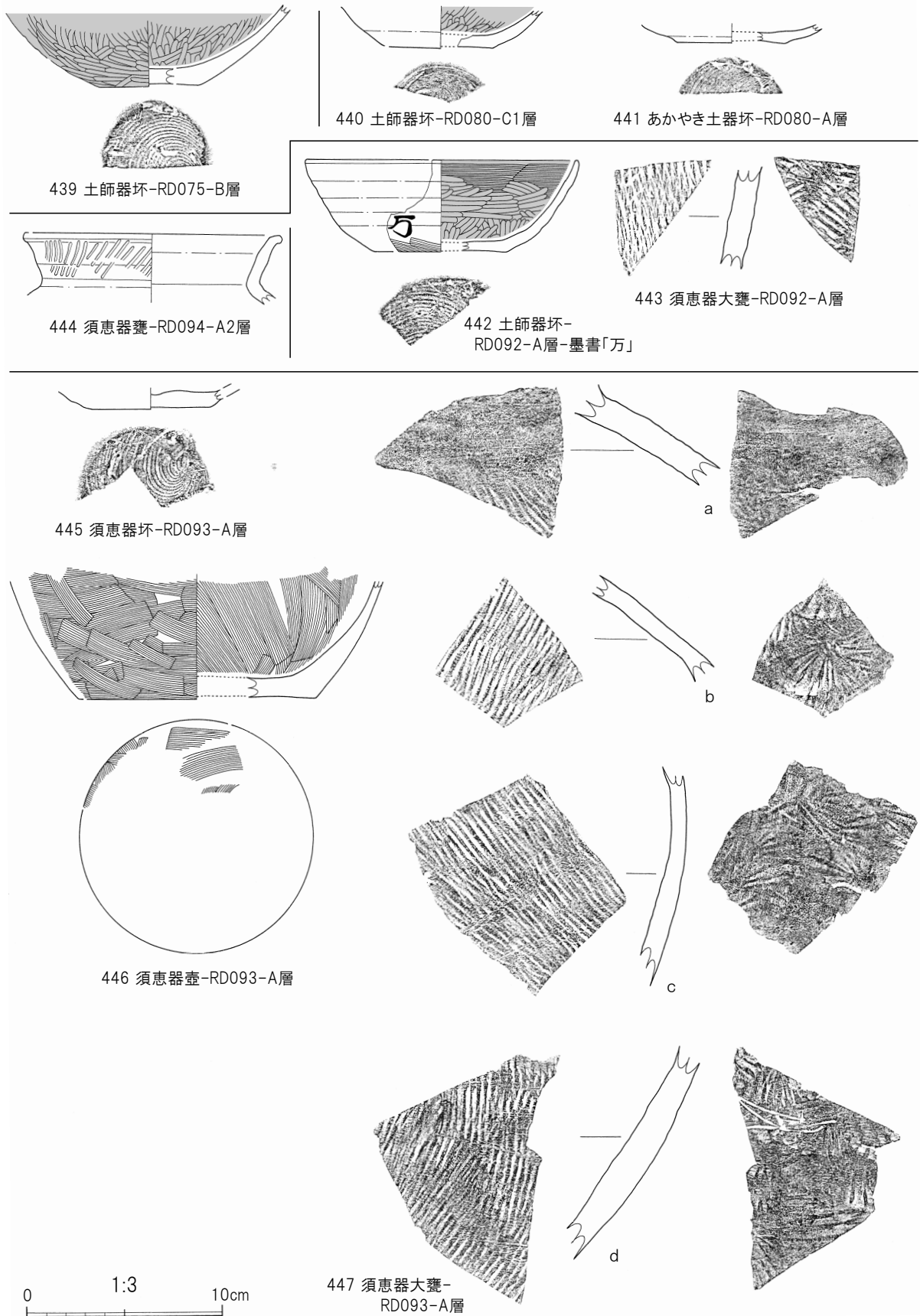

第114図 RD075-080-092-093-094出土土器

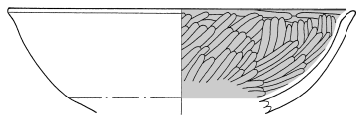

448 土師器坏-RD098-A2層

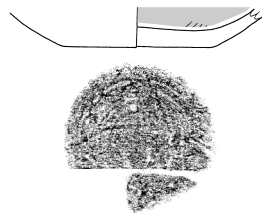

449 土師器坏-RD098-A2層

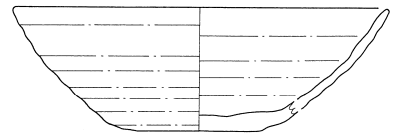

450 土師器坏-RD098-A2層

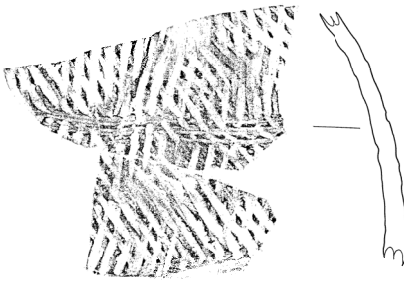

a

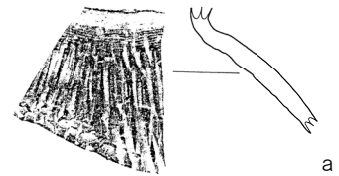

a



b

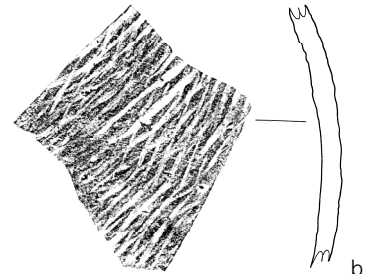
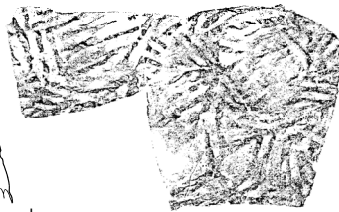

b

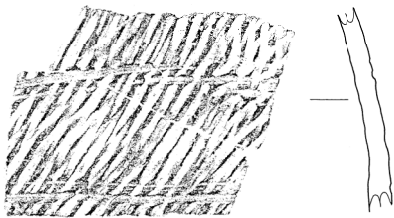

c

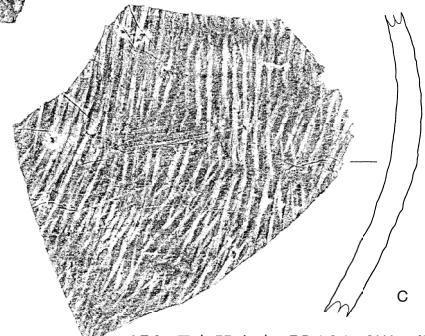

c

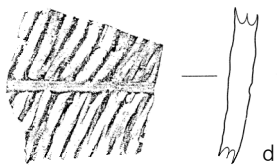

d

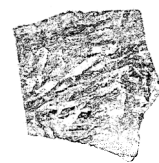

452 須恵器大甕-RD101-SW区埋土

451 須恵器大甕-RD101-A1層

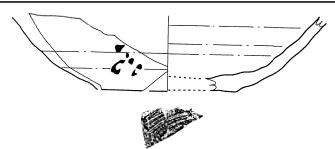

454 須恵器坏-RD111-埋土-墨書

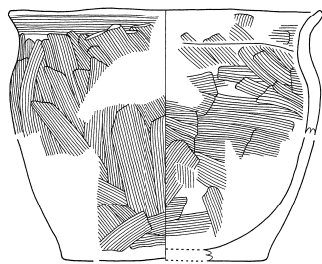

453 土師器小型甕-RD102-埋土

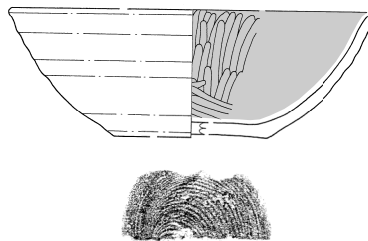

455 土師器坏-RD116-A層

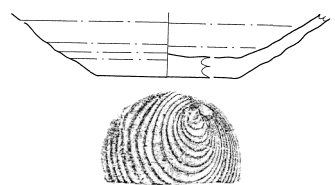

456 須恵器坏-RD116-A層

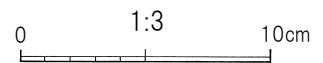

第115図 RD098・101・102・111・116出土土器

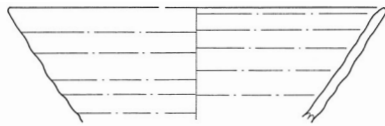

458 須恵器坏-RD178-A1層

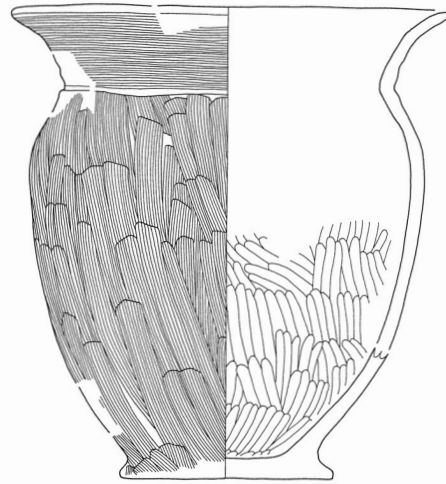

457 土師器甕-RD171-N区 埋土

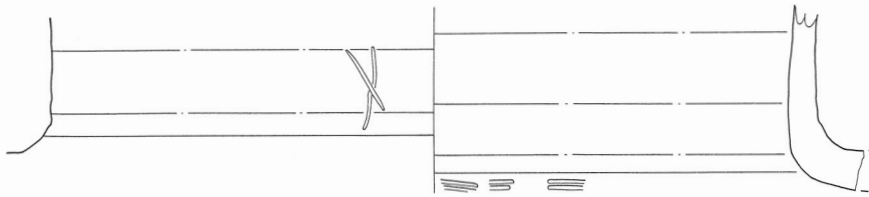

459 須恵器大甕-RD801-埋土

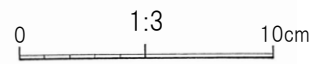

第116図 RD171・178・801出土土器



460 須恵器壺-RG051-埋土

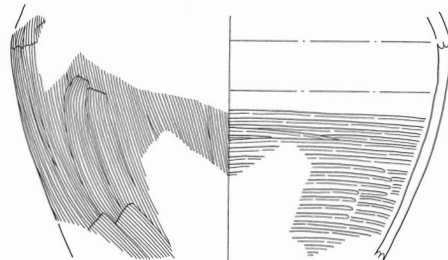

462 須恵器壺-RG068-A層



461 あかやき土器坏-RG059-埋土

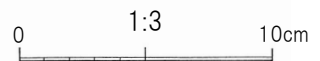

第117図 RG051・059・068出土土器

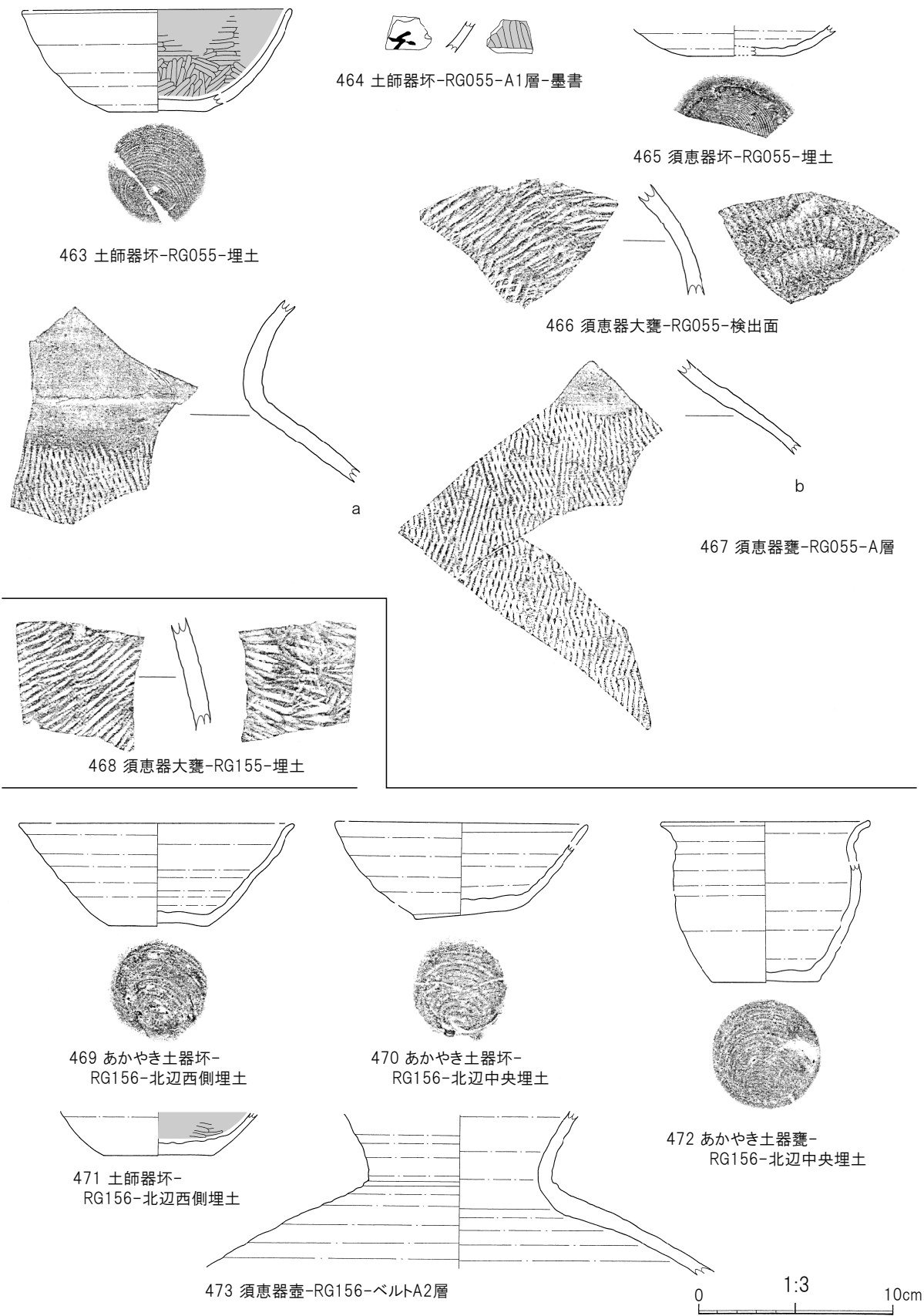

第118図 RG055・155・156出土土器

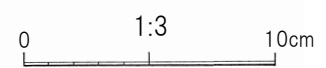
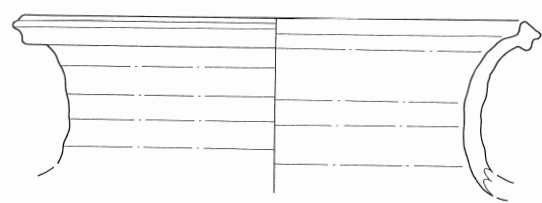
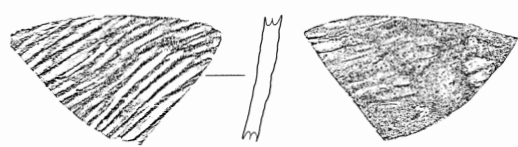
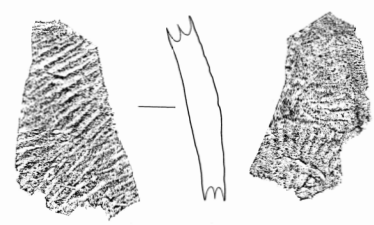
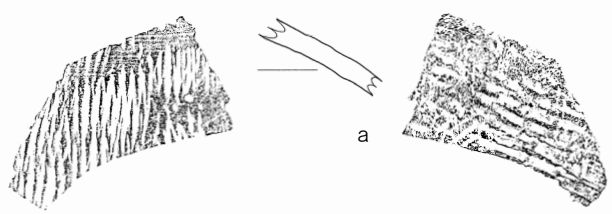
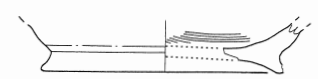
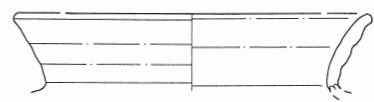
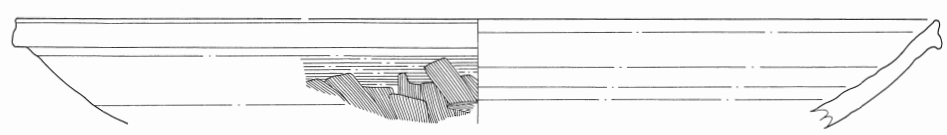
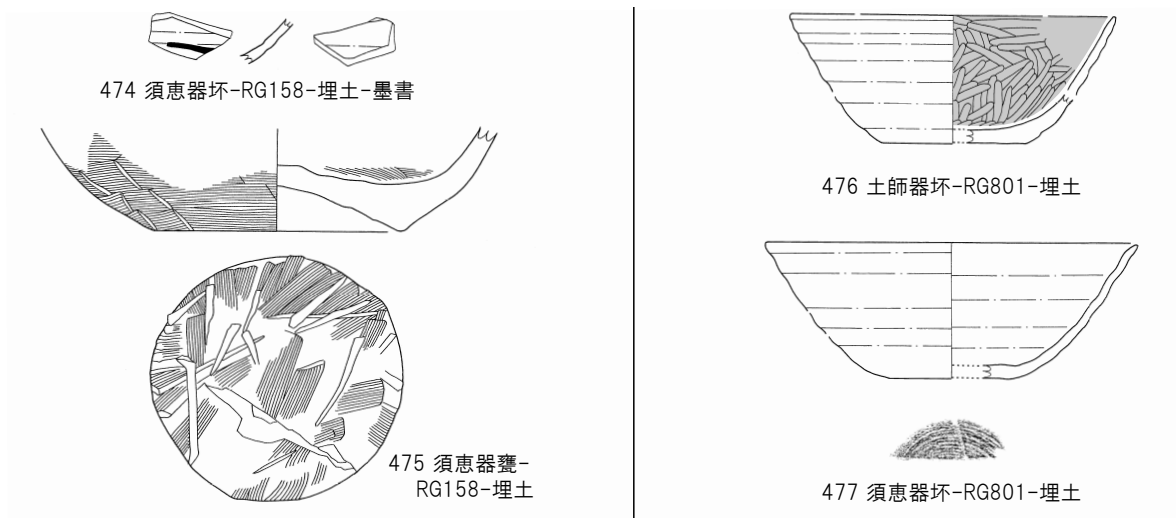

第119図 RG158・801・803出土土器

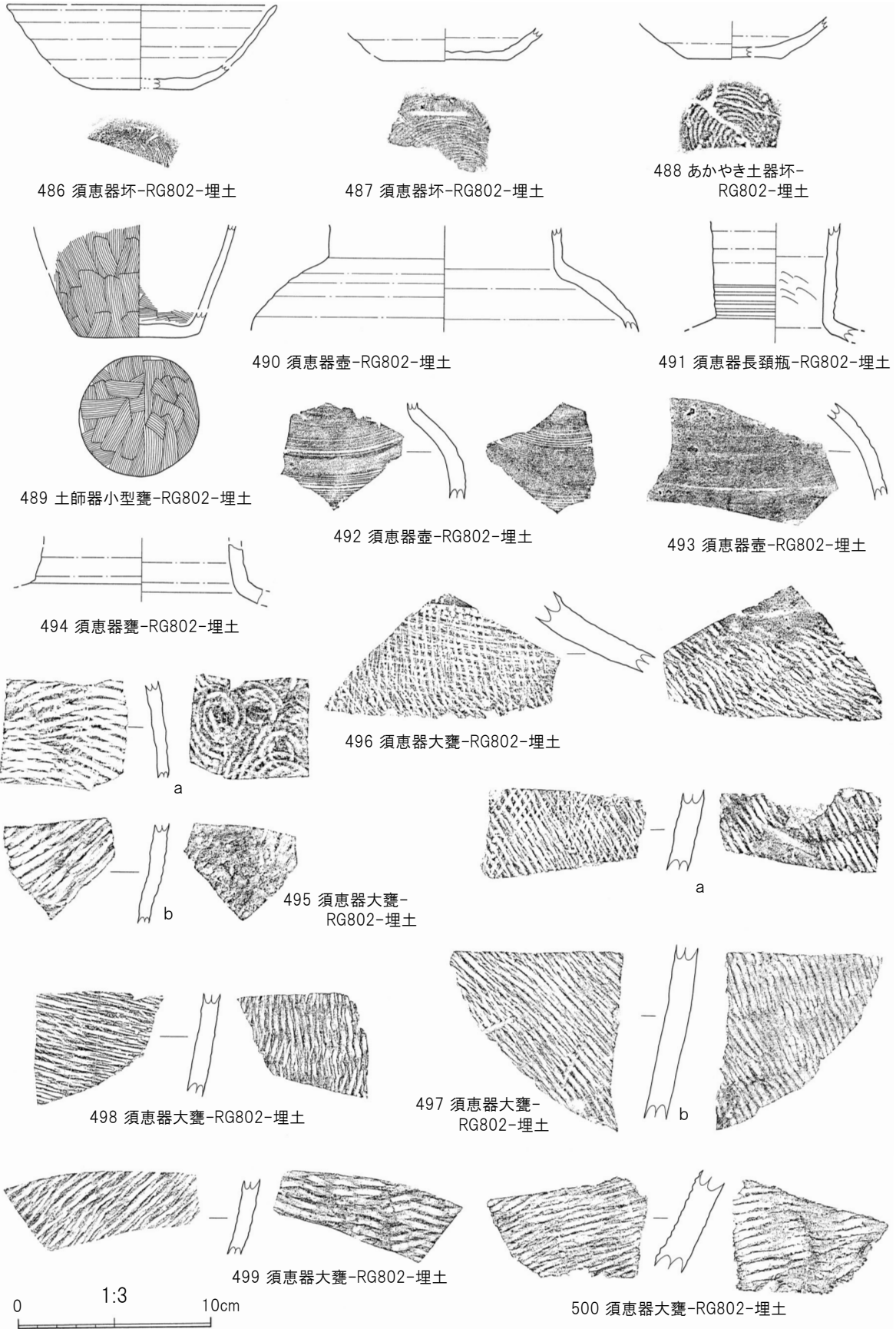

第120図 RG802出土土器

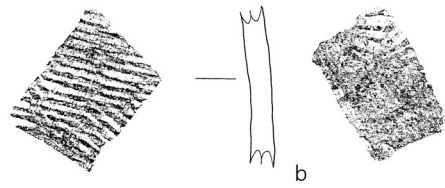
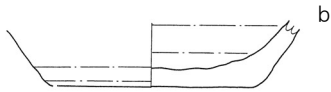
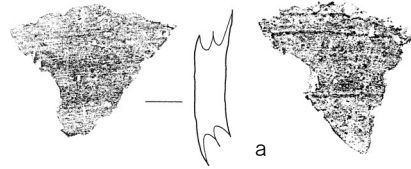
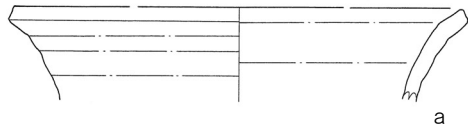
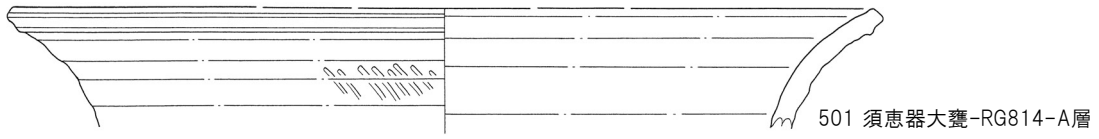

502 須恵器大甕-RG814-埋土

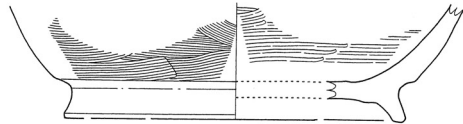

503 須恵器長頸瓶-RG814-埋土

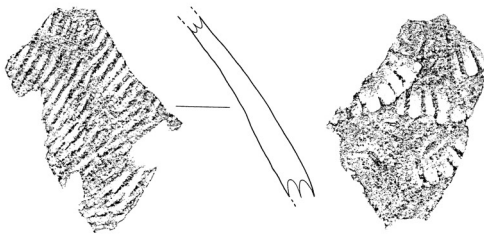
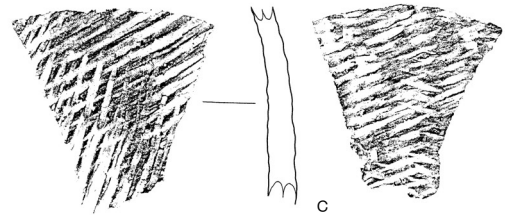

505 須恵器大甕-RG814-埋土

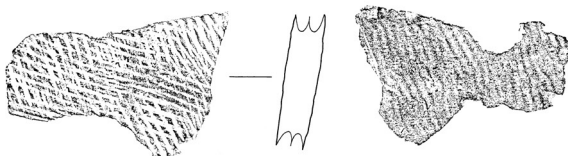
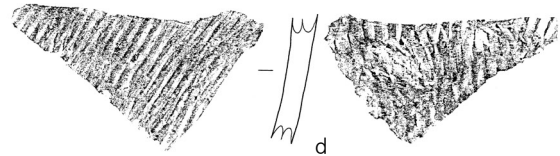

506 須恵器大甕-RG814-埋土

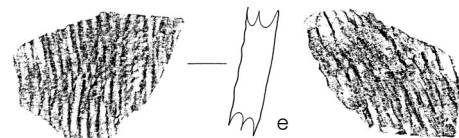

504 須恵器大甕-RG814-埋土

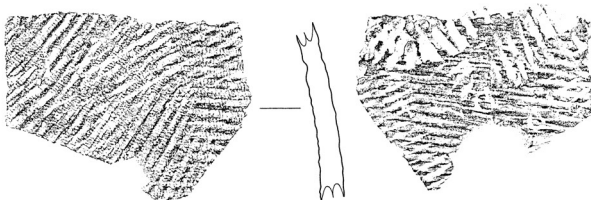

507 須恵器大甕-RG816-A層

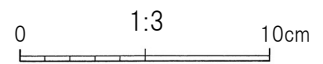

第121図 RG814・816出土土器