

白滝遺跡群 VI

第2分冊（石器実測・分布図編）

白滝村 上白滝8遺跡(2)

一般国道450号白滝丸瀬布道路工事用地内埋蔵文化財発掘調査報告書

平成17年度

財団法人 北海道埋蔵文化財センター

白滝遺跡群 VI

第2分冊（石器実測・分布図編）

白滝村 上白滝8遺跡(2)

一般国道450号白滝丸瀬布道路工事用地内埋蔵文化財発掘調査報告書

平成17年度

財団法人 北海道埋蔵文化財センター

記号等の説明

- 1 調査区域図・遺跡全体の遺物分布図などの縮尺は、任意であるのですべてスケールを付けたが、発掘区の一辺は4mであるので、目安としてもらいたい。
- 2 各石器ブロックの基本的な全遺物分布図の縮尺は以下のようにしたが、器種別分布図、接合分布図などは統一せず、スペースに応じた縮尺とした。いずれの場合も縮尺とスケールを示した。
1 : 150 (Sb-91は1 : 160、Sb-97・110は1 : 200、Sb-93・95・96は1 : 250)
- 3 母岩別・接合資料の接合分布図の基本的な縮尺は、1 : 200としたが、全体図・拡大図の一部は、スペースに応じた縮尺とした。いずれの場合も縮尺とスケールを示した。
- 4 遺物の縮尺は、実測図・写真とも、石器類は1 : 2としたが、H区の石刃核など一部大型の石器については1 : 3とした。接合資料および接合破片は、実測図・写真とも1 : 3とした。
- 5 実測図は最大六面提示し、基本的には正面の右に右面・裏面、左に左面、上に上面、下に下面を配置しているが、紙面の関係で一部配置を変更したのがある。また、右下に掲載番号のある面が正面図であるが、舟底形石器は左面である。
- 6 一部の接合資料実測図においては、図を視覚的に理解し易くするために接合剥片の腹面側、接合資料内の内側部分などをトーンで示した部分がある。
- 7 尖頭器関連の接合資料の実測図においては、全体の状況を示すと同時に腹面側（内側）の状況の実測図を示したものもある。
- 8 接合資料の中で、剥片石器や石核の素材である剥片もしくは原石を分割したものについては「個体A」「個体B」・・・さらにそれらから剥離された剥片を素材にするものは「個体a」「個体b」・・・と呼称した。
- 9 接合資料は、剥離工程を理解し易くするために模式図を作成し、実測図と共に掲載した。模式図は同一段階の剥離群毎にトーンを変え、剥離の流れを番号で示した。ただし、切り合い関係がなく、前後関係が明らかでないものにおいても便宜上番号を付けたので、詳細は個々の説明を参照願いたい。
- 10 剥離模式図の縮尺は任意である。模式図中の矢印（——▶）は接合剥片の剥離方向を示すが、接合剥片の打点側が欠損している場合は切れた矢印（- ——▶）、重なって見えない部分は破線の矢印（-----▶）で示した。また、素材剥離時の打撃点部分に▶を付けたものもある。
- 11 接合資料と共に掲載した接合破片（定形的な石器も含む）は基本的に剥離順に並べてある。
- 12 尖頭器の模式図においては、接合剥片に残存する打点の位置から、搬入・搬出時に想定される輪郭を示したものもある。
- 13 調査区域図および遺物分布図など方位記号は平面直角座標の北を、レベルは標高（単位はm）を示す。
- 14 遺構や石器ブロックについては以下の略号を使用した場合がある。
Sb : 石器ブロック Cb : 炭化木片ブロック
- 15 遺物分布図では以下の記号を用いた。
● : 剥片 ● : 石刃 ● : 縦長剥片 + : 削片 ✎ : 細石刃
✎ : 細石刃核 ◆ : 舟底形石器 ▲ : 尖頭器 ◆ : 両面調整石器 ★ : ナイフ形石器
▲ : 彫器 ■ : 搔器 ◆ : 錐形石器 ▼ : 削器 ▼ : 台形石器
▲ : 裏面微細加工石器 ● : 基部平坦加工石器 ▼ : 二次加工ある剥片
☒ : 石核 ☒ : 石刃核 △ : 石鏃・石刃鏃 人 : つまみ付きナイフ
□ : 礫石器等（斧形石器・敲石・砥石・台石・原石・礫）

- 16 石器ブロックの全遺物分布図については剥片を網点で示した。また、接合分布図、母岩別・接合資料分布図においても、全体の遺物を網点で示したものもある。
- 17 挿図中の番号は、石器ブロック群・区域毎に単体石器、接合資料の順で1から付けた。また、接合破片として接合資料の所に示した場合は、単体石器で付した番号を付けている。
- 18 遺物分布図の記号横の数字は、遺物番号を示している。また、分布図中の縮小した遺物実測図横の数字は挿図中の番号で、さらに出土発掘区・遺物番号を同時に表示したものもある。
- 19 石器ブロック接合分布図の接合線は、剥離順番を示すものではなく、遺物番号の若い順番に機械的に結んだものである。
- 20 接合資料の接合分布図では、折れ面接合をすべて実線で示した。また、個体や段階などを示す場合に破線で示したものもある。
- 21 石質は掲載遺物の一覧表に示したが、黒曜石については、以下の5種類に分けて示した。
 黒曜石1：黒色 黒曜石2：梨肌（黒色） 黒曜石3：黒色に茶色が混じる（黒>茶）
 黒曜石4：茶色に黒色が混じる（茶>黒）
 黒曜石5：黒色に紫がかかった茶色が混じる（黒>紫・茶）
 接合資料の一覧表では、スペースの関係で、上記の黒曜石1～5についてそれぞれを1～5の数字のみで示した。
 碧玉については、色調から濃緑色を1、赤色を2、褐～褐黄色を3とした。
 安山岩については、主に剥片石器に利用される緻密で玄武岩質のものを安山岩1、主に台石や敲石などに利用される輝石安山岩などのものを安山岩2とした。
 珩質頁岩は泥岩質の頁岩と区別するために使用したもので、硬質頁岩や凝灰岩質のものなどを含んでいる。原産地を考慮した細分は今後の課題である。
- 22 黒曜石以外の石質については、実測図番号の下に以下の略号で示した。
 珩質頁岩：Si-Sh めのう：Ag 碧玉：Ja 珩岩：Qu 安山岩：An
 緑色泥岩：Gr-Mu 凝灰岩：Tu 片岩：Sch 粘板岩：Sl 砂岩：Sa

第2分冊（石器実測・分布図編）挿図目次

上白滝8遺跡の調査

図Ⅲ-43	Sb-64~70の石器(1) 基部平坦加工石器・ 裏面微細加工石器……………	1	図Ⅲ-77	Sb-72~79の石器(2) 搔器……………	35
図Ⅲ-44	Sb-64~70の石器(2) 二次加工ある剥片・搔器……………	2	図Ⅲ-78	Sb-72~79の石器(3) 搔器……………	36
図Ⅲ-45	Sb-64~70の石器(3) 搔器・錐形石器・ 削器・縦長剥片・石核……………	3	図Ⅲ-79	Sb-72~79の石器(4) 搔器……………	37
図Ⅲ-46	Sb-64~70の石器(4) 石核……………	4	図Ⅲ-80	Sb-72~79の石器(5) 搔器……………	38
図Ⅲ-47	Sb-64~70の石器(5) 石核……………	5	図Ⅲ-81	Sb-72~79の石器(6) 搔器……………	39
図Ⅲ-48	Sb-64~70の石器(6) 石核……………	6	図Ⅲ-82	Sb-72~79の石器(7) 搔器……………	40
図Ⅲ-49	Sb-64~70の石器(7) 石核……………	7	図Ⅲ-83	Sb-72~79の石器(8) 搔器……………	41
図Ⅲ-50	Sb-64~70の石器(8) 石核……………	8	図Ⅲ-84	Sb-72~79の石器(9) 搔器・錐形石器・削器・縦長剥片……………	42
図Ⅲ-51	Sb-64~70の石器(9) 石核……………	9	図Ⅲ-85	Sb-72~79の石器(10) 石核……………	43
図Ⅲ-52	Sb-64~70の石器(10) 石核……………	10	図Ⅲ-86	Sb-72~79の石器(11) 石核……………	44
図Ⅲ-53	Sb-64の分布図・遺物……………	11	図Ⅲ-87	Sb-72~79の石器(12) 石核……………	45
図Ⅲ-54	Sb-65・66の分布図・遺物……………	12	図Ⅲ-88	Sb-72~79の石器(13) 石核……………	46
図Ⅲ-55	Sb-66の遺物……………	13	図Ⅲ-89	Sb-72~79の石器(14) 石核……………	47
図Ⅲ-56	Sb-67・68の分布図……………	14	図Ⅲ-90	Sb-72~79の石器(15) 石核・斧形石器・台石、 Sb-72の分布図・遺物……………	48
図Ⅲ-57	Sb-67・68の遺物……………	15	図Ⅲ-91	Sb-73の分布図・遺物……………	49
図Ⅲ-58	Sb-69の分布図・遺物……………	16	図Ⅲ-92	Sb-74の分布図・遺物(1)……………	50
図Ⅲ-59	Sb-70の分布図・遺物(1)……………	17	図Ⅲ-93	Sb-74の遺物(2)……………	51
図Ⅲ-60	Sb-70の遺物(2)……………	18	図Ⅲ-94	Sb-75の分布図・遺物……………	52
図Ⅲ-61	Sb-64~70の接合分布図……………	19	図Ⅲ-95	Sb-76の分布図・遺物……………	53
図Ⅲ-62	Sb-64~70の石器(11) 母岩489・接合359 ……	20	図Ⅲ-96	Sb-77の分布図……………	54
図Ⅲ-63	Sb-64~70の石器(12) 母岩493・接合365(1)……………	21	図Ⅲ-97	Sb-77の遺物(1)……………	55
図Ⅲ-64	Sb-64~70の石器(13) 母岩493・接合365(2)、 母岩497・接合370(1)……………	22	図Ⅲ-98	Sb-77の遺物(2)……………	56
図Ⅲ-65	Sb-64~70の石器(14) 母岩497・接合370(2)……………	23	図Ⅲ-99	Sb-77の遺物(3)……………	57
図Ⅲ-66	Sb-64~70の石器(15) 母岩497・接合370(3)、 母岩675・接合468(1)……………	24	図Ⅲ-100	Sb-78・79の分布図・遺物……………	58
図Ⅲ-67	Sb-64~70の石器(16) 母岩675・接合468(2)……………	25	図Ⅲ-101	Sb-72~79の接合分布図(1)……………	59
図Ⅲ-68	Sb-64~70の石器(17) 母岩675・接合468(3)……………	26	図Ⅲ-102	Sb-72~79の接合分布図(2)……………	60
図Ⅲ-69	Sb-64~70の石器(18) 母岩675・接合468(4)……………	27	図Ⅲ-103	Sb-72~79の石器(16) 母岩533・接合436(1)……………	61
図Ⅲ-70	Sb-64~70の石器(19) 母岩675・接合468(5)……………	28	図Ⅲ-104	Sb-72~79の石器(17) 母岩533・接合436(2)……………	62
図Ⅲ-71	Sb-64~70の石器(20) 母岩675・接合468(6)……………	29	図Ⅲ-105	Sb-72~79の石器(18) 母岩533・接合436(3)……………	63
図Ⅲ-72	Sb-71の石器(1) 二次加工ある剥片・ 搔器・石核……………	30	図Ⅲ-106	Sb-72~79の石器(19) 母岩533・接合437 ……	64
図Ⅲ-73	Sb-71の分布図・遺物……………	31	図Ⅲ-107	Sb-72~79の石器(20) 母岩532・接合432(1)……………	65
図Ⅲ-74	Sb-71の接合分布図……………	32	図Ⅲ-108	Sb-72~79の石器(21) 母岩532・接合432(2)……………	66
図Ⅲ-75	Sb-71の石器(2) 母岩509・接合398……………	33	図Ⅲ-109	Sb-72~79の石器(22) 母岩532・接合432(3)……………	67
図Ⅲ-76	Sb-72~79の石器(1) 台形石器・ 二次加工ある剥片・搔器……………	34	図Ⅲ-110	Sb-72~79の石器(23) 母岩532・接合432(4)……………	68
			図Ⅲ-111	Sb-72~79の石器(24) 母岩523・接合420 ……	69
			図Ⅲ-112	Sb-72~79の石器(25) 母岩543・接合457 ……	70
			図Ⅲ-113	石器ブロック外の石器 二次加工ある剥片・搔器・石核、 石器ブロック外の分布図……………	71
			図Ⅲ-114	G区(Sb-80~89)の石器(1) 尖頭器……………	72

図Ⅲ-115	G区(Sb-80~89)の石器(2) 尖頭器・ 尖頭器削片……………	73	図Ⅲ-151	G区(Sb-80~89)の石器(23) 母岩551・接合2807(4) ……	109
図Ⅲ-116	G区(Sb-80~89)の石器(3) 尖頭器削片・ 両面調整石器・ナイフ形石器・彫器……………	74	図Ⅲ-152	G区(Sb-80~89)の石器(24) 母岩551・接合2807(5) ……	110
図Ⅲ-117	G区(Sb-80~89)の石器(4) 彫器・彫器削片・搔器……………	75	図Ⅲ-153	G区(Sb-80~89)の石器(25) 母岩551・接合2807(6) ……	111
図Ⅲ-118	G区(Sb-80~89)の石器(5) 搔器 ……	76	図Ⅲ-154	G区(Sb-80~89)の石器(26) 母岩551・接合2807(7)、 母岩549・接合2799(1) ……	112
図Ⅲ-119	G区(Sb-80~89)の石器(6) 搔器・錐形石器 ……	77	図Ⅲ-155	G区(Sb-80~89)の石器(27) 母岩549・接合2799(2)、母岩549・接合2800……	113
図Ⅲ-120	G区(Sb-80~89)の石器(7) 錐形石器・削器 ……	78	図Ⅲ-156	G区(Sb-80~89)の石器(28) 母岩715・接合3251(1) ……	114
図Ⅲ-121	G区(Sb-80~89)の石器(8) 削器 ……	79	図Ⅲ-157	G区(Sb-80~89)の石器(29) 母岩715・接合3251(2) ……	115
図Ⅲ-122	G区(Sb-80~89)の石器(9) 削器・舟底形石器 ……	80	図Ⅲ-158	G区(Sb-80~89)の石器(30) 母岩628・接合2988……	116
図Ⅲ-123	G区(Sb-80~89)の石器(10) 舟底形石器……………	81	図Ⅲ-159	G区(Sb-80~89)の石器(31) 母岩612・接合2963(1) ……	117
図Ⅲ-124	G区(Sb-80~89)の石器(11) 舟底形石器……………	82	図Ⅲ-160	G区(Sb-80~89)の石器(32) 母岩612・接合2963(2)、母岩637・接合3013(1)、 母岩637・接合3014(1) ……	118
図Ⅲ-125	G区(Sb-80~89)の石器(12) 舟底形石器……………	83	図Ⅲ-161	G区(Sb-80~89)の石器(33) 母岩637・接合3013(2)、母岩637・接合3014(2)、 母岩610・接合2959(1) ……	119
図Ⅲ-126	G区(Sb-80~89)の石器(13) 舟底形石器……………	84	図Ⅲ-162	G区(Sb-80~89)の石器(34) 母岩610・接合2959(2)、母岩633・接合3000……	120
図Ⅲ-127	G区(Sb-80~89)の石器(14) 舟底形石器……………	85	図Ⅲ-163	G区(Sb-80~89)の石器(35) 母岩627・接合2986、母岩586・接合2903(1)……	121
図Ⅲ-128	G区(Sb-80~89)の石器(15) 石刃核 ……	86	図Ⅲ-164	G区(Sb-80~89)の石器(36) 母岩586・接合2903(2)、母岩613・接合2964……	122
図Ⅲ-129	G区(Sb-80~89)の石器(16) 石刃核 ……	87	図Ⅲ-165	G区(Sb-80~89)の石器(37) 母岩606・接合2953(1) ……	123
図Ⅲ-130	G区(Sb-80~89)の石器(17) 石刃核 ……	88	図Ⅲ-166	G区(Sb-80~89)の石器(38) 母岩606・接合2953(2)、 母岩593・接合2927(1) ……	124
図Ⅲ-131	G区(Sb-80~89)の石器(18) 石刃核・石核 ……	89	図Ⅲ-167	G区(Sb-80~89)の石器(39) 母岩593・接合2927(2)、 母岩550・接合2805(1) ……	125
図Ⅲ-132	G区(Sb-80~89)の石器(19) 石核 ……	90	図Ⅲ-168	G区(Sb-80~89)の石器(40) 母岩550・接合2805(2)、 母岩609・接合2958(1) ……	126
図Ⅲ-133	Sb-80・81の分布図・遺物 ……	91	図Ⅲ-169	G区(Sb-80~89)の石器(41) 母岩609・接合2958(2)、母岩604・接合2951……	127
図Ⅲ-134	Sb-82の分布図 ……	92	図Ⅲ-170	G区(Sb-80~89)の石器(42) 母岩590・接合2916(1) ……	128
図Ⅲ-135	Sb-82の遺物 ……	93	図Ⅲ-171	G区(Sb-80~89)の石器(43) 母岩590・接合2916(2) ……	129
図Ⅲ-136	Sb-83の分布図・遺物(1) ……	94	図Ⅲ-172	G区(Sb-80~89)の石器(44) 母岩662・接合3102……	130
図Ⅲ-137	Sb-83の遺物(2) ……	95	図Ⅲ-173	G区(Sb-80~89)の石器(45) 母岩596・接合2938……	131
図Ⅲ-138	Sb-84の分布図・遺物 ……	96			
図Ⅲ-139	Sb-85の分布図 ……	97			
図Ⅲ-140	Sb-85の遺物 ……	98			
図Ⅲ-141	Sb-86の分布図 ……	99			
図Ⅲ-142	Sb-86の遺物(1) ……	100			
図Ⅲ-143	Sb-86の遺物(2)、Sb-87の分布図 ……	101			
図Ⅲ-144	Sb-87の遺物、Sb-88の分布図 ……	102			
図Ⅲ-145	Sb-88の遺物、Sb-89の分布図 ……	103			
図Ⅲ-146	Sb-89の遺物 ……	104			
図Ⅲ-147	G区(Sb-80~89)の接合分布図 ……	105			
図Ⅲ-148	G区(Sb-80~89)の石器(20) 母岩551・接合2807(1) ……	106			
図Ⅲ-149	G区(Sb-80~89)の石器(21) 母岩551・接合2807(2) ……	107			
図Ⅲ-150	G区(Sb-80~89)の石器(22) 母岩551・接合2807(3) ……	108			

図Ⅲ-174	G区(Sb-80~89)の石器(46) 母岩664・接合3109	132	図Ⅲ-206	H区(Sb-90)の石器(27) 母岩688・接合3185(3)	164
図Ⅲ-175	G区(Sb-80~89)の石器(47) 母岩656・接合3086、接合5710、 母岩1221・接合5719	133	図Ⅲ-207	H区(Sb-90)の石器(28) 母岩704・接合3228(1)	165
図Ⅲ-176	H区(Sb-90)の石器(1) 尖頭器・彫器・搔器・舟底形石器・細石刃核・ 彫器削片・削器・石刃	134	図Ⅲ-208	H区(Sb-90)の石器(29) 母岩704・接合3228(2)	166
図Ⅲ-177	H区(Sb-90)の石器(2) 石刃	135	図Ⅲ-209	H区(Sb-90)の石器(30) 母岩704・接合3228(3)	167
図Ⅲ-178	H区(Sb-90)の石器(3) 石刃	136	図Ⅲ-210	H区(Sb-90)の石器(31) 母岩691・接合3195(1)	168
図Ⅲ-179	H区(Sb-90)の石器(4) 石刃	137	図Ⅲ-211	H区(Sb-90)の石器(32) 母岩691・接合3195(2)	169
図Ⅲ-180	H区(Sb-90)の石器(5) 石刃	138	図Ⅲ-212	H区(Sb-90)の石器(33) 母岩699・接合3217(1)	170
図Ⅲ-181	H区(Sb-90)の石器(6) 石刃	139	図Ⅲ-213	H区(Sb-90)の石器(34) 母岩699・接合3217(2)	171
図Ⅲ-182	H区(Sb-90)の石器(7) 石刃核	140	図Ⅲ-214	H区(Sb-90)の石器(35) 母岩700・接合3218(1)	172
図Ⅲ-183	H区(Sb-90)の石器(8) 石刃核	141	図Ⅲ-215	H区(Sb-90)の石器(36) 母岩700・接合3218(2)	173
図Ⅲ-184	H区(Sb-90)の石器(9) 石刃核	142	図Ⅲ-216	H区(Sb-90)の石器(37) 母岩689・接合3187(1)	174
図Ⅲ-185	H区(Sb-90)の石器(10) 石刃核	143	図Ⅲ-217	H区(Sb-90)の石器(38) 母岩689・接合3187(2)	175
図Ⅲ-186	H区(Sb-90)の石器(11) 石刃核	144	図Ⅲ-218	I区(Sb-91~96)の石器(1) 尖頭器	176
図Ⅲ-187	H区(Sb-90)の石器(12) 石刃核・石核	145	図Ⅲ-219	I区(Sb-91~96)の石器(2) 尖頭器	177
図Ⅲ-188	H区(Sb-90)の石器(13) 石核	146	図Ⅲ-220	I区(Sb-91~96)の石器(3) 尖頭器	178
図Ⅲ-189	H区(Sb-90)の石器(14) 石核	147	図Ⅲ-221	I区(Sb-91~96)の石器(4) 尖頭器	179
図Ⅲ-190	Sb-90の分布図・遺物(1)	148	図Ⅲ-222	I区(Sb-91~96)の石器(5) 尖頭器	180
図Ⅲ-191	Sb-90の遺物(2)	149	図Ⅲ-223	I区(Sb-91~96)の石器(6) 尖頭器	181
図Ⅲ-192	Sb-90の遺物(3)	150	図Ⅲ-224	I区(Sb-91~96)の石器(7) 尖頭器	182
図Ⅲ-193	H区(Sb-90)の接合分布図	151	図Ⅲ-225	I区(Sb-91~96)の石器(8) 尖頭器	183
図Ⅲ-194	H区(Sb-90)の石器(15) 母岩683・接合3159(1)	152	図Ⅲ-226	I区(Sb-91~96)の石器(9) 尖頭器	184
図Ⅲ-195	H区(Sb-90)の石器(16) 母岩683・接合3159(2)	153	図Ⅲ-227	I区(Sb-91~96)の石器(10) 尖頭器	185
図Ⅲ-196	H区(Sb-90)の石器(17) 母岩683・接合3159(3)	154	図Ⅲ-228	I区(Sb-91~96)の石器(11) 尖頭器	186
図Ⅲ-197	H区(Sb-90)の石器(18) 母岩683・接合3159(4)	155	図Ⅲ-229	I区(Sb-91~96)の石器(12) 尖頭器	187
図Ⅲ-198	H区(Sb-90)の石器(19) 母岩693・接合3201(1)	156	図Ⅲ-230	I区(Sb-91~96)の石器(13) 尖頭器・尖頭器削片	188
図Ⅲ-199	H区(Sb-90)の石器(20) 母岩693・接合3201(2)	157	図Ⅲ-231	I区(Sb-91~96)の石器(14) 両面調整石器	189
図Ⅲ-200	H区(Sb-90)の石器(21) 母岩693・接合3201(3)	158	図Ⅲ-232	I区(Sb-91~96)の石器(15) 両面調整石器	190
図Ⅲ-201	H区(Sb-90)の石器(22) 母岩693・接合3201(4)、 母岩690・接合3194(1)	159	図Ⅲ-233	I区(Sb-91~96)の石器(16) ナイフ形石器	191
図Ⅲ-202	H区(Sb-90)の石器(23) 母岩690・接合3194(2)	160	図Ⅲ-234	I区(Sb-91~96)の石器(17) ナイフ形石器・彫器	192
図Ⅲ-203	H区(Sb-90)の石器(24) 母岩690・接合3194(3)	161	図Ⅲ-235	I区(Sb-91~96)の石器(18) 彫器	193
図Ⅲ-204	H区(Sb-90)の石器(25) 母岩688・接合3185(1)	162	図Ⅲ-236	I区(Sb-91~96)の石器(19) 彫器	194
図Ⅲ-205	H区(Sb-90)の石器(26) 母岩688・接合3185(2)	163	図Ⅲ-237	I区(Sb-91~96)の石器(20) 彫器削片・搔器	195
			図Ⅲ-238	I区(Sb-91~96)の石器(21) 搔器	196
			図Ⅲ-239	I区(Sb-91~96)の石器(22) 搔器	197

図Ⅲ-240	I区(Sb-91~96)の石器(23) 錐形石器・削器	198	図Ⅲ-278	I区(Sb-91~96)の石器(43) 母岩727・接合3285(2)	236
図Ⅲ-241	I区(Sb-91~96)の石器(24) 削器	199	図Ⅲ-279	I区(Sb-91~96)の石器(44) 母岩727・接合3285(3)、 母岩783・接合3501(1)	237
図Ⅲ-242	I区(Sb-91~96)の石器(25) 削器	200	図Ⅲ-280	I区(Sb-91~96)の石器(45) 母岩783・接合3501(2)	238
図Ⅲ-243	I区(Sb-91~96)の石器(26) 舟底形石器	201	図Ⅲ-281	I区(Sb-91~96)の石器(46) 母岩1067・接合4433(1)	239
図Ⅲ-244	I区(Sb-91~96)の石器(27) 舟底形石器	202	図Ⅲ-282	I区(Sb-91~96)の石器(47) 母岩1067・接合4433(2)	240
図Ⅲ-245	I区(Sb-91~96)の石器(28) 舟底形石器	203	図Ⅲ-283	I区(Sb-91~96)の石器(48) 母岩1067・接合4433(3)	241
図Ⅲ-246	I区(Sb-91~96)の石器(29) 舟底形石器	204	図Ⅲ-284	I区(Sb-91~96)の石器(49) 母岩1067・接合4433(4)、 母岩1067・接合4437	242
図Ⅲ-247	I区(Sb-91~96)の石器(30) 舟底形石器	205	図Ⅲ-285	I区(Sb-91~96)の石器(50) 母岩1067・接合4433(5)、 母岩786・接合3509(1)	243
図Ⅲ-248	I区(Sb-91~96)の石器(31) 舟底形石器・ 二次加工ある剥片・石刃	206	図Ⅲ-286	I区(Sb-91~96)の石器(51) 母岩786・接合3509(2)	244
図Ⅲ-249	I区(Sb-91~96)の石器(32) 石刃	207	図Ⅲ-287	I区(Sb-91~96)の石器(52) 母岩876・接合3849(1)	245
図Ⅲ-250	I区(Sb-91~96)の石器(33) 石刃核	208	図Ⅲ-288	I区(Sb-91~96)の石器(53) 母岩876・接合3849(2)	246
図Ⅲ-251	I区(Sb-91~96)の石器(34) 石刃核	209	図Ⅲ-289	I区(Sb-91~96)の石器(54) 母岩876・接合3849(3)、 母岩862・接合3809(1)	247
図Ⅲ-252	I区(Sb-91~96)の石器(35) 石刃核	210	図Ⅲ-290	I区(Sb-91~96)の石器(55) 母岩862・接合3809(2)、 母岩849・接合3740(1)	248
図Ⅲ-253	I区(Sb-91~96)の石器(36) 石刃核・石核	211	図Ⅲ-291	I区(Sb-91~96)の石器(56) 母岩849・接合3740(2)	249
図Ⅲ-254	I区(Sb-91~96)の石器(37) 石核	212	図Ⅲ-292	I区(Sb-91~96)の石器(57) 母岩852・接合3759(1)	250
図Ⅲ-255	I区(Sb-91~96)の石器(38) 石核・斧形石器	213	図Ⅲ-293	I区(Sb-91~96)の石器(58) 母岩852・接合3759(2)	251
図Ⅲ-256	Sb-91の分布図・遺物	214	図Ⅲ-294	I区(Sb-91~96)の石器(59) 母岩807・接合3583(1)	252
図Ⅲ-257	Sb-92の分布図・遺物	215	図Ⅲ-295	I区(Sb-91~96)の石器(60) 母岩807・接合3583(2)	253
図Ⅲ-258	Sb-93の分布図	216	図Ⅲ-296	I区(Sb-91~96)の石器(61) 母岩816・接合3617	254
図Ⅲ-259	Sb-93の遺物(1)	217	図Ⅲ-297	I区(Sb-91~96)の石器(62) 母岩748・接合3396	255
図Ⅲ-260	Sb-93の遺物(2)	218	図Ⅲ-298	I区(Sb-91~96)の石器(63) 母岩749・接合3397	256
図Ⅲ-261	Sb-93の遺物(3)	219	図Ⅲ-299	I区(Sb-91~96)の石器(64) 母岩736・接合3336	257
図Ⅲ-262	Sb-93の遺物(4)	220	図Ⅲ-300	I区(Sb-91~96)の石器(65) 母岩923・接合4035(1)	258
図Ⅲ-263	Sb-93の遺物(5)	221			
図Ⅲ-264	Sb-93の遺物(6)	222			
図Ⅲ-265	Sb-94の分布図・遺物	223			
図Ⅲ-266	Sb-95の分布図	224			
図Ⅲ-267	Sb-95の遺物(1)	225			
図Ⅲ-268	Sb-95の遺物(2)	226			
図Ⅲ-269	Sb-95の遺物(3)	227			
図Ⅲ-270	Sb-95の遺物(4)	228			
図Ⅲ-271	Sb-95の遺物(5)	229			
図Ⅲ-272	Sb-96の分布図・遺物	230			
図Ⅲ-273	I区(Sb-91~96)の接合分布図	231			
図Ⅲ-274	I区(Sb-91~96)の石器(39) 母岩740・接合3358(1)	232			
図Ⅲ-275	I区(Sb-91~96)の石器(40) 母岩740・接合3358(2)	233			
図Ⅲ-276	I区(Sb-91~96)の石器(41) 母岩740・接合3358(3)	234			
図Ⅲ-277	I区(Sb-91~96)の石器(42) 母岩727・接合3285(1)	235			

図Ⅲ-301	I区(Sb-91~96)の石器(66) 母岩923・接合4035(2) ……………259	図Ⅲ-325	I区(Sb-91~96)の石器(90) 母岩732・接合3316(3) ……………283
図Ⅲ-302	I区(Sb-91~96)の石器(67) 母岩923・接合4035(3)、 母岩887・接合3883(1) ……………260	図Ⅲ-326	I区(Sb-91~96)の石器(91) 母岩933・接合4061(1) ……………284
図Ⅲ-303	I区(Sb-91~96)の石器(68) 母岩887・接合3883(2) ……………261	図Ⅲ-327	I区(Sb-91~96)の石器(92) 母岩933・接合4061(2) ……………285
図Ⅲ-304	I区(Sb-91~96)の石器(69) 母岩887・接合3883(3) ……………262	図Ⅲ-328	I区(Sb-91~96)の石器(93) 母岩933・接合4061(3) ……………286
図Ⅲ-305	I区(Sb-91~96)の石器(70) 母岩887・接合3883(4)、 母岩927・接合4044(1) ……………263	図Ⅲ-329	I区(Sb-91~96)の石器(94) 母岩934・接合4063……………287
図Ⅲ-306	I区(Sb-91~96)の石器(71) 母岩927・接合4044(2) ……………264	図Ⅲ-330	I区(Sb-91~96)の石器(95) 母岩738・接合3339(1) ……………288
図Ⅲ-307	I区(Sb-91~96)の石器(72) 母岩789・接合3515(1) ……………265	図Ⅲ-331	I区(Sb-91~96)の石器(96) 母岩738・接合3339(2)、 母岩829・接合3660(1) ……………289
図Ⅲ-308	I区(Sb-91~96)の石器(73) 母岩789・接合3515(2) ……………266	図Ⅲ-332	I区(Sb-91~96)の石器(97) 母岩829・接合3660(2)、 母岩758・接合3434(1) ……………290
図Ⅲ-309	I区(Sb-91~96)の石器(74) 母岩717・接合3257……………267	図Ⅲ-333	I区(Sb-91~96)の石器(98) 母岩758・接合3434(2) ……………291
図Ⅲ-310	I区(Sb-91~96)の石器(75) 母岩716・接合3252(1) ……………268	図Ⅲ-334	I区(Sb-91~96)の石器(99) 母岩904・接合3964(1) ……………292
図Ⅲ-311	I区(Sb-91~96)の石器(76) 母岩716・接合3252(2)、 母岩850・接合3745(1) ……………269	図Ⅲ-335	I区(Sb-91~96)の石器(100) 母岩904・接合3964(2)、 母岩922・接合4032(1) ……………293
図Ⅲ-312	I区(Sb-91~96)の石器(77) 母岩850・接合3745(2) ……………270	図Ⅲ-336	I区(Sb-91~96)の石器(101) 母岩922・接合4032(2)、母岩667・接合3122、 母岩878・接合3851(1) ……………294
図Ⅲ-313	I区(Sb-91~96)の石器(78) 母岩850・接合3745(3)、母岩737・接合3337……………271	図Ⅲ-337	I区(Sb-91~96)の石器(102) 母岩878・接合3851(2)、 母岩856・接合3781(1) ……………295
図Ⅲ-314	I区(Sb-91~96)の石器(79) 母岩725・接合3276(1) ……………272	図Ⅲ-338	I区(Sb-91~96)の石器(103) 母岩856・接合3781(2) ……………296
図Ⅲ-315	I区(Sb-91~96)の石器(80) 母岩725・接合3276(2) ……………273	図Ⅲ-339	I区(Sb-91~96)の石器(104) 母岩856・接合3781(3) ……………297
図Ⅲ-316	I区(Sb-91~96)の石器(81) 母岩725・接合3276(3) ……………274	図Ⅲ-340	I区(Sb-91~96)の石器(105) 母岩857・接合3783(1) ……………298
図Ⅲ-317	I区(Sb-91~96)の石器(82) 母岩725・接合3276(4) ……………275	図Ⅲ-341	I区(Sb-91~96)の石器(106) 母岩857・接合3783(2) ……………299
図Ⅲ-318	I区(Sb-91~96)の石器(83) 母岩728・接合3287(1) ……………276	図Ⅲ-342	I区(Sb-91~96)の石器(107) 母岩867・接合3823……………300
図Ⅲ-319	I区(Sb-91~96)の石器(84) 母岩728・接合3287(2) ……………277	図Ⅲ-343	I区(Sb-91~96)の石器(108) 母岩866・接合3822(1) ……………301
図Ⅲ-320	I区(Sb-91~96)の石器(85) 母岩728・接合3287(3) ……………278	図Ⅲ-344	I区(Sb-91~96)の石器(109) 母岩866・接合3822(2)、母岩842・接合3703……………302
図Ⅲ-321	I区(Sb-91~96)の石器(86) 母岩757・接合3430……………279	図Ⅲ-345	I区(Sb-91~96)の石器(110) 母岩926・接合4043……………303
図Ⅲ-322	I区(Sb-91~96)の石器(87) 母岩788・接合3514……………280	図Ⅲ-346	I区(Sb-91~96)の石器(111) 母岩931・接合4053……………304
図Ⅲ-323	I区(Sb-91~96)の石器(88) 母岩732・接合3316(1) ……………281	図Ⅲ-347	I区(Sb-91~96)の石器(112) 母岩722・接合3268(1) ……………305
図Ⅲ-324	I区(Sb-91~96)の石器(89) 母岩732・接合3316(2) ……………282		

図Ⅲ-348	I区(Sb-91~96)の石器(113) 母岩722・接合3268(2) ……………306	図Ⅲ-368	I区(Sb-91~96)の石器(133) 母岩734・接合3324、母岩734・接合3326、 母岩944・接合4093……………326
図Ⅲ-349	I区(Sb-91~96)の石器(114) 母岩911・接合3989(1) ……………307	図Ⅲ-369	J区(Sb-97~107)の石器(1) 尖頭器 ……327
図Ⅲ-350	I区(Sb-91~96)の石器(115) 母岩911・接合3989(2)、 母岩928・接合4046(1) ……………308	図Ⅲ-370	J区(Sb-97~107)の石器(2) 尖頭器 ……328
図Ⅲ-351	I区(Sb-91~96)の石器(116) 母岩928・接合4046(2)、 母岩827・接合3658(1) ……………309	図Ⅲ-371	J区(Sb-97~107)の石器(3) 尖頭器 ……329
図Ⅲ-352	I区(Sb-91~96)の石器(117) 母岩827・接合3658(2)、 母岩814・接合3611(1) ……………310	図Ⅲ-372	J区(Sb-97~107)の石器(4) 尖頭器 ……330
図Ⅲ-353	I区(Sb-91~96)の石器(118) 母岩814・接合3611(2)、 母岩708・接合3237(1) ……………311	図Ⅲ-373	J区(Sb-97~107)の石器(5) 尖頭器 ……331
図Ⅲ-354	I区(Sb-91~96)の石器(119) 母岩708・接合3237(2)、 母岩830・接合3661(1) ……………312	図Ⅲ-374	J区(Sb-97~107)の石器(6) 尖頭器 ……332
図Ⅲ-355	I区(Sb-91~96)の石器(120) 母岩830・接合3661(2)、 母岩778・接合3496(1) ……………313	図Ⅲ-375	J区(Sb-97~107)の石器(7) 尖頭器・尖頭器削片 ……………333
図Ⅲ-356	I区(Sb-91~96)の石器(121) 母岩778・接合3496(2)、 母岩755・接合3420(1) ……………314	図Ⅲ-376	J区(Sb-97~107)の石器(8) 両面調整石器……………334
図Ⅲ-357	I区(Sb-91~96)の石器(122) 母岩755・接合3420(2)、 母岩773・接合3489(1) ……………315	図Ⅲ-377	J区(Sb-97~107)の石器(9) 両面調整石器……………335
図Ⅲ-358	I区(Sb-91~96)の石器(123) 母岩773・接合3489(2) ……………316	図Ⅲ-378	J区(Sb-97~107)の石器(10) 両面調整石器……………336
図Ⅲ-359	I区(Sb-91~96)の石器(124) 母岩929・接合4050……………317	図Ⅲ-379	J区(Sb-97~107)の石器(11) 両面調整石器……………337
図Ⅲ-360	I区(Sb-91~96)の石器(125) 母岩726・接合3283……………318	図Ⅲ-380	J区(Sb-97~107)の石器(12) 両面調整石器……………338
図Ⅲ-361	I区(Sb-91~96)の石器(126) 母岩798・接合3543、母岩864・接合3813(1)……319	図Ⅲ-381	J区(Sb-97~107)の石器(13) 彫器 ……339
図Ⅲ-362	I区(Sb-91~96)の石器(127) 母岩864・接合3813(2)、母岩889・接合3898……………320	図Ⅲ-382	J区(Sb-97~107)の石器(14) 彫器 ……340
図Ⅲ-363	I区(Sb-91~96)の石器(128) 母岩912・接合3990、母岩914・接合3992(1)……321	図Ⅲ-383	J区(Sb-97~107)の石器(15) 彫器 ……341
図Ⅲ-364	I区(Sb-91~96)の石器(129) 母岩914・接合3992(2)、 母岩883・接合3875(1) ……………322	図Ⅲ-384	J区(Sb-97~107)の石器(16) 彫器 ……342
図Ⅲ-365	I区(Sb-91~96)の石器(130) 母岩883・接合3875(2)、母岩813・接合3610……………323	図Ⅲ-385	J区(Sb-97~107)の石器(17) 彫器削片・搔器 ……………343
図Ⅲ-366	I区(Sb-91~96)の石器(131) 母岩939・接合4078、接合5744 ……………324	図Ⅲ-386	J区(Sb-97~107)の石器(18) 搔器 ……344
図Ⅲ-367	I区(Sb-91~96)の石器(132) 母岩729・接合3294、母岩729・接合3295、 接合5749……………325	図Ⅲ-387	J区(Sb-97~107)の石器(19) 錐形石器・削器 ……………345
		図Ⅲ-388	J区(Sb-97~107)の石器(20) 削器 ……346
		図Ⅲ-389	J区(Sb-97~107)の石器(21) 舟底形石器……………347
		図Ⅲ-390	J区(Sb-97~107)の石器(22) 舟底形石器……………348
		図Ⅲ-391	J区(Sb-97~107)の石器(23) 舟底形石器……………349
		図Ⅲ-392	J区(Sb-97~107)の石器(24) 舟底形石器……………350
		図Ⅲ-393	J区(Sb-97~107)の石器(25) 舟底形石器……………351
		図Ⅲ-394	J区(Sb-97~107)の石器(26) 舟底形石器……………352
		図Ⅲ-395	J区(Sb-97~107)の石器(27) 舟底形石器……………353
		図Ⅲ-396	J区(Sb-97~107)の石器(28) 舟底形石器……………354
		図Ⅲ-397	J区(Sb-97~107)の石器(29) 舟底形石器……………355
		図Ⅲ-398	J区(Sb-97~107)の石器(30) 舟底形石器……………356

図Ⅲ-399	J区(Sb-97~107)の石器(31) 舟底形石器削片・二次加工ある剥片・ つまみ付きナイフ・石刃 ……………357	図Ⅲ-441	J区(Sb-97~107)の石器(47) 母岩975・接合4201(2) ……………399
図Ⅲ-400	J区(Sb-97~107)の石器(32) 石刃 ……………358	図Ⅲ-442	J区(Sb-97~107)の石器(48) 母岩975・接合4201(3)、 母岩985・接合4225(1) ……………400
図Ⅲ-401	J区(Sb-97~107)の石器(33) 石刃・石刃核 ……………359	図Ⅲ-443	J区(Sb-97~107)の石器(49) 母岩985・接合4225(2) ……………401
図Ⅲ-402	J区(Sb-97~107)の石器(34) 石刃核 ……………360	図Ⅲ-444	J区(Sb-97~107)の石器(50) 母岩947・接合4116(1) ……………402
図Ⅲ-403	J区(Sb-97~107)の石器(35) 石刃核 ……………361	図Ⅲ-445	J区(Sb-97~107)の石器(51) 母岩947・接合4116(2) ……………403
図Ⅲ-404	J区(Sb-97~107)の石器(36) 石刃核 ……………362	図Ⅲ-446	J区(Sb-97~107)の石器(52) 母岩947・接合4116(3) ……………404
図Ⅲ-405	J区(Sb-97~107)の石器(37) 石刃核 ……………363	図Ⅲ-447	J区(Sb-97~107)の石器(53) 母岩947・接合4116(4) ……………405
図Ⅲ-406	J区(Sb-97~107)の石器(38) 石核 ……………364	図Ⅲ-448	J区(Sb-97~107)の石器(54) 母岩947・接合4116(5) ……………406
図Ⅲ-407	J区(Sb-97~107)の石器(39) 石核 ……………365	図Ⅲ-449	J区(Sb-97~107)の石器(55) 母岩1185・接合4734(1) ……………407
図Ⅲ-408	J区(Sb-97~107)の石器(40) 石核・剥片・台石 ……………366	図Ⅲ-450	J区(Sb-97~107)の石器(56) 母岩1185・接合4734(2) ……………408
図Ⅲ-409	Sb-97の分布図 ……………367	図Ⅲ-451	J区(Sb-97~107)の石器(57) 母岩1185・接合4734(3) ……………409
図Ⅲ-410	Sb-97の遺物(1) ……………368	図Ⅲ-452	J区(Sb-97~107)の石器(58) 母岩1133・接合4611(1) ……………410
図Ⅲ-411	Sb-97の遺物(2) ……………369	図Ⅲ-453	J区(Sb-97~107)の石器(59) 母岩1133・接合4611(2) ……………411
図Ⅲ-412	Sb-97の遺物(3) ……………370	図Ⅲ-454	J区(Sb-97~107)の石器(60) 母岩952・接合4136 ……………412
図Ⅲ-413	Sb-97の遺物(4) ……………371	図Ⅲ-455	J区(Sb-97~107)の石器(61) 母岩1046・接合4366 ……………413
図Ⅲ-414	Sb-97の遺物(5) ……………372	図Ⅲ-456	J区(Sb-97~107)の石器(62) 母岩1147・接合4632 ……………414
図Ⅲ-415	Sb-97の遺物(6) ……………373	図Ⅲ-457	J区(Sb-97~107)の石器(63) 母岩982・接合4217(1) ……………415
図Ⅲ-416	Sb-97の遺物(7) ……………374	図Ⅲ-458	J区(Sb-97~107)の石器(64) 母岩982・接合4217(2)、 母岩1006・接合4274(1) ……………416
図Ⅲ-417	Sb-98の分布図・遺物 ……………375	図Ⅲ-459	J区(Sb-97~107)の石器(65) 母岩1006・接合4274(2)、 母岩1038・接合4347(1) ……………417
図Ⅲ-418	Sb-99の分布図 ……………376	図Ⅲ-460	J区(Sb-97~107)の石器(66) 母岩1038・接合4347(2) ……………418
図Ⅲ-419	Sb-99の遺物(1) ……………377	図Ⅲ-461	J区(Sb-97~107)の石器(67) 母岩990・接合4230(1) ……………419
図Ⅲ-420	Sb-99の遺物(2) ……………378	図Ⅲ-462	J区(Sb-97~107)の石器(68) 母岩990・接合4230(2) ……………420
図Ⅲ-421	Sb-99の遺物(3)、Sb-100の分布図 ……………379	図Ⅲ-463	J区(Sb-97~107)の石器(69) 母岩958・接合4152(1) ……………421
図Ⅲ-422	Sb-100の遺物(1) ……………380	図Ⅲ-464	J区(Sb-97~107)の石器(70) 母岩958・接合4152(2)、 母岩1000・接合4257(1) ……………422
図Ⅲ-423	Sb-100の遺物(2) ……………381		
図Ⅲ-424	Sb-101の分布図 ……………382		
図Ⅲ-425	Sb-101の遺物(1) ……………383		
図Ⅲ-426	Sb-101の遺物(2) ……………384		
図Ⅲ-427	Sb-101の遺物(3) ……………385		
図Ⅲ-428	Sb-102の分布図・遺物 ……………386		
図Ⅲ-429	Sb-103・104の分布図 ……………387		
図Ⅲ-430	Sb-104の遺物 ……………388		
図Ⅲ-431	Sb-105の分布図・遺物 ……………389		
図Ⅲ-432	Sb-106の分布図 ……………390		
図Ⅲ-433	Sb-106・107の分布図・遺物 ……………391		
図Ⅲ-434	J区(Sb-97~107)の接合分布図 ……………392		
図Ⅲ-435	J区(Sb-97~107)の石器(41) 母岩1029・接合4324(1) ……………393		
図Ⅲ-436	J区(Sb-97~107)の石器(42) 母岩1029・接合4324(2) ……………394		
図Ⅲ-437	J区(Sb-97~107)の石器(43) 母岩1029・接合4324(3) ……………395		
図Ⅲ-438	J区(Sb-97~107)の石器(44) 母岩1134・接合4613(1) ……………396		
図Ⅲ-439	J区(Sb-97~107)の石器(45) 母岩1134・接合4613(2) ……………397		
図Ⅲ-440	J区(Sb-97~107)の石器(46) 母岩975・接合4201(1) ……………398		

図Ⅲ-465	J区(Sb-97~107)の石器(71) 母岩1000・接合4257(2)、母岩1141・接合4623…423	図Ⅲ-487	J区(Sb-97~107)の石器(93) 母岩1186・接合4744、母岩1091・接合4522 ……445
図Ⅲ-466	J区(Sb-97~107)の石器(72) 母岩1164・接合4678、母岩1007・接合4275 ……424	図Ⅲ-488	J区(Sb-97~107)の石器(94) 母岩1191・接合4752(1) ……446
図Ⅲ-467	J区(Sb-97~107)の石器(73) 母岩1142・接合4626 ……425	図Ⅲ-489	J区(Sb-97~107)の石器(95) 母岩1191・接合4752(2)、母岩1074・接合4480…447
図Ⅲ-468	J区(Sb-97~107)の石器(74) 母岩965・接合4173(1)、 母岩965・接合4174(1) ……426	図Ⅲ-490	J区(Sb-97~107)の石器(96) 接合5951、接合5822 ……448
図Ⅲ-469	J区(Sb-97~107)の石器(75) 母岩965・接合4173(2)、 母岩965・接合4174(2) ……427	図Ⅲ-491	J区(Sb-97~107)の石器(97) 母岩1039・接合4349、母岩972・接合4197(1) …449
図Ⅲ-470	J区(Sb-97~107)の石器(76) 母岩965・接合4174(3)、 母岩1016・接合4287(1) ……428	図Ⅲ-492	J区(Sb-97~107)の石器(98) 母岩972・接合4197(2)、母岩1087・接合4508 …450
図Ⅲ-471	J区(Sb-97~107)の石器(77) 母岩1016・接合4287(2)、 母岩1028・接合4322 ……429	図Ⅲ-493	J区(Sb-97~107)の石器(99) 母岩1121・接合4584、接合5837 ……451
図Ⅲ-472	J区(Sb-97~107)の石器(78) 母岩1034・接合4337(1) ……430	図Ⅲ-494	J区(Sb-97~107)の石器(100) 母岩1220・接合5801、母岩1220・接合5843 ……452
図Ⅲ-473	J区(Sb-97~107)の石器(79) 母岩1034・接合4337(2) ……431	図Ⅲ-495	J区(Sb-97~107)の石器(101) 母岩1158・接合4663、接合5823、 母岩1179・接合4719 ……453
図Ⅲ-474	J区(Sb-97~107)の石器(80) 母岩1108・接合4556(1) ……432	図Ⅲ-496	K区(Sb-108~111)の石器(1) 尖頭器 ……454
図Ⅲ-475	J区(Sb-97~107)の石器(81) 母岩1108・接合4556(2) ……433	図Ⅲ-497	K区(Sb-108~111)の石器(2) 尖頭器・両面調整石器 ……455
図Ⅲ-476	J区(Sb-97~107)の石器(82) 母岩948・接合4125(1) ……434	図Ⅲ-498	K区(Sb-108~111)の石器(3) 両面調整石器・彫器・搔器・削器・舟底形石器…456
図Ⅲ-477	J区(Sb-97~107)の石器(83) 母岩948・接合4125(2)、 母岩1104・接合4552(1) ……435	図Ⅲ-499	K区(Sb-108~111)の石器(4) 舟底形石器・石刃・石刃核・石核 ……457
図Ⅲ-478	J区(Sb-97~107)の石器(84) 母岩1104・接合4552(2)、 母岩1089・接合4520(1) ……436	図Ⅲ-500	Sb-108・109の分布図・遺物 ……458
図Ⅲ-479	J区(Sb-97~107)の石器(85) 母岩1089・接合4520(2)、 母岩1079・接合4498(1) ……437	図Ⅲ-501	Sb-109の遺物、Sb-110の分布図 ……459
図Ⅲ-480	J区(Sb-97~107)の石器(86) 母岩1079・接合4498(2) ……438	図Ⅲ-502	Sb-110の遺物 ……460
図Ⅲ-481	J区(Sb-97~107)の石器(87) 母岩1079・接合4498(3) ……439	図Ⅲ-503	Sb-111の分布図・遺物 ……461
図Ⅲ-482	J区(Sb-97~107)の石器(88) 母岩1174・接合4701(1) ……440	図Ⅲ-504	K区(Sb-108~111)の接合分布図 ……462
図Ⅲ-483	J区(Sb-97~107)の石器(89) 母岩1174・接合4701(2) ……441	図Ⅲ-505	K区(Sb-108~111)の石器(5) 母岩1198・接合4773(1) ……463
図Ⅲ-484	J区(Sb-97~107)の石器(90) 母岩1174・接合4701(3)、 母岩1120・接合4583(1) ……442	図Ⅲ-506	K区(Sb-108~111)の石器(6) 母岩1198・接合4773(2) ……464
図Ⅲ-485	J区(Sb-97~107)の石器(91) 母岩1120・接合4583(2) ……443	図Ⅲ-507	K区(Sb-108~111)の石器(7) 母岩1198・接合4773(3)、 母岩1203・接合4784(1) ……465
図Ⅲ-486	J区(Sb-97~107)の石器(92) 母岩1120・接合4583(3) ……444	図Ⅲ-508	K区(Sb-108~111)の石器(8) 母岩1203・接合4784(2)、 母岩1202・接合4783(1) ……466
		図Ⅲ-509	K区(Sb-108~111)の石器(9) 母岩1202・接合4783(2) ……467
		図Ⅲ-510	石器ブロック外の石器 尖頭器・石刃、 石器ブロック外の石器分布図 ……468
		図Ⅲ-511	表土(重機調査)の石器(1) 削器・舟底形石器・ 石刃核・石核 ……469
		図Ⅲ-512	表土(重機調査)の石器(2) 石刃核 ……470
		図Ⅲ-513	追加報告の石器(1) 尖頭器・削器、 追加報告の石器分布図 ……471
		図Ⅲ-514	追加報告の石器(2) 母岩702・接合3222 ……472

Ⅲ 上白滝 8 遺跡の調査(2)

- 図Ⅲ-43～52 Sb-64～70の石器
図Ⅲ-53～61 Sb-64～70の分布図
図Ⅲ-62～71 Sb-64～70の接合資料
- 図Ⅲ-72 Sb-71の石器
図Ⅲ-73・74 Sb-71の分布図
図Ⅲ-75 Sb-71の接合資料
- 図Ⅲ-76～90 Sb-72～79の石器
図Ⅲ-90～102 Sb-72～79の分布図
図Ⅲ-103～112 Sb-72～79の接合資料
- 図Ⅲ-113 石器ブロック外の石器、分布図
- 図Ⅲ-114～132 G区(Sb-80～89)の石器
図Ⅲ-133～147 G区(Sb-80～89)の分布図
図Ⅲ-148～175 G区(Sb-80～89)の接合資料
- 図Ⅲ-176～189 H区(Sb-90)の石器
図Ⅲ-190～193 H区(Sb-90)の分布図
図Ⅲ-194～217 H区(Sb-90)の接合資料
- 図Ⅲ-218～255 I区(Sb-91～96)の石器
図Ⅲ-256～273 I区(Sb-91～96)の分布図
図Ⅲ-274～368 I区(Sb-91～96)の接合資料
- 図Ⅲ-369～408 J区(Sb-97～107)の石器
図Ⅲ-409～434 J区(Sb-97～107)の分布図
図Ⅲ-435～495 J区(Sb-97～107)の接合資料
- 図Ⅲ-496～499 K区(Sb-108～111)の石器
図Ⅲ-500～504 K区(Sb-108～111)の分布図
図Ⅲ-505～509 K区(Sb-108～111)の接合資料
- 図Ⅲ-510 石器ブロック外の石器、分布図
- 図Ⅲ-511・512 表土(重機調査)の石器
- 図Ⅲ-513 追加報告の石器、分布図
図Ⅲ-514 追加報告の接合資料



図Ⅲ-43 Sb-64~70の石器(1) 基部平坦加工石器・裏面微細加工石器

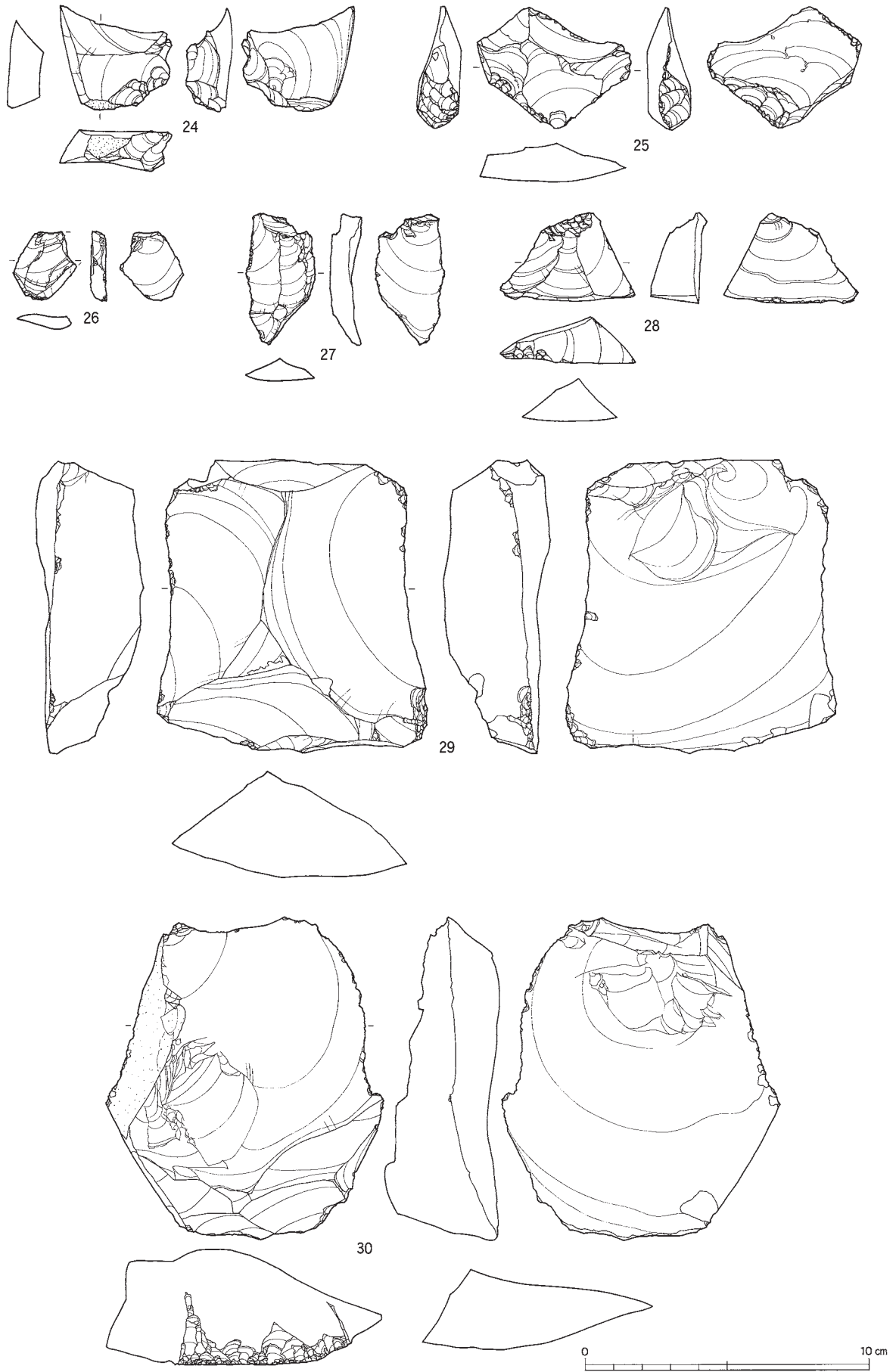

図Ⅲ-44 Sb-64~70の石器(2) 二次加工ある剥片・搔器

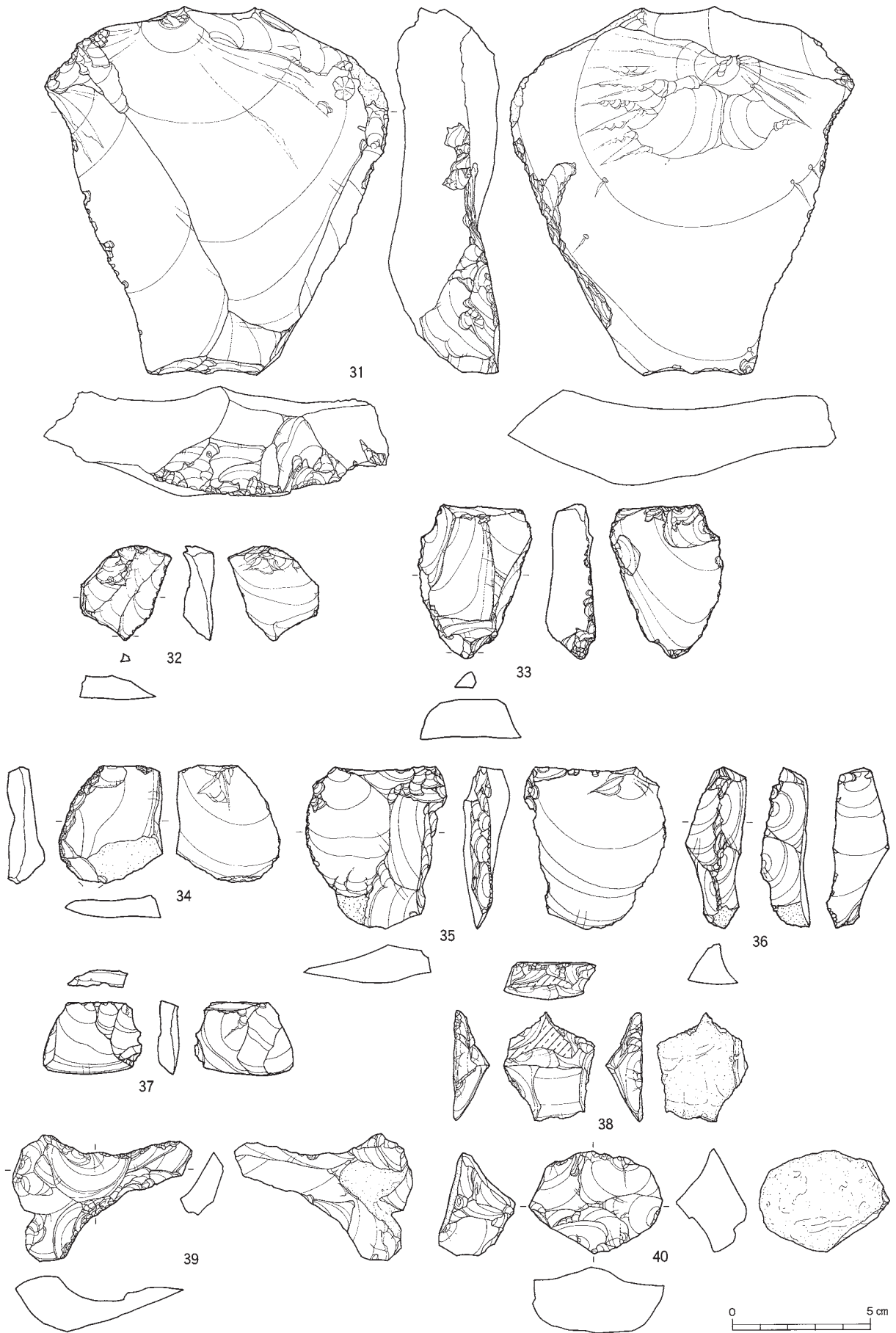

図Ⅲ-45 Sb-64~70の石器(3) 搔器・錐形石器・削器・縦長剥片・石核

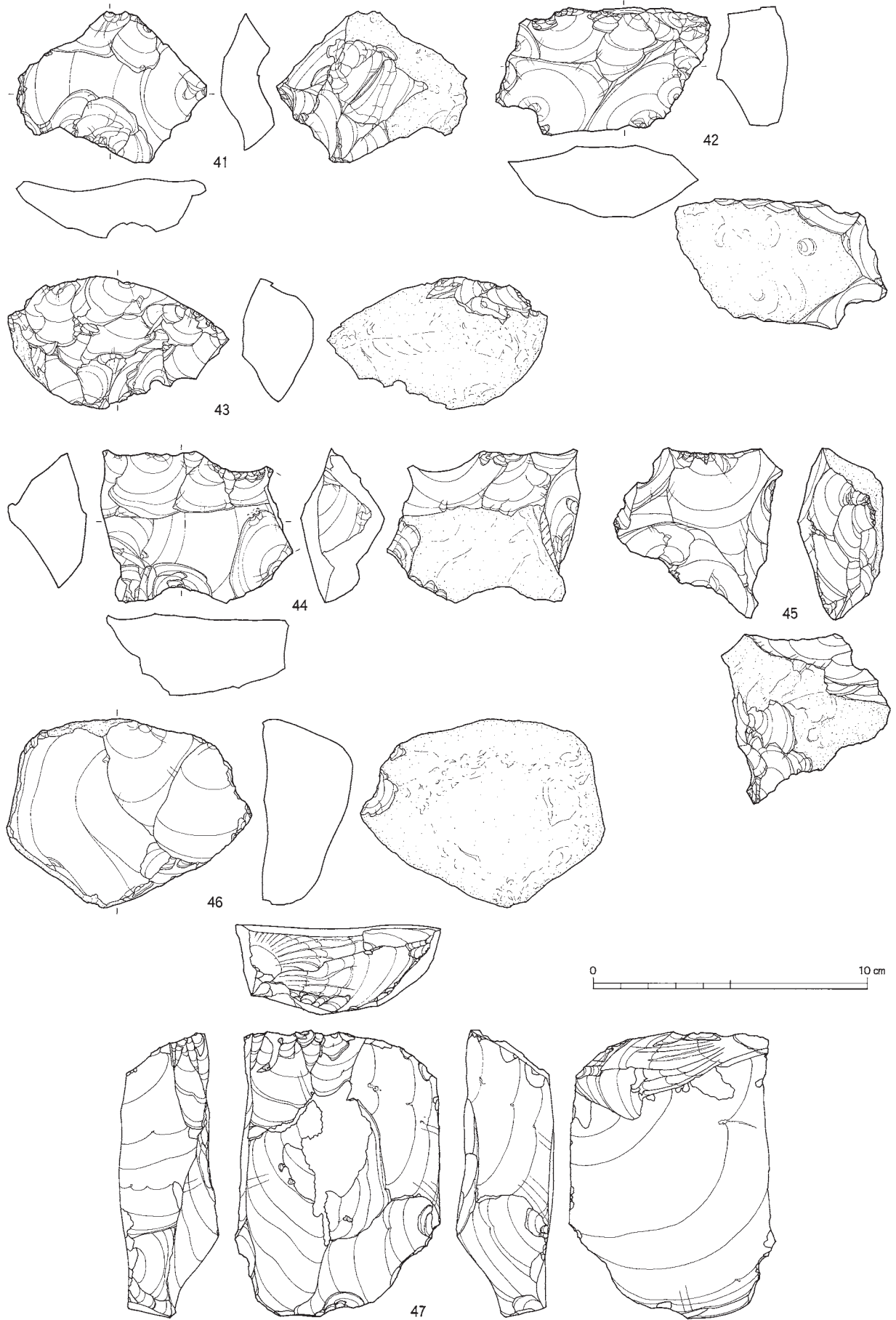

図Ⅲ-46 Sb-64~70の石器(4) 石核

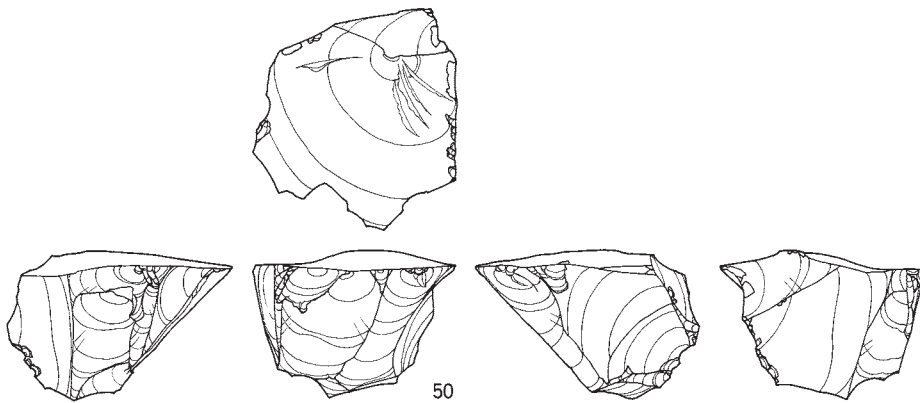
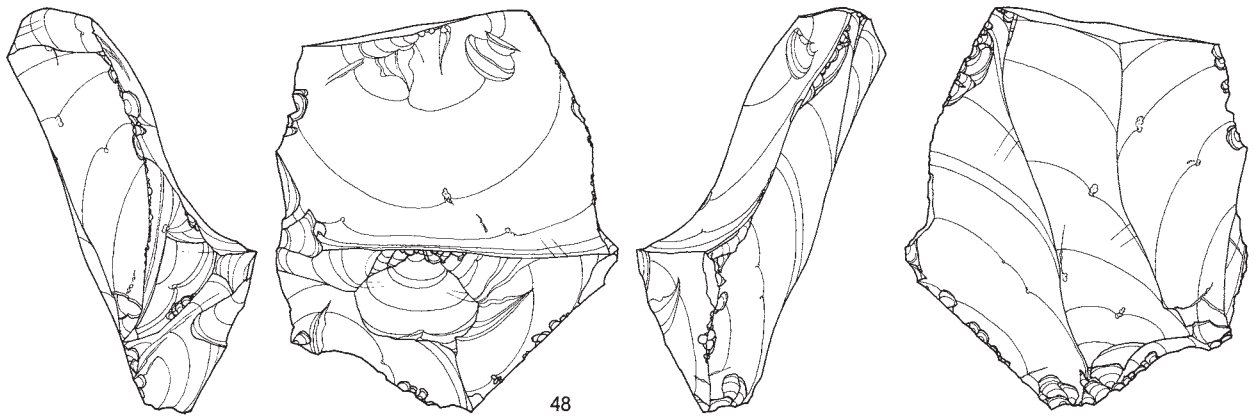

図Ⅲ-47 Sb-64~70の石器(5) 石核

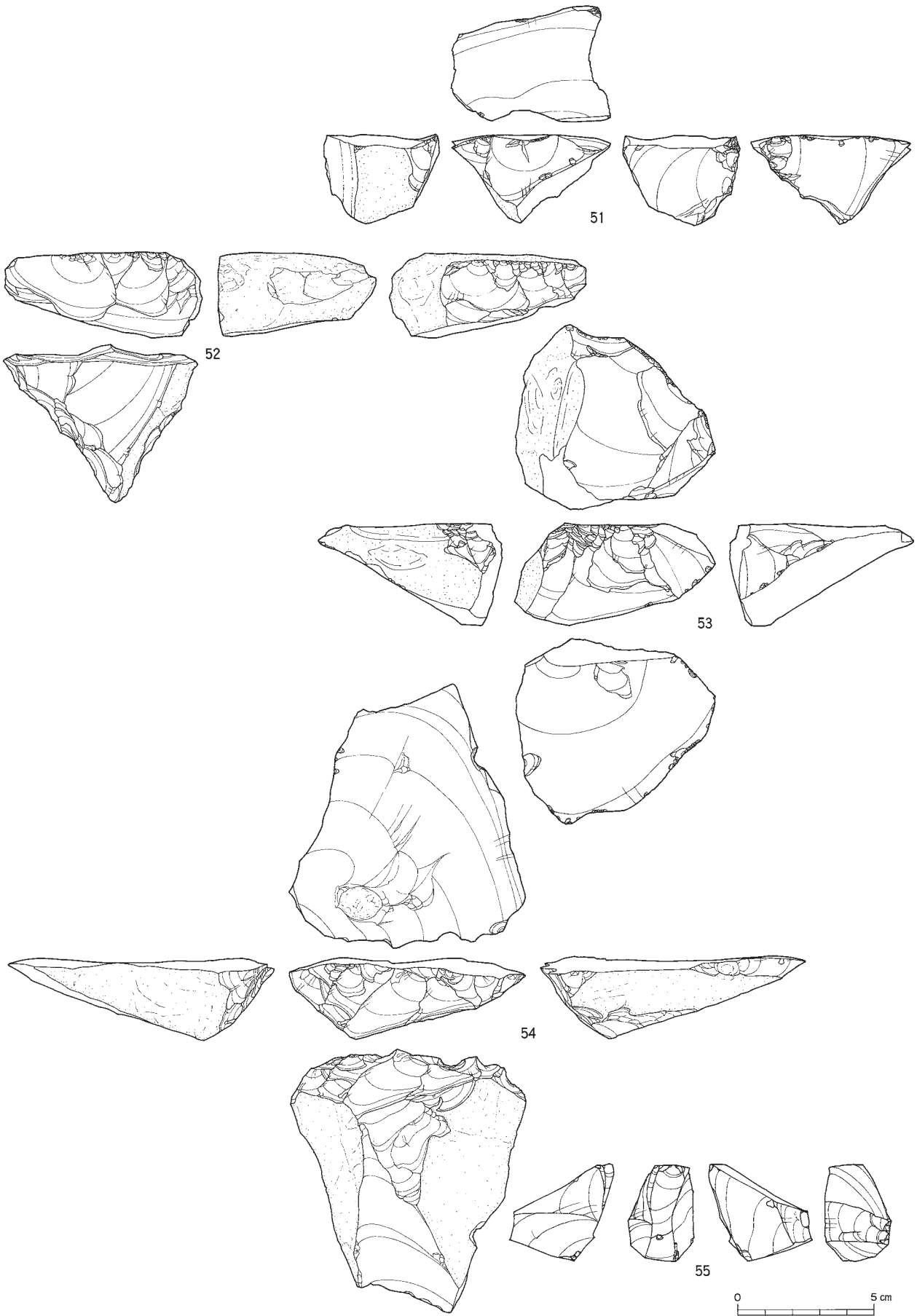

図Ⅲ-48 Sb-64~70の石器(6) 石核

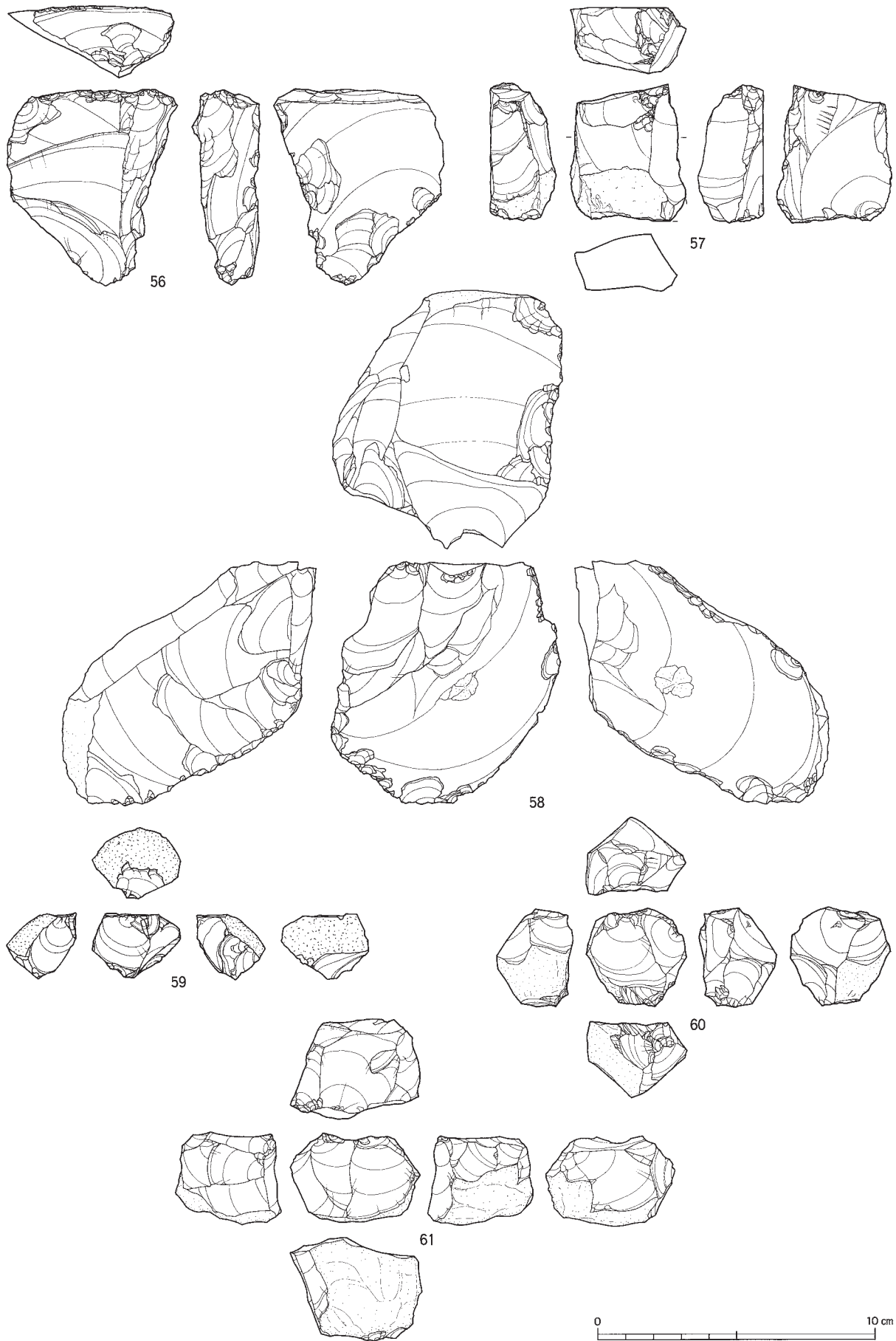

図Ⅲ-49 Sb-64~70の石器(7) 石核

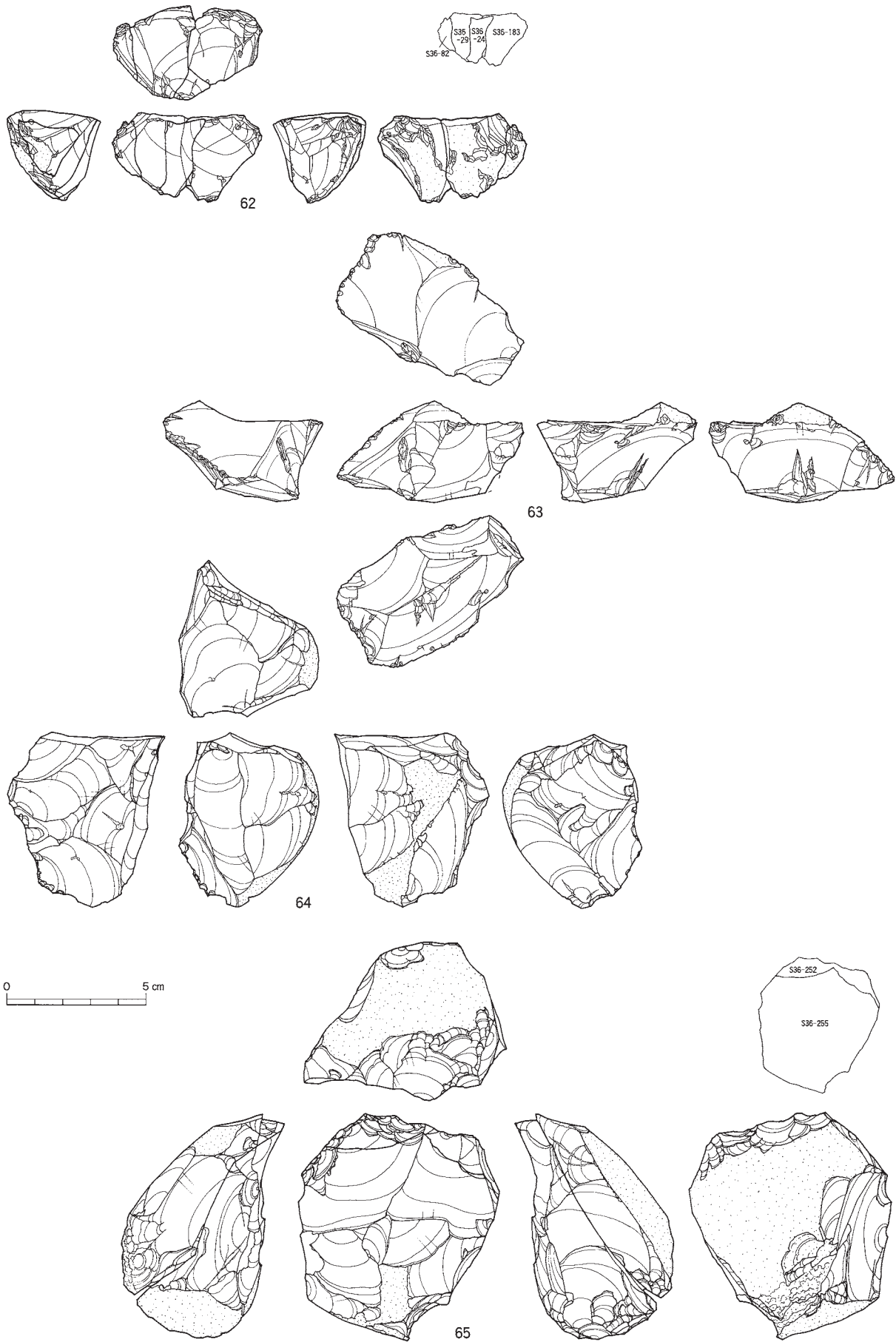

図Ⅲ-50 Sb-64~70の石器(8) 石核

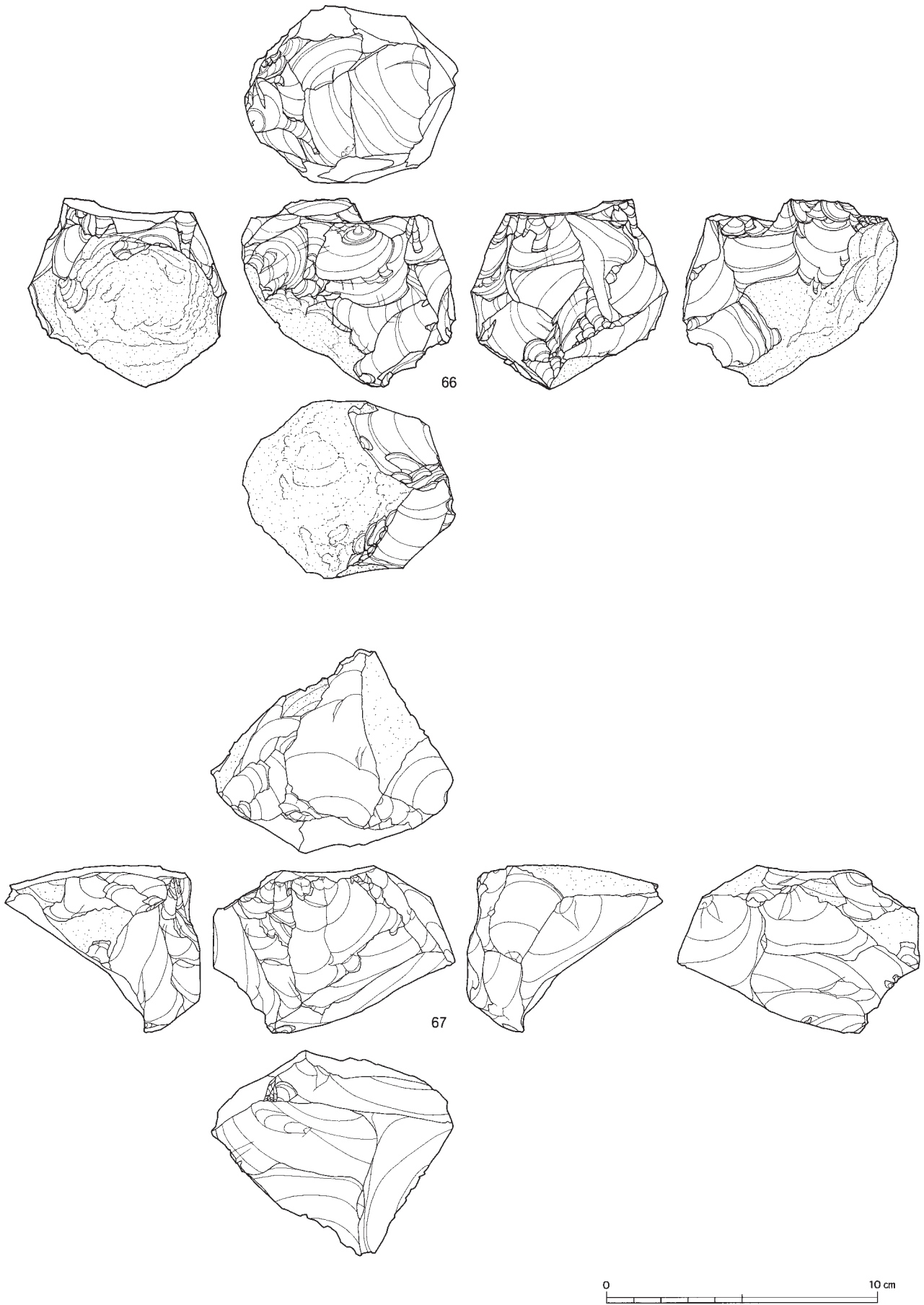

図Ⅲ-51 Sb-64~70の石器(9) 石核

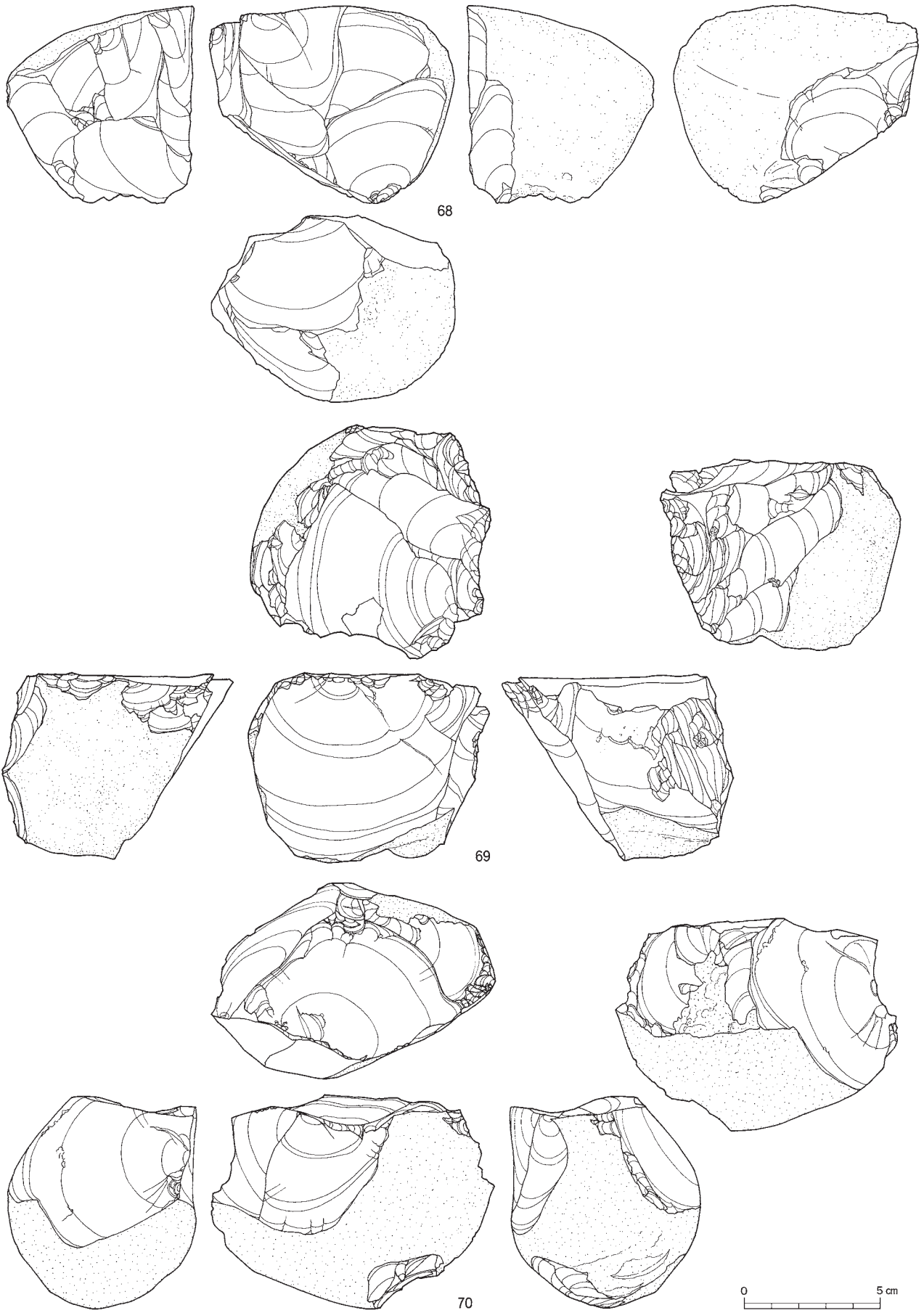

図Ⅲ-52 Sb-64~70の石器(10) 石核

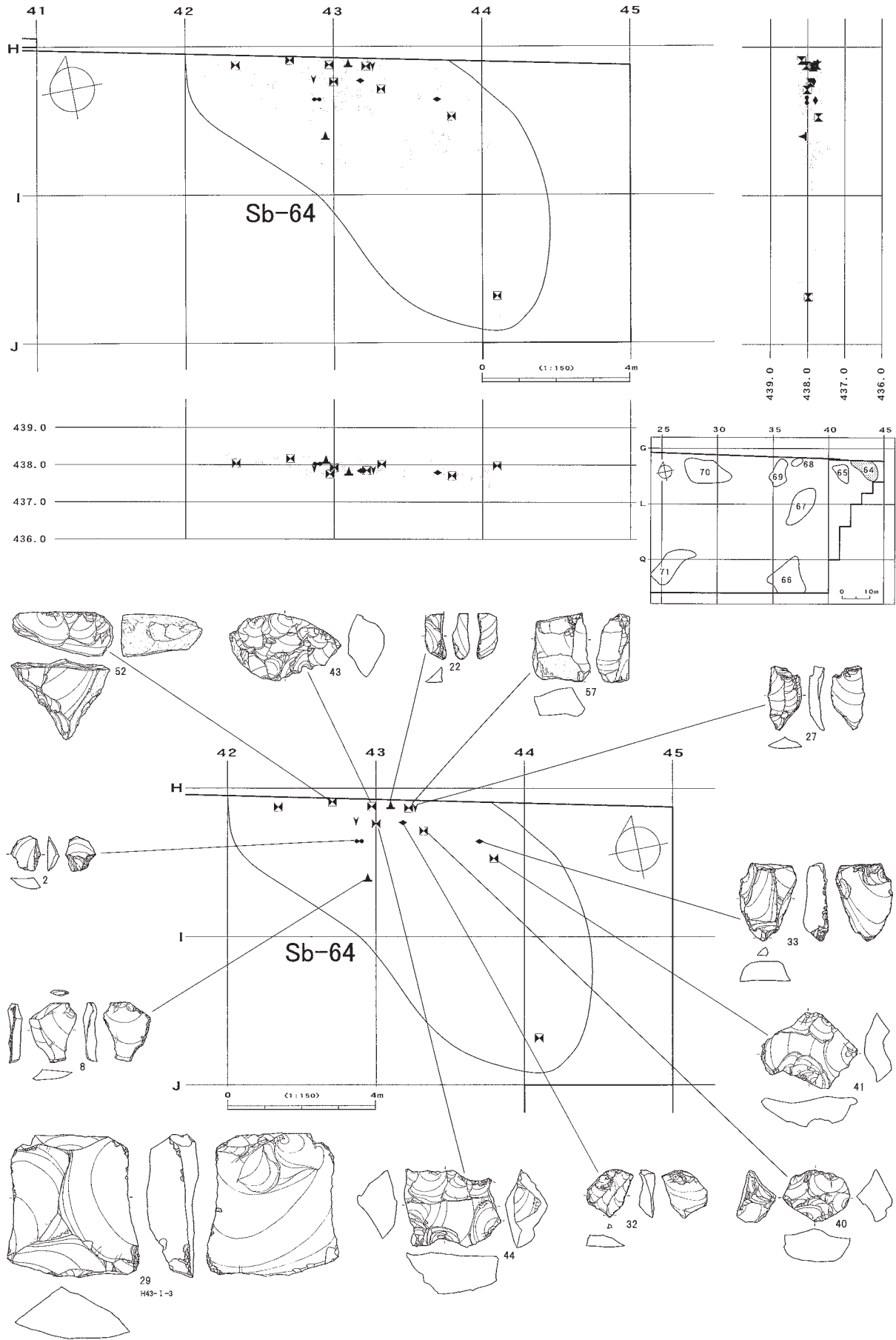

図Ⅲ-53 Sb-64の分布図・遺物

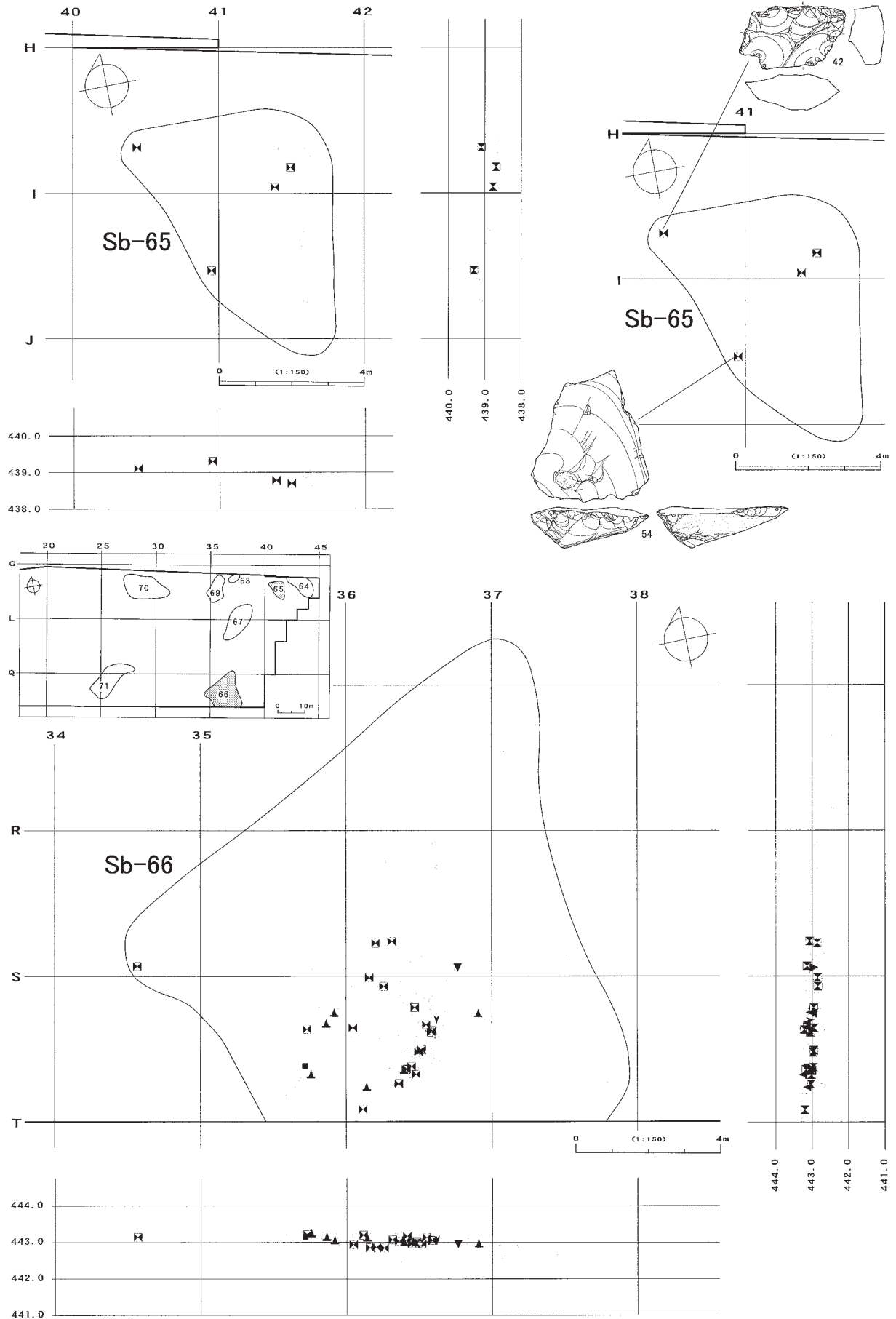

図Ⅲ-54 Sb-65・66の分布図・遺物

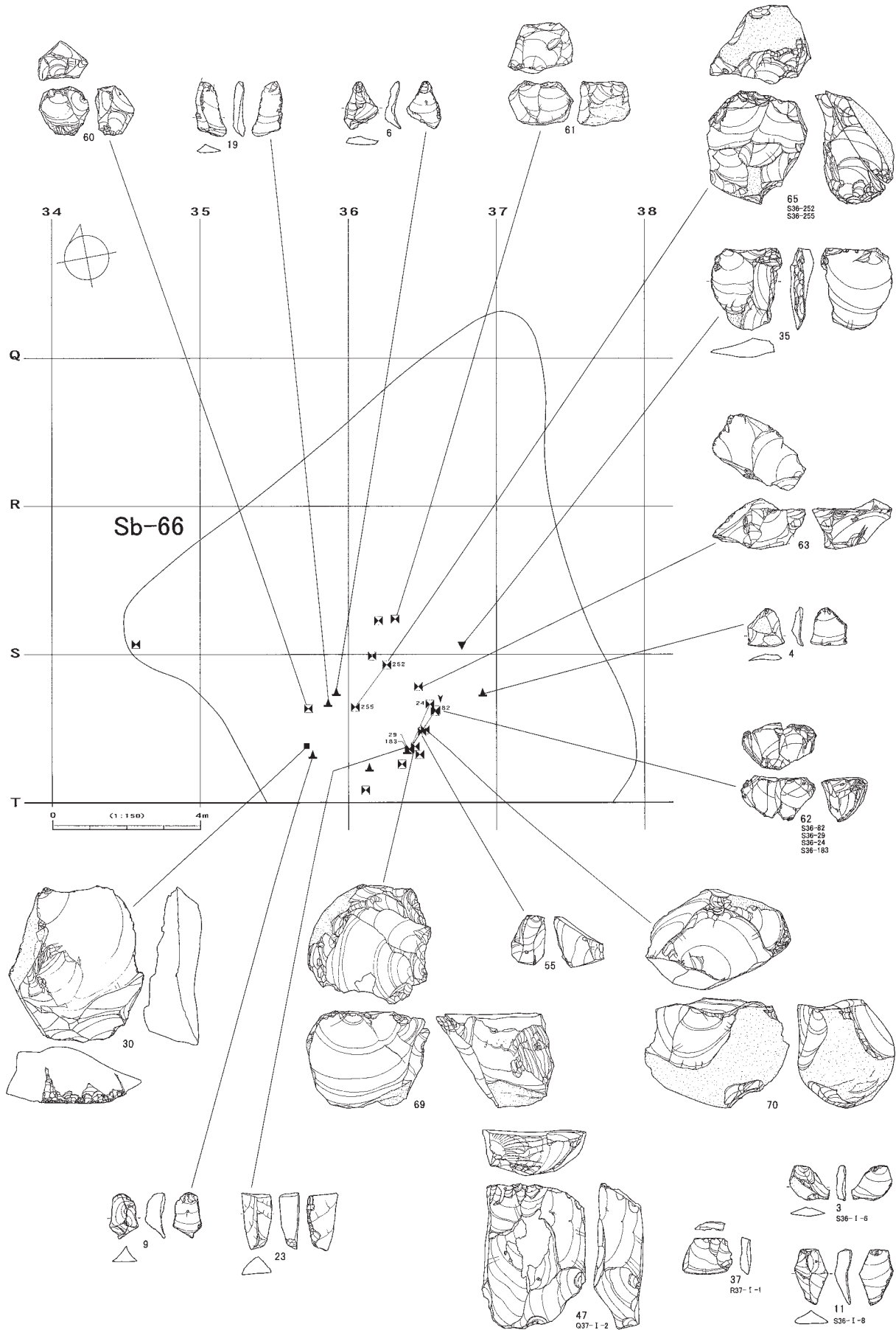

図Ⅲ-55 Sb-66の遺物

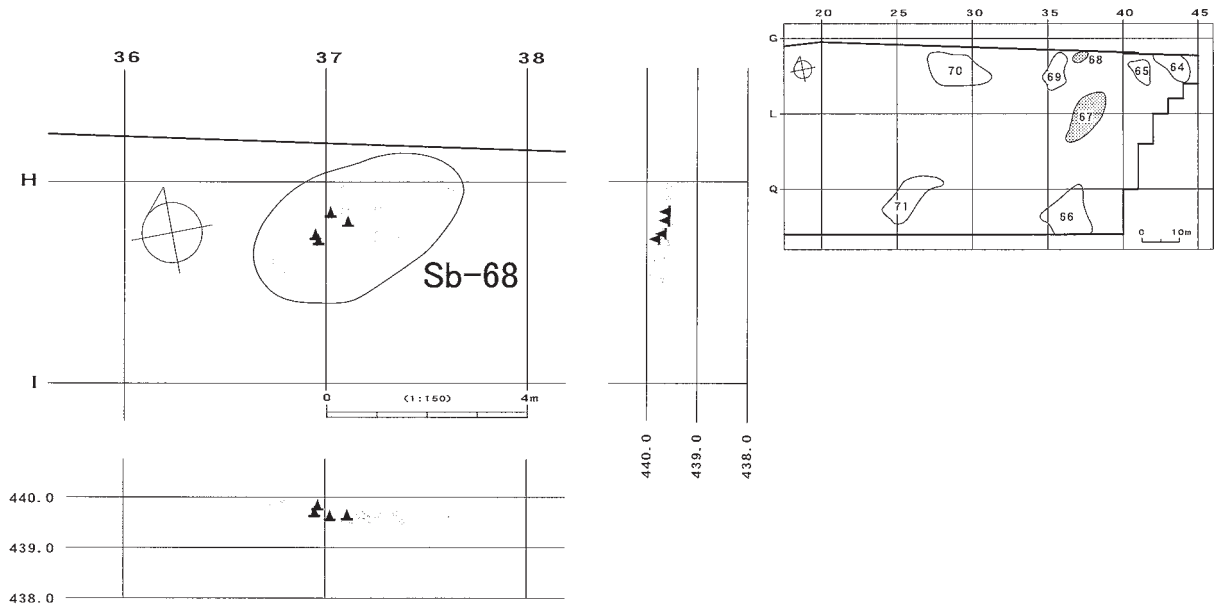
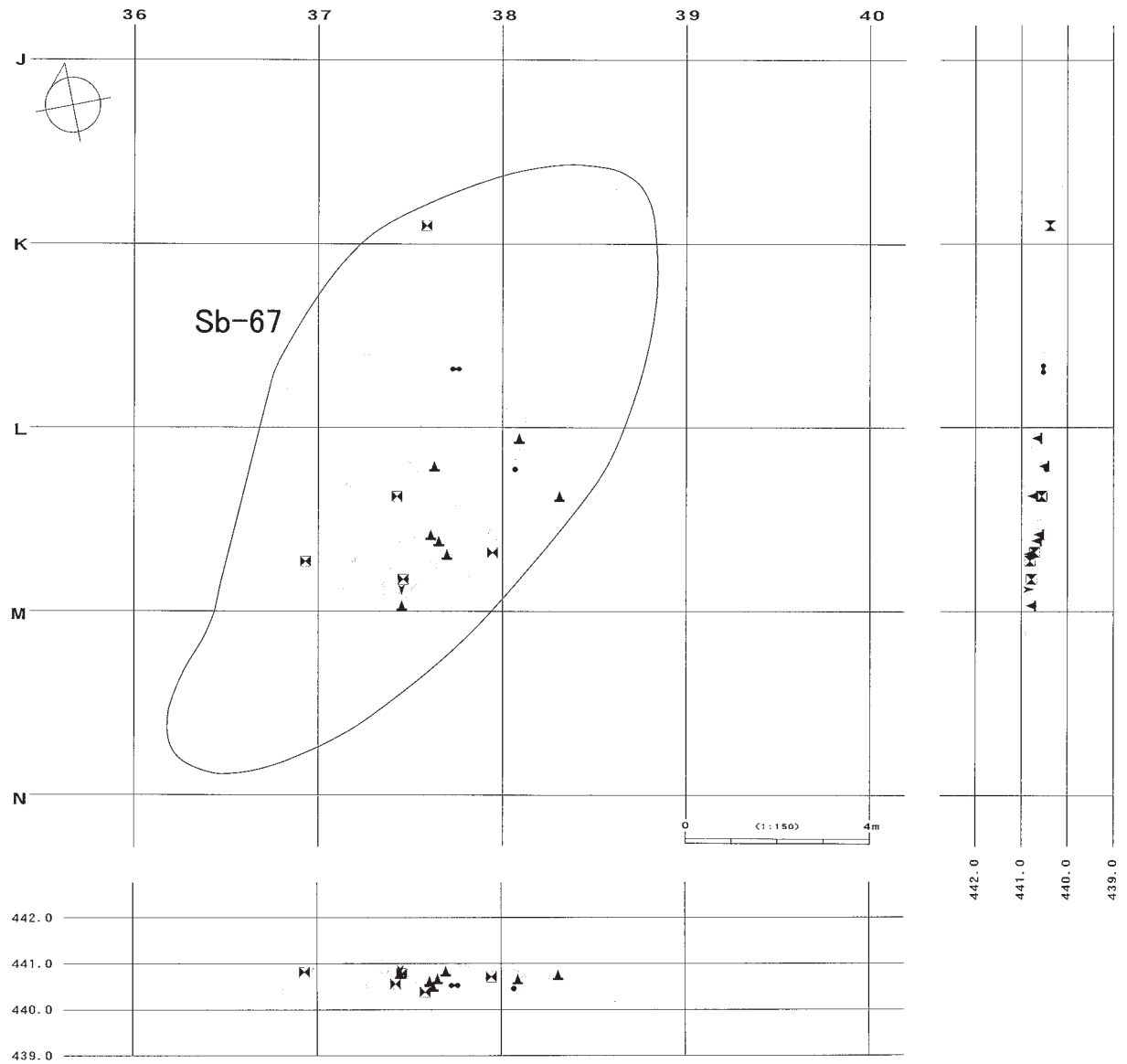

図Ⅲ-56 Sb-67・68の分布図

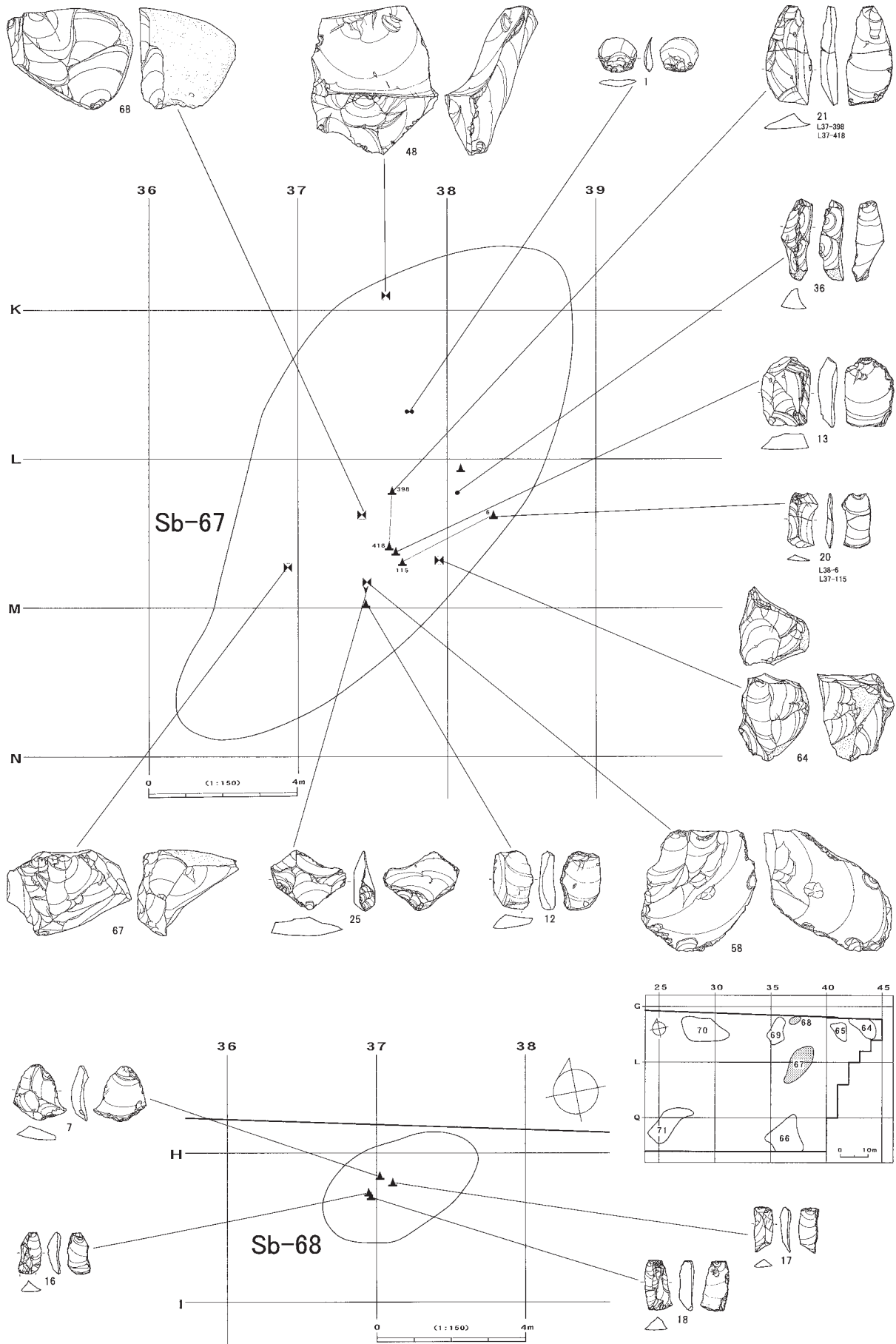

図III-57 Sb-67・68の遺物

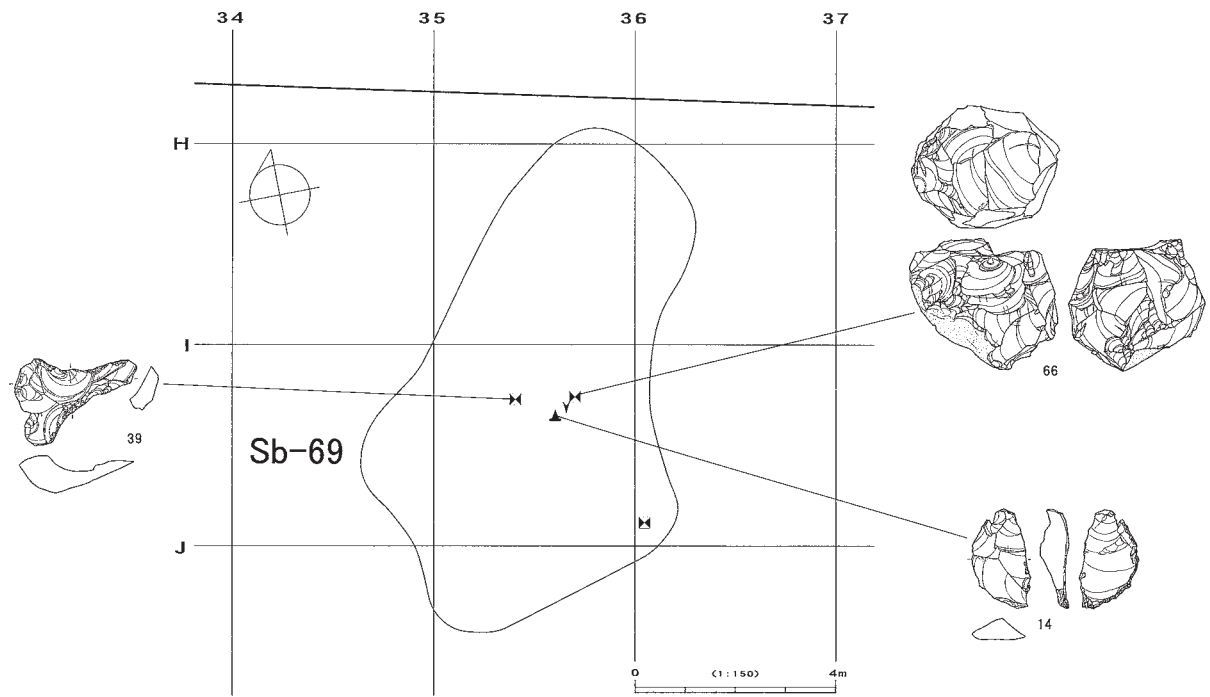
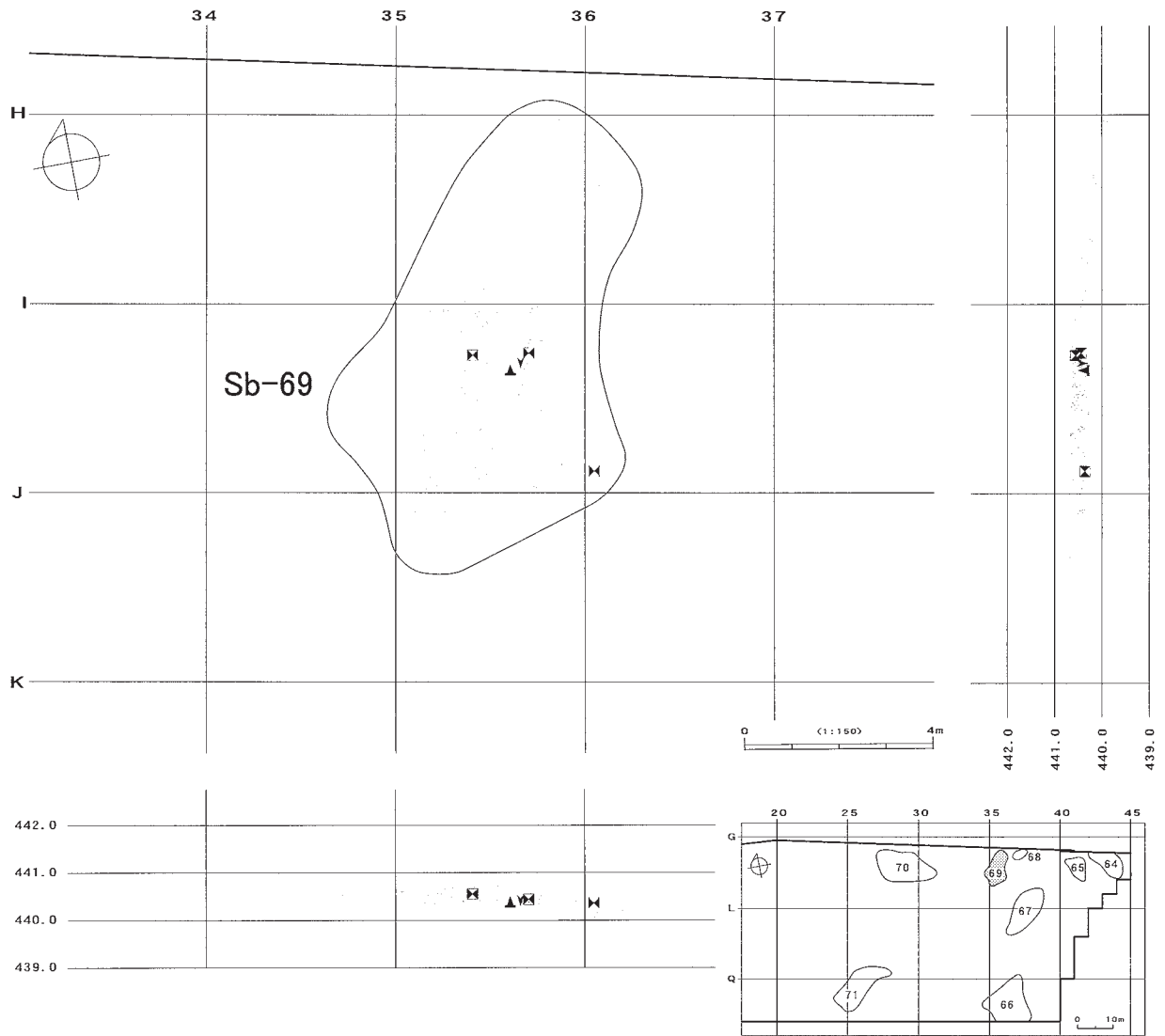

図Ⅲ-58 Sb-69の分布図・遺物

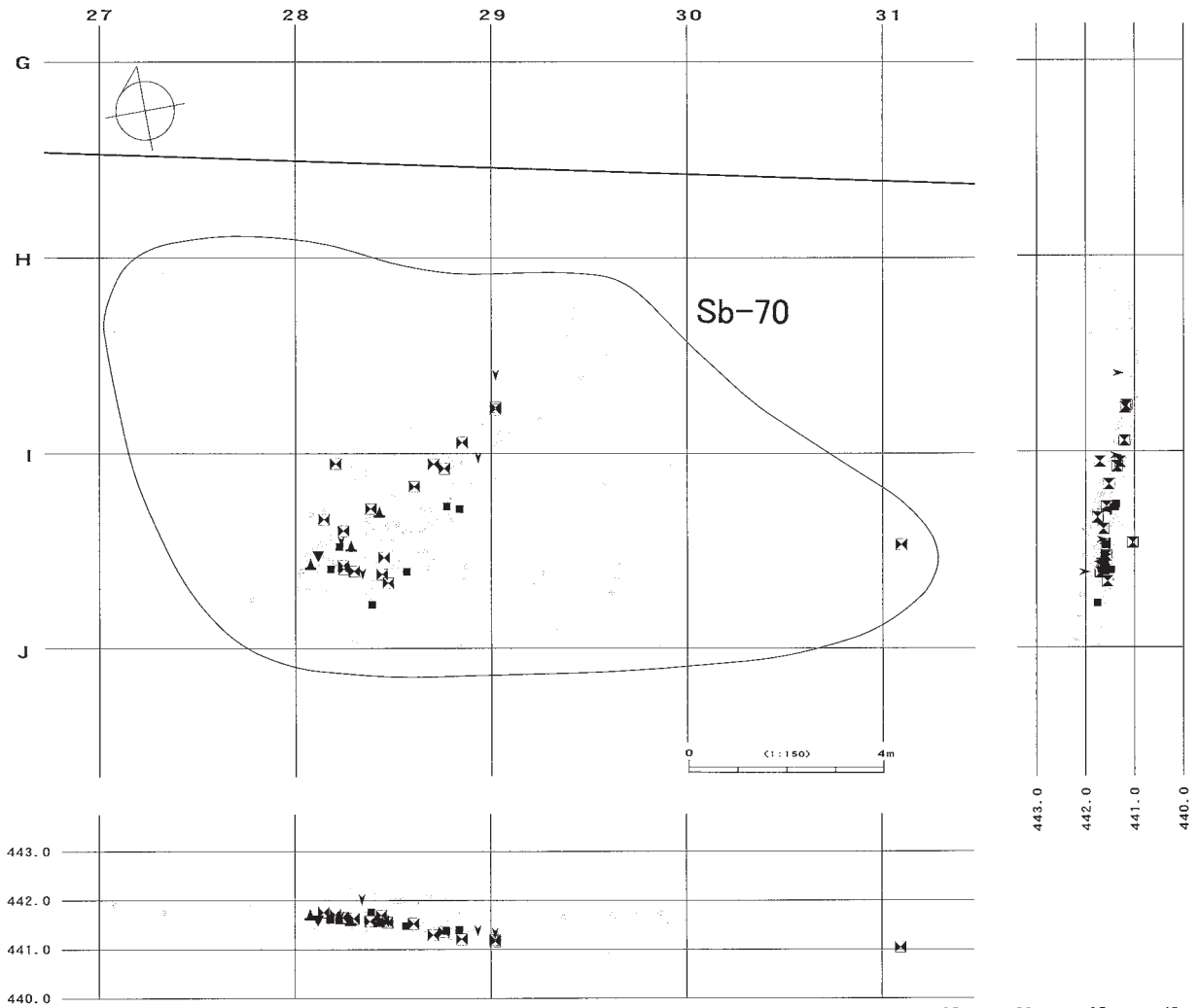

裏面微細加工石器、二次加工ある剥片

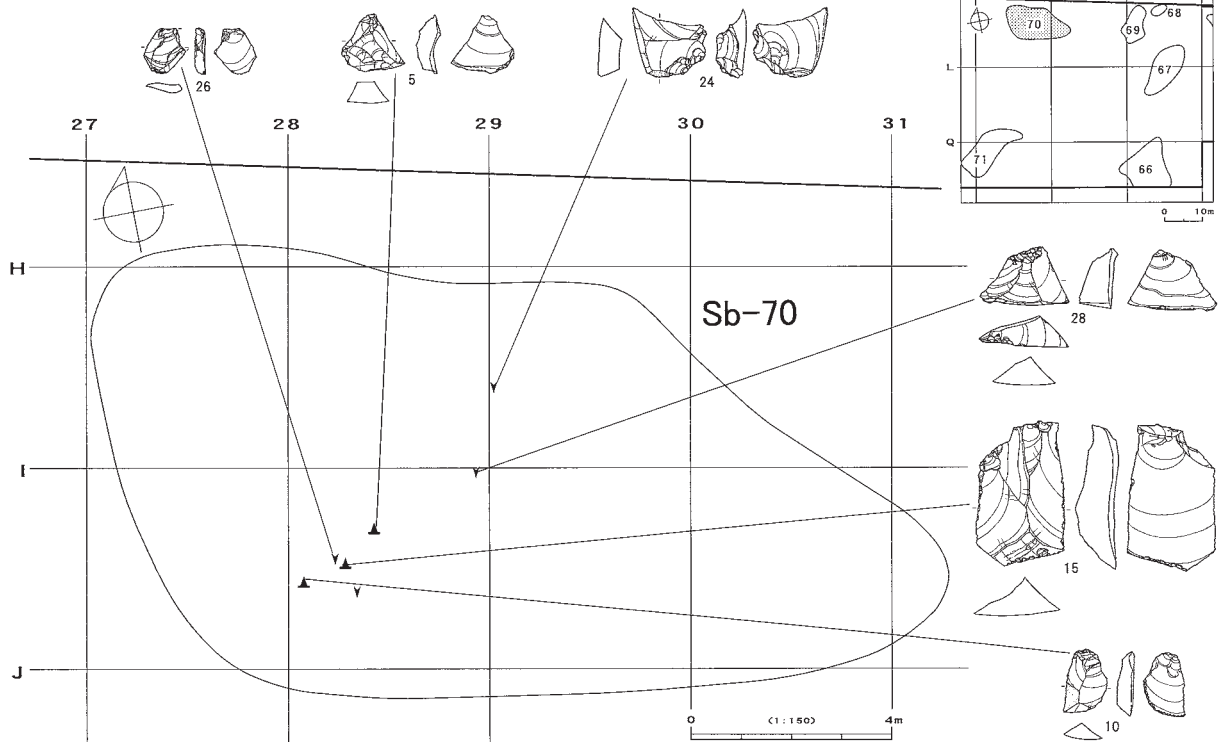

図Ⅲ-59 Sb-70の分布図・遺物(1)

搔器、削器、石核

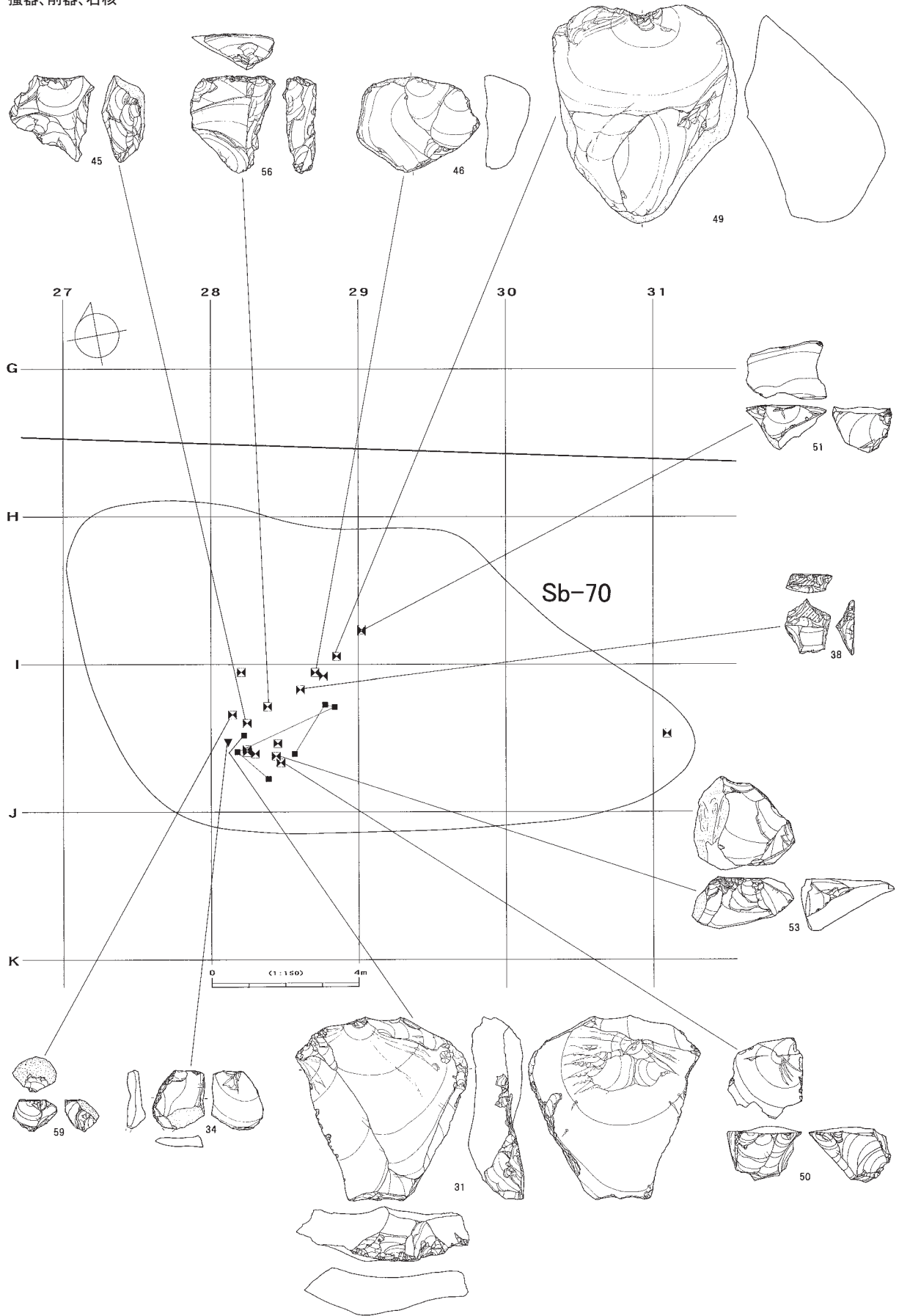

図Ⅲ-60 Sb-70の遺物(2)

全接合分布図

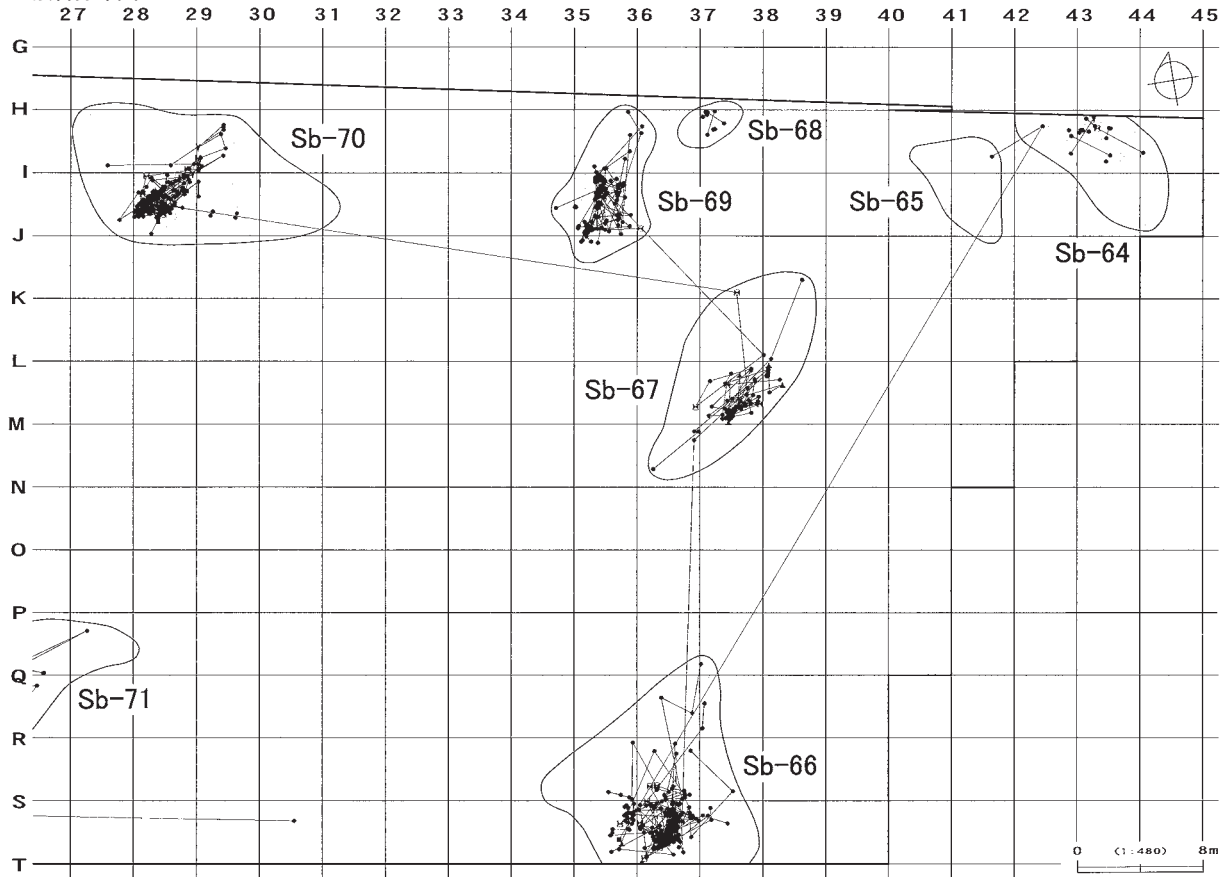

折れ面接合分布図

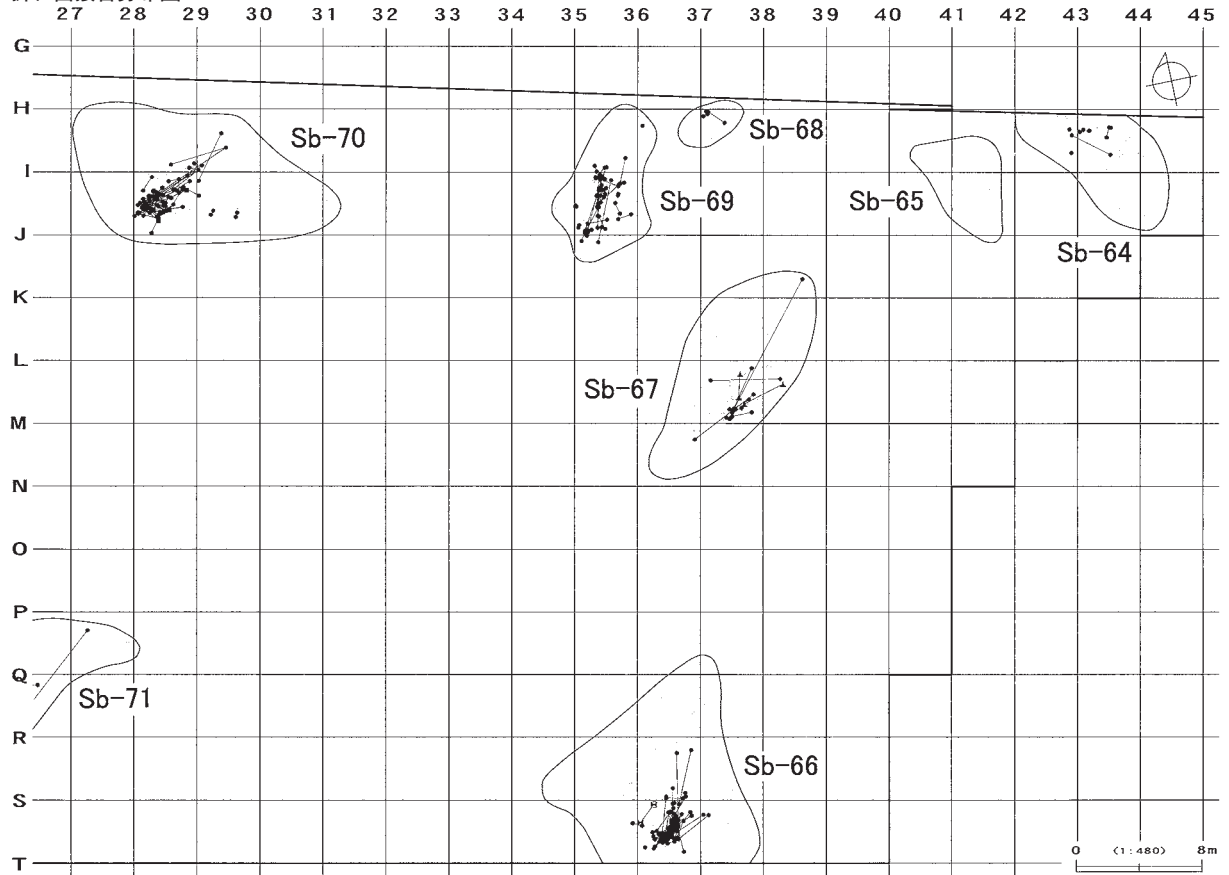

図Ⅲ-61 Sb-64~70の接合分布図

母岩489・接合359

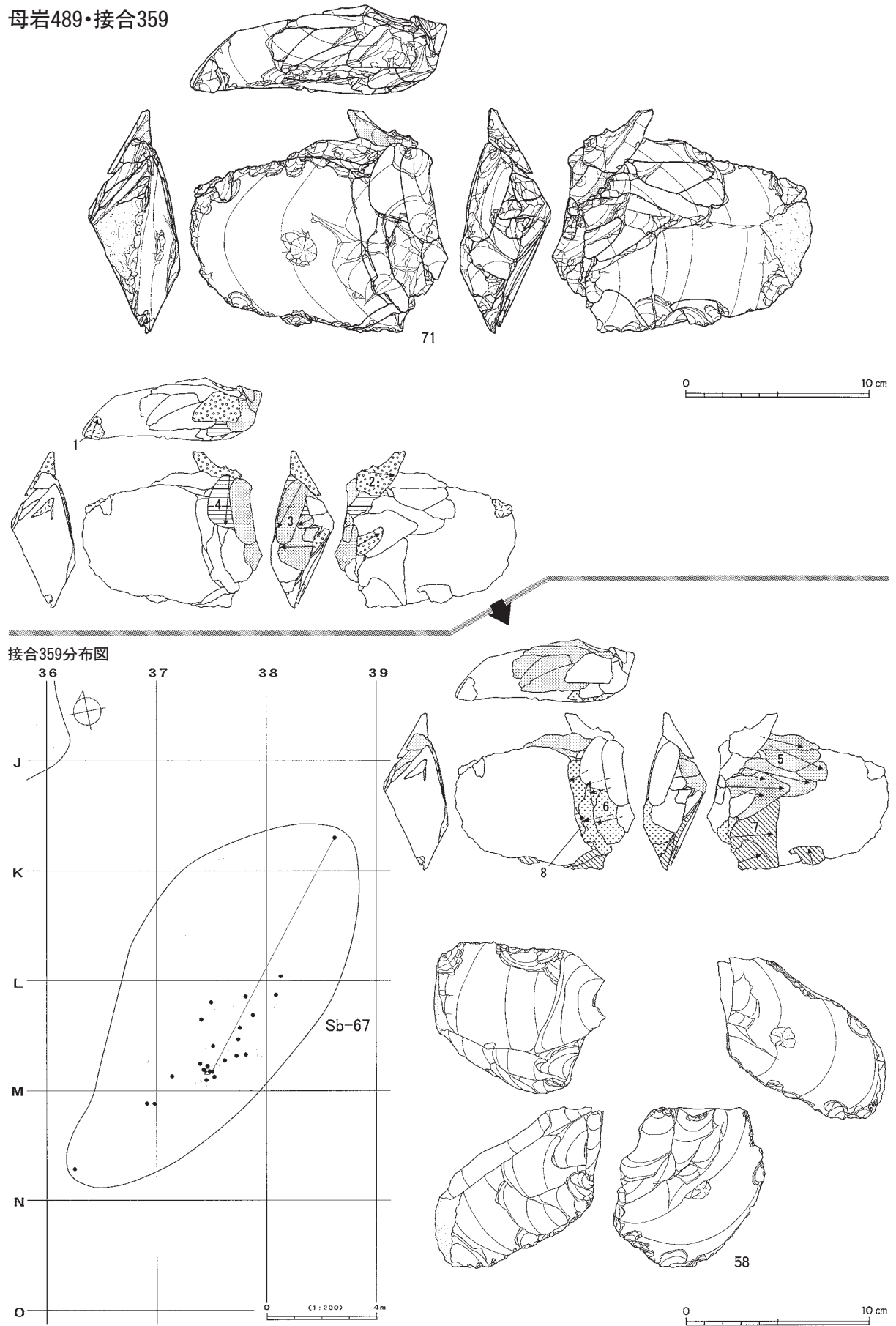

図Ⅲ-62 Sb-64~70の石器(11) 母岩489・接合359

母岩493・接合365

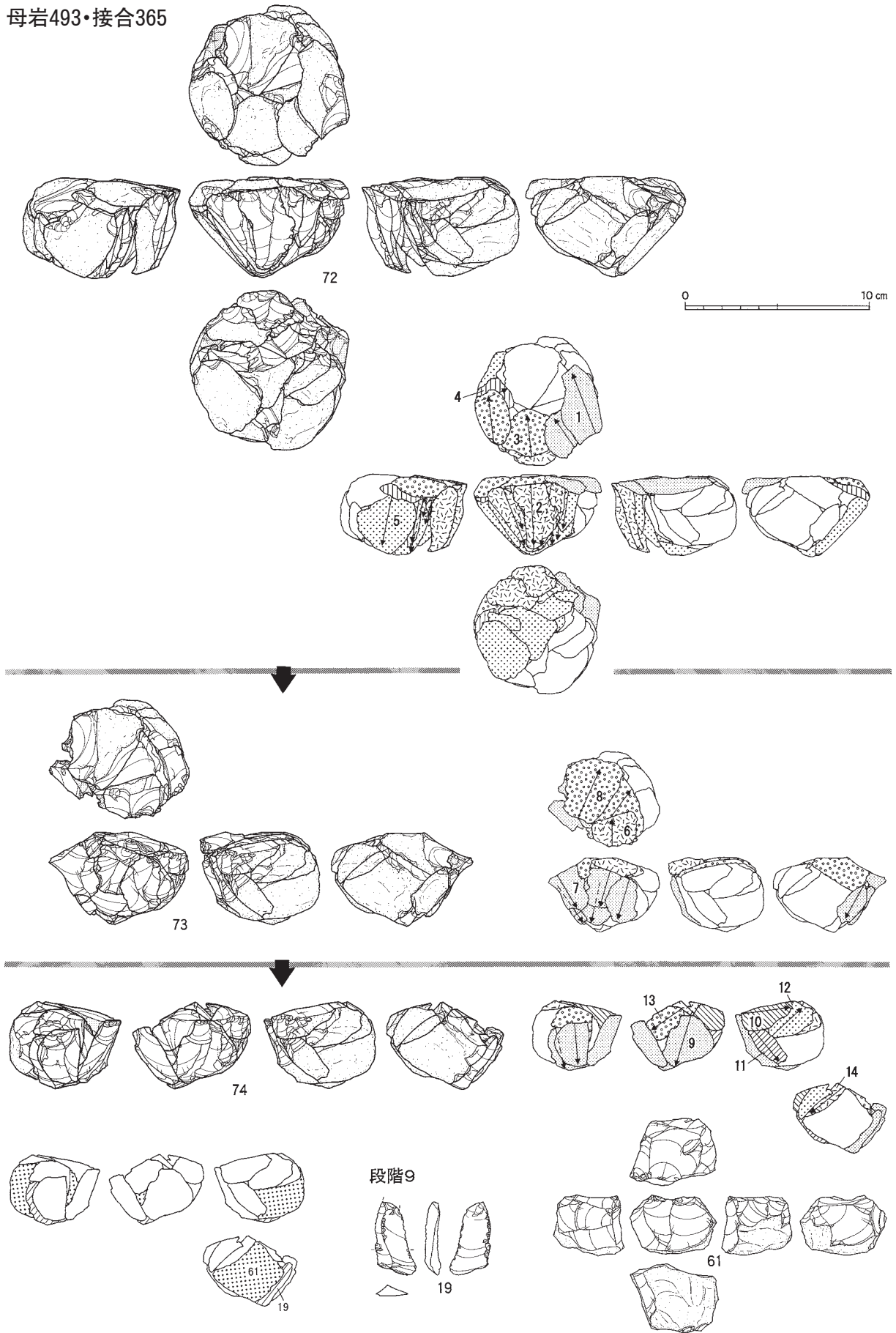

図Ⅲ-63 Sb-64~70の石器(12) 母岩493・接合365(1)

Sb-64~70

接合365分布図

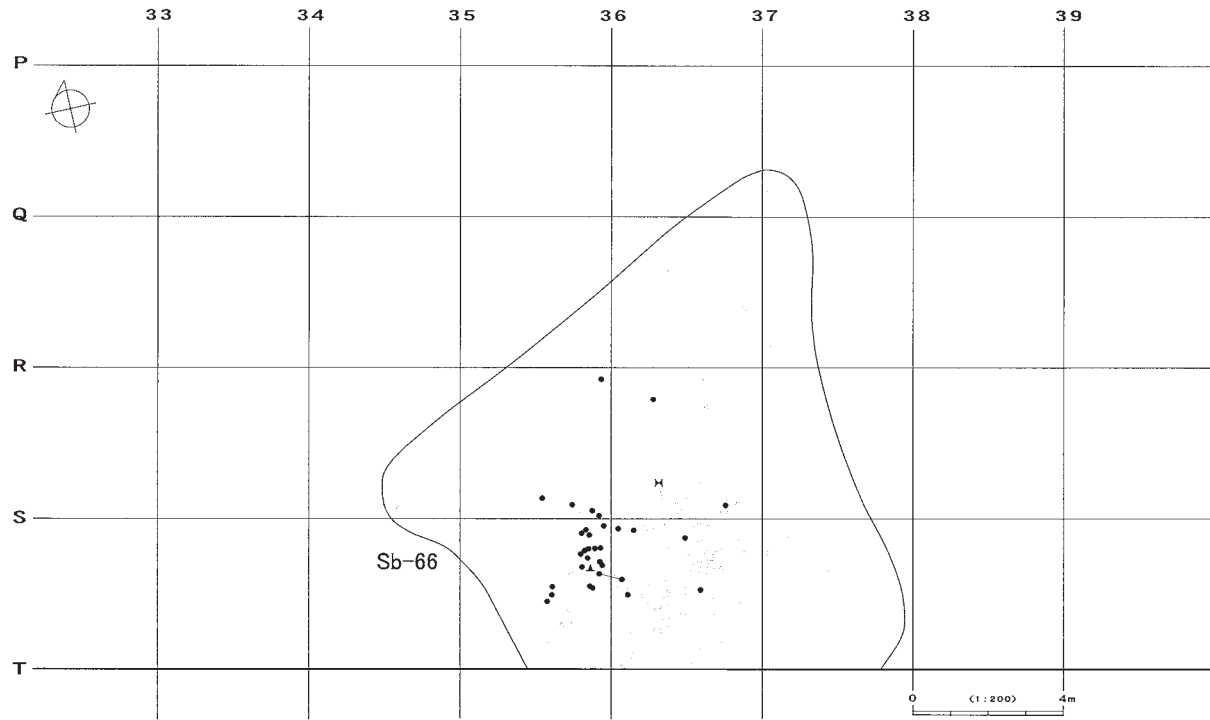

母岩497・接合370

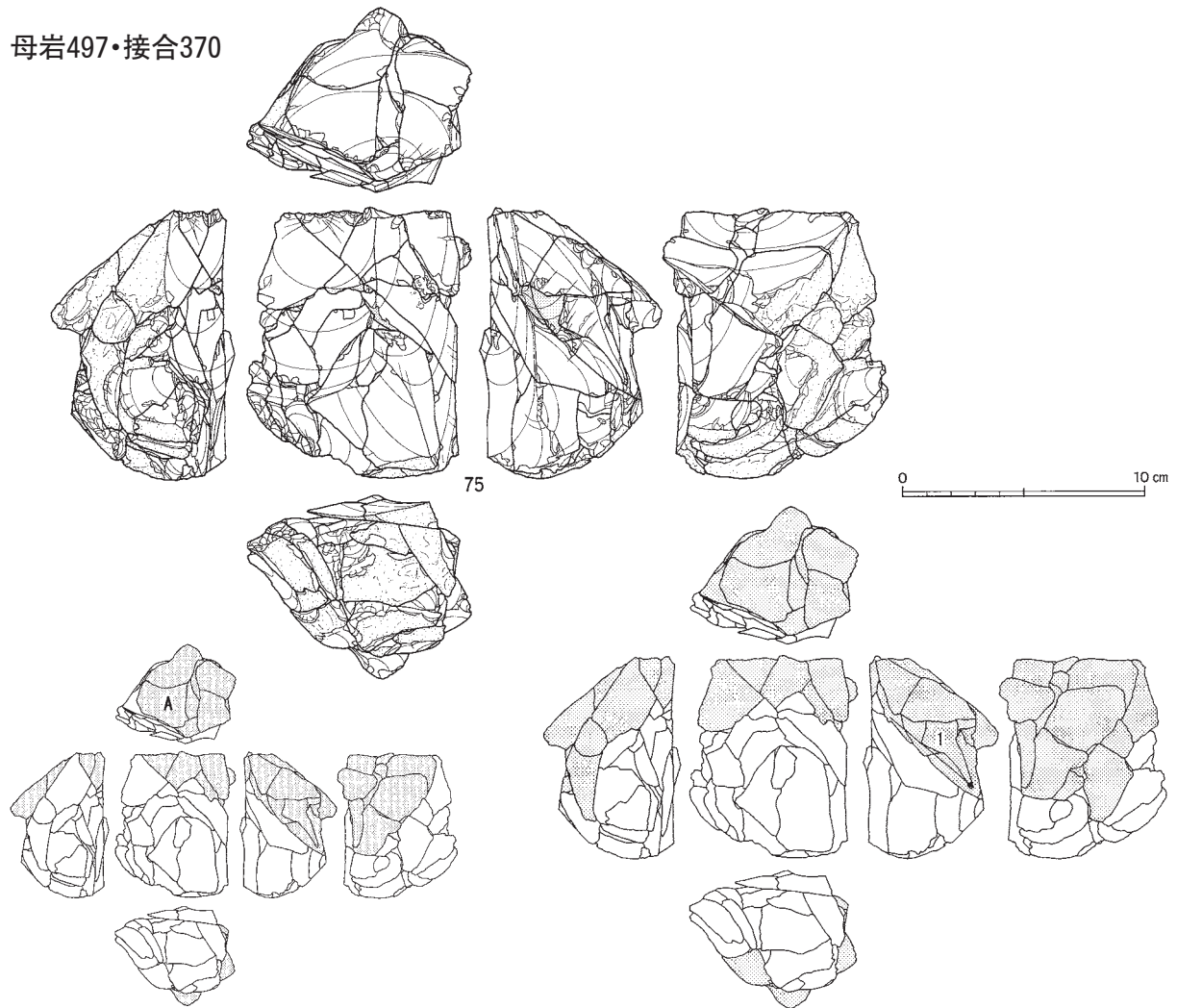

図Ⅲ-64 Sb-64~70の石器(13) 母岩493・接合365(2)、母岩497・接合370(1)

段階1

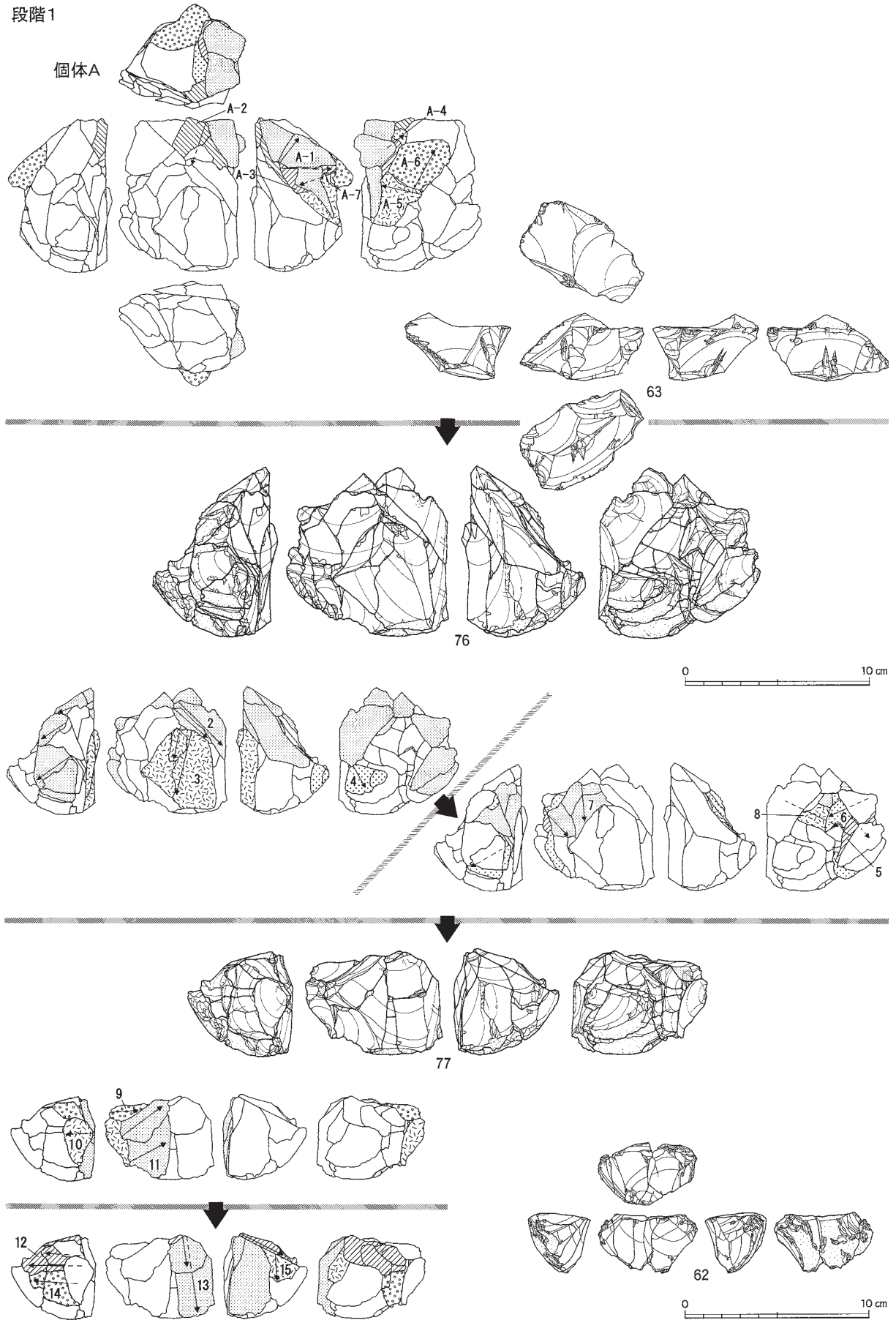

図Ⅲ-65 Sb-64~70の石器(14) 母岩497・接合370(2)

Sb-64~70

接合370分布図

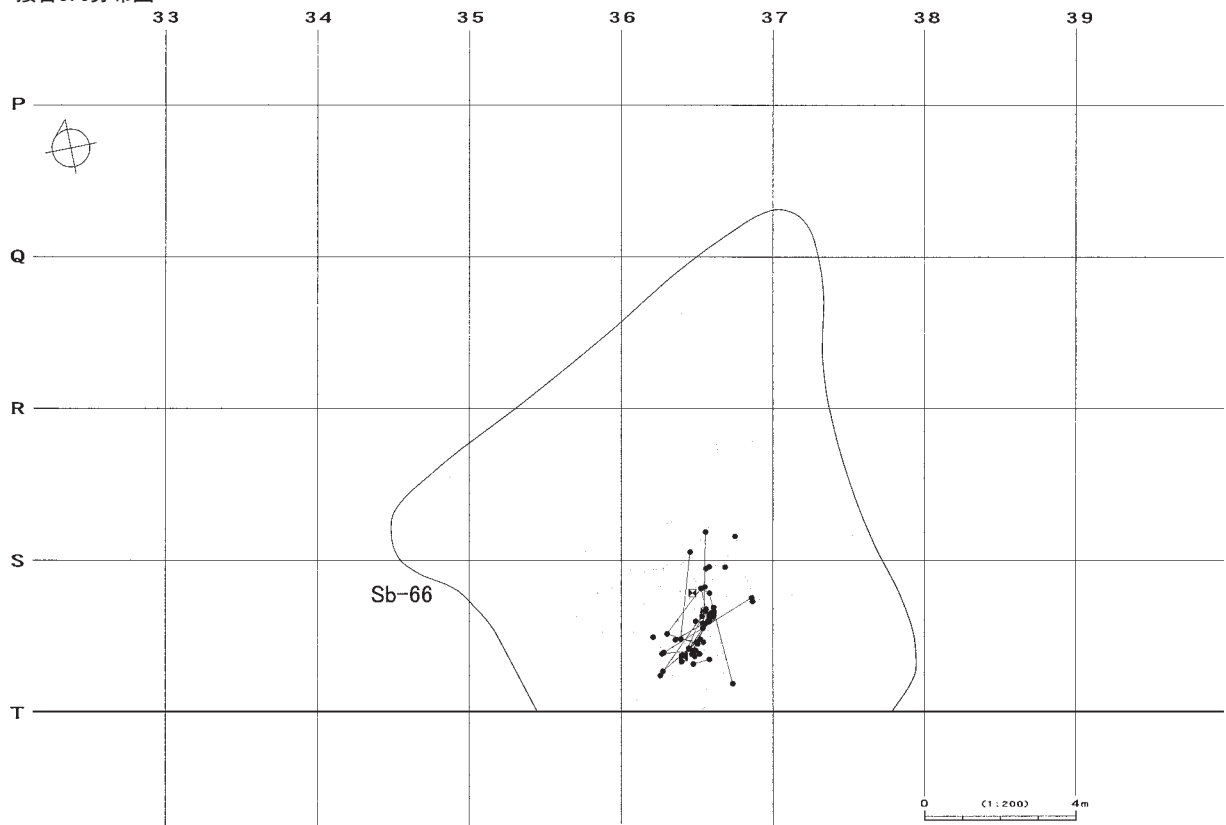

母岩675・接合468

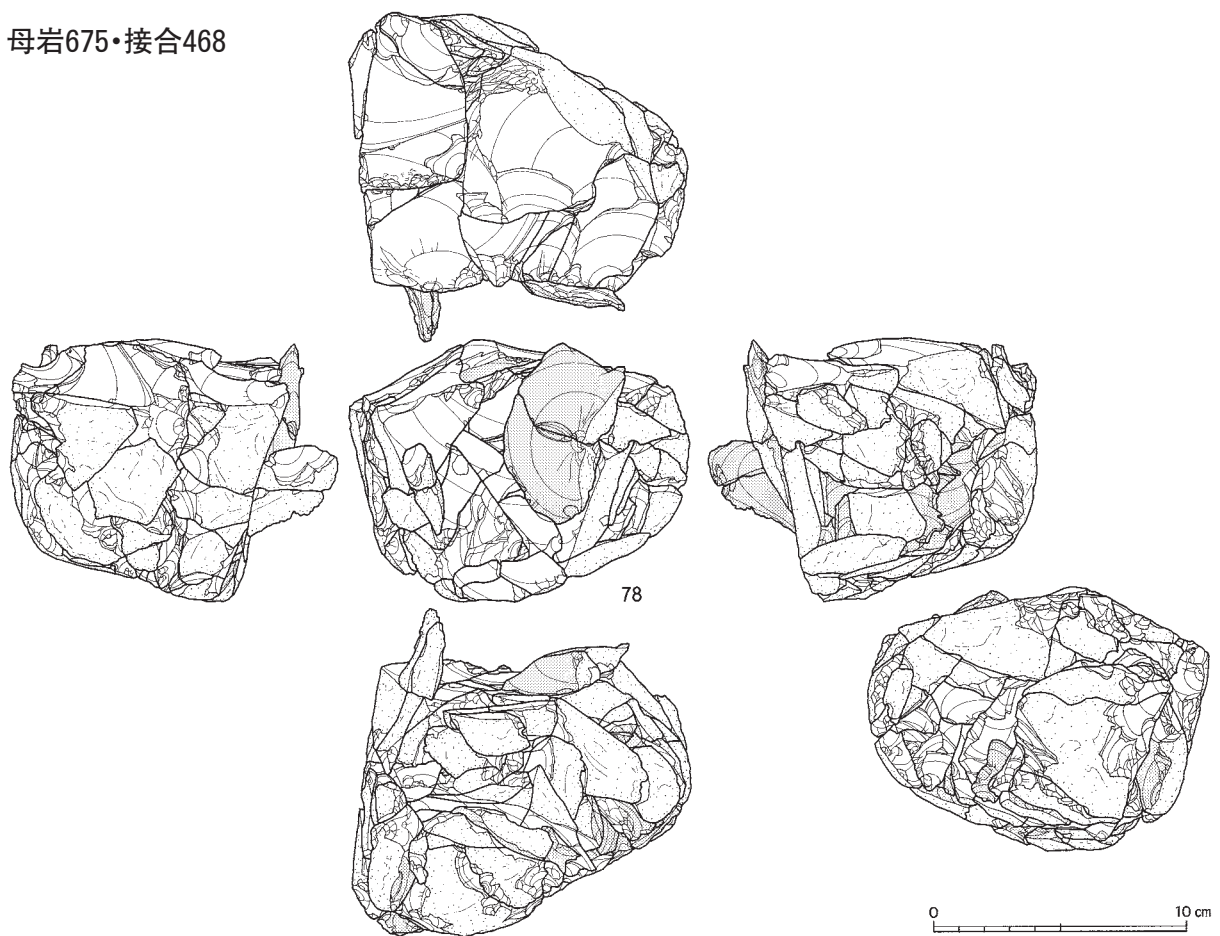

図Ⅲ-66 Sb-64~70の石器(15) 母岩497・接合370(3)、母岩675・接合468(1)

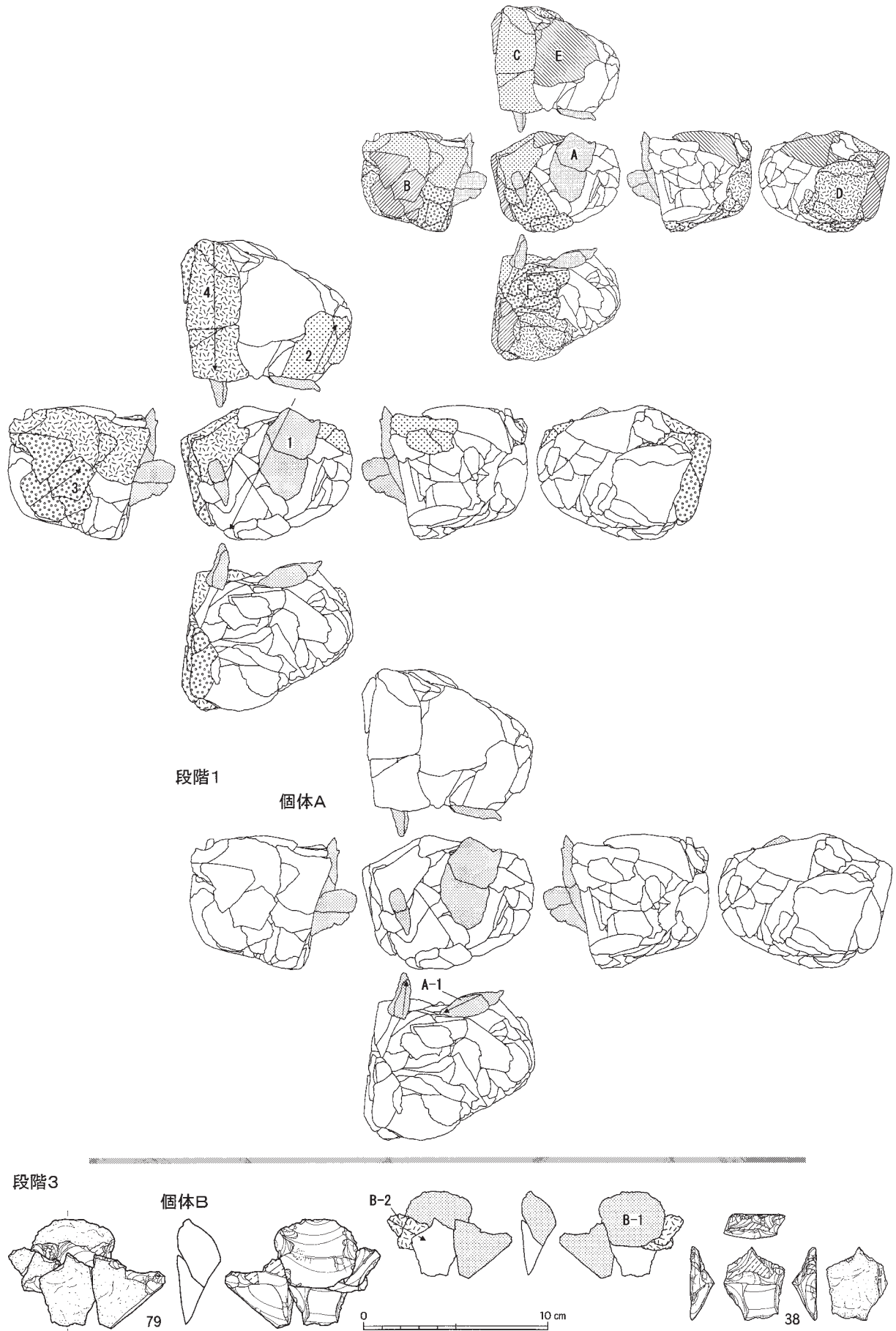

図III-67 Sb-64~70の石器(16) 母岩675・接合468(2)

段階4

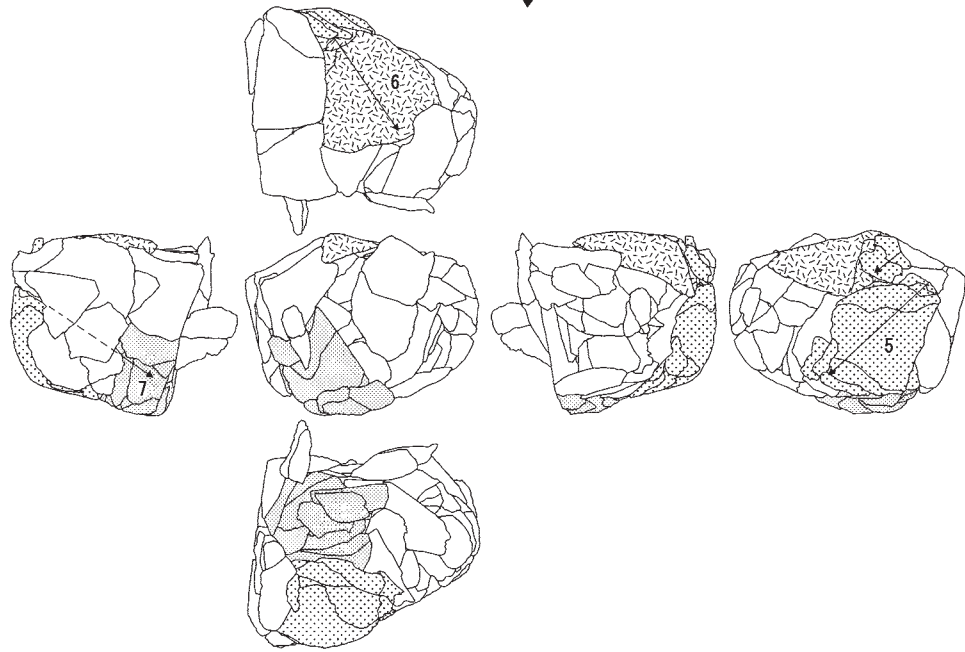
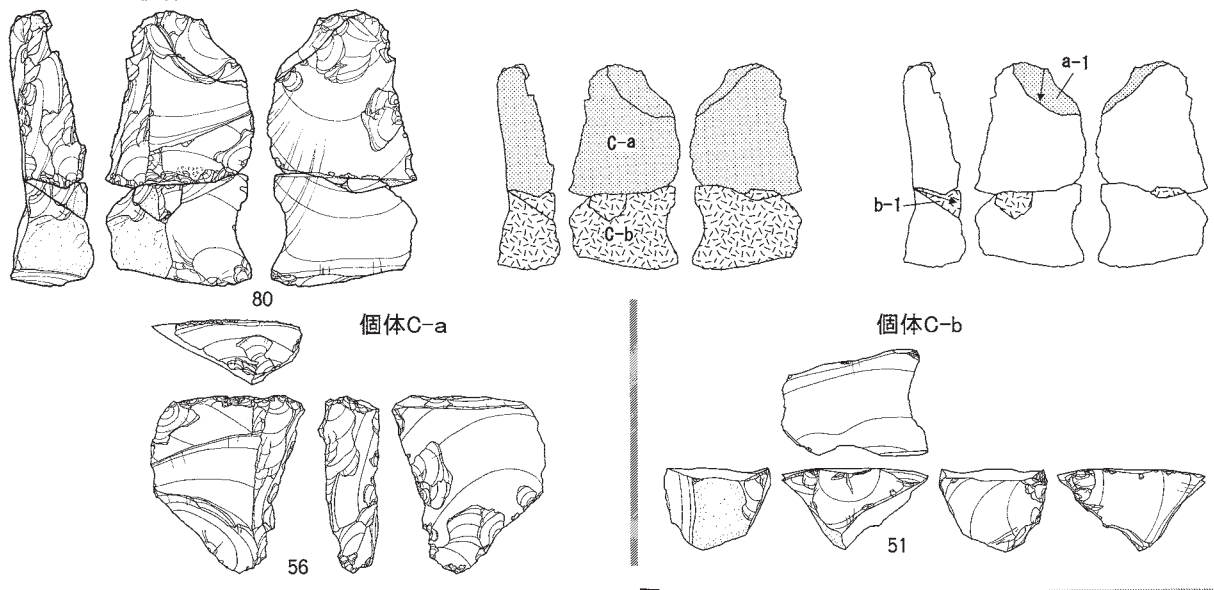

段階5

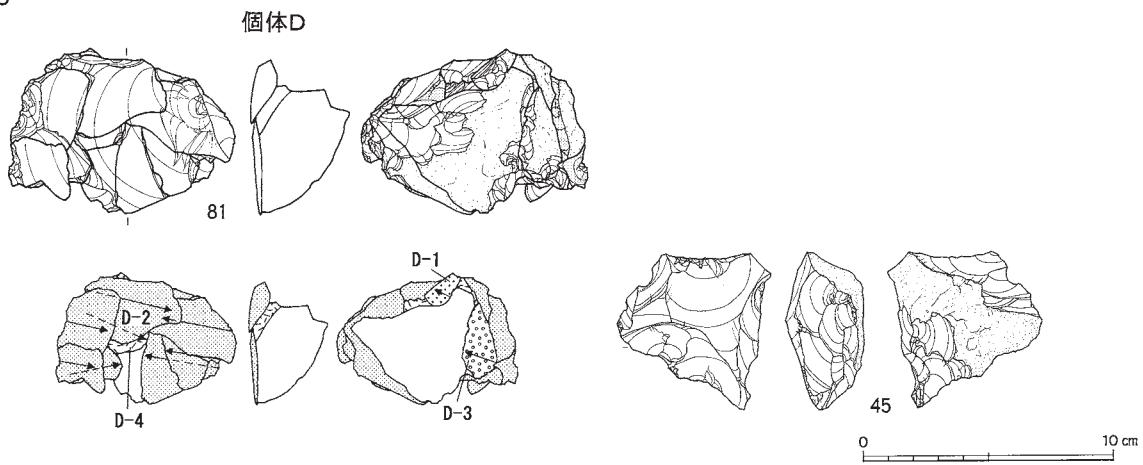

図Ⅲ-68 Sb-64~70の石器(17) 母岩675・接合468(3)

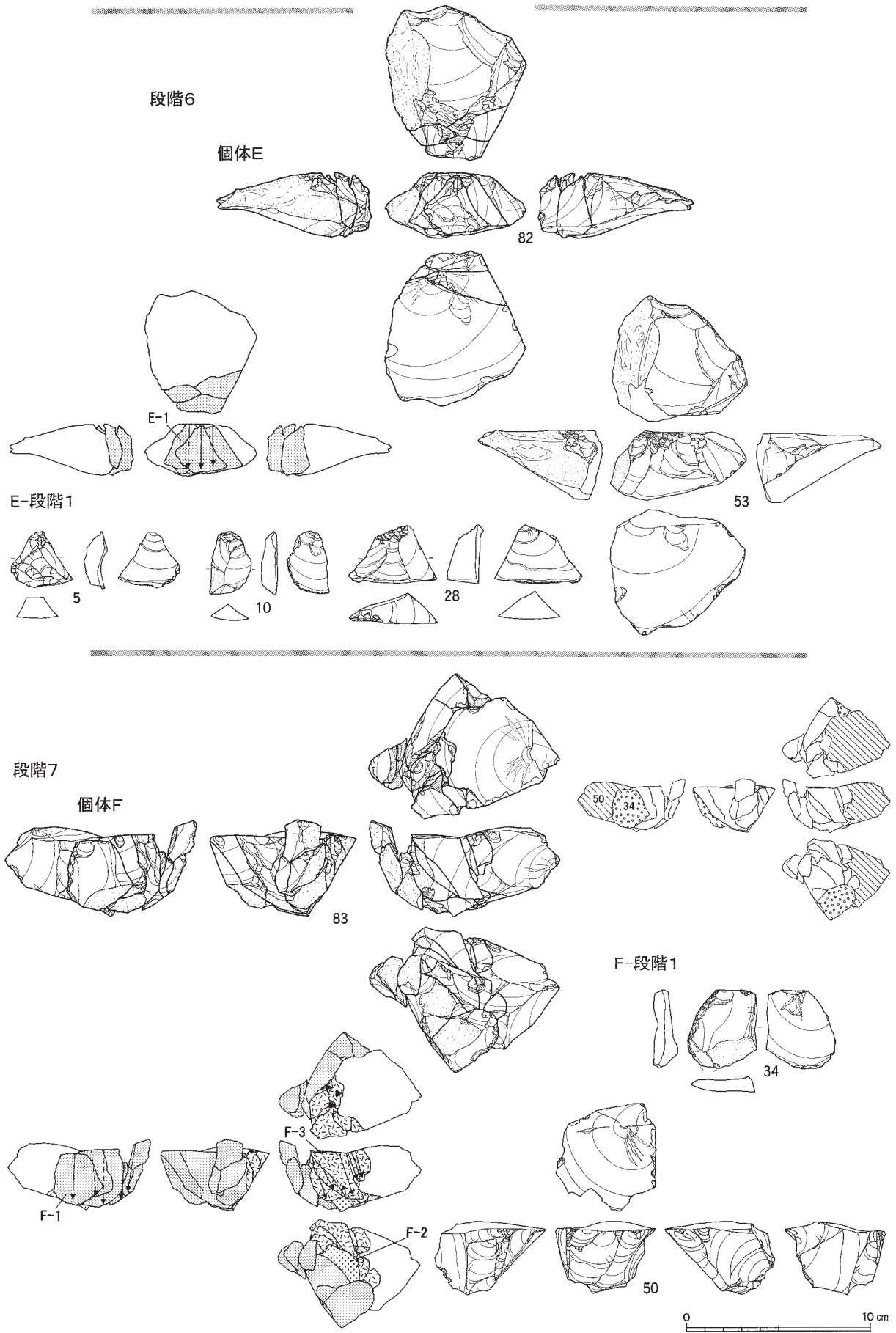

図III-69 Sb-64~70の石器(18) 母岩675・接合468(4)

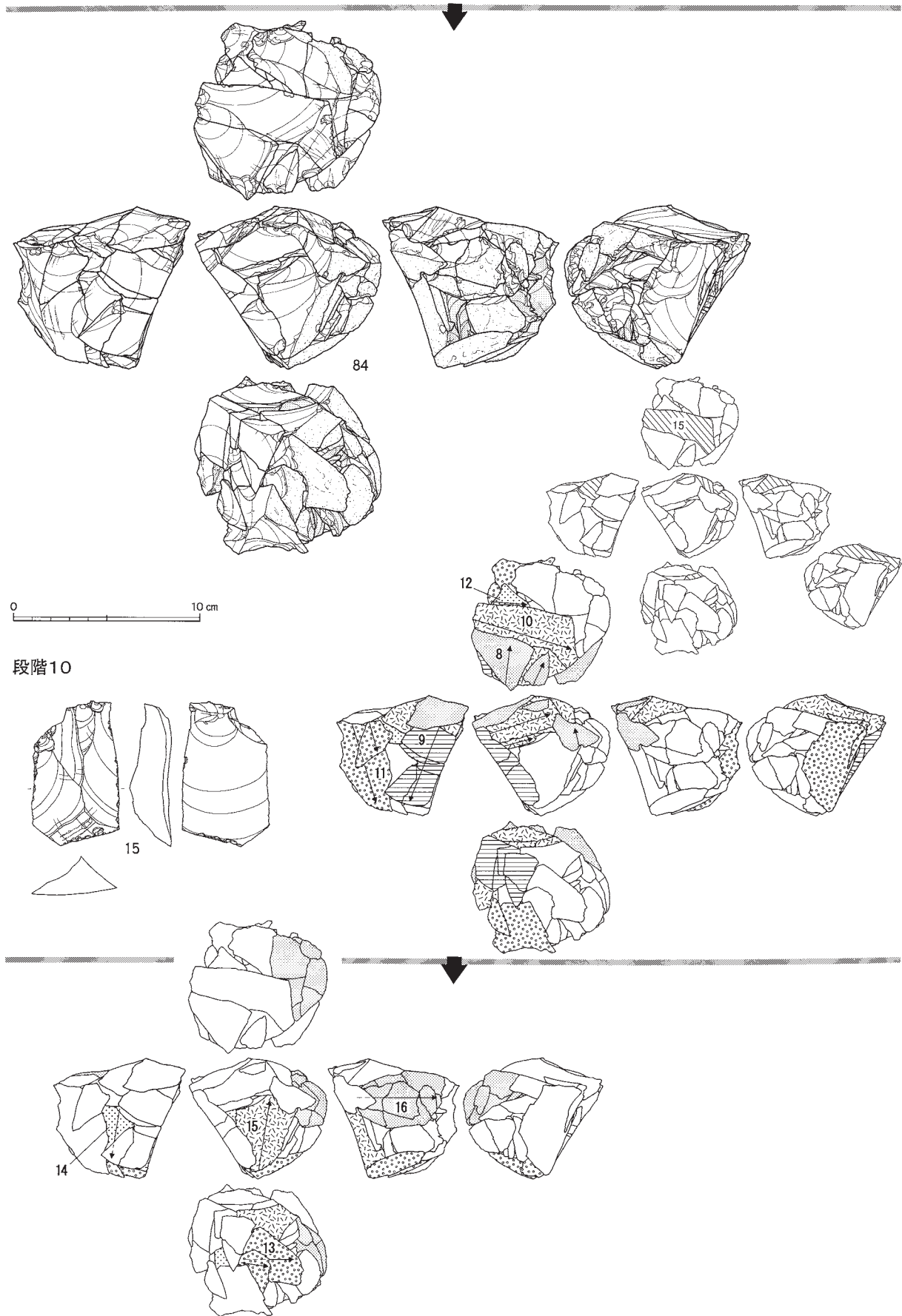

図Ⅲ-70 Sb-64~70の石器(19) 母岩675・接合468(5)

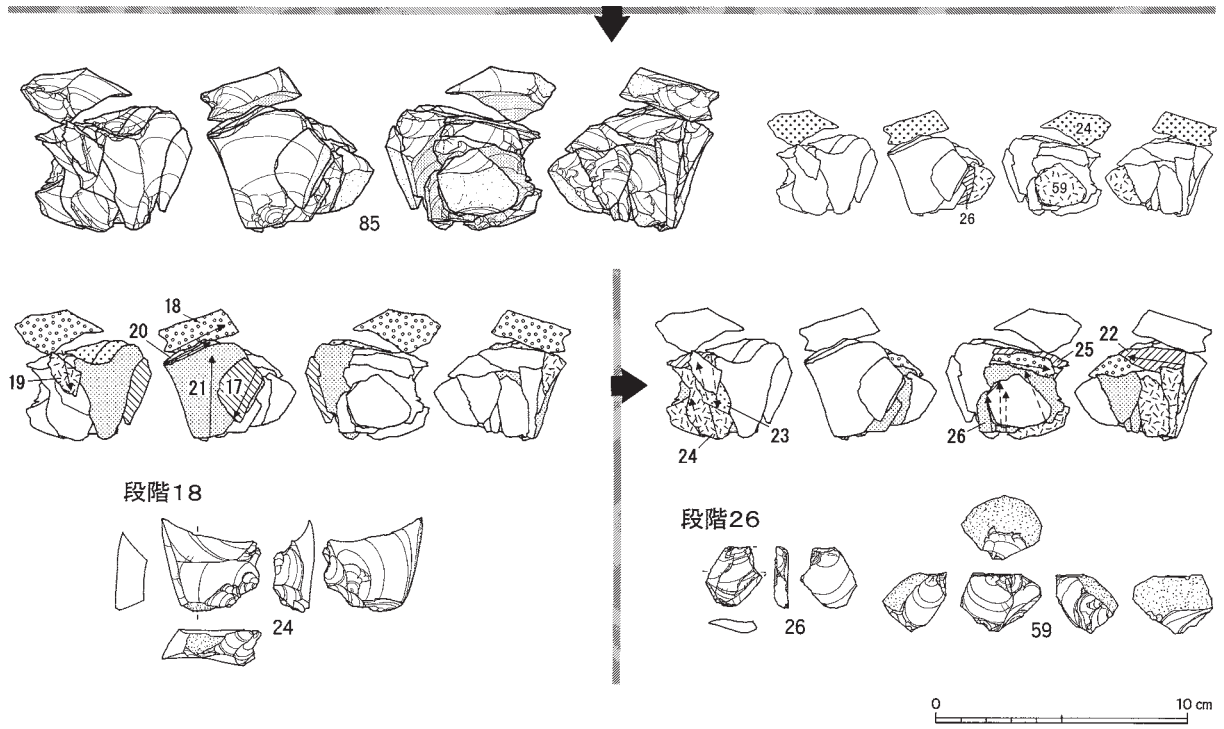

接合468分布図

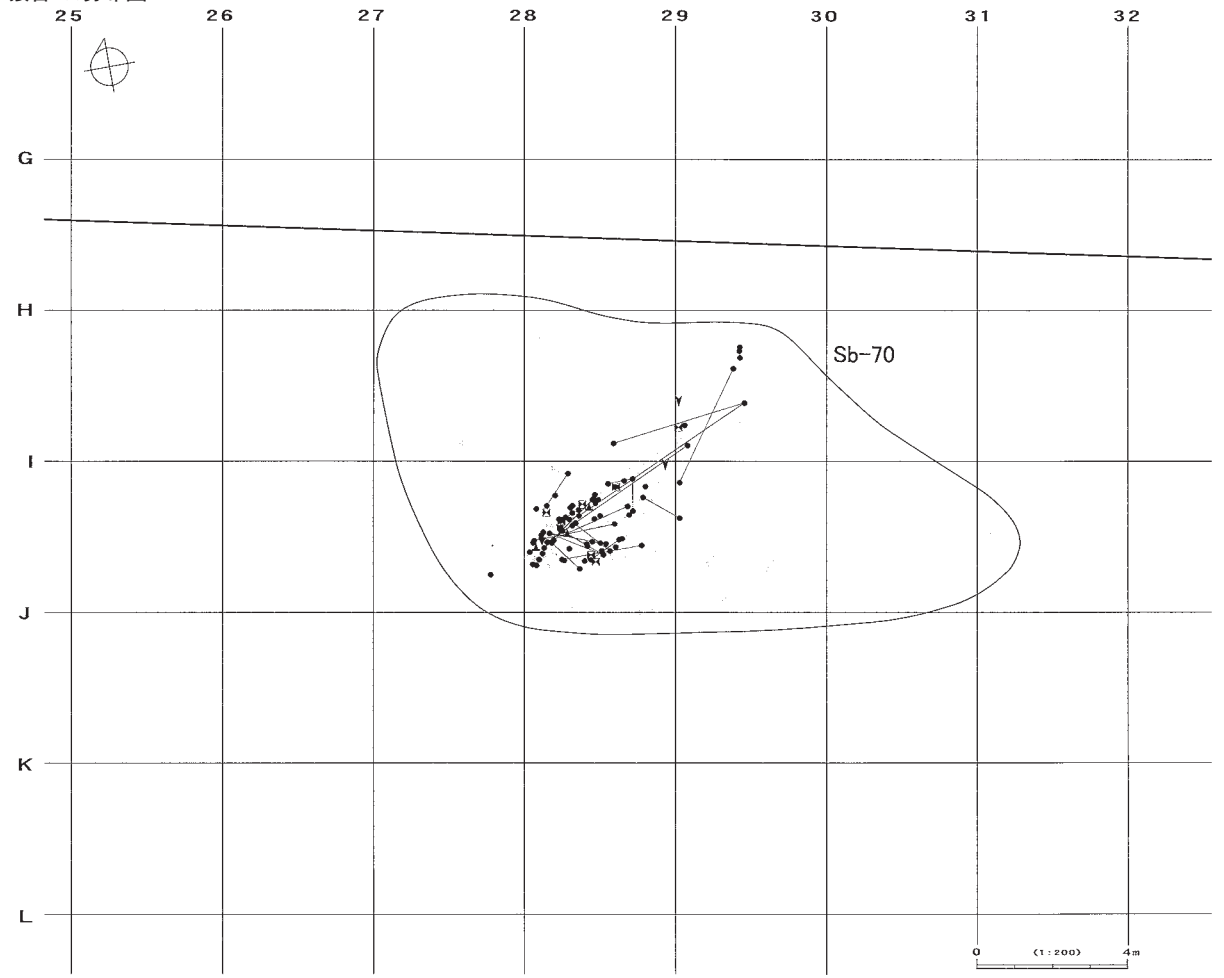

図Ⅲ-71 Sb-64~70の石器(20) 母岩675・接合468(6)

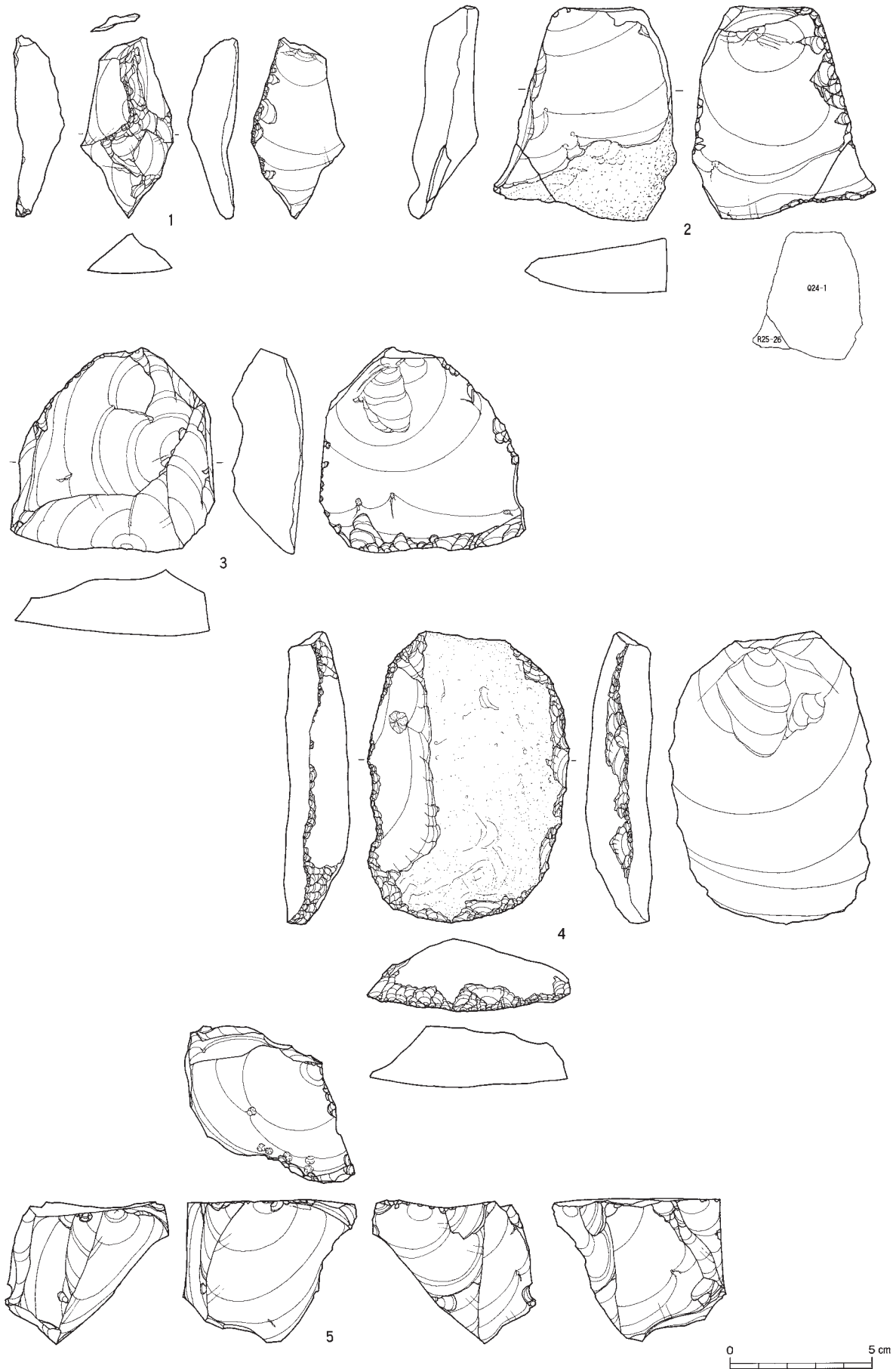

図Ⅲ-72 Sb-71の石器(1) 二次加工ある剥片・搔器・石核

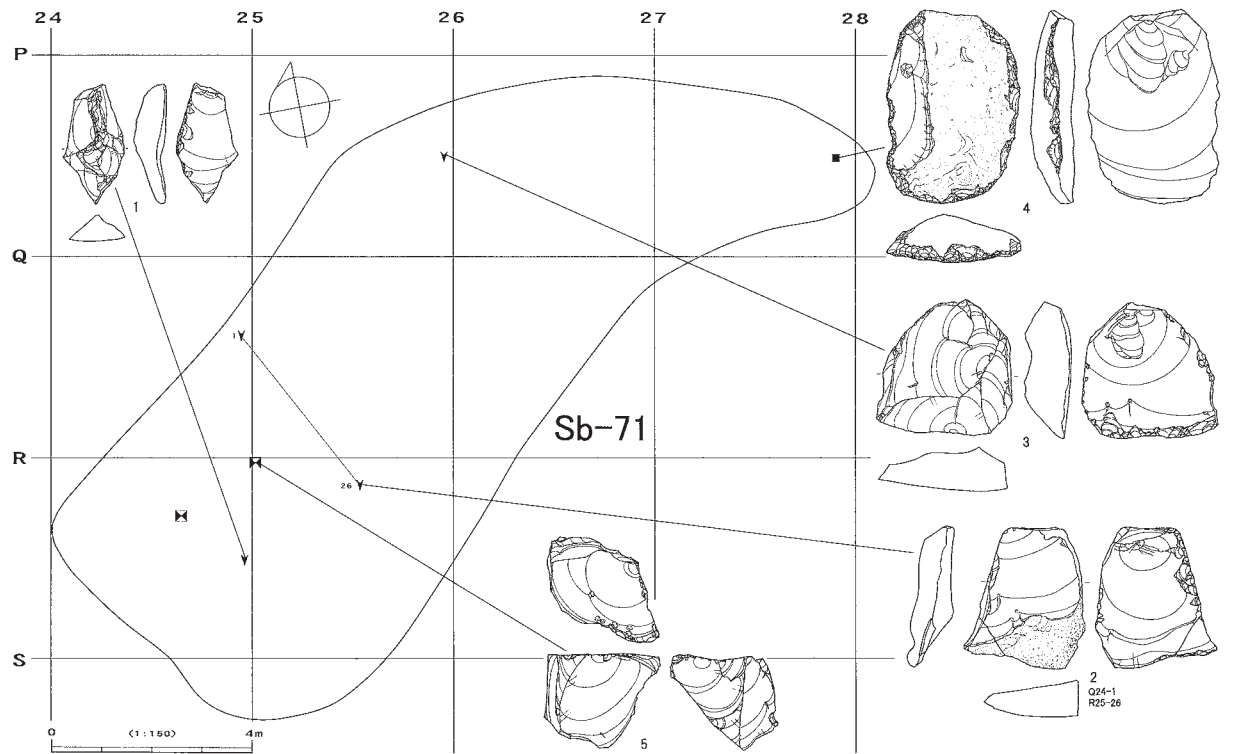
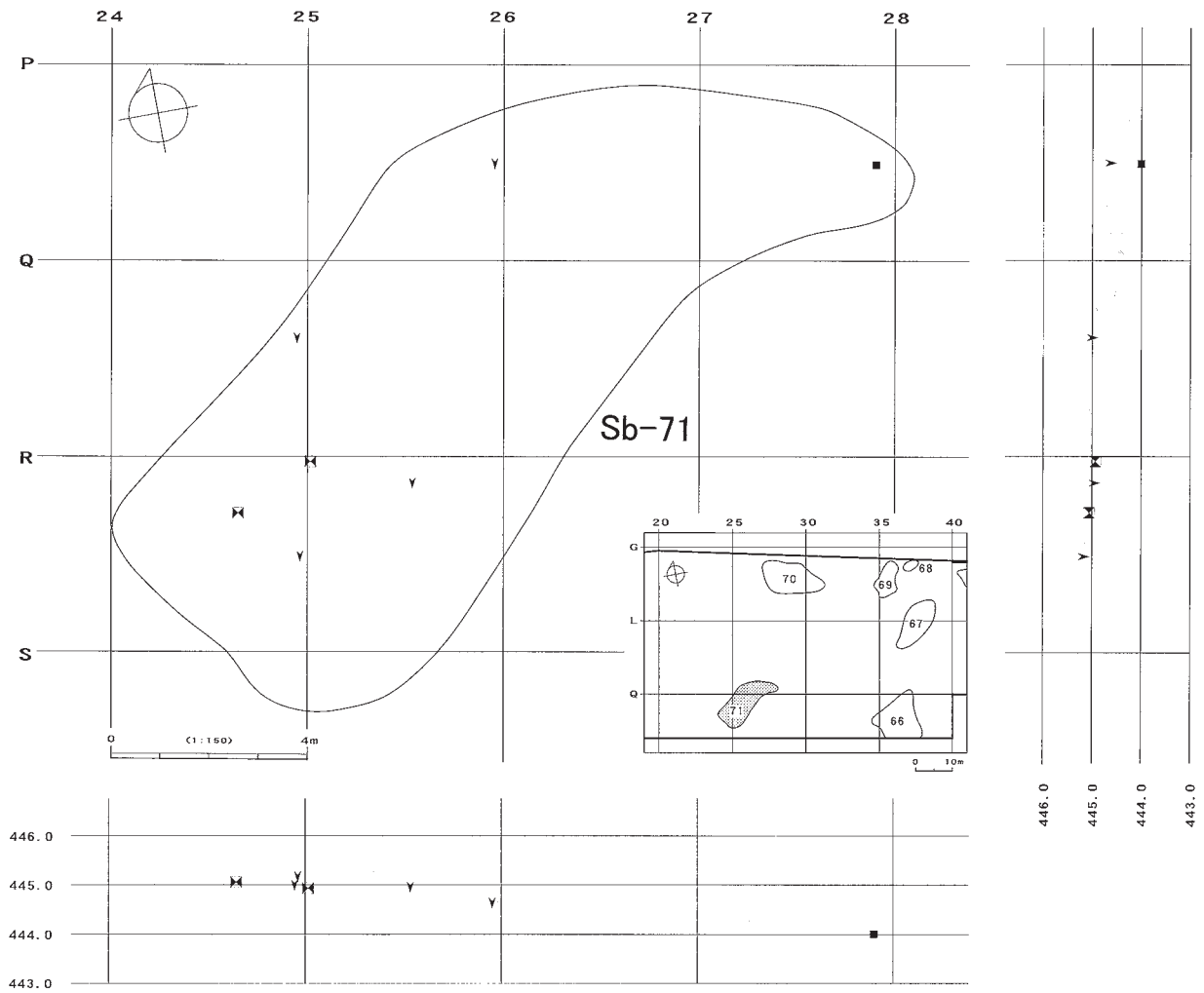

図Ⅲ-73 Sb-71の分布図・遺物

全接合分布図

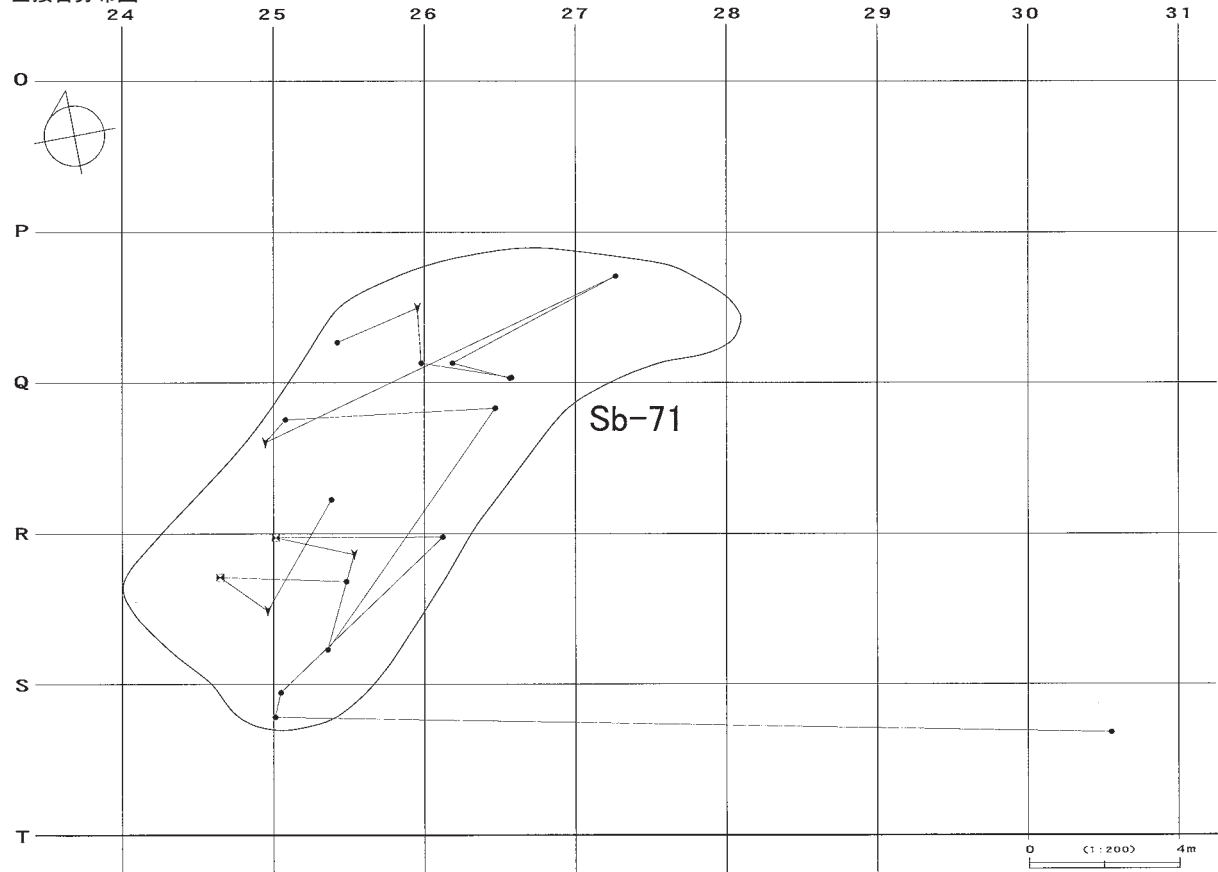

折れ面接合分布図

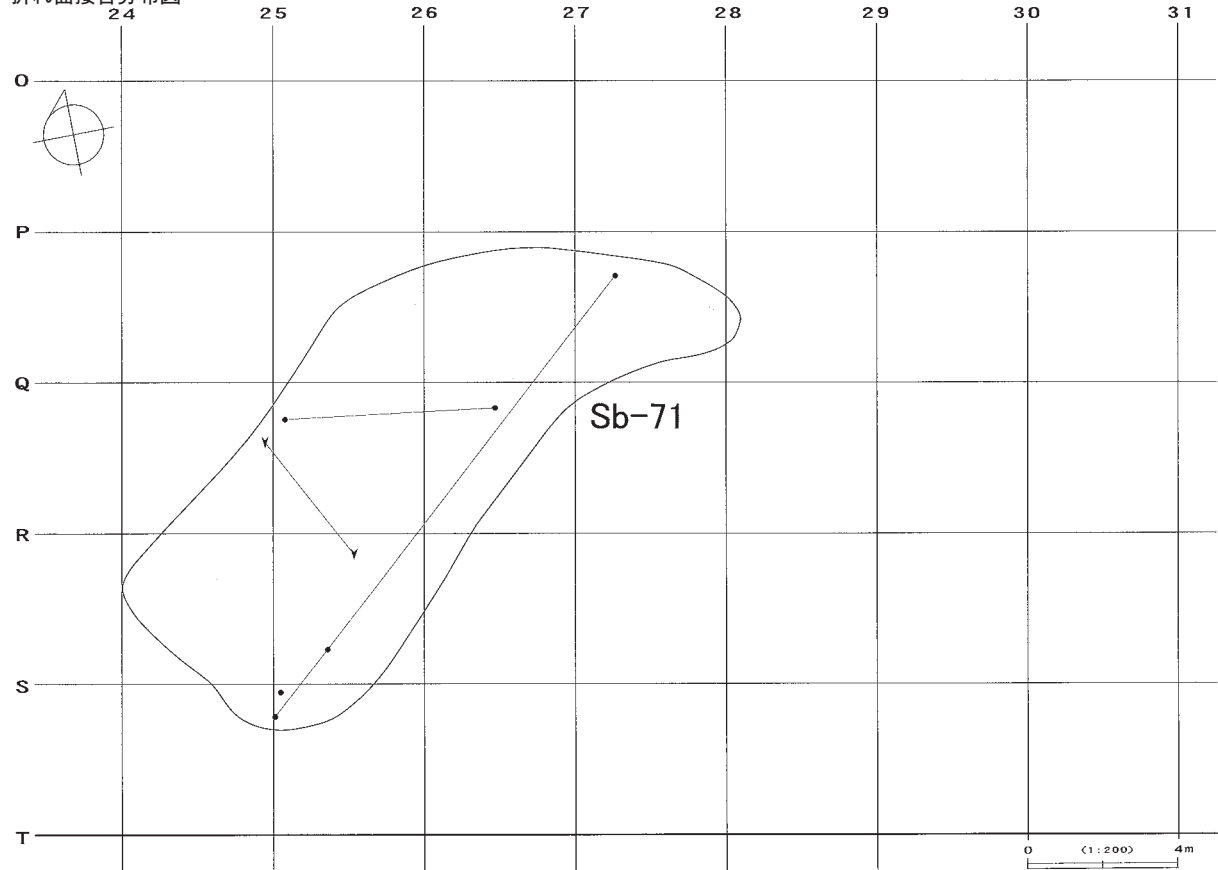

図Ⅲ-74 Sb-71の接合分布図

母岩509・接合398

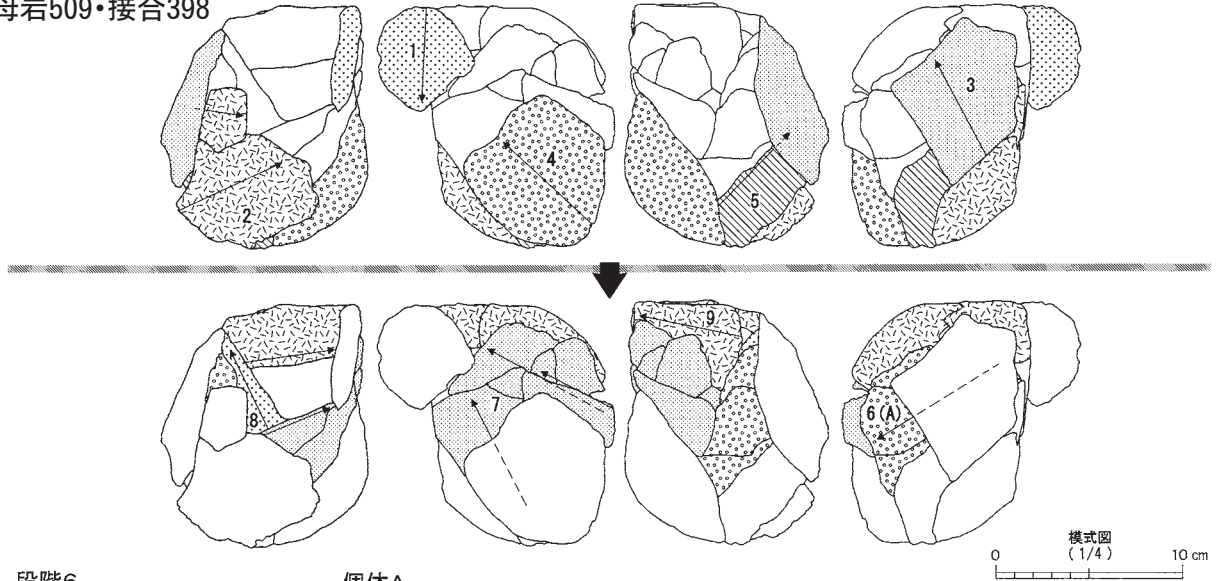

段階6

個体A

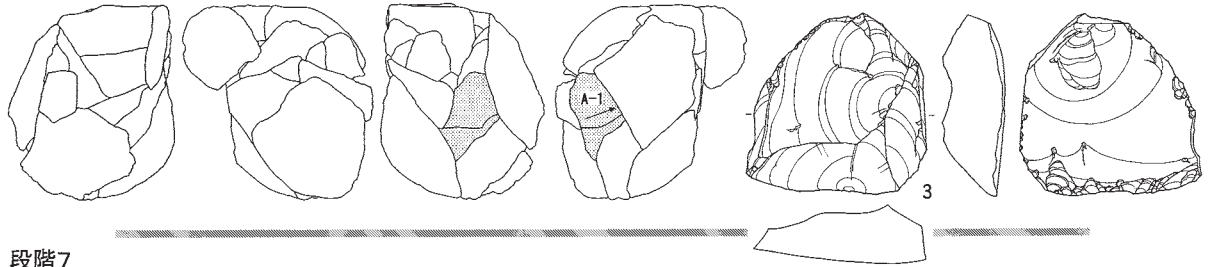

段階7

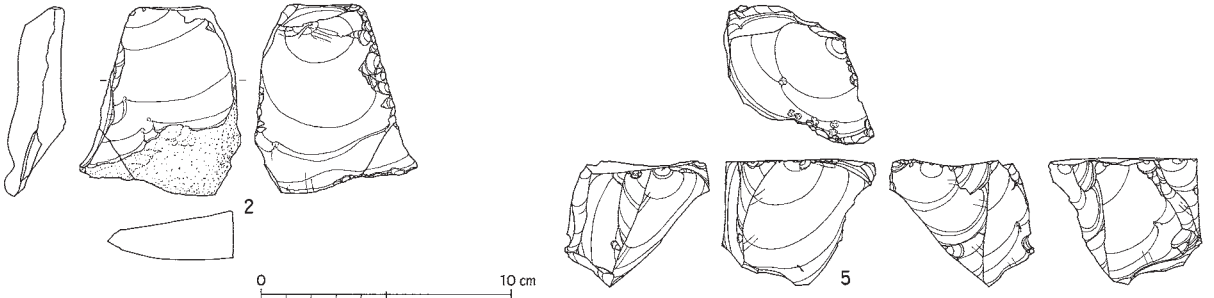

接合398分布図

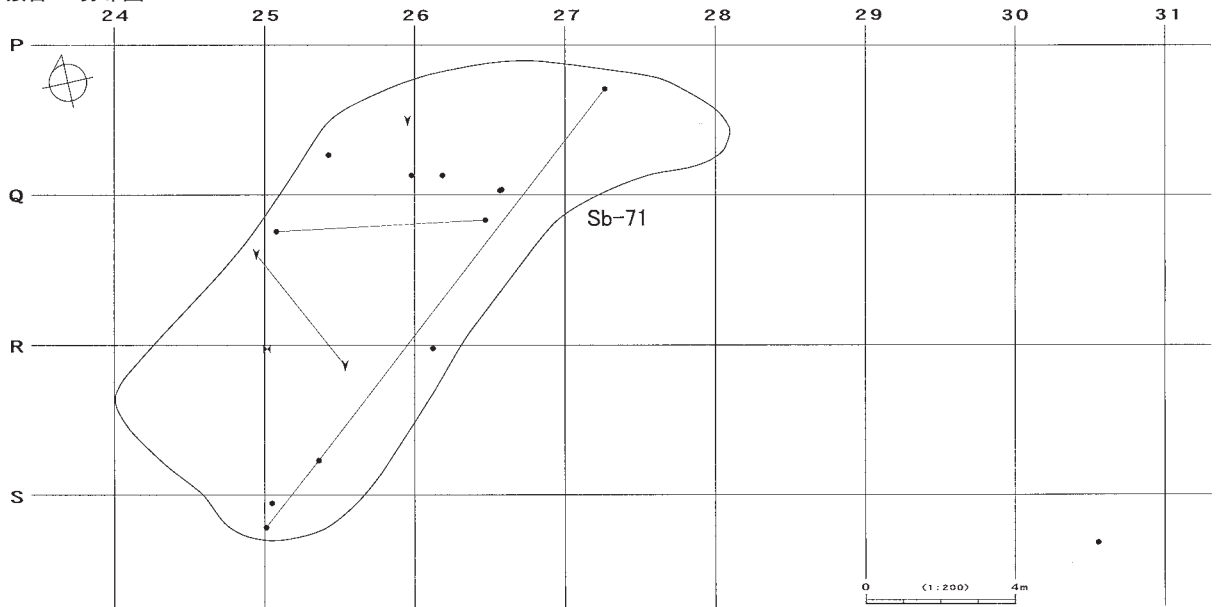

図Ⅲ-75 Sb-71の石器(2) 母岩509・接合398

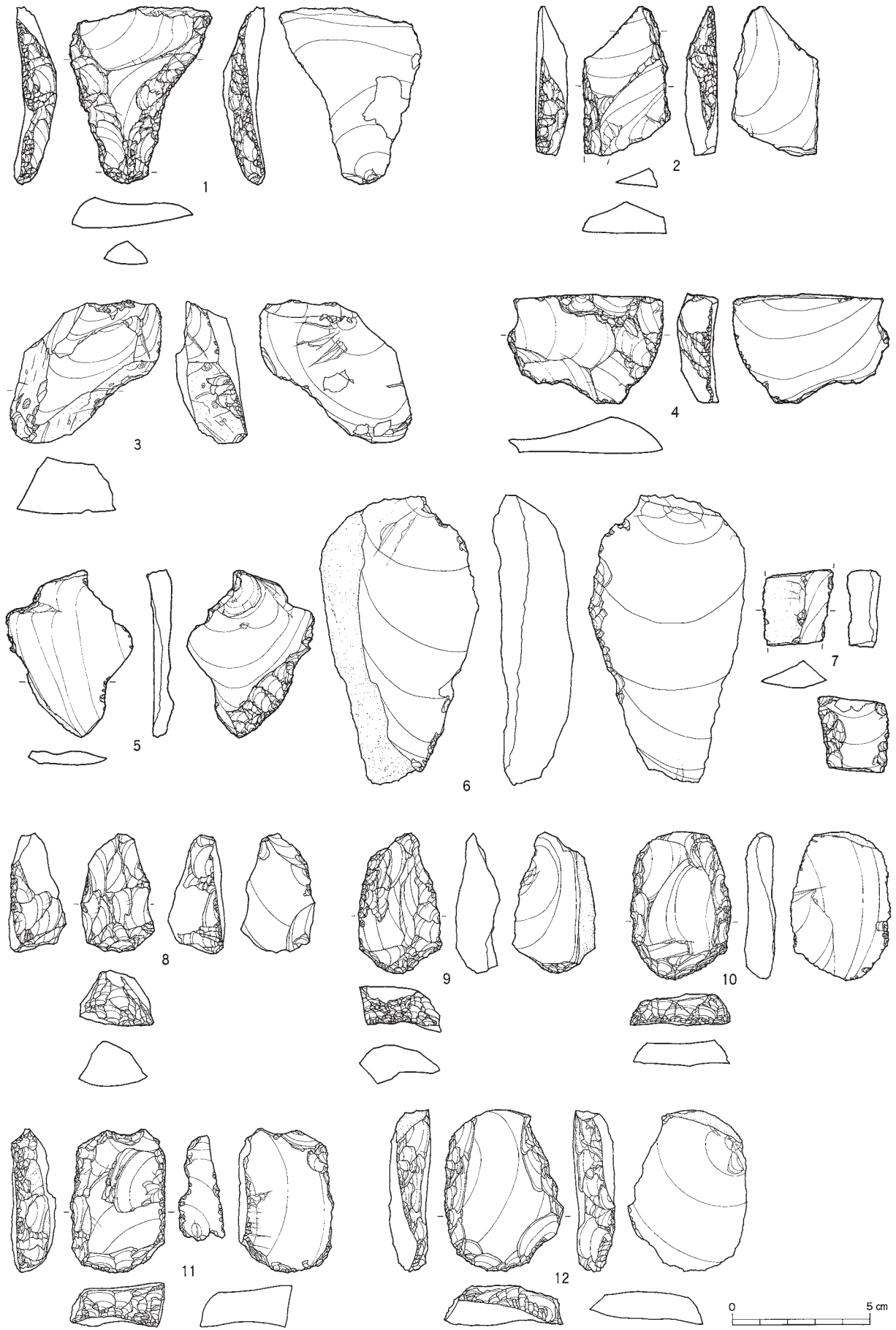

図Ⅲ-76 Sb-72~79の石器(1) 台形石器・二次加工ある剥片・搔器

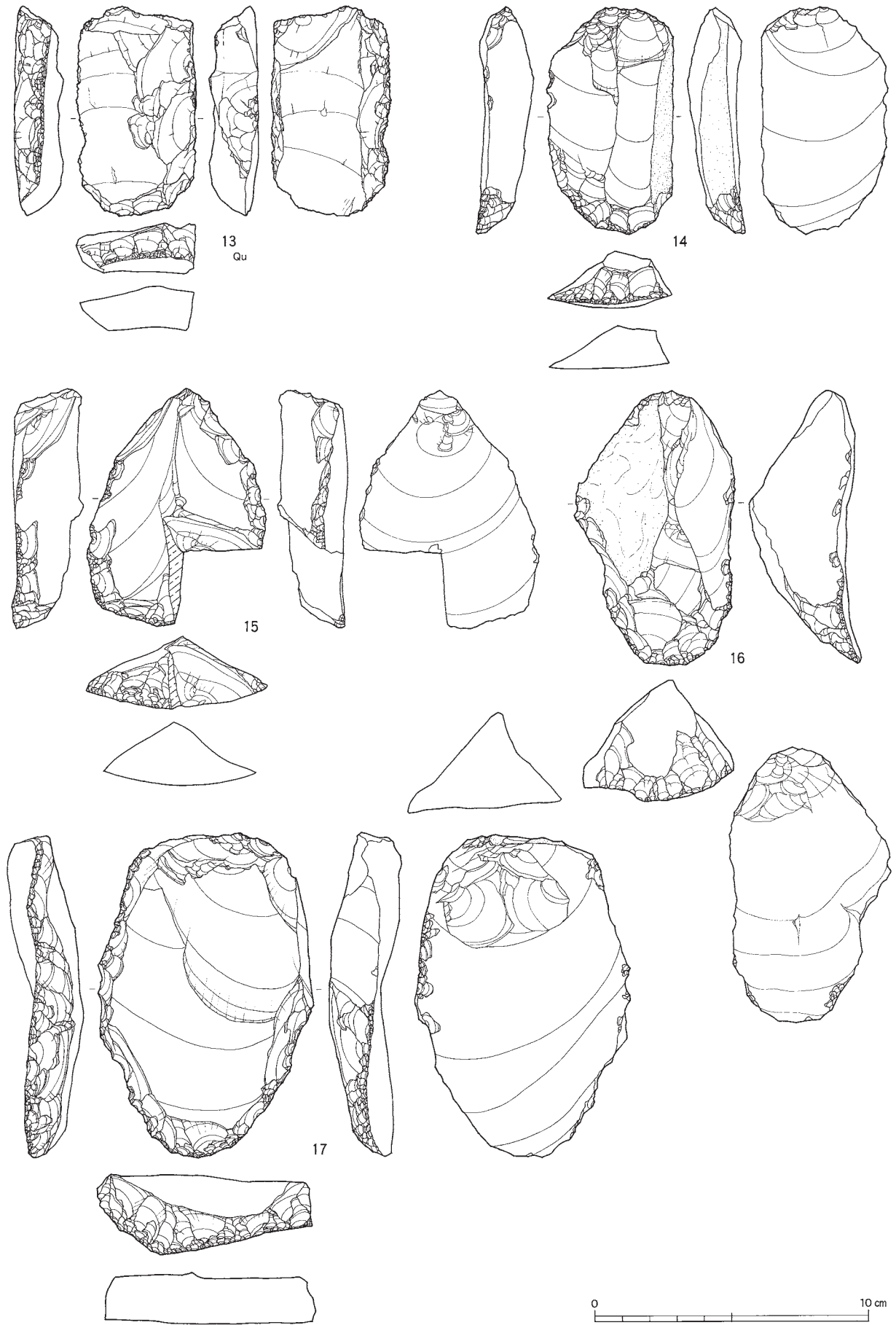

図Ⅲ-77 Sb-72~79の石器(2) 搔器

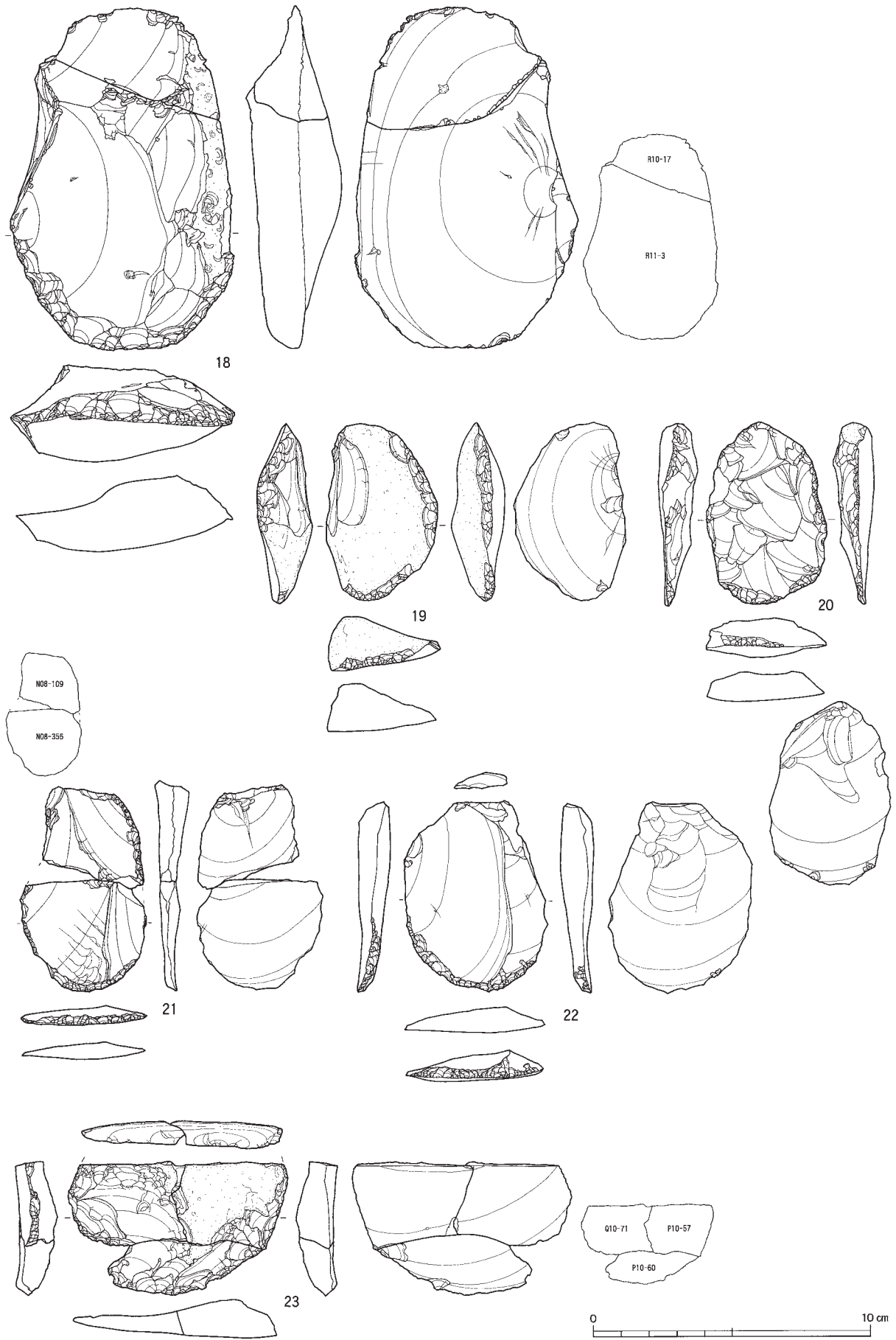

図Ⅲ-78 Sb-72~79の石器(3) 搔器

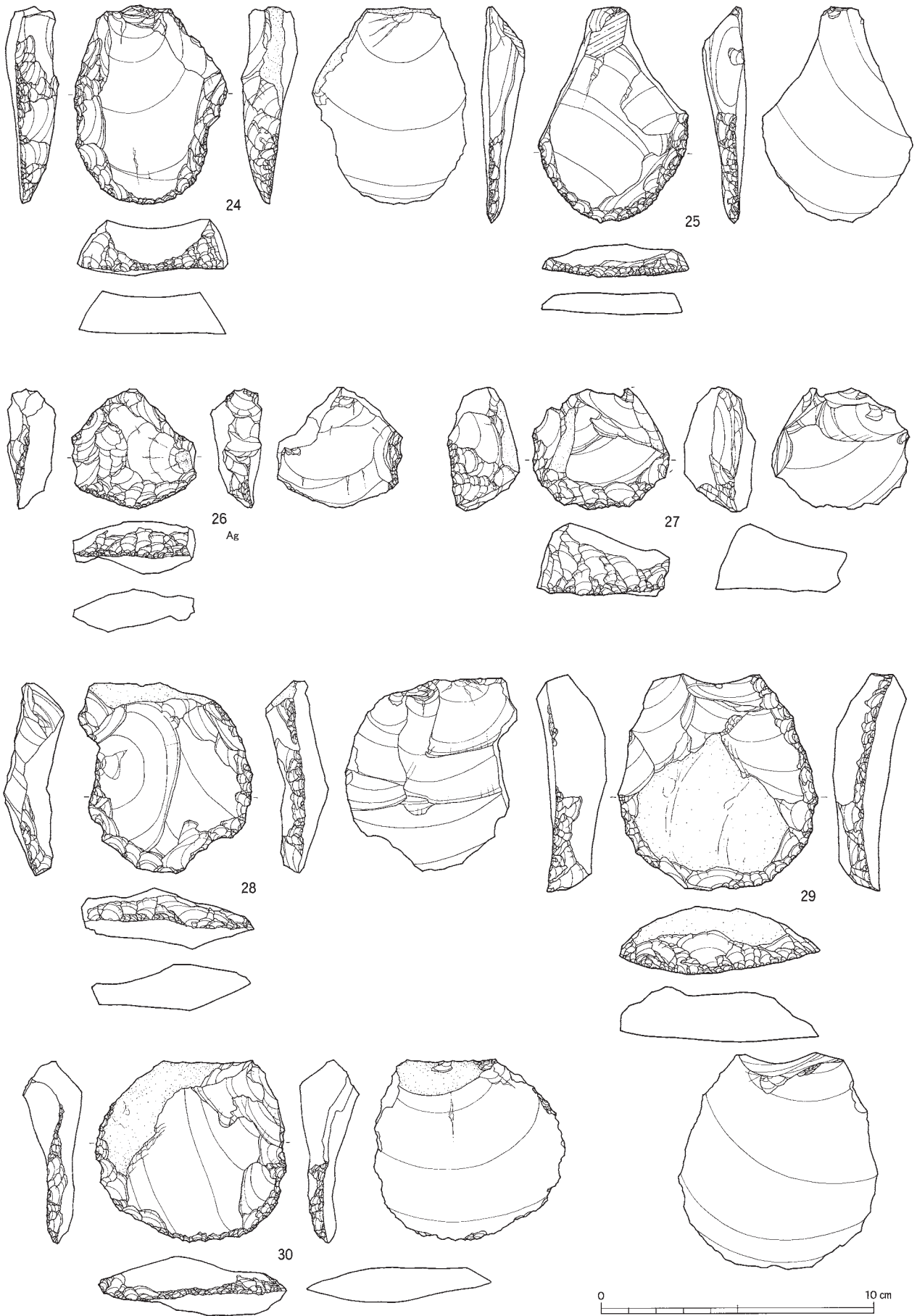

図Ⅲ-79 Sb-72~79の石器(4) 搔器

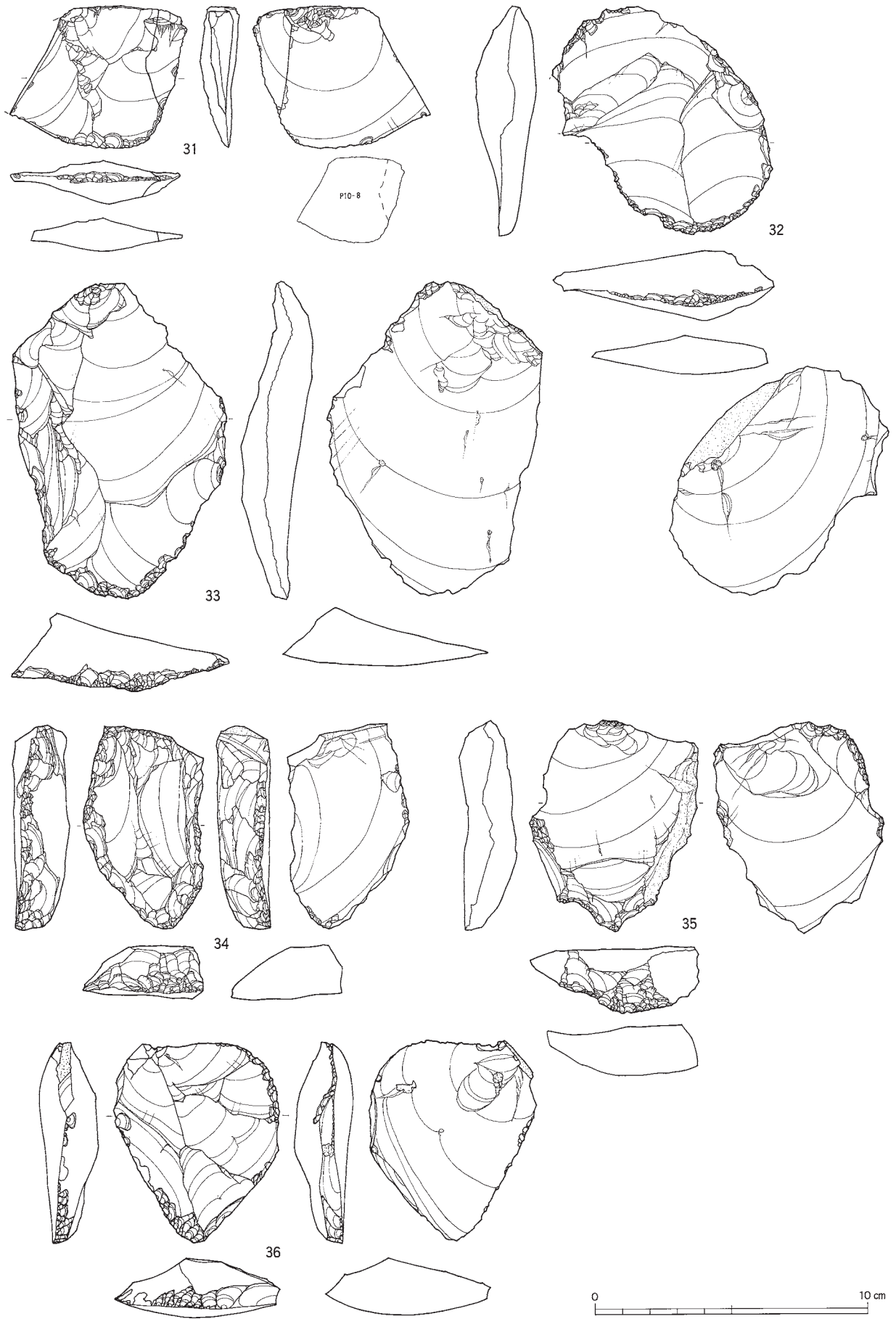

図Ⅲ-80 Sb-72~79の石器(5) 搔器

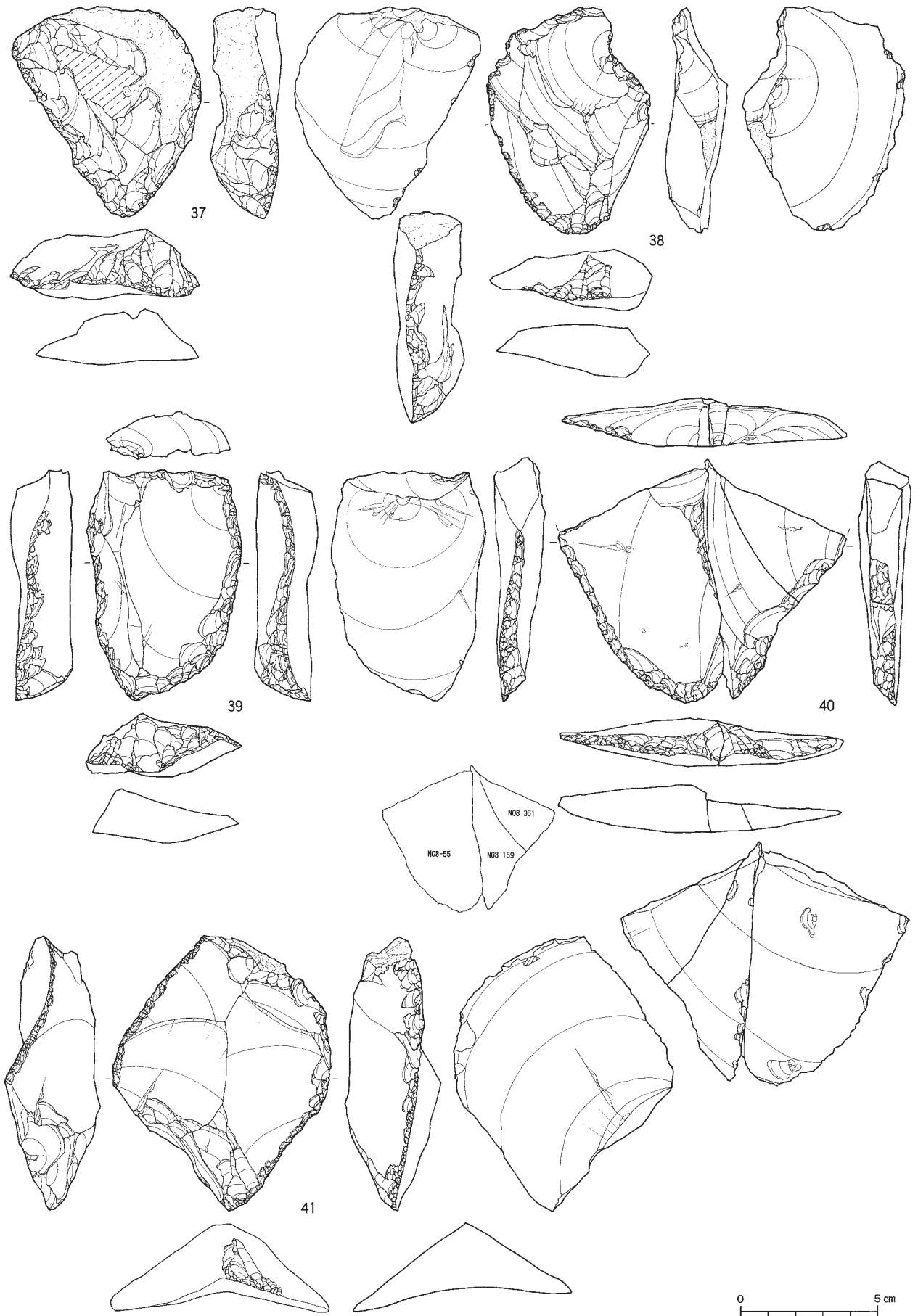

図Ⅲ-81 Sb-72~79の石器(6) 搔器

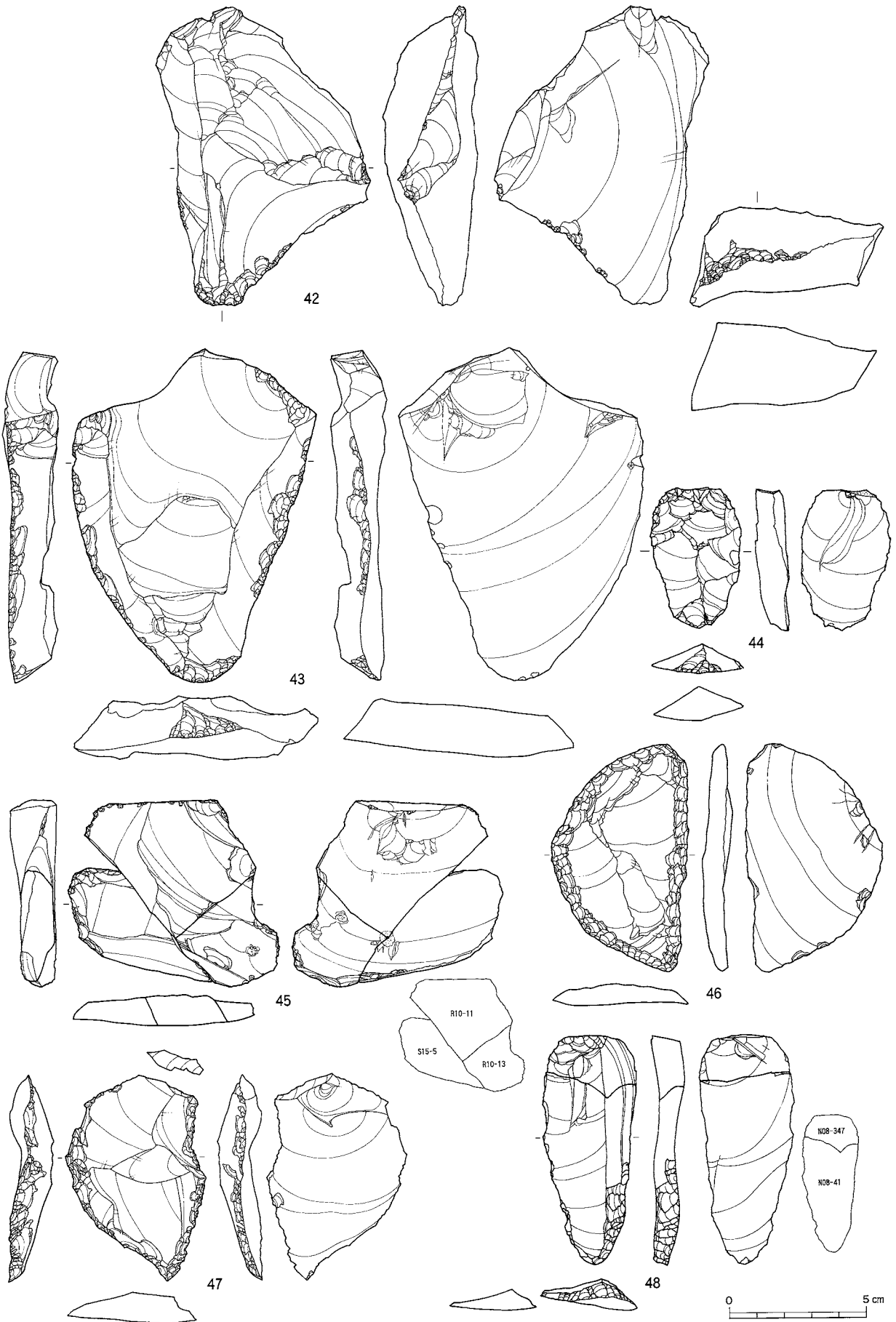

図Ⅲ-82 Sb-72~79の石器(7) 搔器

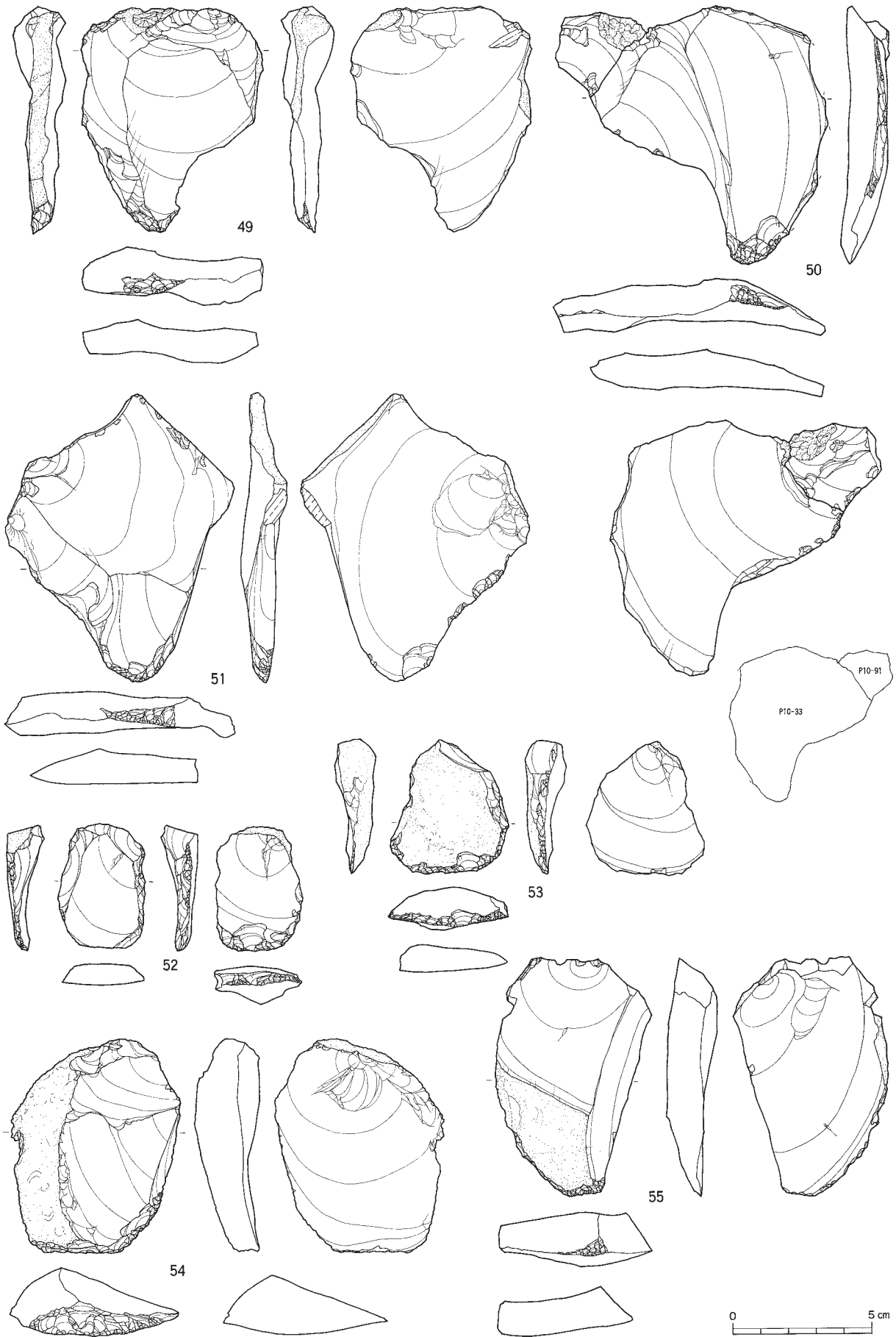

図Ⅲ-83 Sb-72~79の石器(8) 搔器

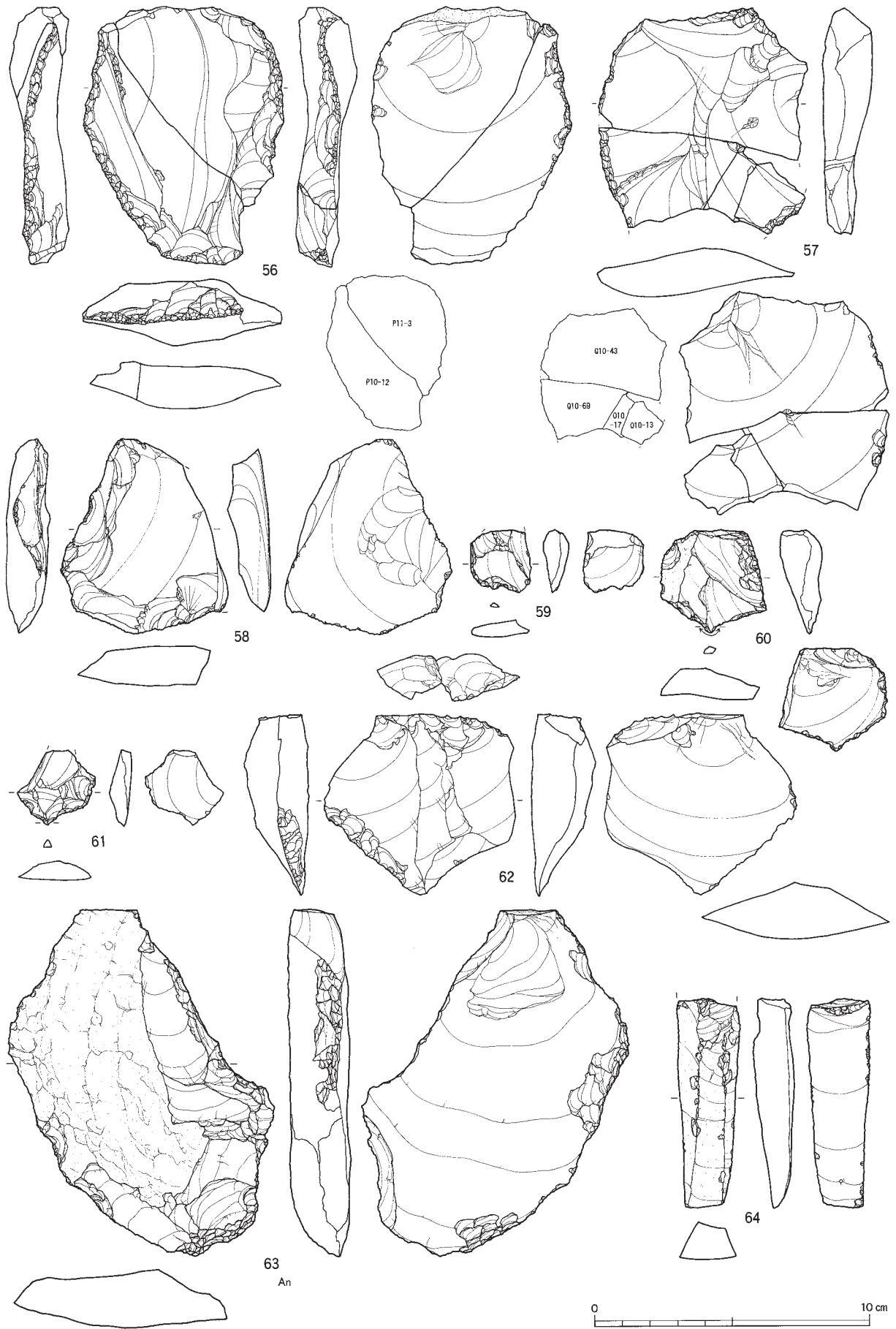

図III-84 Sb-72~79の石器(9) 搔器・錐形石器・削器・縦長剥片

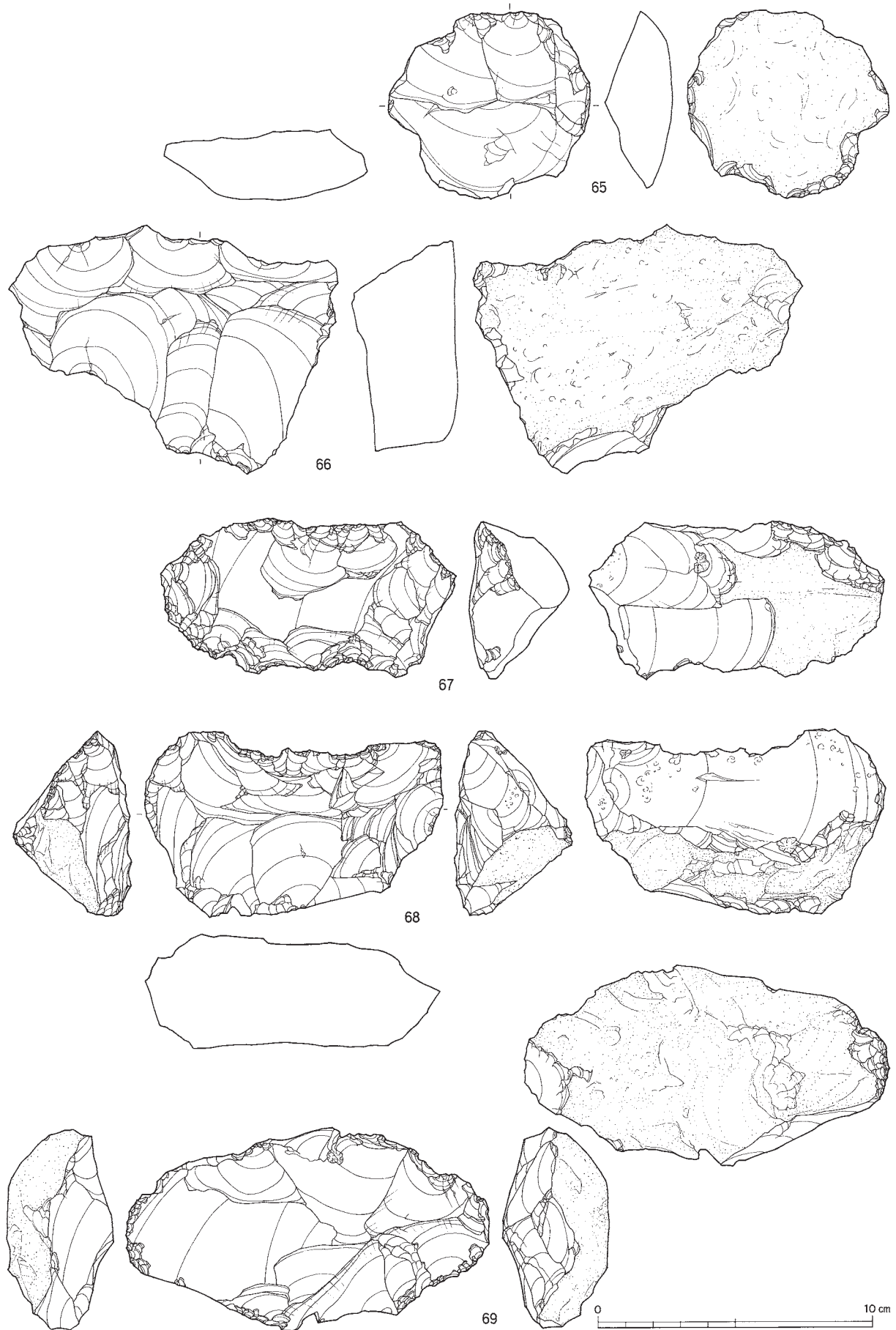

図Ⅲ-85 Sb-72~79の石器(10) 石核

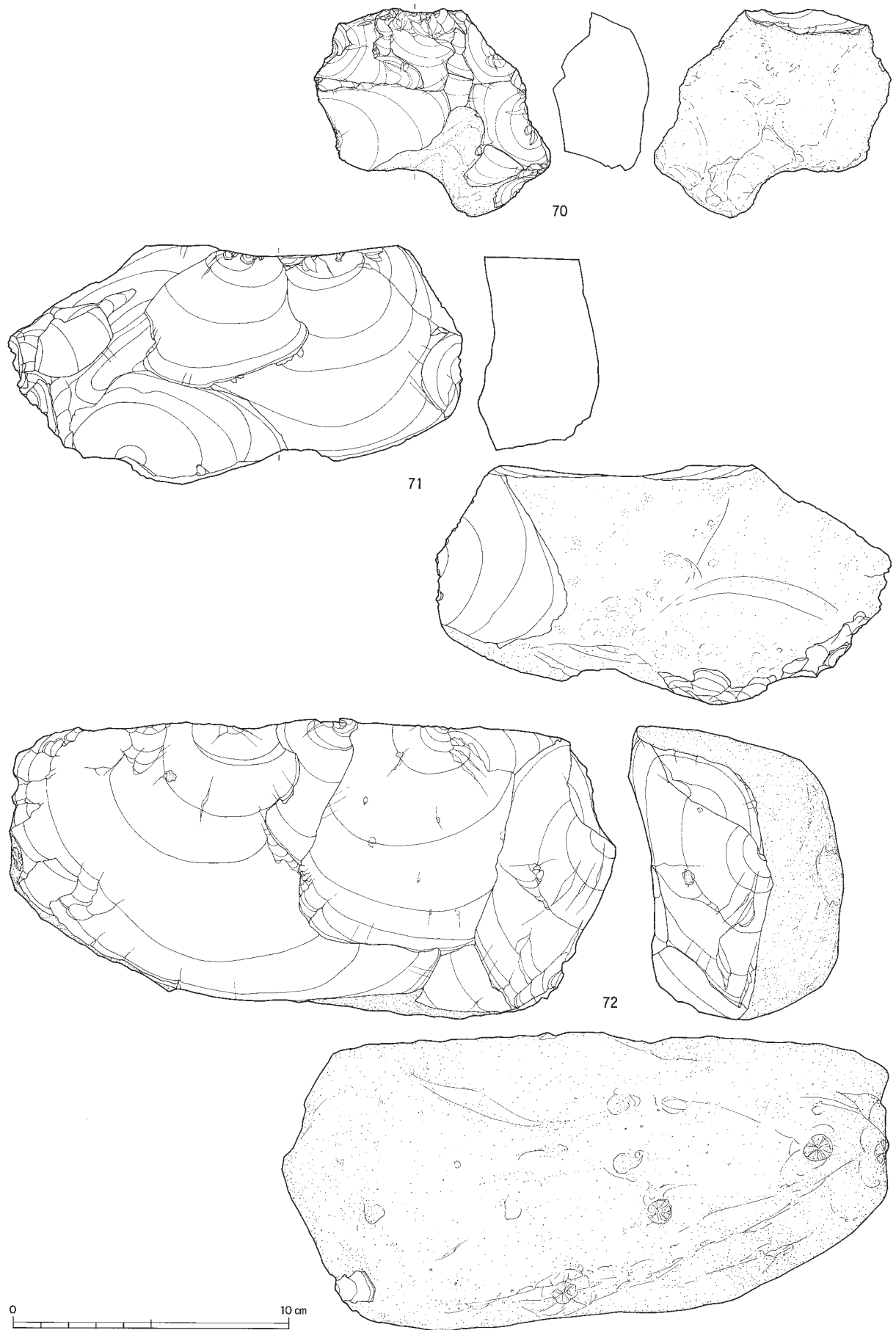

図Ⅲ-86 Sb-72~79の石器(11) 石核

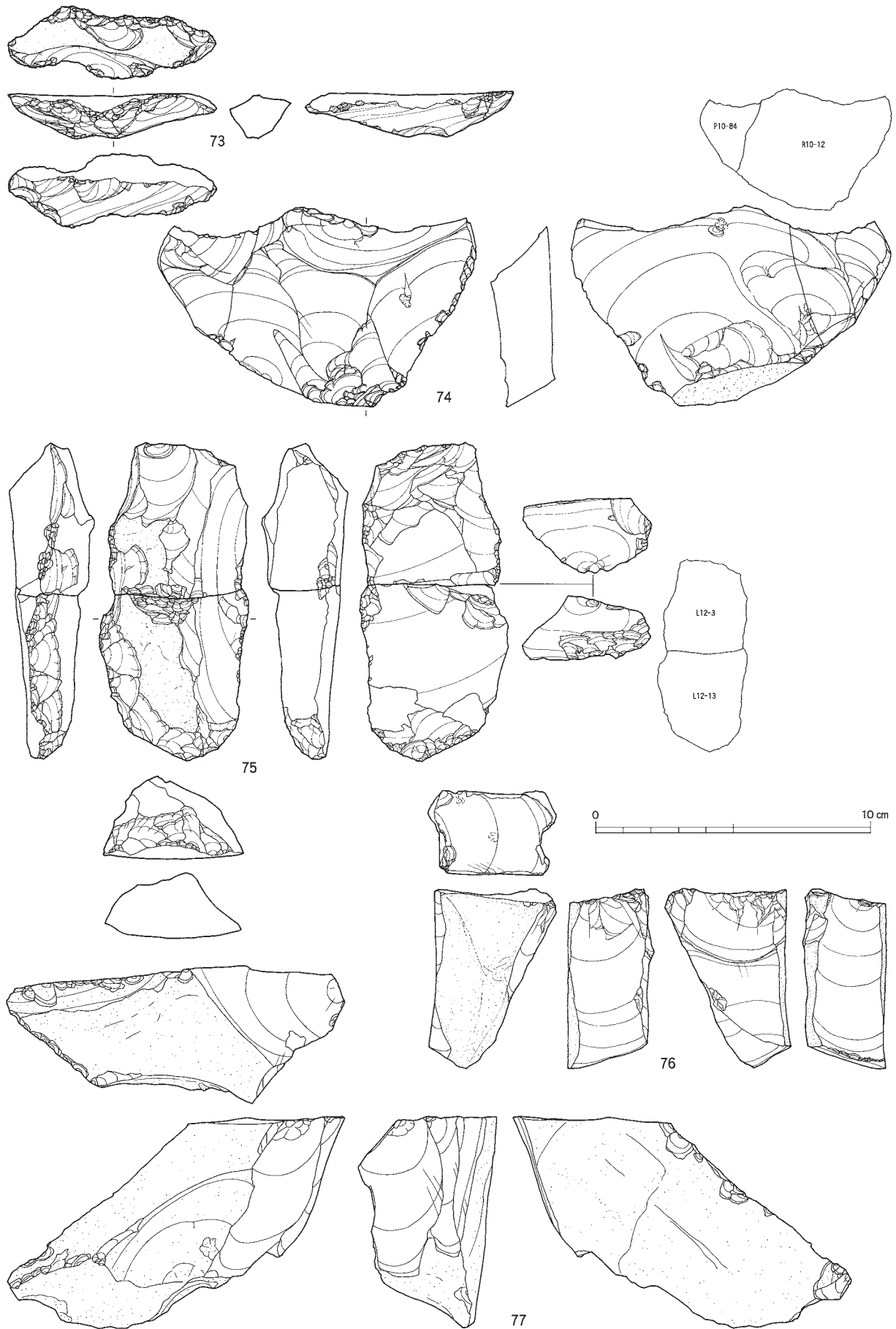

図Ⅲ-87 Sb-72~79の石器(12) 石核

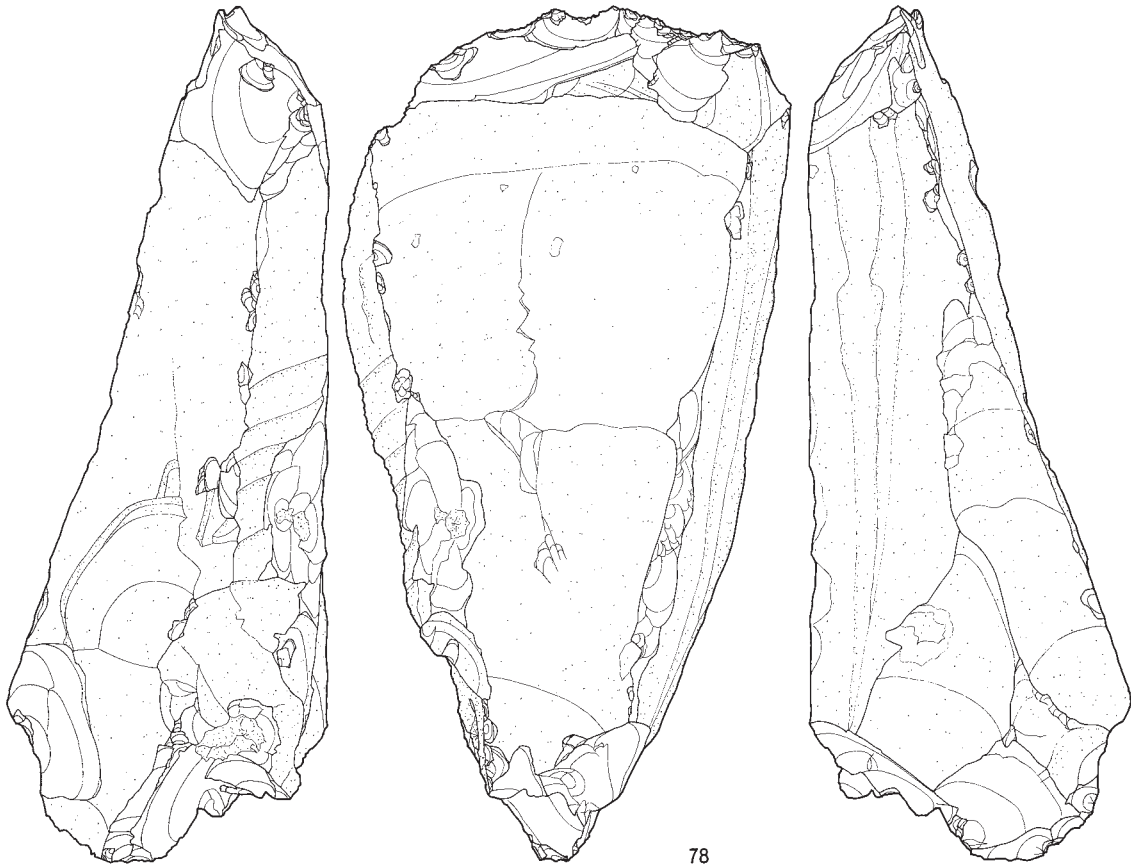

78

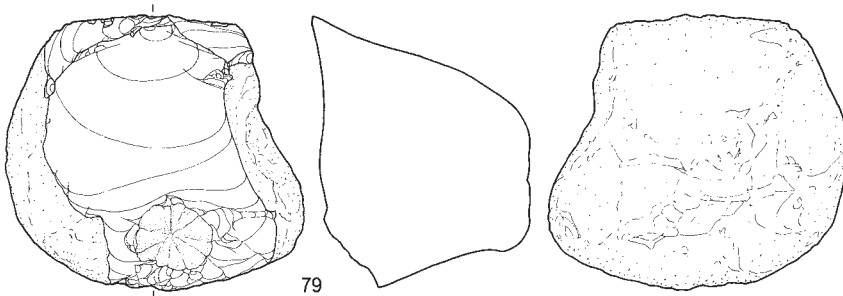
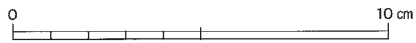

79

図Ⅲ-88 Sb-72~79の石器(13) 石核

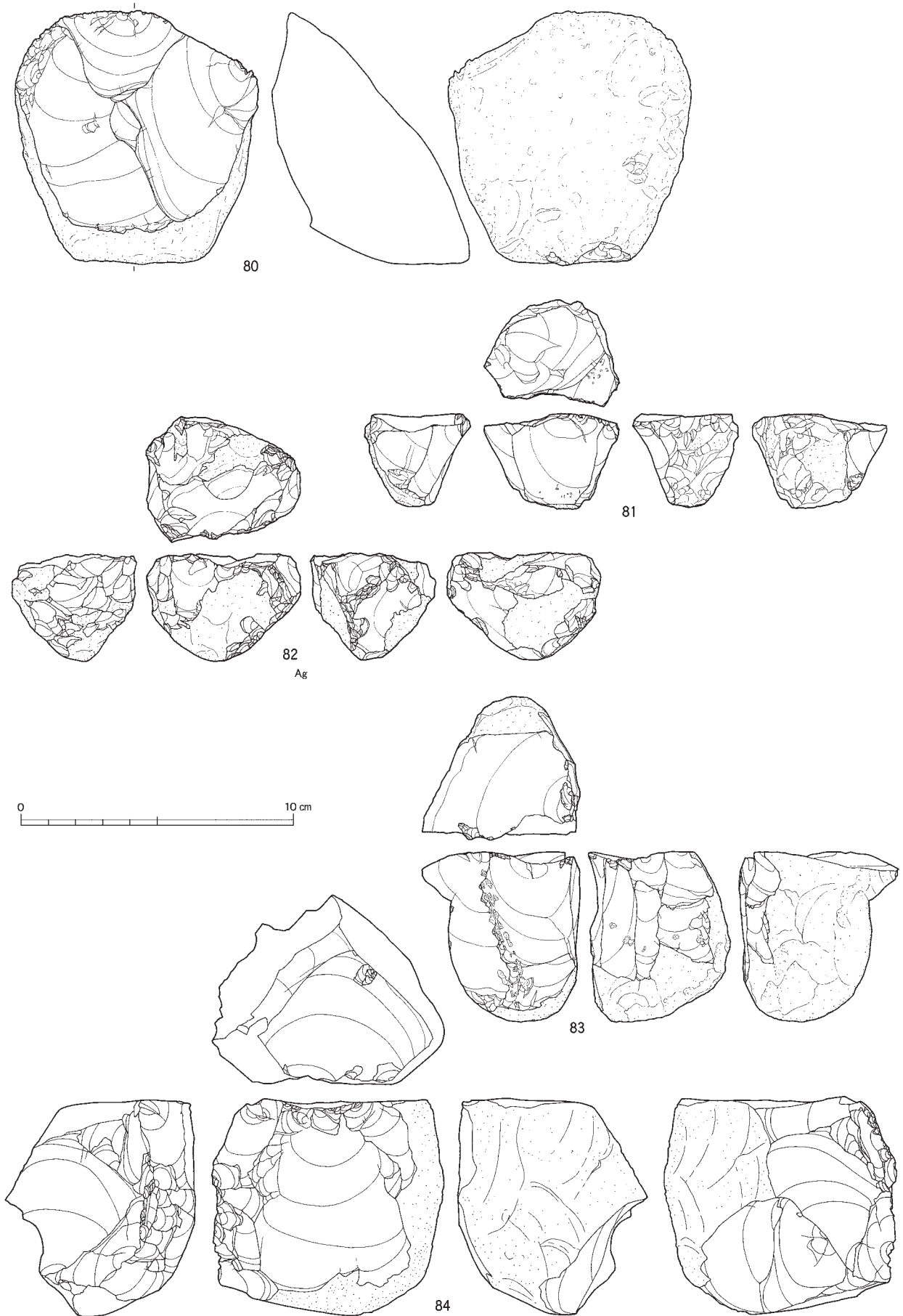

図Ⅲ-89 Sb-72~79の石器(14) 石核

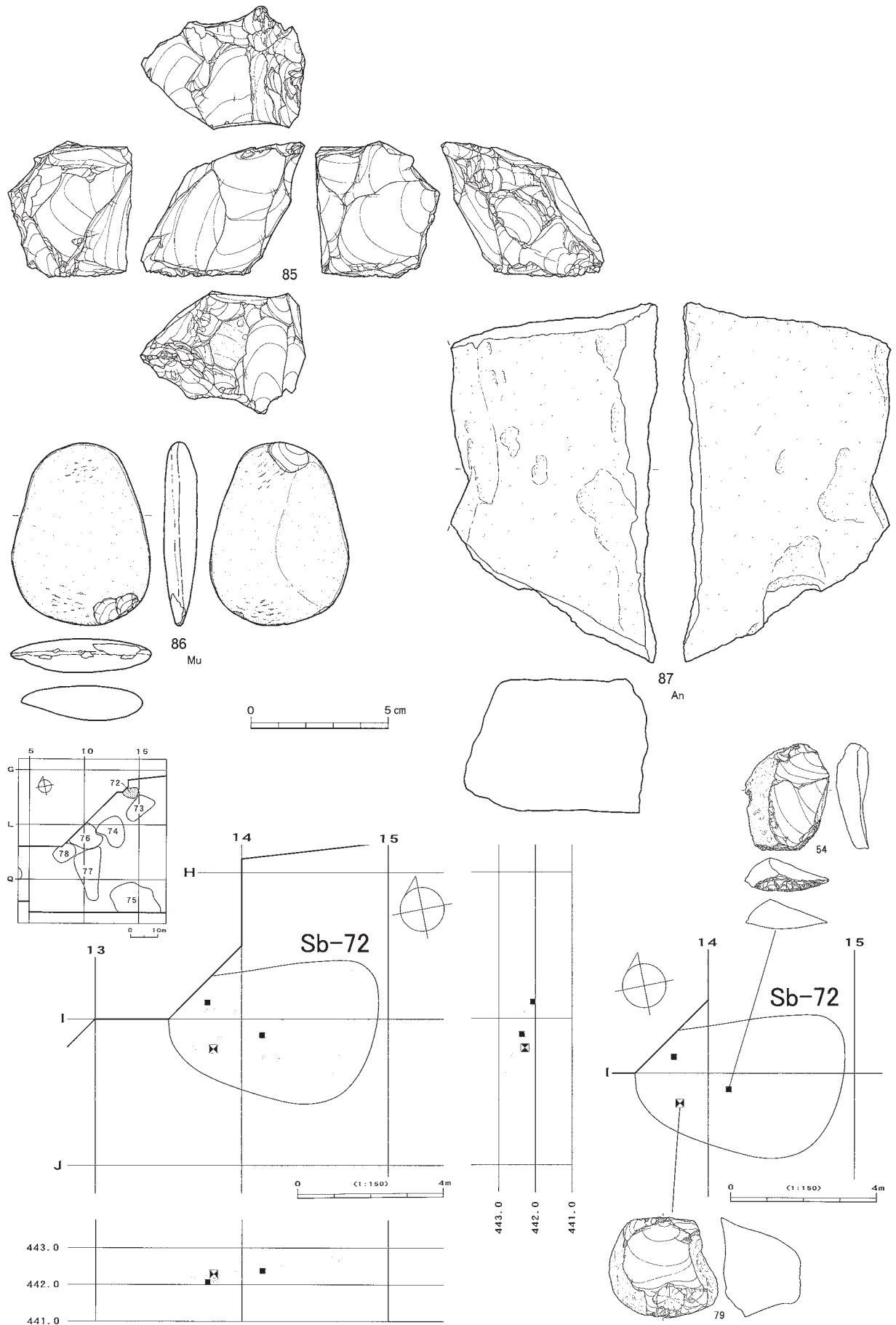

図Ⅲ-90 Sb-72~79の石器(15) 石核・斧形石器・台石、Sb-72の分布図・遺物

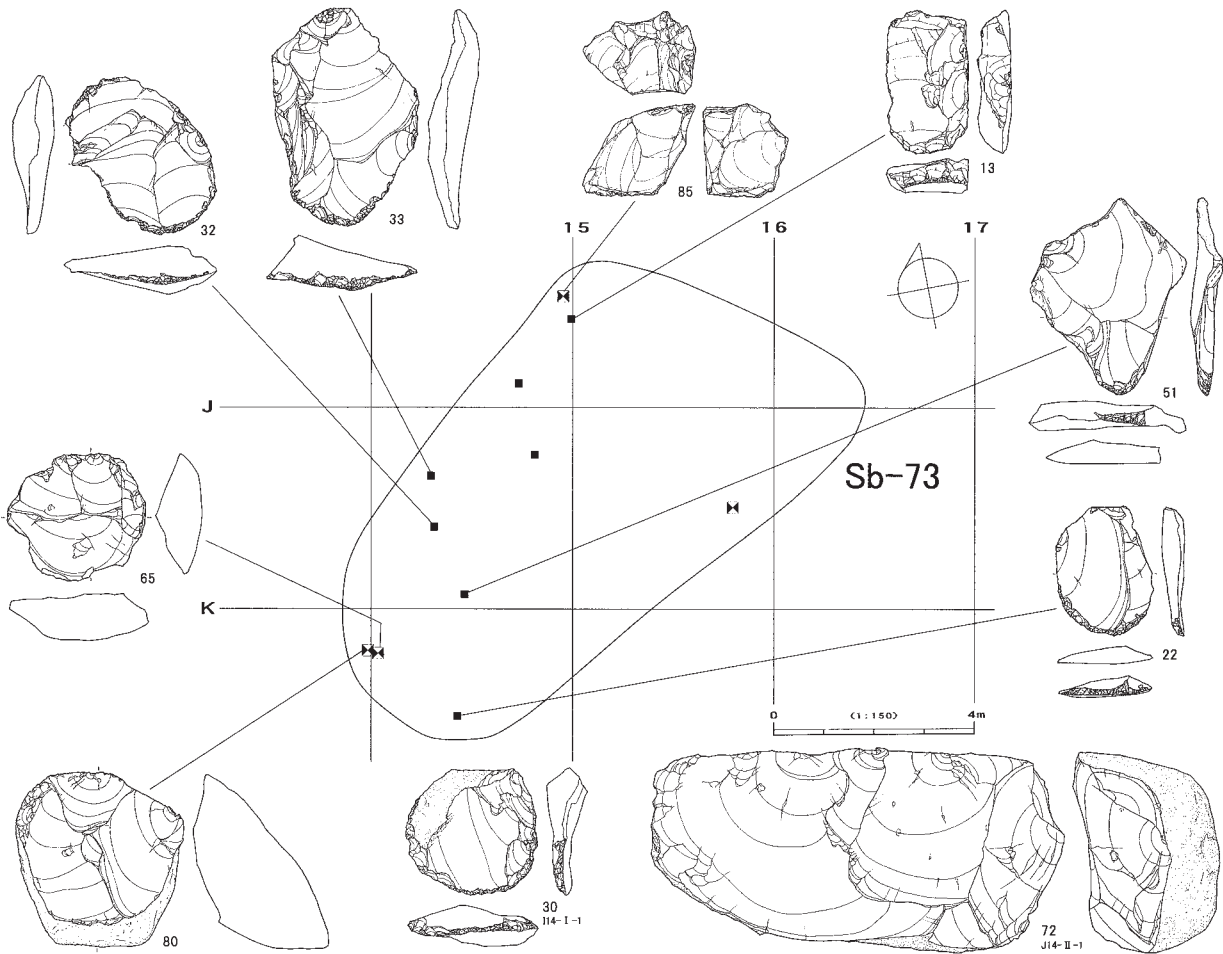
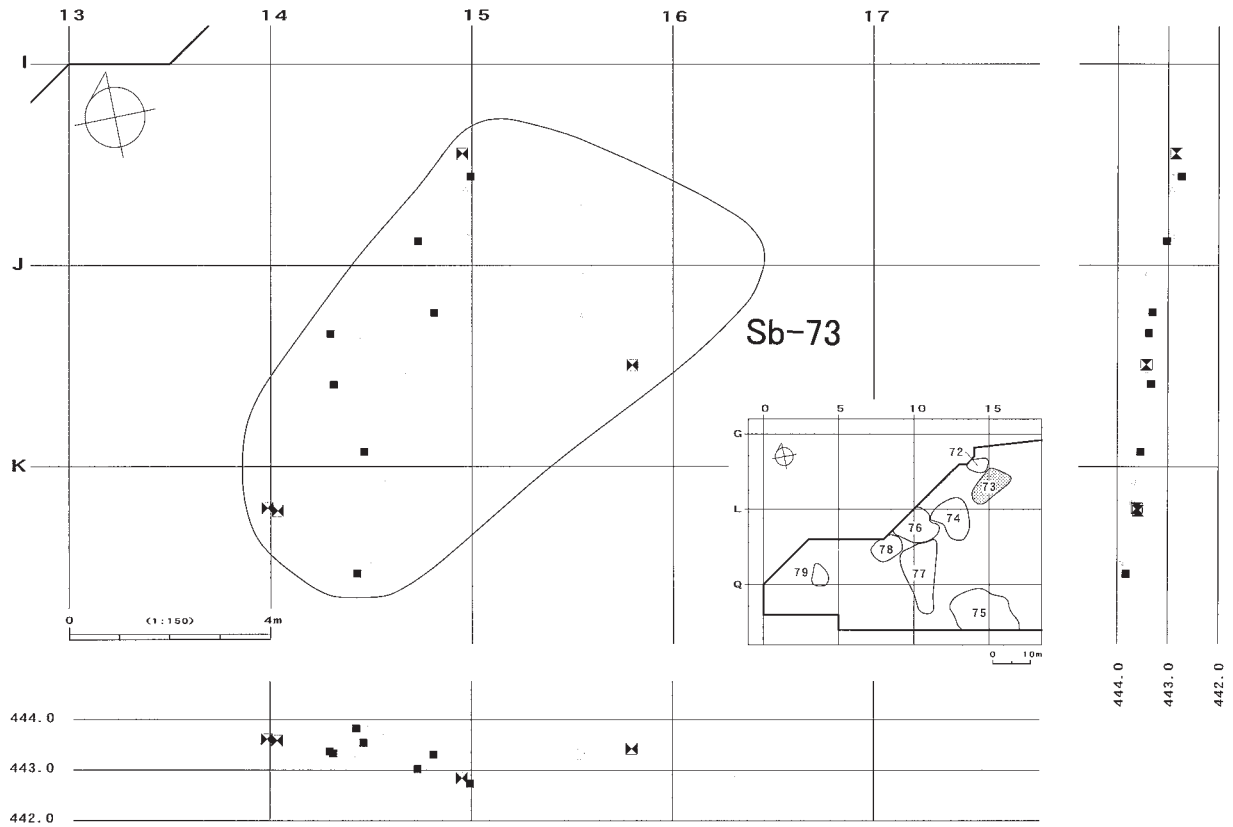

図Ⅲ-91 Sb-73の分布図・遺物

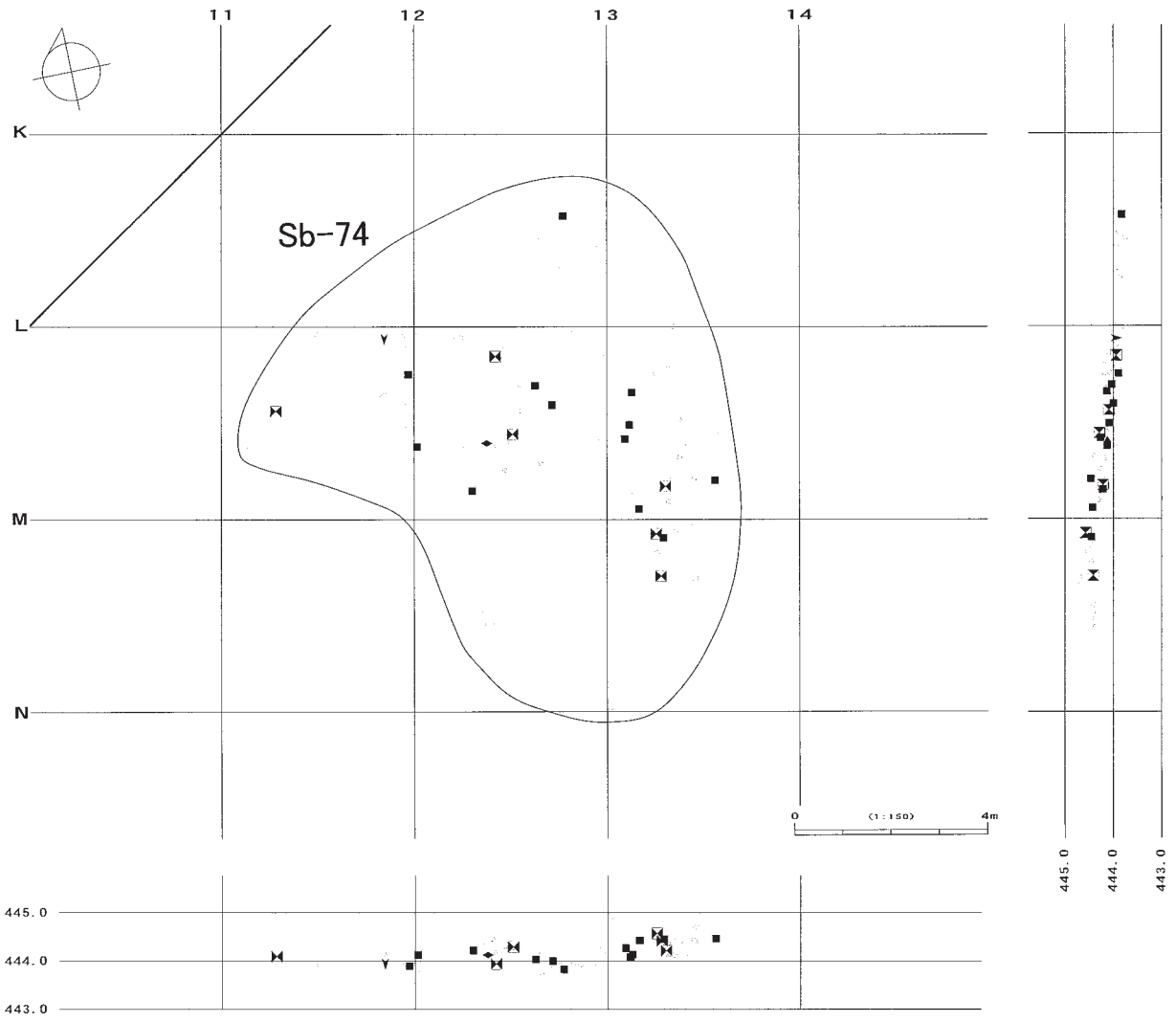

台形石器、二次加工ある剥片、錐形石器

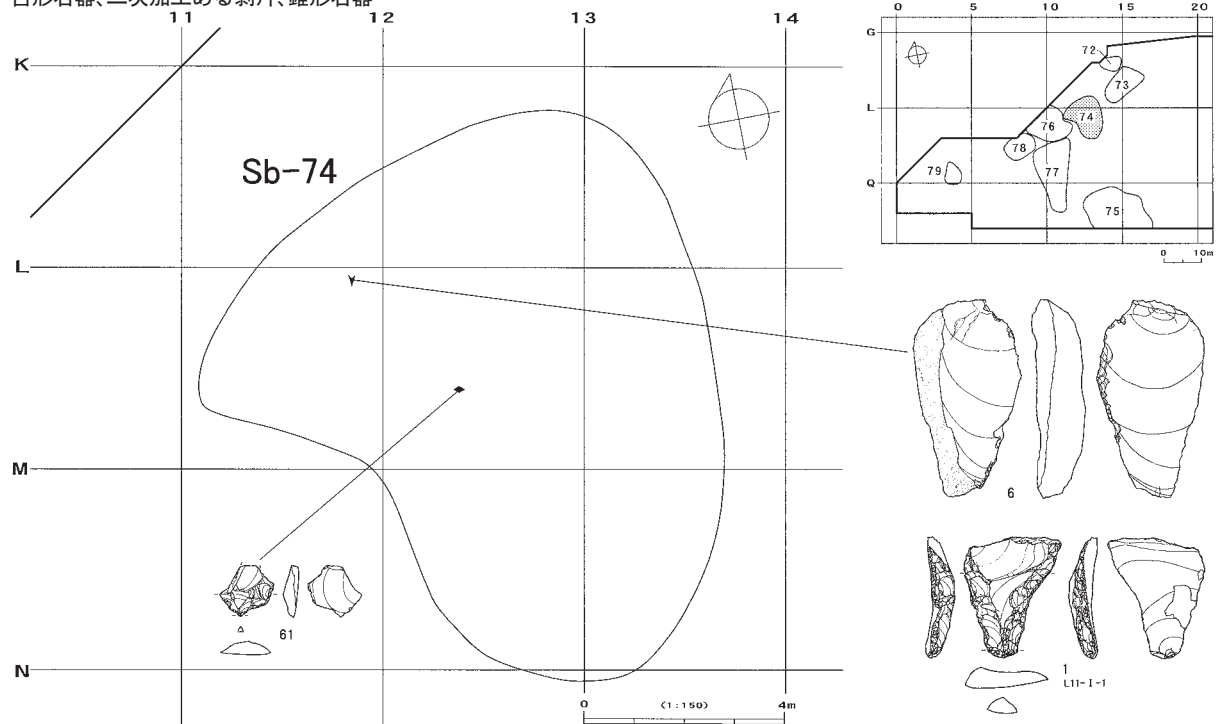

図Ⅲ-92 Sb-74の分布図・遺物(1)

搔器、石核

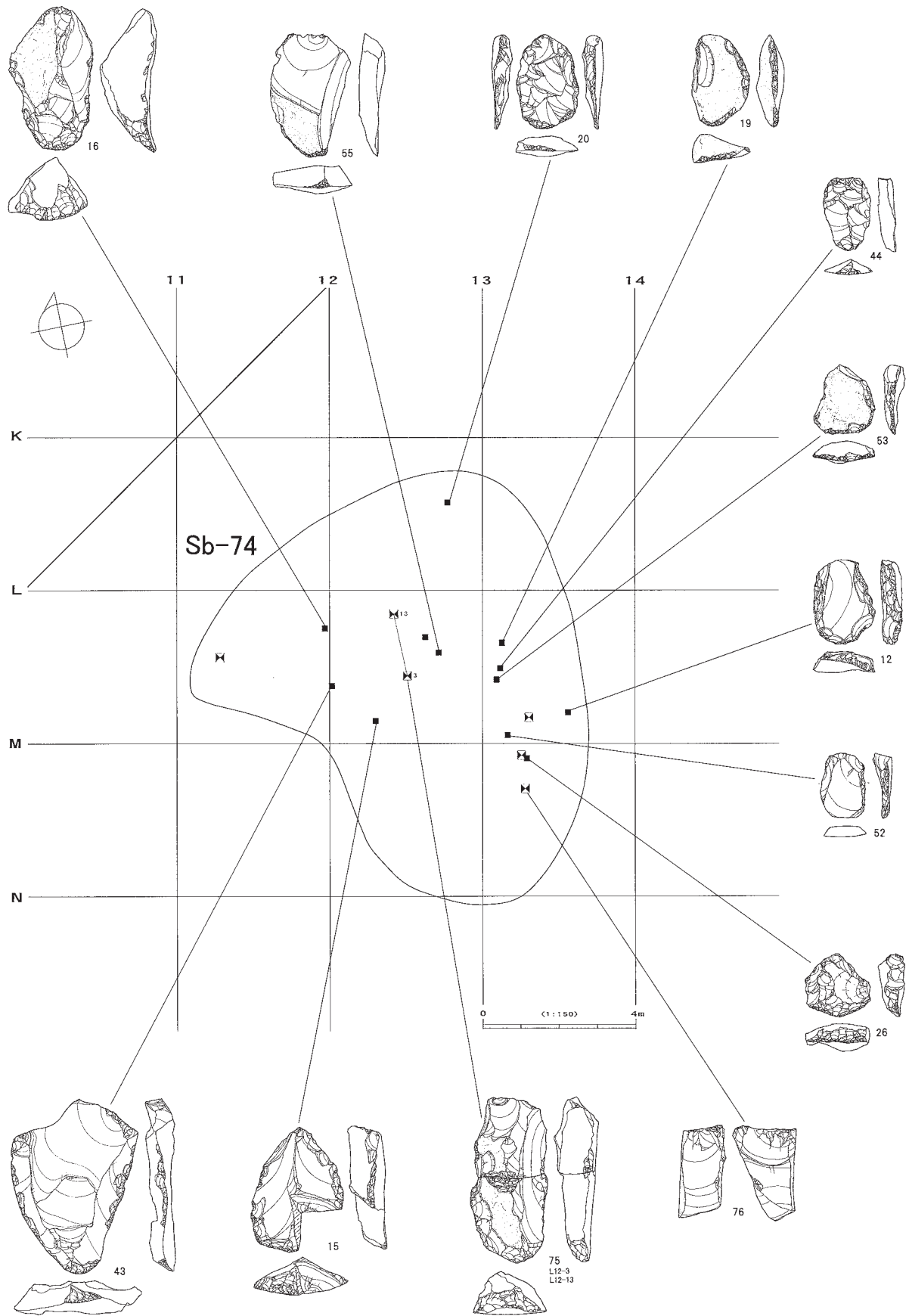

図III-93 Sb-74の遺物(2)

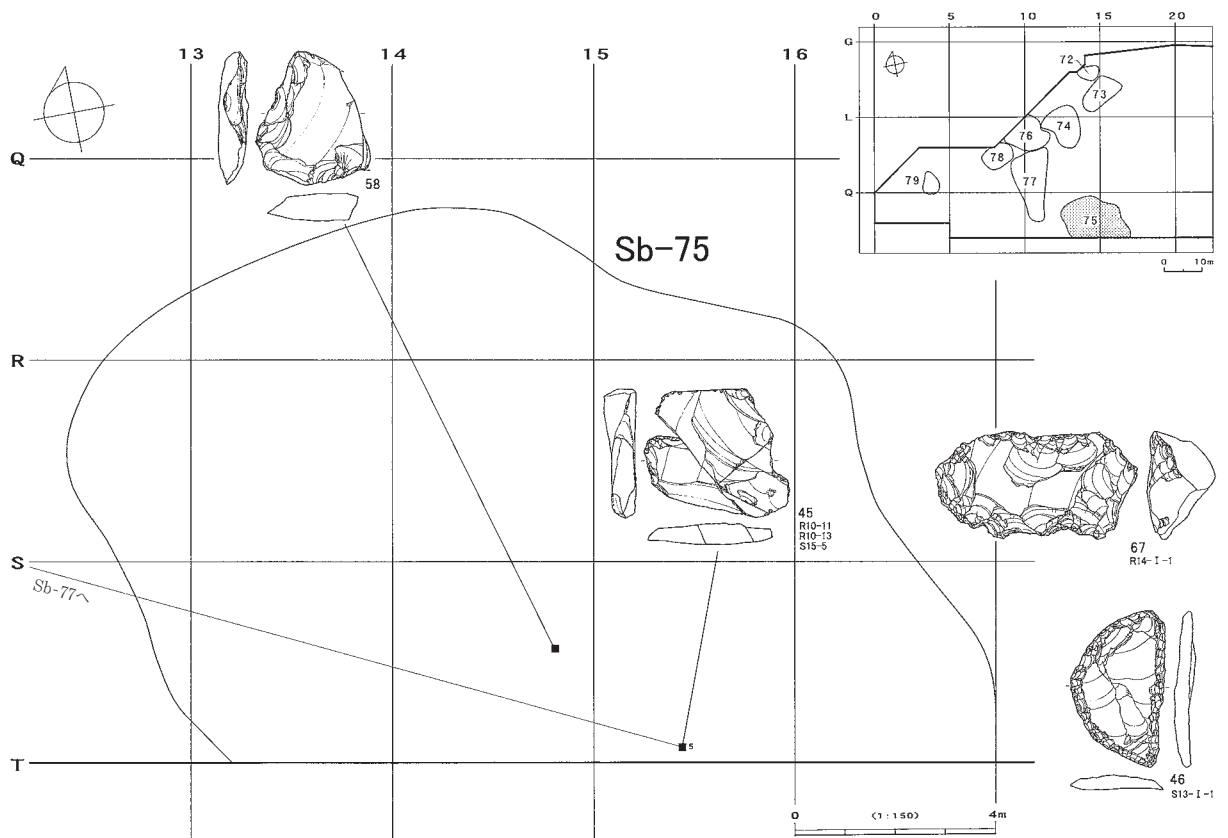
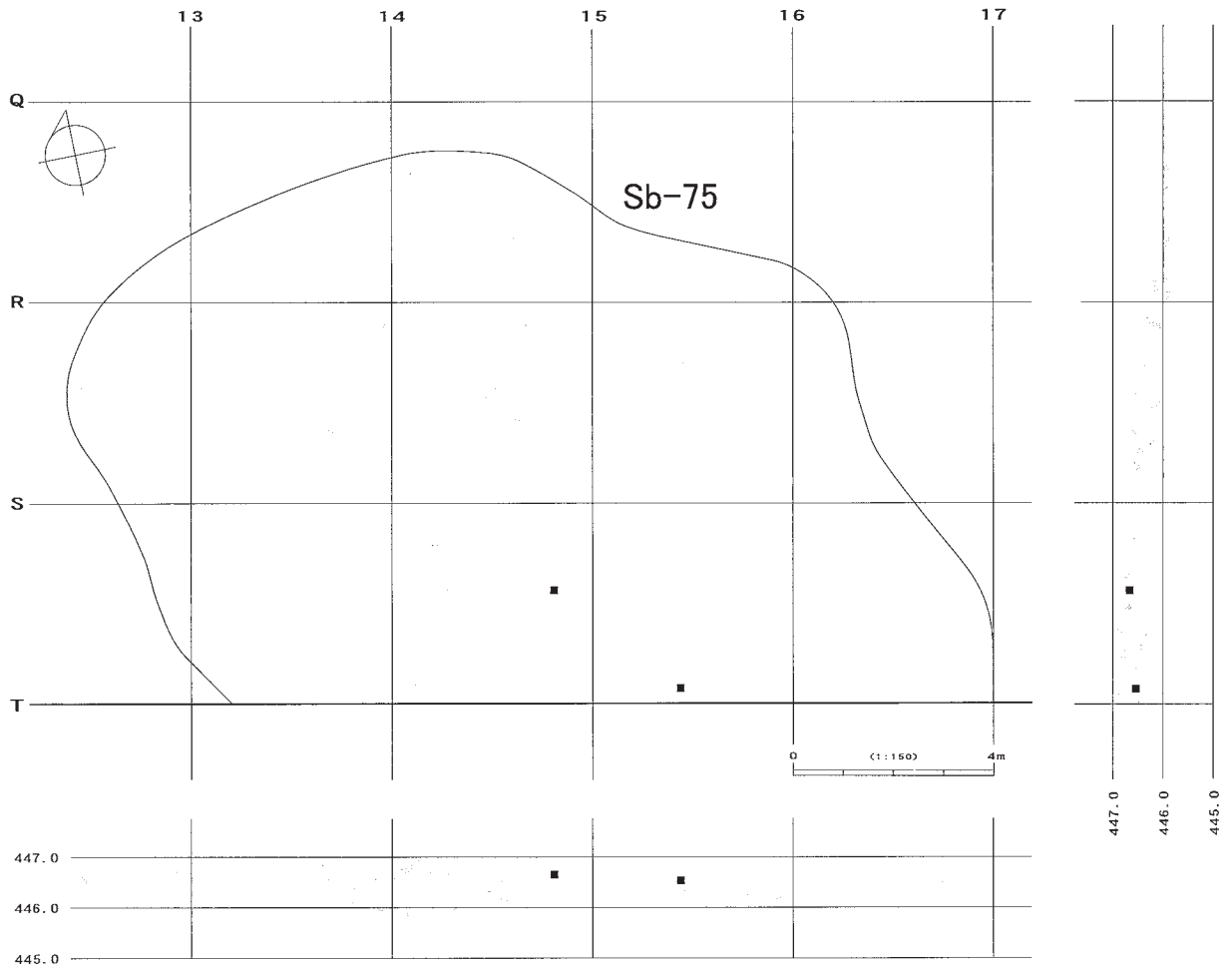

図Ⅲ-94 Sb-75の分布図・遺物

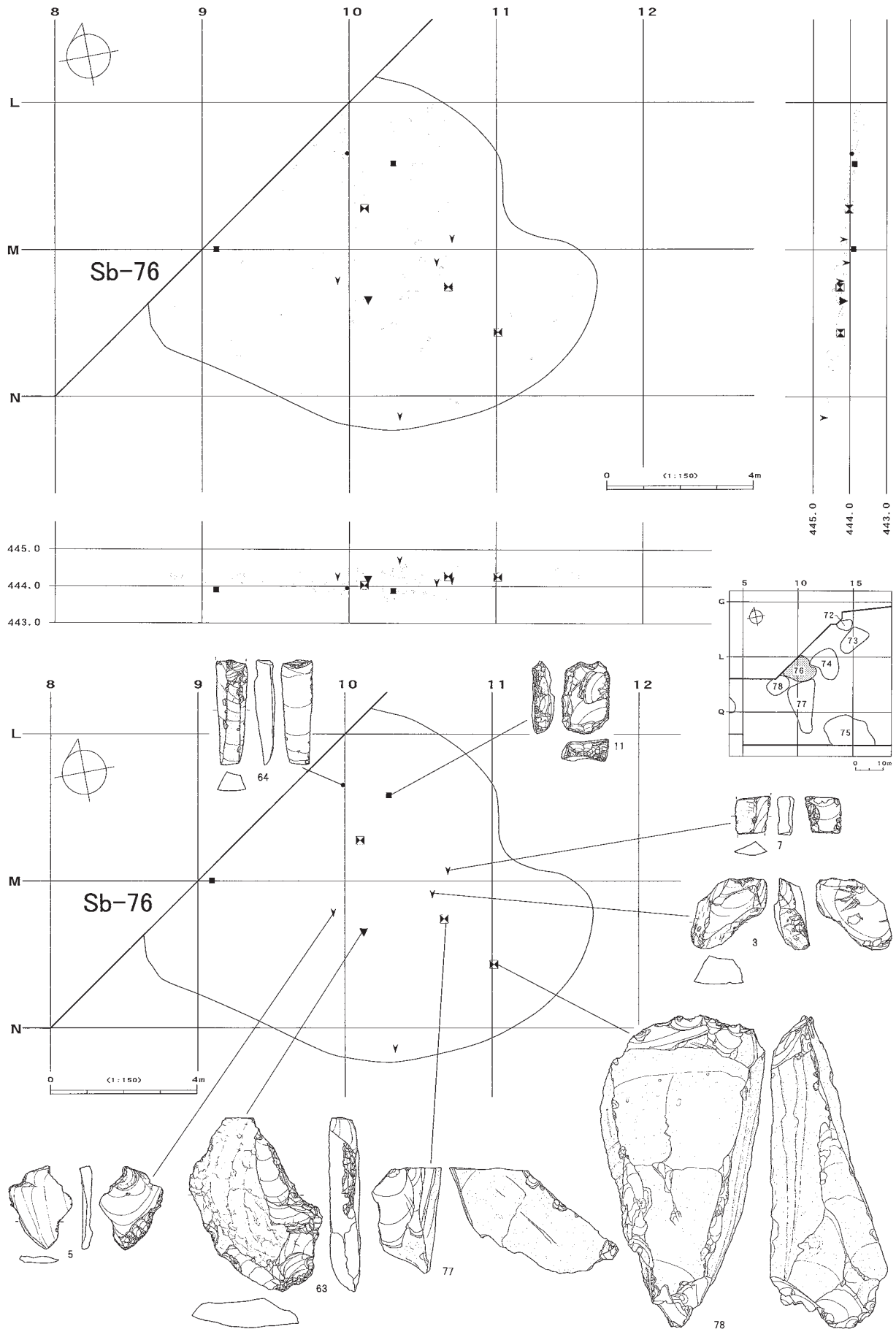

図Ⅲ-95 Sb-76の分布図・遺物

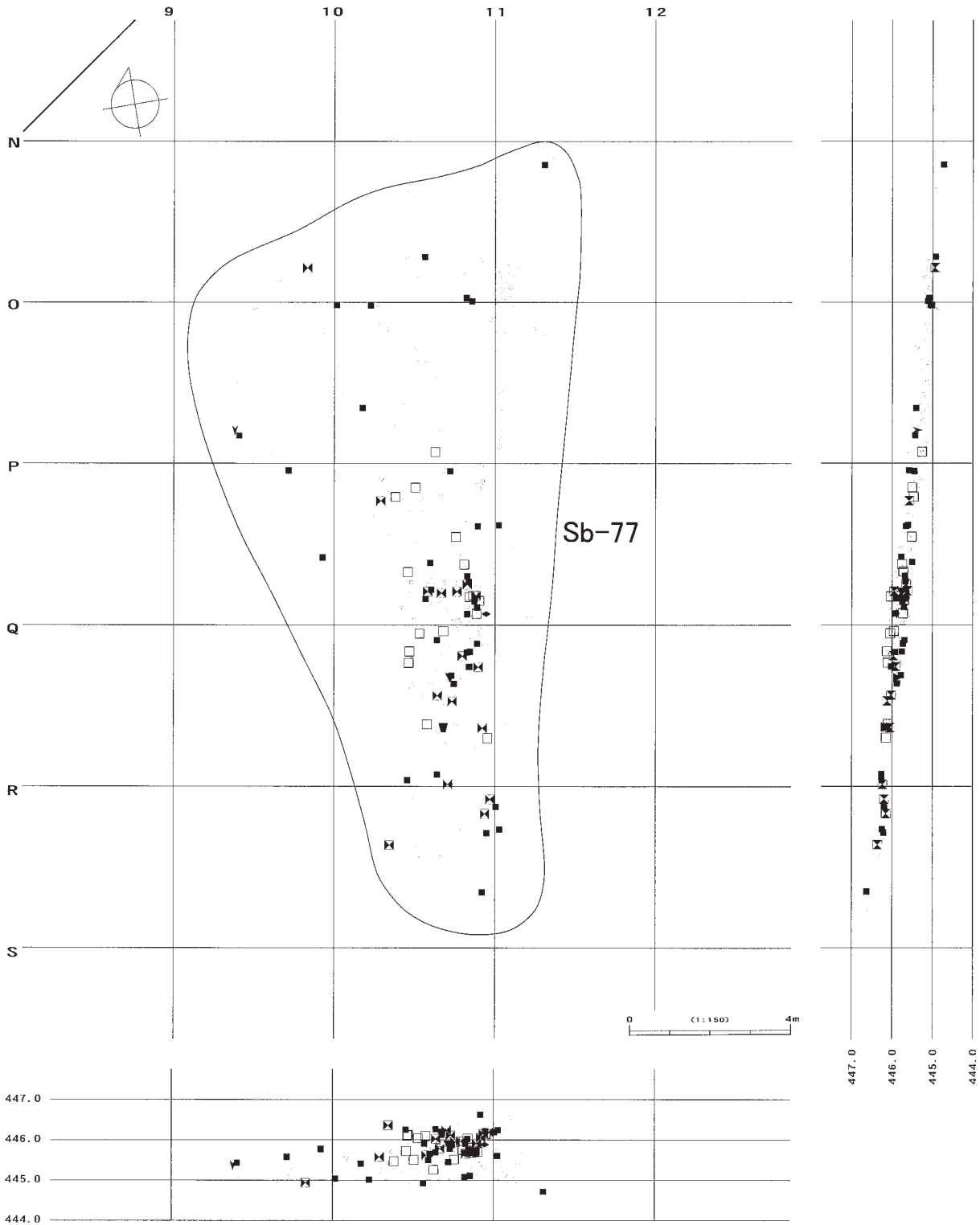
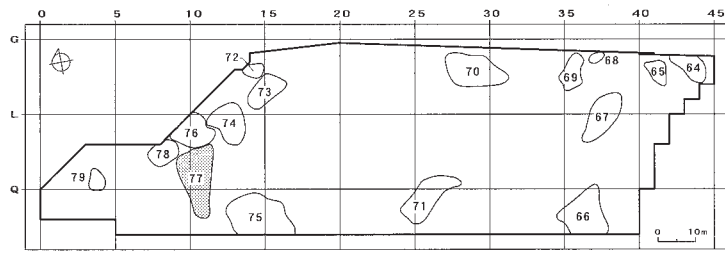

図Ⅲ-96 Sb-77の分布図

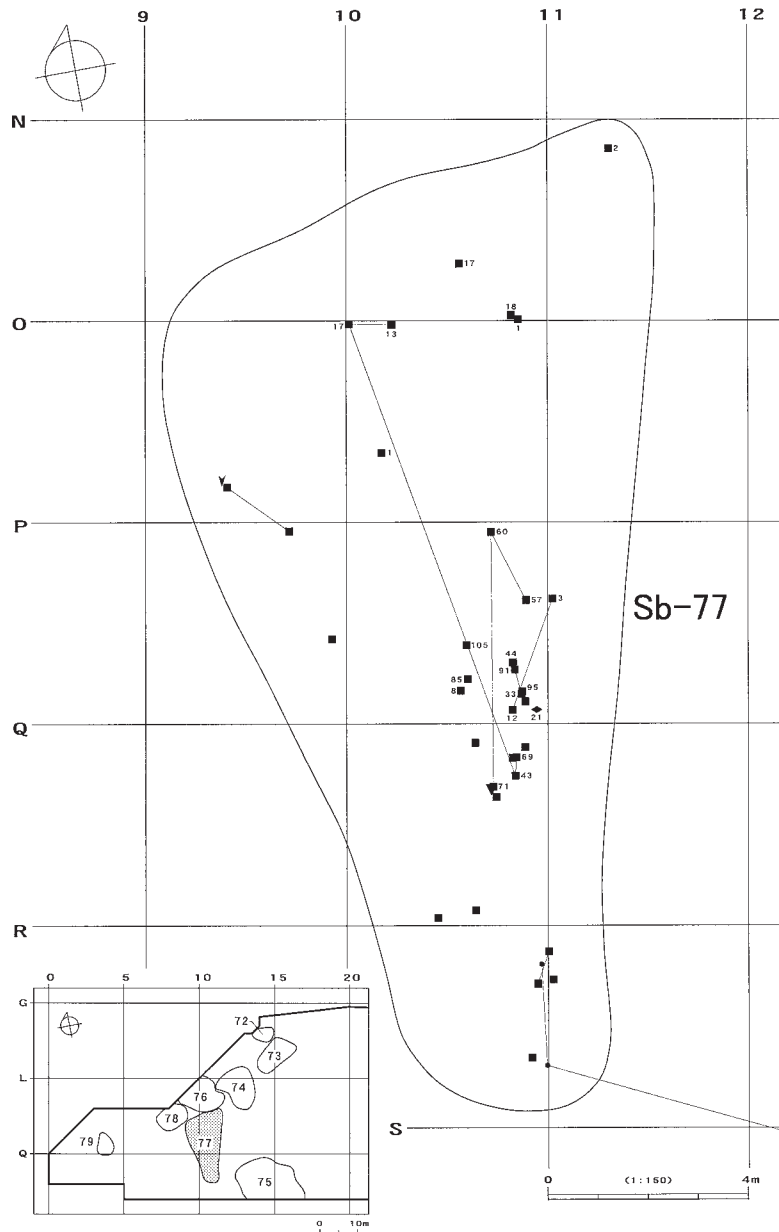

搔器(N・O・P列)、錐形石器、二次加工ある剥片

N10

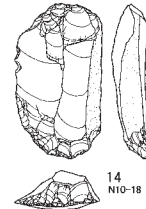
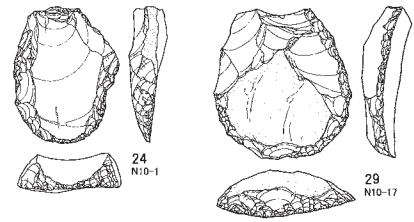

N11

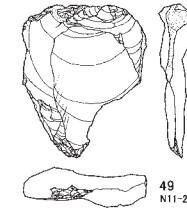

O10

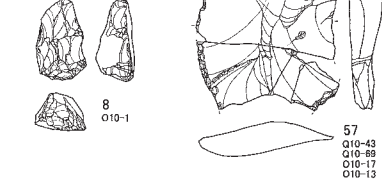

P10

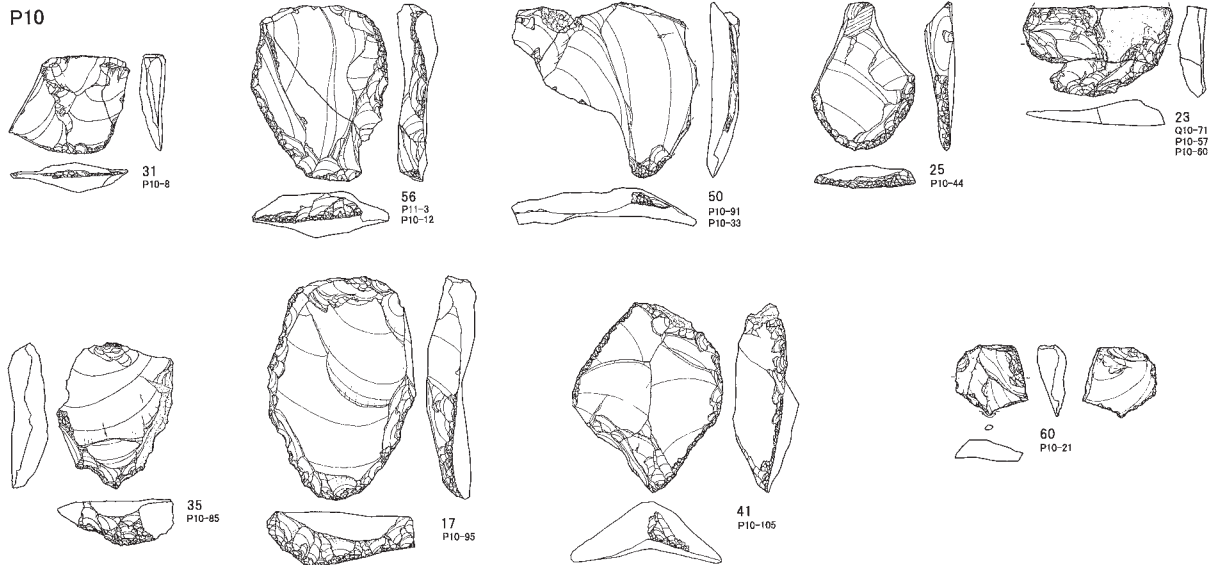

図III-97 Sb-77の遺物(1)

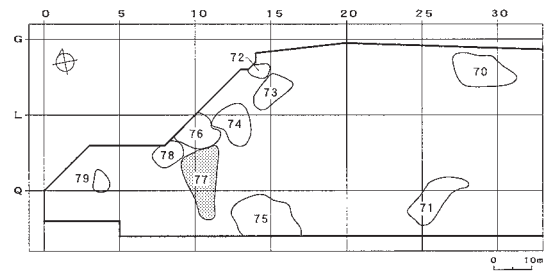

搔器(Q・R列)、台形石器

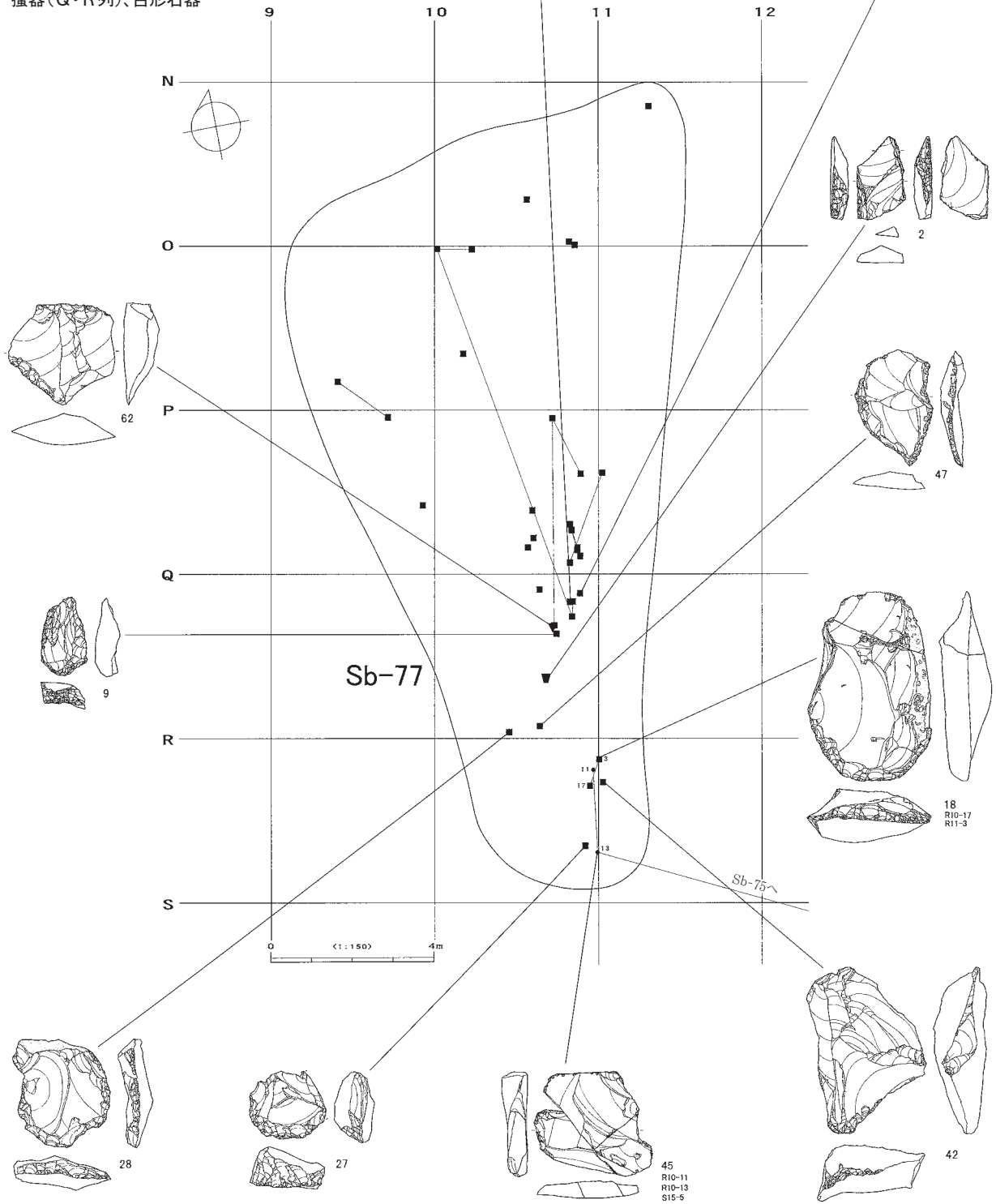

図III-98 Sb-77の遺物(2)

石核、斧形石器、台石、棒状原石

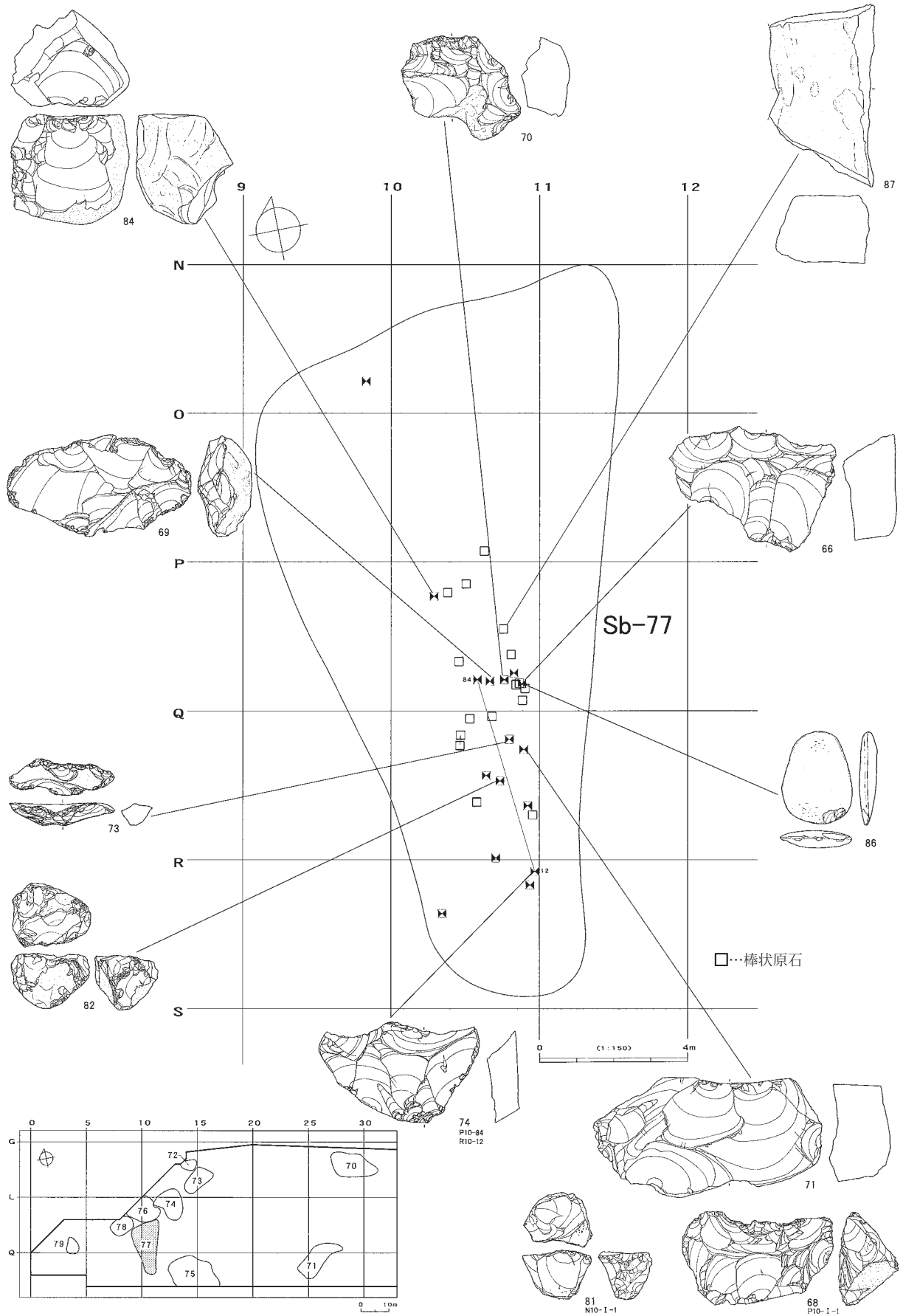

図Ⅲ-99 Sb-77の遺物(3)

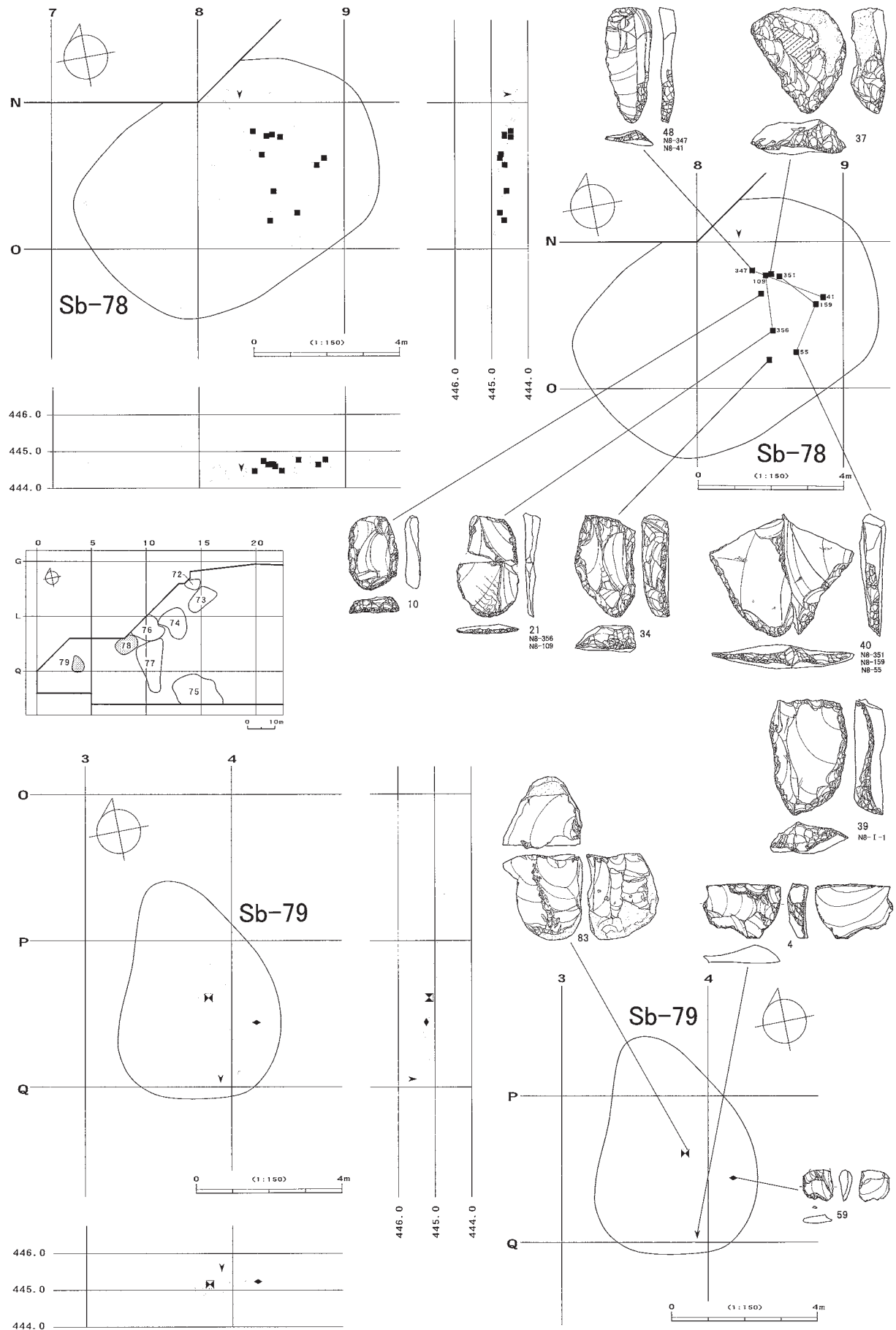

図Ⅲ-100 Sb-78・79の分布図・遺物

全接合分布図

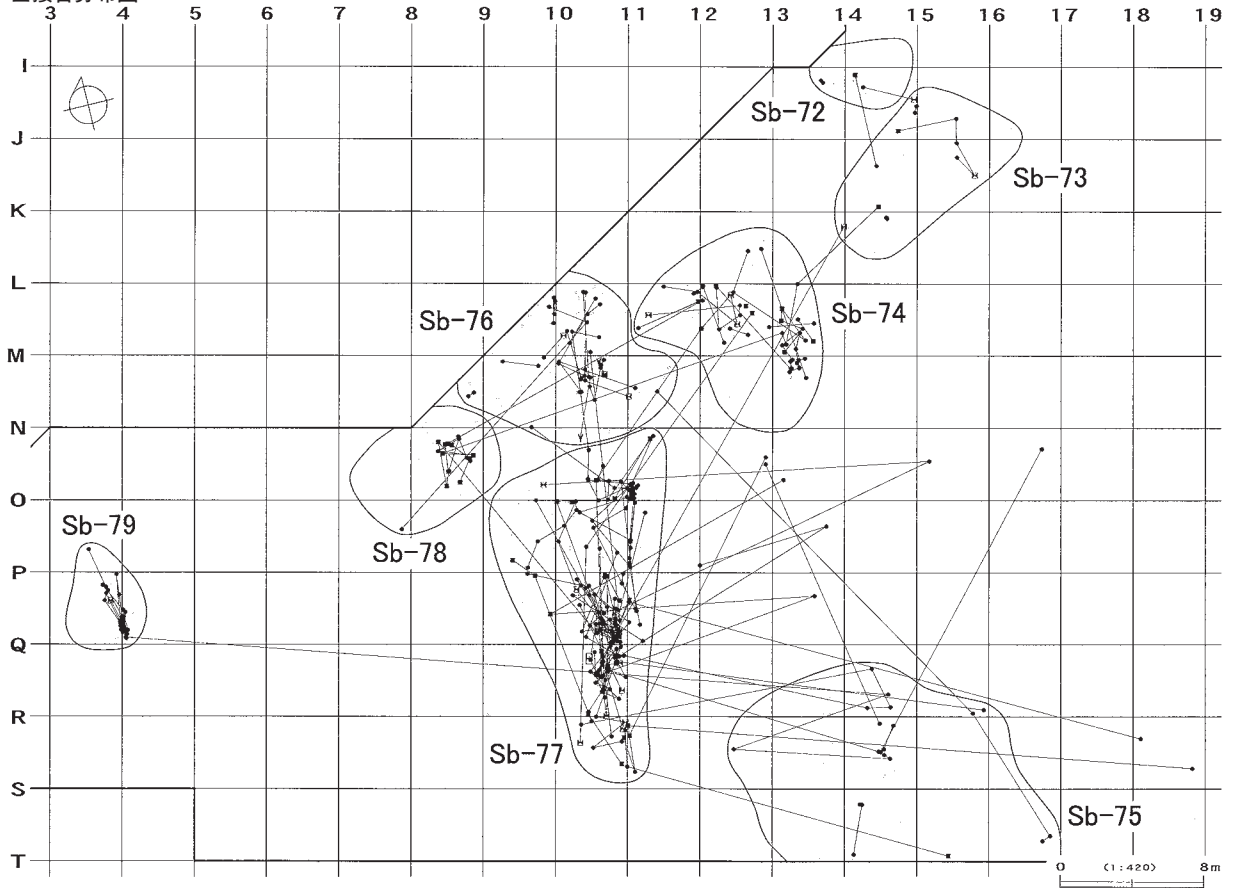

折れ面接合分布図

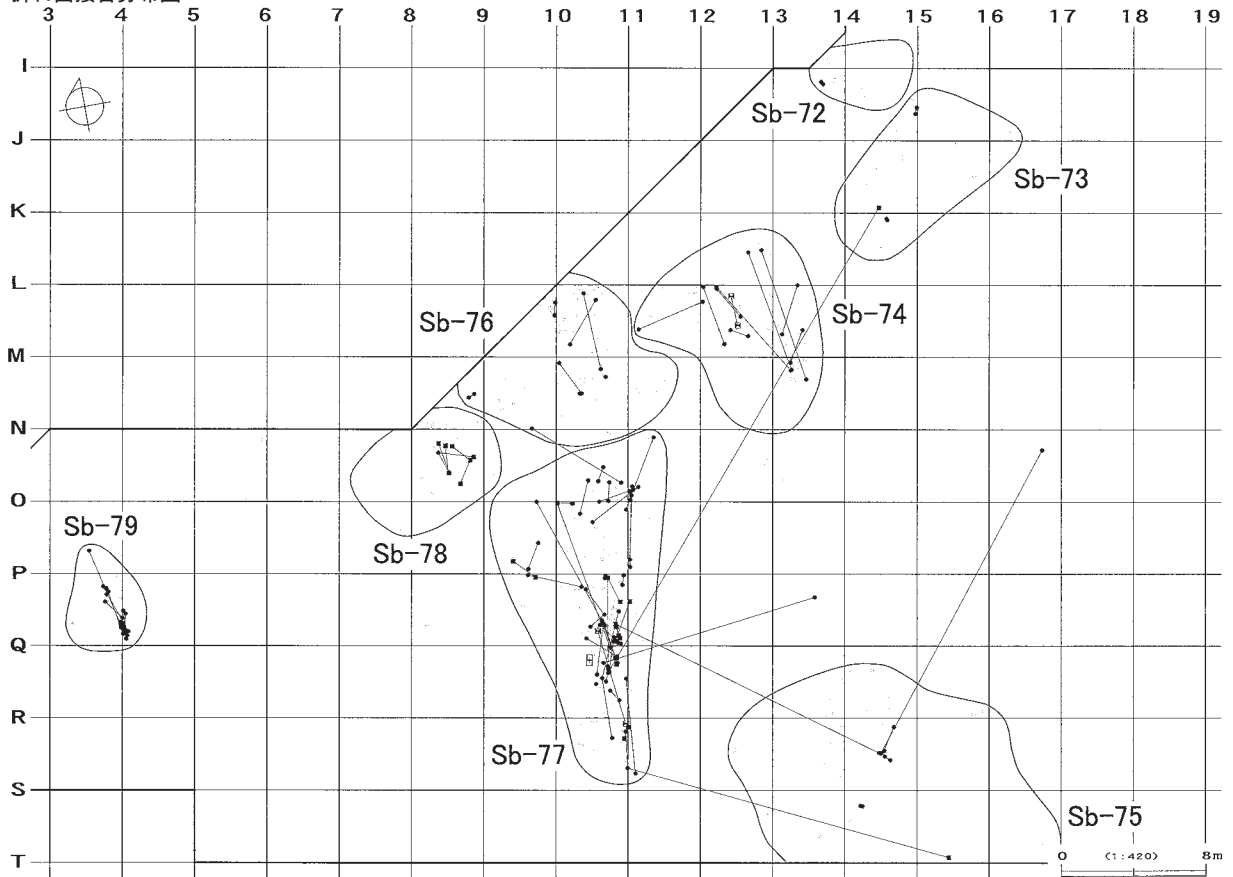

図Ⅲ-101 Sb-72~79の接合分布図(1)

角礫素材全接合分布図

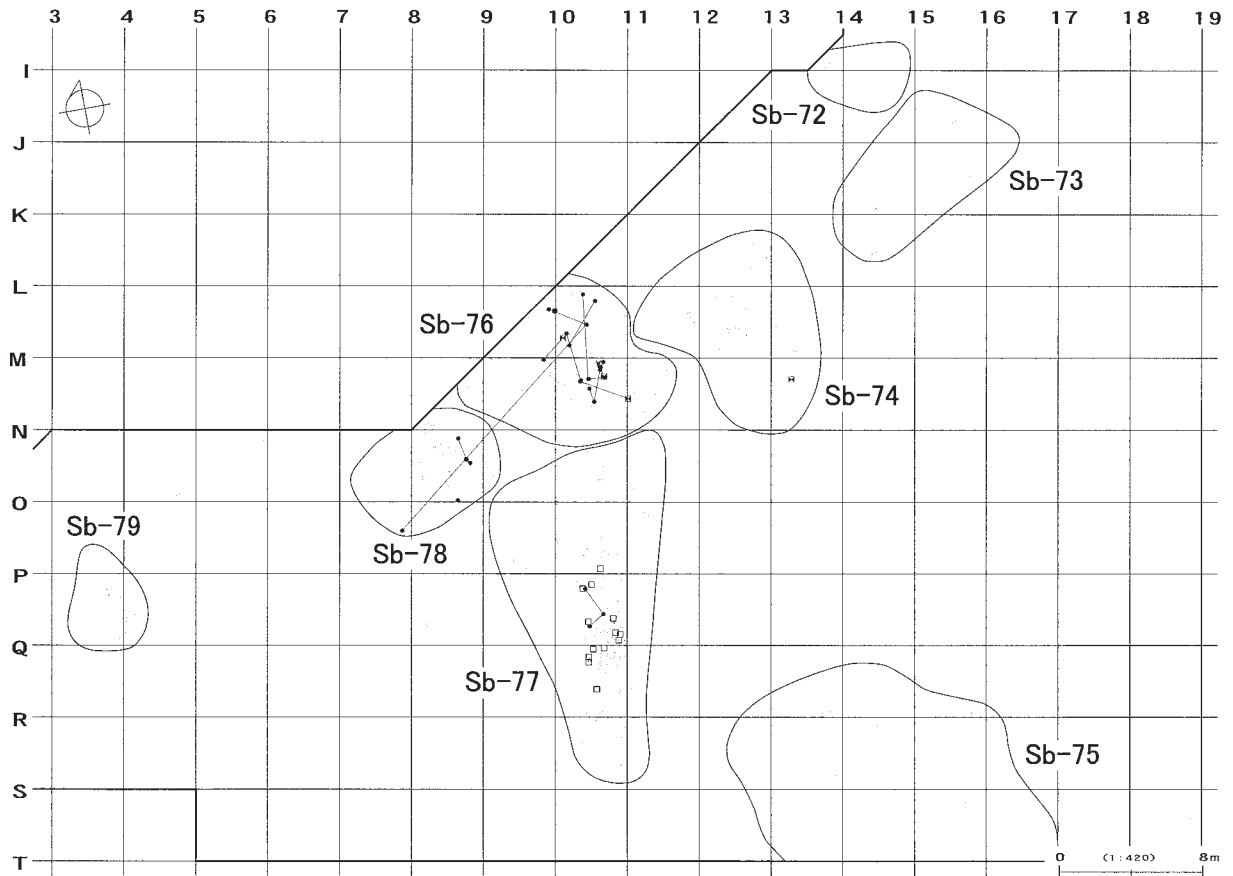

角礫素材折れ面接合分布図

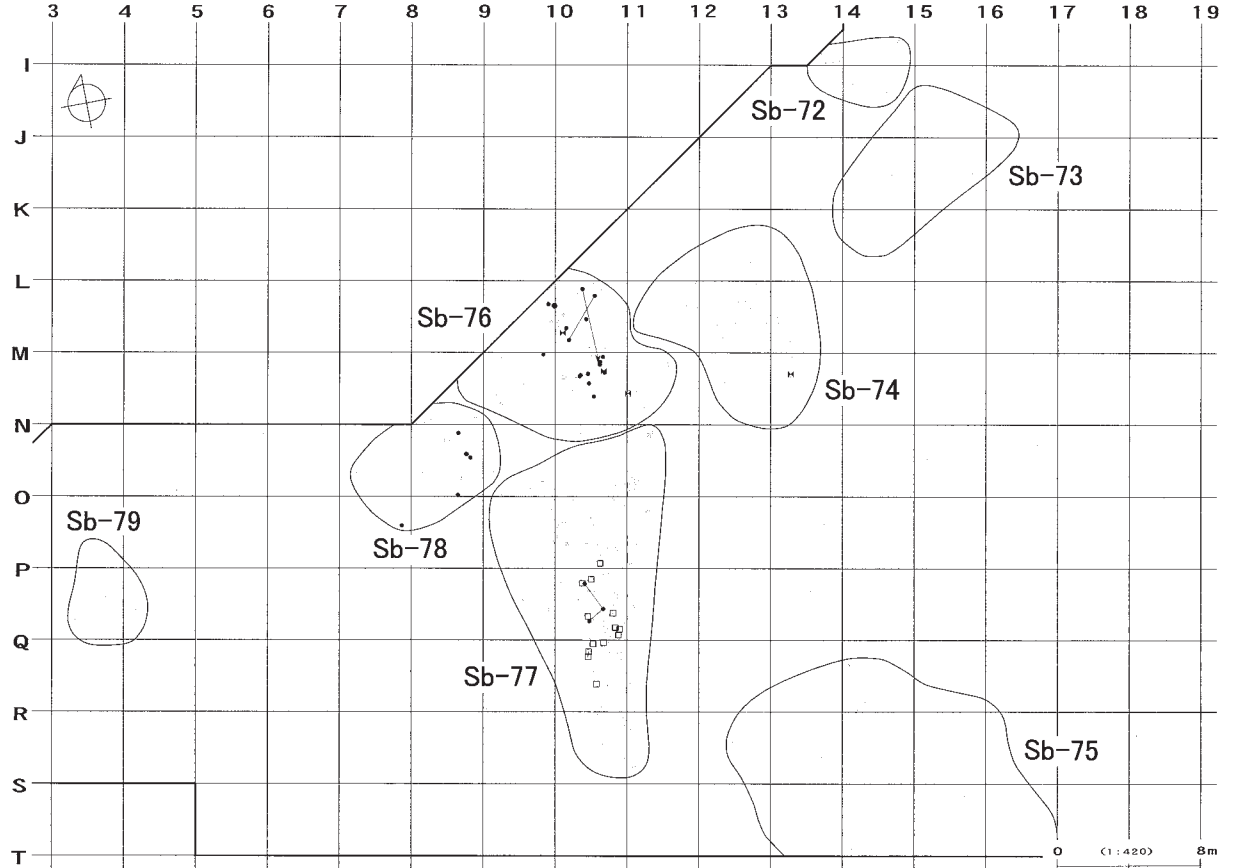

図Ⅲ-102 Sb-72~79の接合分布図(2)

母岩533・接合436

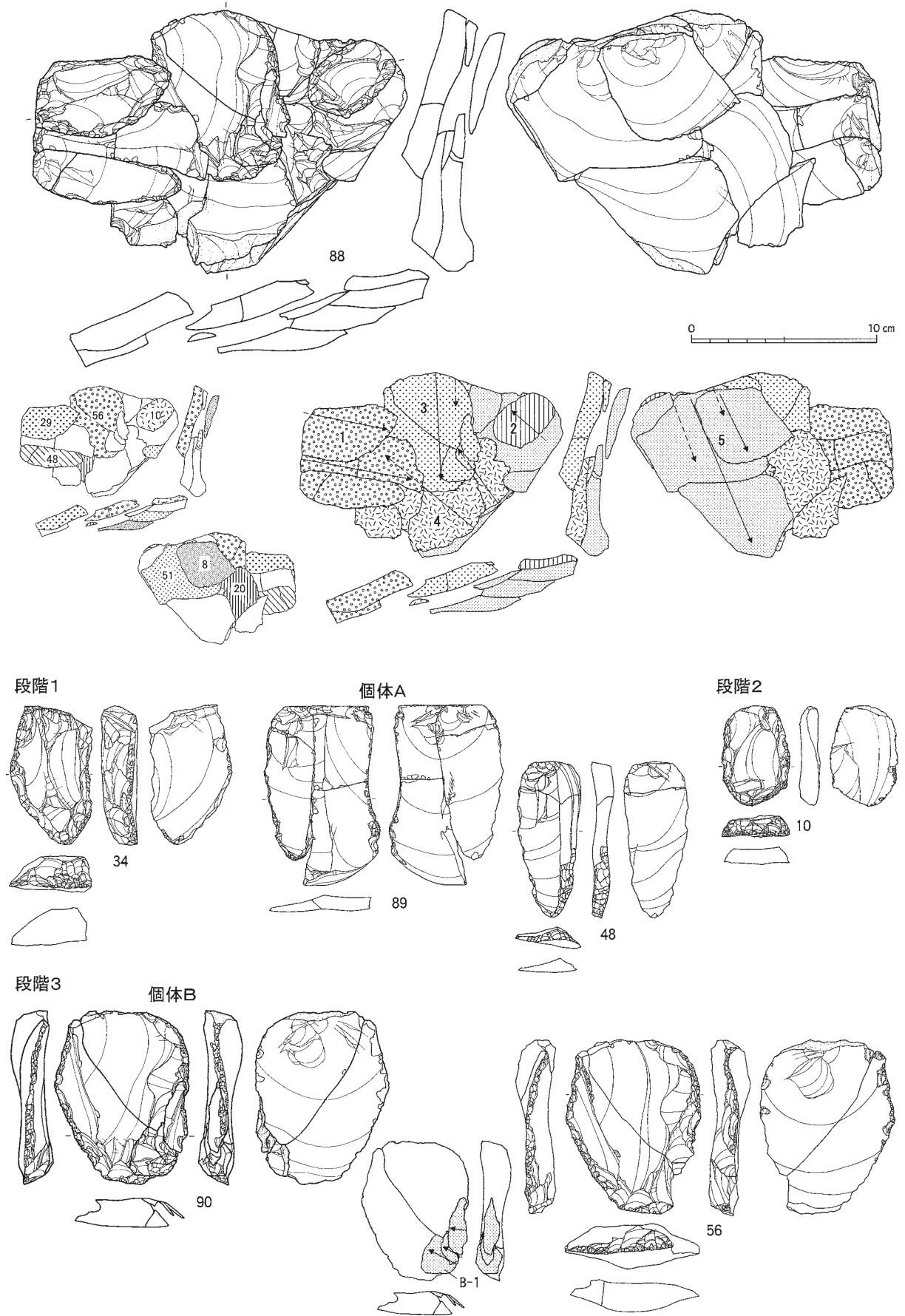

図Ⅲ-103 Sb-72~79の石器(16) 母岩533・接合436(1)

段階4

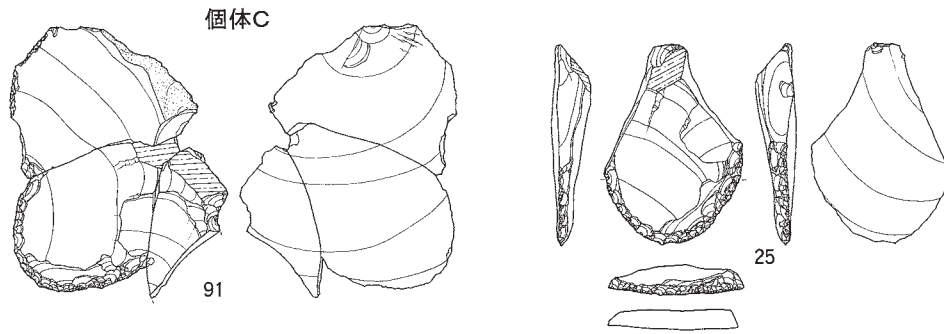

段階5

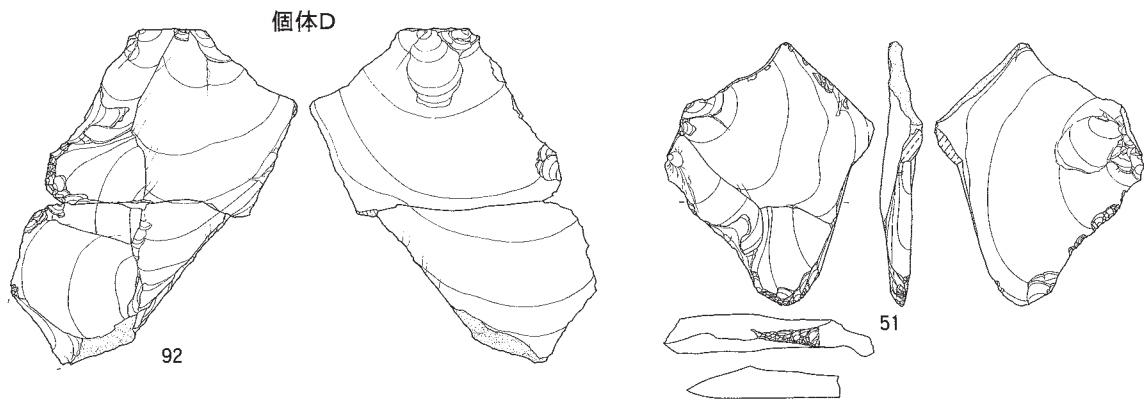

接合436分布図

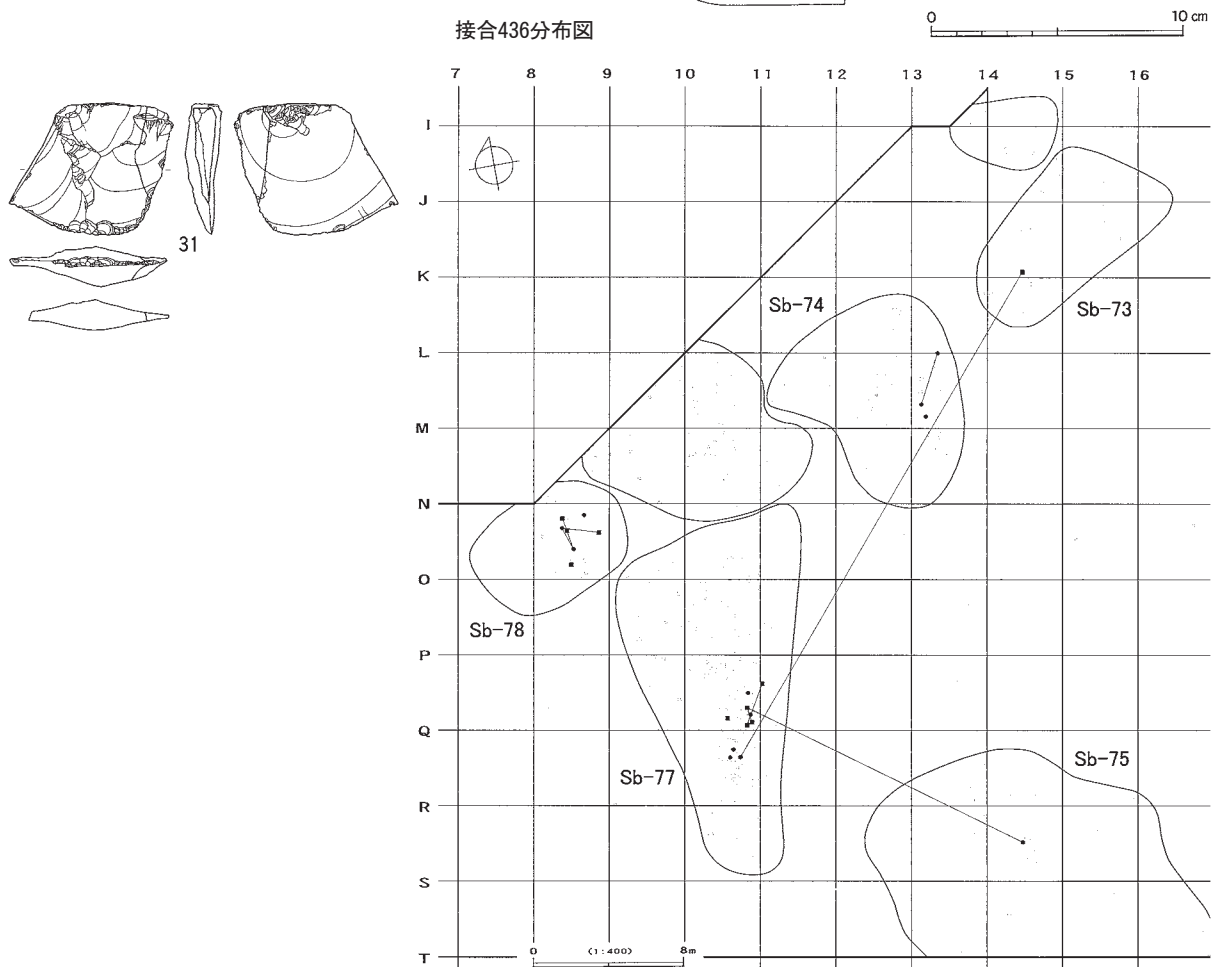

図Ⅲ-104 Sb-72~79の石器(17) 母岩533・接合436(2)

接合436(個体Bを除く段階1~3)分布図

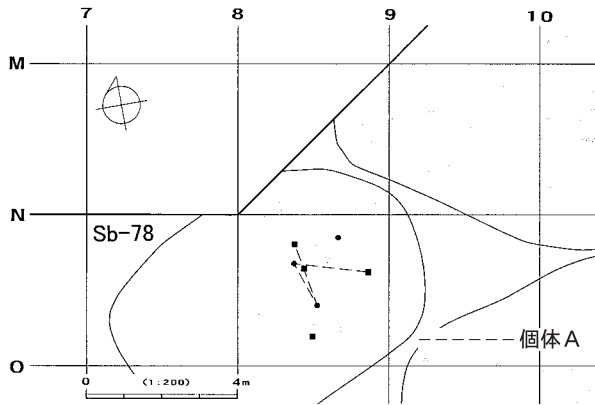

接合436(個体B)分布図

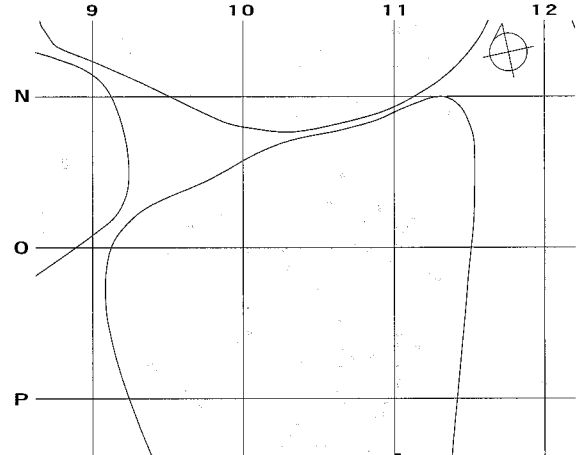

接合436(段階4・5)分布図

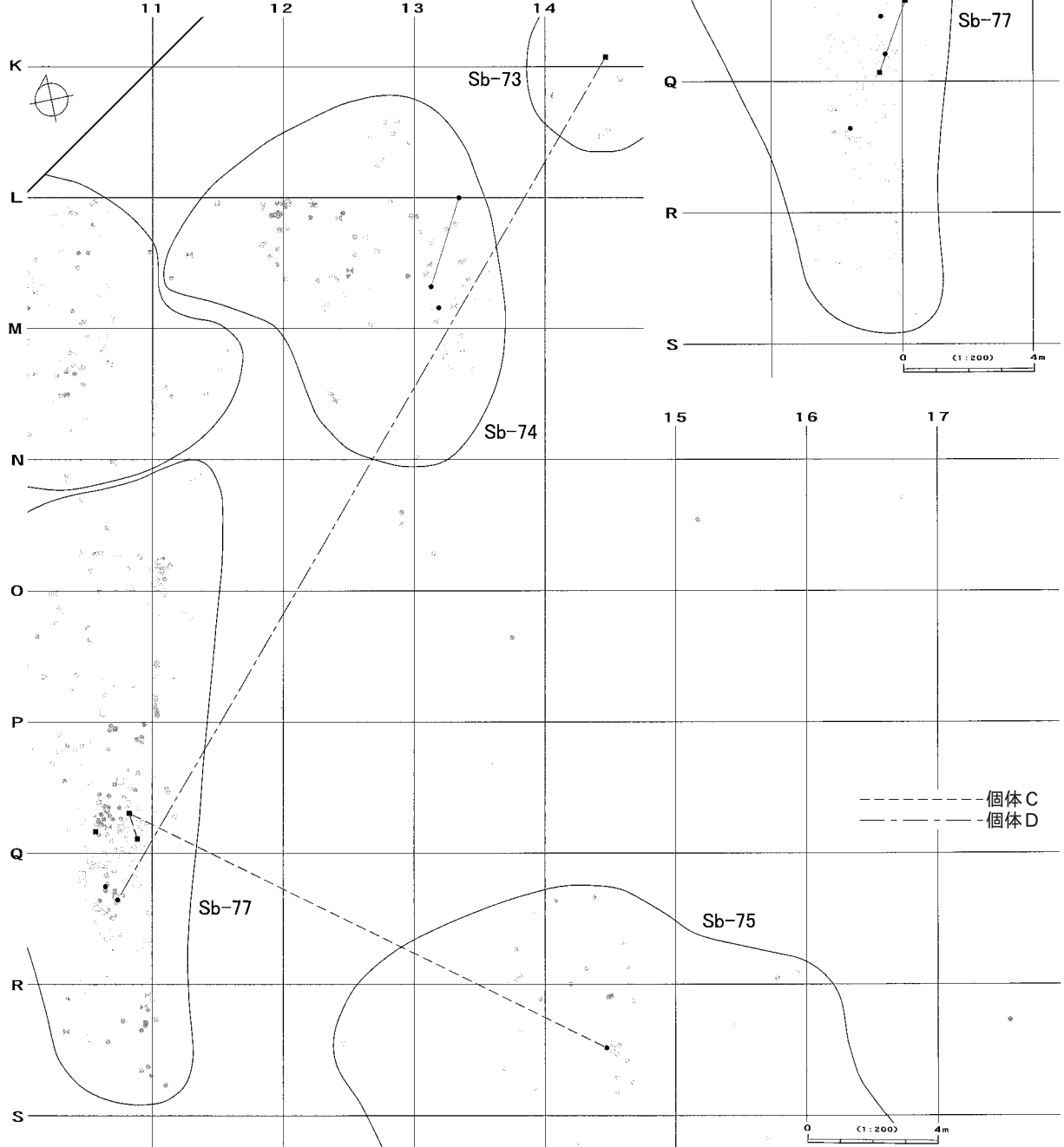

図Ⅲ-105 Sb-72~79の石器(18) 母岩533・接合436(3)

母岩533・接合437

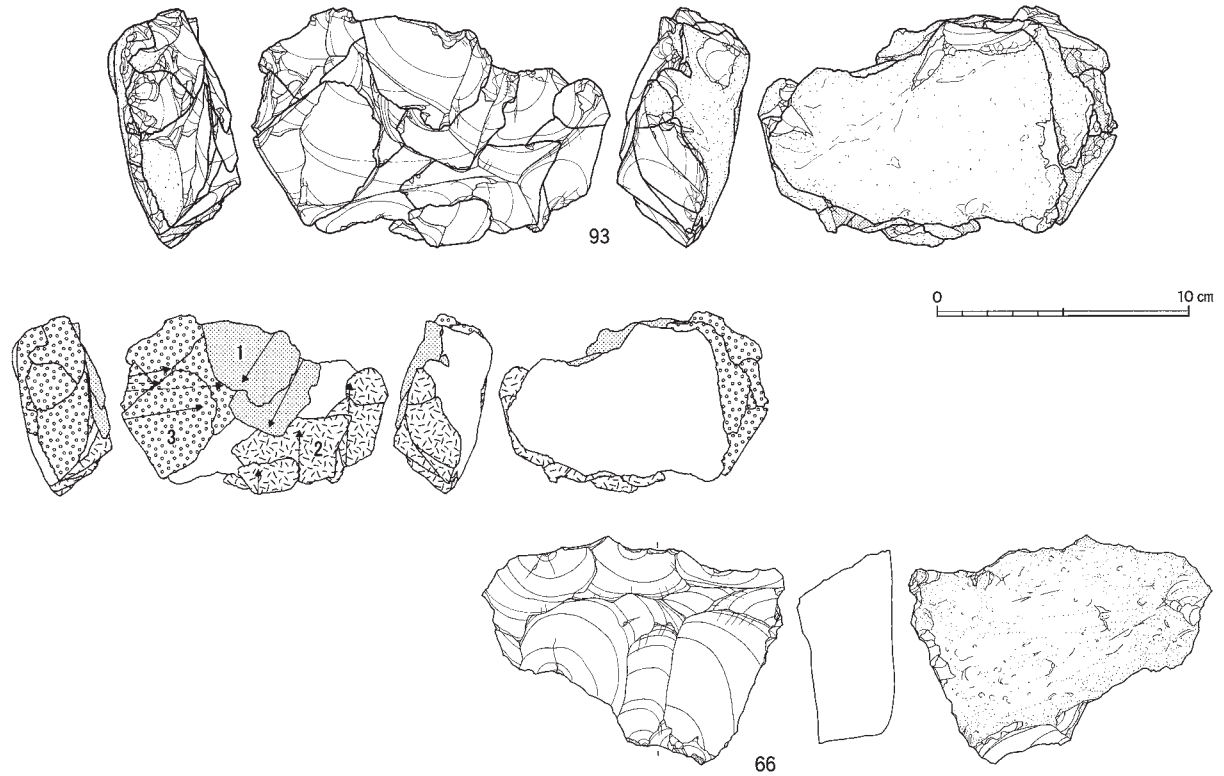

接合437分布図

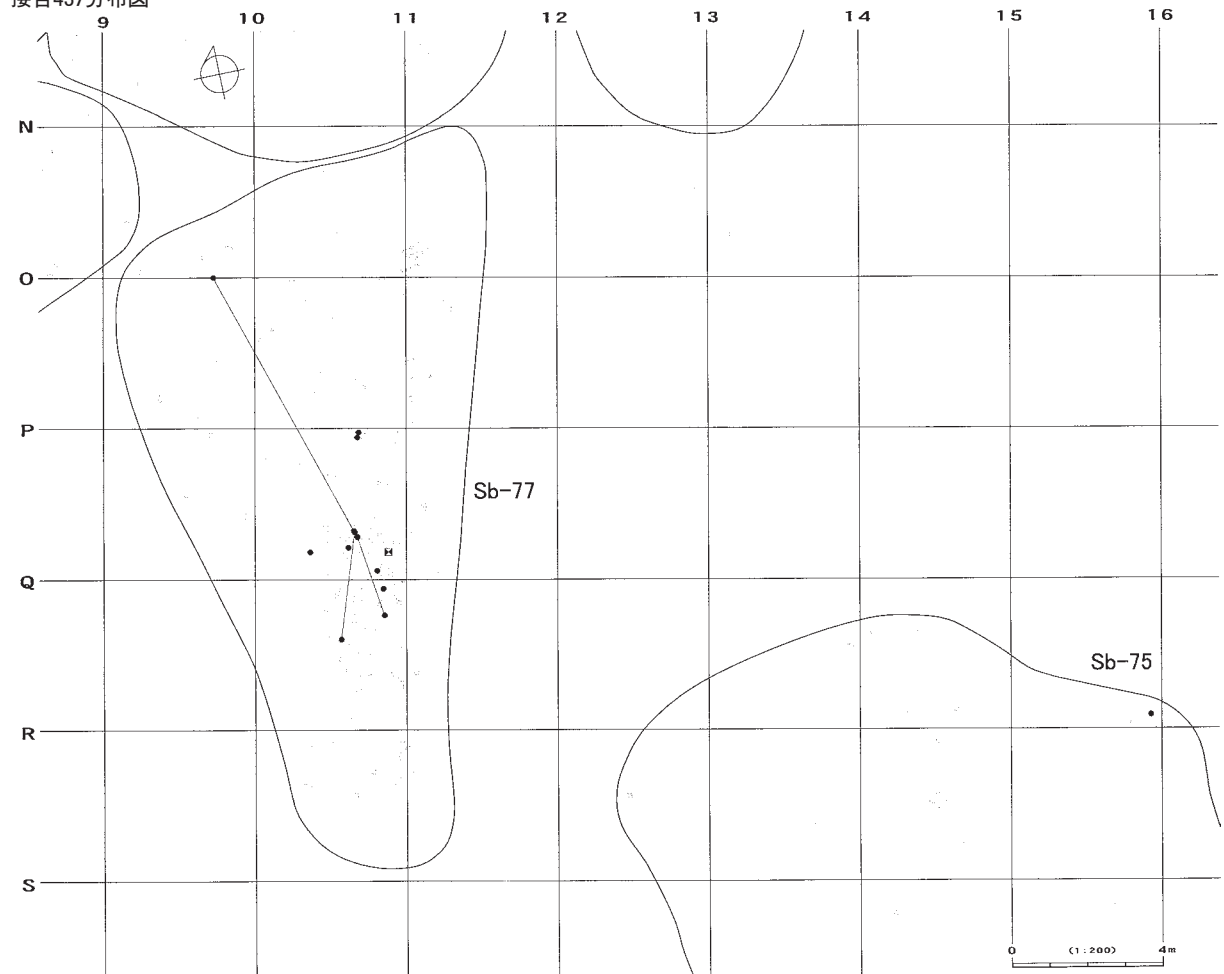

図Ⅲ-106 Sb-72~79の石器(19) 母岩533・接合437

母岩532・接合432

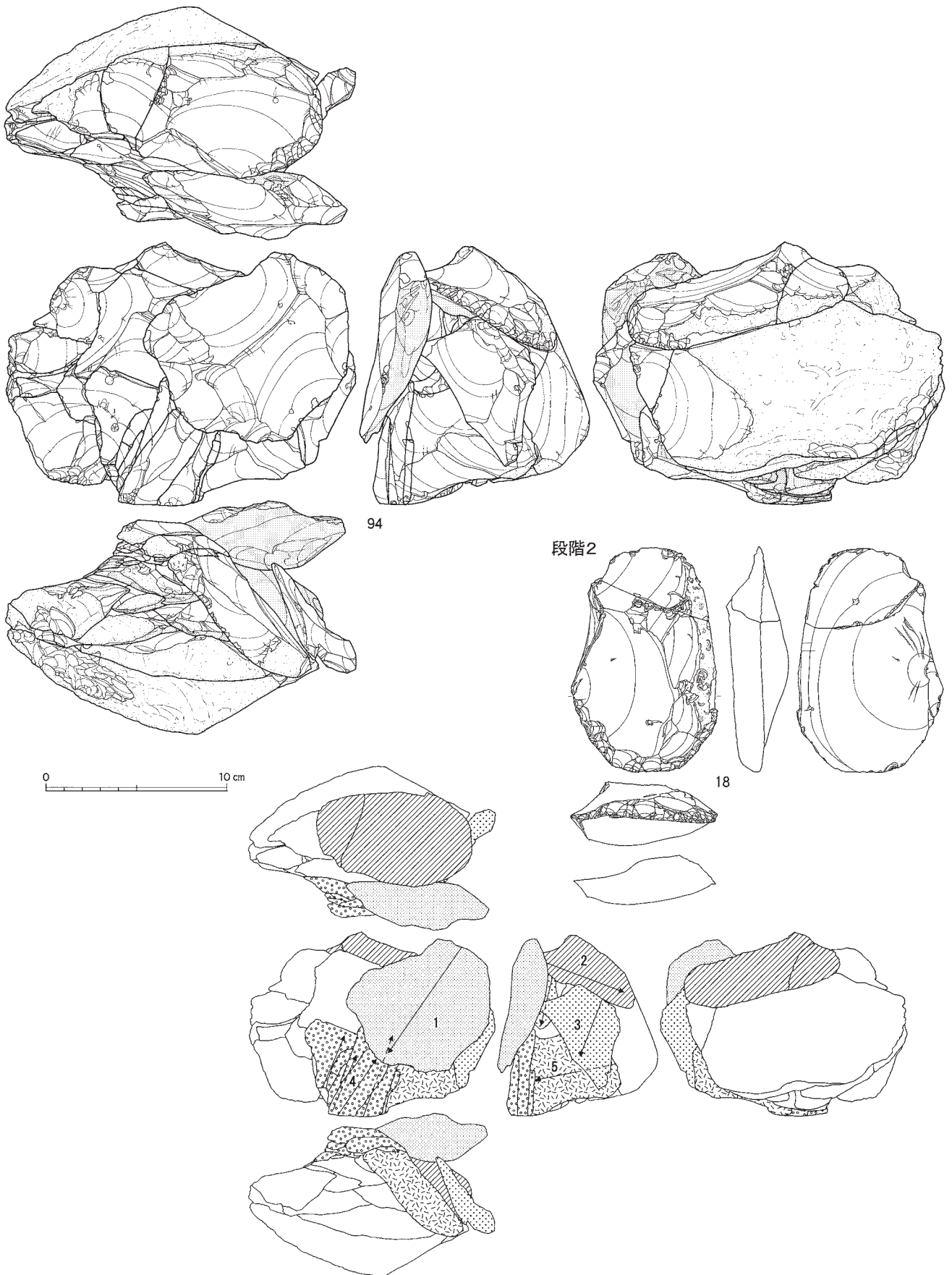

図Ⅲ-107 Sb-72~79の石器(20) 母岩532・接合432(1)

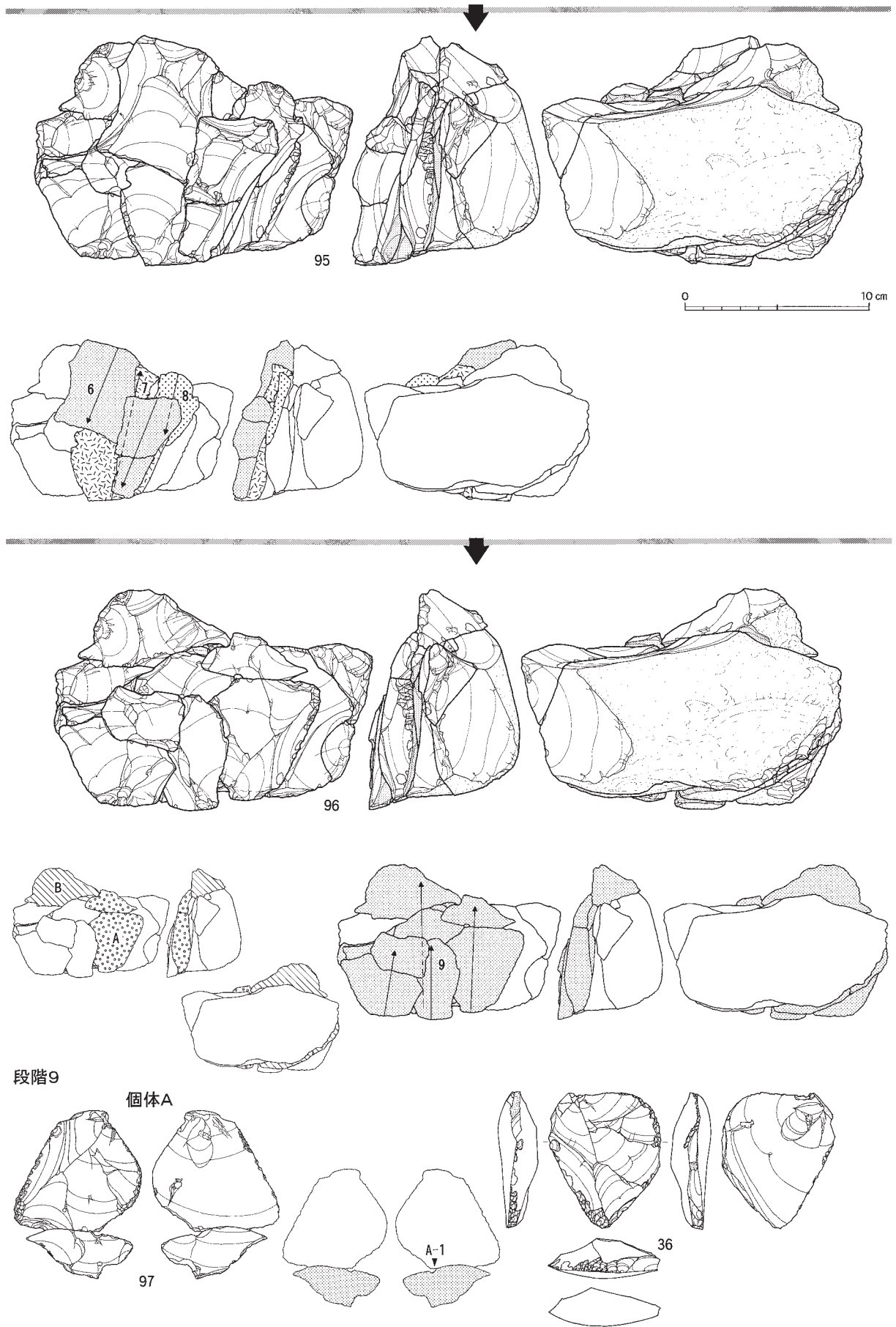

図Ⅲ-108 Sb-72~79の石器(21) 母岩532・接合432(2)

段階9

個体B

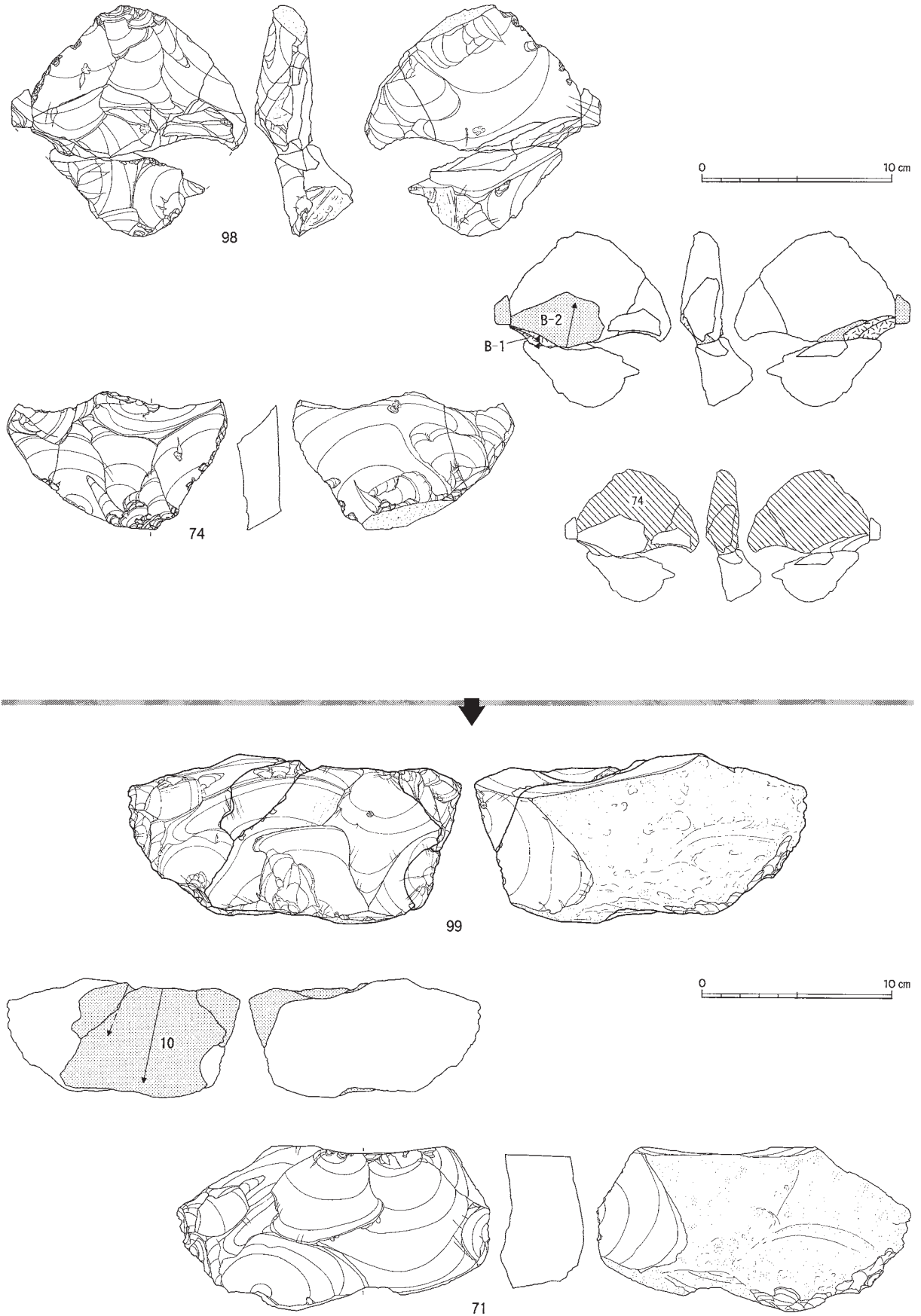

図Ⅲ-109 Sb-72~79の石器(22) 母岩532・接合432(3)

接合432分布図

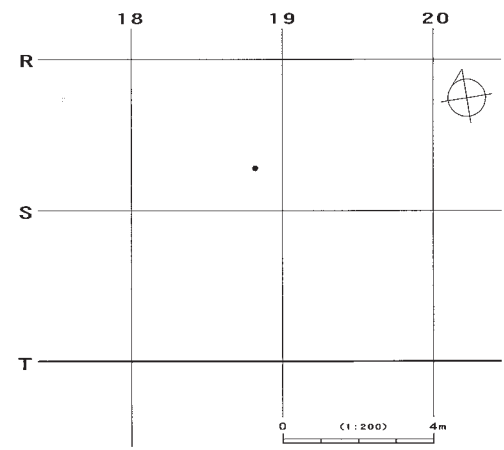
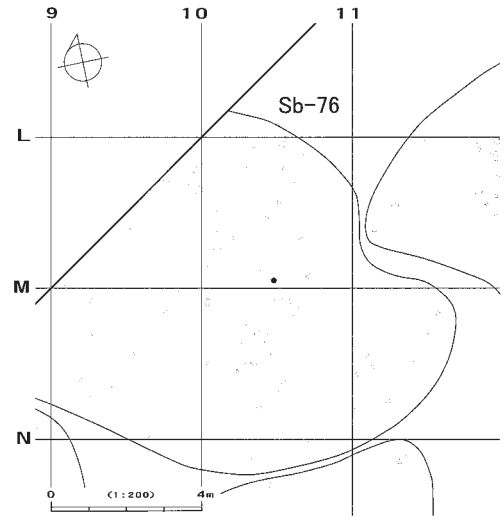
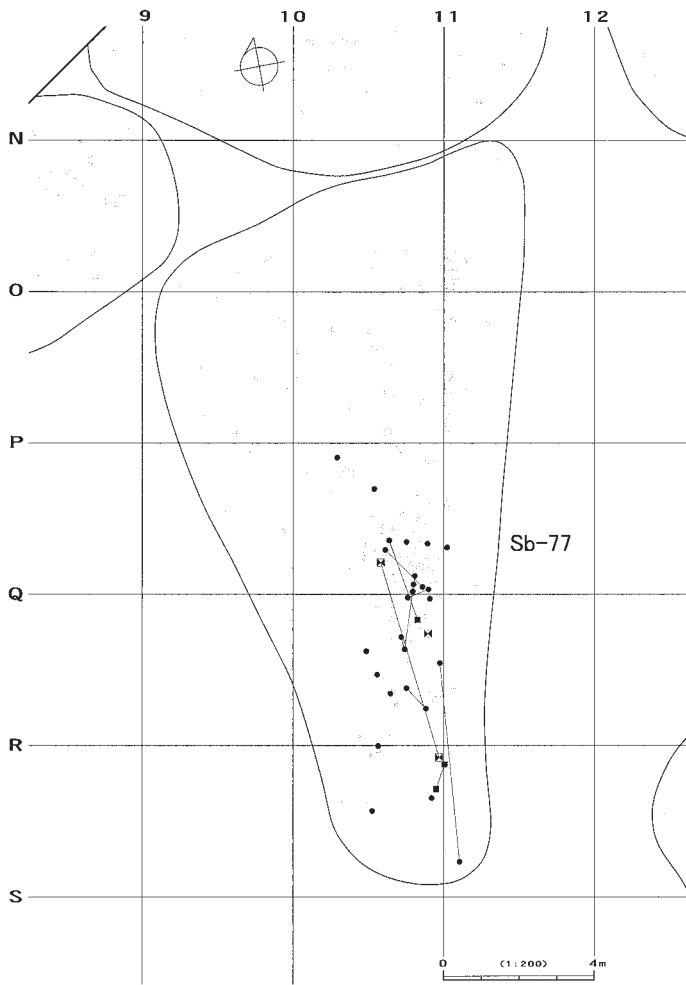
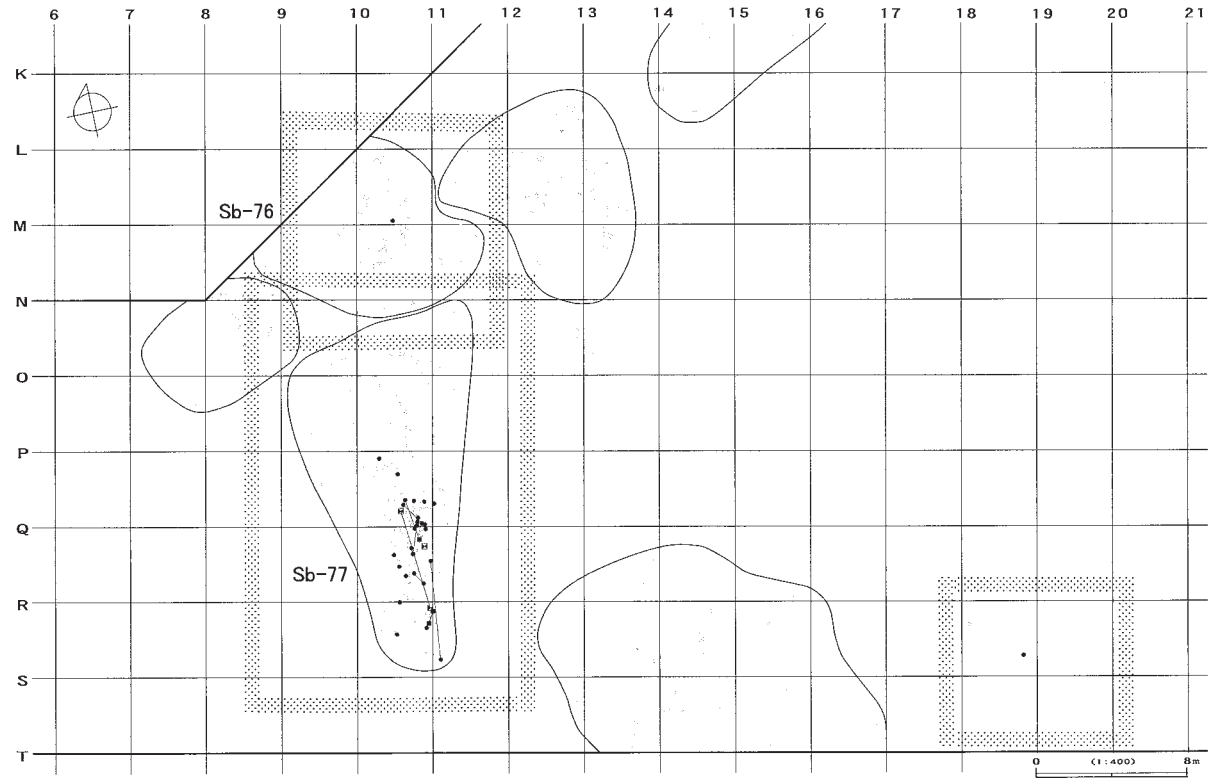

図Ⅲ-110 Sb-72~79の石器(23) 母岩532・接合432(4)

母岩532・接合420

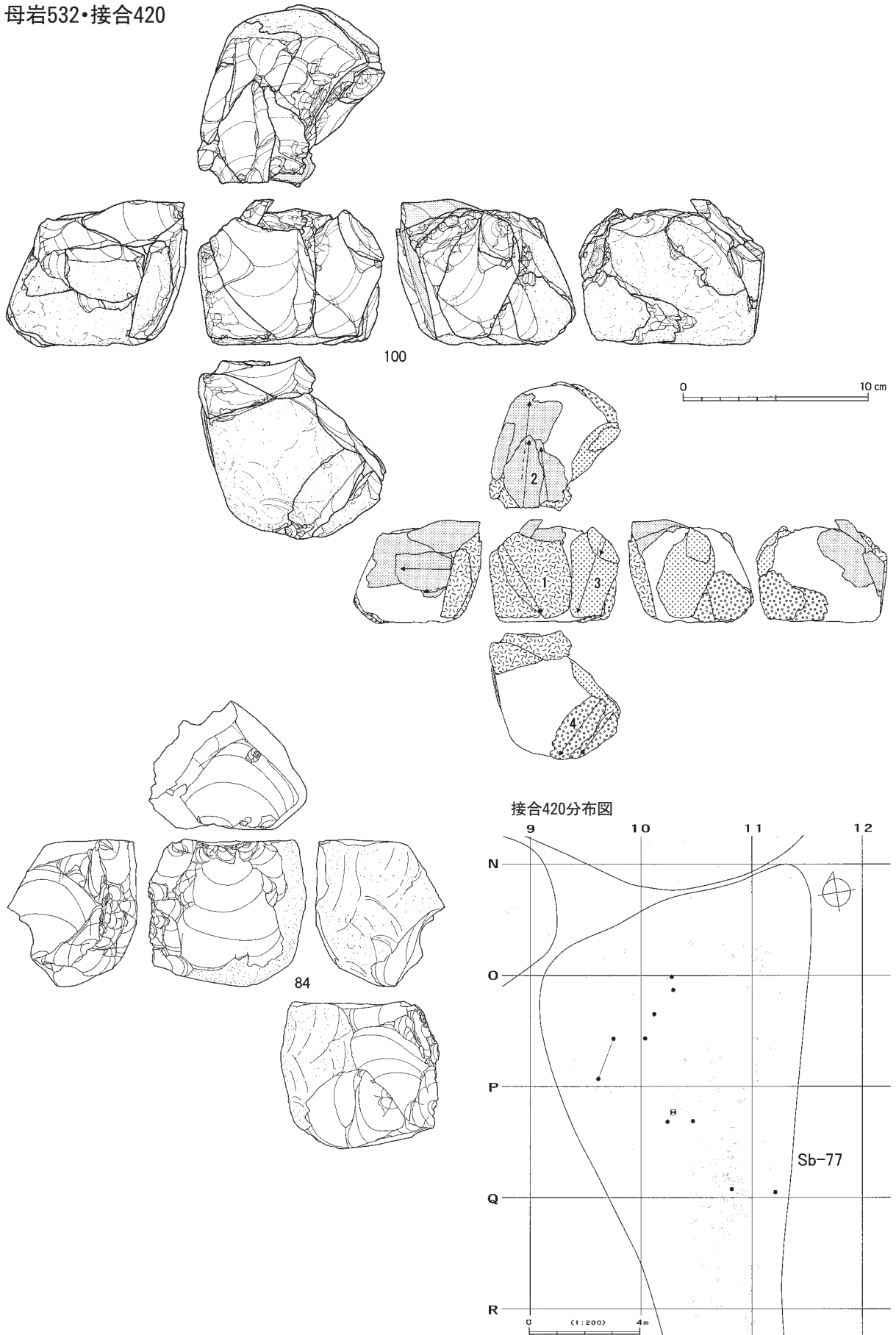

図Ⅲ-111 Sb-72~79の石器(24) 母岩523・接合420

母岩543・接合457

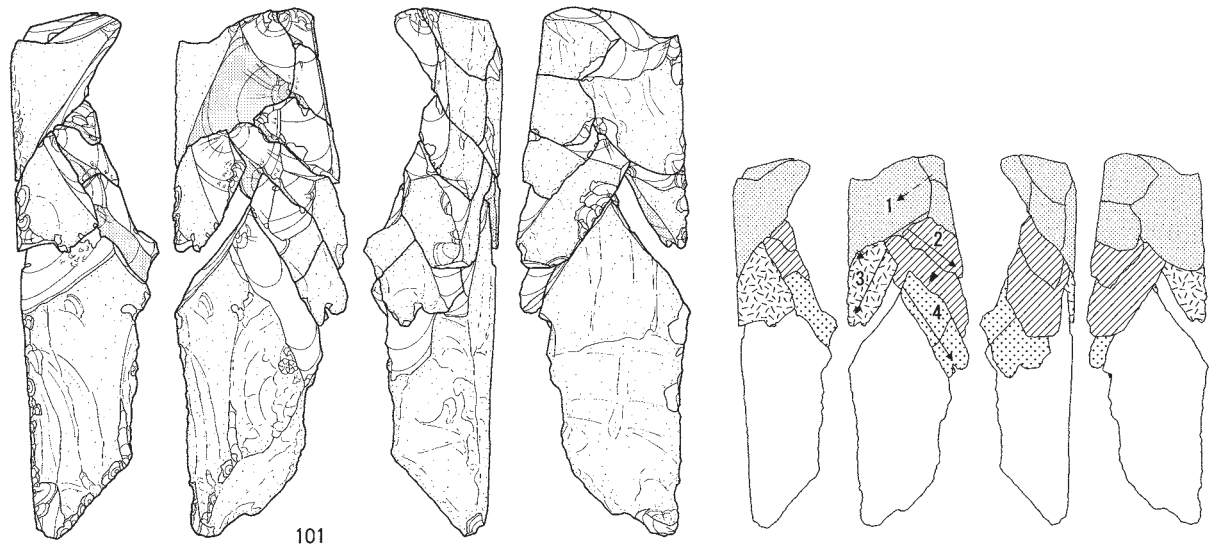

0 10 cm

段階2



接合457分布図

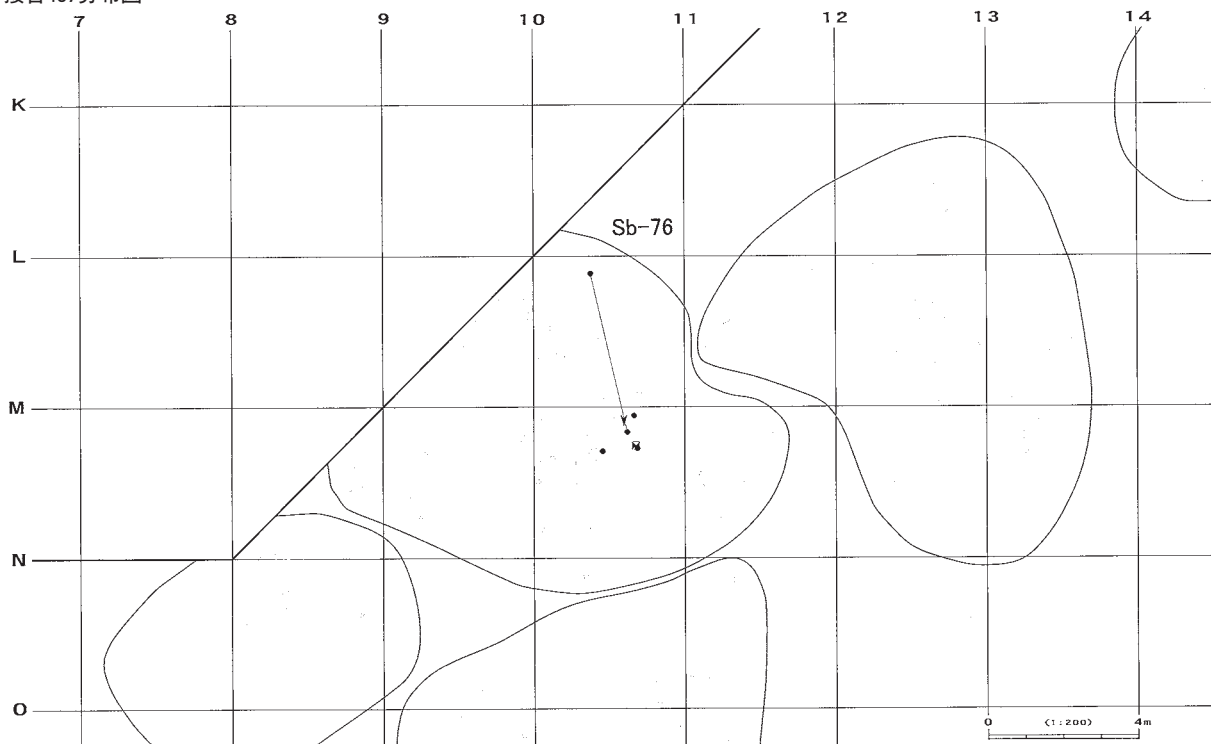

図Ⅲ-112 Sb-72~79の石器(25) 母岩543・接合457

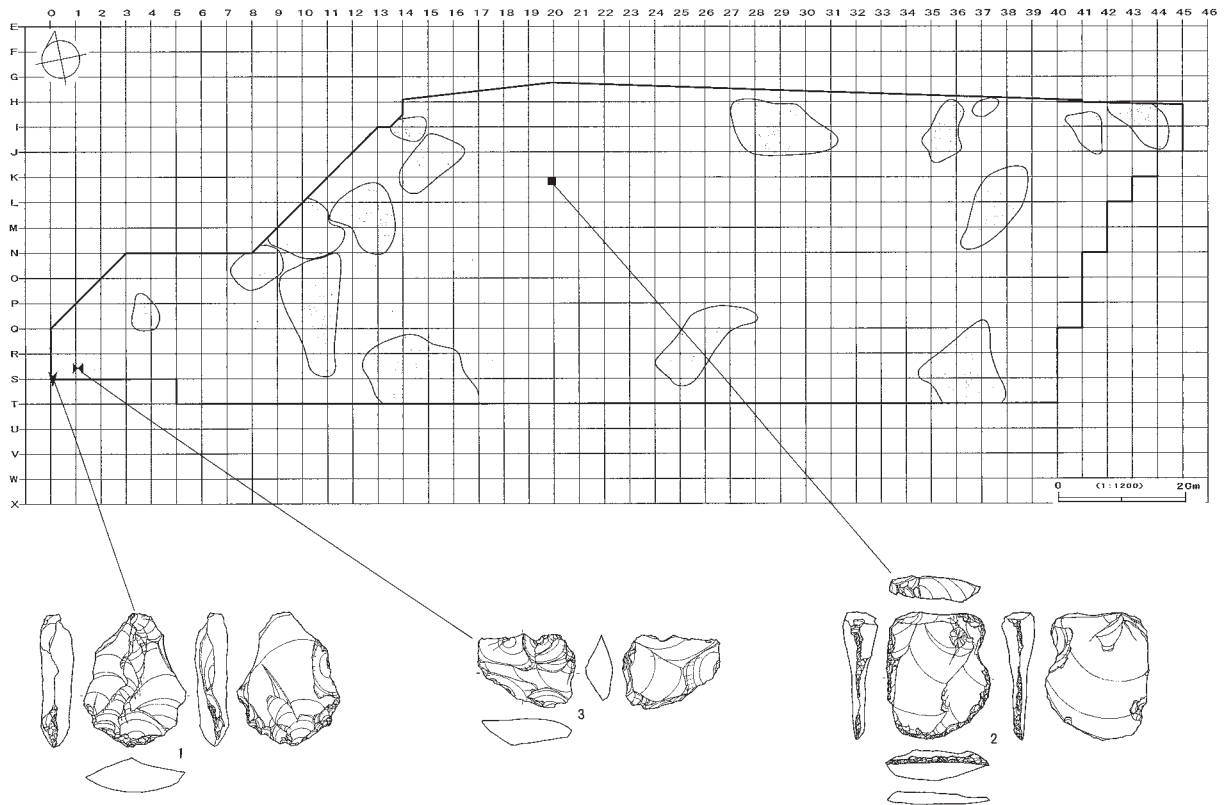
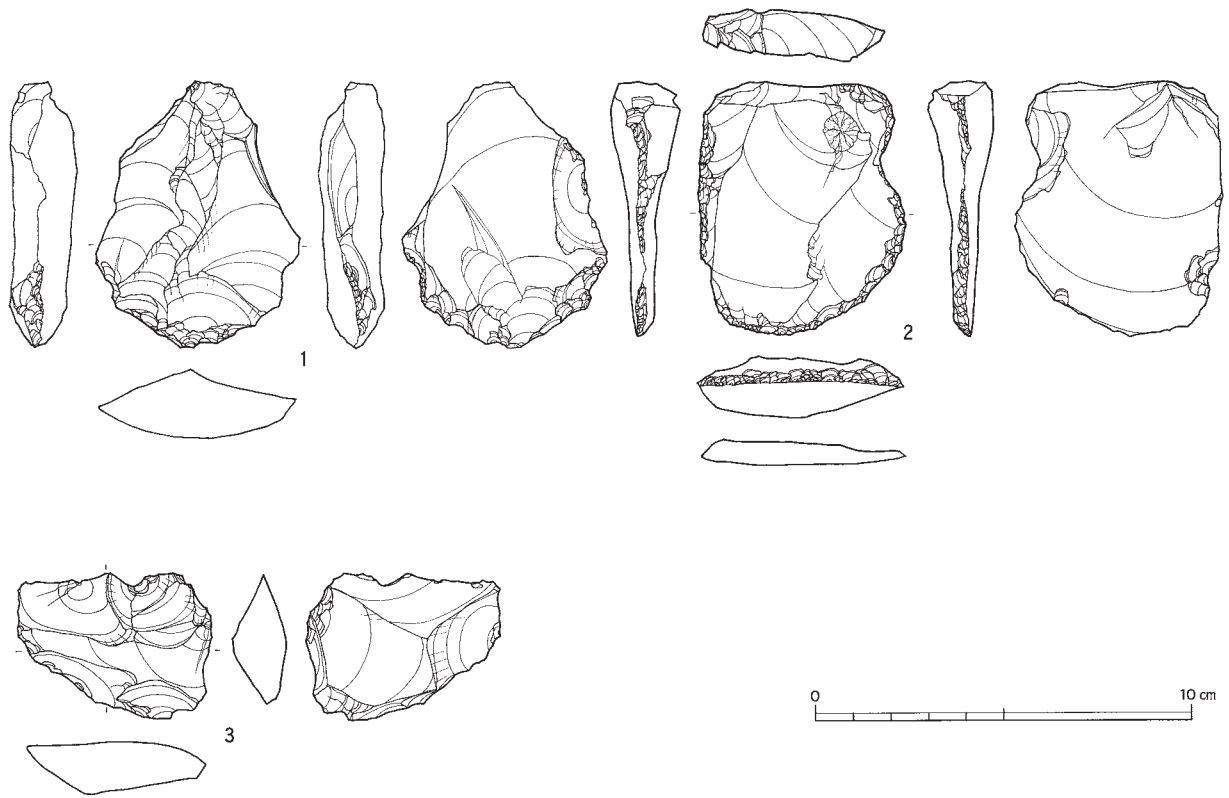

図Ⅲ-113 石器ブロック外の石器 二次加工ある剥片・搔器・石核、石器ブロック外の分布図

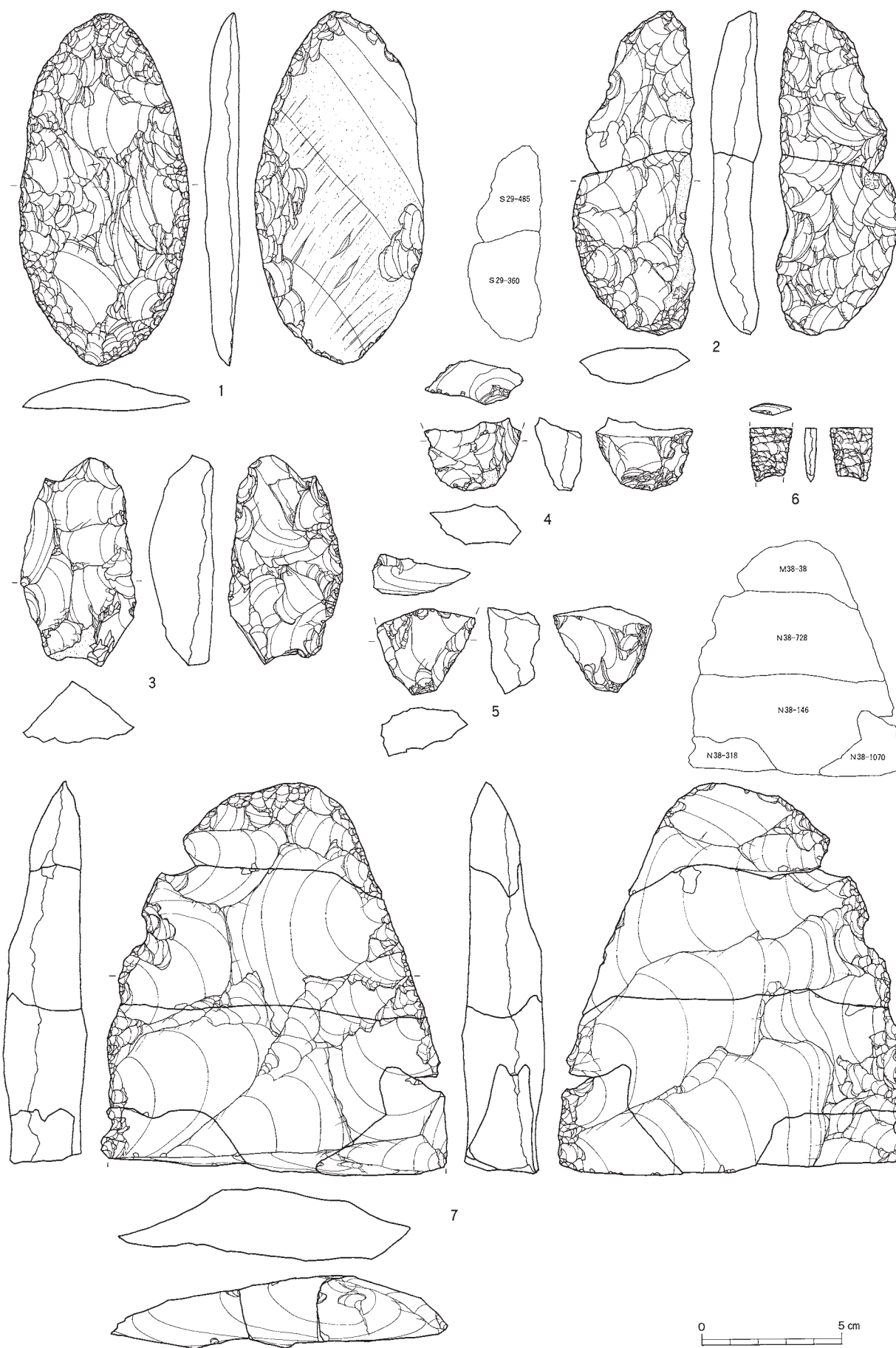

図Ⅲ-114 G区(Sb-80~89)の石器(1) 尖頭器



図Ⅲ-115 G区(Sb-80~89)の石器(2) 尖頭器・尖頭器削片



図Ⅲ-116 G区(Sb-80~89)の石器(3) 尖頭器削片・両面調整石器・ナイフ形石器・彫器

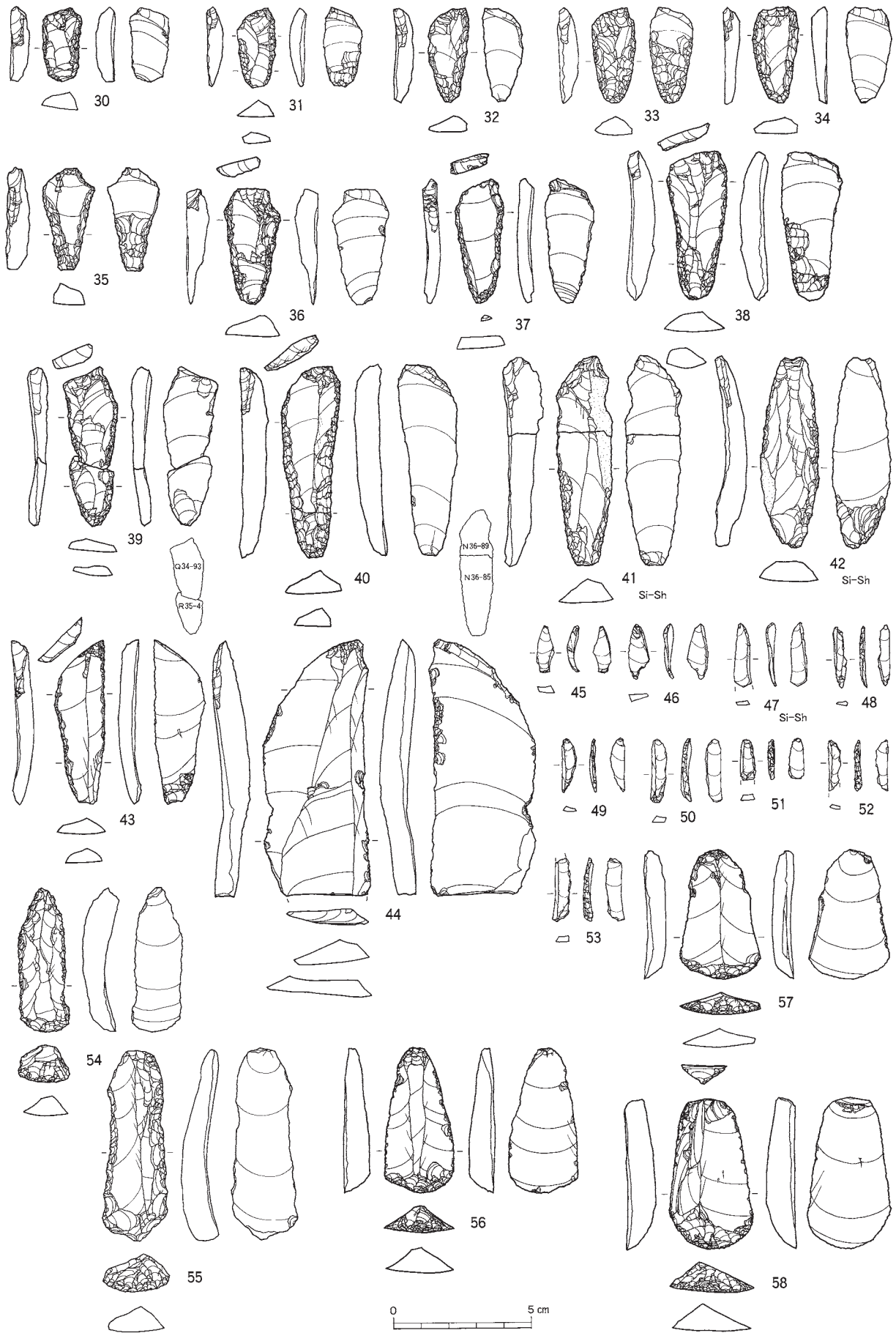

図III-117 G区(Sb-80~89)の石器(4) 彫器・彫器削片・搔器

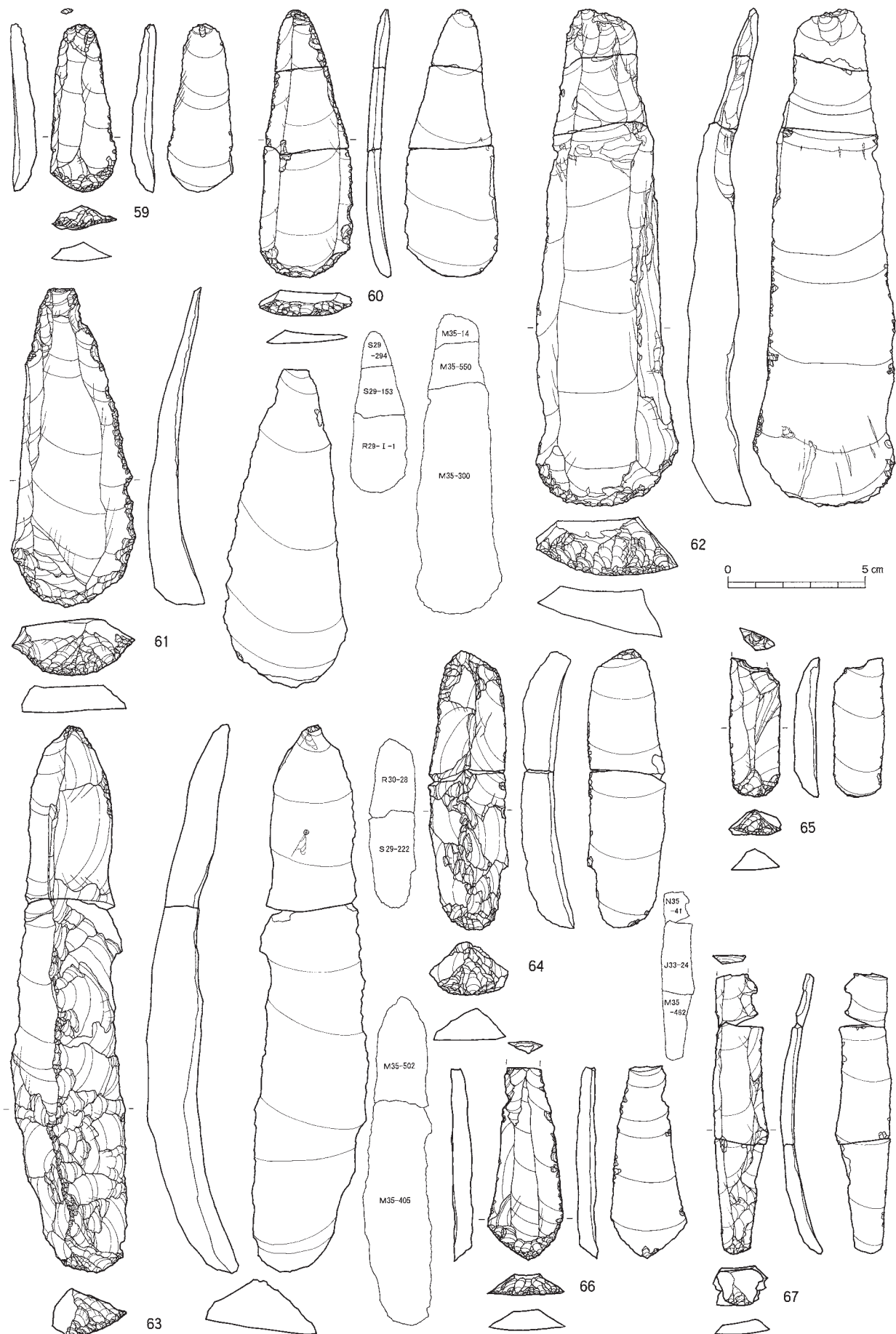

図III-118 G区(Sb-80~89)の石器(5) 搔器

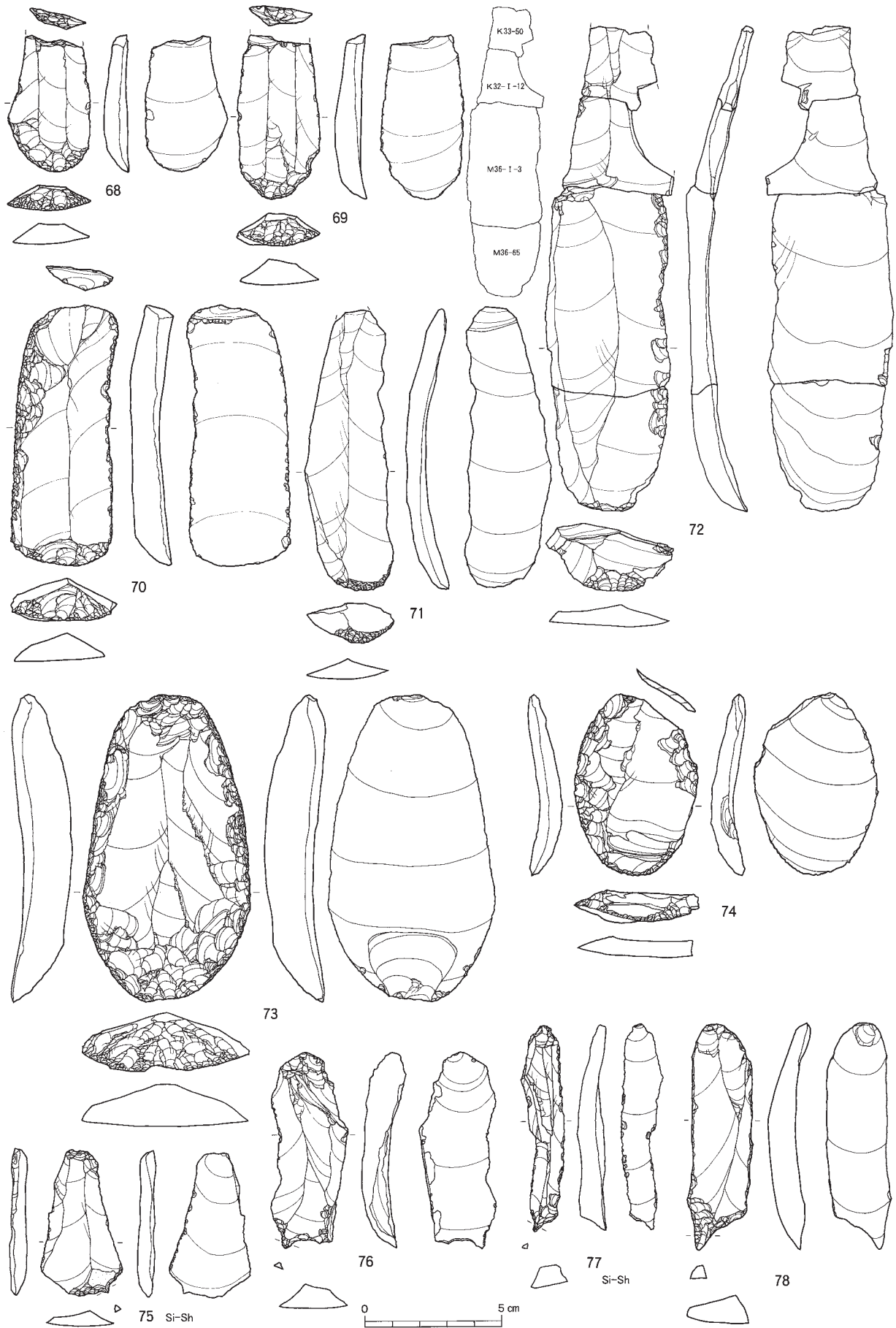

図III-119 G区(Sb-80~89)の石器(6) 搔器・錐形石器

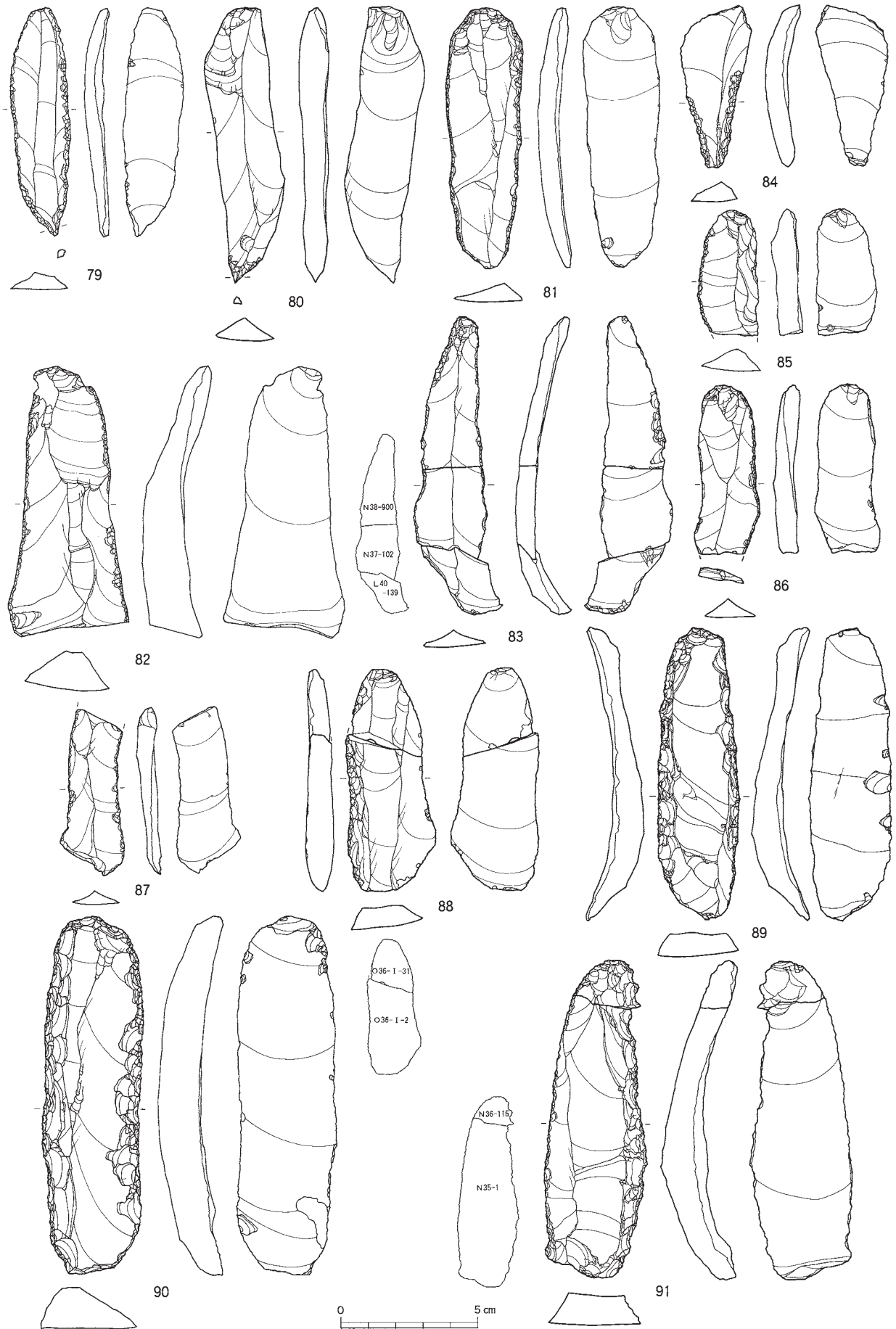

図Ⅲ-120 G区(Sb-80~89)の石器(7) 錐形石器・削器



図III-121 G区(Sb-80~89)の石器(8) 削器

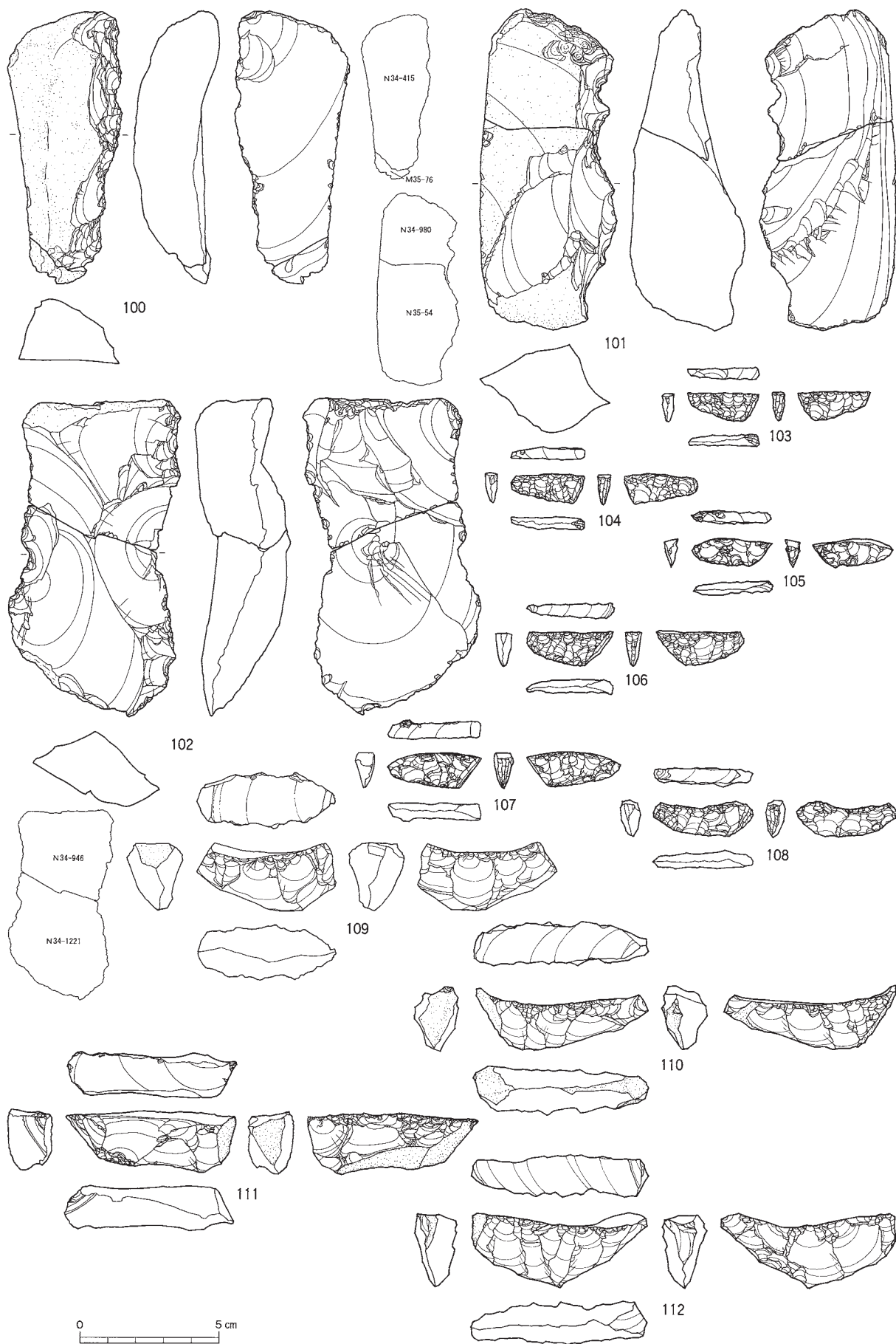

図Ⅲ-122 G区(Sb-80~89)の石器(9) 削器・舟底形石器

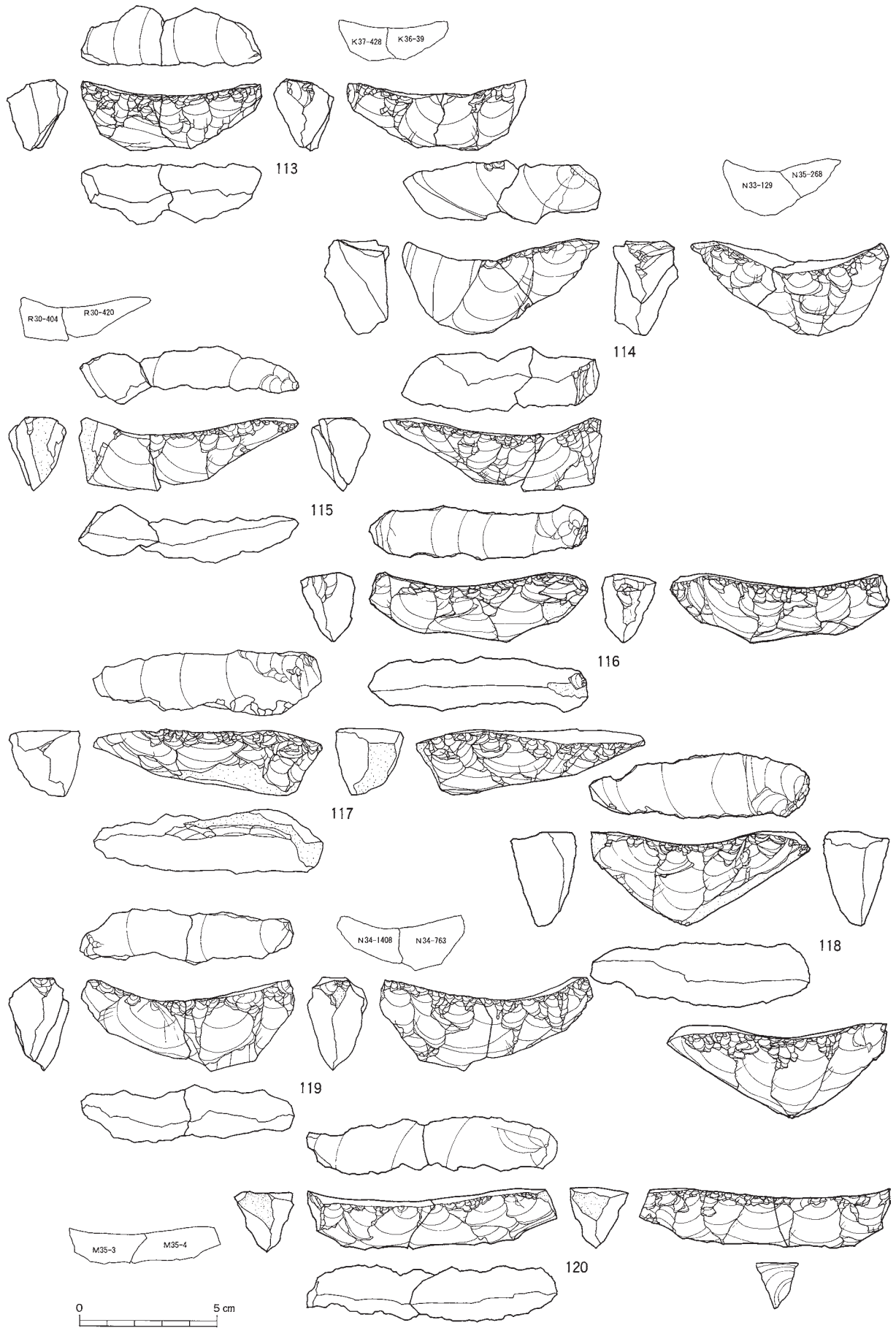

図Ⅲ-123 G区(Sb-80~89)の石器(10) 舟底形石器



图Ⅲ-124 G区(Sb-80~89)の石器(11) 舟底形石器

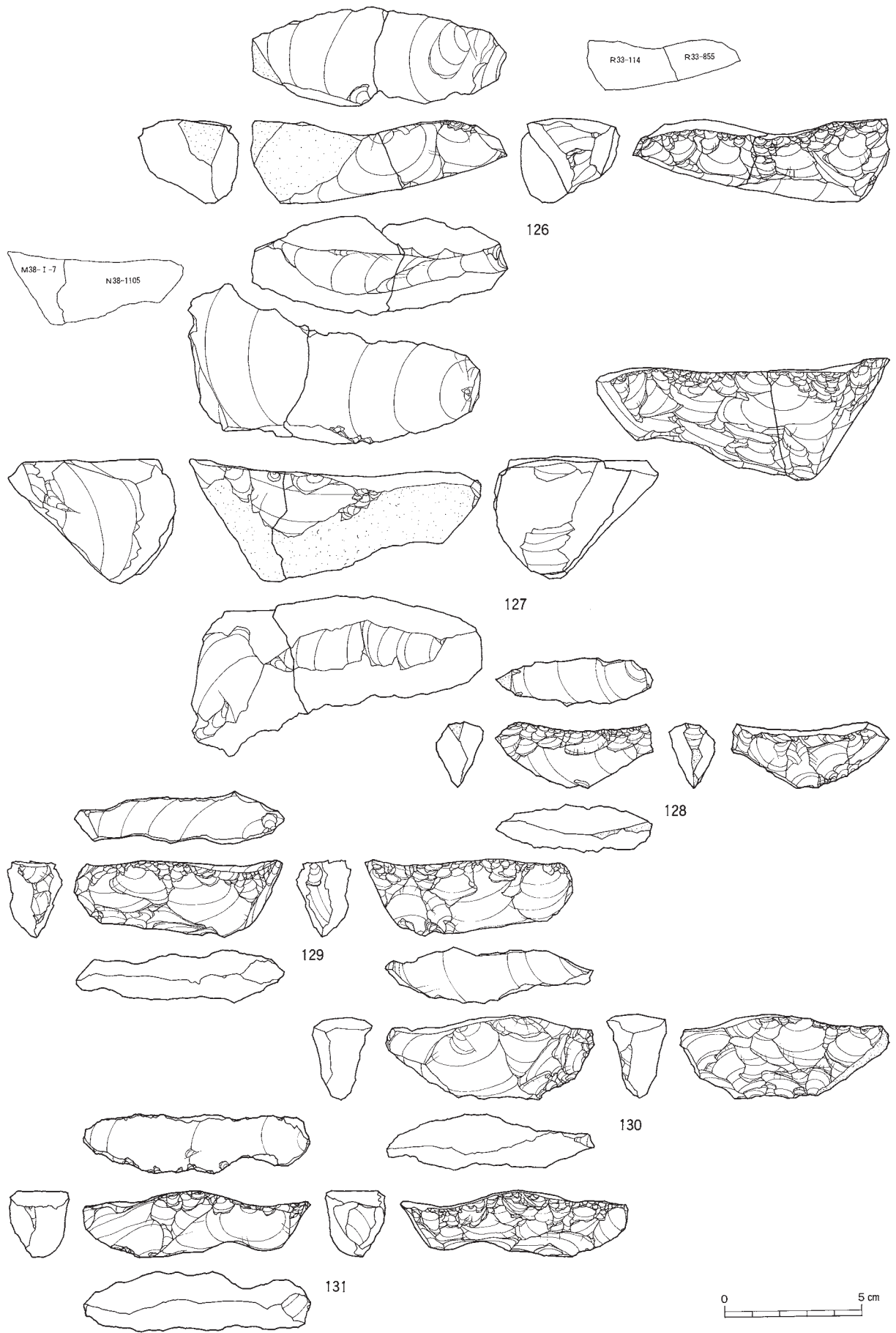

図Ⅲ-125 G区(Sb-80~89)の石器(12) 舟底形石器

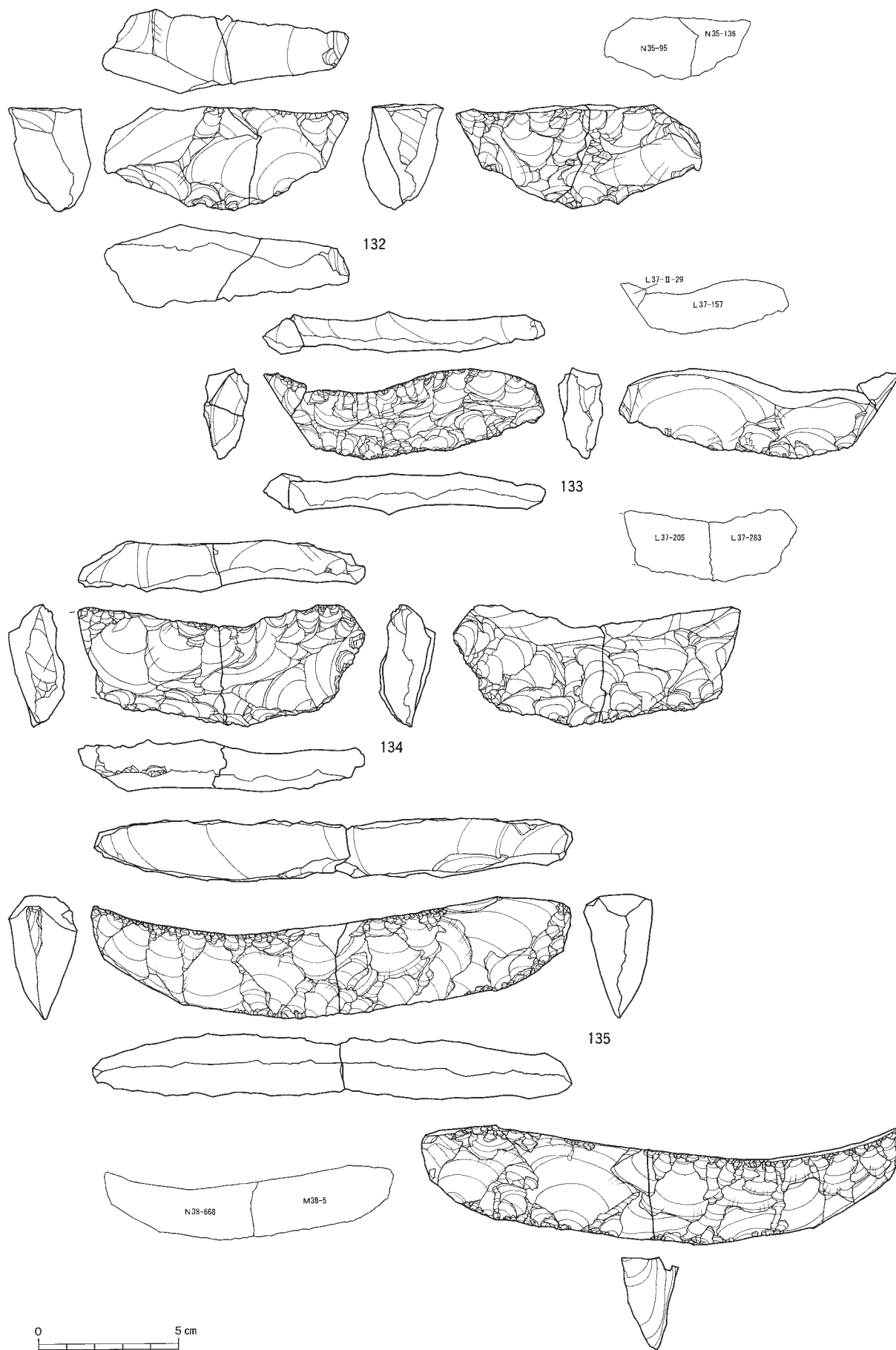

図Ⅲ-126 G区(Sb-80~89)の石器(13) 舟底形石器

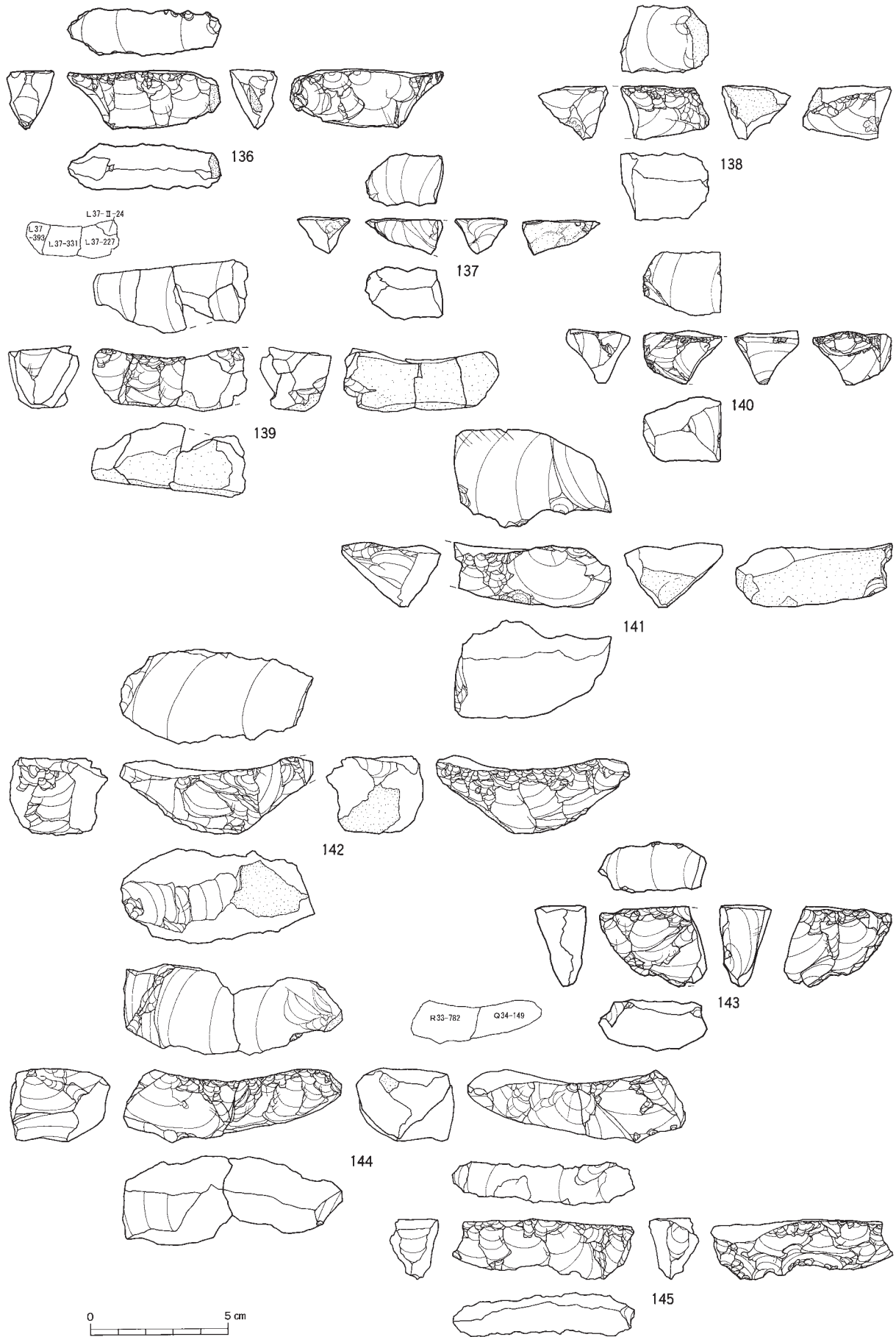

図Ⅲ-127 G区(Sb-80~89)の石器(14) 舟底形石器

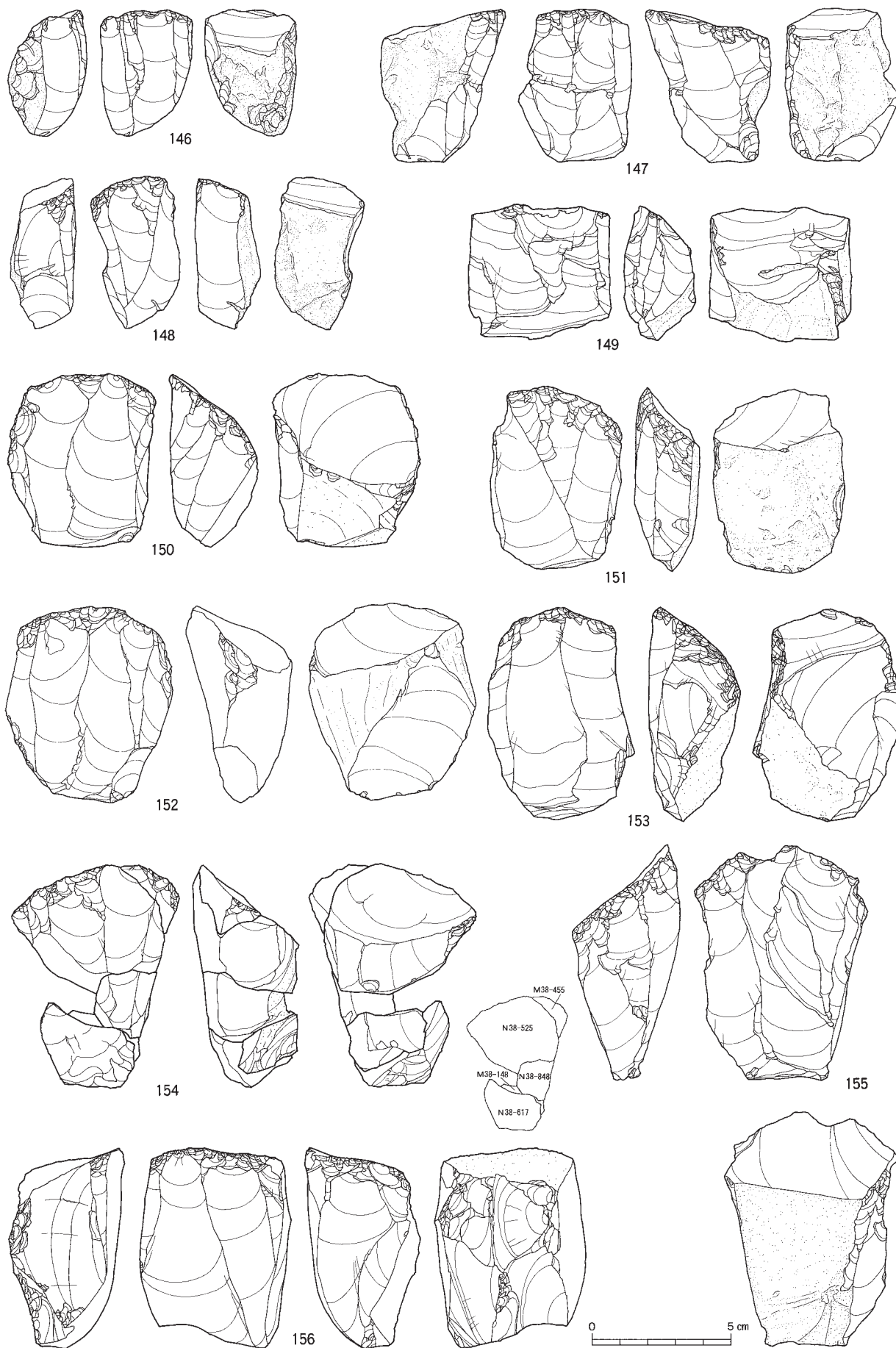

図Ⅲ-128 G区(Sb-80~89)の石器(15) 石刃核

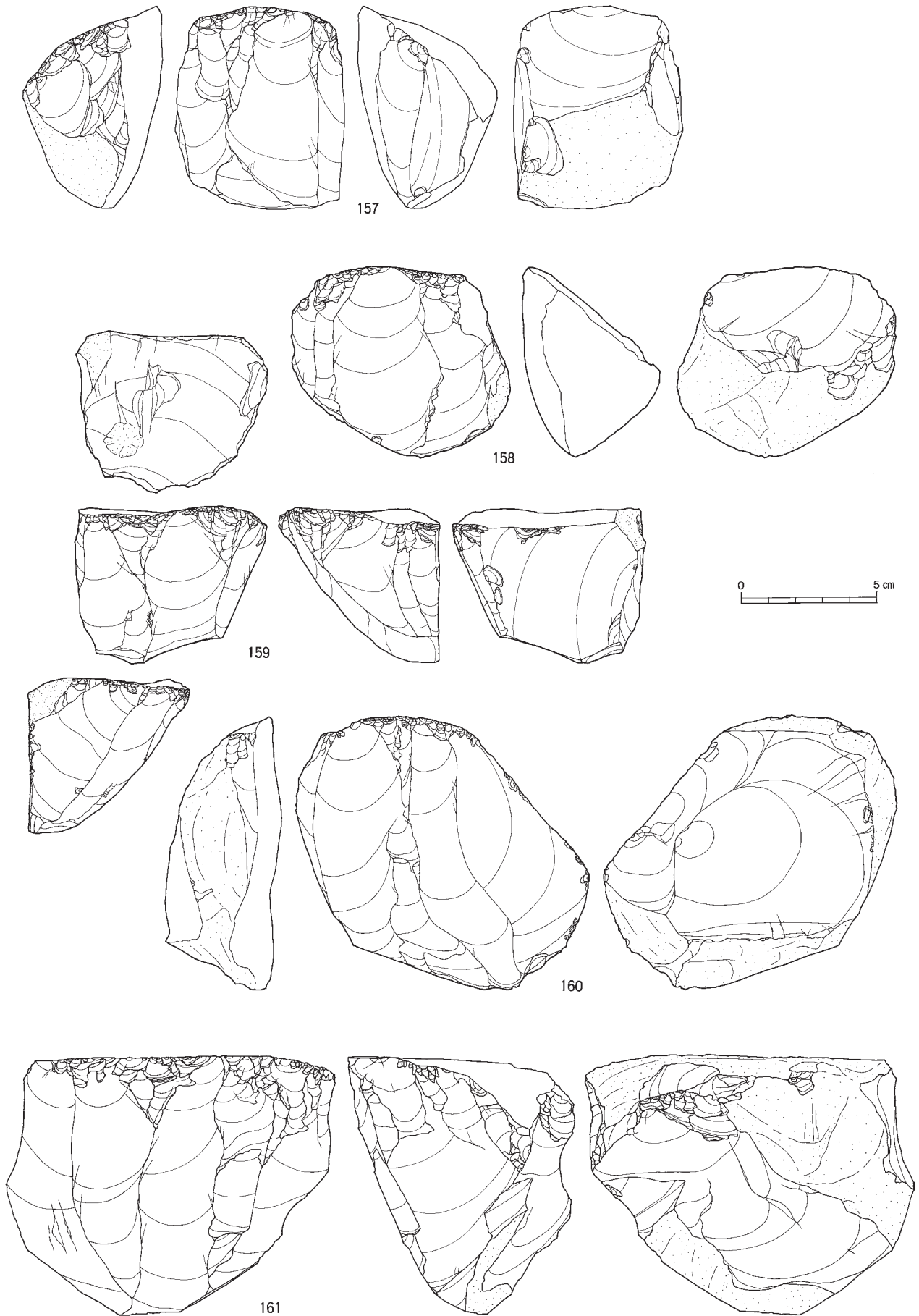

図Ⅲ-129 G区(Sb-80~89)の石器(16) 石刃核

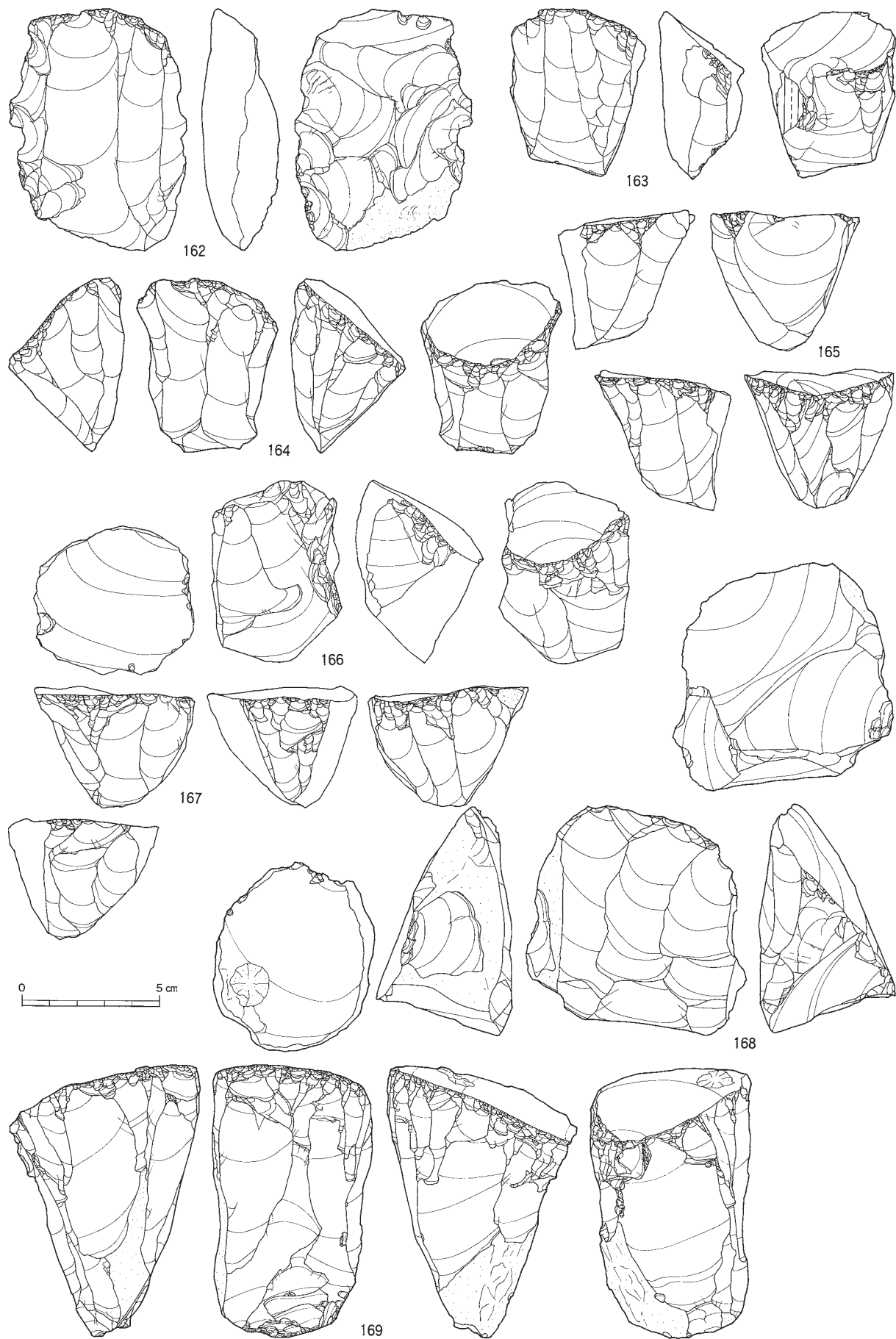

図Ⅲ-130 G区(Sb-80~89)の石器(17) 石刃核

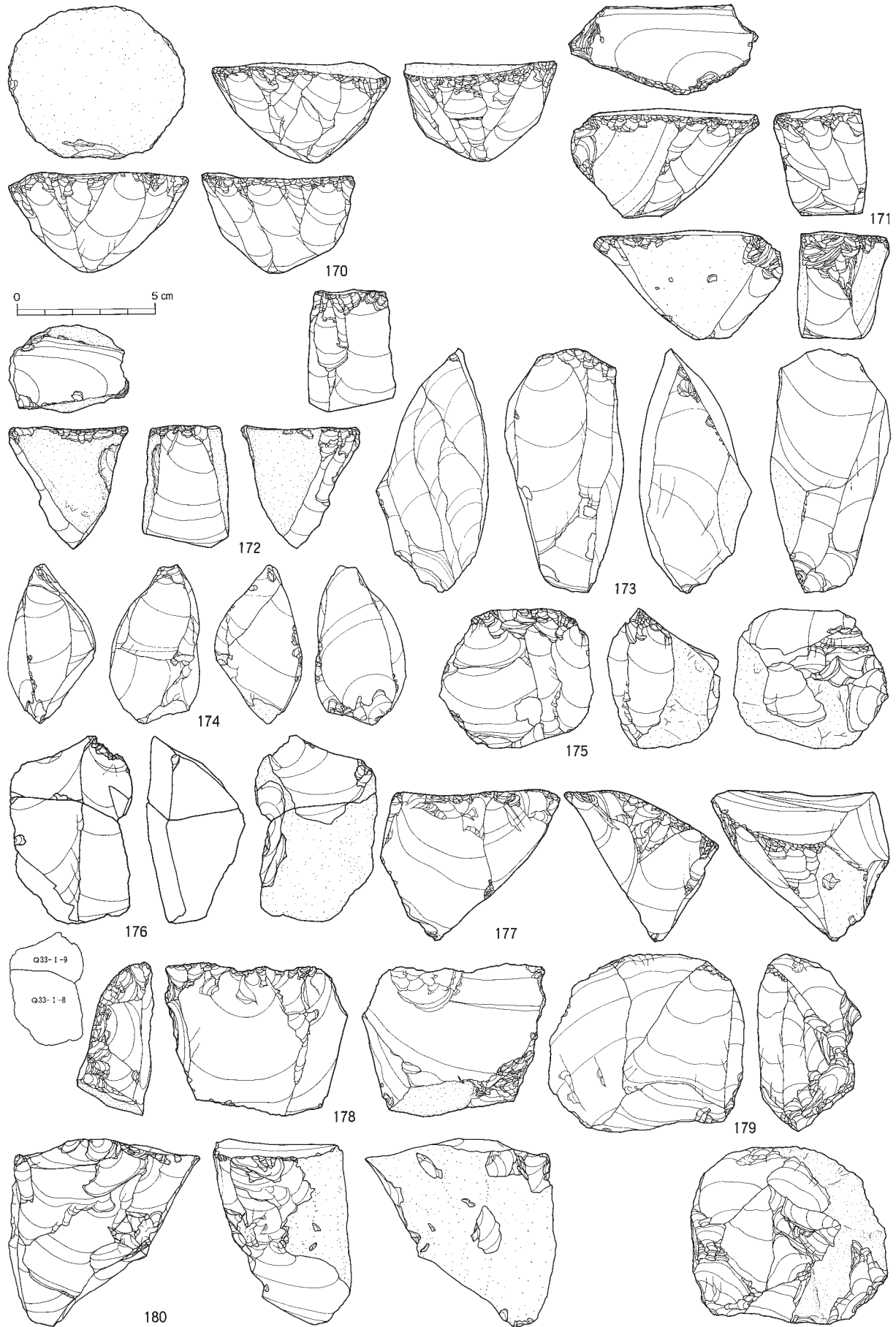

図Ⅲ-131 G区(Sb-80~89)の石器(18) 石刃核・石核

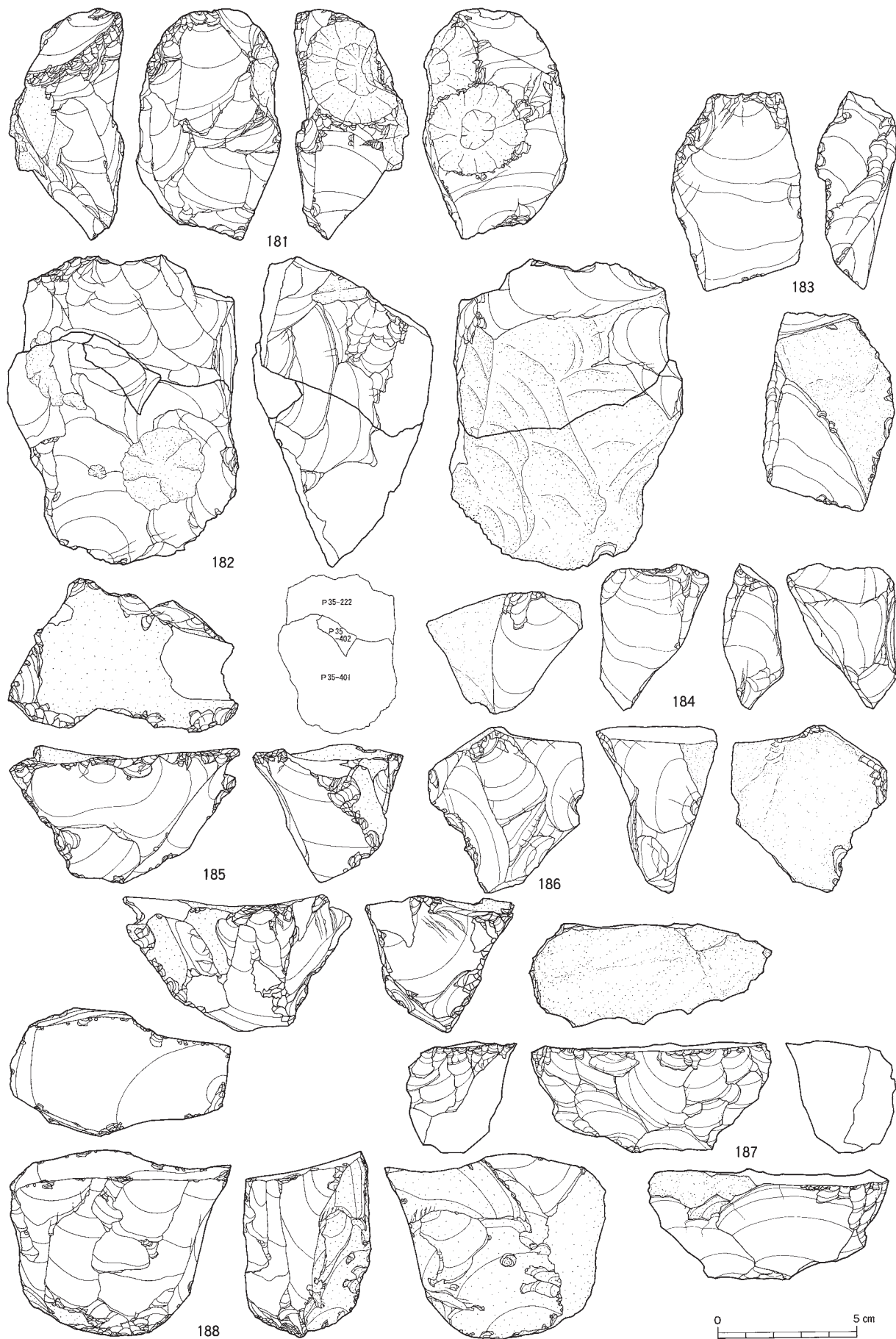

図Ⅲ-132 G区(Sb-80~89)の石器(19) 石核

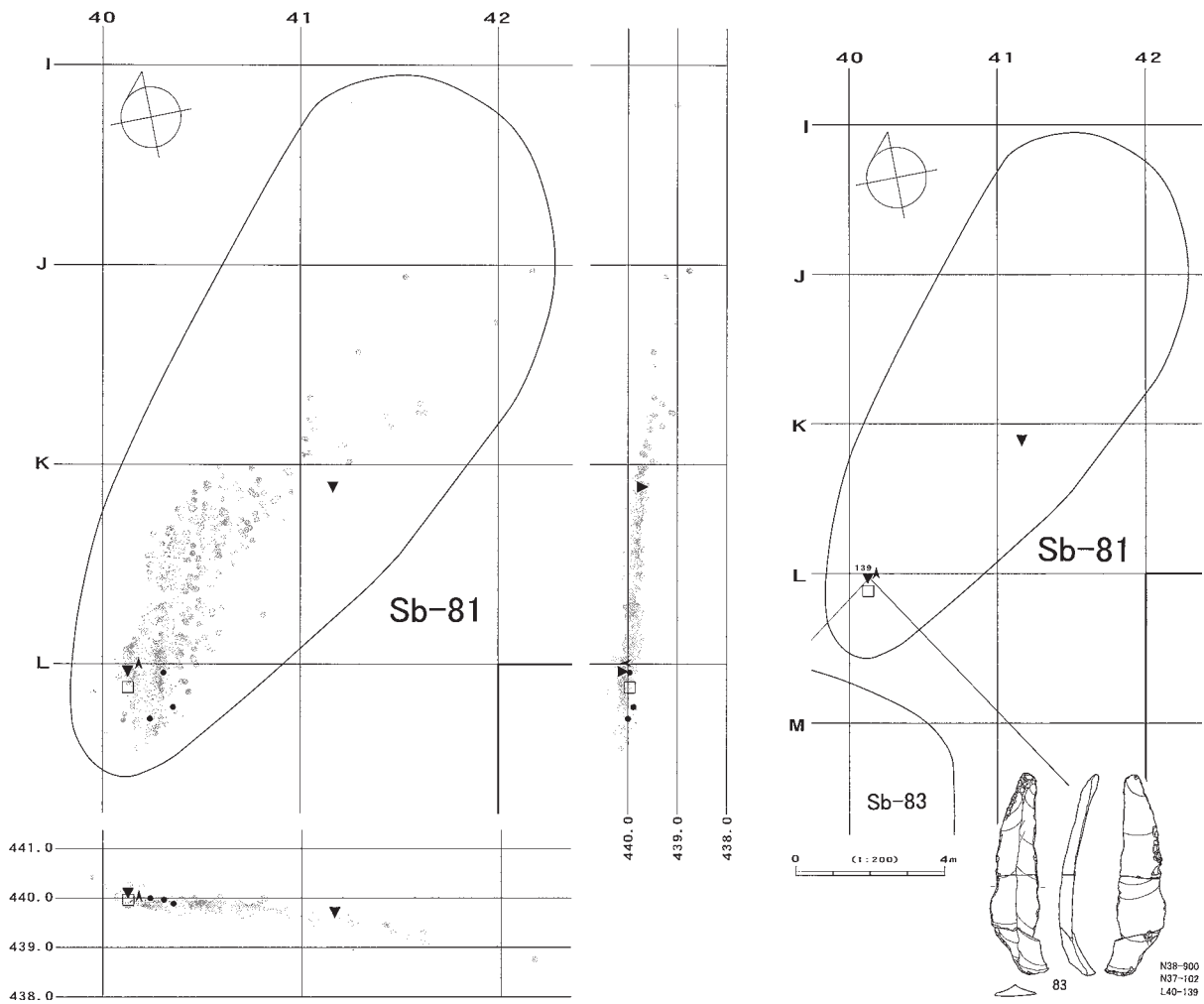
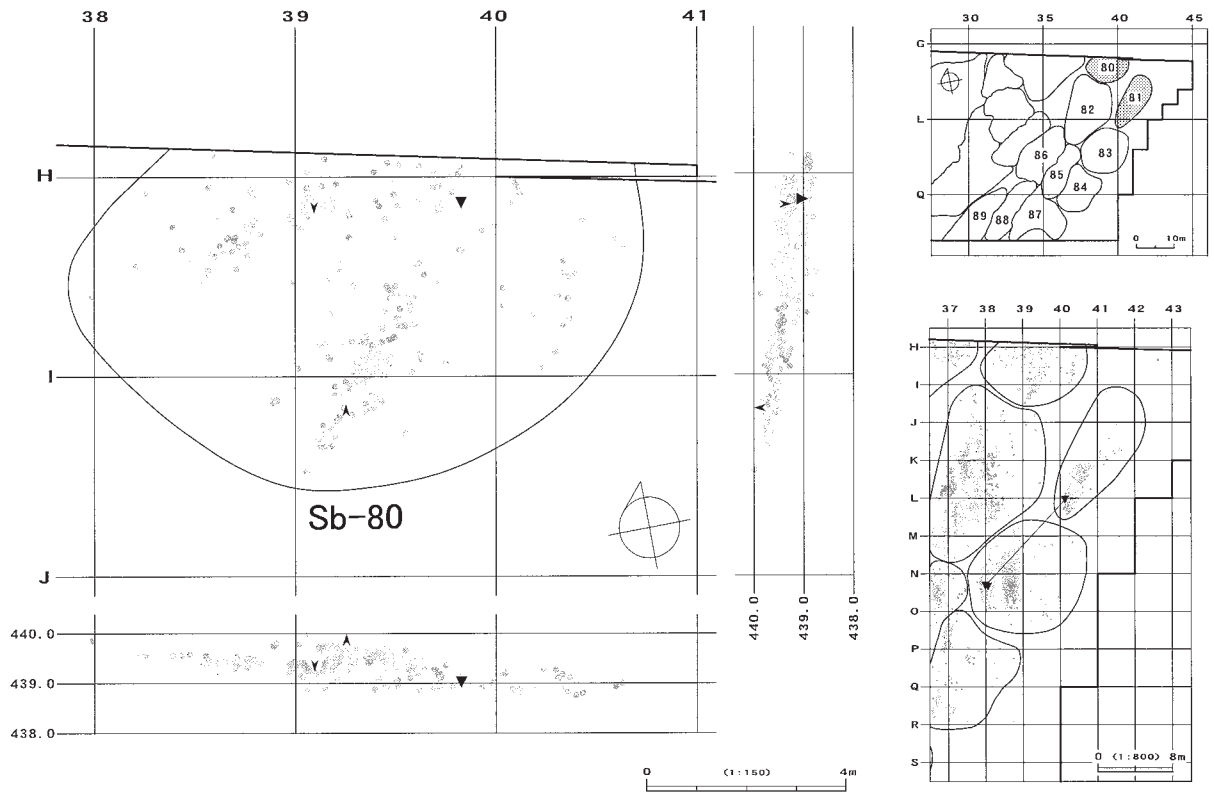

図Ⅲ-133 Sb-80・81の分布図・遺物

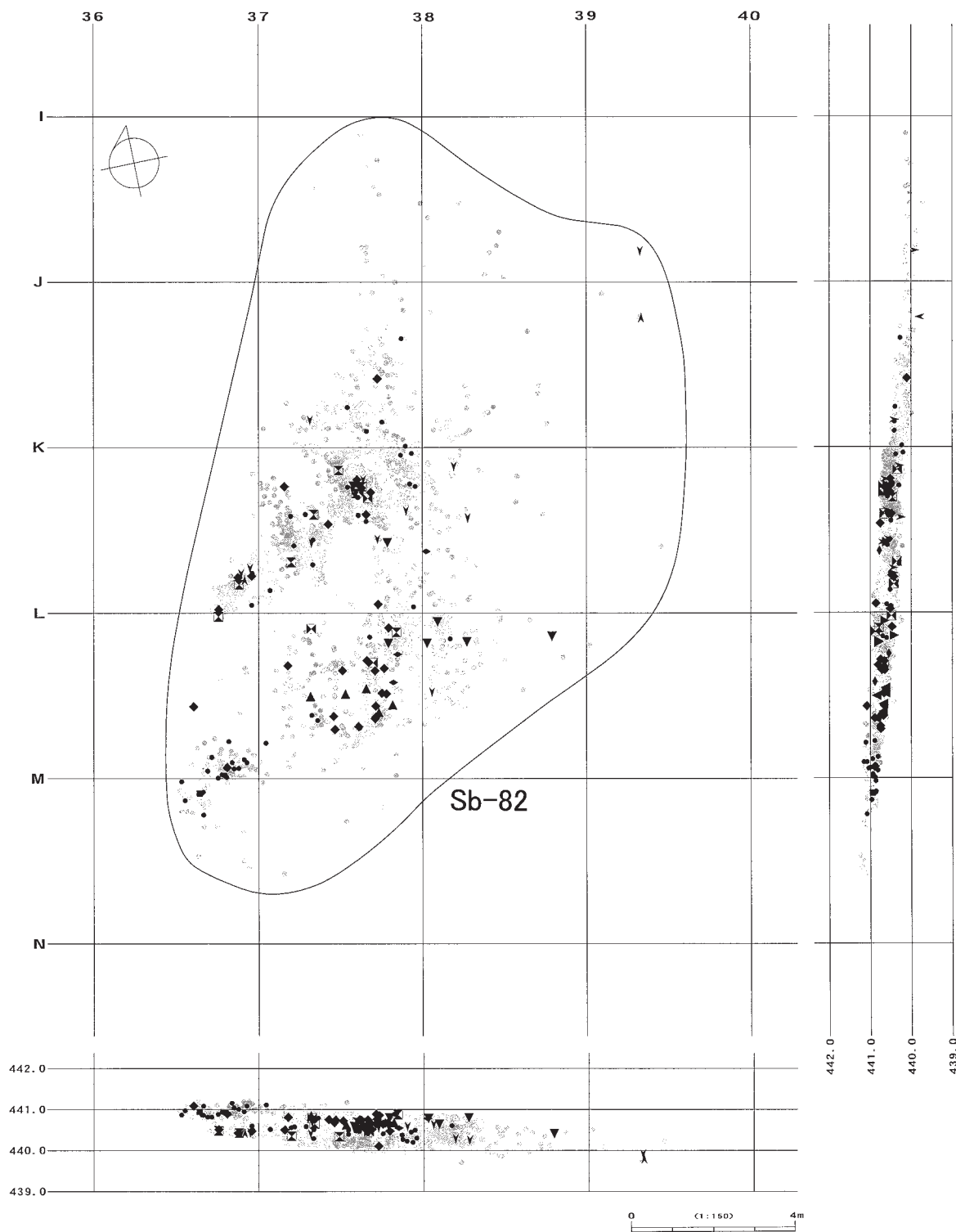
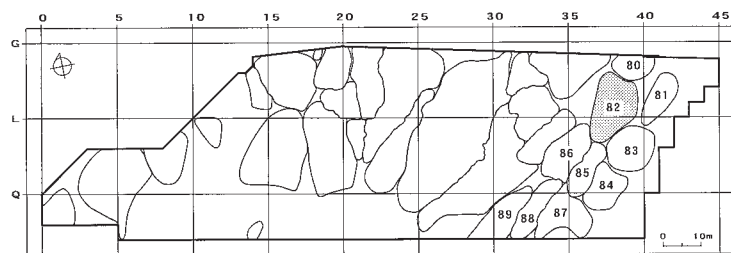

図Ⅲ-134 Sb-82の分布図

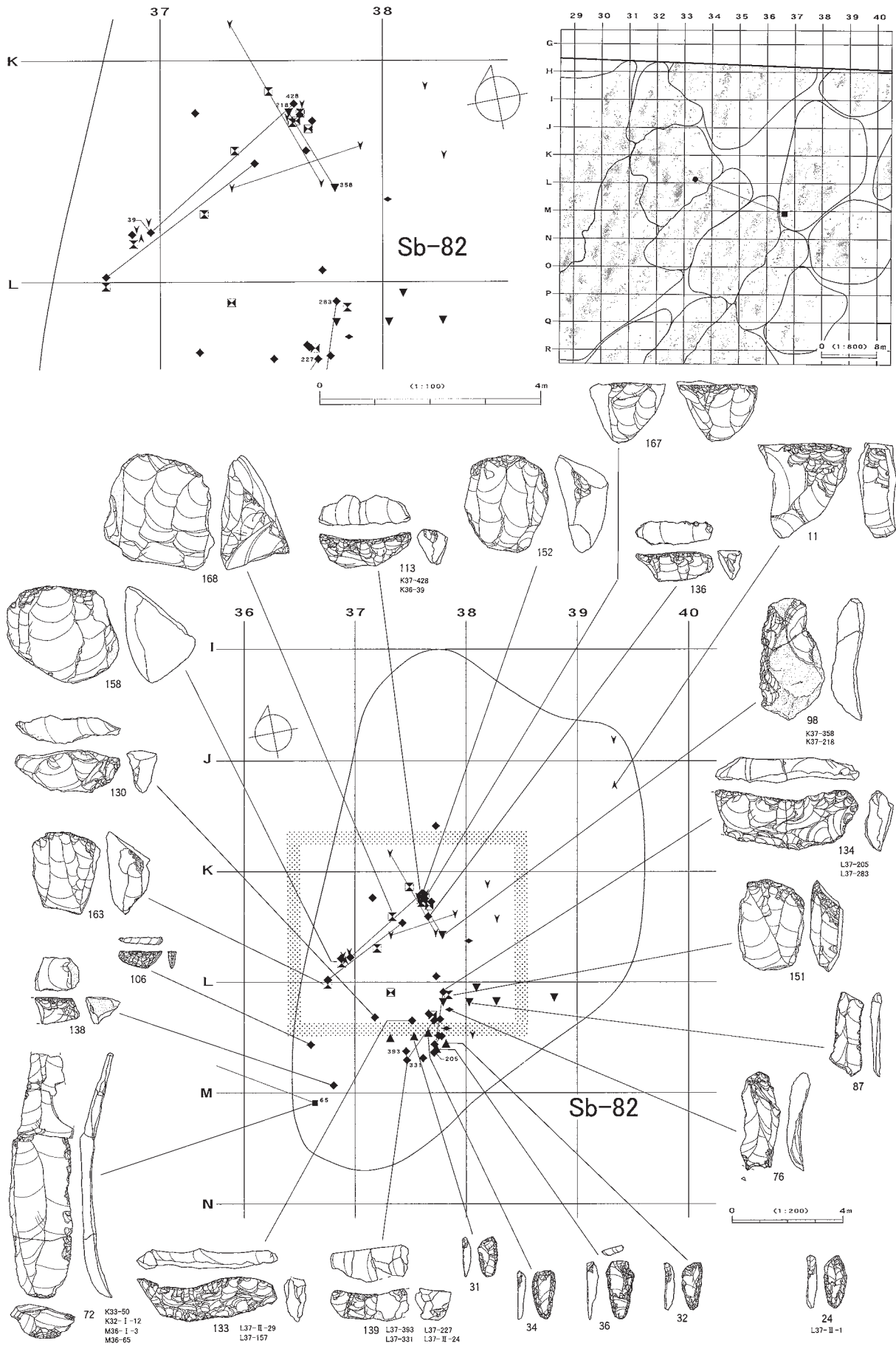

図Ⅲ-135 Sb-82の遺物

G区(Sb-80~89)

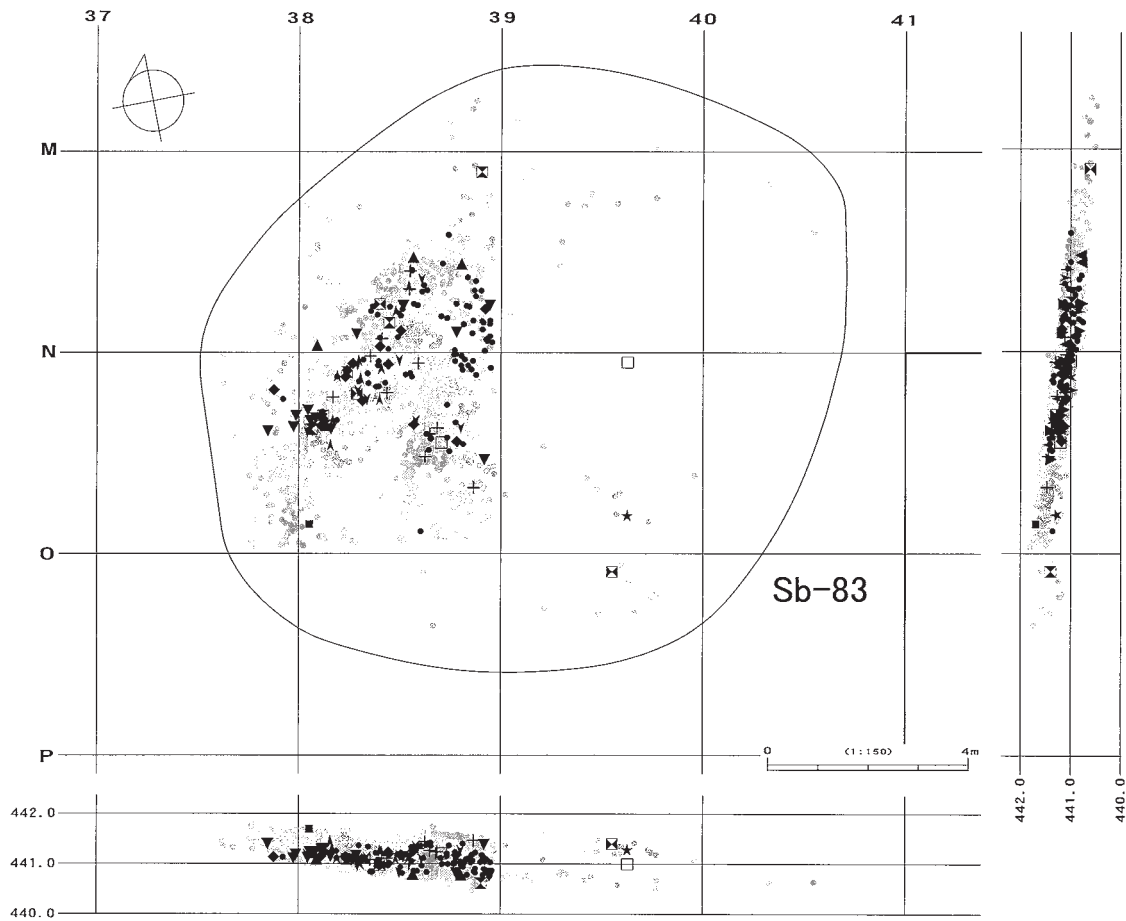

石刃核、石核

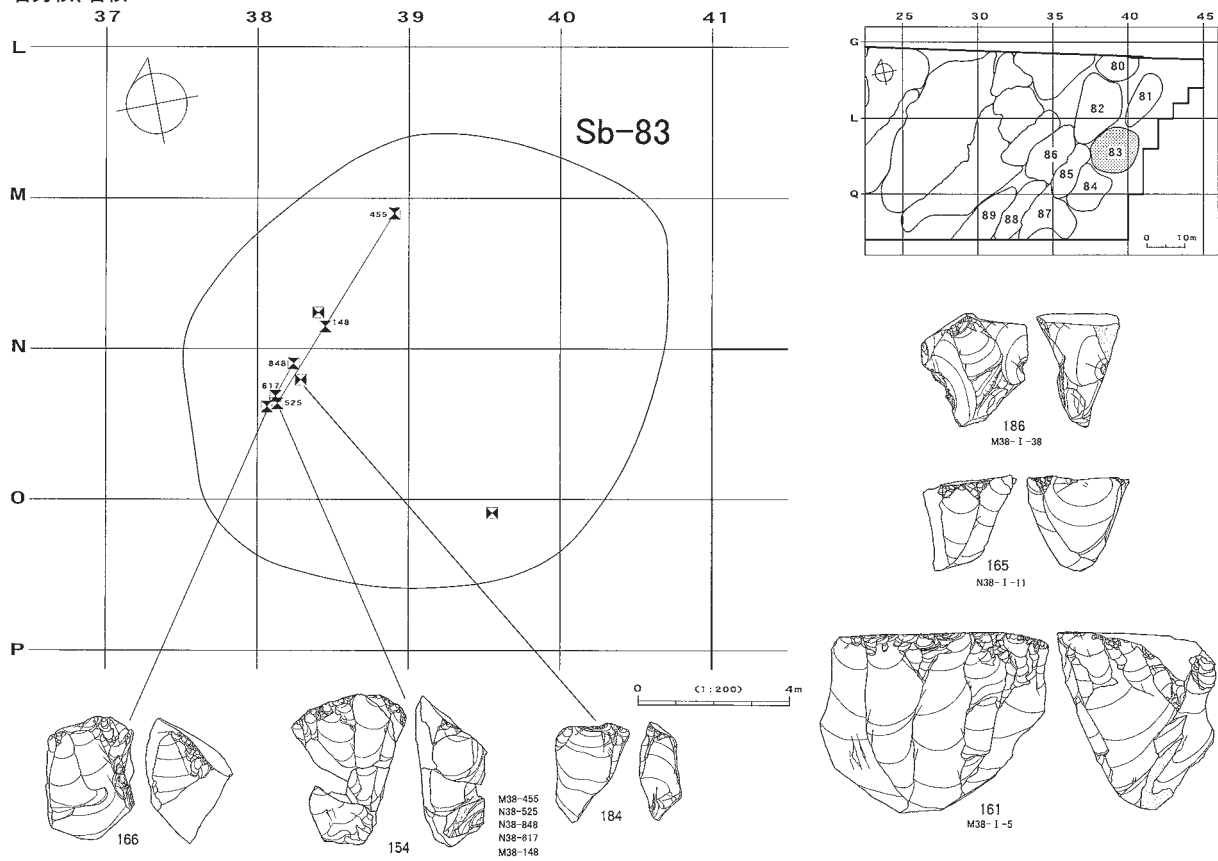

図Ⅲ-136 Sb-83の分布図・遺物(1)

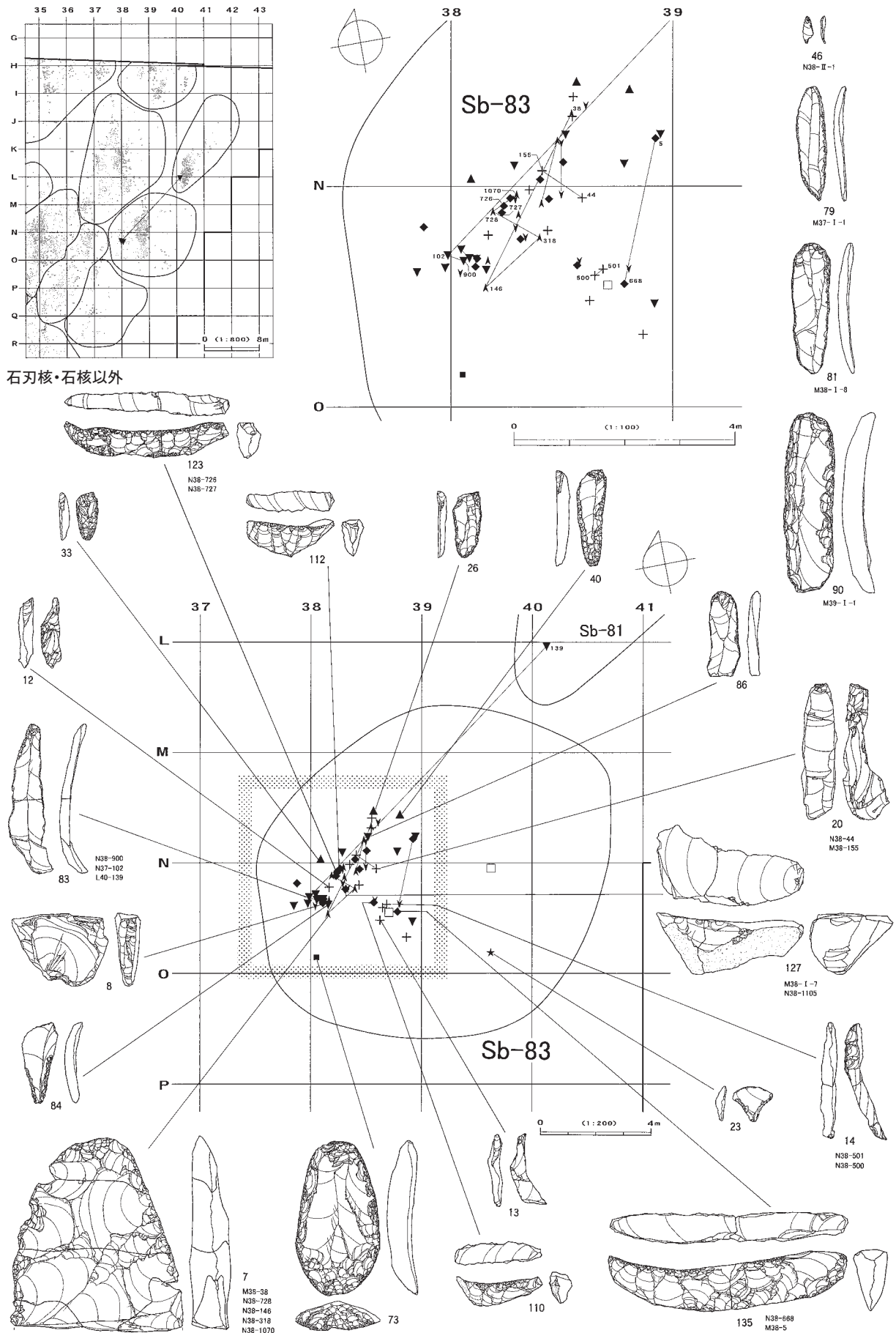

図III-137 Sb-83の遺物(2)

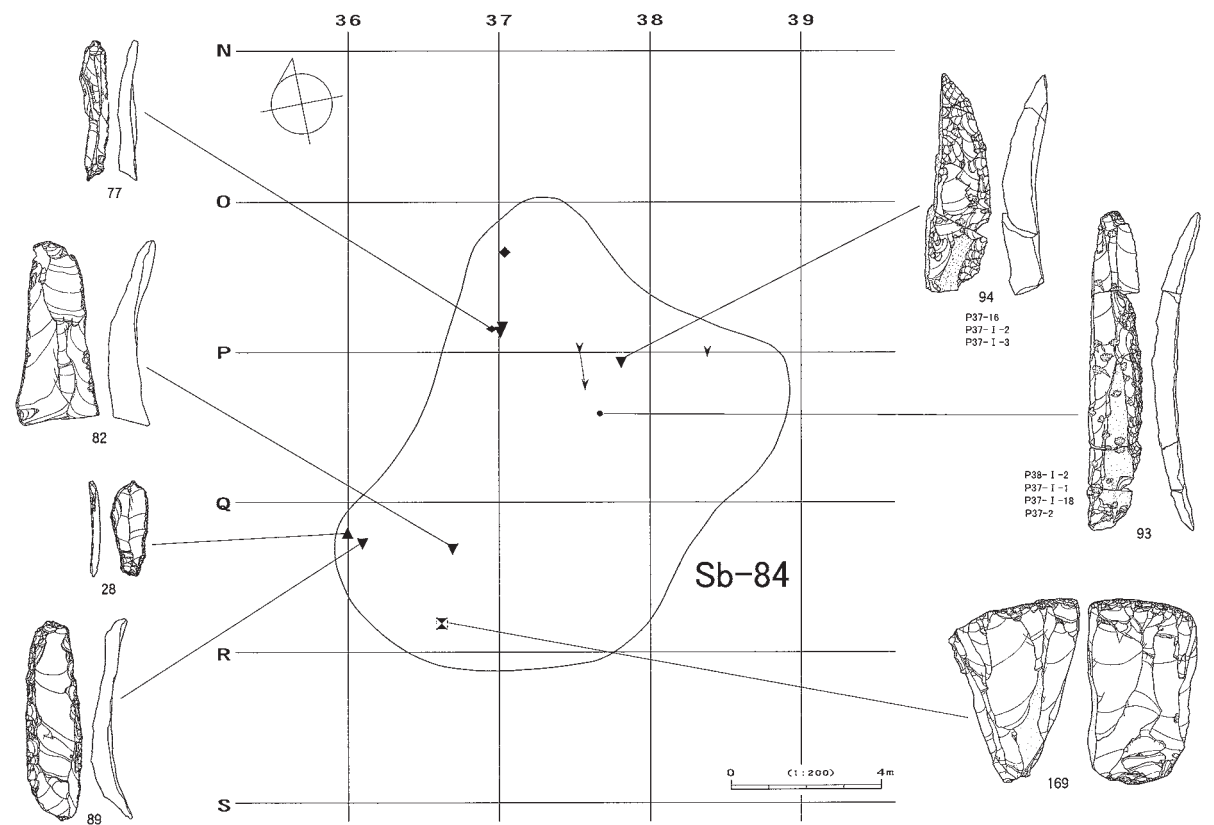
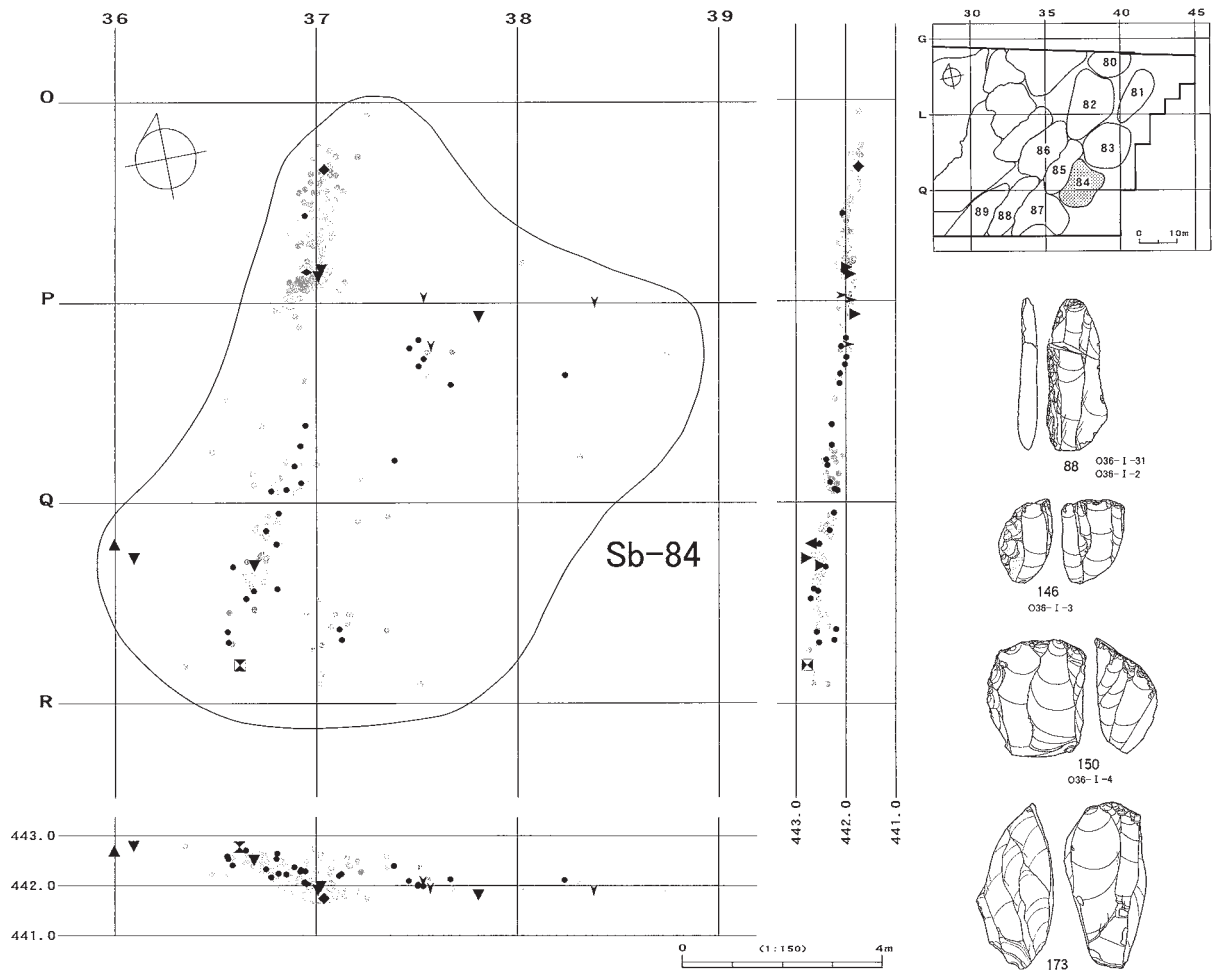

図Ⅲ-138 Sb-84の分布図・遺物

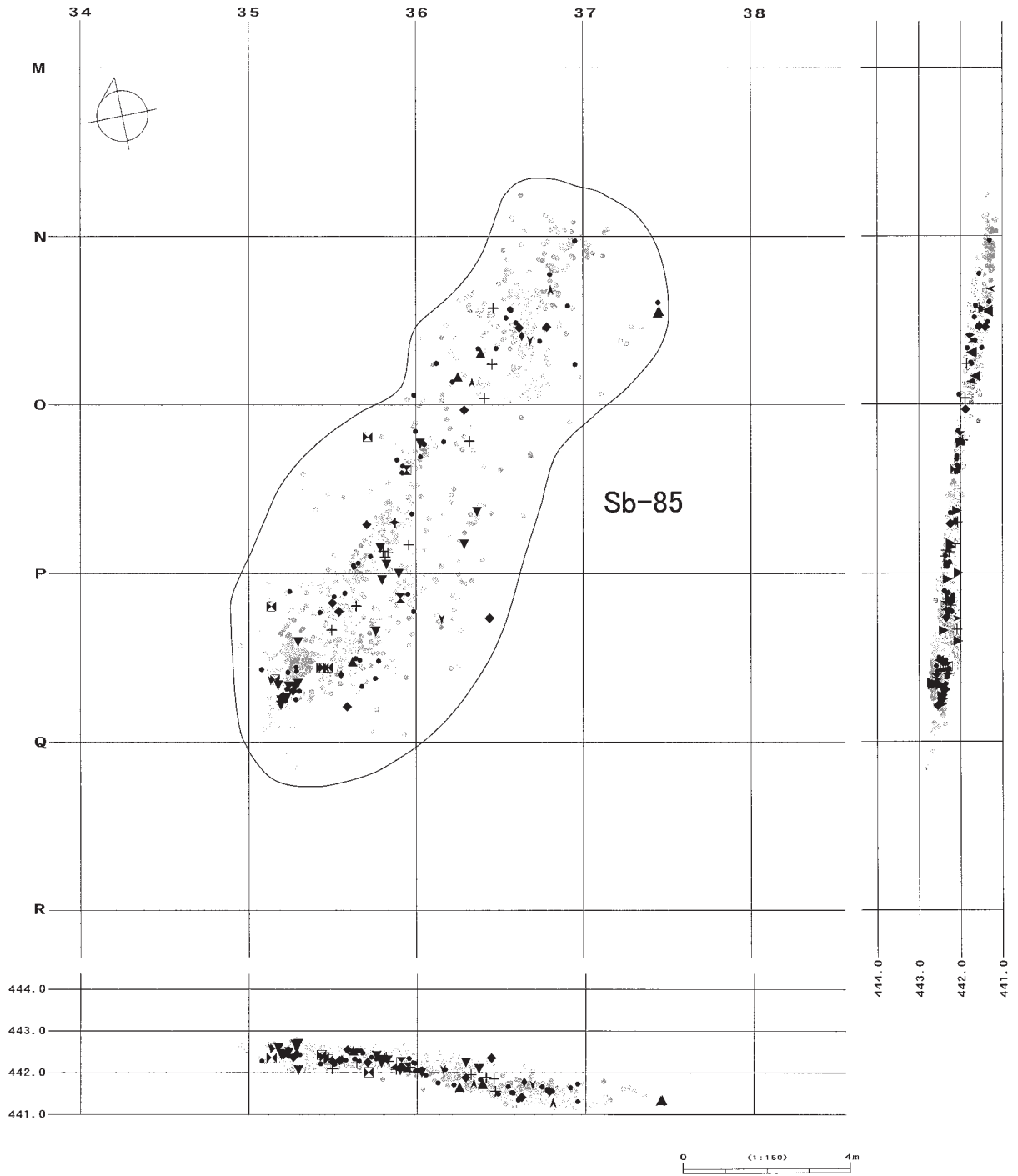
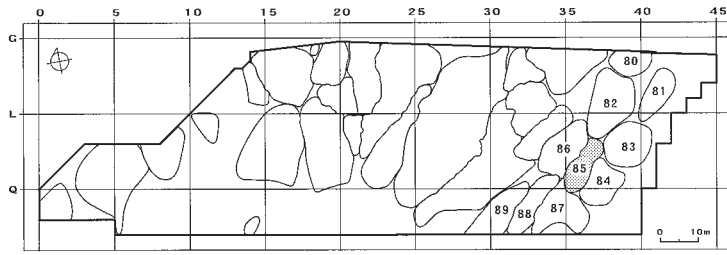

図Ⅲ-139 Sb-85の分布図

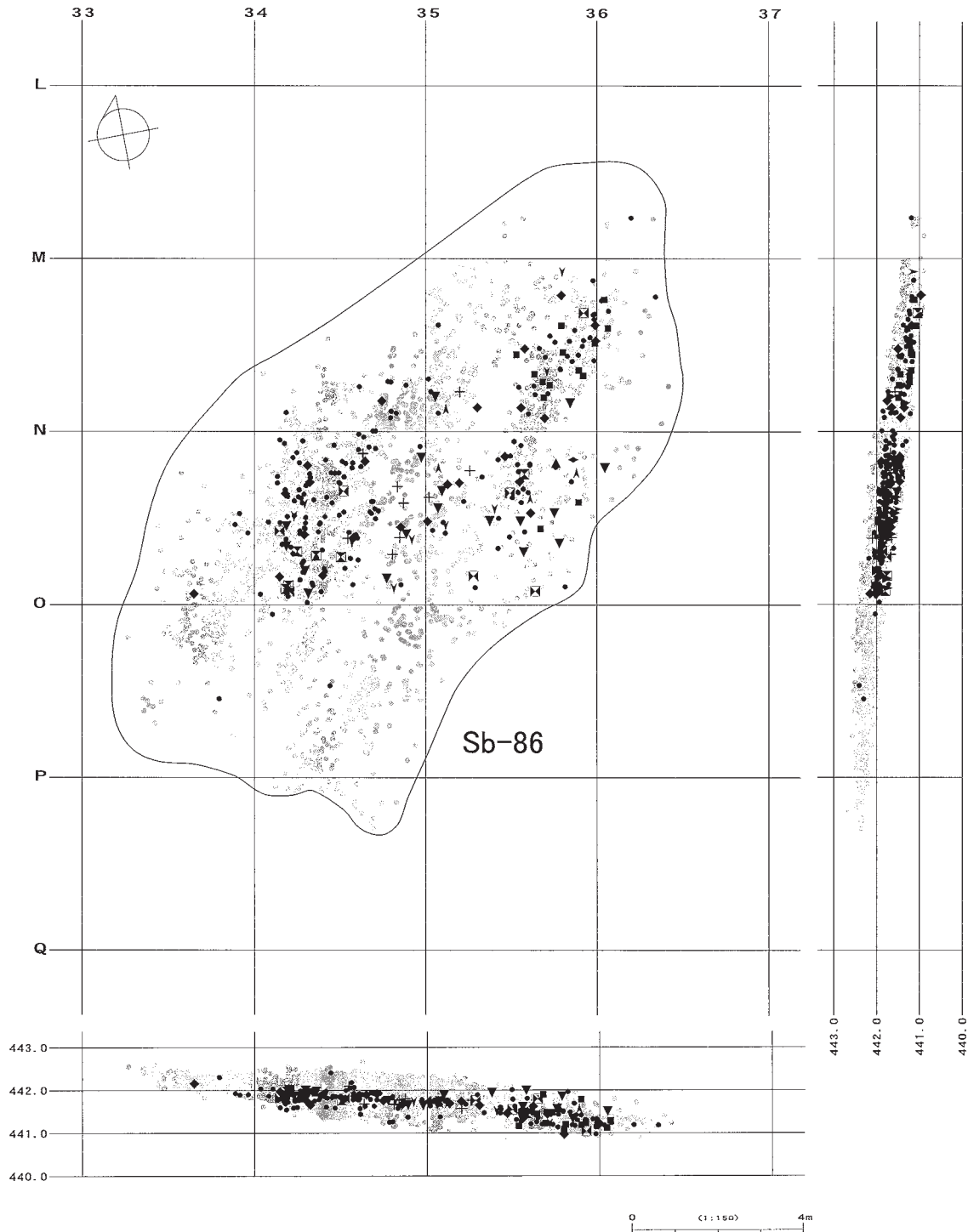
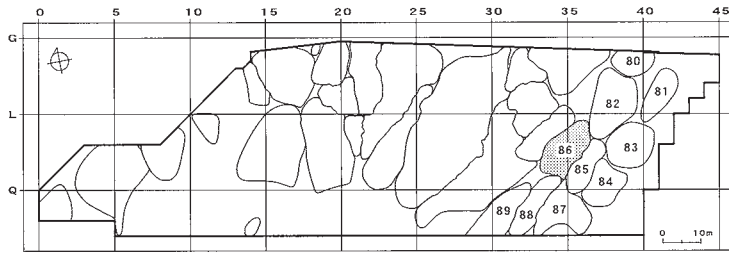

図Ⅲ-141 Sb-86の分布図

石刃核・石核以外

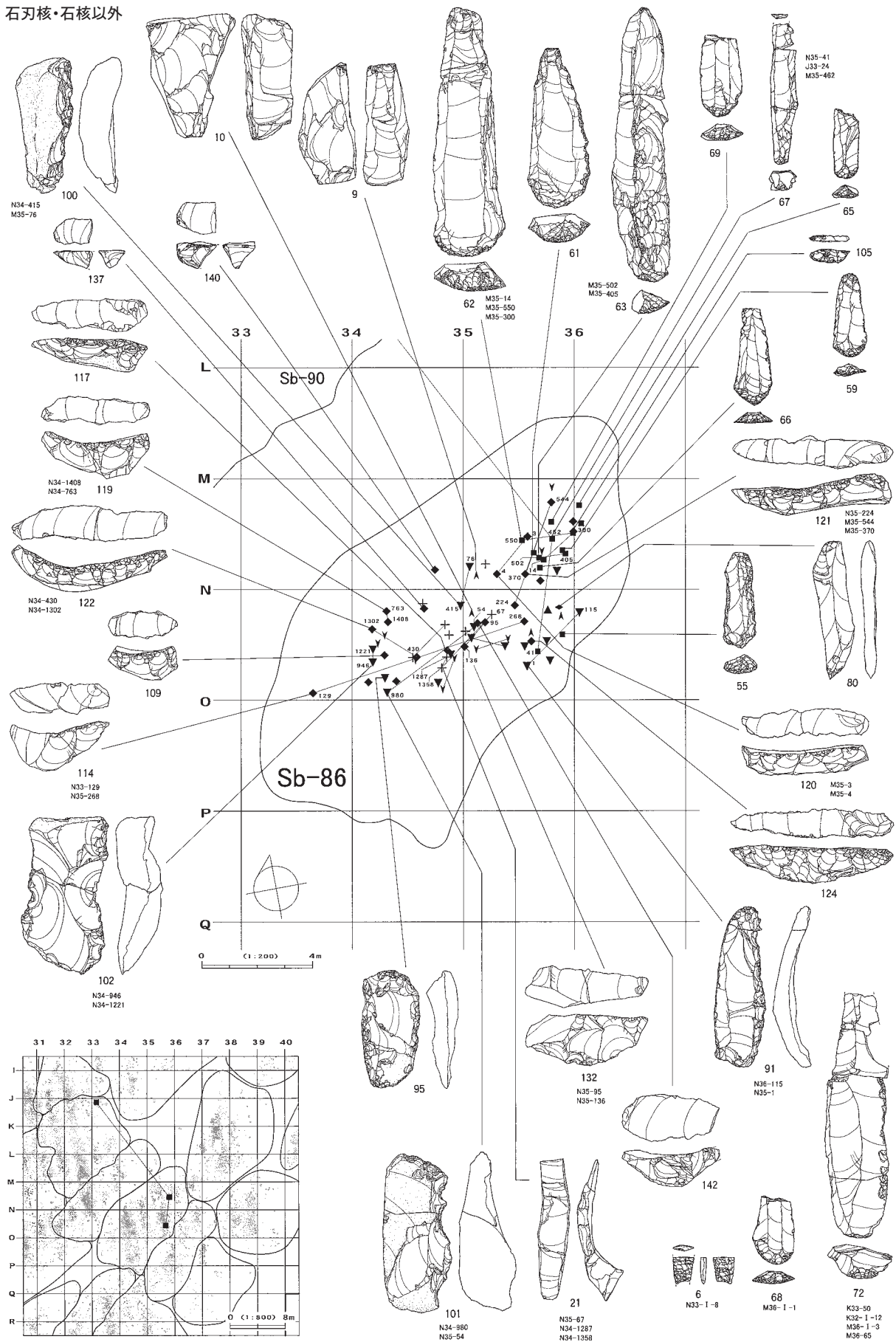

図III-142 Sb-86の遺物(1)

石刃核、石核

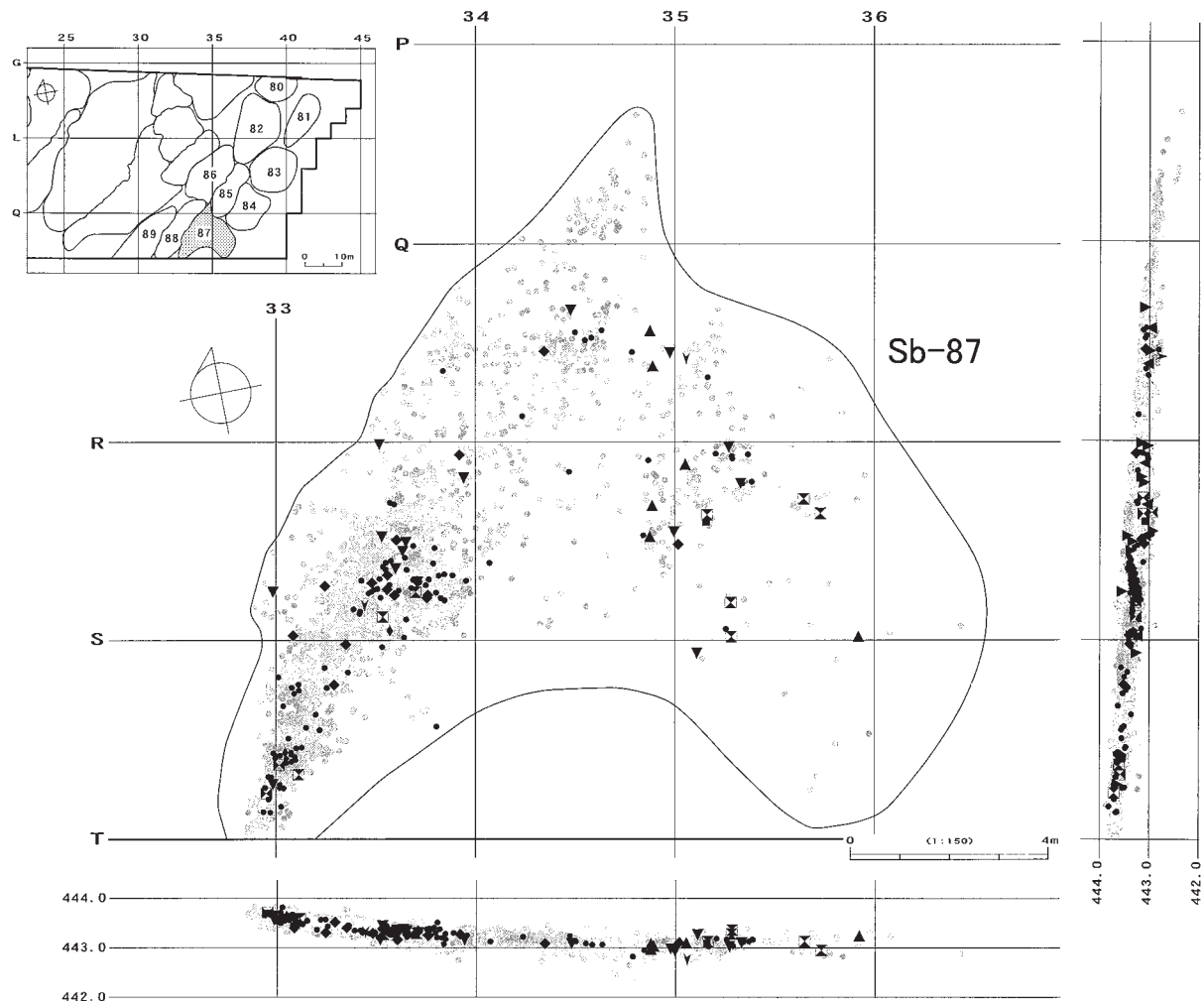
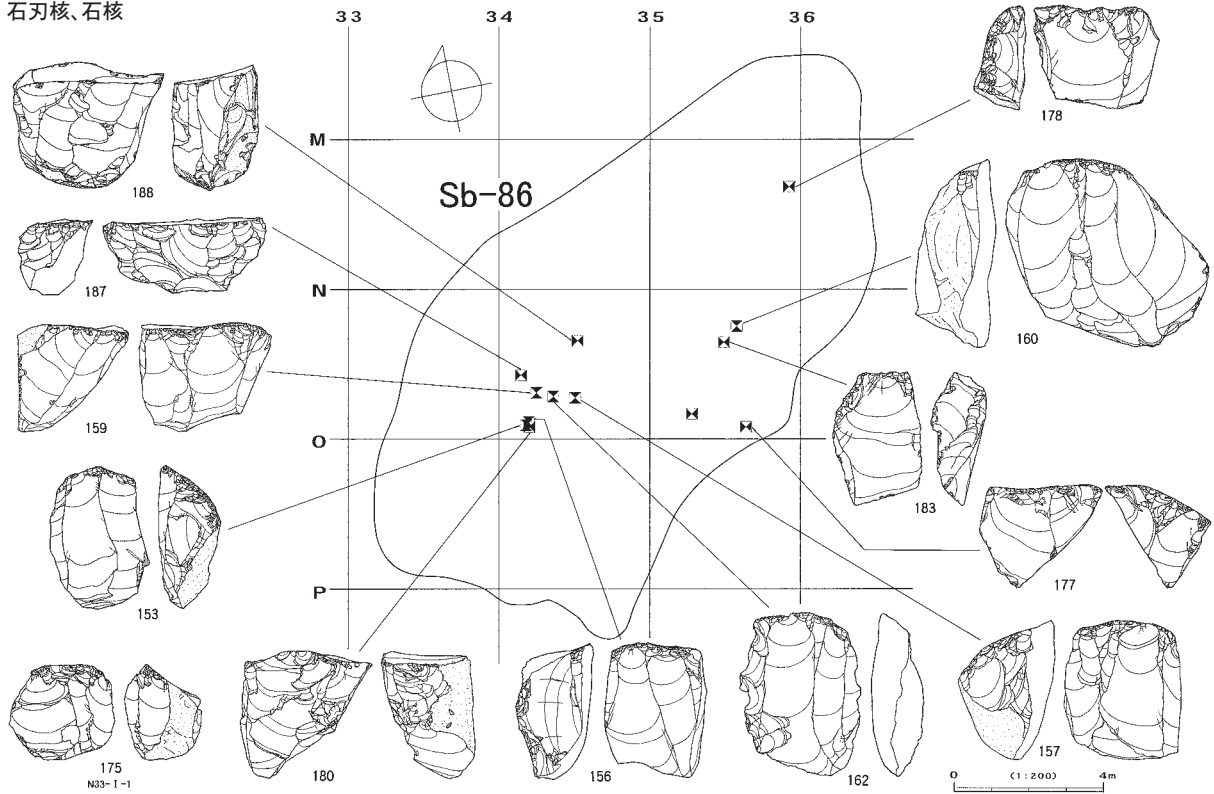

図Ⅲ-143 Sb-86の遺物(2)、Sb-87の分布図

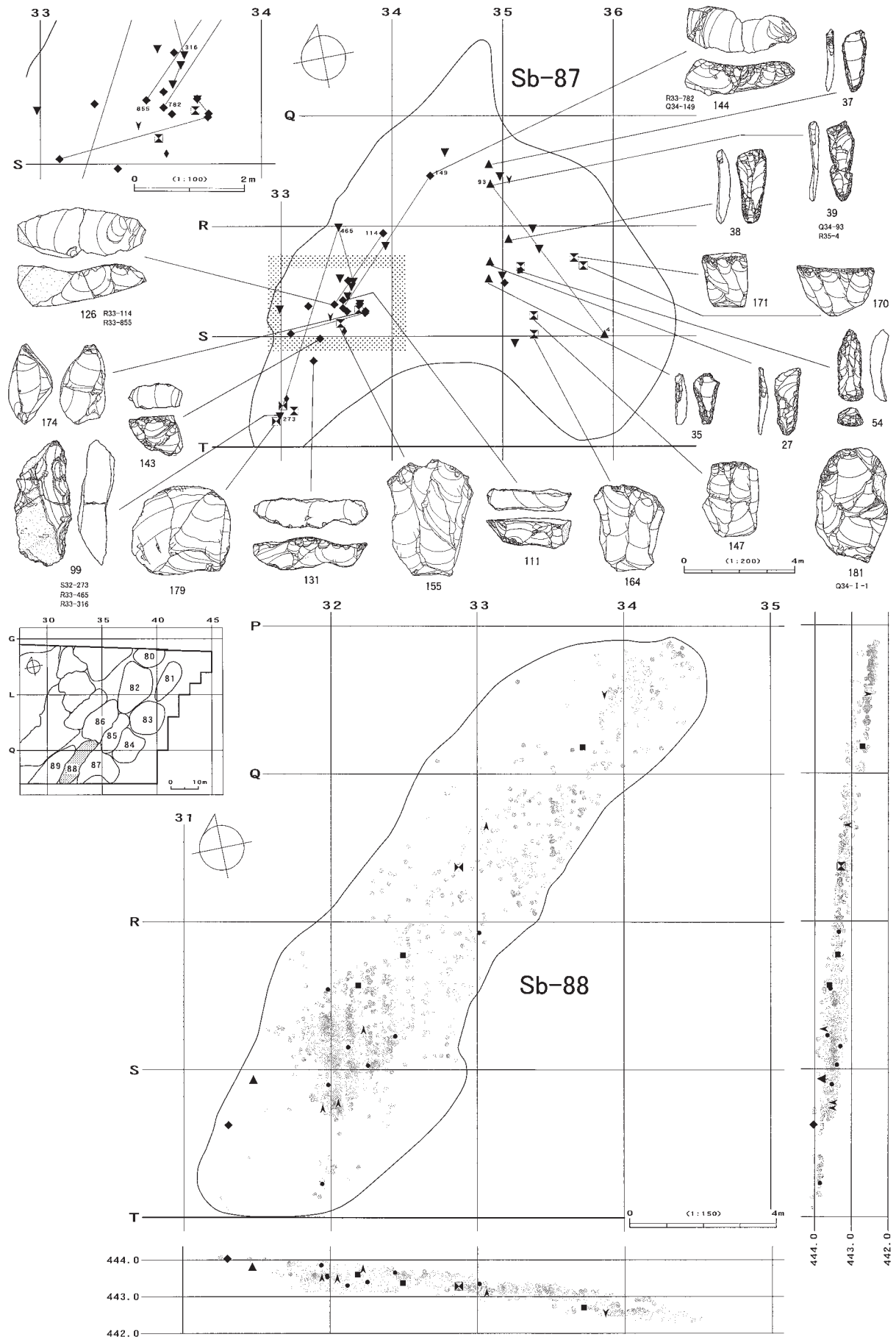

図三-144 Sb-87の遺物、Sb-88の分布図

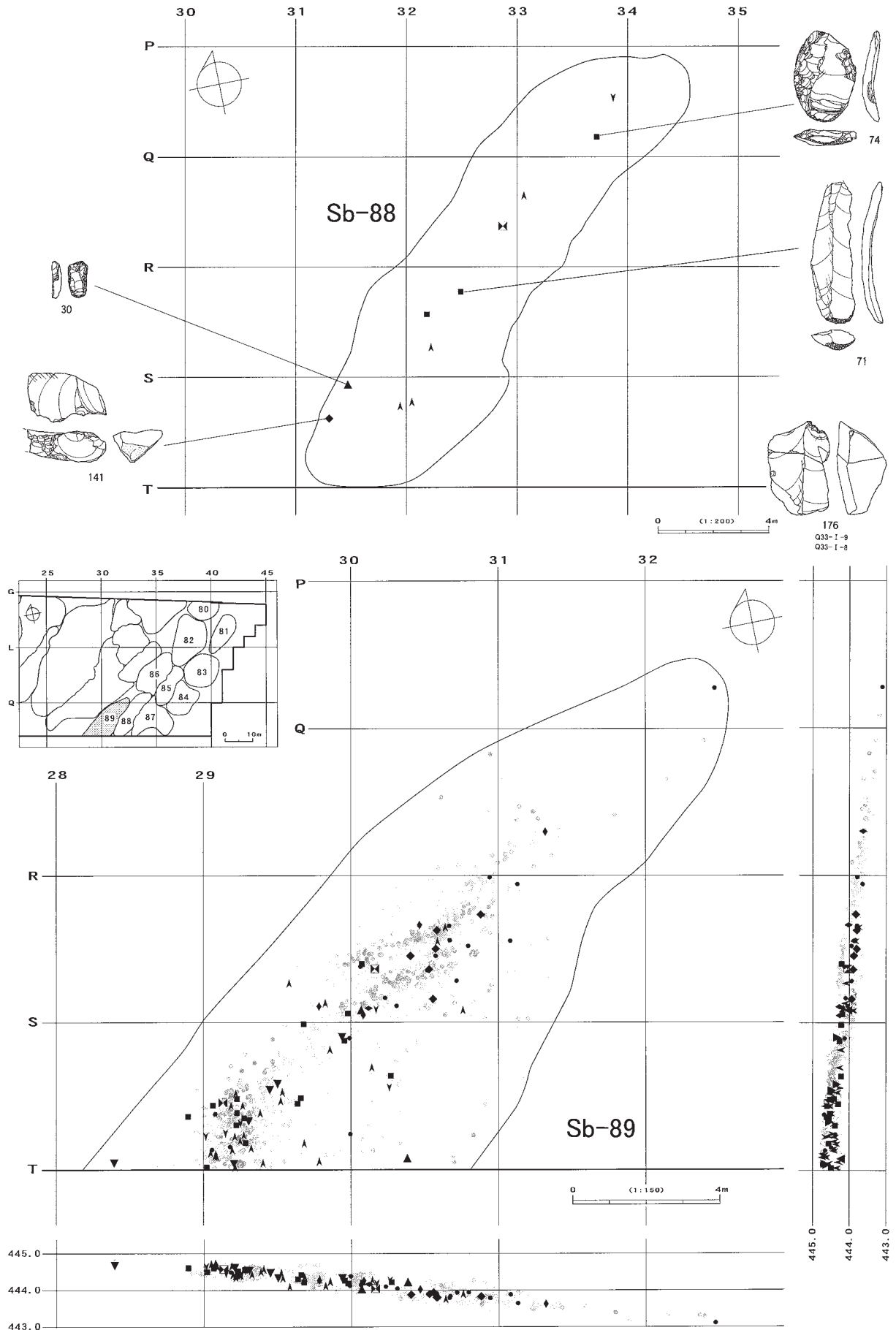

図Ⅲ-145 Sb-88の遺物、Sb-89の分布図

尖頭器

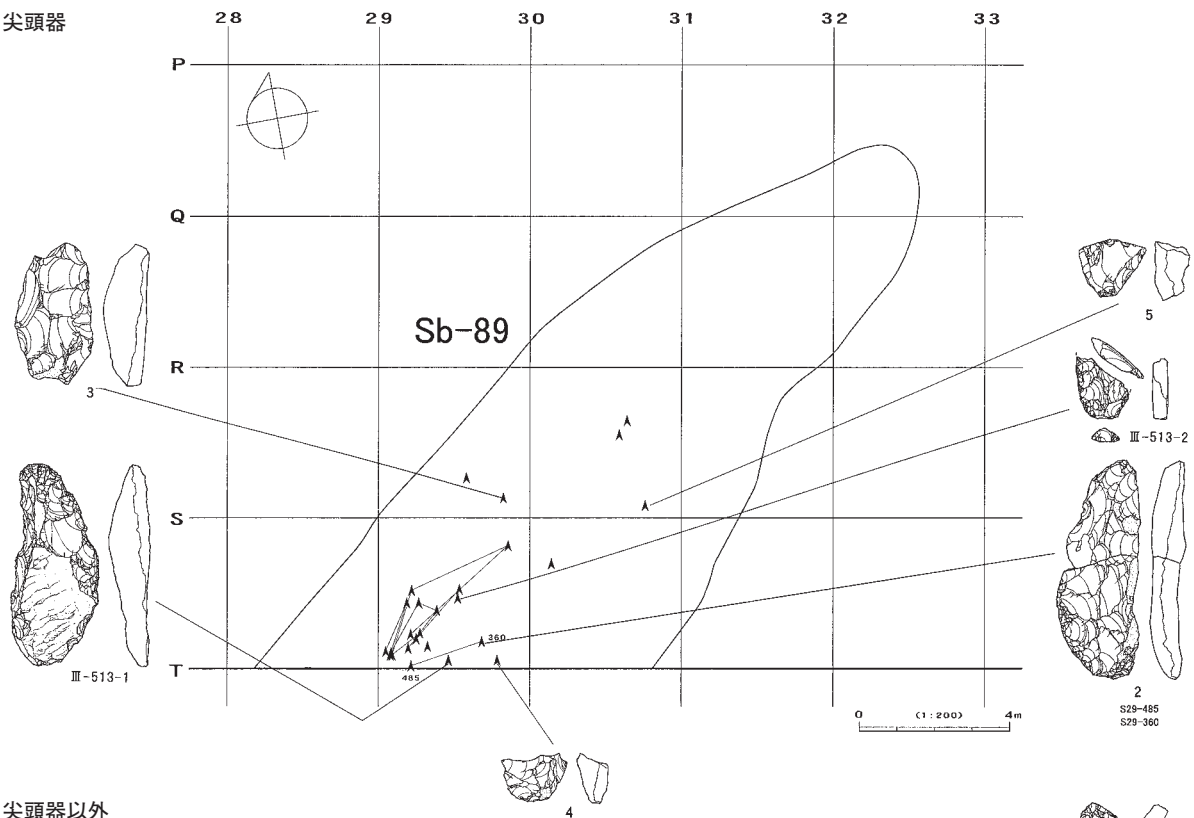

尖頭器以外

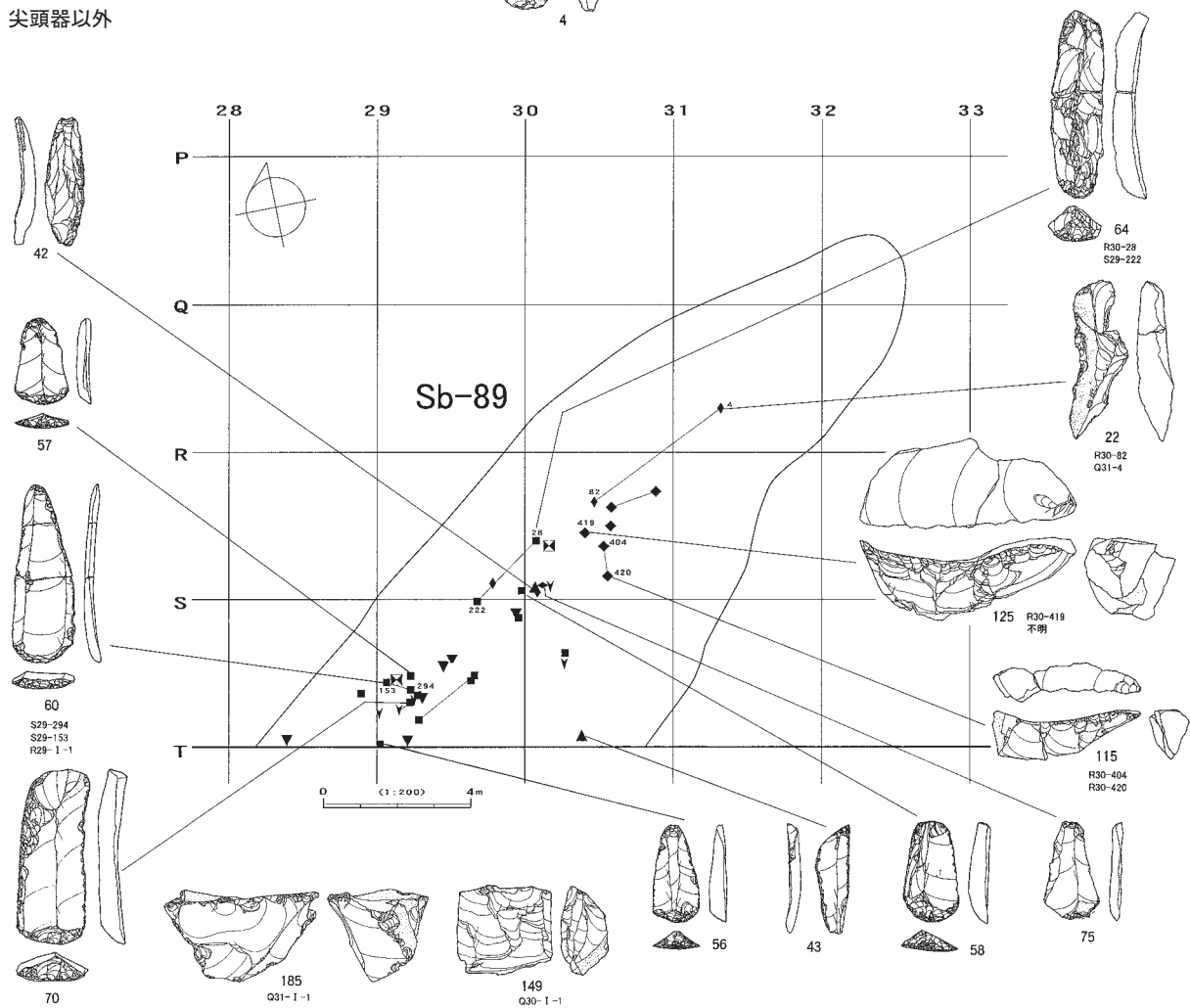

図Ⅲ-146 Sb-89の遺物

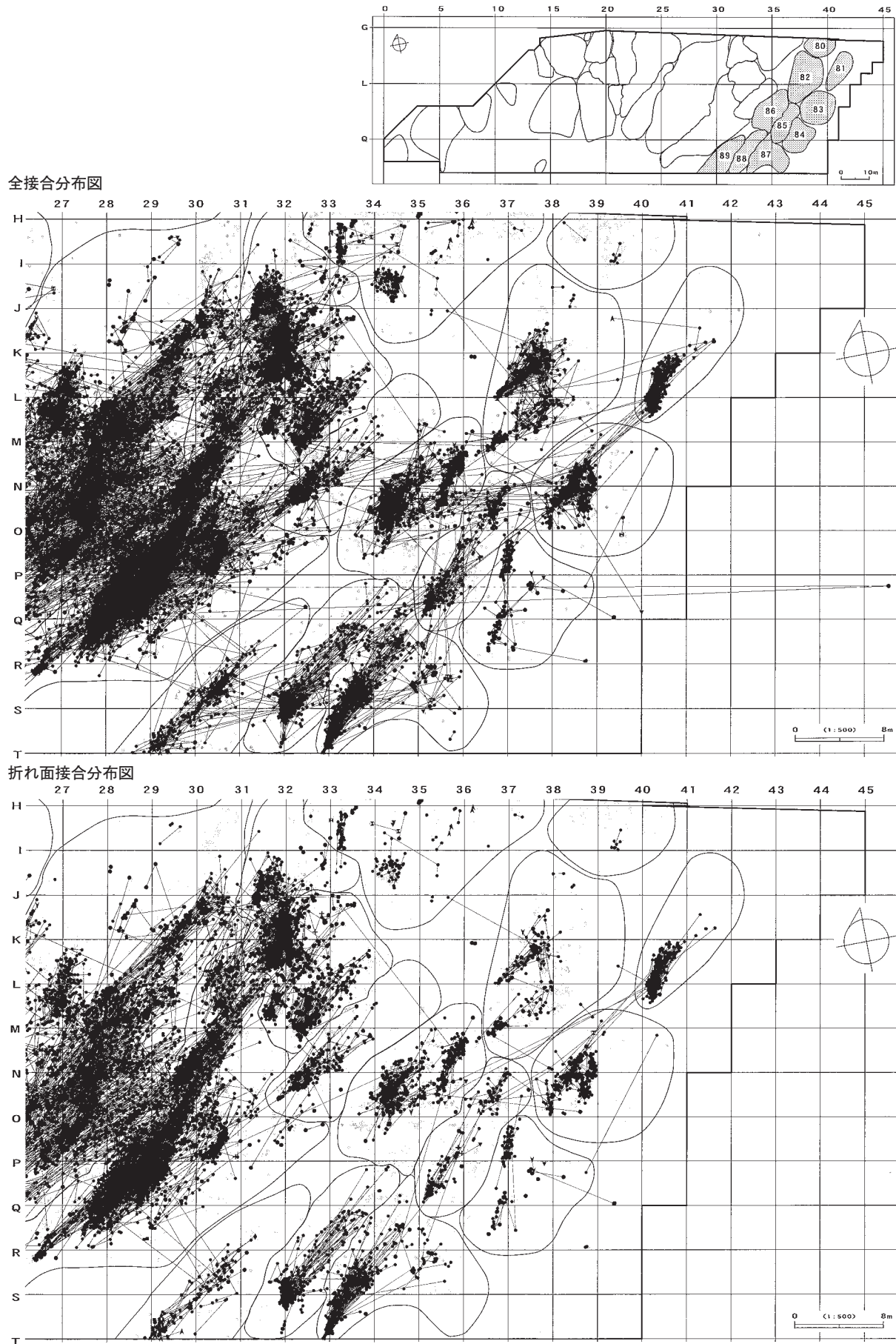

図Ⅲ-147 G区(Sb-80~89)の接合分布図

母岩551・接合2807
個体A

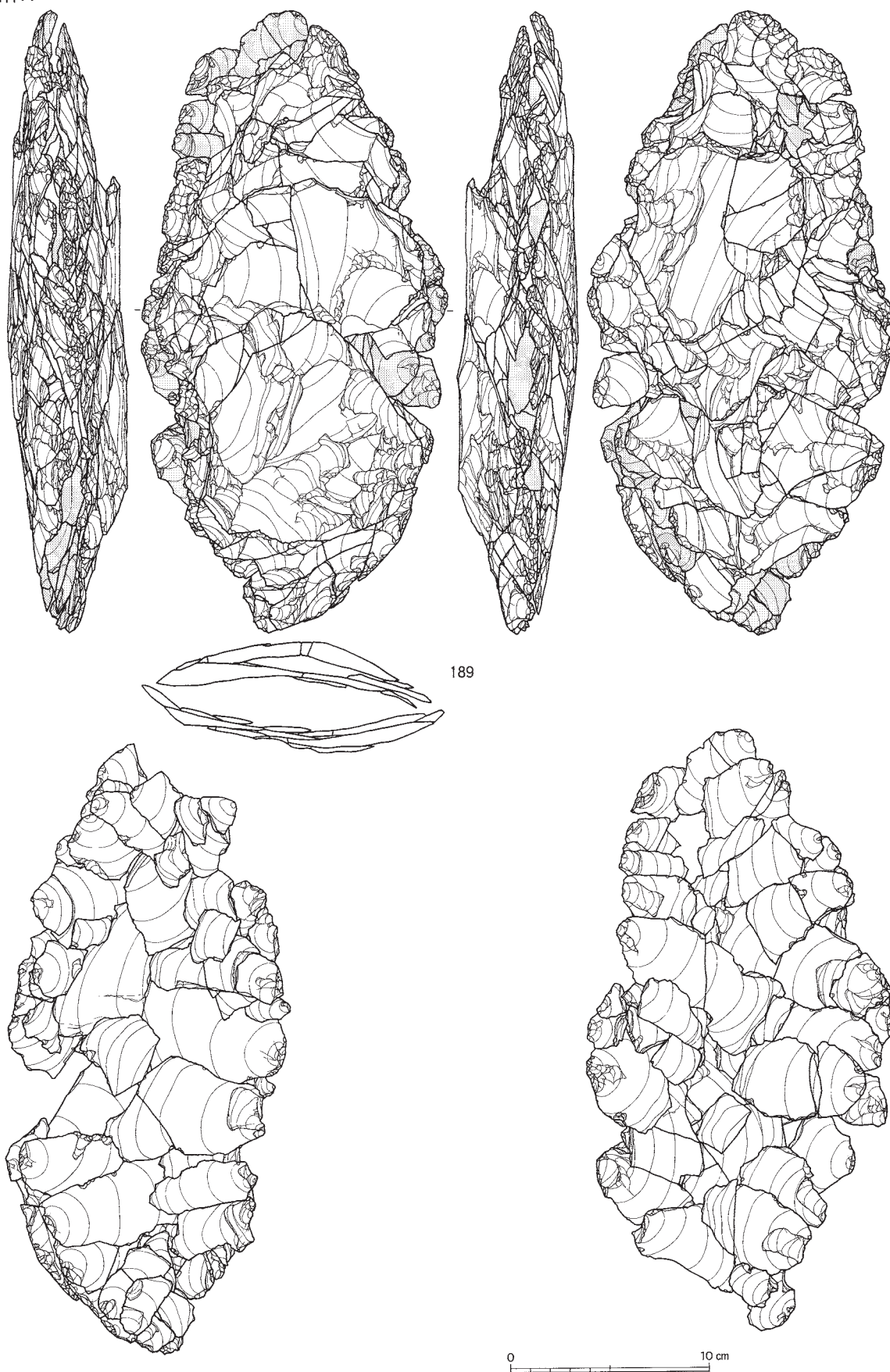

図Ⅲ-148 G区(Sb-80~89)の石器(20) 母岩551・接合2807(1)

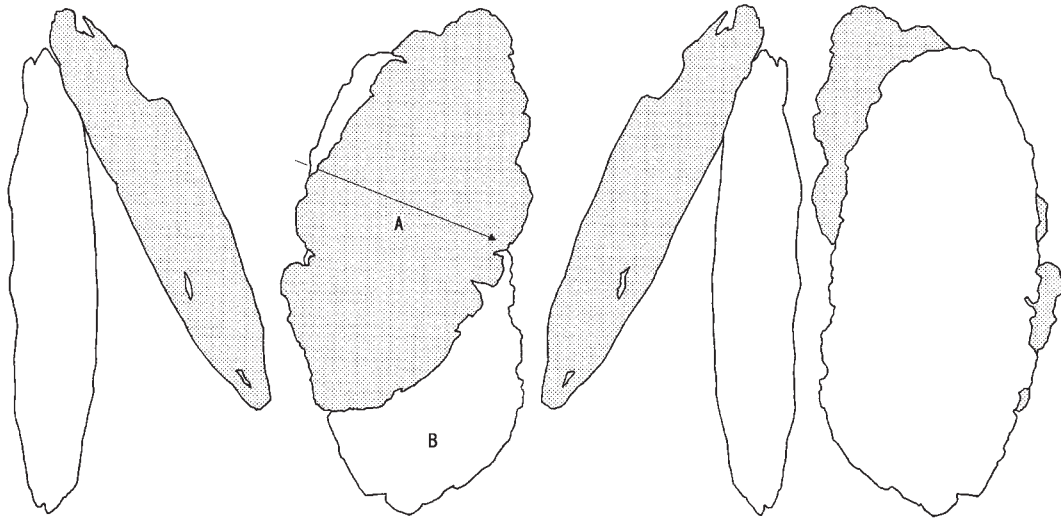

個体A

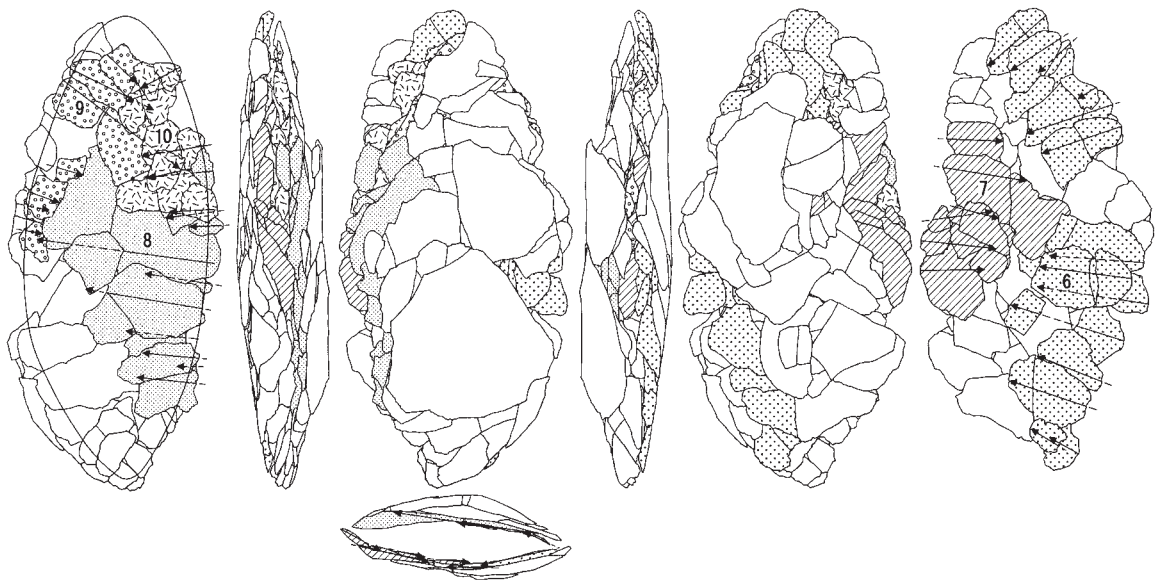
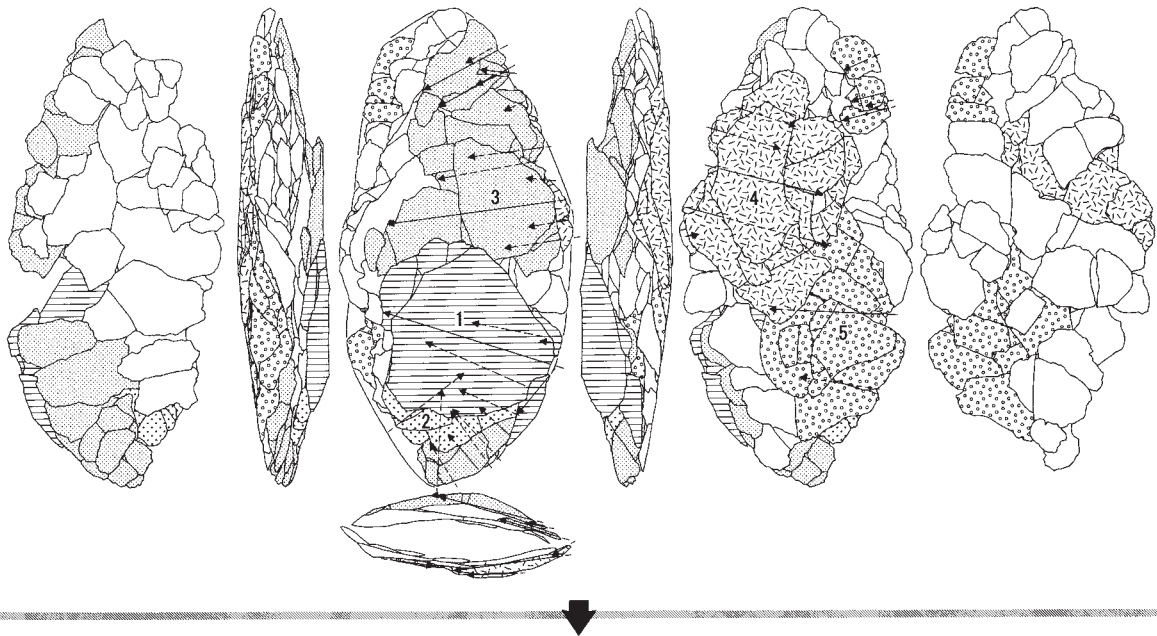

図Ⅲ-149 G区(Sb-80~89)の石器(2) 母岩551・接合2807(2)

個体B

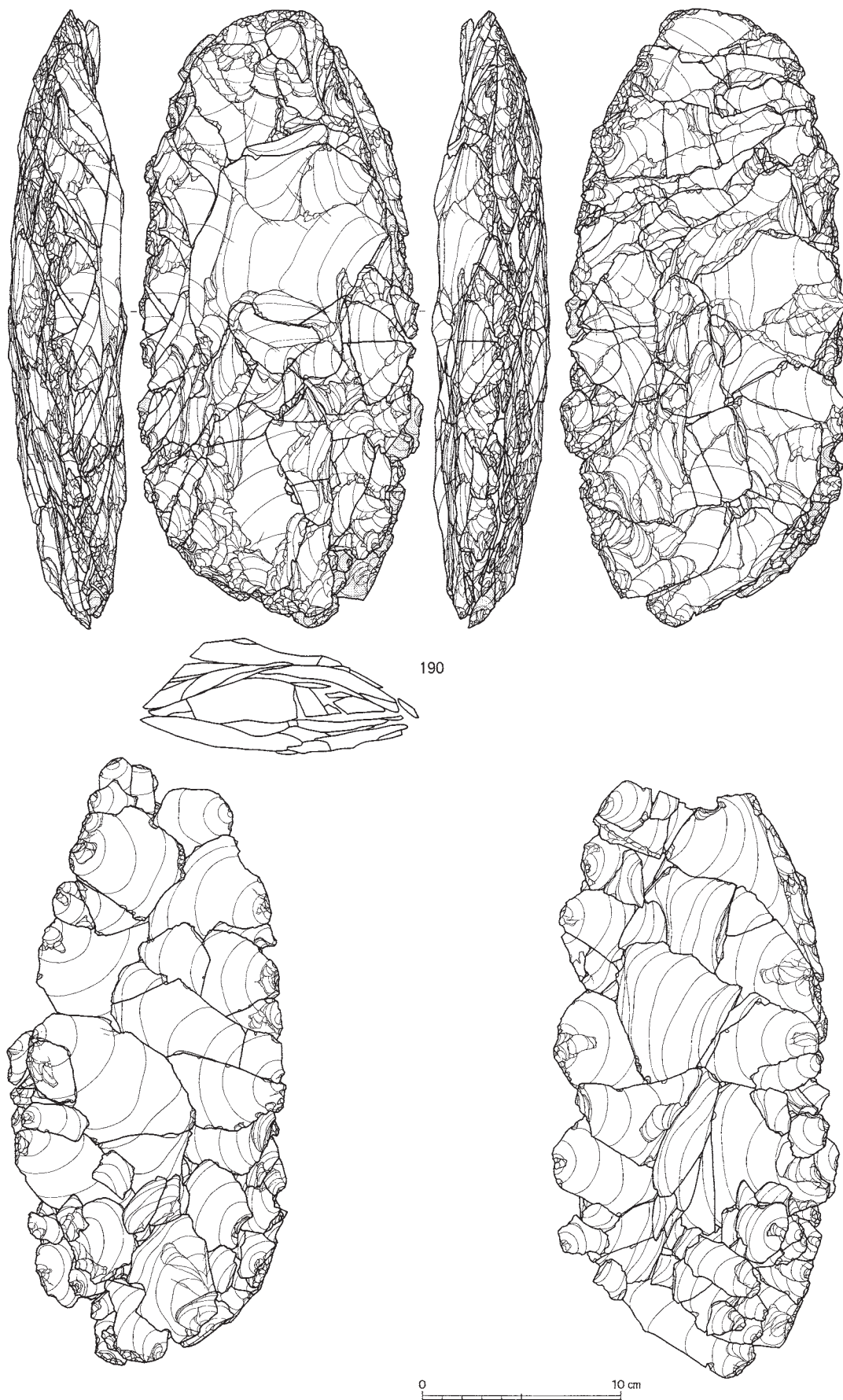

図Ⅲ-150 G区(Sb-80~89)の石器(22) 母岩551・接合2807(3)

個体B

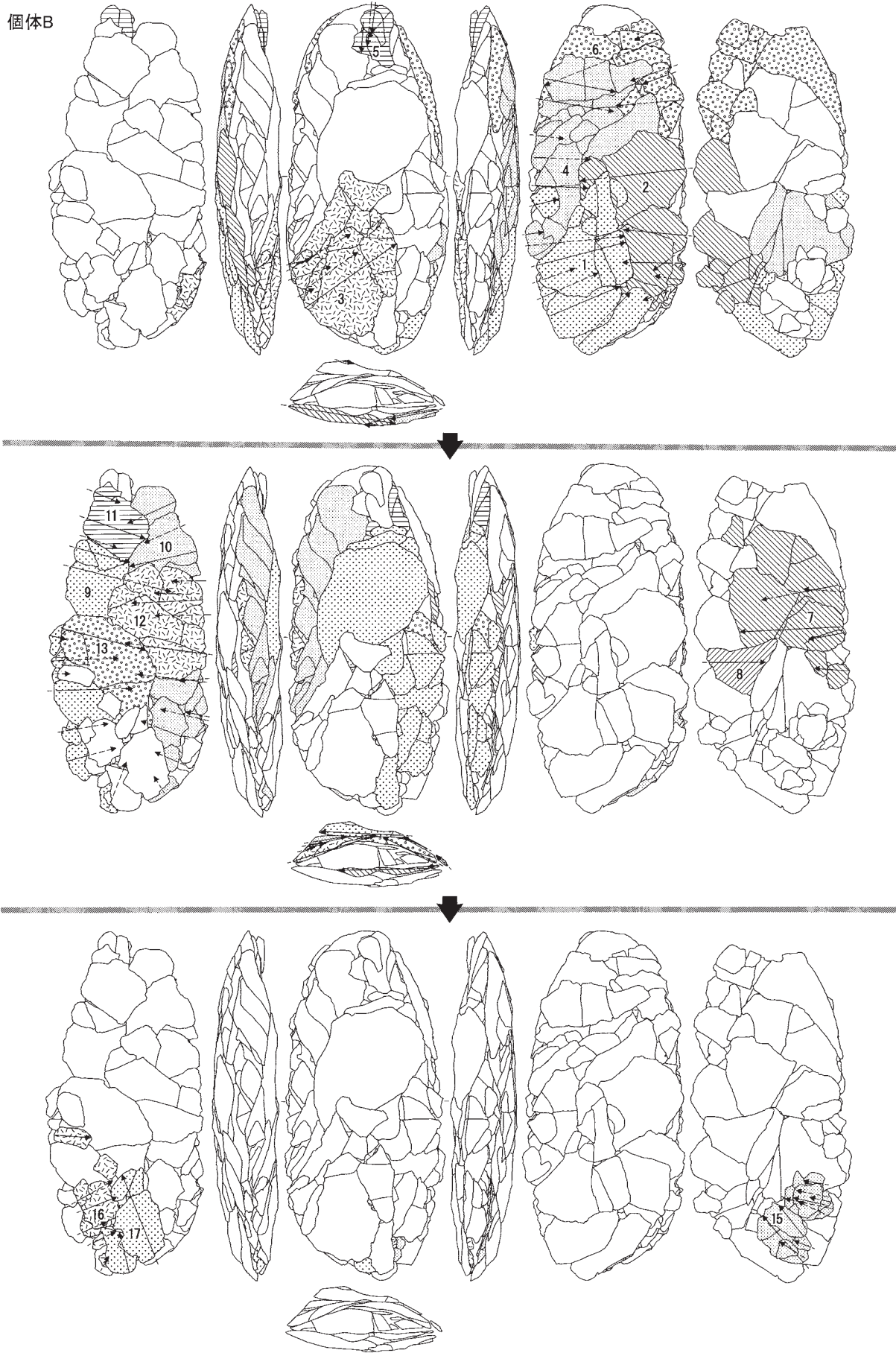

図Ⅲ-151 G区(Sb-80~89)の石器(23) 母岩551・接合2807(4)

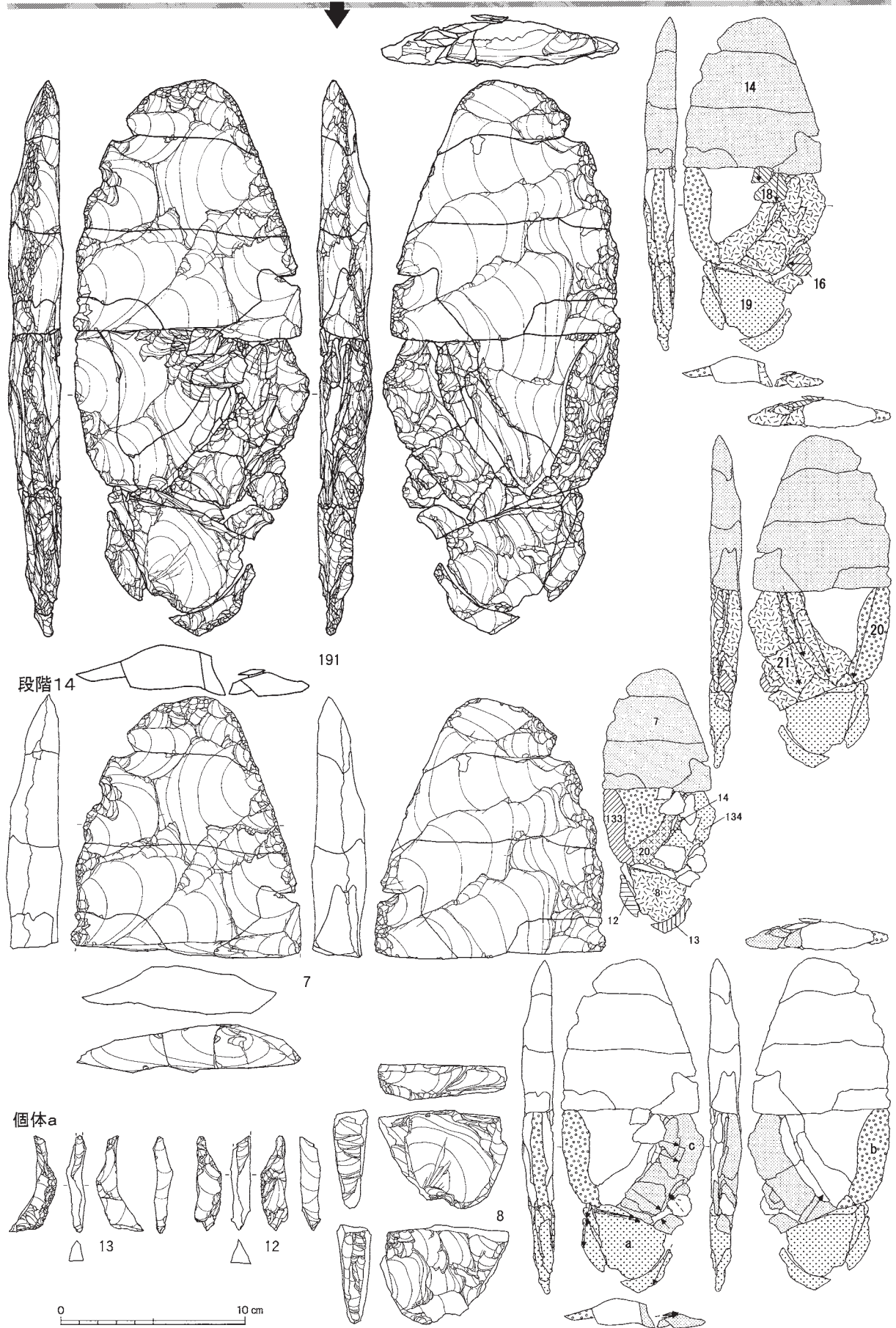

図III-152 G区(Sb-80~89)の石器(24) 母岩551・接合2807(5)

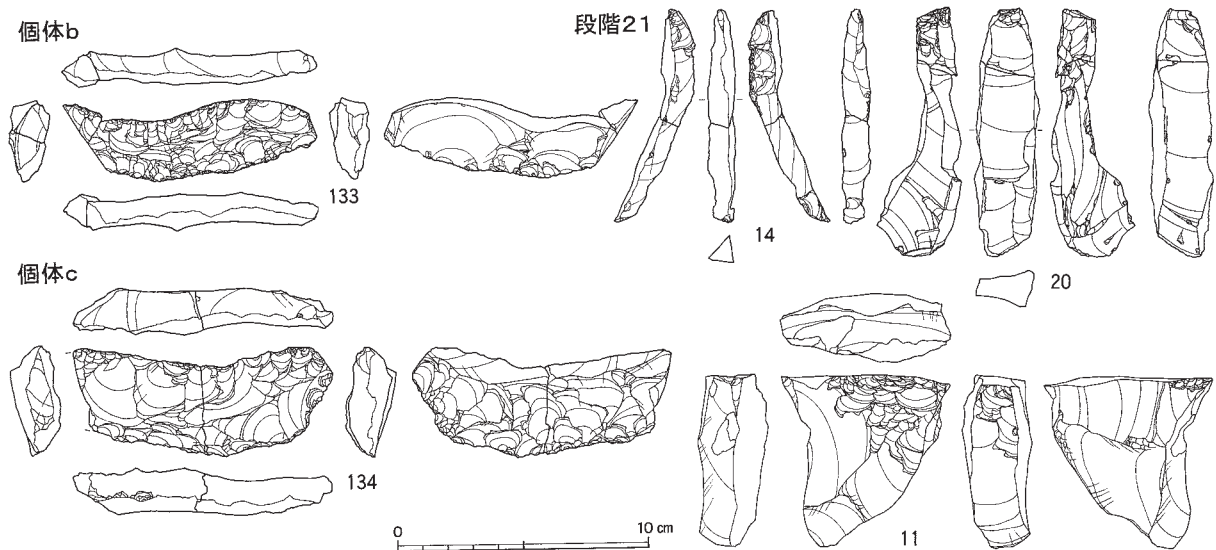

接合2807(全体)分布図

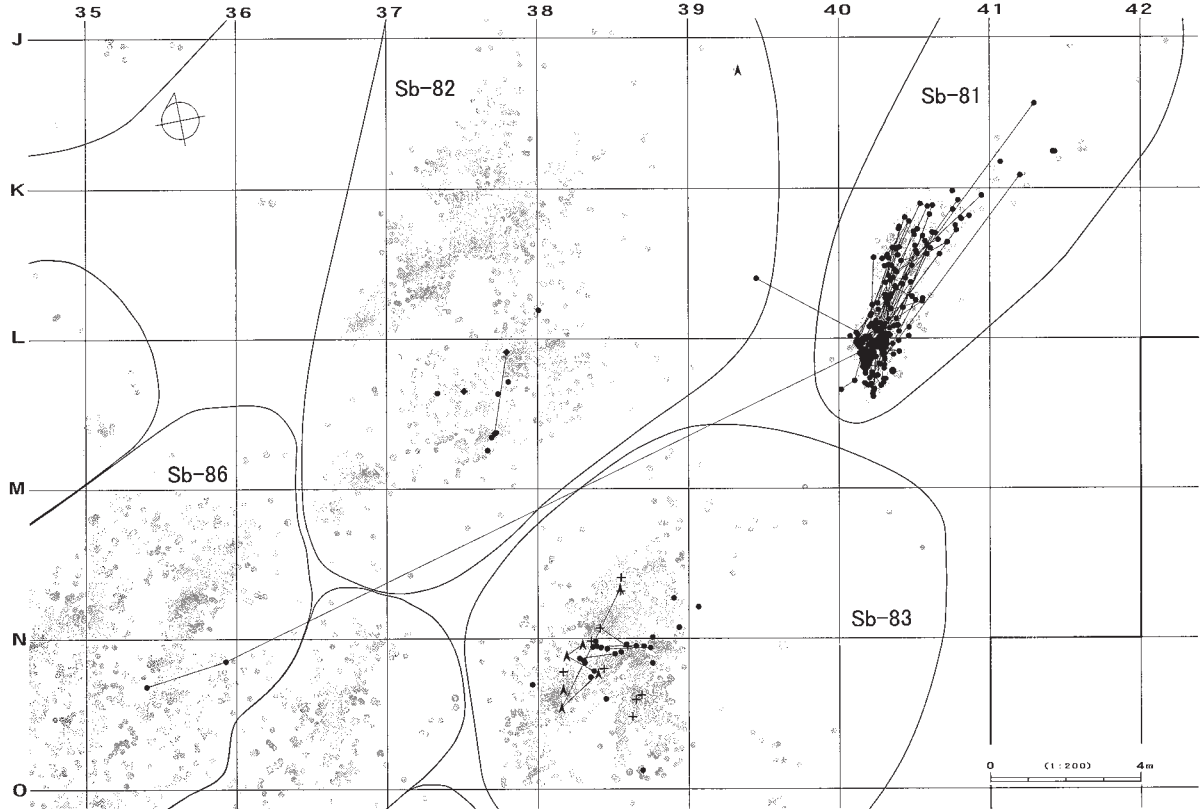

接合2807(個体A)分布図

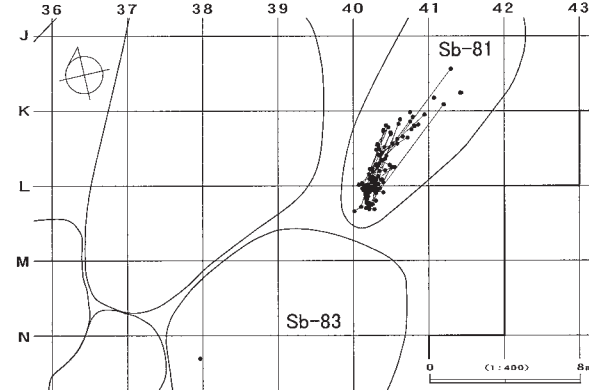

接合2807(個体a)分布図

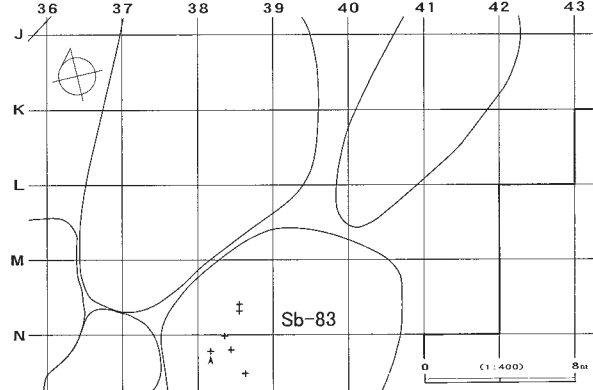

図III-153 G区(Sb-80~89)の石器(25) 母岩551・接合2807(6)

G区(Sb-80~89)

接合2807(个体b)分布图

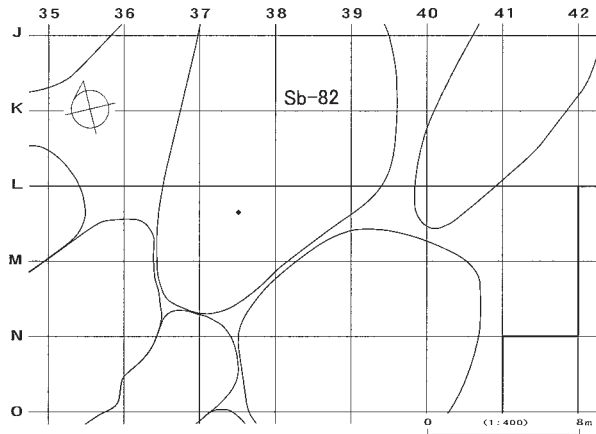

接合2807(个体c)分布图

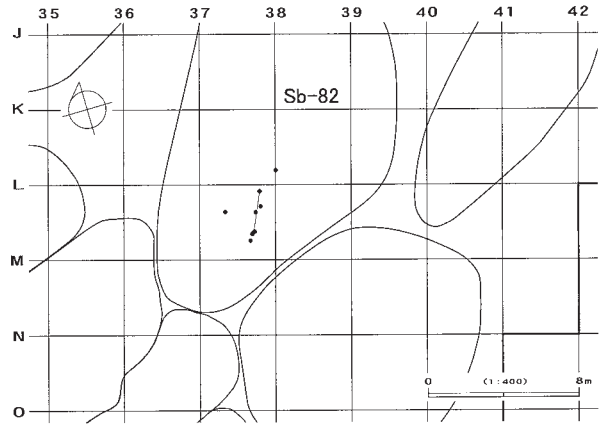

接合2807(个体B-段階1~13)分布图

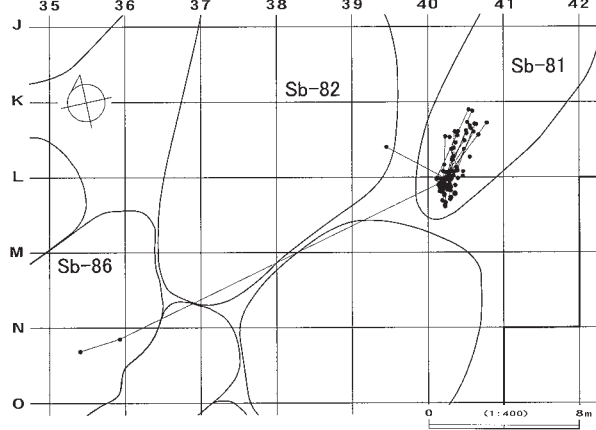

接合2807(个体B-段階14~21・尖頭器(个体a~c以外))分布图

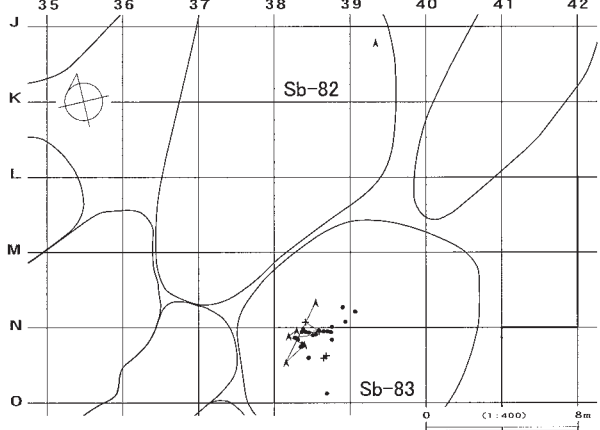

母岩549・接合2799

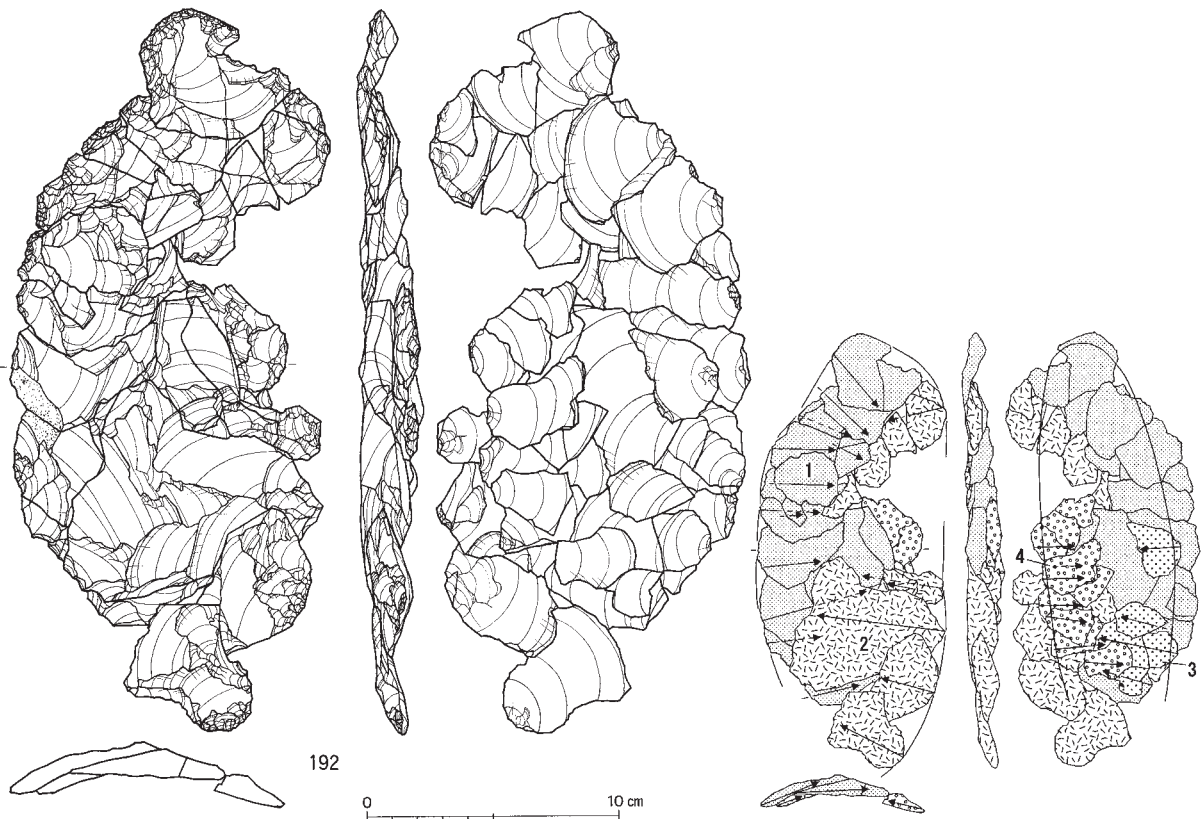

図Ⅲ-154 G区(Sb-80~89)の石器(26) 母岩551・接合2807(7)、母岩549・接合2799(1)

母岩549・接合2800

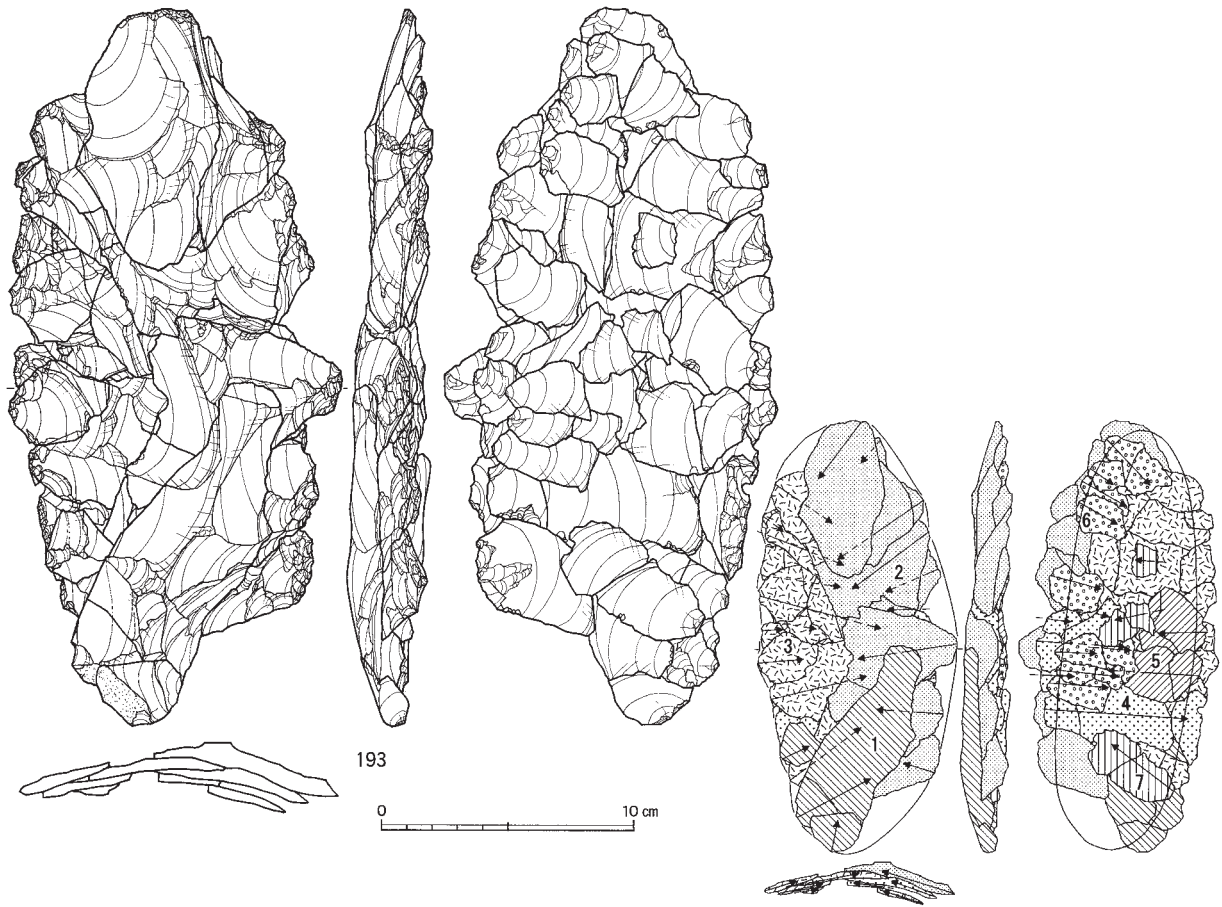

接合2799(段階1・2)・接合2800(段階1~5)分布図

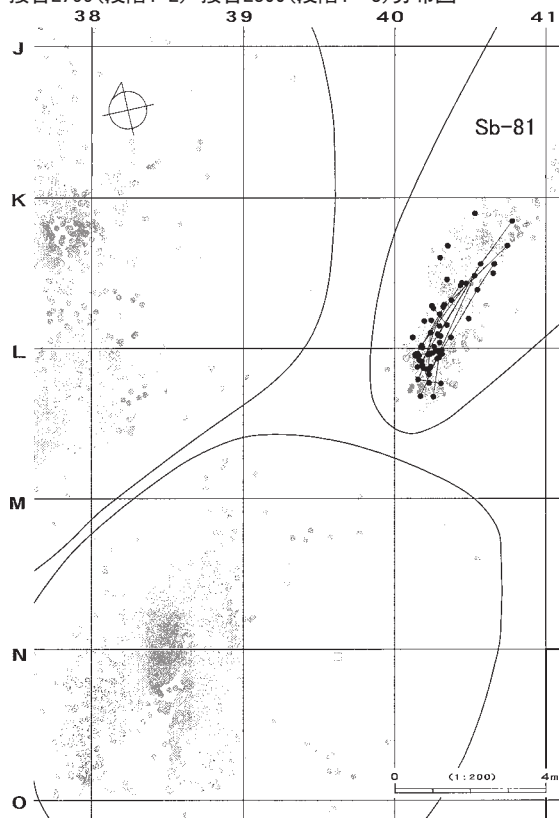

接合2799(段階3・4)・接合2800(段階6・7)分布図

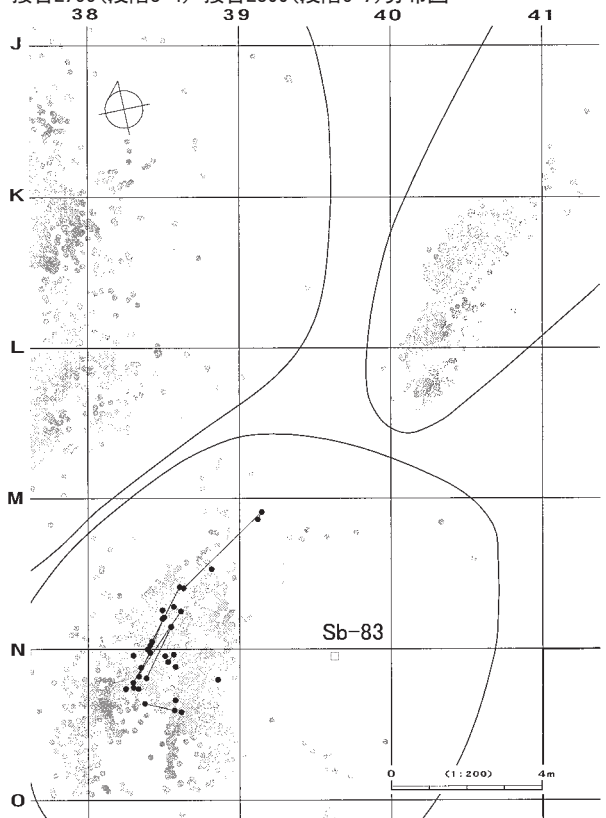

図III-155 G区(Sb-80~89)の石器(27) 母岩549・接合2799(2)、母岩549・接合2800

母岩715・接合3251

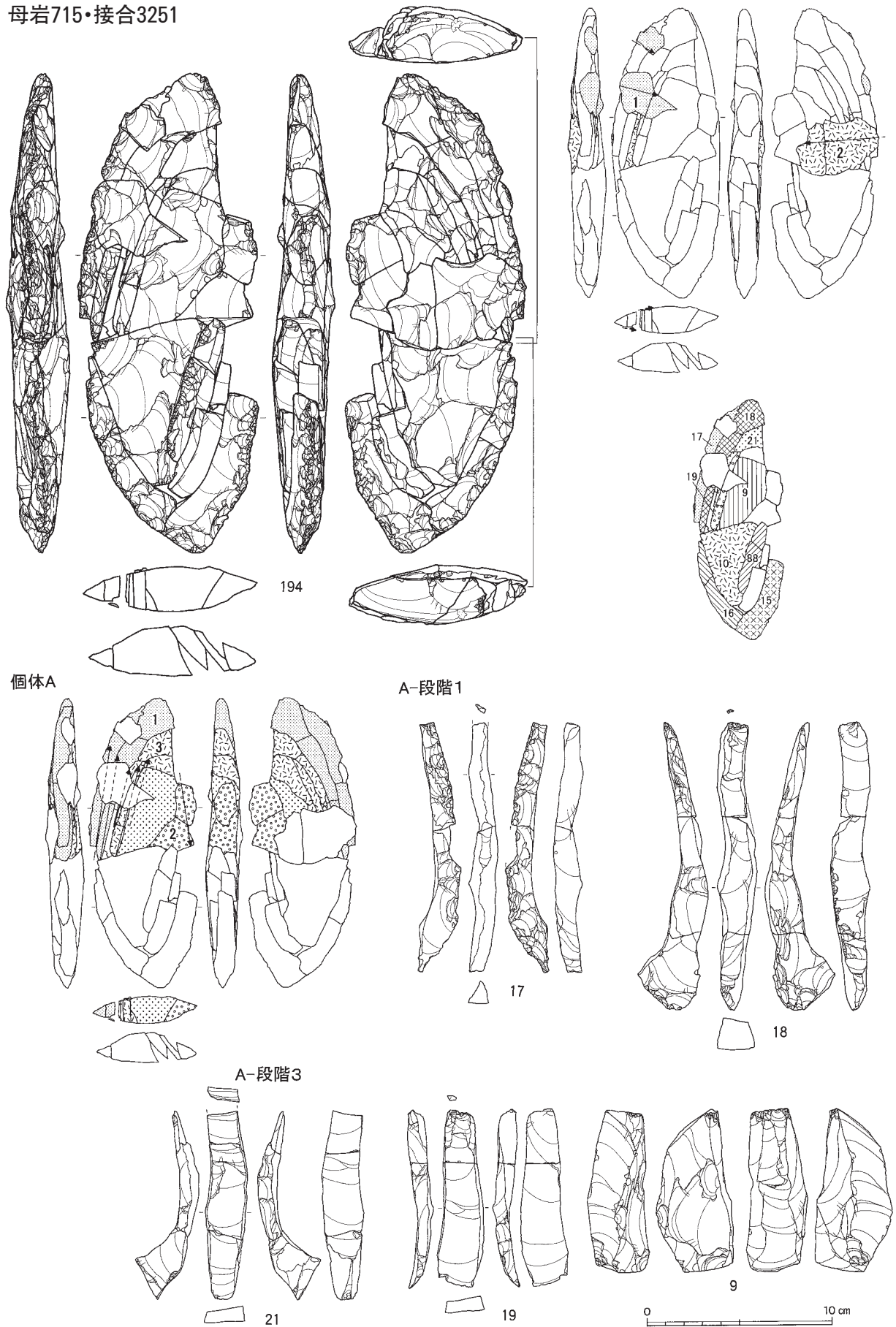

図III-156 G区(Sb-80~89)の石器(28) 母岩715・接合3251(1)

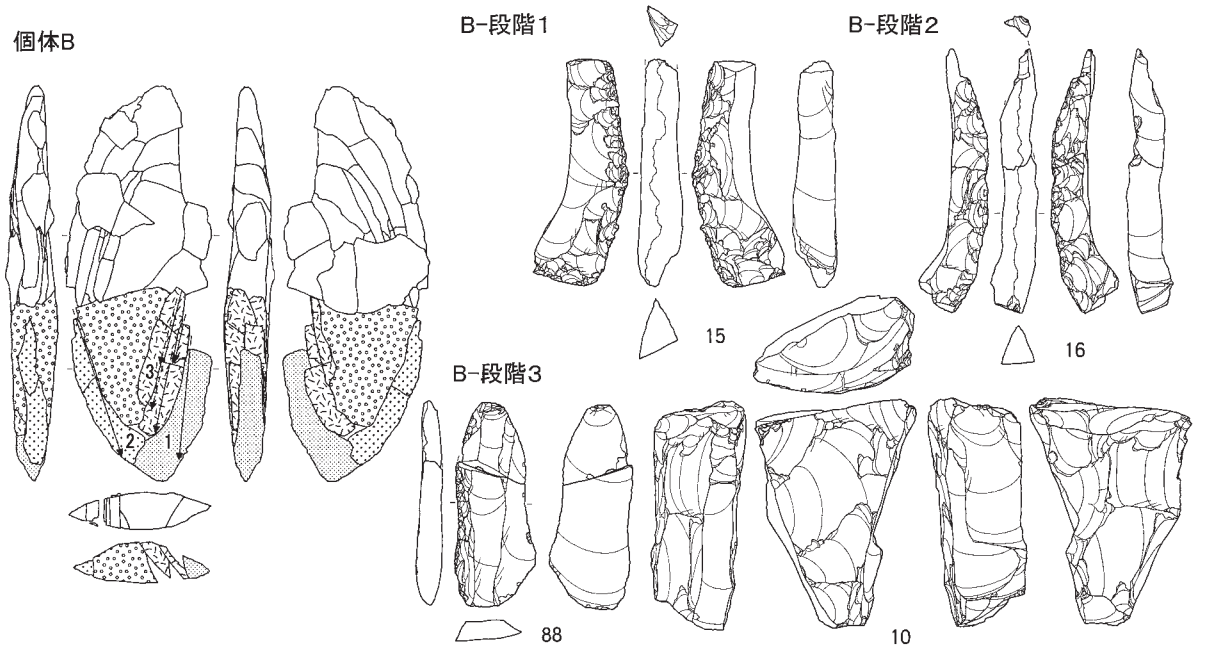

接合3251(個体A)分布図

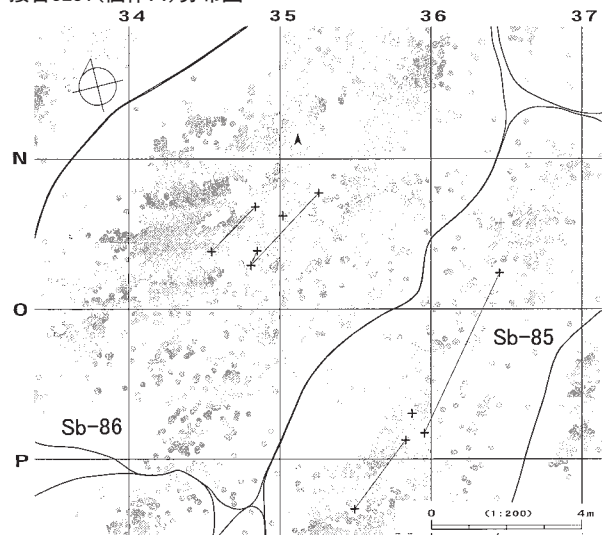

接合3251(個体B)分布図

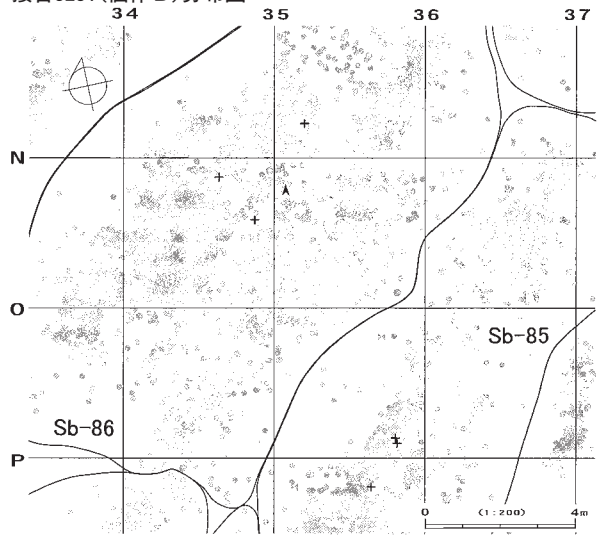

接合3251(個体A・B以外)分布図

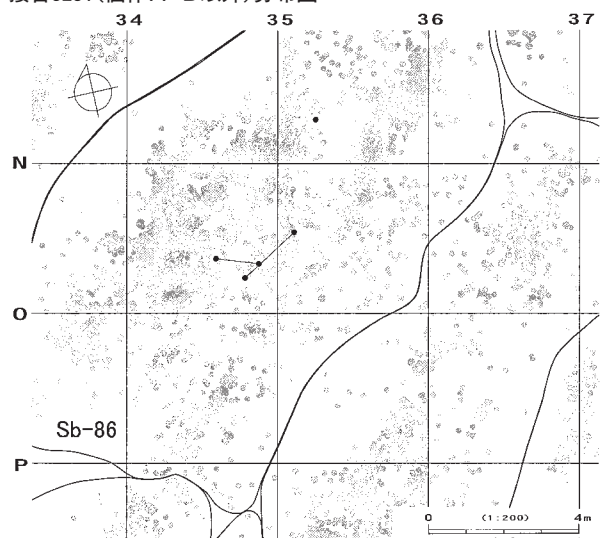

接合3251(全体)分布図

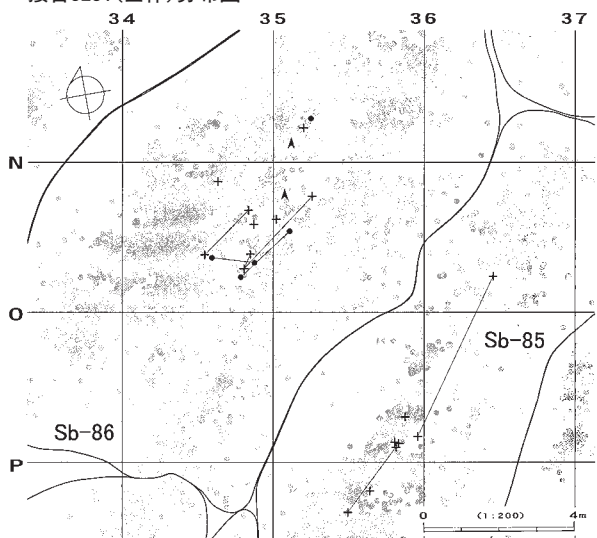

図Ⅲ-157 G区(Sb-80~89)の石器(29) 母岩715・接合3251(2)

母岩628・接合2988

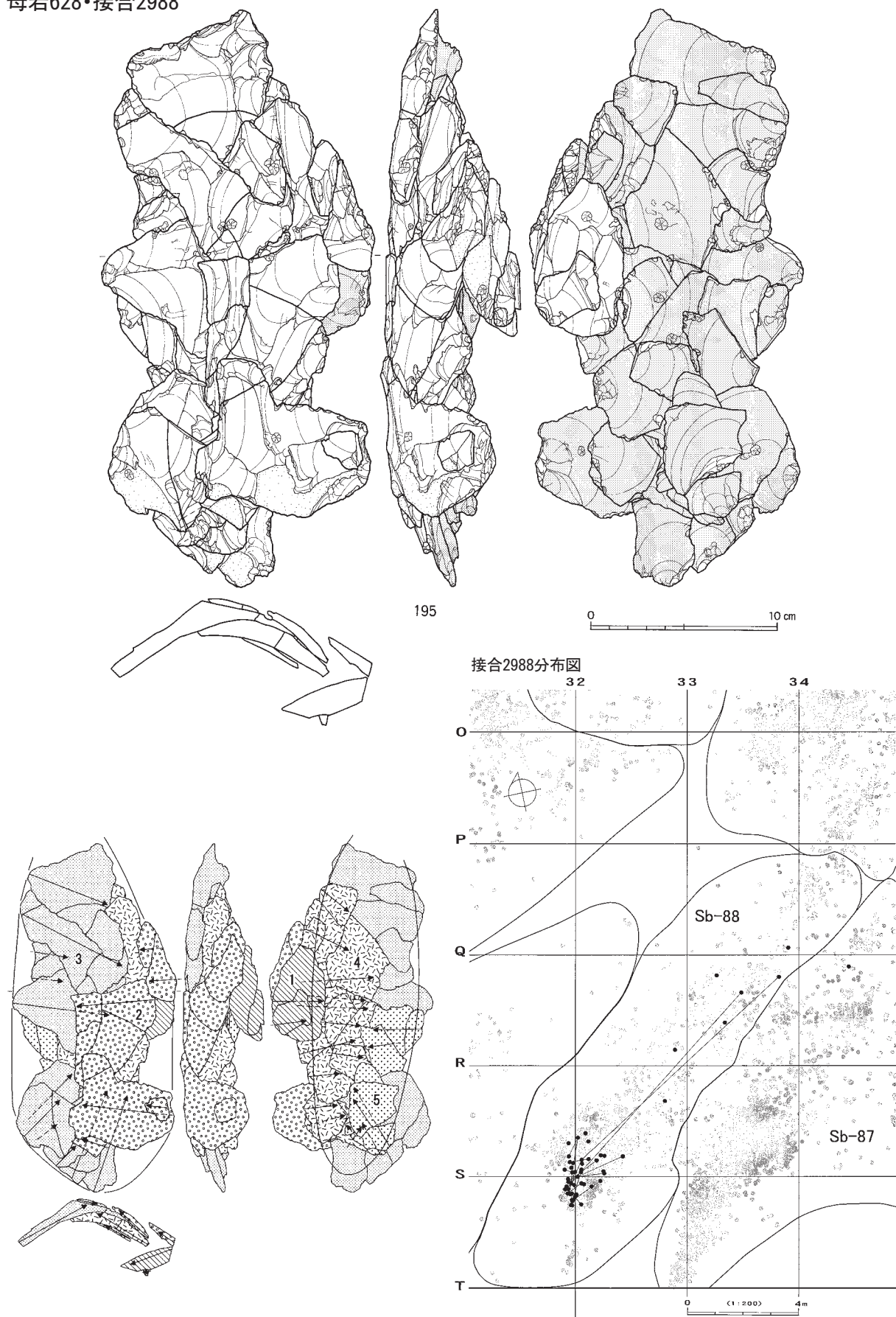

図Ⅲ-158 G区(Sb-80~89)の石器(30) 母岩628・接合2988

母岩612・接合2963



図Ⅲ-159 G区(Sb-80~89)の石器(31) 母岩612・接合2963(1)

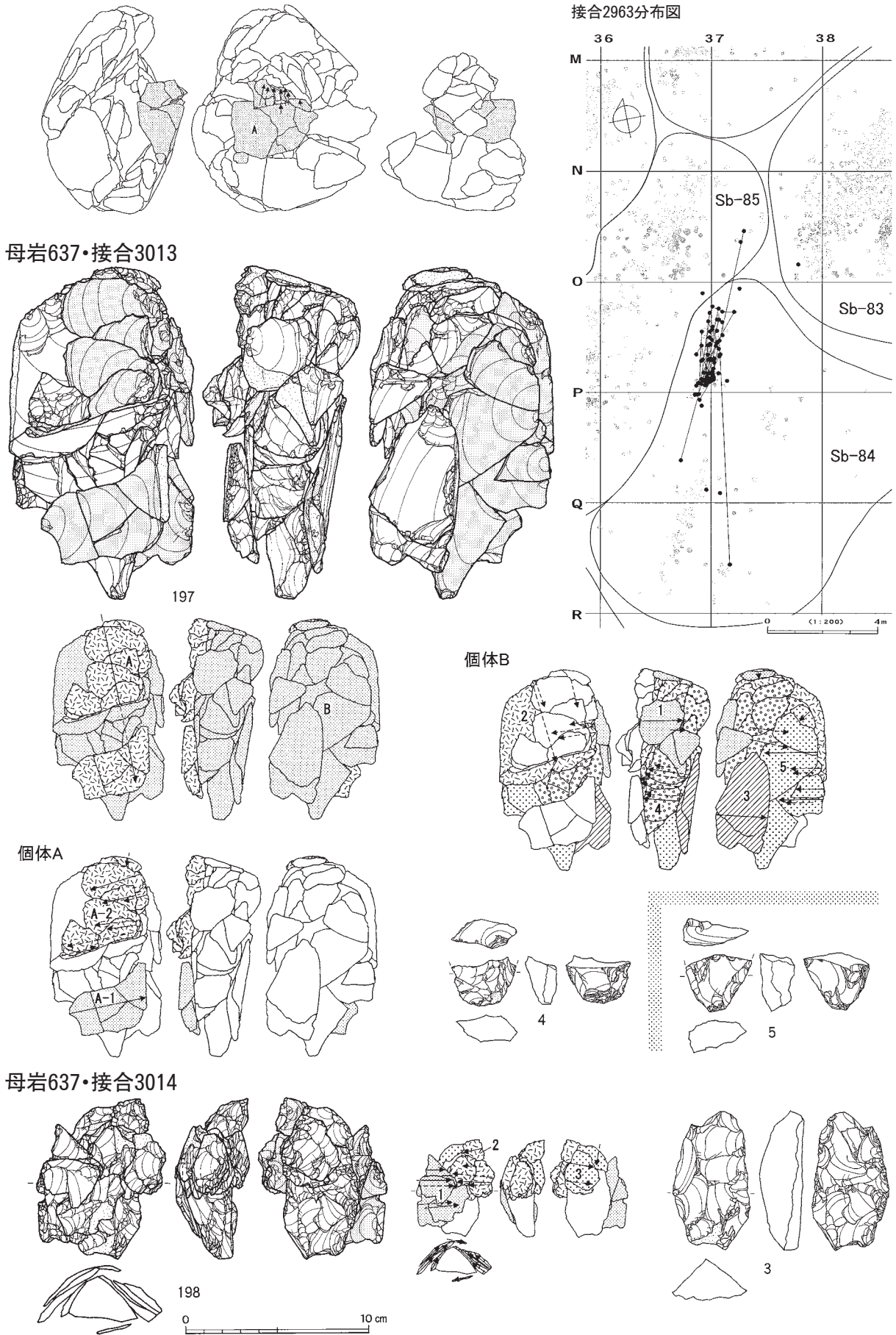

図Ⅲ-160 G区(Sb-80~89)の石器(32) 母岩612・接合2963(2)、母岩637・接合3013(1)、母岩637・接合3014(1)

接合3013(全体)分布図

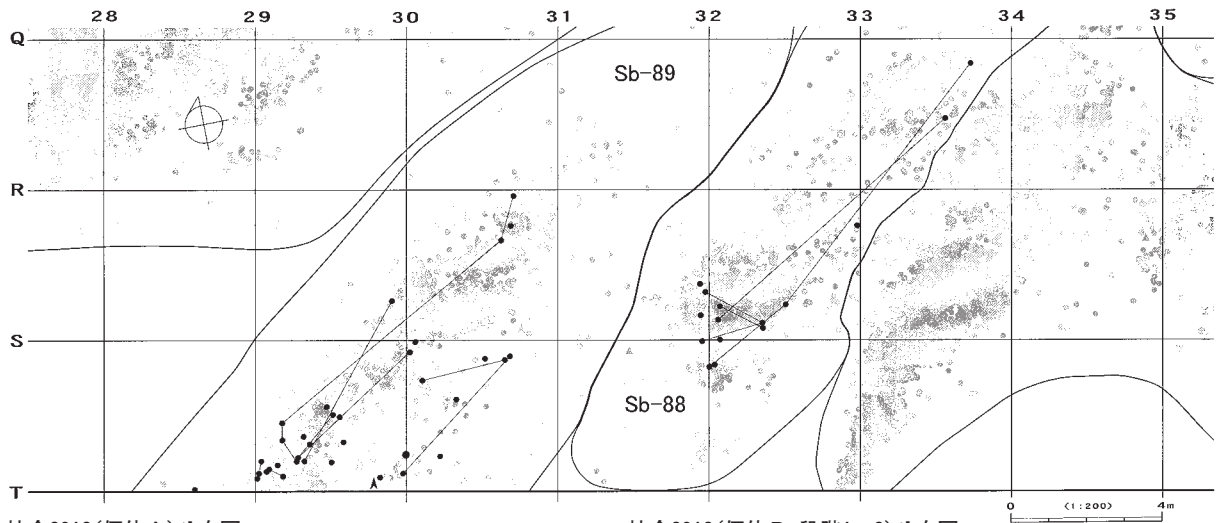

接合3013(個体A)分布図

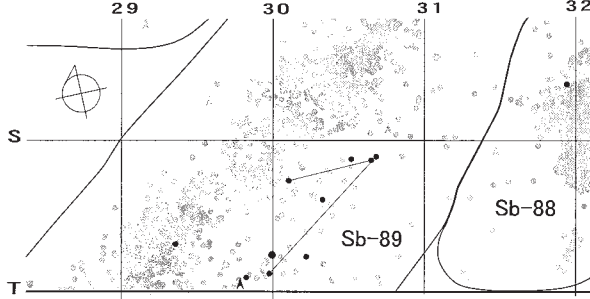

接合3013(個体B-段階1~3)分布図

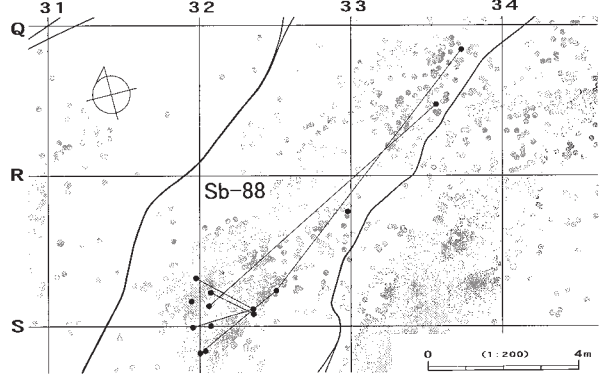

接合3013(個体B-段階4・5)分布図

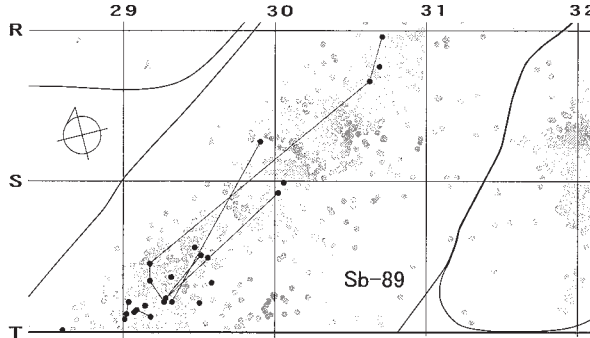

接合3014分布図

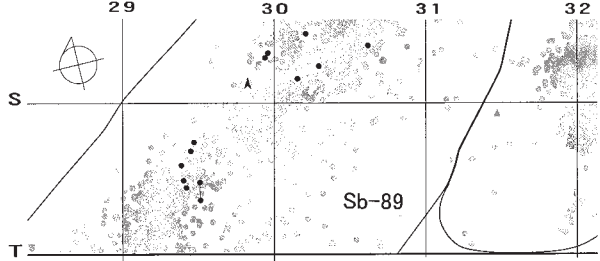

母岩610・接合2959

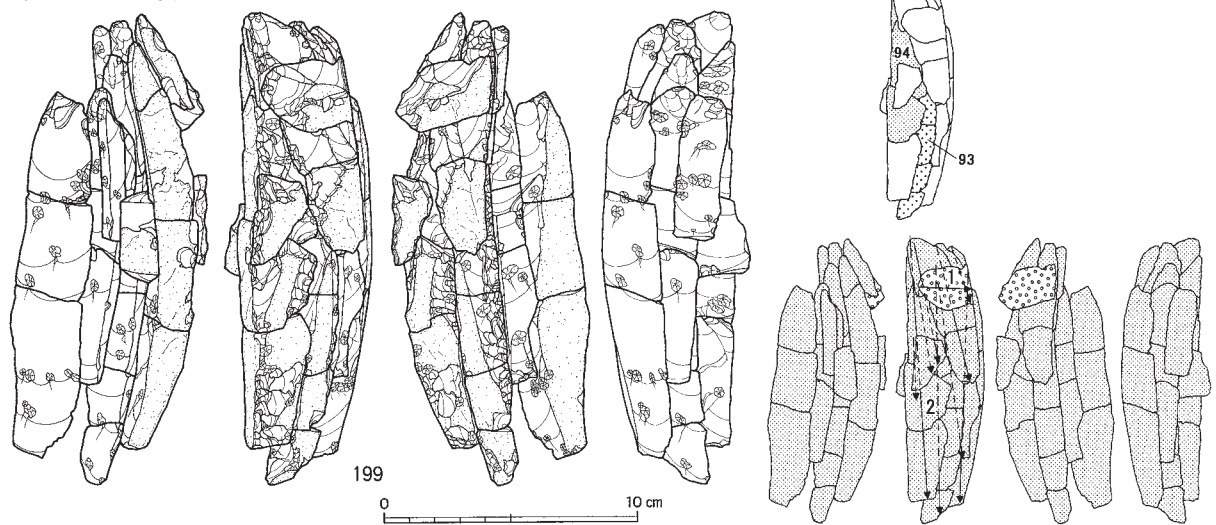

図Ⅲ-161 G区(Sb-80~89)の石器(33) 母岩637・接合3013(2)、母岩637・接合3014(2)、母岩610・接合2959(1)

G区(Sb-80~89)

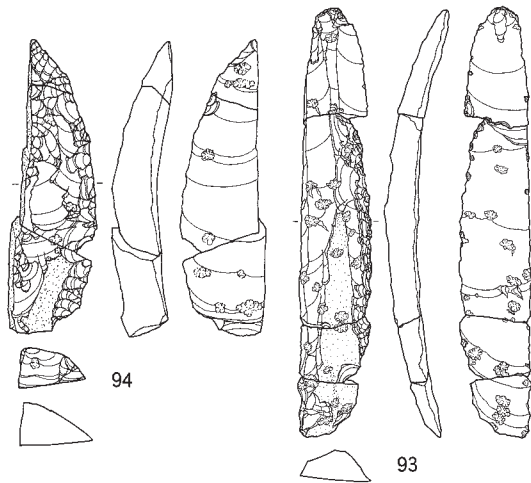

接合2959分布図

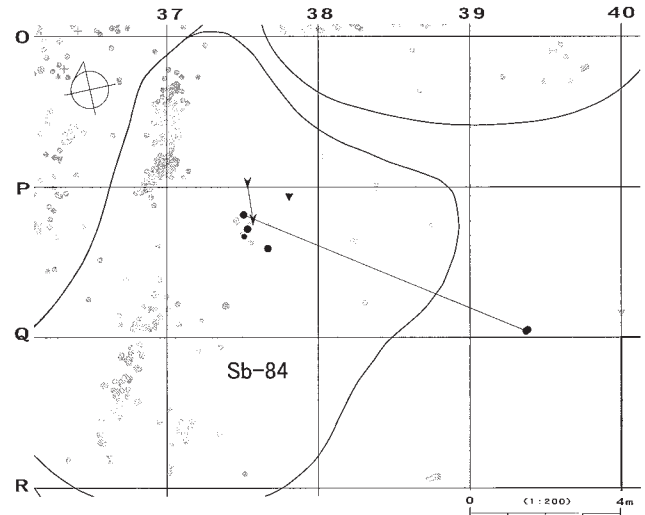

母岩633・接合3000

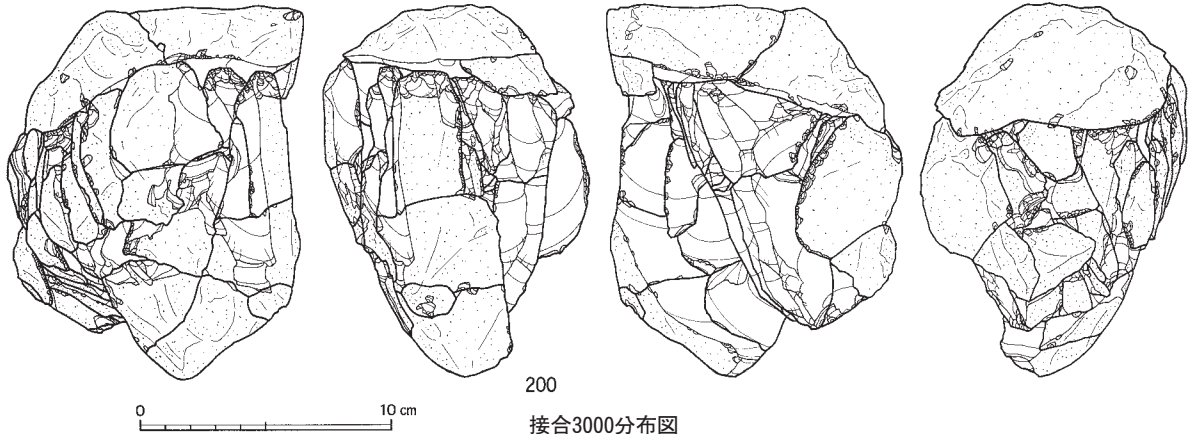

200

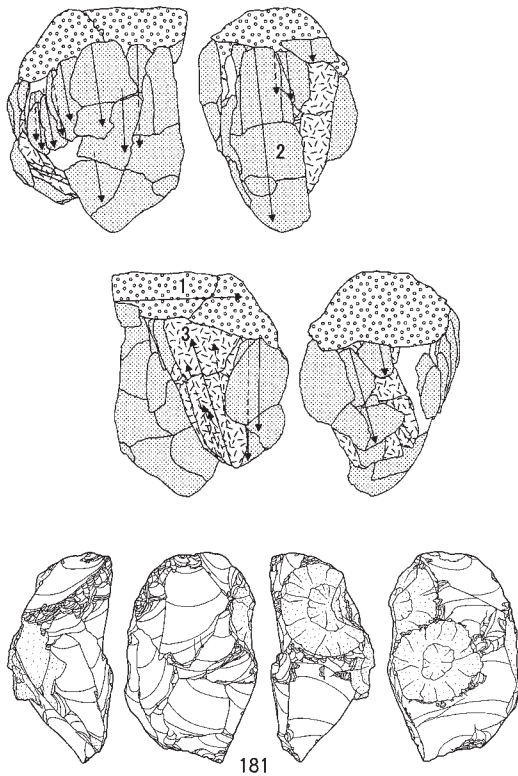

接合3000分布図

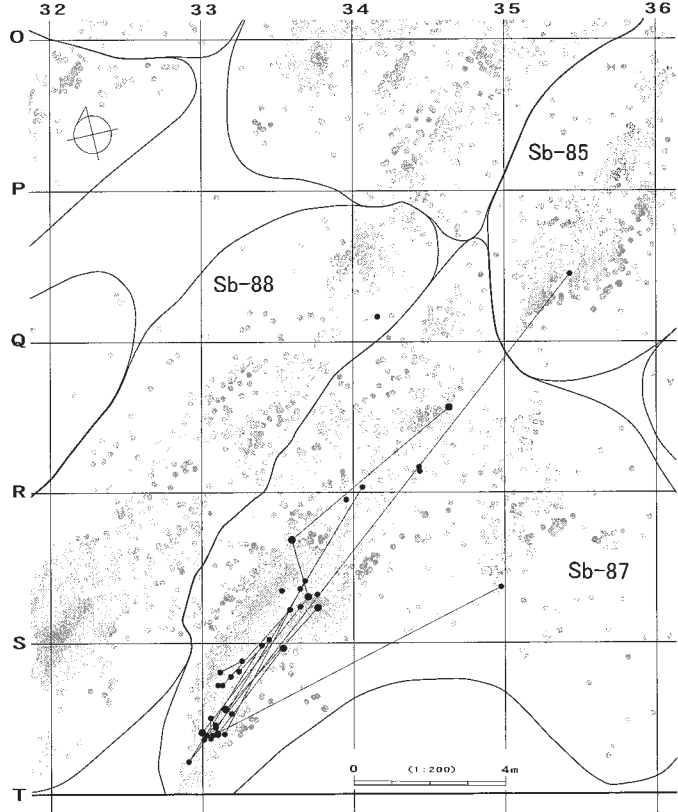

図Ⅲ-162 G区(Sb-80~89)の石器(34) 母岩610・接合2959(2)、母岩633・接合3000

母岩627・接合2986

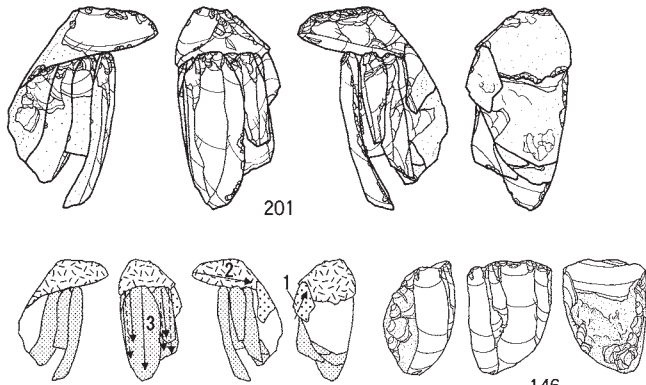

接合2986分布図

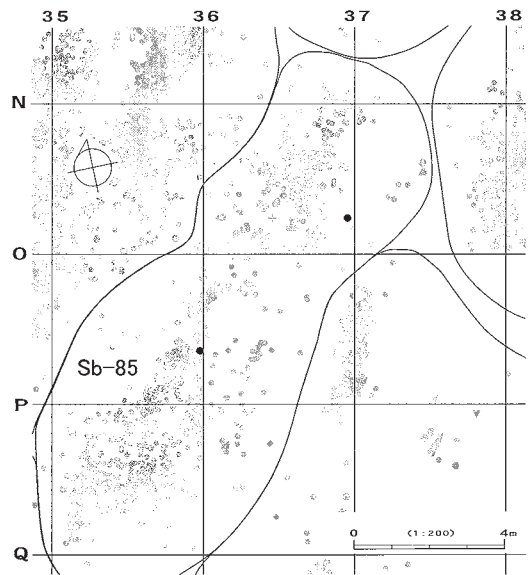

母岩586・接合2903

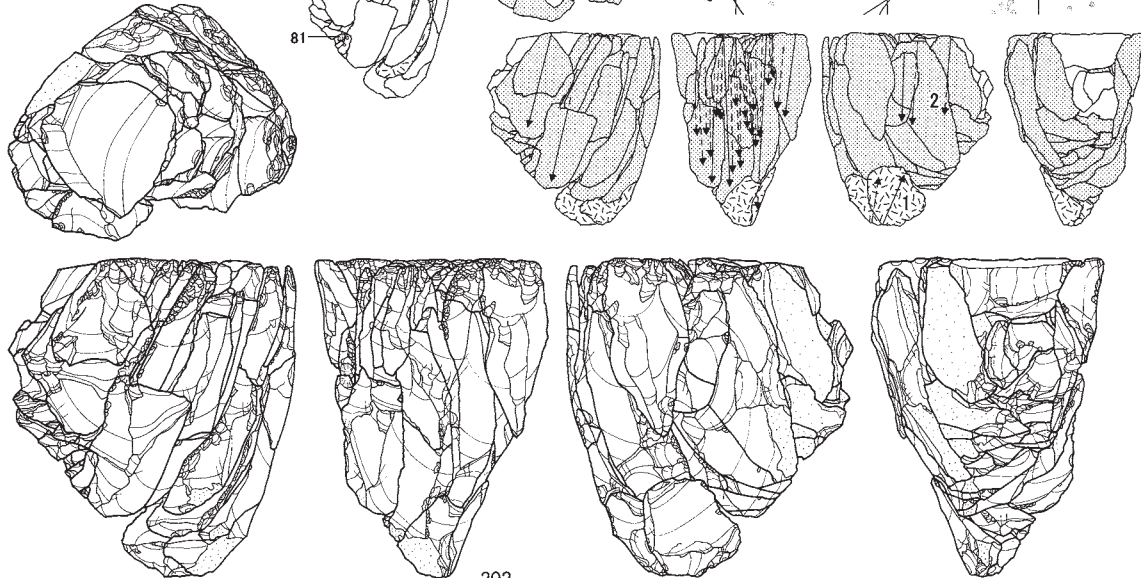

段階2

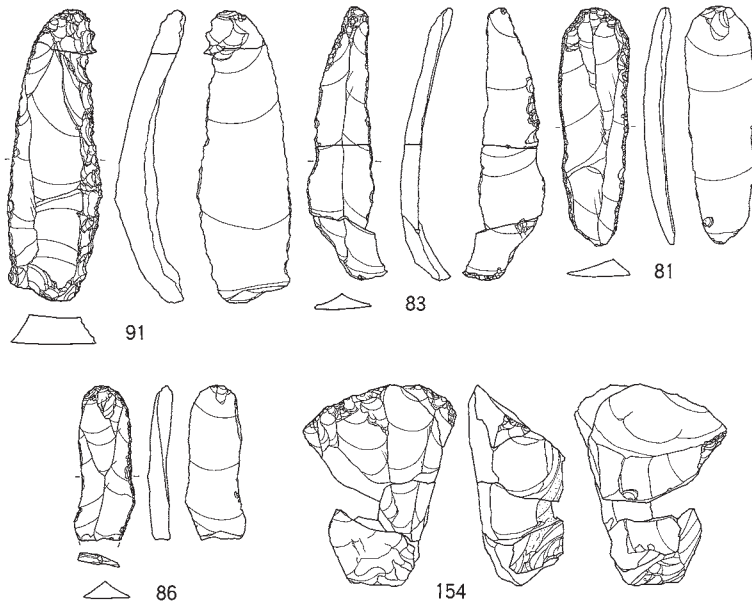

接合2903分布図

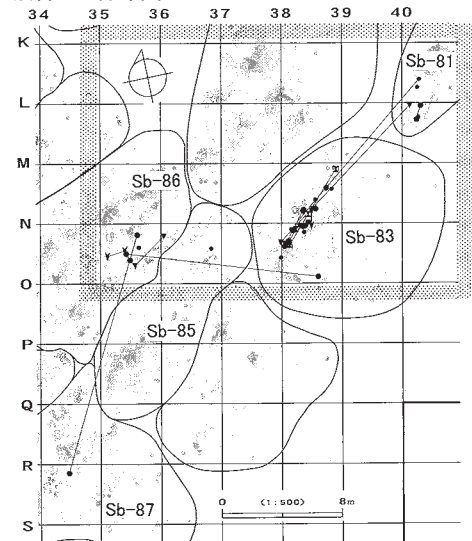

図III-163 G区(Sb-80~89)の石器(35) 母岩627・接合2986、母岩586・接合2903(1)

接合2903分布図

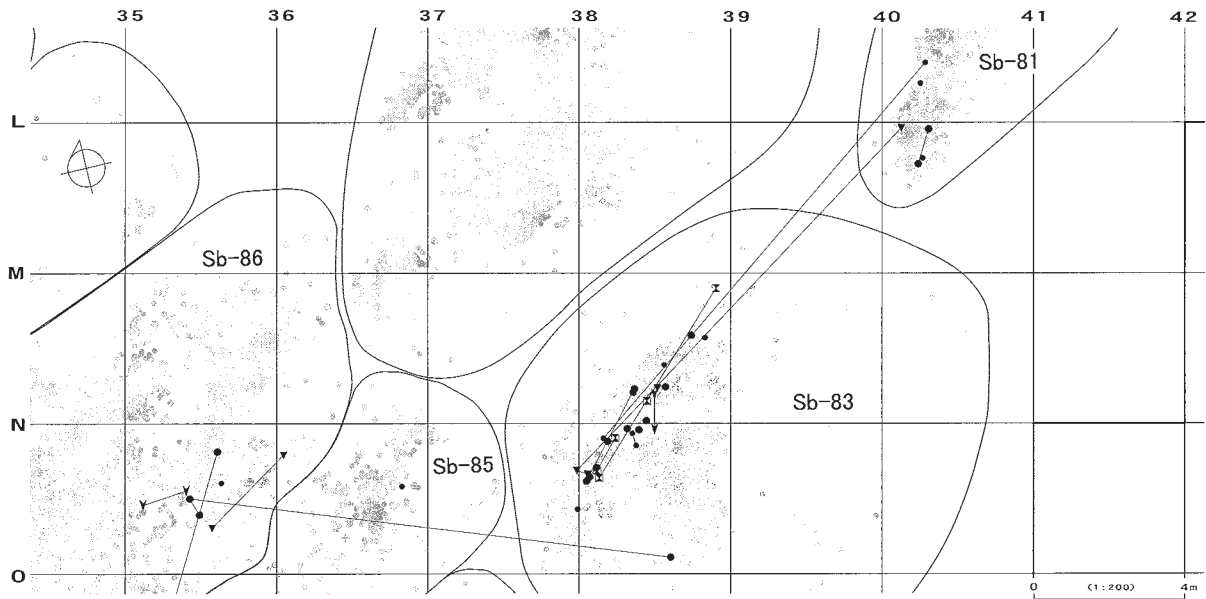

母岩613・接合2964

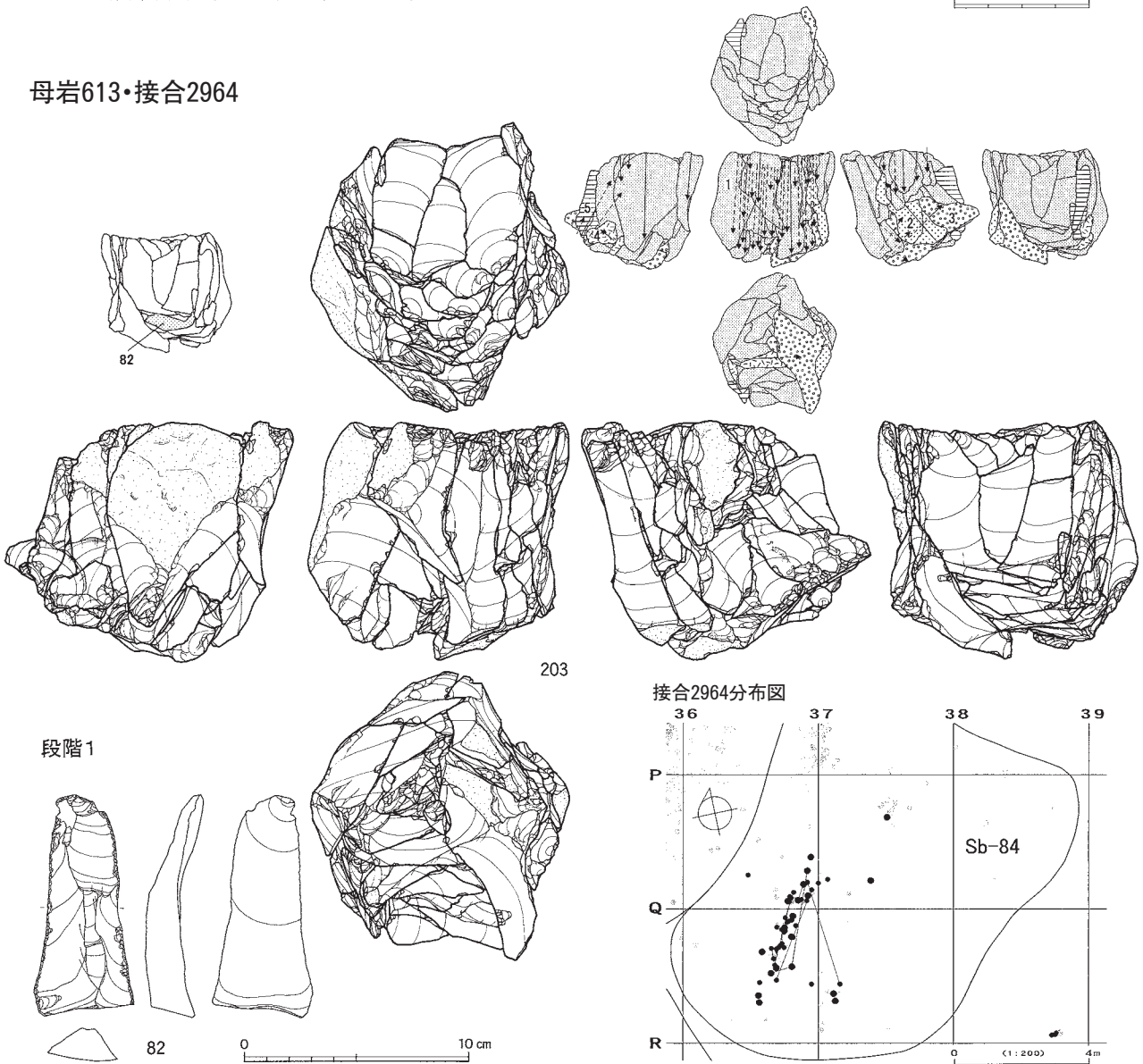

図Ⅲ-164 G区(Sb-80~89)の石器(36) 母岩586・接合2903(2)、母岩613・接合2964

母岩606・接合2953

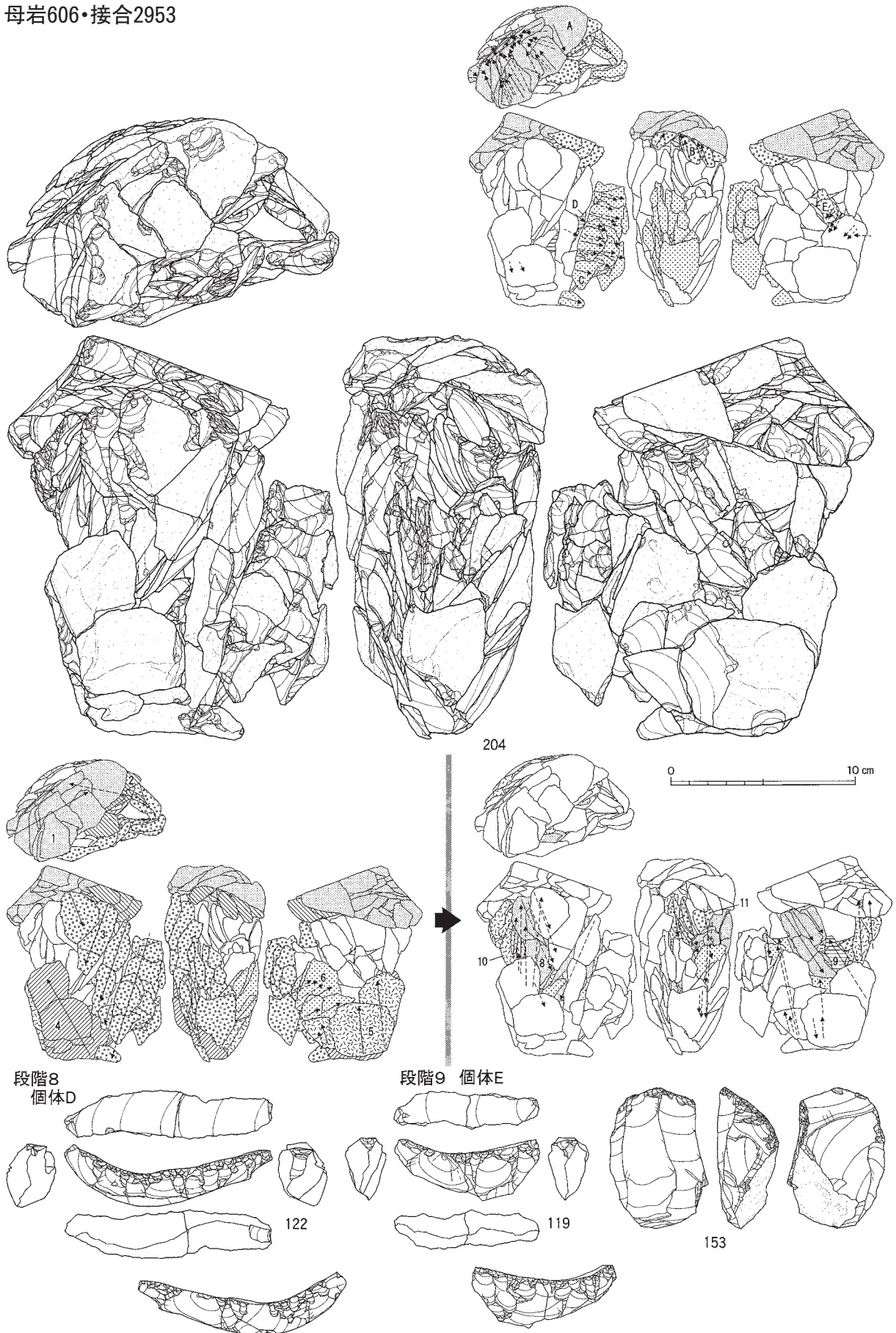

図III-165 G区(Sb-80~89)の石器(37) 母岩606・接合2953(1)

接合2953(个体A)分布图

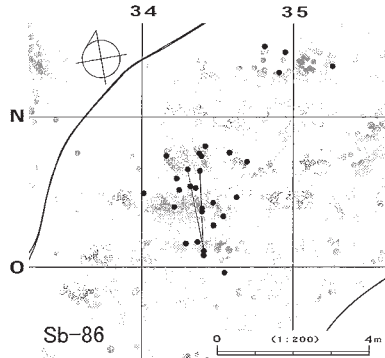

接合2953(个体B)分布图

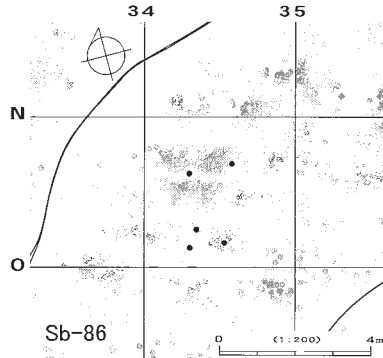

接合2953(个体C)分布图

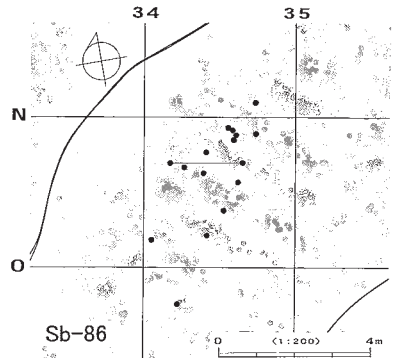

接合2953(个体D)分布图

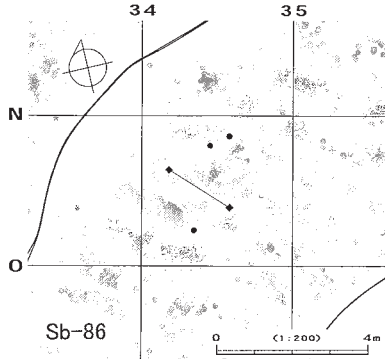

接合2953(个体E)分布图

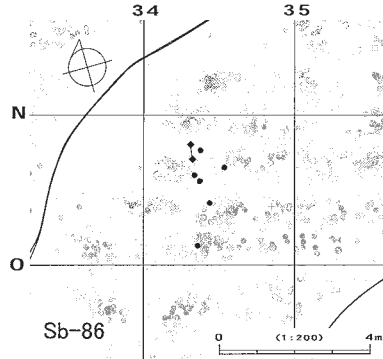

接合2953(个体A~E以外)分布图

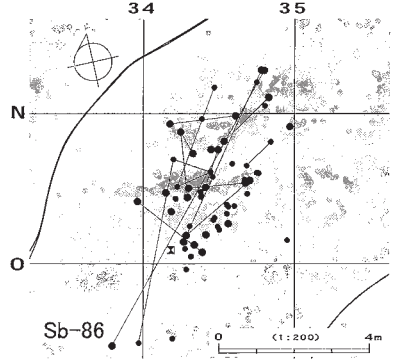

母岩593・接合2927

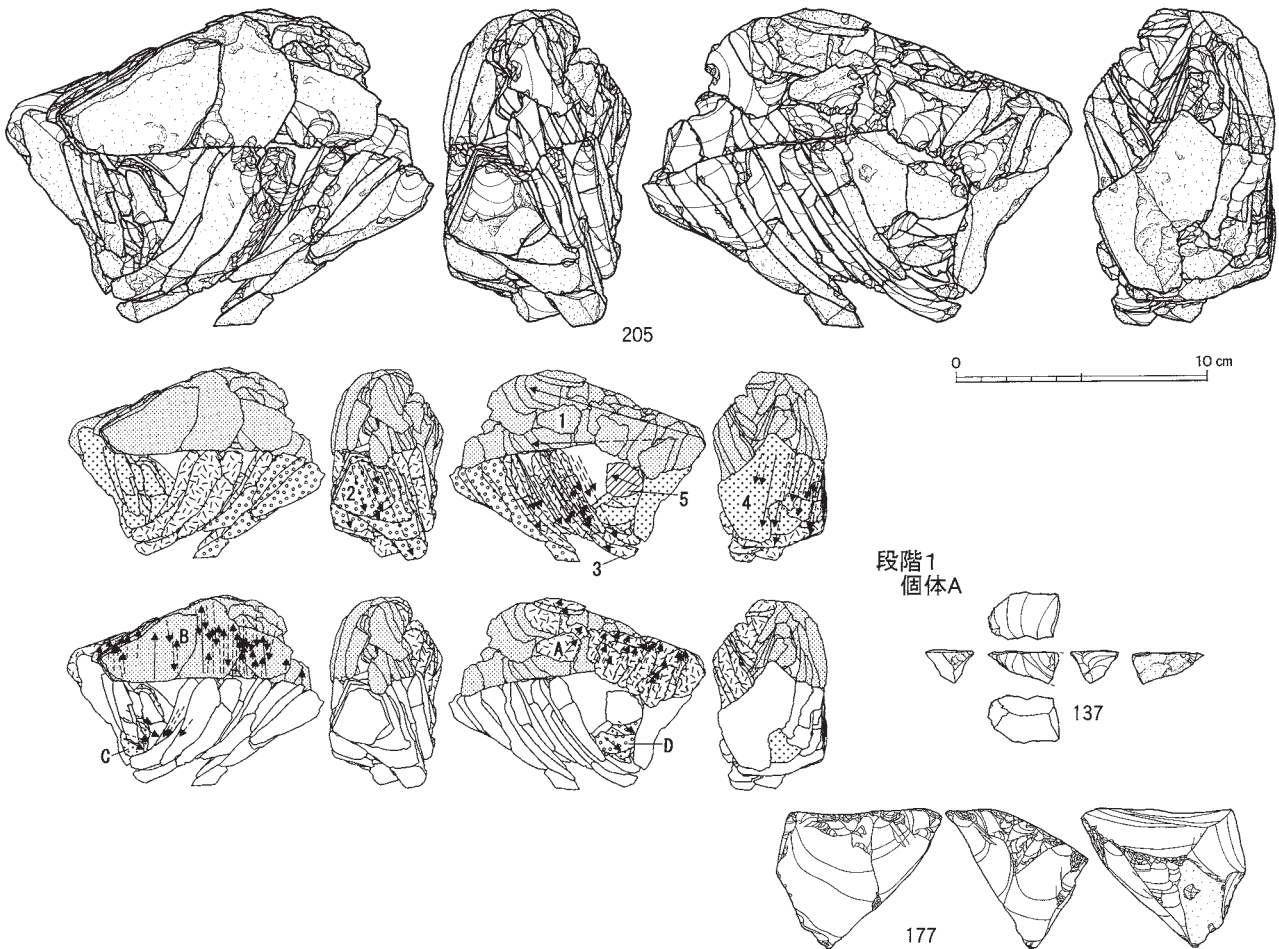

図Ⅲ-166 G区(Sb-80~89)の石器(38) 母岩606・接合2953(2)、母岩593・接合2927(1)

接合2927(全体)分布図

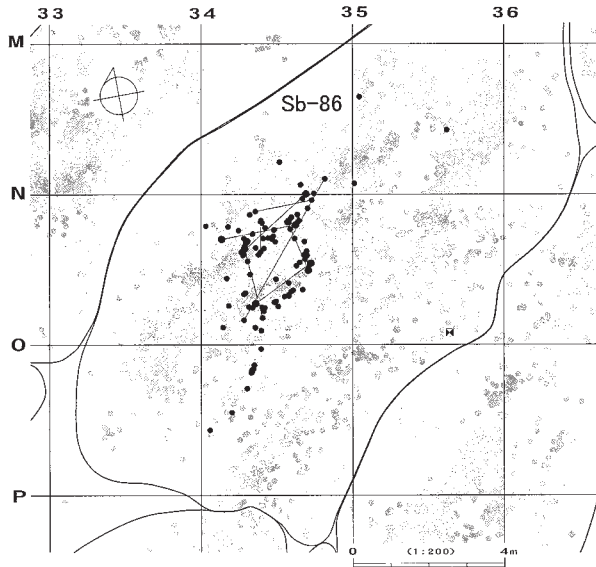

接合2927(個体A)分布図



接合2927(個体B)分布図

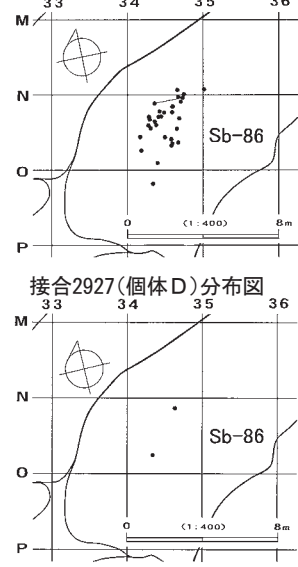

接合2927(個体C)分布図

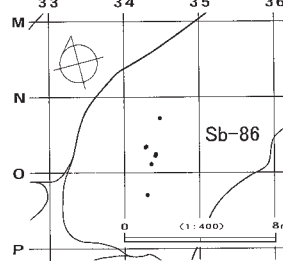

接合2927(個体D)分布図

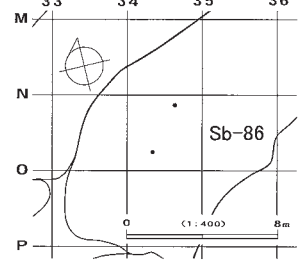

母岩550・接合2805

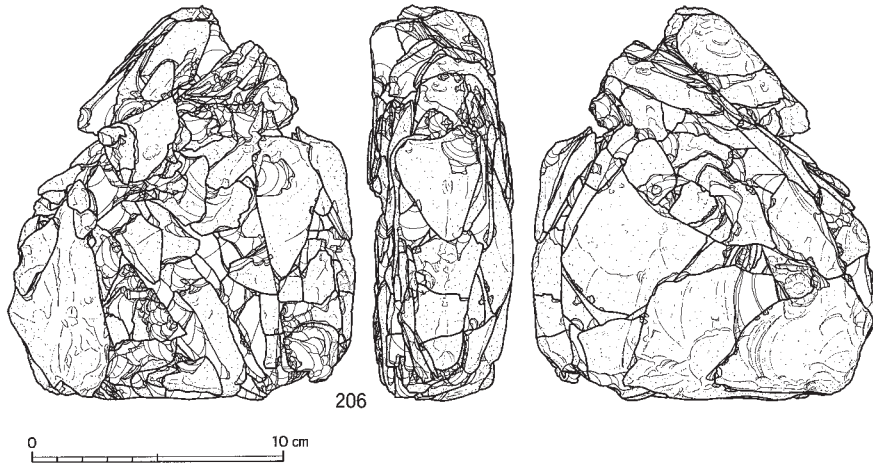

接合2927(個体A~D以外)分布図

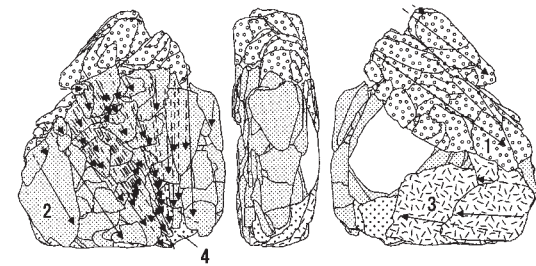
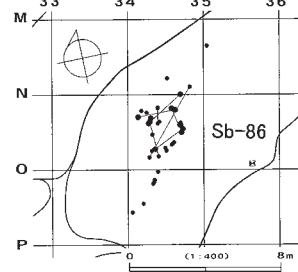

段階1
個体B

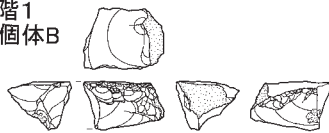

段階2
個体A

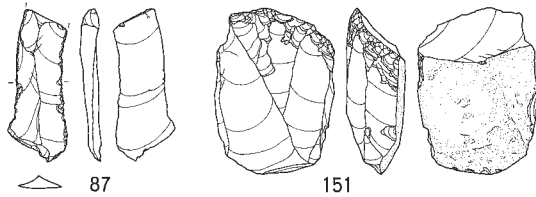
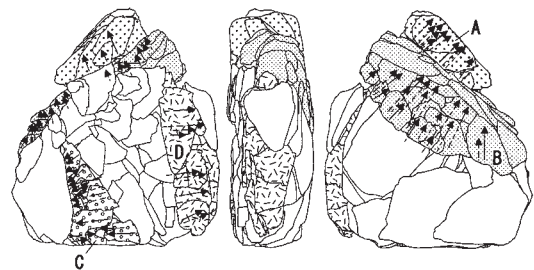
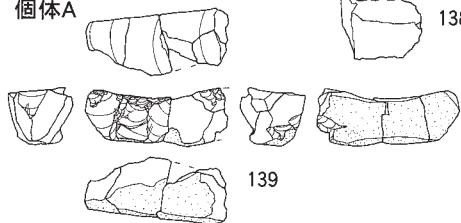

図III-167 G区(Sb-80~89)の石器(39) 母岩593・接合2927(2)、母岩550・接合2805(1)

接合2805(全体)分布図

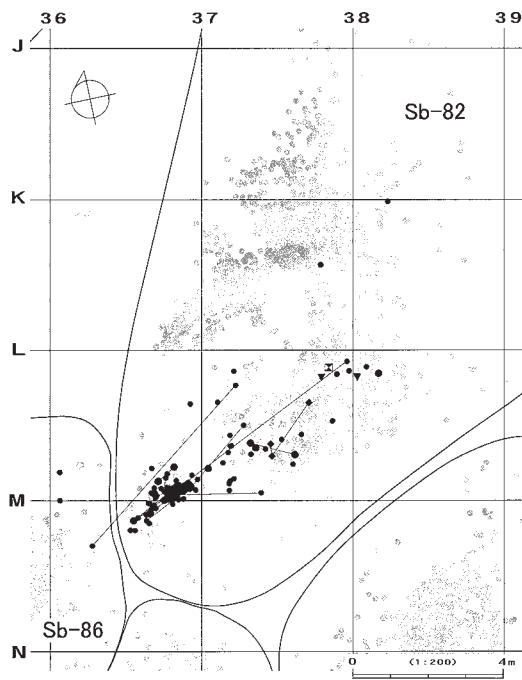

接合2805(個体A)分布図

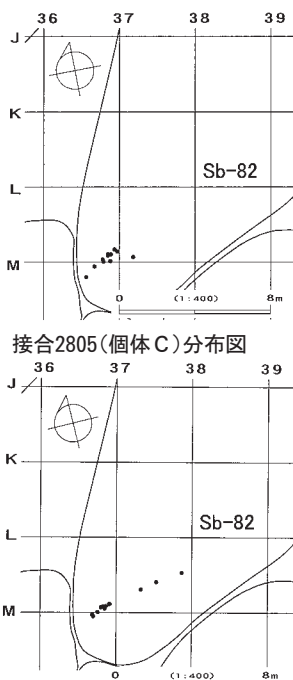

接合2805(個体B)分布図

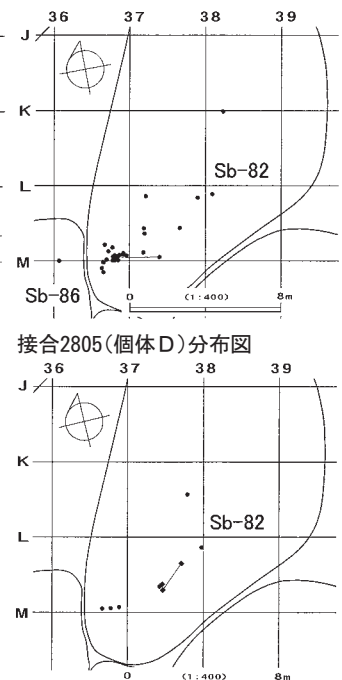

接合2805(個体C)分布図

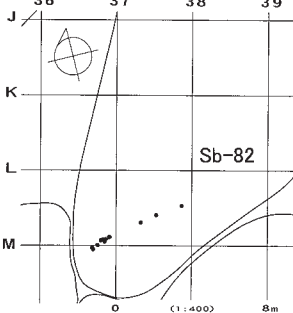

接合2805(個体D)分布図

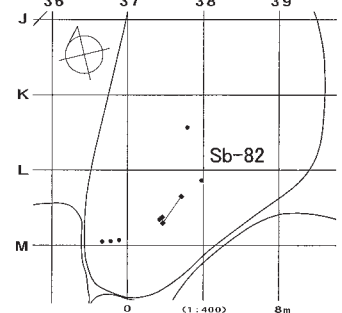

母岩609・接合2958

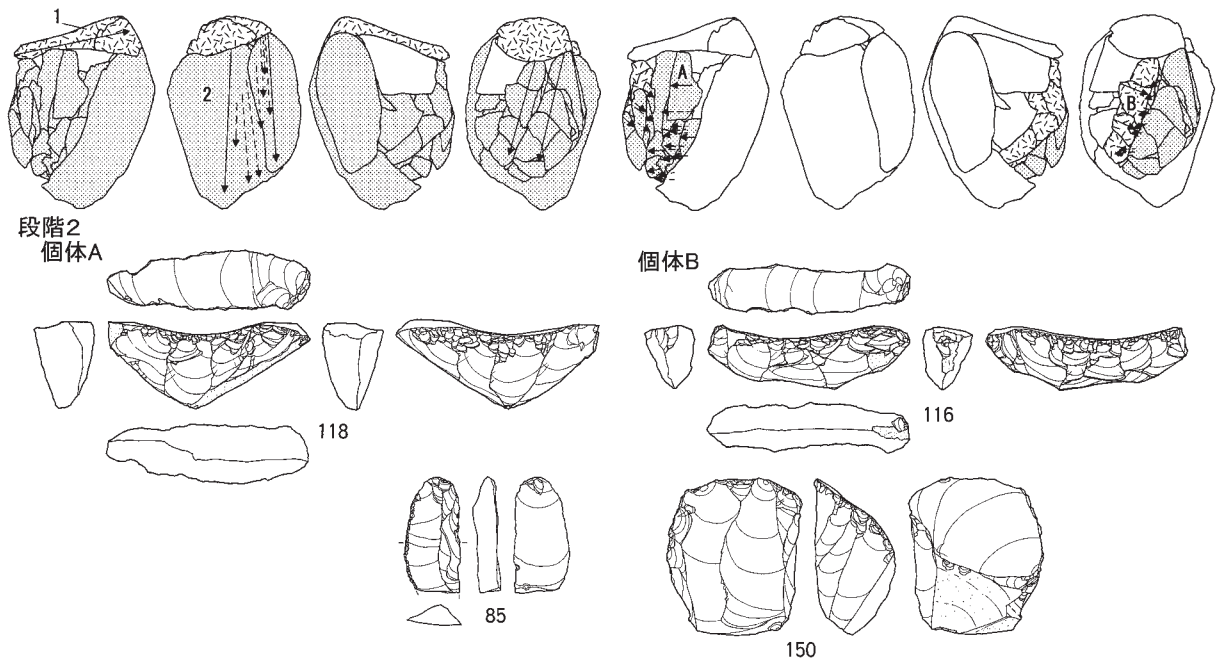
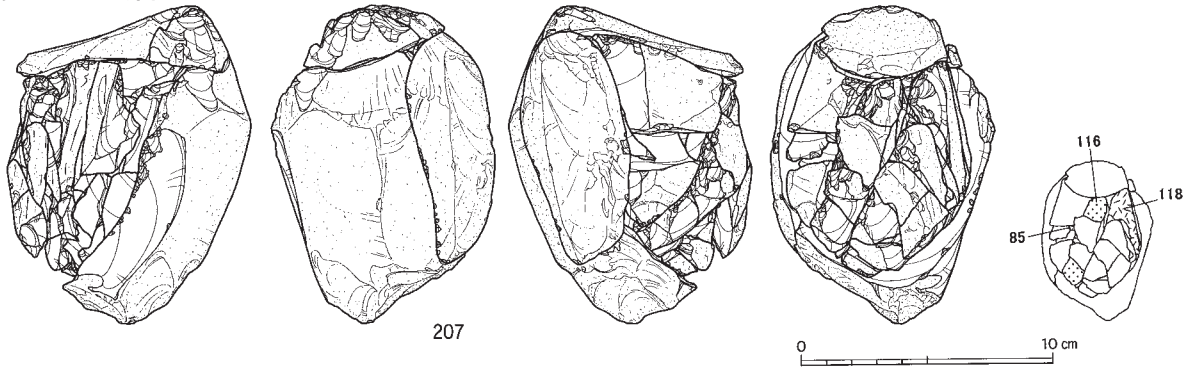

図Ⅲ-168 G区(Sb-80~89)の石器(40) 母岩550・接合2805(2)、母岩609・接合2958(1)

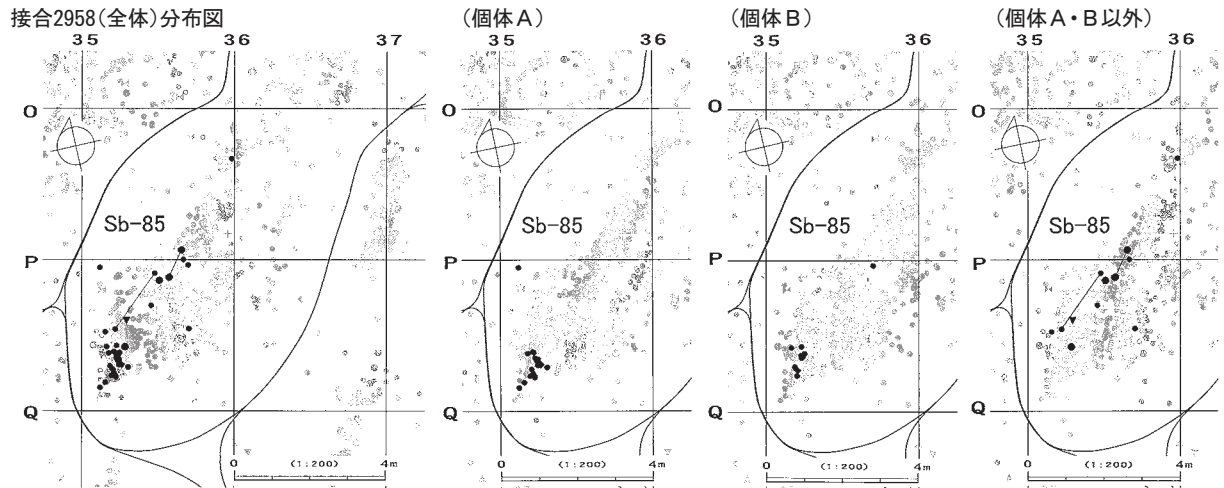

母岩604・接合2951

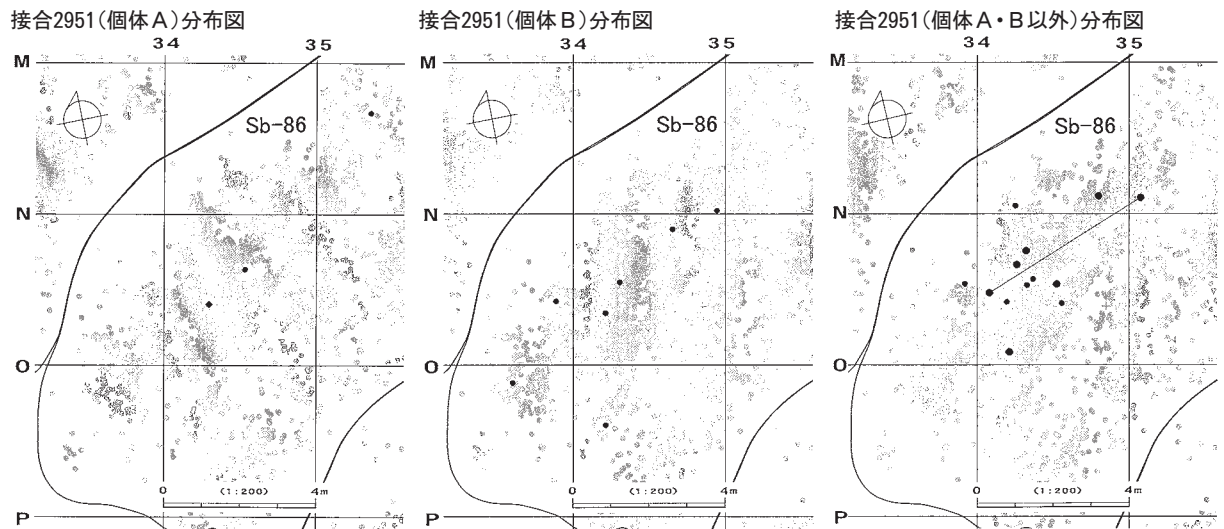
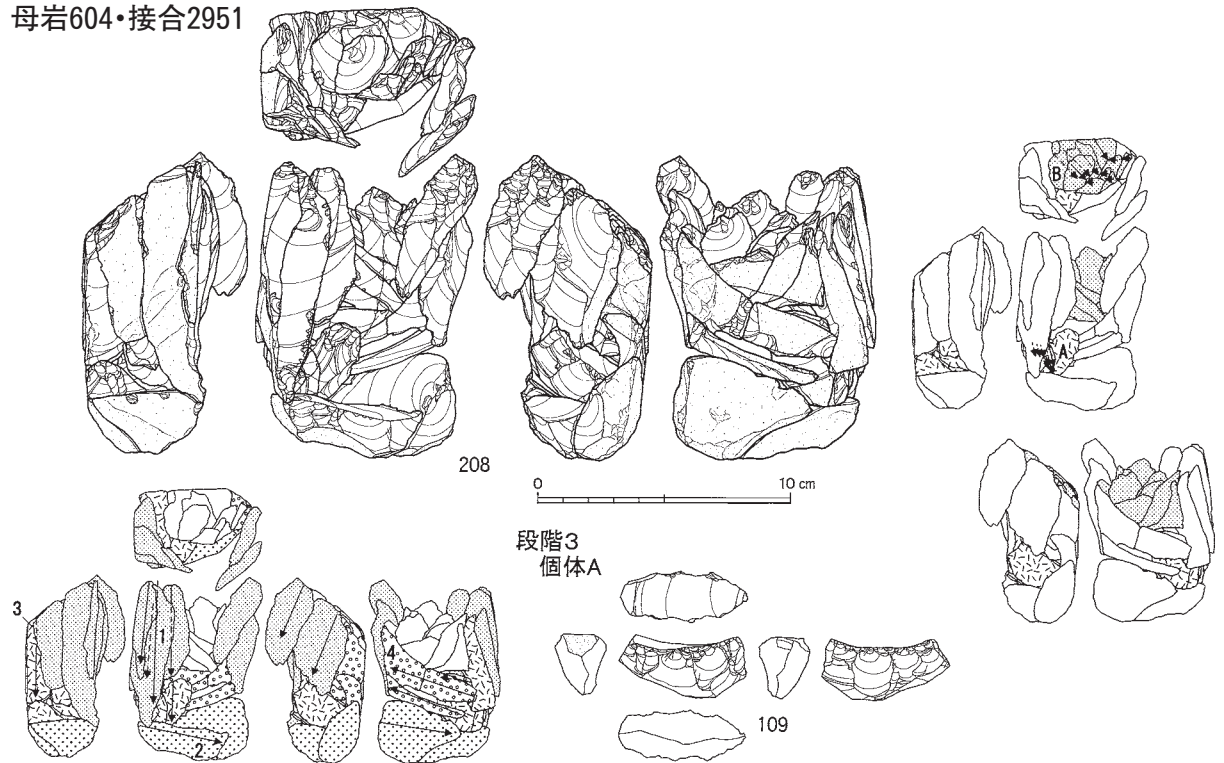

図Ⅲ-169 G区(Sb-80~89)の石器(41) 母岩609・接合2958(2)、母岩604・接合2951

母岩590・接合2916

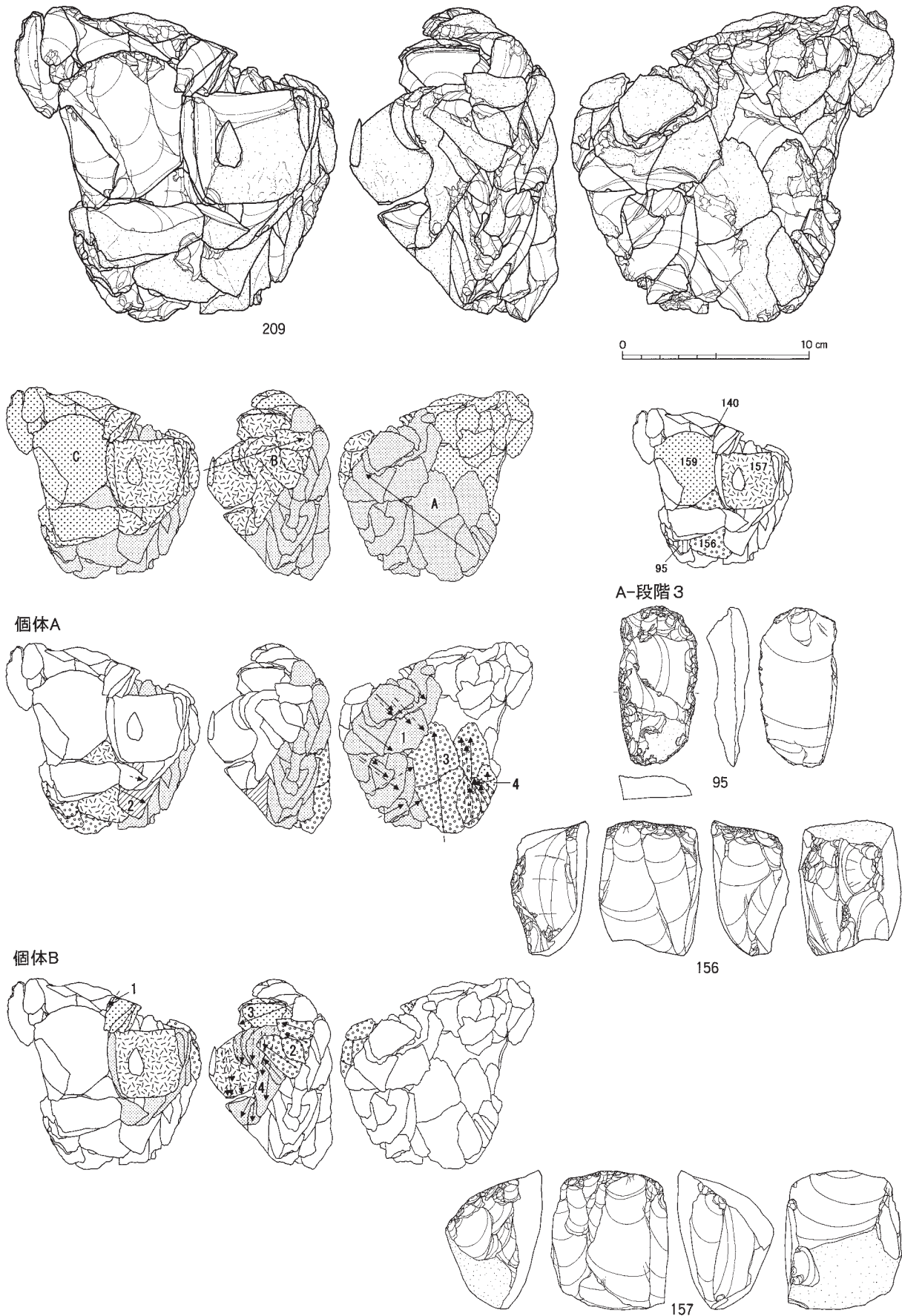

図Ⅲ-170 G区(Sb-80~89)の石器(42) 母岩590・接合2916(1)

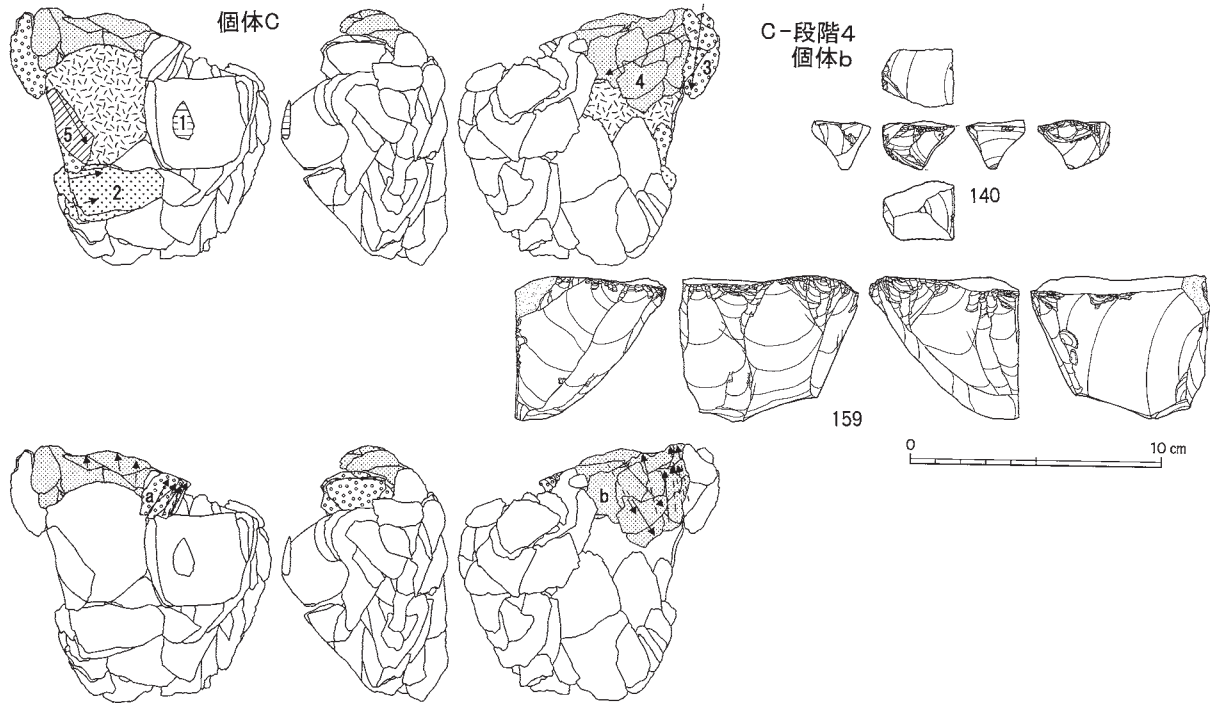

接合2916(全体)分布図

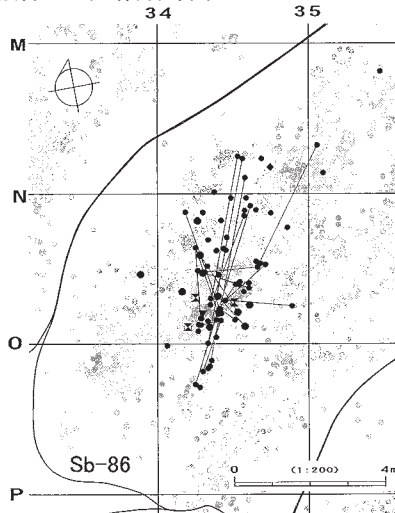

接合2916(个体A)分布図

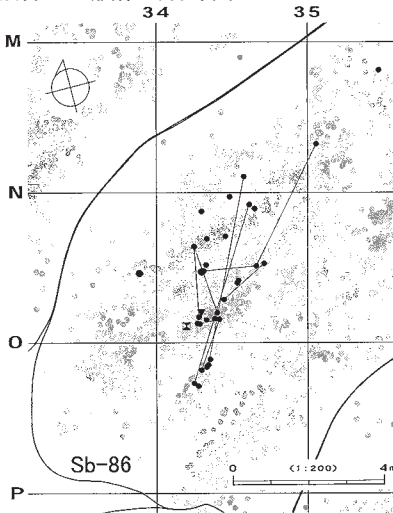

接合2916(个体B)分布図

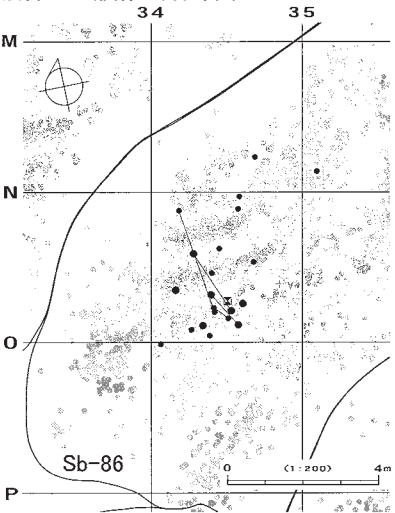

接合2916(个体C)分布図

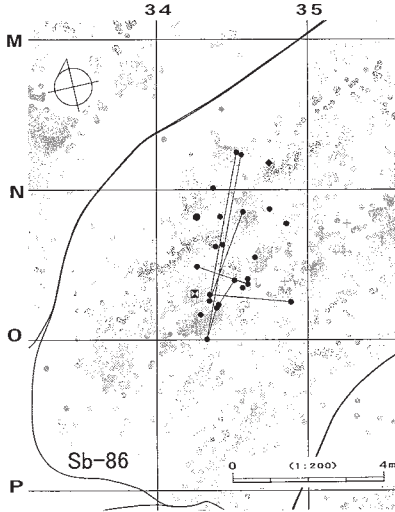

接合2916(个体a)分布図

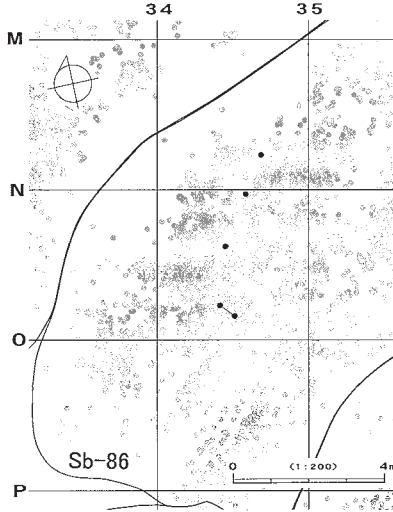

接合2916(个体b)分布図

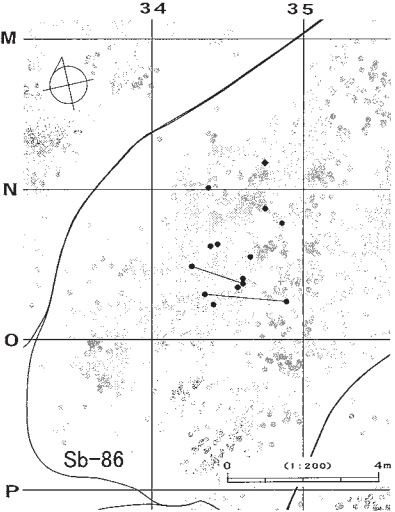

図III-171 G区(Sb-80~89)の石器(43) 母岩590・接合2916(2)

母岩662・接合3102

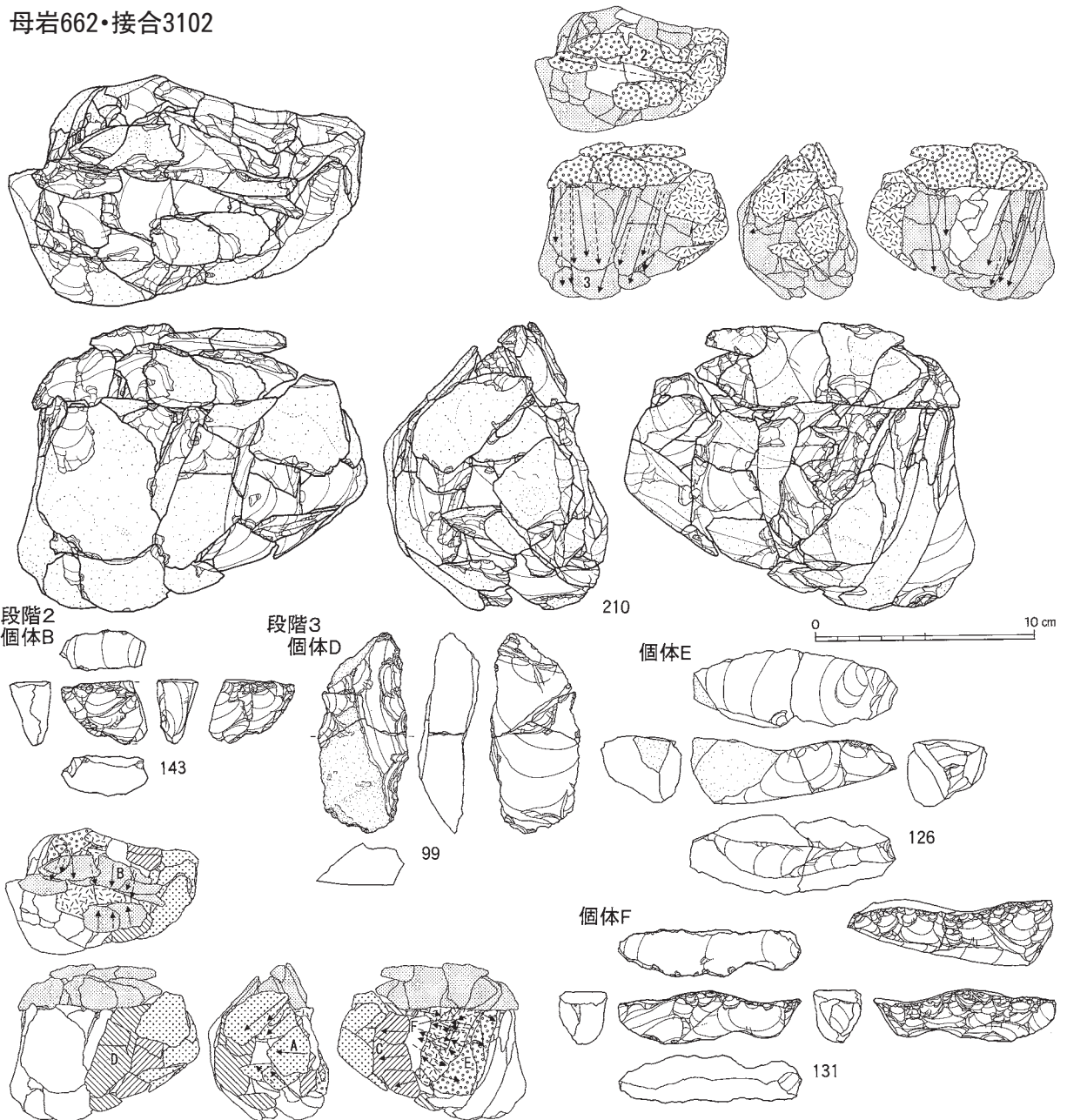

接合3102(全体)分布図

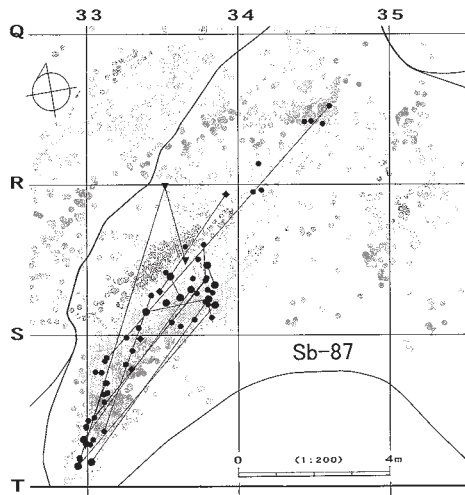

接合3102(個体A)分布図 接合3102(個体B)分布図 接合3102(個体C)分布図

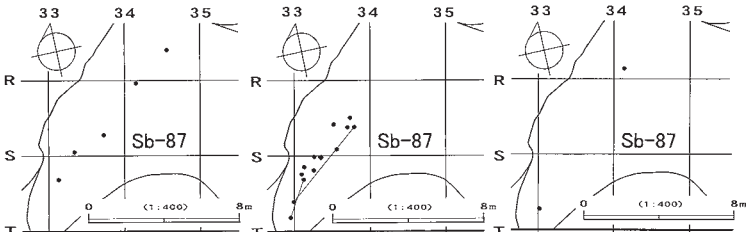

接合3102(個体D)分布図 接合3102(個体E)分布図 接合3102(個体F)分布図

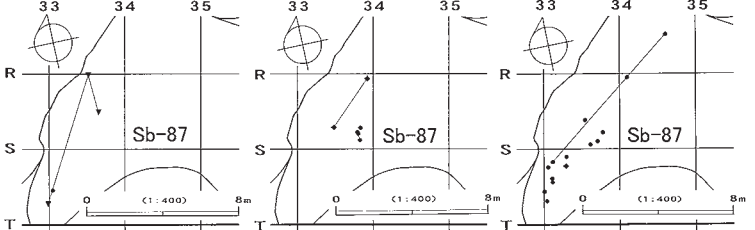

図Ⅲ-172 G区(Sb-80~89)の石器(44) 母岩662・接合3102

母岩596・接合2938

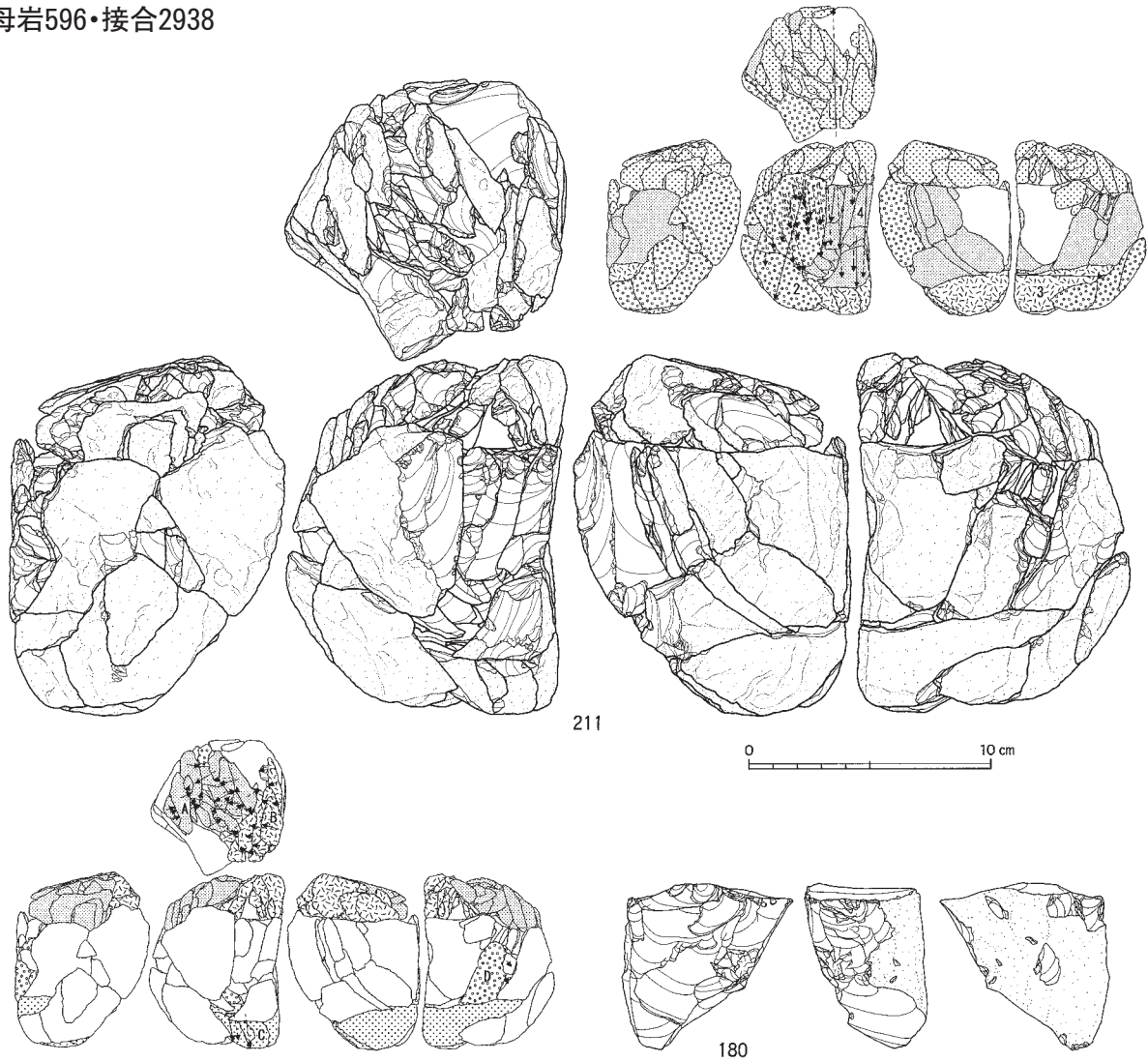

接合2938(全体)分布図

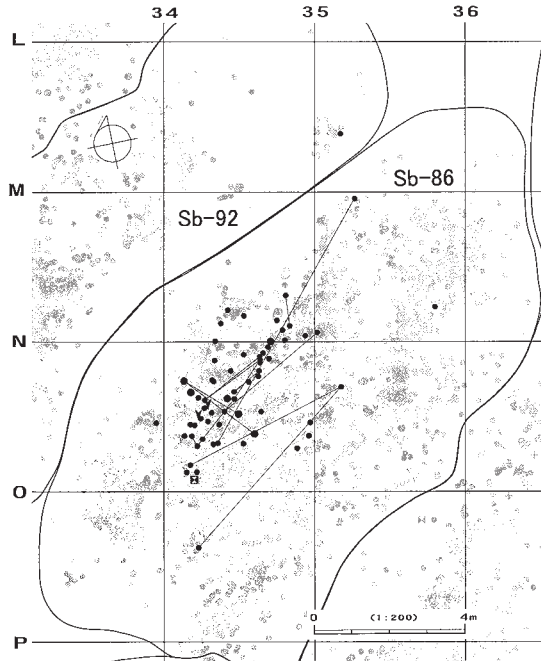

接合2938(個体A)分布図

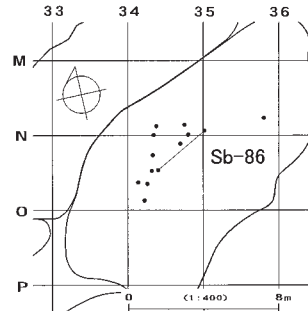

接合2938(個体B)分布図

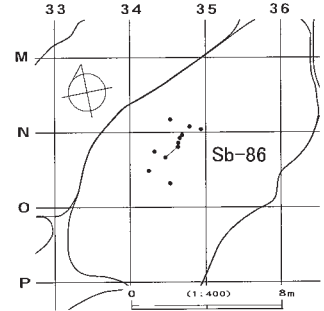

接合2938(個体C)分布図

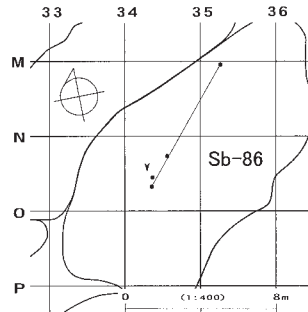

接合2938(個体D)分布図

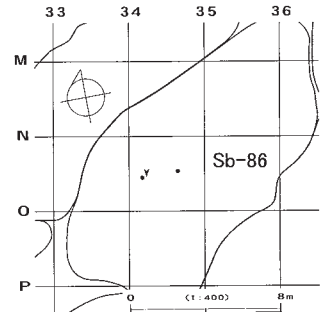

図Ⅲ-173 G区(Sb-80~89)の石器(45) 母岩596・接合2938

母岩664・接合3109

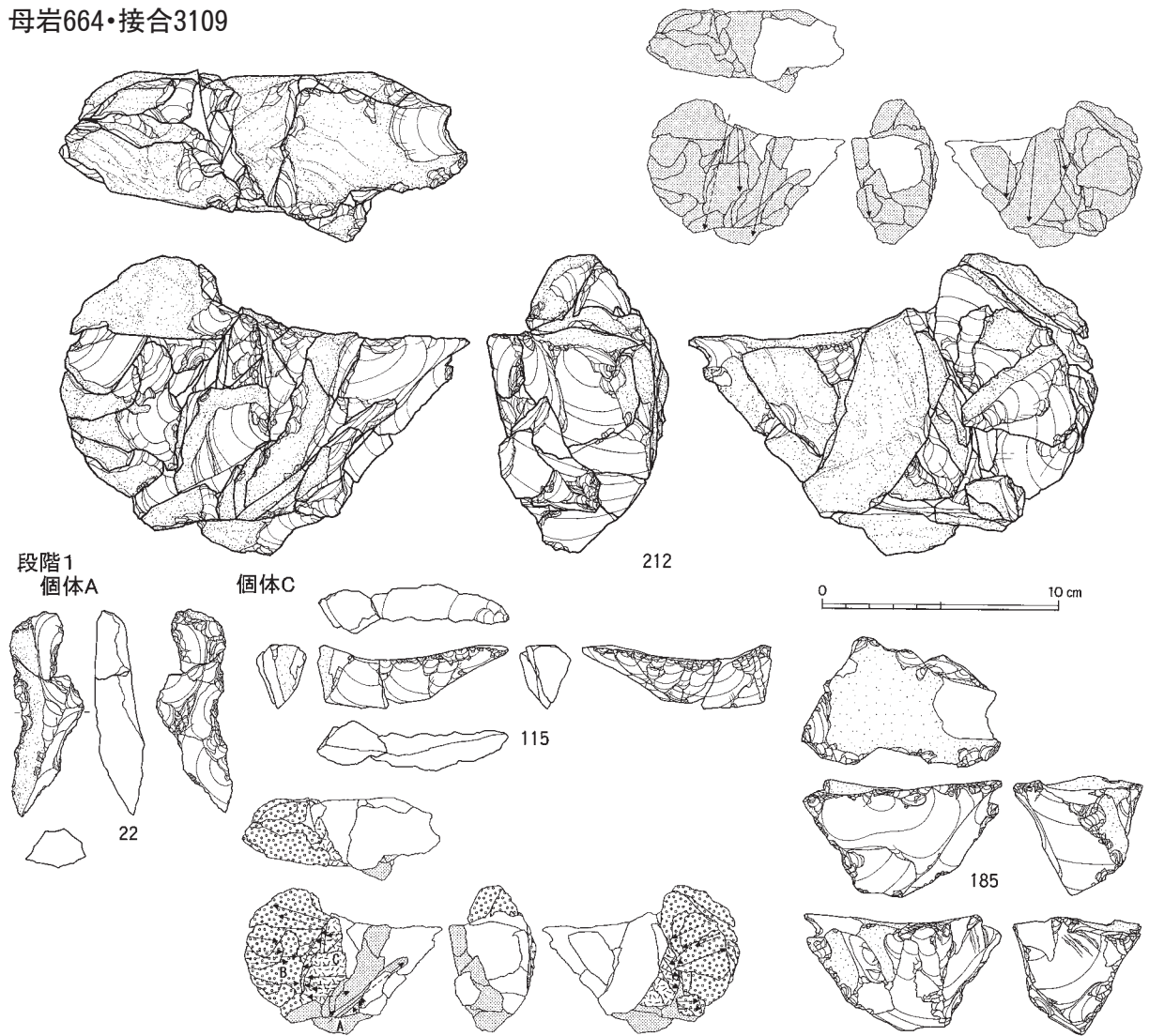

接合3109(全体)分布図

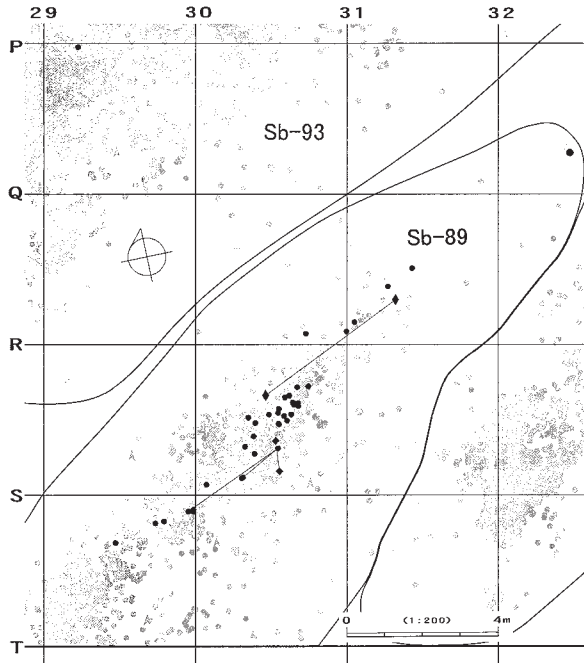

接合3109(個体A)分布図

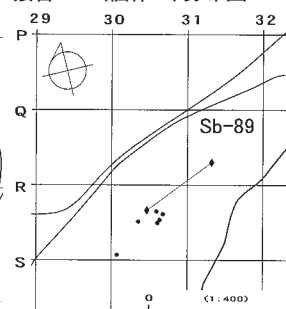

接合3109(個体B)分布図

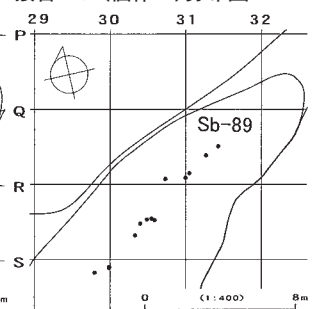

接合3109(個体C)分布図

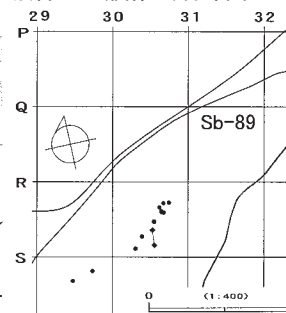

接合3109(個体A~C以外)分布図

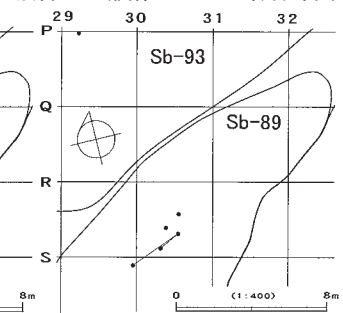

図Ⅲ-174 G区(Sb-80~89)の石器(46) 母岩664・接合3109

母岩656・接合3086

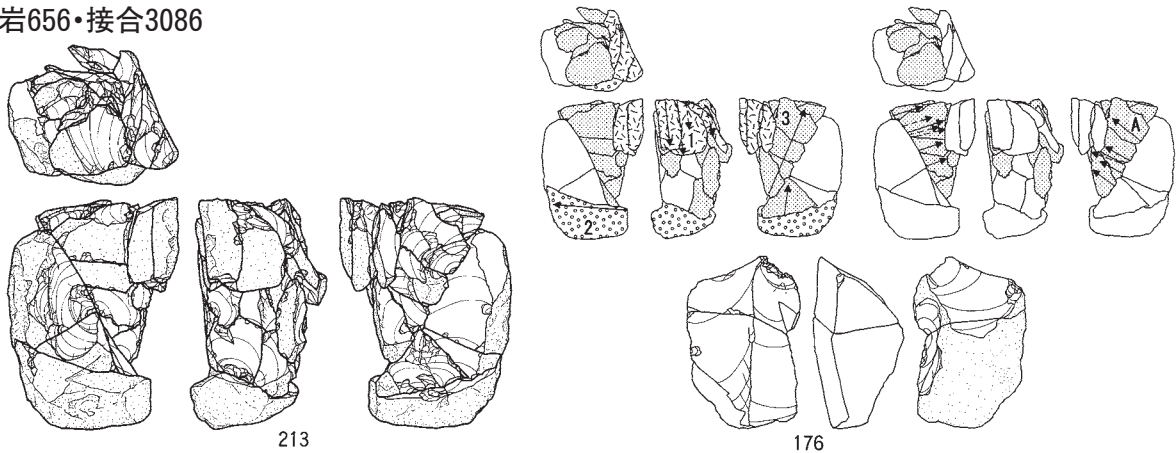

接合3086(個体A)分布図

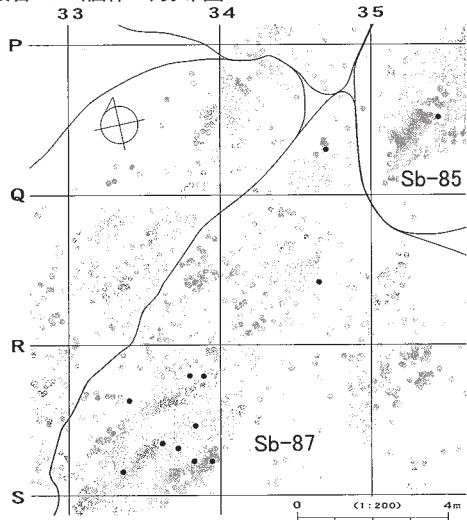

接合3086(個体A以外)分布図

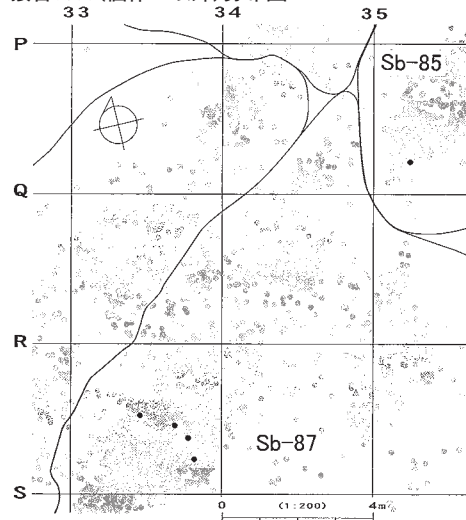

接合5710

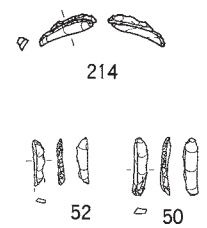

接合5710分布図

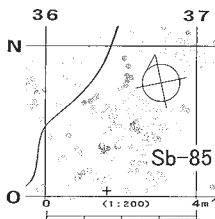

母岩1221・接合5719

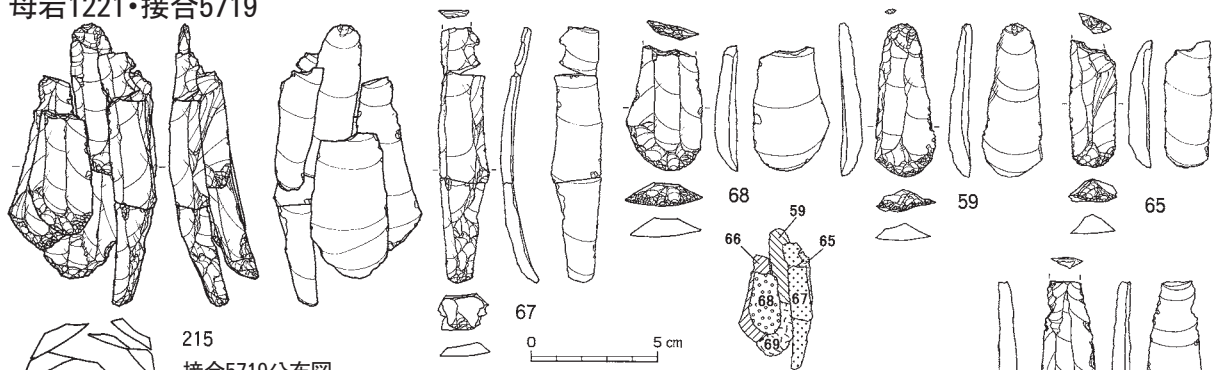

接合5719分布図

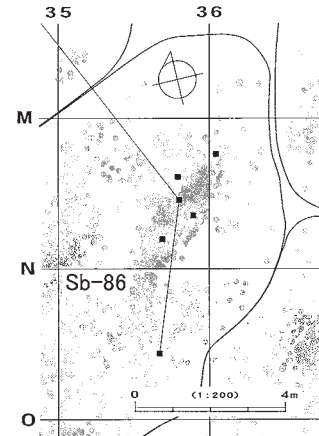
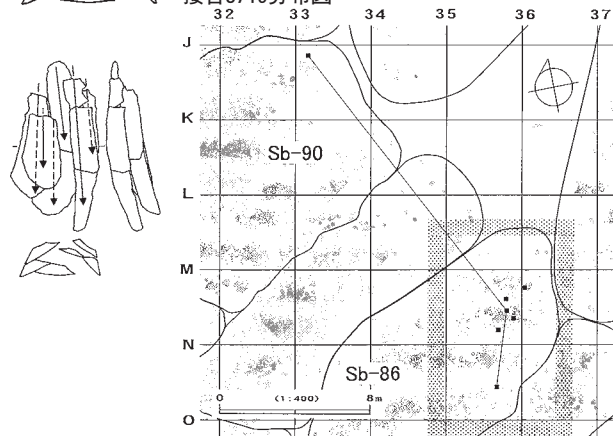

図III-175 G区(Sb-80~89)の石器(47) 母岩656・接合3086、接合5710、母岩1221・接合5719

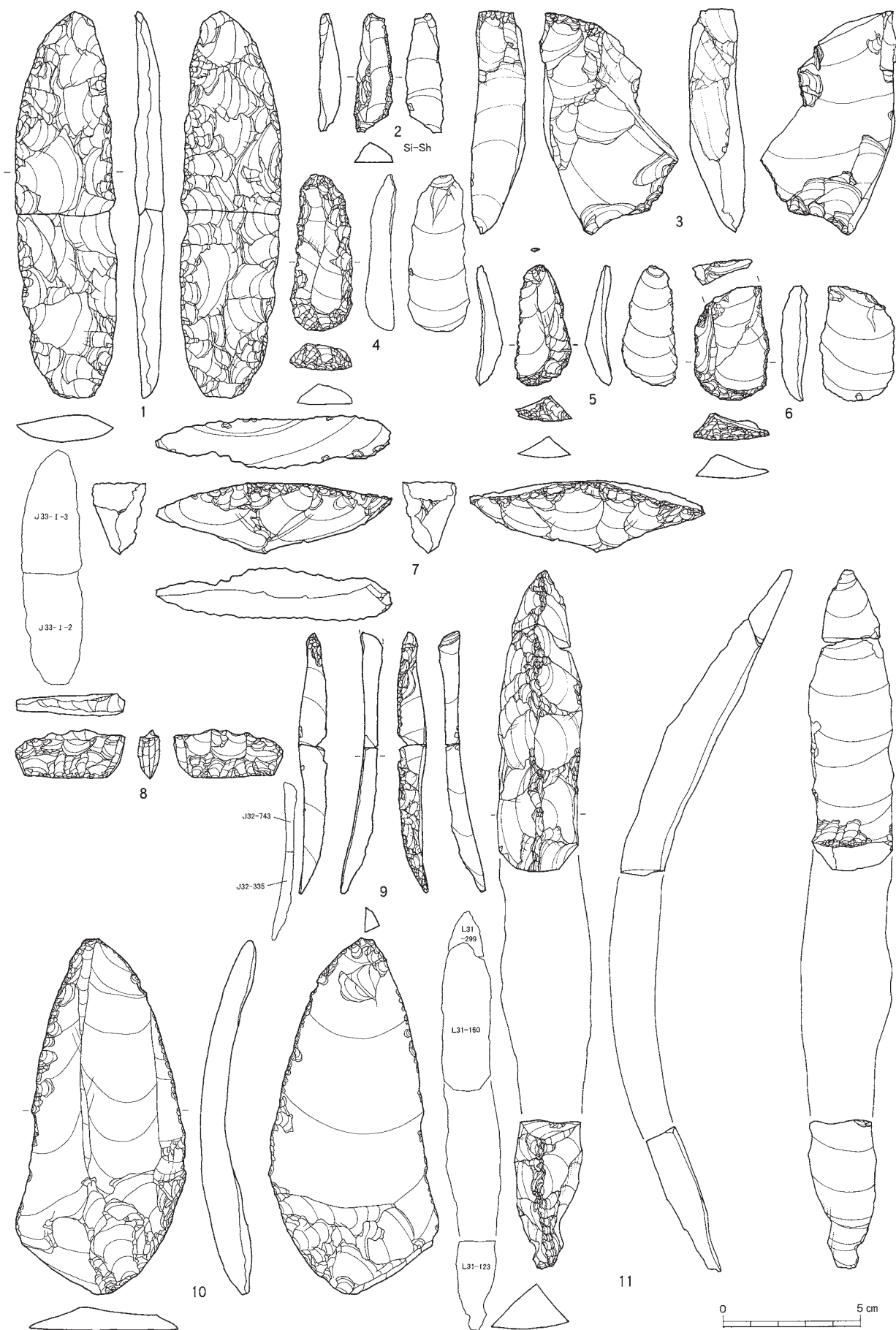

図Ⅲ-176 H区(Sb-90)の石器(1) 尖頭器・彫器・搔器・舟底形石器・細石刃核・彫器削片・削器・石刃

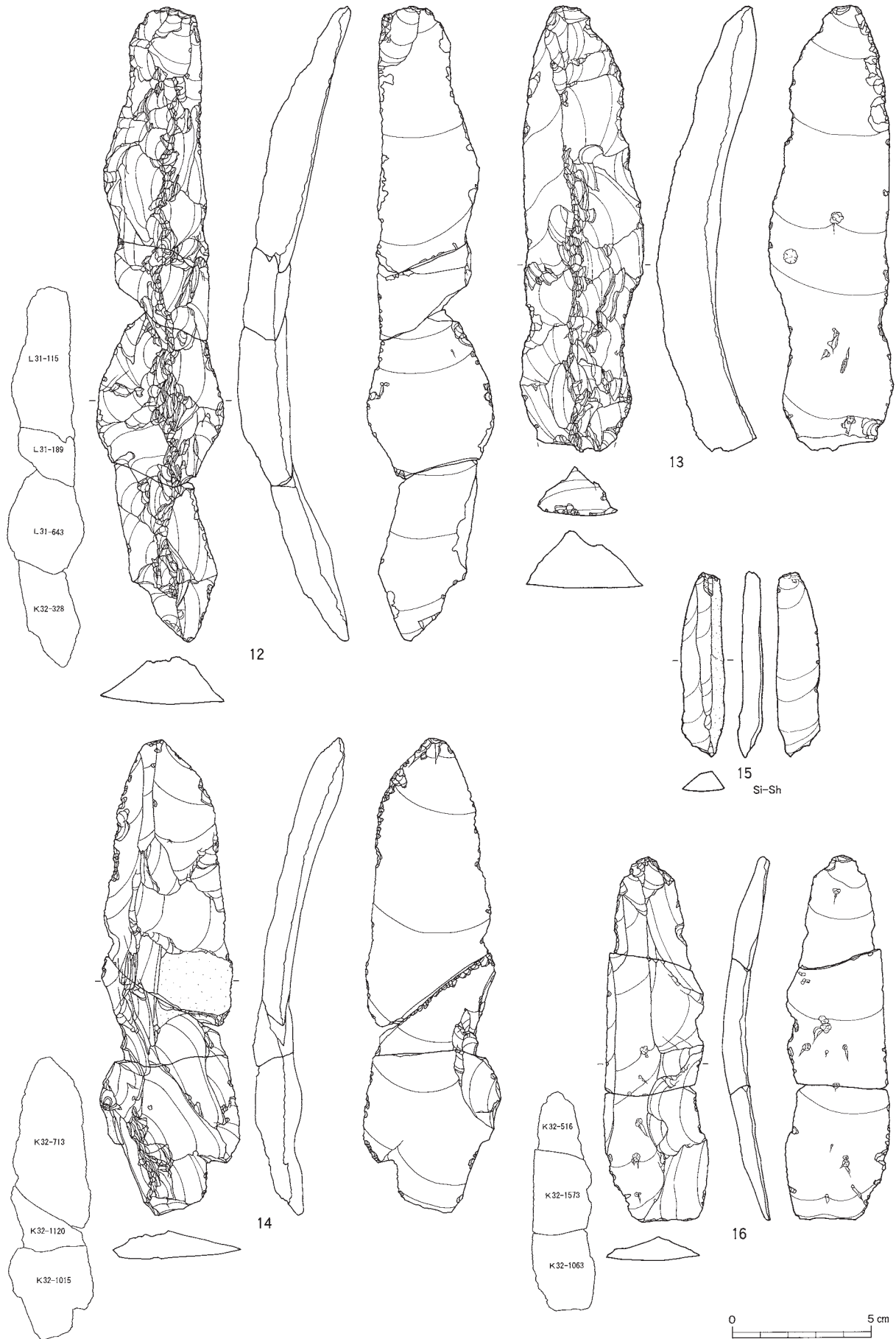

図Ⅲ-177 H区(Sb-90)の石器(2) 石刃

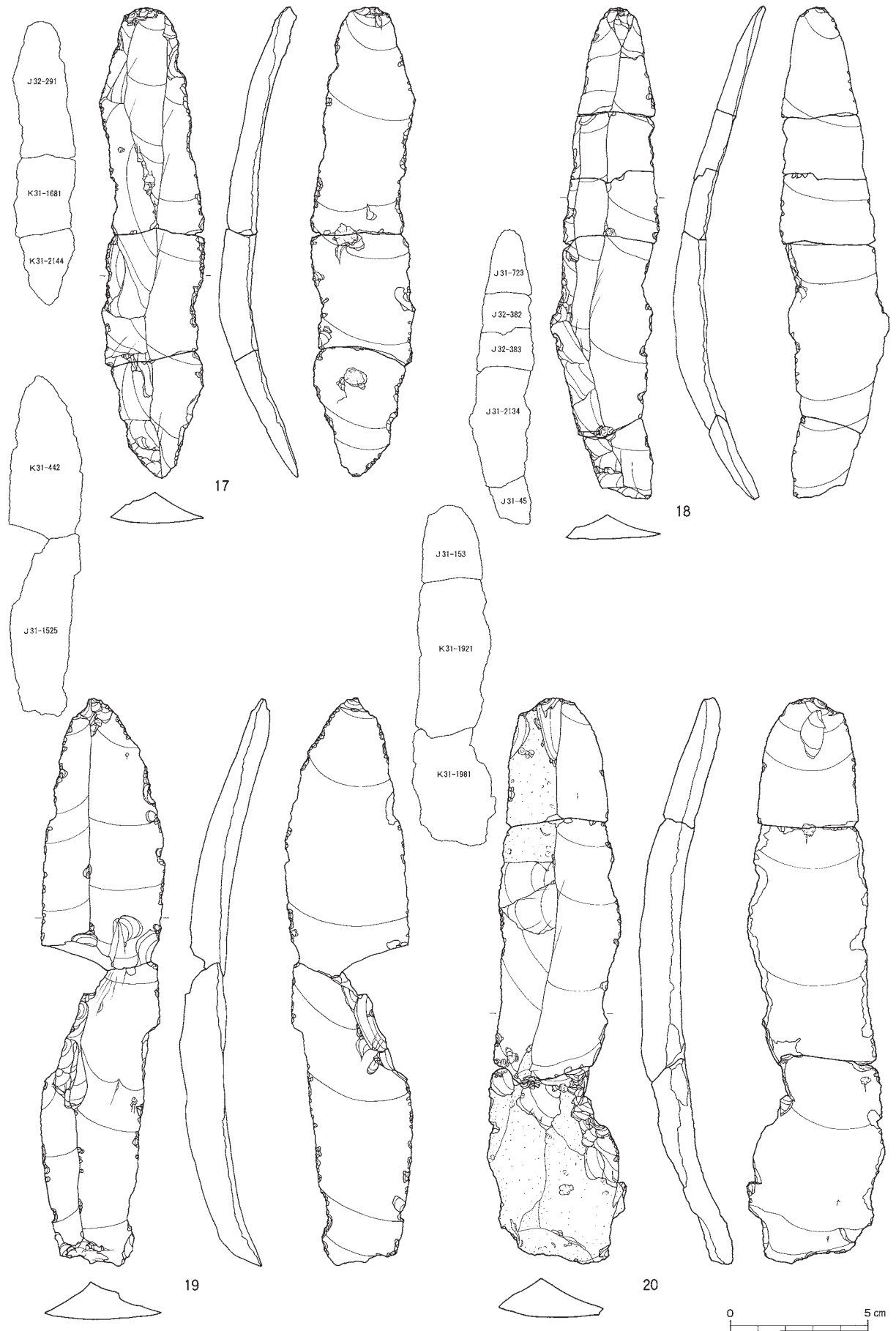

図III-178 H区(Sb-90)の石器(3) 石刃

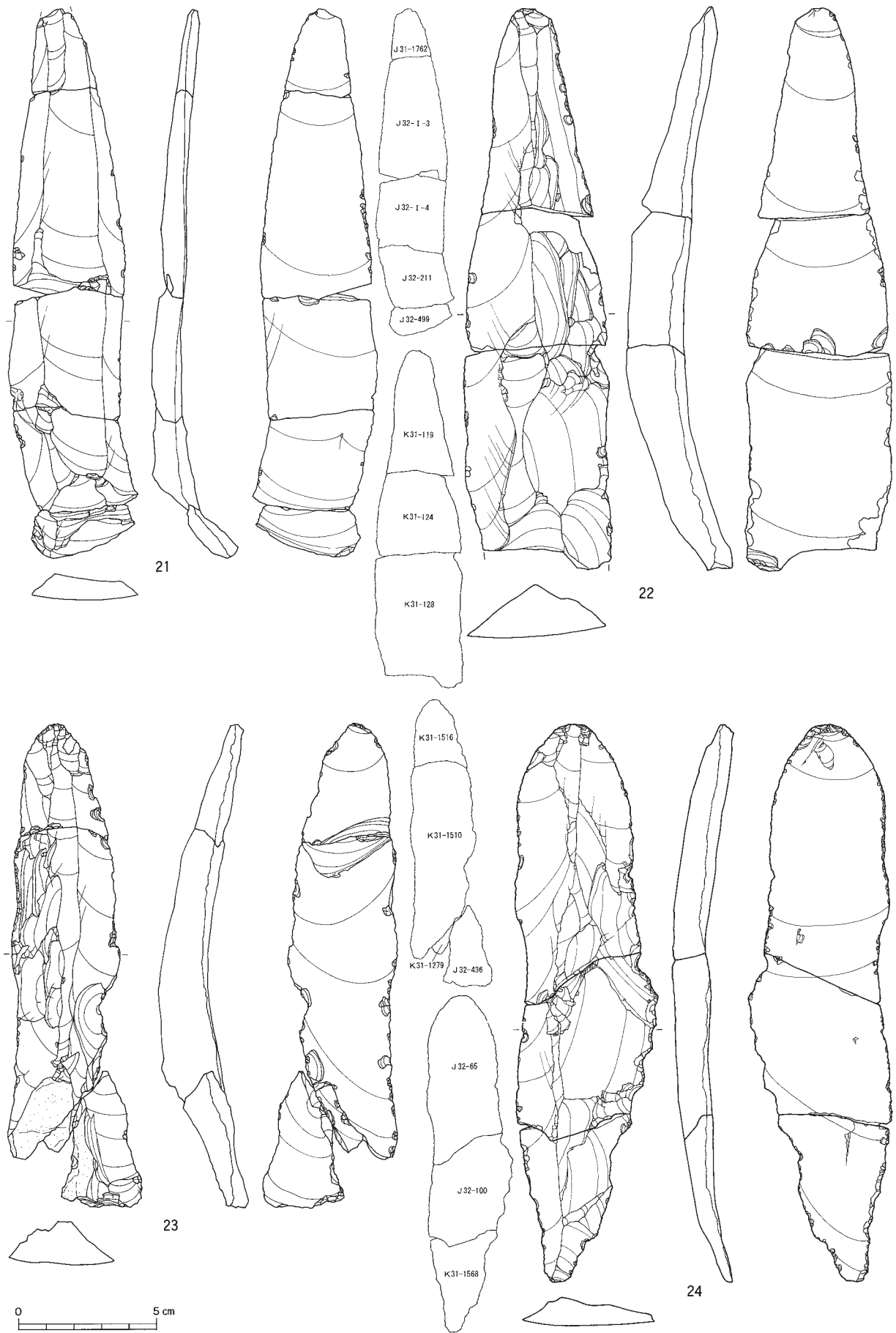

図Ⅲ-179 H区(Sb-90)の石器(4) 石刃

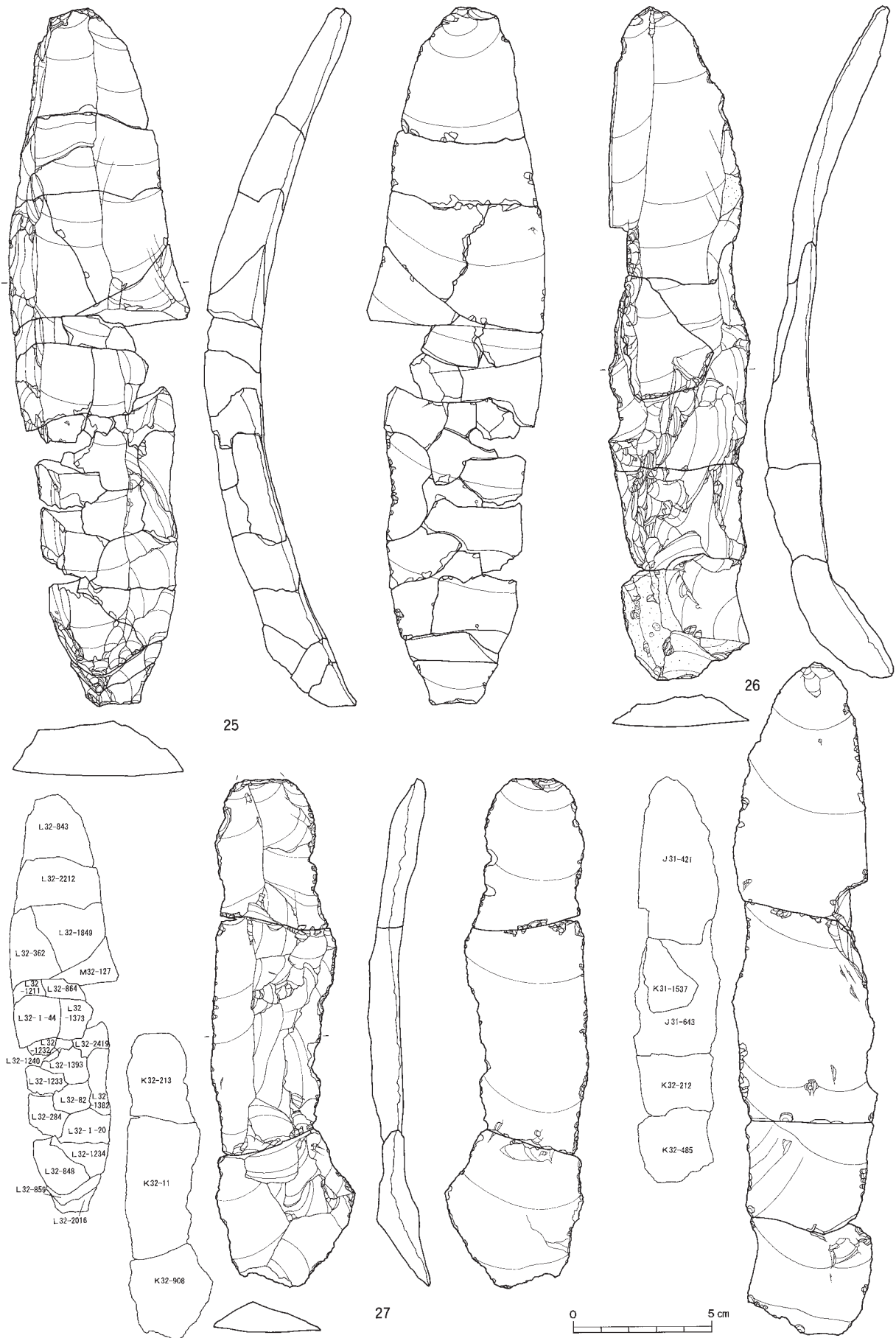

図Ⅲ-180 H区(Sb-90)の石器(5) 石刃

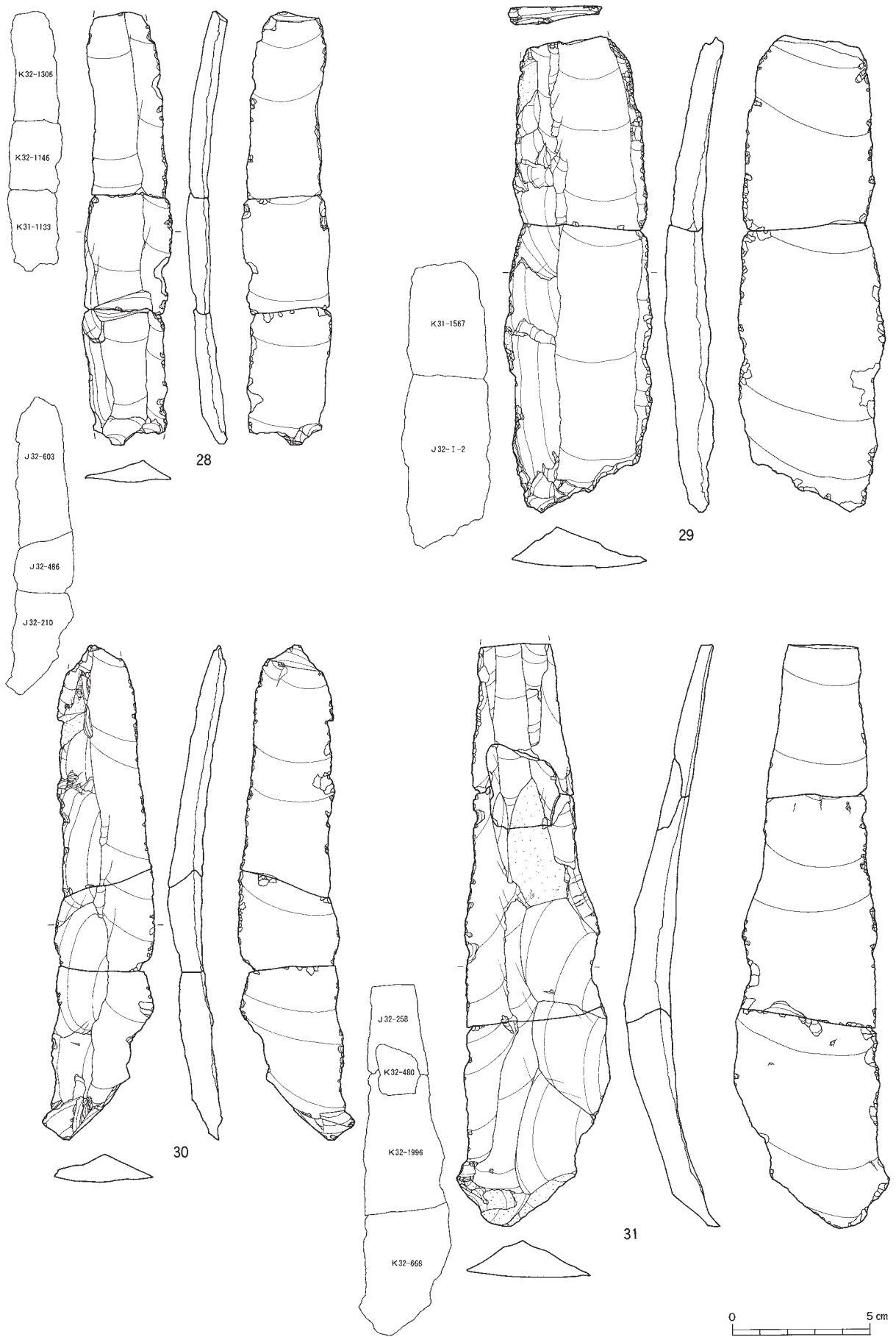

図Ⅲ-181 H区(Sb-90)の石器(6) 石刃

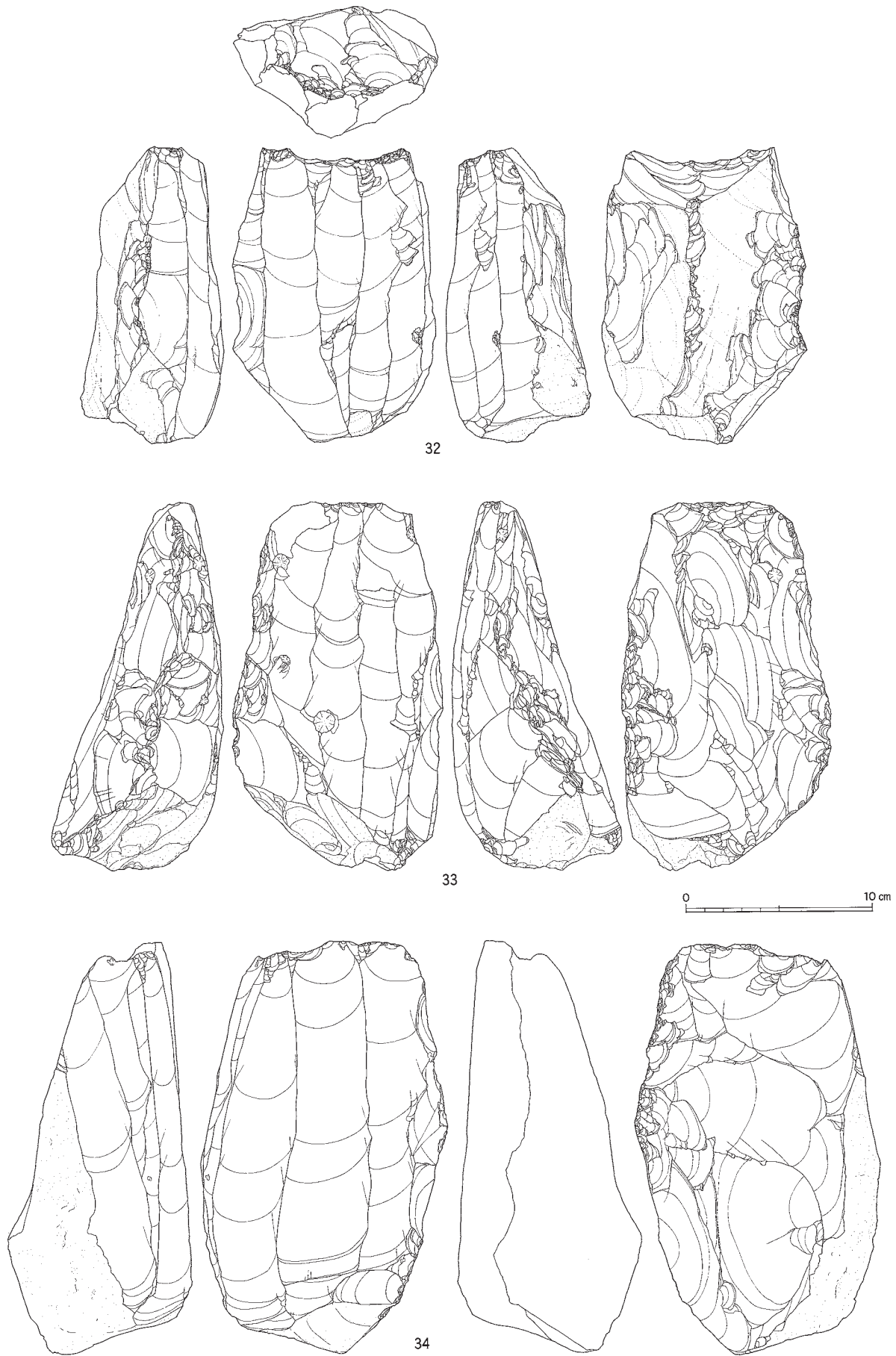

図Ⅲ-182 H区(Sb-90)の石器(7) 石刃核

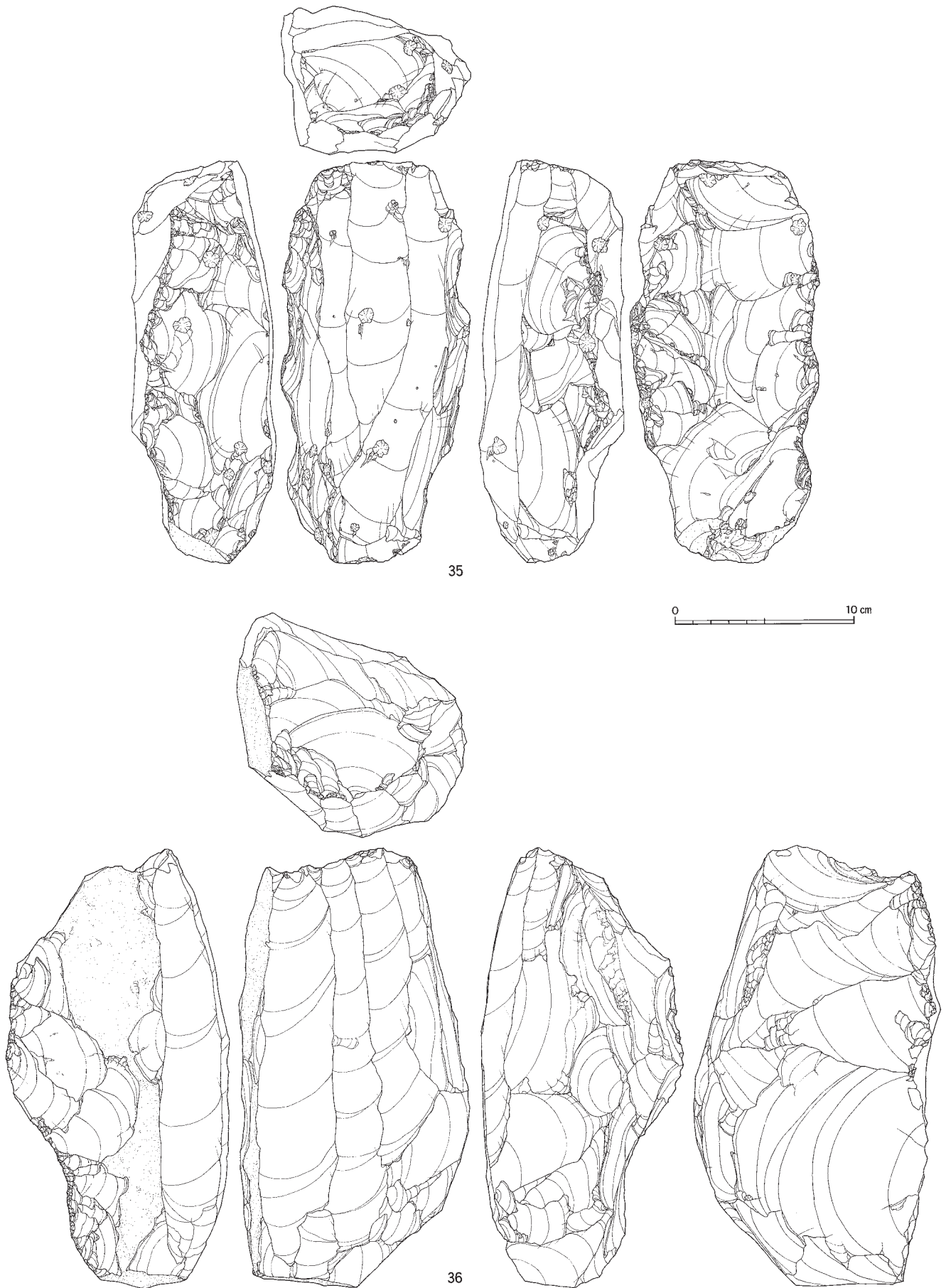

図Ⅲ-183 H区(Sb-90)の石器(8) 石刃核

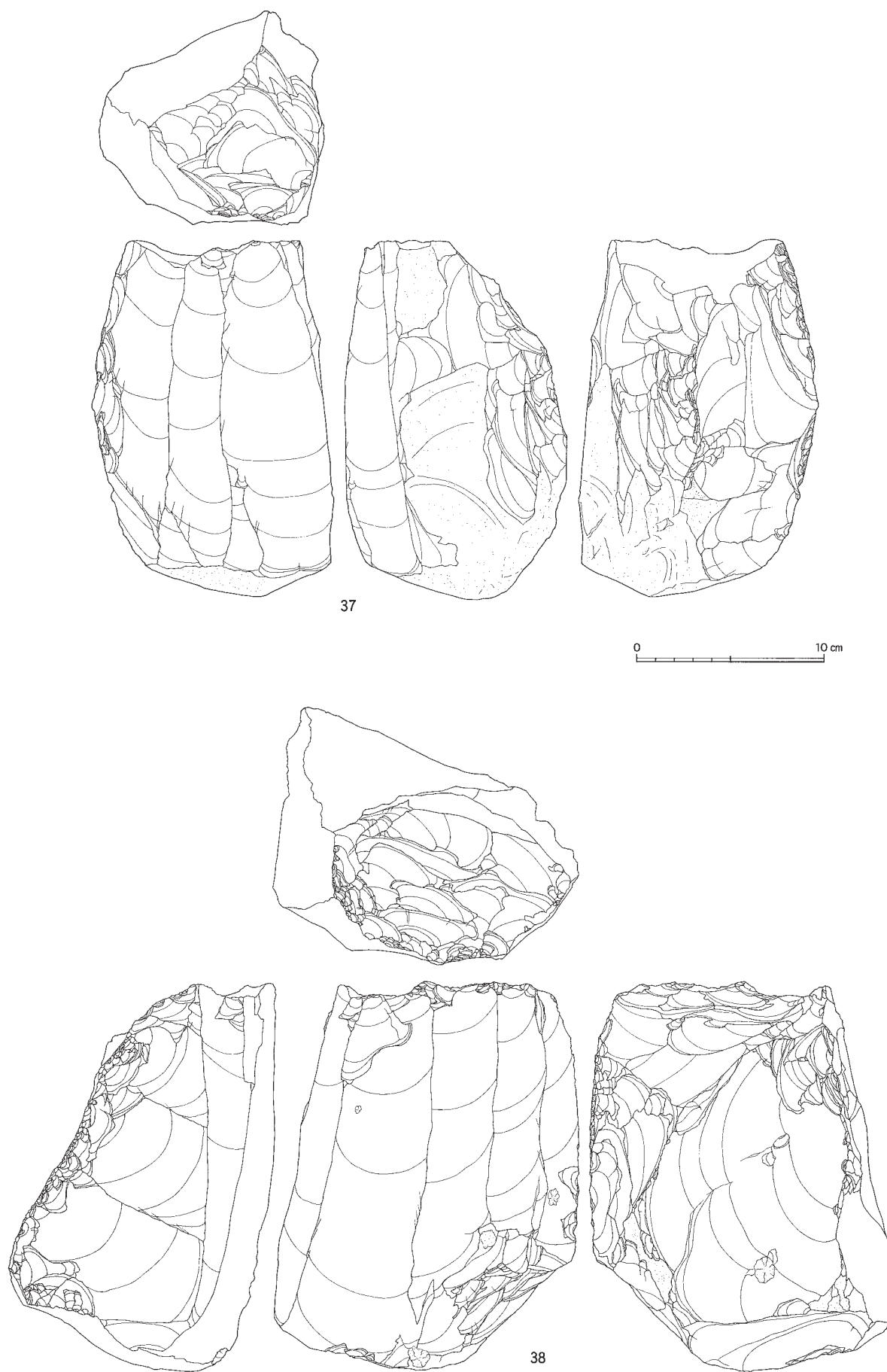

図Ⅲ-184 H区(Sb-90)の石器(9) 石刃核

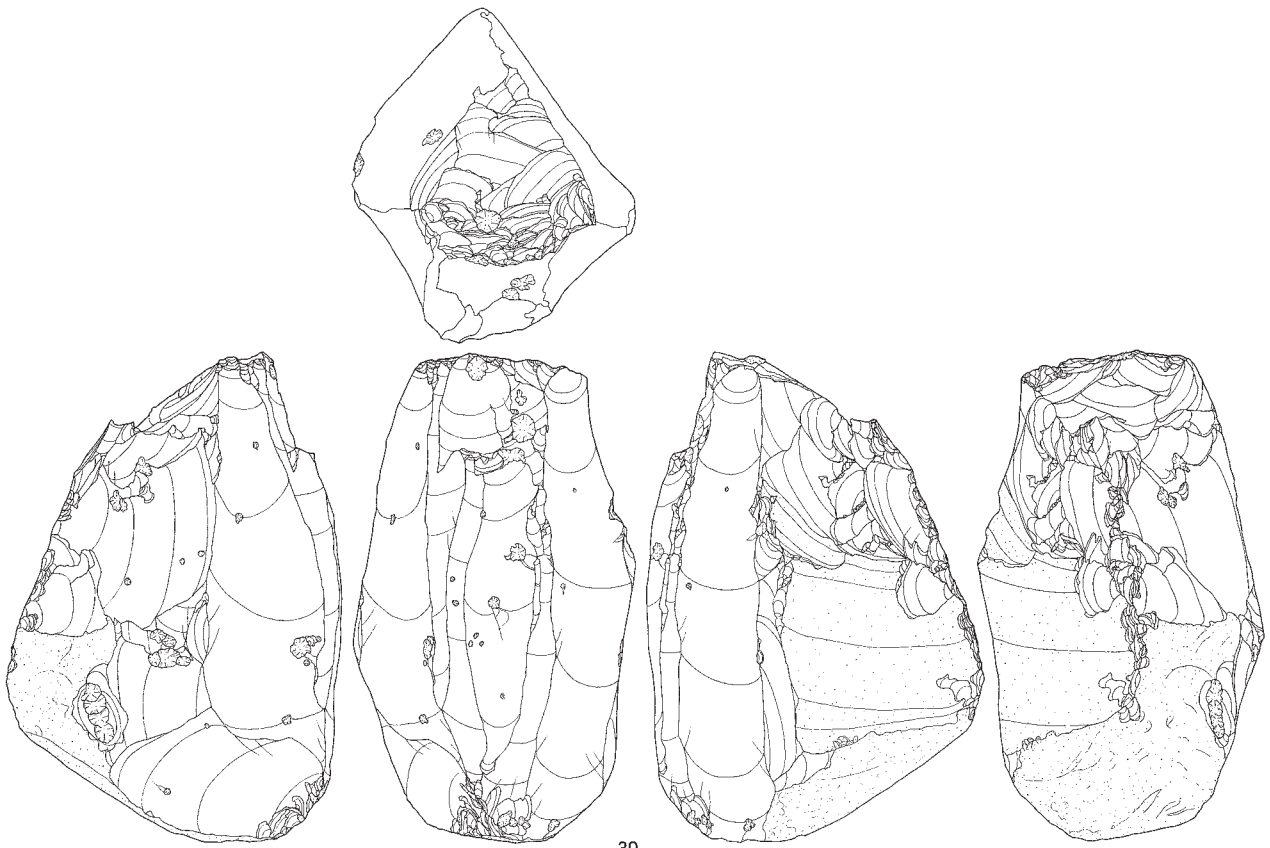

39

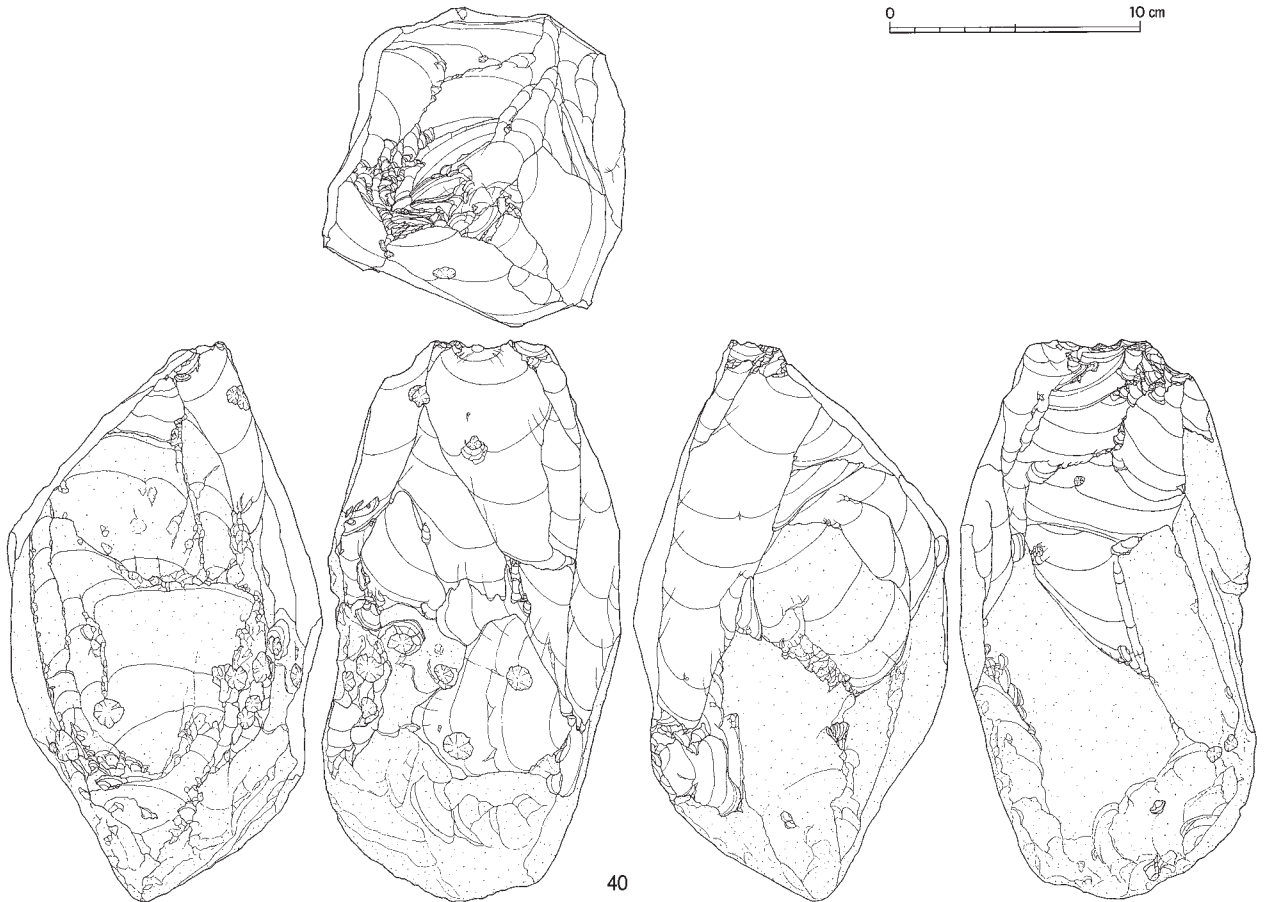
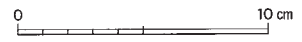

40

図Ⅲ-185 H区(Sb-90)の石器(10) 石刃核

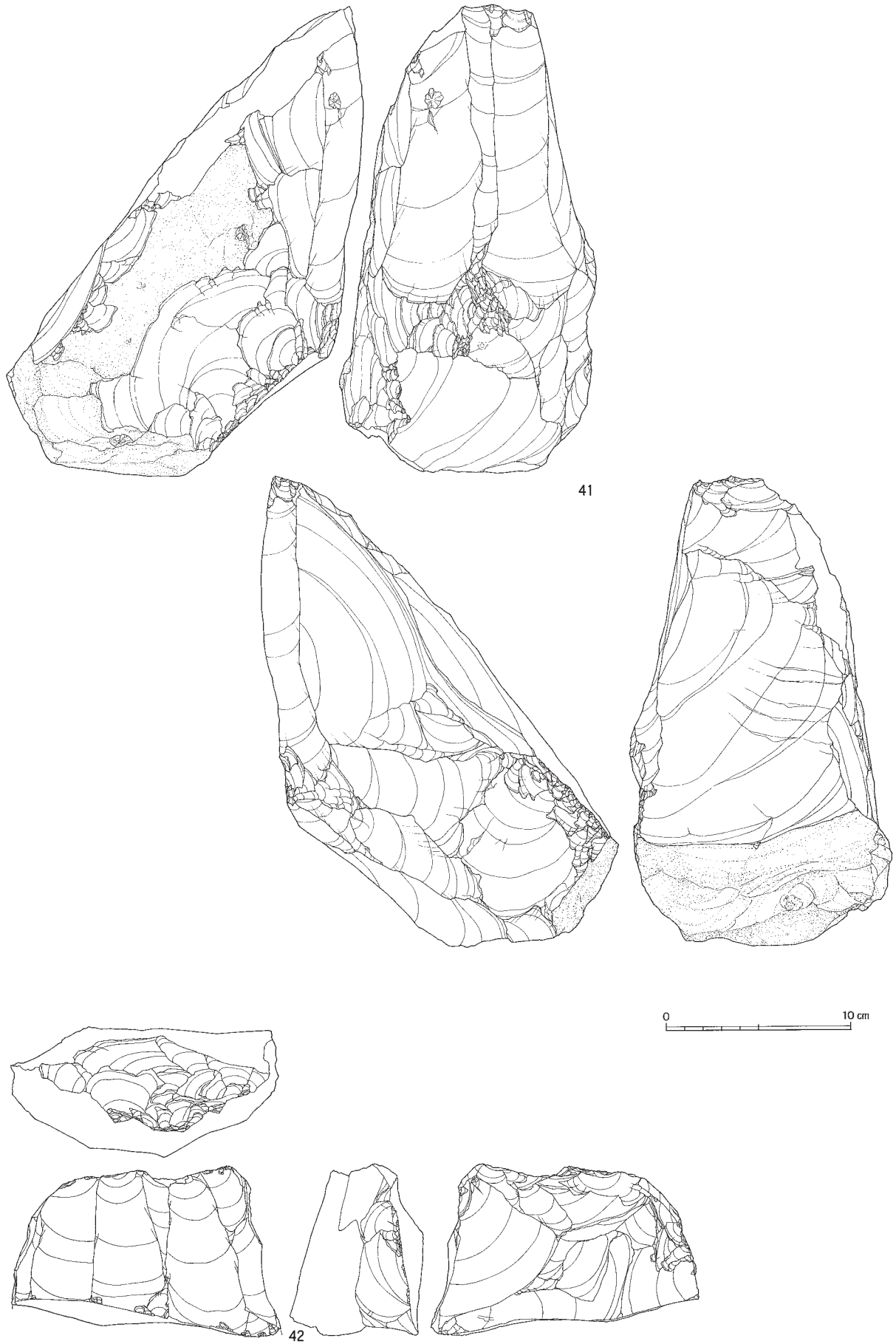

图Ⅲ-186 H区(Sb-90)の石器(11) 石刃核

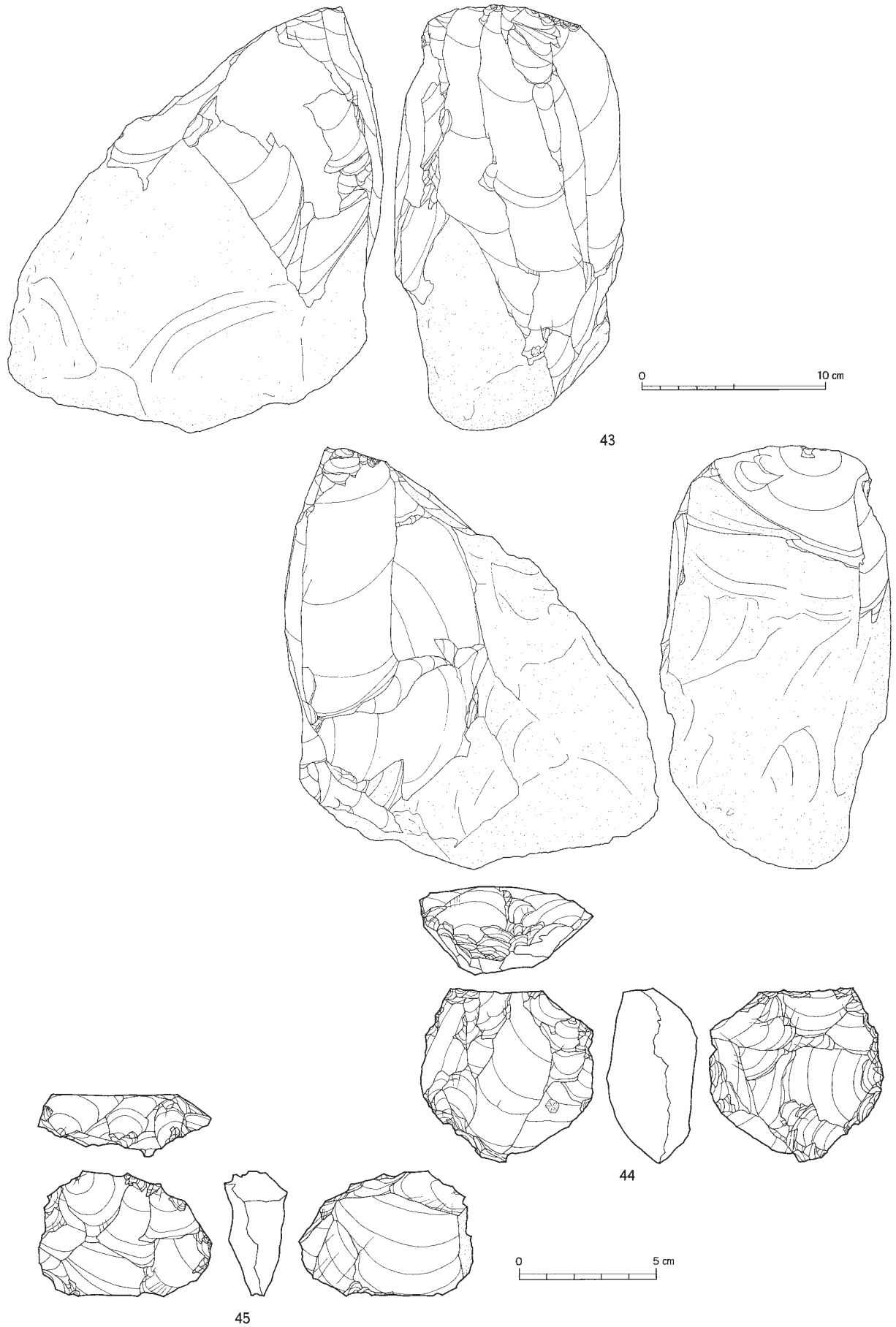

図Ⅲ-187 H区(Sb-90)の石器(12) 石刃核・石核

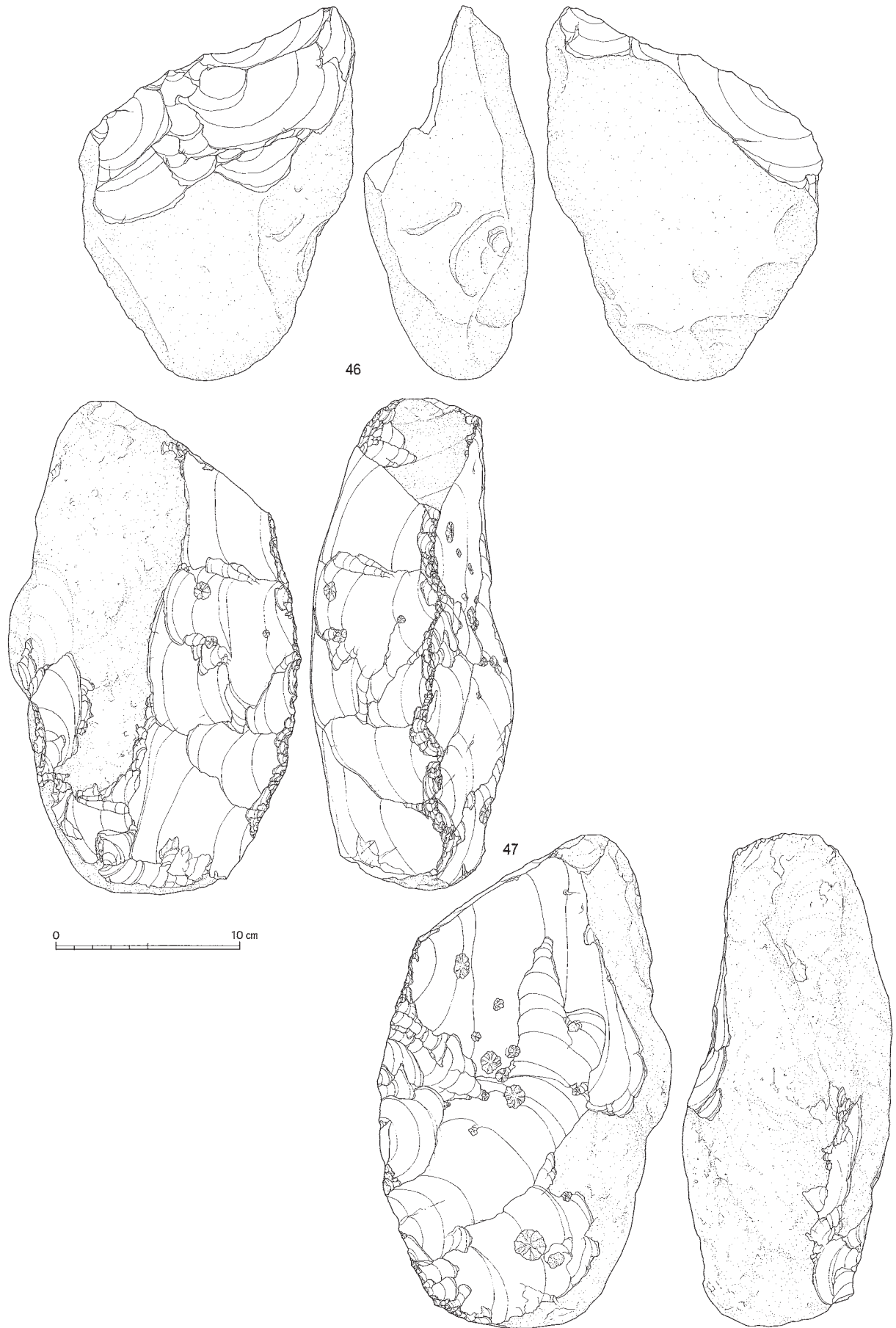

図Ⅲ-188 H区(Sb-90)の石器(13) 石核

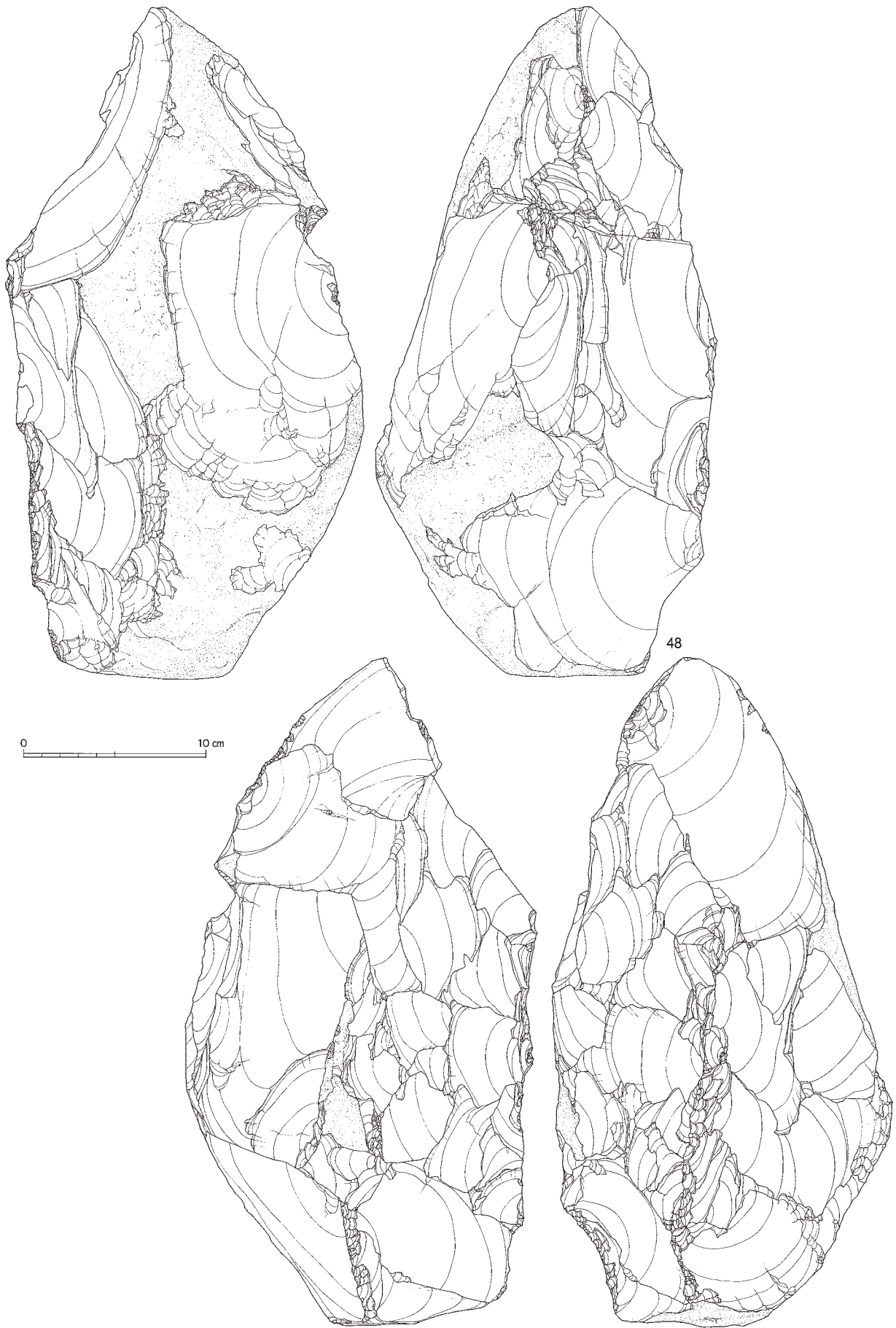

図Ⅲ-189 H区(Sb-90)の石器(14) 石核

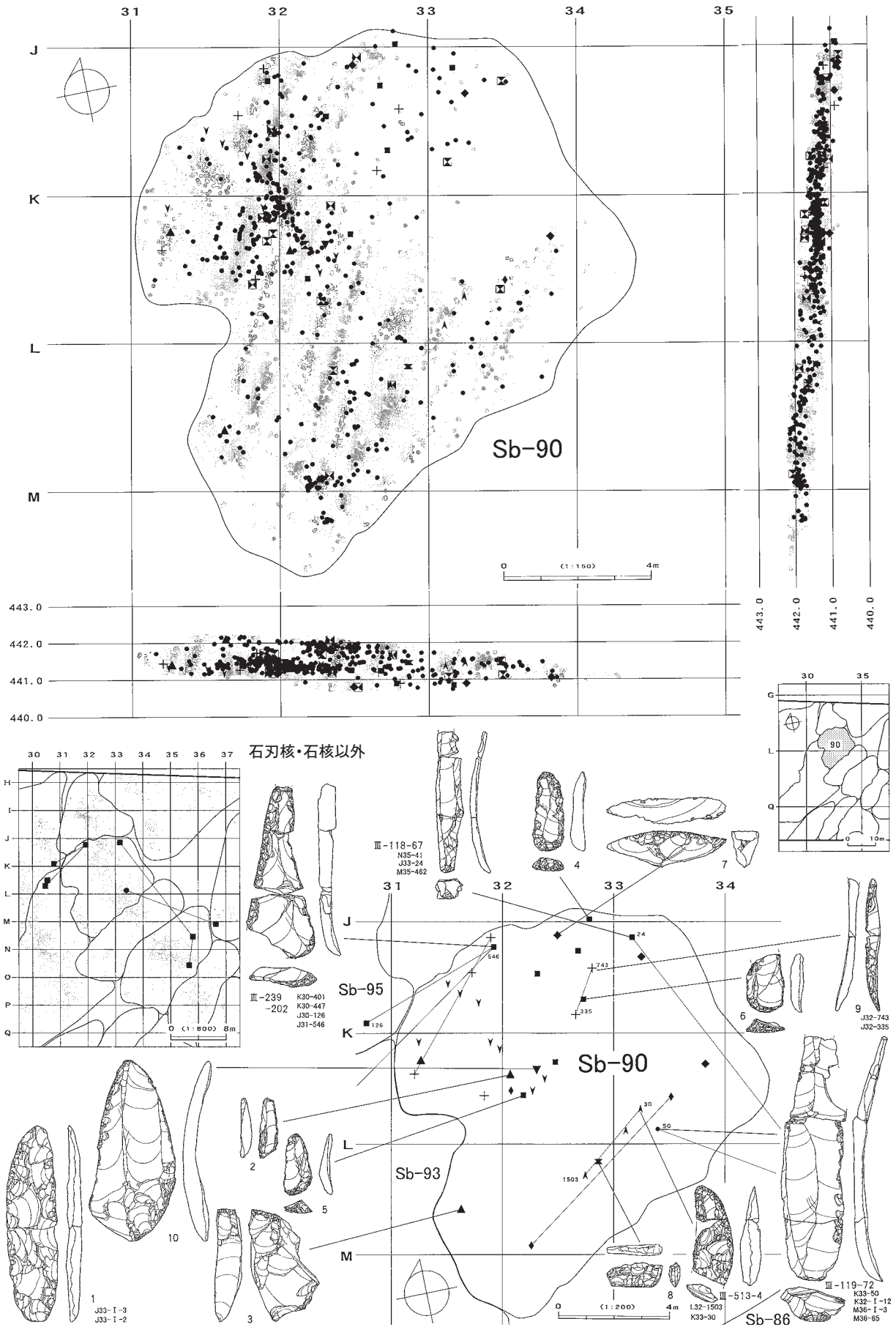

図Ⅲ-190 Sb-90の分布図・遺物(1)

石刃核

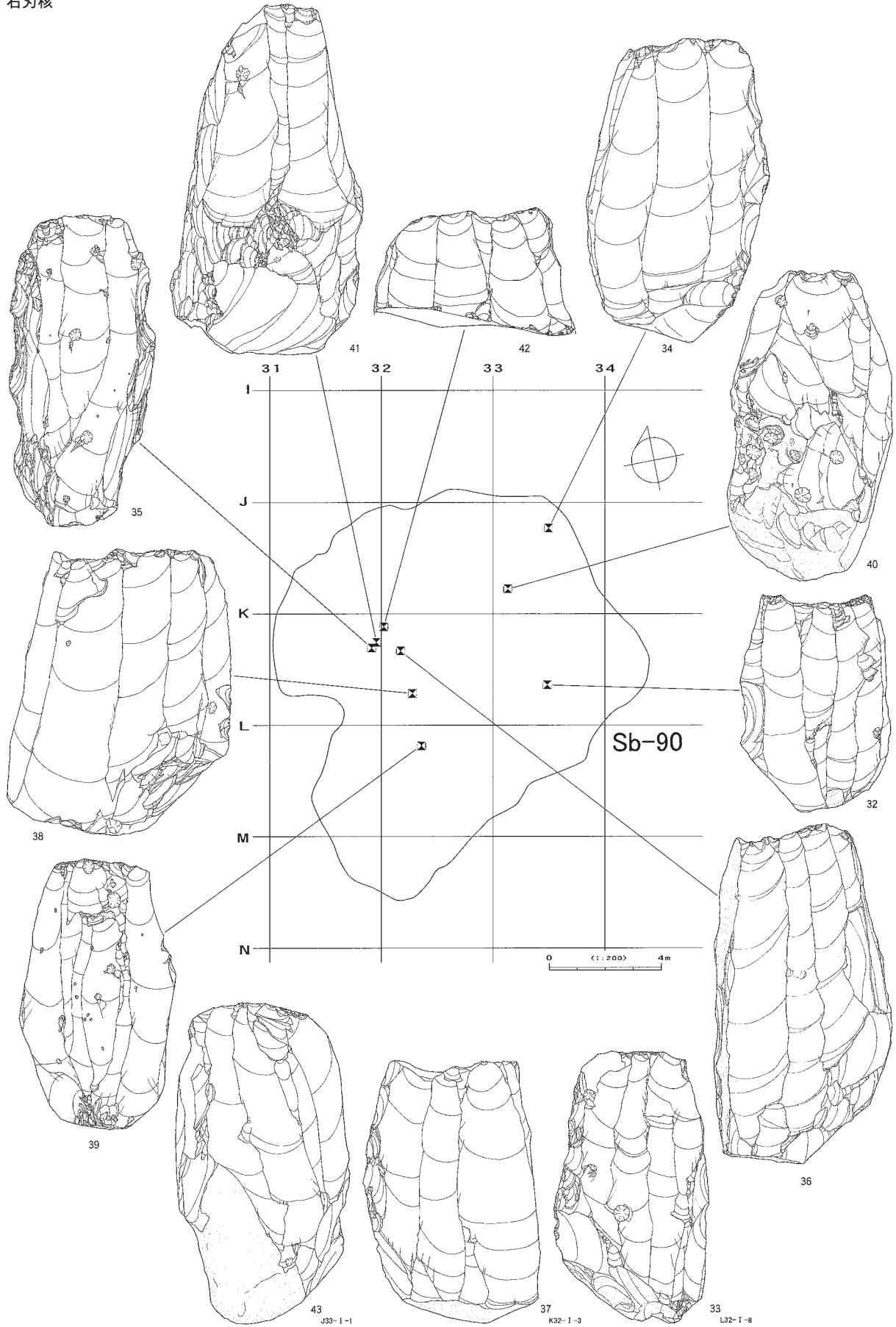

図III-191 Sb-90の遺物(2)

石核

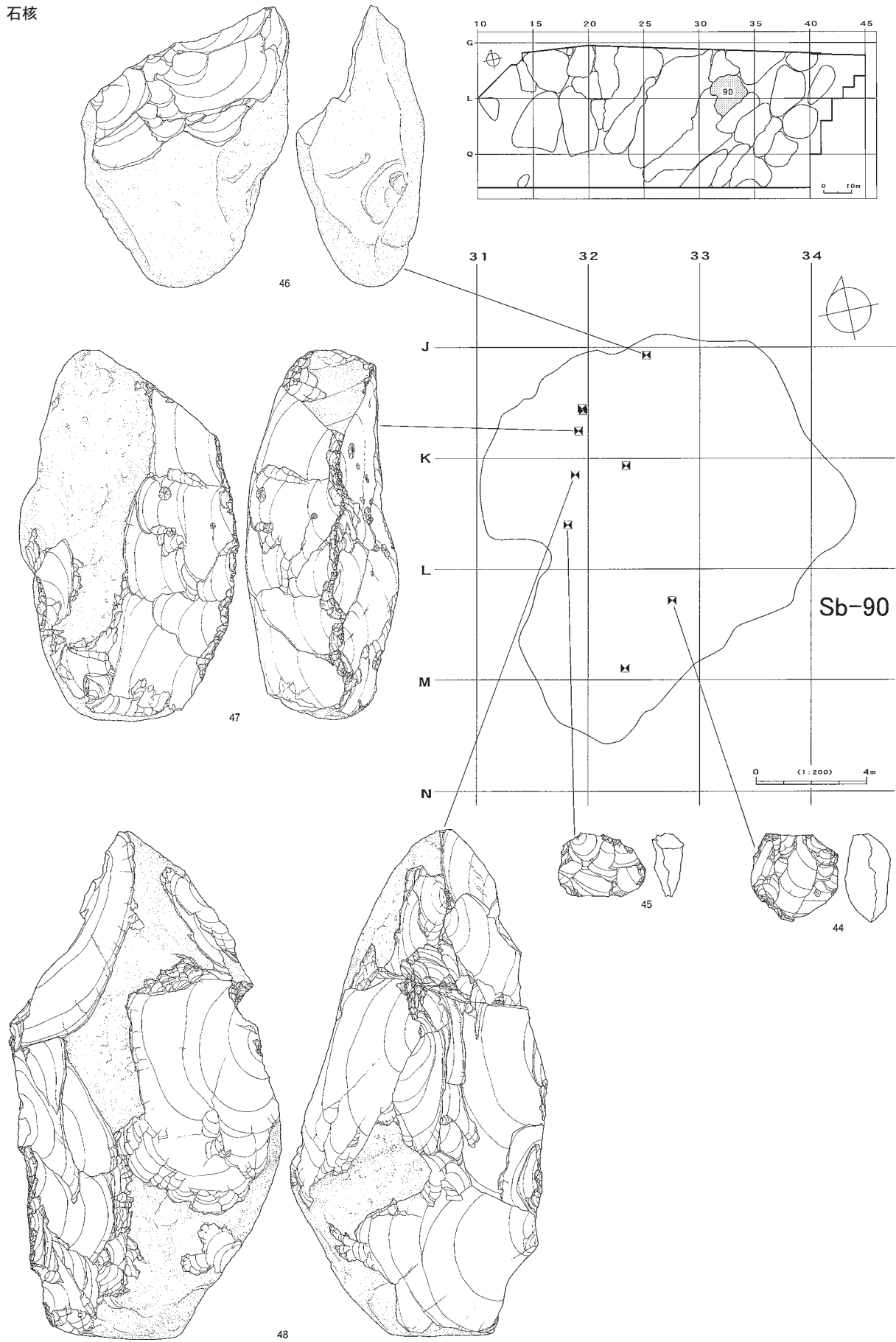

図Ⅲ-192 Sb-90の遺物(3)

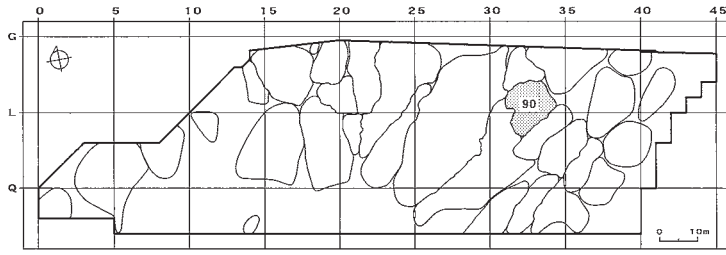

全接合分布図

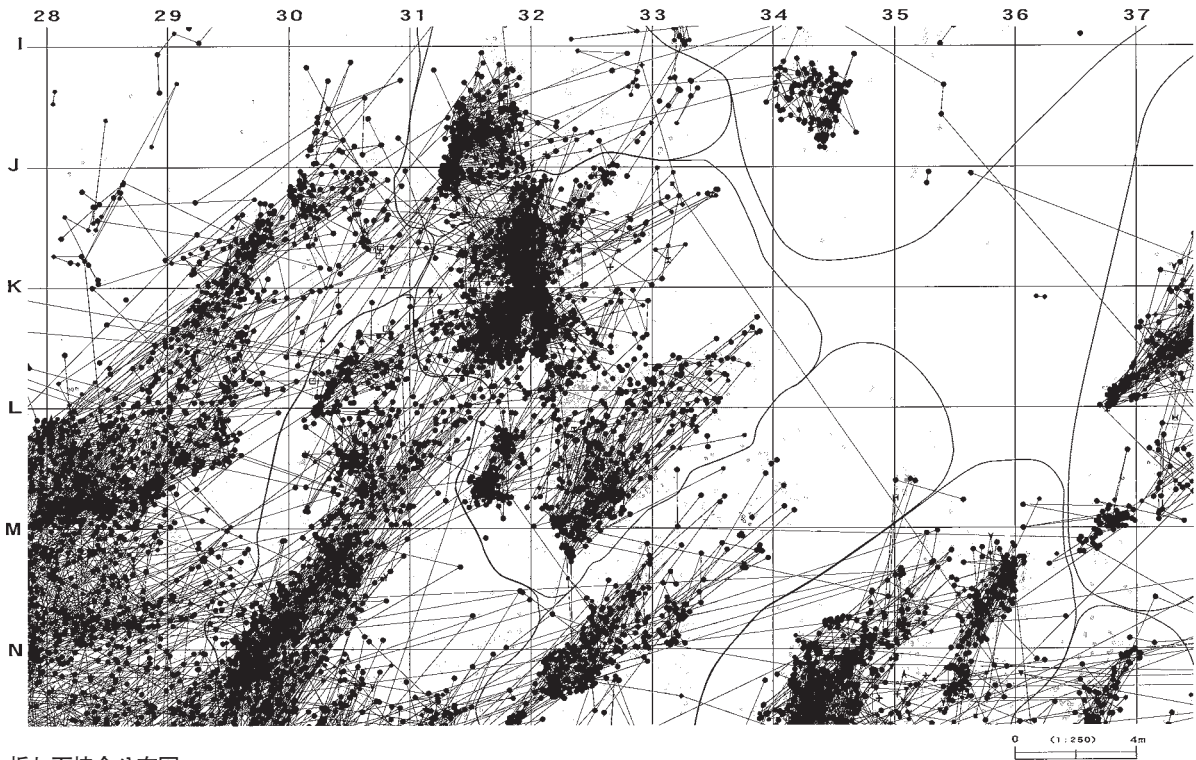

折れ面接合分布図

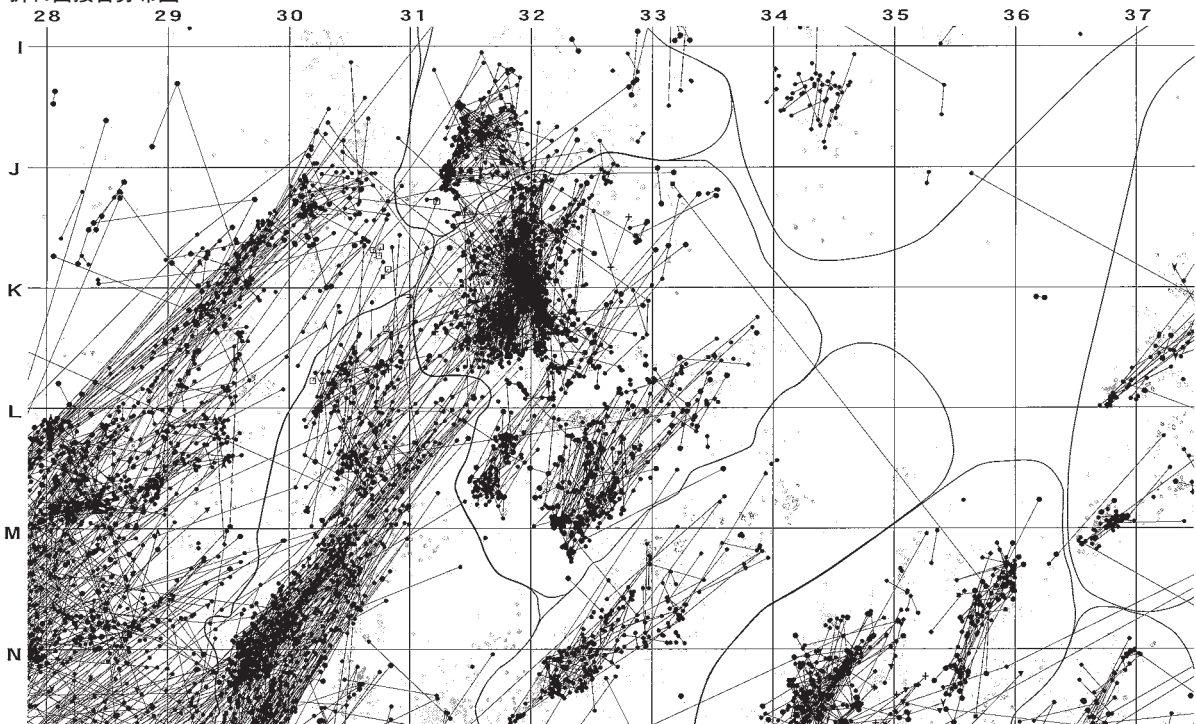

図Ⅲ-193 H区(Sb-90)の接合分布図

母岩683・接合3159

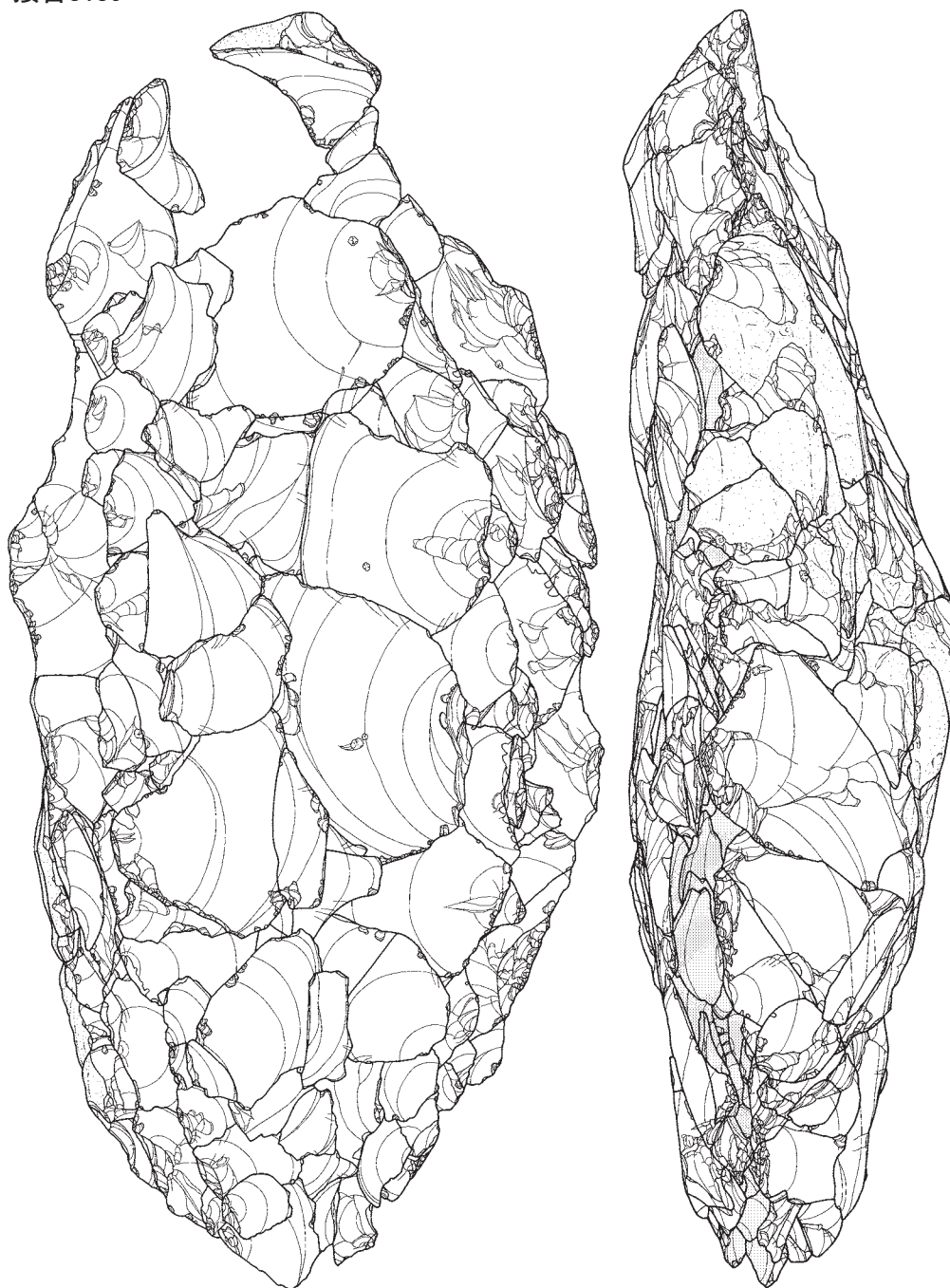

図Ⅲ-194 H区(Sb-90)の石器(15) 母岩683・接合3159(1)

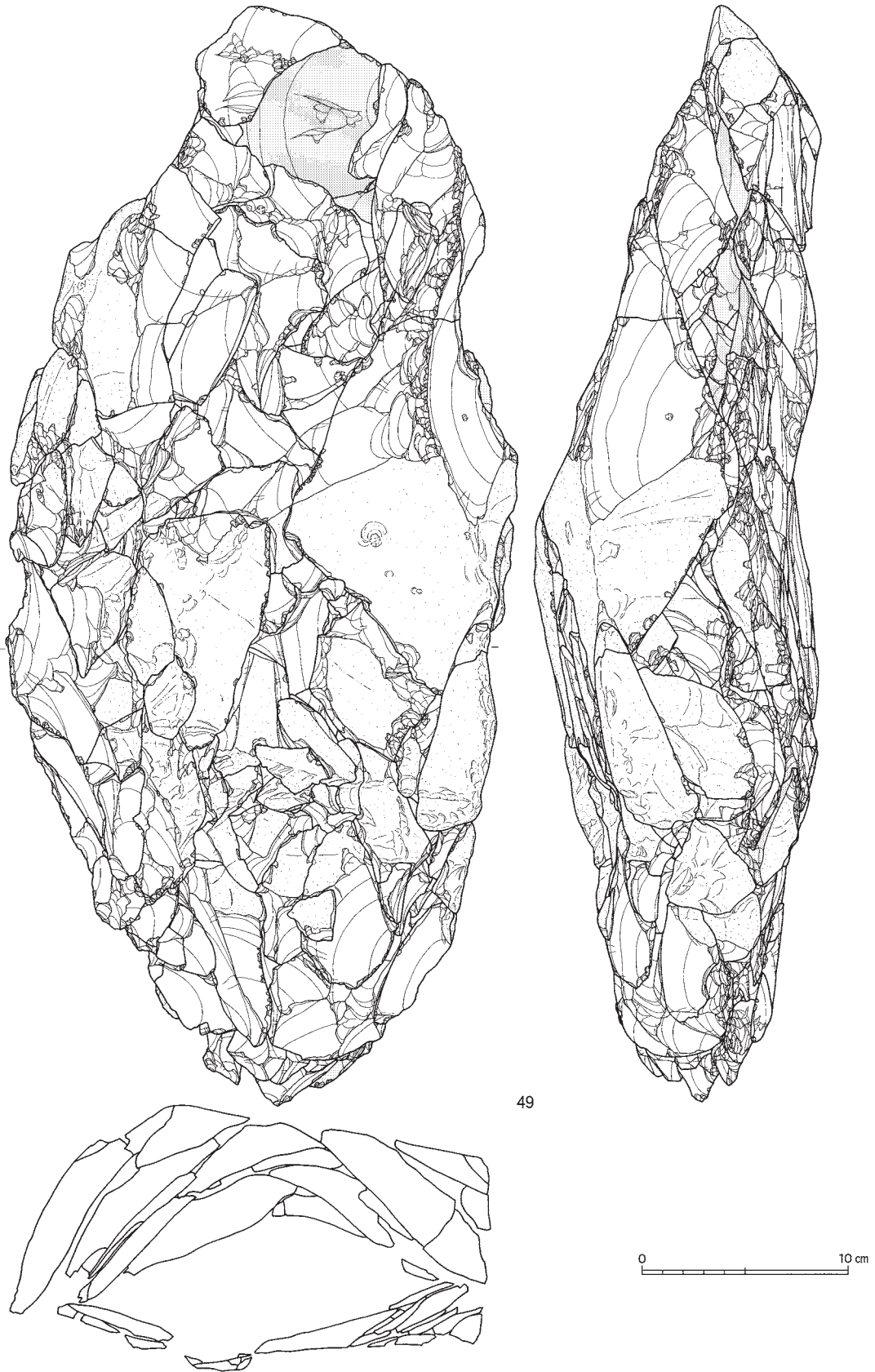

図Ⅲ-195 H区(Sb-90)の石器(16) 母岩683・接合3159(2)

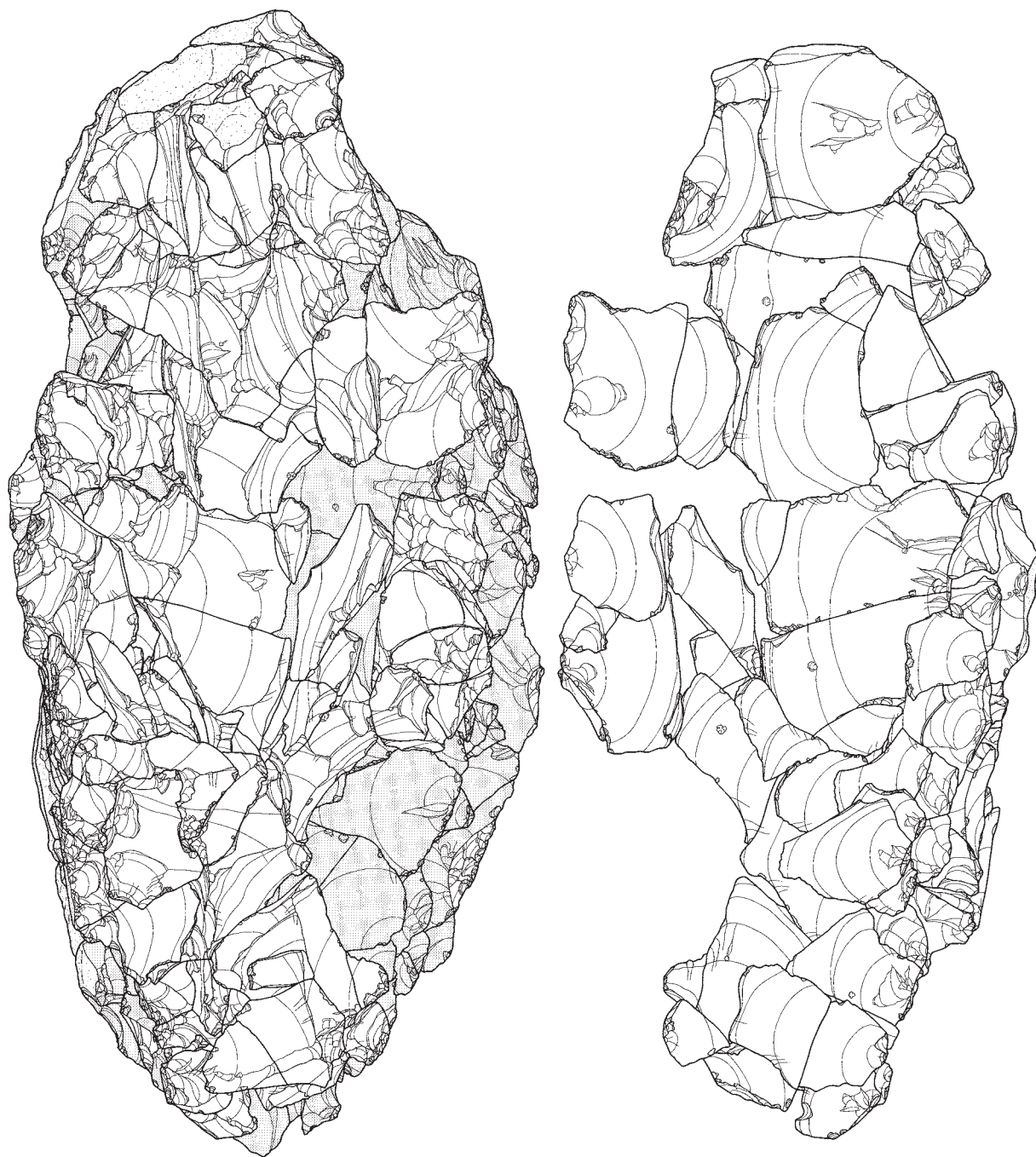

図Ⅲ-196 H区(Sb-90)の石器(17) 母岩683・接合3159(3)

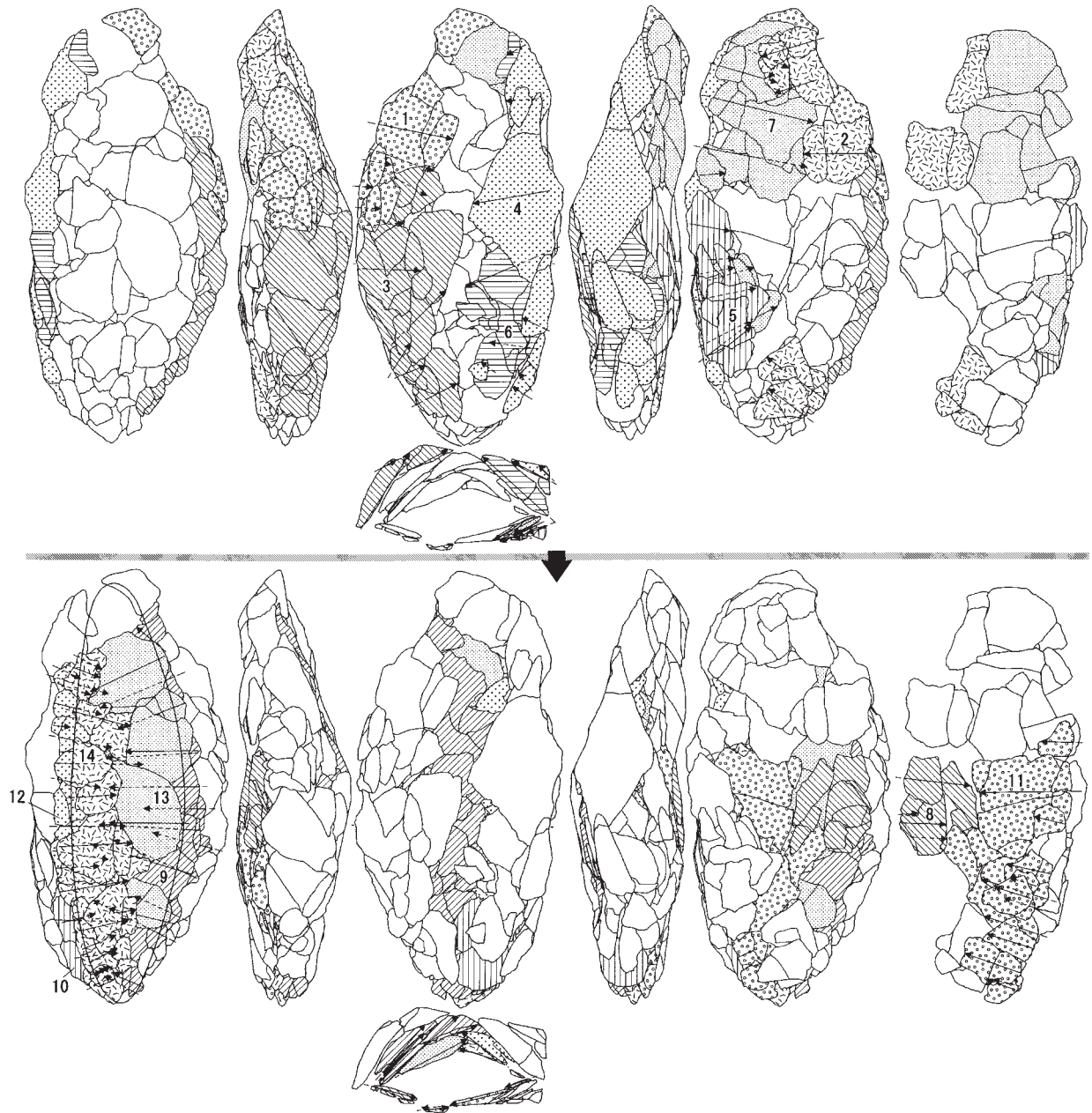

接合3159分布図

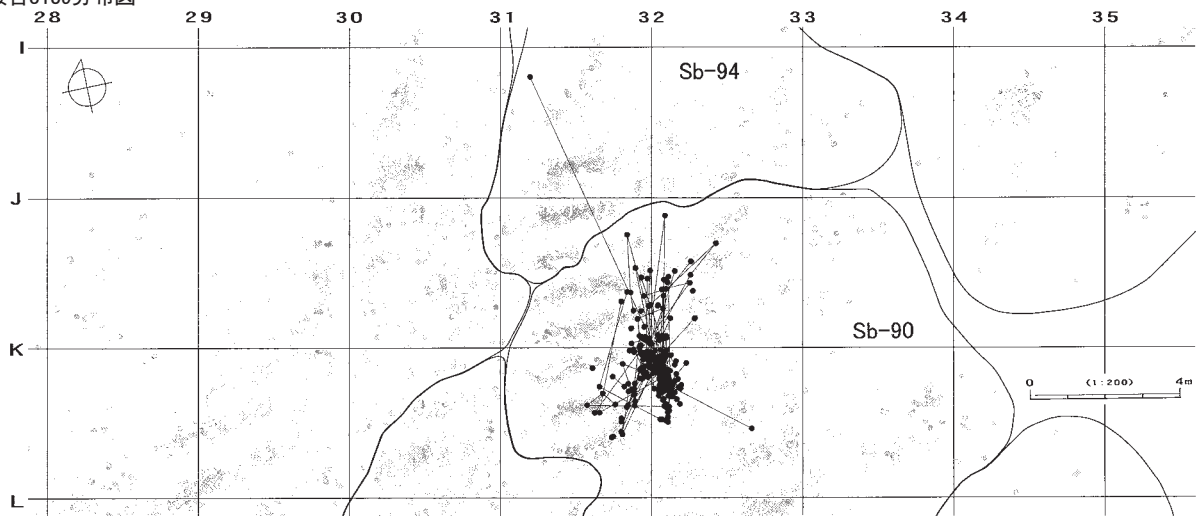

図Ⅲ-197 H区(Sb-90)の石器(18) 母岩683・接合3159(4)

母岩693・接合3201

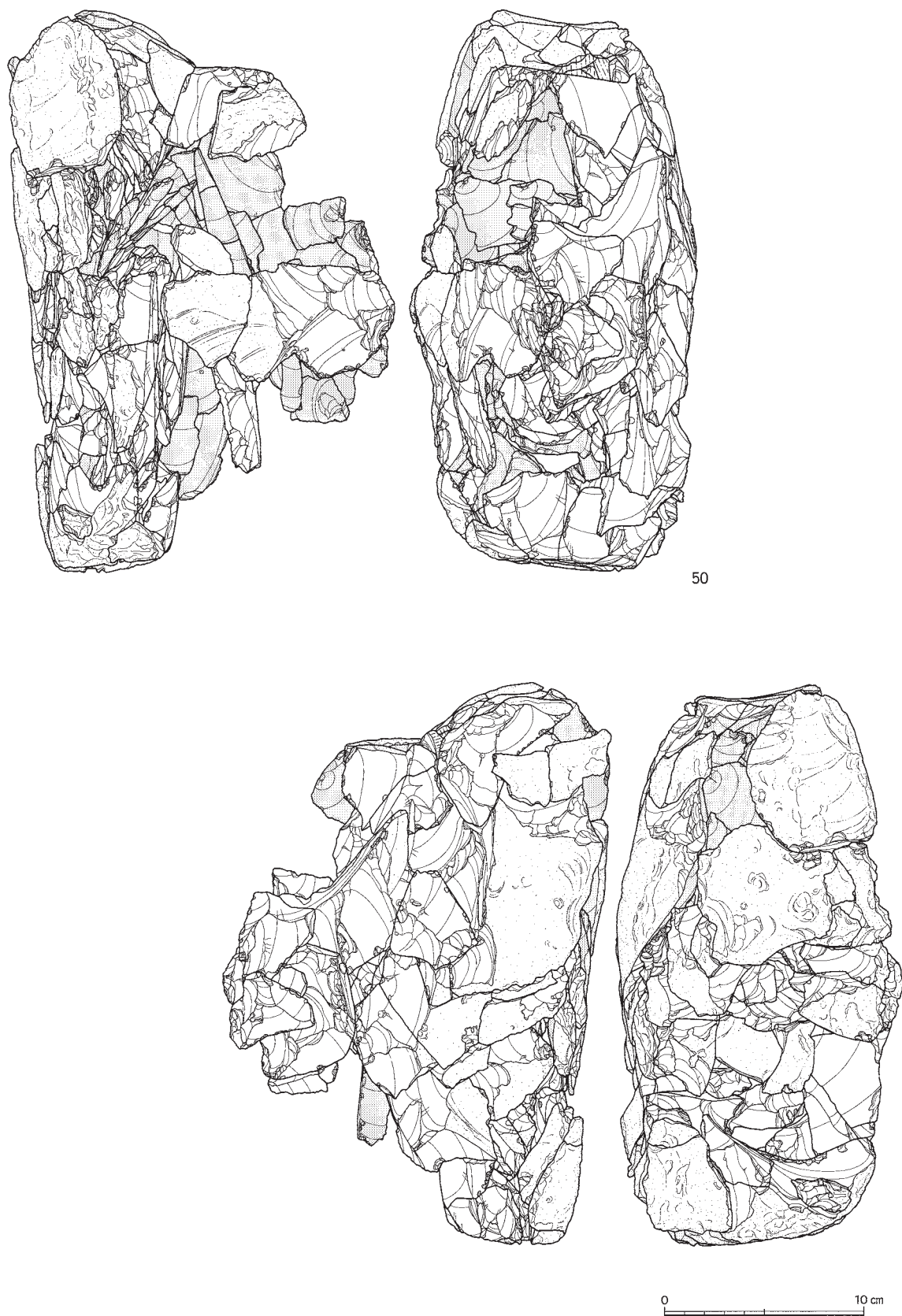

図Ⅲ-198 H区(Sb-90)の石器(19) 母岩693・接合3201(1)

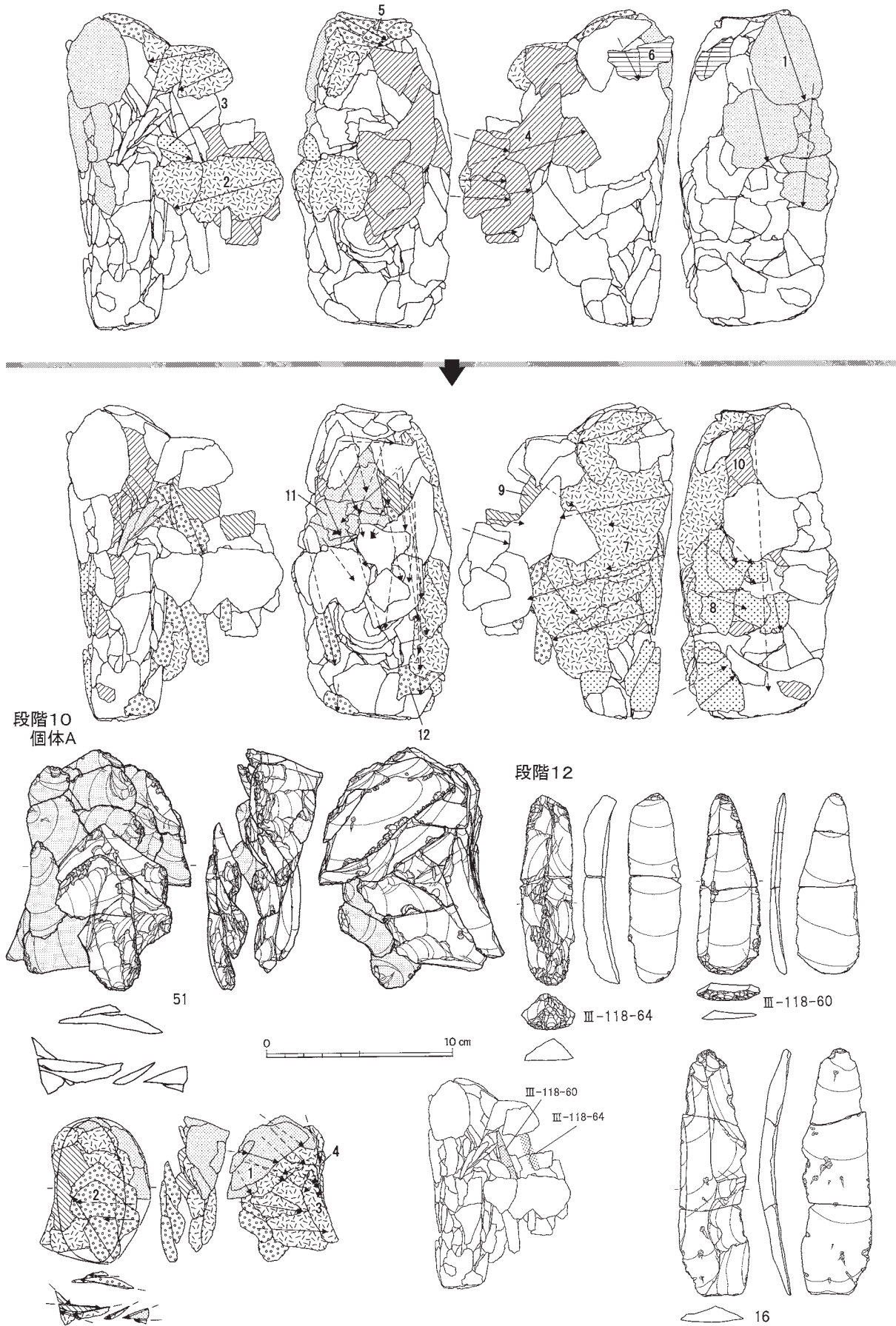

図Ⅲ-199 H区(Sb-90)の石器(20) 母岩693・接合3201(2)

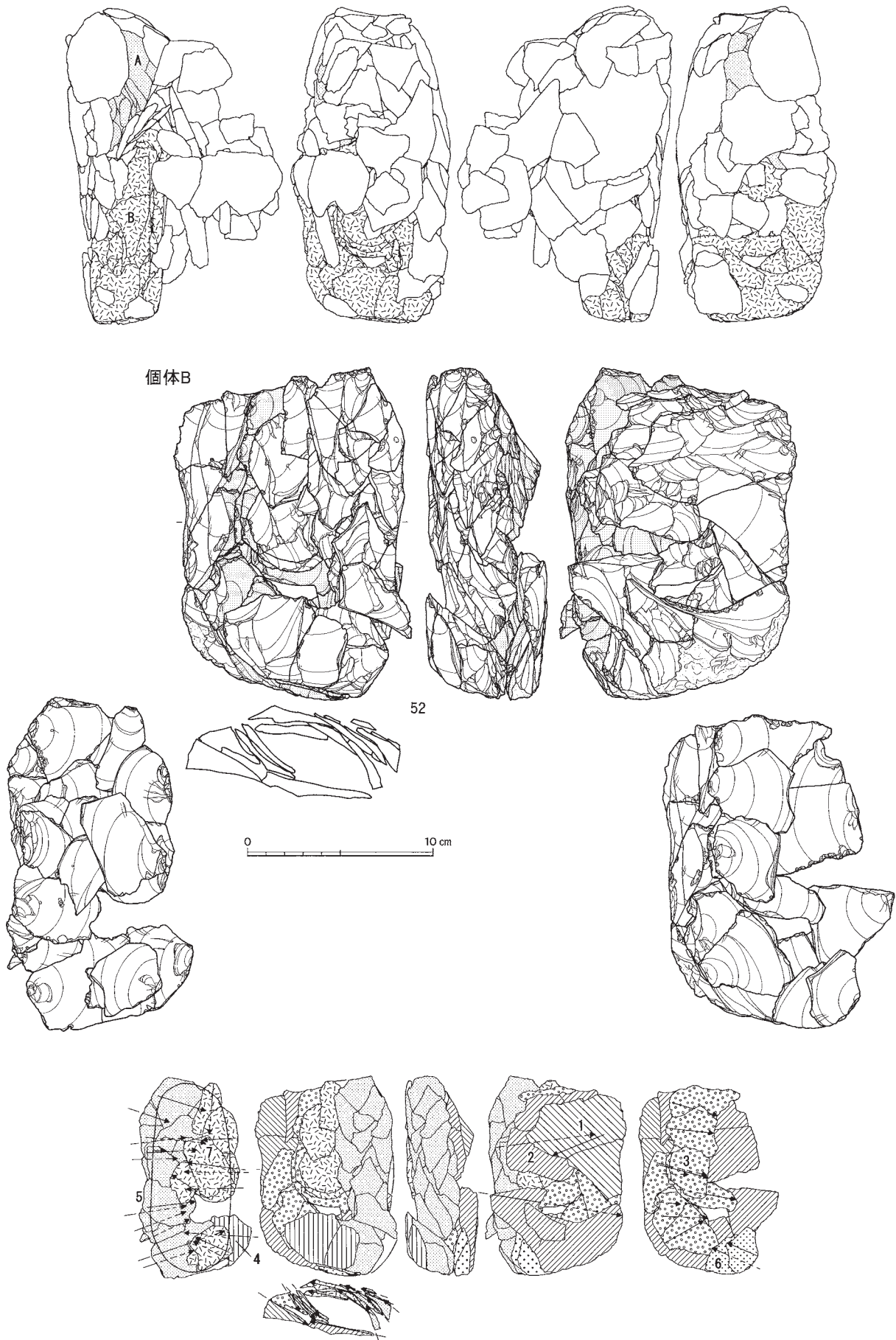

図Ⅲ-200 H区(Sb-90)の石器(21) 母岩693・接合3201(3)

接合3201(全体)分布図

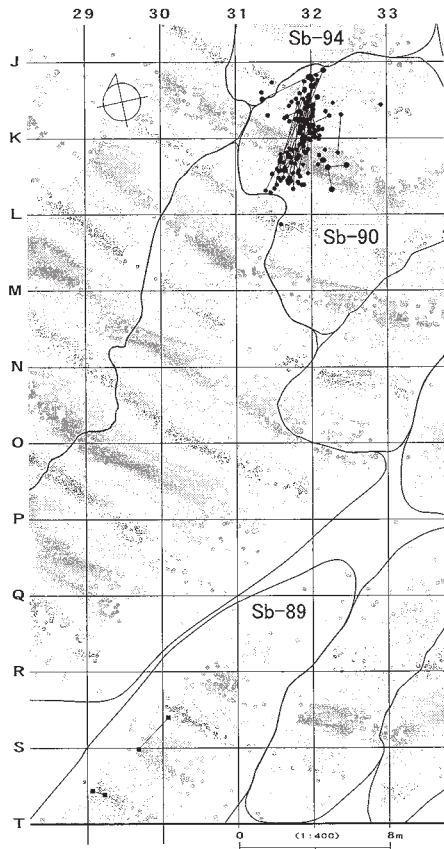

接合3201(個体A)分布図

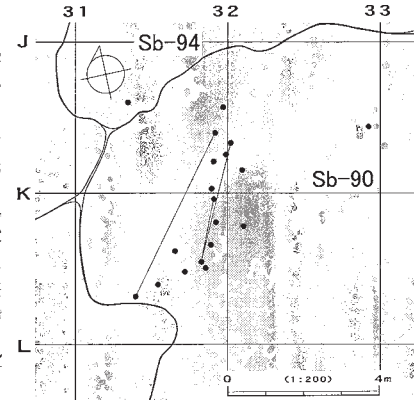

接合3201(個体B)分布図

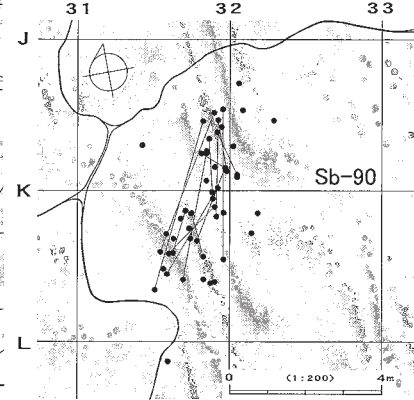

母岩690・接合3194

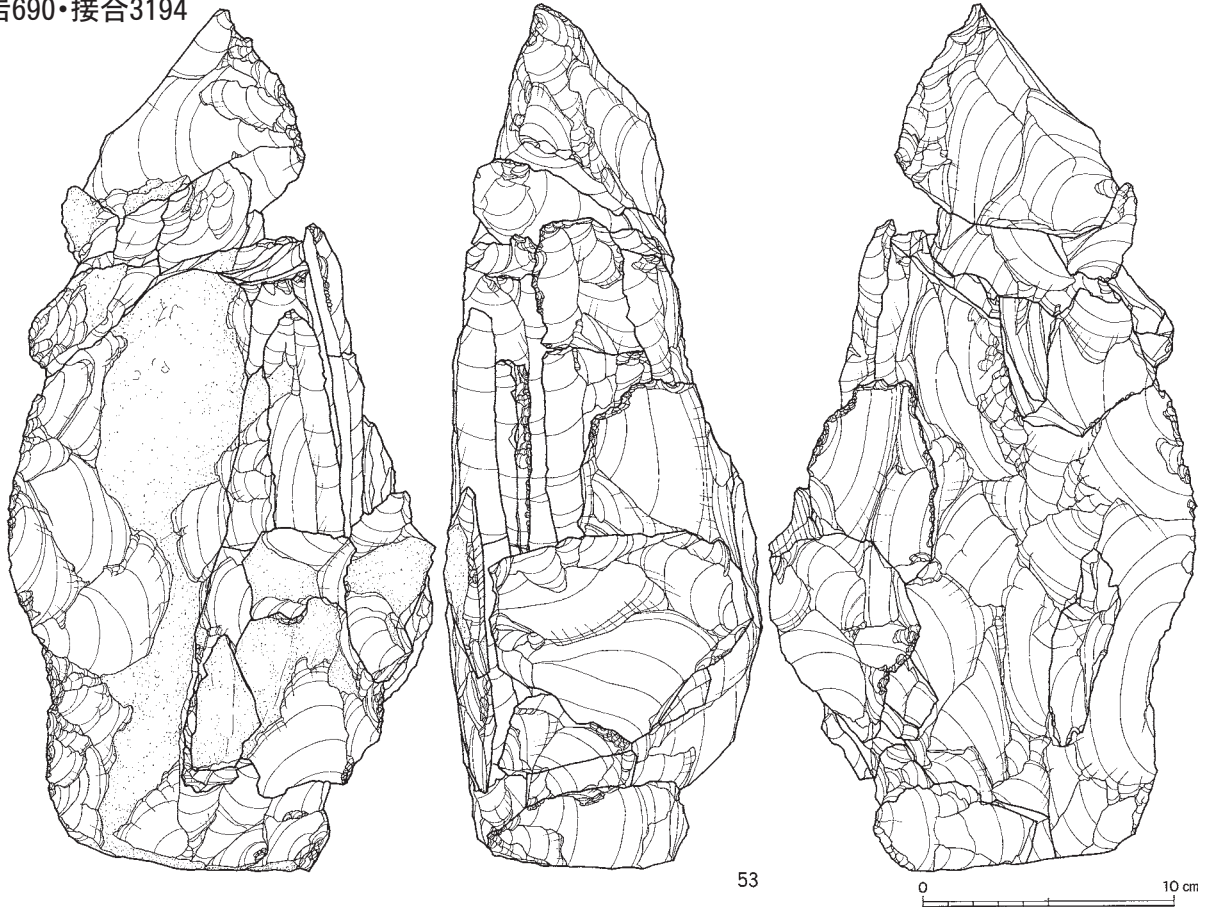

図Ⅲ-201 H区(Sb-90)の石器(22) 母岩693・接合3201(4)、母岩690・接合3194(1)

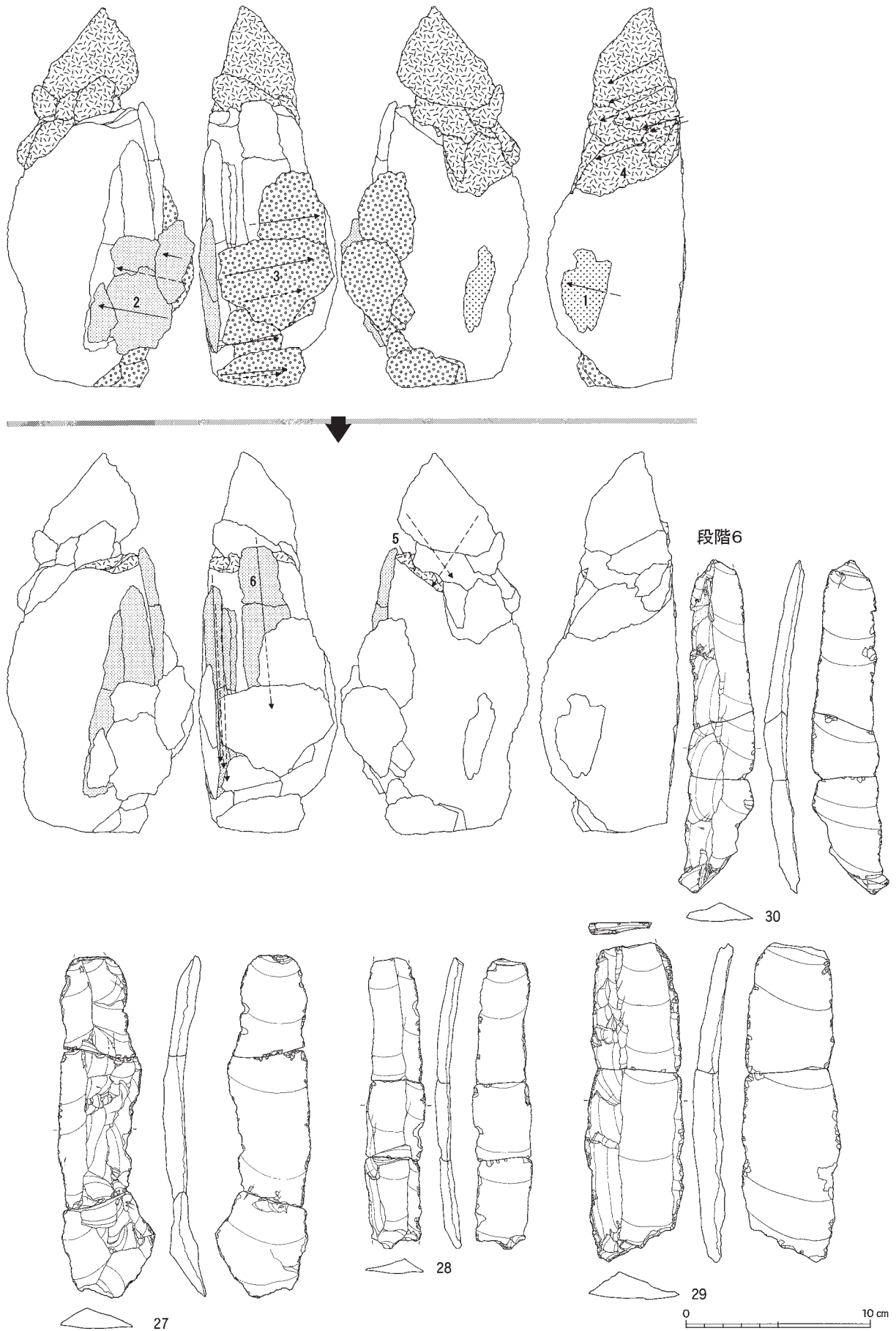

図Ⅲ-202 H区(Sb-90)の石器(23) 母岩690・接合3194(2)

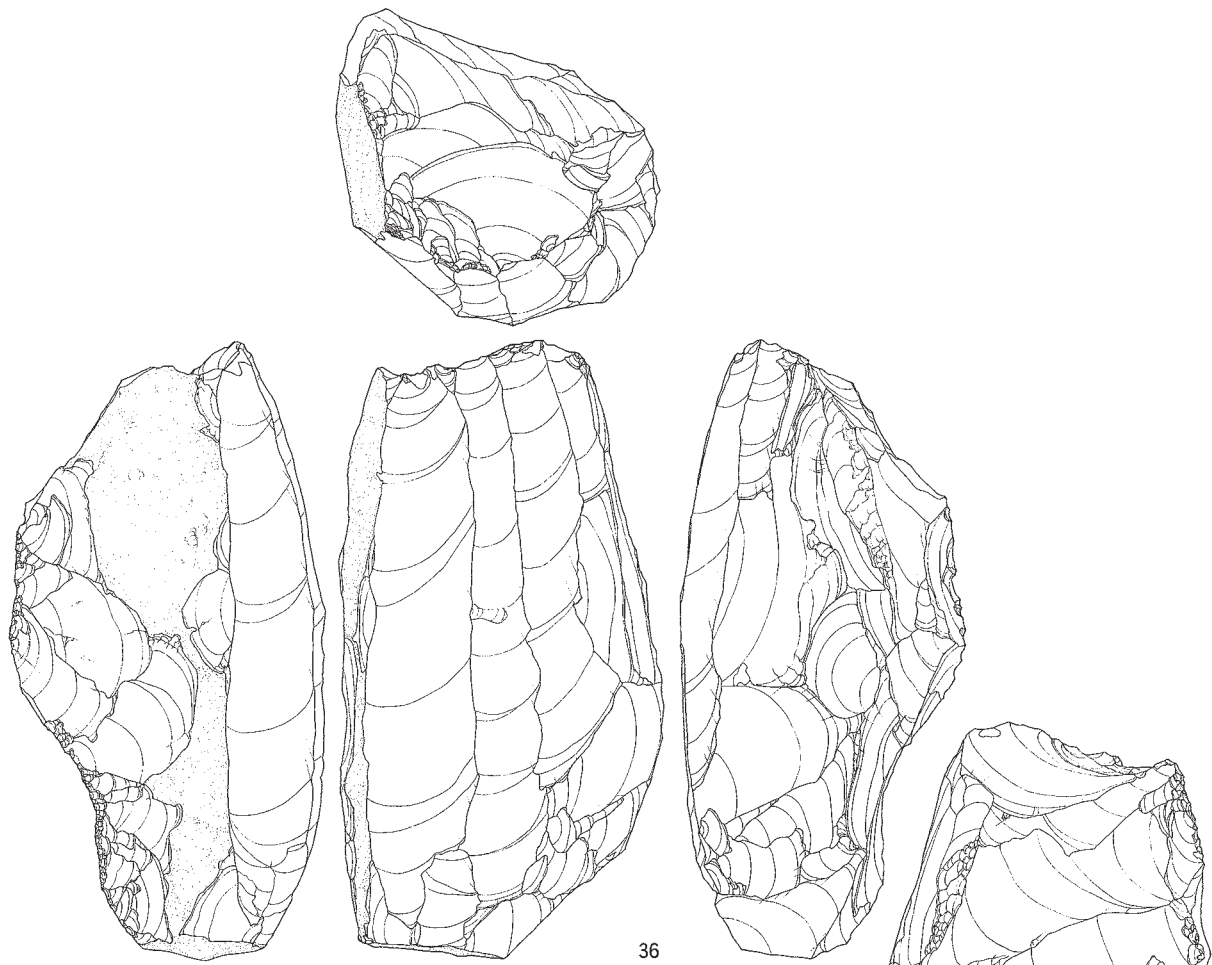

接合3194分布図

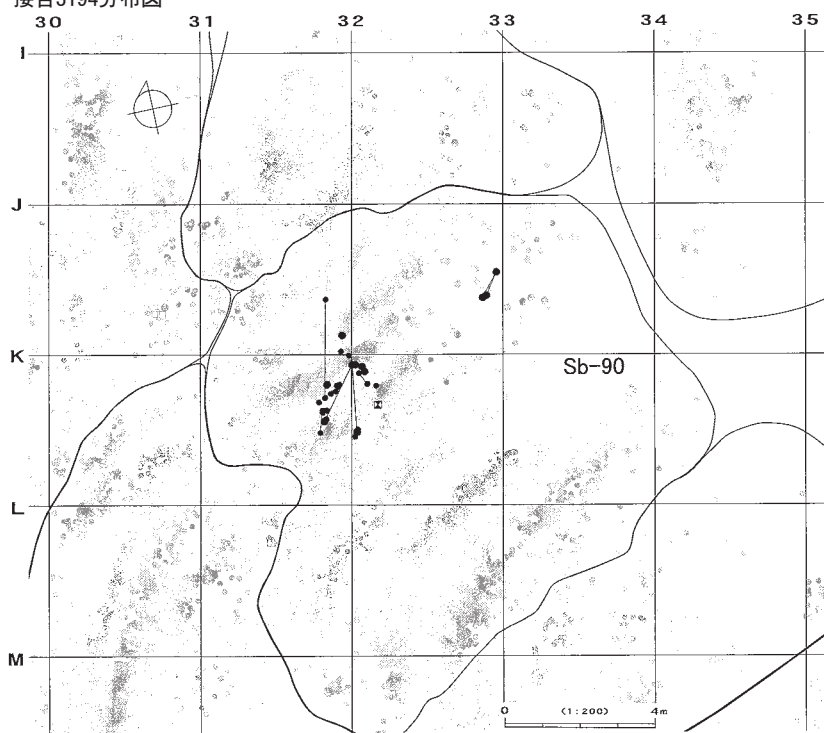

図Ⅲ-203 H区(Sb-90)の石器(24) 母岩690・接合3194(3)

母岩688・接合3185

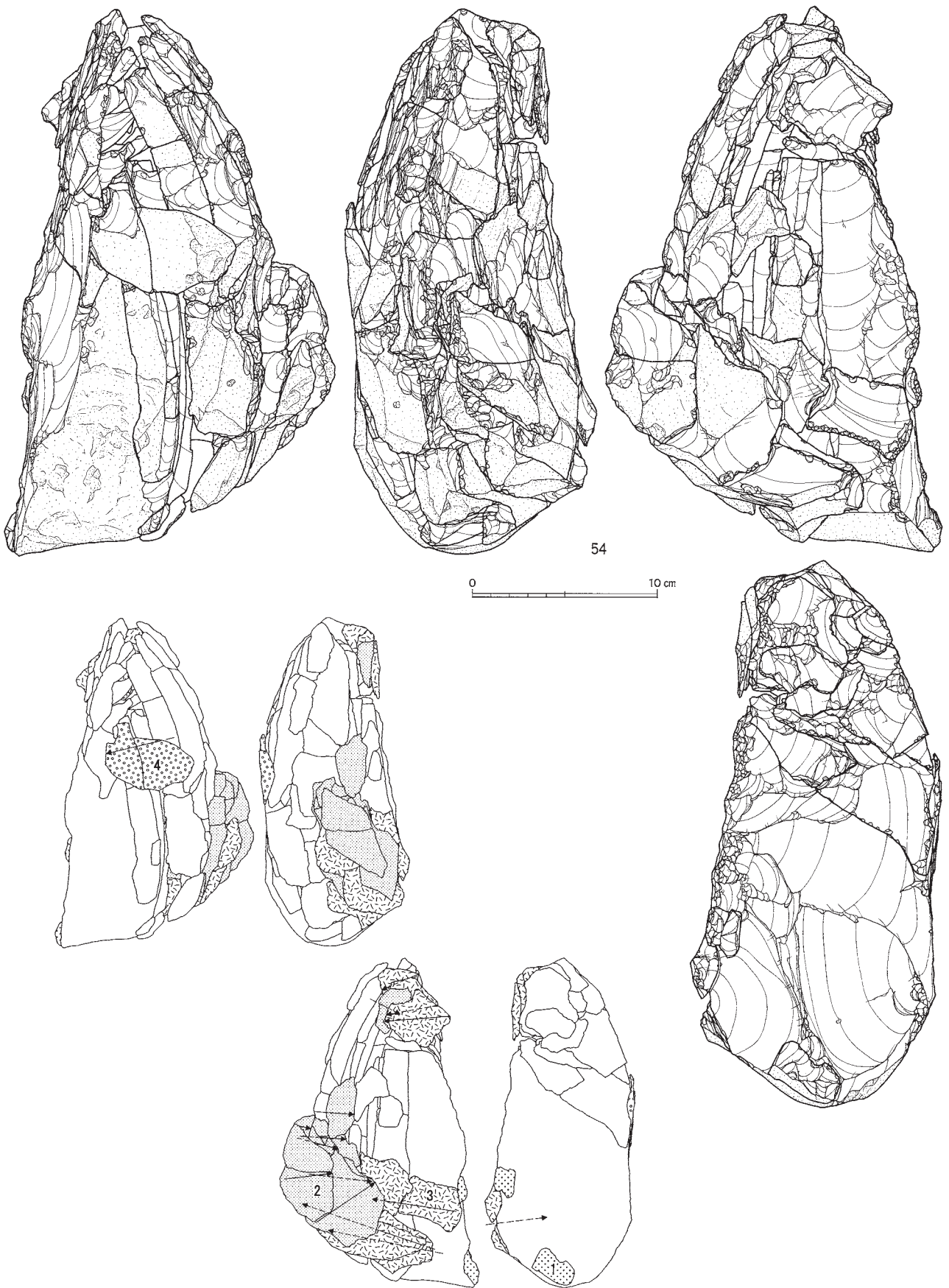

図Ⅲ-204 H区(Sb-90)の石器(25) 母岩688・接合3185(1)

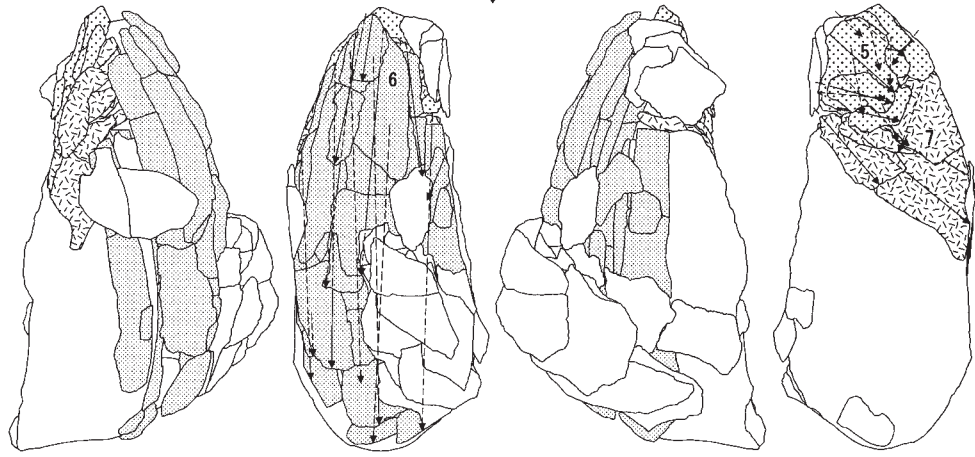

段階6

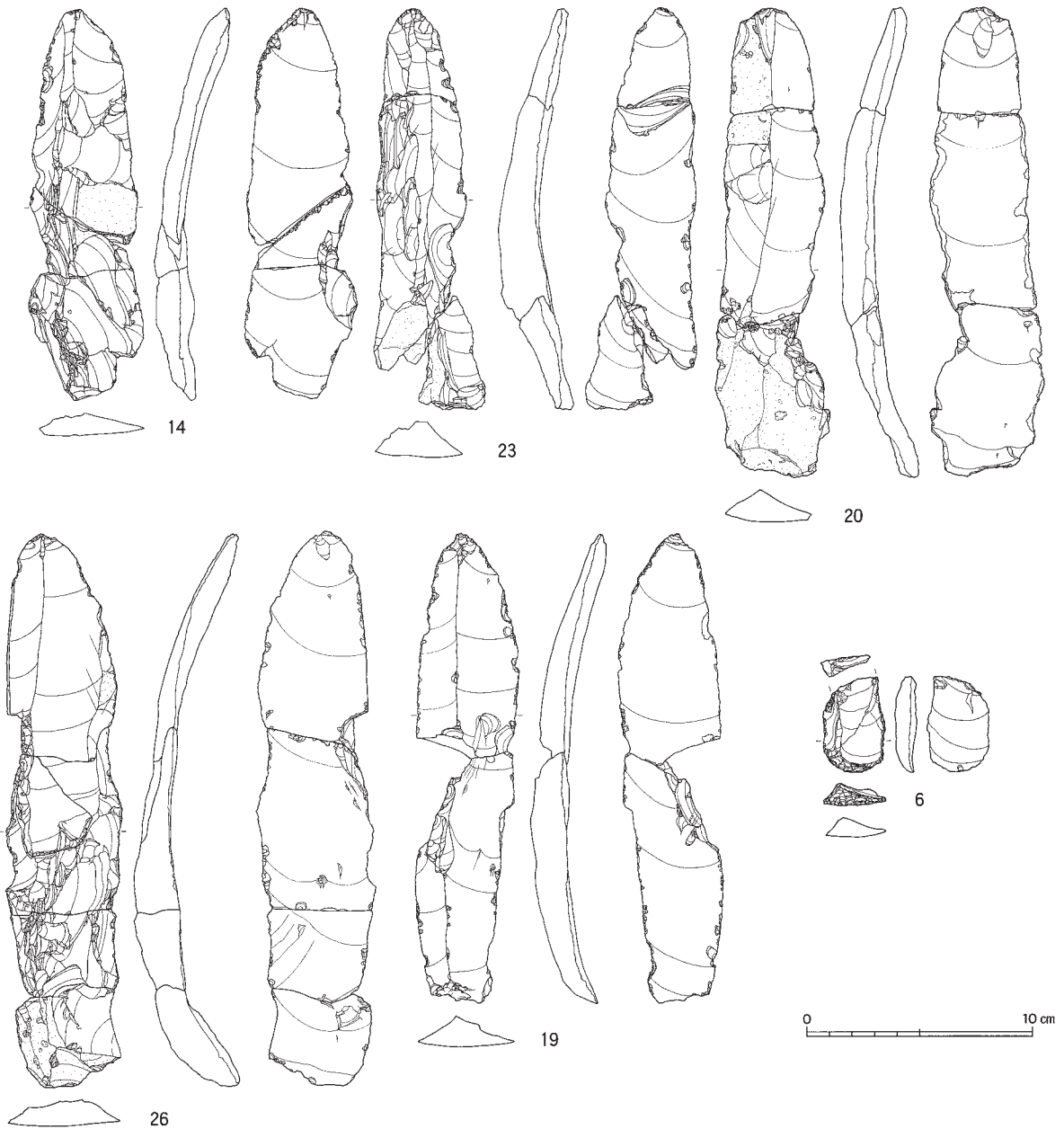

図Ⅲ-205 H区(Sb-90)の石器(26) 母岩688・接合3185(2)

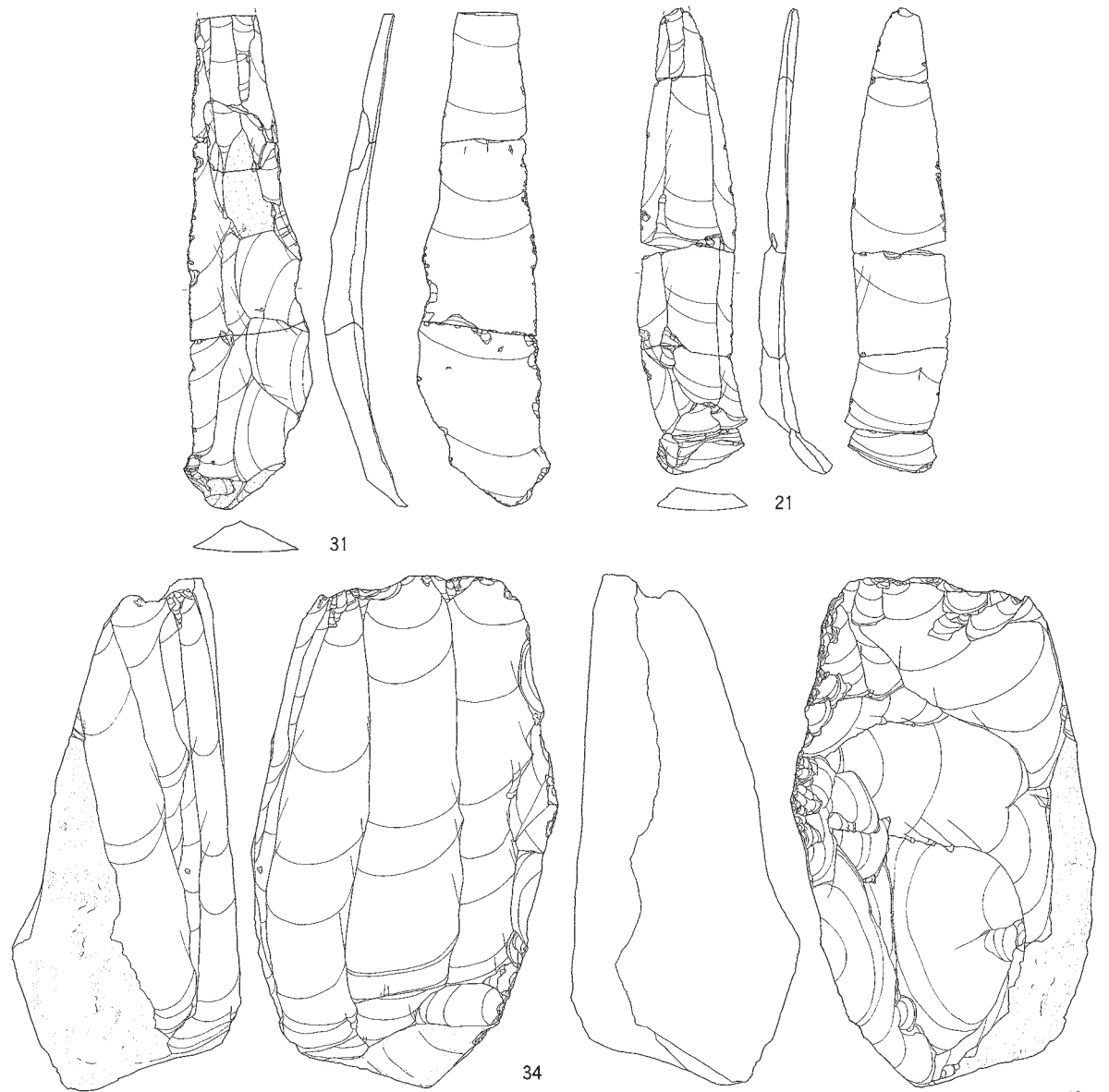

10 cm

接合3185分布図

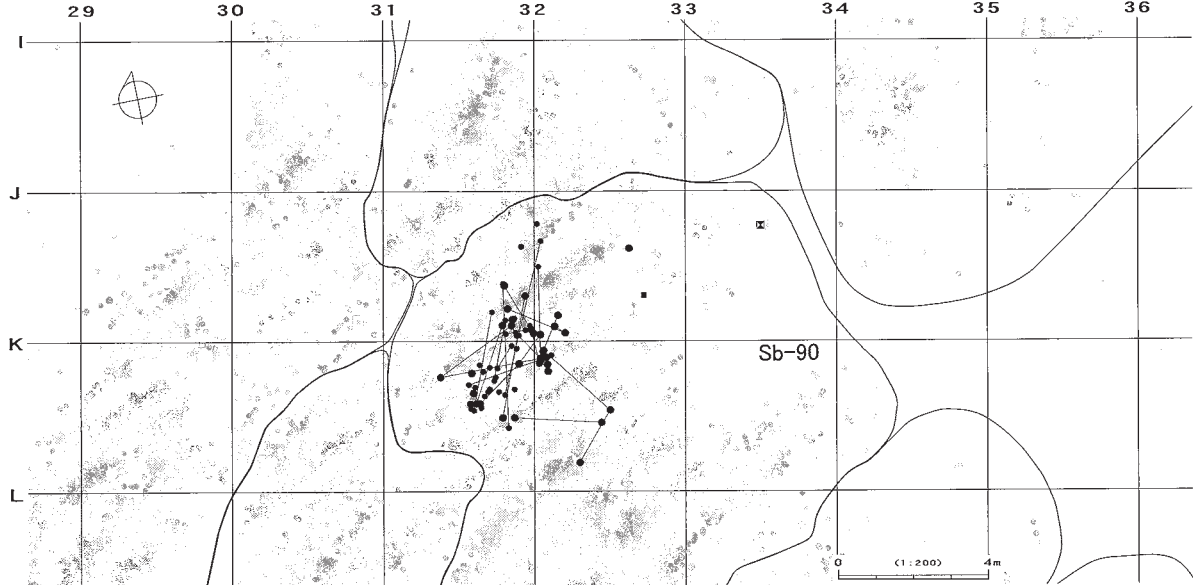

図Ⅲ-206 H区(Sb-90)の石器(27) 母岩688・接合3185(3)

母岩704・接合3228

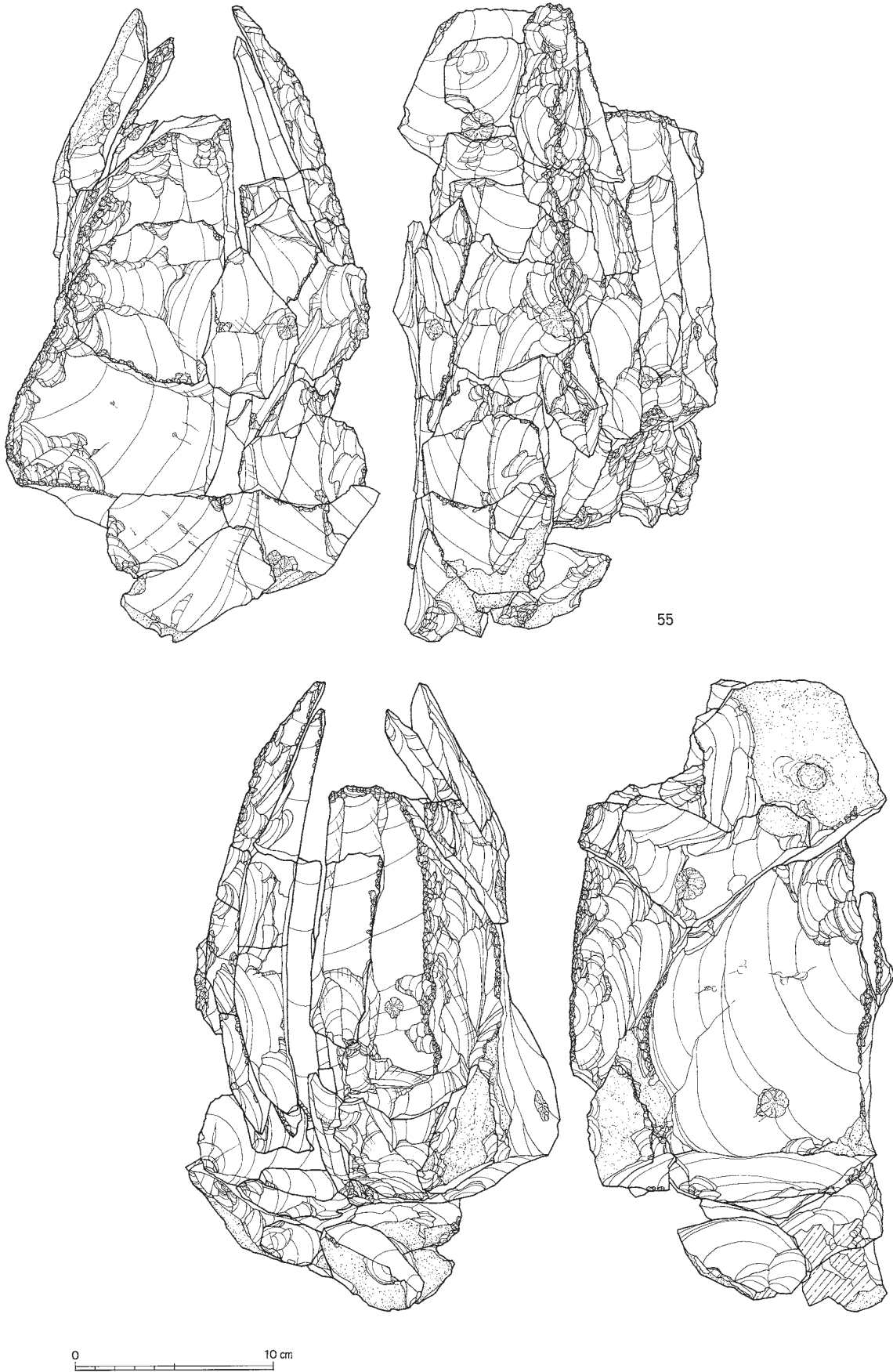

図Ⅲ-207 H区(Sb-90)の石器(28) 母岩704・接合3228(1)

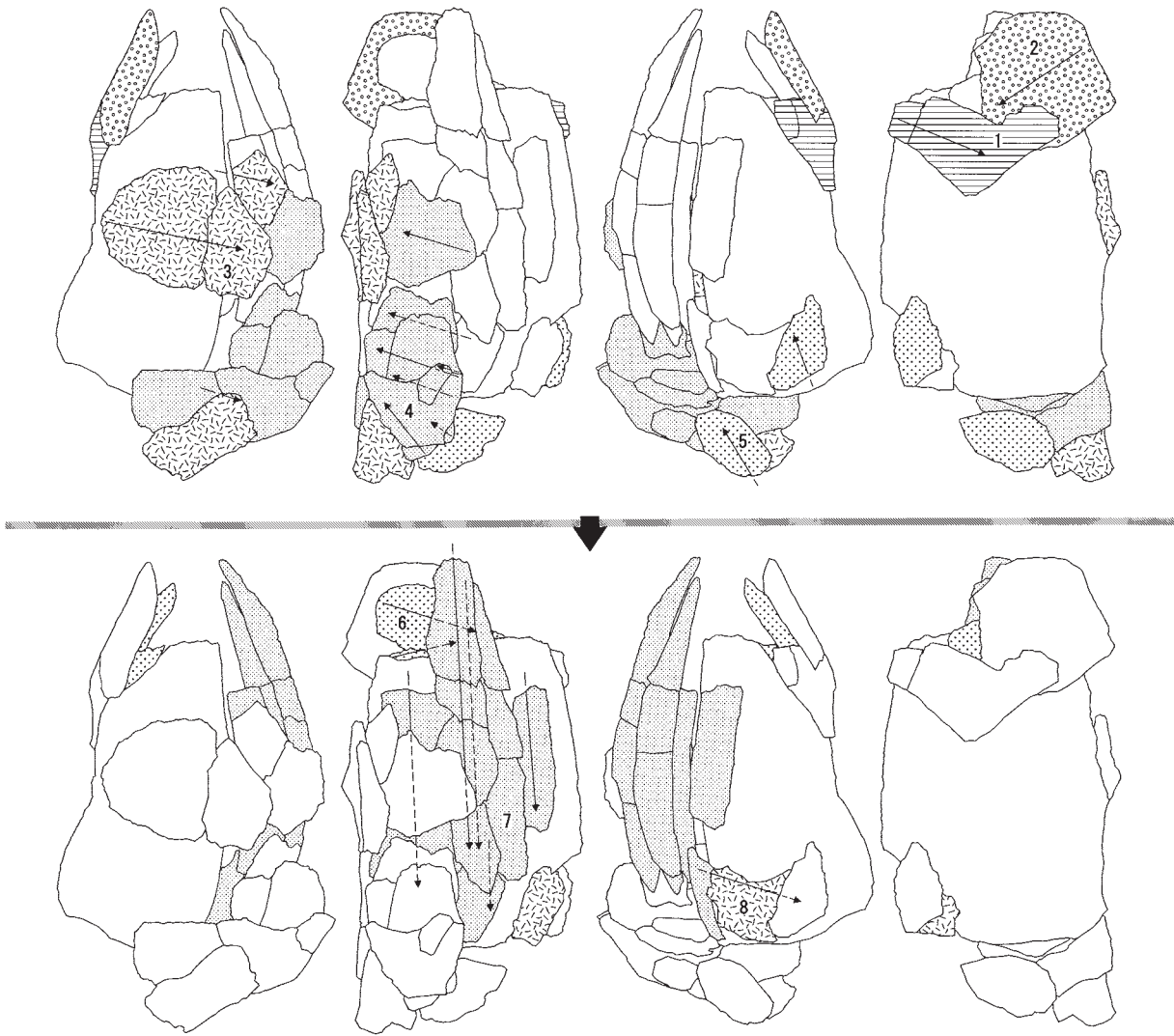

段階7

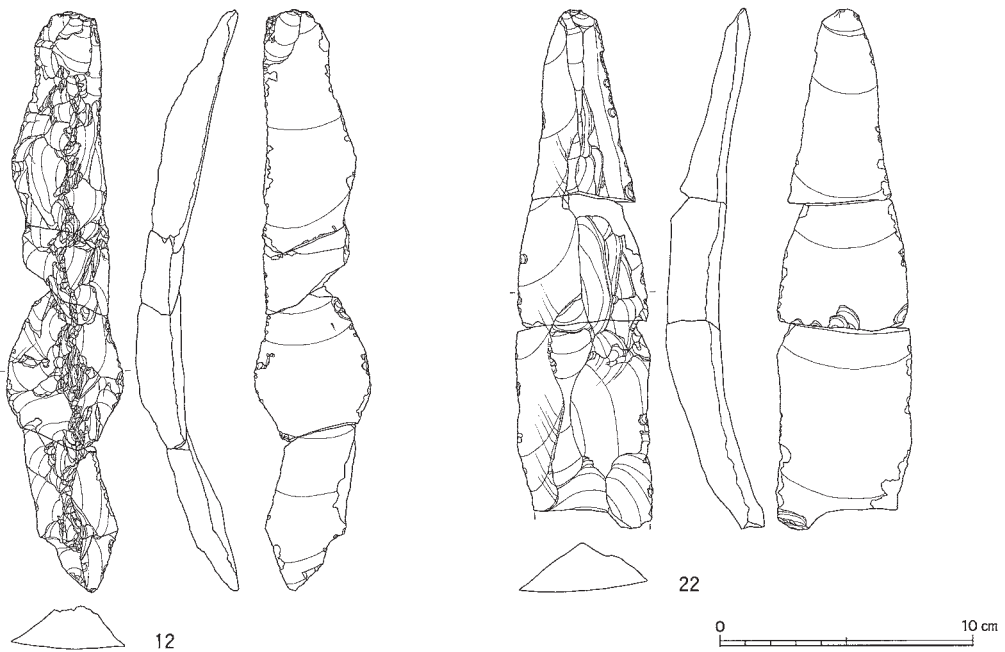

図Ⅲ-208 H区(Sb-90)の石器(29) 母岩704・接合3228(2)

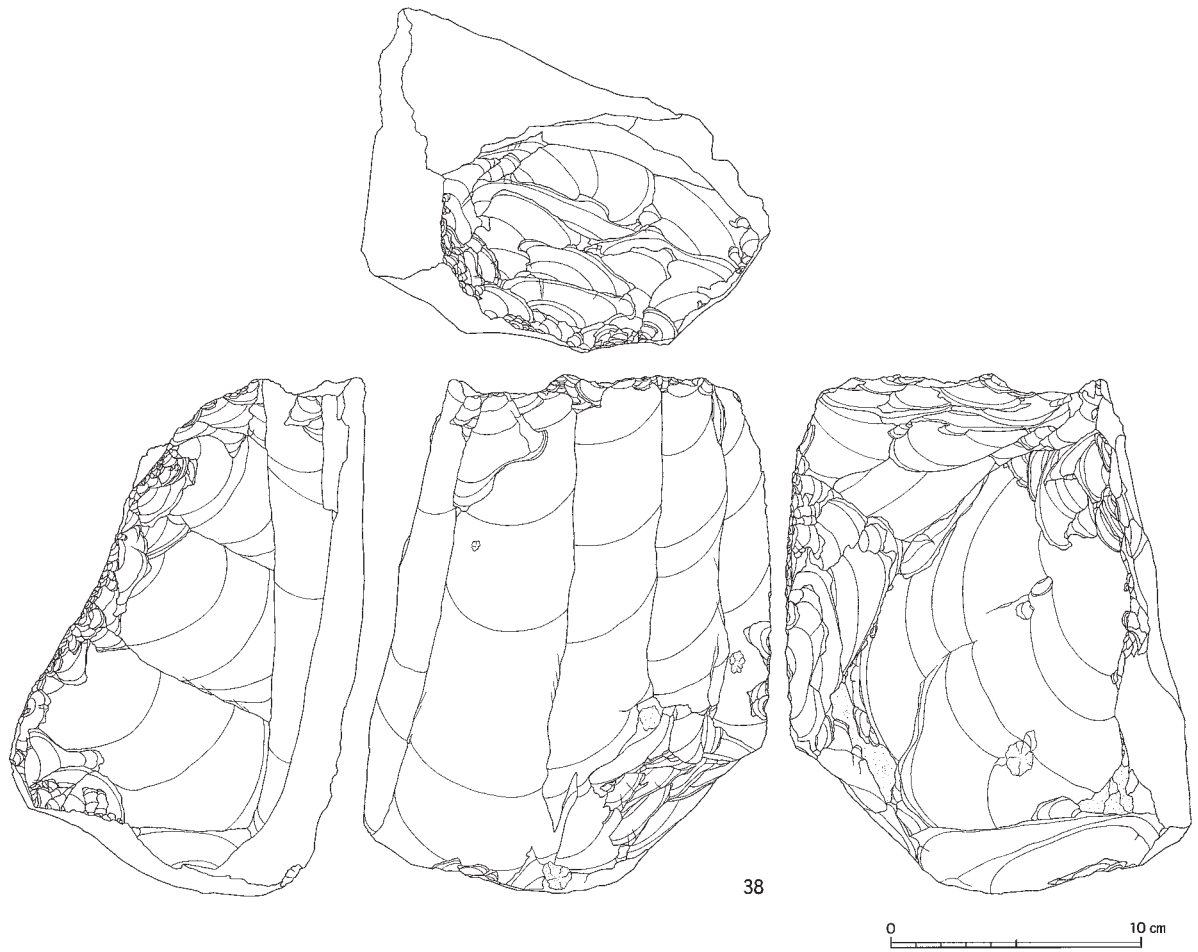

接合3228分布図

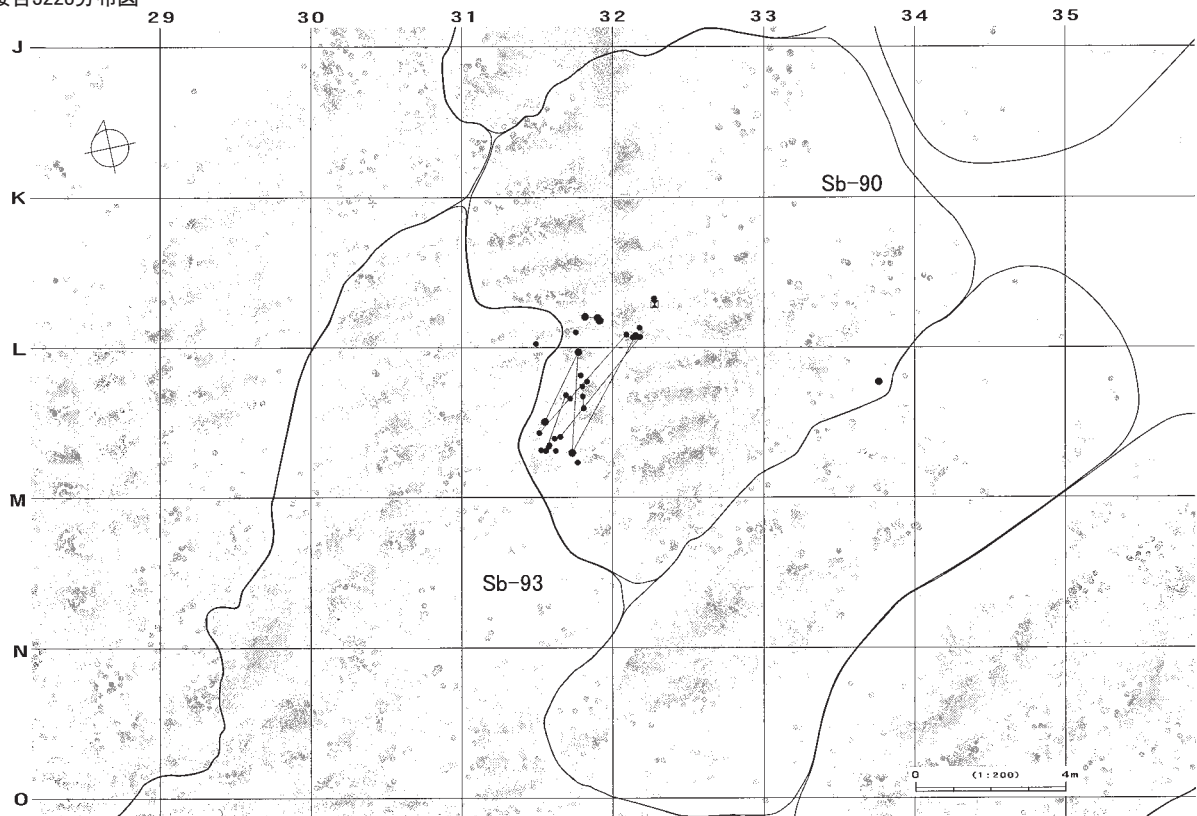

図Ⅲ-209 H区(Sb-90)の石器(30) 母岩704・接合3228(3)

母岩691・接合3195

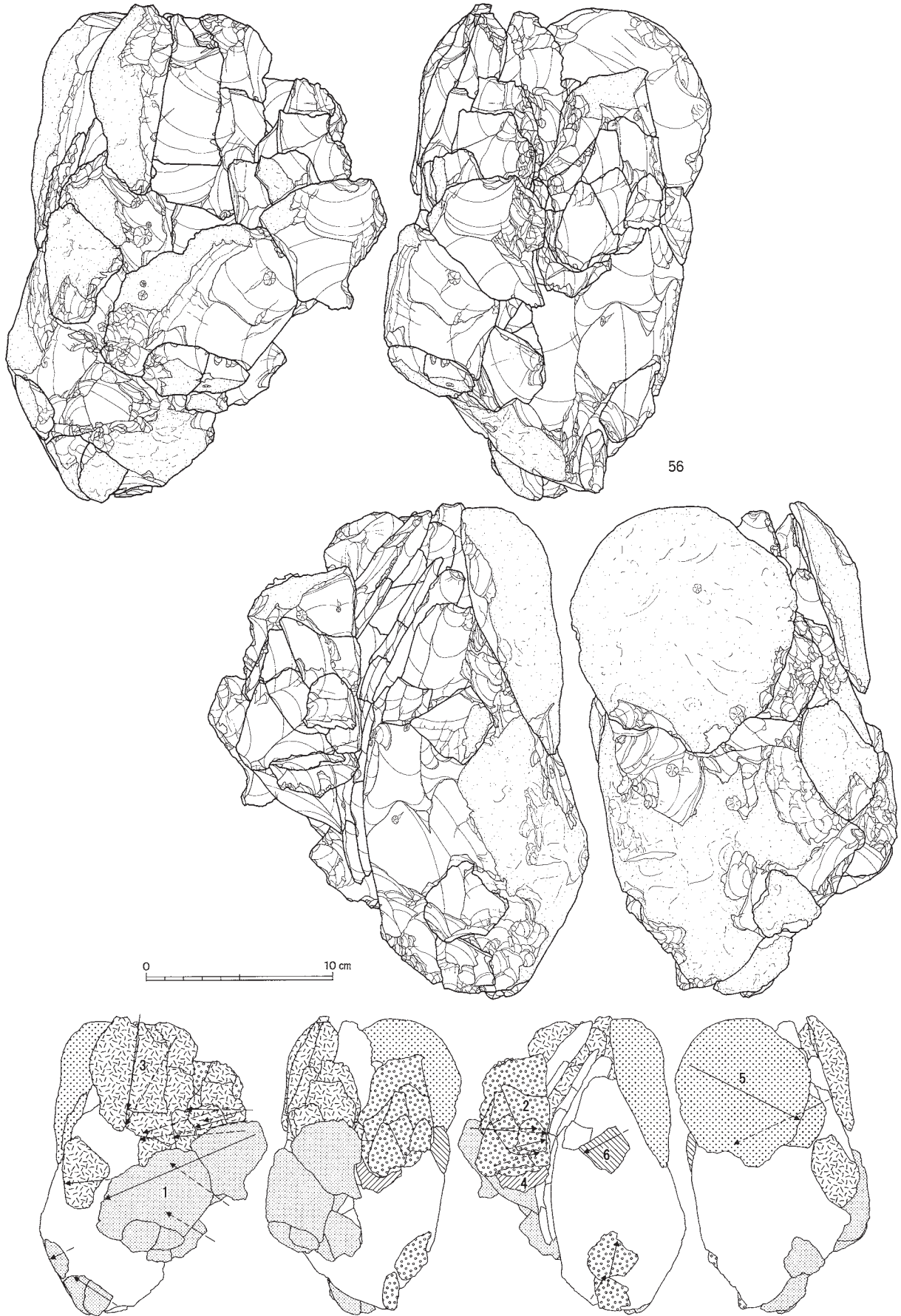

図Ⅲ-210 H区(Sb-90)の石器(31) 母岩691・接合3195(1)

段階6

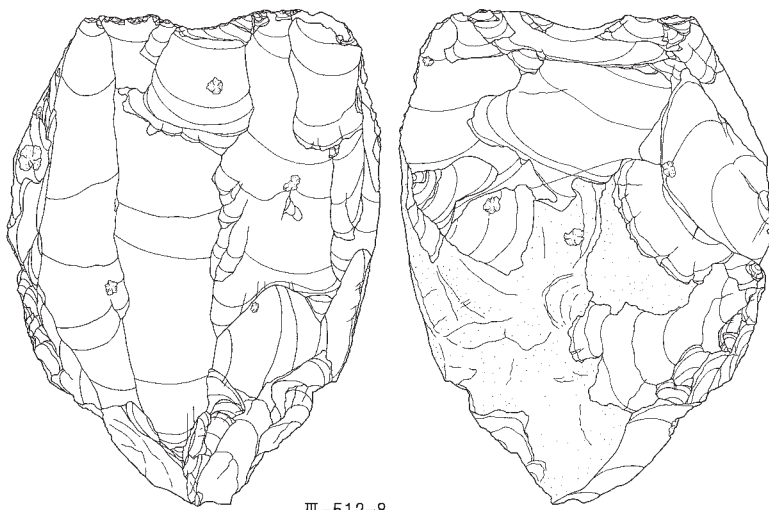
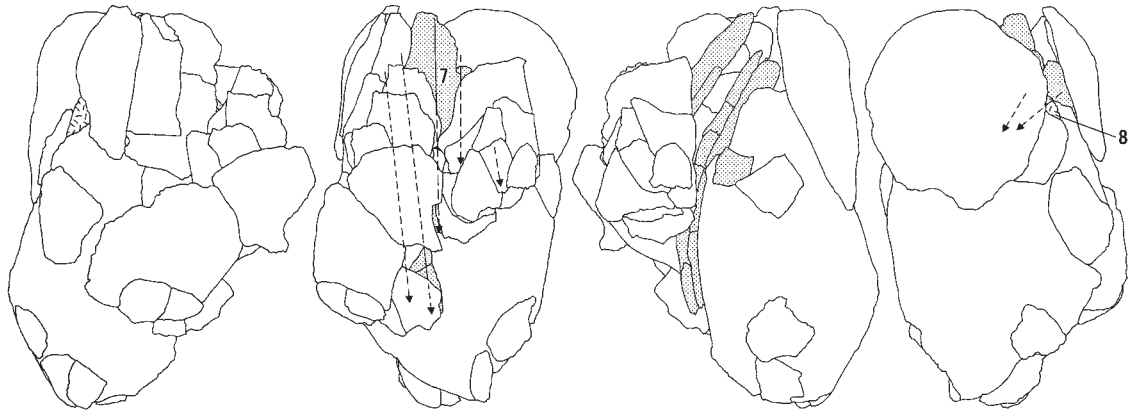
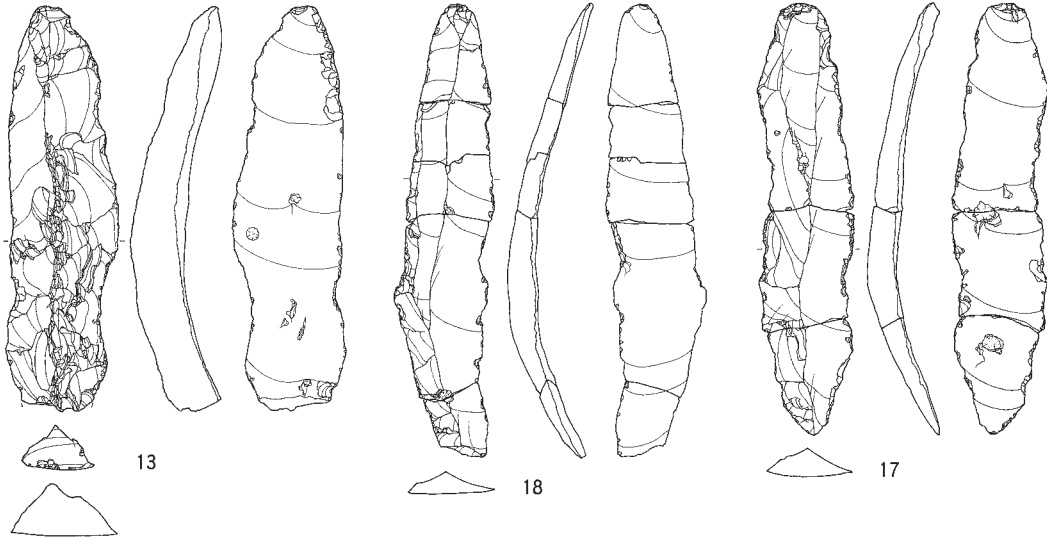

0 10 cm

接合3195分布図

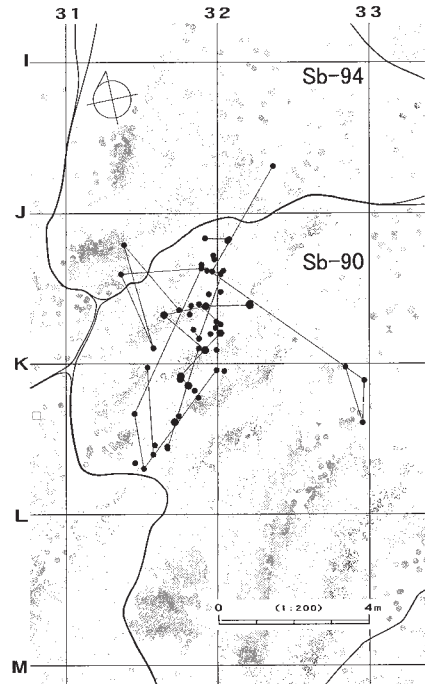

図Ⅲ-211 H区(Sb-90)の石器(32) 母岩691・接合3195(2)

母岩699・接合3217

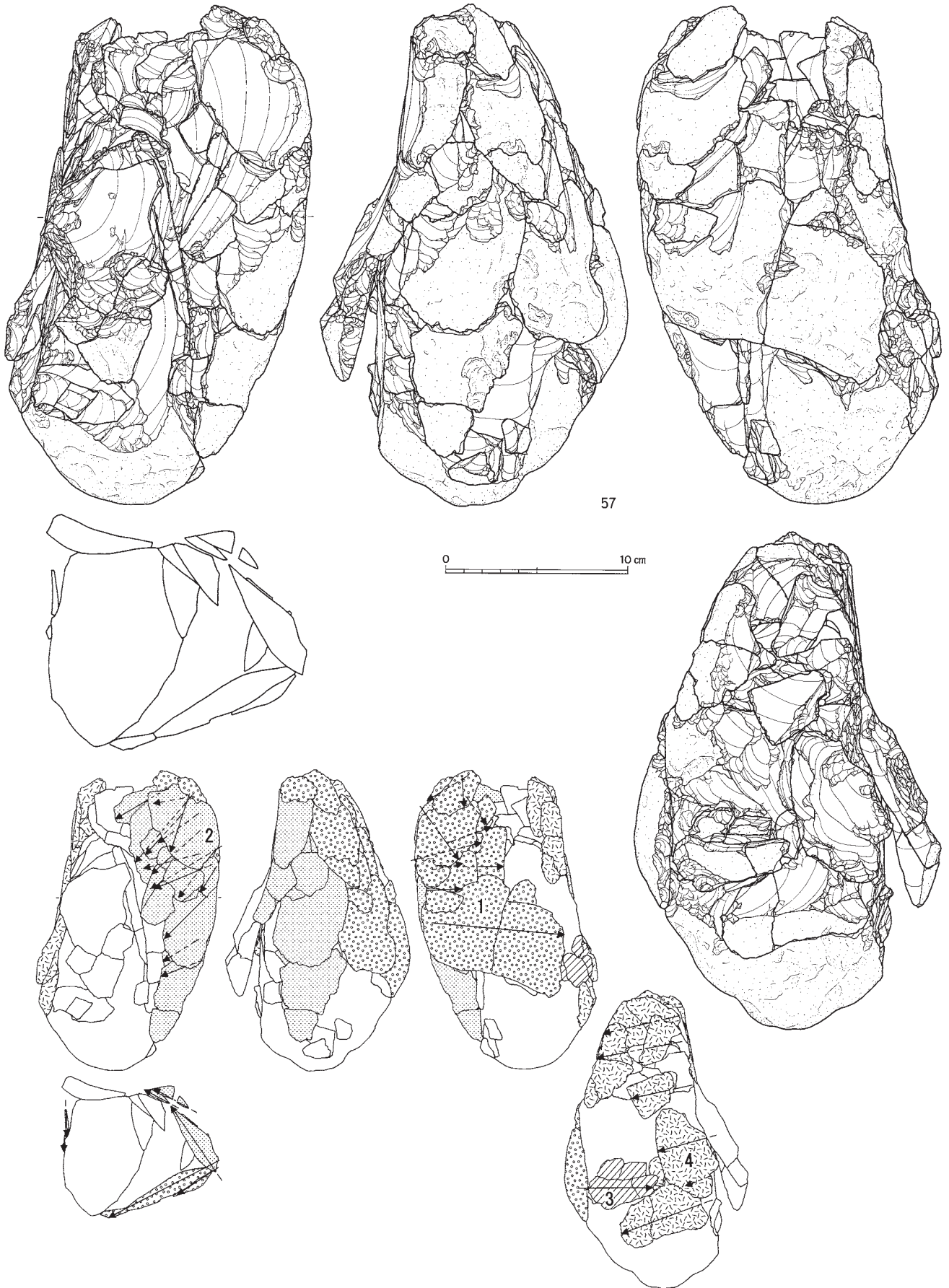

図Ⅲ-212 H区(Sb-90)の石器(33) 母岩699・接合3217(1)

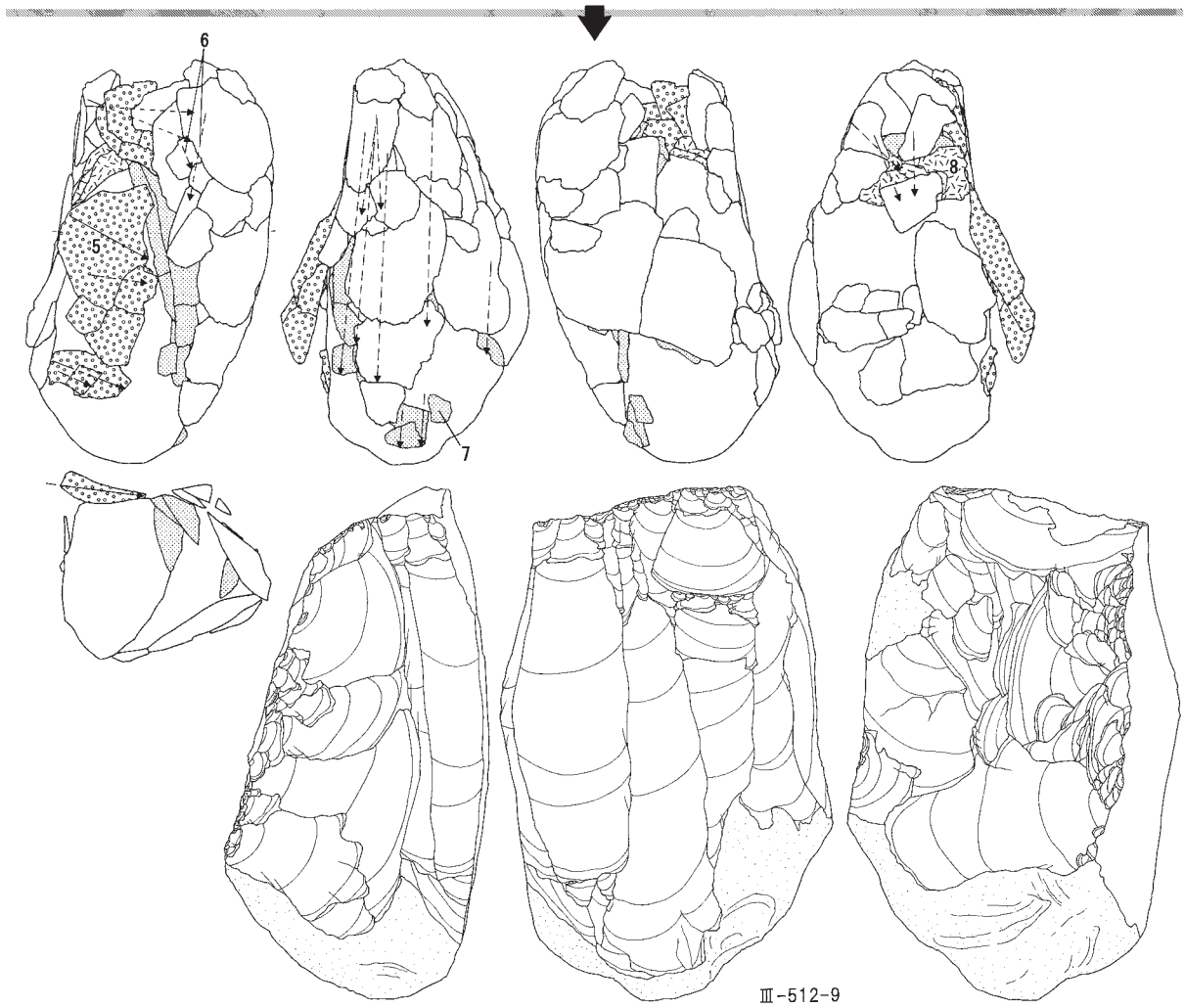

Ⅲ-512-9

0 10 cm

接合3217分布図

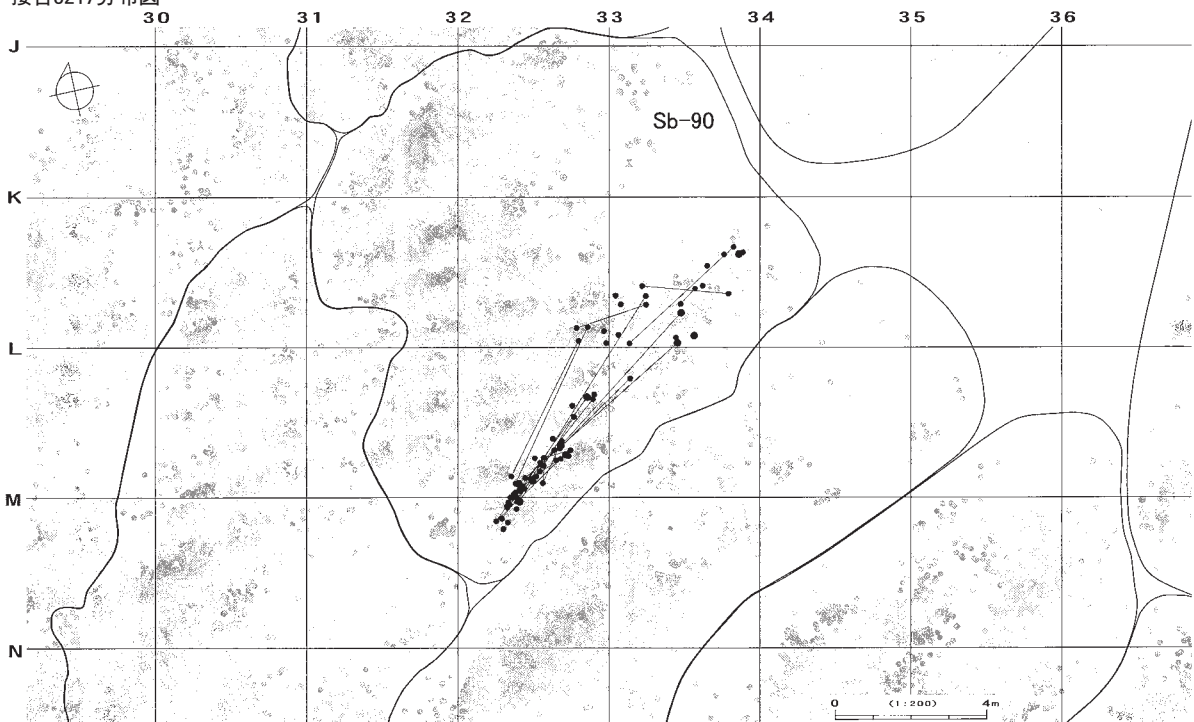

図Ⅲ-213 H区(Sb-90)の石器(34) 母岩699・接合3217(2)

母岩700・接合3218

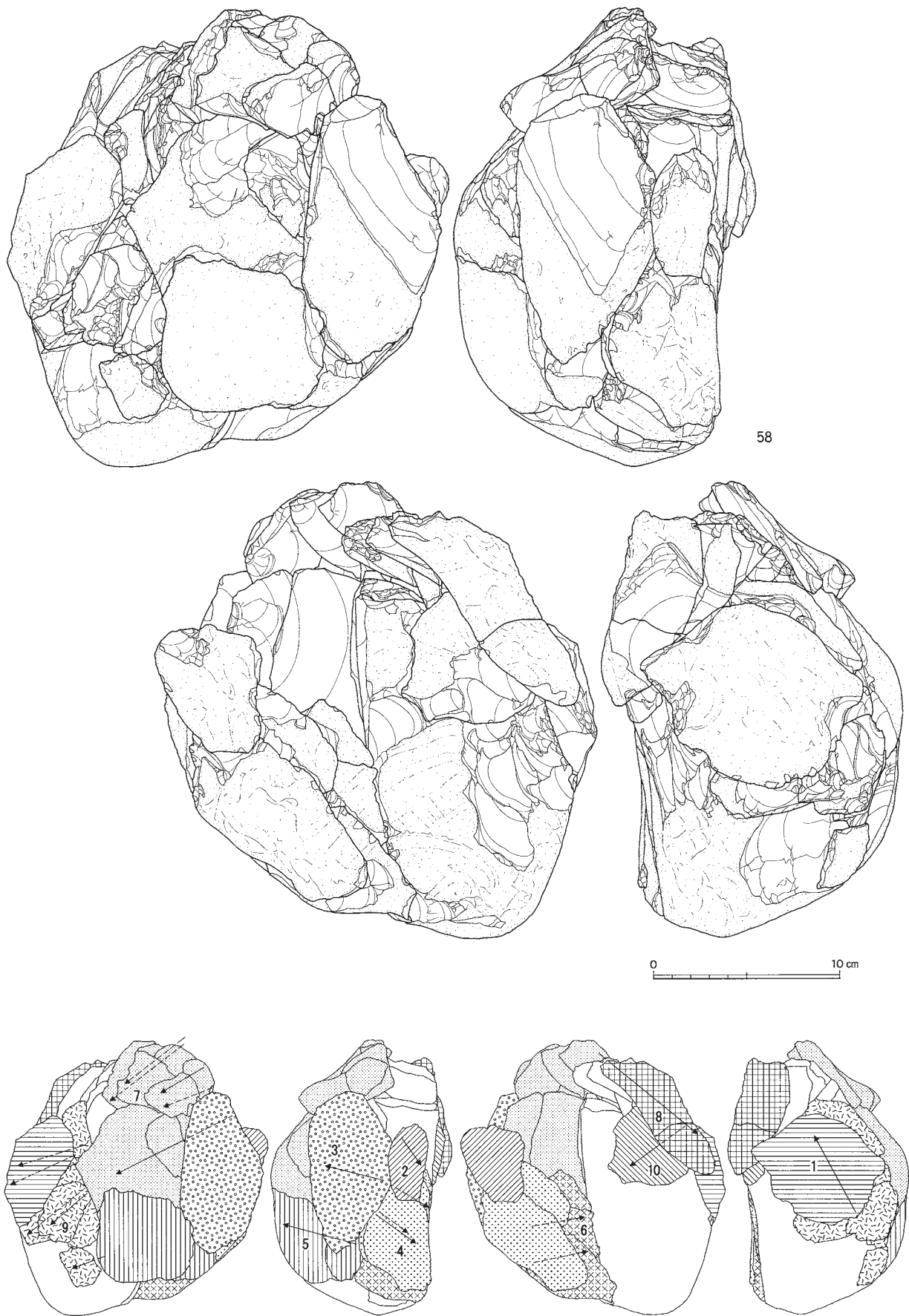

図Ⅲ-214 H区(Sb-90)の石器(35) 母岩700・接合3218(1)

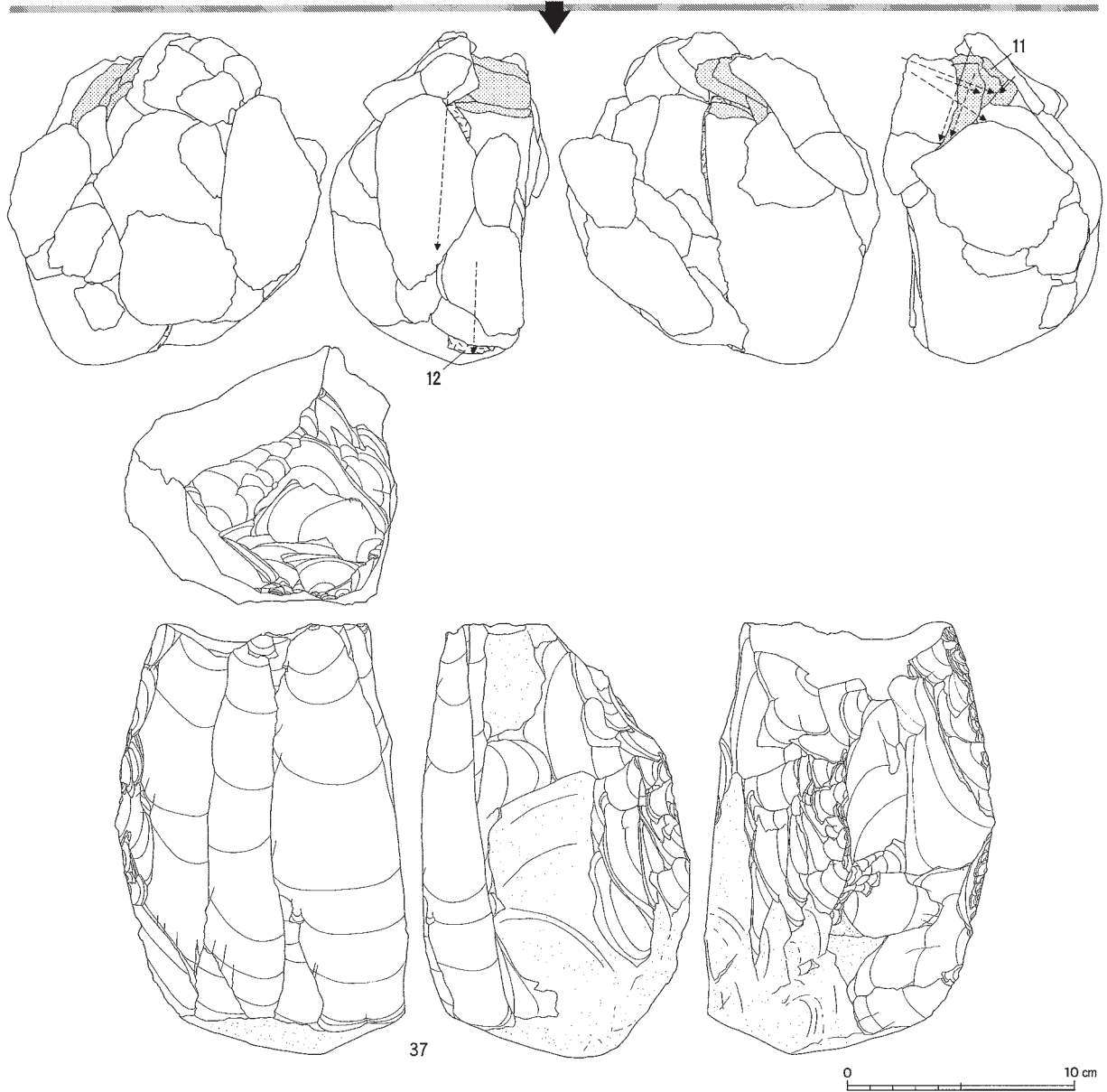

接合3218分布図

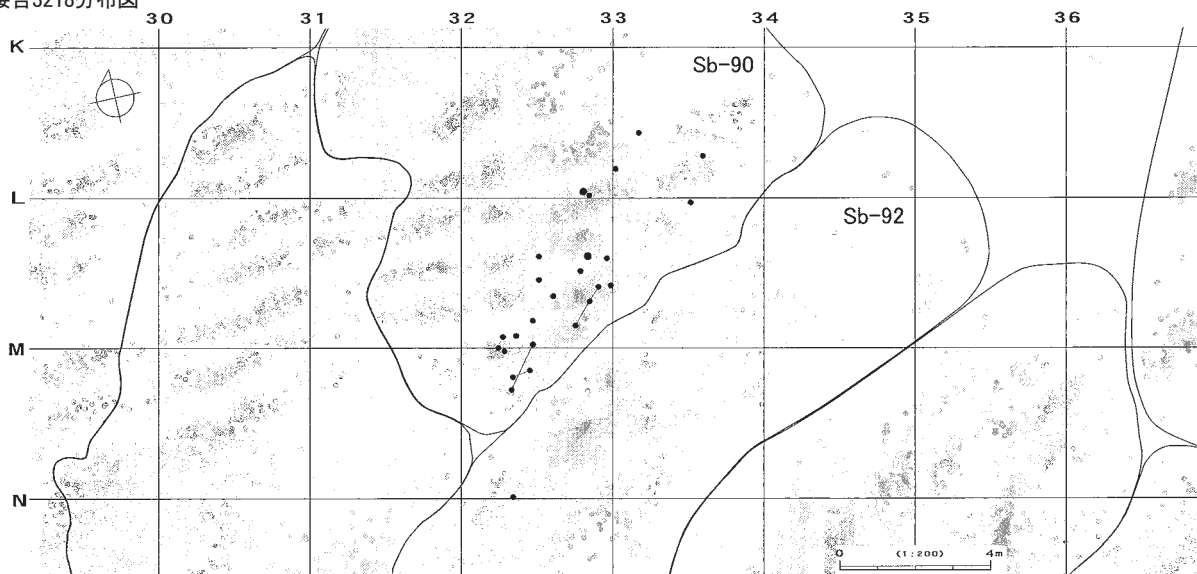

図Ⅲ-215 H区(Sb-90)の石器(36) 母岩700・接合3218(2)

母岩689・接合3187



図Ⅲ-216 H区(Sb-90)の石器(37) 母岩689・接合3187(1)

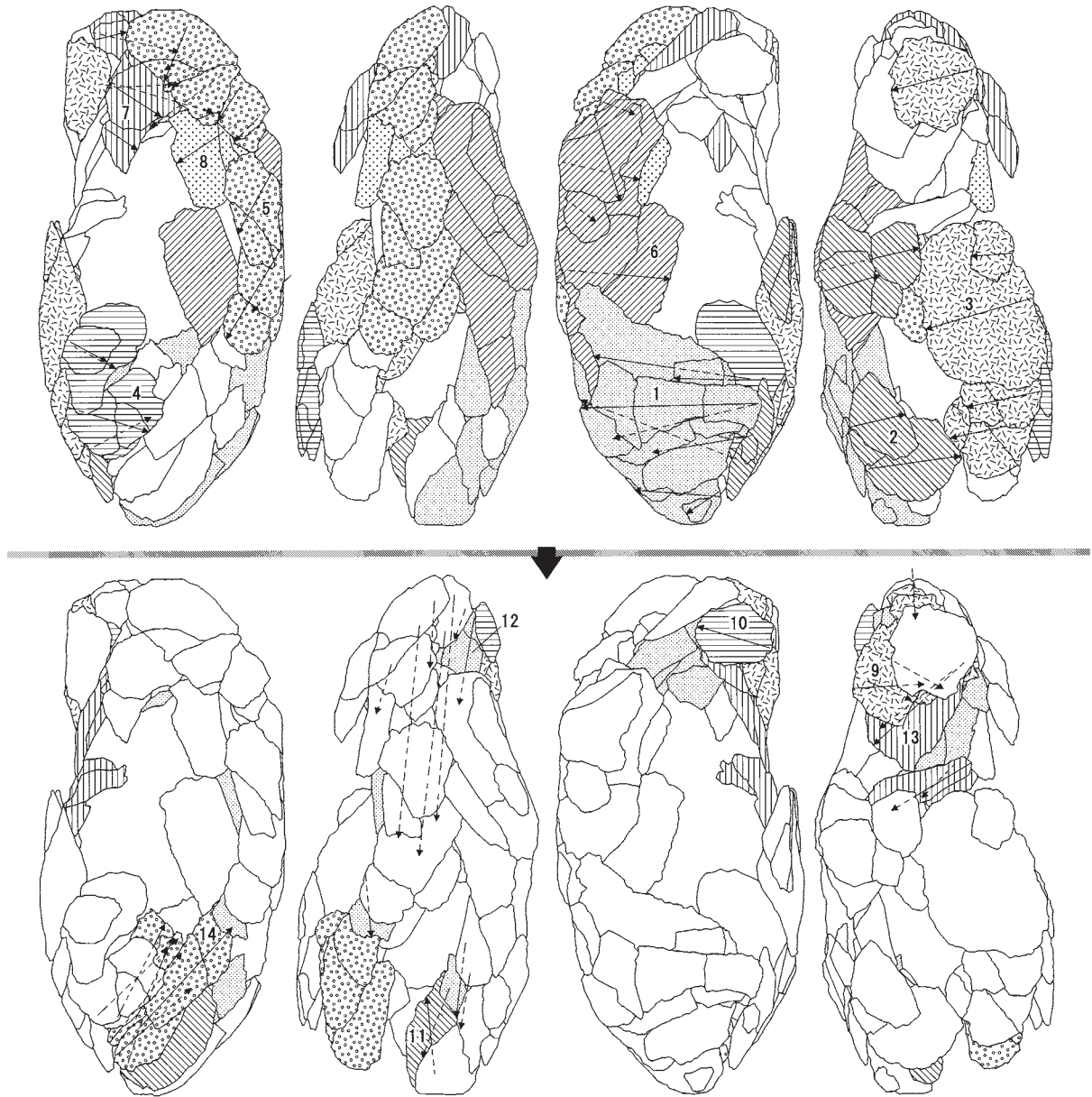

接合3187分布図

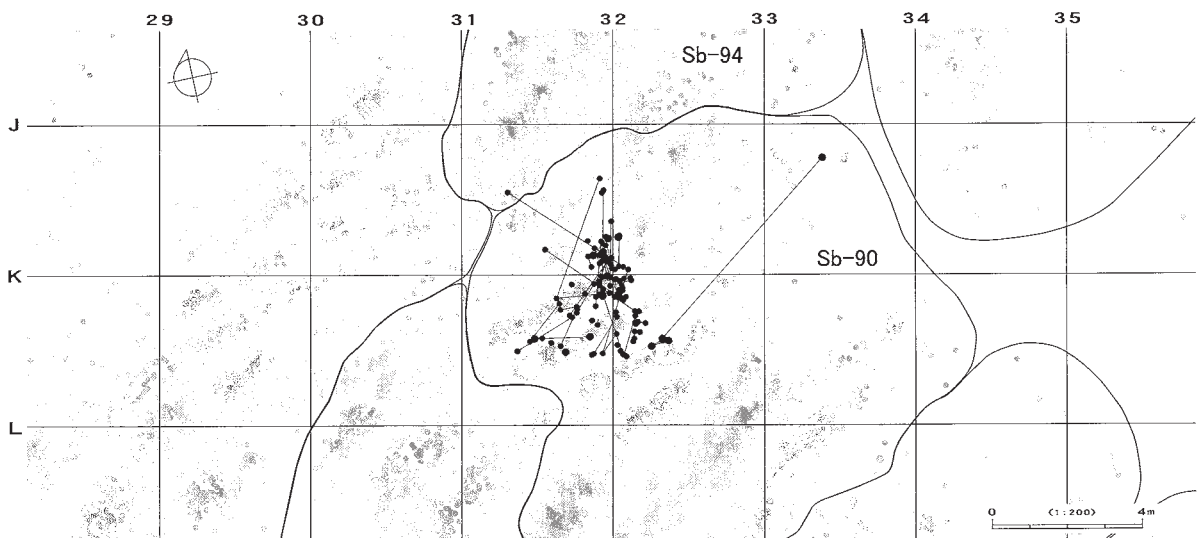

図Ⅲ-217 H区(Sb-90)の石器(38) 母岩689・接合3187(2)

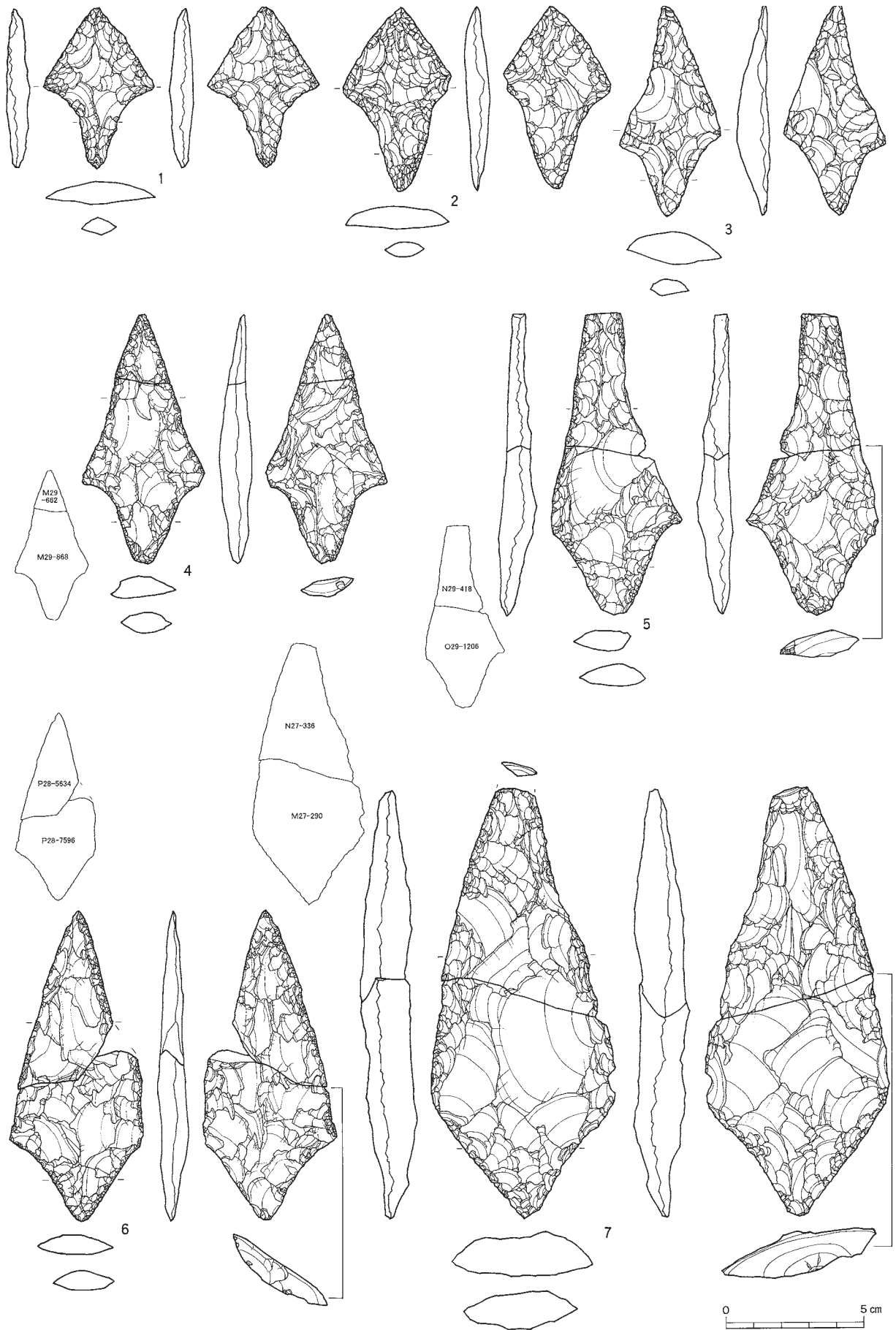

図Ⅲ-218 I区(Sb-91~96)の石器(1) 尖頭器

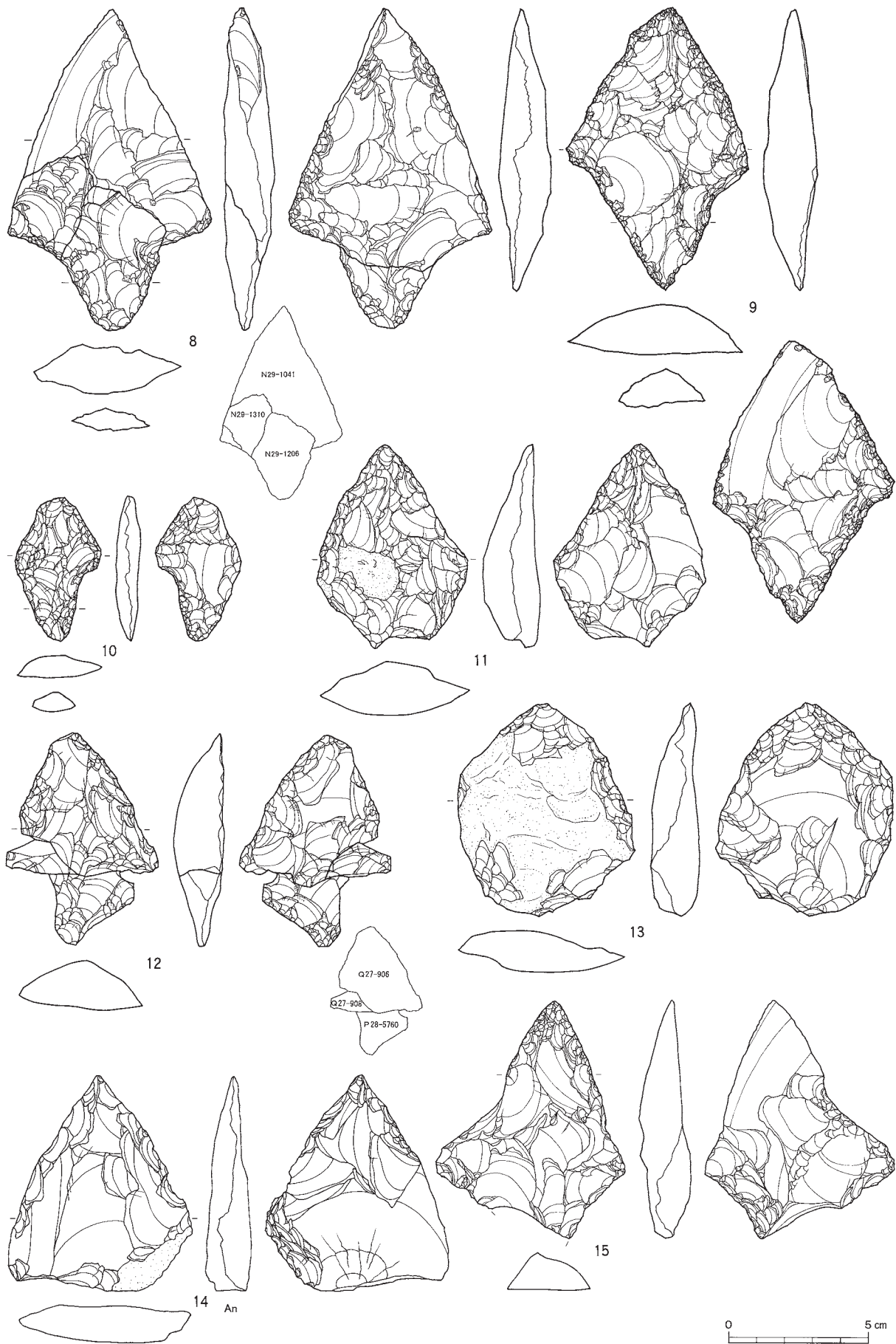

図III-219 I区(Sb-91~96)の石器(2) 尖頭器

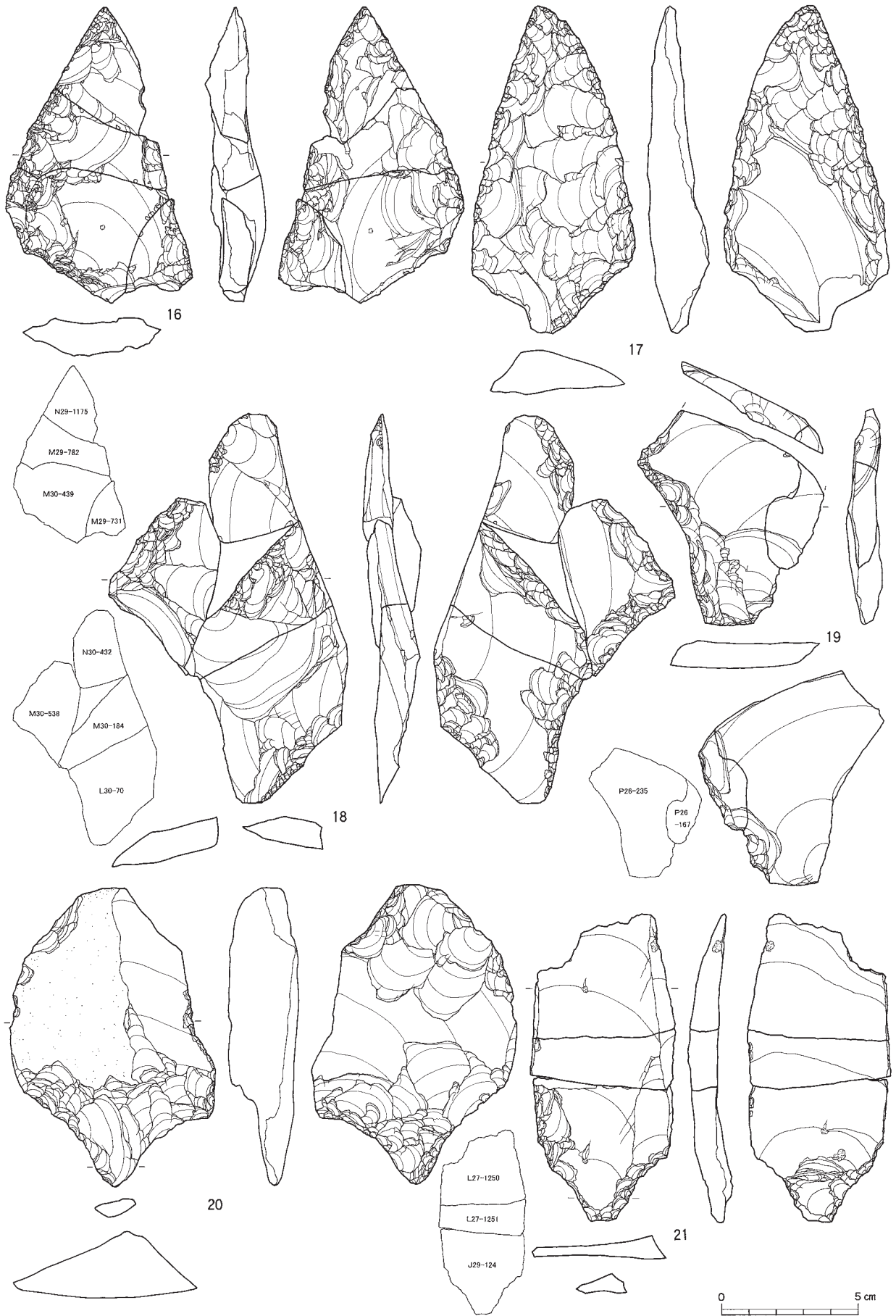

図III-220 I区(Sb-91~96)の石器(3) 尖頭器

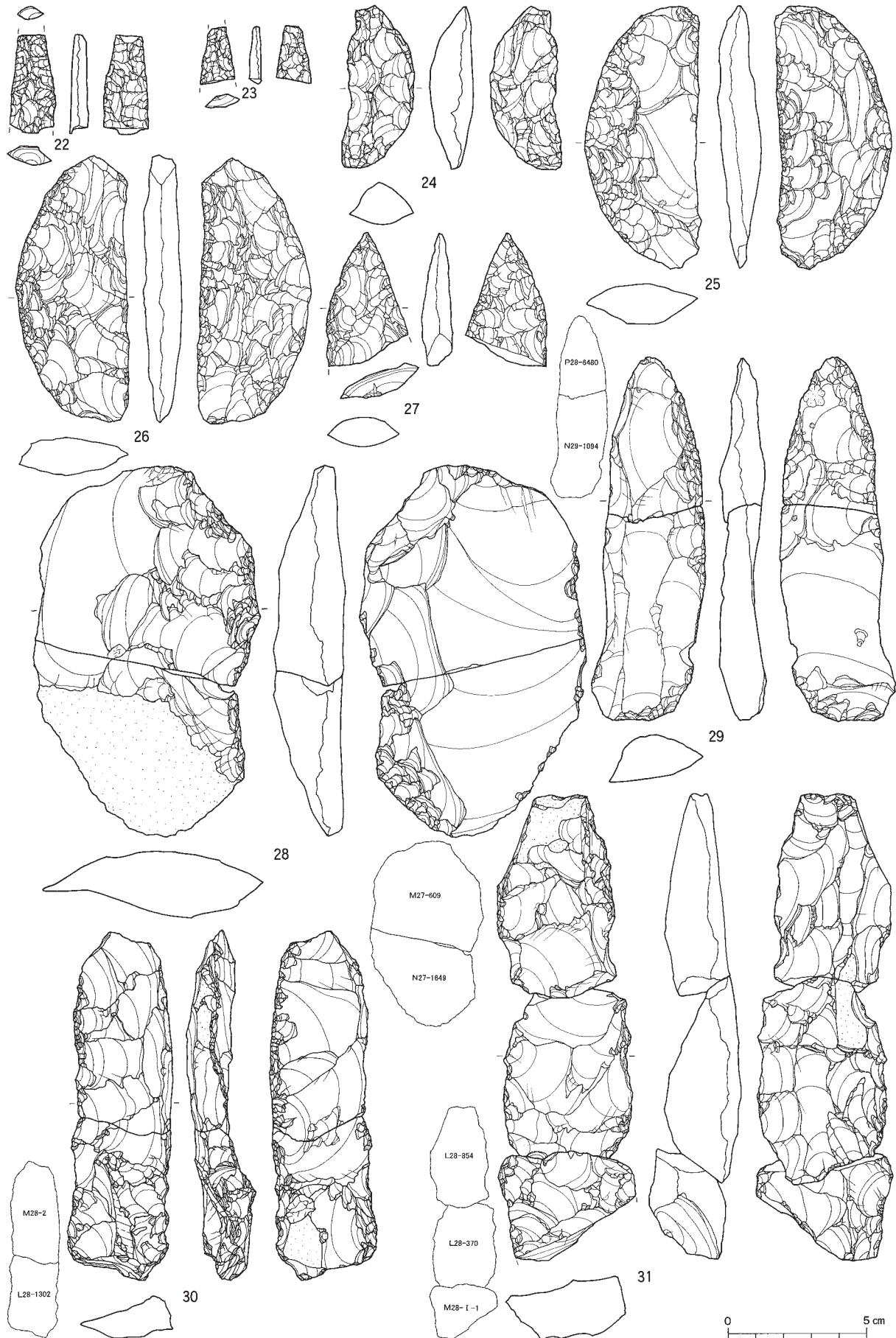

図III-221 I区(Sb-91~96)の石器(4) 尖頭器

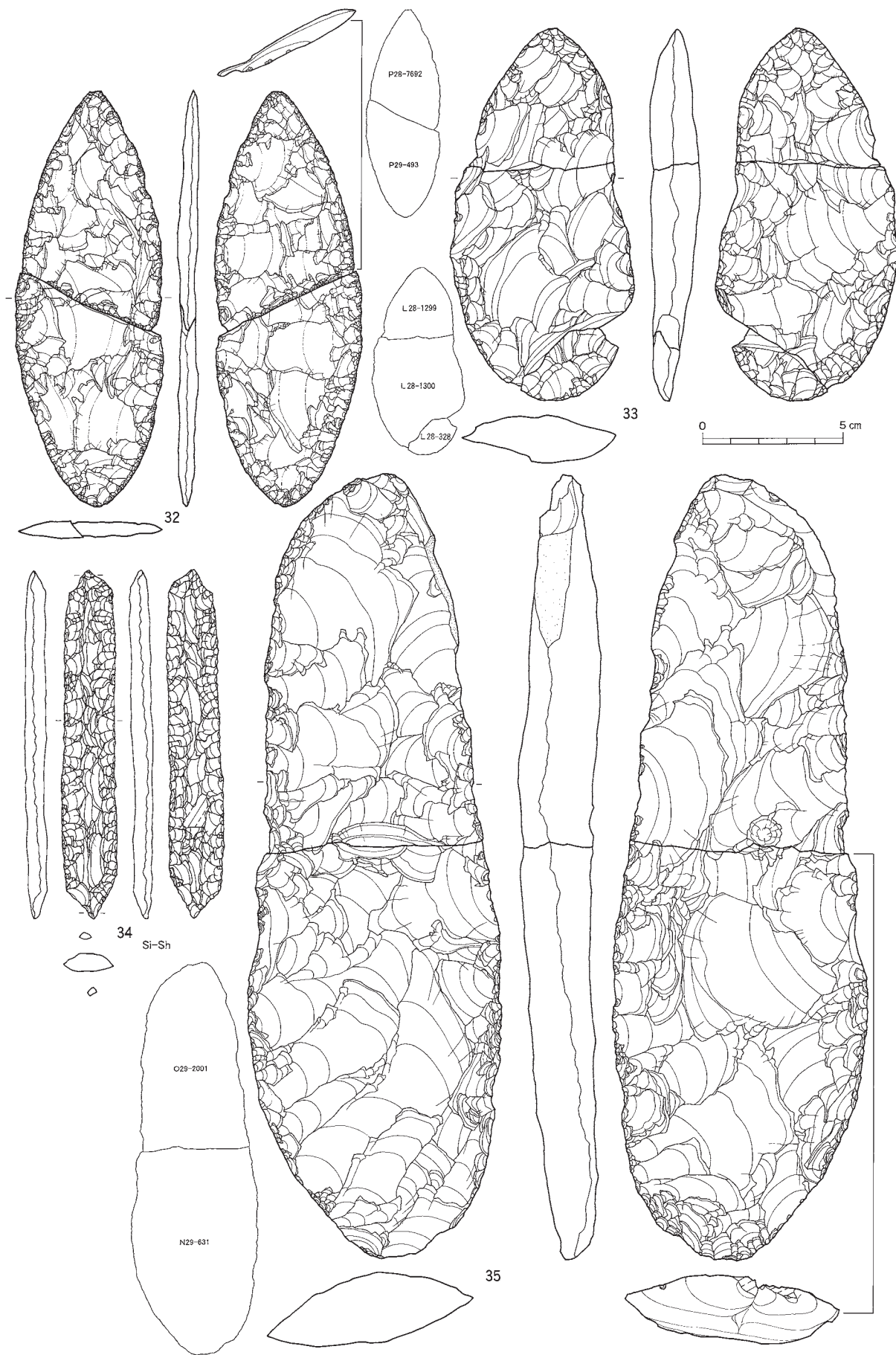

図III-222 I区(Sb-91~96)の石器(5) 尖頭器

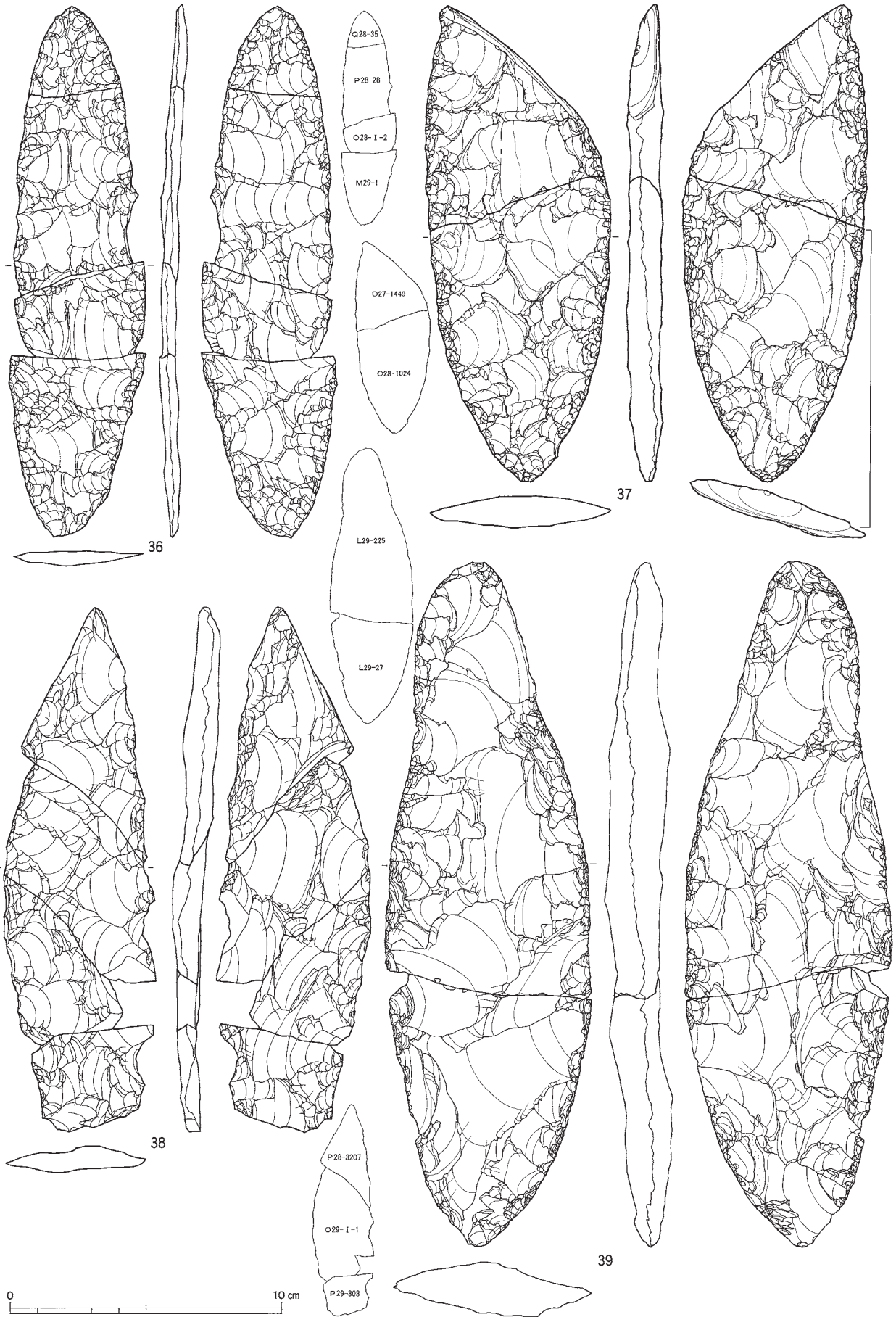

図III-223 I区(Sb-91~96)の石器(6) 尖頭器

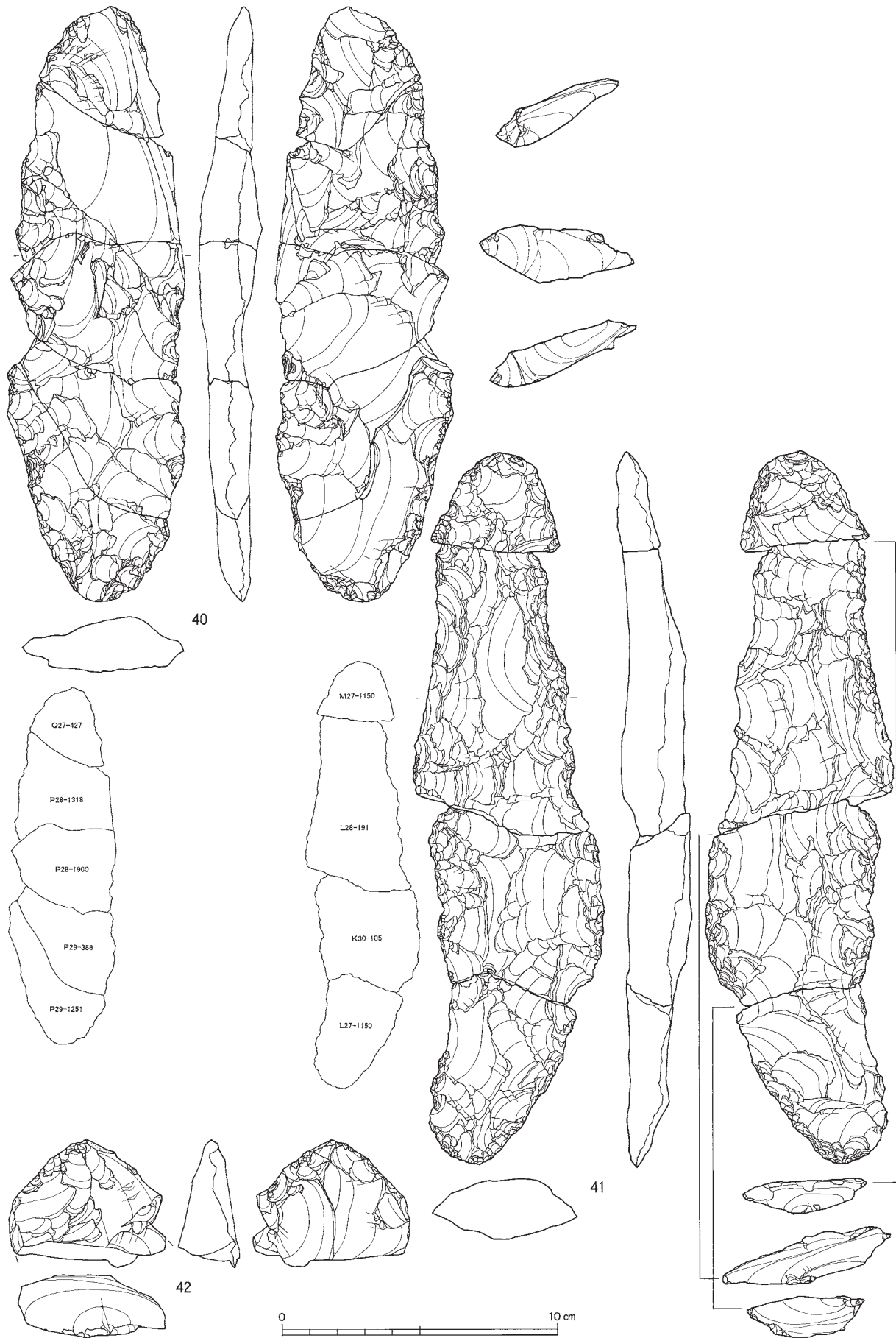

図Ⅲ-224 I区(Sb-91~96)の石器(7) 尖頭器

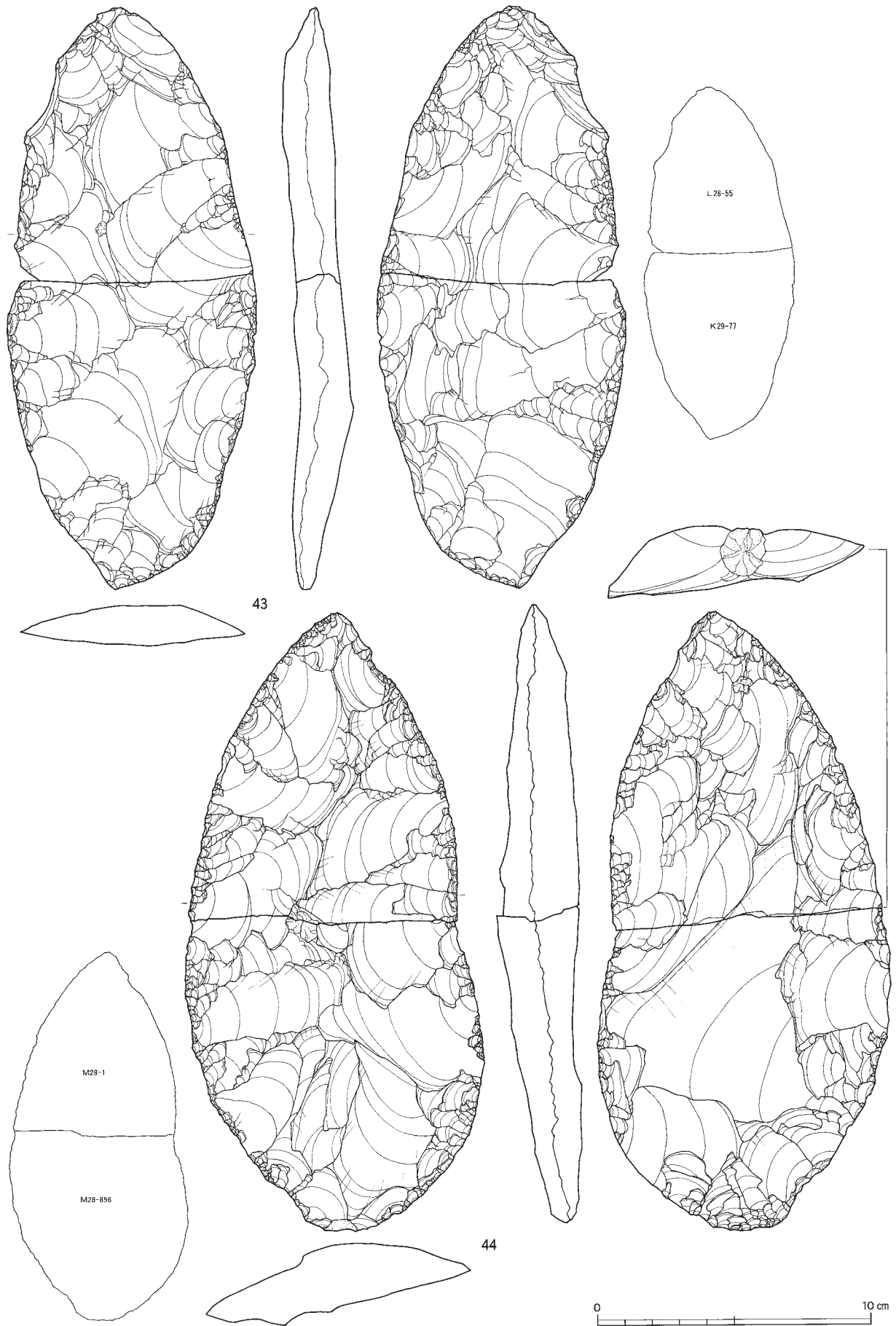

図III-225 I区(Sb-91~96)の石器(8) 尖頭器



図Ⅲ-226 I区(Sb-91~96)の石器(9) 尖頭器

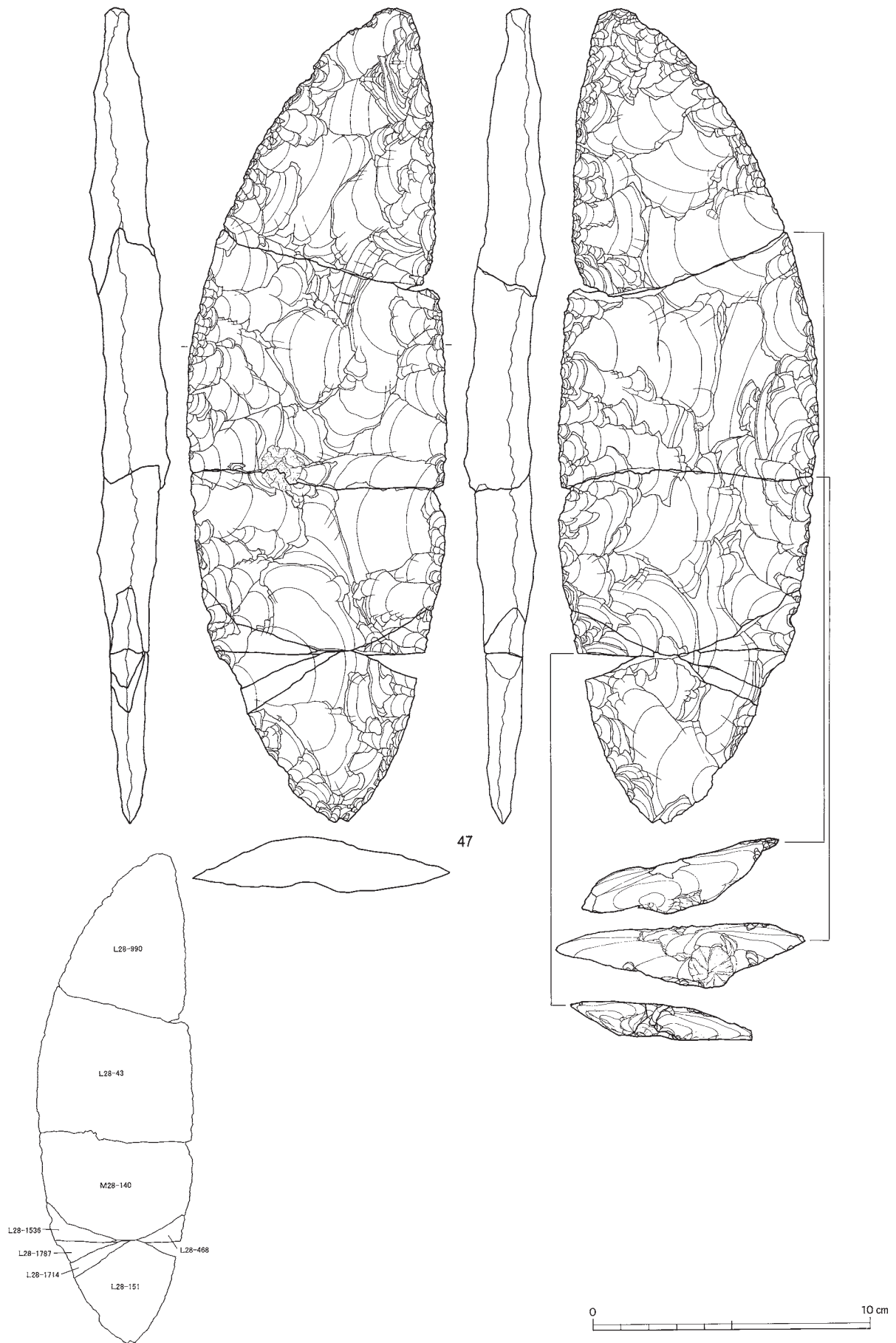

図Ⅲ-227 I区(Sb-91~96)の石器(10) 尖頭器

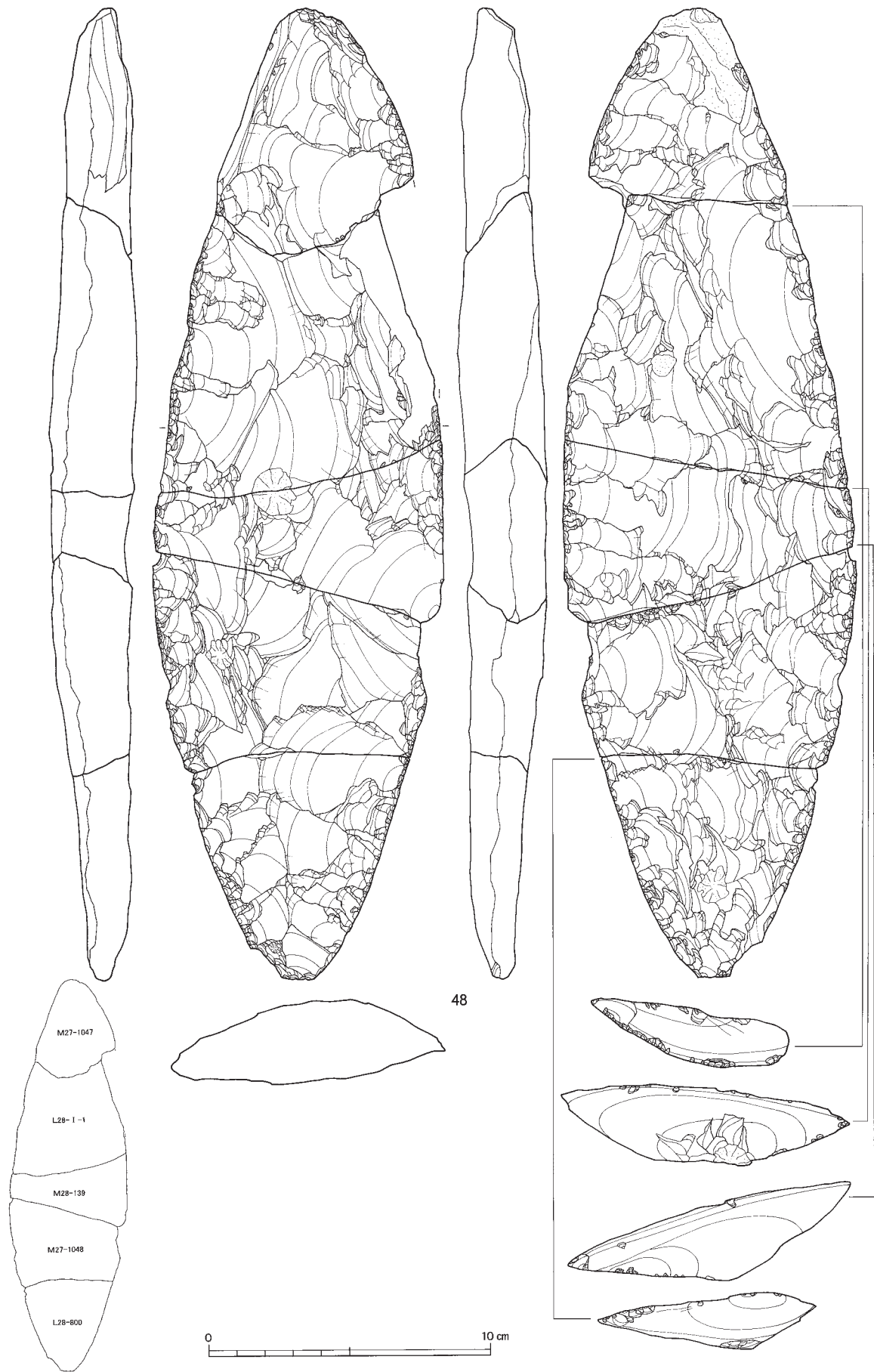

図Ⅲ-228 I区(Sb-91~96)の石器(11) 尖頭器

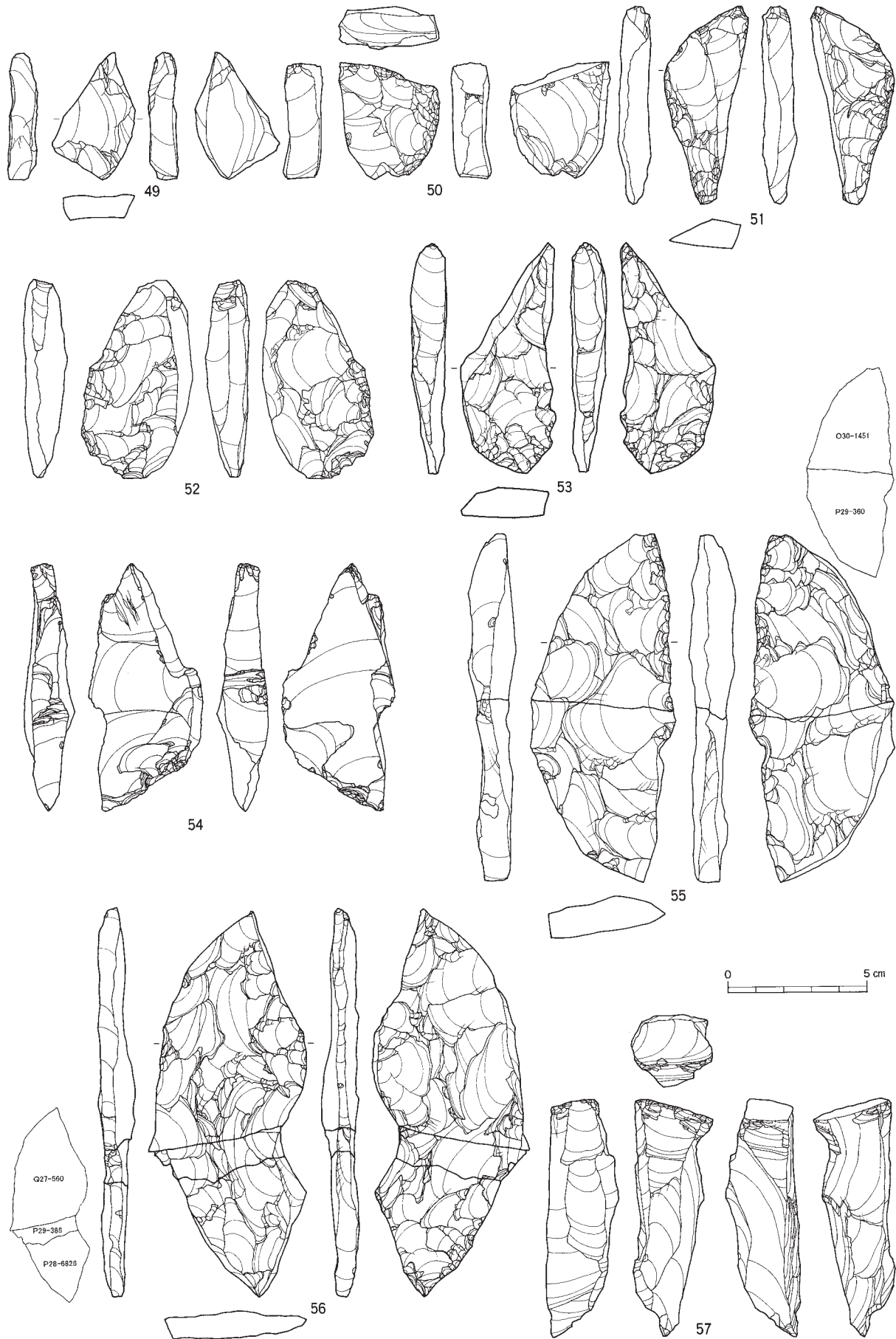

図Ⅲ-229 I区(Sb-91~96)の石器(12) 尖頭器

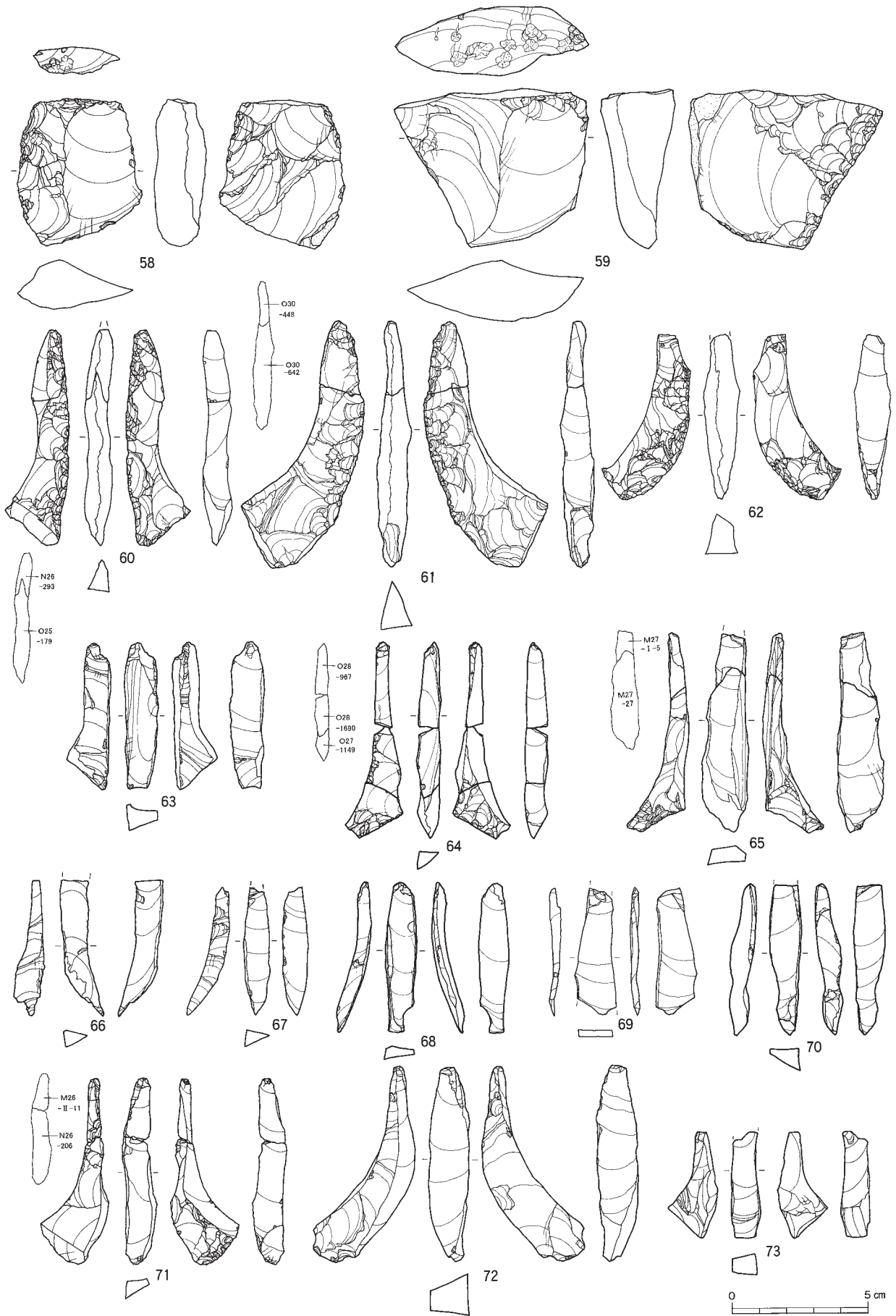

図Ⅲ-230 I区(Sb-91~96)の石器(13) 尖頭器・尖頭器削片

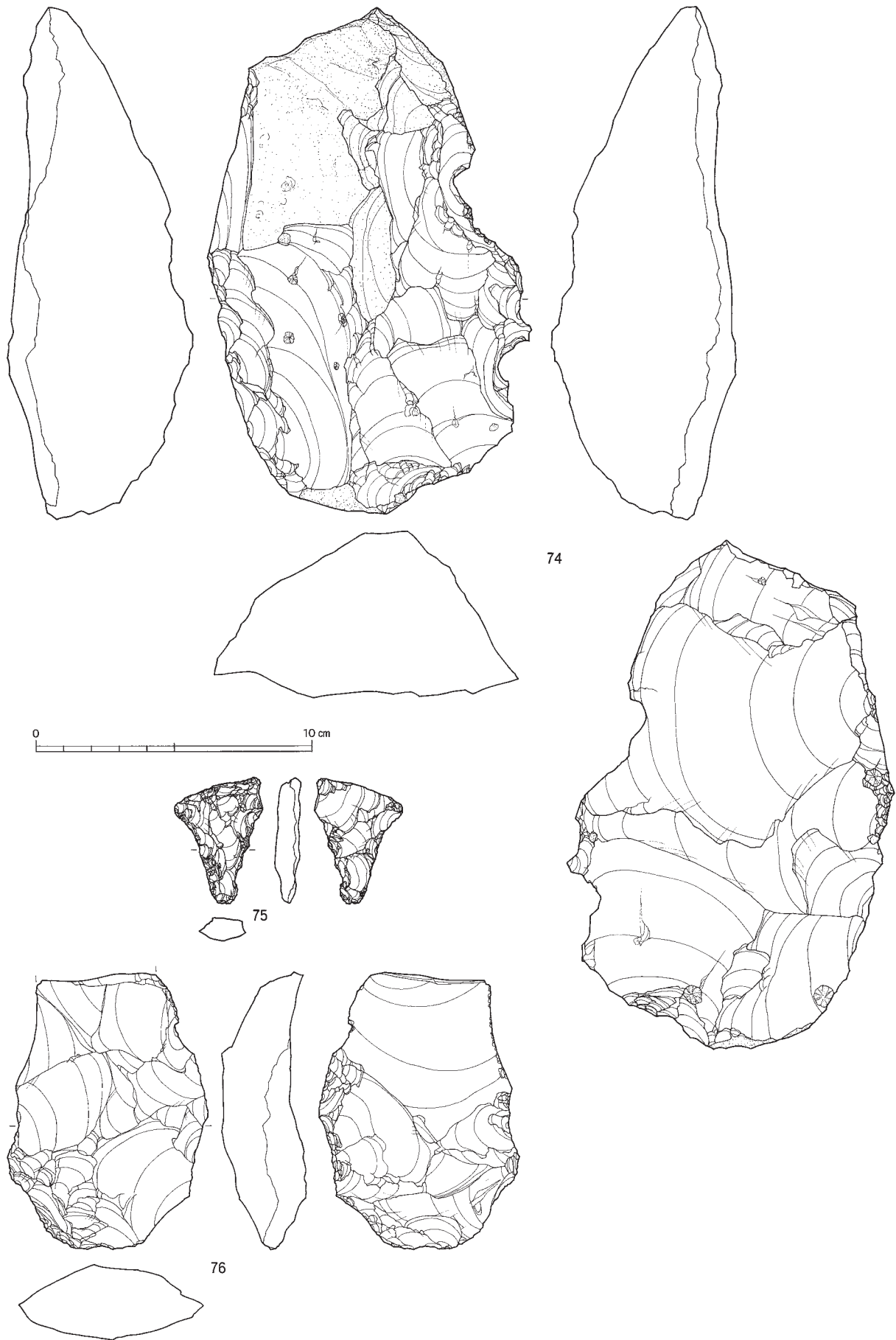

図Ⅲ-231 I区(Sb-91~96)の石器(14) 両面調整石器

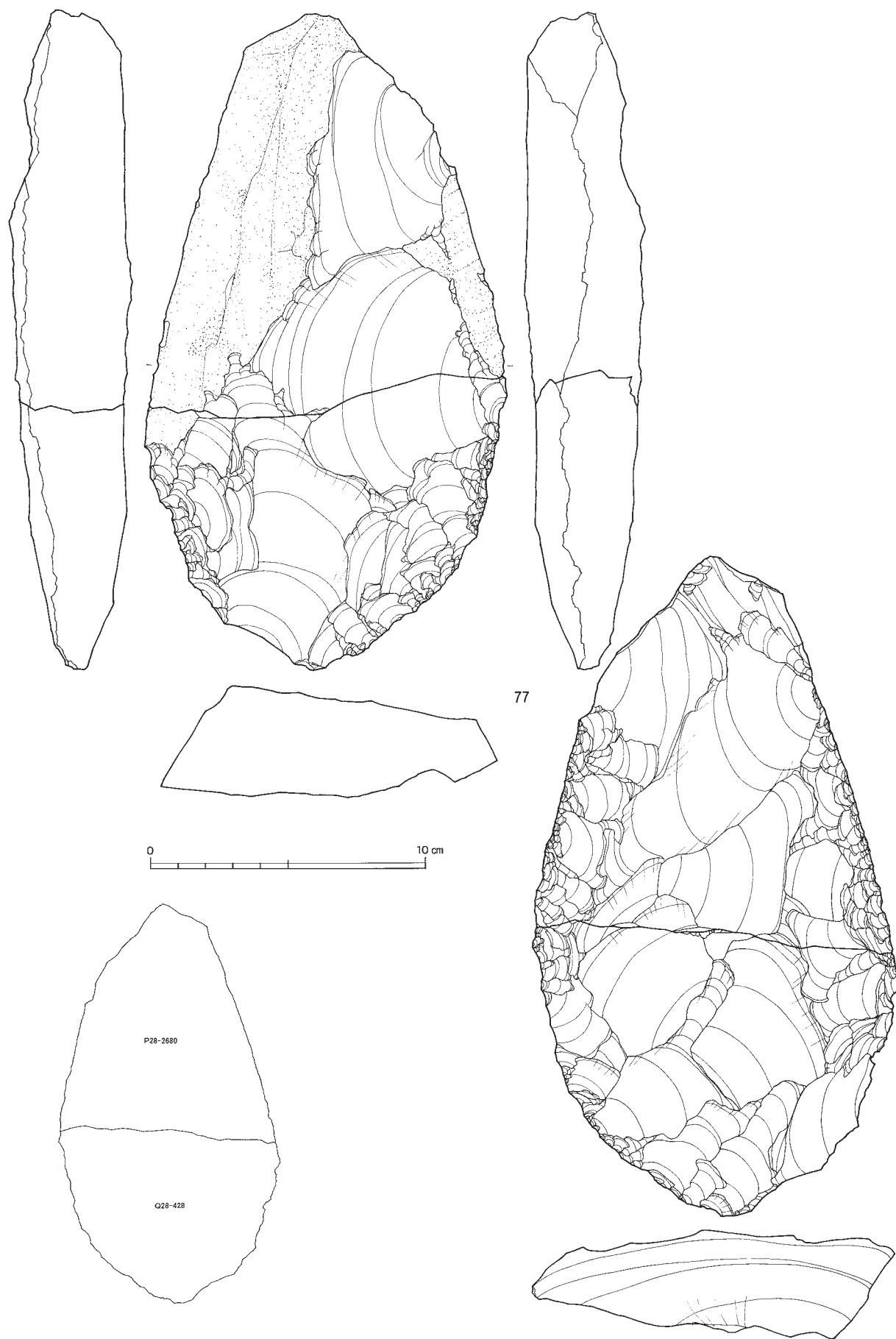

図Ⅲ-232 I区(Sb-91~96)の石器(15) 両面調整石器

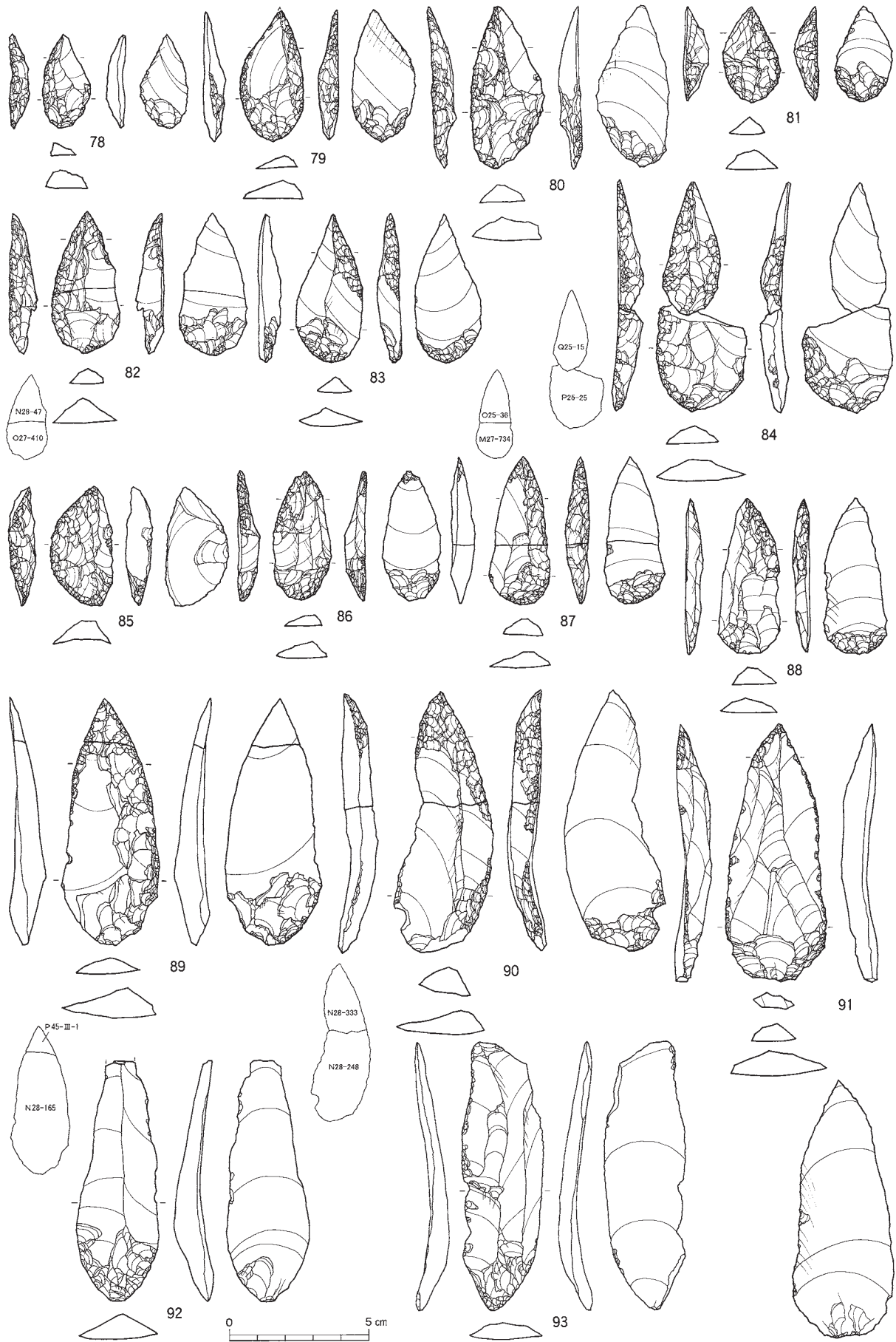

図Ⅲ-233 I区(Sb-91~96)の石器(16) ナイフ形石器



図Ⅲ-234 I区(Sb-91~96)の石器(17) ナイフ形石器・彫器

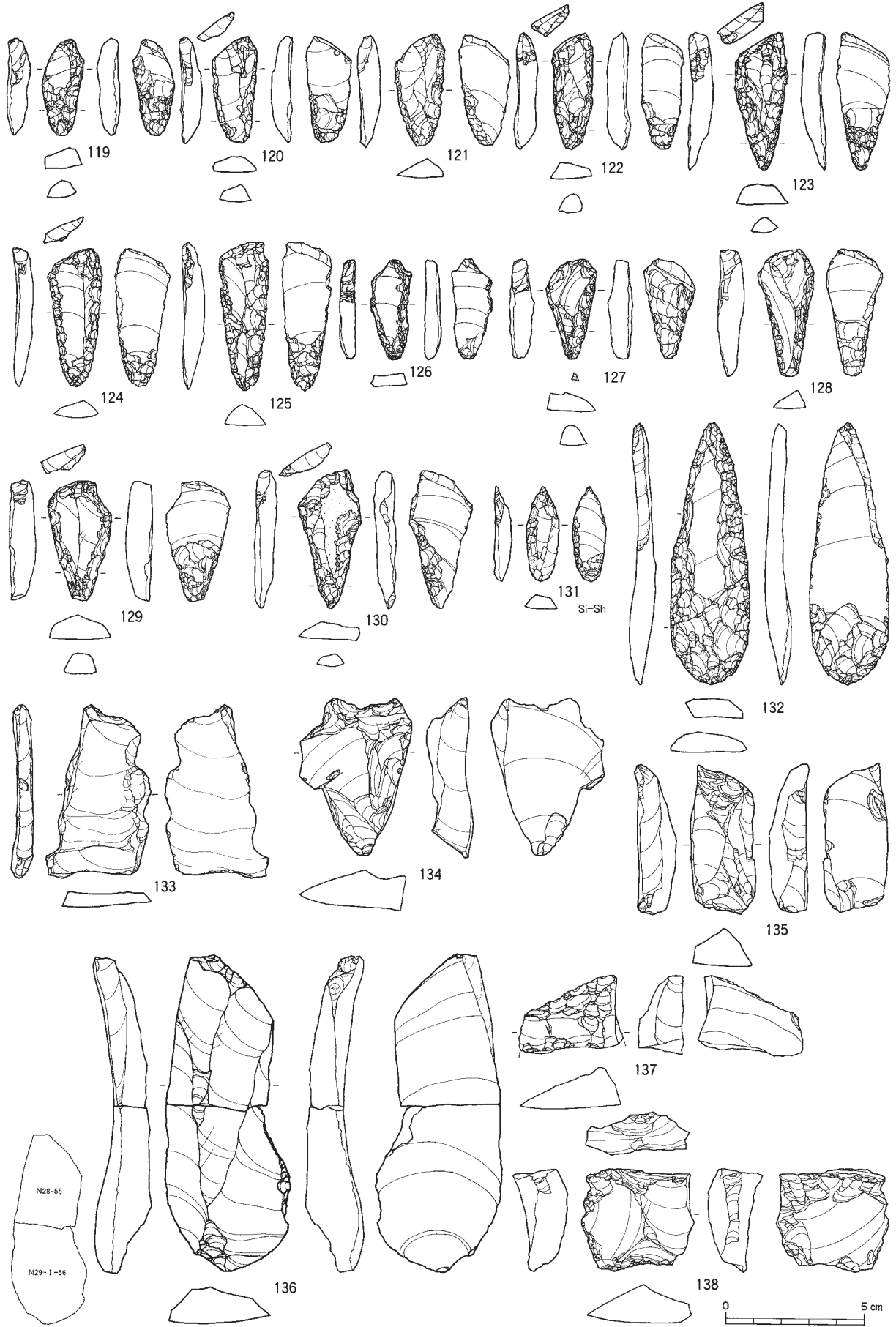

図III-235 I区(Sb-91~96)の石器(18) 彫器

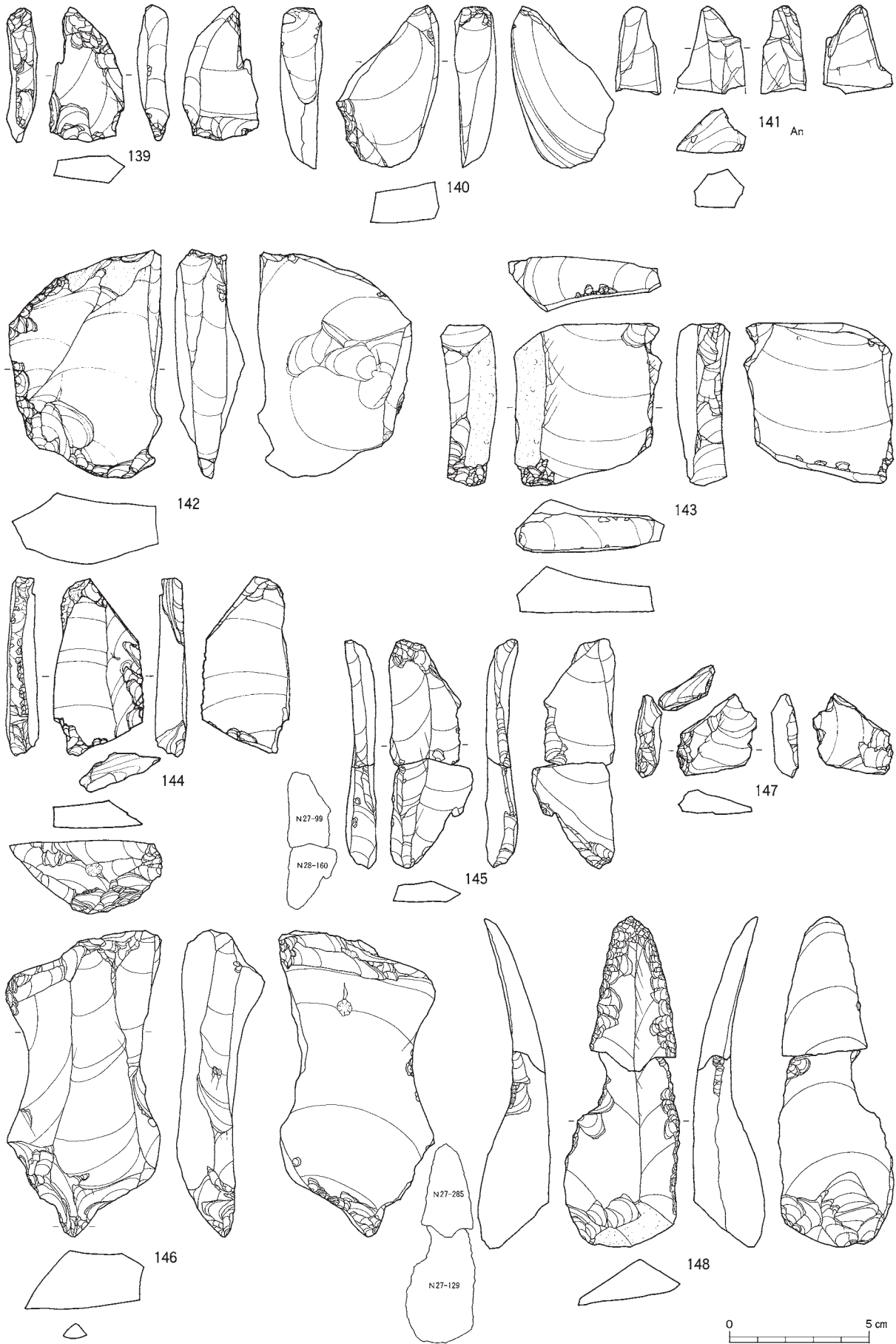

図Ⅲ-236 I区(Sb-91~96)の石器(19) 彫器

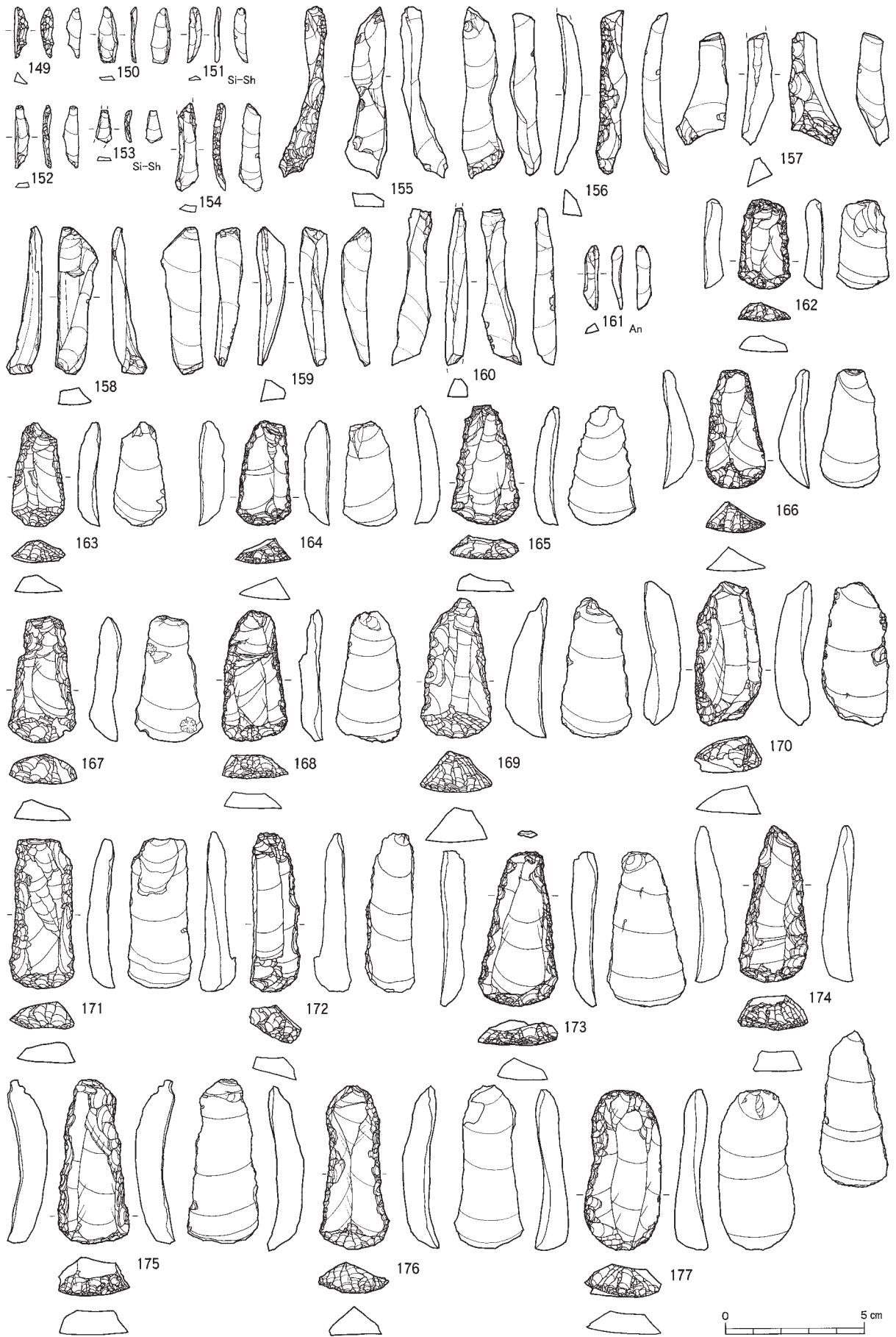

図III-237 I区(Sb-91~96)の石器(20) 彫器削片・搔器

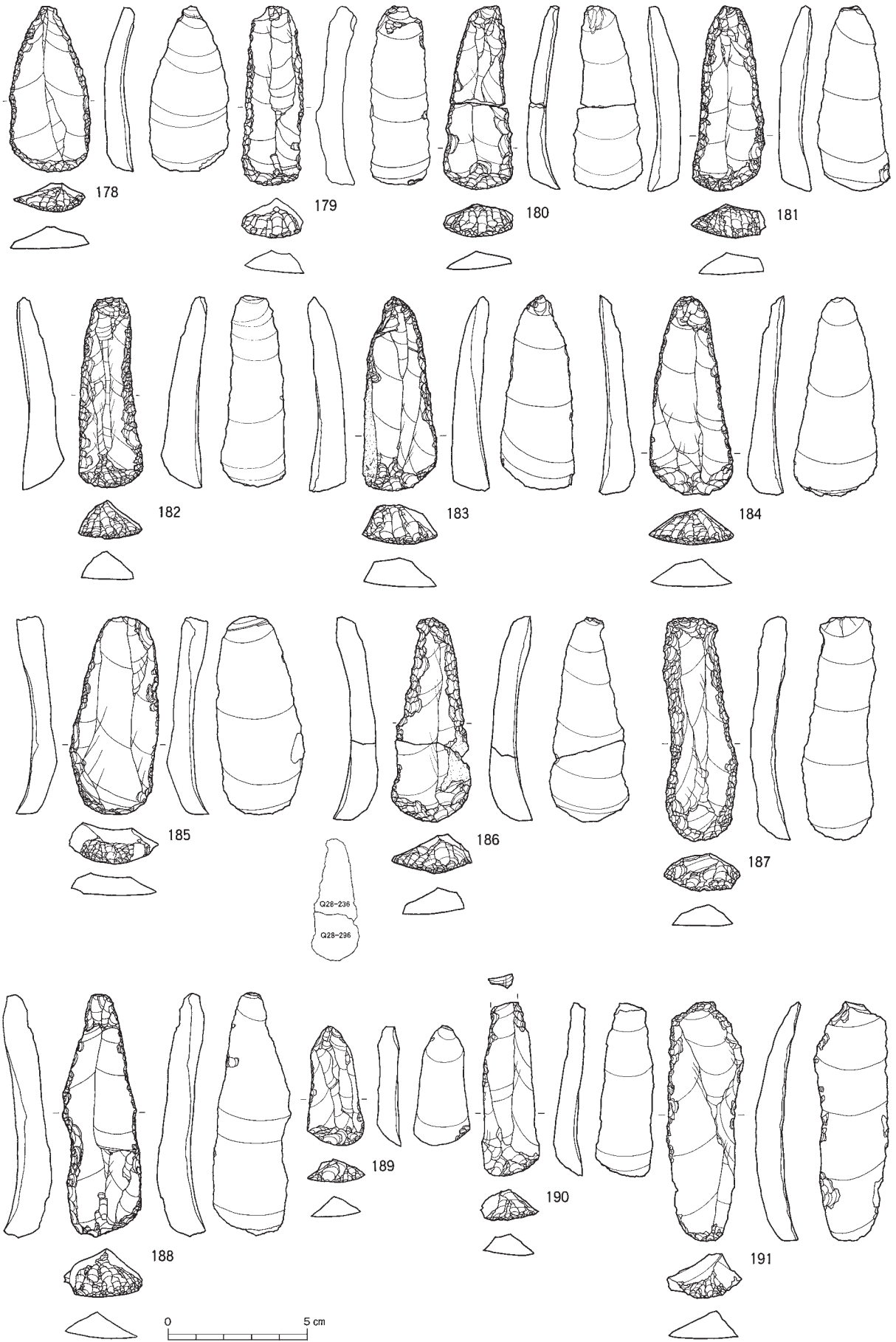

図Ⅲ-238 I区(Sb-91~96)の石器(21) 搔器

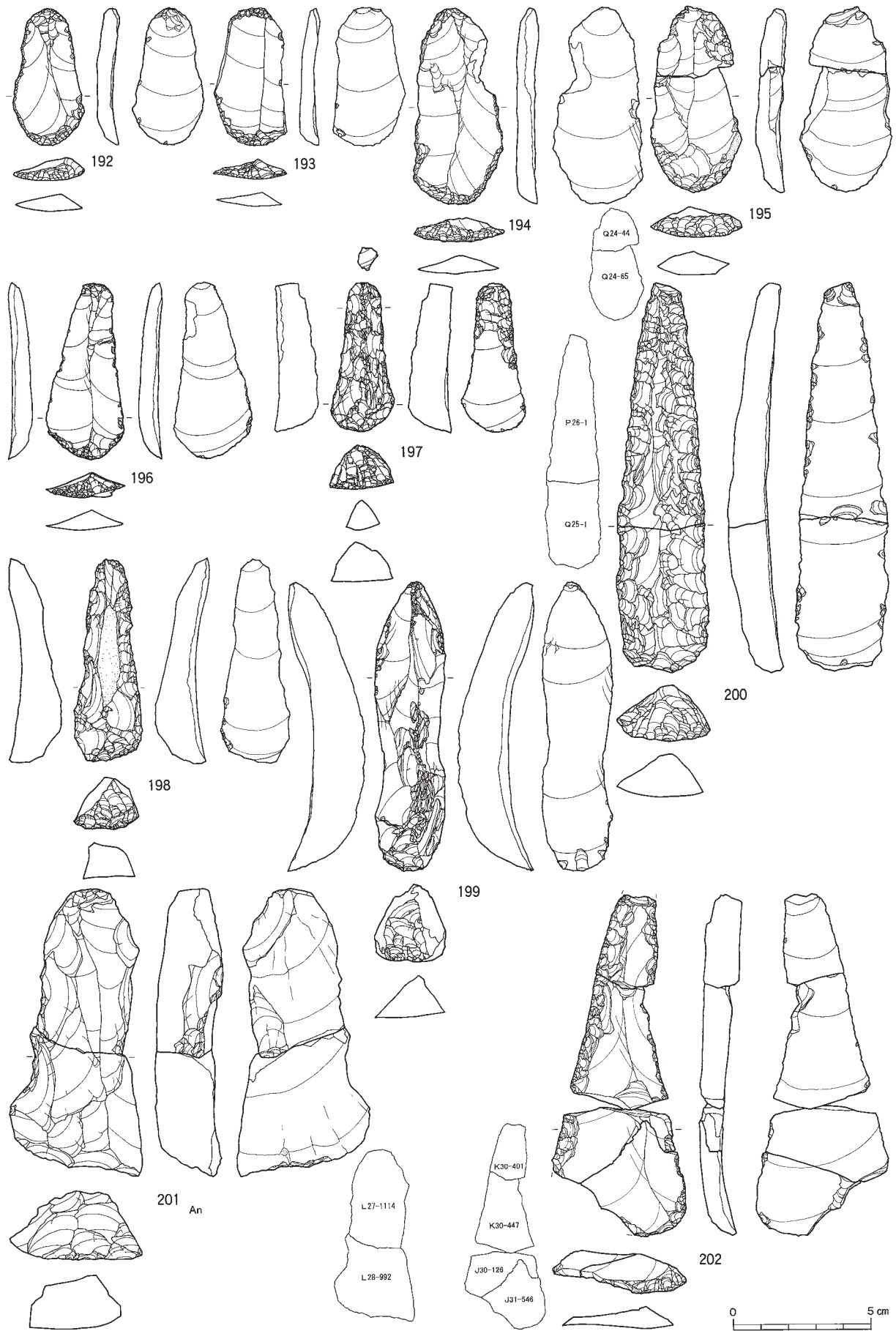

図III-239 I区(Sb-91~96)の石器(22) 搔器

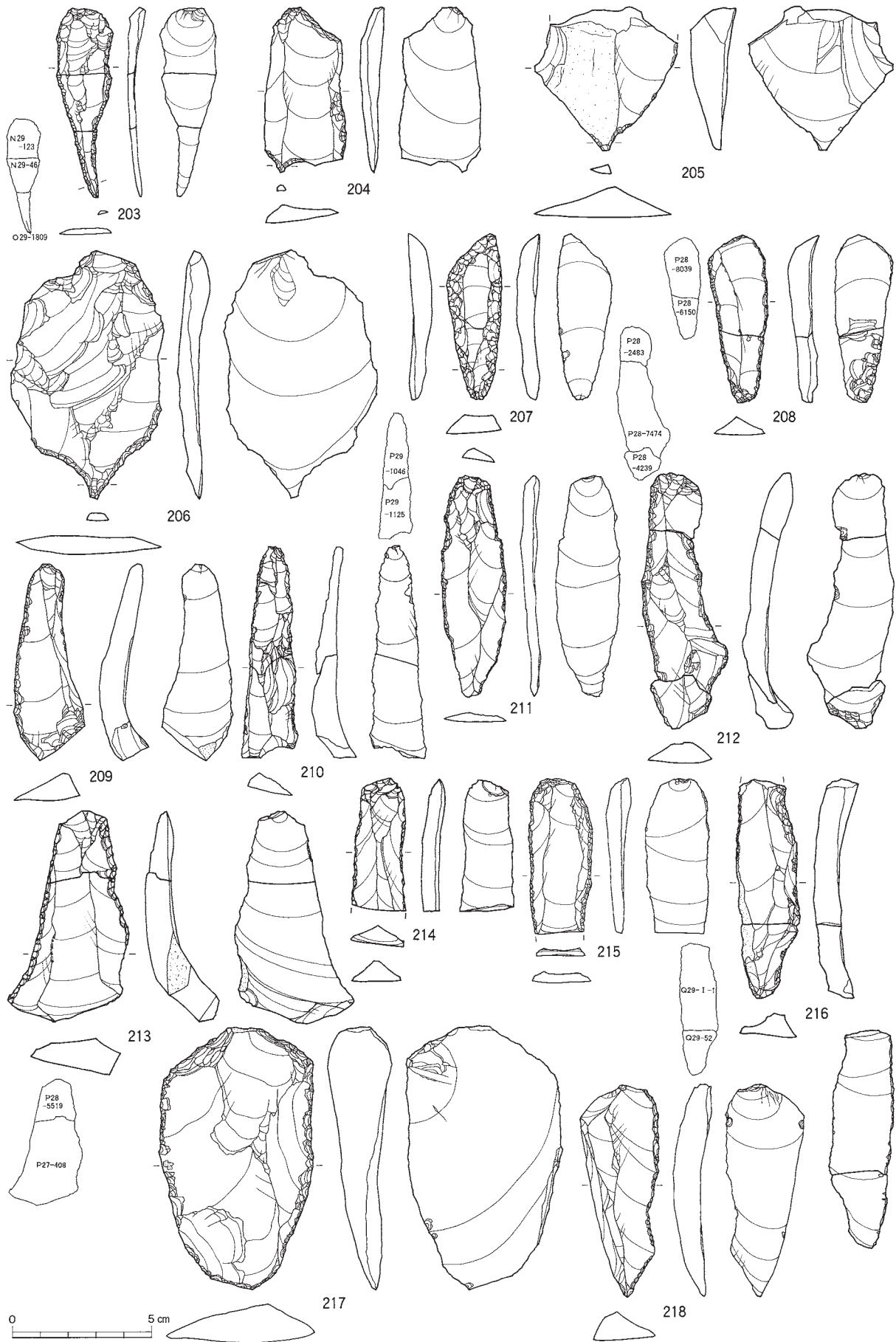

図III-240 I区(Sb-91~96)の石器(23) 錐形石器・削器



図III-241 I区(Sb-91~96)の石器(24) 削器

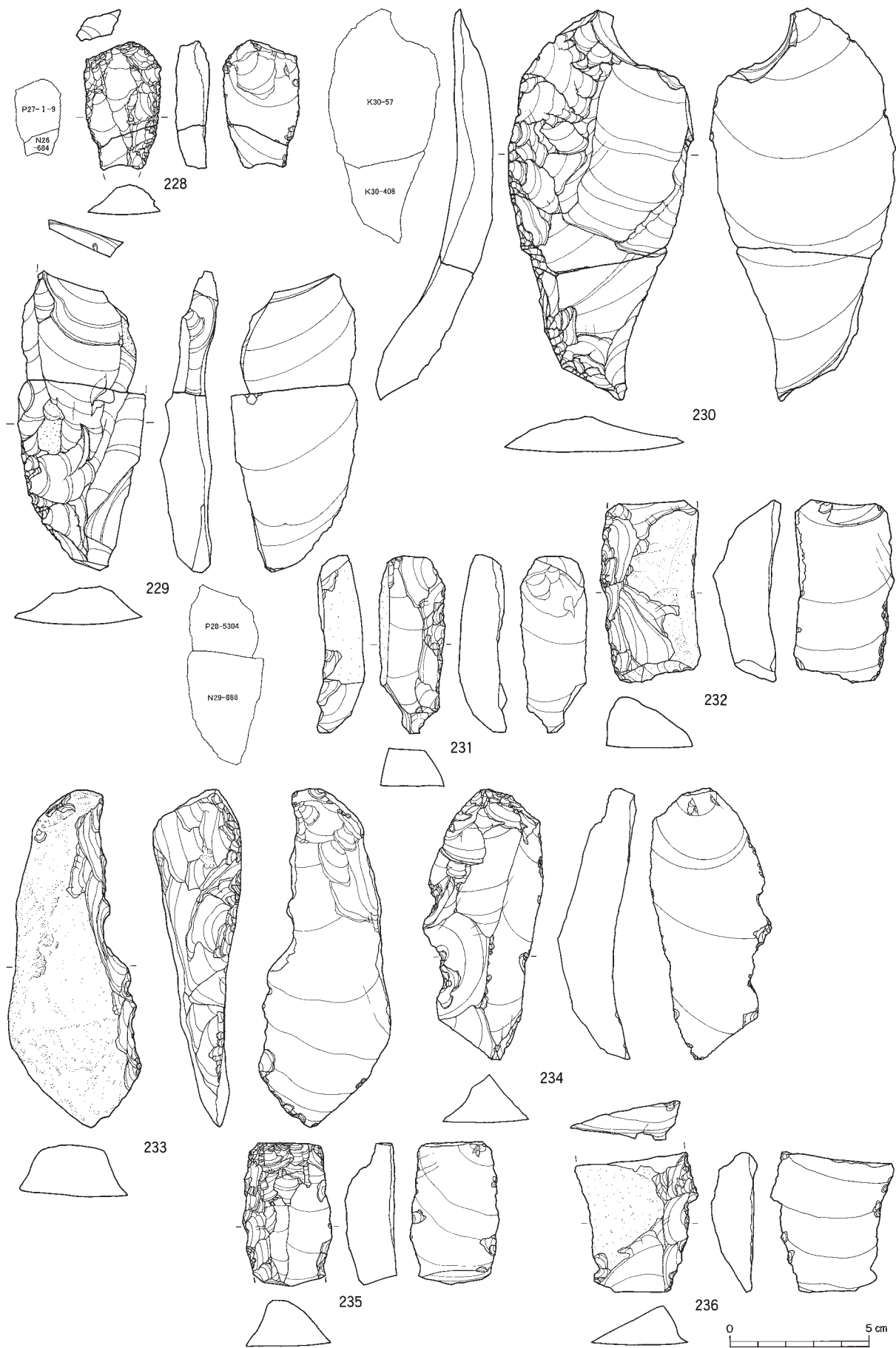

図Ⅲ-242 I区(Sb-91~96)の石器(25) 削器

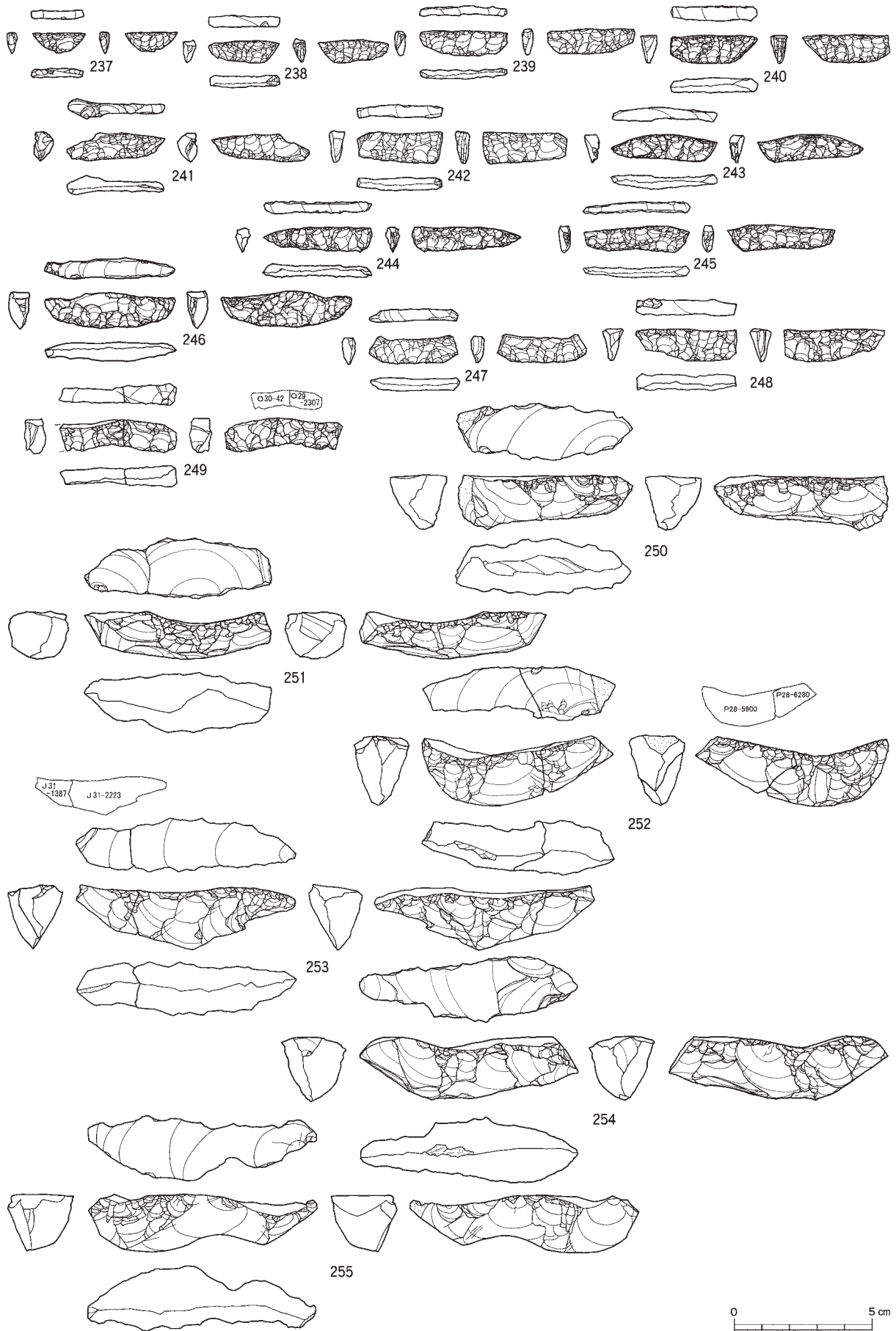

図III-243 I区(Sb-91~96)の石器(26) 舟底形石器

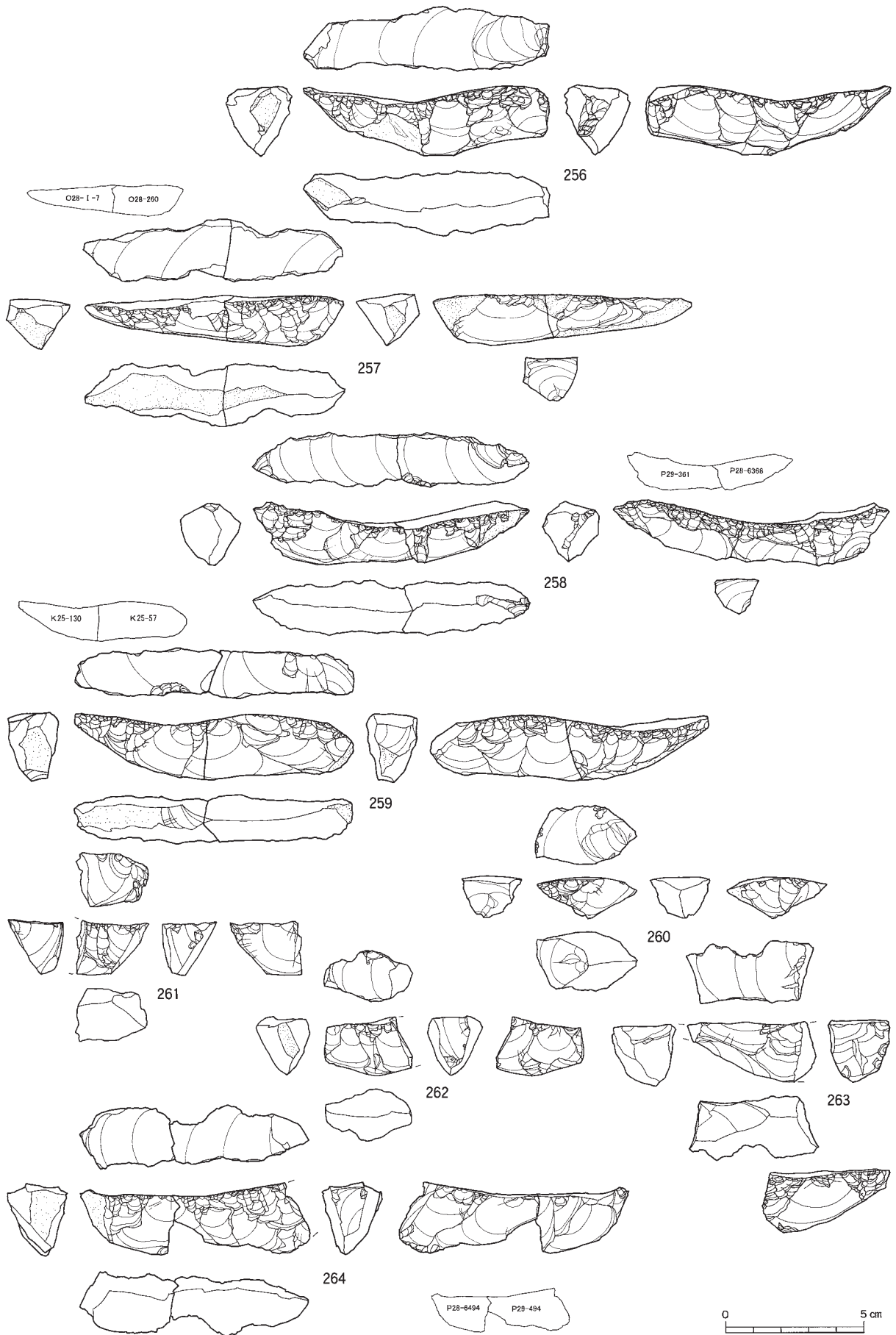

図Ⅲ-244 I区(Sb-91~96)の石器(27) 舟底形石器

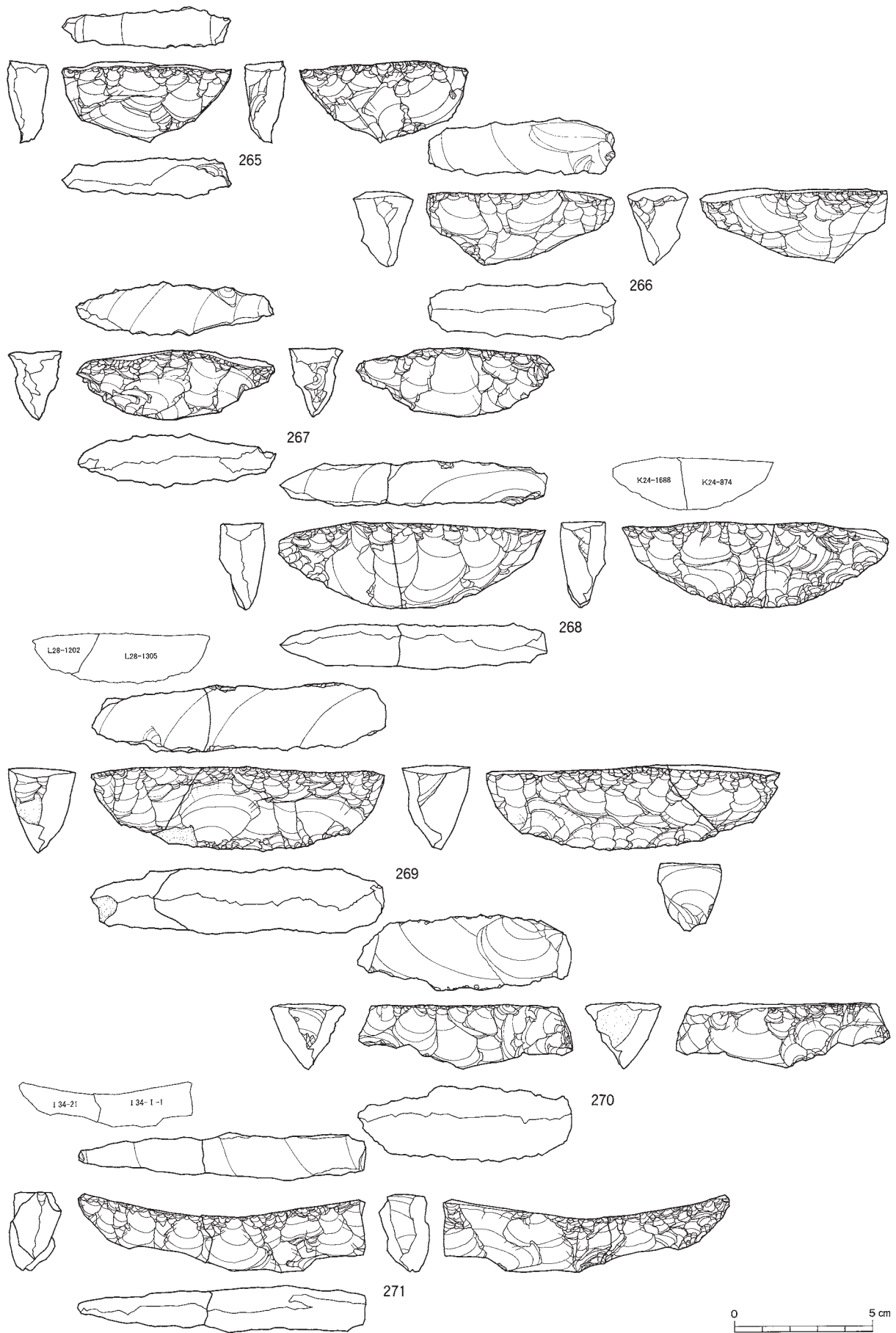

図Ⅲ-245 I区(Sb-91~96)の石器(28) 舟底形石器

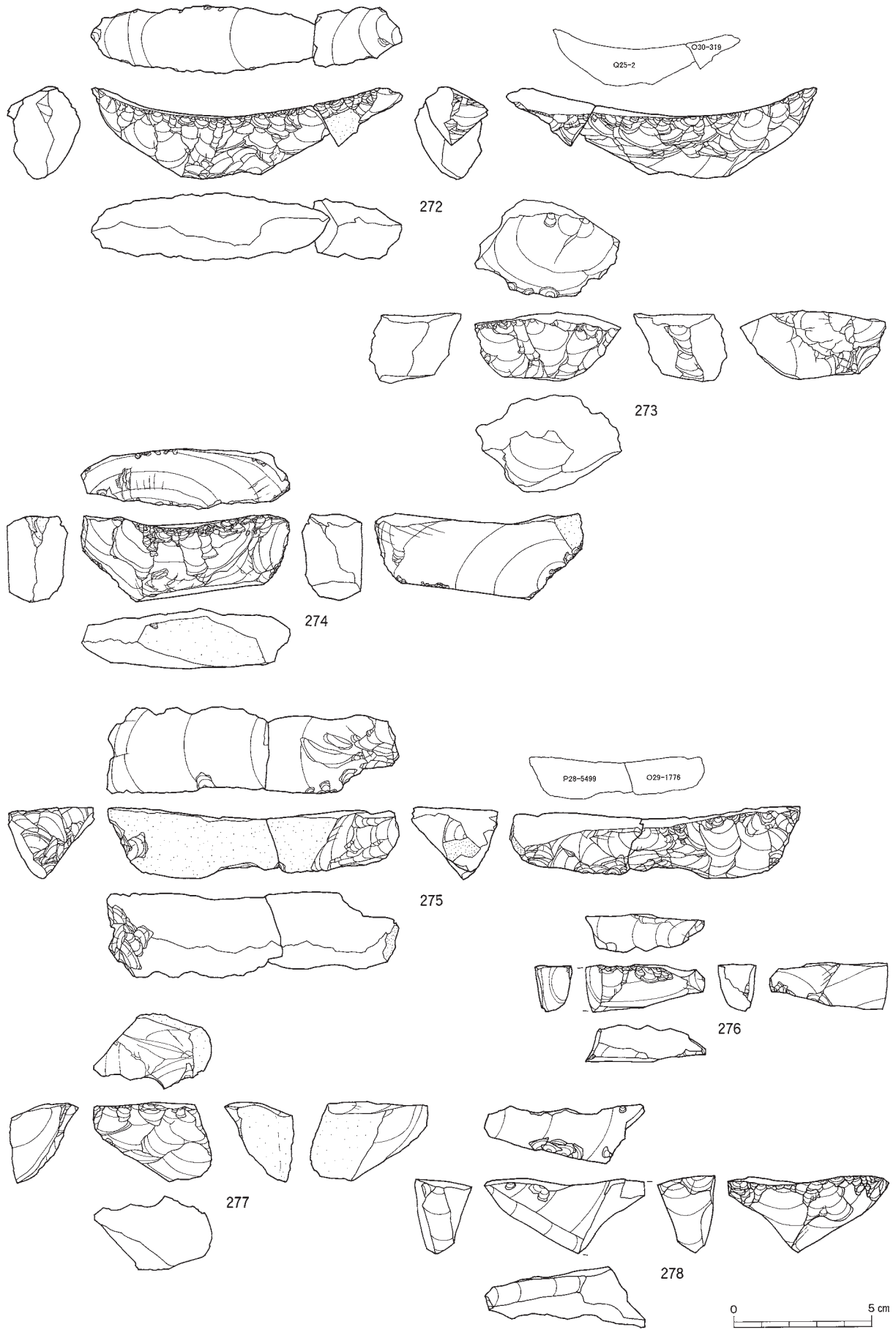

図Ⅲ-246 I区(Sb-91~96)の石器(29) 舟底形石器

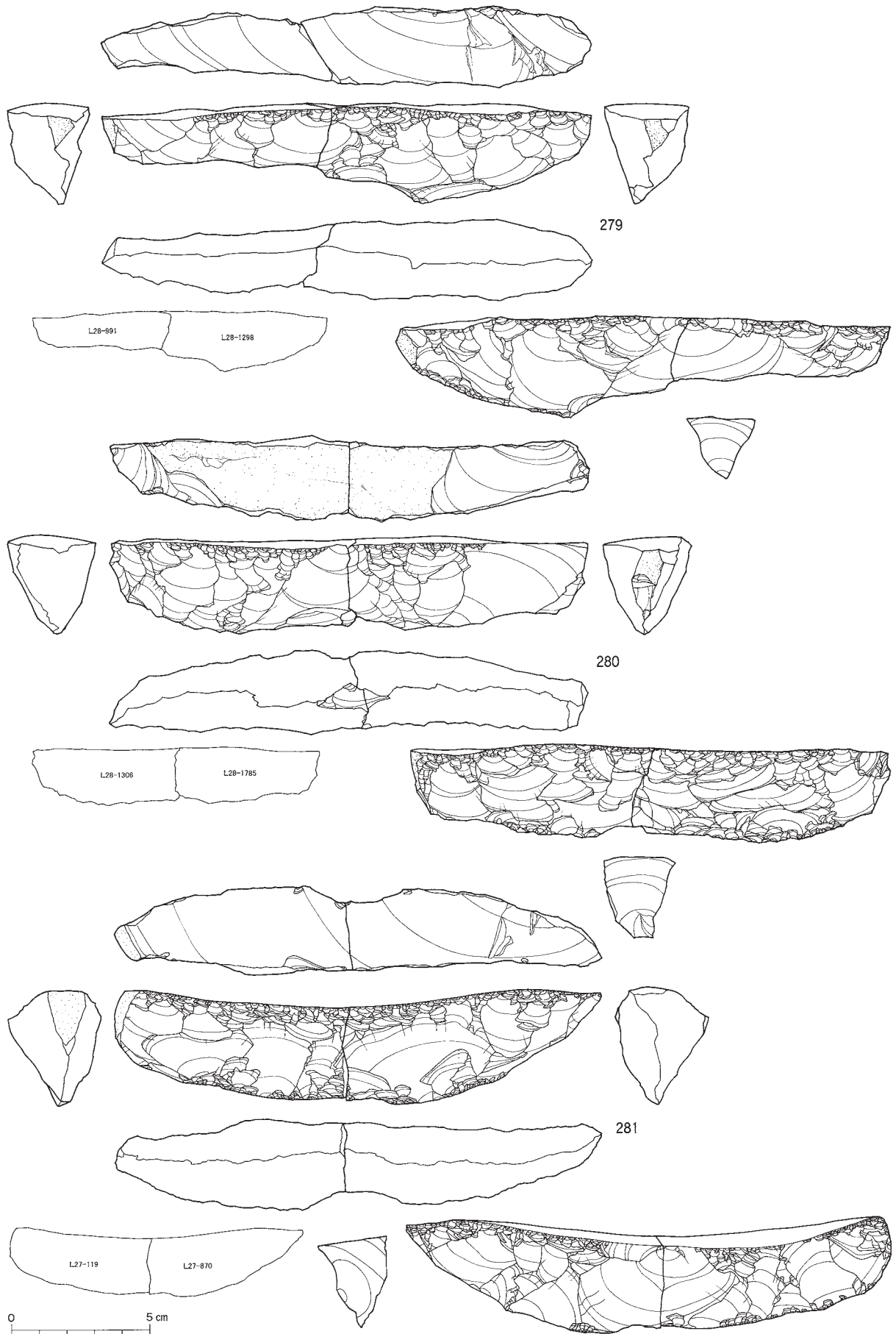

図Ⅲ-247 I区(Sb-91~96)の石器(30) 舟底形石器

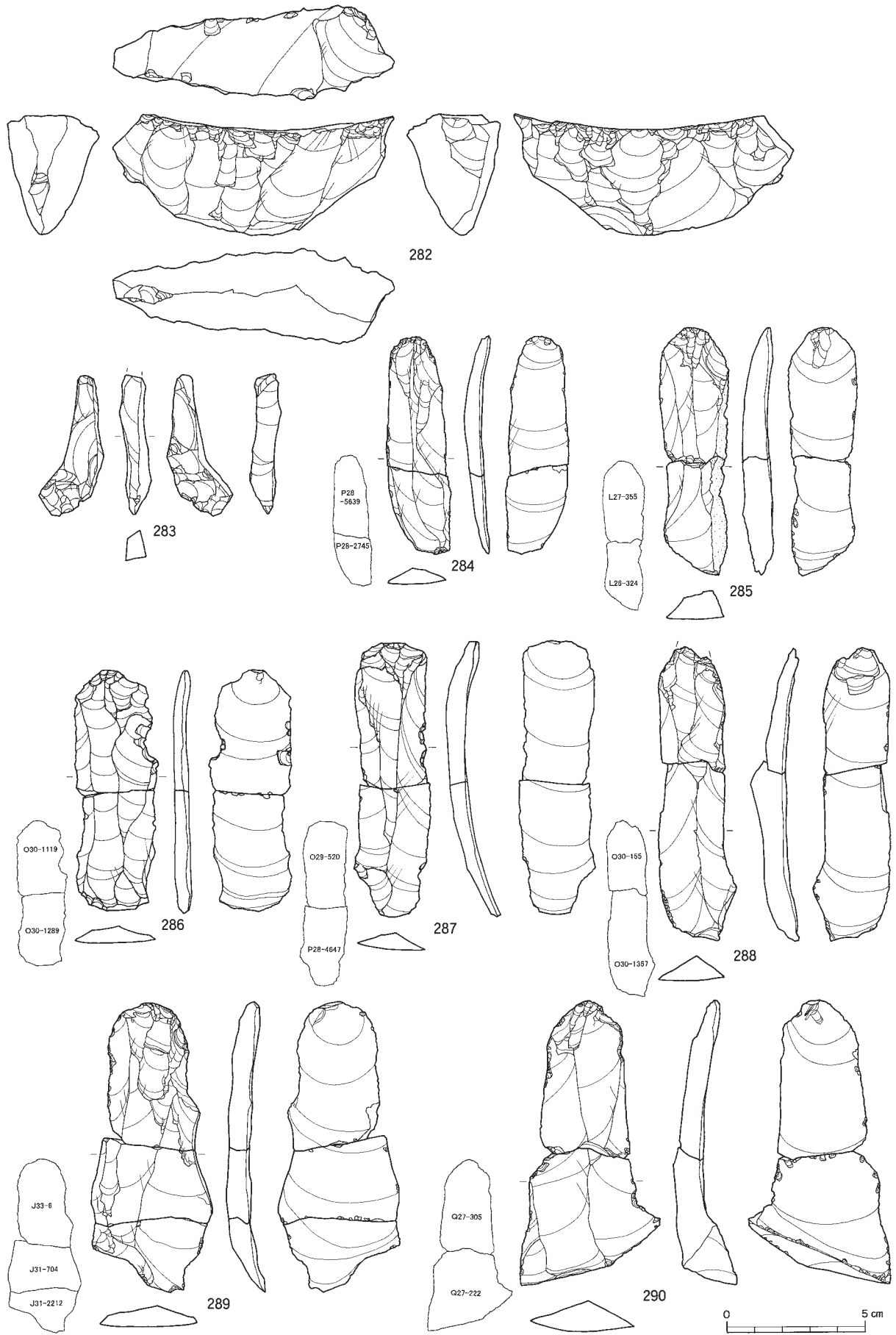

図Ⅲ-248 I区(Sb-91~96)の石器(31) 舟底形石器・二次加工ある剥片・石刃

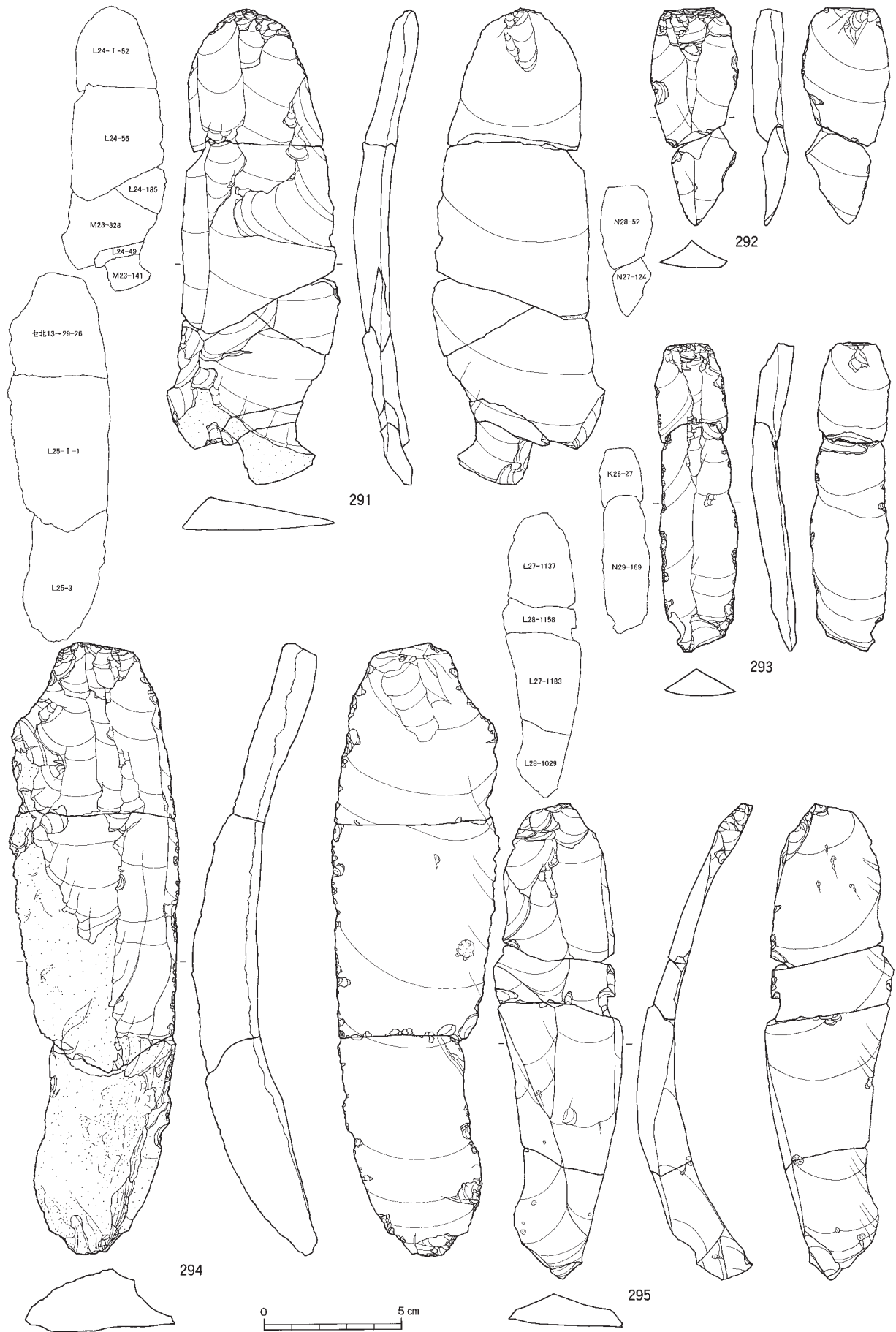

図Ⅲ-249 I区(Sb-91~96)の石器(32) 石刃

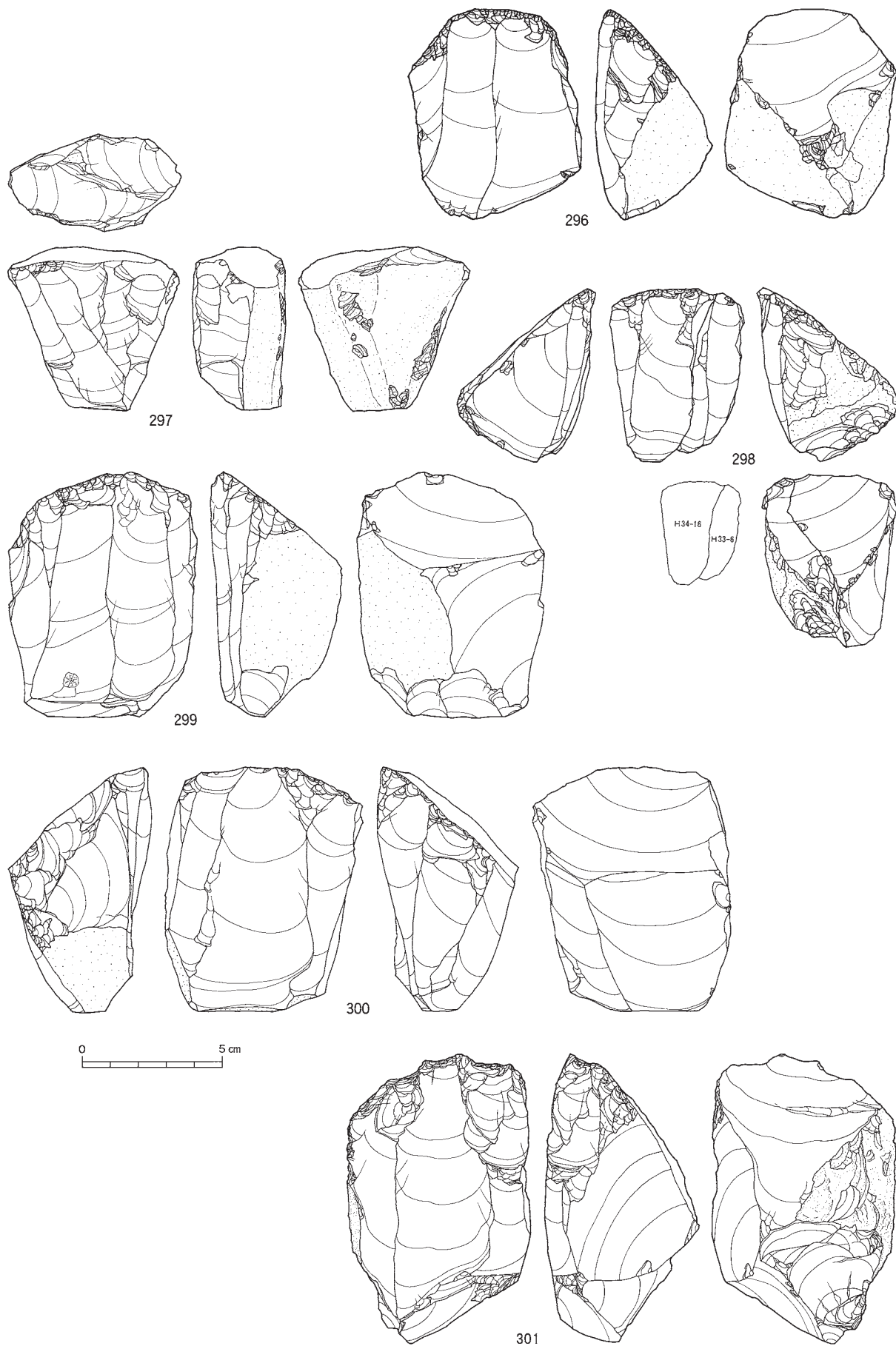

図Ⅲ-250 I区(Sb-91~96)の石器(33) 石刃核

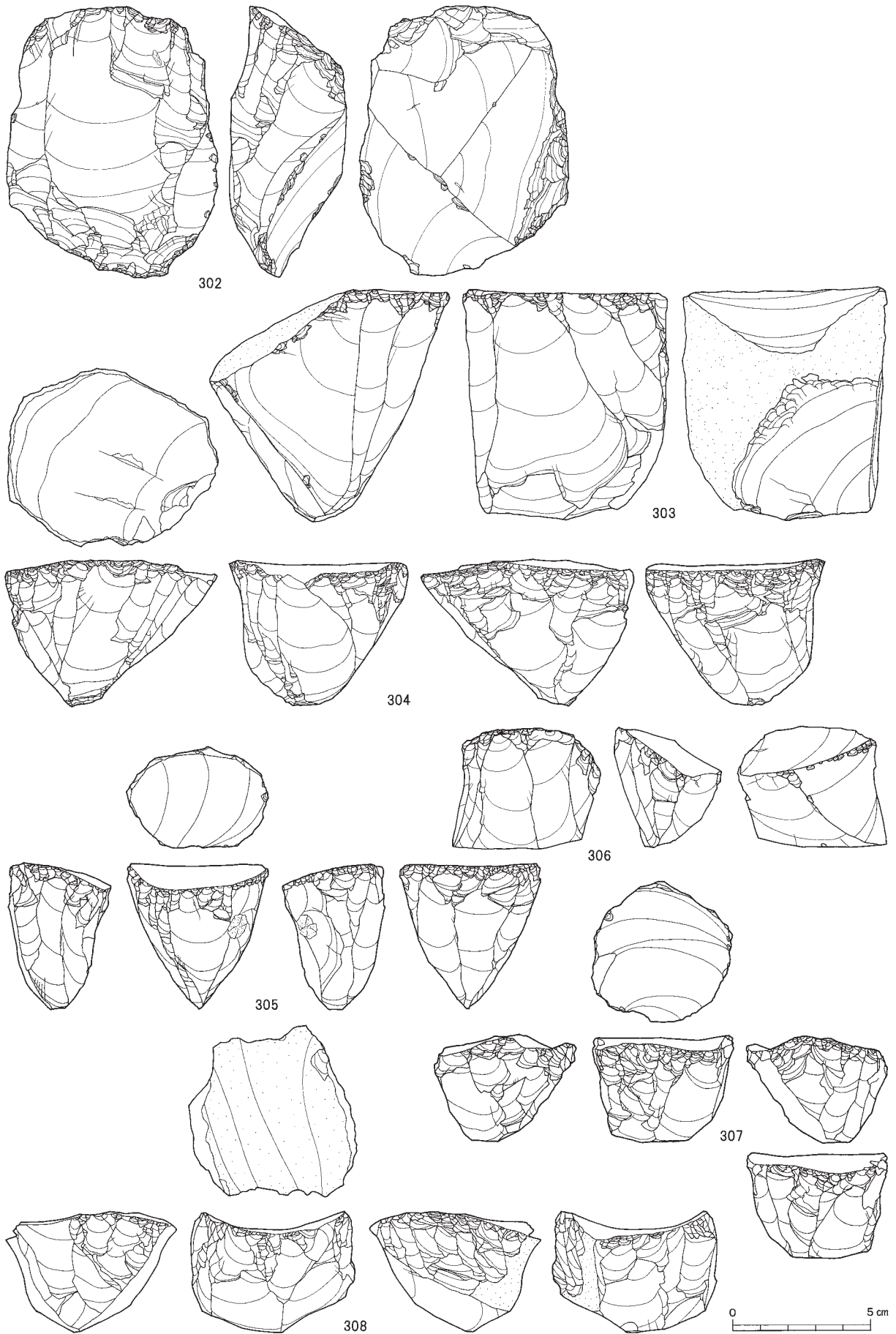

図Ⅲ-251 I区(Sb-91~96)の石器(34) 石刃核

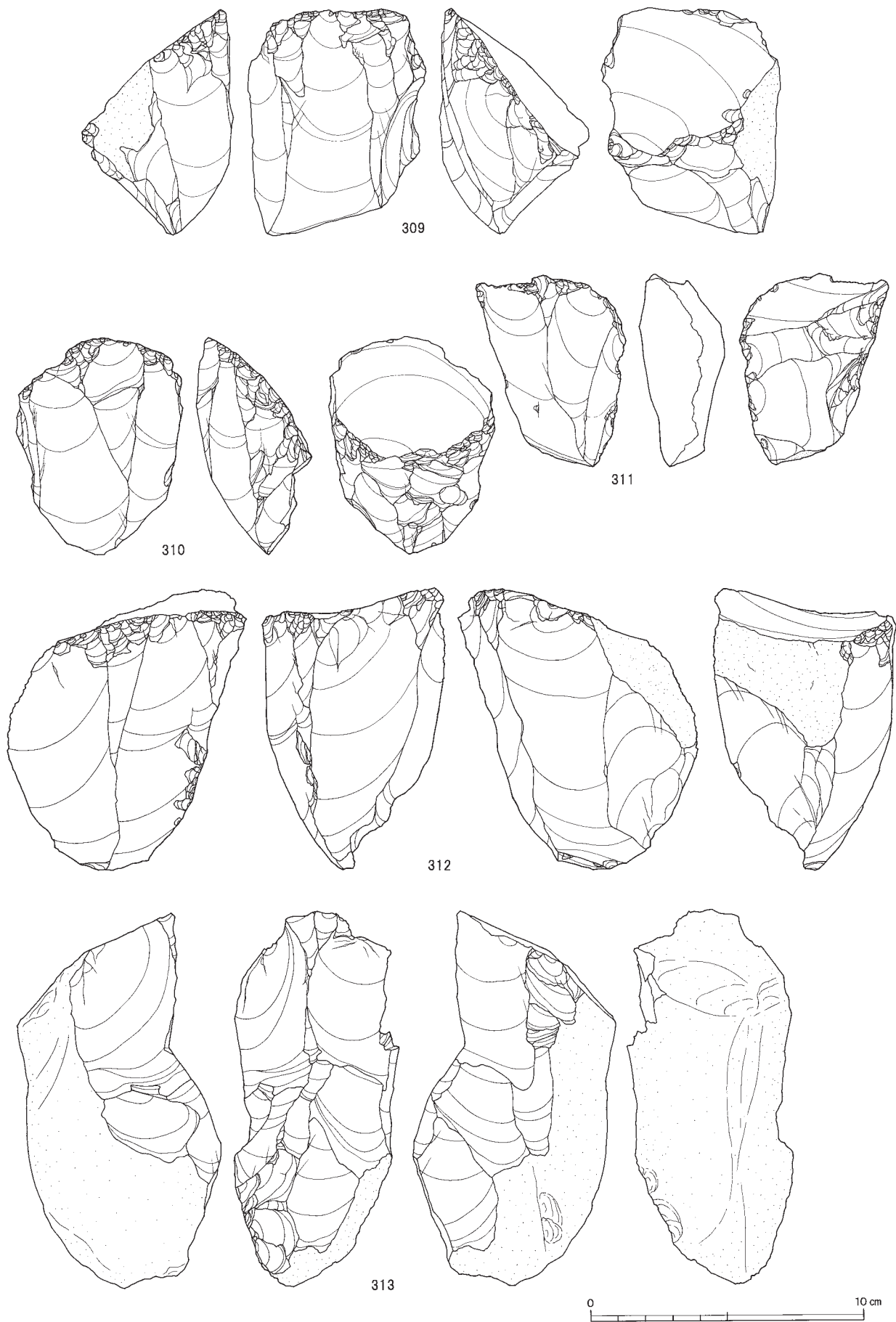

図Ⅲ-252 I区(Sb-91~96)の石器(35) 石刃核

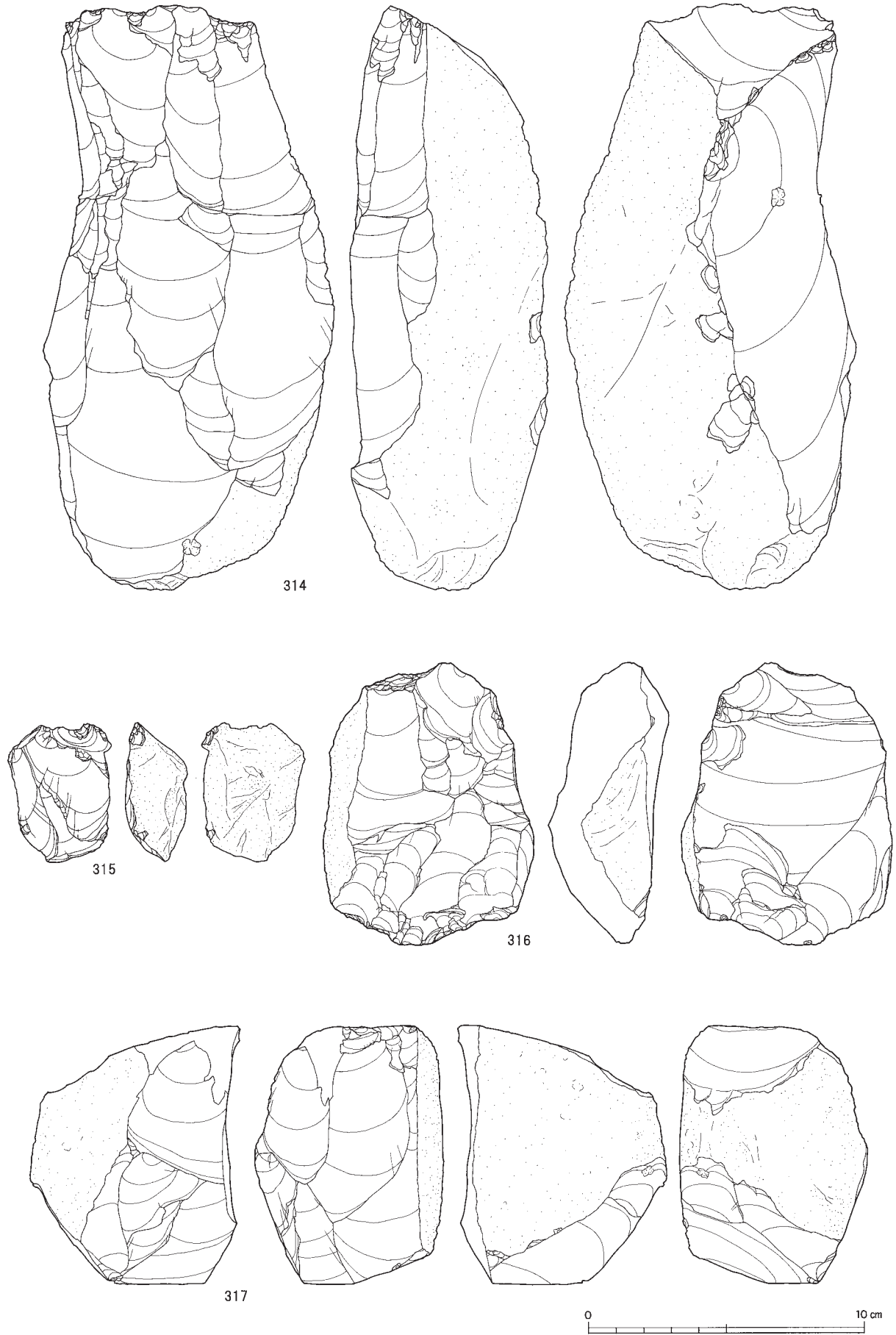

図Ⅲ-253 I区(Sb-91~96)の石器(36) 石刃核・石核

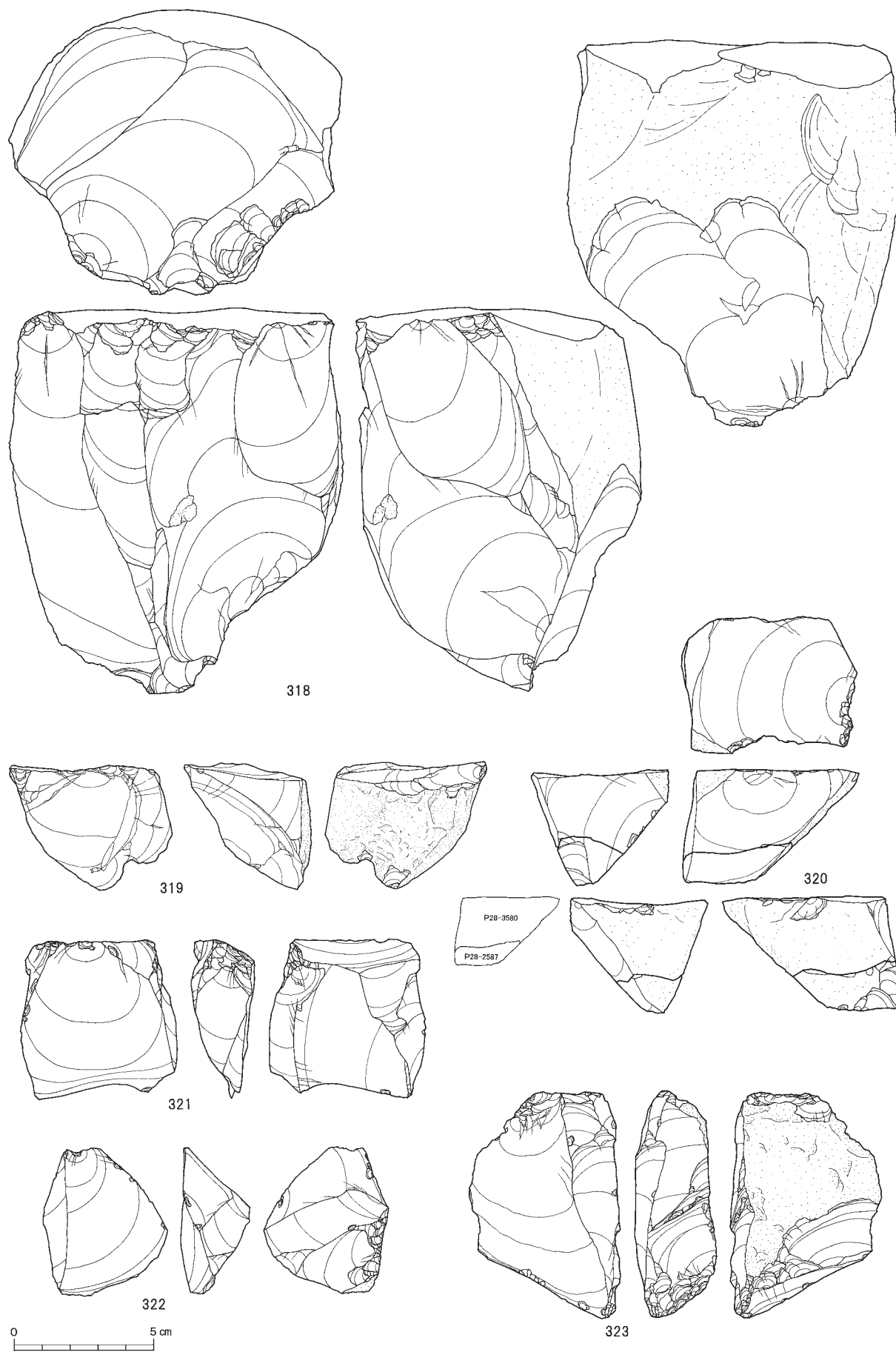

図Ⅲ-254 I区(Sb-91~96)の石器(37) 石核

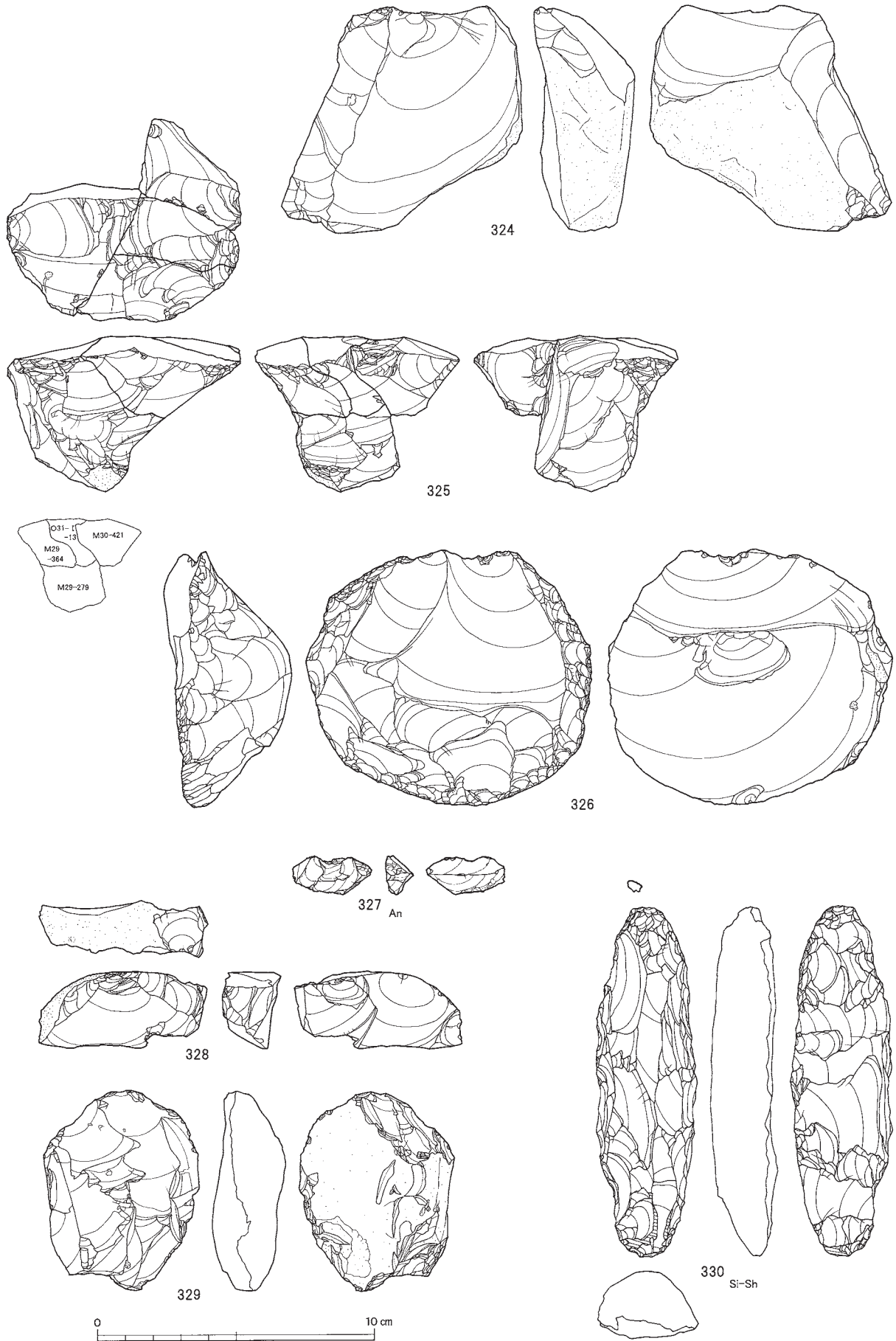

図Ⅲ-255 I区(Sb-91~96)の石器(38) 石核・斧形石器

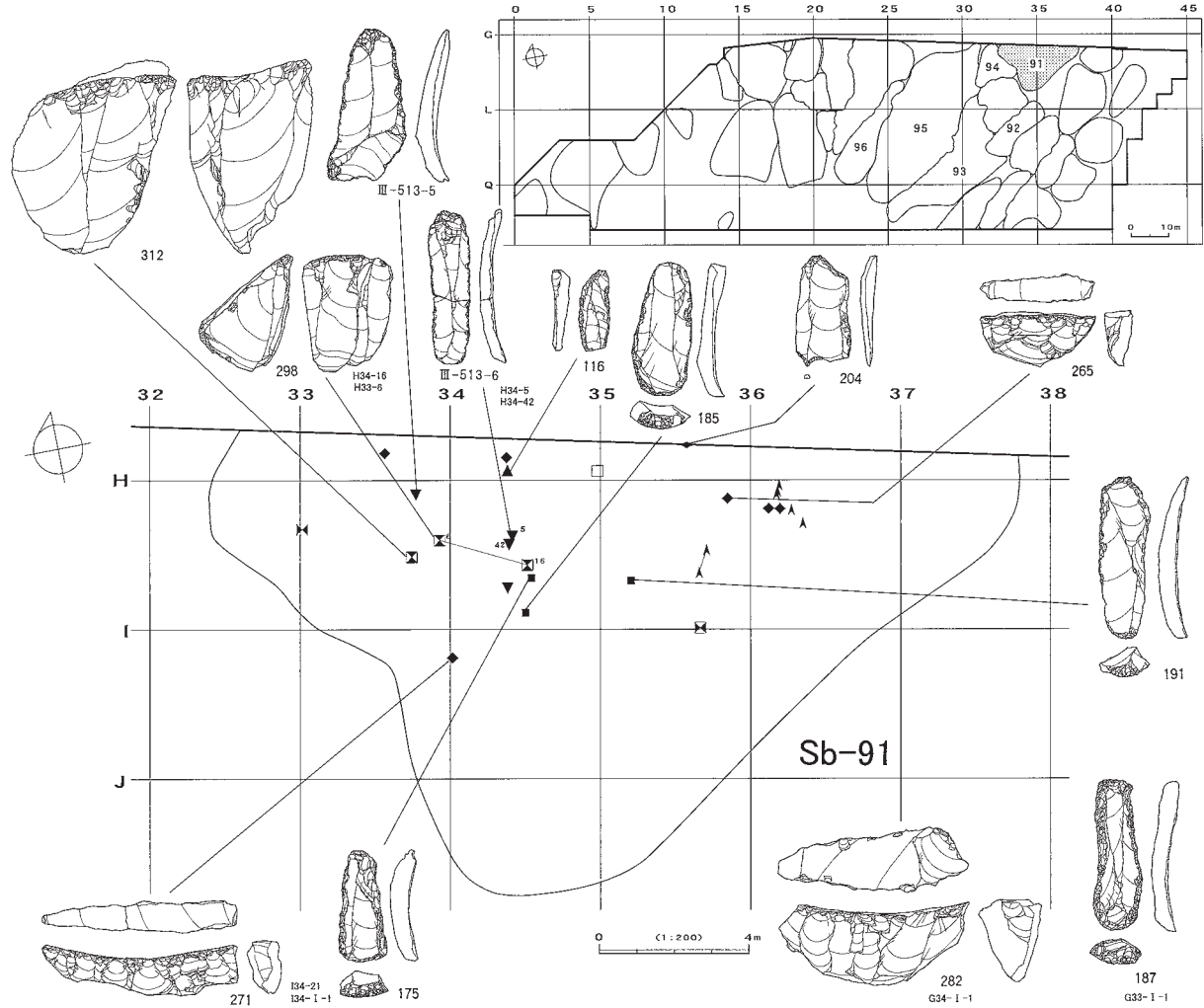
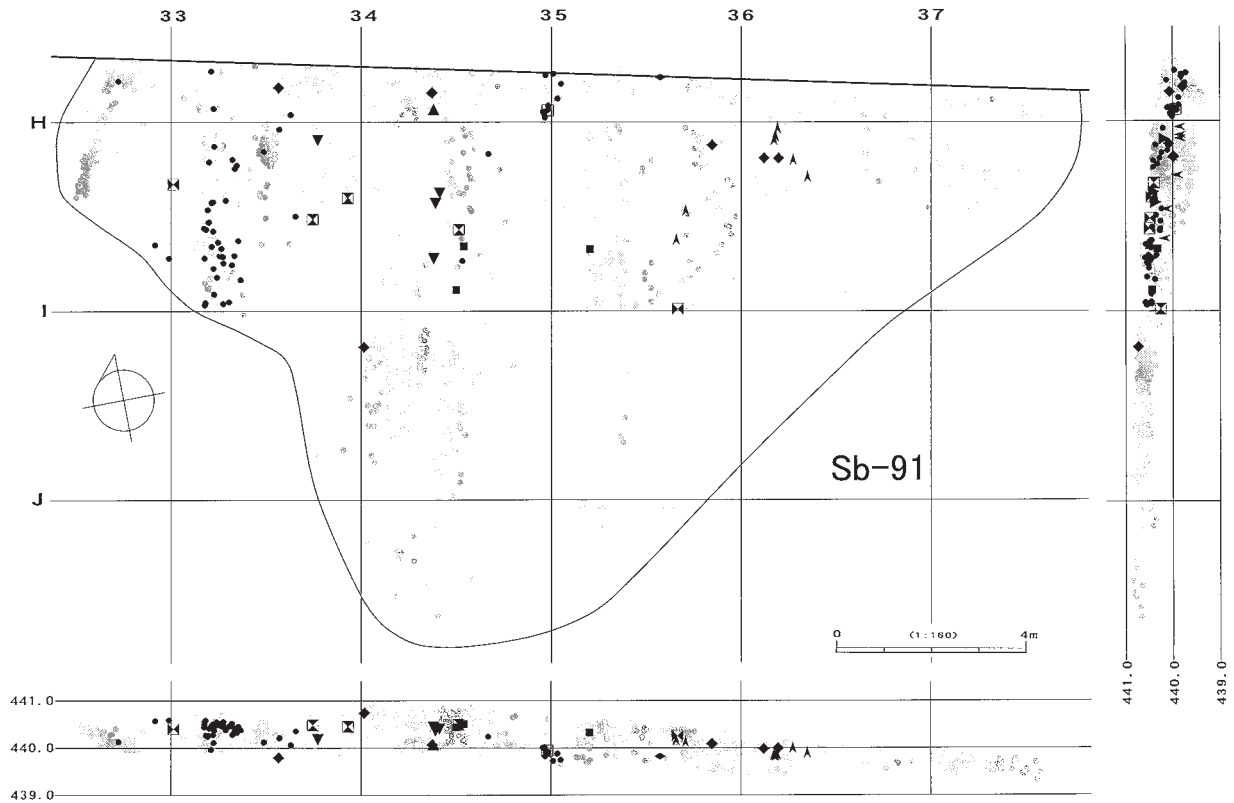

図Ⅲ-256 Sb-91の分布図・遺物

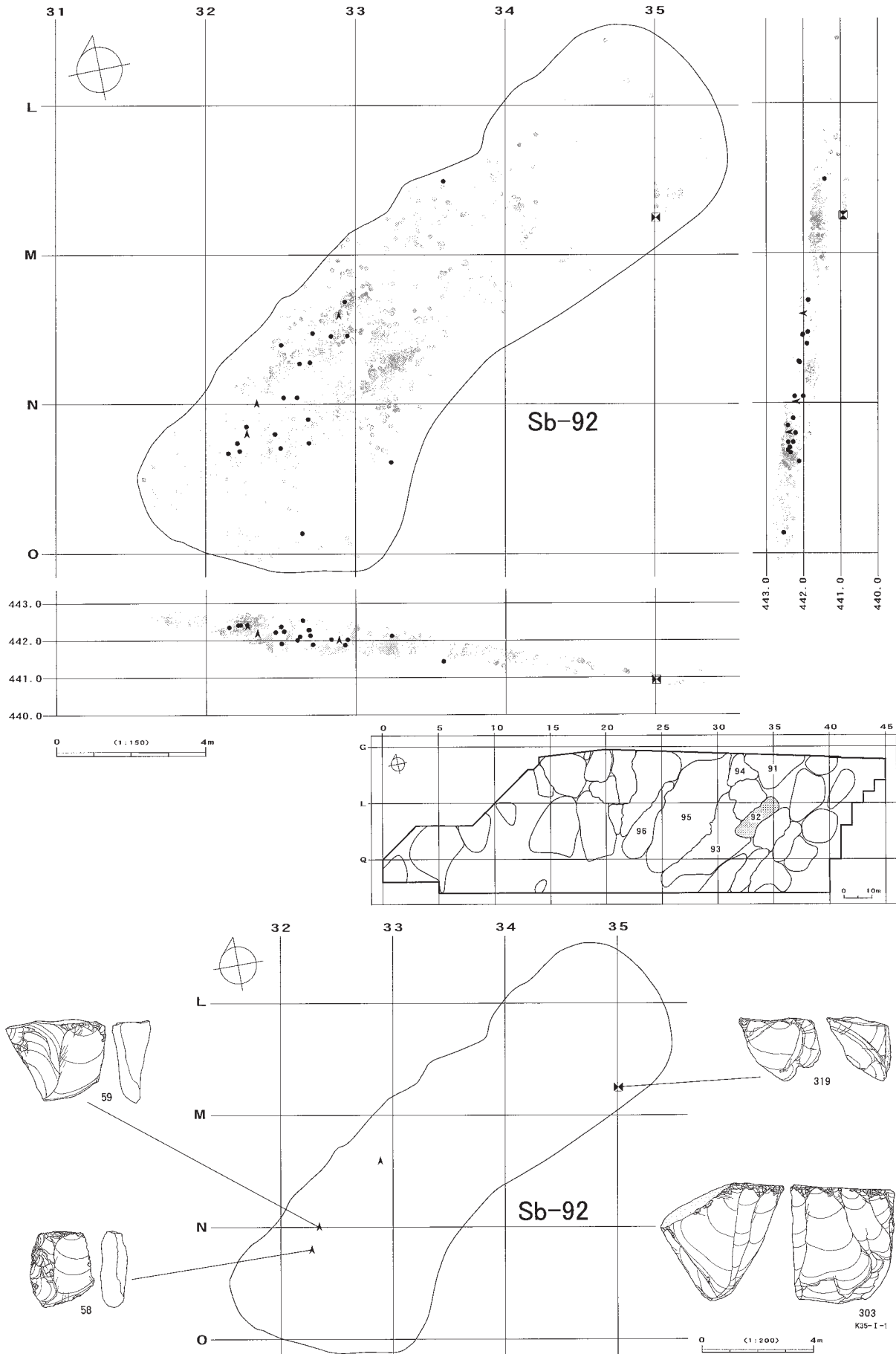

図Ⅲ-257 Sb-92の分布図・遺物

I 区 (Sb-91~96)

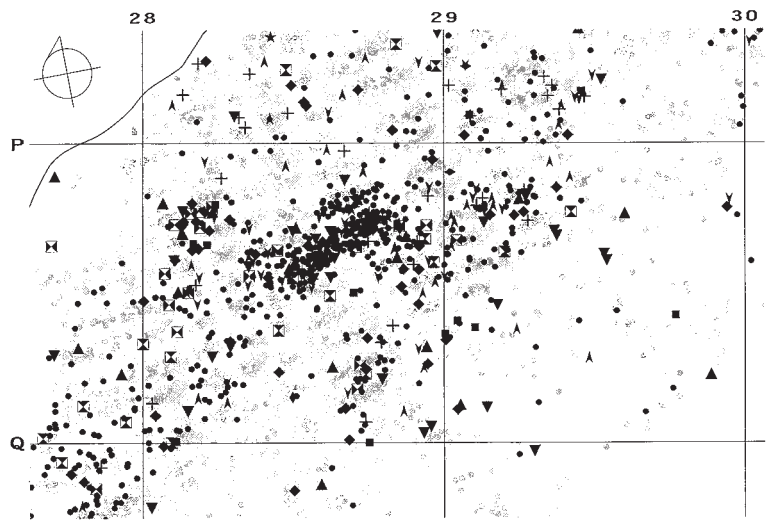
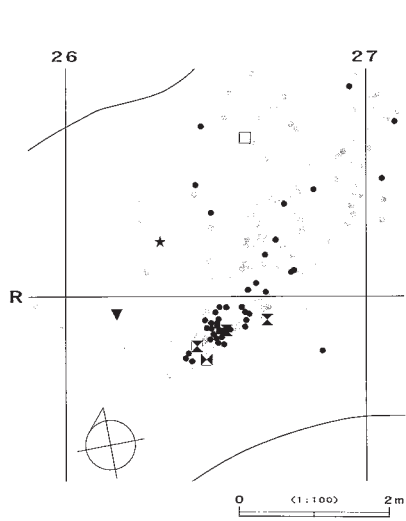
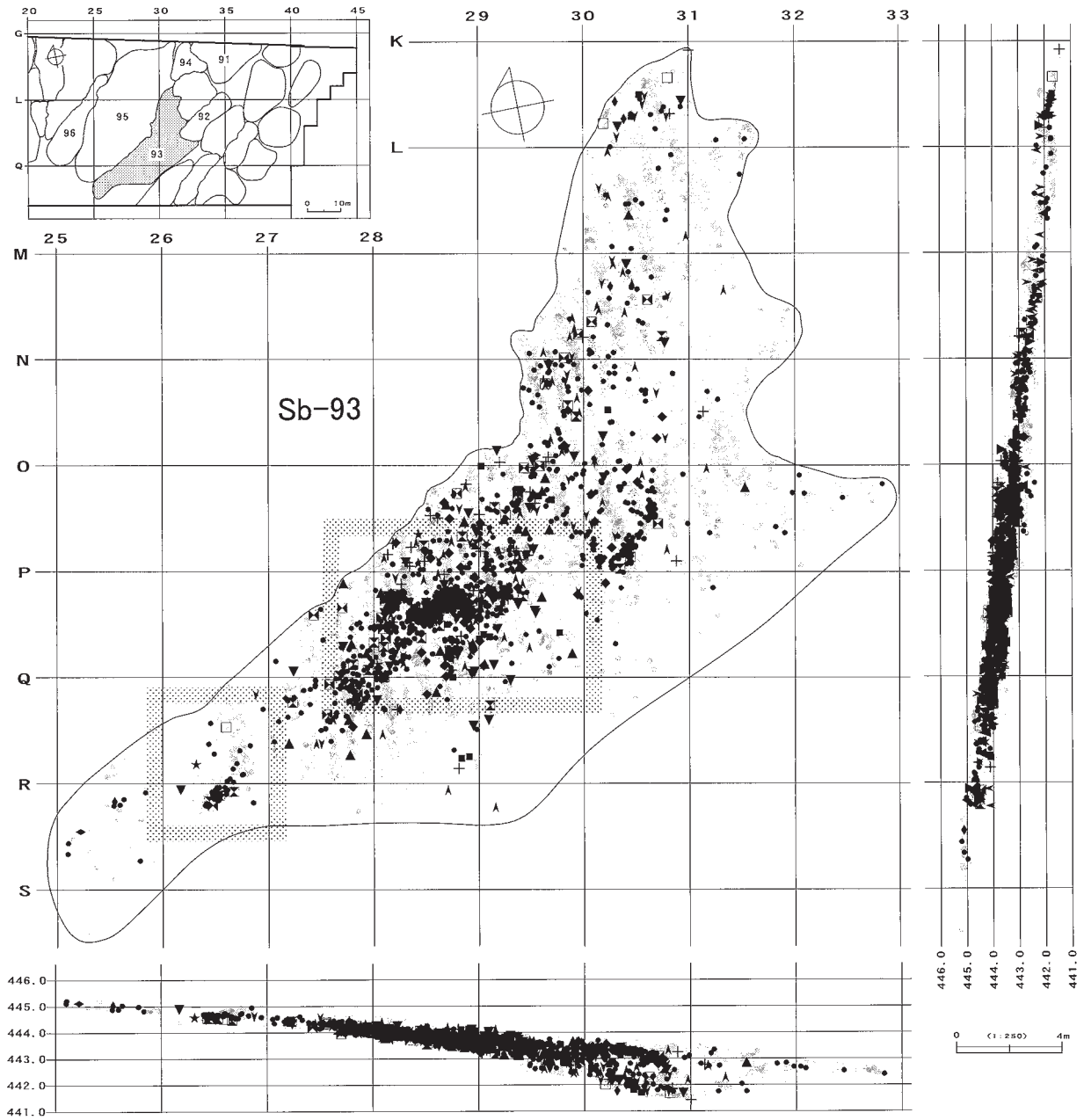

図Ⅲ-258 Sb-93の分布図

尖頭器Ⅲ類

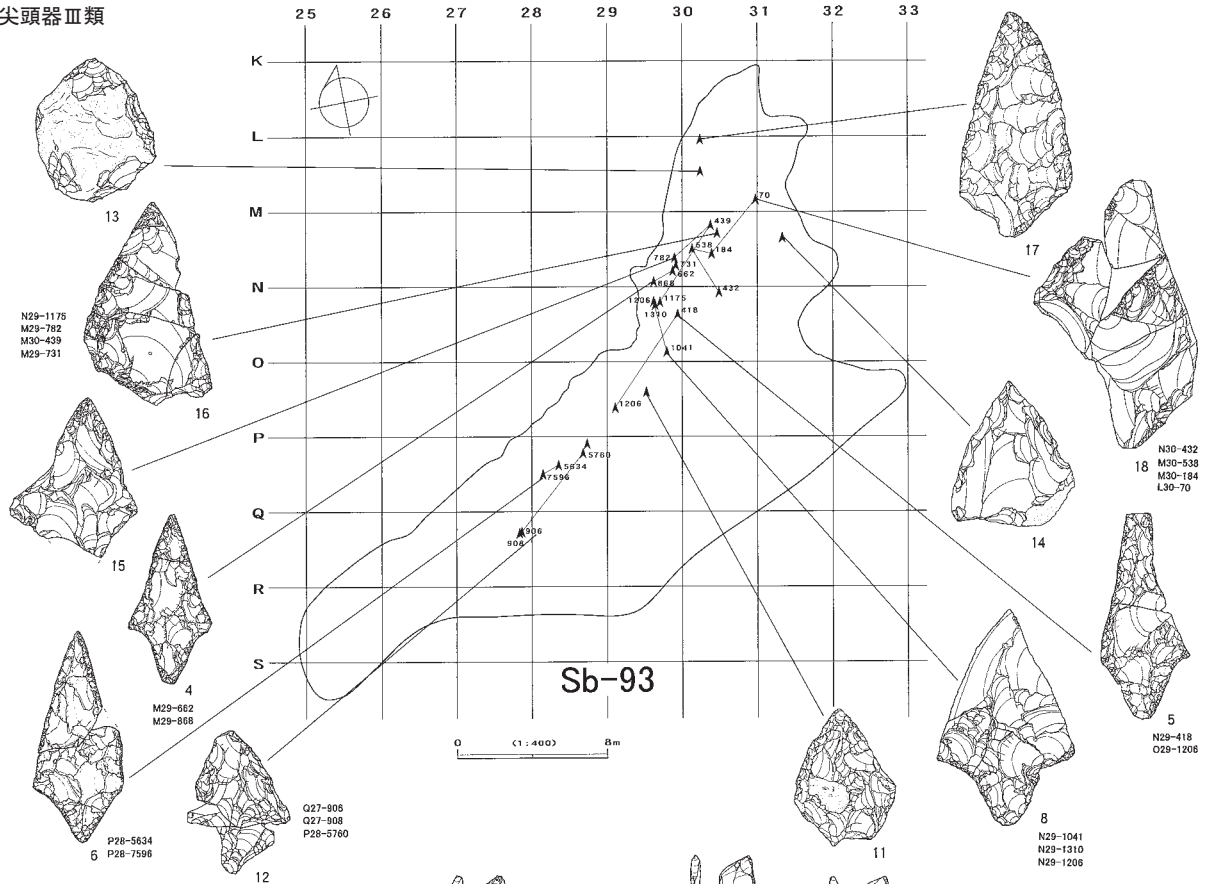

彫器Ⅰ・Ⅱ類、彫器削片Ⅰ・Ⅱ類

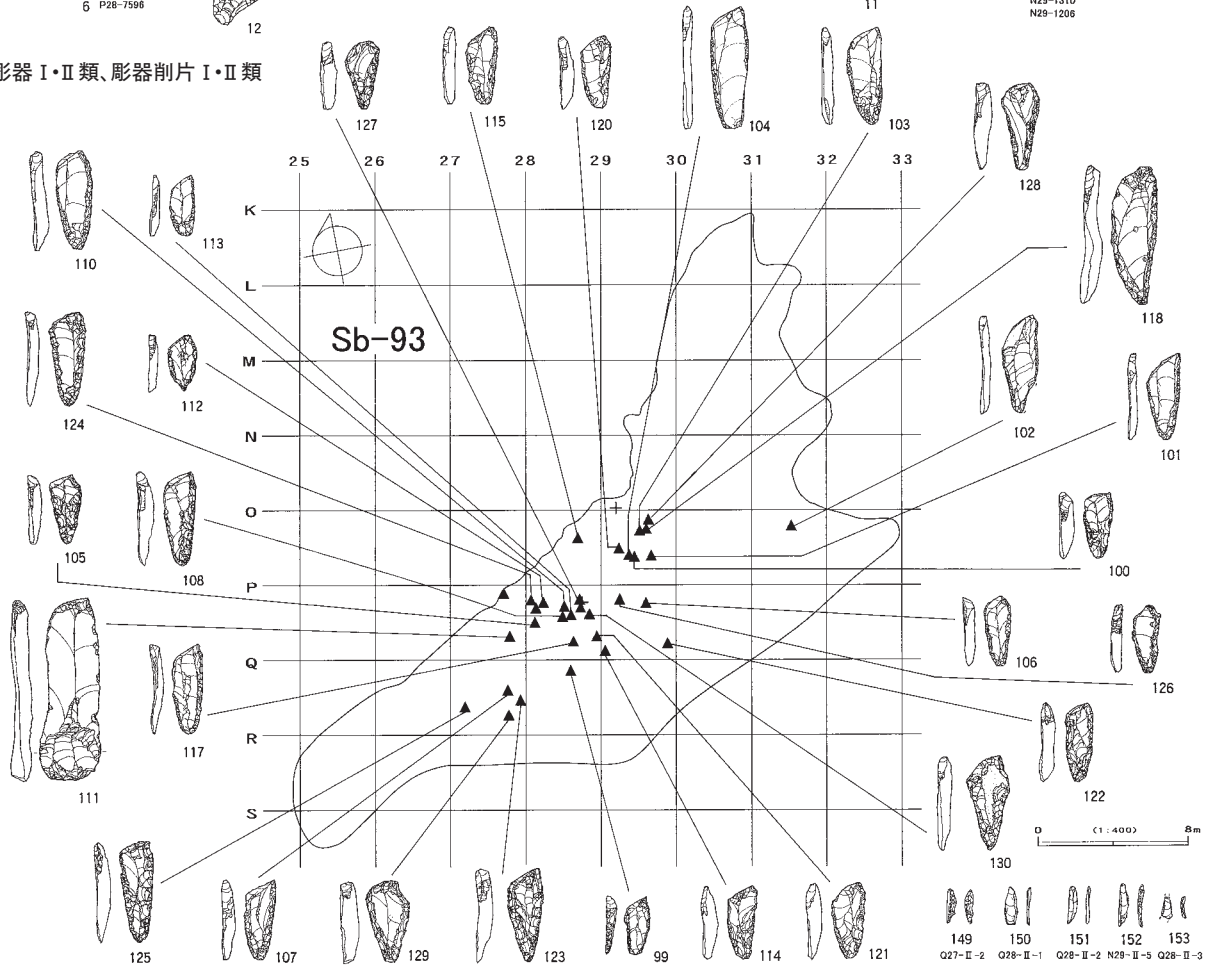

図Ⅲ-259 Sb-93の遺物(1)

尖頭器Ⅰ類、両面調整石器

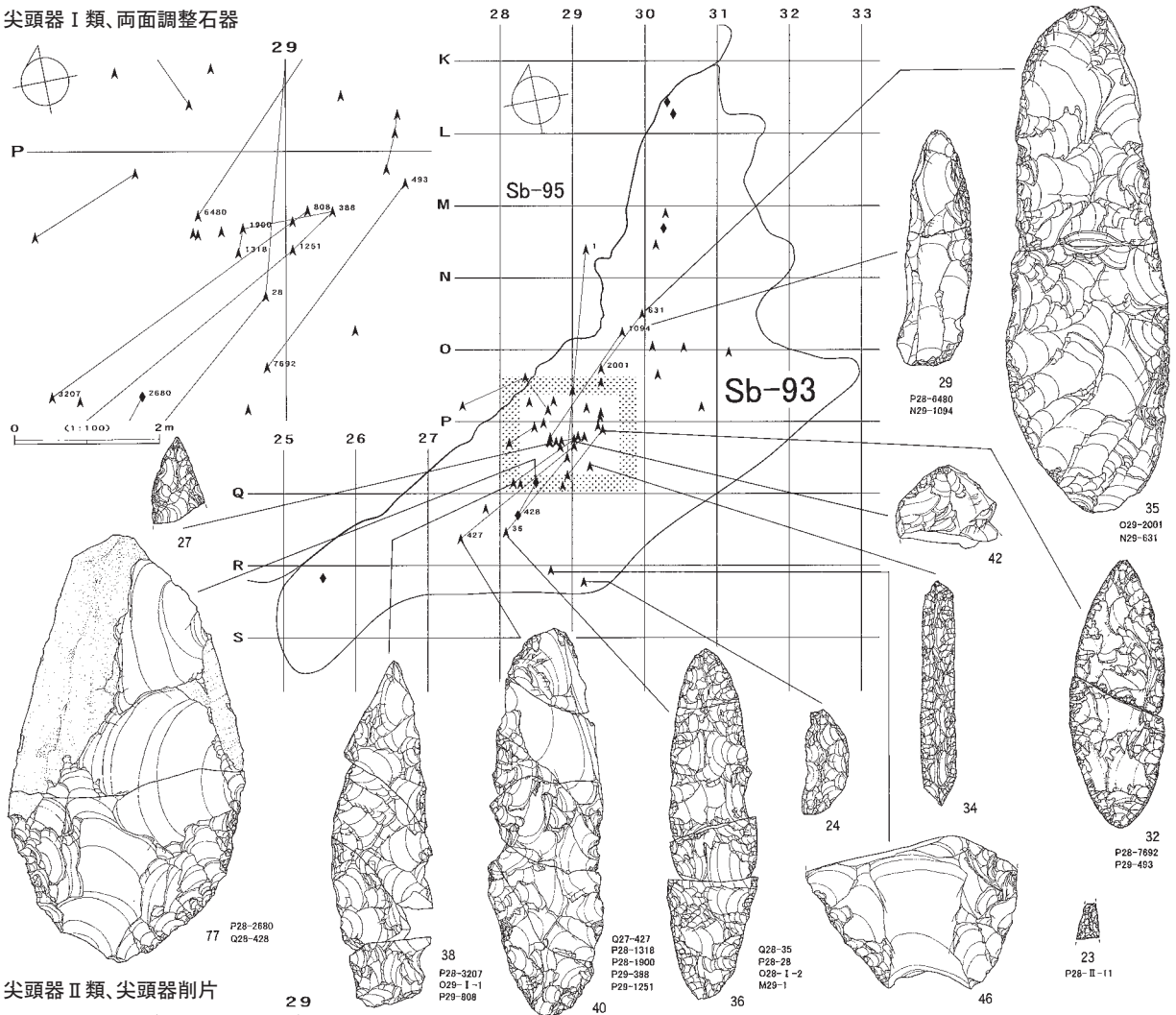

尖頭器Ⅱ類、尖頭器削片

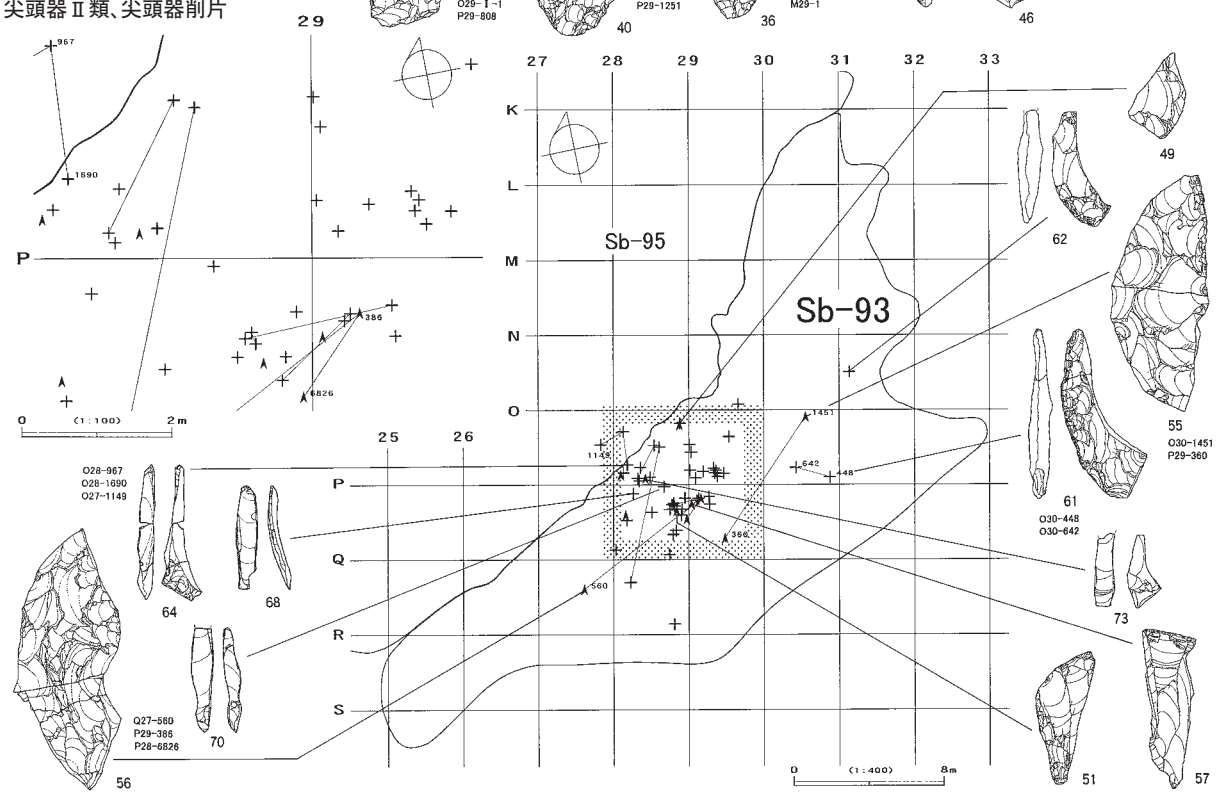

図Ⅲ-260 Sb-93の遺物(2)

彫器皿類、彫器削片皿類

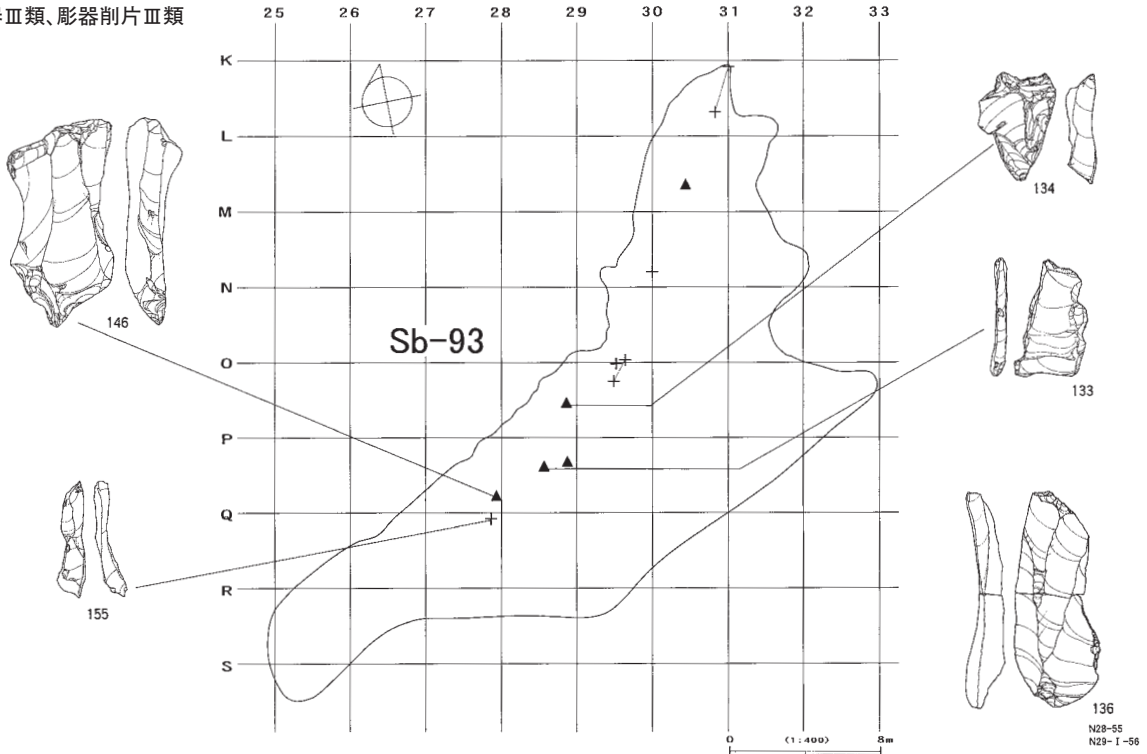

燧石

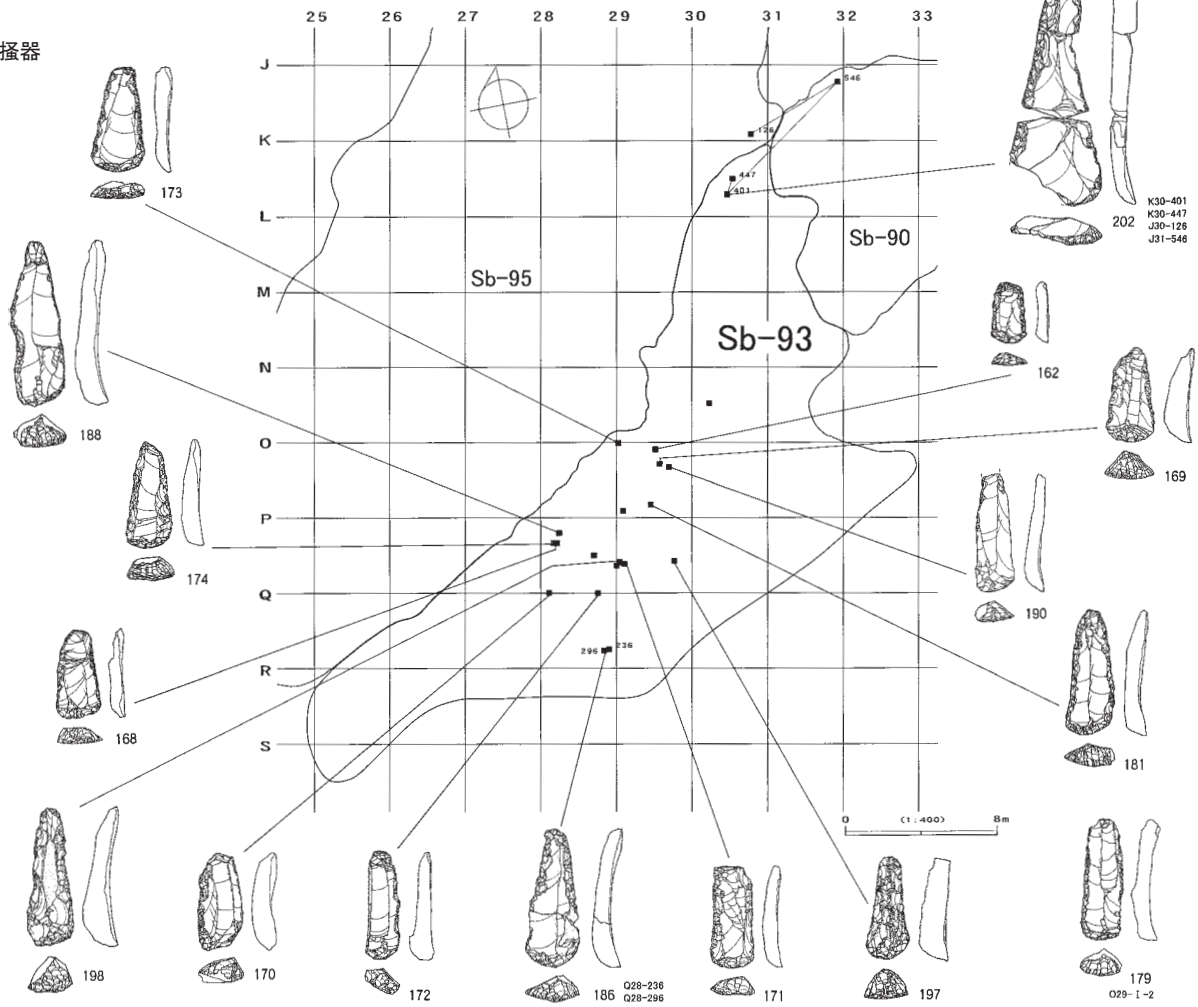

図III-261 Sb-93の遺物(3)

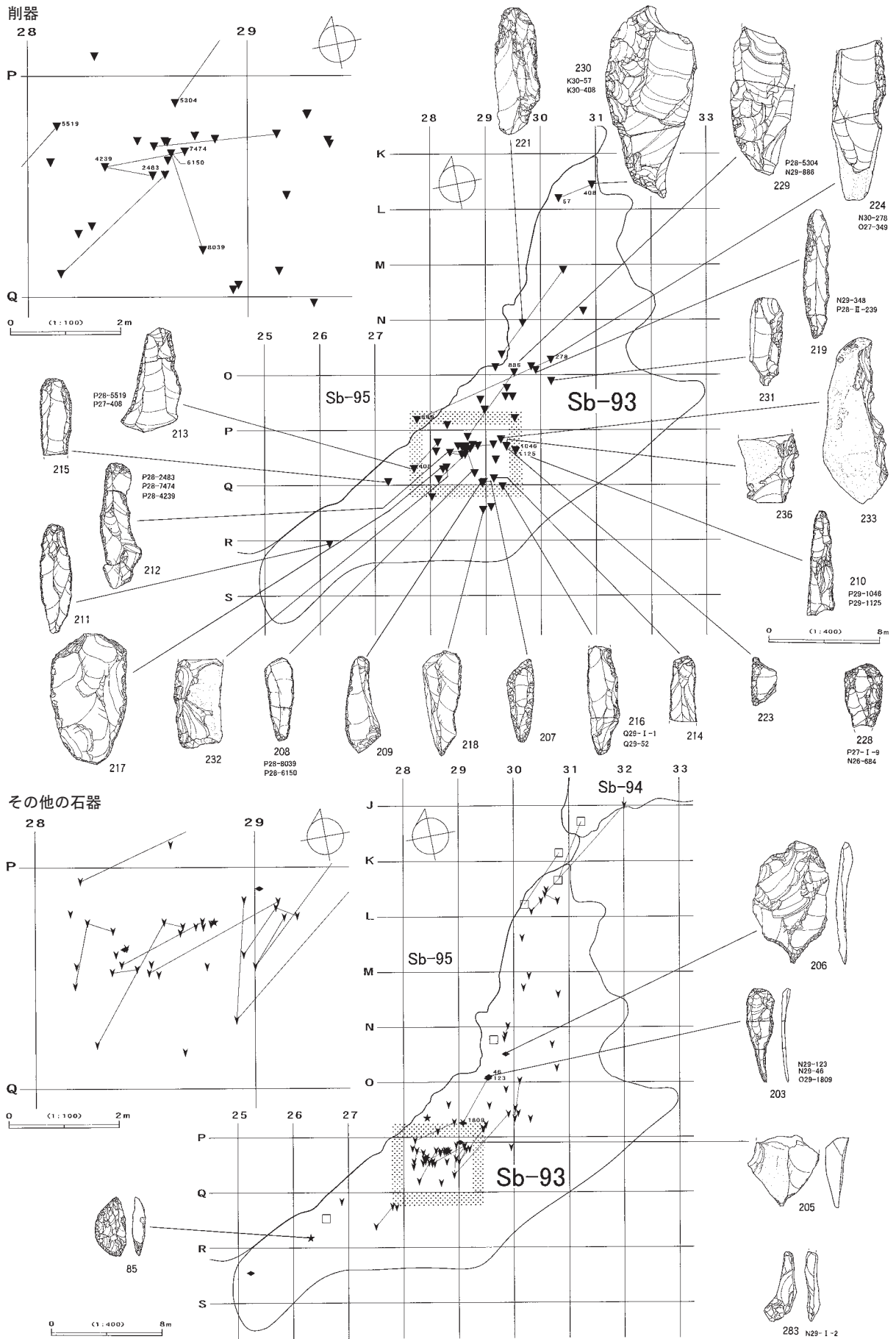

図Ⅲ-262 Sb-93の遺物(4)

舟底形石器Ⅰ類

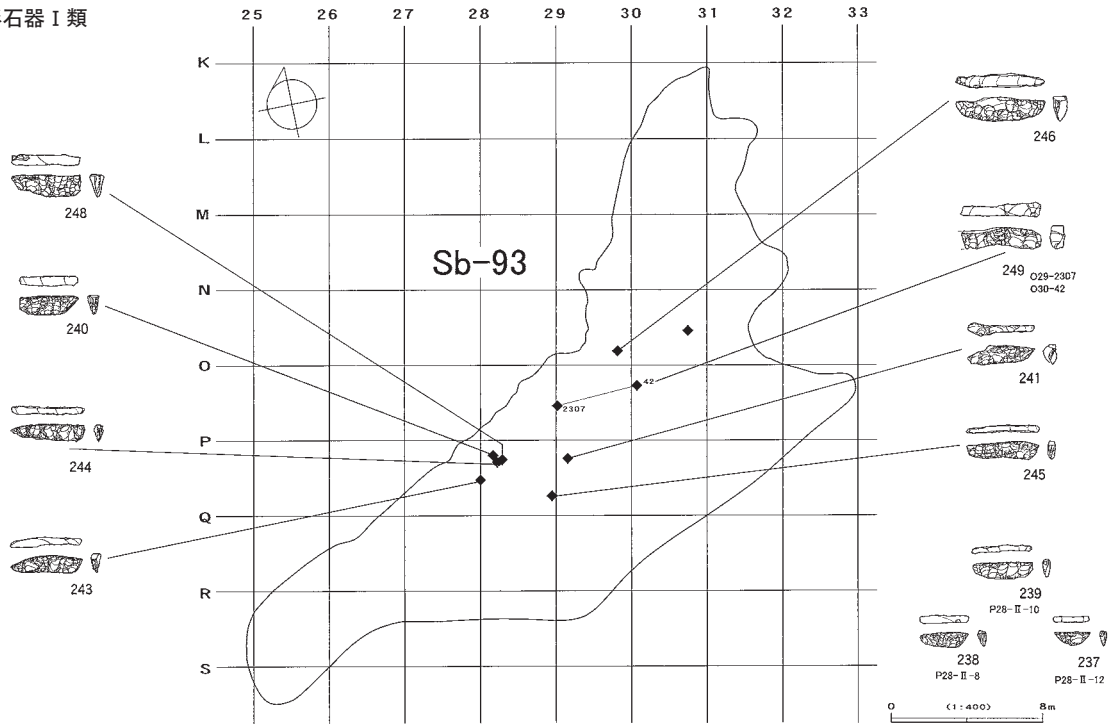

舟底形石器Ⅱ類

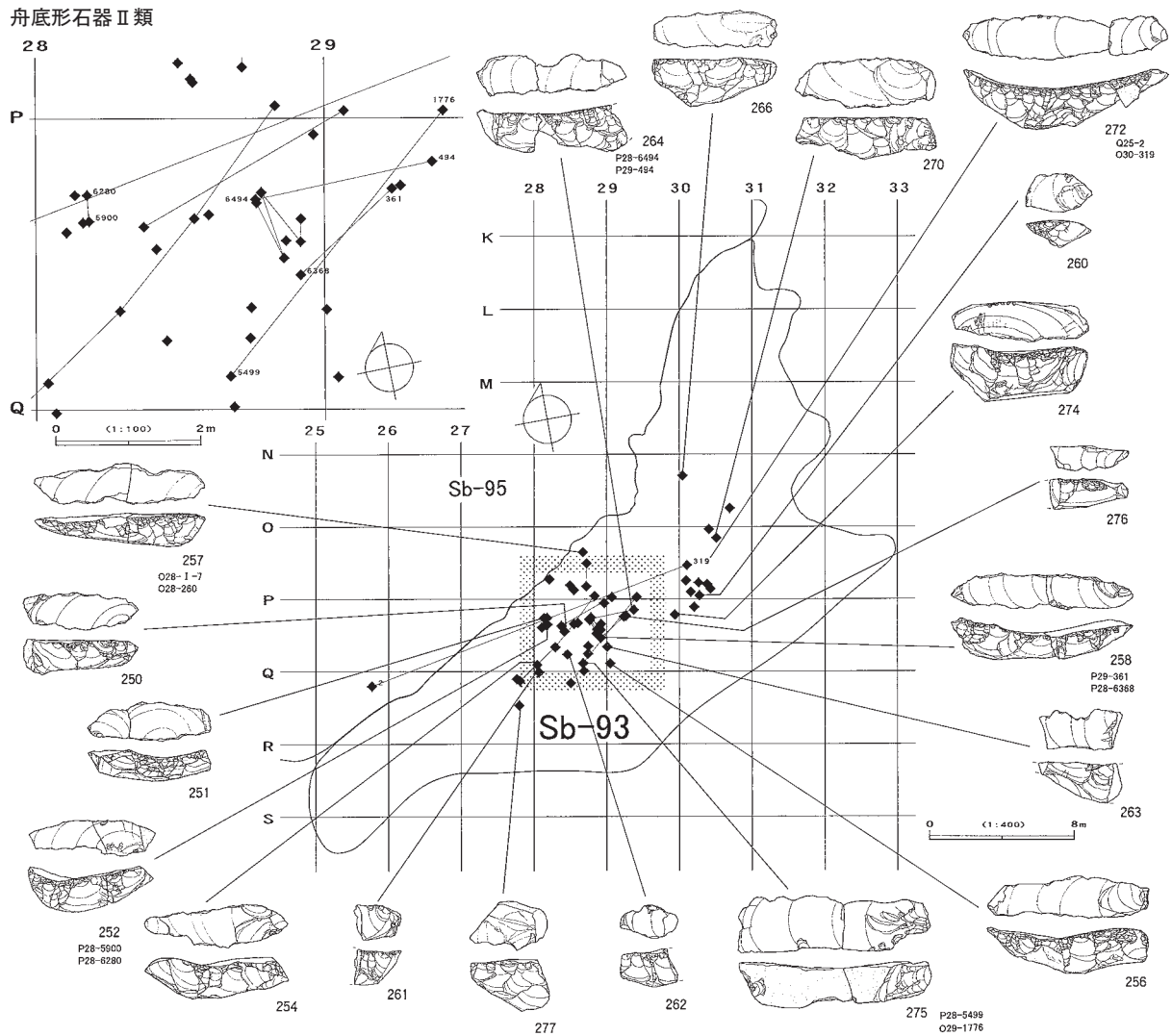

図Ⅲ-263 Sb-93の遺物(5)

石刃核

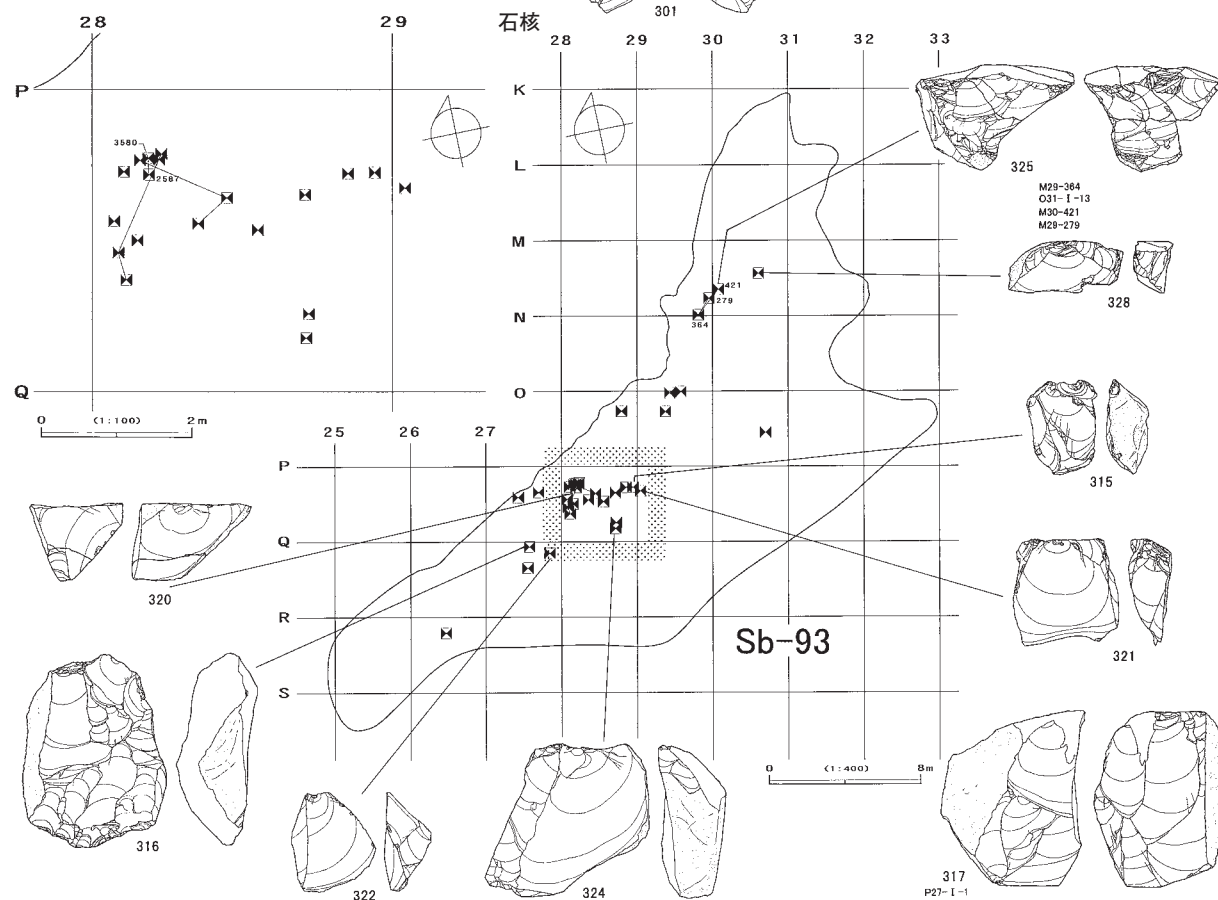
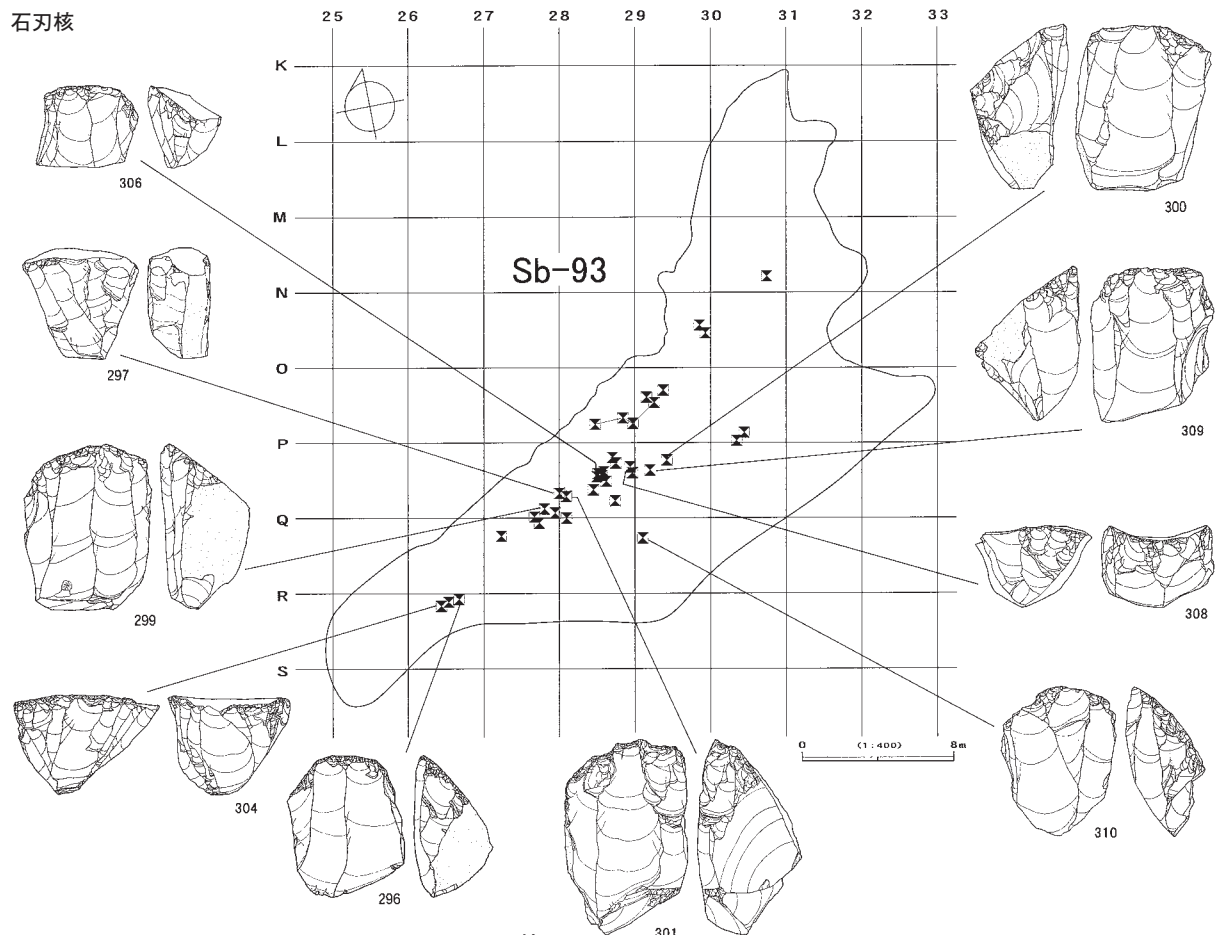

図Ⅲ-264 Sb-93の遺物(6)

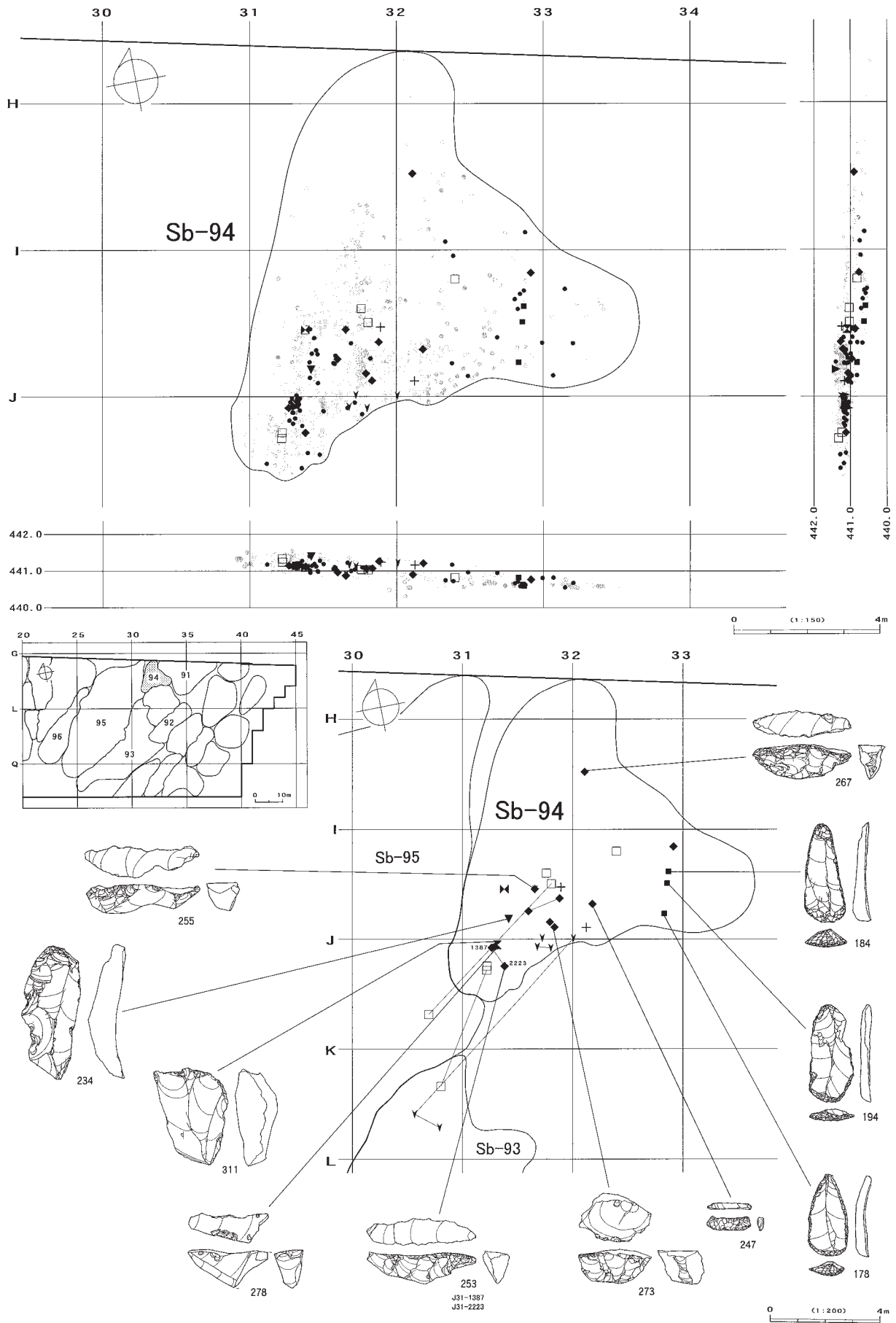

図Ⅲ-265 Sb-94の分布図・遺物

I 区 (Sb-91~96)

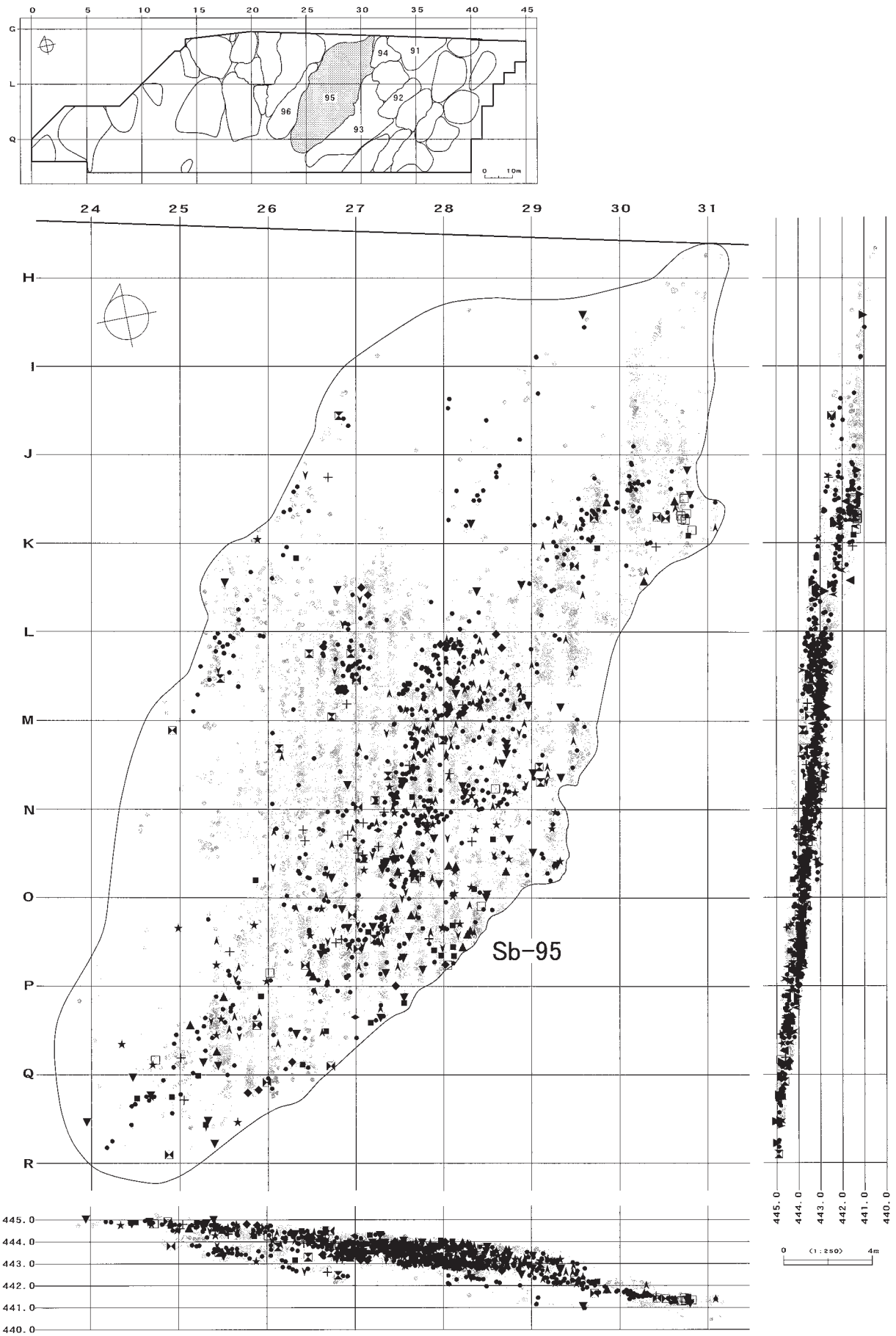

図III-266 Sb-95の分布図

尖頭器Ⅲ類

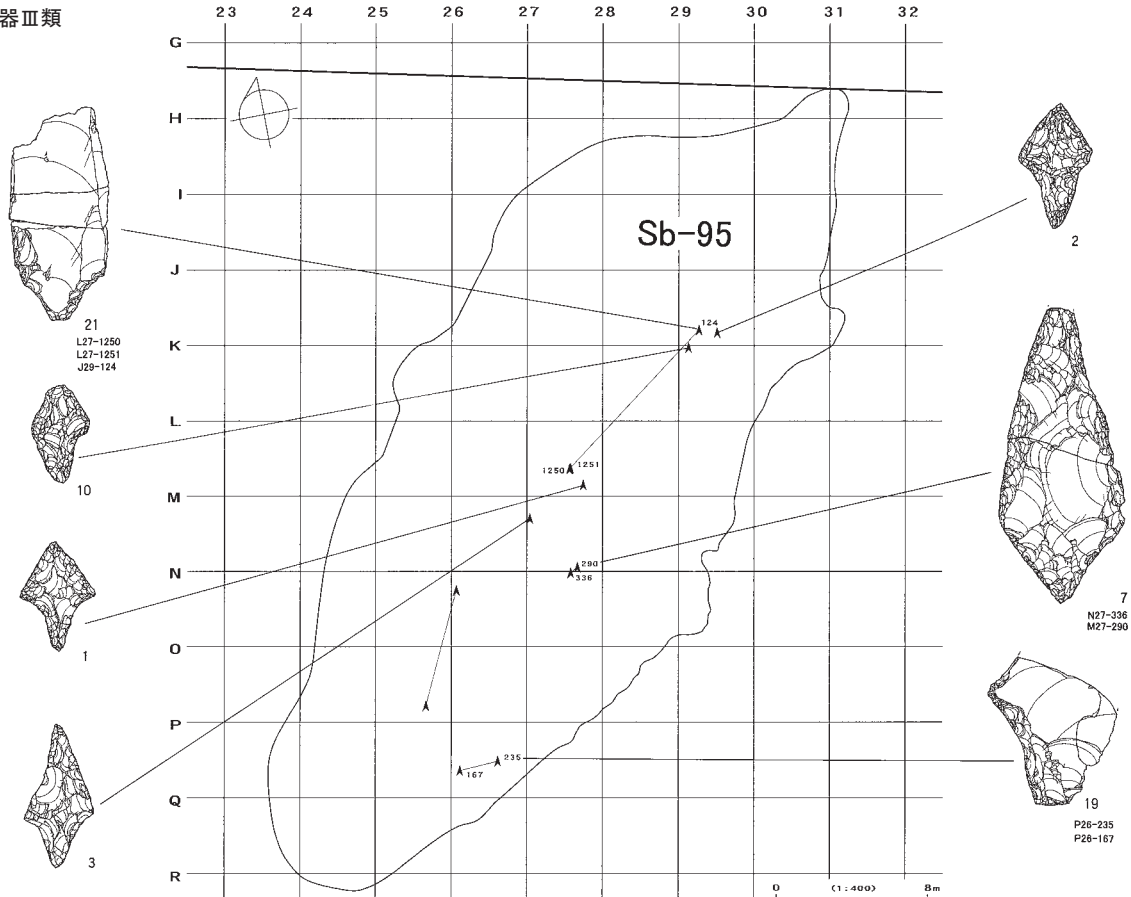

尖頭器Ⅱ類、尖頭器削片

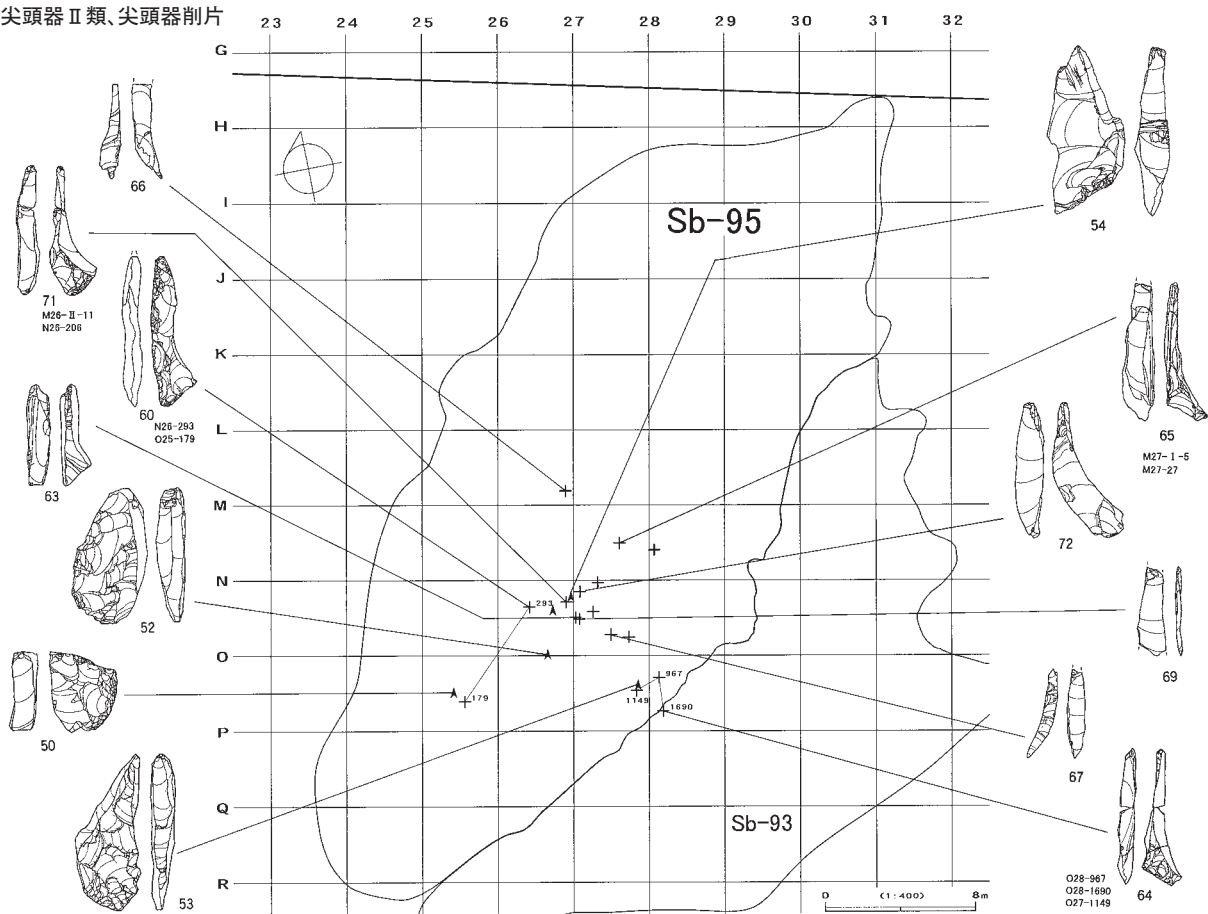

図III-267 Sb-95の遺物(1)

尖頭器I類、両面調整石器

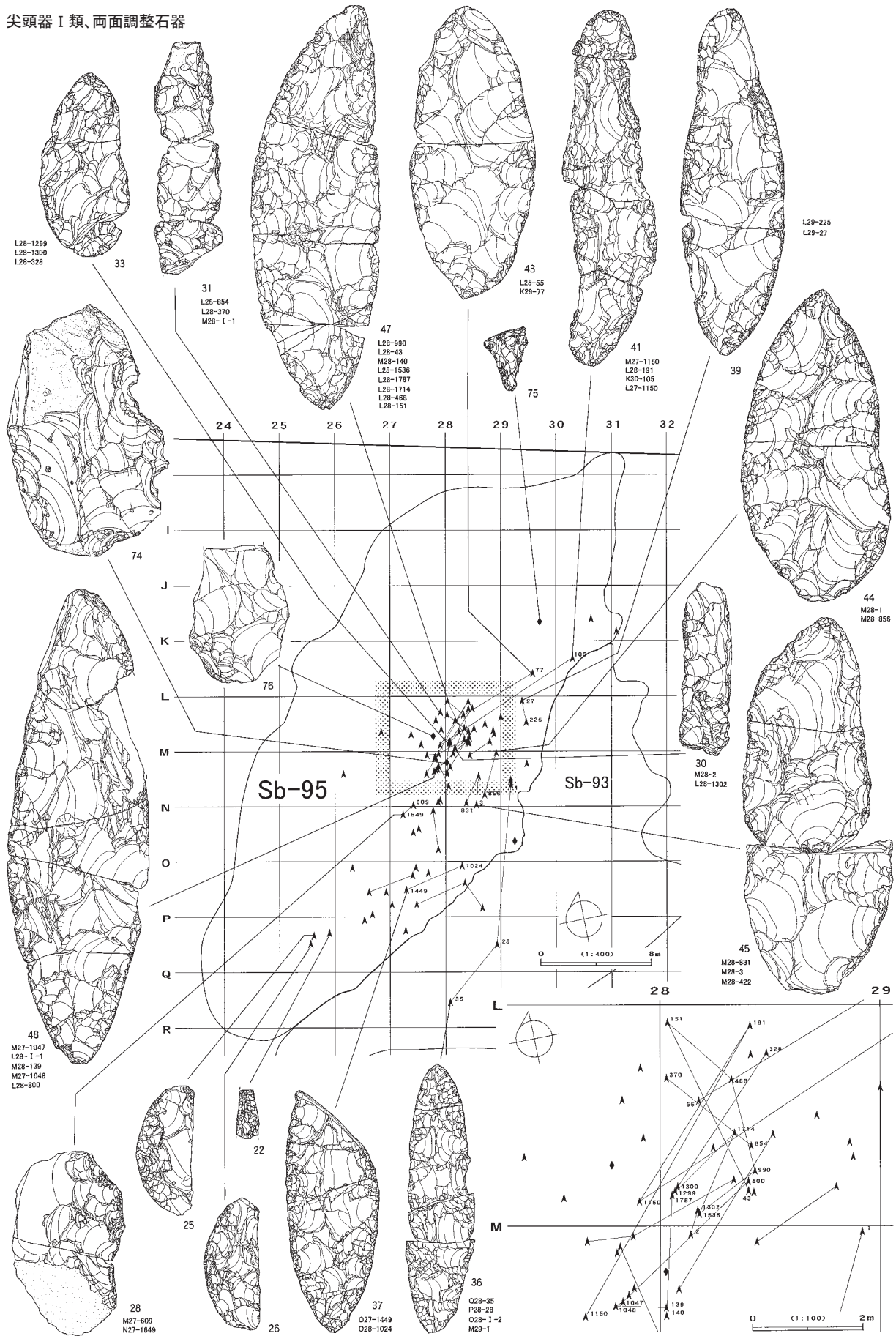

図III-268 Sb-95の遺物(2)

ナイフ形石器

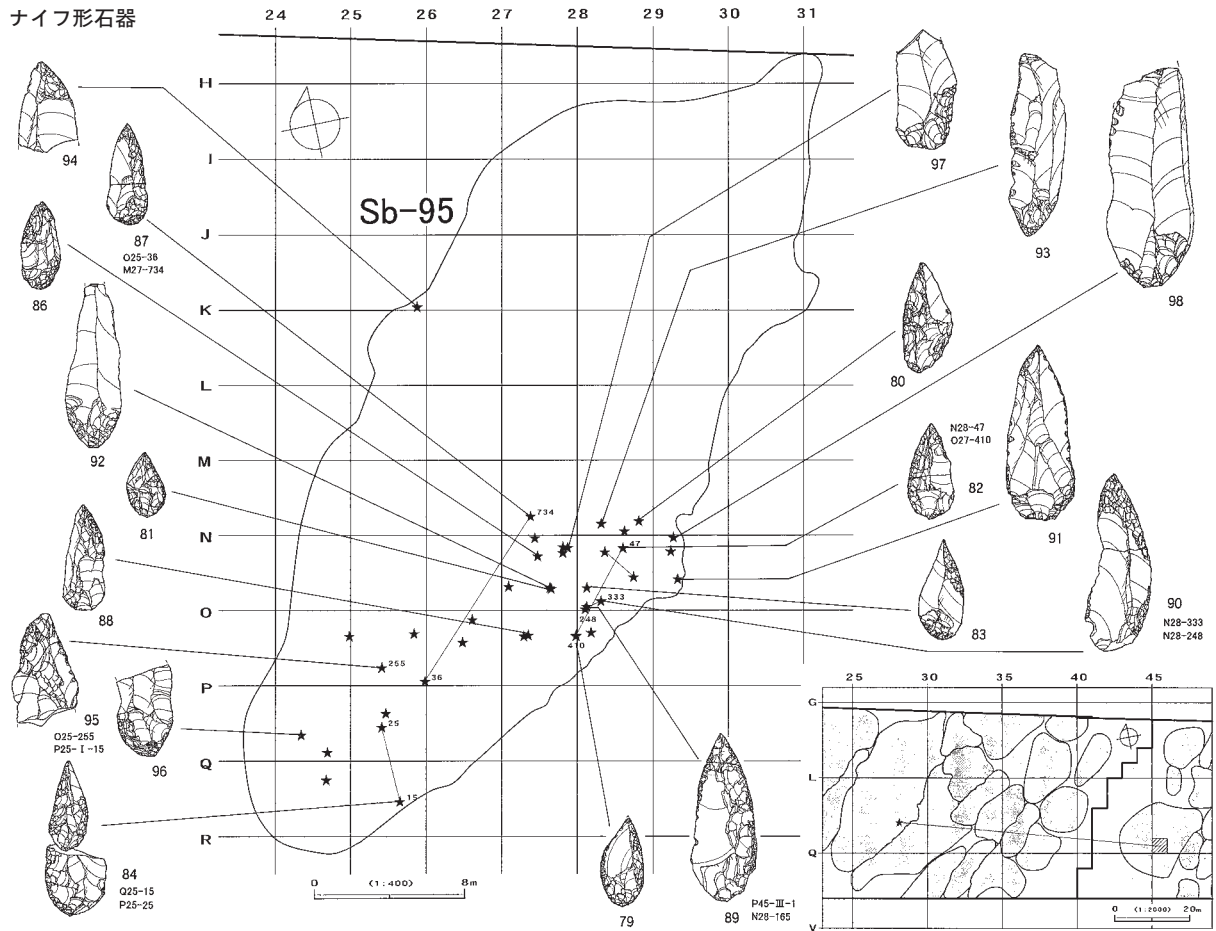

彫器、彫器削片

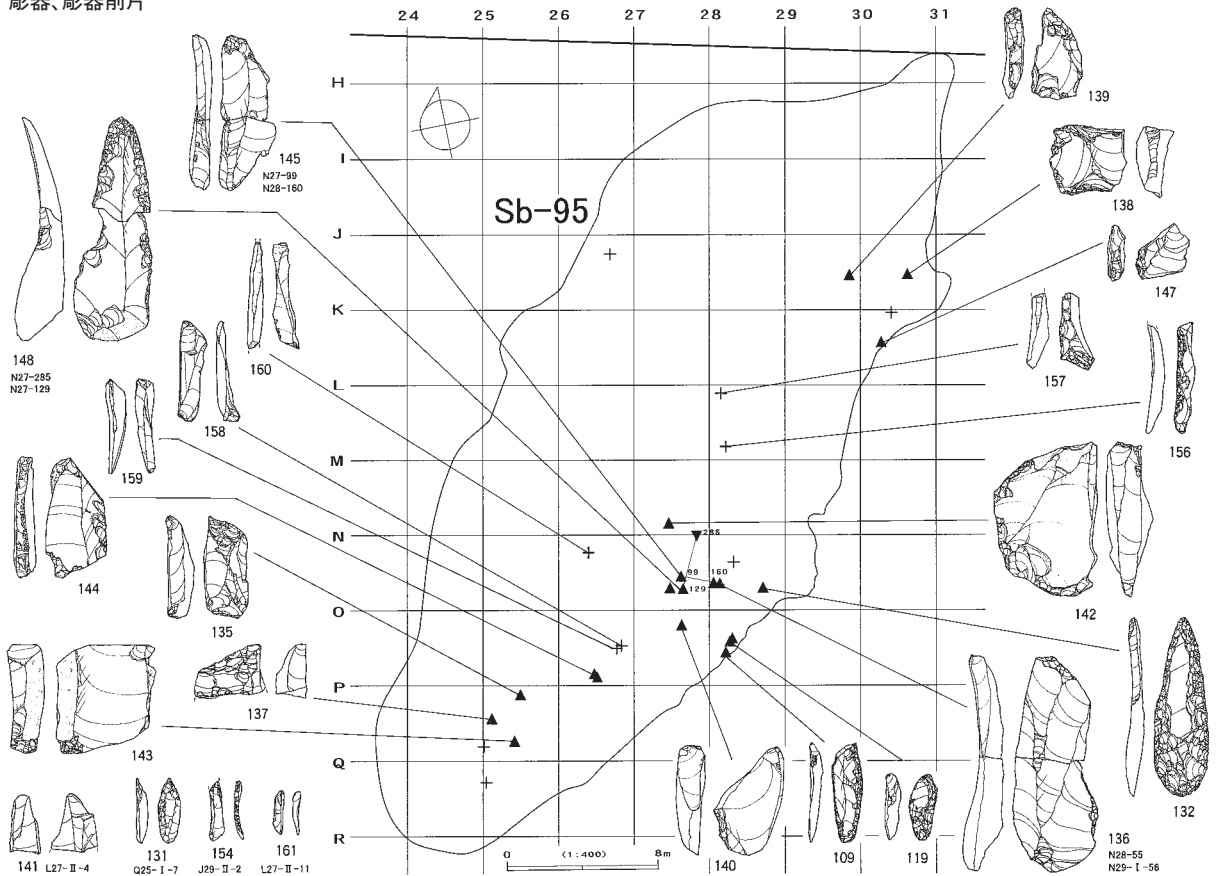

図III-269 Sb-95の遺物(3)

搔器

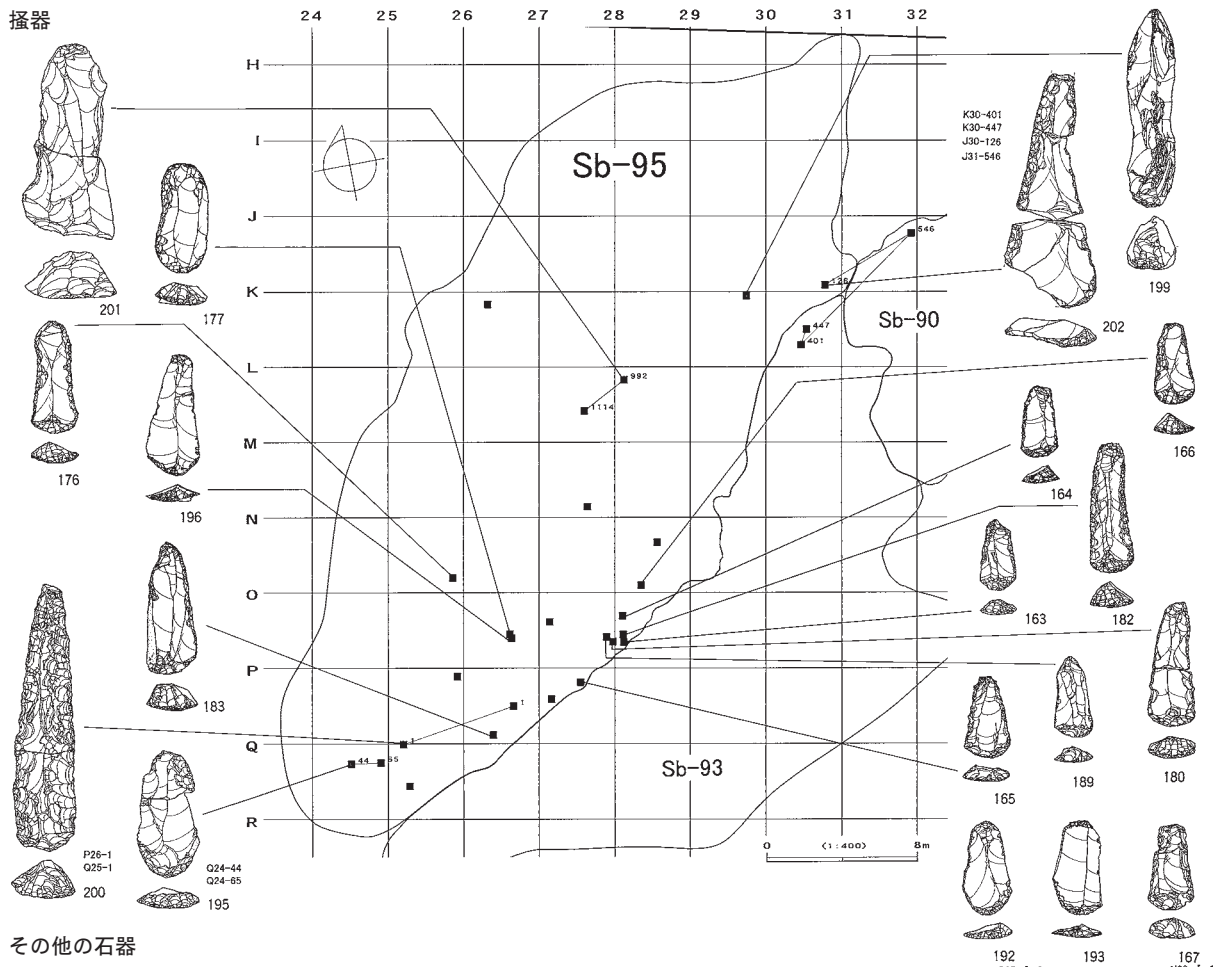

その他の石器

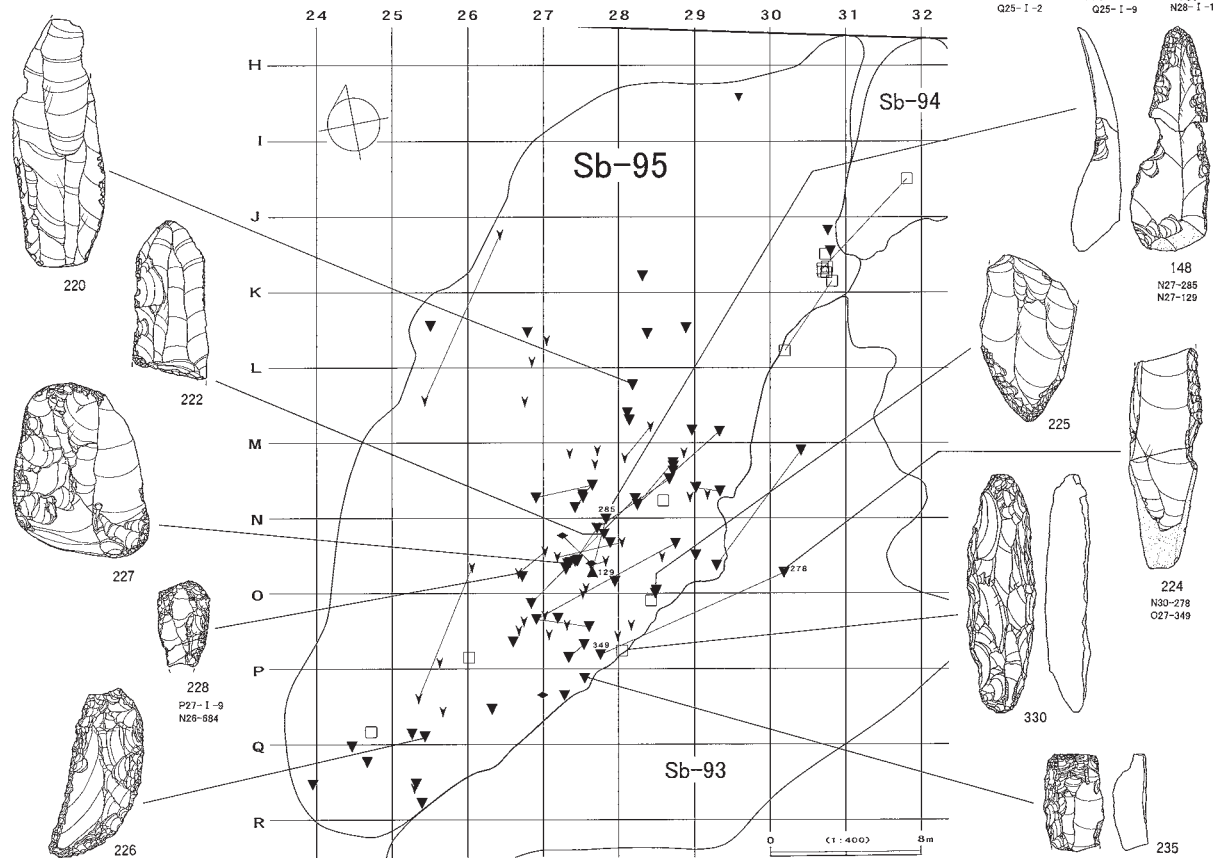

図Ⅲ-270 Sb-95の遺物(4)

舟底形石器

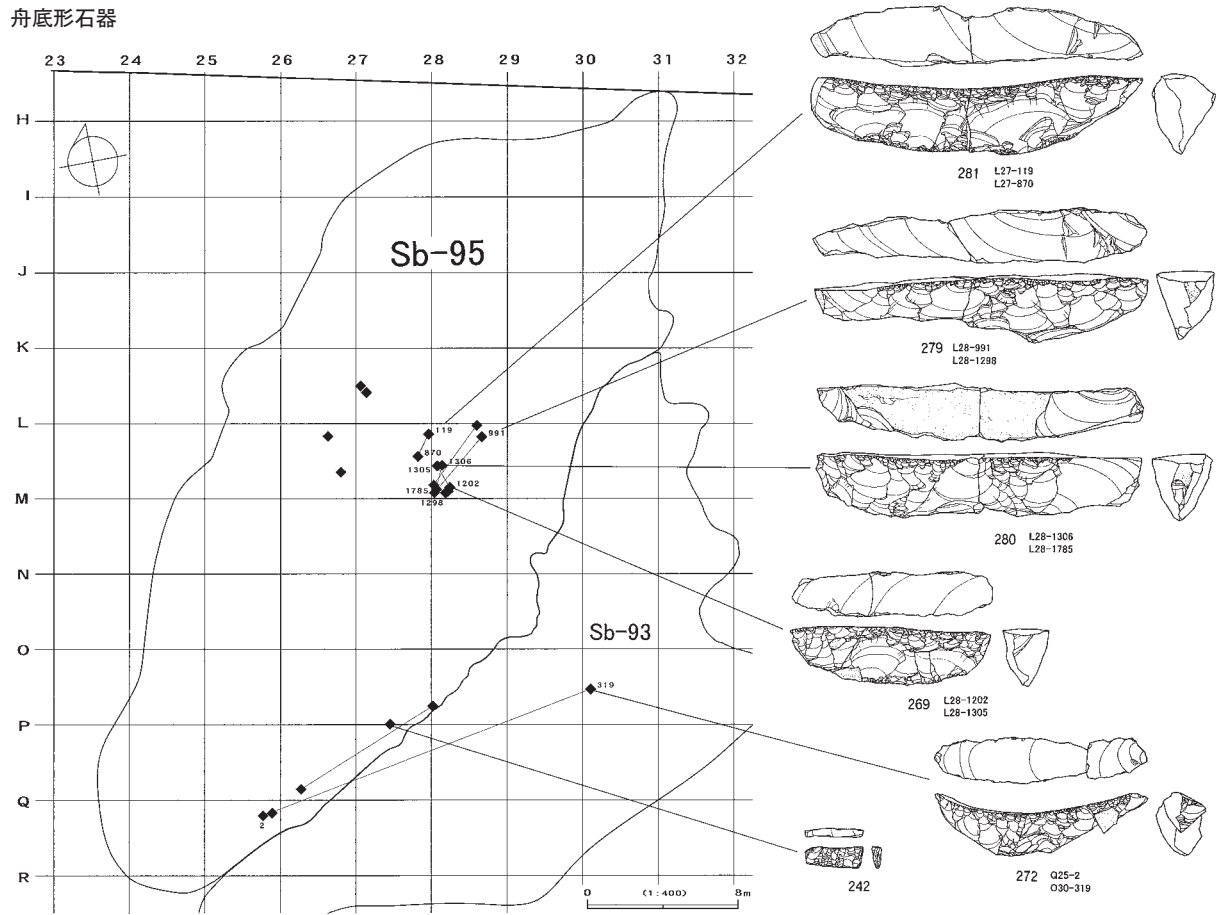

石刃核、石核

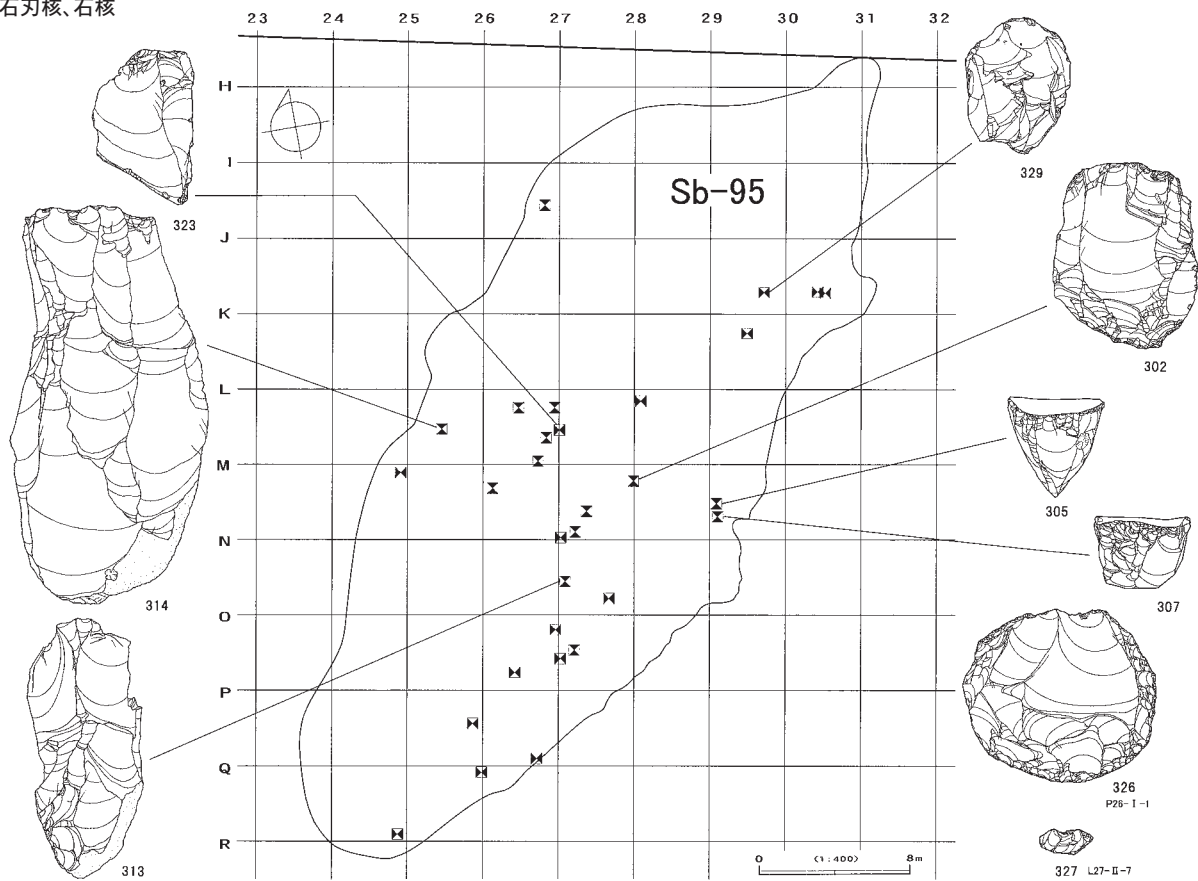

図Ⅲ-271 Sb-95の遺物(5)

I 区 (Sb-91~96)

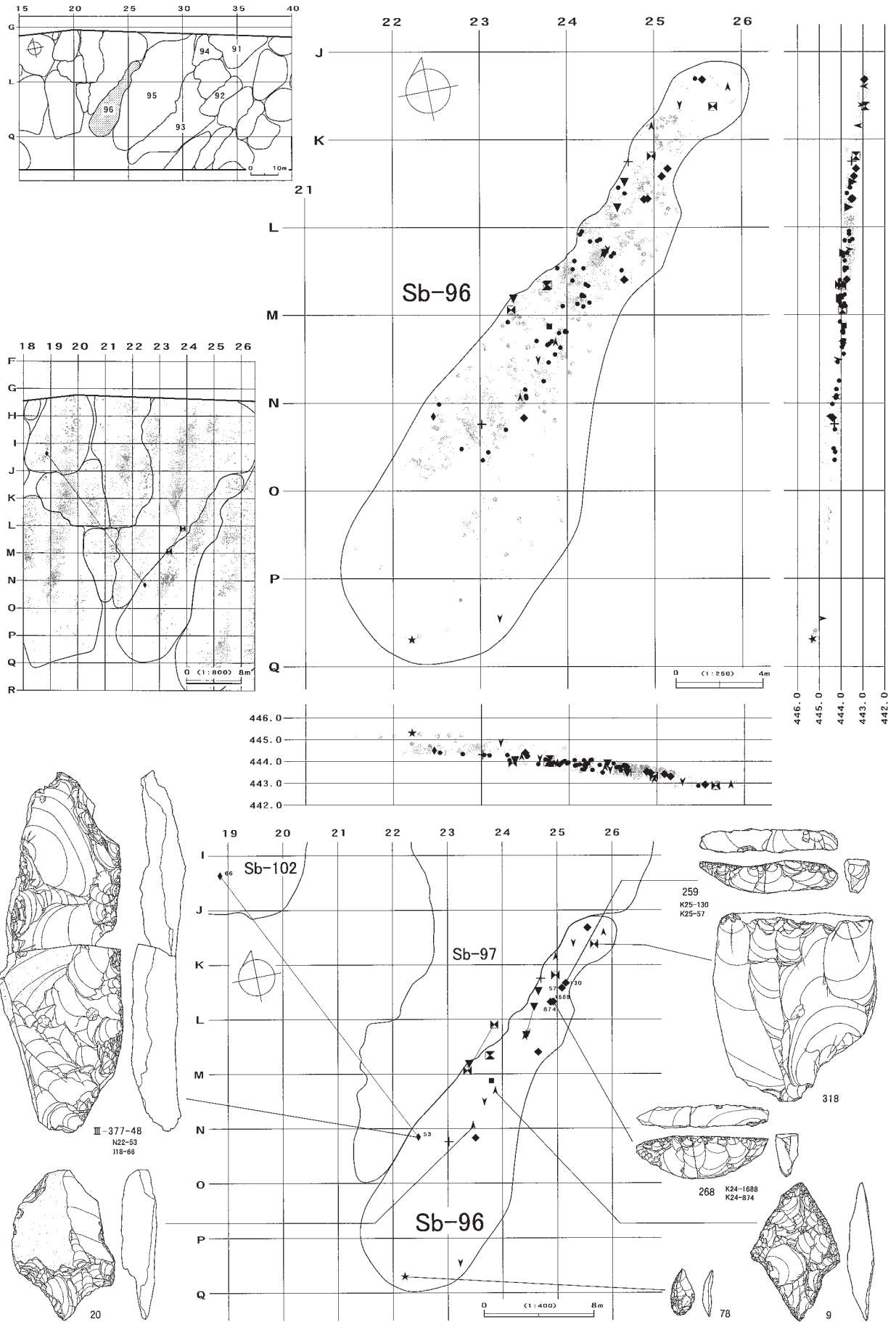

図Ⅲ-272 Sb-96の分布図・遺物

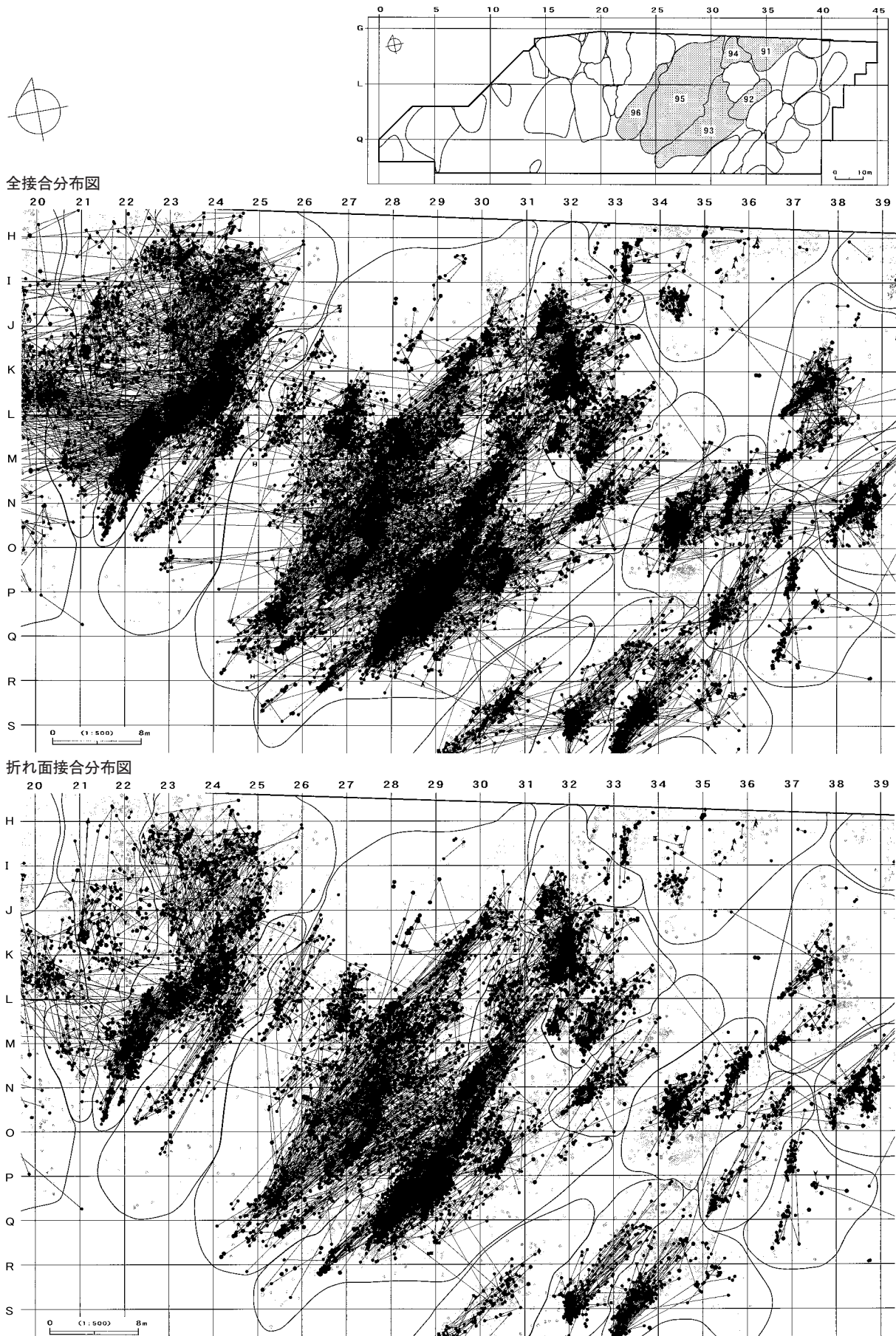

図Ⅲ-273 I区(Sb-91~96)の接合分布図

母岩740・接合3358

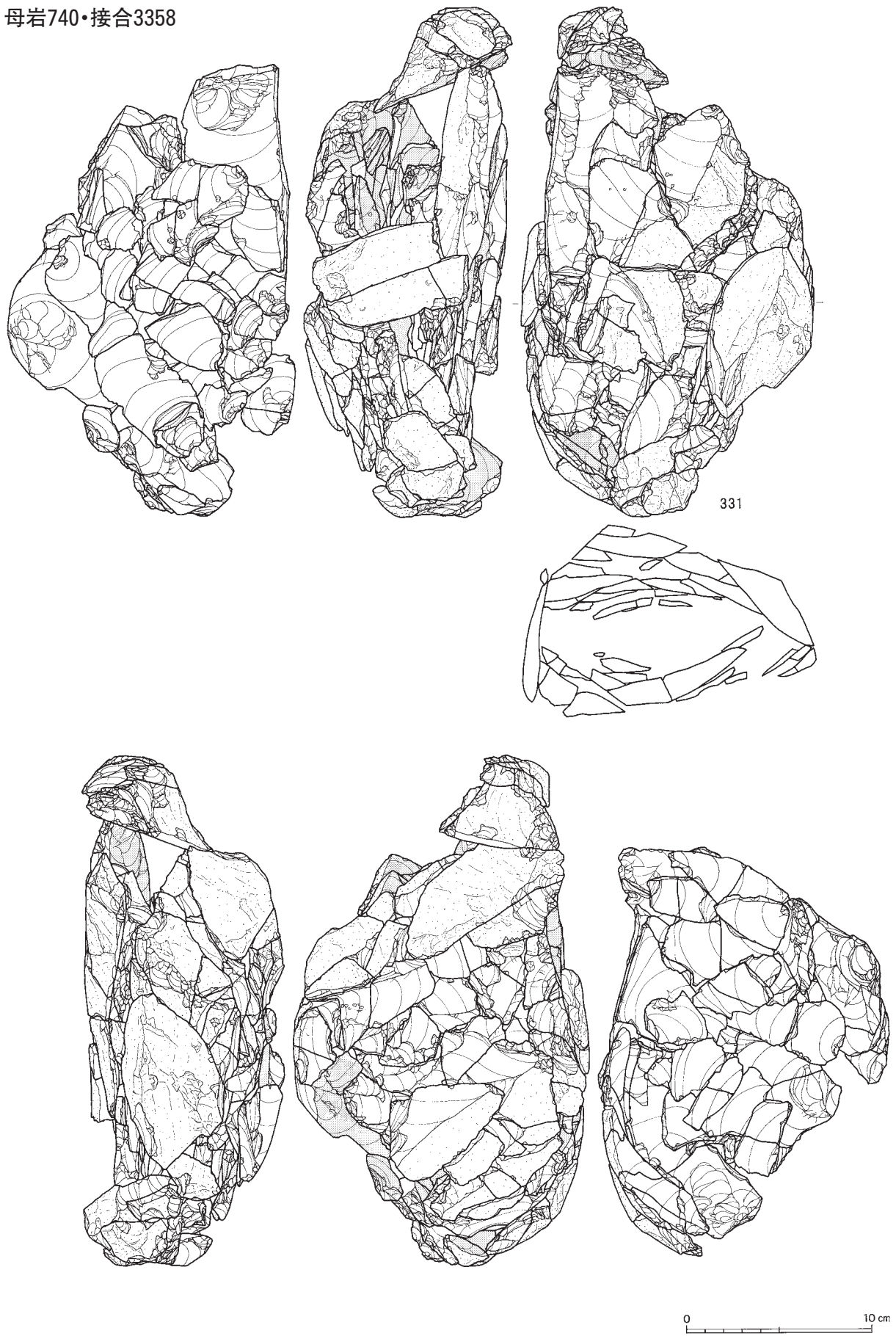

図Ⅲ-274 I区(Sb-91~96)の石器(39) 母岩740・接合3358(1)

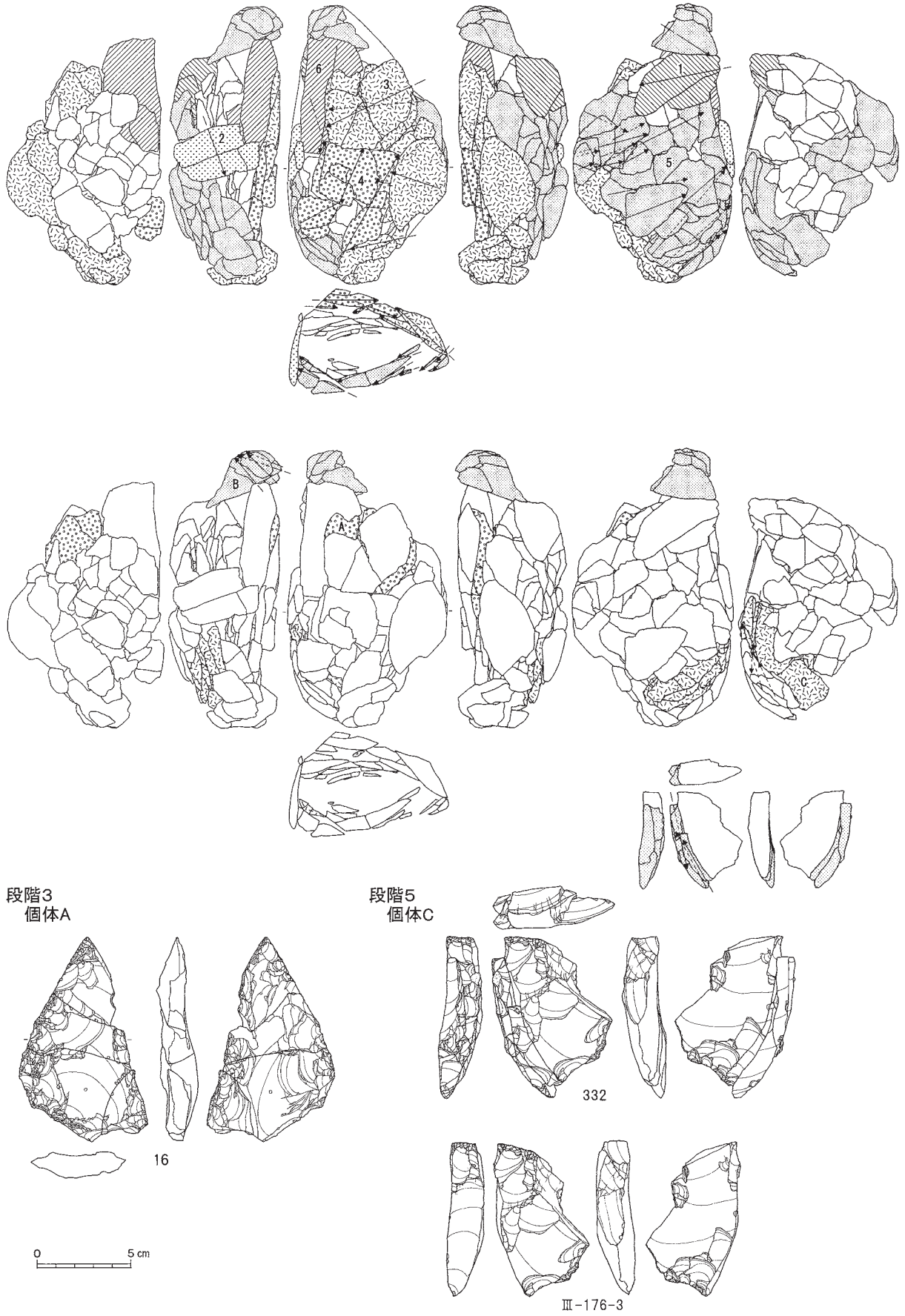

図Ⅲ-275 I区(Sb-91~96)の石器(40) 母岩740・接合3358(2)

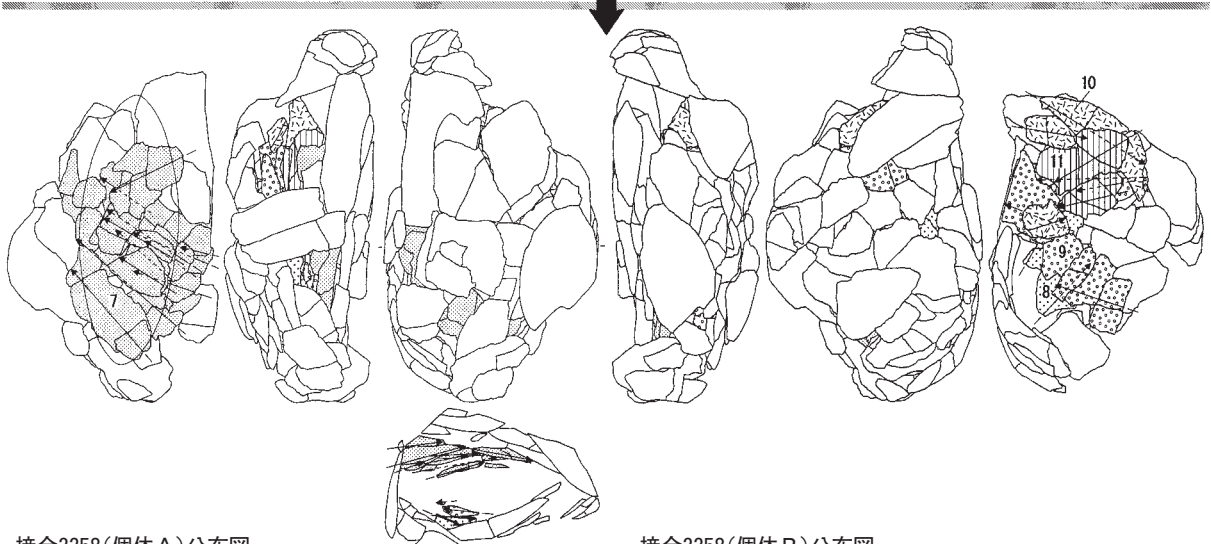

接合3358(個体A)分布図

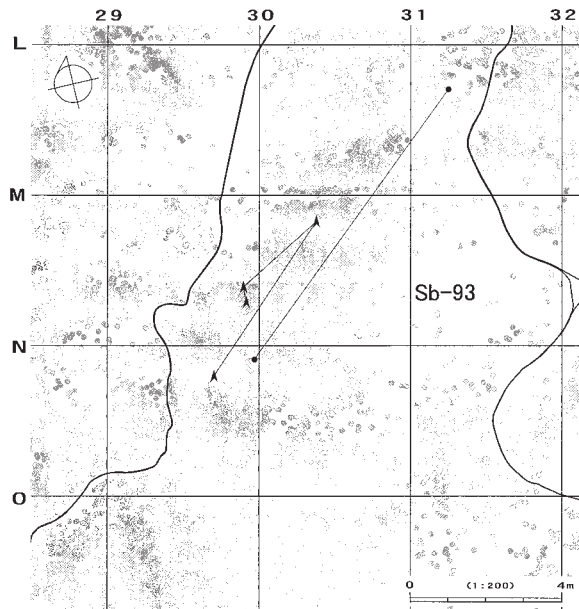

接合3358(個体B)分布図

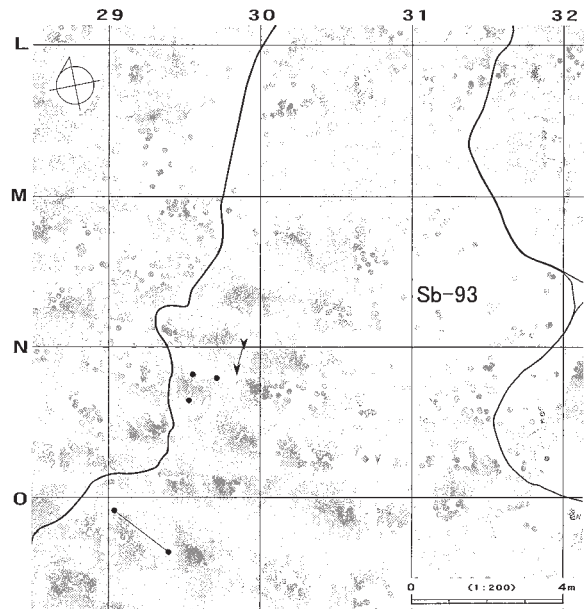

接合3358(個体C)分布図

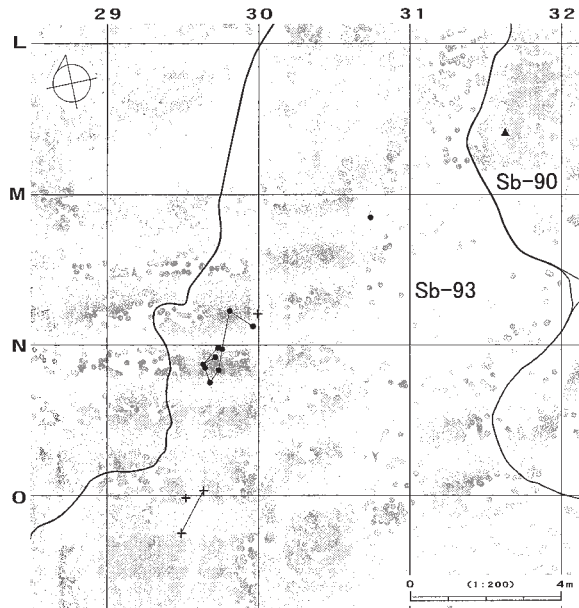

接合3358(個体A~C以外)分布図

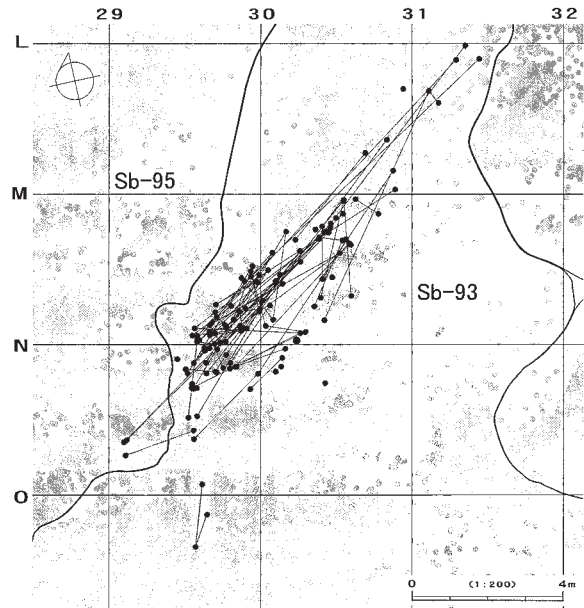

図Ⅲ-276 I区(Sb-91~96)の石器(41) 母岩740・接合3358(3)

母岩727・接合3285

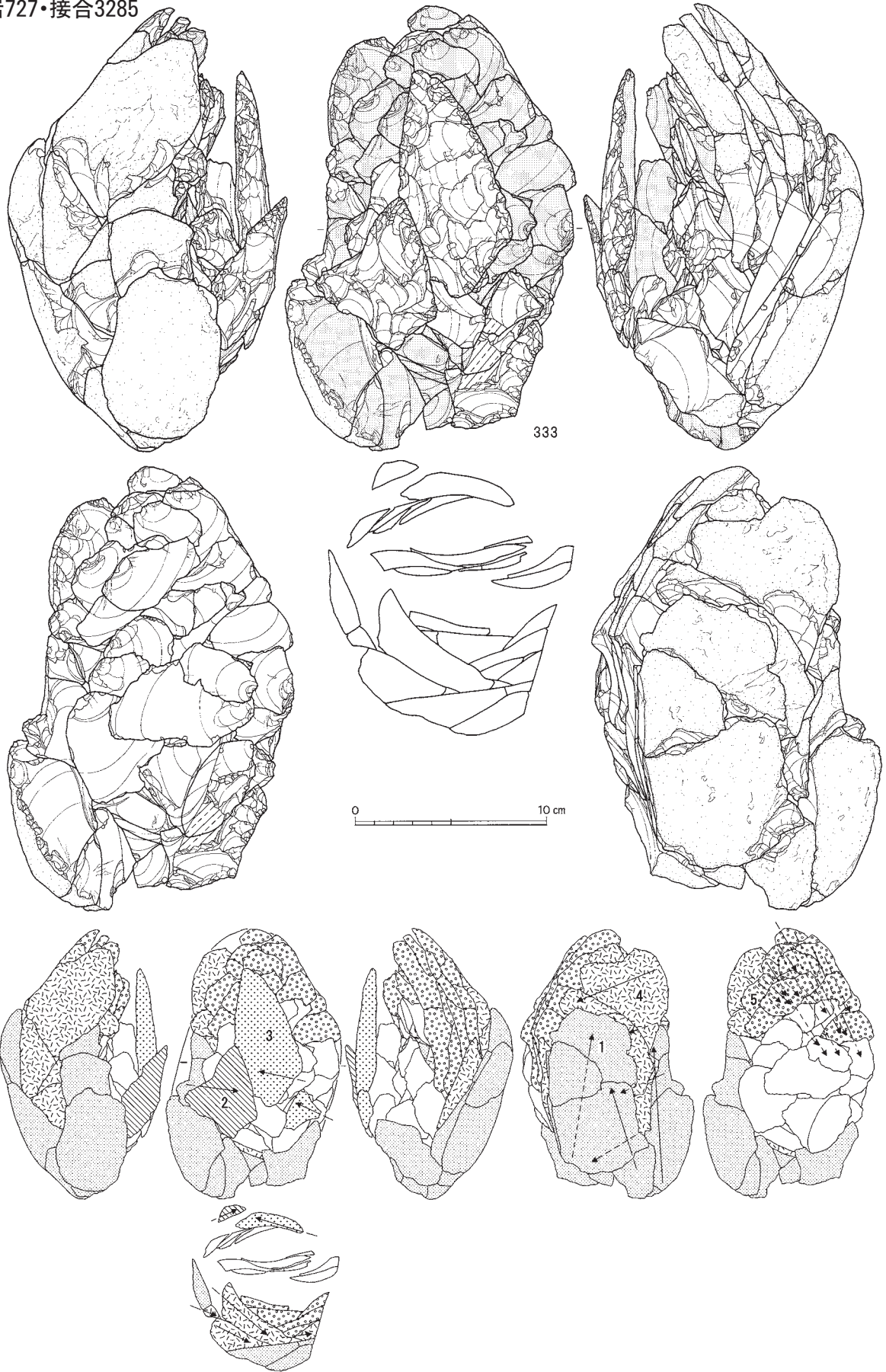

図Ⅲ-277 I区(Sb-91~96)の石器(42) 母岩727・接合3285(1)

段階2
個体A

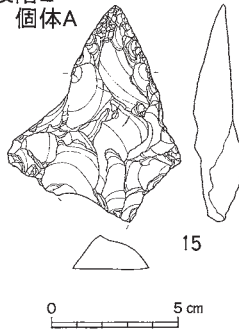

15

段階3
個体B

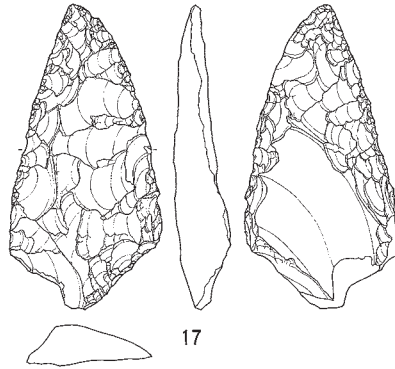

17

段階5

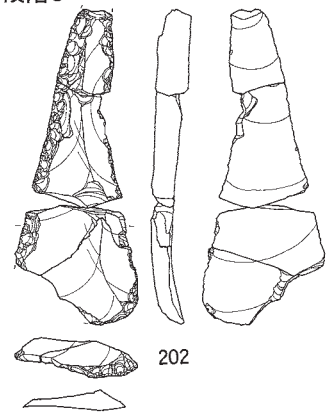

202

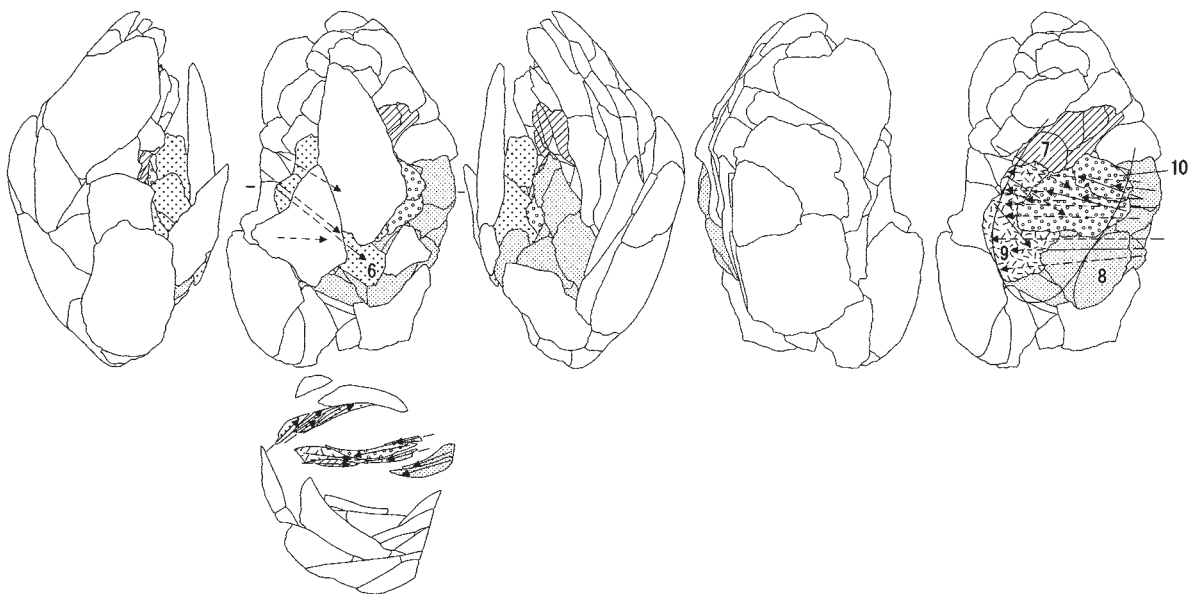
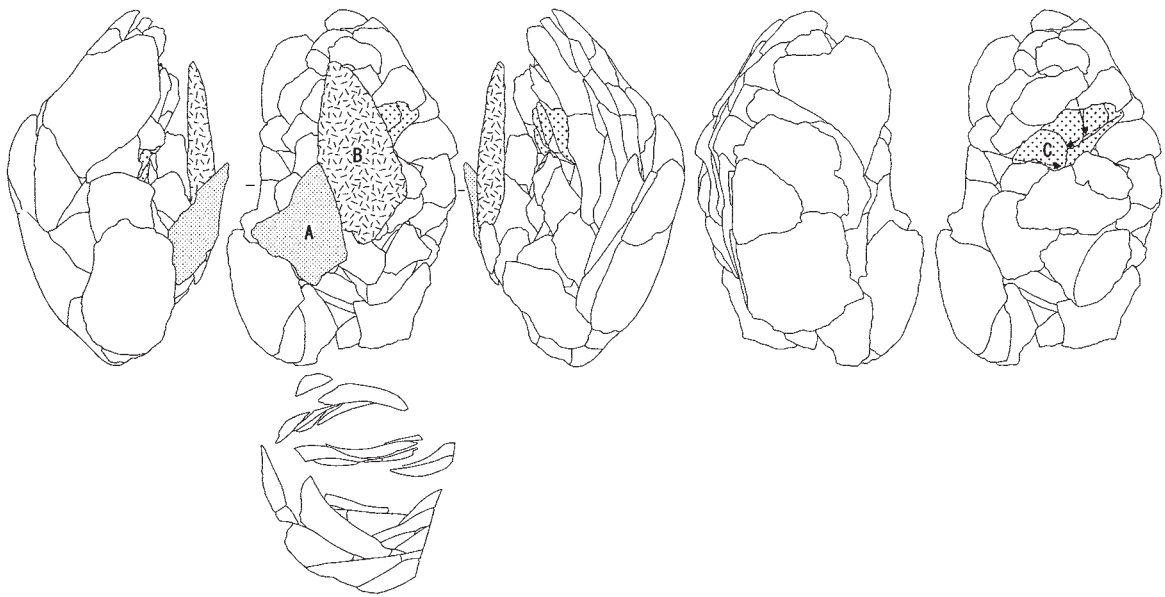

図Ⅲ-278 I区(Sb-91~96)の石器(43) 母岩727・接合3285(2)

接合3285(個体A(▲)、B(▲)、C(●)分布図

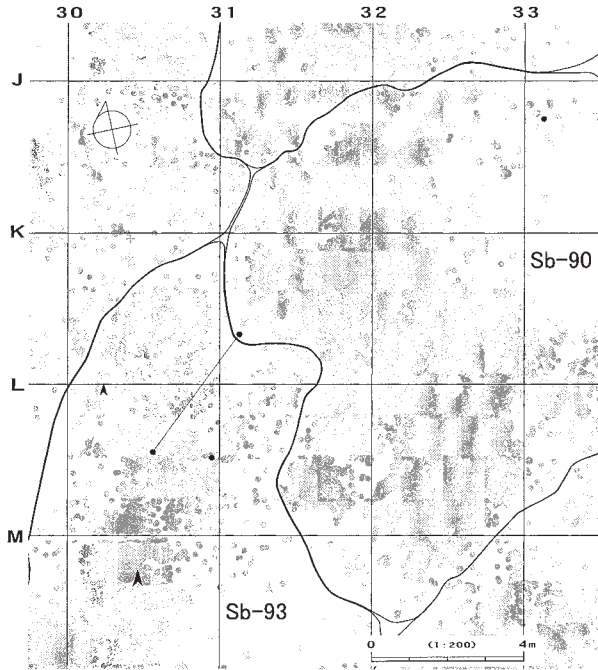

接合3285(個体A~C以外)分布図

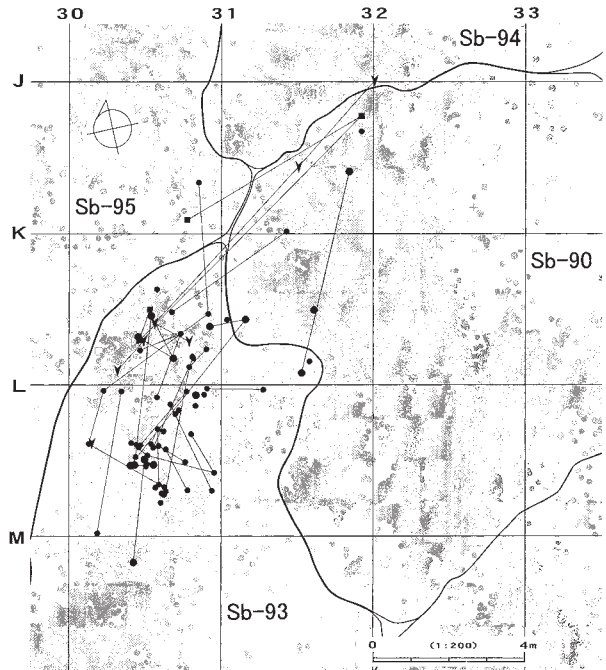

母岩783・接合3501

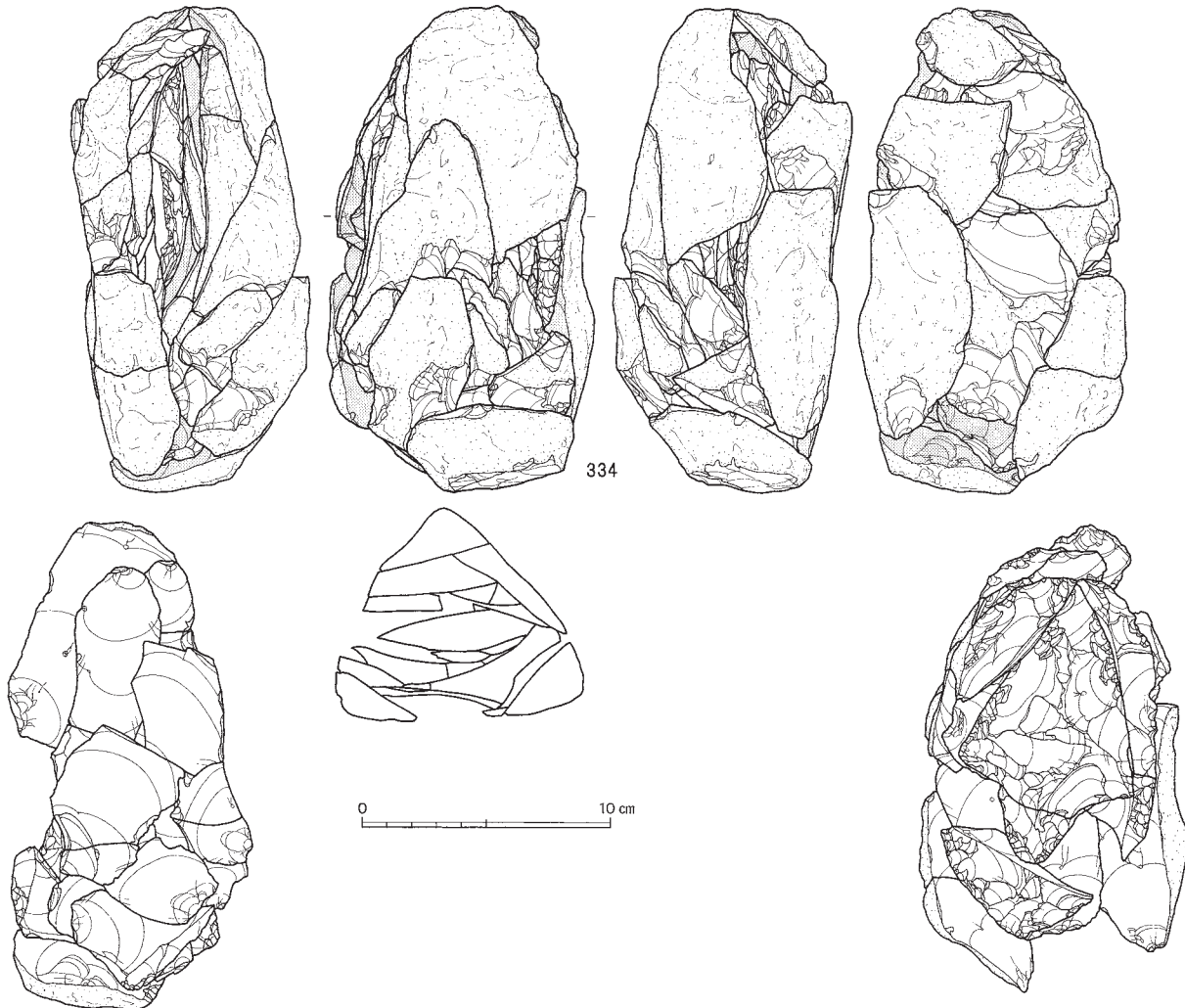

図Ⅲ-279 I区(Sb-91~96)の石器(44) 母岩727・接合3285(3)、母岩783・接合3501(1)

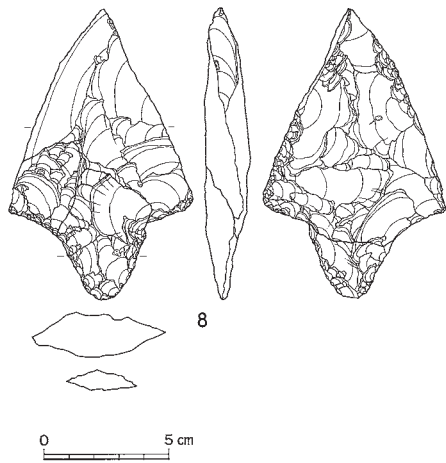
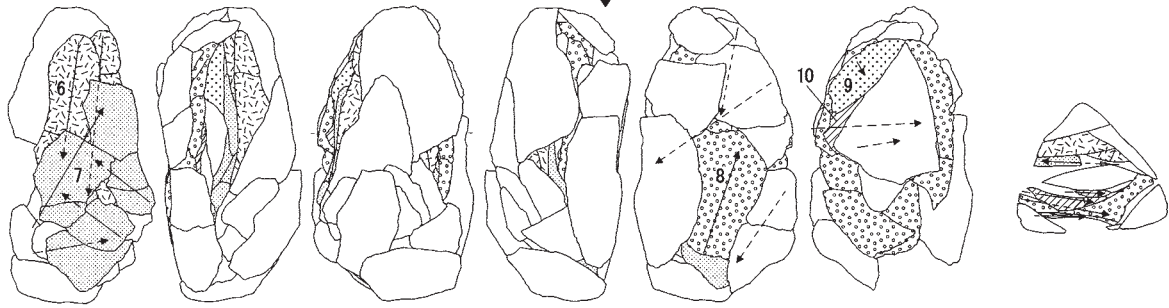
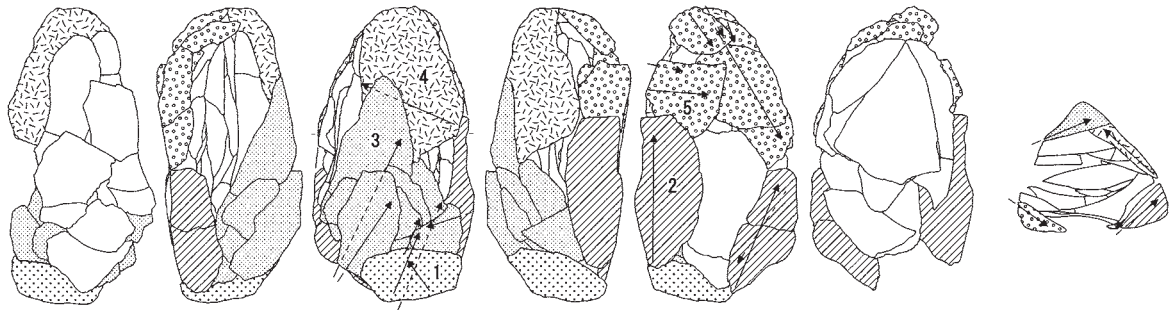

接合3501分布図

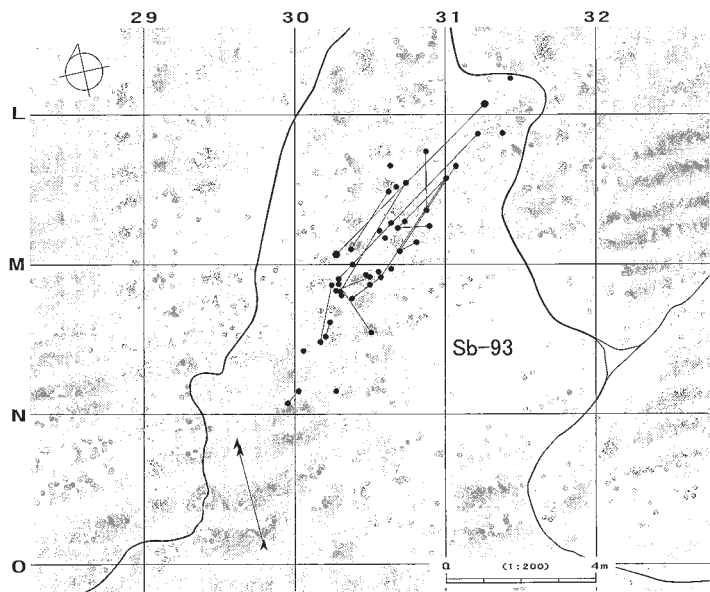
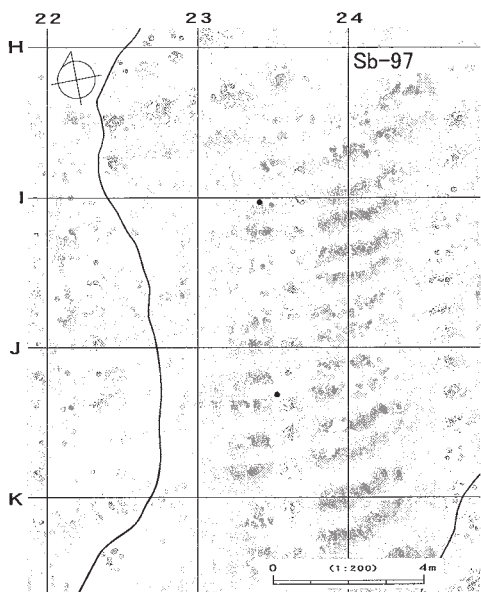
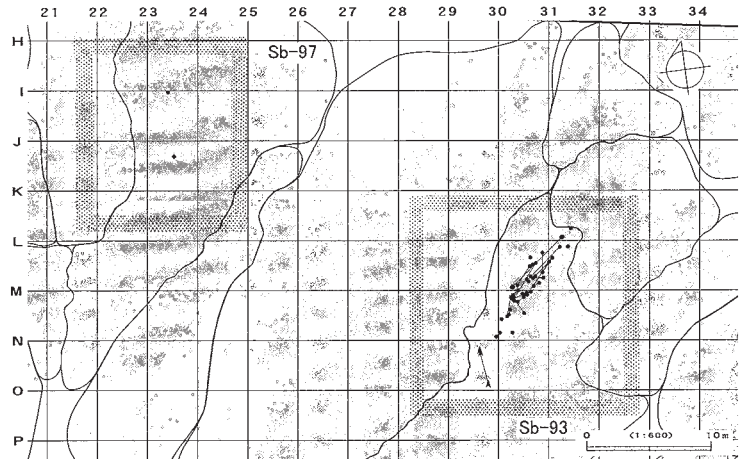

図Ⅲ-280 I区(Sb-91~96)の石器(45) 母岩783・接合3501(2)

母岩1067・接合4433

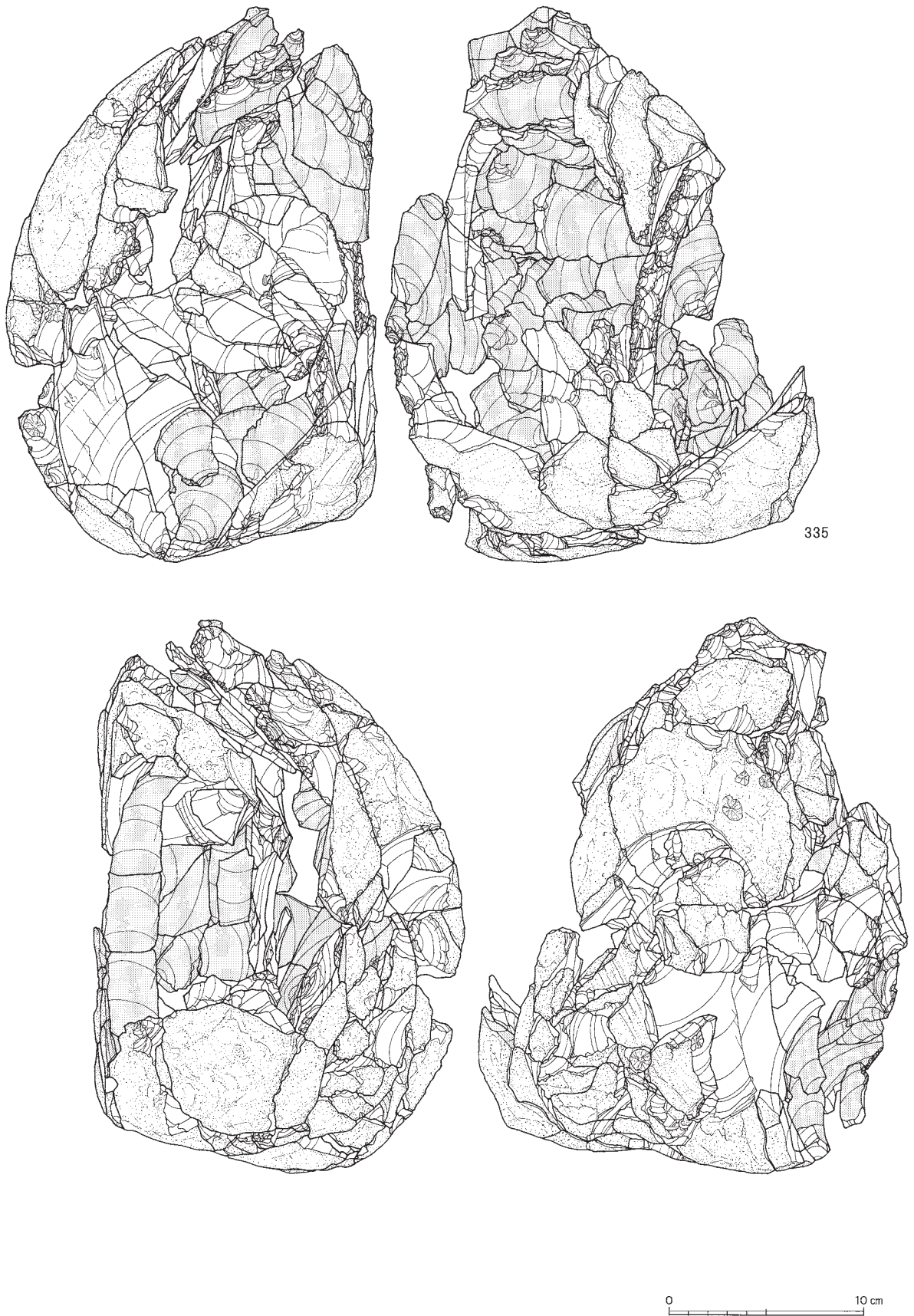

図Ⅲ-281 I区(Sb-91~96)の石器(46) 母岩1067・接合4433(1)

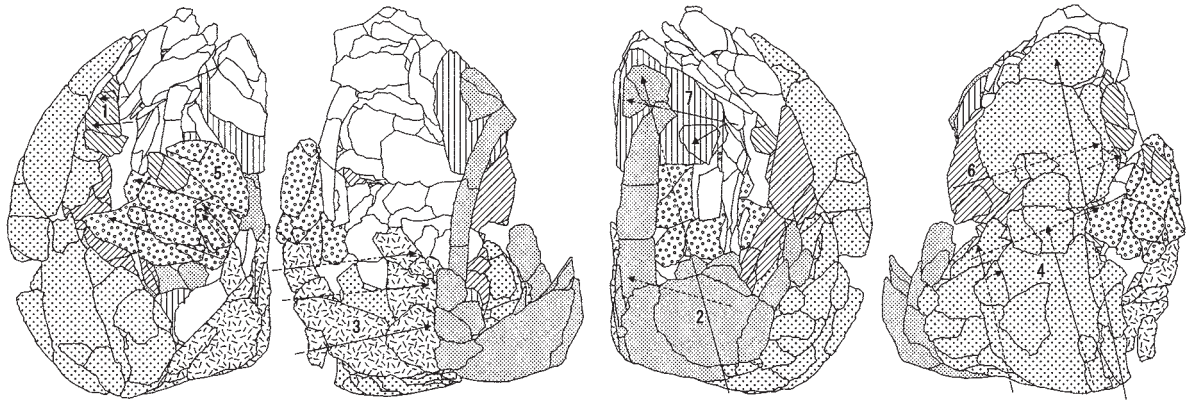

段階2 個体A

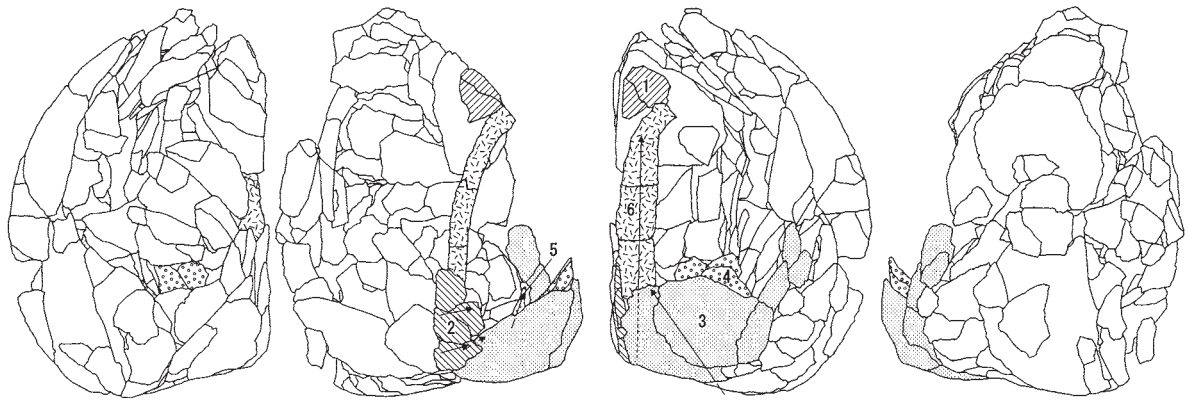

段階2 個体a

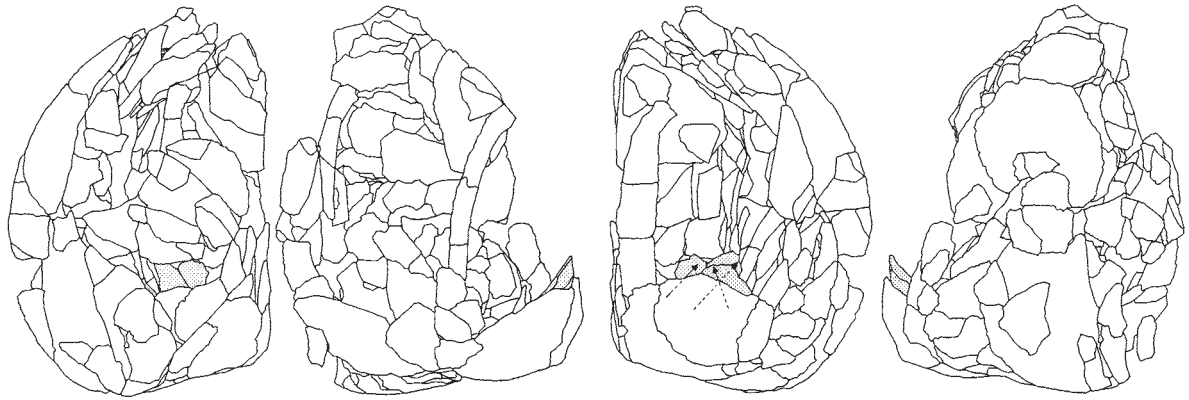

段階4 個体B

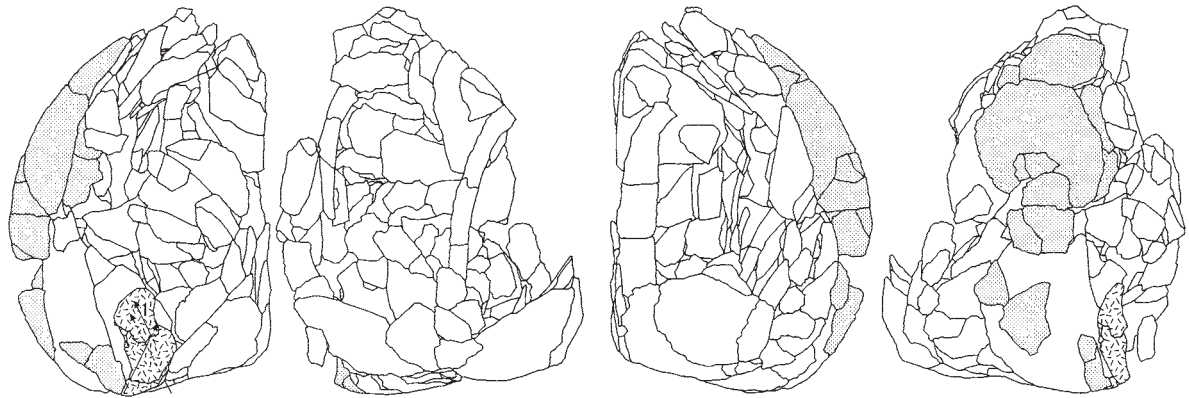

図Ⅲ-282 I区(Sb-91~96)の石器(47) 母岩1067・接合4433(2)

個体C

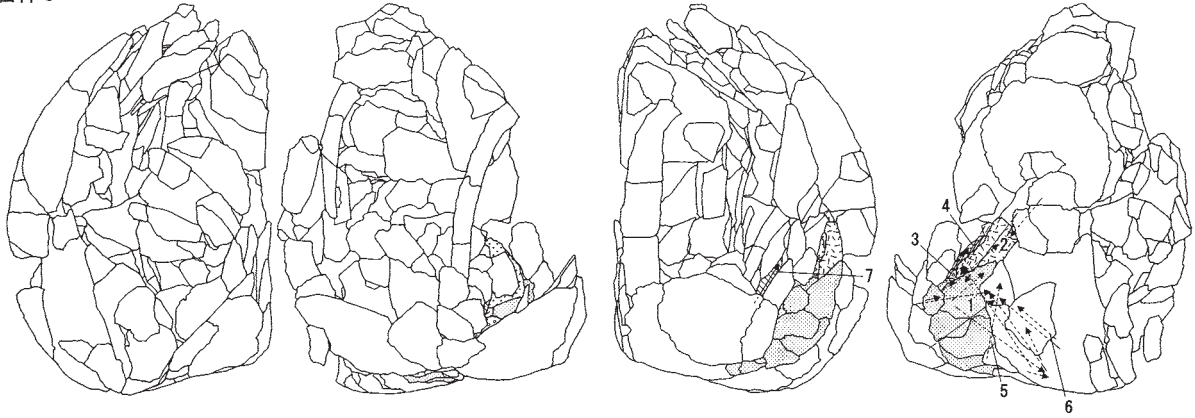

段階8~14

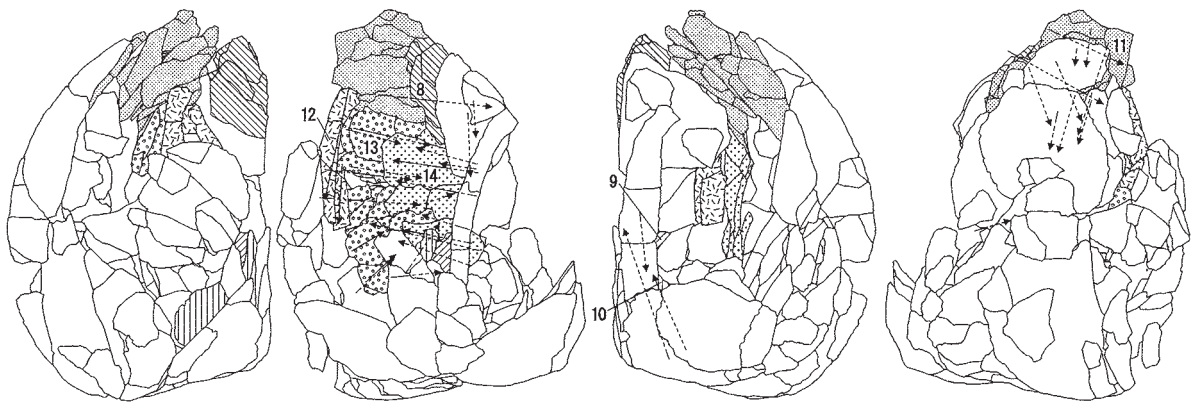

段階8 個体D

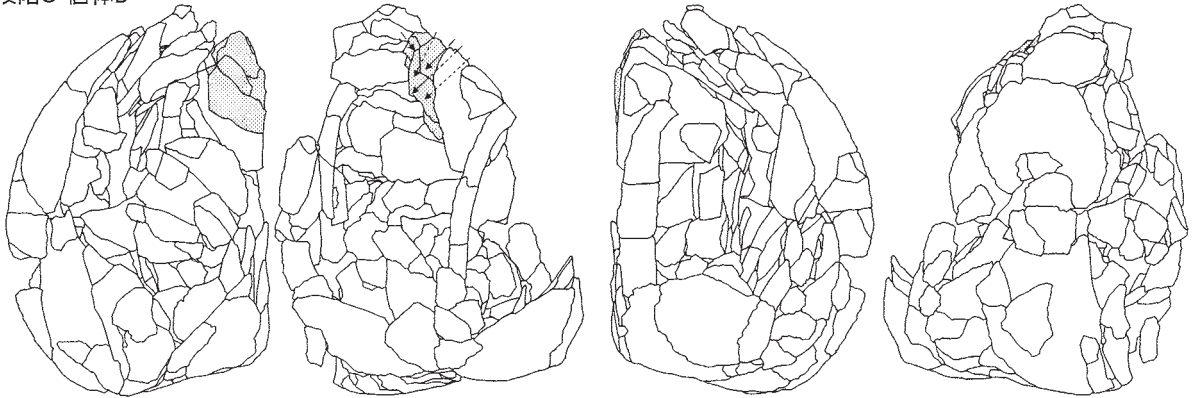

段階11 個体E

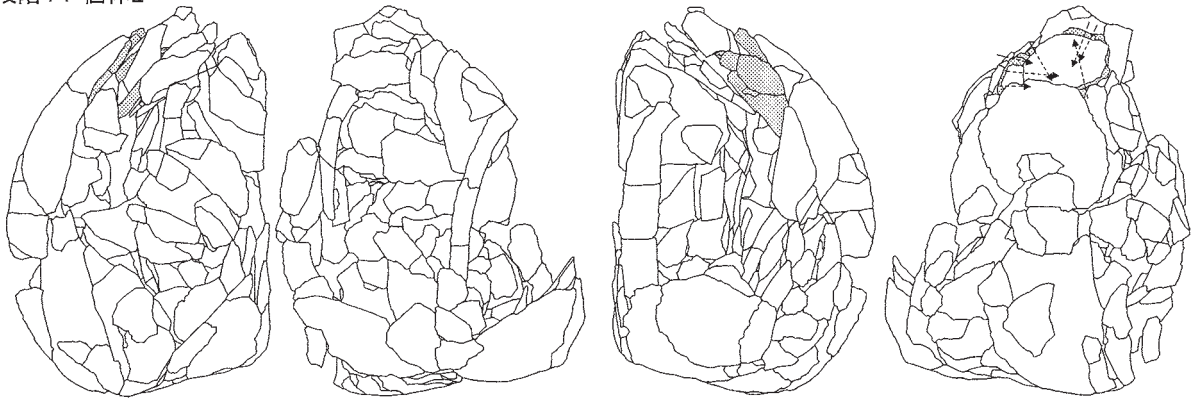

図Ⅲ-283 I区(Sb-91~96)の石器(48) 母岩1067・接合4433(3)

個体E

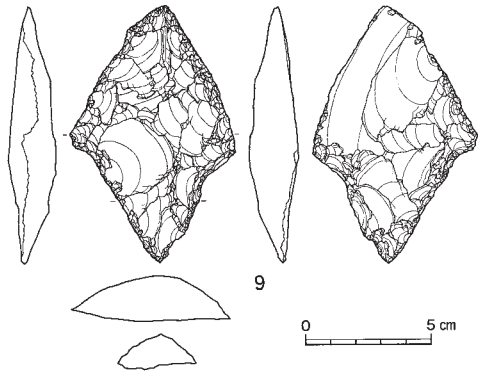

母岩1067・接合4437

個体A

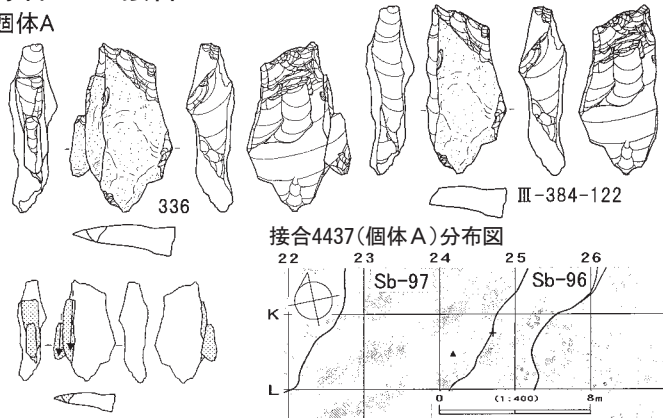

接合4433(個体A)分布図

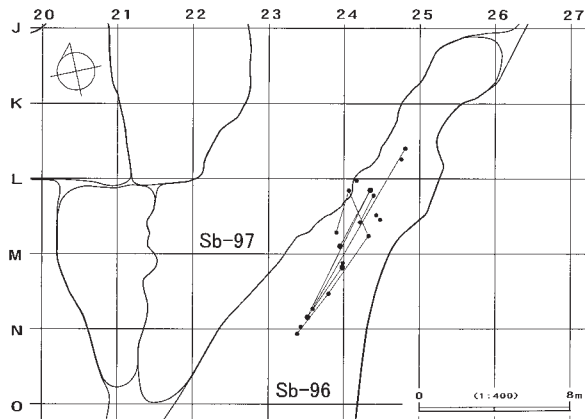

接合4433(個体a)分布図

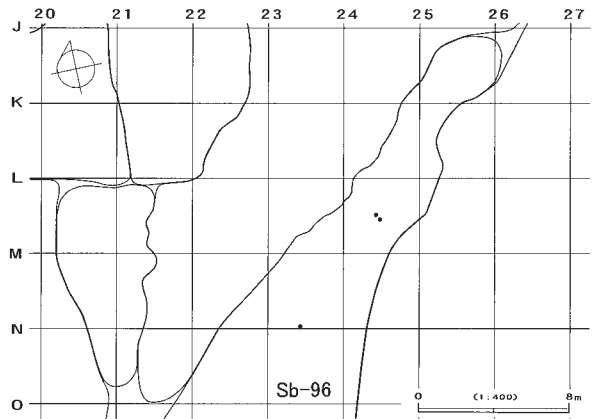

接合4433(個体B)分布図

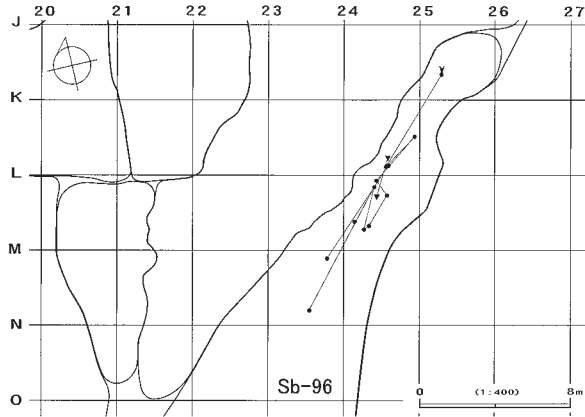

接合4433(個体C)分布図

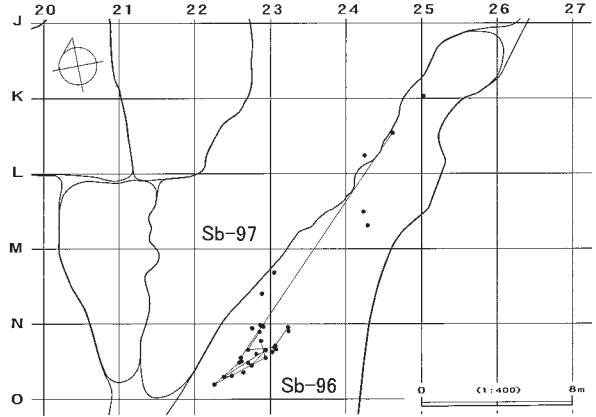

接合4433(個体D)分布図

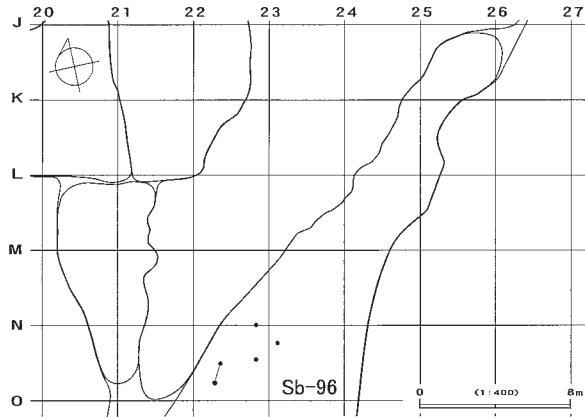

接合4433(個体E)分布図

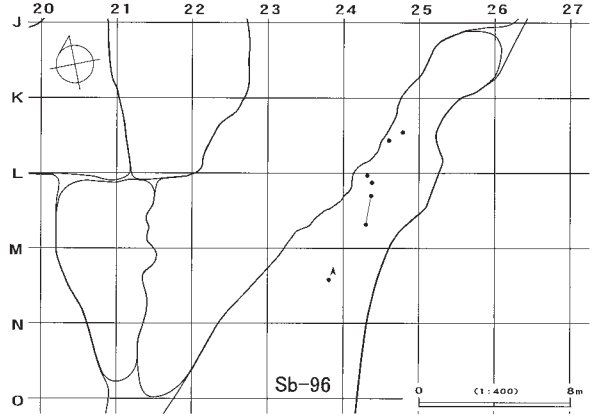

図Ⅲ-284 I区(Sb-91~96)の石器(49) 母岩1067・接合4433(4)、母岩1067・接合4437

接合4433(全体)分布図

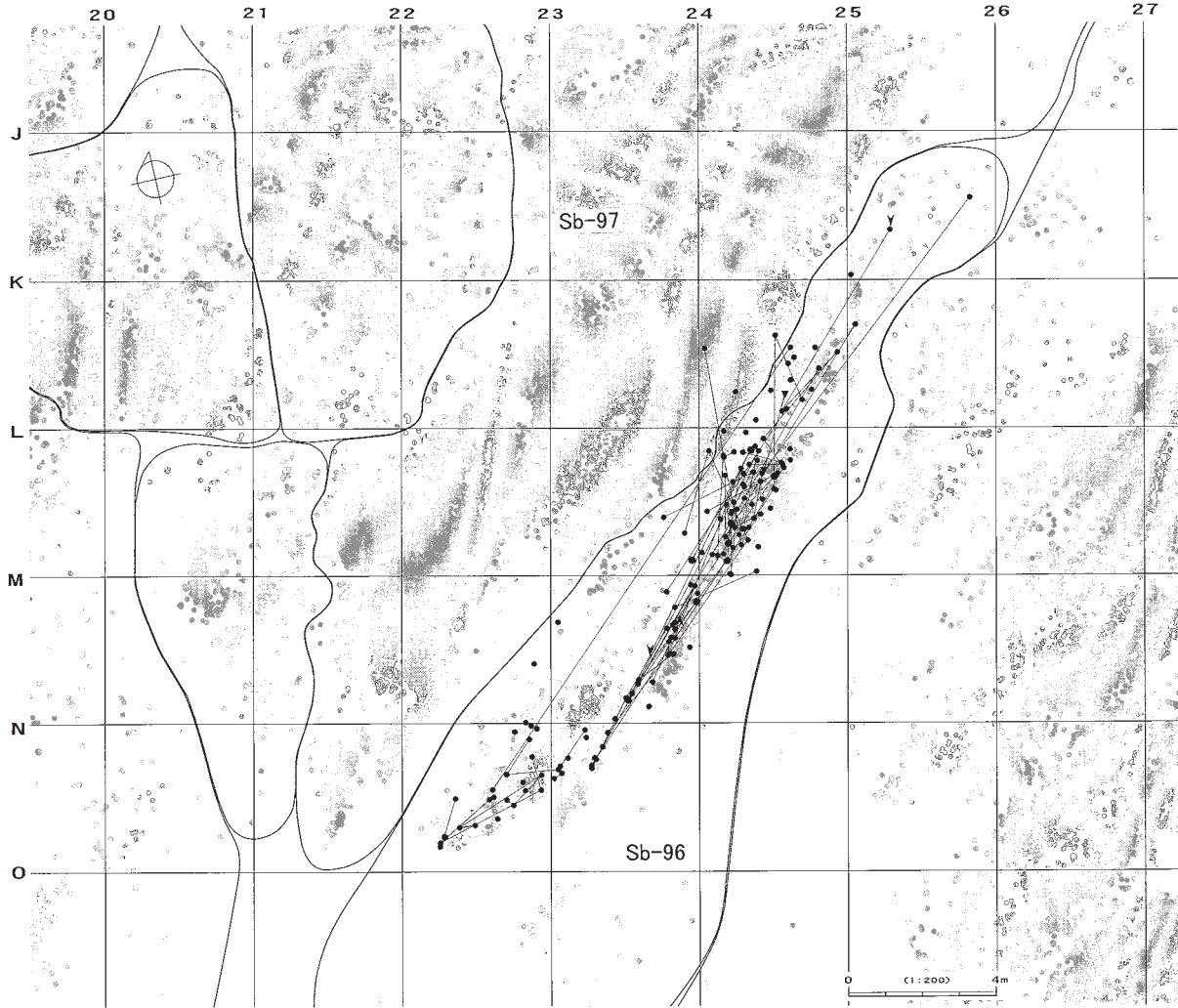

母岩786・接合3509

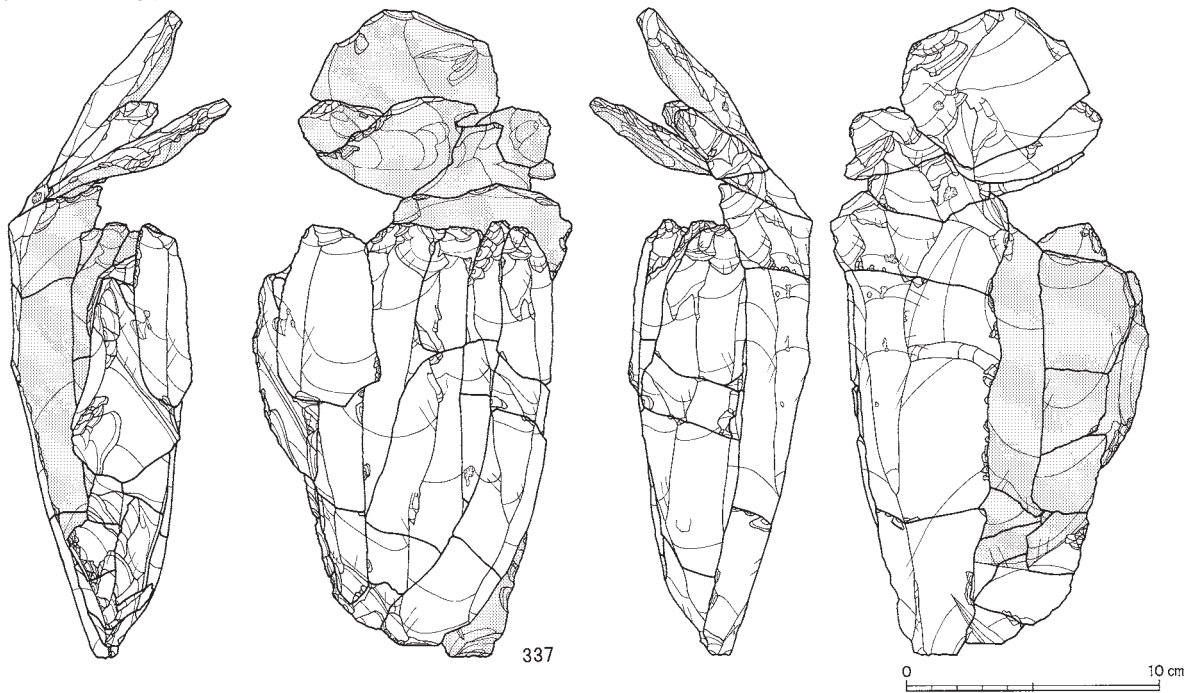

図Ⅲ-285 I区(Sb-91~96)の石器(50) 母岩1067・接合4433(5)、母岩786・接合3509(1)

I区(Sb-91~96)

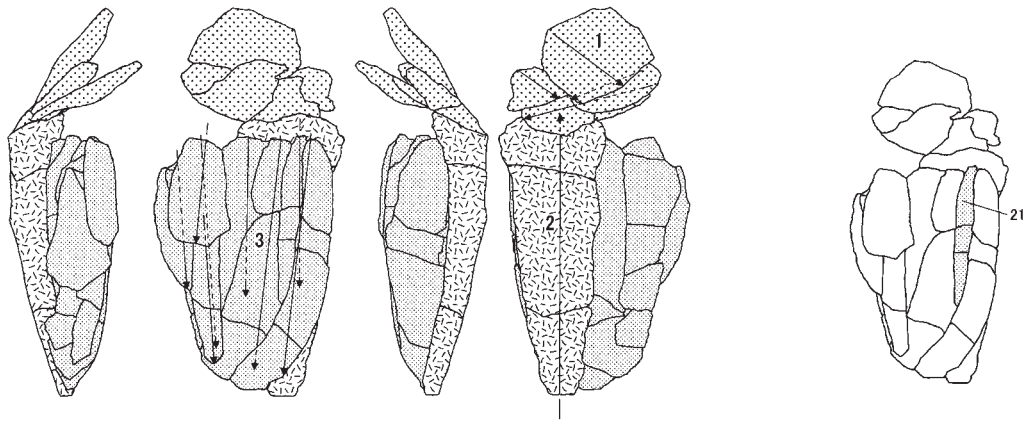

段階3

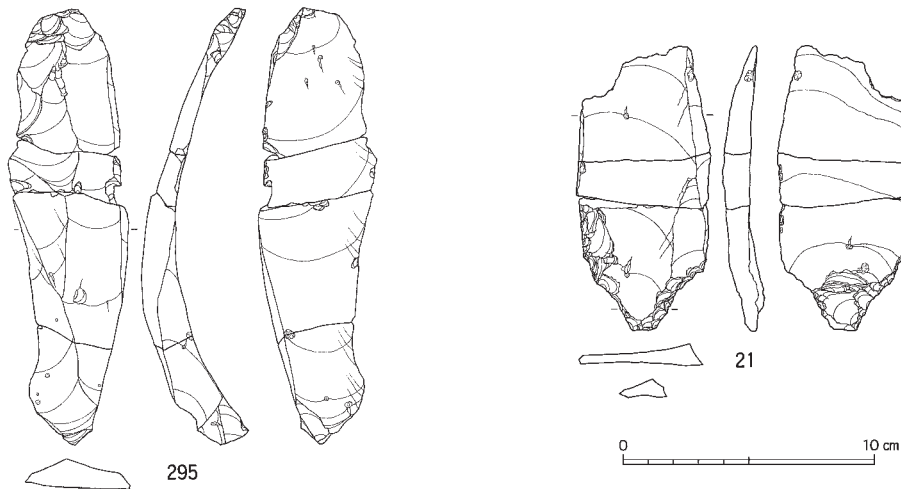

接合3509分布図

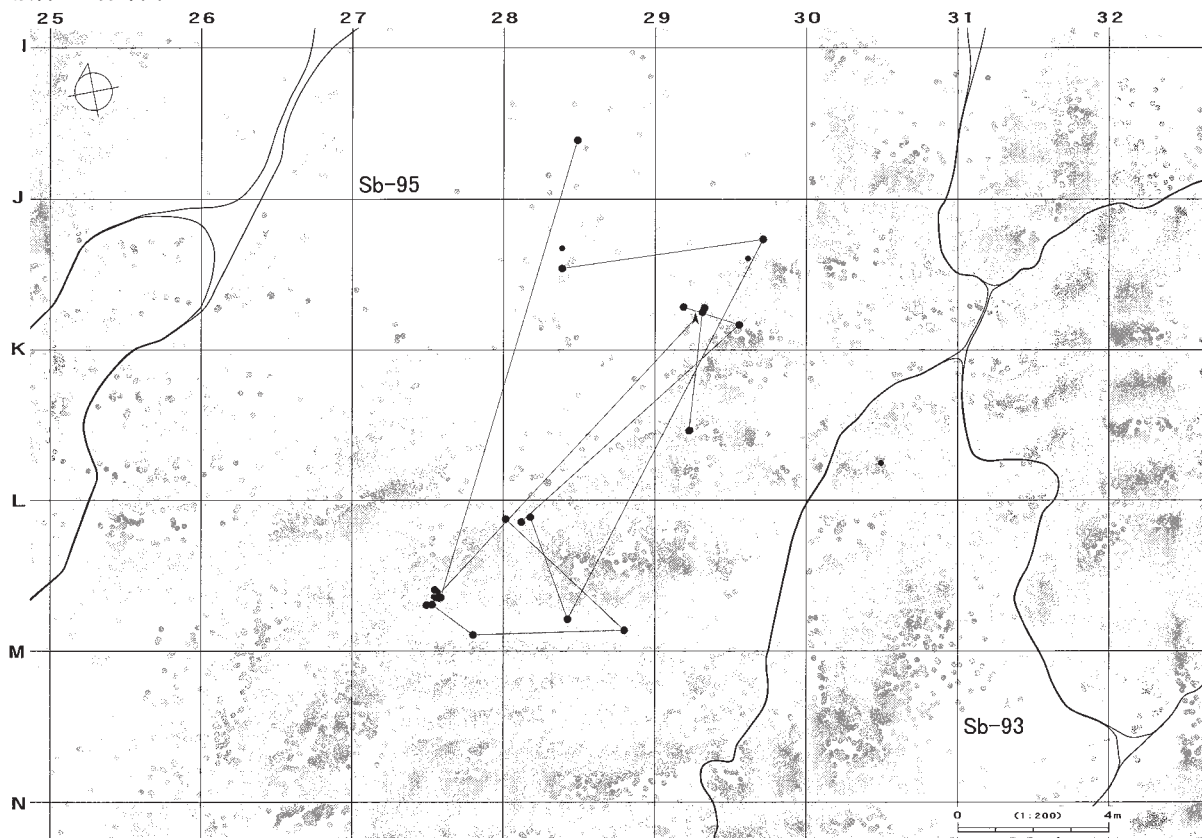

図Ⅲ-286 I区(Sb-91~96)の石器(51) 母岩786・接合3509(2)

母岩876・接合3849

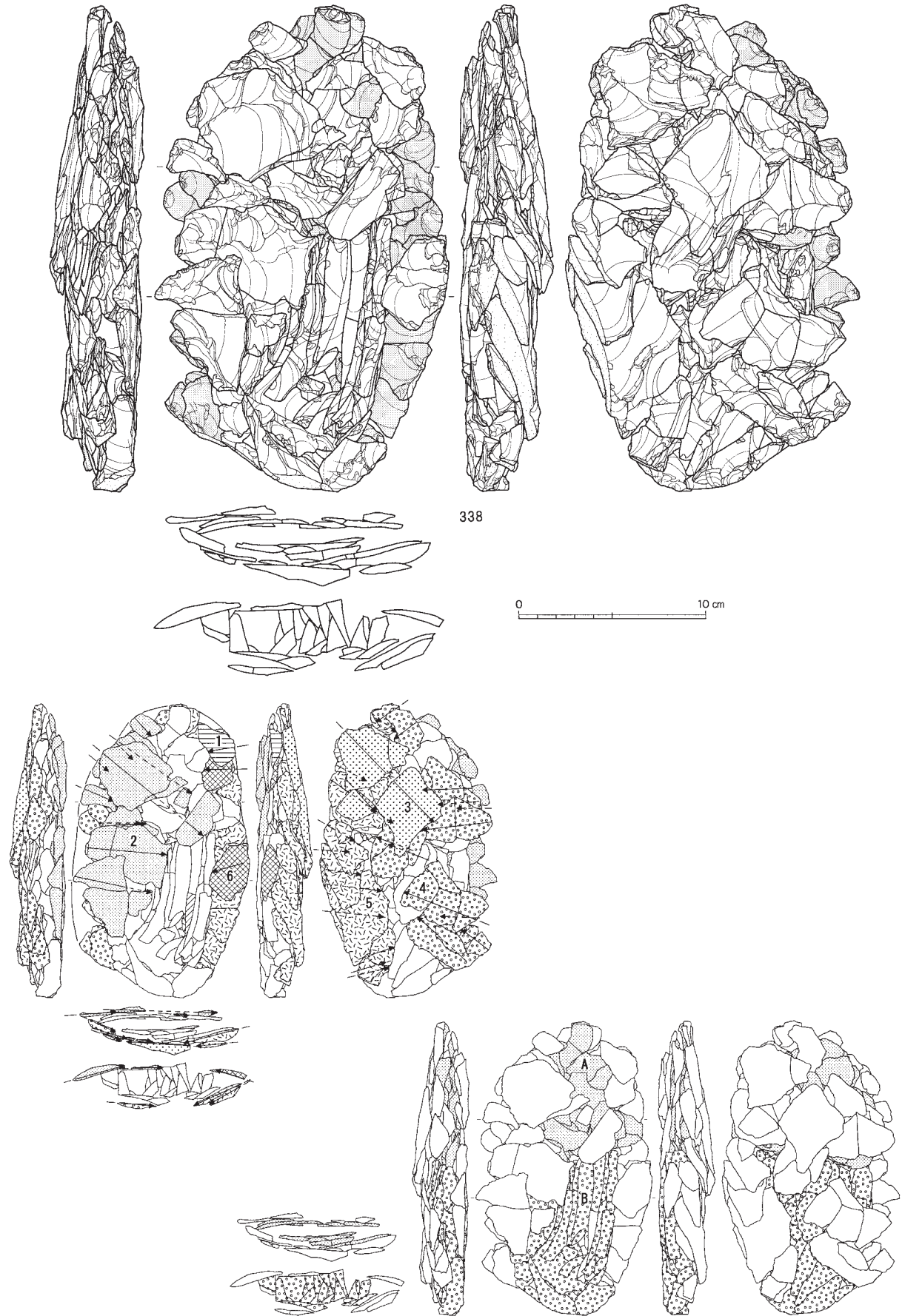

図Ⅲ-287 I区(Sb-91~96)の石器(52) 母岩876・接合3849(1)

個体A

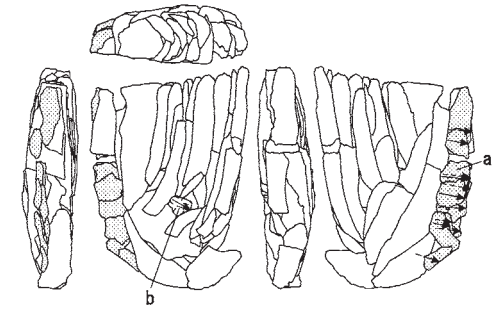

B-段階2

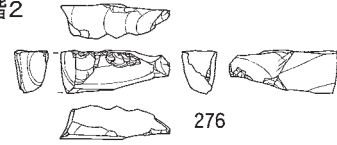

B-段階3

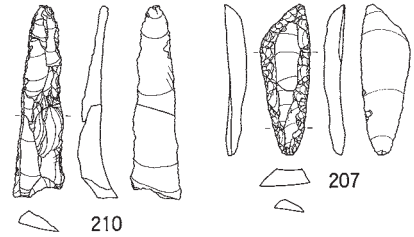

個体B

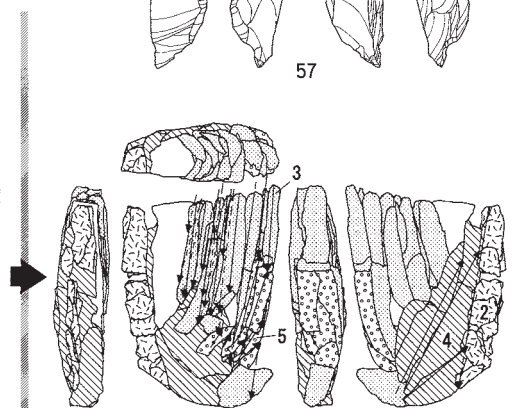
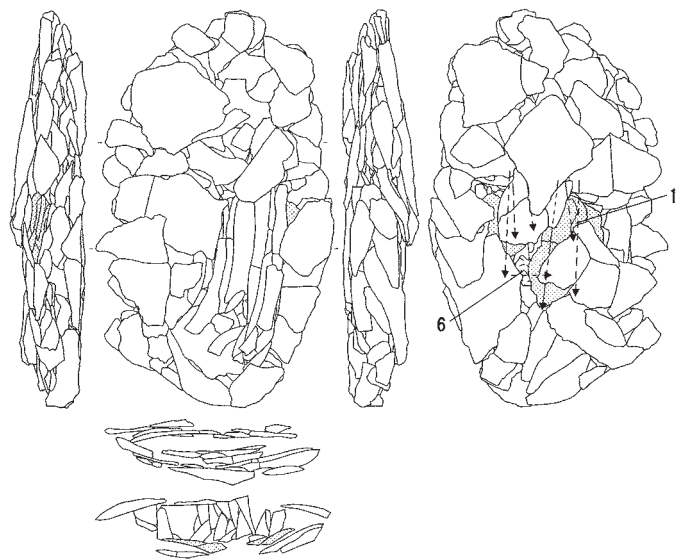
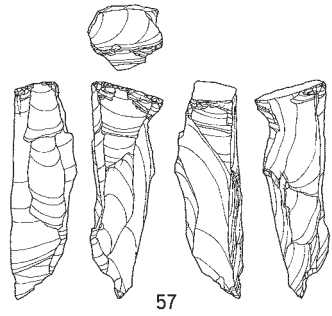
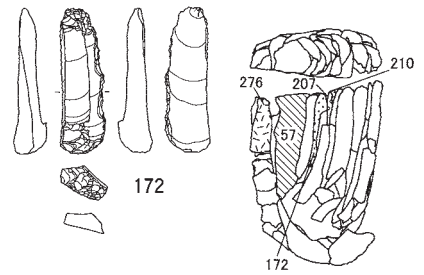
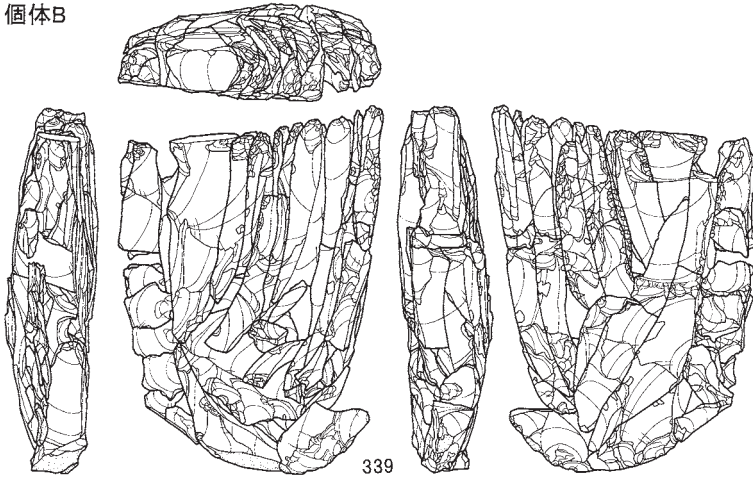

図III-288 I区(Sb-91~96)の石器(53) 母岩876・接合3849(2)

接合3849(段階1~6)分布図

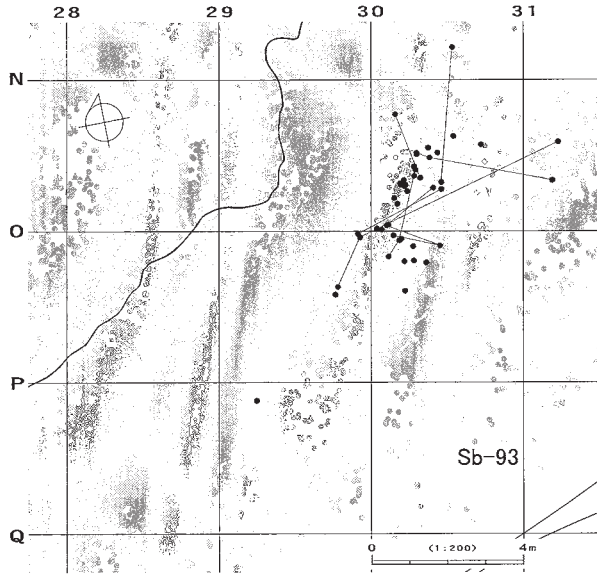

接合3849(個体A)分布図

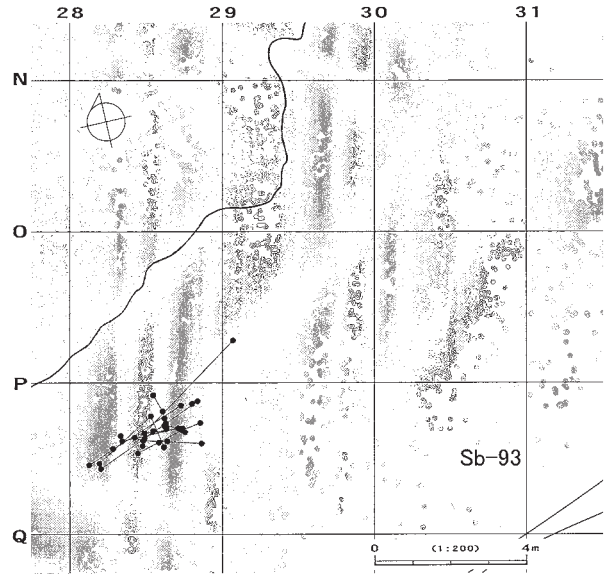

接合3849(個体B)分布図

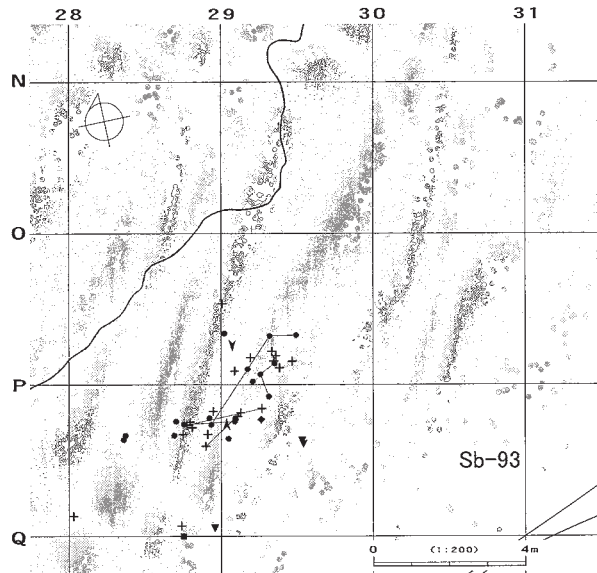

接合3849(全体)分布図

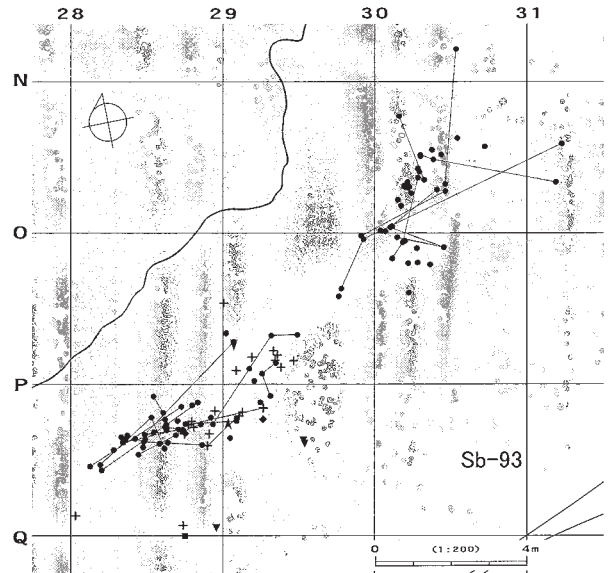

母岩862・接合3809

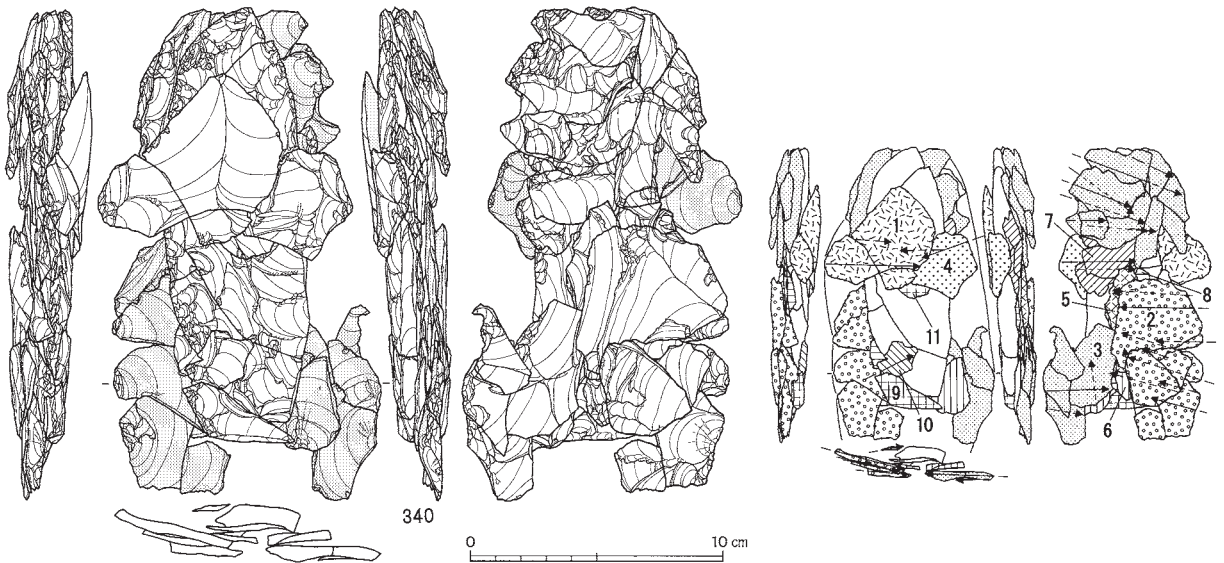

図Ⅲ-289 I区(Sb-91~96)の石器(54) 母岩876・接合3849(3)、母岩862・接合3809(1)

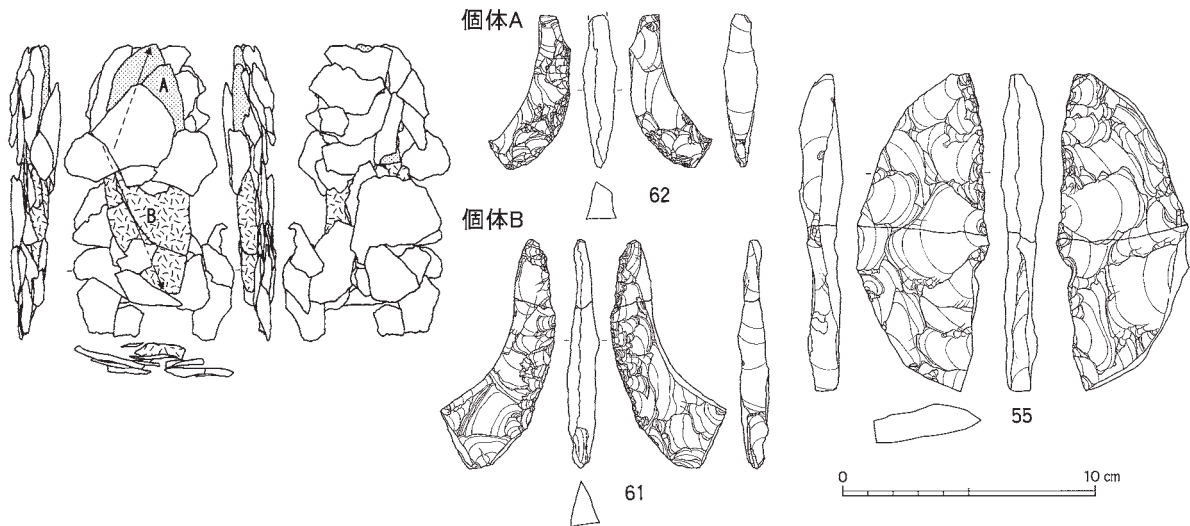

接合3809(個体A・B)分布図

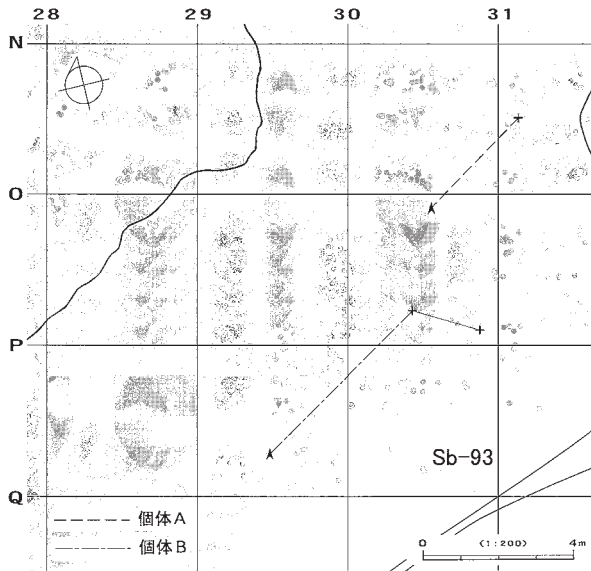

接合3809(個体A・B以外)分布図

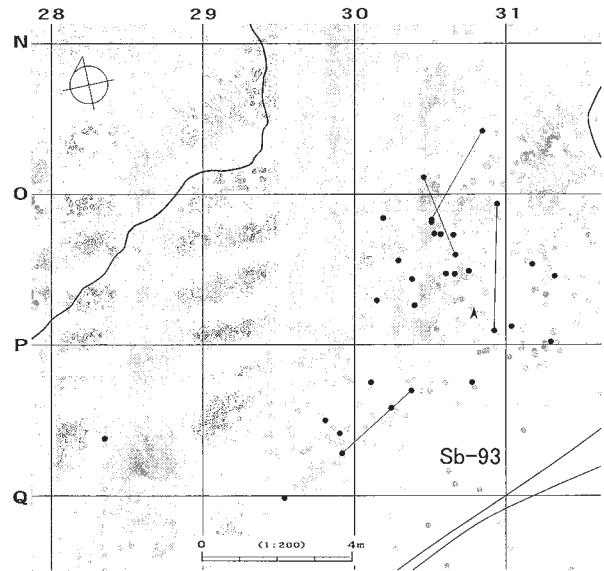

母岩849・接合3740

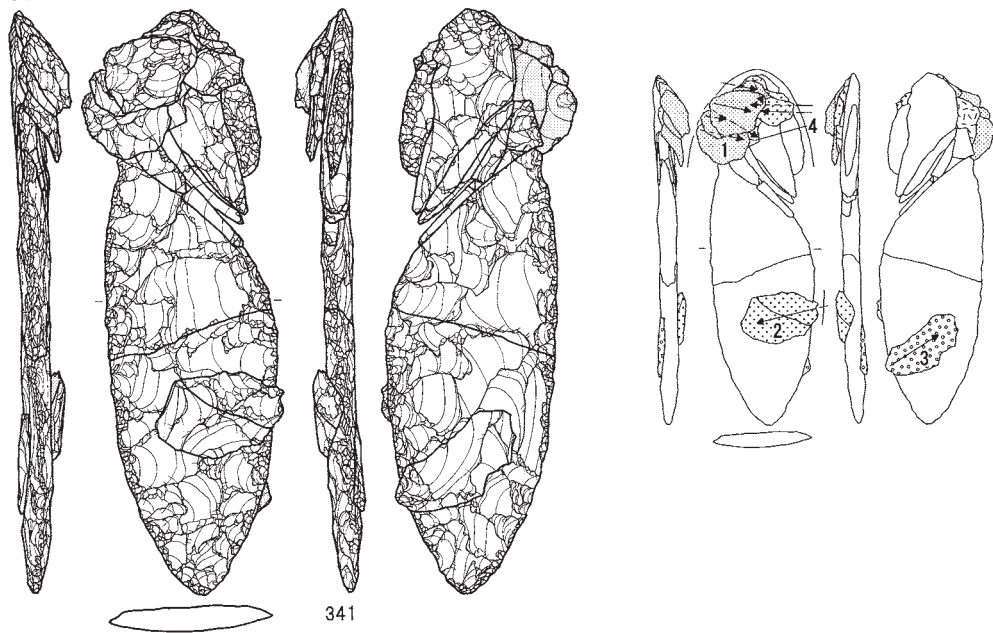

図Ⅲ-290 I区(Sb-91~96)の石器(55) 母岩862・接合3809(2)、母岩849・接合3740(1)

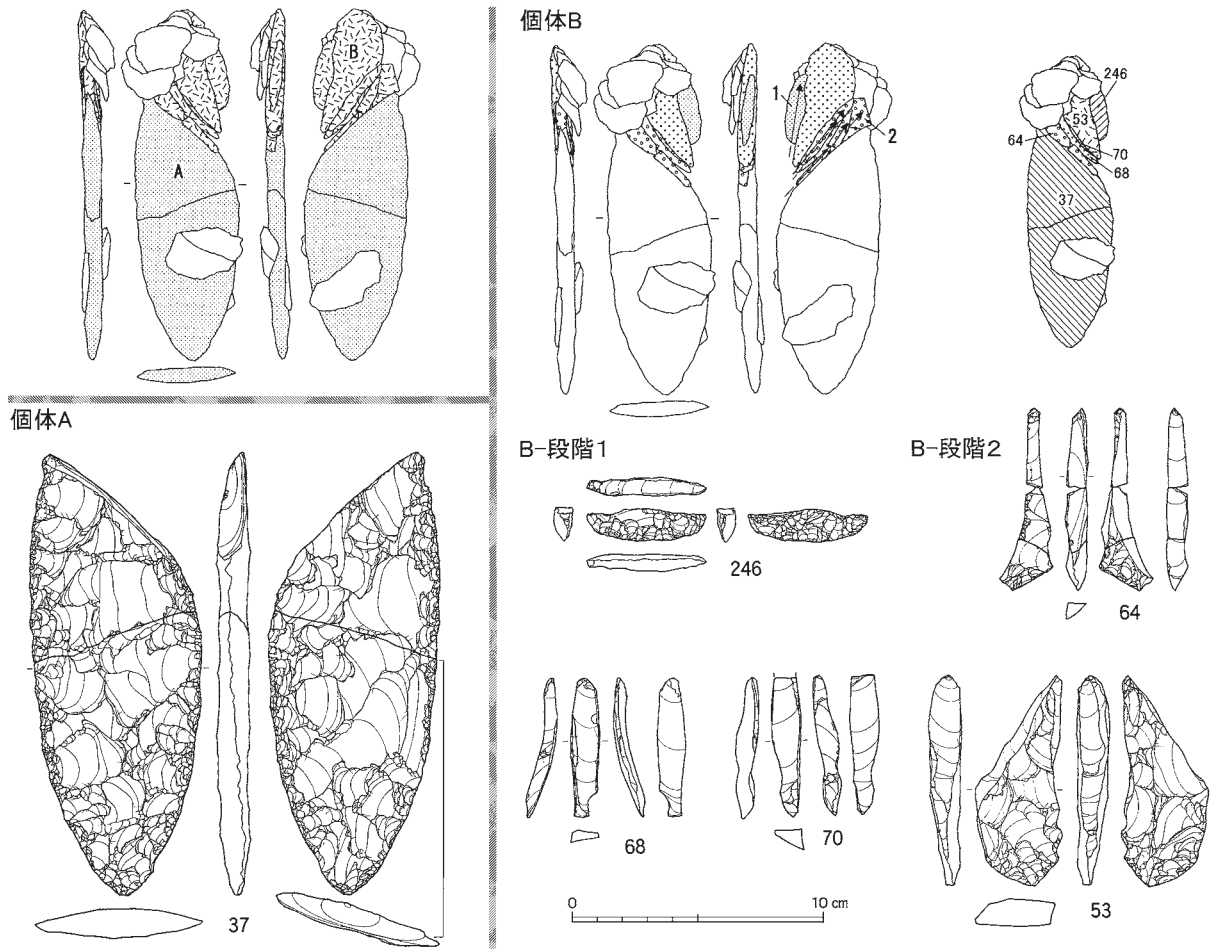

接合3740(个体A)分布図

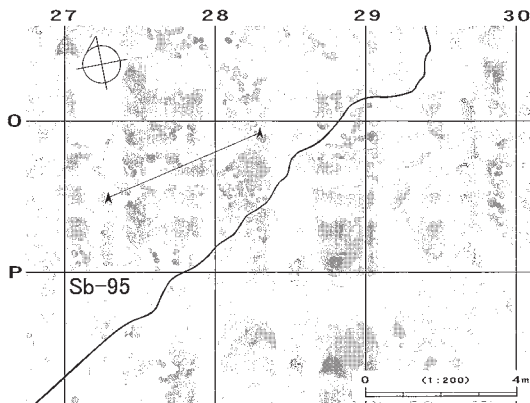

接合3740(个体B)分布図

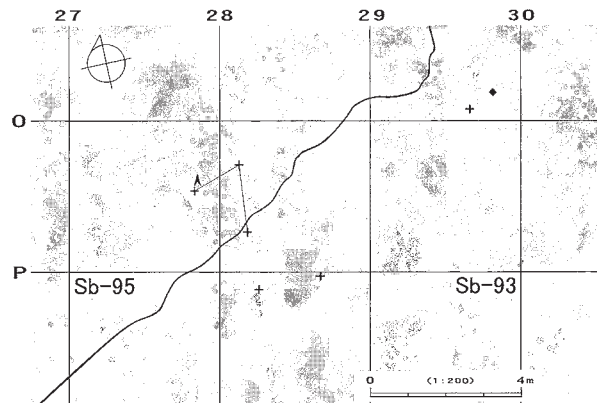

接合3740(个体A・B以外-段階1~4)分布図

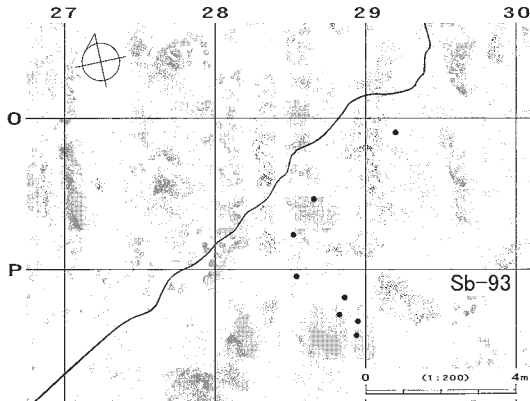

接合3740(全体)分布図

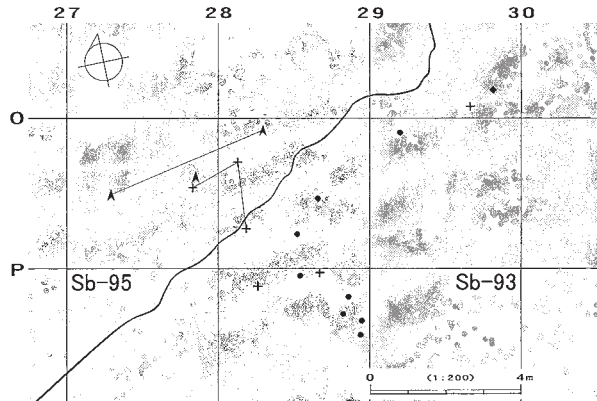

図III-291 I区(Sb-91~96)の石器(56) 母岩849・接合3740(2)

母岩852・接合3759

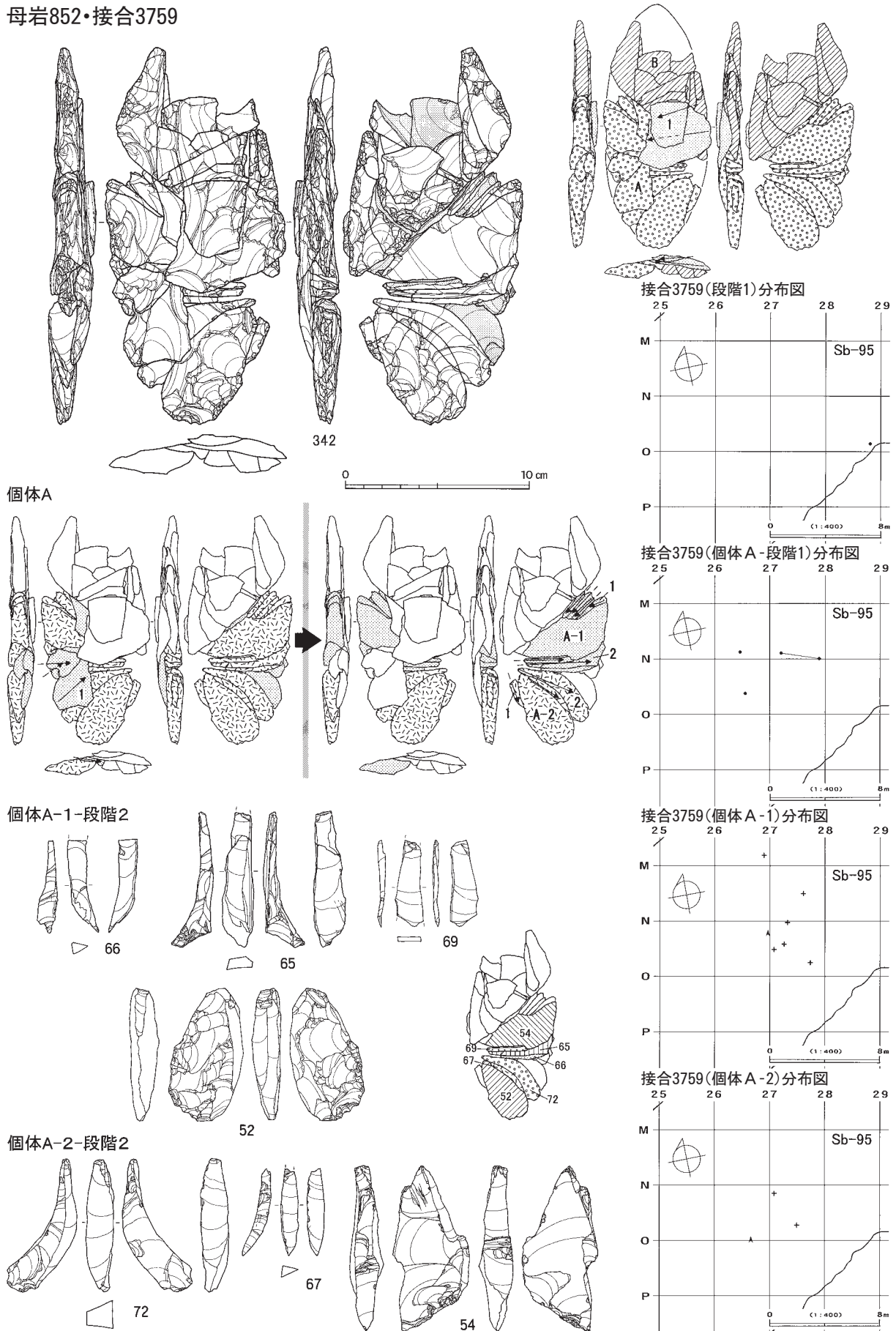

図Ⅲ-292 I区(Sb-91~96)の石器(57) 母岩852・接合3759(1)

個体B

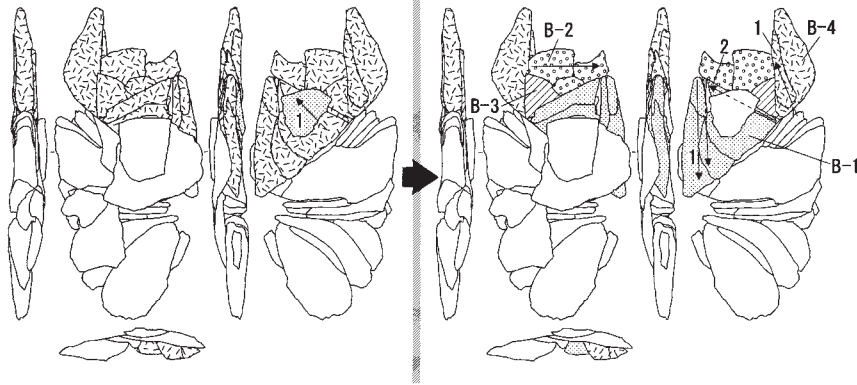

個体B-1-段階1

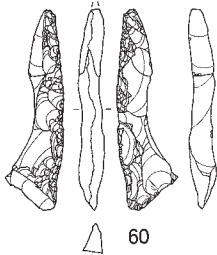

個体B-1-段階2

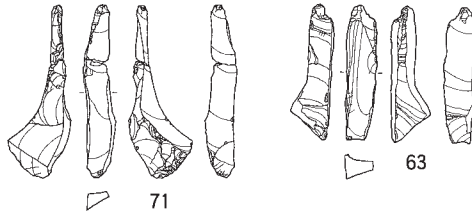

個体B-4

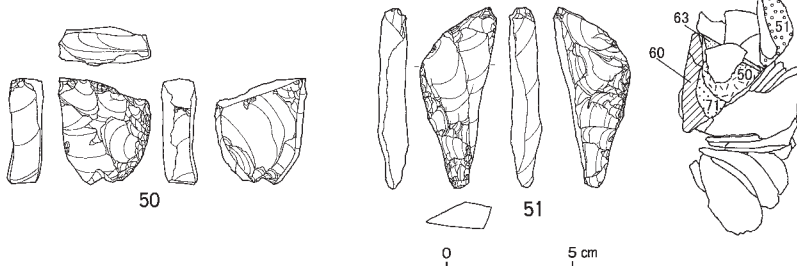

接合3759(全体)分布図

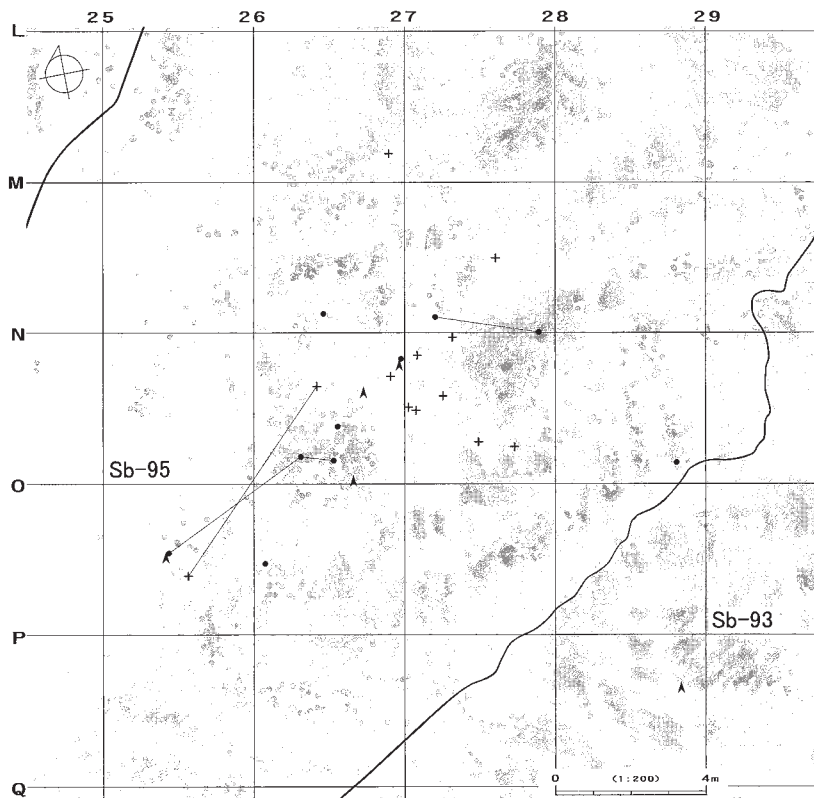

接合3759(個体B-段階1)分布図

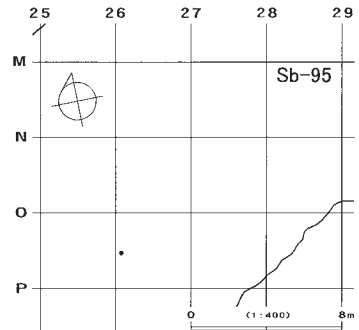

接合3759(個体B-1)分布図

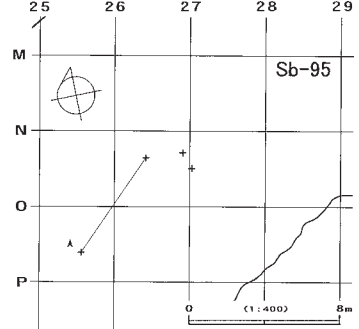

接合3759(個体B-2)分布図

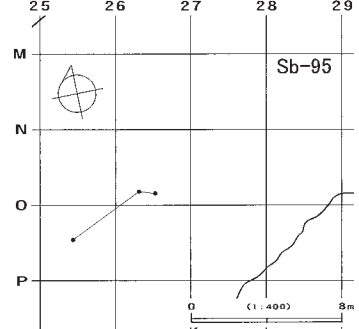

接合3759(個体B-3)分布図

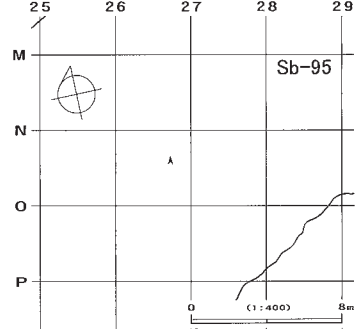

接合3759(個体B-4)分布図

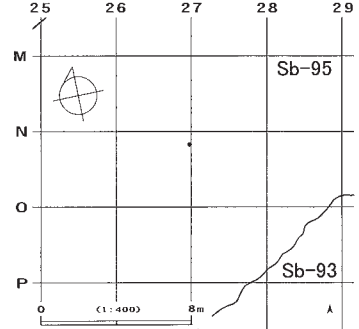

図III-293 I区(Sb-91~96)の石器(58) 母岩852・接合3759(2)

母岩807・接合3583

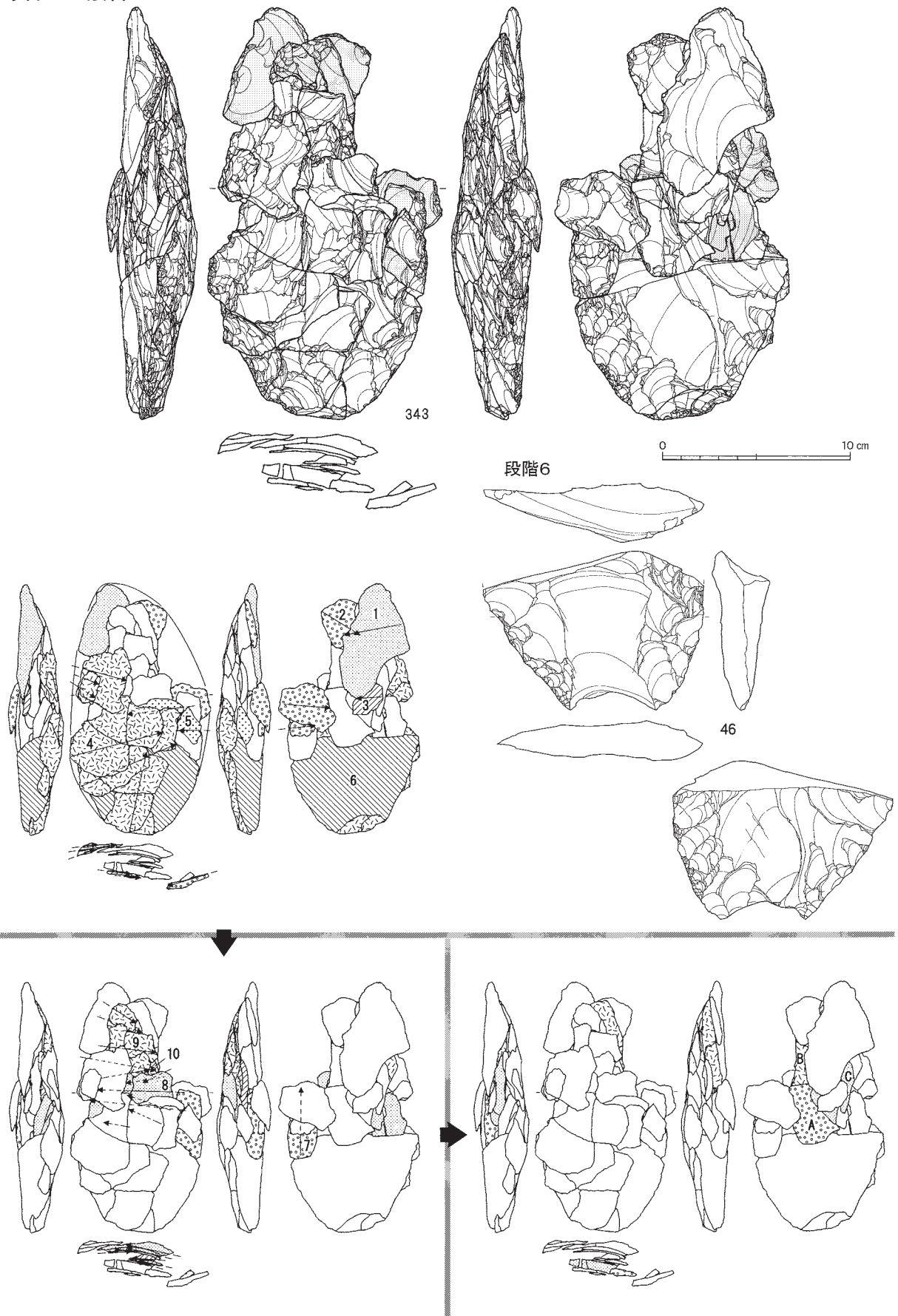

図Ⅲ-294 I区(Sb-91~96)の石器(59) 母岩807・接合3583(1)

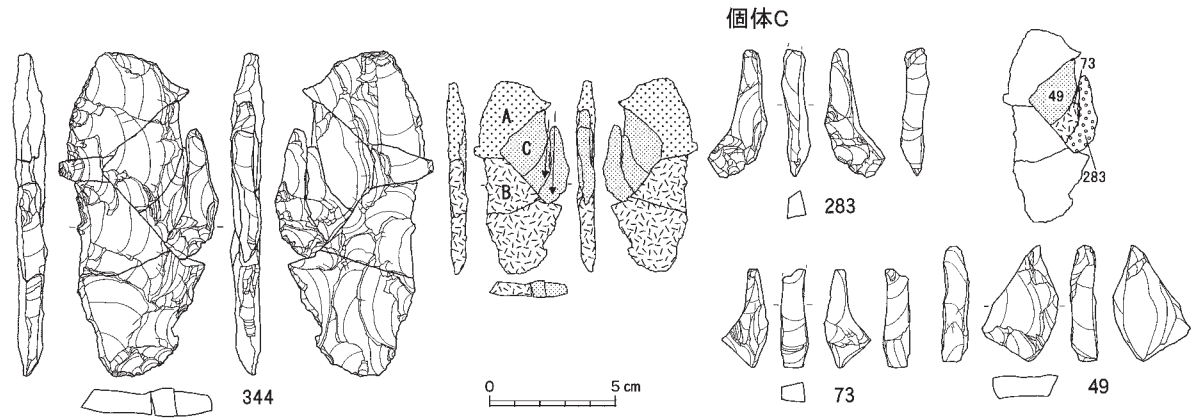

接合3583(段階1~6)分布図

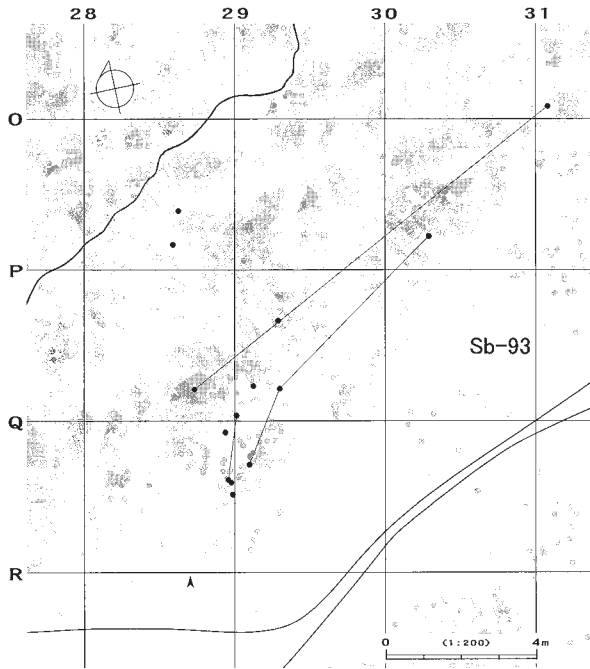

接合3583(段階7~10)分布図

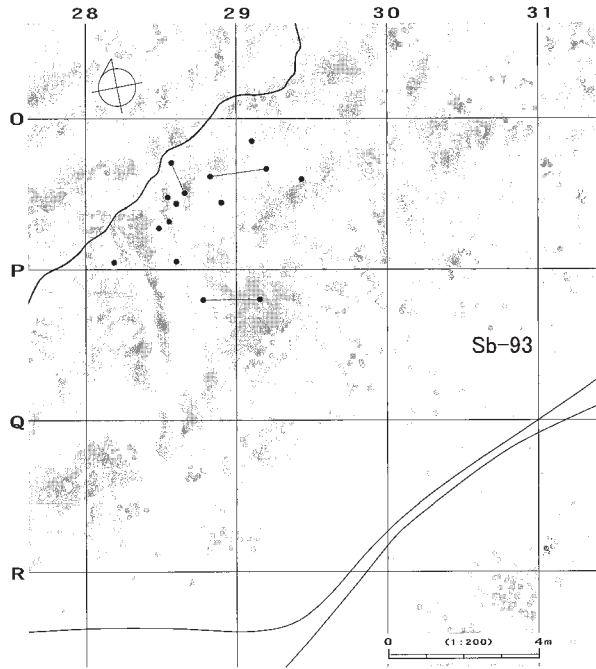

接合3583(個体C)分布図

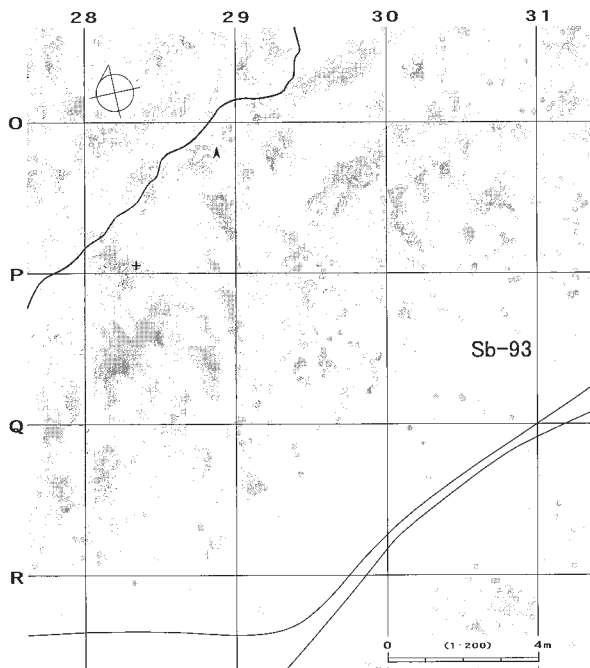

接合3583(全体)分布図

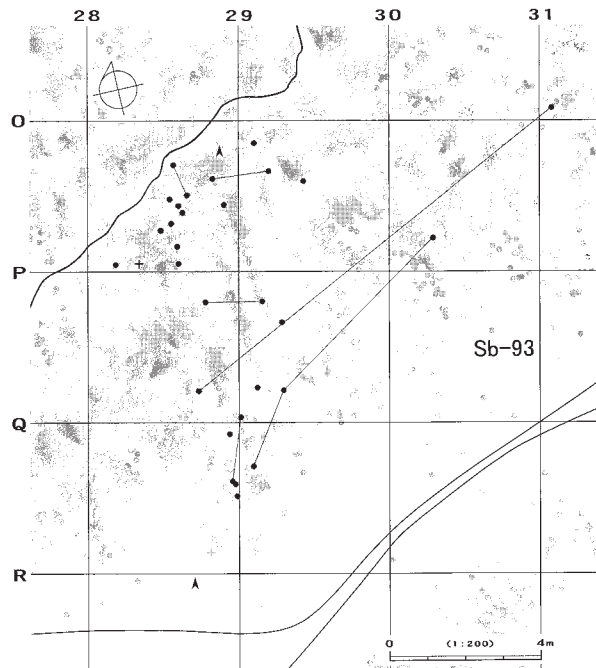

図Ⅲ-295 I区(Sb-91~96)の石器(60) 母岩807・接合3583(2)

母岩816・接合3617

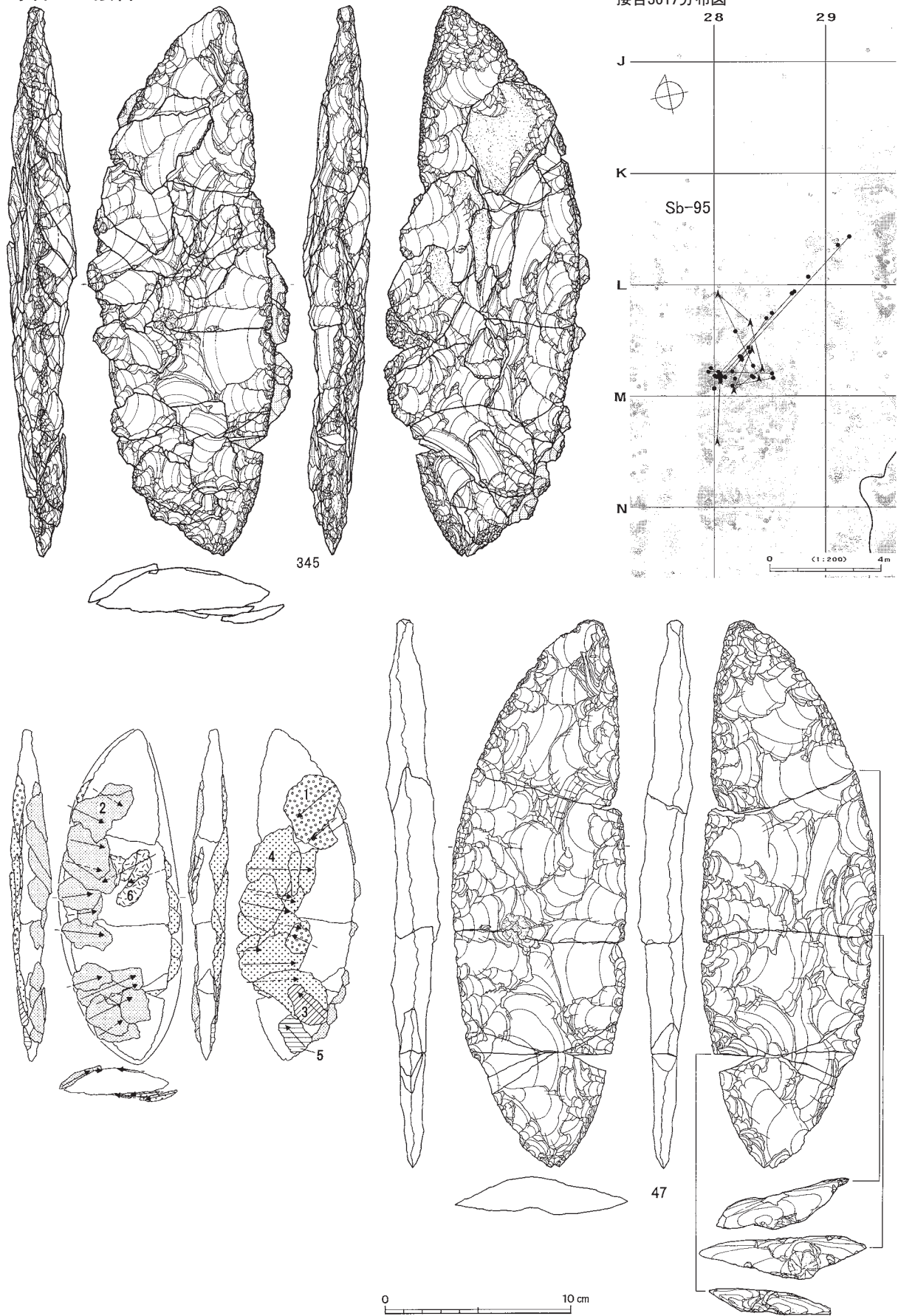

図Ⅲ-296 I区(Sb-91~96)の石器(61) 母岩816・接合3617

母岩748・接合3396

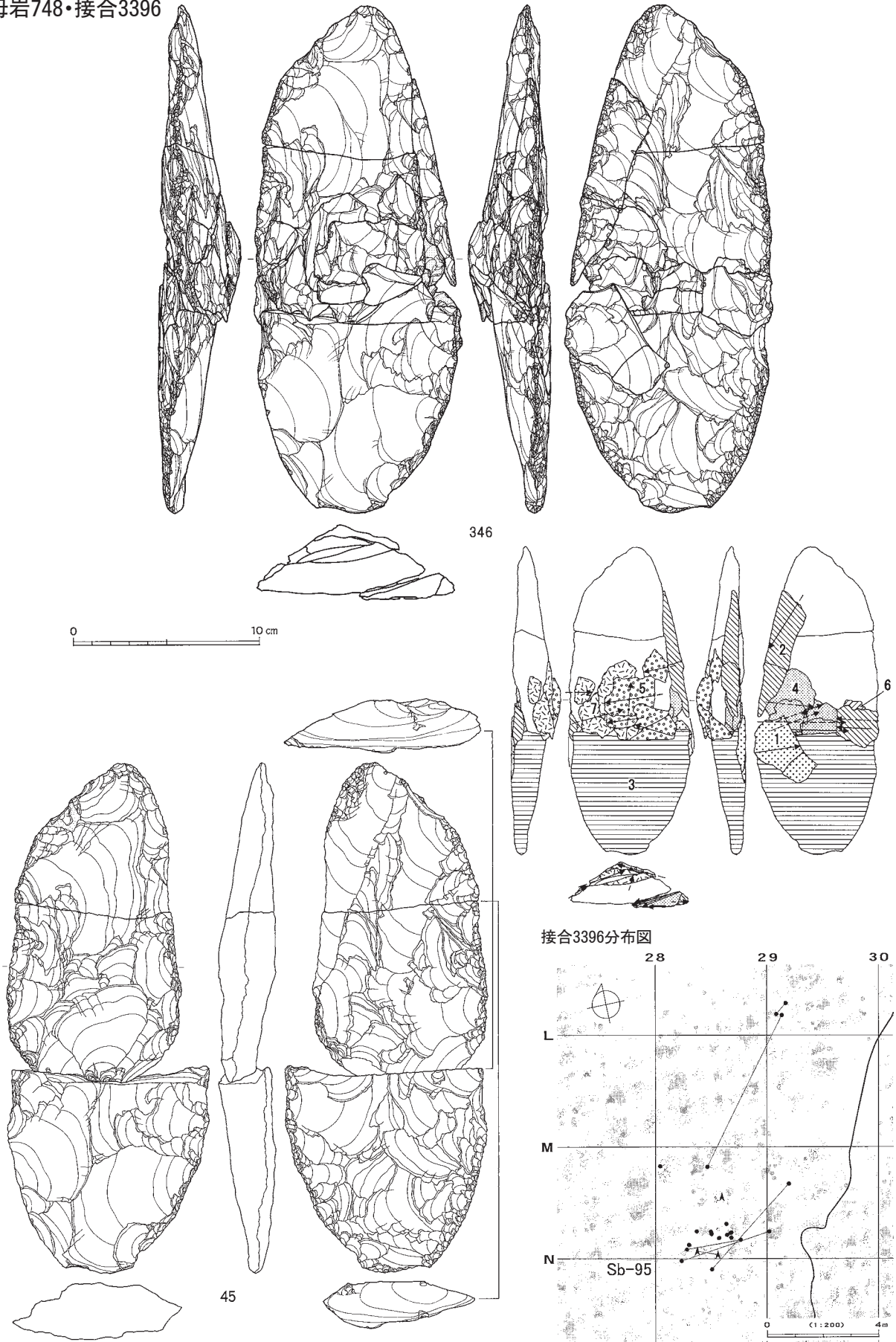

図Ⅲ-297 I区(Sb-91~96)の石器(62) 母岩748・接合3396

母岩749・接合3397

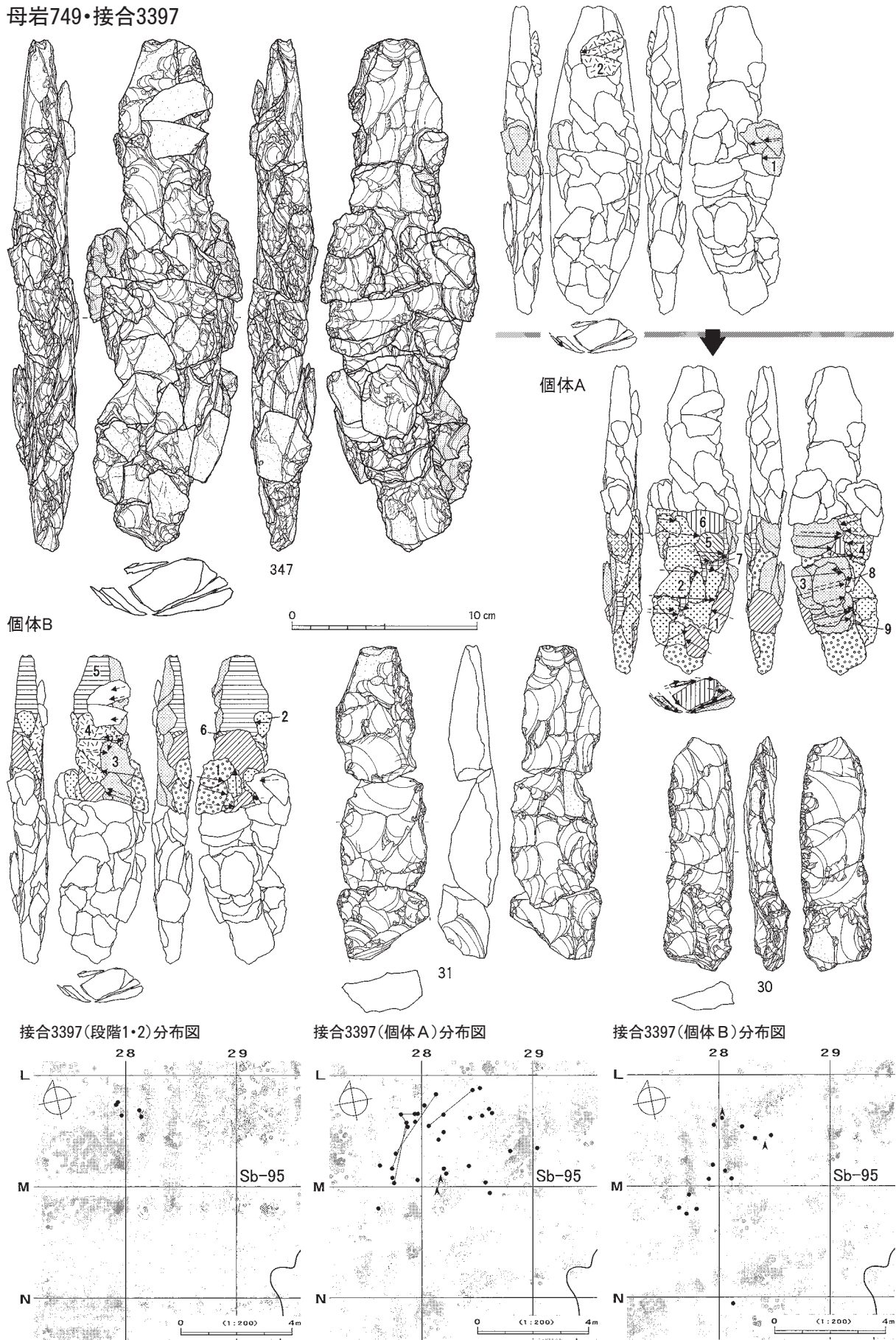

図Ⅲ-298 I区(Sb-91~96)の石器(63) 母岩749・接合3397

母岩736・接合3336

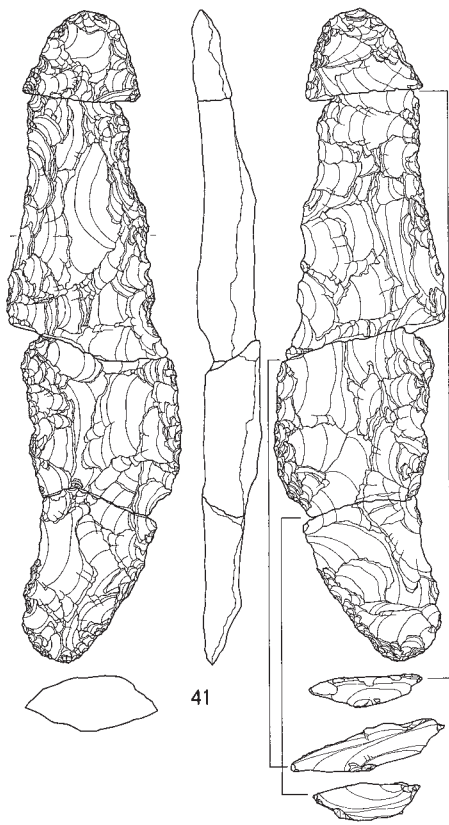
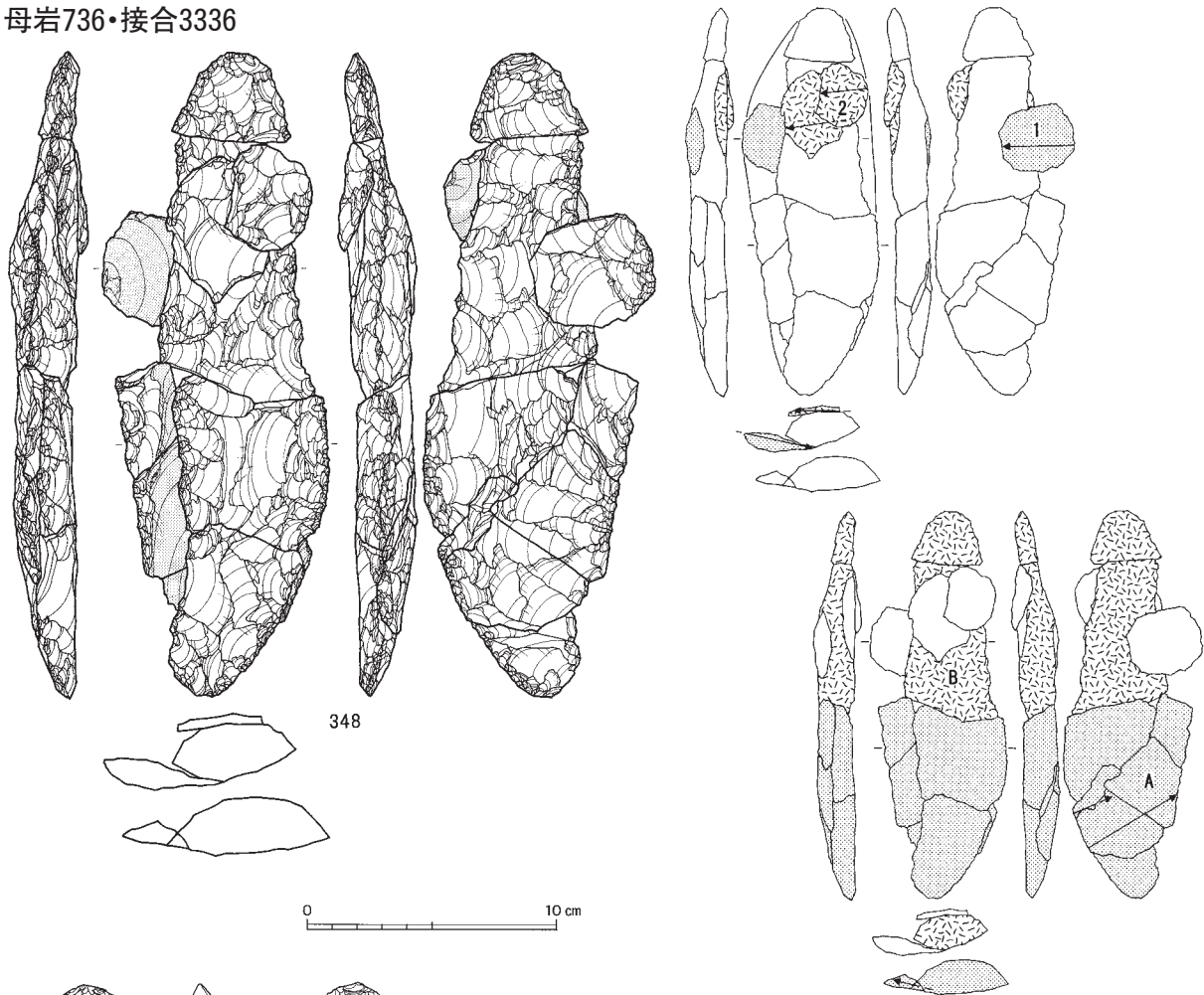

接合3336分布図

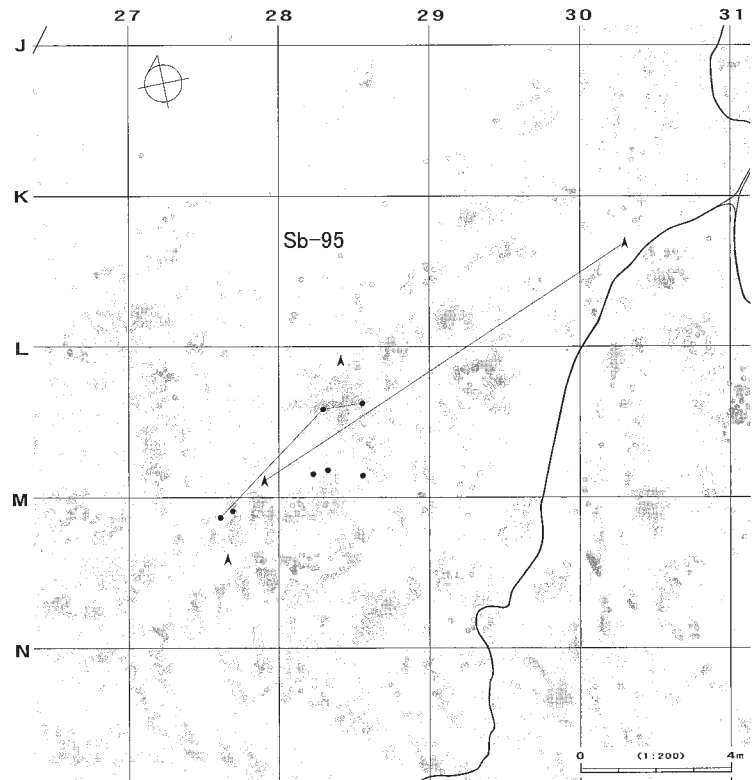

図Ⅲ-299 I区(Sb-91~96)の石器(64) 母岩736・接合3336

母岩923・接合4035
個体B

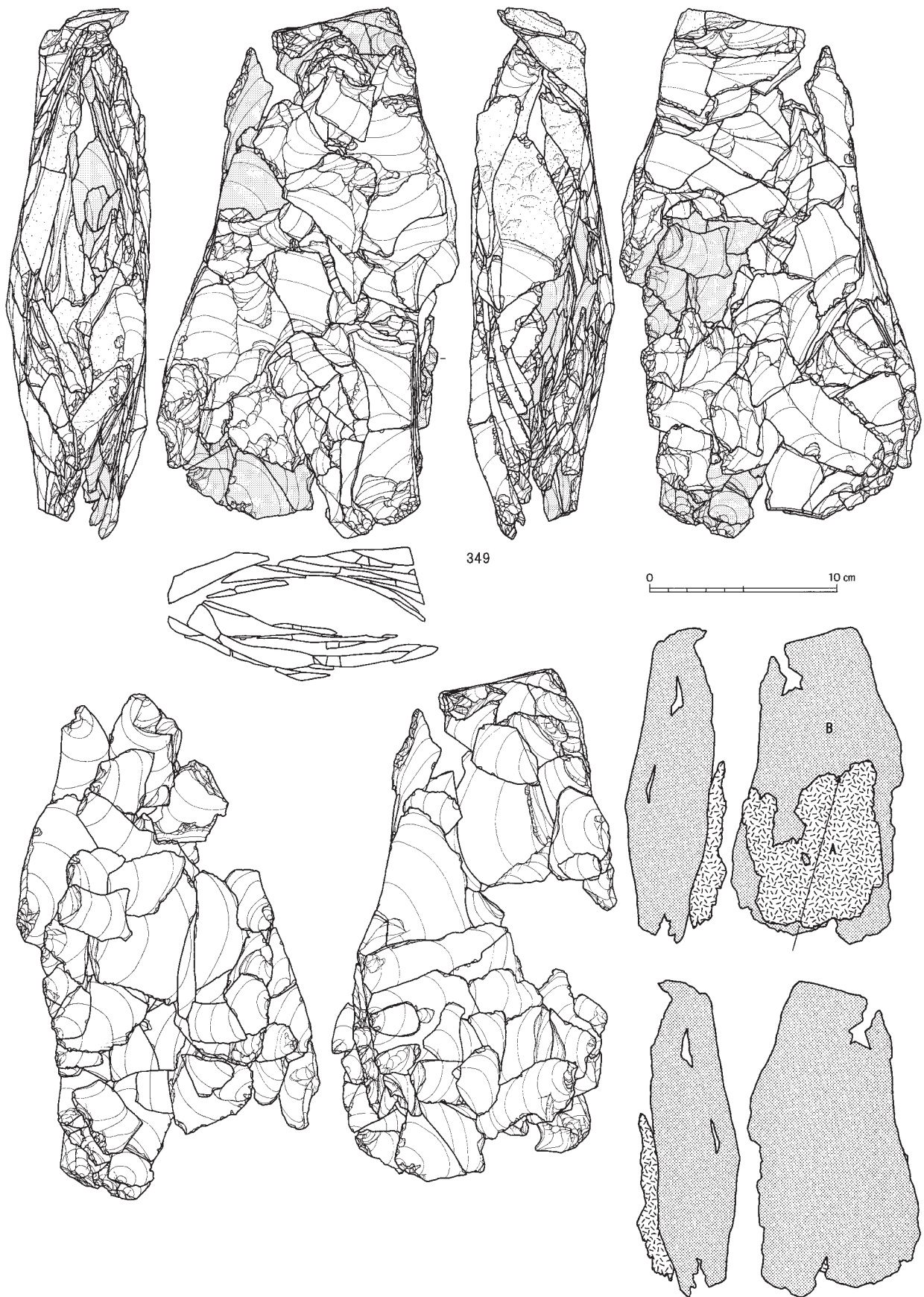

図Ⅲ-300 I区(Sb-91~96)の石器(65) 母岩923・接合4035(1)

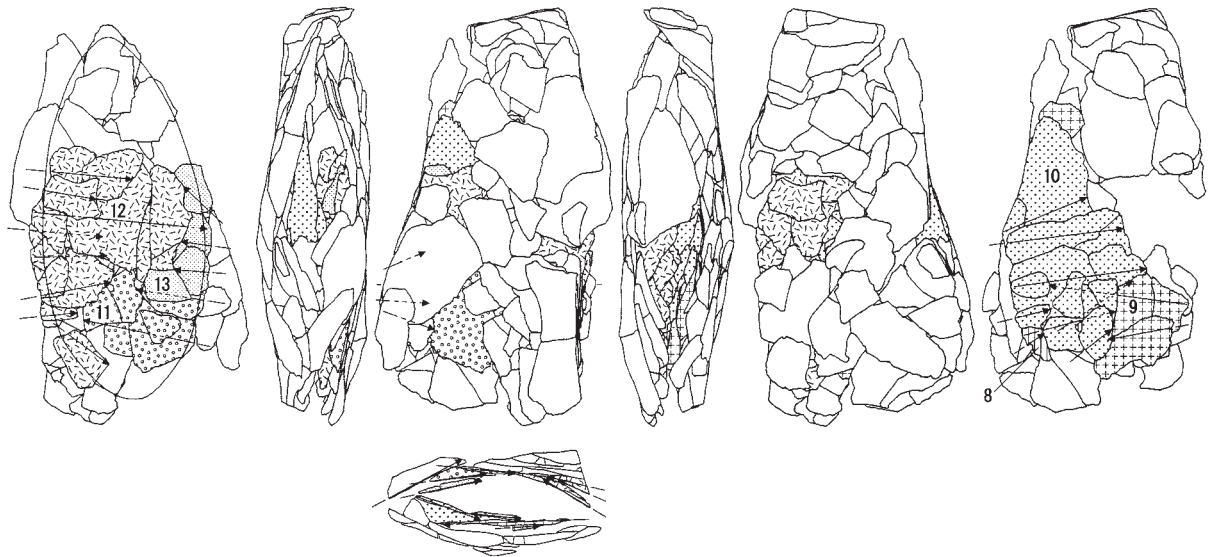
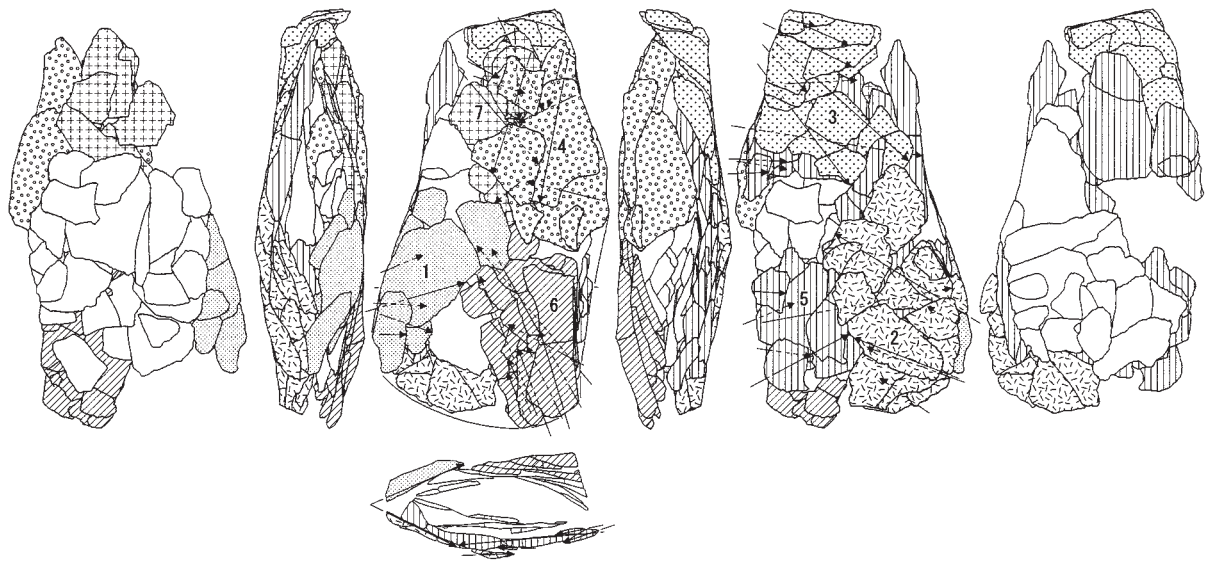

個体A

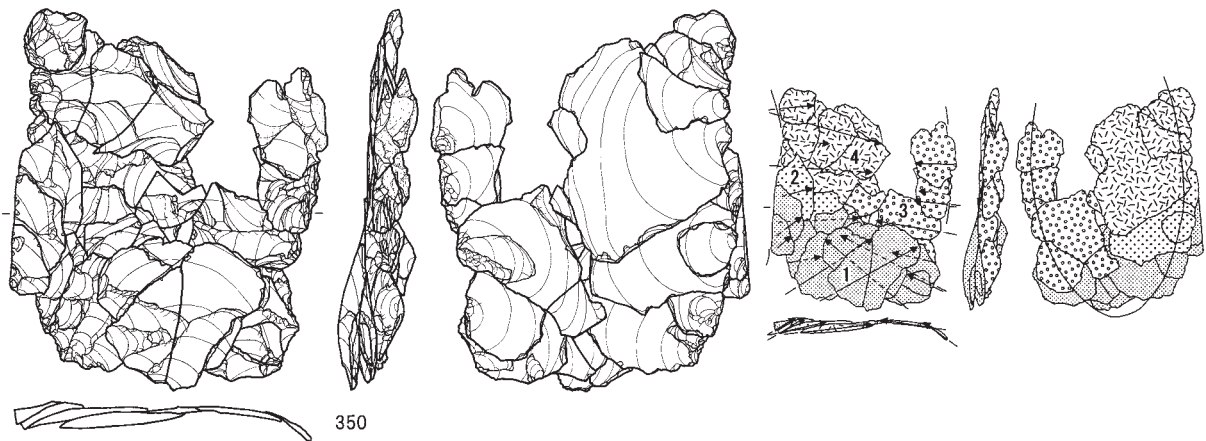

350

0 10 cm

図III-301 I区(Sb-91~96)の石器(66) 母岩923・接合4035(2)

I区(Sb-91~96)

接合4035(个体A)分布图

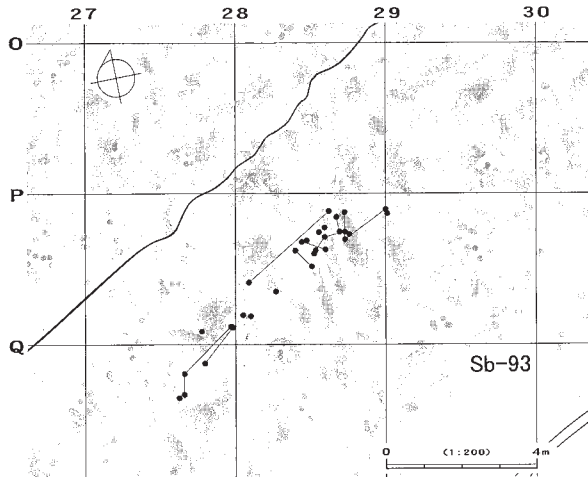

接合4035(个体B)分布图

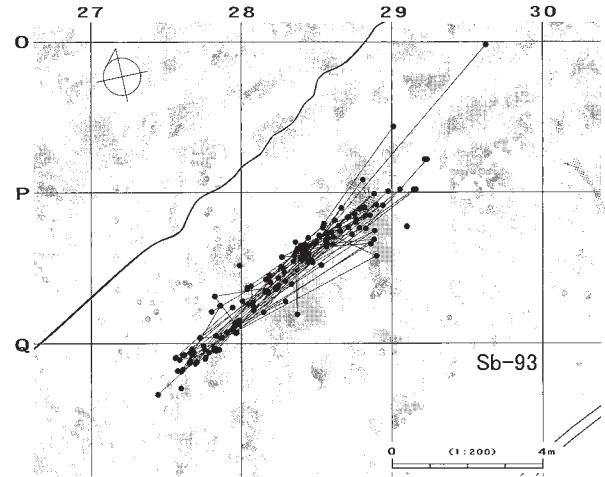

母岩887・接合3883

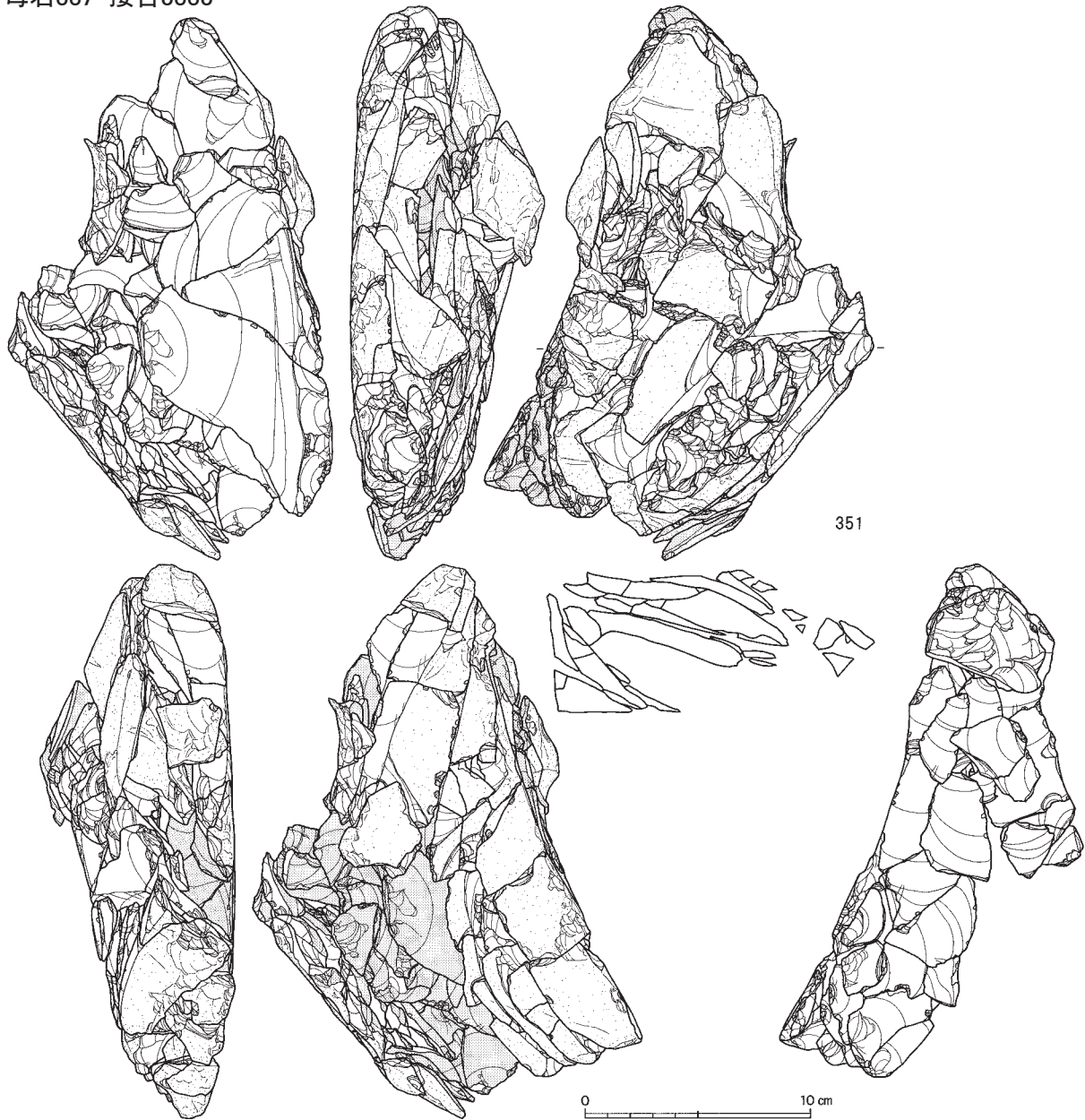

図Ⅲ-302 I区(Sb-91~96)の石器(67) 母岩923・接合4035(3)、母岩887・接合3883(1)

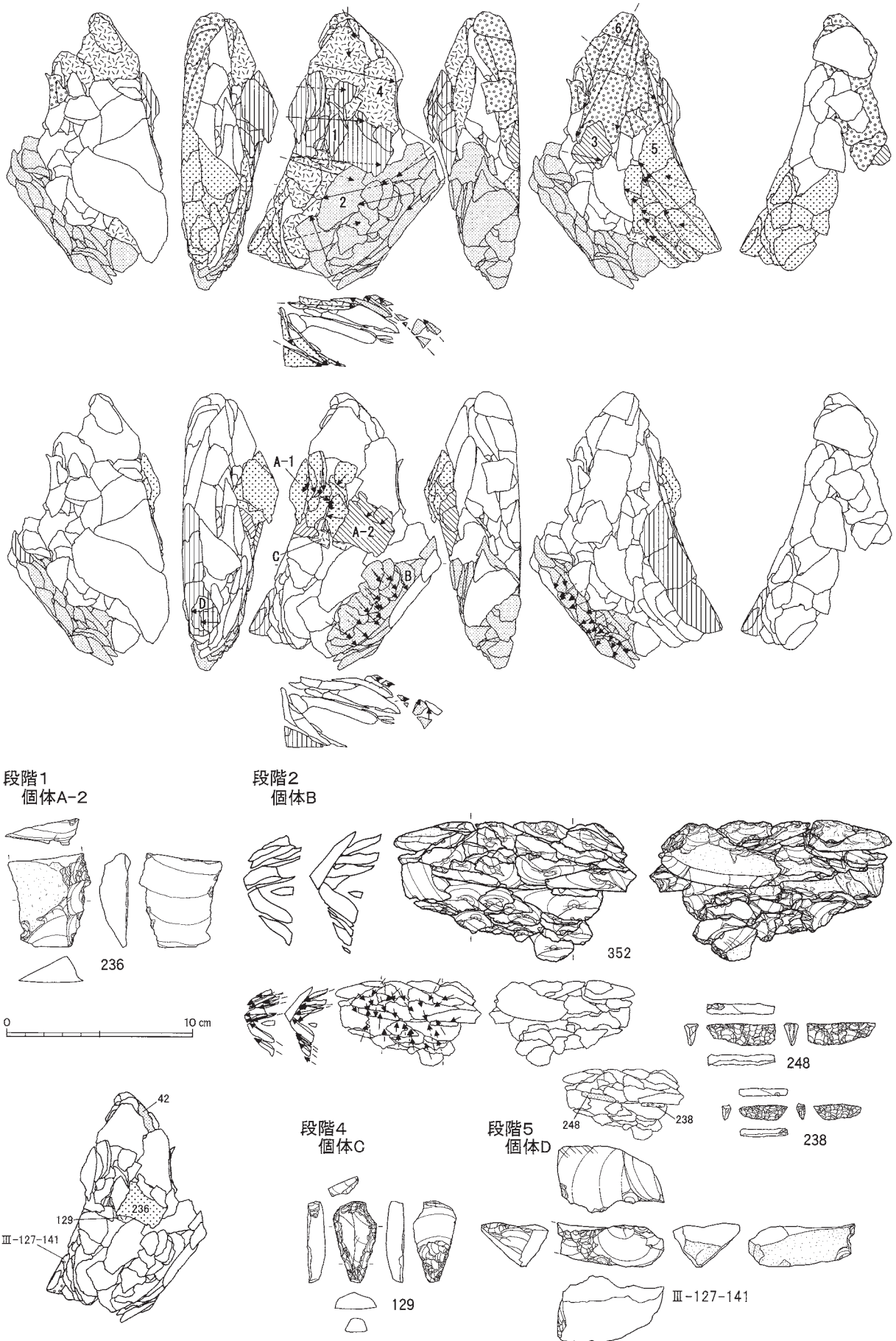

図Ⅲ-303 I区(Sb-91~96)の石器(68) 母岩887・接合3883(2)

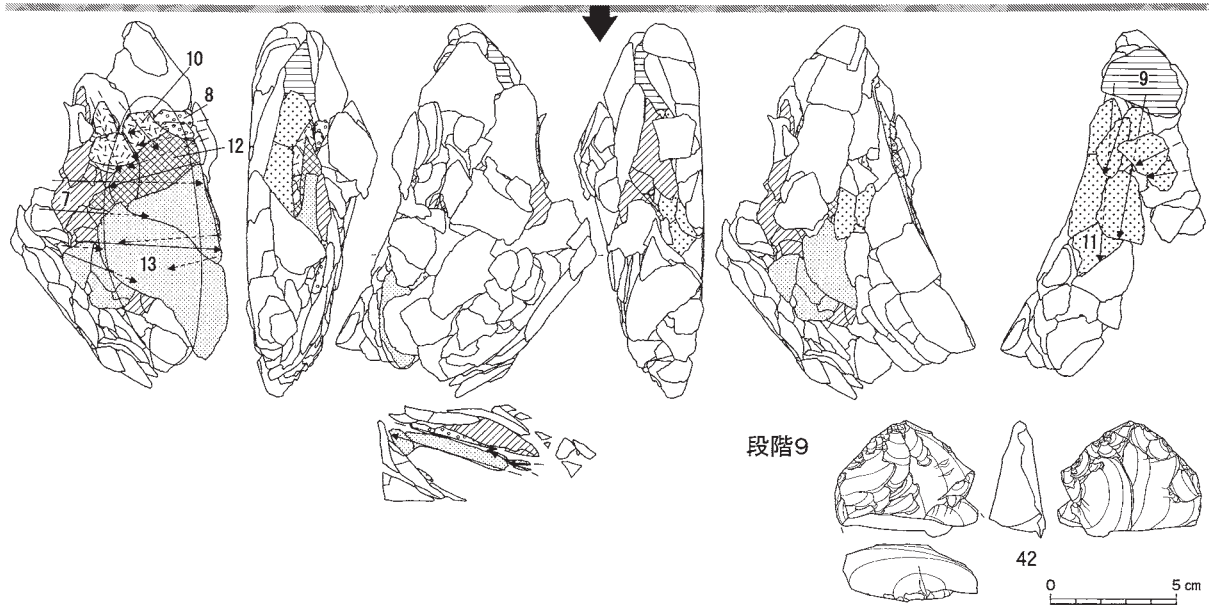

接合3883(個体A)分布図

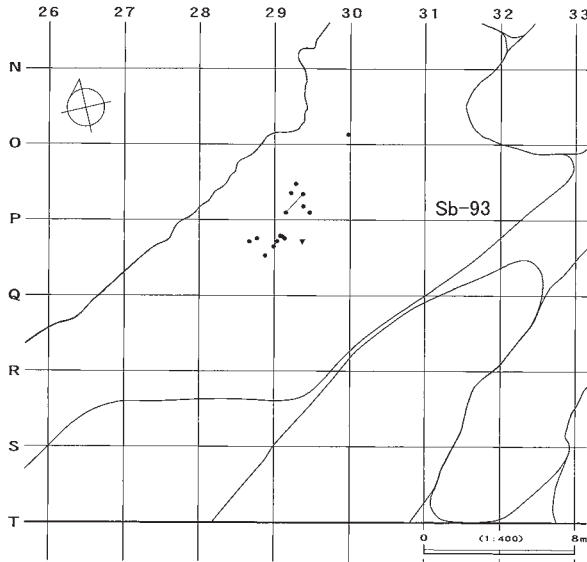

接合3883(個体B)分布図

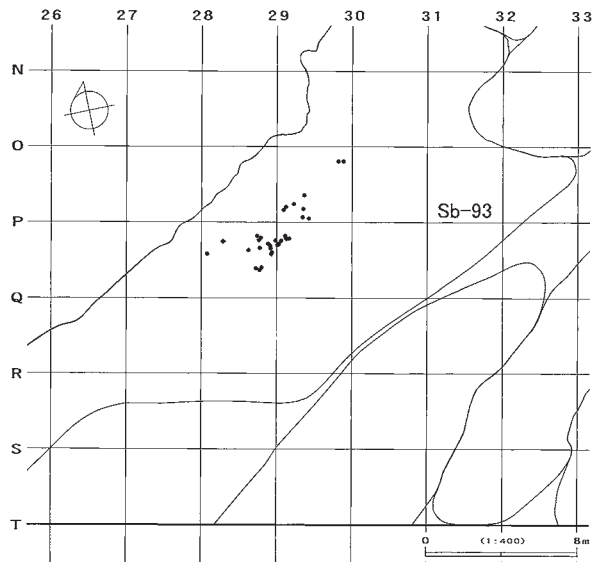

接合3883(個体C・D)分布図

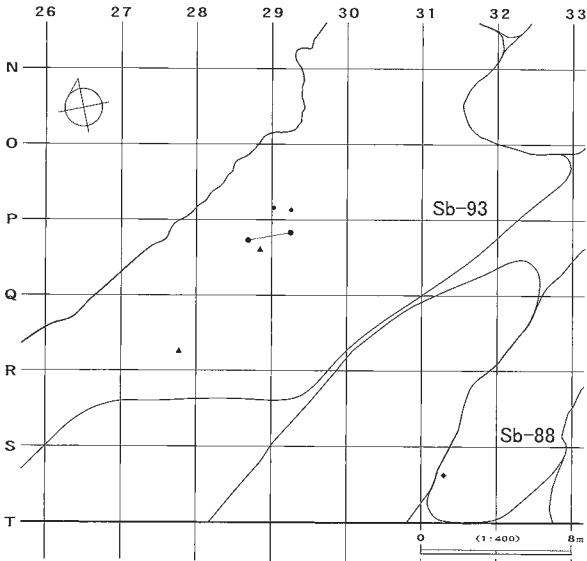

接合3883(個体A~D以外)分布図

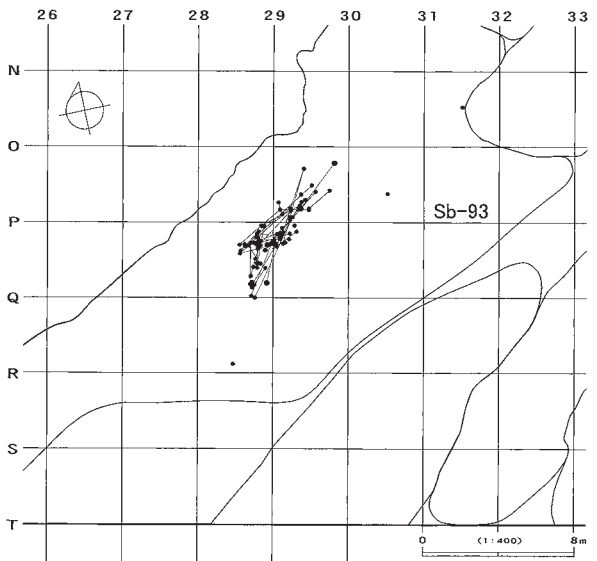

図Ⅲ-304 I区(Sb-91~96)の石器(69) 母岩887・接合3883(3)

接合3883(全体)分布図

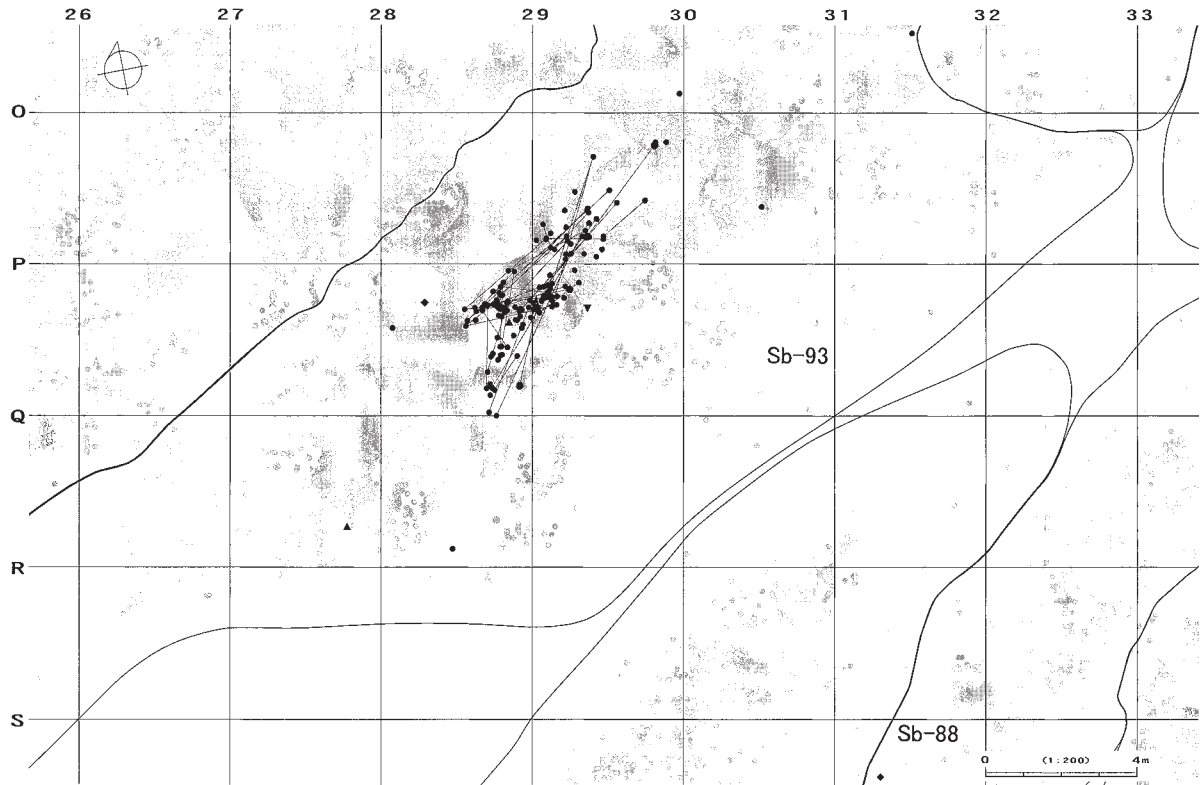

母岩927・接合4044

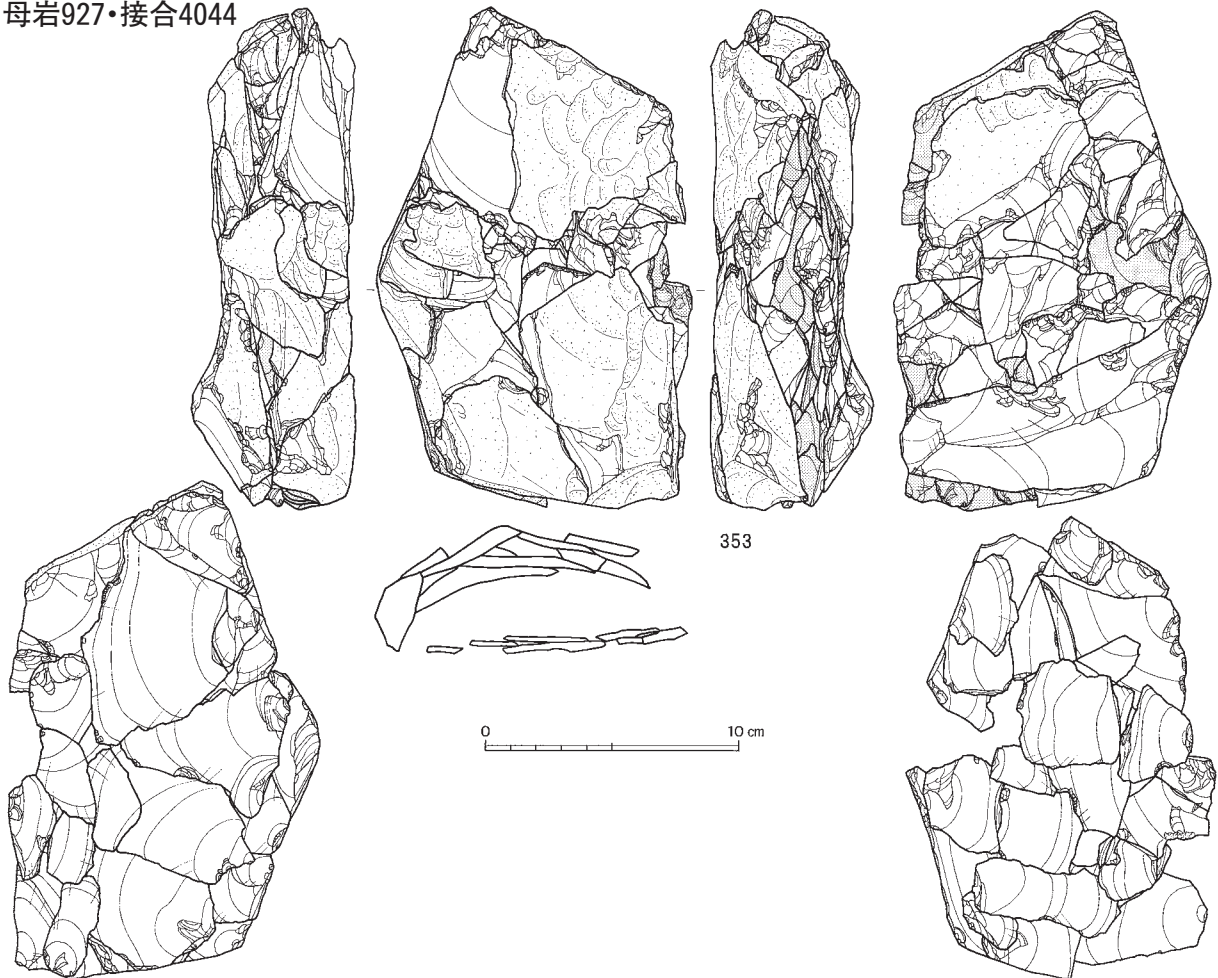

図Ⅲ-305 I区(Sb-91~96)の石器(70) 母岩887・接合3883(4)、母岩927・接合4044(1)

I区(Sb-91~96)

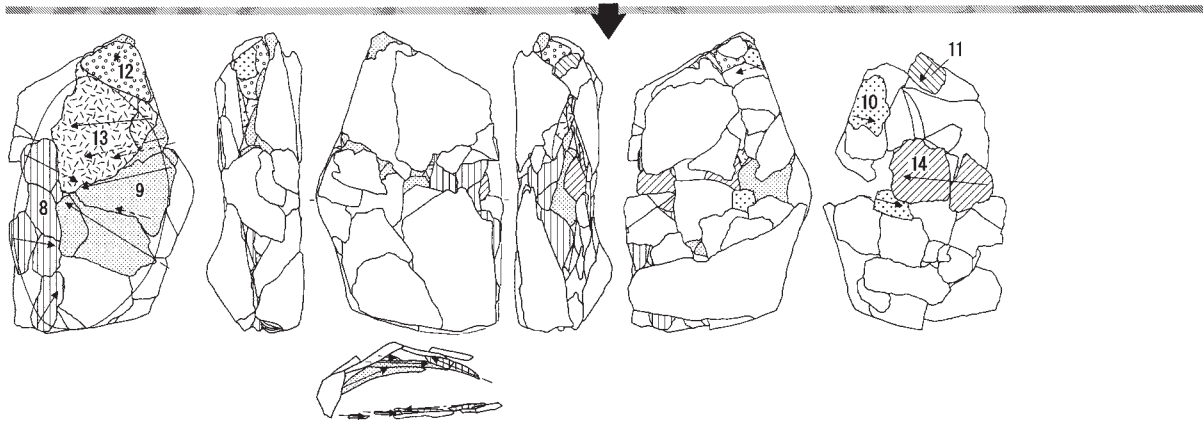
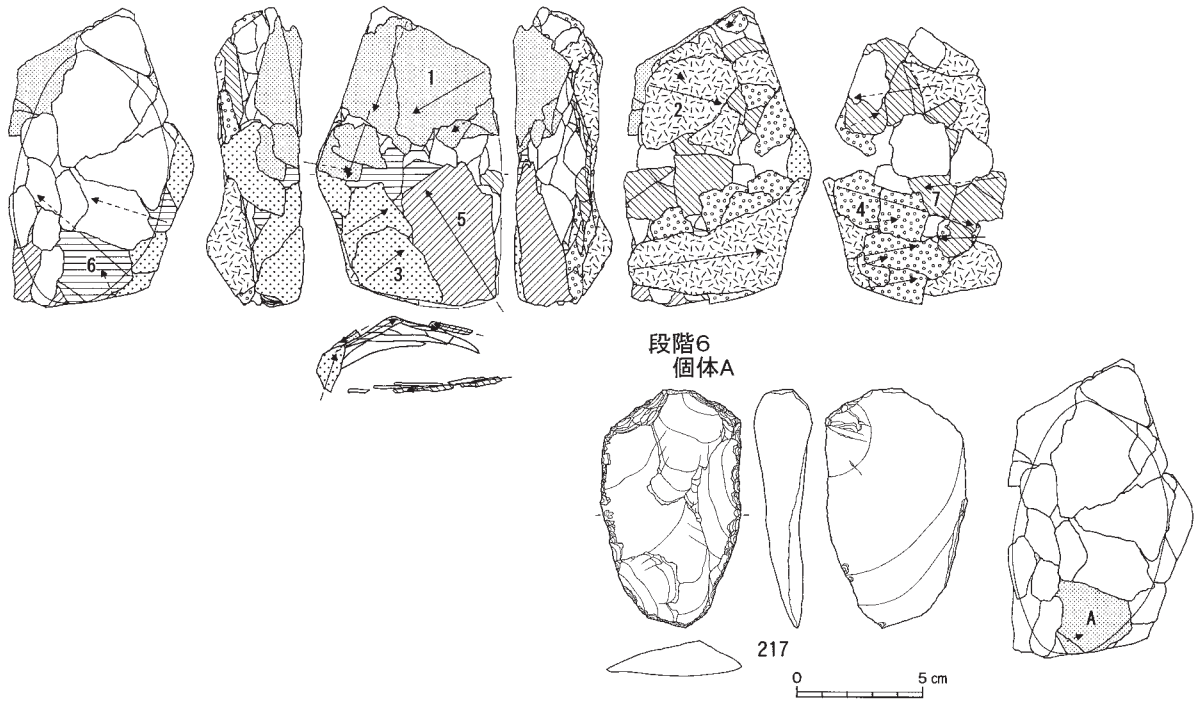

接合4044分布図

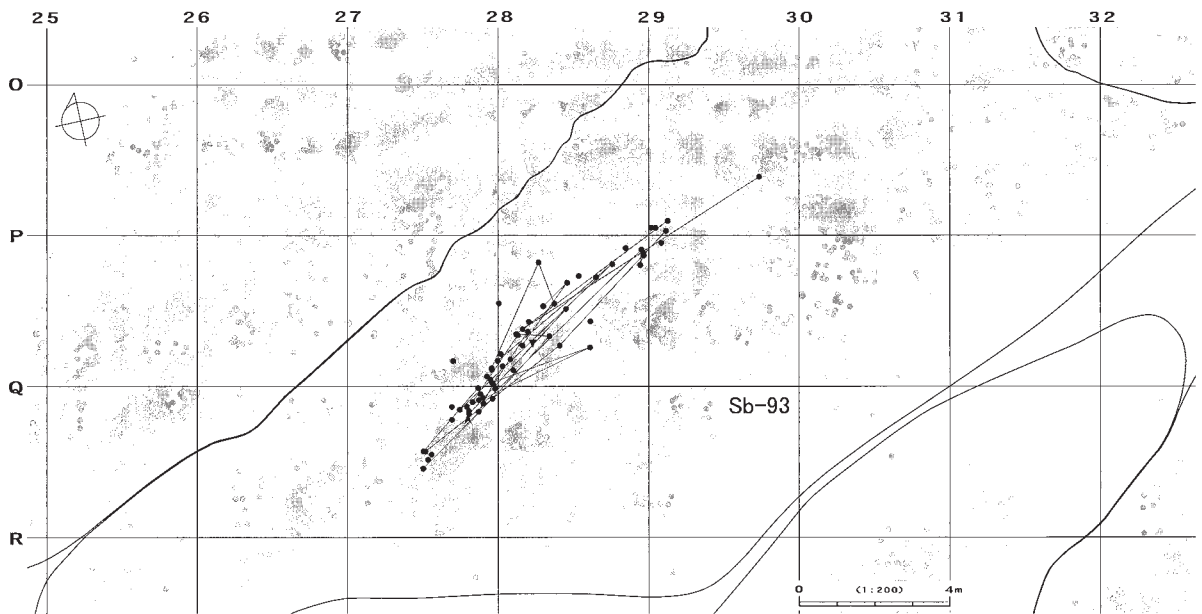

図III-306 I区(Sb-91~96)の石器(71) 母岩927・接合4044(2)

母岩789・接合3515

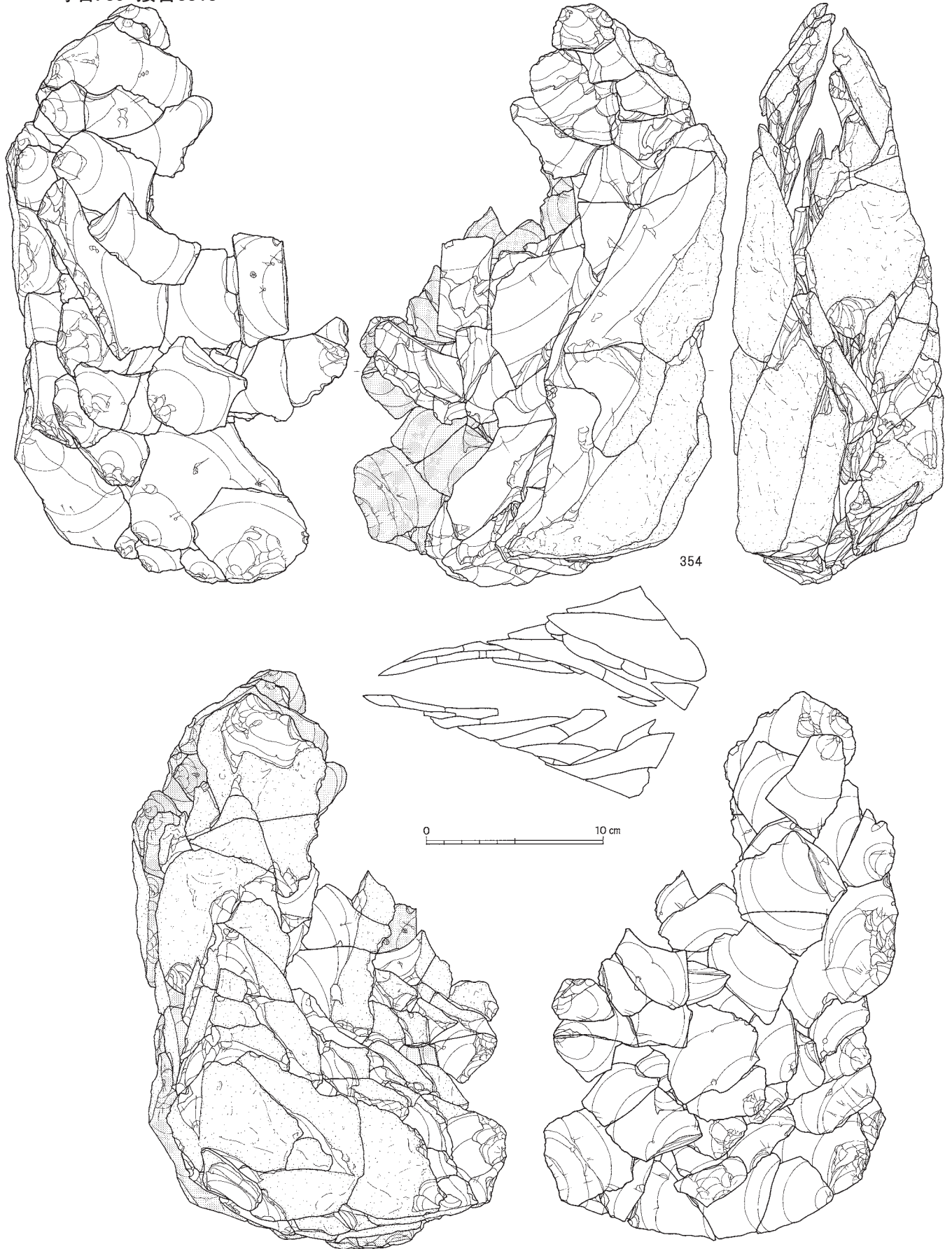

図Ⅲ-307 I区(Sb-91~96)の石器(72) 母岩789・接合3515(1)

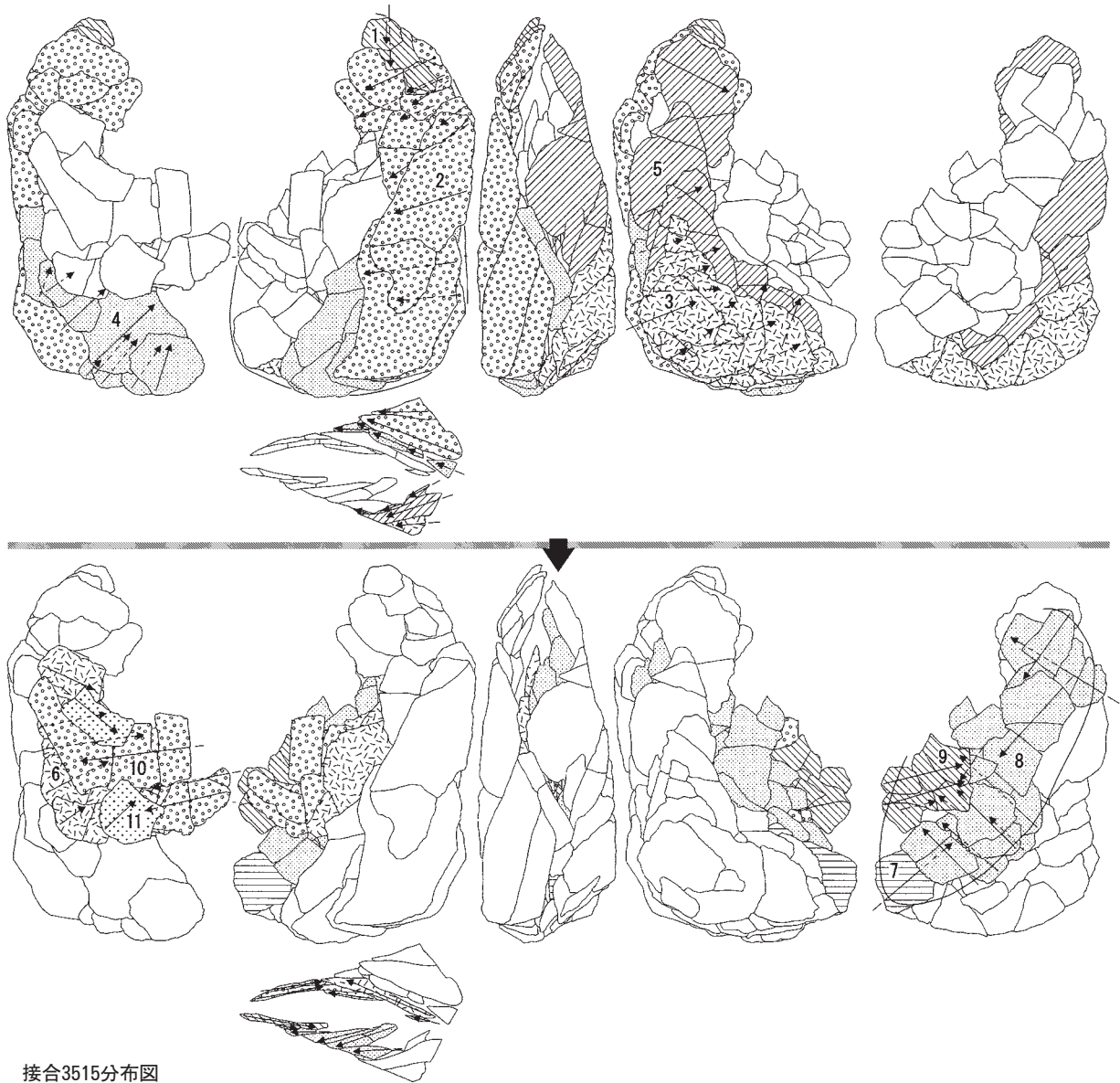

接合3515分布図

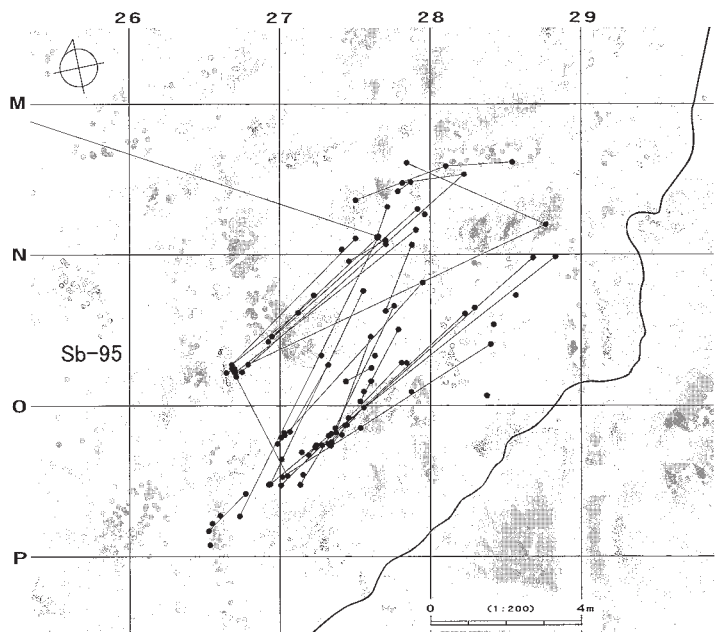
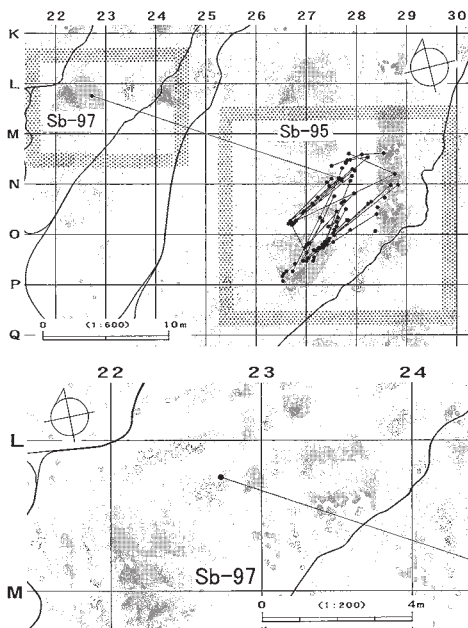

図III-308 I区(Sb-91~96)の石器(73) 母岩789・接合3515(2)

母岩717・接合3257

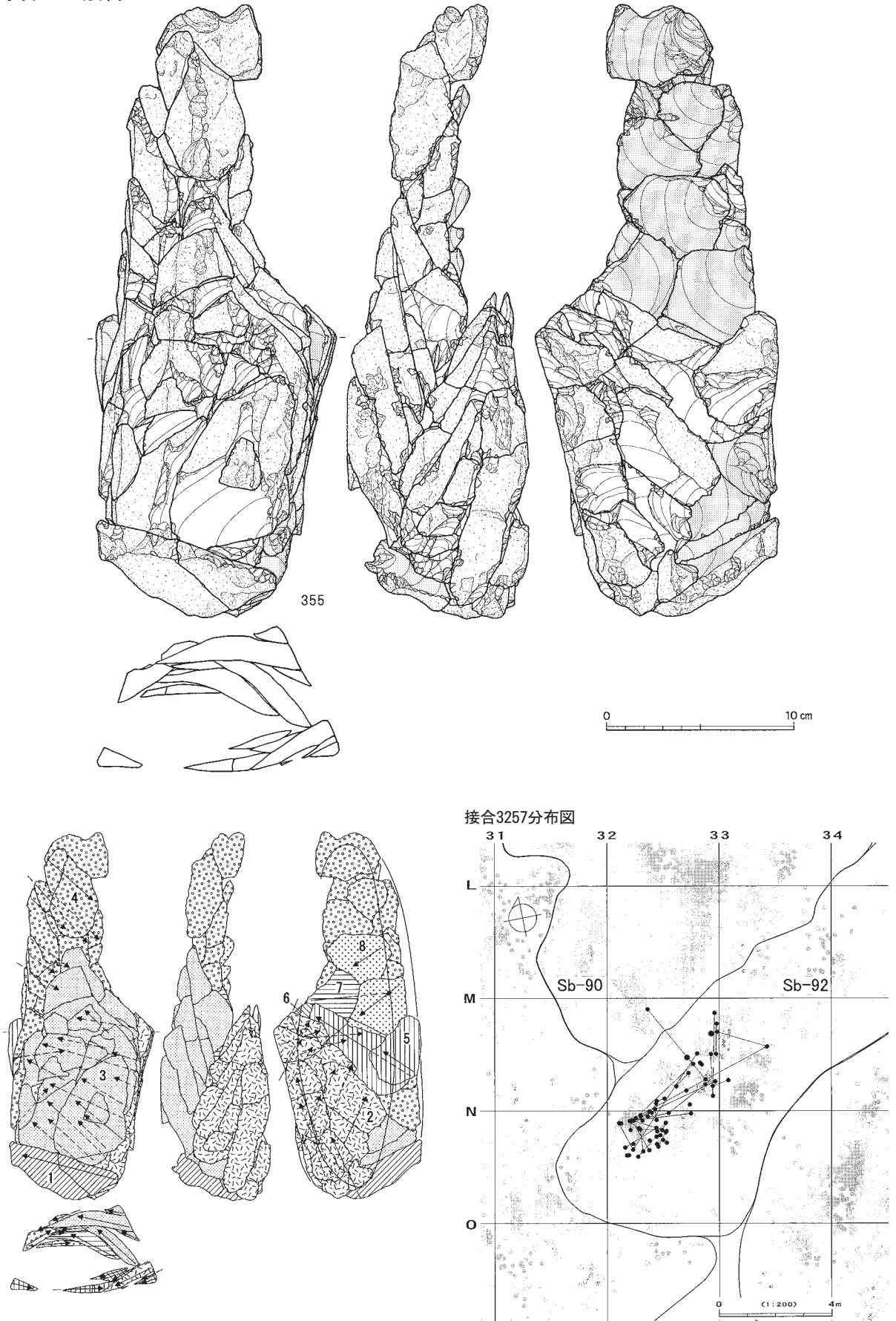

図Ⅲ-309 I区(Sb-91~96)の石器(74) 母岩717・接合3257

母岩716・接合3252

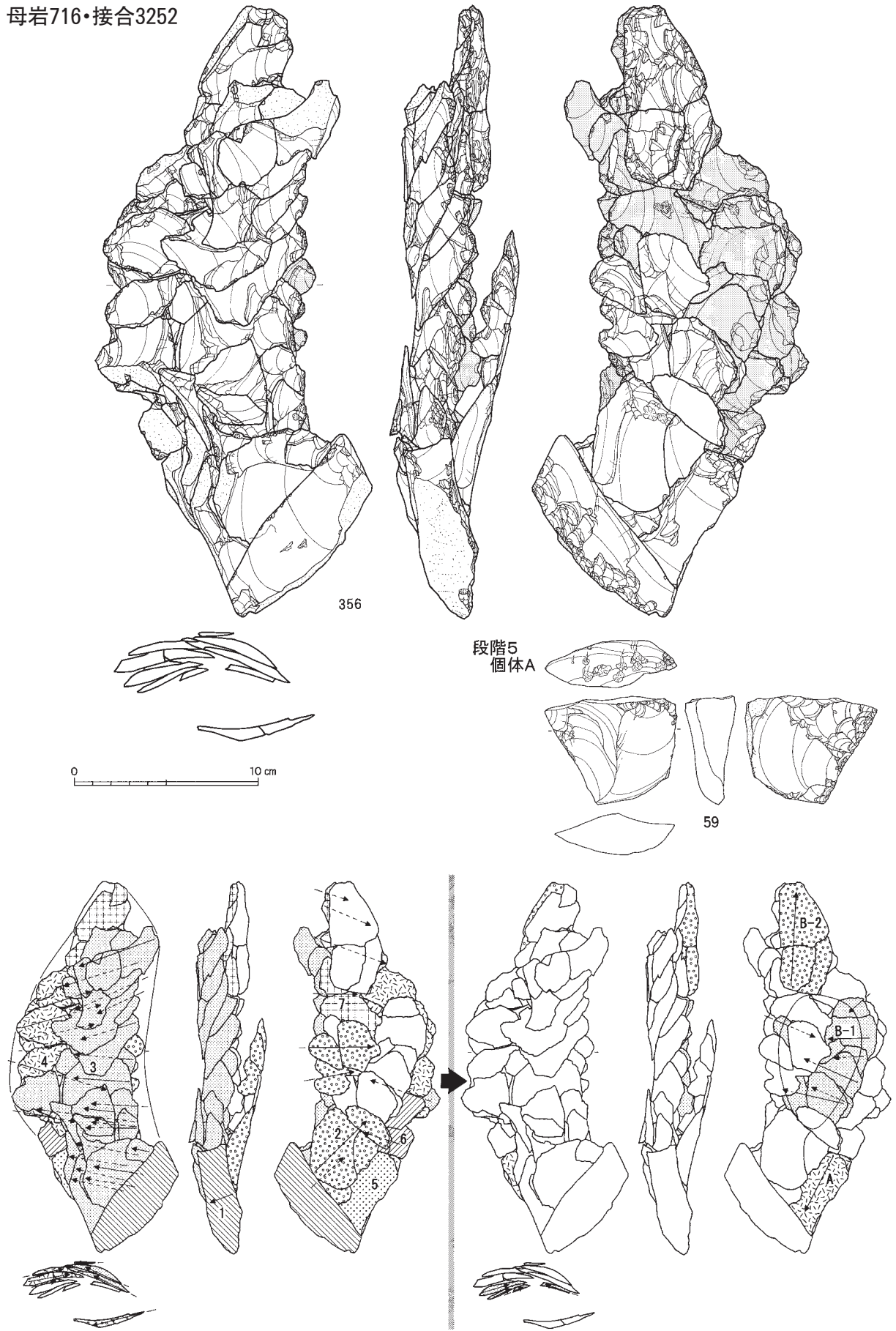

図Ⅲ-310 I区(Sb-91~96)の石器(75) 母岩716・接合3252(1)

個体B-2

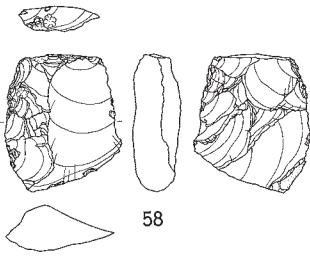

接合3252(段階1・2)分布図

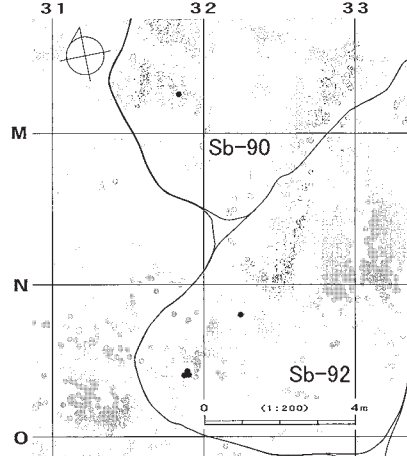

接合3252(段階3~7、B-1・2)分布図

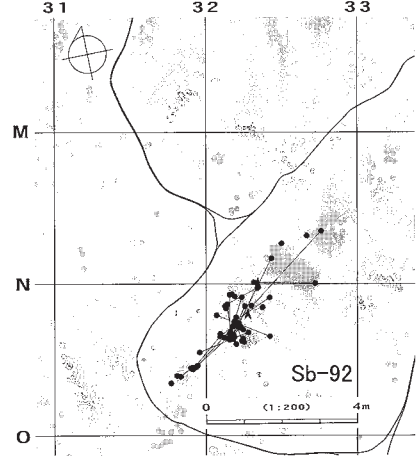

母岩850・接合3745

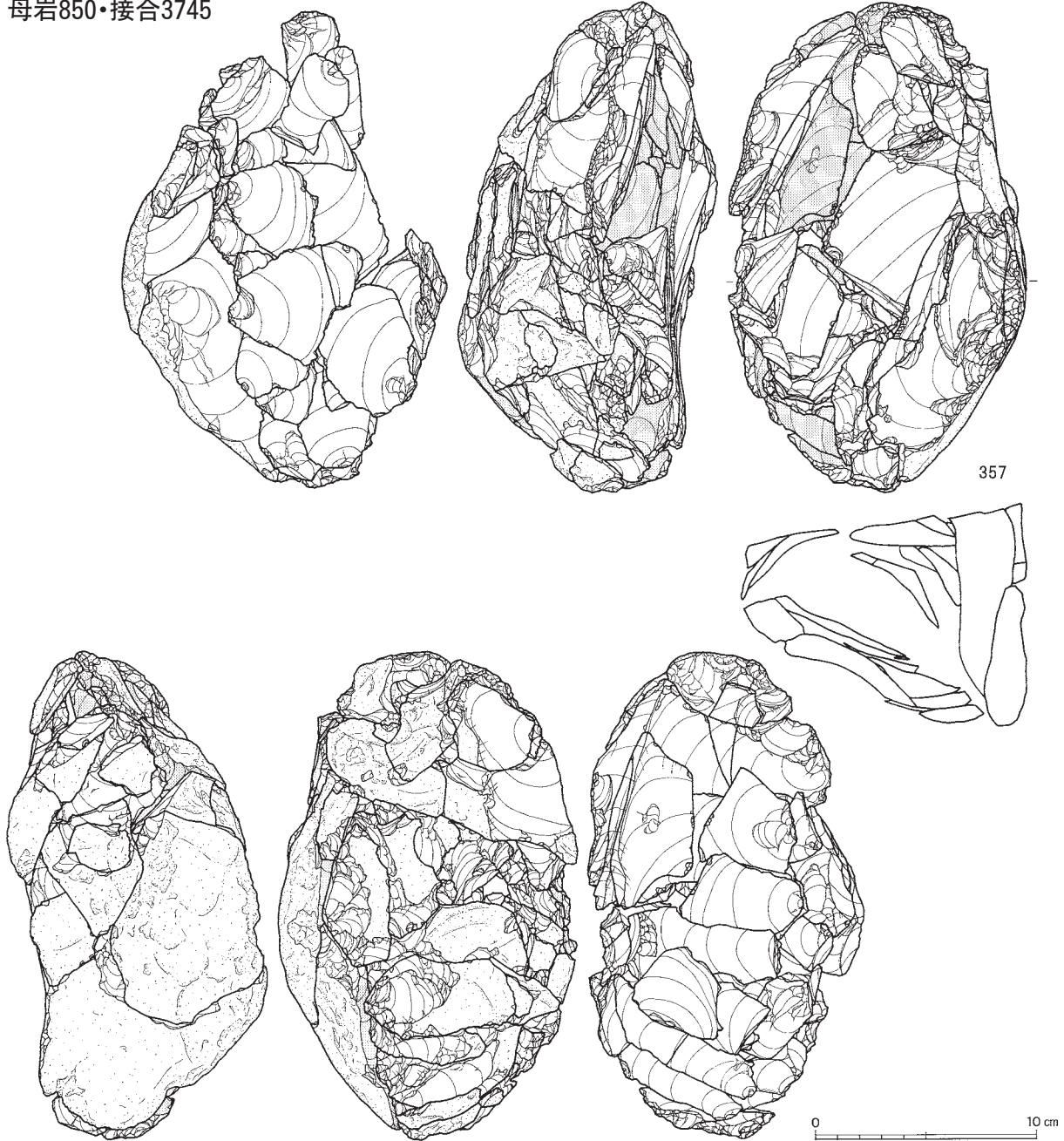

図Ⅲ-311 I区(Sb-91~96)の石器(76) 母岩716・接合3252(2)、母岩850・接合3745(1)

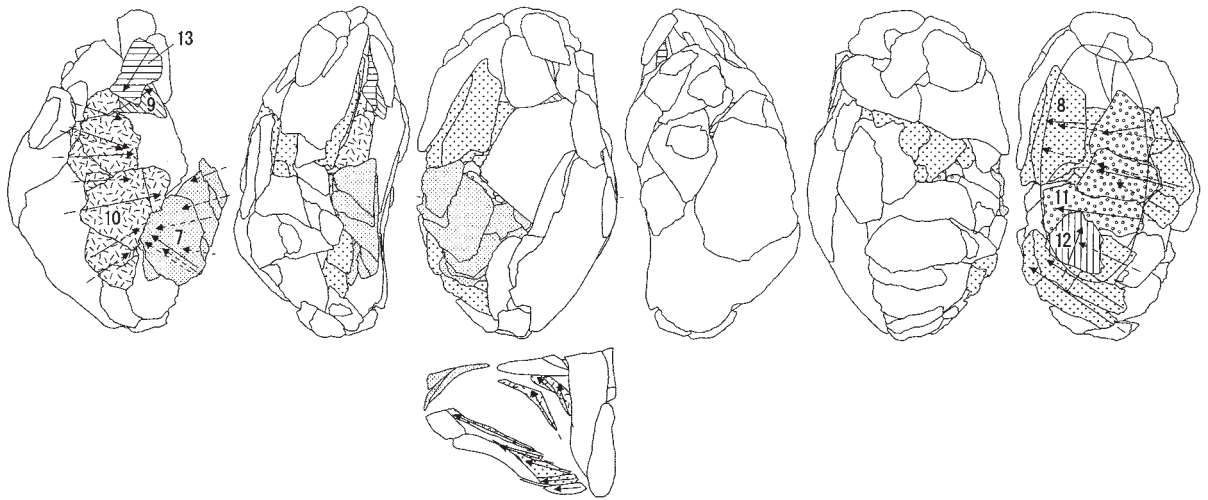
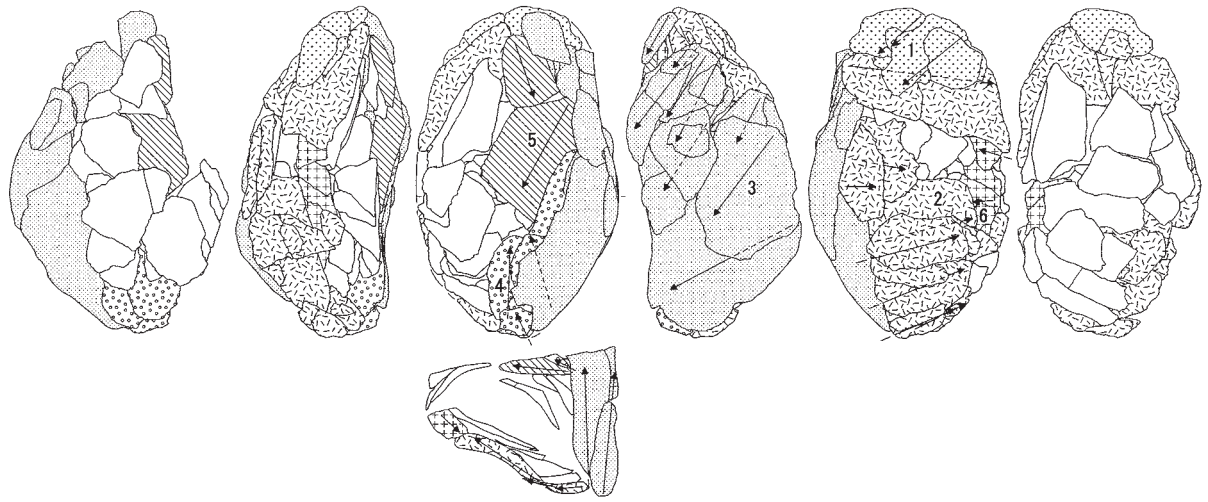

接合3745(段階1~3)分布図

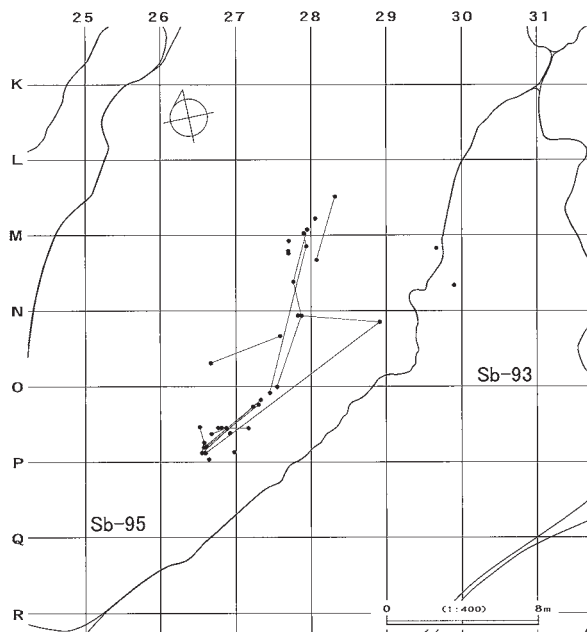

接合3745(段階4~13)分布図

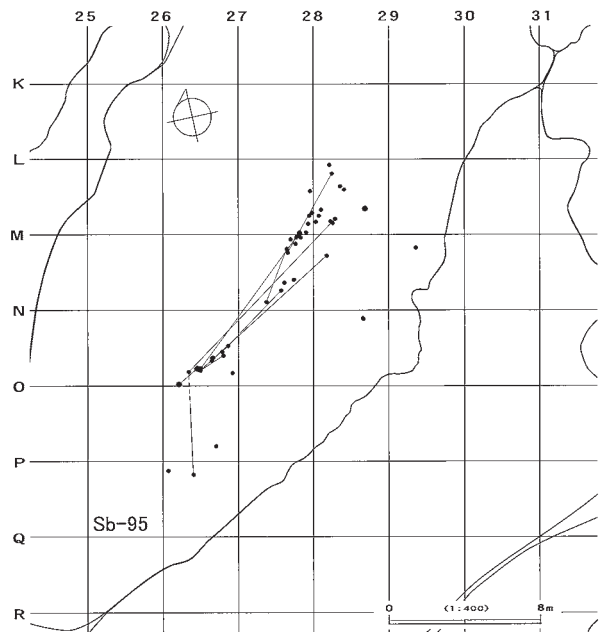

図Ⅲ-312 I区(Sb-91~96)の石器(77) 母岩850・接合3745(2)

接合3745分布図

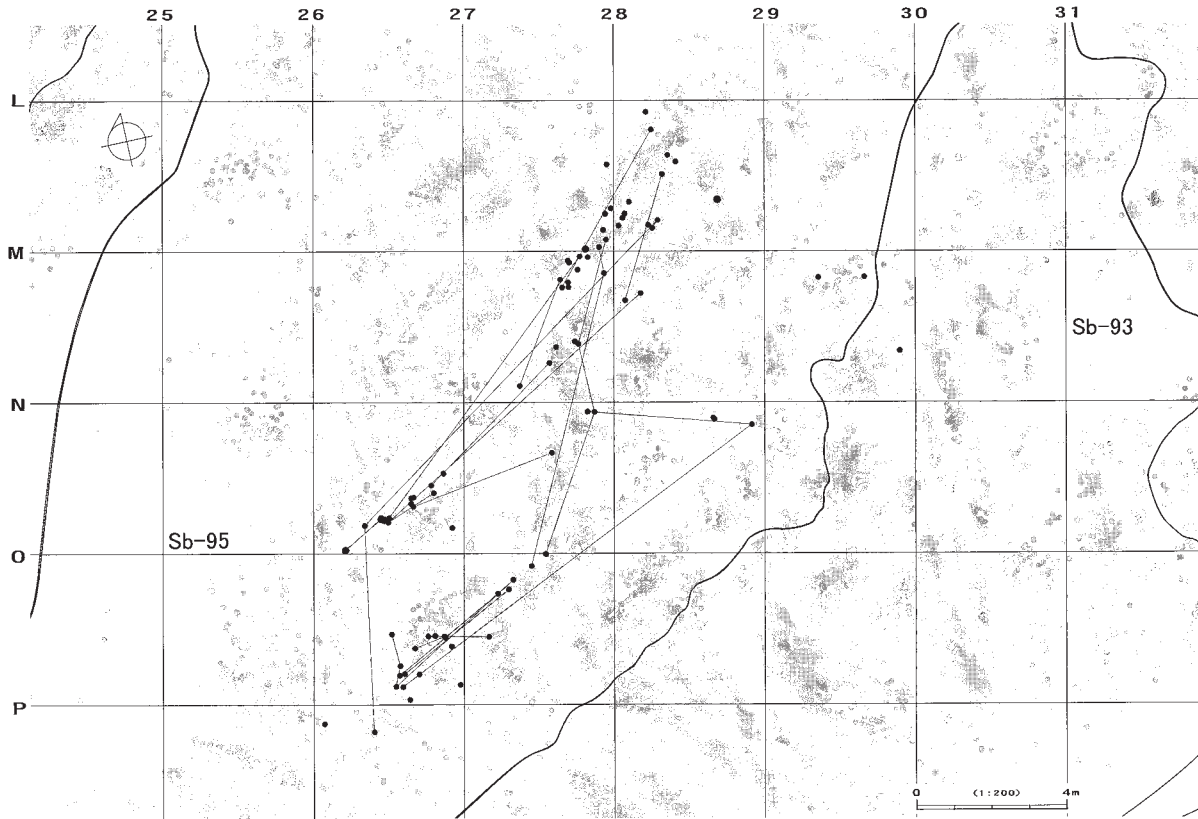

母岩737・接合3337

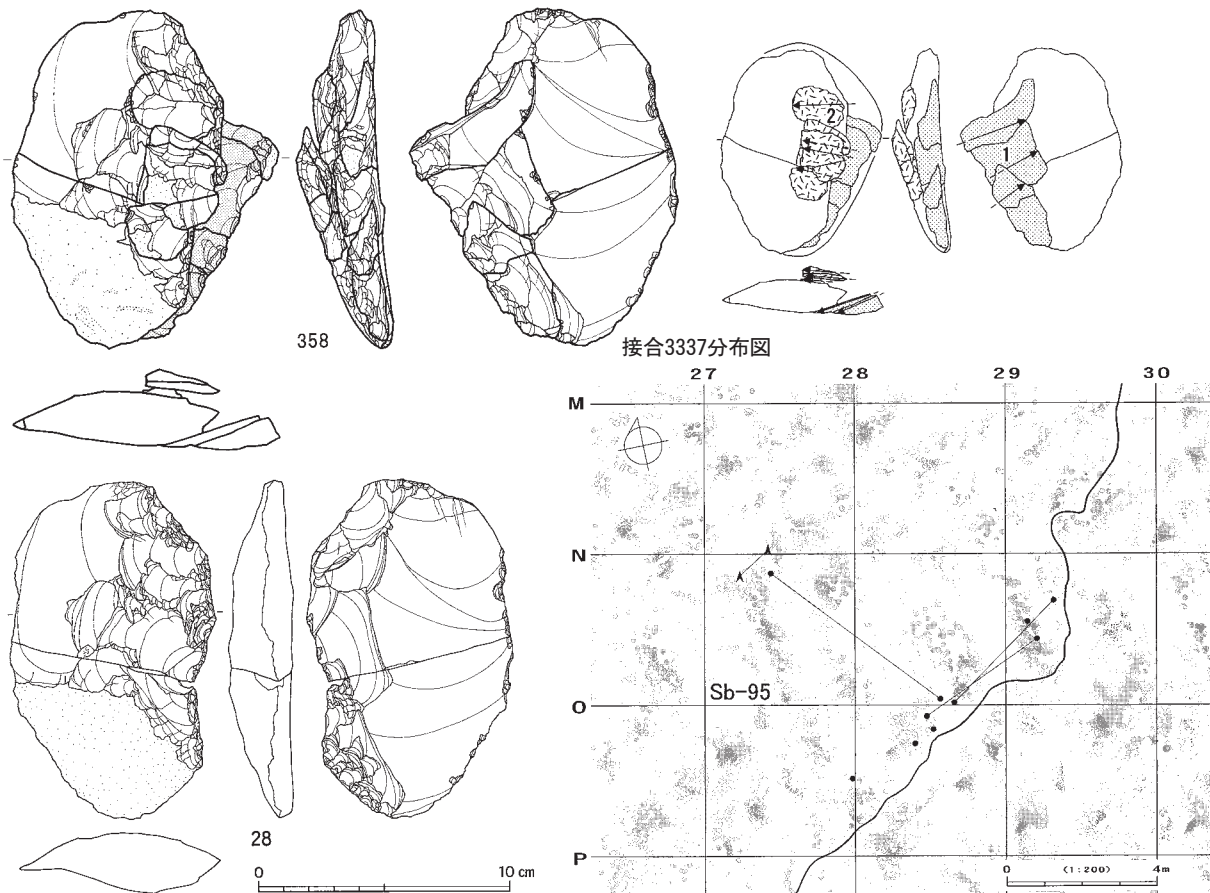

図Ⅲ-313 I区(Sb-91~96)の石器(78) 母岩850・接合3745(3)、母岩737・接合3337

母岩725・接合3276

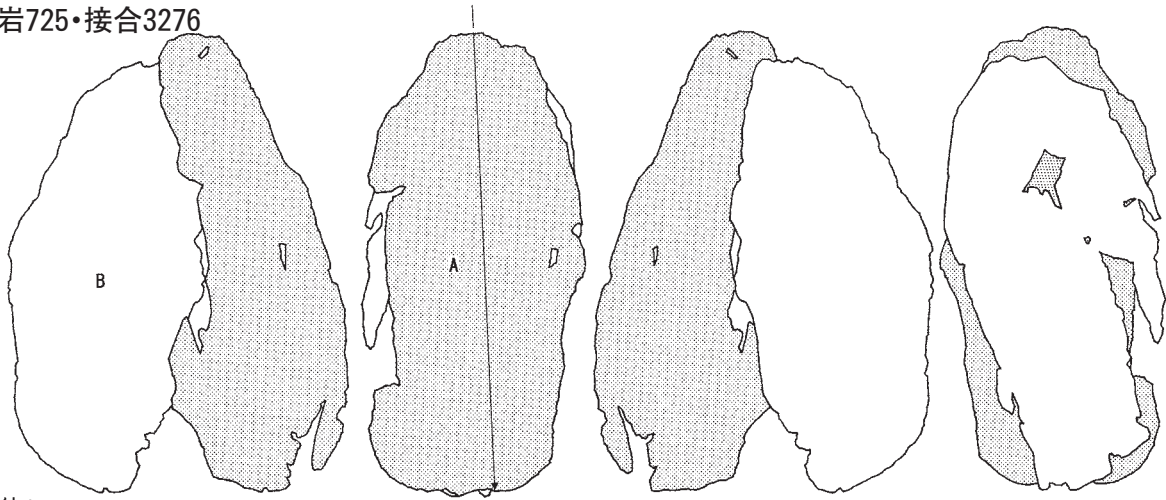

個体A

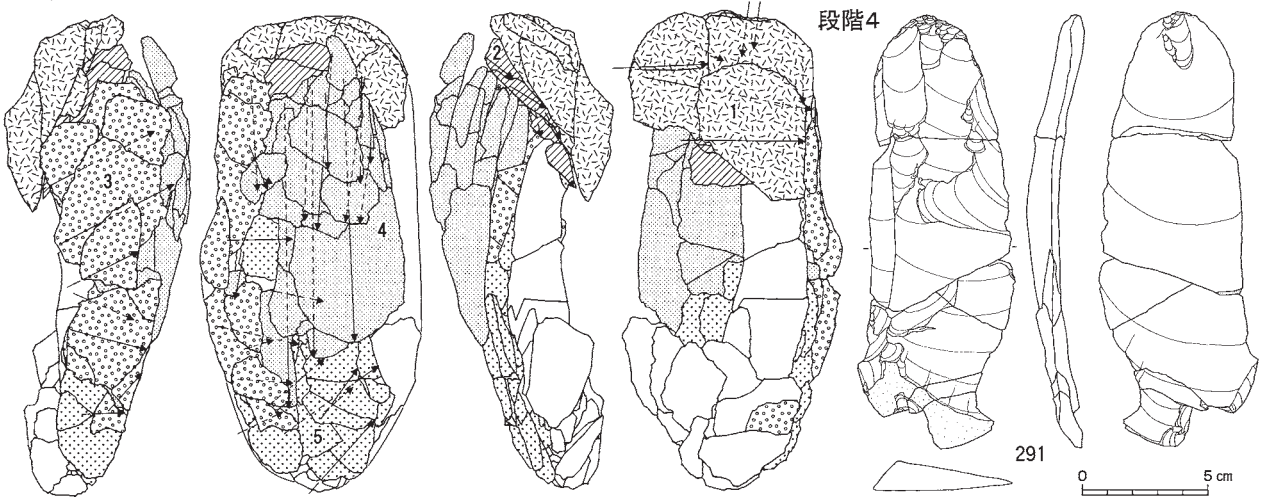
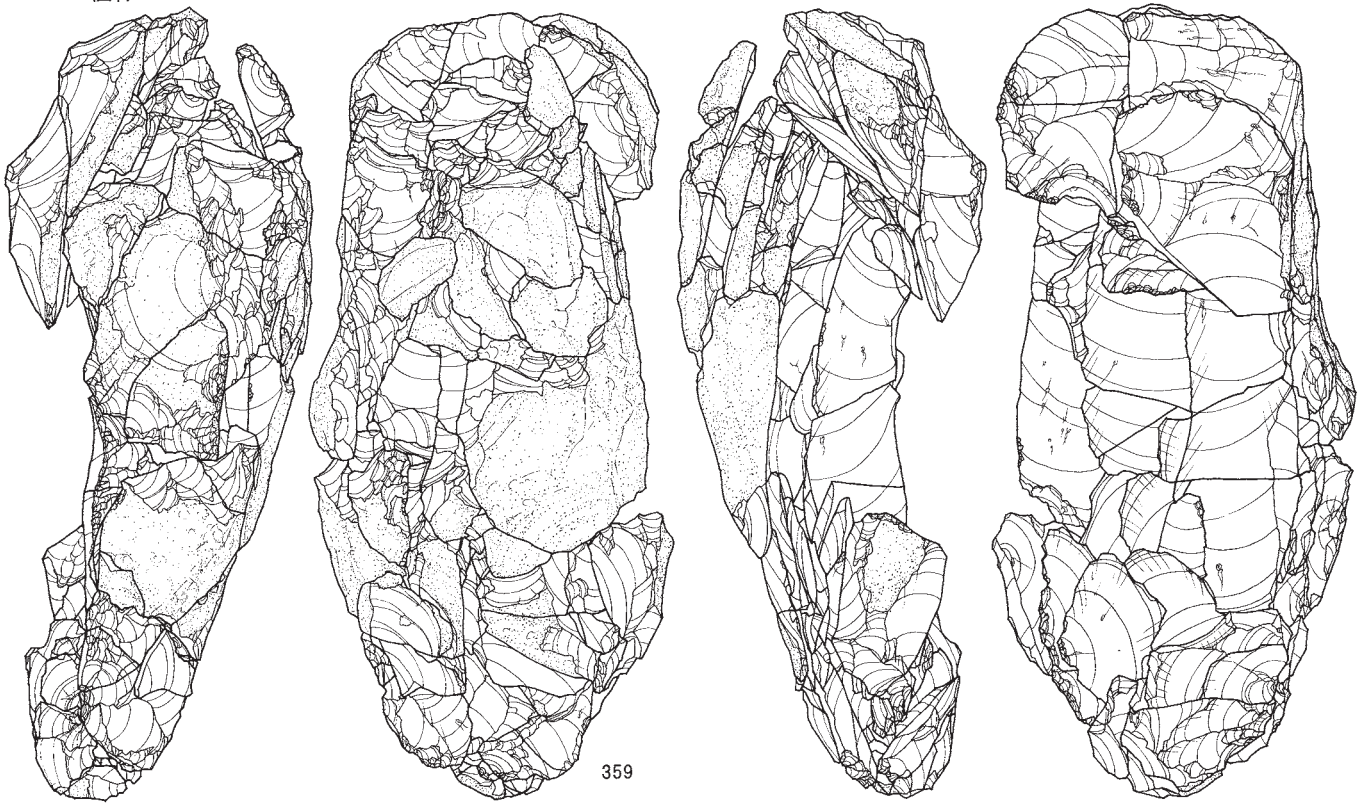

図III-314 I区(Sb-91~96)の石器(79) 母岩725・接合3276(1)

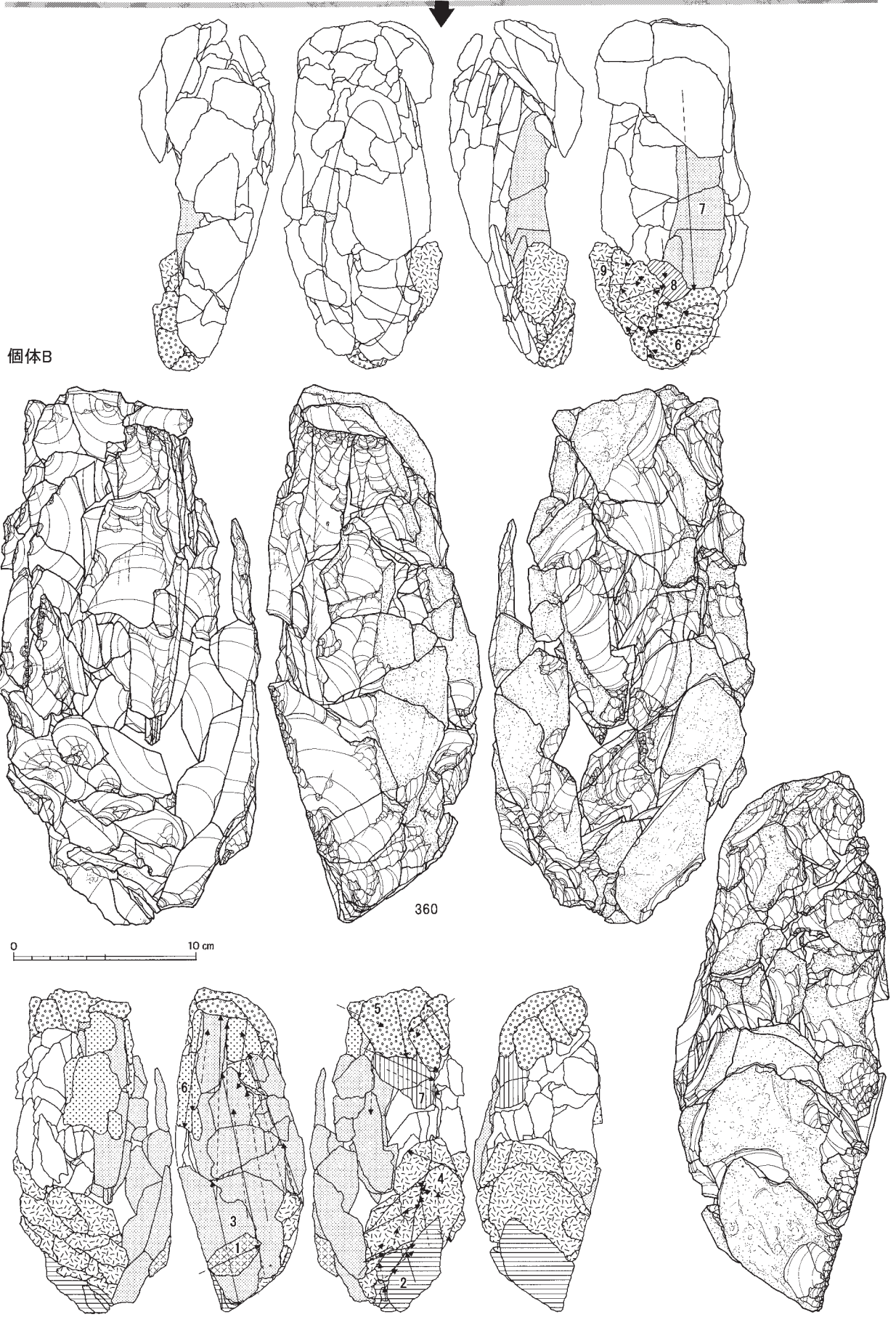

図III-315 I区(Sb-91~96)の石器(80) 母岩725・接合3276(2)

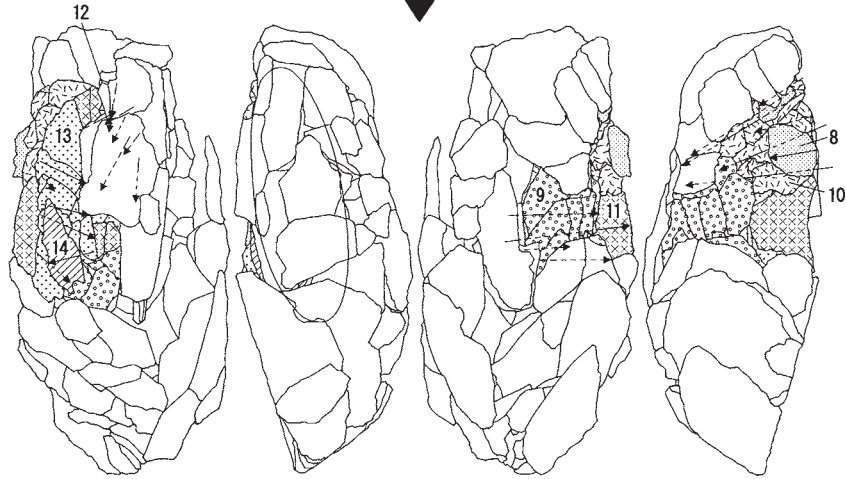

接合3276(個体A-段階1・2)分布図

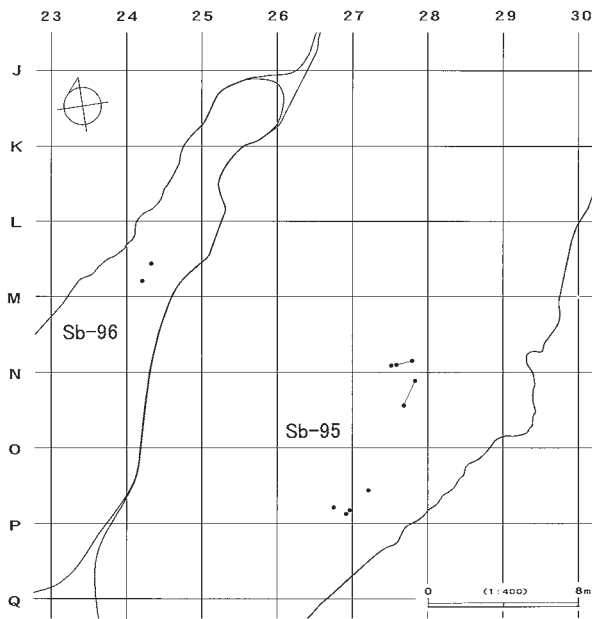

接合3276(個体A-段階3)分布図

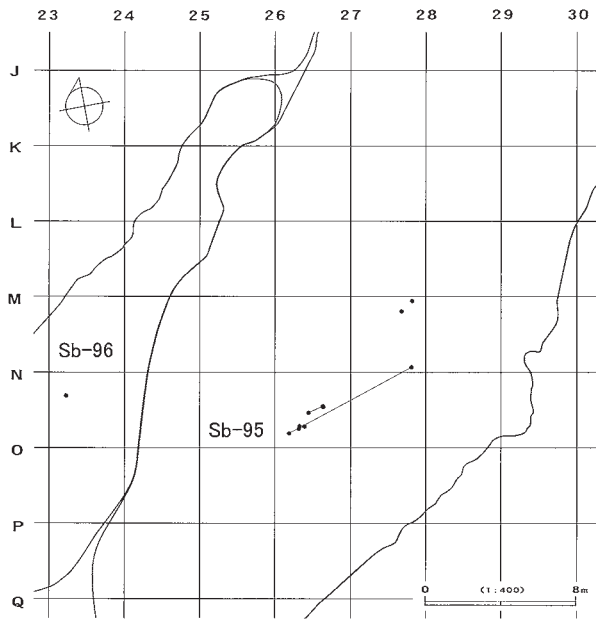

接合3276(個体A-段階4)分布図

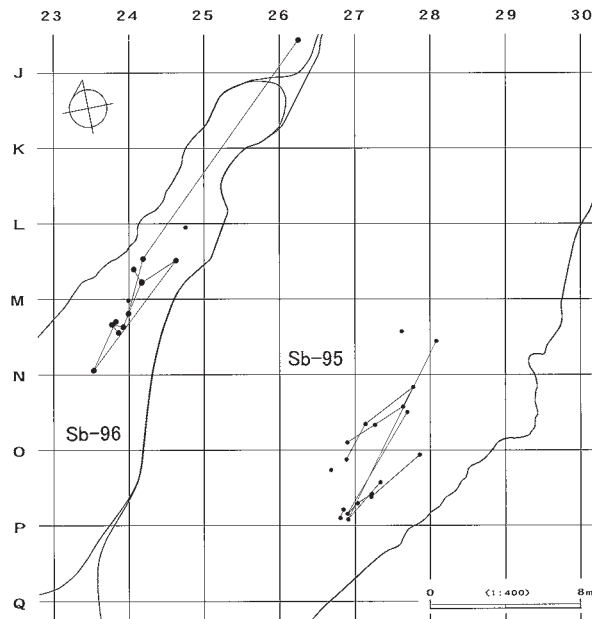

接合3276(個体A-段階5~9)分布図

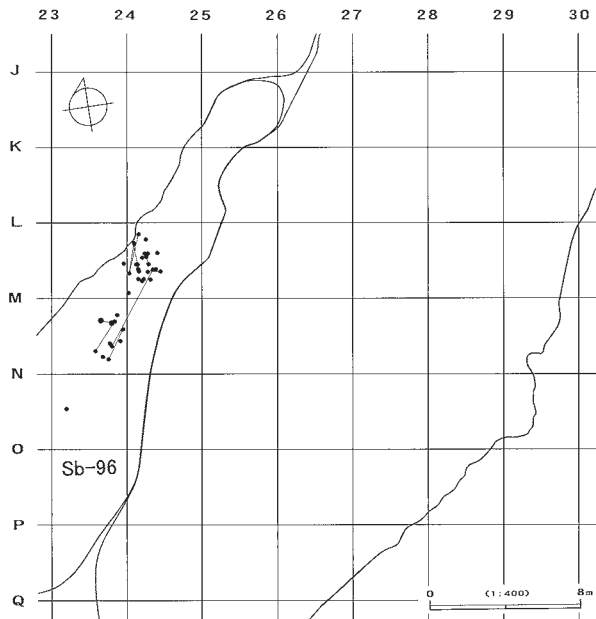

図Ⅲ-316 I区(Sb-91~96)の石器(81) 母岩725・接合3276(3)

接合3276(個体B-段階1・2)分布図

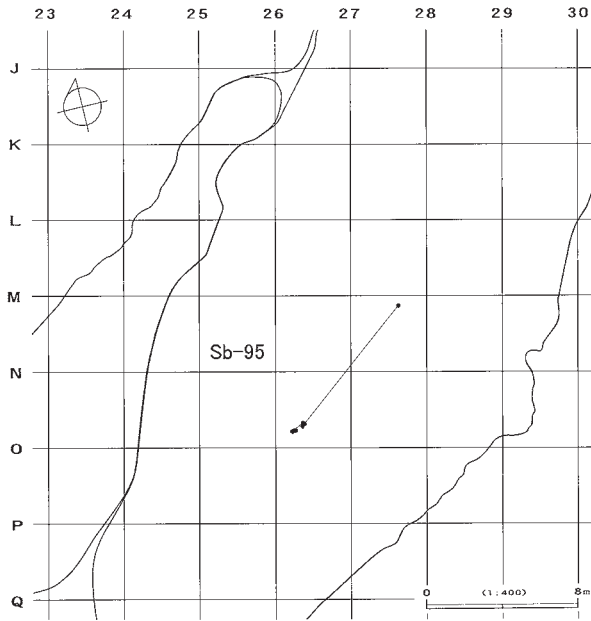

接合3276(個体B-段階3~14)分布図

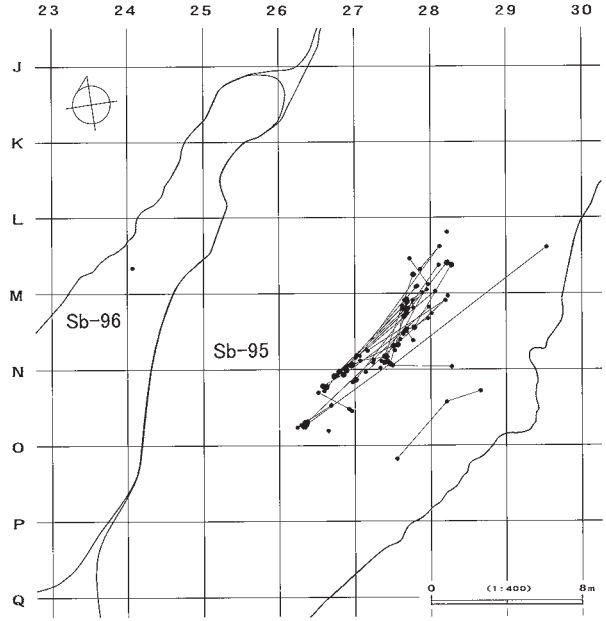

接合3276(全体)分布図

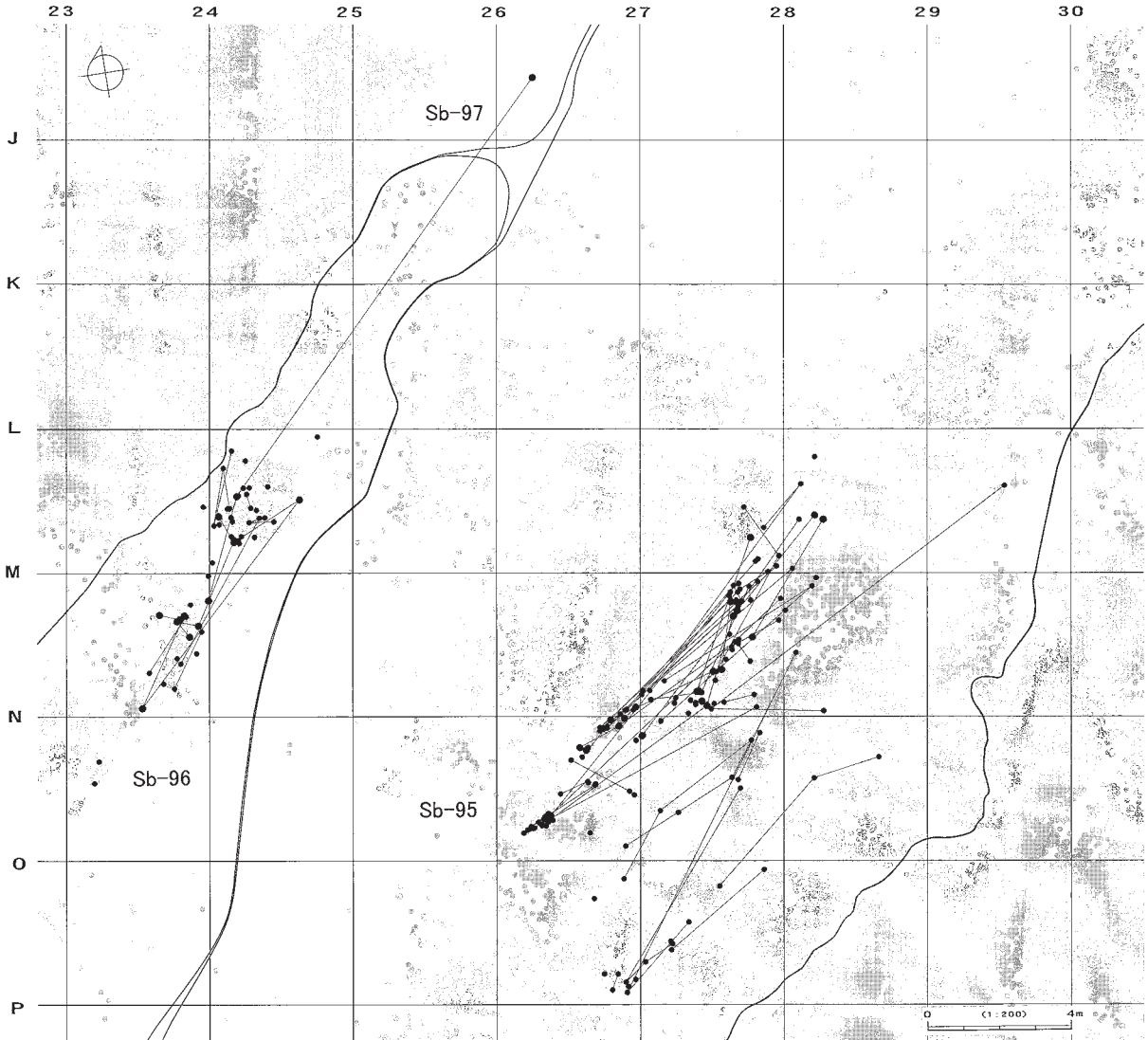

図Ⅲ-317 I区(Sb-91~96)の石器(82) 母岩725・接合3276(4)

母岩728・接合3287

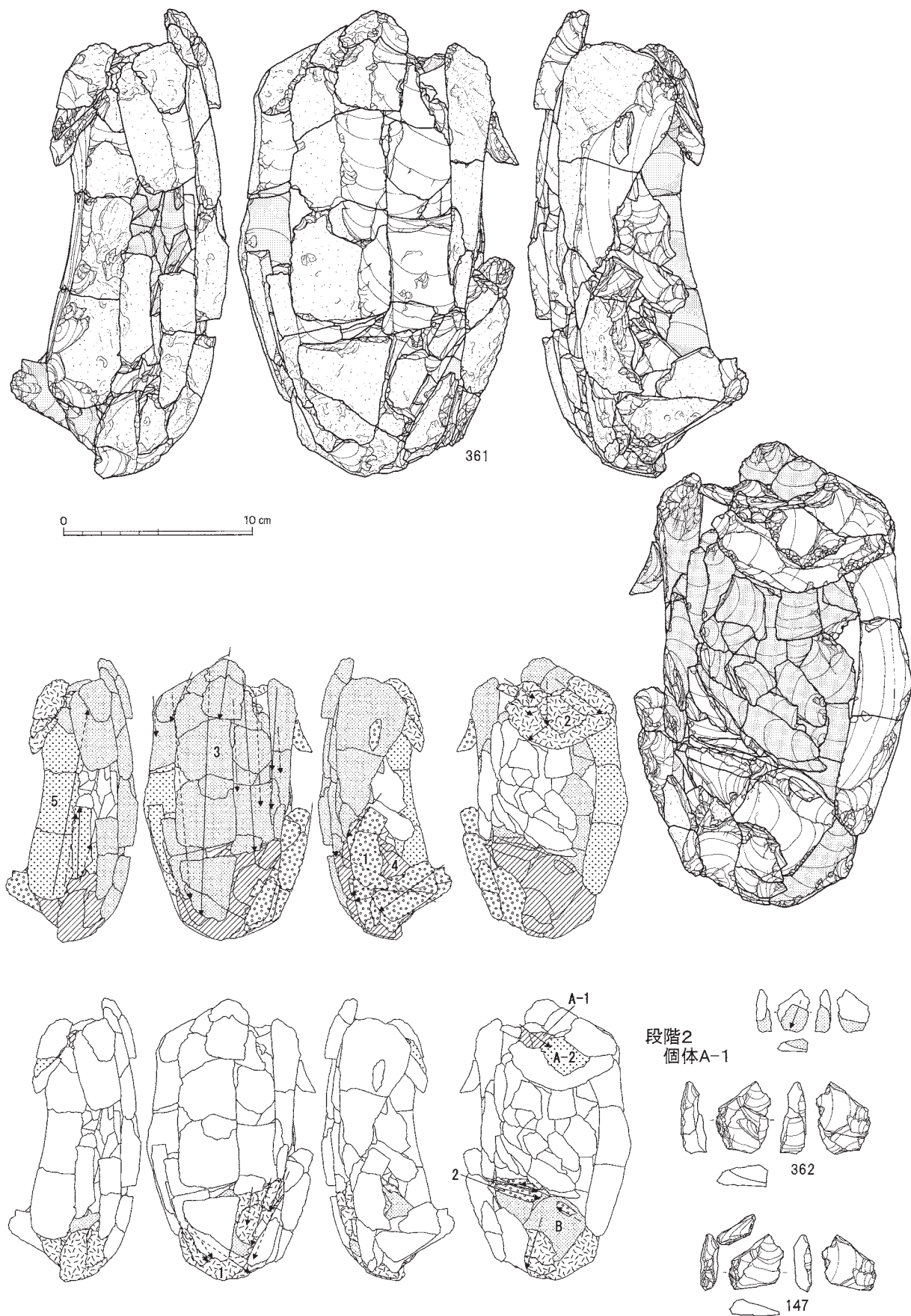

図Ⅲ-318 I区(Sb-91~96)の石器(83) 母岩728・接合3287(1)

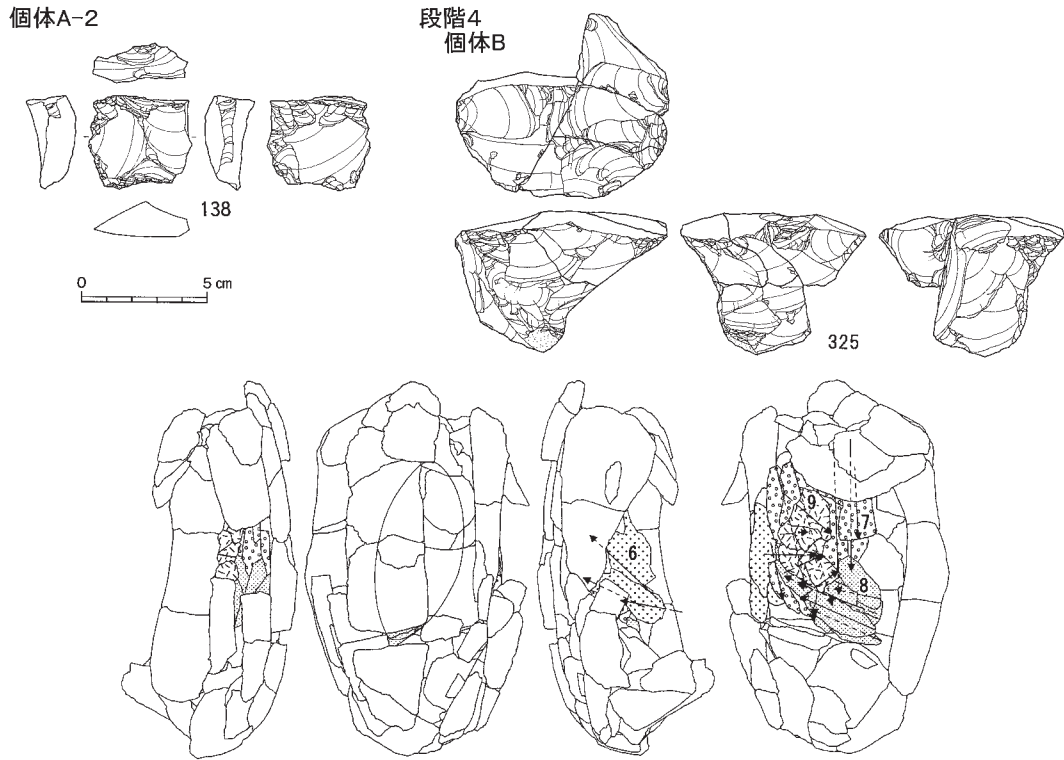

接合3287(全体)分布図

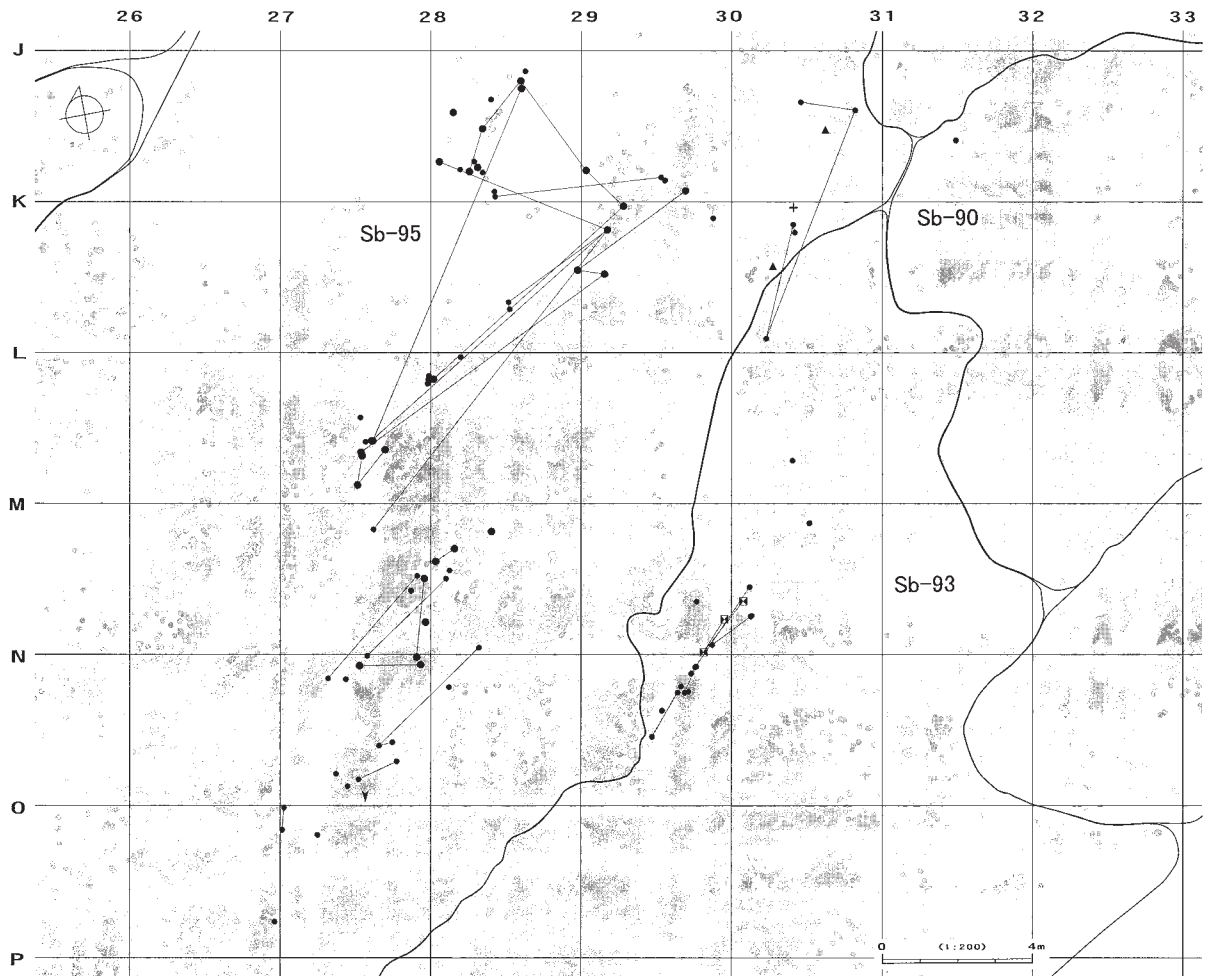

図Ⅲ-319 I区(Sb-91~96)の石器(84) 母岩728・接合3287(2)

接合3287(个体A)分布图

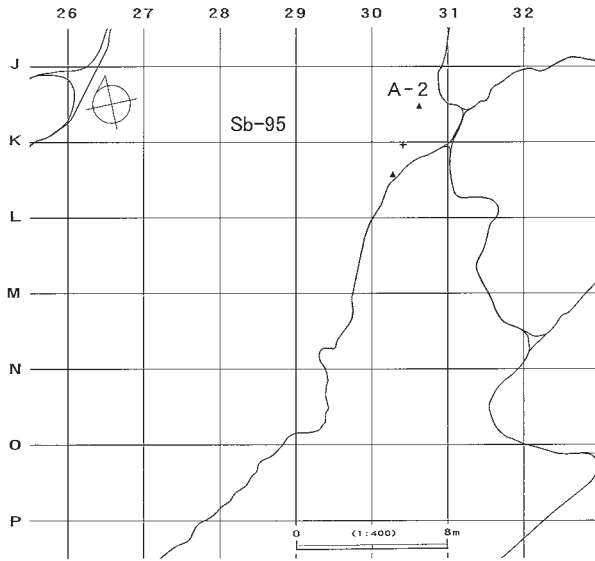

接合3287(个体B)分布图

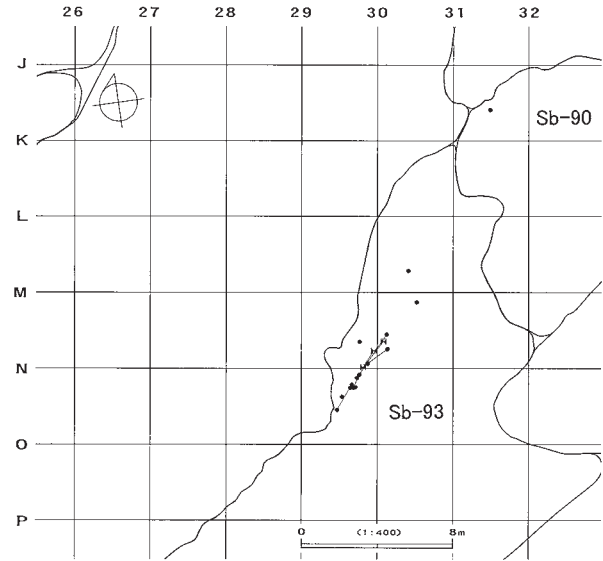

接合3287(段階1・2)分布图

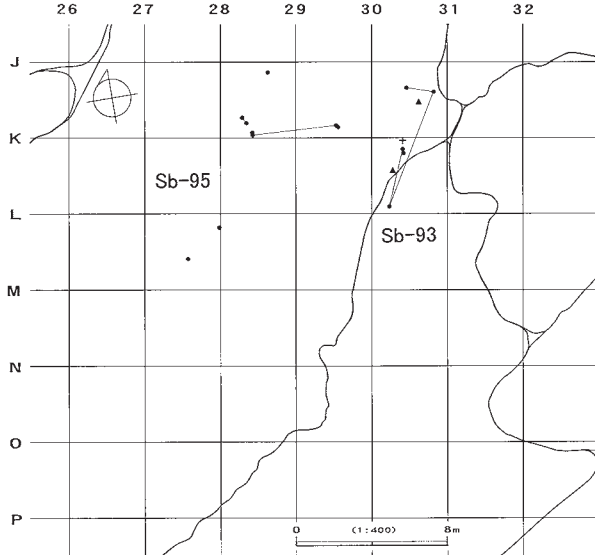

接合3287(段階3)分布图

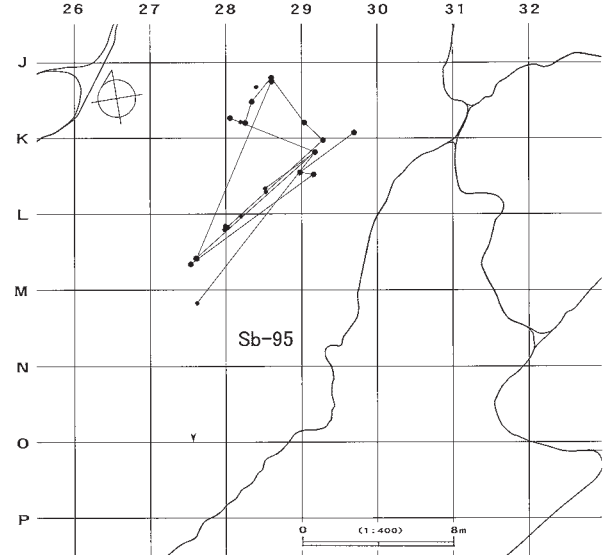

接合3287(段階5)分布图

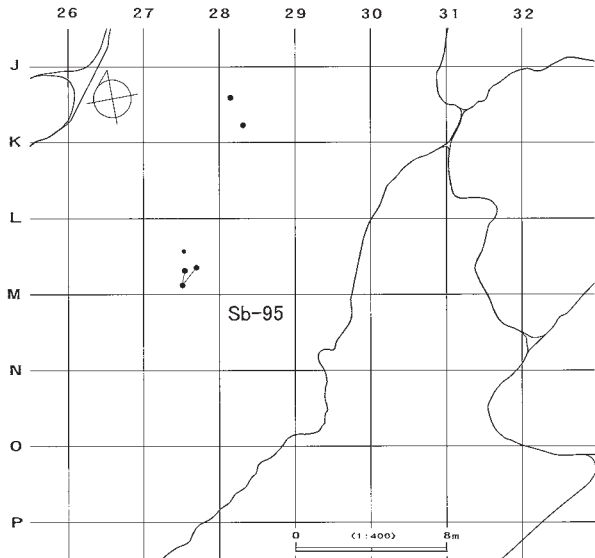

接合3287(段階6~9)分布图

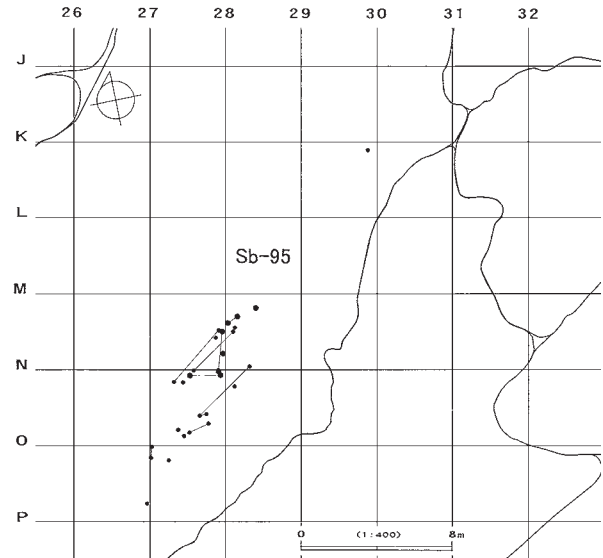

図Ⅲ-320 I区(Sb-91~96)の石器(85) 母岩728・接合3287(3)

母岩757・接合3430

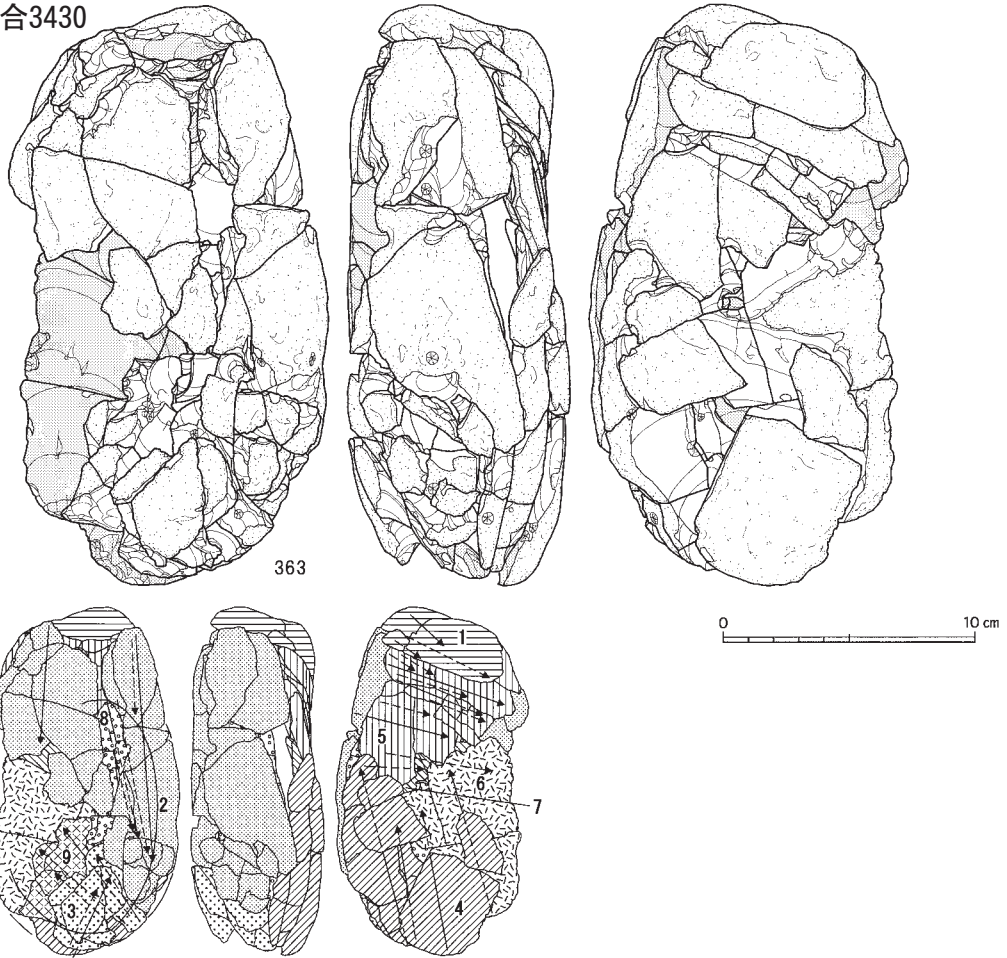

接合3430分布図

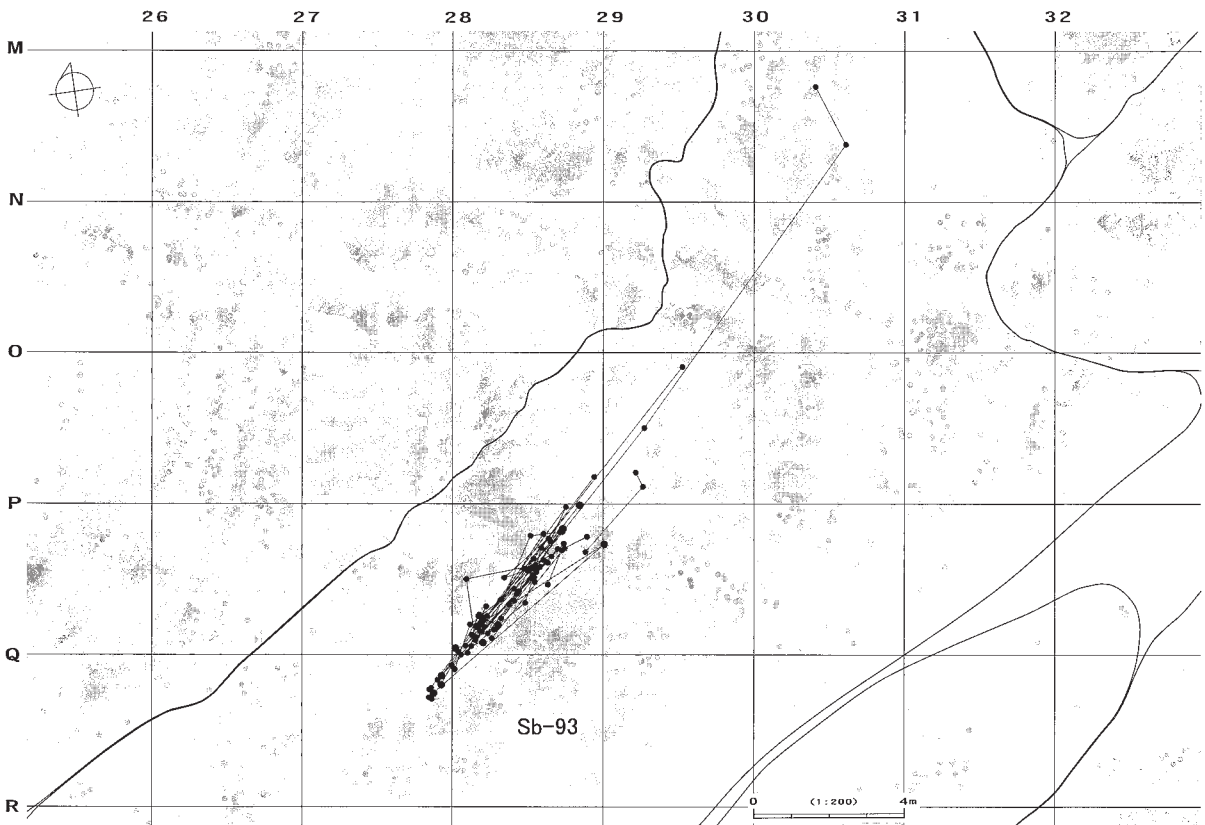

図Ⅲ-321 I区(Sb-91~96)の石器(86) 母岩757・接合3430

母岩788・接合3514

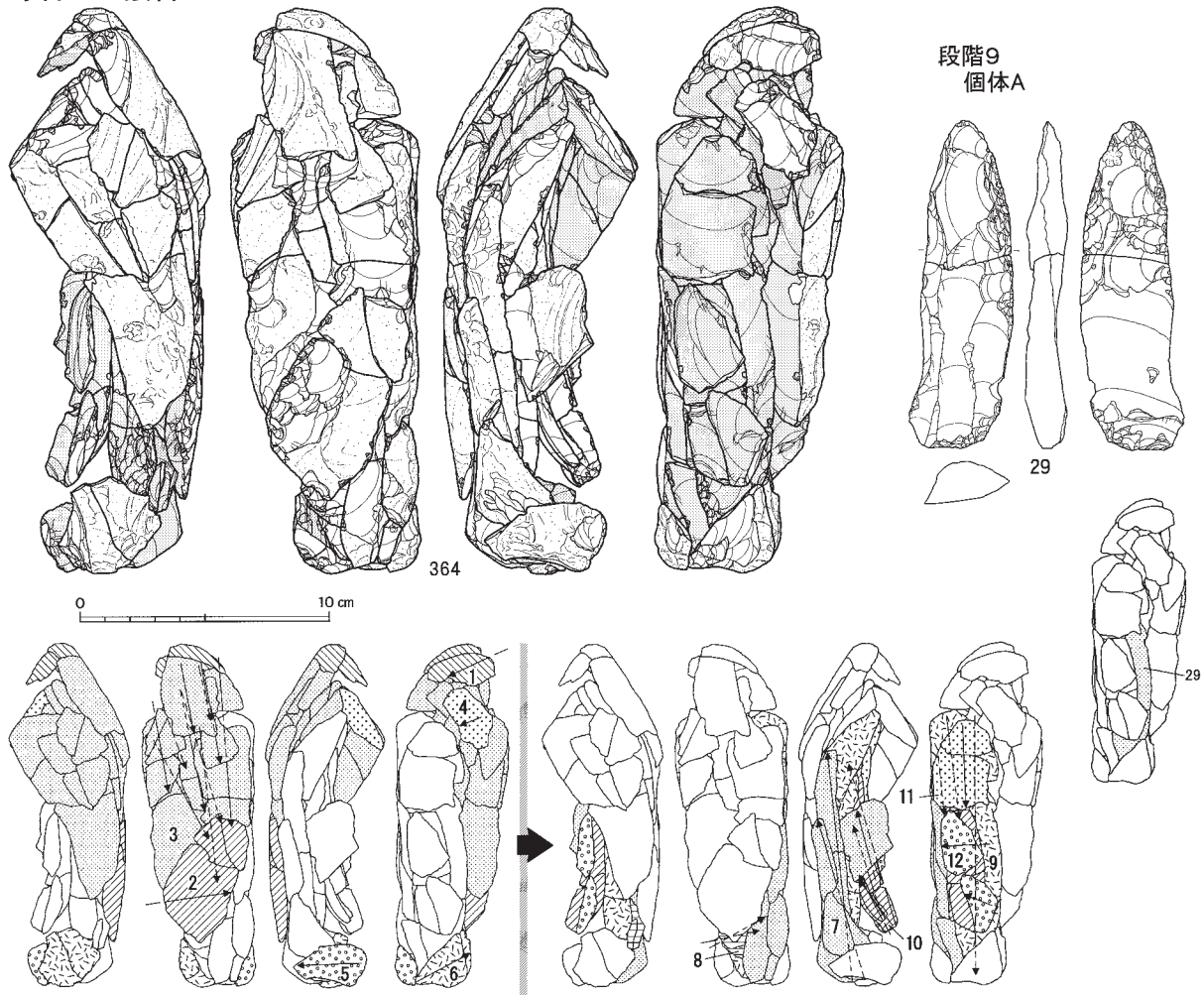

接合3514(个体A)分布図

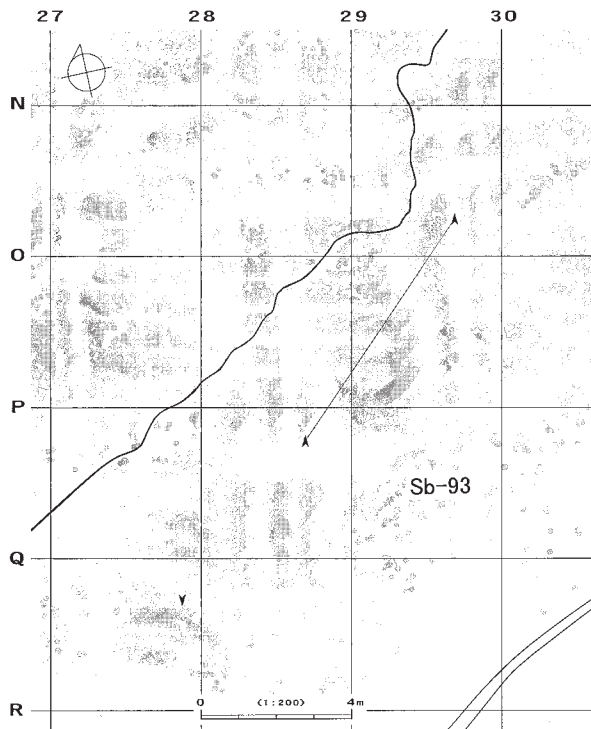

接合3514(个体A以外)分布図

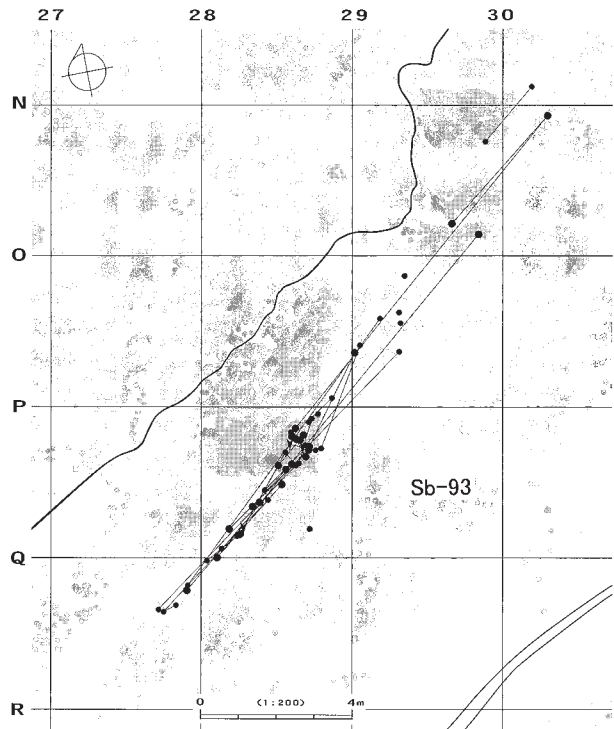

図Ⅲ-322 I区(Sb-91~96)の石器(87) 母岩788・接合3514

母岩732・接合3316

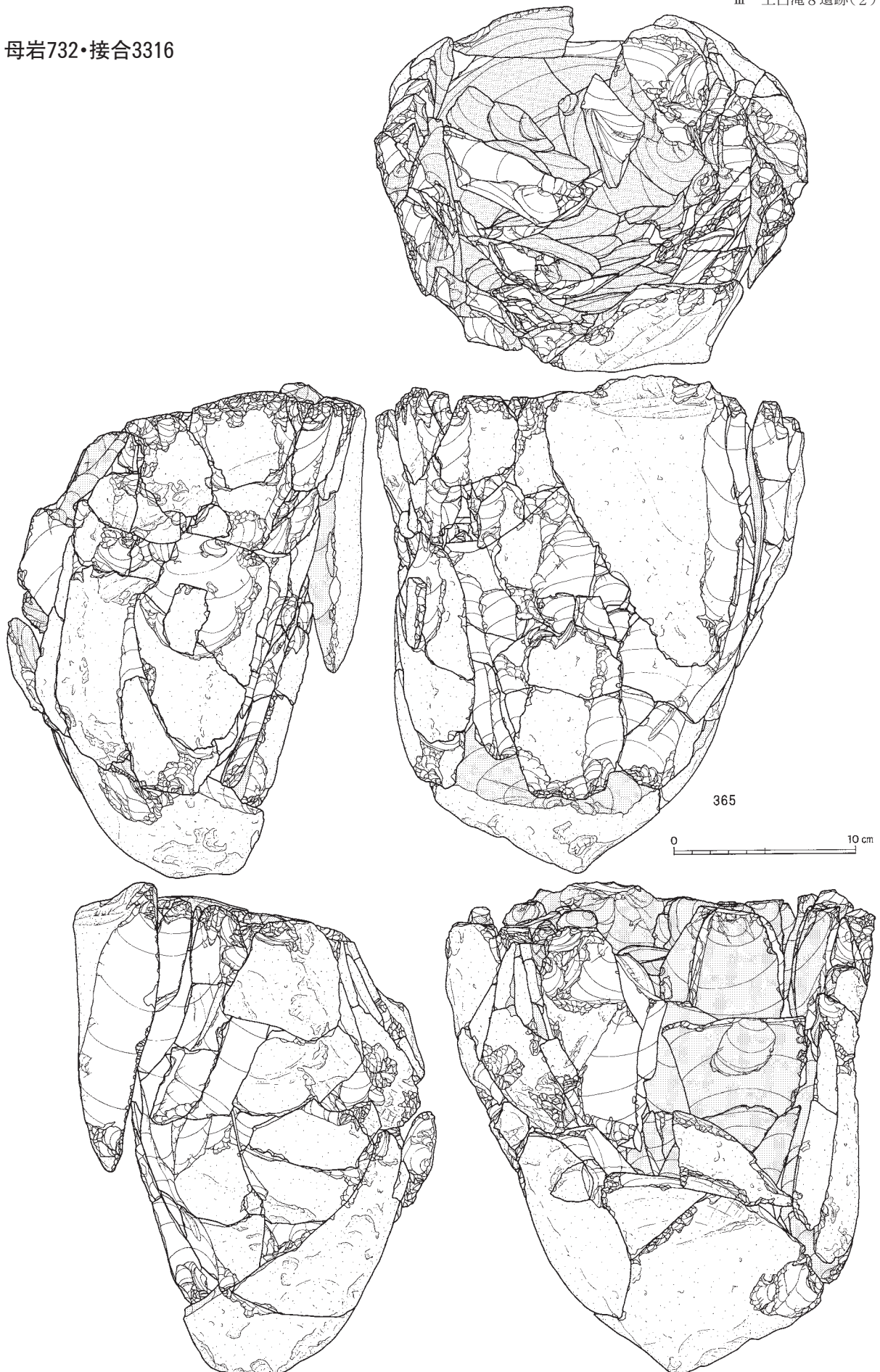

図Ⅲ-323 I区(Sb-91~96)の石器(88) 母岩732・接合3316(1)

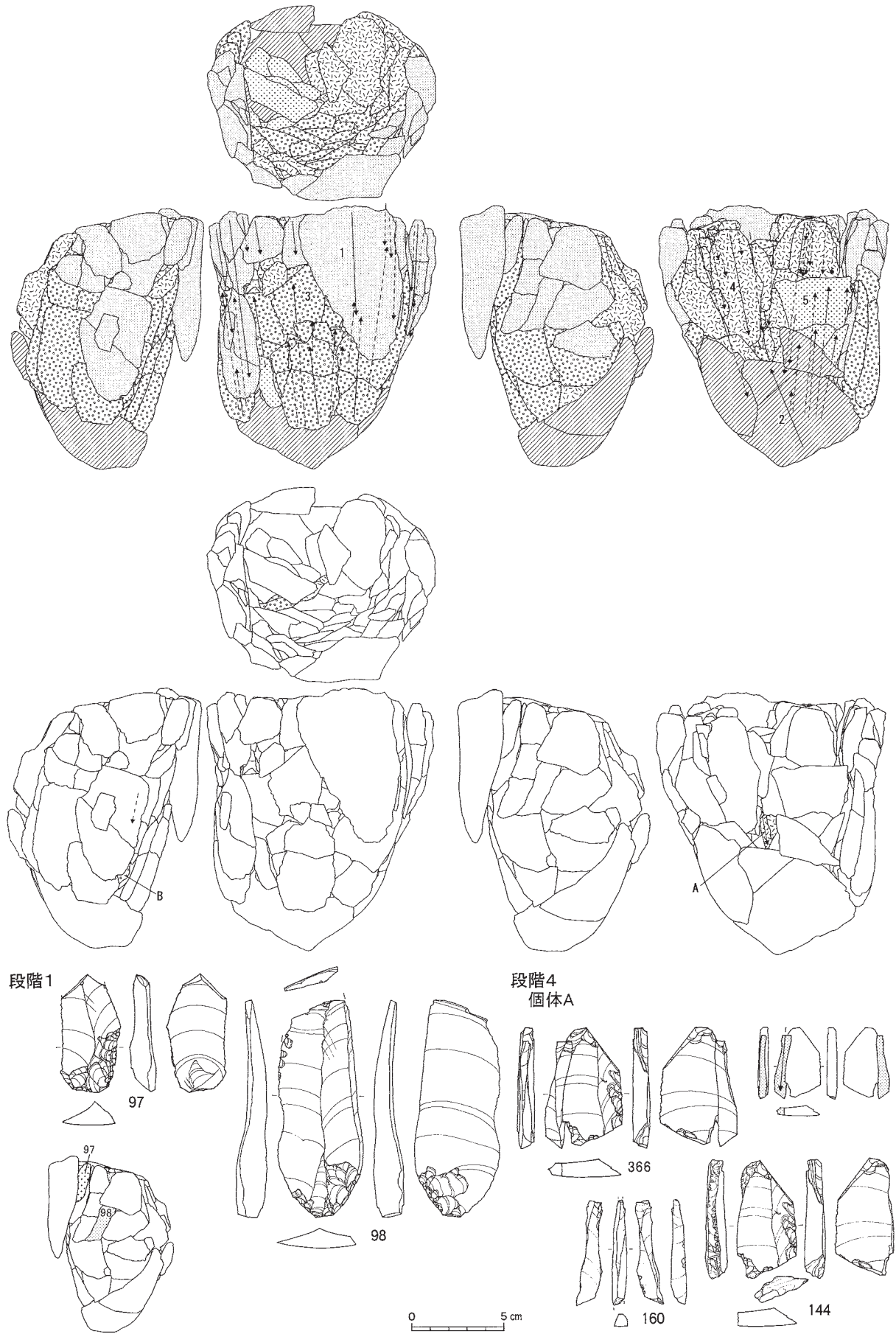

図Ⅲ-324 I区(Sb-91~96)の石器(89) 母岩732・接合3316(2)

段階5
個体B

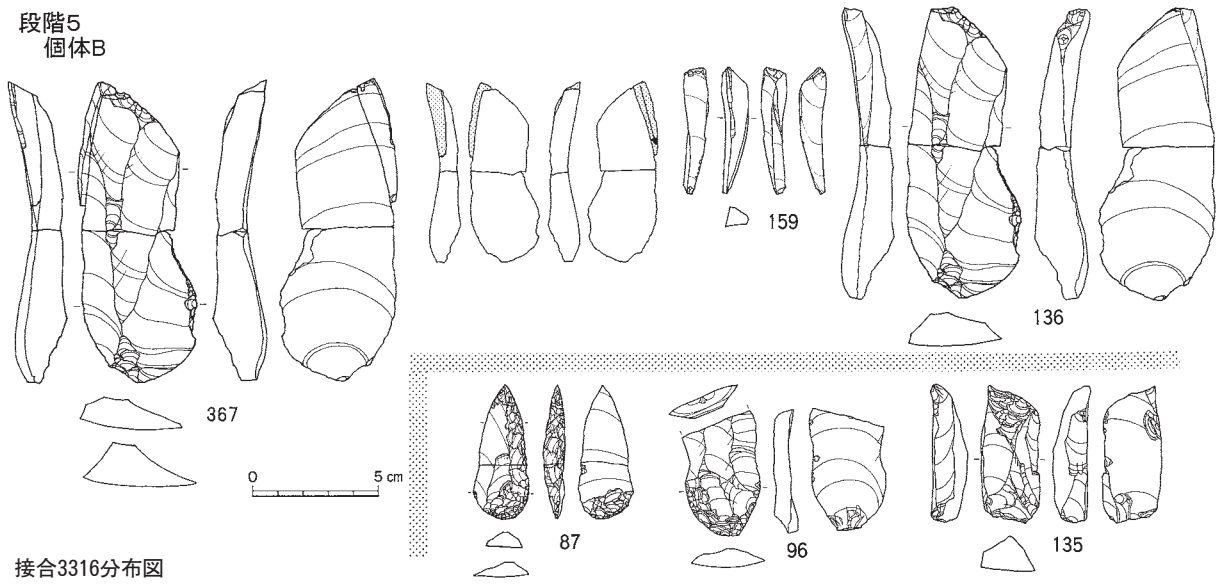

接合3316分布図

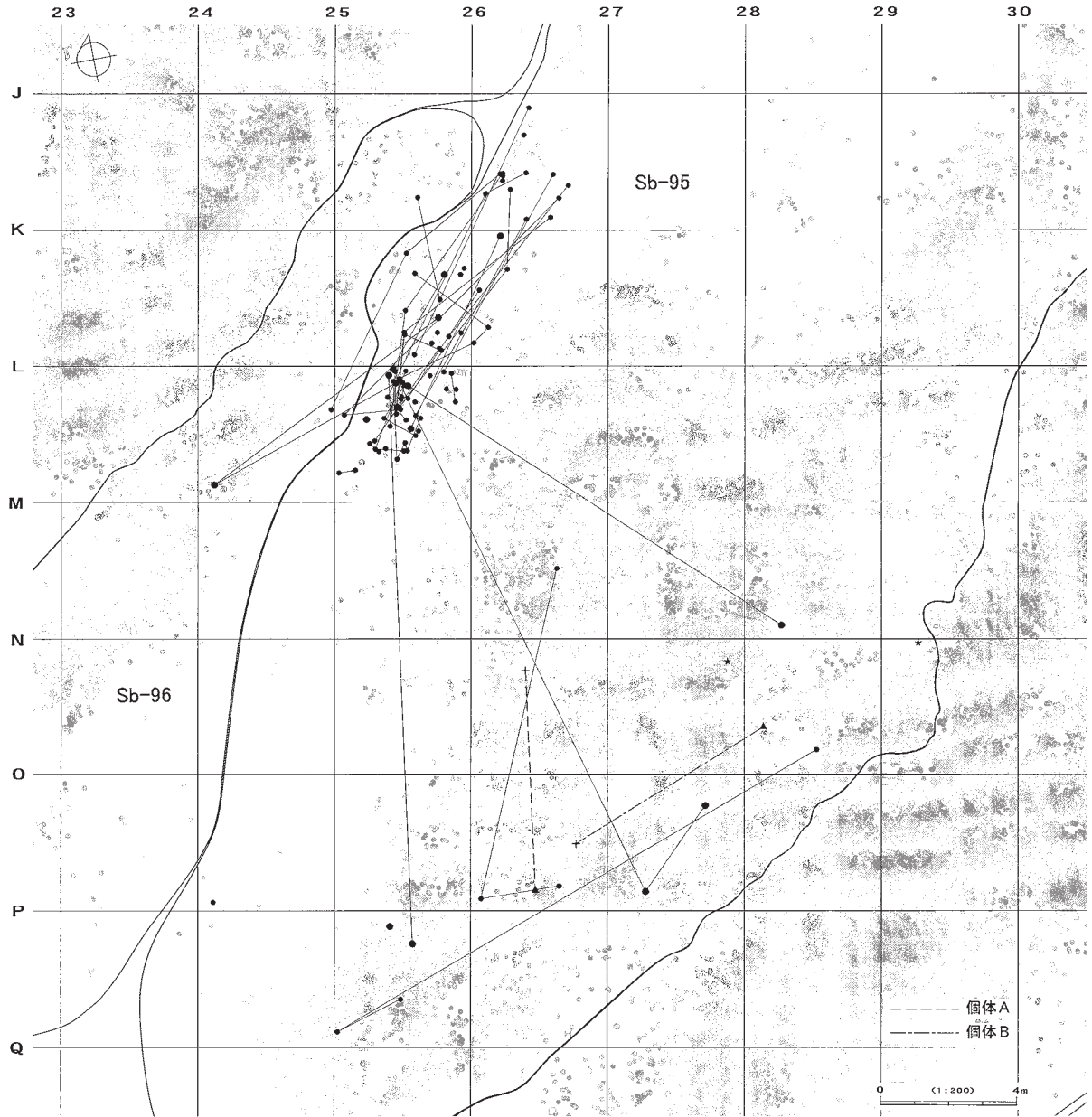

図Ⅲ-325 I区(Sb-91~96)の石器(90) 母岩732・接合3316(3)

母岩933・接合4061

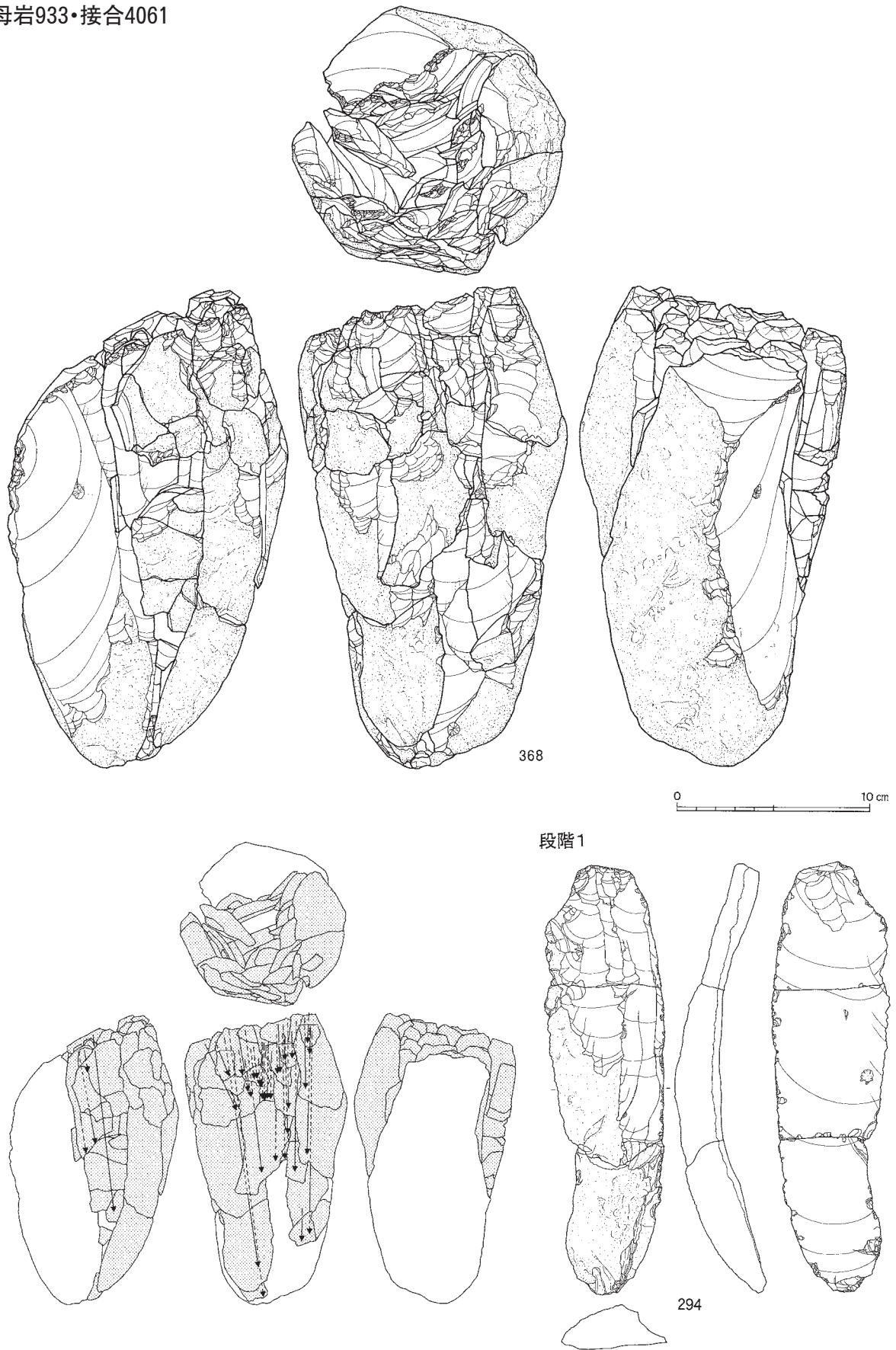

図Ⅲ-326 I区(Sb-91~96)の石器(91) 母岩933・接合4061(1)

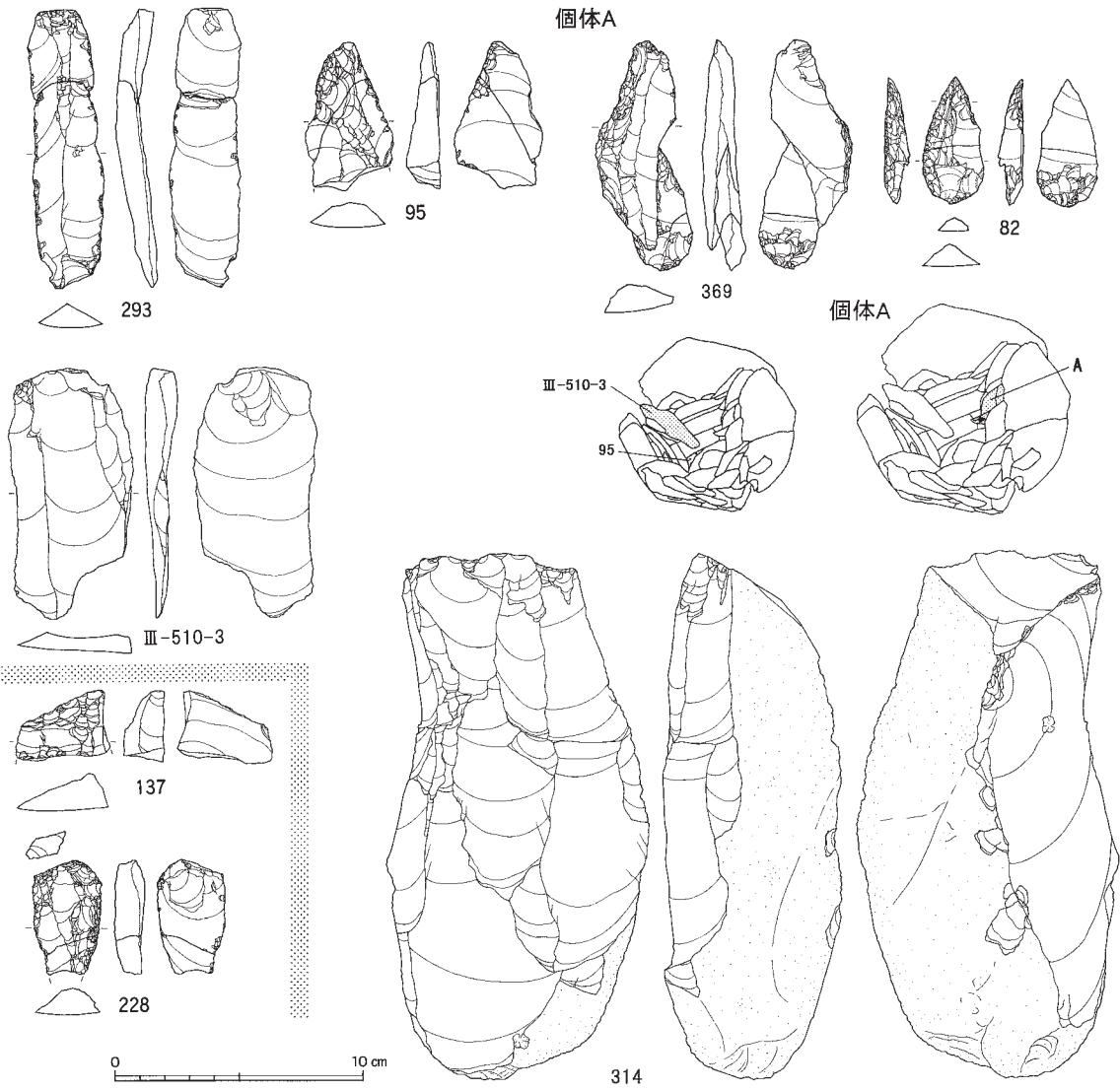

接合4061(全体)分布図

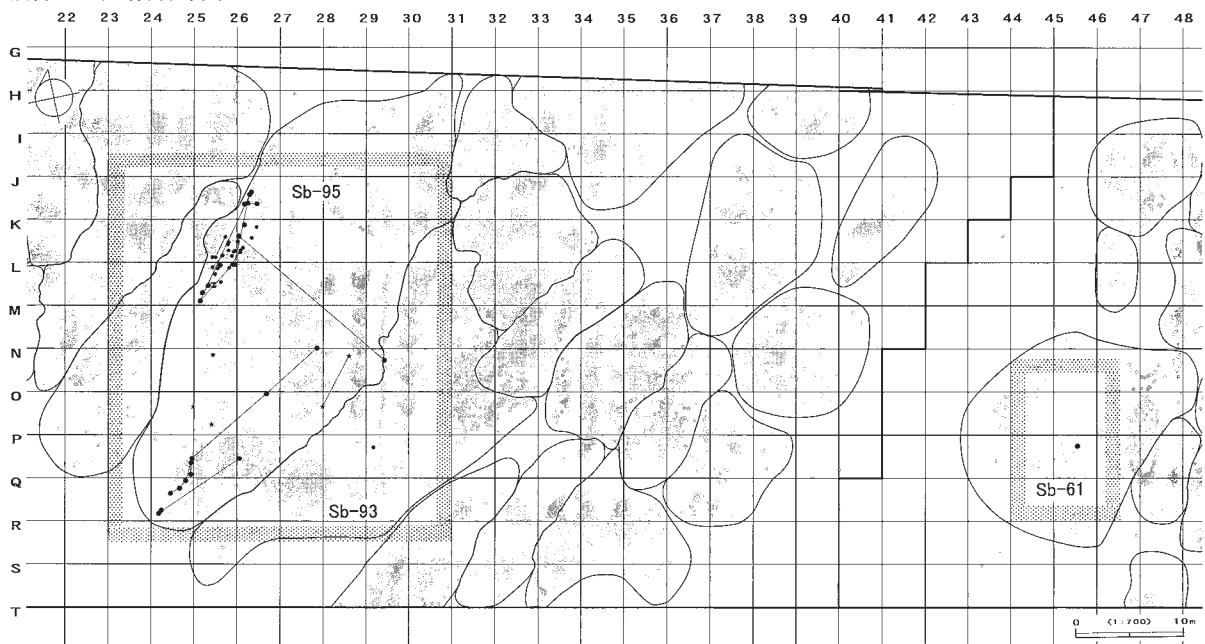

図Ⅲ-327 I区(Sb-91~96)の石器(92) 母岩933・接合4061(2)

I区(Sb-91~96)

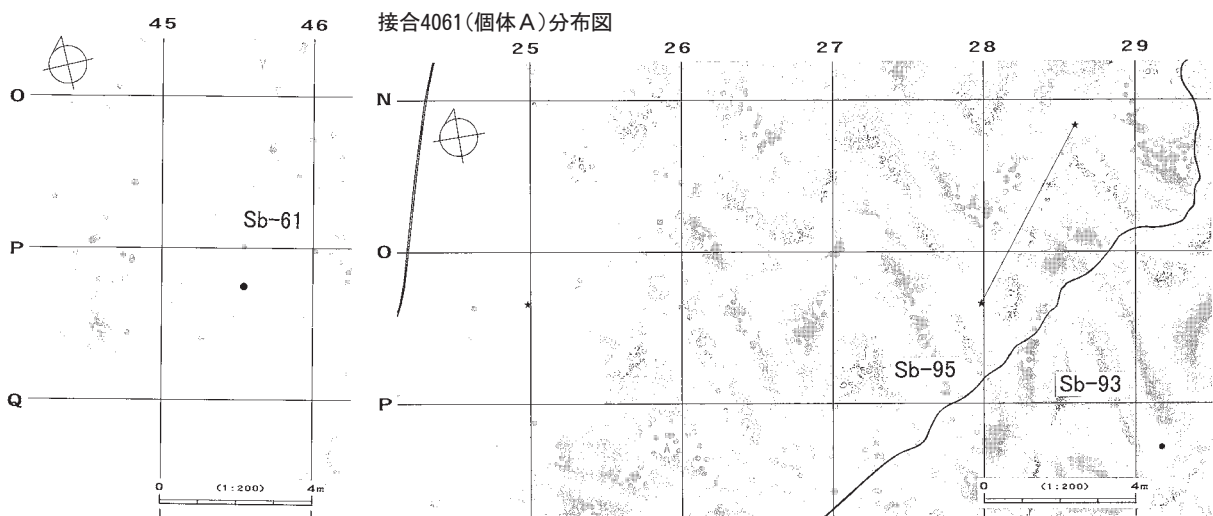
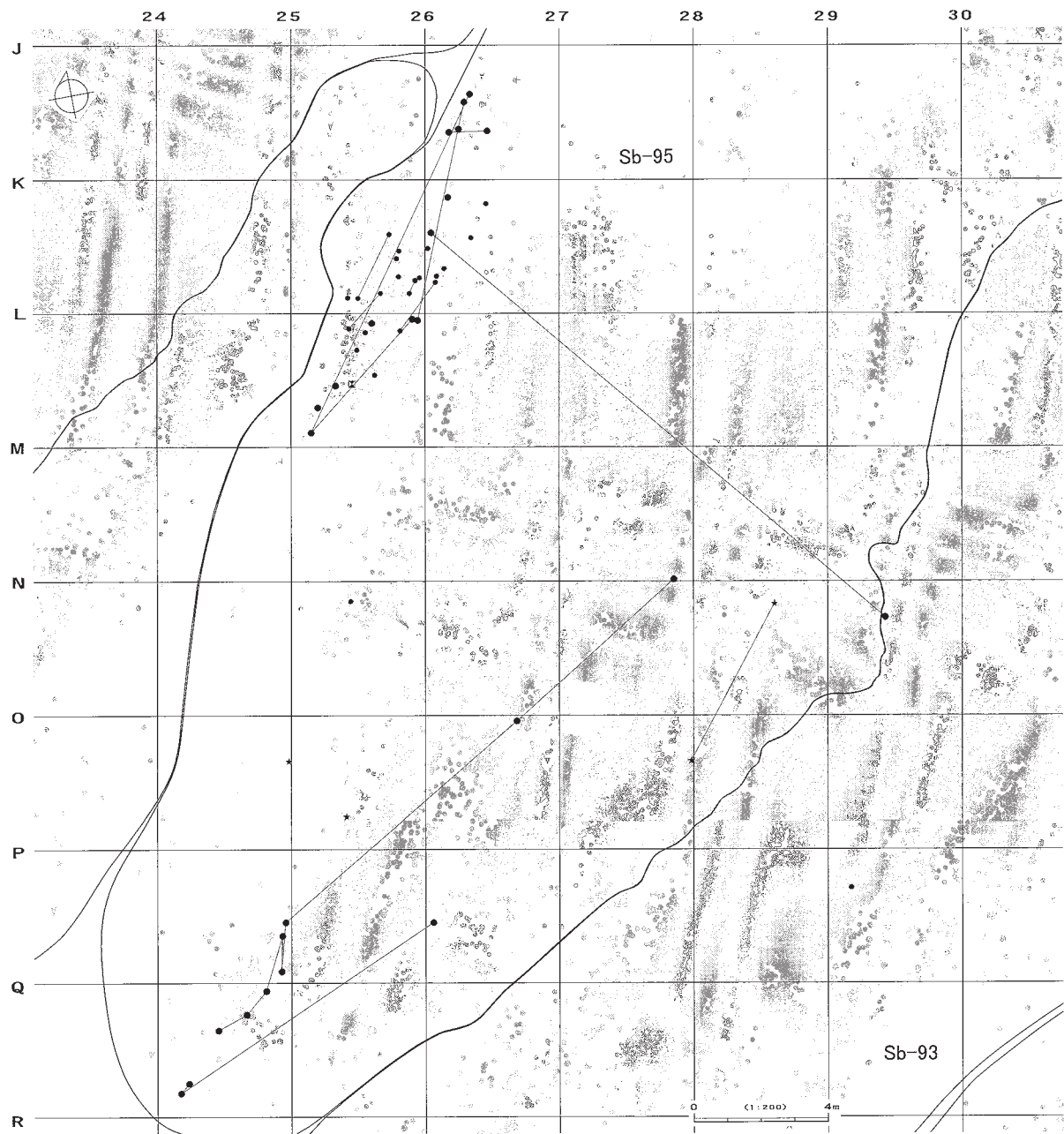

図Ⅲ-328 I区(Sb-91~96)の石器(93) 母岩933・接合4061(3)

母岩934・接合4063

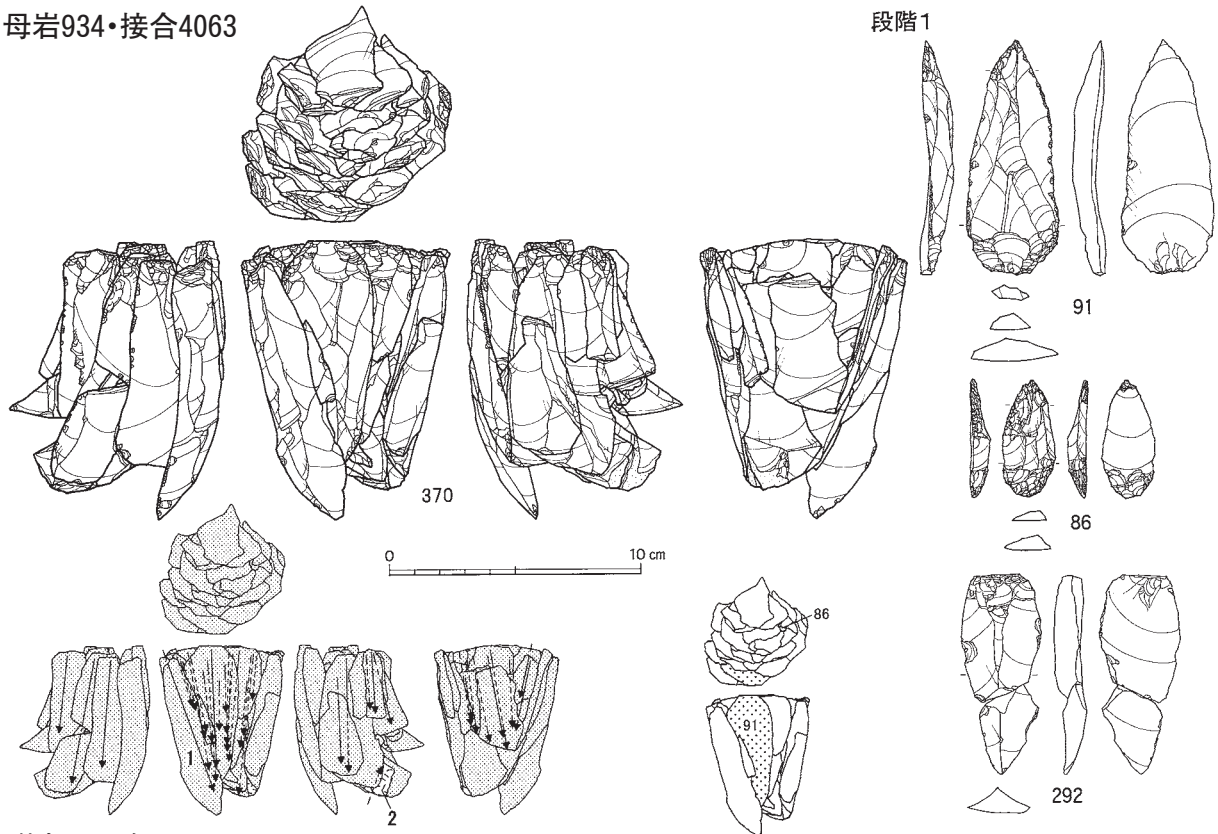

接合4063分布図

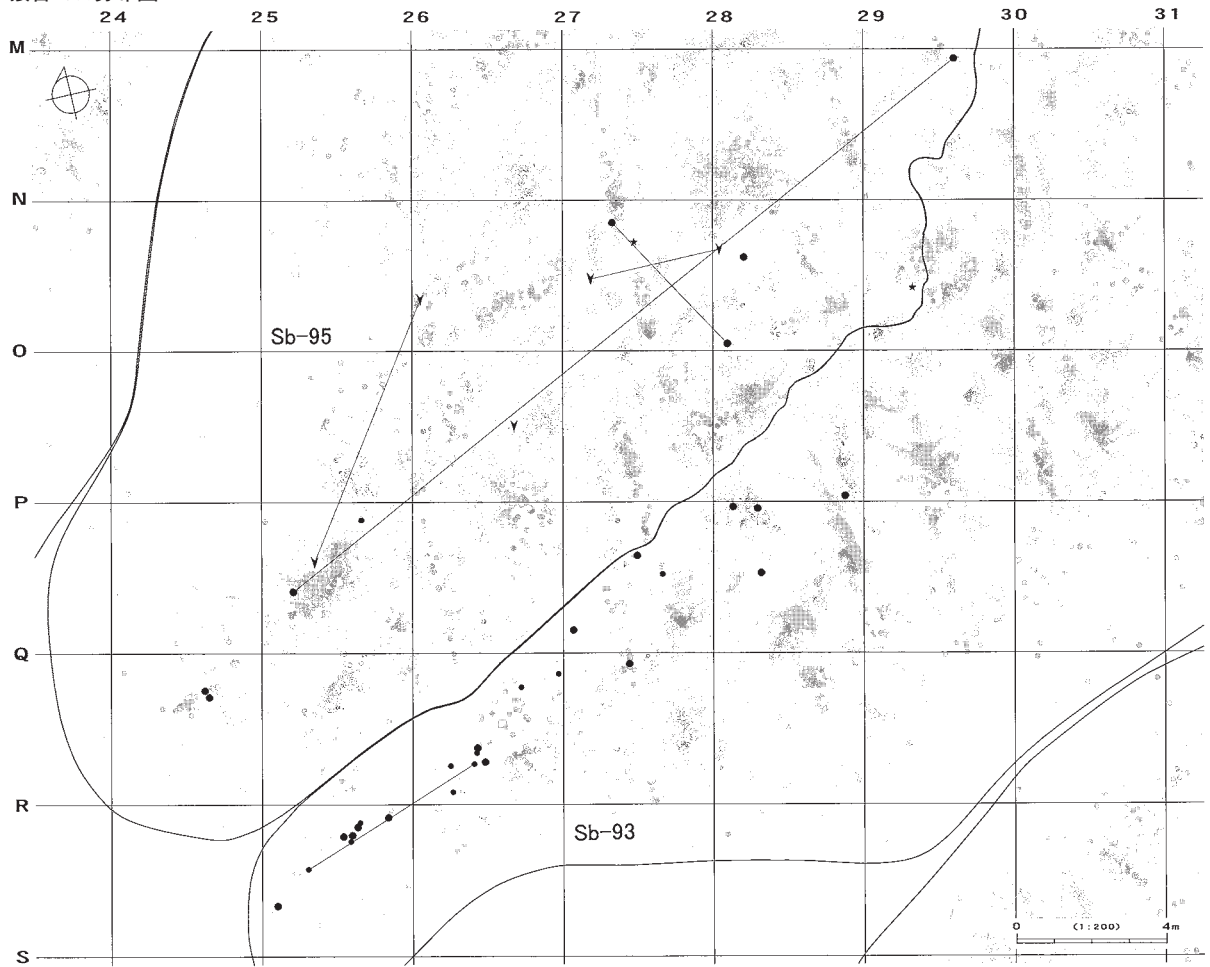

図Ⅲ-329 I区(Sb-91~96)の石器(94) 母岩934・接合4063

母岩738・接合3339

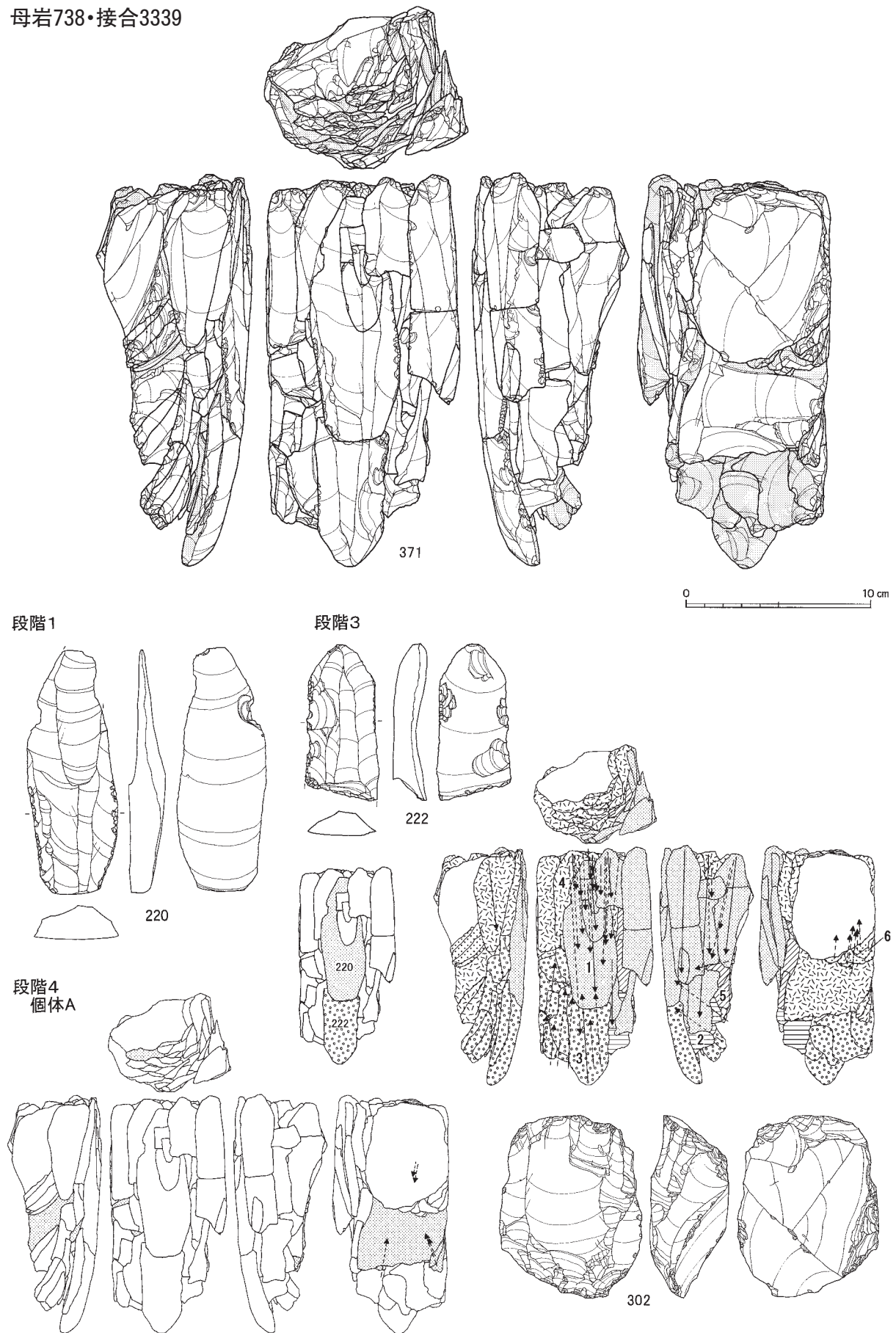

図Ⅲ-330 I区(Sb-91~96)の石器(95) 母岩738・接合3339(1)

接合3339分布図

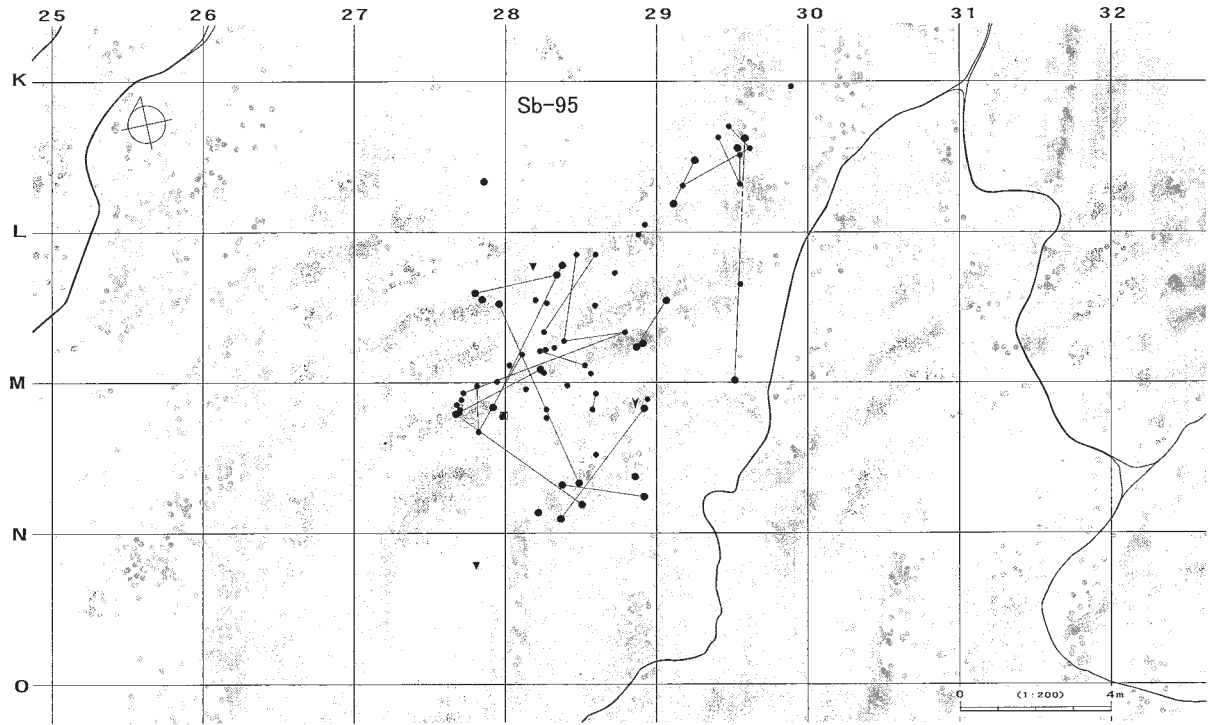

母岩829・接合3660

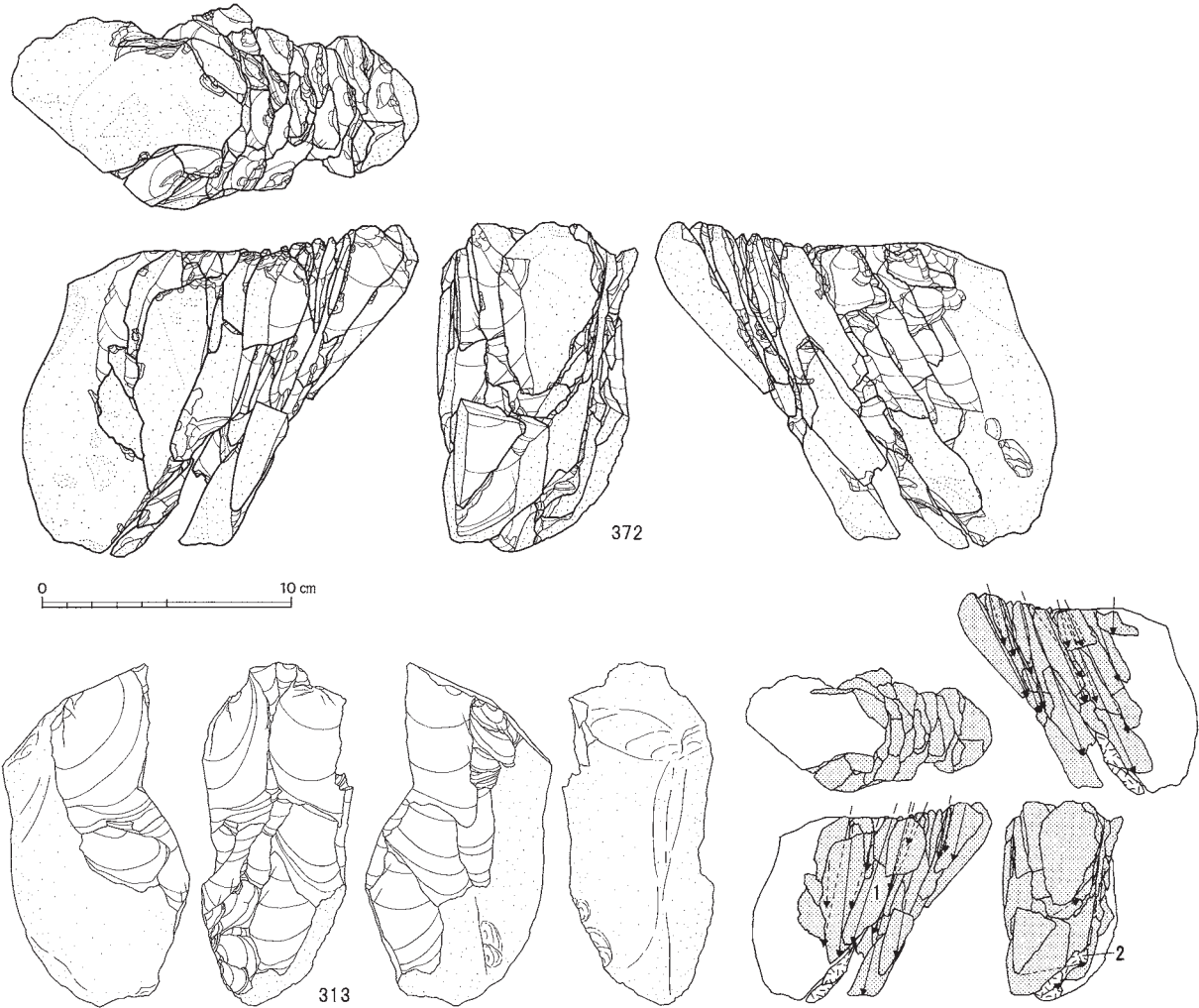

図Ⅲ-331 I区(Sb-91~96)の石器(96) 母岩738・接合3339(2)、母岩829・接合3660(1)

I区(Sb-91~96)

接合3660分布図

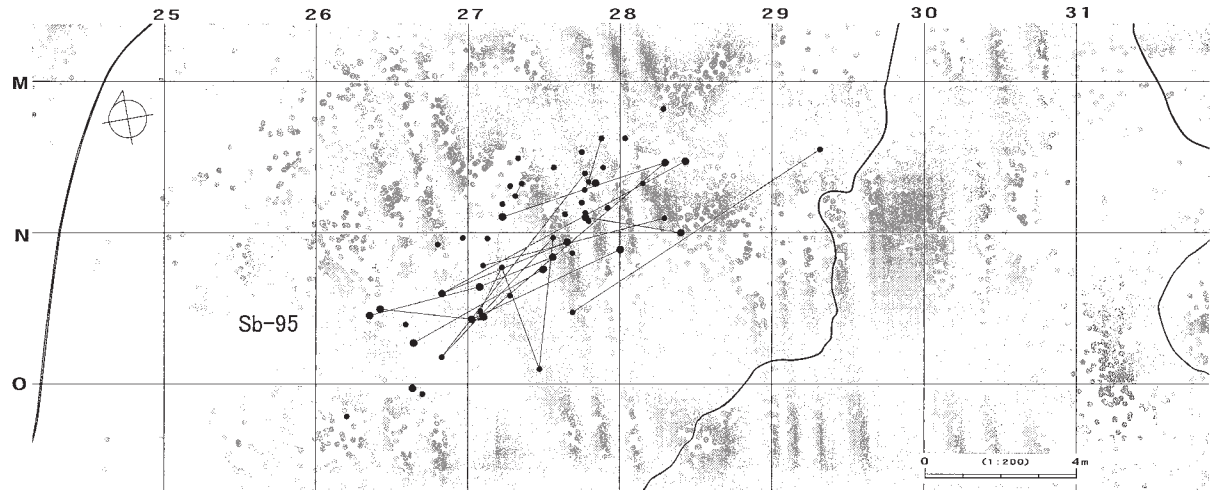

母岩758・接合3434

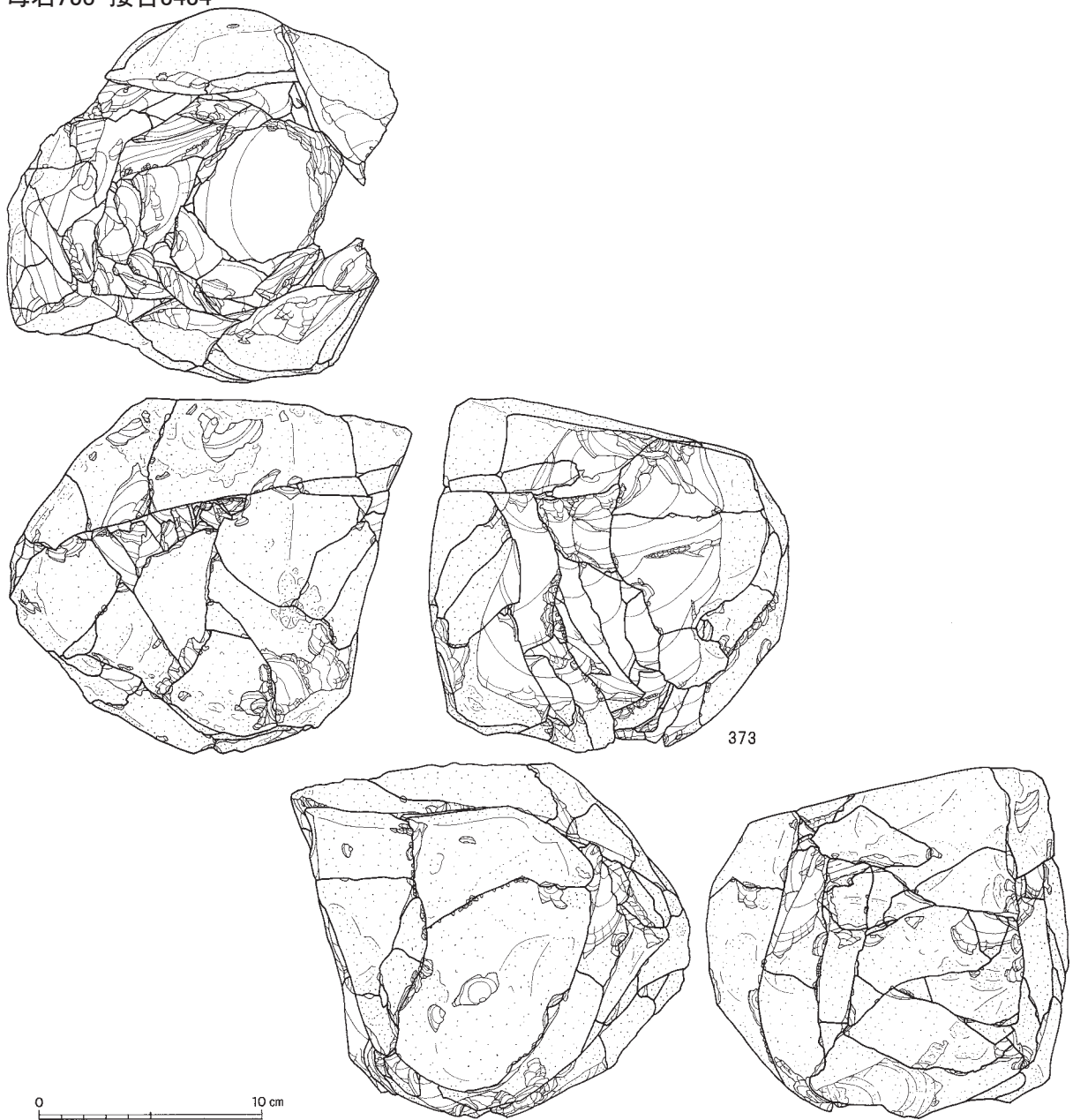

図Ⅲ-332 I区(Sb-91~96)の石器(97) 母岩829・接合3660(2)、母岩758・接合3434(1)

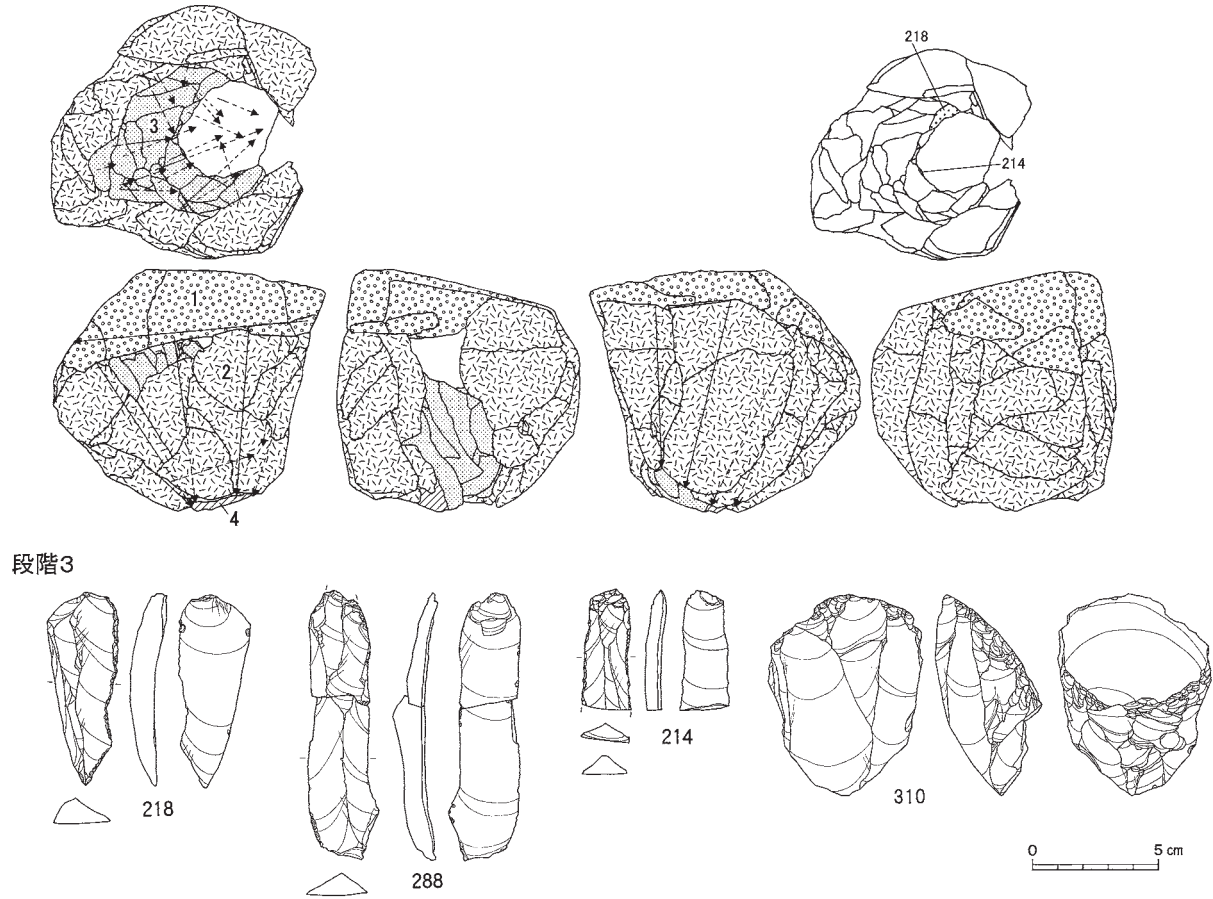

接合3434(段階1~2)分布図

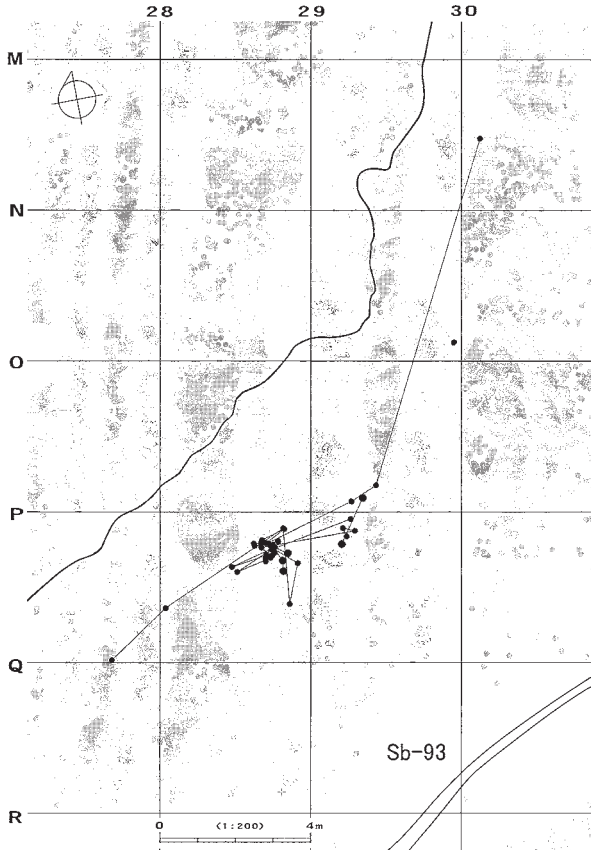

接合3434(段階3・4・石刃核)分布図

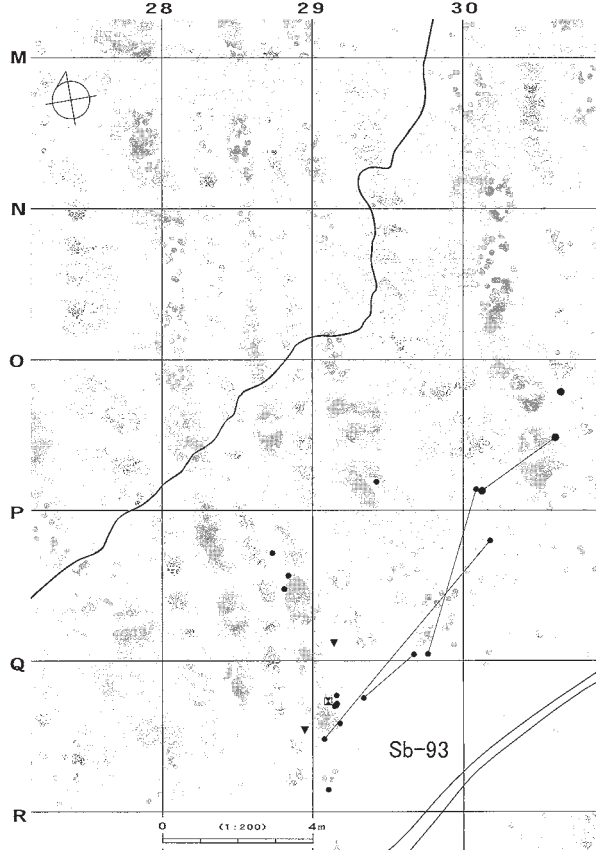

図Ⅲ-333 I区(Sb-91~96)の石器(98) 母岩758・接合3434(2)

母岩904・接合3964

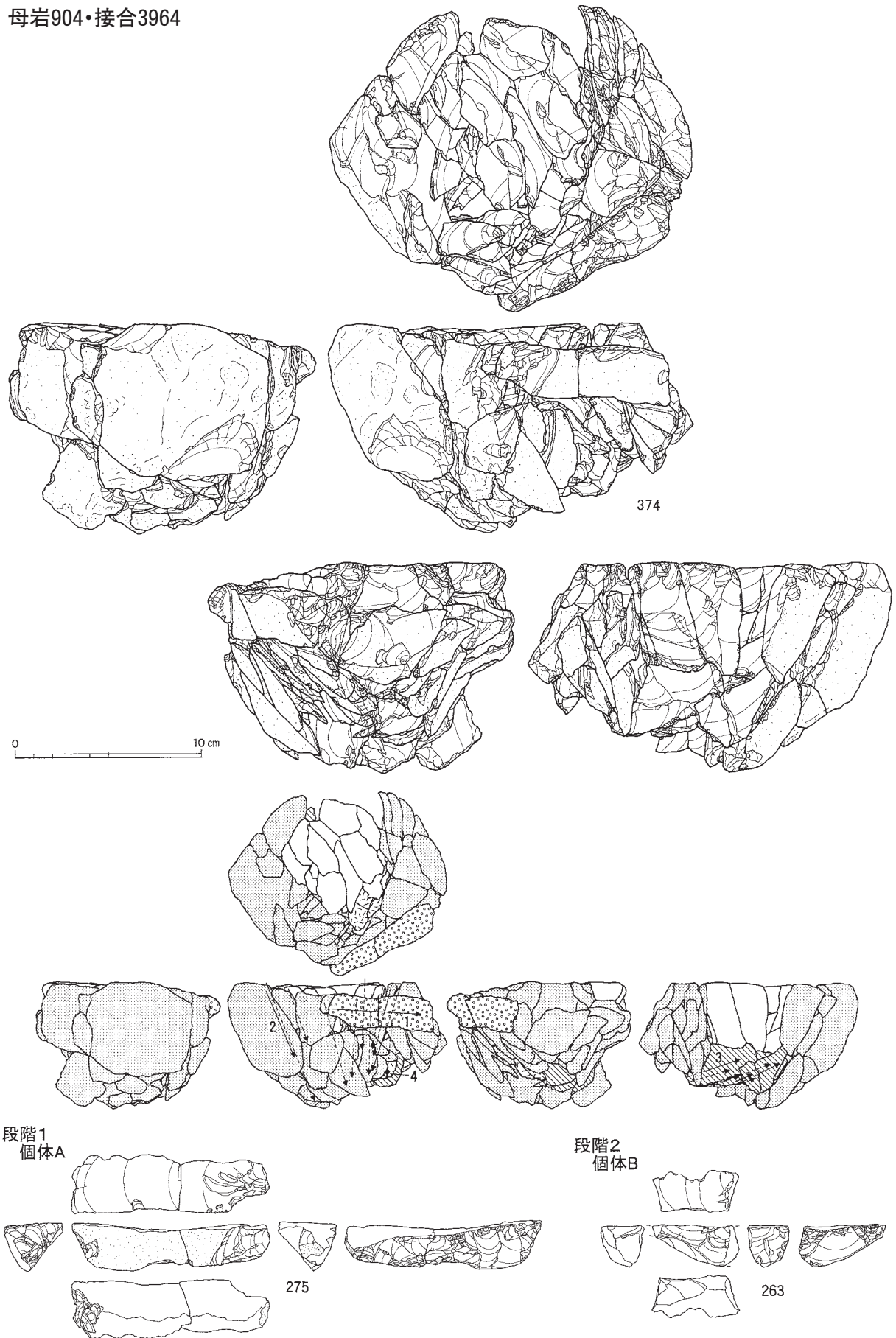

図Ⅲ-334 I区(Sb-91~96)の石器(99) 母岩904・接合3964(1)

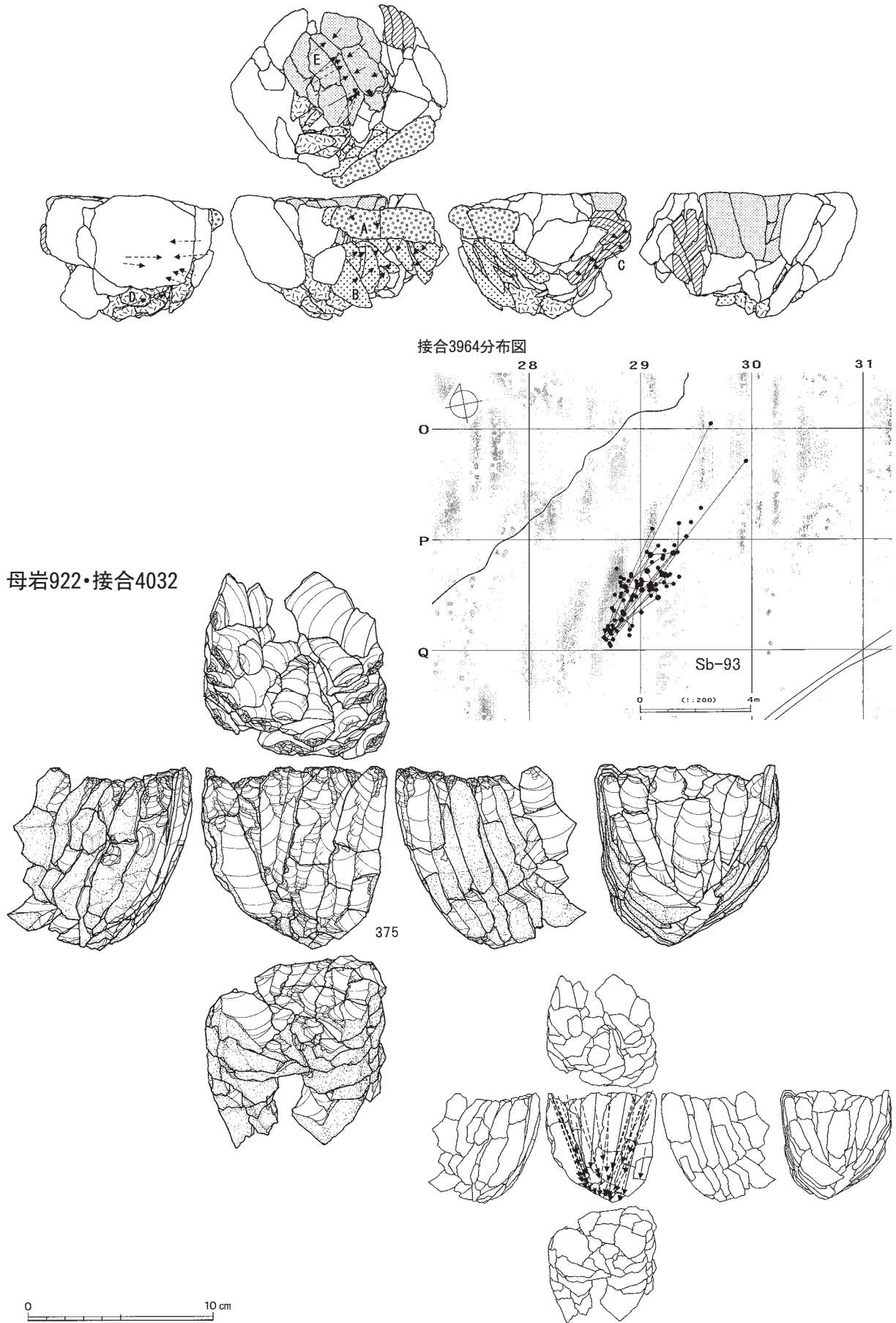

図Ⅲ-335 I区(Sb-91~96)の石器(100) 母岩904・接合3964(2)、母岩922・接合4032(1)

I区(Sb-91~96)

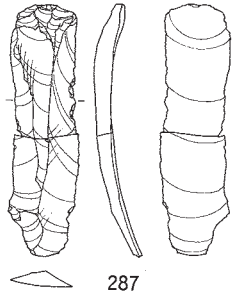

接合4032分布図

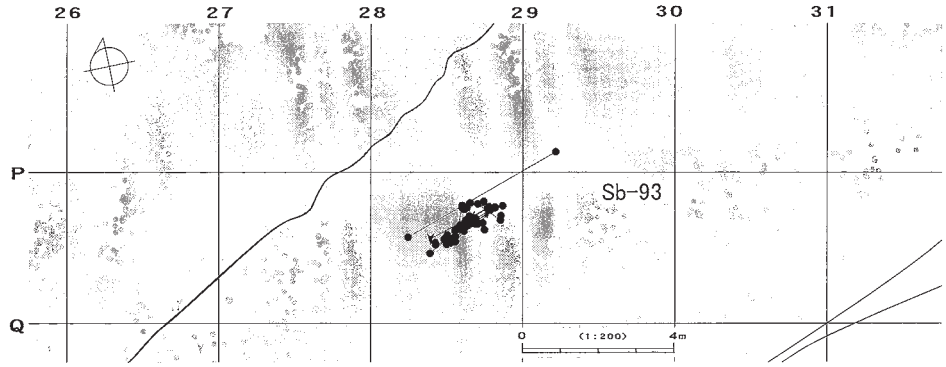

母岩667・接合3122

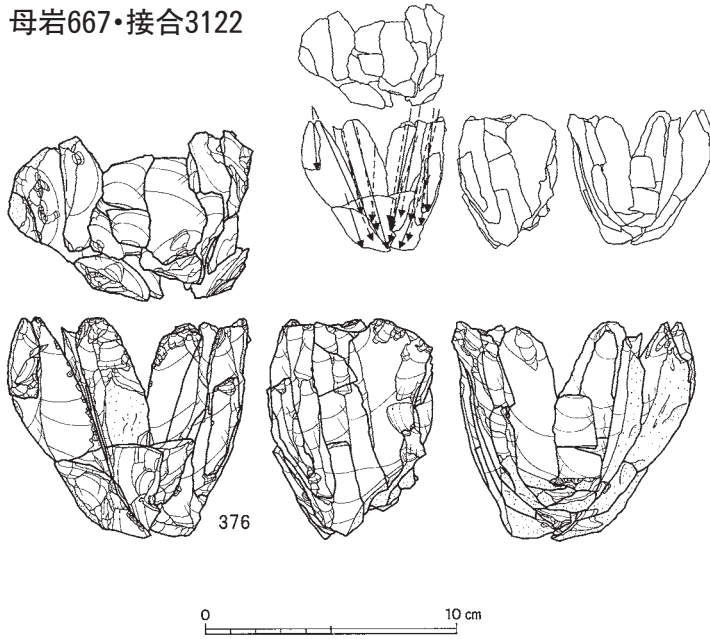

接合3122分布図

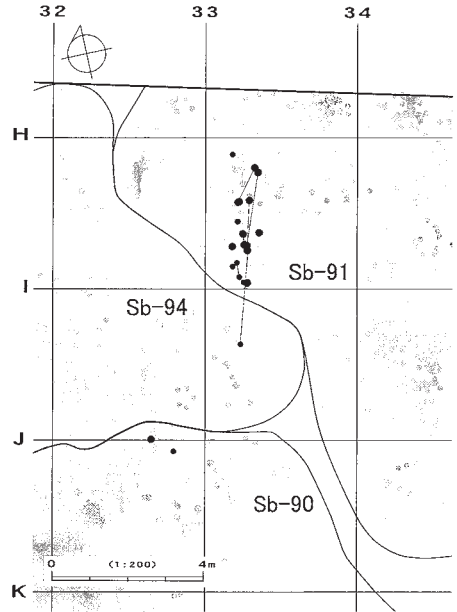

母岩878・接合3851

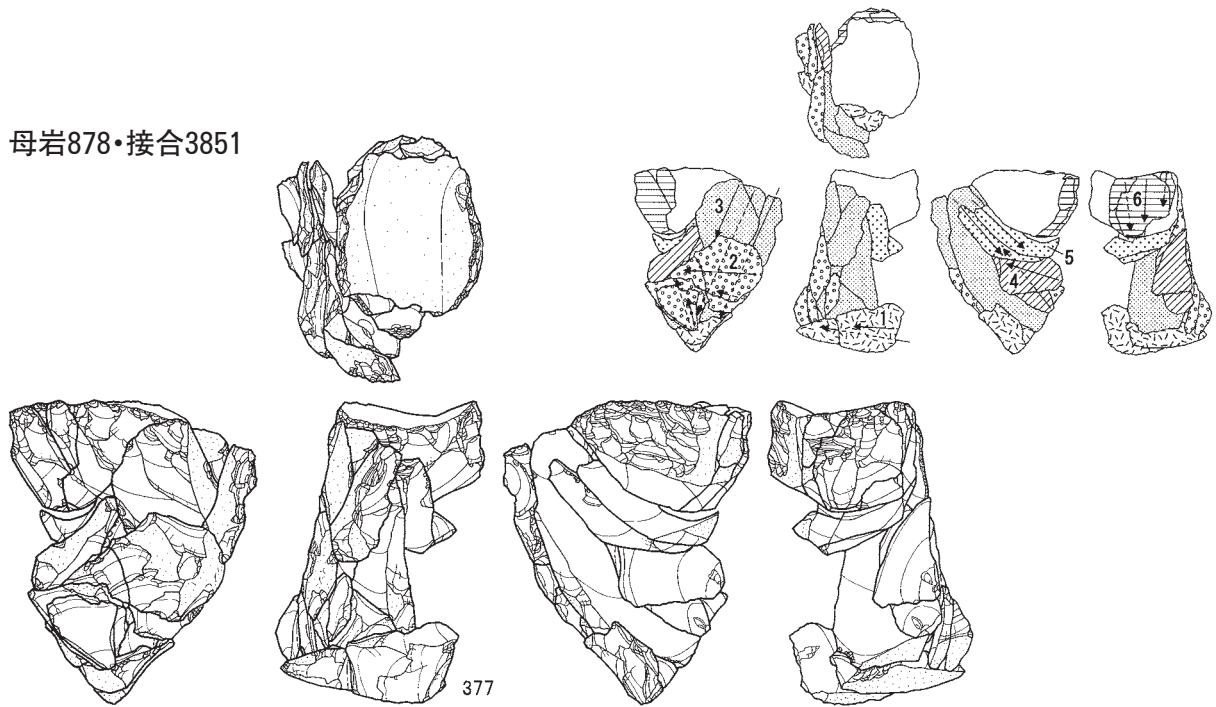

図Ⅲ-336 I区(Sb-91~96)の石器(101) 母岩922・接合4032(2)、母岩667・接合3122、母岩878・接合3851(1)

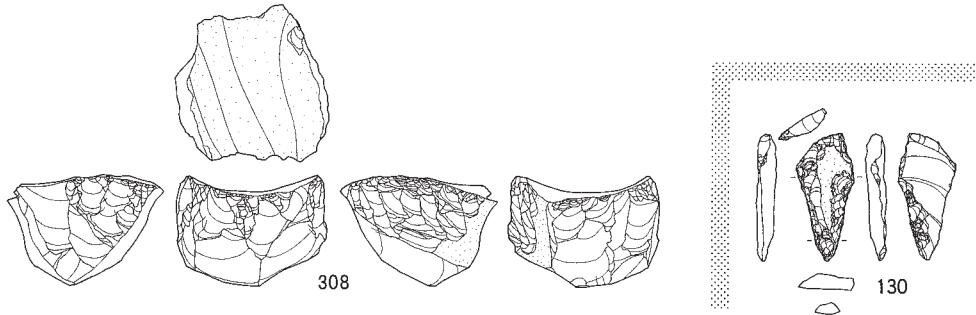

接合3851(段階1~5)分布図

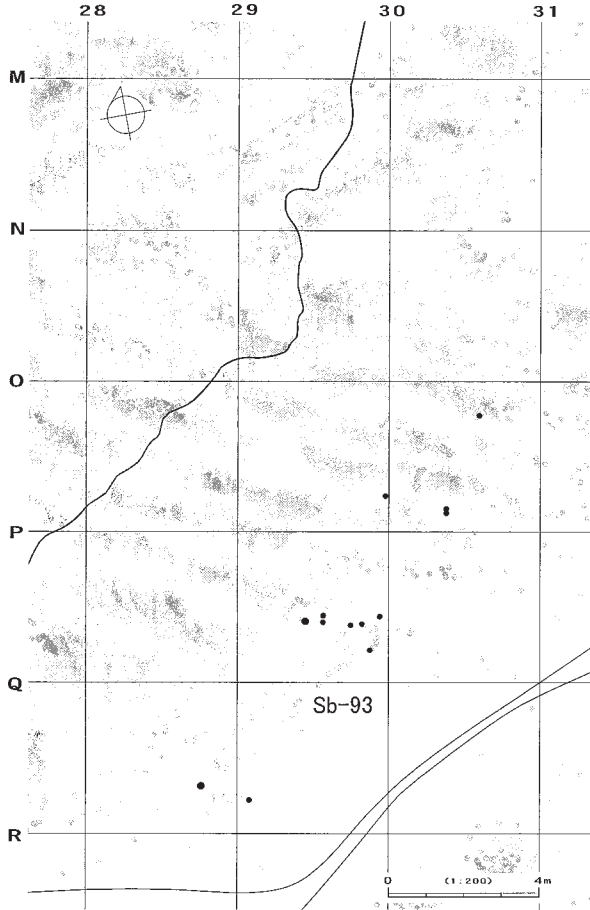

接合3851(段階6・石刃核)分布図

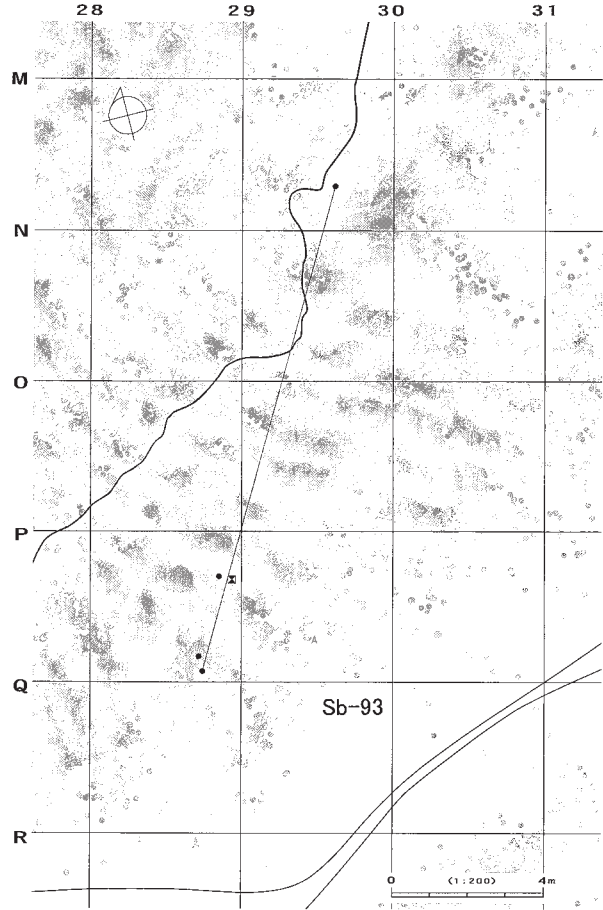

母岩856・接合3781

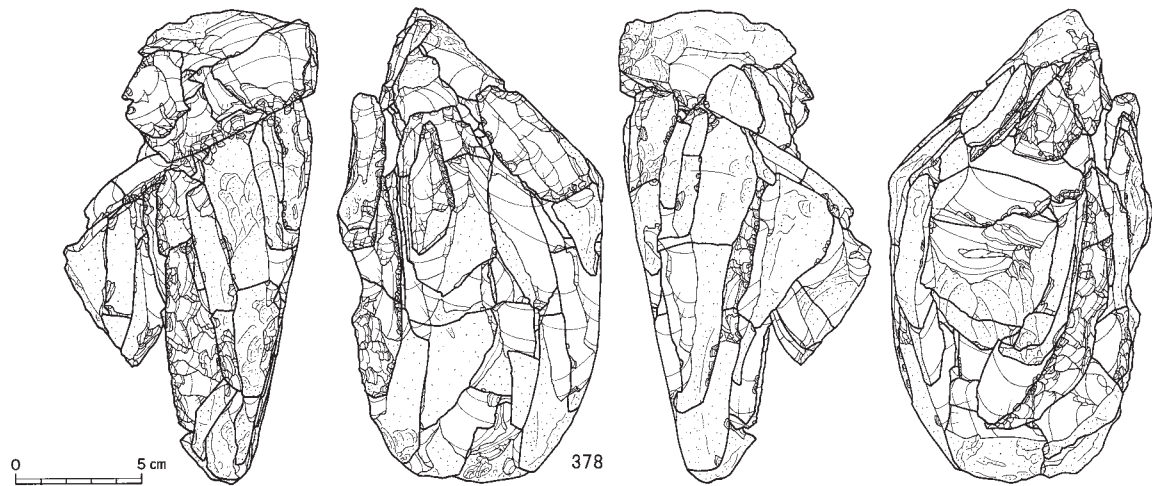

図Ⅲ-337 I区(Sb-91~96)の石器(102) 母岩878・接合3851(2)、母岩856・接合3781(1)

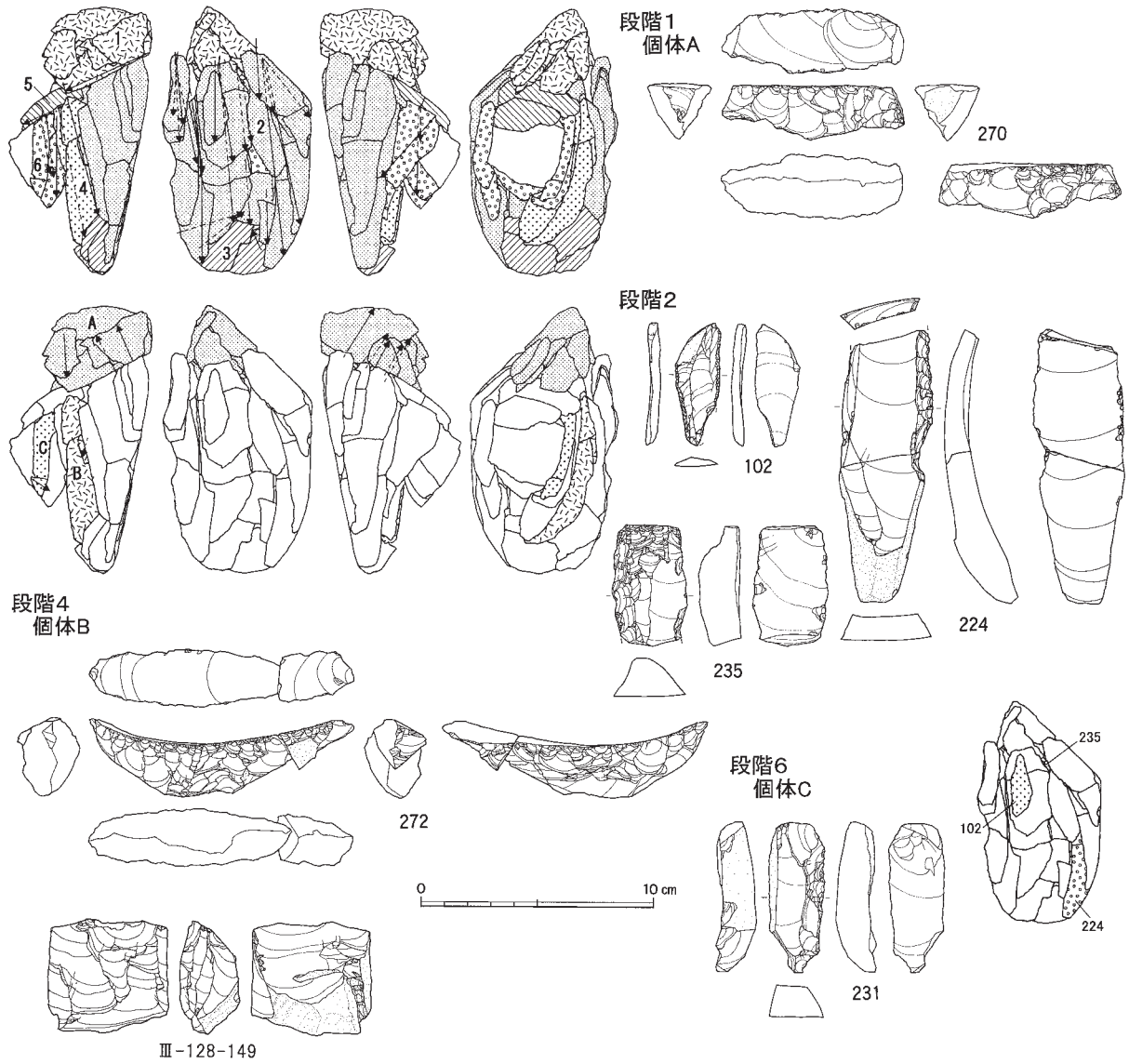

接合3781(個体A)分布図

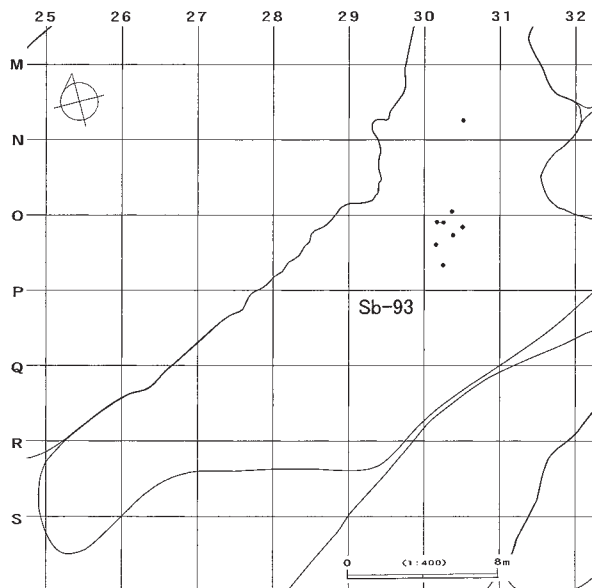

接合3781(個体B・C)分布図

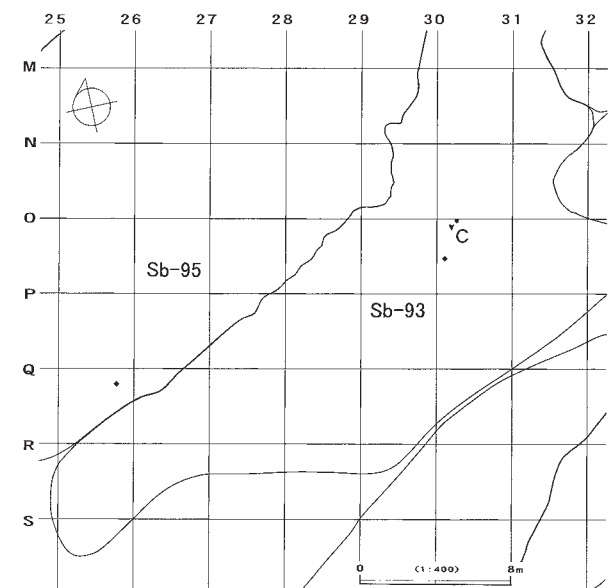

図Ⅲ-338 I区(Sb-91~96)の石器(103) 母岩856・接合3781(2)

接合3781(個体A~C以外段階1~5)分布図

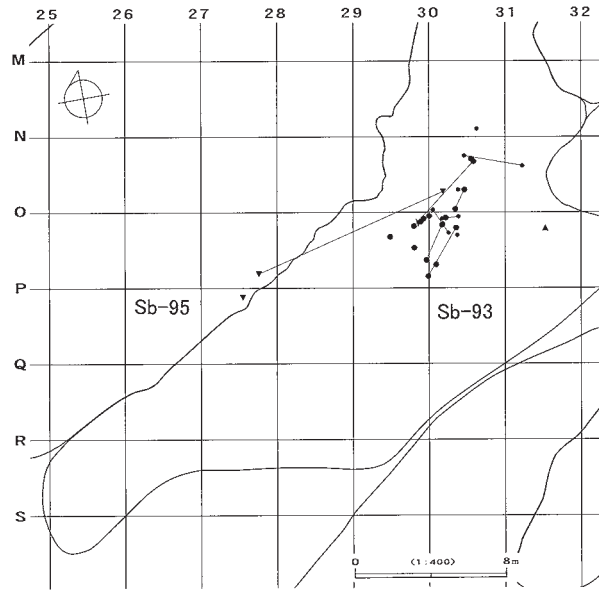

接合3781(個体A~C以外段階6・石刃核)分布図

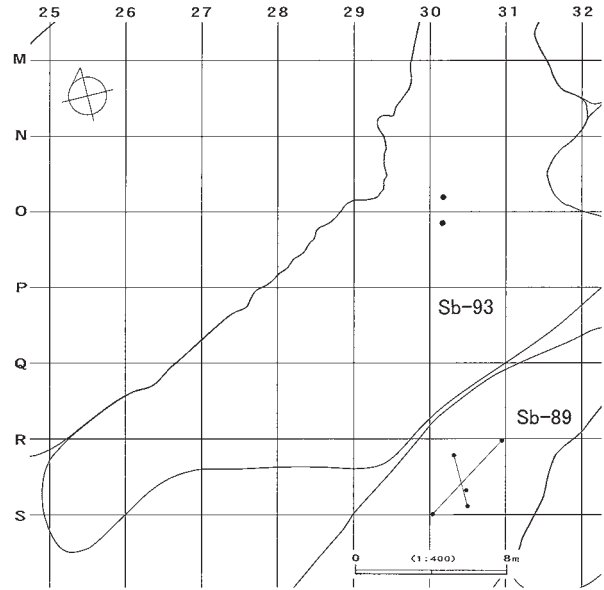

接合3781(全体)分布図

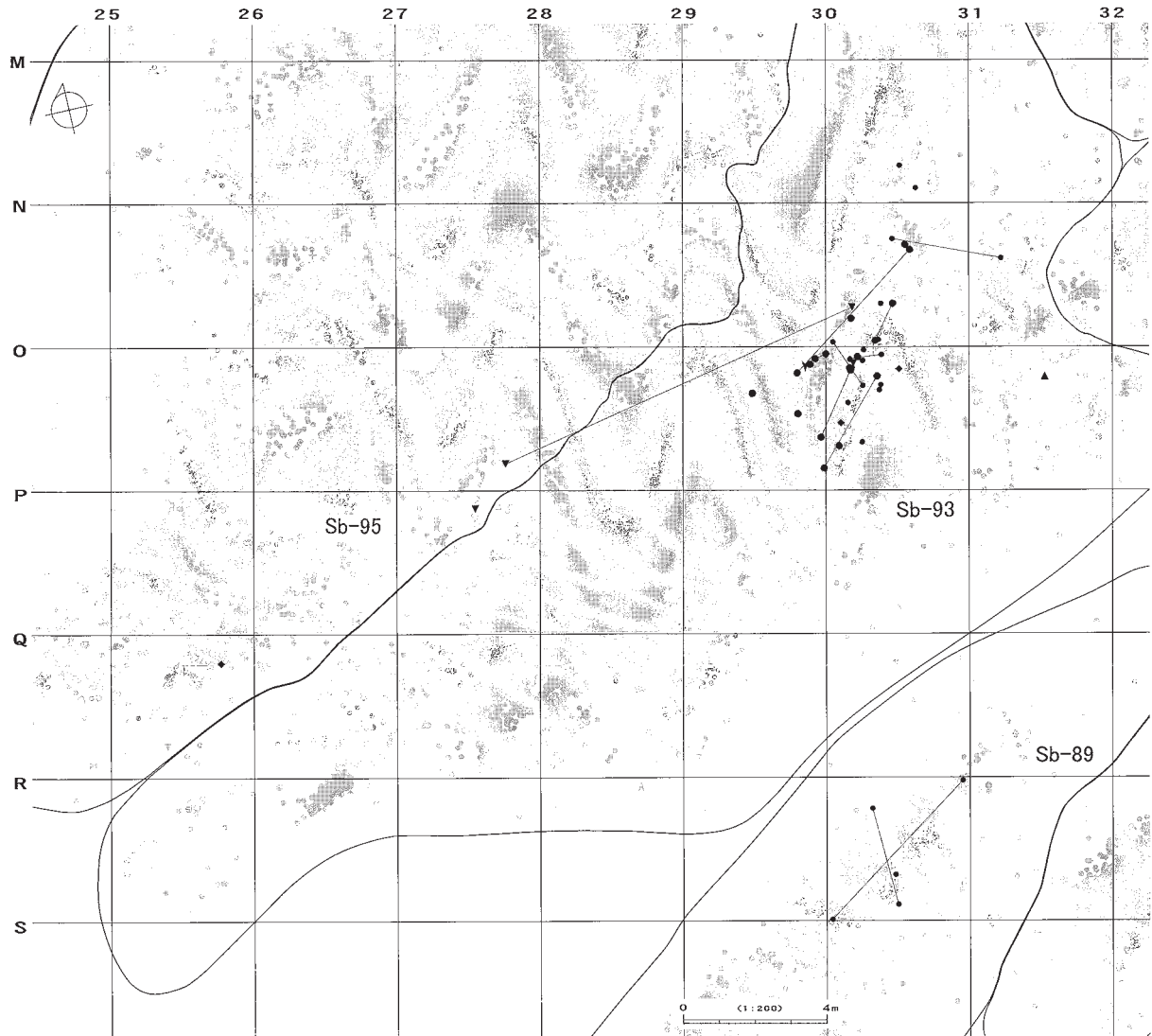

図Ⅲ-339 I区(Sb-91~96)の石器(104) 母岩856・接合3781(3)

母岩857・接合3783

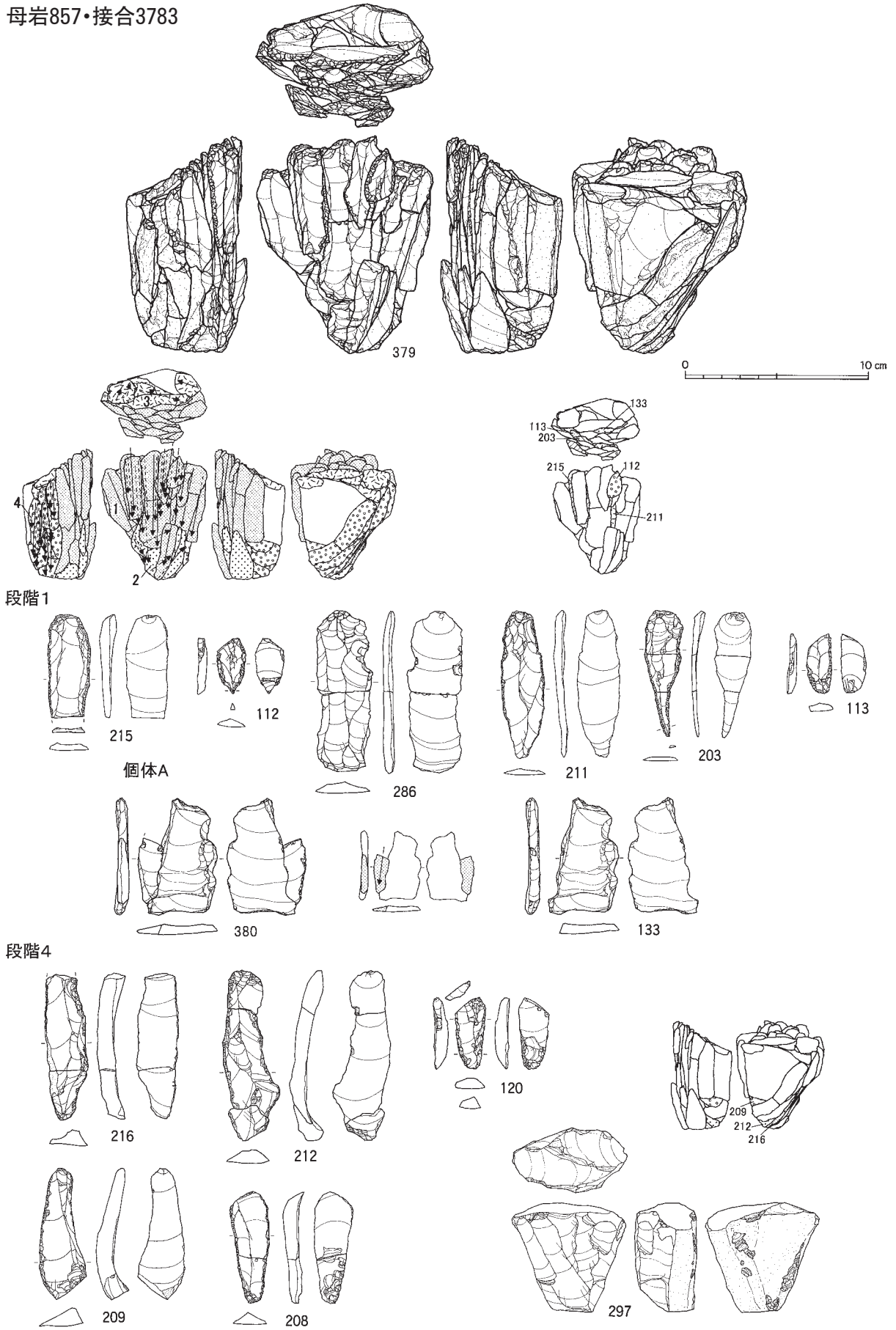

図Ⅲ-340 I区(Sb-91~96)の石器(105) 母岩857・接合3783(1)

接合3783(全体)分布図

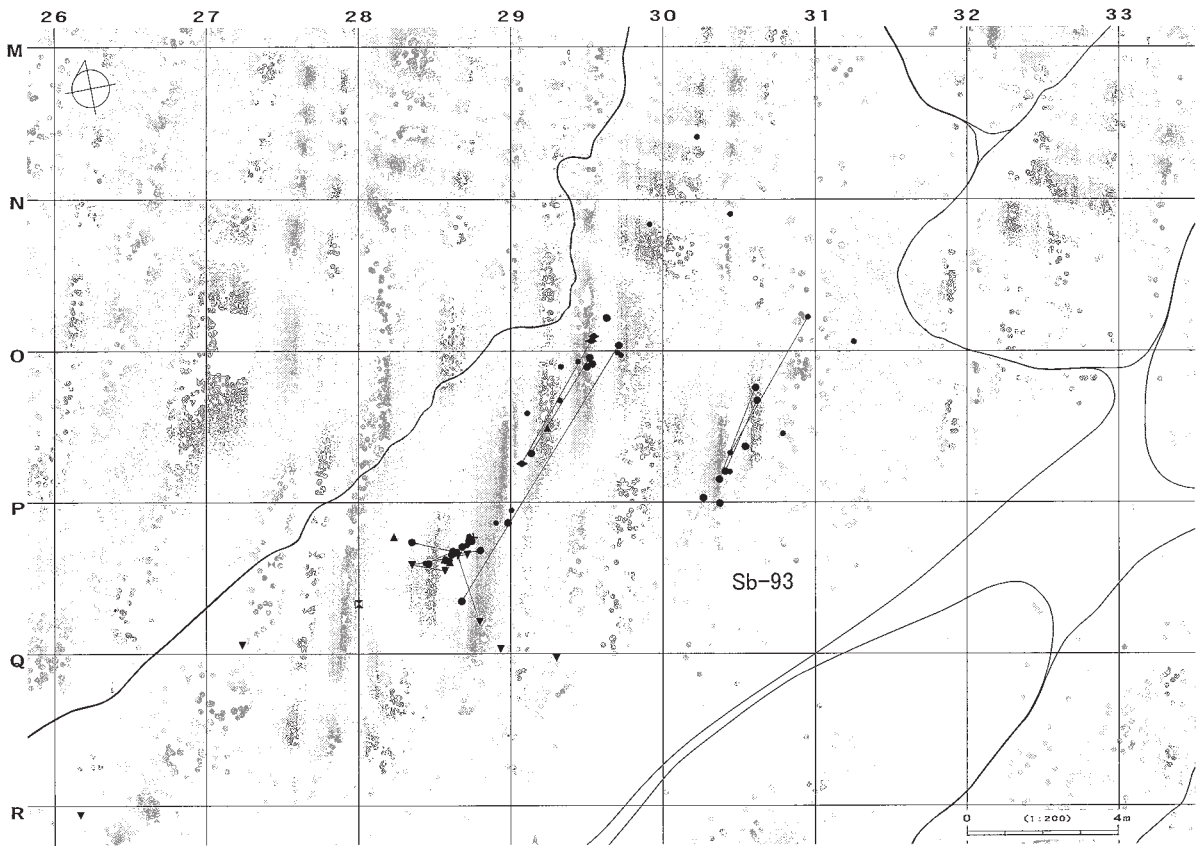
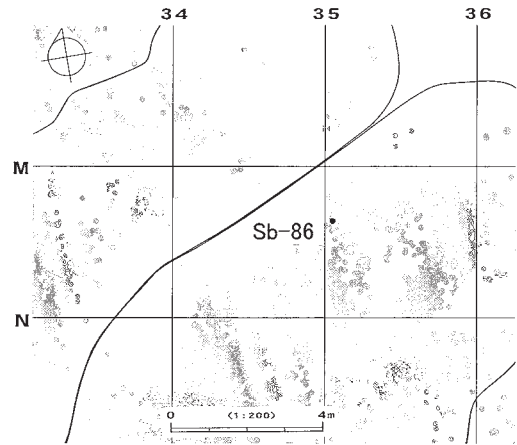
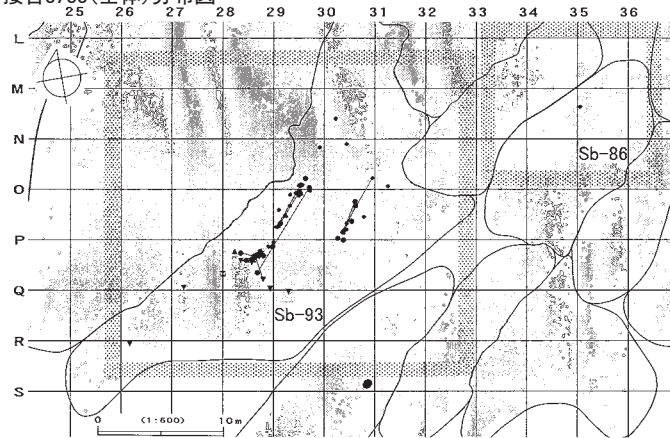

接合3783(段階1・2)分布図

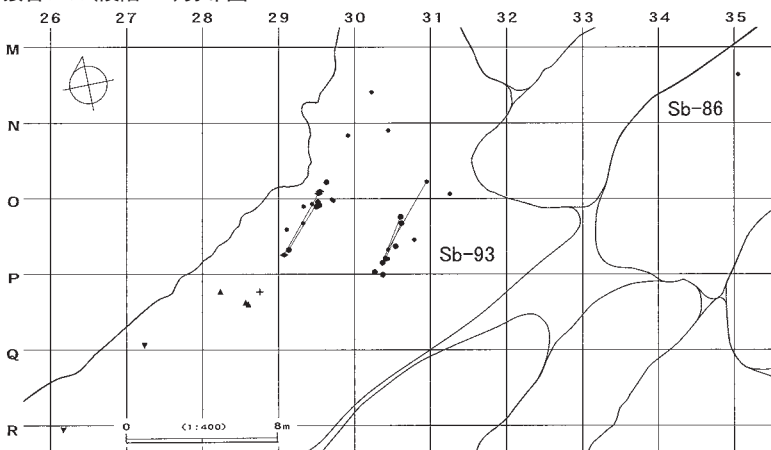

接合3783(段階3・4・石刃核)分布図

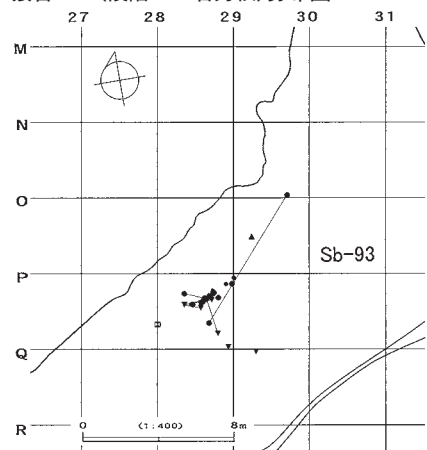

図Ⅲ-341 I区(Sb-91~96)の石器(106) 母岩857・接合3783(2)

母岩867・接合3823

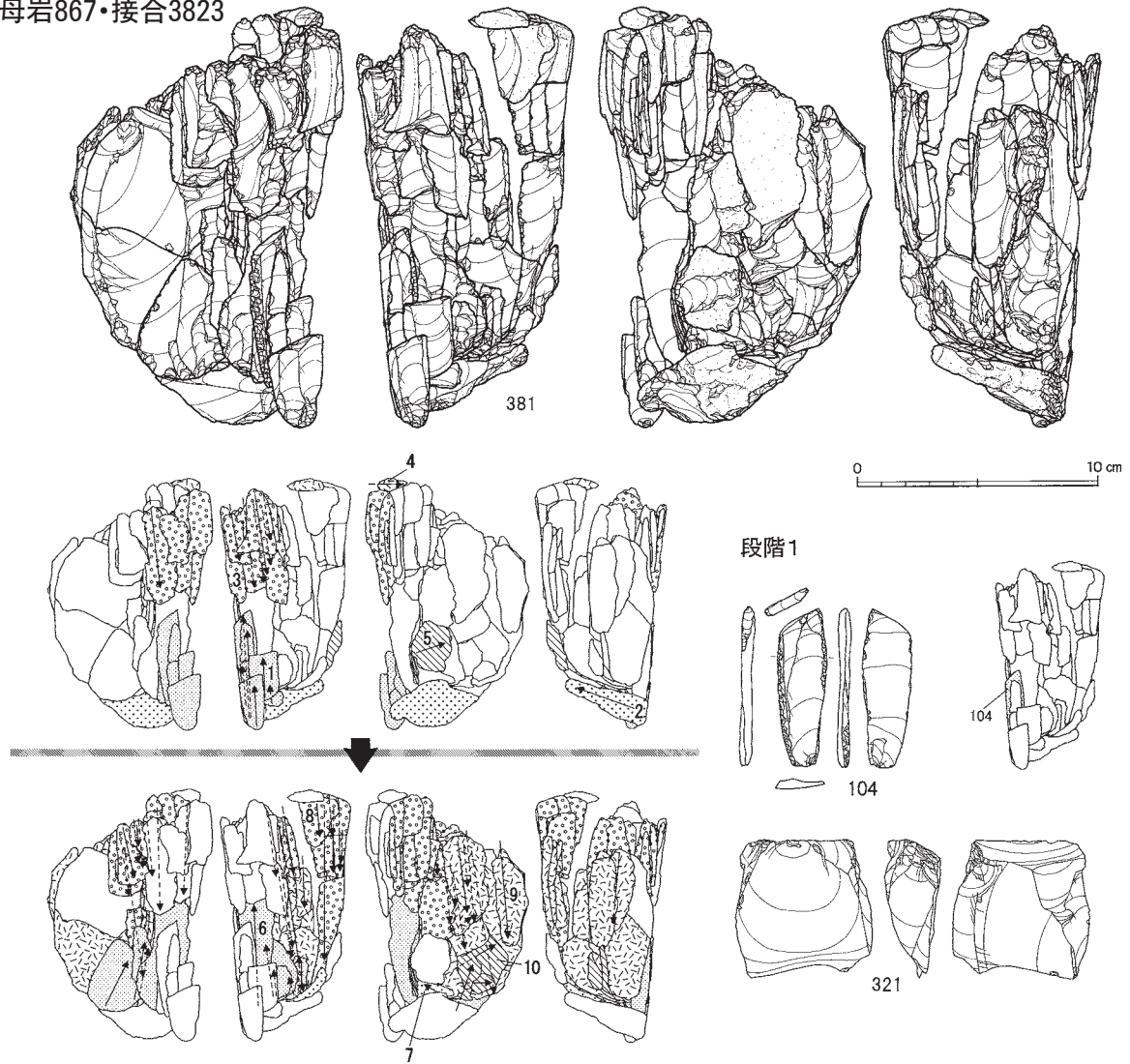

接合3823分布図

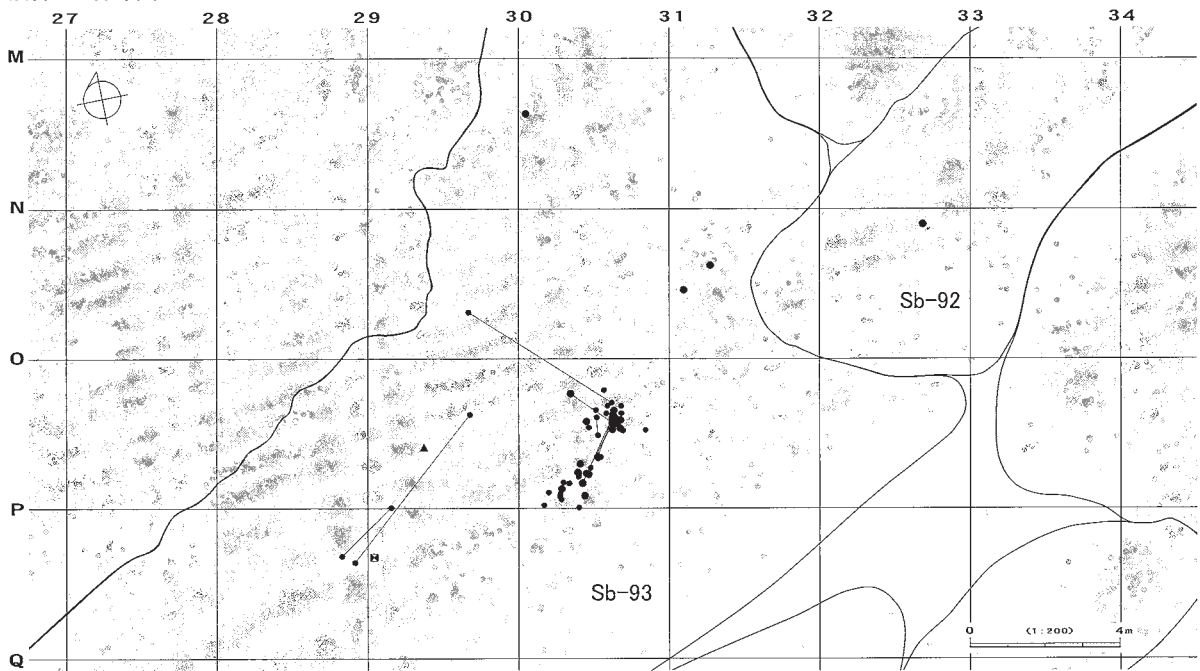

図Ⅲ-342 I区(Sb-91~96)の石器(107) 母岩867・接合3823

母岩866・接合3822

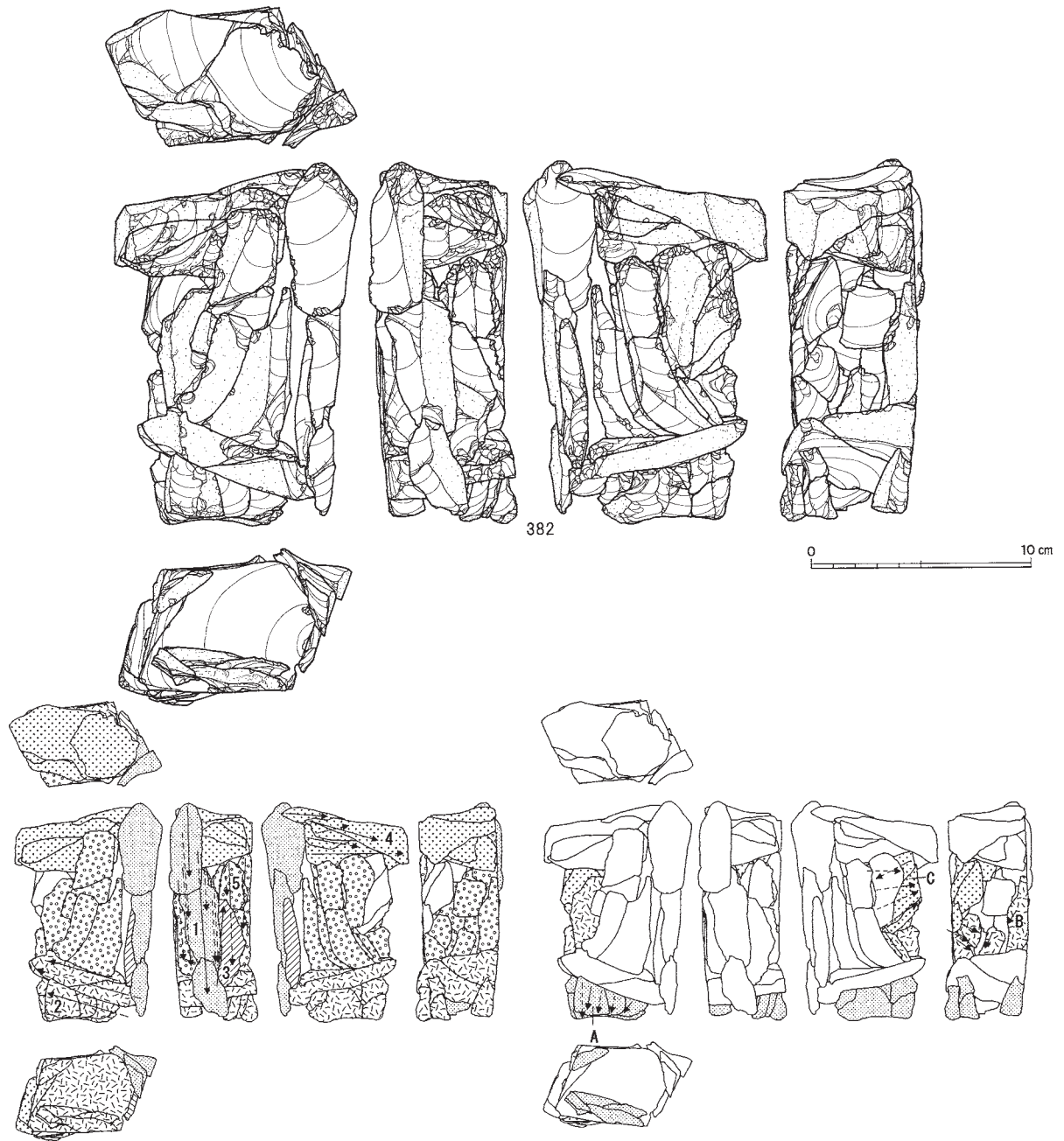

接合3822(個体A)分布図

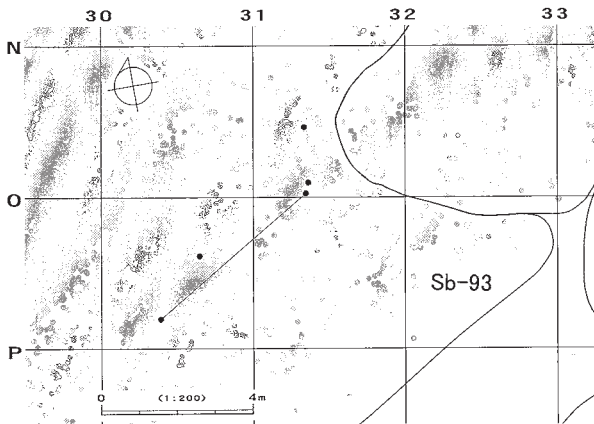

接合3822(個体B)分布図

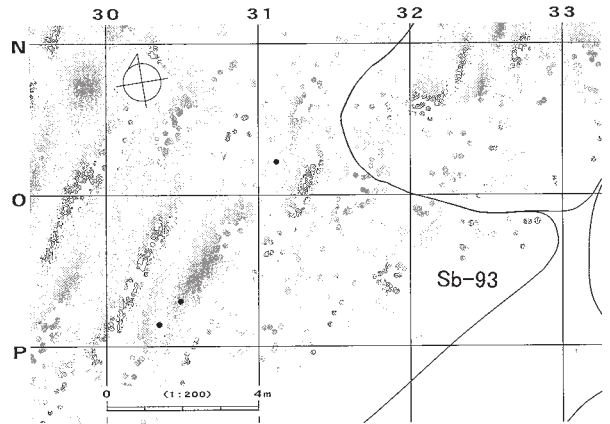

図Ⅲ-343 I区(Sb-91~96)の石器(108) 母岩866・接合3822(1)

I区(Sb-91~96)

接合3822(個体C)分布図

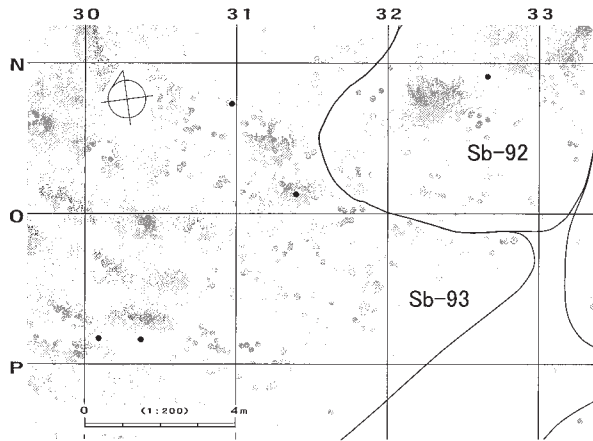

接合3822(個体A~C以外)分布図

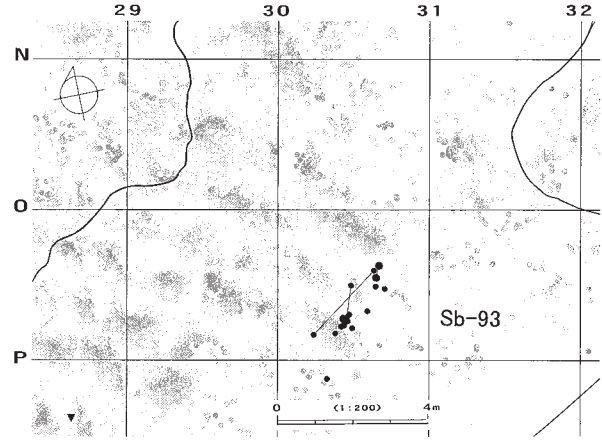

母岩842・接合3703

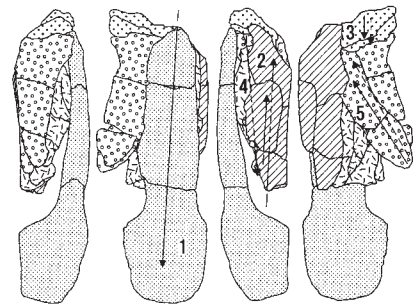
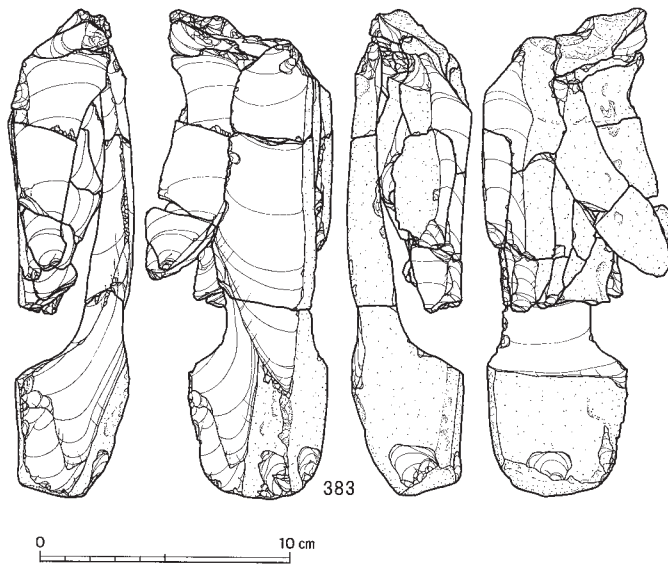

段階4
個体A

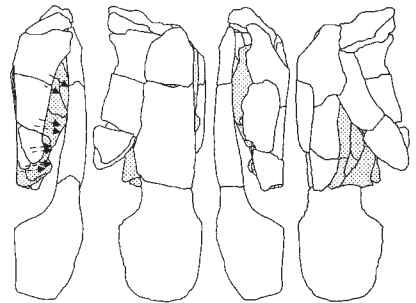

接合3703(個体A)分布図

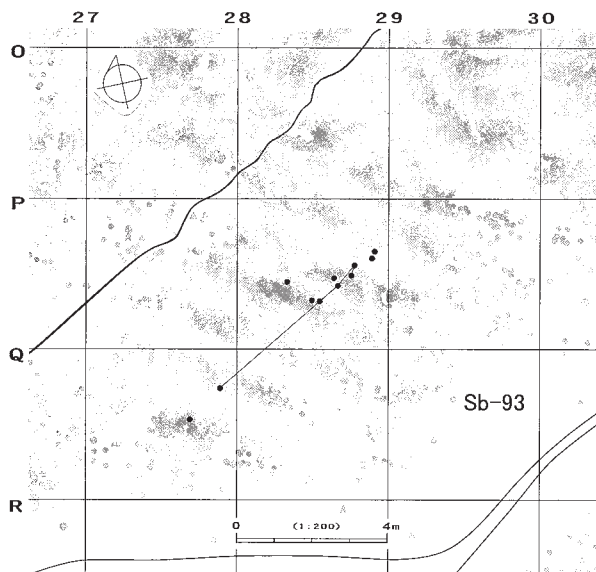

接合3703(個体A以外)分布図

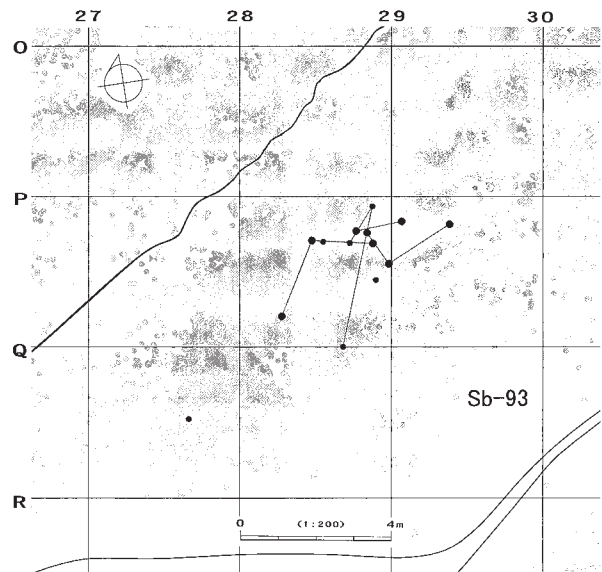

図Ⅲ-344 I区(Sb-91~96)の石器(109) 母岩866・接合3822(2)、母岩842・接合3703

母岩926・接合4043

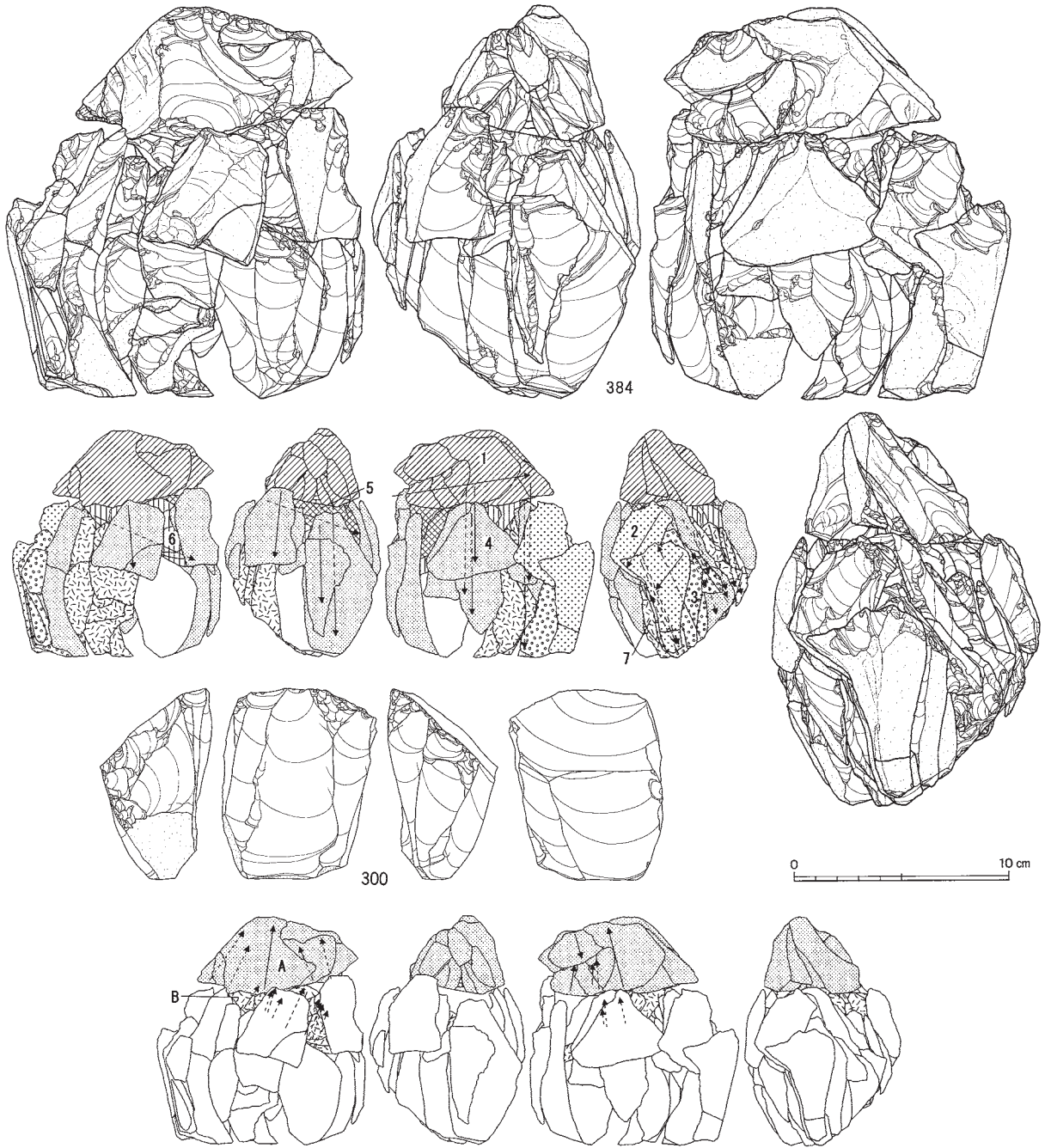

接合4043(個体A)分布図

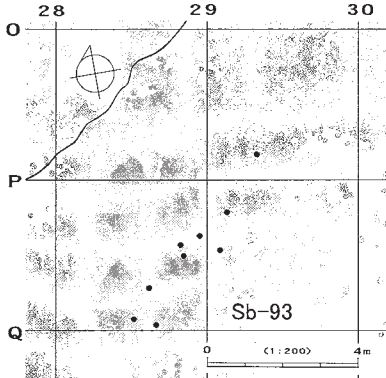

接合4043(個体B)分布図

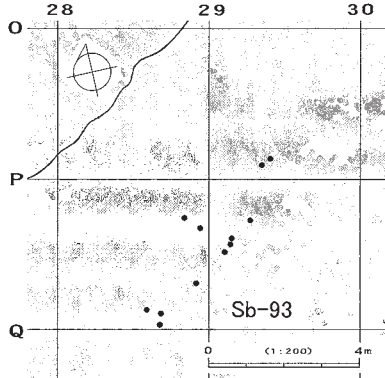

接合4043(個体A・B以外)分布図

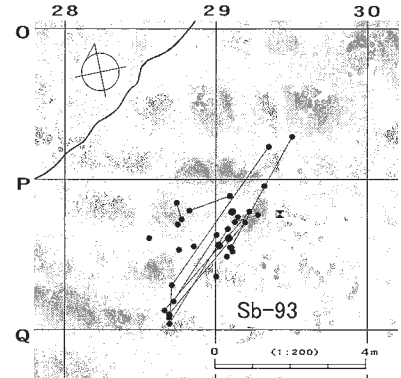

図Ⅲ-345 I区(Sb-91~96)の石器(110) 母岩926・接合4043

母岩931・接合4053

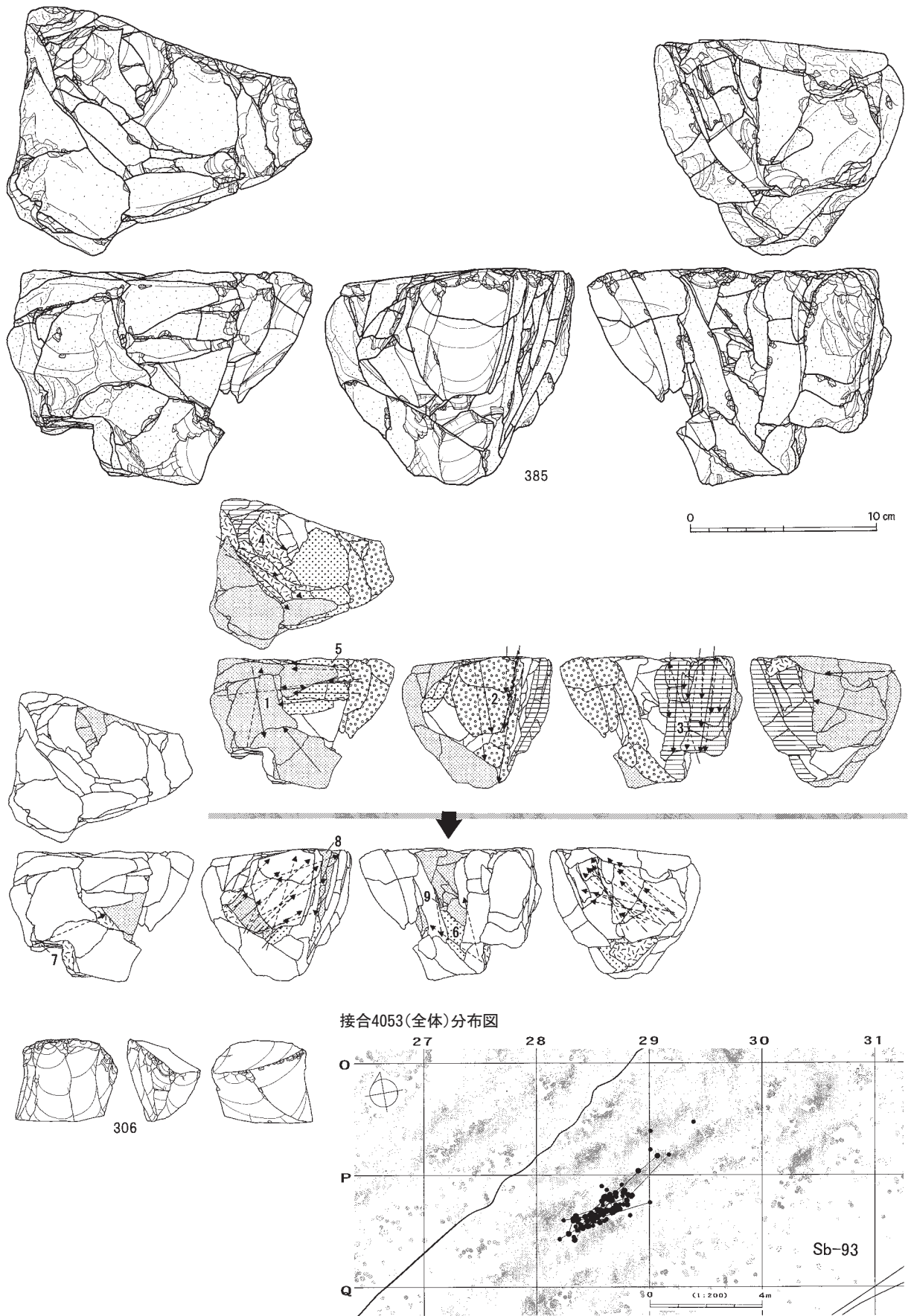

図Ⅲ-346 I区(Sb-91~96)の石器(111) 母岩931・接合4053

母岩722・接合3268

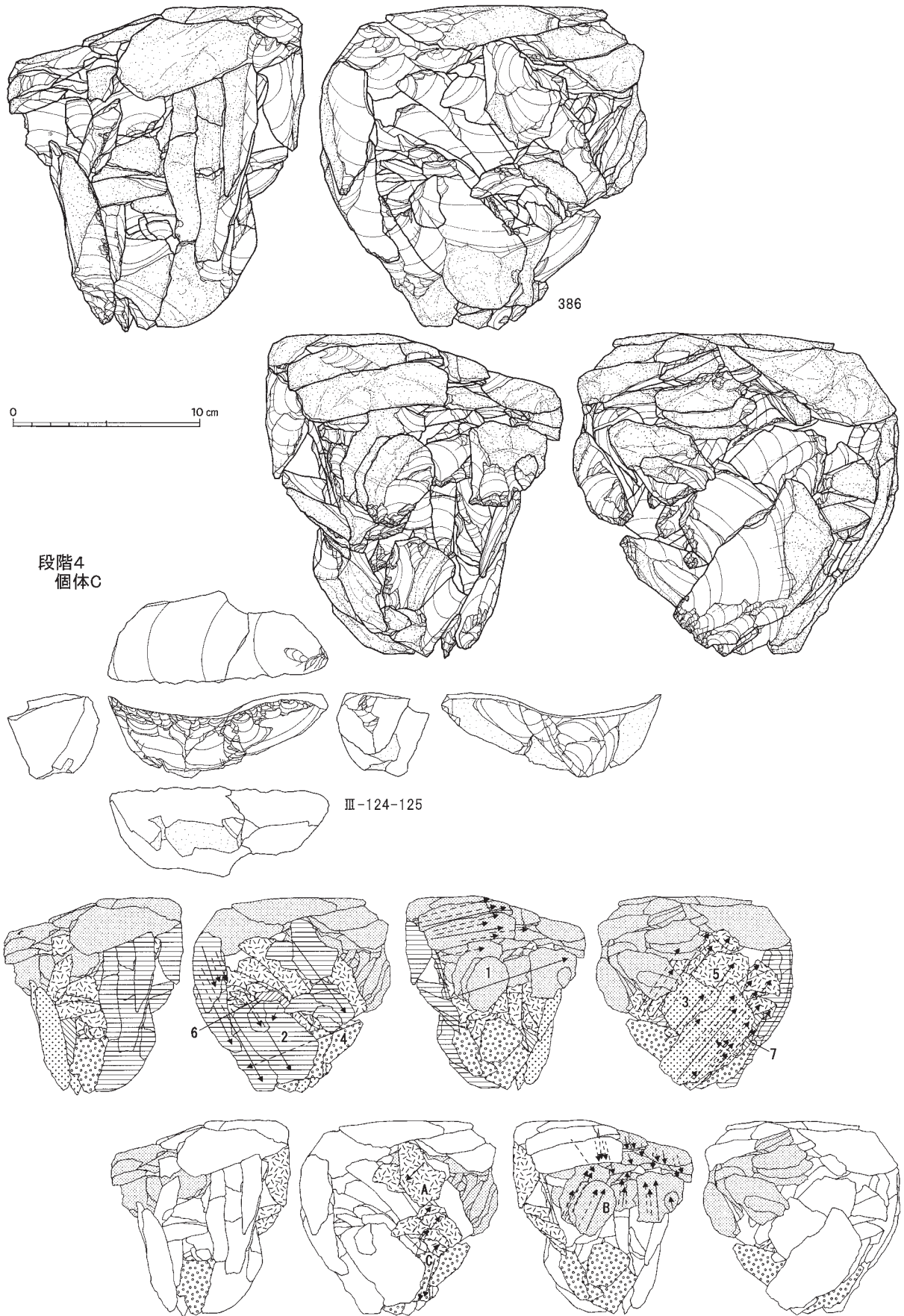

図Ⅲ-347 I区(Sb-91~96)の石器(112) 母岩722・接合3268(1)

接合3268(個体A)分布図

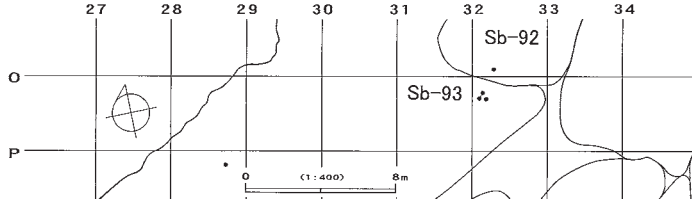

接合3268(段階1・2(個体A・B除く))分布図

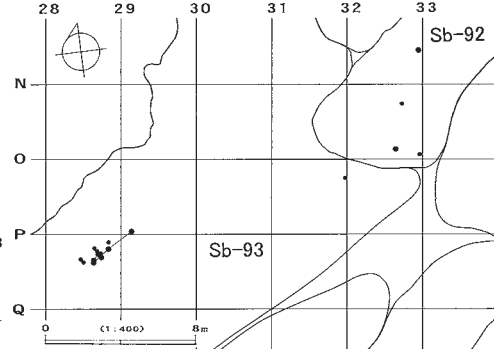

接合3268(個体B)分布図

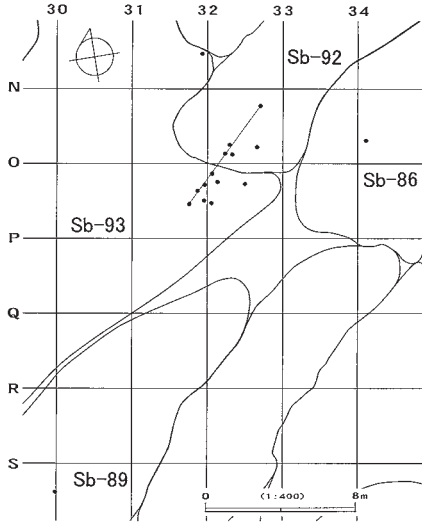

接合3268(個体C)分布図

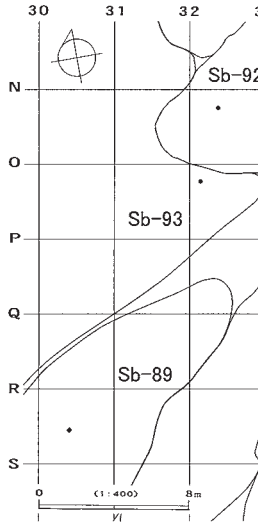

接合3268(段階3~7(個体C除く))分布図

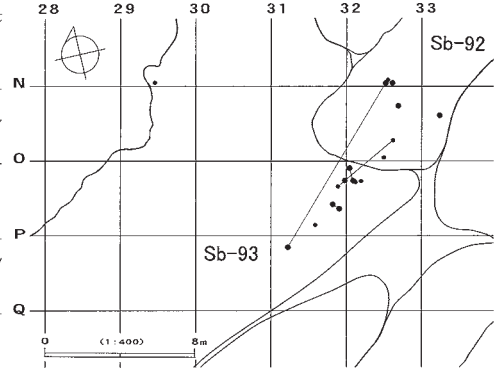

接合3268(全体)分布図

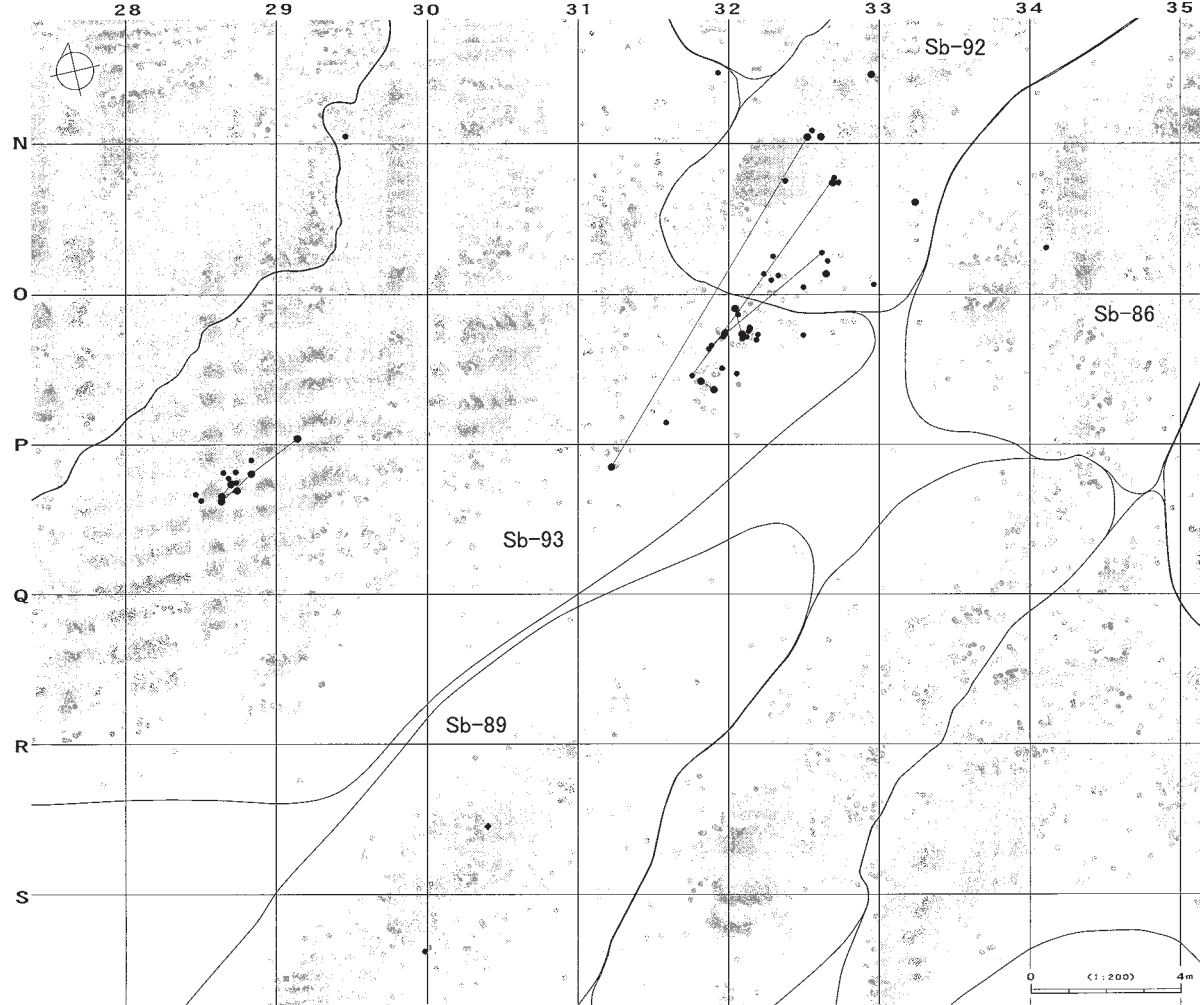

図Ⅲ-348 I区(Sb-91~96)の石器(113) 母岩722・接合3268(2)

母岩911・接合3989

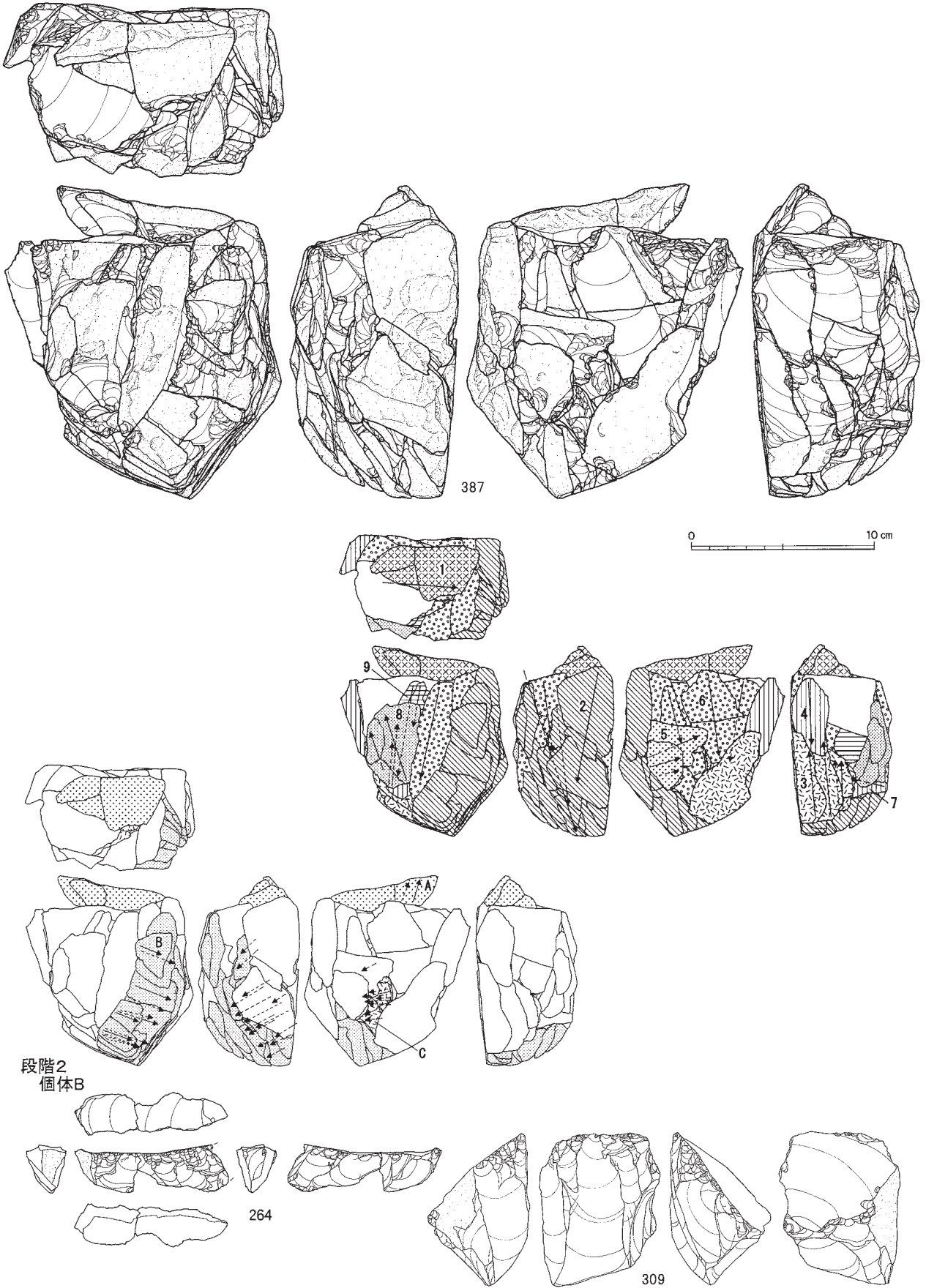

図Ⅲ-349 I区(Sb-91~96)の石器(114) 母岩911・接合3989(1)

I区(Sb-91~96)

接合3989(個体A)分布図

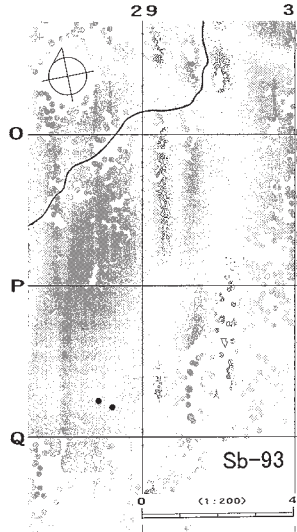

接合3989(個体B)分布図

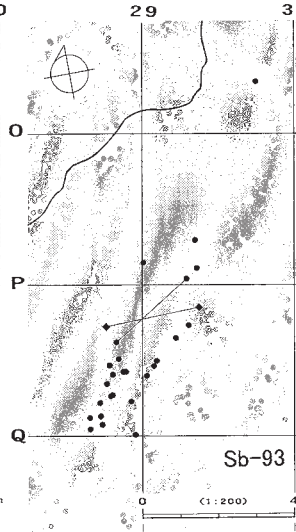

接合3989(個体C)分布図

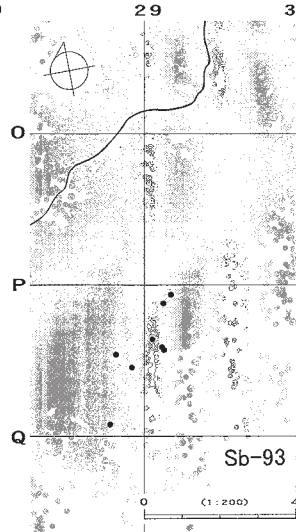

接合3989(個体A~C以外)分布図

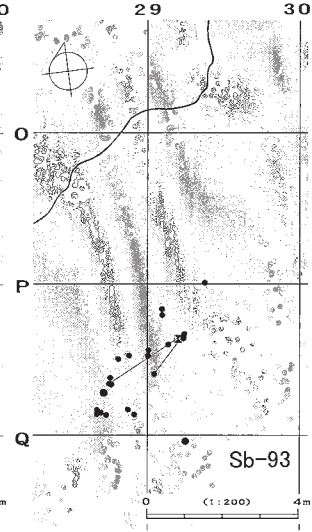

母岩928・接合4046

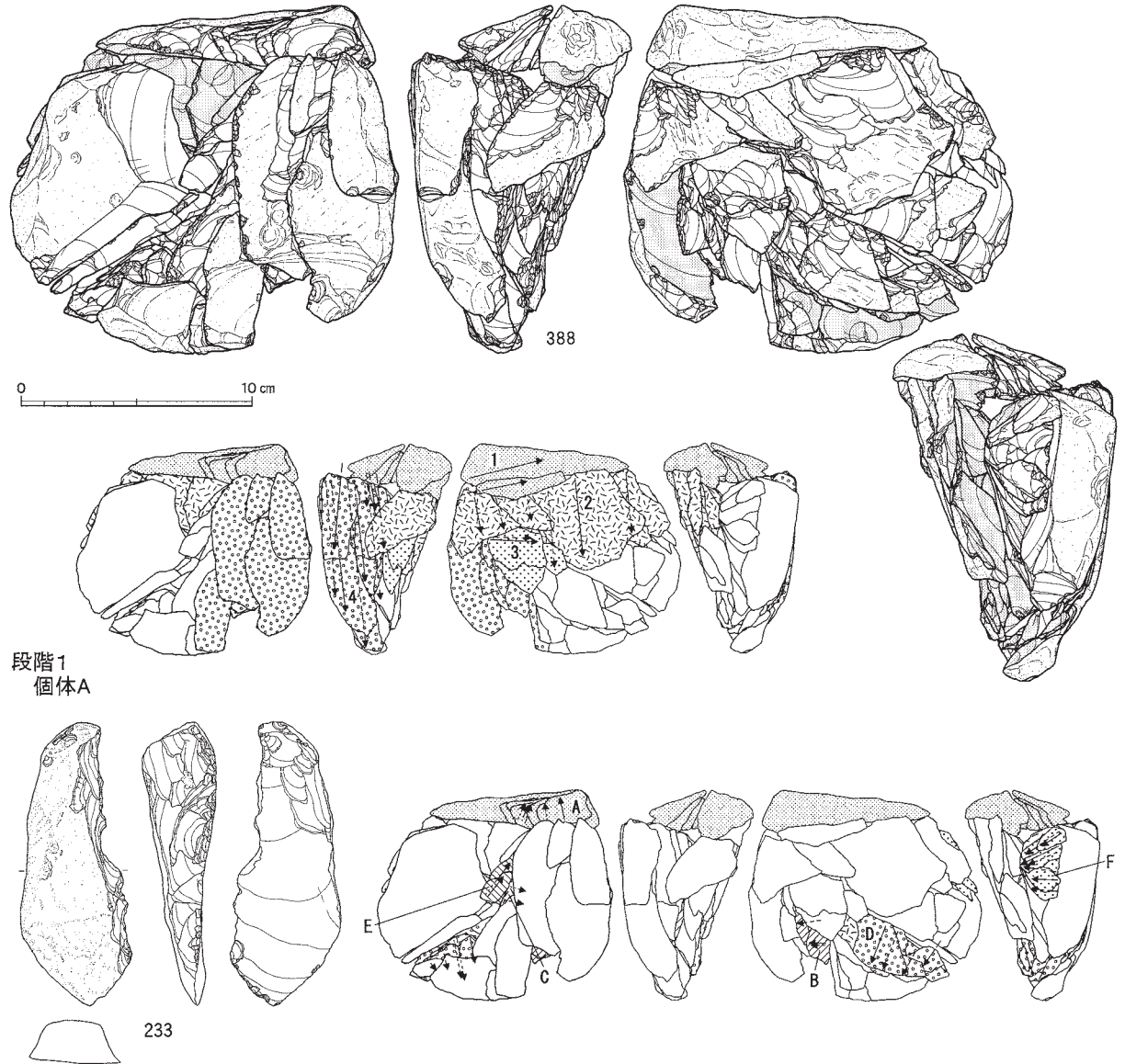

図Ⅲ-350 I区(Sb-91~96)の石器(115) 母岩911・接合3989(2)、母岩928・接合4046(1)

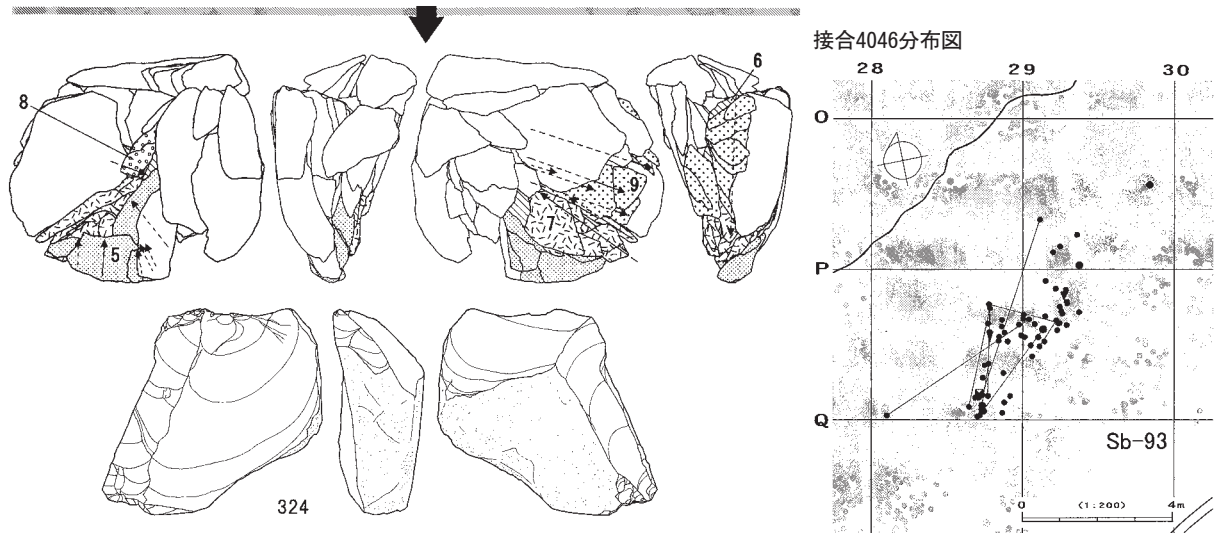

母岩827・接合3658

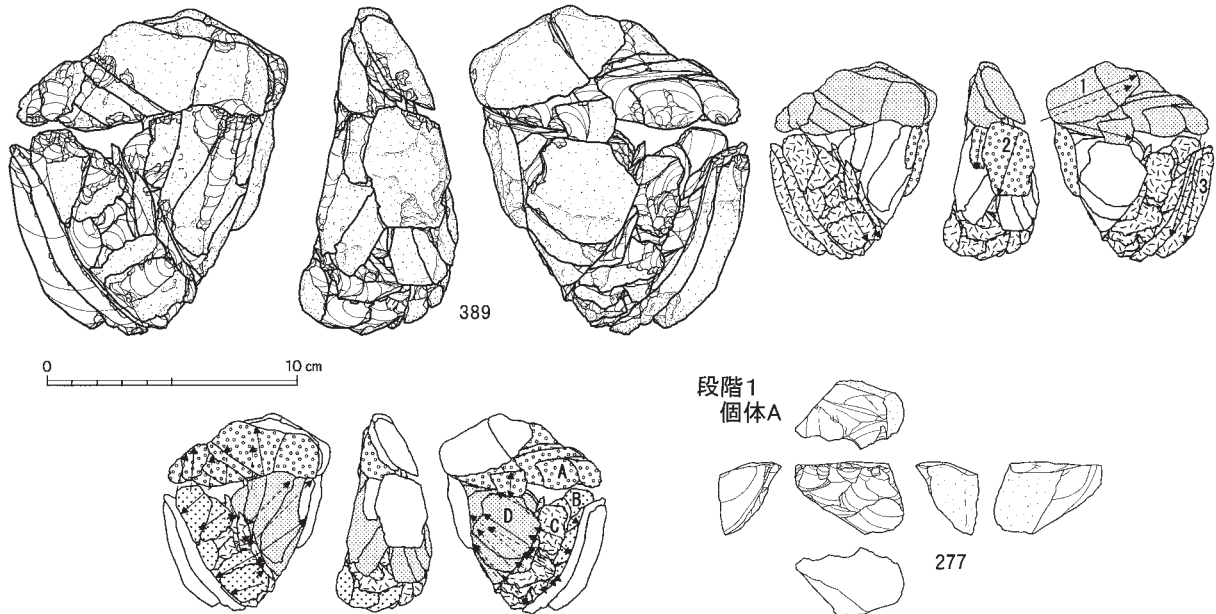

接合3658(個体A)分布図

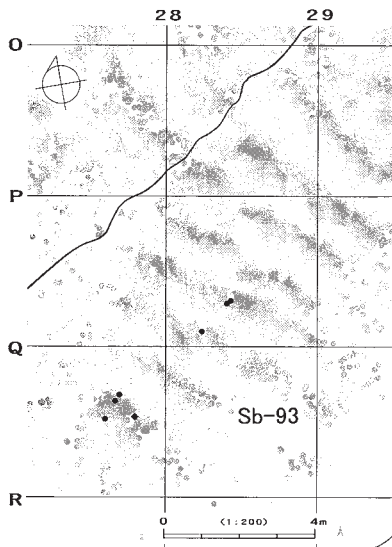

接合3658(個体B)分布図

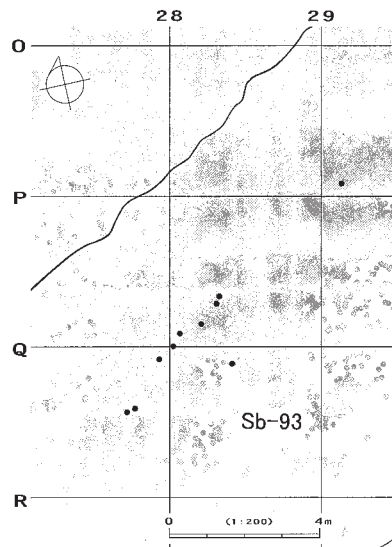

接合3658(個体C)分布図

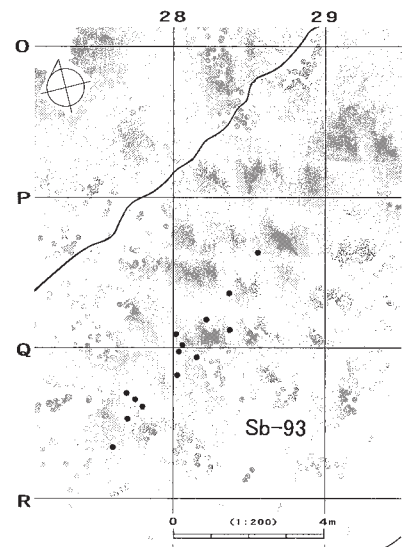

図Ⅲ-351 I区(Sb-91~96)の石器(116) 母岩928・接合4046(2)、母岩827・接合3658(1)

接合3658(個体D)分布図

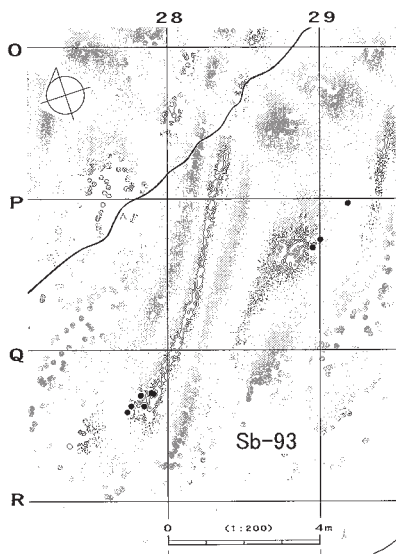

接合3658(個体A~D以外)分布図

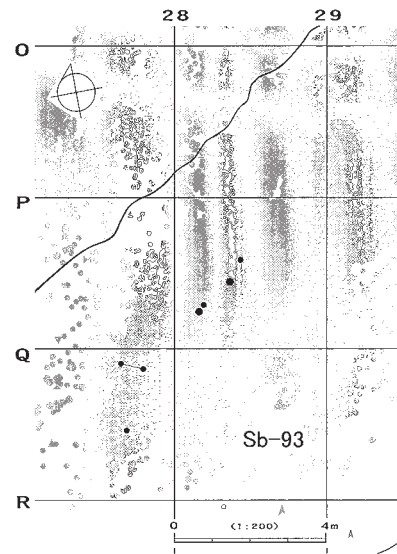

接合3658(全体)分布図

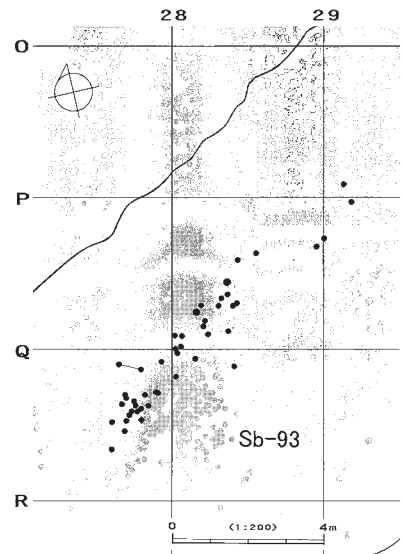

母岩814・接合3611



図Ⅲ-352 I区(Sb-91~96)の石器(117) 母岩827・接合3658(2)、母岩814・接合3611(1)

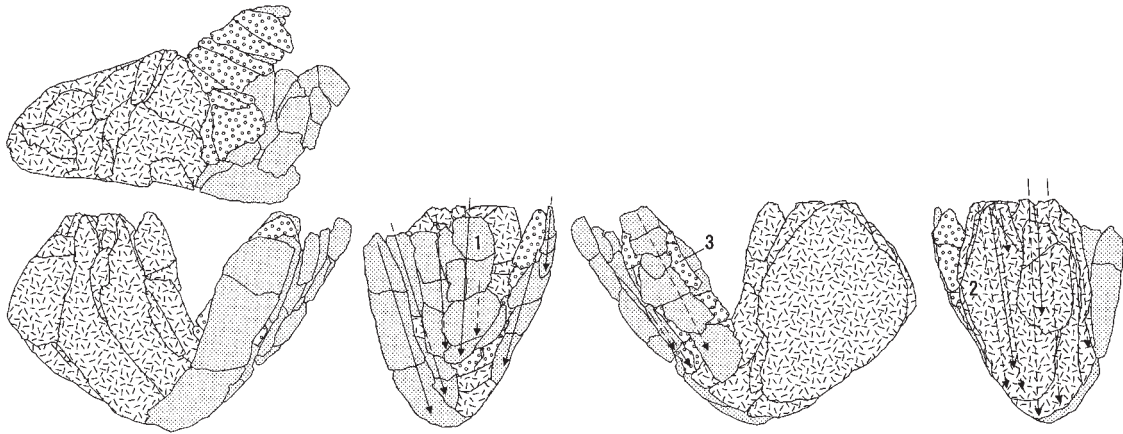

接合3611分布図

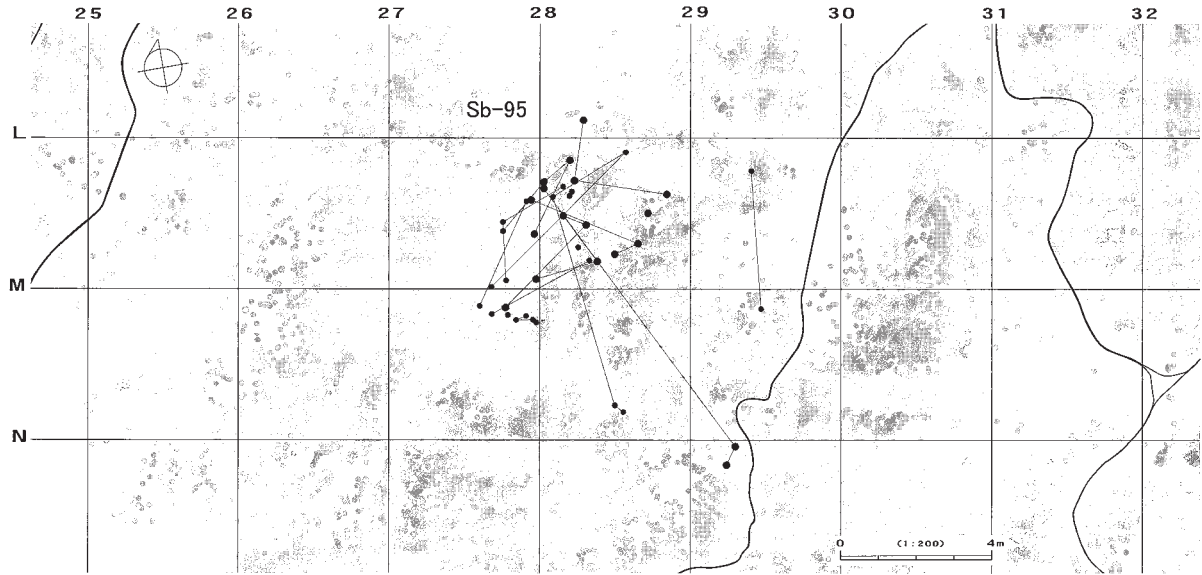

母岩708・接合3237

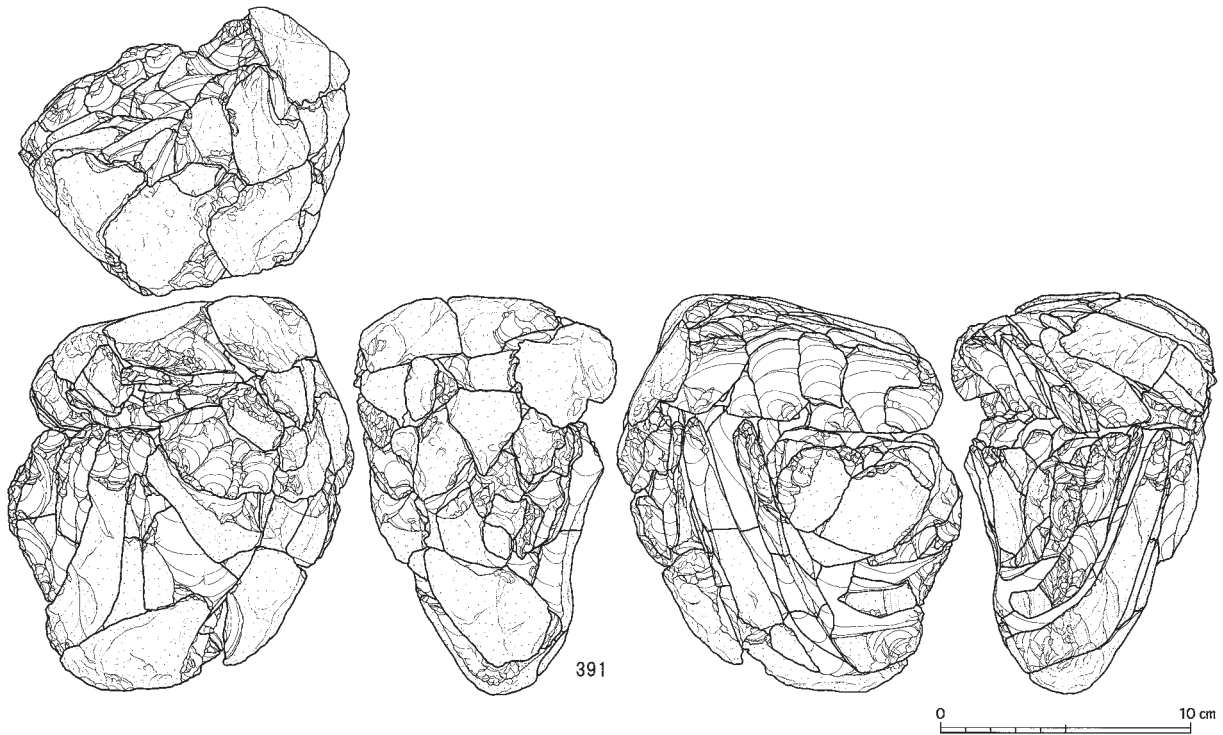

図Ⅲ-353 I区(Sb-91~96)の石器(118) 母岩814・接合3611(2)、母岩708・接合3237(1)

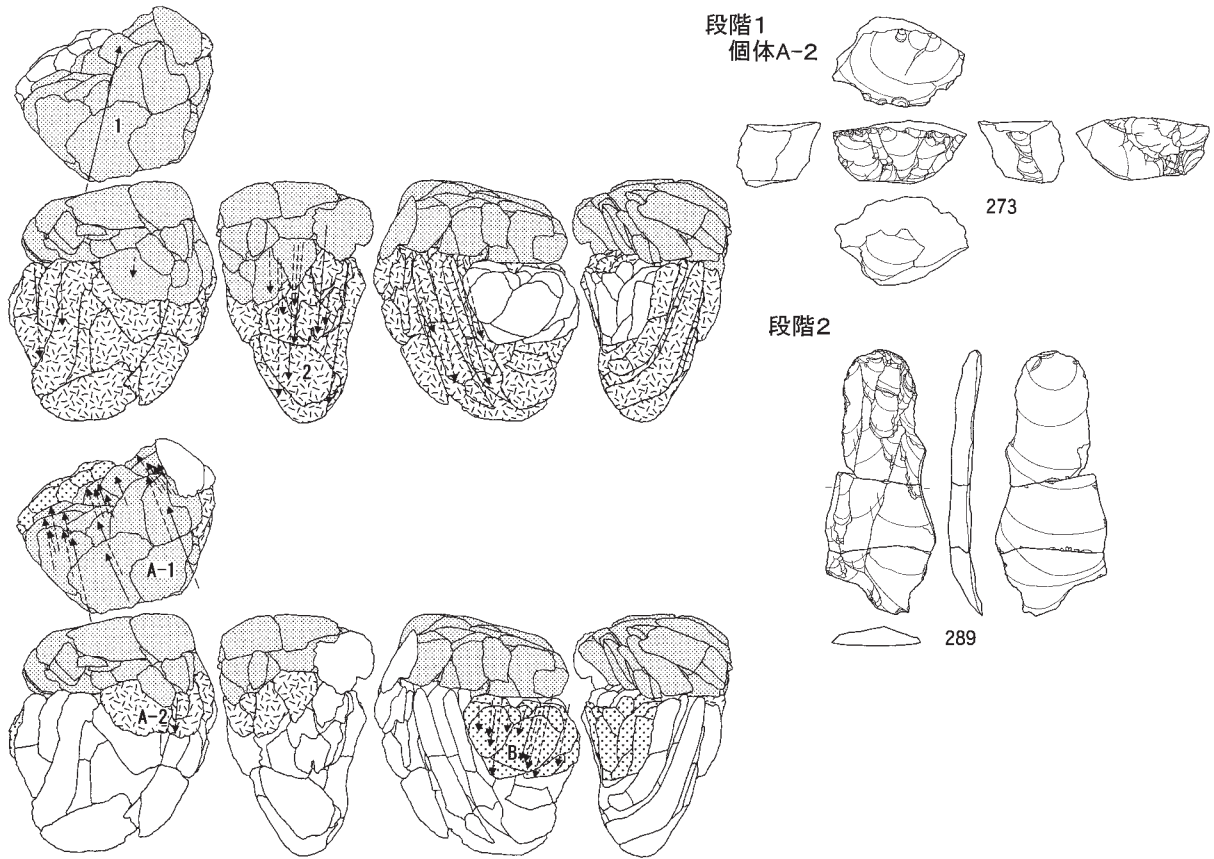

接合3237(个体A)分布図

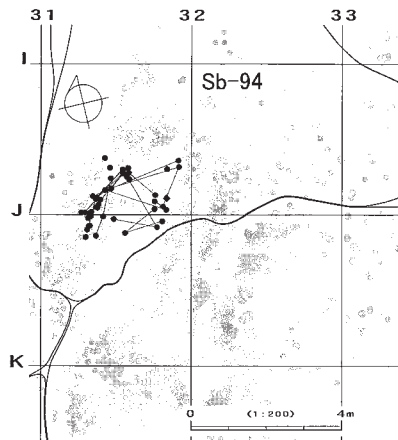

接合3237(个体B)分布図

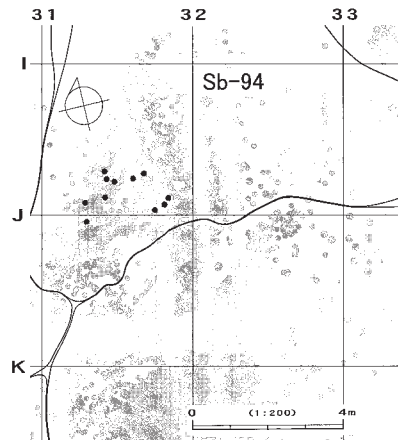

接合3237(个体A・B以外)分布図

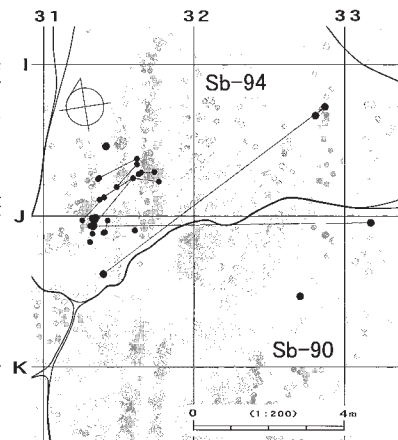

母岩830・接合3661



図Ⅲ-354 I区(Sb-91~96)の石器(119) 母岩708・接合3237(2)、母岩830・接合3661(1)

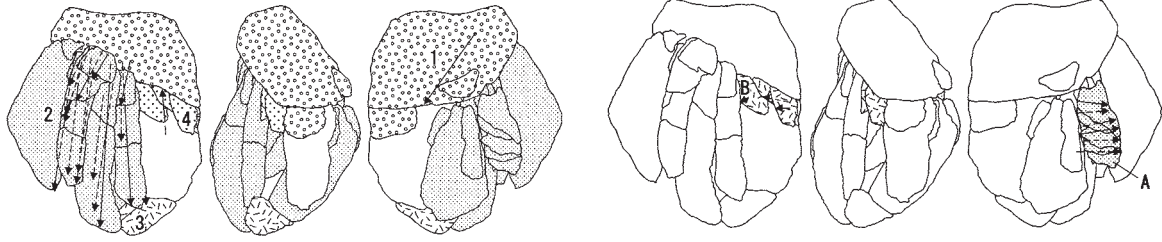

段階2

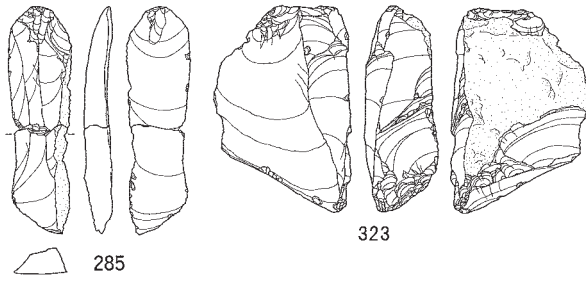

接合3661分布図

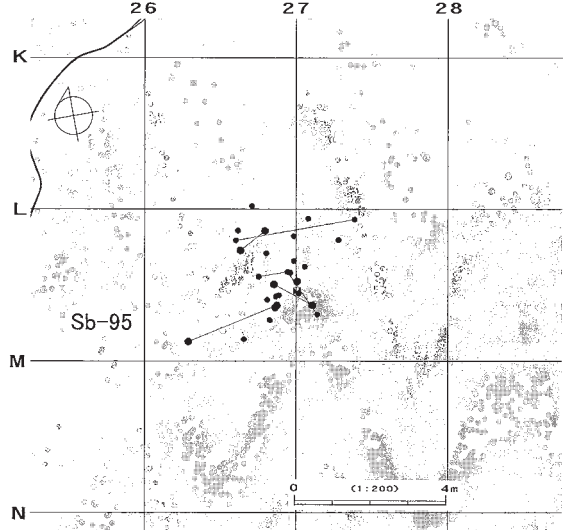

母岩778・接合3496

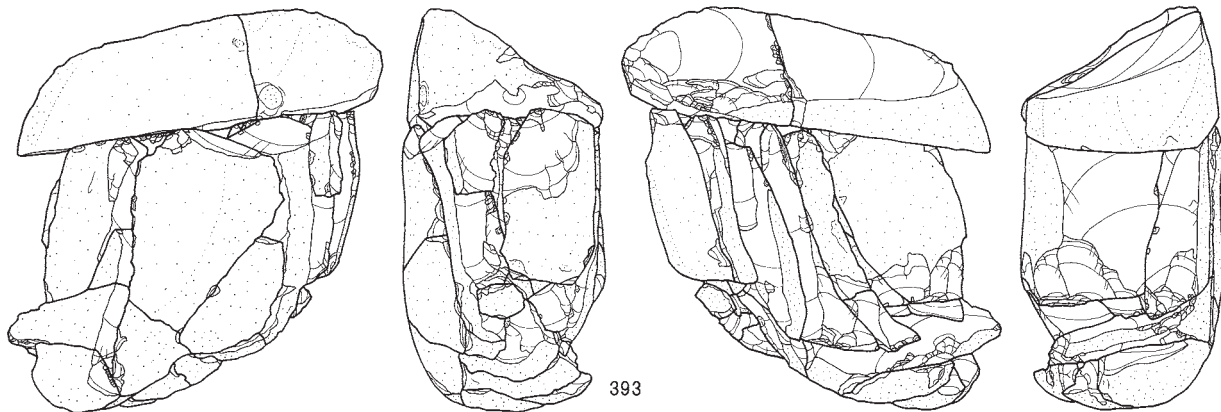

0 10 cm

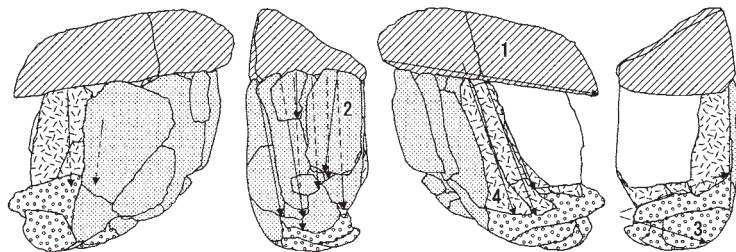

299

図Ⅲ-355 I区(Sb-91~96)の石器(120) 母岩830・接合3661(2)、母岩778・接合3496(1)

接合3496分布図

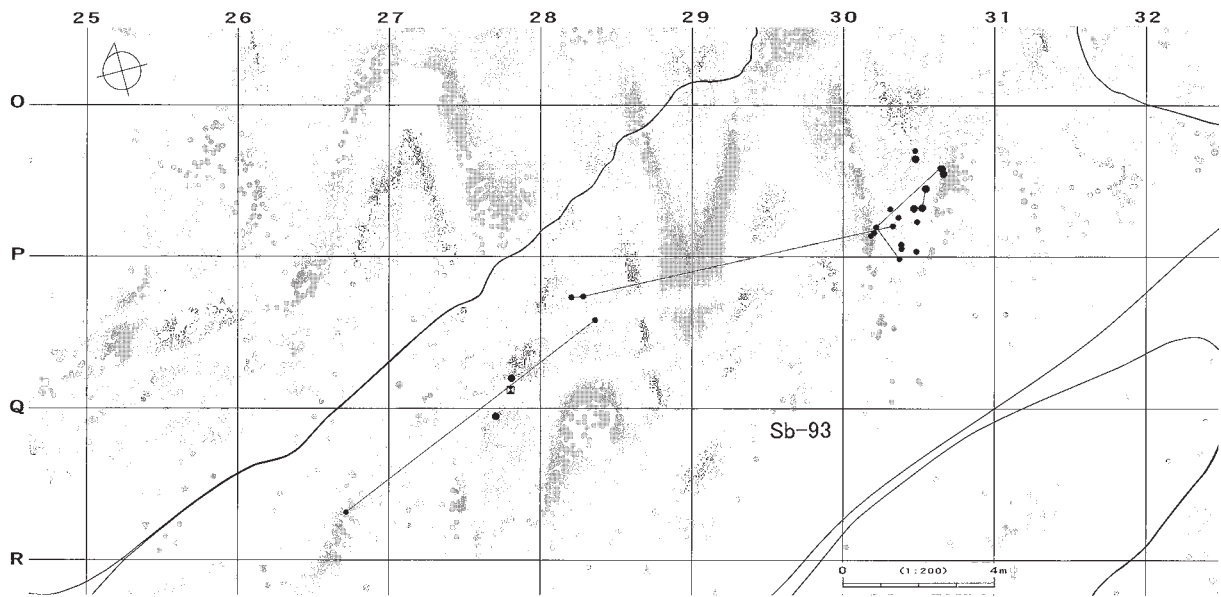

母岩755・接合3420

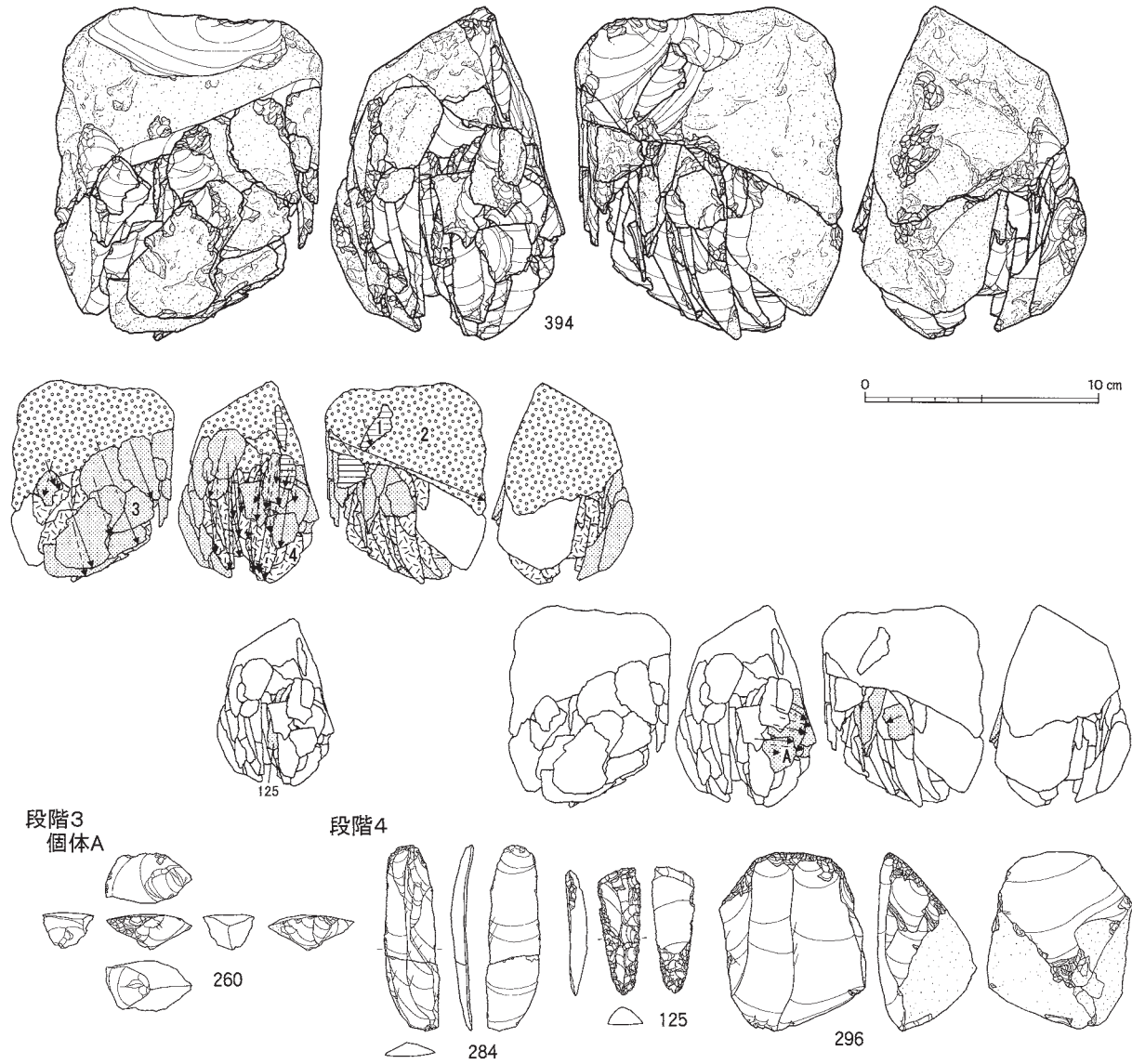

図III-356 I区(Sb-91~96)の石器(121) 母岩778・接合3496(2)、母岩755・接合3420(1)

接合3420分布図

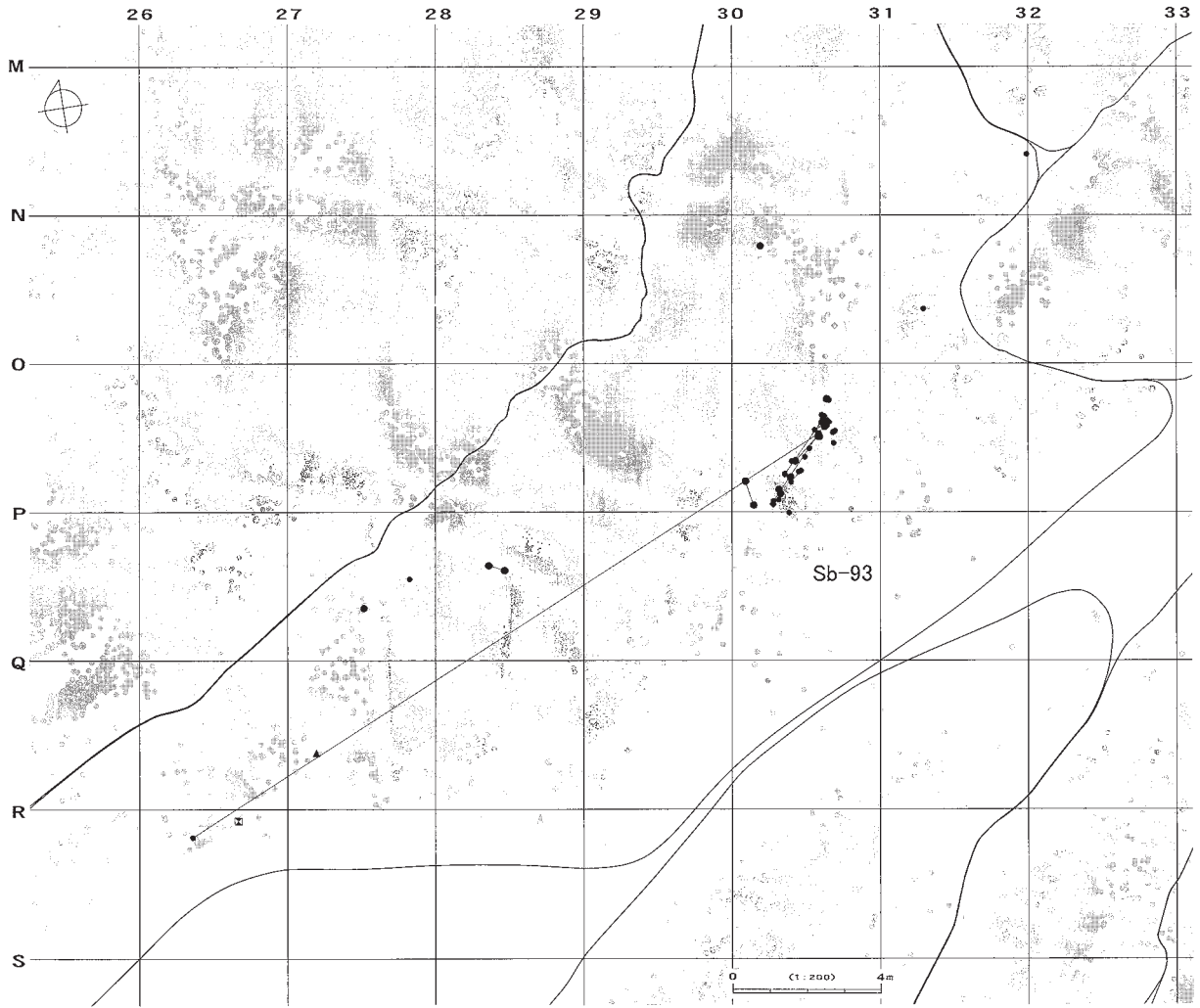

母岩773・接合3489

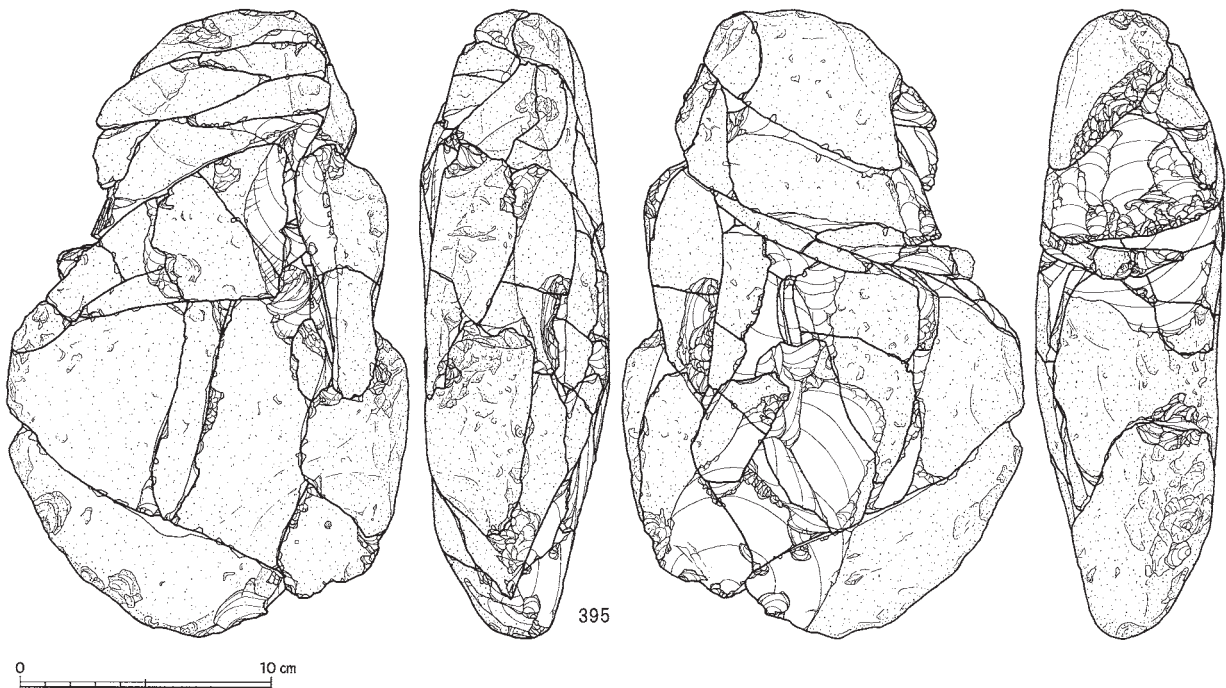

図Ⅲ-357 I区(Sb-91~96)の石器(122) 母岩755・接合3420(2)、母岩773・接合3489(1)

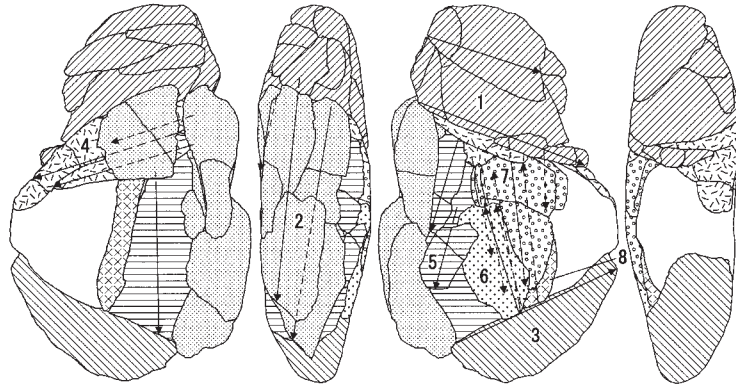

個体A

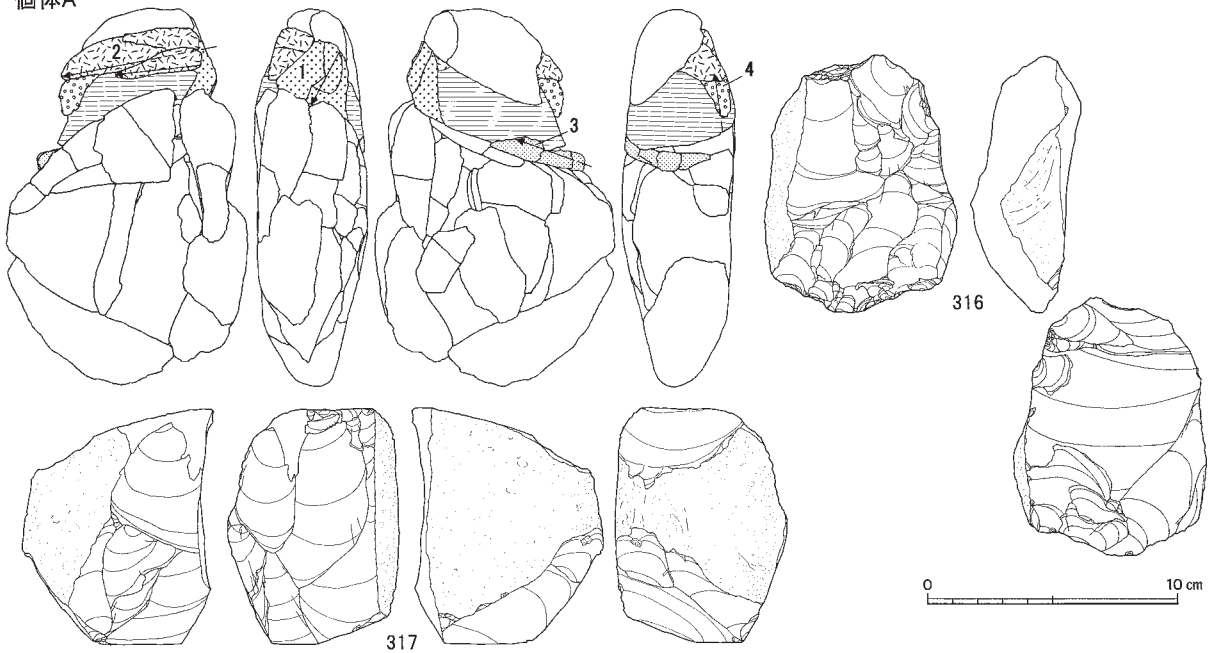

接合3489(個体A)分布図

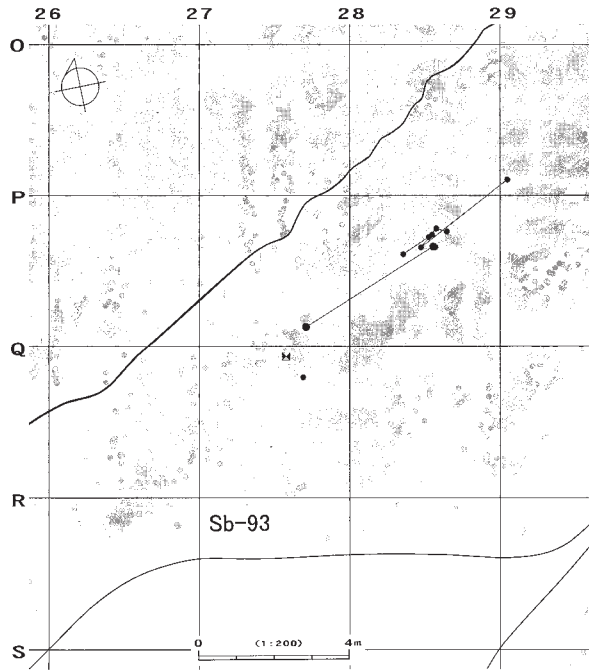

接合3489(個体A以外)分布図

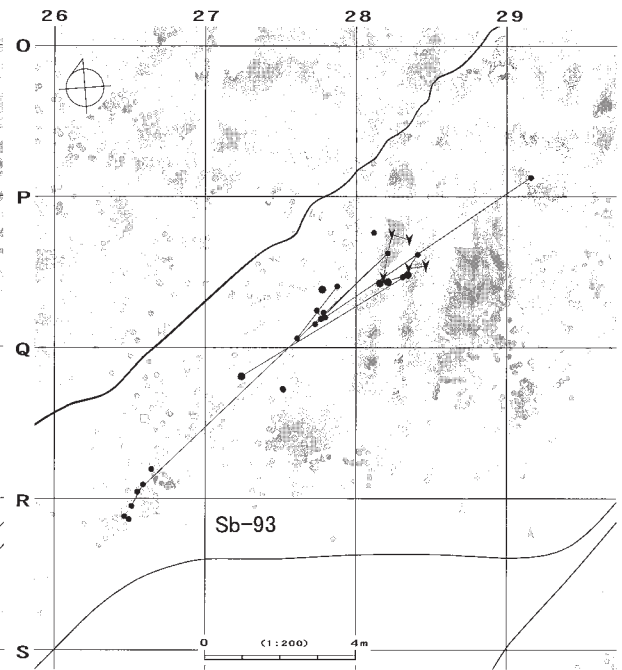

図Ⅲ-358 I区(Sb-91~96)の石器(123) 母岩773・接合3489(2)

母岩929・接合4050

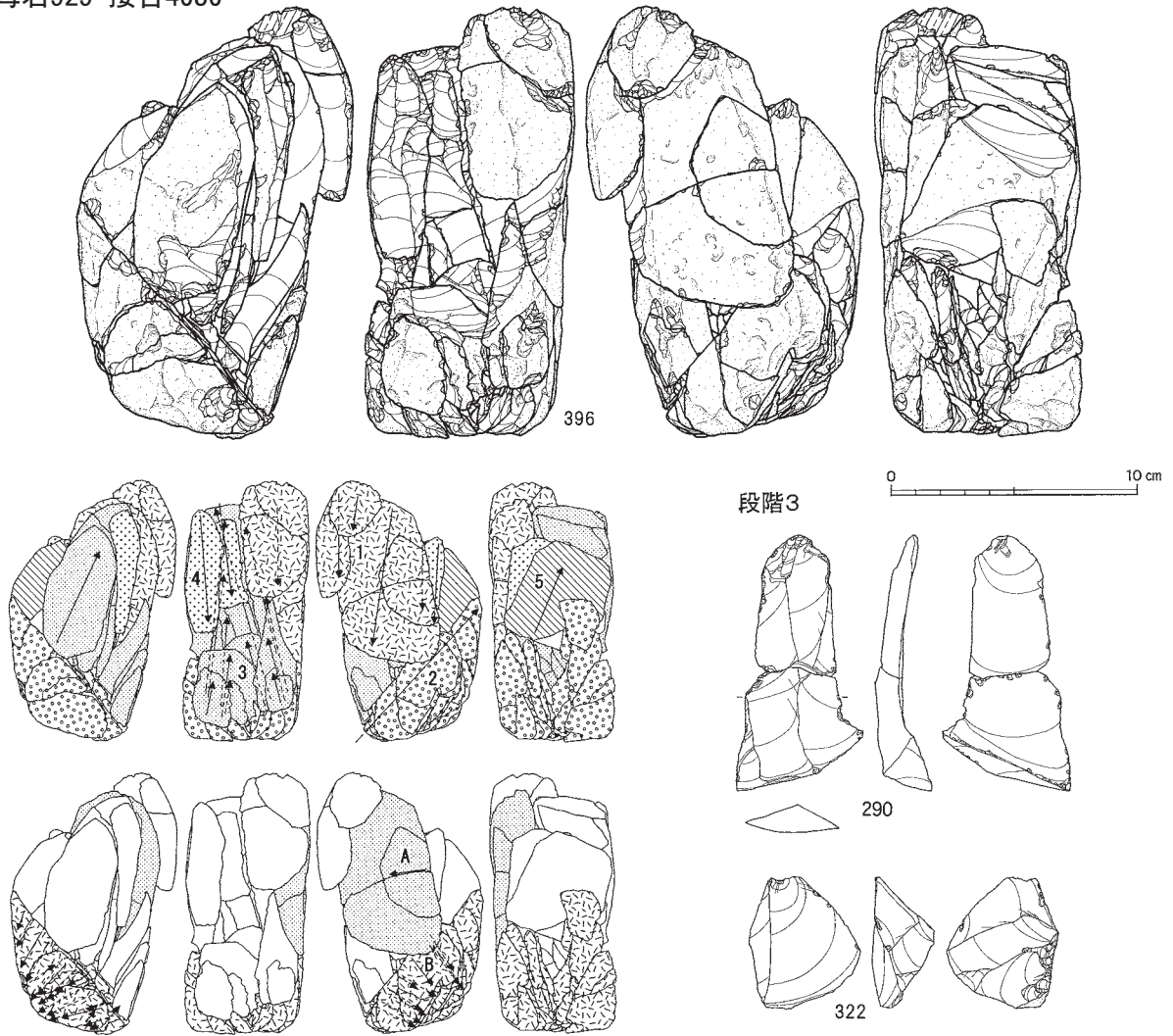

接合4050(個体A)分布図

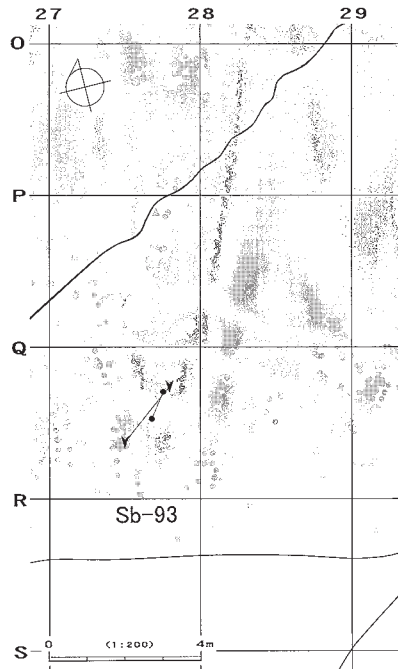

接合4050(個体B)分布図

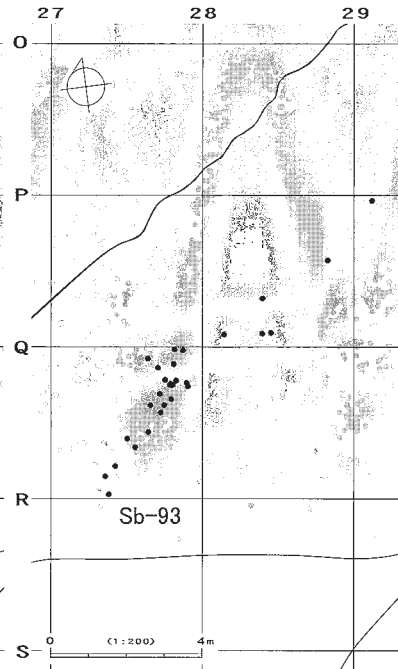

接合4050(個体A・B以外)分布図

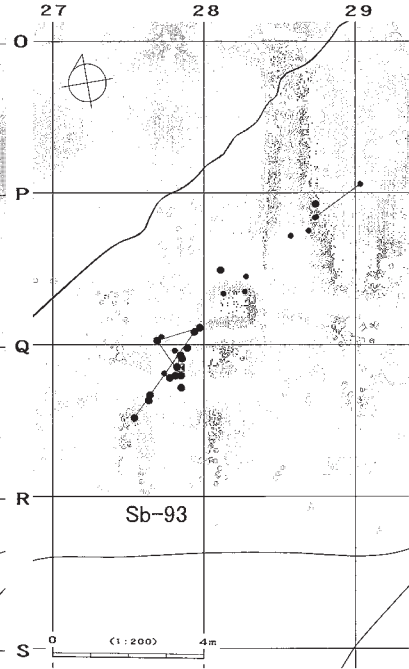

図Ⅲ-359 I区(Sb-91~96)の石器(124) 母岩929・接合4050

母岩726・接合3283

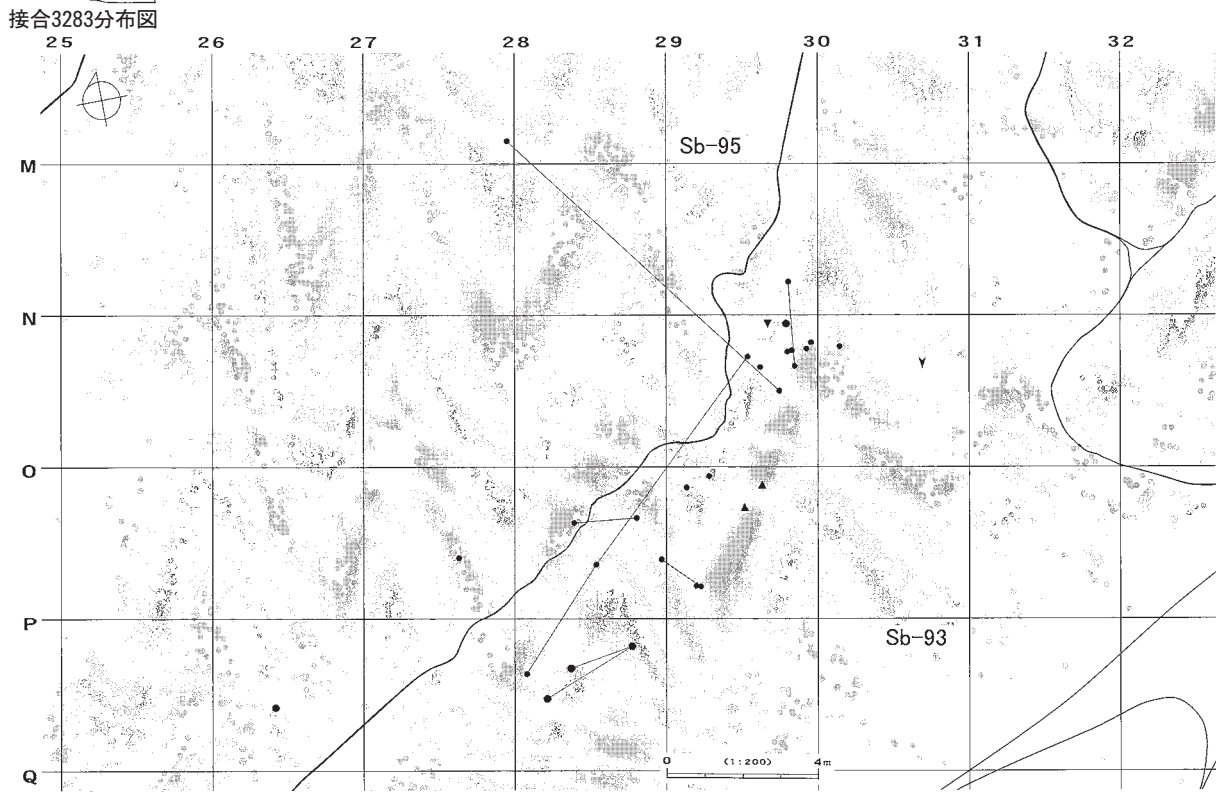
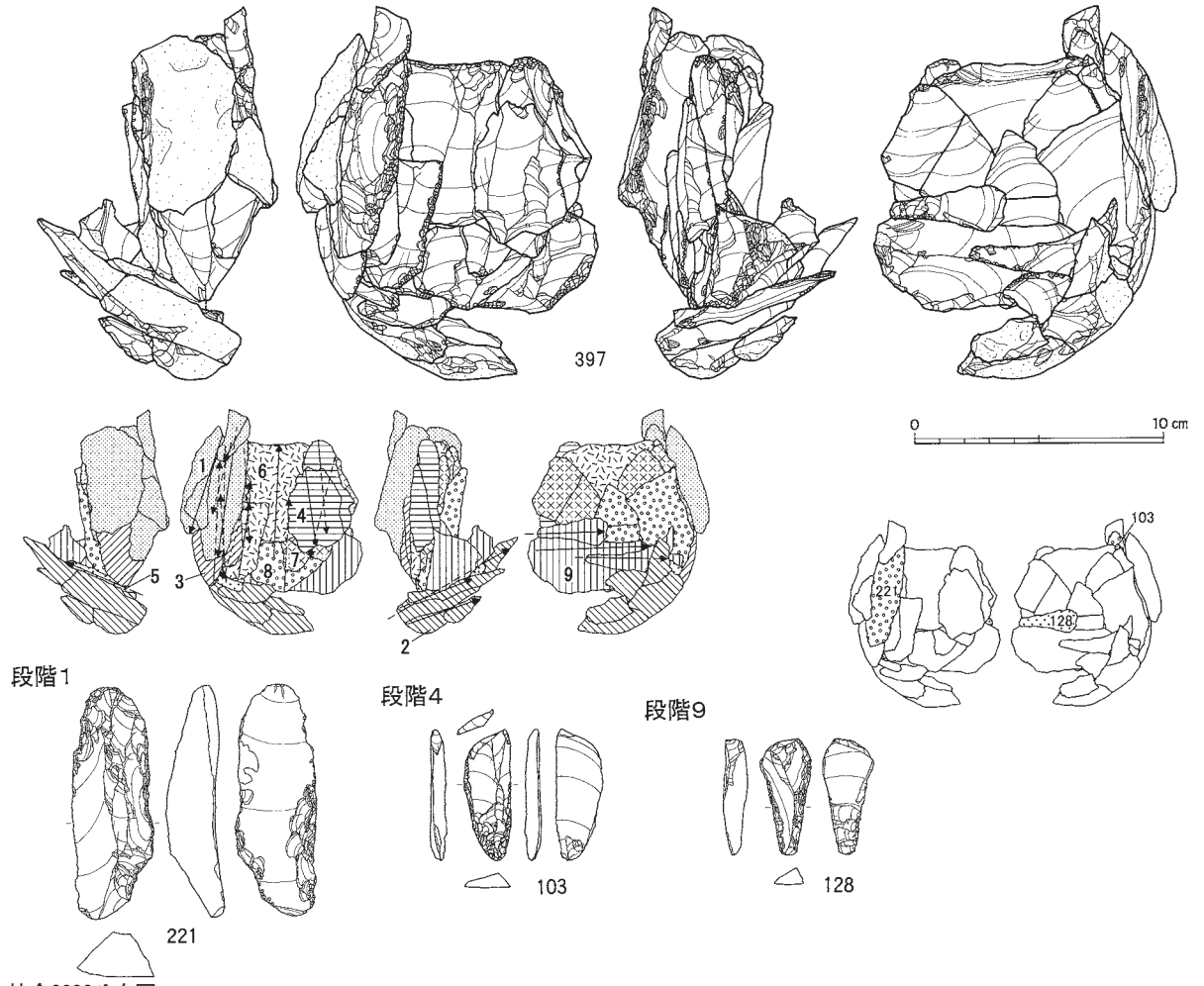

図Ⅲ-360 I区(Sb-91~96)の石器(125) 母岩726・接合3283

母岩798・接合3543

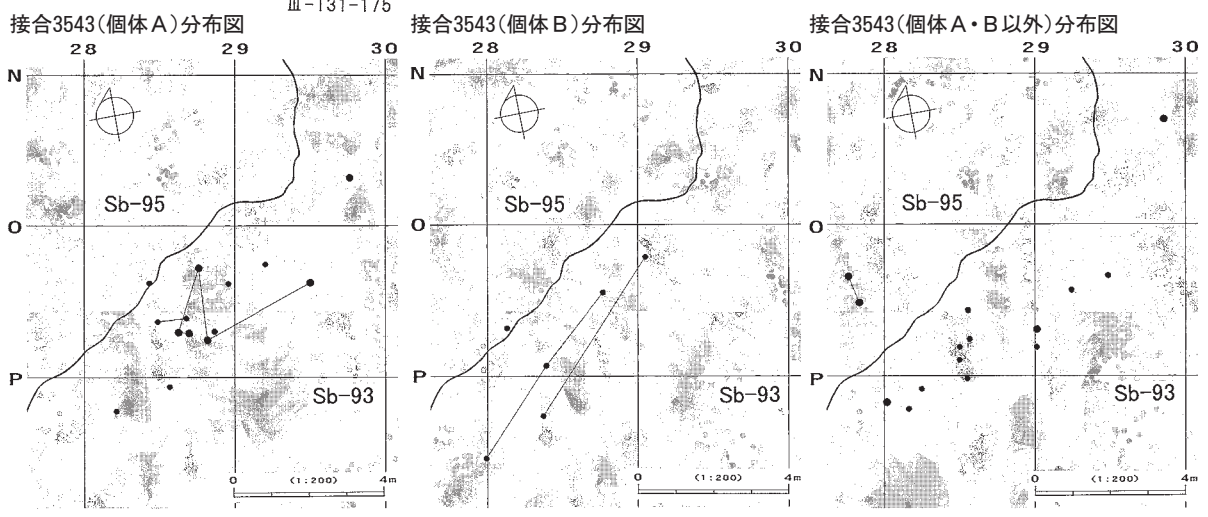
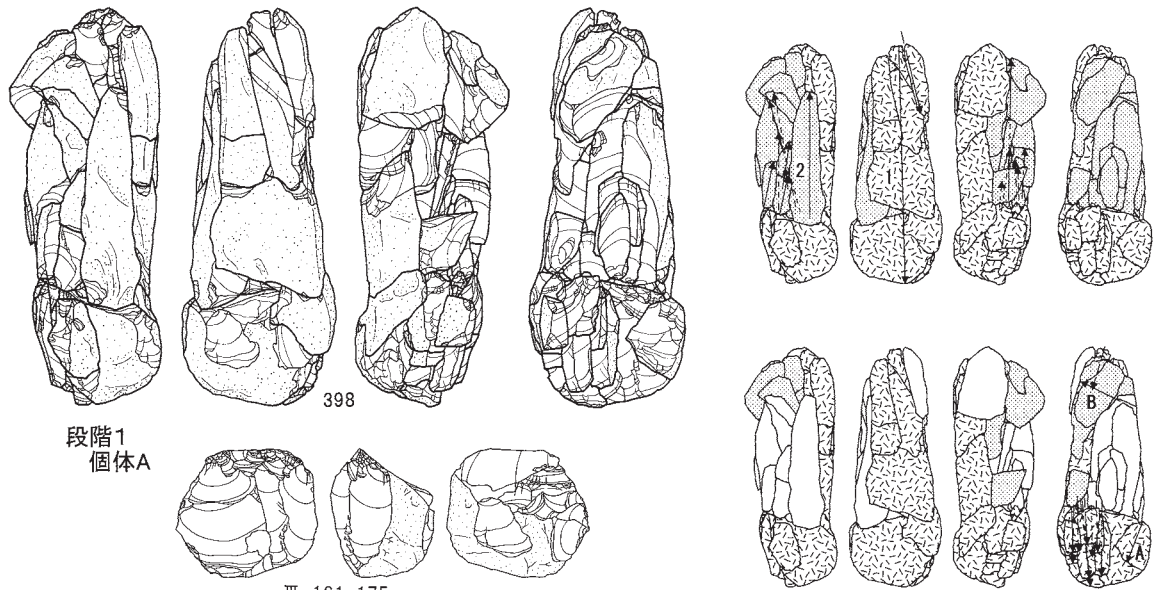

母岩864・接合3813

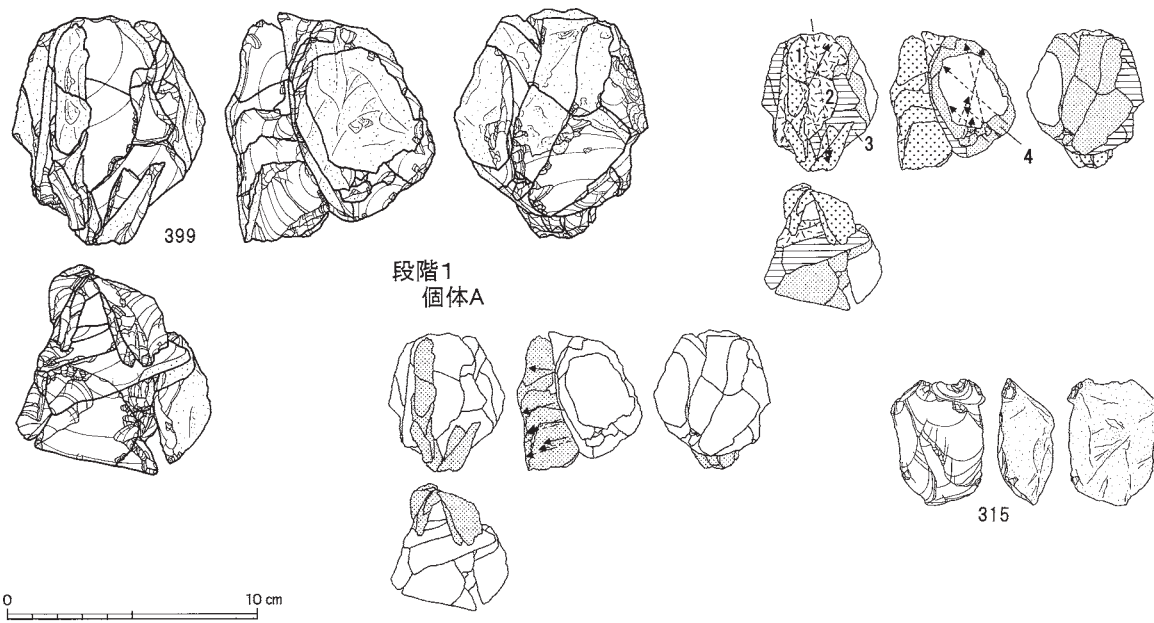

図Ⅲ-361 I区(Sb-91~96)の石器(126) 母岩798・接合3543、母岩864・接合3813(1)

接合3813(个体A)分布图

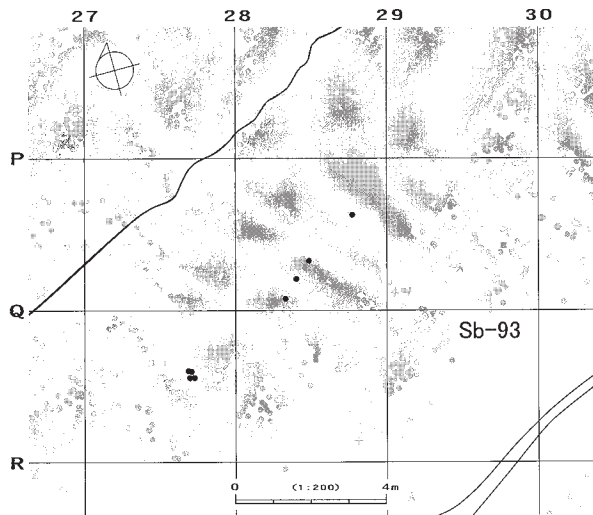

接合3813(个体A以外)分布图

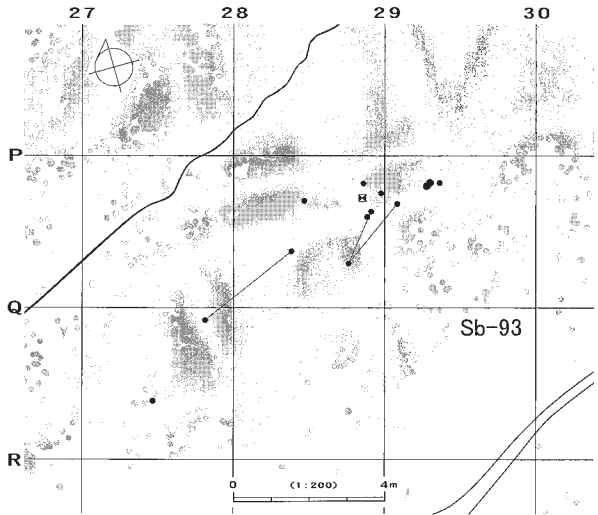

母岩889・接合3898

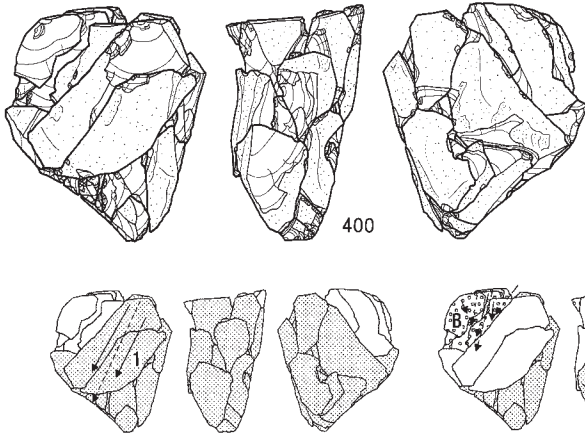

段階1
个体A

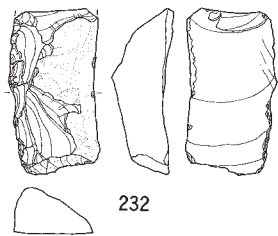

接合3898(段階1)分布图

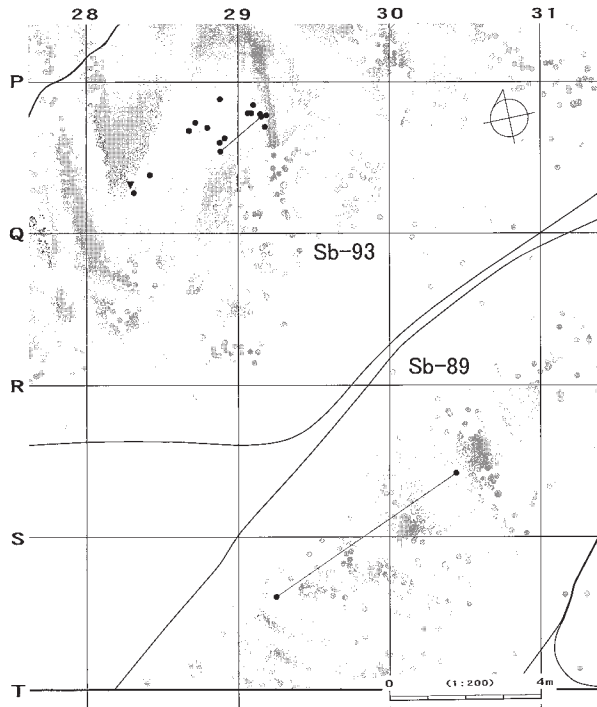

接合3898(个体B)分布图

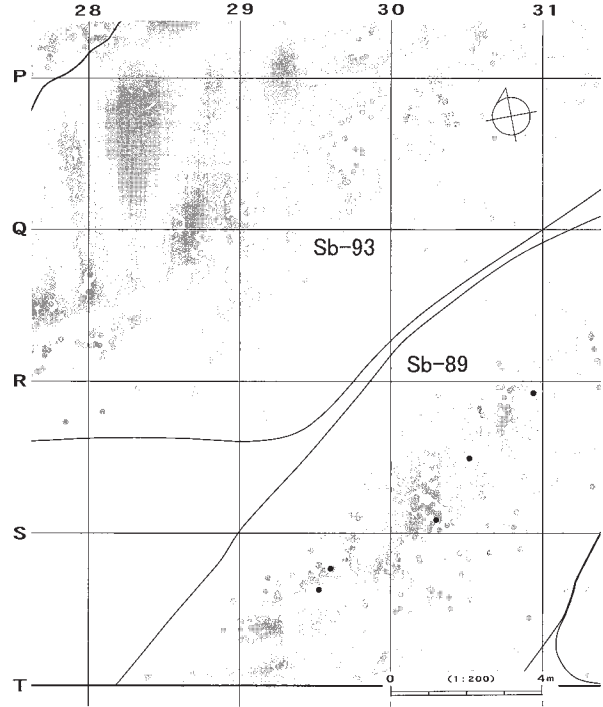

図Ⅲ-362 I区(Sb-91~96)の石器(127) 母岩864・接合3813(2)、母岩889・接合3898

母岩912・接合3990

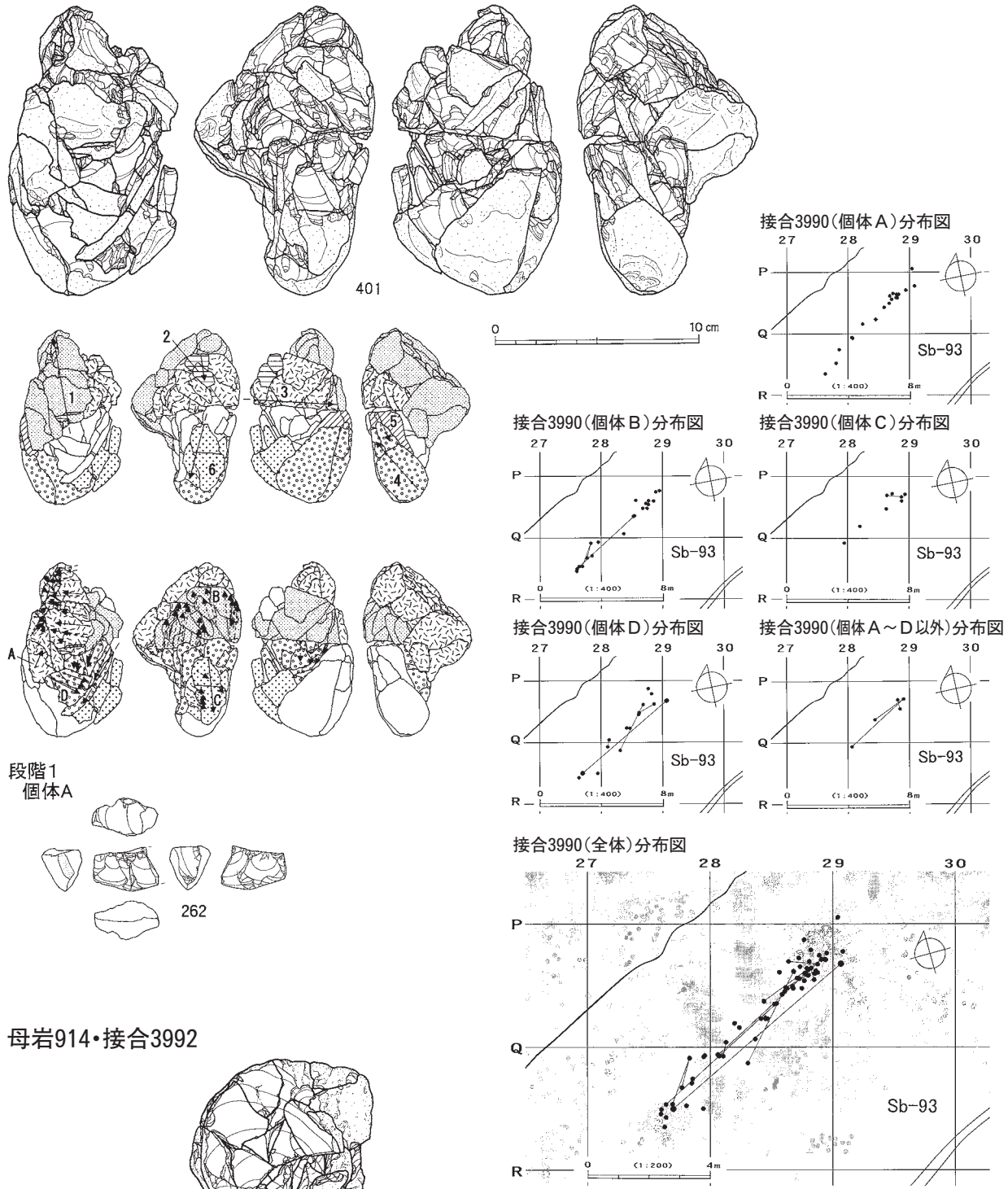

母岩914・接合3992

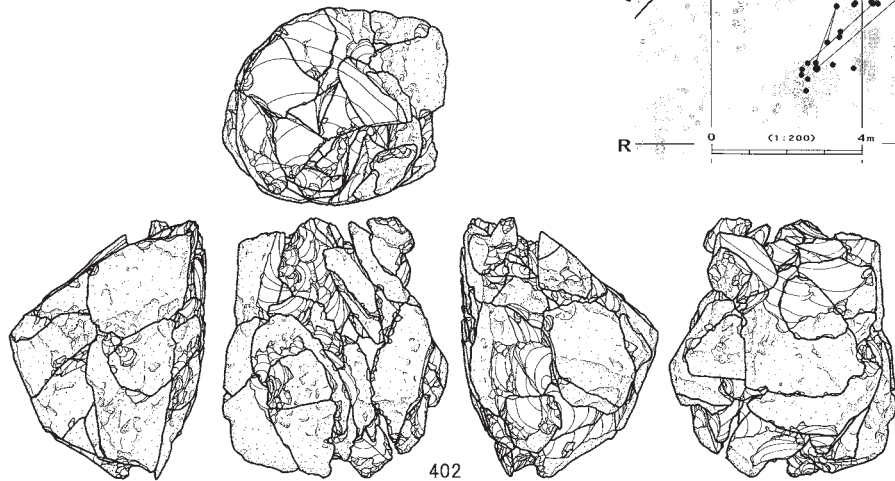

図Ⅲ-363 I区(Sb-91~96)の石器(128) 母岩912・接合3990、母岩914・接合3992(1)

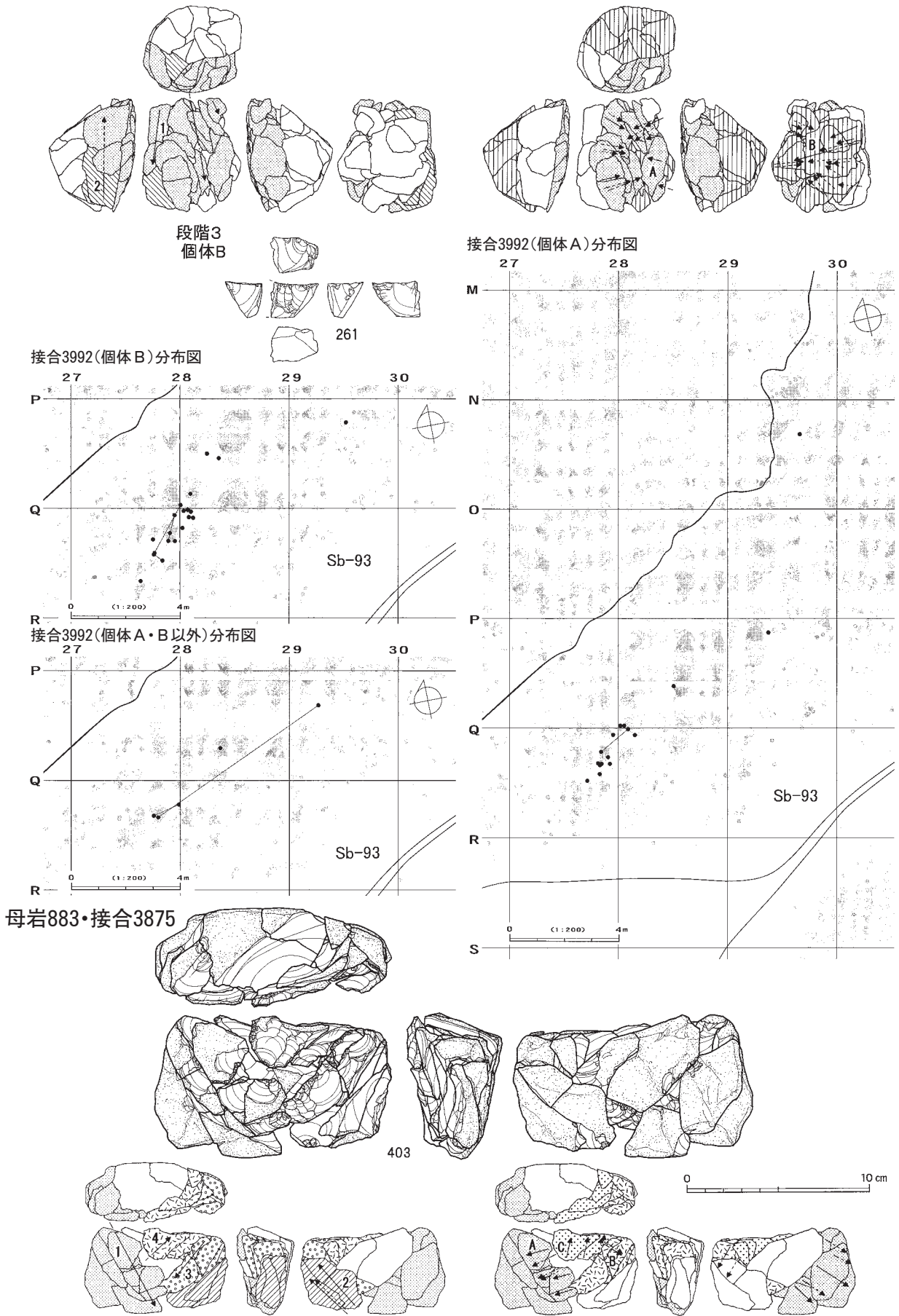

図Ⅲ-364 I区(Sb-91~96)の石器(129) 母岩914・接合3992(2)、母岩883・接合3875(1)

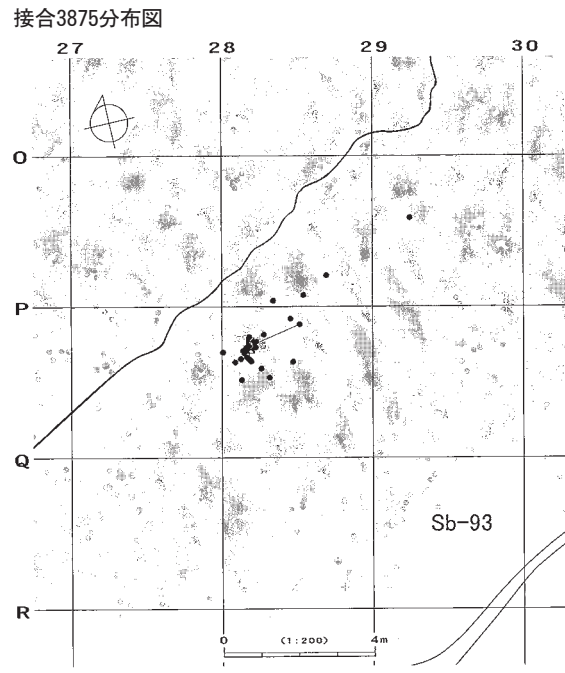
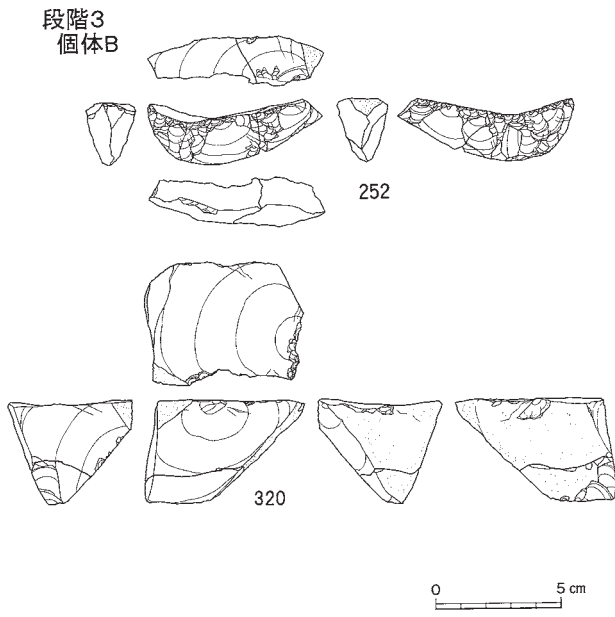

母岩813・接合3610

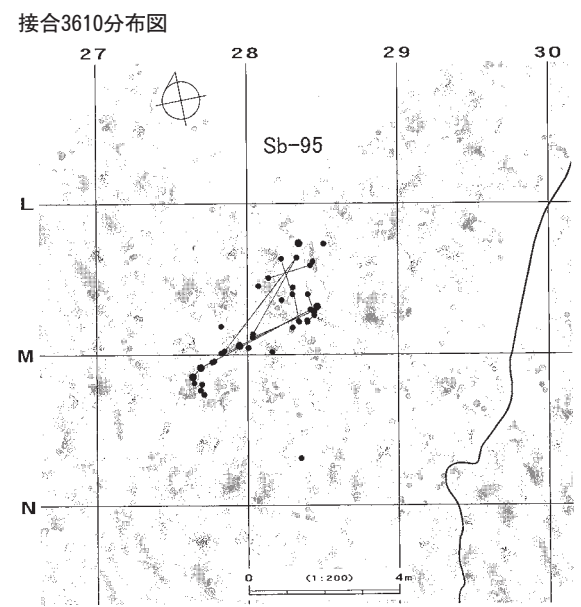
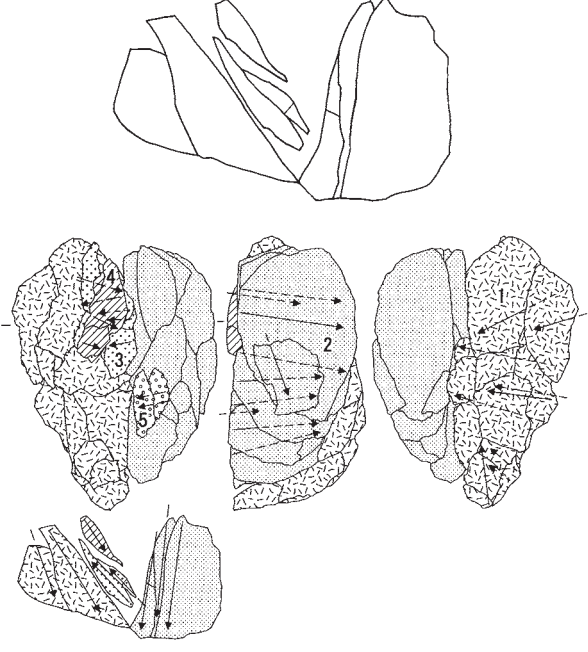
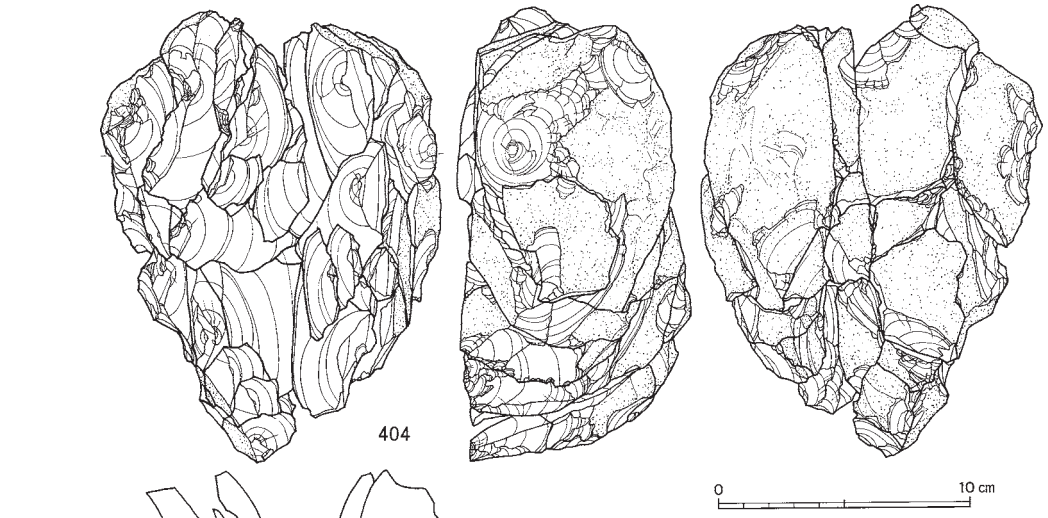

図Ⅲ-365 I区(Sb-91~96)の石器(130) 母岩883・接合3875(2)、母岩813・接合3610

母岩939・接合4078

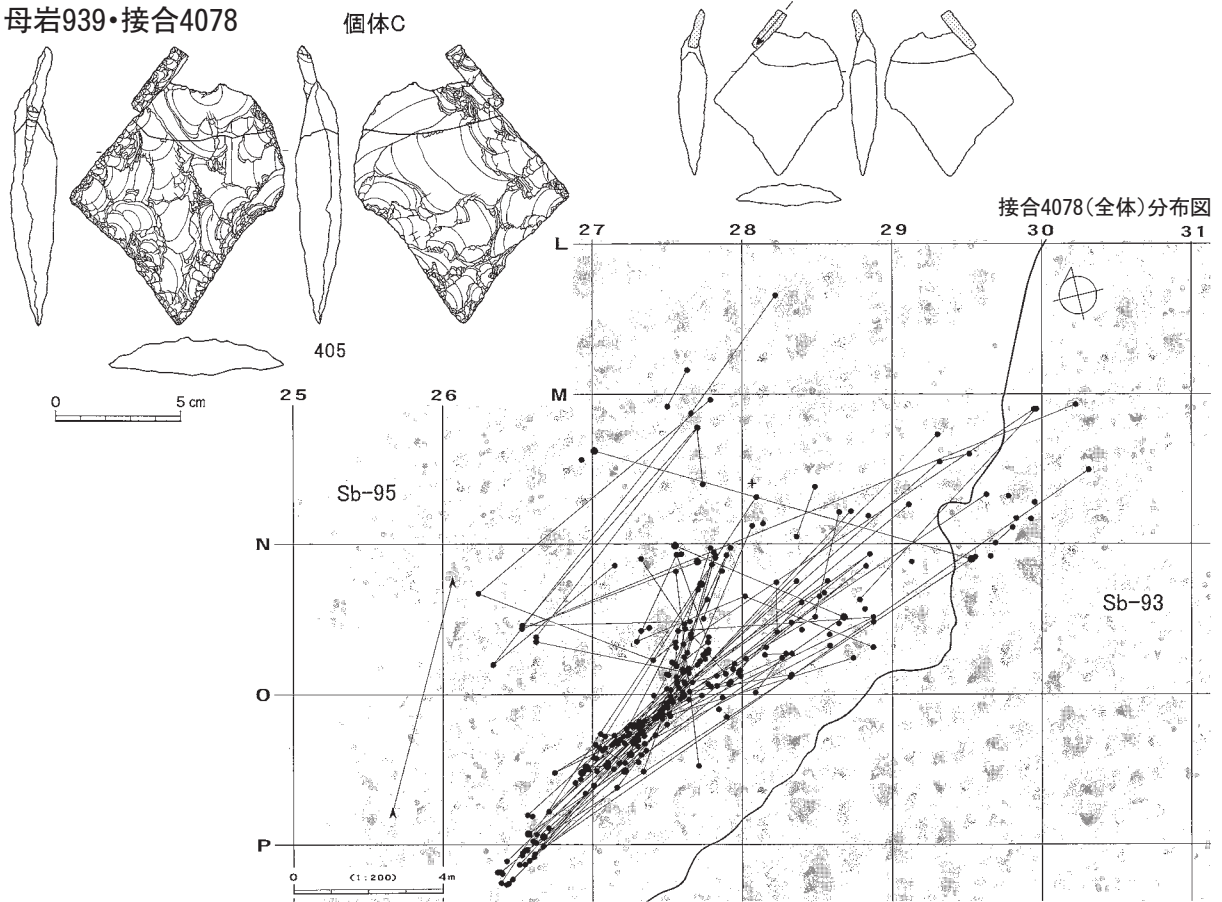

接合5744

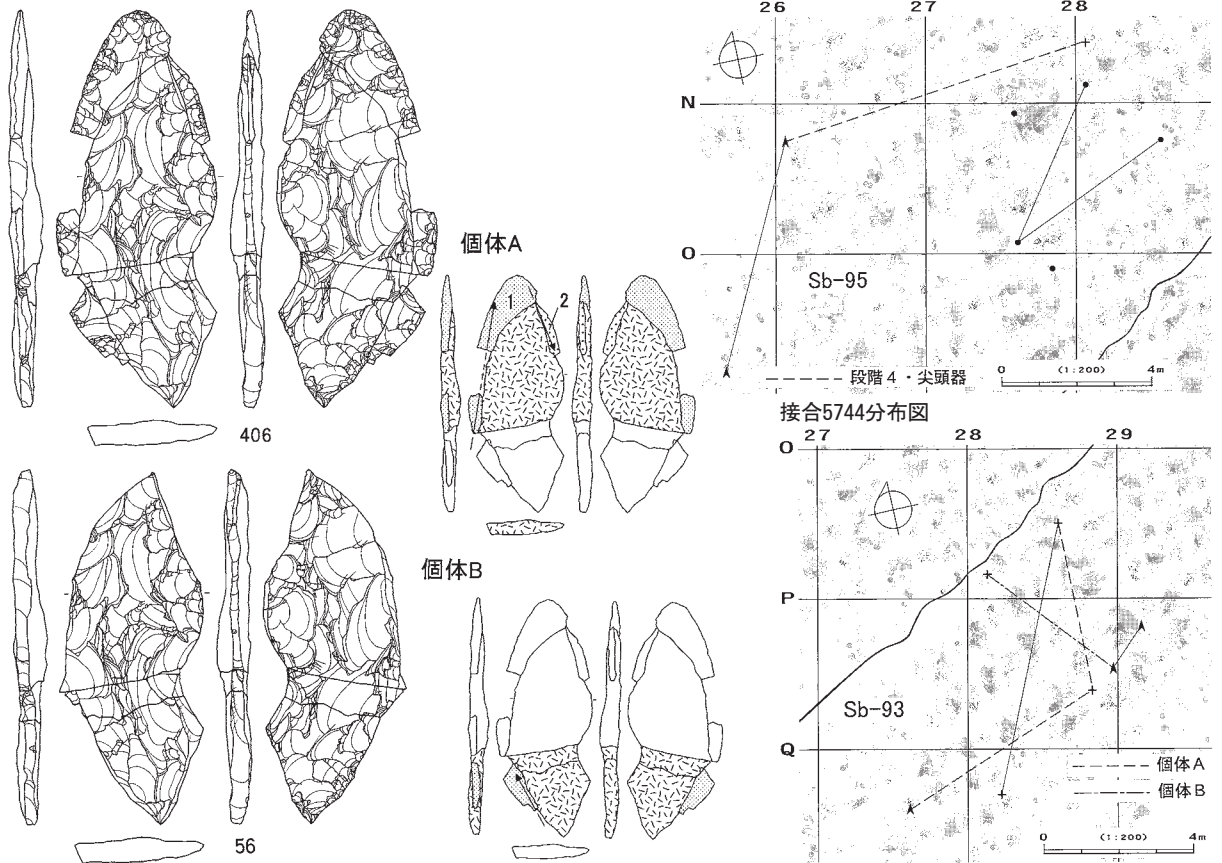

図Ⅲ-366 I区(Sb-91~96)の石器(131) 母岩939・接合4078、接合5744

母岩729・接合3294

個体A

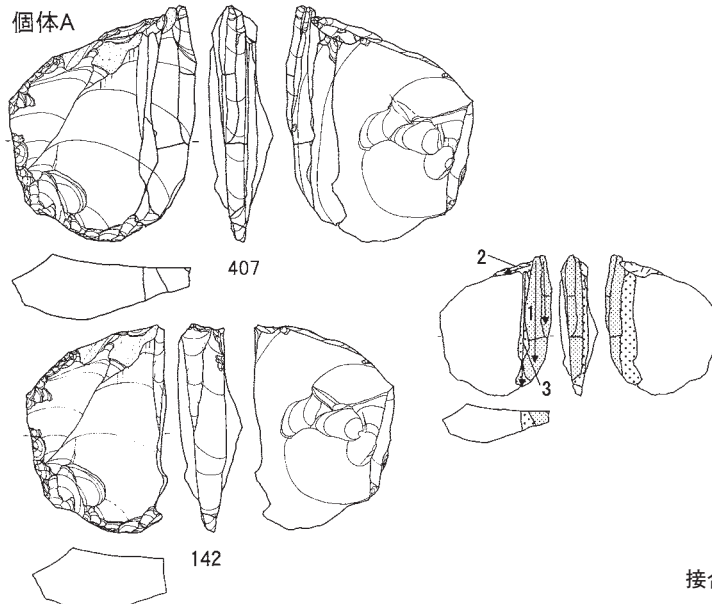

接合3294(全体)分布図

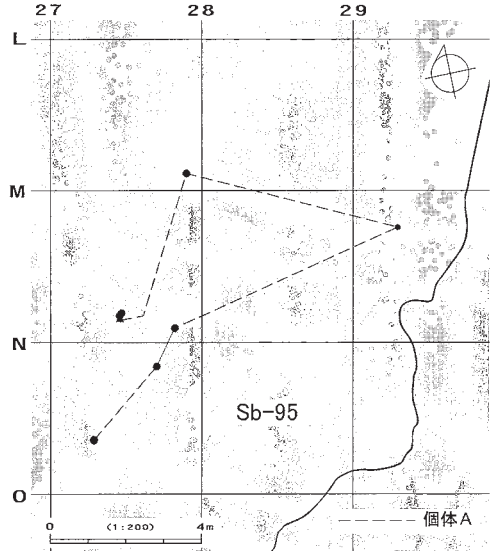

母岩729・接合3295

個体A

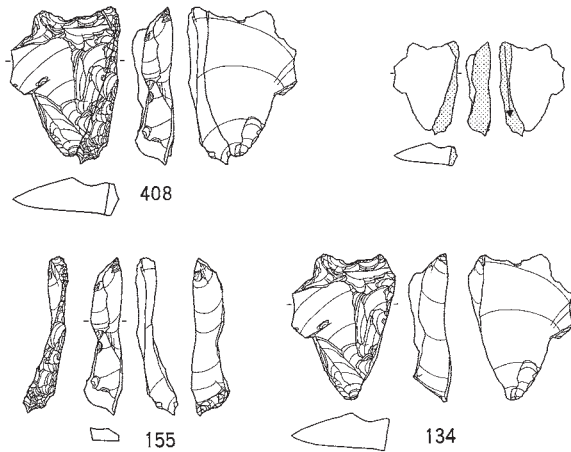

接合3295(全体)分布図

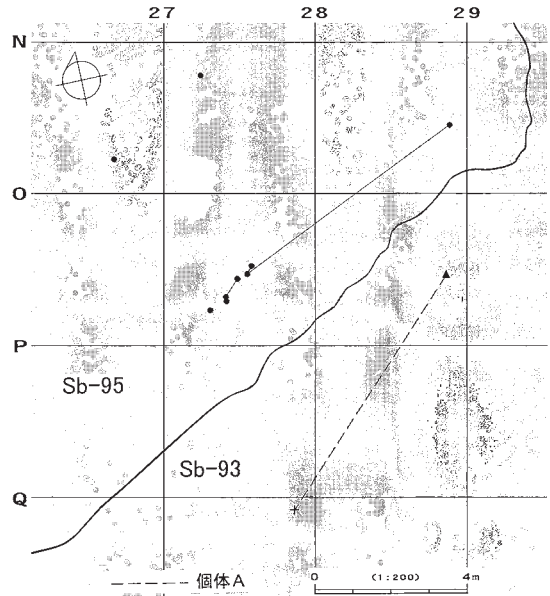

接合5749

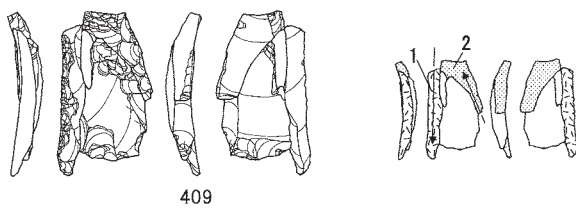

段階1

段階2

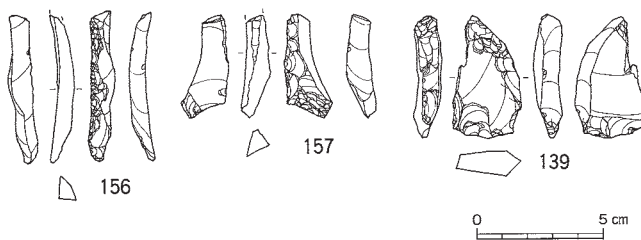

接合5749分布図

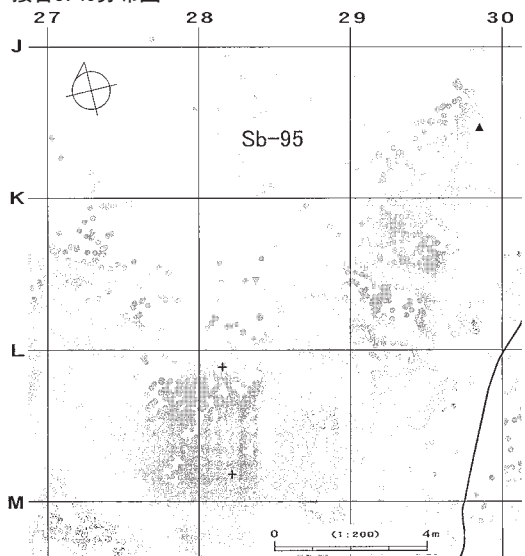

図Ⅲ-367 I区(Sb-91~96)の石器(132) 母岩729・接合3294、母岩729・接合3295、接合5749

母岩734・接合3324

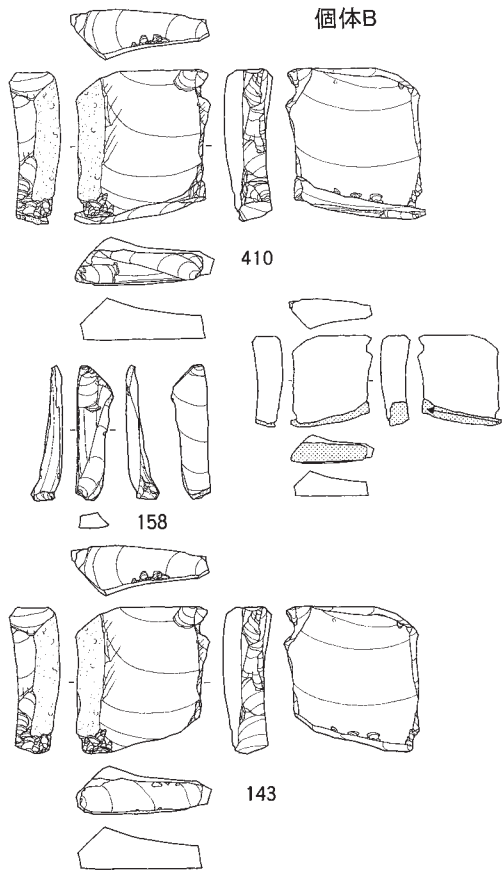

母岩734・接合3326

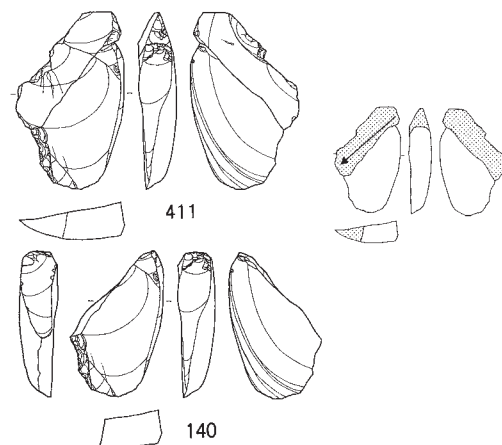

母岩944・接合4093

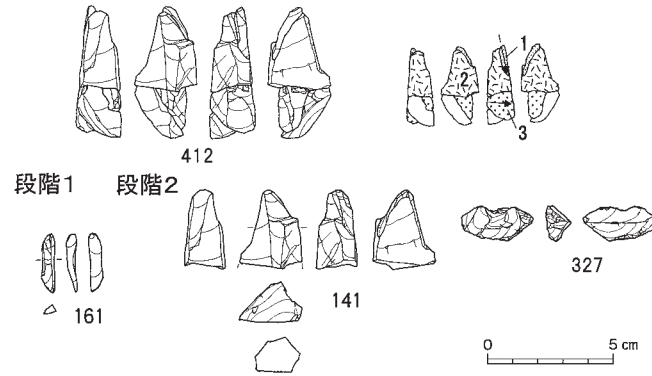

接合3324(全体)・3326分布図

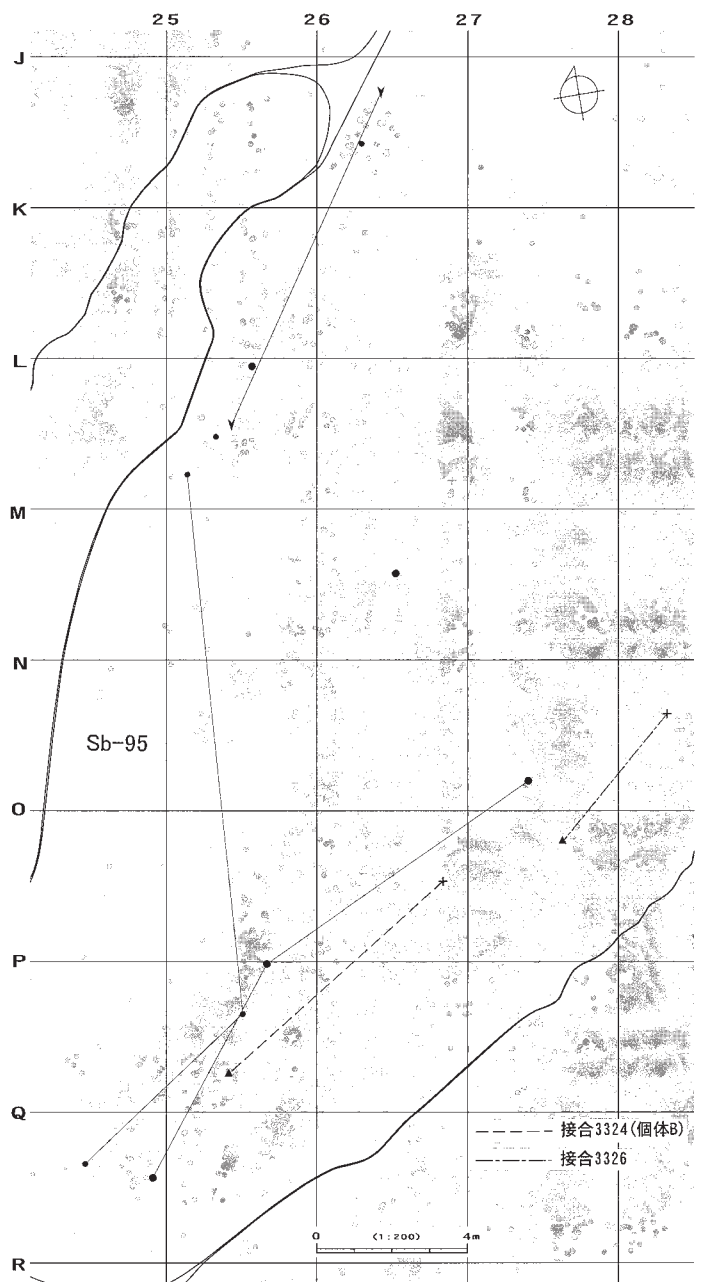

接合4093分布図

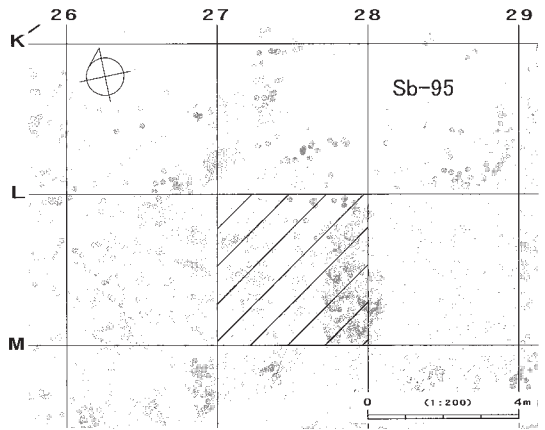

図Ⅲ-368 I区(Sb-91~96)の石器(133) 母岩734・接合3324、母岩734・接合3326、母岩944・接合4093

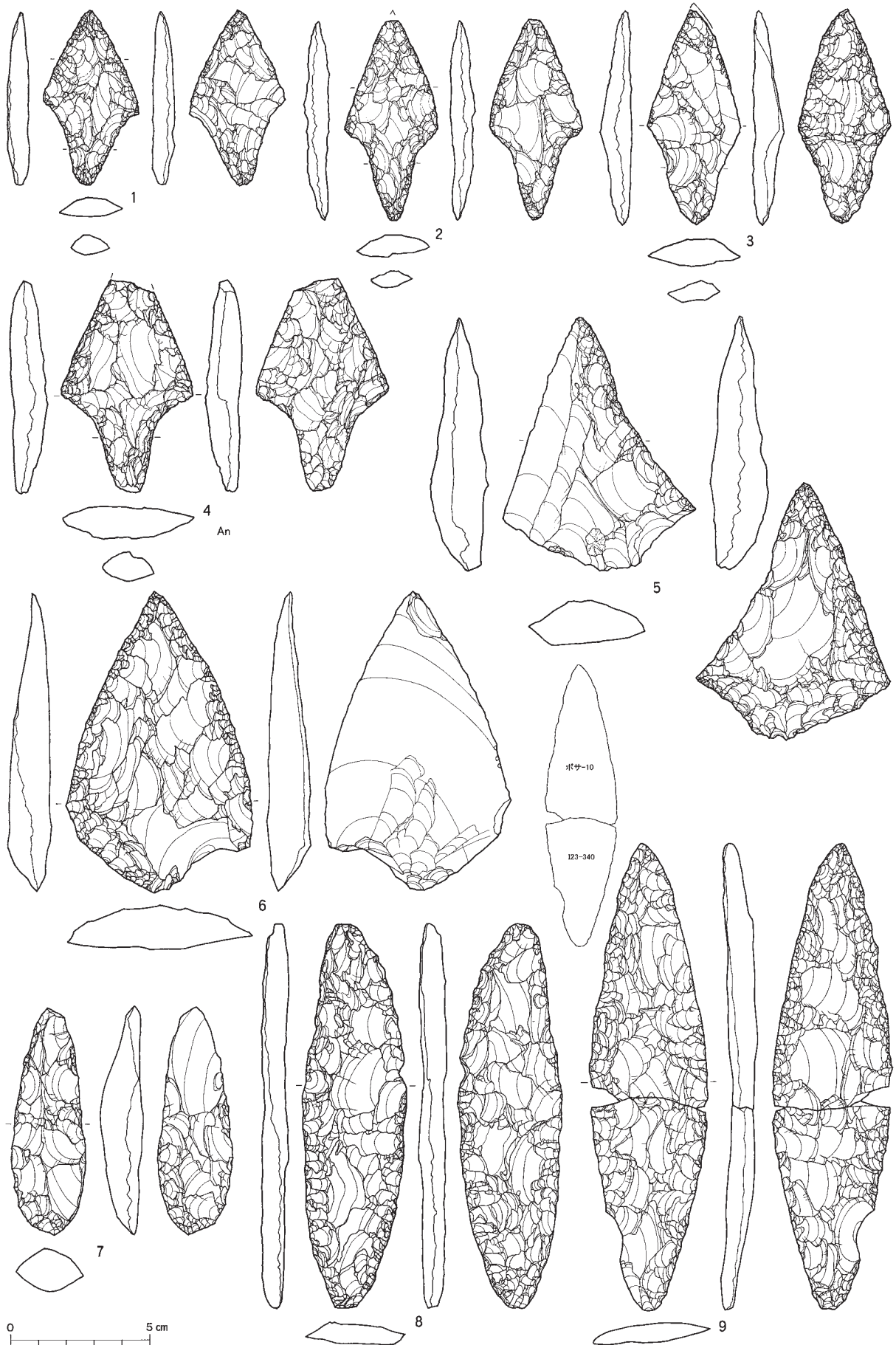

図Ⅲ-369 J区(Sb-97~107)の石器(1) 尖頭器

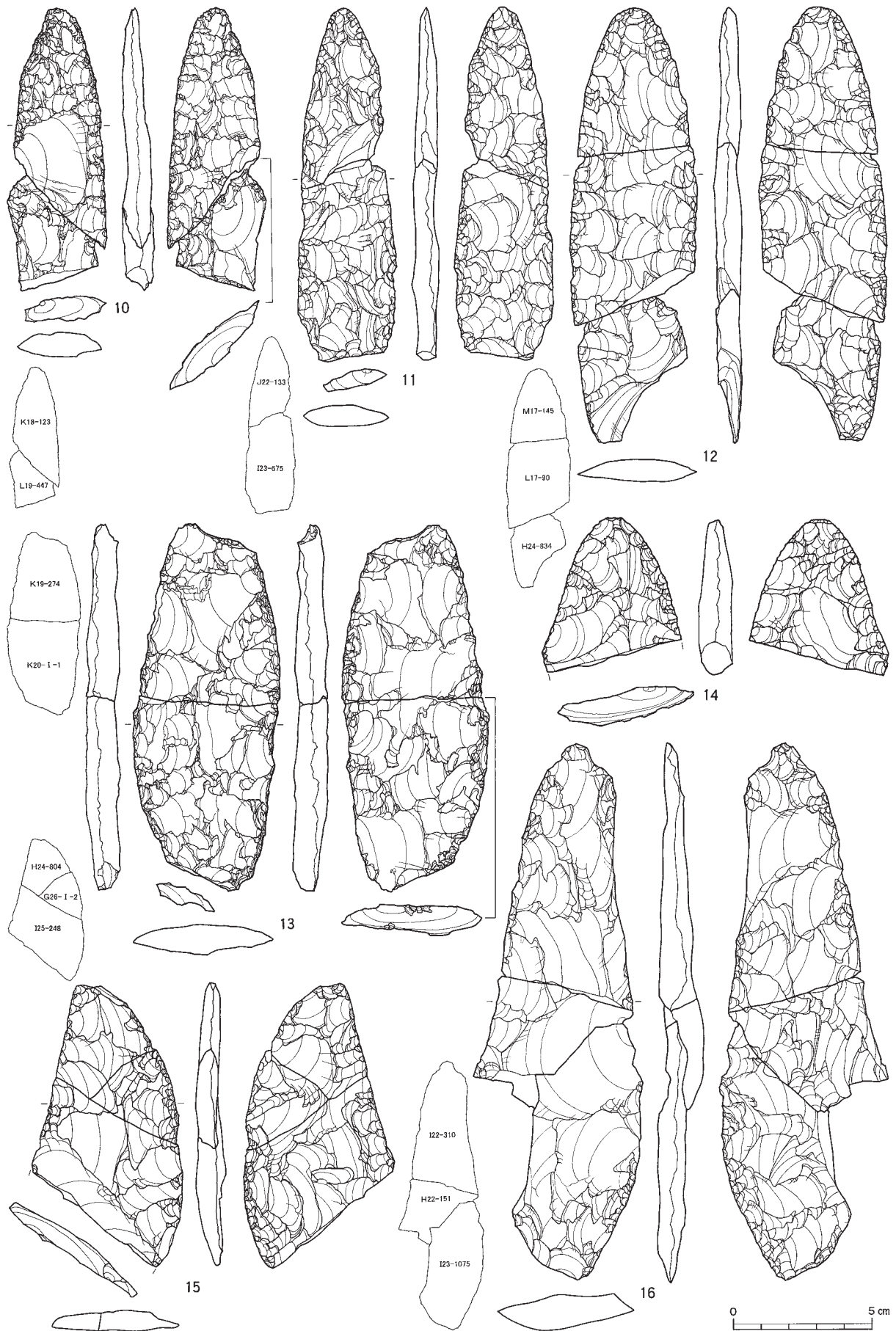

図III-370 J区(Sb-97~107)の石器(2) 尖頭器

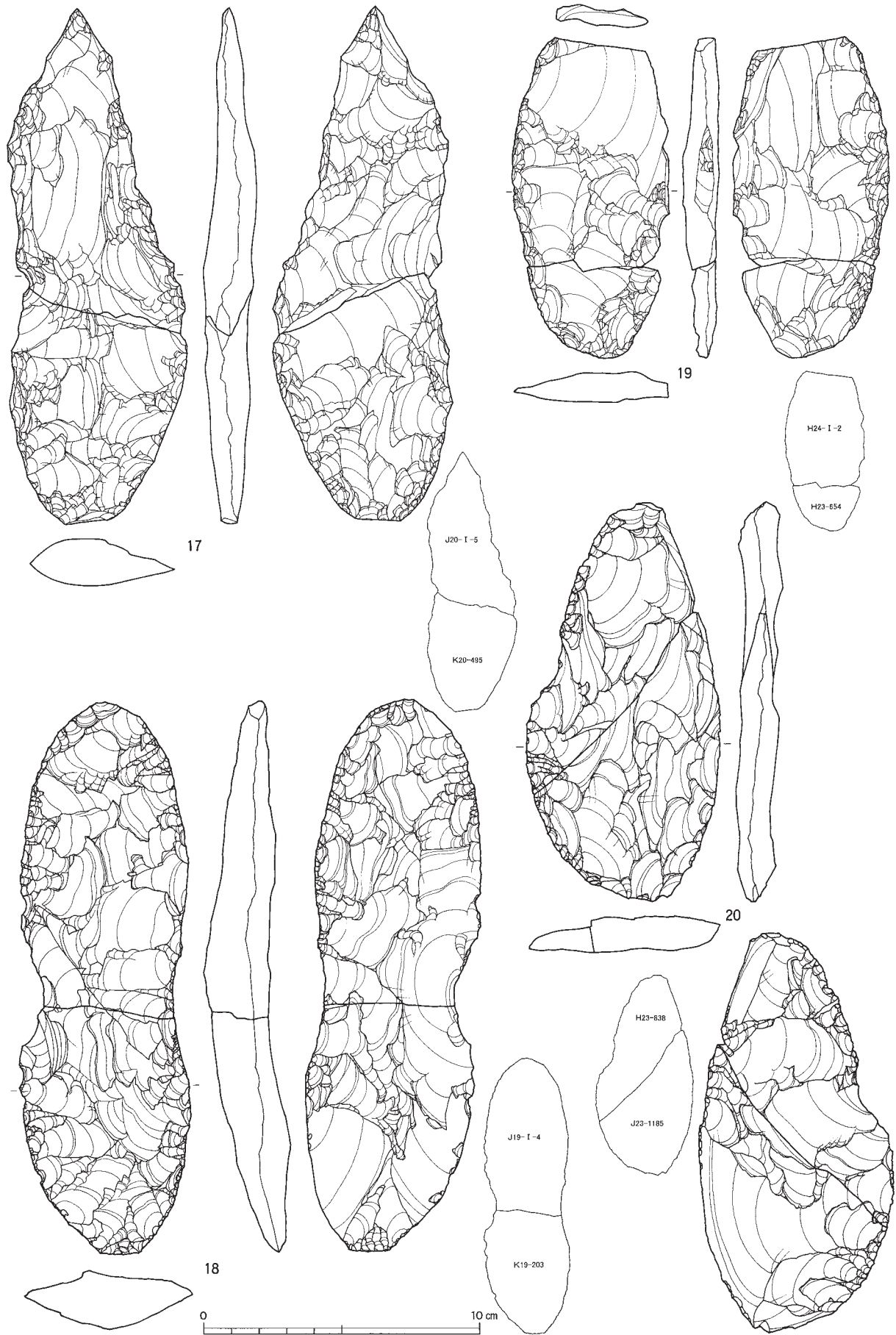

図Ⅲ-371 J区(Sb-97~107)の石器(3) 尖頭器

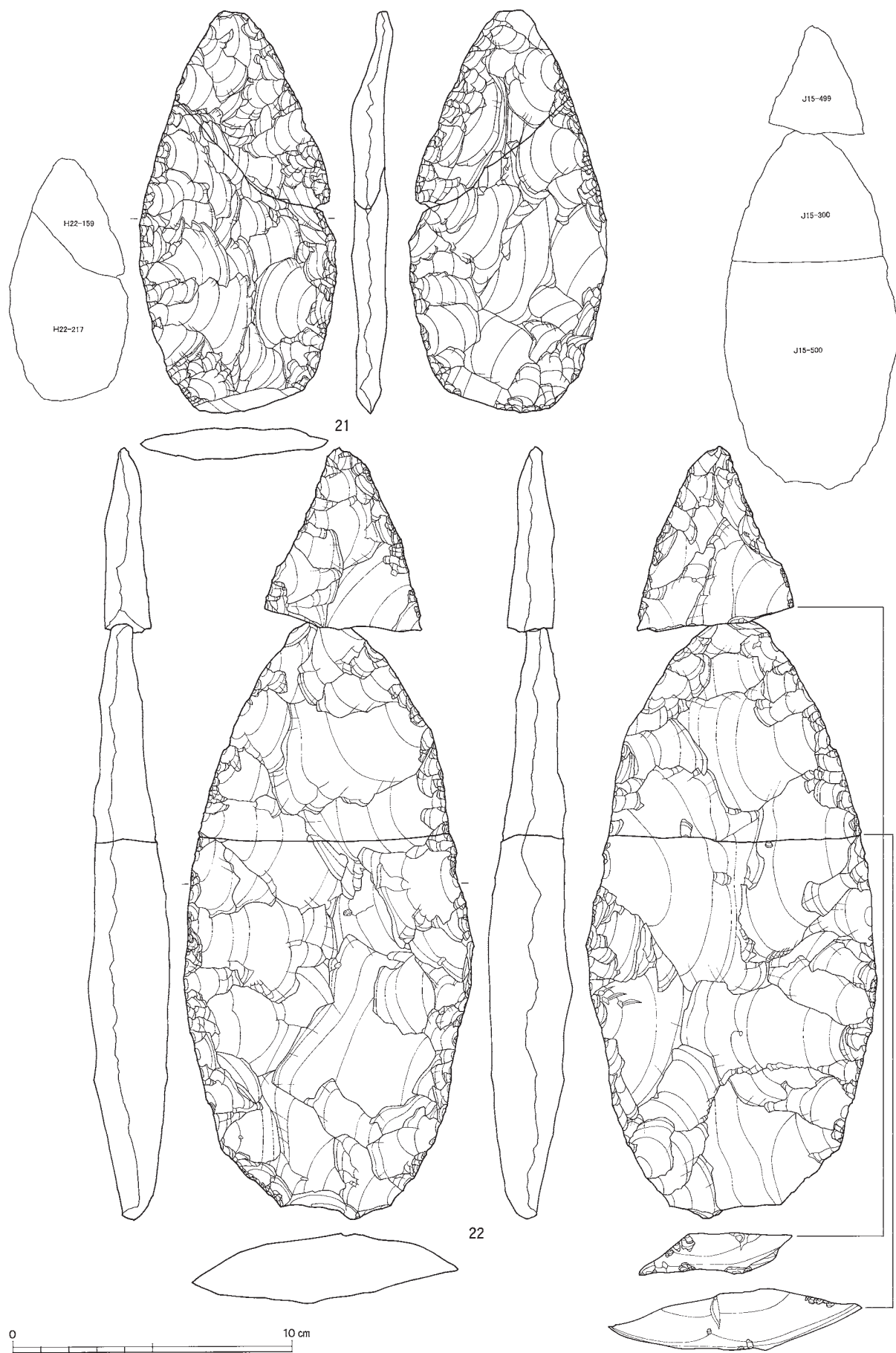

図Ⅲ-372 J区(Sb-97~107)の石器(4) 尖頭器

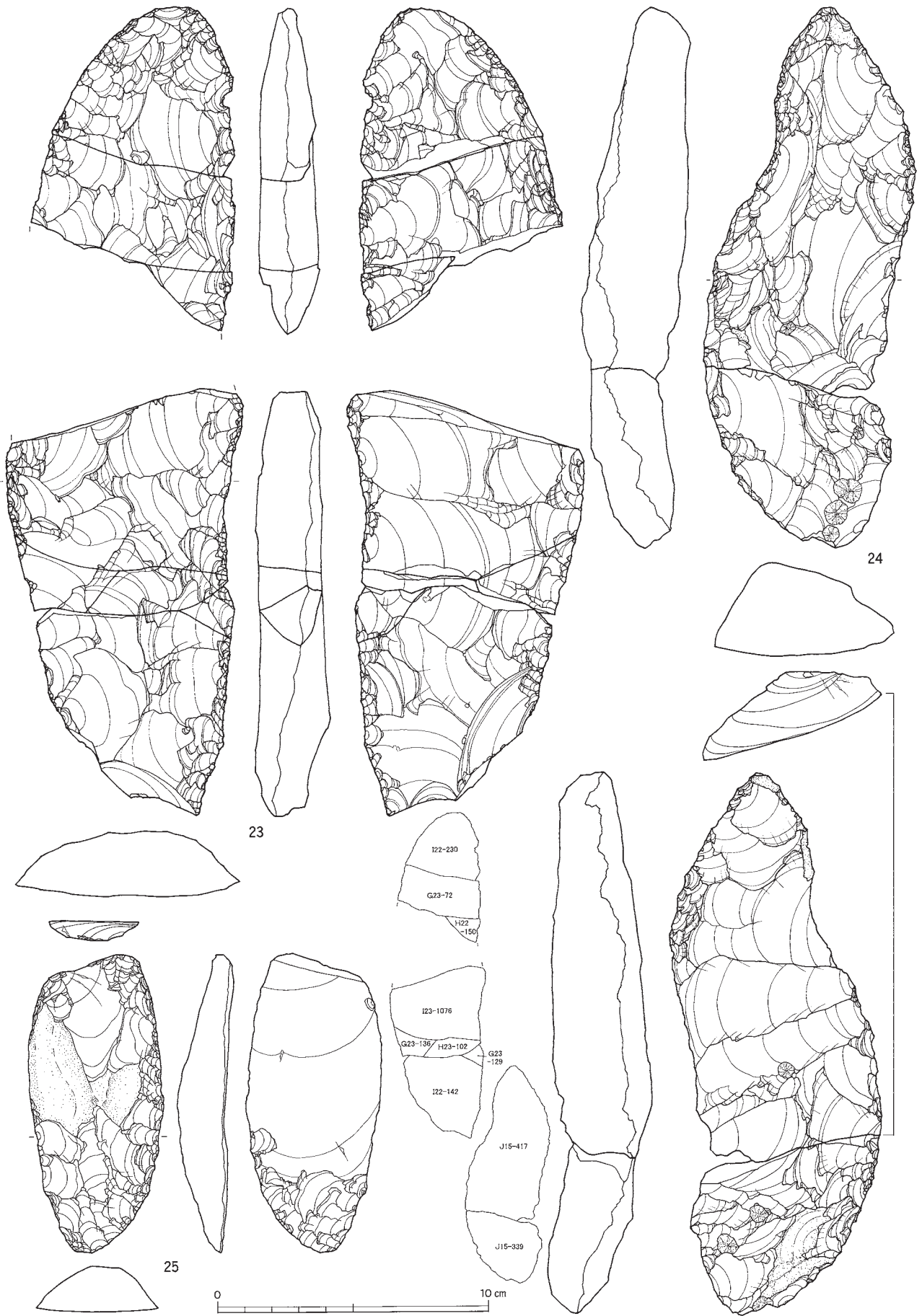

図Ⅲ-373 J区(Sb-97~107)の石器(5) 尖頭器



図Ⅲ-374 J区(Sb-97~107)の石器(6) 尖頭器

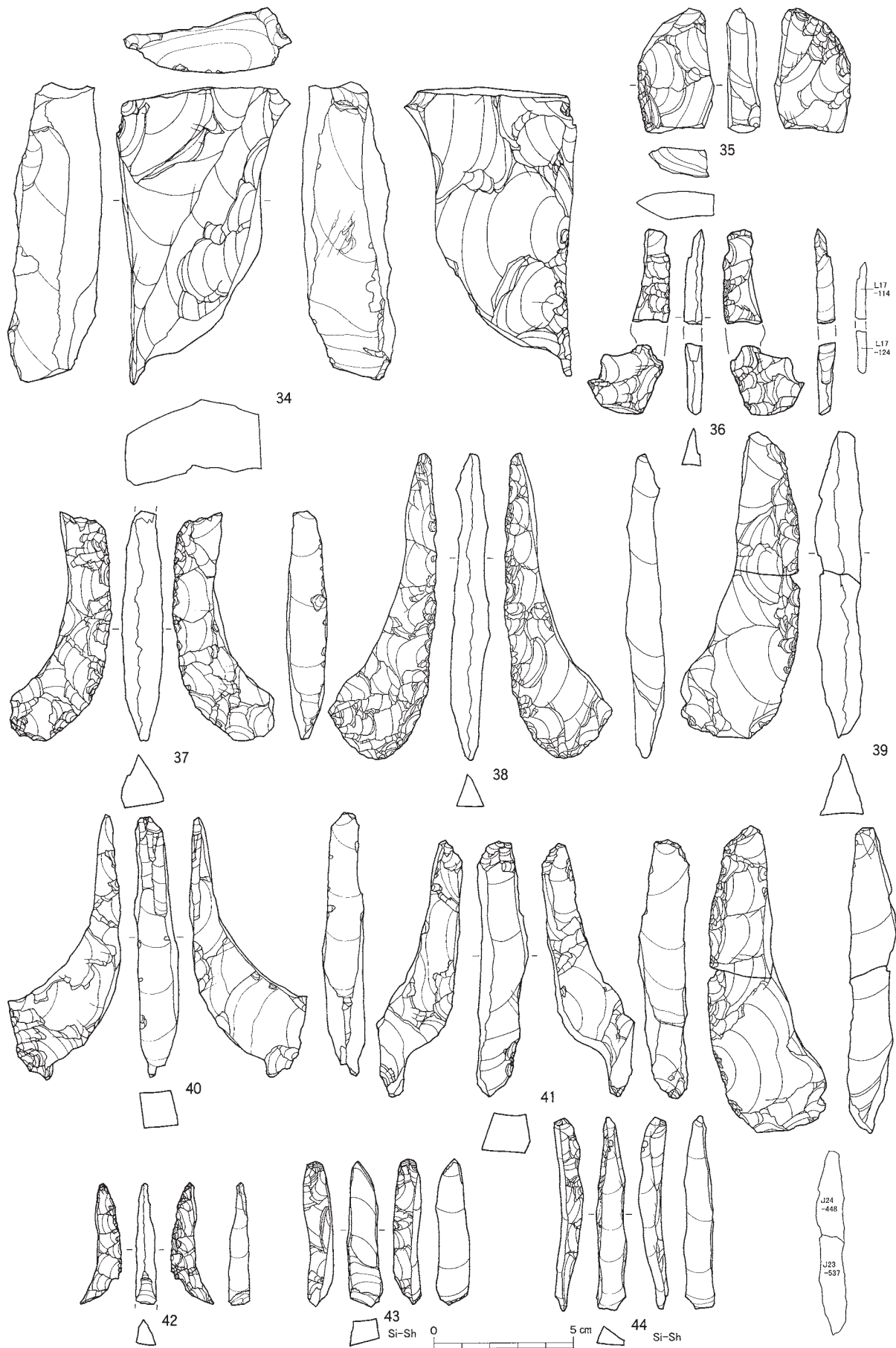

図Ⅲ-375 J区(Sb-97~107)の石器(7) 尖頭器・尖頭器削片



図Ⅲ-376 J区(Sb-97~107)の石器(8) 両面調整石器



図Ⅲ-377 J区(Sb-97~107)の石器(9) 両面調整石器

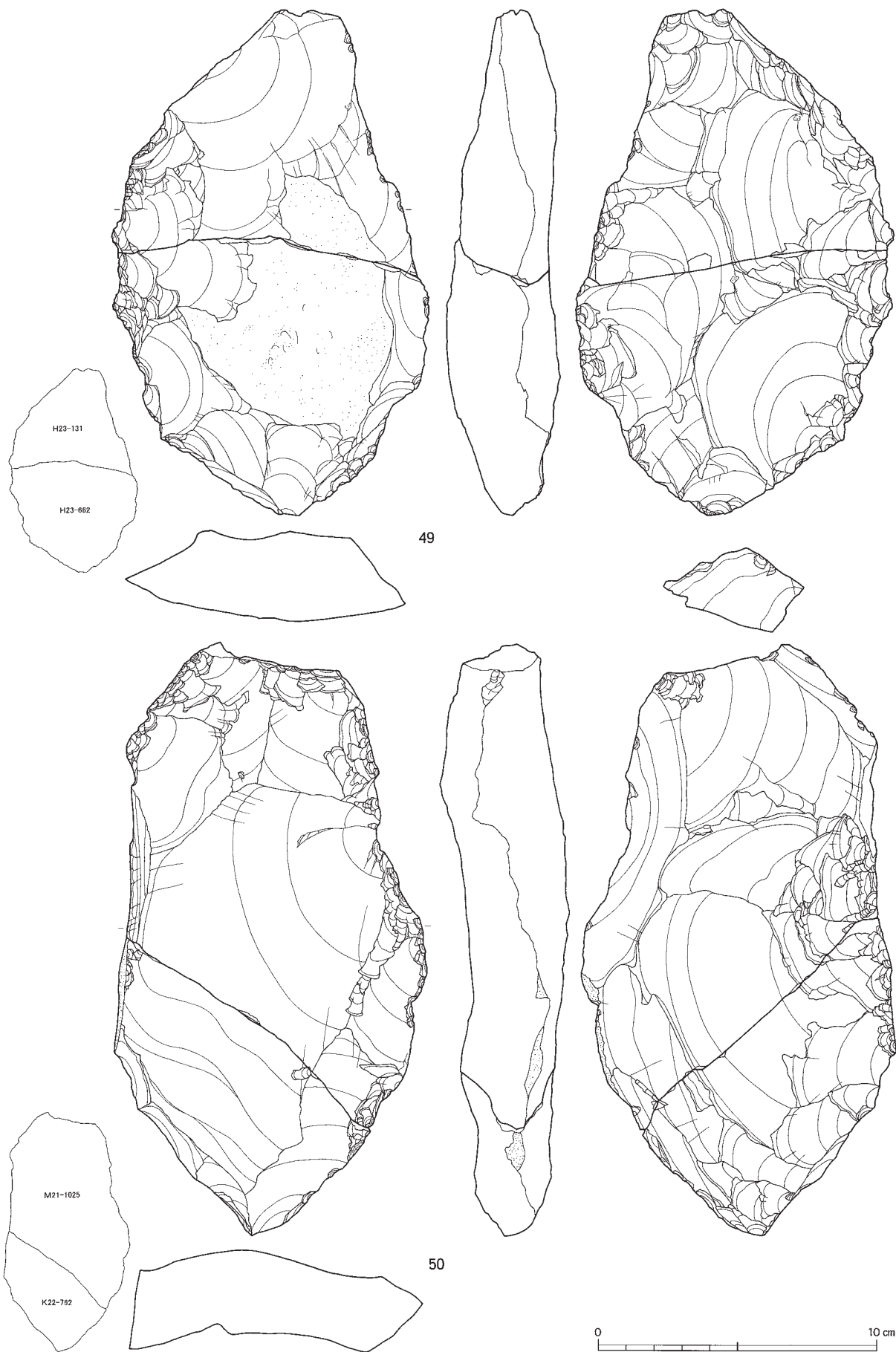

図Ⅲ-378 J区(Sb-97~107)の石器(10) 両面調整石器

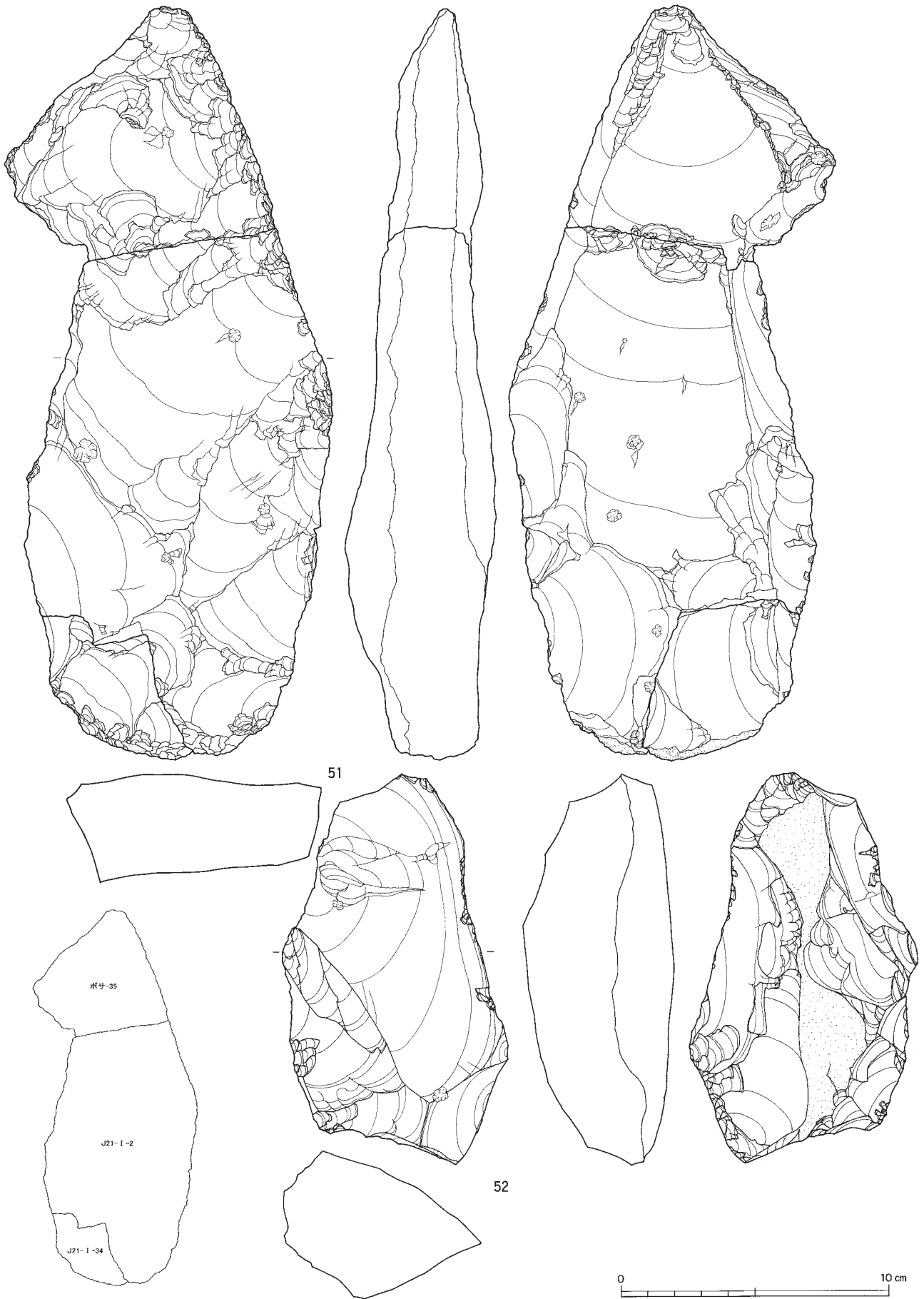

図Ⅲ-379 J区(Sb-97~107)の石器(11) 両面調整石器



図Ⅲ-380 J区(Sb-97~107)の石器(12) 両面調整石器



図III-381 J区(Sb-97~107)の石器(13) 彫器



図Ⅲ-382 J区(Sb-97~107)の石器(14) 彫器

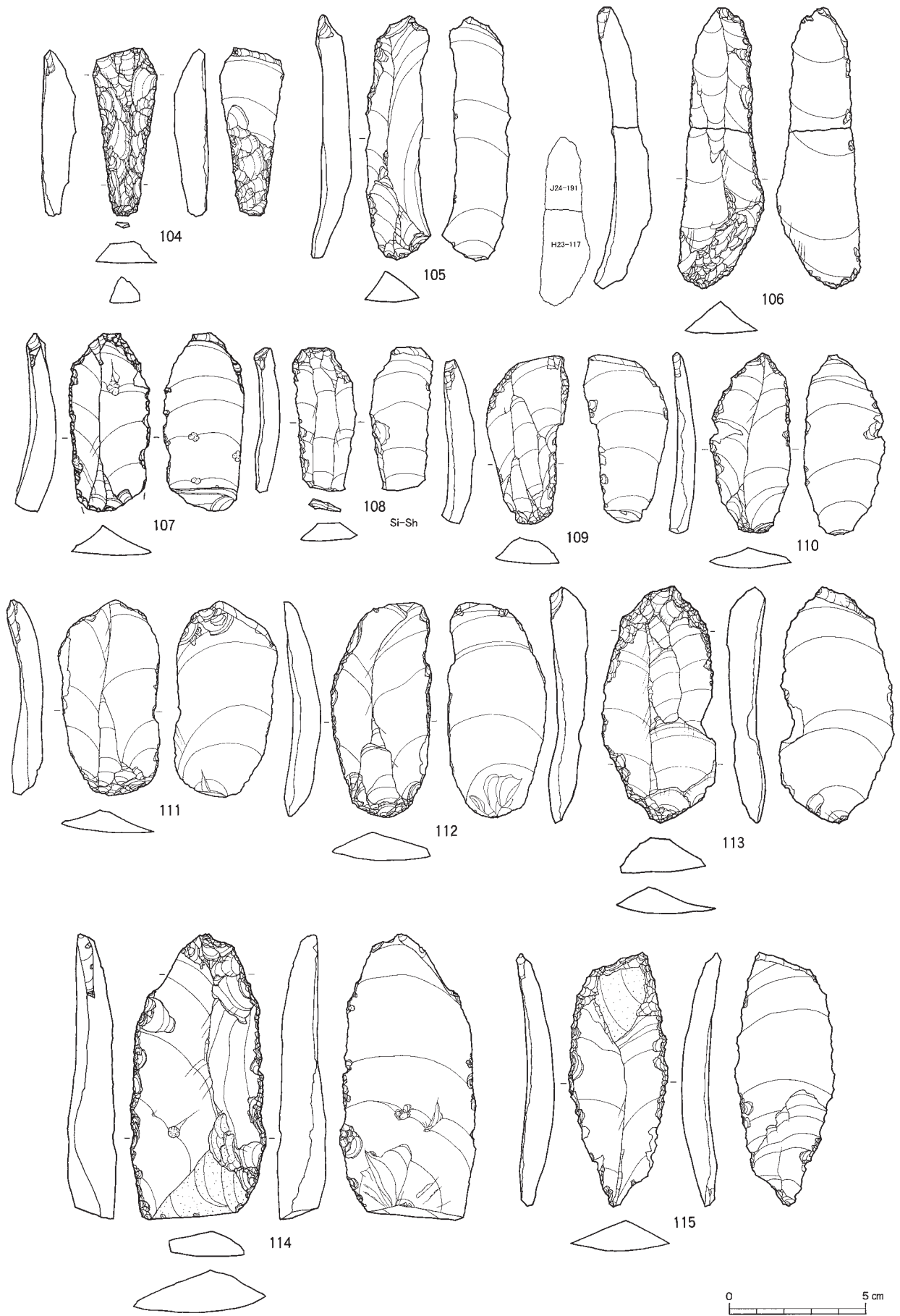

図Ⅲ-383 J区(Sb-97~107)の石器(15) 彫器

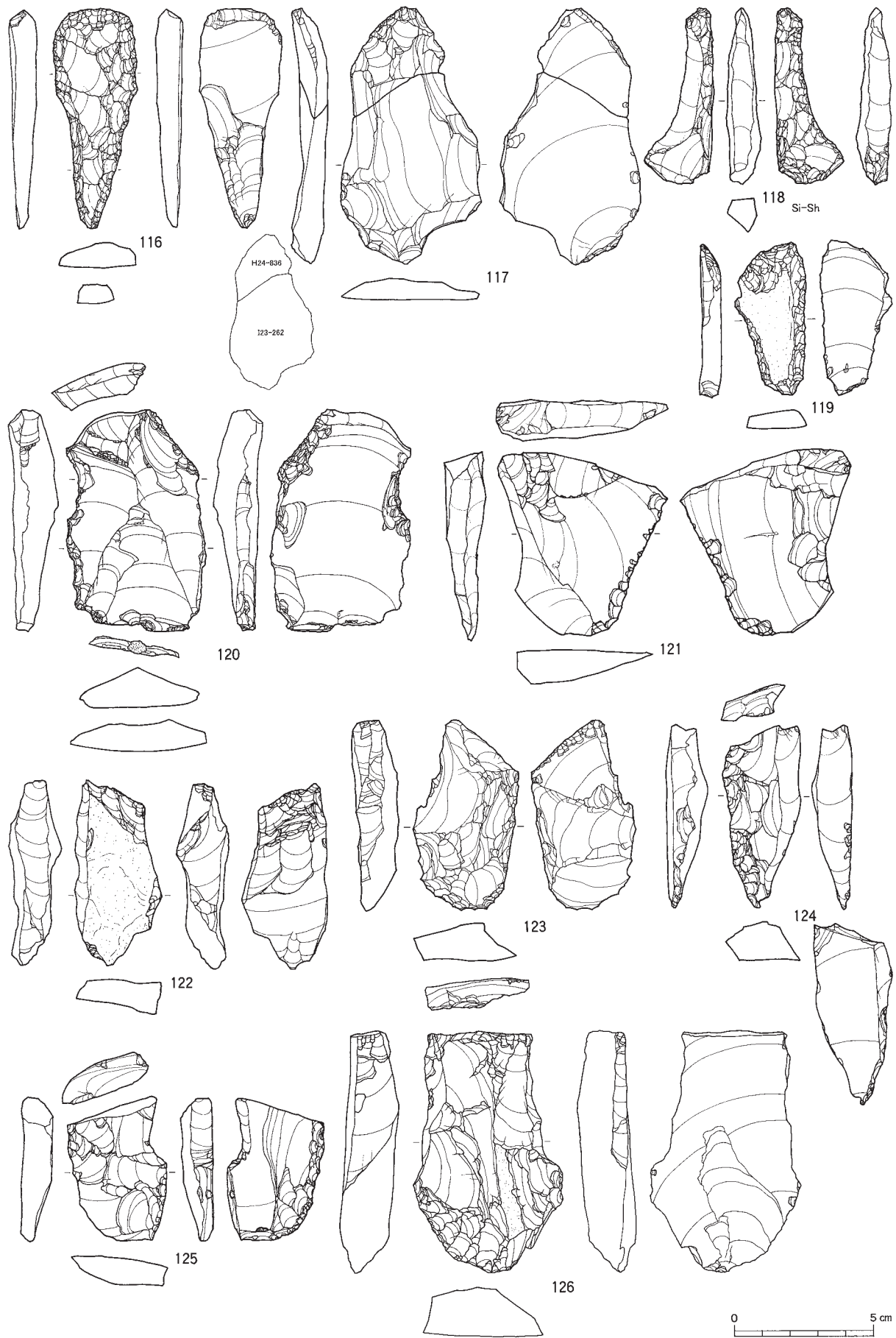

図三-384 J区(Sb-97~107)の石器(16) 彫器

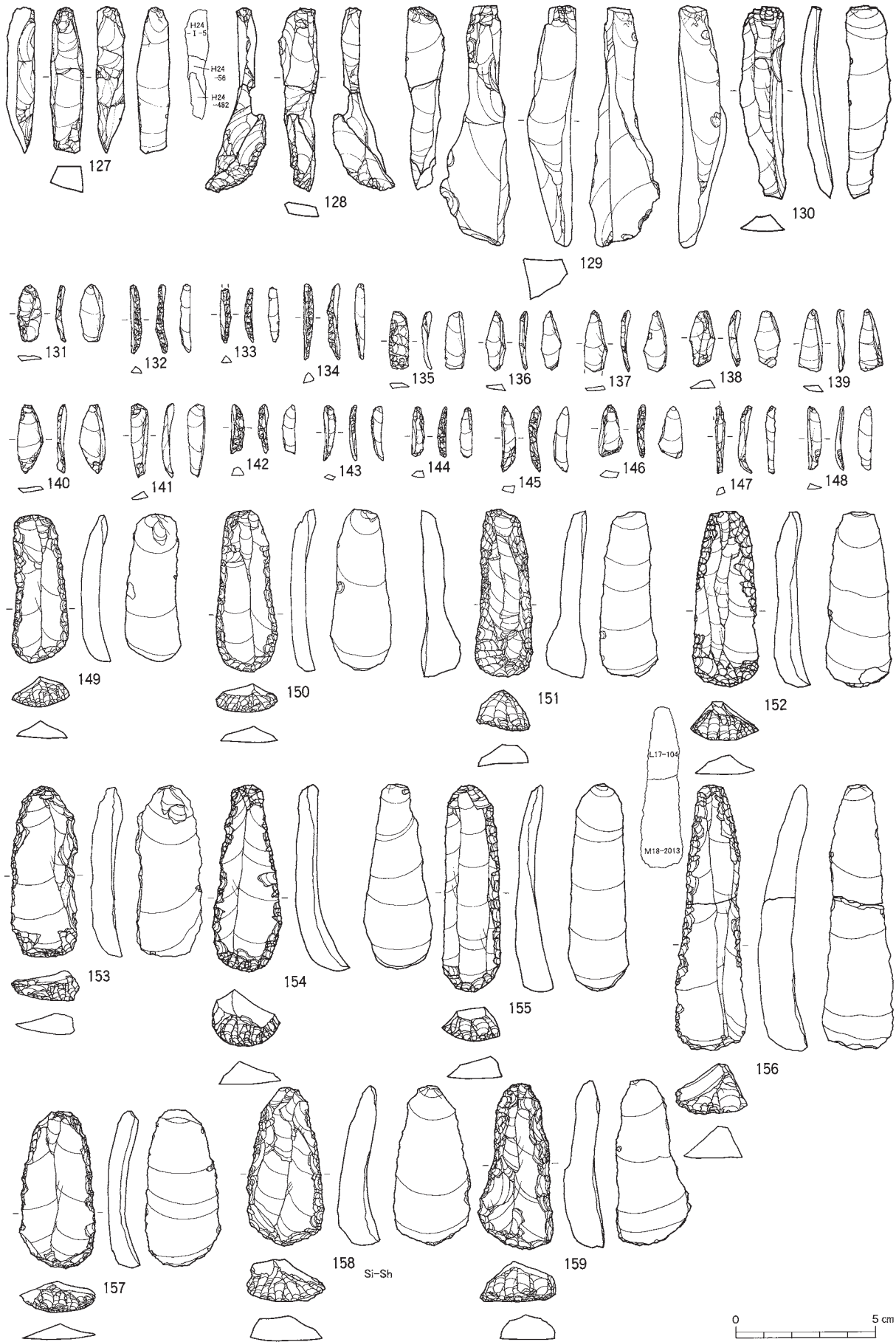

図Ⅲ-385 J区(Sb-97~107)の石器(17) 彫器削片・搔器



図Ⅲ-386 J区(Sb-97~107)の石器(18) 搔器

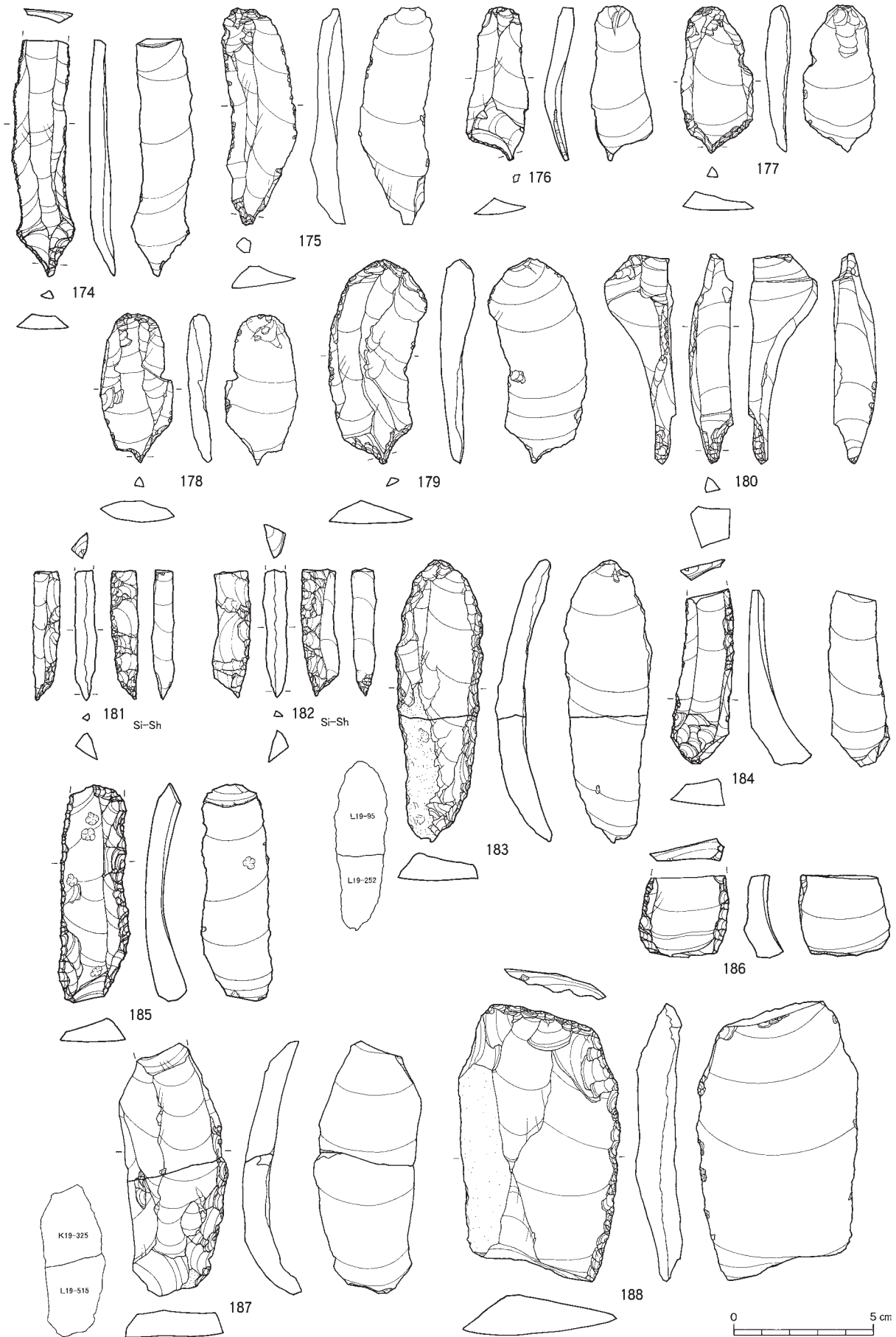

図Ⅲ-387 J区(Sb-97~107)の石器(19) 錐形石器・削器

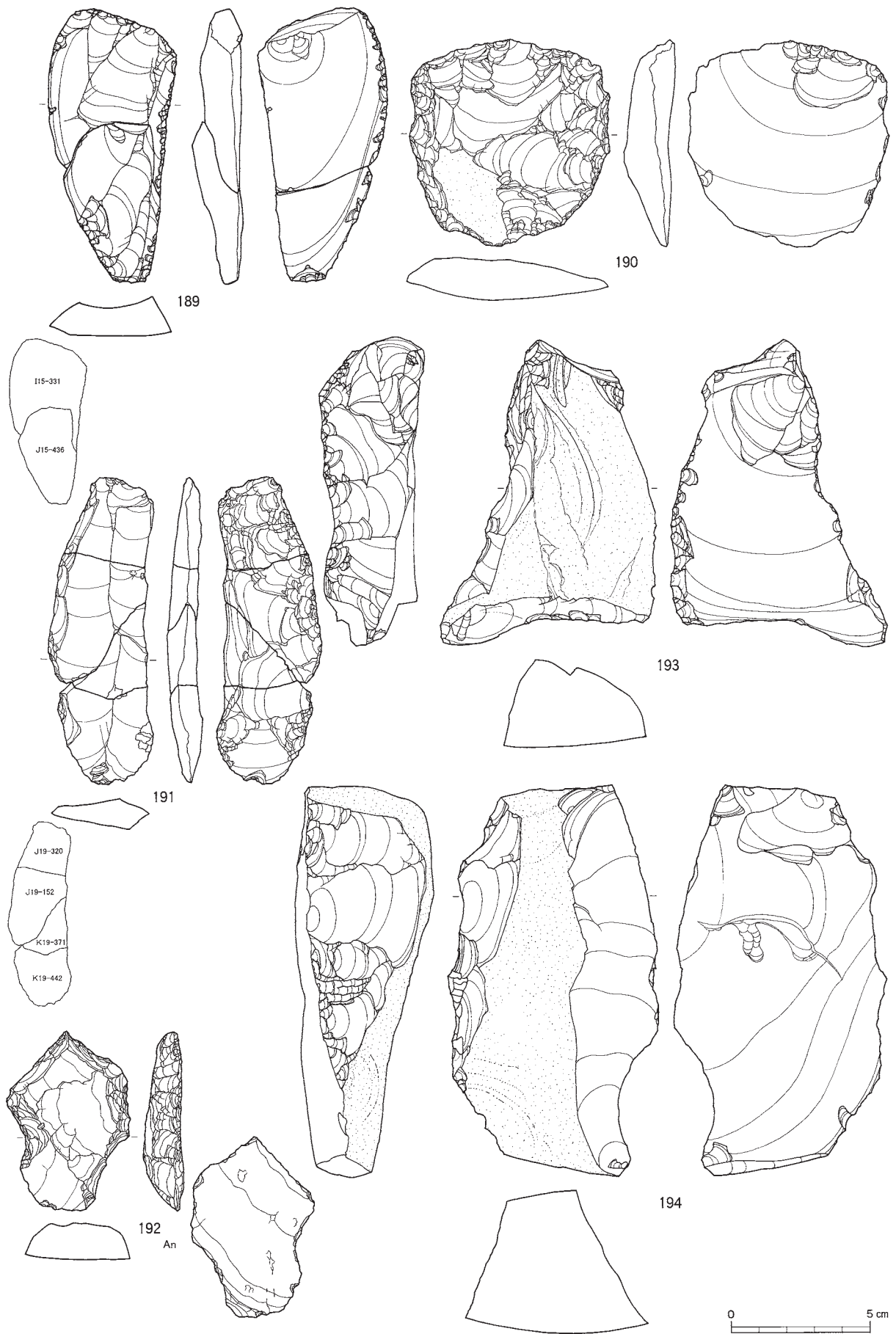

図Ⅲ-388 J区(Sb-97~107)の石器(20) 削器



図III-389 J区(Sb-97~107)の石器(21) 舟底形石器

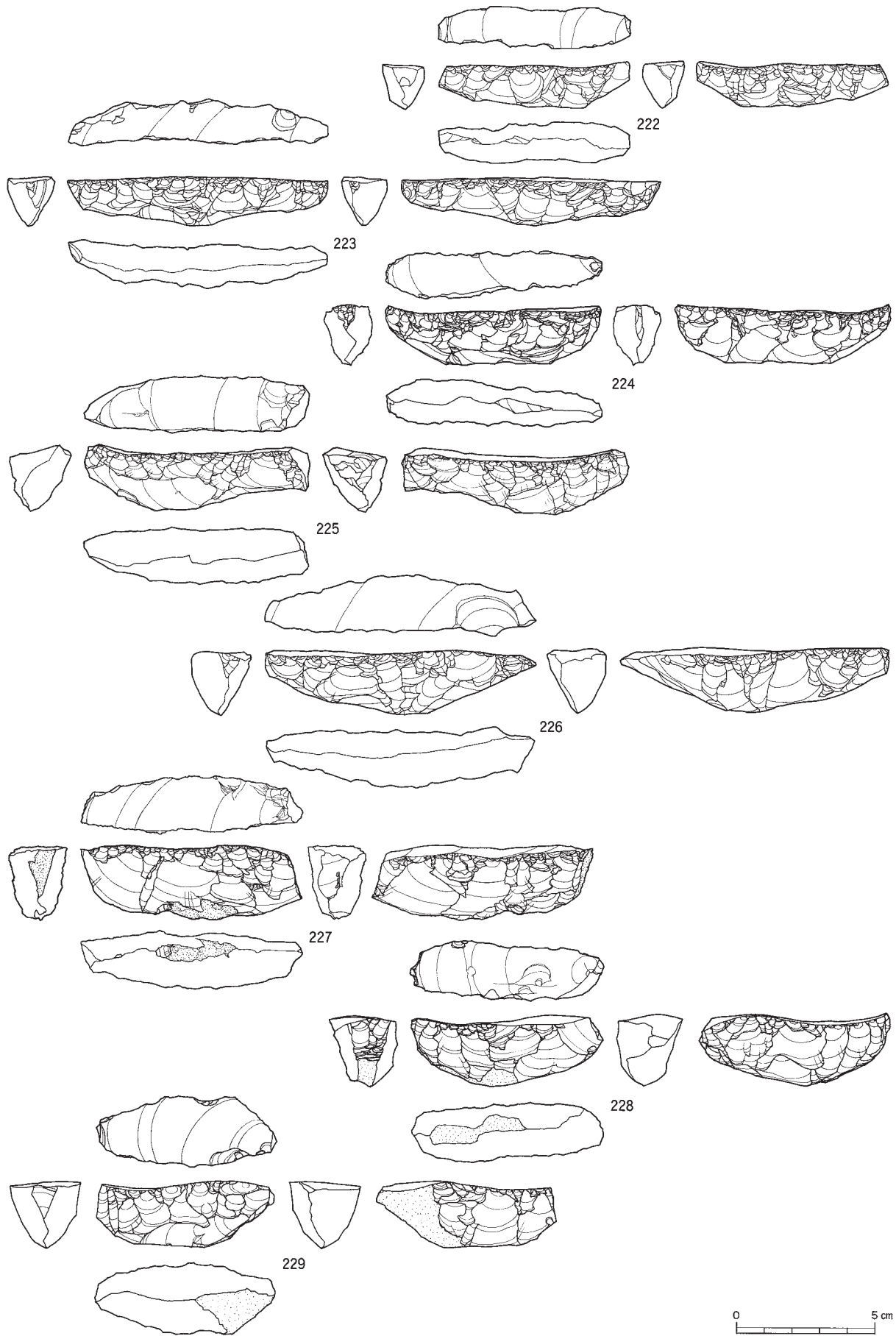

図Ⅲ-390 J区(Sb-97~107)の石器(22) 舟底形石器

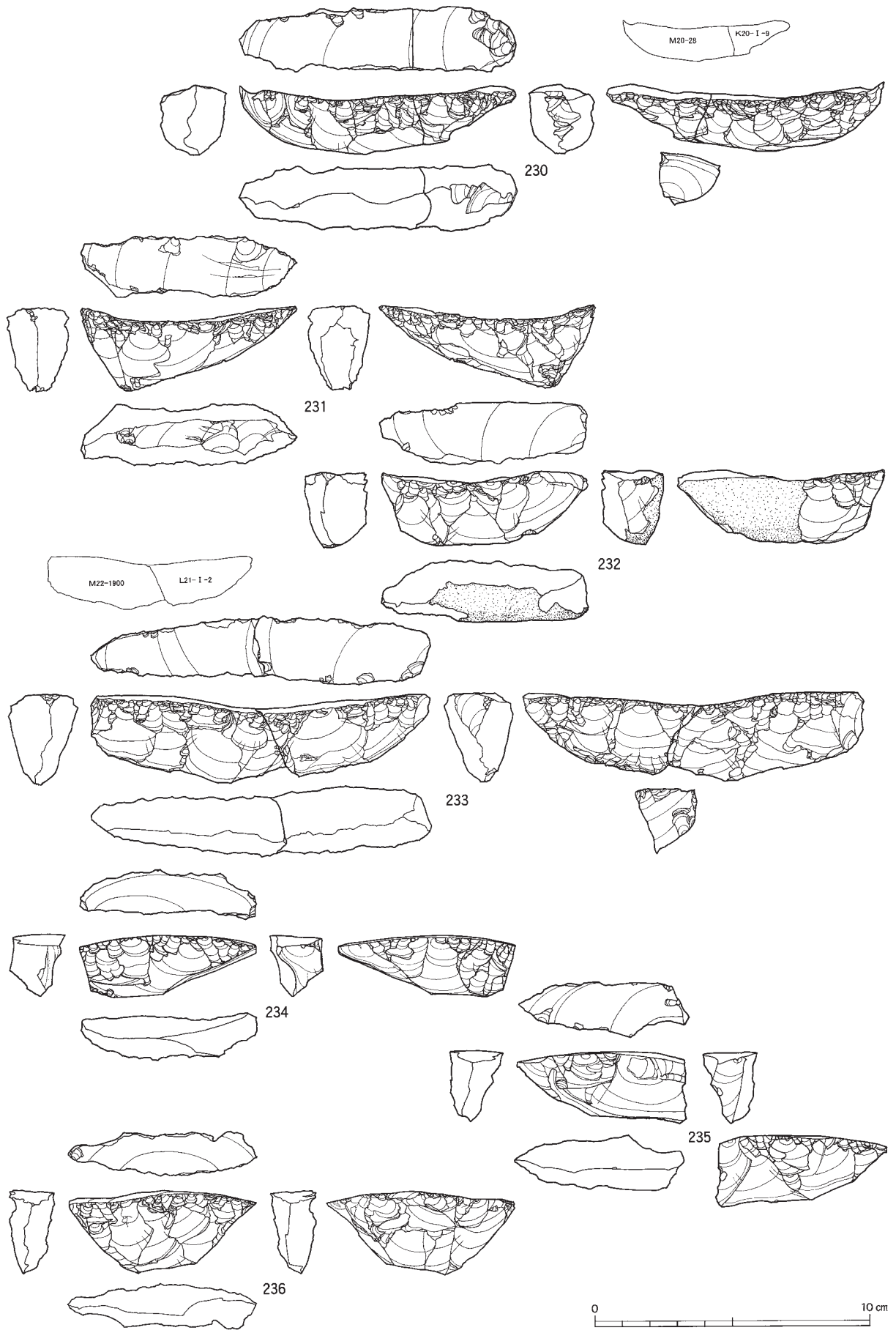

図Ⅲ-391 J区(Sb-97~107)の石器(23) 舟底形石器

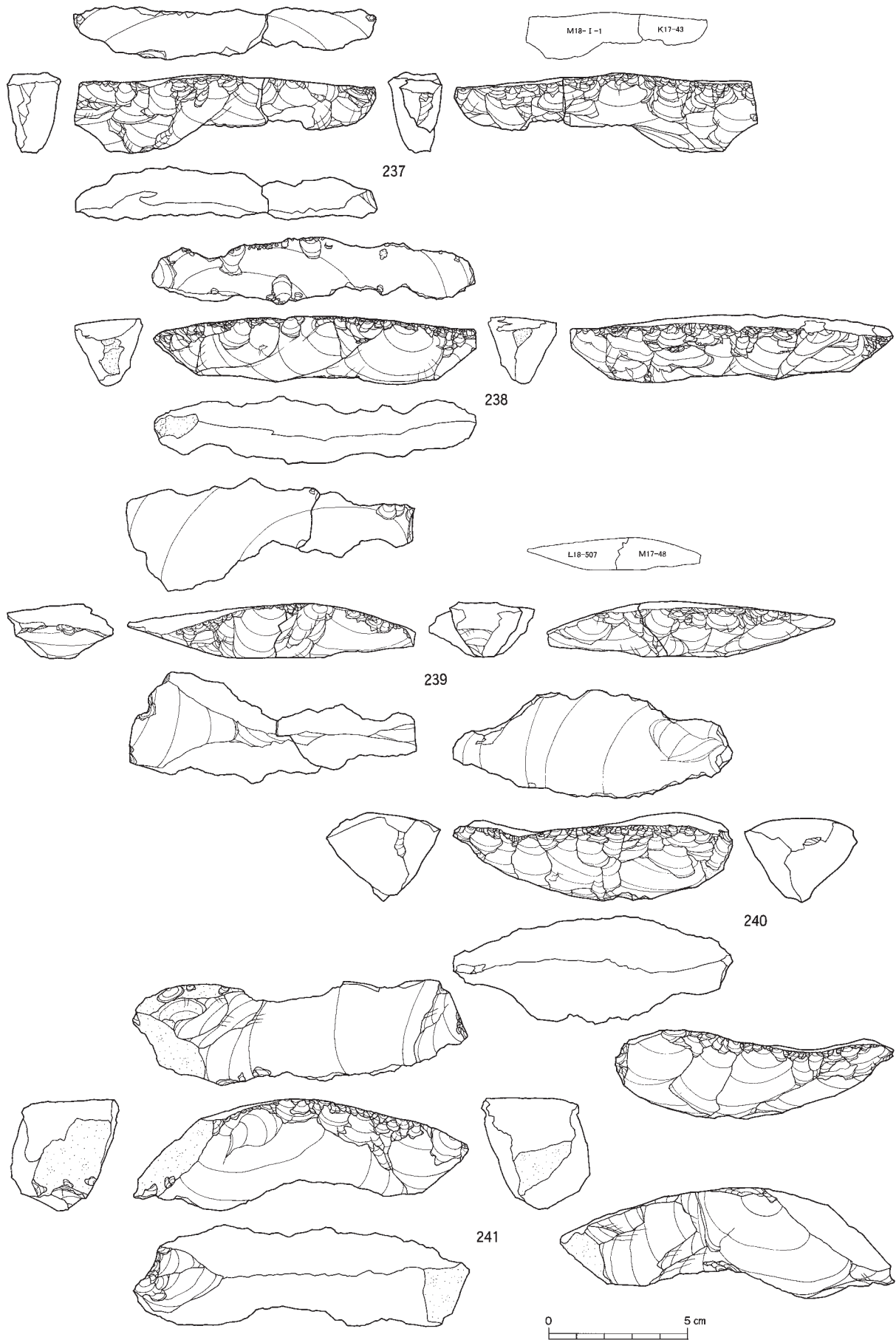

図Ⅲ-392 J区(Sb-97~107)の石器(24) 舟底形石器

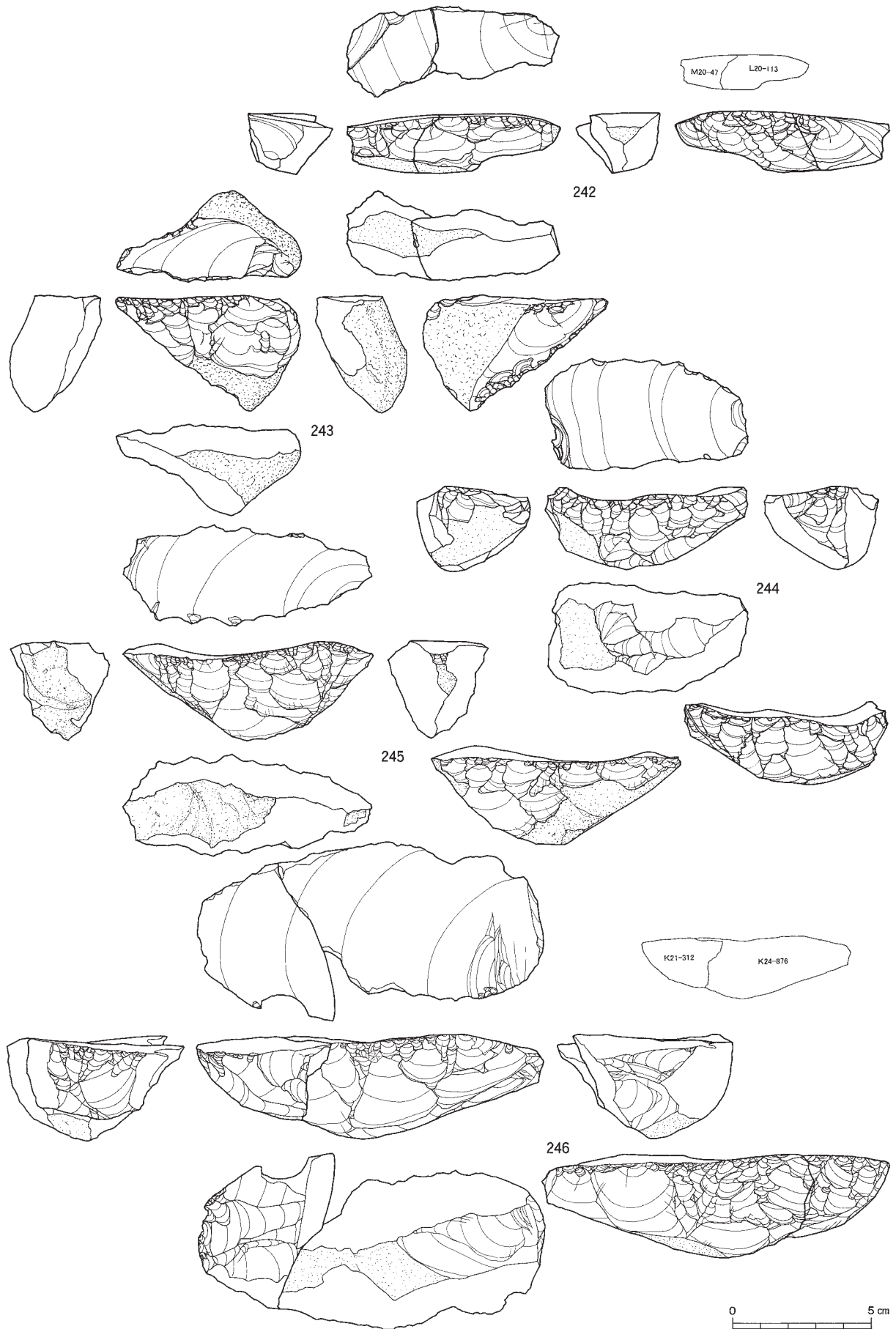

図Ⅲ-393 J区(Sb-97~107)の石器(25) 舟底形石器

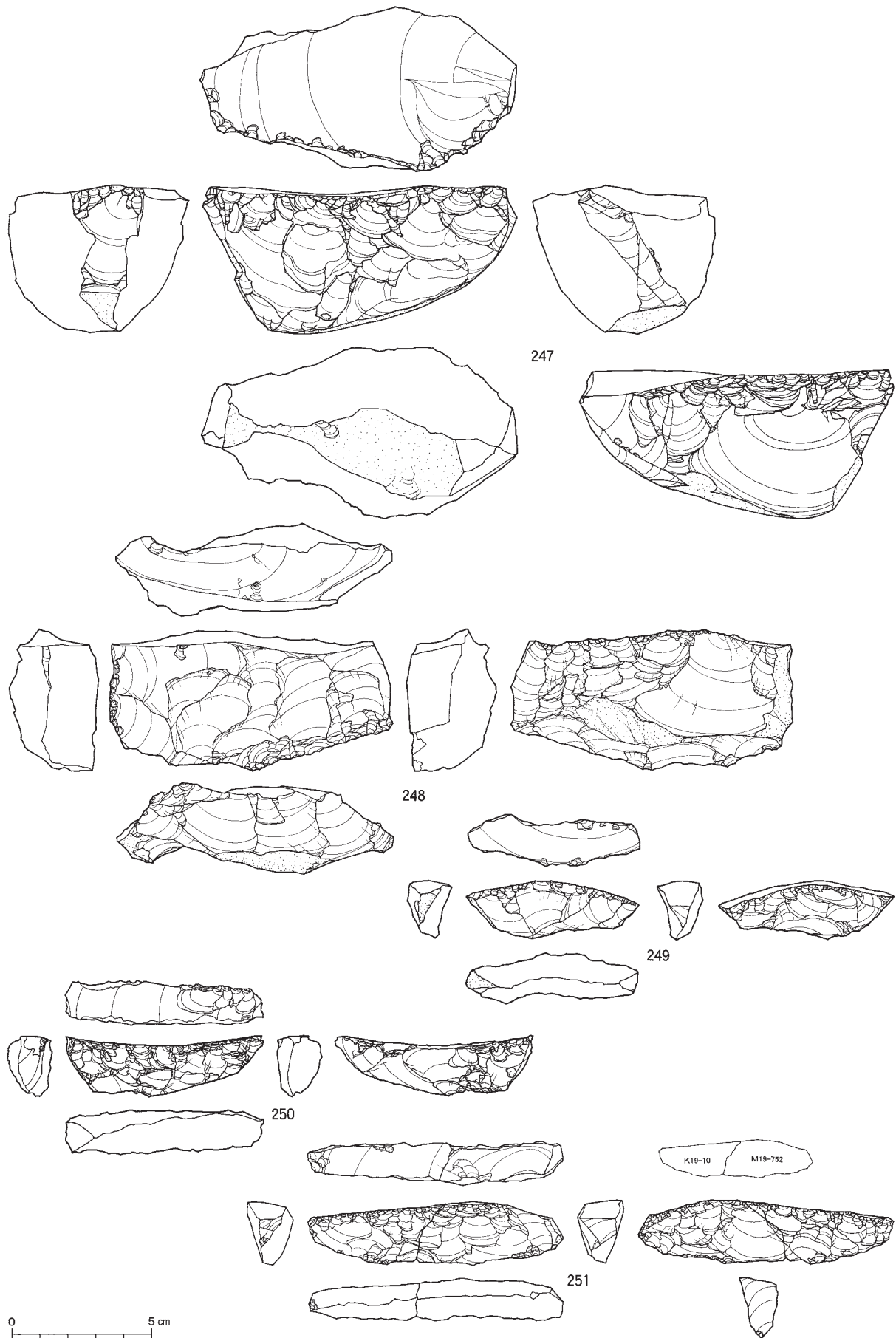

図Ⅲ-394 J区(Sb-97~107)の石器(26) 舟底形石器

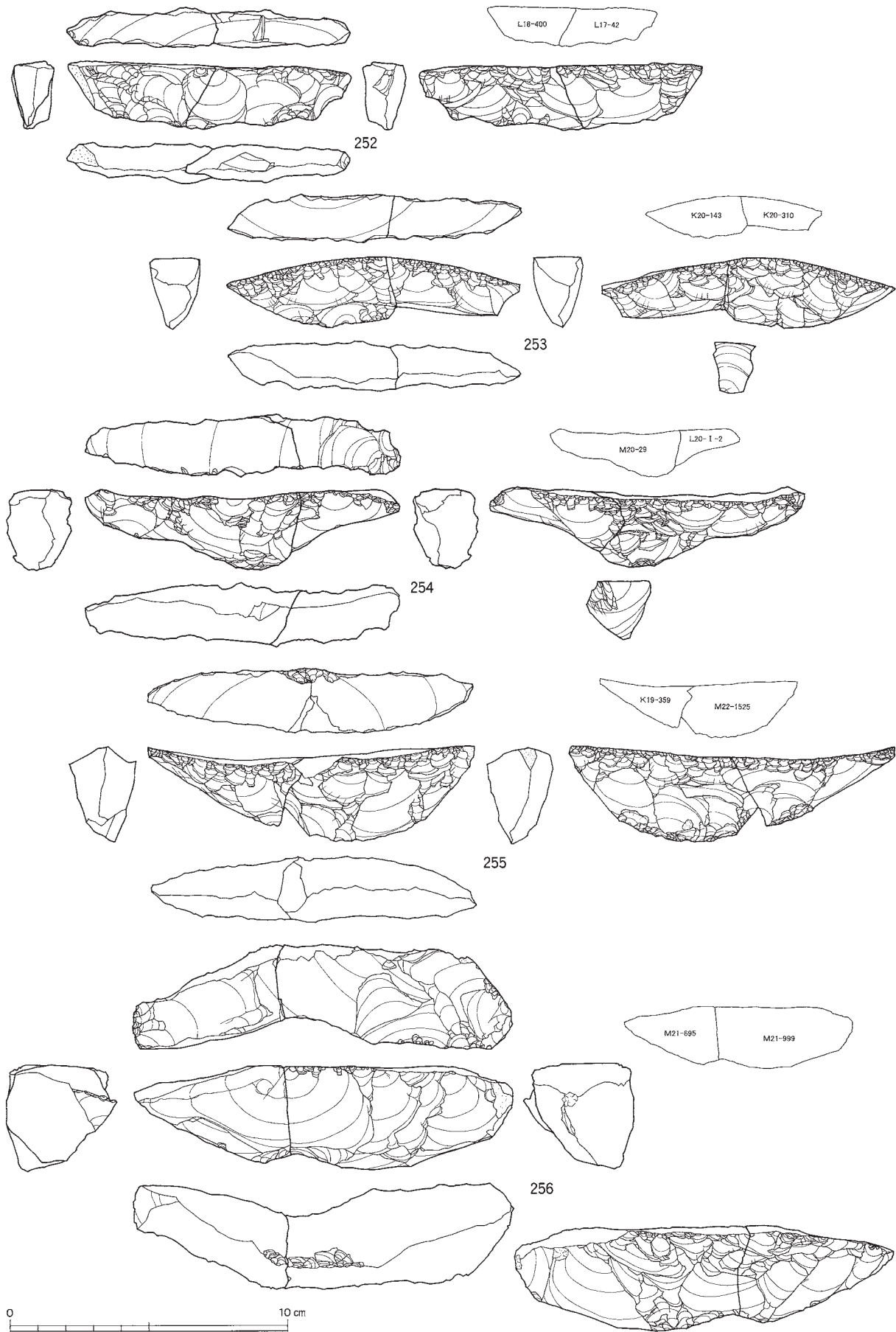

図Ⅲ-395 J区(Sb-97~107)の石器(27) 舟底形石器

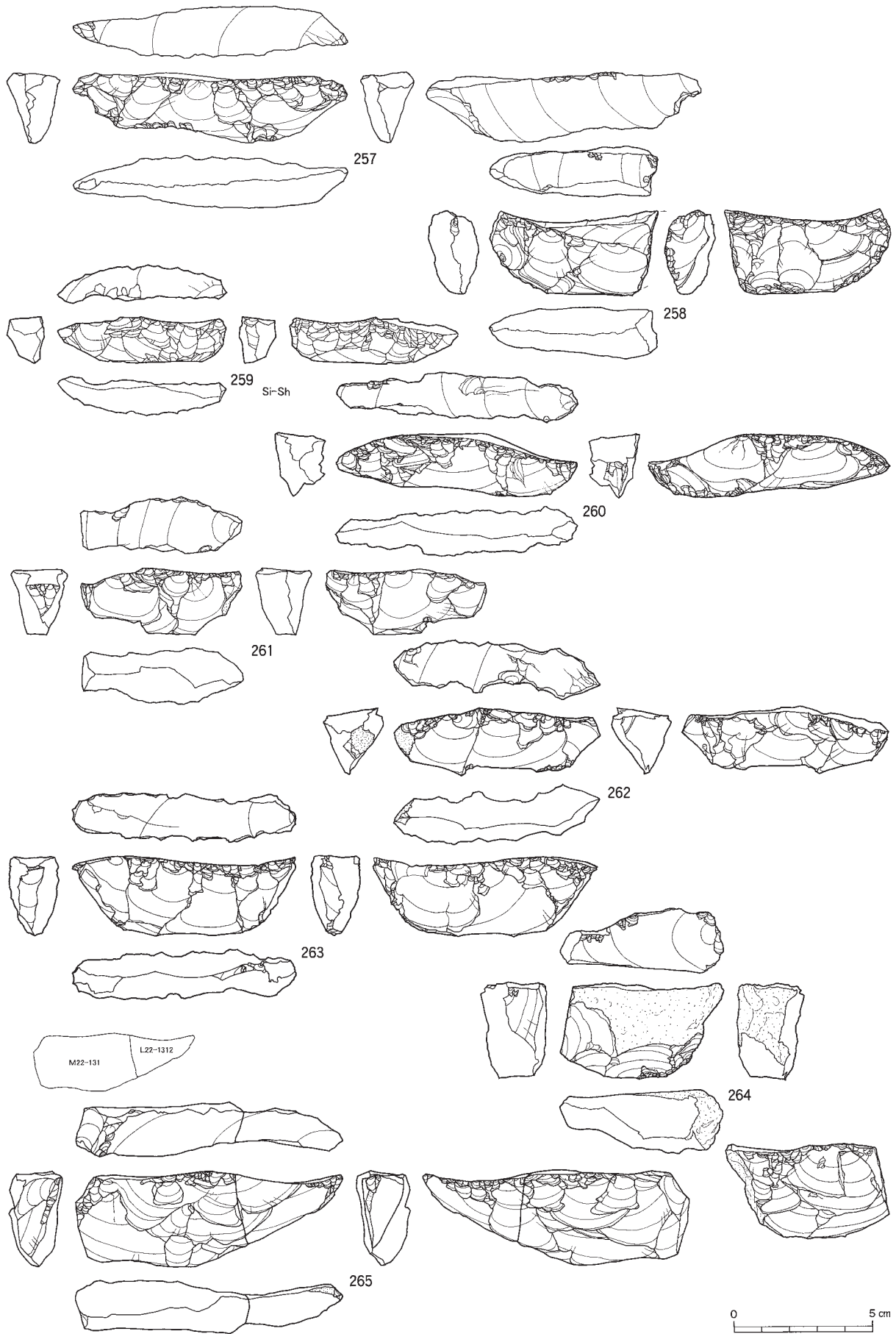

図Ⅲ-396 J区(Sb-97~107)の石器(28) 舟底形石器

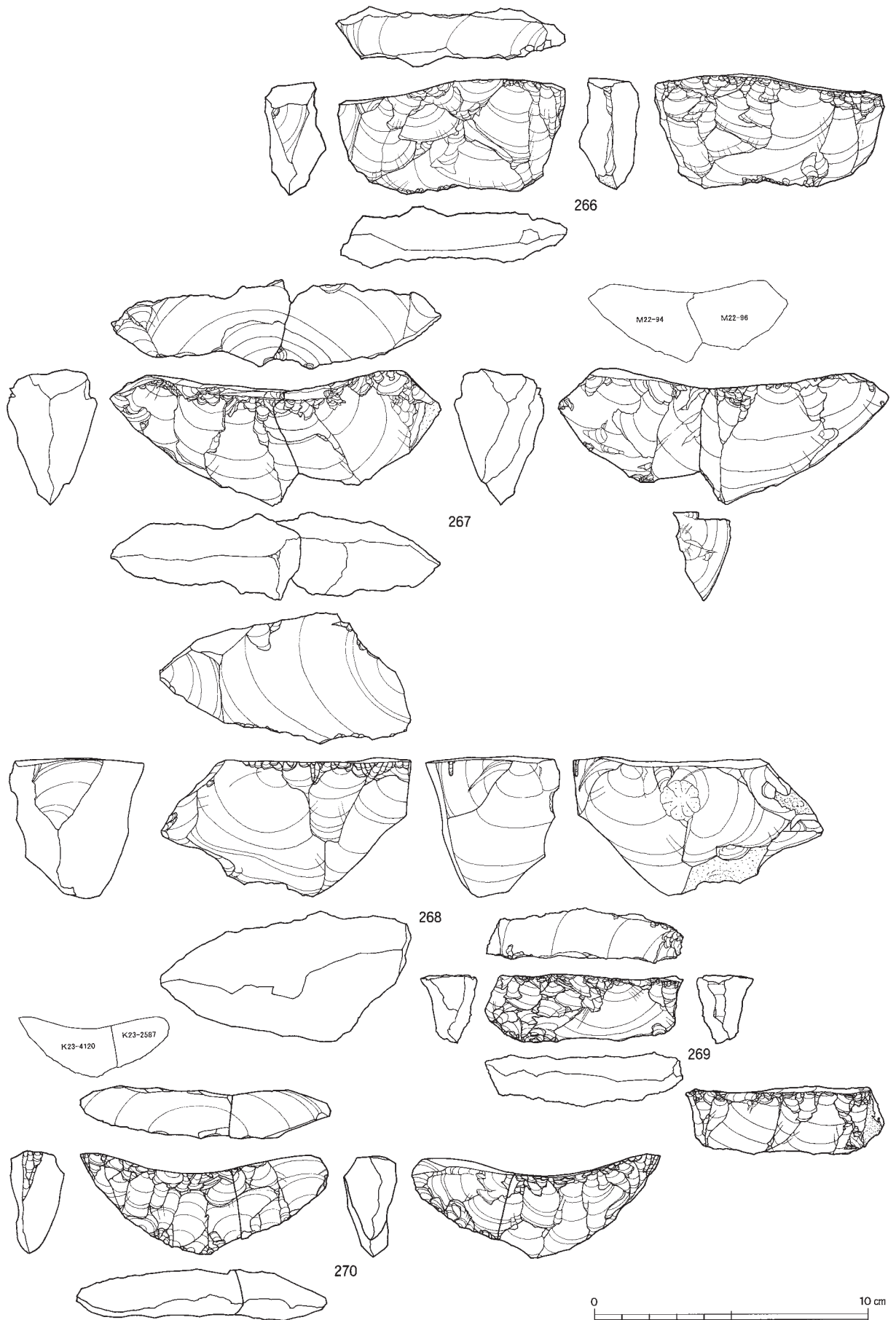

図Ⅲ-397 J区(Sb-97~107)の石器(29) 舟底形石器



図Ⅲ-398 J区(Sb-97~107)の石器(30) 舟底形石器

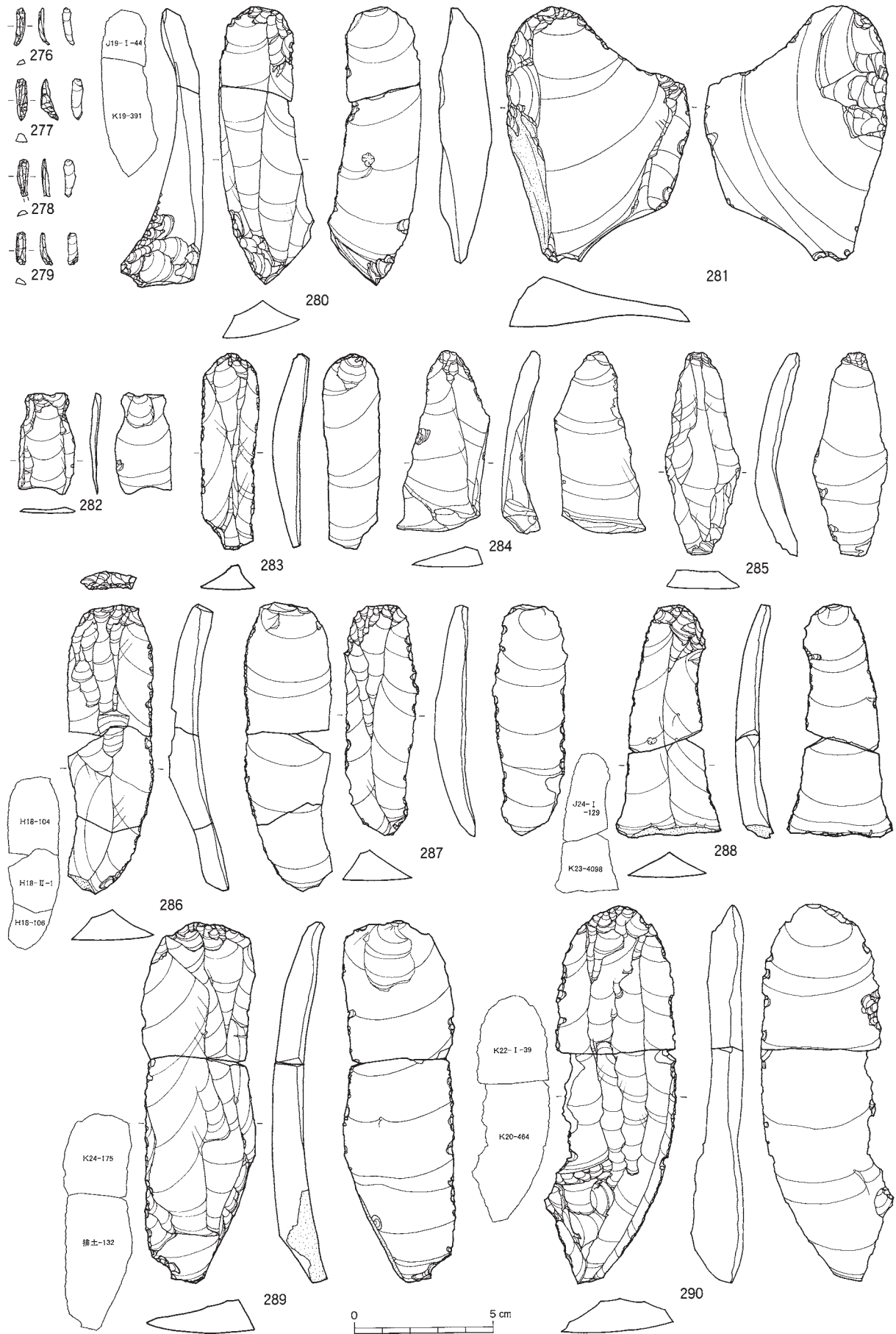

図Ⅲ-399 J区(Sb-97~107)の石器(31) 舟底形石器削片・二次加工ある剥片・つまみ付きナイフ・石刃

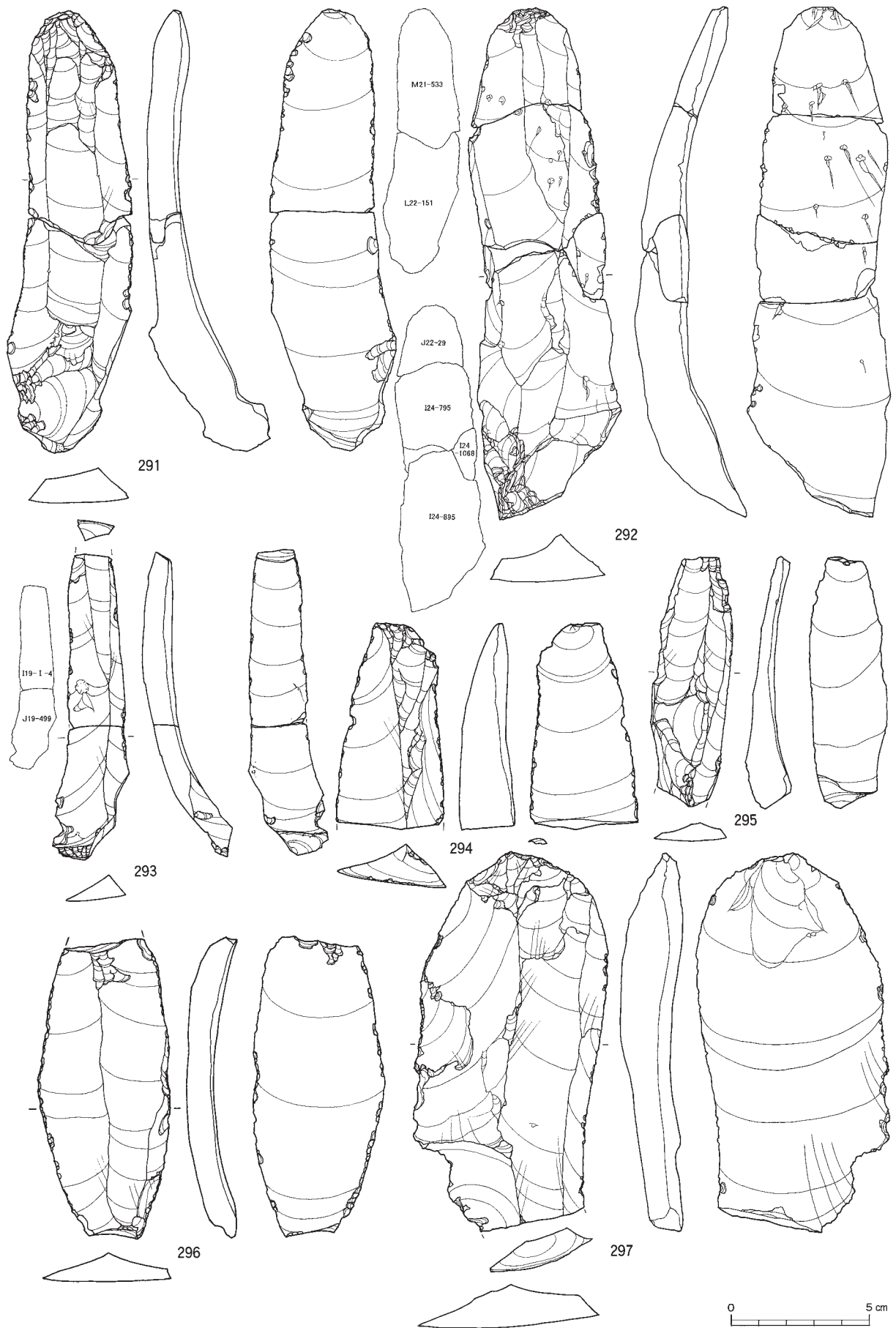

図Ⅲ-400 J区(Sb-97~107)の石器(32) 石刃

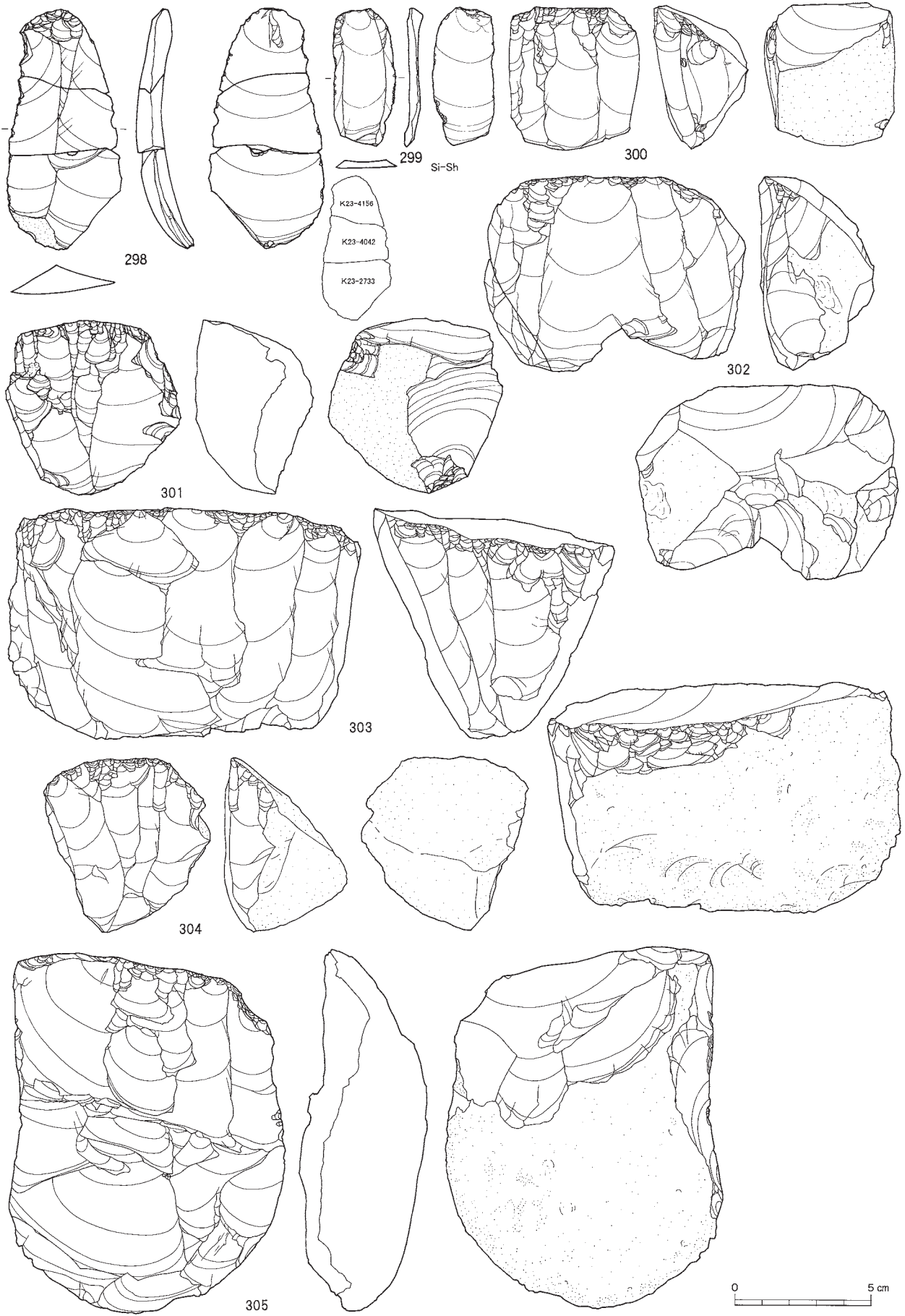

図III-401 J区(Sb-97~107)の石器(33) 石刃・石刃核

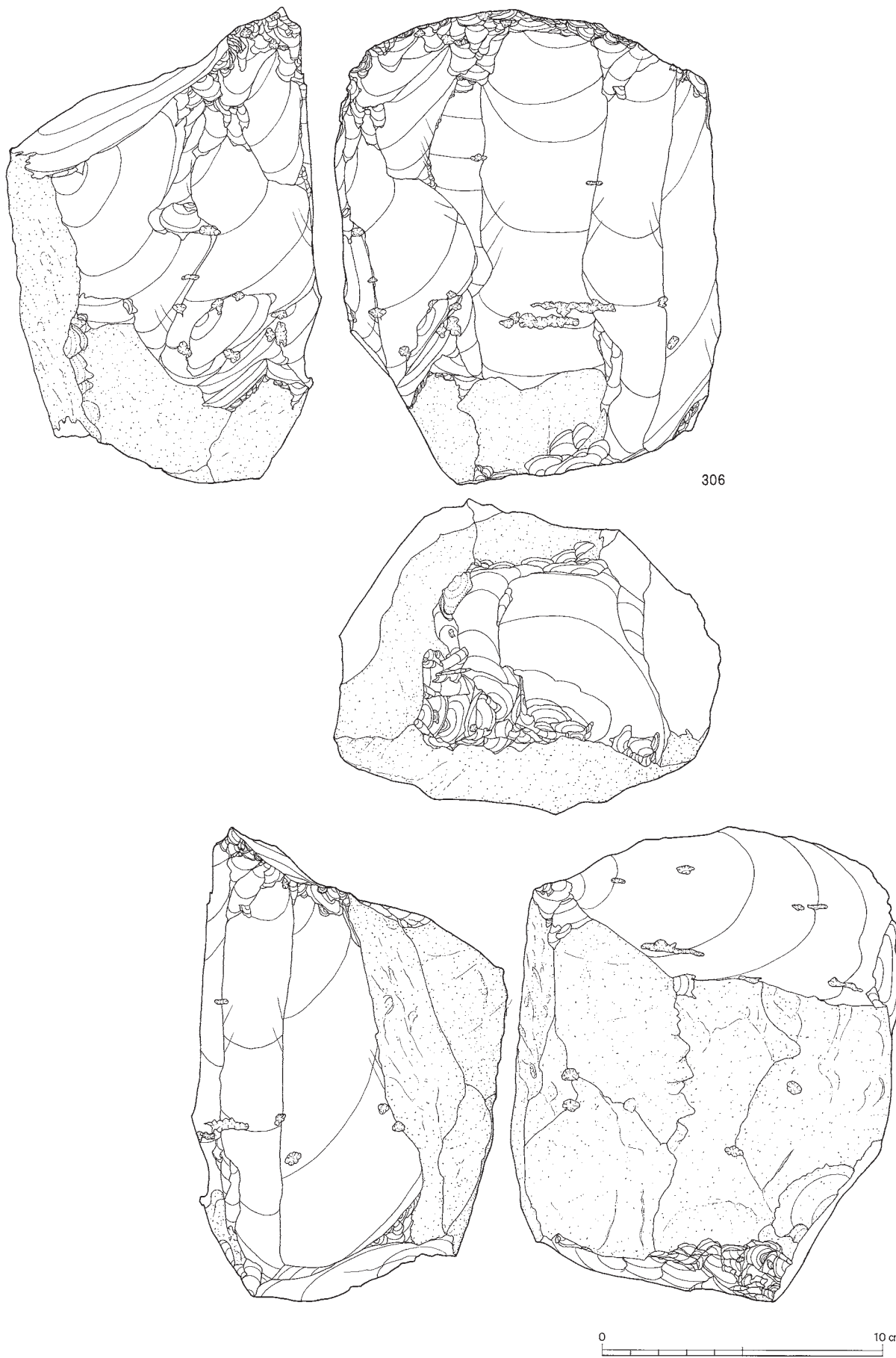

図Ⅲ-402 J区(Sb-97~107)の石器(34) 石刃核

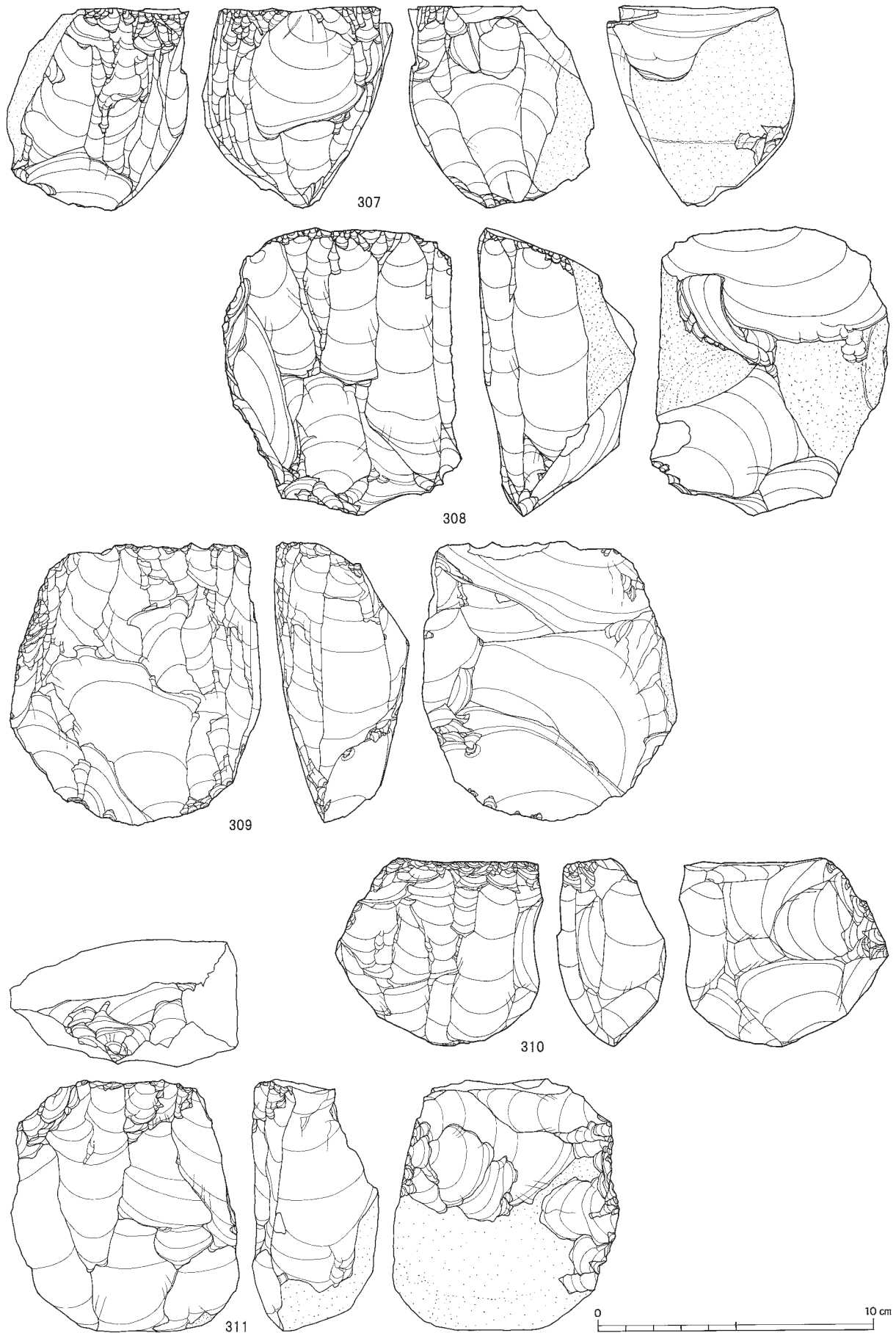

図Ⅲ-403 J区(Sb-97~107)の石器(35) 石刃核

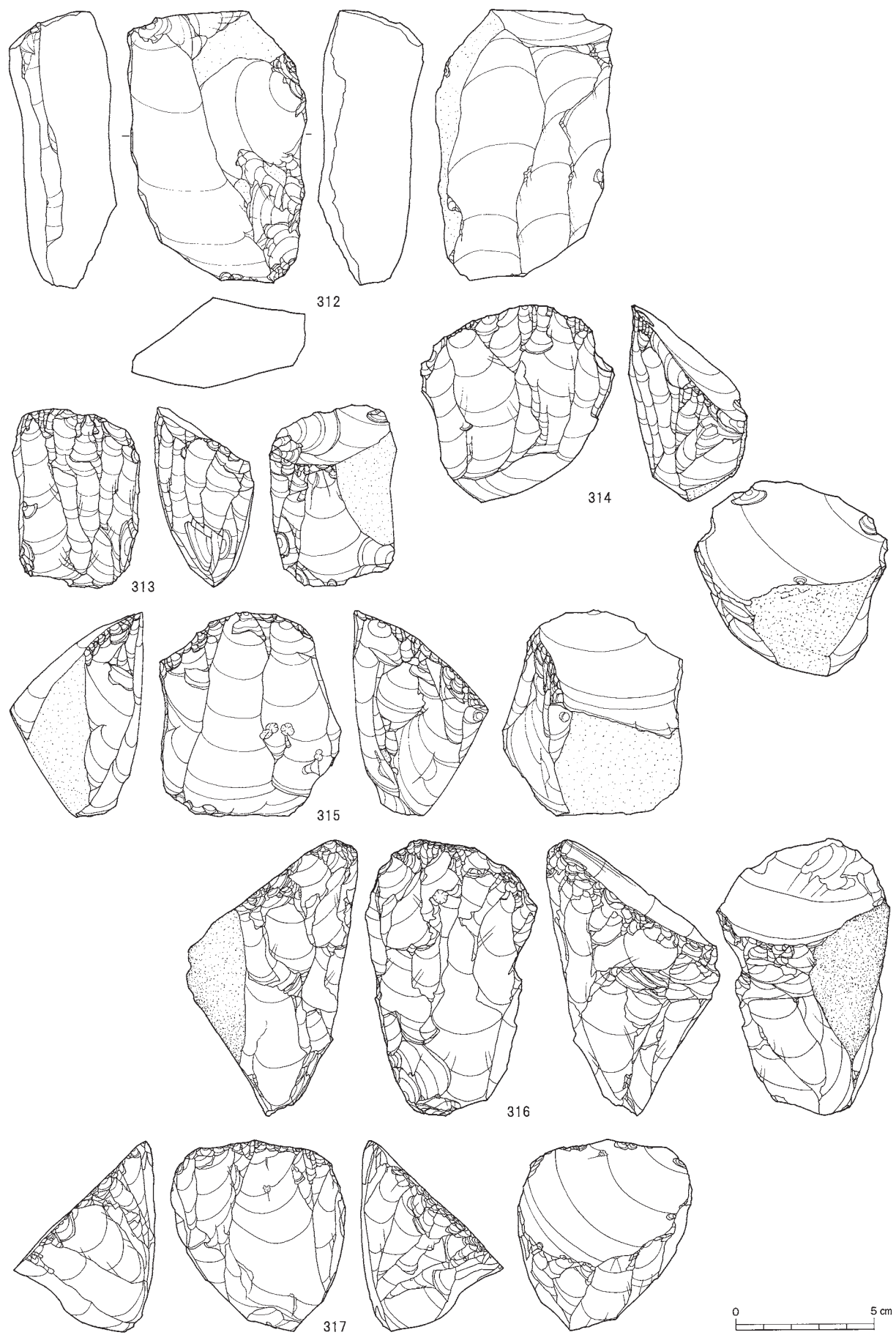

図Ⅲ-404 J区(Sb-97~107)の石器(36) 石刃核

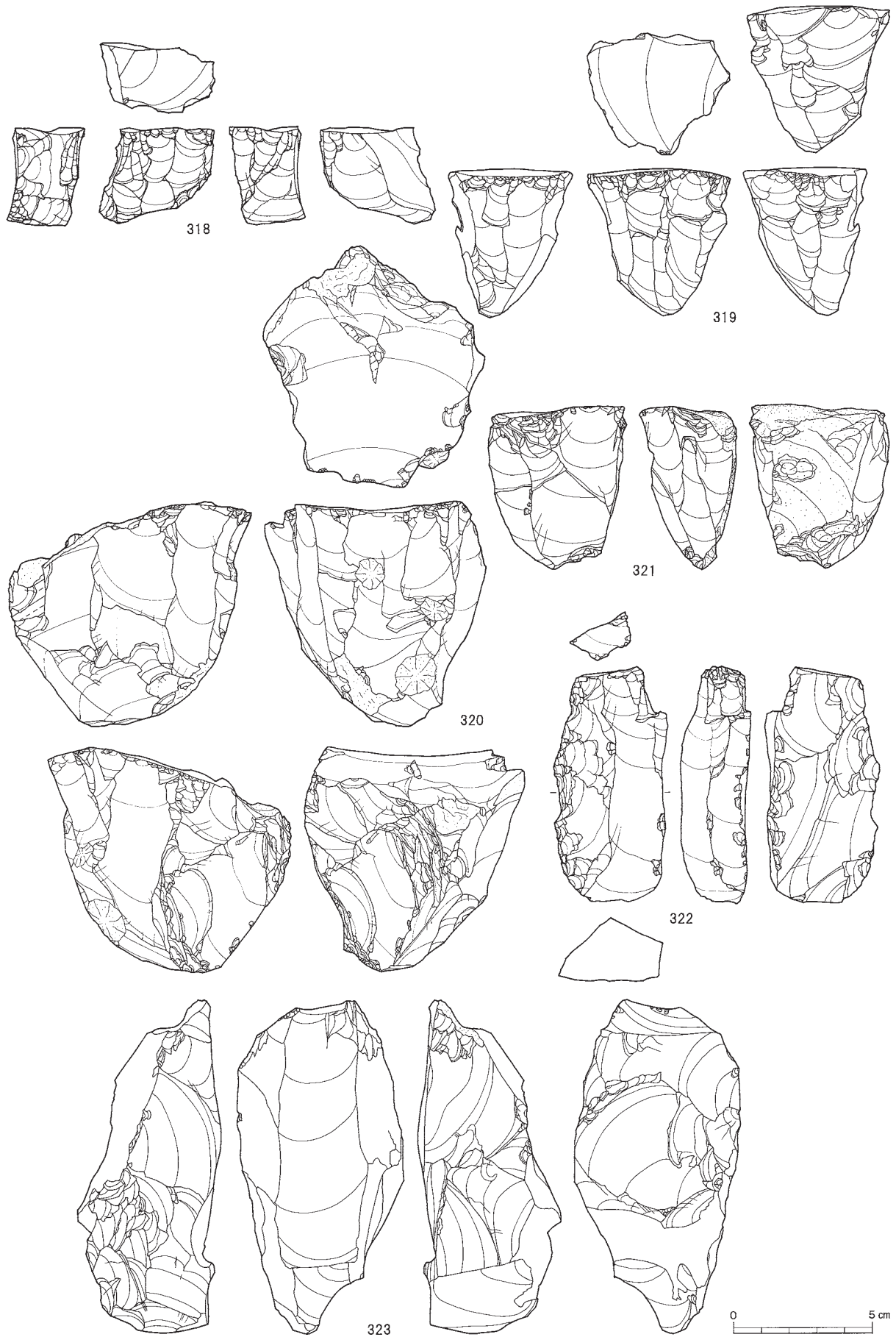

図Ⅲ-405 J区(Sb-97~107)の石器(37) 石刃核

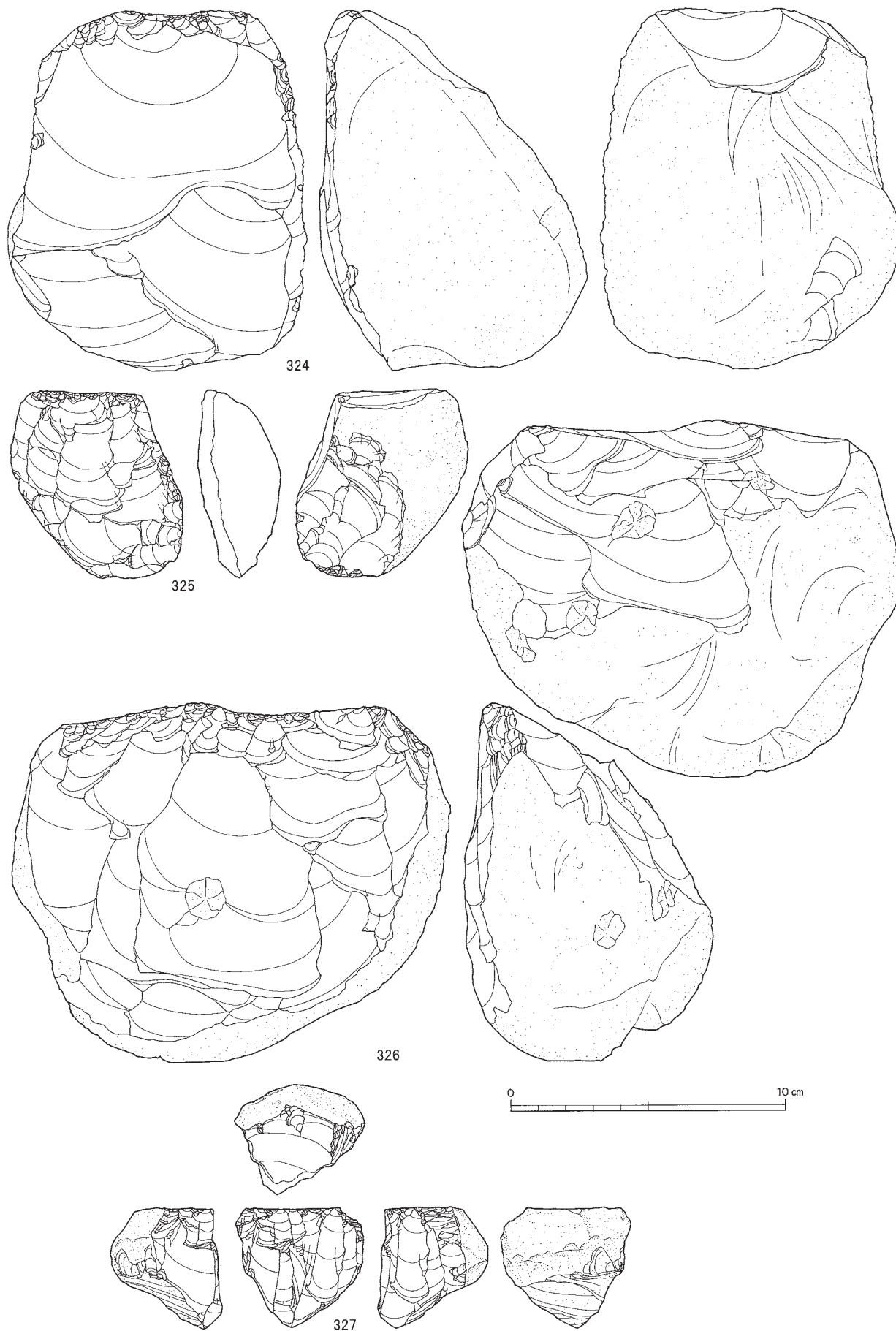

図Ⅲ-406 J区(Sb-97~107)の石器(38) 石核

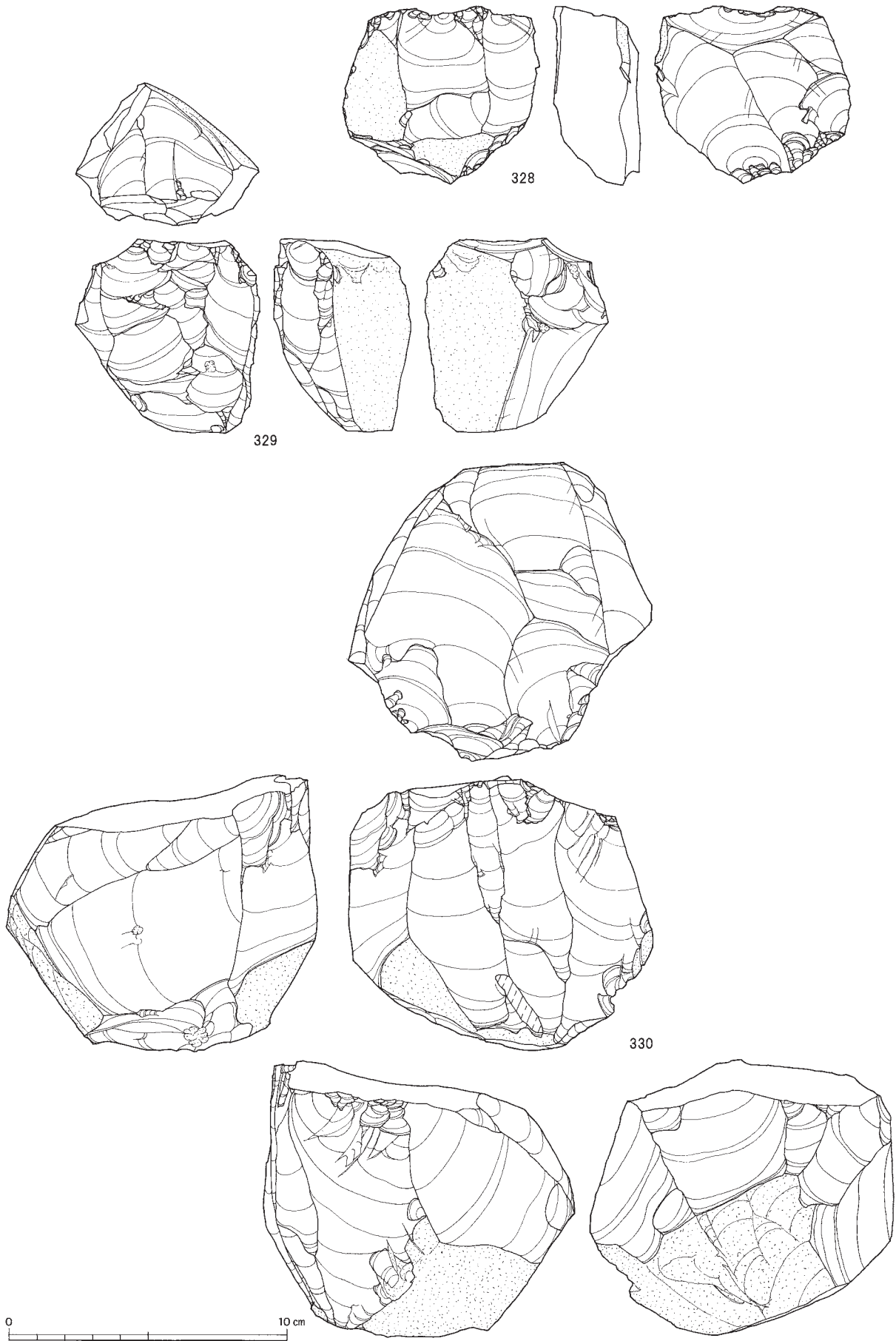

図Ⅲ-407 J区(Sb-97~107)の石器(39) 石核

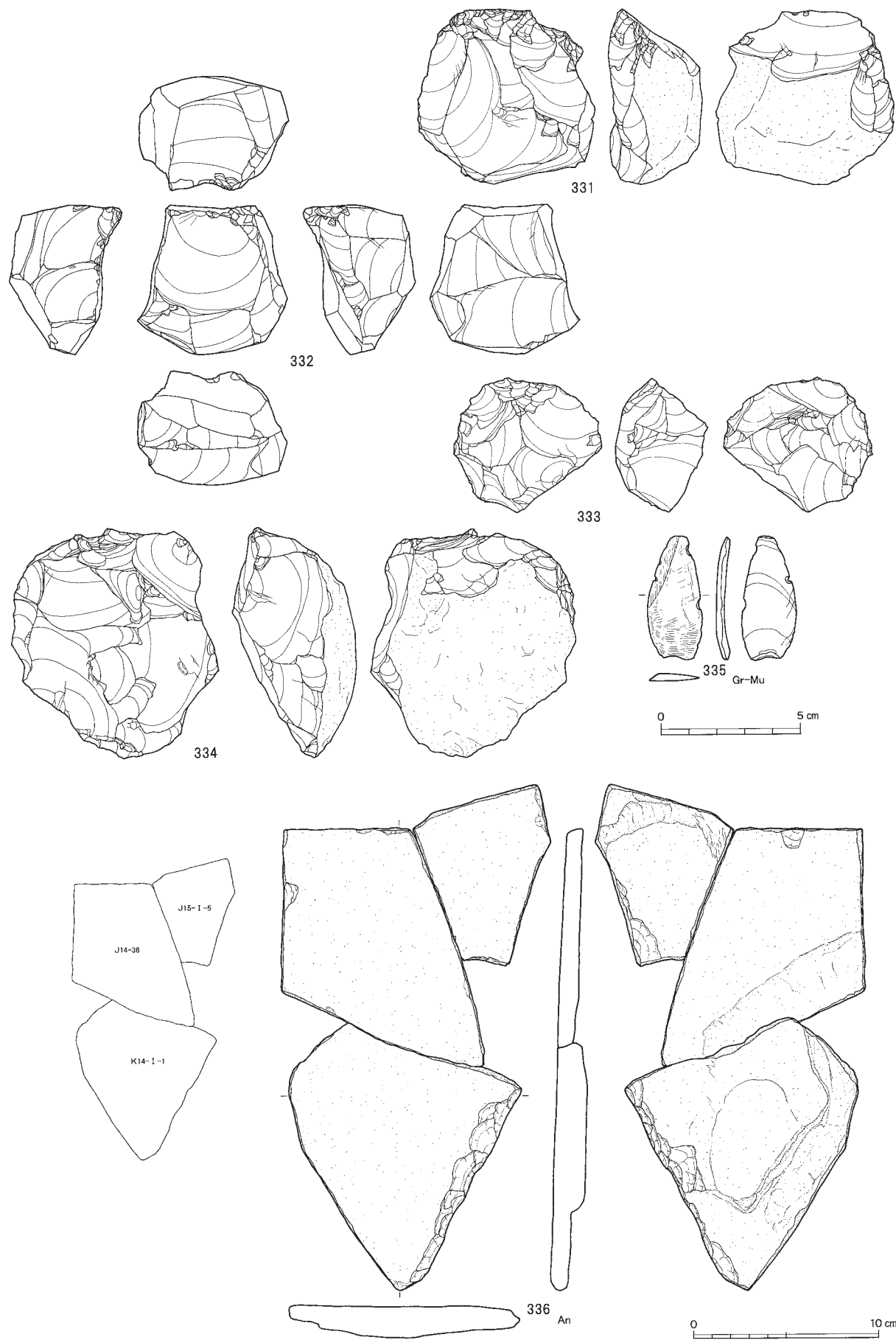

図Ⅲ-408 J区(Sb-97~107)の石器(40) 石核・剥片・台石

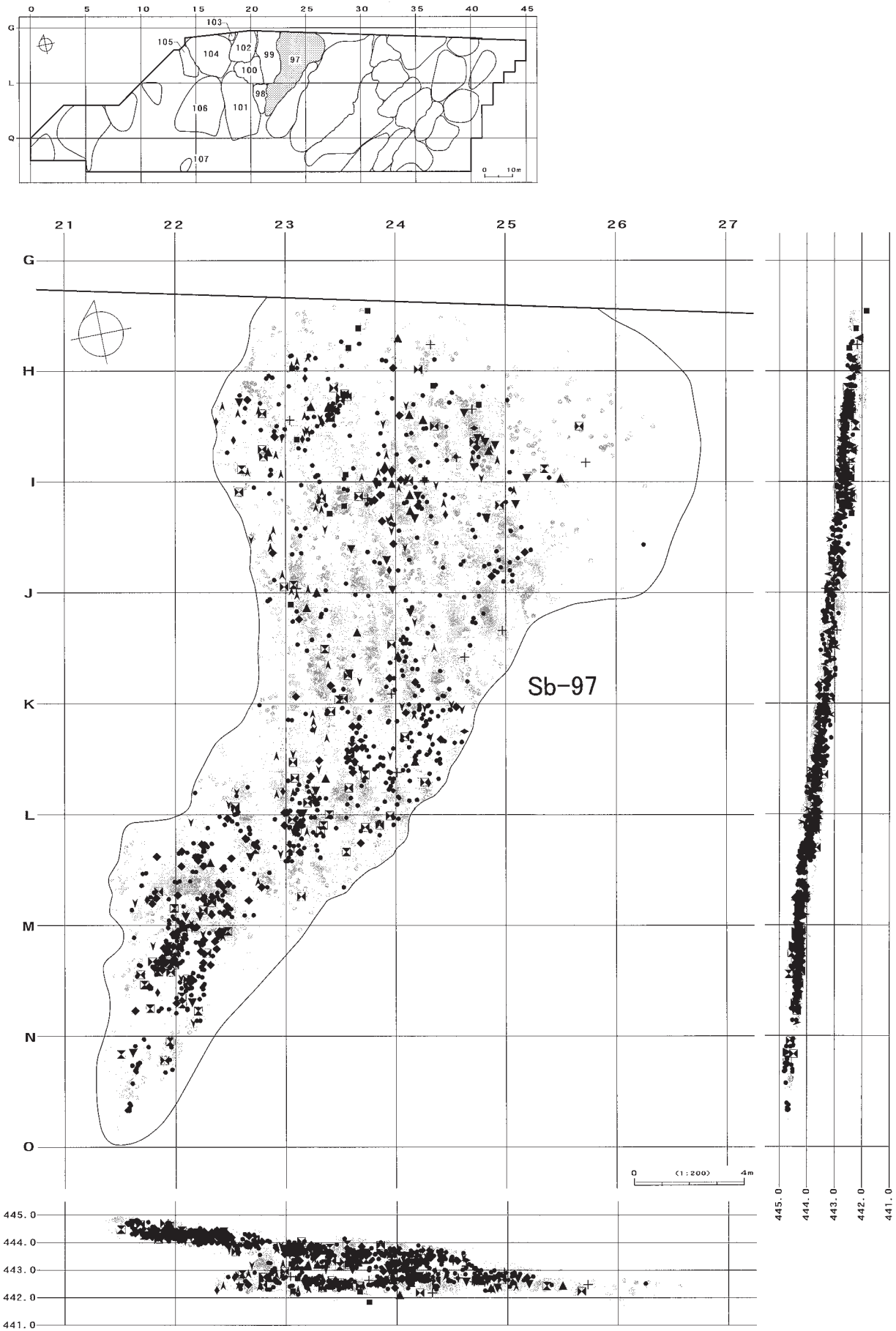

図Ⅲ-409 Sb-97の分布図

尖頭器Ⅲ類

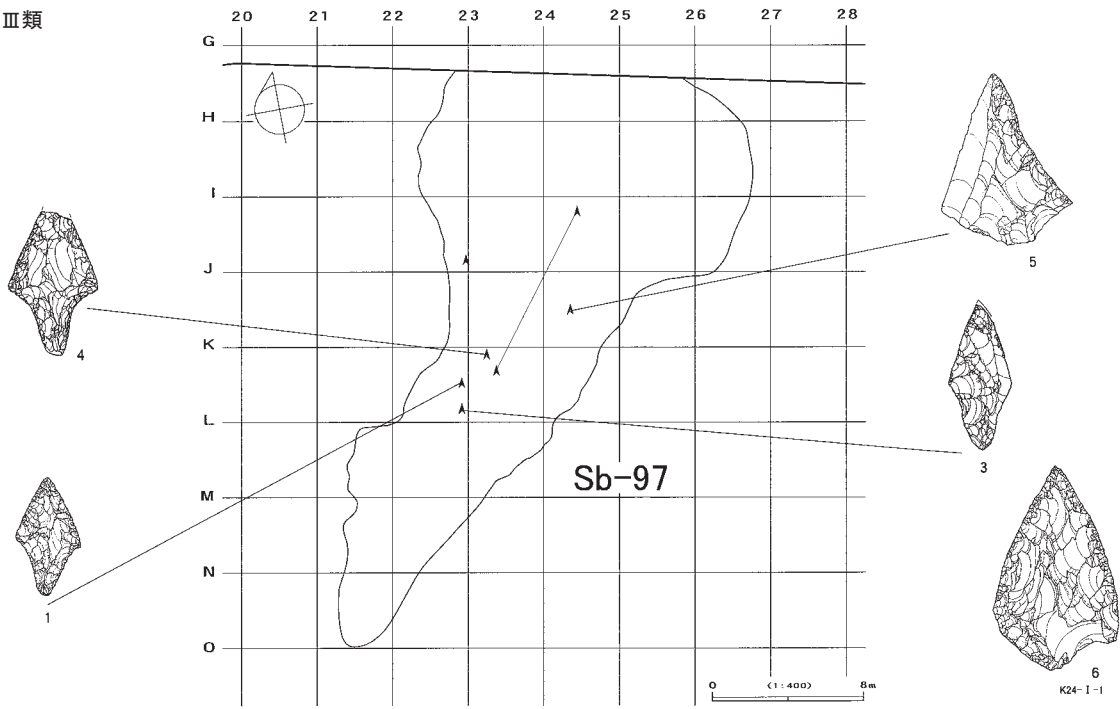

尖頭器Ⅰ類

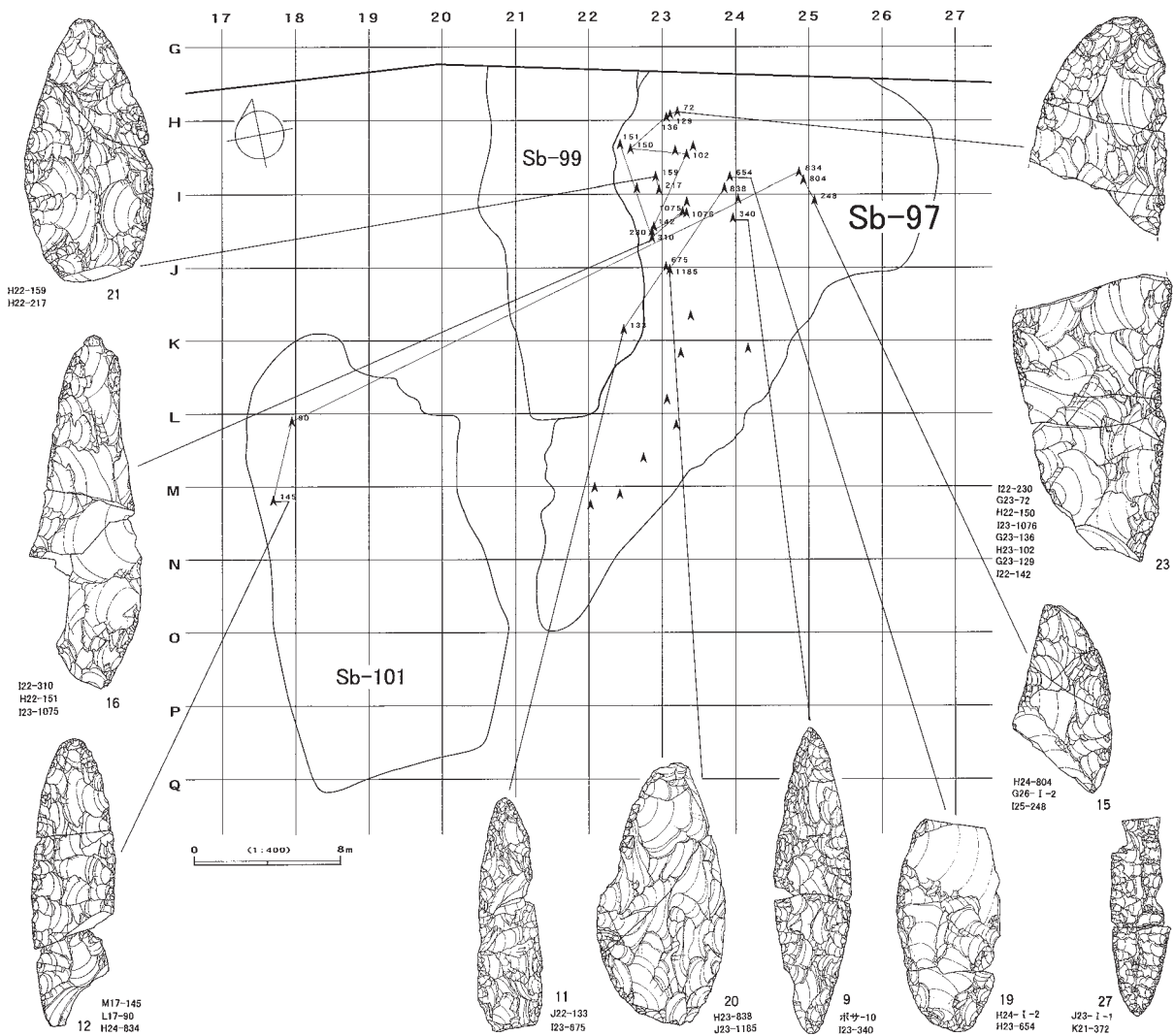

図Ⅲ-410 Sb-97の遺物(1)

尖頭器Ⅱ類、尖頭器削片

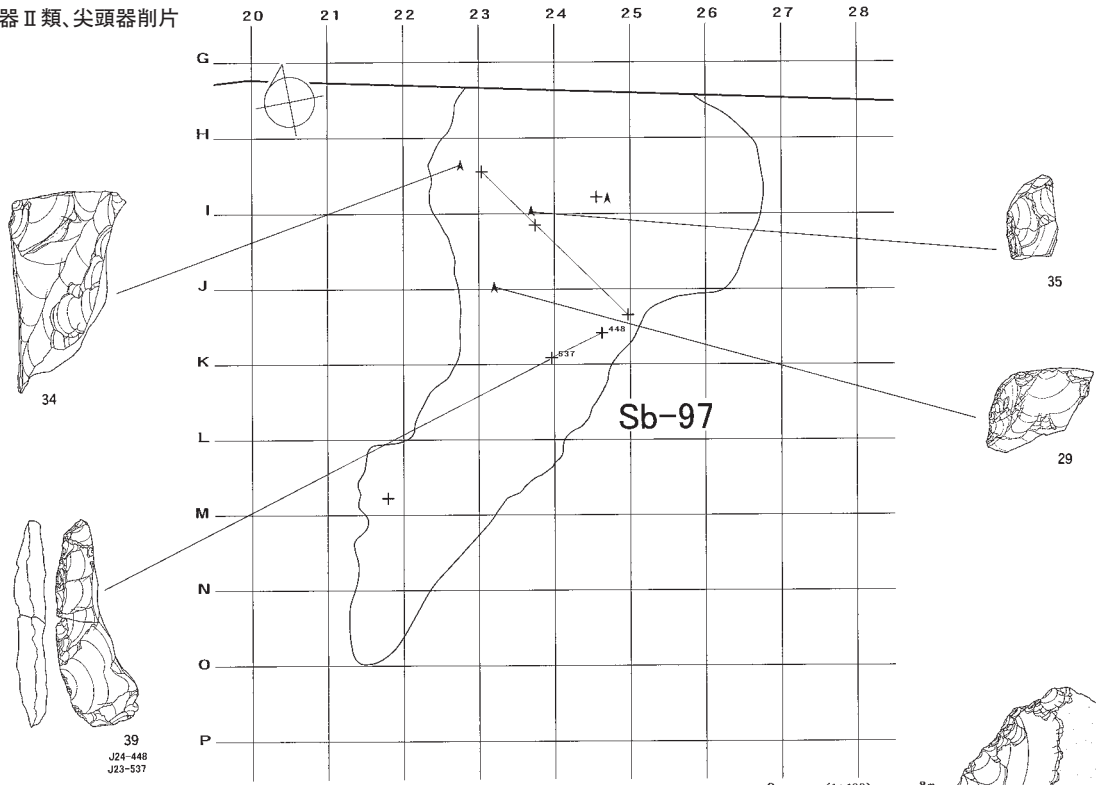

両面調整石器

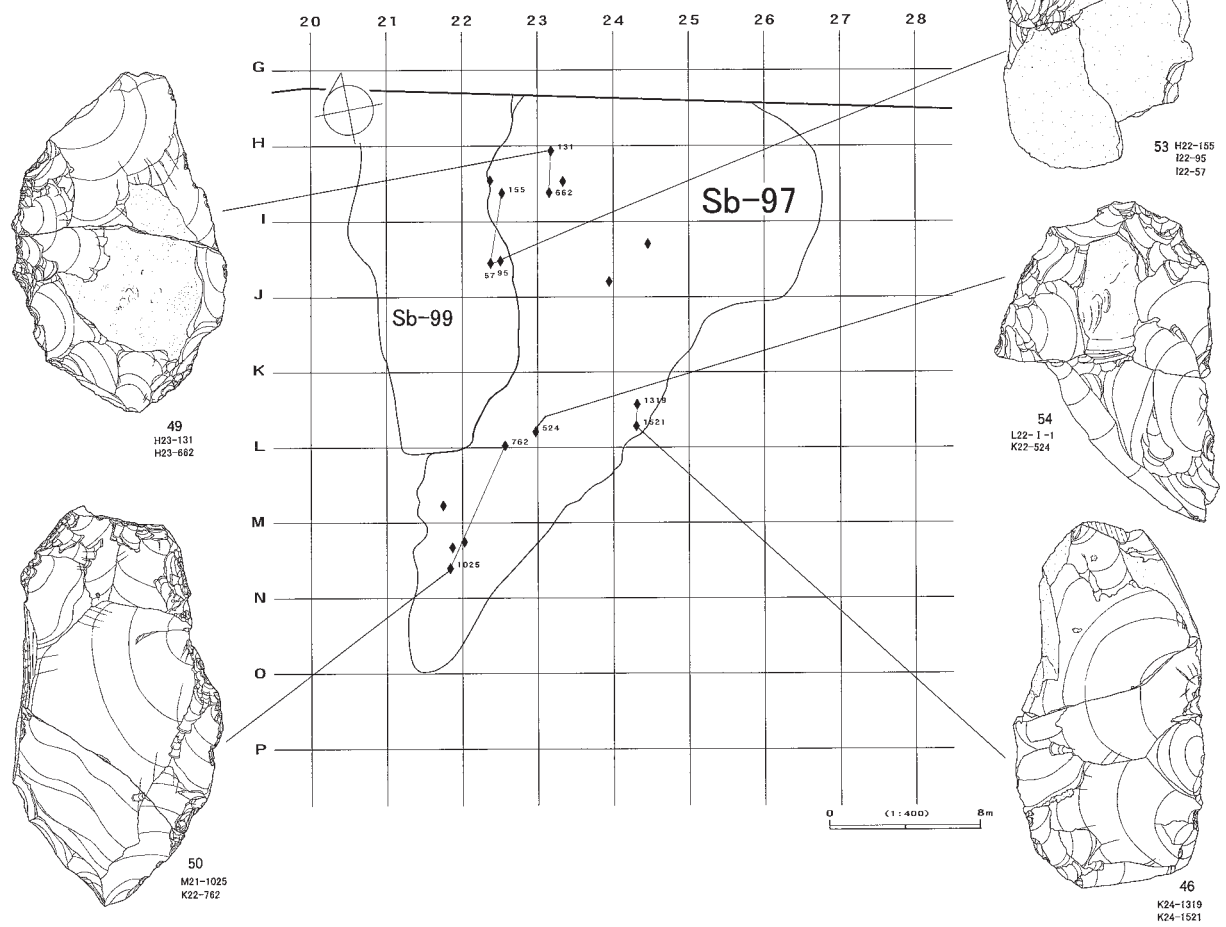

図Ⅲ-411 Sb-97の遺物(2)

彫器Ⅰ・Ⅱ類、彫器削片Ⅰ・Ⅱ類

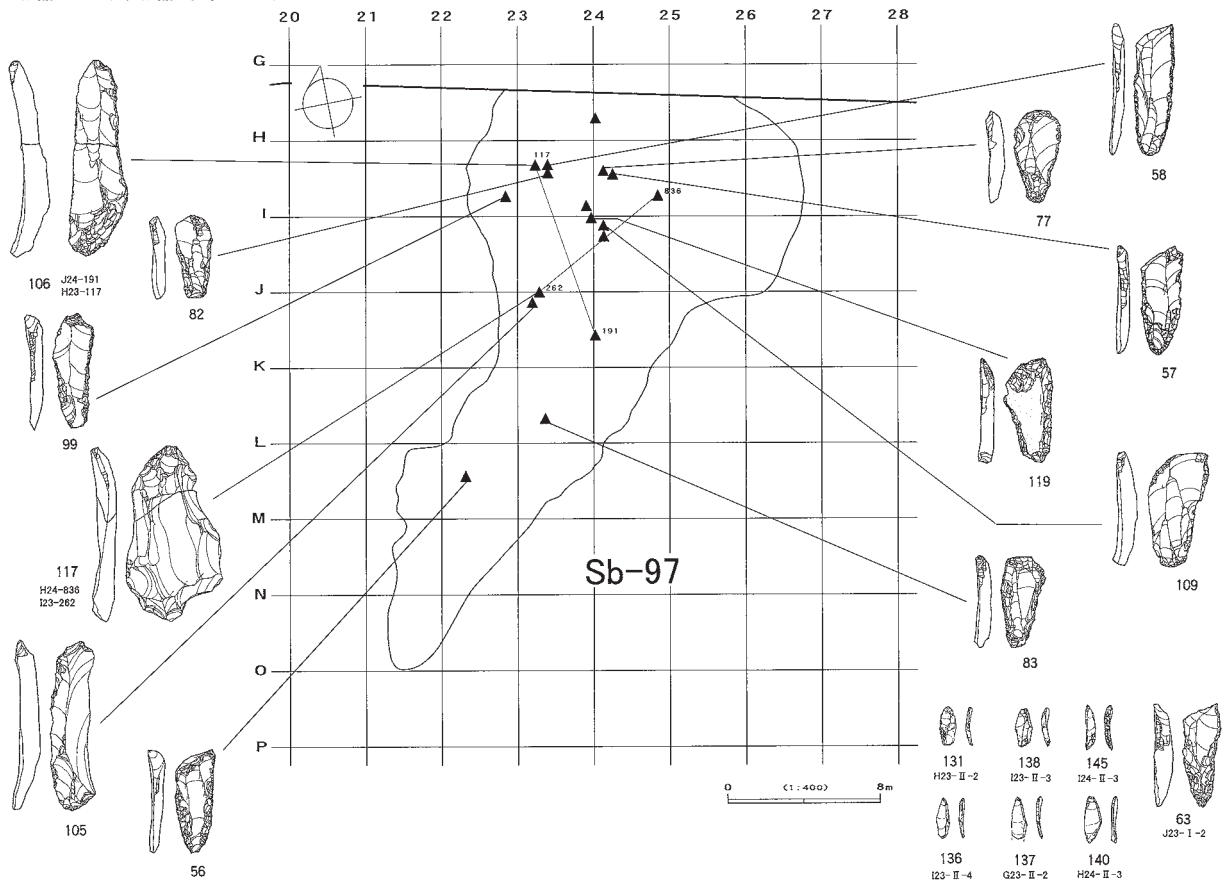

彫器Ⅲ類、彫器削片Ⅲ類

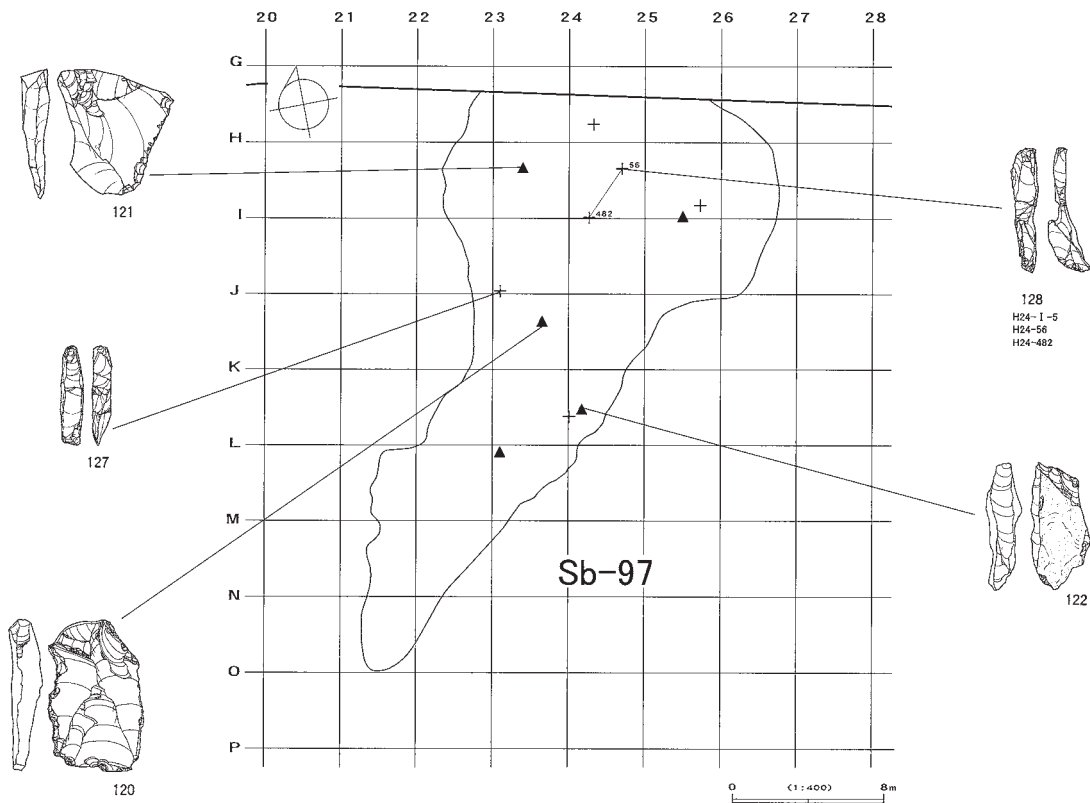

図Ⅲ-412 Sb-97の遺物(3)

搔器

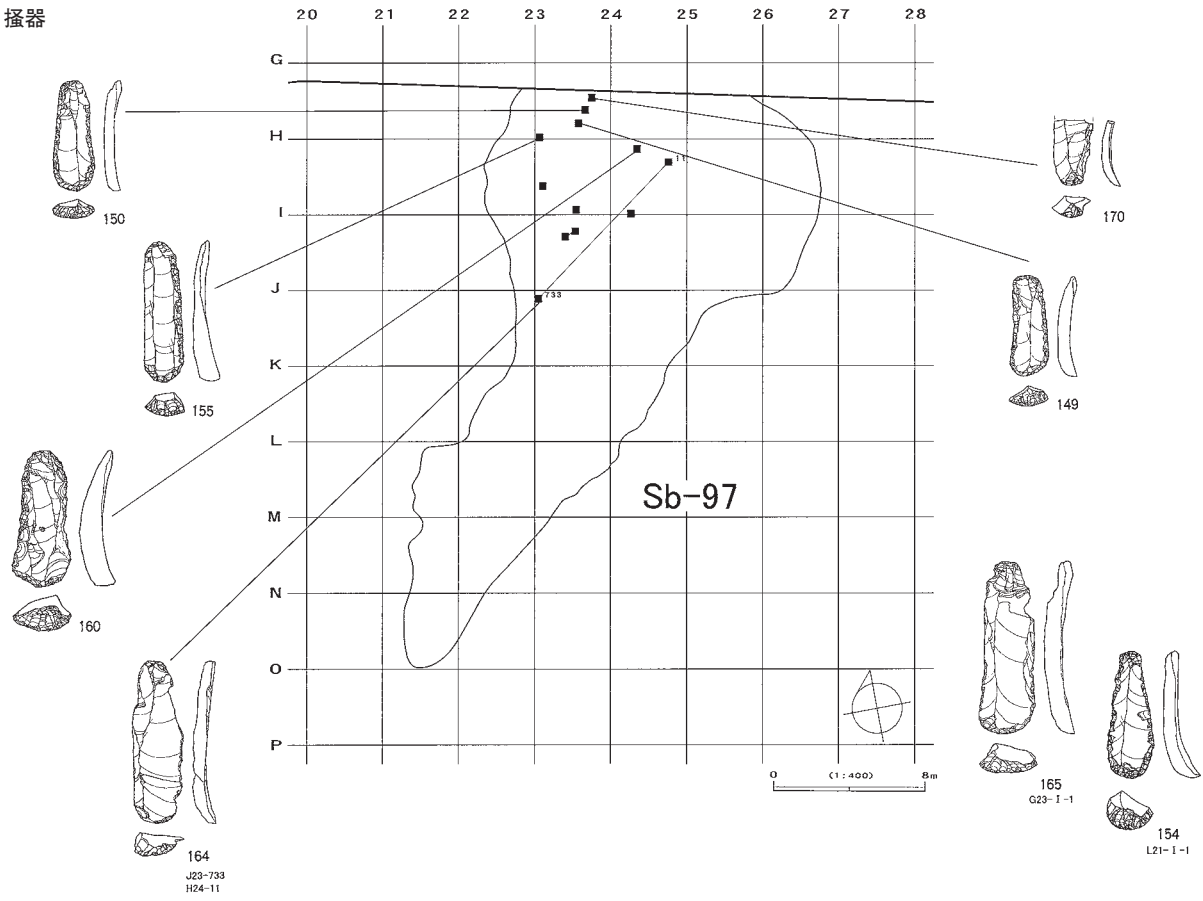

削器

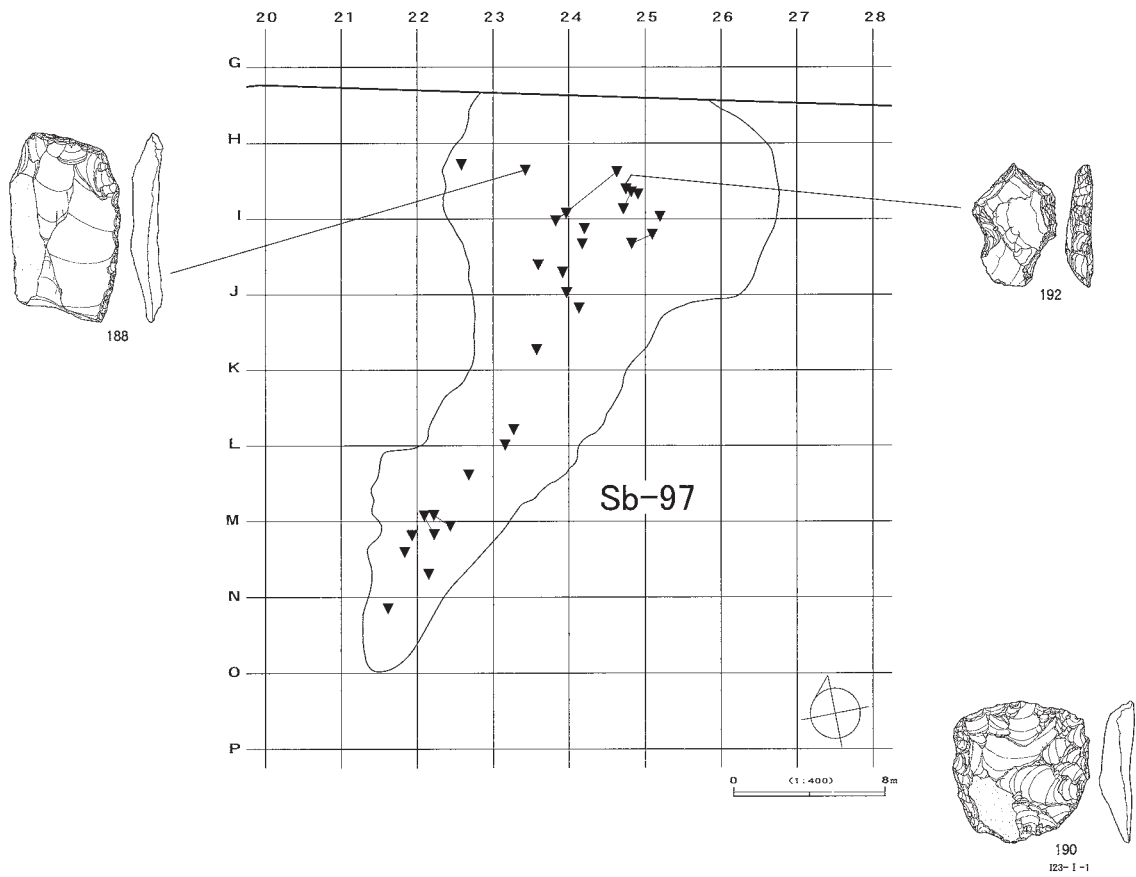

図Ⅲ-413 Sb-97の遺物(4)

その他の石器

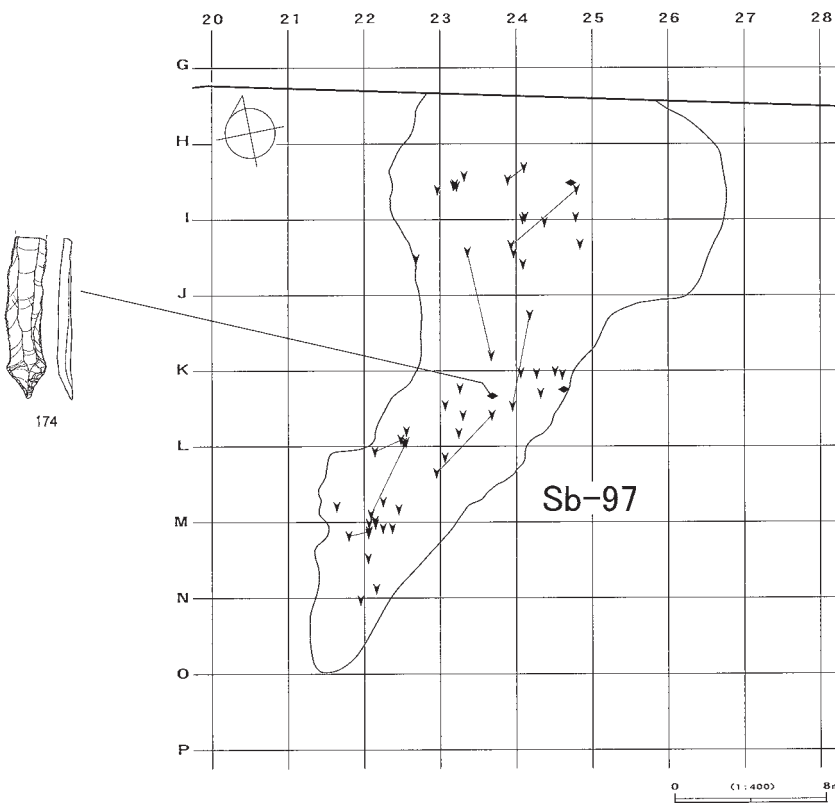

舟底形石器I類

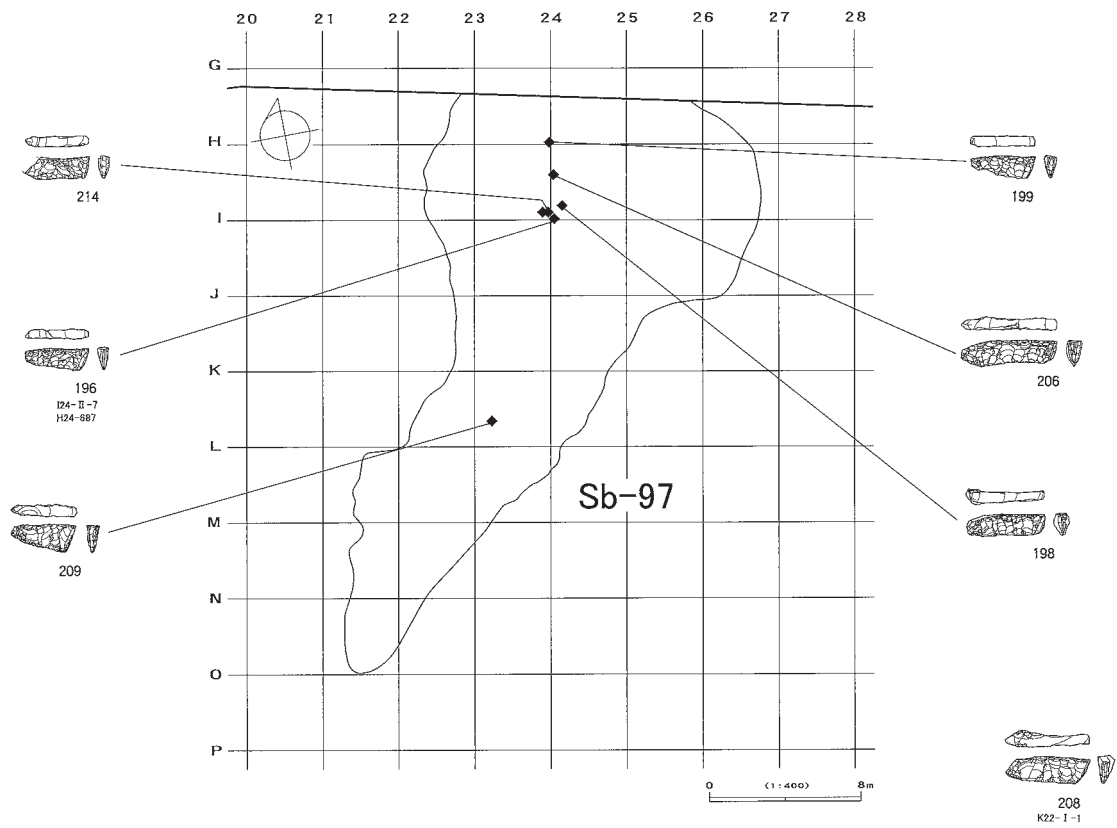

図III-414 Sb-97の遺物(5)

舟底形石器Ⅱ類

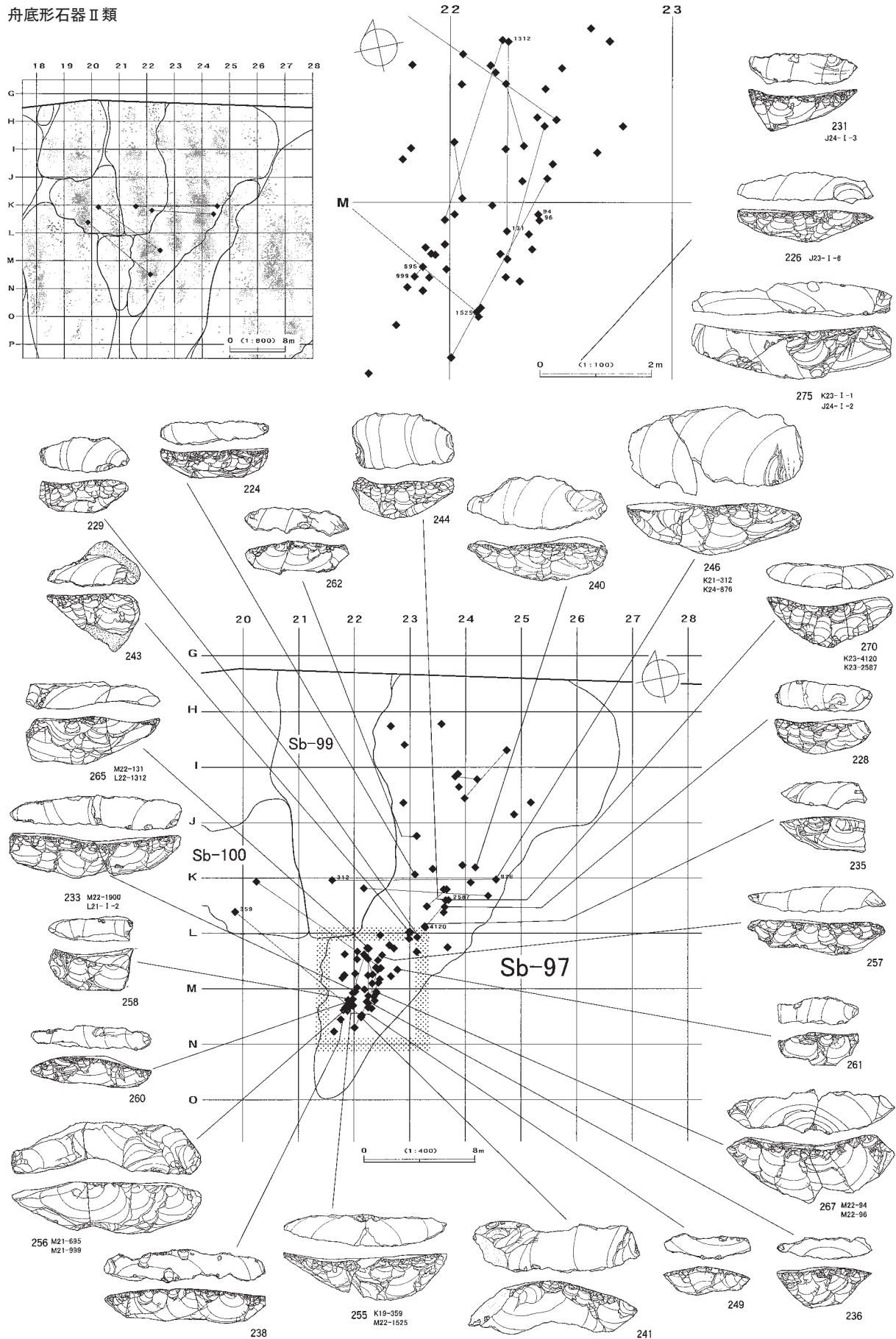

図Ⅲ-415 Sb-97の遺物(6)

石刃核

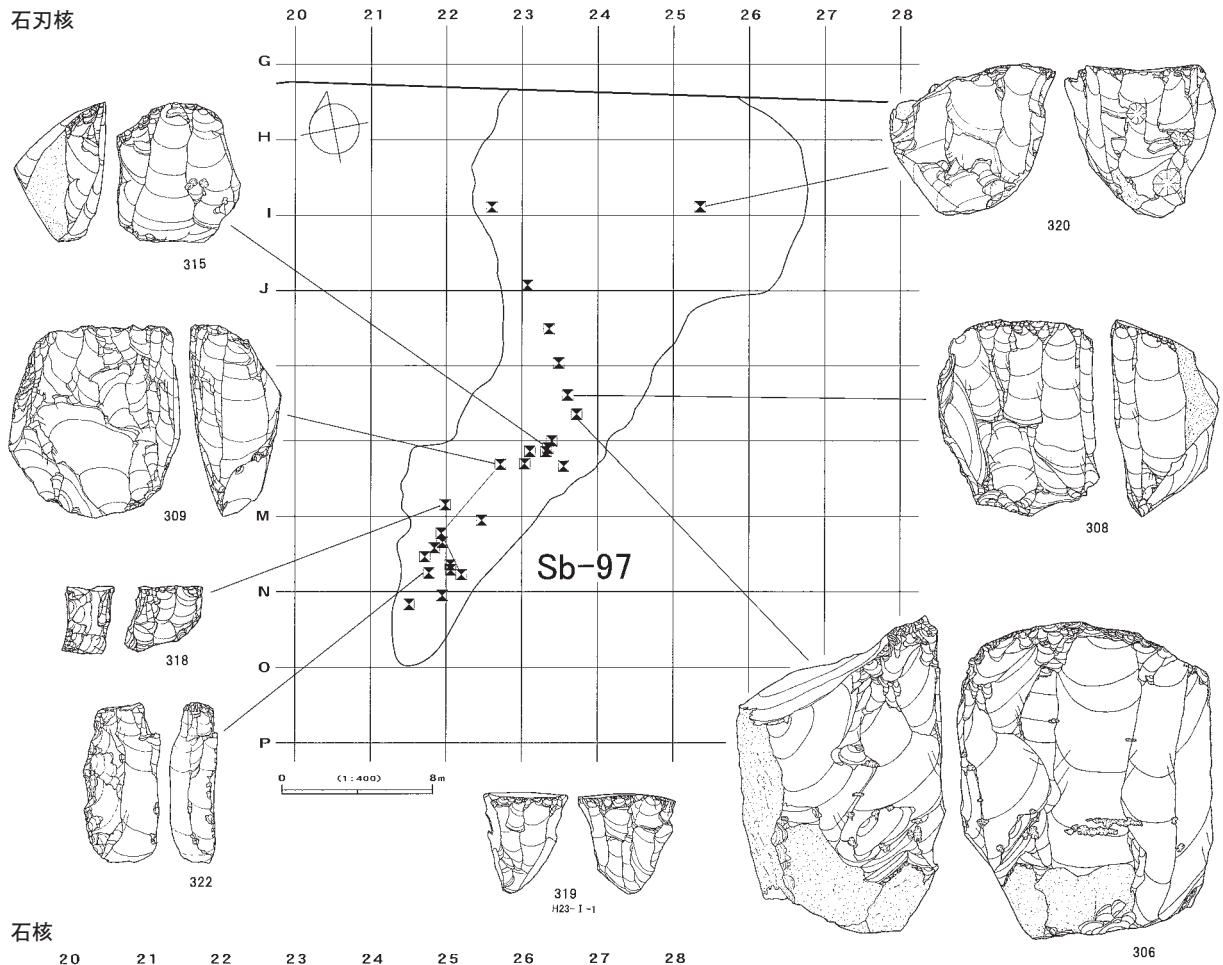

石核

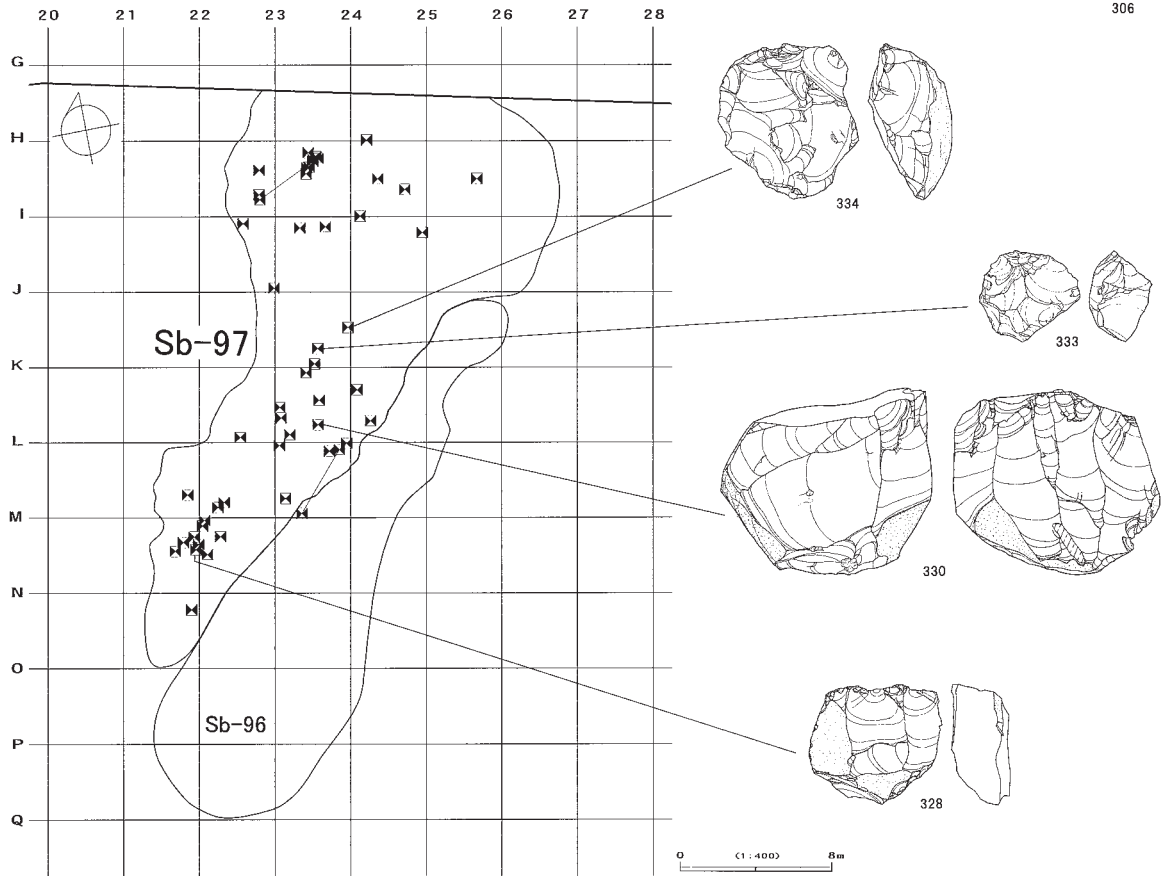

図Ⅲ-416 Sb-97の遺物(7)

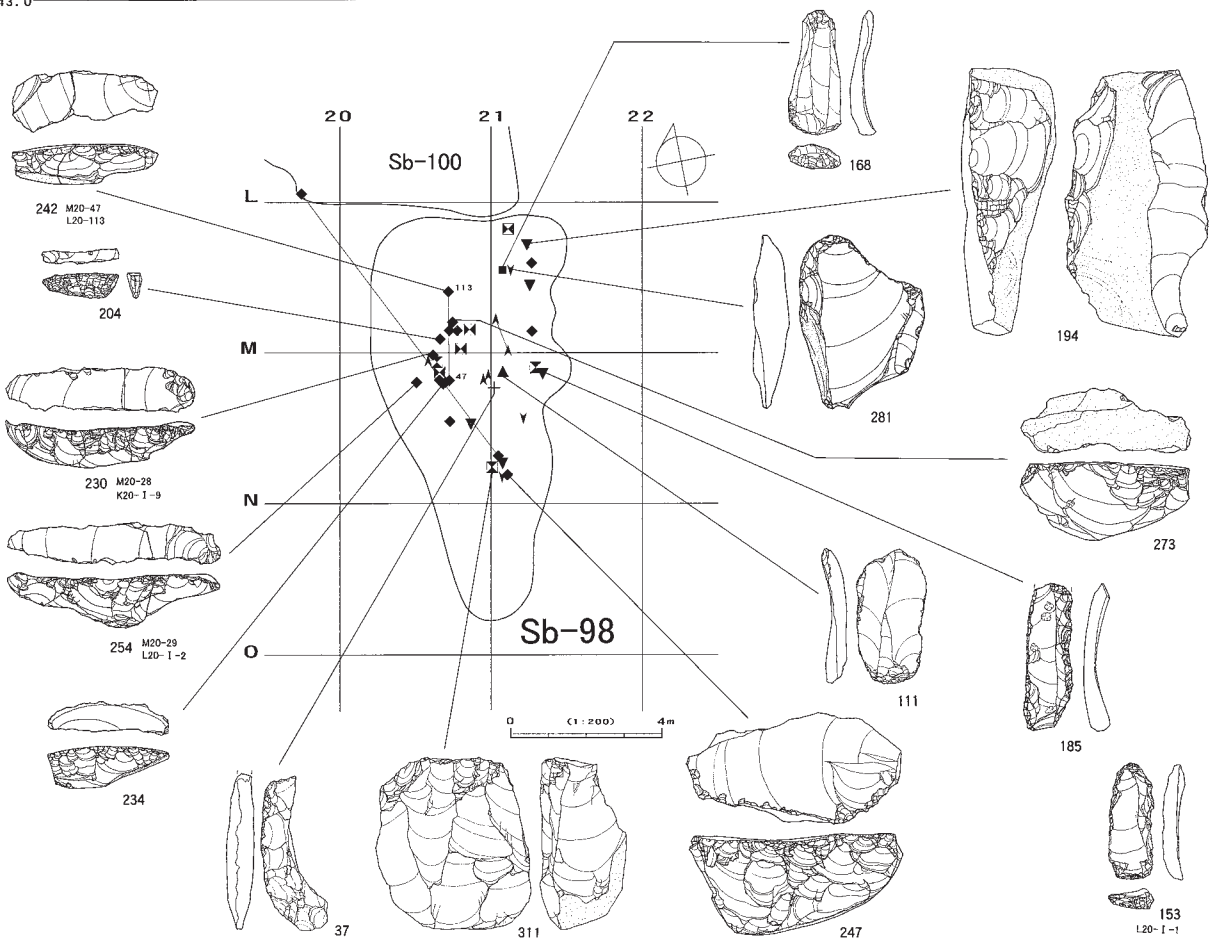
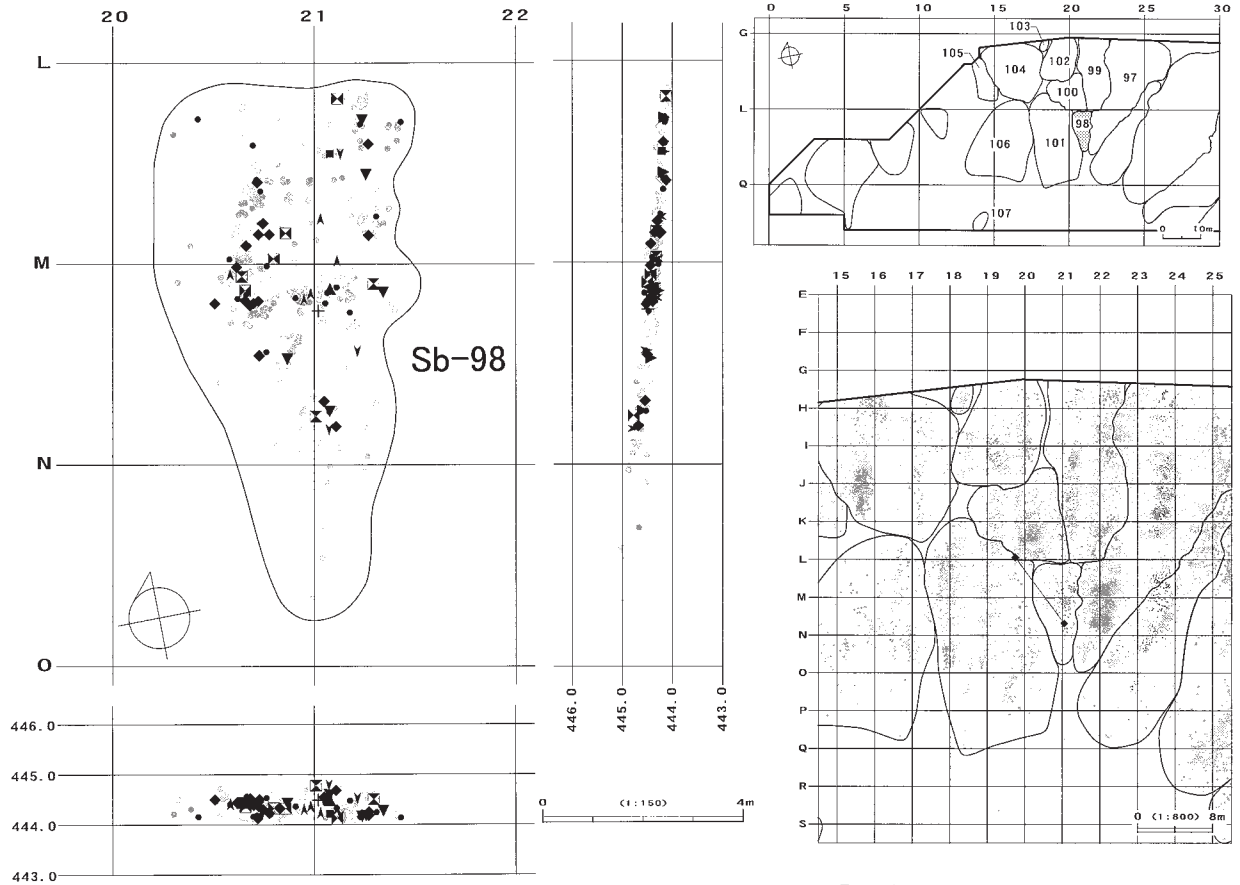

図Ⅲ-417 Sb-98の分布図・遺物

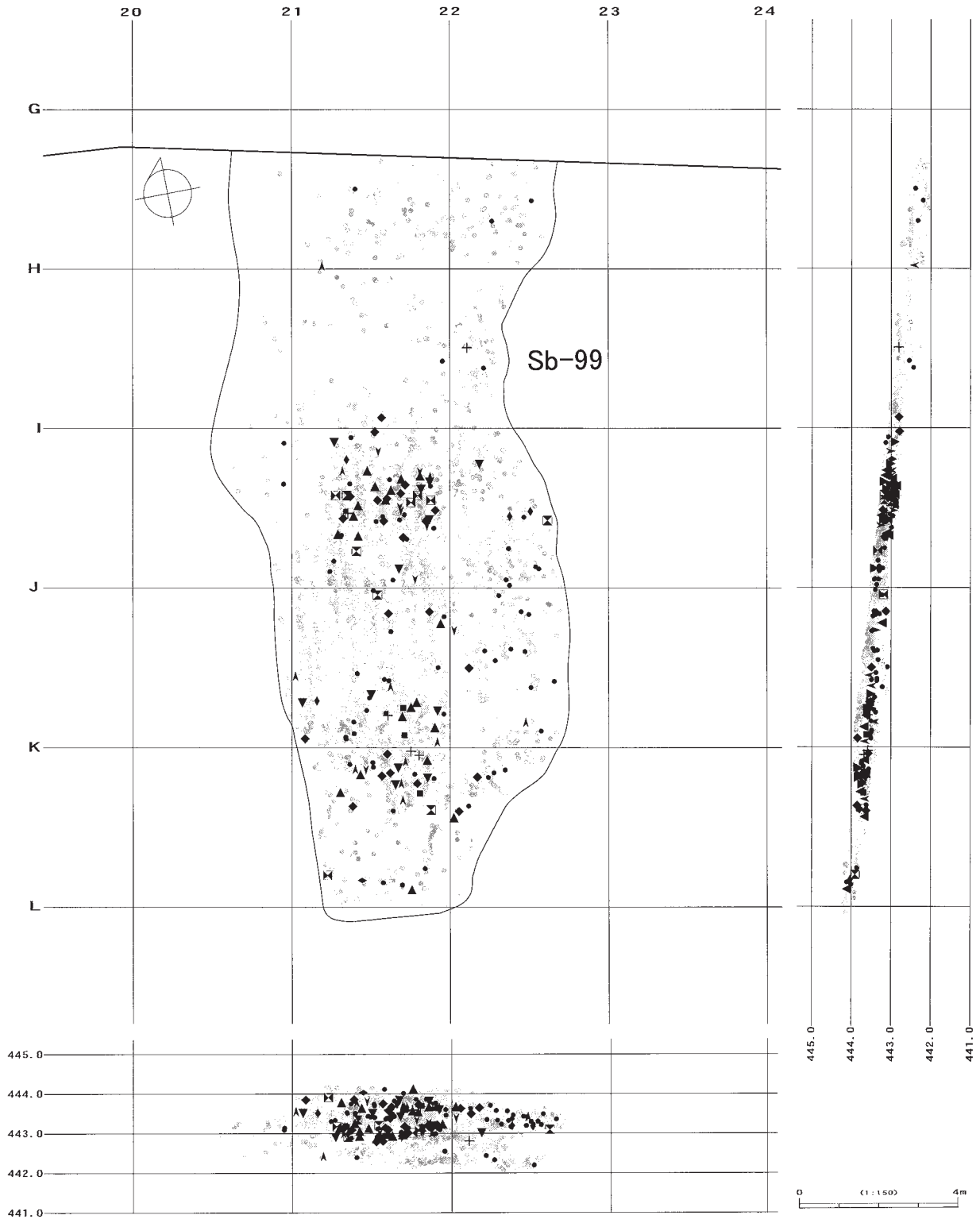
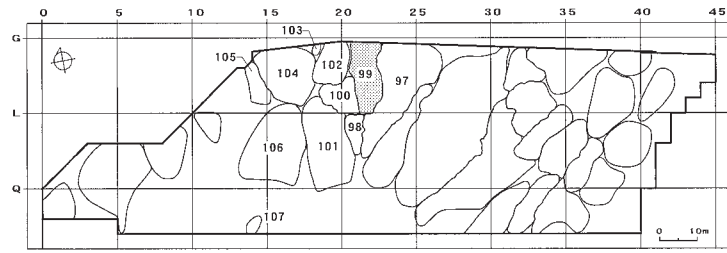

図Ⅲ-418 Sb-99の分布図

尖頭器Ⅱ類(▲)・Ⅲ類(▲)、尖頭器削片

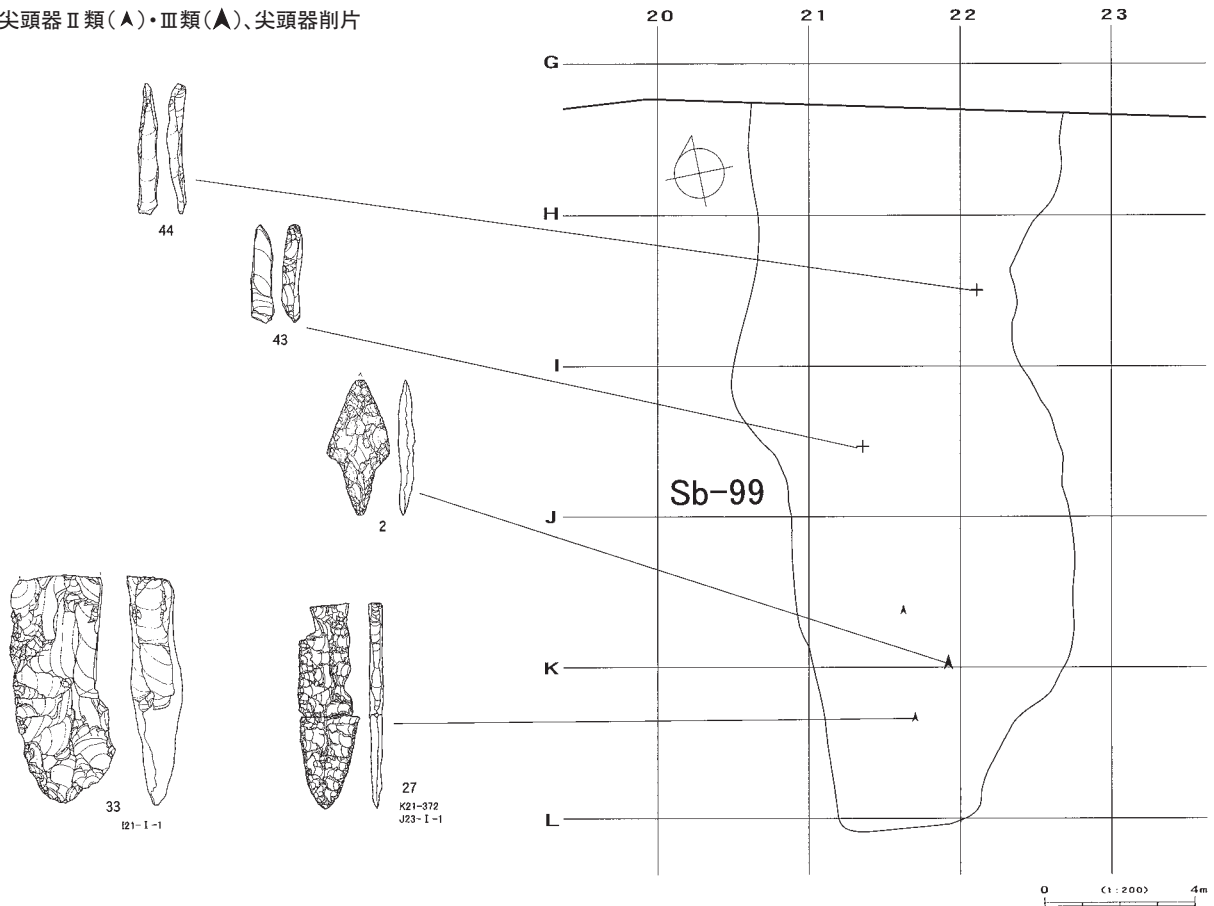

尖頭器Ⅰ類、両面調整石器

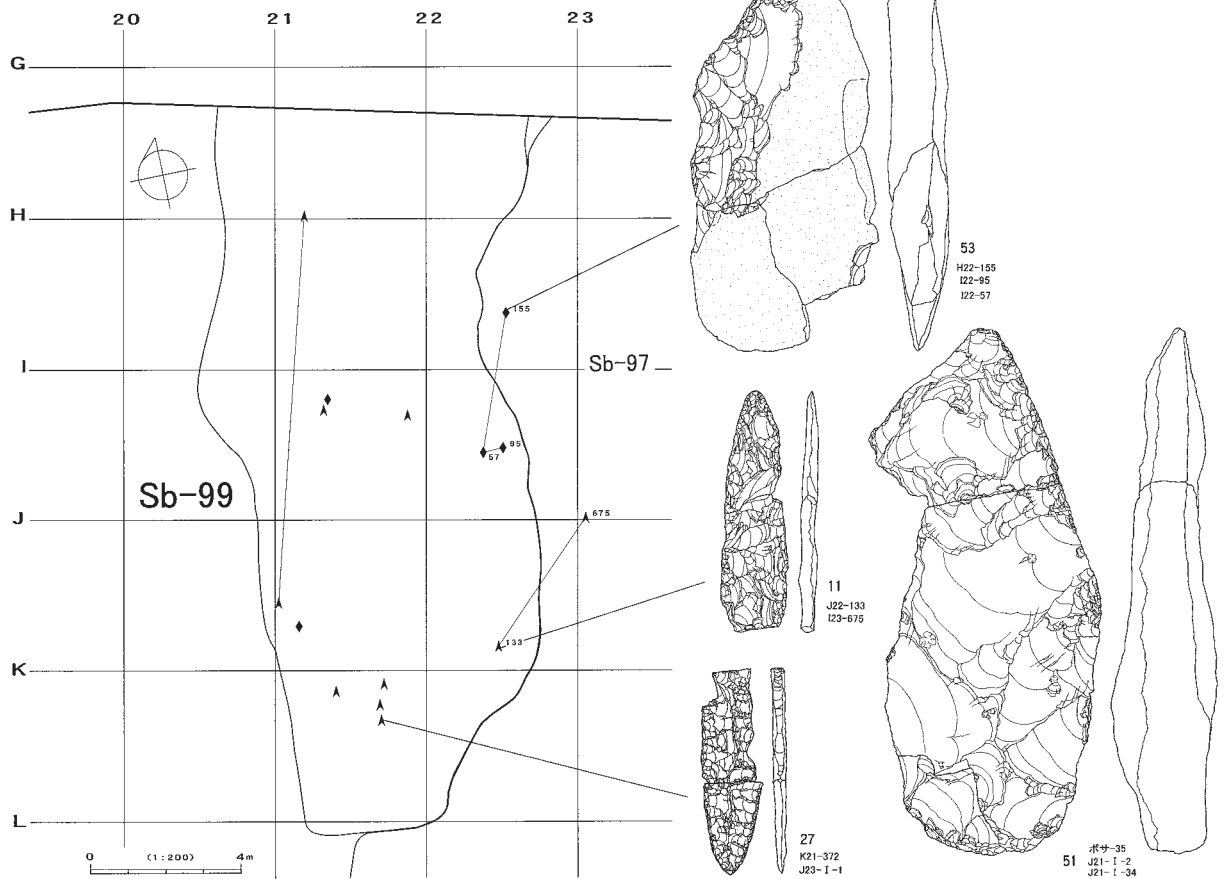

図Ⅲ-419 Sb-99の遺物(1)

彫器、彫器削片

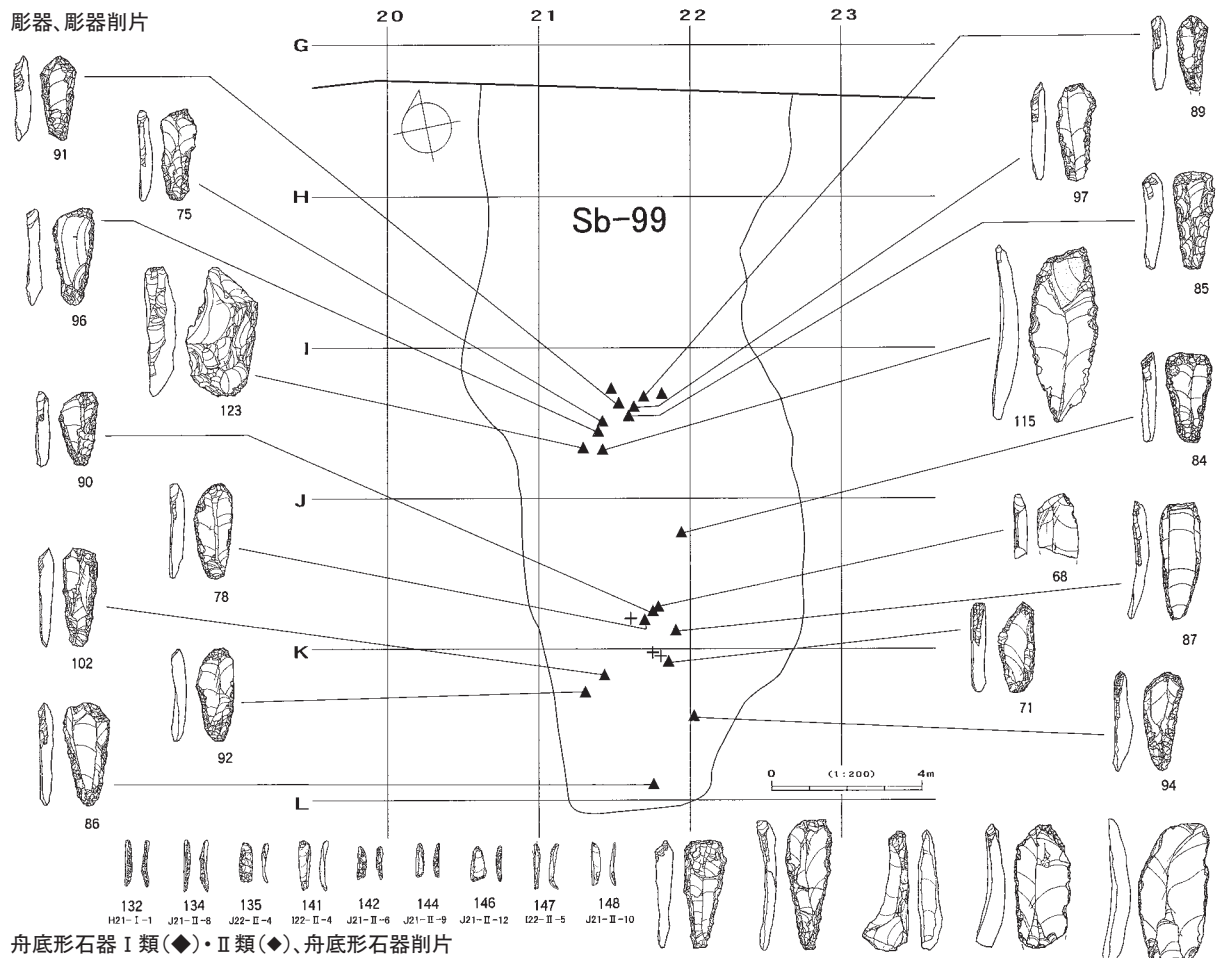

舟底形石器 I類(◆)・II類(◇)、舟底形石器削片

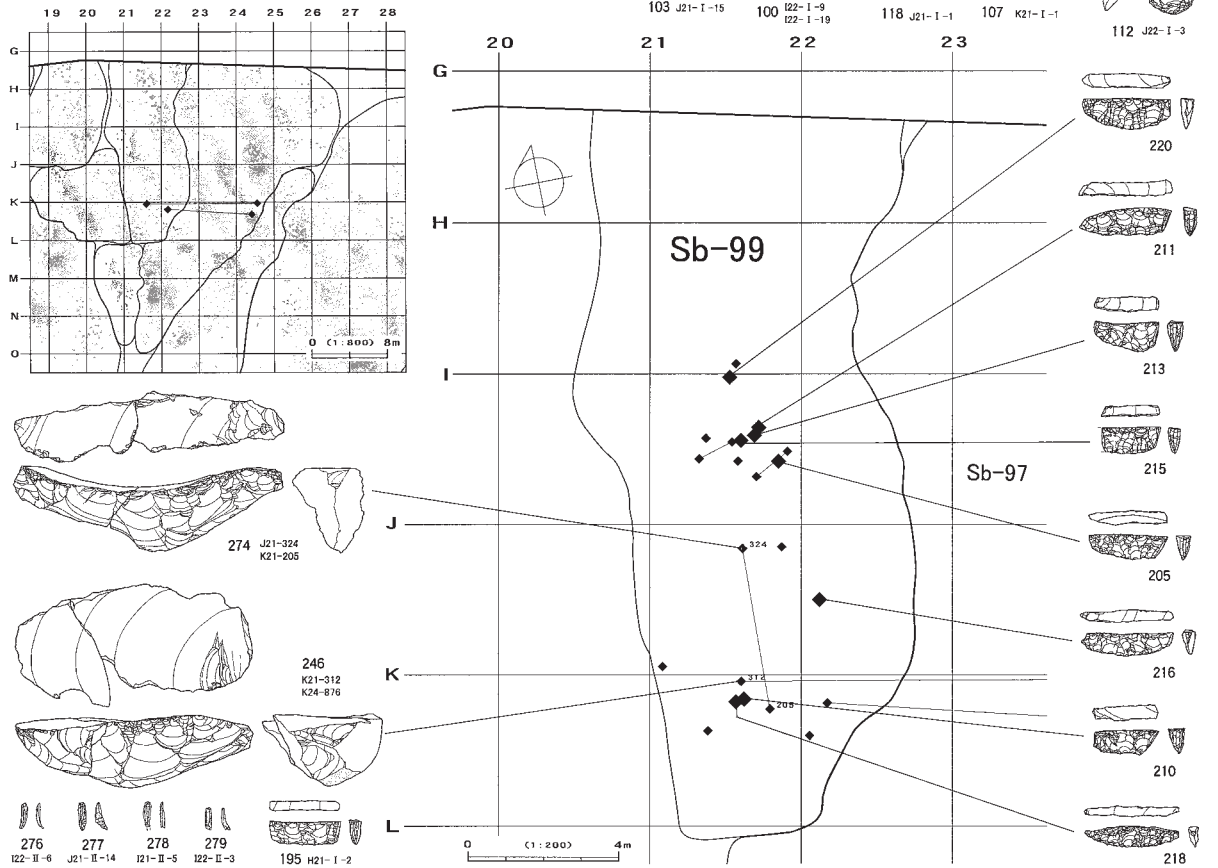

図Ⅲ-420 Sb-99の遺物(2)

その他の石器、石刃核、石核

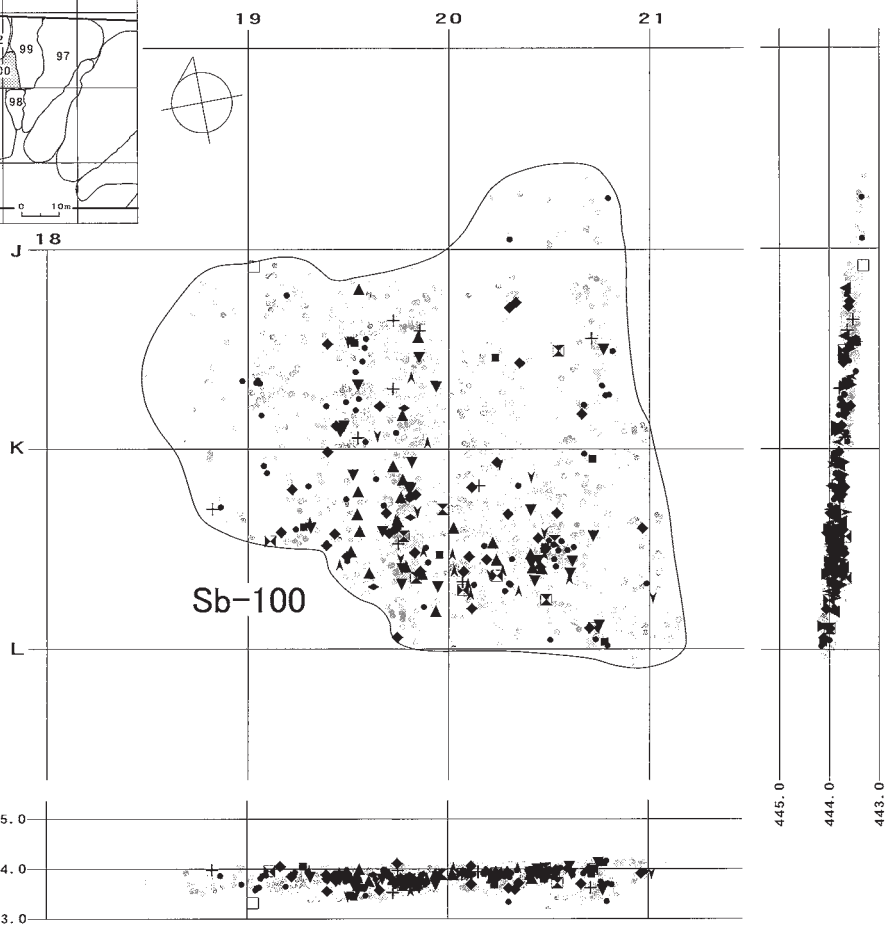
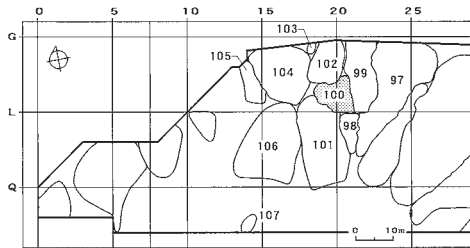
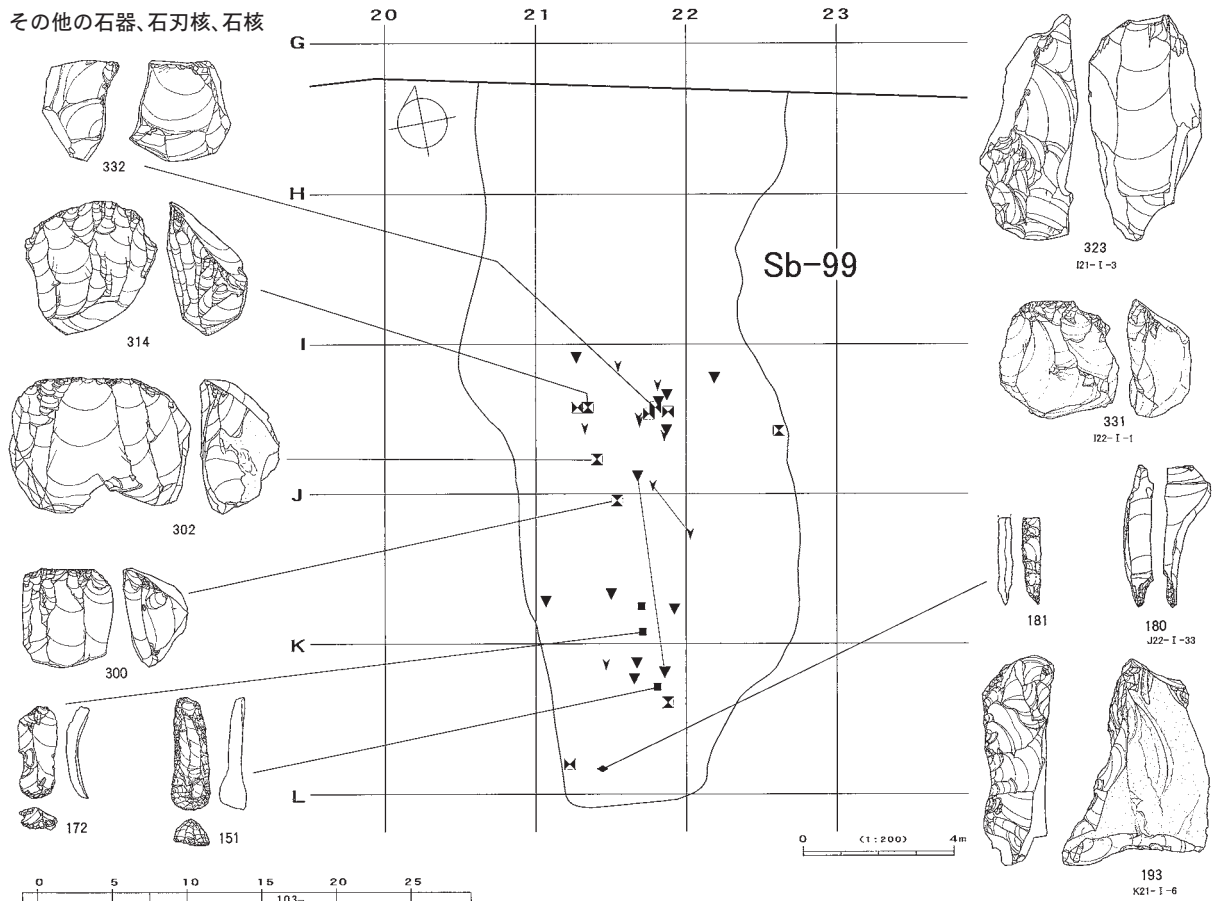

図Ⅲ-421 Sb-99の遺物(3)、Sb-100の分布図

尖頭器

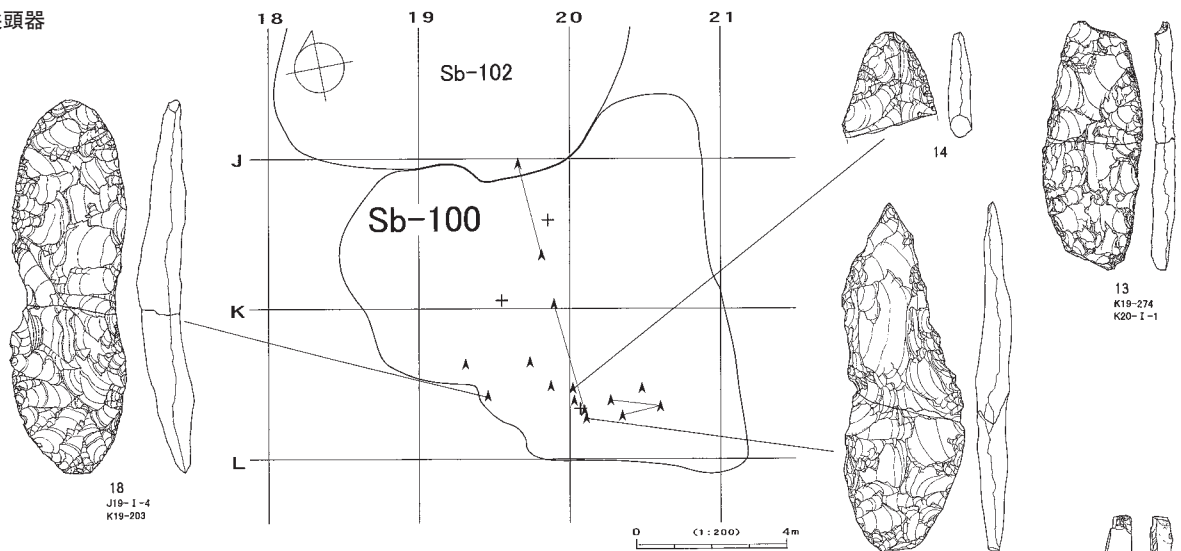

彫器、彫器削片

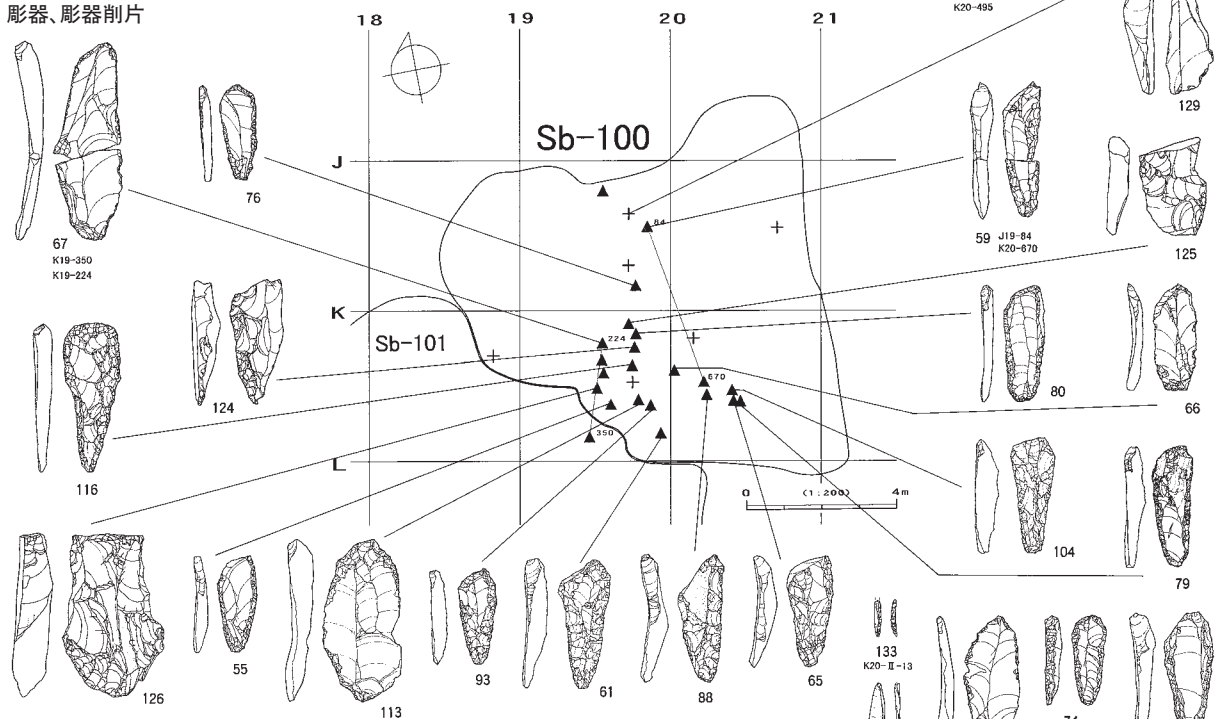

搔器

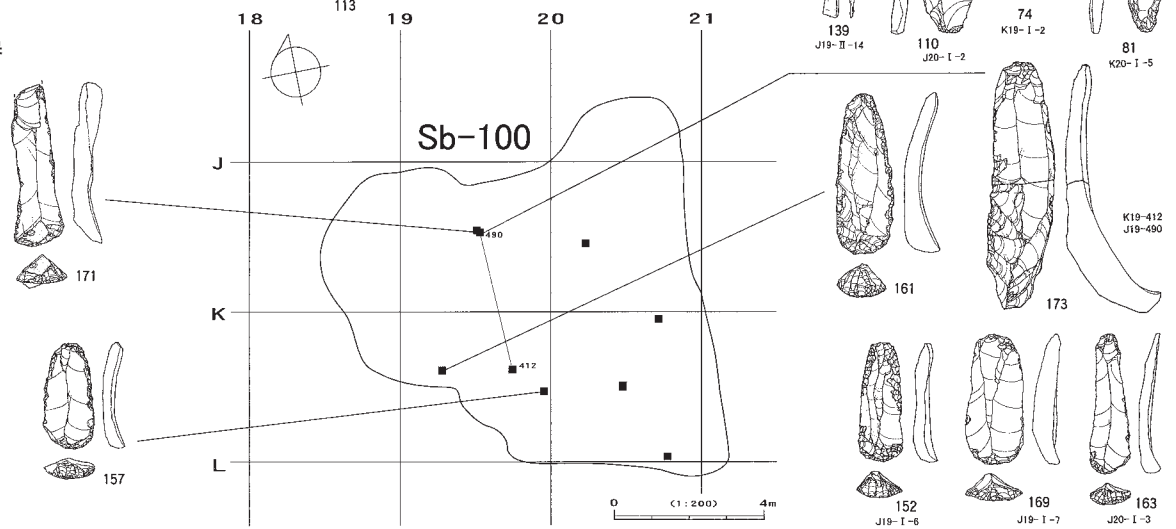

図三-422 Sb-100の遺物(1)

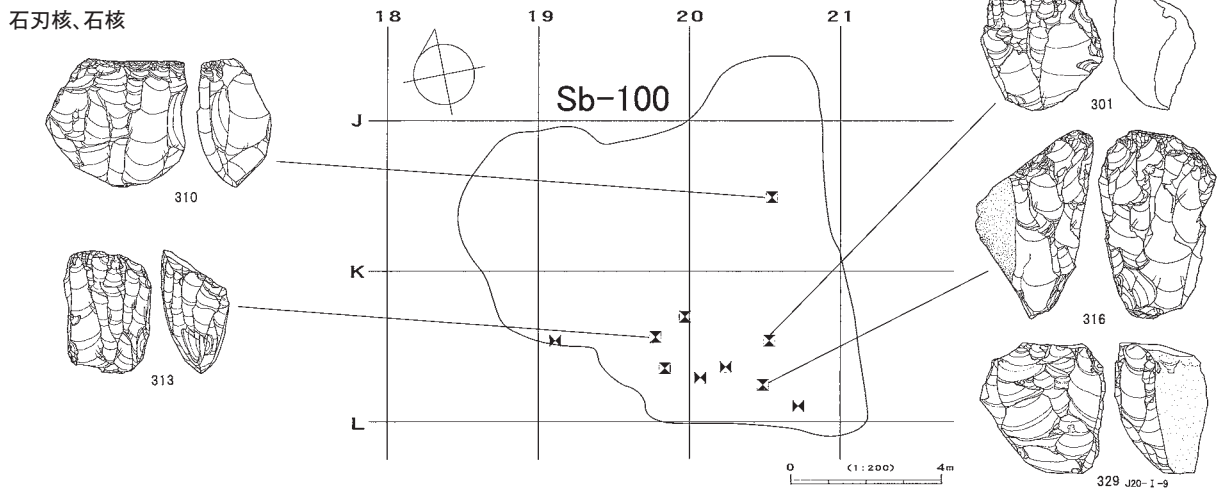
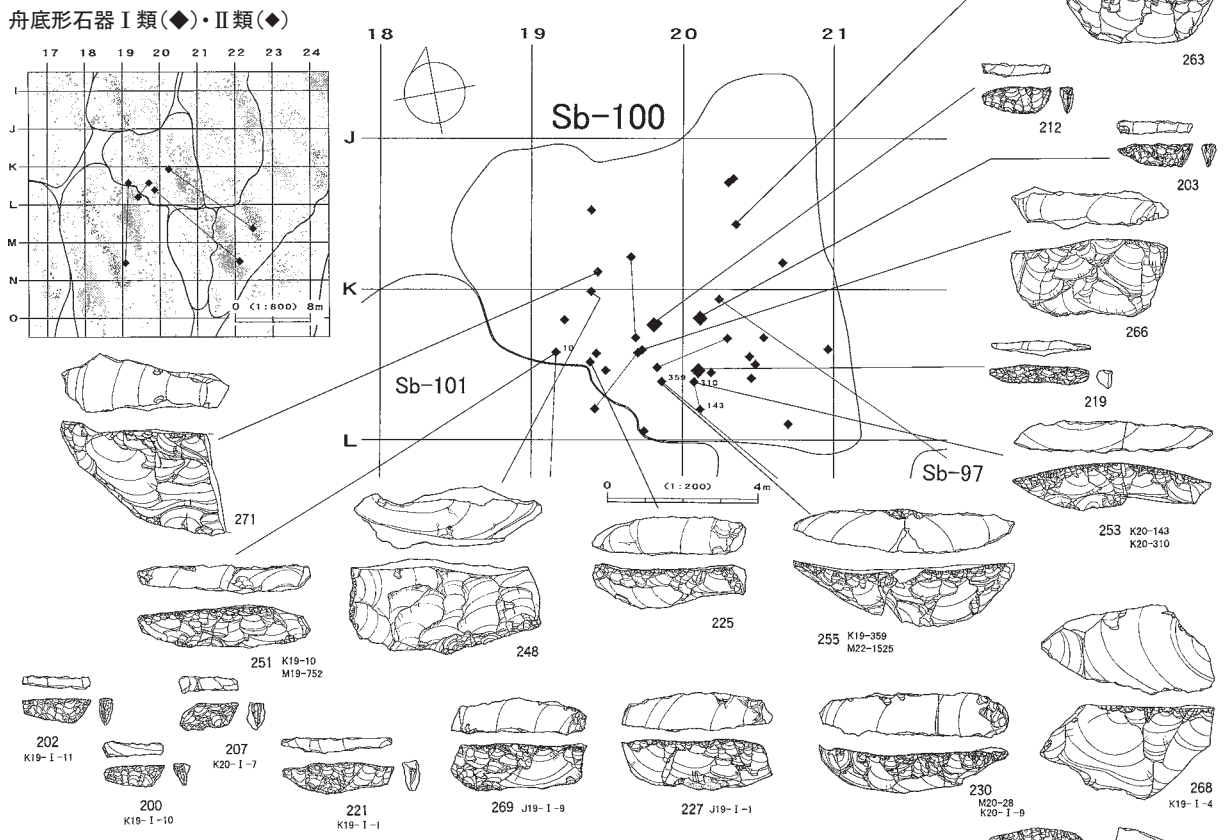
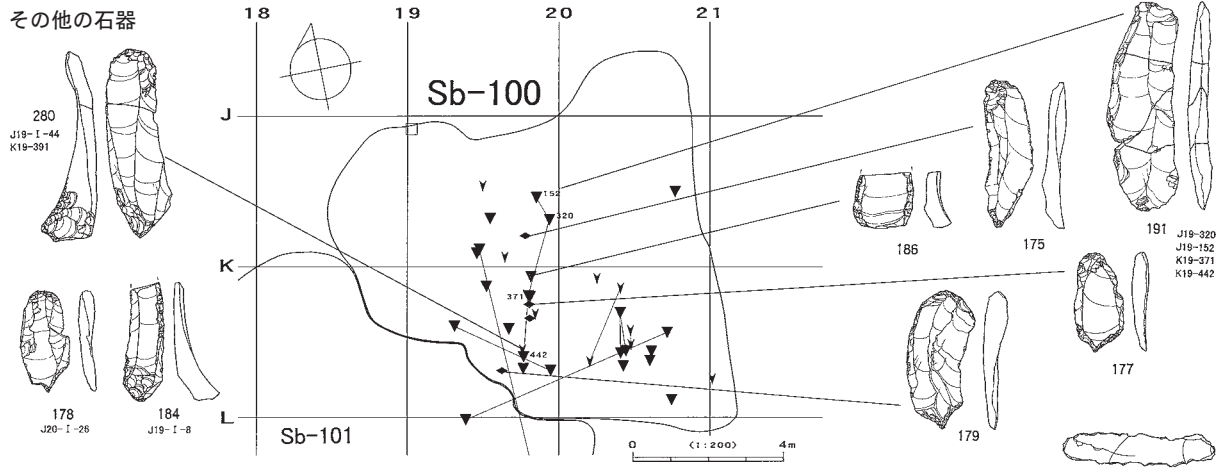

図Ⅲ-423 Sb-100の遺物(2)

J区(Sb-97~107)

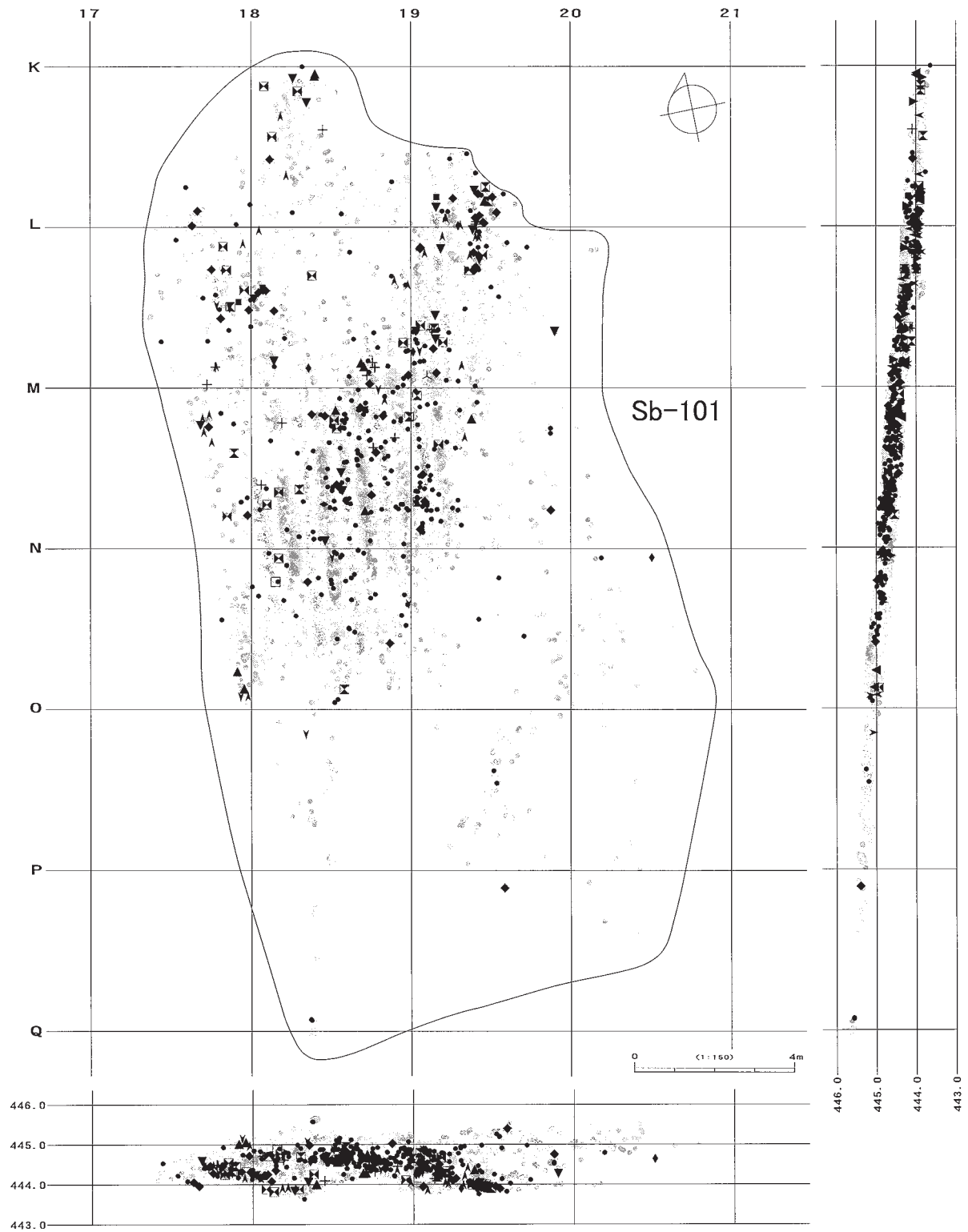
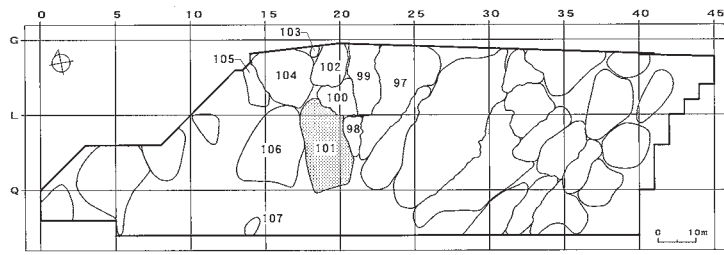

図Ⅲ-424 Sb-101の分布図

尖頭器Ⅰ類、両面調整石器

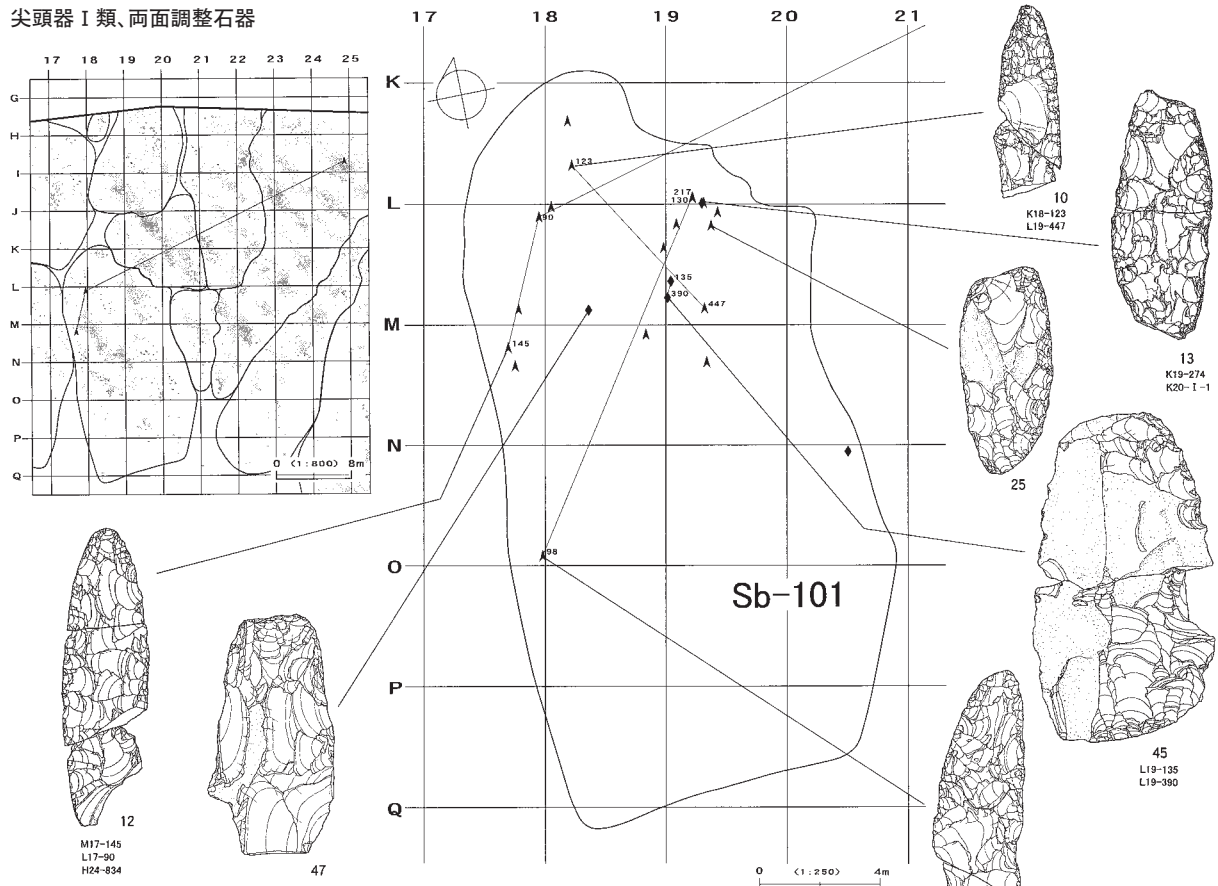

尖頭器Ⅱ類、尖頭器削片

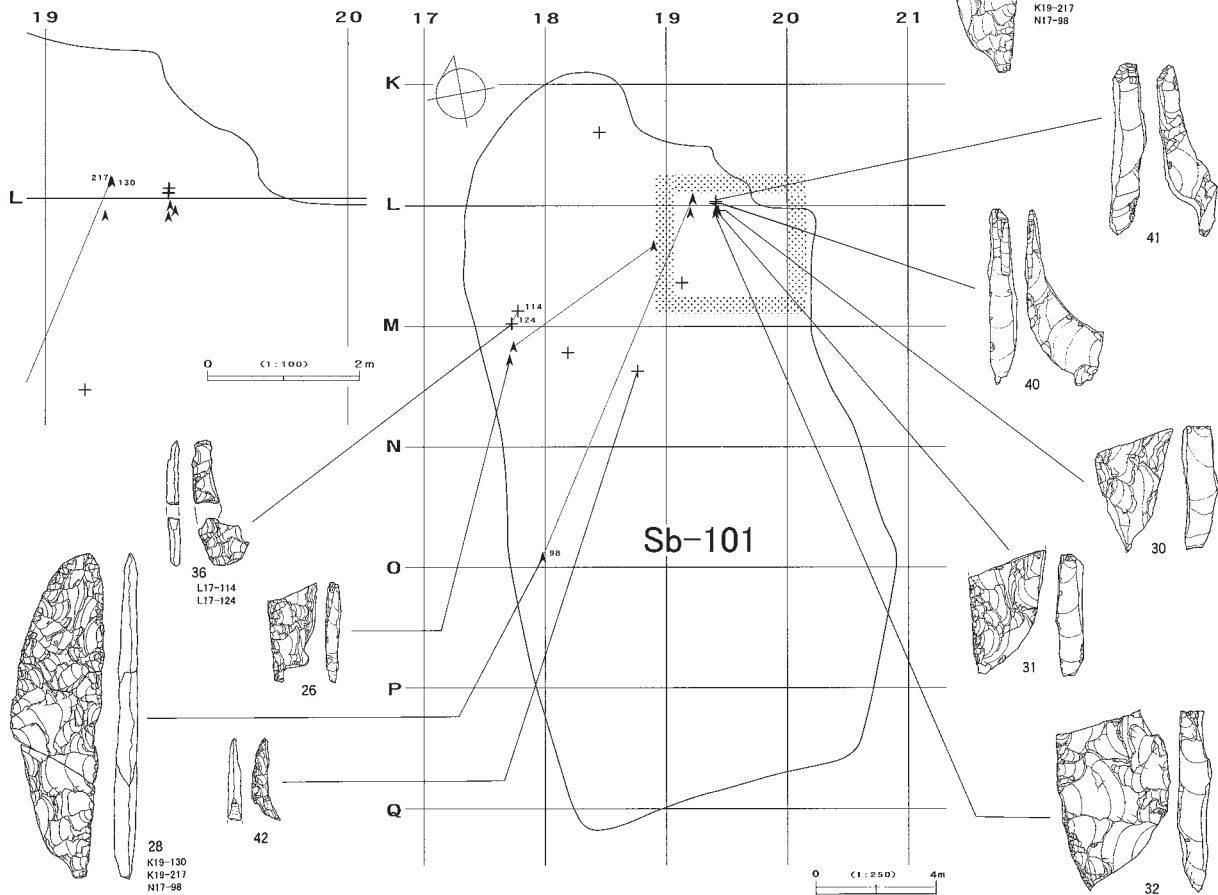

図Ⅲ-425 Sb-101の遺物(1)

彫器、彫器削片、搔器

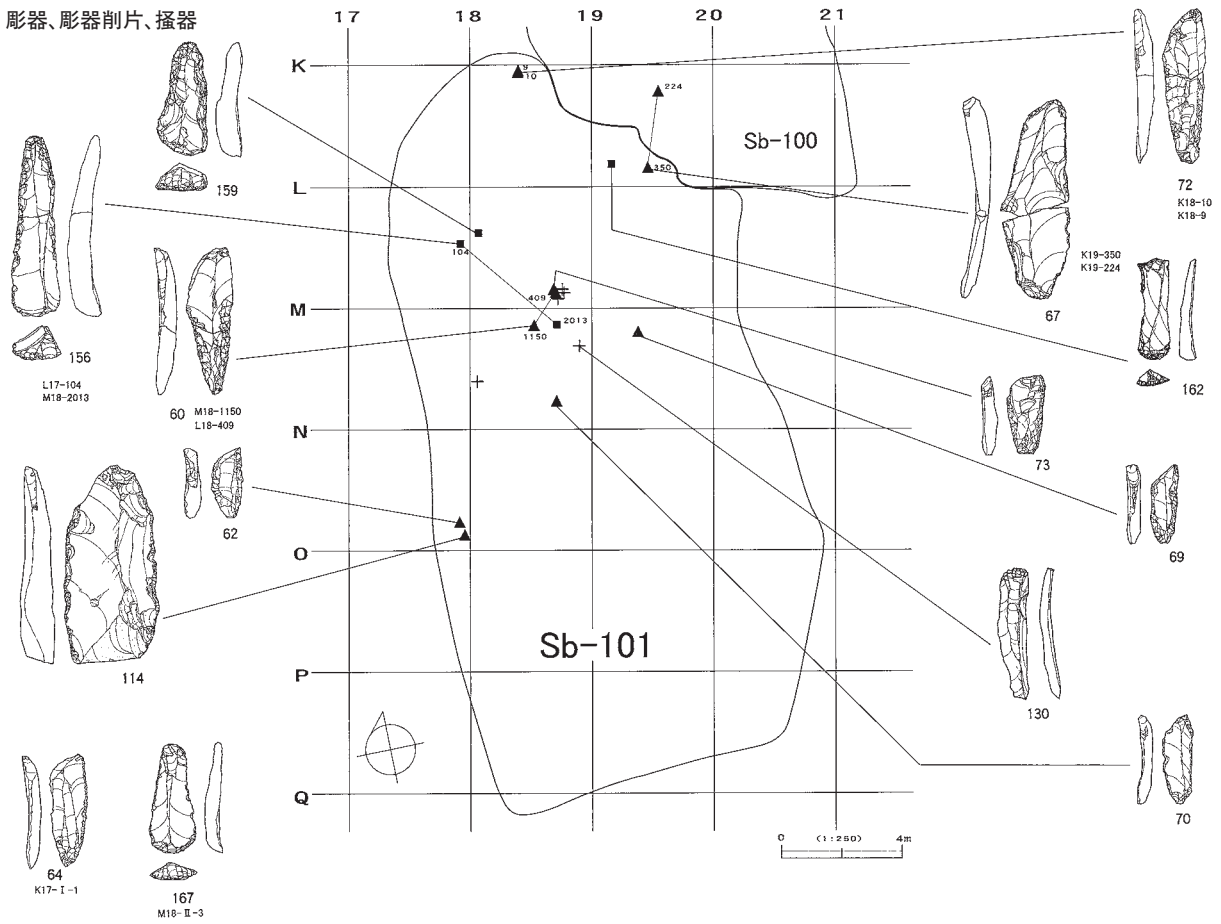

その他の石器

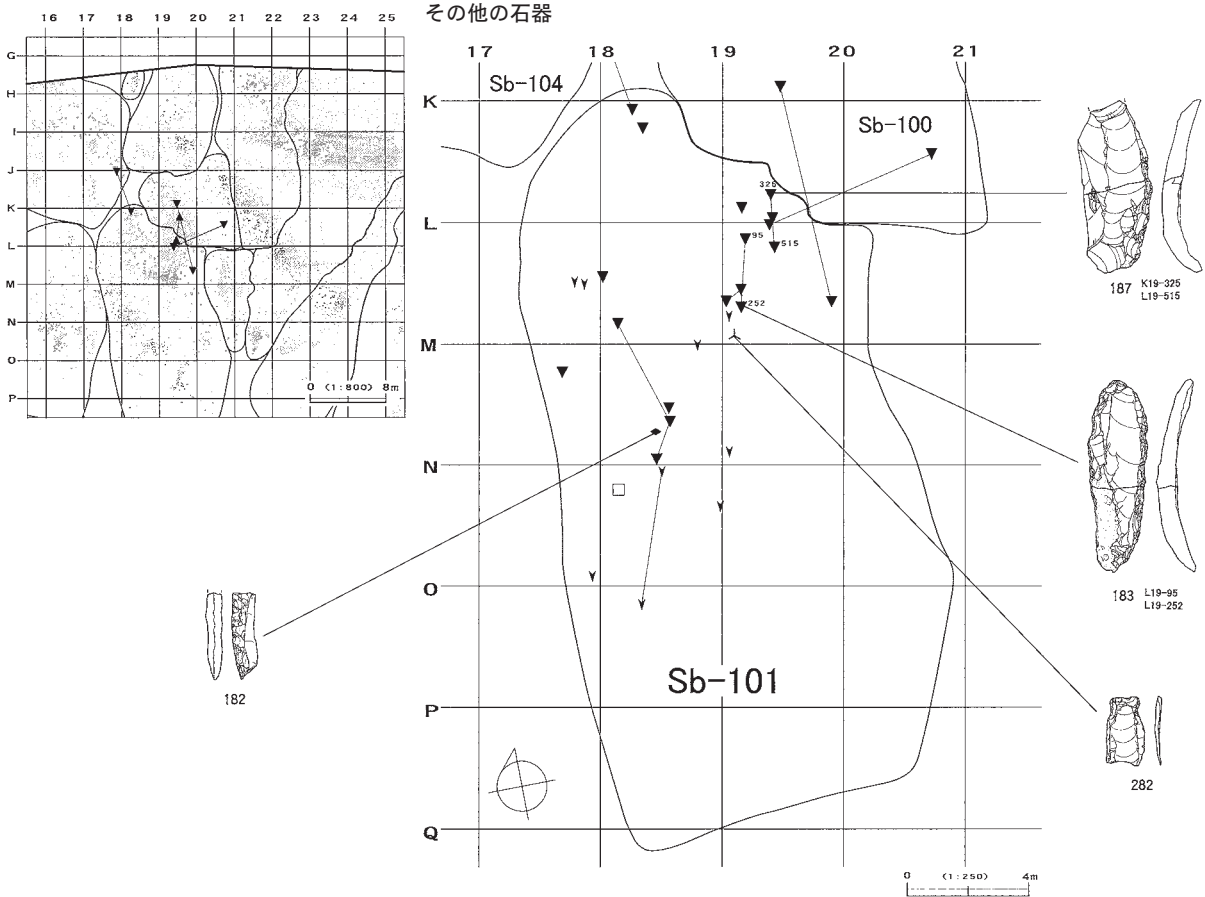

図Ⅲ-426 Sb-101の遺物(2)

舟底形石器 I類(◆)・II類(◇)

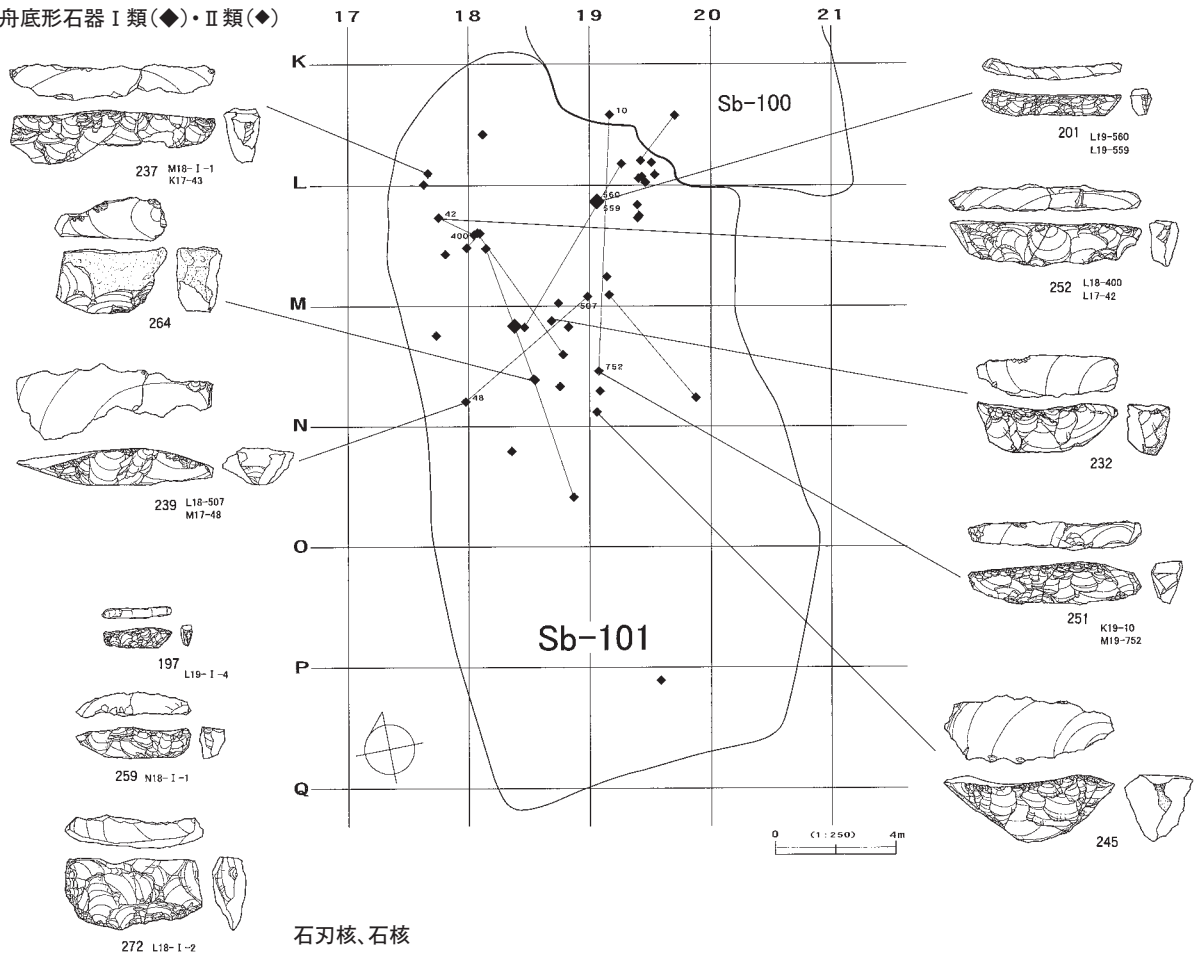

石刃核、石核

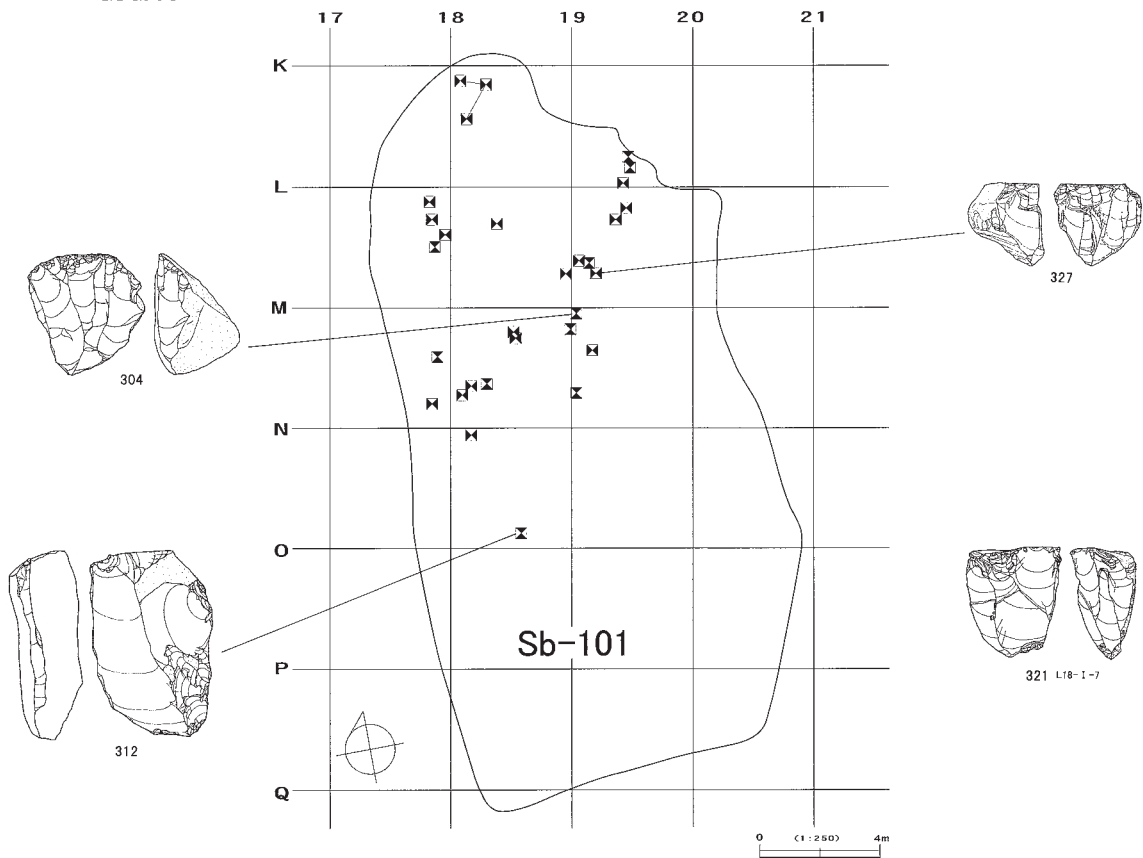

図Ⅲ-427 Sb-101の遺物(3)

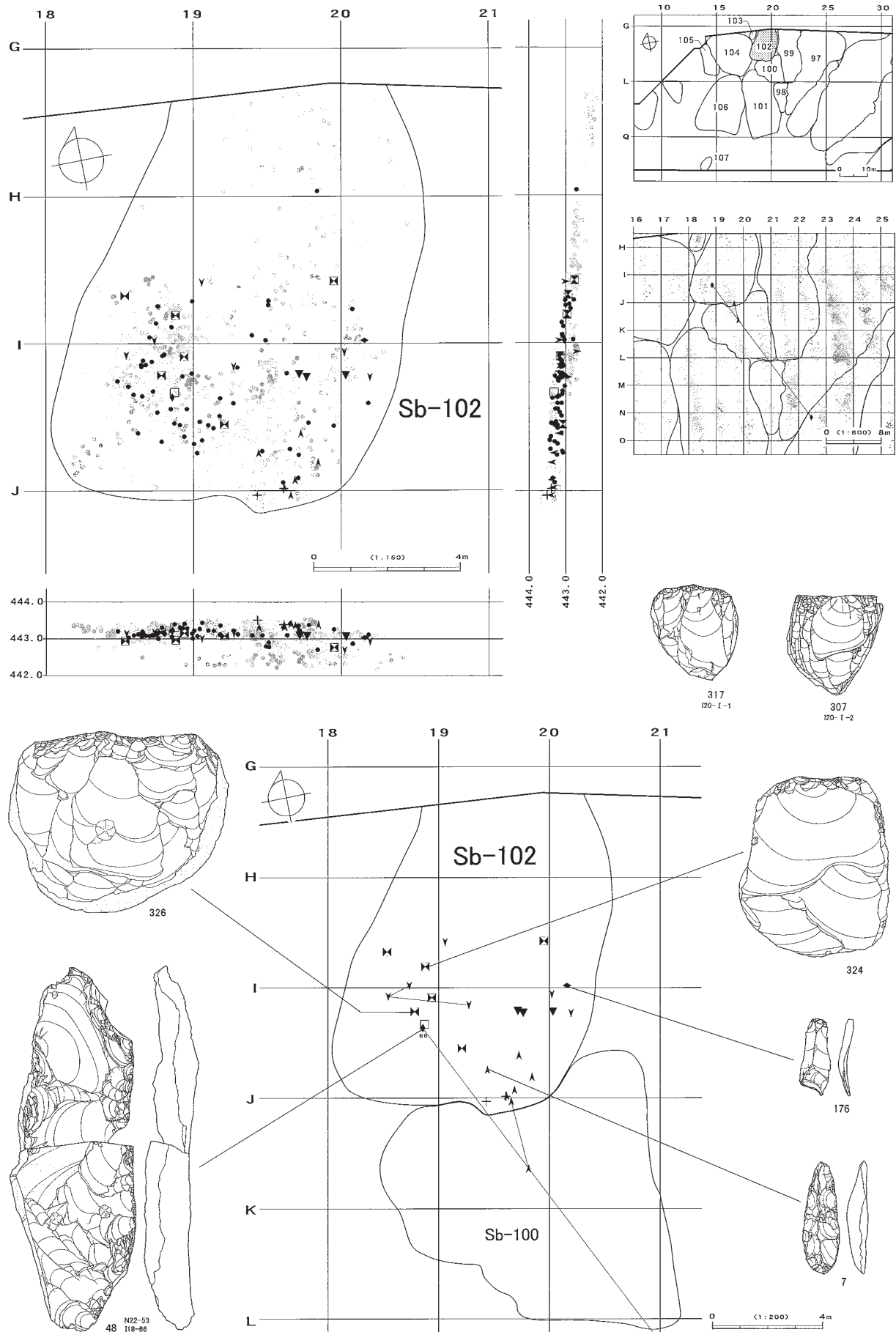

図III-428 Sb-102の分布図・遺物

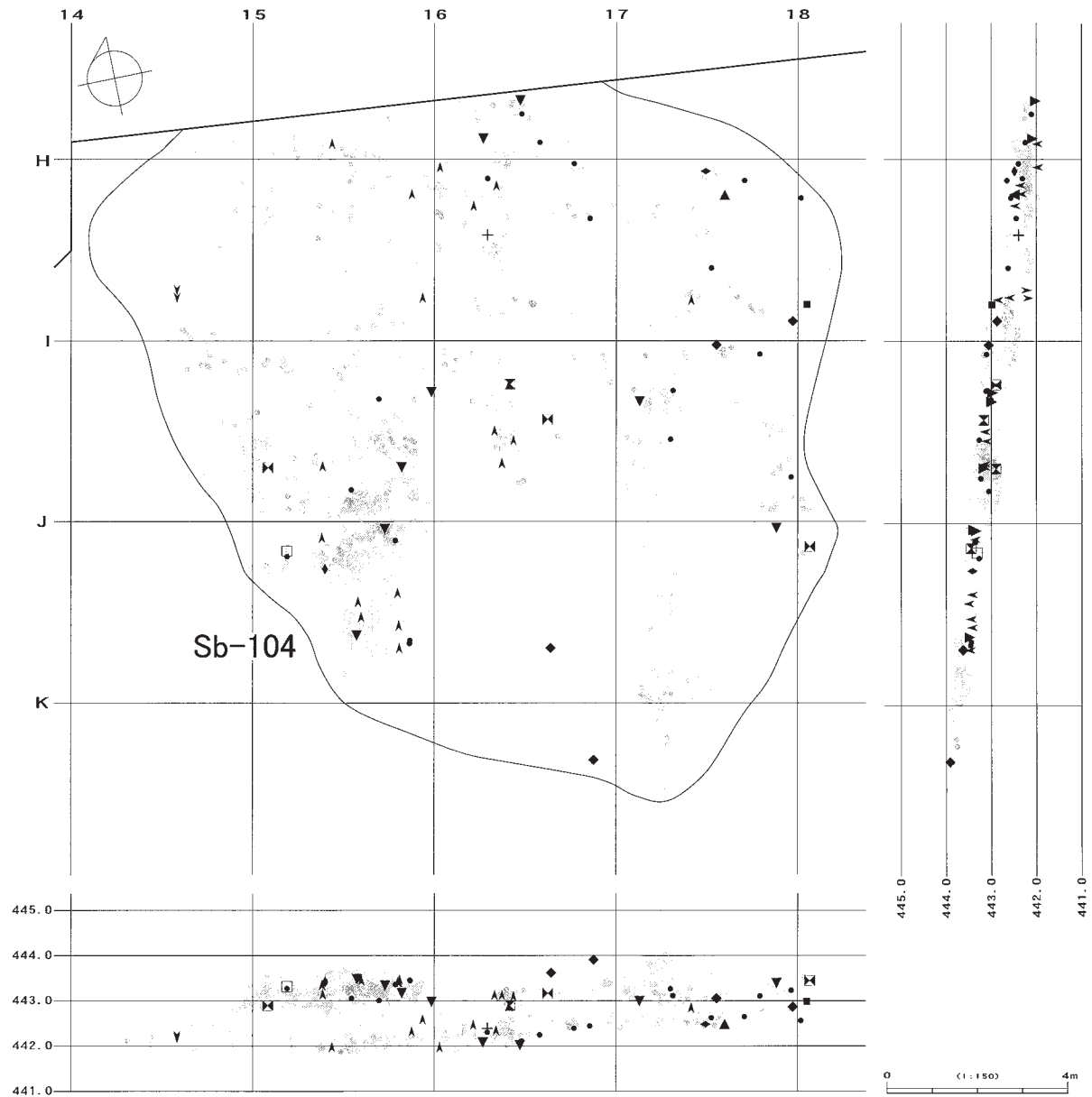
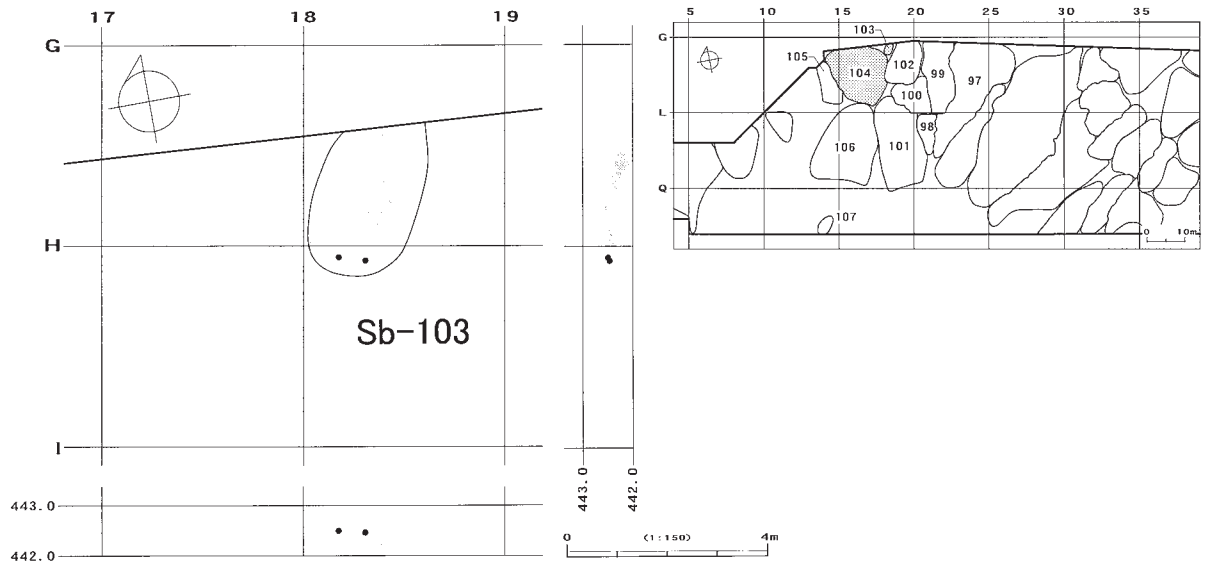

図Ⅲ-429 Sb-103・104の分布図

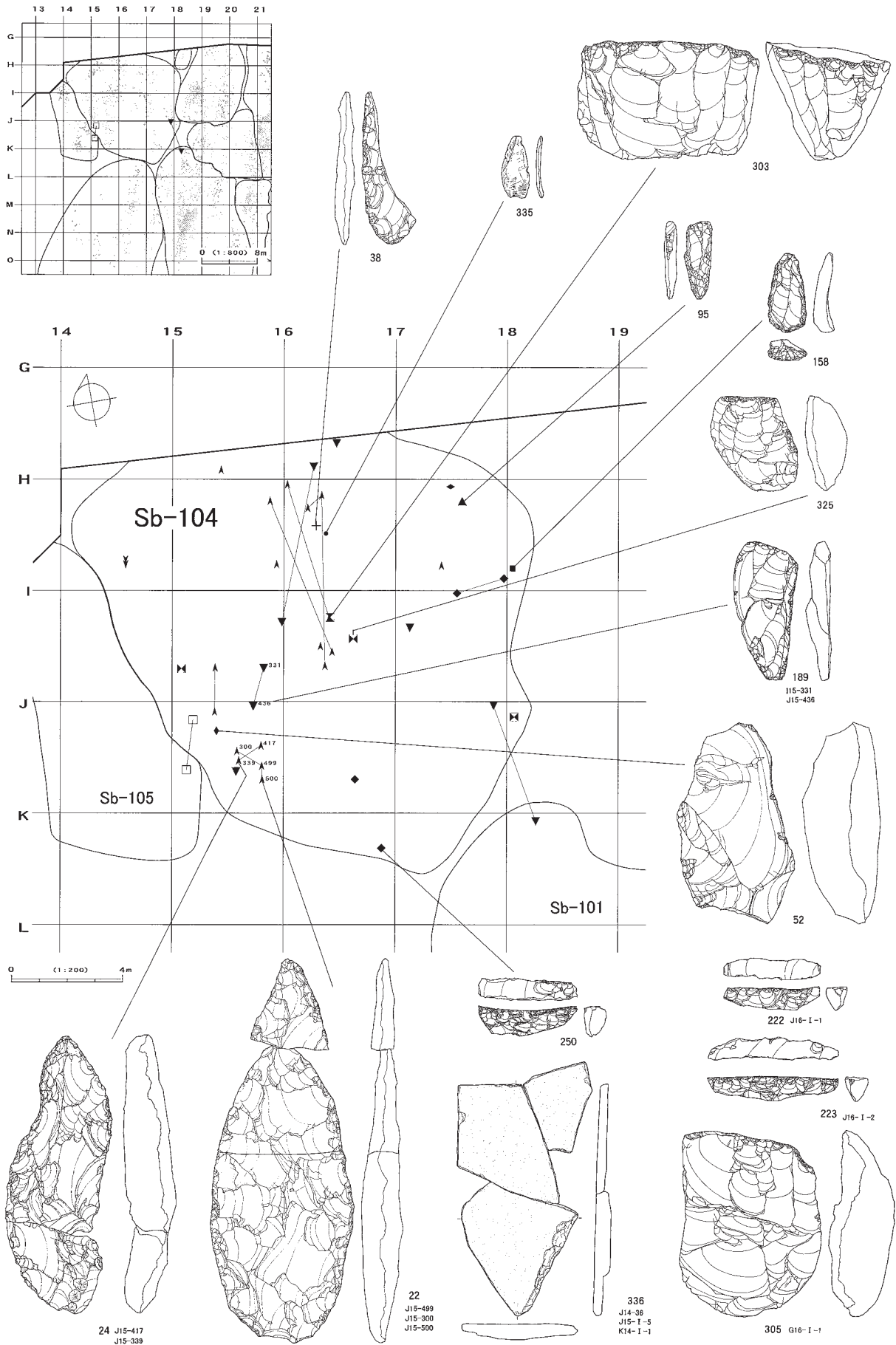

図Ⅲ-430 Sb-104の遺物

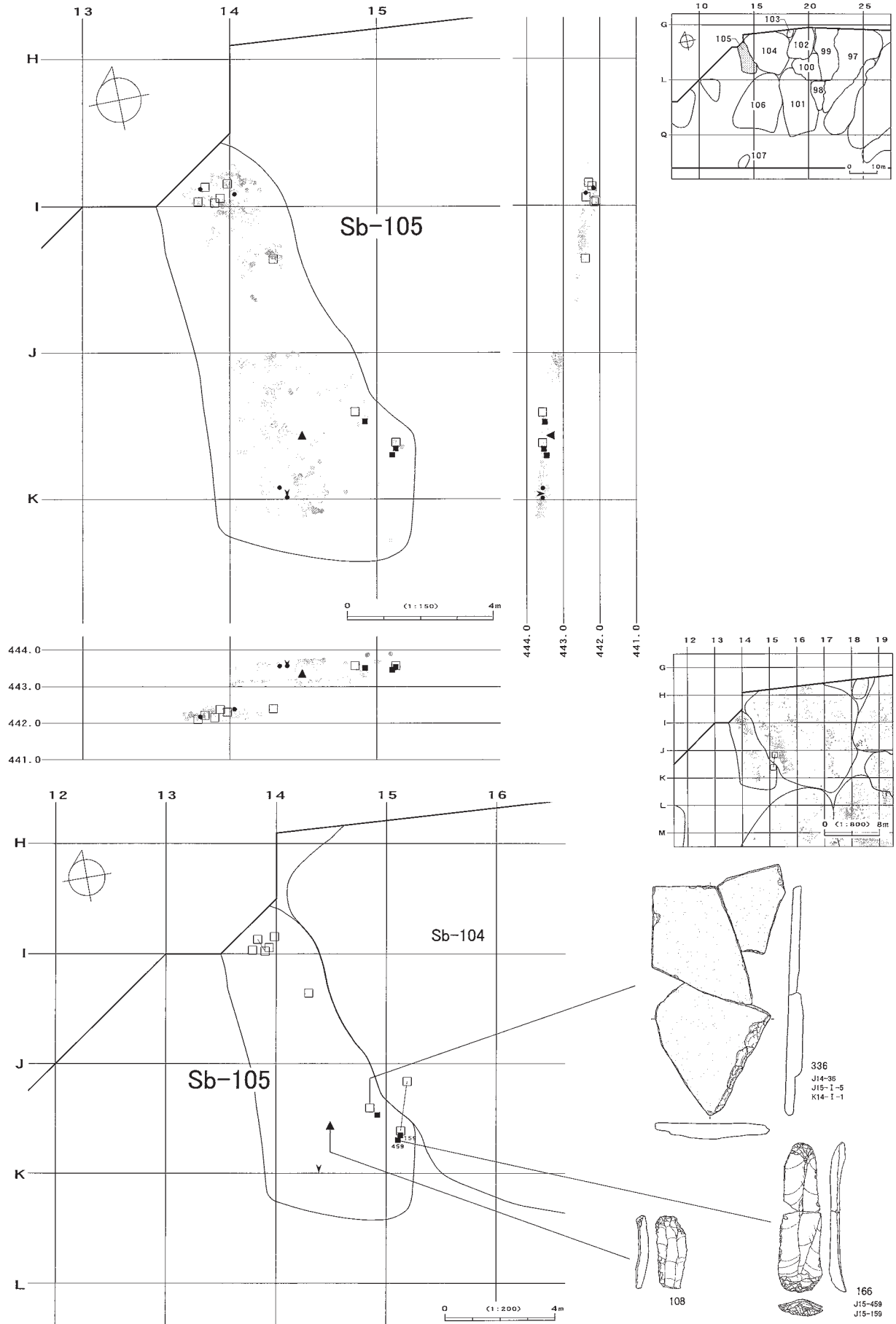

図Ⅲ-431 Sb-105の分布図・遺物

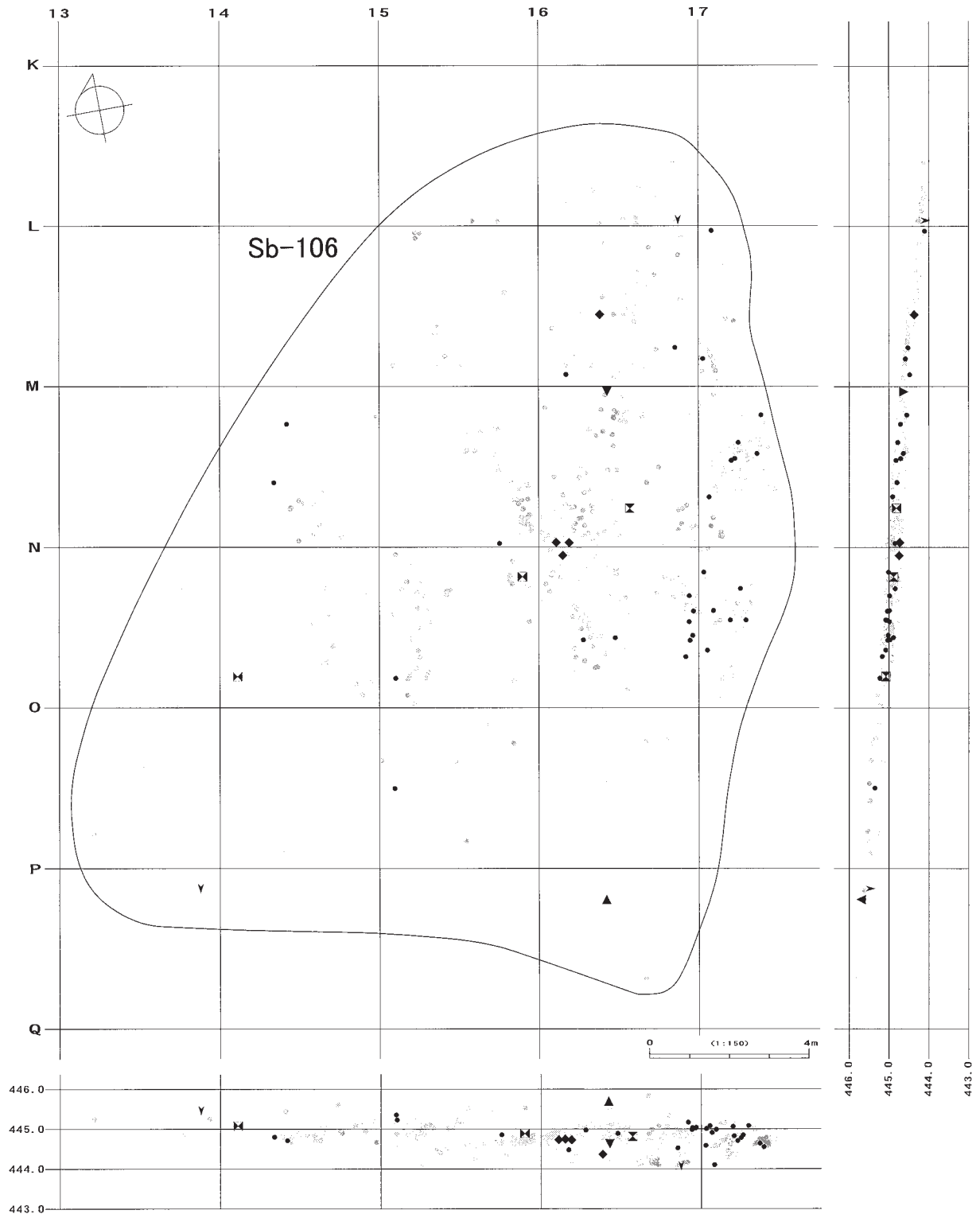
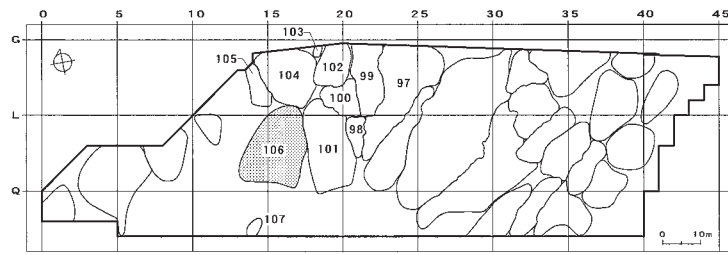

図Ⅲ-432 Sb-106の分布図

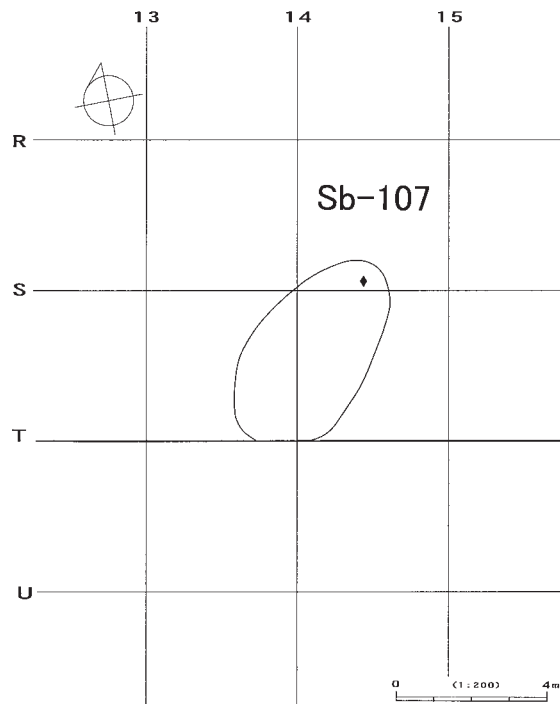
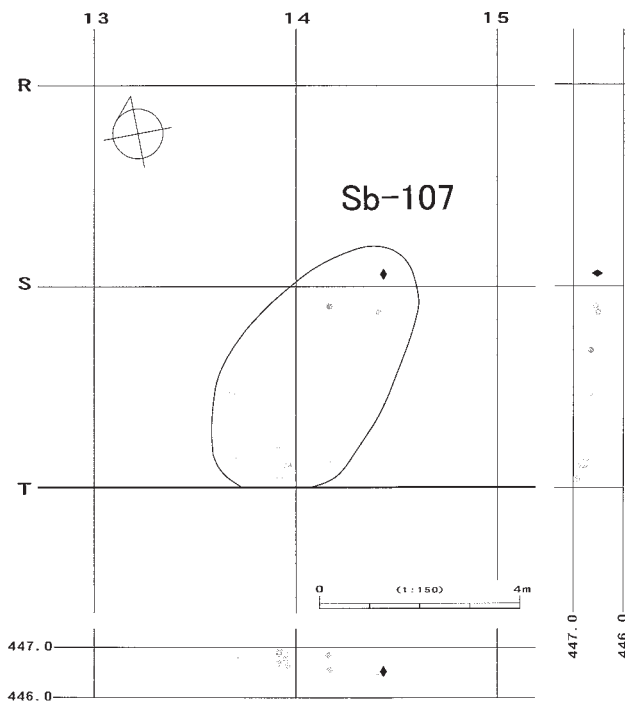
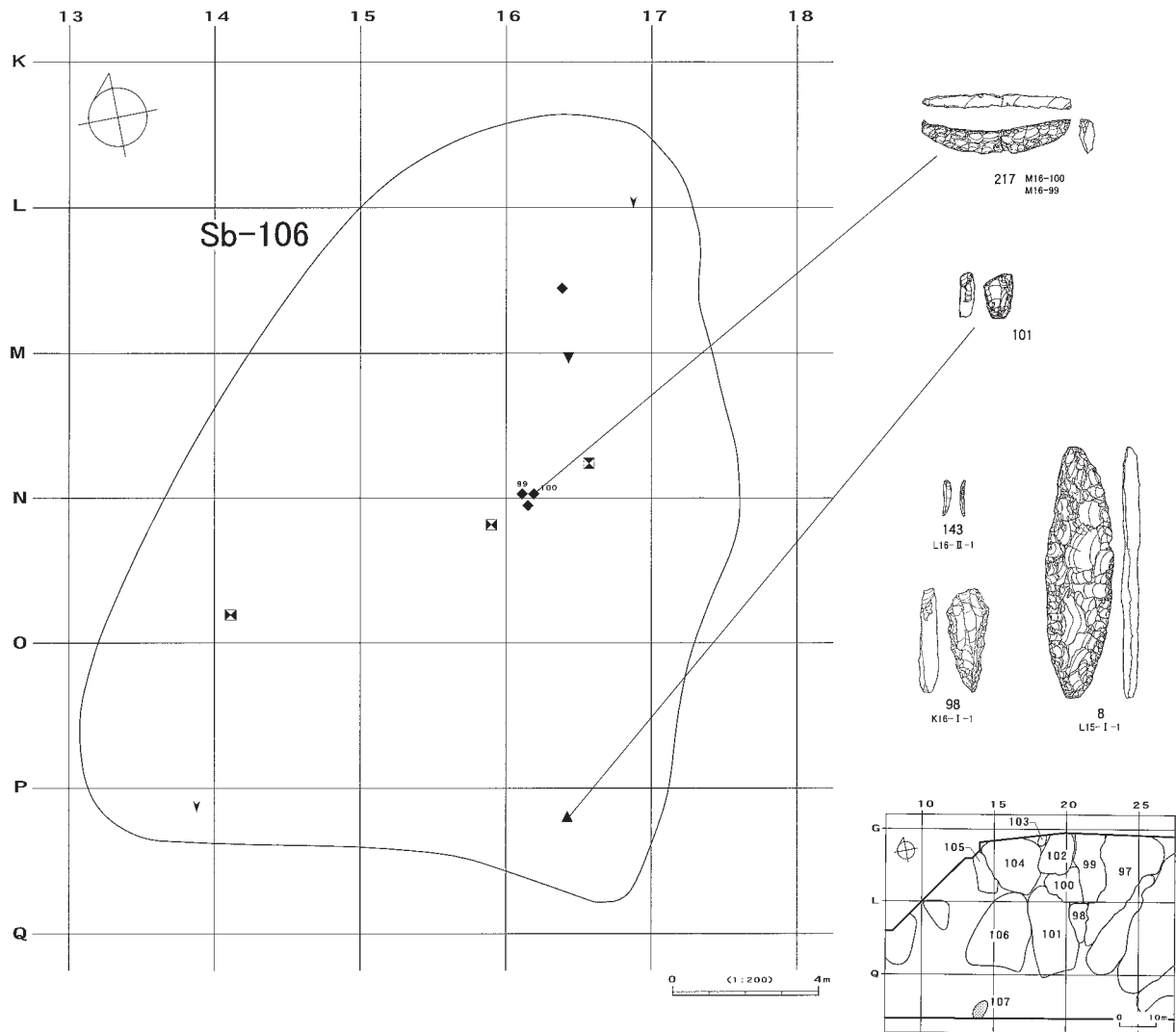

図Ⅲ-433 Sb-106・107の分布図・遺物

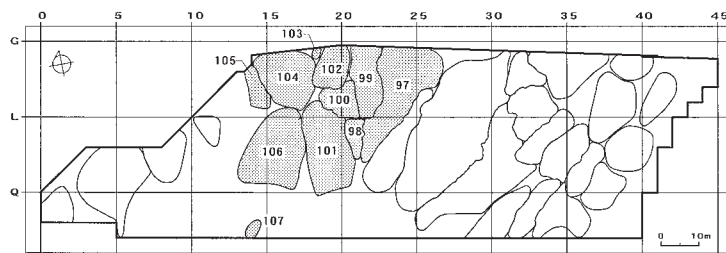

全接合分布図

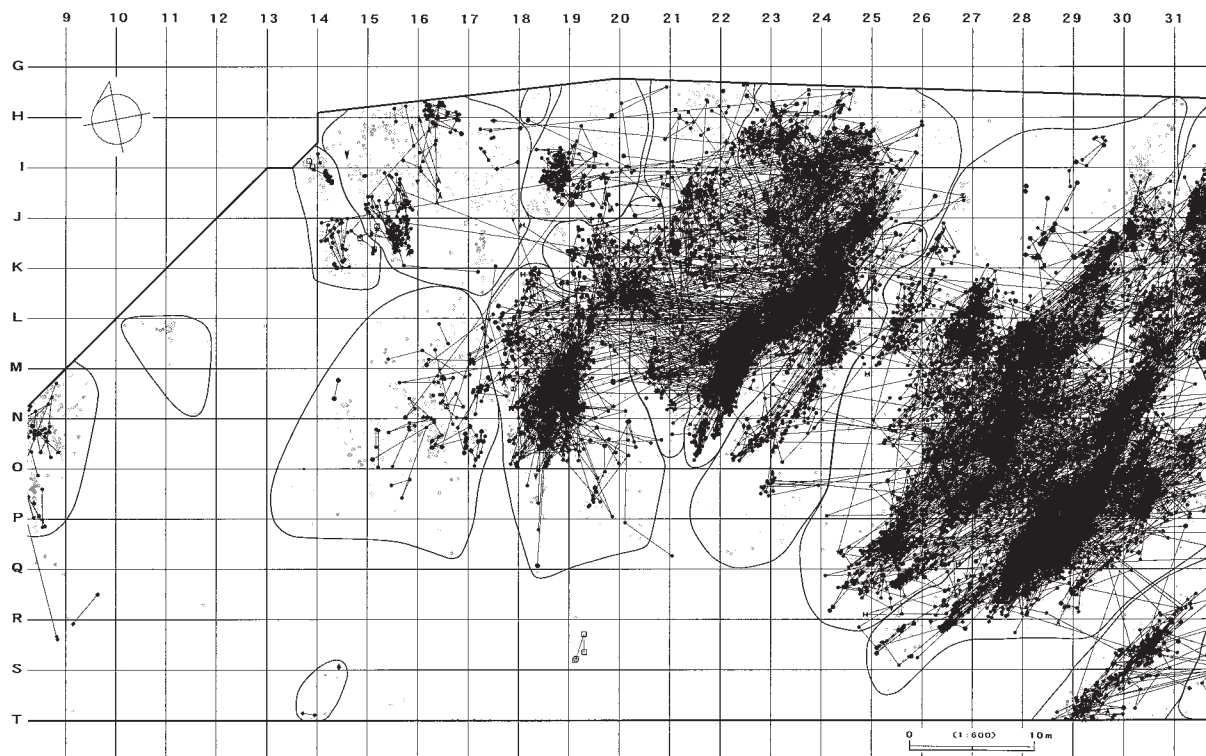

折れ面接合分布図

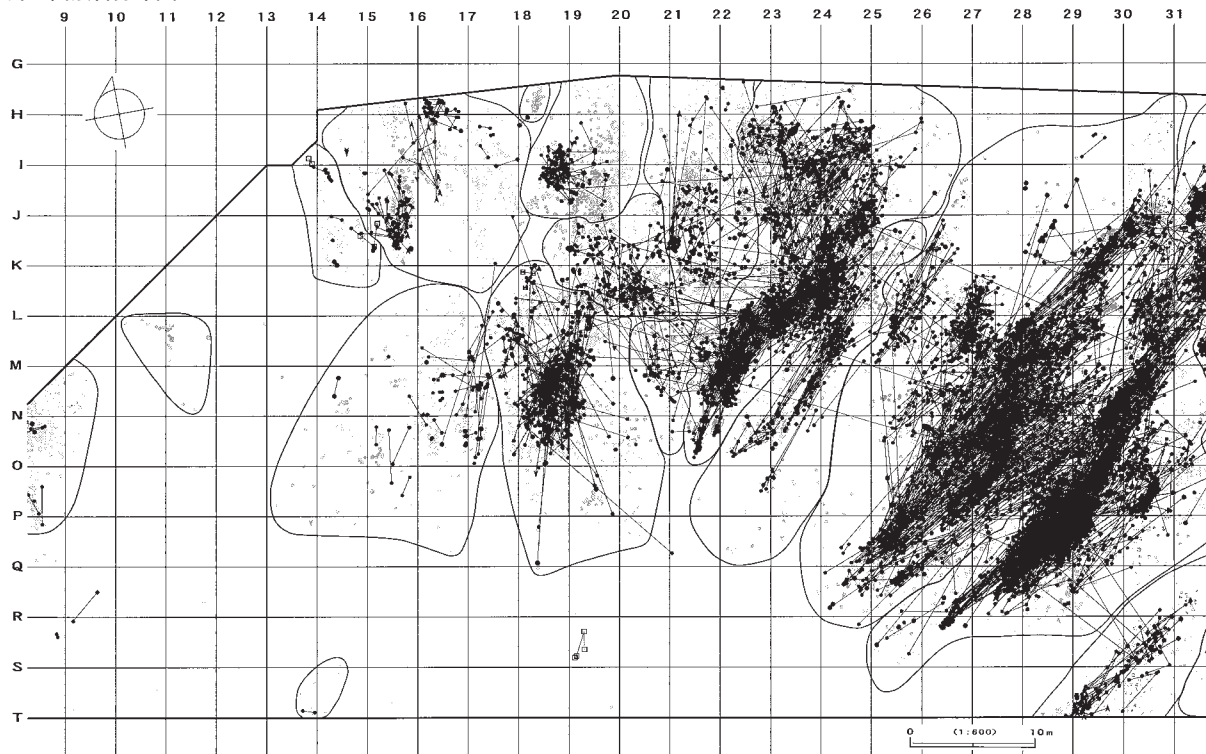

図Ⅲ-434 J区(Sb-97~107)の接合分布図

母岩1029・接合4324

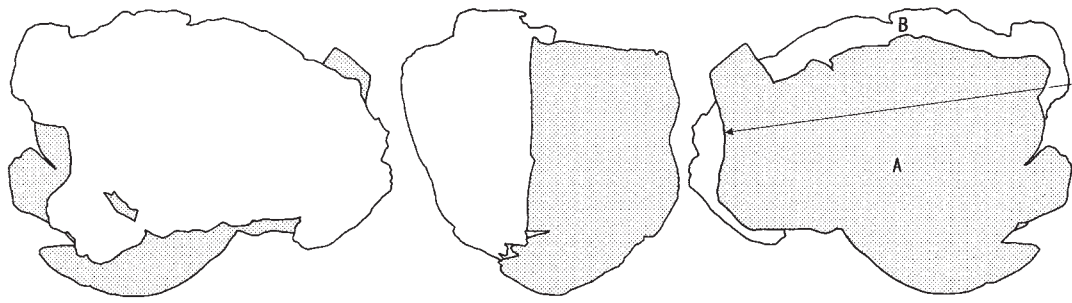

個体A

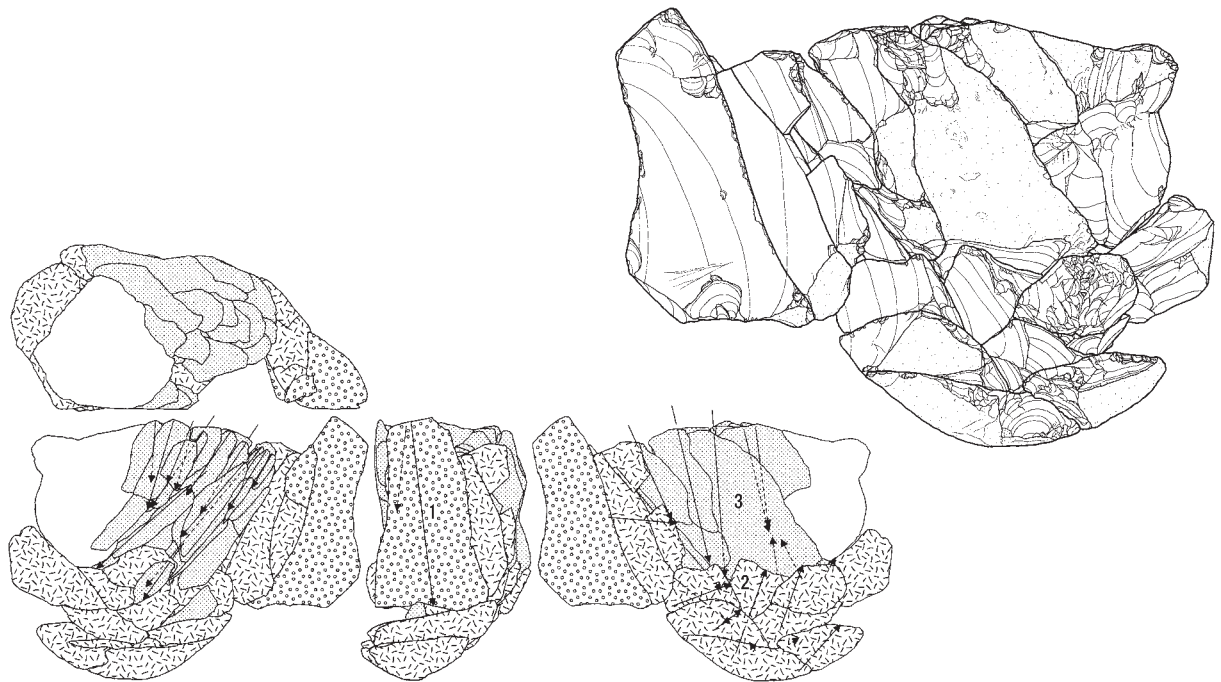
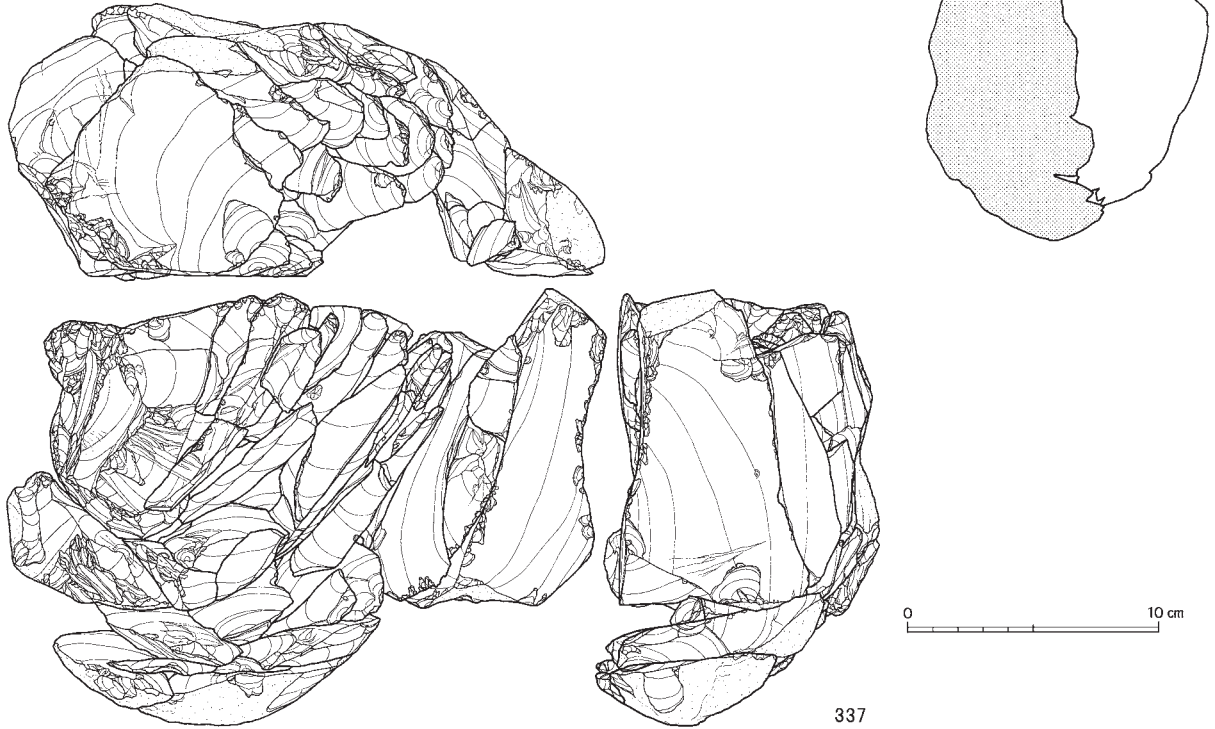

図Ⅲ-435 J区(Sb-97~107)の石器(41) 母岩1029・接合4324(1)

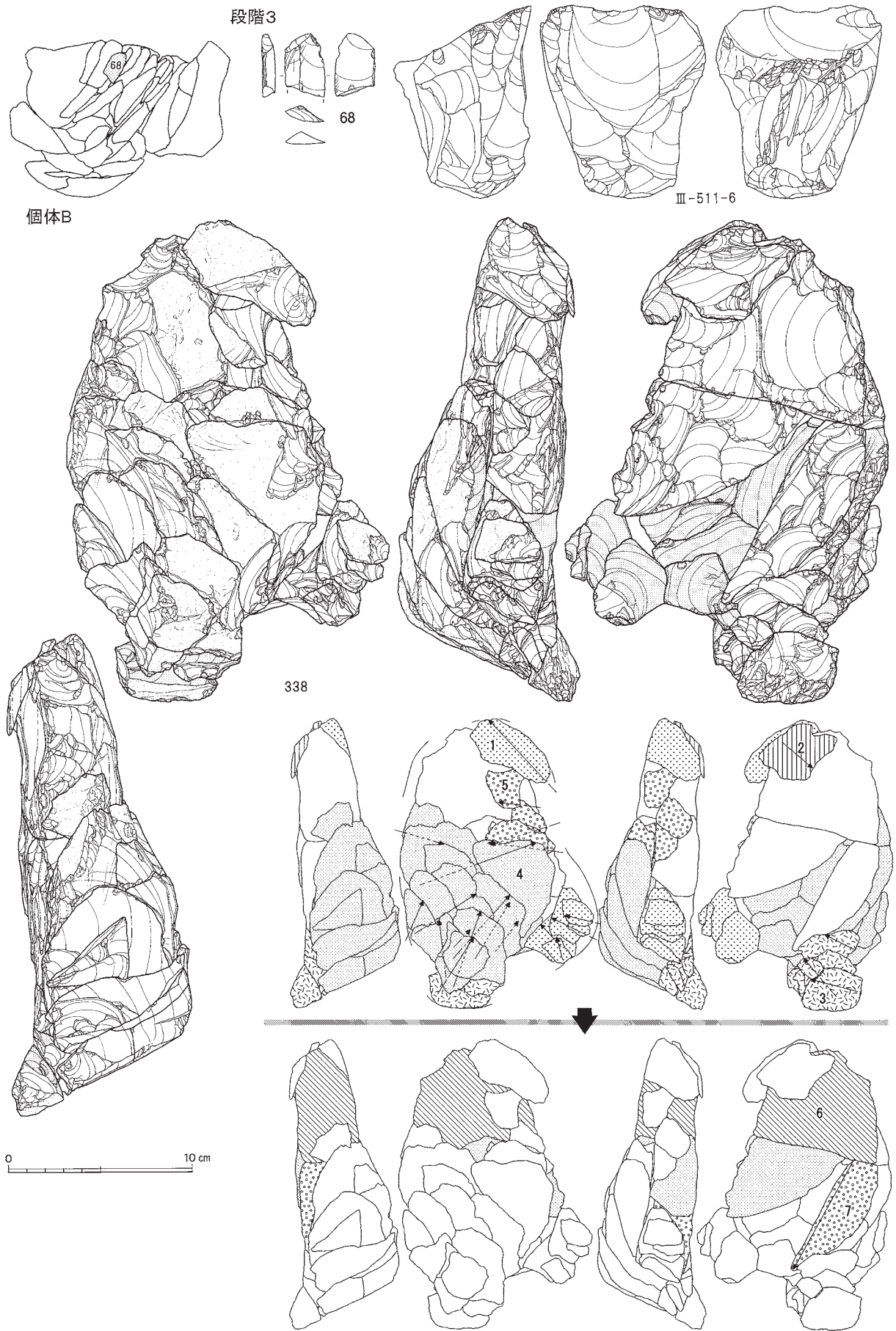

図Ⅲ-436 J区(Sb-97~107)の石器(42) 母岩1029・接合4324(2)

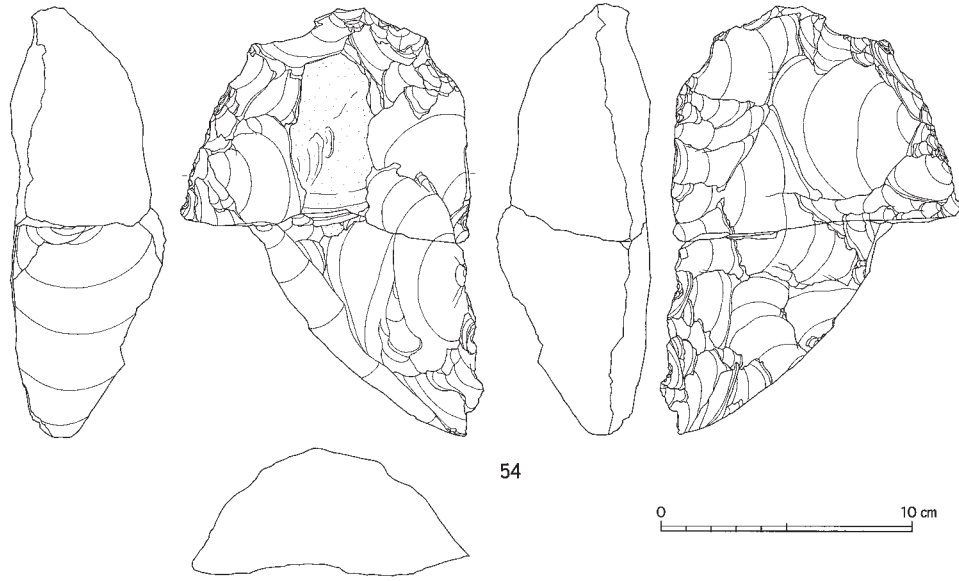

54

接合4324(個体A)分布図

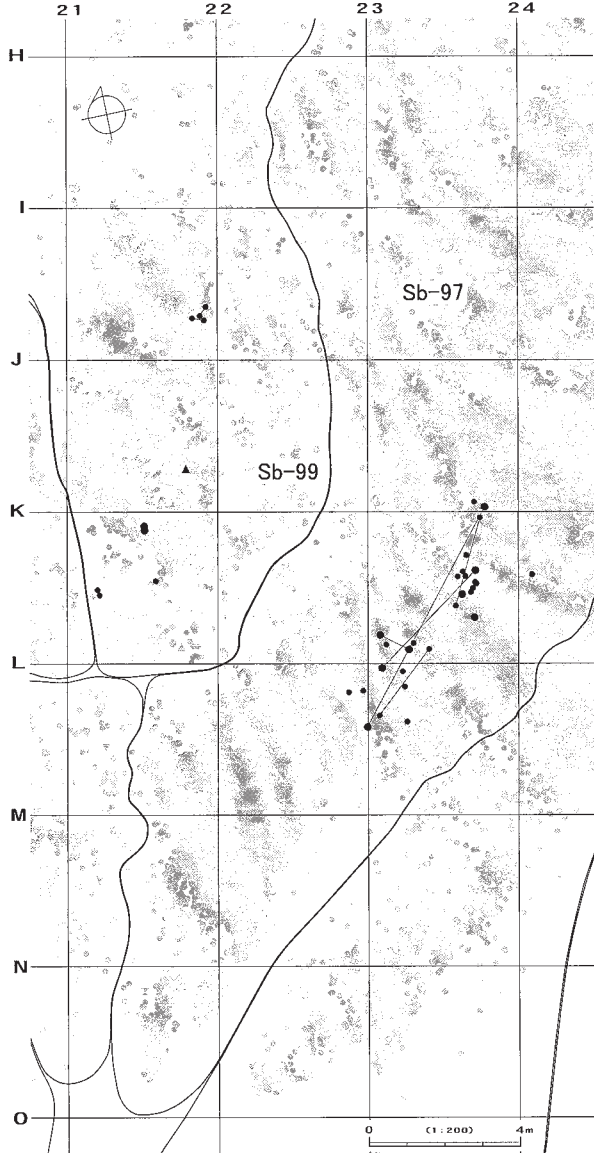

接合4324(個体B)分布図

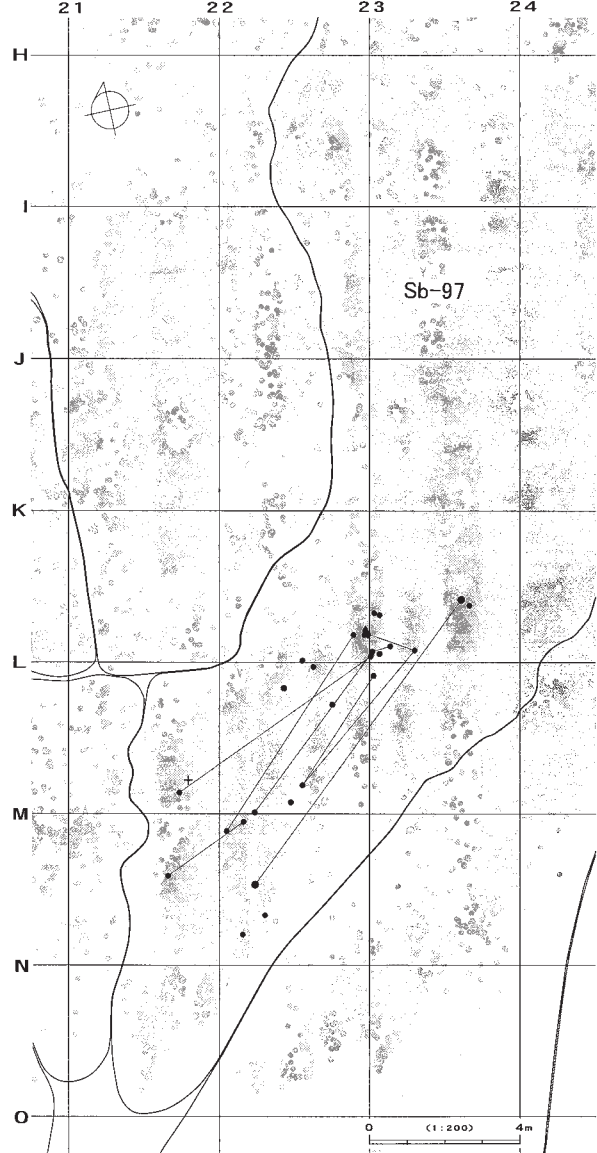

図Ⅲ-437 J区(Sb-97~107)の石器(43) 母岩1029・接合4324(3)

母岩1134・接合4613

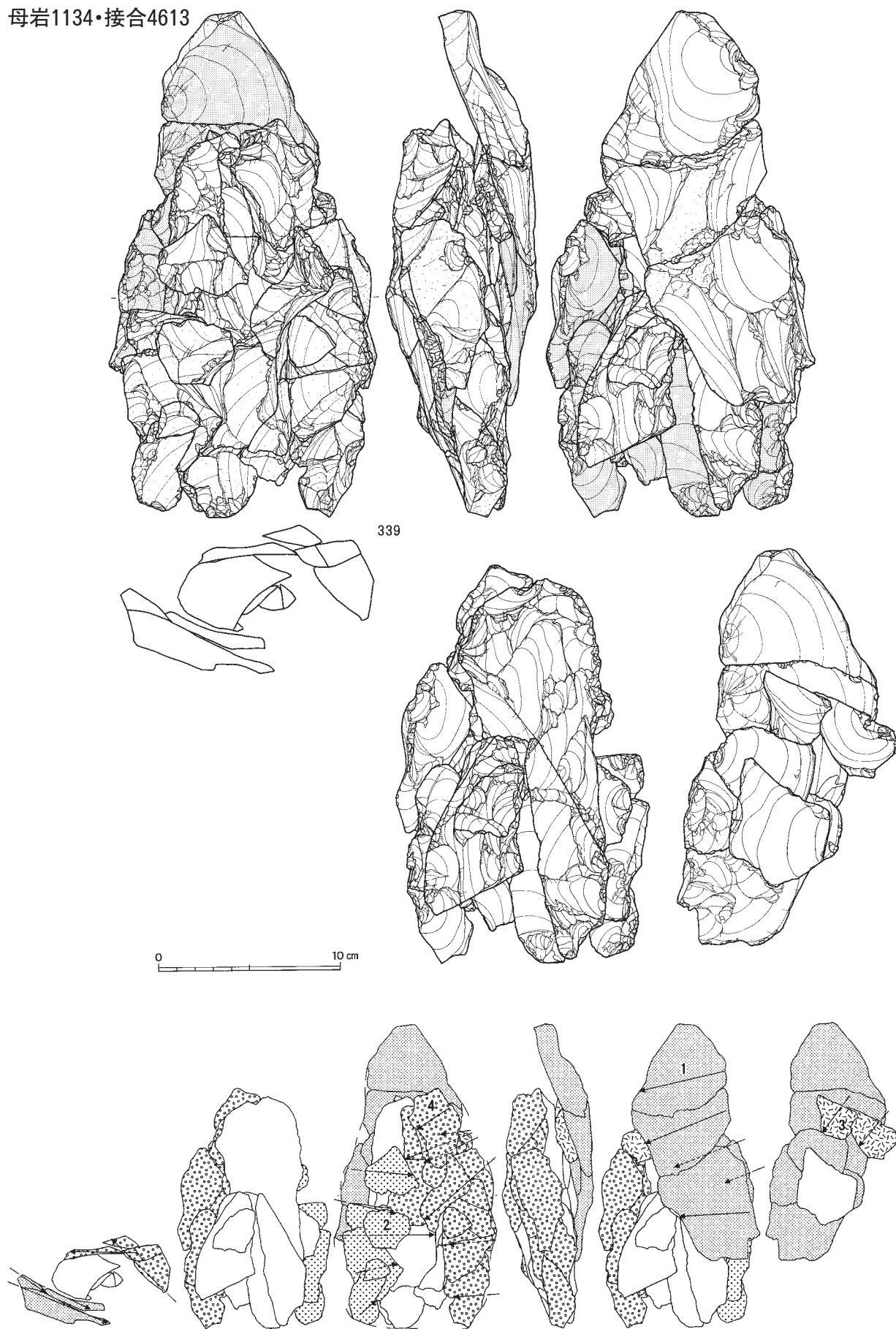

図Ⅲ-438 J区(Sb-97~107)の石器(44) 母岩1134・接合4613(1)

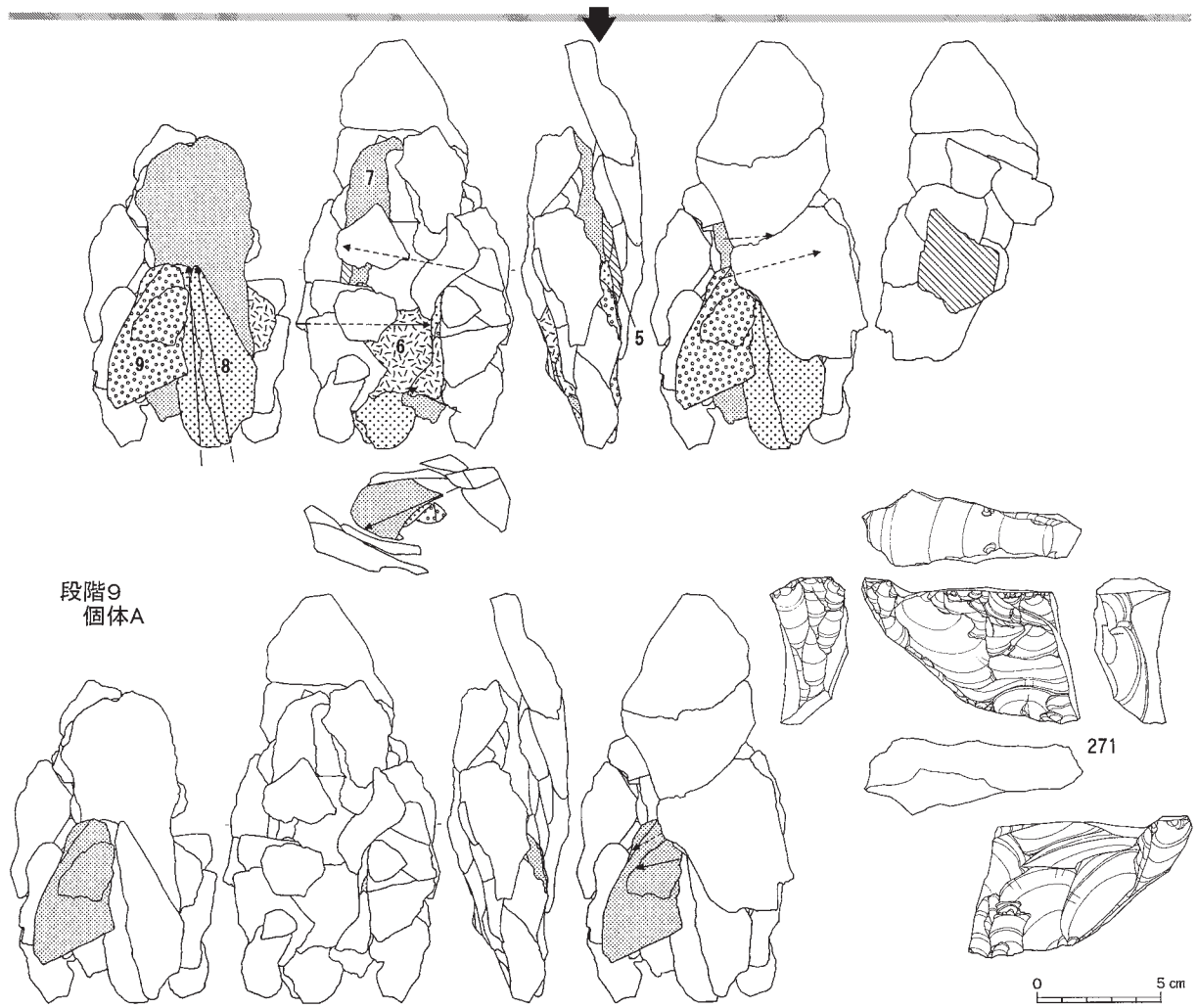

段階9
個体A

接合4613分布図

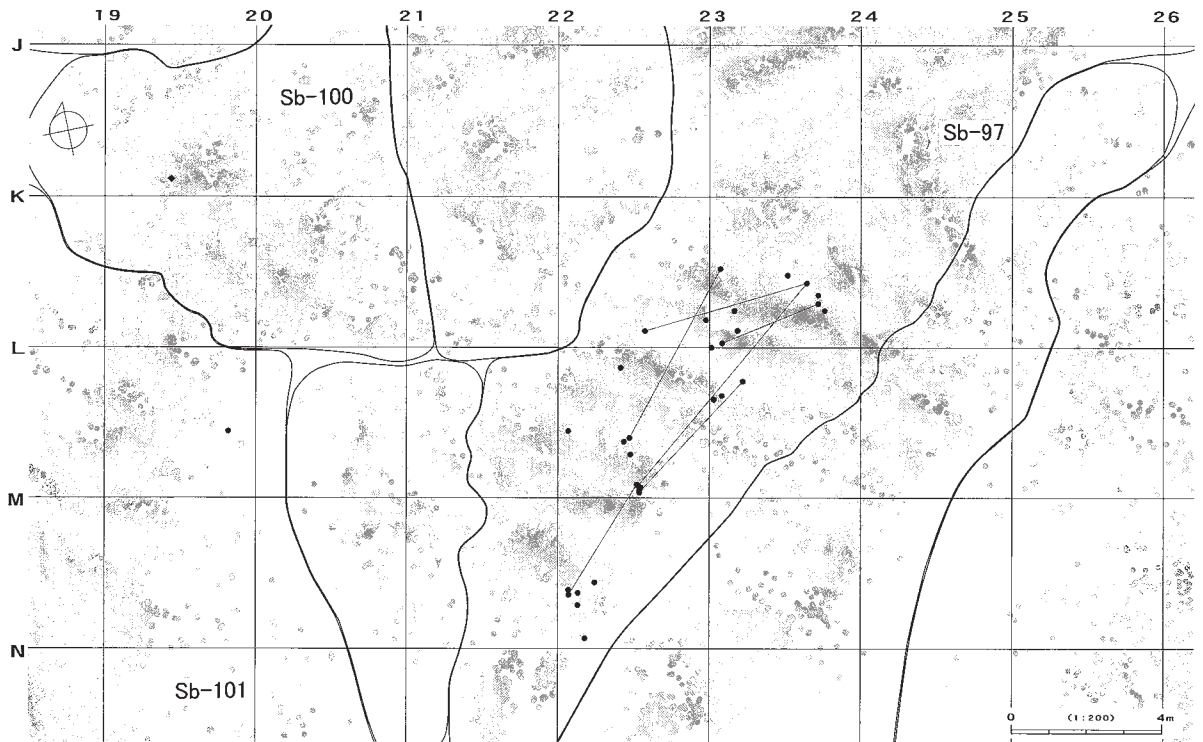

図Ⅲ-439 J区(Sb-97~107)の石器(45) 母岩1134・接合4613(2)

母岩975・接合4201

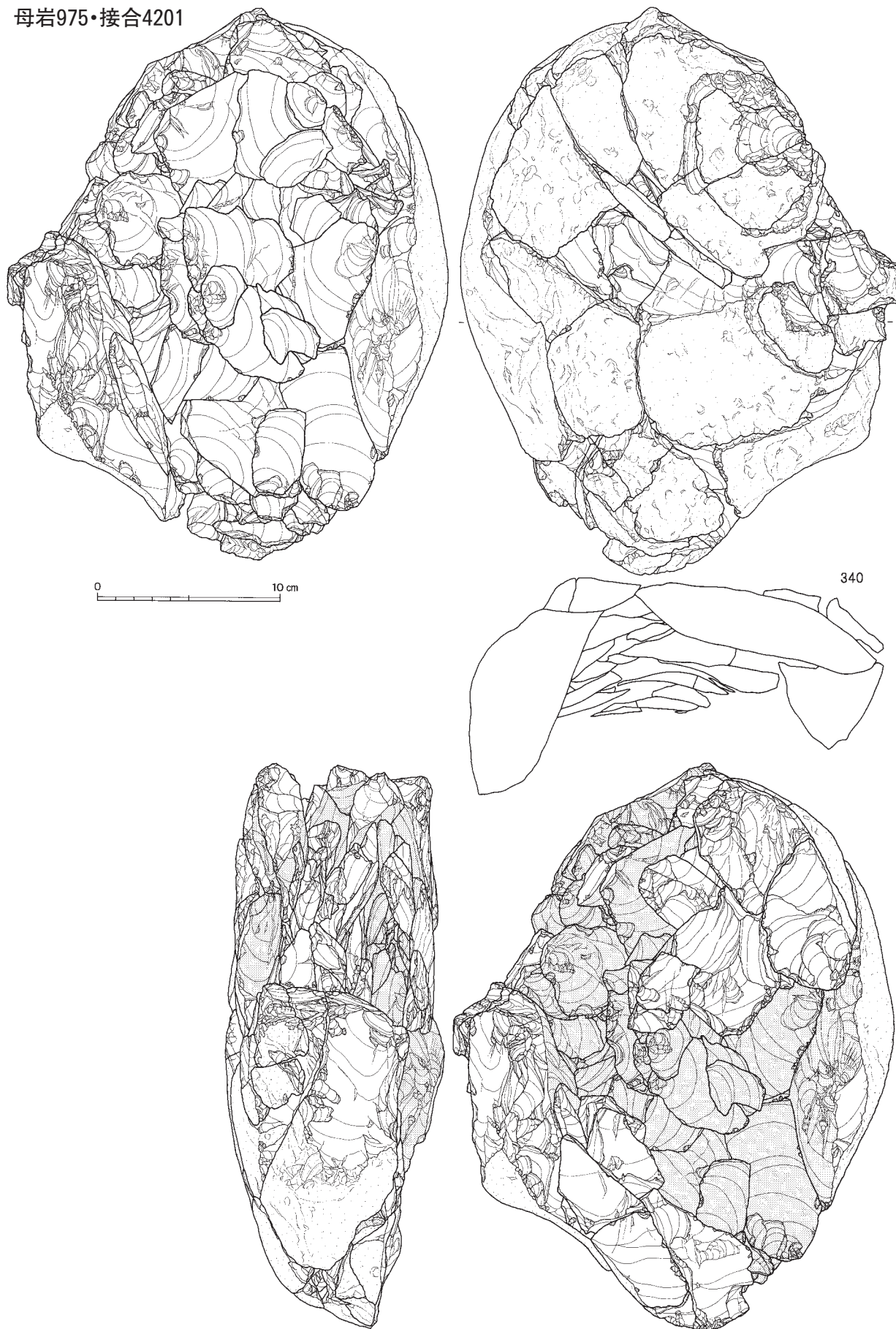

図Ⅲ-440 J区(Sb-97~107)の石器(46) 母岩975・接合4201(1)

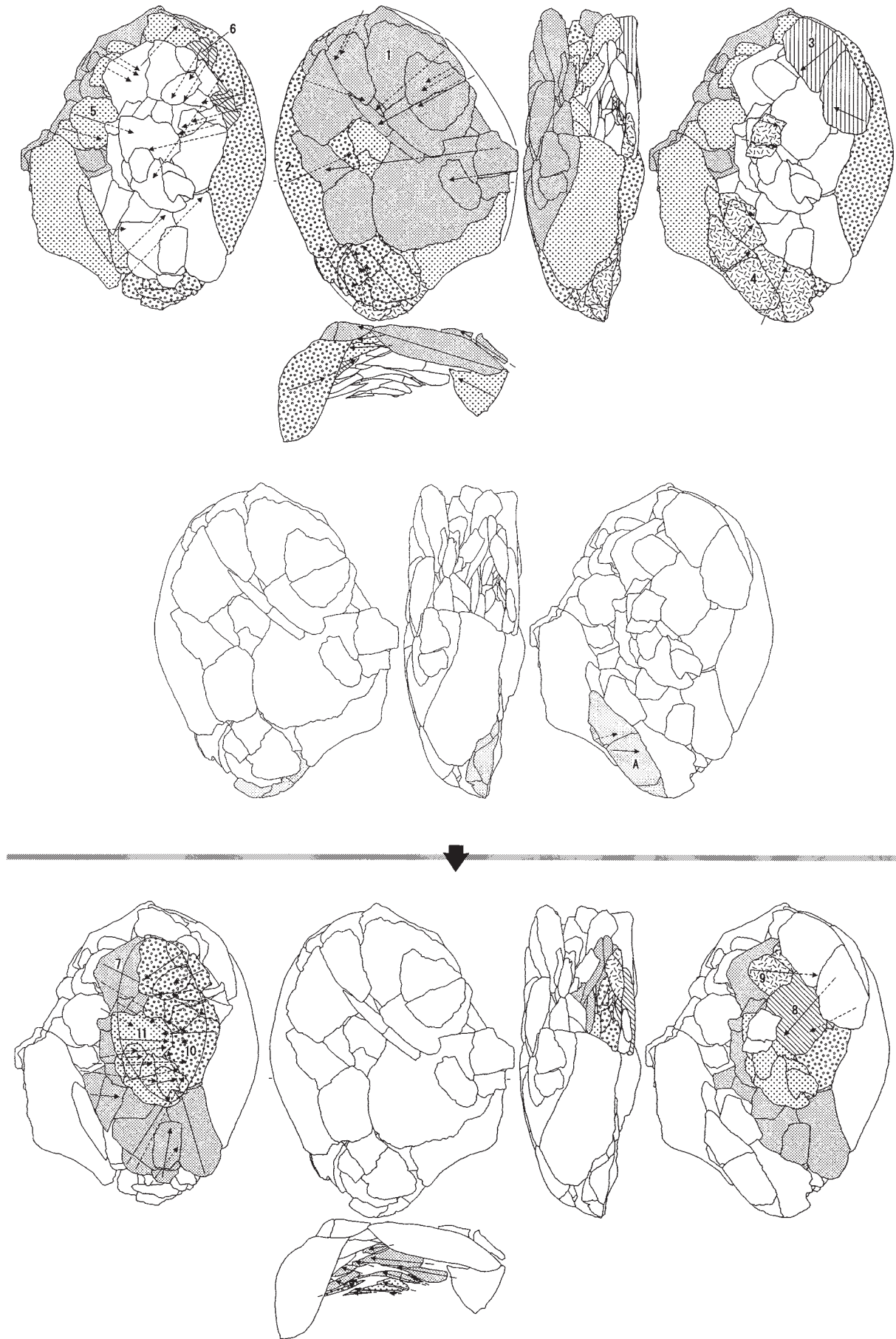

図Ⅲ-441 J区(Sb-97~107)の石器(47) 母岩975・接合4201(2)

接合4201分布図

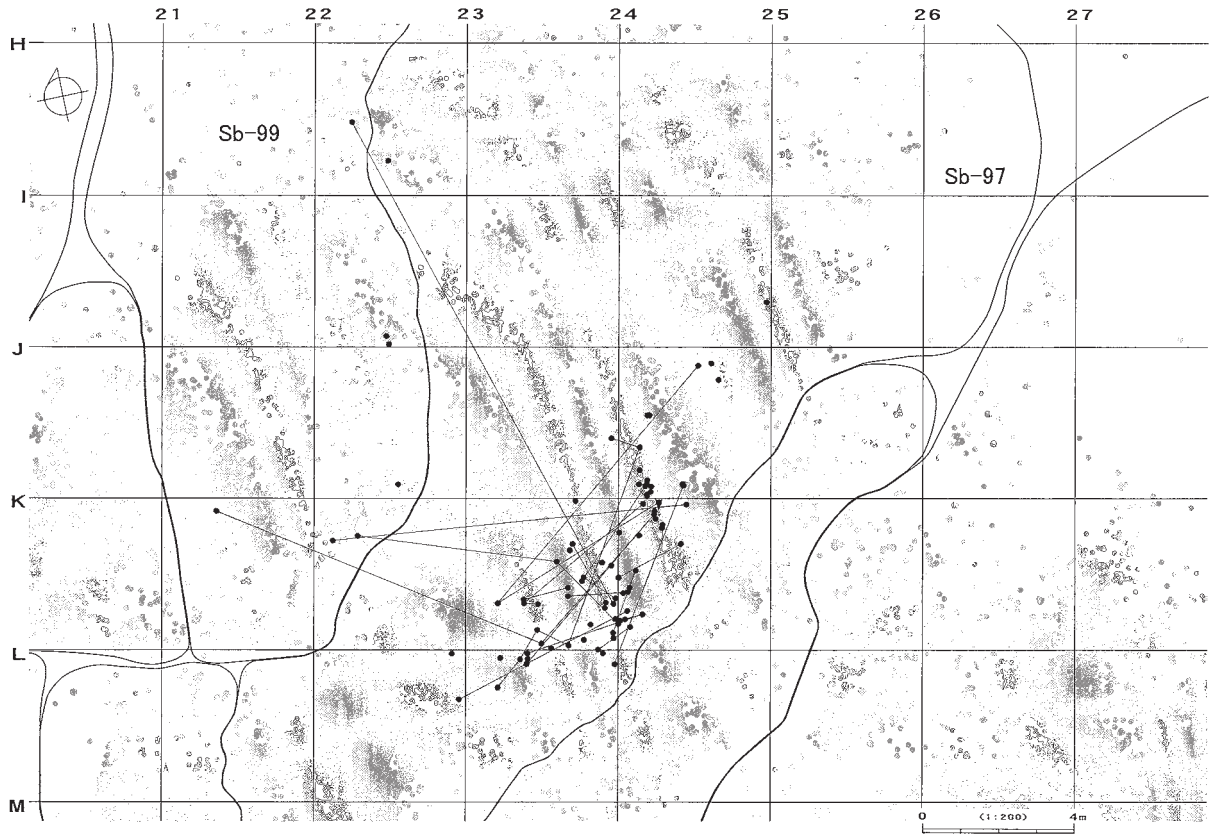

母岩985・接合4225

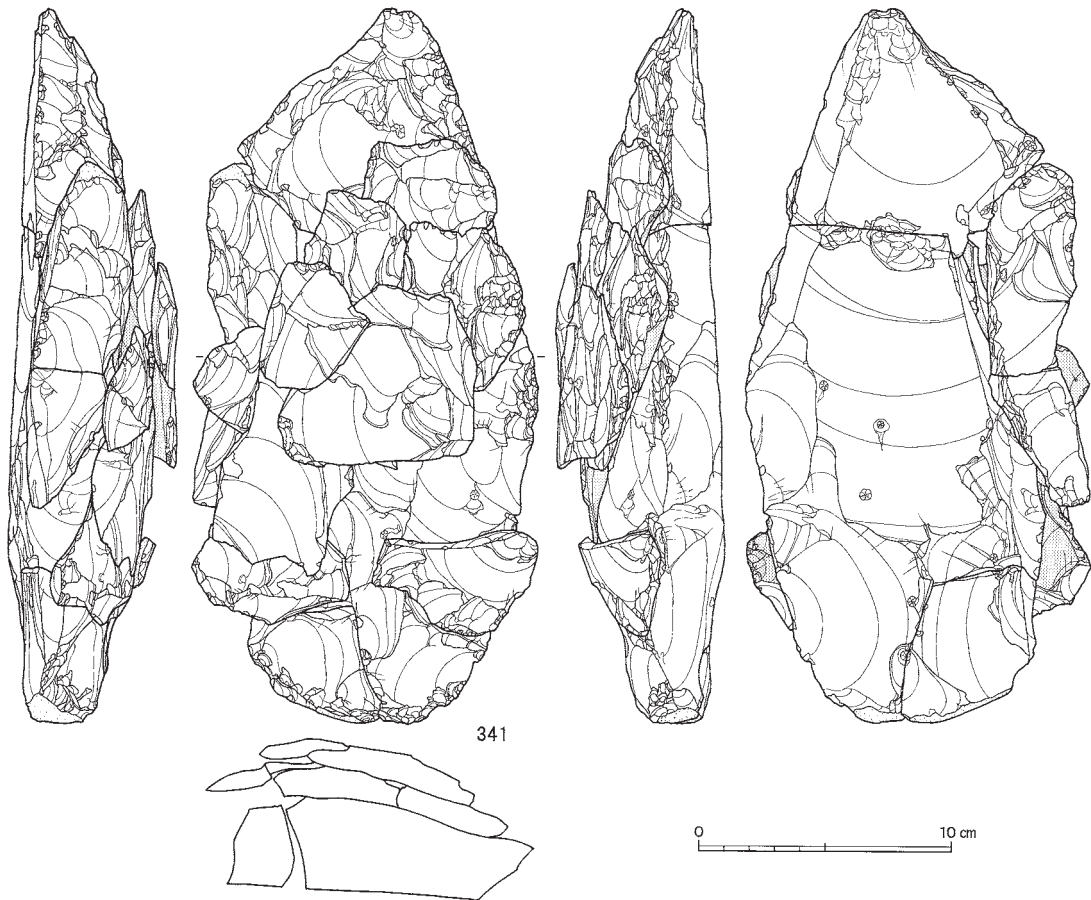

図Ⅲ-442 J区(Sb-97~107)の石器(48) 母岩975・接合4201(3)、母岩985・接合4225(1)

段階5

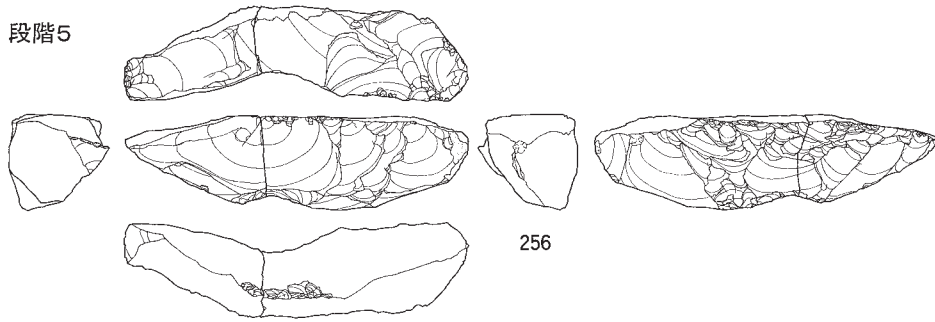

256

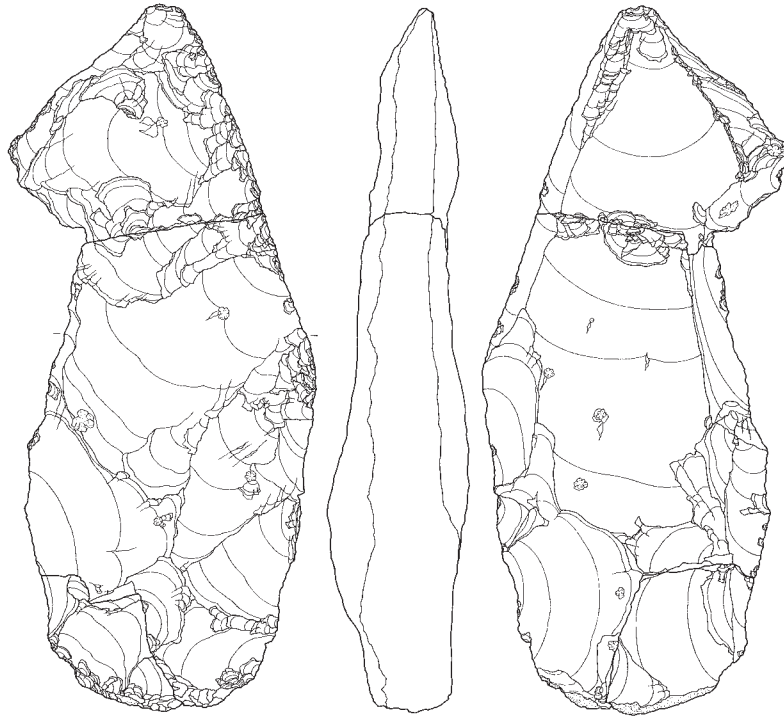

51

0 10 cm

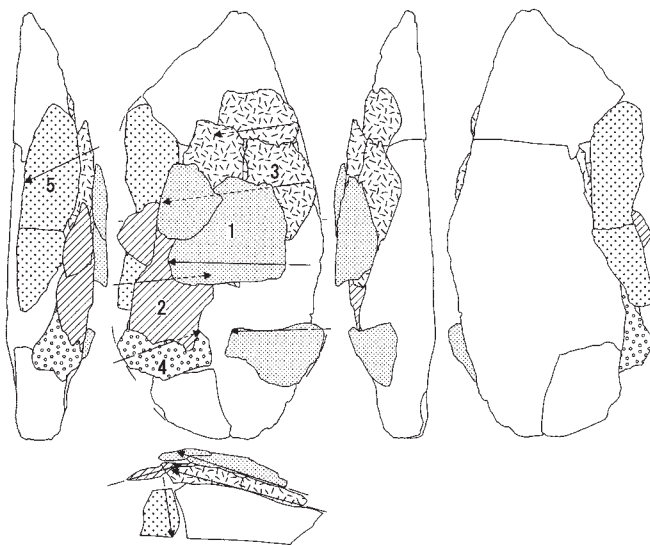

接合4225分布図

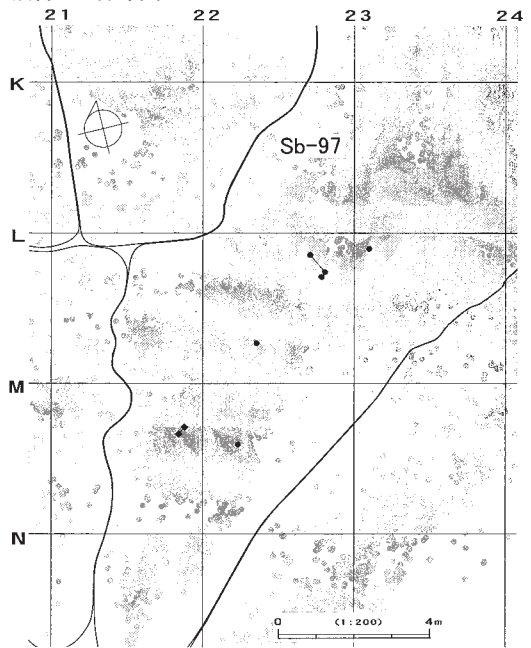

図Ⅲ-443 J区(Sb-97~107)の石器(49) 母岩985・接合4225(2)

母岩947・接合4116

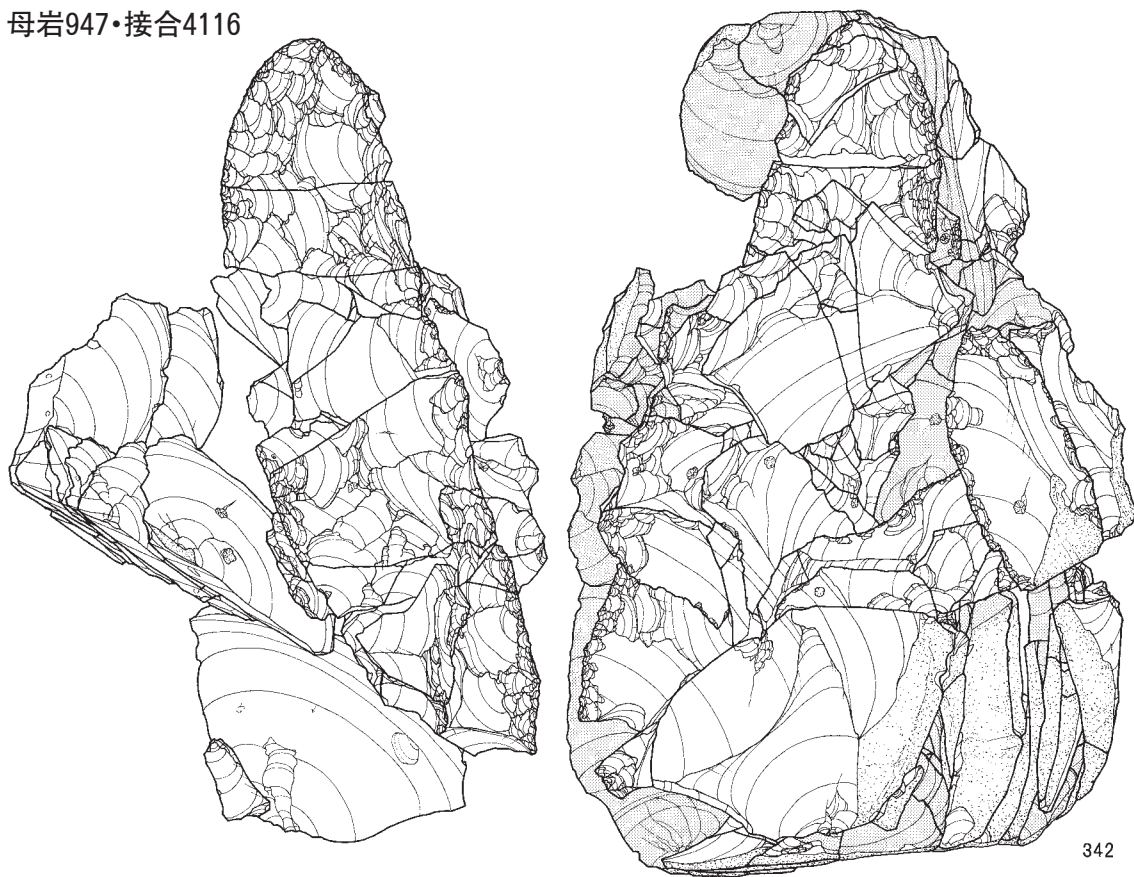

342

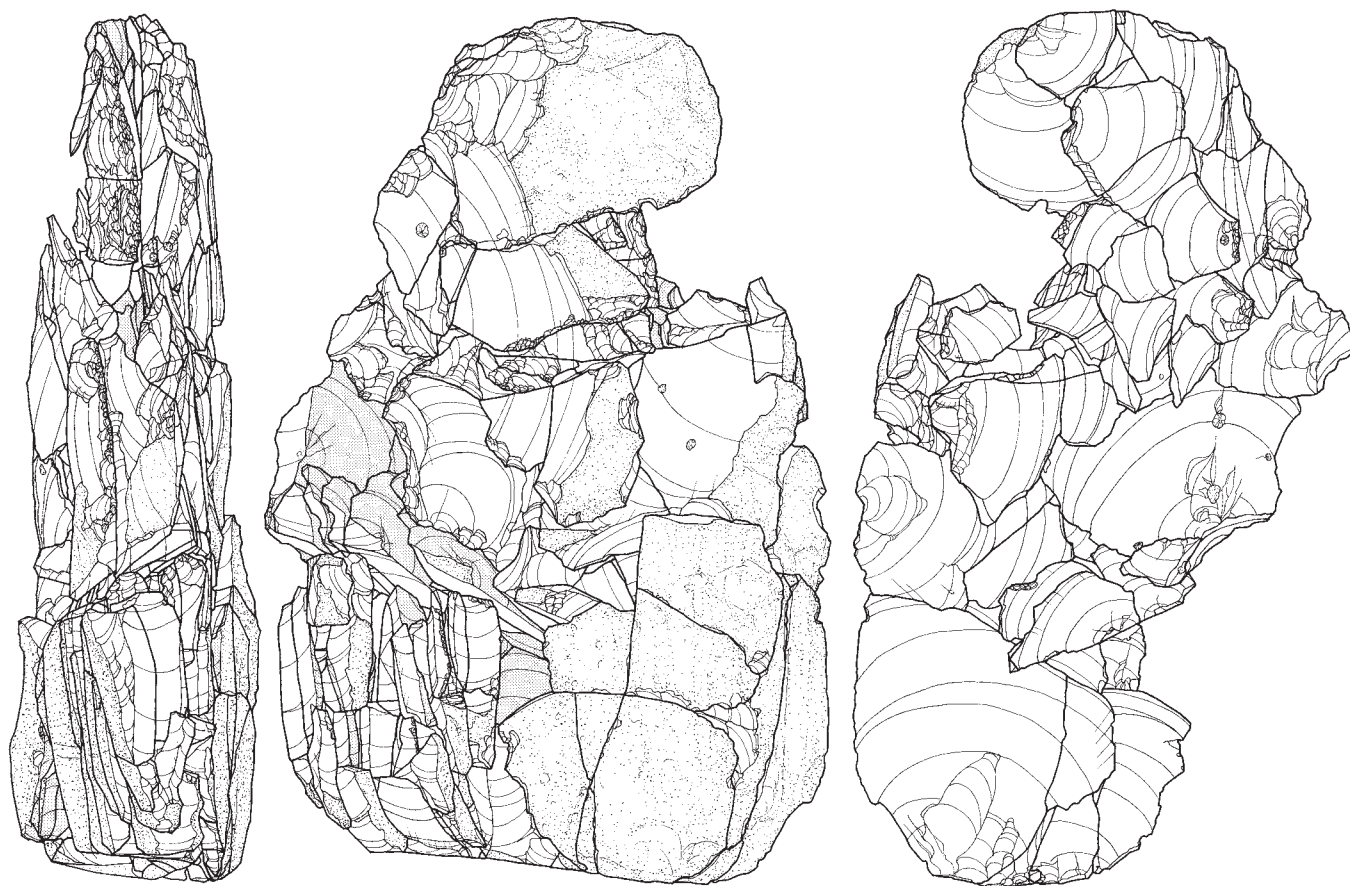

図Ⅲ-444 J区(Sb-97~107)の石器(50) 母岩947・接合4116(1)

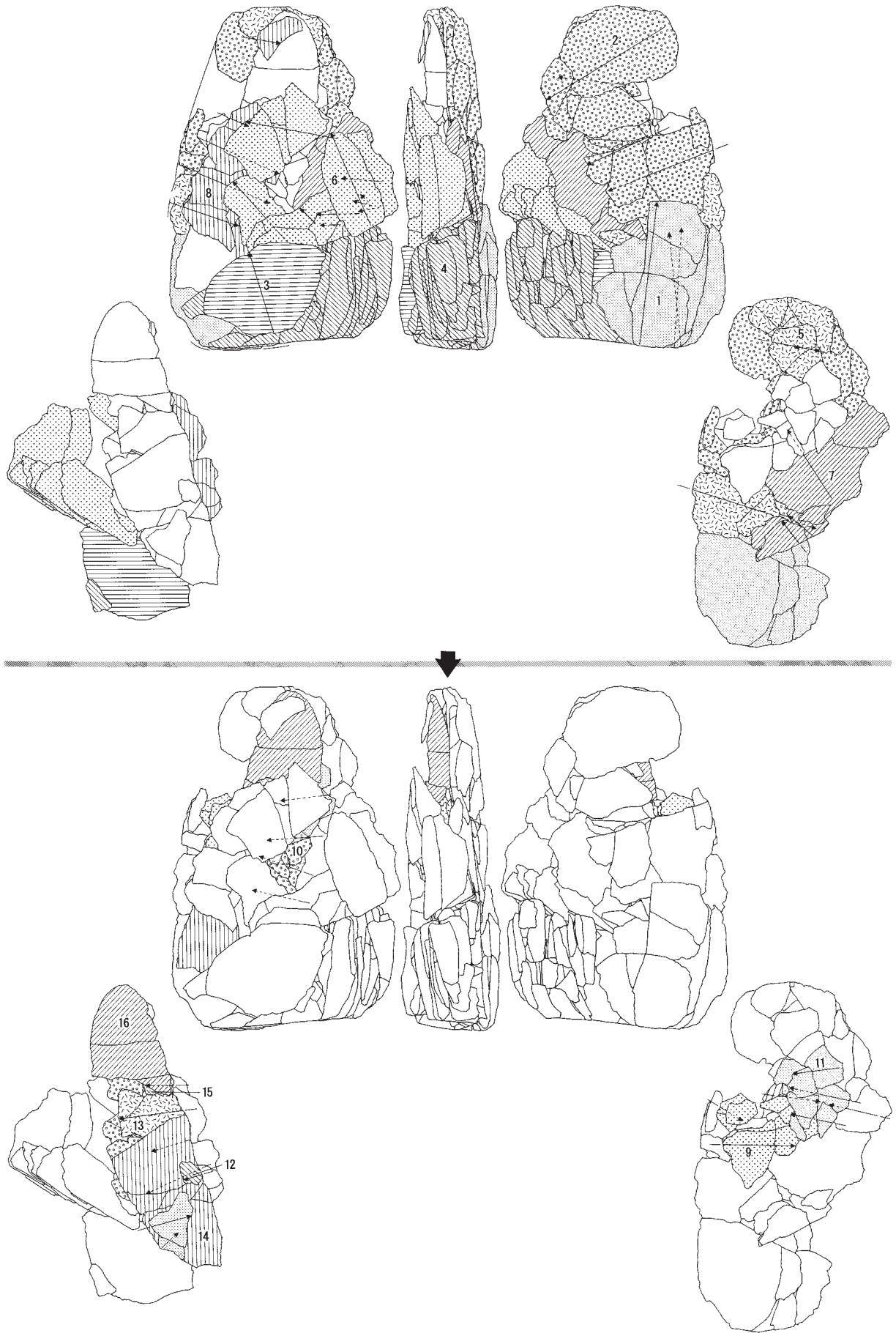

図Ⅲ-445 J区(Sb-97~107)の石器(51) 母岩947・接合4116(2)

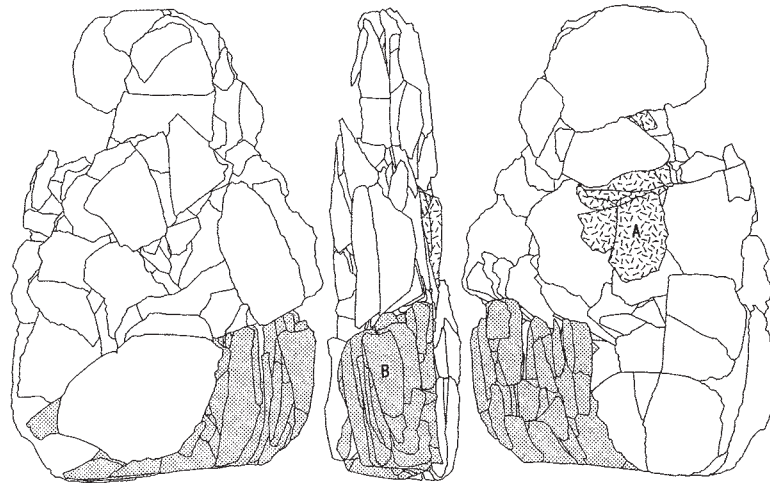

段階2
個体A

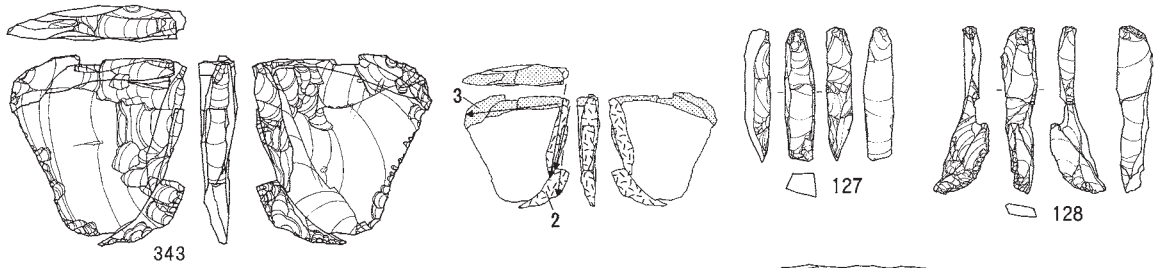

段階4
個体B

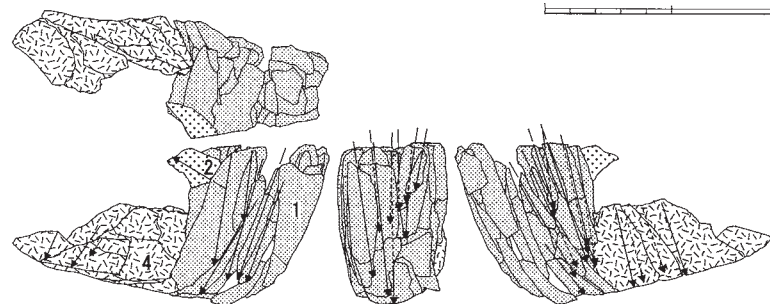
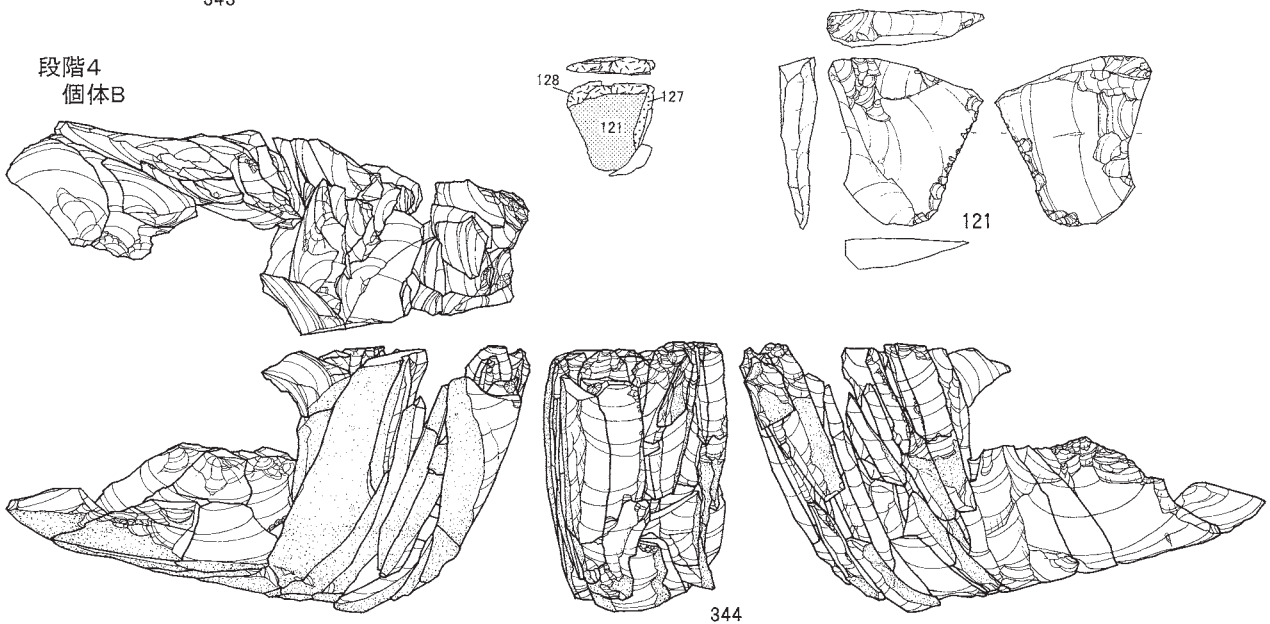

図Ⅲ-446 J区(Sb-97~107)の石器(52) 母岩947・接合4116(3)

段階6

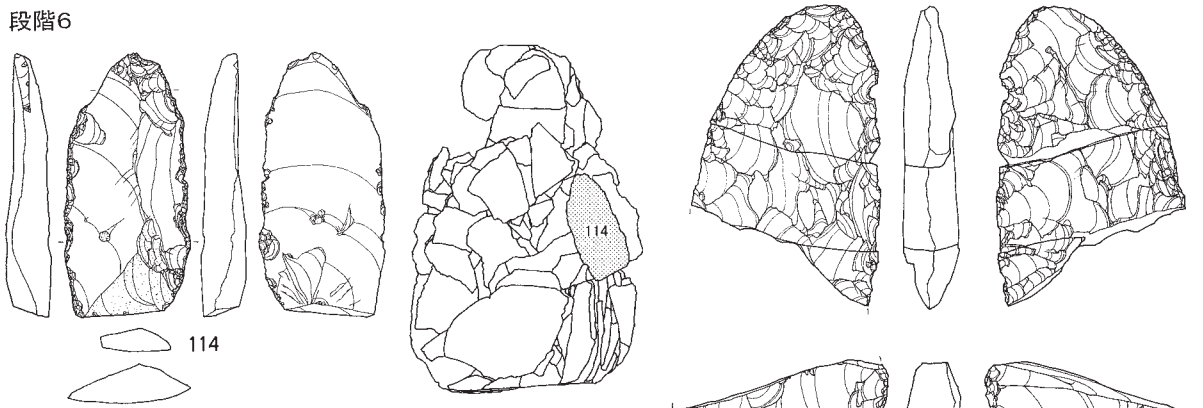

接合4116(全体)分布図

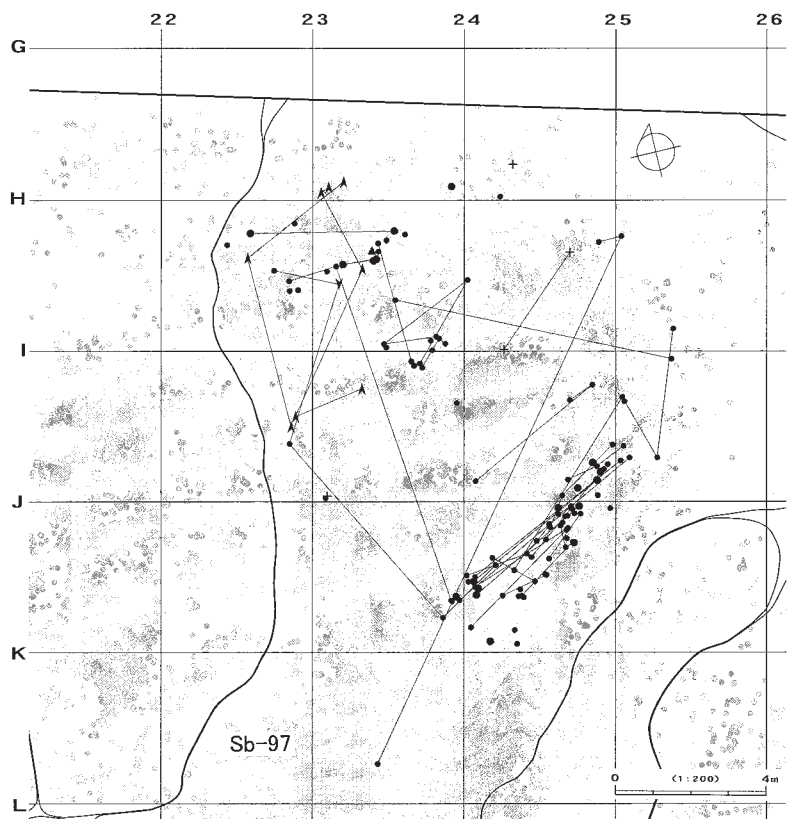
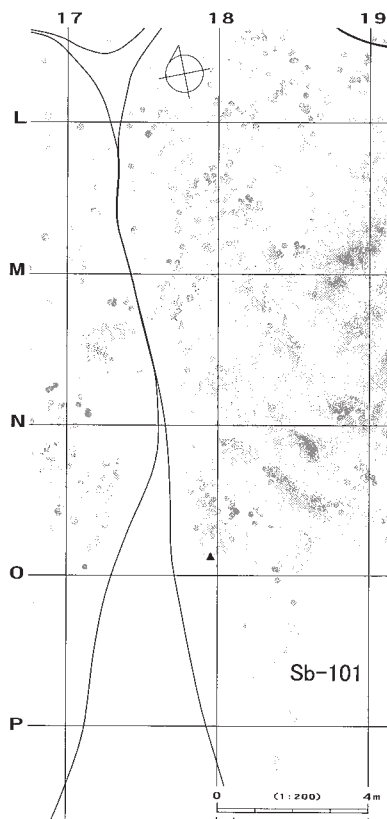
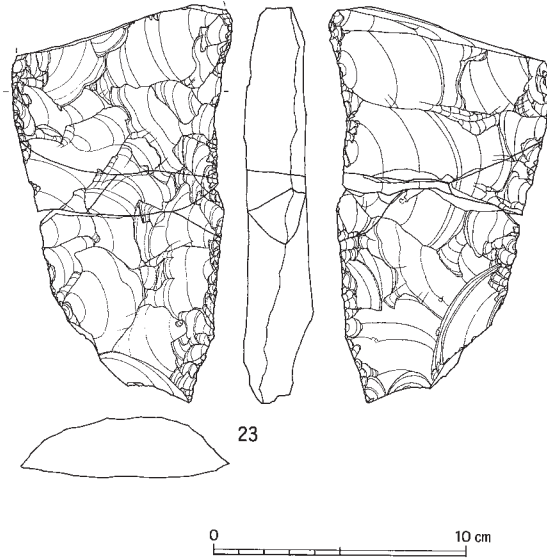
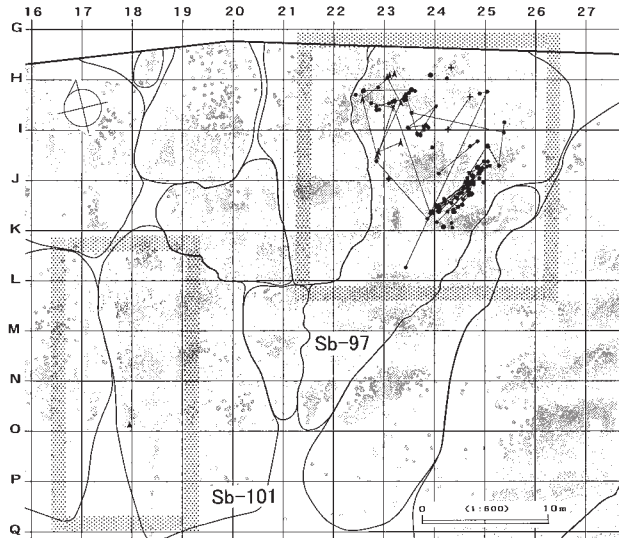

図Ⅲ-447 J区(Sb-97~107)の石器(53) 母岩947・接合4116(4)

J区(Sb-97~107)

接合4116(个体A)分布图

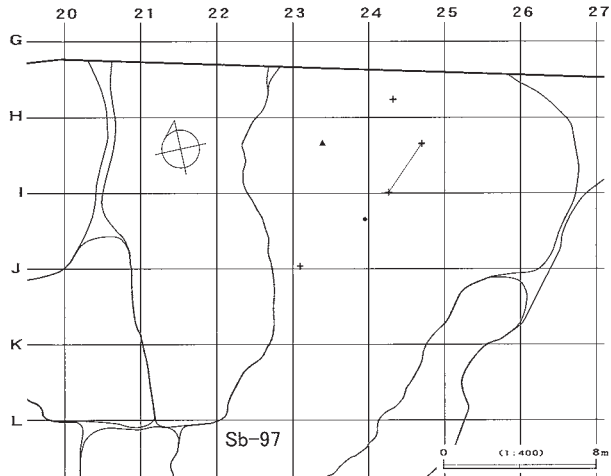

接合4116(个体B-段階1・2)分布图

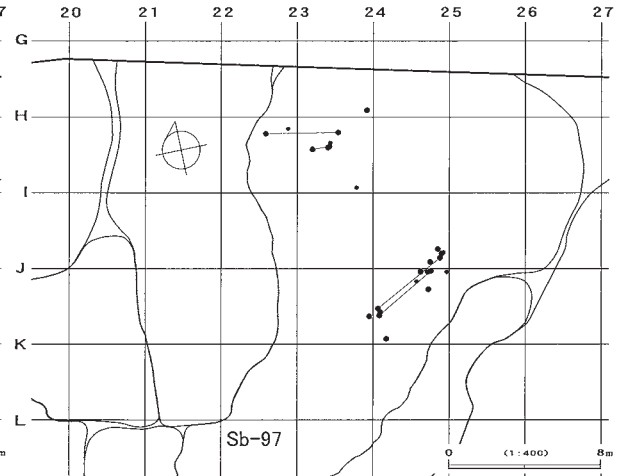

接合4116(个体B-段階3・4)分布图

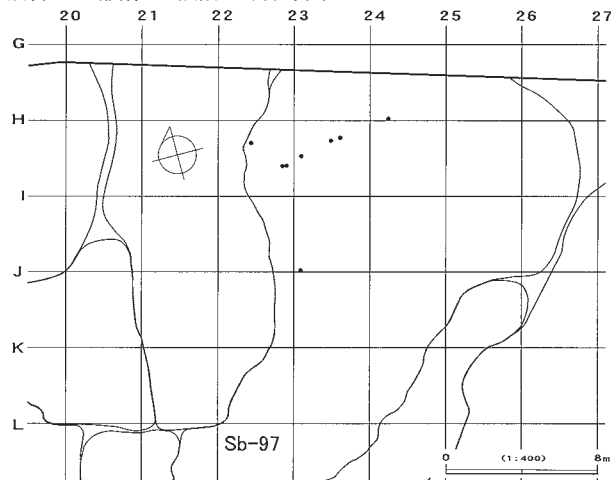

接合4116(个体A除く段階1~3)分布图

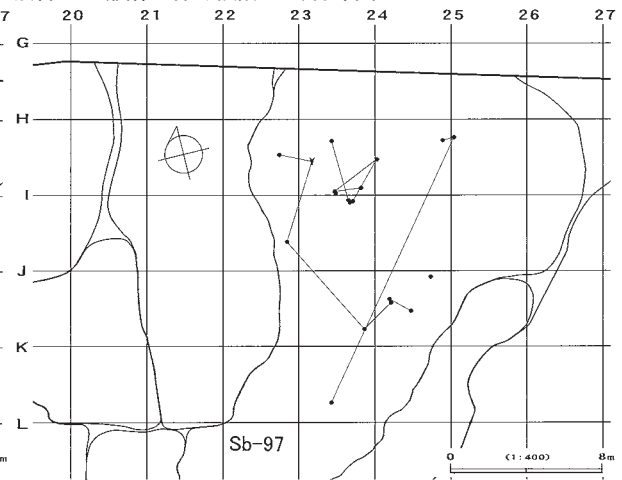

接合4116(段階5~13)分布图

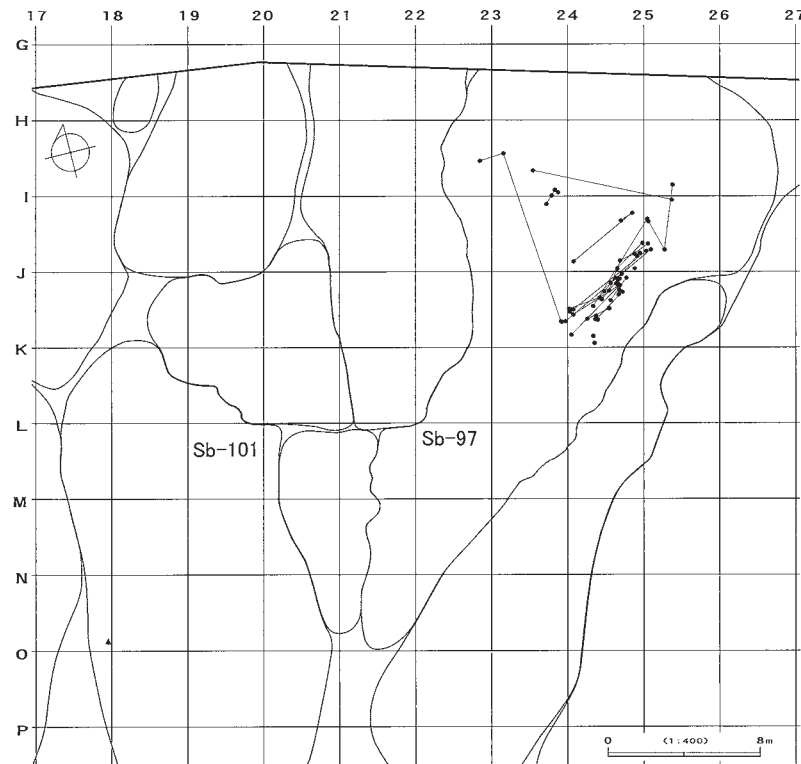

接合4116(段階14~16)分布图

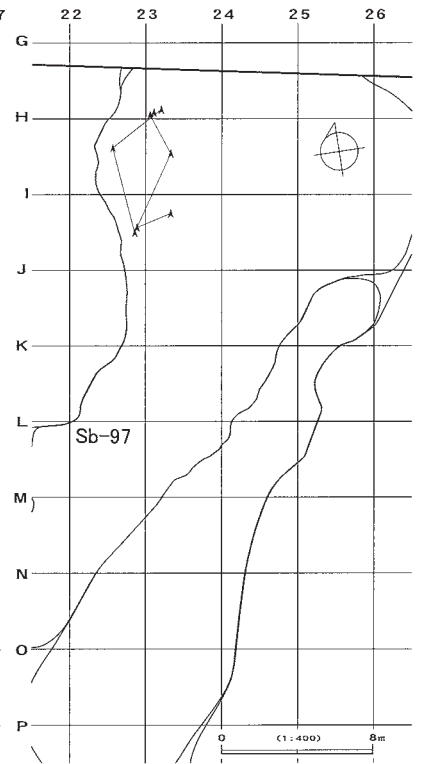

图Ⅲ-448 J区(Sb-97~107)の石器(54) 母岩947・接合4116(5)

母岩1185・接合4734

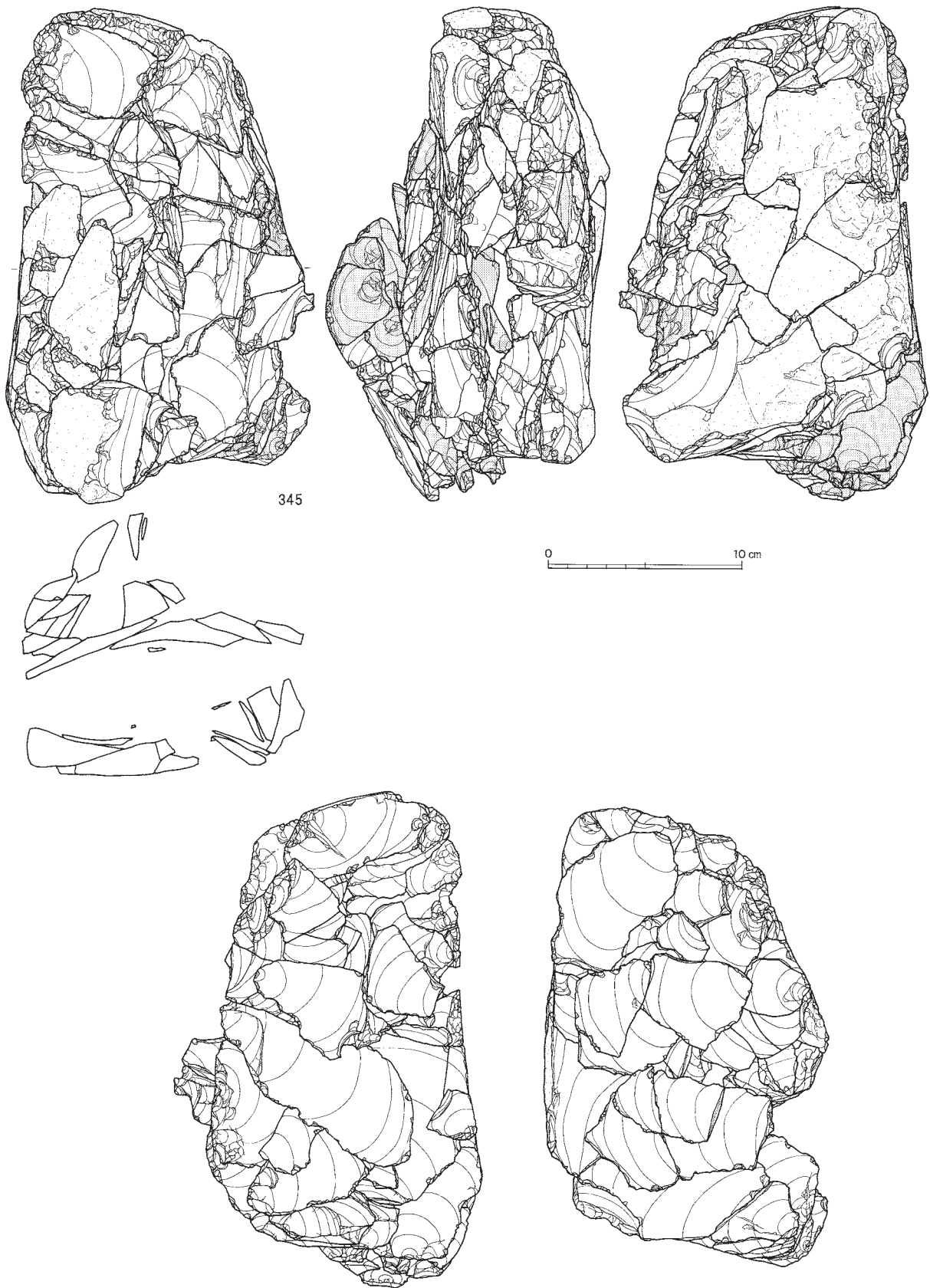

図Ⅲ-449 J区(Sb-97~107)の石器(55) 母岩1185・接合4734(1)

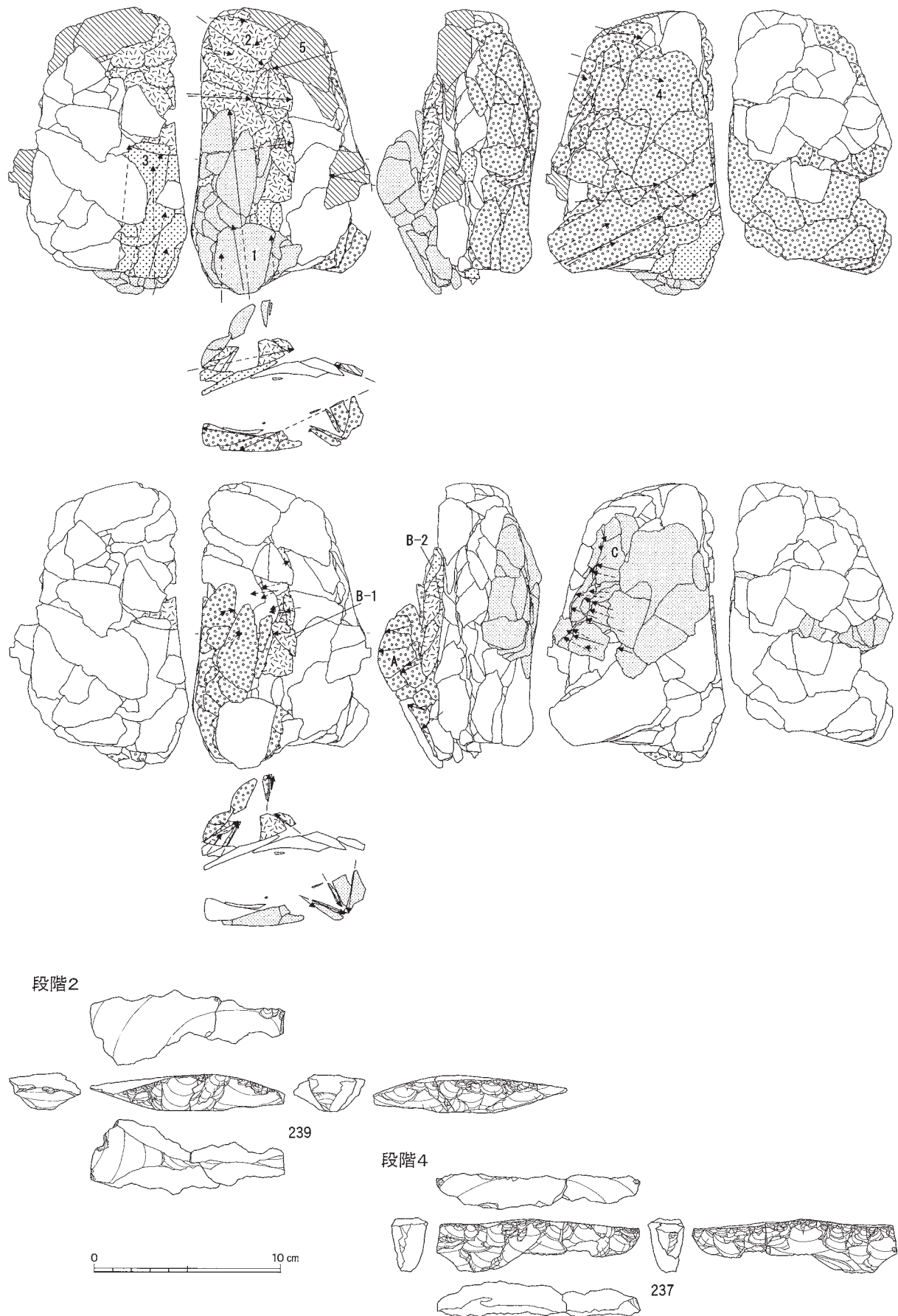

図Ⅲ-450 J区(Sb-97~107)の石器(56) 母岩1185・接合4734(2)

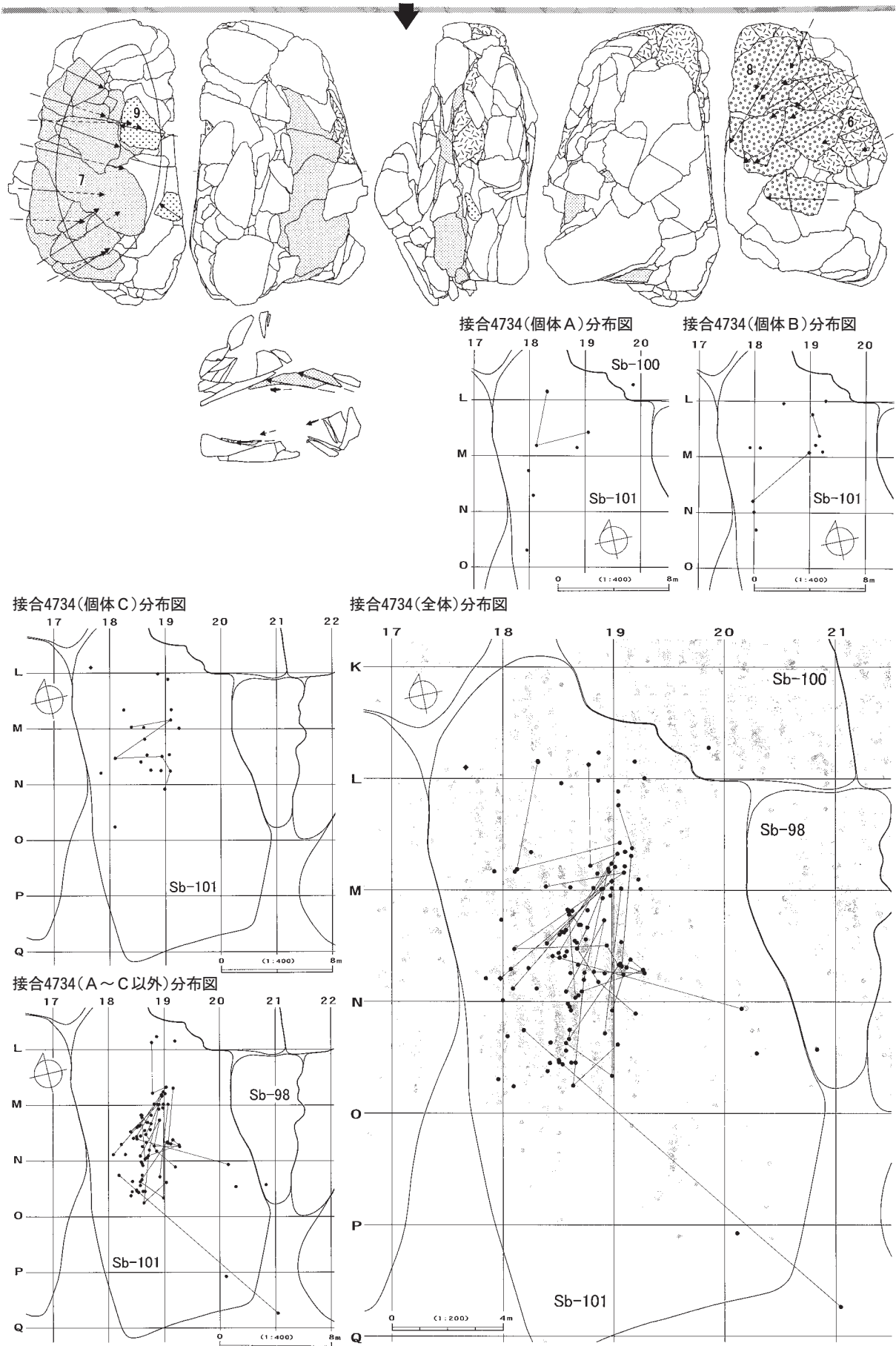

図Ⅲ-451 J区(Sb-97~107)の石器(57) 母岩1185・接合4734(3)

母岩1133・接合4611

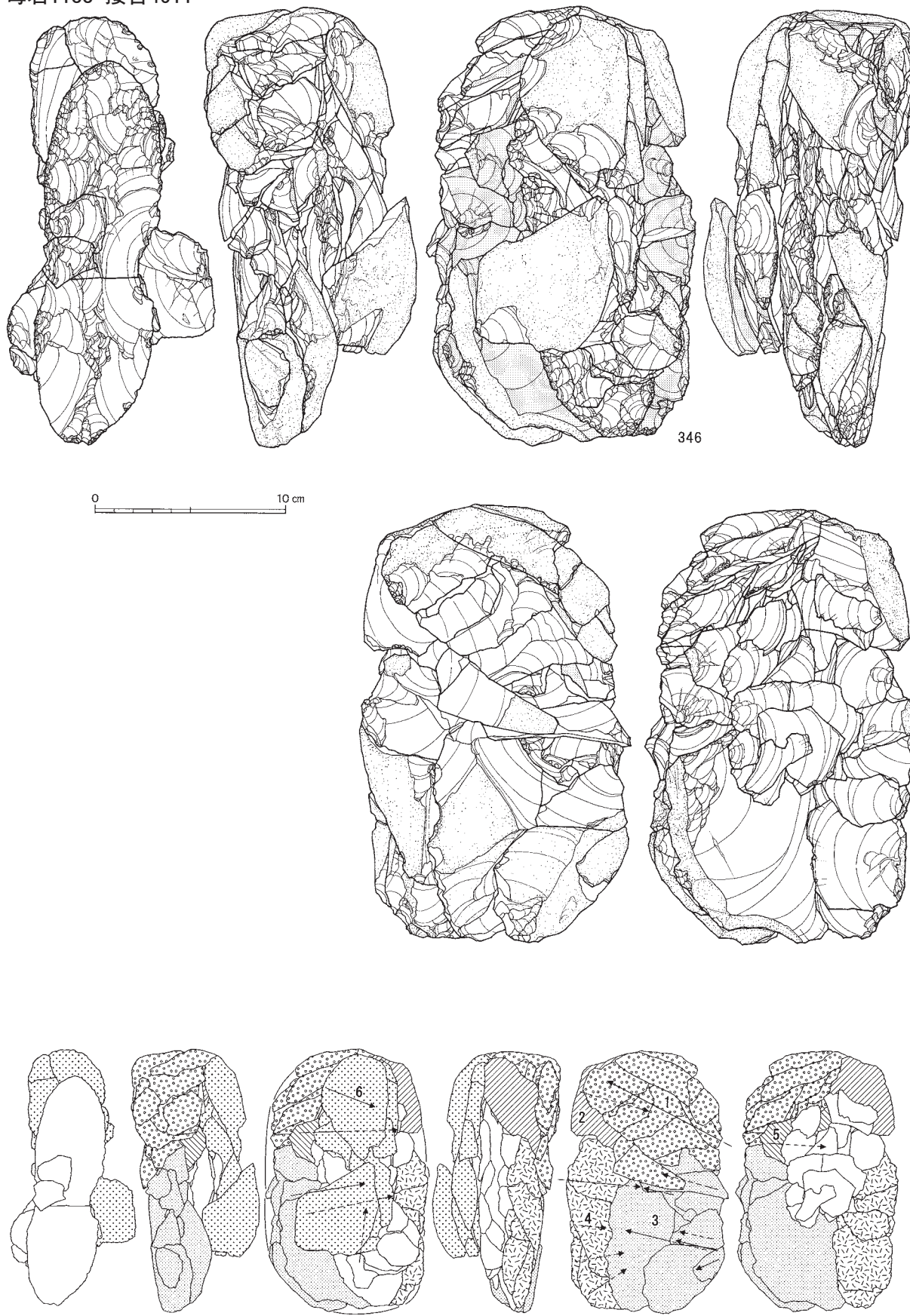

図Ⅲ-452 J区(Sb-97~107)の石器(58) 母岩1133・接合4611(1)

個体A

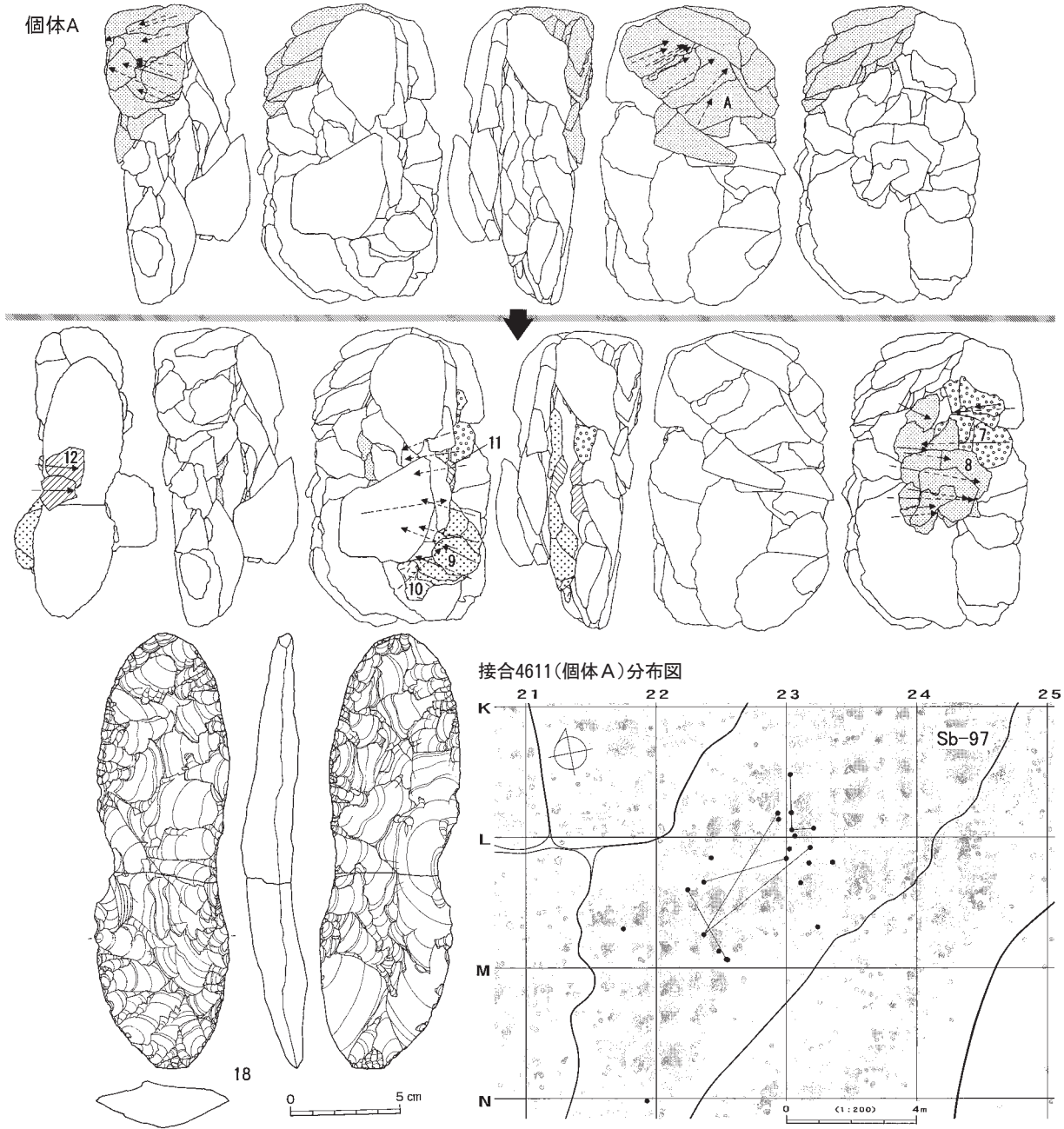

接合4611(個体A以外)分布図

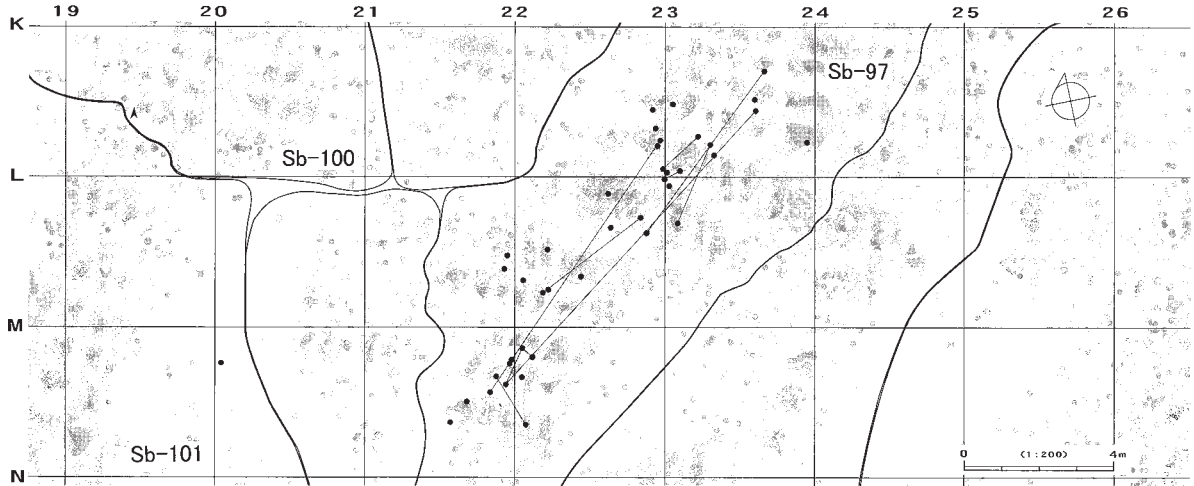

図Ⅲ-453 J区(Sb-97~107)の石器(59) 母岩1133・接合4611(2)

母岩952・接合4136

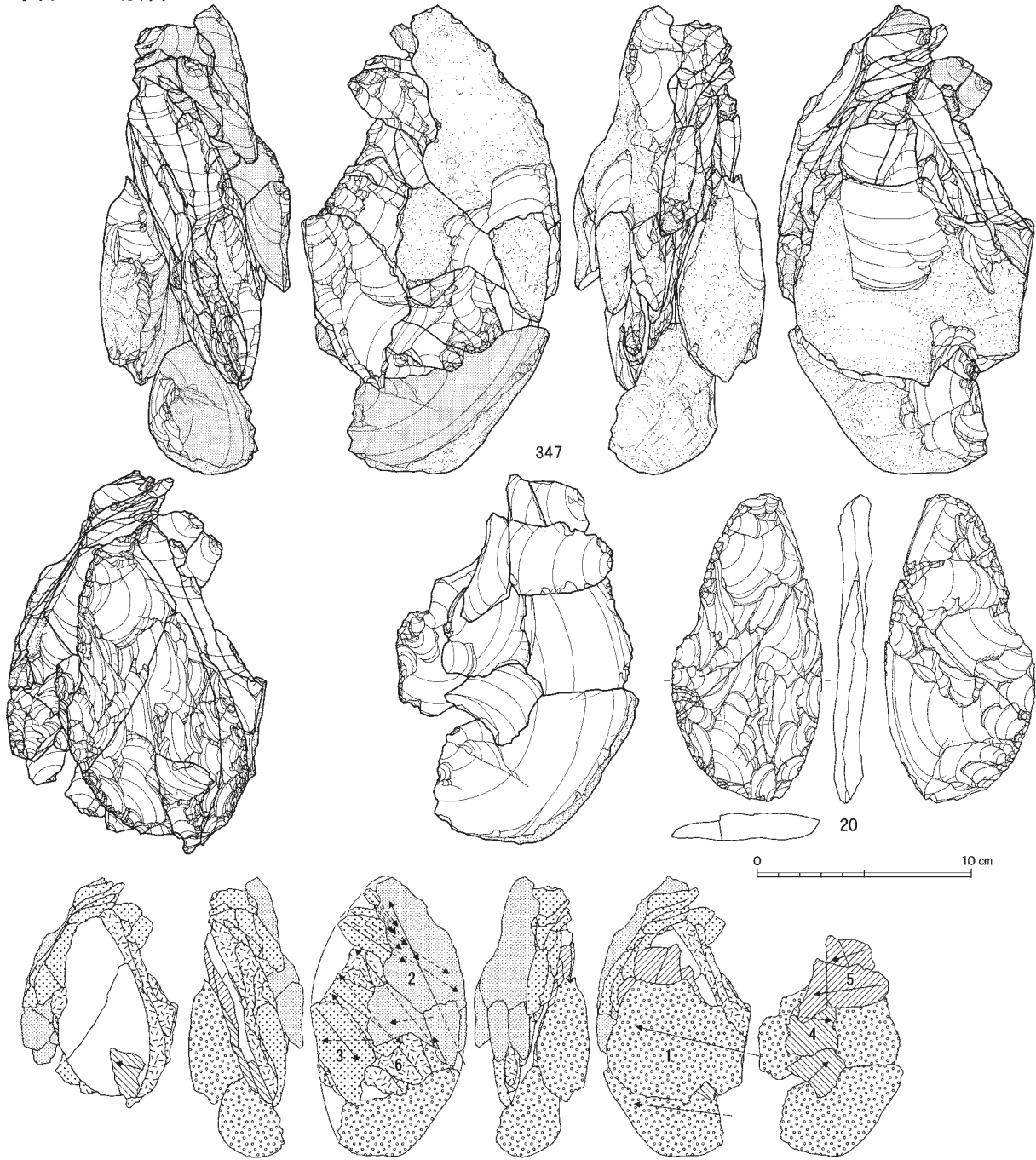

接合4136(段階1・2)分布図

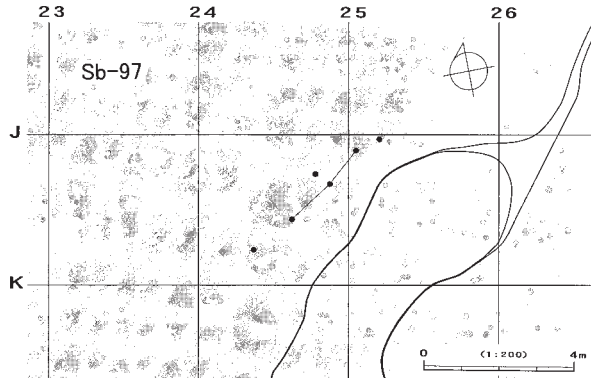

接合4136(段階3~6・尖頭器)分布図

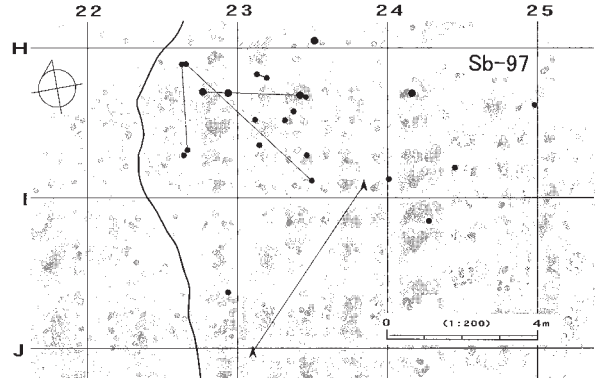

図Ⅲ-454 J区(Sb-97~107)の石器(60) 母岩952・接合4136

母岩1046・接合4366

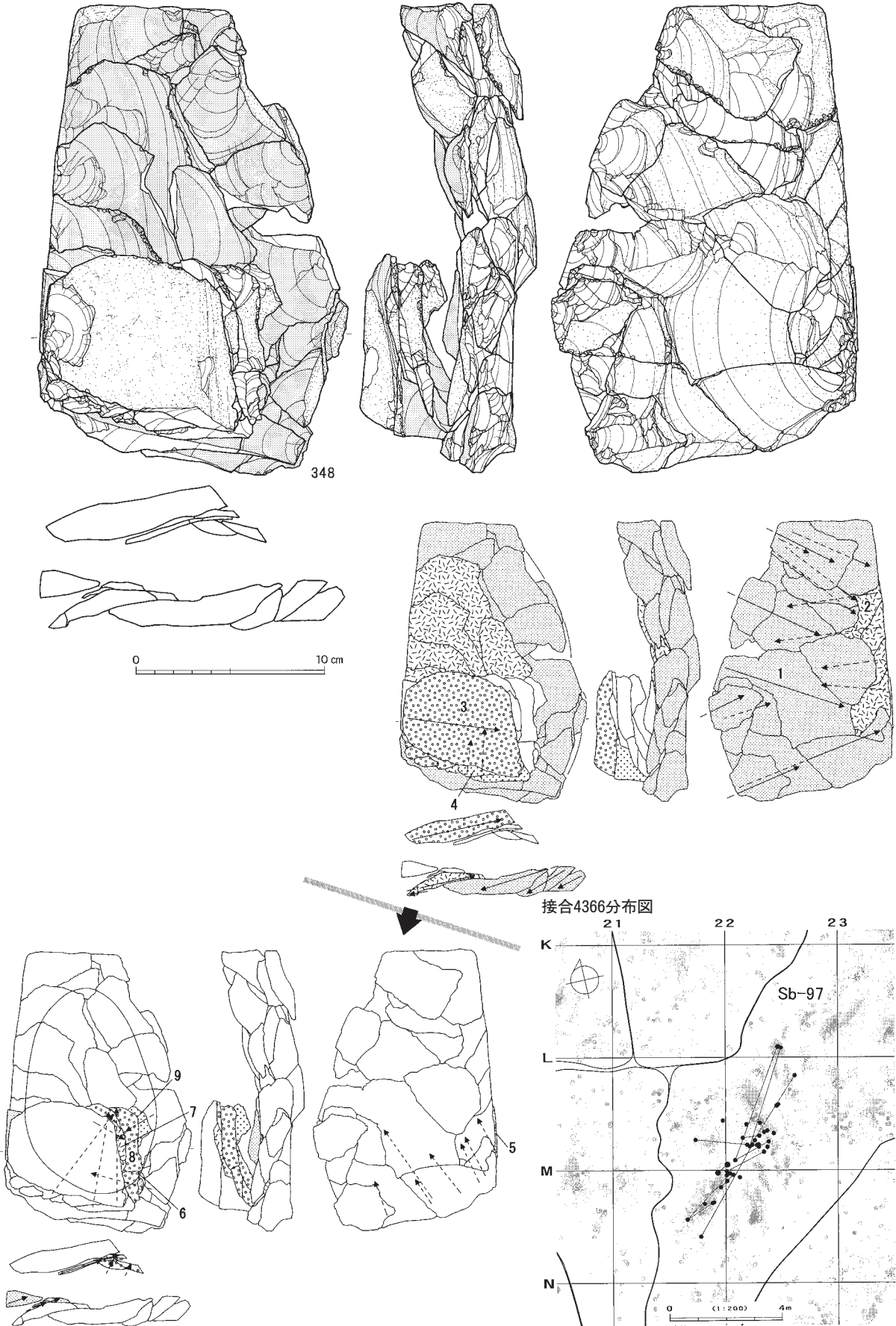

図Ⅲ-455 J区(Sb-97~107)の石器(61) 母岩1046・接合4366

母岩1147・接合4632



349

0 10 cm

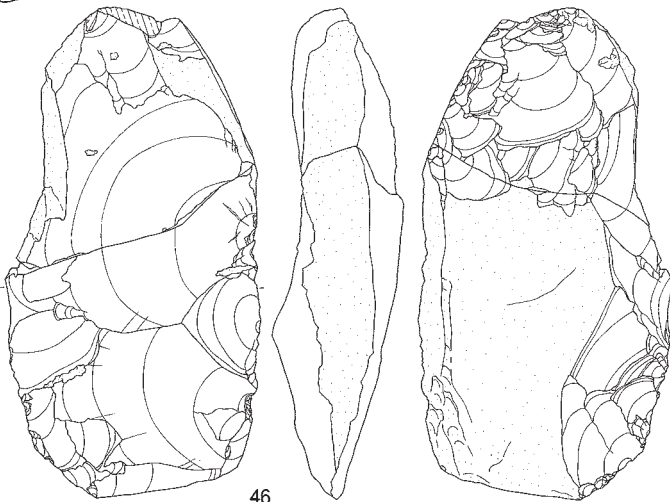

46

接合4632(段階6~8
・両面調整石器)分布図

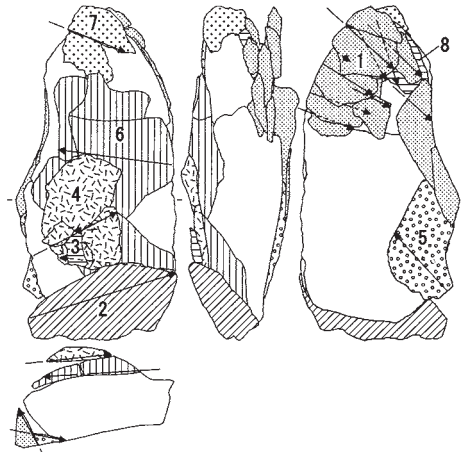
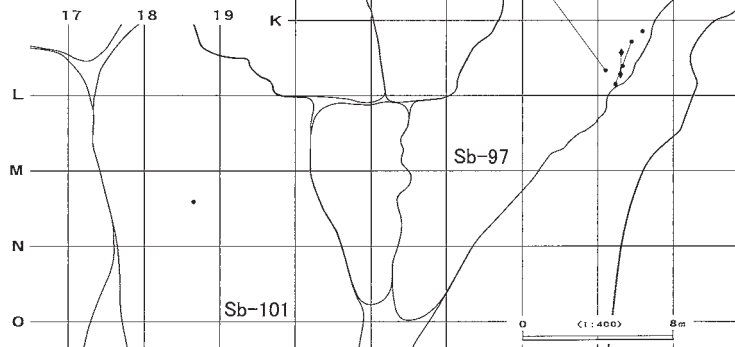

接合4632(全体)分布図

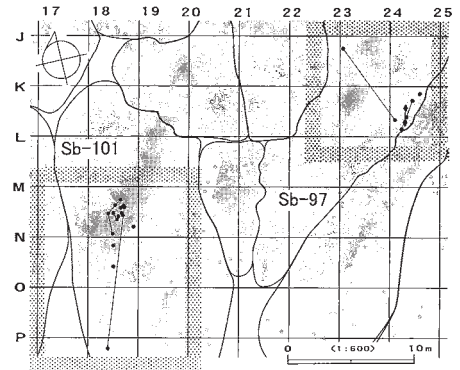

18

19

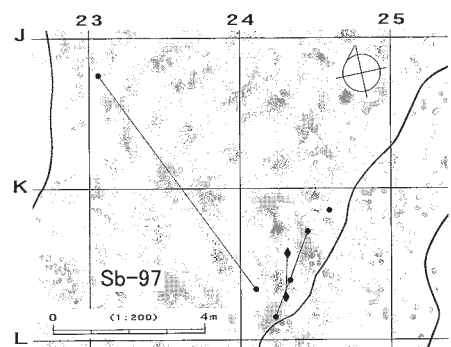
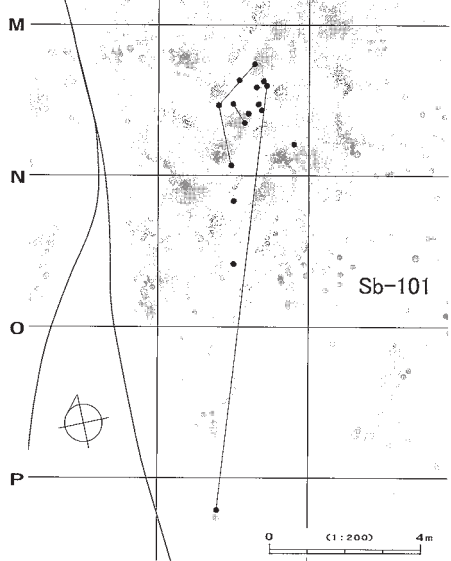

図Ⅲ-456 J区(Sb-97~107)の石器(62) 母岩1147・接合4632

母岩982・接合4217

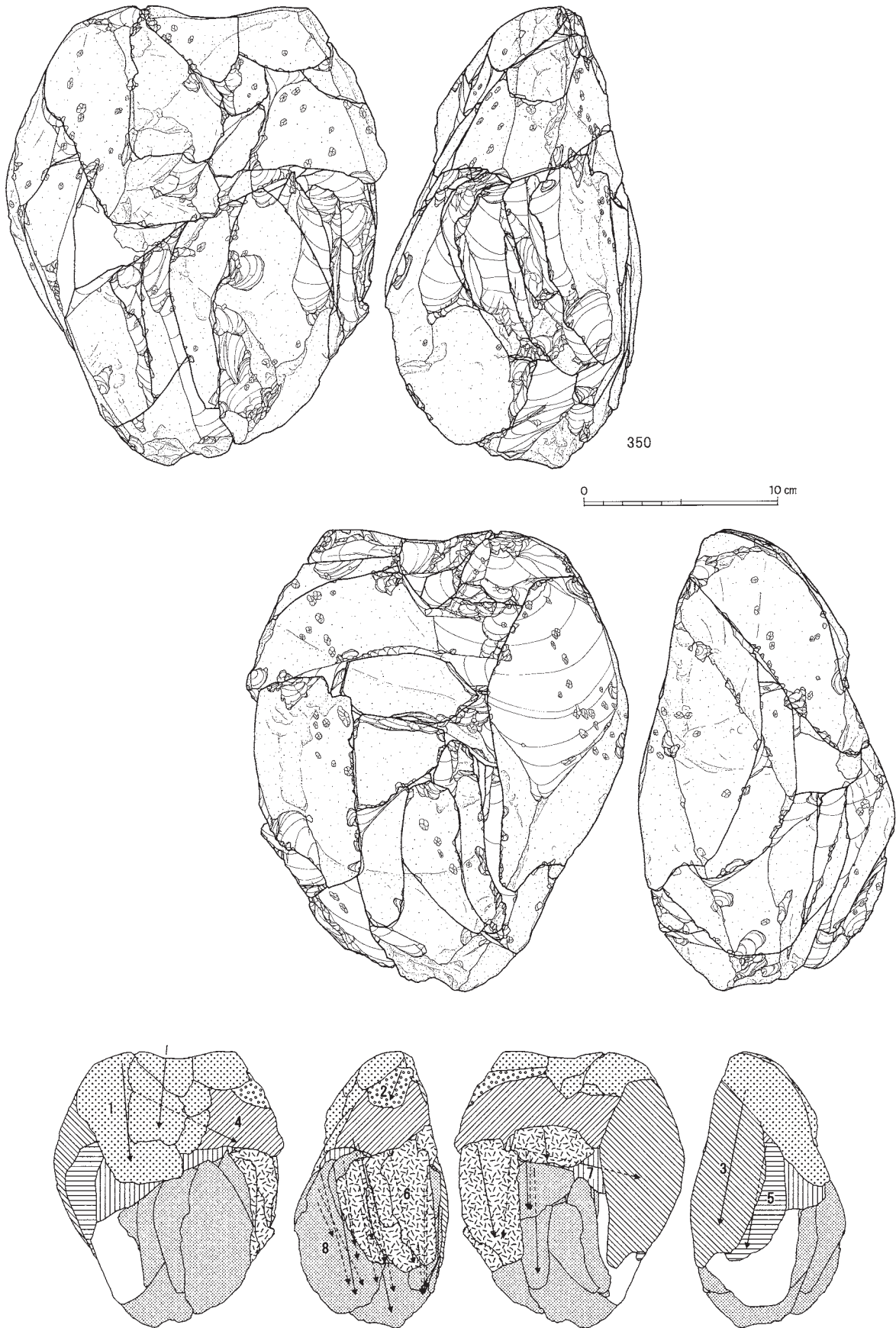

図Ⅲ-457 J区(Sb-97~107)の石器(63) 母岩982・接合4217(1)

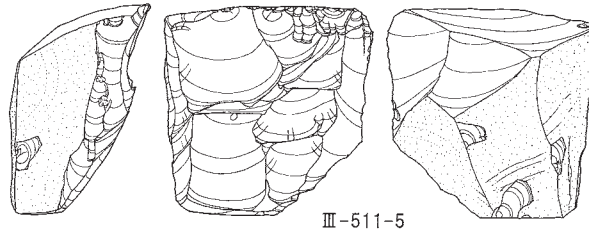

Ⅲ-511-5

接合4217分布図

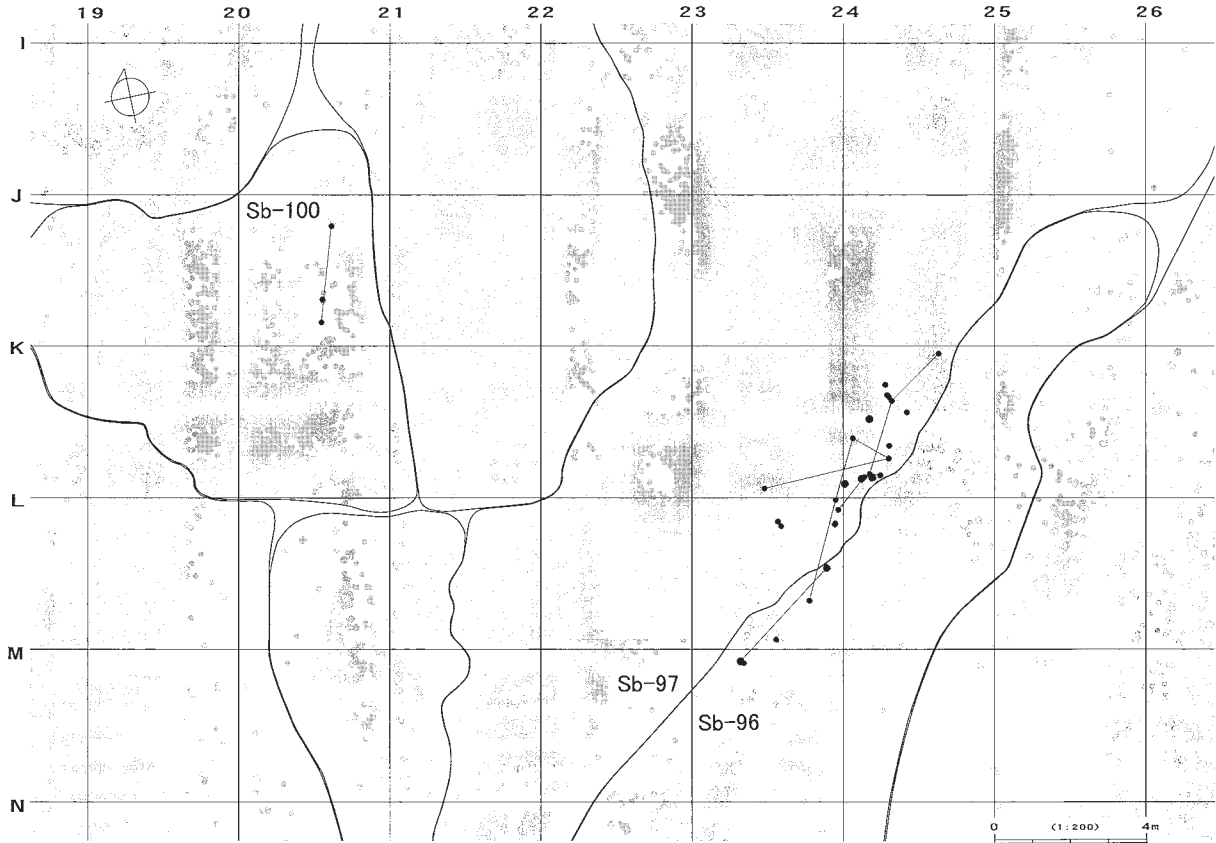

母岩1006・接合4274

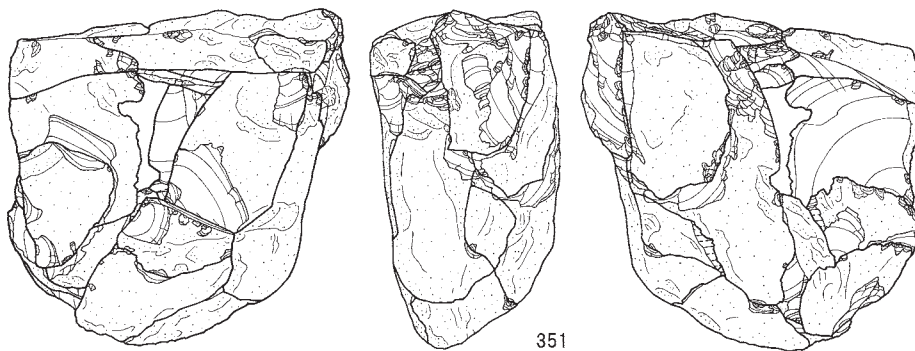

351

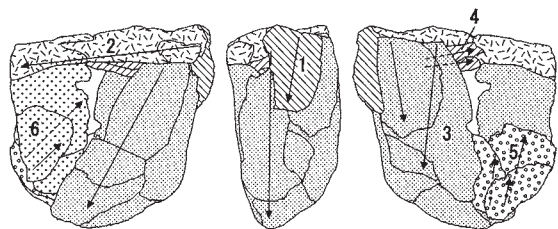
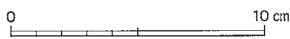

図Ⅲ-458 J区(Sb-97~107)の石器(64) 母岩982・接合4217(2)、母岩1006・接合4274(1)

接合4274分布図

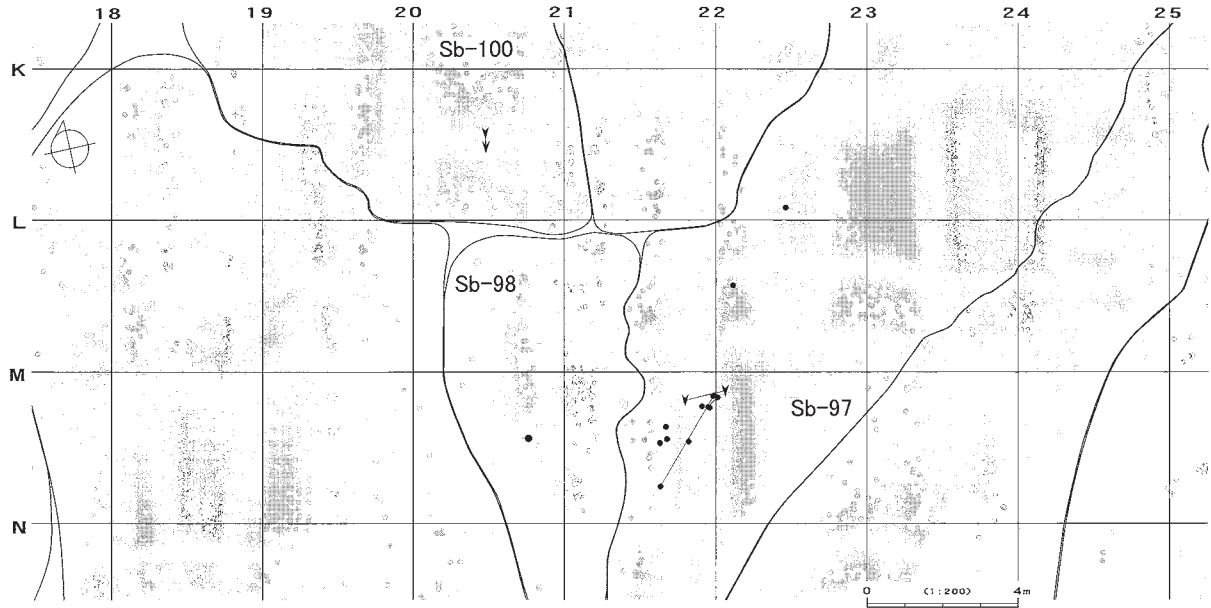

母岩1038・接合4347

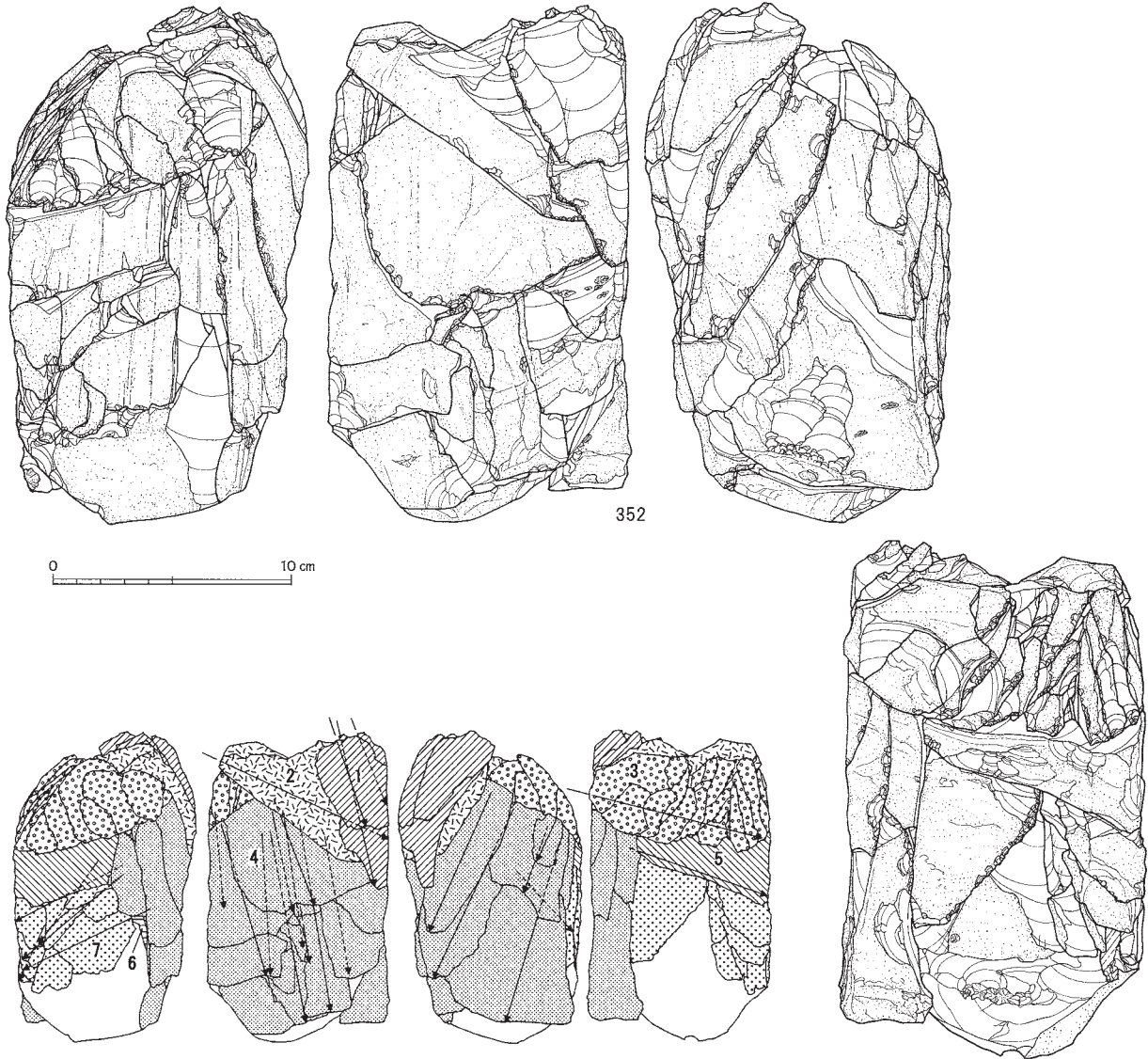

図Ⅲ-459 J区(Sb-97~107)の石器(65) 母岩1006・接合4274(2)、母岩1038・接合4347(1)

段階3
個体A

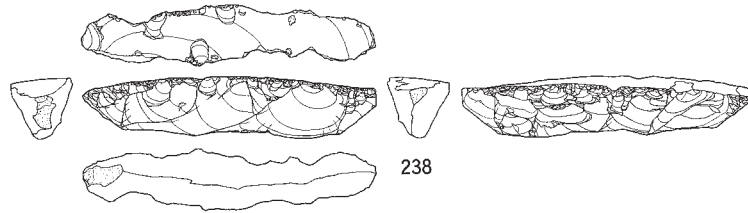
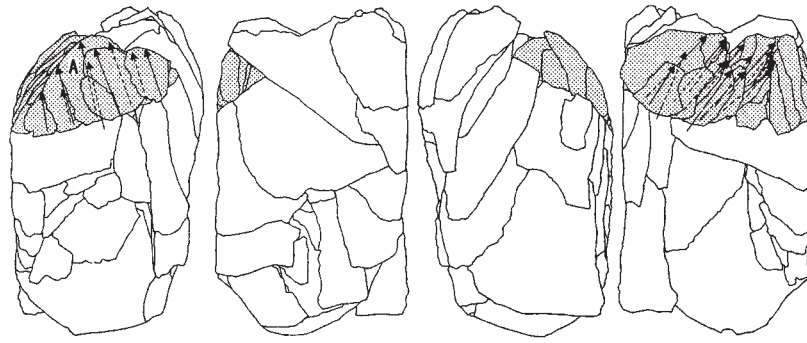

238

0 10 cm

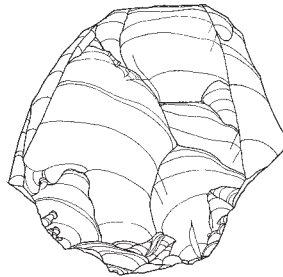

330

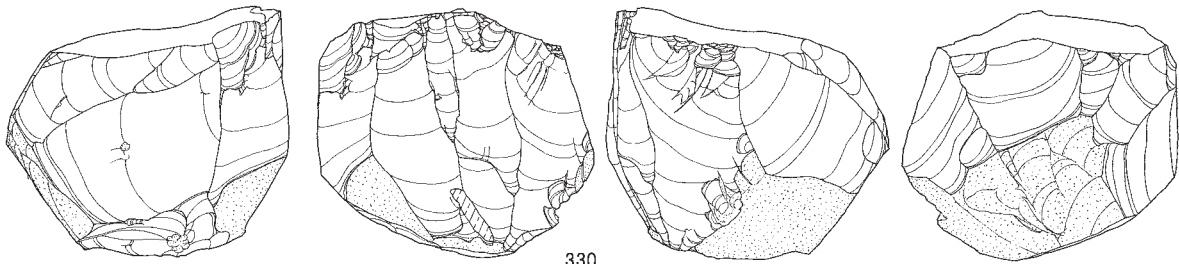

接合4347(個体A)分布図

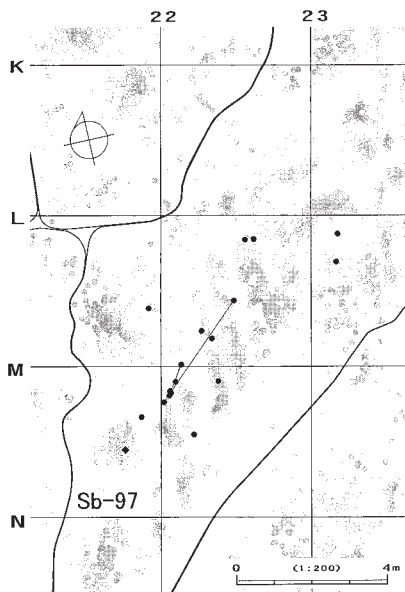

接合4347(個体A以外)分布図

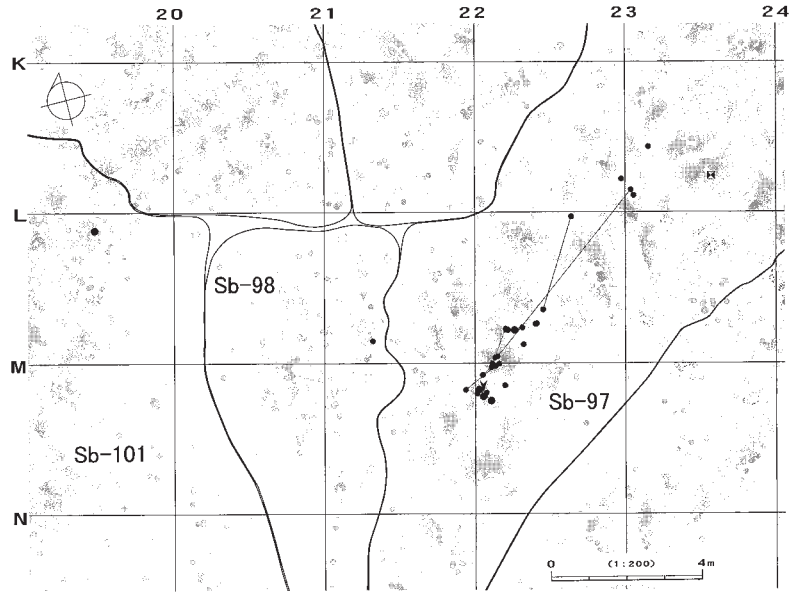

図Ⅲ-460 J区(Sb-97~107)の石器(66) 母岩1038・接合4347(2)

母岩990・接合4230

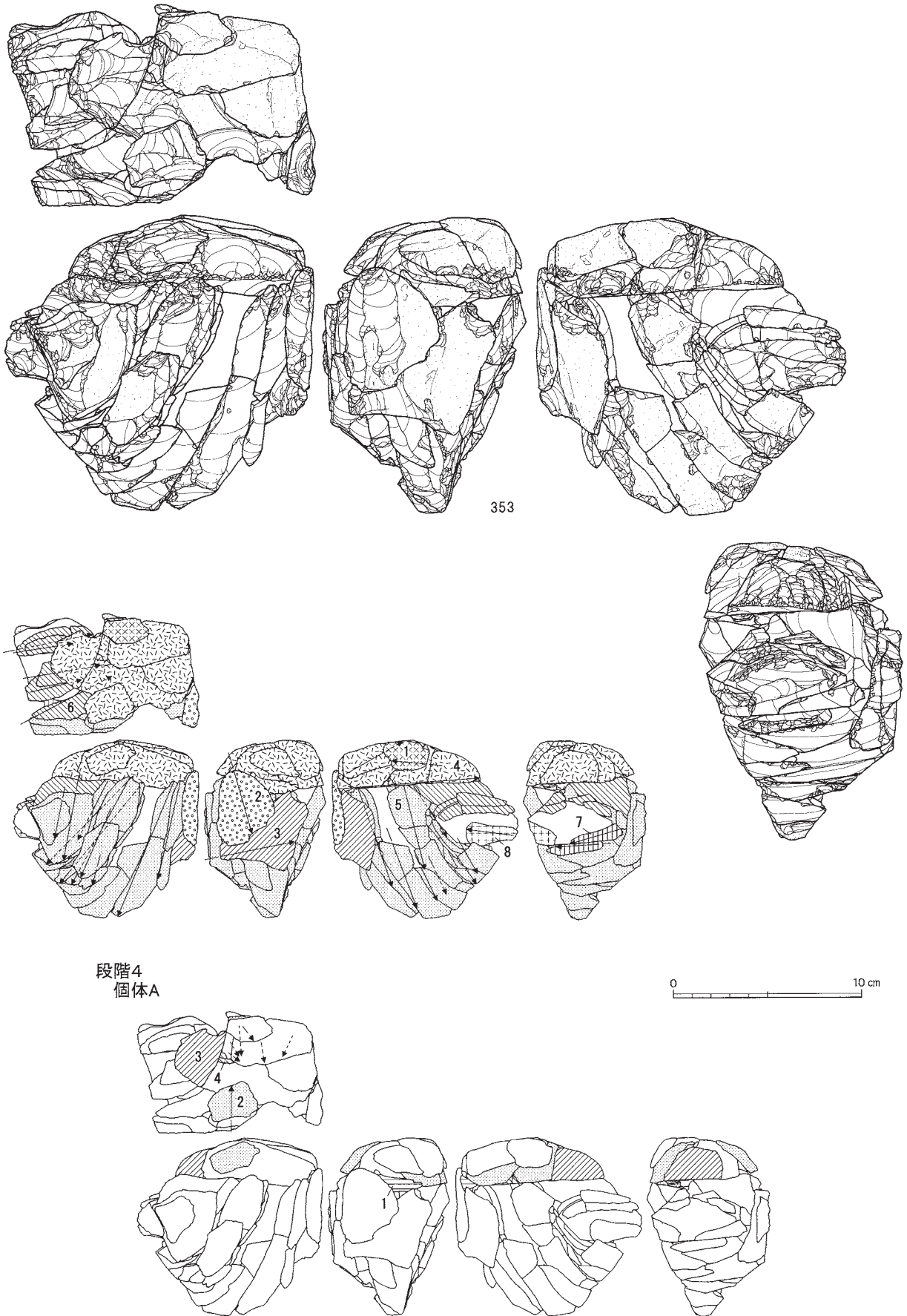

図Ⅲ-461 J区(Sb-97~107)の石器(67) 母岩990・接合4230(1)

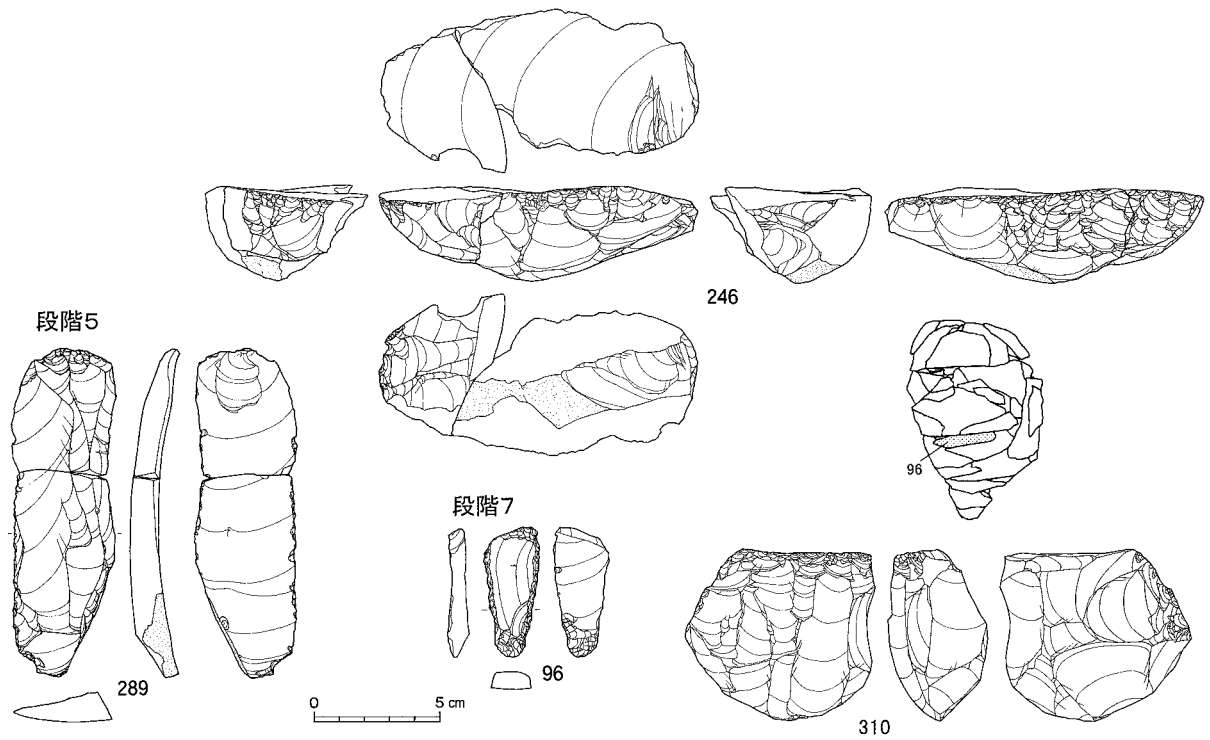

接合4230(個体A)分布図

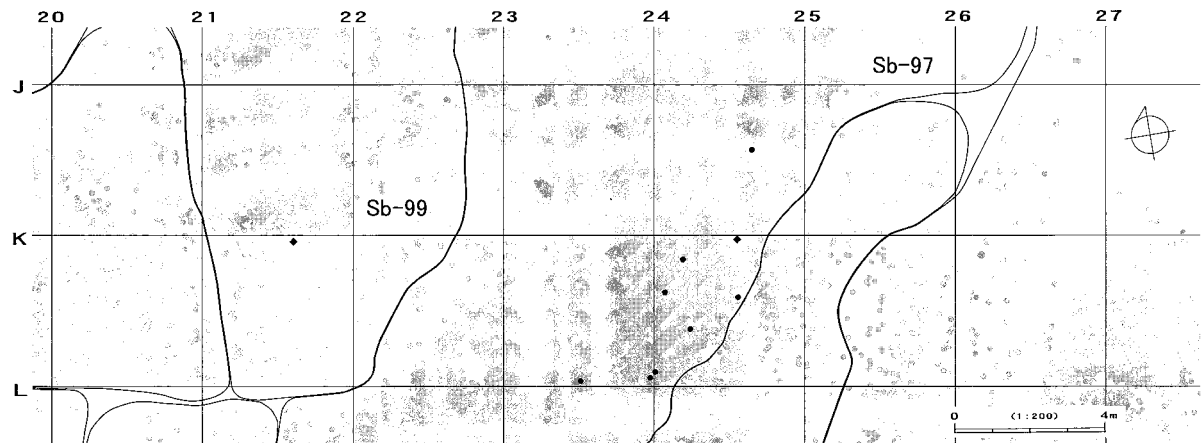

接合4230(個体A以外)分布図

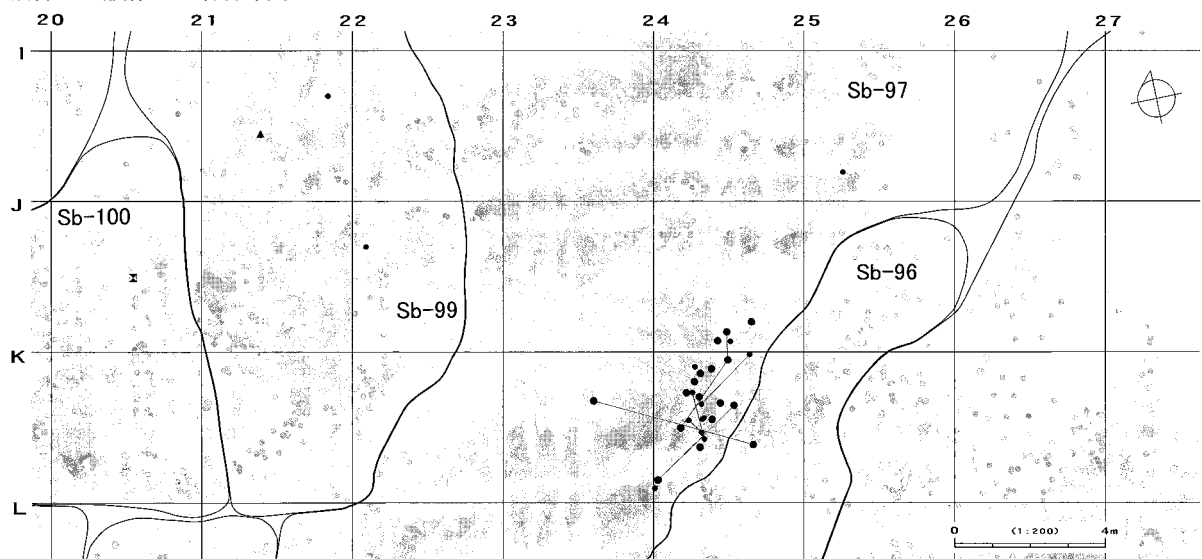

図Ⅲ-462 J区(Sb-97~107)の石器(68) 母岩990・接合4230(2)

母岩958・接合4152

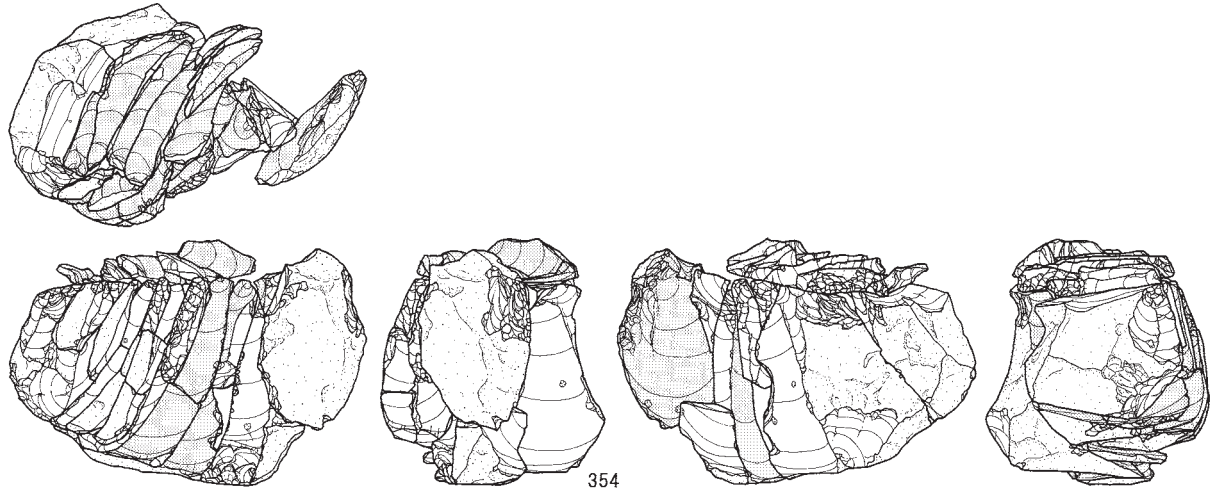

段階2
個体A

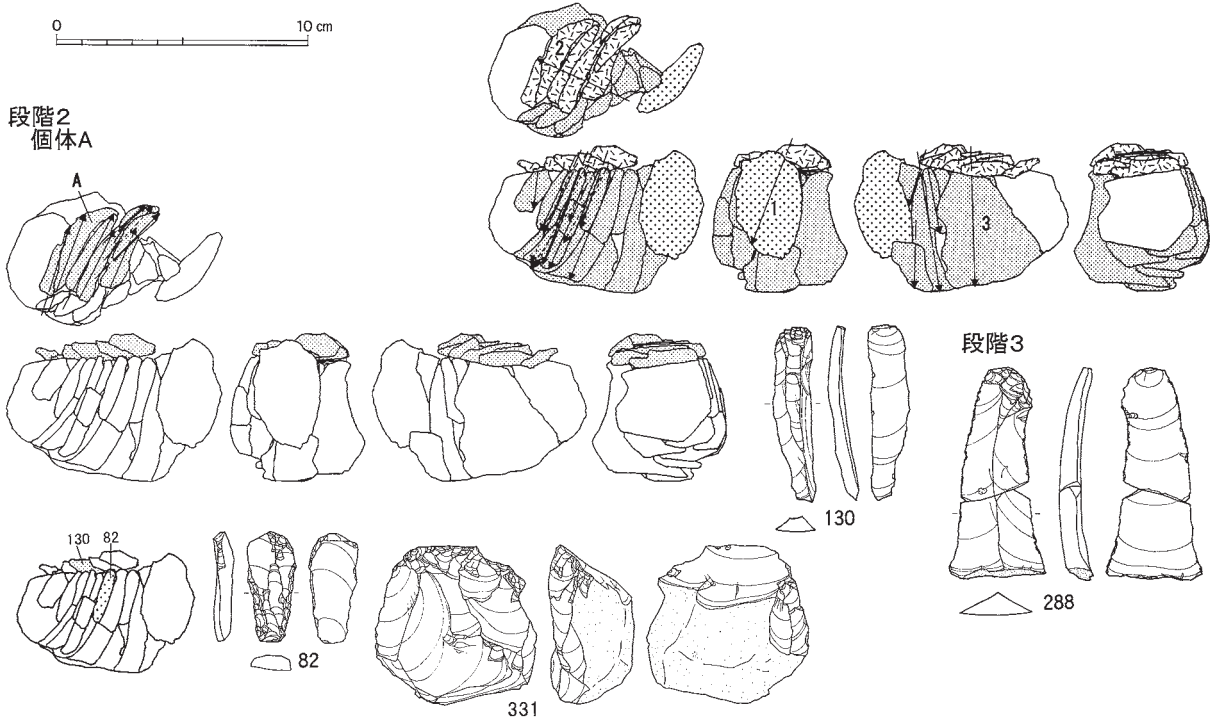

接合4152(個体A)分布図

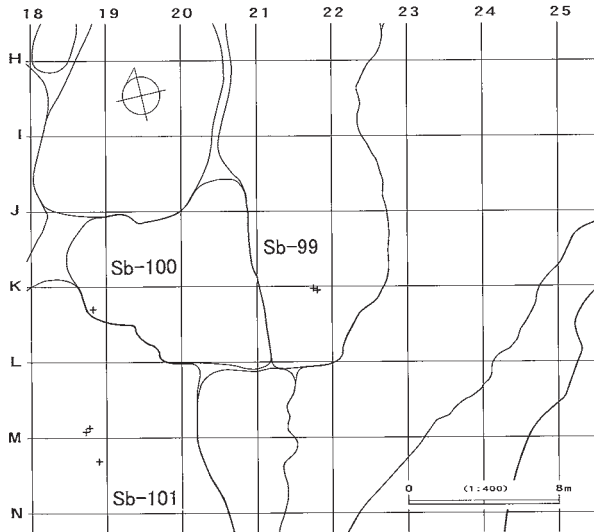

接合4152(個体A以外)分布図

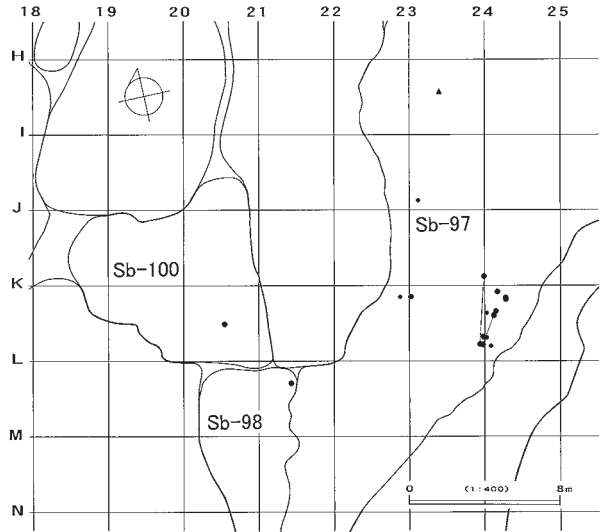

図III-463 J区(Sb-97~107)の石器(69) 母岩958・接合4152(1)

接合4152(全体)分布図

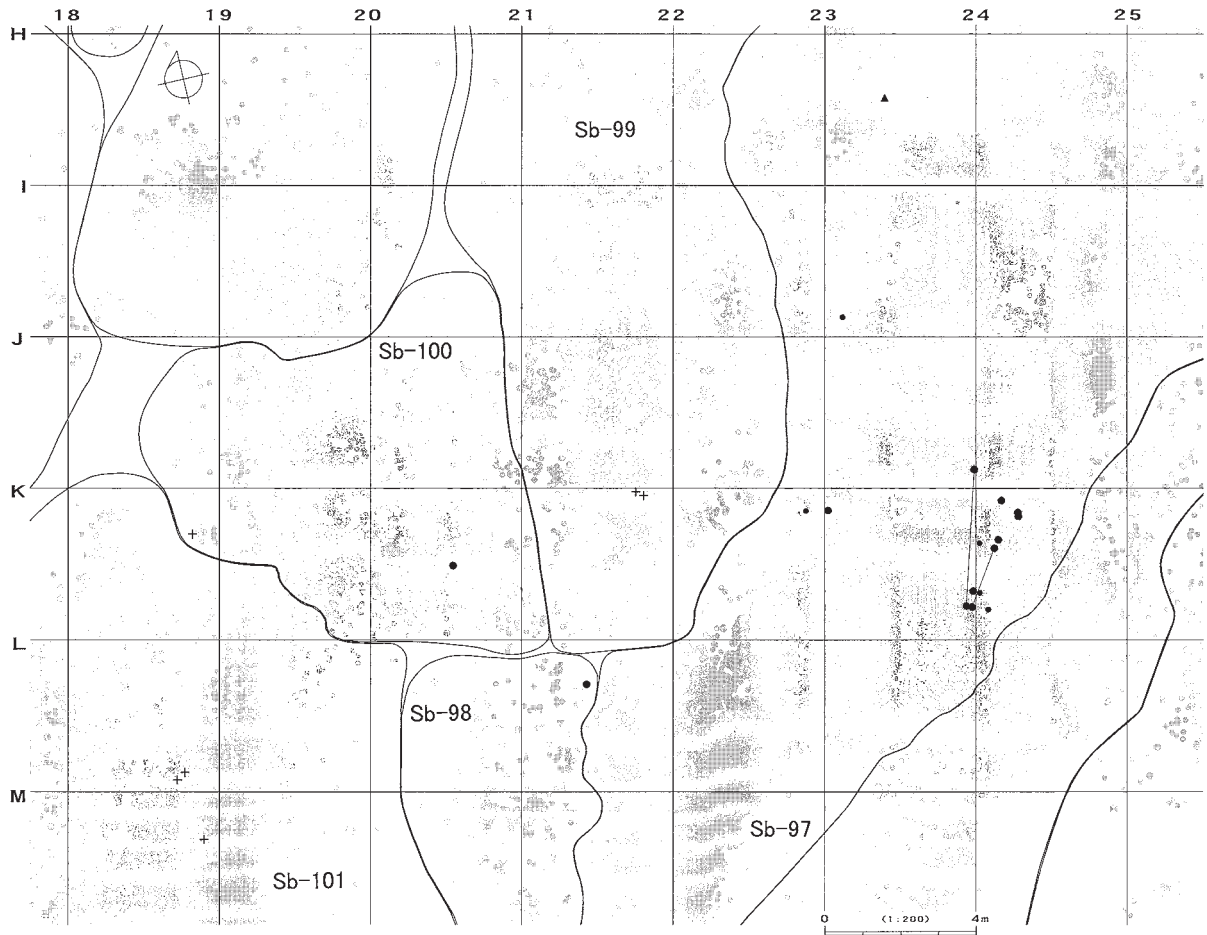

母岩1000・接合4257

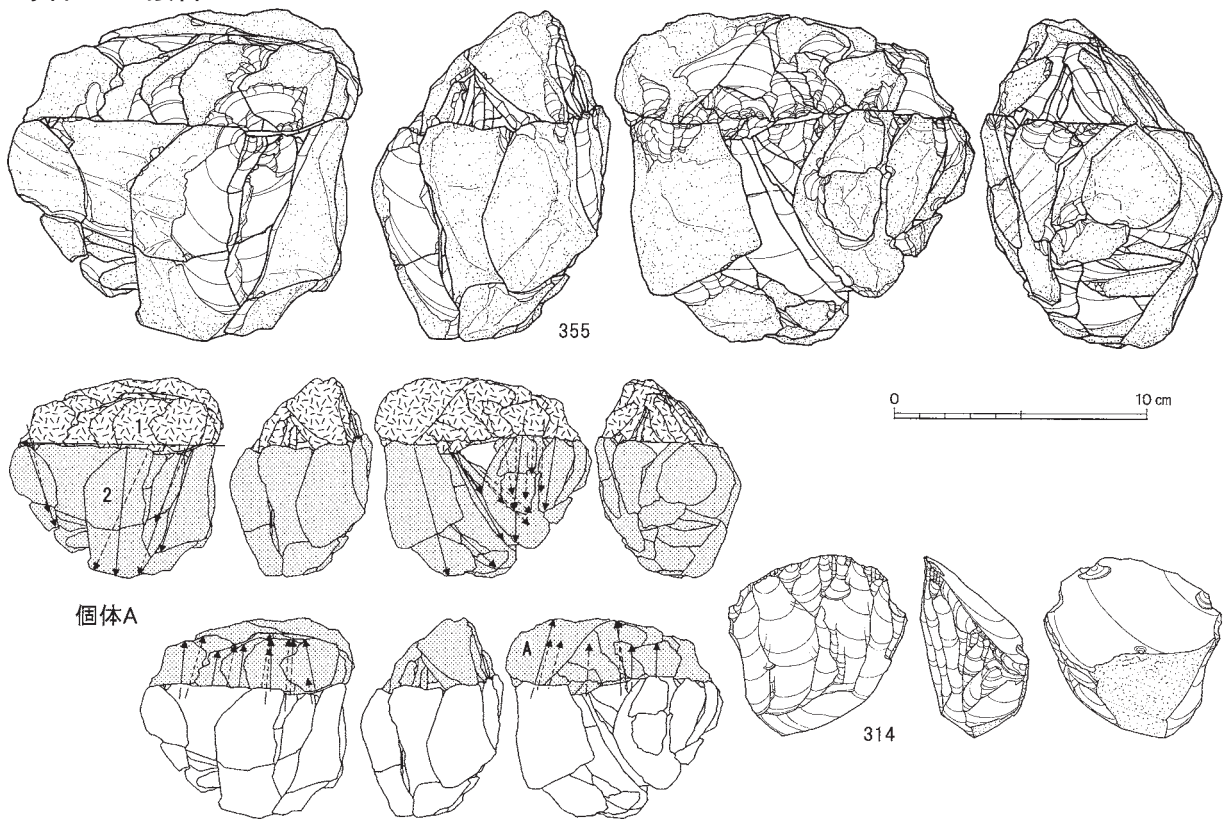

図Ⅲ-464 J区(Sb-97~107)の石器(70) 母岩958・接合4152(2)、母岩1000・接合4257(1)

接合4257(個体A)分布図

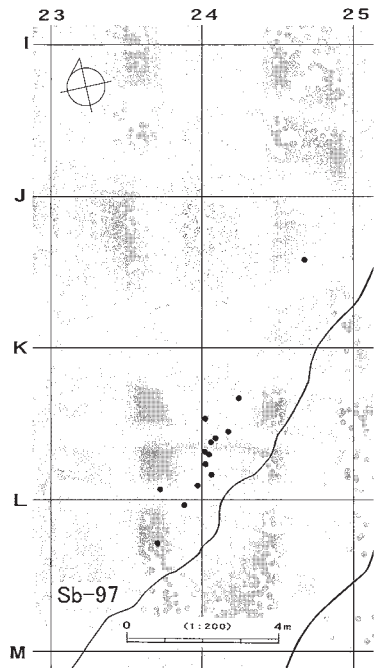

接合4257(個体A以外)分布図

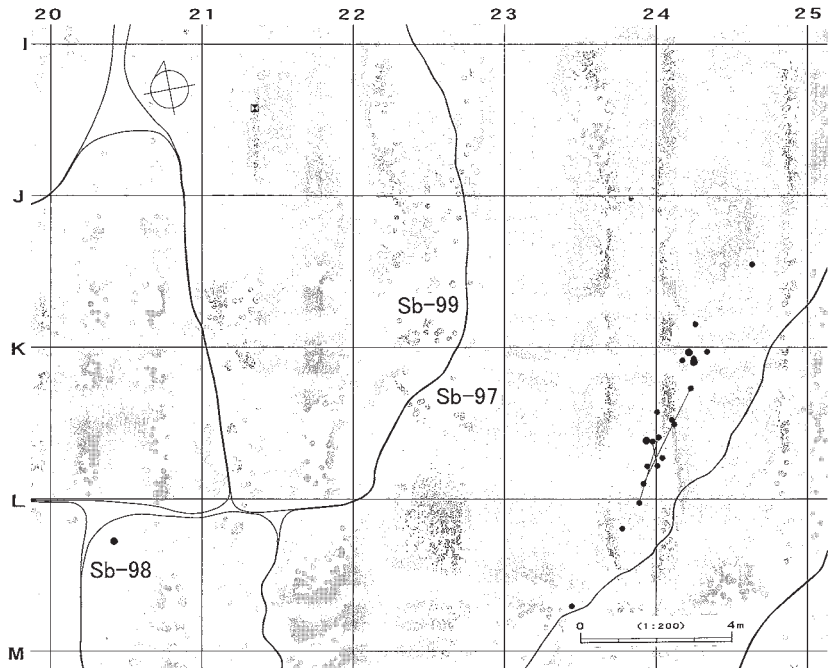

母岩1141・接合4623

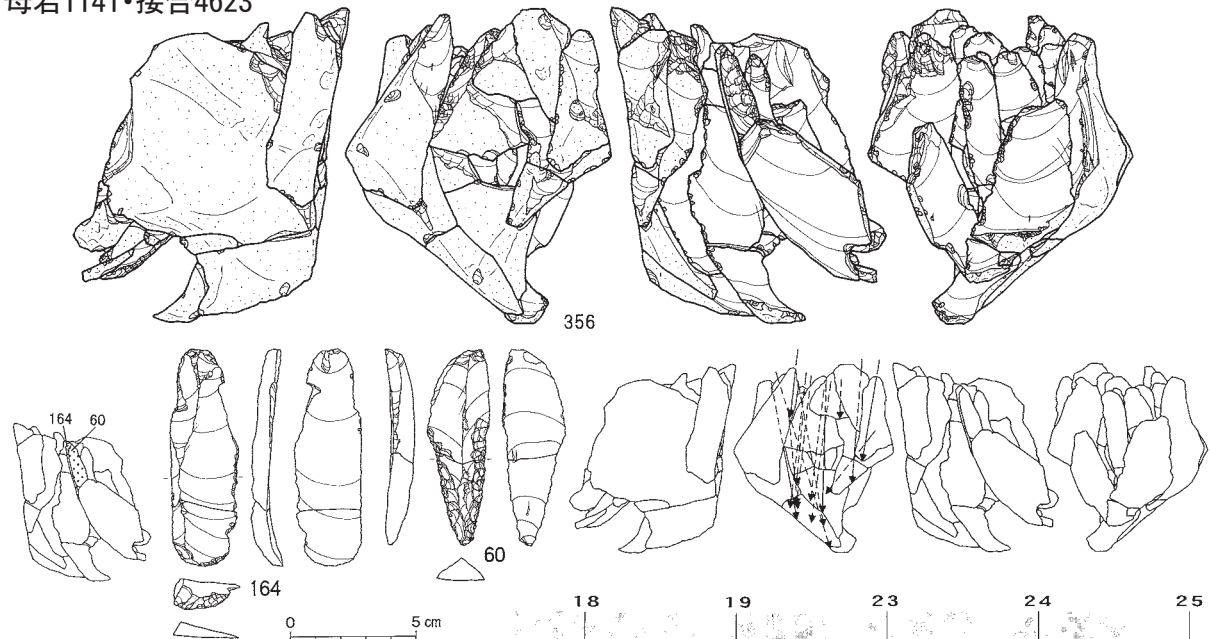

接合4623分布図

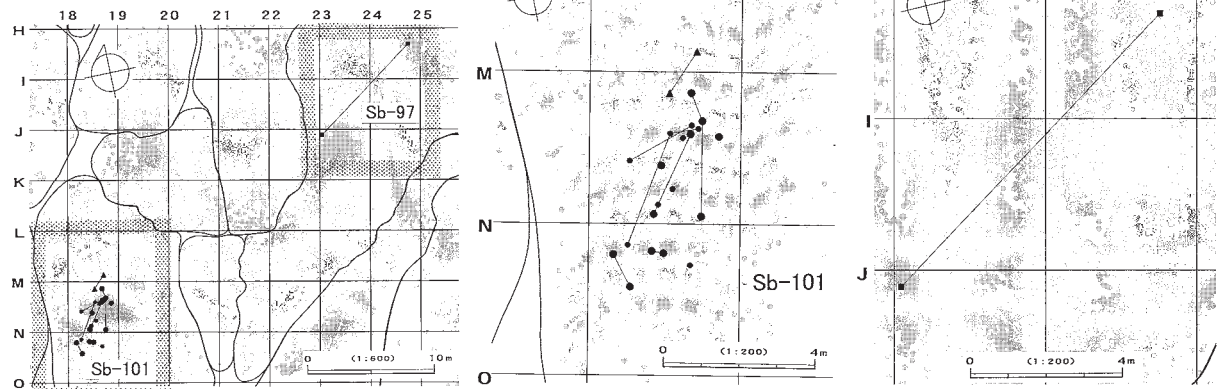

図Ⅲ-465 J区(Sb-97~107)の石器(71) 母岩1000・接合4257(2)、母岩1141・接合4623

母岩1164・接合4678

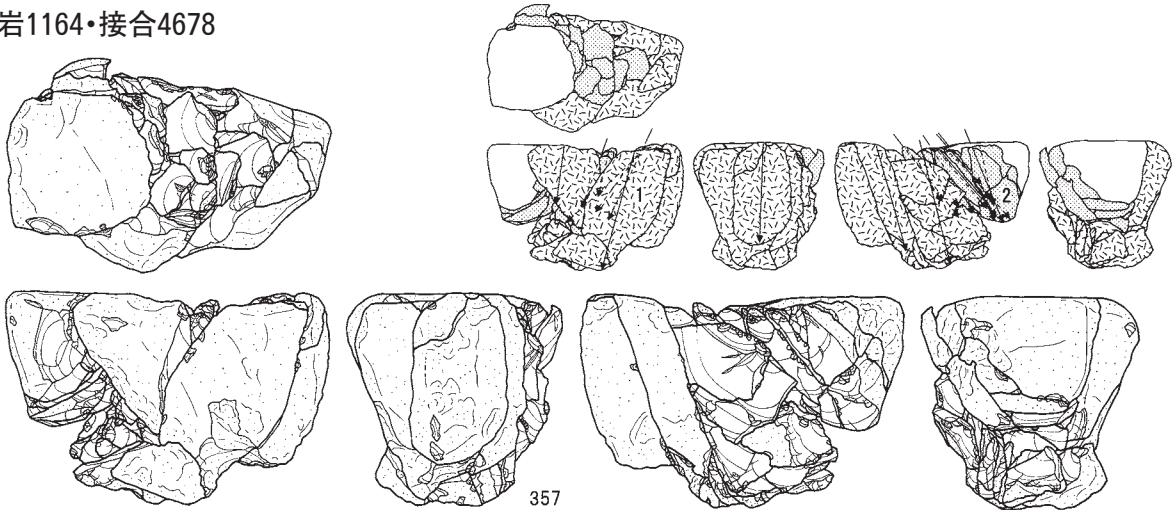

個体A

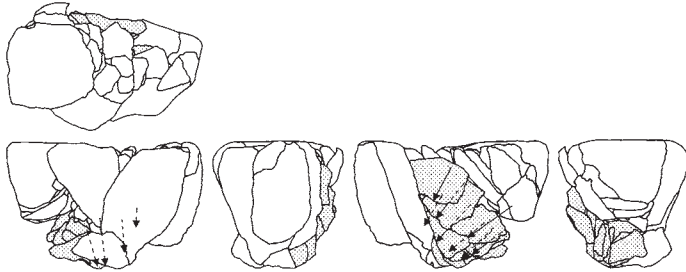

母岩1007・接合4275

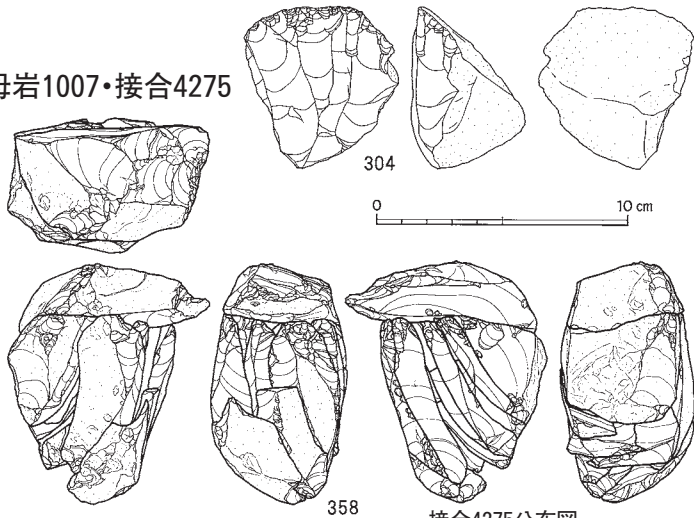

接合4678分布図

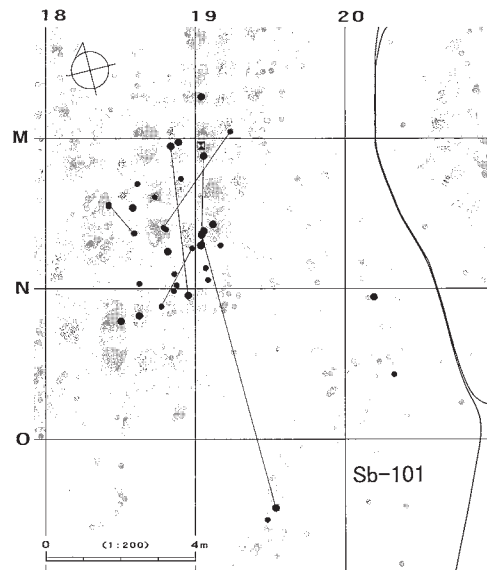

段階2

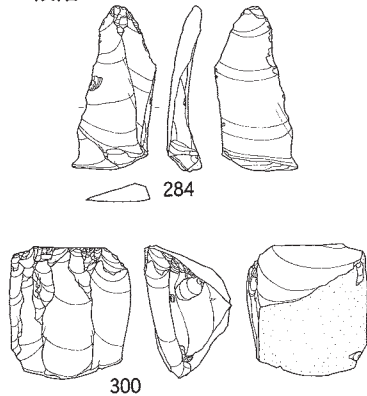

接合4275分布図

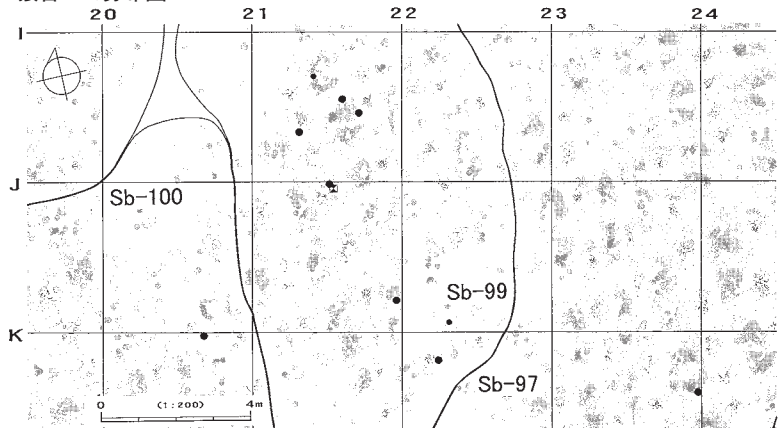

図Ⅲ-466 J区(Sb-97~107)の石器(72) 母岩1164・接合4678、母岩1007・接合4275

母岩1142・接合4626

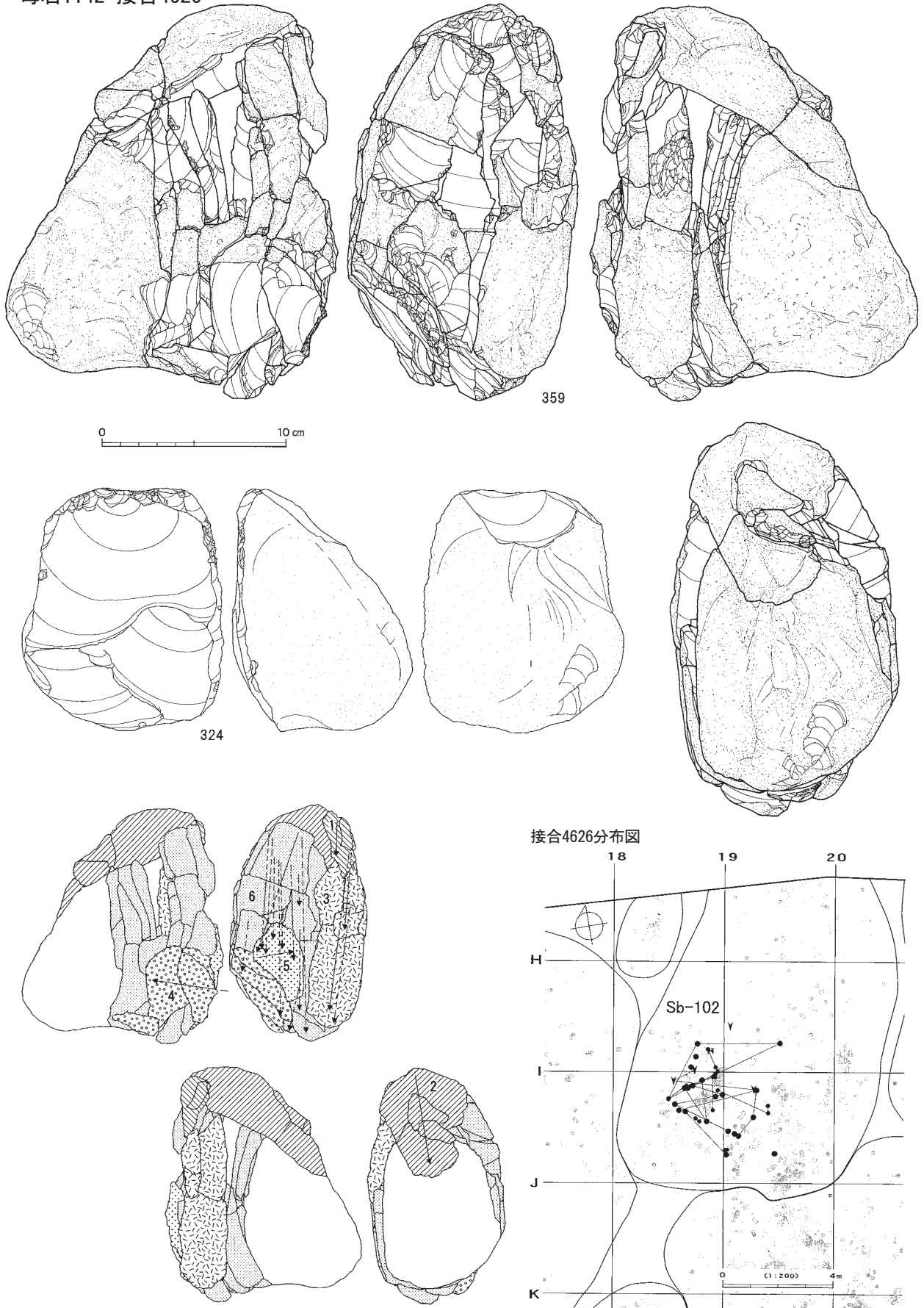

図Ⅲ-467 J区(Sb-97~107)の石器(73) 母岩1142・接合4626

母岩965・接合4173

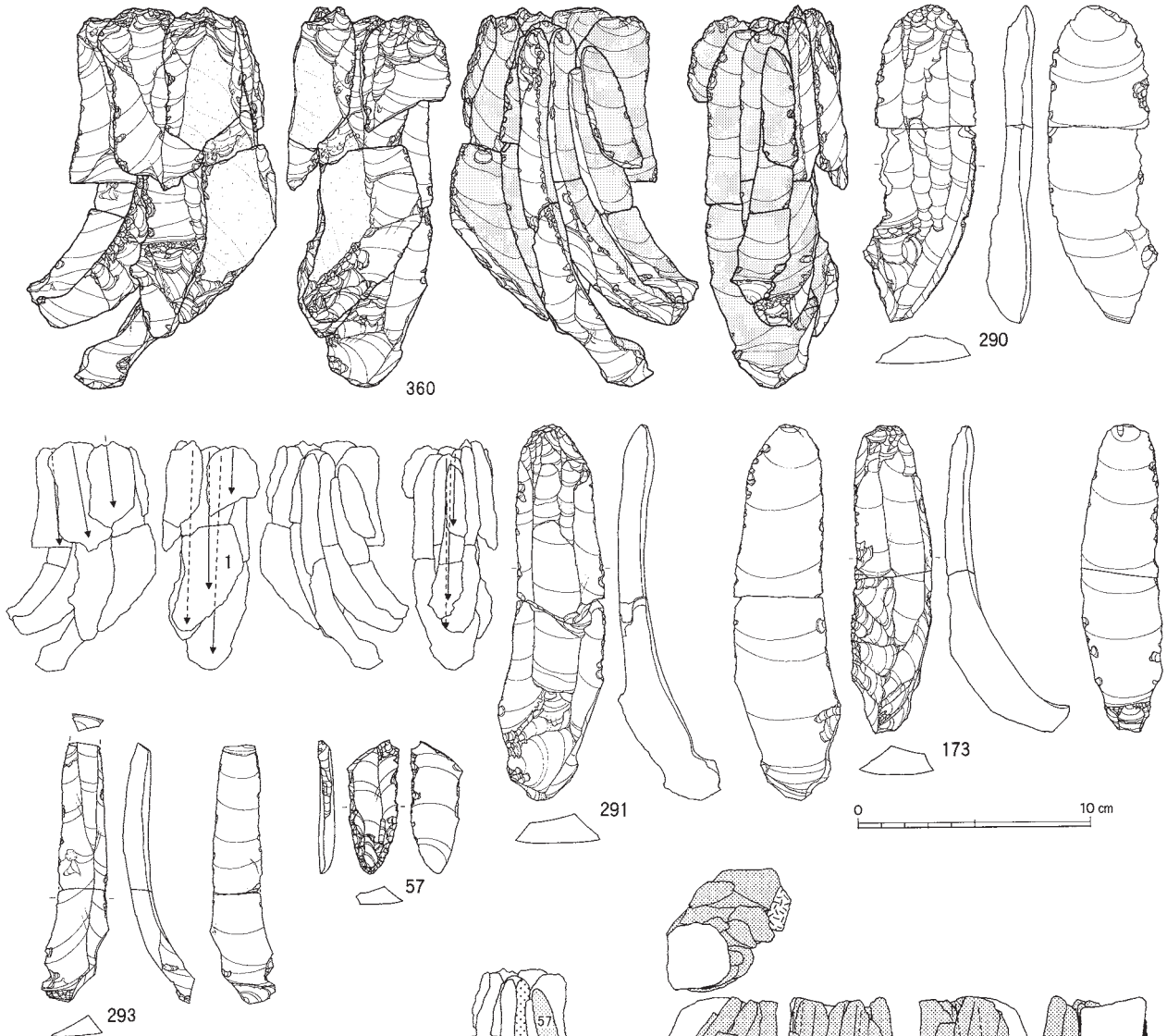

母岩965・接合4174

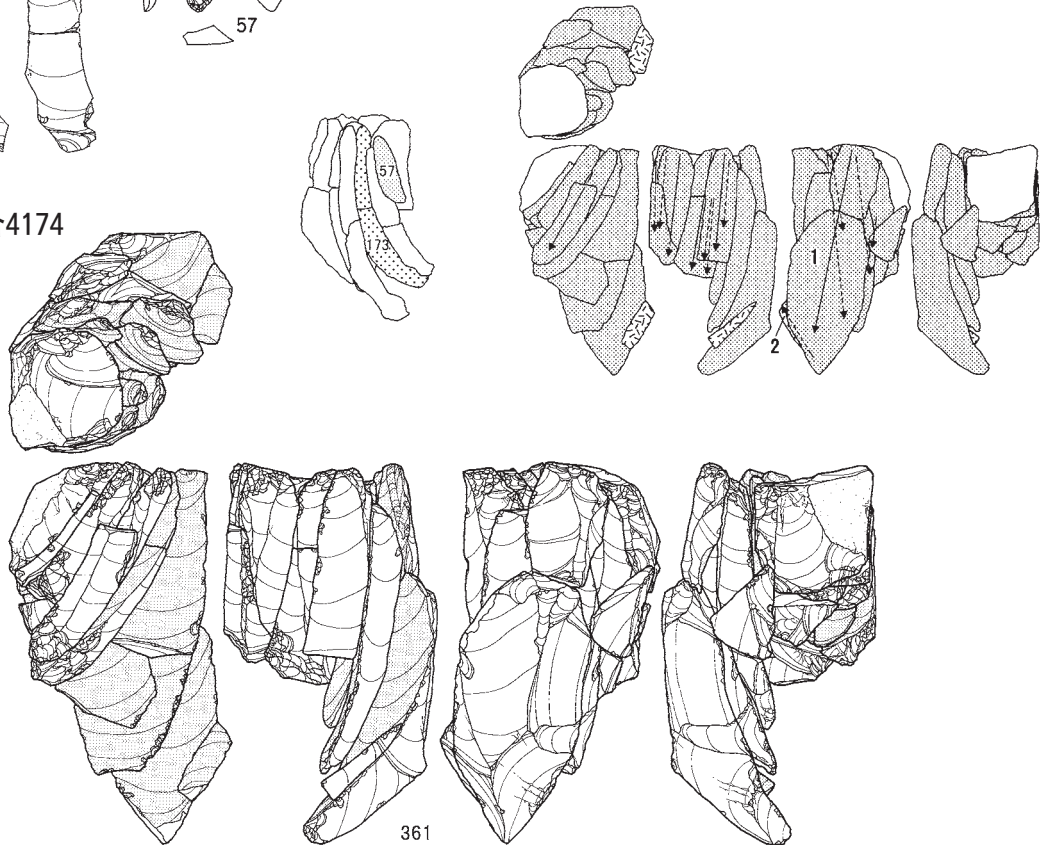

図三-468 J区(Sb-97~107)の石器(74) 母岩965・接合4173(1)、母岩965・接合4174(1)

段階1

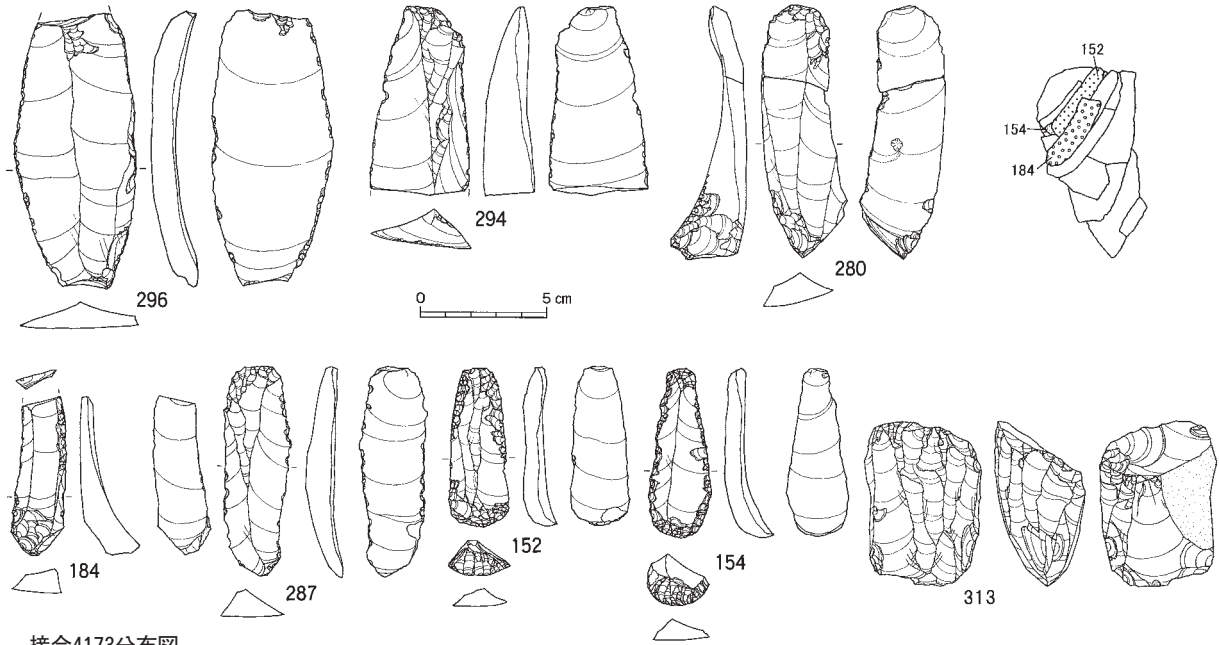

接合4173分布図

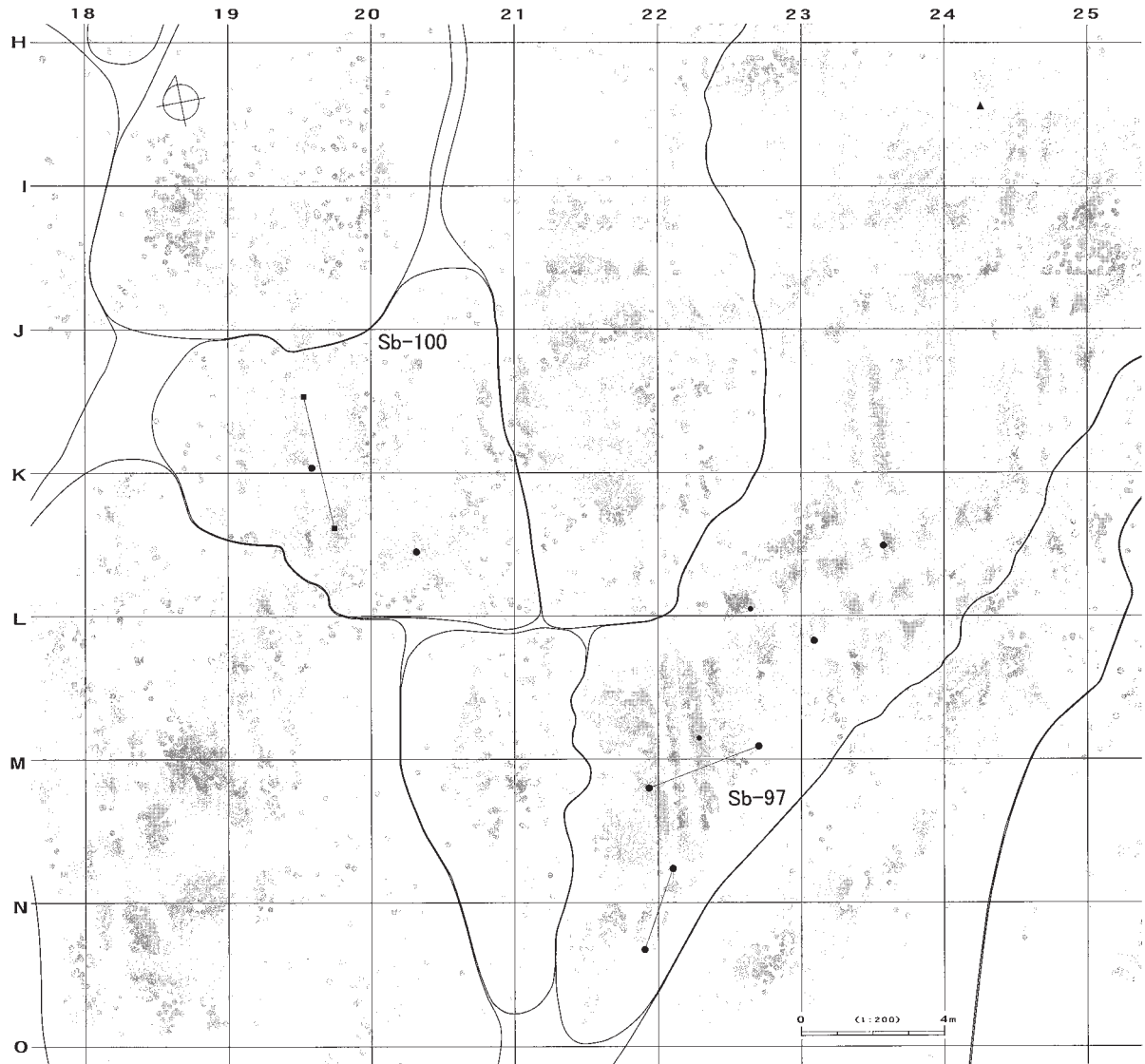

図III-469 J区(Sb-97~107)の石器(75) 母岩965・接合4173(2)、母岩965・接合4174(2)

接合4174分布図

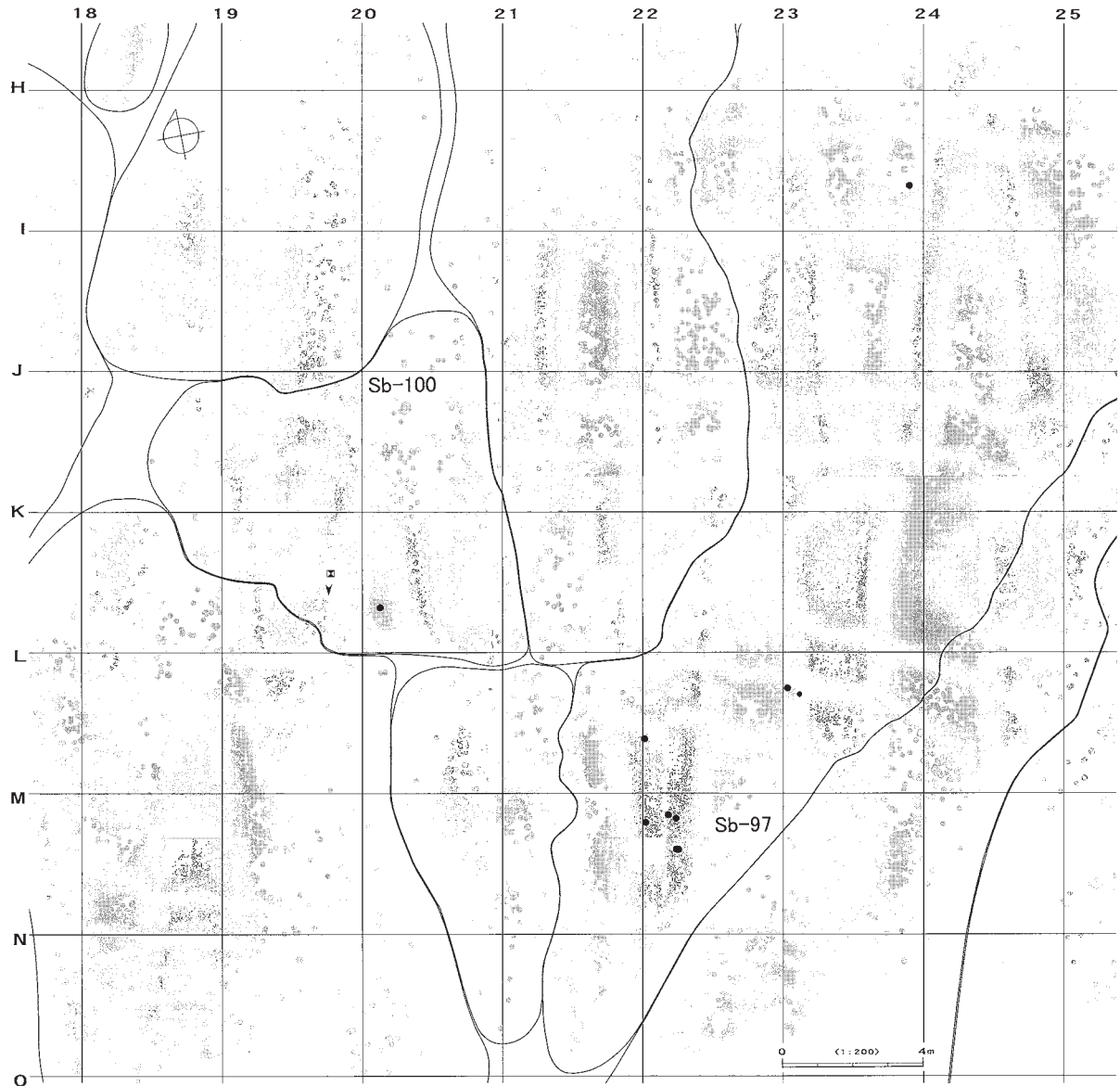

母岩1016・接合4287

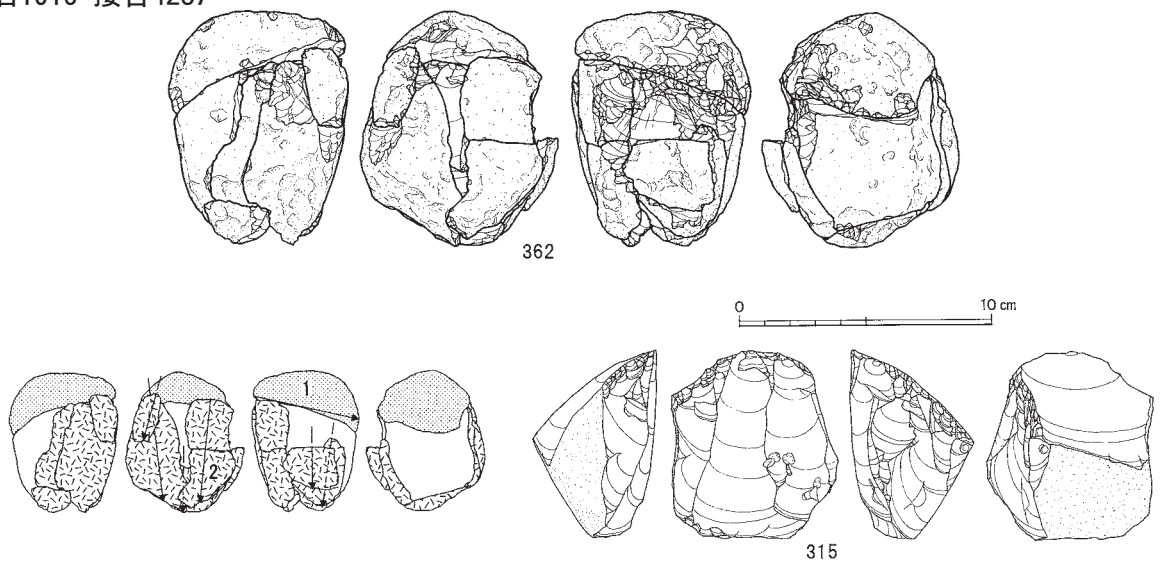

図Ⅲ-470 J区(Sb-97~107)の石器(76) 母岩965・接合4174(3)、母岩1016・接合4287(1)

接合4287分布図

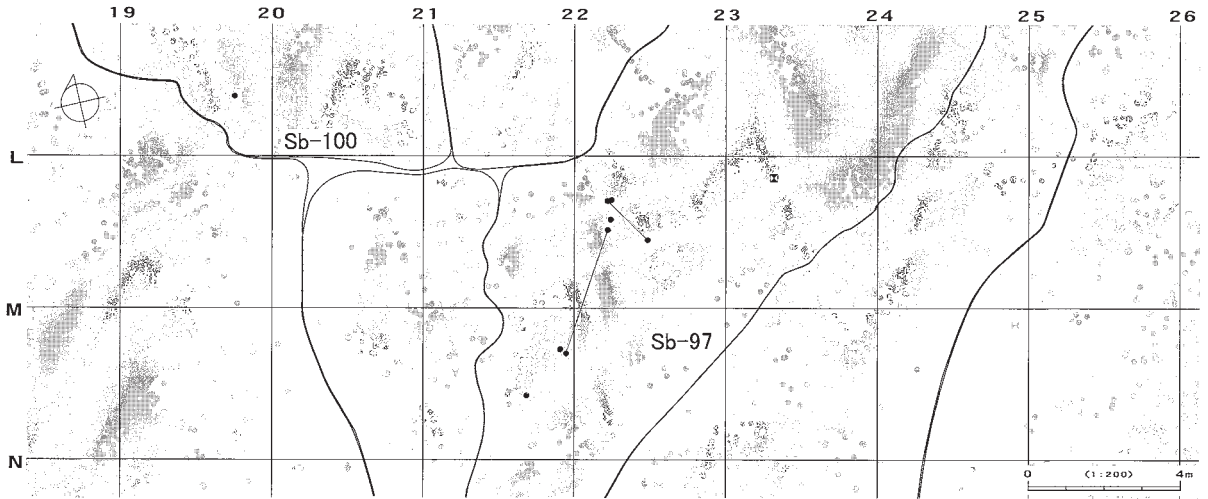

母岩1028・接合4322

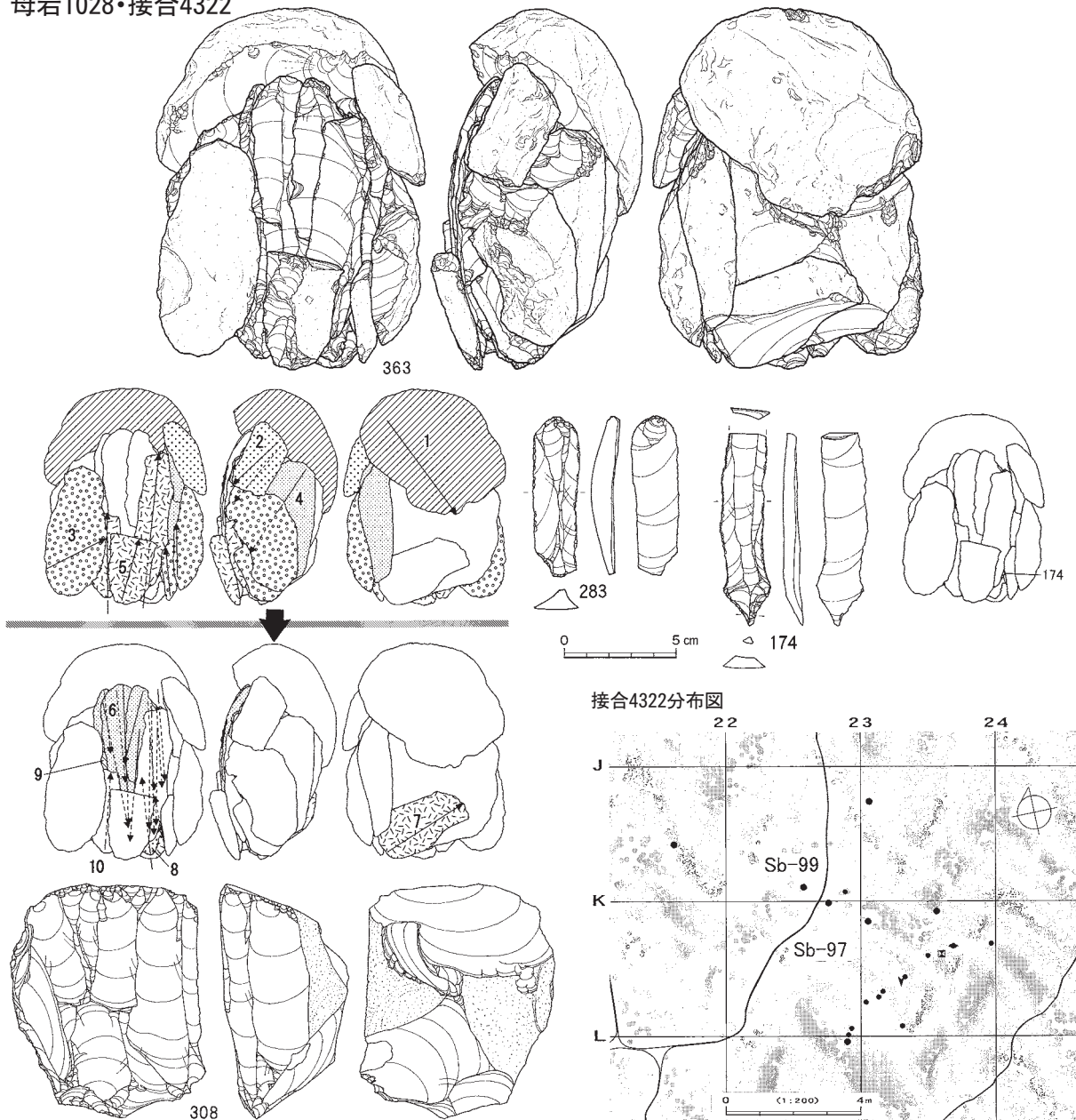

図Ⅲ-471 J区(Sb-97~107)の石器(77) 母岩1016・接合4287(2)、母岩1028・接合4322

母岩1034・接合4337

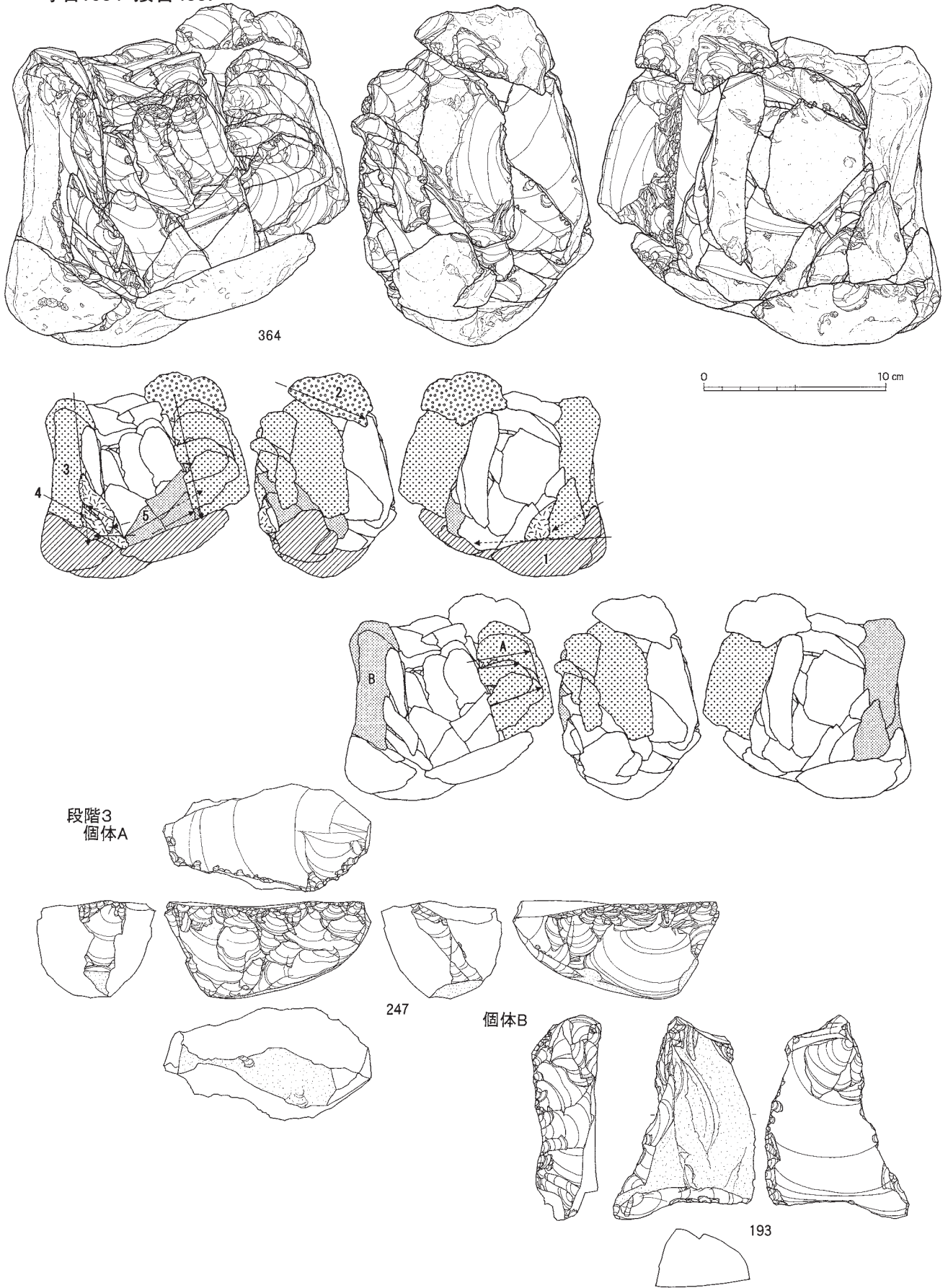

図Ⅲ-472 J区(Sb-97~107)の石器(78) 母岩1034・接合4337(1)

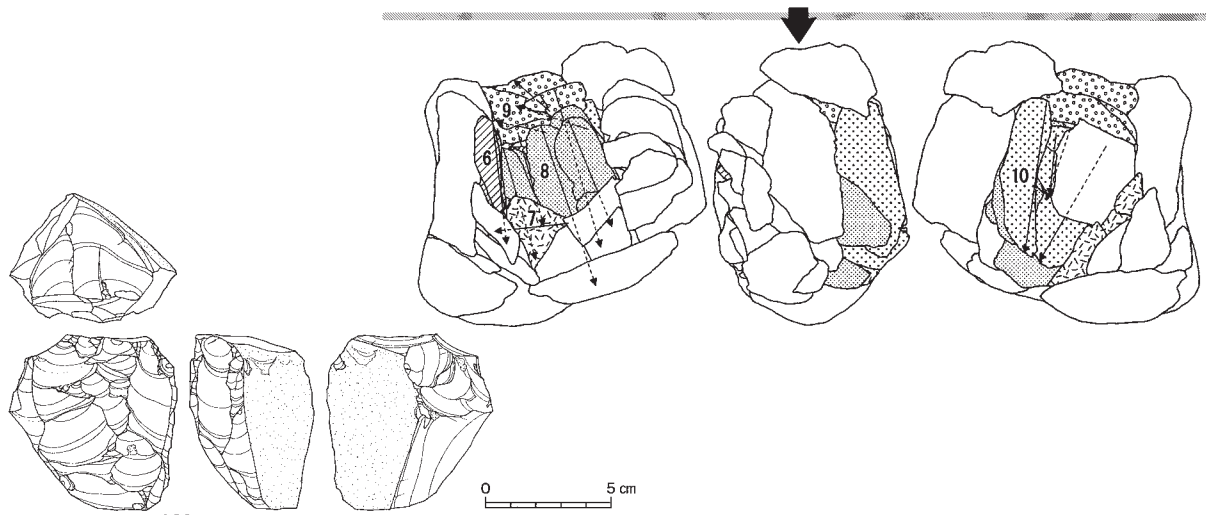

329

接合4337(個体A)分布図

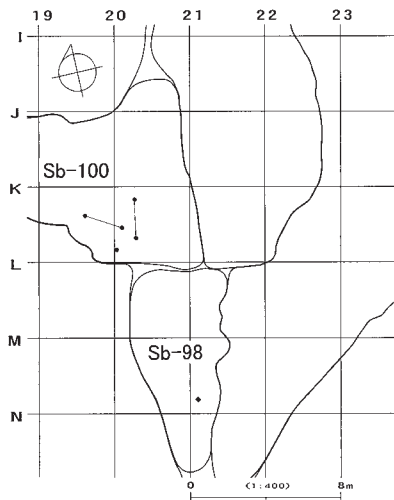

接合4337(個体B)分布図

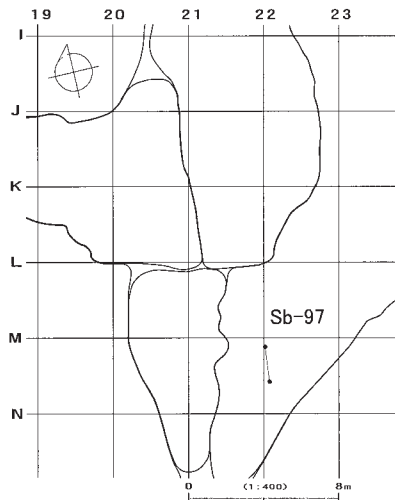

接合4337(個体A・B以外)分布図

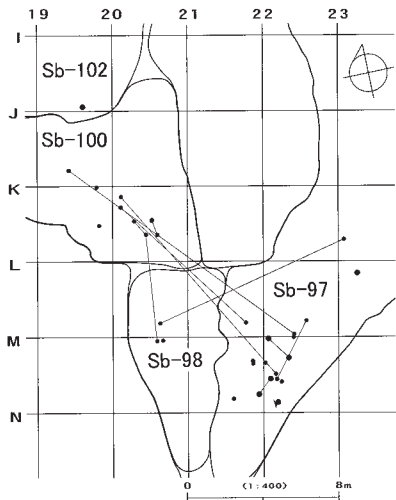

接合4337(全体)分布図

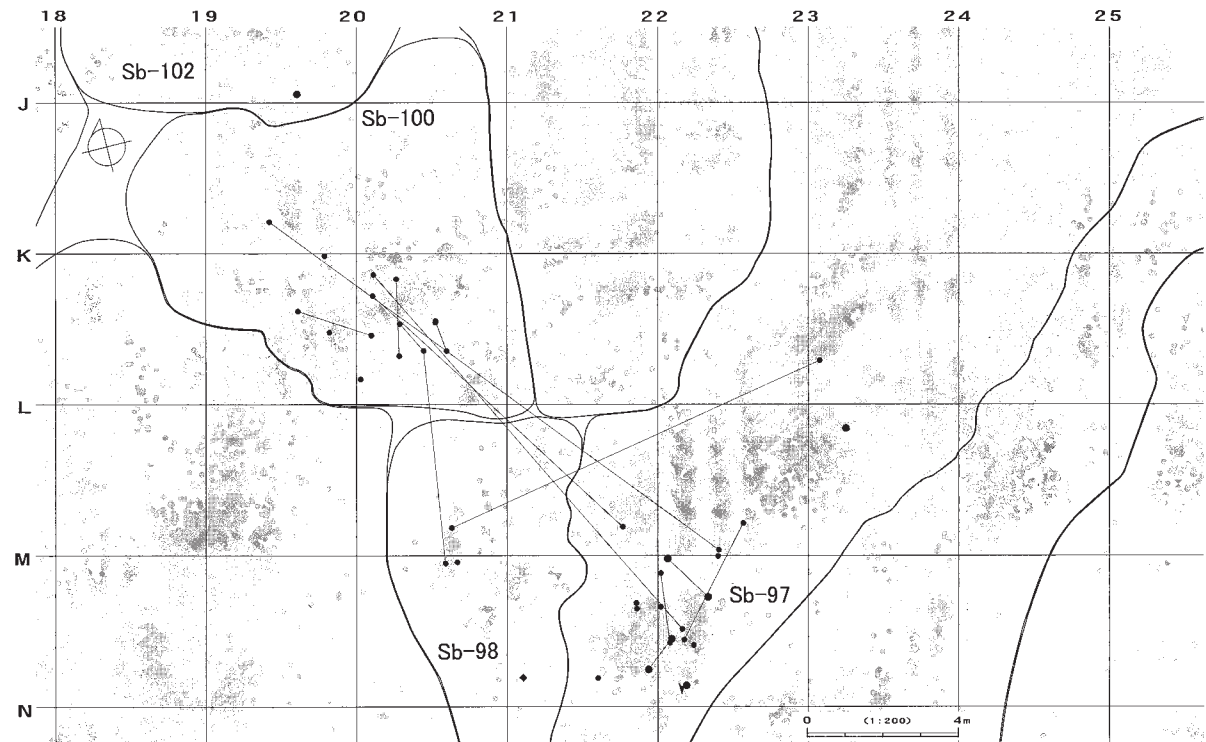

図Ⅲ-473 J区(Sb-97~107)の石器(79) 母岩1034・接合4337(2)

母岩1108・接合4556

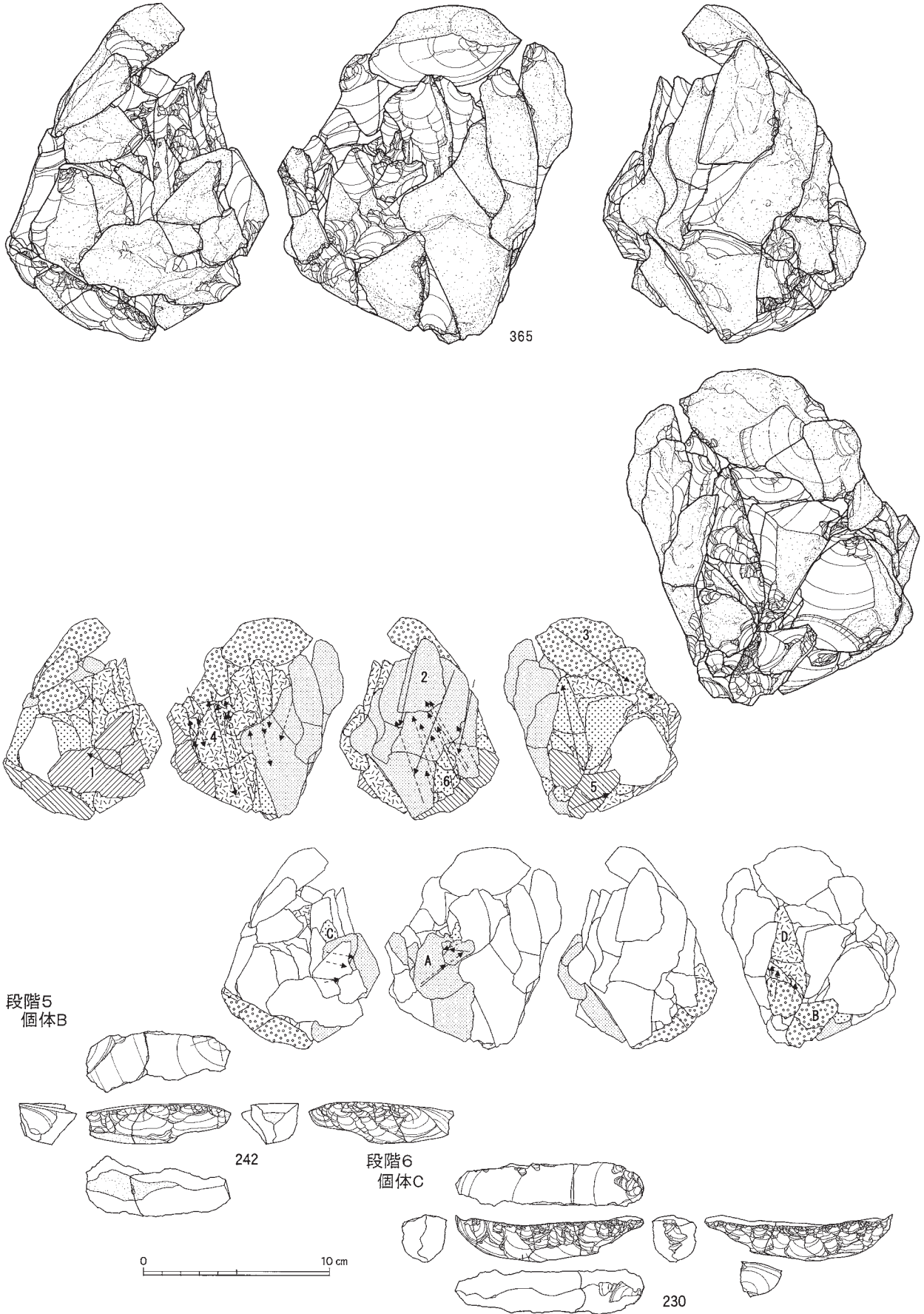

図Ⅲ-474 J区(Sb-97~107)の石器(80) 母岩1108・接合4556(1)

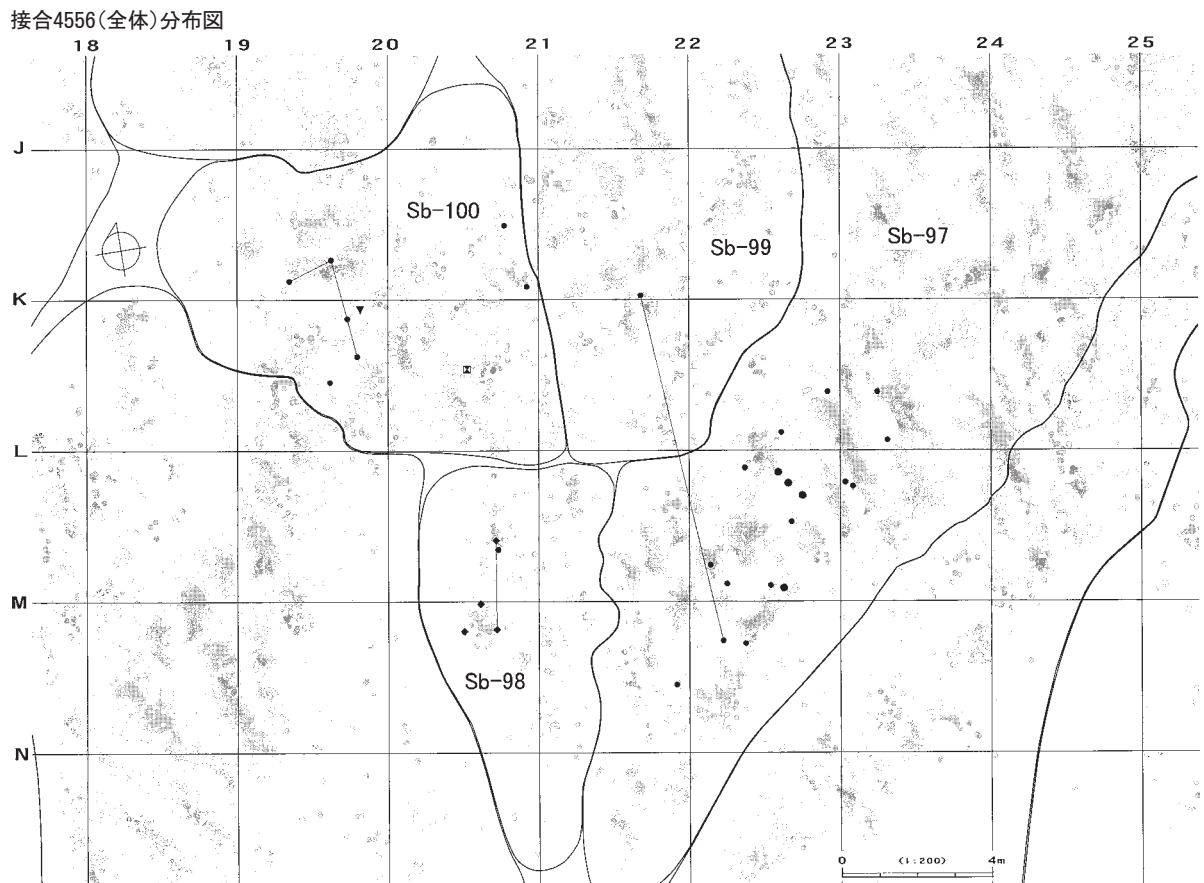
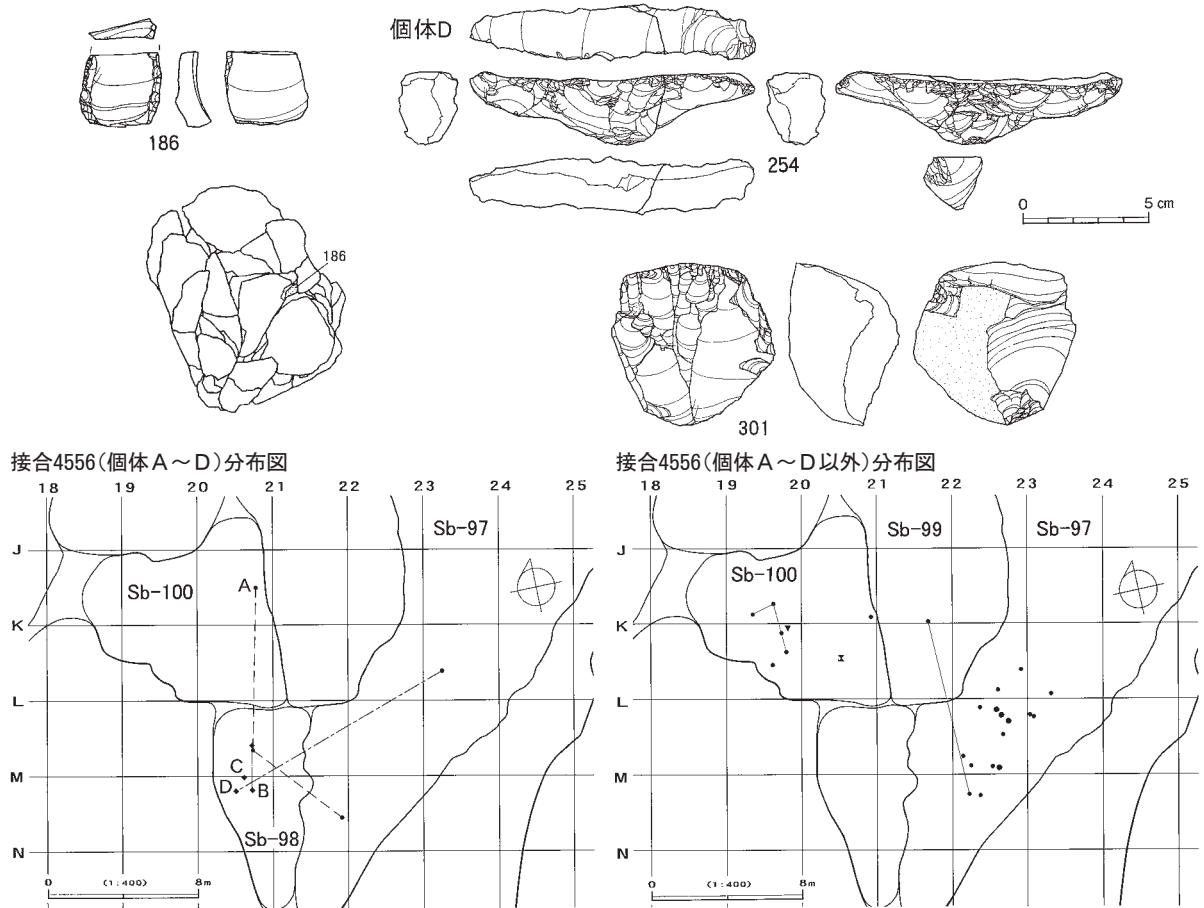

図Ⅲ-475 J区(Sb-97~107)の石器(81) 母岩1108・接合4556(2)

母岩948・接合4125

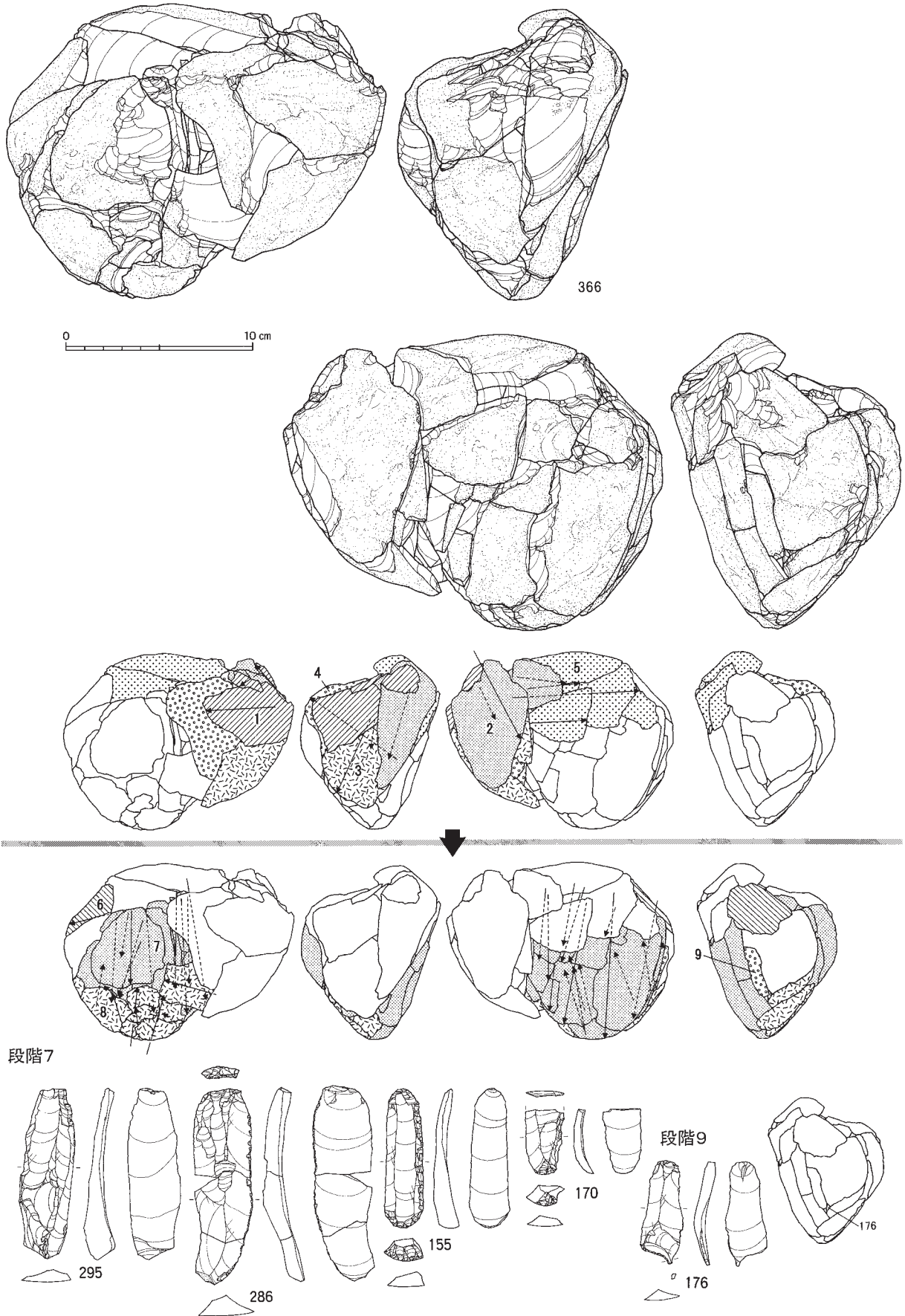

図Ⅲ-476 J区(Sb-97~107)の石器(82) 母岩948・接合4125(1)

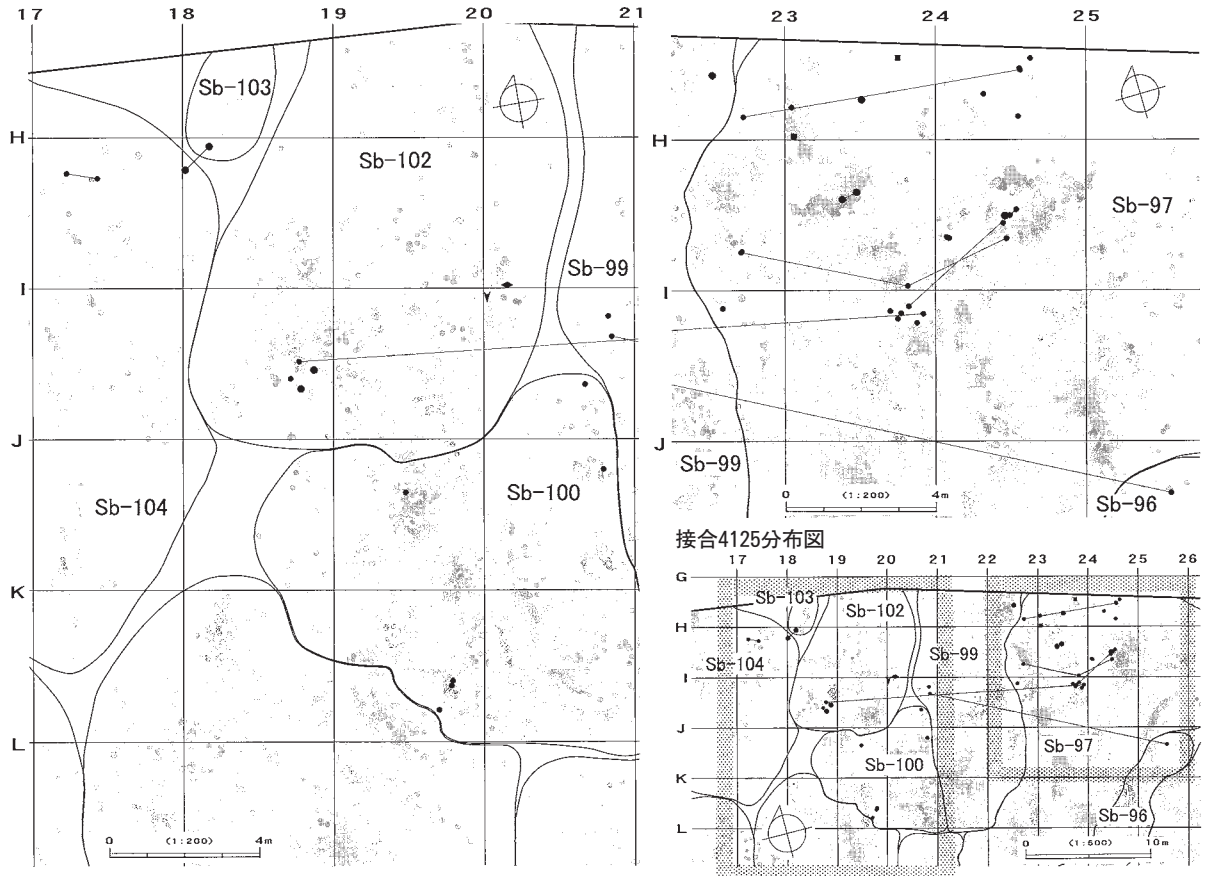
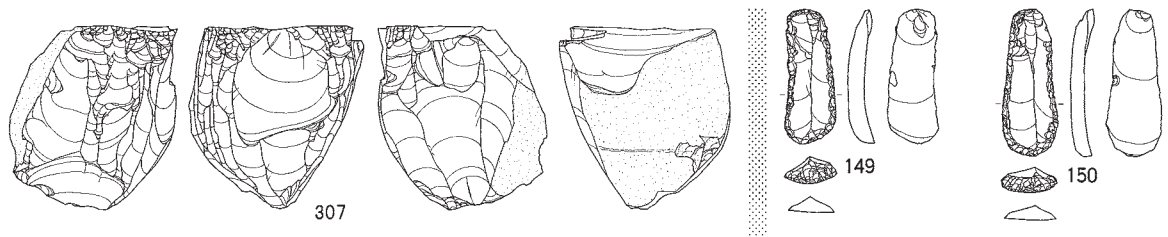

母岩1104・接合4552

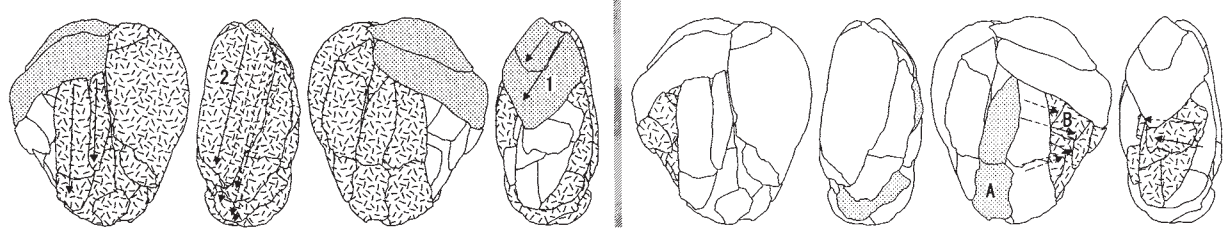
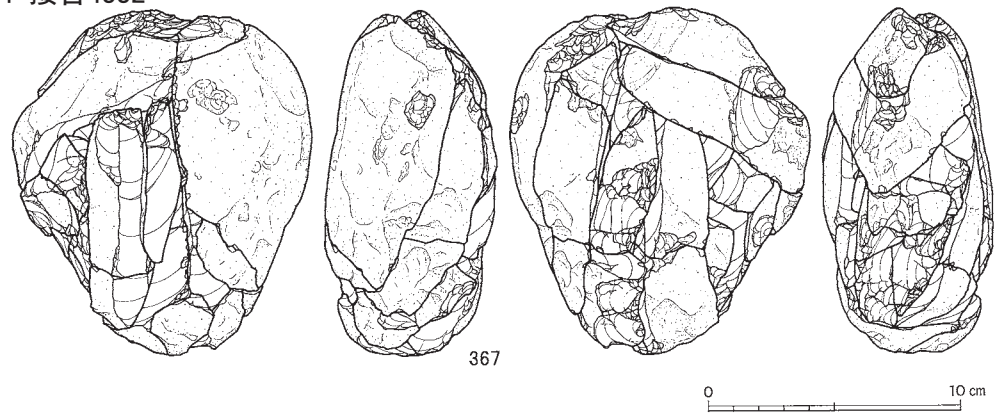

図III-477 J区(Sb-97~107)の石器(83) 母岩948・接合4125(2)、母岩1104・接合4552(1)

段階2
個体A

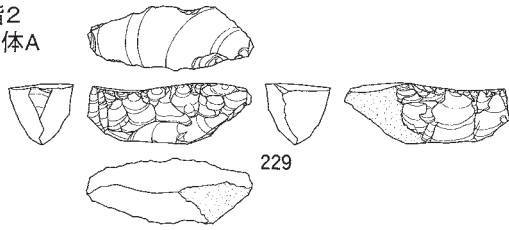

段階3
個体B

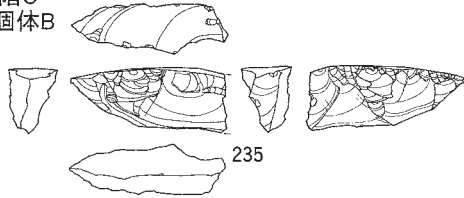

接合4552分布図

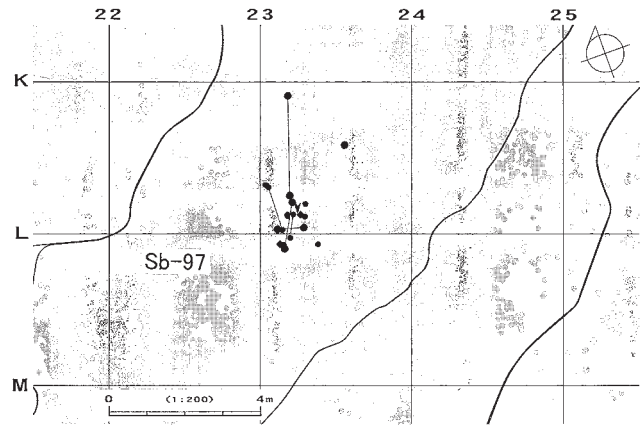

母岩1089・接合4520

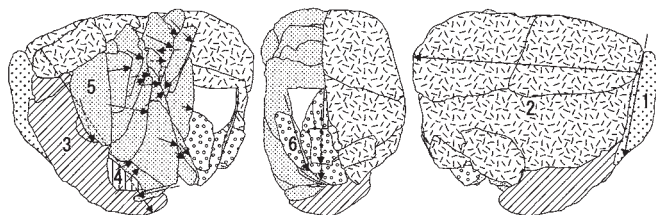
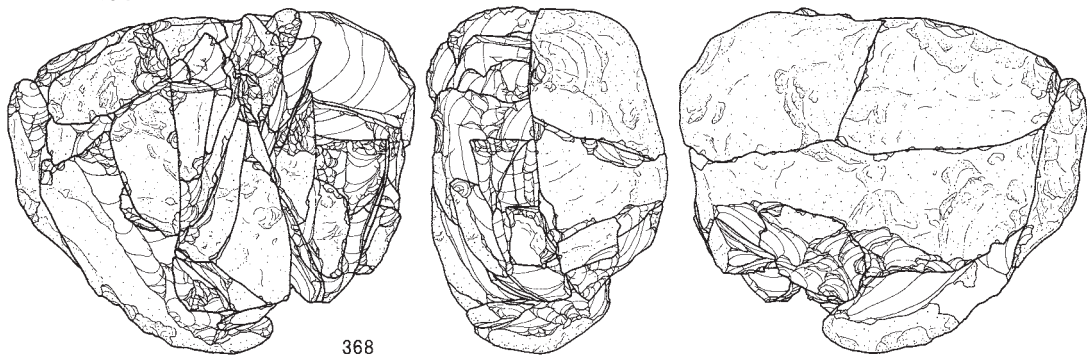

0 10 cm

段階2
個体A

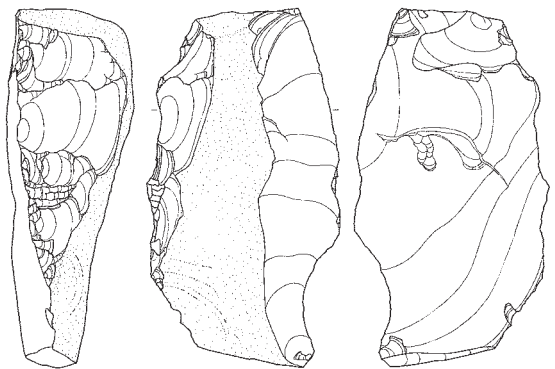
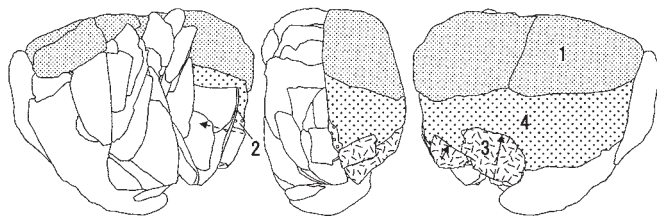

194

段階3
個体B

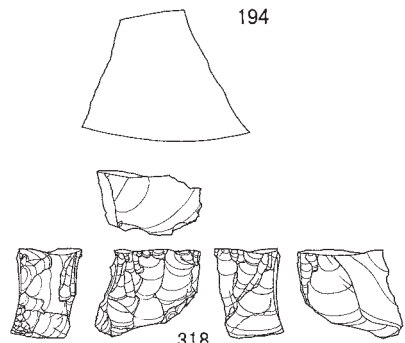
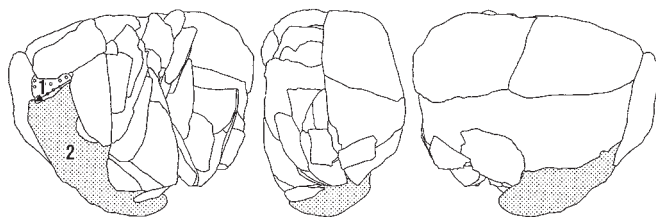

318

図Ⅲ-478 J区(Sb-97~107)の石器(84) 母岩1104・接合4552(2)、母岩1089・接合4520(1)

接合4520(個体A・B)分布図

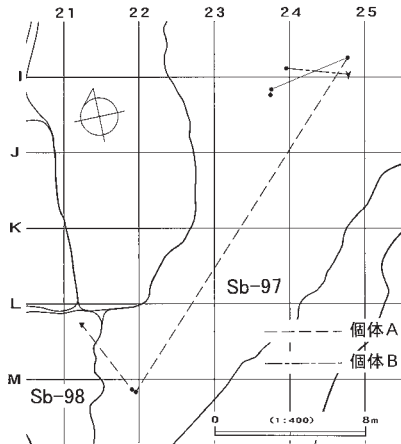

接合4520(全体)分布図

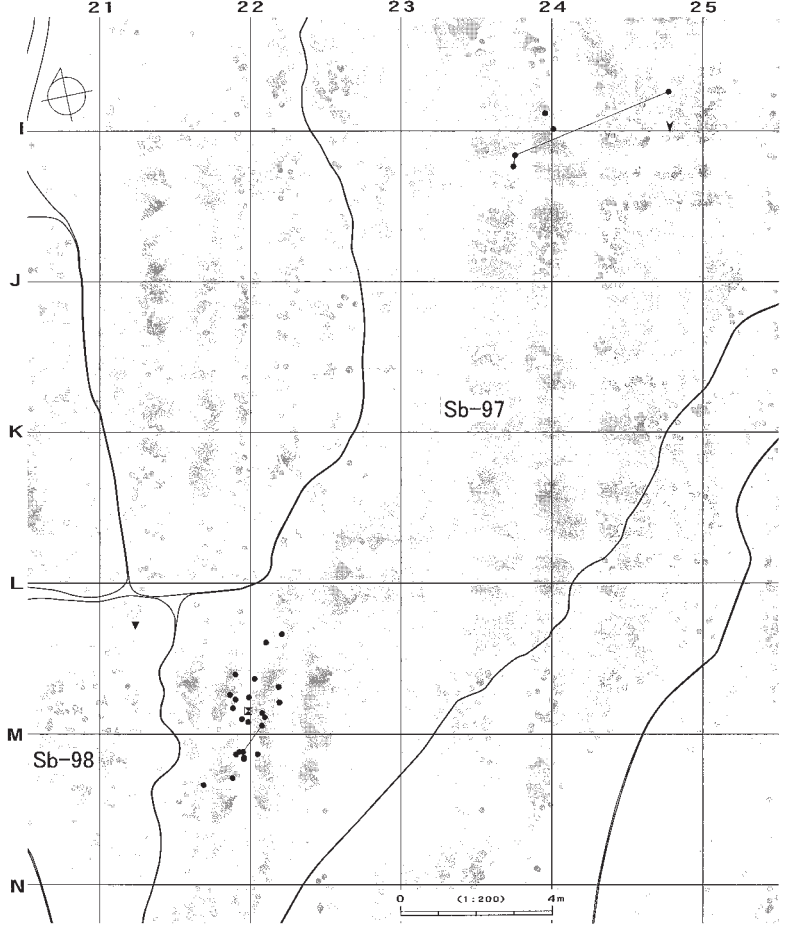

接合4520(個体A・B以外)分布図

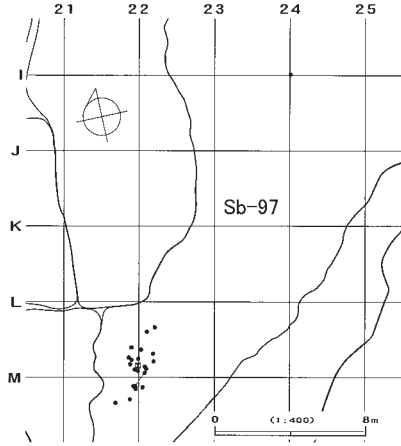

母岩1079・接合4498

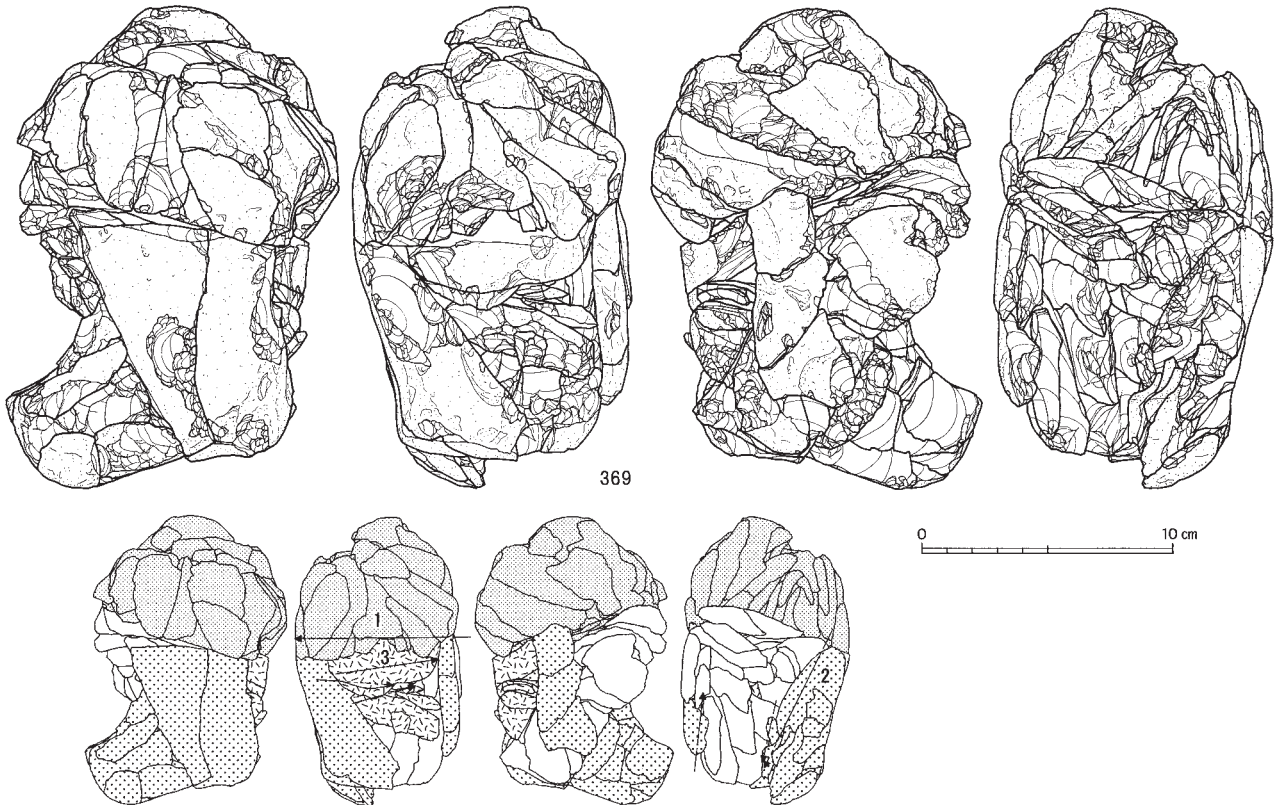

図Ⅲ-479 J区(Sb-97~107)の石器(85) 母岩1089・接合4520(2)、母岩1079・接合4498(1)

段階1
個体A

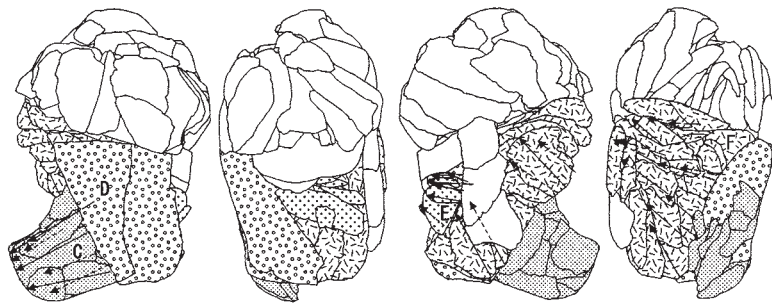
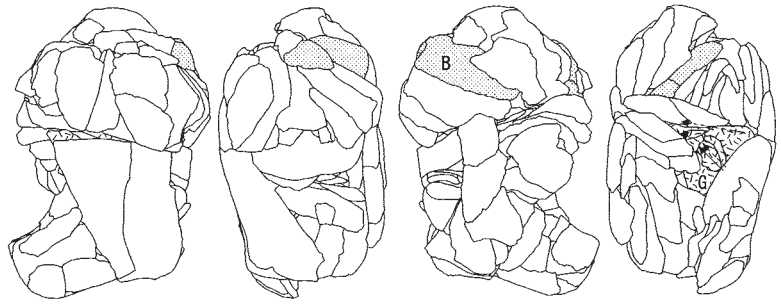
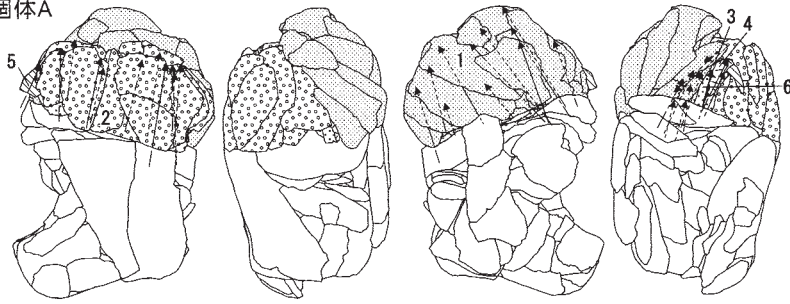

段階1
個体B

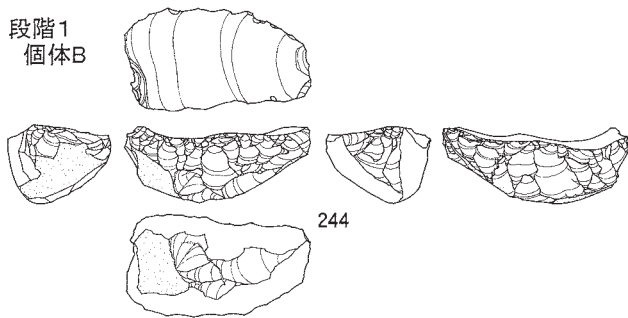

段階2
個体C



段階3
個体E

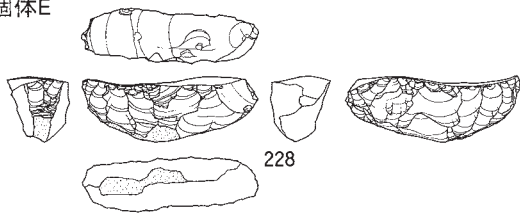

段階4
個体G

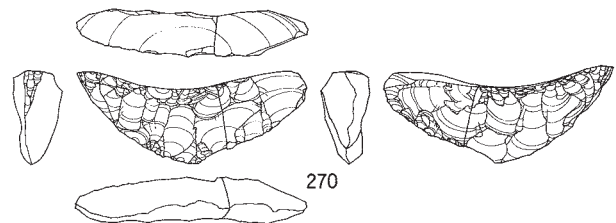

図Ⅲ-480 J区(Sb-97~107)の石器(86) 母岩1079・接合4498(2)

接合4498(個体A・B)分布図

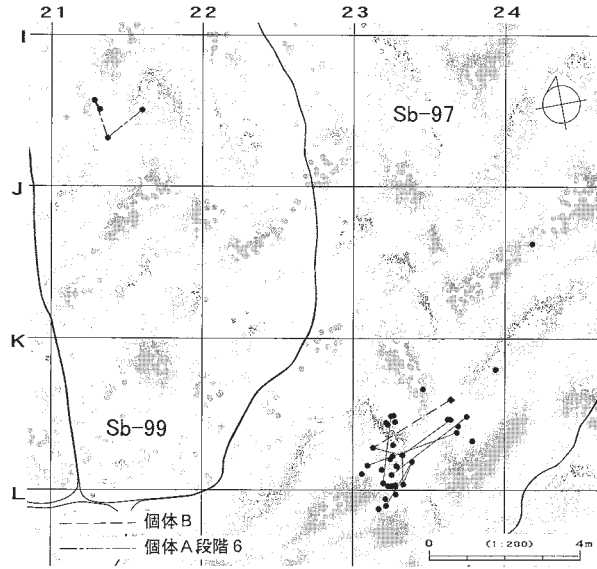

接合4498(個体C)分布図

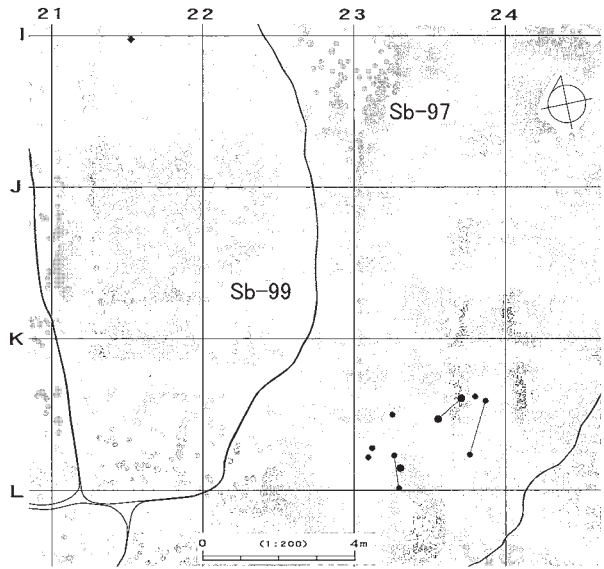

接合4498(個体D)分布図

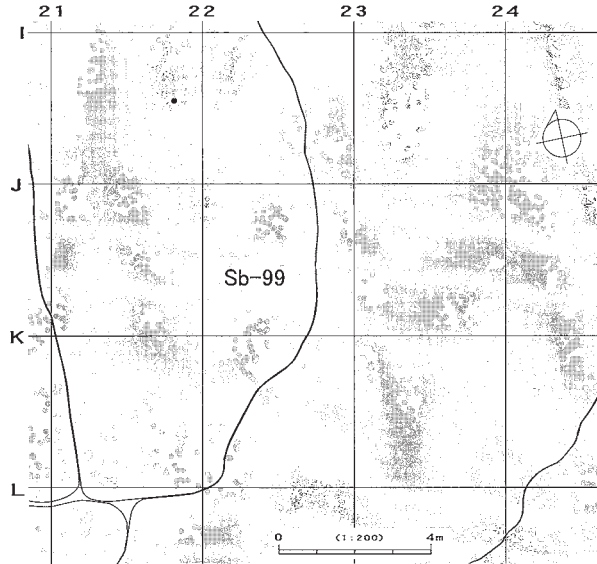

接合4498(個体E)分布図

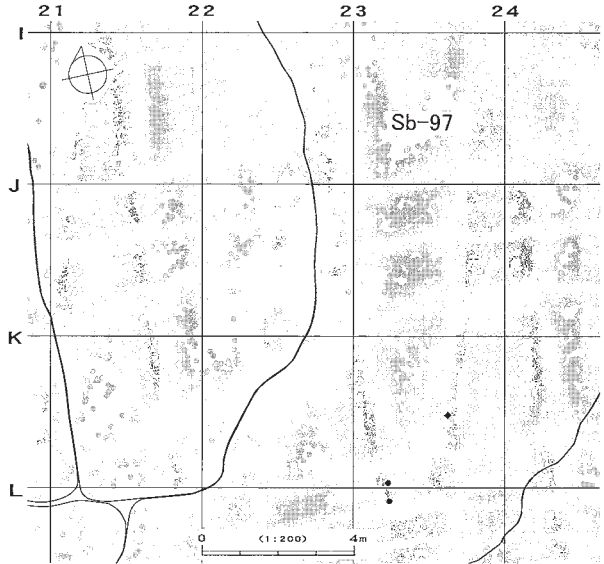

接合4498(個体F・G)分布図

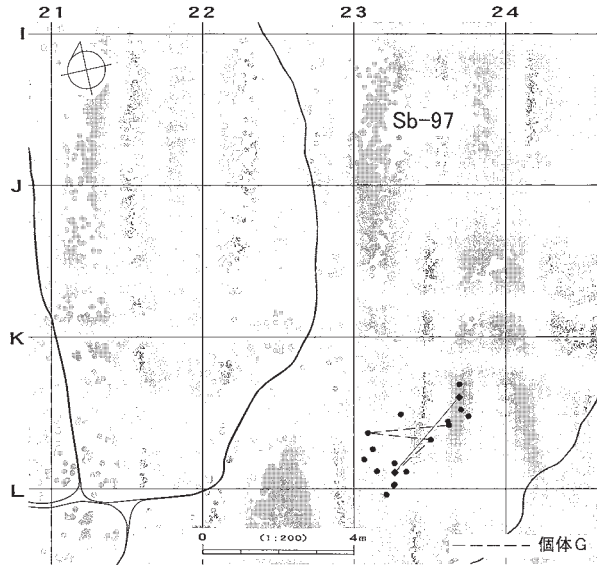

接合4498(個体A~G以外)分布図

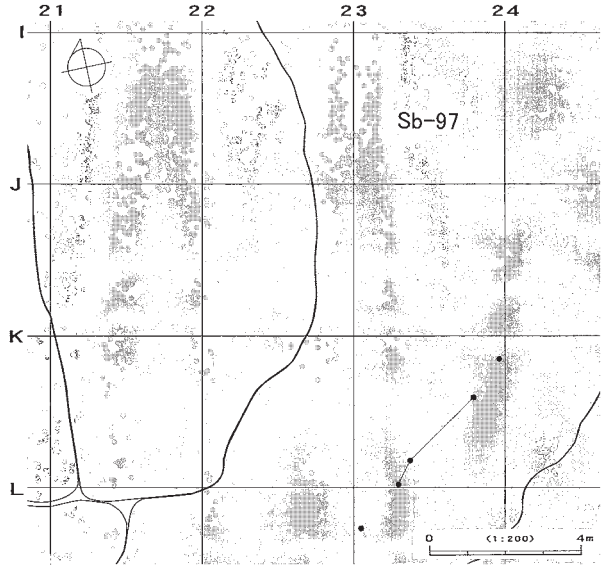

図Ⅲ-481 J区(Sb-97~107)の石器(87) 母岩1079・接合4498(3)

母岩1174・接合4701

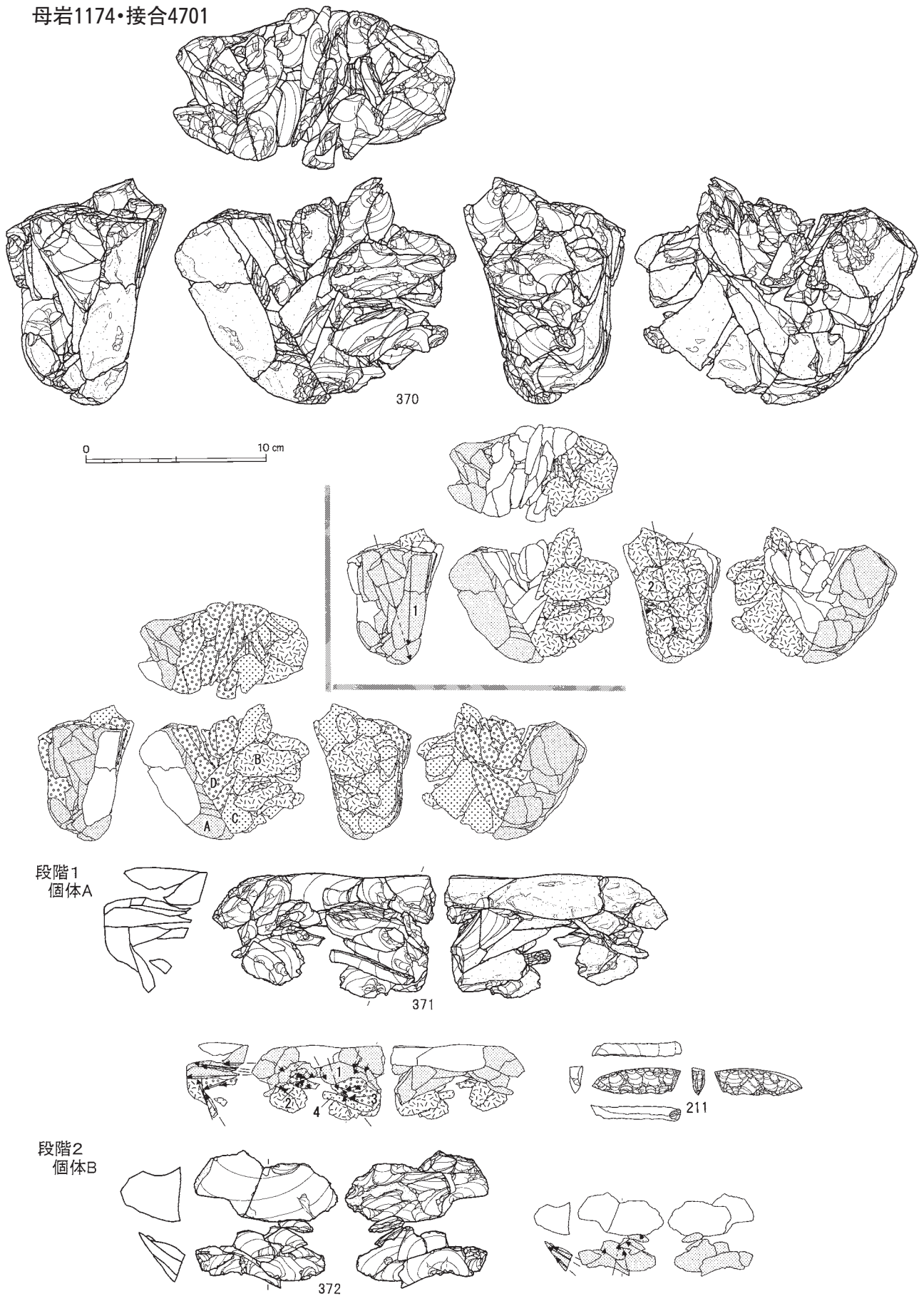

図Ⅲ-482 J区(Sb-97~107)の石器(88) 母岩1174・接合4701(1)

個体C

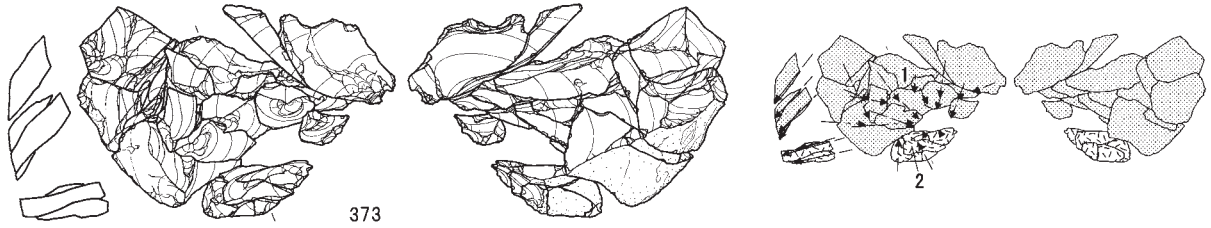

段階3
個体D

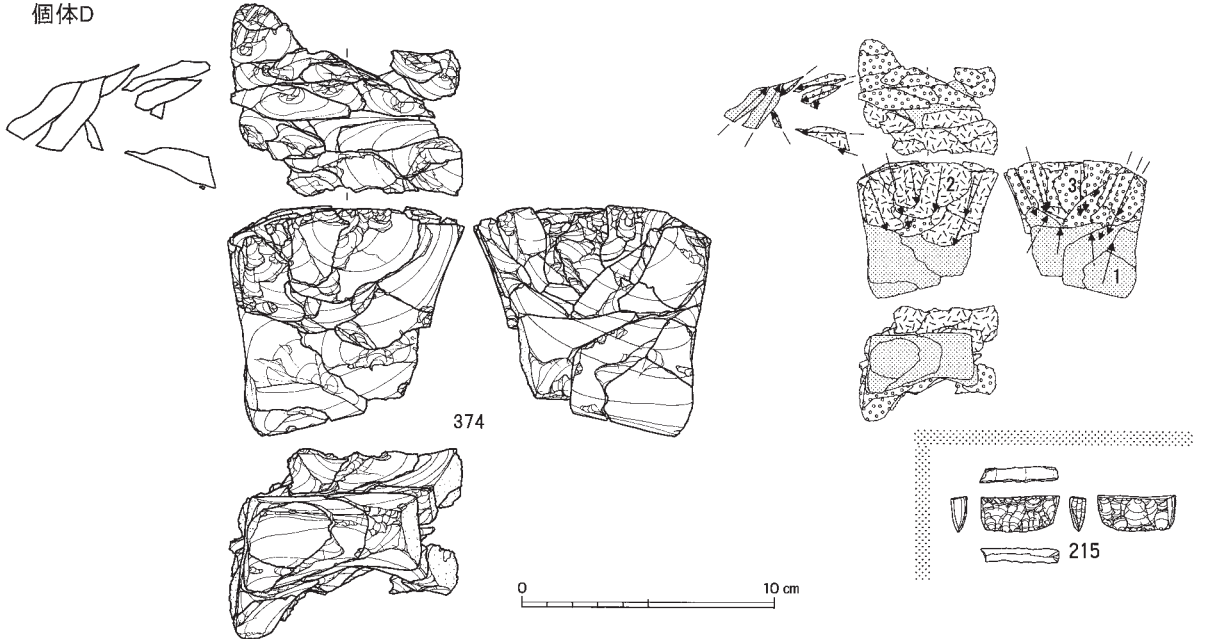

接合4701(個体A)分布図

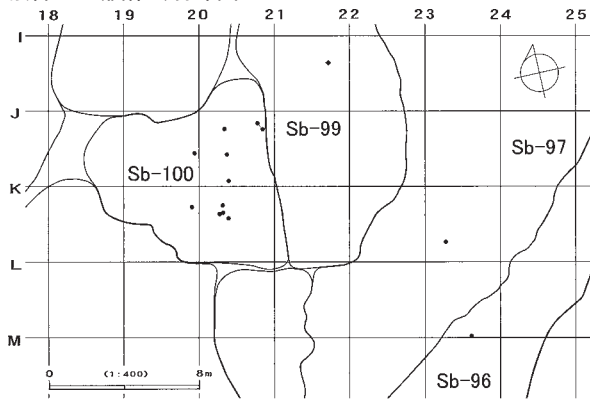

接合4701(個体B)分布図

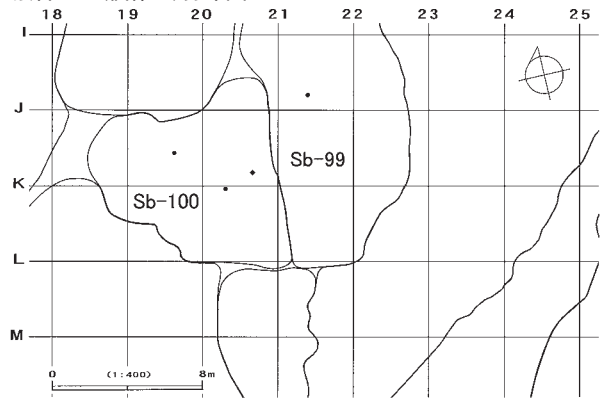

接合4701(個体C)分布図

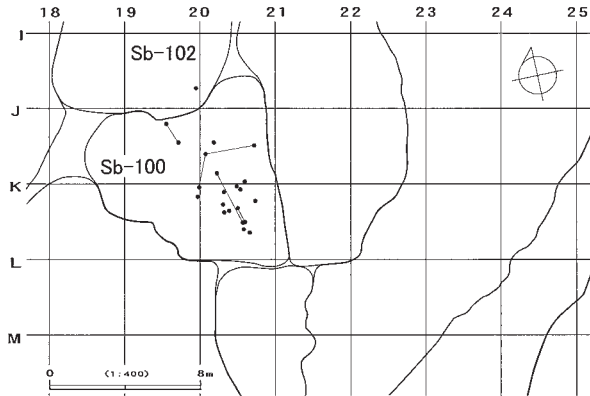

接合4701(個体D)分布図

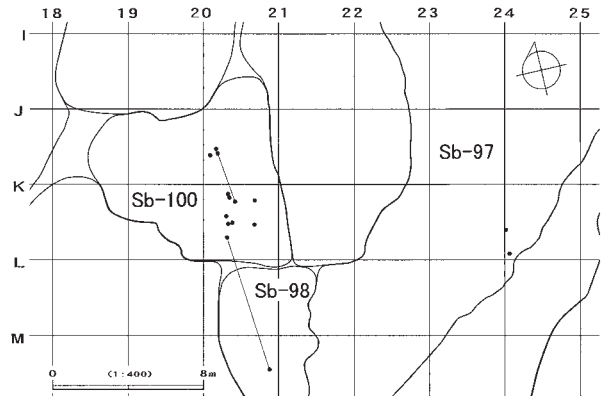

図Ⅲ-483 J区(Sb-97~107)の石器(89) 母岩1174・接合4701(2)

接合4701(全体)分布図

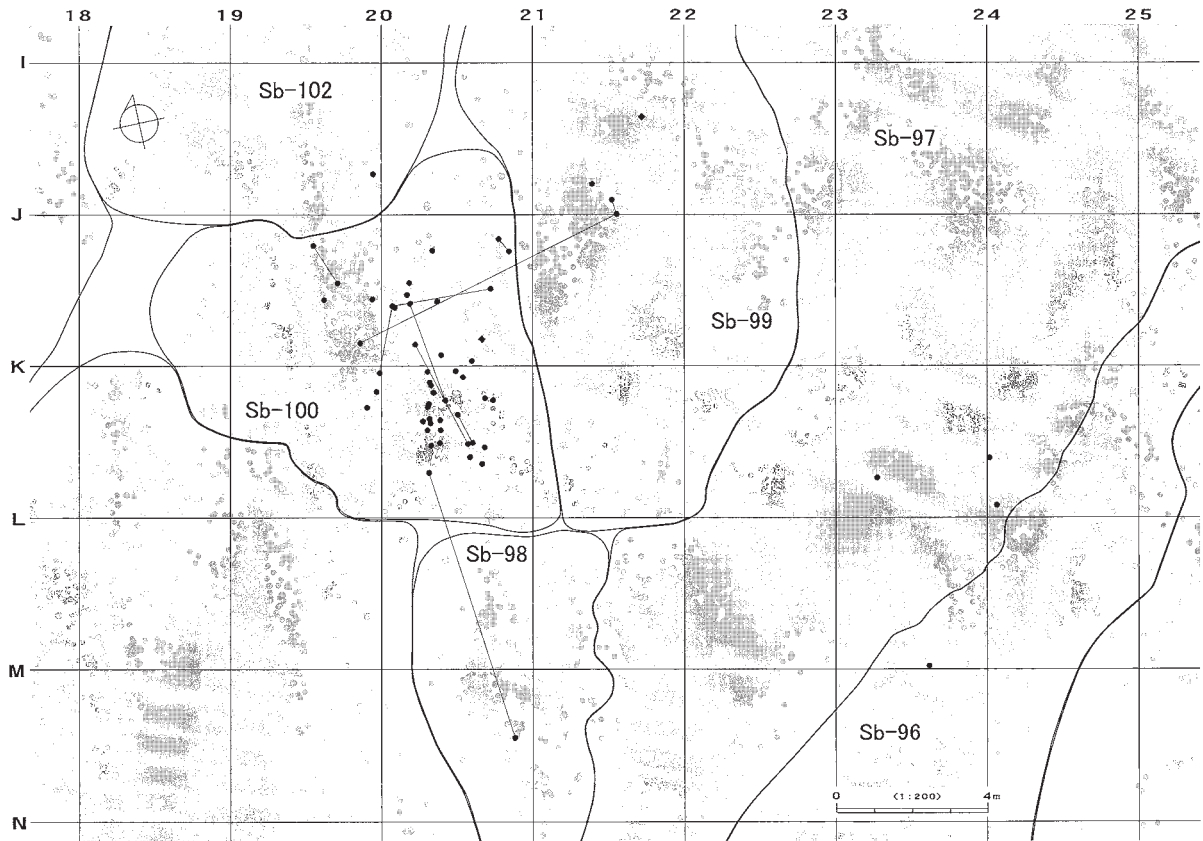

母岩1120・接合4583

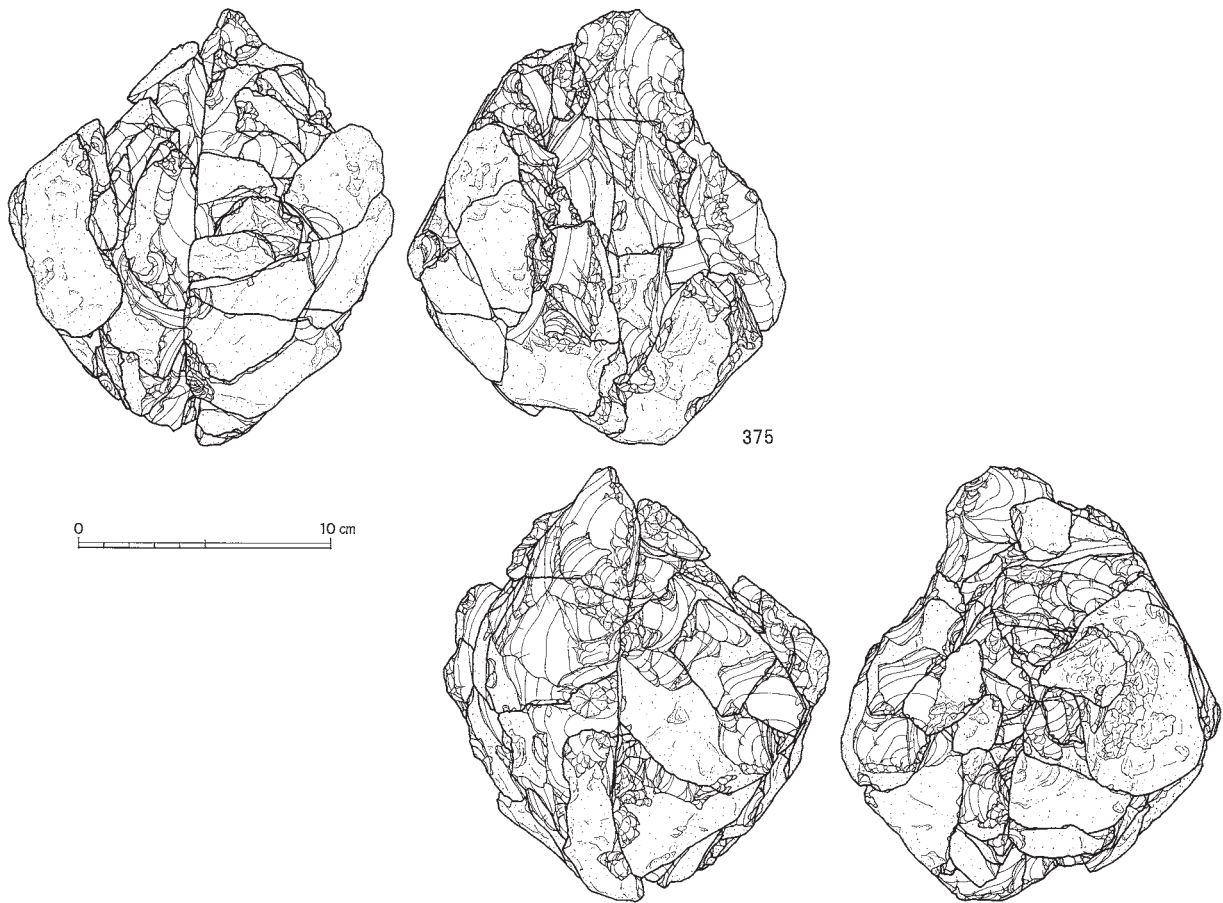

図Ⅲ-484 J区(Sb-97~107)の石器(90) 母岩1174・接合4701(3)、母岩1120・接合4583(1)

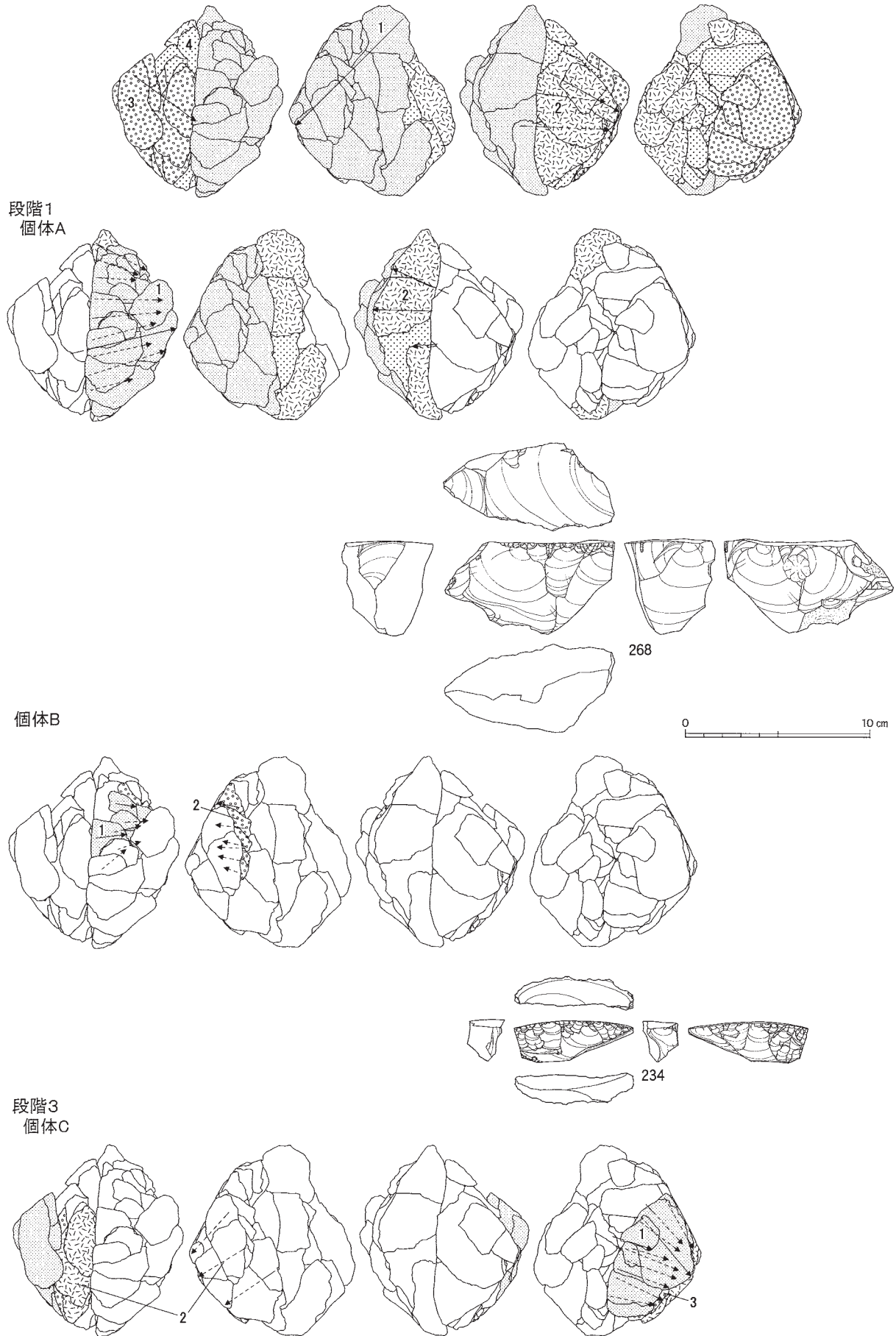

図Ⅲ-485 J区(Sb-97~107)の石器(91) 母岩1120・接合4583(2)

段階4
個体D

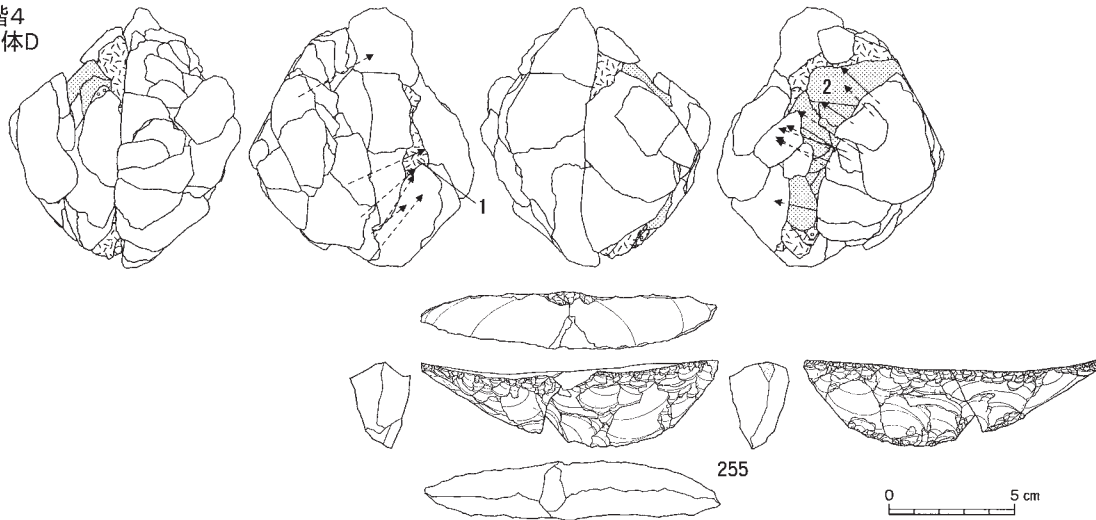

接合4583(個体A(個体B除く))分布図

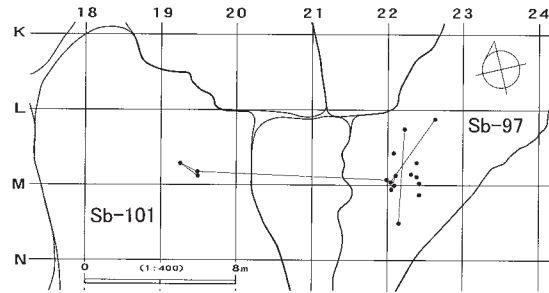

接合4583(個体B)分布図

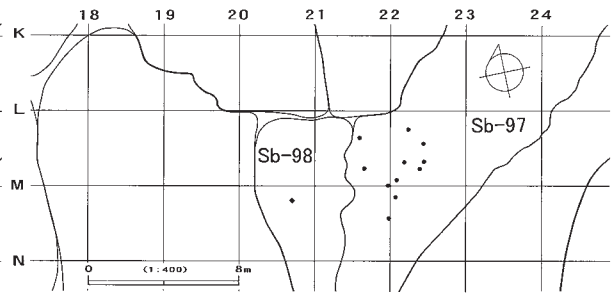

接合4583(個体C)分布図

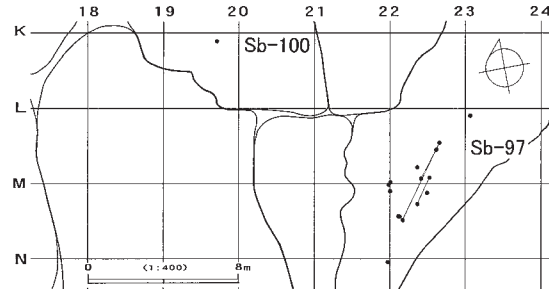

接合4583(個体D)分布図

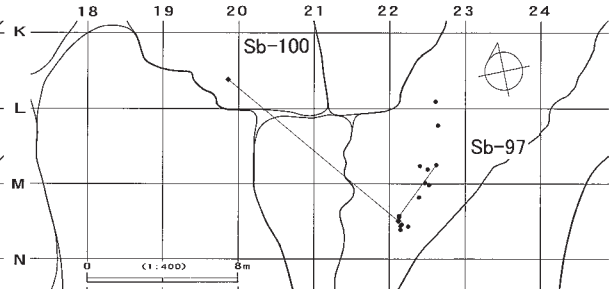

接合4583(全体)分布図

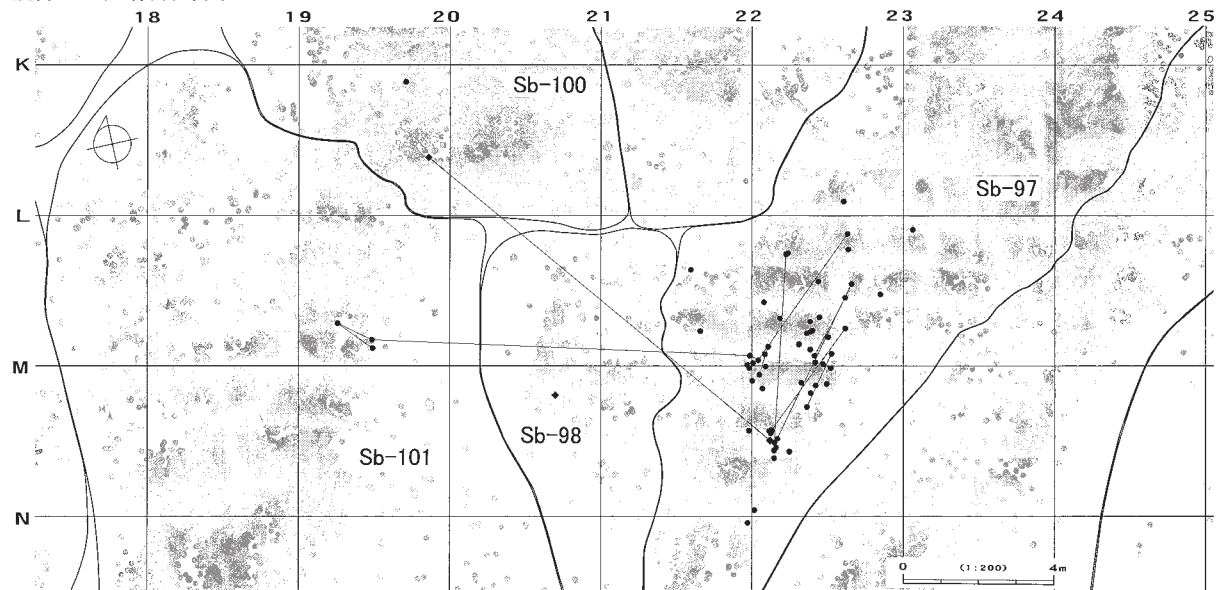

図Ⅲ-486 J区(Sb-97~107)の石器(92) 母岩1120・接合4583(3)

母岩1186・接合4744

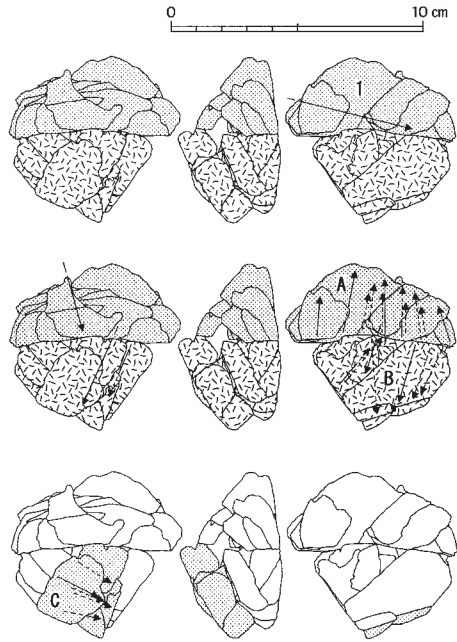
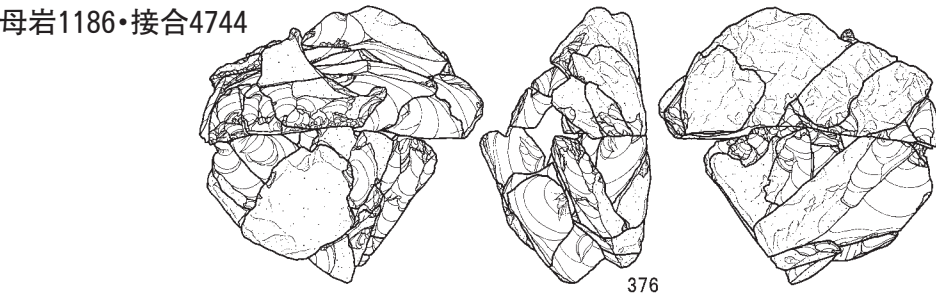

接合4744分布図

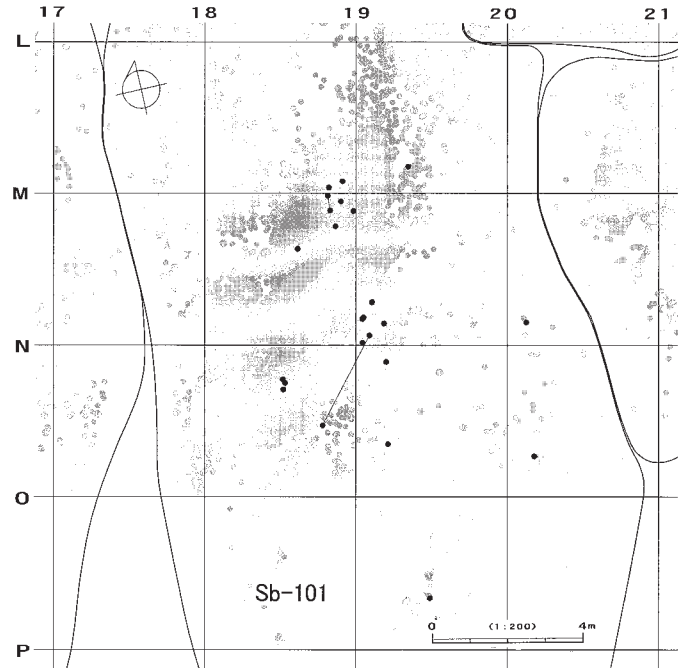

母岩1091・接合4522

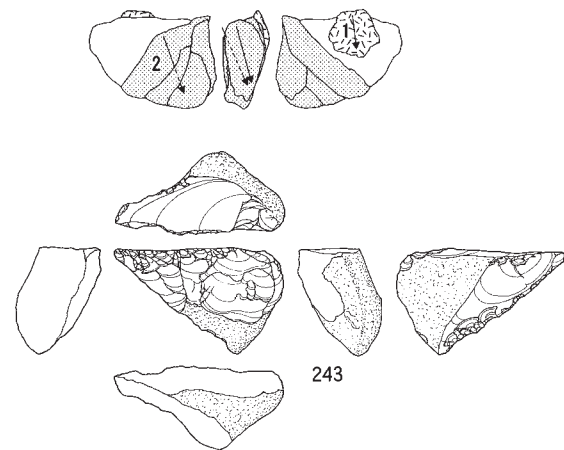
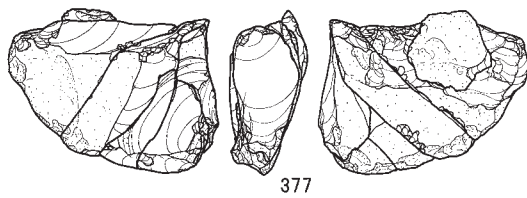

接合4522分布図

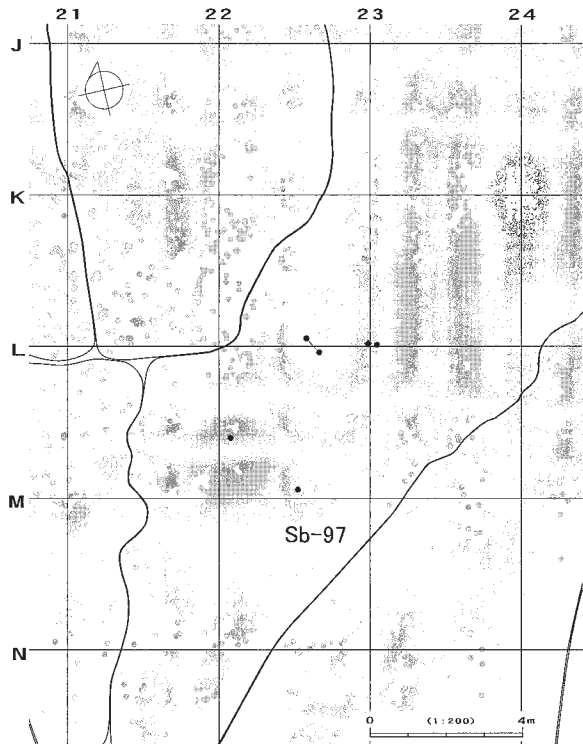

図Ⅲ-487 J区(Sb-97~107)の石器(93) 母岩1186・接合4744、母岩1091・接合4522

母岩1191・接合4752

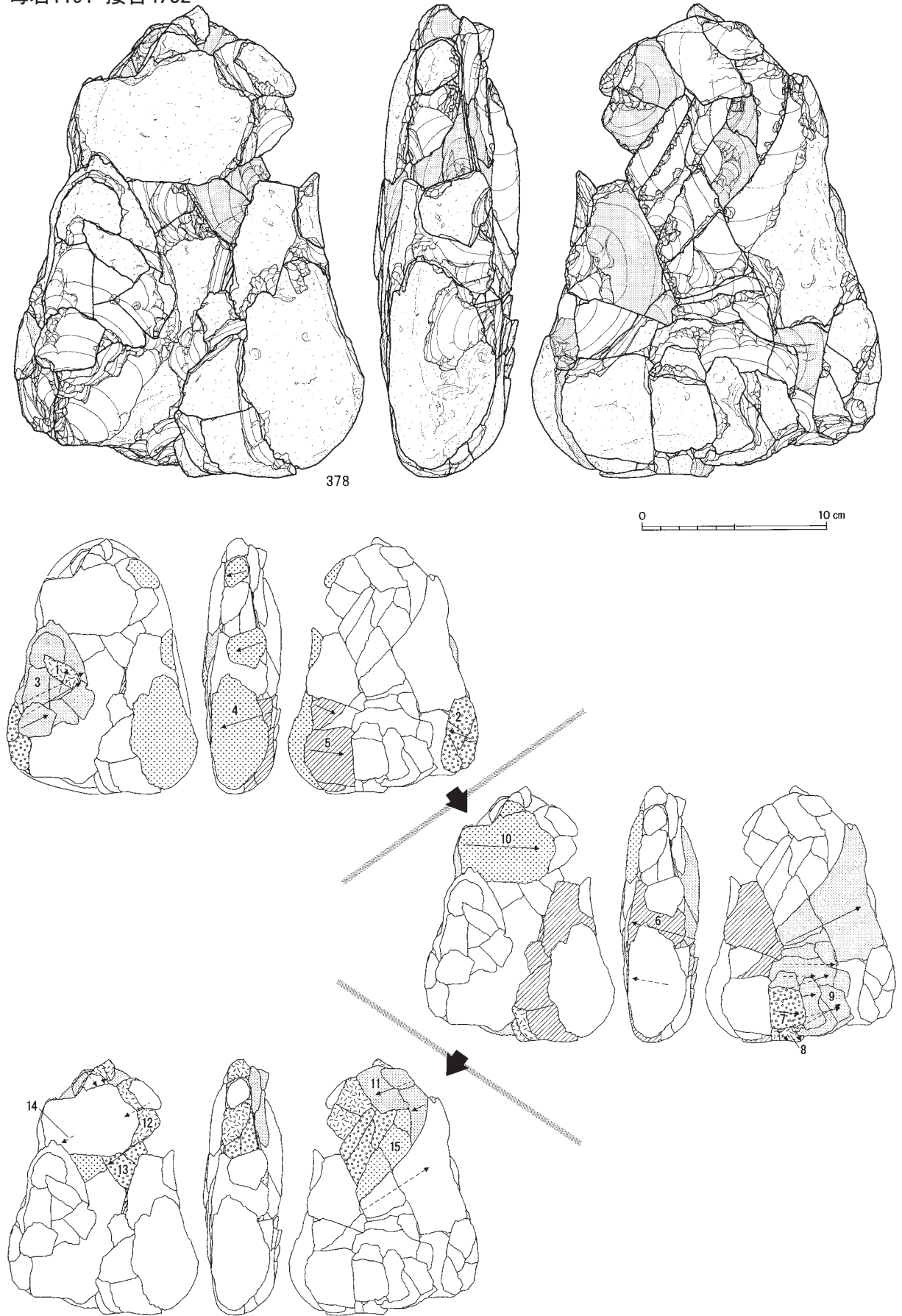

図Ⅲ-488 J区(Sb-97~107)の石器(94) 母岩1191・接合4752(1)

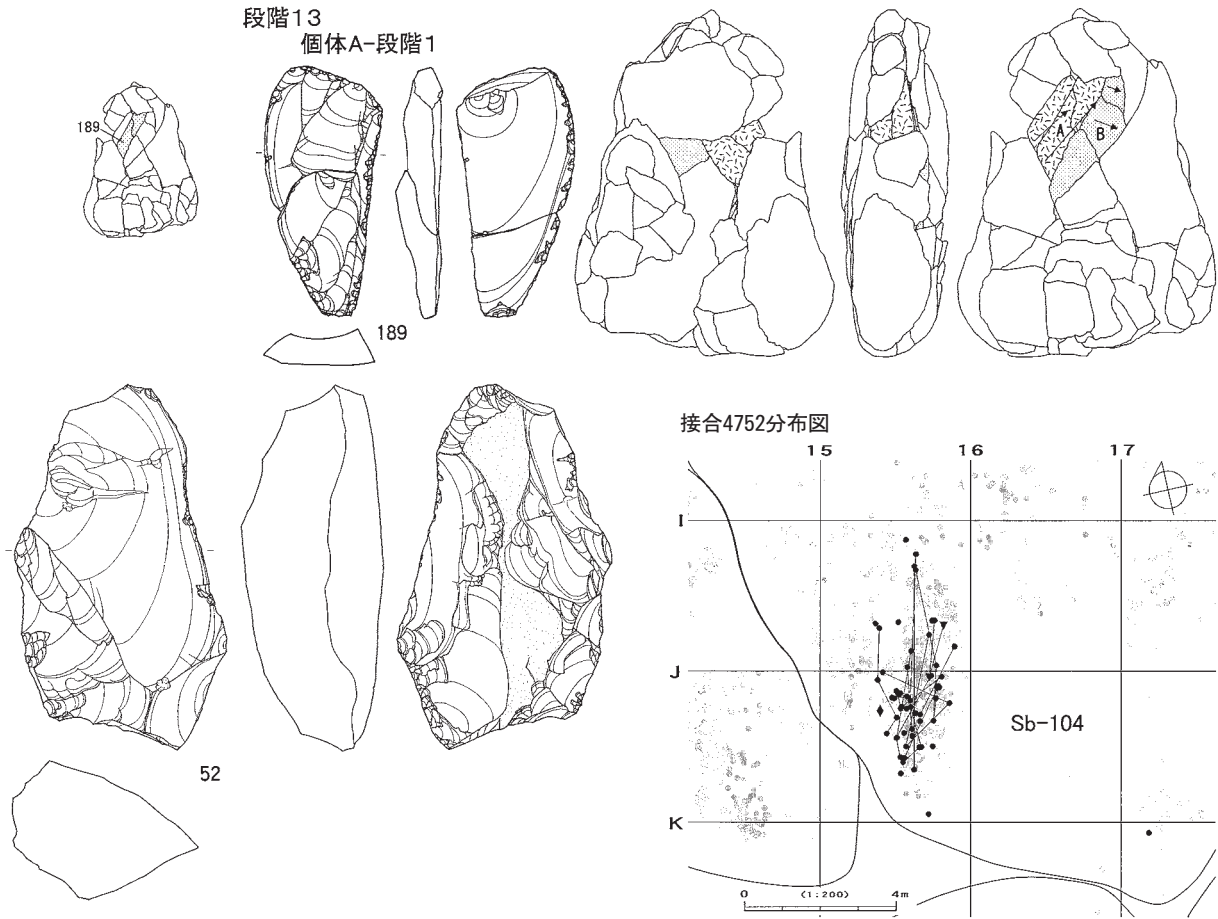

母岩1074・接合4480

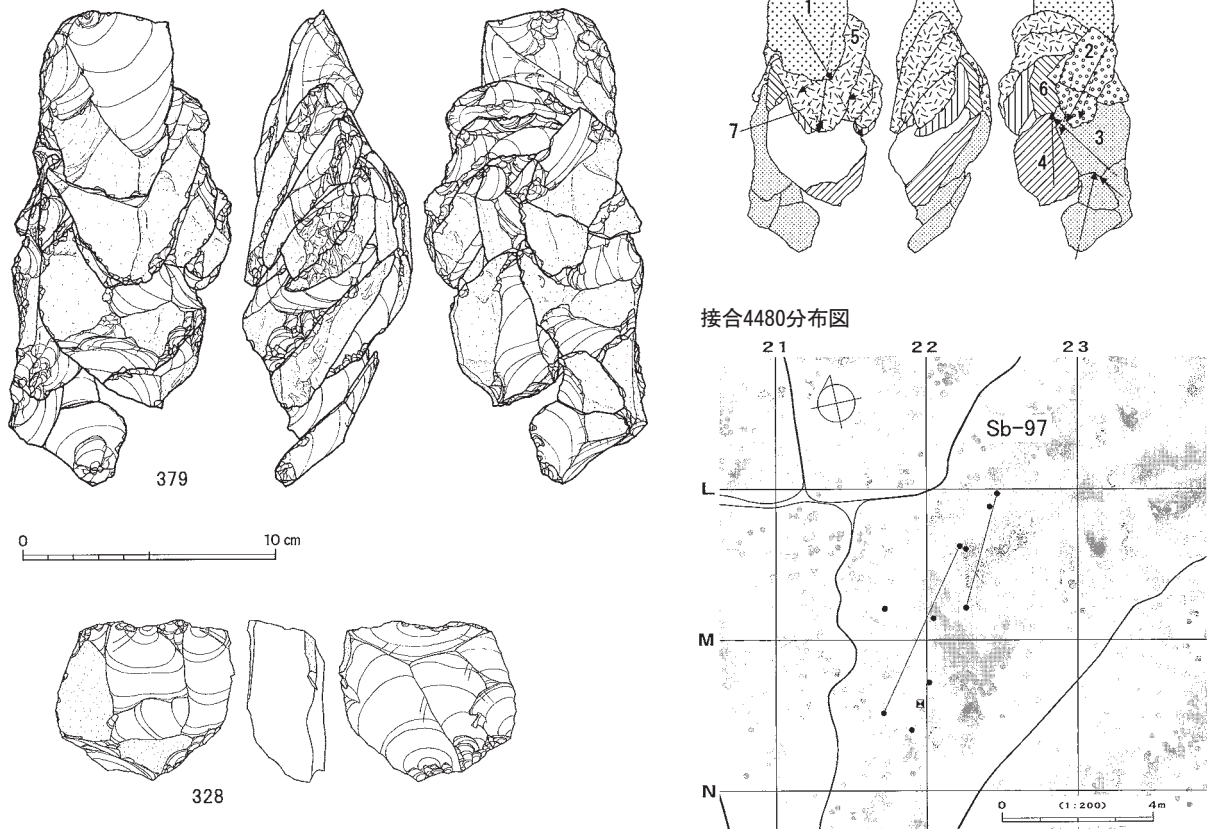

図Ⅲ-489 J区(Sb-97~107)の石器(95) 母岩1191・接合4752(2)、母岩1074・接合4480

接合5951

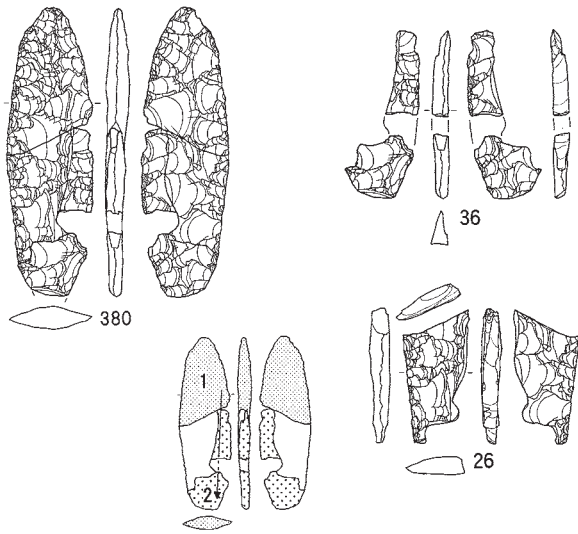

接合5951分布図

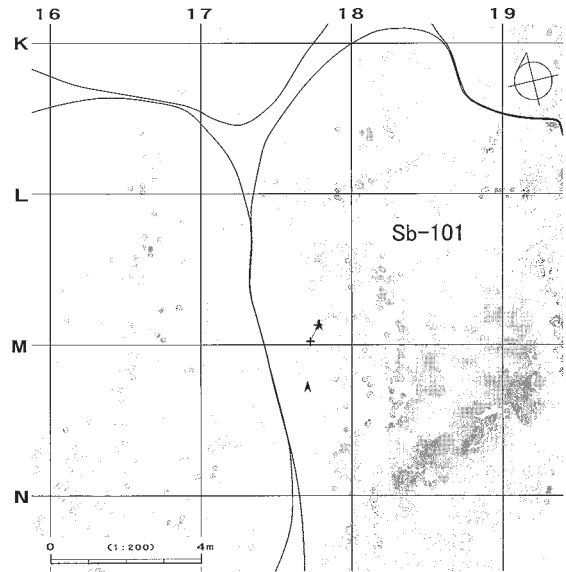

接合5822

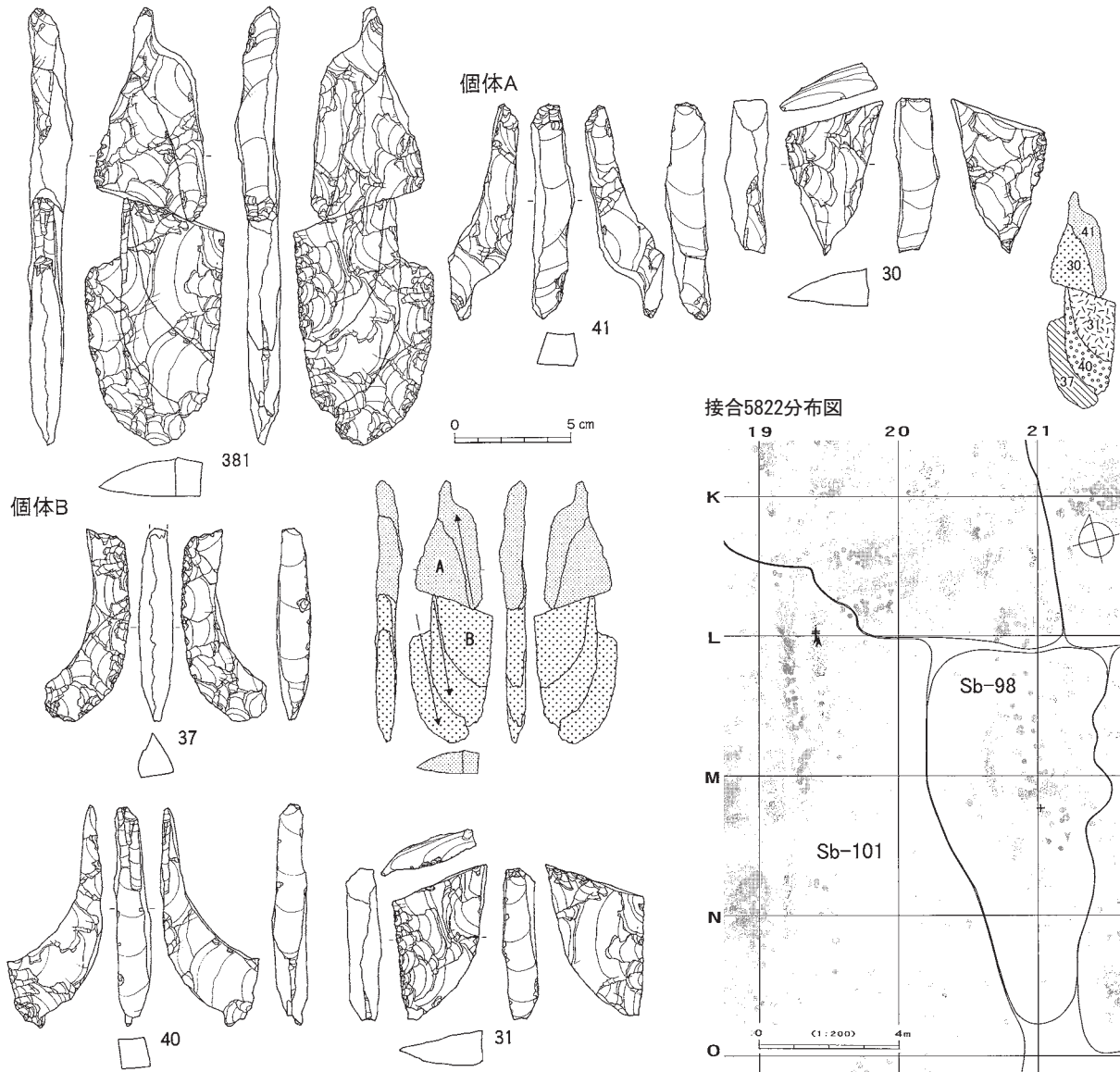

接合5822分布図

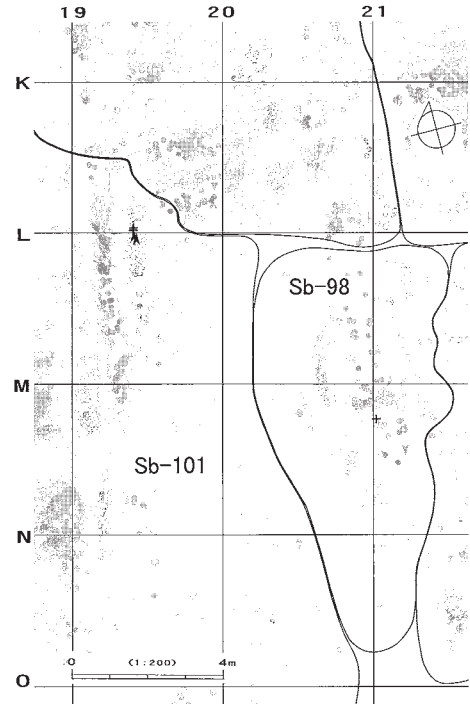

図Ⅲ-490 J区(Sb-97~107)の石器(96) 接合5951、接合5822

母岩1039・接合4349

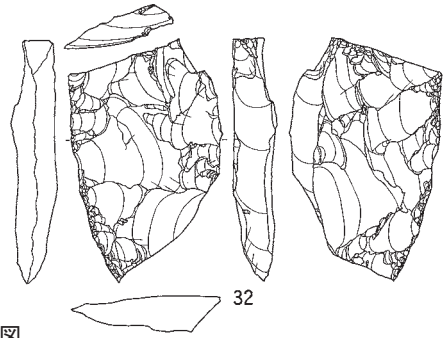
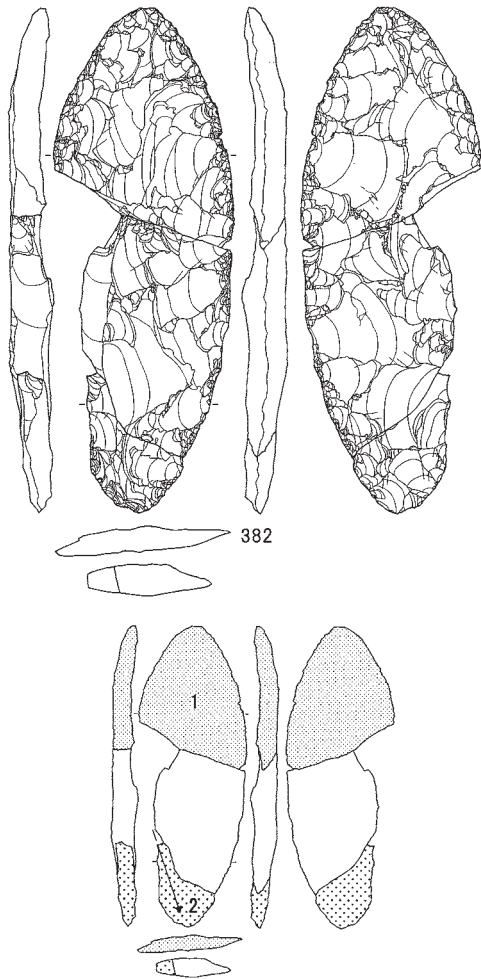

接合4349(全体)分布図

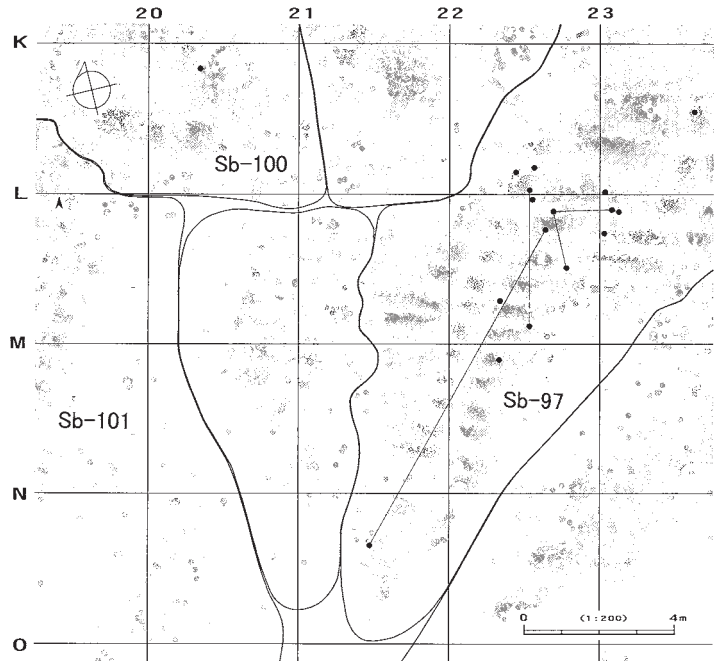

母岩972・接合4197

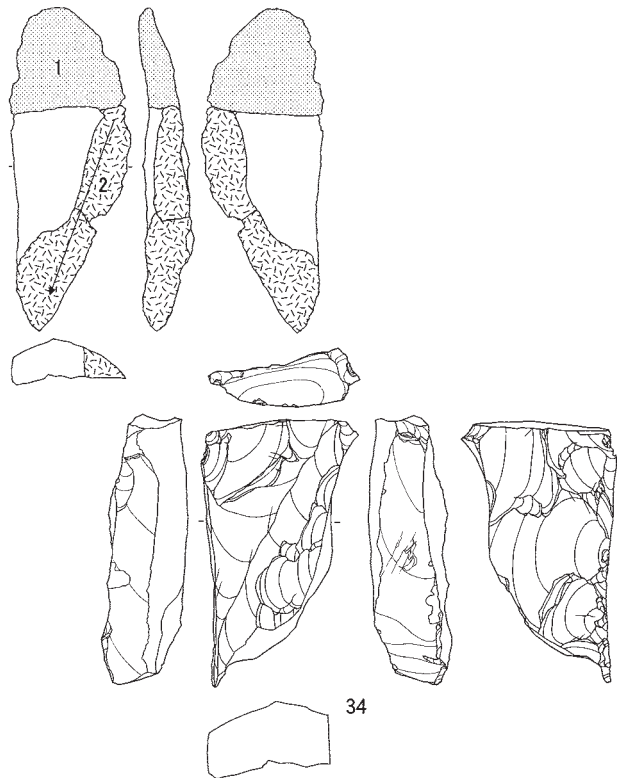
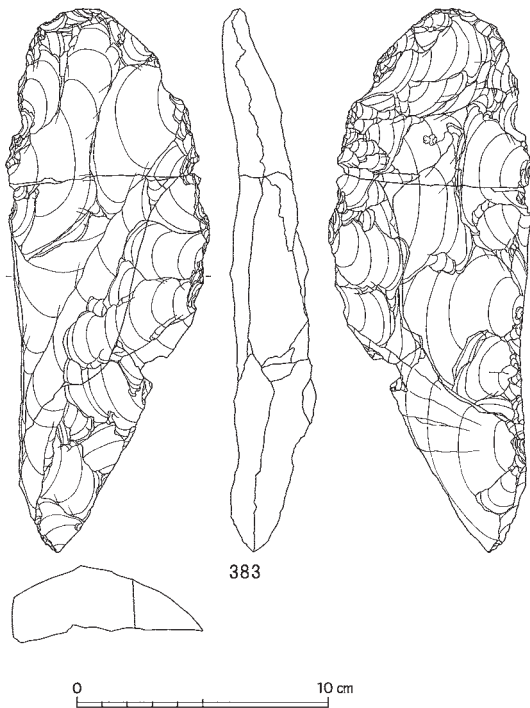

図III-491 J区(Sb-97~107)の石器(97) 母岩1039・接合4349、母岩972・接合4197(1)

接合4197(全体)分布図

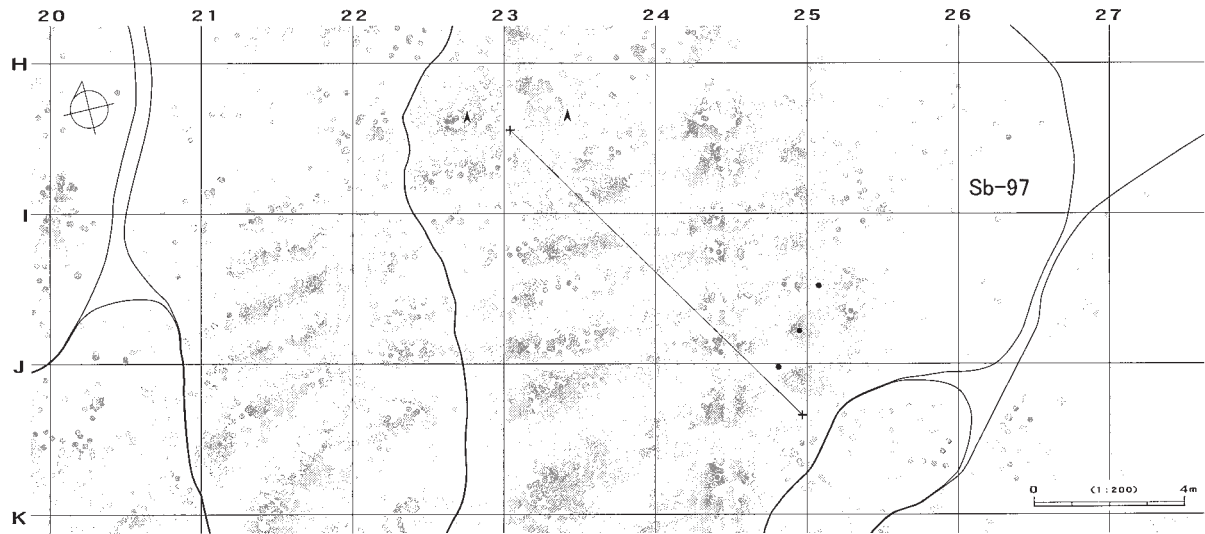

母岩1087・接合4508

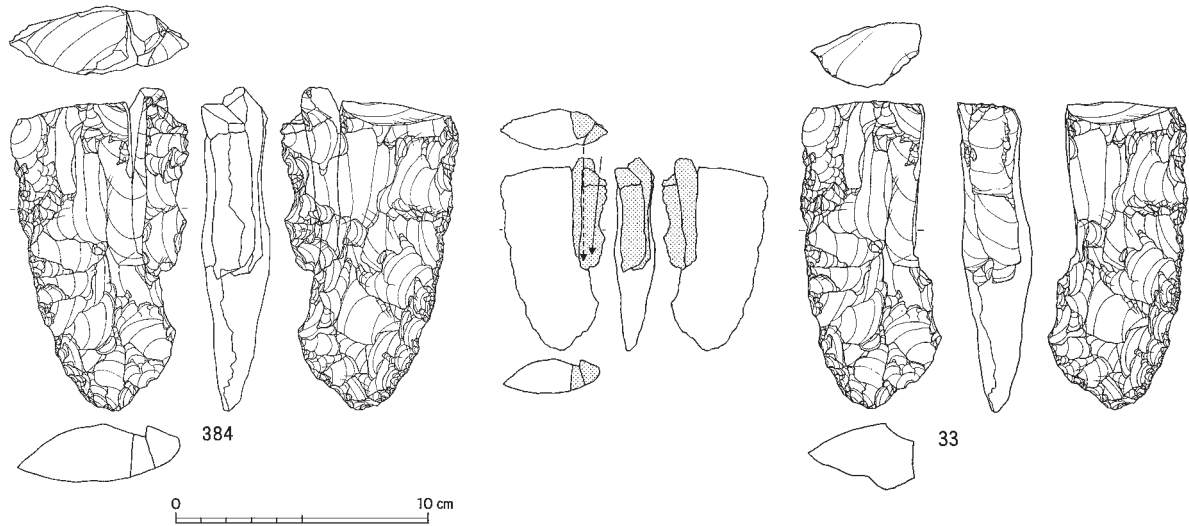

接合4508(全体)分布図

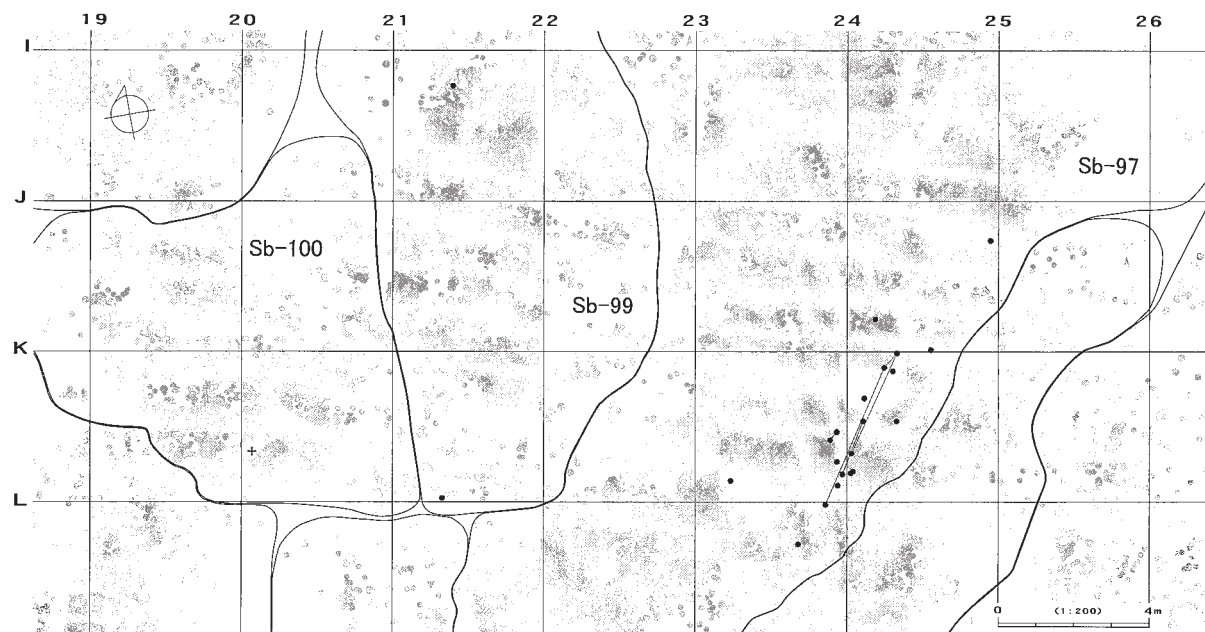

図Ⅲ-492 J区(Sb-97~107)の石器(98) 母岩972・接合4197(2)、母岩1087・接合4508

母岩1121・接合4584

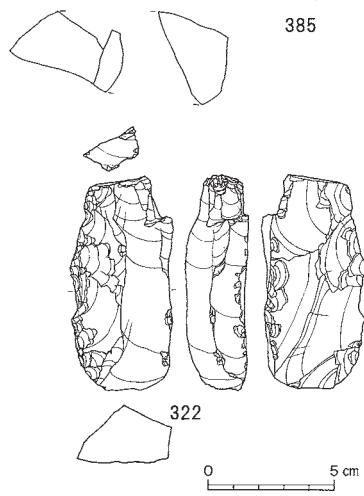
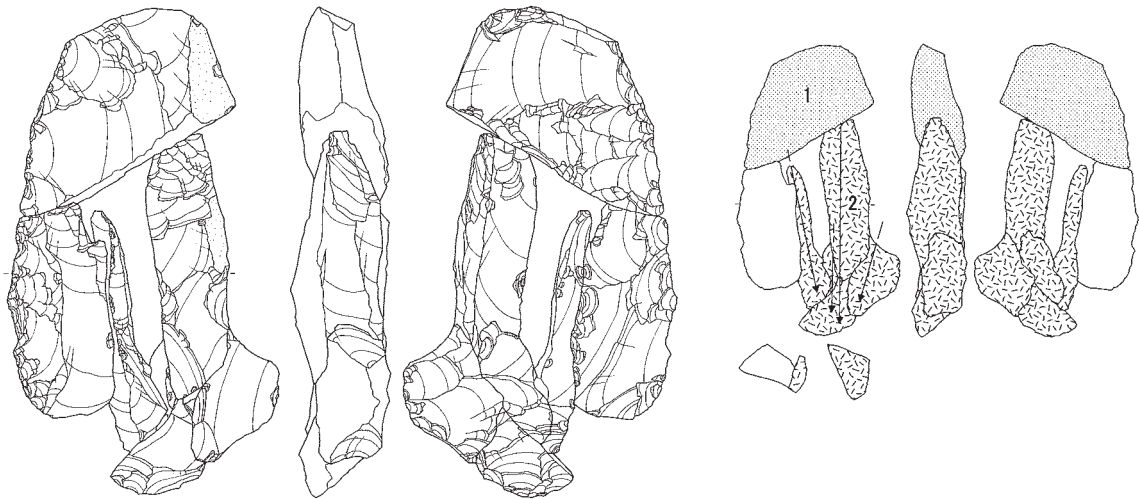

接合4584(全体)分布図

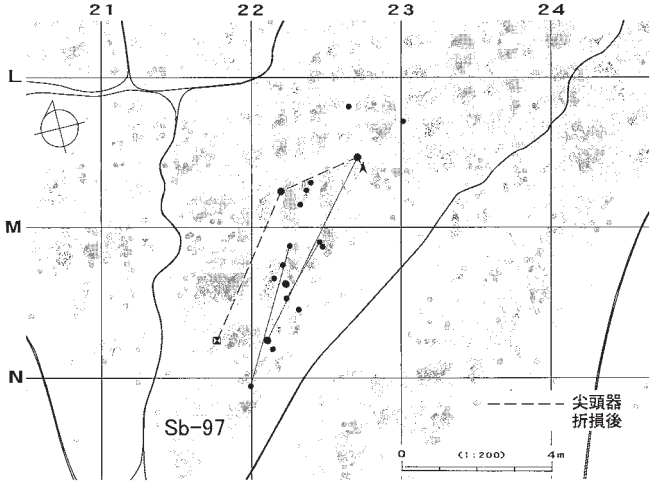

接合5837

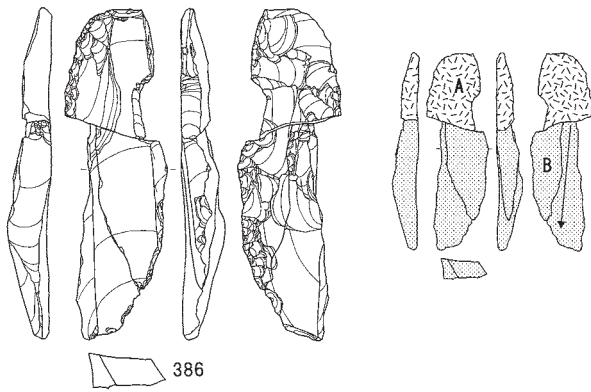

個体A

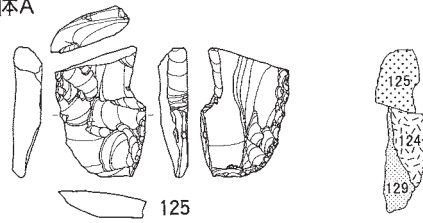

個体B

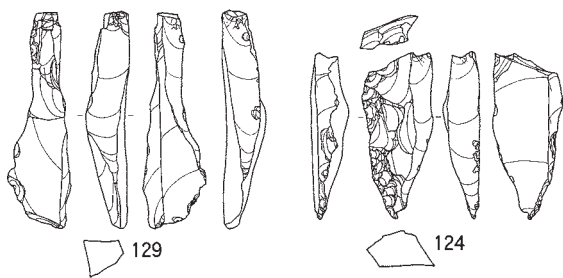

接合5837分布図

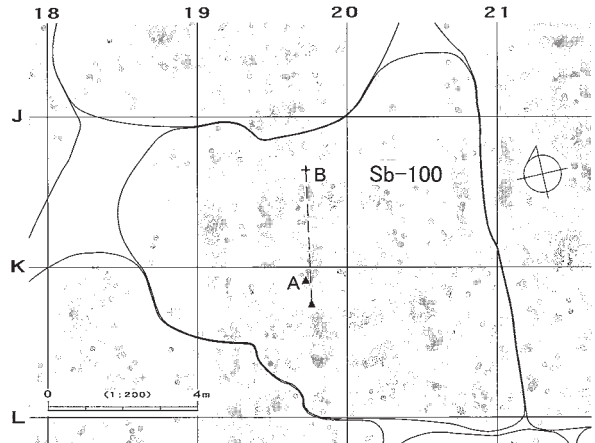

図Ⅲ-493 J区(Sb-97~107)の石器(99) 母岩1121・接合4584、接合5837

母岩1220・接合5801

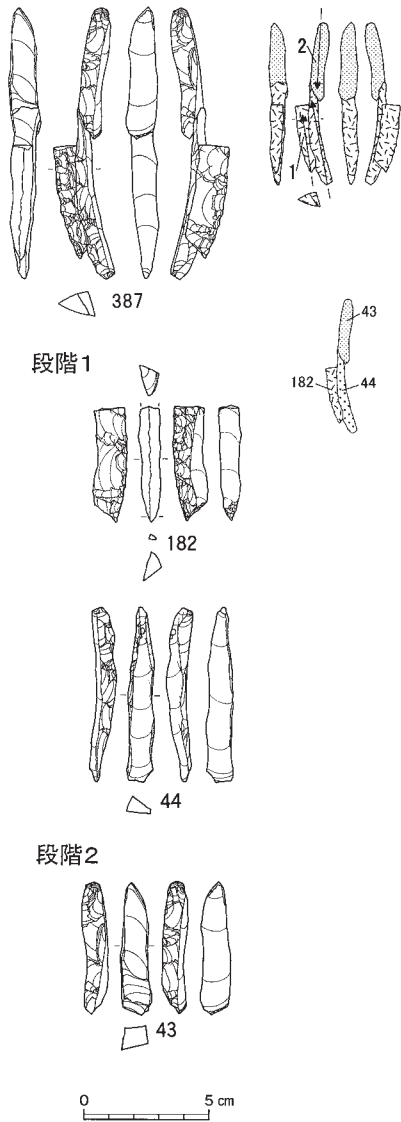

接合5801分布図

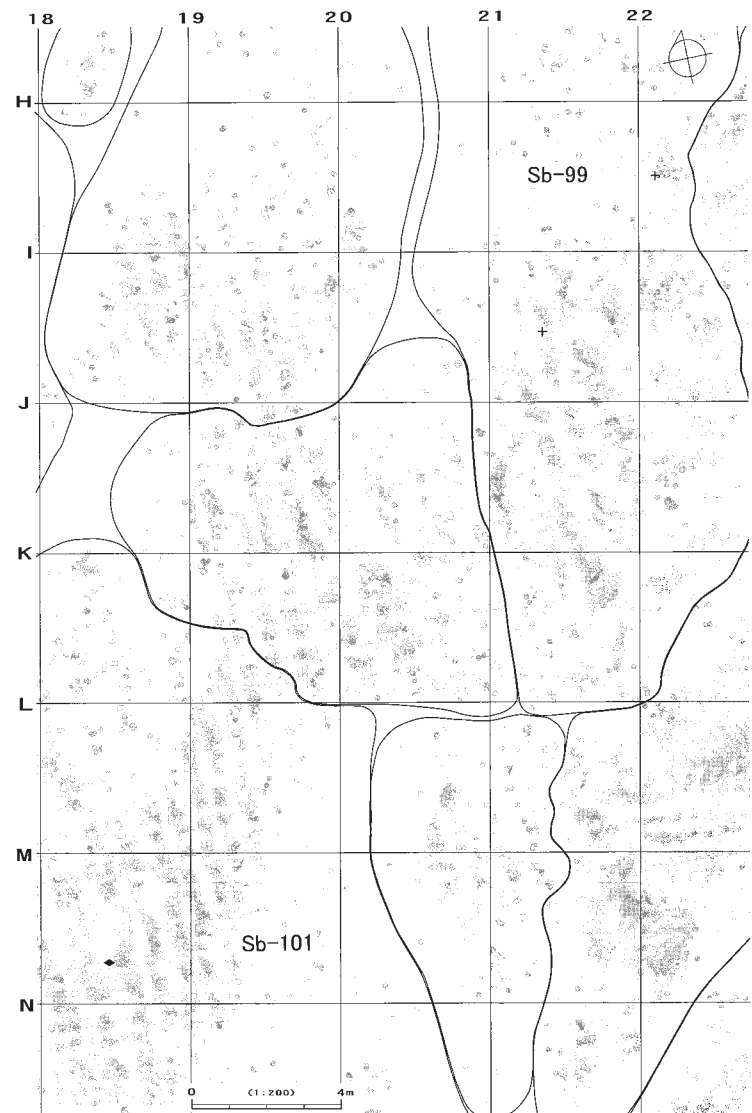

母岩1220・接合5843

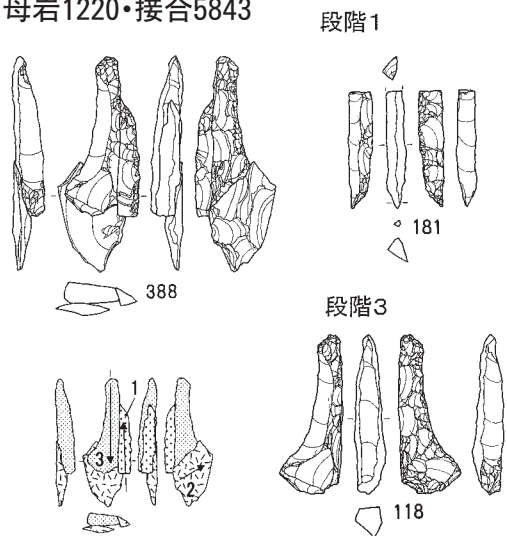

接合5843分布図

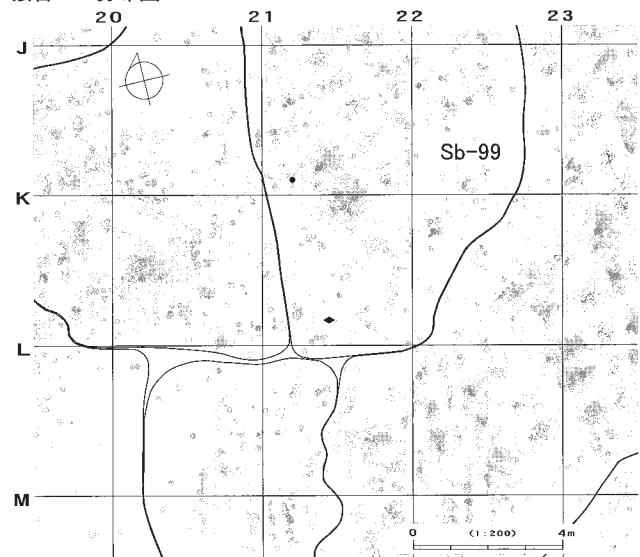

図Ⅲ-494 J区(Sb-97~107)の石器(100) 母岩1220・接合5801、母岩1220・接合5843

母岩1158・接合4663

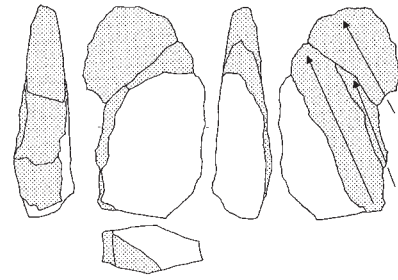
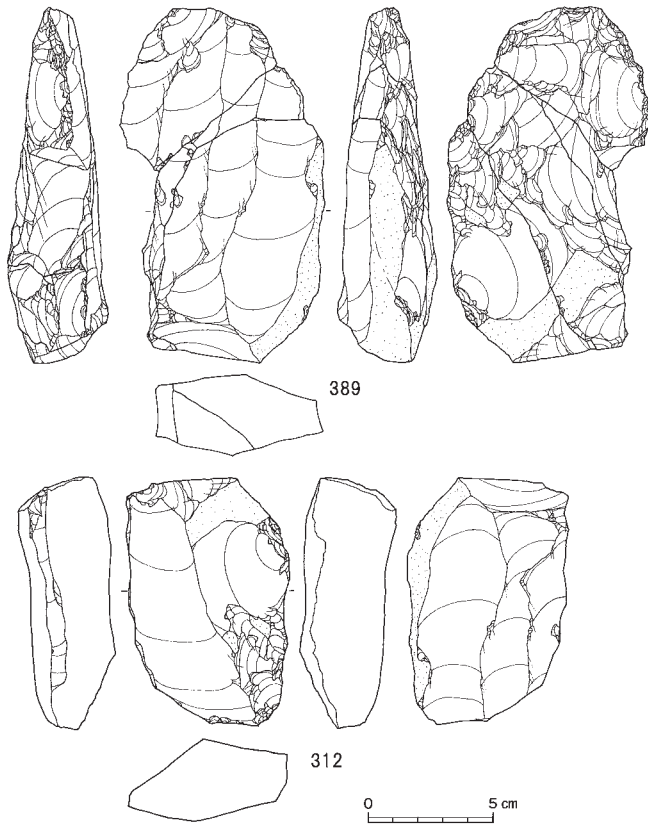

接合4663分布図

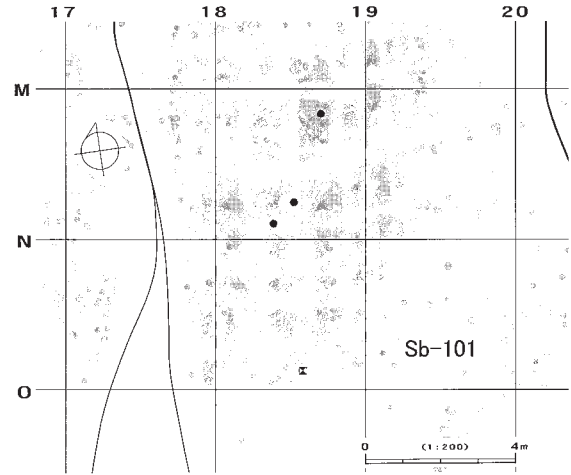

接合5823

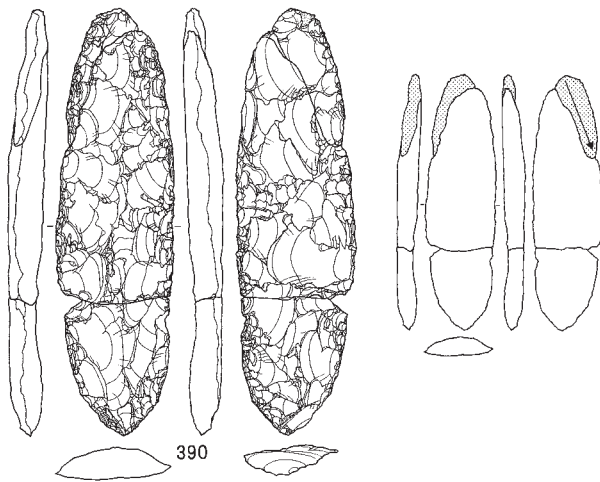

母岩1179・接合4719

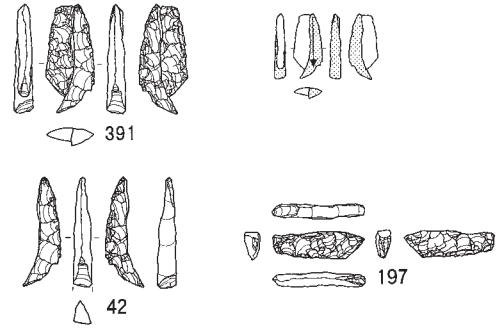

接合4719分布図

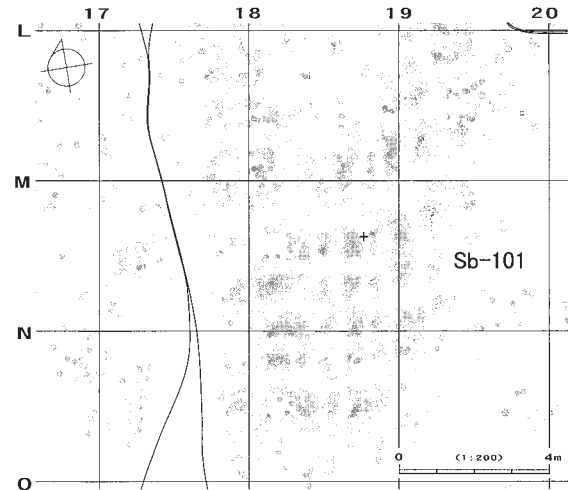

接合5823分布図

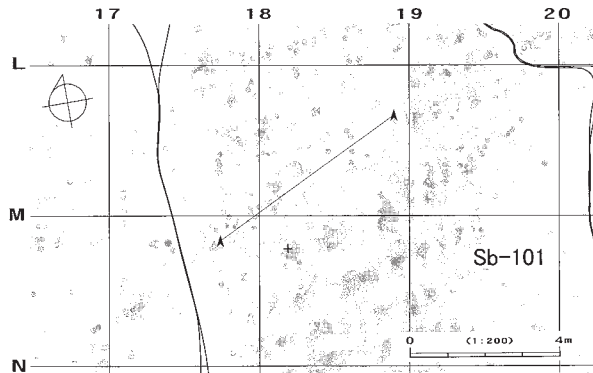

図Ⅲ-495 J区(Sb-97~107)の石器(101) 母岩1158・接合4663、接合5823、母岩1179・接合4719

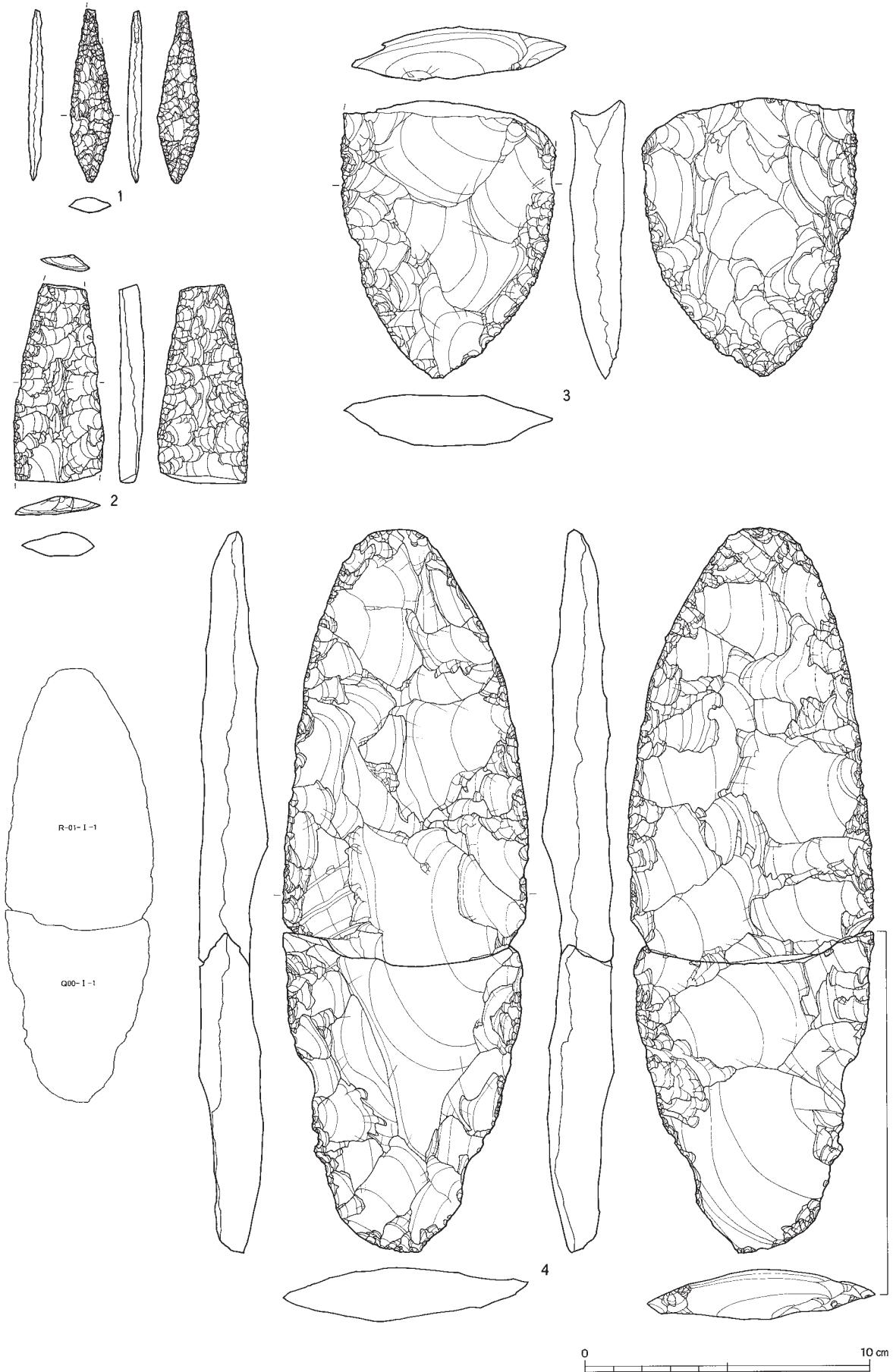

図Ⅲ-496 K区(Sb-108~111)の石器(1) 尖頭器

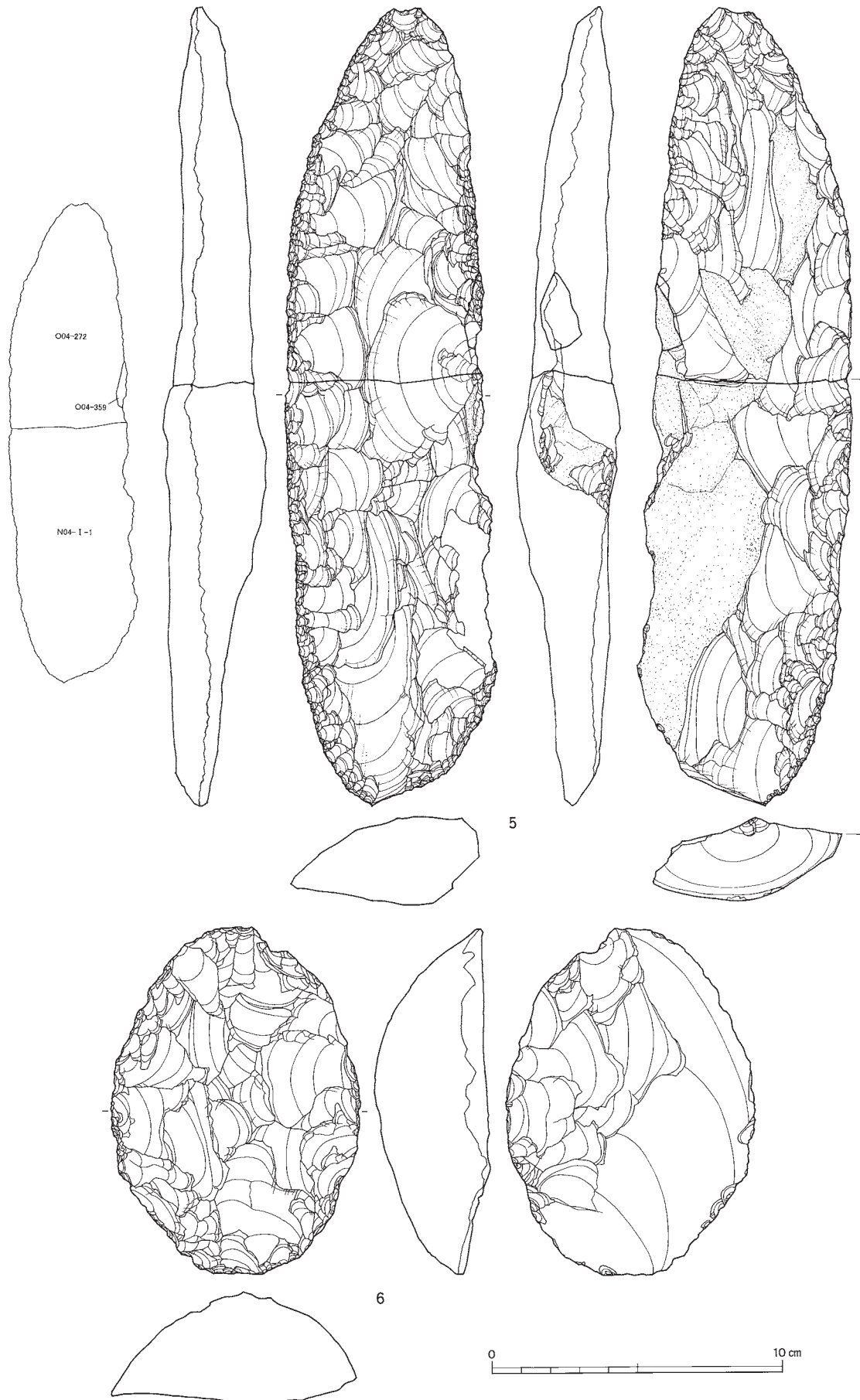

図Ⅲ-497 K区(Sb-108~111)の石器(2) 尖頭器・両面調整石器

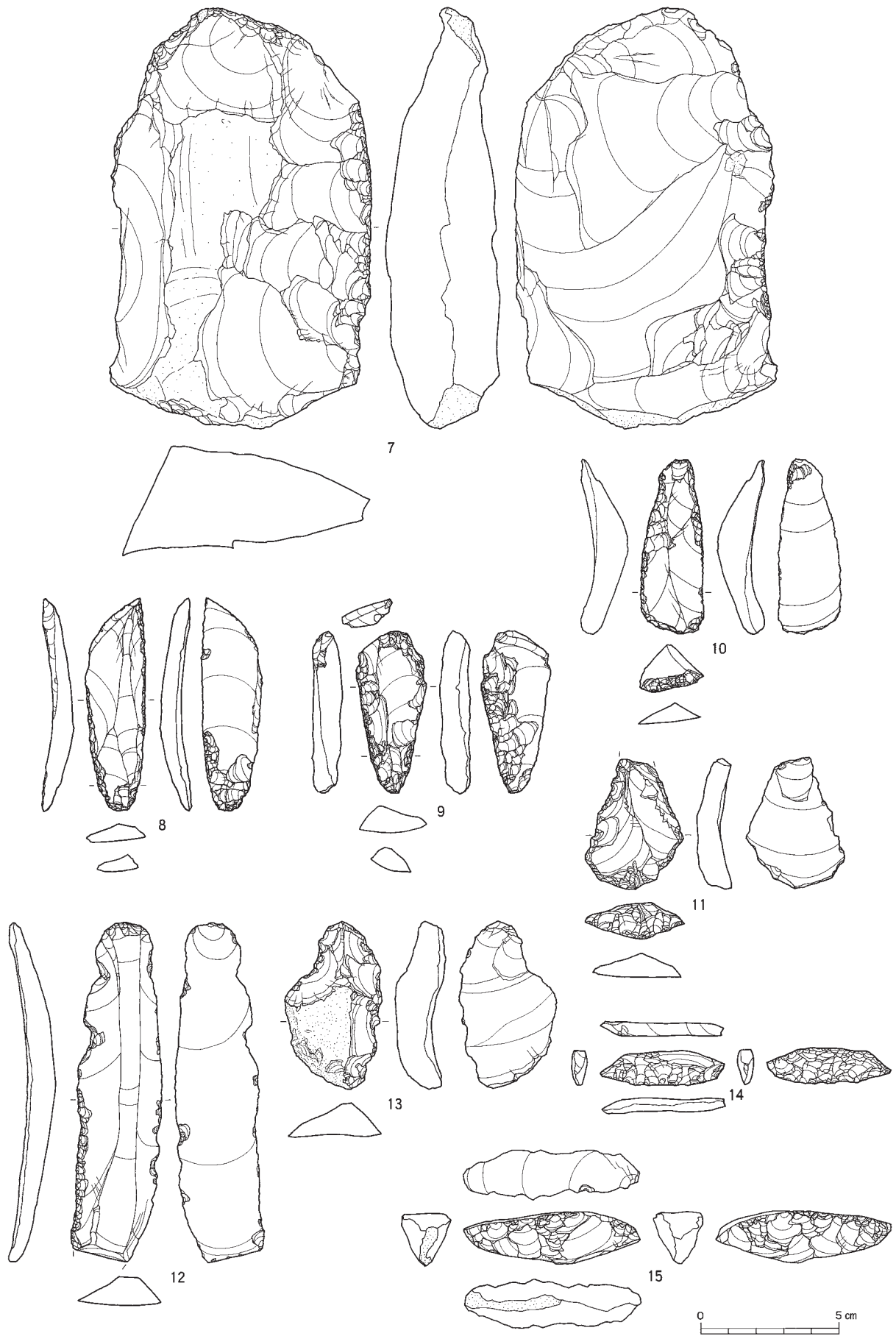

図Ⅲ-498 K区(Sb-108~111)の石器(3) 両面調整石器・彫器・搔器・削器・舟底形石器

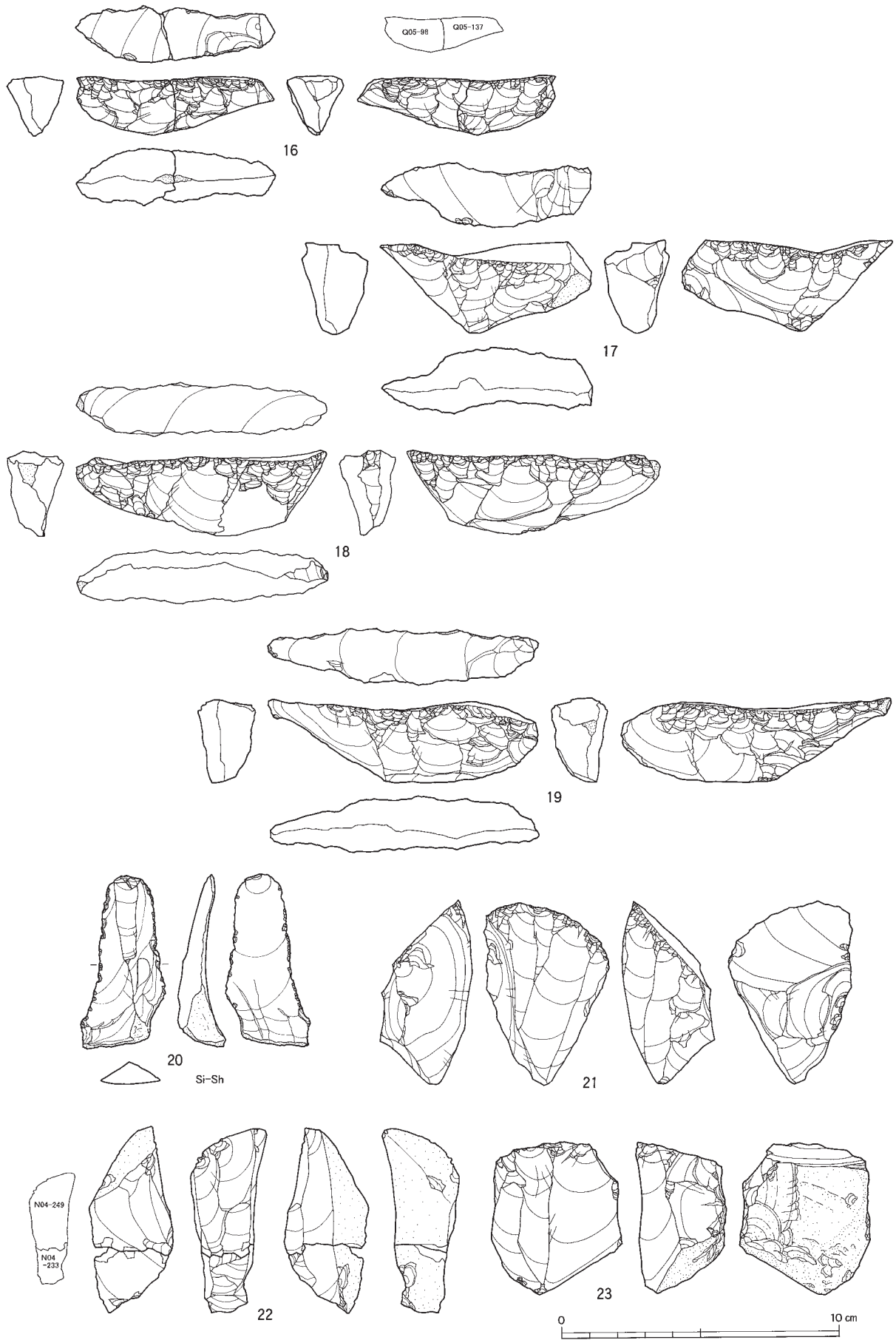

図Ⅲ-499 K区(Sb-108~111)の石器(4) 舟底形石器・石刃・石刃核・石核

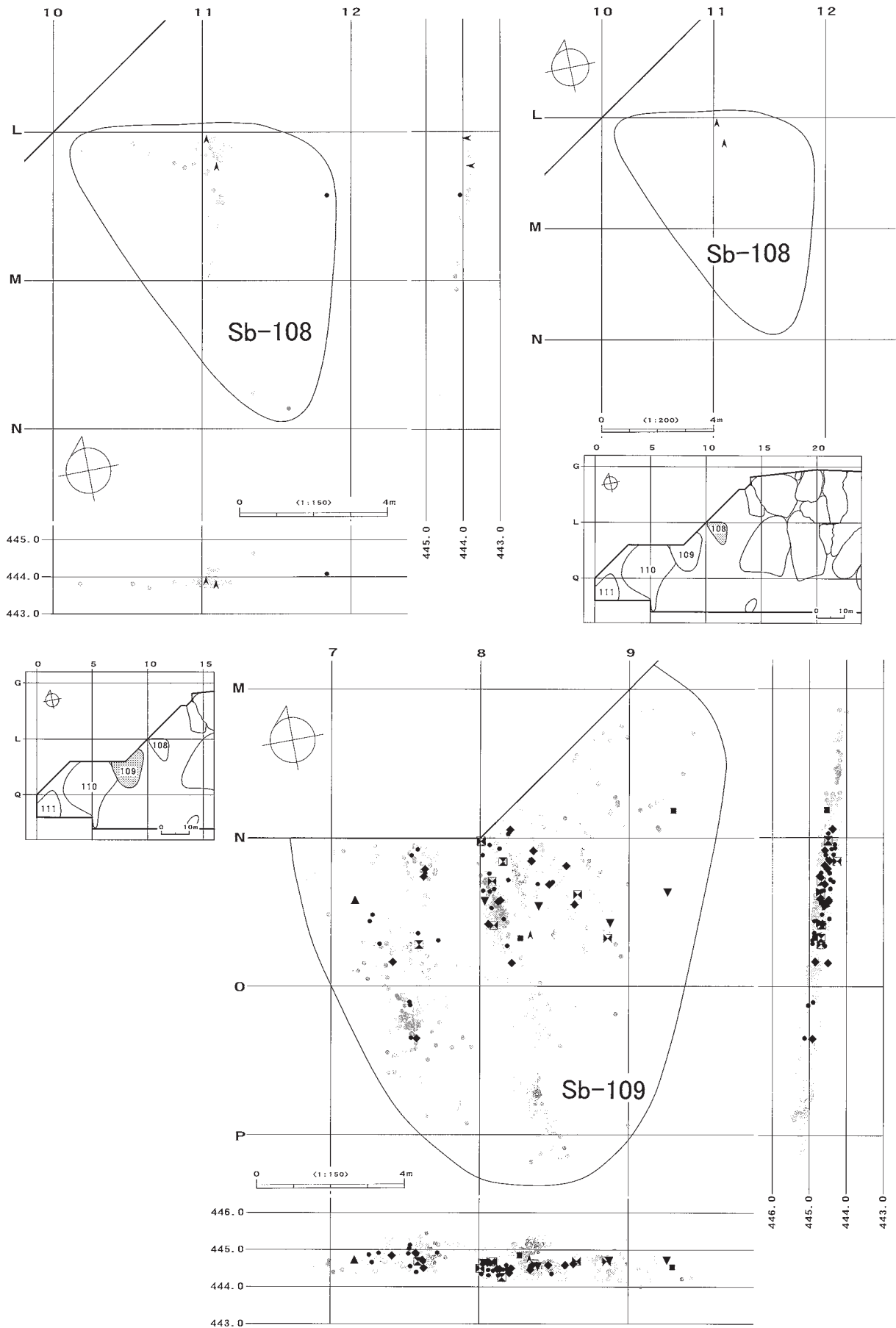

図Ⅲ-500 Sb-108・109の分布図・遺物

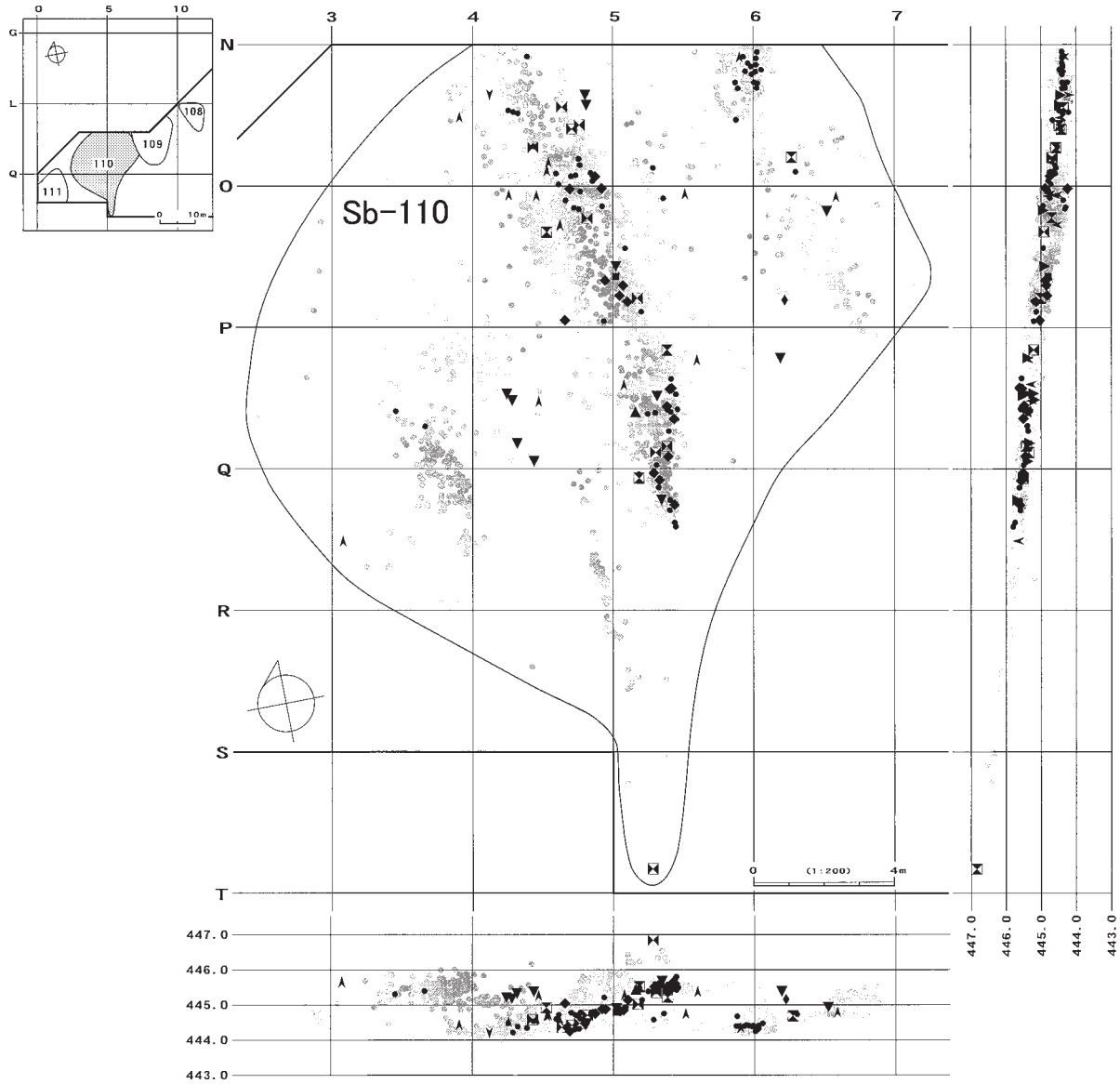
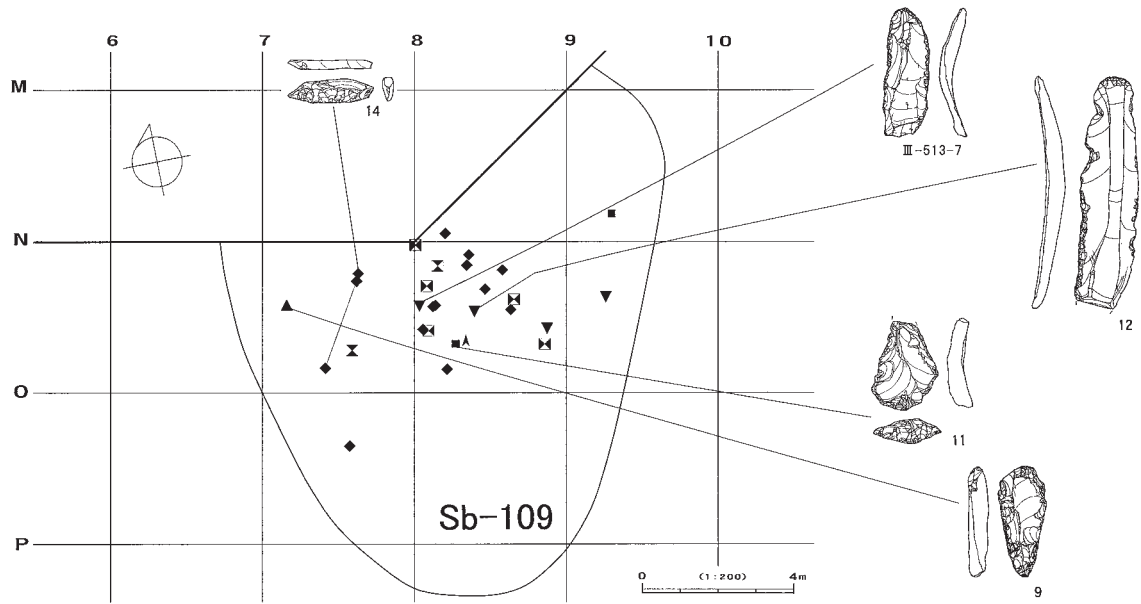

図Ⅲ-501 Sb-109の遺物、Sb-110の分布図

尖頭器、その他の石器

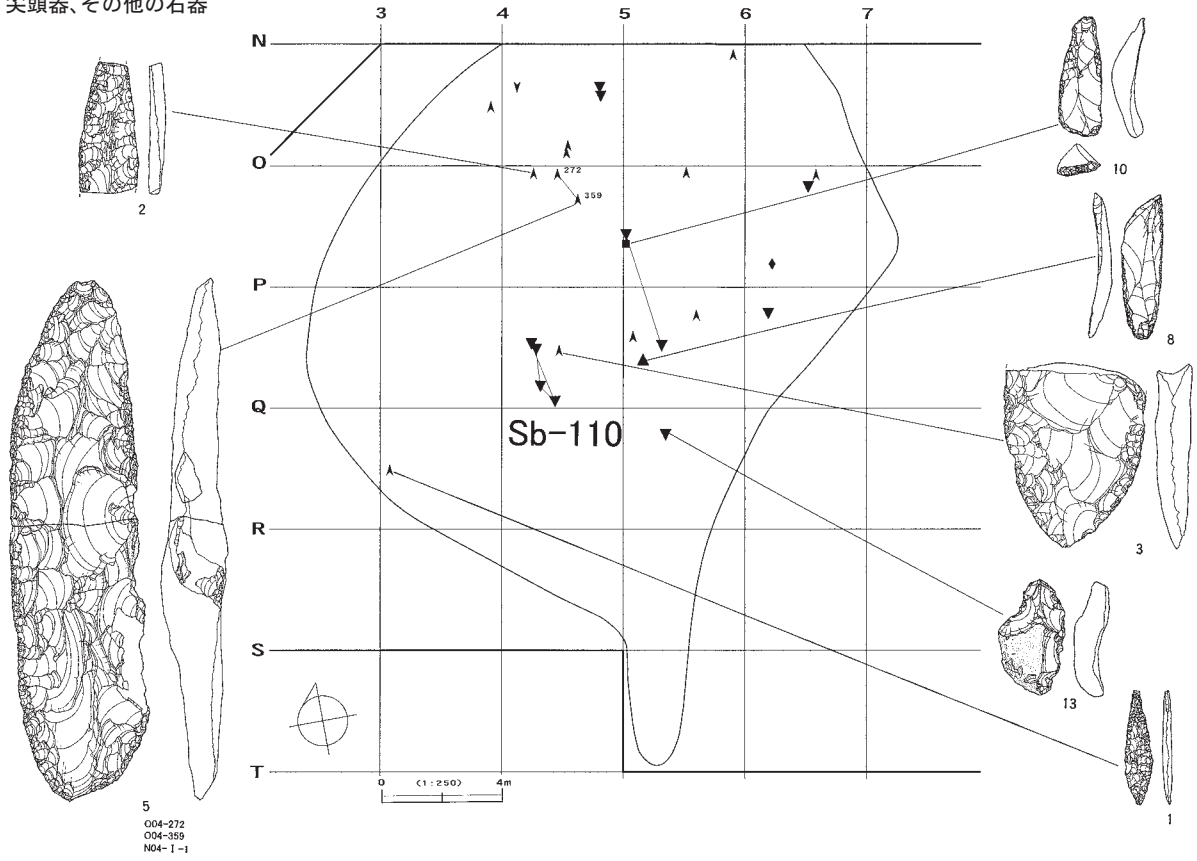

舟底形石器、石刃核、石核

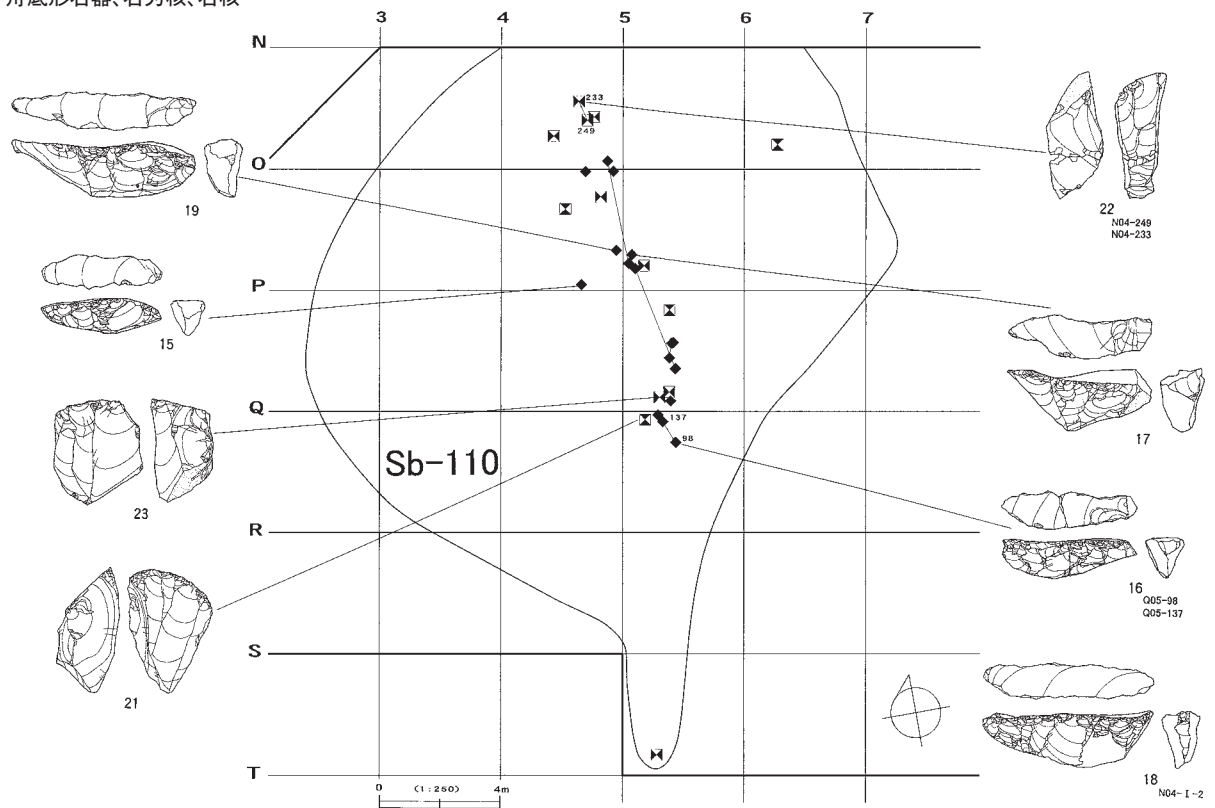

図Ⅲ-502 Sb-110の遺物

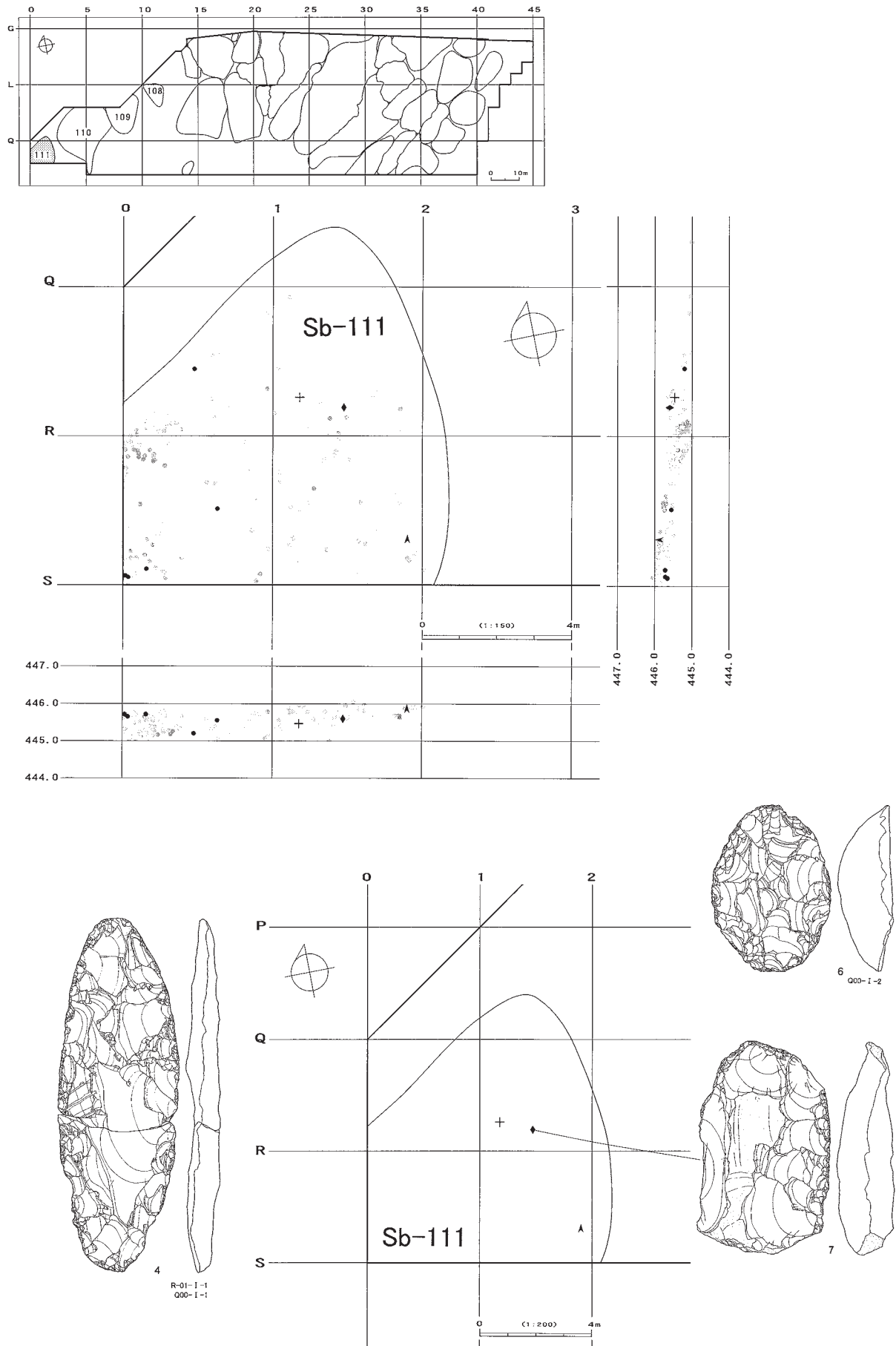

図Ⅲ-503 Sb-111の分布図・遺物

K区(Sb-108~111)

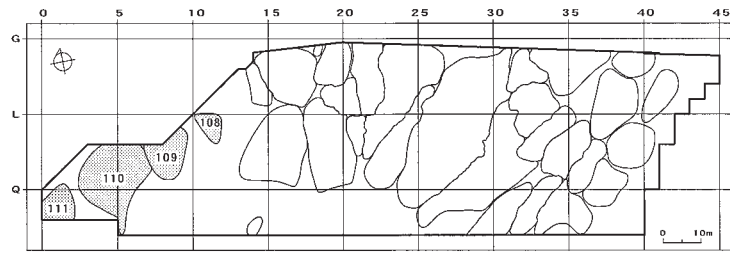

全接合分布図

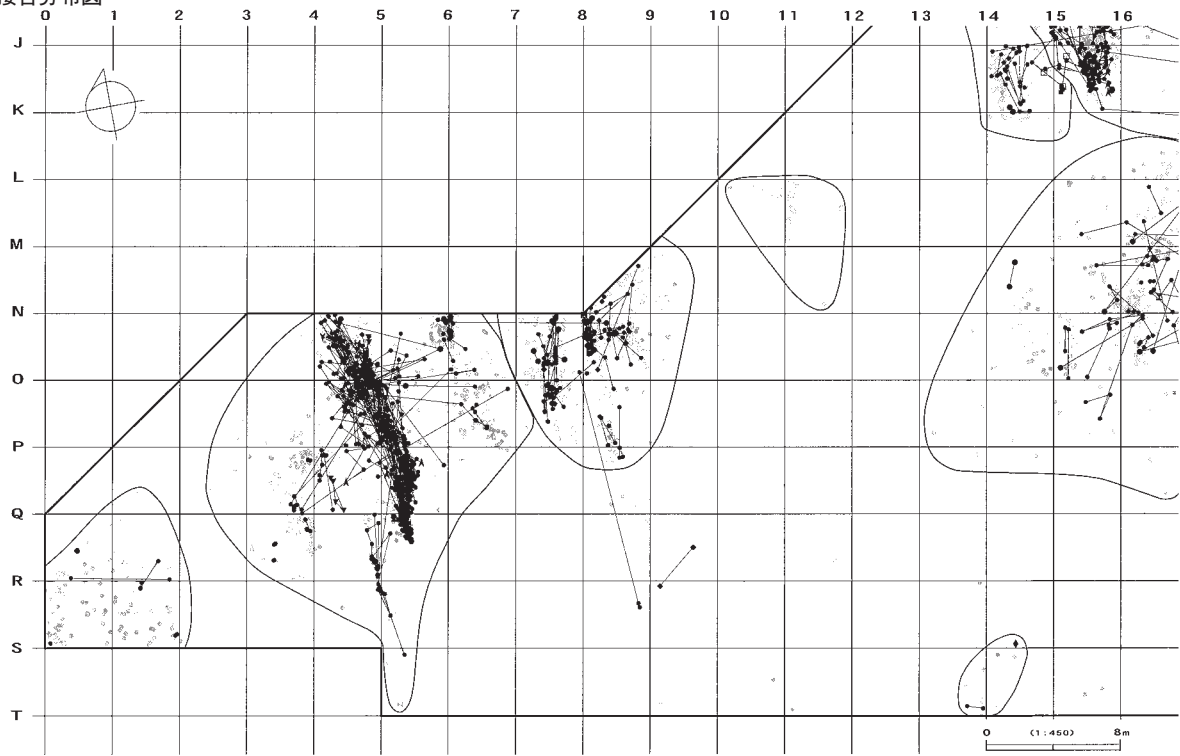

折れ面接合分布図

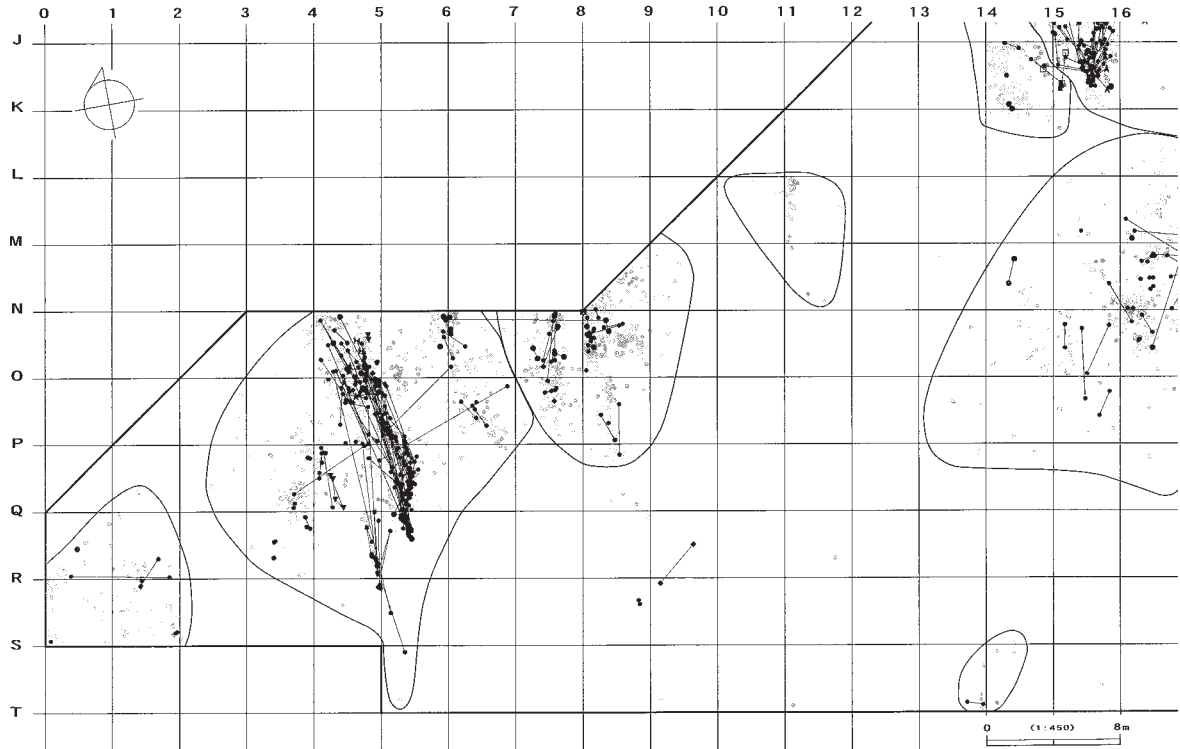

図Ⅲ-504 K区(Sb-108~111)の接合分布図

母岩1198・接合4773

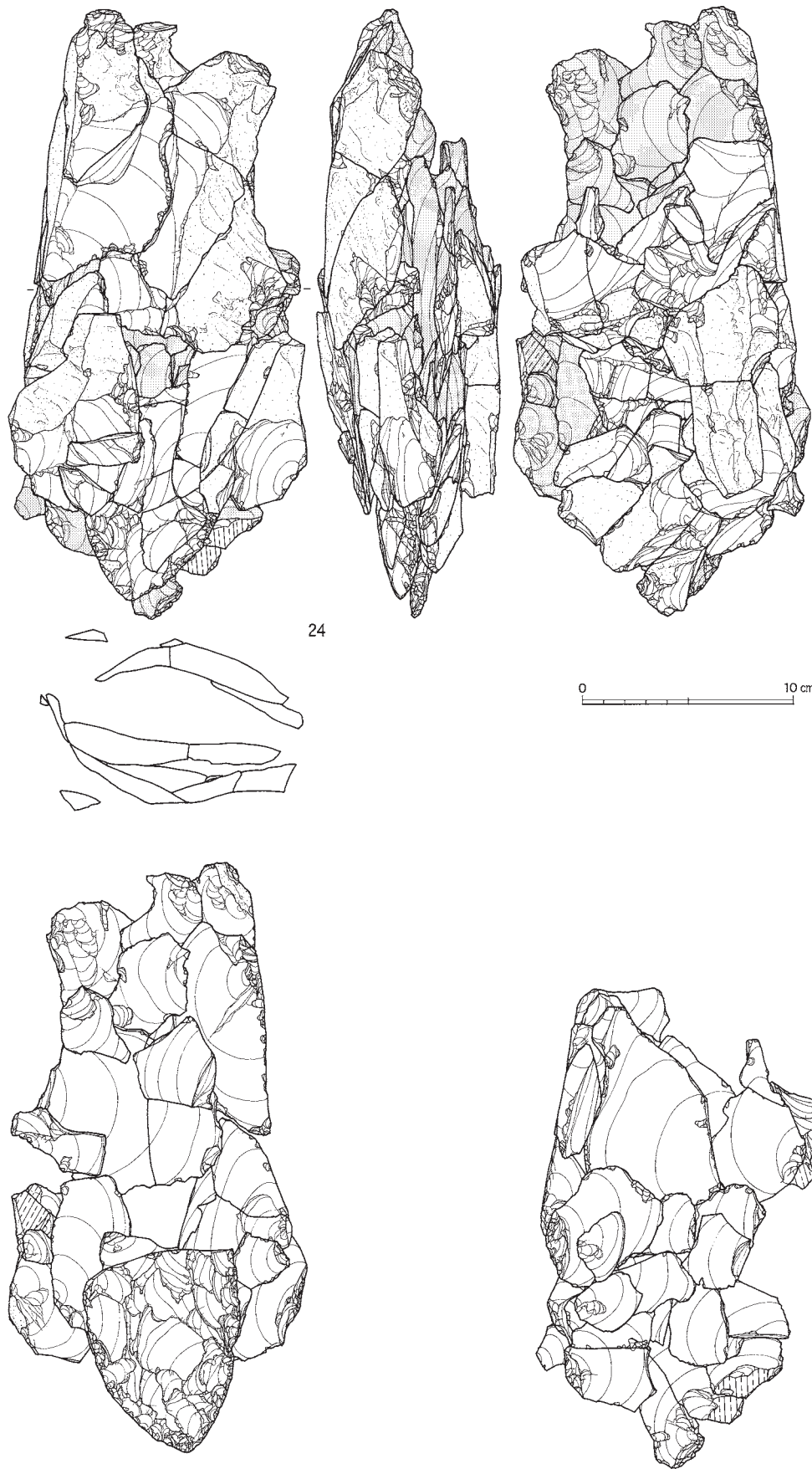

図Ⅲ-505 K区(Sb-108~111)の石器(5) 母岩1198・接合4773(1)

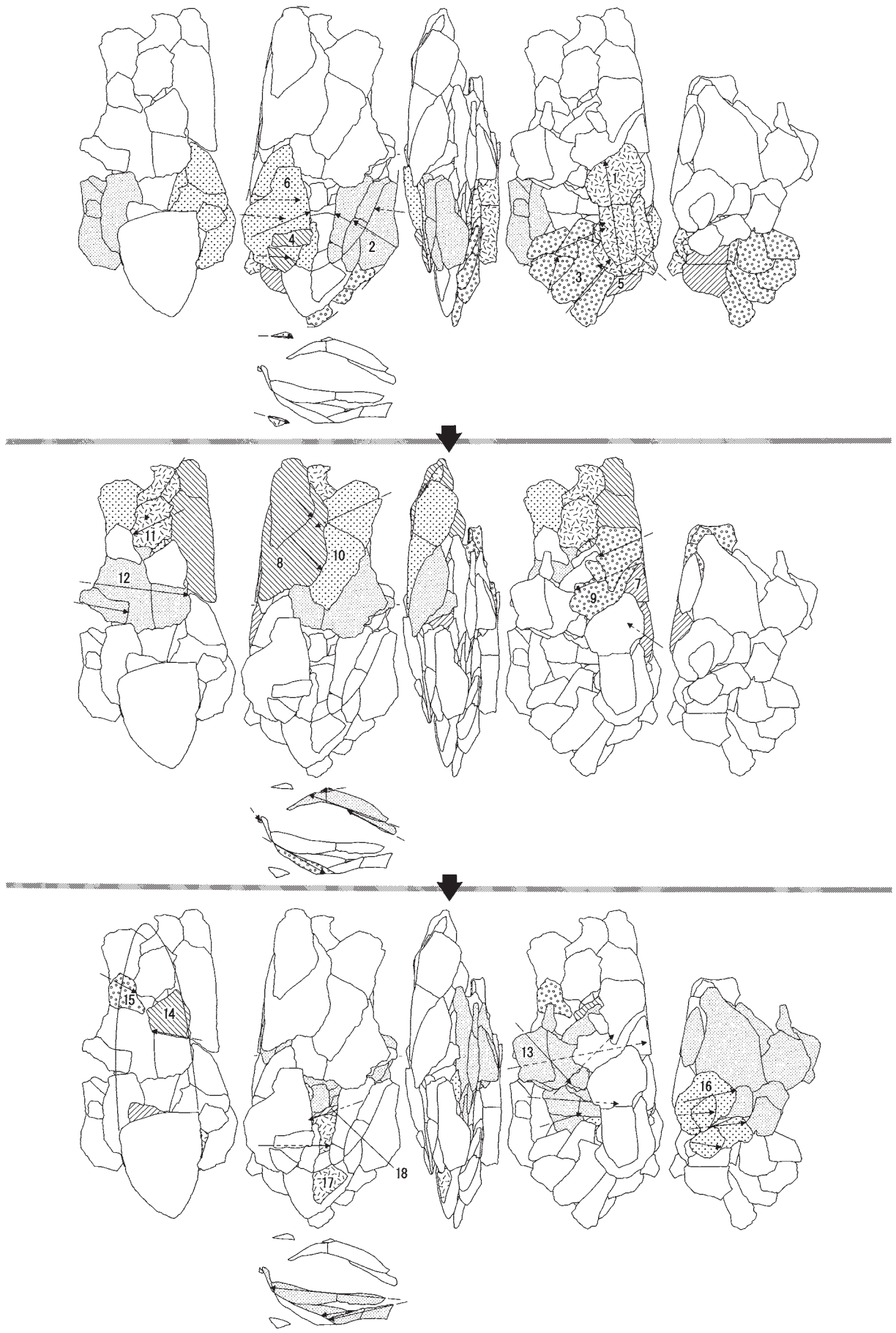

図Ⅲ-506 K区(Sb-108~111)の石器(6) 母岩1198・接合4773(2)

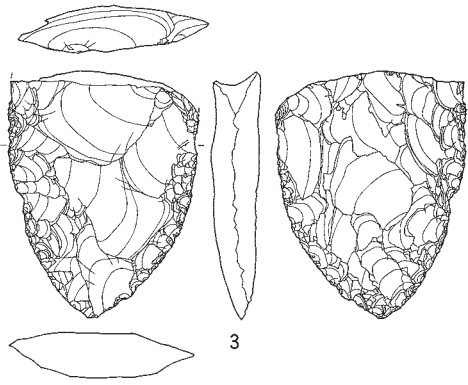

接合4773分布図

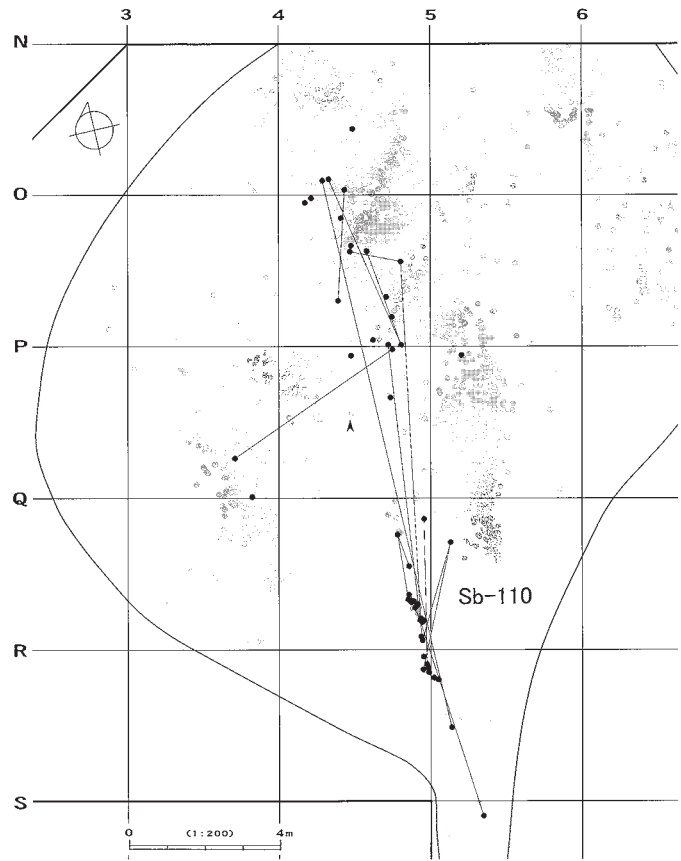

母岩1203・接合4784

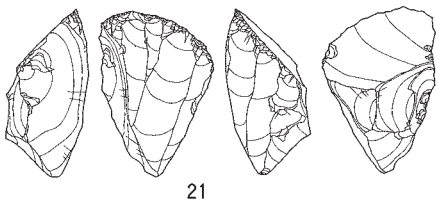
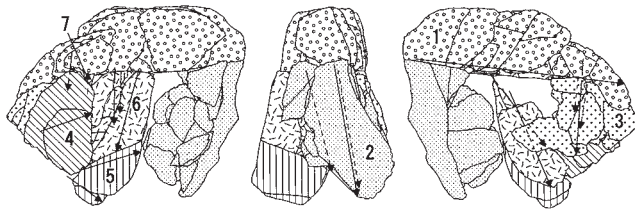
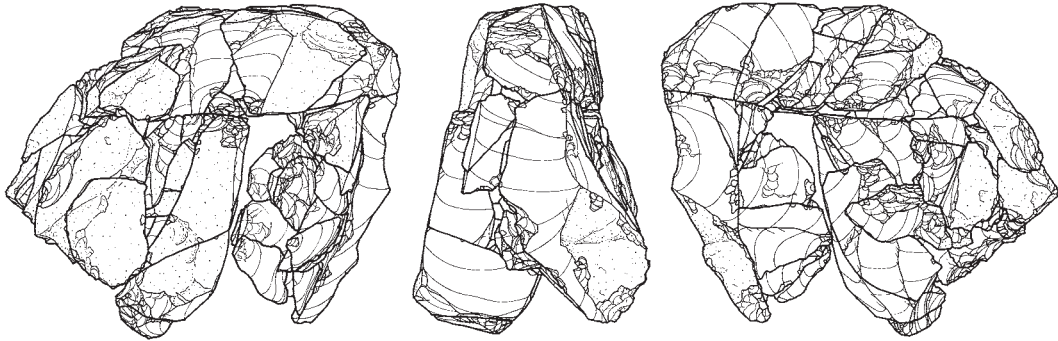

21

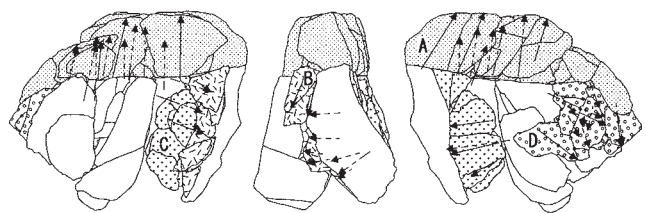

図Ⅲ-507 K区(Sb-108~111)の石器(7) 母岩1198・接合4773(3)、母岩1203・接合4784(1)

接合4784(個体A)分布図

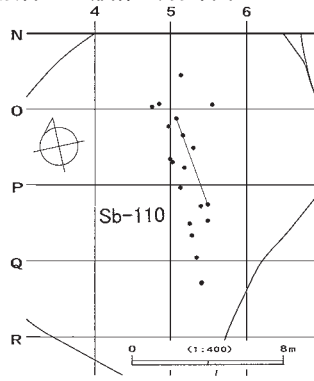

接合4784(個体B)分布図

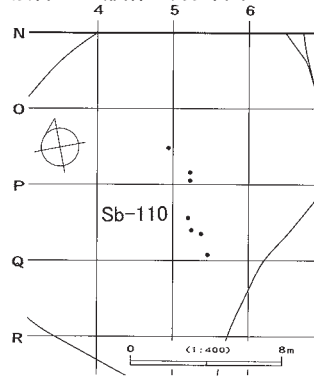

接合4784(全体)分布図

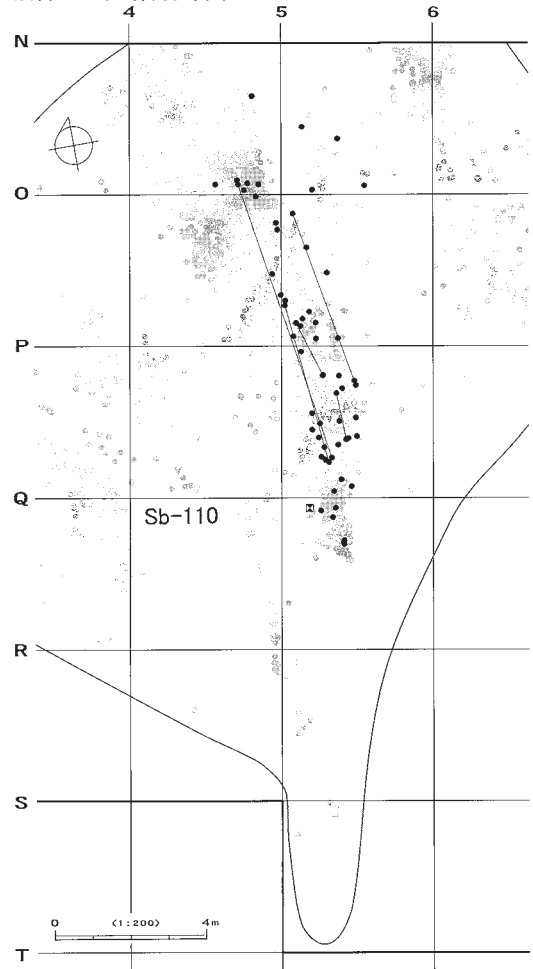

接合4784(個体C)分布図

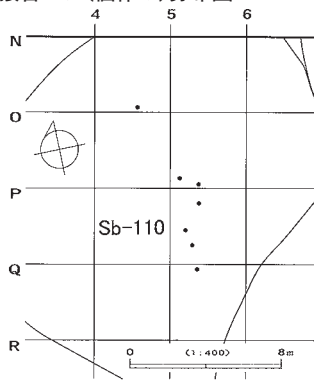

接合4784(個体D)分布図

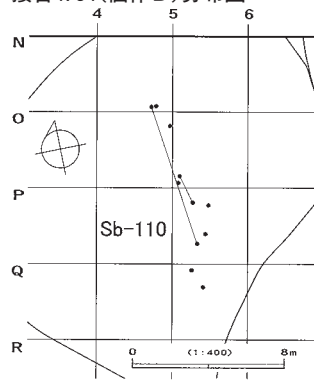

接合4784(個体A~D)分布図

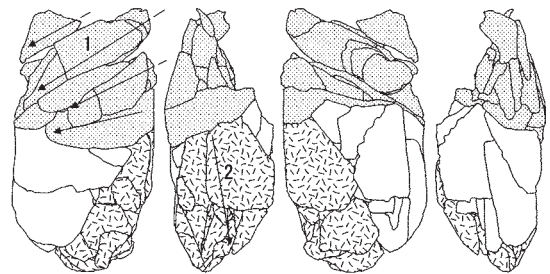
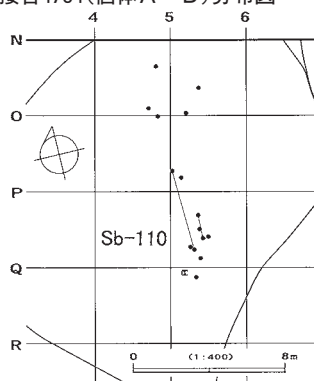

母岩1202・接合4783

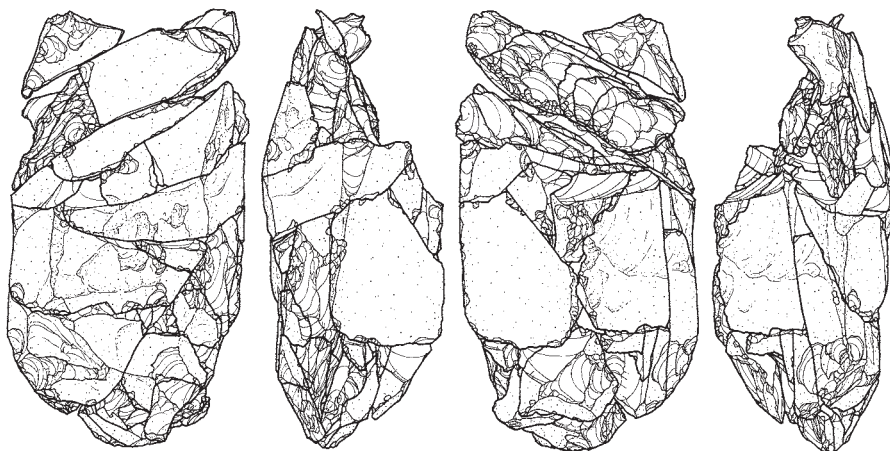

26

0 10 cm

図Ⅲ-508 K区(Sb-108~111)の石器(8) 母岩1203・接合4784(2)、母岩1202・接合4783(1)

段階1
個体A

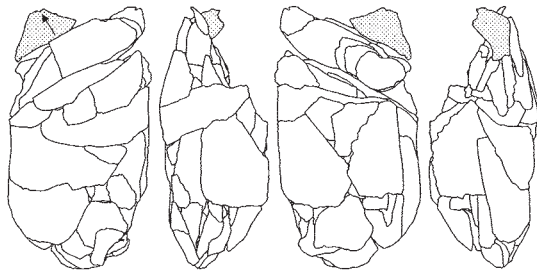

個体B

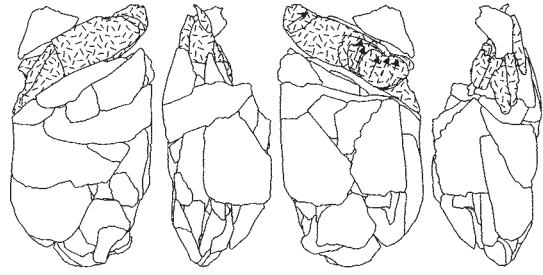

個体C

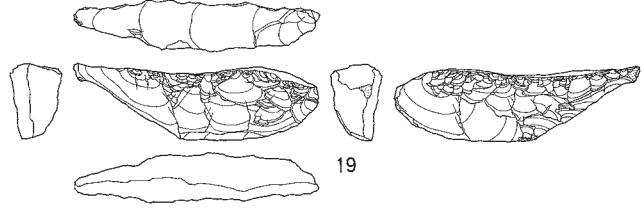
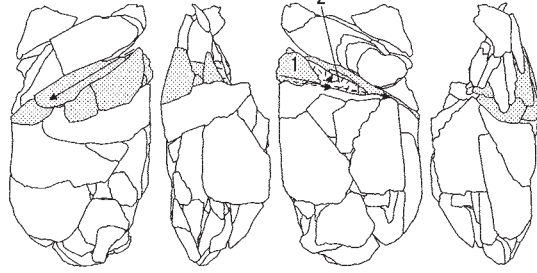

段階2
個体D

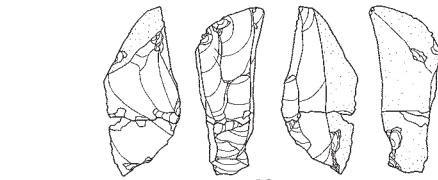
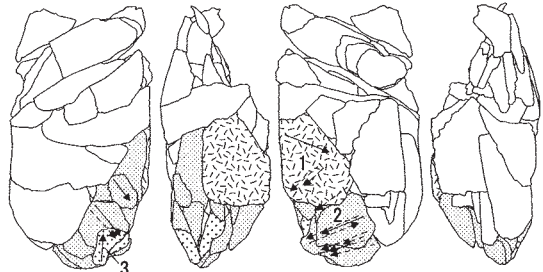

個体E

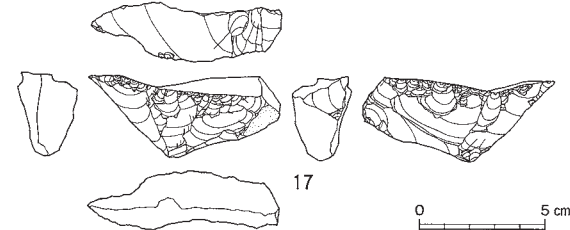
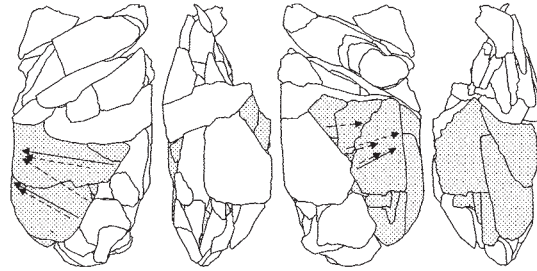

0 5 cm

接合4783(個体A・B)分布図

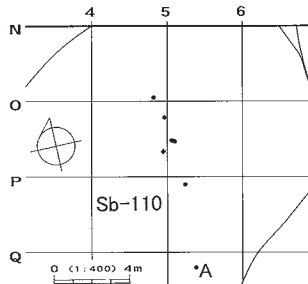

接合4783(個体C)分布図

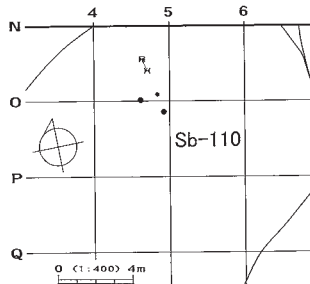

接合4783(全体)分布図

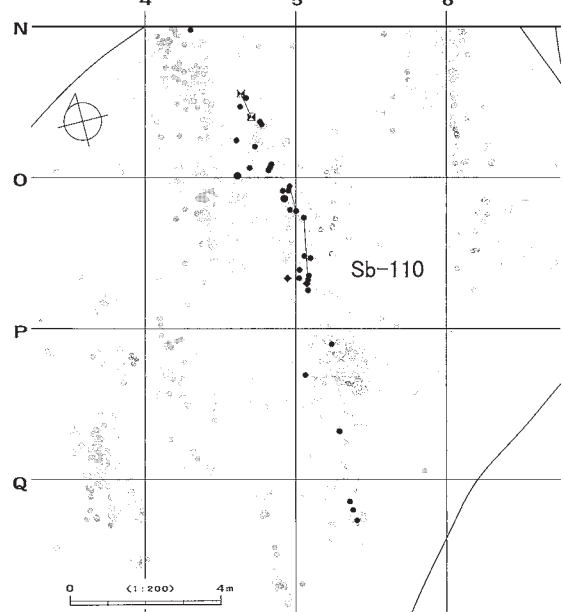

接合4783(個体D)分布図

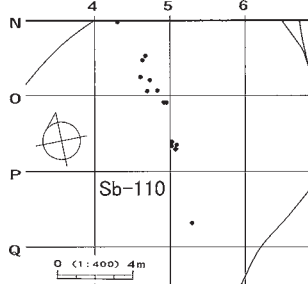

接合4783(個体E)分布図

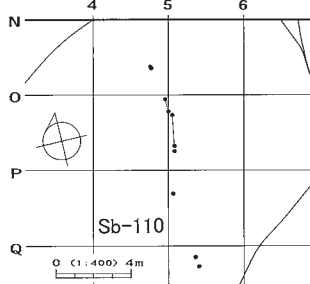

図Ⅲ-509 K区(Sb-108~111)の石器(9) 母岩1202・接合4783(2)

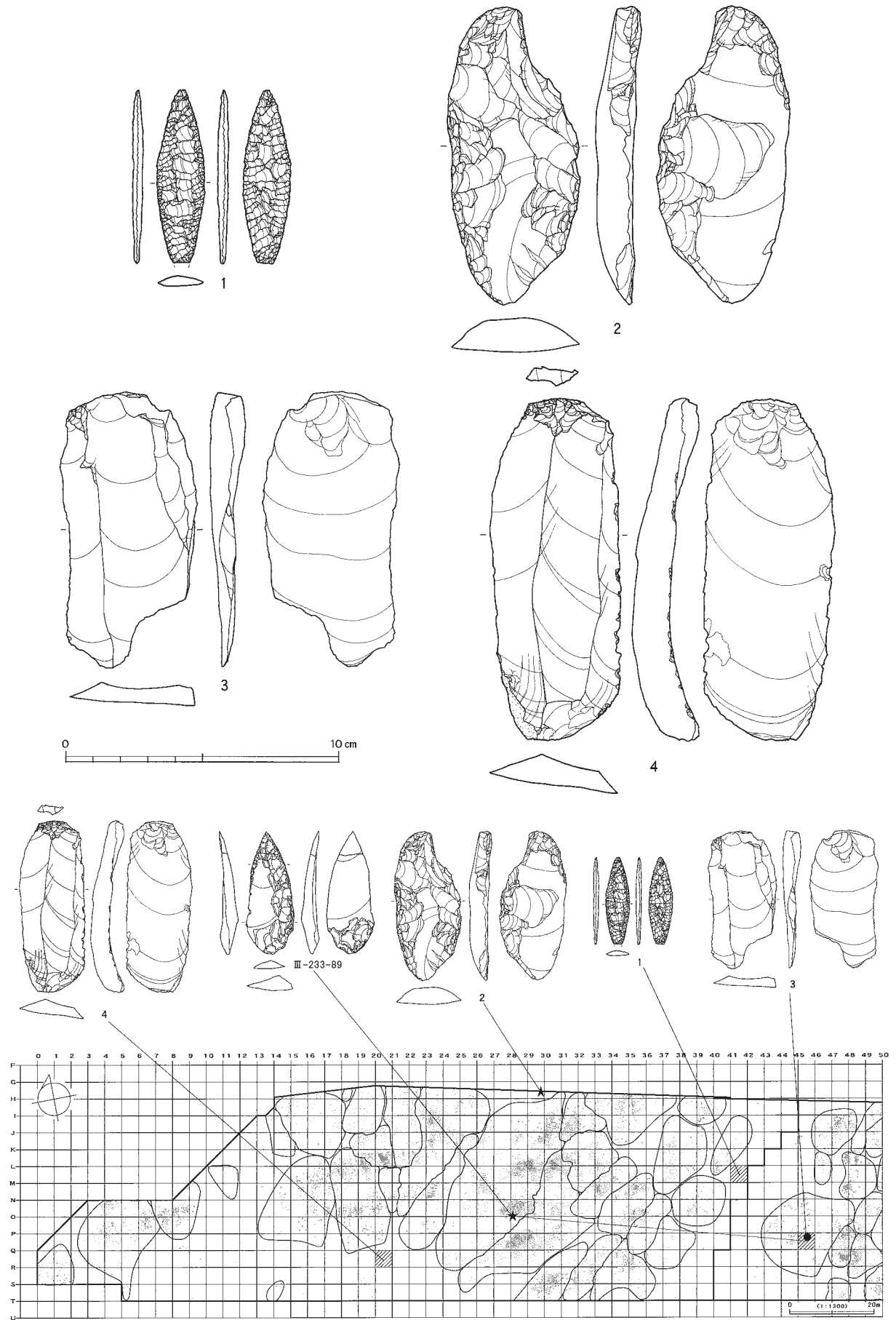

図Ⅲ-510 石器ブロック外の石器 尖頭器・石刃、石器ブロック外の石器分布図

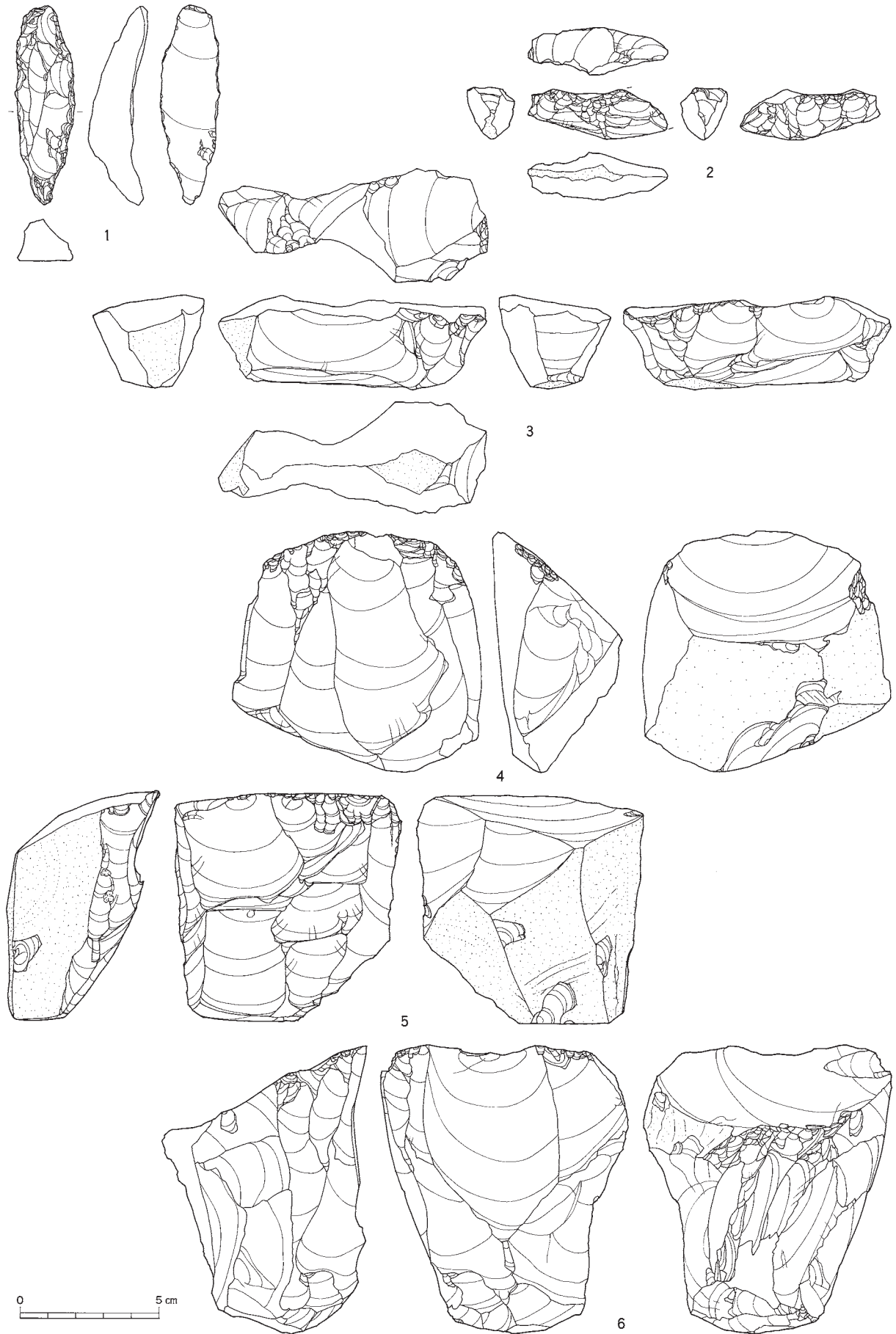

図Ⅲ-511 表土(重機調査)の石器(1) 削器・舟底形石器・石刃核・石核

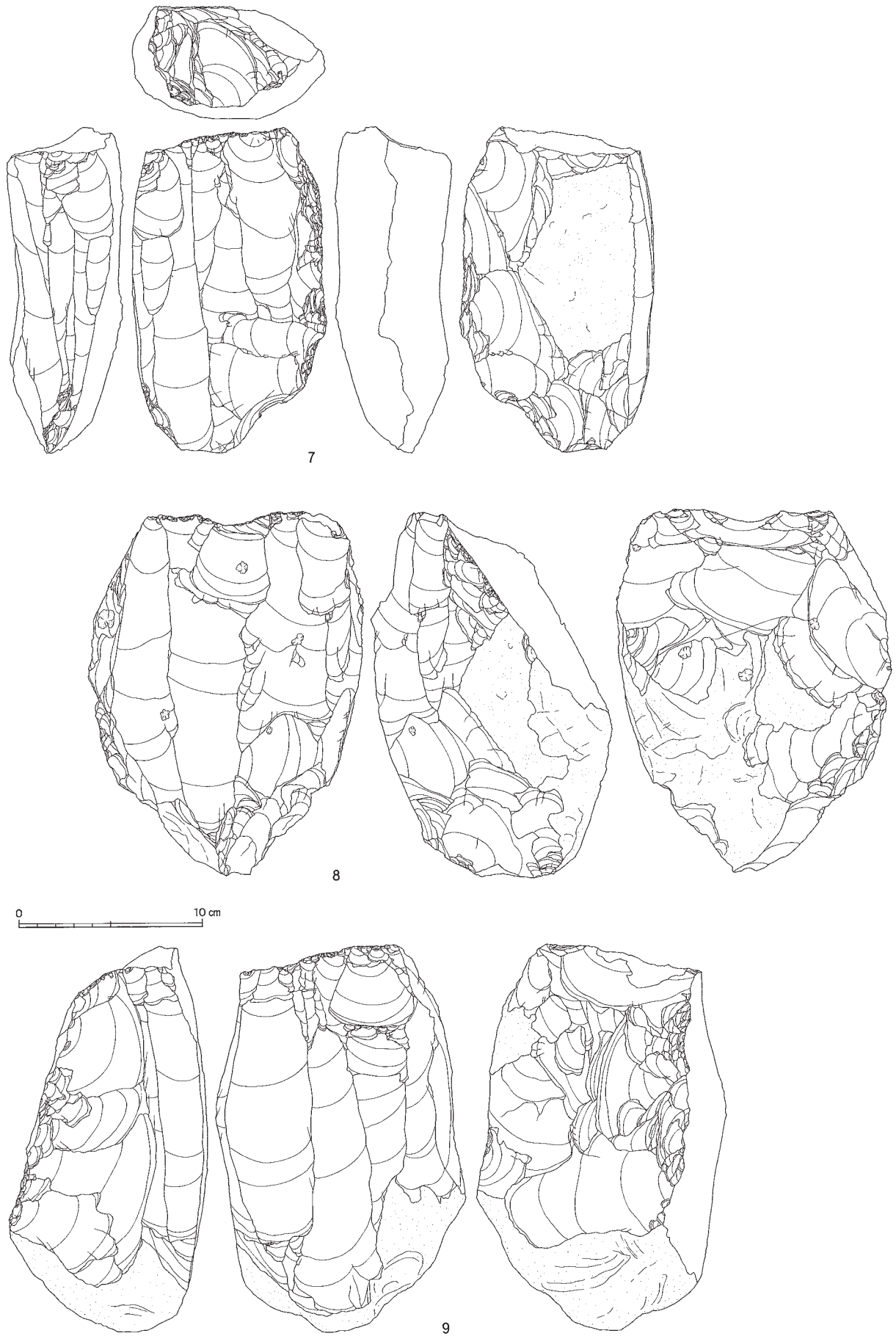

図Ⅲ-512 表土(重機調査)の石器(2) 石刃核

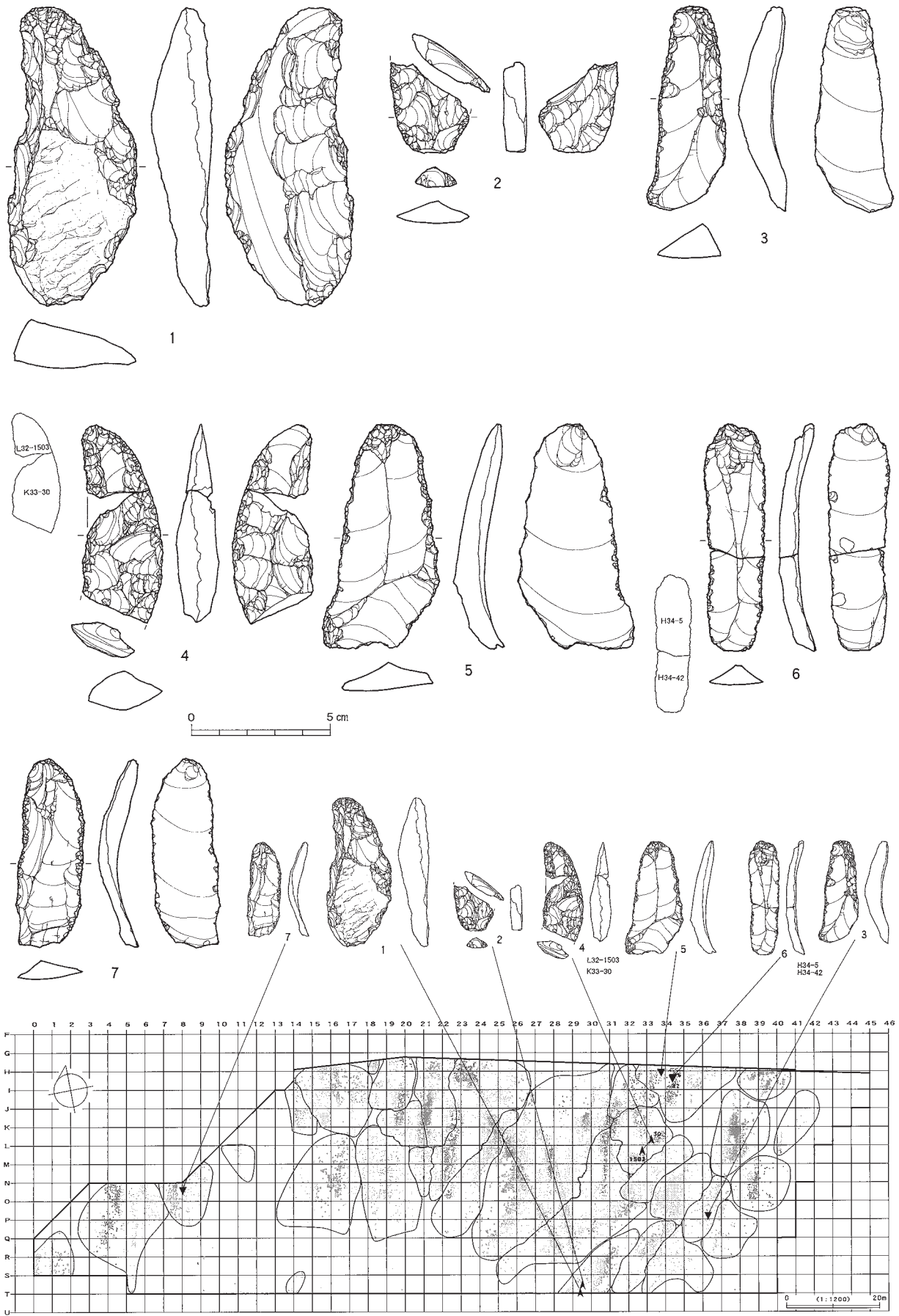

図Ⅲ-513 追加報告の石器(1) 尖頭器・削器、追加報告の石器分布図

母岩702・接合3222

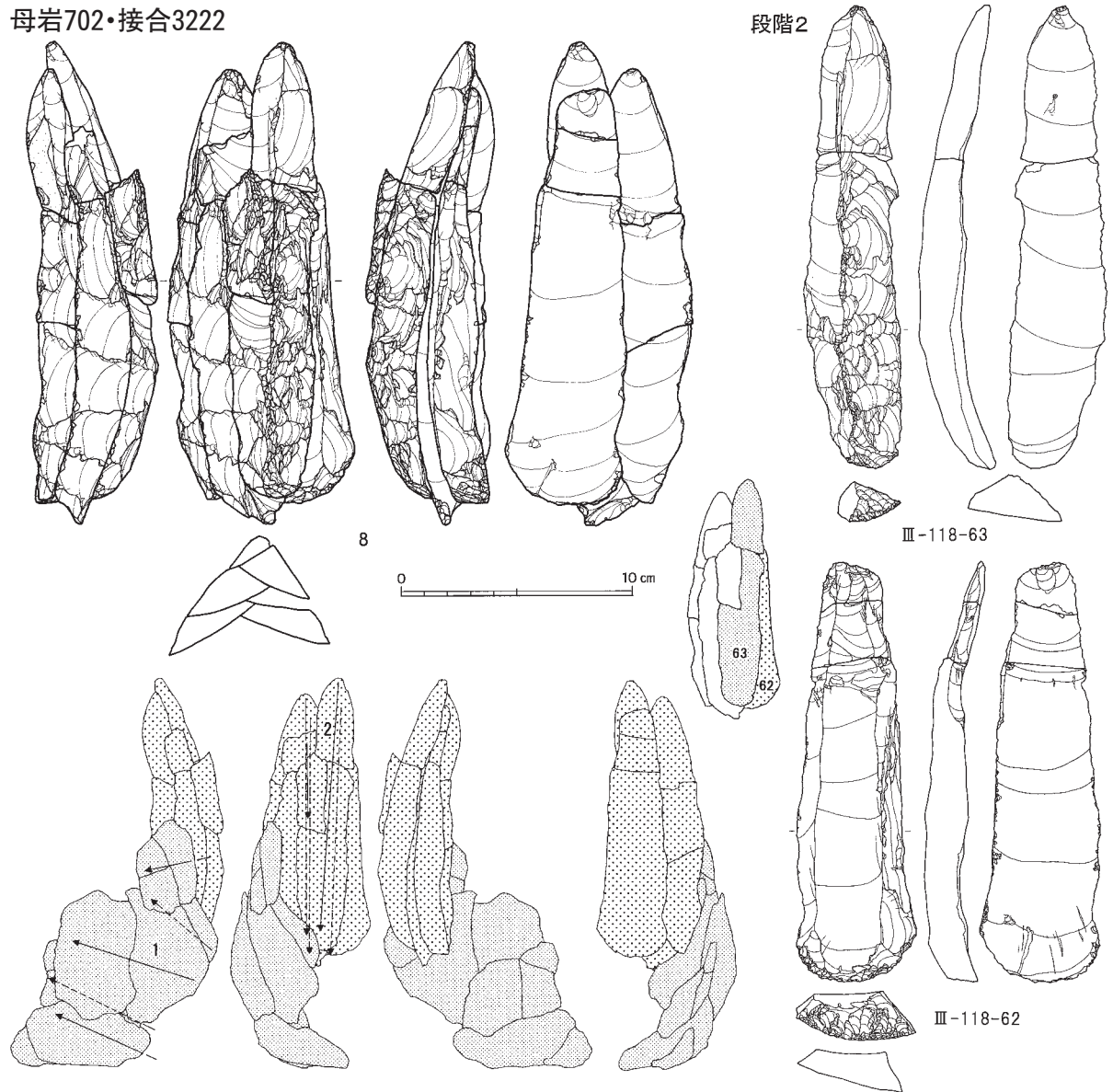

接合3222分布図

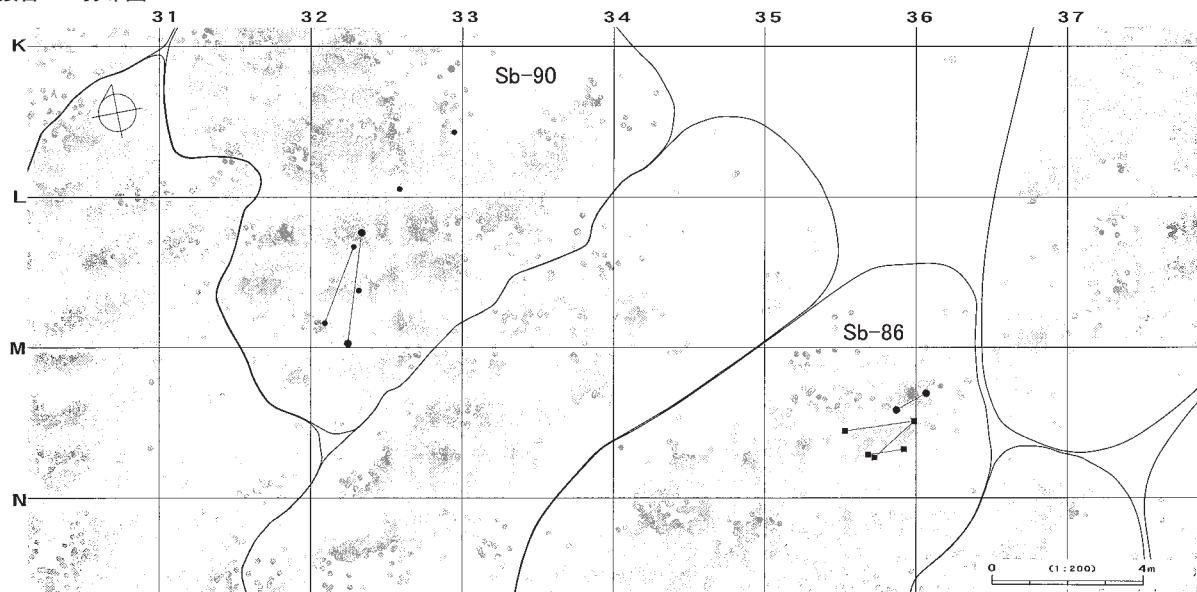

図Ⅲ-514 追加報告の石器(2) 母岩702・接合3222

(財)北海道埋蔵文化財センター調査報告書 第223集

白滝遺跡群 VI

第2分冊 (石器実測・分布図編)

白滝村 上白滝8遺跡(2)

一般国道450号白滝丸瀬布道路工事用地内埋蔵文化財発掘調査報告書

平成18年3月17日

編集・発行 財団法人 北海道埋蔵文化財センター
〒069-0832 江別市西野幌685番地1
☎011(386)3231 FAX011(386)3238
印刷 ひまわり印刷株式会社
