

版 圖

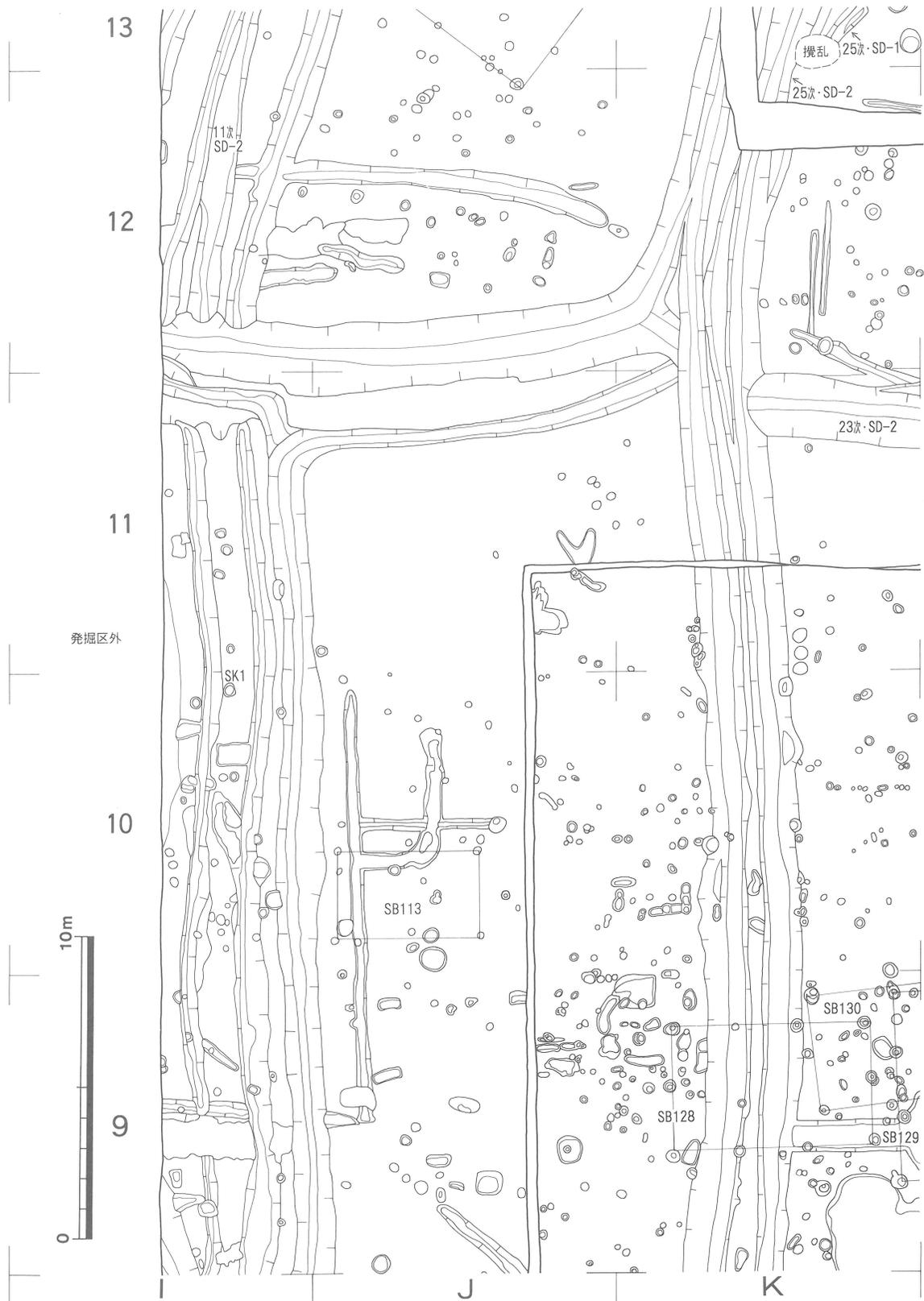

第1図 発掘区平面図-1 (1/200)

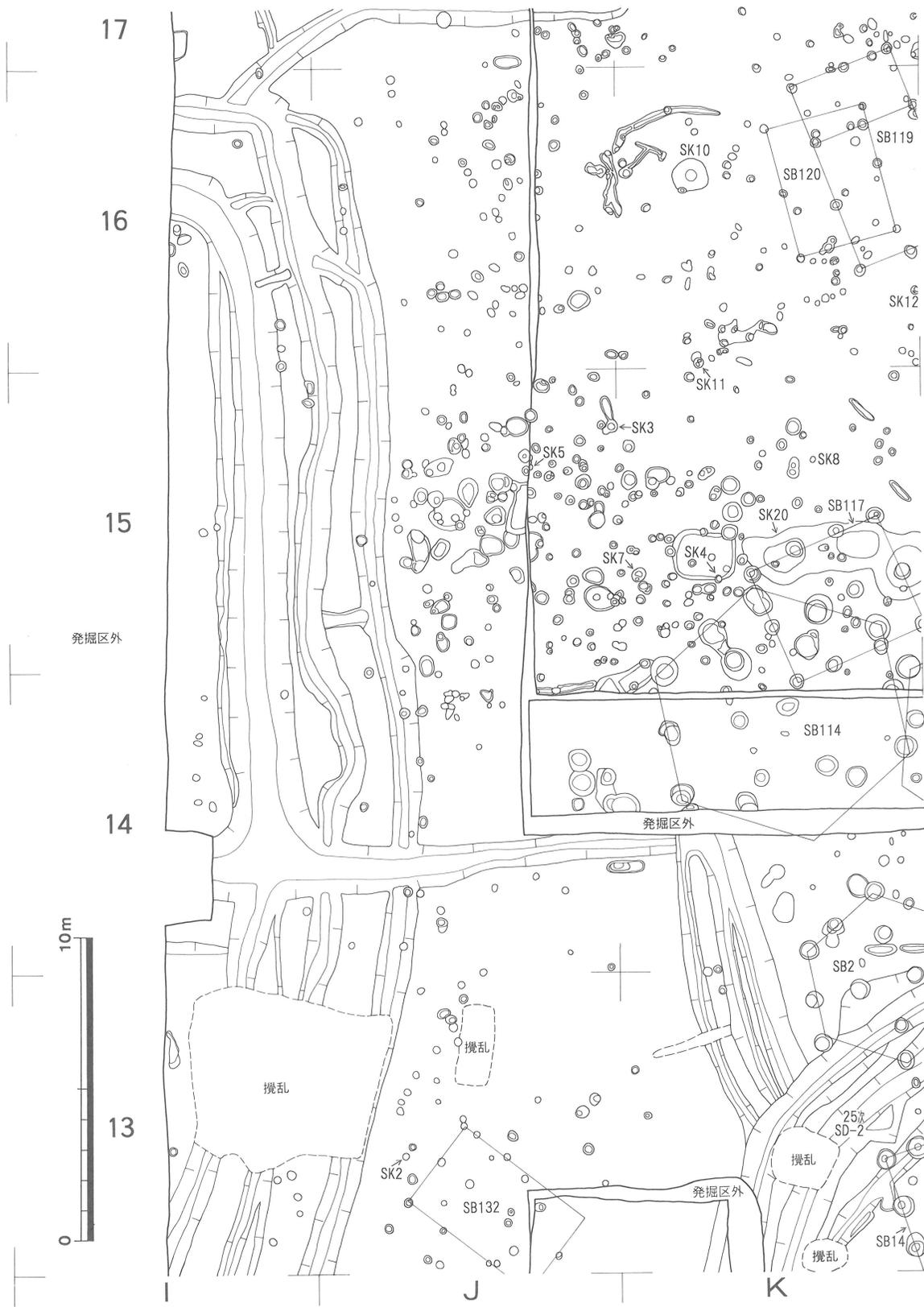

第2図 発掘区平面図一2 (1/200)



第3图 发掘区平面图—3 (1/200)

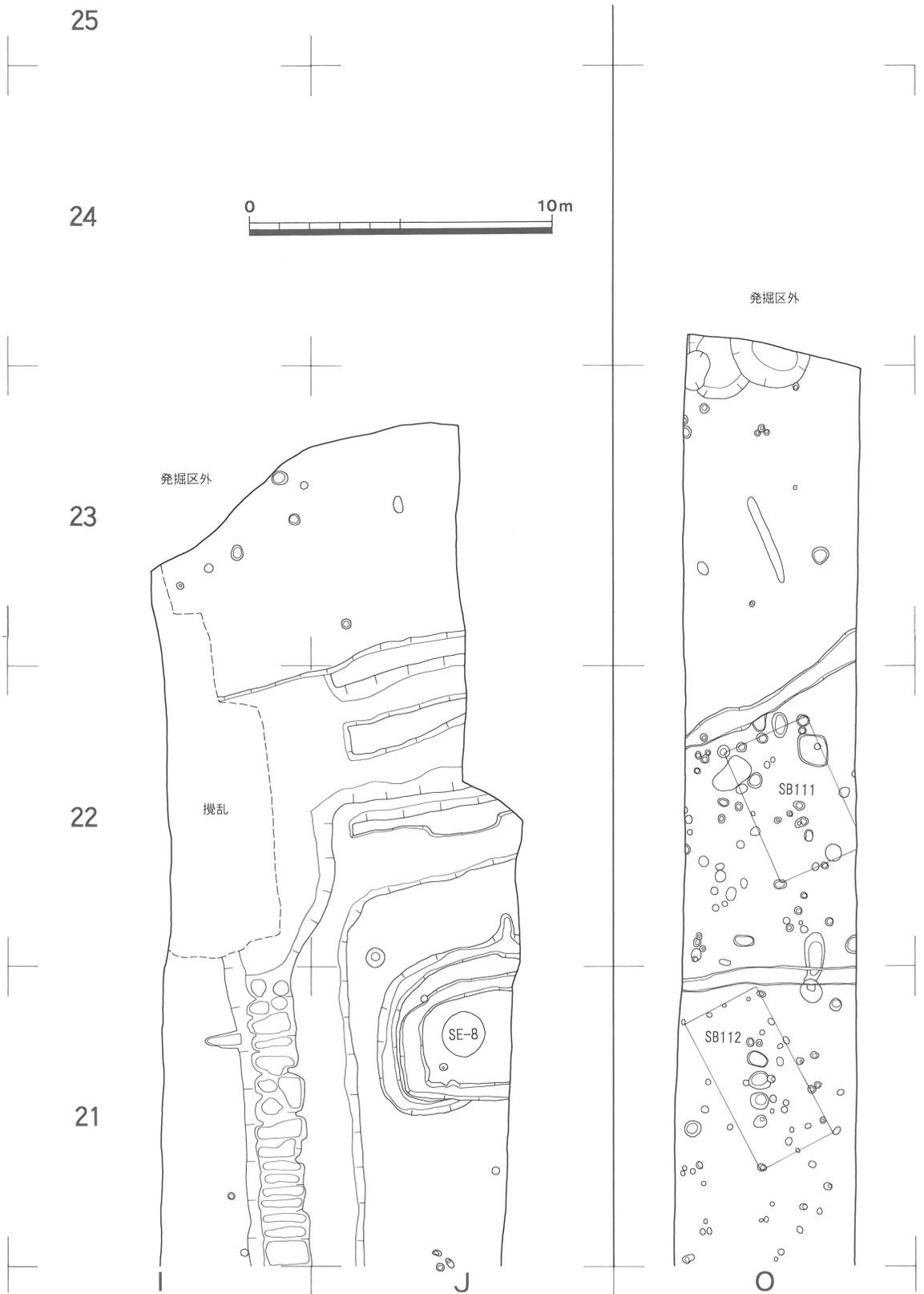

第4图 发掘区平面图—4 (1/200)

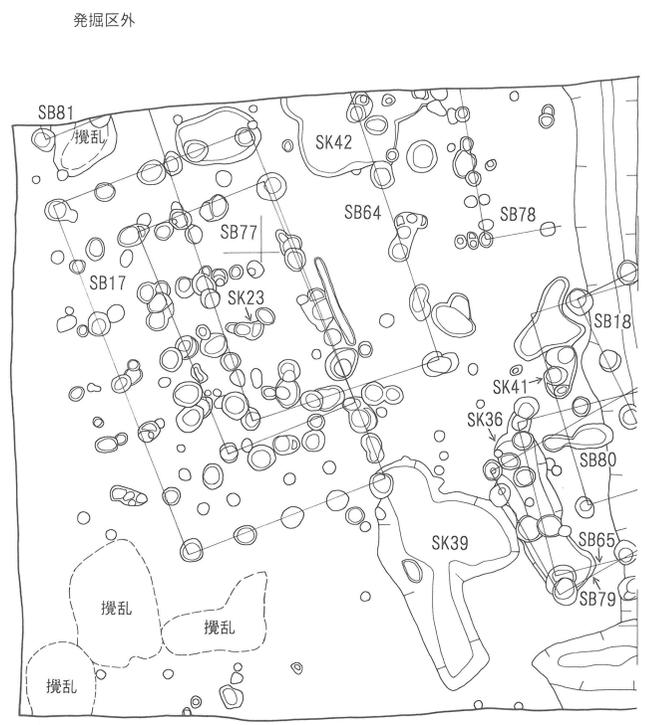
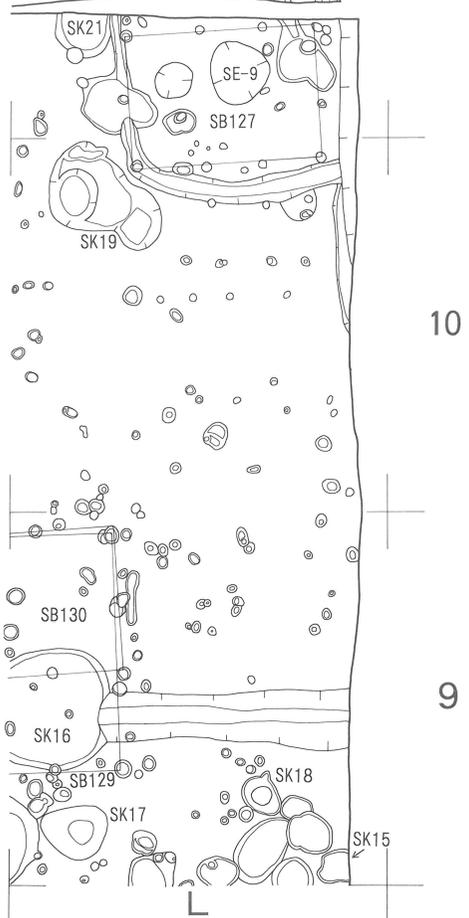
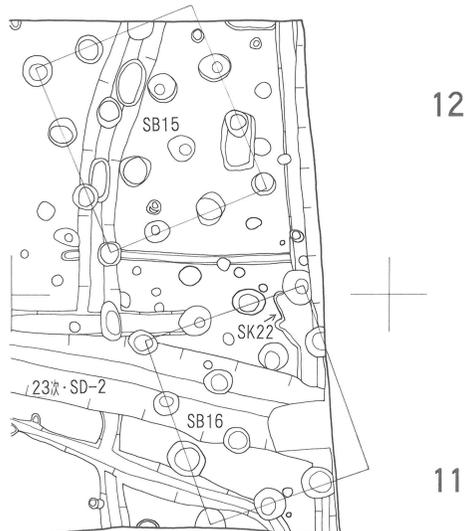
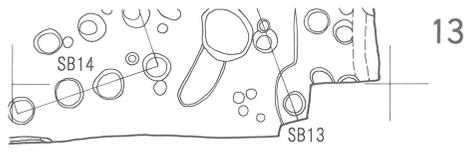

発掘区外

発掘区外



M

N

第5図 発掘区平面図—5 (1/200)



第6図 発掘区平面図-6 (1/200)

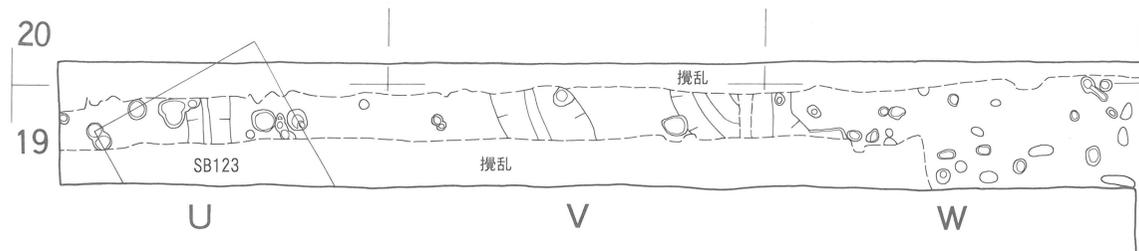

発掘区外

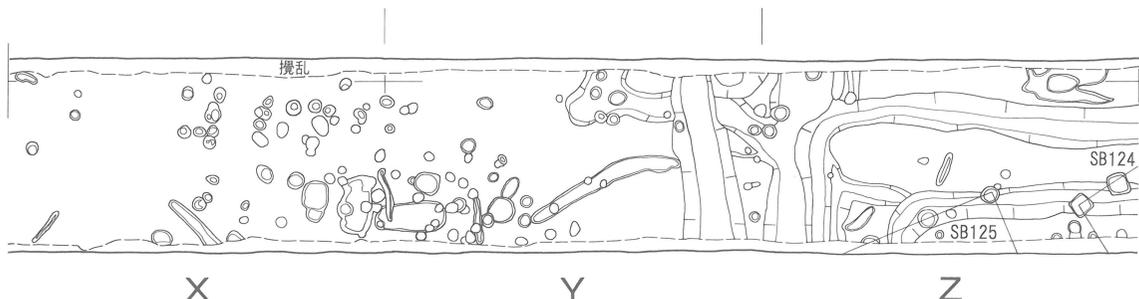

発掘区外

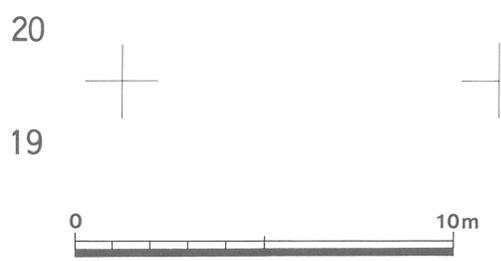
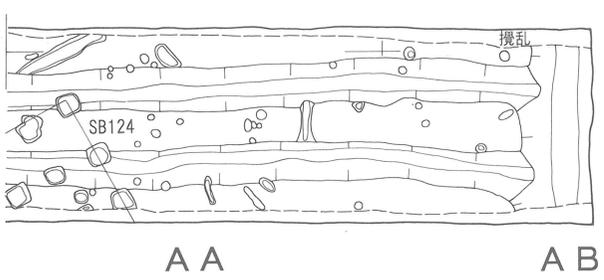

発掘区外

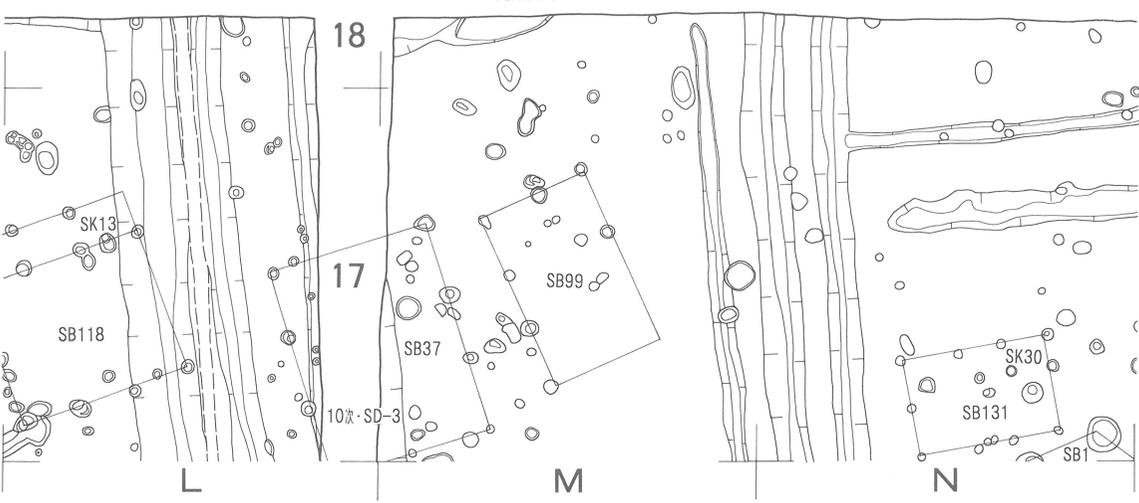

第7図 発掘区平面図一7 (1/200)

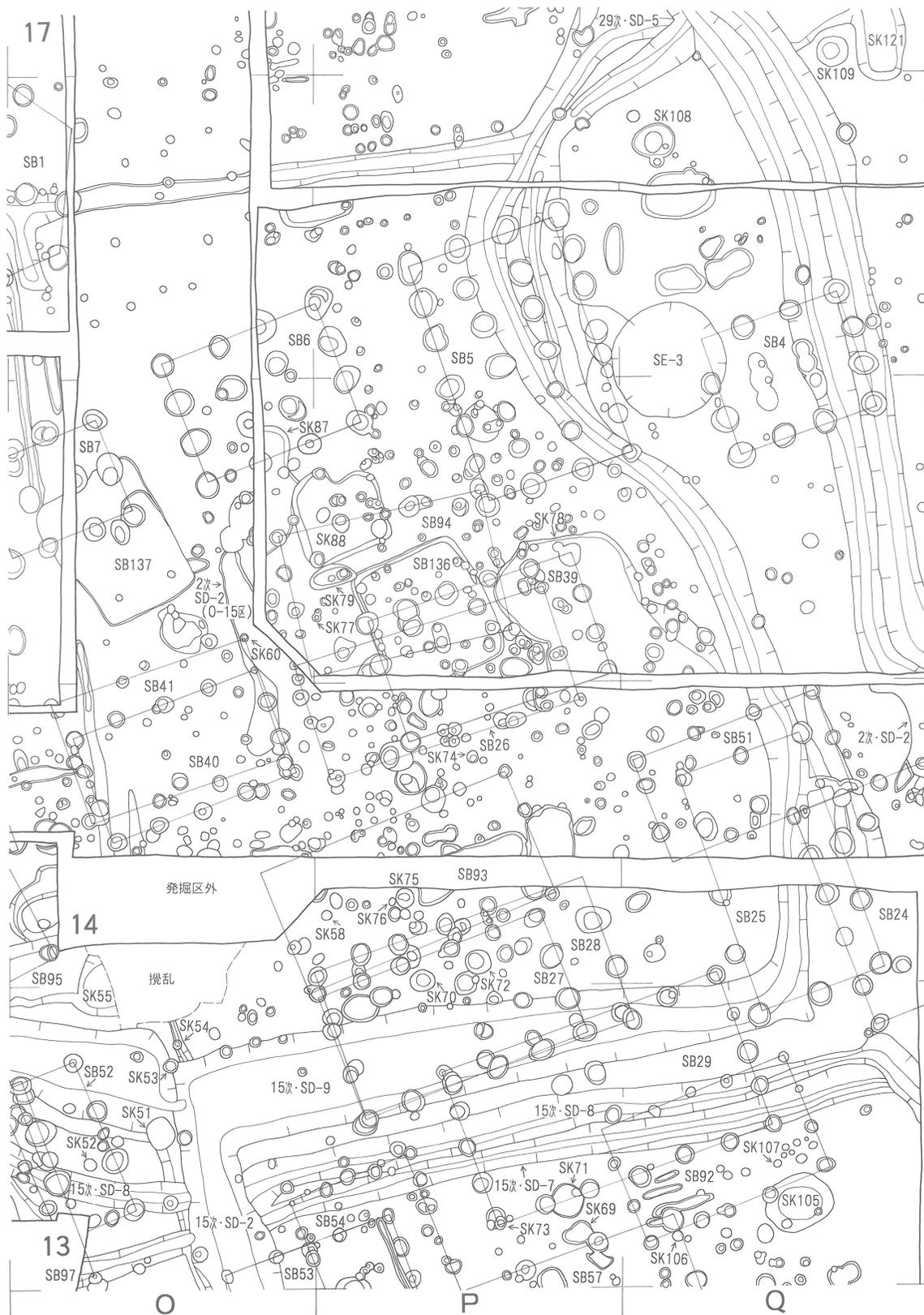

第9図 発掘区平面図-9 (1/200)

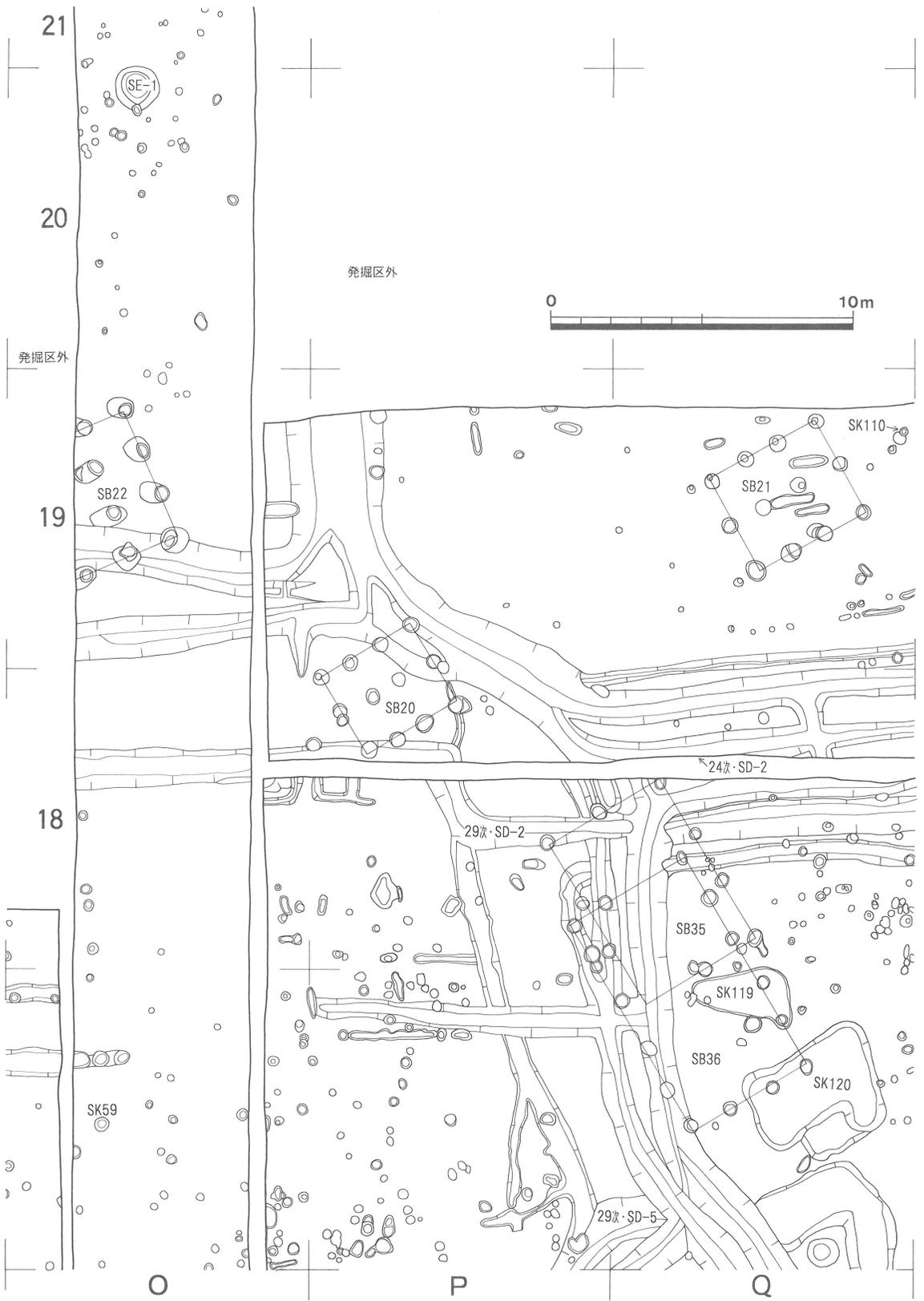

第10図 発掘区平面図-10 (1/200)

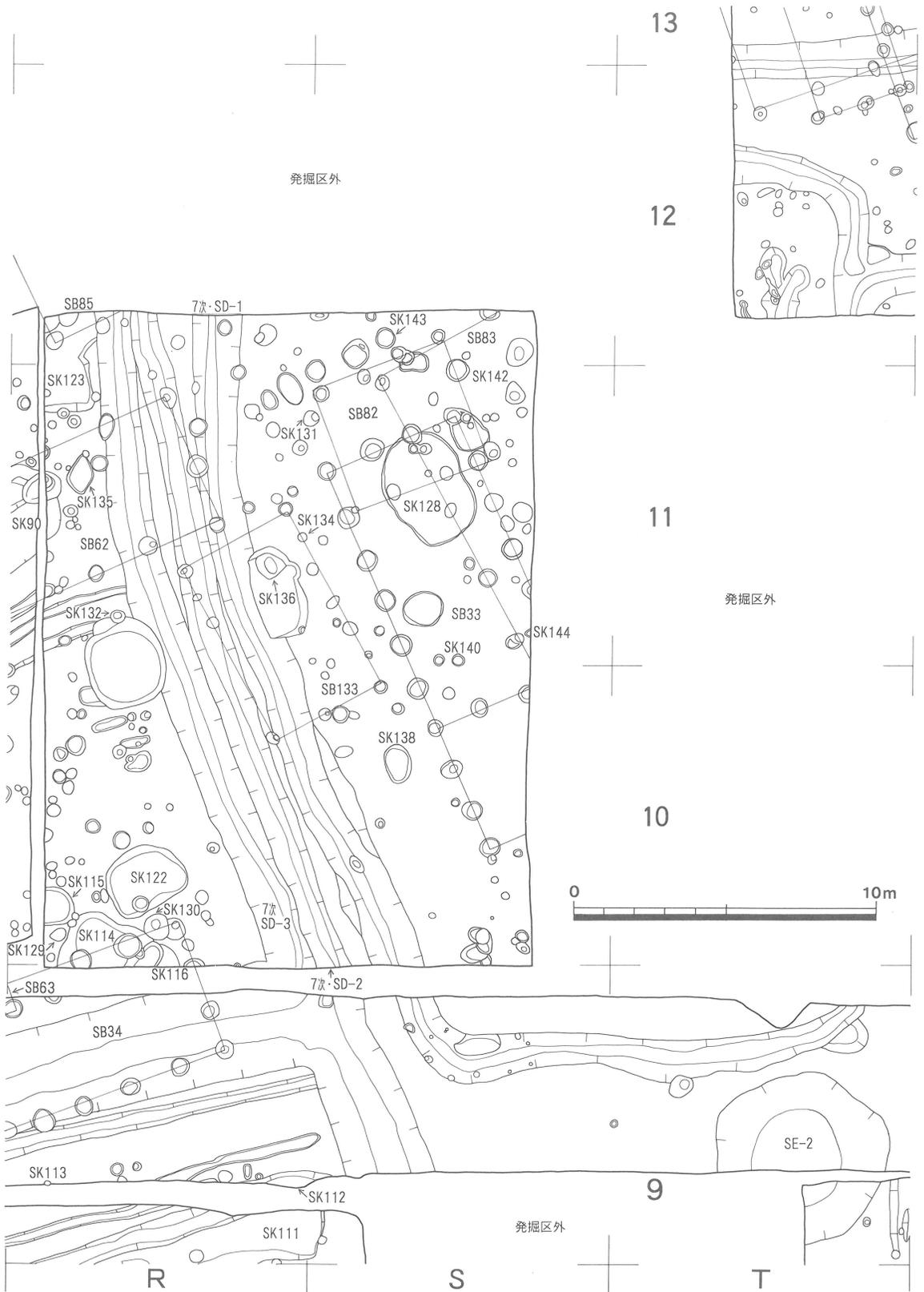

第11図 発掘区平面図-11 (1/200)



第12図 発掘区平面図-12 (1/200)

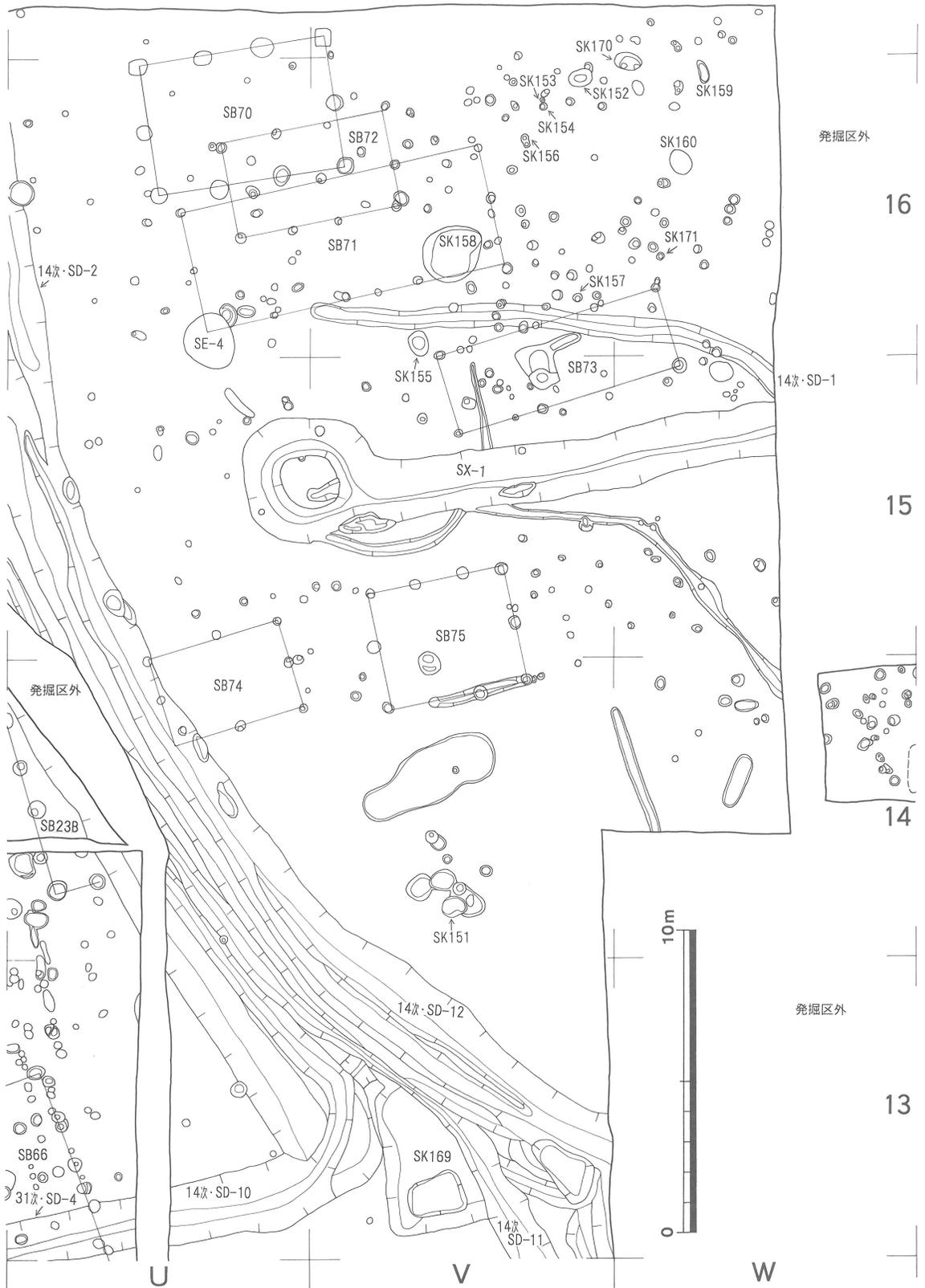

第13図 発掘区平面図-13 (1/200)

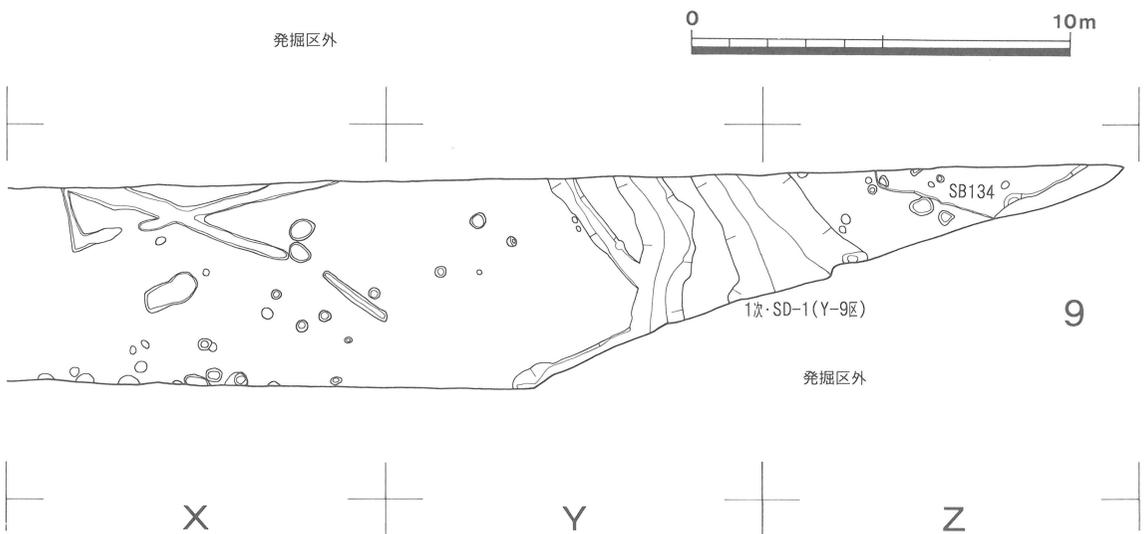
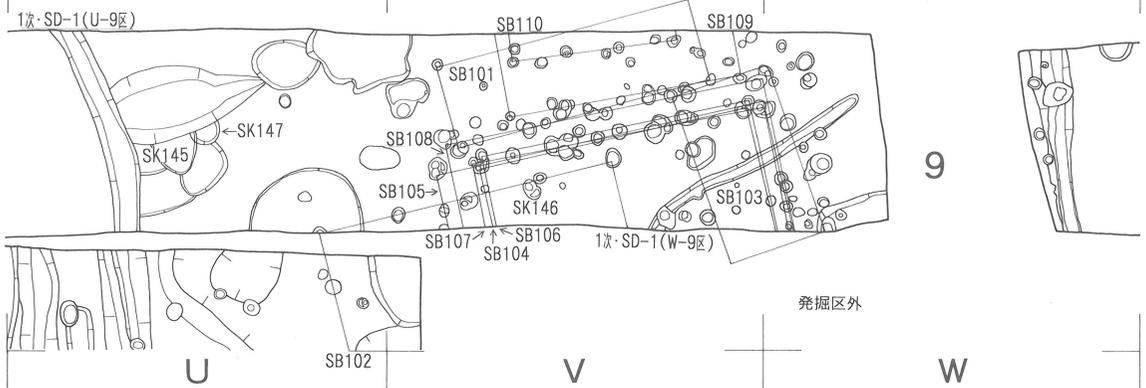
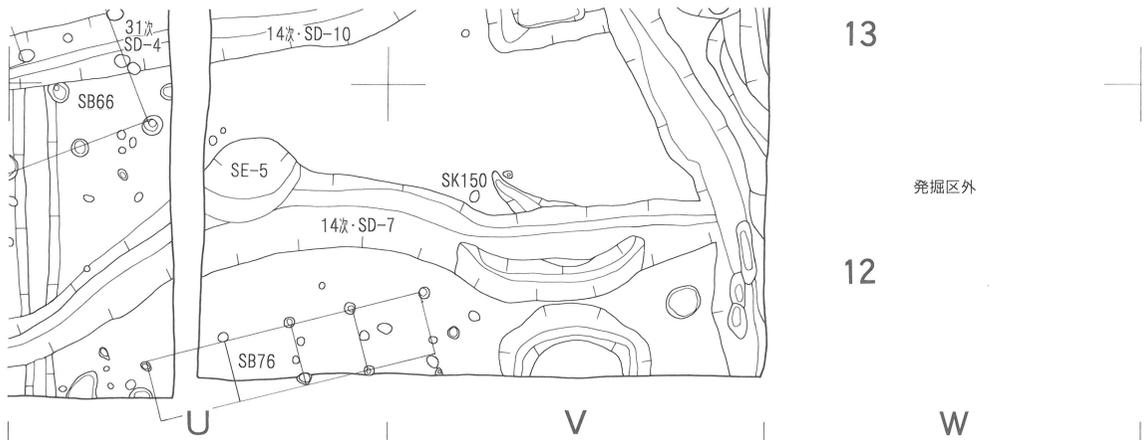

第14図 発掘区平面図-14 (1/200)

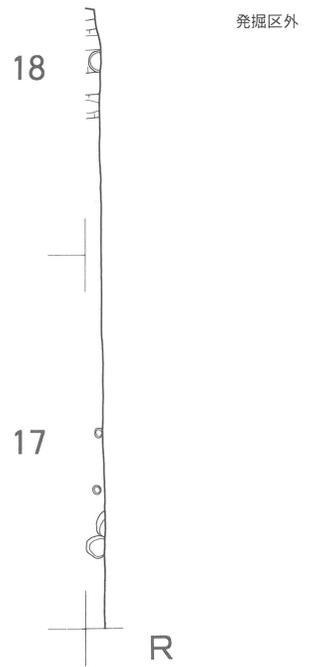
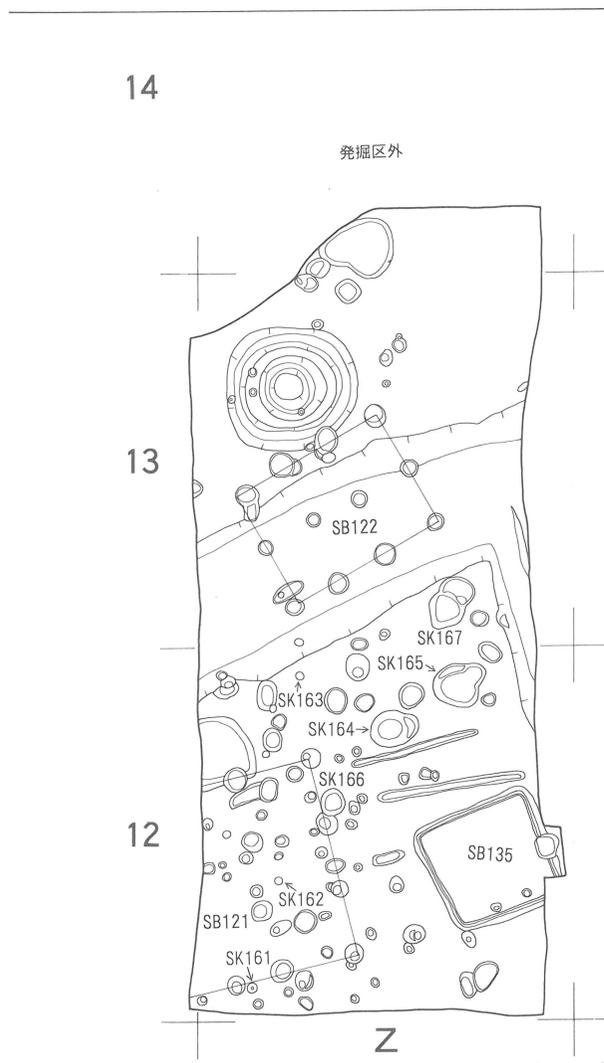
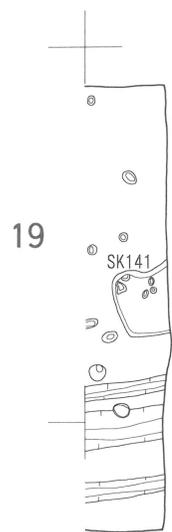
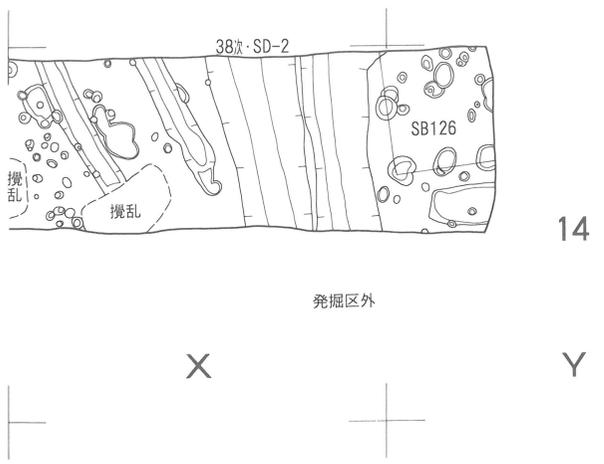

第15図 発掘区平面図一15 (1/200)

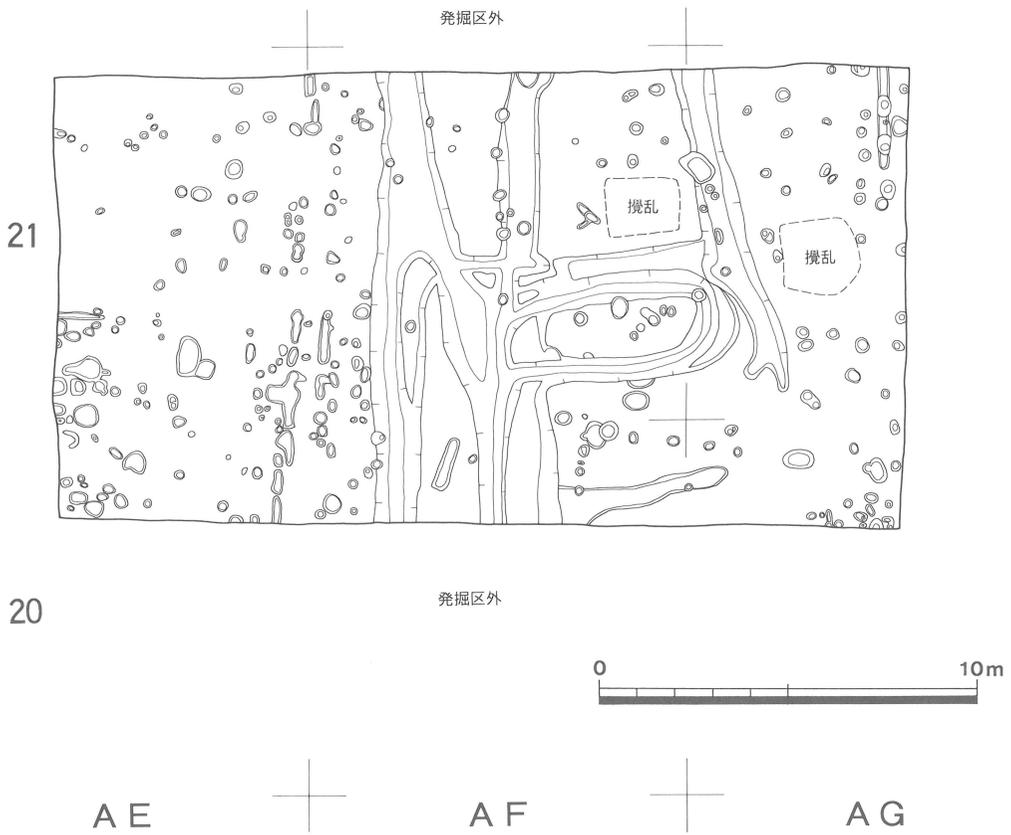

第16図 発掘区平面図-16 (1/200)

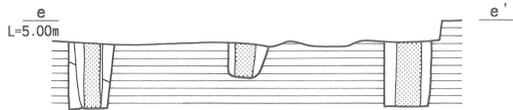
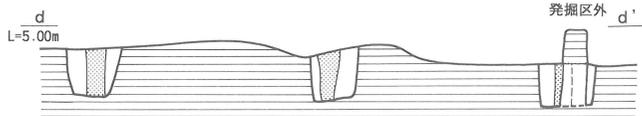
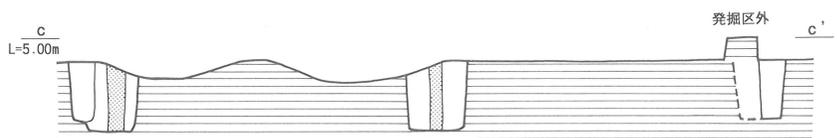
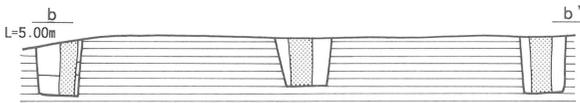
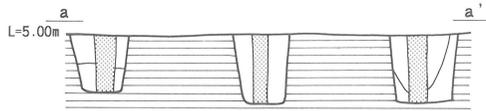
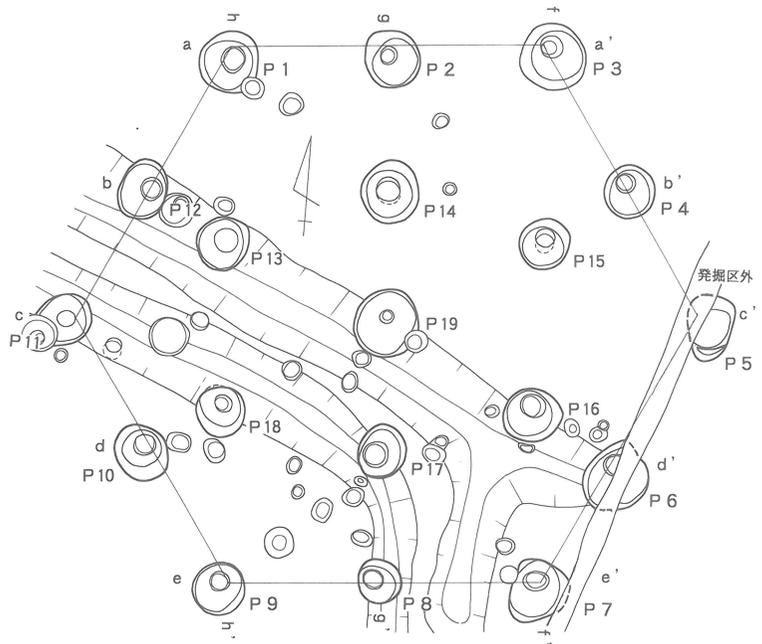
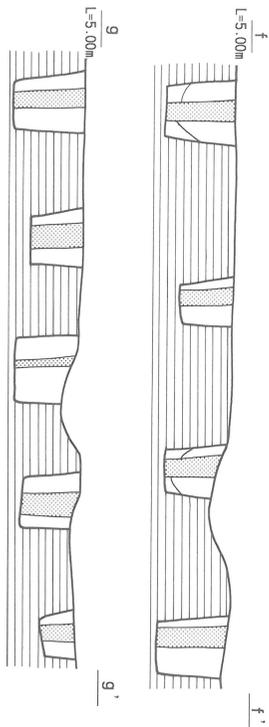

SB-1



第17图 掘立柱建物一1 (1/100)

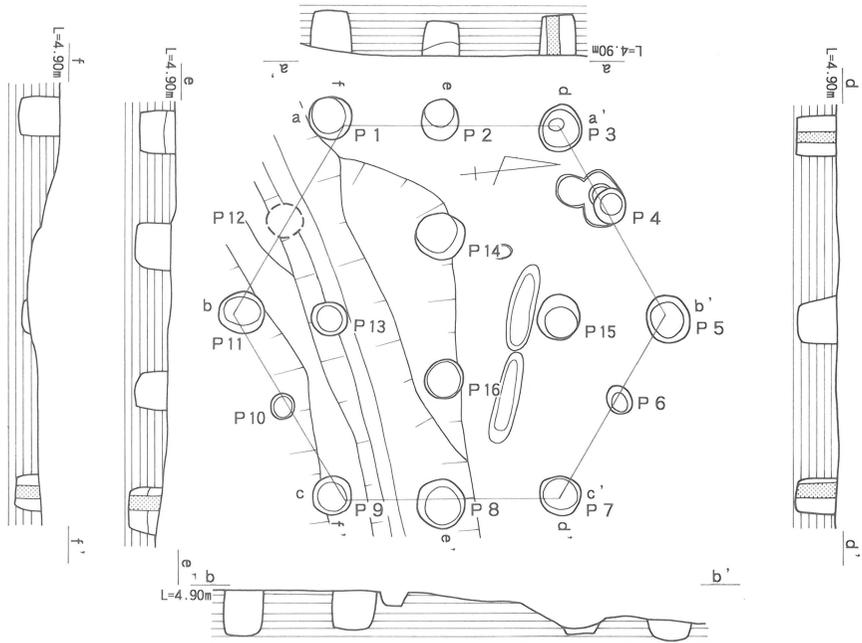

SB-2

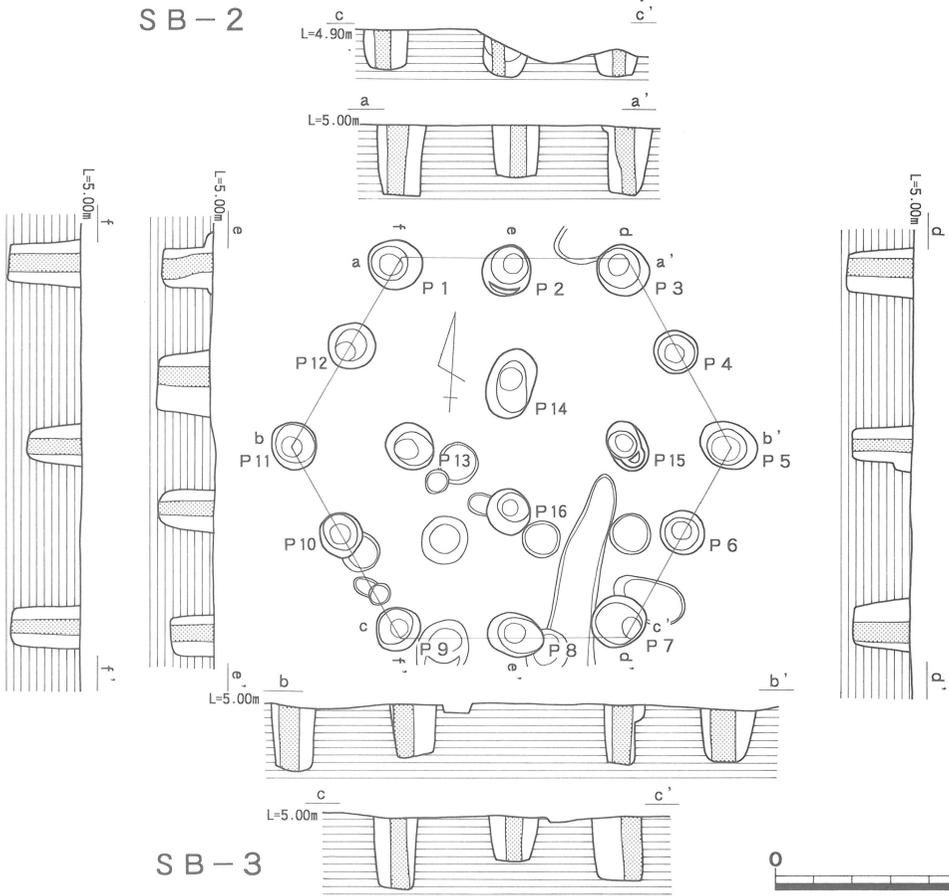

SB-3

第18図 掘立柱建物-2 (1/100)

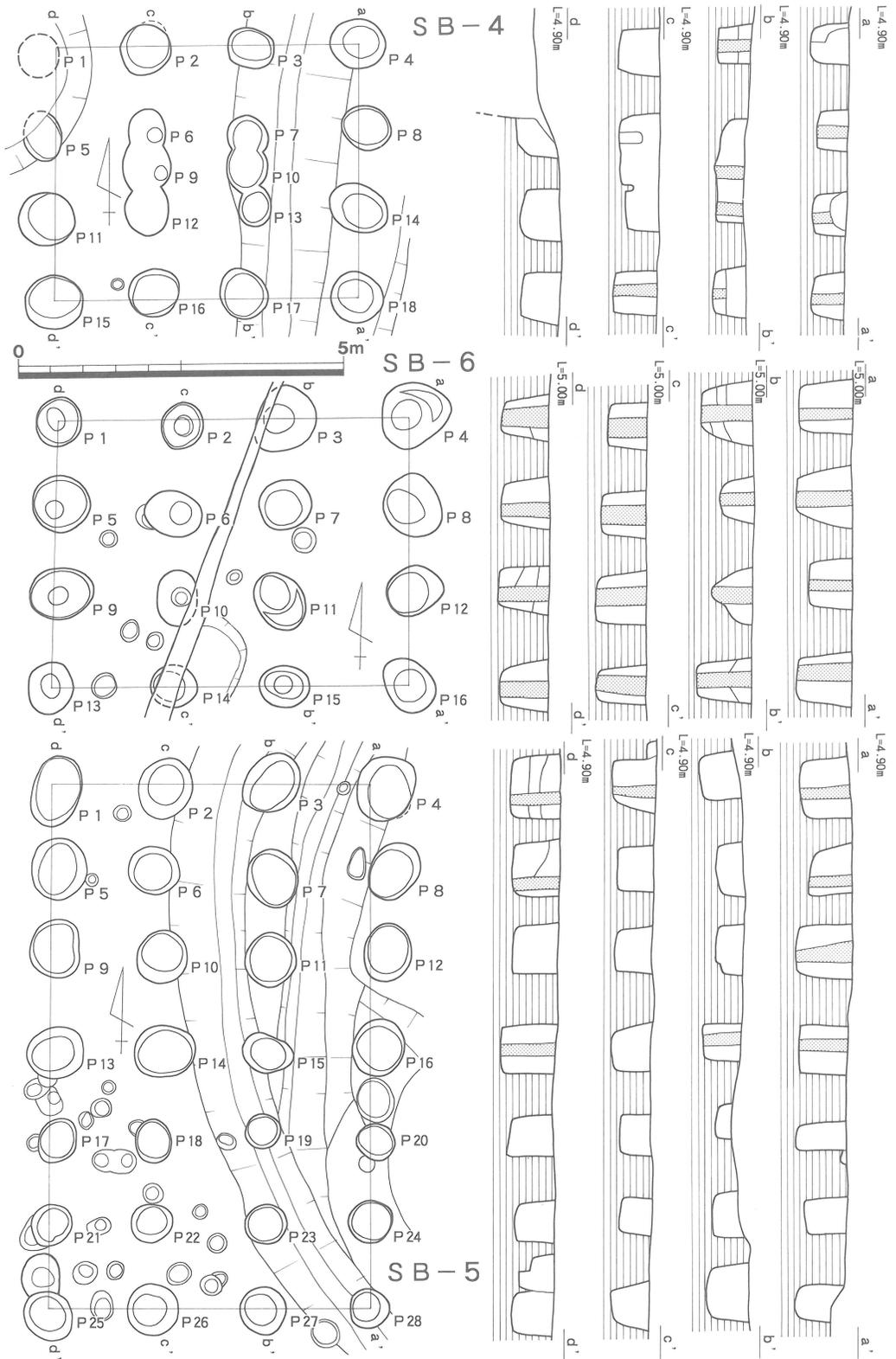

第19図 掘立柱建物—3 (1/100)

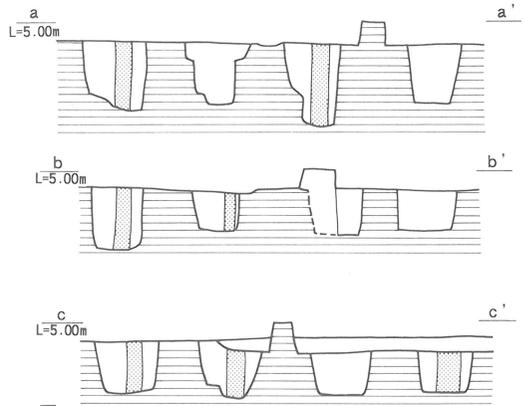
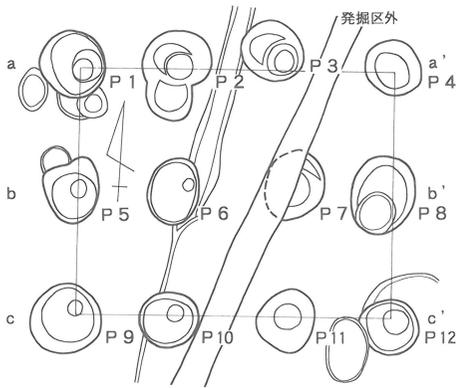

SB-7

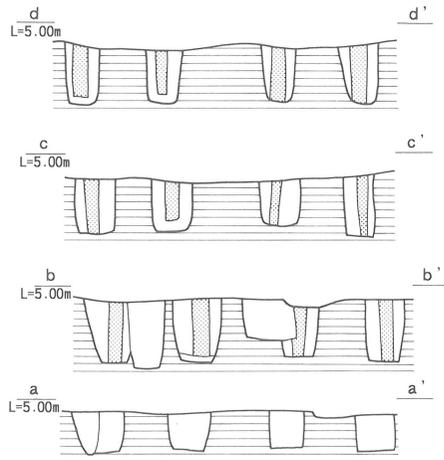
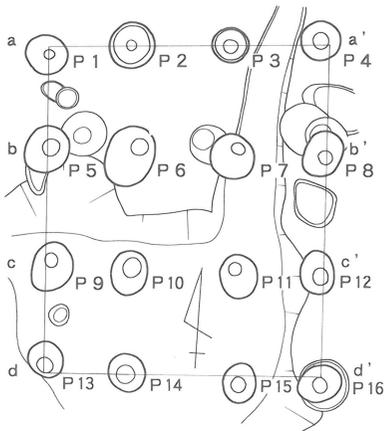

SB-8

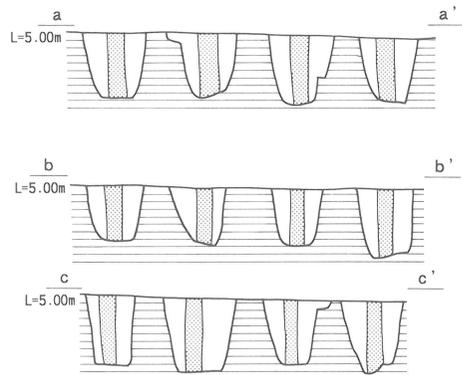
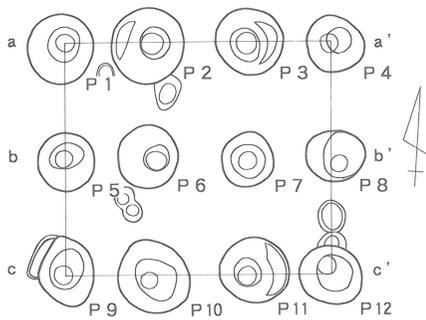

SB-9



第20図 掘立柱建物一4 (1/100)

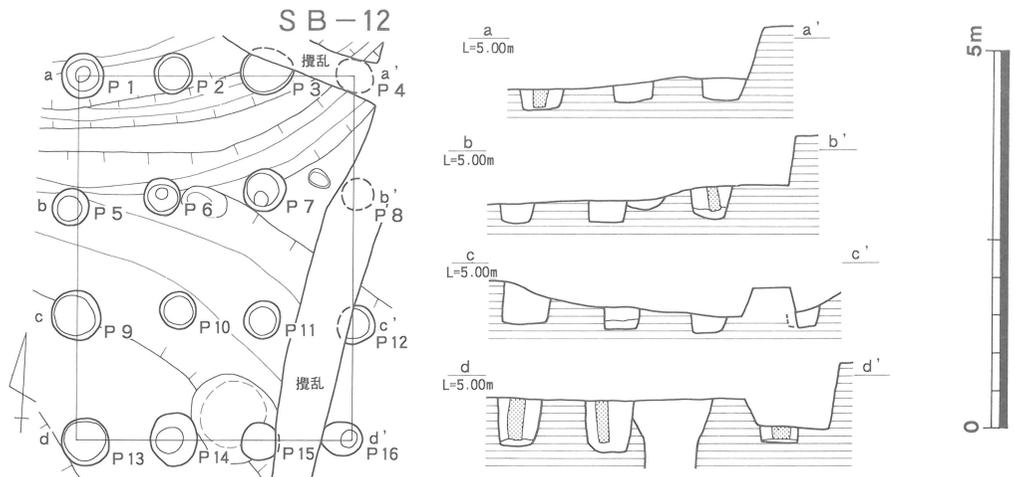
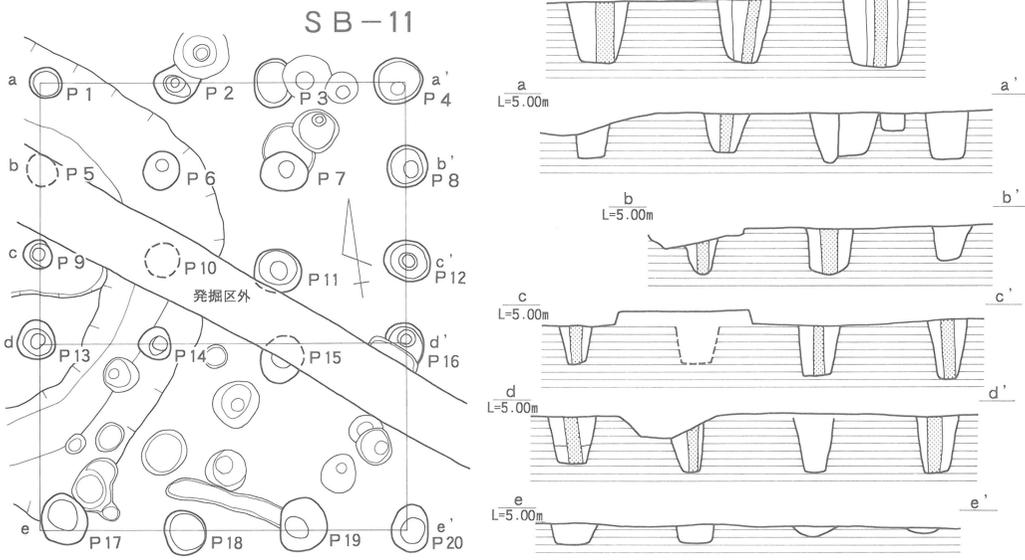
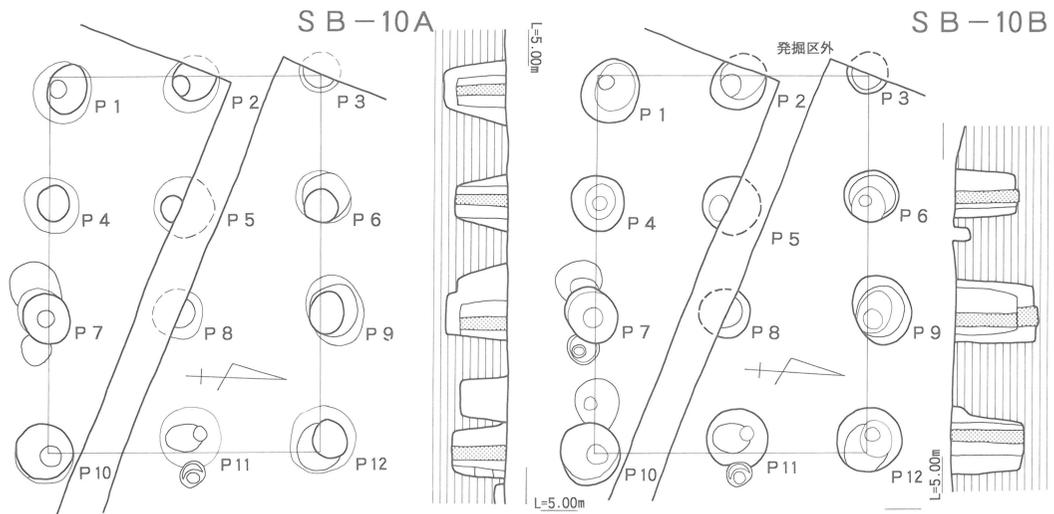

第21图 掘立柱建物—5 (1/100)

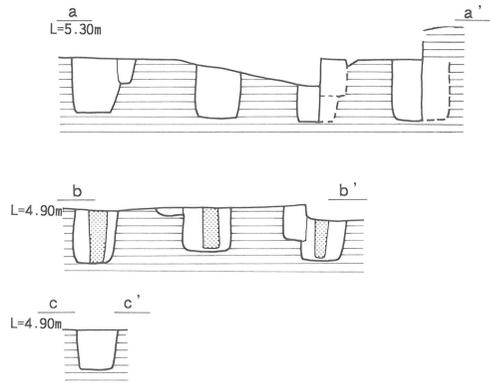
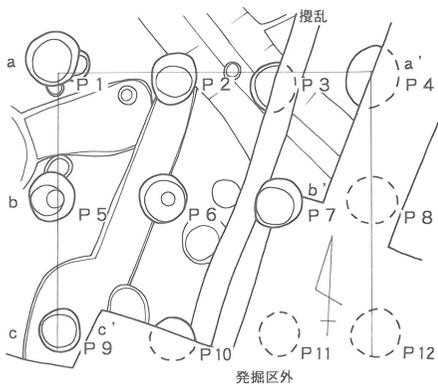

SB-13

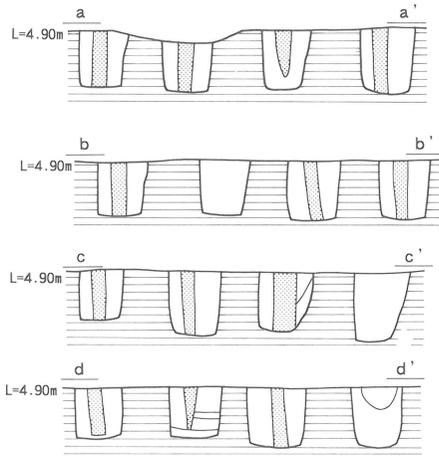
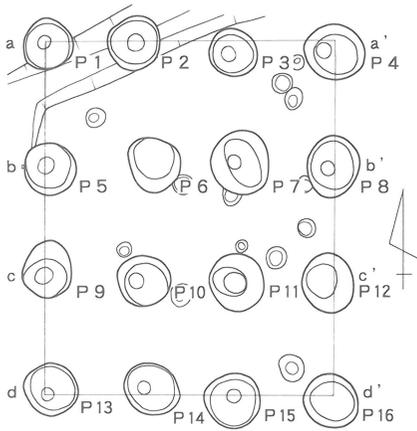

SB-14

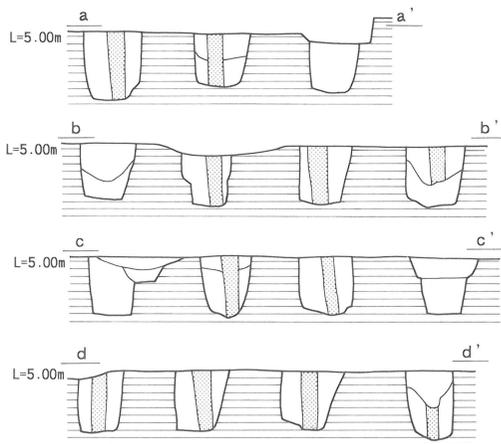
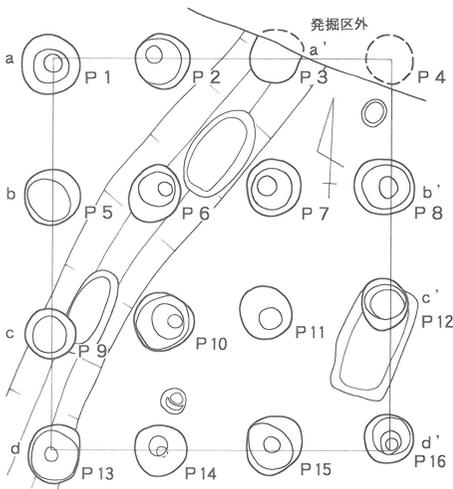

SB-15



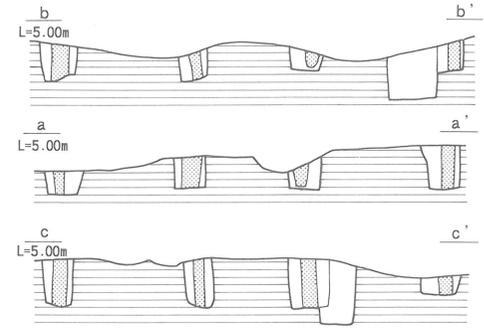
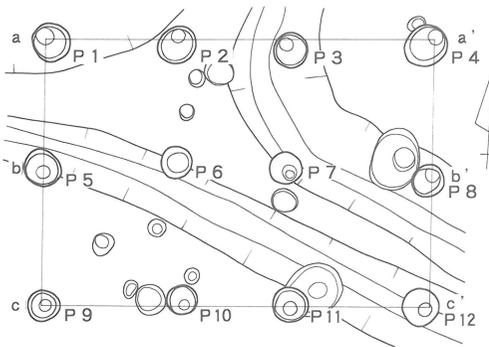
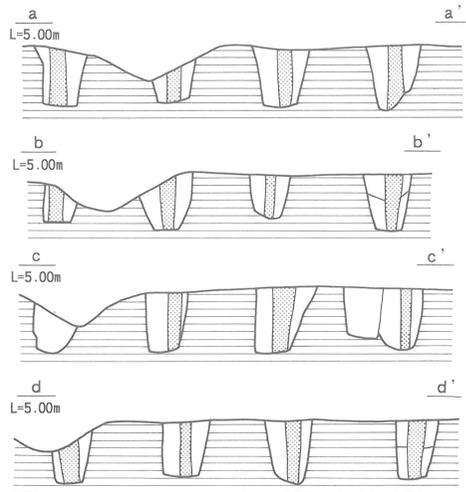
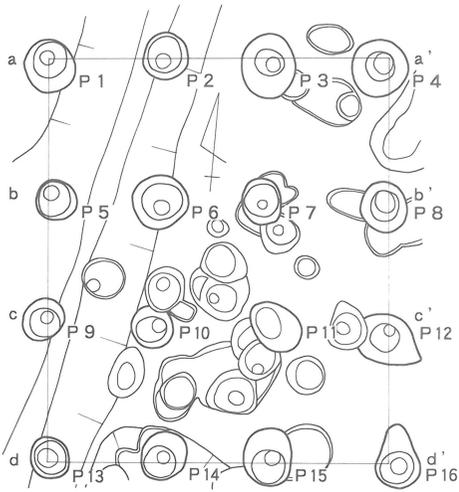
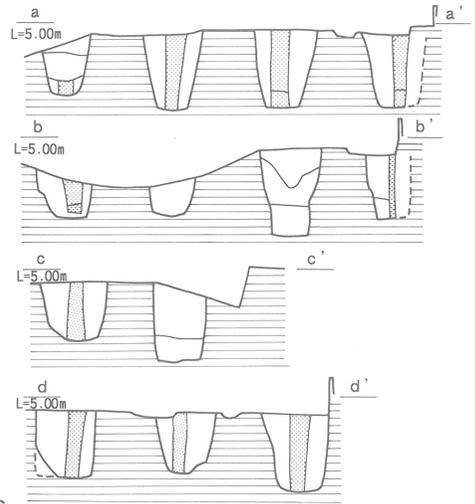
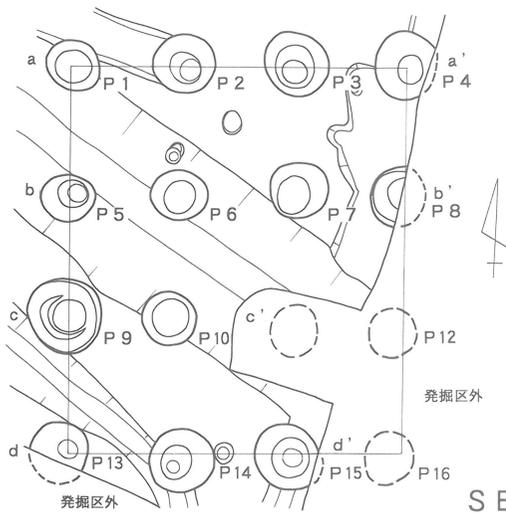

第23図 掘立柱建物一7 (1/100)

S B - 17

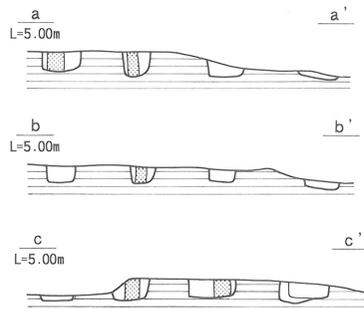
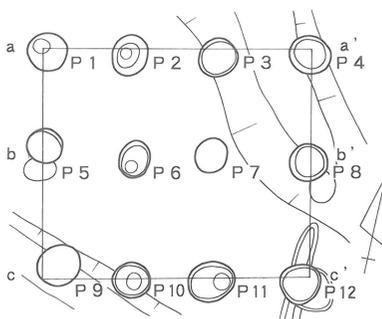
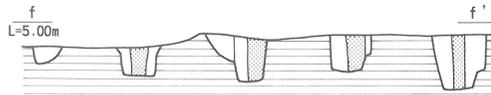
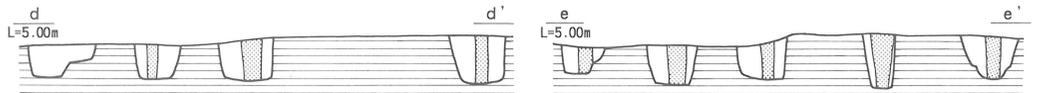
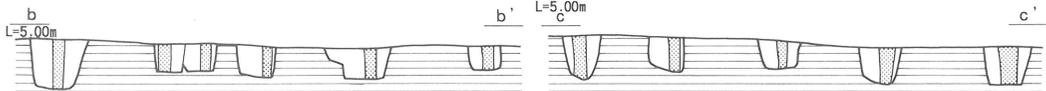
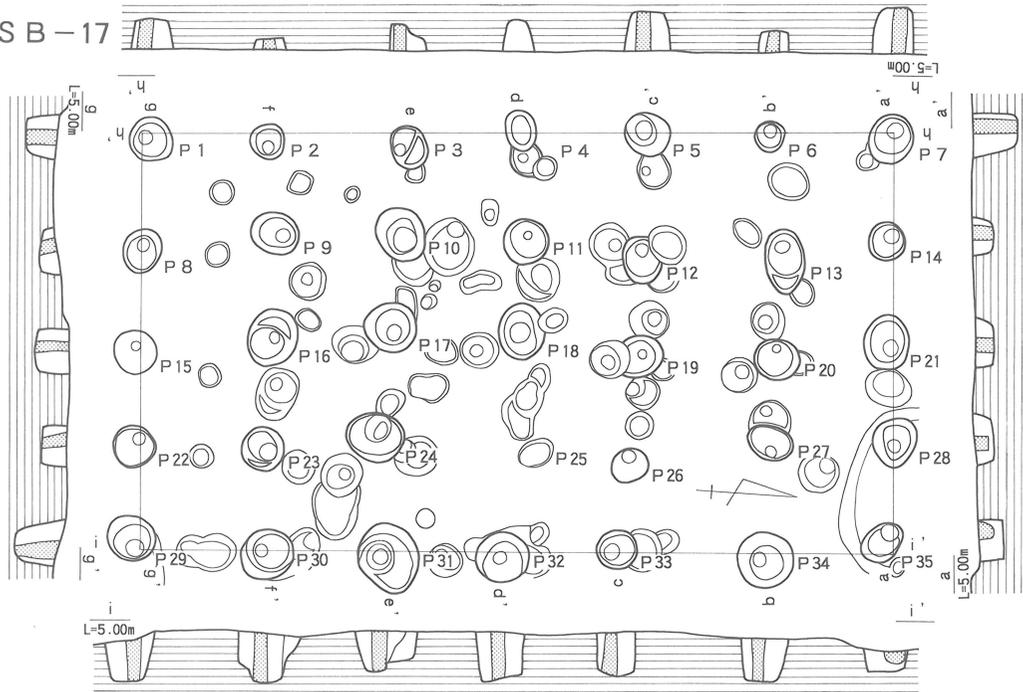

S B - 20



第24图 掘立柱建物—8 (1/100)

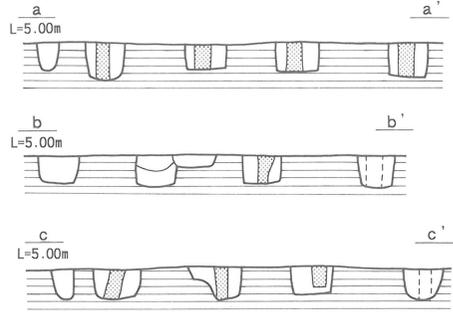
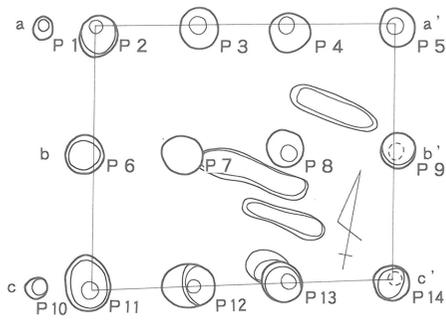

SB-21

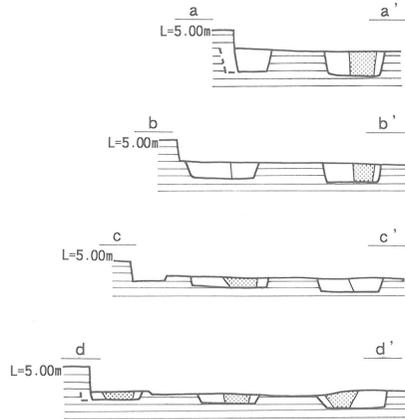
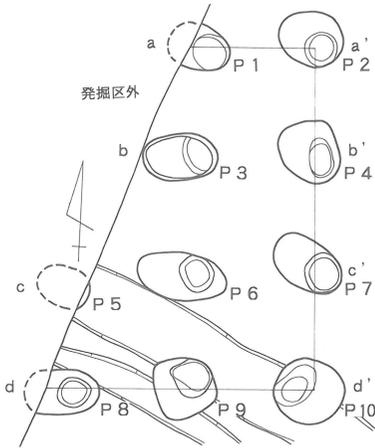

SB-22

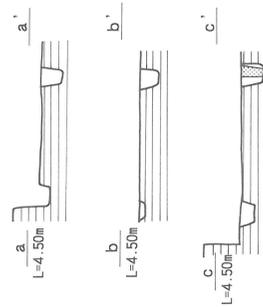
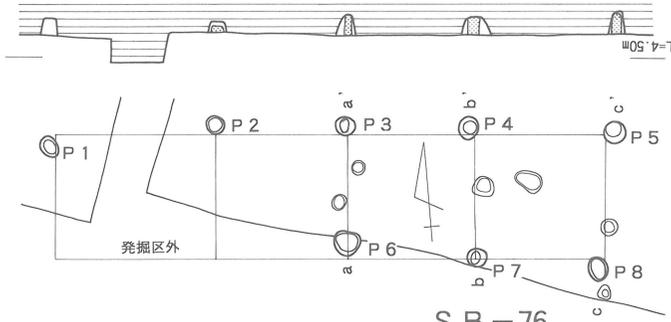

SB-76

SB-81

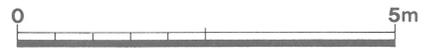
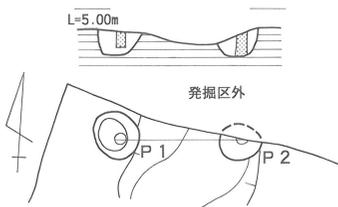

SB-38

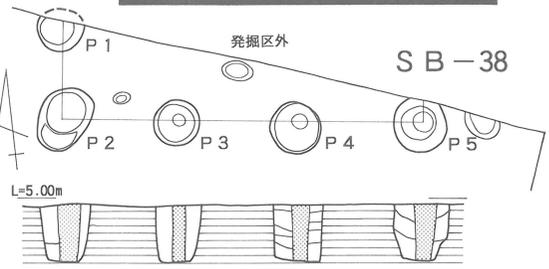

第25図 掘立柱建物—9 (1/100)

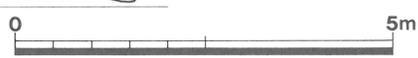
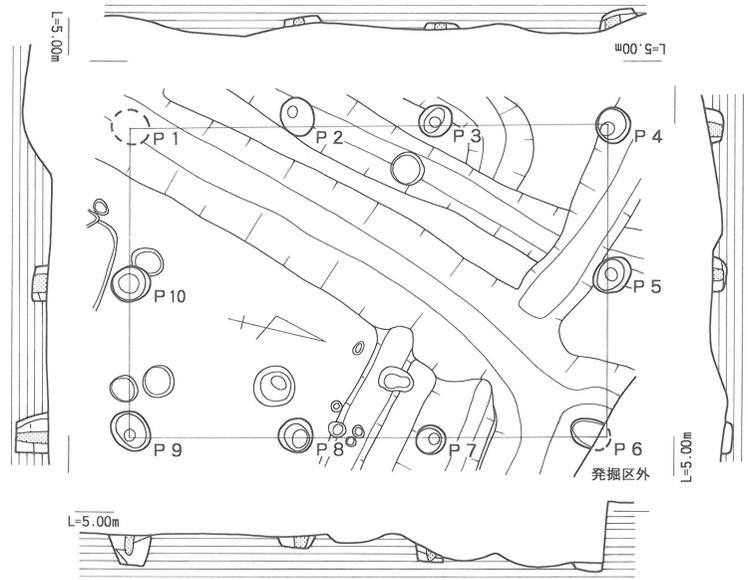
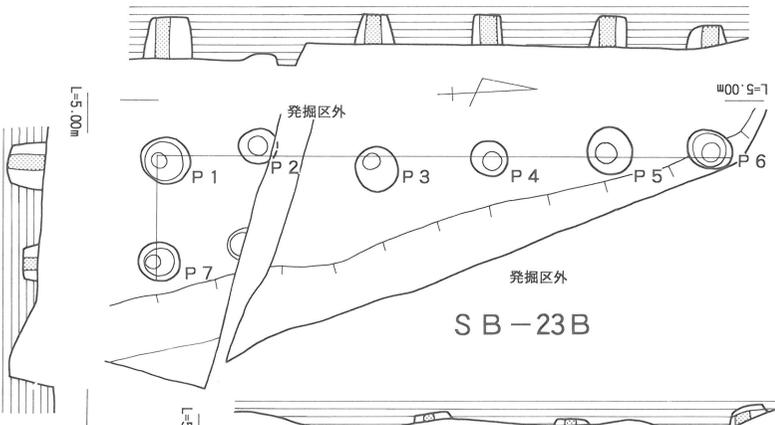
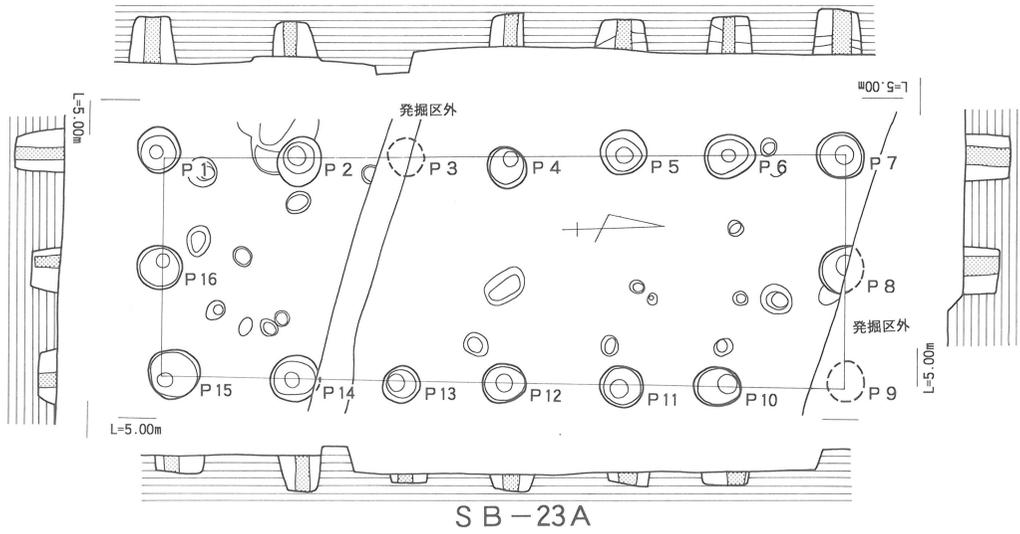

第26図 掘立柱建物-10 (1/100)

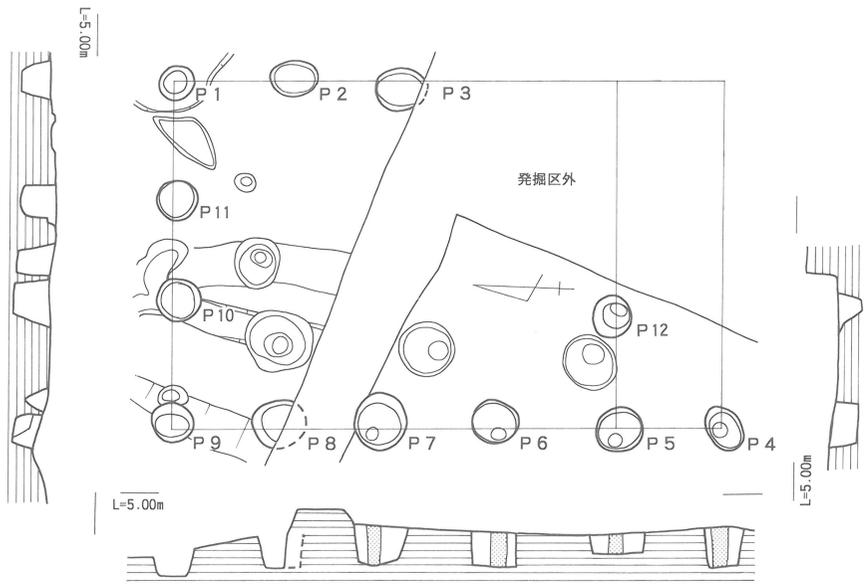

S B - 24

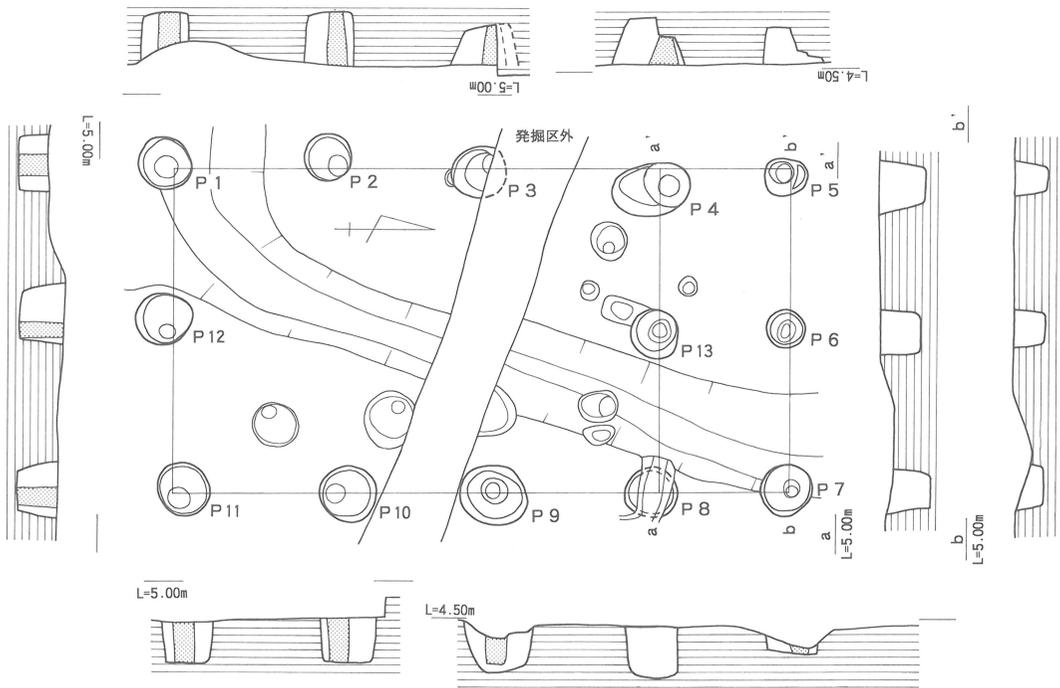

S B - 25



第27図 掘立柱建物一11 (1/100)

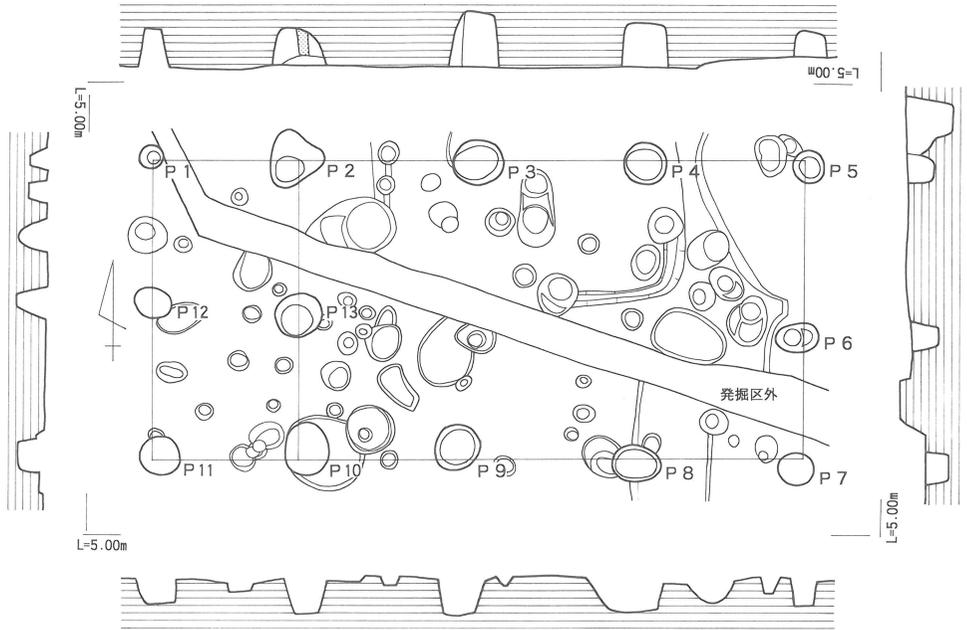

S B - 26

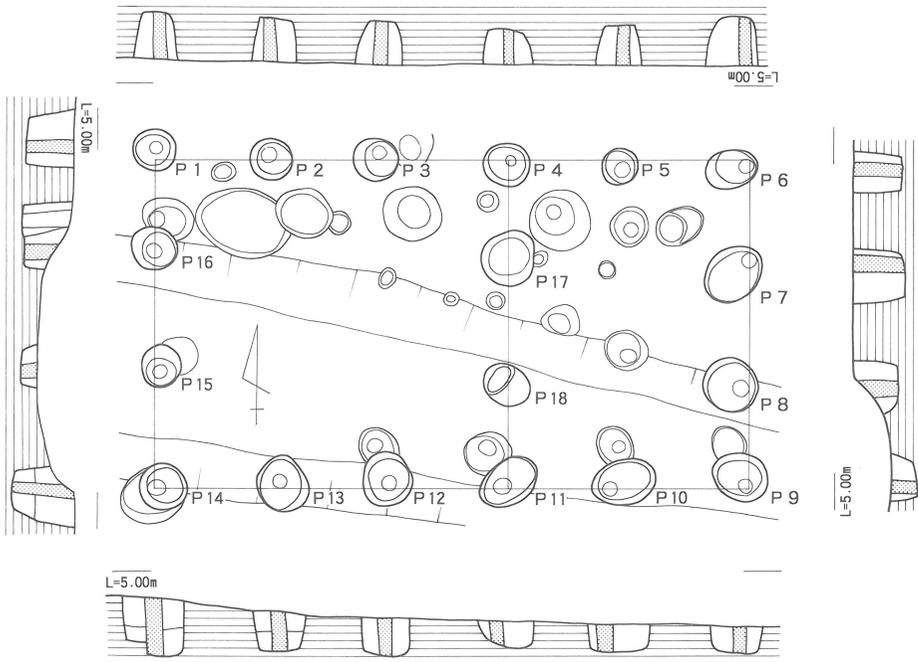

S B - 27



第28図 掘立柱建物-12 (1/100)

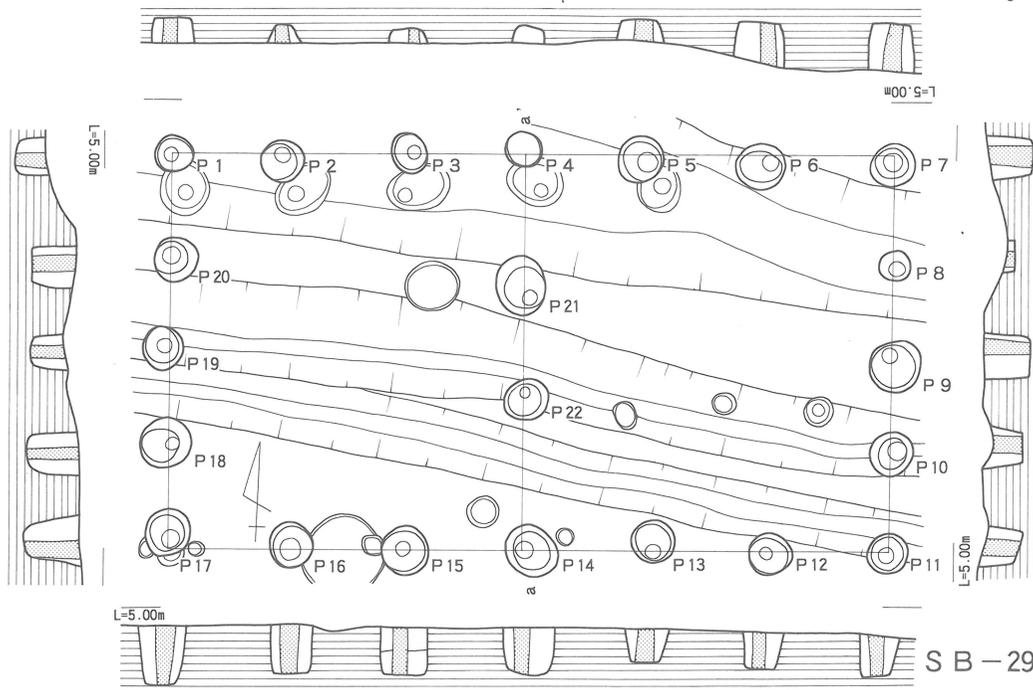
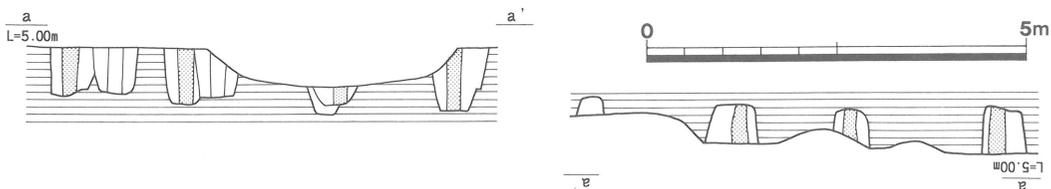
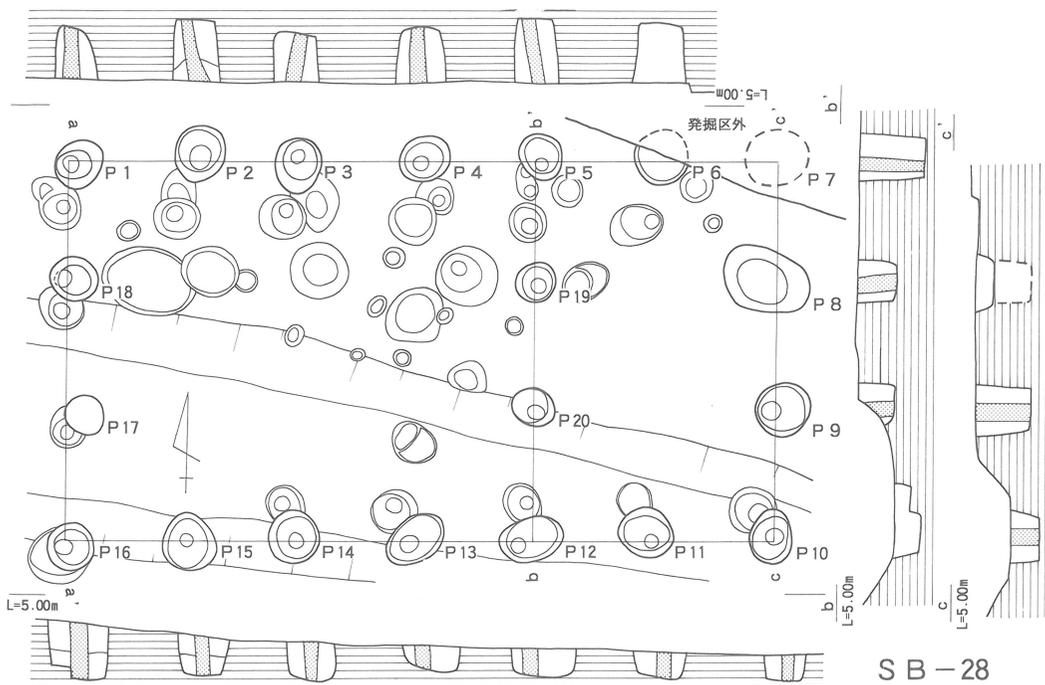

第29図 掘立柱建物-13 (1/100)

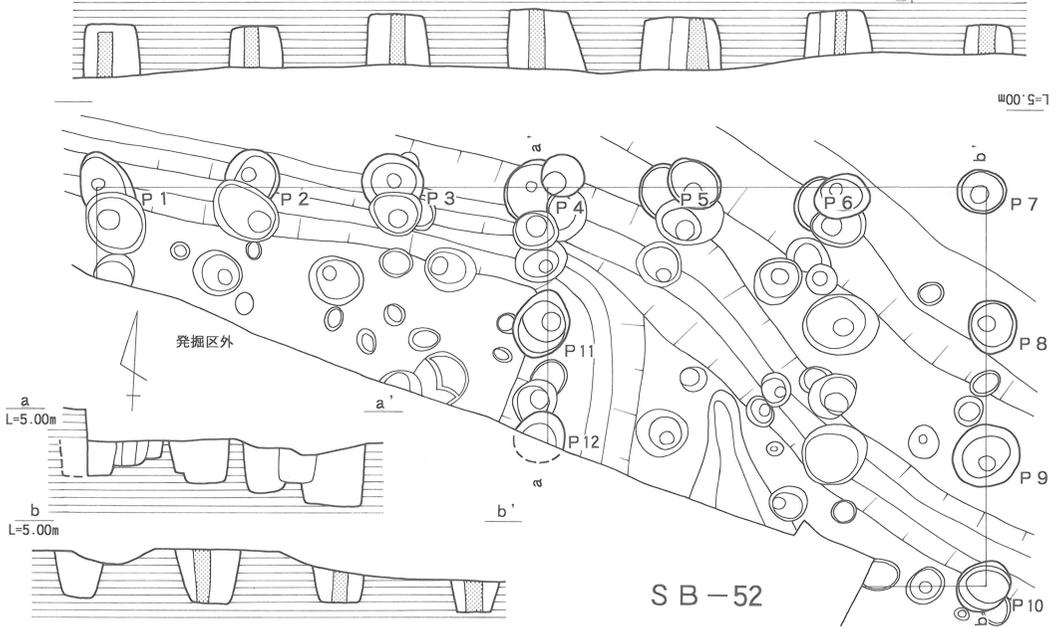
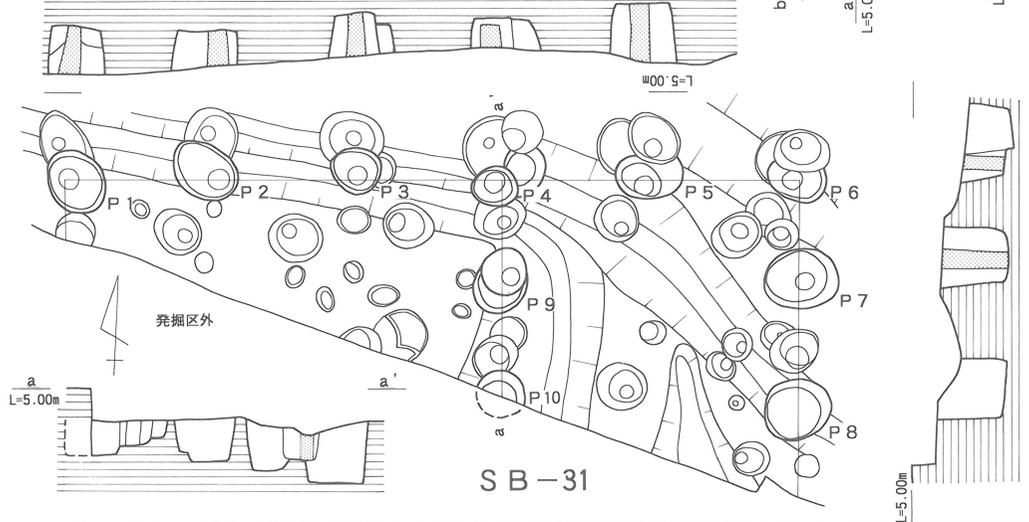
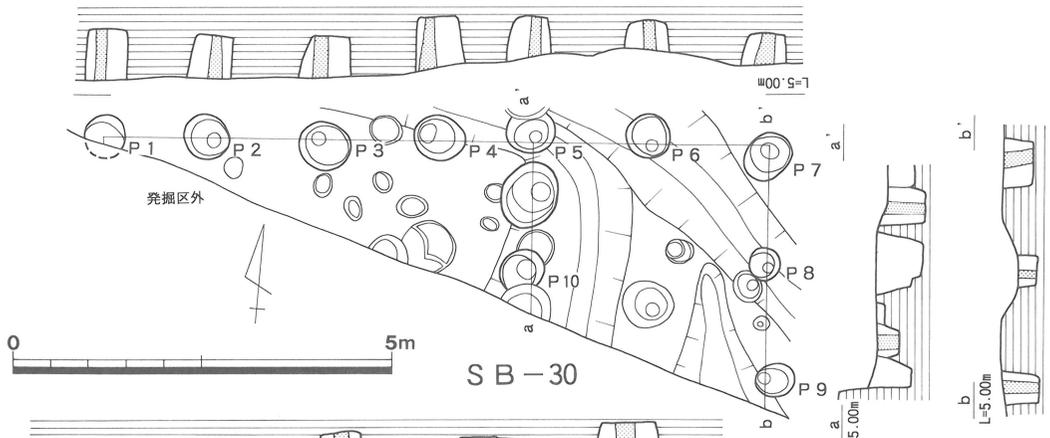

第30图 掘立柱建物-14 (1/100)

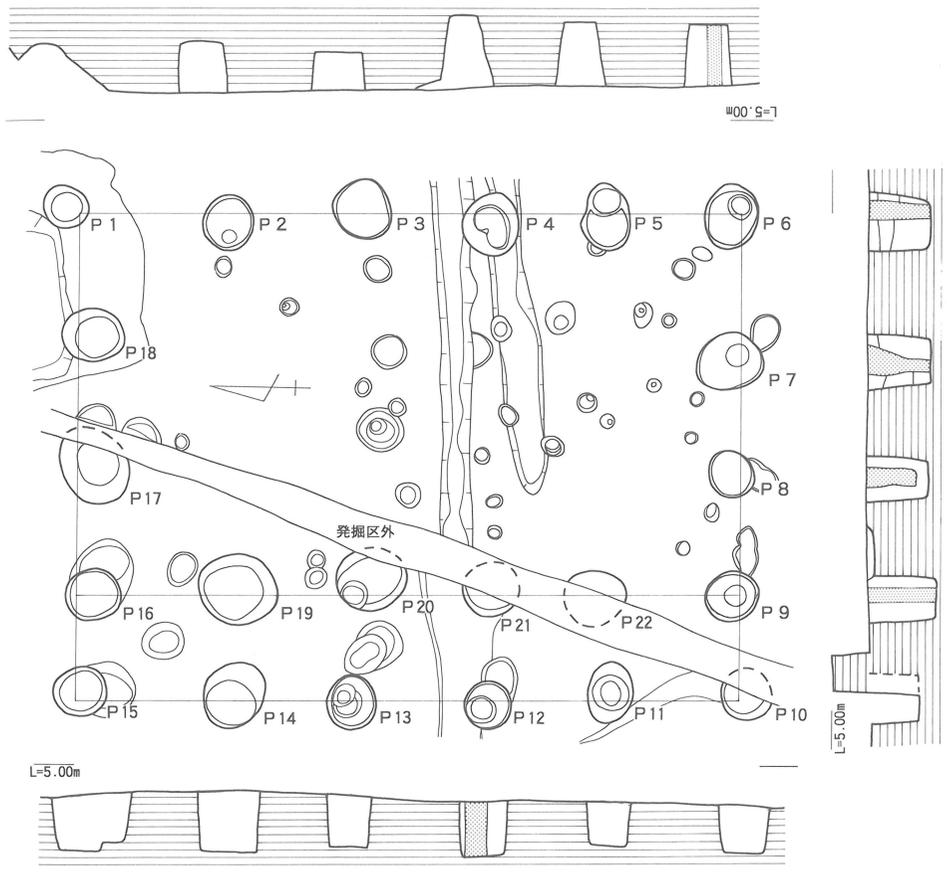
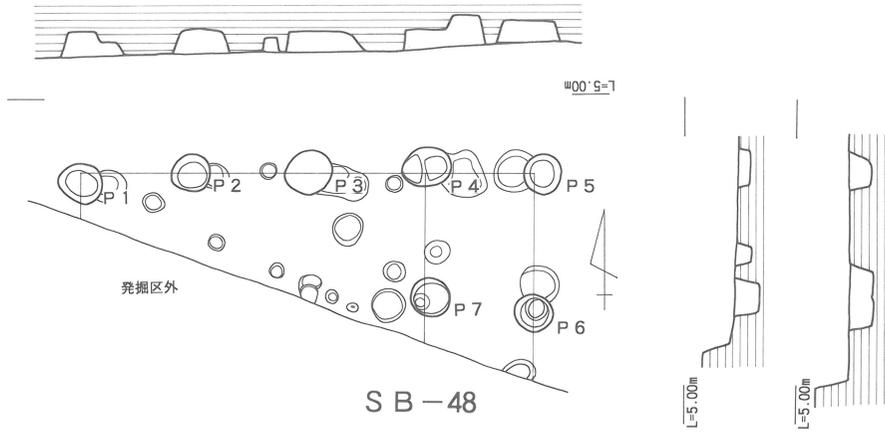

第31図 掘立柱建物-15 (1/100)

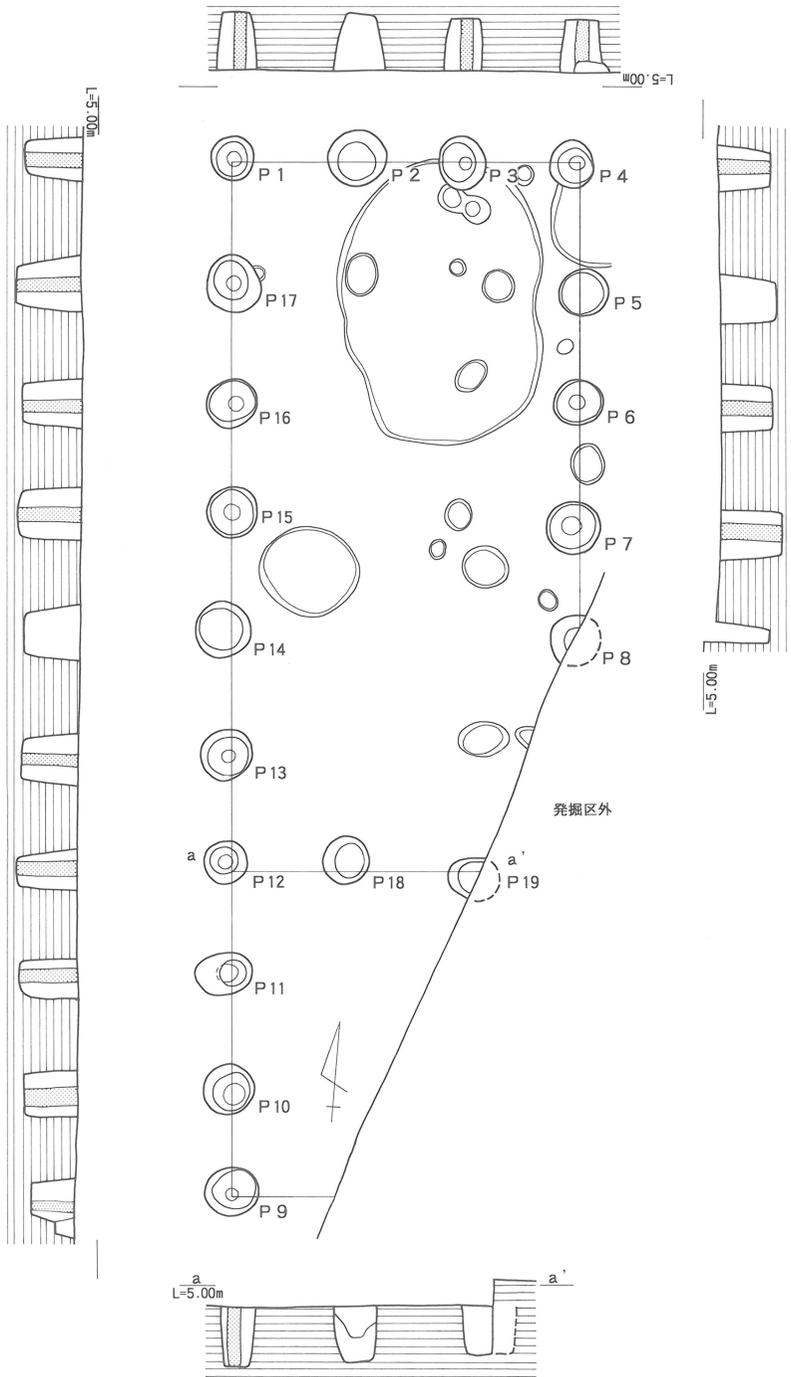

S B - 33



第32図 掘立柱建物—16 (1/100)

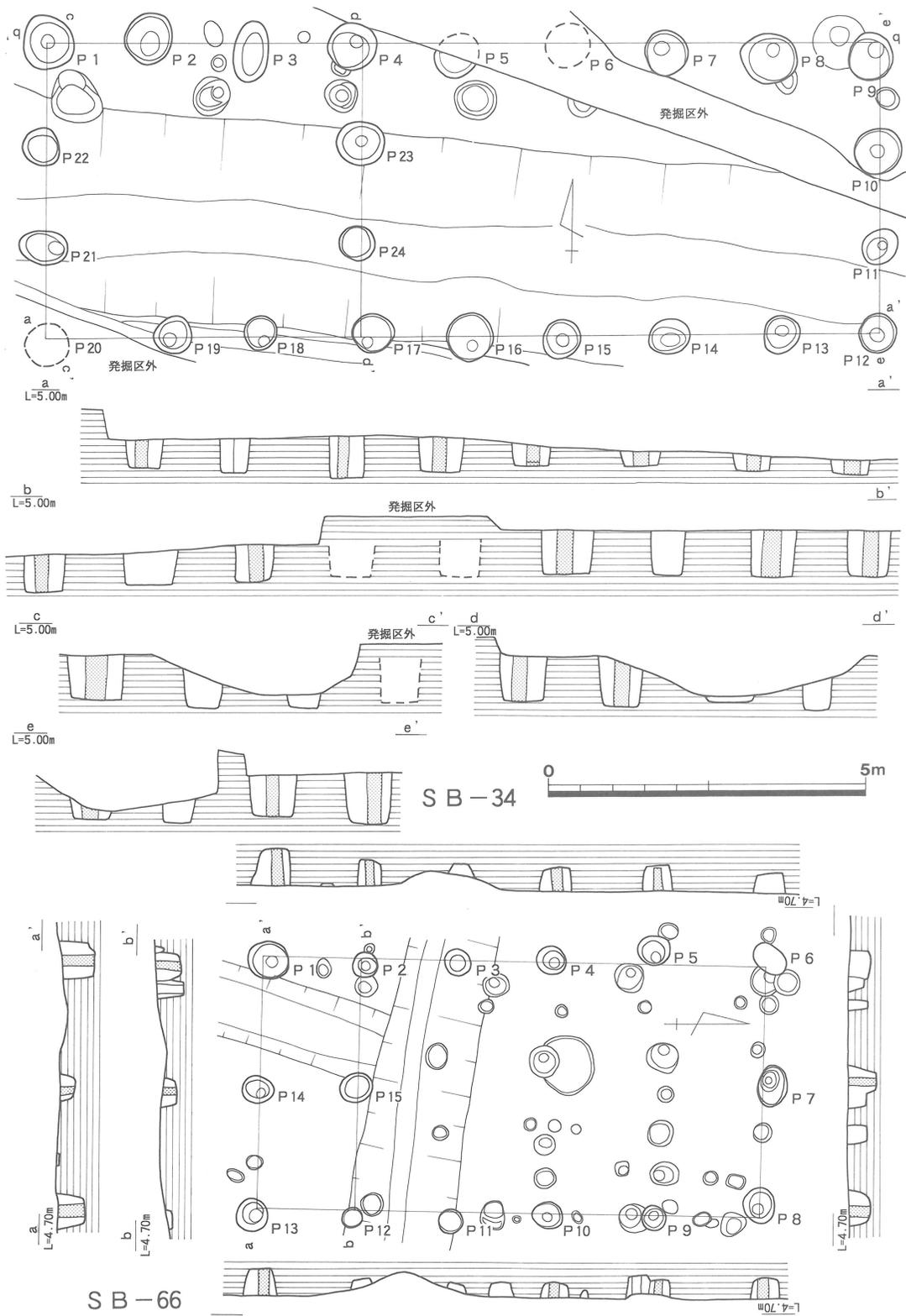

第33图 掘立柱建物-17 (1/100)

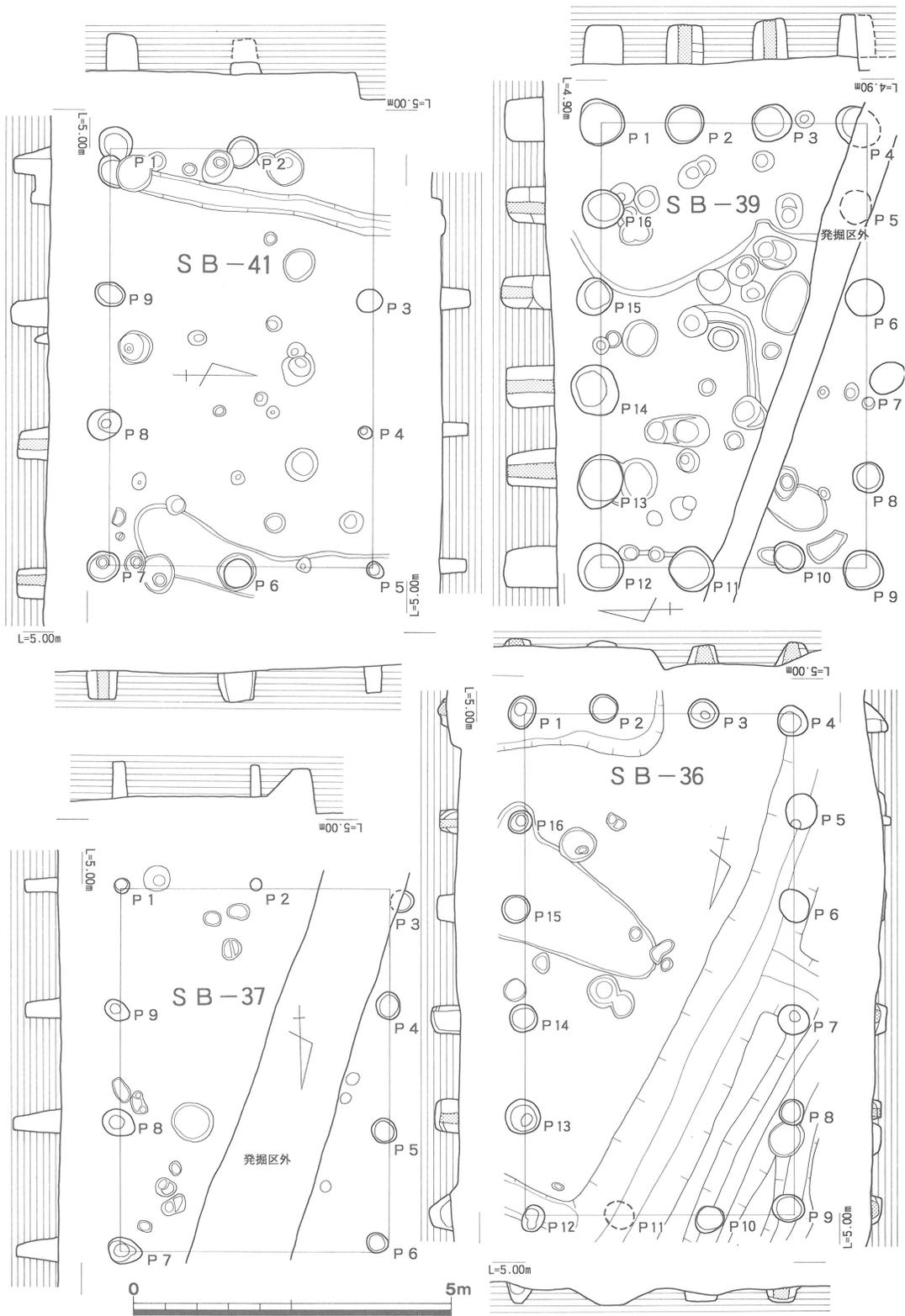

第34図 掘立柱建物-18 (1/100)

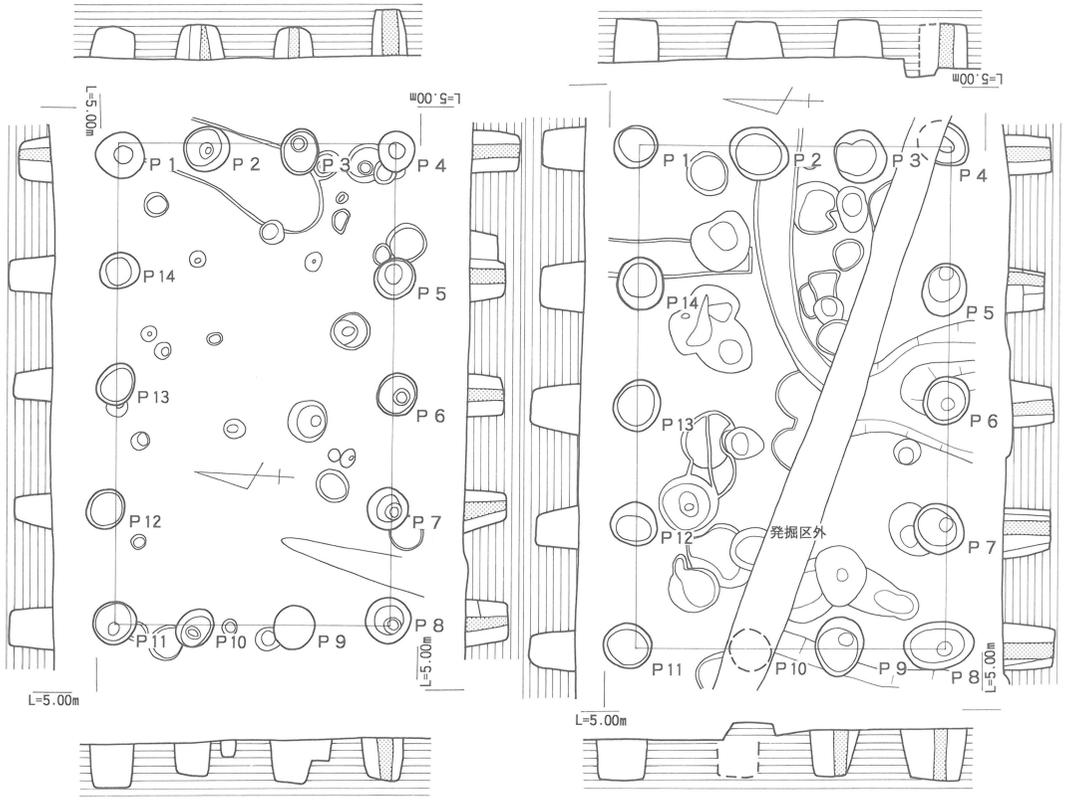

S B - 40

S B - 42

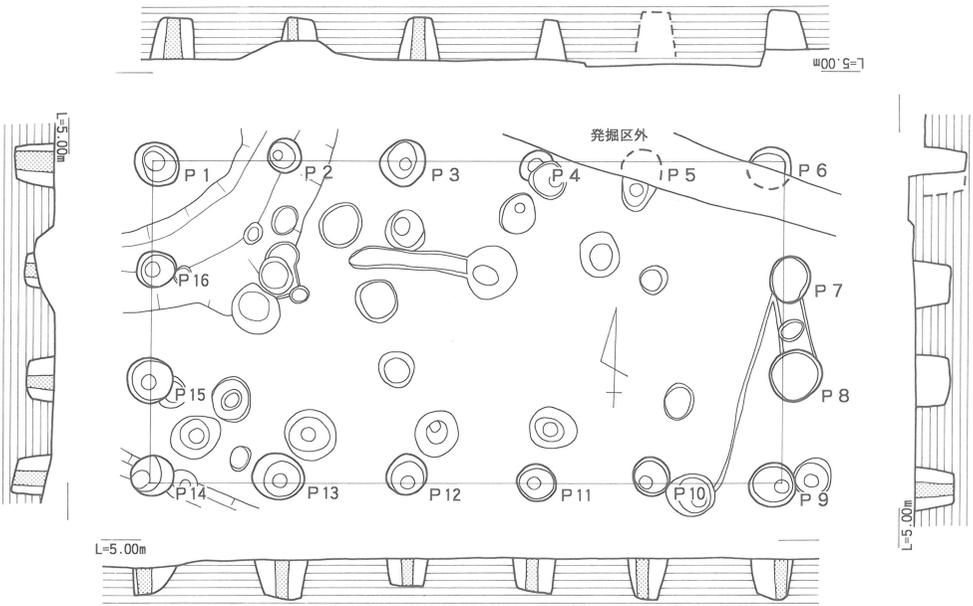

S B - 43



第35図 掘立柱建物-19 (1/100)

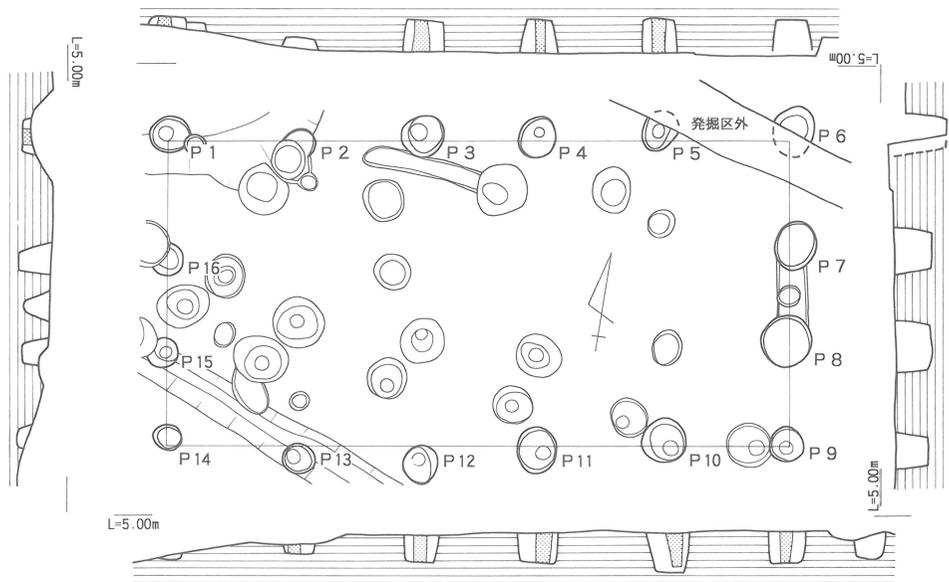

SB-44

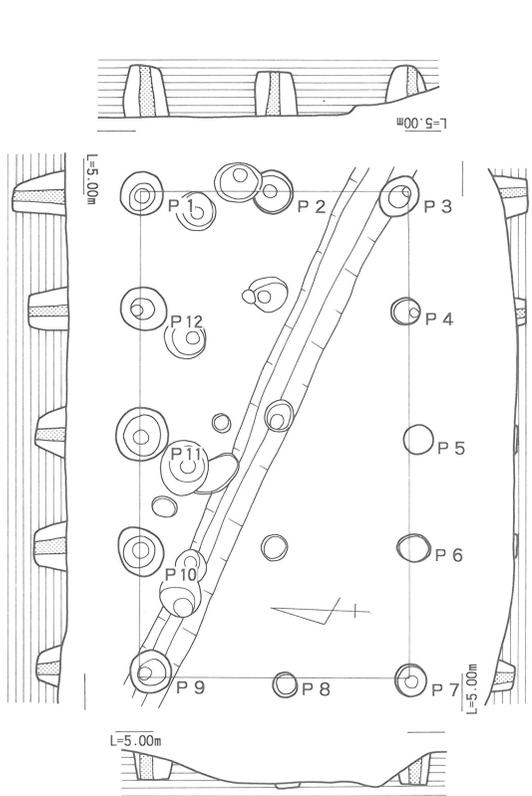

SB-46

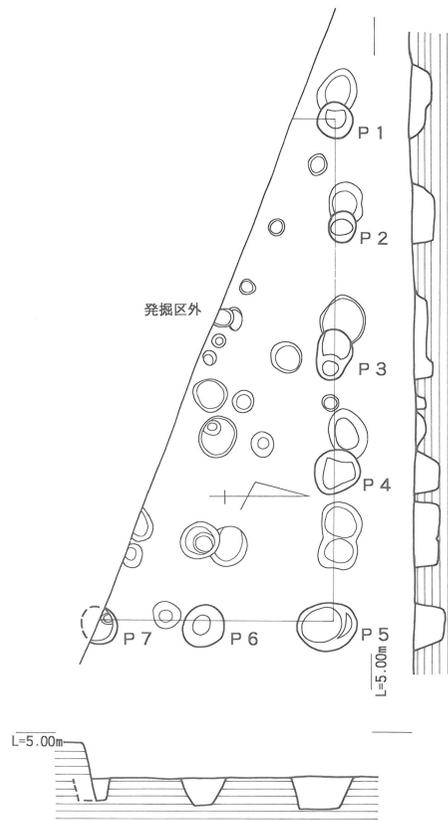

SB-47

第36図 掘立柱建物-20 (1/100)

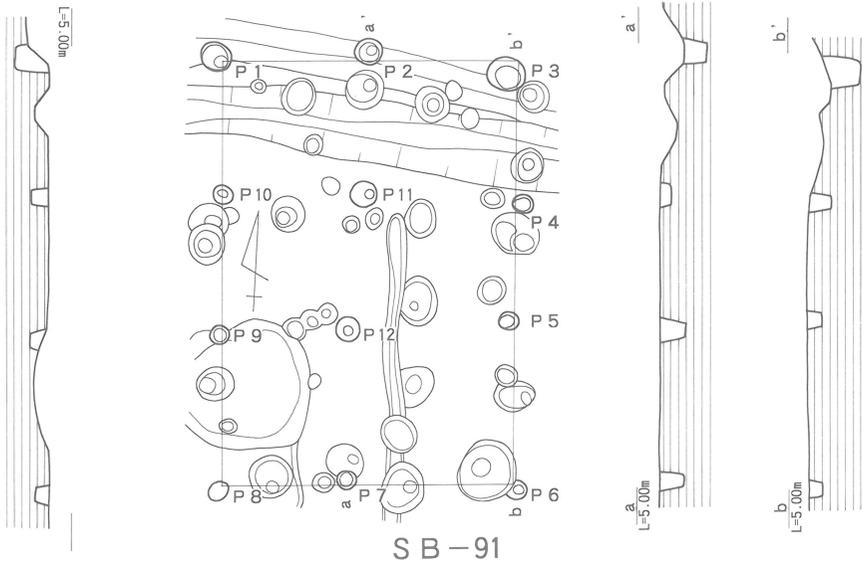

S B - 91

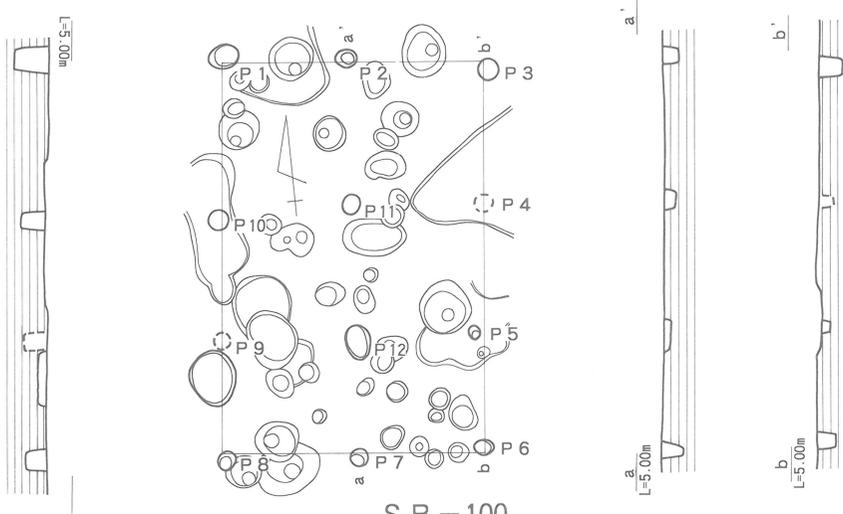

S B - 100

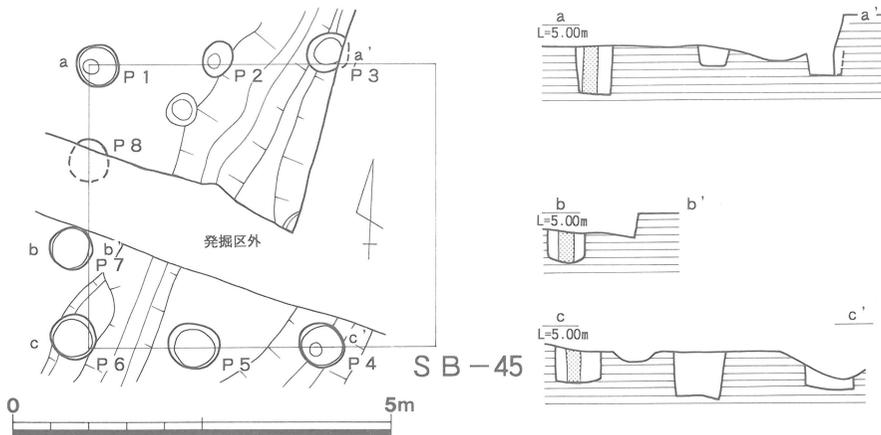

S B - 45

第37图 掘立柱建物-21 (1/100)

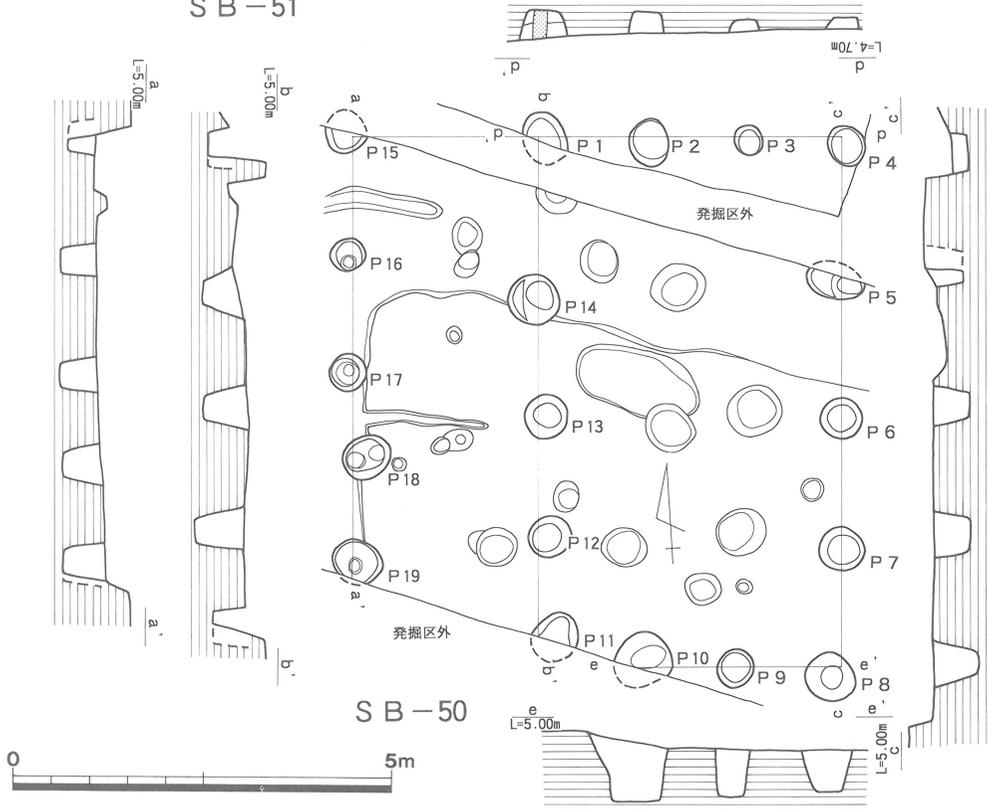
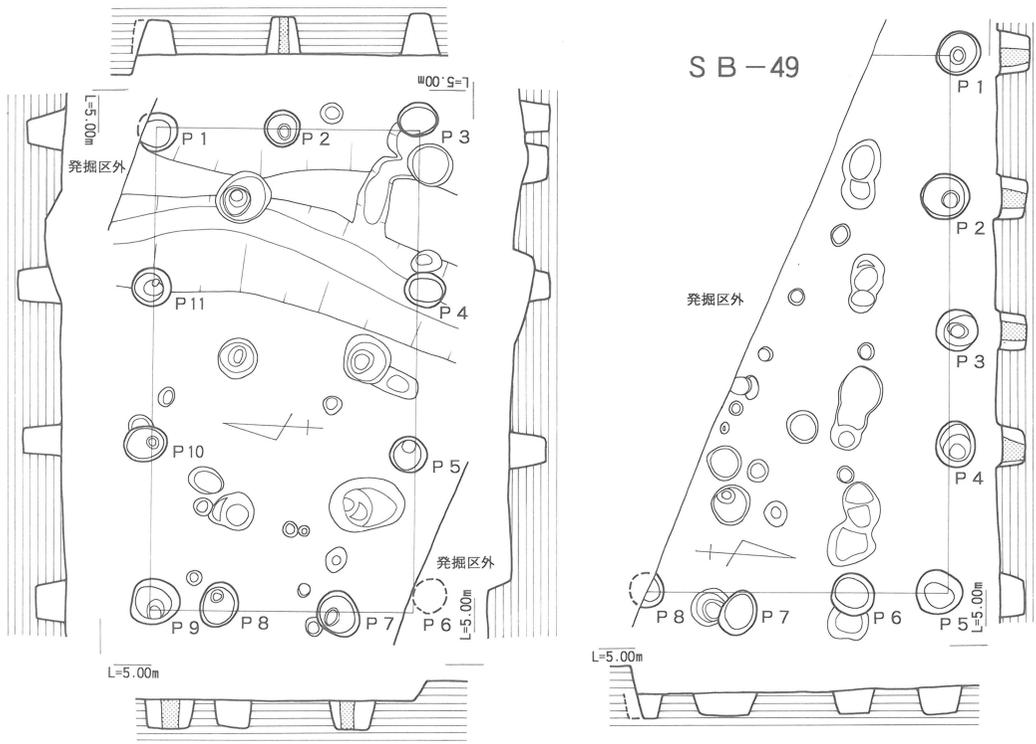

第38図 掘立柱建物-22 (1/100)

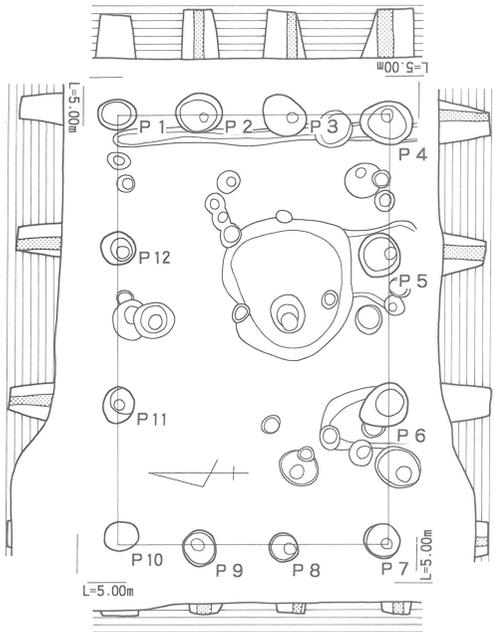

S B - 53

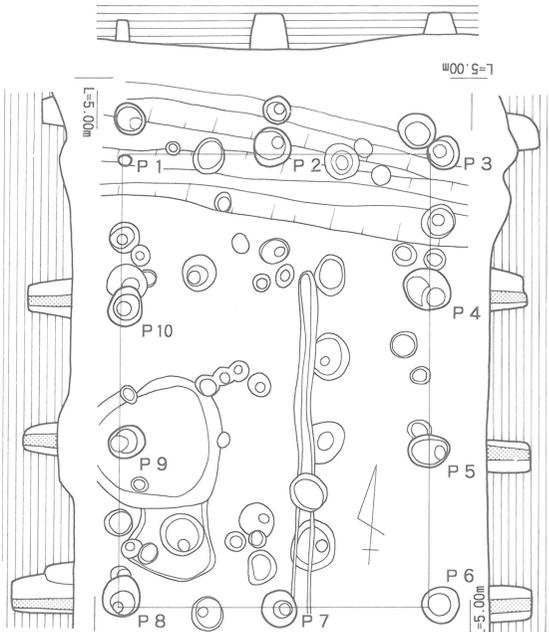

S B - 54

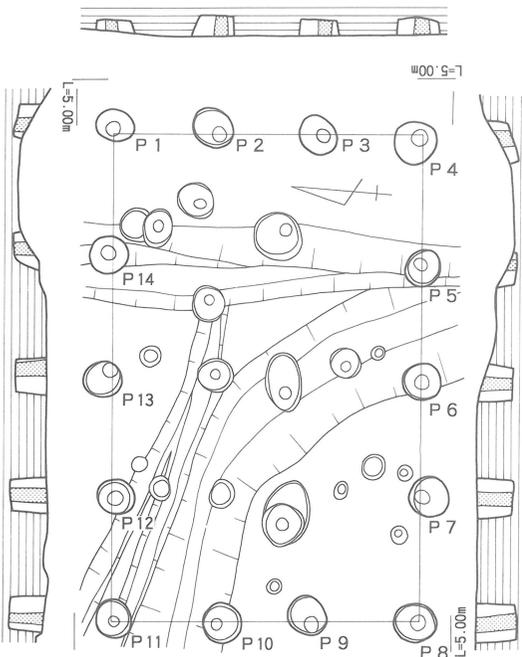

S B - 55

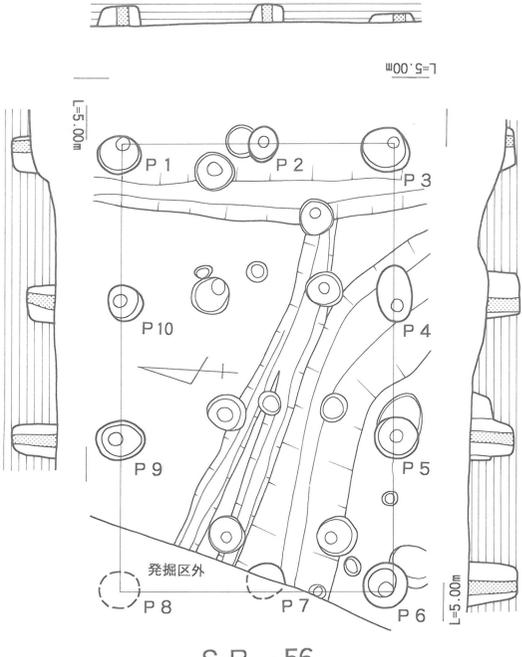

S B - 56

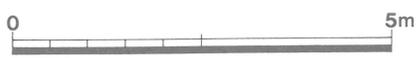

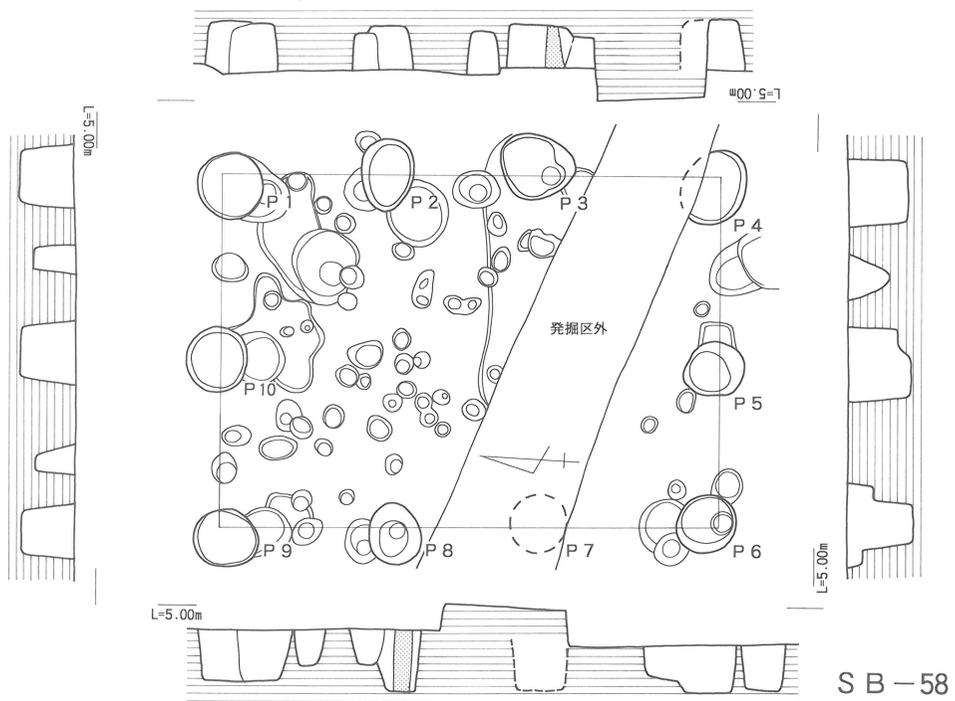
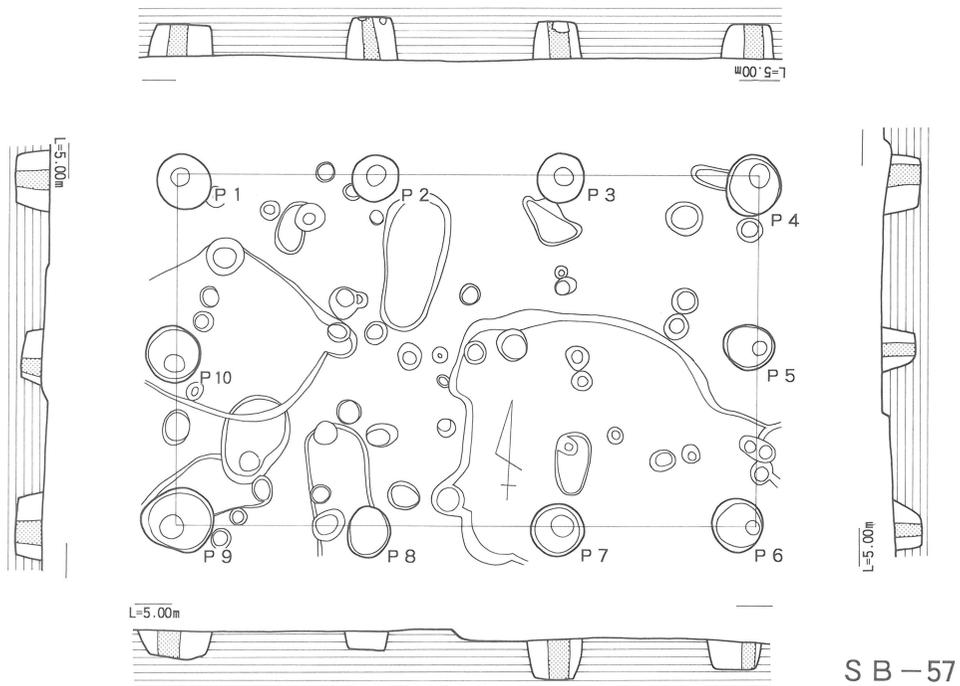

第40図 掘立柱建物-24 (1/100)

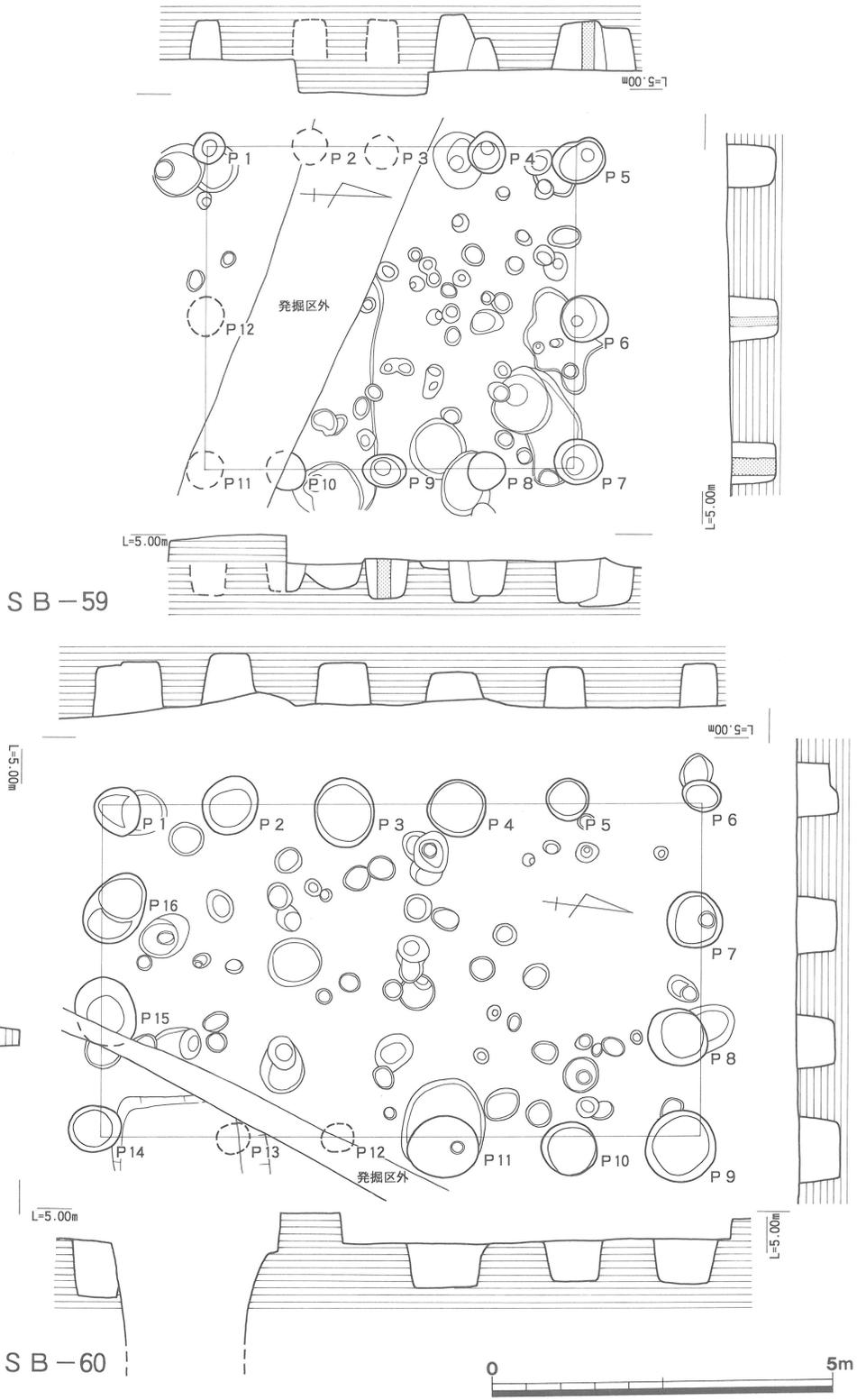

第41図 掘立柱建物-25 (1/100)

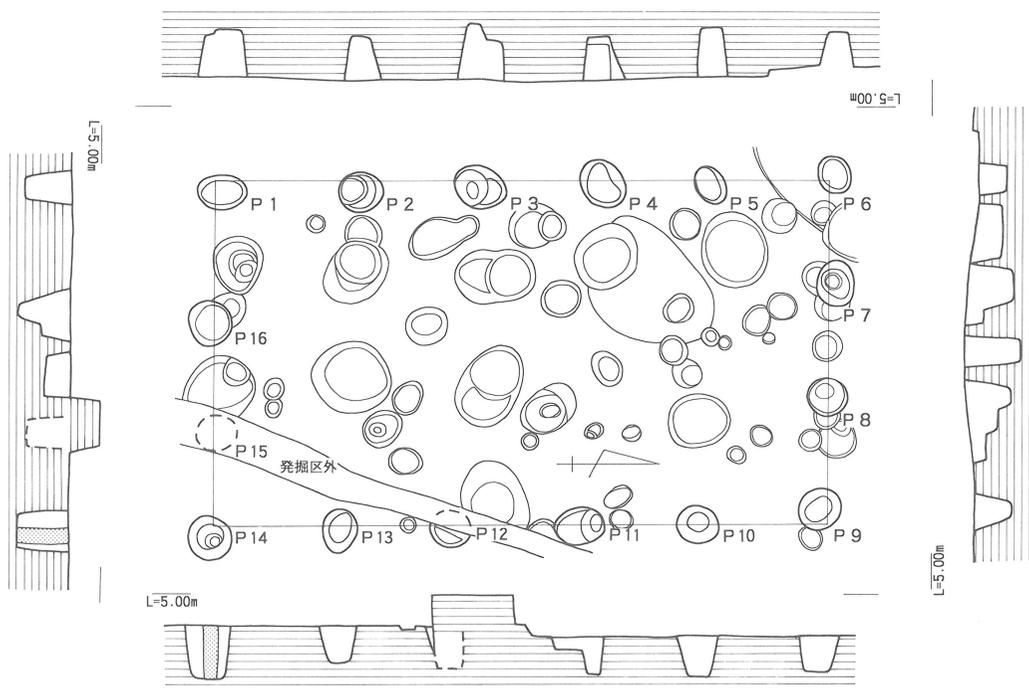

SB-61

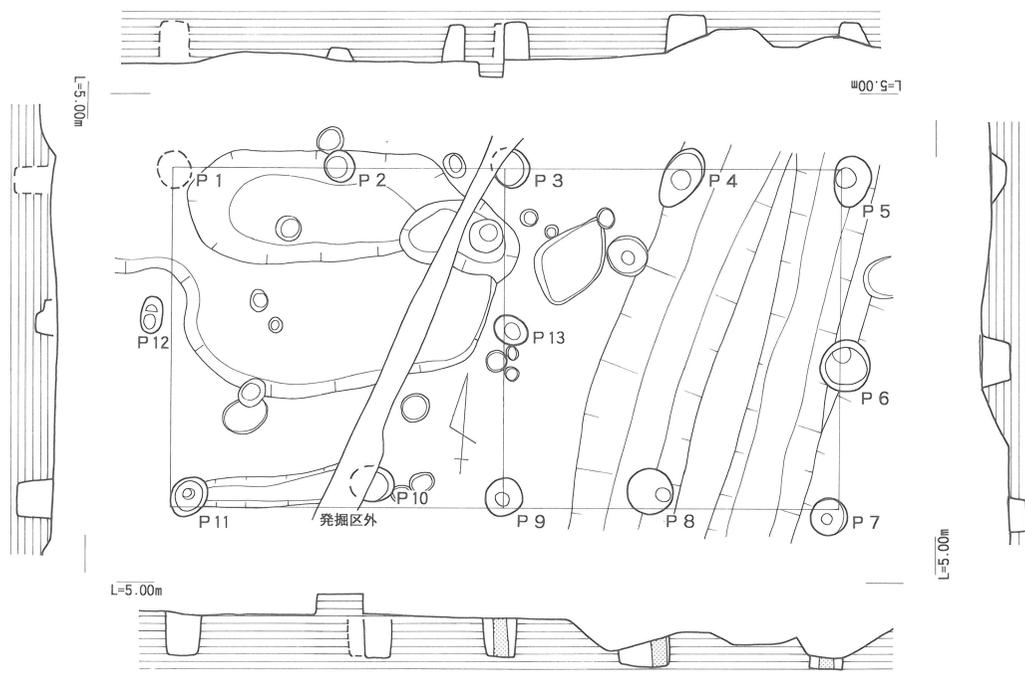

SB-62



第42図 掘立柱建物-26 (1/100)

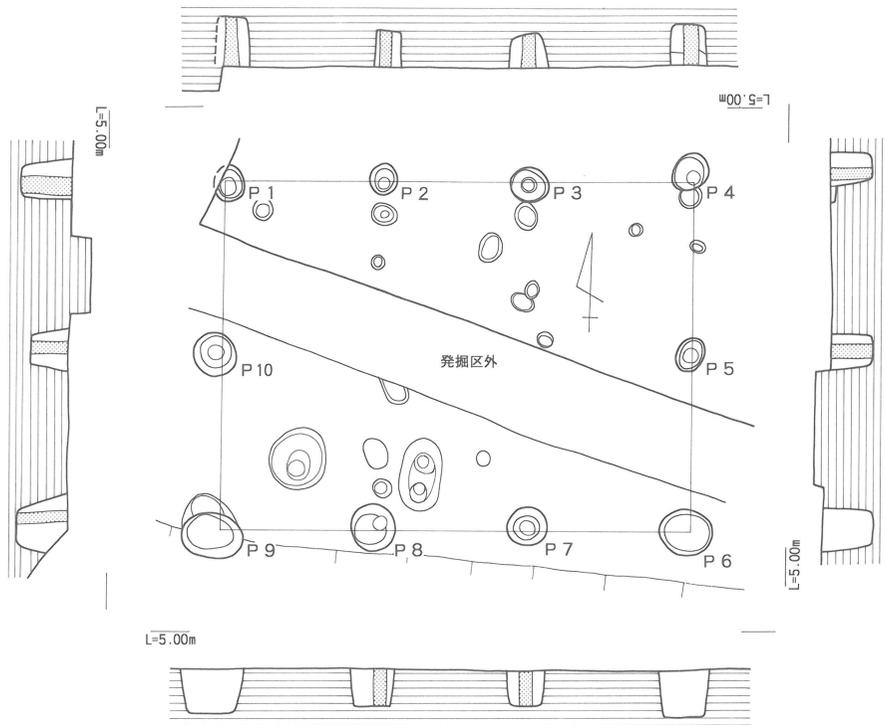

S B - 63

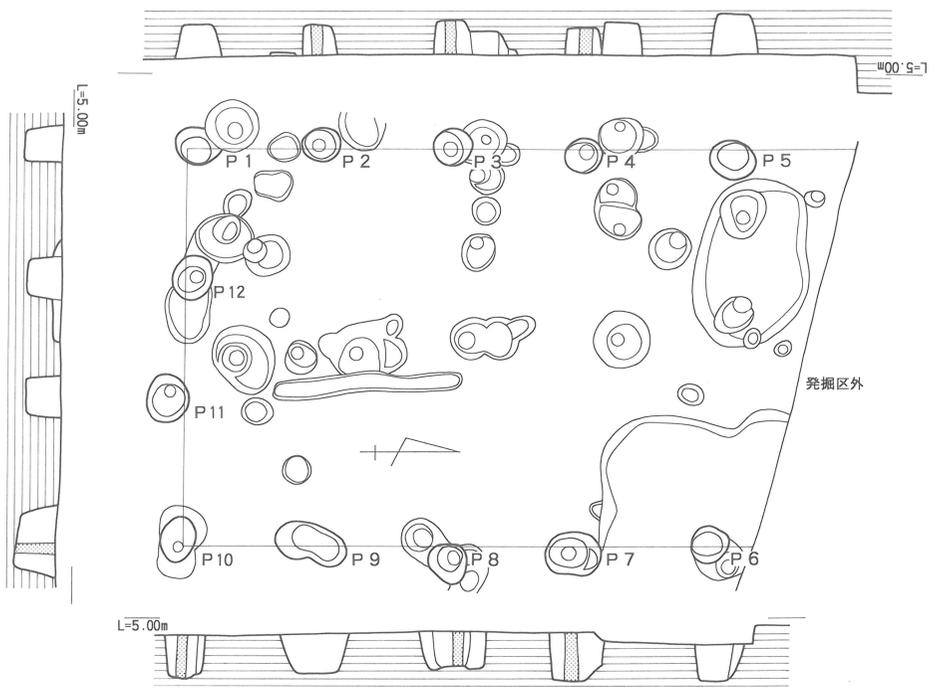

S B - 64



第43図 掘立柱建物-27 (1/100)

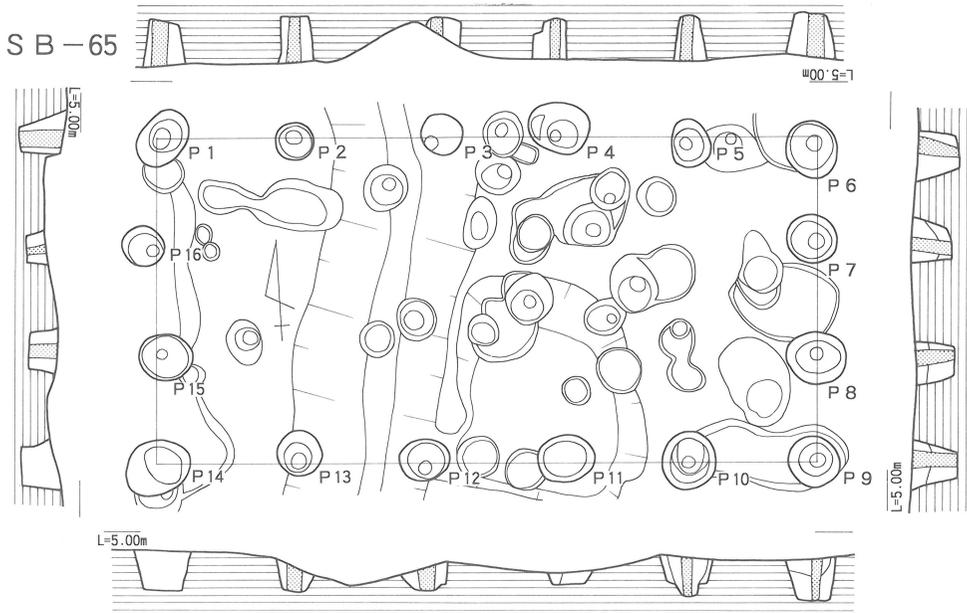

S B - 67

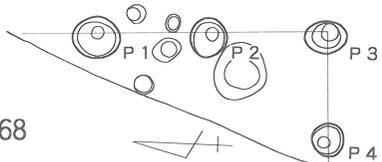

S B - 69

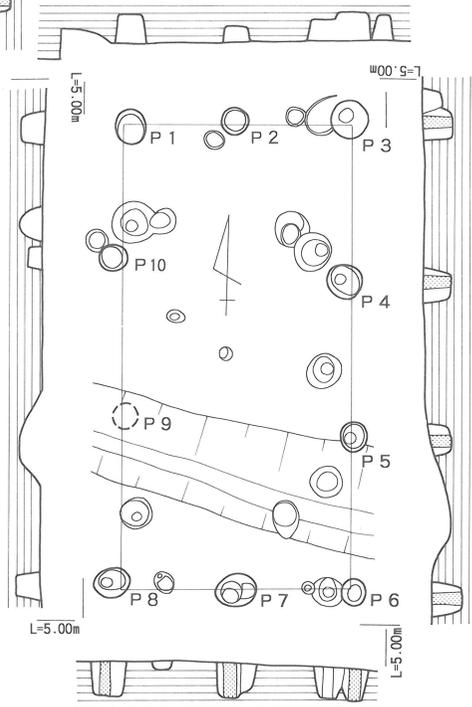

S B - 68

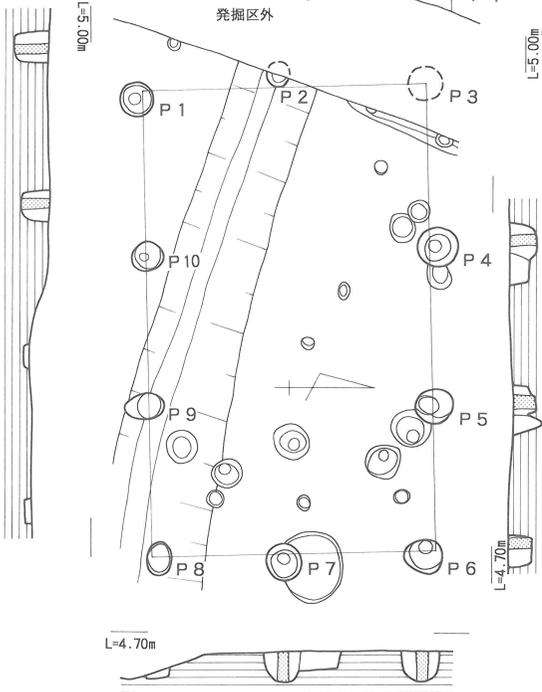

第44図 掘立柱建物-28 (1/100)

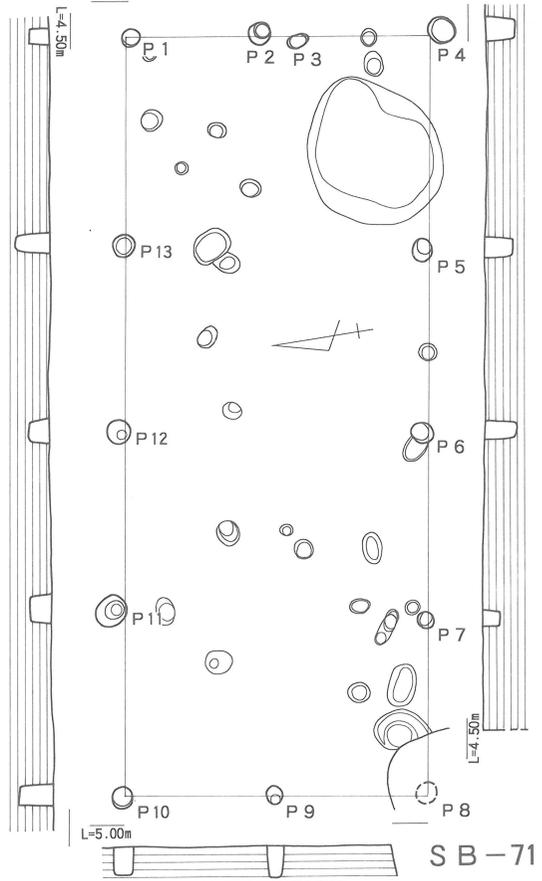
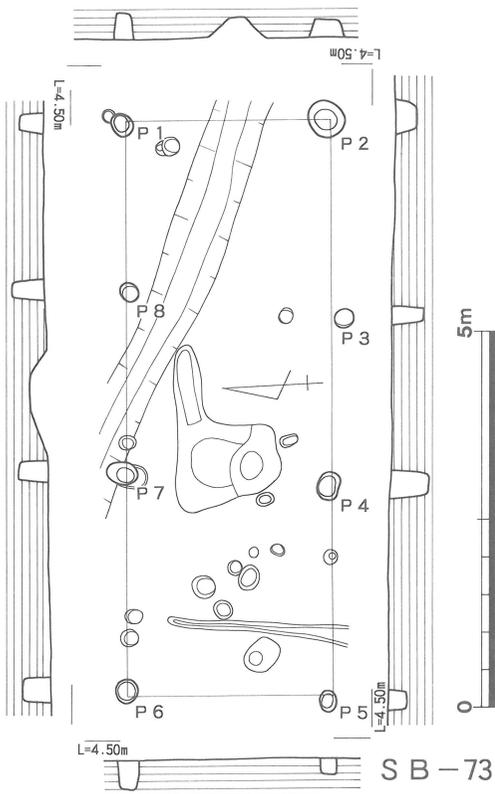
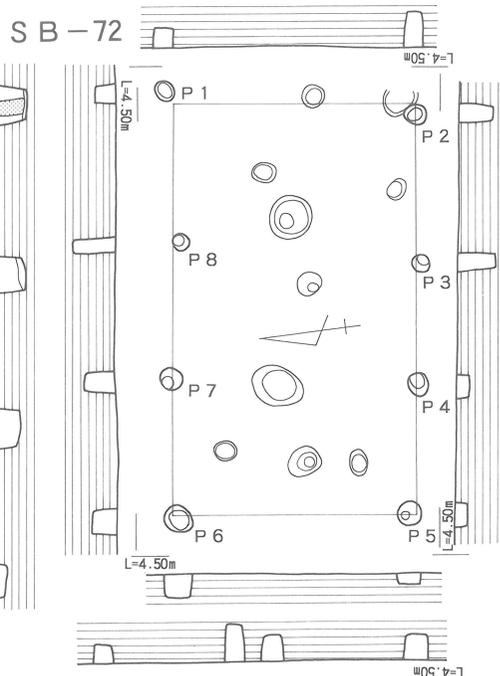
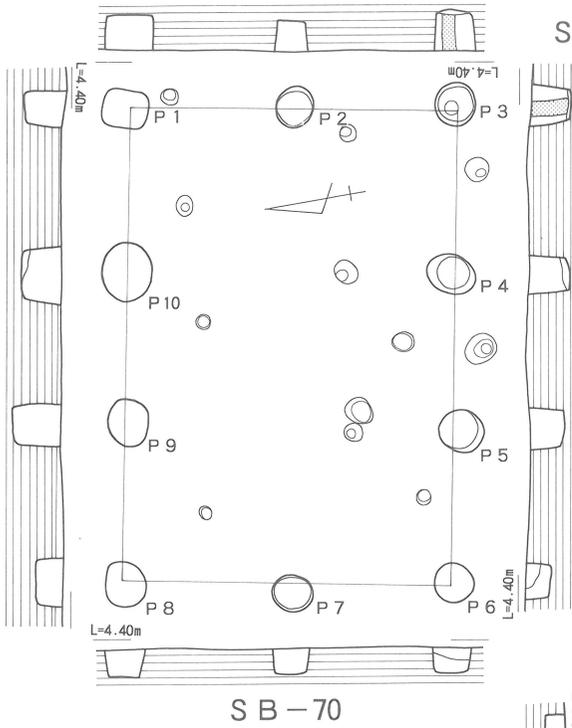

第45図 掘立柱建物-29 (1/100)

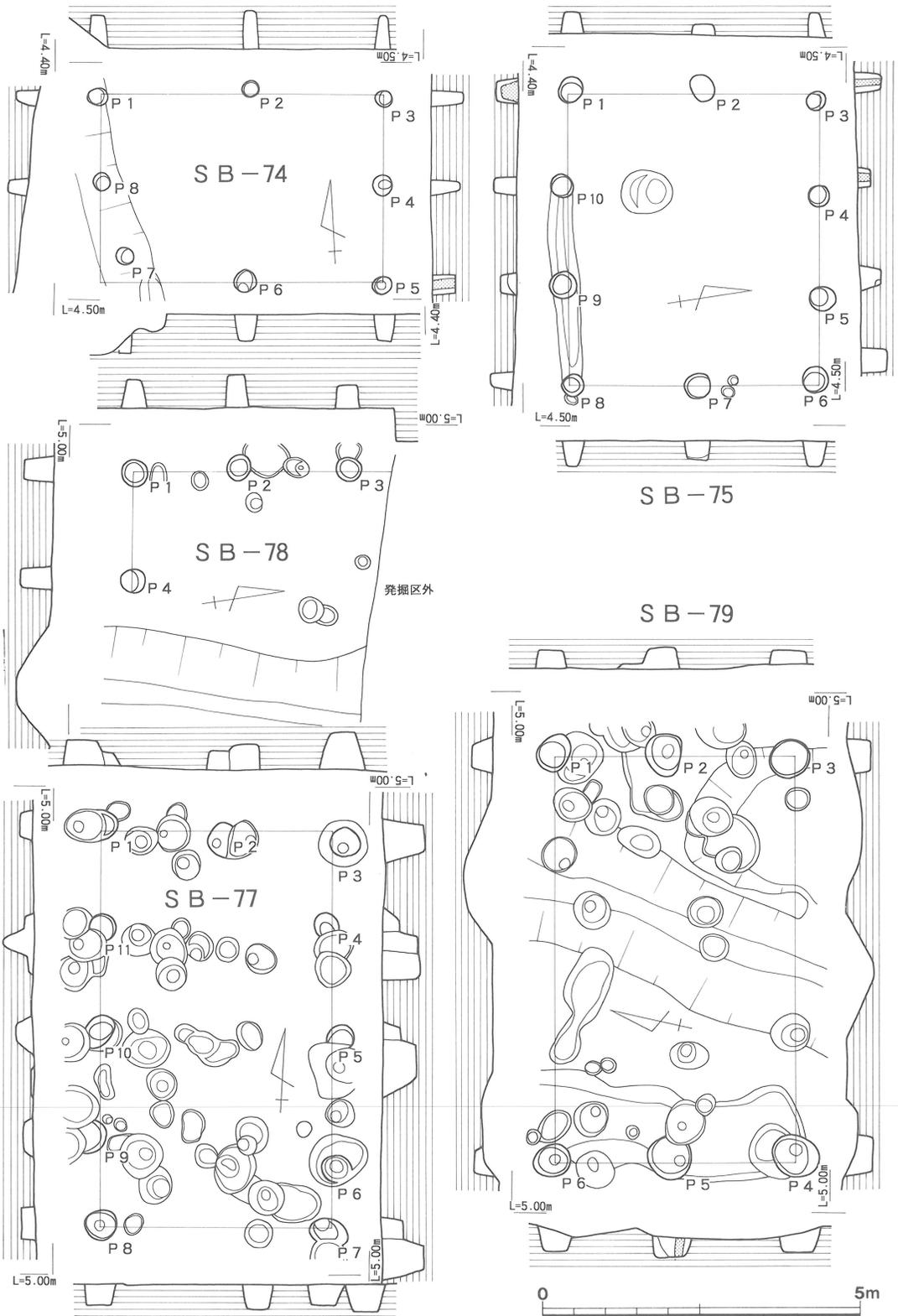

第46図 掘立柱建物-30 (1/100)

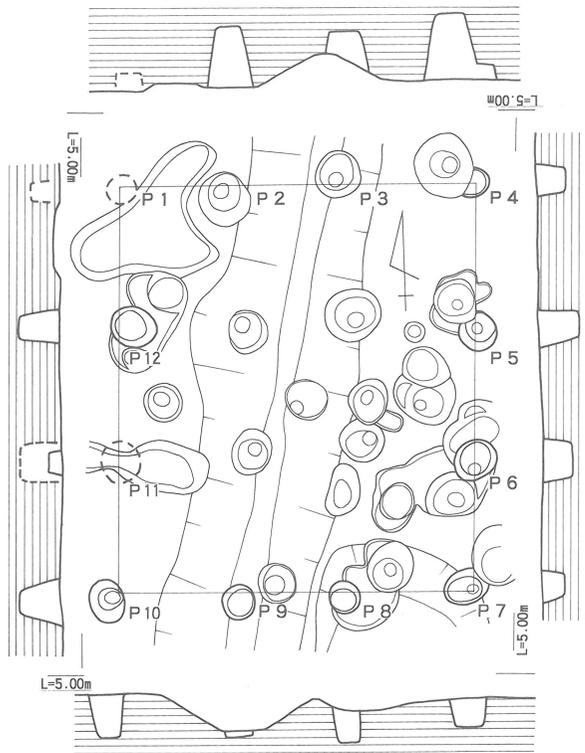

SB-80

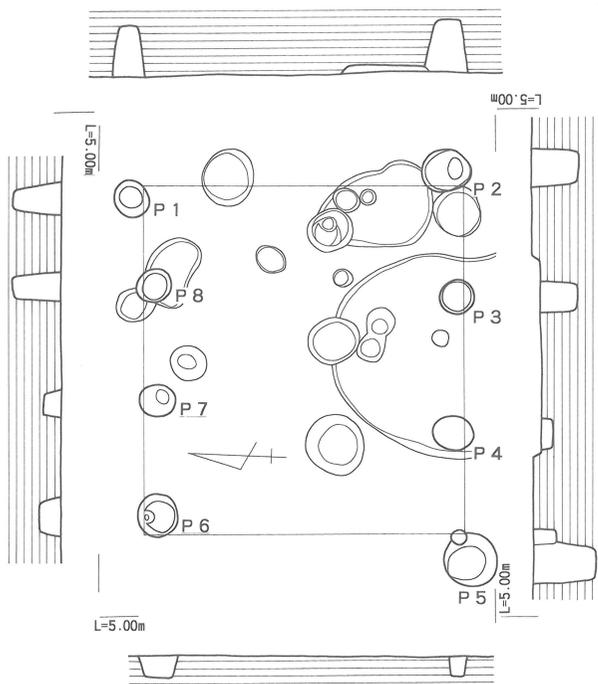

SB-82

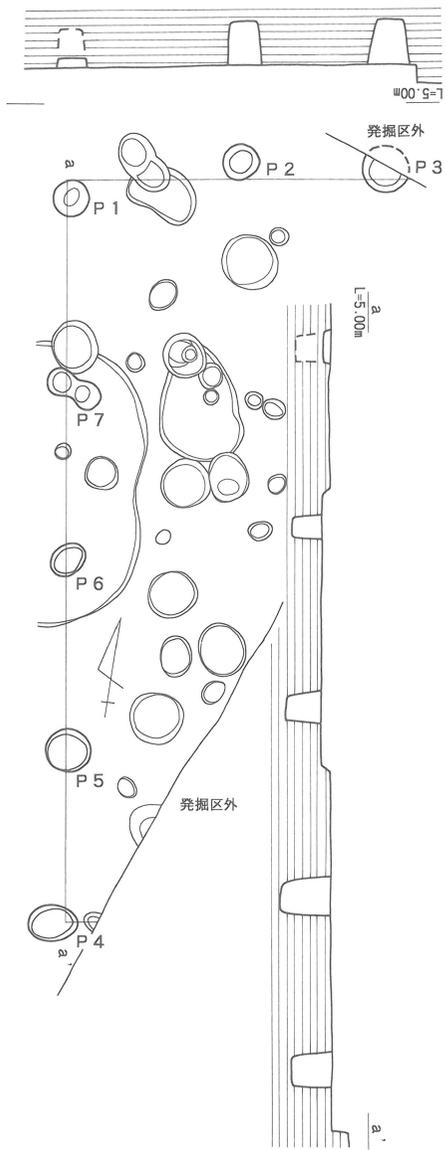

SB-83



第47図 掘立柱建物-31 (1/100)

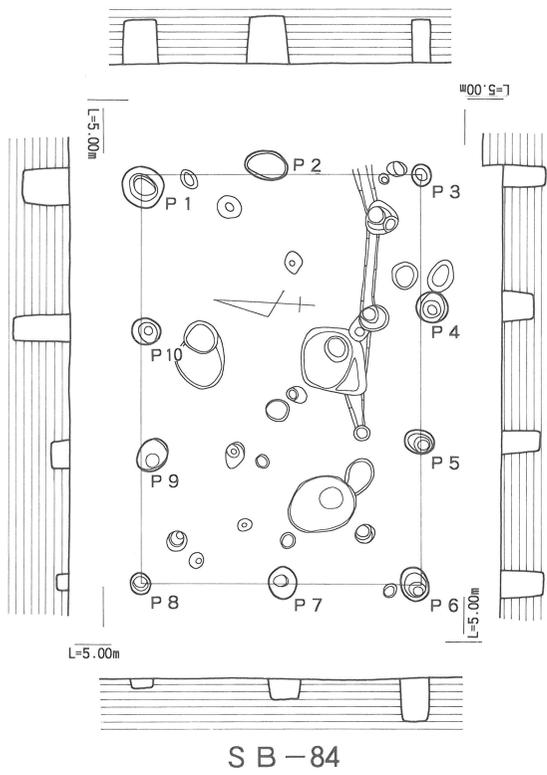

S B - 84

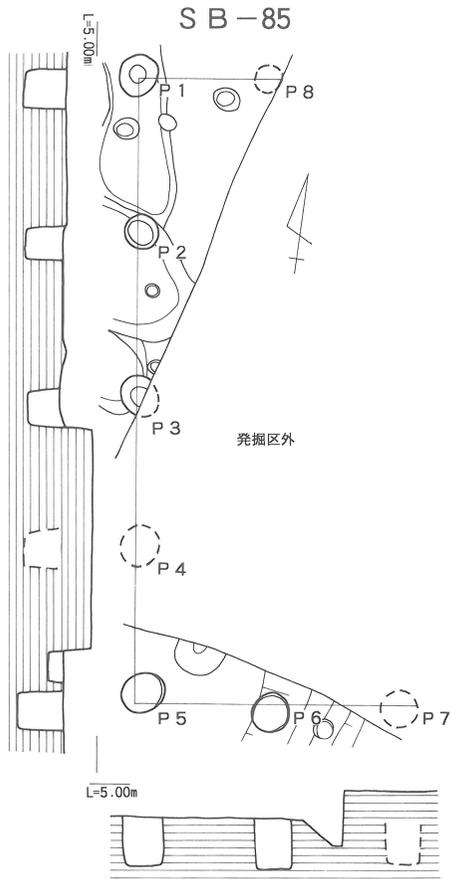

S B - 85

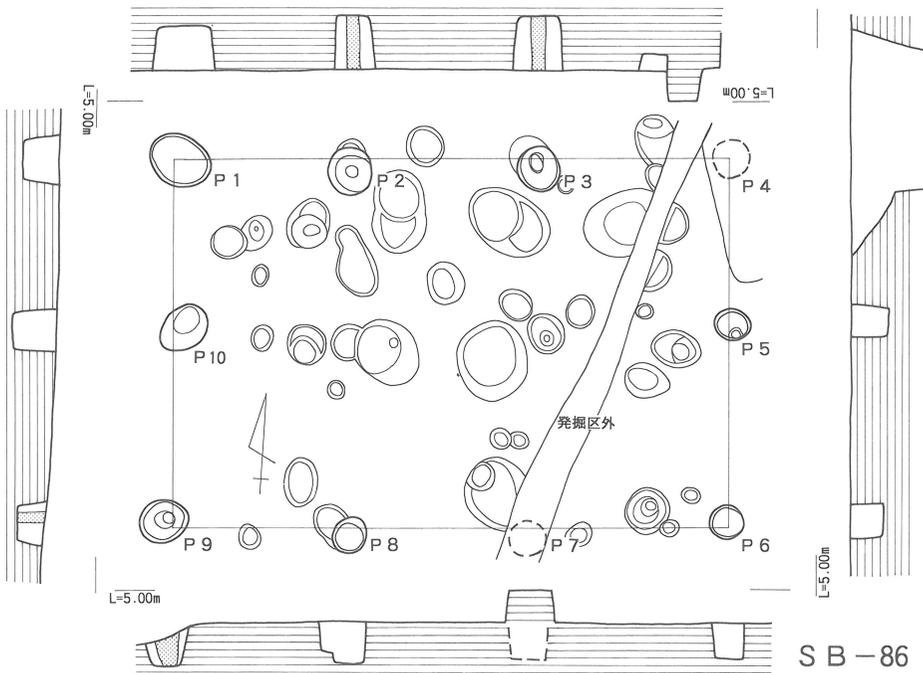
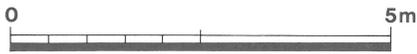

S B - 86

第48図 掘立柱建物-32 (1/100)

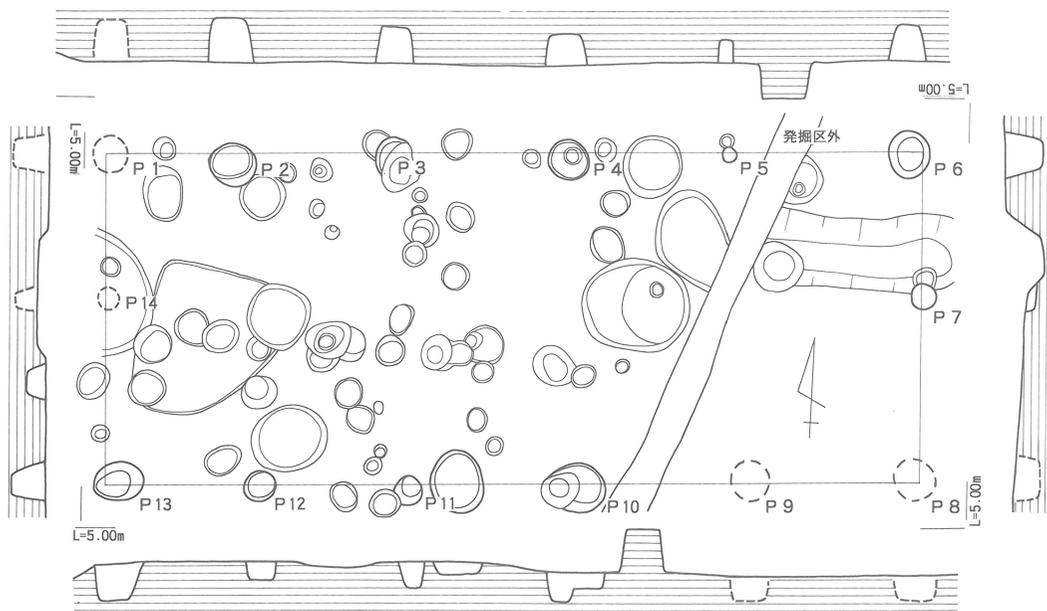

S B - 87

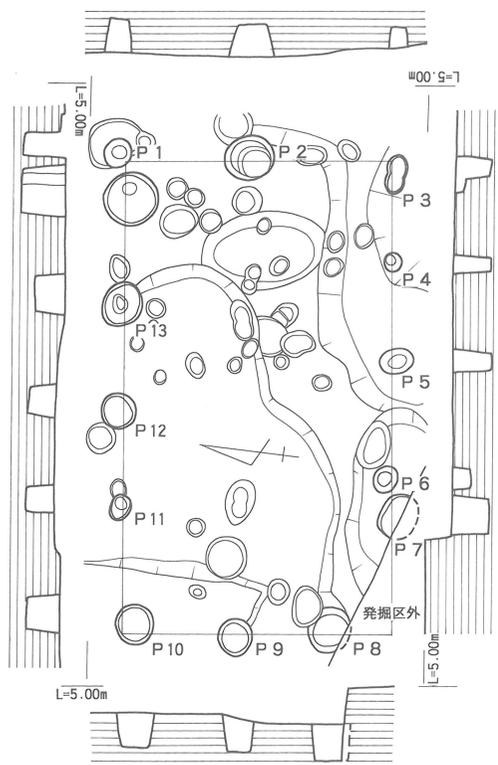

S B - 88

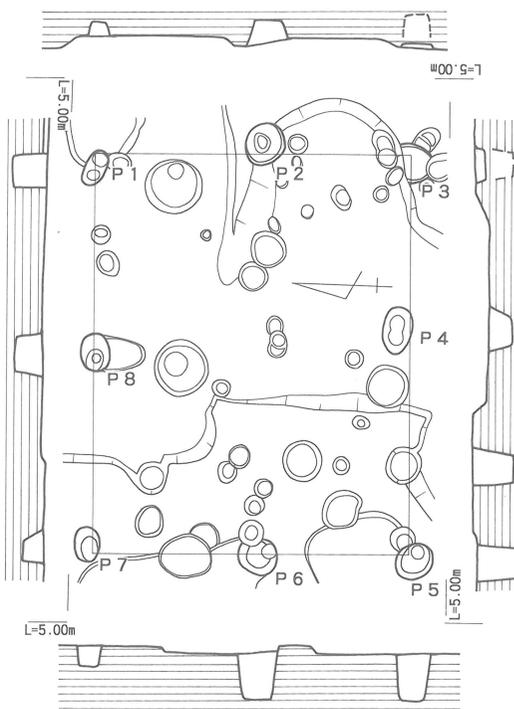

S B - 89

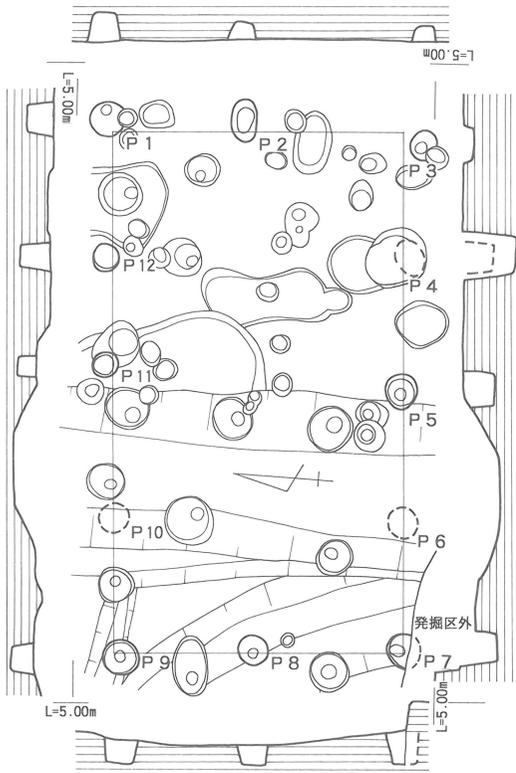

S B - 90

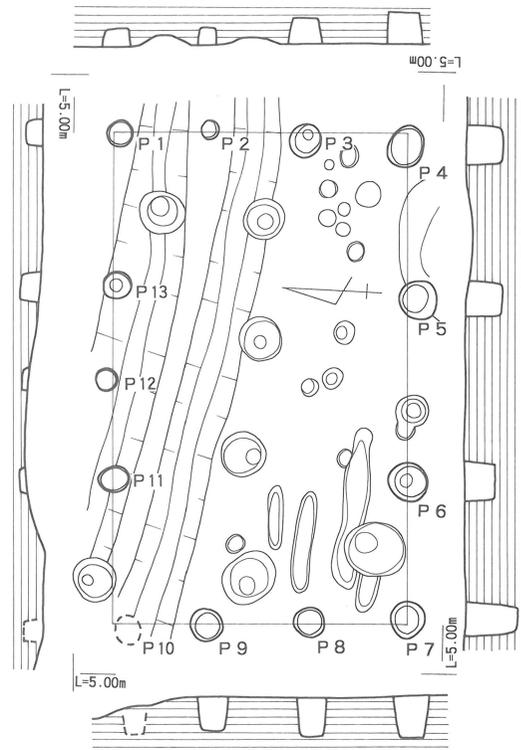

S B - 92

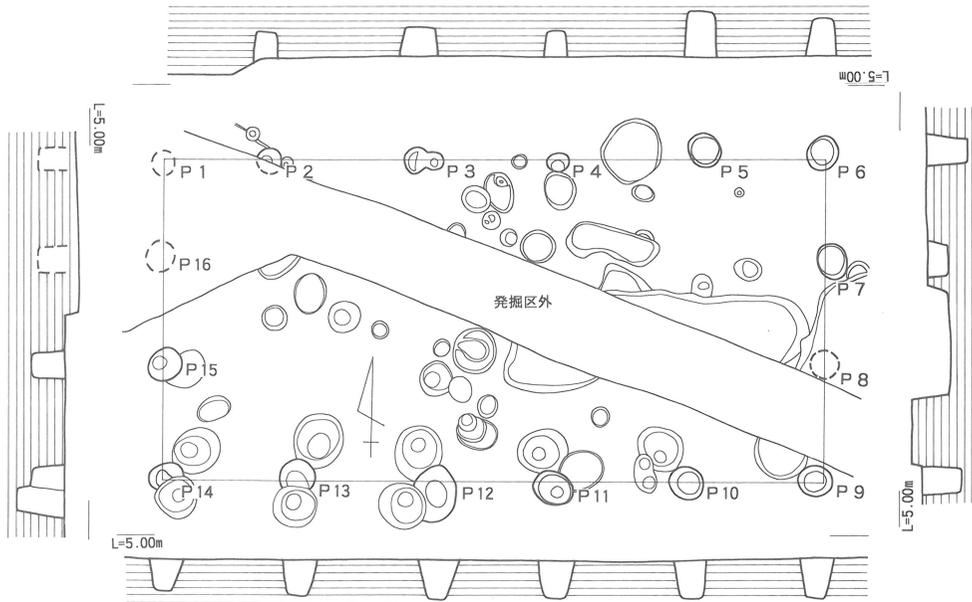

S B - 93



第50図 掘立柱建物-34 (1/100)

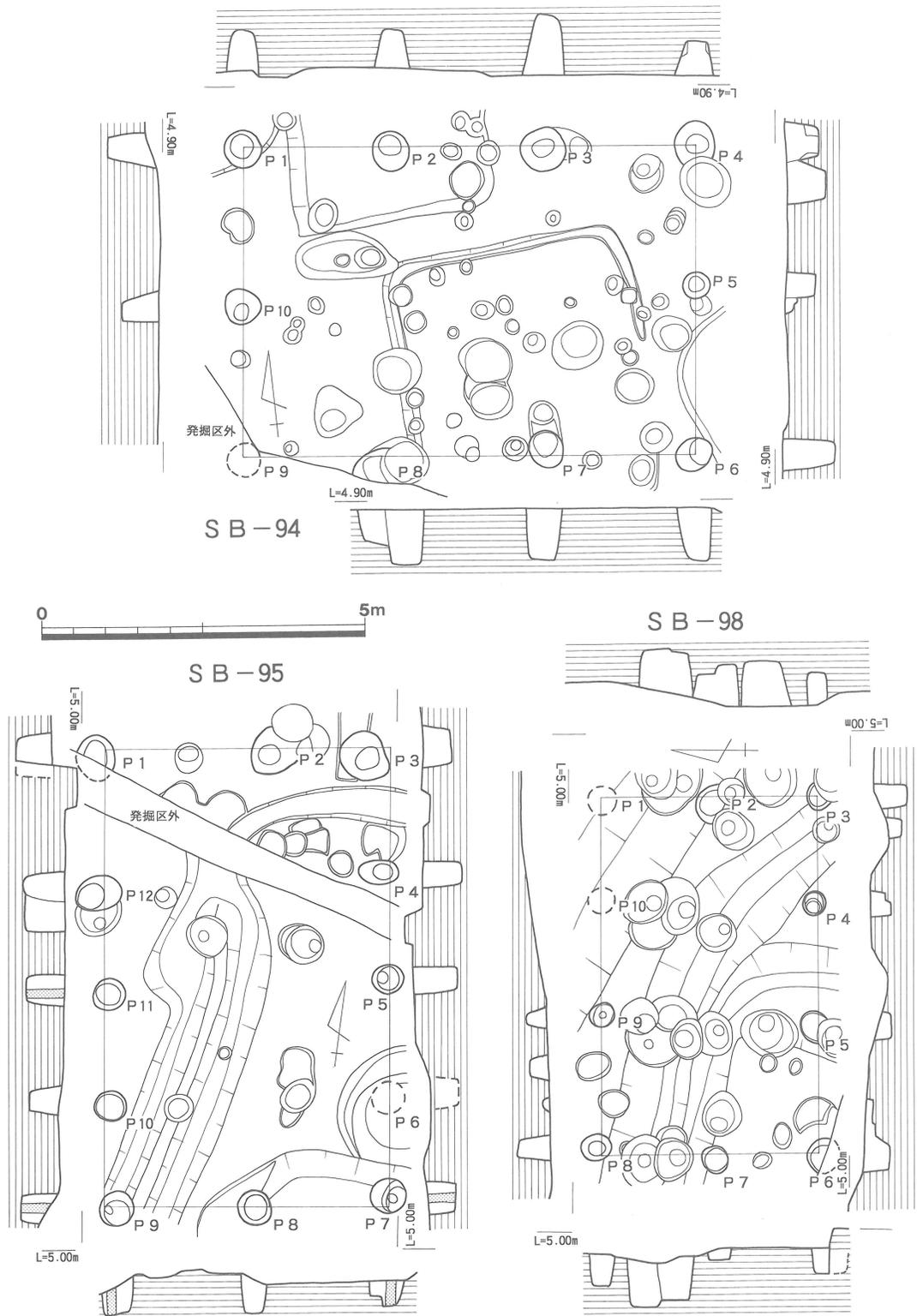

第51図 掘立柱建物—35 (1/100)

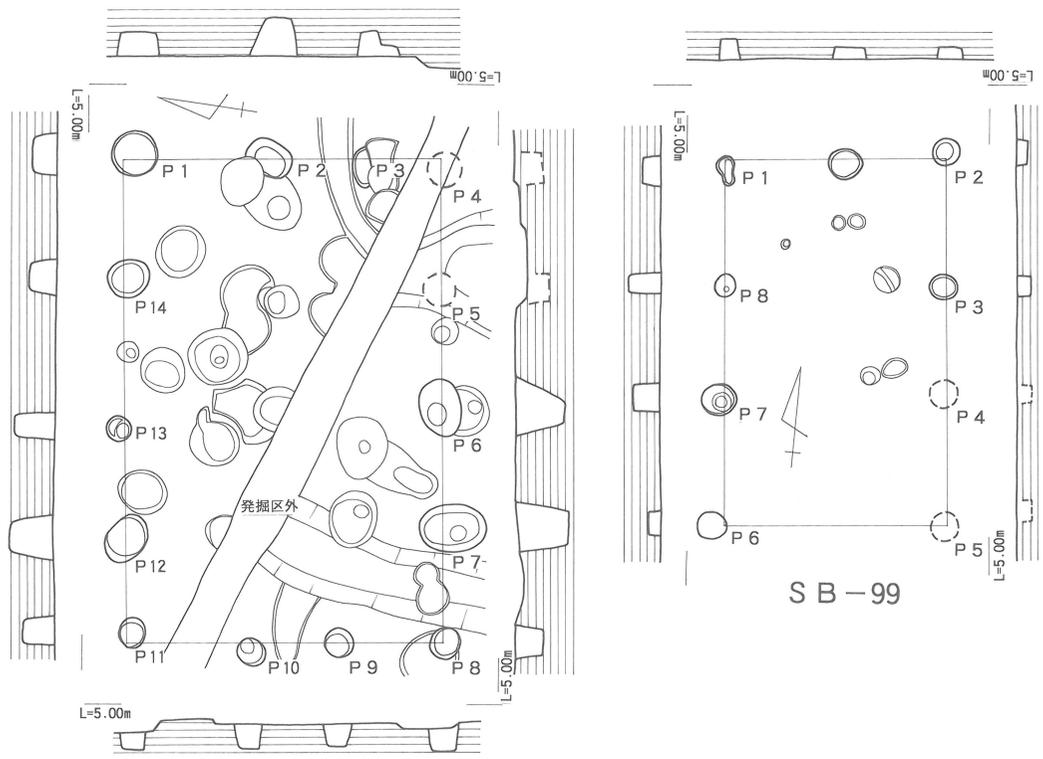

S B - 96

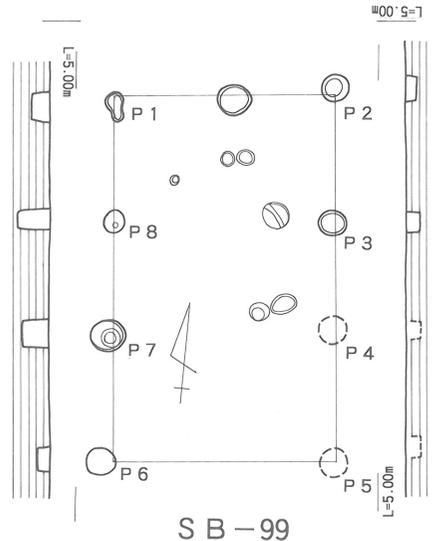

S B - 99

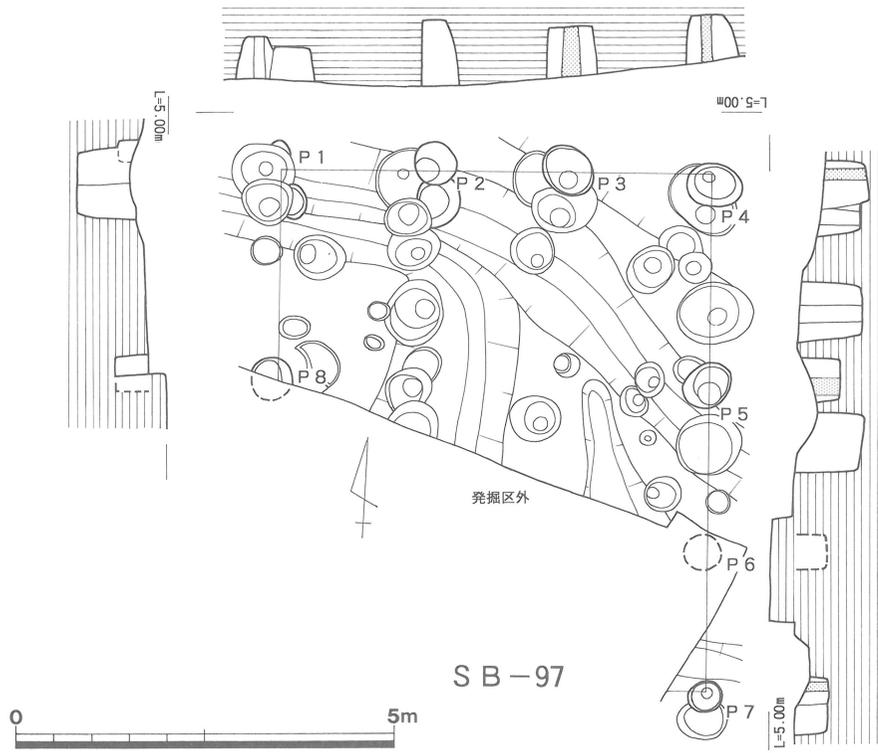

S B - 97

第52図 掘立柱建物-36 (1/100)

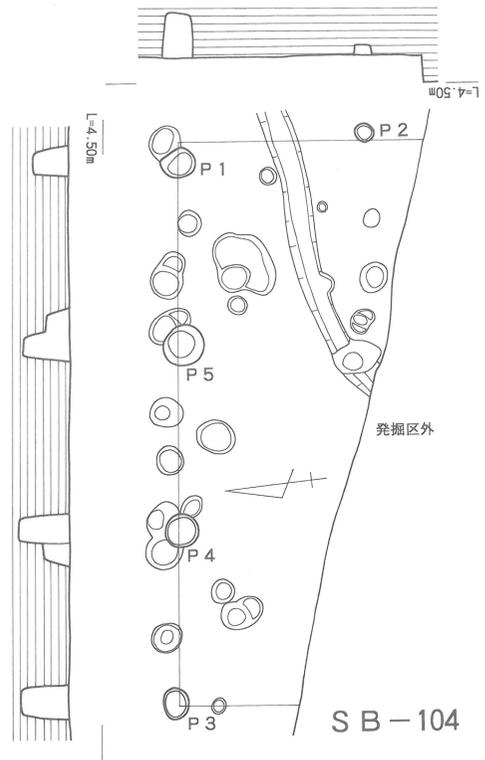
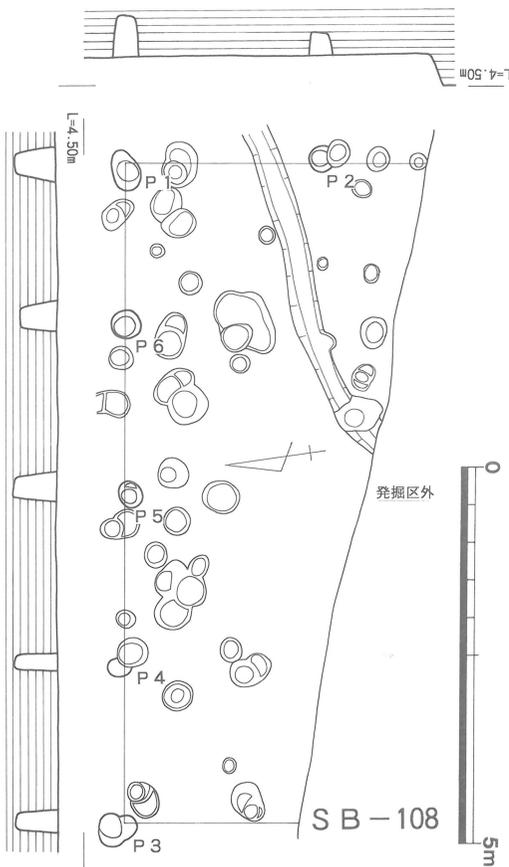
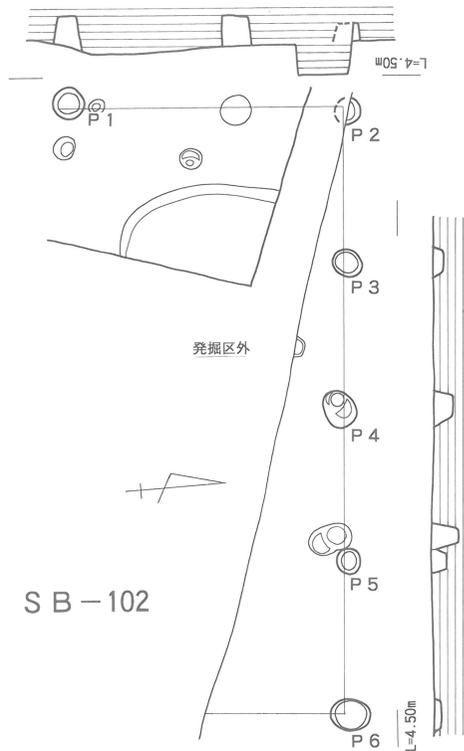
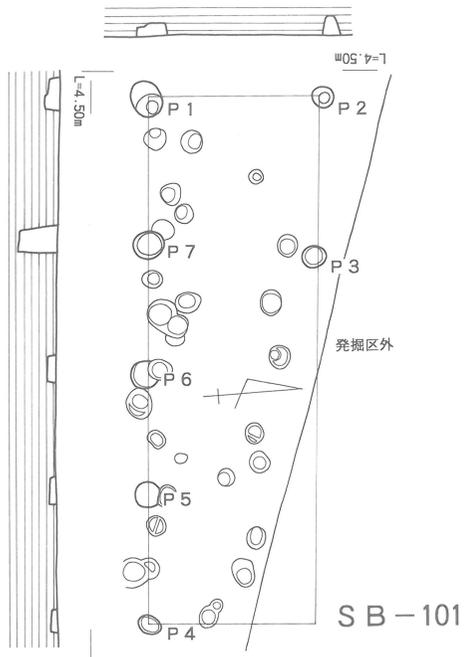

第53図 掘立柱建物-37 (1/100)

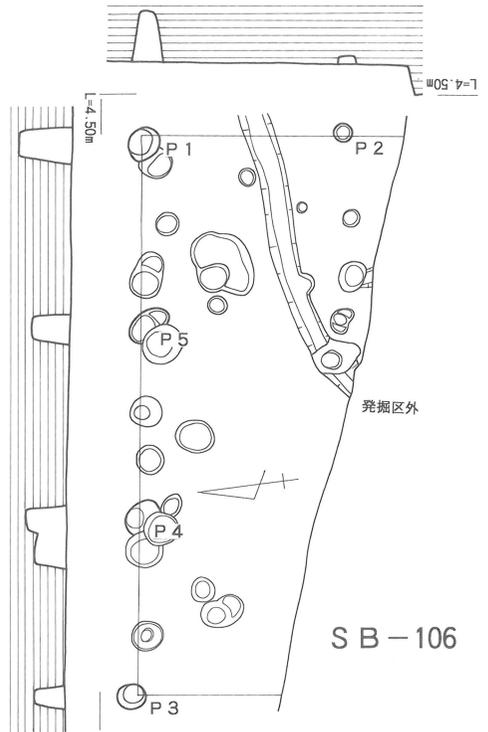
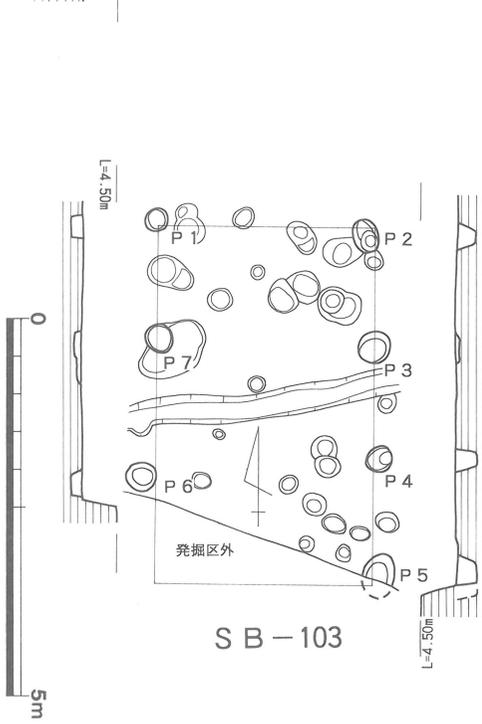
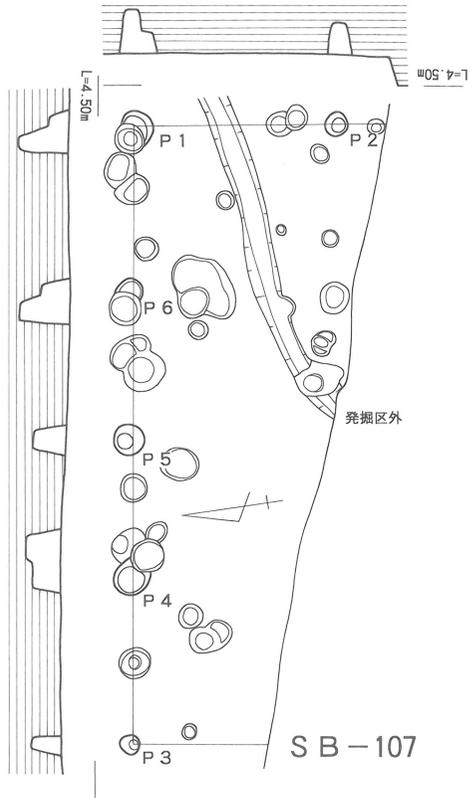
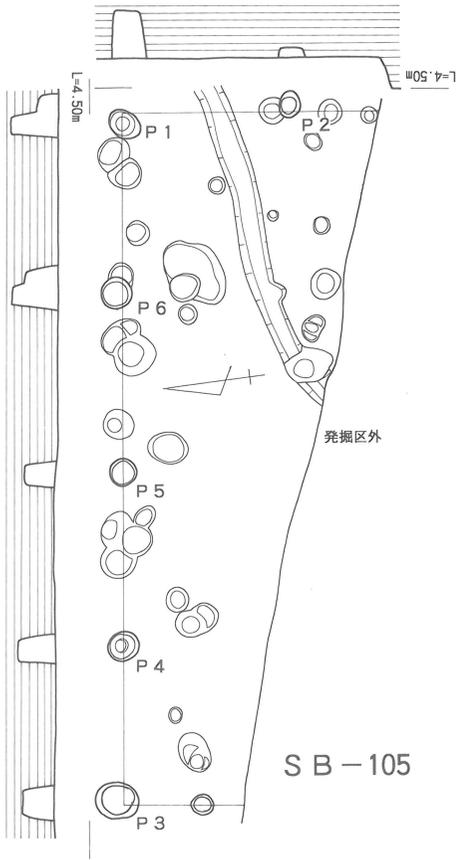

第54図 掘立柱建物—38 (1/100)

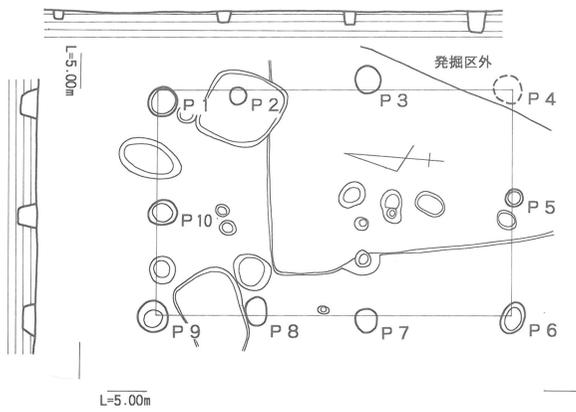
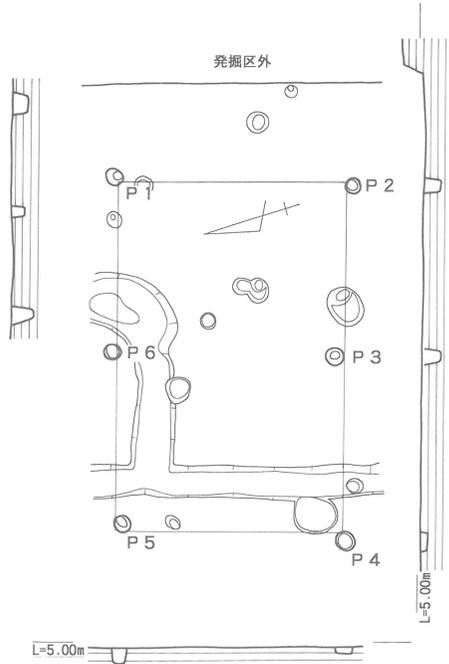
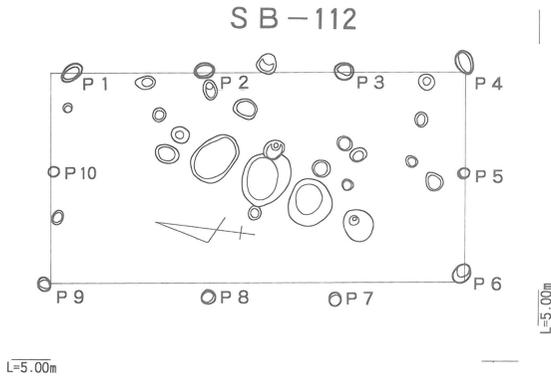
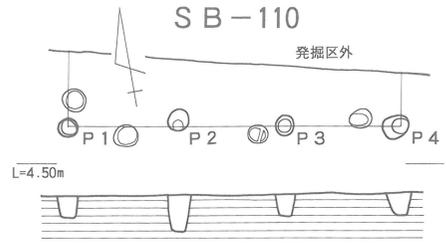
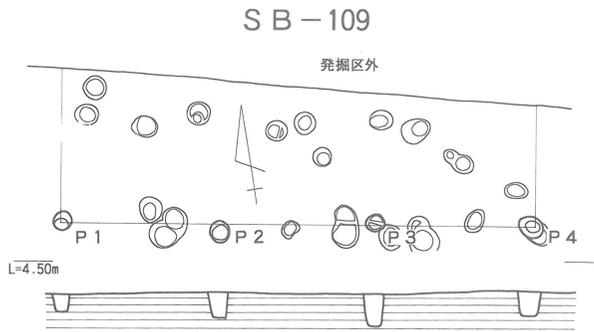

第55図 掘立柱建物-39 (1/100)

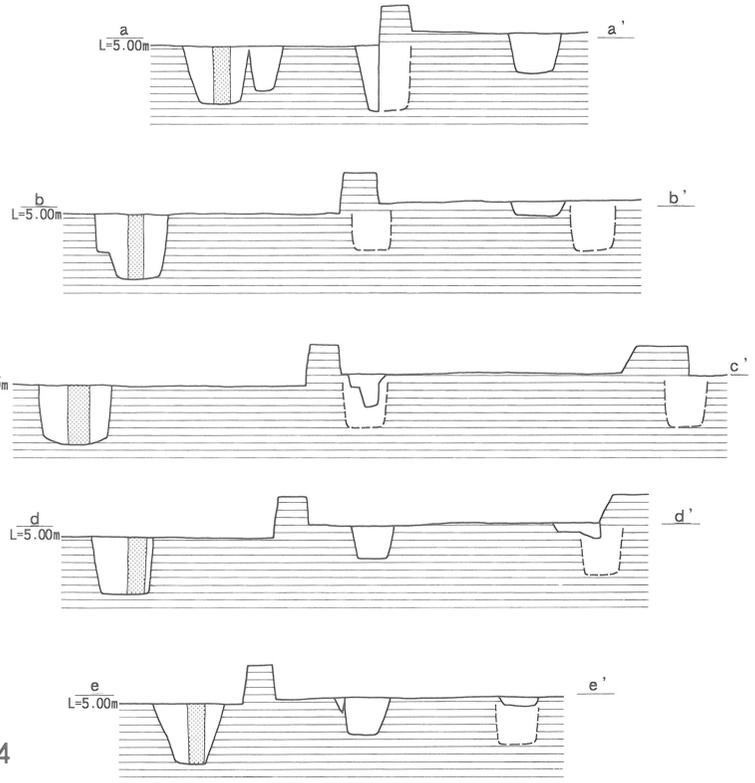
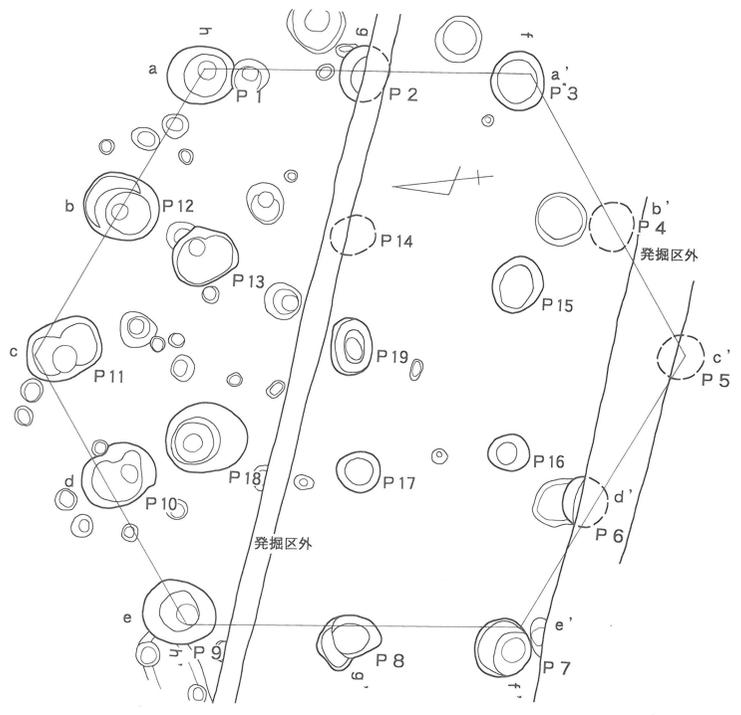
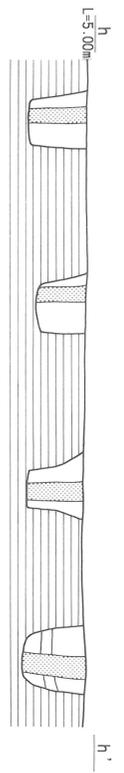
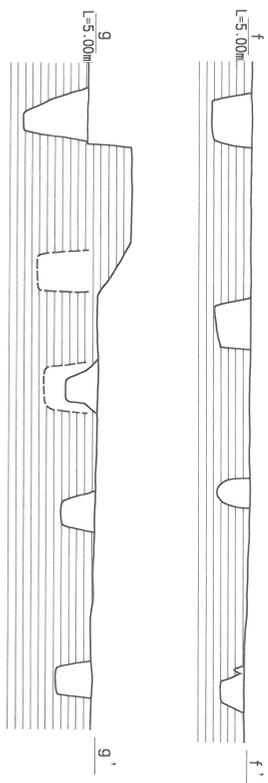

SB-114

第56图 掘立柱建物-40 (1/100)

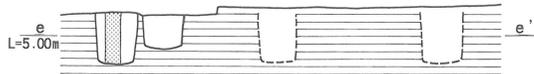
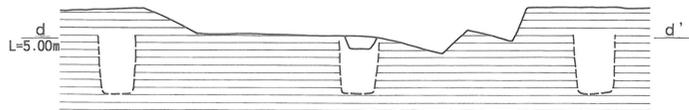
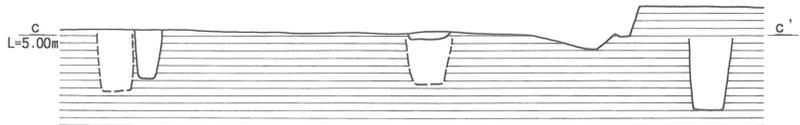
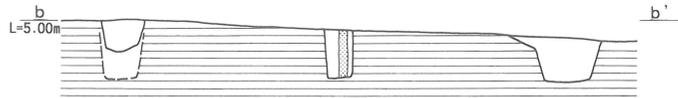
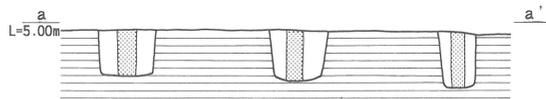
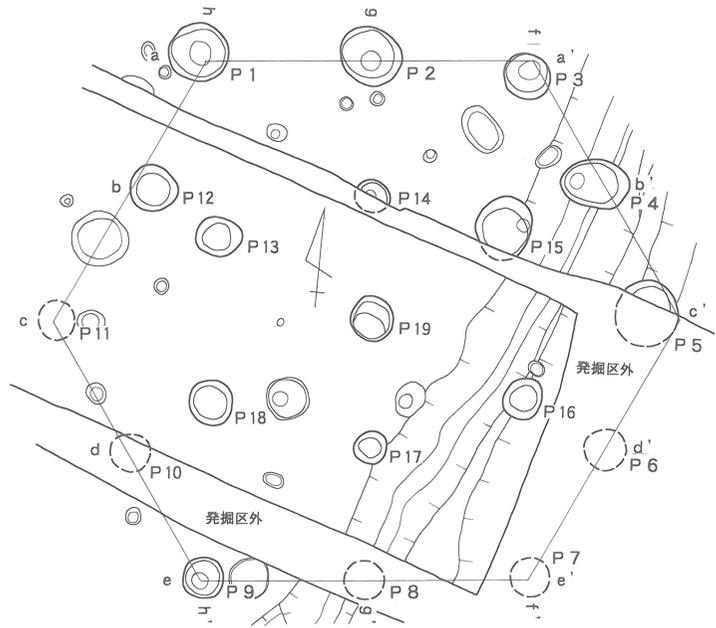
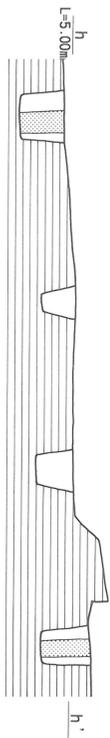
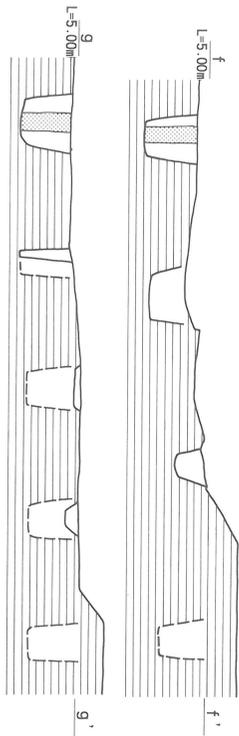

SB-115

第57図 掘立柱建物-41 (1/100)

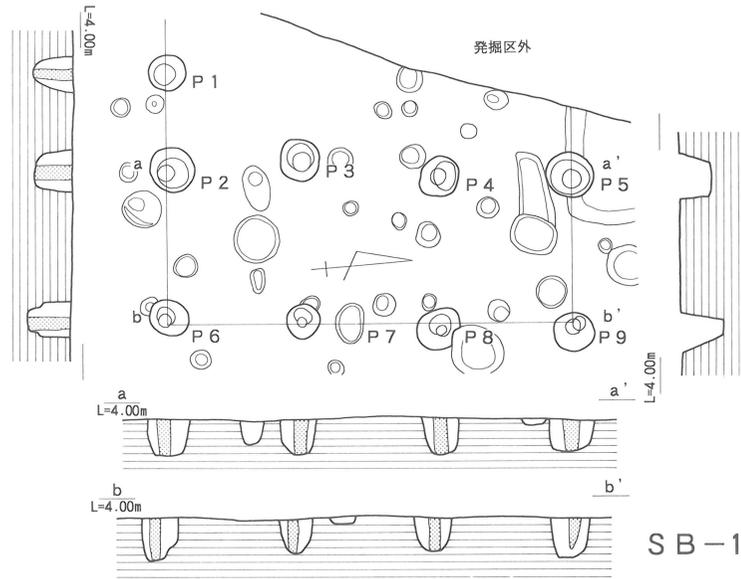
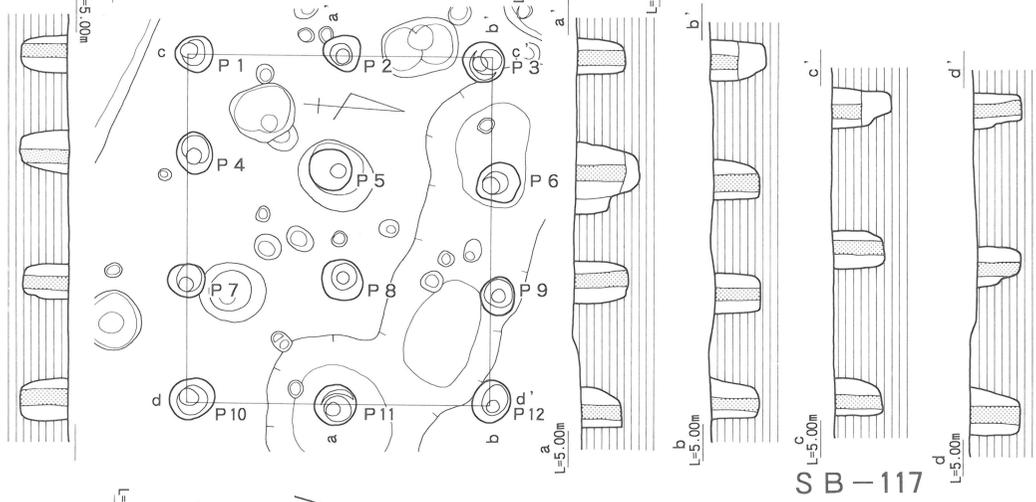
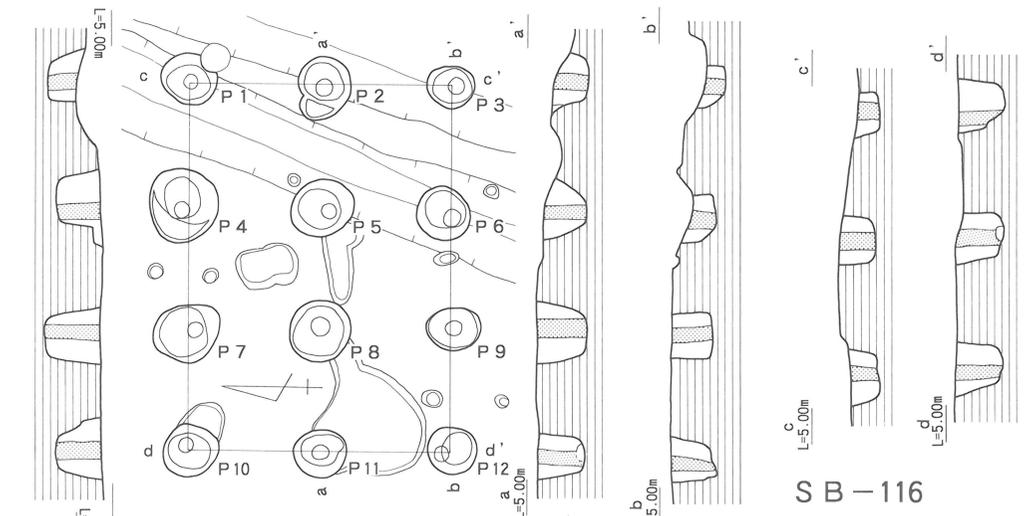

第58図 掘立柱建物-42 (1/100)

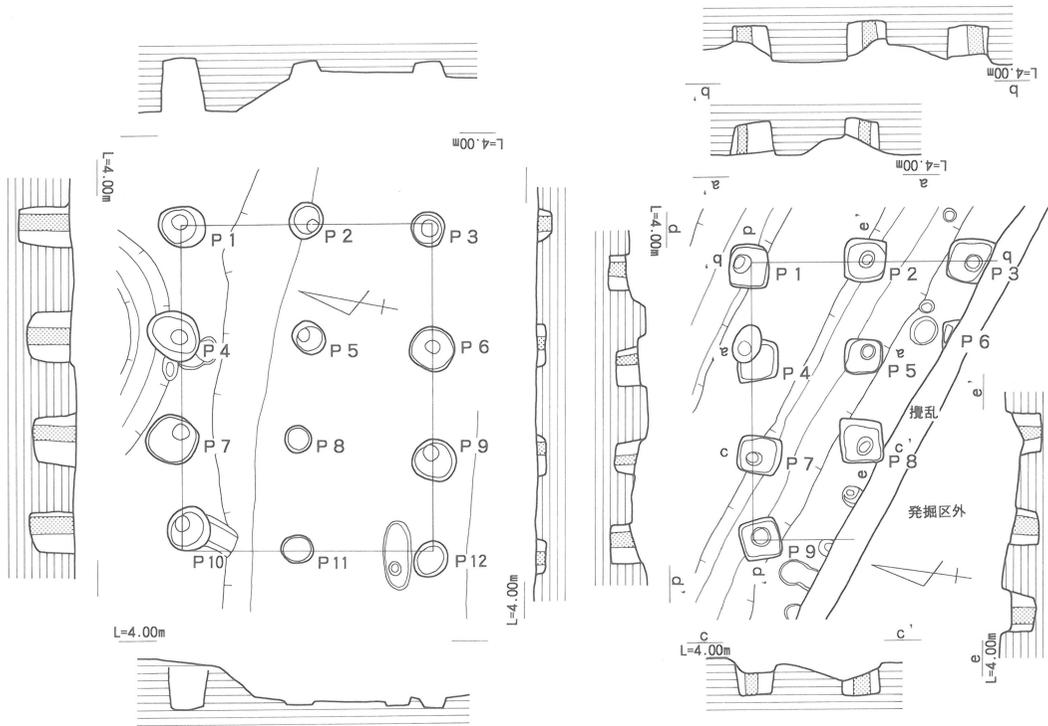

SB-122

SB-124

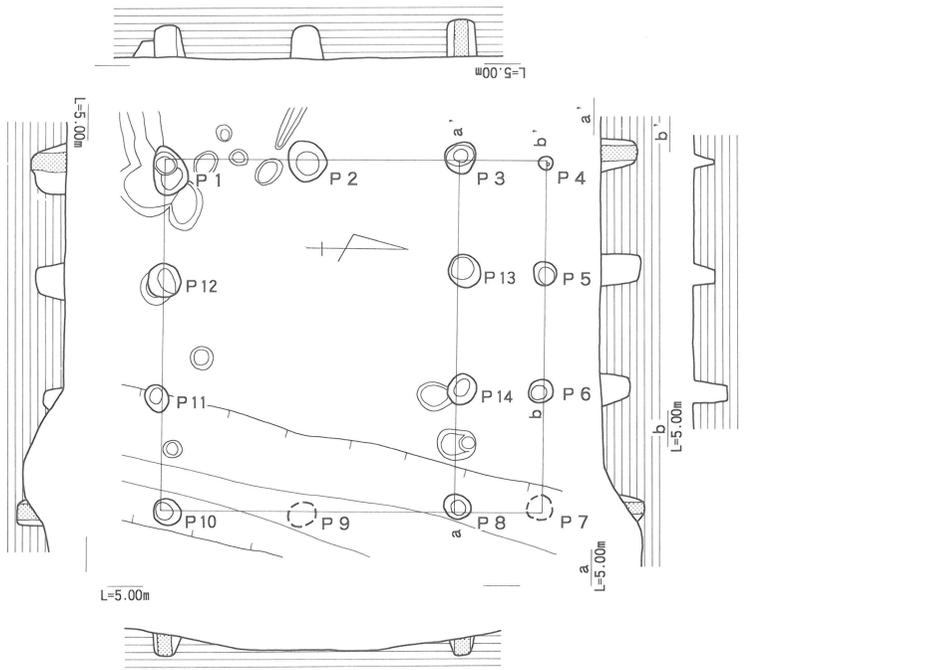

SB-118

第59図 掘立柱建物-43 (1/100)

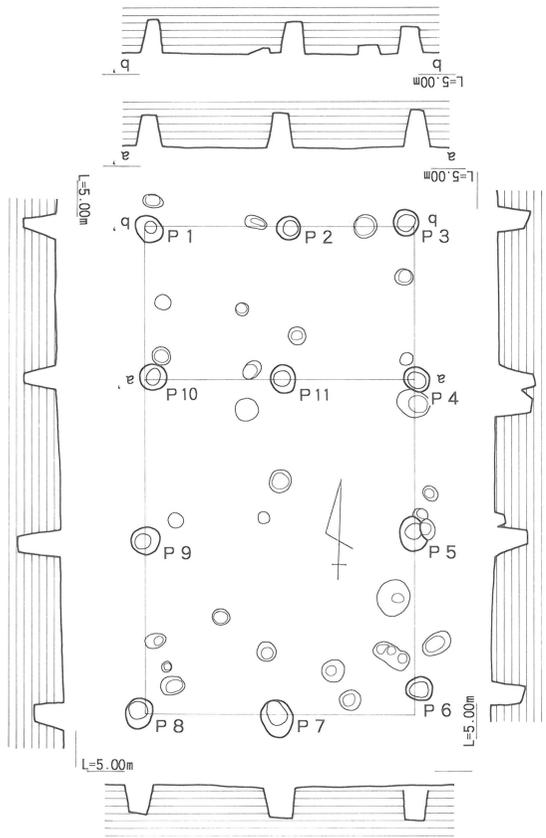

S B - 119

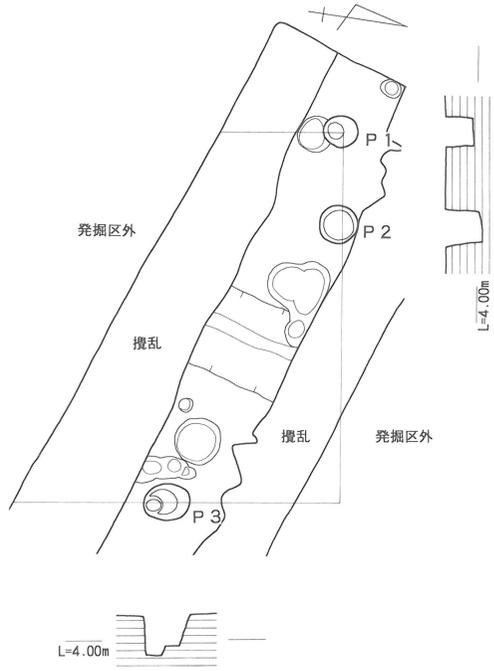

S B - 123

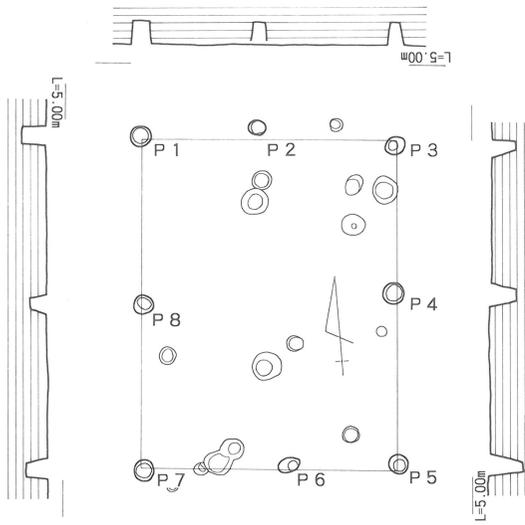

S B - 120

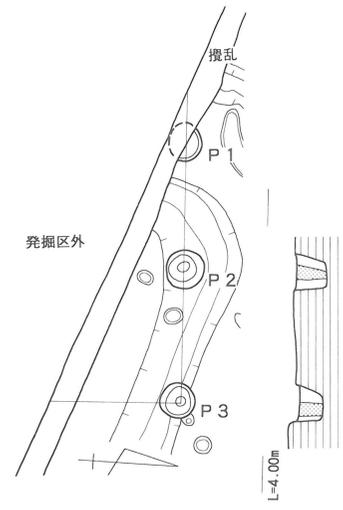

S B - 125



第60图 掘立柱建物-44 (1/100)

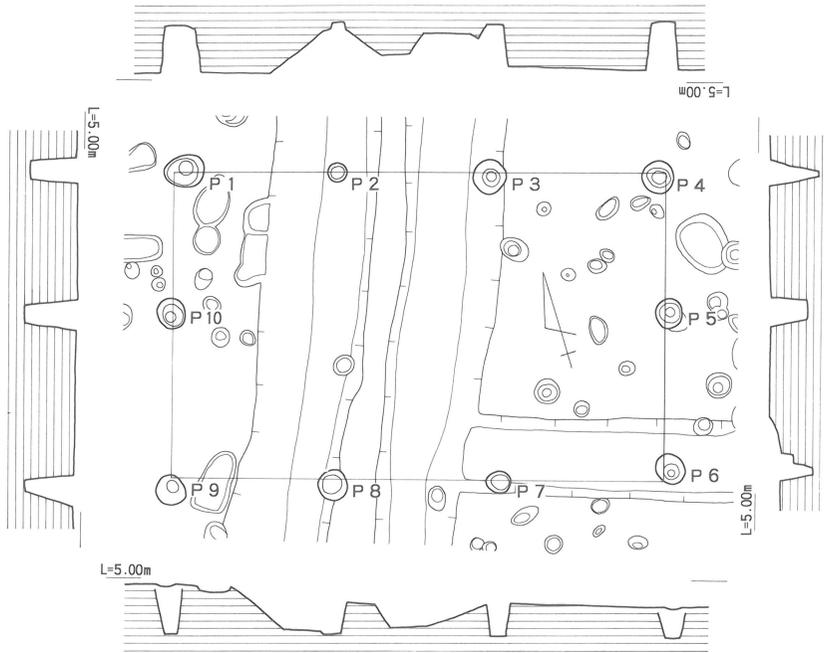

S B - 128

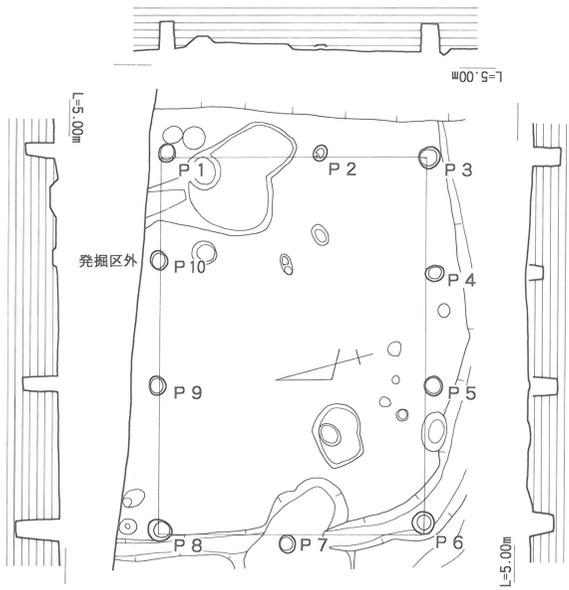

S B - 127

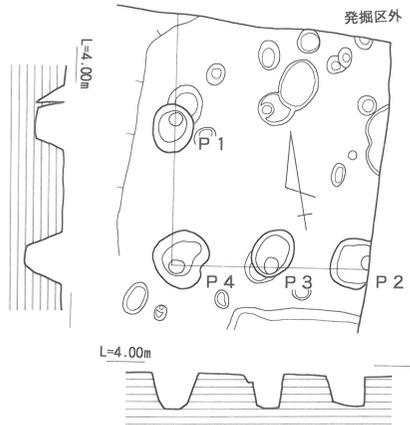

S B - 126



第61図 掘立柱建物-45 (1/100)

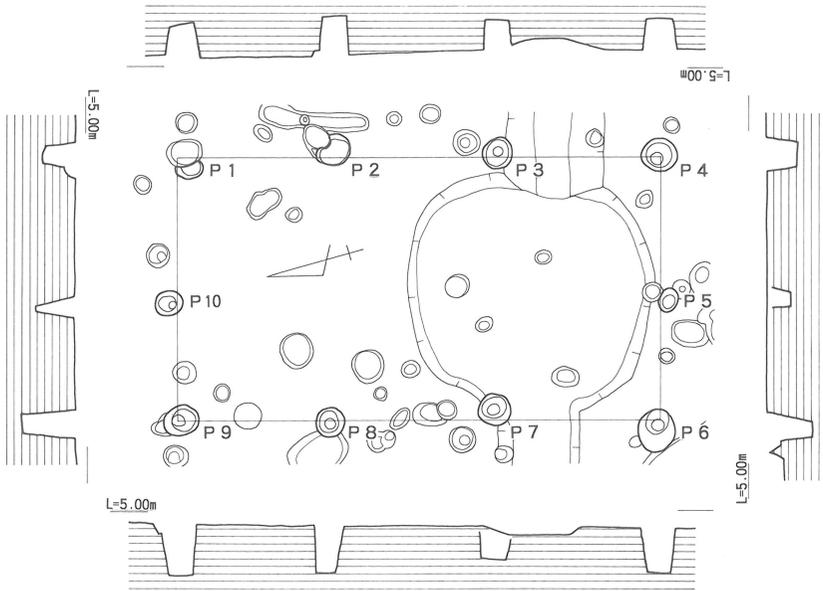

S B - 129

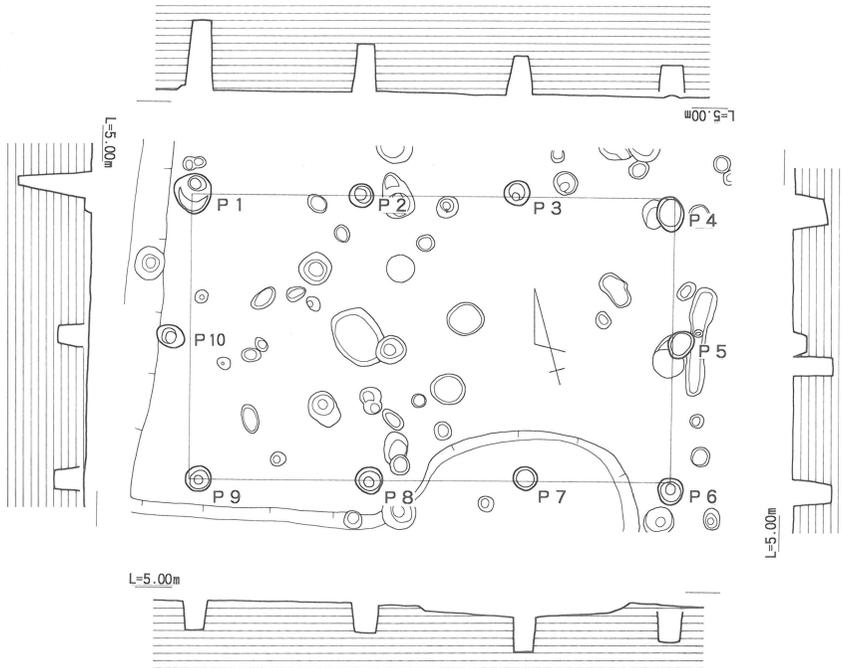

S B - 130



第62図 掘立柱建物-46 (1/100)

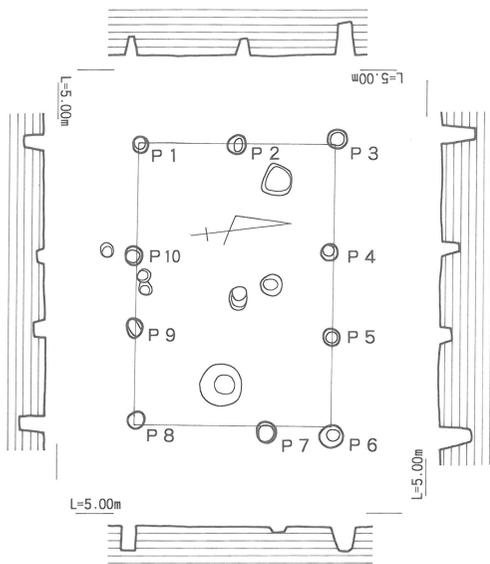

S B - 131

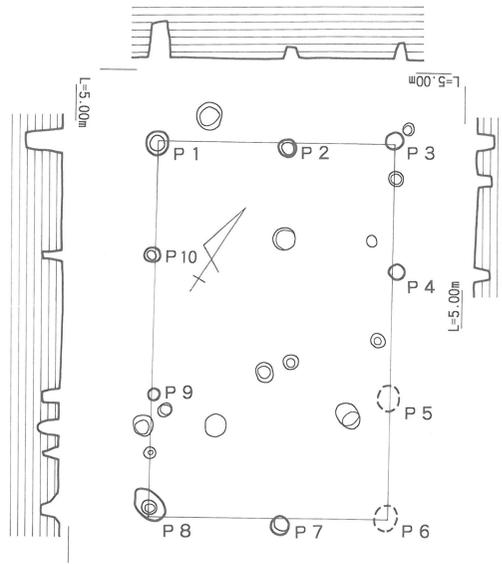

S B - 132

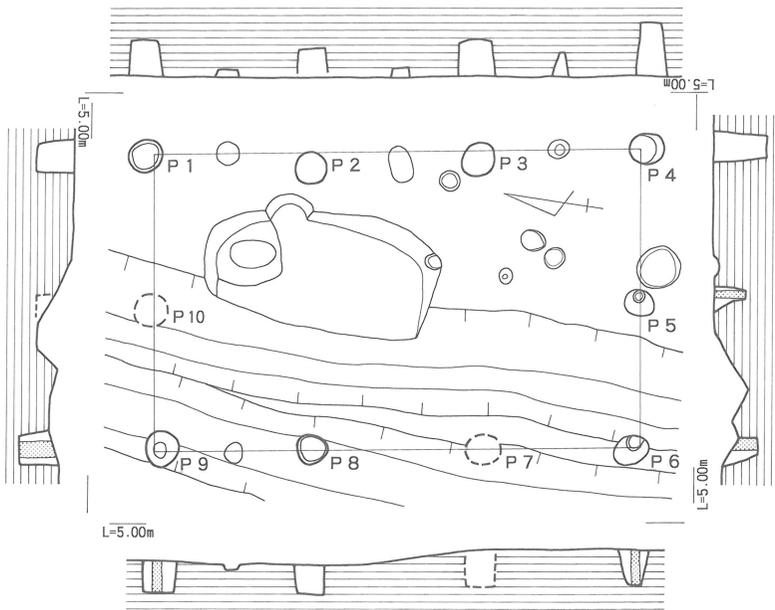

S B - 133



第63図 掘立柱建物-47 (1/100)

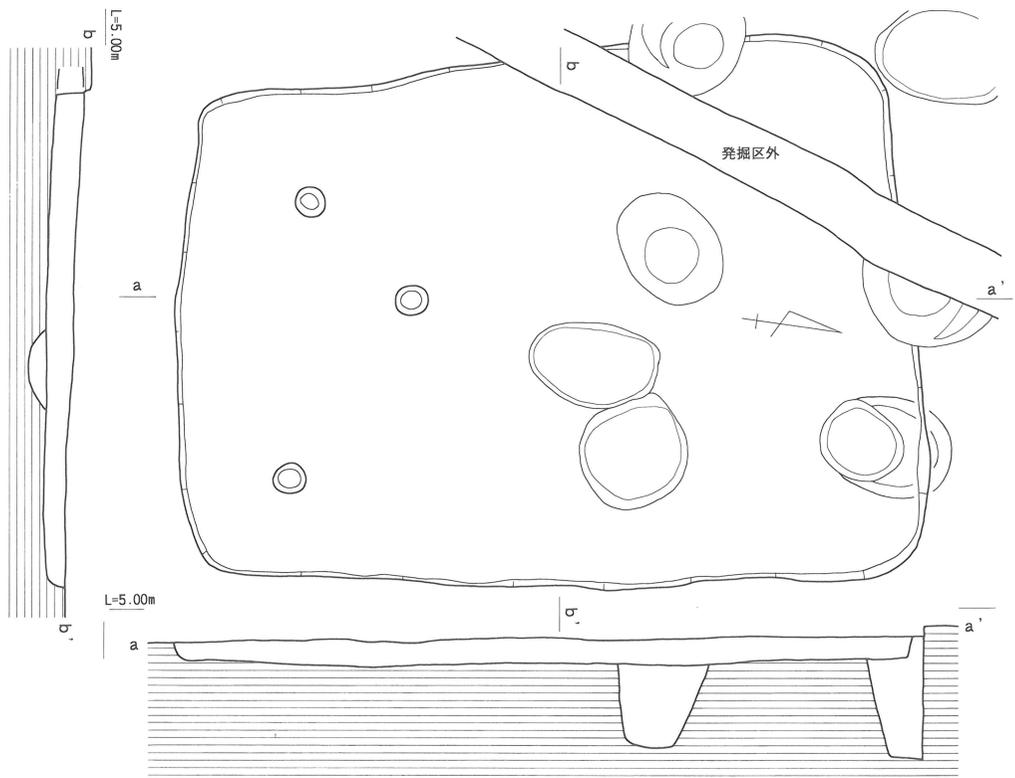

S B - 137

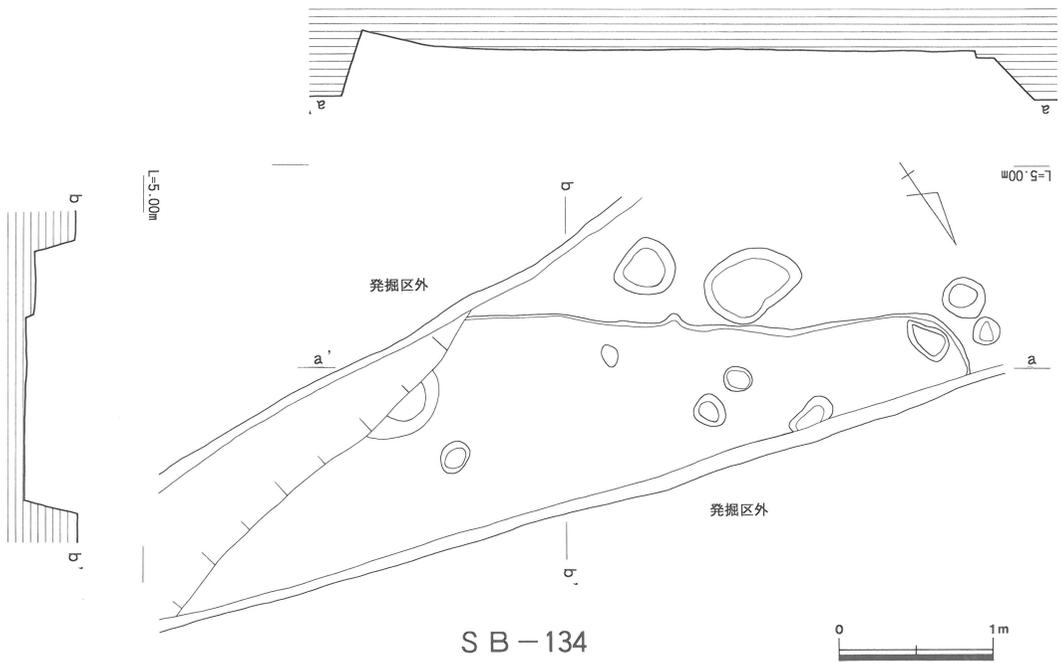

S B - 134

第64图 豎穴住居-1 (1/50)

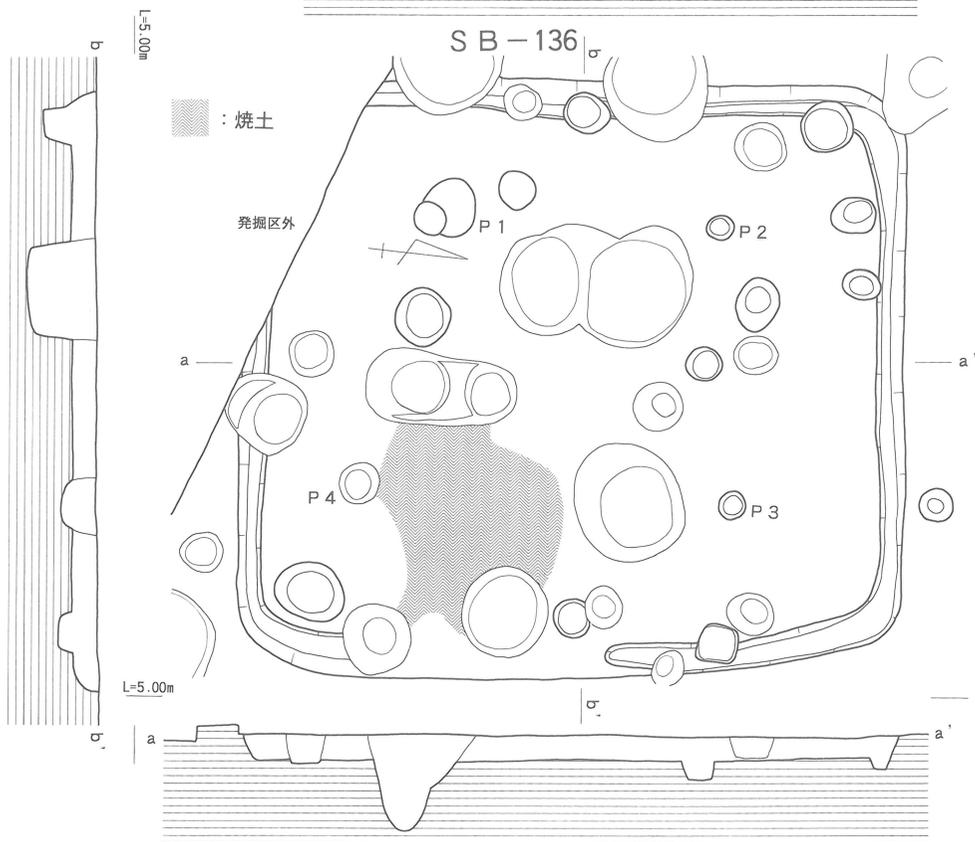
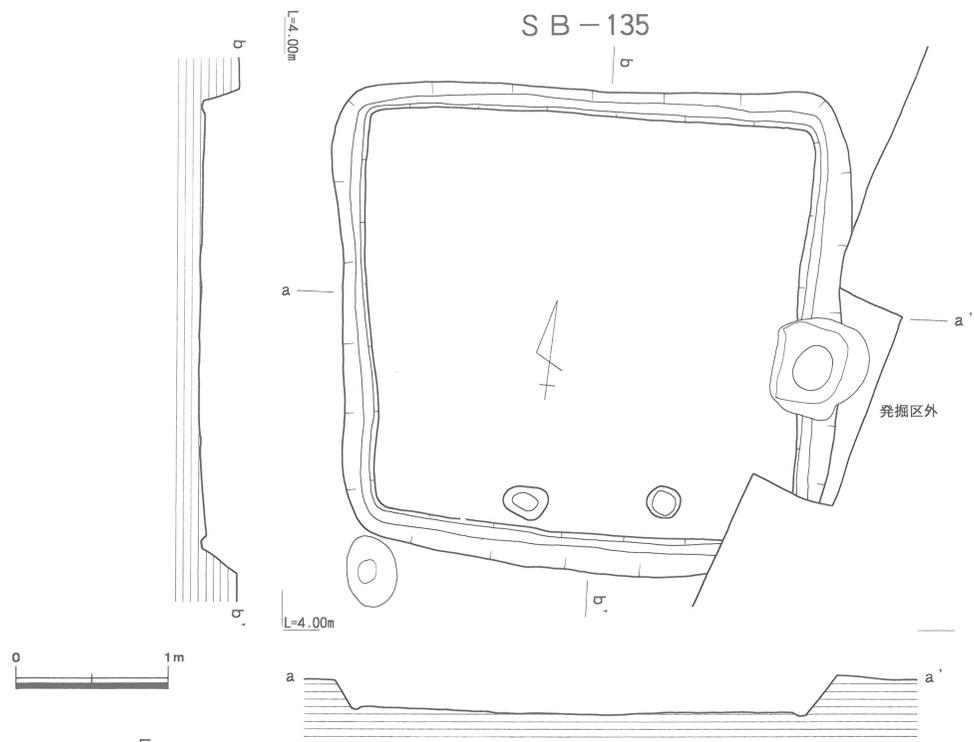

第65图 竖穴住居-2 (1/50)

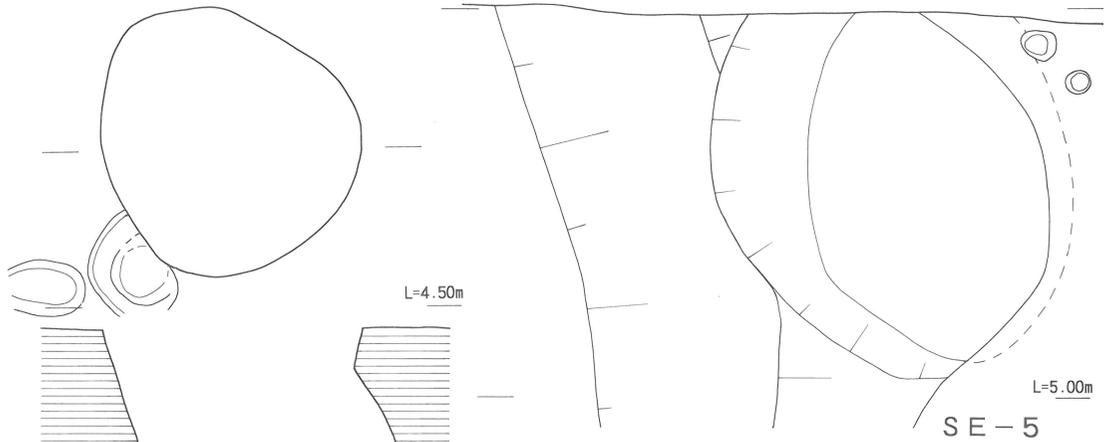

SE-4

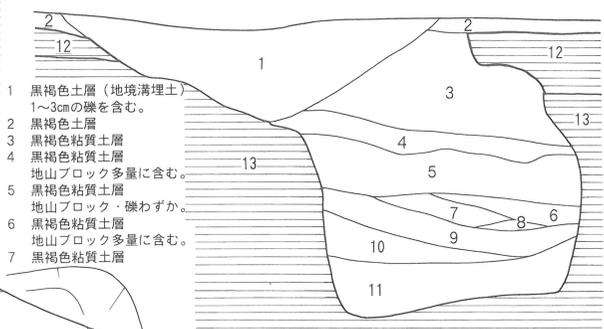
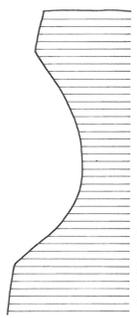

- 1 黒褐色土層 (地境溝埋土)
1~3cmの礫を含む。
- 2 黒褐色土層
- 3 黒褐色粘質土層
- 4 黒褐色粘質土層
地山ブロック多量に含む。
- 5 黒褐色粘質土層
地山ブロック・礫わずか。
- 6 黒褐色粘質土層
地山ブロック多量に含む。
- 7 黒褐色粘質土層

- 8 黄褐色砂礫層 (地山ブロック)
- 9 黒褐色粘質土層
地山ブロック多量に含む。
- 10 黒褐色粘質土層
地山ブロック・礫わずか。
- 11 黒褐色粘質土層 (地山)
- 12 赤褐色粘質土層 (地山)
- 13 黄褐色砂礫層 (地山)

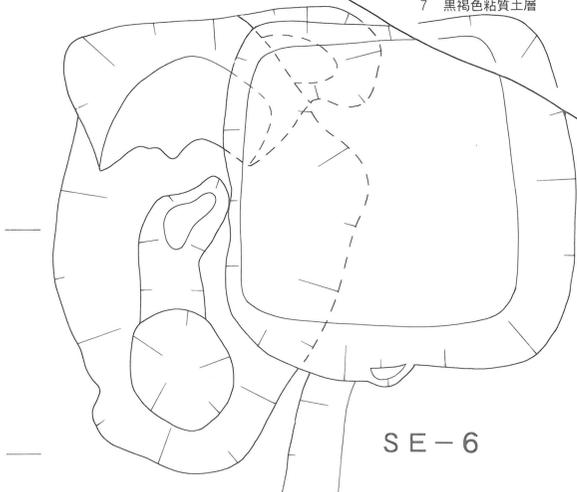

SE-6

L=5.00m

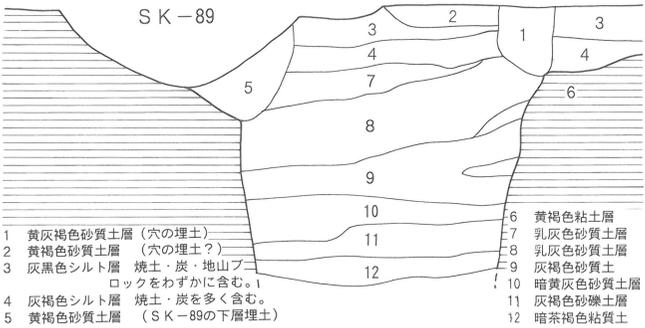
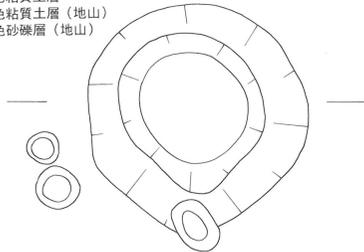

- 1 黄灰褐色砂質土層 (穴の埋土)
- 2 黄褐色砂質土層 (穴の埋土?)
- 3 灰黒色シルト層 焼土・炭・地山ブ
ロックをわずかに含む。
- 4 灰褐色シルト層 焼土・炭を多く含む。
- 5 黄褐色砂質土層 (SK-89の下層埋土)

- 6 黄褐色粘土層 (地山)
- 7 乳灰色砂質土層 (SE-6埋土) 礫が混じる。
- 8 乳灰色砂質土層 (SE-6埋土)
- 9 灰褐色砂質土層 (SE-6埋土) 礫が混じる。
- 10 暗黄灰色砂質土層 (SE-6埋土)
- 11 灰褐色砂礫層 (SE-6埋土)
- 12 暗茶褐色粘質土 (SE-6埋土)

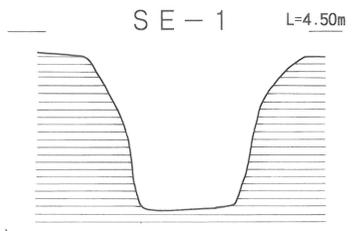

SE-1

L=4.50m



第66図 井戸 (1/50)

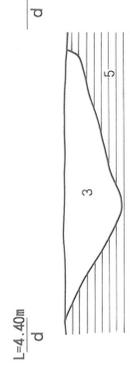
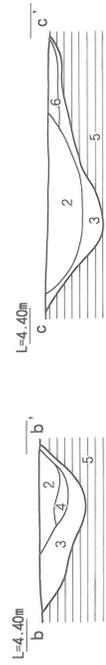
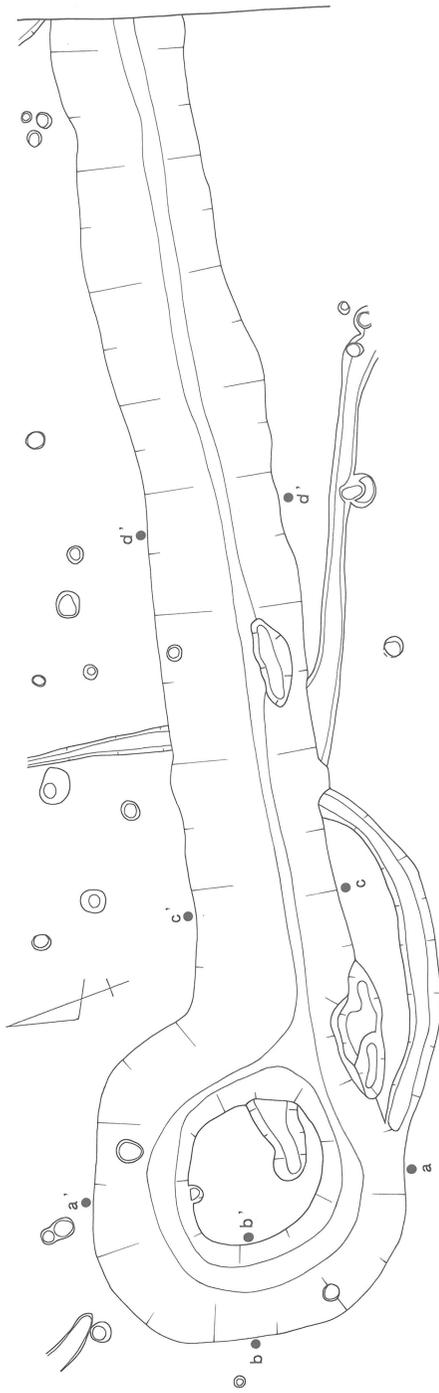

- 1 黒褐色土層
- 2 貝層 (張り直しの溝)
- 3 黒灰色土層
- 4 暗褐色土層
- 5 黄褐色土層 (地山)
- 6 混貝土層

第67図 不明遺構 (S X - 1) (1/50)



第68図 不明遺構 (SX-2) - 1 (1/50)



6次・SD-2

a L=5.00m

b L=5.00m

c L=5.00m

d L=5.00m



- 1 灰黒色シルト層 焼土・炭・地山ブロックをわずかに含む。
- 2 黄灰色シルト層 わずかに黒色土ブロックを含む。
- 3 灰褐色シルト層 焼土・炭を多く含む。
- 4 暗黄褐色粘土層 焼土・炭の小片をこくわずかに含む。地山に灰黒色土が理じった程度。
- 5 黄褐色粘土層 (地山)
- 6 暗灰褐色シルト層 焼土・炭をわずかに含む。
- 7 暗黄褐色シルト層 2層より黒色土ブロックが多い。
- 8 灰褐色シルト層 (柱痕跡) 焼土・炭の小片をこくわずかに含む。
- 9 明黄褐色シルト層 (掘方) 焼土・炭の小片をこくわずかに含む。8層より少ない。
- 10 灰黒色シルト層 炭を多量に含む。焼土ブロックを少量含む。
- 11 明灰黒色シルト層 焼土・炭の小片をこくわずかに含む。地山ブロックを含む。
- 12 明灰黒色粘土層 焼土・炭の小片をこくわずかに含む。
- 13 黒色土層 (穴の埋土) 焼土・炭の小片を含む。
- 14 黄灰色シルト層 焼土・炭はほとんど含まない。3層より地山ブロックが多い。
- 15 灰褐色シルト層 (穴の埋土) 地山ブロックを多く含む。
- 16 灰黒色シルト層 (穴の埋土) 焼土・炭をわずかに含む。
- 17 灰黒色シルト層 (穴の埋土) 焼土・炭を少し含む。
- 18 明灰黒色シルト層 (穴の埋土) 焼土・炭の小片を多く含む。

- 19 灰褐色シルト層 (穴の埋土) 地山ブロックを多く含む。16層と類似している。
- 20 灰黒色シルト層 (穴の埋土) 焼土・炭の小ブロックを含む。
- 21 暗黄褐色粘質シルト層 (穴の埋土) 1~3cm次の隙をわずかに含む。かなり地山に近い。
- 22 黄褐色粘質土層 (穴の埋土?)

- 23 黄灰褐色砂質土層 (穴の埋土)
- 24 黄灰褐色砂質土層 (SK-88の下層埋土)
- 25 灰褐色土層 (6次・SD-2埋土)
- 26 灰黒色土層 焼土ブロックを含む。(SK-57埋土)

第69図 不明遺構 (SX-2) - 2 (1/50)

- 1 灰黒色シルト層
- 2 灰褐色シルト層
- 3 灰褐色シルト層
- 4 暗黄褐色粘土層
- 5 黄褐色粘土層
- 6 暗灰褐色シルト層
- 7 暗黄褐色シルト層
- 8 灰褐色シルト層
- 9 明黄褐色シルト層
- 10 明灰褐色シルト層
- 11 明灰黒色シルト層
- 12 黒色シルト層
- 13 黄灰色シルト層
- 14 灰褐色シルト層
- 15 灰褐色シルト層
- 16 灰黒色シルト層
- 17 明灰褐色シルト層
- 18 灰褐色シルト層
- 19 暗灰褐色砂質シルト層
- 20 暗黄褐色砂質シルト層
- 21 黄褐色砂質シルト層
- 22 黄褐色砂質シルト層
- 23 黄褐色砂質シルト層
- 24 黄褐色砂質シルト層
- 25 灰褐色土層
- 26 灰黒色土層

焼土・炭・地山アロロックをわずかに含む。
 わずかに黒色土アロロックを含む。
 焼土・炭を多く含む。
 焼土・炭の小片をこくわずかに含む。地山に灰黒色土が混じった層状。
 (地山)
 焼土・炭をわずかに含む。
 2層より黒色土アロロックが多い。
 (柱痕跡) 焼土・炭の小片をこくわずかに含む。
 (腹方) 焼土・炭の小片をこくわずかに含む。8層より少ない。
 炭を多量に含む。焼土アロロックを少量含む。
 焼土・炭の小片をこくわずかに含む。
 焼土・炭の小片をこくわずかに含む。地山アロロックを含む。
 (穴の埋土) 焼土・炭の小片を含む。
 焼土・炭はほとんど含まない。3層より地山アロロックが多い。
 (穴の埋土) 地山アロロックを多く含む。
 (穴の埋土) 焼土・炭をわずかに含む。
 (穴の埋土) 焼土・炭を少し含む。
 (穴の埋土) 焼土・炭の小片を少し含む。地山アロロックを多く含む。
 (穴の埋土) 地山アロロックを多く含む。10層と類似している。
 (穴の埋土) 焼土・炭の小片を含む。
 (穴の埋土) 1〜3cm次の隙をわずかに含む。かなり地山に近い。
 (穴の埋土?)
 (穴の埋土)
 (穴の埋土)
 (SK-89の下層埋土)
 (6次・SD-2埋土)
 焼土アロロックを含む。(SK-57埋土)

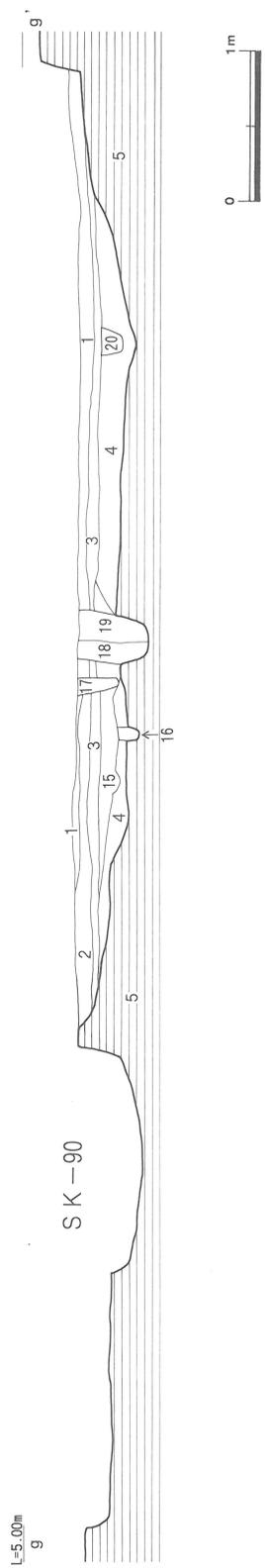
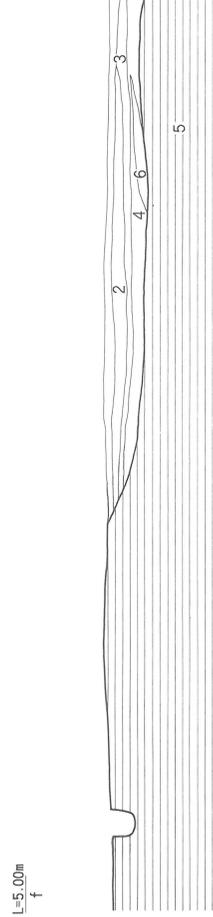
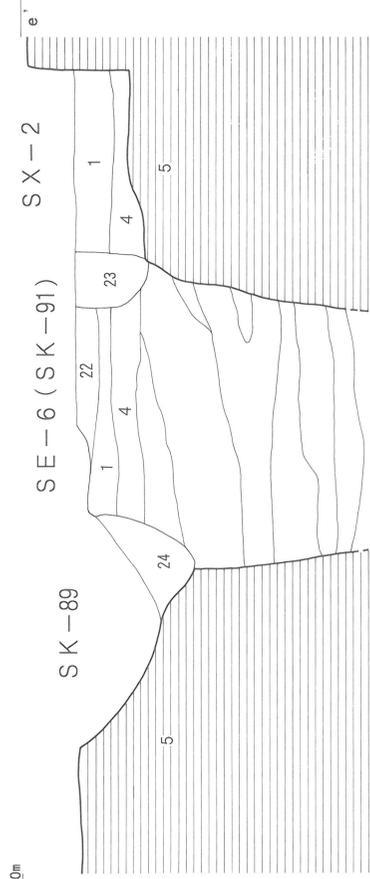

第70図 不明遺構 (SX-2) - 3 (1/50)

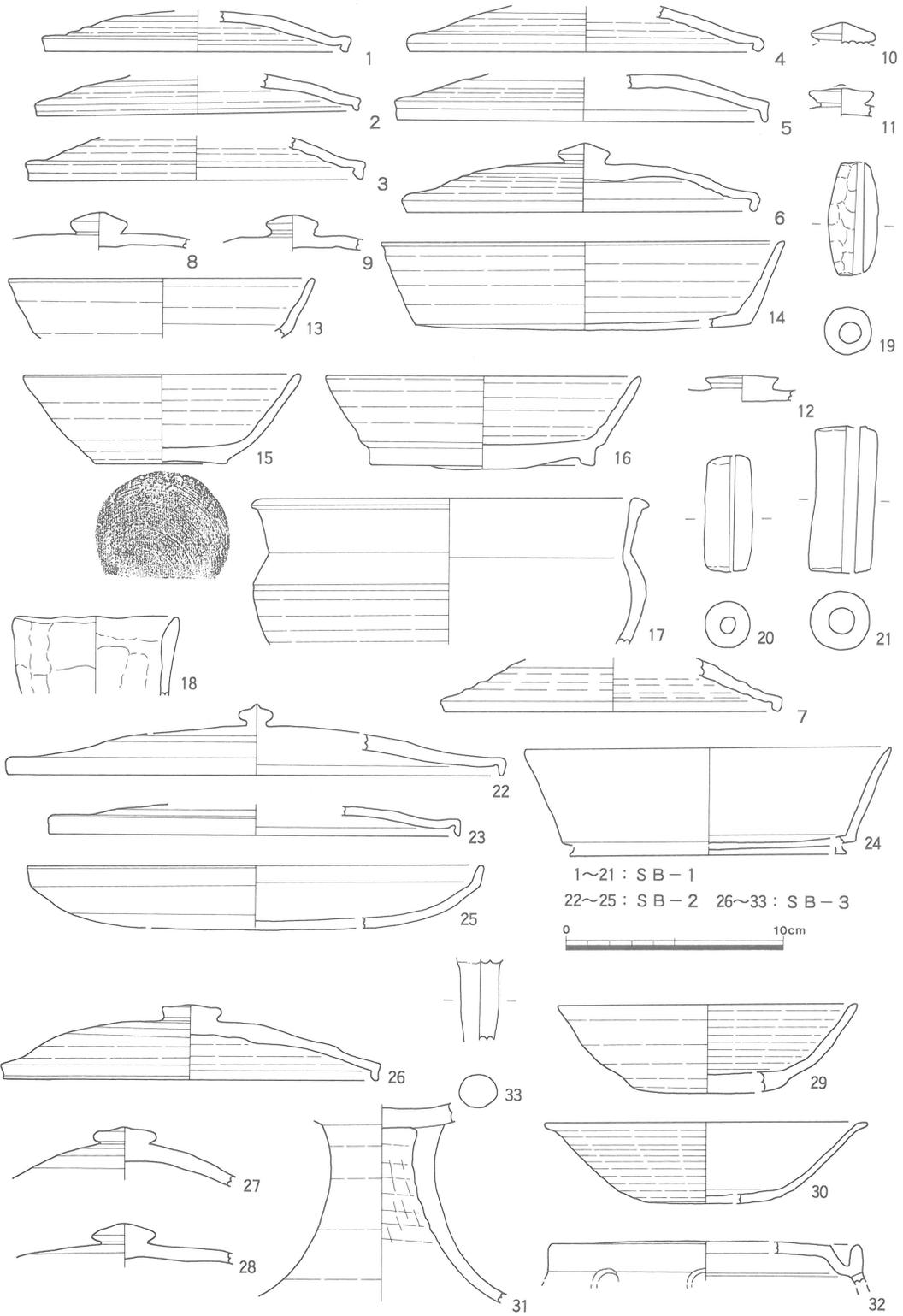

第71图 出土遺物実測図一 1 (1/3)

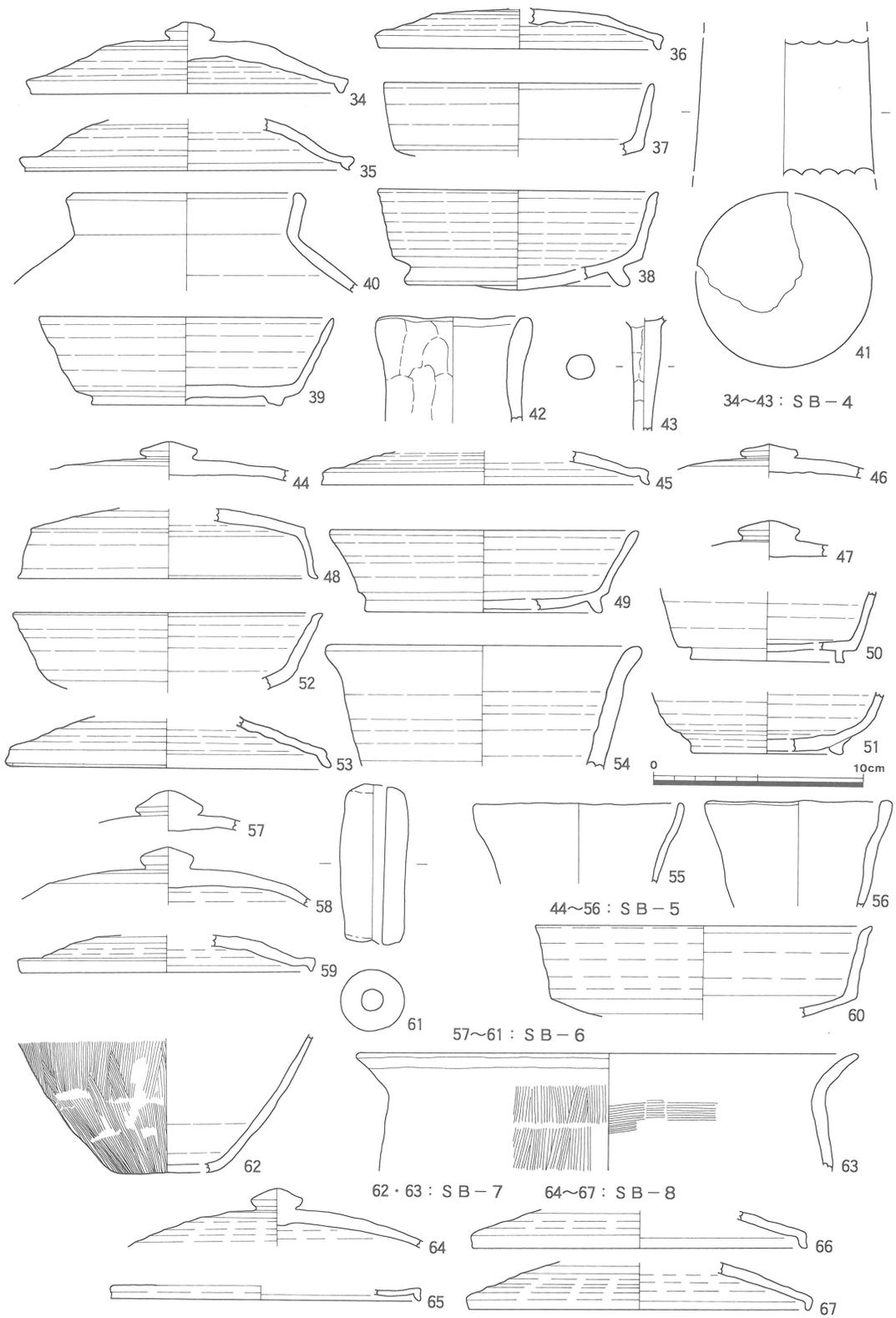

第72図 出土遺物実測図一 2 (1/3)

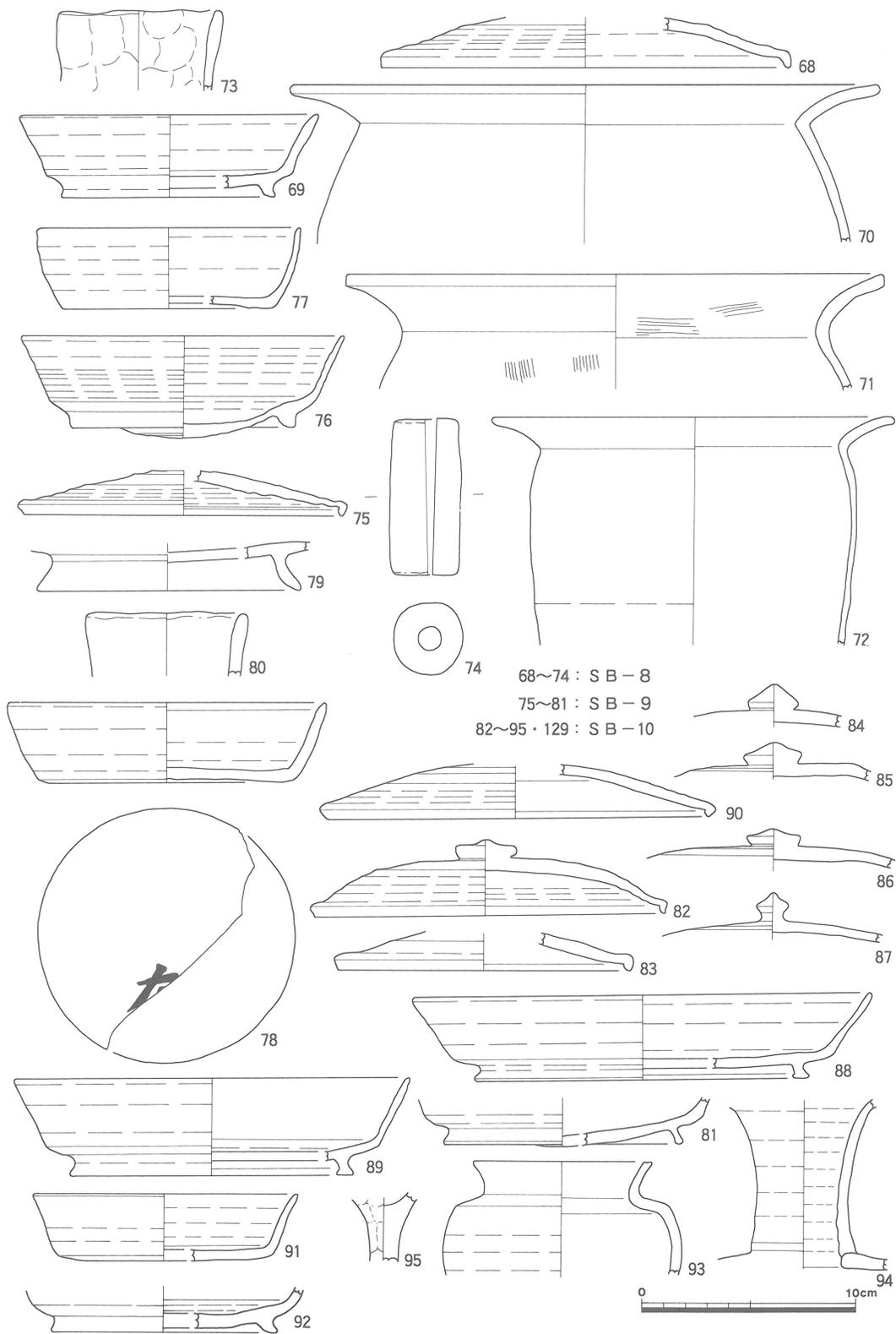

第73図 出土遺物実測図一 3 (1/3)

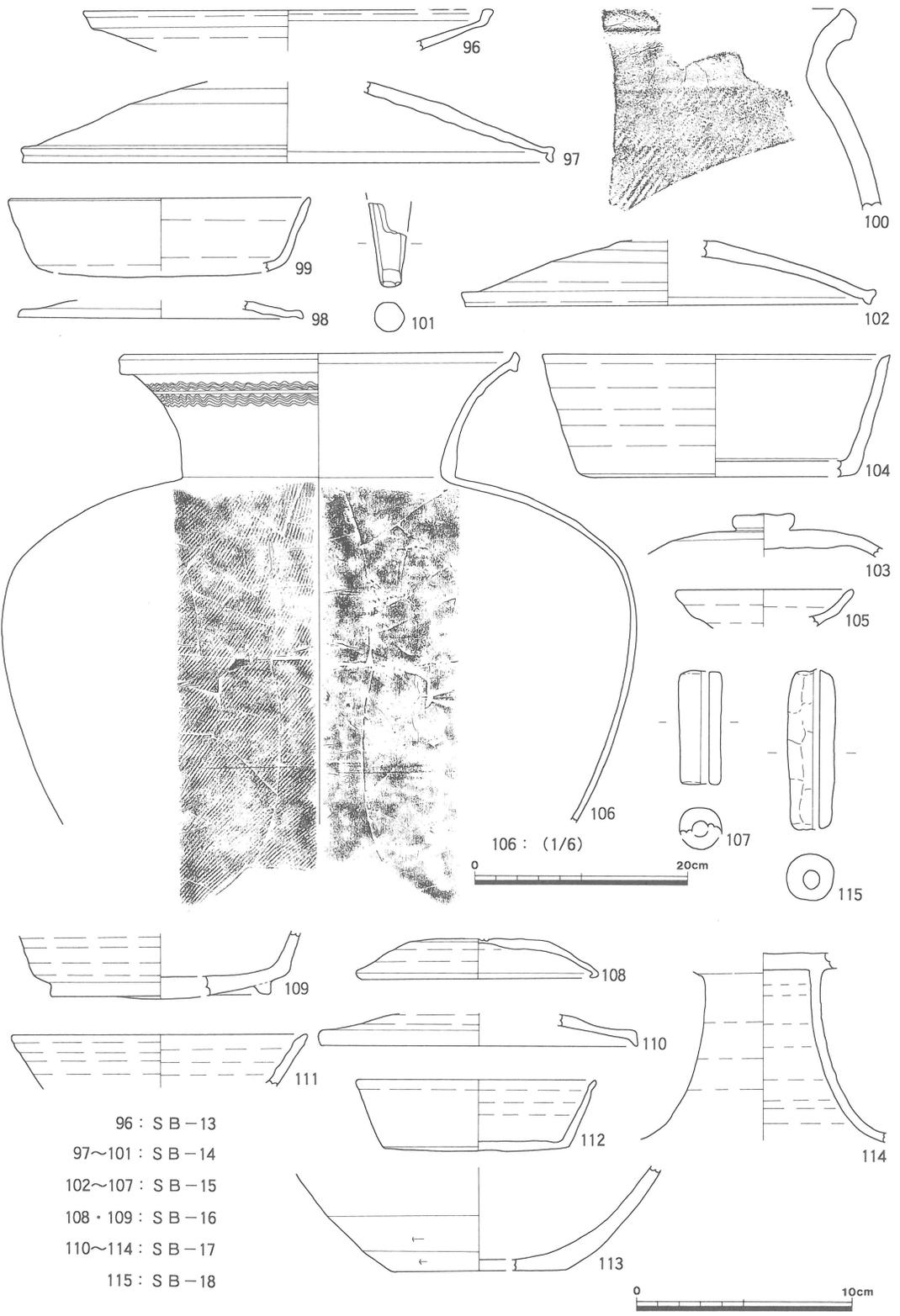

- 96 : S B - 13
- 97 ~ 101 : S B - 14
- 102 ~ 107 : S B - 15
- 108 · 109 : S B - 16
- 110 ~ 114 : S B - 17
- 115 : S B - 18

第74図 出土遺物実測図一 4 (1/3, 1/6)

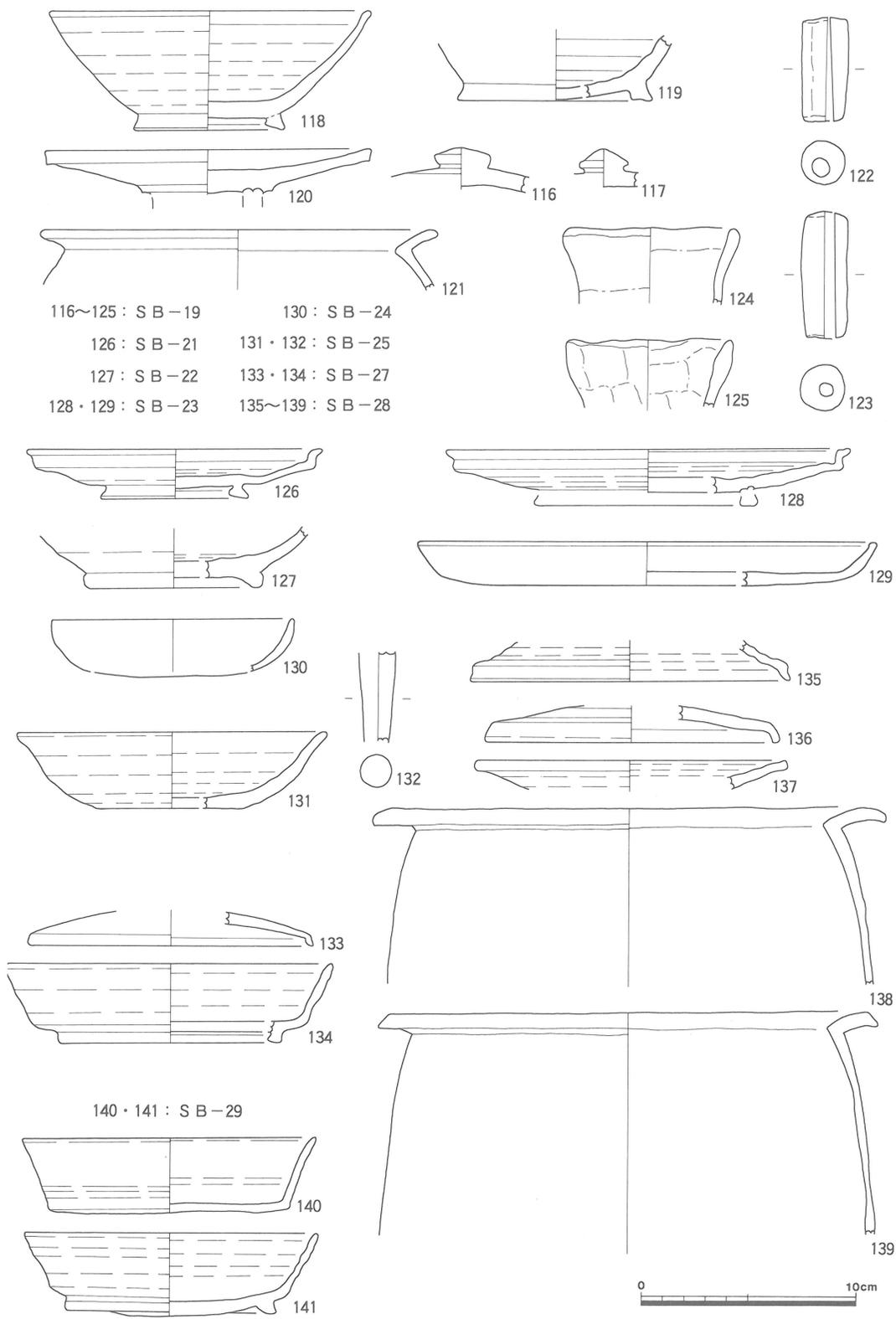

第75図 出土遺物実測図一5 (1/3)

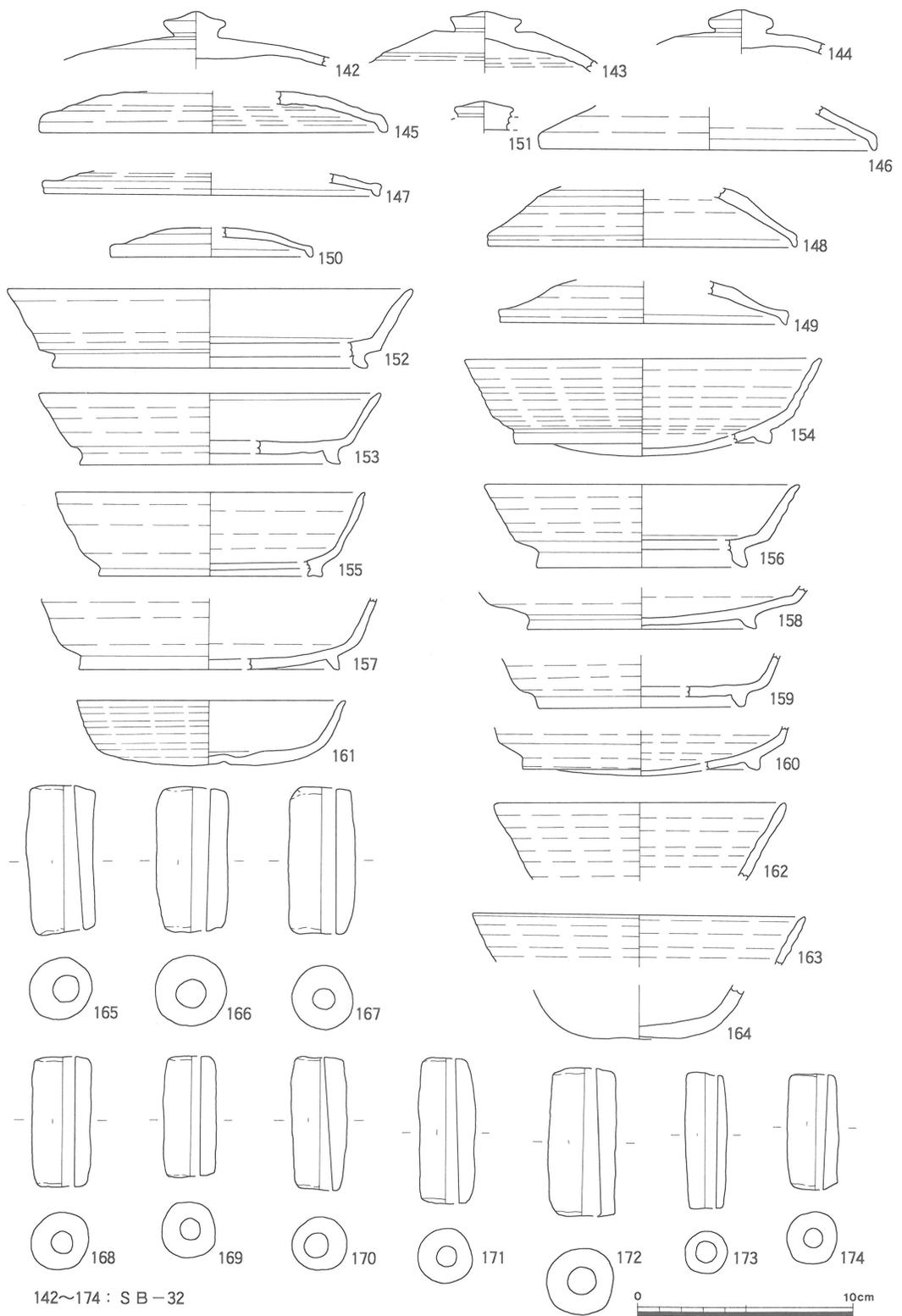

第76图 出土遺物実測図—6 (1/3)

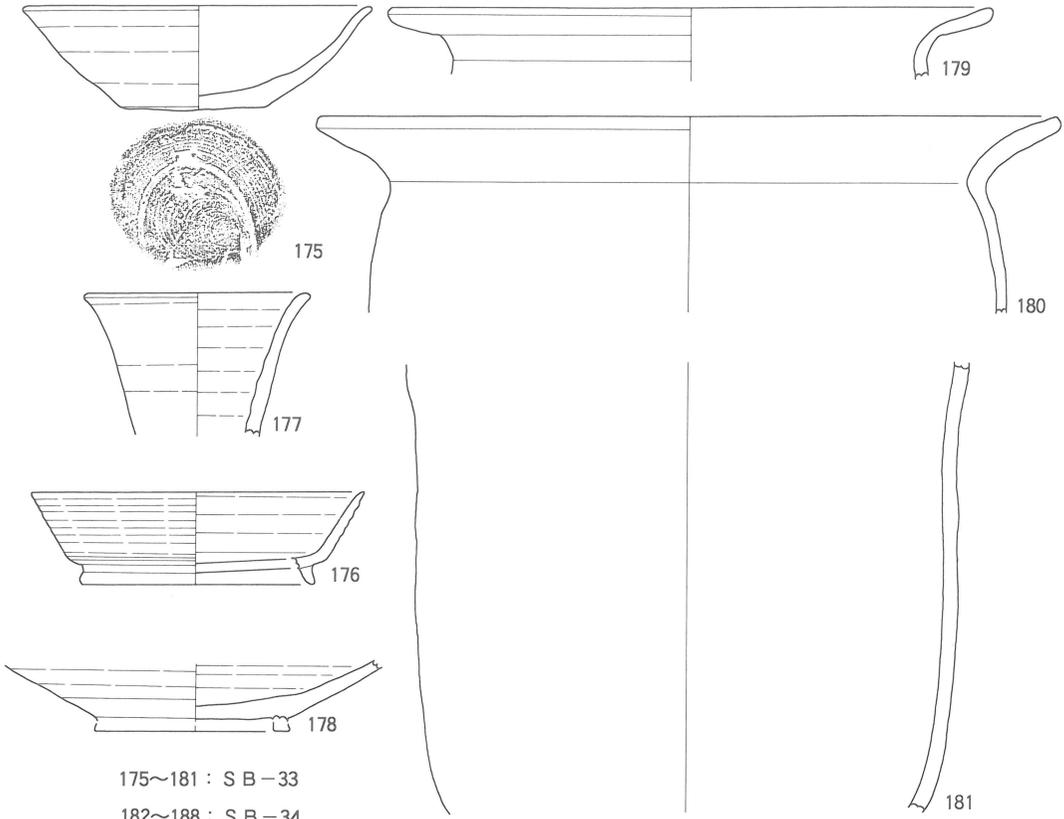

175~181 : S B - 33
 182~188 : S B - 34
 189~191 : S B - 37

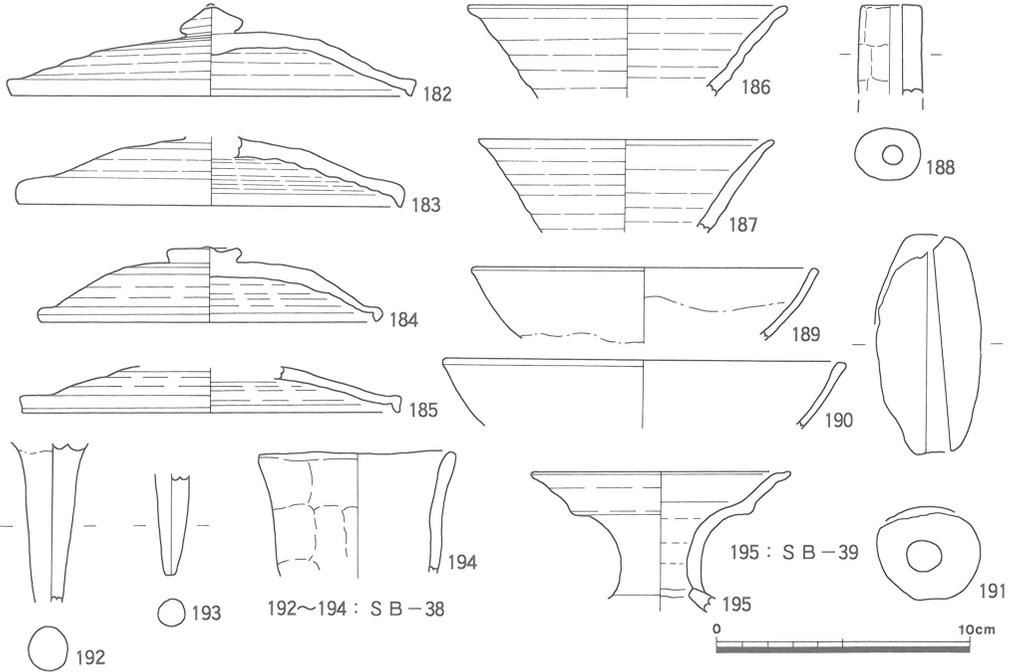

第77図 出土遺物実測図一7 (1/3)

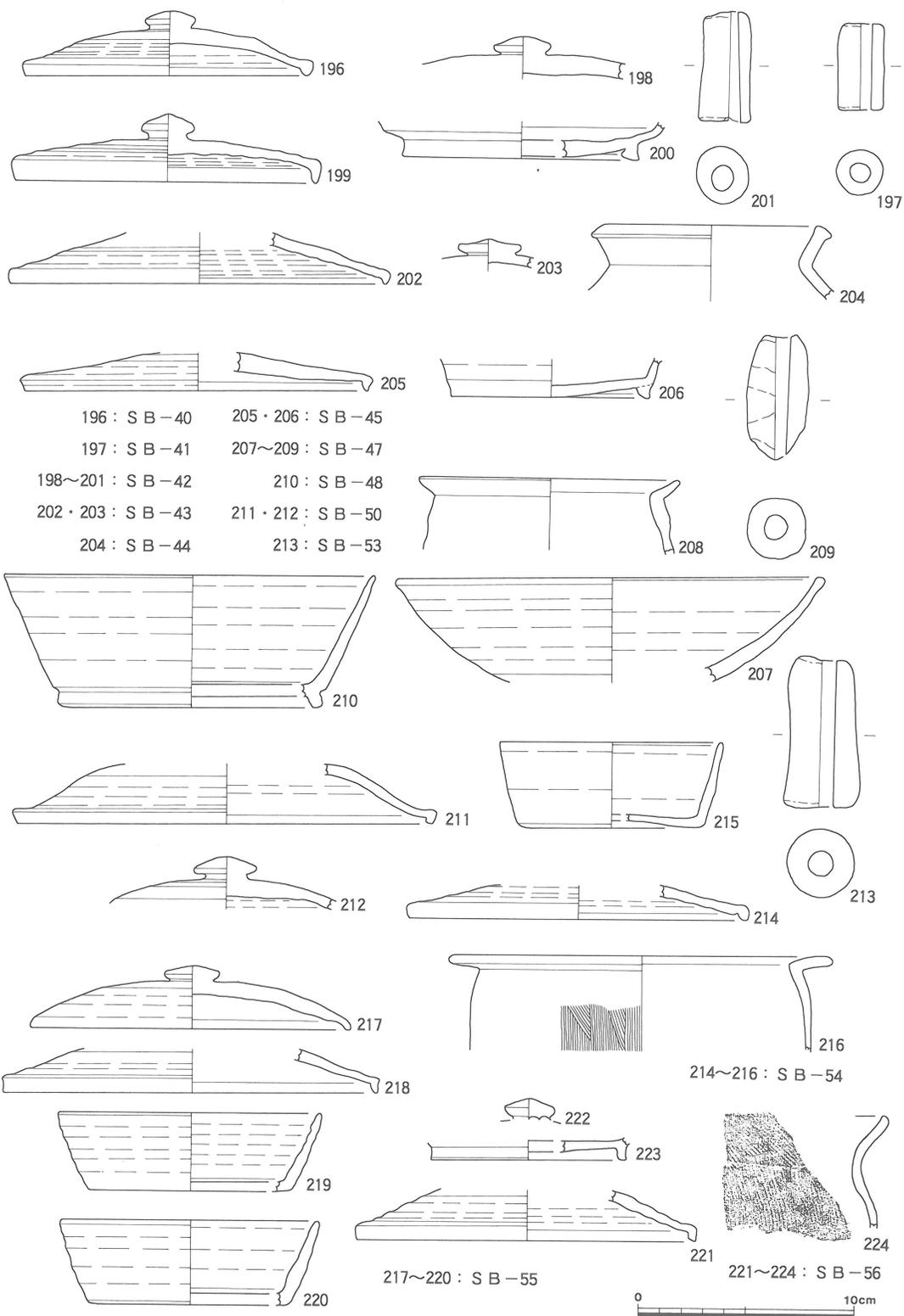

第78図 出土遺物実測図一 8 (1/3)

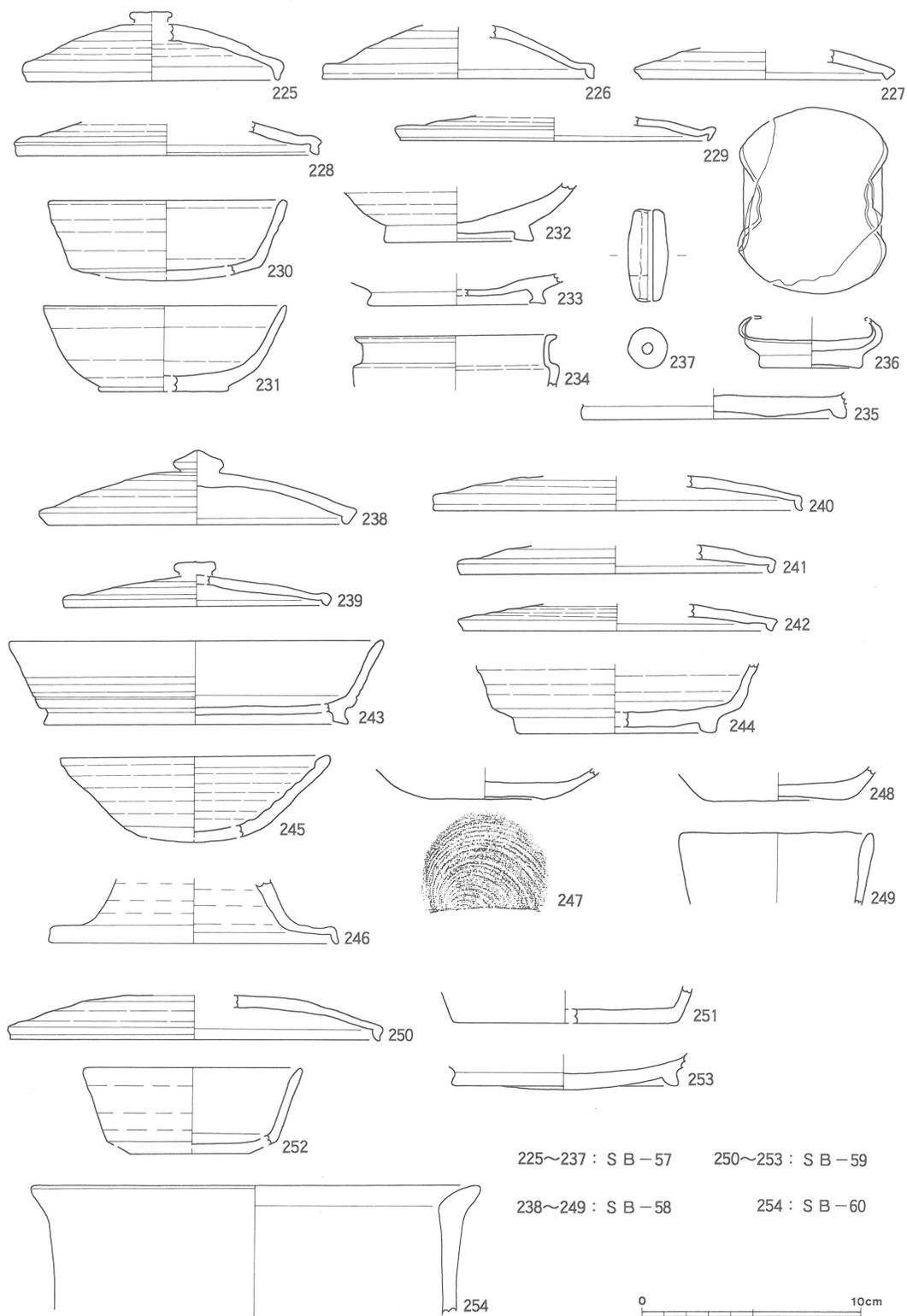

第79図 出土遺物実測図-9 (1/3)

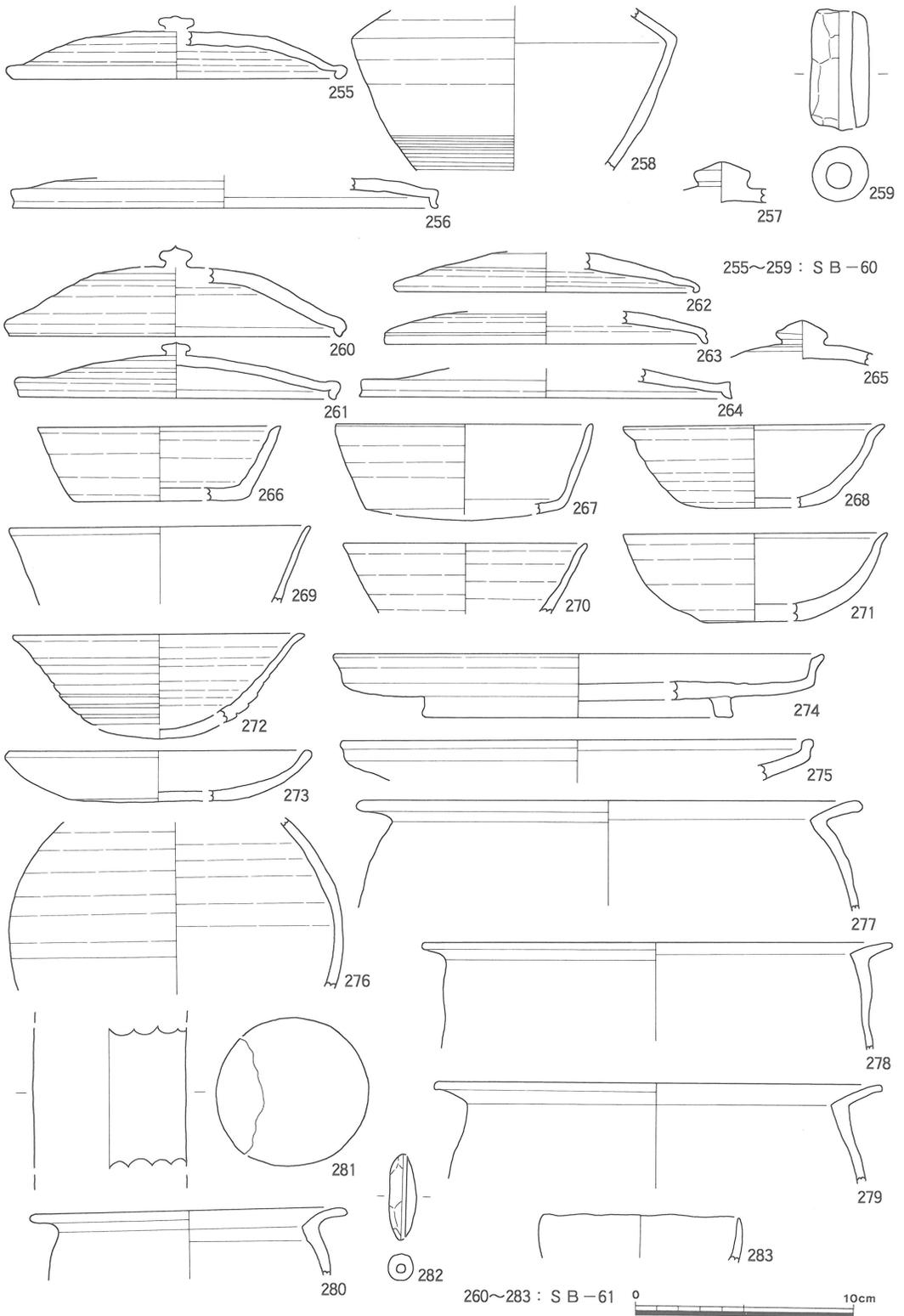

第80図 出土遺物実測図-10 (1/3)

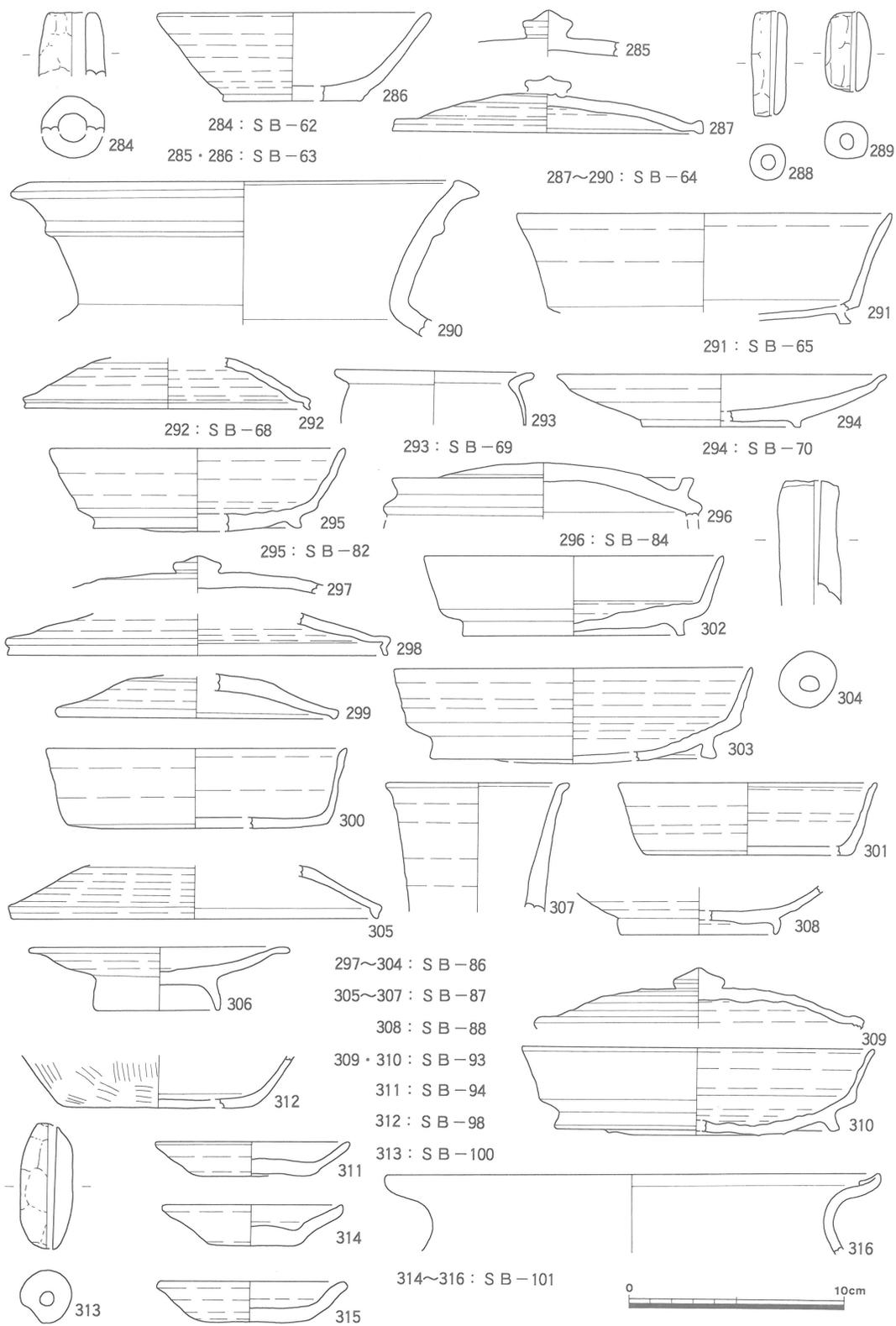

第81図 出土遺物実測図一11 (1/3)

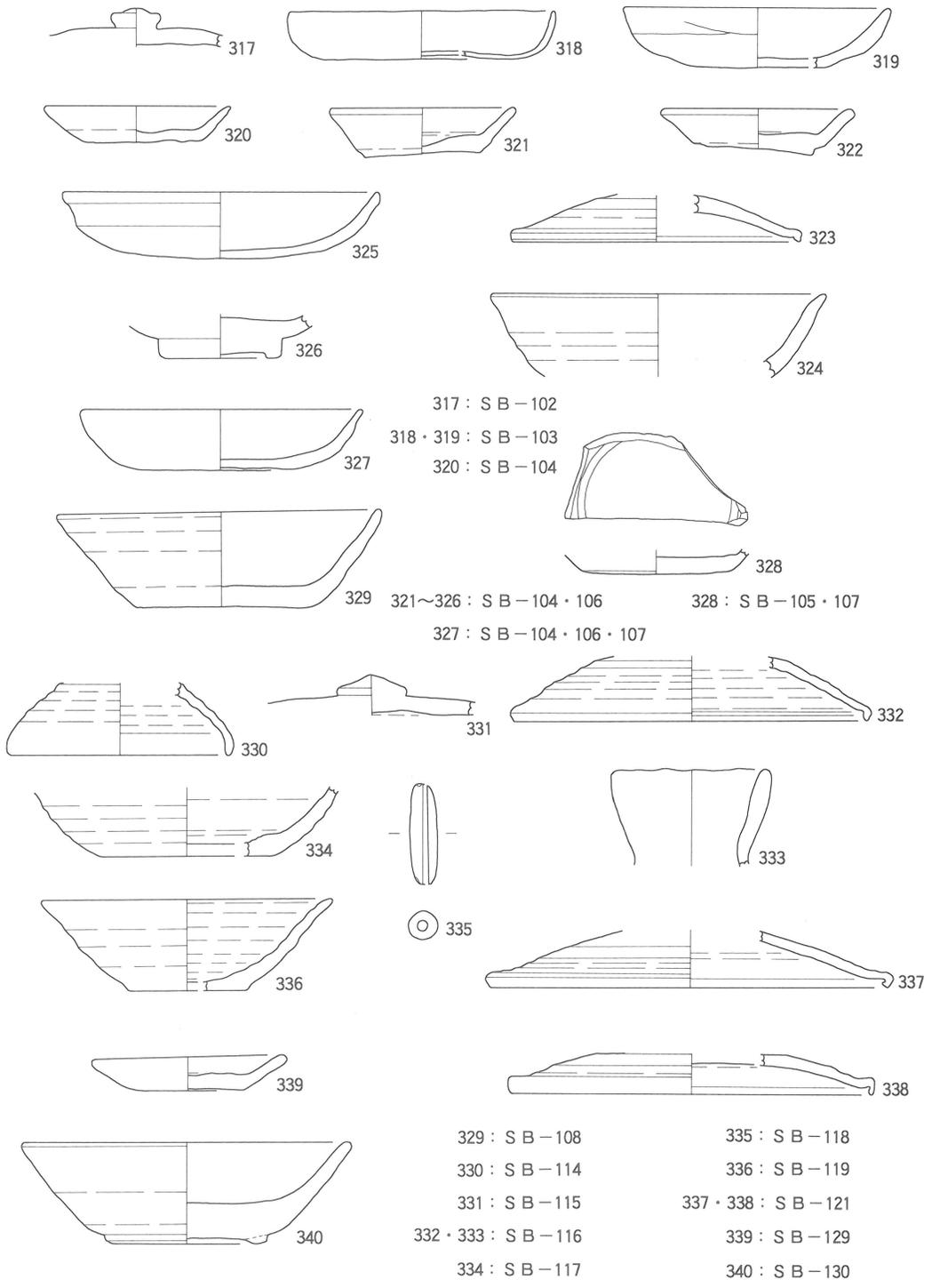

第82図 出土遺物実測図-12 (1/3)

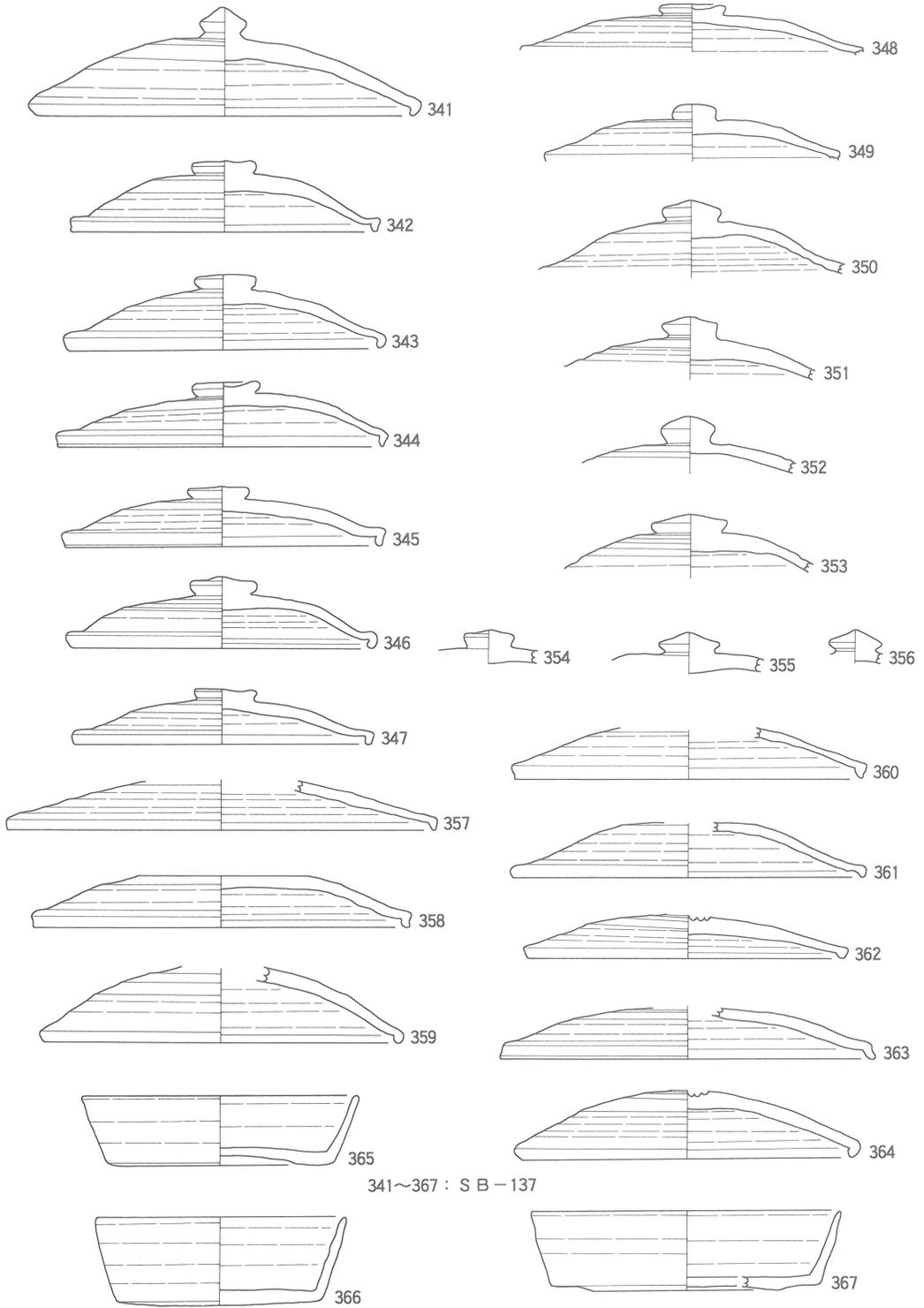

第83图 出土遺物実測図-13 (1/3)

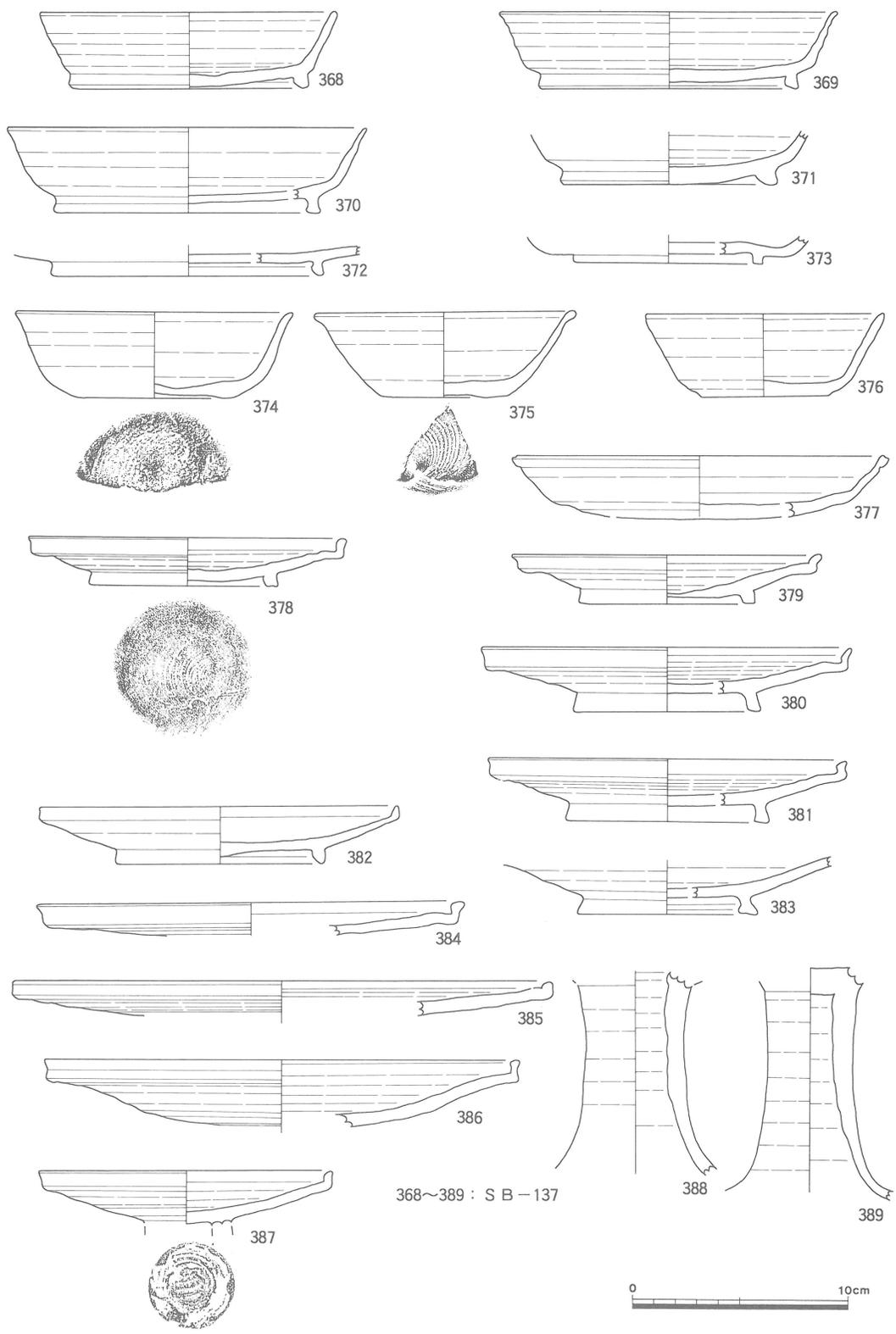

第84図 出土遺物実測図-14 (1/3)

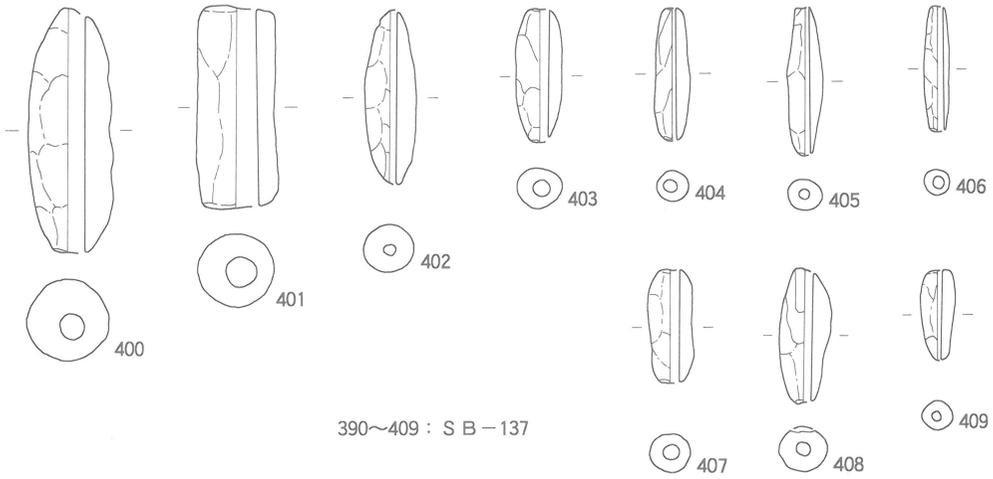
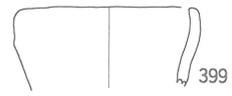
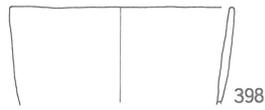
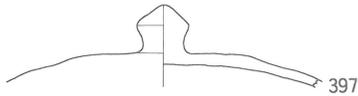
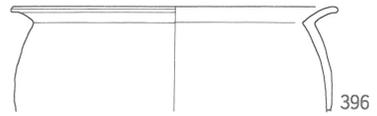
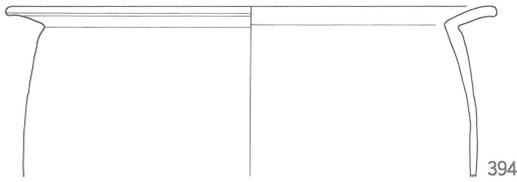
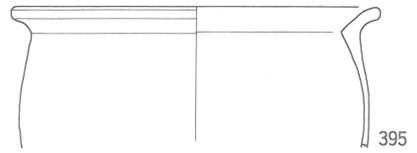
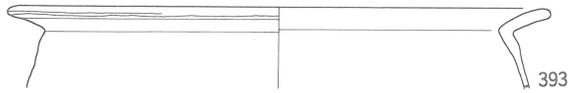
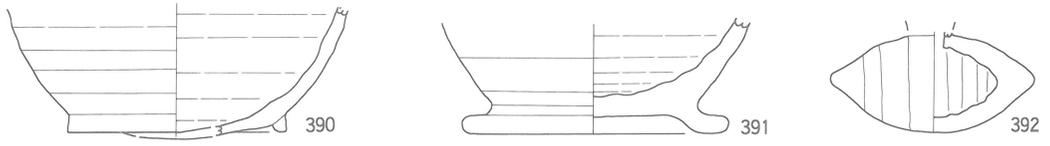

390~409 : S B - 137



410 : S B - 134

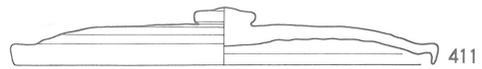

411 : S B - 135



第85図 出土遺物実測図-15 (1/3)

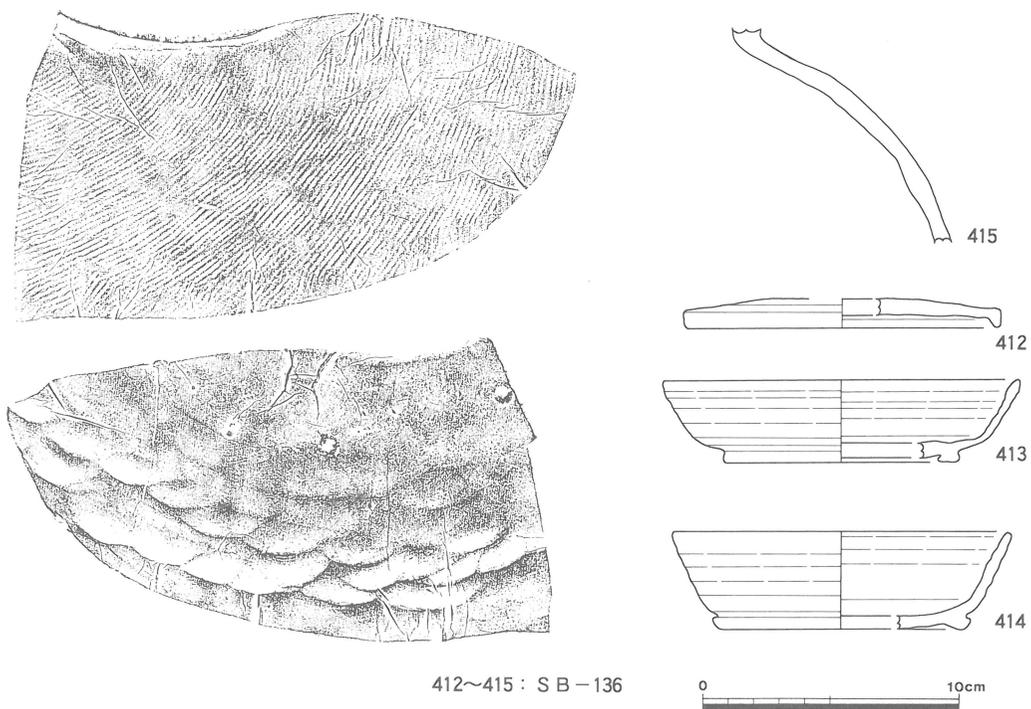

第86図 出土遺物実測図-16 (1/3)

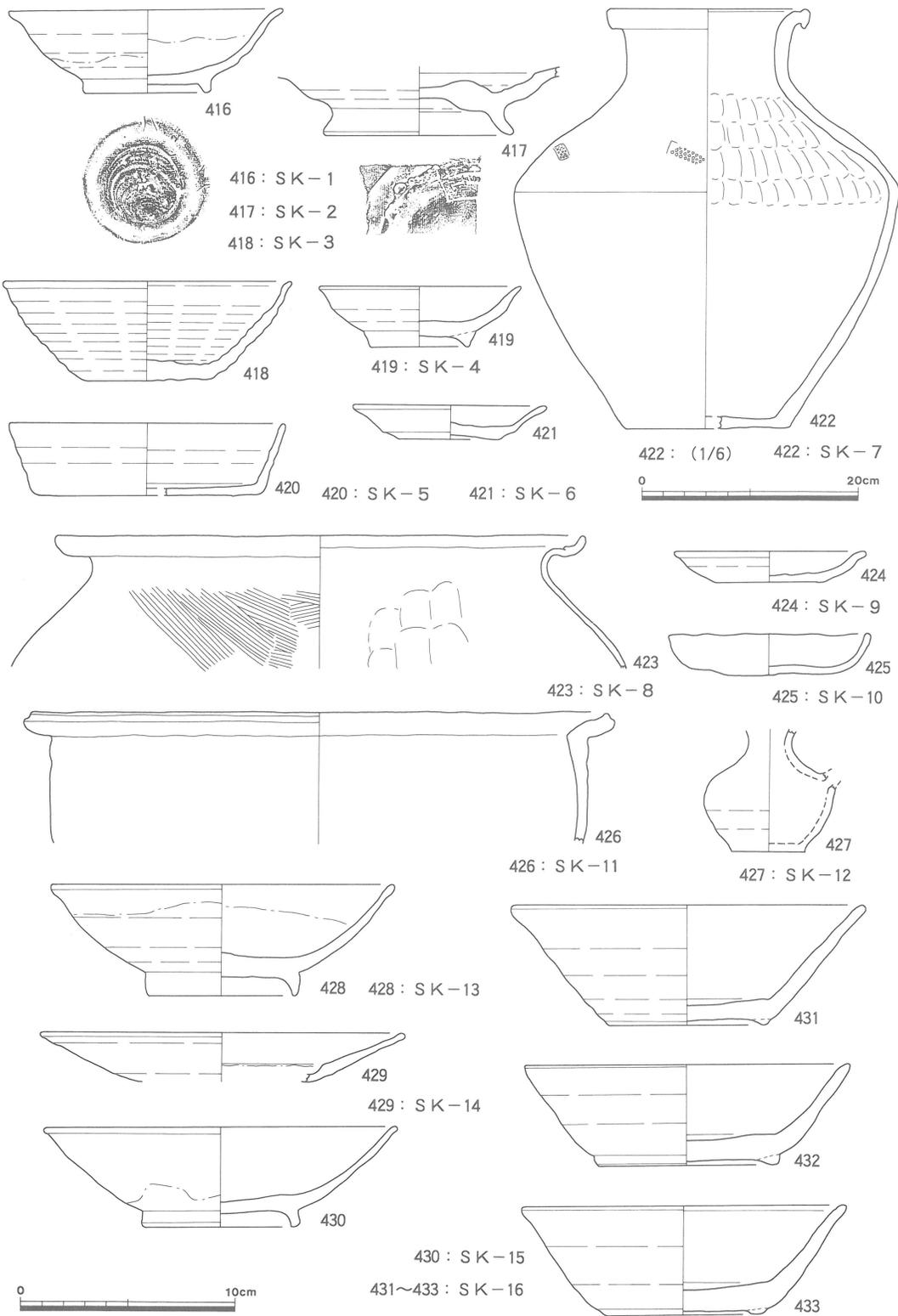

第87図 出土遺物実測図-17 (1/3、1/6)

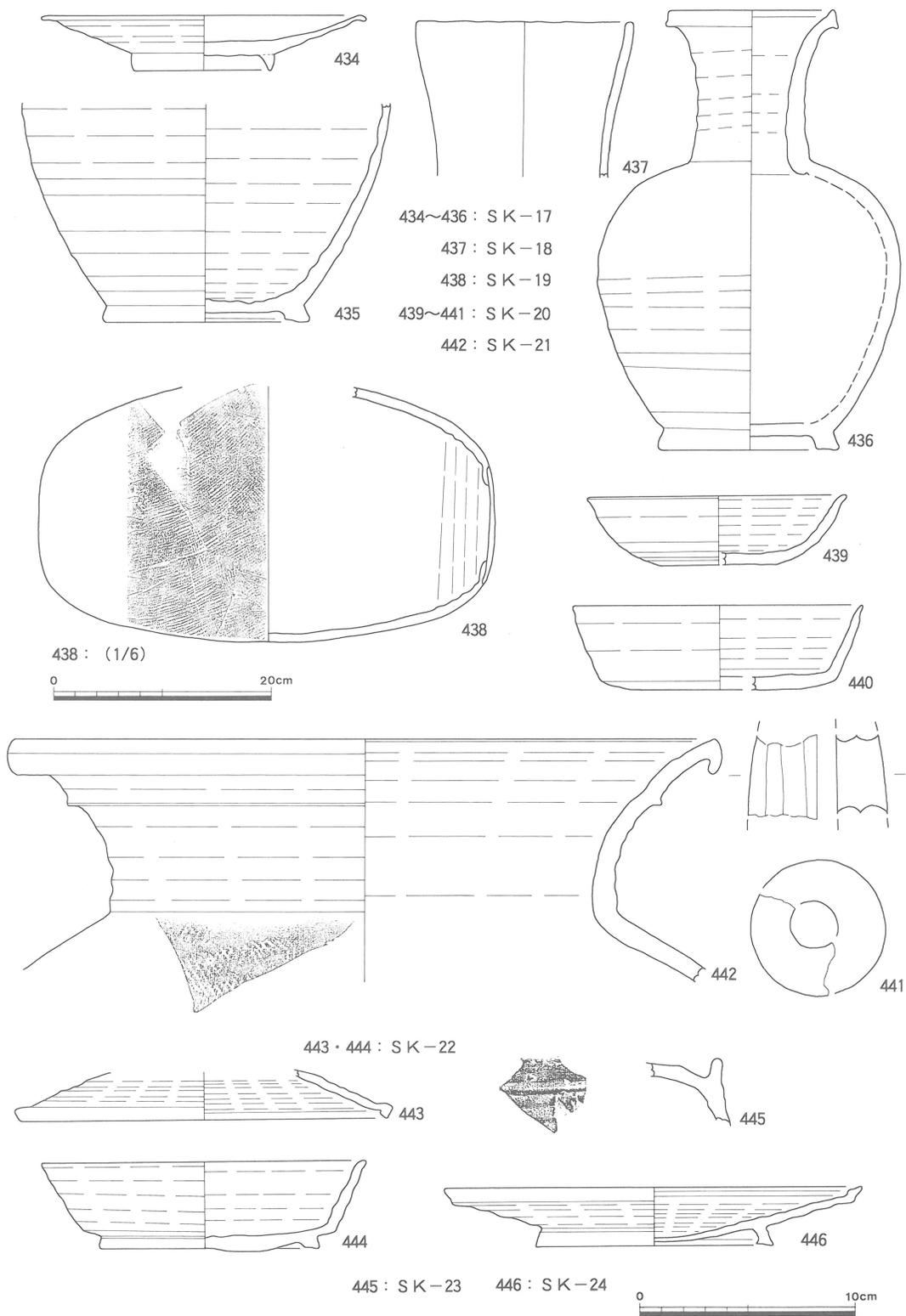

第88図 出土遺物実測図-18 (1/3、1/6)

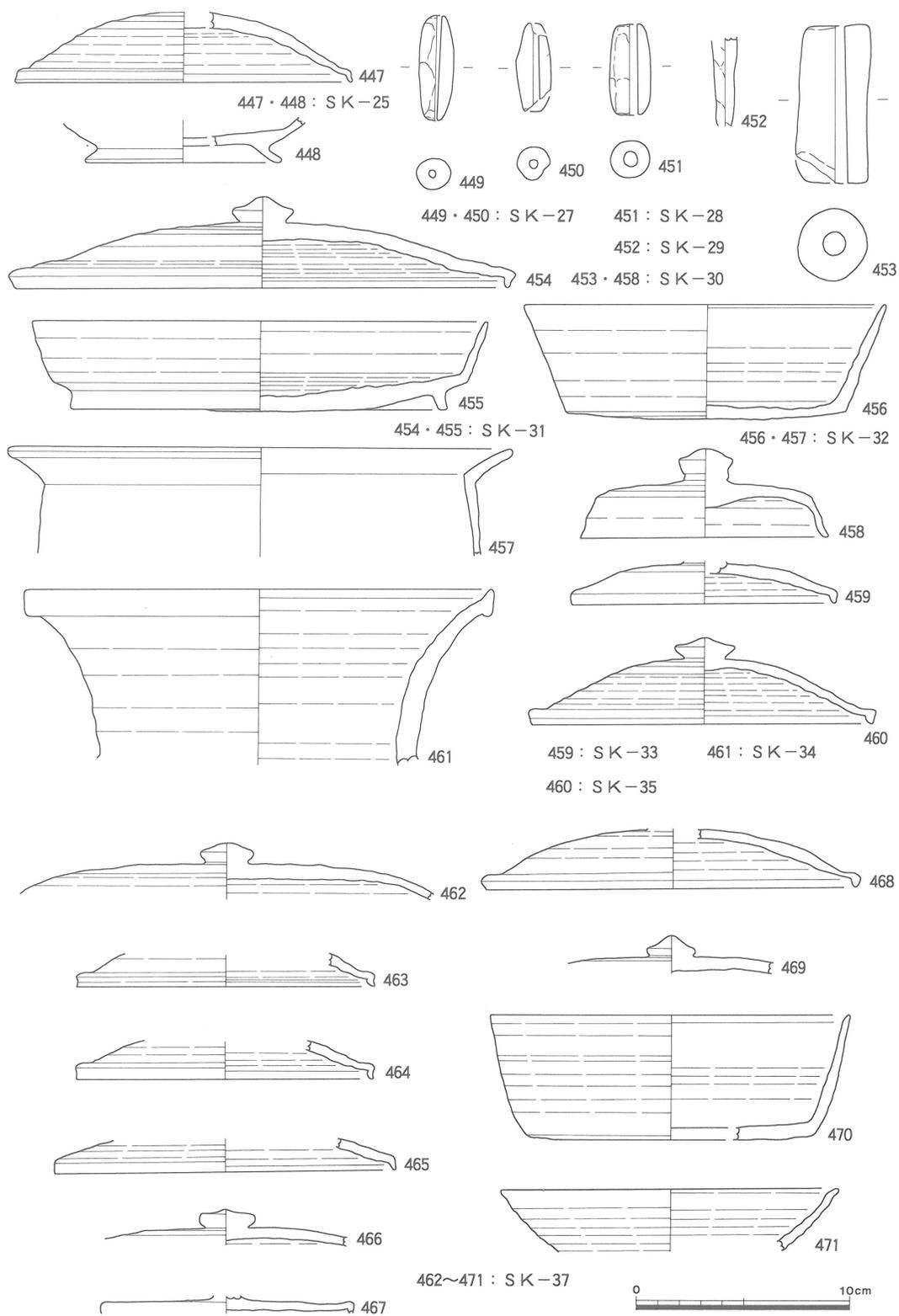

第89図 出土遺物実測図—19 (1/3)

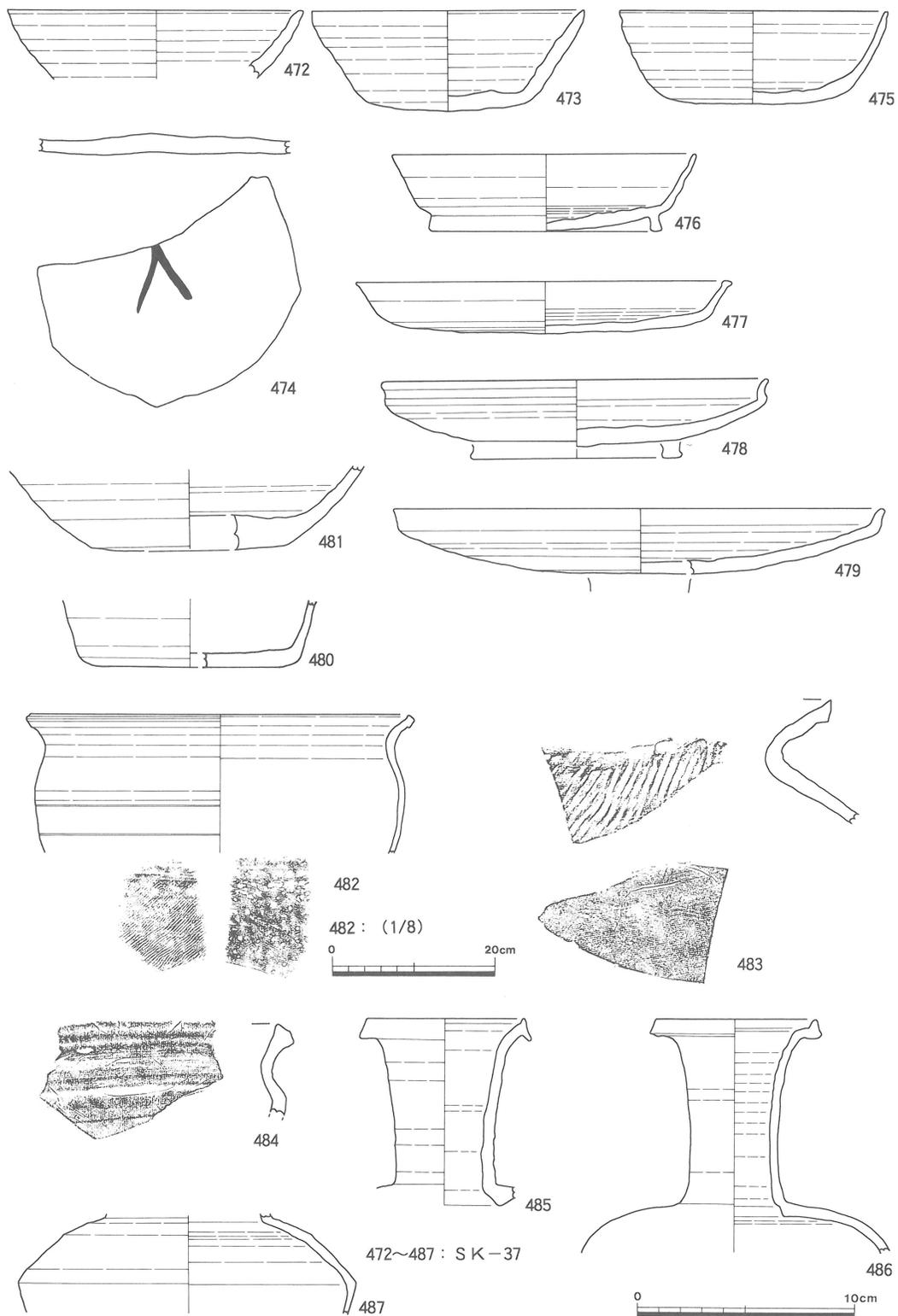

第90図 出土遺物実測図-20 (1/3, 1/8)

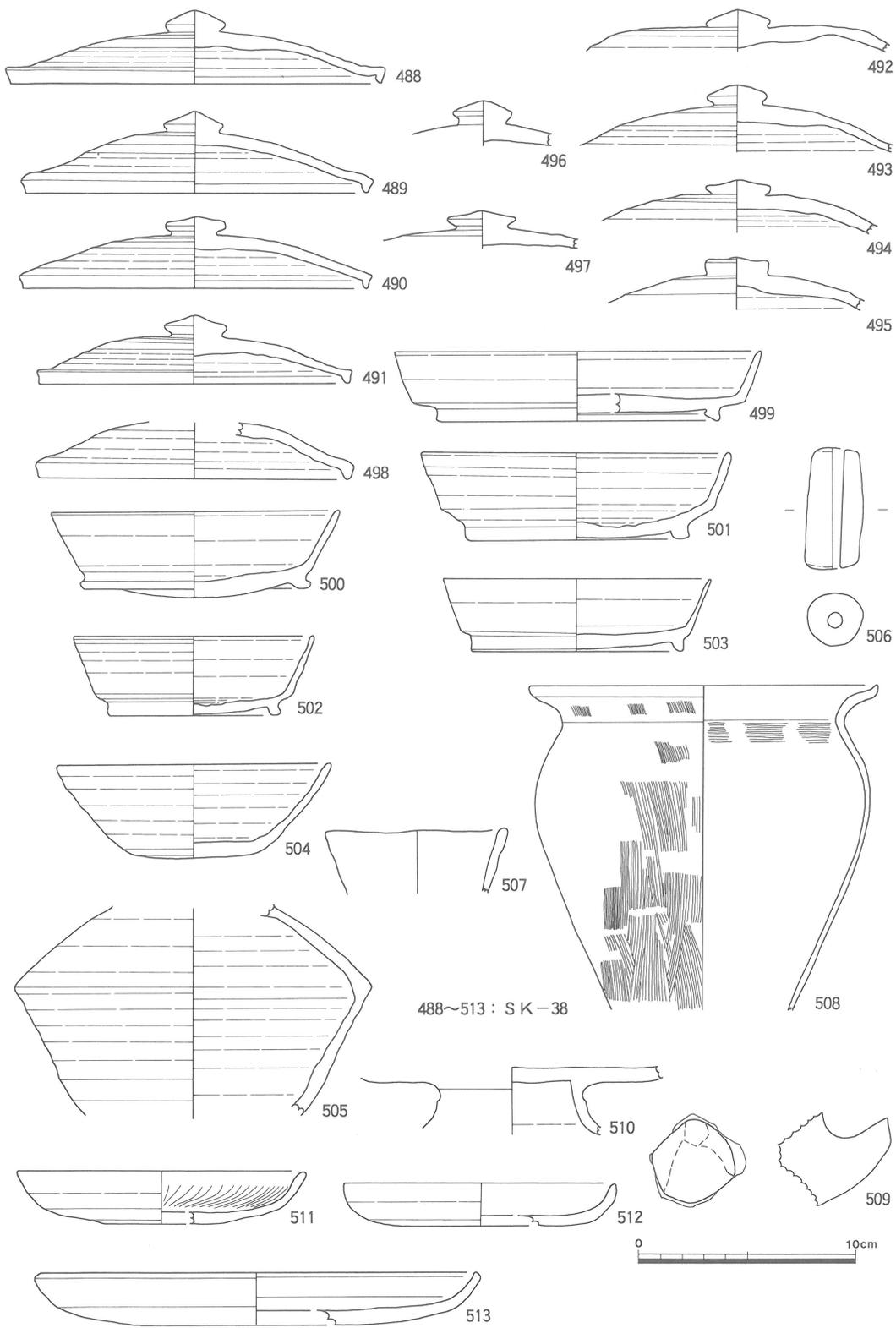

第91図 出土遺物実測図-21 (1/3)

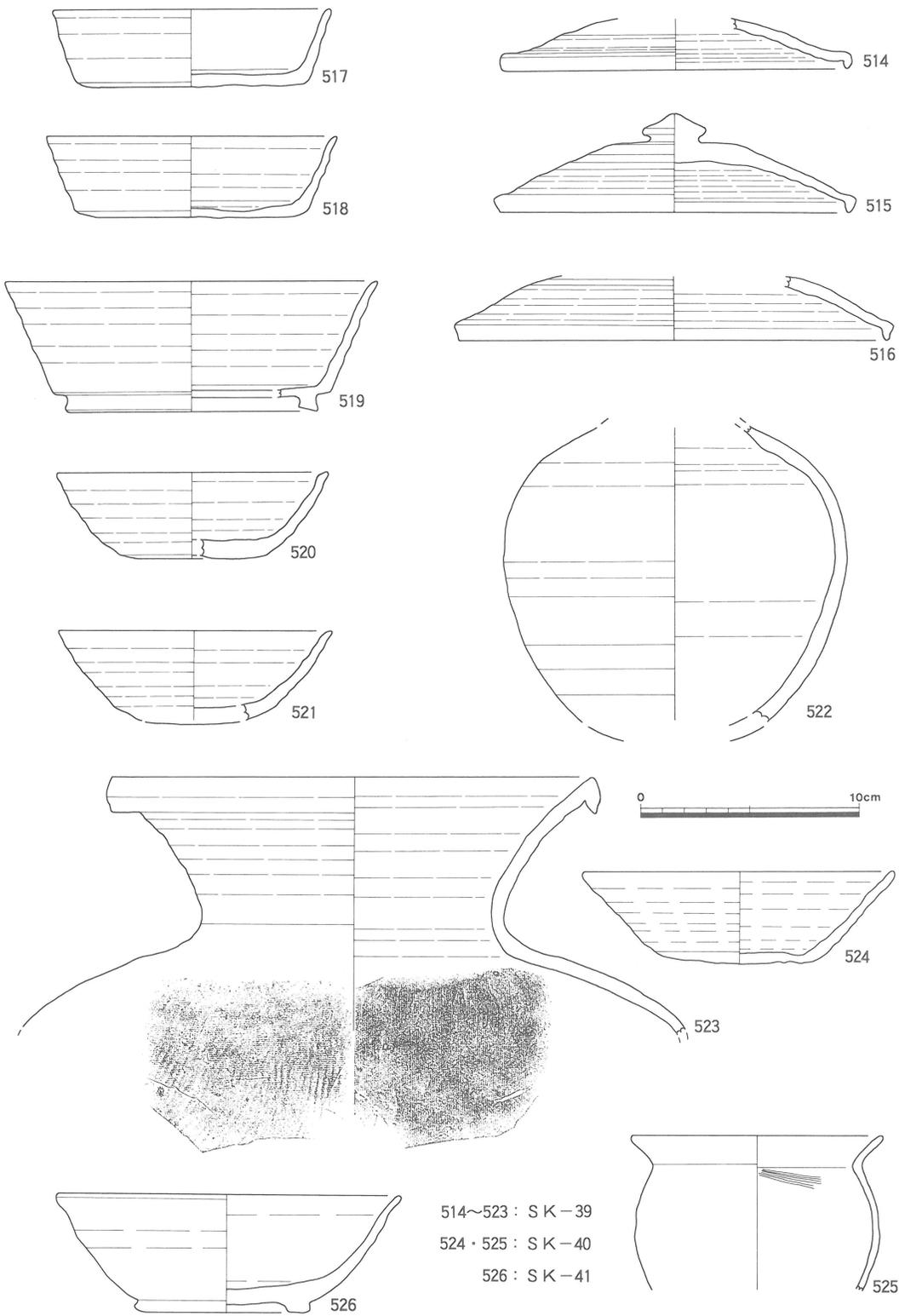

第92図 出土遺物実測図-22 (1/3)

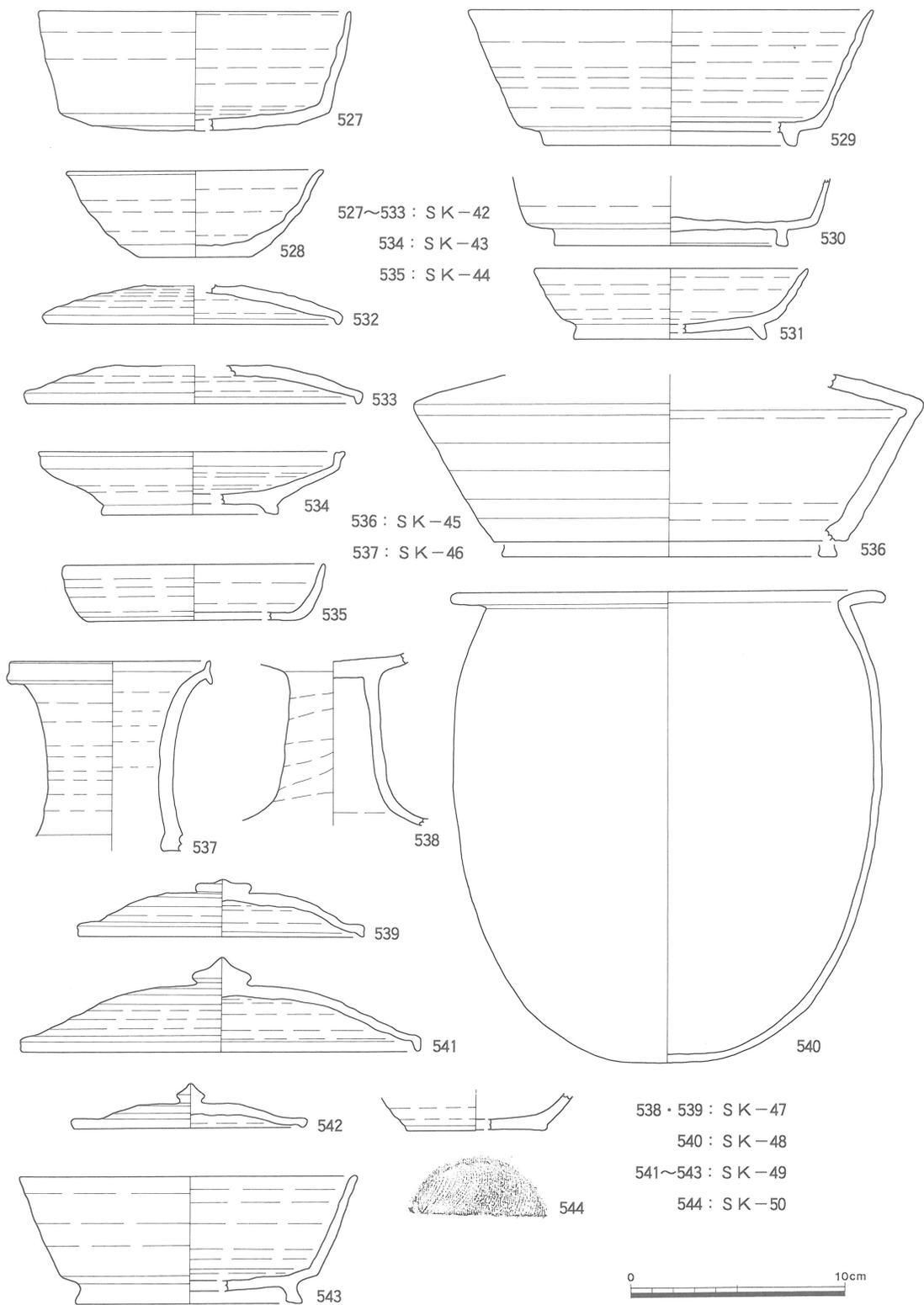

第93図 出土遺物実測図-23 (1/3)

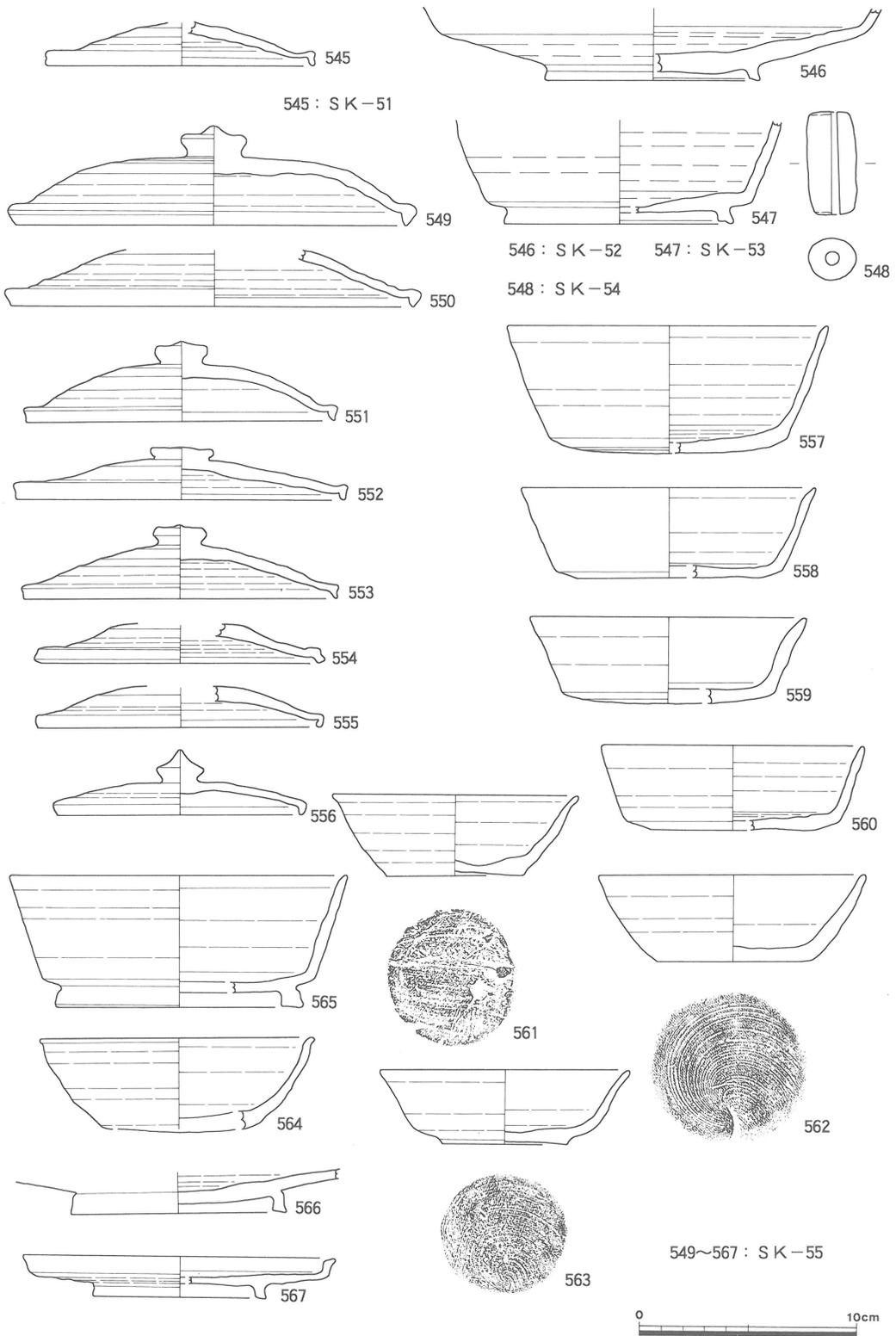

第94図 出土遺物実測図一24 (1/3)

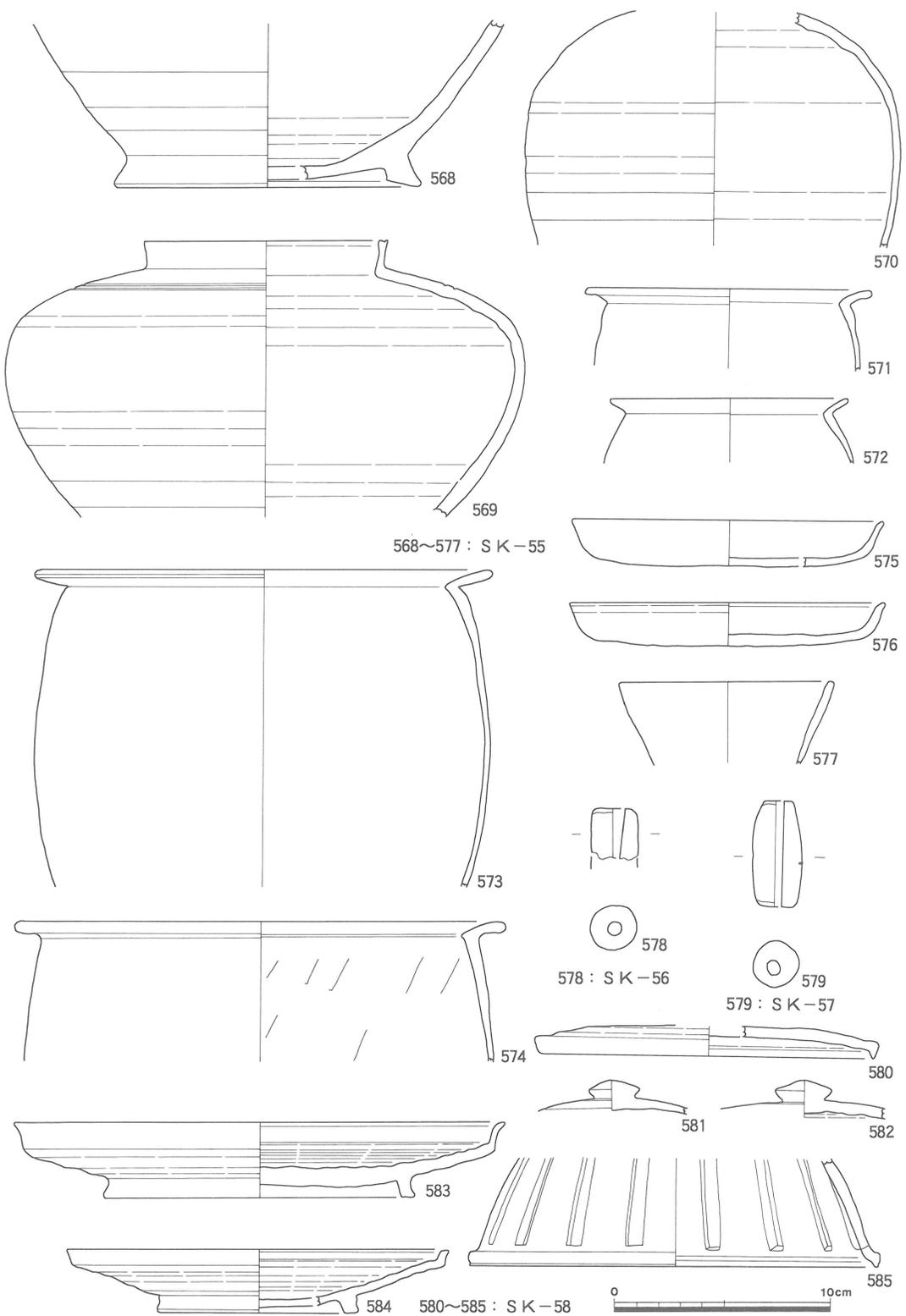

第95図 出土遺物実測図一25 (1/3)

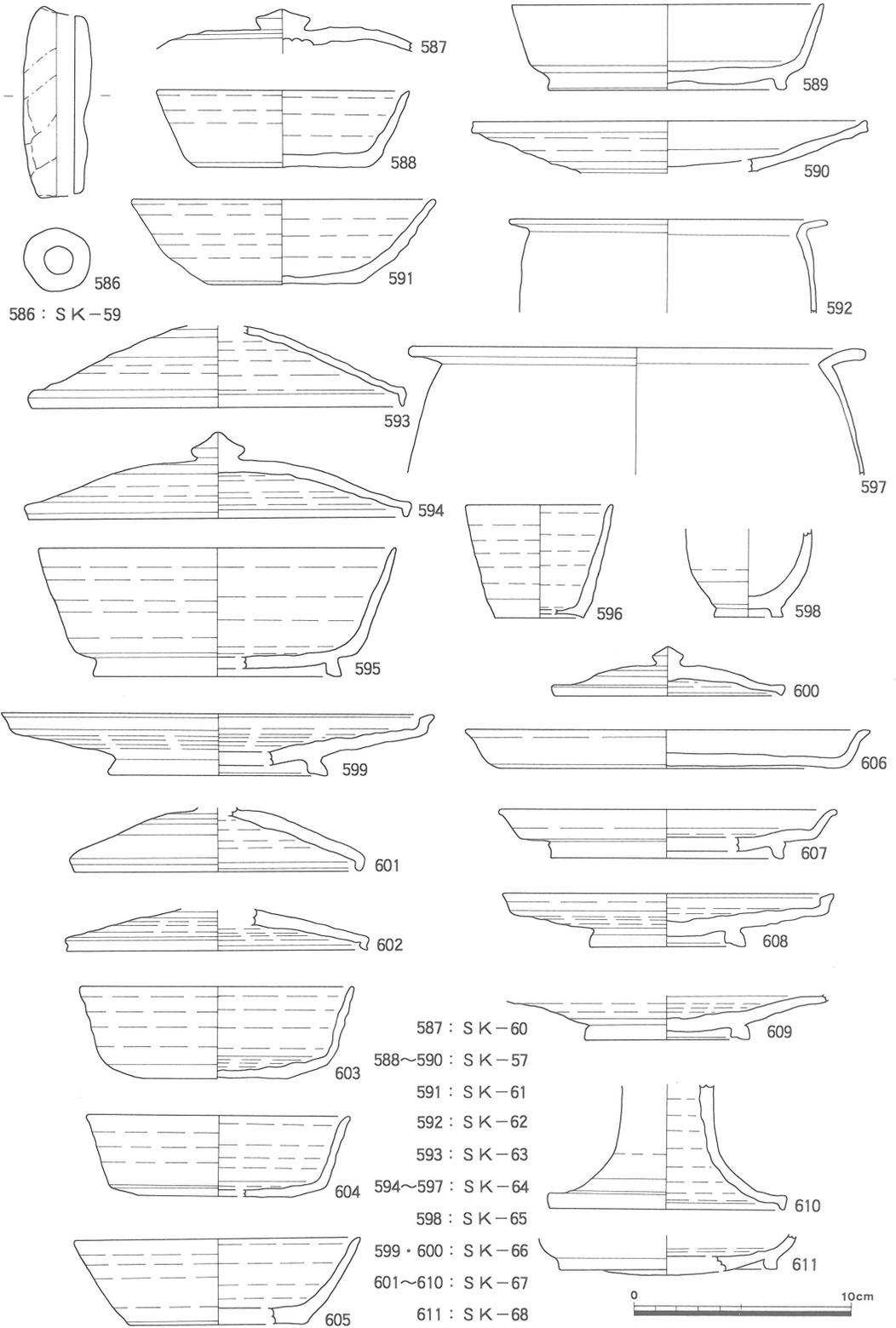

第96図 出土遺物実測図-26 (1/3)

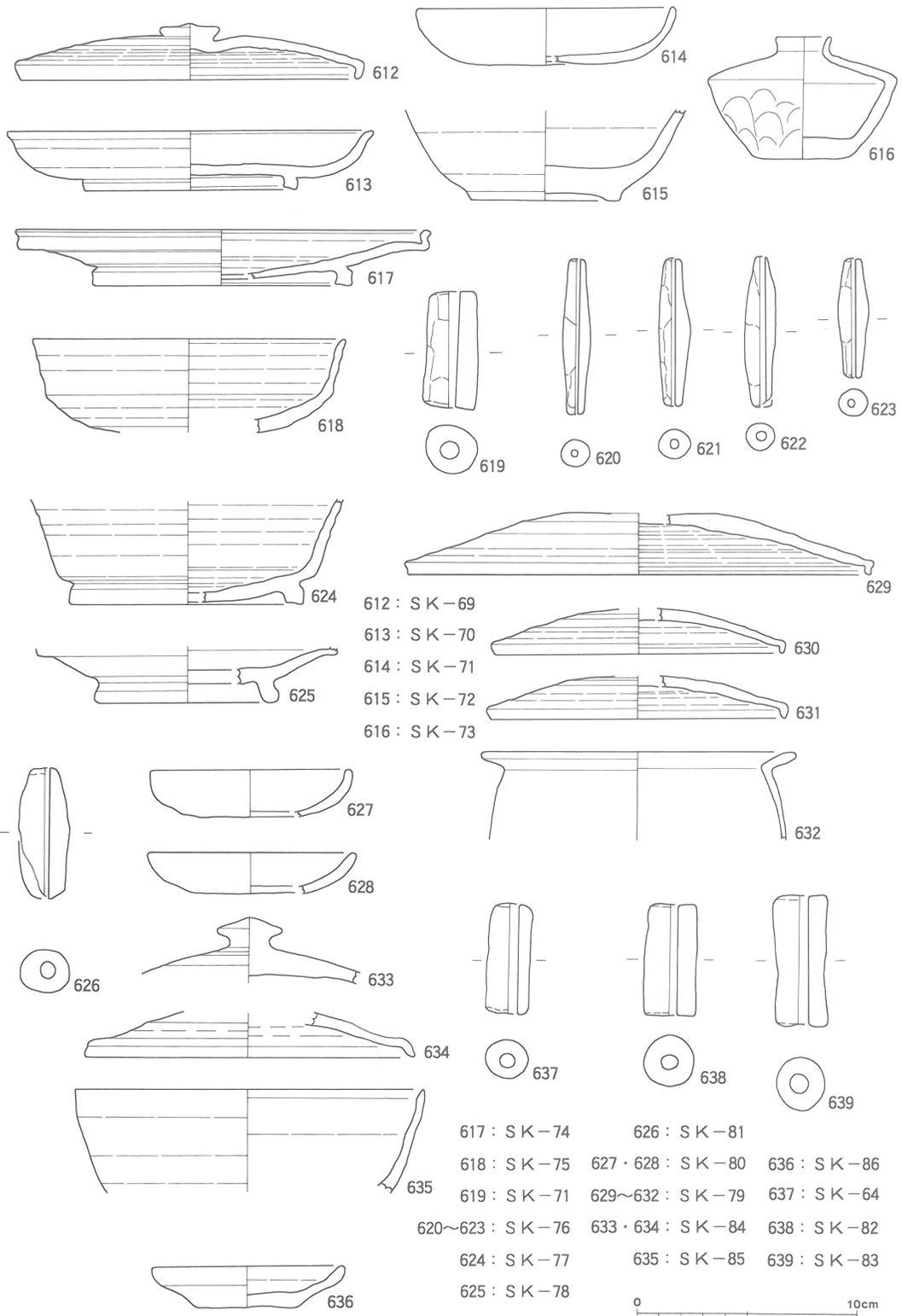

第97図 出土遺物実測図-27 (1/3)

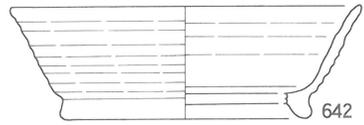
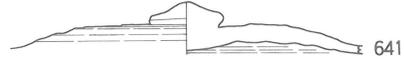
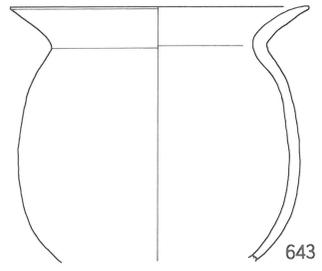
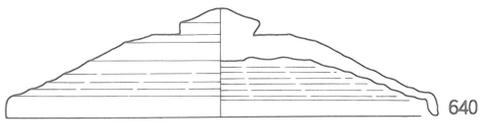

640~643 : S K - 87

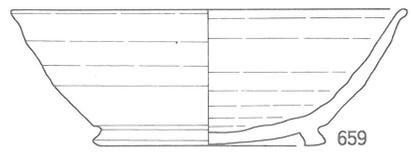
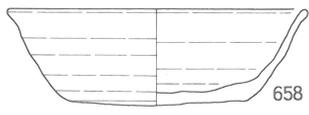
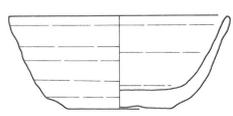
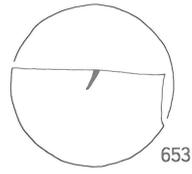
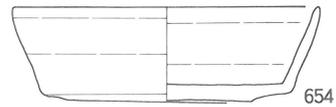
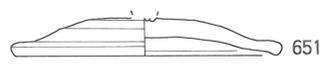
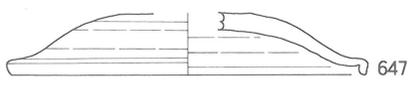
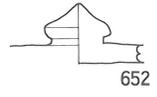
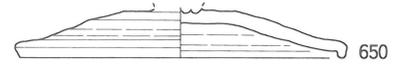
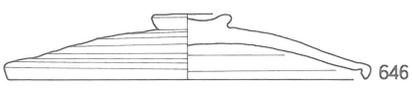
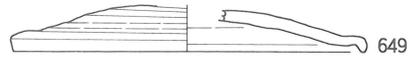
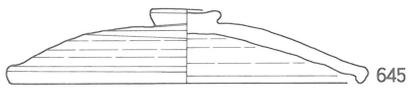
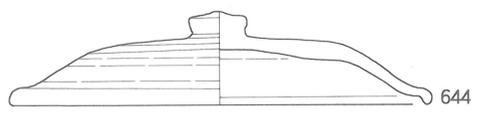

644~660 : S K - 88

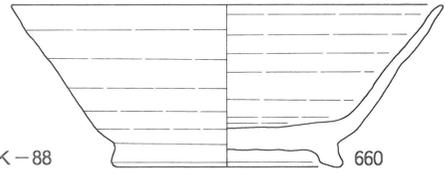

第98図 出土遺物実測図一28 (1/3)

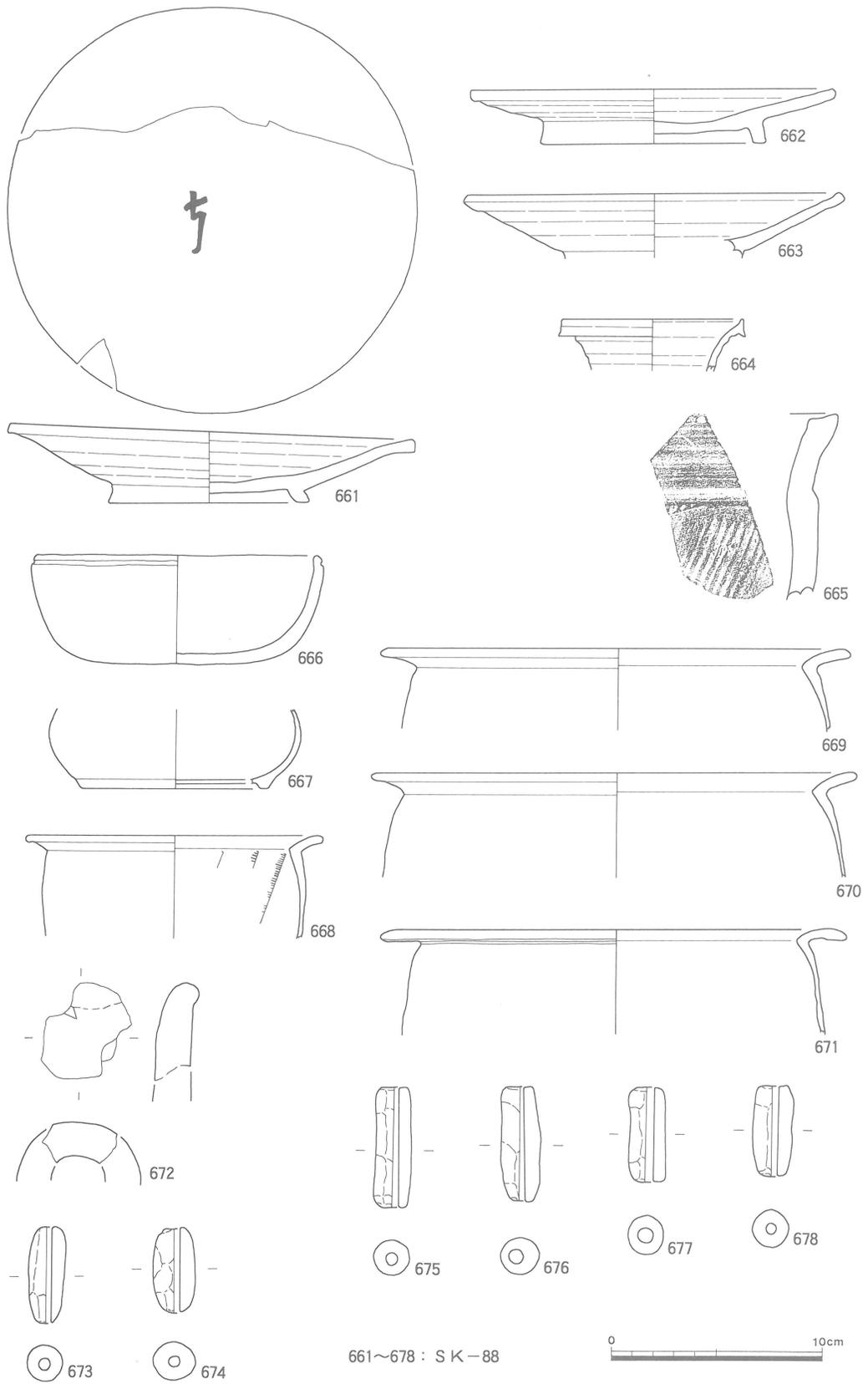

661~678 : S K - 88

第99图 出土遺物実測図-29 (1/3)

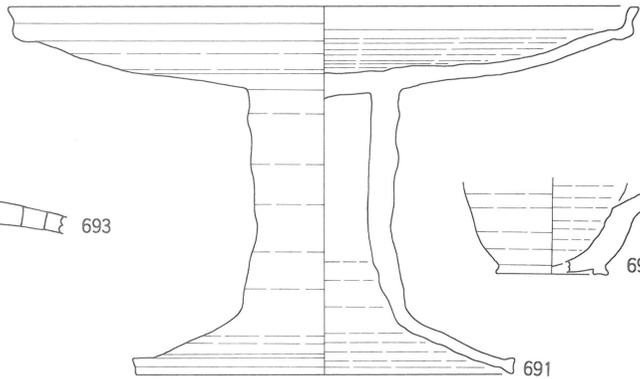
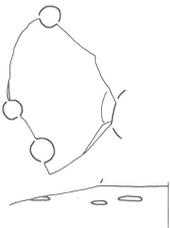
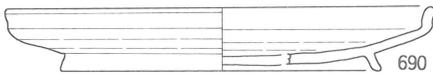
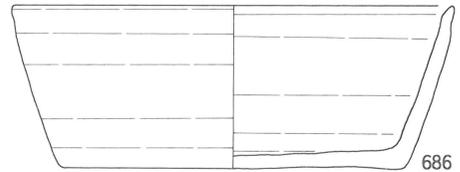
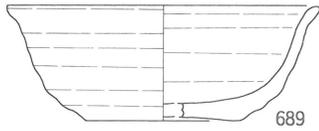
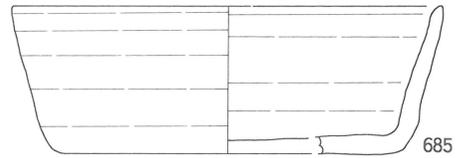
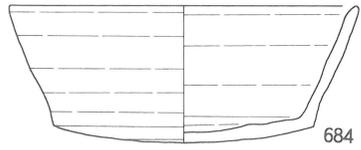
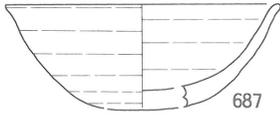
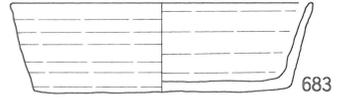
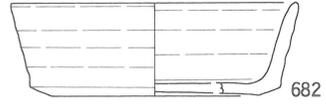
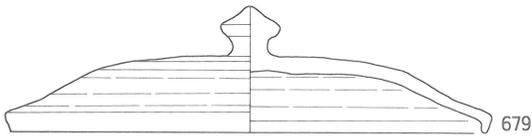

679~693 : S K - 89



第100図 出土遺物実測図-30 (1/3)

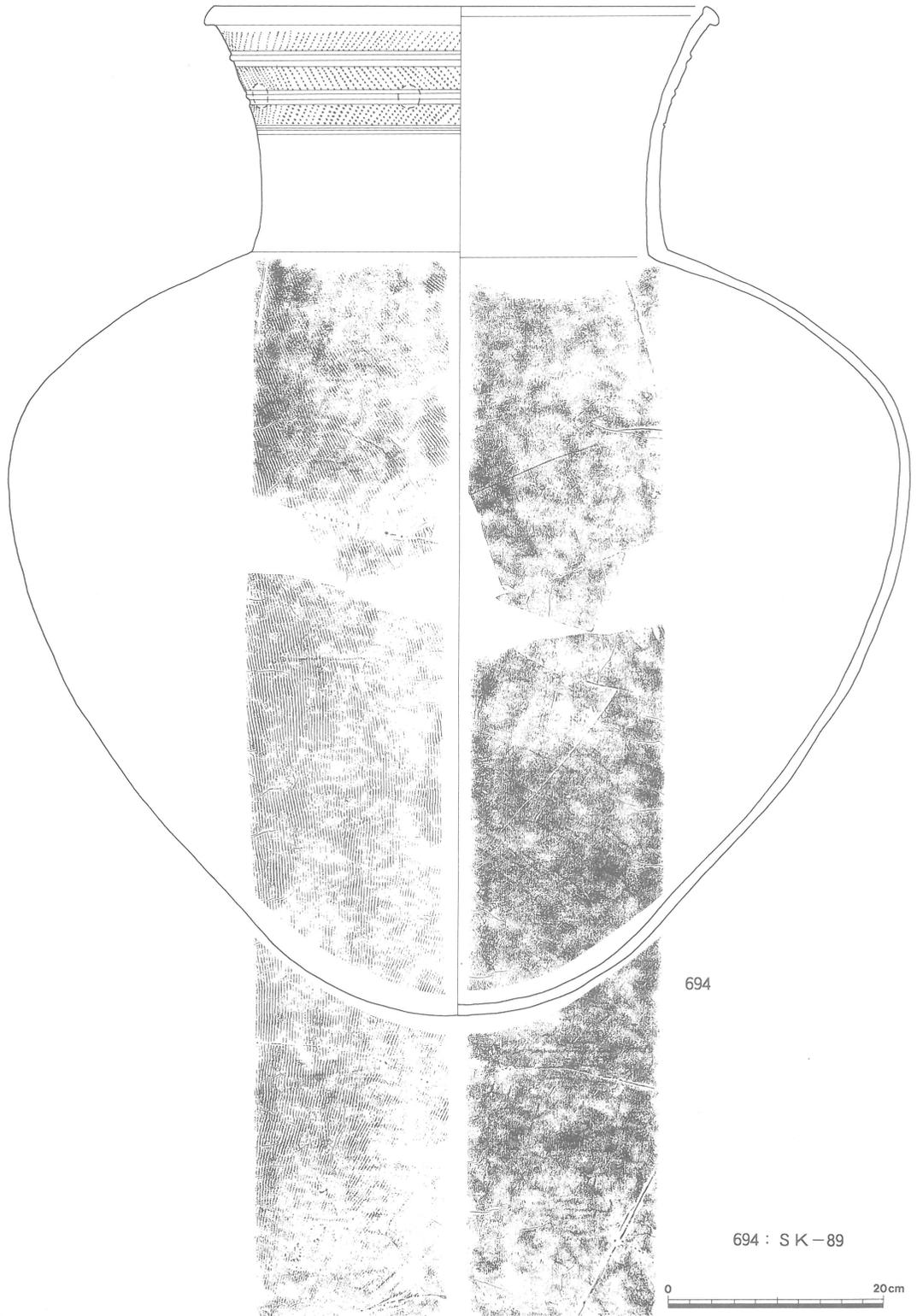

第101図 出土遺物実測図-31 (1/6)

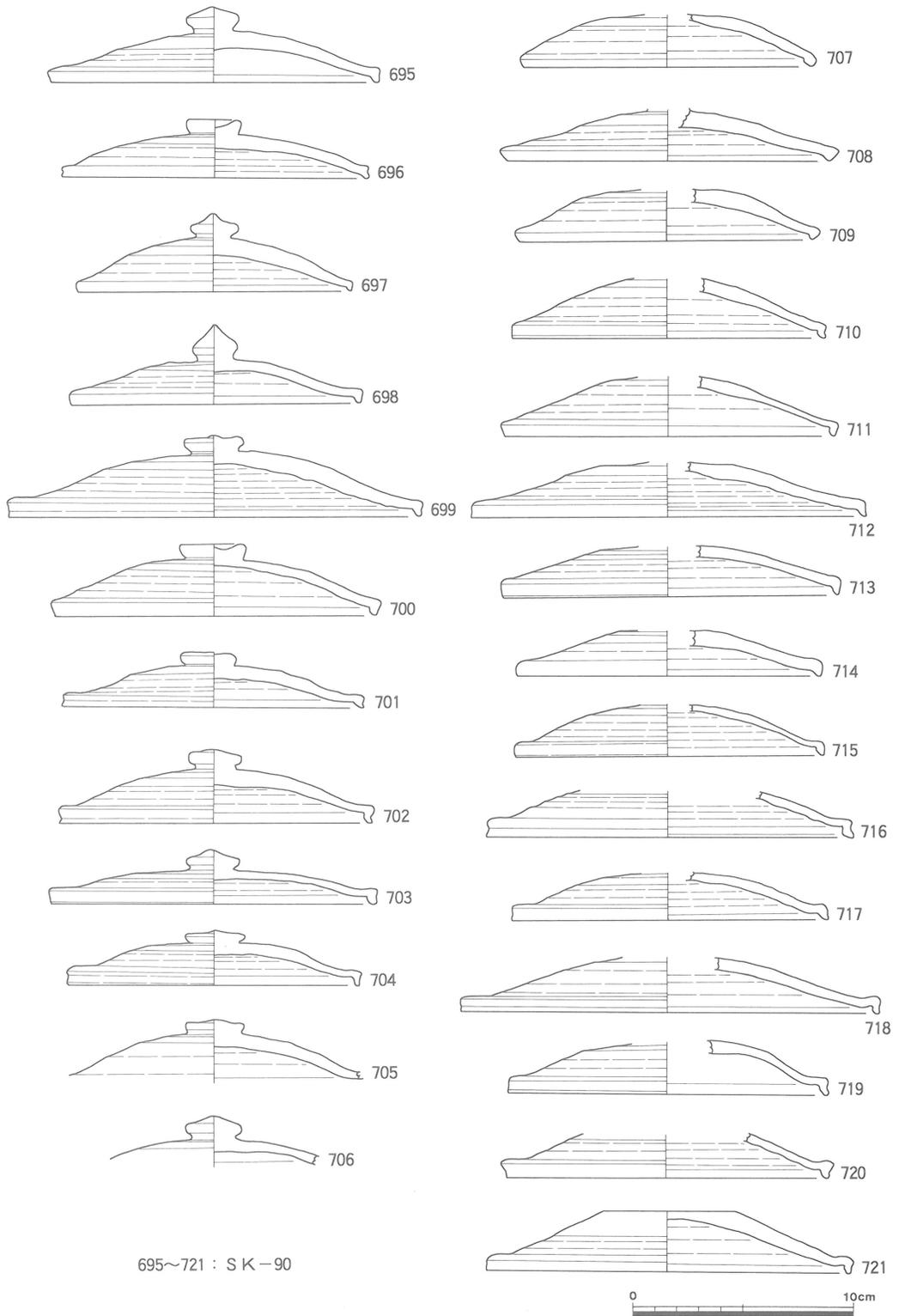

第102図 出土遺物実測図-32 (1/3)

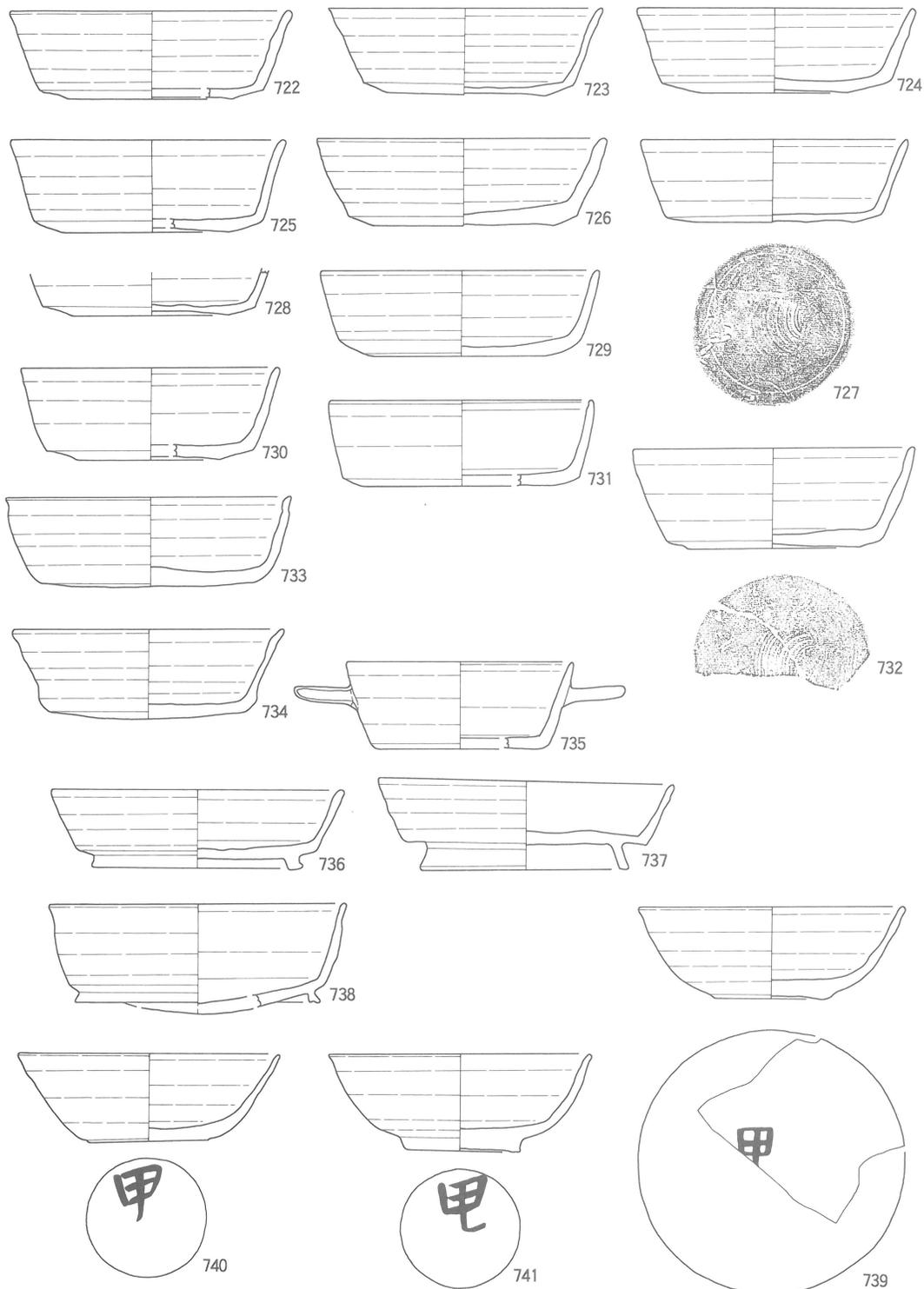

722~741 : S K - 90

0 10cm

第103図 出土遺物実測図-33 (1/3)

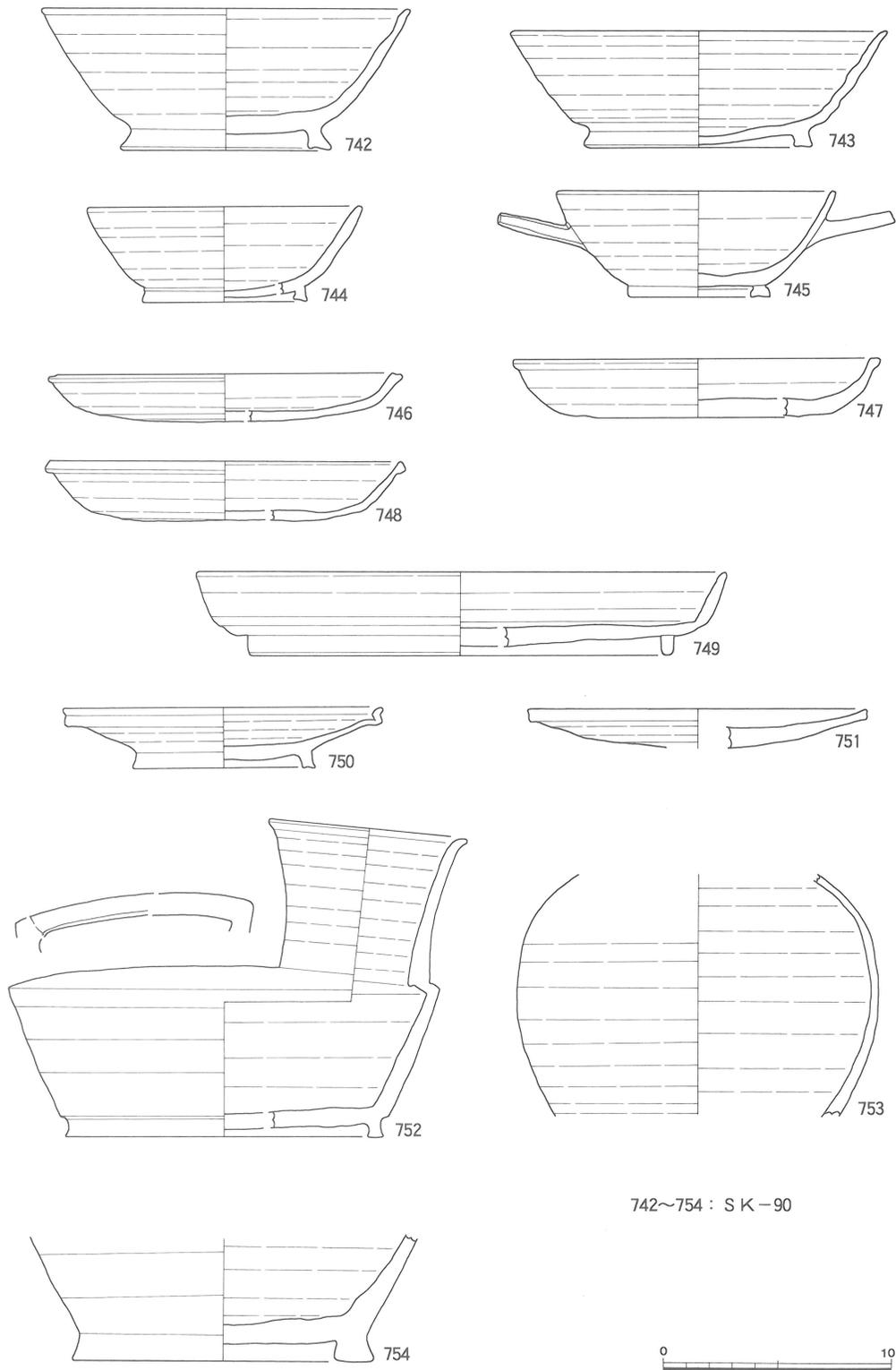

742~754 : S K - 90

第104図 出土遺物実測図-34 (1/3)

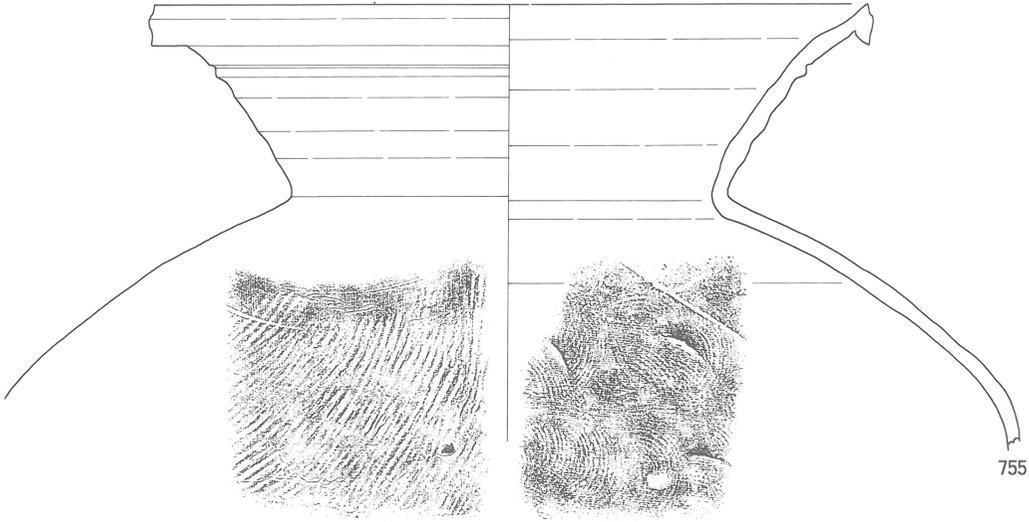

755

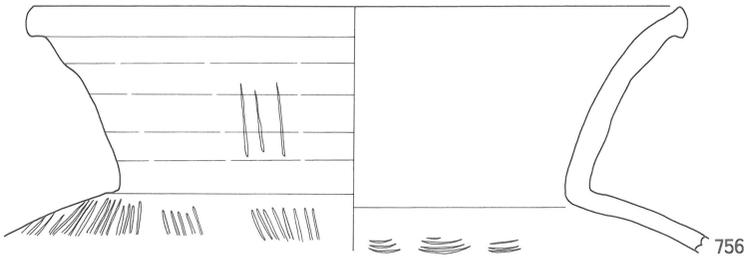

756

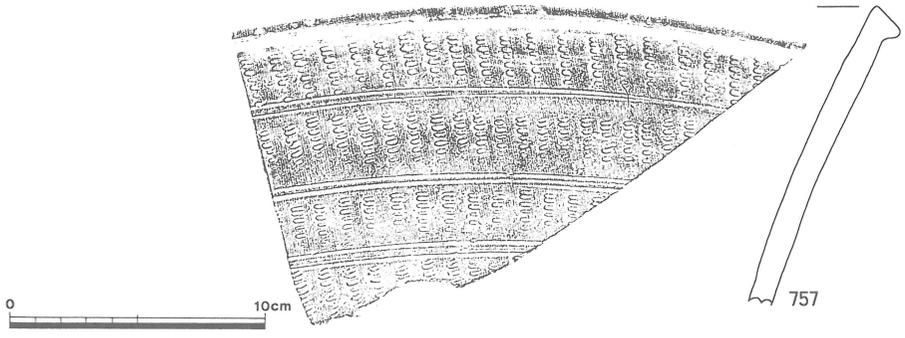

757

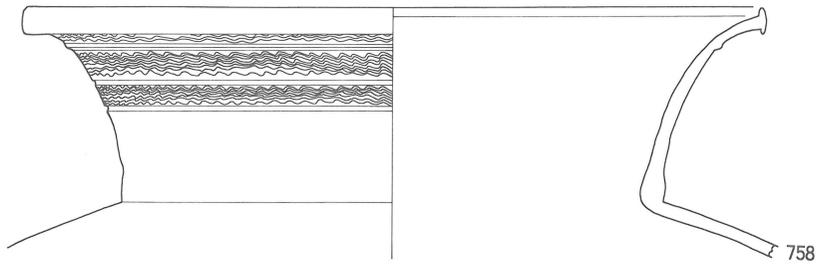

758

755~758 : S K - 90

758 : (1/6)



第105図 出土遺物実測図一35 (1/3、1/6)

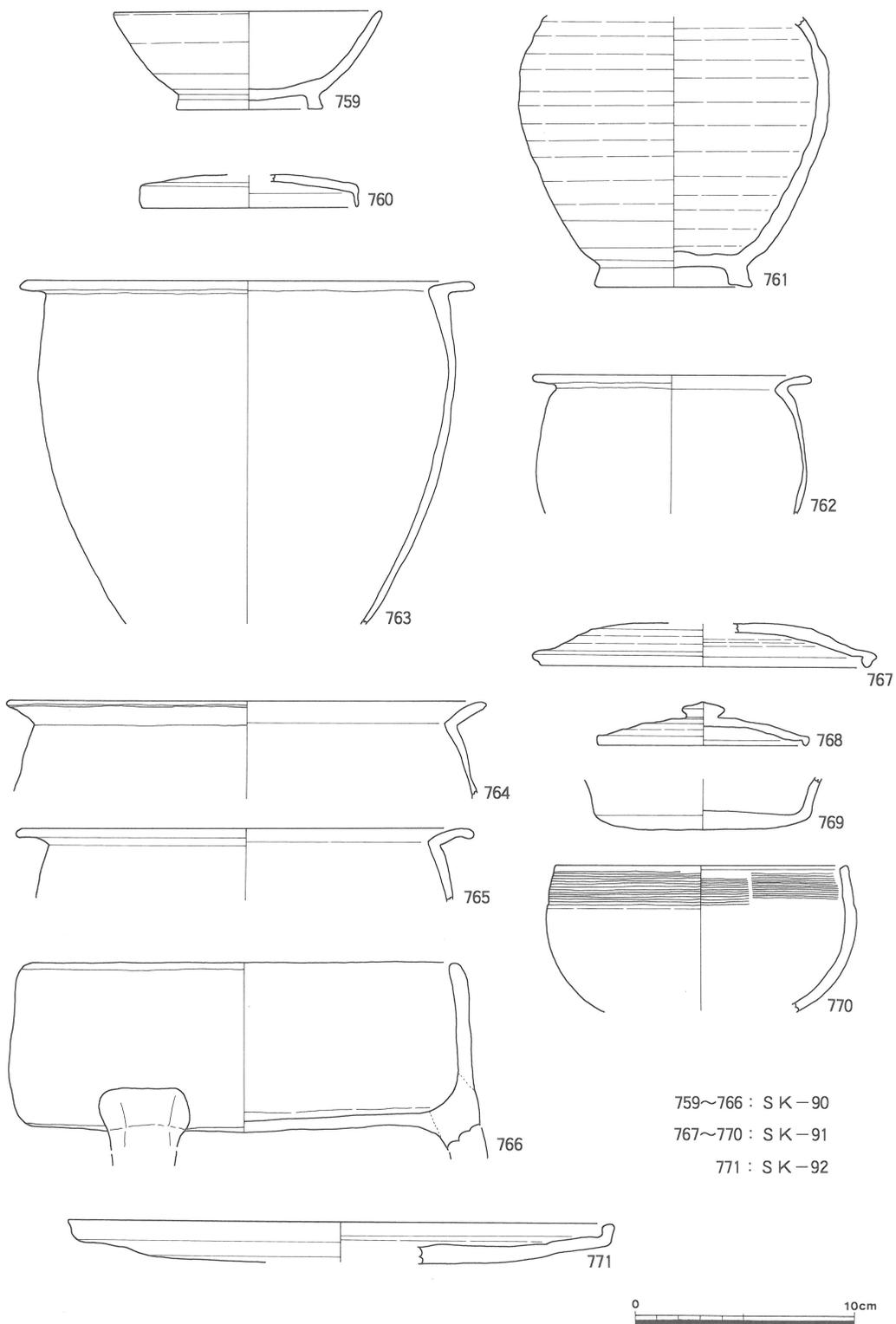

759~766 : S K - 90

767~770 : S K - 91

771 : S K - 92

第106図 出土遺物実測図-36 (1/3)

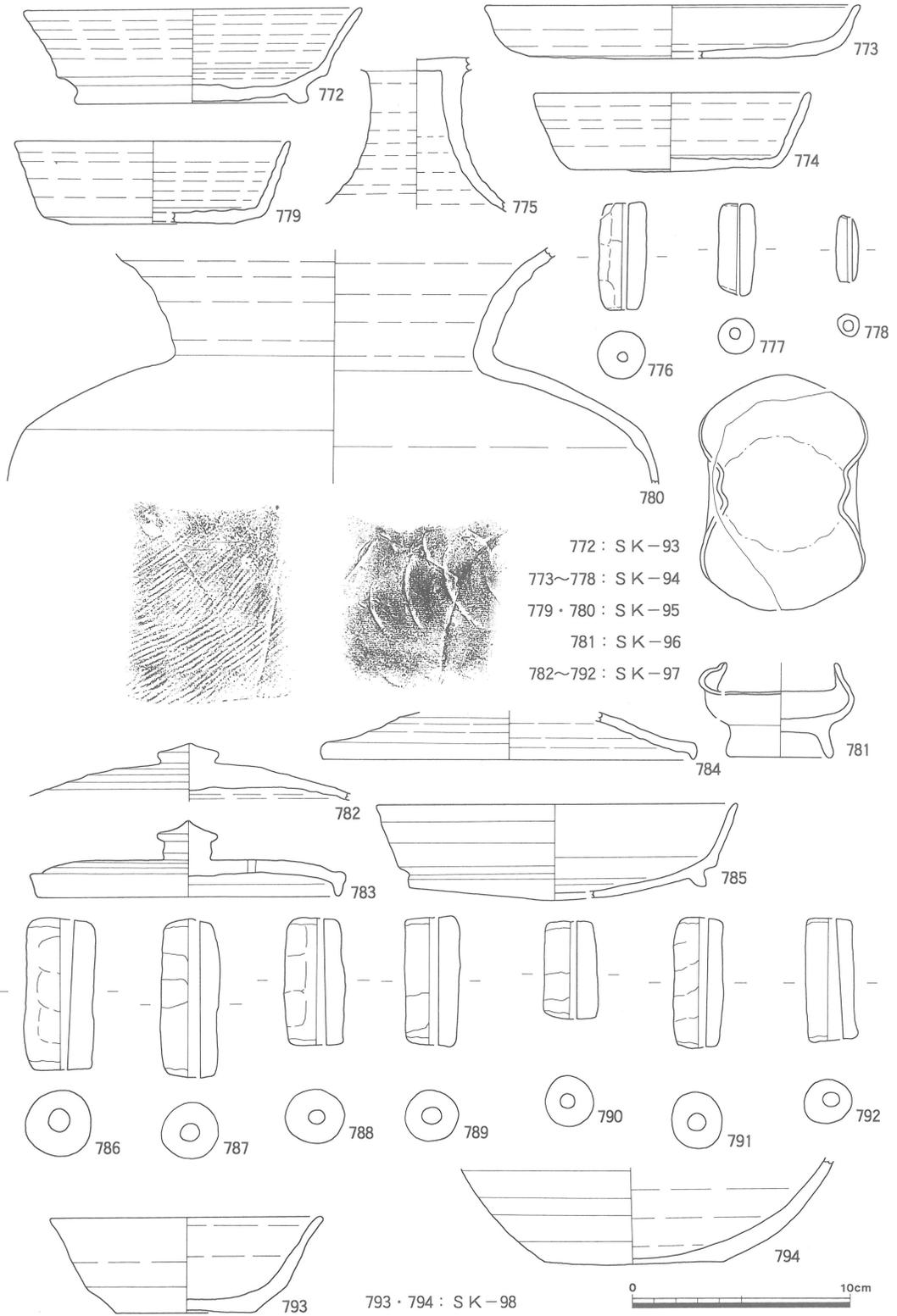

第107図 出土遺物実測図-37 (1/3)

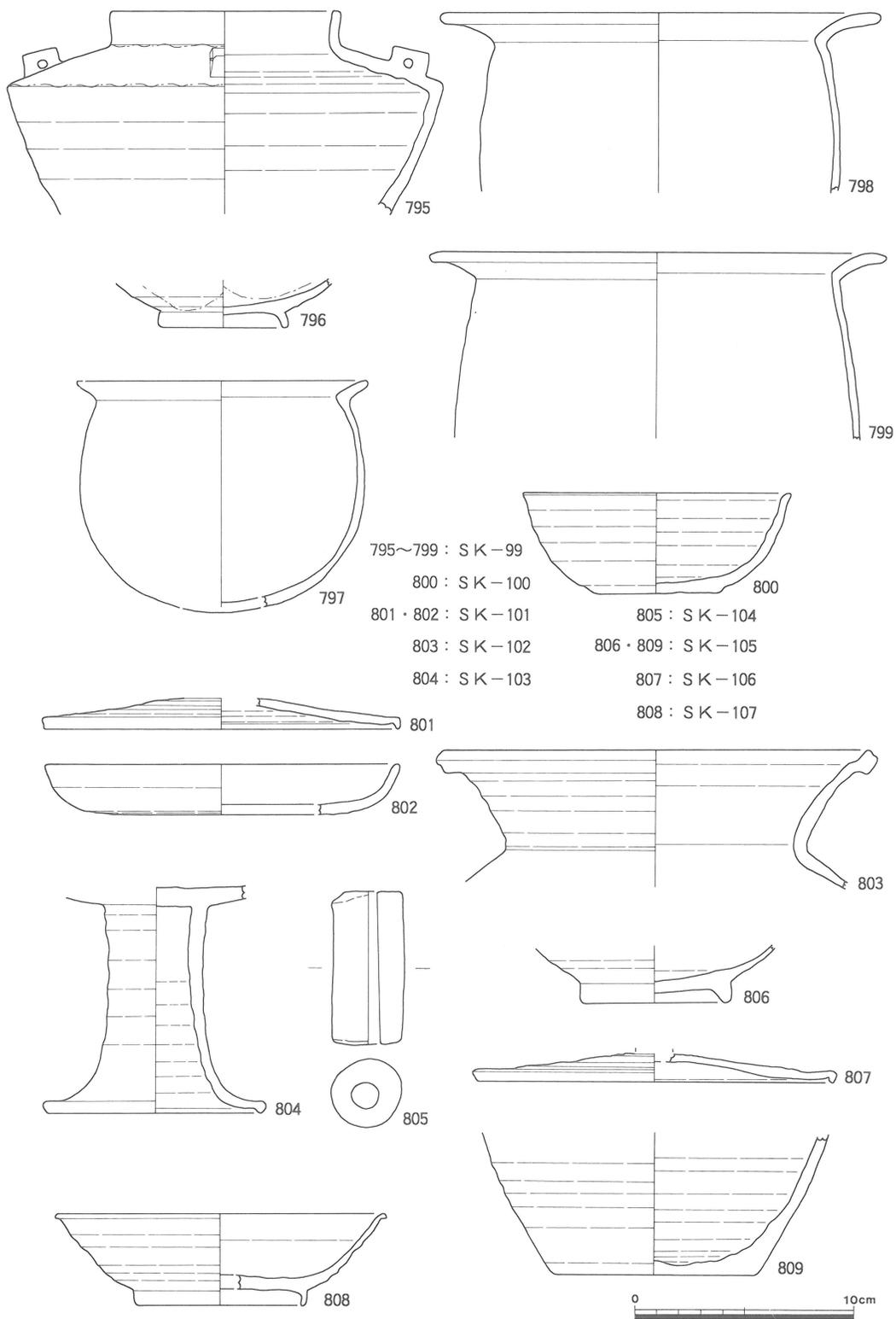

第108図 出土遺物実測図-38 (1/3)

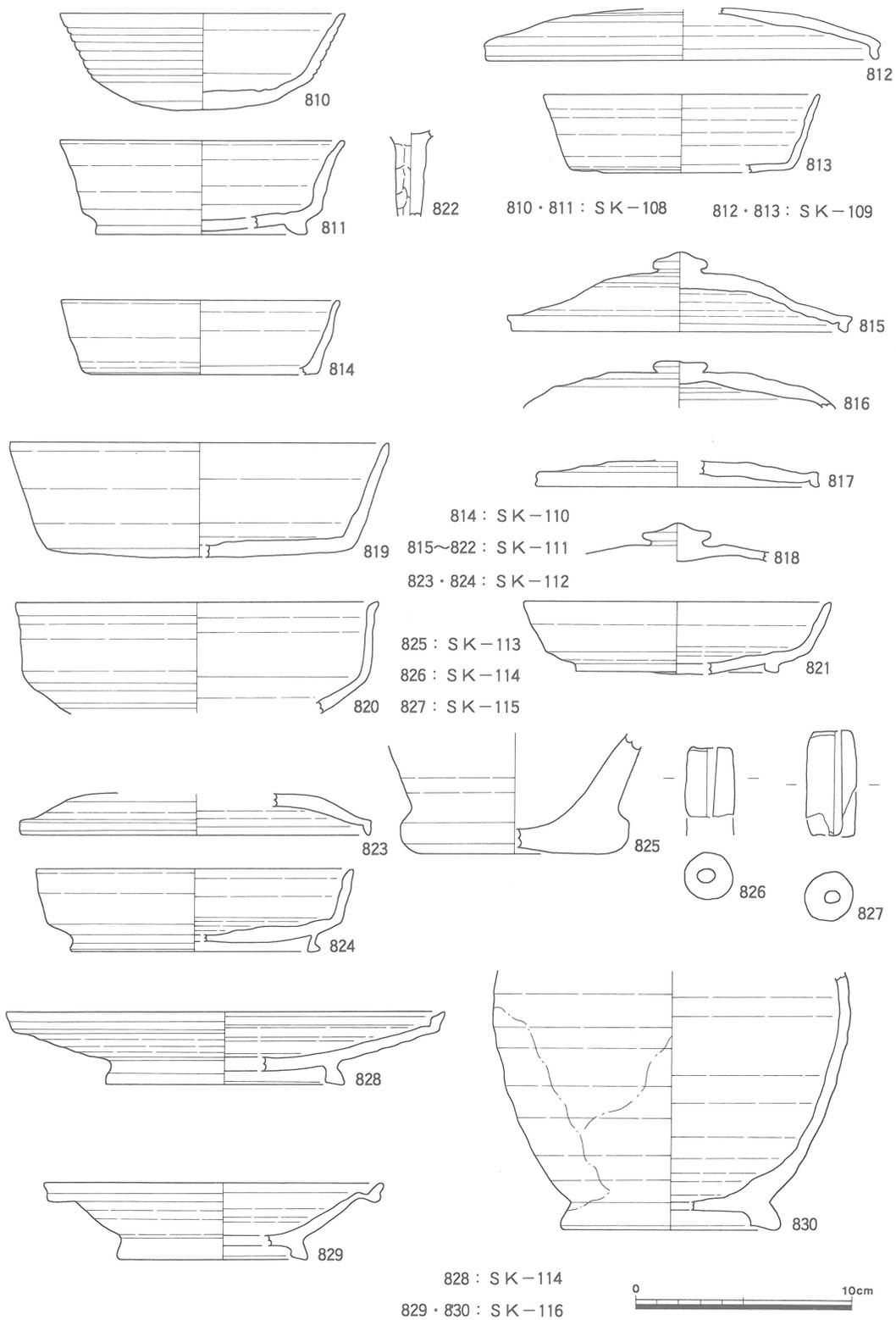

第109図 出土遺物実測図-39 (1/3)

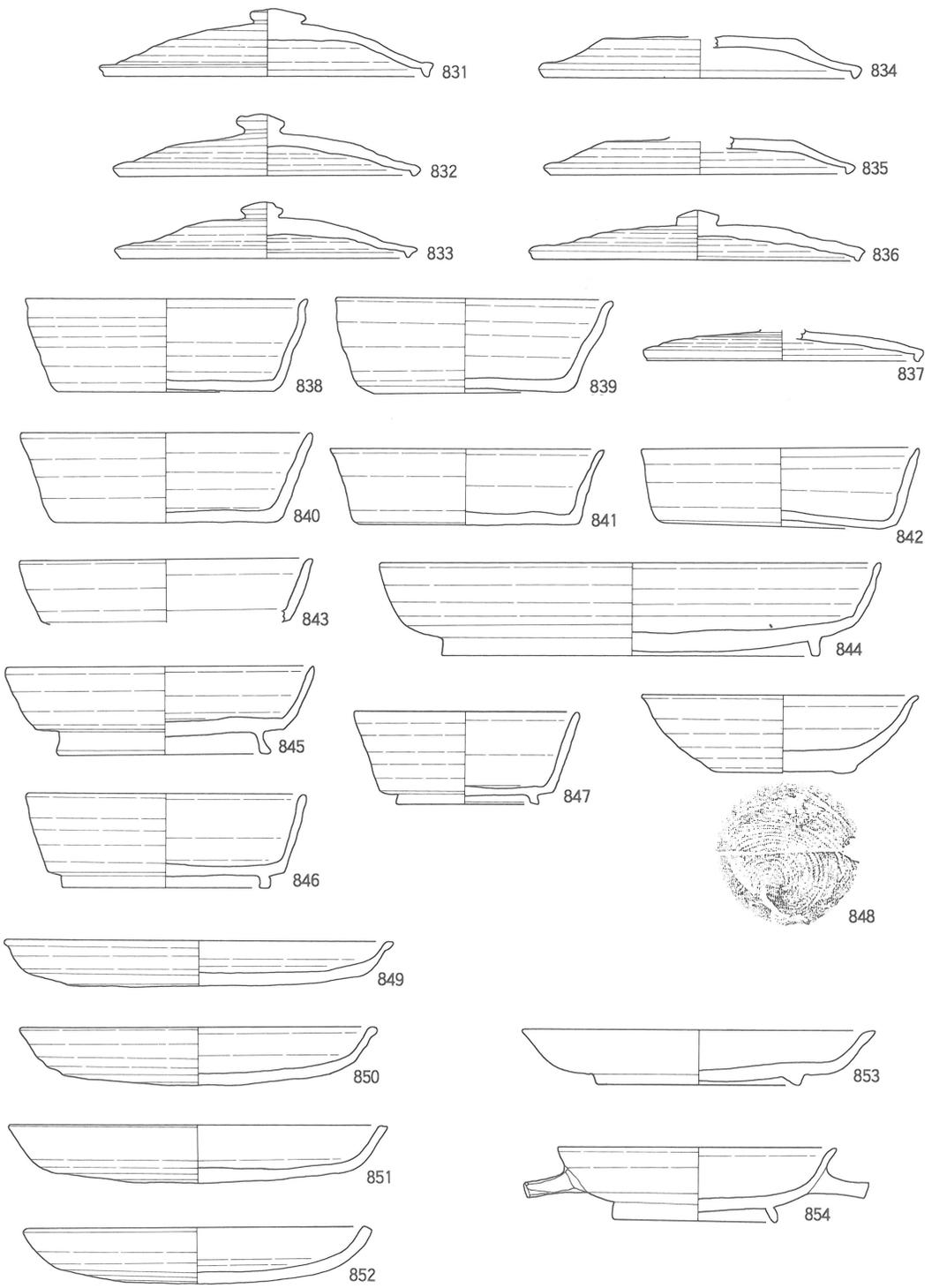

831~854 : S K - 118



第110図 出土遺物実測図-40 (1/3)

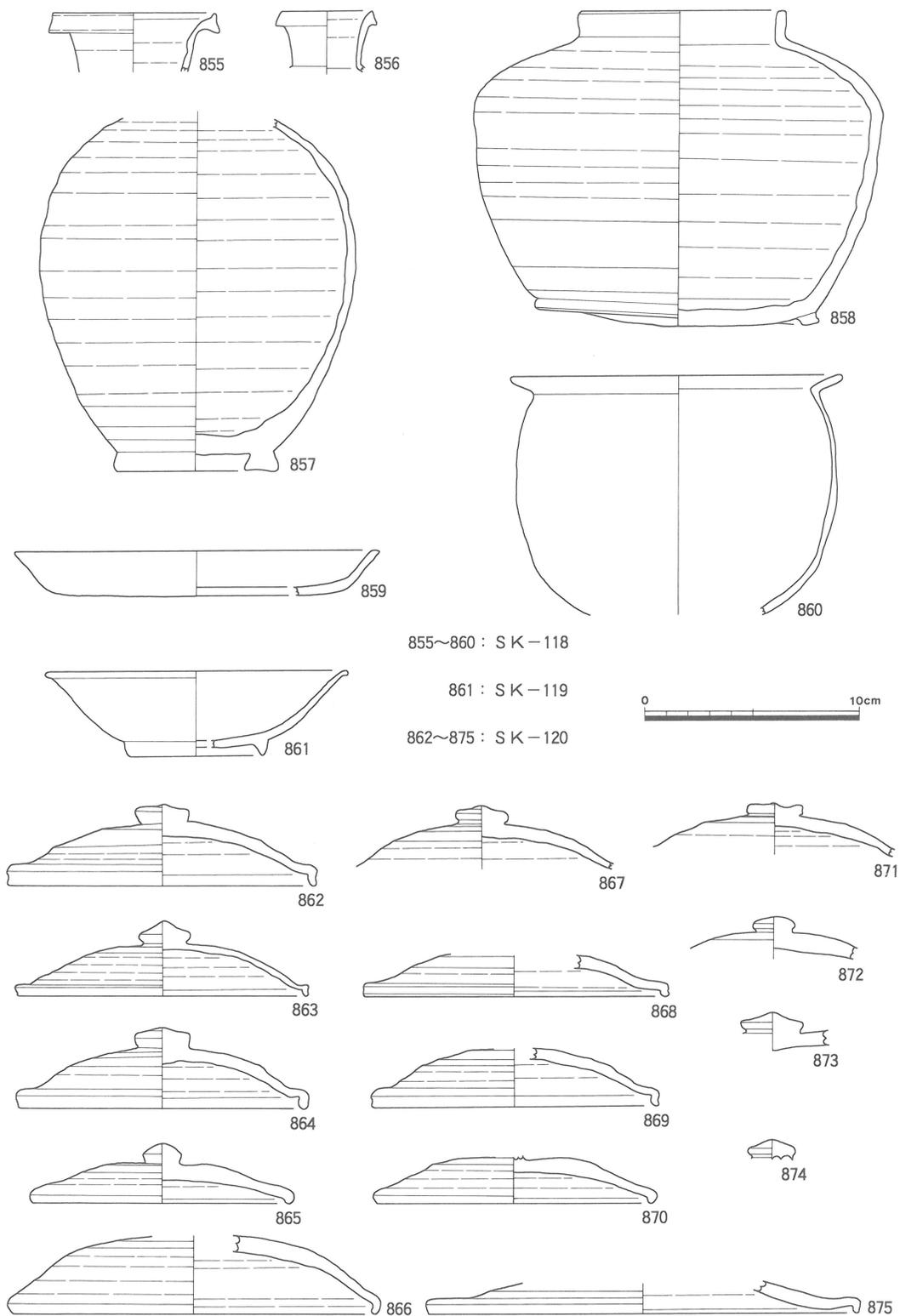

第111図 出土遺物実測図-41 (1/3)

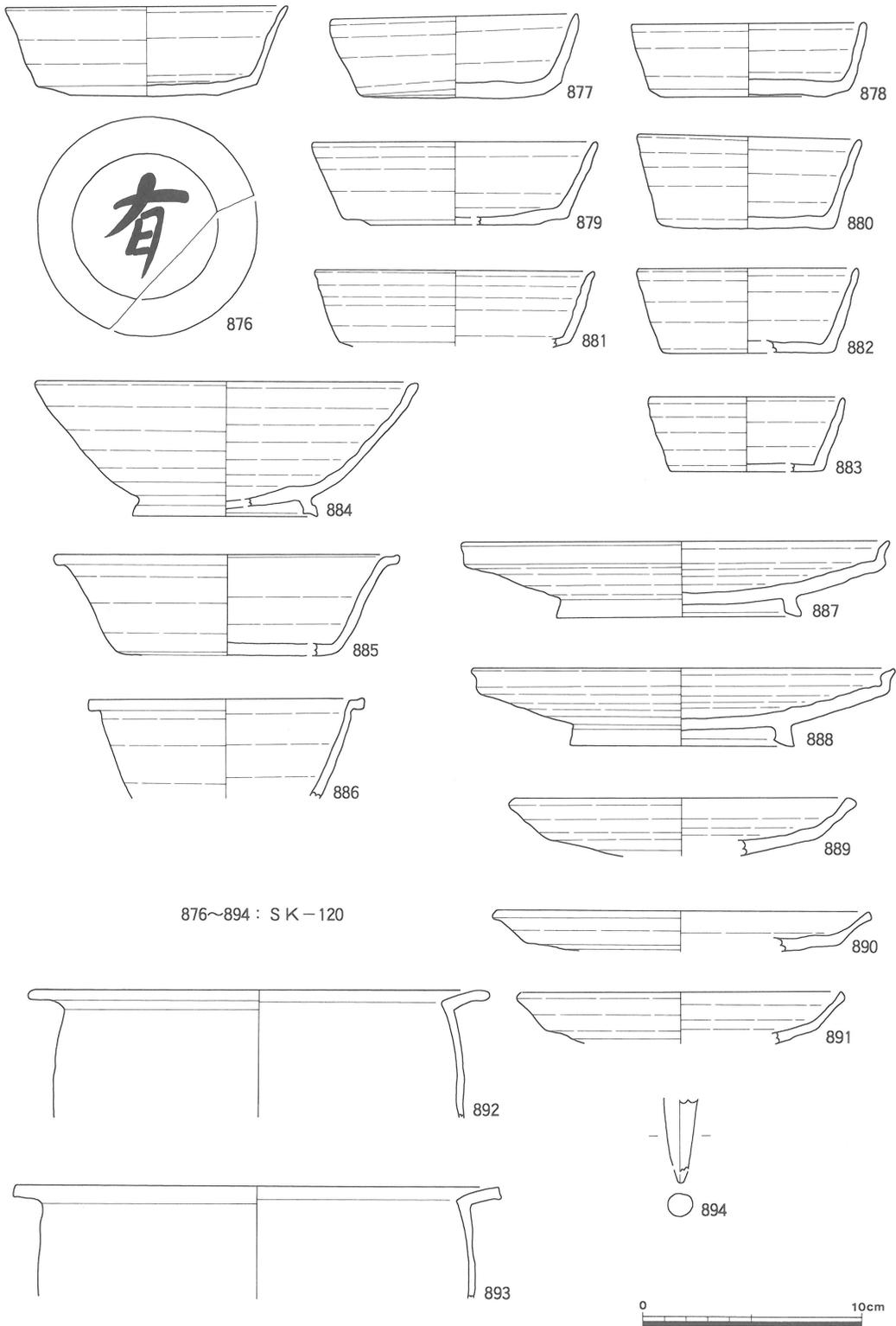

876~894 : S K - 120

第112図 出土遺物実測図-42 (1/3)

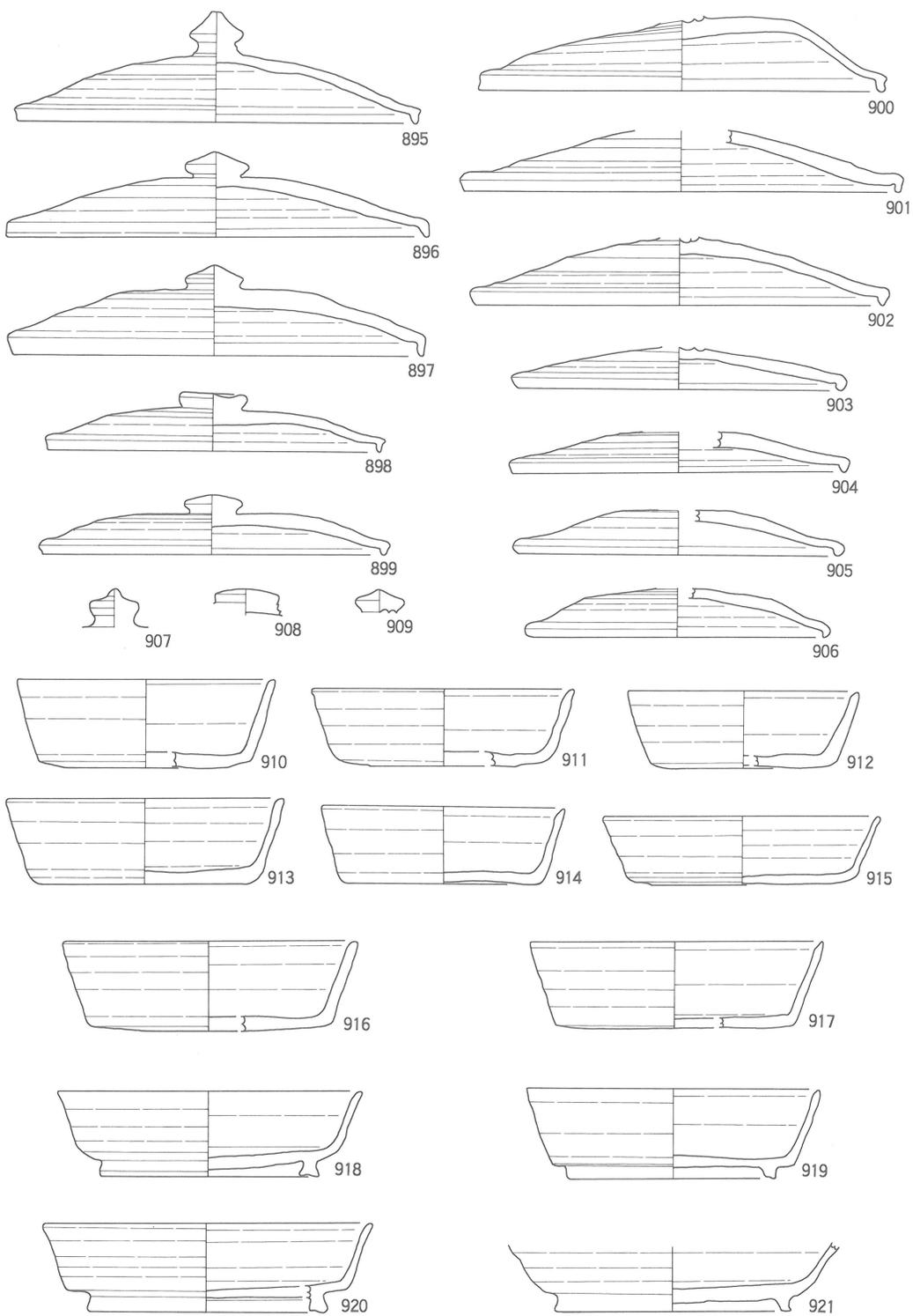

895~921 : S K - 121



第113図 出土遺物実測図-43 (1/3)

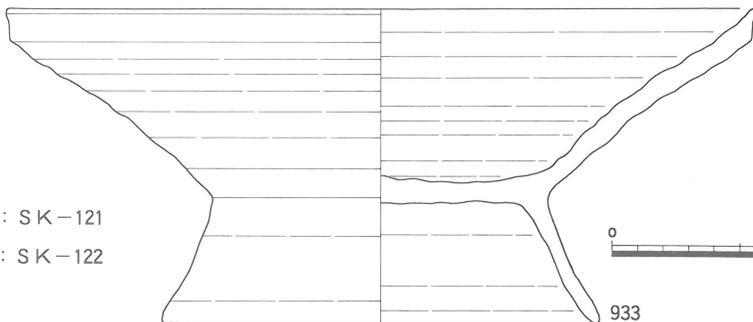
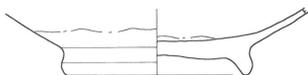
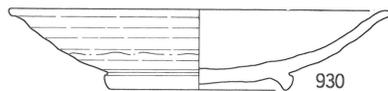
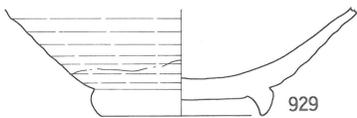
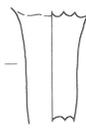
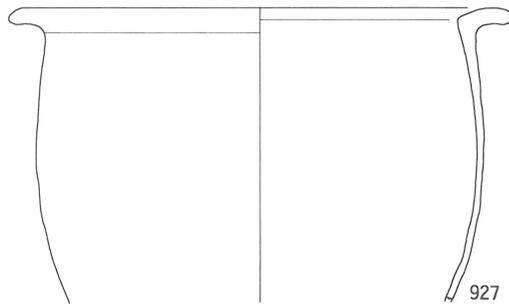
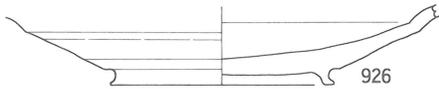
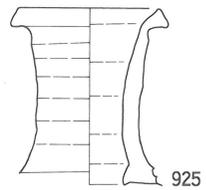
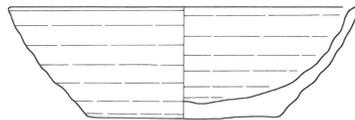
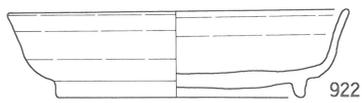

922~928 : S K - 121

929~933 : S K - 122



第114図 出土遺物実測図-44 (1/3)

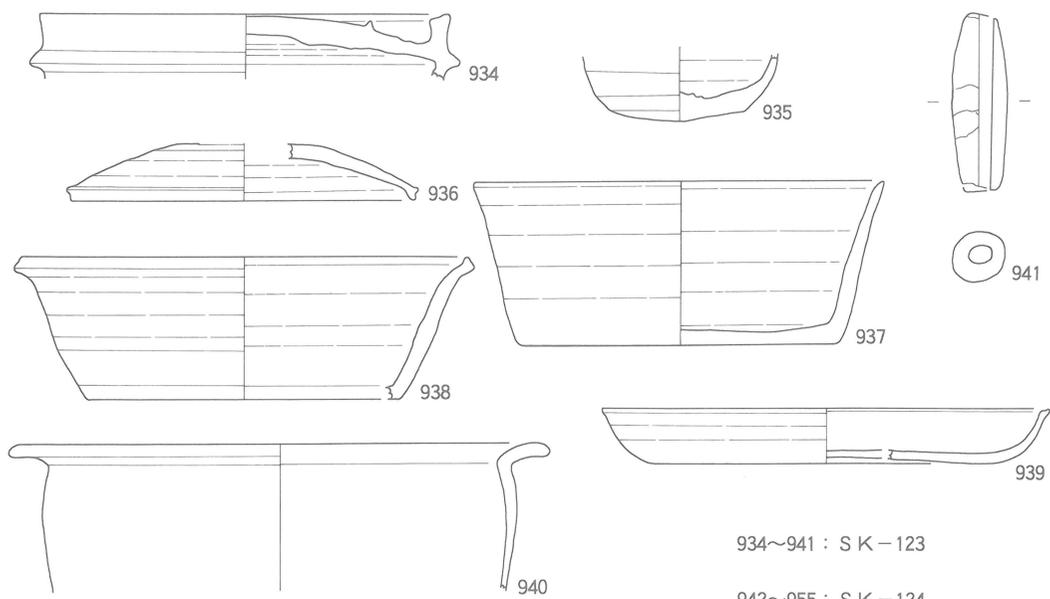

934~941 : S K - 123

942~955 : S K - 124

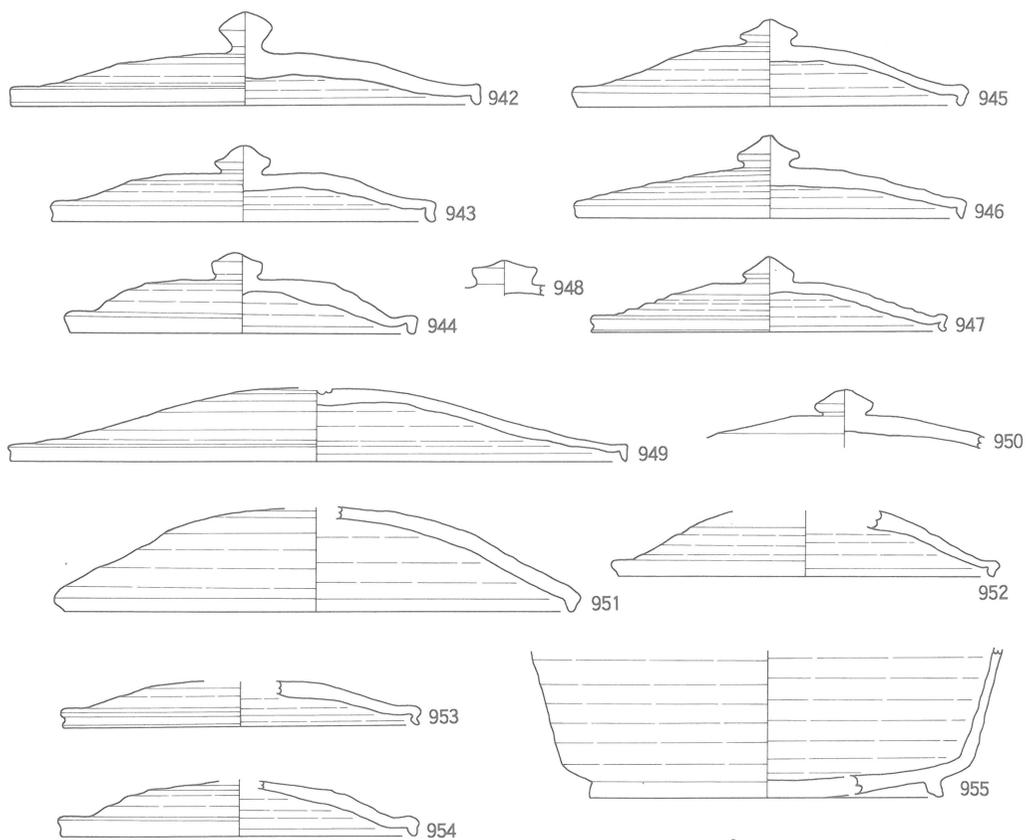

第115図 出土遺物実測図-45 (1/3)

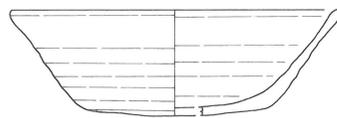
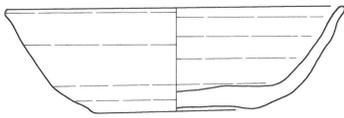
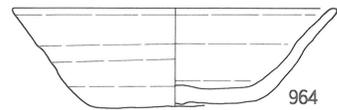
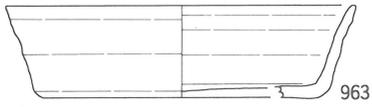
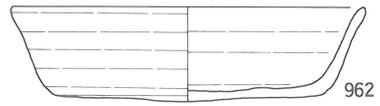
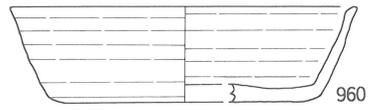
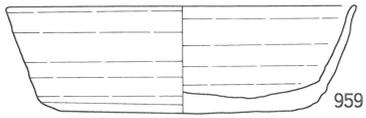
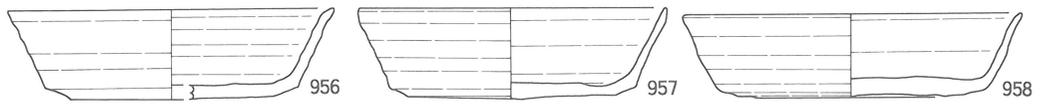

956~973 : S K - 124



965

966

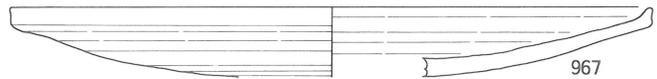

967

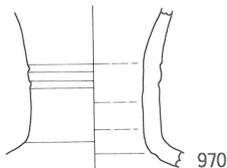

970

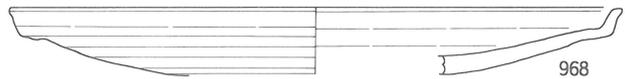

968

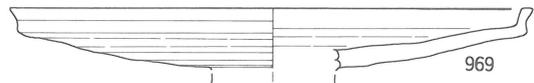

969

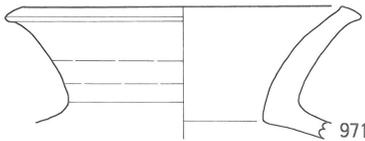

971

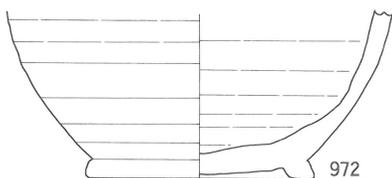

972

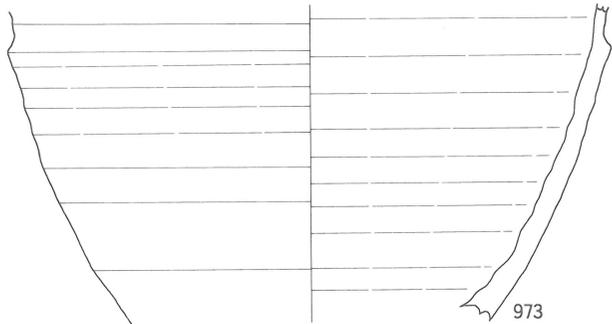

973



第116図 出土遺物実測図-46 (1/3)

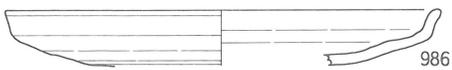
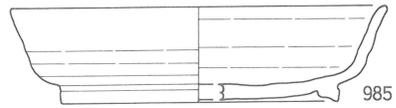
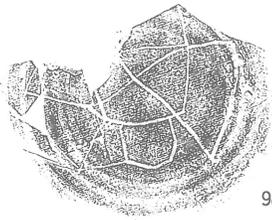
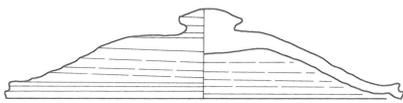
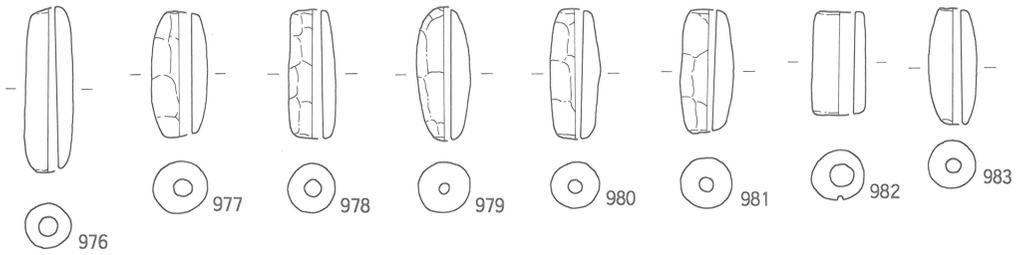

第117図 出土遺物実測図-47 (1/3)

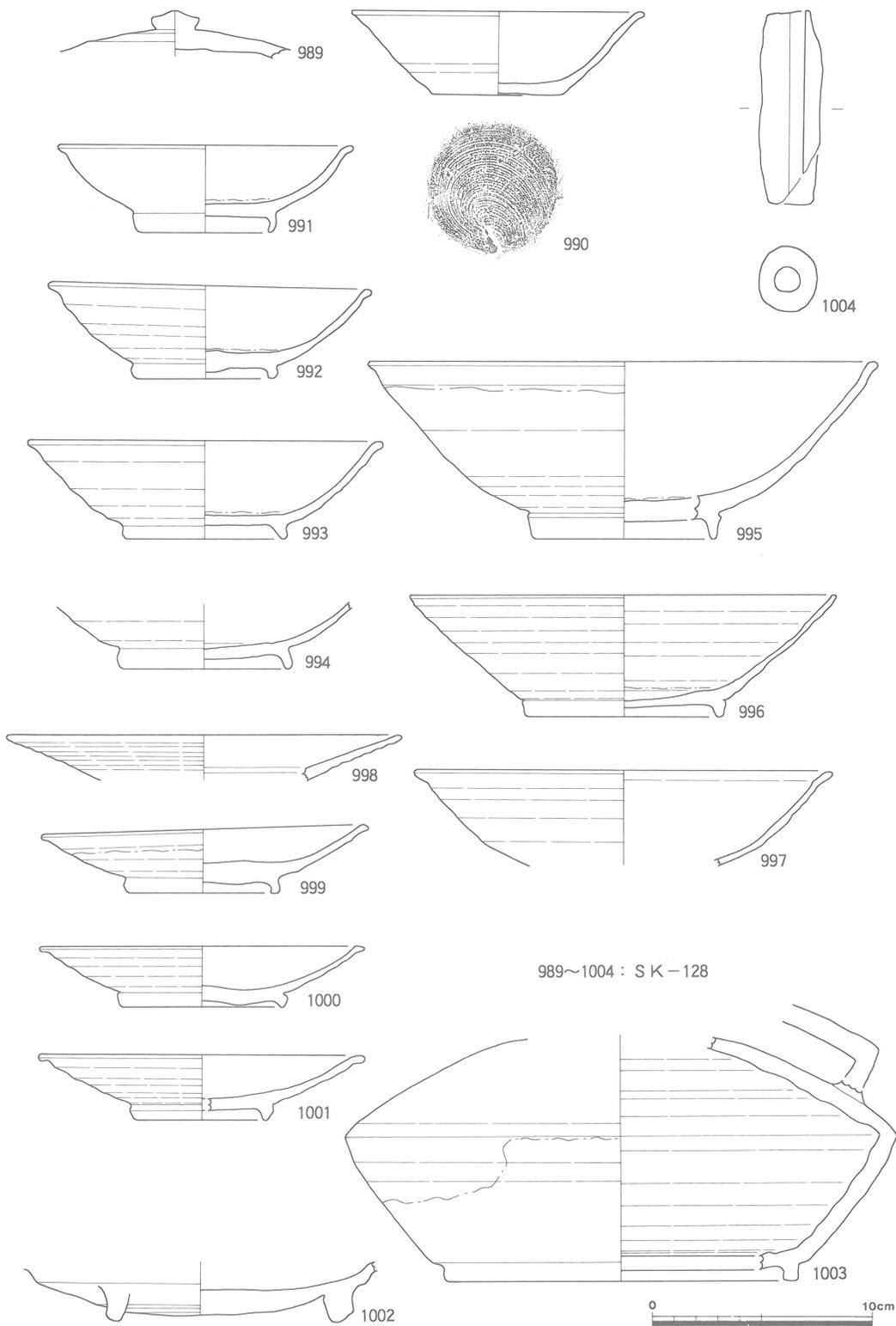

第118図 出土遺物実測図-48 (1/3)

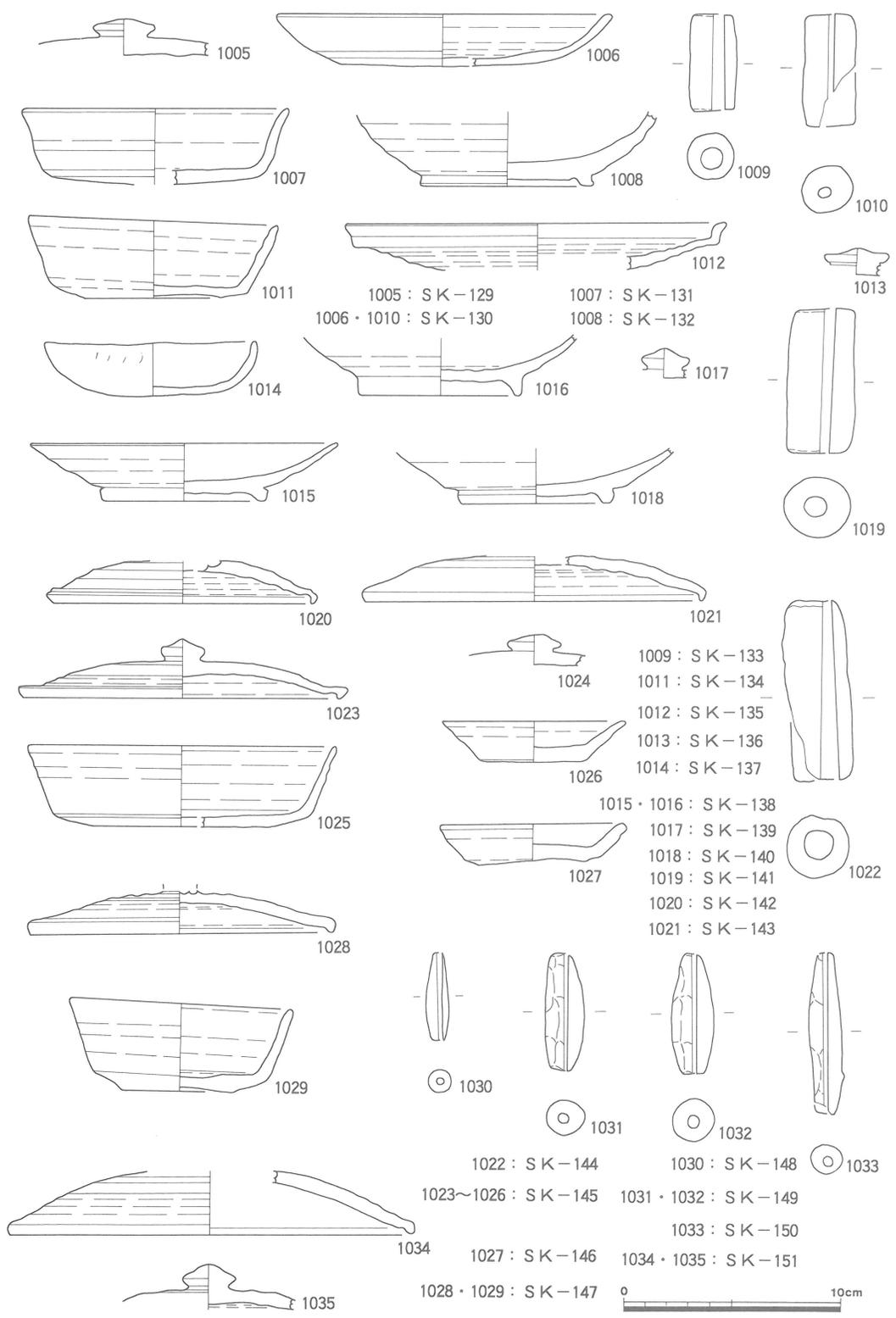

第119図 出土遺物実測図-49 (1/3)

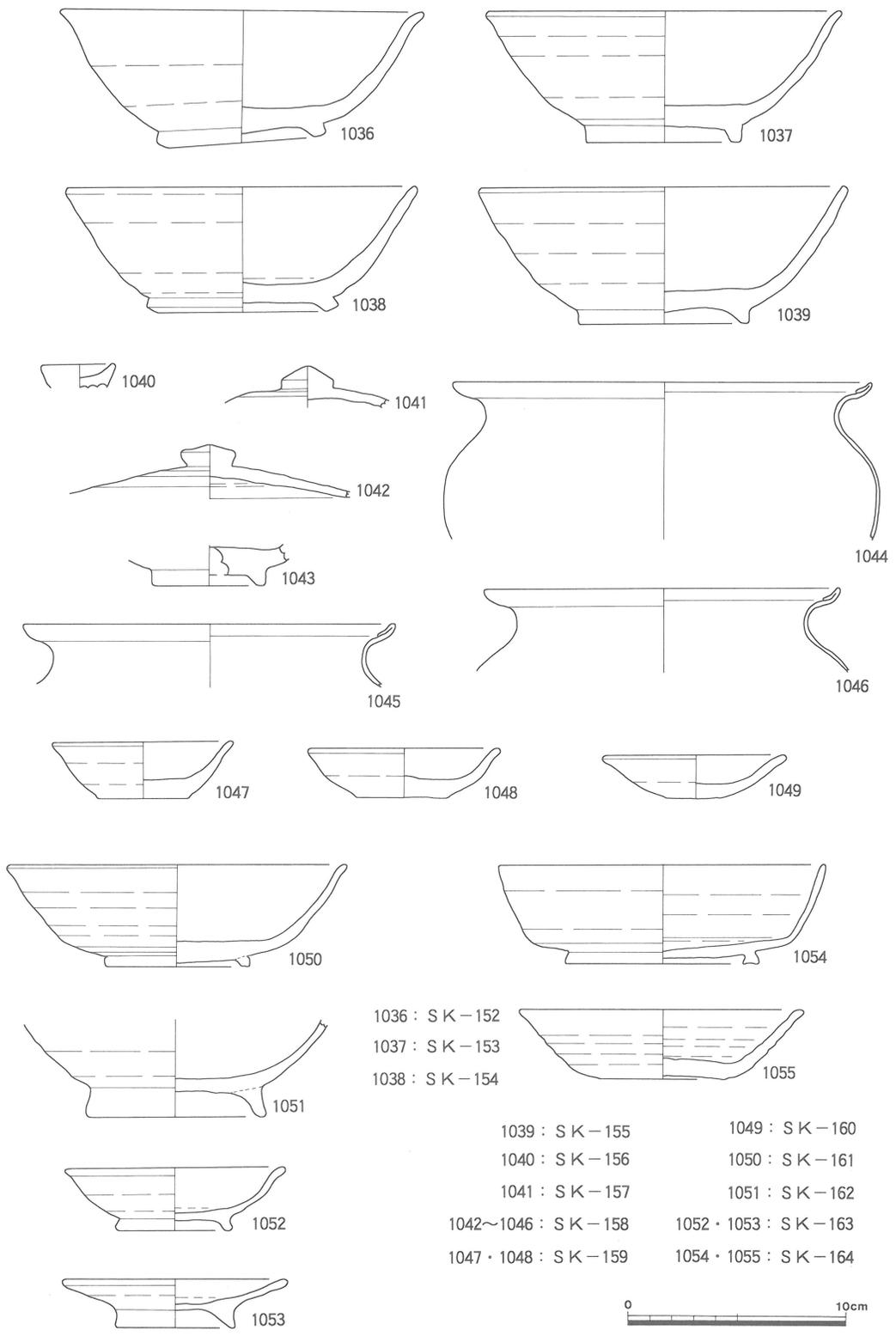

第120図 出土遺物実測図-50 (1/3)

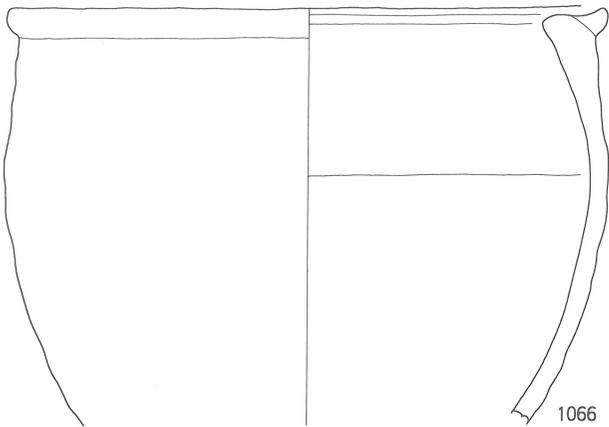
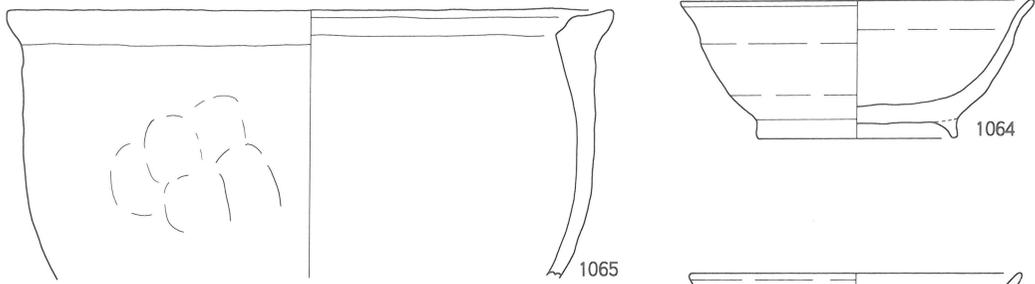
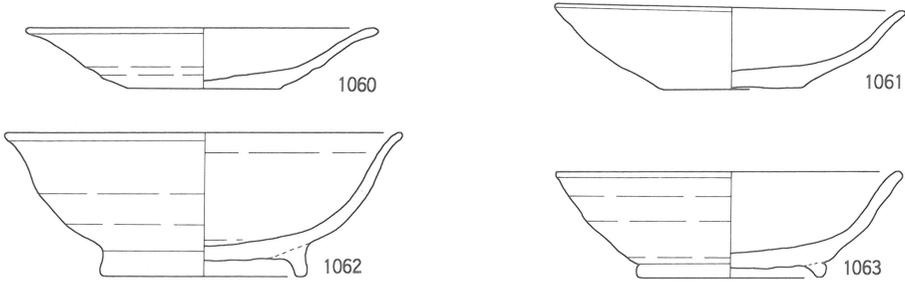
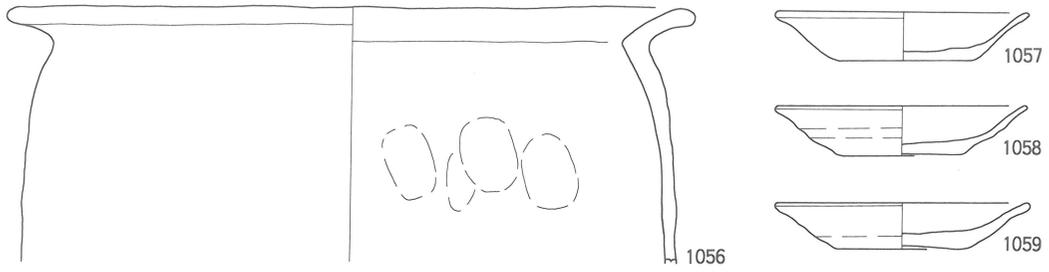

1056 : S K - 165

1057~1066 : S K - 166

1067 : S K - 167



第121図 出土遺物実測図-51 (1/3)

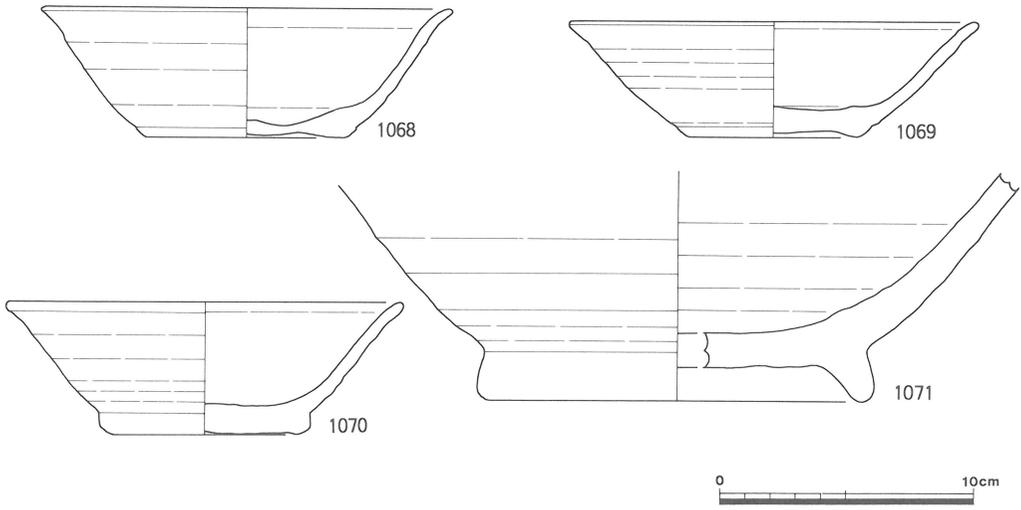

1068~1078 : S X - 1

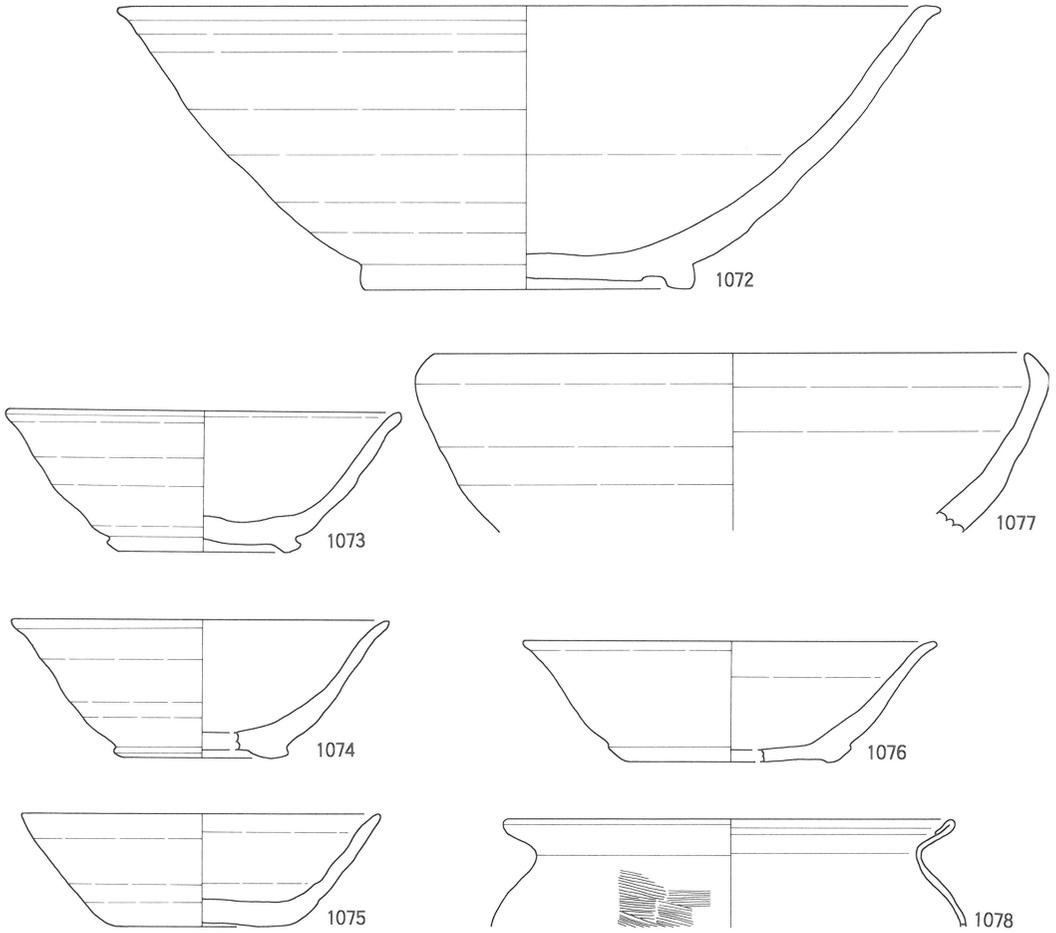

第122図 出土遺物実測図—52 (1/3)

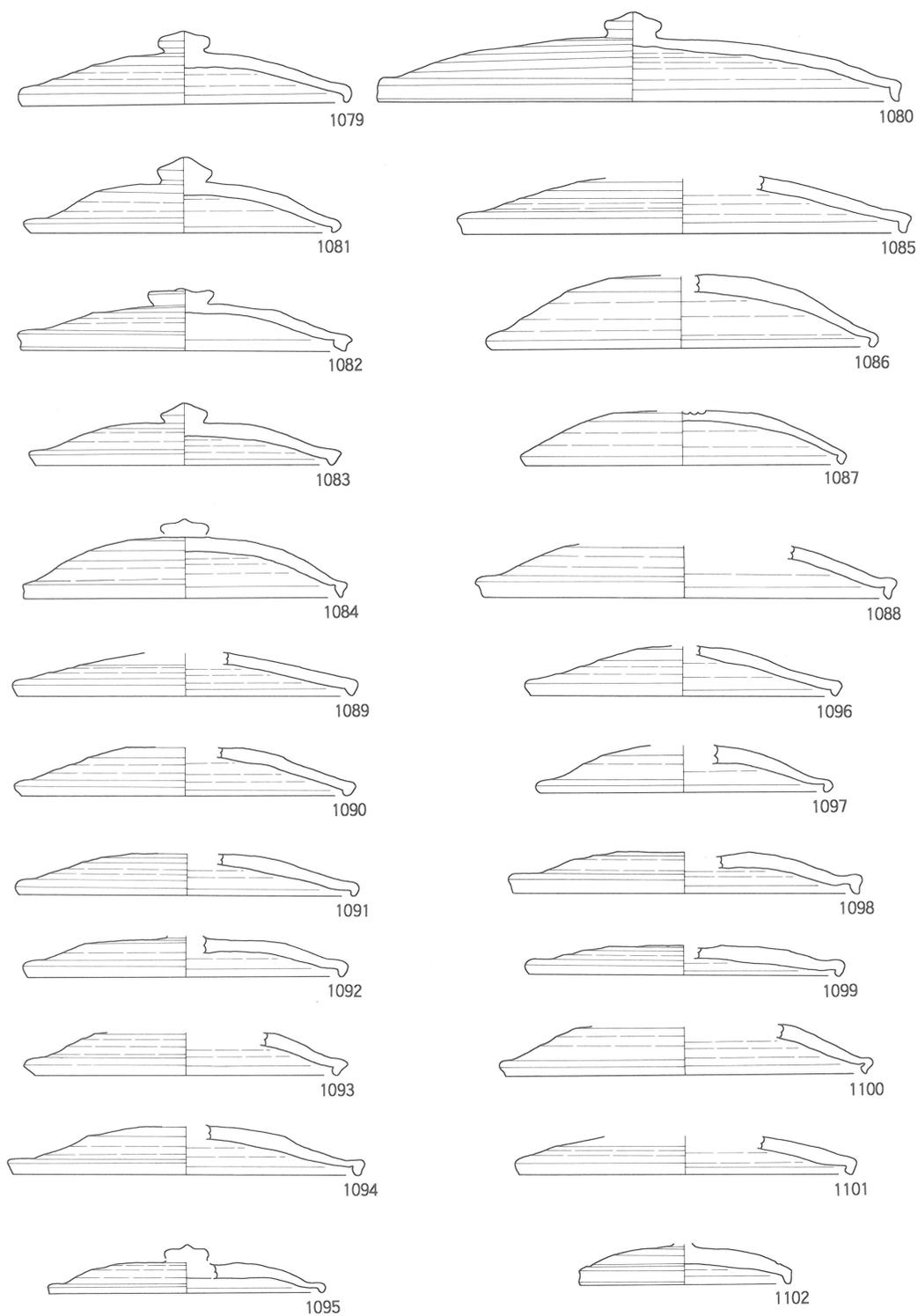

1079~1102 : S X - 2



第123图 出土遺物実測図—53 (1/3)

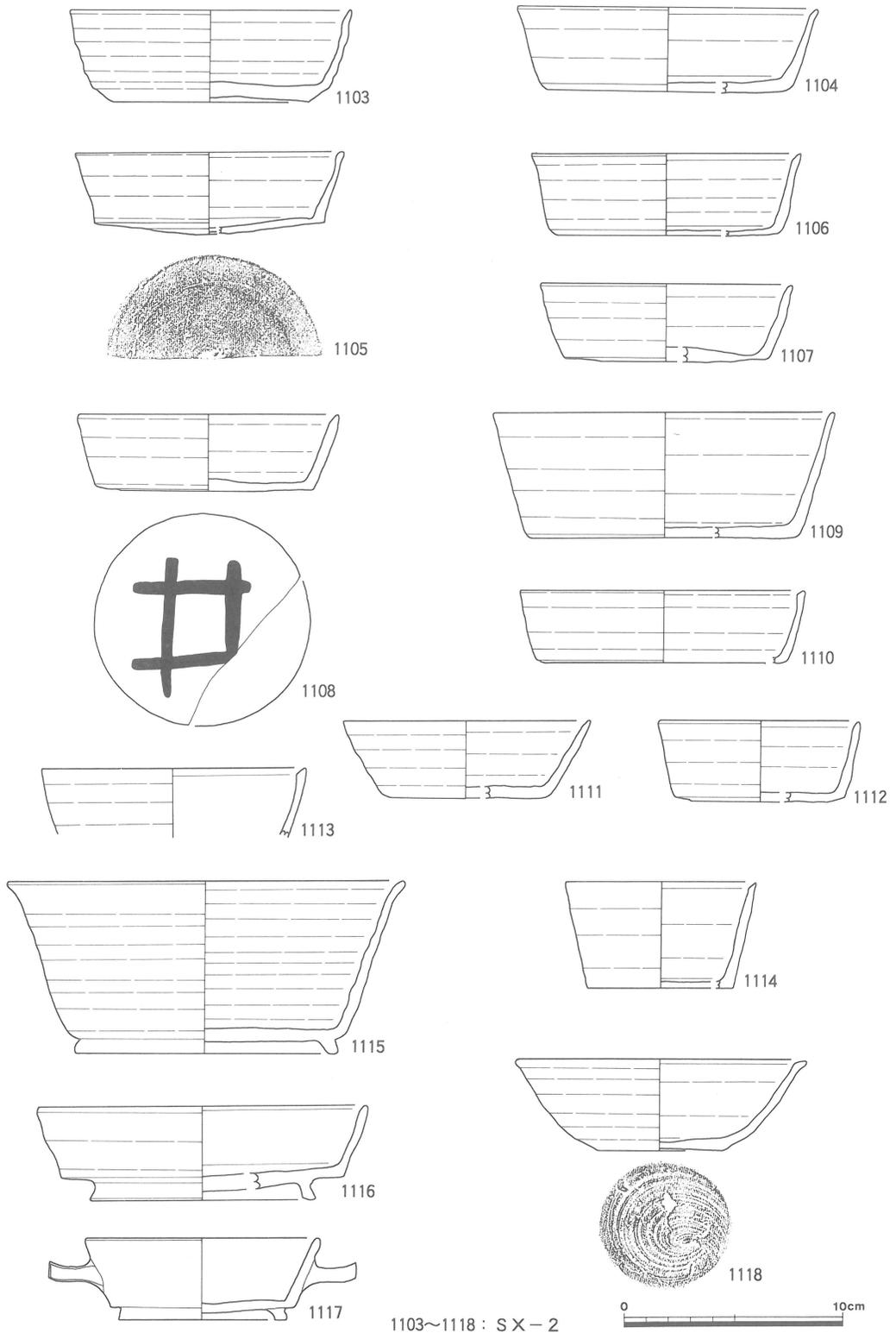

1103~1118 : SX - 2

第124図 出土遺物実測図-54 (1/3)

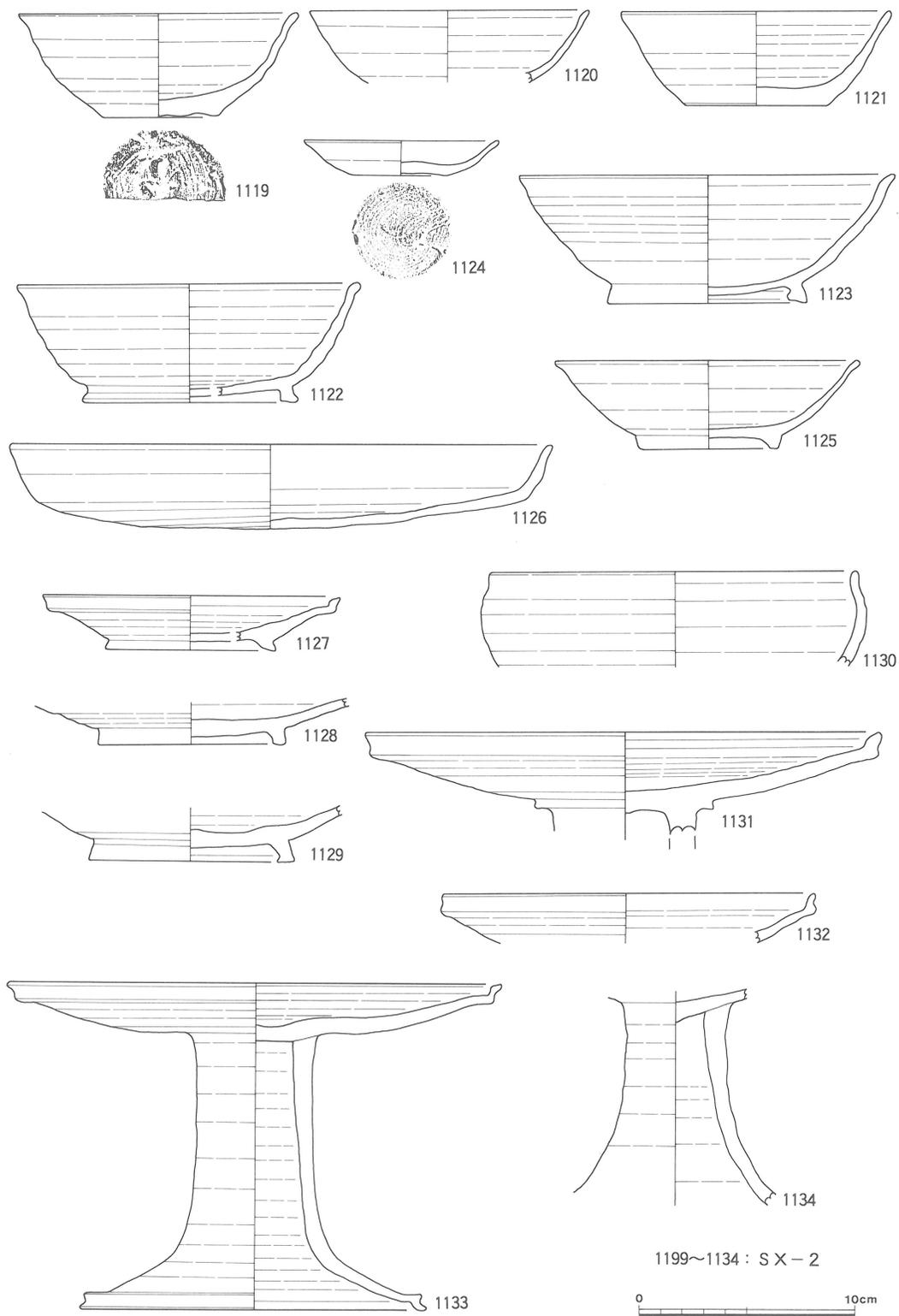

第125図 出土遺物実測図-55 (1/3)

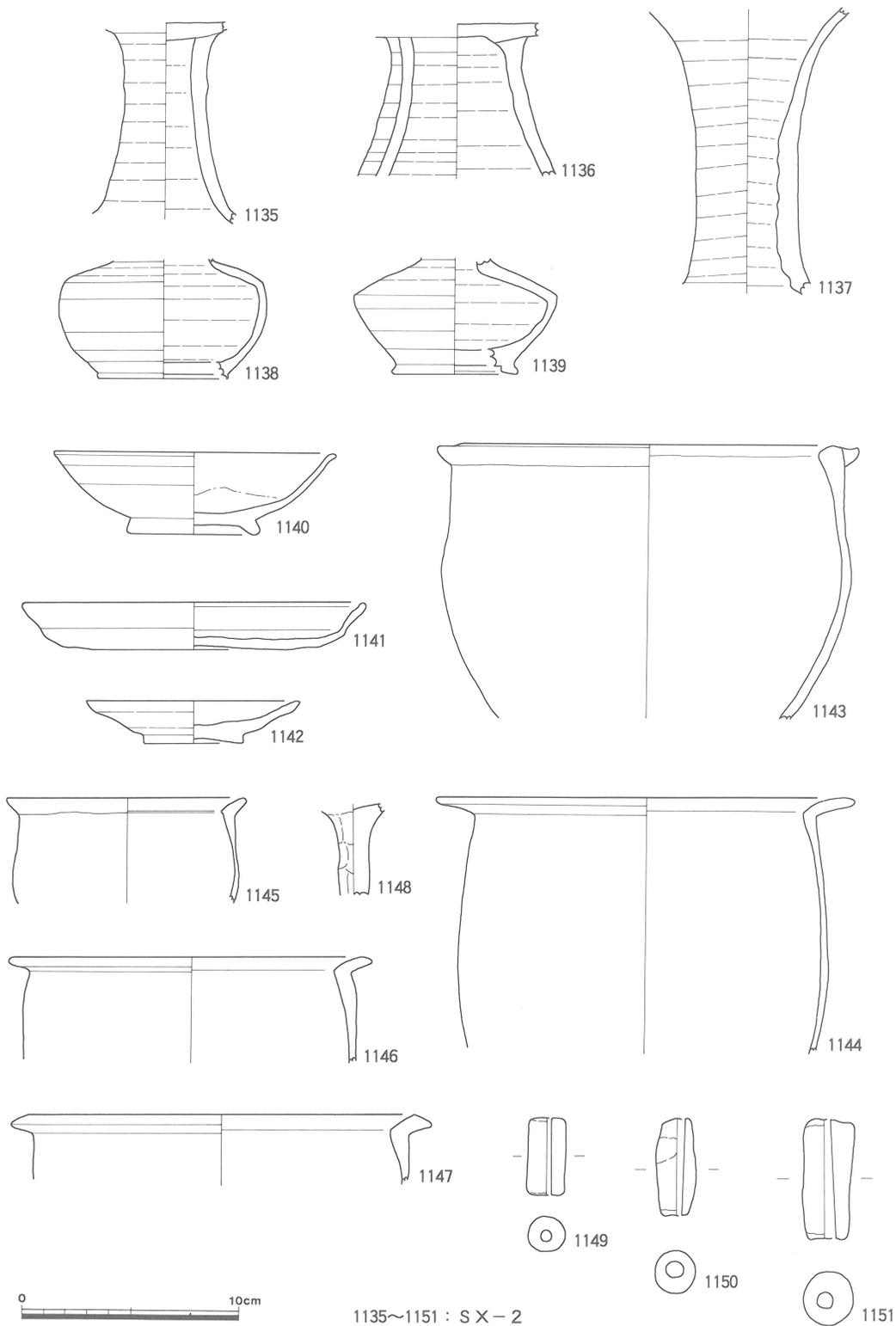

第126図 出土遺物実測図-56 (1/3)

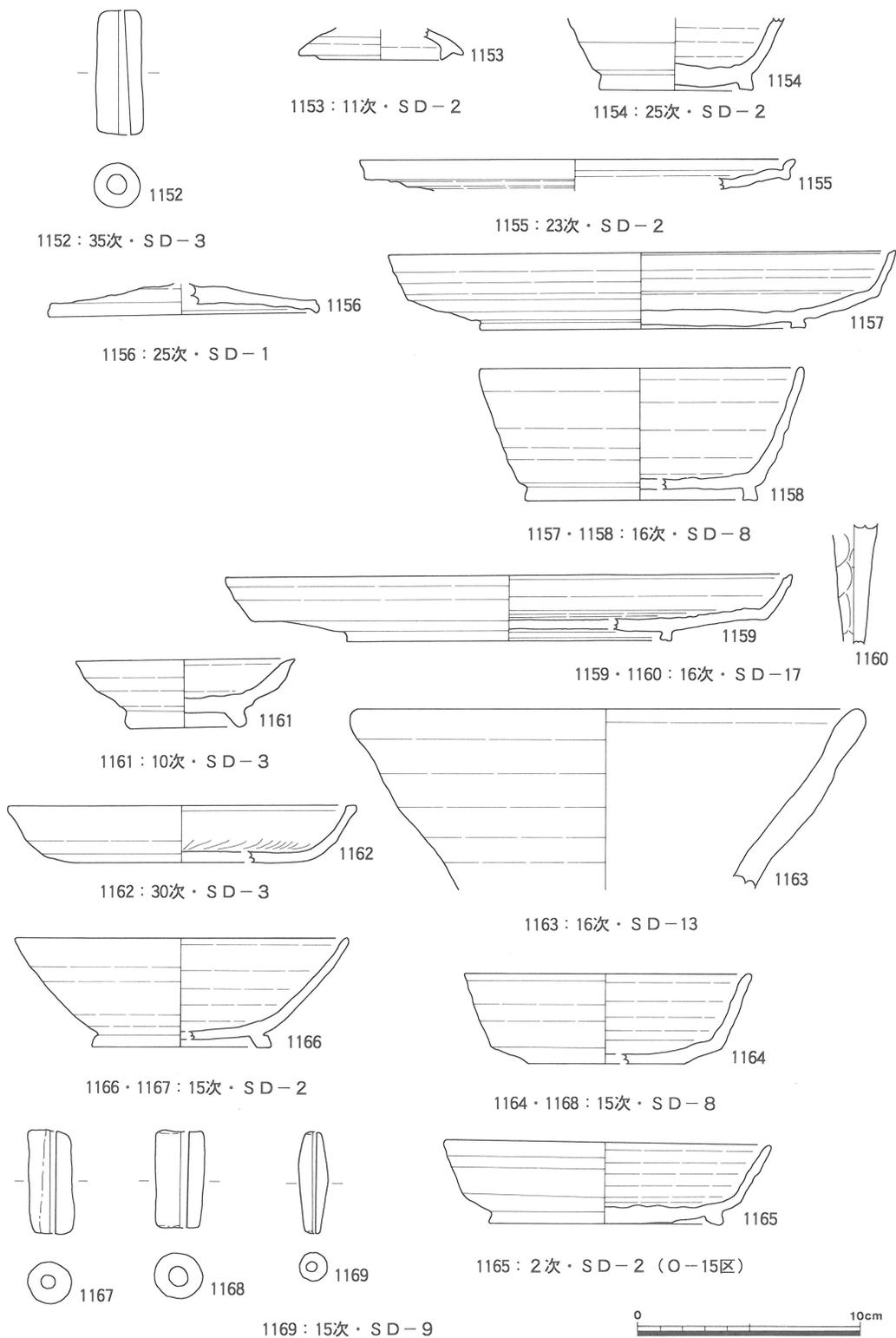

第127図 出土遺物実測図-57 (1/3)

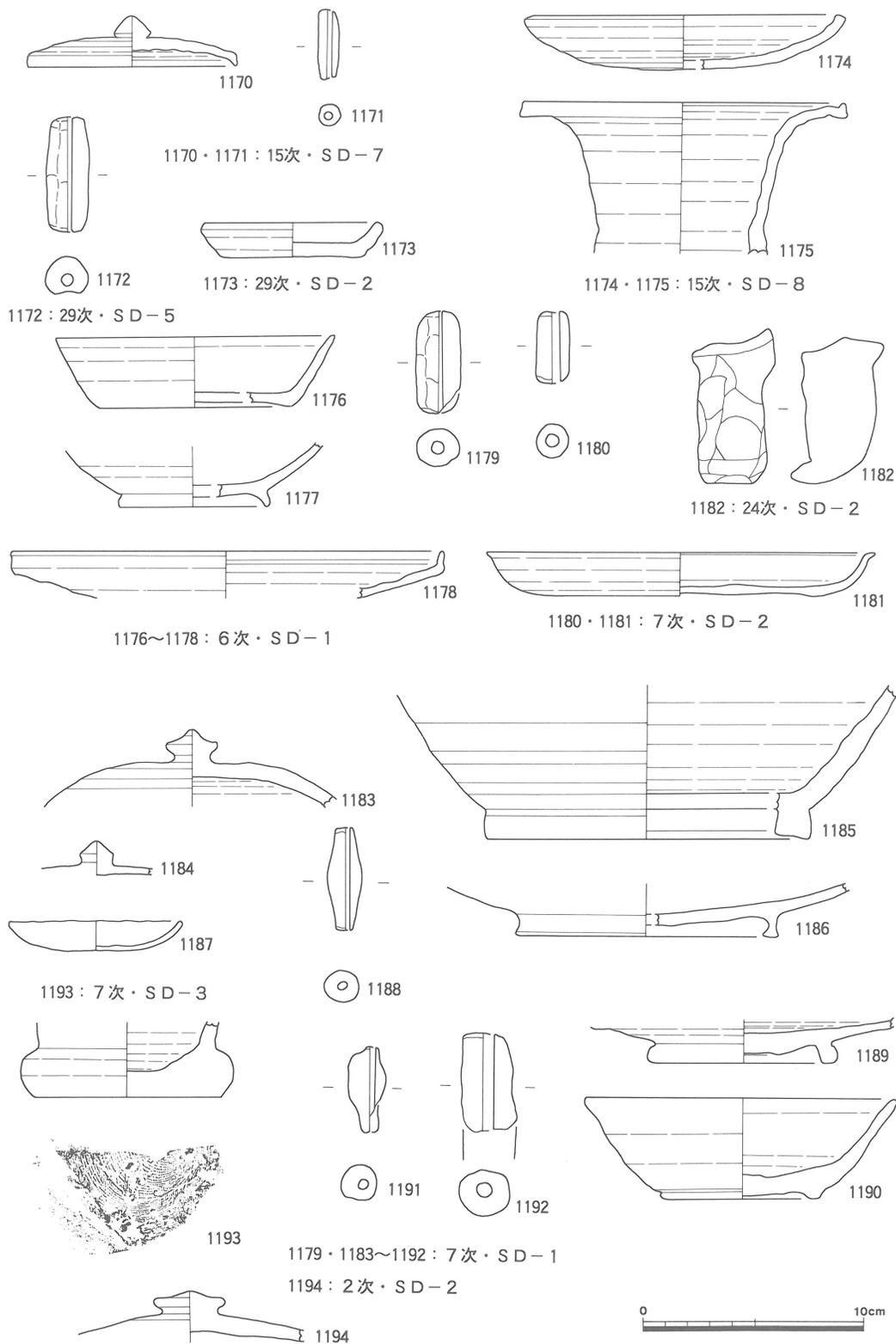

第128図 出土遺物実測図—58 (1/3)

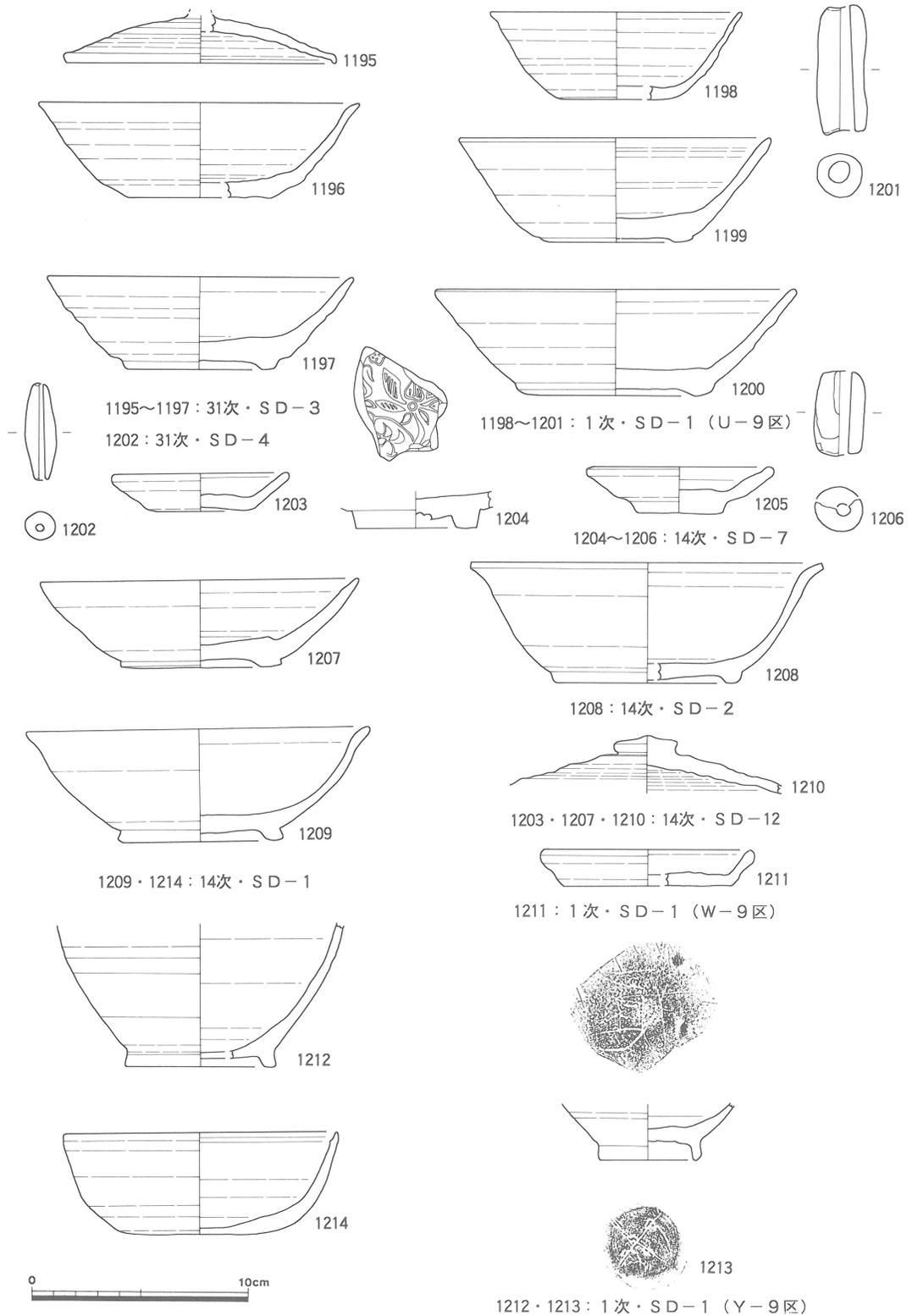

第129図 出土遺物実測図-59 (1/3)

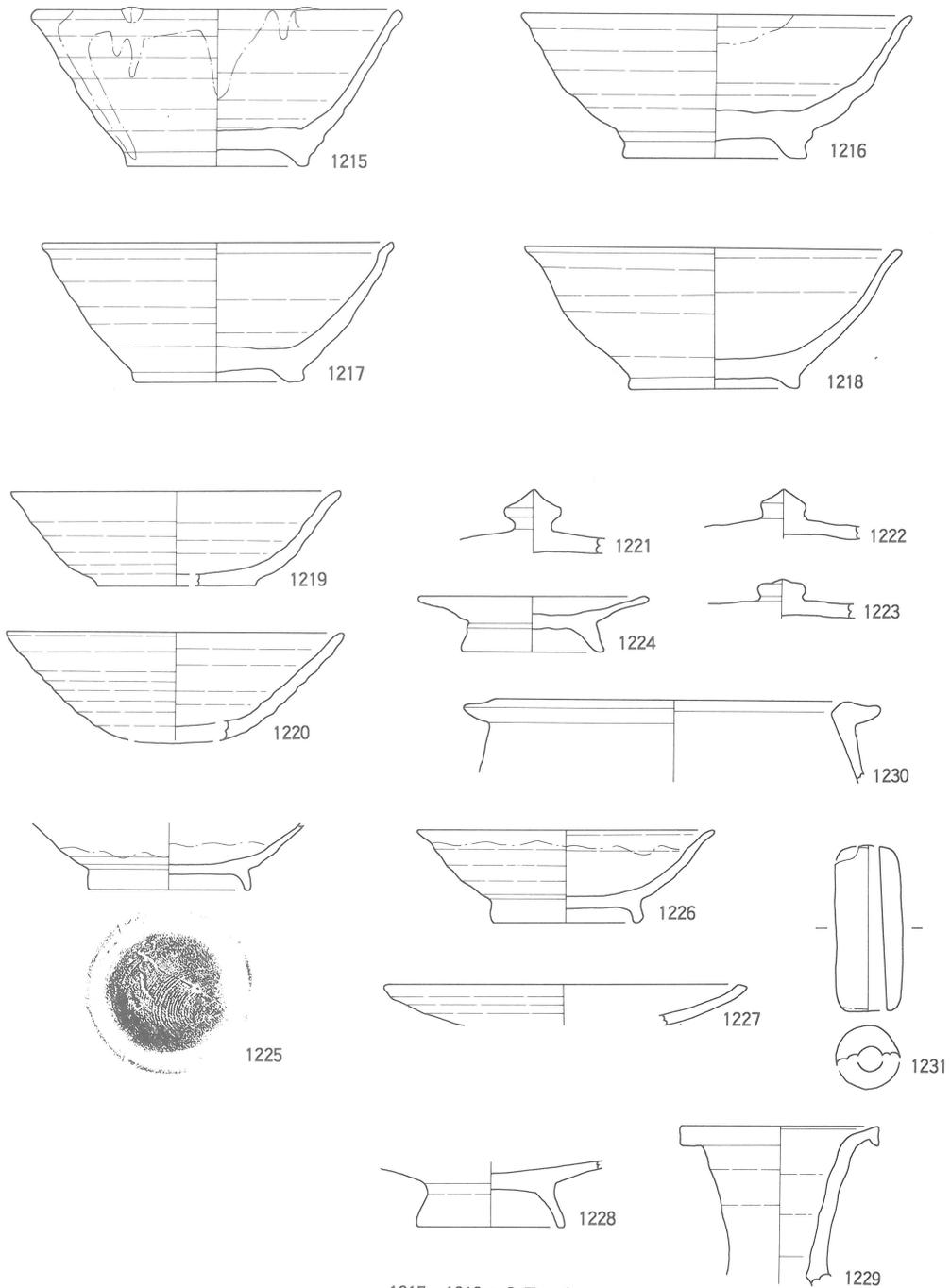

1215~1218 : S E - 1

1219~1231 : S E - 2

0 10cm

第130図 出土遺物実測図-60 (1/3)

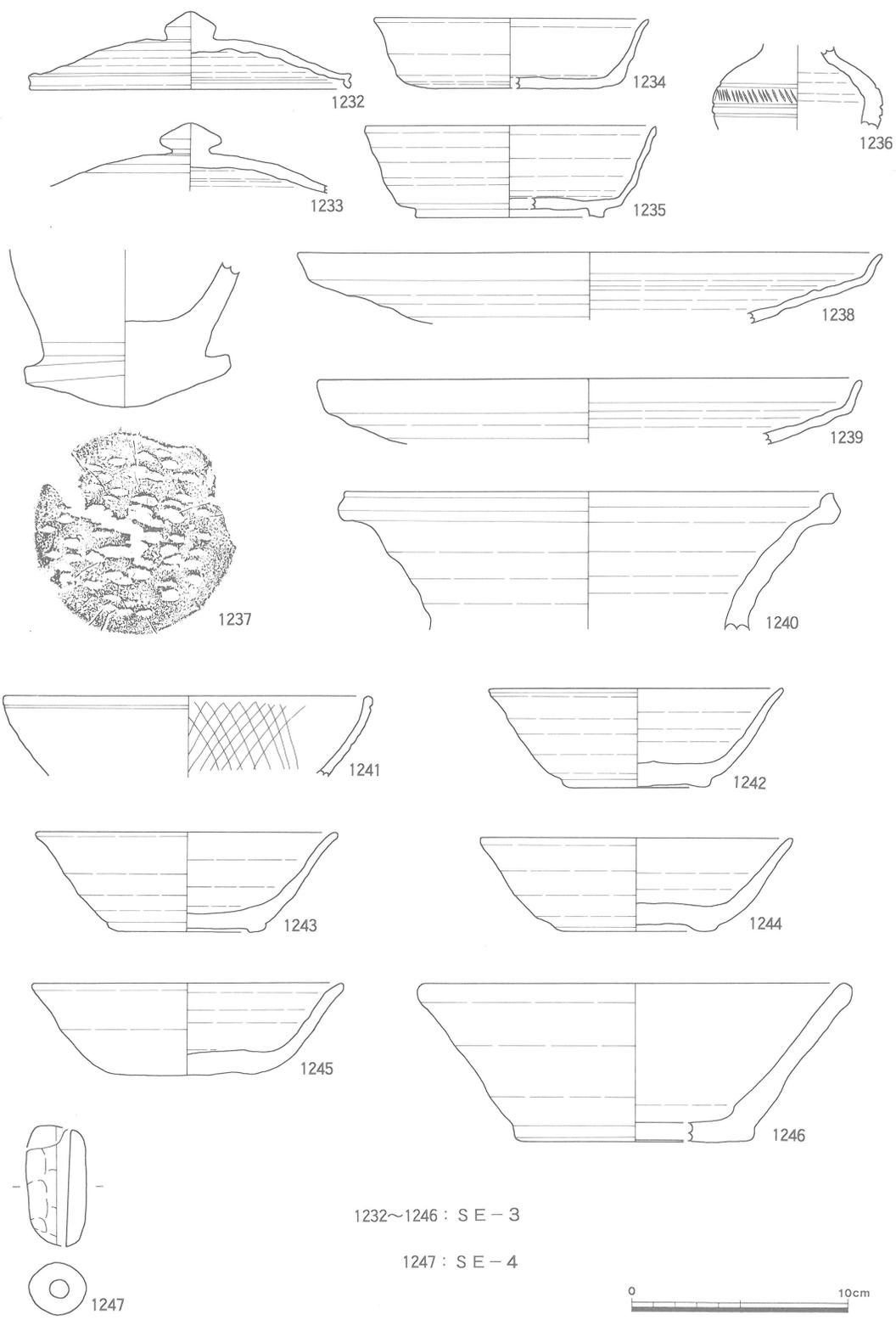

1232~1246 : SE-3

1247 : SE-4



第131图 出土遺物実測図—61 (1/3)

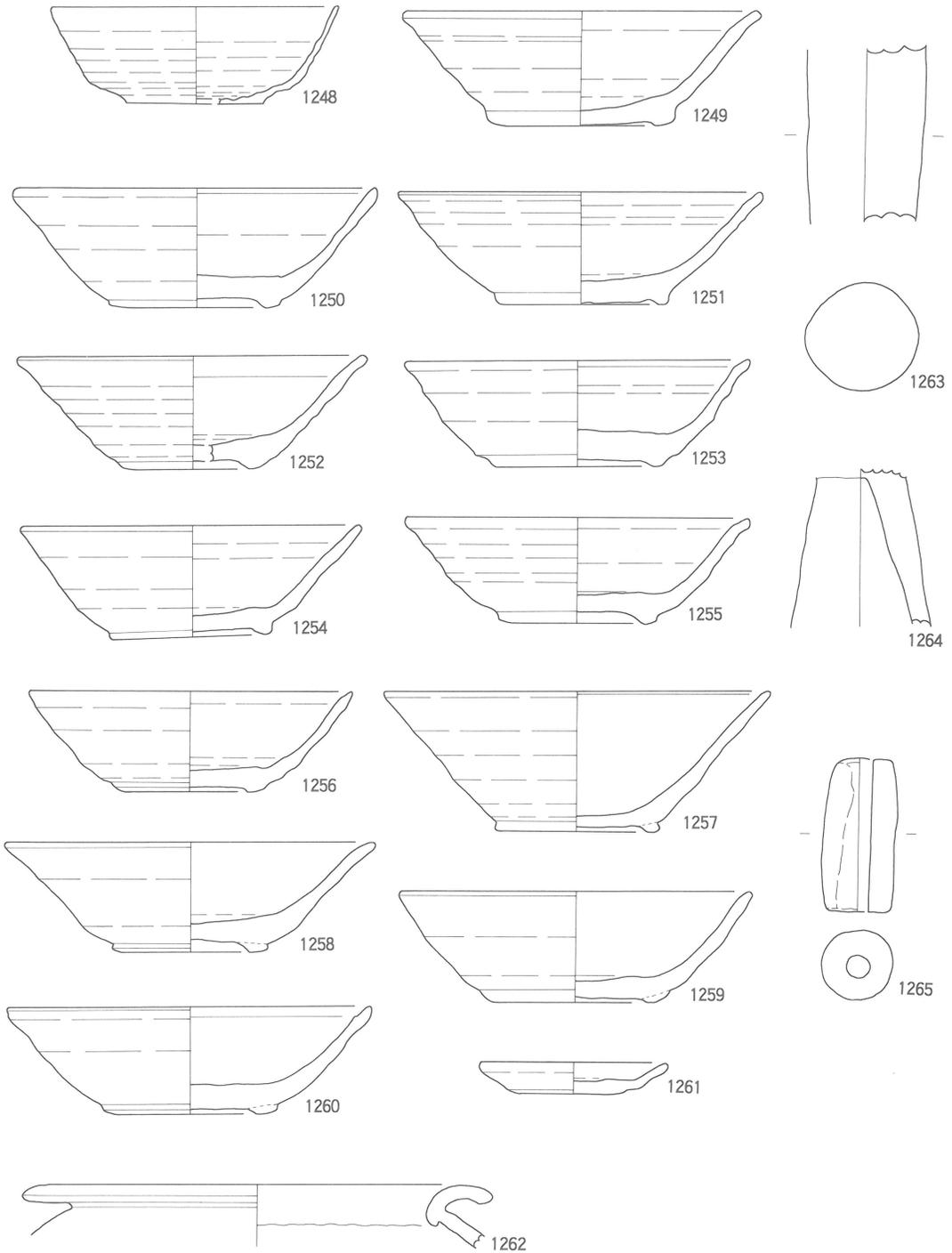

1257・1262 : (1/6)

0 20cm

1248~1265 : S E - 5

0 10cm

第132図 出土遺物実測図-62 (1/3、1/6)

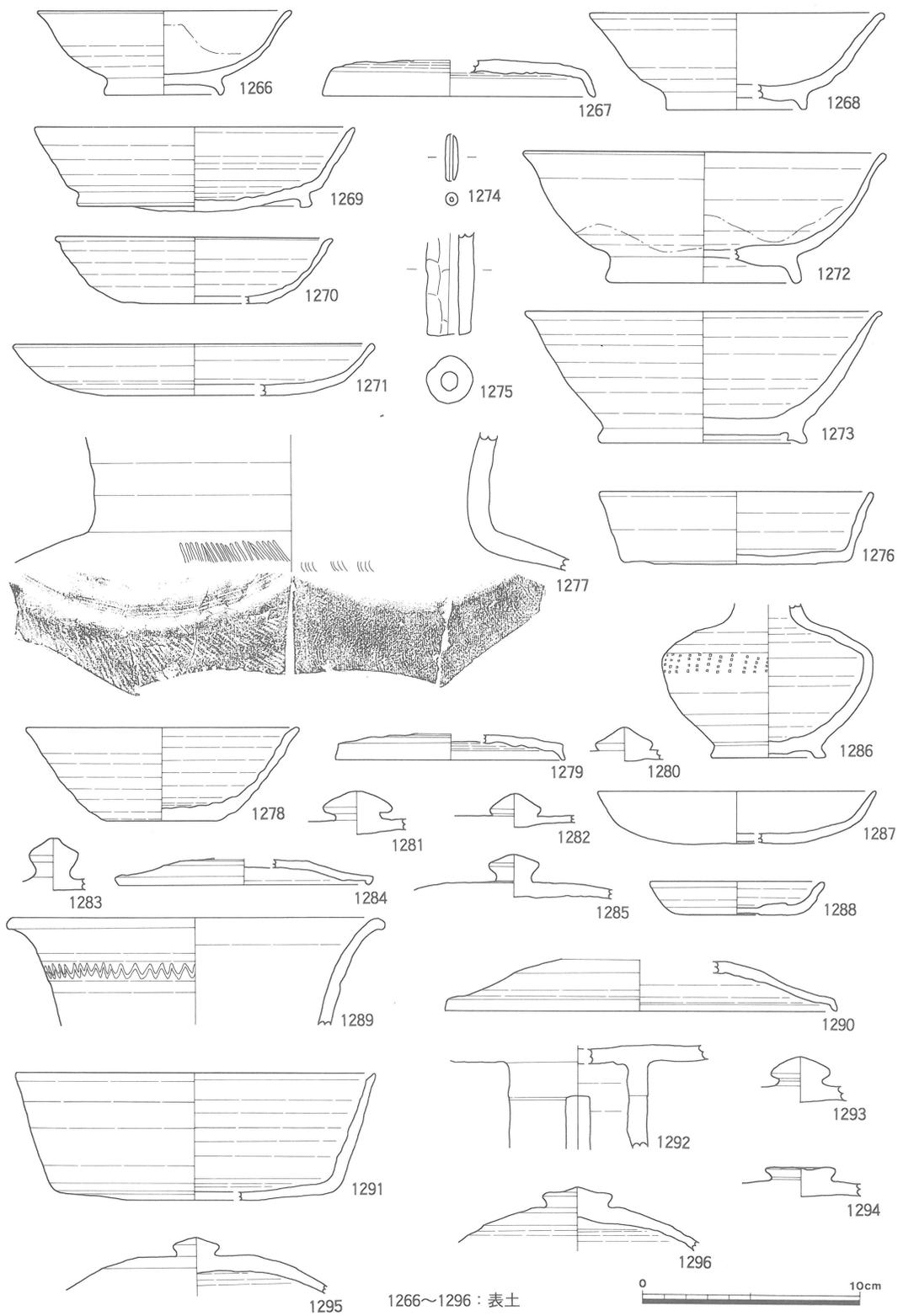

第133图 出土遺物実測図-63 (1/3)

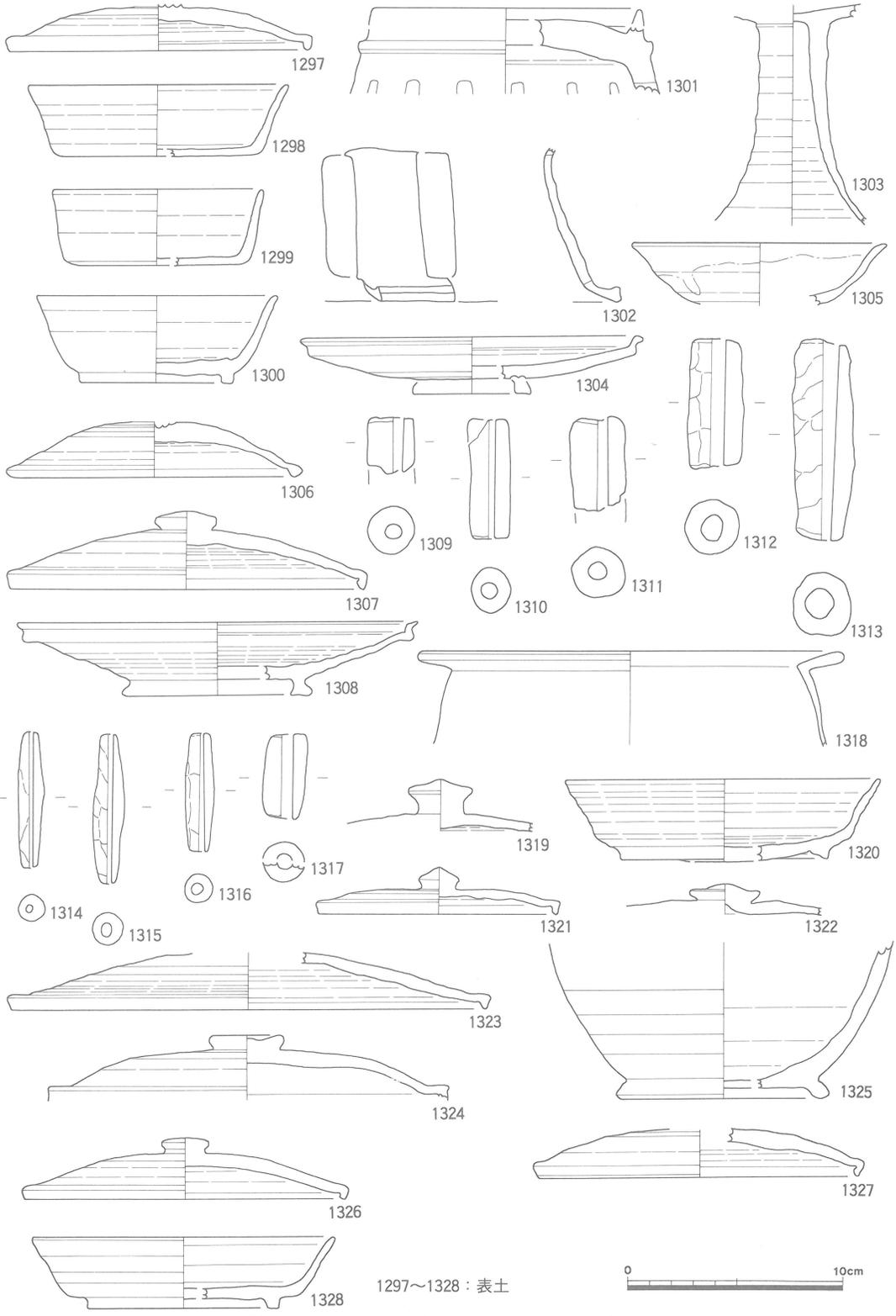

第134图 出土遺物実測図一64 (1/3)

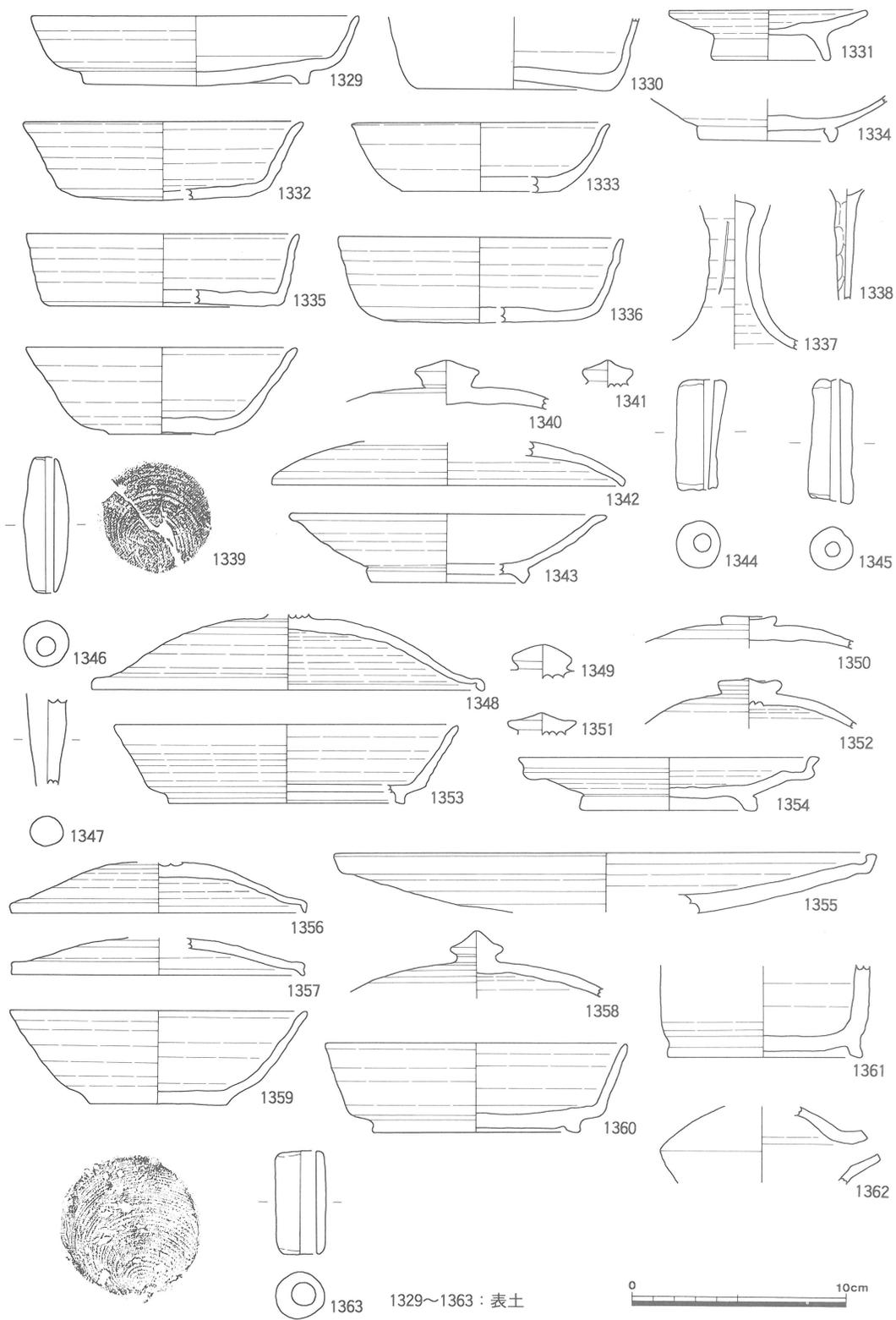

第135図 出土遺物実測図—65 (1/3)

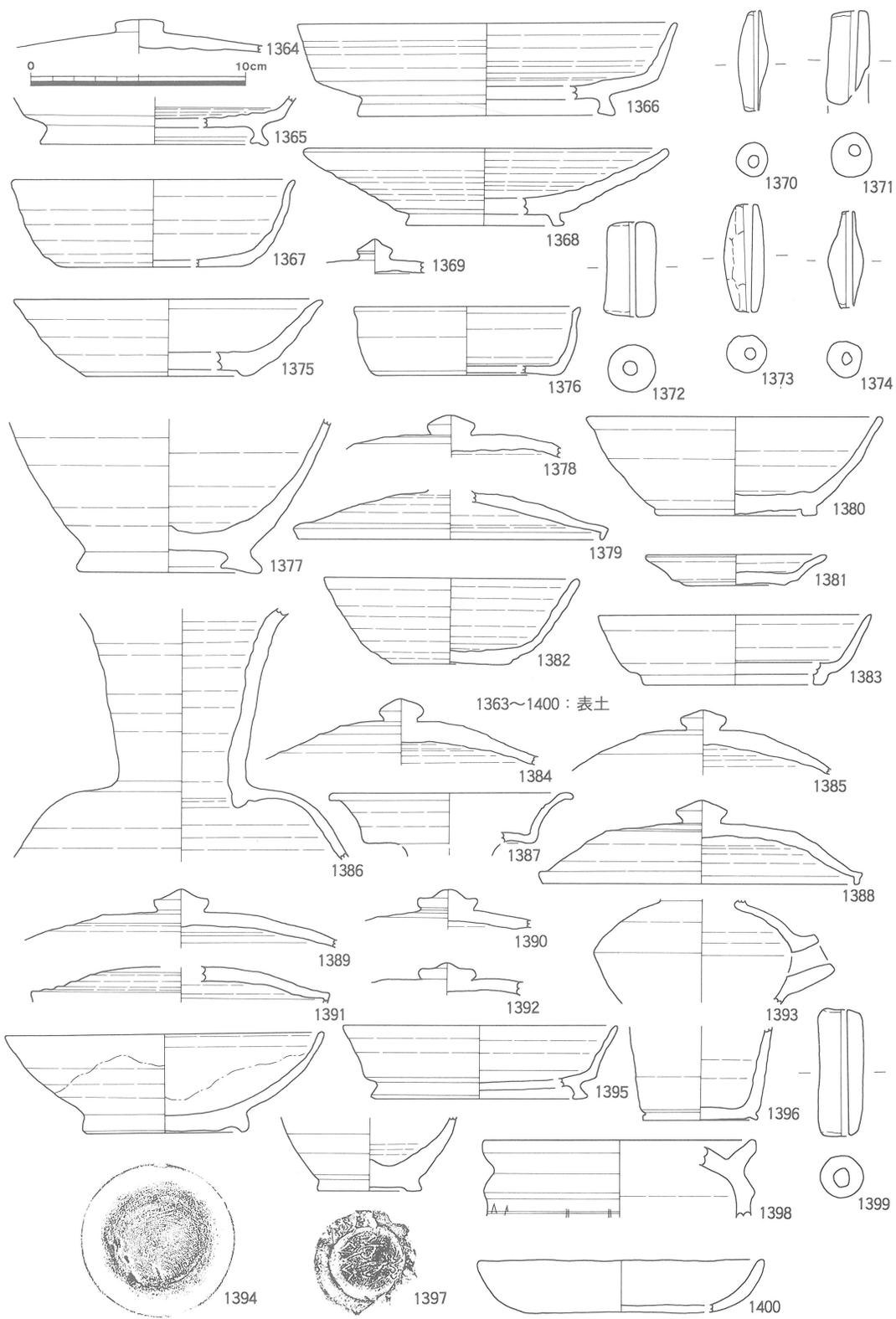

第136図 出土遺物実測図-66 (1/3)

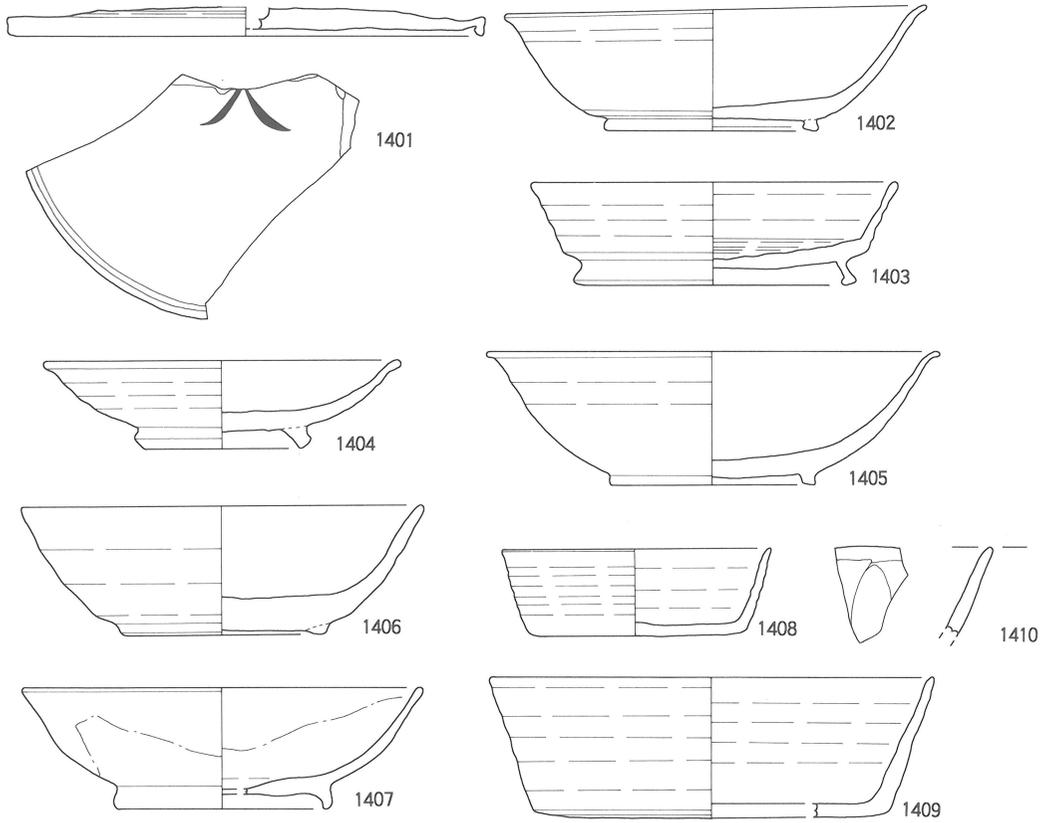

1401~1410 : 表土



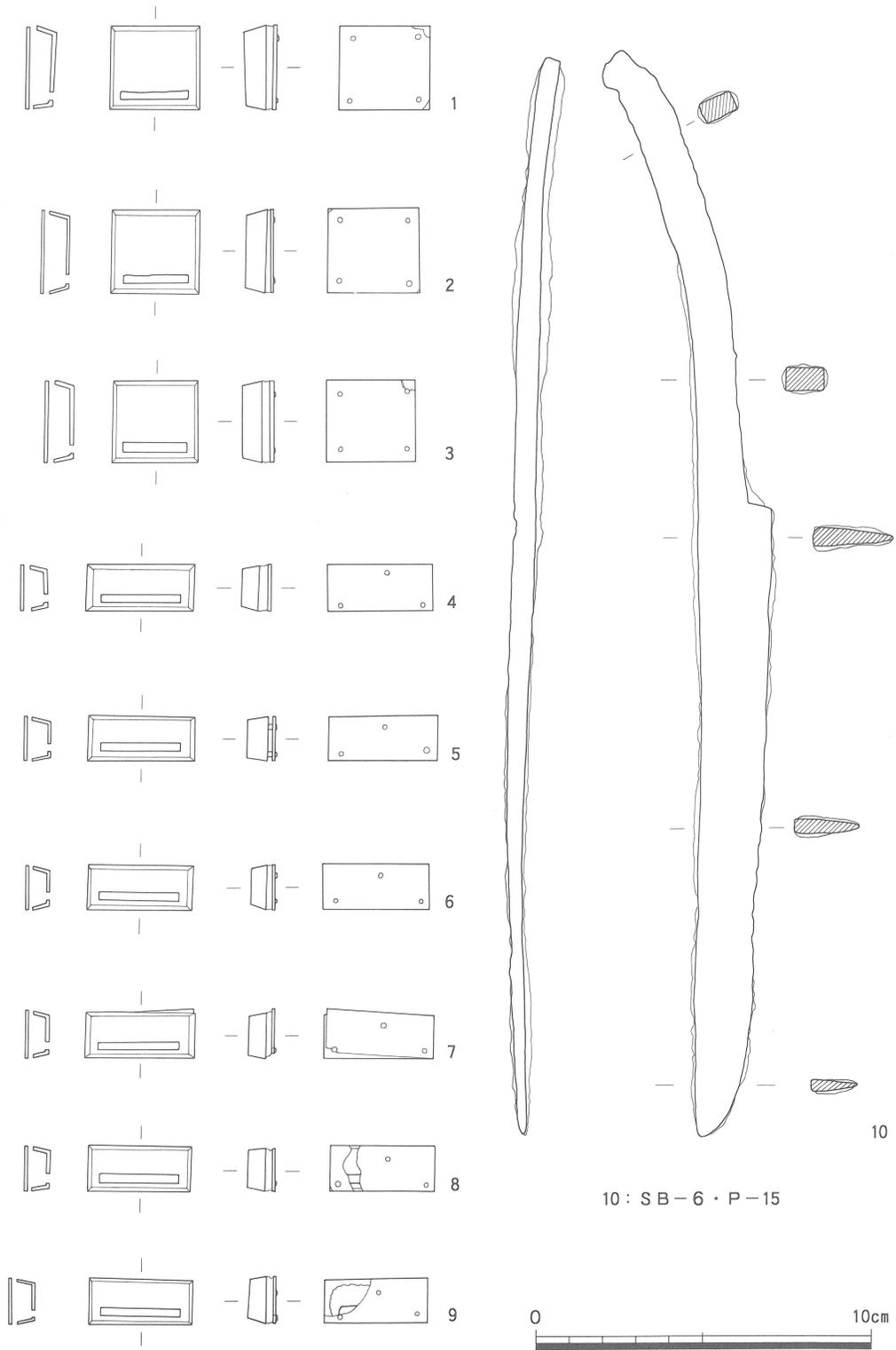

1~9 : 5次 · SE-6付近

第138図 出土遺物実測図-68 (1/2)

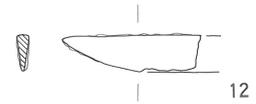
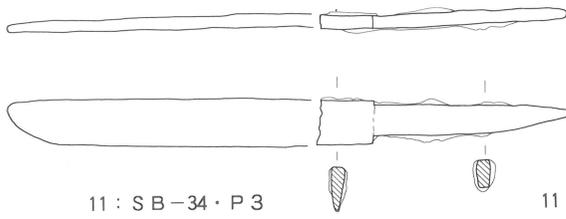

12 : SB-60 · P 6

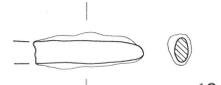

13 : SB-63 · P 1

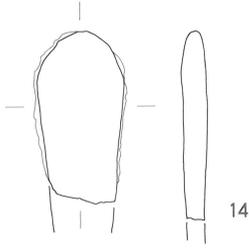

14 : SB-63 · P 3

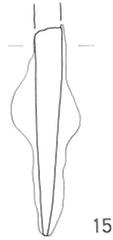

15 : SK-36

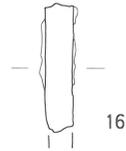

16 : SK-42

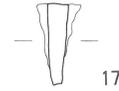

17 : SK-26

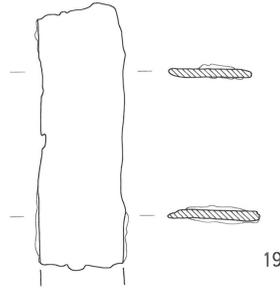
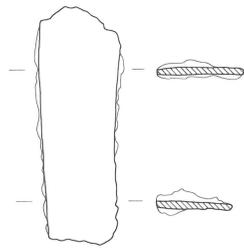

18~20 : SK-48

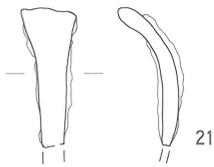
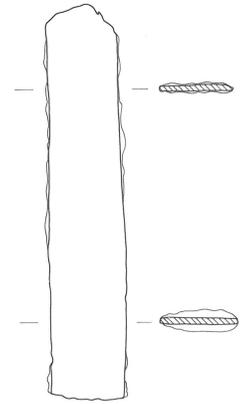

21 : SK-55

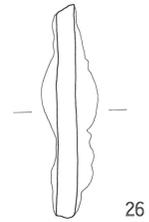
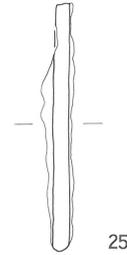
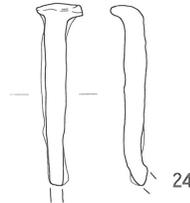
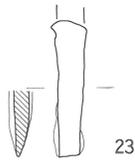

22~26 : SK-88

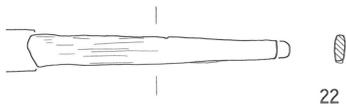

第139図 出土遺物実測図-69 (1/2)

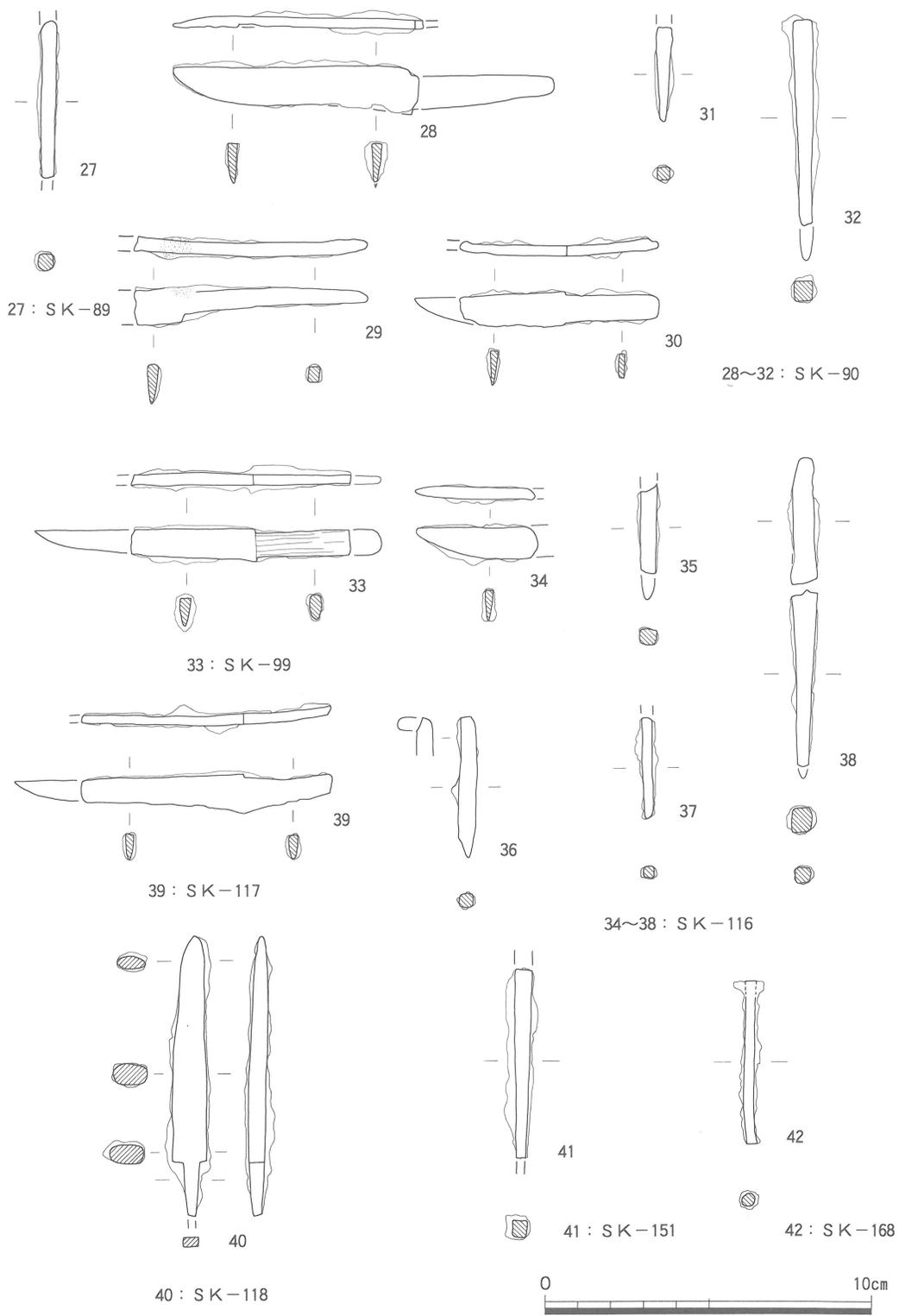

第140図 出土遺物実測図一70 (1/2)

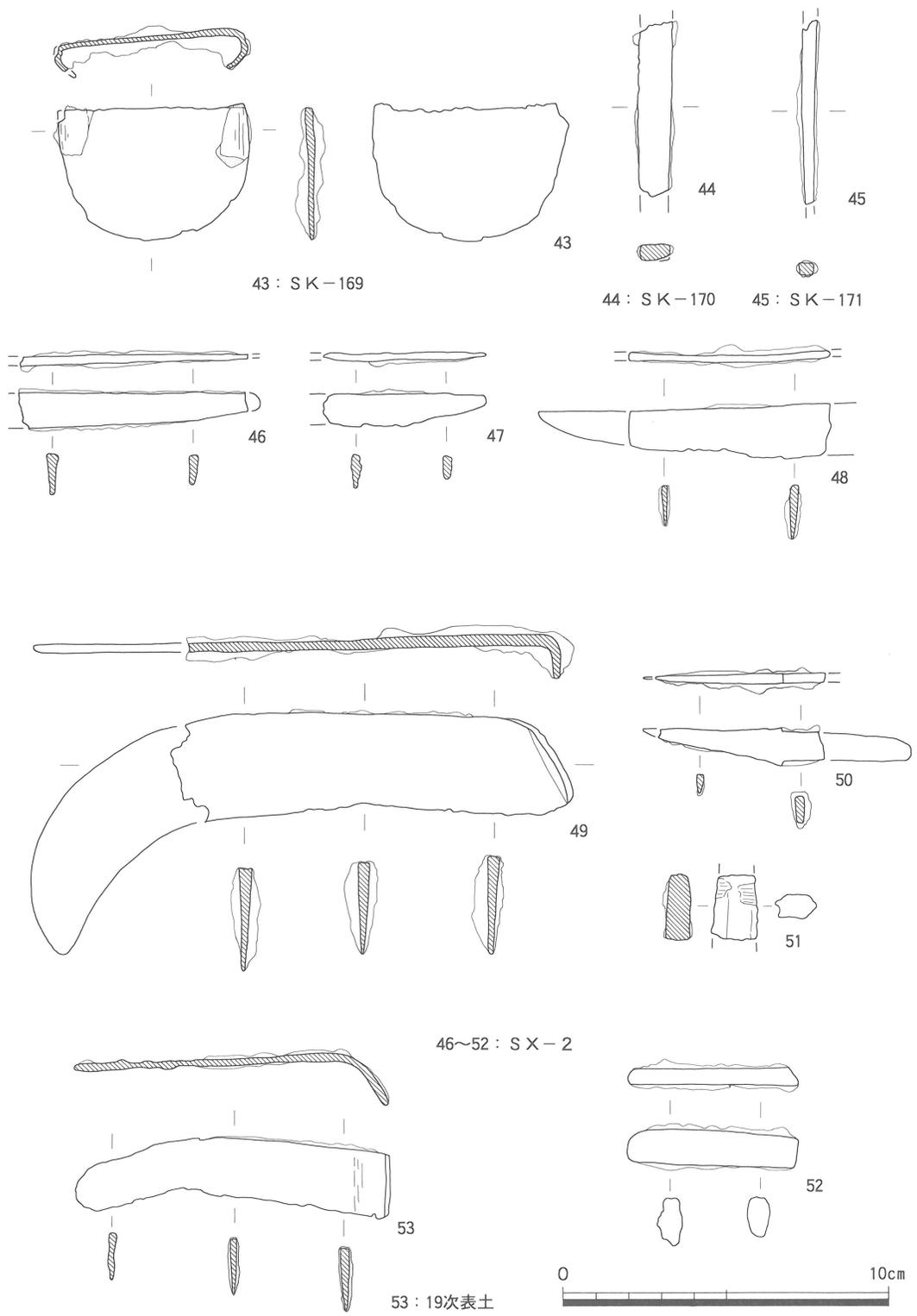

第141図 出土遺物実測図-71 (1/2)

