

岩手県文化振興事業団埋蔵文化財調査報告書第709集

いしとうげ
石峠Ⅱ 遺跡発掘調査報告書

三陸沿岸道路建設事業関連遺跡発掘調査

第3分冊

2020

国土交通省東北地方整備局三陸国道事務所
(公財)岩手県文化振興事業団

石峠Ⅱ遺跡発掘調査報告書

三陸沿岸道路建設事業関連遺跡発掘調査

第3分冊

凡例

土器類

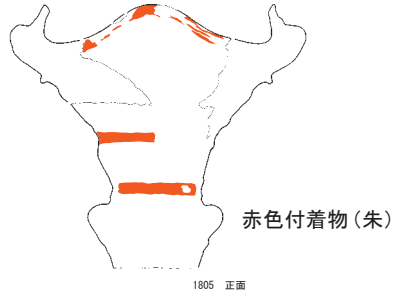

石器類

計測部分

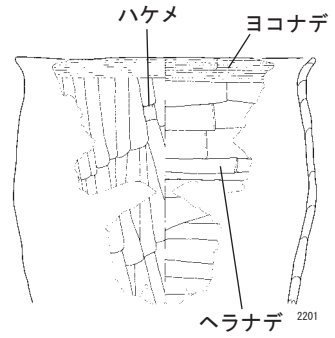
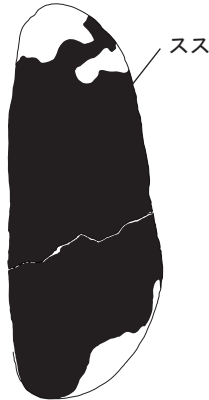
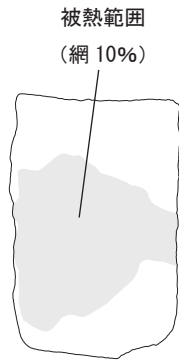
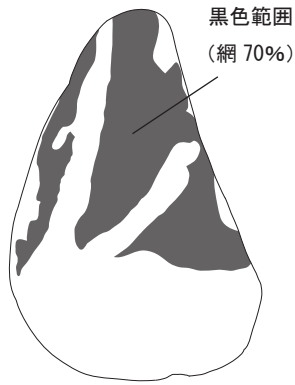
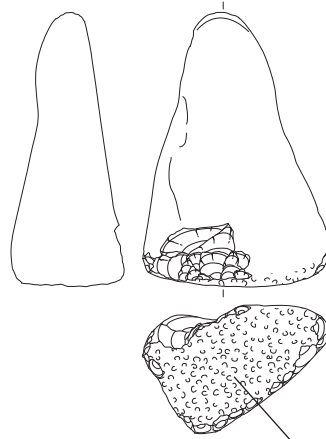
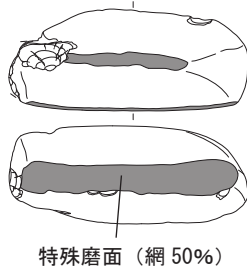
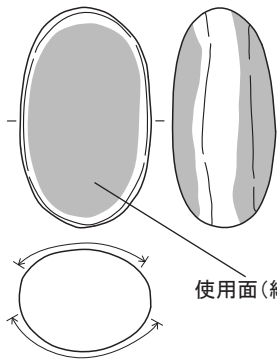
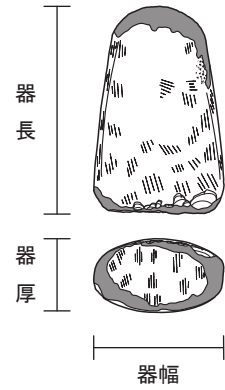
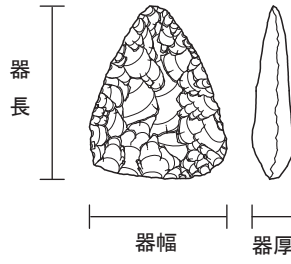

羽口

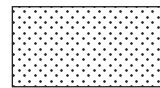
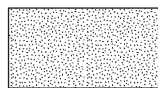
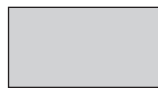
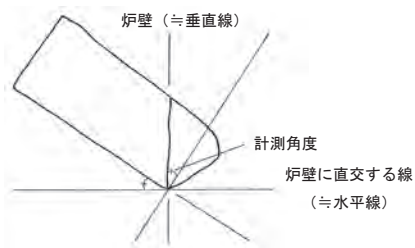

<略号・表記について>

観察表等で使用した略号は以下の通りである。

遺構名：遺構種別の頭文字と遺構種別毎の通り番号を記載。頭文字が同じものについては、2文字目も記載。

竪穴住居：竪 住居状遺構：住 掘立柱建物：掘 土坑：土 陥し穴：陥 柱穴：柱 製鉄炉：製鉄、製

例：1号竪穴住居→1 竪 2号陥し穴→2 陥 3号土坑→3 土坑 4号土取り穴→4 土取

<出土地点・層位>

床面直上：床直 底面直上：底直 ベルト：B 埋土●位～○位：埋土●○位 攪乱：攪 北：N 南：S
西：W 東：E 中央：C

<部位・文様等>各部位は以下の通り。

口縁端部：口端 口縁部：口 口縁上部：口上 頸部：頸 胴部：胴 胴上部：胴上 胴下部：胴下 底上
：底部直上 底部：底 底部外面：底外

端部のない口縁：(口) 肩部：肩

<文様等>

結束第1種羽状縄文：結1羽 非結束羽状縄文：非結羽 単軸絡条体1類：単絡1 ナデ：N ミガキ：M
ハケメ：H ヘラナデ：HN ヘラケズリ：HK ケズリ：K

ヨコナデ：YN 指頭圧痕：指 内面調整：内 胎土：胎 黒色鈳物：黒色 透明鈳物：透明 赤色付着物：赤
色

<型式(時期)>

前期初頭～前葉：前期初前 中期後葉～末葉：中期後末 大木10(古)～大木10(中)：大木10(古中)
大木10(中)～大木10(新)：大木10(中新)

土製品

<器種>

ミニチュア土器：ミニ キノコ形土製品：キノコ ●●状土製品：●●状

円盤状土製品

残存：残

完形：完 一部欠：一部 半分以上：以上 半分以下：以下

形状：形

多角形：多 円形：円 矩形：矩 不明：不

研磨状態：研状

剥離：剥 全面：前 半分以上：以上 半分以下：以下 不明：不

研磨度：研度

平滑：平 若干：若 剥離：剥

石器

<器種>

スクレイパー：SCR 矩形扁平石器：矩形扁平 半円状扁平打製石器：半円状 円盤状石器：円盤状

○○石製品：○○

<掲載番号>

接合資料●：接●

<備考>

部分：部 磨面：磨 凹部：凹 敲打痕：敲 剥離：剥 敲打痕+剥離：敲剥 潰れ：潰

羽口

<残存部位>

先端：先 基部：基

<その他>

当センターで使用しているコンテナの大きさは以下の通りである。

大コンテナ：42×32×30 cm 中コンテナ：42×32×20 cm 小コンテナ：42×32×10 cm

(第 3 分 冊)

遺物図版目次

遺物図版 1	縄文時代の遺物 1	1	遺物図版41	縄文時代の遺物41	41
遺物図版 2	縄文時代の遺物 2	2	遺物図版42	縄文時代の遺物42	42
遺物図版 3	縄文時代の遺物 3	3	遺物図版43	縄文時代の遺物43	43
遺物図版 4	縄文時代の遺物 4	4	遺物図版44	縄文時代の遺物44	44
遺物図版 5	縄文時代の遺物 5	5	遺物図版45	縄文時代の遺物45	45
遺物図版 6	縄文時代の遺物 6	6	遺物図版46	縄文時代の遺物46	46
遺物図版 7	縄文時代の遺物 7	7	遺物図版47	縄文時代の遺物47	47
遺物図版 8	縄文時代の遺物 8	8	遺物図版48	縄文時代の遺物48	48
遺物図版 9	縄文時代の遺物 9	9	遺物図版49	縄文時代の遺物49	49
遺物図版10	縄文時代の遺物10	10	遺物図版50	縄文時代の遺物50	50
遺物図版11	縄文時代の遺物11	11	遺物図版51	縄文時代の遺物51	51
遺物図版12	縄文時代の遺物12	12	遺物図版52	縄文時代の遺物52	52
遺物図版13	縄文時代の遺物13	13	遺物図版53	縄文時代の遺物53	53
遺物図版14	縄文時代の遺物14	14	遺物図版54	縄文時代の遺物54	54
遺物図版15	縄文時代の遺物15	15	遺物図版55	縄文時代の遺物55	55
遺物図版16	縄文時代の遺物16	16	遺物図版56	縄文時代の遺物56	56
遺物図版17	縄文時代の遺物17	17	遺物図版57	縄文時代の遺物57	57
遺物図版18	縄文時代の遺物18	18	遺物図版58	縄文時代の遺物58	58
遺物図版19	縄文時代の遺物19	19	遺物図版59	縄文時代の遺物59	59
遺物図版20	縄文時代の遺物20	20	遺物図版60	縄文時代の遺物60	60
遺物図版21	縄文時代の遺物21	21	遺物図版61	縄文時代の遺物61	61
遺物図版22	縄文時代の遺物22	22	遺物図版62	縄文時代の遺物62	62
遺物図版23	縄文時代の遺物23	23	遺物図版63	縄文時代の遺物63	63
遺物図版24	縄文時代の遺物24	24	遺物図版64	縄文時代の遺物64	64
遺物図版25	縄文時代の遺物25	25	遺物図版65	縄文時代の遺物65	65
遺物図版26	縄文時代の遺物26	26	遺物図版66	縄文時代の遺物66	66
遺物図版27	縄文時代の遺物27	27	遺物図版67	縄文時代の遺物67	67
遺物図版28	縄文時代の遺物28	28	遺物図版68	縄文時代の遺物68	68
遺物図版29	縄文時代の遺物29	29	遺物図版69	縄文時代の遺物69	69
遺物図版30	縄文時代の遺物30	30	遺物図版70	縄文時代の遺物70	70
遺物図版31	縄文時代の遺物31	31	遺物図版71	縄文時代の遺物71	71
遺物図版32	縄文時代の遺物32	32	遺物図版72	縄文時代の遺物72	72
遺物図版33	縄文時代の遺物33	33	遺物図版73	縄文時代の遺物73	73
遺物図版34	縄文時代の遺物34	34	遺物図版74	縄文時代の遺物74	74
遺物図版35	縄文時代の遺物35	35	遺物図版75	縄文時代の遺物75	75
遺物図版36	縄文時代の遺物36	36	遺物図版76	縄文時代の遺物76	76
遺物図版37	縄文時代の遺物37	37	遺物図版77	縄文時代の遺物77	77
遺物図版38	縄文時代の遺物38	38	遺物図版78	縄文時代の遺物78	78
遺物図版39	縄文時代の遺物39	39	遺物図版79	縄文時代の遺物79	79
遺物図版40	縄文時代の遺物40	40	遺物図版80	縄文時代の遺物80	80

遺物図版81	縄文時代の遺物81	81	遺物図版126	縄文時代の遺物126	126
遺物図版82	縄文時代の遺物82	82	遺物図版127	縄文時代の遺物127	127
遺物図版83	縄文時代の遺物83	83	遺物図版128	縄文時代の遺物128	128
遺物図版84	縄文時代の遺物84	84	遺物図版129	縄文時代の遺物129	129
遺物図版85	縄文時代の遺物85	85	遺物図版130	縄文時代の遺物130	130
遺物図版86	縄文時代の遺物86	86	遺物図版131	縄文時代の遺物131	131
遺物図版87	縄文時代の遺物87	87	遺物図版132	縄文時代の遺物132	132
遺物図版88	縄文時代の遺物88	88	遺物図版133	縄文時代の遺物133	133
遺物図版89	縄文時代の遺物89	89	遺物図版134	縄文時代の遺物134	134
遺物図版90	縄文時代の遺物90	90	遺物図版135	縄文時代の遺物135	135
遺物図版91	縄文時代の遺物91	91	遺物図版136	縄文時代の遺物136	136
遺物図版92	縄文時代の遺物92	92	遺物図版137	縄文時代の遺物137	137
遺物図版93	縄文時代の遺物93	93	遺物図版138	縄文時代の遺物138	138
遺物図版94	縄文時代の遺物94	94	遺物図版139	縄文時代の遺物139	139
遺物図版95	縄文時代の遺物95	95	遺物図版140	縄文時代の遺物140	140
遺物図版96	縄文時代の遺物96	96	遺物図版141	縄文時代の遺物141	141
遺物図版97	縄文時代の遺物97	97	遺物図版142	縄文時代の遺物142	142
遺物図版98	縄文時代の遺物98	98	遺物図版143	縄文時代の遺物143	143
遺物図版99	縄文時代の遺物99	99	遺物図版144	縄文時代の遺物144	144
遺物図版100	縄文時代の遺物100	100	遺物図版145	縄文時代の遺物145	145
遺物図版101	縄文時代の遺物101	101	遺物図版146	縄文時代の遺物146	146
遺物図版102	縄文時代の遺物102	102	遺物図版147	縄文時代の遺物147	147
遺物図版103	縄文時代の遺物103	103	遺物図版148	縄文時代の遺物148	148
遺物図版104	縄文時代の遺物104	104	遺物図版149	縄文時代の遺物149	149
遺物図版105	縄文時代の遺物105	105	遺物図版150	縄文時代の遺物150	150
遺物図版106	縄文時代の遺物106	106	遺物図版151	縄文時代の遺物151	151
遺物図版107	縄文時代の遺物107	107	遺物図版152	縄文時代の遺物152	152
遺物図版108	縄文時代の遺物108	108	遺物図版153	縄文時代の遺物153	153
遺物図版109	縄文時代の遺物109	109	遺物図版154	縄文時代の遺物154	154
遺物図版110	縄文時代の遺物110	110	遺物図版155	縄文時代の遺物155	155
遺物図版111	縄文時代の遺物111	111	遺物図版156	縄文時代の遺物156	156
遺物図版112	縄文時代の遺物112	112	遺物図版157	縄文時代の遺物157	157
遺物図版113	縄文時代の遺物113	113	遺物図版158	縄文時代の遺物158	158
遺物図版114	縄文時代の遺物114	114	遺物図版159	縄文時代の遺物159	159
遺物図版115	縄文時代の遺物115	115	遺物図版160	縄文時代の遺物160	160
遺物図版116	縄文時代の遺物116	116	遺物図版161	縄文時代の遺物161	161
遺物図版117	縄文時代の遺物117	117	遺物図版162	縄文時代の遺物162	162
遺物図版118	縄文時代の遺物118	118	遺物図版163	縄文時代の遺物163	163
遺物図版119	縄文時代の遺物119	119	遺物図版164	縄文時代の遺物164	164
遺物図版120	縄文時代の遺物120	120	遺物図版165	縄文時代の遺物165	165
遺物図版121	縄文時代の遺物121	121	遺物図版166	縄文時代の遺物166	166
遺物図版122	縄文時代の遺物122	122	遺物図版167	縄文時代の遺物167	167
遺物図版123	縄文時代の遺物123	123	遺物図版168	縄文時代の遺物168	168
遺物図版124	縄文時代の遺物124	124	遺物図版169	縄文時代の遺物169	169
遺物図版125	縄文時代の遺物125	125	遺物図版170	縄文時代の遺物170	170

遺物図版171	縄文時代の遺物171	171	遺物図版216	縄文時代の遺物216	216
遺物図版172	縄文時代の遺物172	172	遺物図版217	縄文時代の遺物217	217
遺物図版173	縄文時代の遺物173	173	遺物図版218	縄文時代の遺物218	218
遺物図版174	縄文時代の遺物174	174	遺物図版219	縄文時代の遺物219	219
遺物図版175	縄文時代の遺物175	175	遺物図版220	縄文時代の遺物220	220
遺物図版176	縄文時代の遺物176	176	遺物図版221	縄文時代の遺物221	221
遺物図版177	縄文時代の遺物177	177	遺物図版222	縄文時代の遺物222	222
遺物図版178	縄文時代の遺物178	178	遺物図版223	縄文時代の遺物223	223
遺物図版179	縄文時代の遺物179	179	遺物図版224	縄文時代の遺物224	224
遺物図版180	縄文時代の遺物180	180	遺物図版225	縄文時代の遺物225	225
遺物図版181	縄文時代の遺物181	181	遺物図版226	縄文時代の遺物226	226
遺物図版182	縄文時代の遺物182	182	遺物図版227	縄文時代の遺物227	227
遺物図版183	縄文時代の遺物183	183	遺物図版228	縄文時代の遺物228	228
遺物図版184	縄文時代の遺物184	184	遺物図版229	縄文時代の遺物229	229
遺物図版185	縄文時代の遺物185	185	遺物図版230	縄文時代の遺物230	230
遺物図版186	縄文時代の遺物186	186	遺物図版231	縄文時代の遺物231	231
遺物図版187	縄文時代の遺物187	187	遺物図版232	縄文時代の遺物232	232
遺物図版188	縄文時代の遺物188	188	遺物図版233	縄文時代の遺物233	233
遺物図版189	縄文時代の遺物189	189	遺物図版234	縄文時代の遺物234	234
遺物図版190	縄文時代の遺物190	190	遺物図版235	縄文時代の遺物235	235
遺物図版191	縄文時代の遺物191	191	遺物図版236	縄文時代の遺物236	236
遺物図版192	縄文時代の遺物192	192	遺物図版237	縄文時代の遺物237	237
遺物図版193	縄文時代の遺物193	193	遺物図版238	縄文時代の遺物238	238
遺物図版194	縄文時代の遺物194	194	遺物図版239	縄文時代の遺物239	239
遺物図版195	縄文時代の遺物195	195	遺物図版240	縄文時代の遺物240	240
遺物図版196	縄文時代の遺物196	196	遺物図版241	縄文時代の遺物241	241
遺物図版197	縄文時代の遺物197	197	遺物図版242	縄文時代の遺物242	242
遺物図版198	縄文時代の遺物198	198	遺物図版243	縄文時代の遺物243	243
遺物図版199	縄文時代の遺物199	199	遺物図版244	縄文時代の遺物244	244
遺物図版200	縄文時代の遺物200	200	遺物図版245	縄文時代の遺物245	245
遺物図版201	縄文時代の遺物201	201	遺物図版246	縄文時代の遺物246	246
遺物図版202	縄文時代の遺物202	202	遺物図版247	縄文時代の遺物247	247
遺物図版203	縄文時代の遺物203	203	遺物図版248	縄文時代の遺物248	248
遺物図版204	縄文時代の遺物204	204	遺物図版249	縄文時代の遺物249	249
遺物図版205	縄文時代の遺物205	205	遺物図版250	縄文時代の遺物250	250
遺物図版206	縄文時代の遺物206	206	遺物図版251	縄文時代の遺物251	251
遺物図版207	縄文時代の遺物207	207	遺物図版252	縄文時代の遺物252	252
遺物図版208	縄文時代の遺物208	208	遺物図版253	縄文時代の遺物253	253
遺物図版209	縄文時代の遺物209	209	遺物図版254	縄文時代の遺物254	254
遺物図版210	縄文時代の遺物210	210	遺物図版255	縄文時代の遺物255	255
遺物図版211	縄文時代の遺物211	211	遺物図版256	縄文時代の遺物256	256
遺物図版212	縄文時代の遺物212	212	遺物図版257	縄文時代の遺物257	257
遺物図版213	縄文時代の遺物213	213	遺物図版258	縄文時代の遺物258	258
遺物図版214	縄文時代の遺物214	214	遺物図版259	縄文時代の遺物259	259
遺物図版215	縄文時代の遺物215	215	遺物図版260	縄文時代の遺物260	260

遺物図版261	縄文時代の遺物261	261	遺物図版287	縄文時代の遺物287	287
遺物図版262	縄文時代の遺物262	262	遺物図版288	縄文時代の遺物288	288
遺物図版263	縄文時代の遺物263	263	遺物図版289	縄文時代の遺物289	289
遺物図版264	縄文時代の遺物264	264	遺物図版290	縄文時代の遺物290	290
遺物図版265	縄文時代の遺物265	265	遺物図版291	縄文時代の遺物291	291
遺物図版266	縄文時代の遺物266	266	遺物図版292	縄文時代の遺物292	292
遺物図版267	縄文時代の遺物267	267	遺物図版293	縄文時代の遺物293	293
遺物図版268	縄文時代の遺物268	268	遺物図版294	縄文時代の遺物294	294
遺物図版269	縄文時代の遺物269	269	遺物図版295	縄文時代の遺物295	295
遺物図版270	縄文時代の遺物270	270	遺物図版296	縄文時代の遺物296	296
遺物図版271	縄文時代の遺物271	271	遺物図版297	縄文時代の遺物297	297
遺物図版272	縄文時代の遺物272	272	遺物図版298	縄文時代の遺物298	298
遺物図版273	縄文時代の遺物273	273	遺物図版299	縄文時代の遺物299	299
遺物図版274	縄文時代の遺物274	274	遺物図版300	縄文時代の遺物300	300
遺物図版275	縄文時代の遺物275	275	遺物図版301	縄文時代の遺物301	301
遺物図版276	縄文時代の遺物276	276	遺物図版302	古代の遺物 1	302
遺物図版277	縄文時代の遺物277	277	遺物図版303	古代の遺物 2	303
遺物図版278	縄文時代の遺物278	278	遺物図版304	古代の遺物 3・中世以降の遺物 1	304
遺物図版279	縄文時代の遺物279	279	遺物図版305	中世以降の遺物 2	305
遺物図版280	縄文時代の遺物280	280	遺物図版306	中世以降の遺物 3	306
遺物図版281	縄文時代の遺物281	281	遺物図版307	中世以降の遺物 4	307
遺物図版282	縄文時代の遺物282	282	遺物図版308	中世以降の遺物 5	308
遺物図版283	縄文時代の遺物283	283	遺物図版309	中世以降の遺物 6	309
遺物図版284	縄文時代の遺物284	284	遺物図版310	中世以降の遺物 7	310
遺物図版285	縄文時代の遺物285	285	遺物図版311	中世以降の遺物 8	311
遺物図版286	縄文時代の遺物286	286	遺物図版312	中世以降の遺物 9	312

表 目 次

遺物観察表 1	縄文時代の遺物（土器）	313～324	遺物観察表10	中世以降の遺物（石器）	350
遺物観察表 2	縄文時代の遺物（土製品）	324・325	遺物観察表11	中世以降の遺物（金属製品）	351
遺物観察表 3	縄文時代の遺物（石器）	326～348	遺物観察表12	中世以降の遺物（羽口）	351
遺物観察表 4	縄文時代の遺物（石製品）	349	遺物観察表13	中世以降の遺物（炉壁）	351
遺物観察表 5	縄文時代の遺物（その他）	349	遺物観察表14	鉄滓	352・353
遺物観察表 6	古代の遺物（土器）	349	遺物計測表 1	縄文時代の石器・石製品	354～360
遺物観察表 7	古代の遺物（石器）	350	遺物計測表 2	古代の石器	360
遺物観察表 8	古代の遺物（羽口）	350	遺物計測表 3	中世以降の石器	360
遺物観察表 9	中世以降の遺物（陶磁器）	350			

遺物写真図版目次

カラー遺物写真図版 1	363	遺物写真図版35	縄文時代の遺物35	405
カラー遺物写真図版 2	364	遺物写真図版36	縄文時代の遺物36	406
カラー遺物写真図版 3	365	遺物写真図版37	縄文時代の遺物37	407
カラー遺物写真図版 4	366	遺物写真図版38	縄文時代の遺物38	408
カラー遺物写真図版 5	367	遺物写真図版39	縄文時代の遺物39	409
カラー遺物写真図版 6	368	遺物写真図版40	縄文時代の遺物40	410
カラー遺物写真図版 7	369	遺物写真図版41	縄文時代の遺物41	411
カラー遺物写真図版 8	370	遺物写真図版42	縄文時代の遺物42	412
遺物写真図版 1	縄文時代の遺物 1	遺物写真図版43	縄文時代の遺物43	413
遺物写真図版 2	縄文時代の遺物 2	遺物写真図版44	縄文時代の遺物44	414
遺物写真図版 3	縄文時代の遺物 3	遺物写真図版45	縄文時代の遺物45	415
遺物写真図版 4	縄文時代の遺物 4	遺物写真図版46	縄文時代の遺物46	416
遺物写真図版 5	縄文時代の遺物 5	遺物写真図版47	縄文時代の遺物47	417
遺物写真図版 6	縄文時代の遺物 6	遺物写真図版48	縄文時代の遺物48	418
遺物写真図版 7	縄文時代の遺物 7	遺物写真図版49	縄文時代の遺物49	419
遺物写真図版 8	縄文時代の遺物 8	遺物写真図版50	縄文時代の遺物50	420
遺物写真図版 9	縄文時代の遺物 9	遺物写真図版51	縄文時代の遺物51	421
遺物写真図版10	縄文時代の遺物10	遺物写真図版52	縄文時代の遺物52	422
遺物写真図版11	縄文時代の遺物11	遺物写真図版53	縄文時代の遺物53	423
遺物写真図版12	縄文時代の遺物12	遺物写真図版54	縄文時代の遺物54	424
遺物写真図版13	縄文時代の遺物13	遺物写真図版55	縄文時代の遺物55	425
遺物写真図版14	縄文時代の遺物14	遺物写真図版56	縄文時代の遺物56	426
遺物写真図版15	縄文時代の遺物15	遺物写真図版57	縄文時代の遺物57	427
遺物写真図版16	縄文時代の遺物16	遺物写真図版58	縄文時代の遺物58	428
遺物写真図版17	縄文時代の遺物17	遺物写真図版59	縄文時代の遺物59	429
遺物写真図版18	縄文時代の遺物18	遺物写真図版60	縄文時代の遺物60	430
遺物写真図版19	縄文時代の遺物19	遺物写真図版61	縄文時代の遺物61	431
遺物写真図版20	縄文時代の遺物20	遺物写真図版62	縄文時代の遺物62	432
遺物写真図版21	縄文時代の遺物21	遺物写真図版63	縄文時代の遺物63	433
遺物写真図版22	縄文時代の遺物22	遺物写真図版64	縄文時代の遺物64	434
遺物写真図版23	縄文時代の遺物23	遺物写真図版65	縄文時代の遺物65	435
遺物写真図版24	縄文時代の遺物24	遺物写真図版66	縄文時代の遺物66	436
遺物写真図版25	縄文時代の遺物25	遺物写真図版67	縄文時代の遺物67	437
遺物写真図版26	縄文時代の遺物26	遺物写真図版68	縄文時代の遺物68	438
遺物写真図版27	縄文時代の遺物27	遺物写真図版69	縄文時代の遺物69	439
遺物写真図版28	縄文時代の遺物28	遺物写真図版70	縄文時代の遺物70	440
遺物写真図版29	縄文時代の遺物29	遺物写真図版71	縄文時代の遺物71	441
遺物写真図版30	縄文時代の遺物30	遺物写真図版72	縄文時代の遺物72	442
遺物写真図版31	縄文時代の遺物31	遺物写真図版73	縄文時代の遺物73	443
遺物写真図版32	縄文時代の遺物32	遺物写真図版74	縄文時代の遺物74	444
遺物写真図版33	縄文時代の遺物33	遺物写真図版75	縄文時代の遺物75	445
遺物写真図版34	縄文時代の遺物34	遺物写真図版76	縄文時代の遺物76	446

遺物写真図版77	縄文時代の遺物77	447	遺物写真図版113	縄文時代の遺物113	483
遺物写真図版78	縄文時代の遺物78	448	遺物写真図版114	縄文時代の遺物114	484
遺物写真図版79	縄文時代の遺物79	449	遺物写真図版115	縄文時代の遺物115	485
遺物写真図版80	縄文時代の遺物80	450	遺物写真図版116	縄文時代の遺物116	486
遺物写真図版81	縄文時代の遺物81	451	遺物写真図版117	縄文時代の遺物117	487
遺物写真図版82	縄文時代の遺物82	452	遺物写真図版118	縄文時代の遺物118	488
遺物写真図版83	縄文時代の遺物83	453	遺物写真図版119	縄文時代の遺物119	489
遺物写真図版84	縄文時代の遺物84	454	遺物写真図版120	縄文時代の遺物120	490
遺物写真図版85	縄文時代の遺物85	455	遺物写真図版121	縄文時代の遺物121	491
遺物写真図版86	縄文時代の遺物86	456	遺物写真図版122	縄文時代の遺物122	492
遺物写真図版87	縄文時代の遺物87	457	遺物写真図版123	縄文時代の遺物123	493
遺物写真図版88	縄文時代の遺物88	458	遺物写真図版124	縄文時代の遺物124	494
遺物写真図版89	縄文時代の遺物89	459	遺物写真図版125	縄文時代の遺物125	495
遺物写真図版90	縄文時代の遺物90	460	遺物写真図版126	縄文時代の遺物126	496
遺物写真図版91	縄文時代の遺物91	461	遺物写真図版127	縄文時代の遺物127	497
遺物写真図版92	縄文時代の遺物92	462	遺物写真図版128	縄文時代の遺物128	498
遺物写真図版93	縄文時代の遺物93	463	遺物写真図版129	縄文時代の遺物129	499
遺物写真図版94	縄文時代の遺物94	464	遺物写真図版130	縄文時代の遺物130	500
遺物写真図版95	縄文時代の遺物95	465	遺物写真図版131	縄文時代の遺物131	501
遺物写真図版96	縄文時代の遺物96	466	遺物写真図版132	縄文時代の遺物132	502
遺物写真図版97	縄文時代の遺物97	467	遺物写真図版133	縄文時代の遺物133	503
遺物写真図版98	縄文時代の遺物98	468	遺物写真図版134	縄文時代の遺物134	504
遺物写真図版99	縄文時代の遺物99	469	遺物写真図版135	縄文時代の遺物135	505
遺物写真図版100	縄文時代の遺物100	470	遺物写真図版136	縄文時代の遺物136	506
遺物写真図版101	縄文時代の遺物101	471	遺物写真図版137	縄文時代の遺物137	507
遺物写真図版102	縄文時代の遺物102	472	遺物写真図版138	縄文時代の遺物138	508
遺物写真図版103	縄文時代の遺物103	473	遺物写真図版139	縄文時代の遺物139	509
遺物写真図版104	縄文時代の遺物104	474	遺物写真図版140	縄文時代の遺物140	510
遺物写真図版105	縄文時代の遺物105	475	遺物写真図版141	縄文時代の遺物141	511
遺物写真図版106	縄文時代の遺物106	476	遺物写真図版142	古代の遺物1・中世以降の遺物1	512
遺物写真図版107	縄文時代の遺物107	477			
遺物写真図版108	縄文時代の遺物108	478	遺物写真図版143	中世以降の遺物2	513
遺物写真図版109	縄文時代の遺物109	479	遺物写真図版144	中世以降の遺物3	514
遺物写真図版110	縄文時代の遺物110	480	遺物写真図版145	中世以降の遺物4	515
遺物写真図版111	縄文時代の遺物111	481	遺物写真図版146	中世以降の遺物5	516
遺物写真図版112	縄文時代の遺物112	482	遺物写真図版147	中世以降の遺物6	517

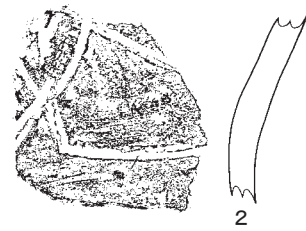

1 ~ 3 0 (1:2) 10 cm

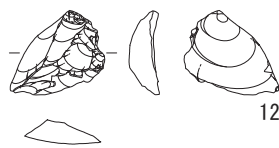
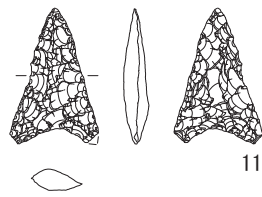
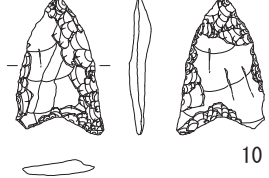
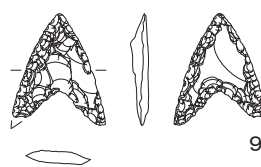
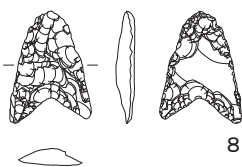
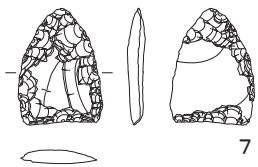
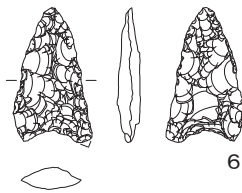
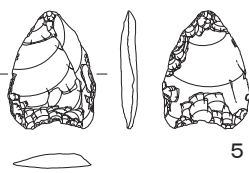
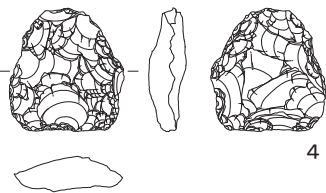

1 豎

4 ~ 12 0 (2:3) 5 cm



13

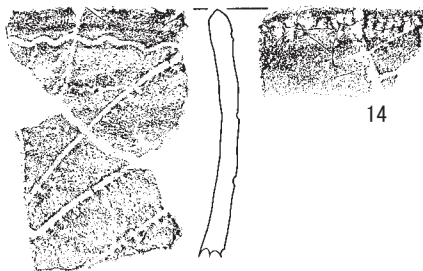

14

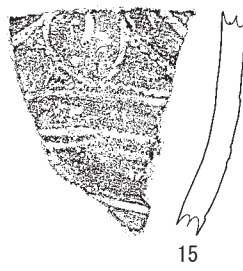

15

2 豎

13 ~ 15 0 (1:2) 10 cm

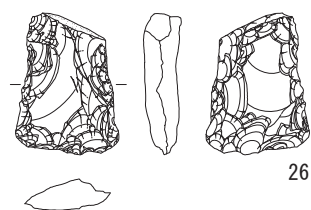
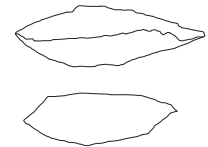
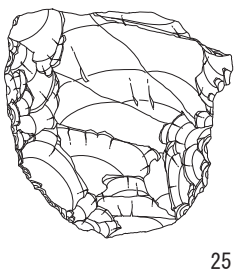
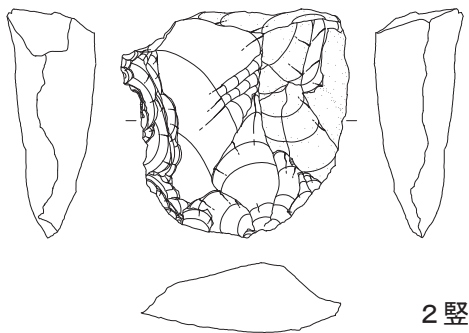
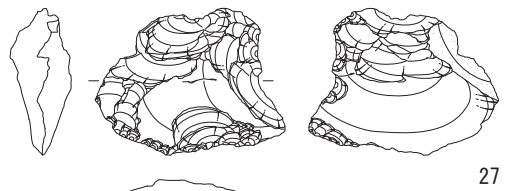
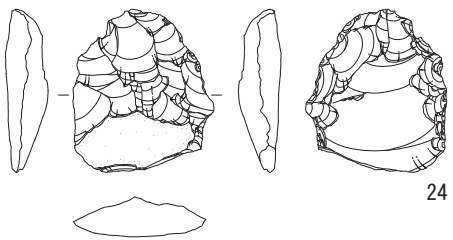
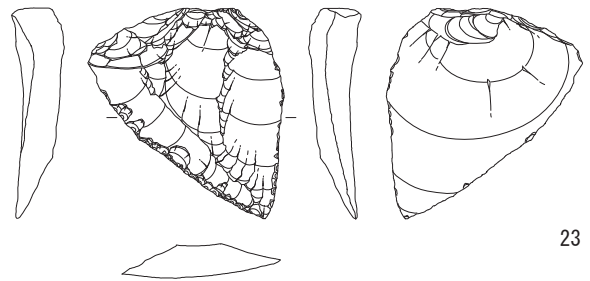
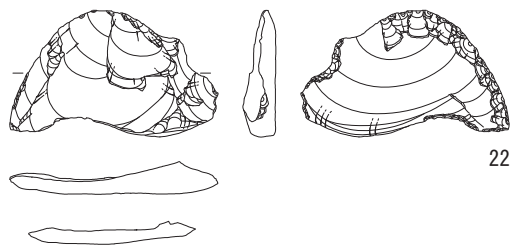
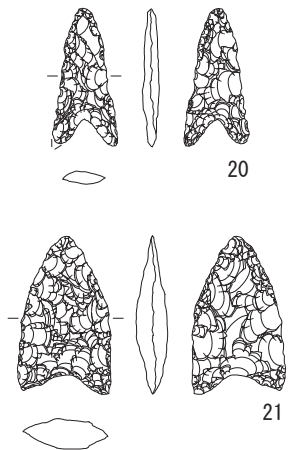
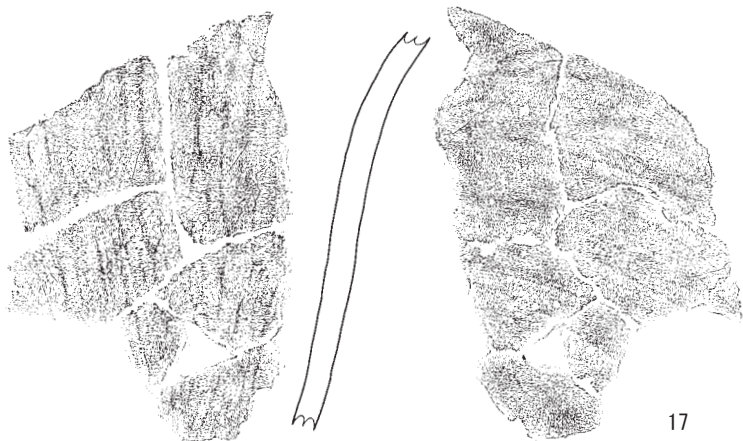
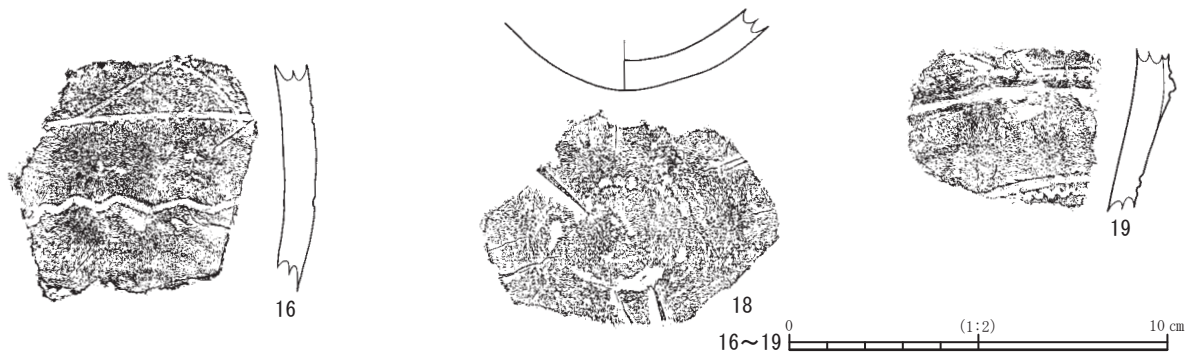

2 豎 20~27 (2:3) 5 cm

遺物図版 2 縄文時代の遺物 2



遺物図版3 縄文時代の遺物3

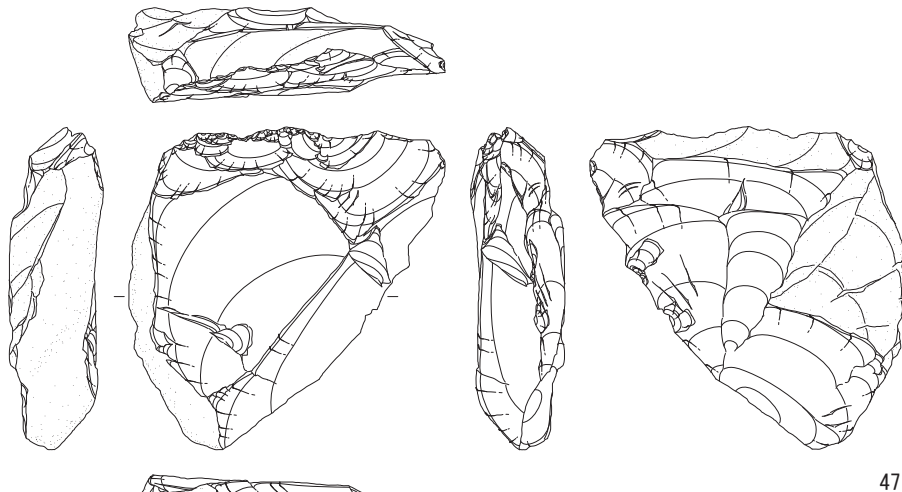

47

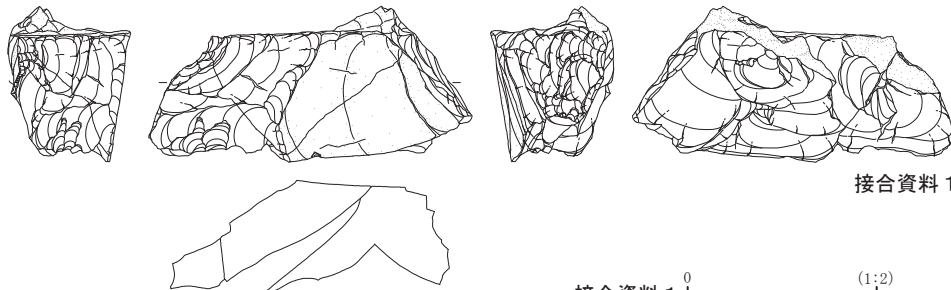
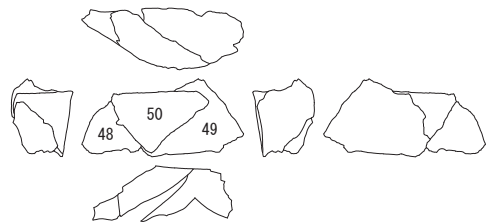
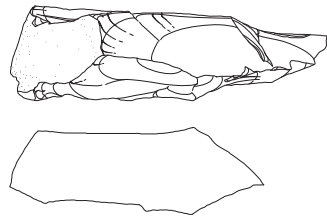

接合資料 1

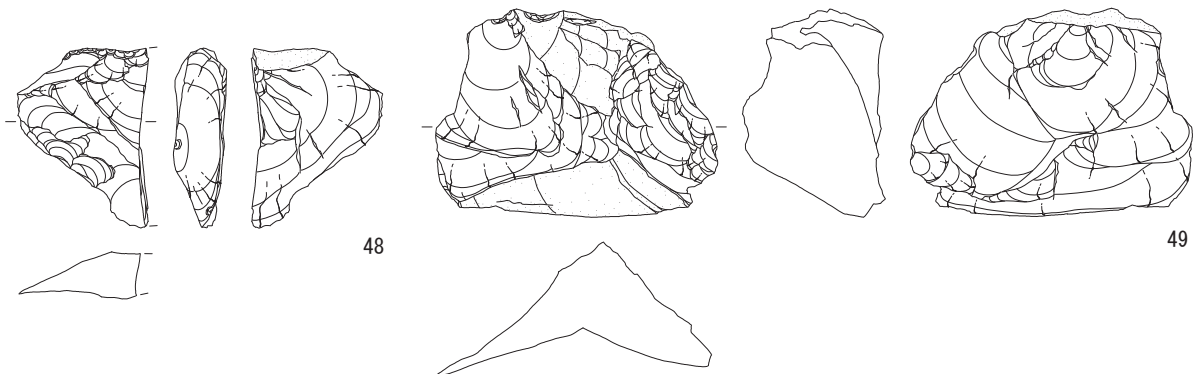

48

49

2 豎



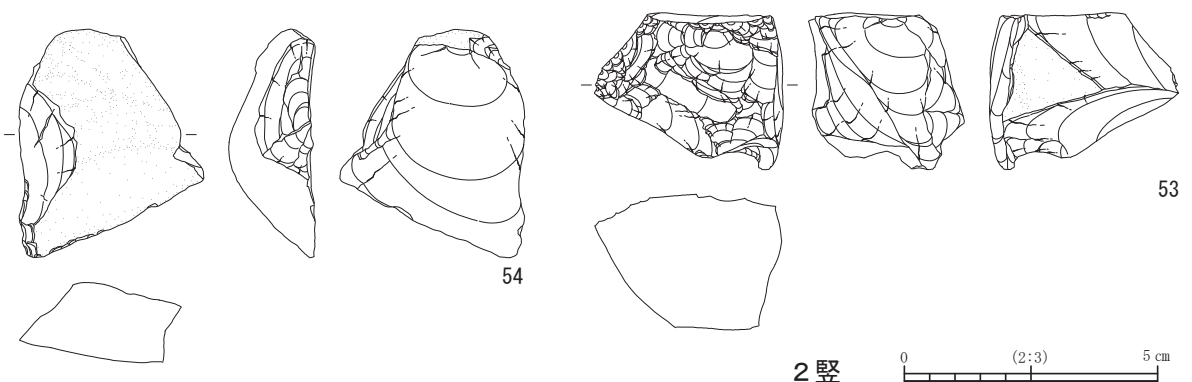
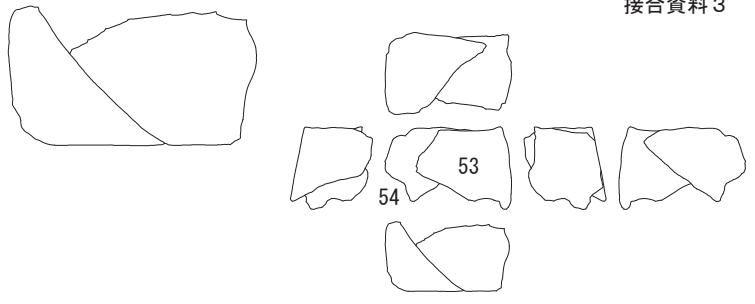
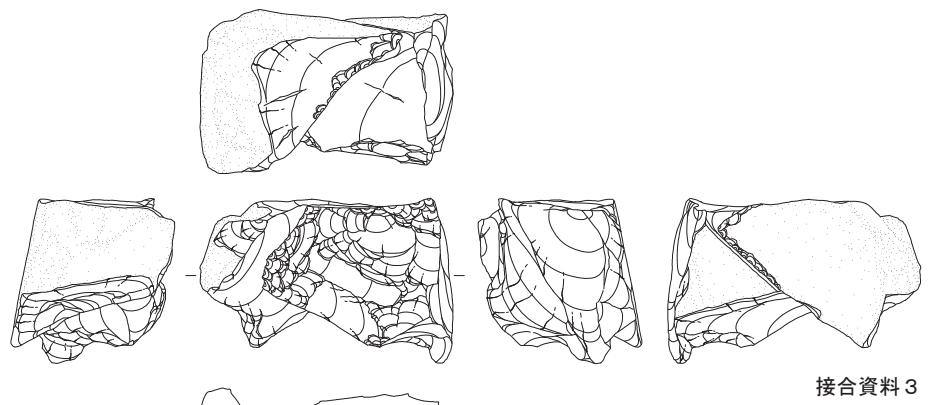
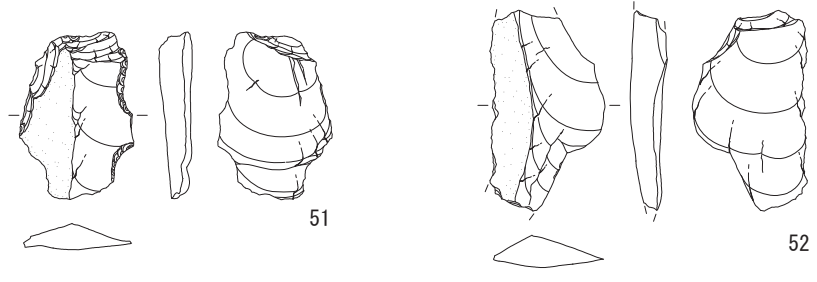
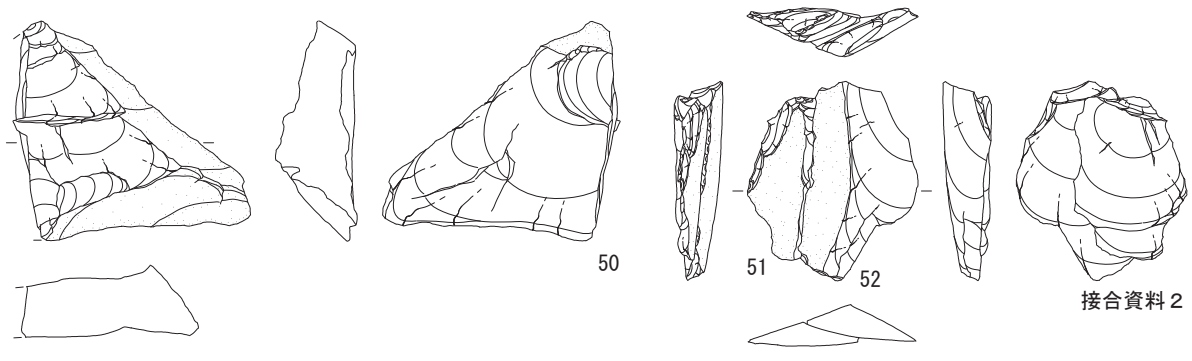

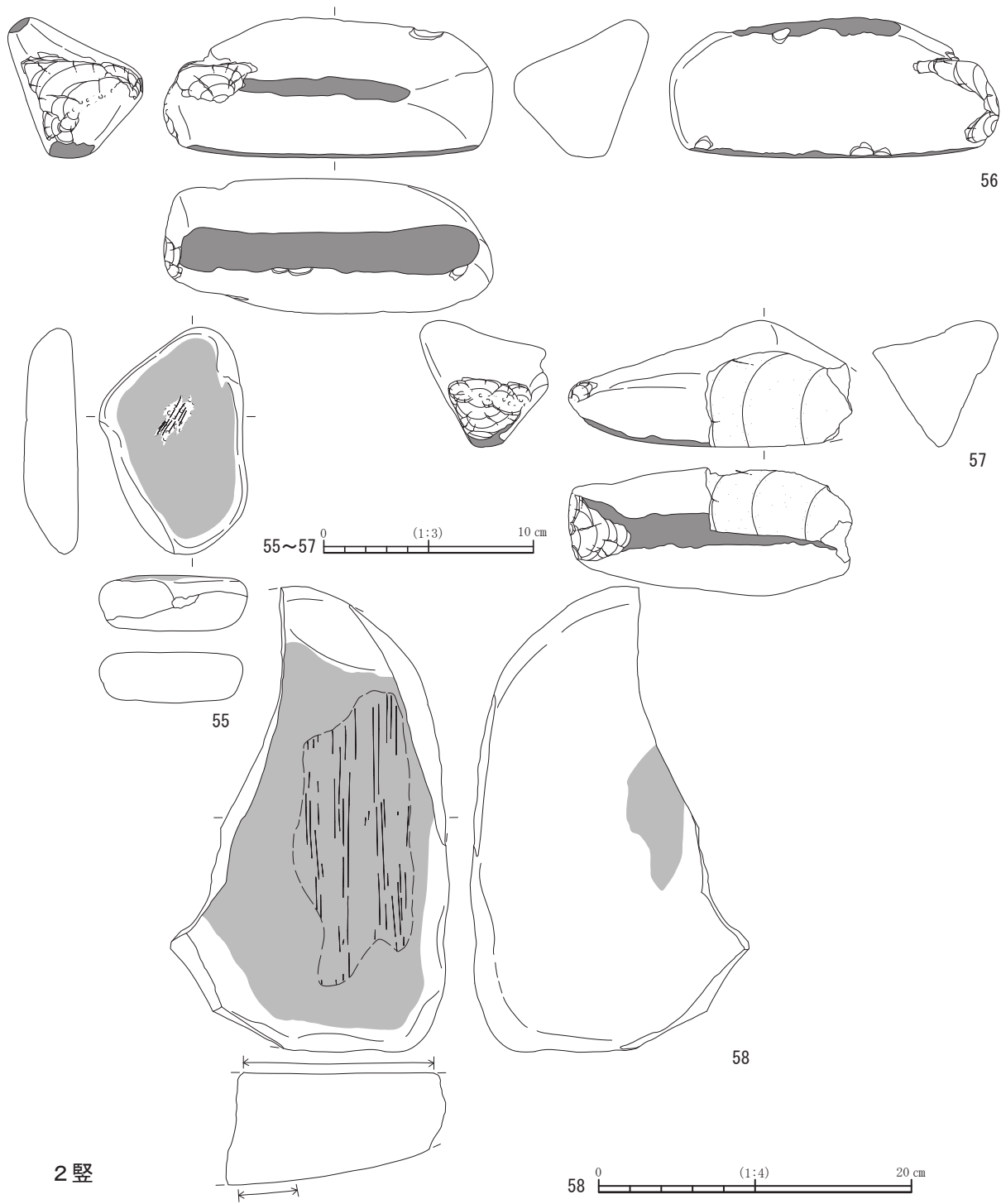

2 豎

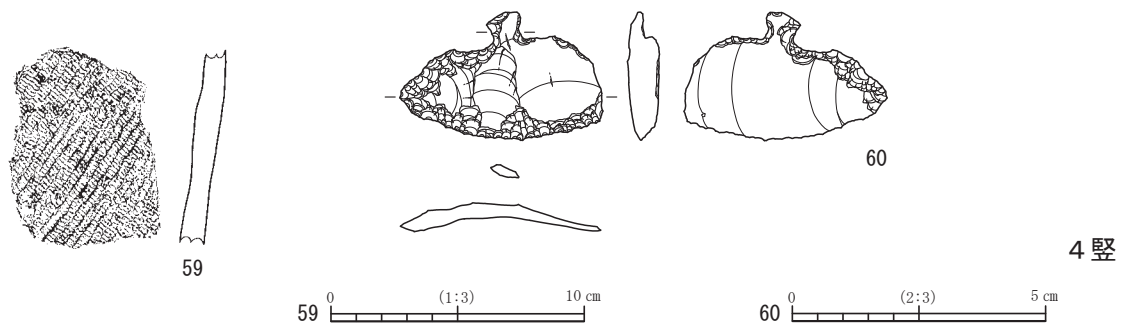

4 豎

遺物図版 6 縄文時代の遺物 6

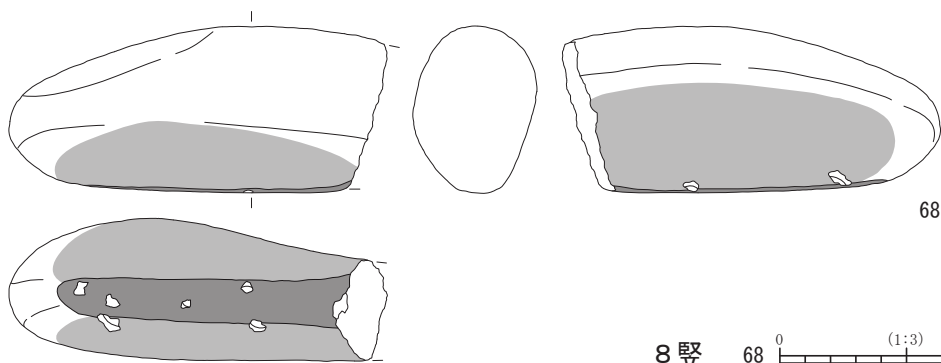
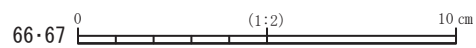
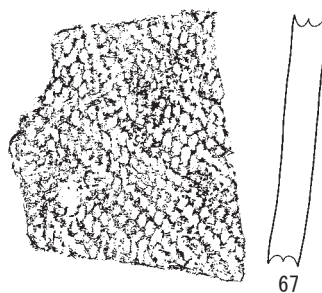
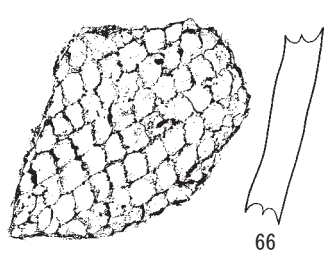
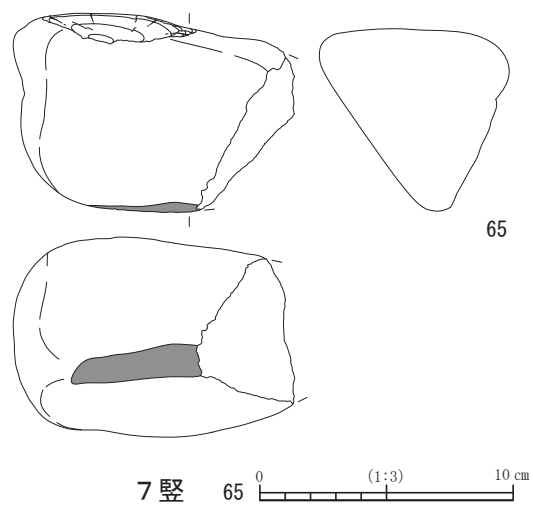
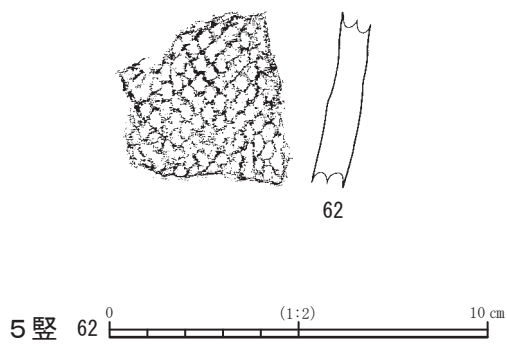
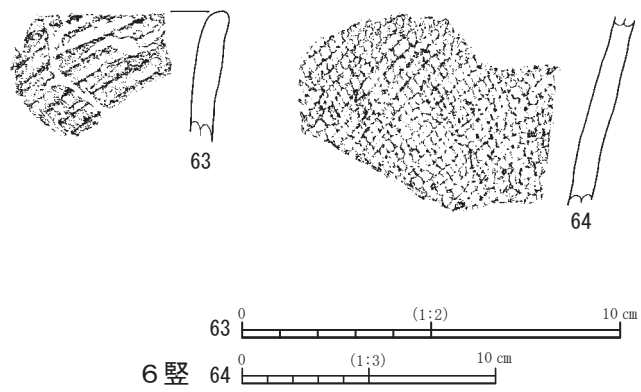
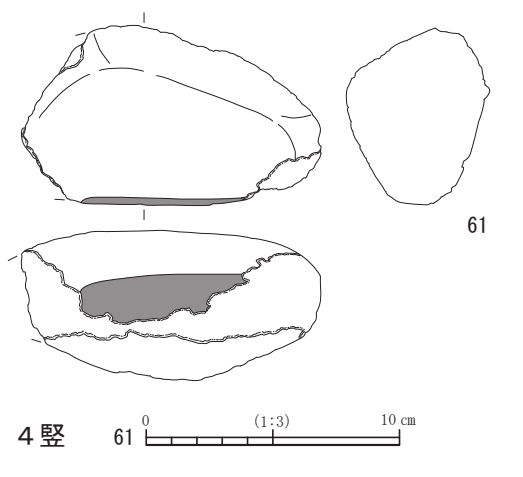

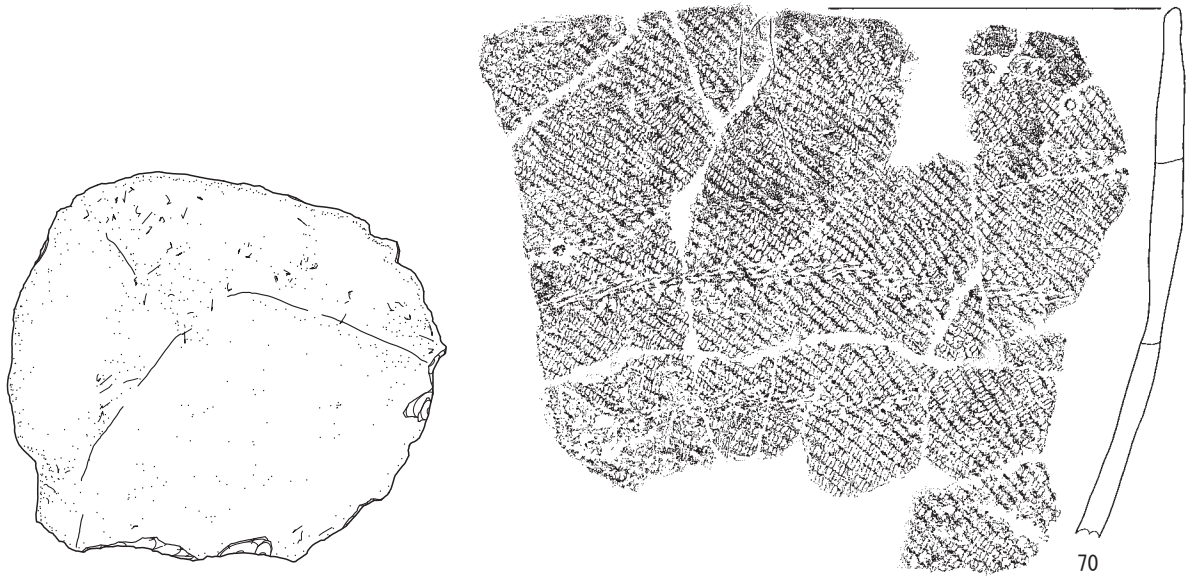

70

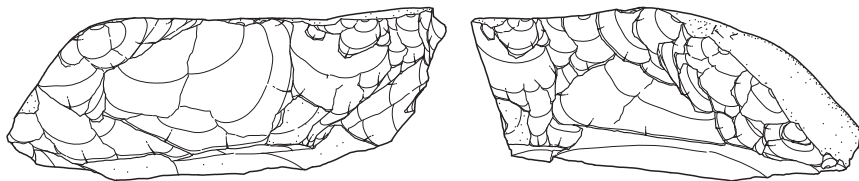

71

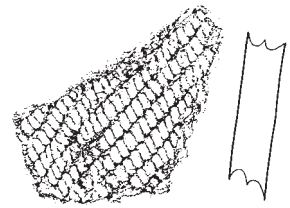
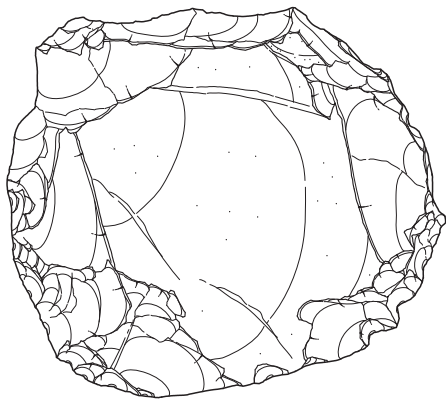

69



70・72 0 (1:3) 10 cm

10 豎

69・71 0 (1:2) 10 cm

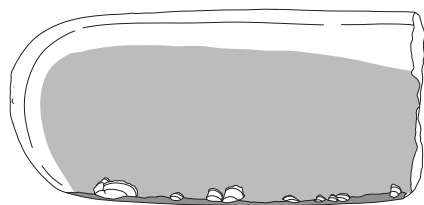
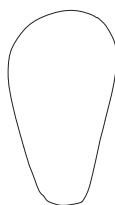
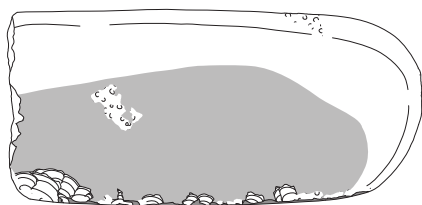

72

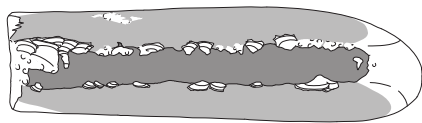

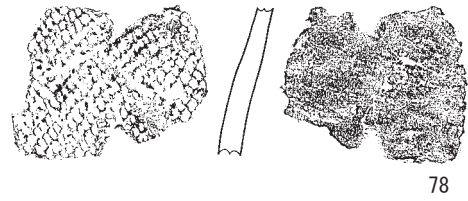
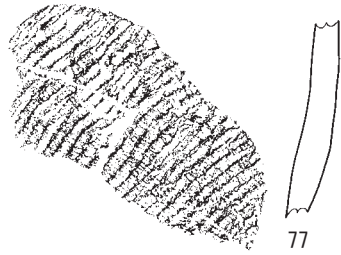
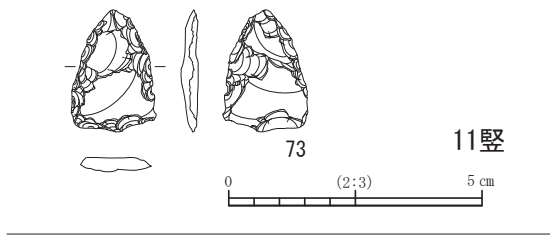

17 豎 76~78 0 (1:3) 10 cm

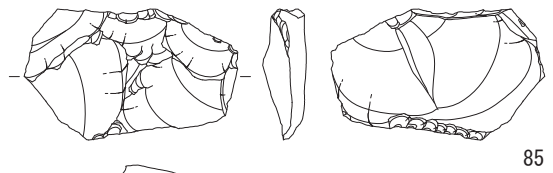
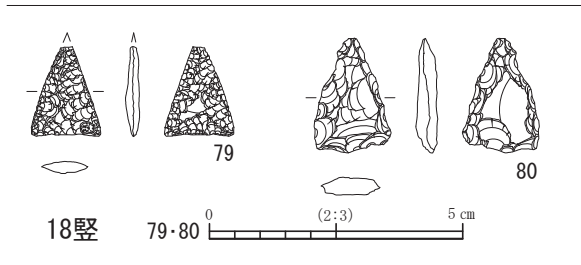

18 豎 79-80 0 (2:3) 5 cm

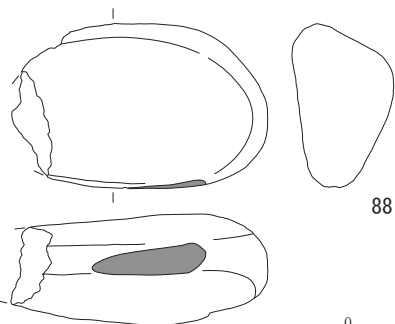
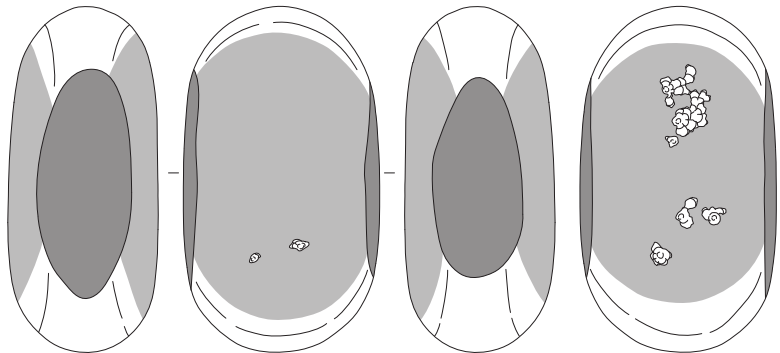
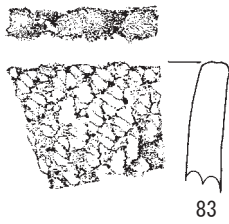
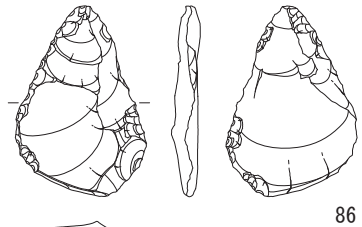
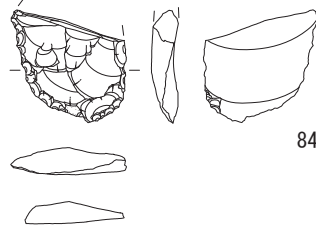

20 豎

82-83 0 (1:2) 10 cm

84~86 0 (2:3) 5 cm

87-88 0 (1:3) 10 cm

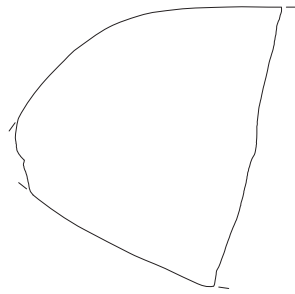
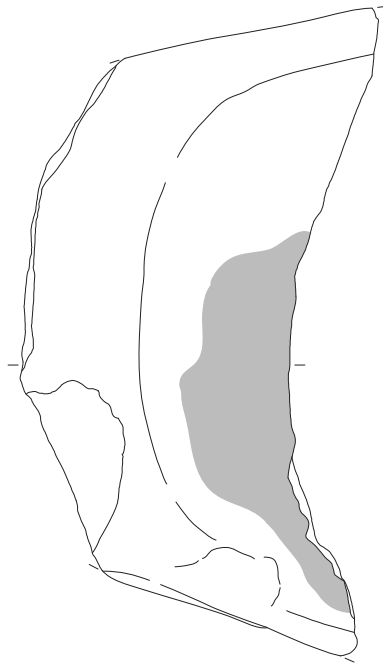

20 豎 89 0 (1:3) 10 cm

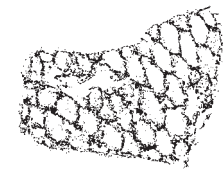
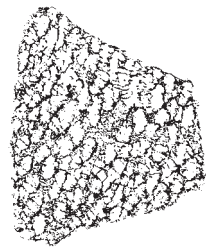

90-91 0 (1:2) 10 cm

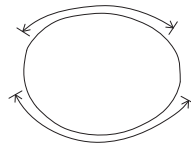
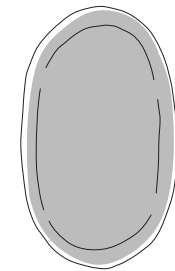
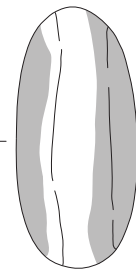
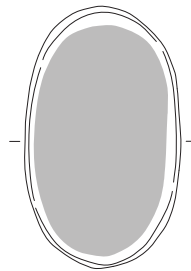

92 0 (1:3) 10 cm

21 豎

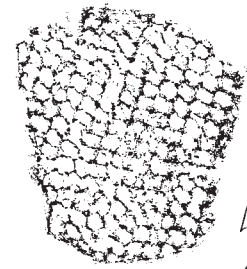
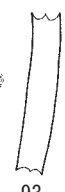

93 94



95



96

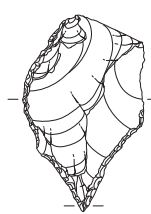

97

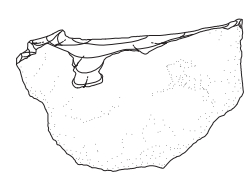
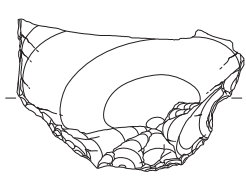

98

22 豎 93-94 0 (1:2) 10 cm

95~98 0 (2:3) 5 cm

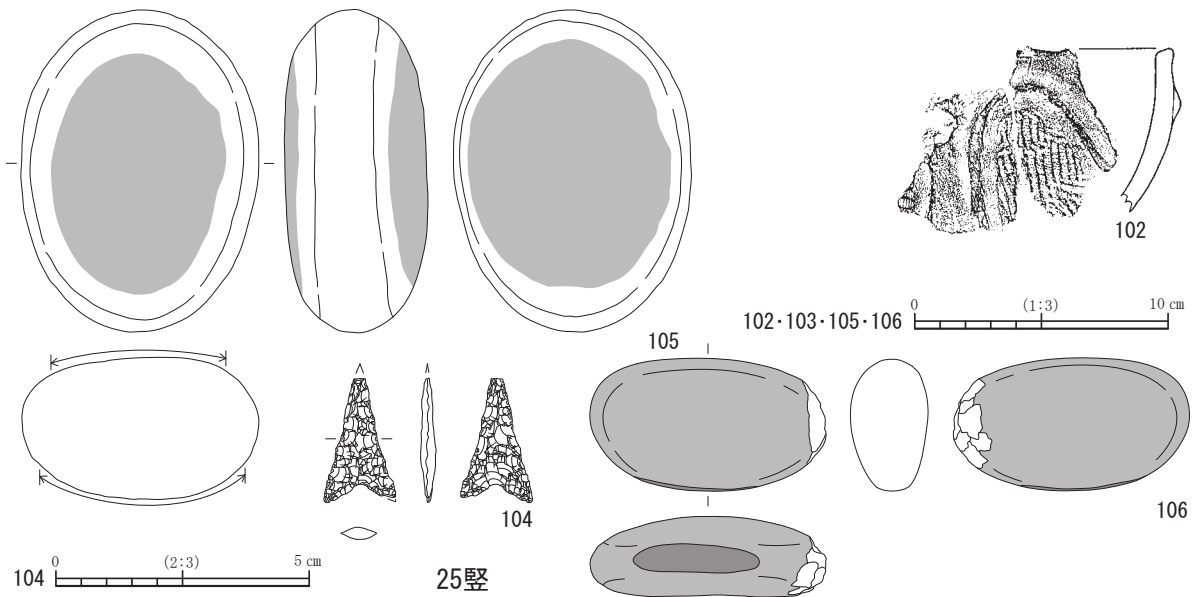
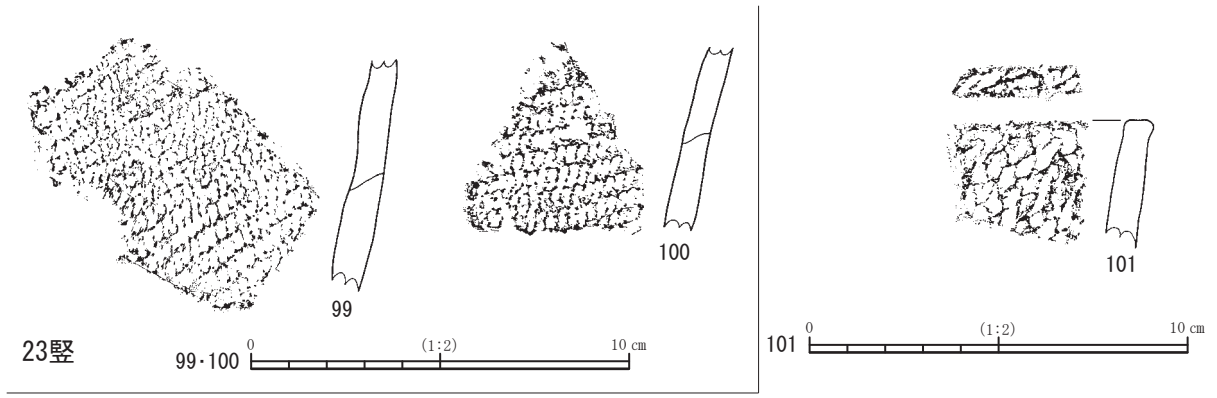

遺物図版11 縄文時代の遺物11

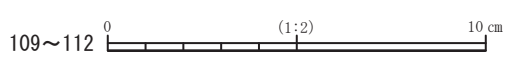
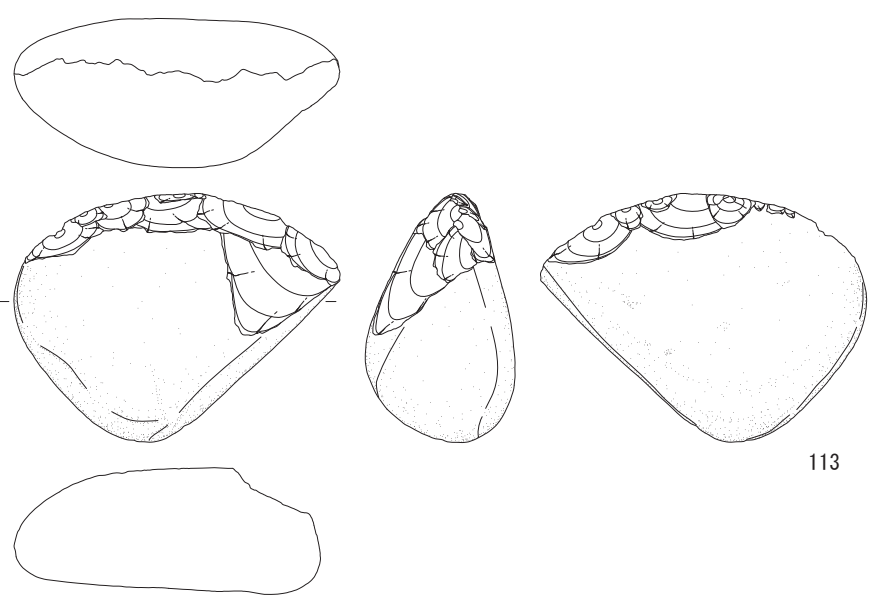
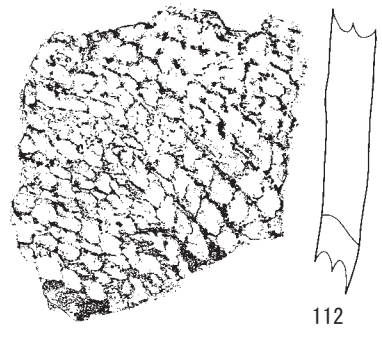
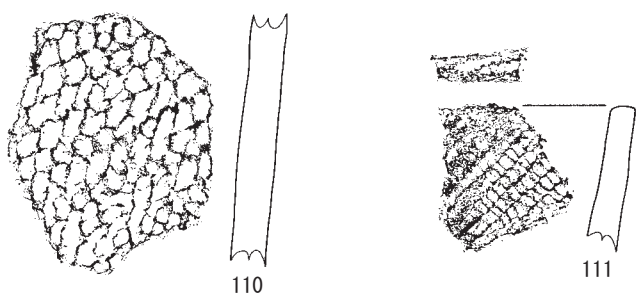
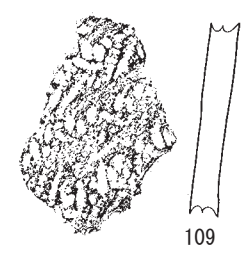
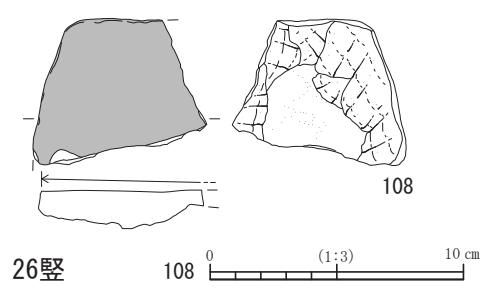

遺物図版12 縄文時代の遺物12

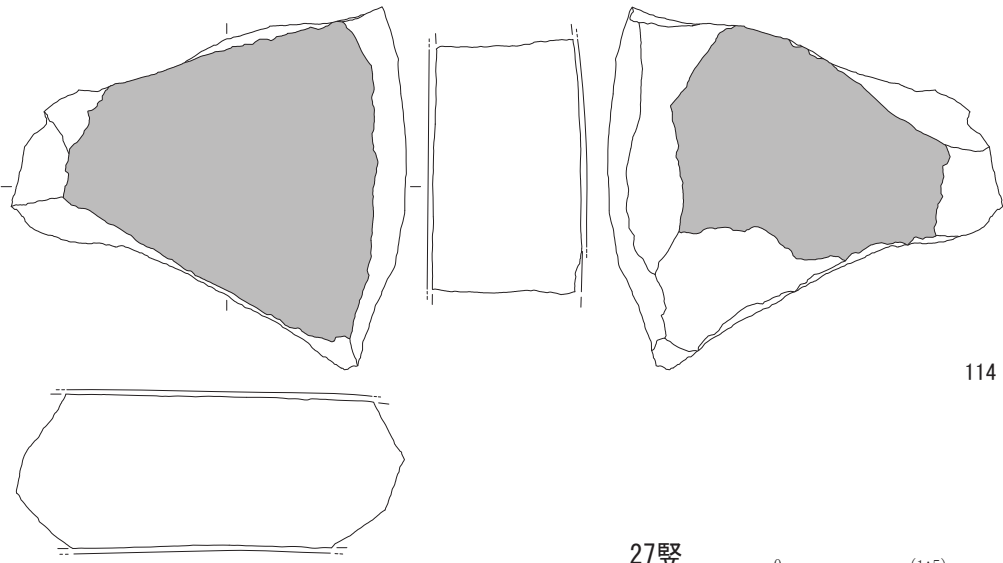

114

27 豎

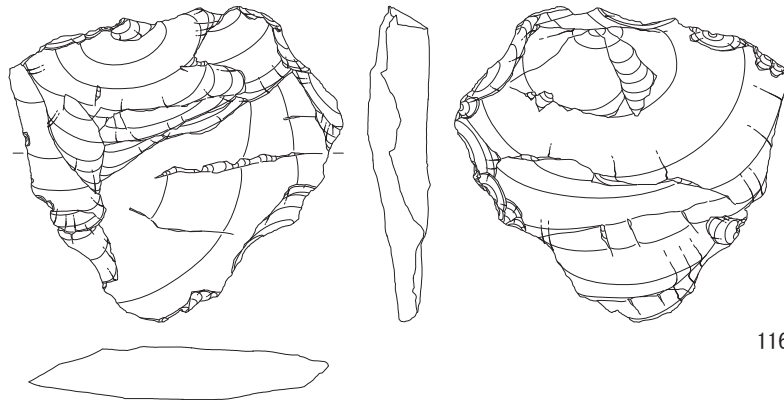
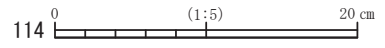

116

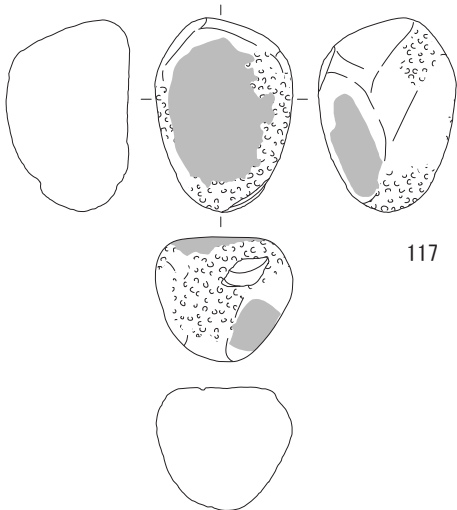

117

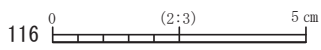

28 豎

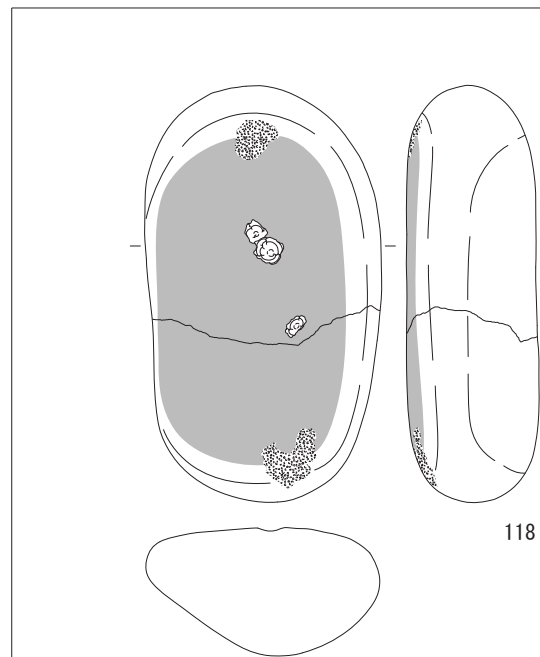
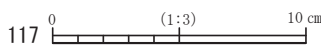

118

29 豎

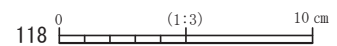

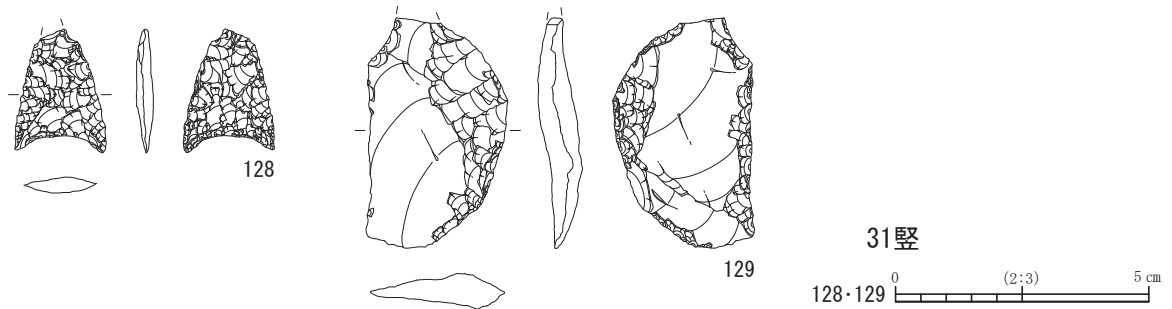
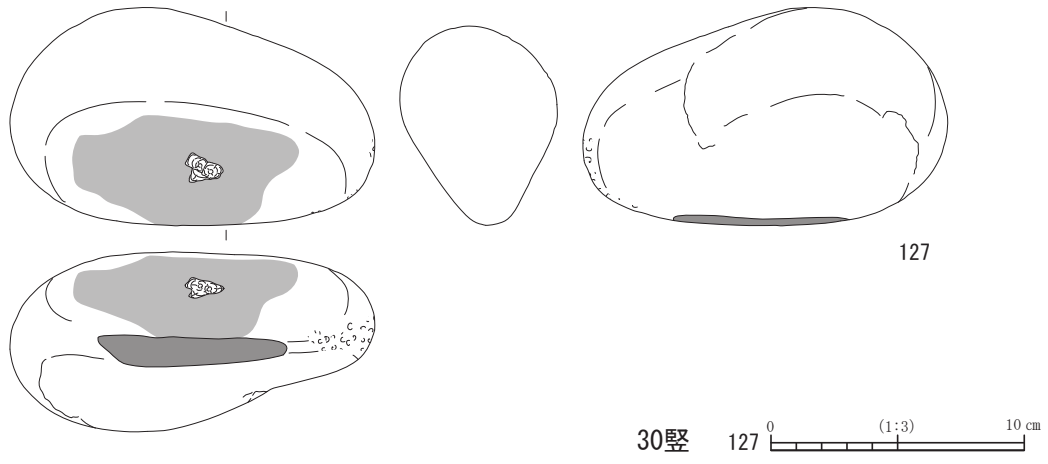
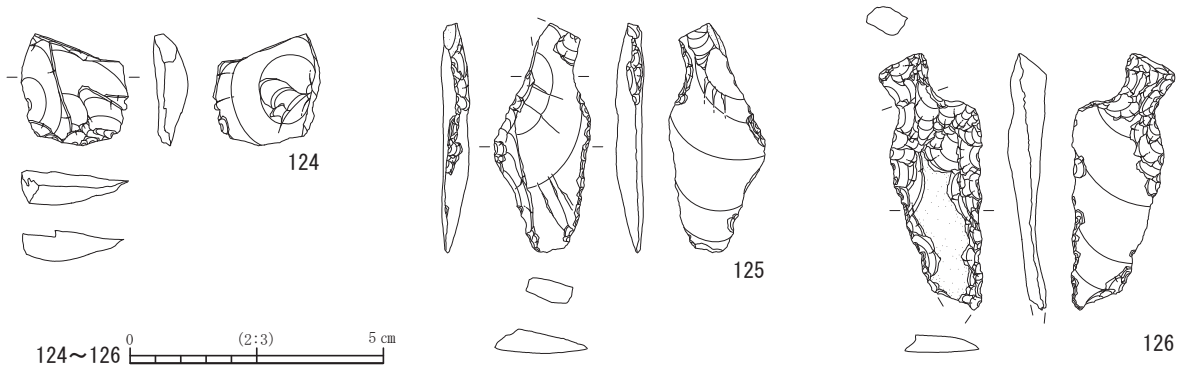
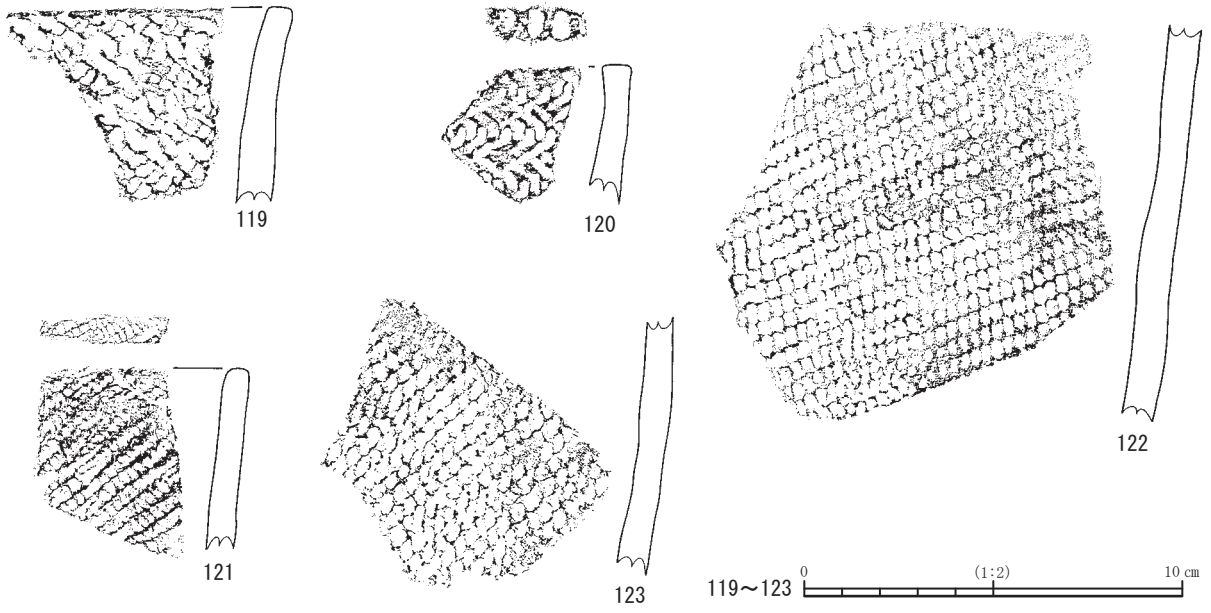

遺物図版14 縄文時代の遺物14

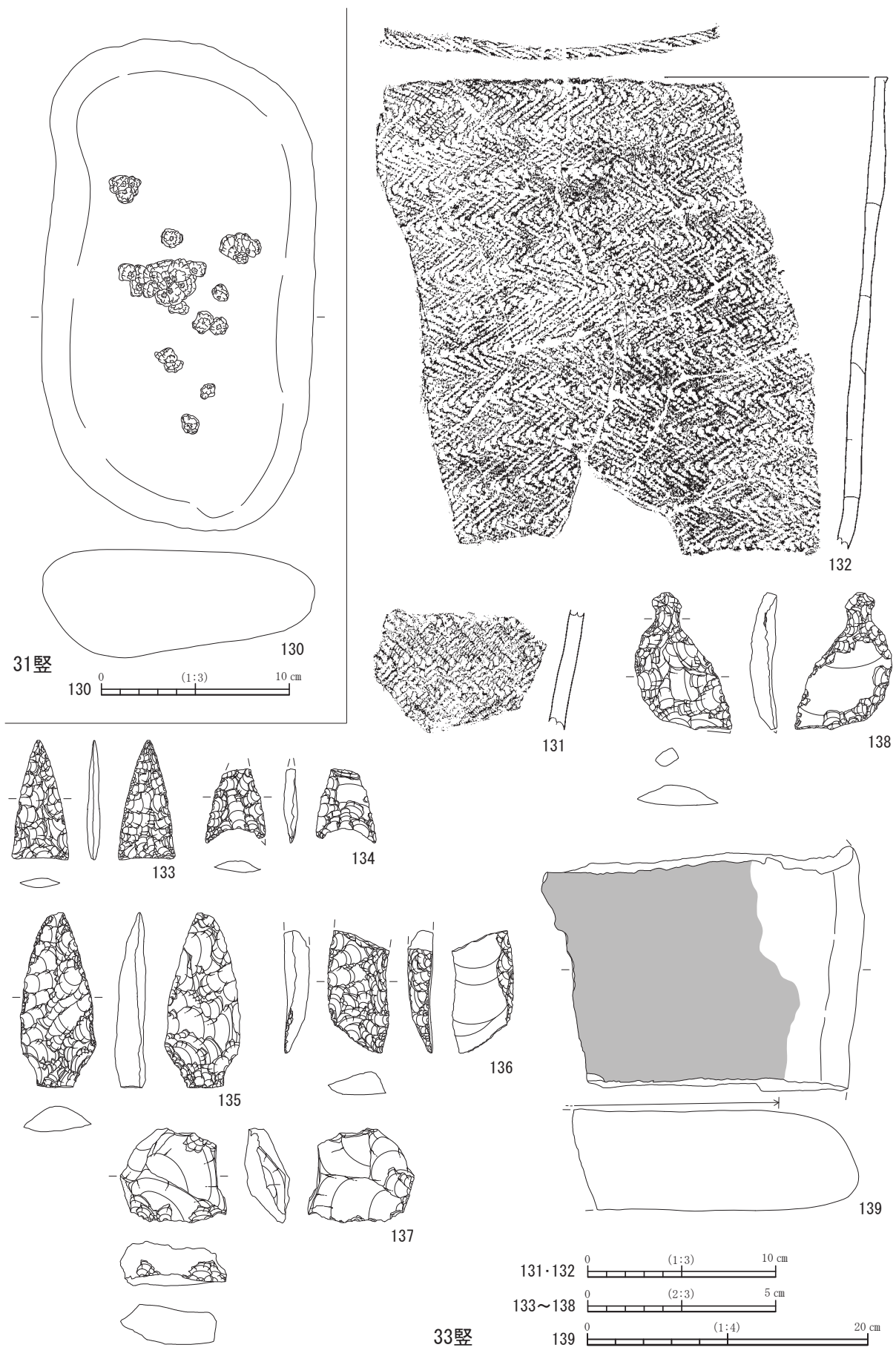

遺物図版15 縄文時代の遺物15

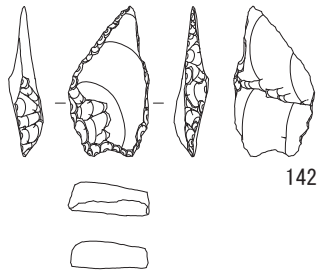

142

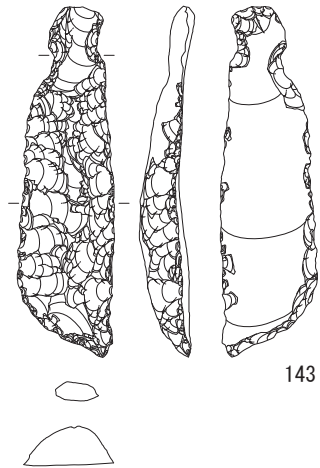

143

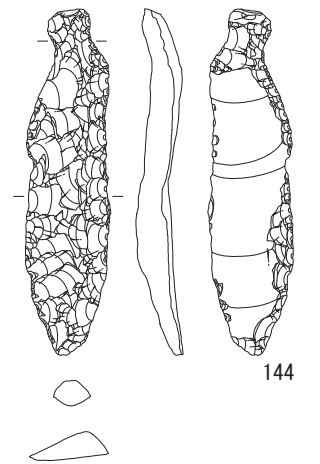

144

142~144 0 (2:3) 5 cm

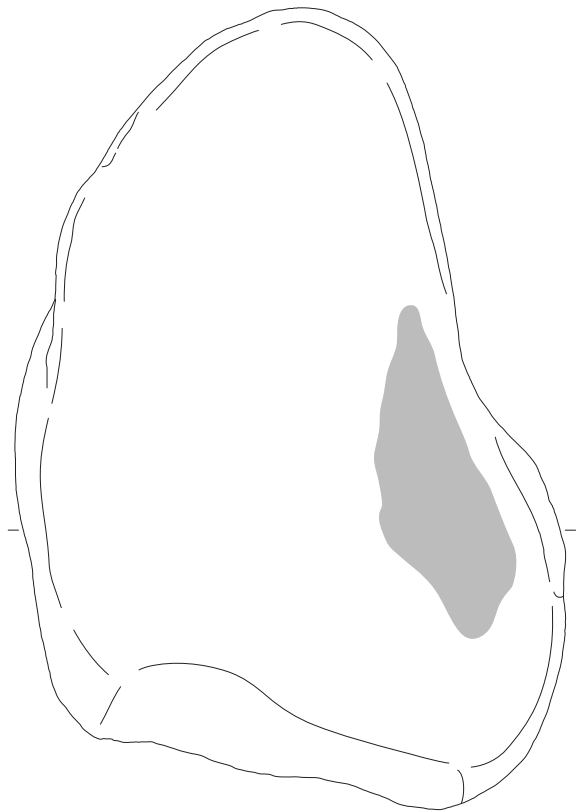

145

0 (1:5) 20 cm

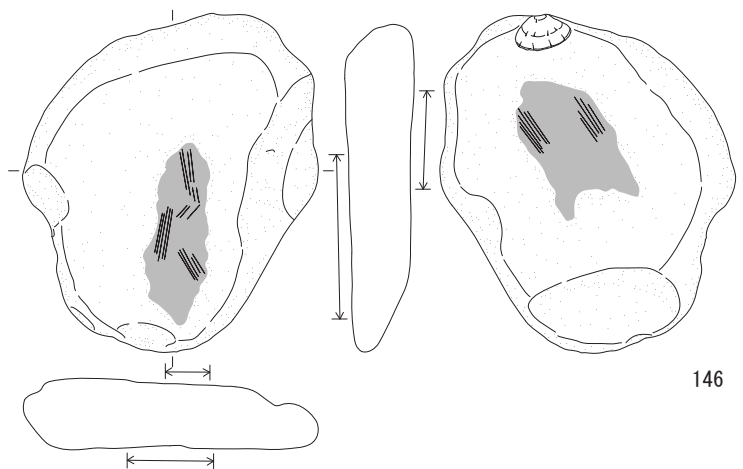
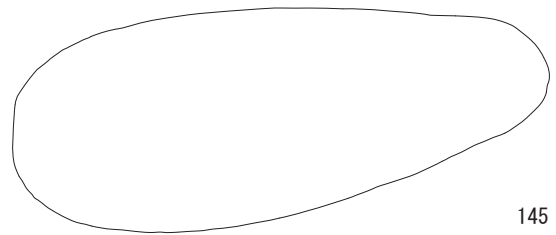

146

0 (1:4) 20 cm

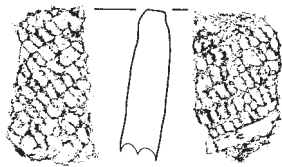

147

0 (1:2) 10 cm

35 豎

34 豎

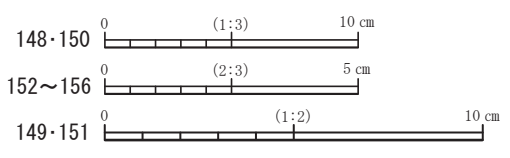

35 豎

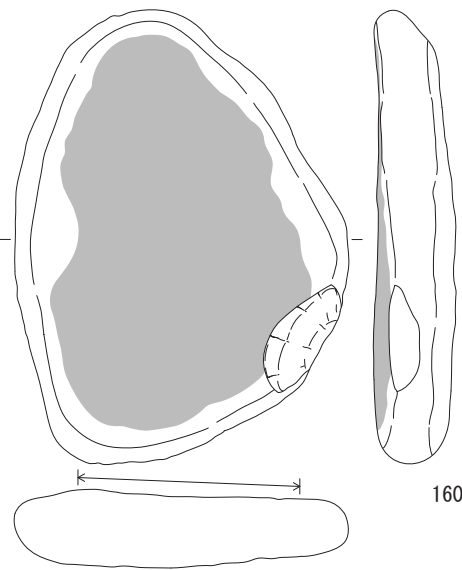
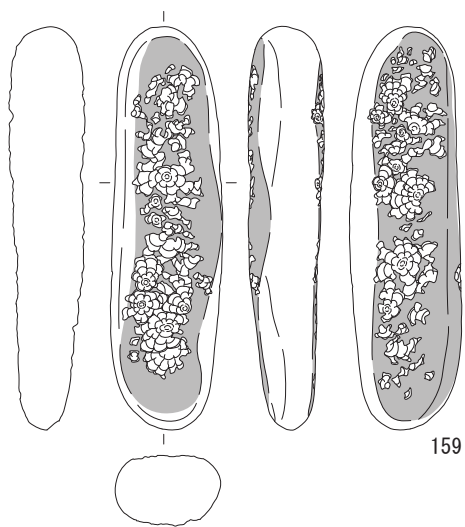
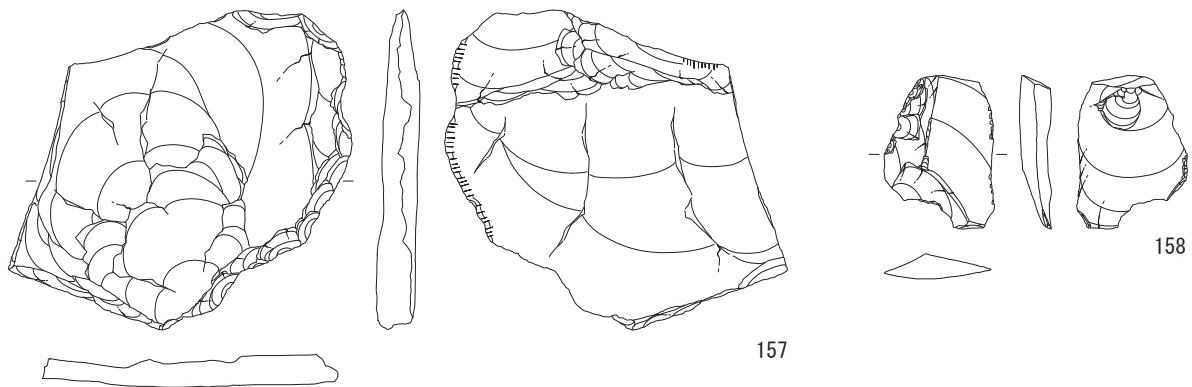

35 豎

157-158 0 (2:3) 5 cm

159-160 0 (1:3) 10 cm

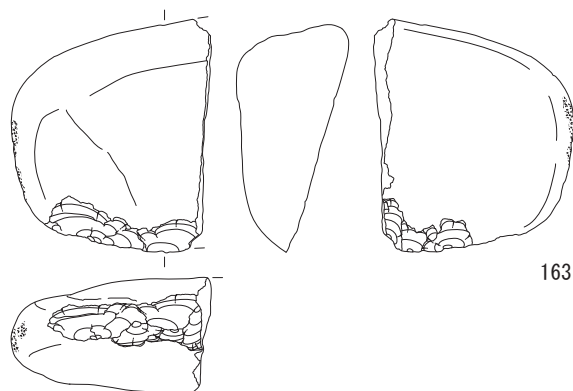
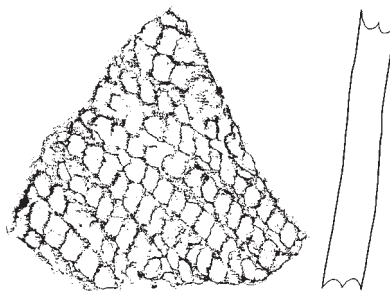
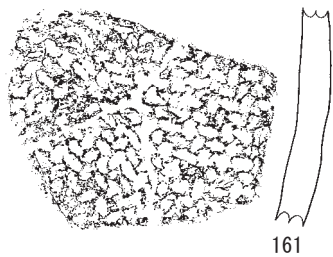

161-162 0 (1:2) 10 cm

163 0 (1:3) 10 cm

36 豎

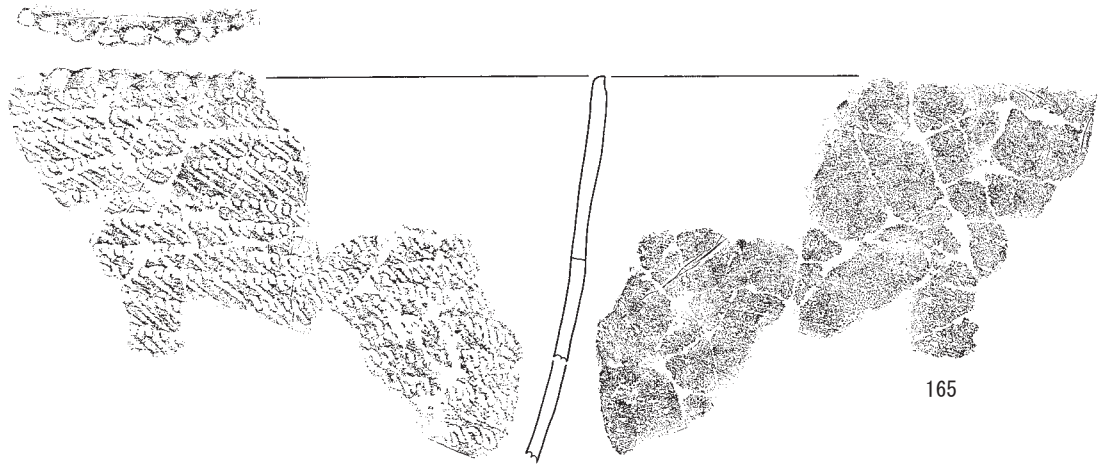

165



166

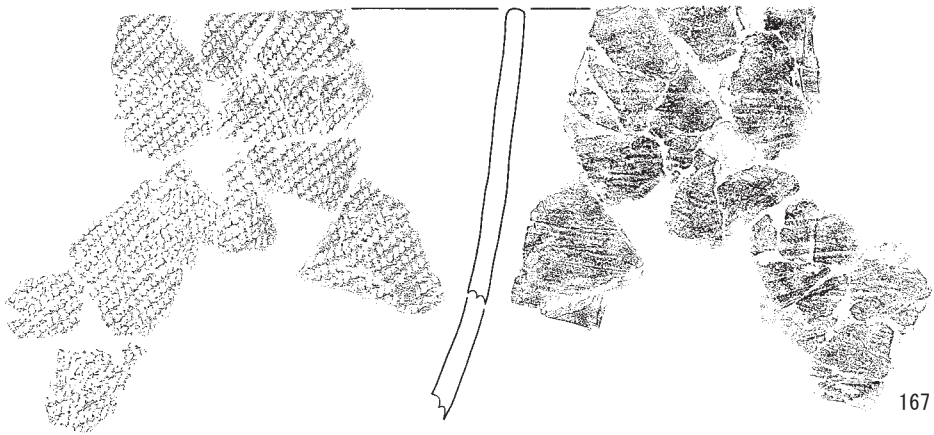

167

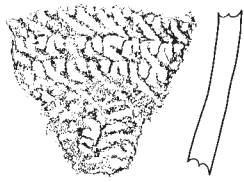

168

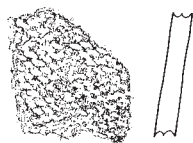

169

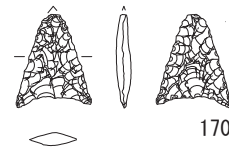

170

166~169 0 (1:3) 10 cm

165 0 (1:4) 20 cm

170 0 (2:3) 5 cm

37 豎

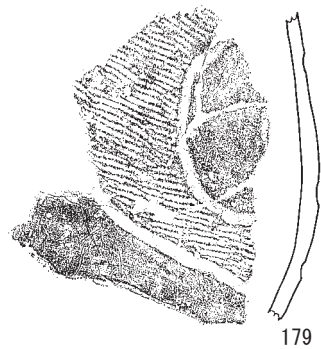
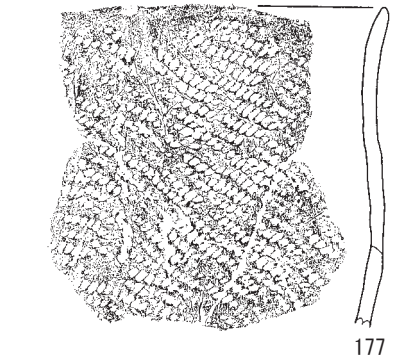
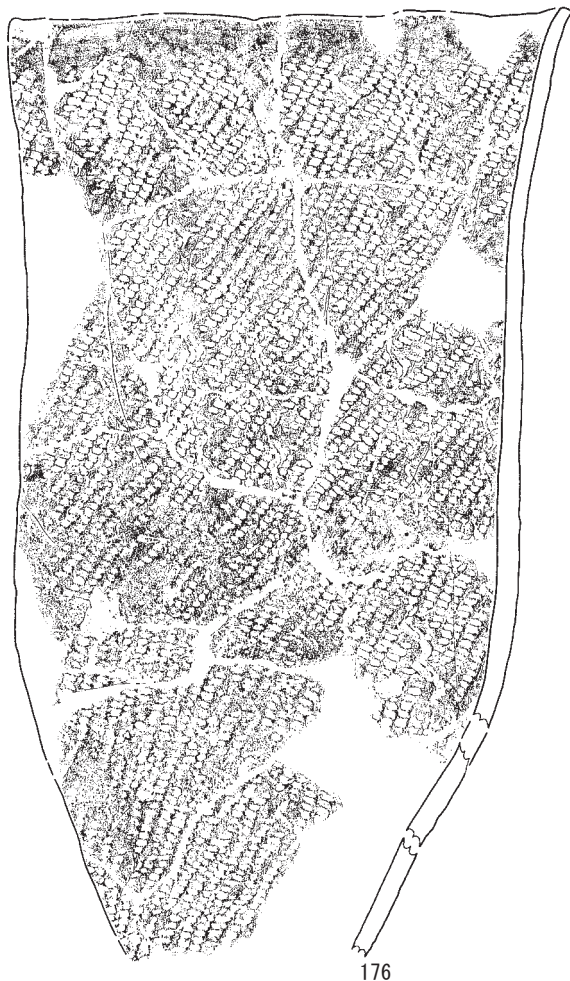
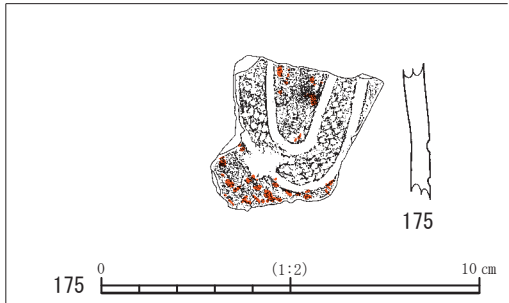
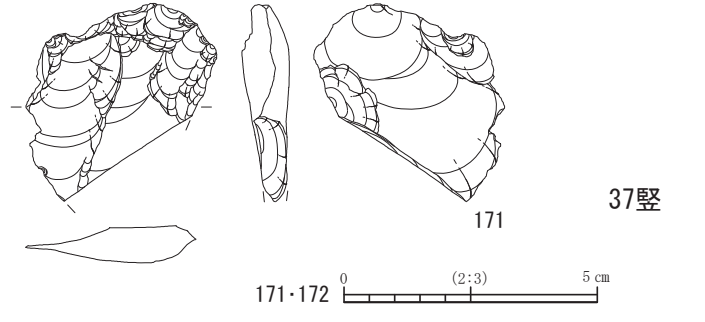
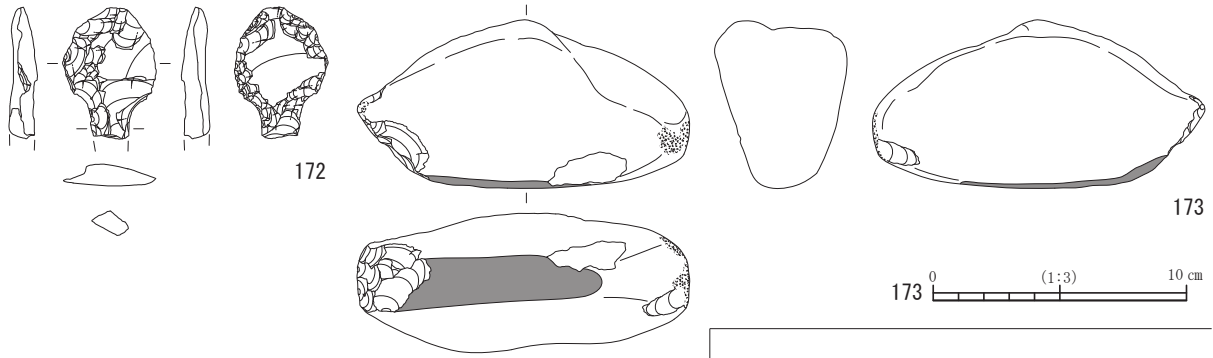

176 0 (1:4) 20 cm

177~179 0 (1:3) 10 cm

37 豎

38 豎

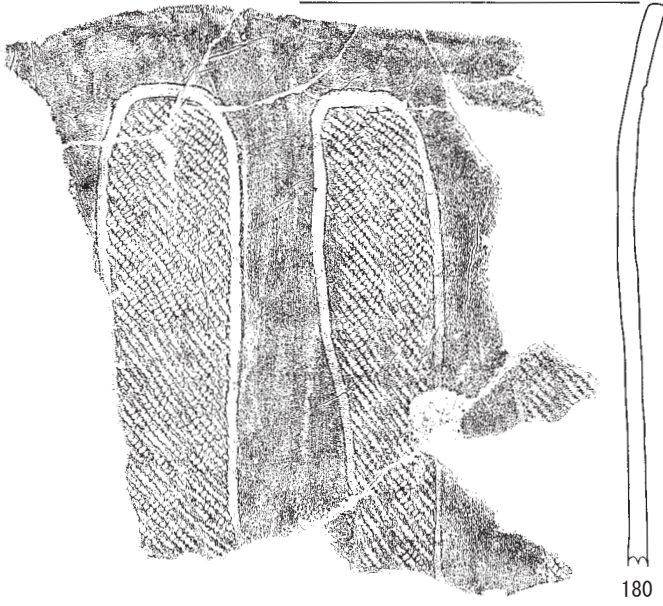

180



184

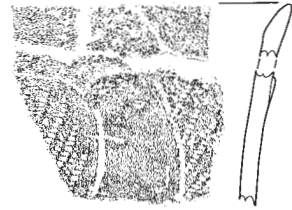

185



182

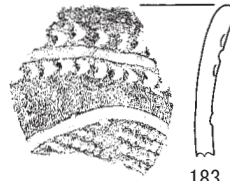

183

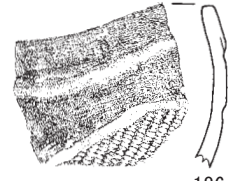

186

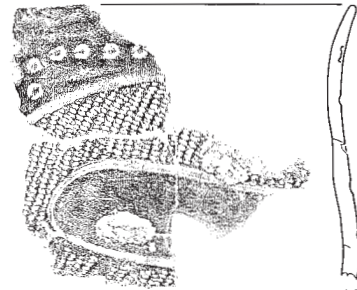

188

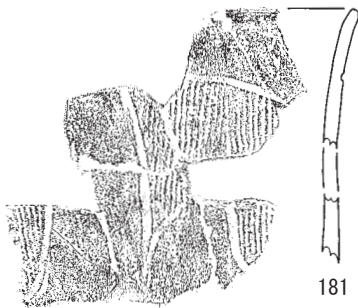

181



189

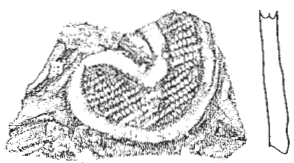

187

38 豎

0 (1:3) 10 cm

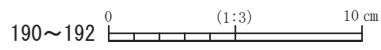
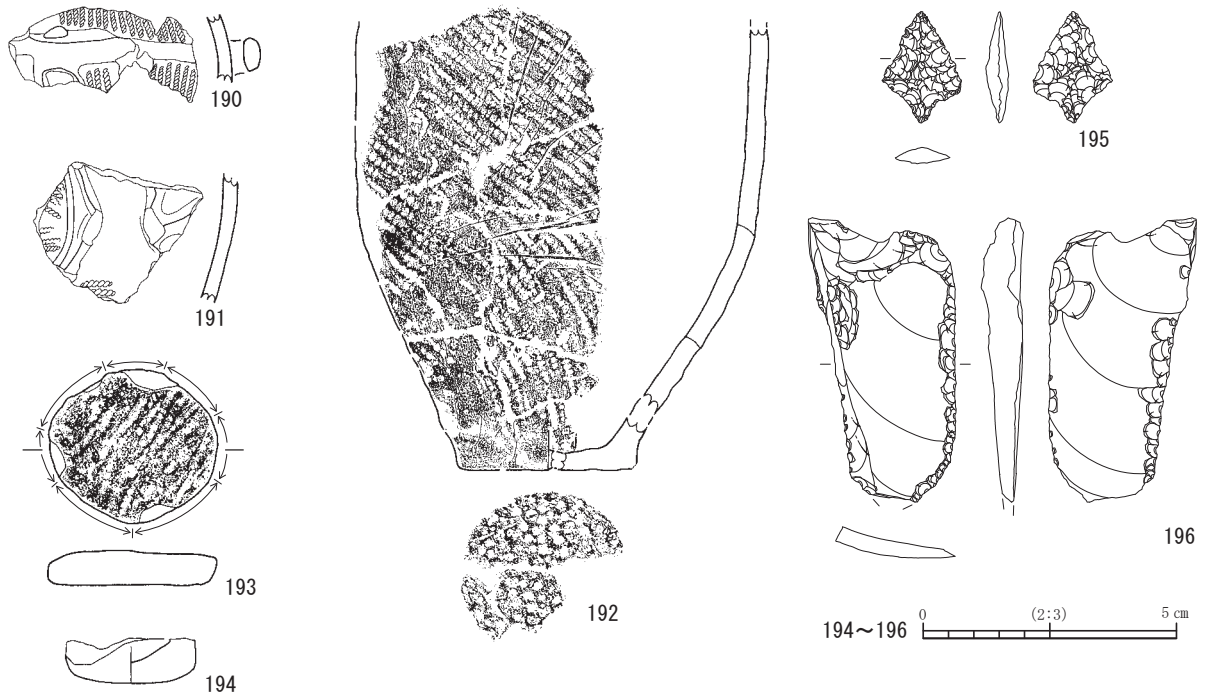

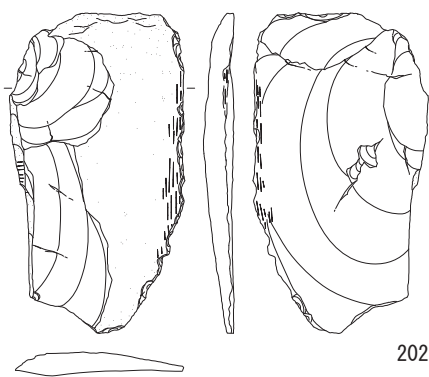

202

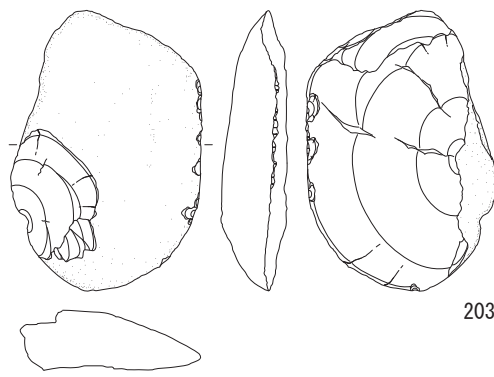

203

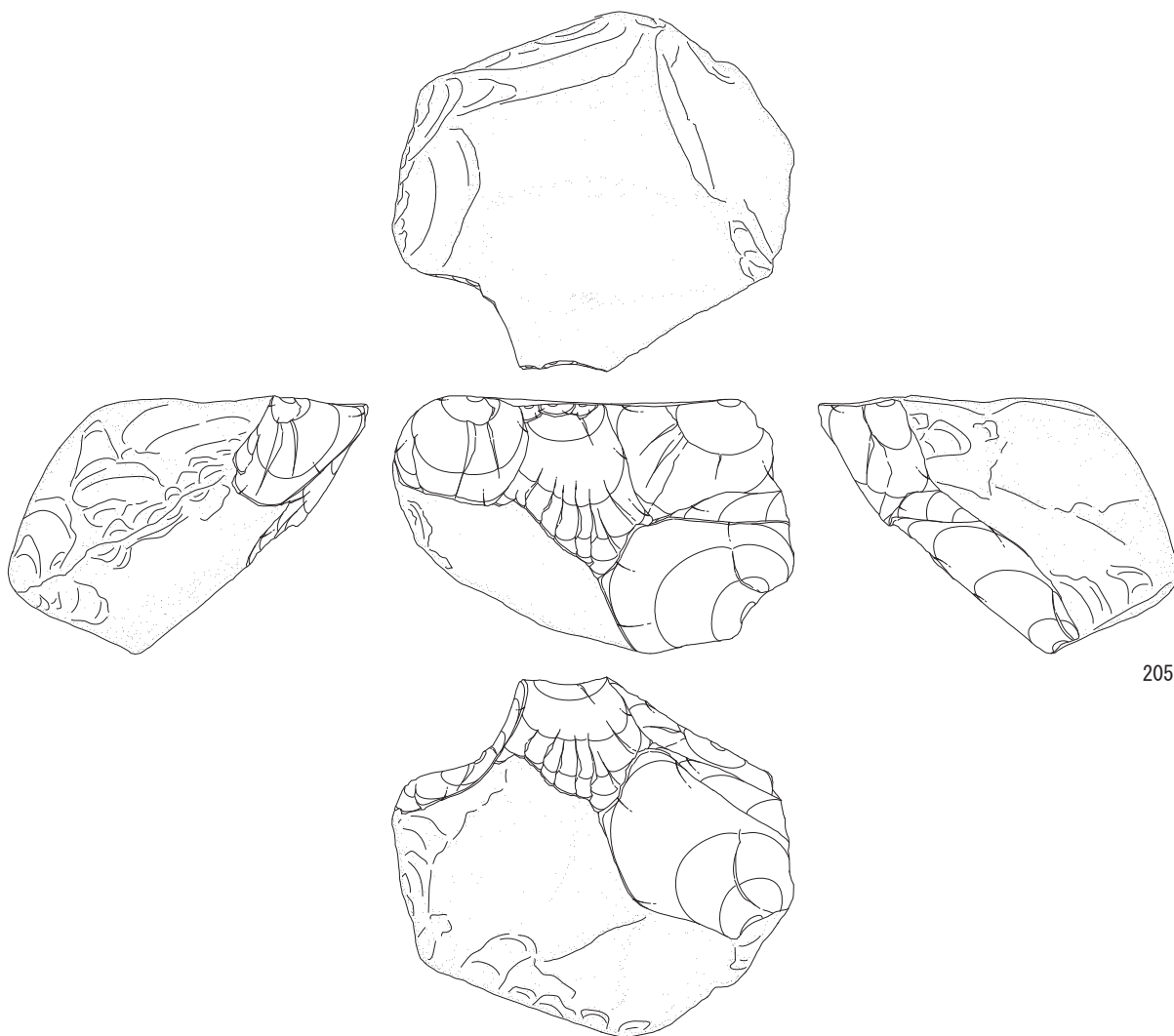

205

38 豎

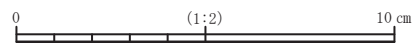

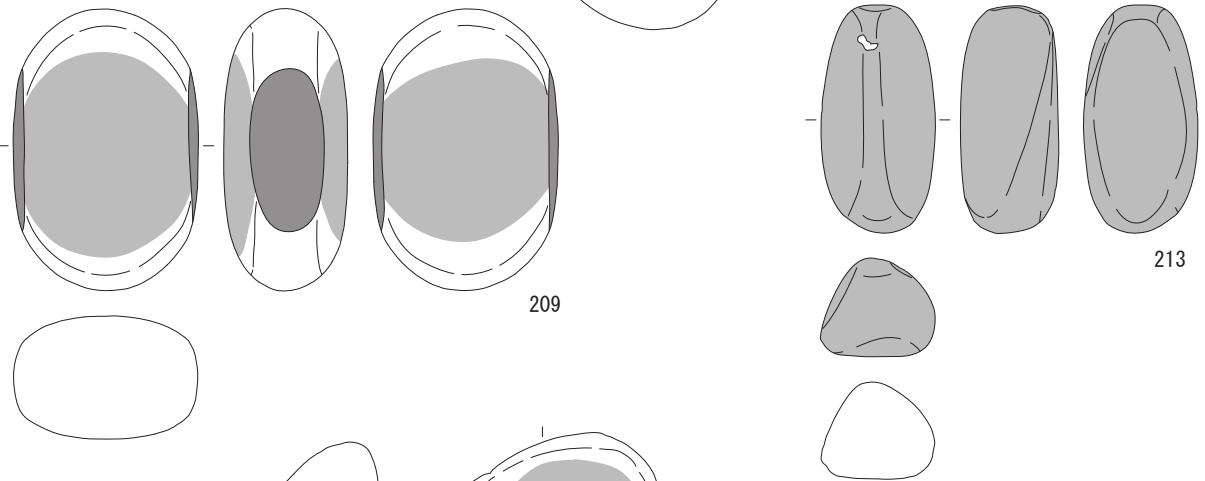
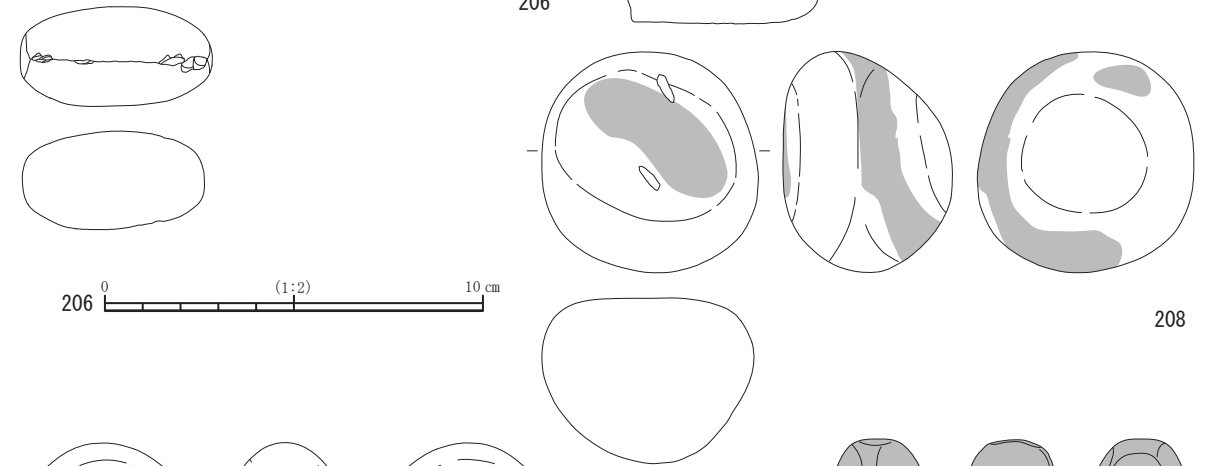
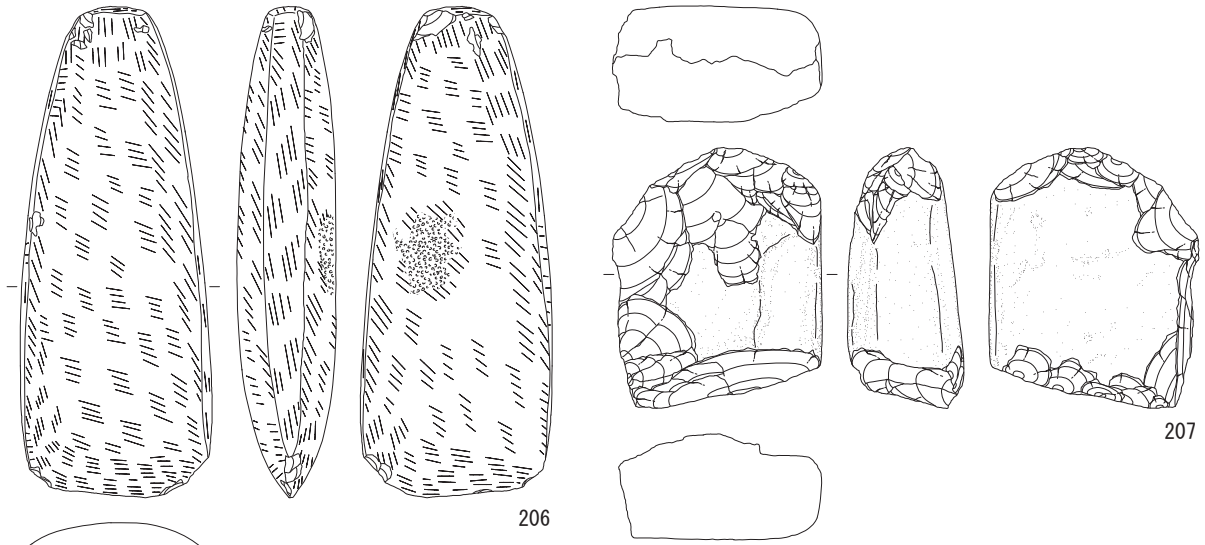

213 0 (2:3) 5 cm

214 207~209・214 0 (1:3) 10 cm

38 豎

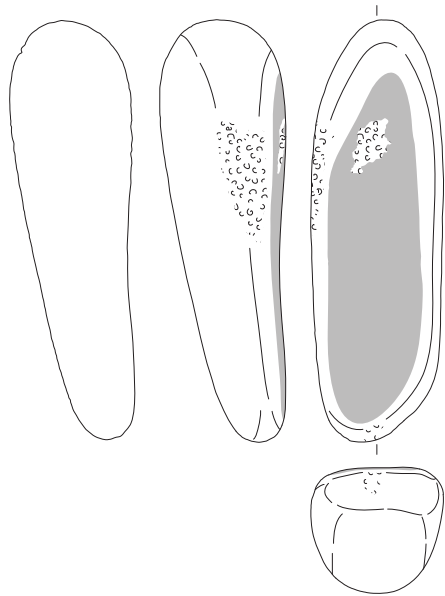

215

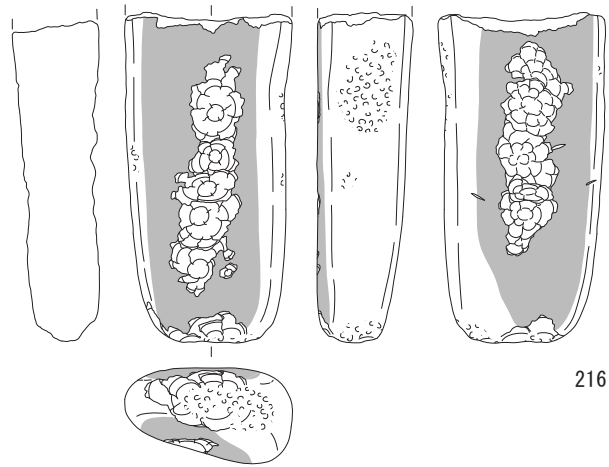

216

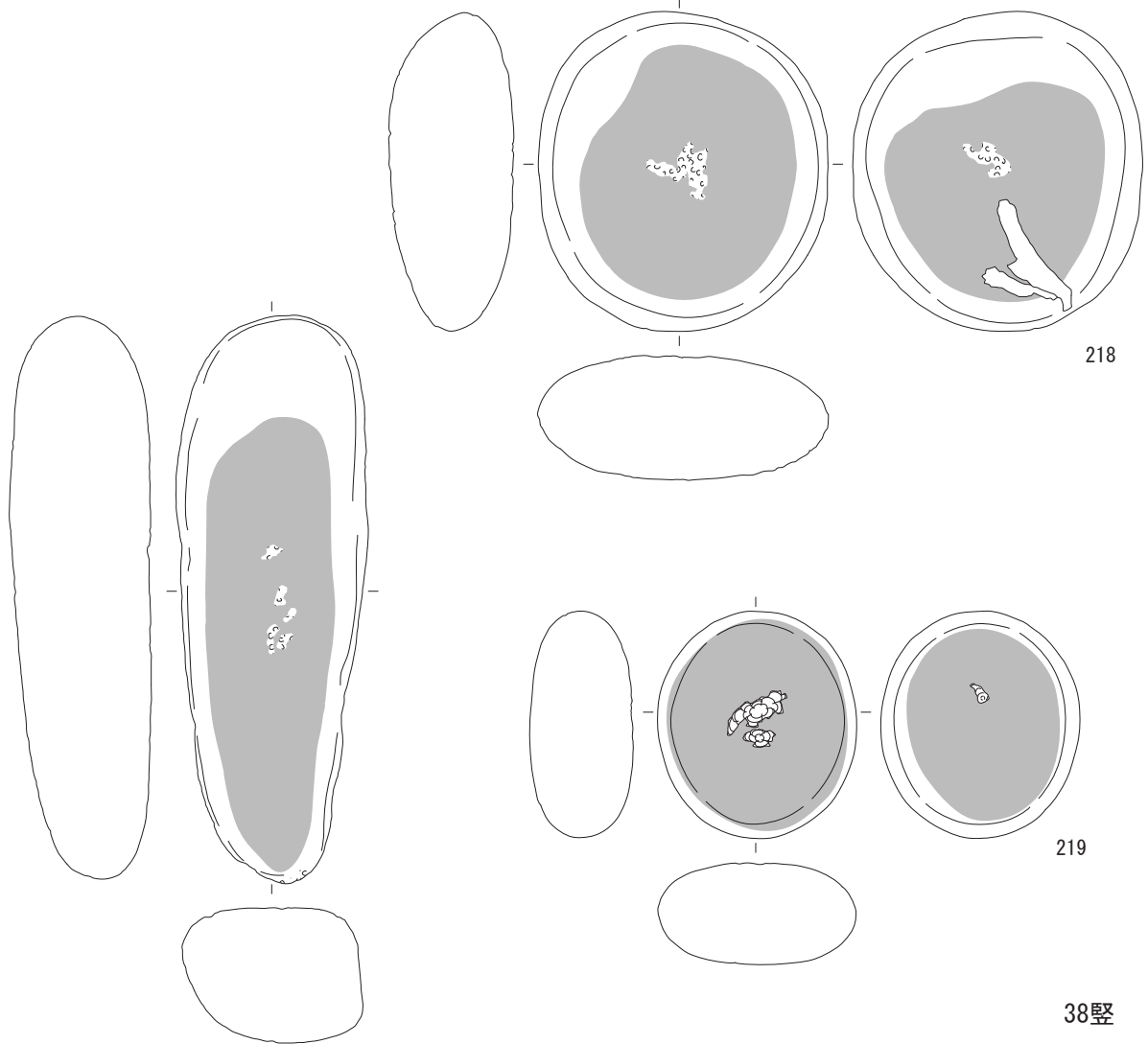

217

218

219

38 竖

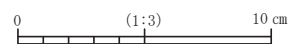

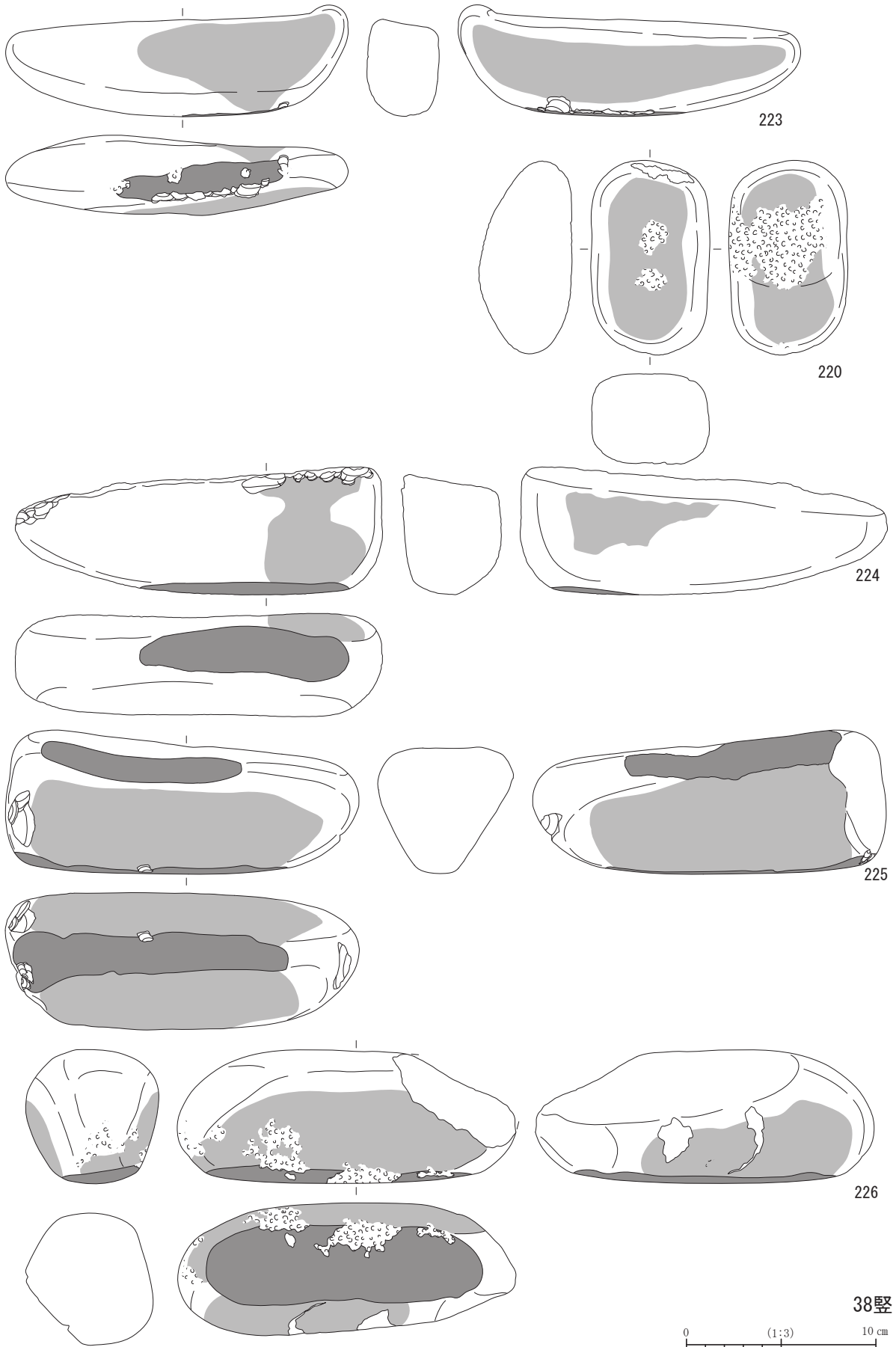

遺物図版26 縄文時代の遺物26

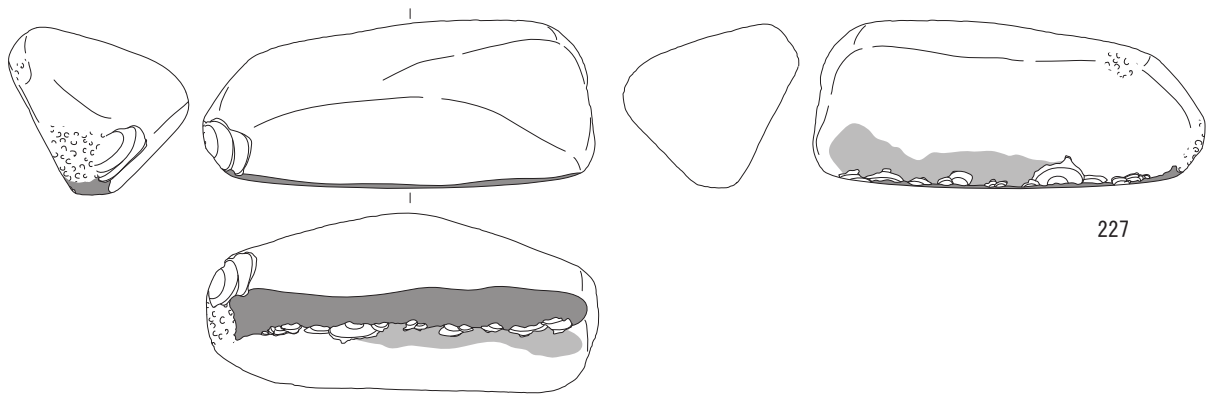

227



228

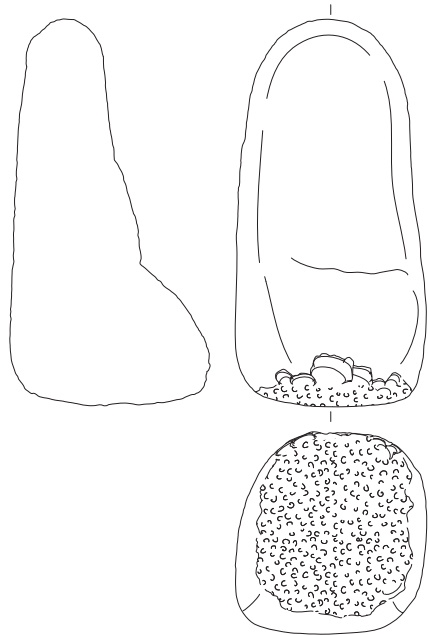

229



231

38 豎

227~229 0 (1:3) 10 cm

231 0 (1:4) 20 cm

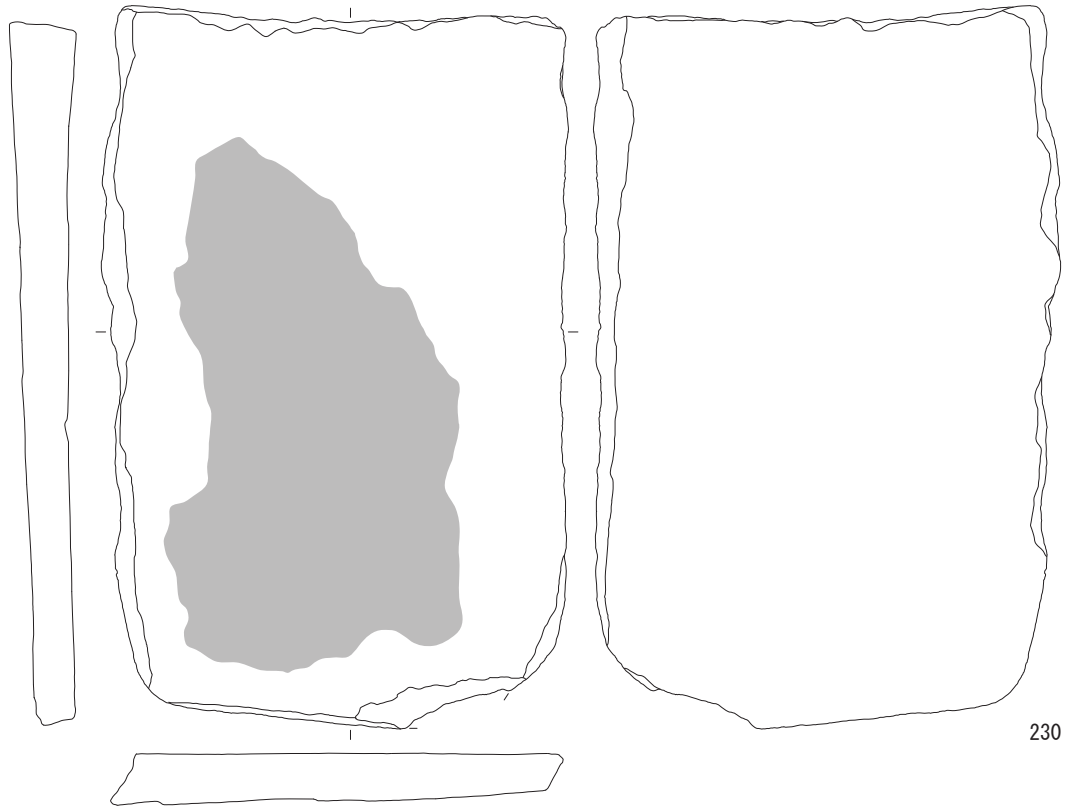

230

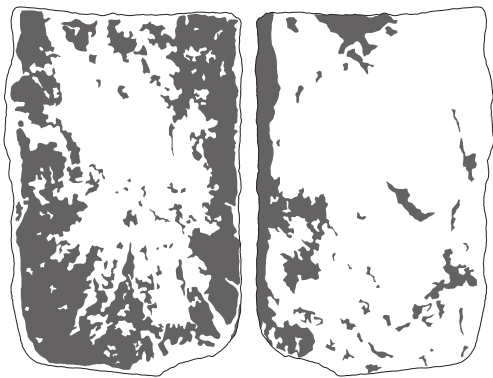

黒色範囲S=1/8

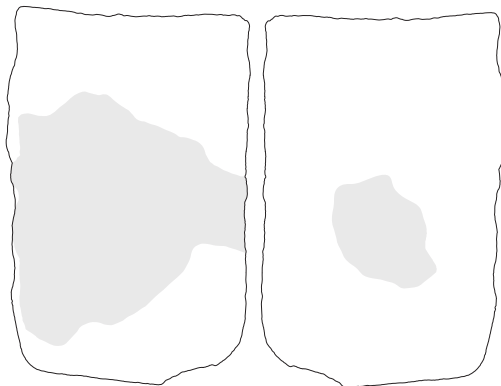

被熱(赤)S=1/8

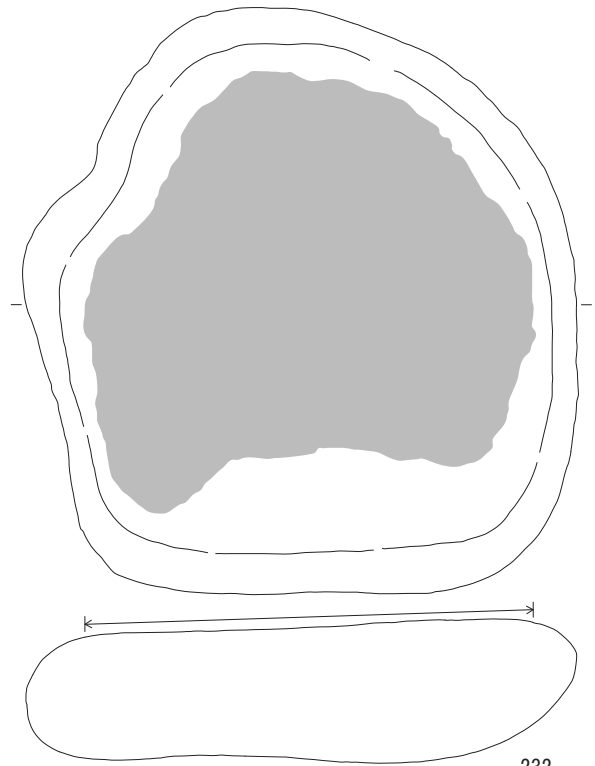

232

38 豎

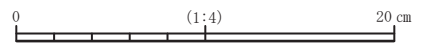

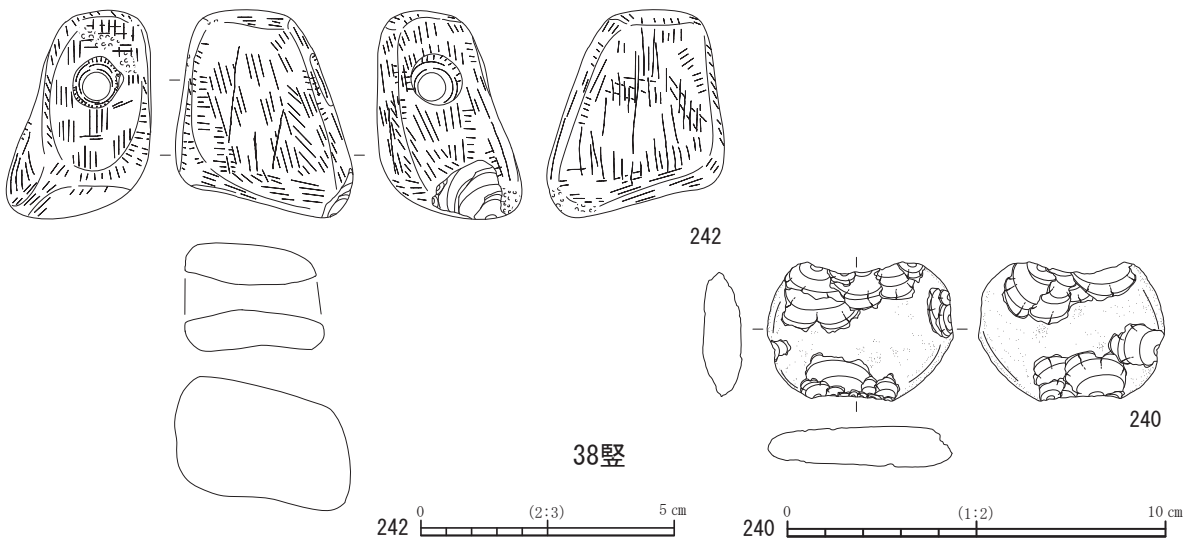
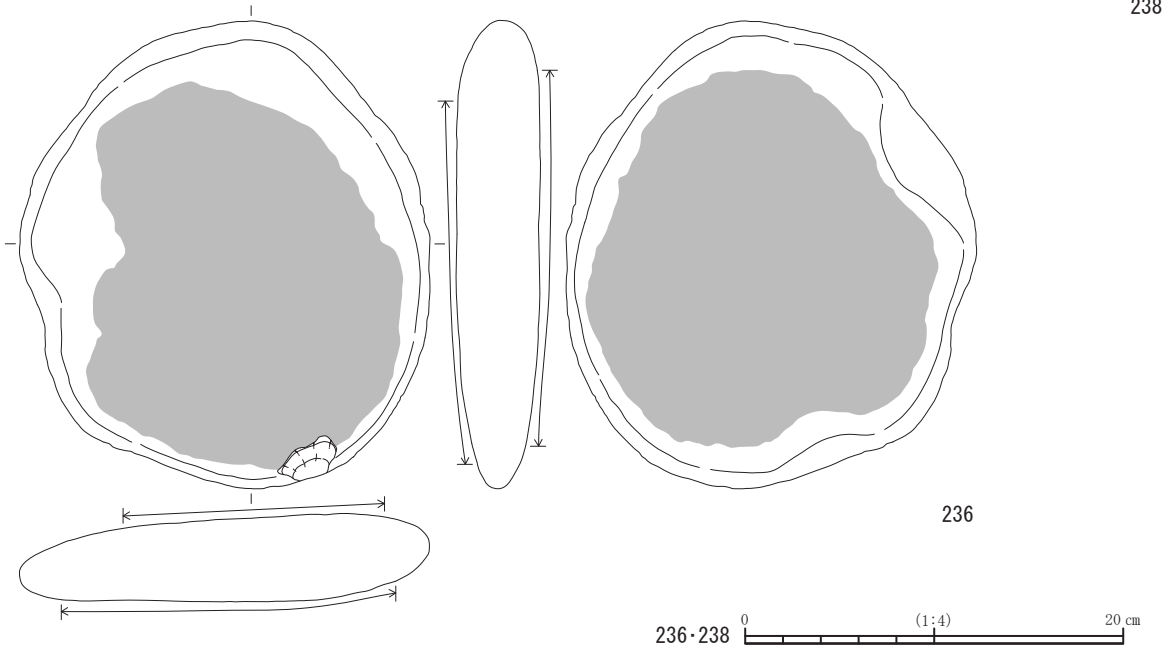
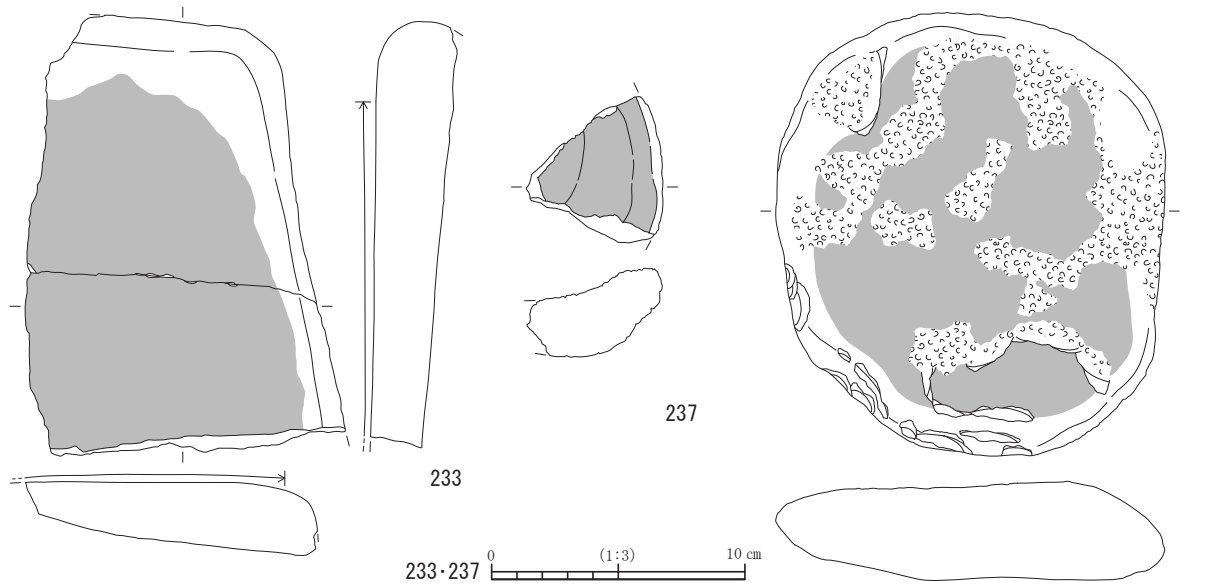

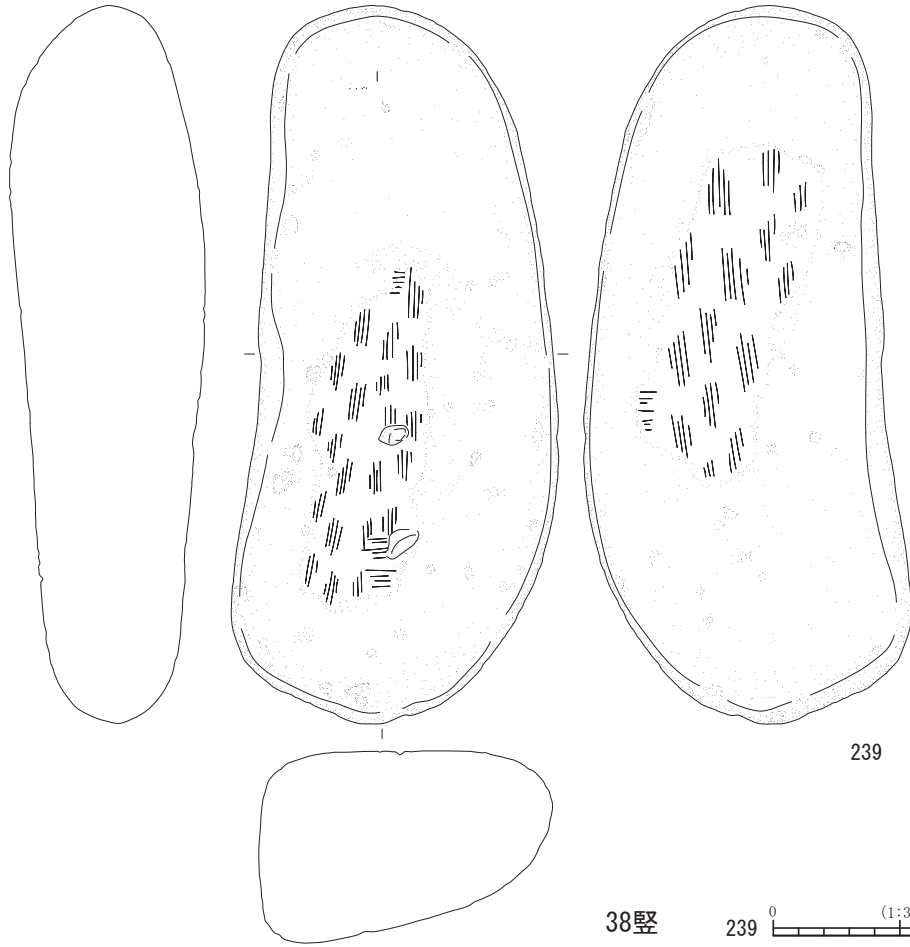

239

38 豎

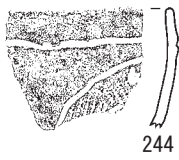
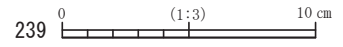

244



245

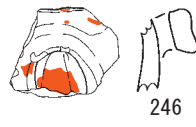

246



248

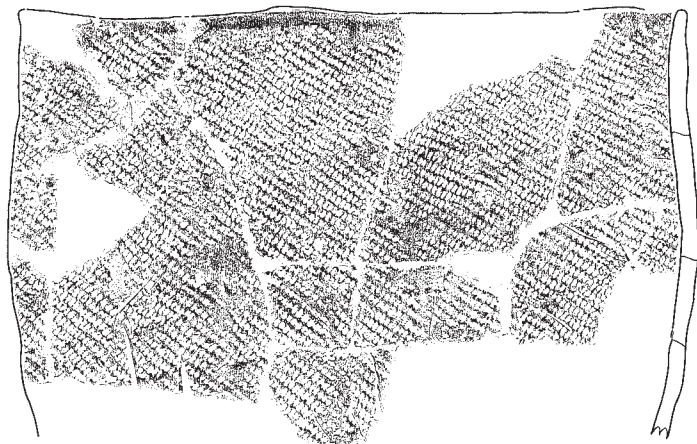

247

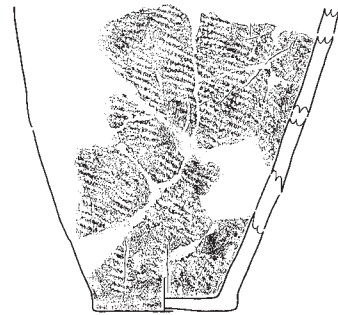

249

39 豎

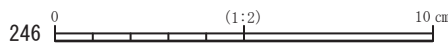

244・245・247~249

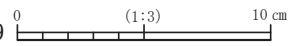

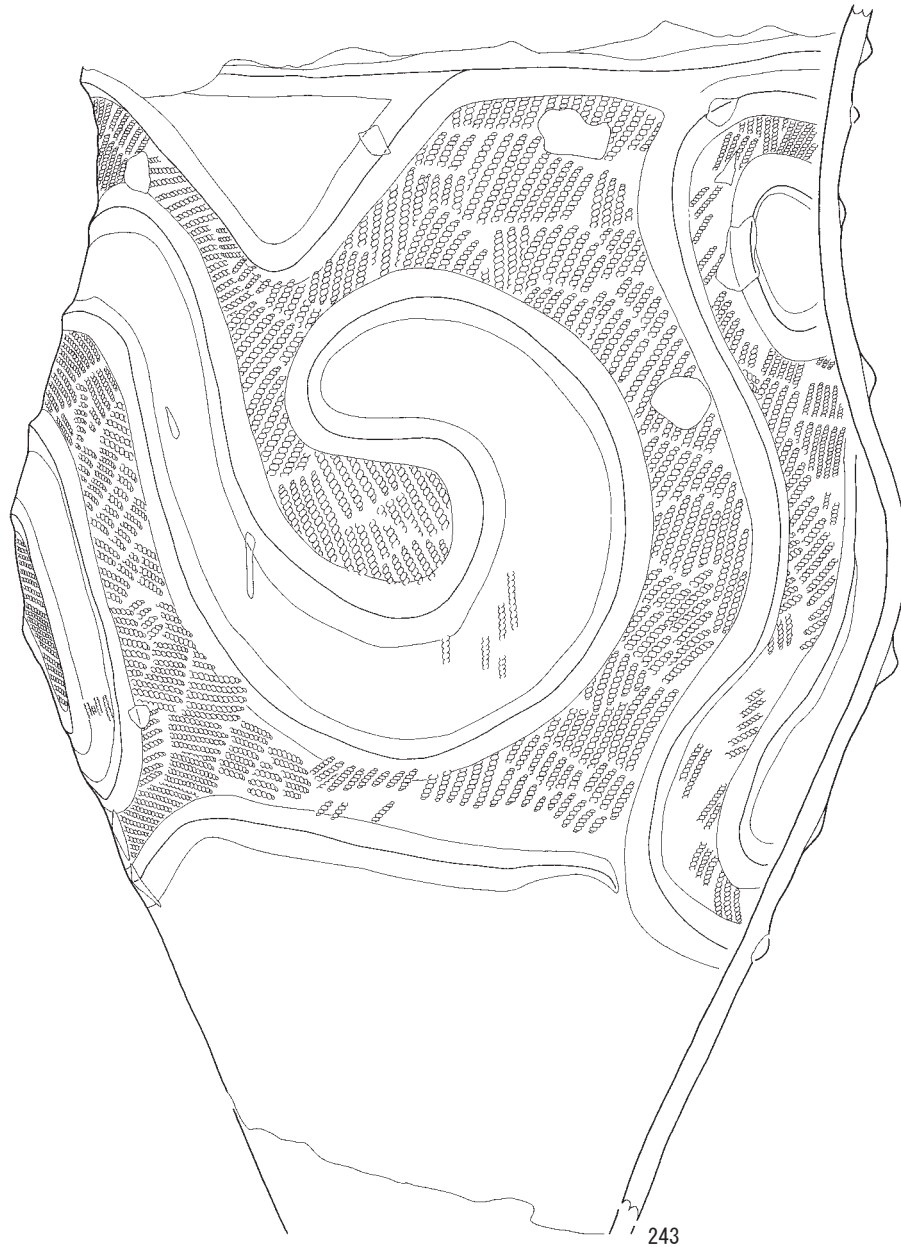

展開図 0 (1:8) 40 cm

0 (1:3) 10 cm

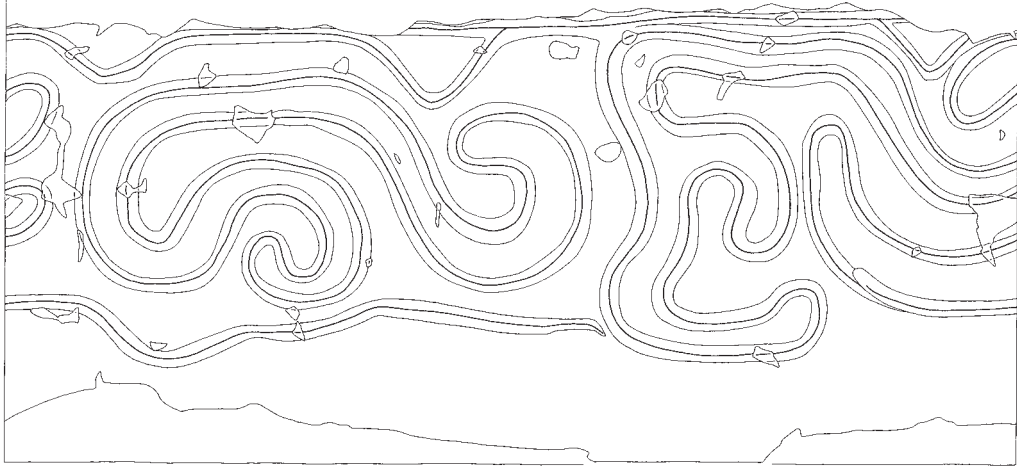

展開図

39 縦

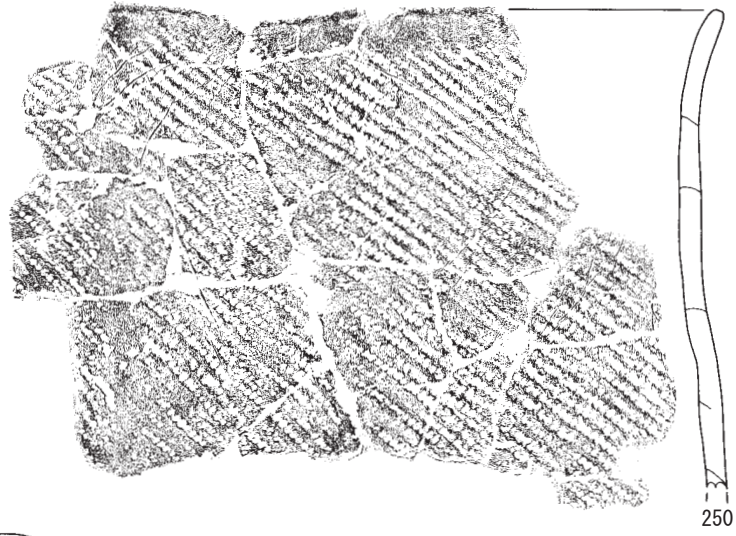

250

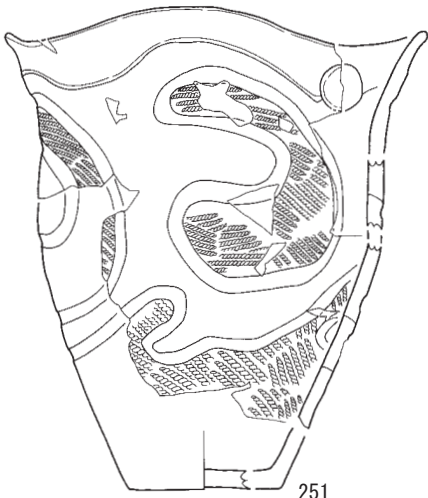

251

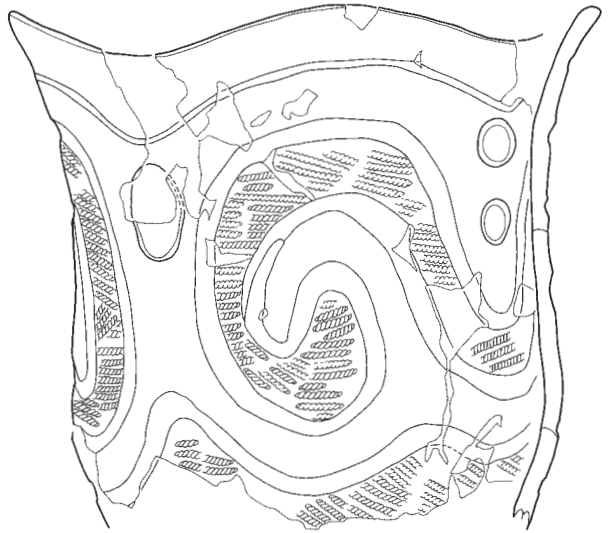

252

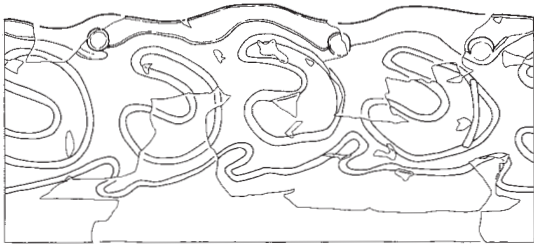

251展開図

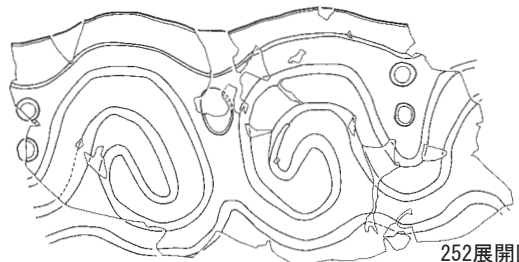

252展開図

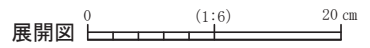

展開図

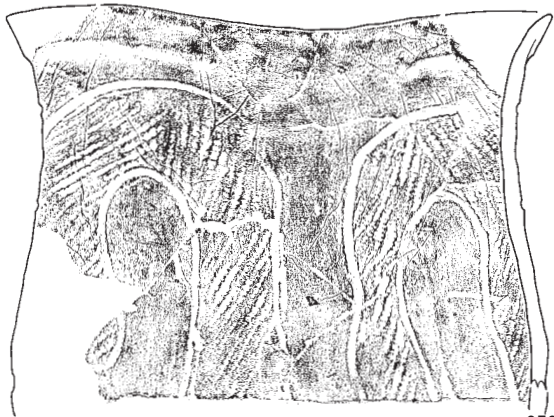

253

39 縦

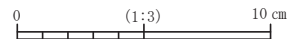



254

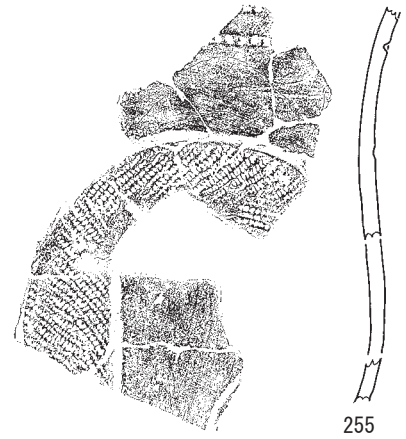

255

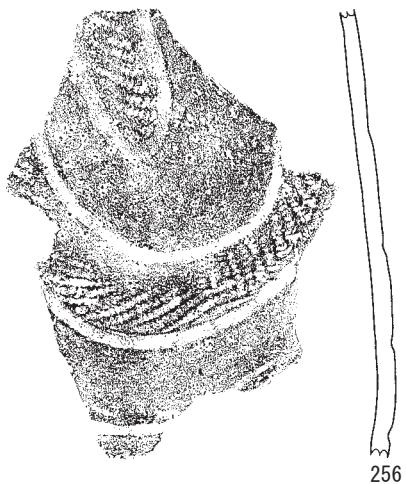

256

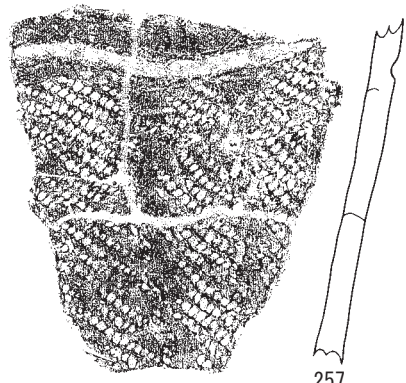

257

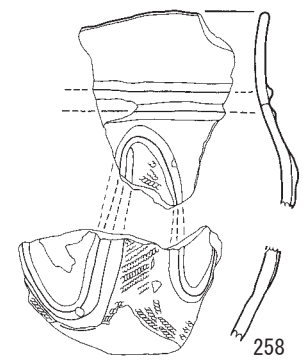

258



259

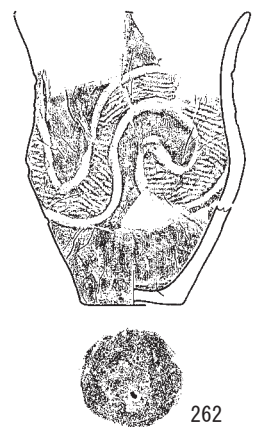

262

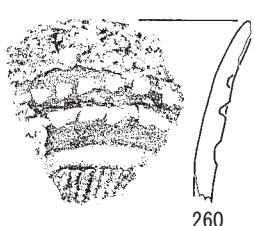

260

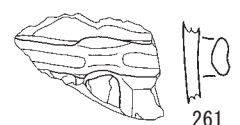

261

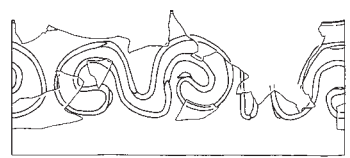

262展開図

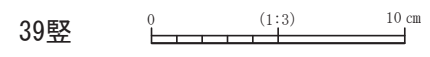
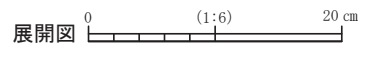

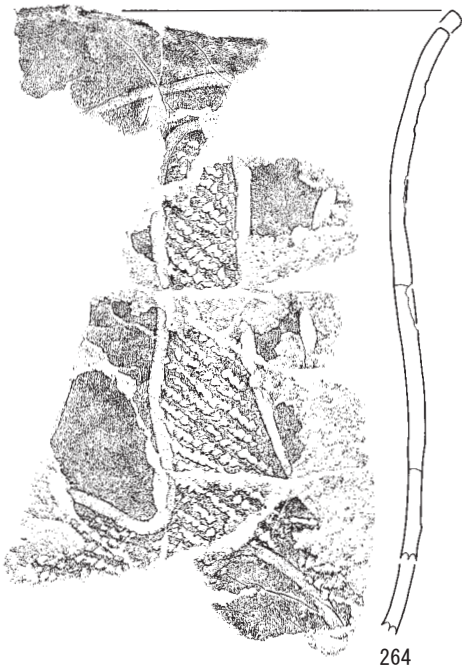

264

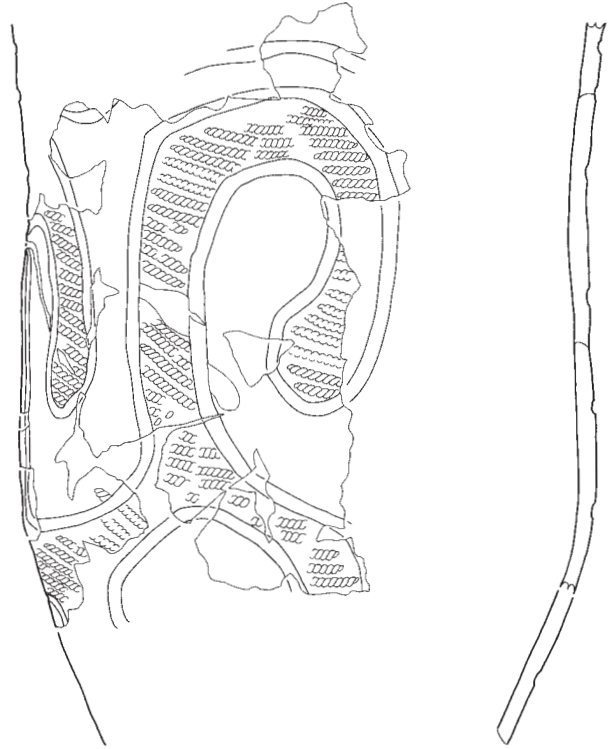

265

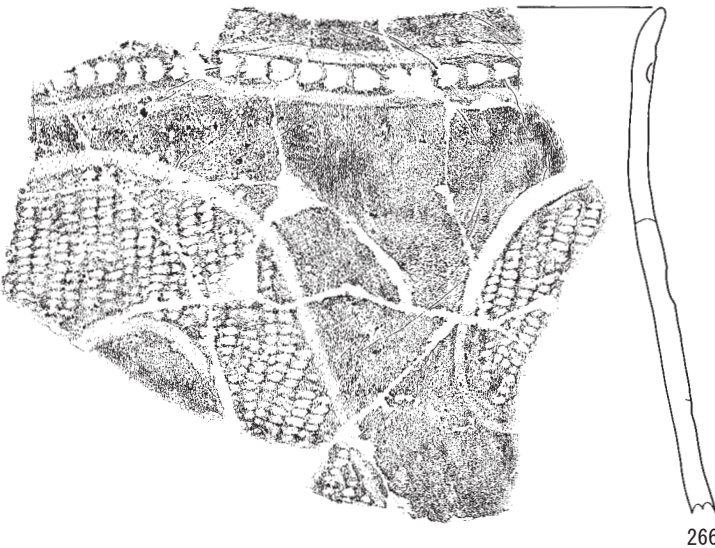

266

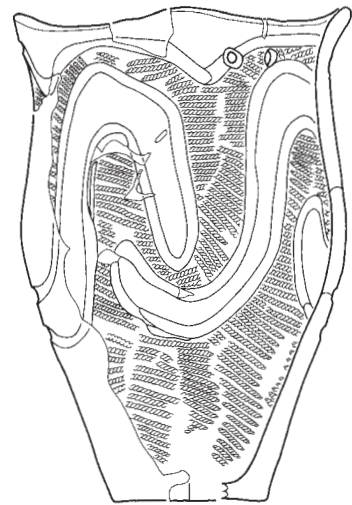

267

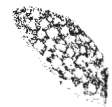

263

39 豎

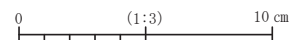

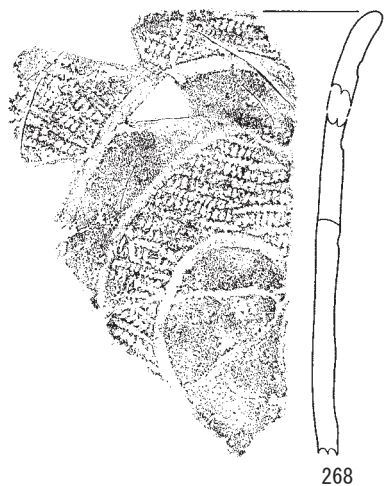

268

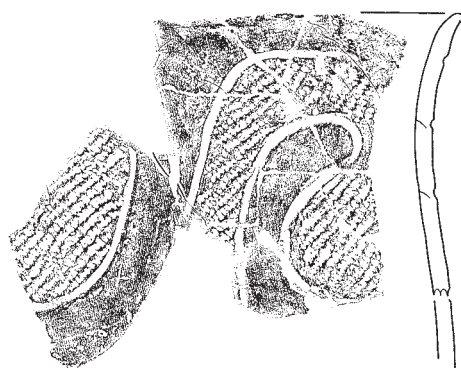

269

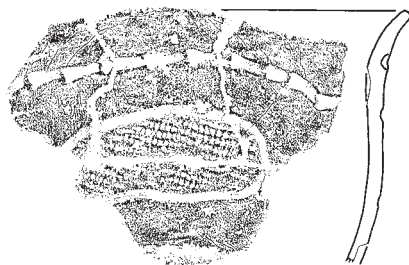

270

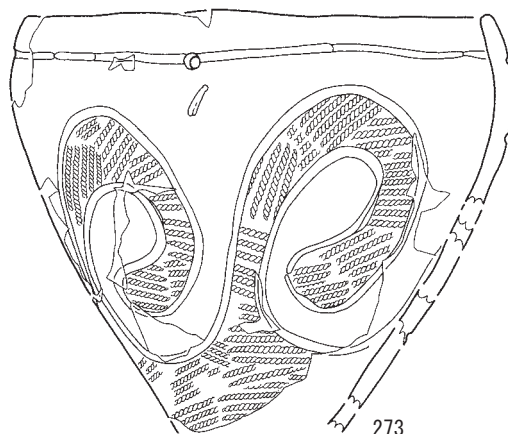

273

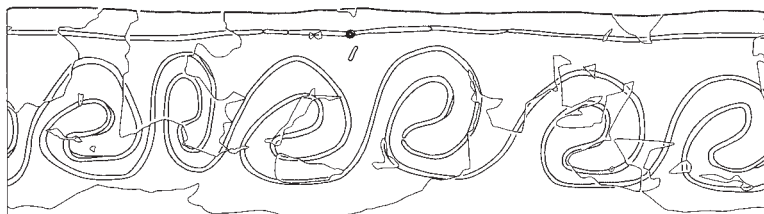

273展開図

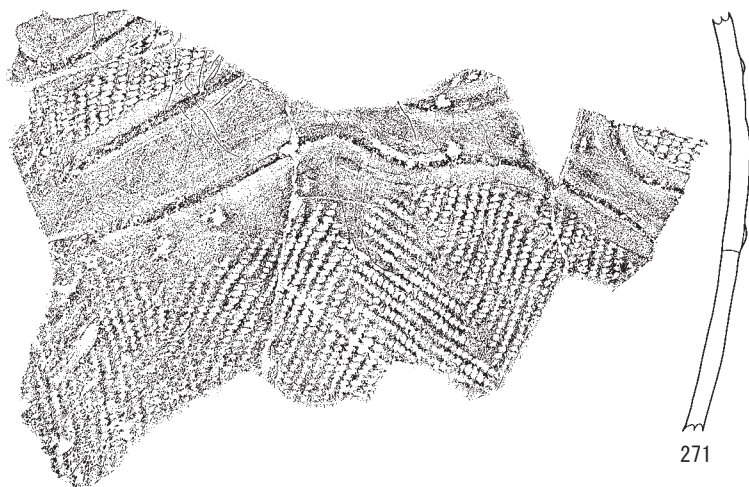

271



展開図

(1:6)

20 cm



272

39 縦

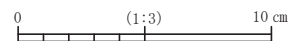

(1:3)

10 cm

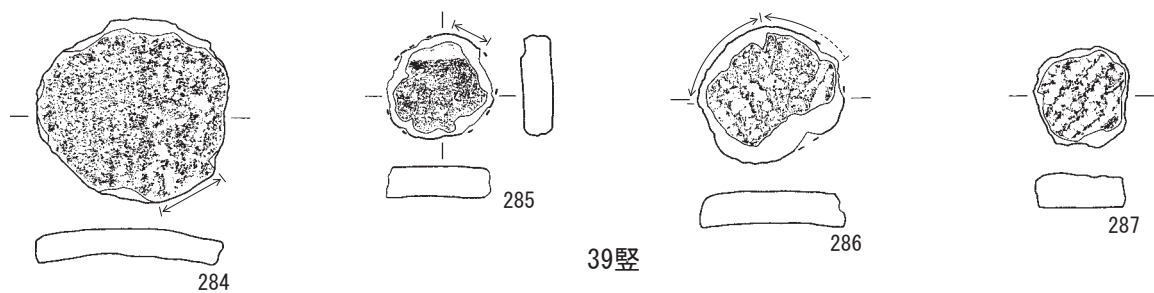
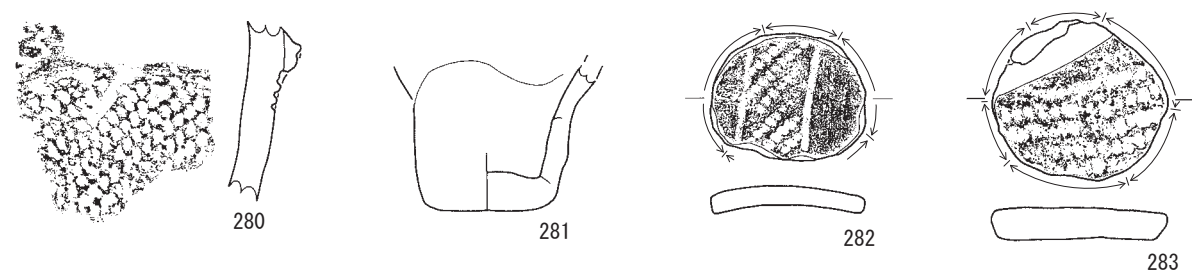
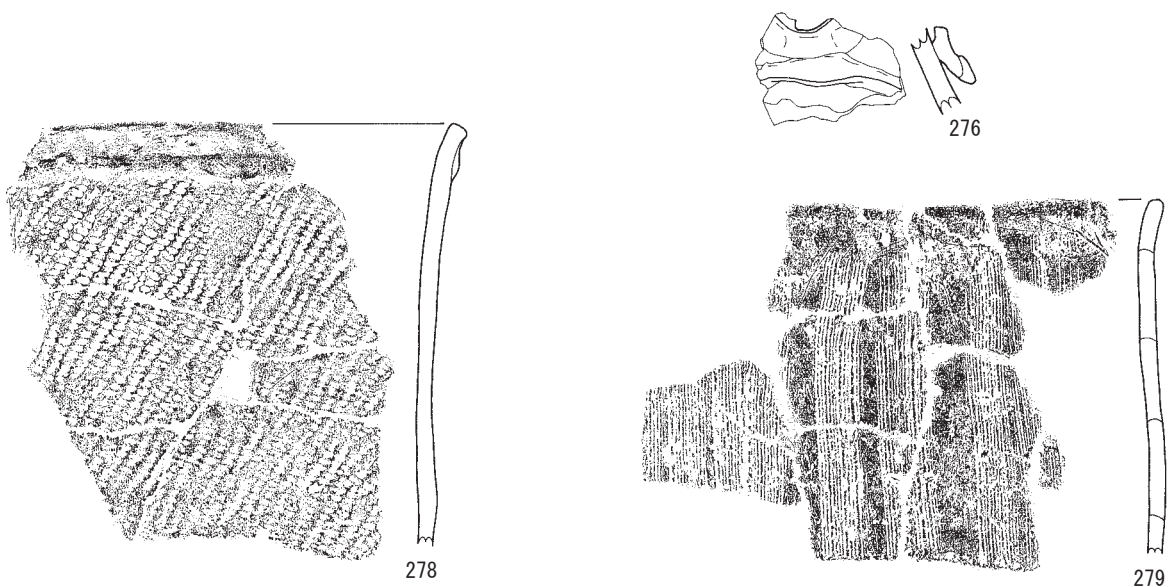
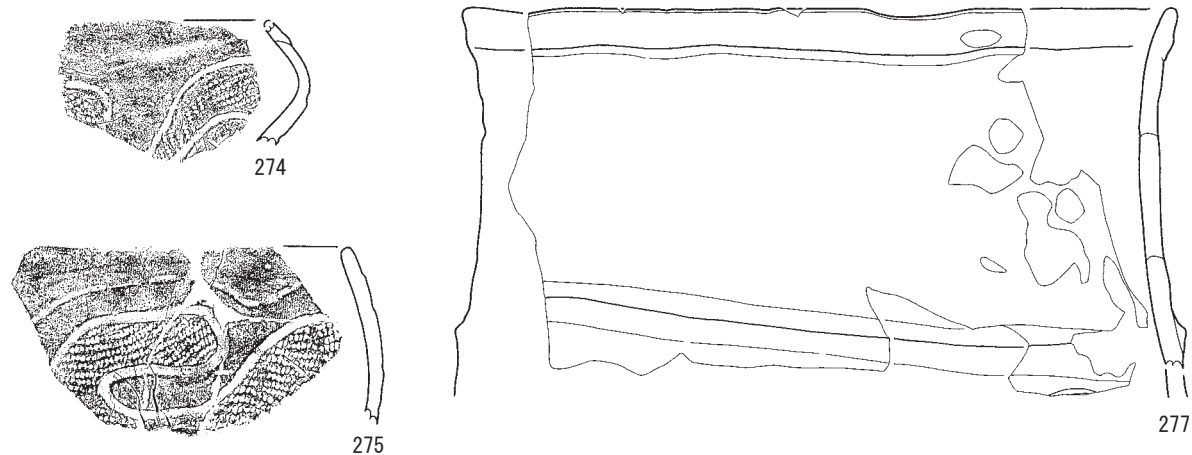

274・275・277～279 0 (1:3) 10 cm

276・280～287 0 (1:2) 10 cm

39 豎



39 豎

288~297 0 (2:3) 5 cm

298・299 0 (1:2) 10 cm

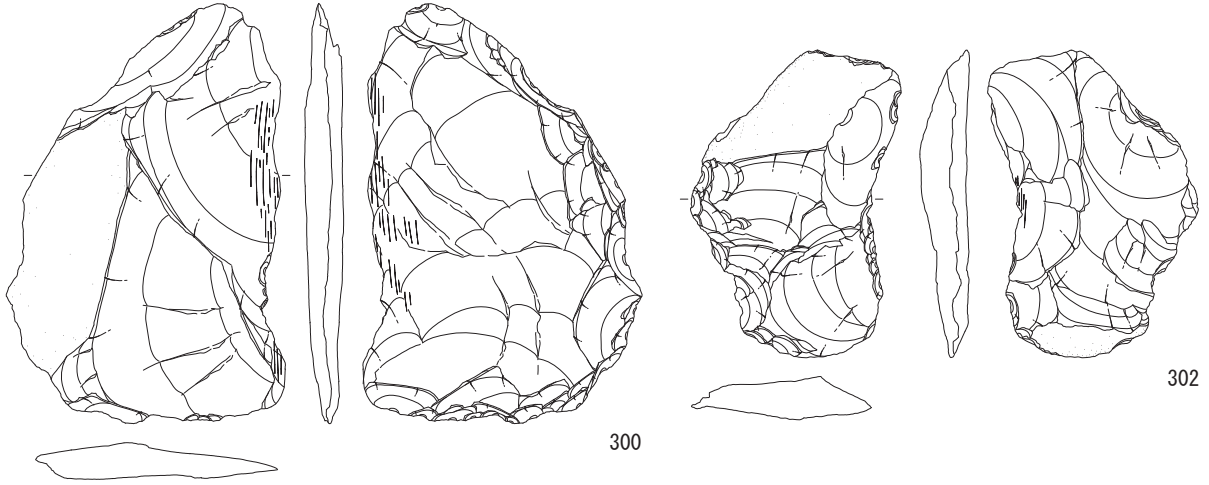

300

302

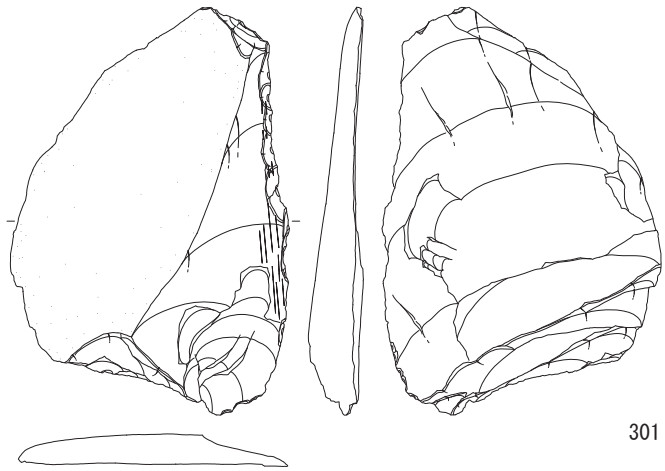

301

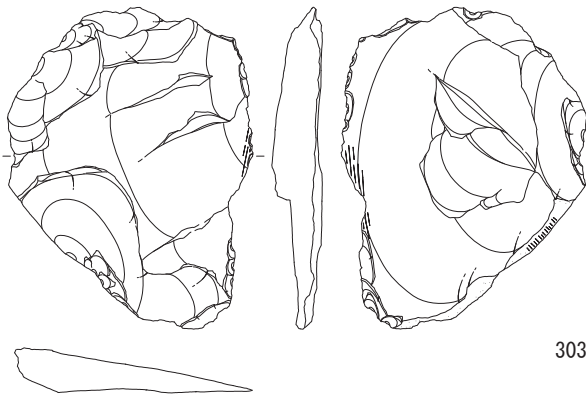

303

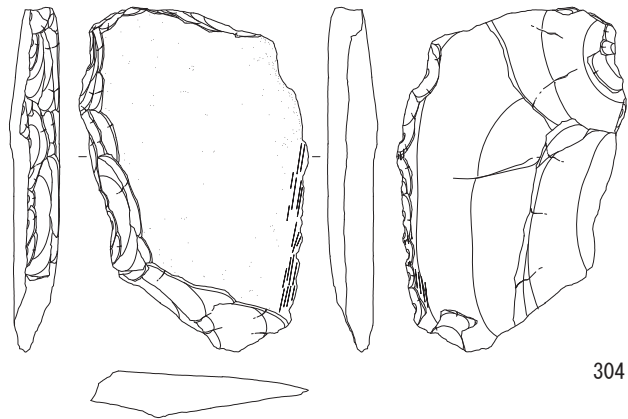

304

39 豎

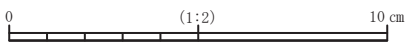

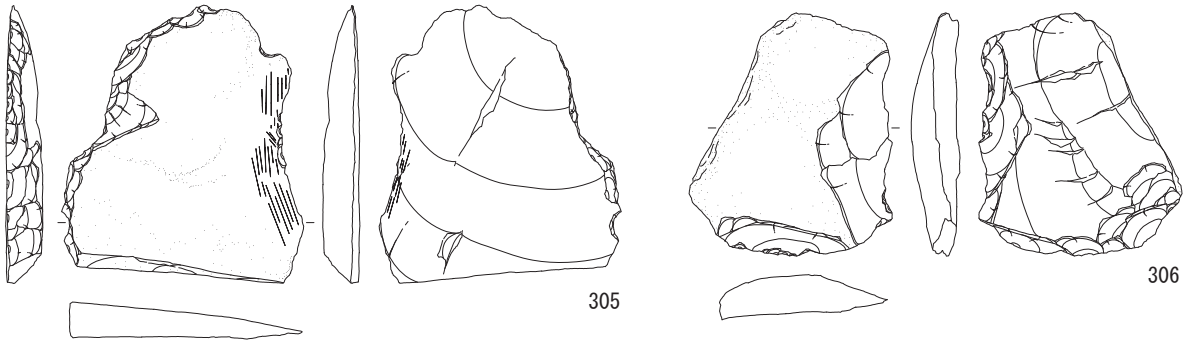

305

306

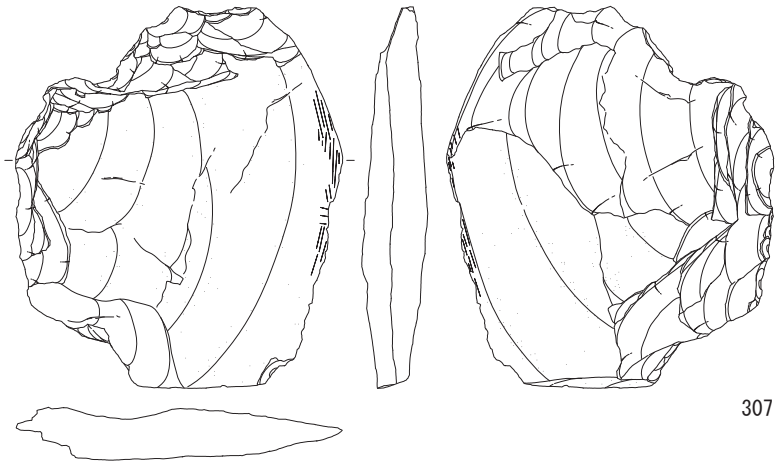

307

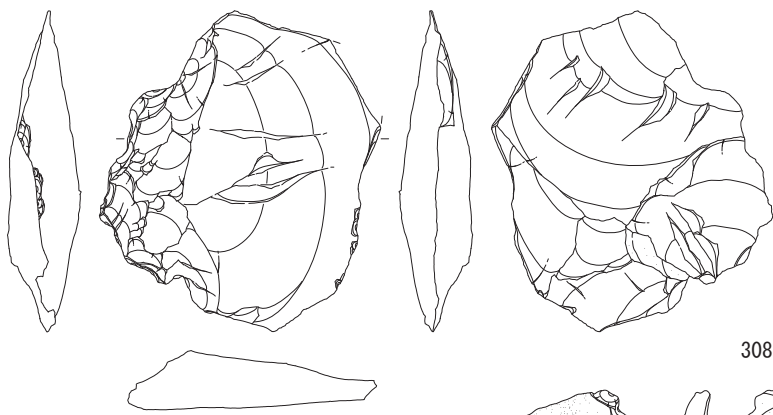

308

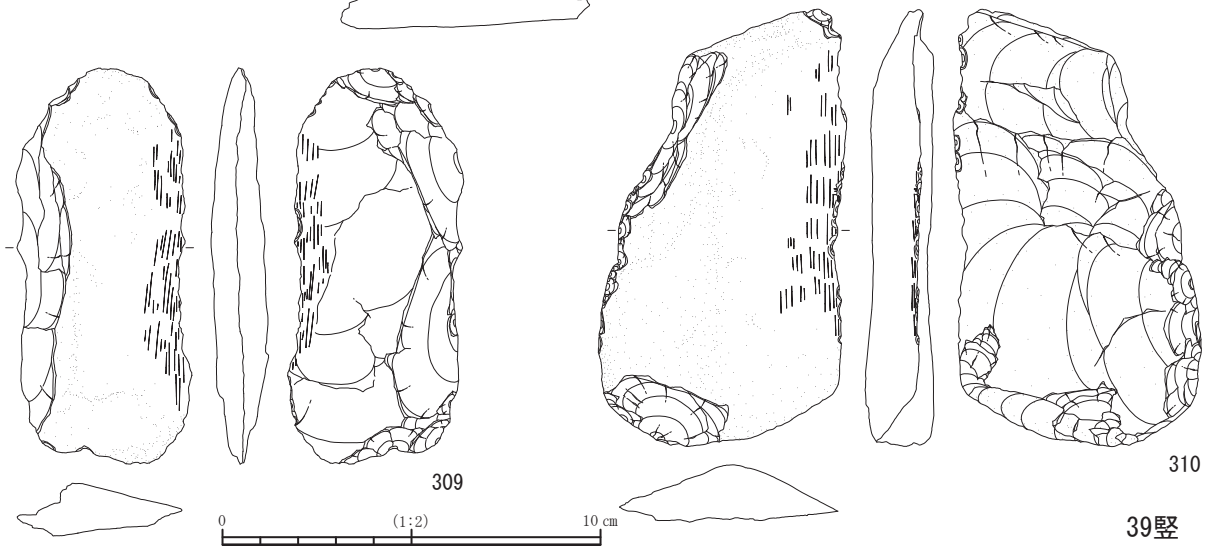

309

310

0 (1:2) 10 cm

39 豎

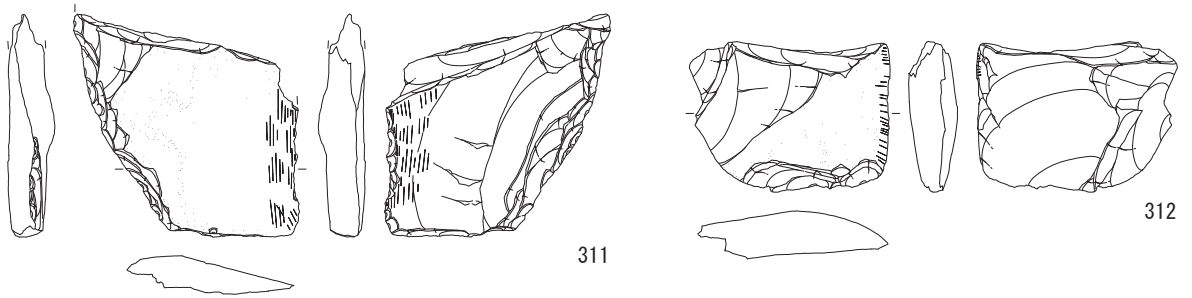

311

312

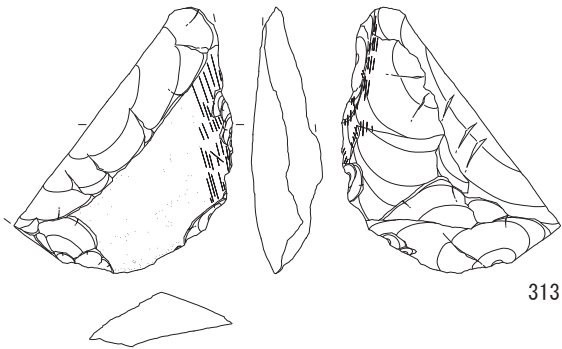

313

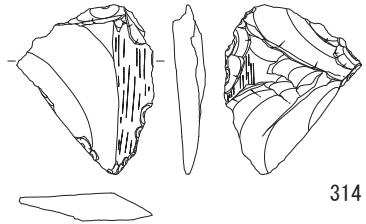

314

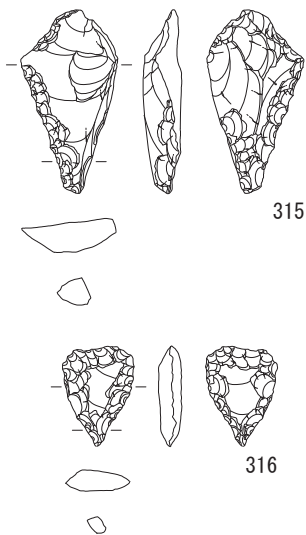

315

316



317

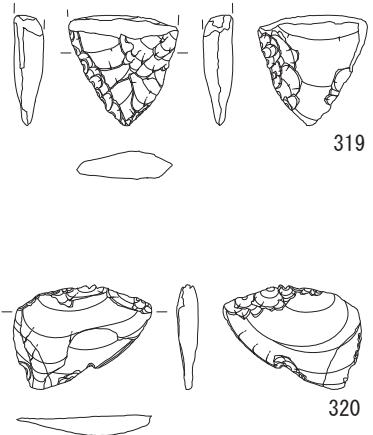

319

320

315~317・319・320 0 (2:3) 5 cm

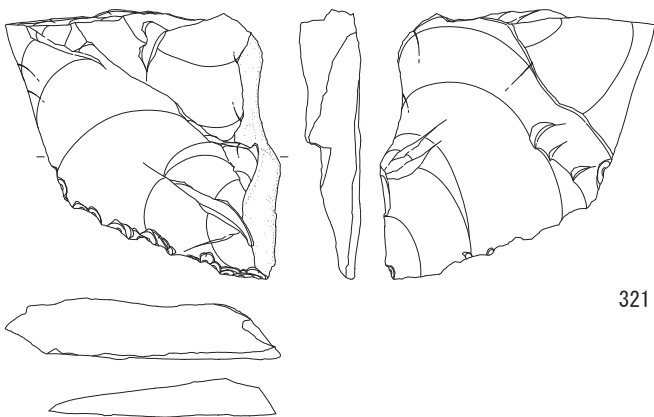

321

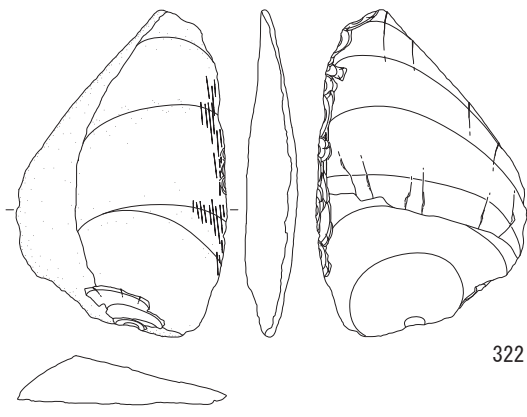

322

311~314・321・322 0 (1:2) 10 cm

39 豎

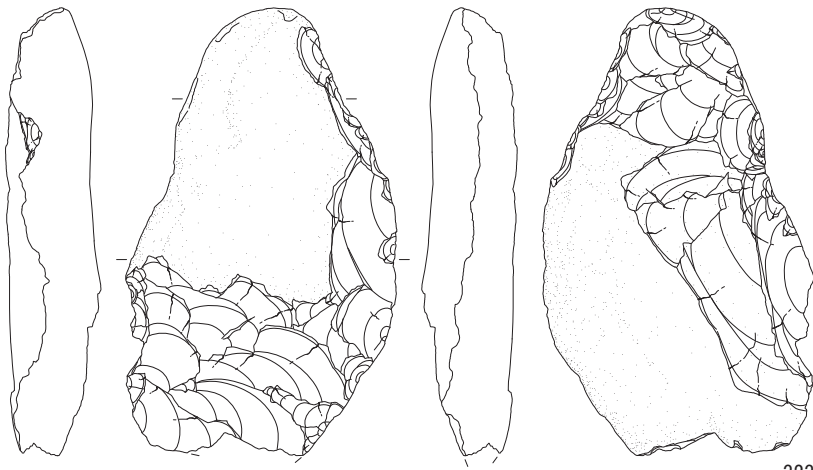

323

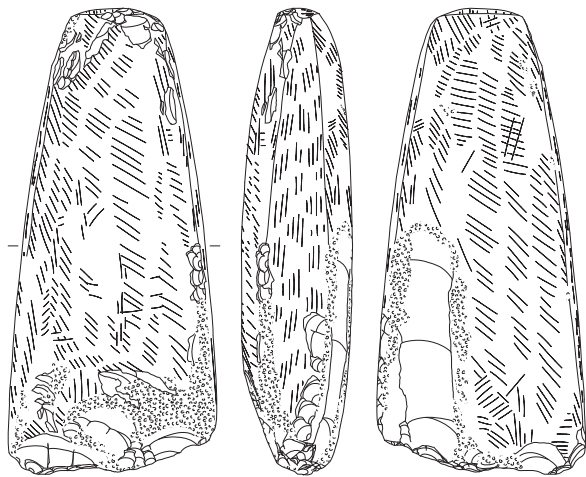
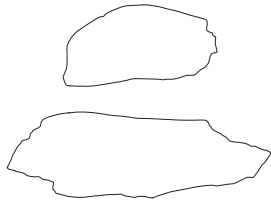

329

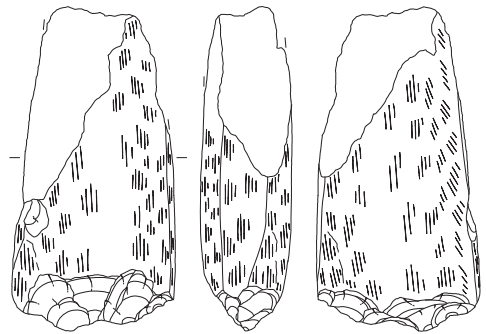

330

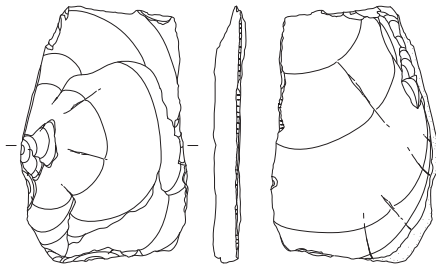
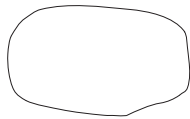
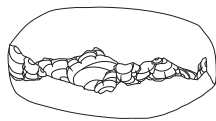

324

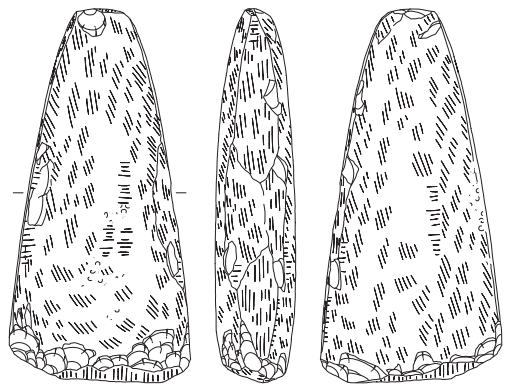
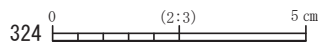

331



39 豎



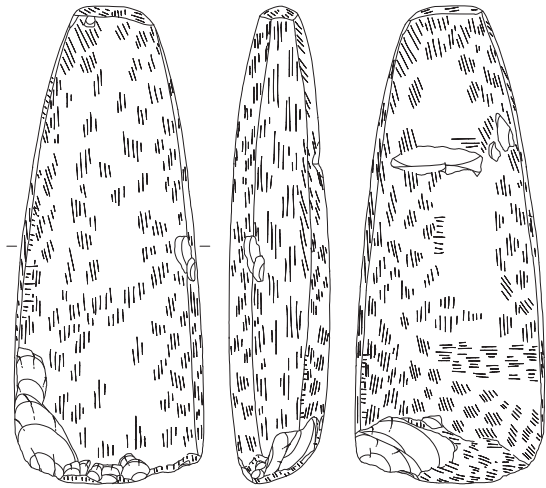

332

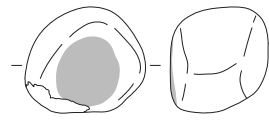
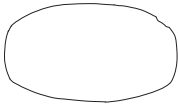

334

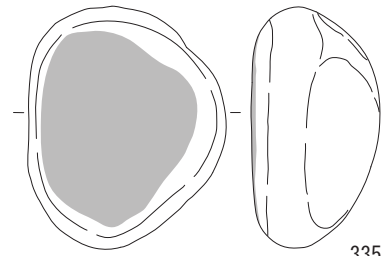
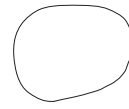

335

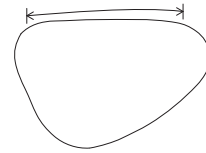

334・335 0 (1:3) 10 cm

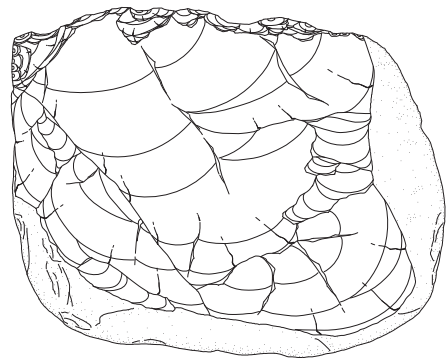
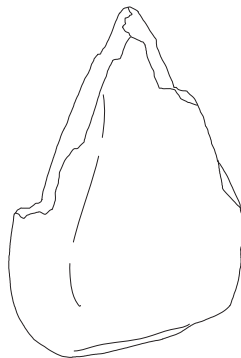
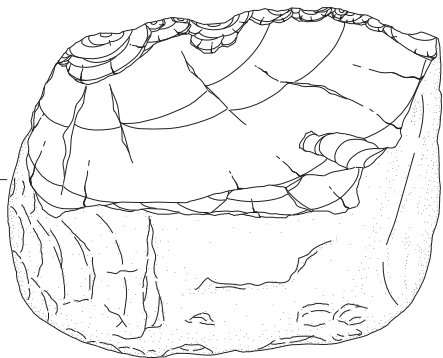
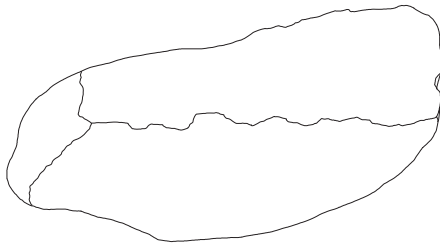

333

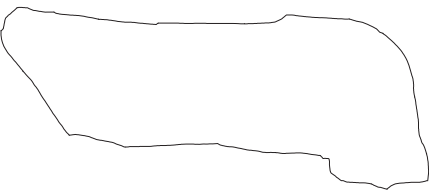

39 豎

332・333 0 (1:2) 10 cm

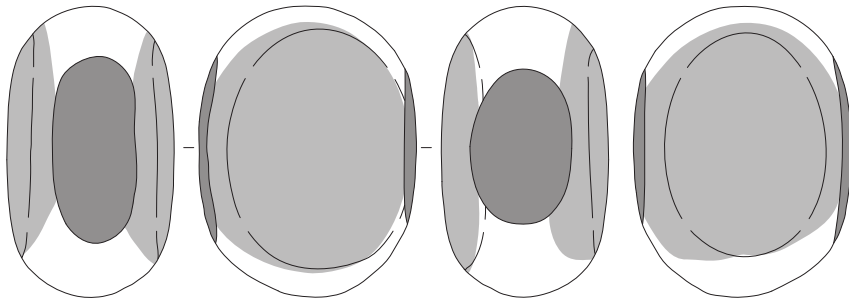

336

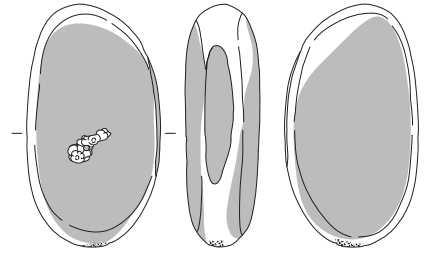
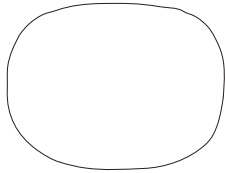

341

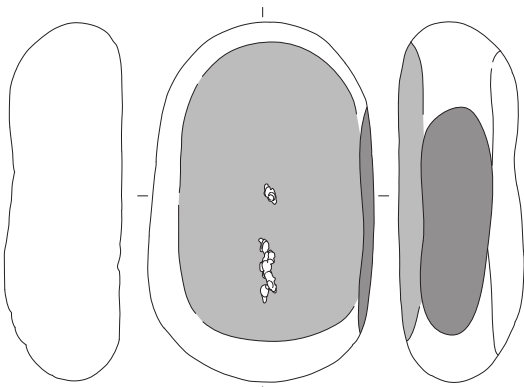
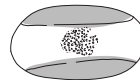

343

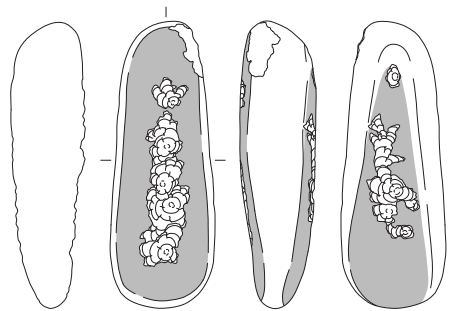
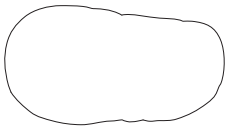

346

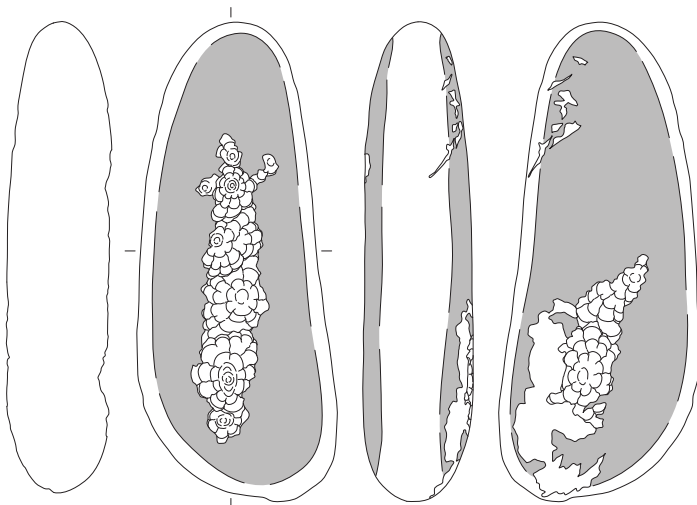
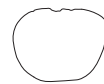

345

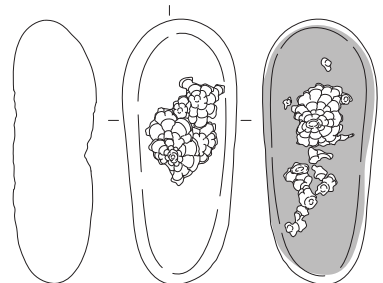
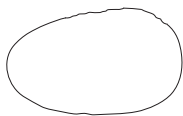

344

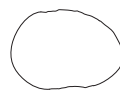

39 竖

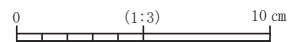

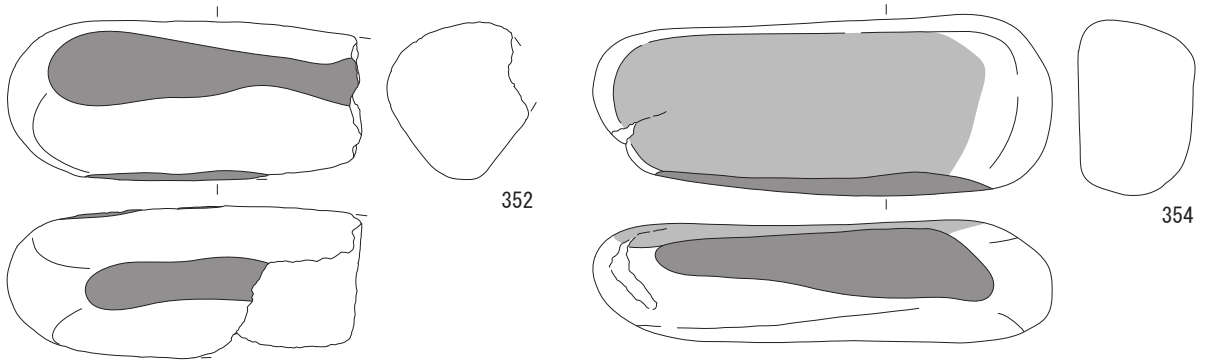

352

354

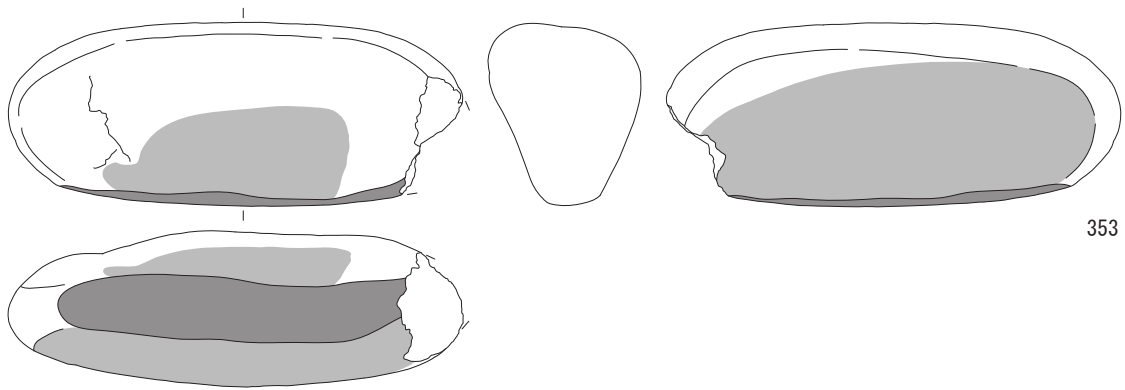

353

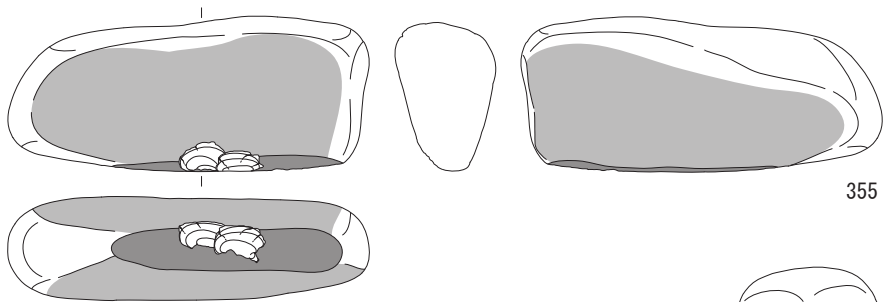

355

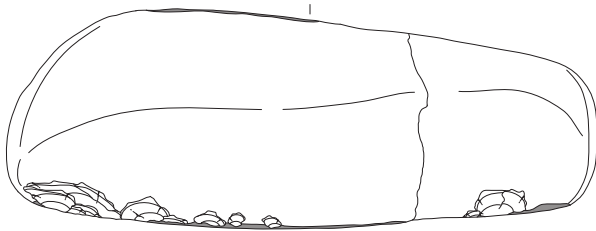
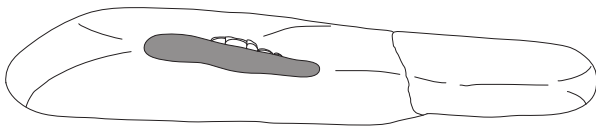

356

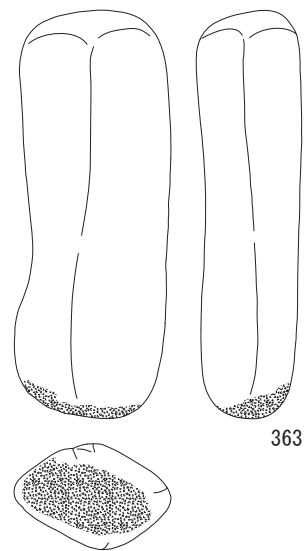
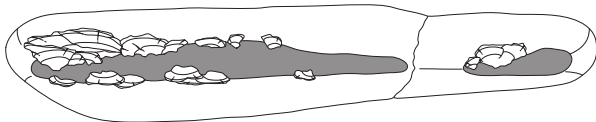

363

39 豎

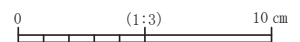

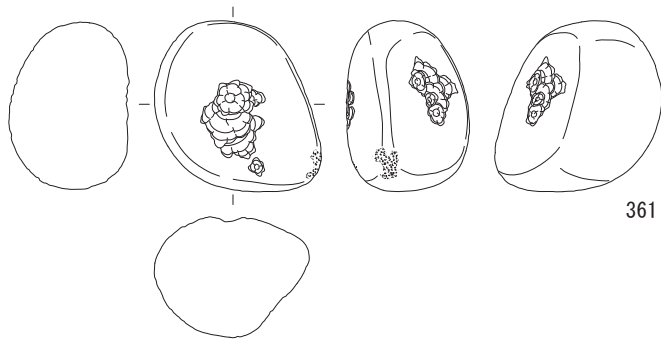

361



369

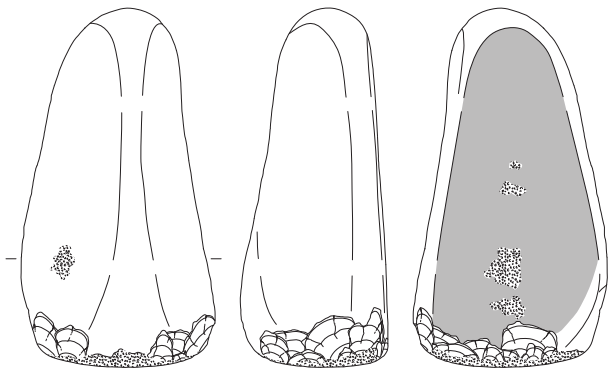

364

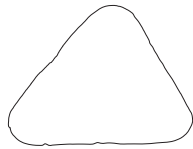
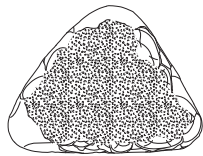

361・364・369 0 (1:3) 10 cm



370

39 豎

370 0 (1:4) 20 cm

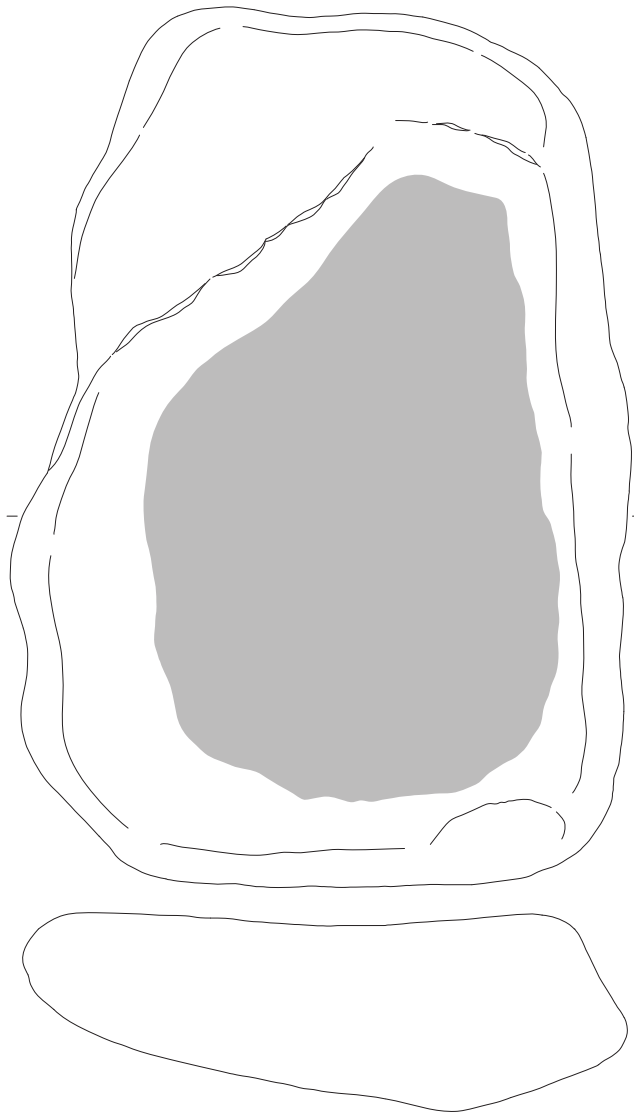

371 0 (1:5) 20 cm

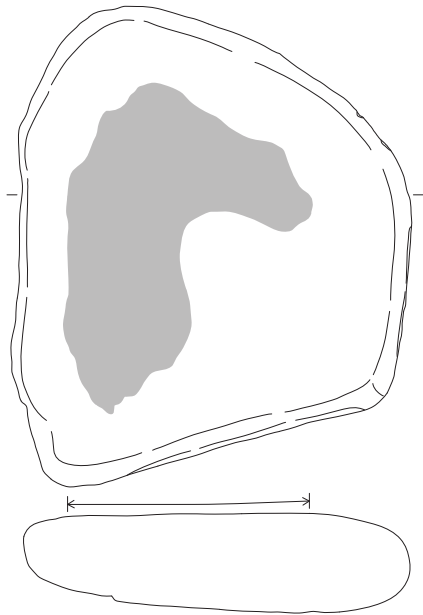

372

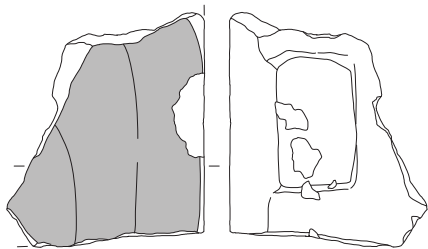

374

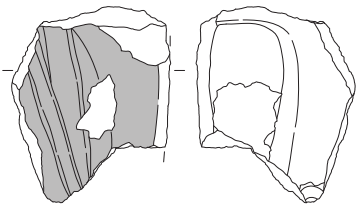

375

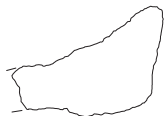

371

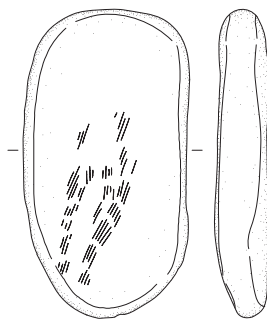

377

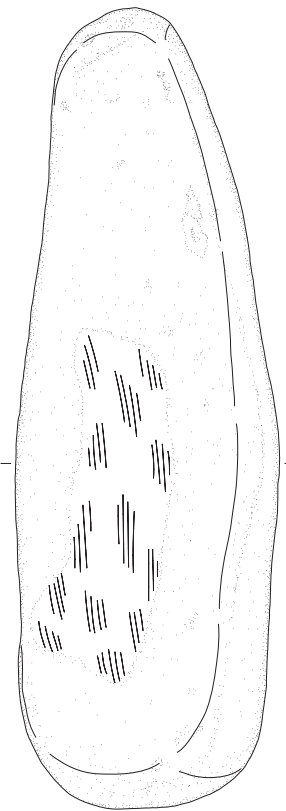

376

374·375·377 0 (1:3) 10 cm

372·376 0 (1:4) 20 cm

39 豎

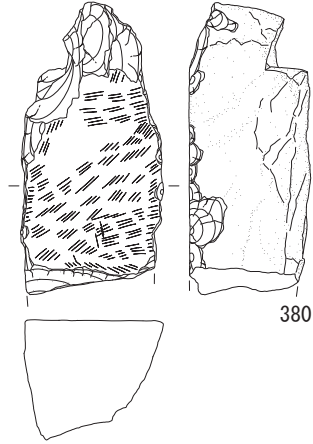
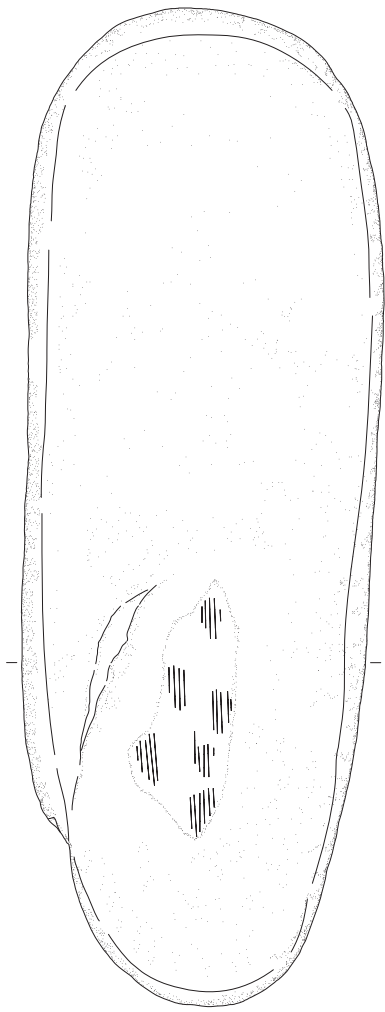

380

379 0 (1:4) 20 cm

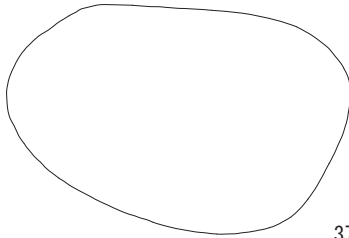
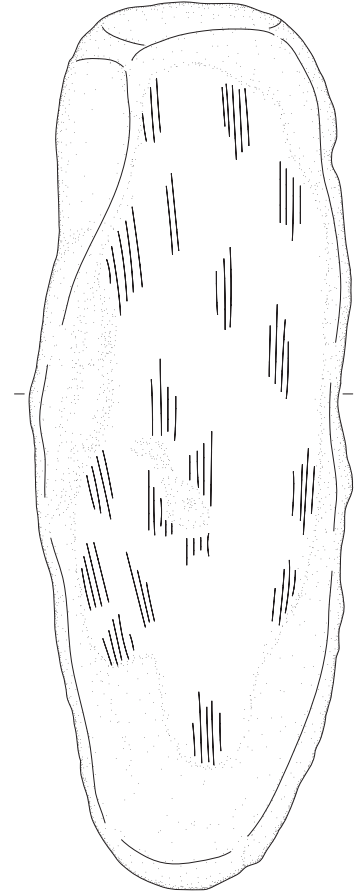

378

378 0 (1:5) 20 cm

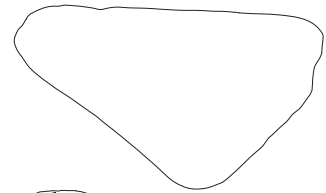
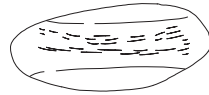

379

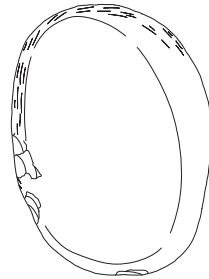
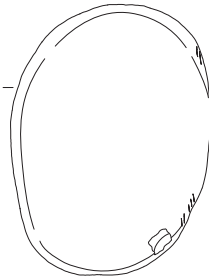

383

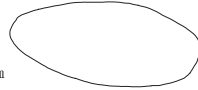

381·383 0 (1:2) 10 cm

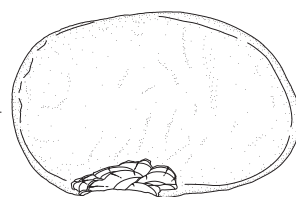
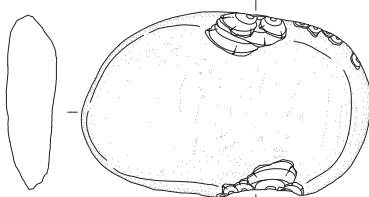

381

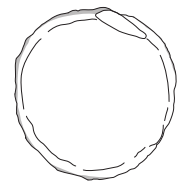
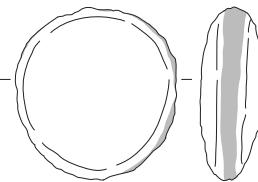

384



39 豎

380·384 0 (1:3) 10 cm

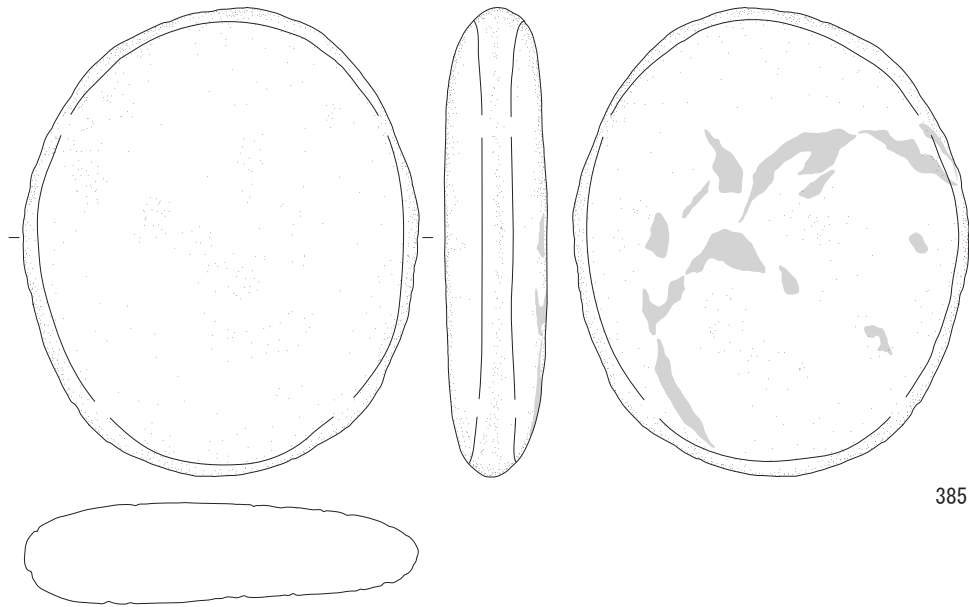

385

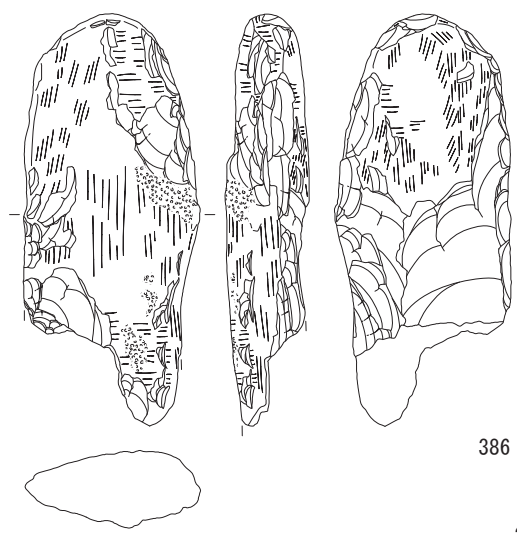

386

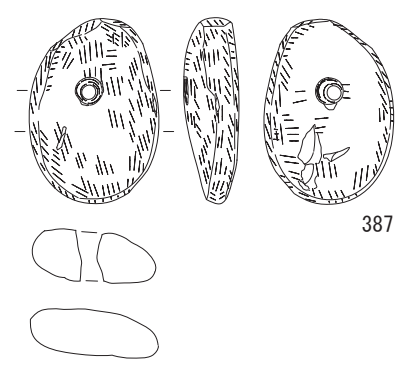

387

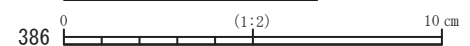
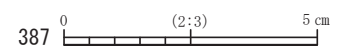
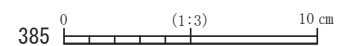

39 豎

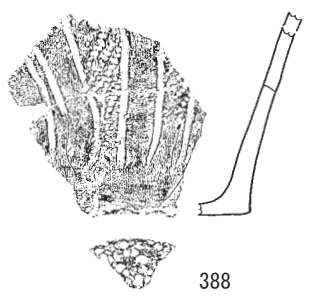

388

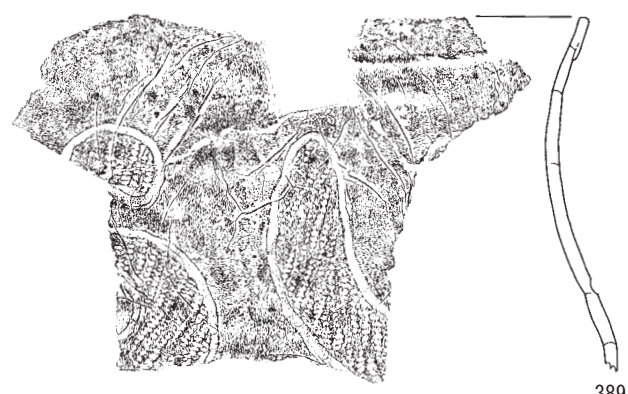

389

40 豎



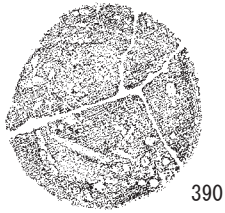
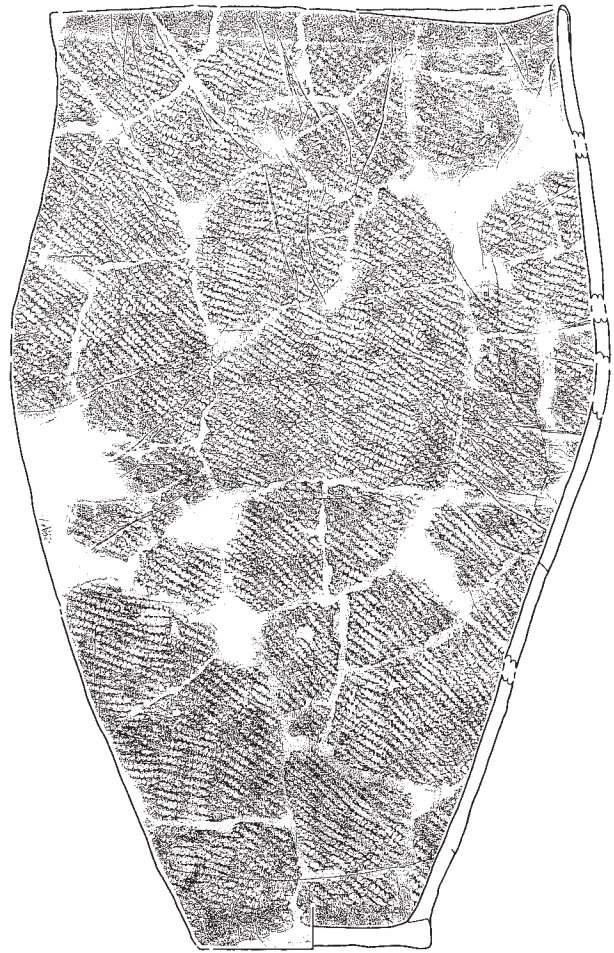

390

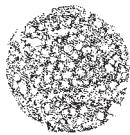
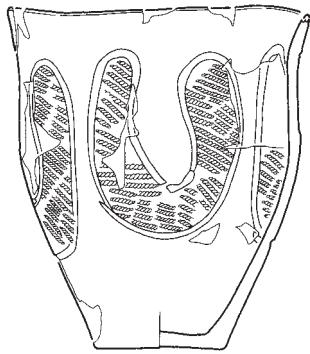

392

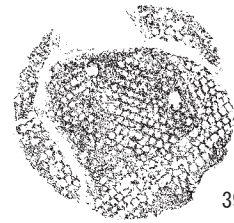

391

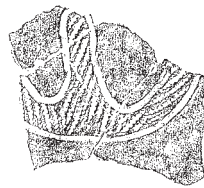

395



396

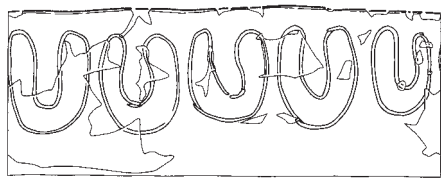

392展開図



397

展開図 0 (1:6) 20 cm

40 豎

391 0 (1:4) 20 cm

390・392・395~397 0 (1:3) 10 cm

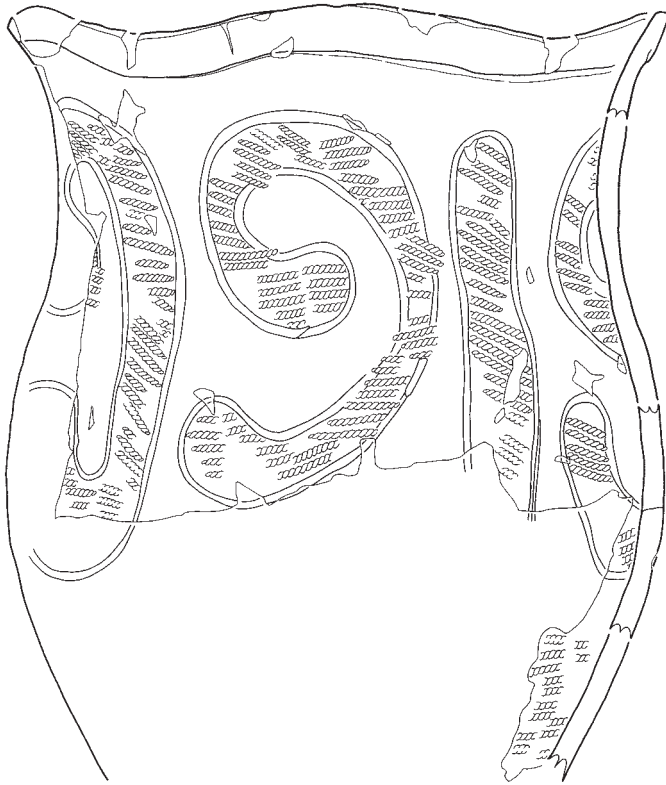

393



398

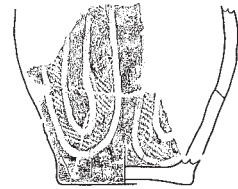

401



394

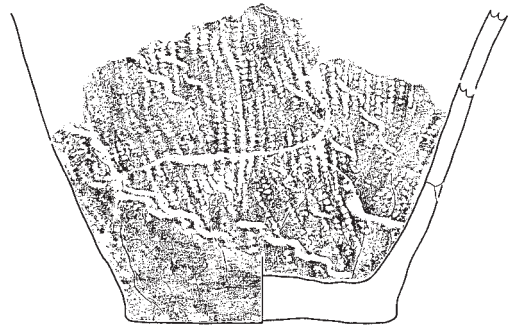

399

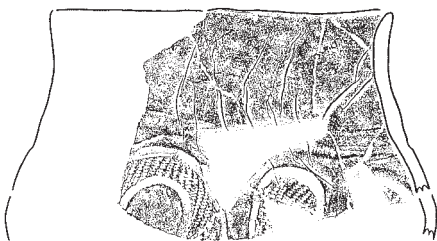

400 40 豎

393・398~401 0 (1:3) 10 cm

394 0 (1:4) 20 cm

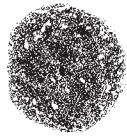
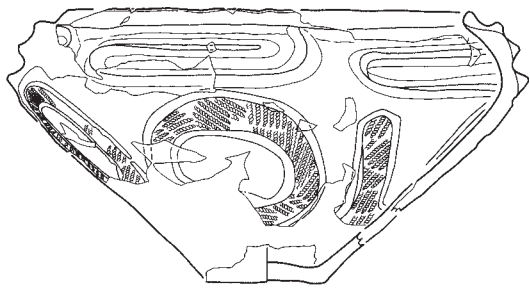

402

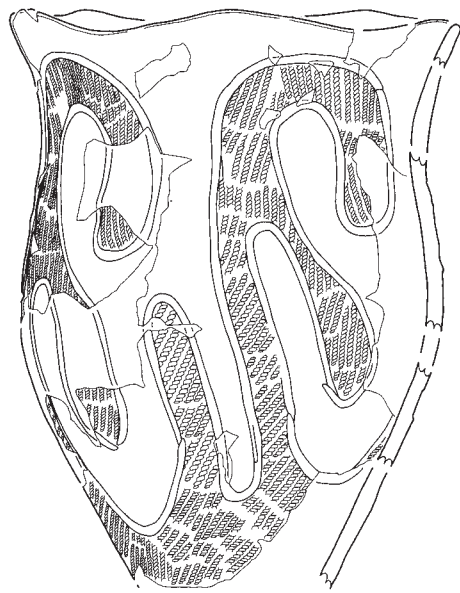

404

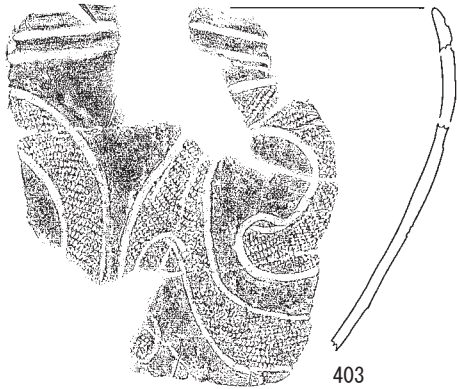

403

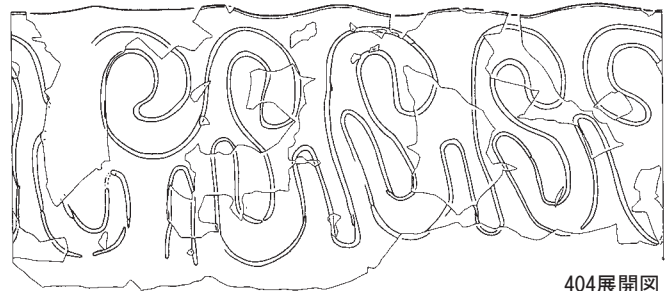

404展開図

展開図 0 (1:6) 20 cm

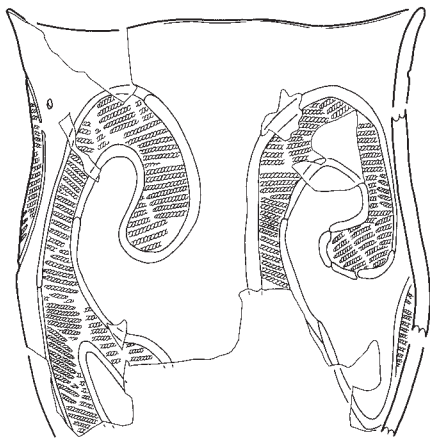

405



406

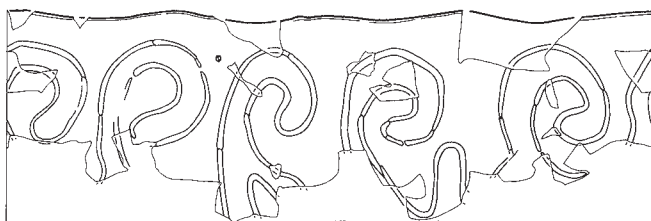

405展開図

40 豎

0 (1:3) 10 cm

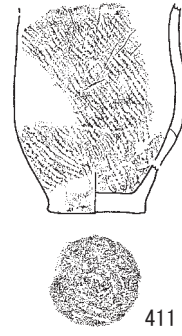

411 0 (1:3) 10 cm

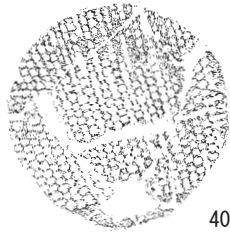

407



412

412 0 (1:2) 10 cm

40 豎 407-408 0 (1:4) 20 cm

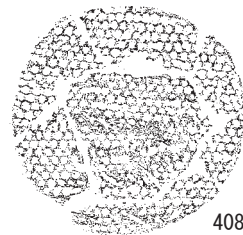

408

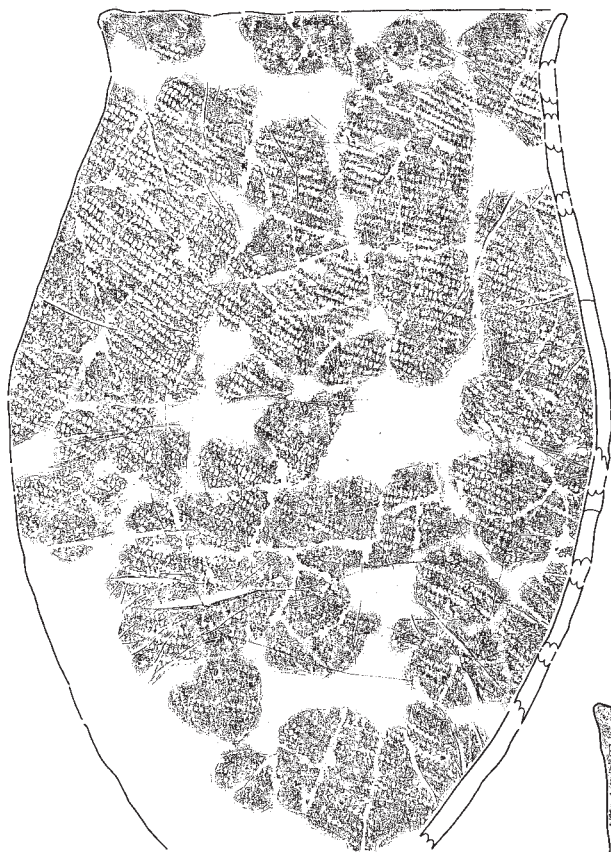

409

0 (1:4) 20 cm

0 (1:3) 10 cm

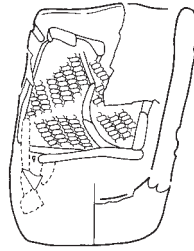

414

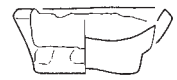

415

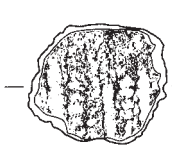

416

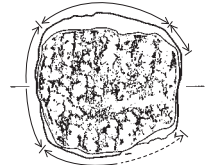

417

0 (1:2) 10 cm

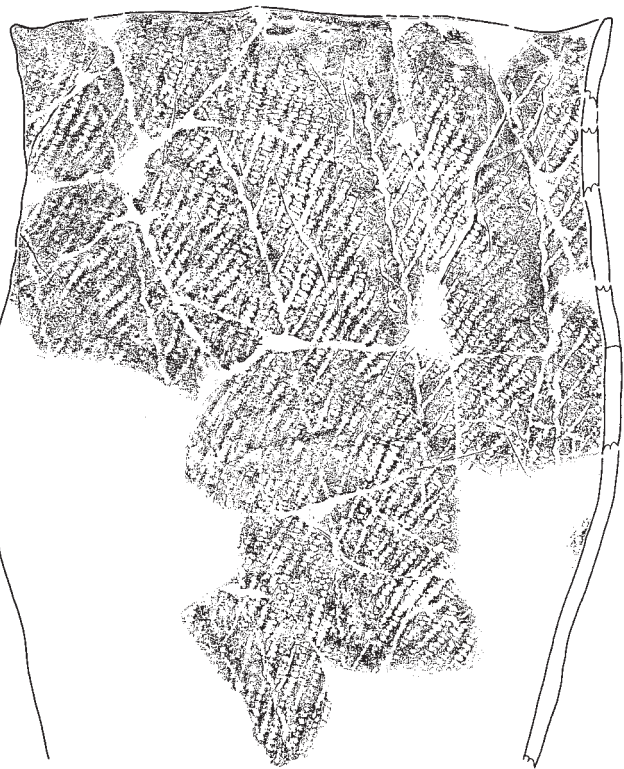

410

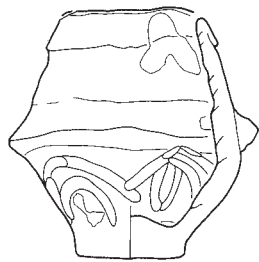

413

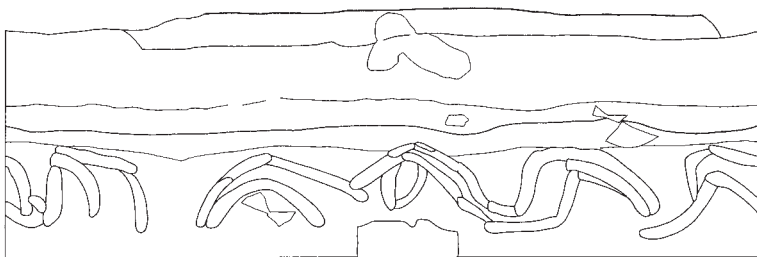

413展開図

0 (2:3) 5 cm

40 豎

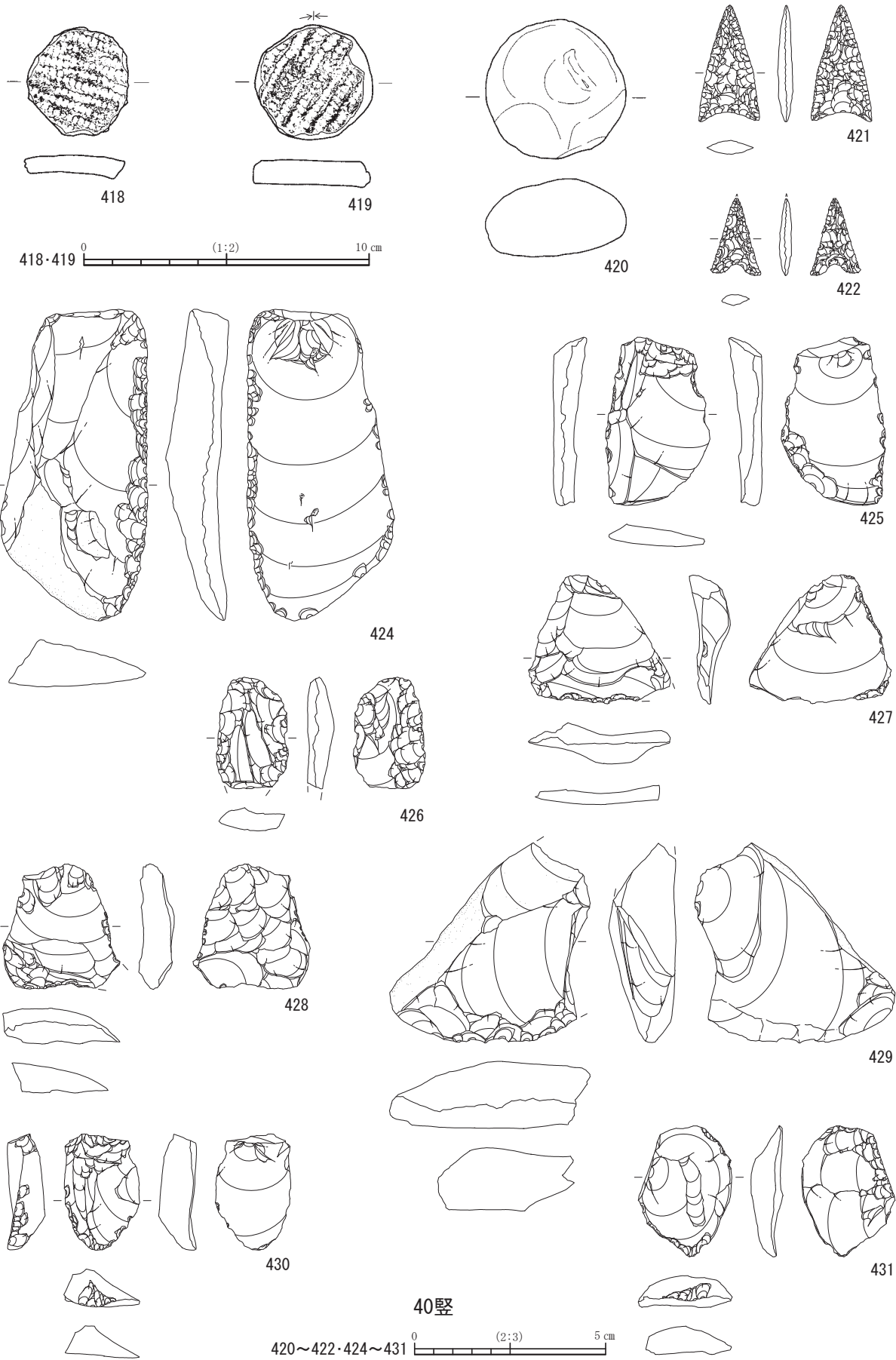

遺物図版54 縄文時代の遺物54

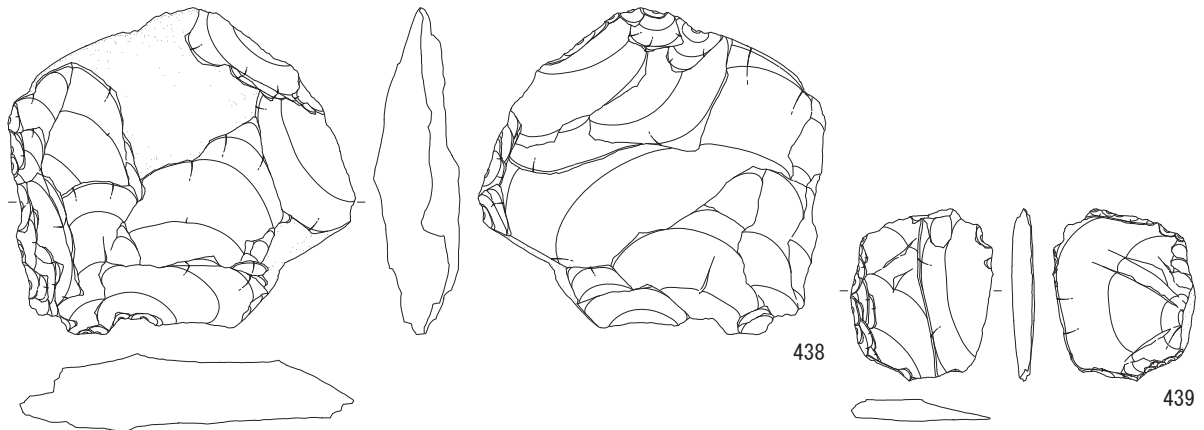
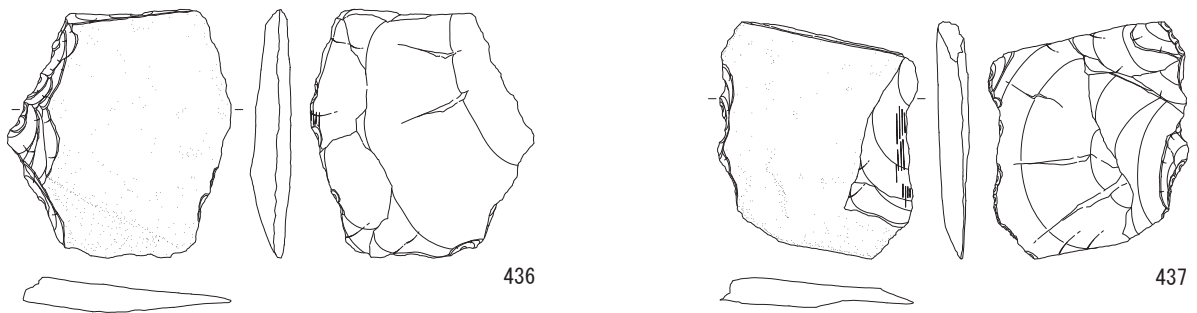
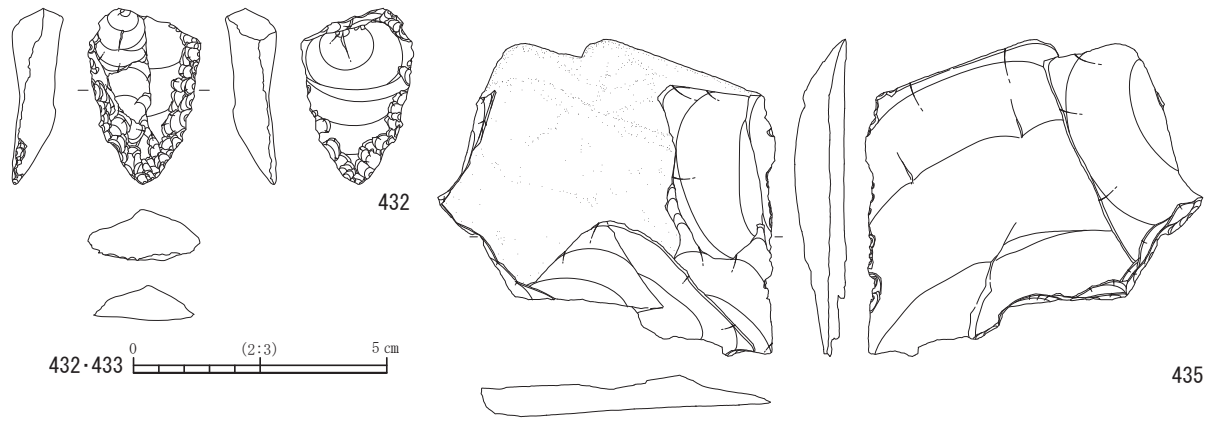
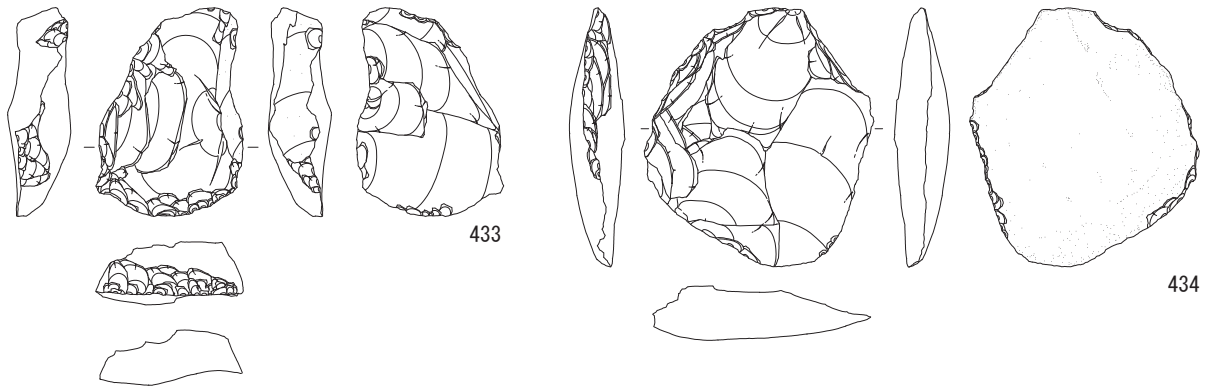

40 豎

434~439 0 (1:2) 10 cm

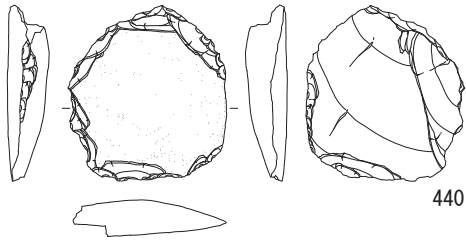

440

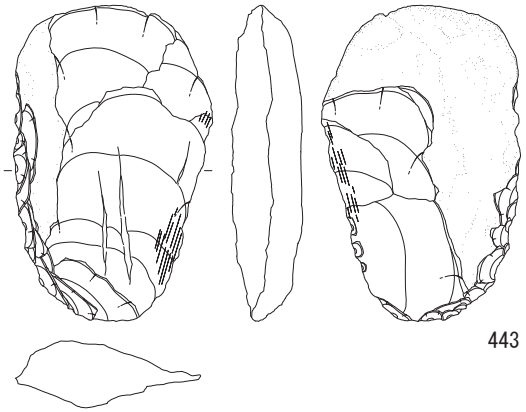

443

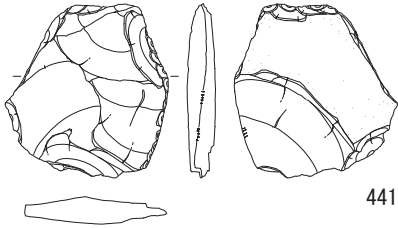

441

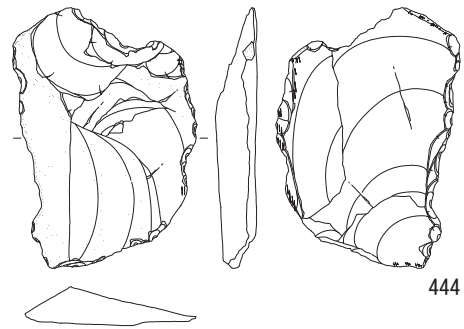

444

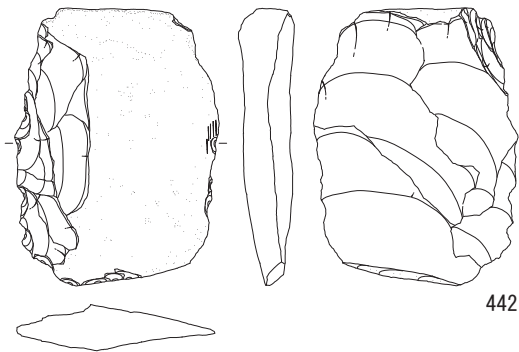

442

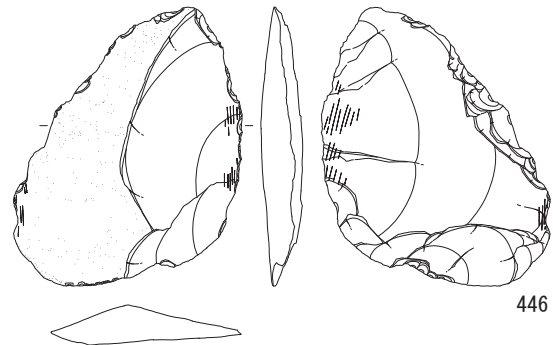

446

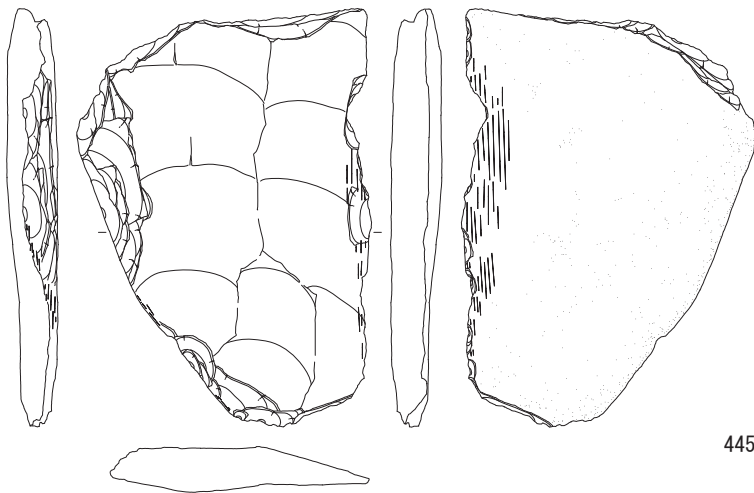

445

40 豎

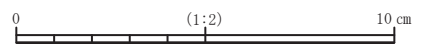

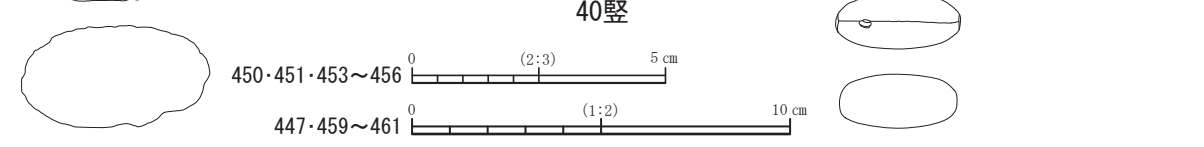
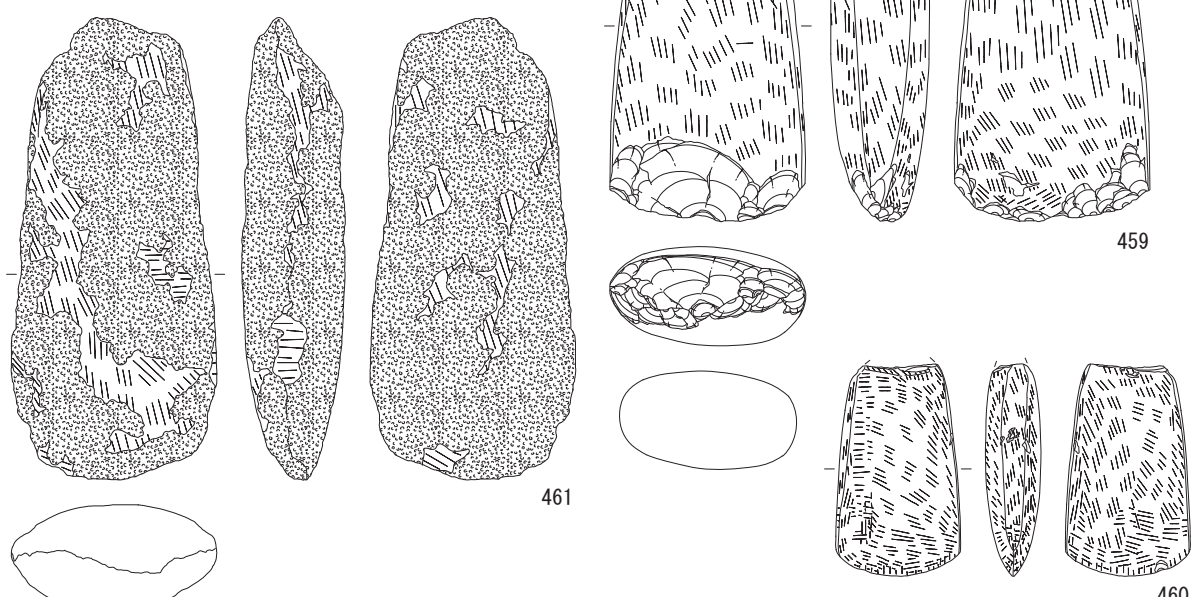
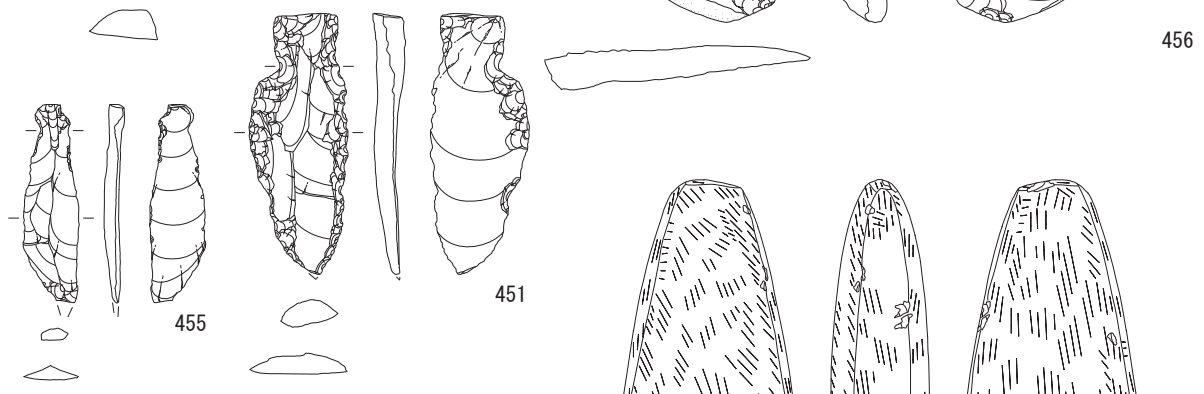
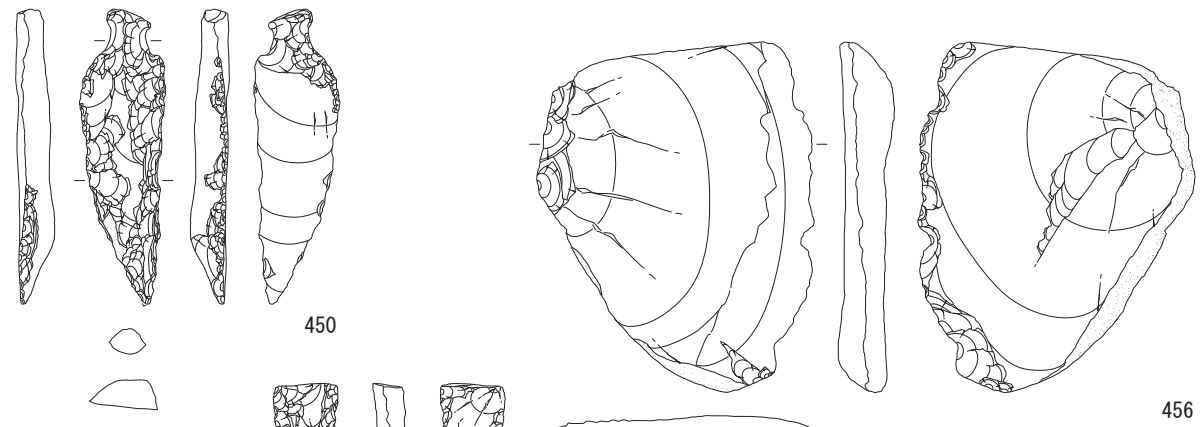
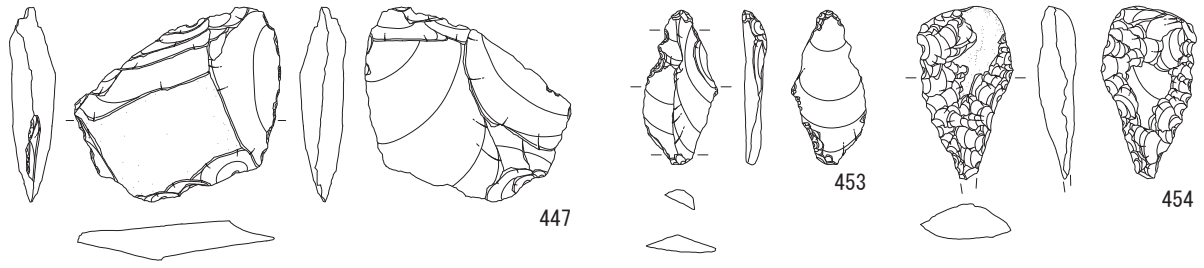

40 豎

450・451・453～456 0 (2:3) 5 cm

447・459～461 0 (1:2) 10 cm

遺物図版57 縄文時代の遺物57

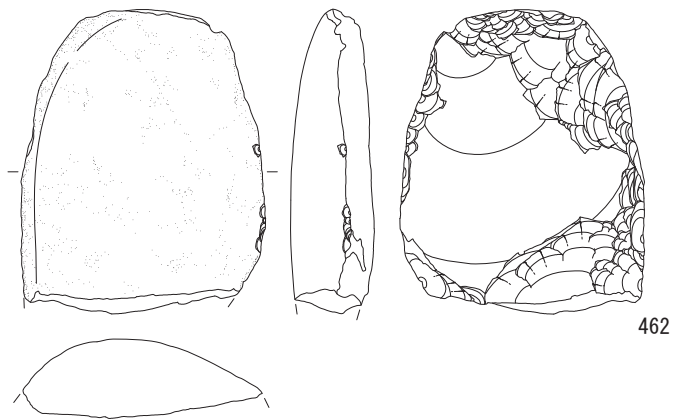

462

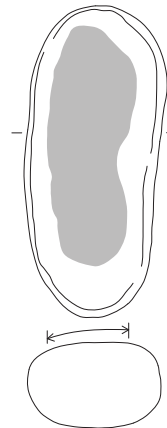

463

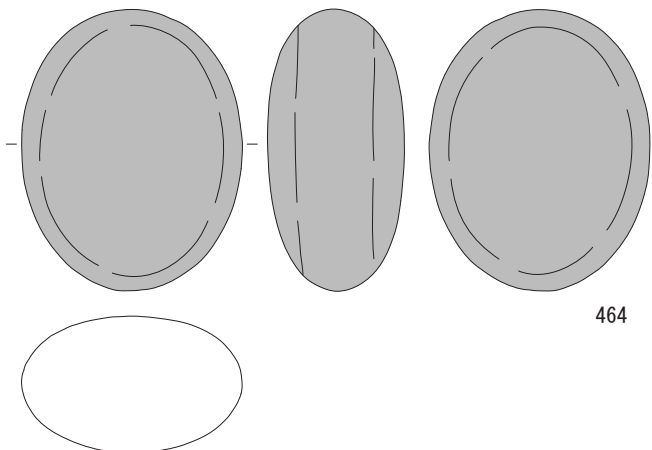

464

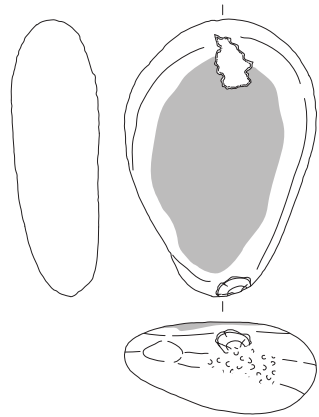

467

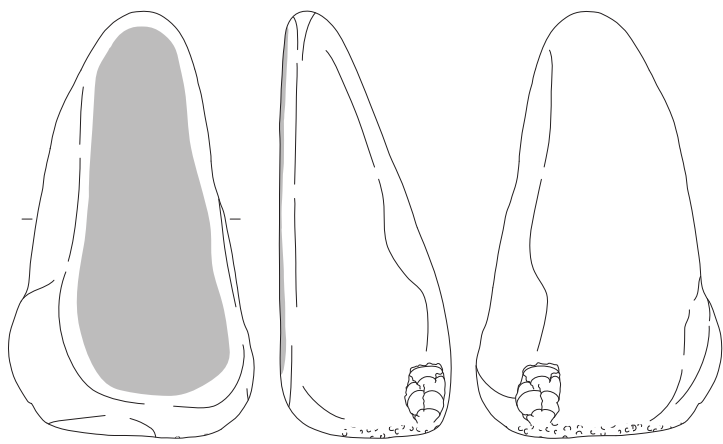

468

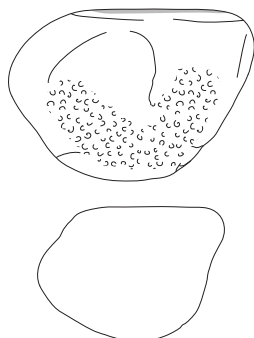

469

40 豎

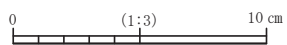

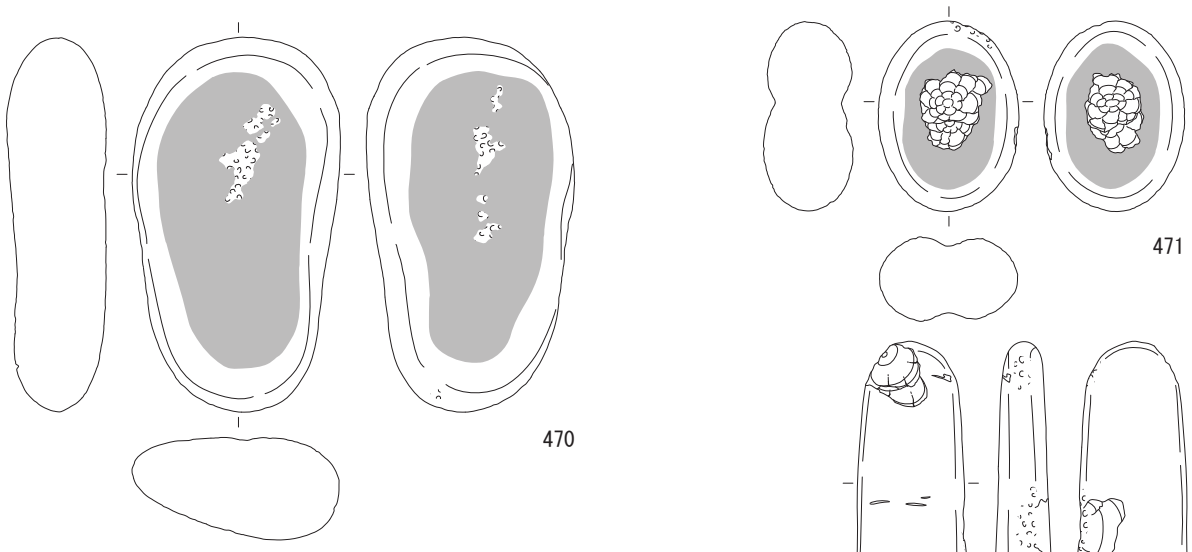

470

471

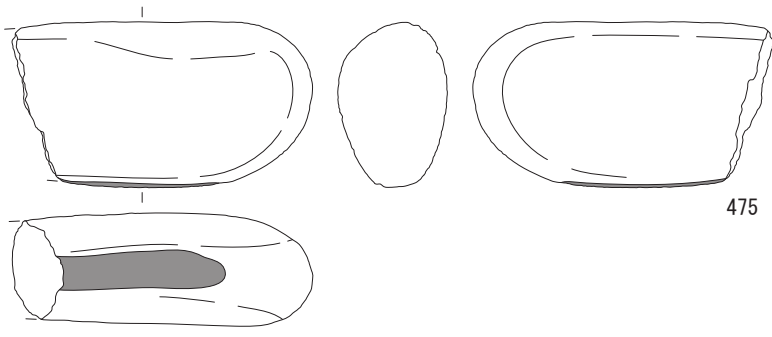

475

477

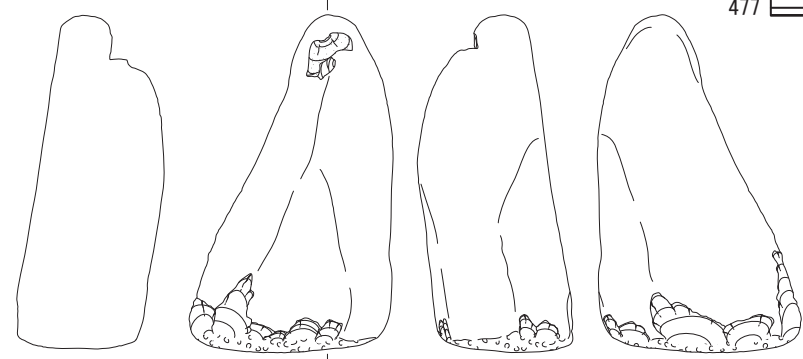
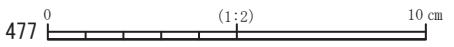

478

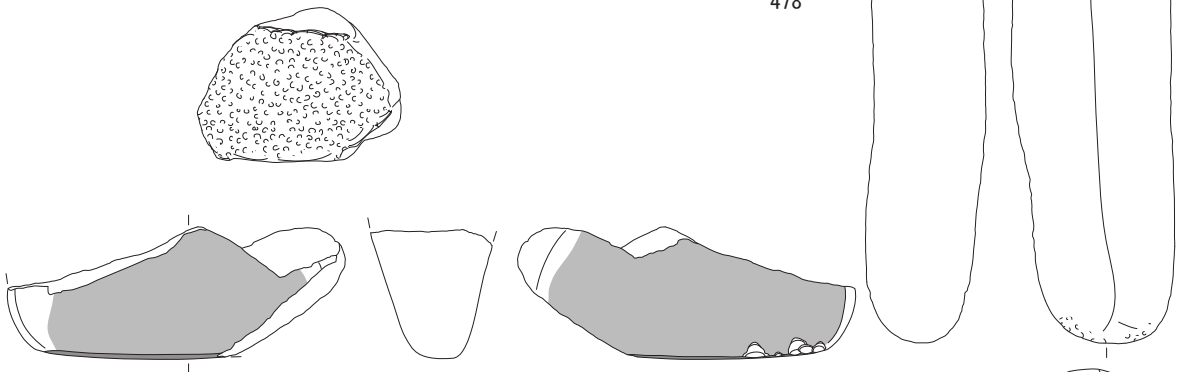

474

476

40 豎



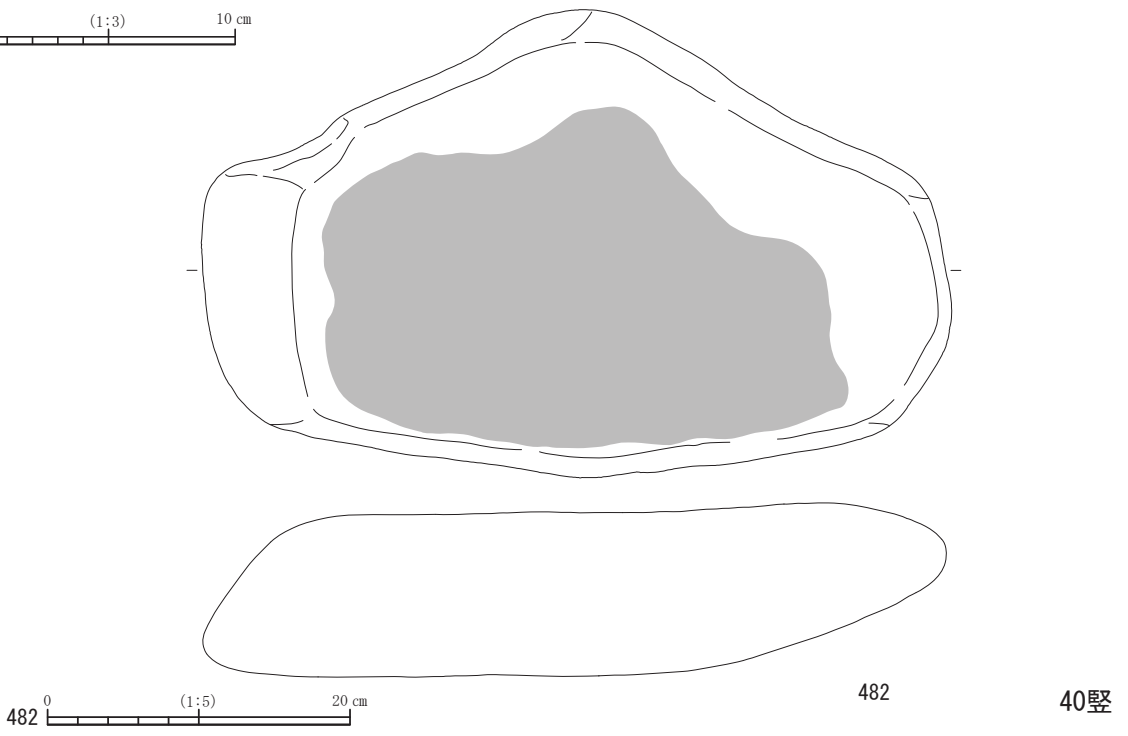
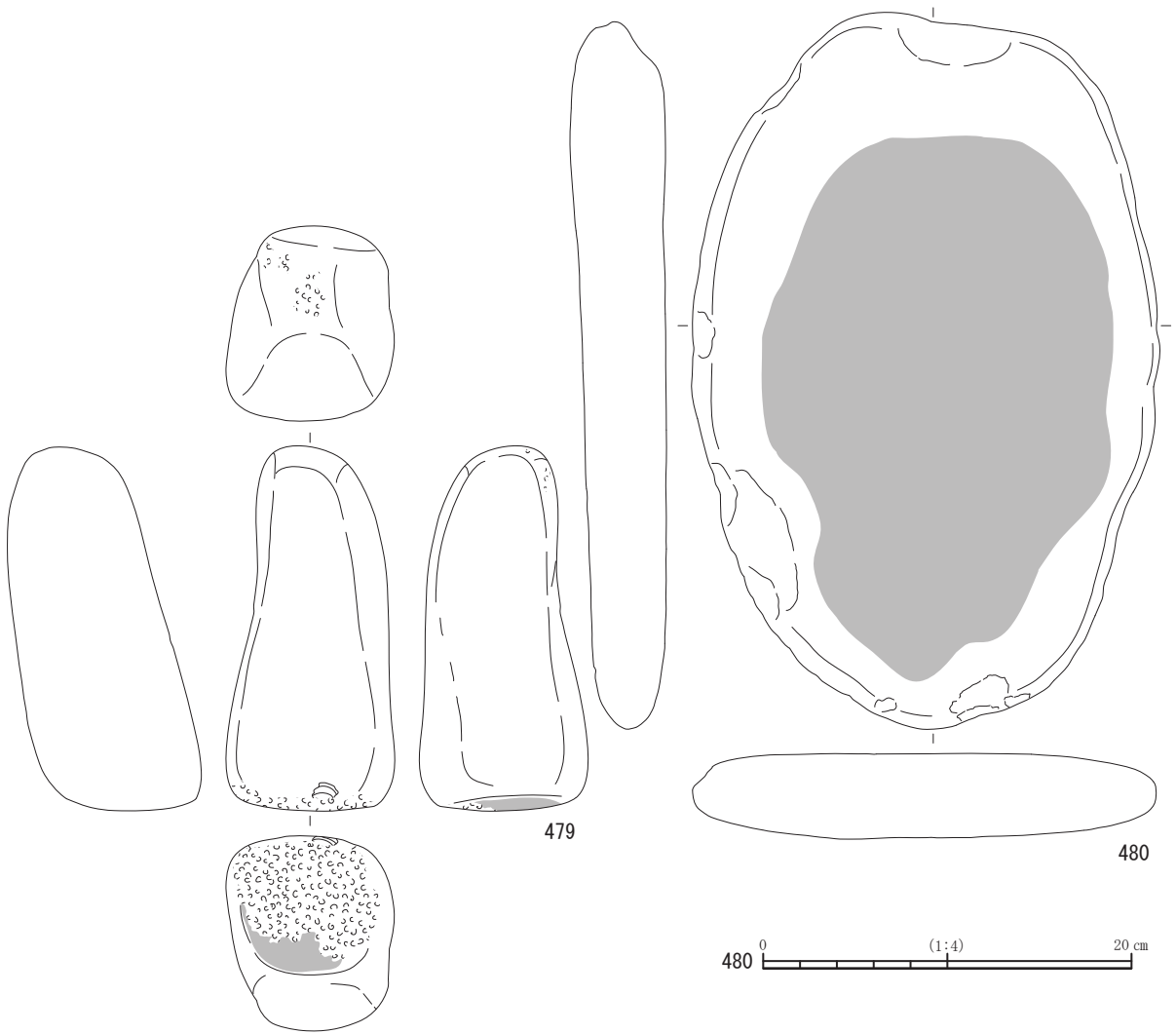

遺物図版60 縄文時代の遺物60

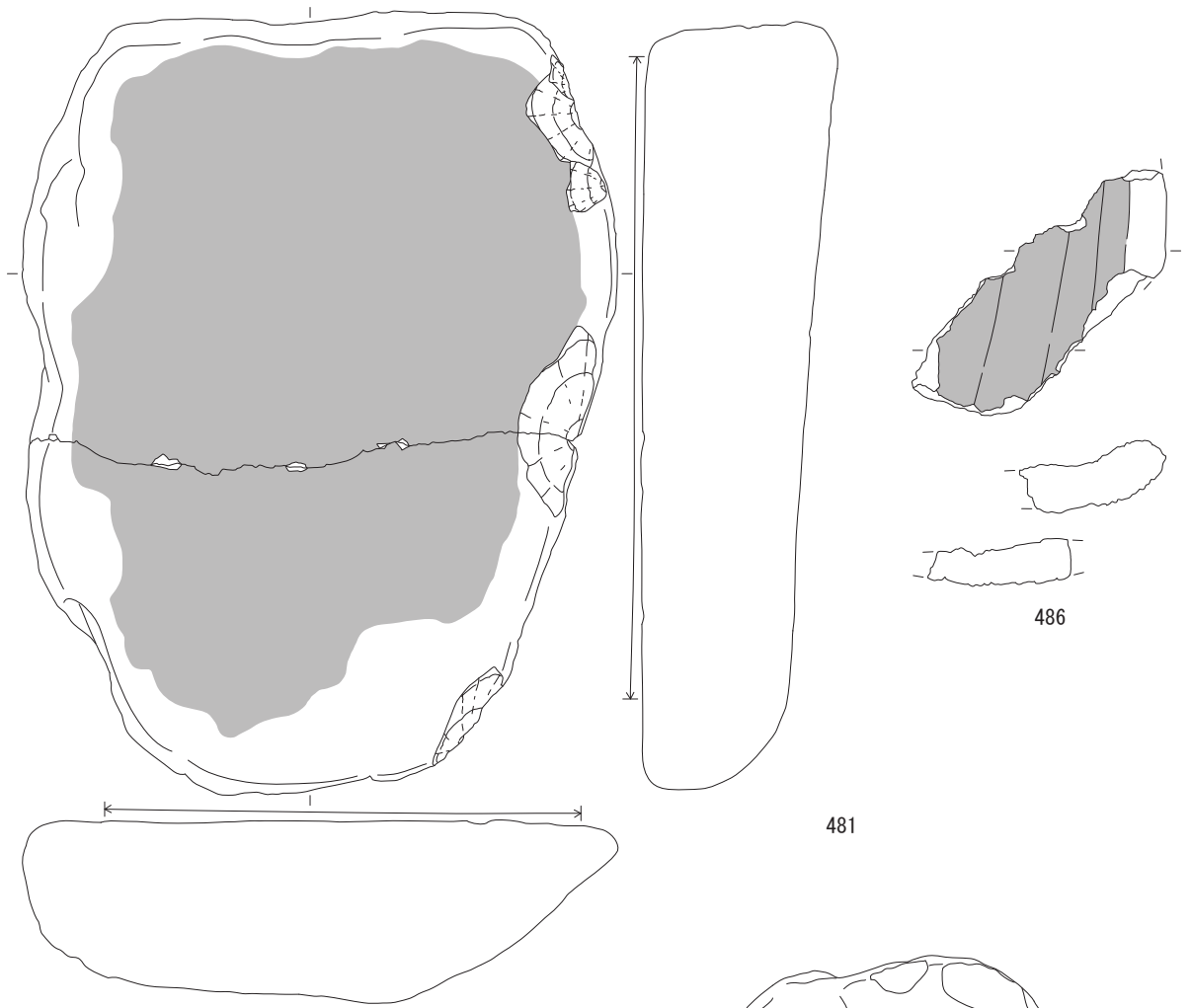

481

486

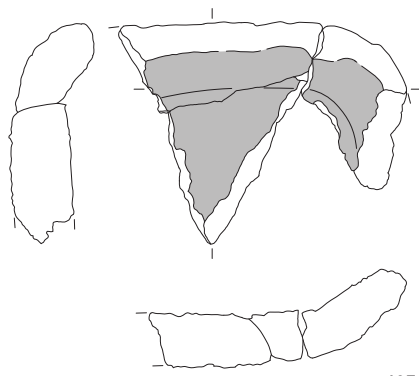

487

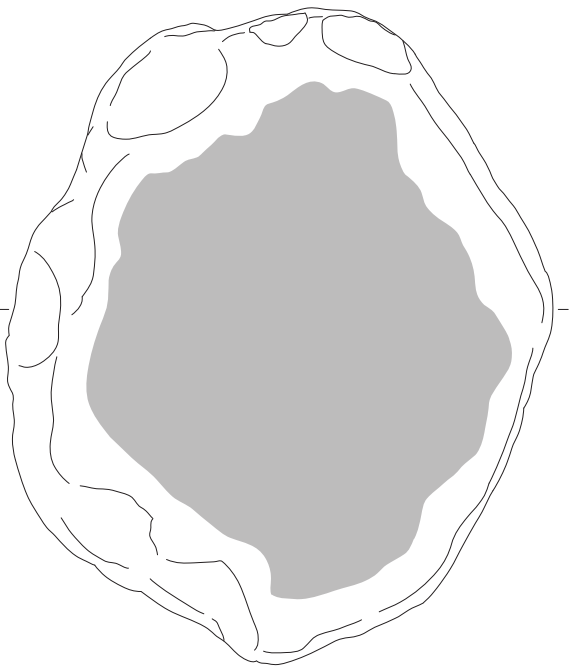

483

40 豎



483・486・487

(1:3)

10 cm

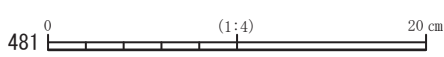

481

(1:4)

20 cm

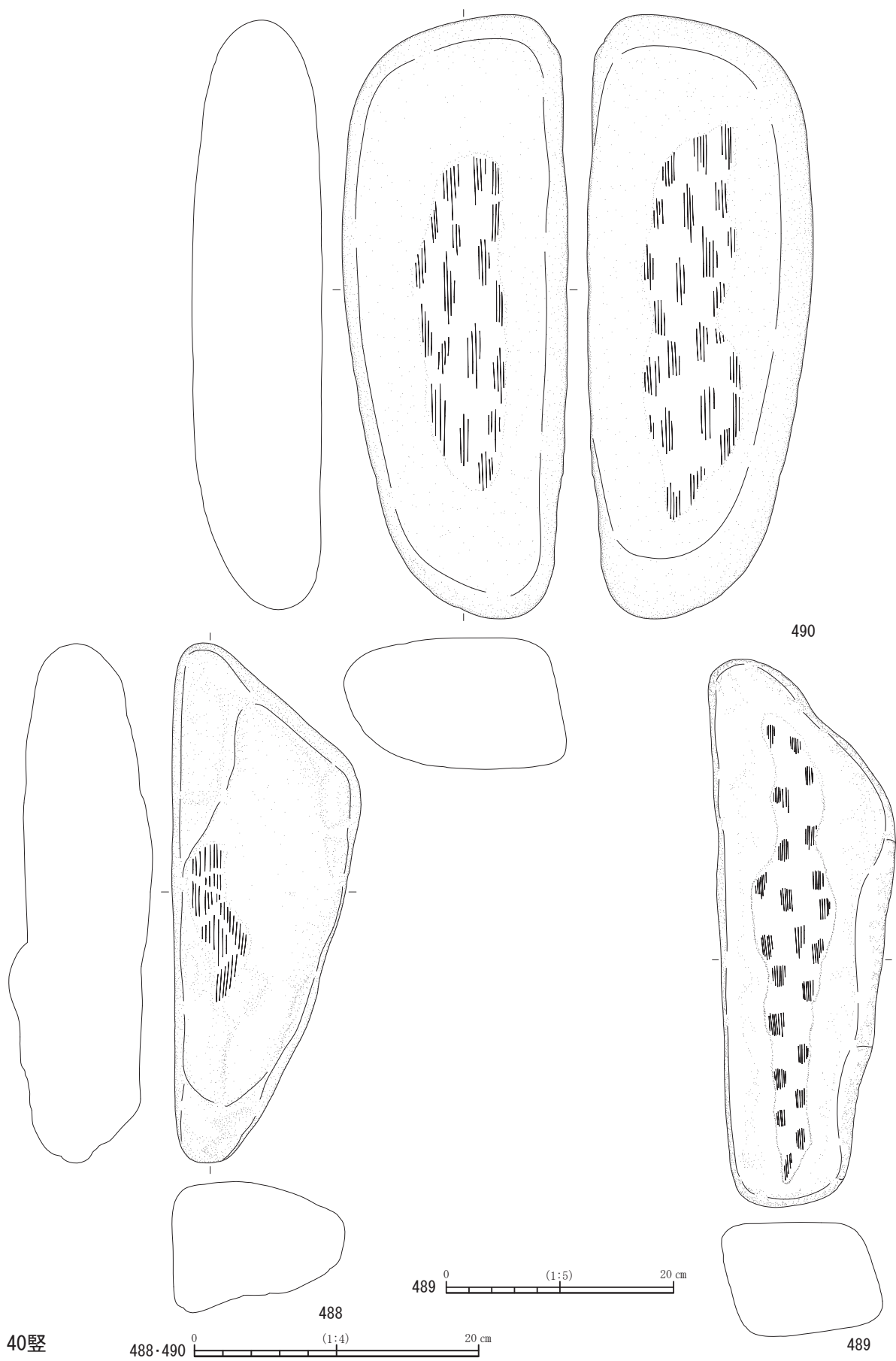

40 豎

488・490 0 (1:4) 20 cm

489 0 (1:5) 20 cm

遺物図版62 縄文時代の遺物62

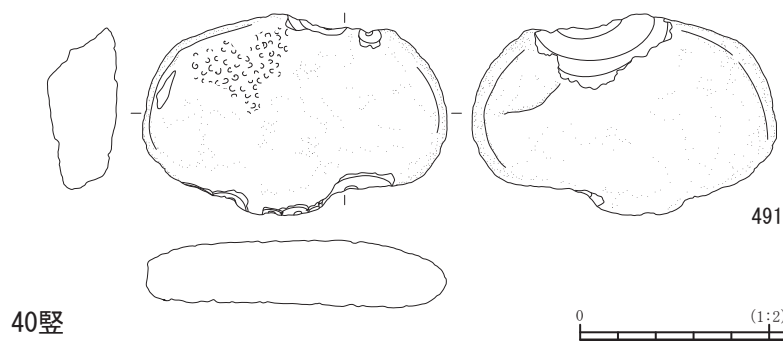

40 豎

491

0 (1:2) 10 cm

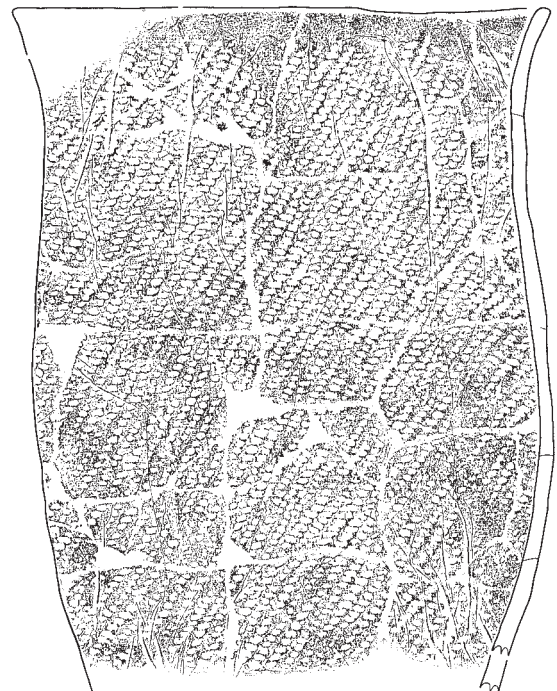
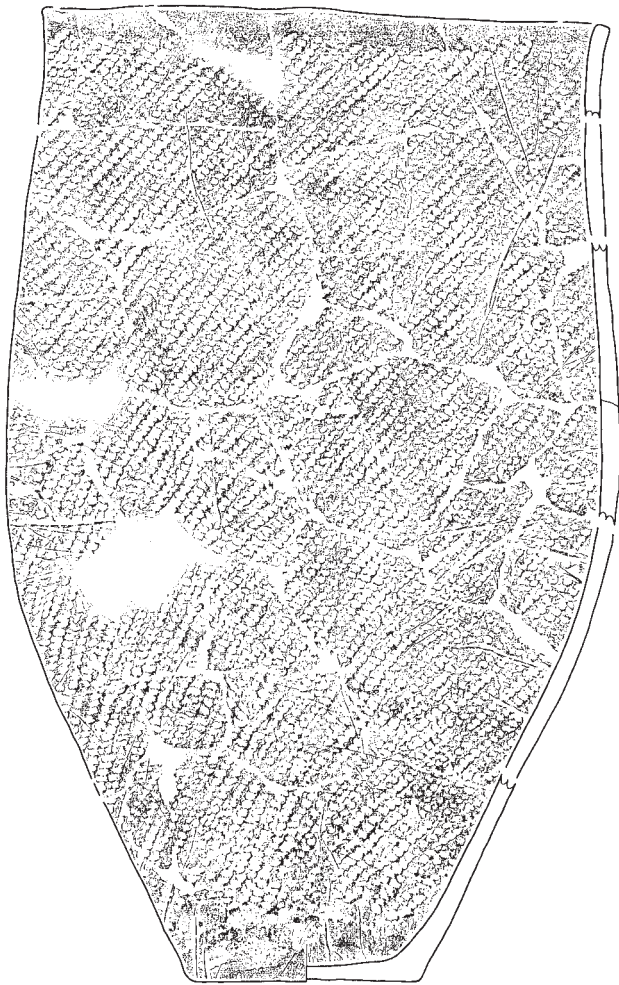

495

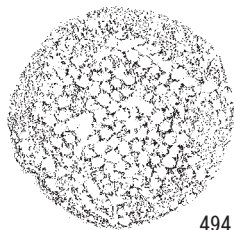

494



497

41 豎

0 (1:3) 10 cm

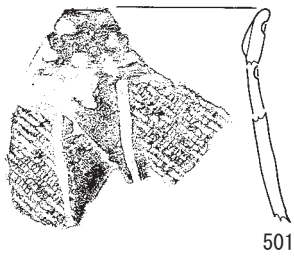

501



499

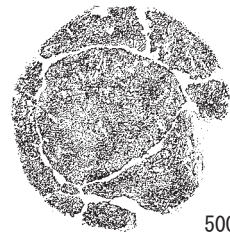
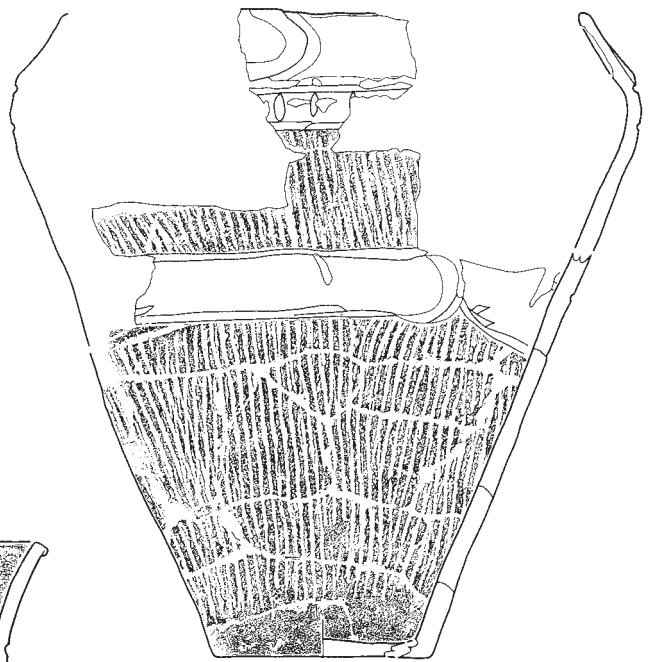

500

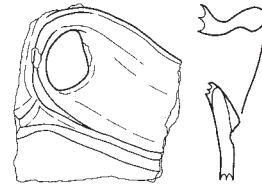

503

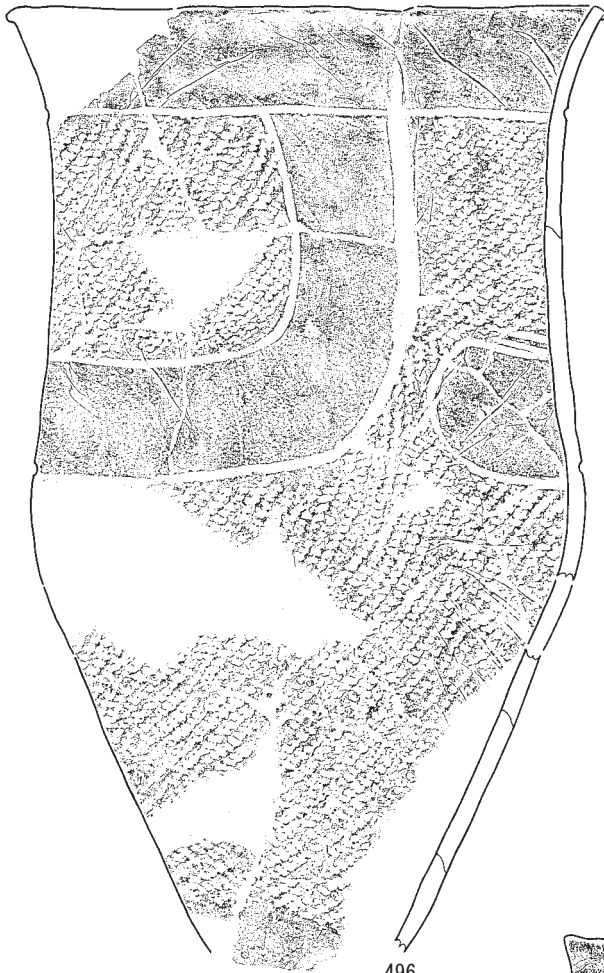

496

41 豎

496・498・500・501・503 0 (1:3) 10 cm

499・502 0 (1:2) 10 cm



502



498



504・506・508・509・511・513

0 (1:3) 10 cm

505・507・510・512

0 (1:2) 10 cm

41 豎



遺物図版66 縄文時代の遺物66

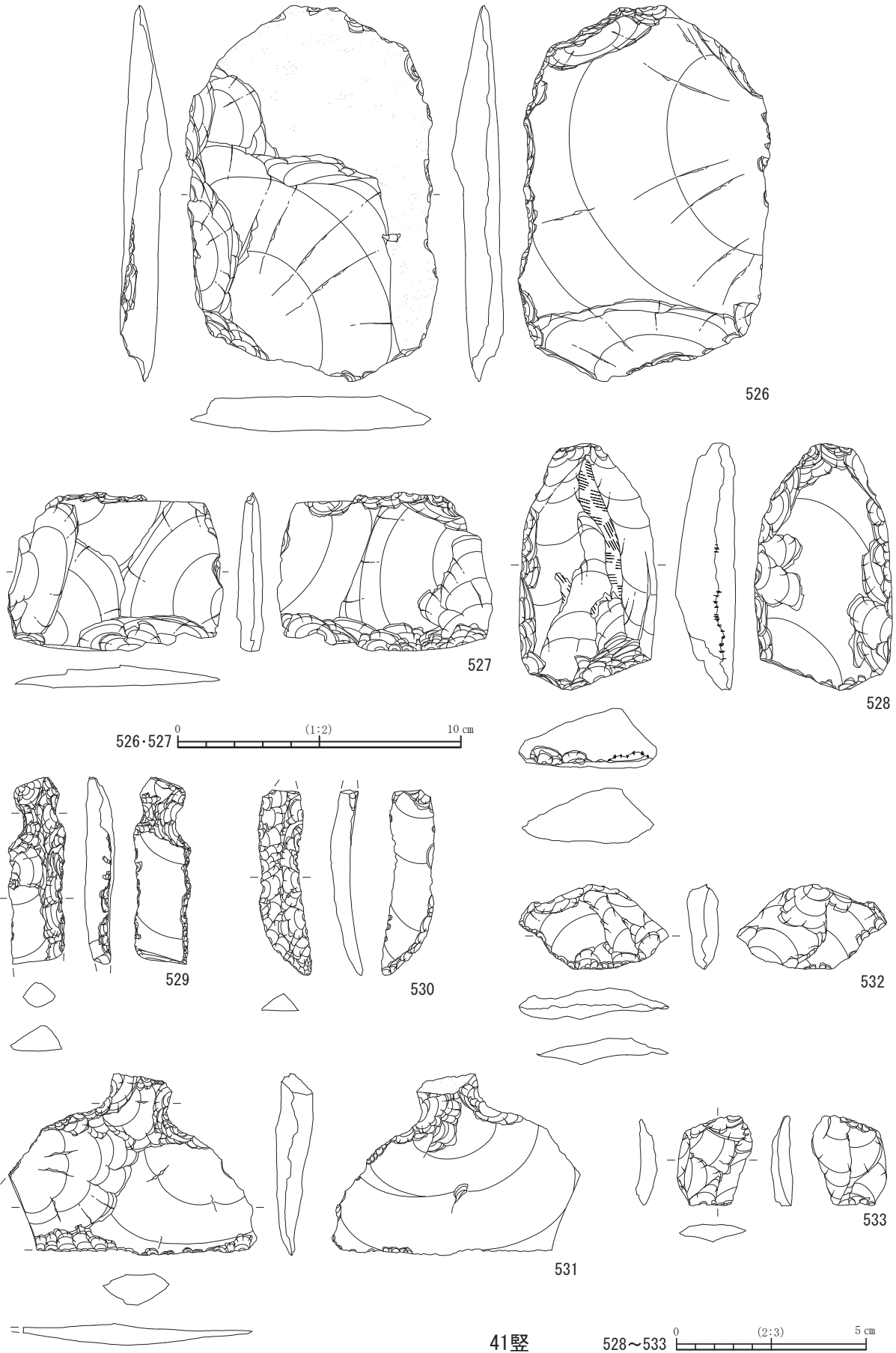

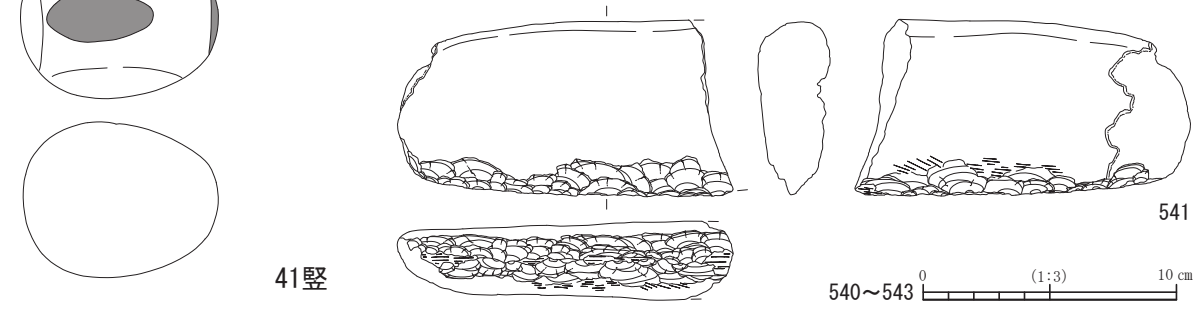
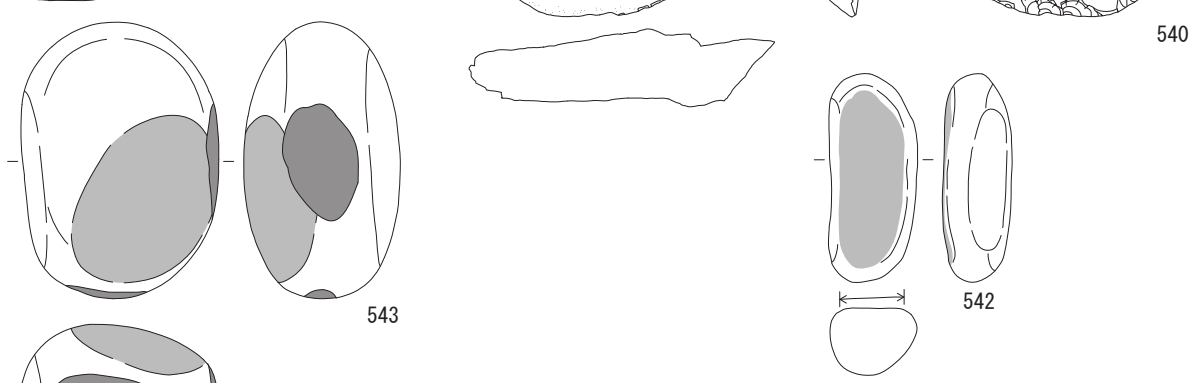
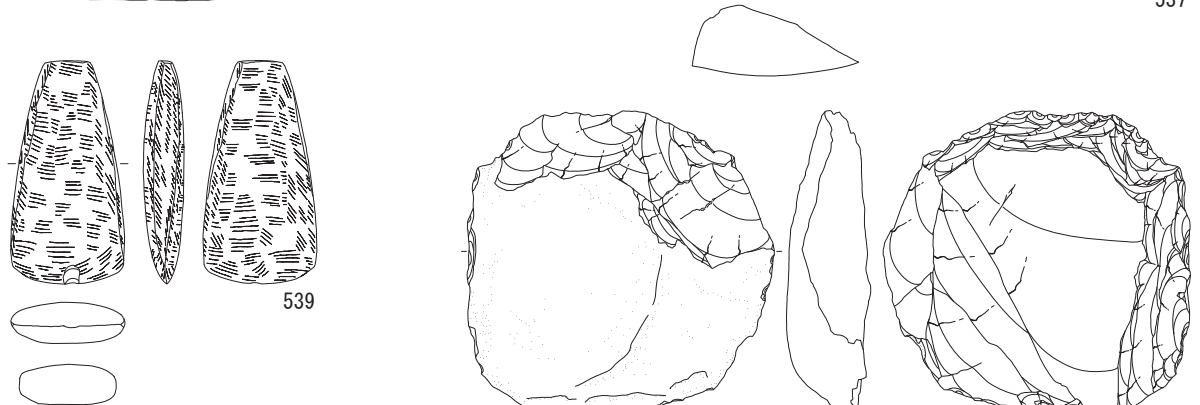
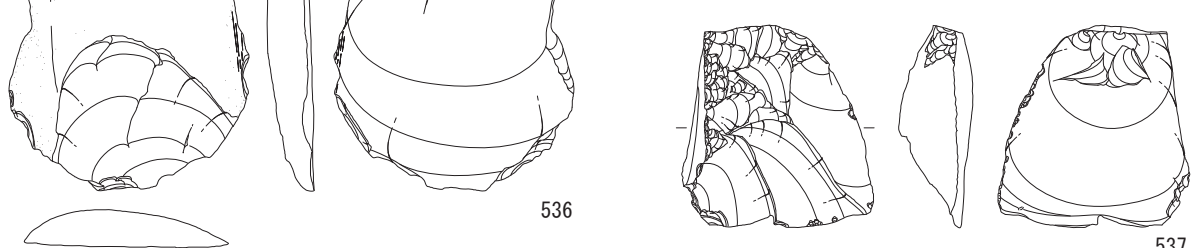
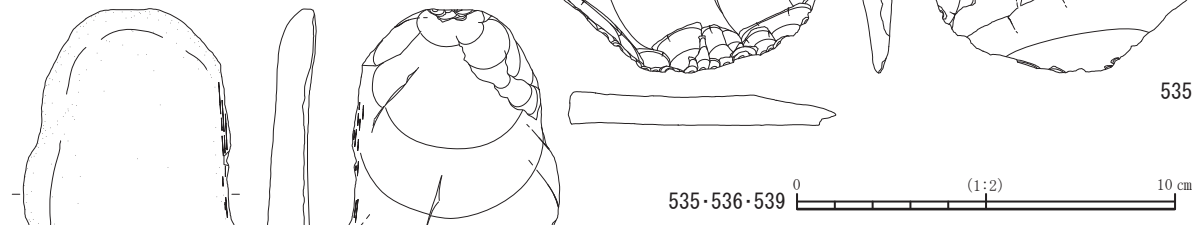
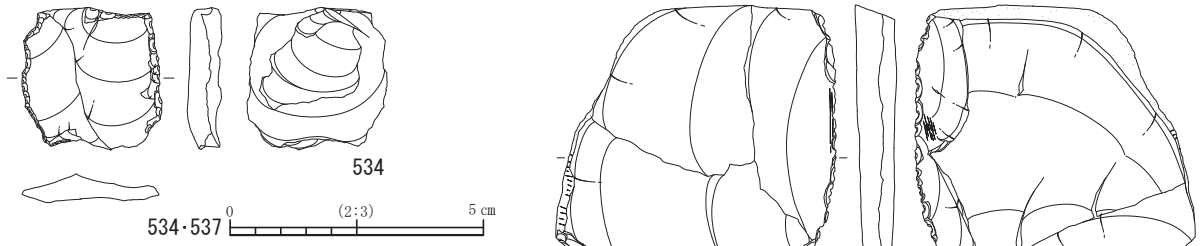

遺物図版68 縄文時代の遺物68

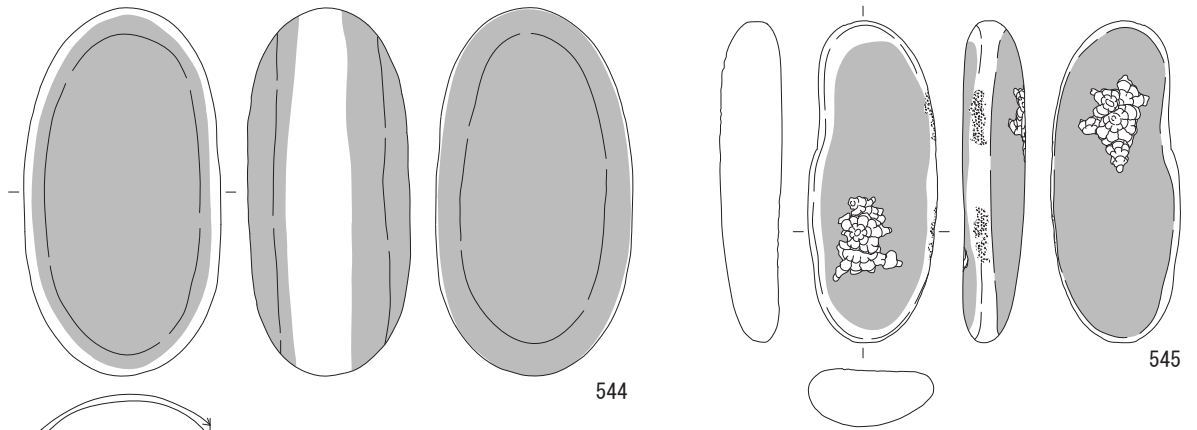

544

545

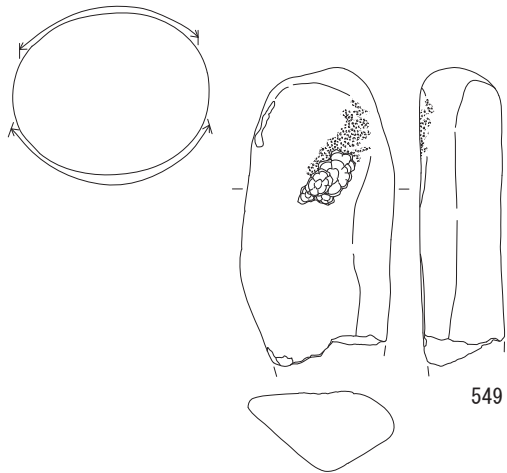

549

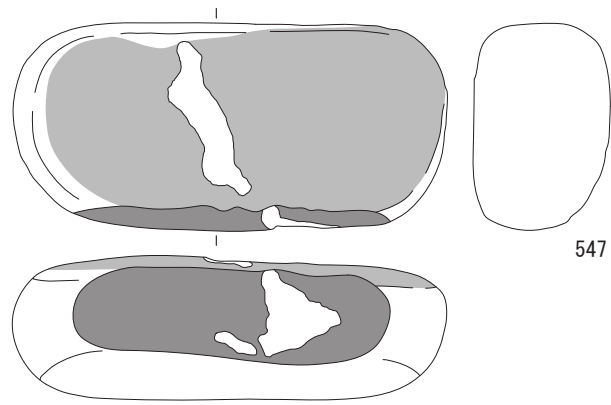

547

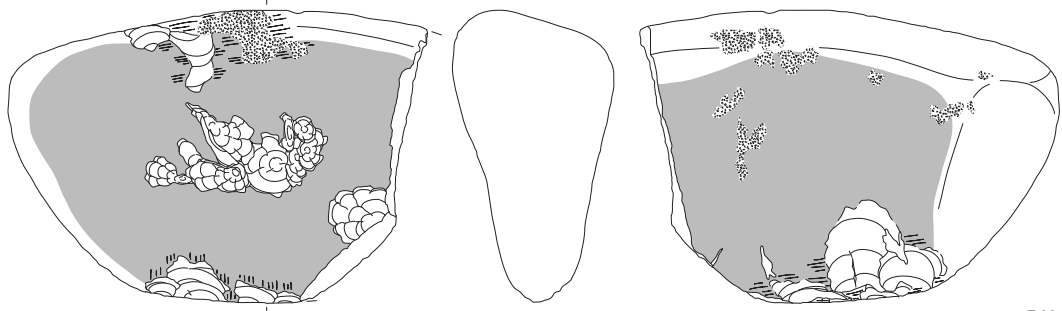

548

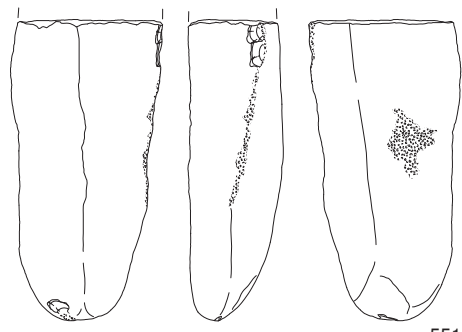
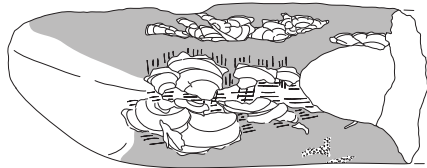

551

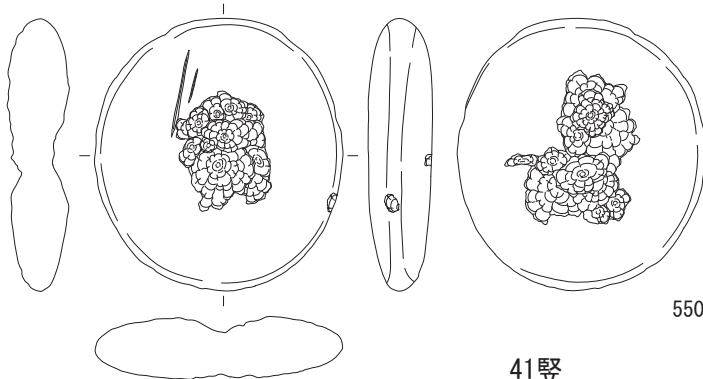

550

41 豎

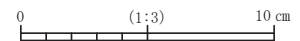

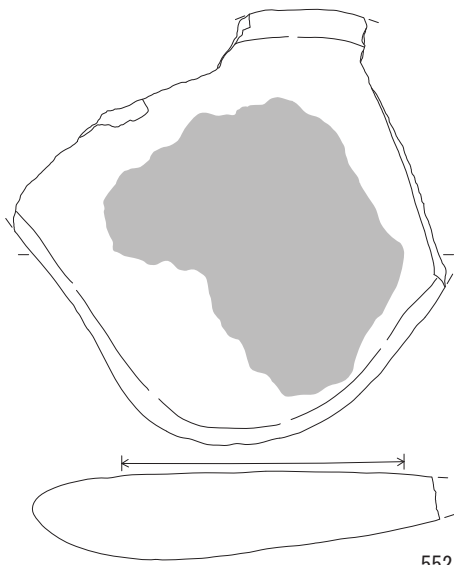

552

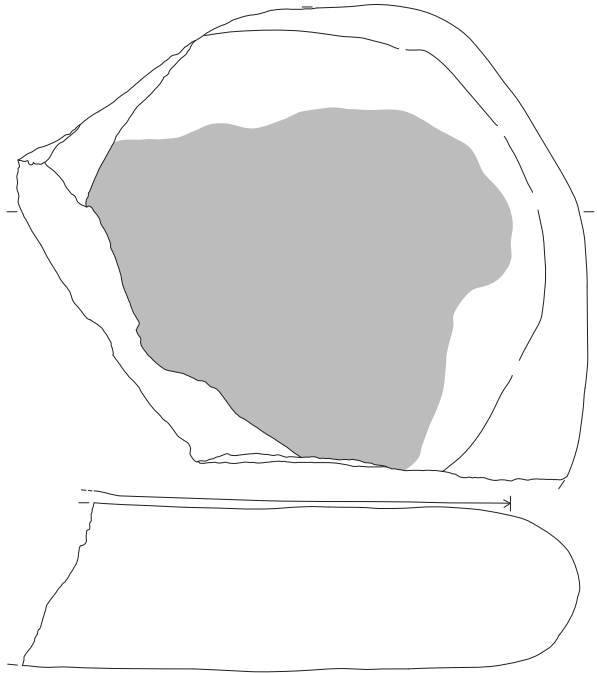

553

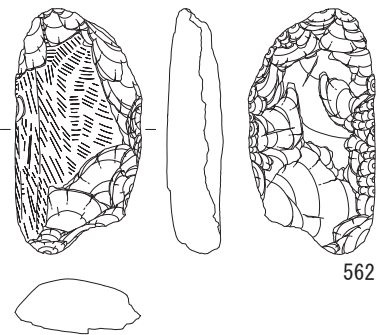
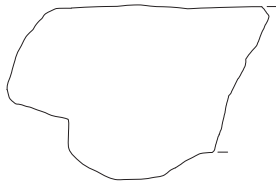
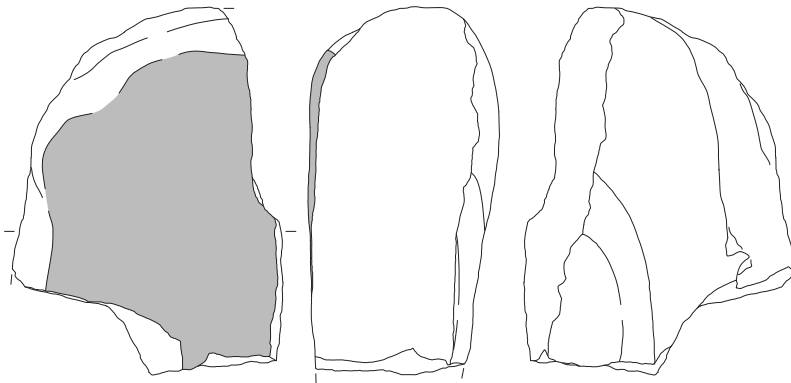

562

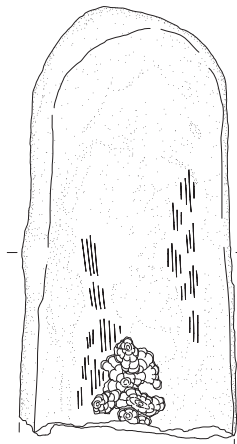

560

558

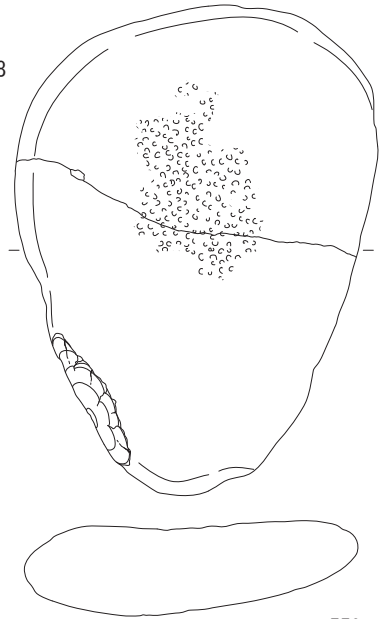

559

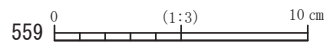

41 豎

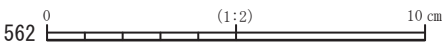

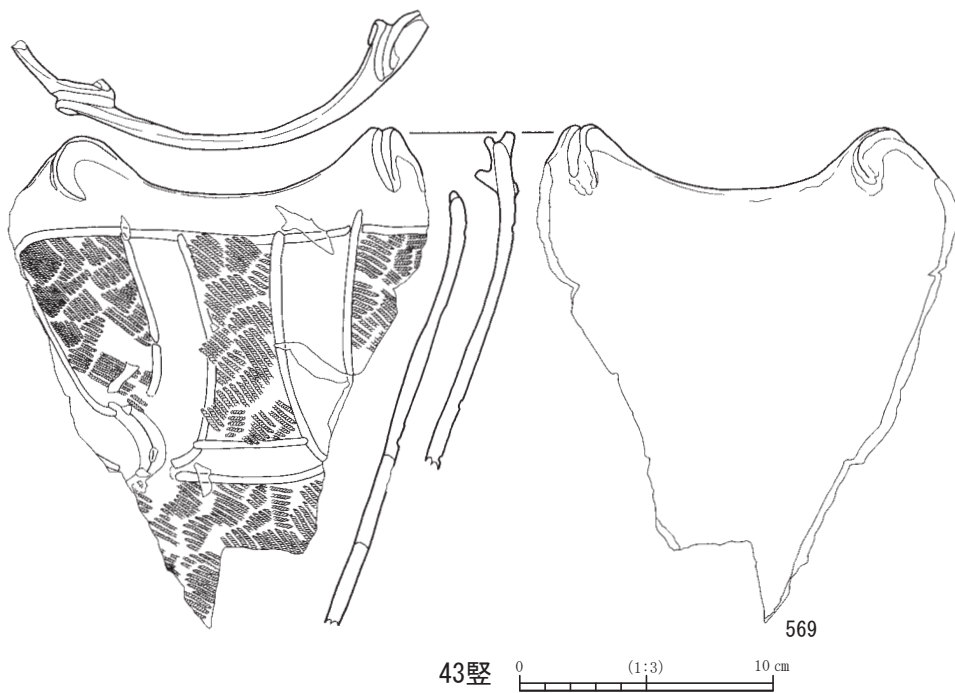
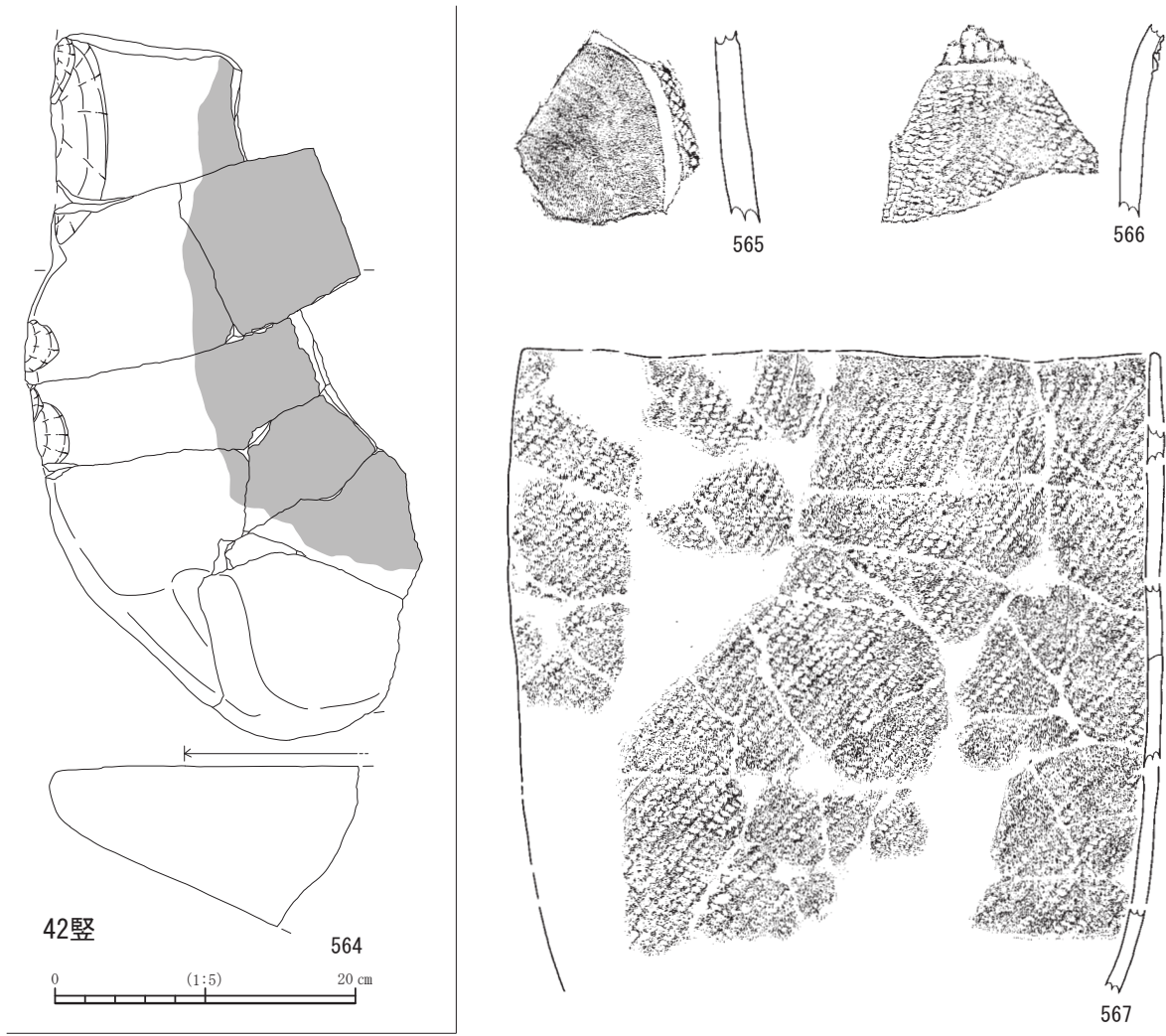

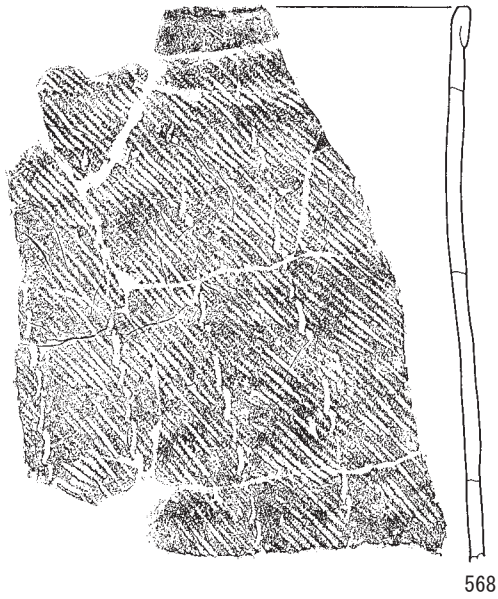

568

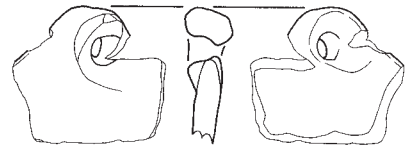

570

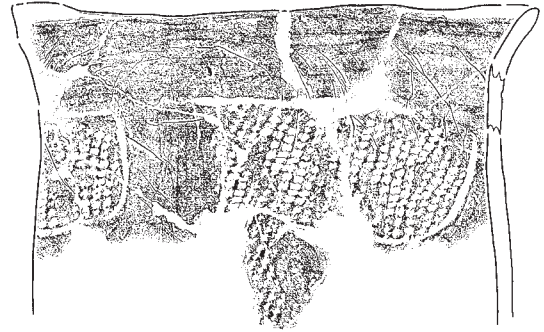

572

568・571~574 (1:3) 10 cm



571



573



578



578

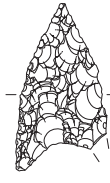

579

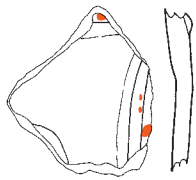

574

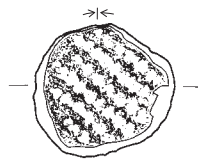

575

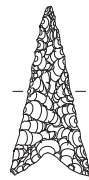

580

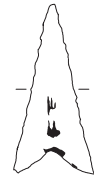

黒色付着物の範囲

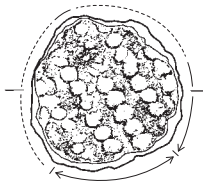

576

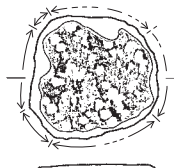

577

570・575~577 (1:2) 10 cm

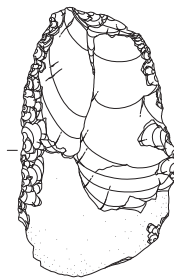

581

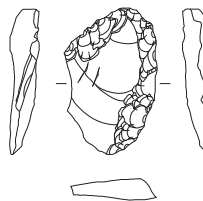

583

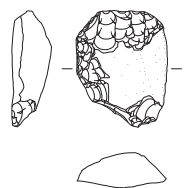

582

578~583 (2:3) 5 cm

43 豎

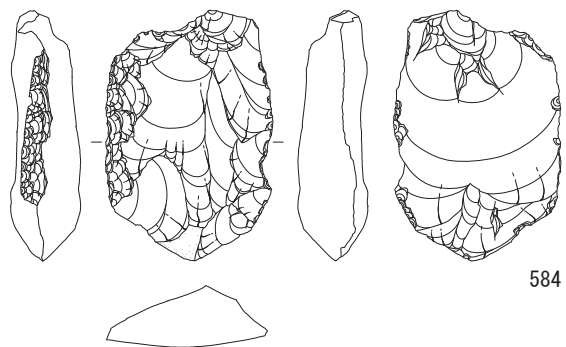

584

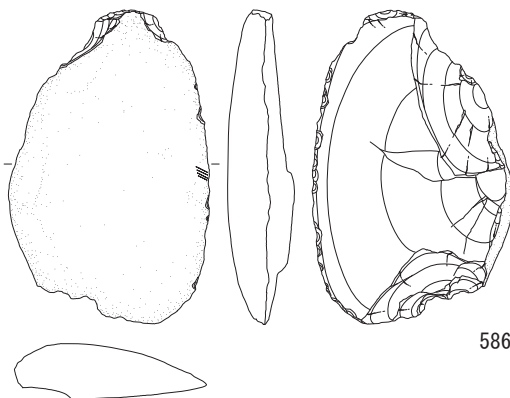

586

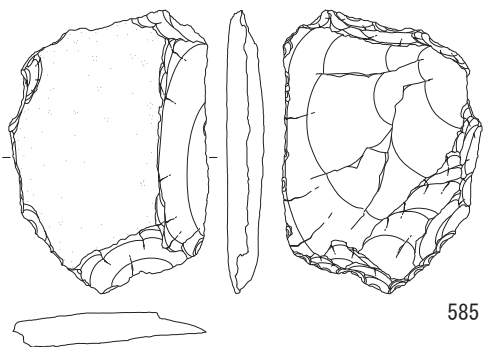

585

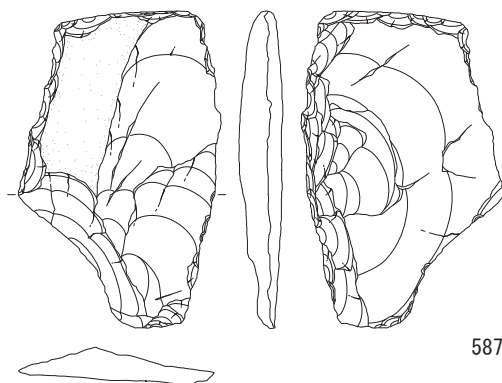

587

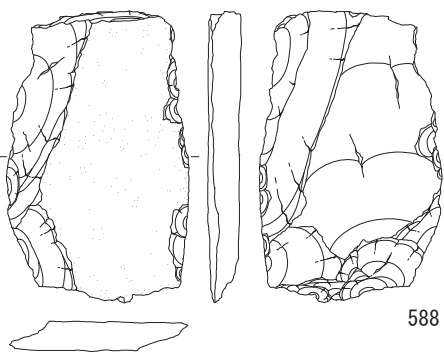

588

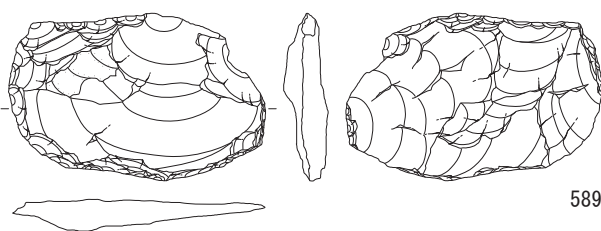

589

585~589 0 (1:2) 10 cm

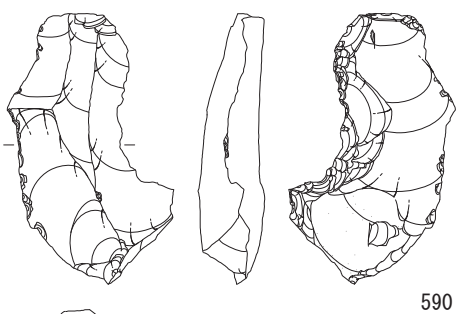

590

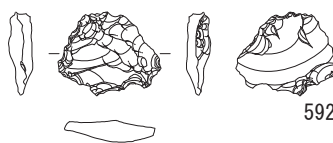

592



591

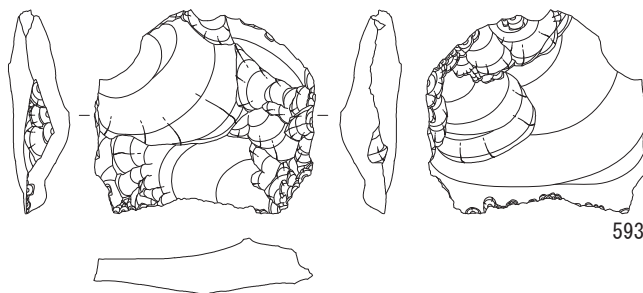

593

584・590~593 0 (2:3) 5 cm

43 豎

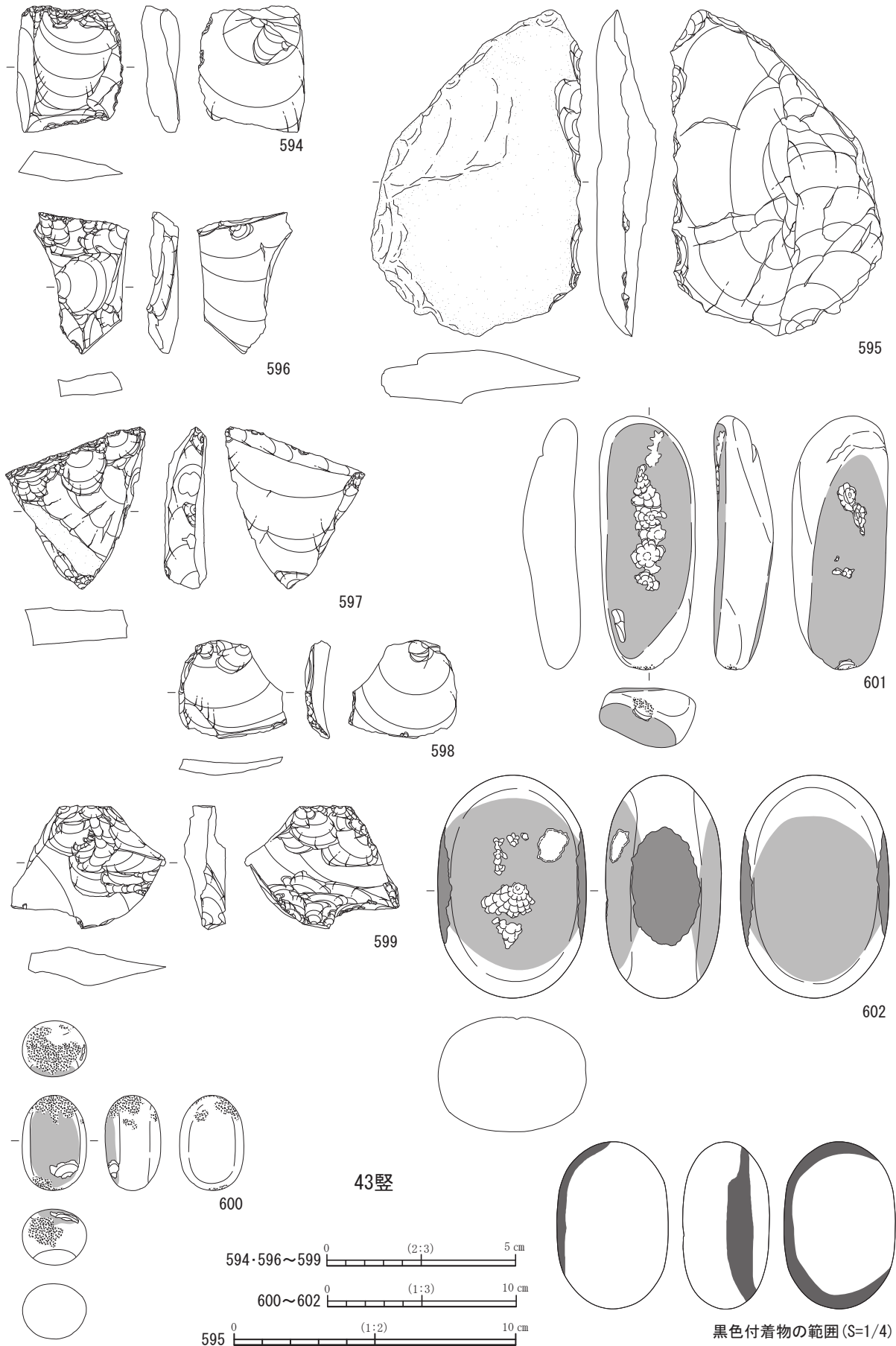

遺物図版74 縄文時代の遺物74

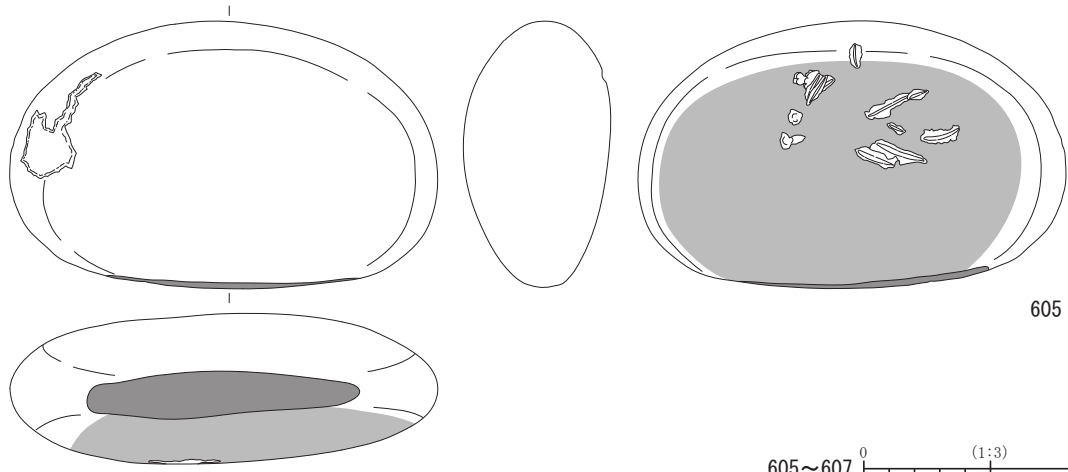

605

605~607 0 (1:3) 10 cm

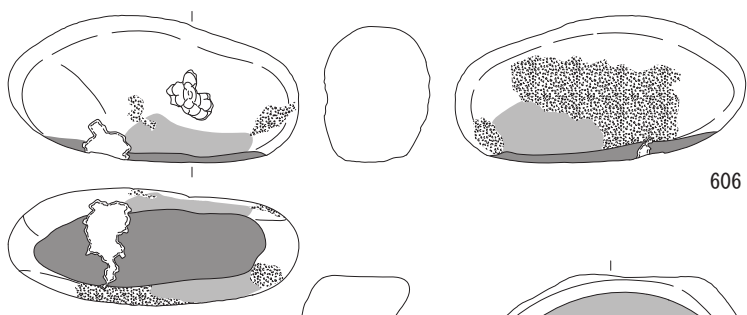

606

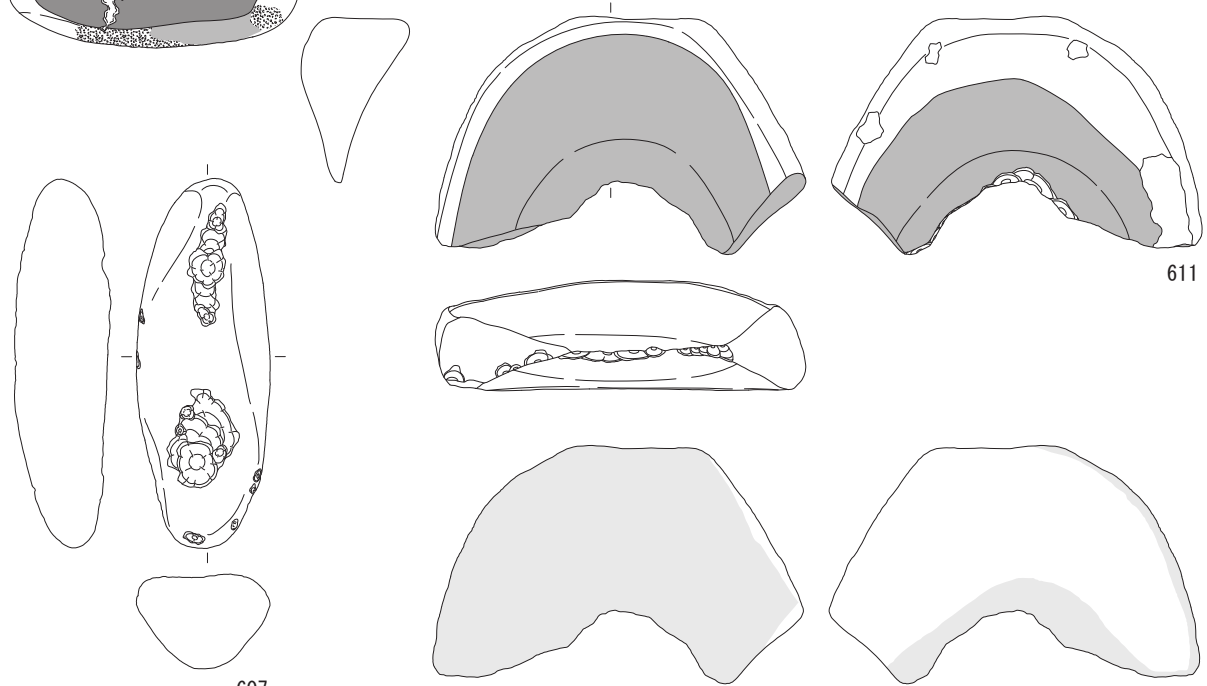

607

611

被熱範囲

611 0 (1:4) 20 cm

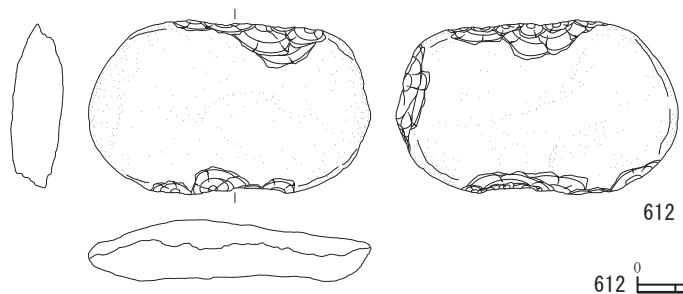

612

612 0 (1:2) 10 cm

43 豎

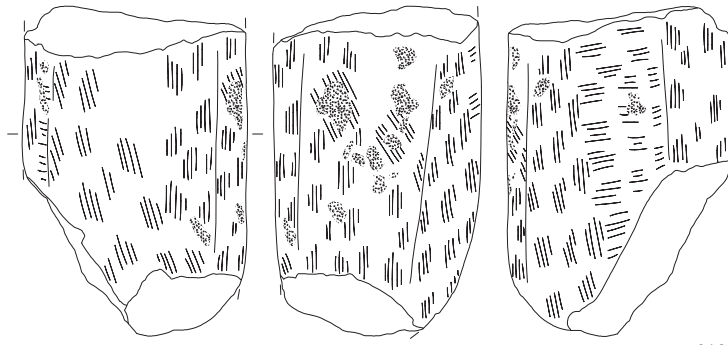

613

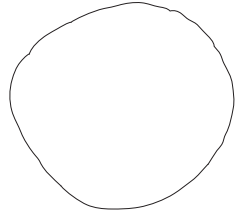

43 豎

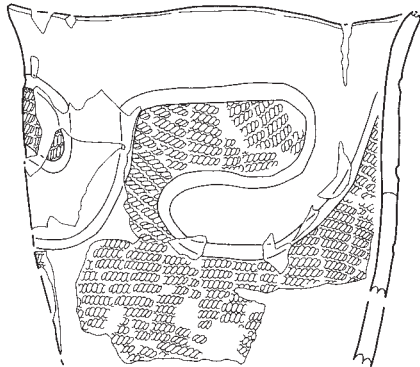
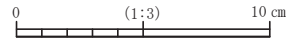

615

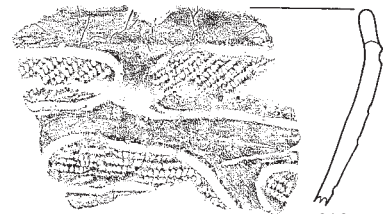

616

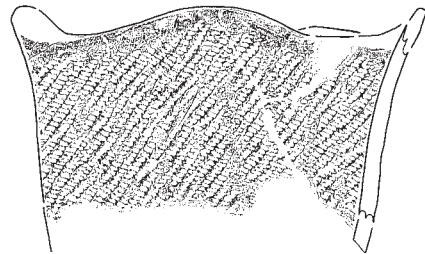

617

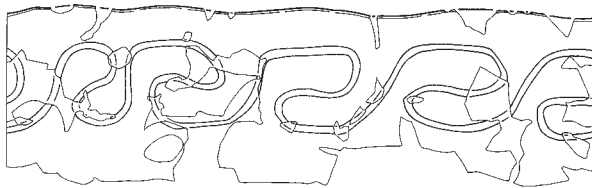

615 展開図

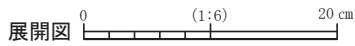

展開図

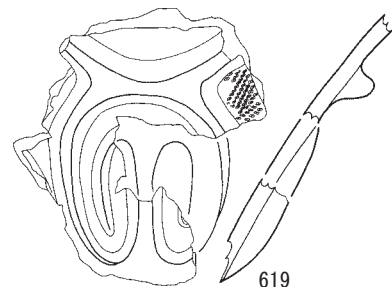

619



618

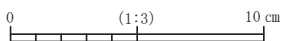

620

44 豎

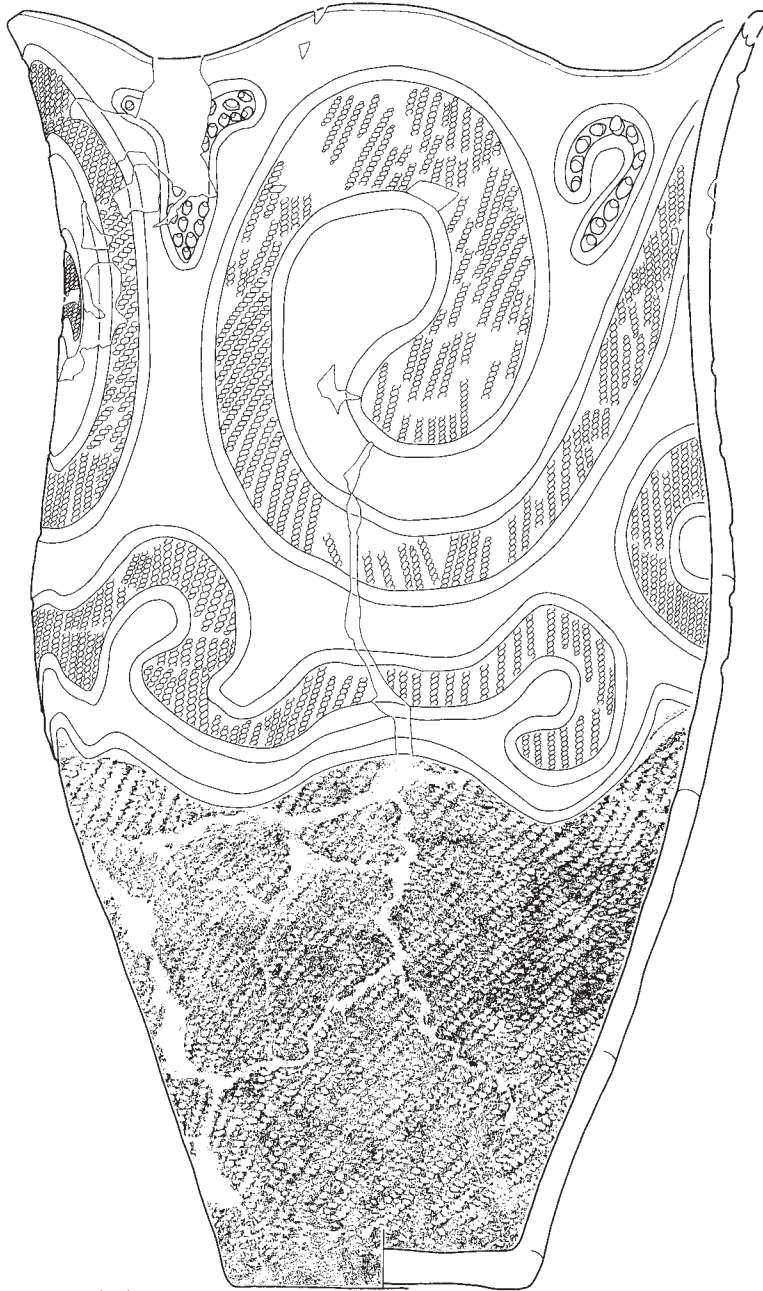

展開図

(1:8)

40 cm

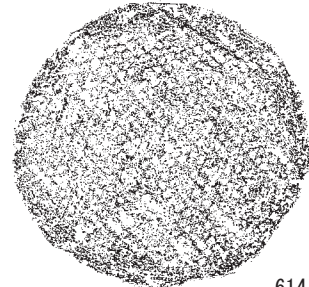

614

0 (1:3) 10 cm

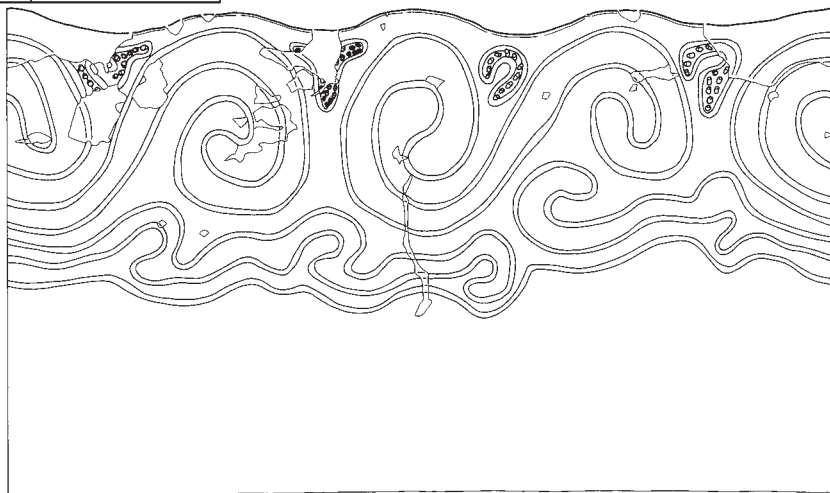

44 豎

614 展開図

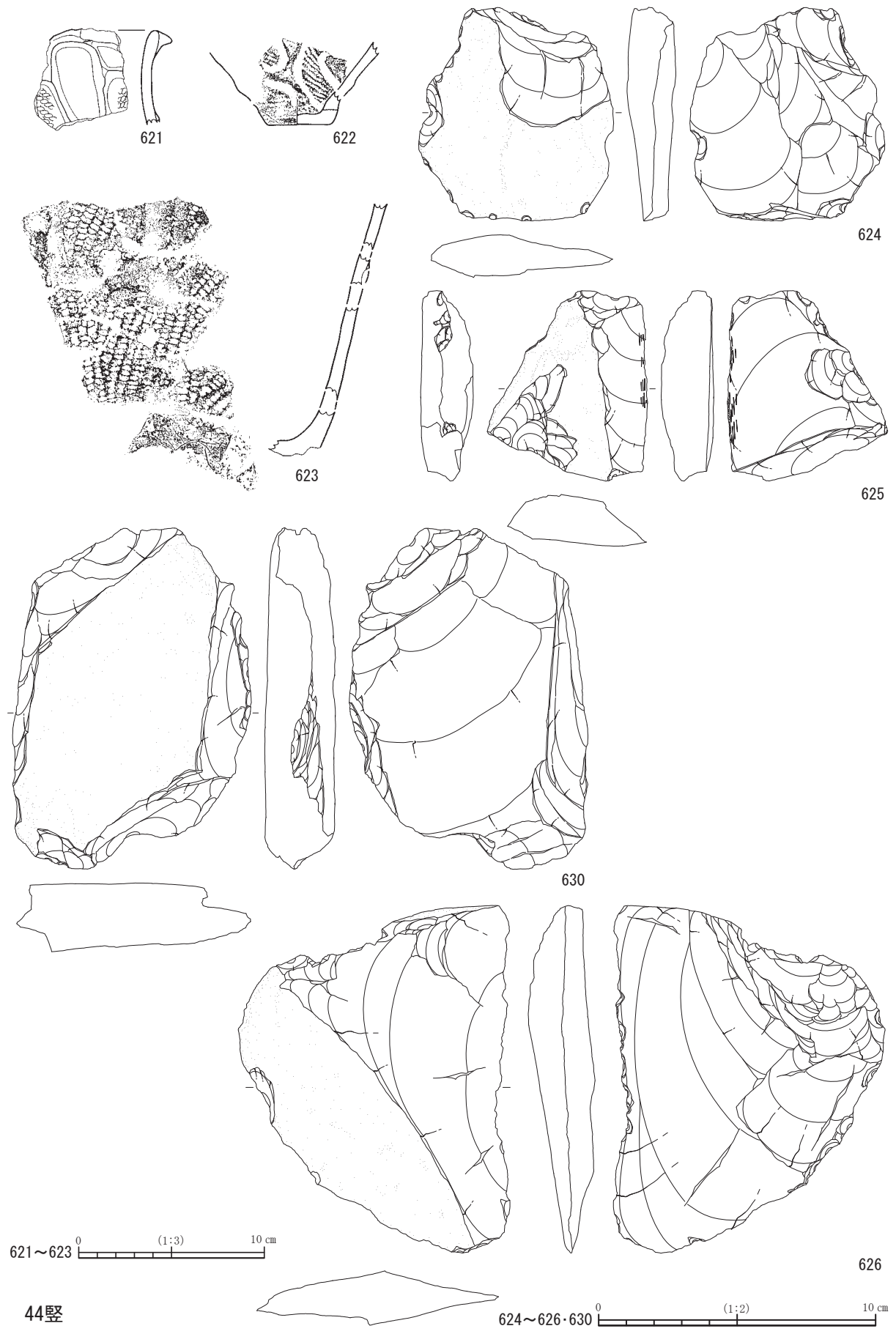

44 豎

遺物図版78 縄文時代の遺物78

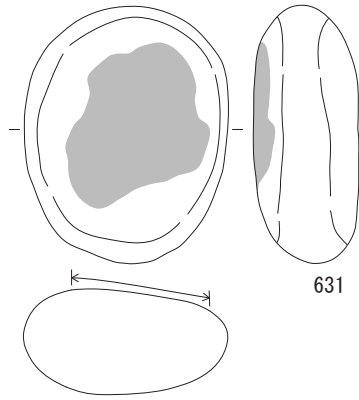

631

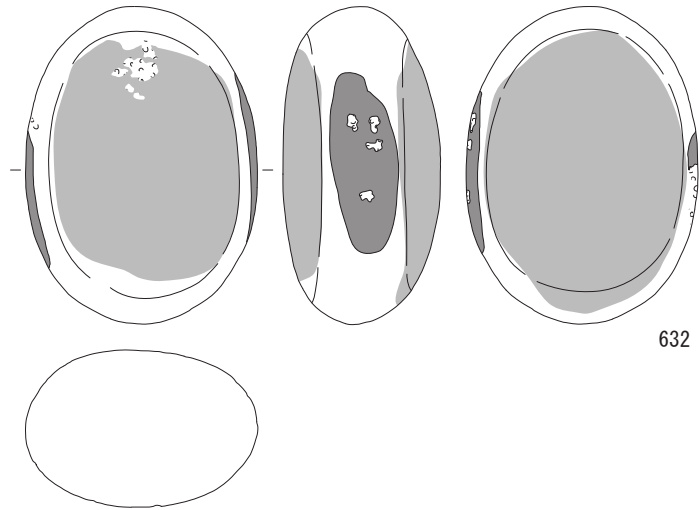

632

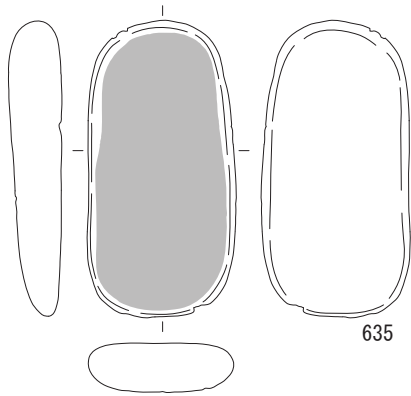

635

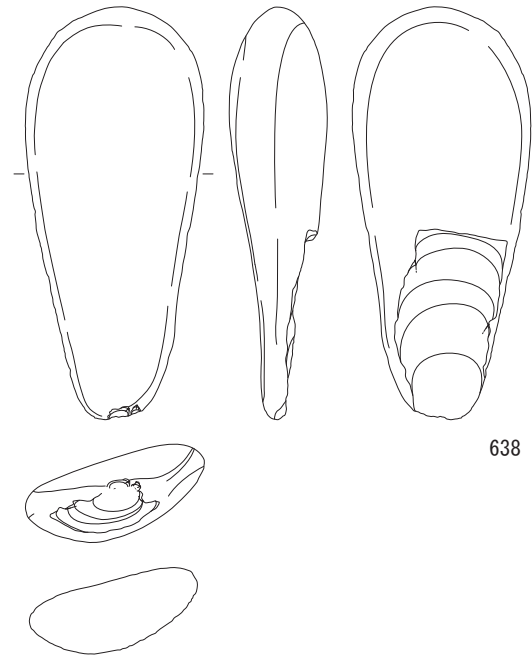

638

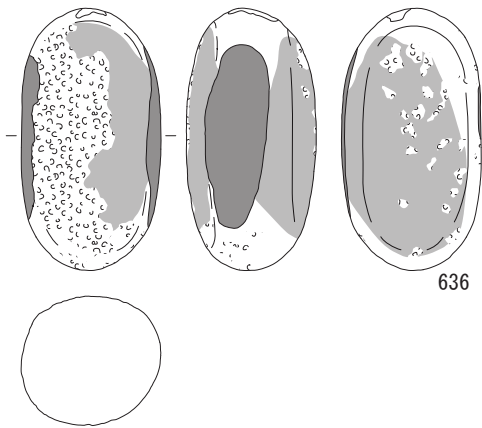

636

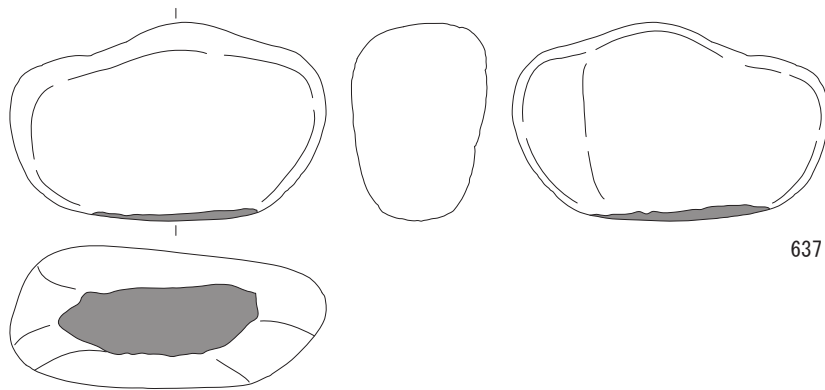

637

44 豎

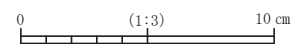

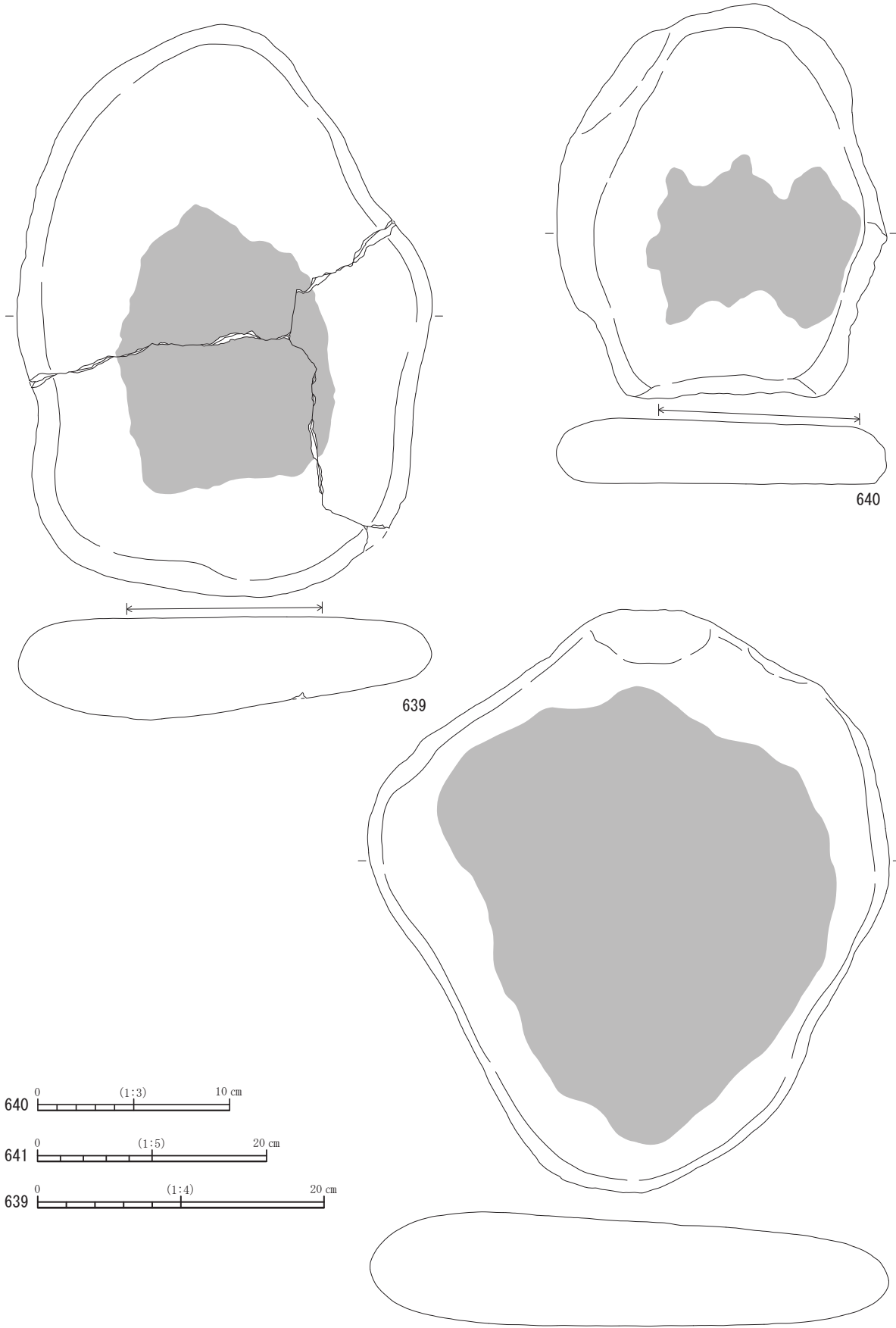

640 0 (1:3) 10 cm

641 0 (1:5) 20 cm

639 0 (1:4) 20 cm

44 豎

641

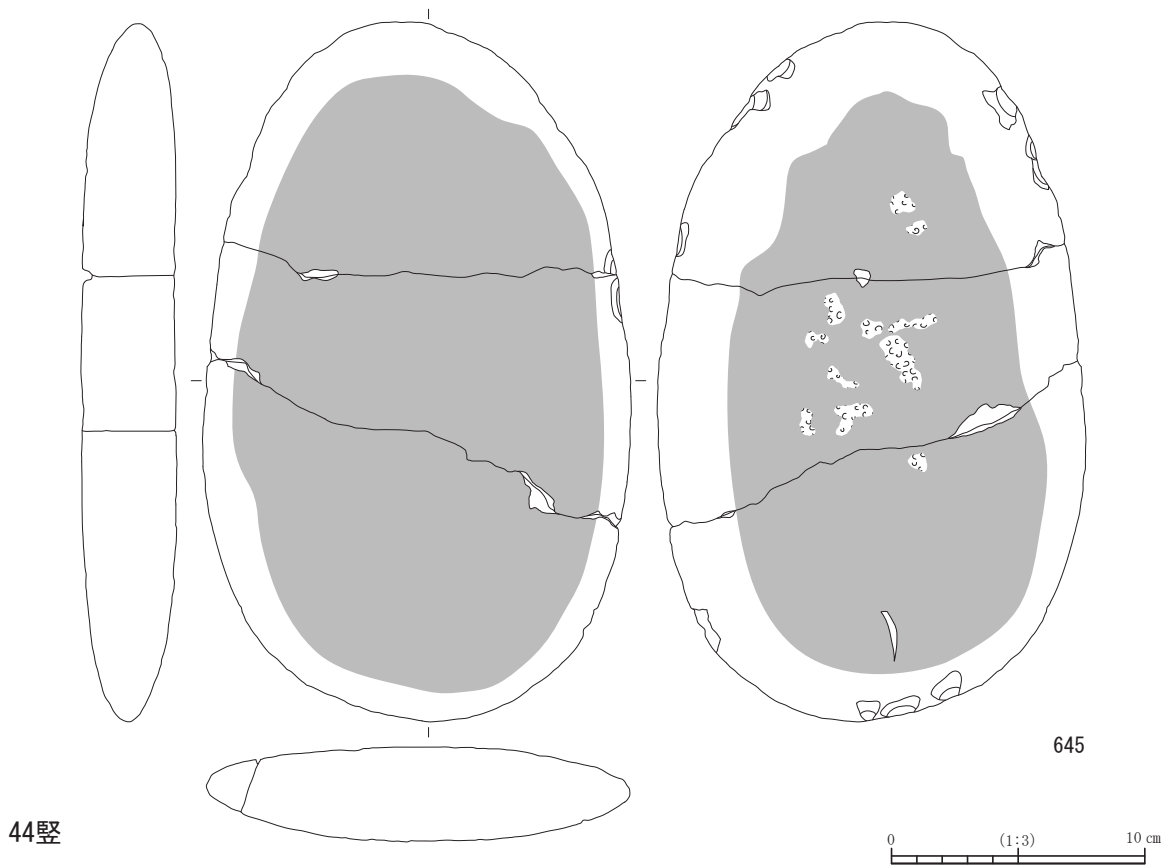

44 豎

645

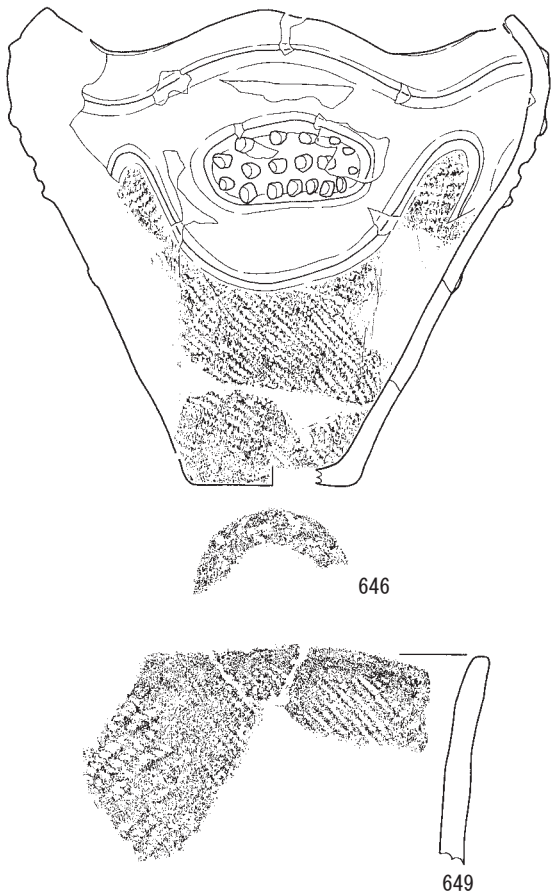

646

649

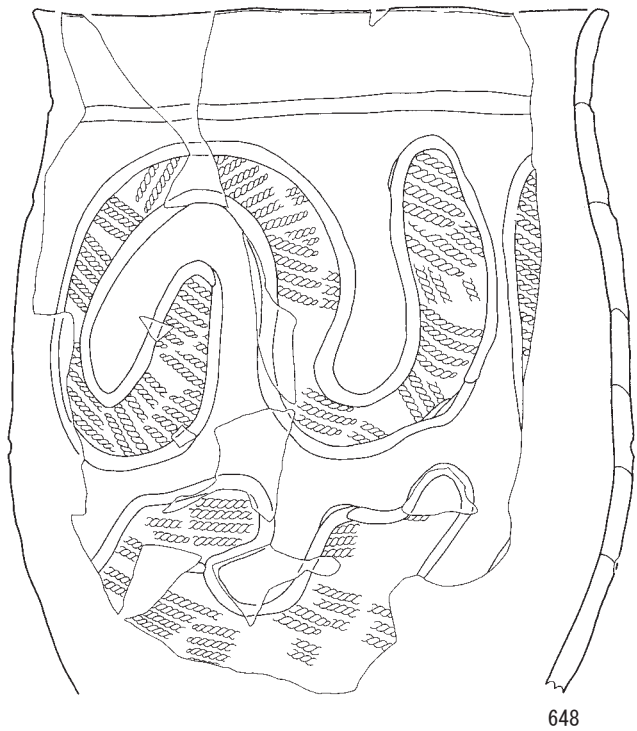

648

45 豎



45 豎

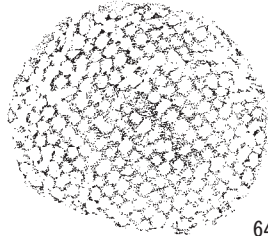
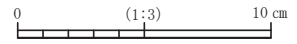

647

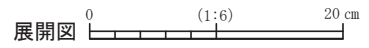

展開図

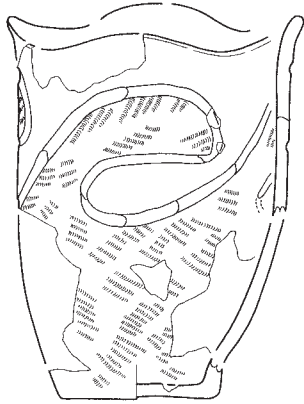

655

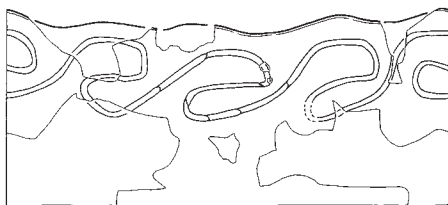

655 展開図

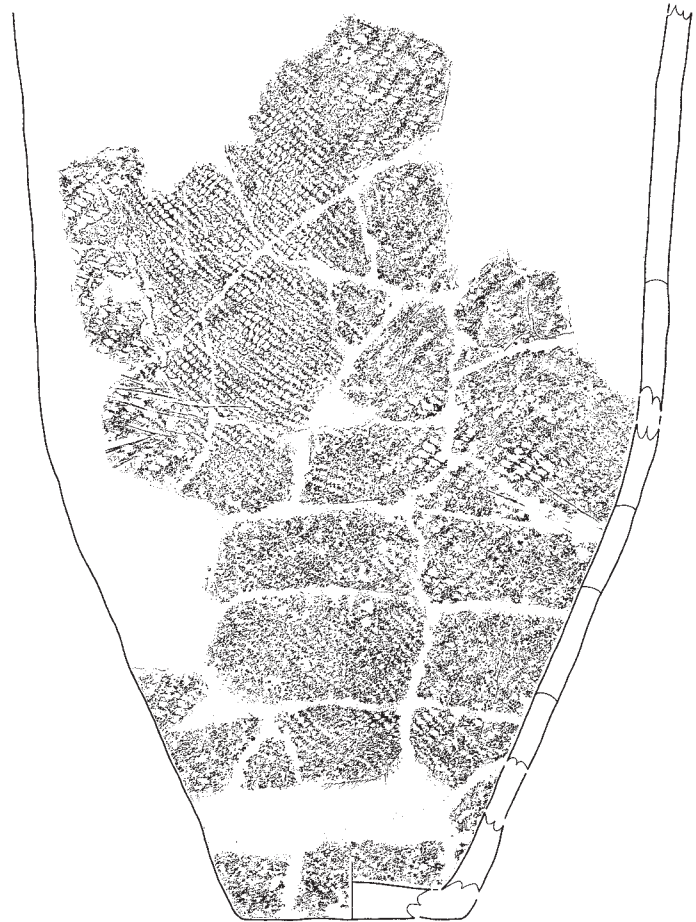

650

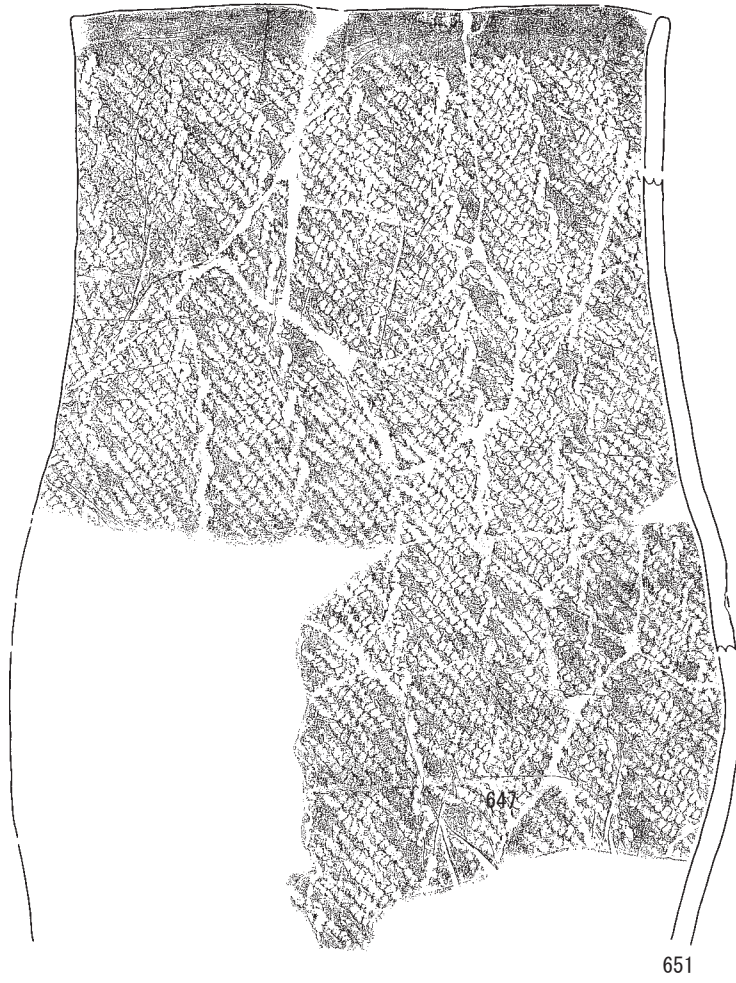

651

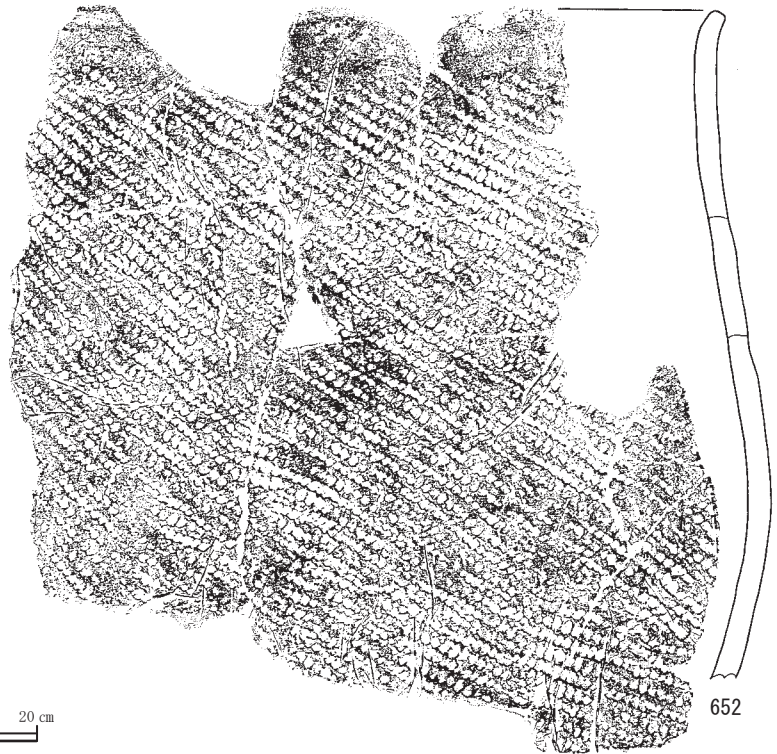

45 豎

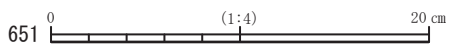
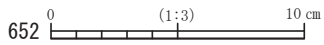

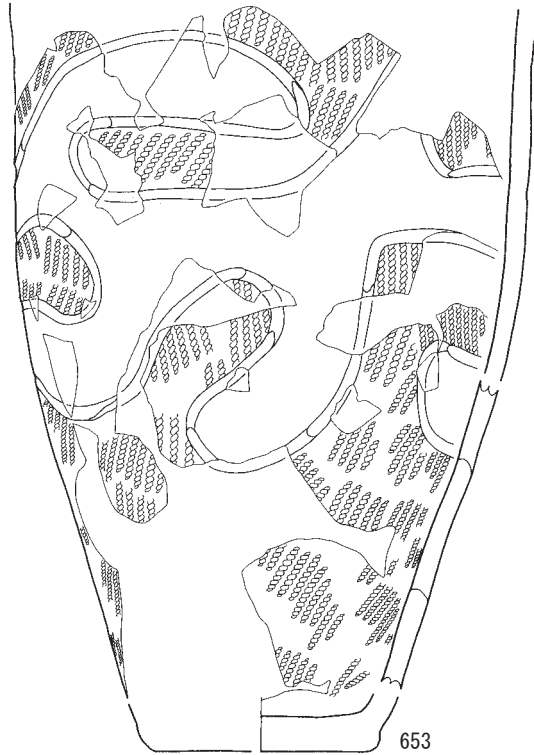

653

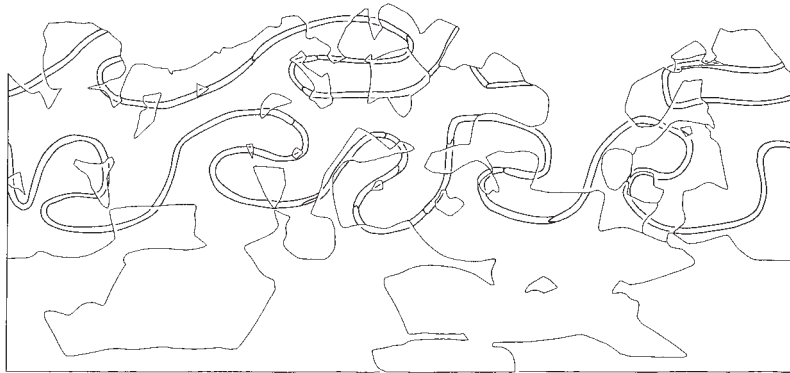

653展開図

0 (1:6) 20 cm 展開図

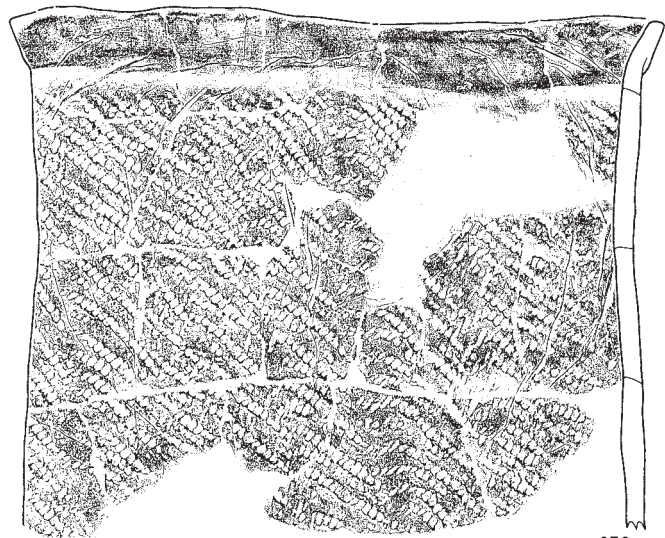

656

45 豎

0 (1:3) 10 cm



45 豎

展開図 0 (1:6) 20 cm



654

0 (1:3) 10 cm

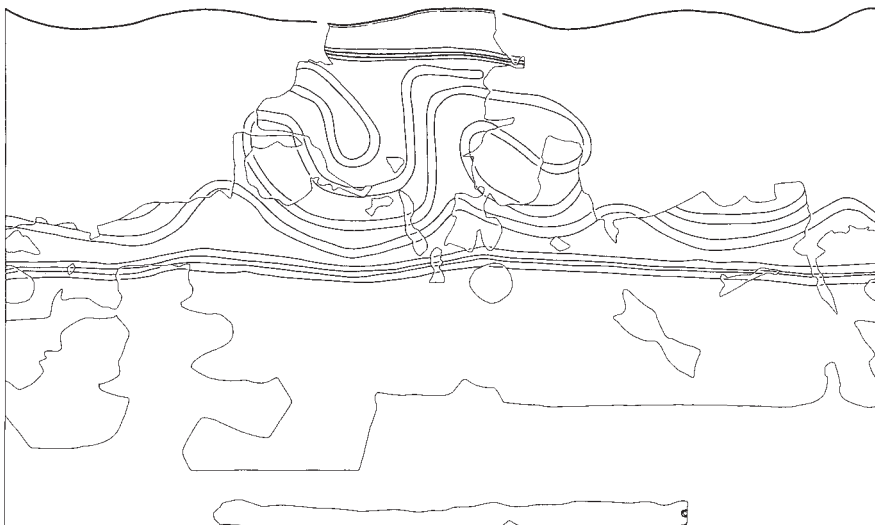

654 展開図



遺物図版86 縄文時代の遺物86

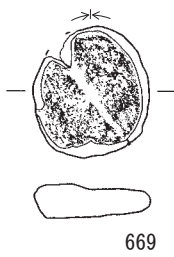
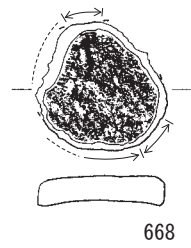
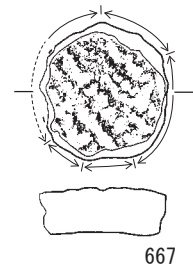
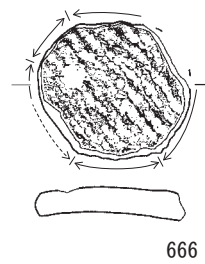
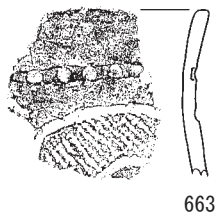
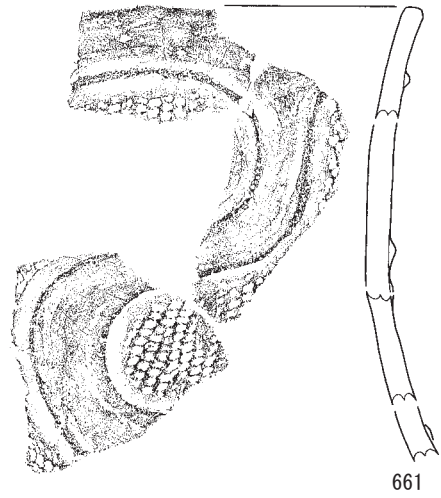
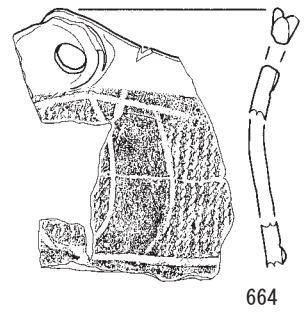
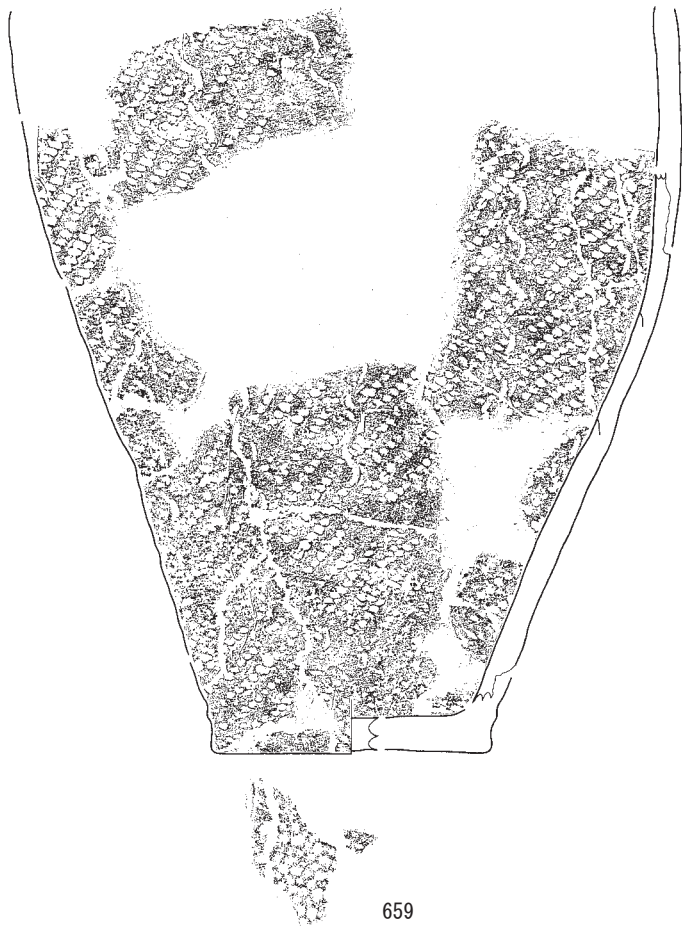

45 豎

659・661・663・664 0 (1:3) 10 cm

665~669 0 (1:2) 10 cm

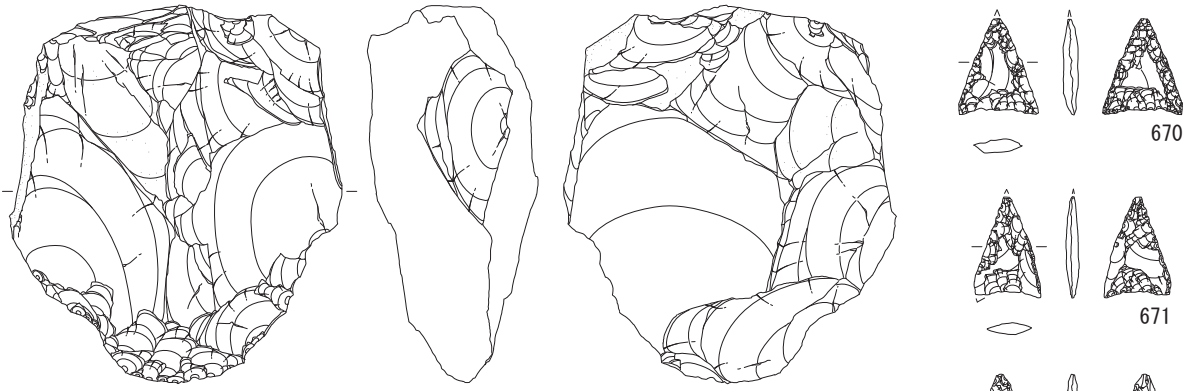

670

671

672

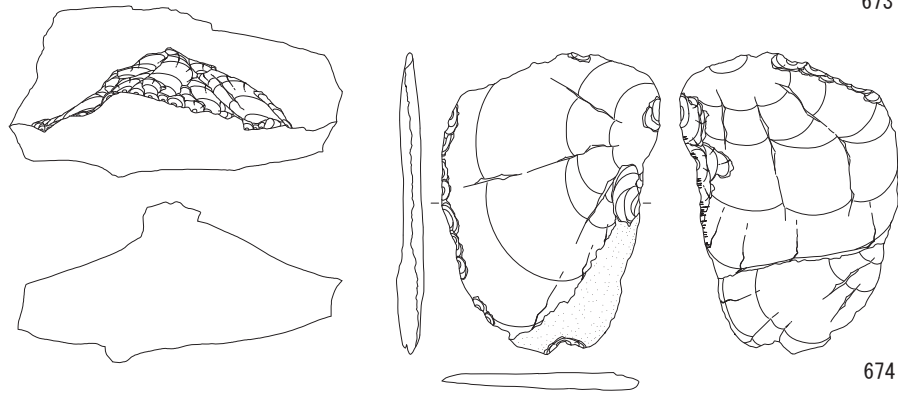

673

674

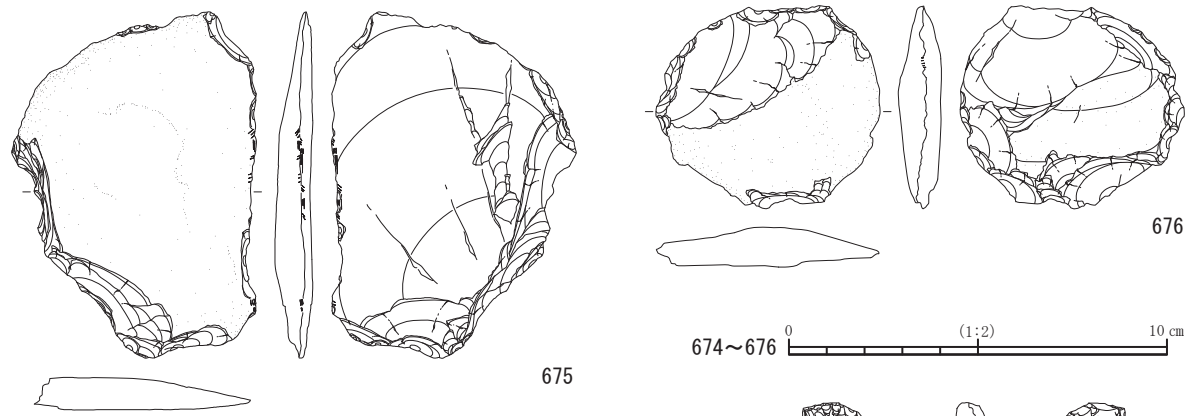

676

675

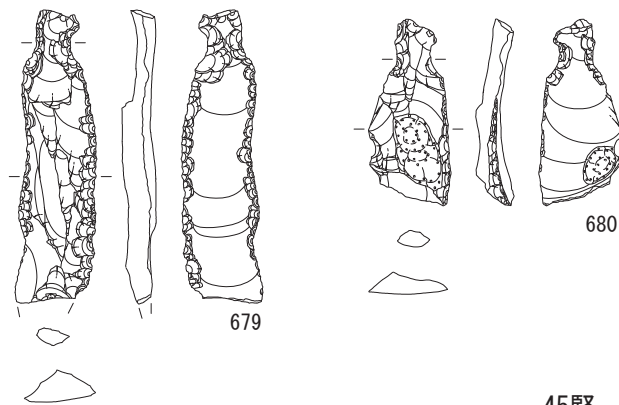

679

680

45 豎

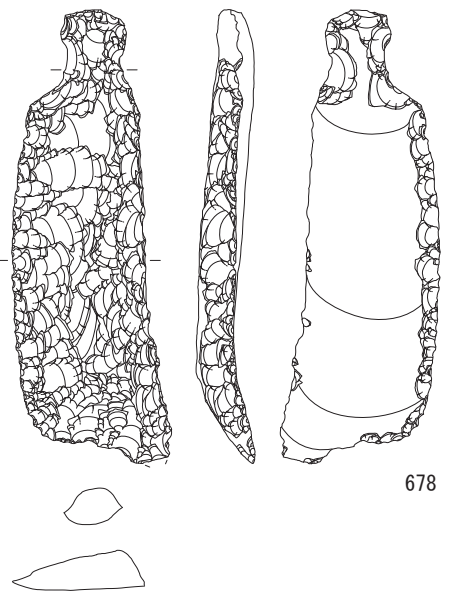

678



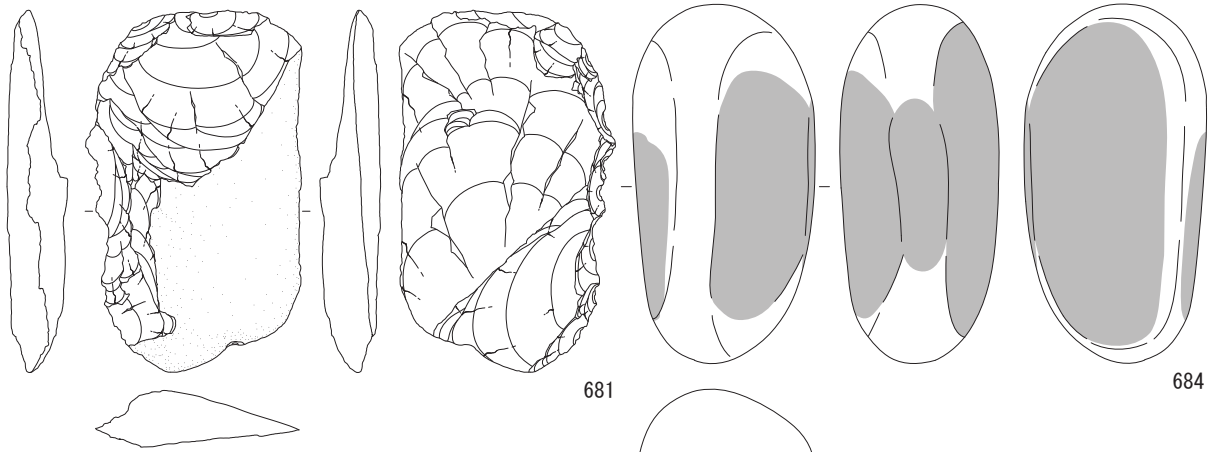

681

684

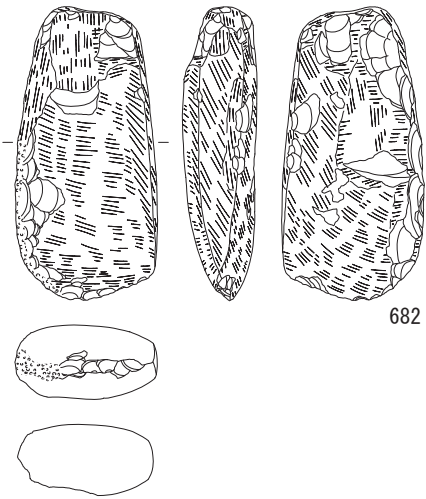

682

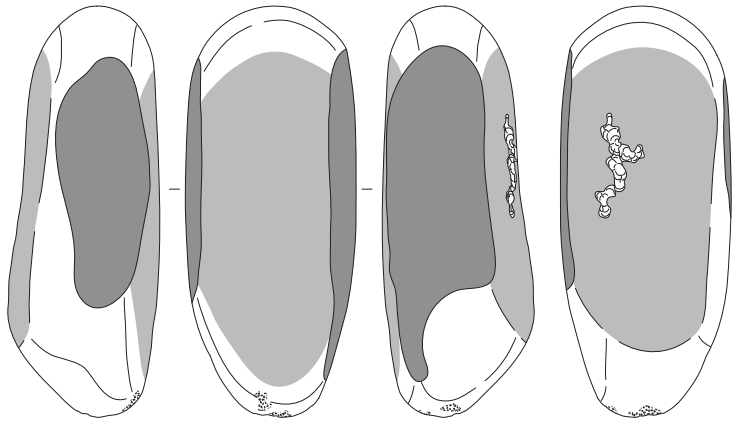

686

681・682 0 (1:2) 10 cm

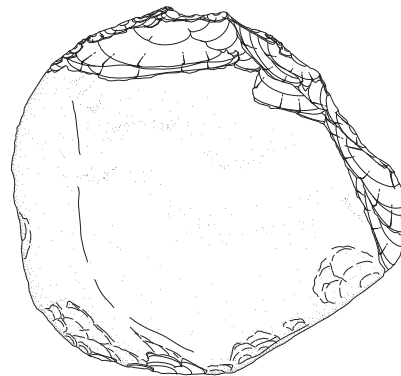
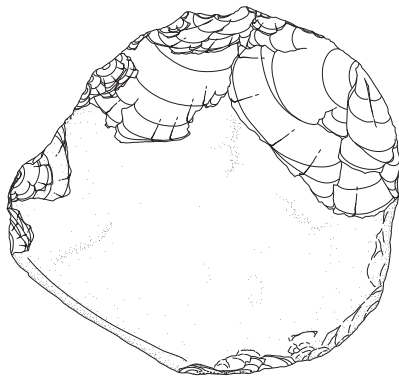
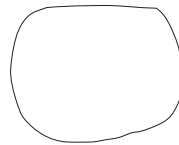
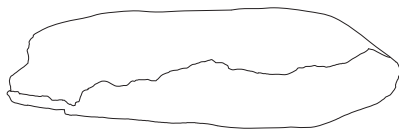

683

683・684・686 0 (1:3) 10 cm

45 豎

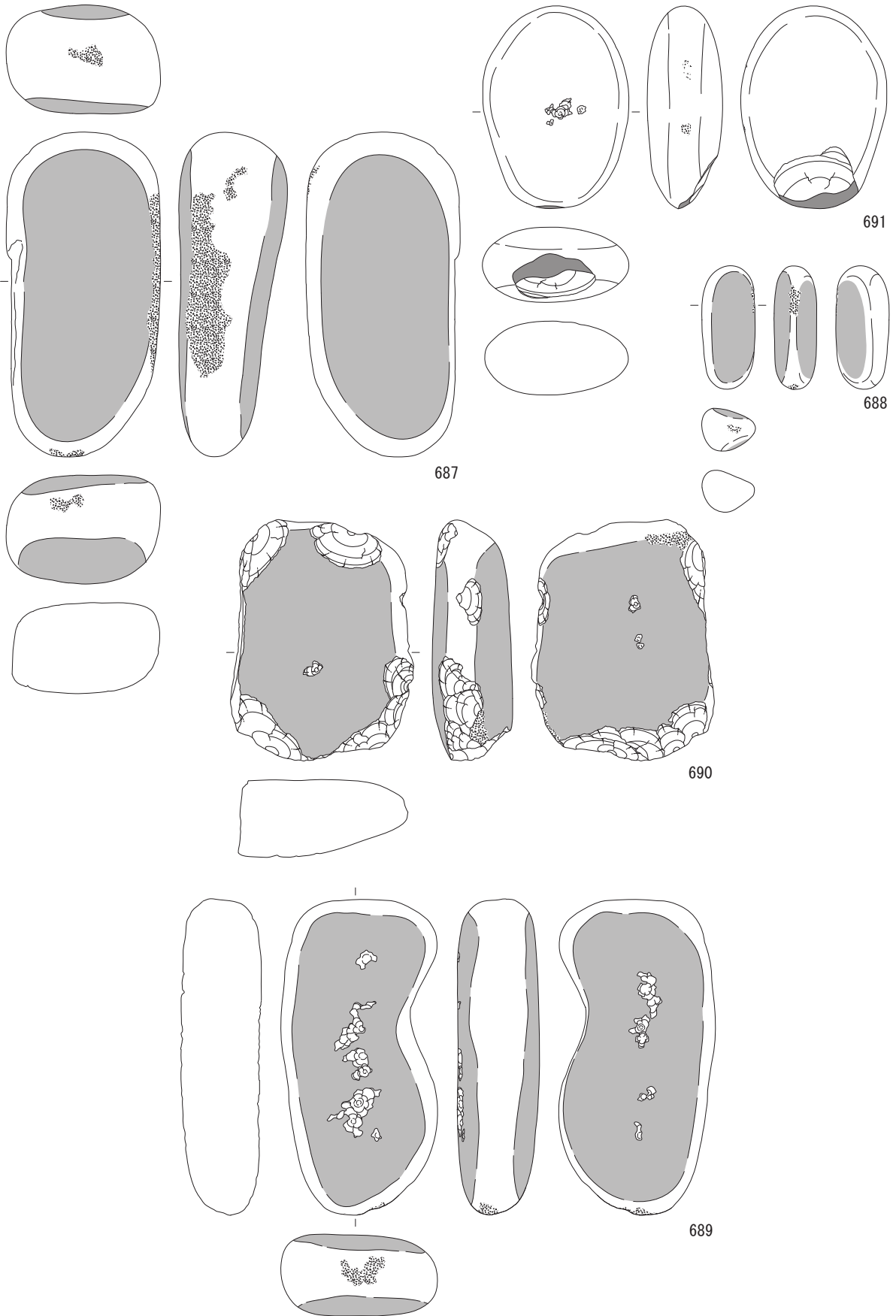

45 豎

0 (1:3) 10 cm

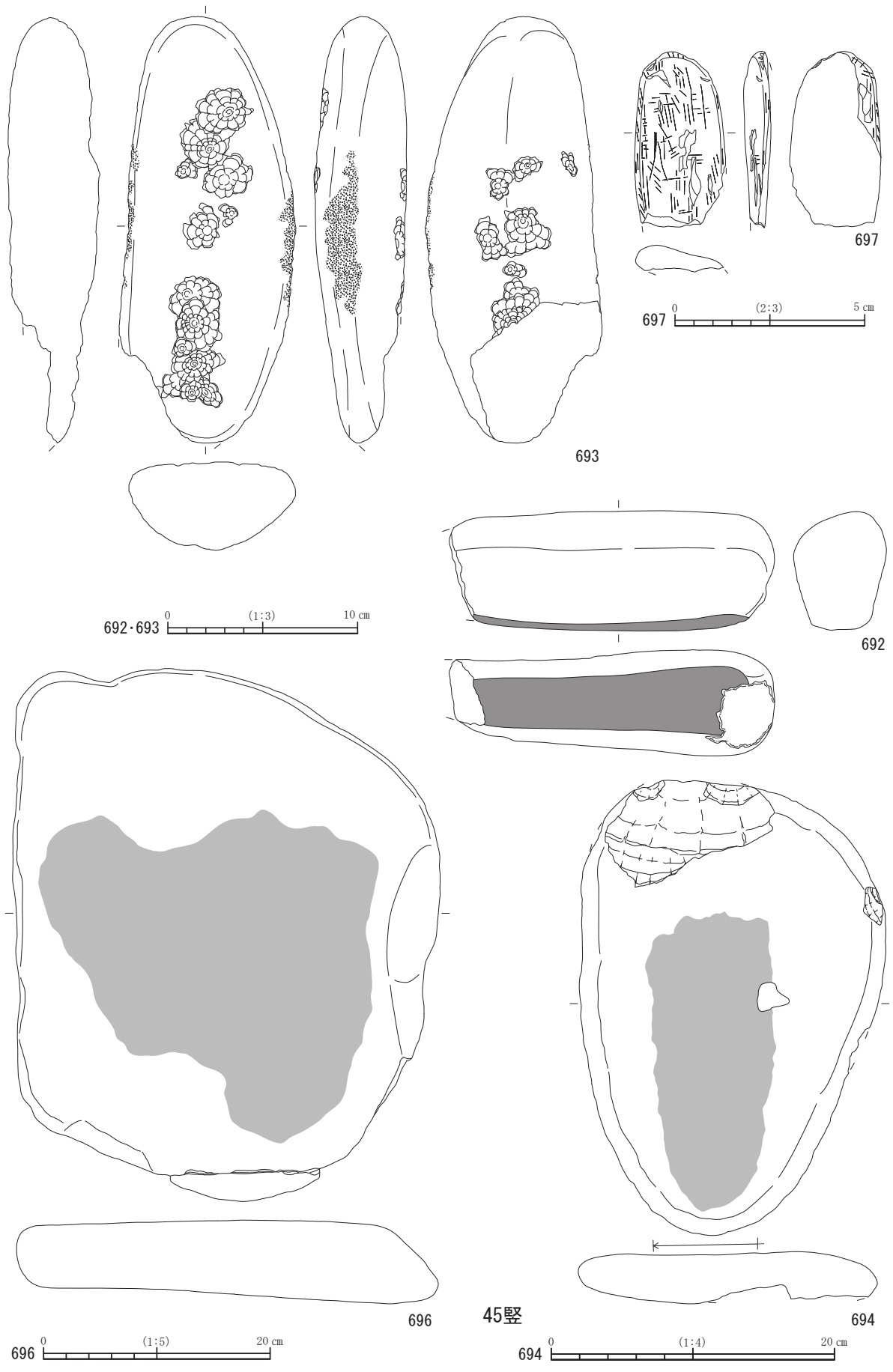

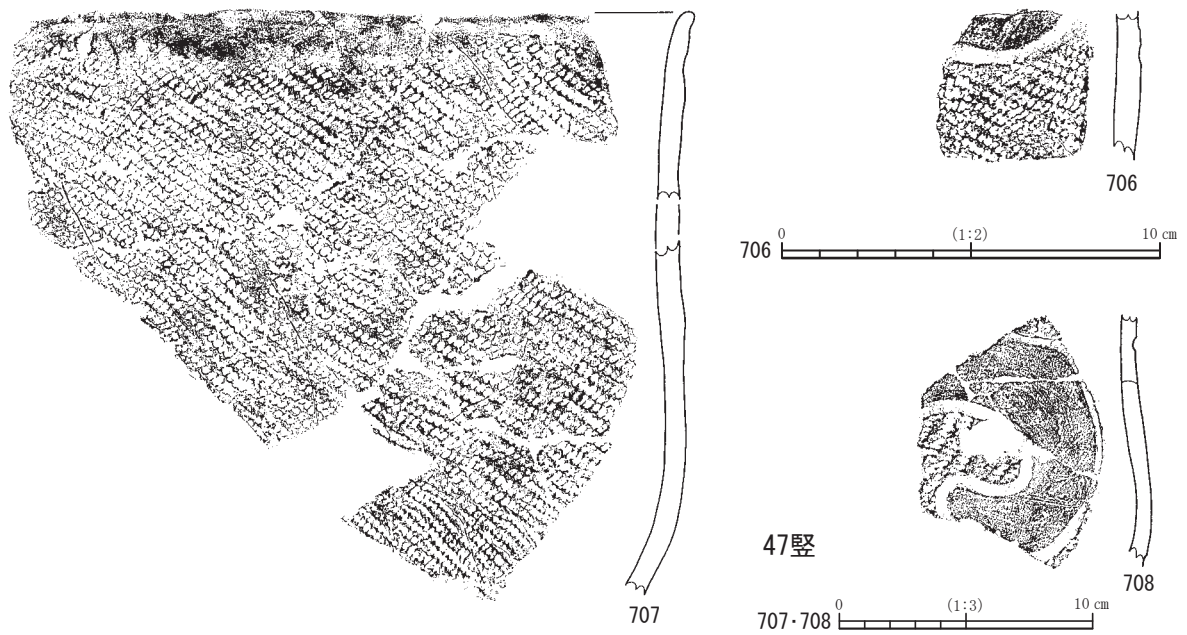
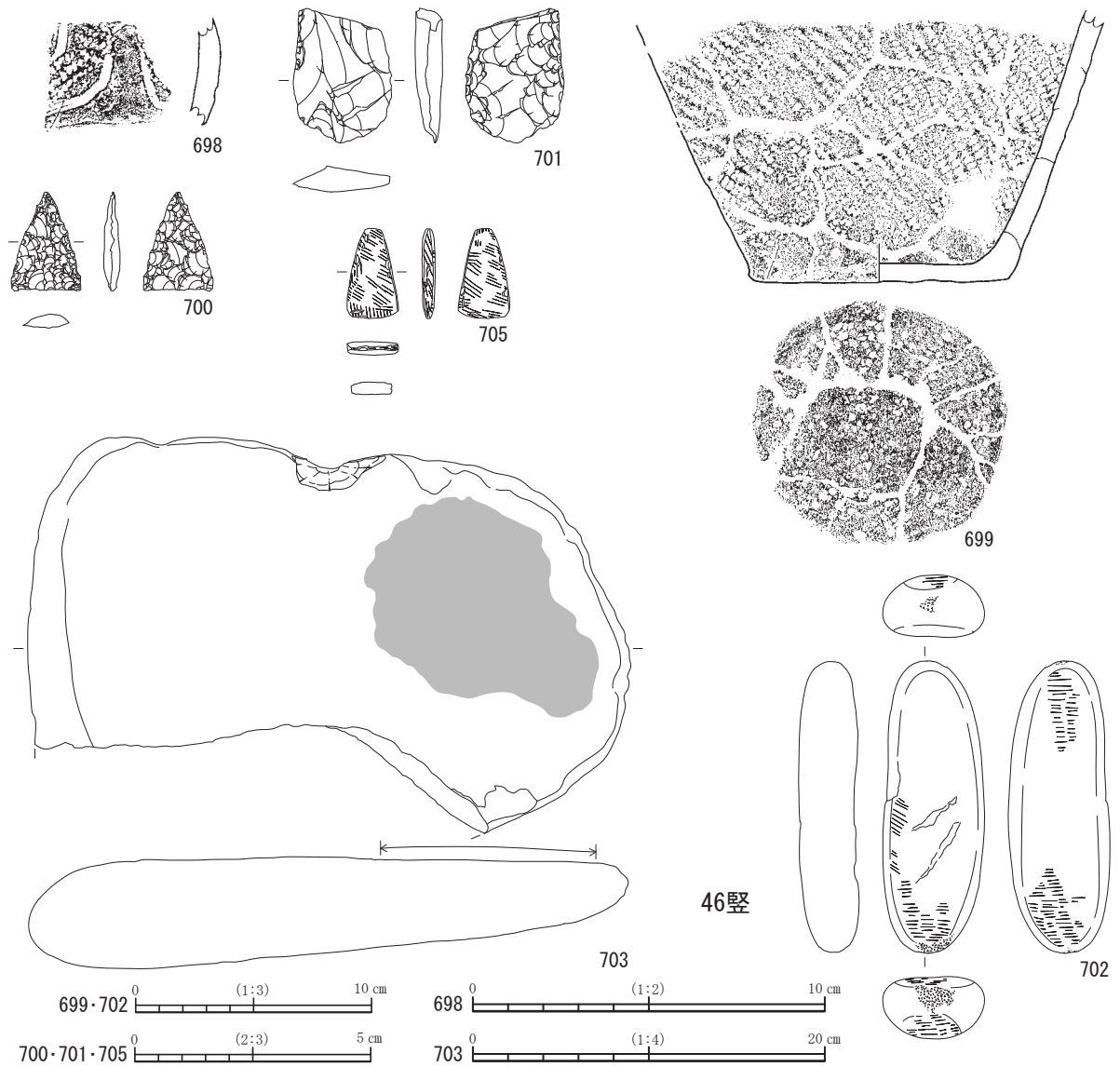

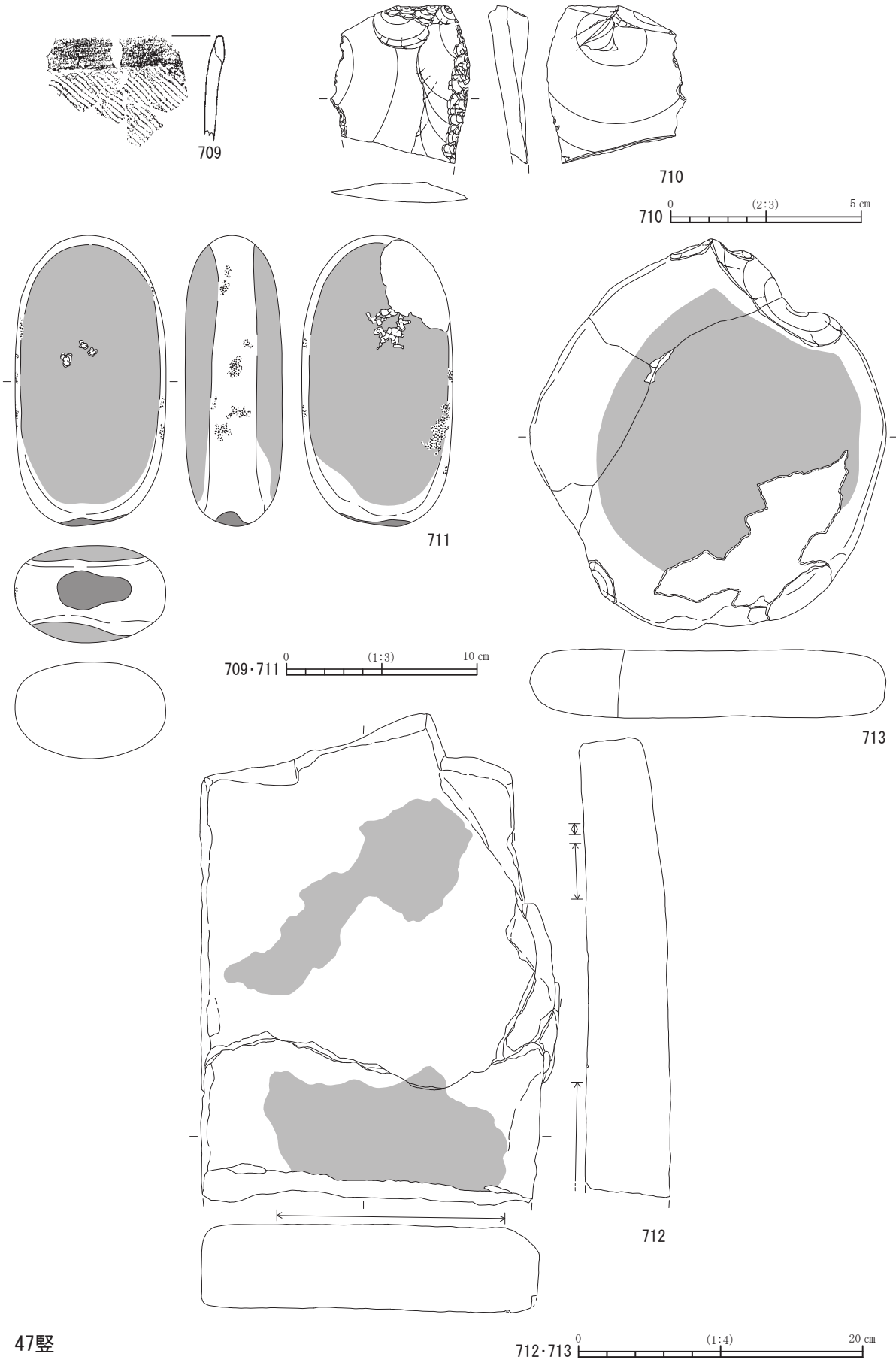

47 豎

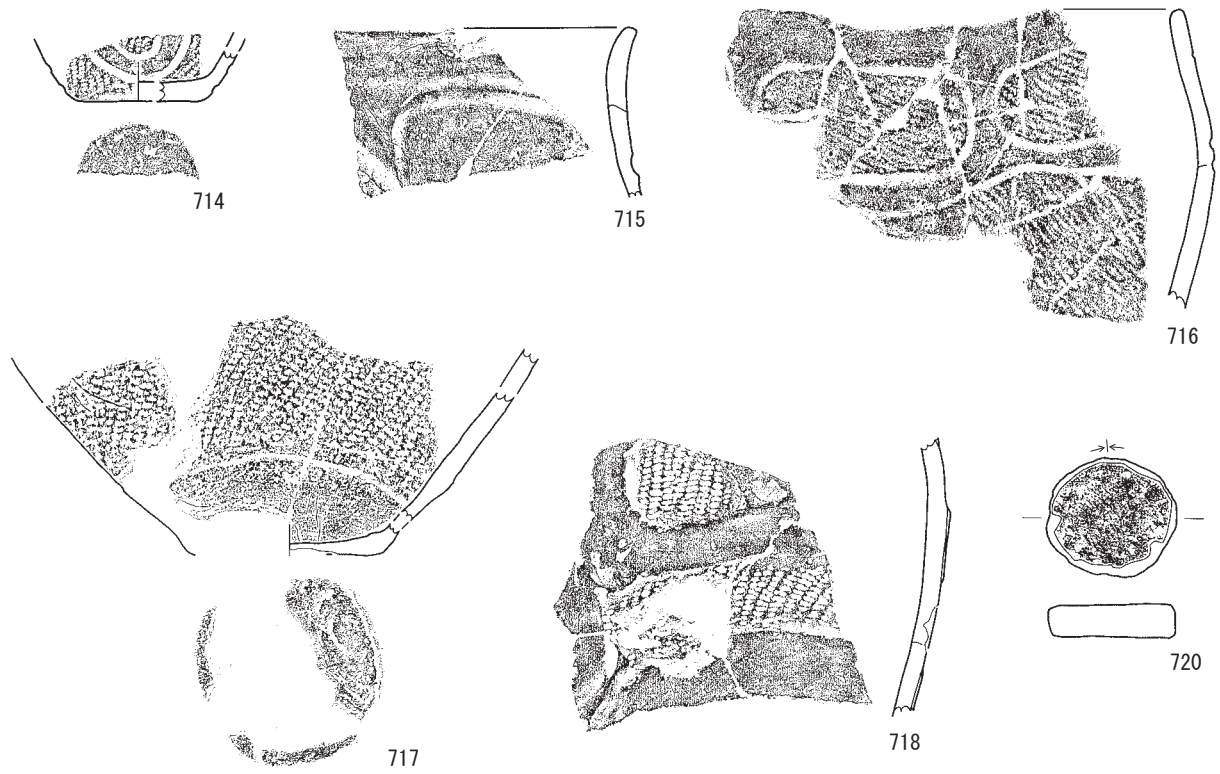

714~719 0 (1:3) 10 cm

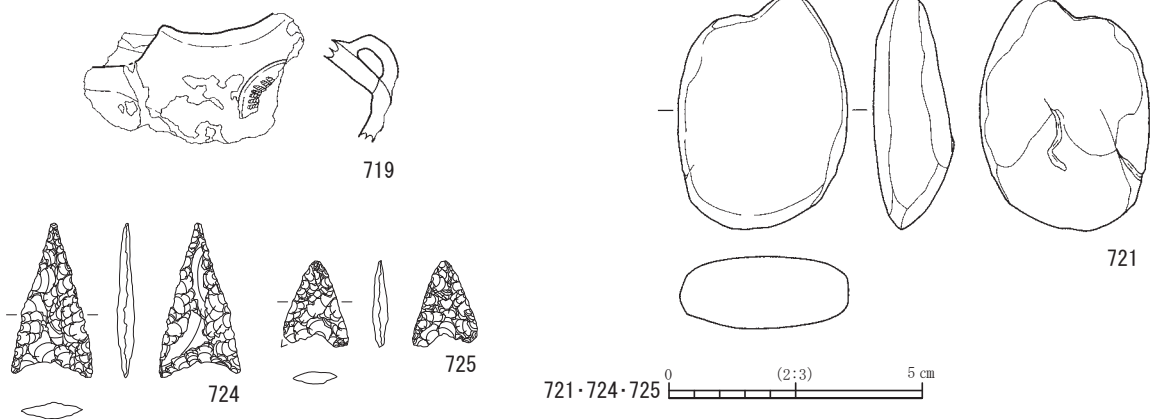

721・724・725 0 (2:3) 5 cm

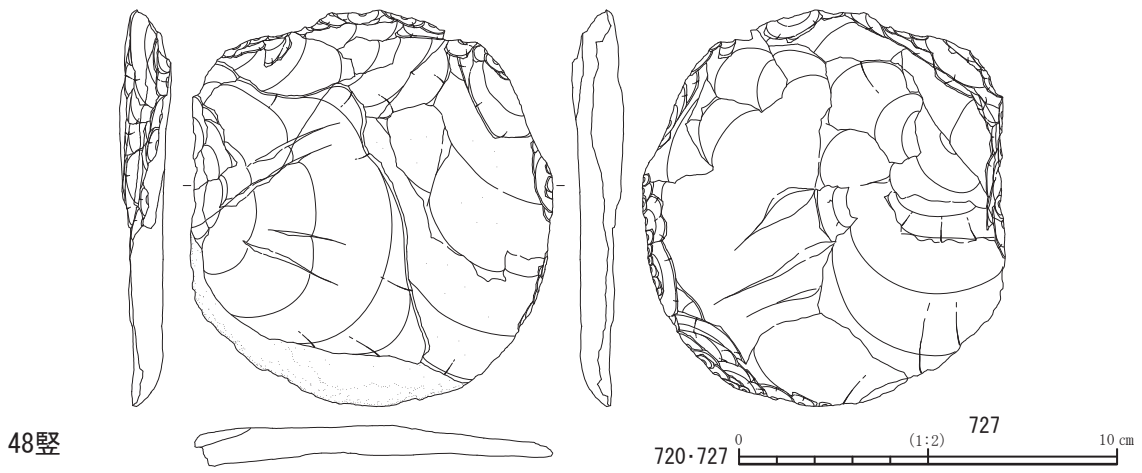

720・727 0 (1:2) 10 cm

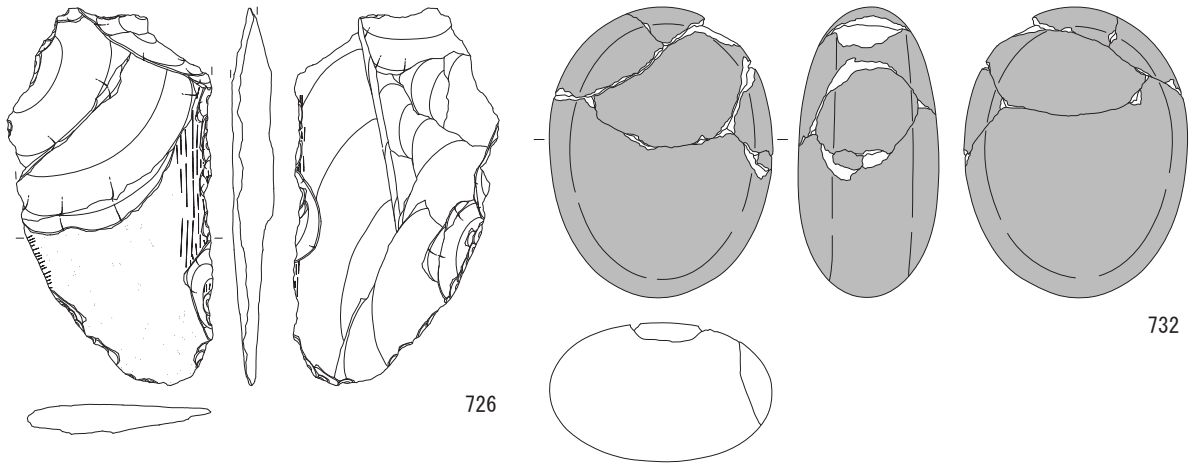

726

732

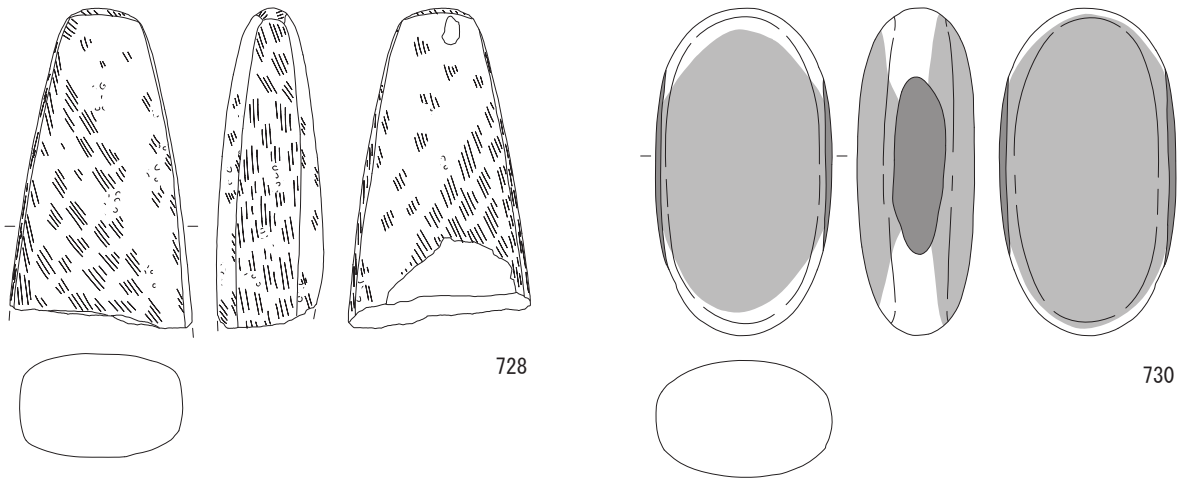

728

730

726-728 0 (1:2) 10 cm

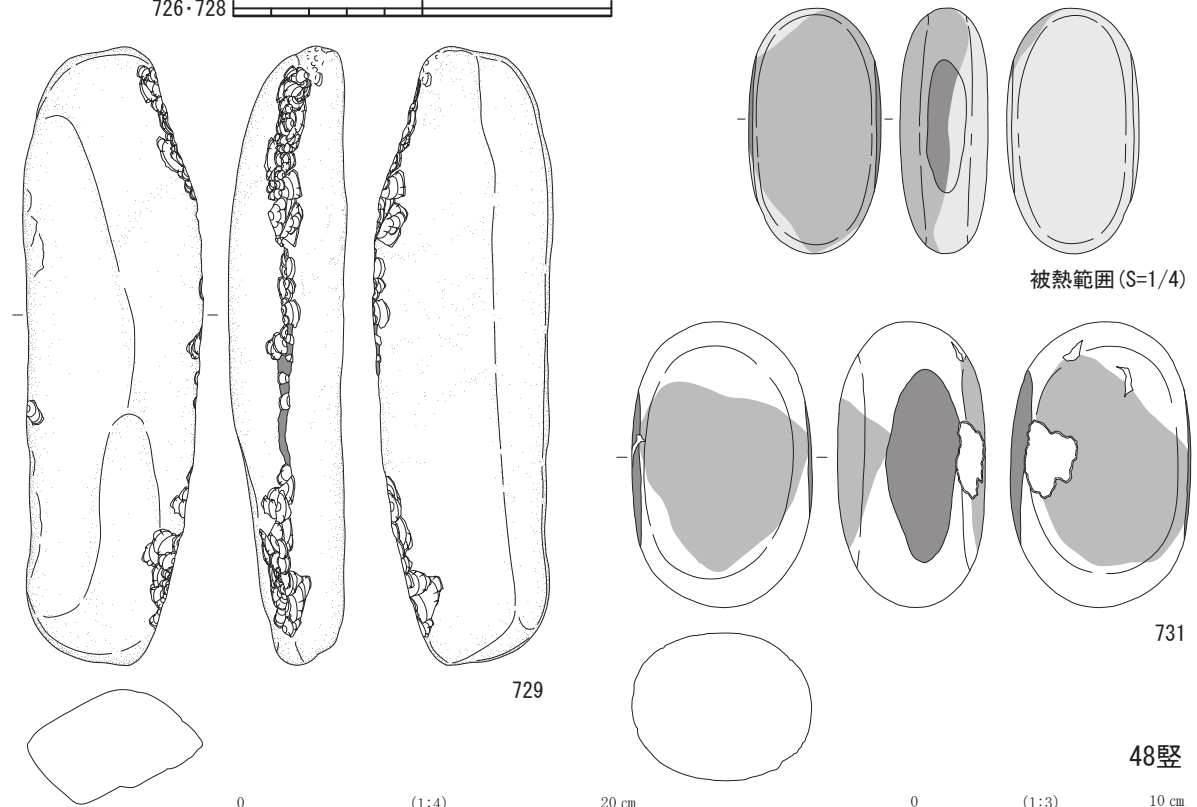

729

731

被熱範囲 (S=1/4)

48 豎

729 0 (1:4) 20 cm

730~732 0 (1:3) 10 cm

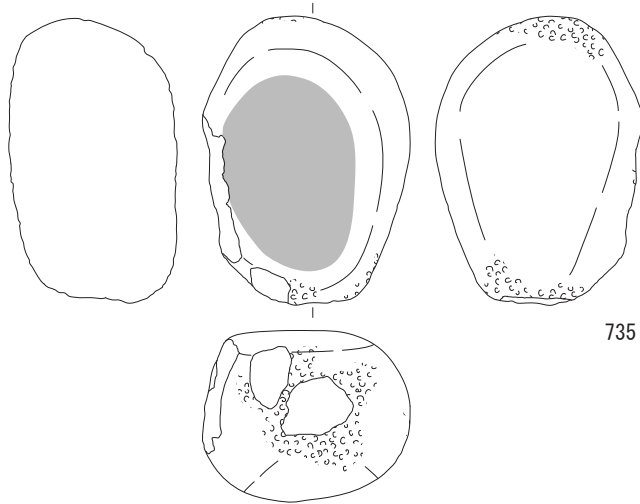

735

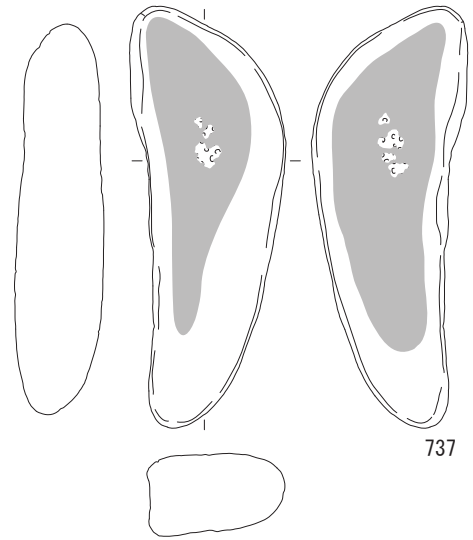

737

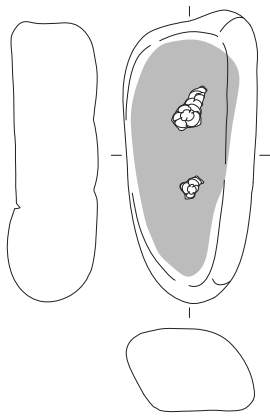

736

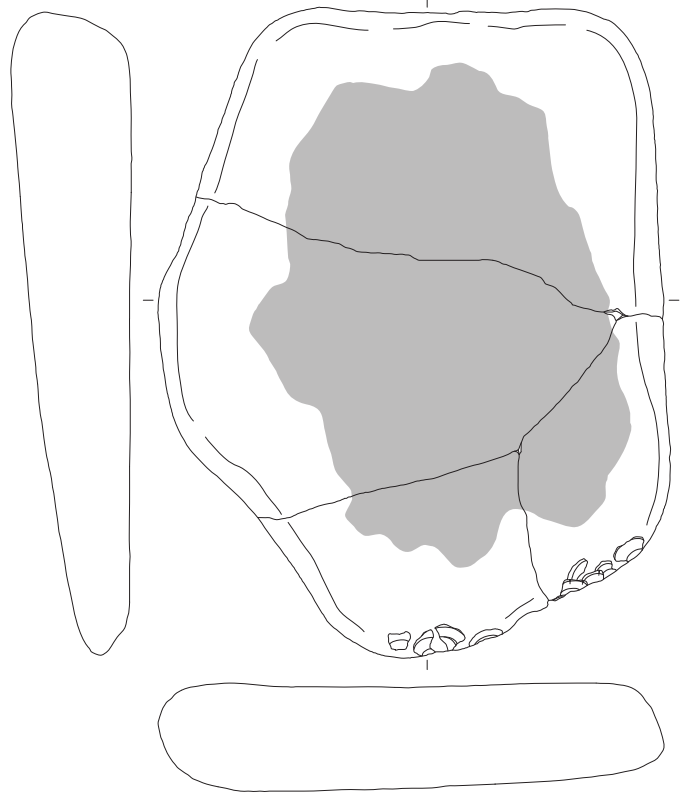

739

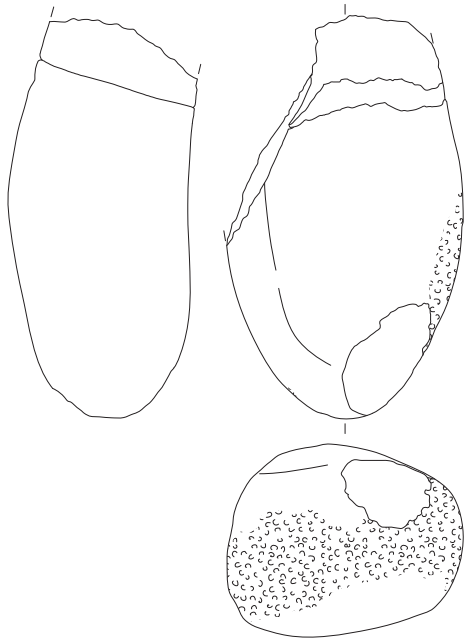

738

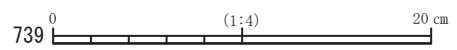

48 豎



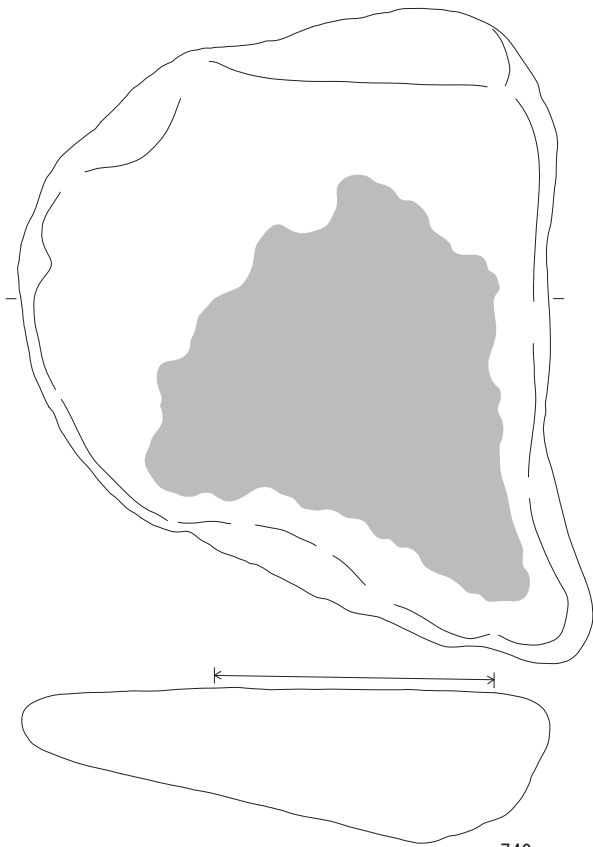

740

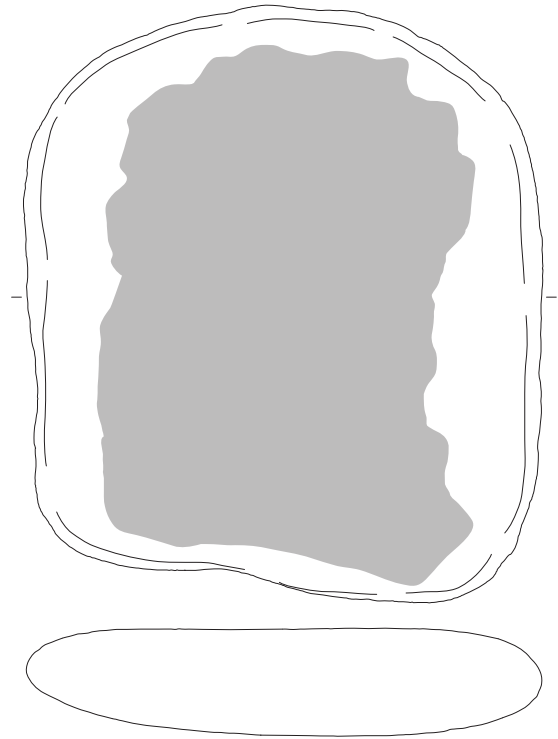

742



741

48 豎

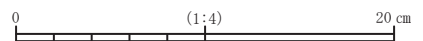

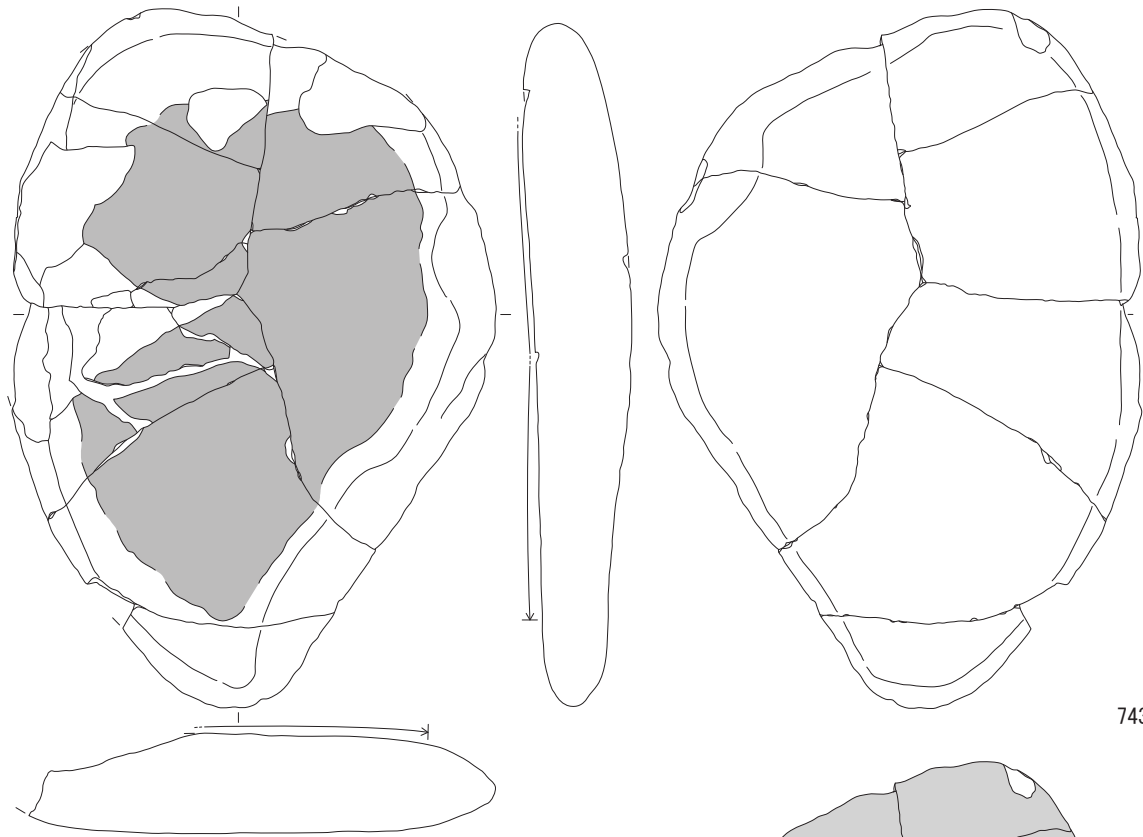

743

0 (1:5) 20 cm

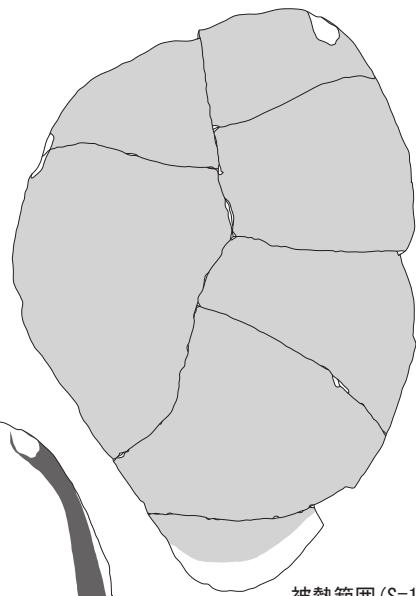

被熱範囲 (S=1/6)



黒色範囲 (S=1/6)

48 豎

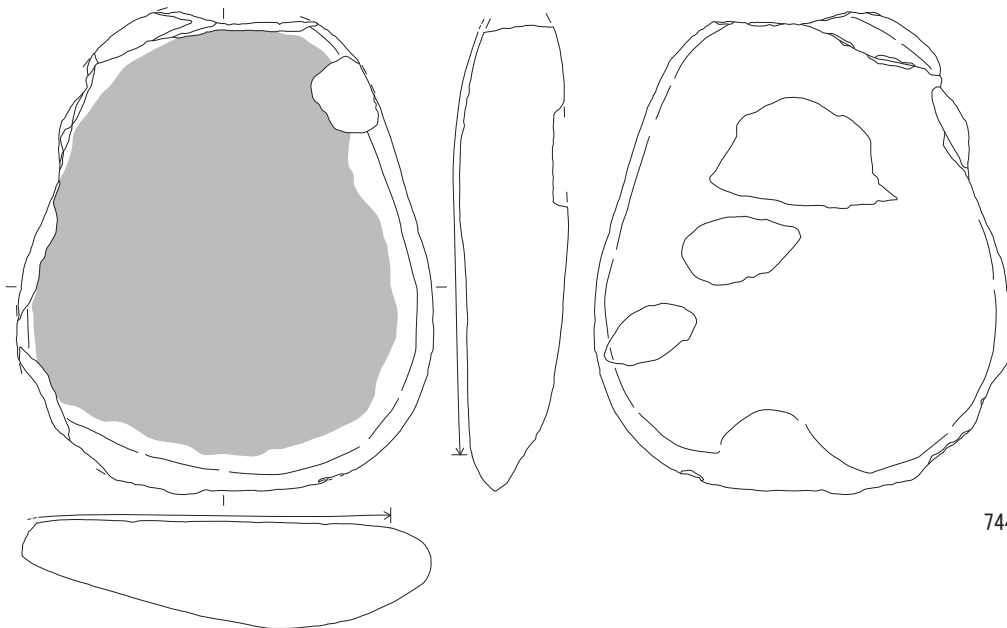

744

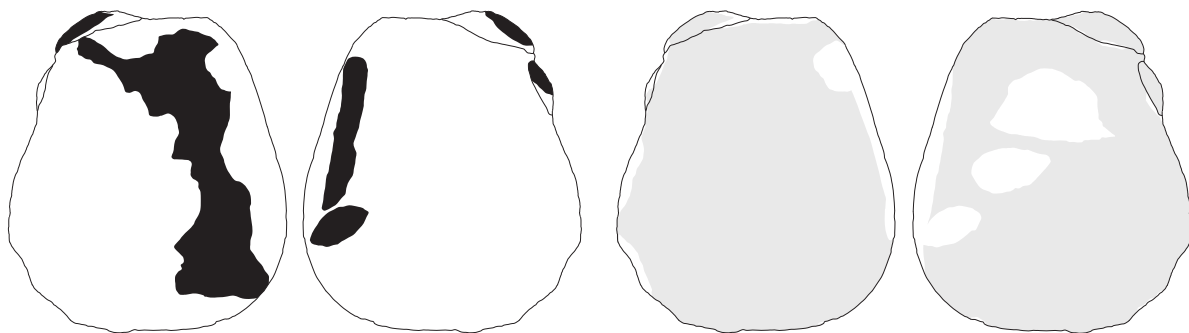

スス範囲 (S=1/6)

被熱範囲 (S=1/6)

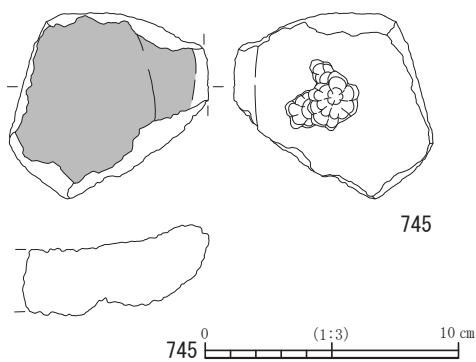

745

745 0 (1:3) 10 cm

48 豎

744 0 (1:4) 20 cm

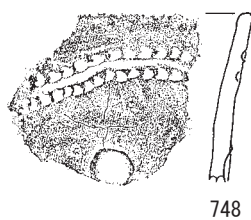

748



749



747

49 豎

0 (1:3) 10 cm

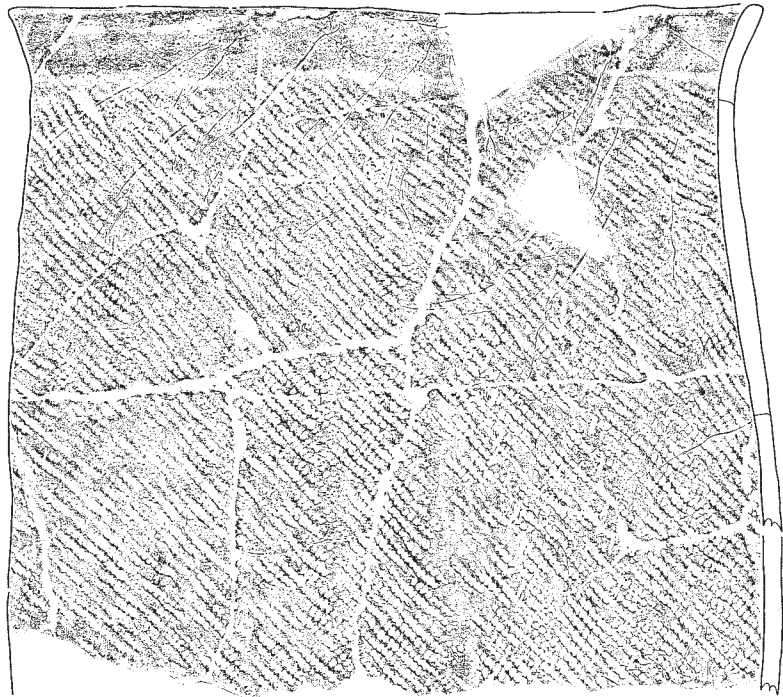

751

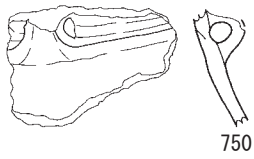

750

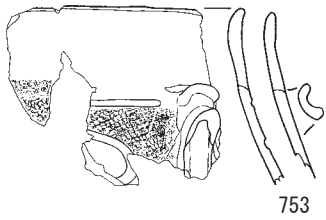

753

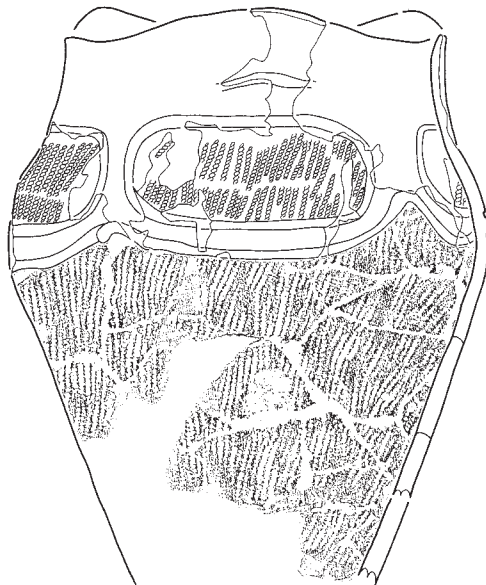
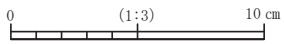

752

49 豎

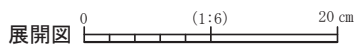

展開図

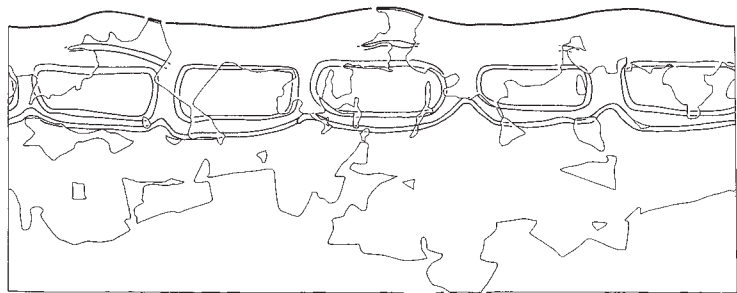

752 展開図



754

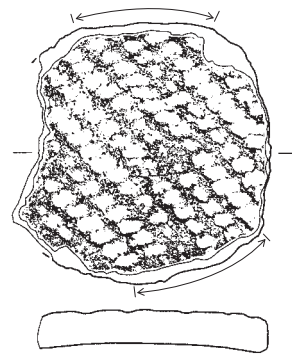

758

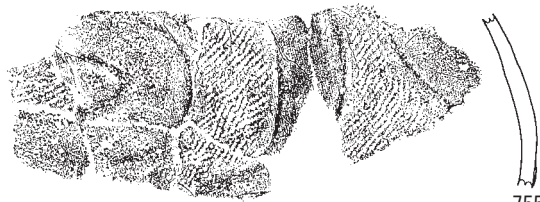

755

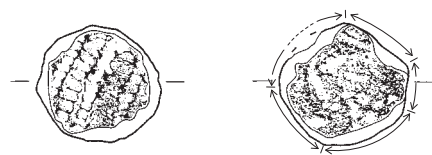

759

760

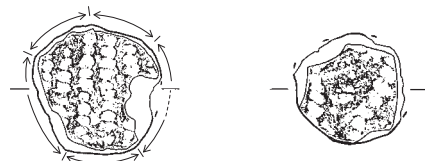

761

762



756

754~756 (1:3) 10 cm



757

758~762·766 (1:2) 10 cm

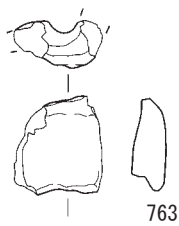

763

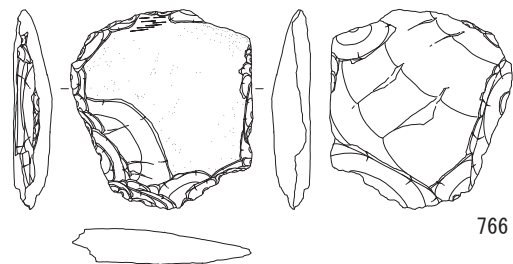

766

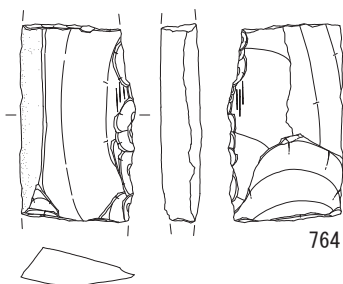

764

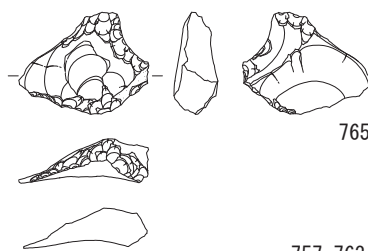

765

49 豎

757·763~765 (2:3) 5 cm

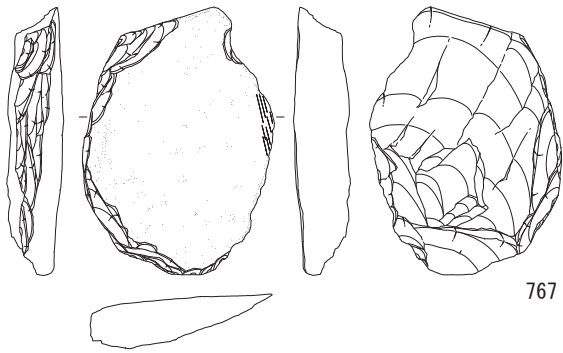

767

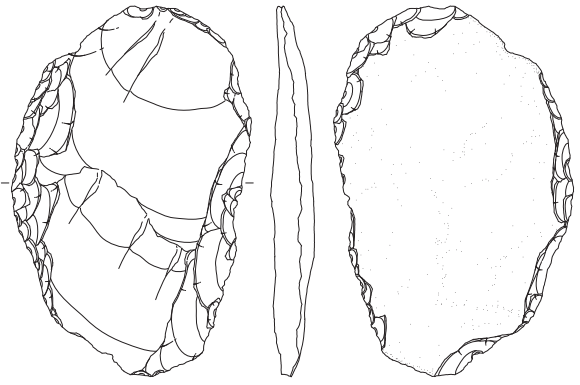

768

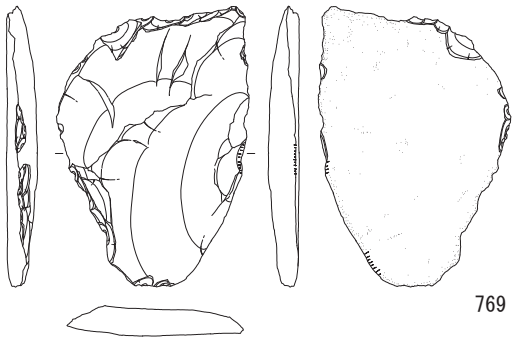

769

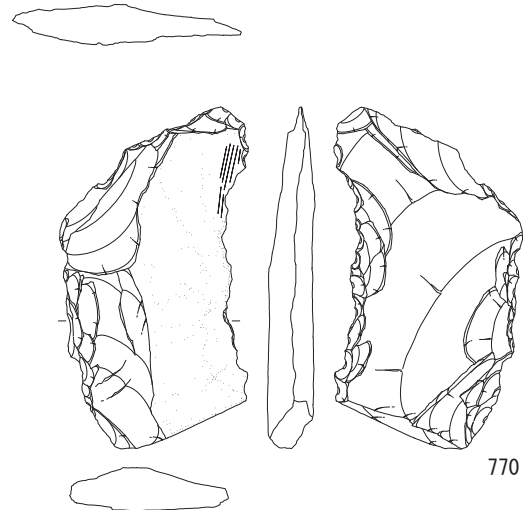

770

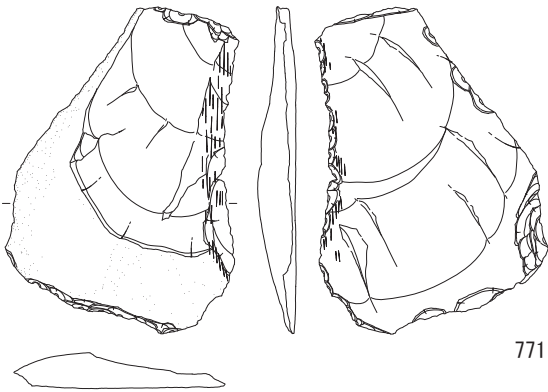

771

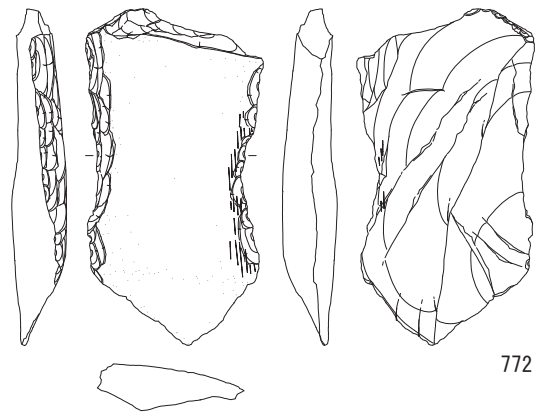

772

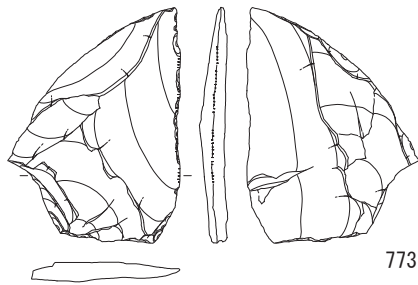

773

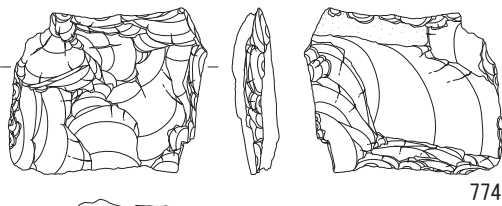

774

49 豎

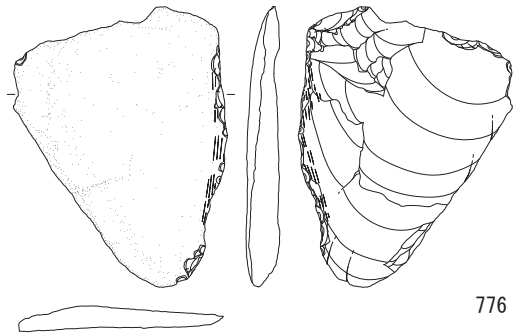

776

774 0 (2:3) 5 cm

767~773・776 0 (1:2) 10 cm

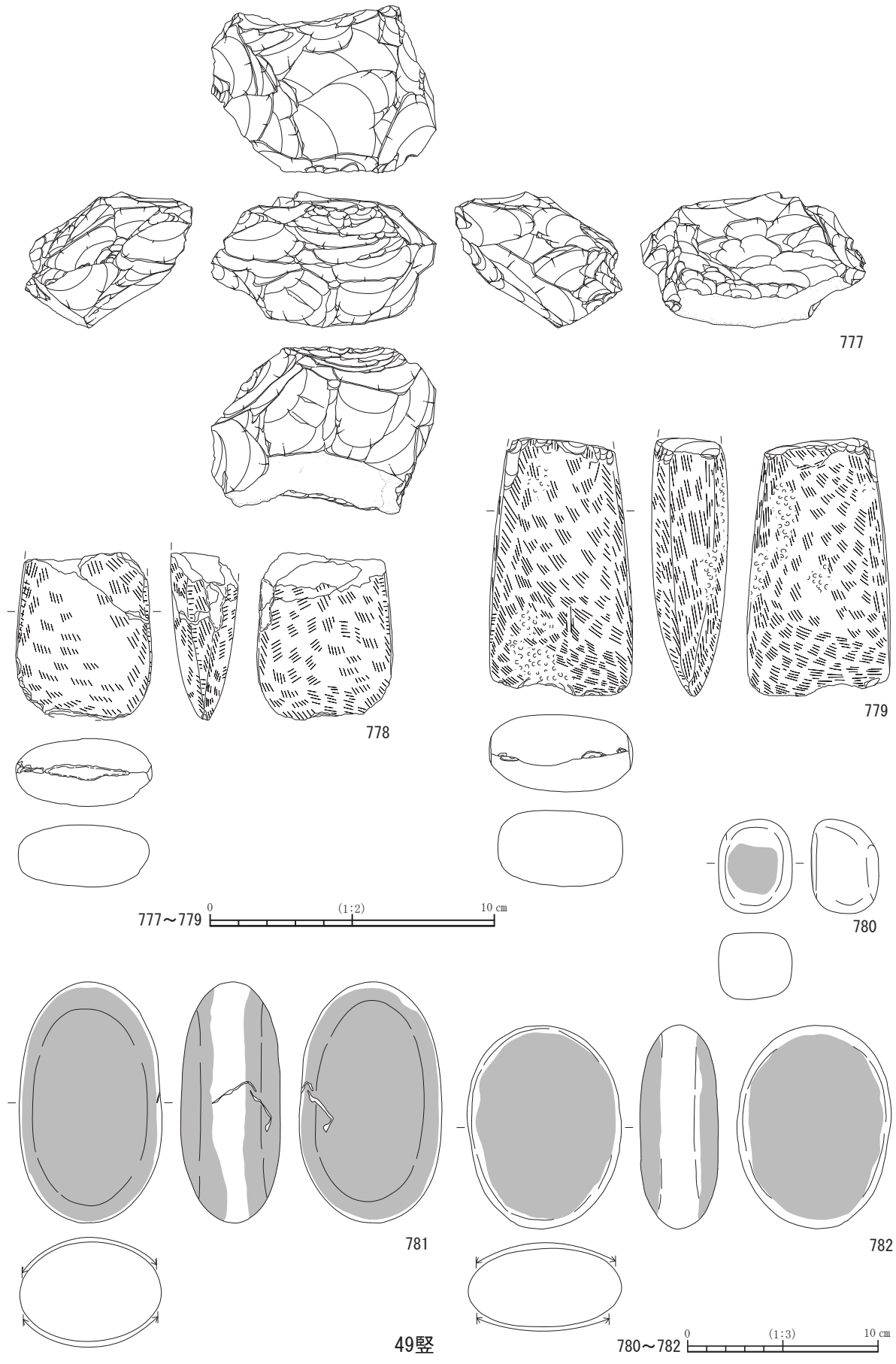

遺物図版103 縄文時代の遺物103

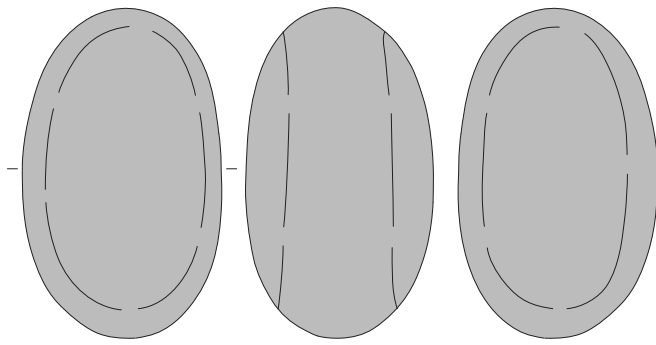

783

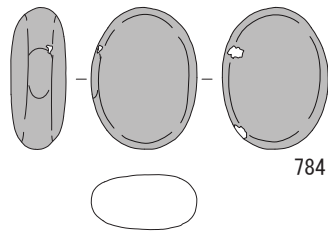
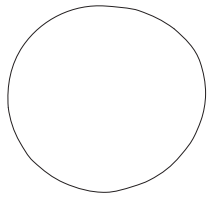

784

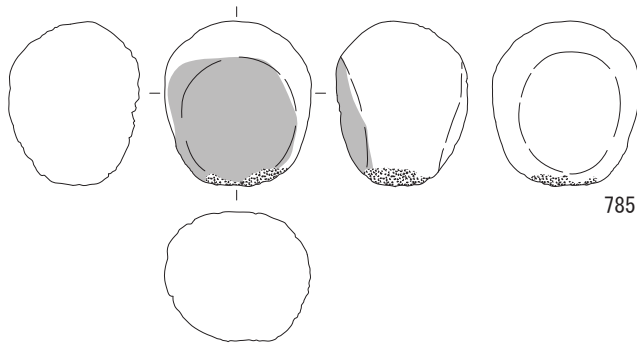

785

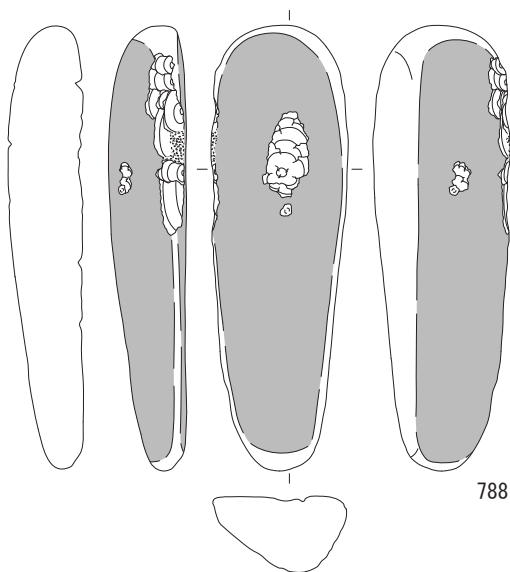

788

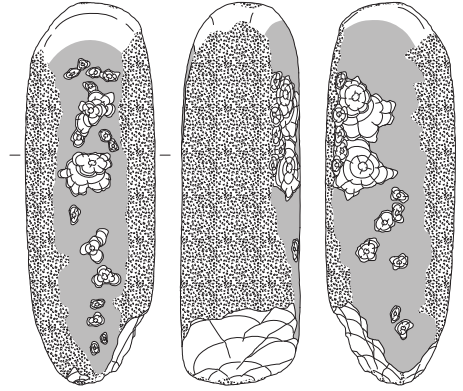

787

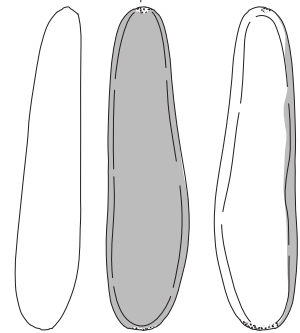
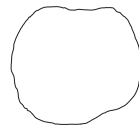
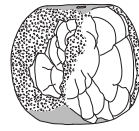

786

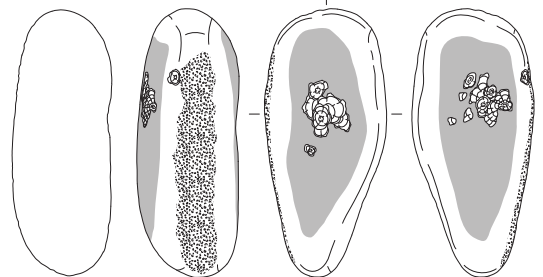

789

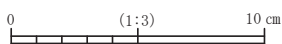

49 豎

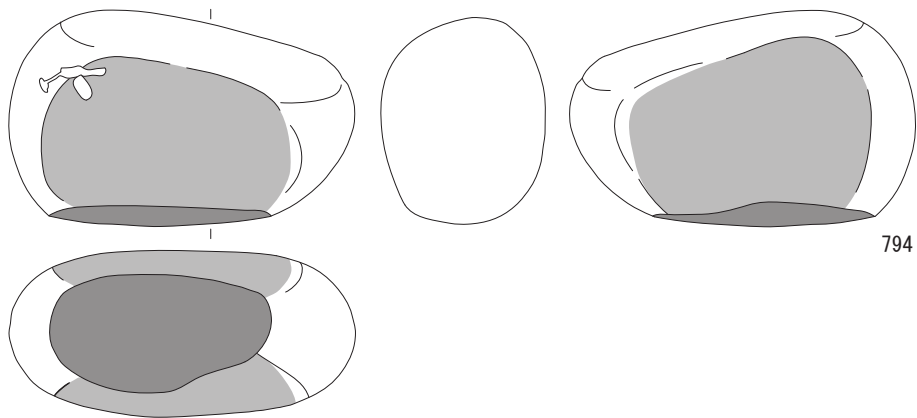
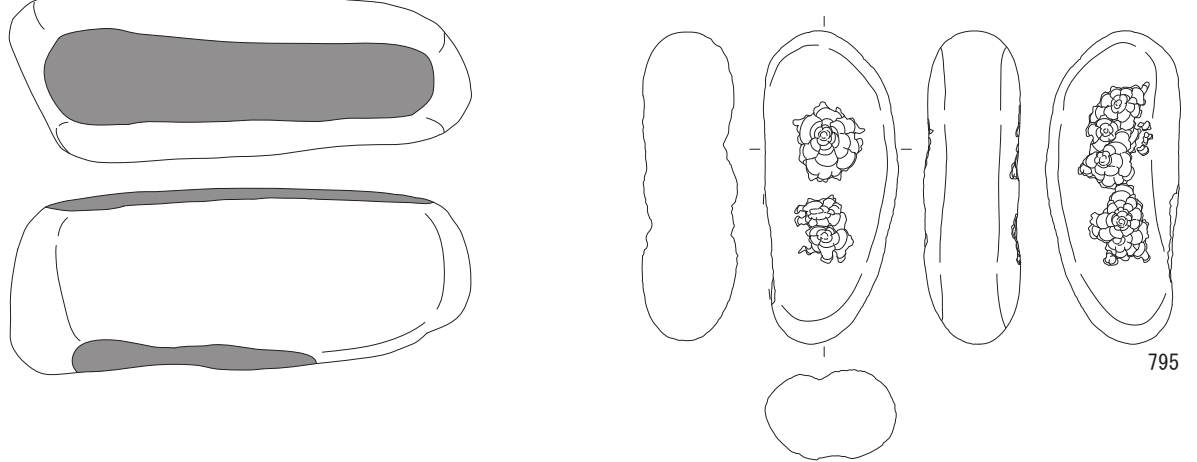
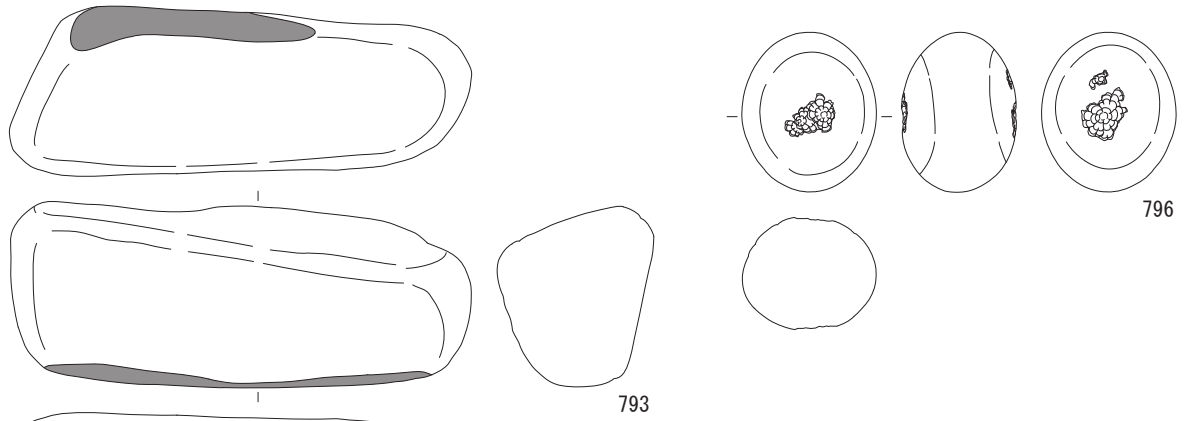
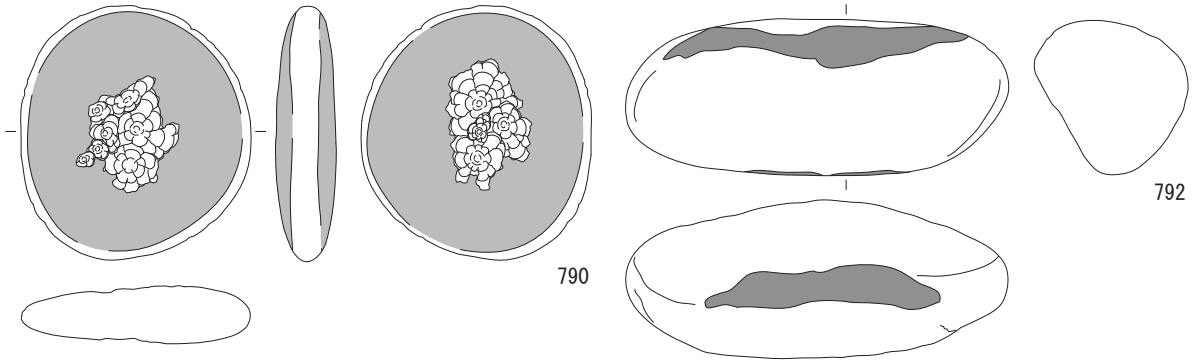

49 豎

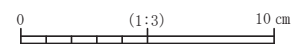

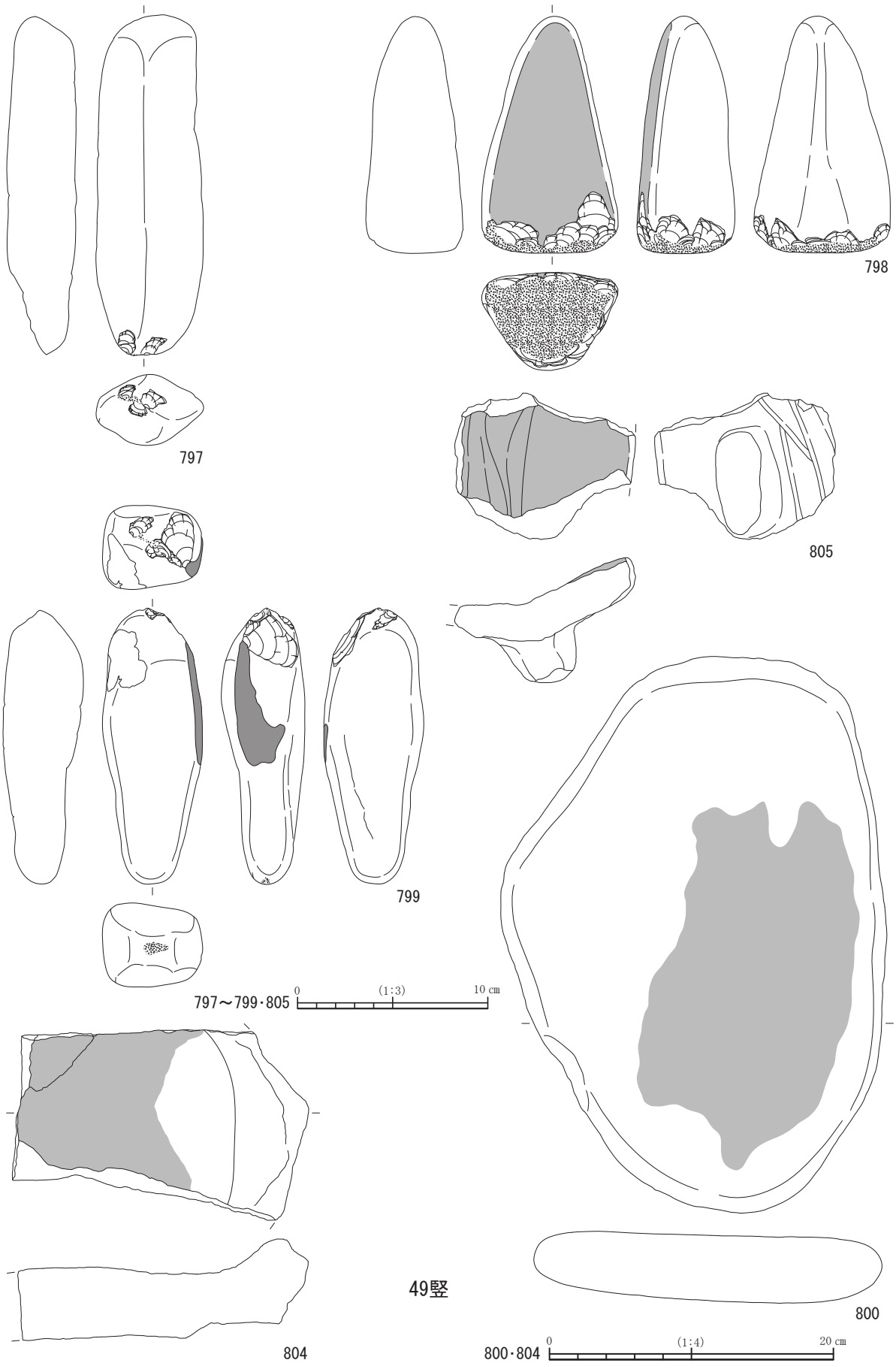

遺物図版106 縄文時代の遺物106

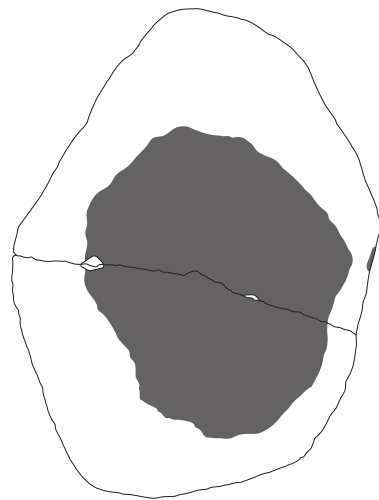
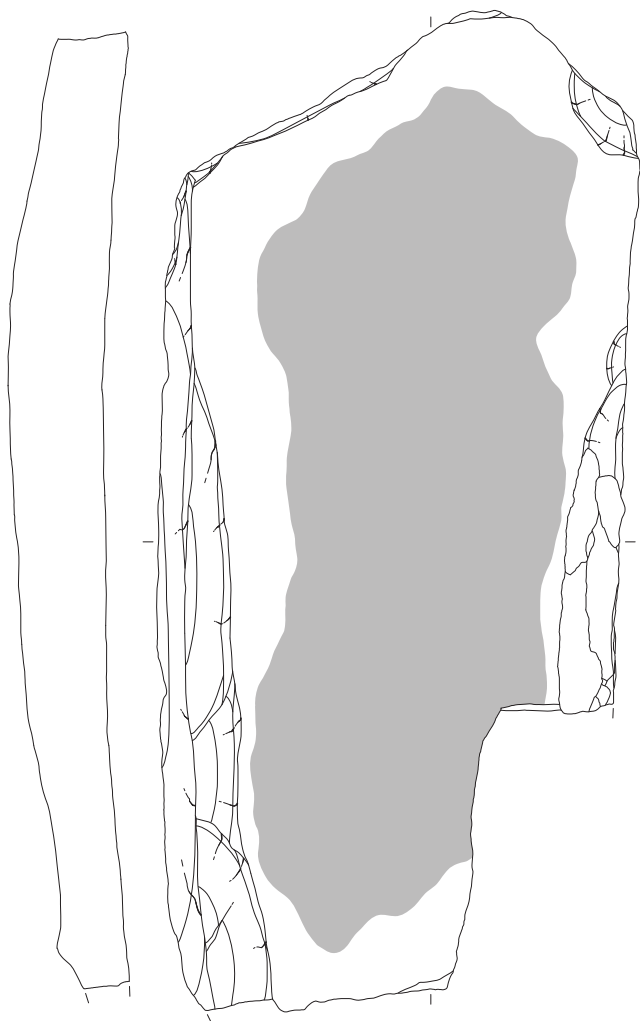

黒色範囲(S=1/6)

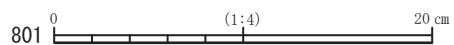

801



802

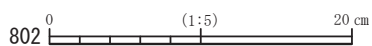

802

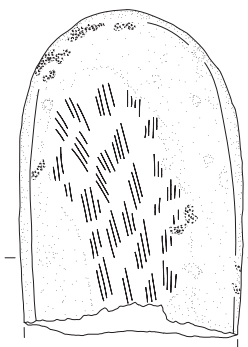

806

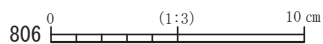

806

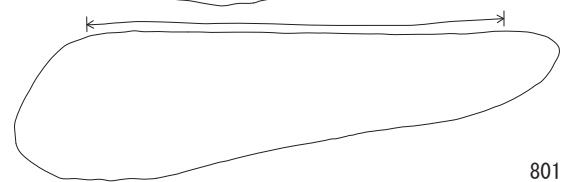
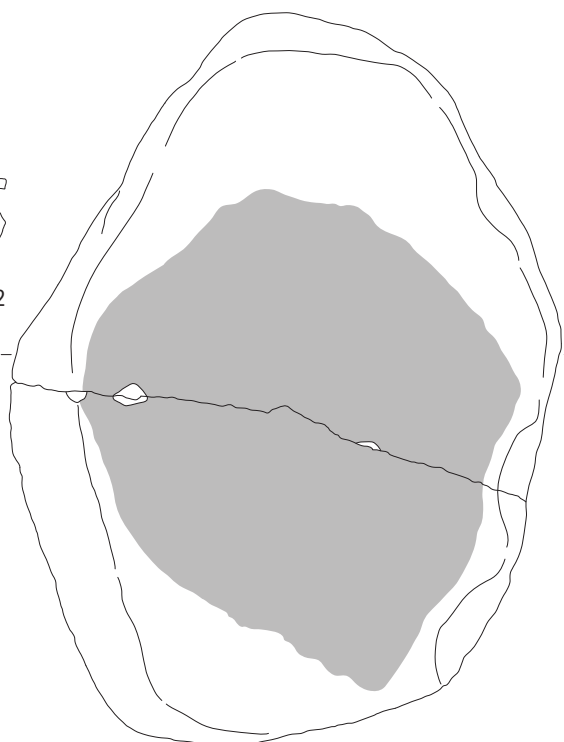

801

49 豎

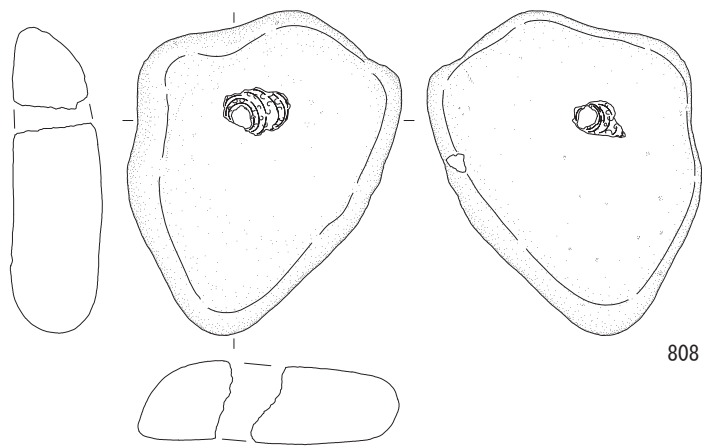

808

0 (1:3) 10 cm

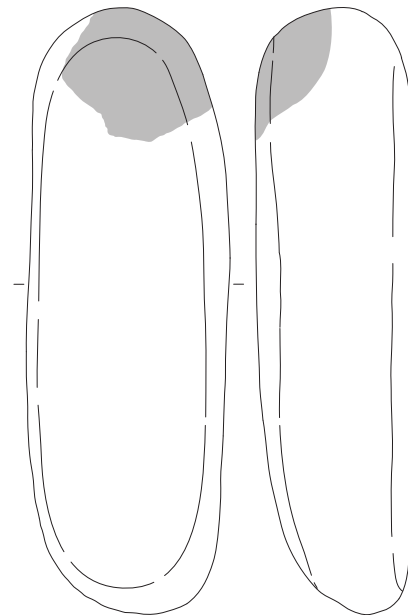

809

0 (1:4) 20 cm

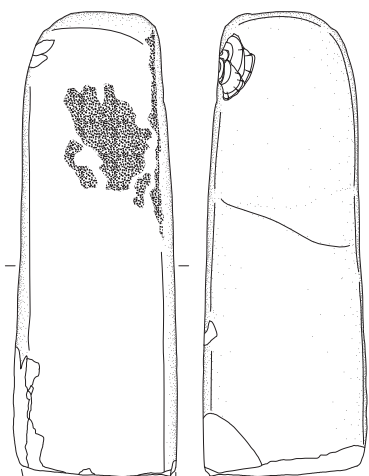

810

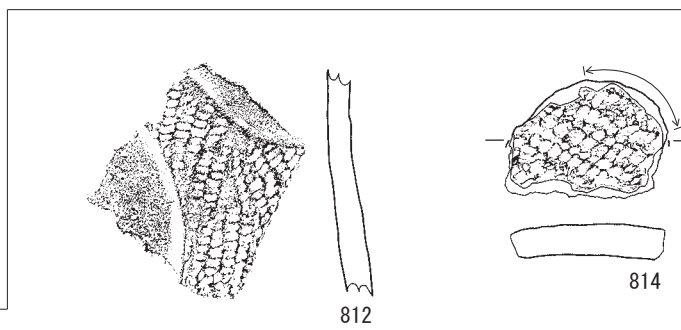

812

814

0 (1:2) 10 cm



811

0 (1:3) 10 cm

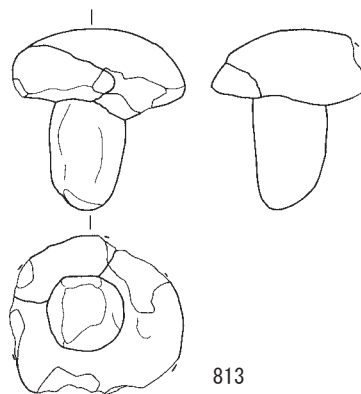

813

0 (2:3) 5 cm

50 豎

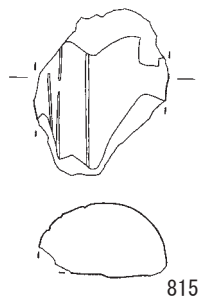

815

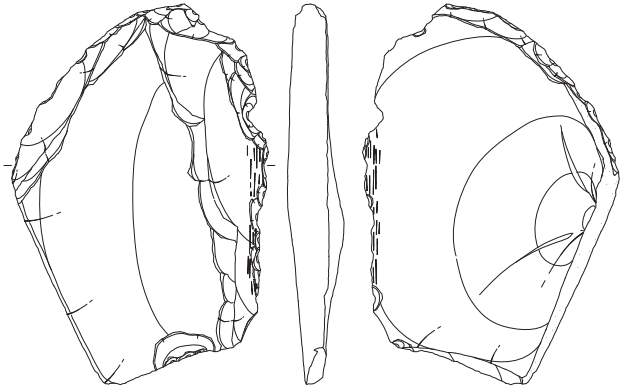

816



817

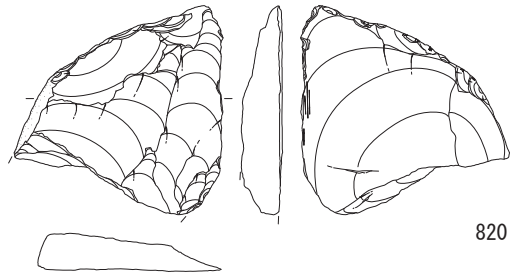

820

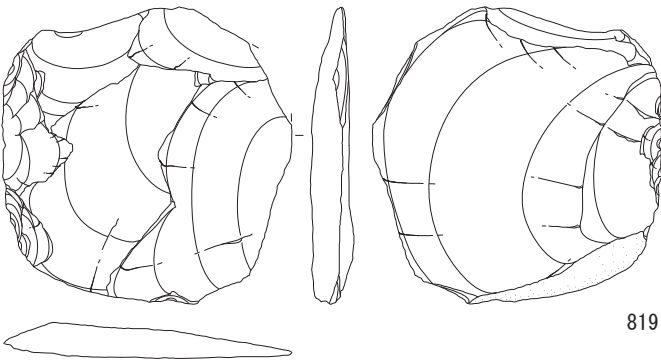

819

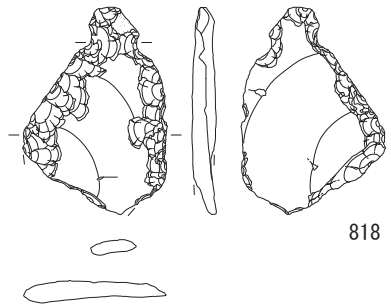

818

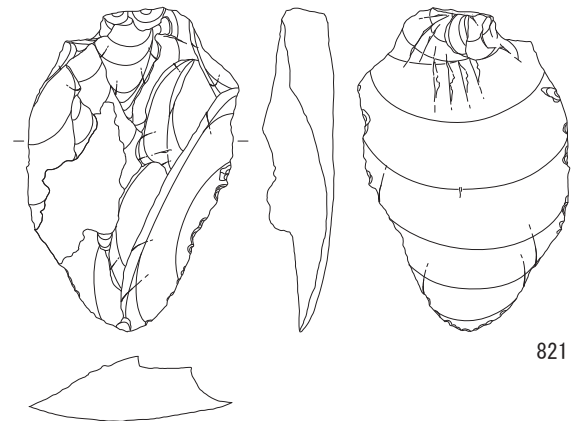

821

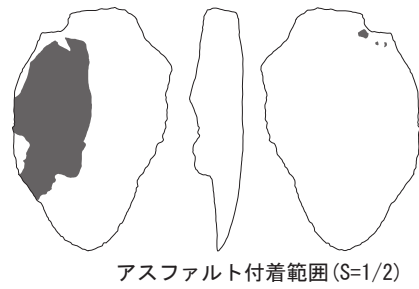

アスファルト付着範囲 (S=1/2)

50 豎

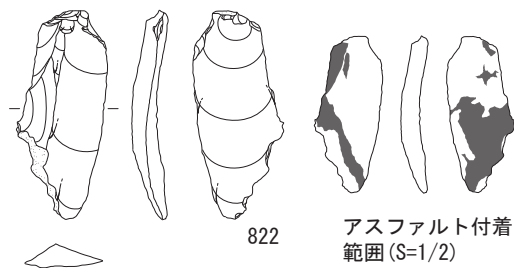

822

アスファルト付着範囲 (S=1/2)

815・818・821・822 0 (2:3) 5 cm

816・817・819・820 0 (1:2) 10 cm

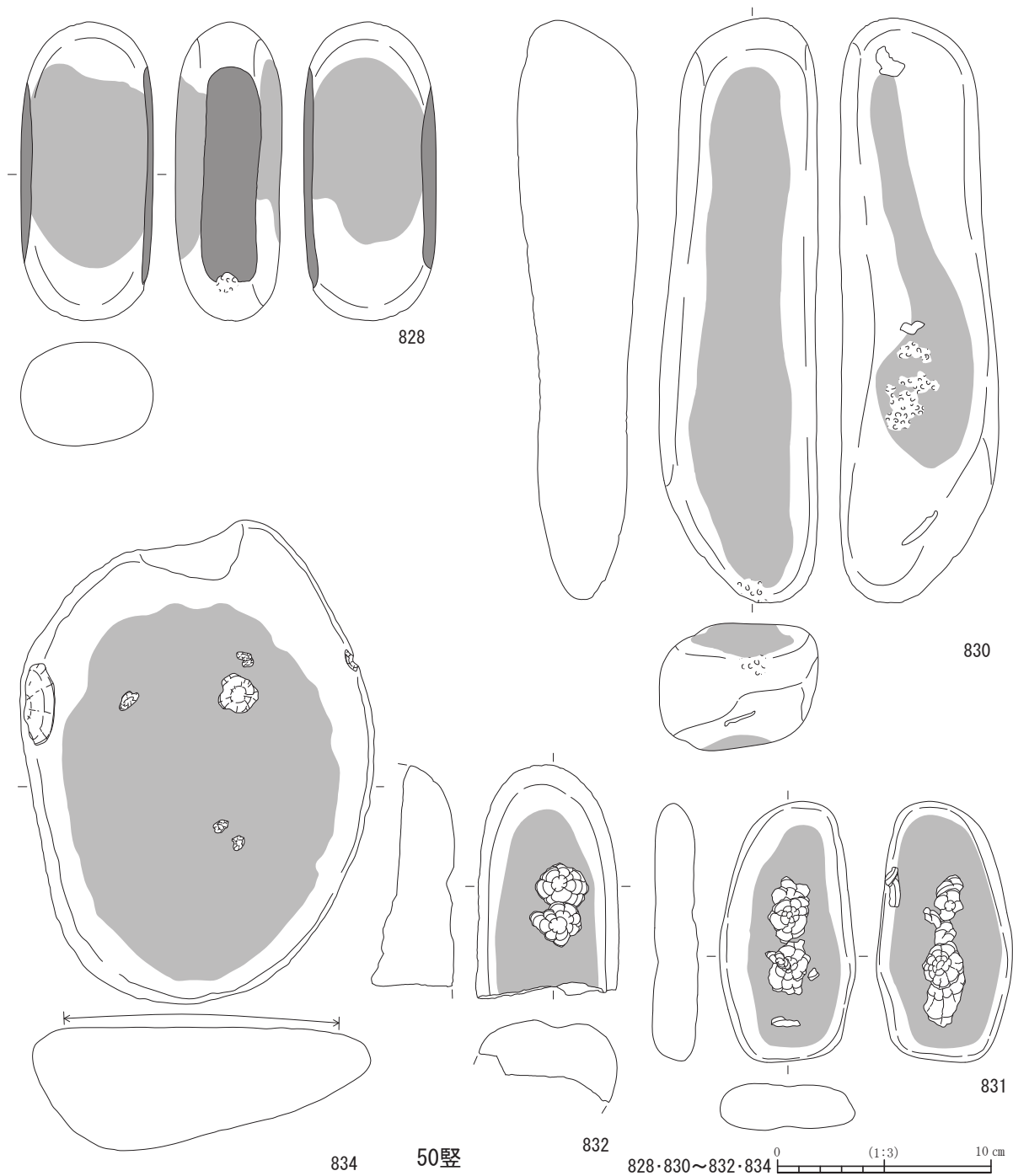
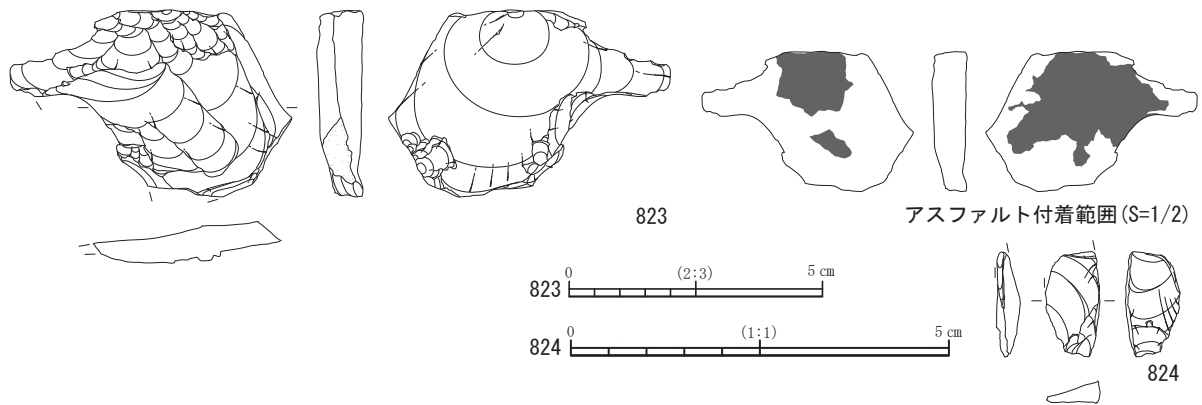

遺物図版110 縄文時代の遺物110

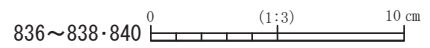
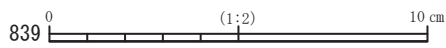
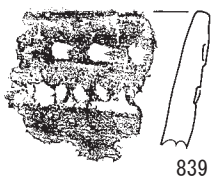
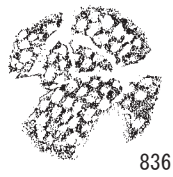
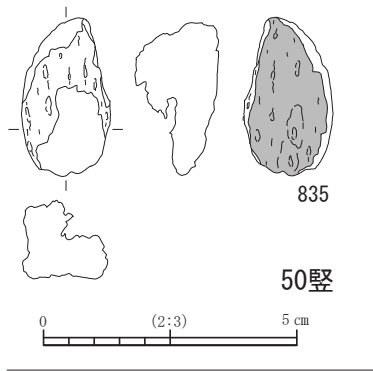

遺物図版111 縄文時代の遺物111

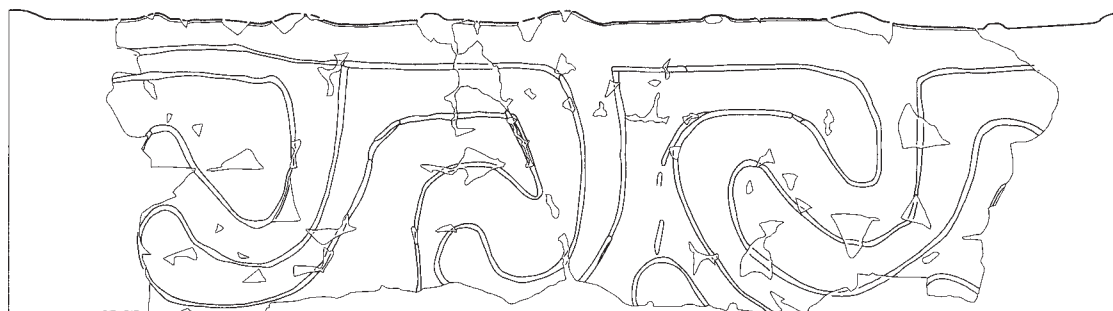

展開図 0 (1:6) 20 cm

840展開図

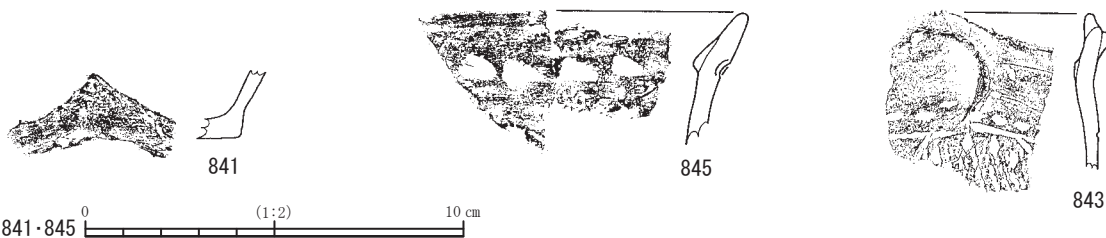

841・845 0 (1:2) 10 cm

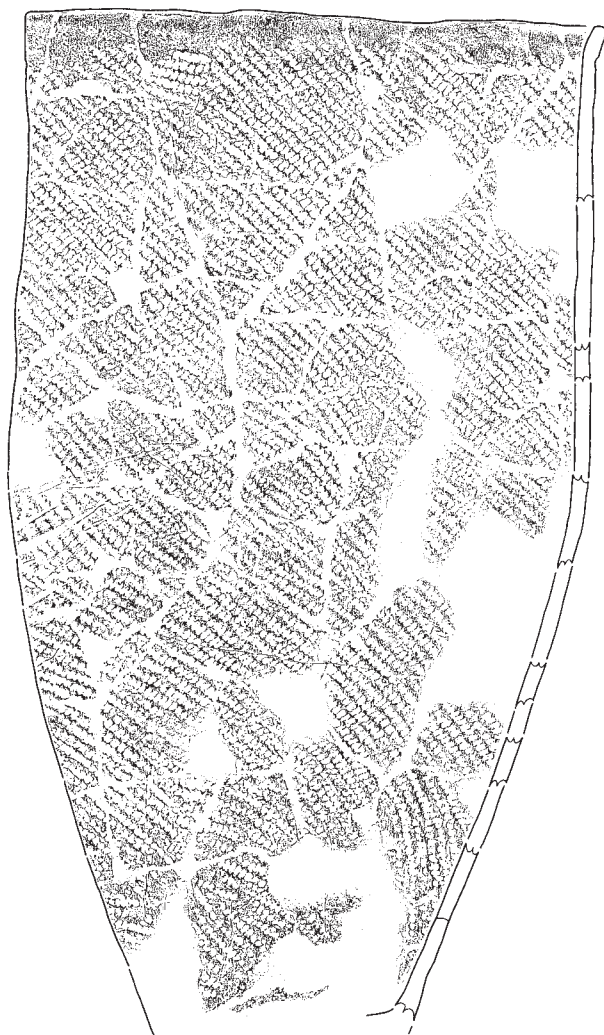

842

51 豎

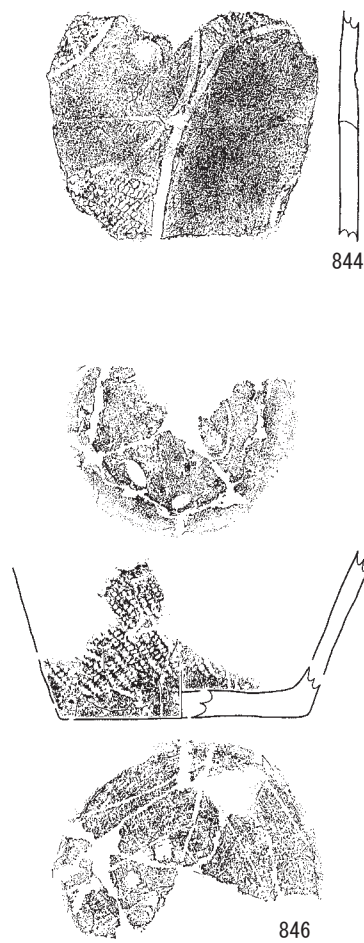

842~844・846 0 (1:3) 10 cm

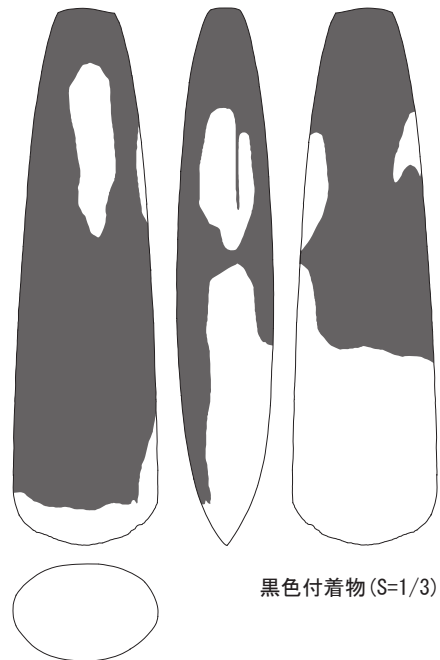
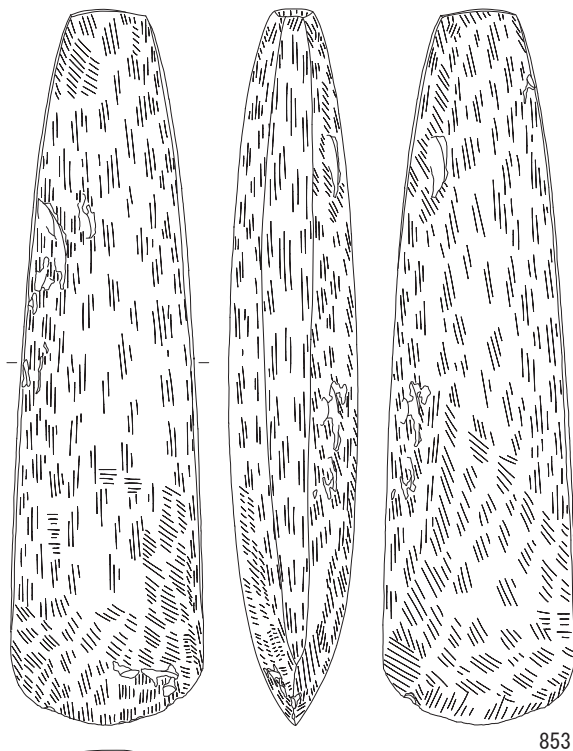
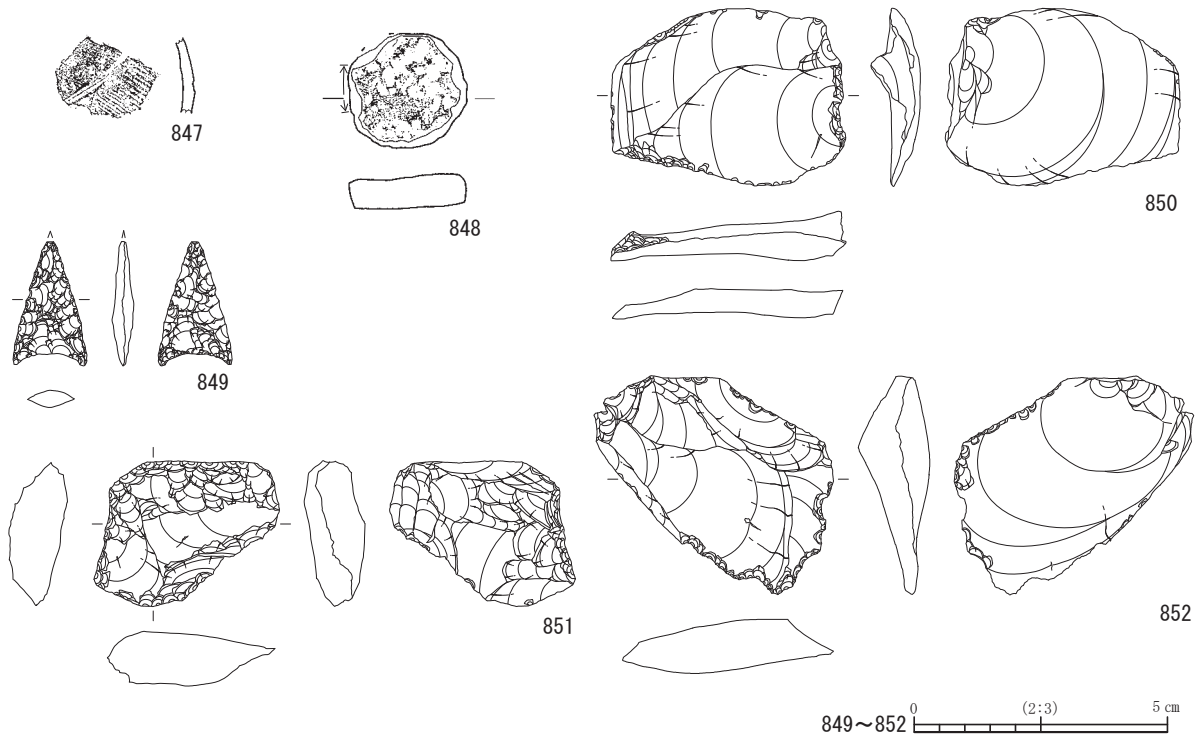

黒色付着物(S=1/3)

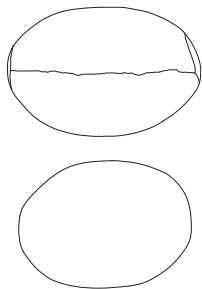

51 豎



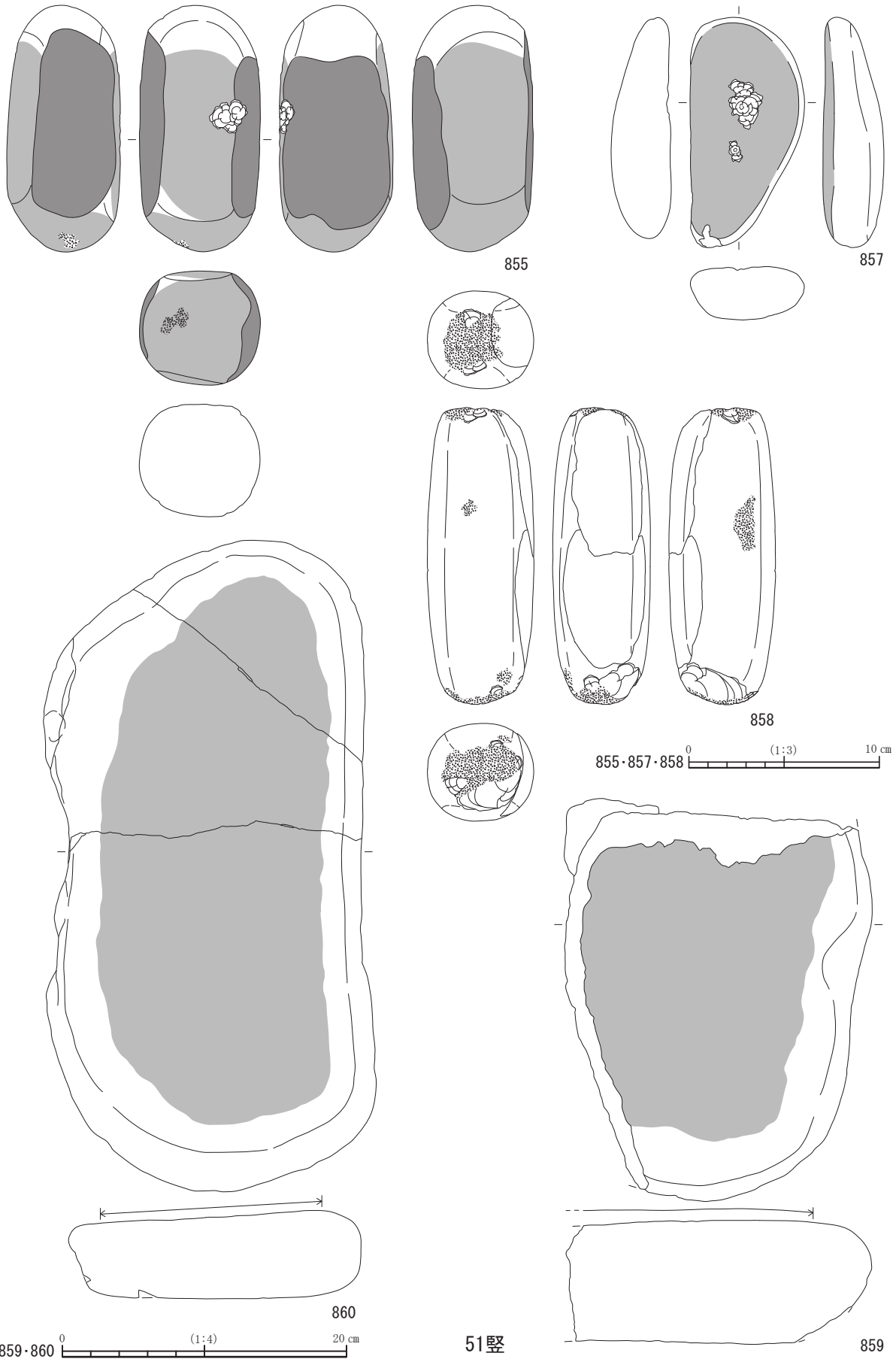

遺物図版114 縄文時代の遺物114

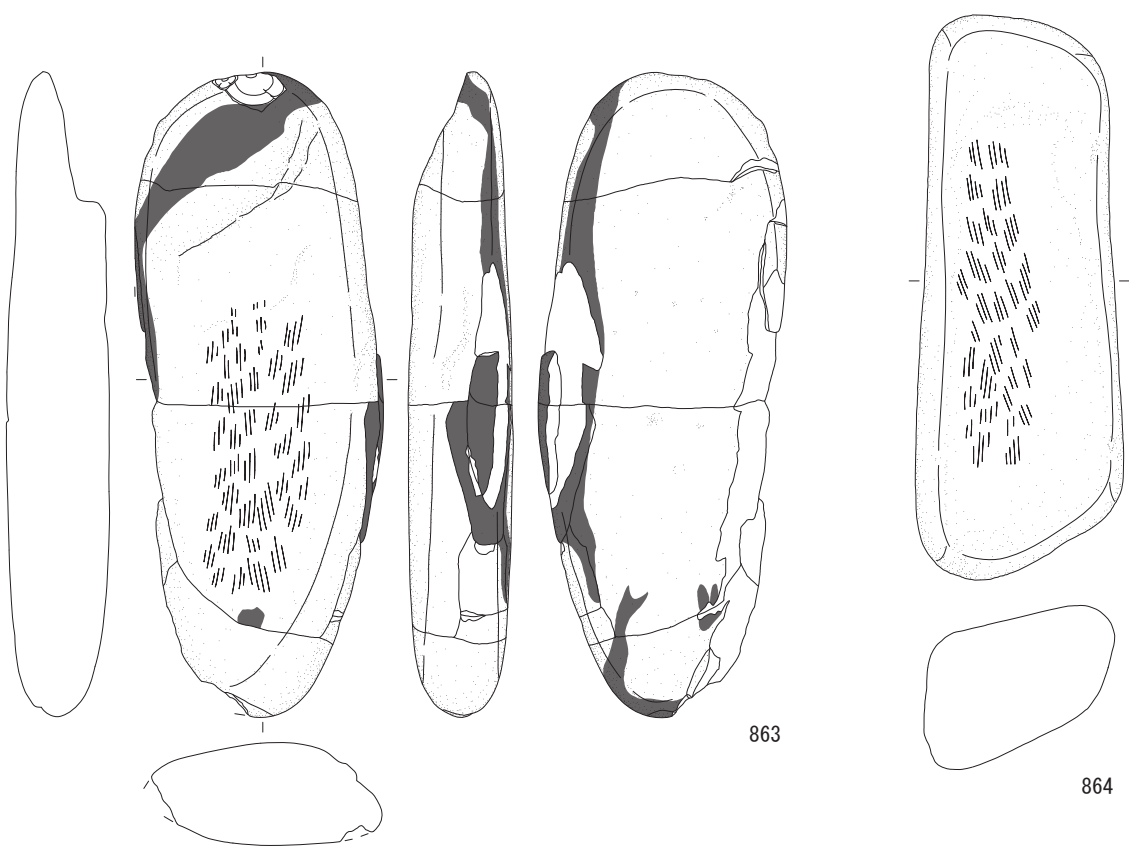
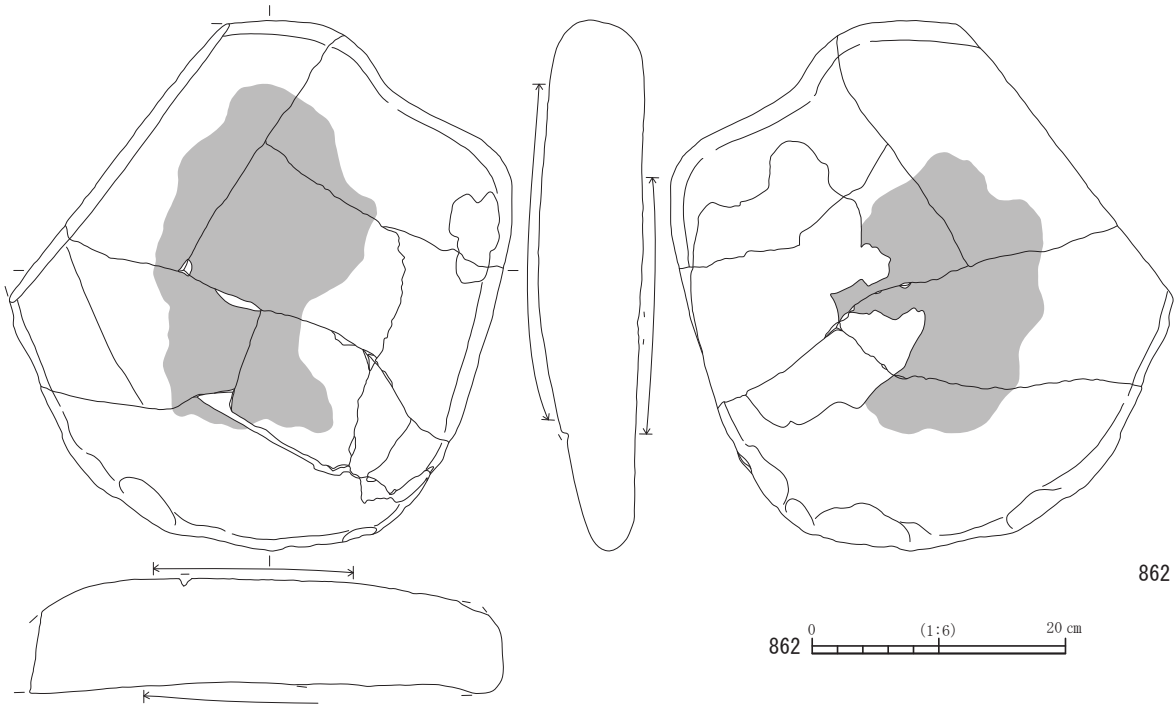

51 豎

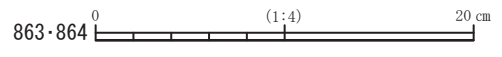

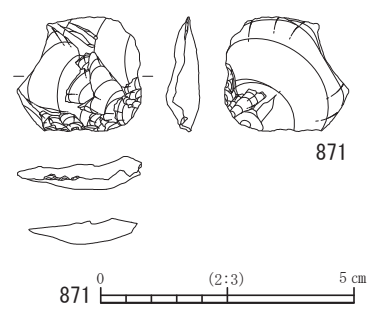
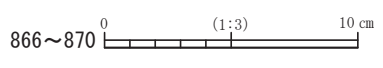
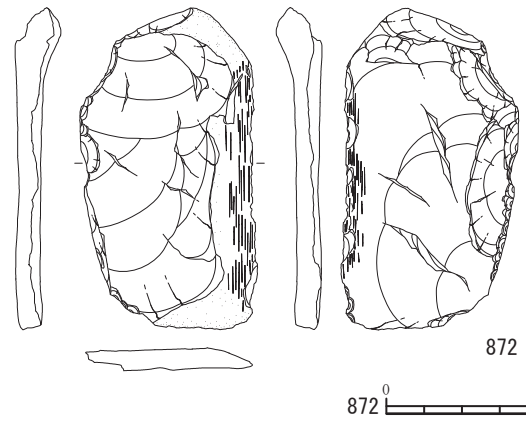
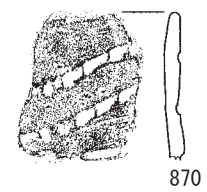
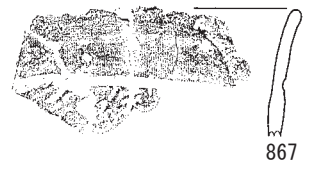
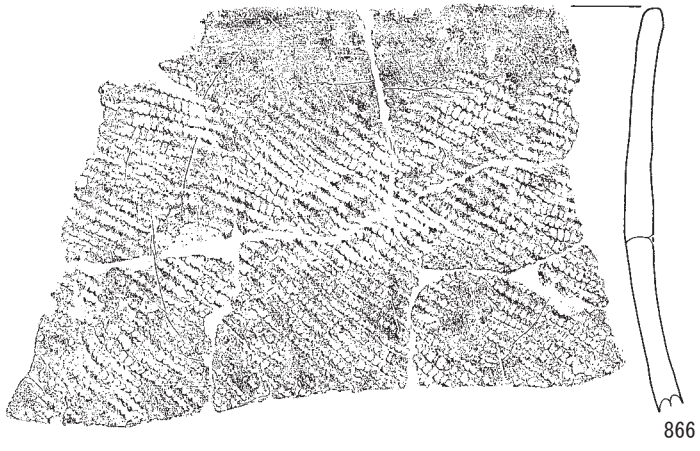
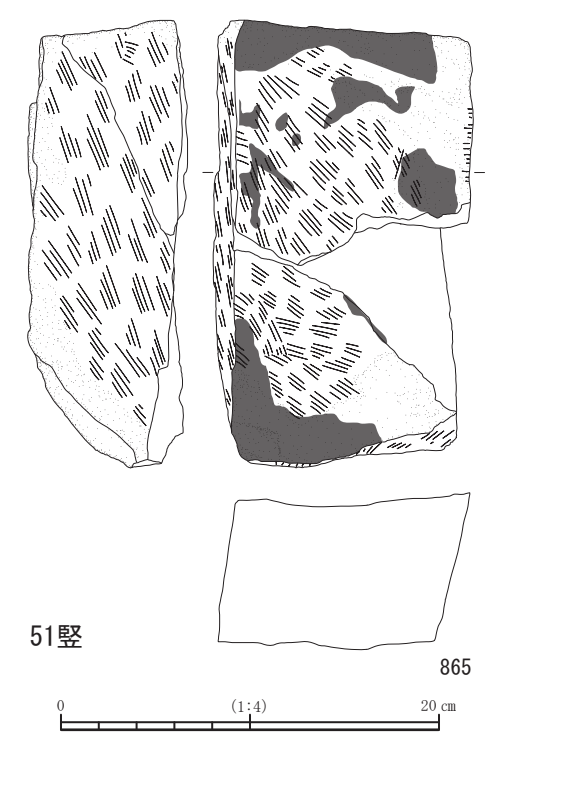

52 豎

遺物図版116 縄文時代の遺物116



873

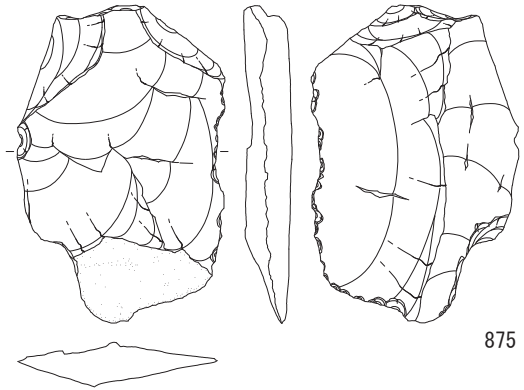

875

873-875 0 (1:2) 10 cm

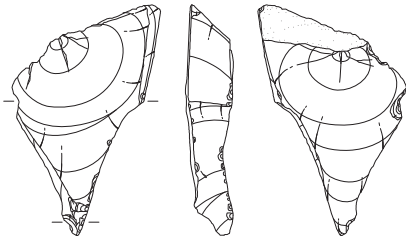

874

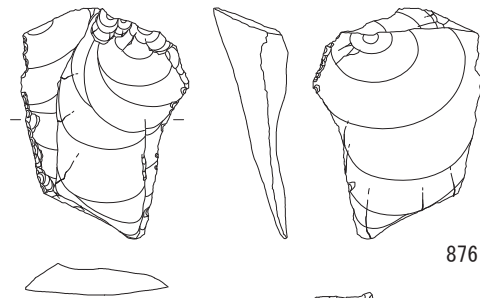

876

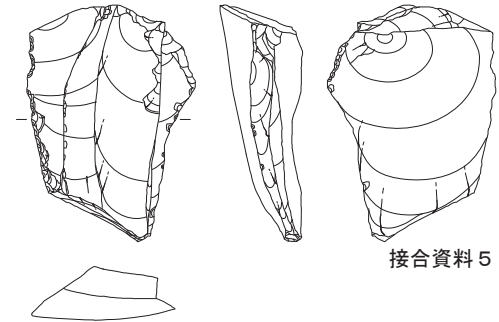

接合資料 5

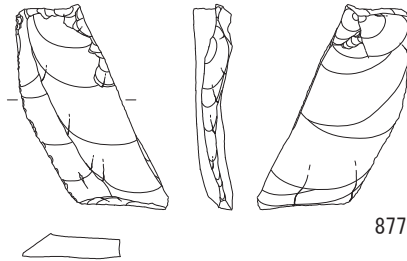

877

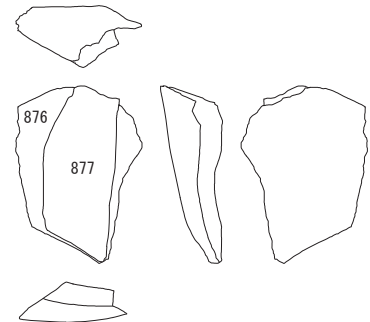

876

877

874-876-877-接合資料 5 0 (2:3) 5 cm

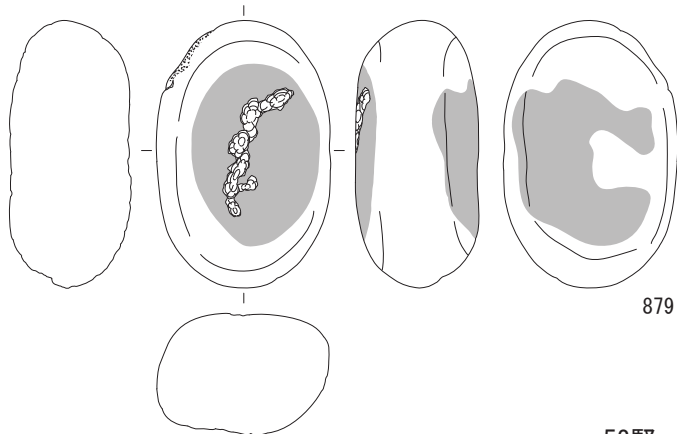

879

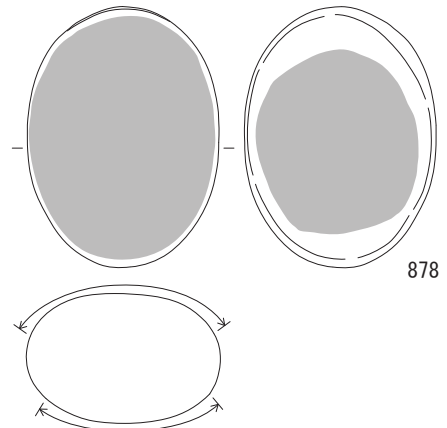

878

52 豎

878-879 0 (1:3) 10 cm

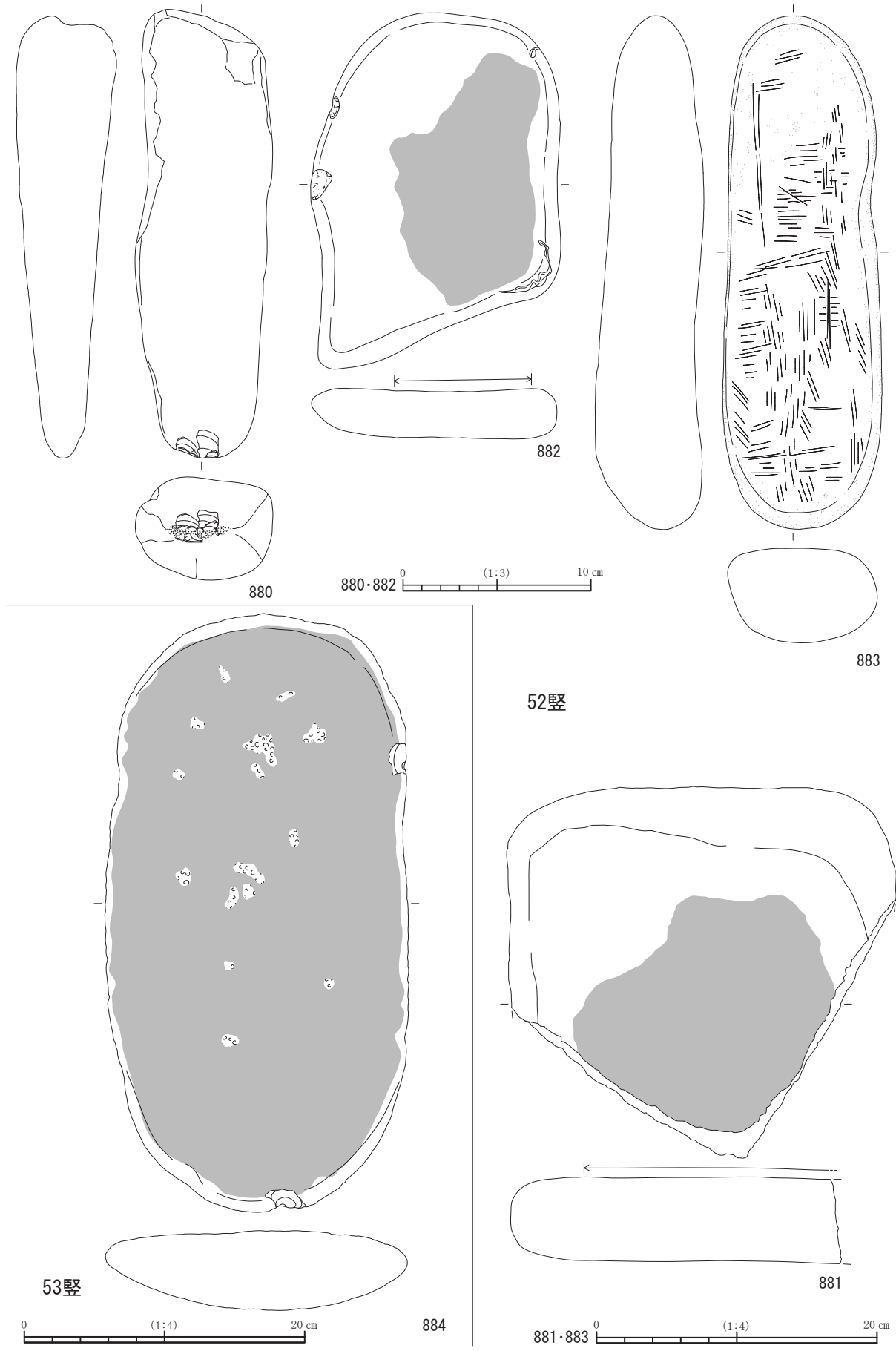

遺物図版118 縄文時代の遺物118

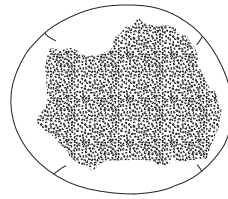
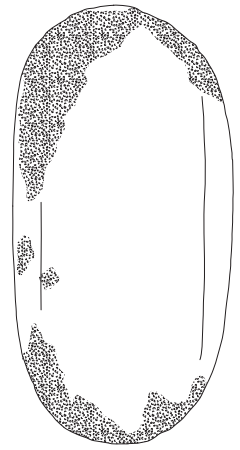
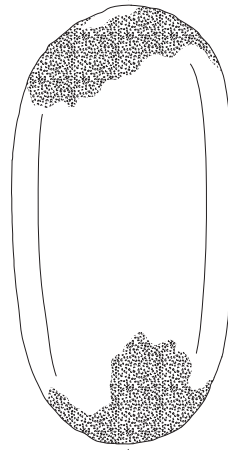
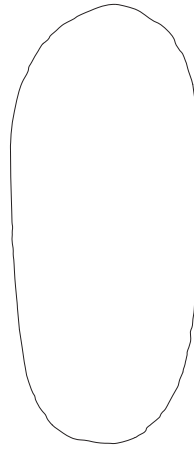
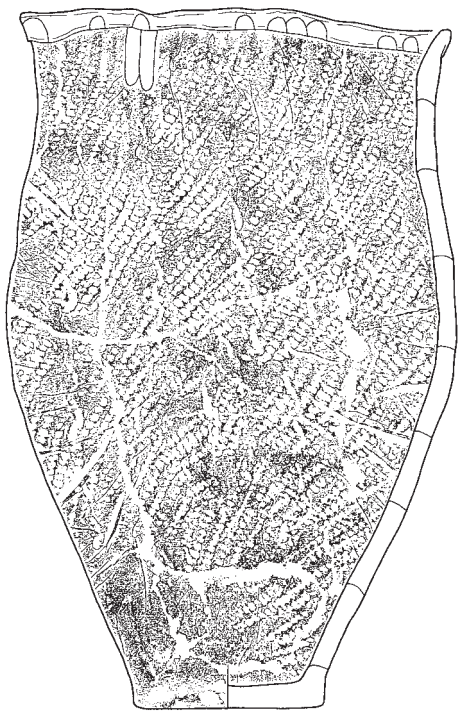

886

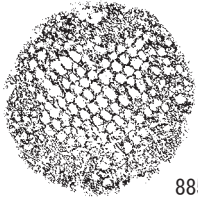
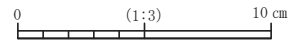

885

54 豎

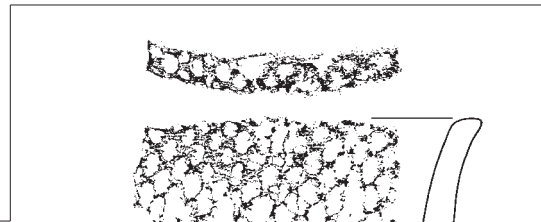

888

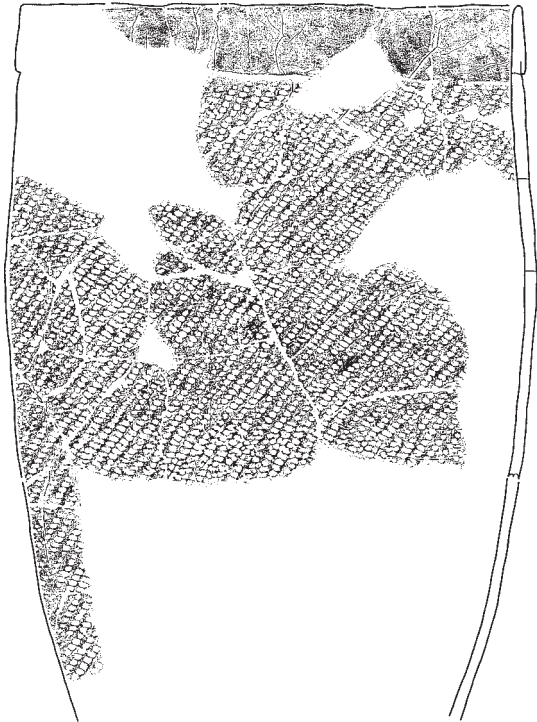
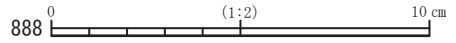

887



889

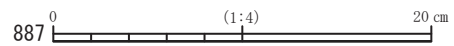
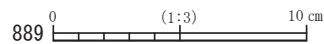

55 豎

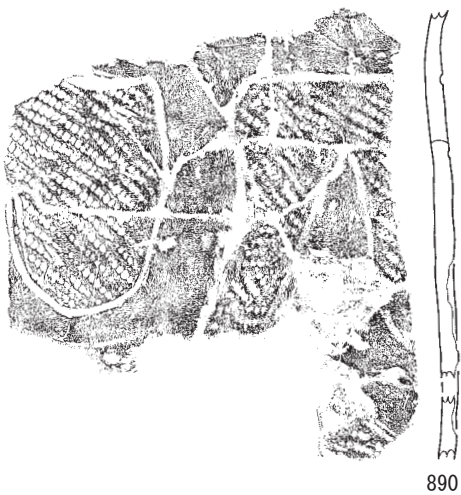

890



891

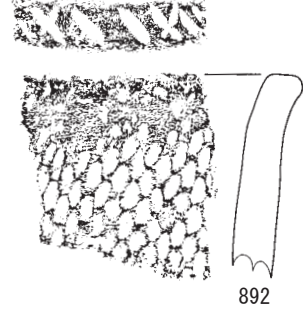

892



893



894

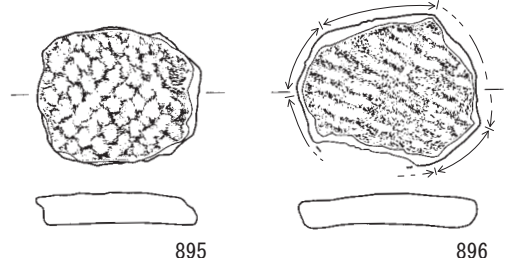

895

896

890・891・893 0 (1:3) 10 cm

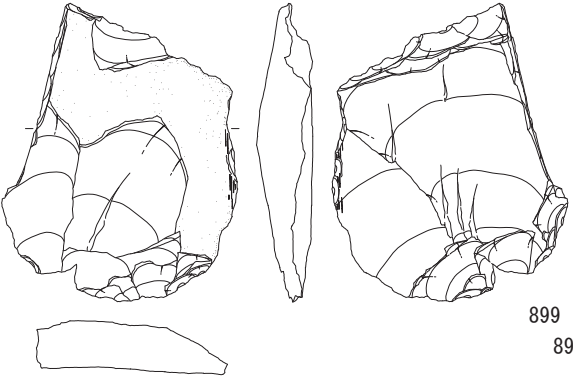

899

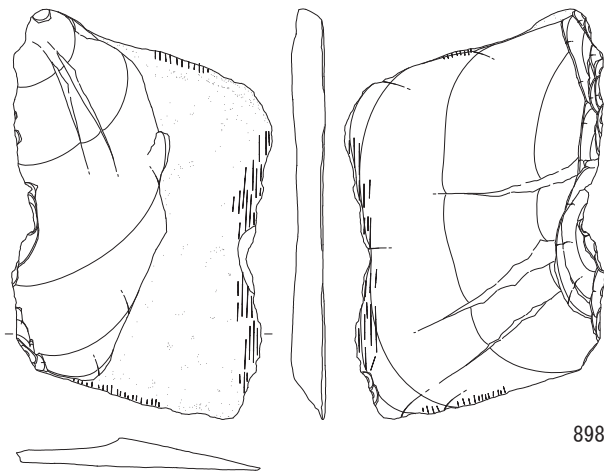

898

892・894~896・898・899 0 (1:2) 10 cm

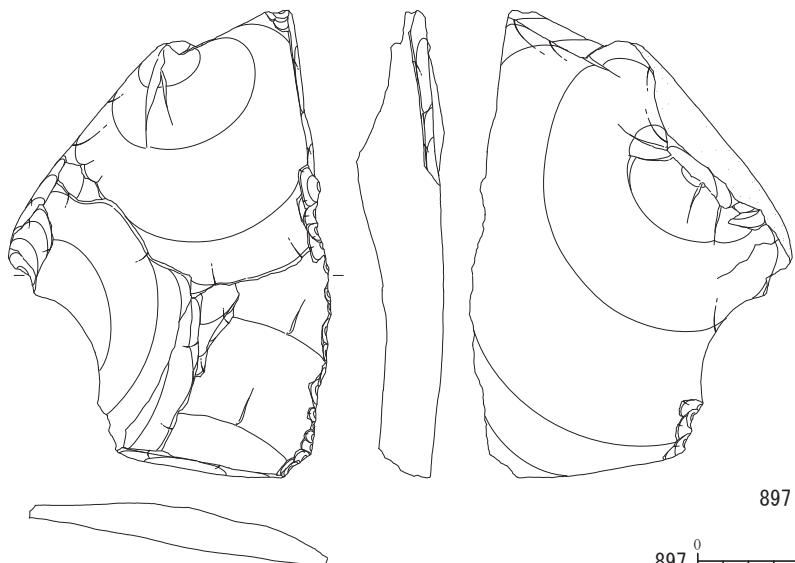

897

897 0 (2:3) 5 cm

55 豎

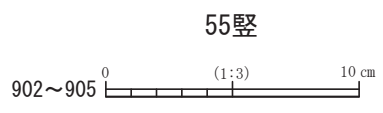
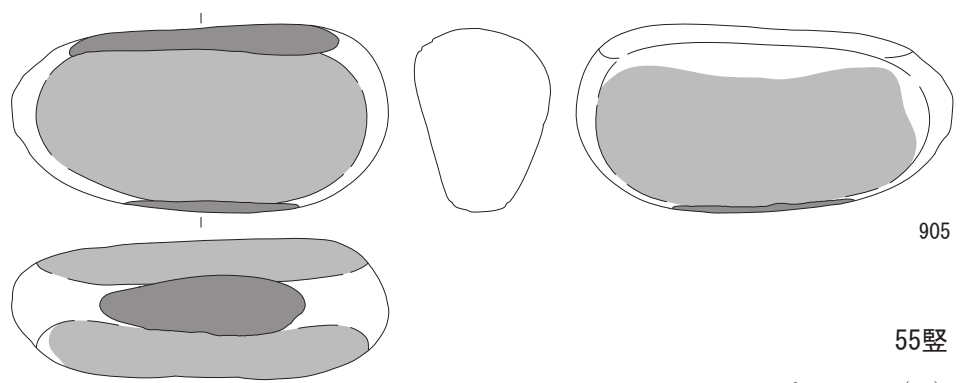
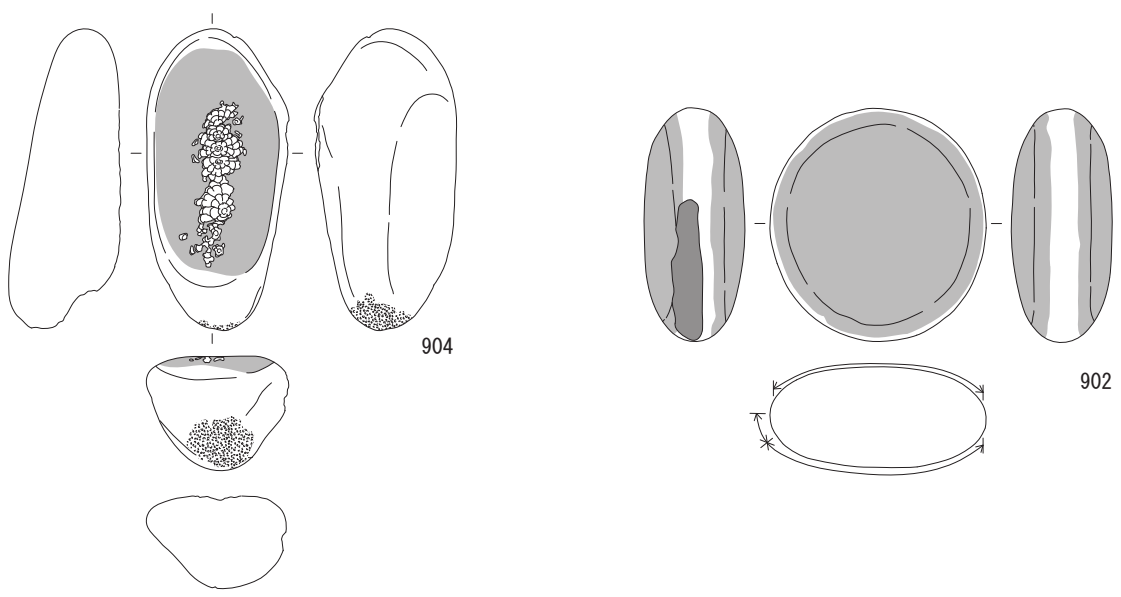
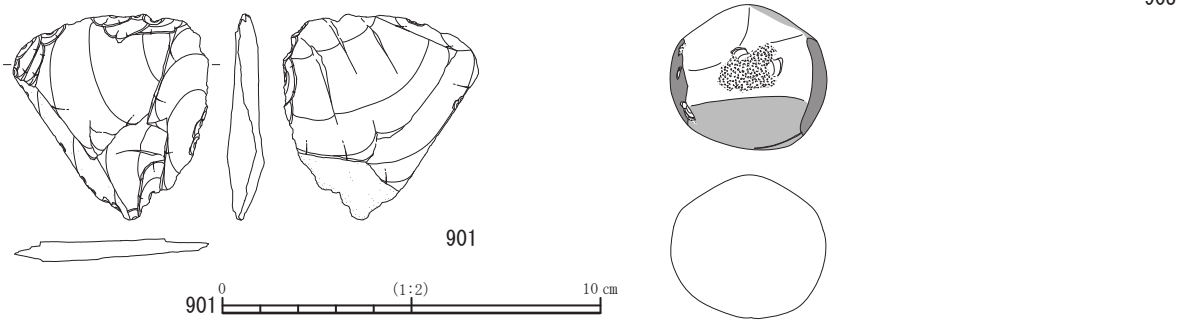
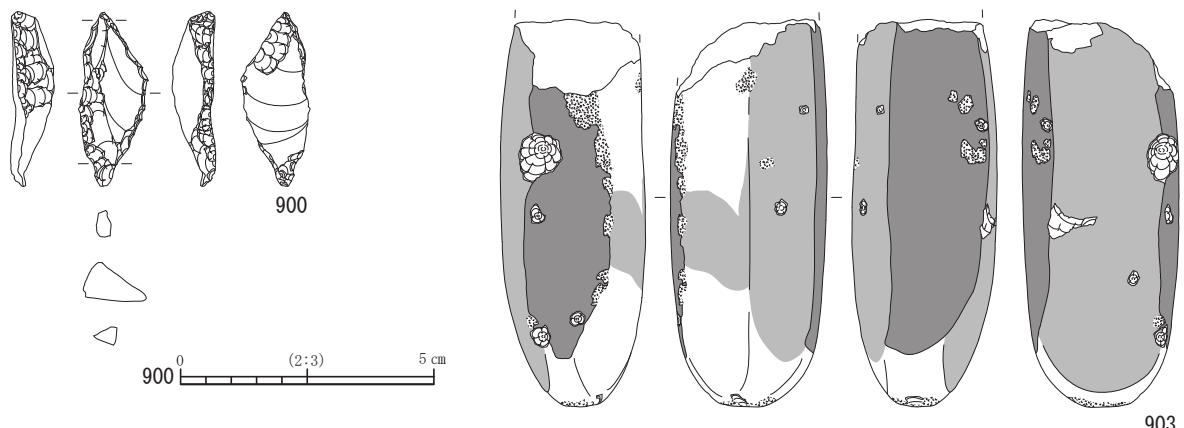

遺物図版121 縄文時代の遺物121



906

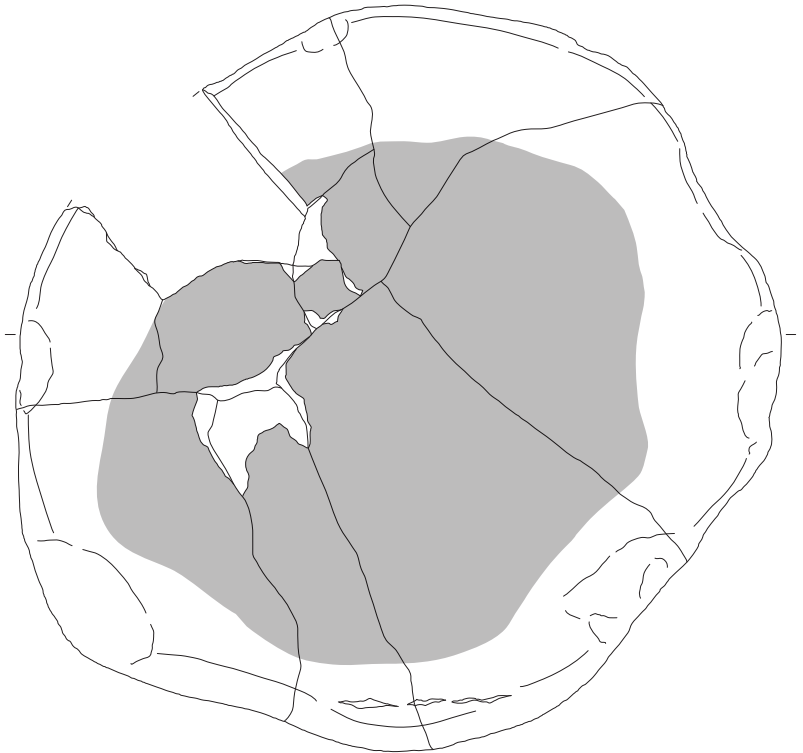

907

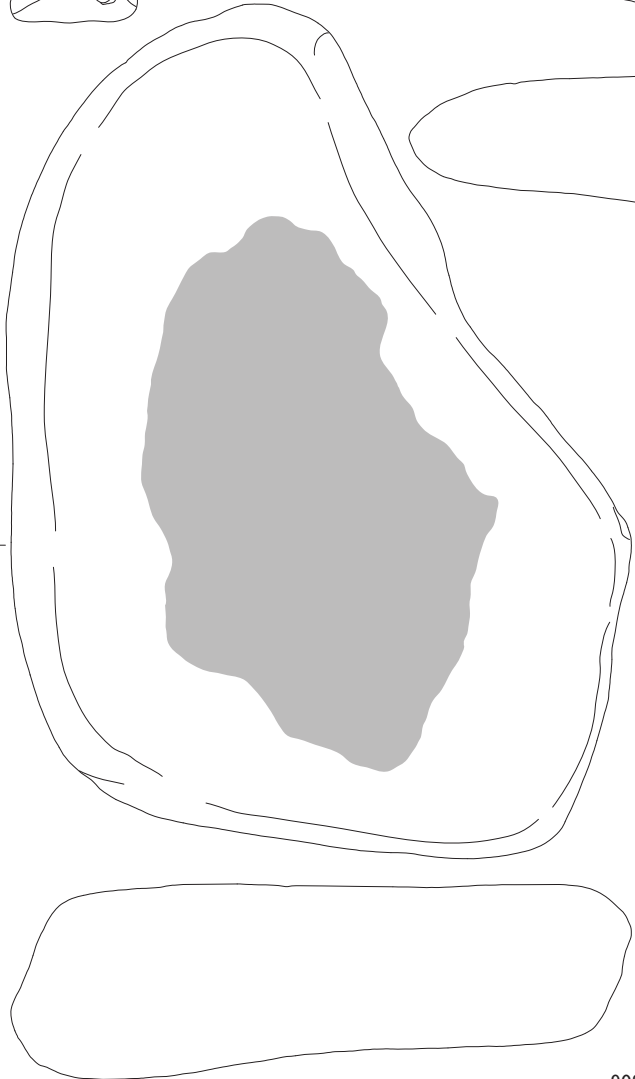

908

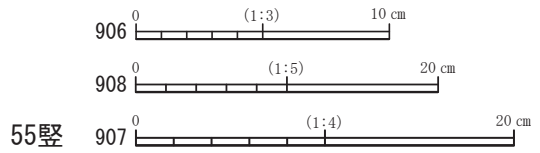
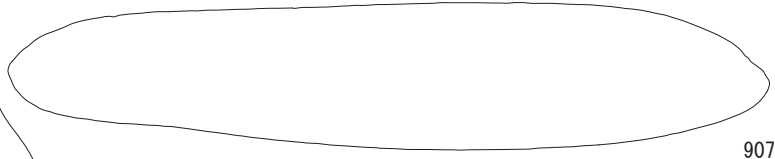

55 907

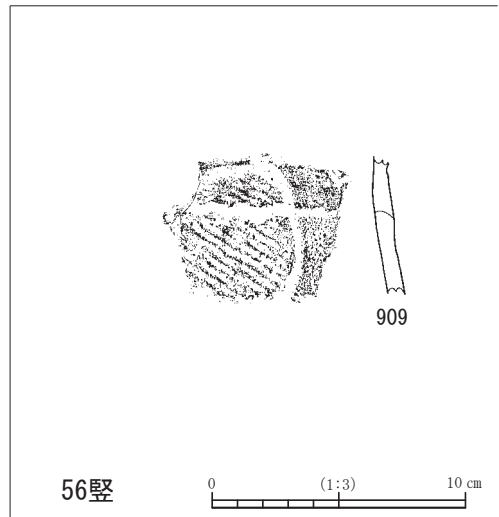

909

56 909

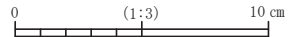

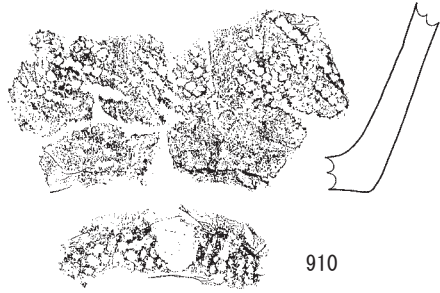

910

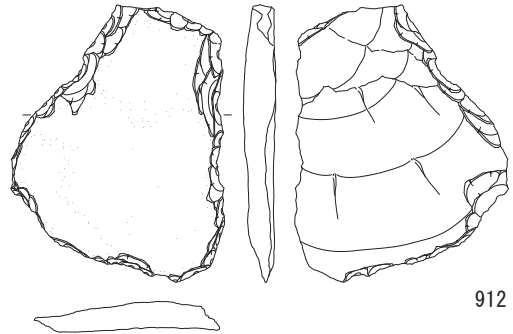

912

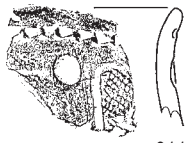
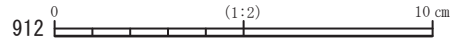

911

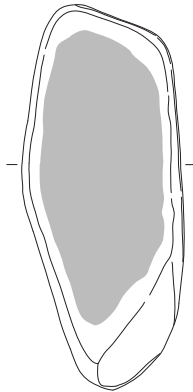

914

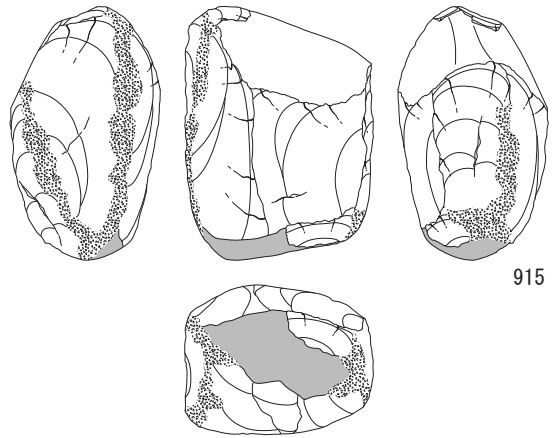

915

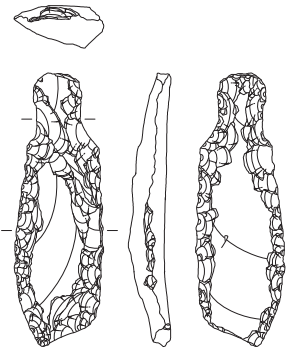

913

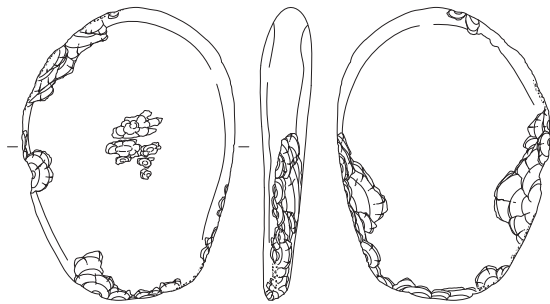

917



913

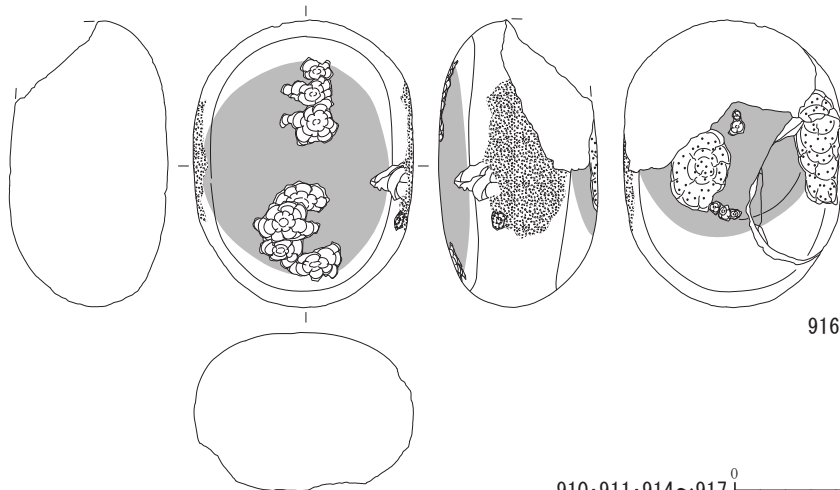

916

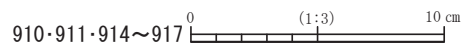

910・911・914~917

56 豎

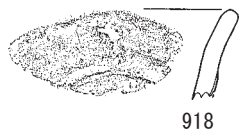

918

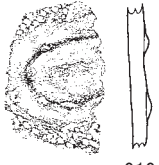

919

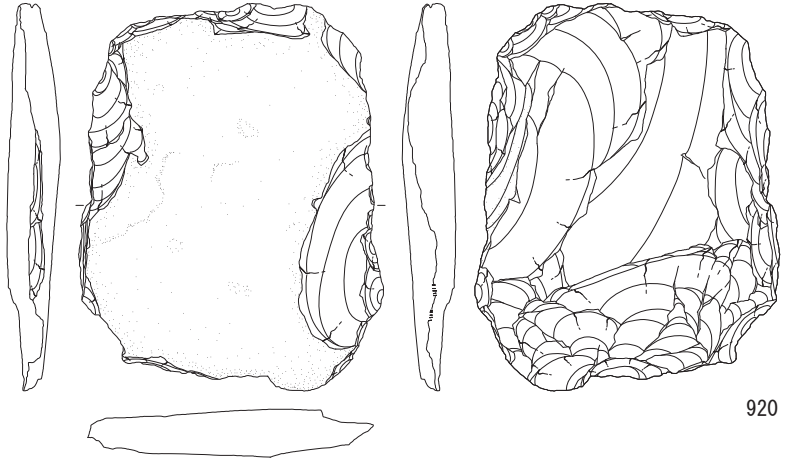

920

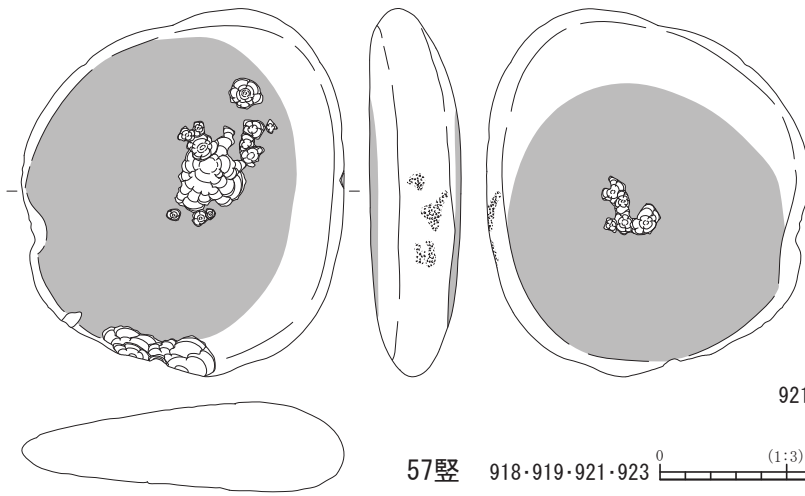
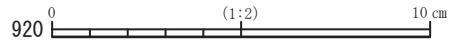

921

923

57 縦 918・919・921・923

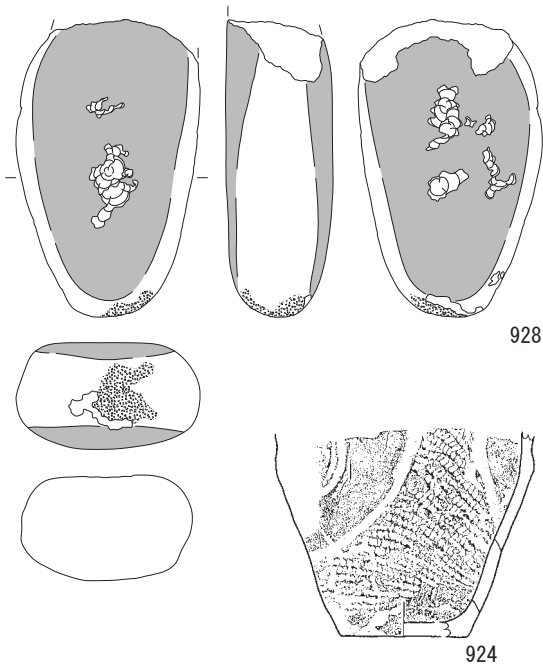
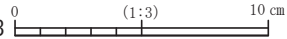

928

924

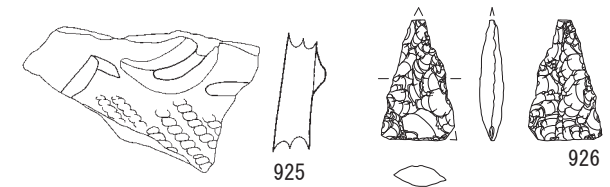

925

926

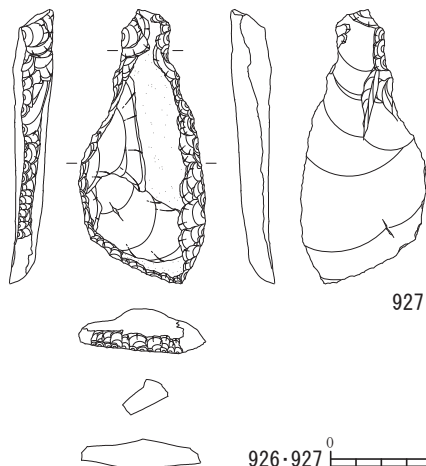
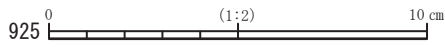

927

58 縦



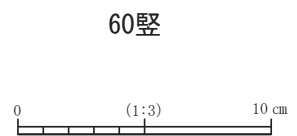
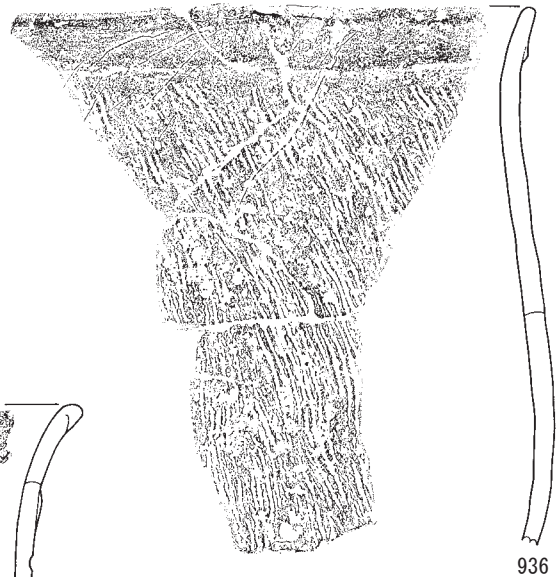
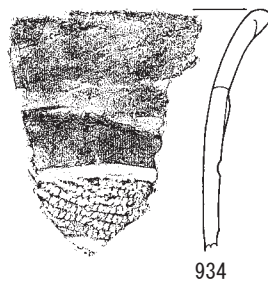
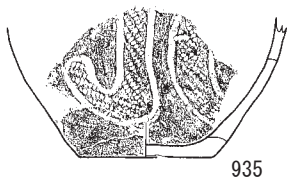
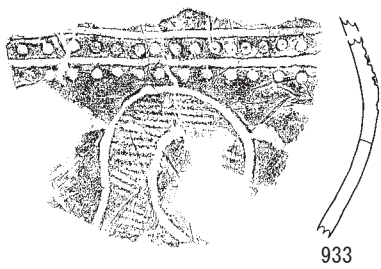
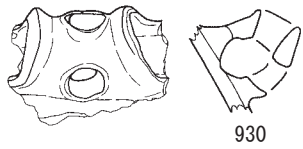
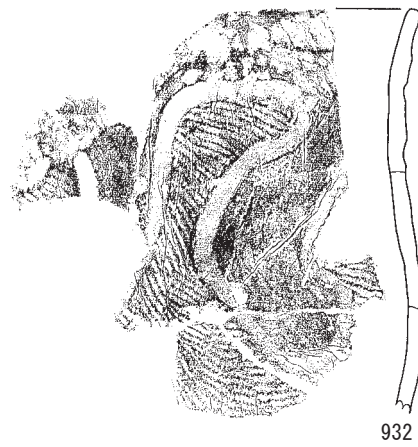
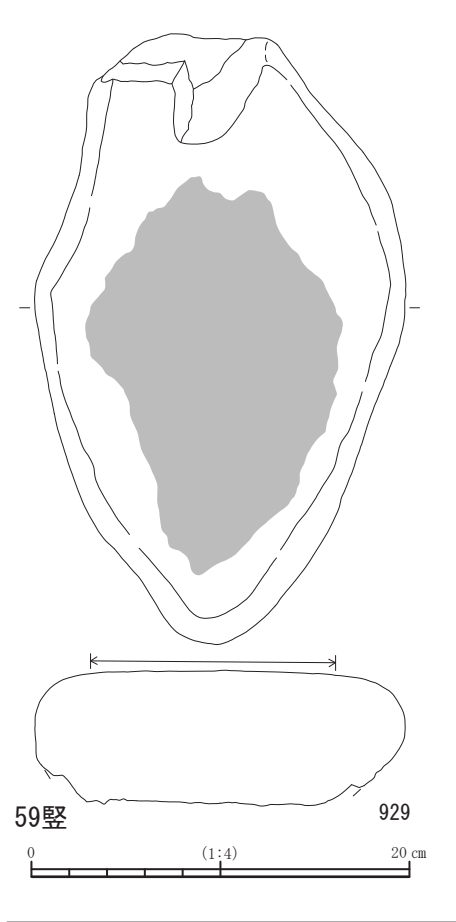

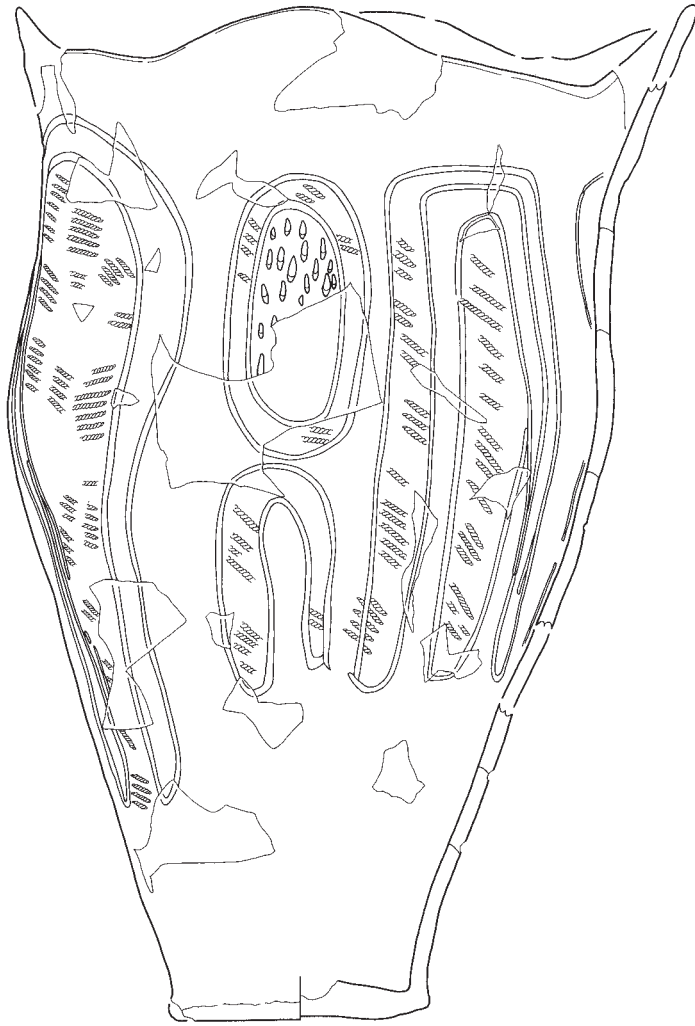

展開図 0 (1:6) 20 cm

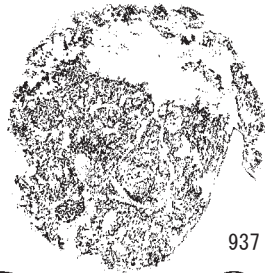

937

0 (1:3) 10 cm

60 豎

937 展開図



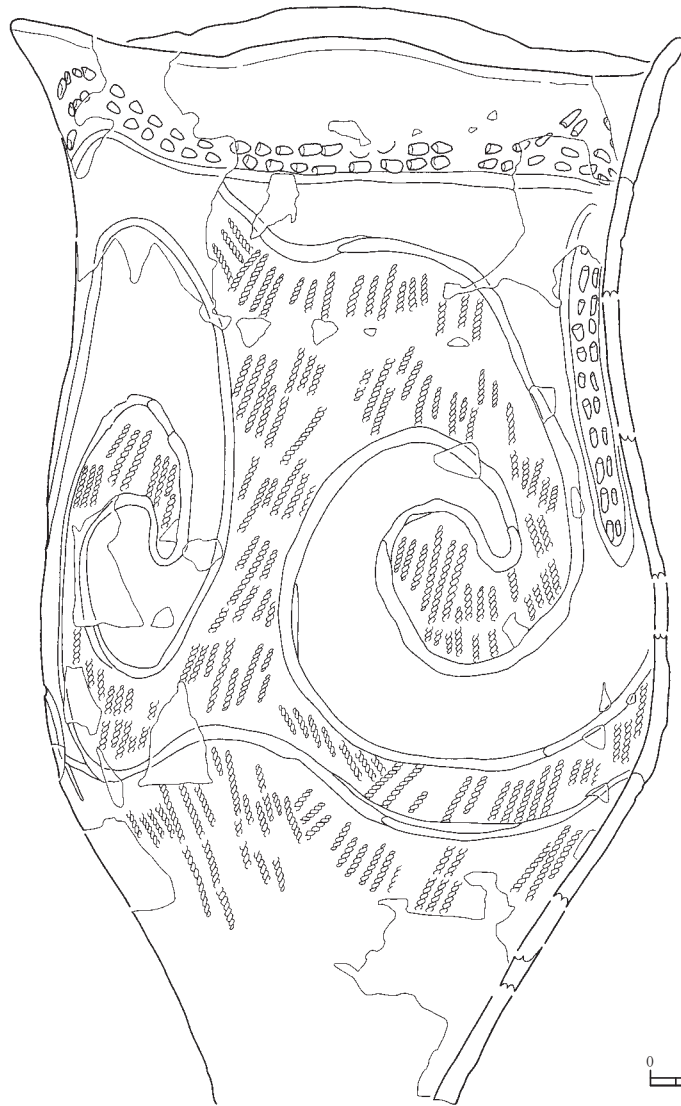

938

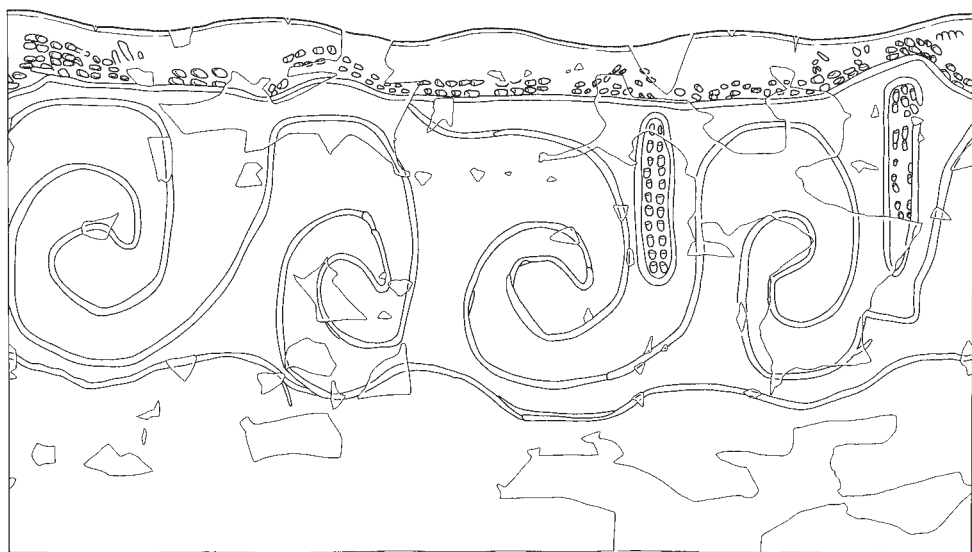
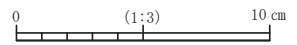

938展開図

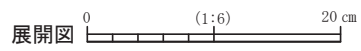

展開図

60 縦



939

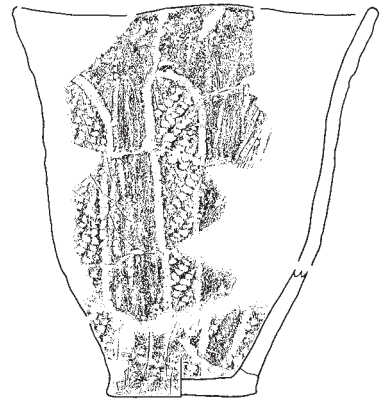

940

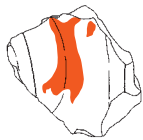

942



943

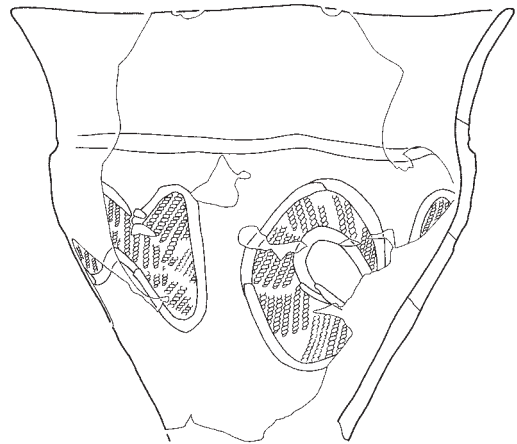

947

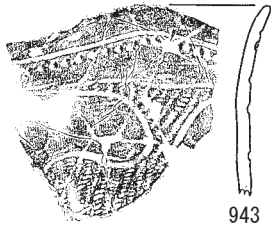

944

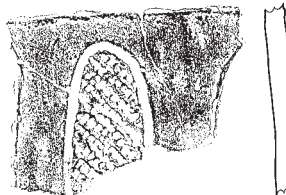

945

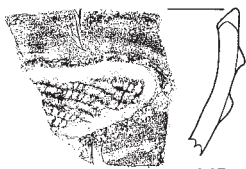

946

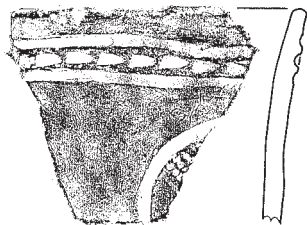

948



950

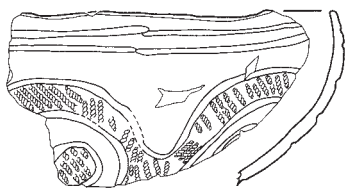

949

60 豎

939・941～945・947～950 0 (1:3) 10 cm

940 0 (1:2) 10 cm

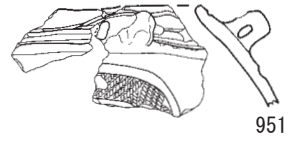

951

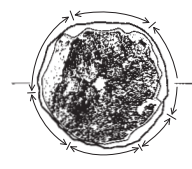

952

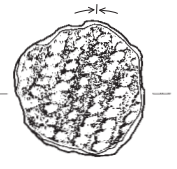

953

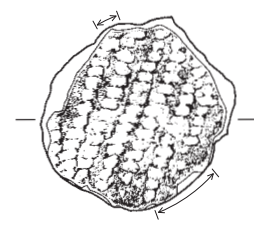

954



957

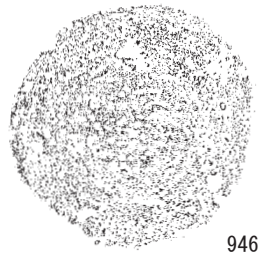

946

946-951 0 (1:3) 10 cm

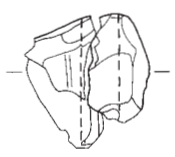

955

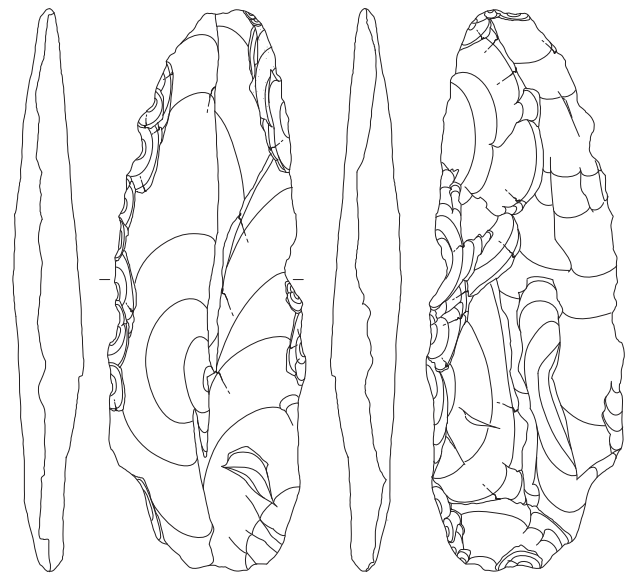

958

60 豎

952-954 0 (1:2) 10 cm

955-957-958 0 (2:3) 5 cm

遺物図版129 縄文時代の遺物129

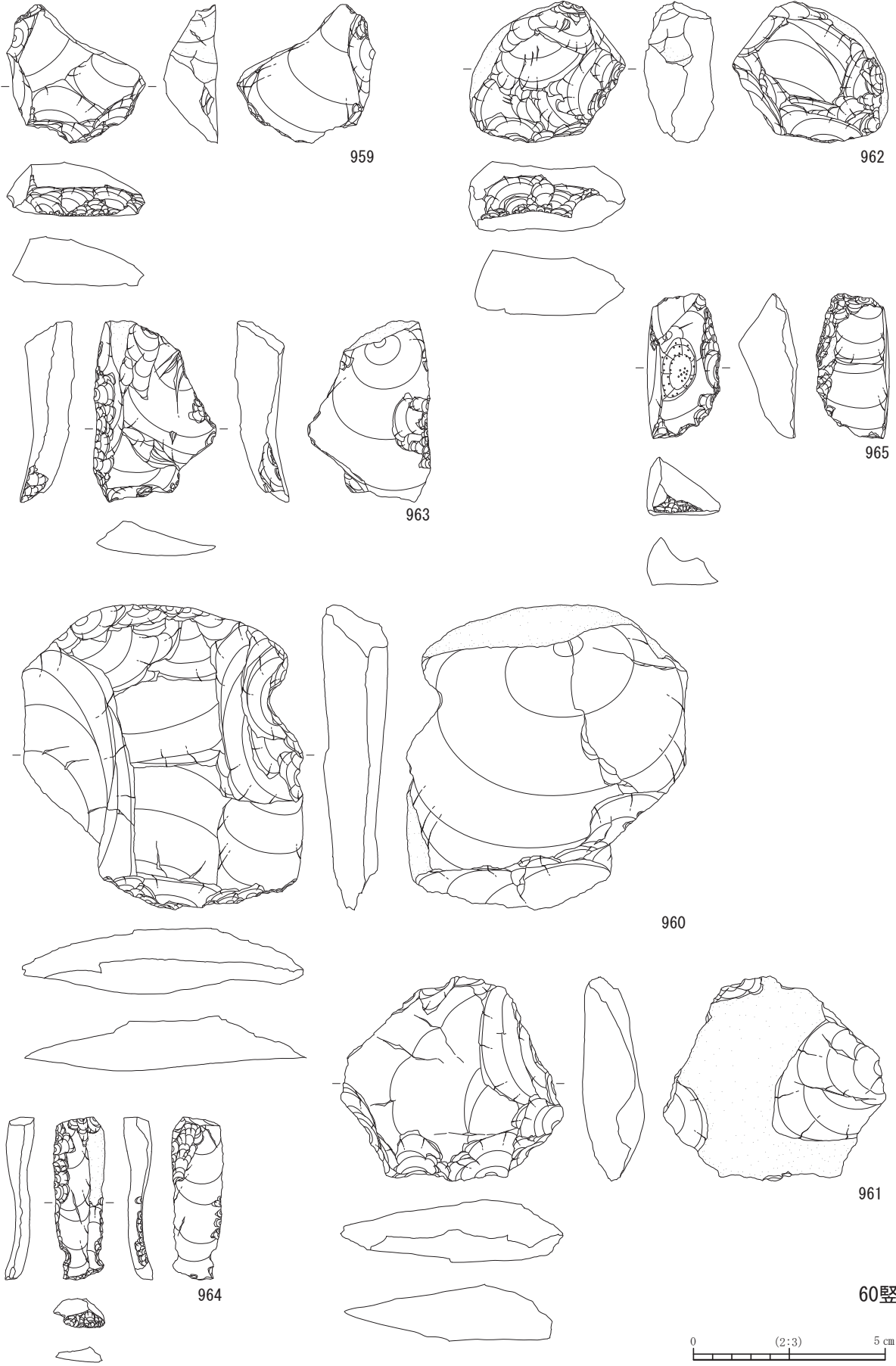

遺物図版130 縄文時代の遺物130

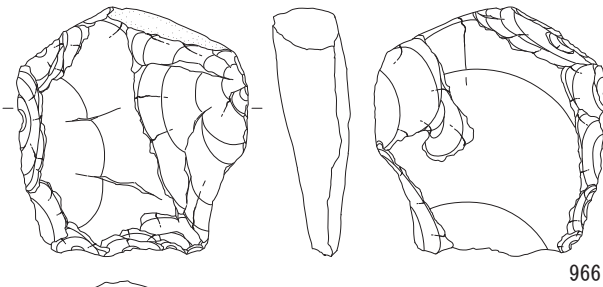

966

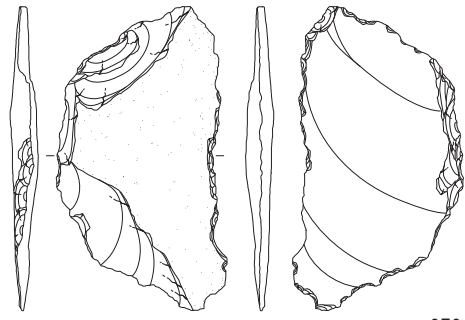
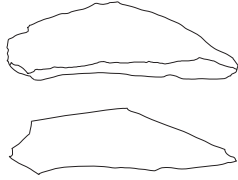

970

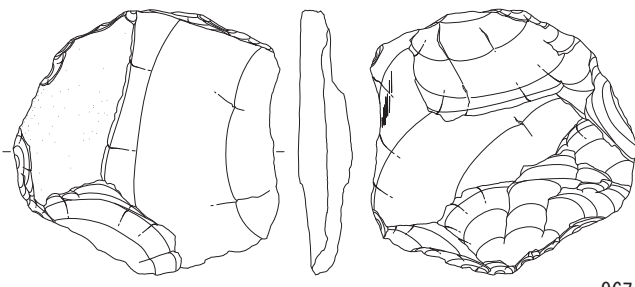

967

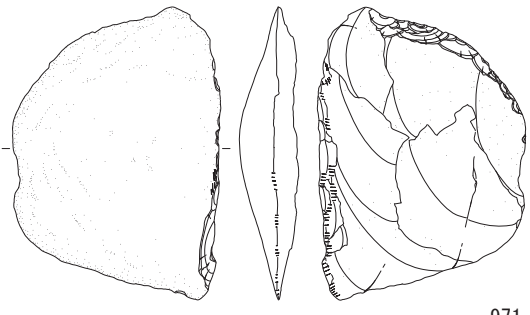
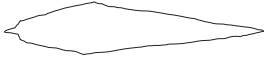

971

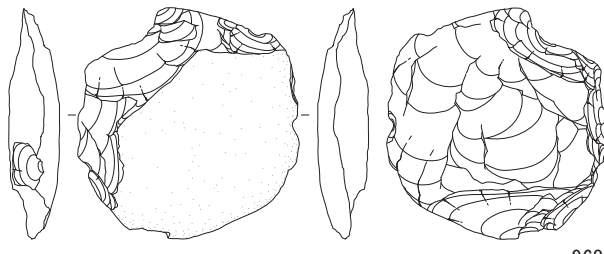

968

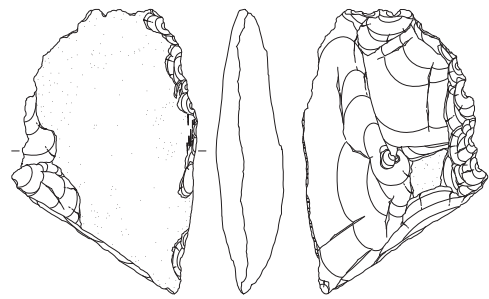

972

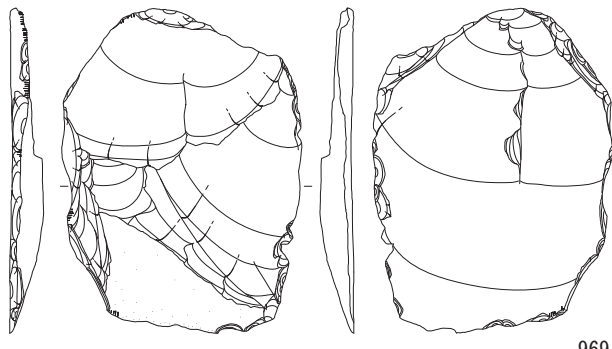

969

60 豎

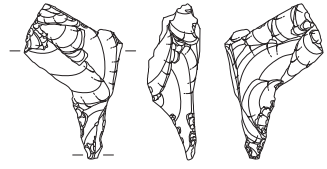

973

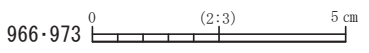

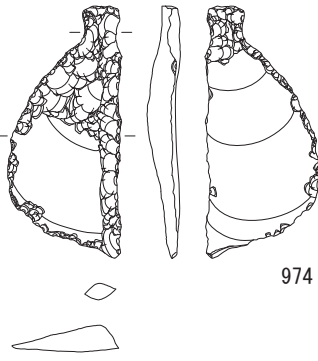

974

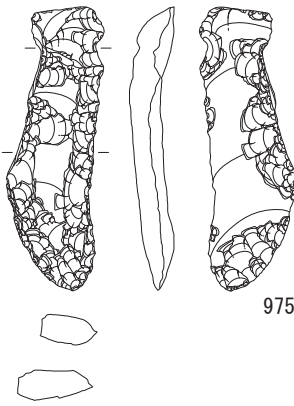

975

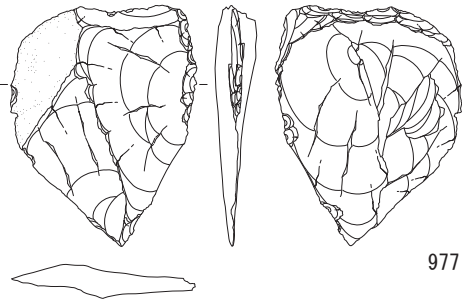

977

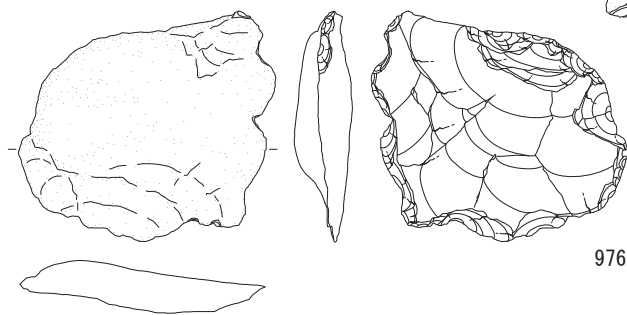

976

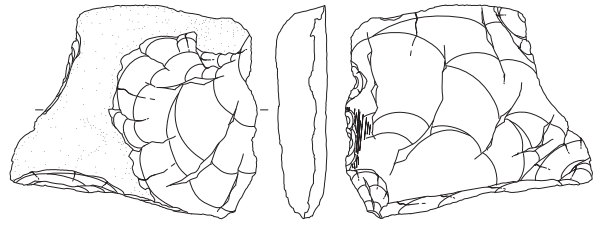

980

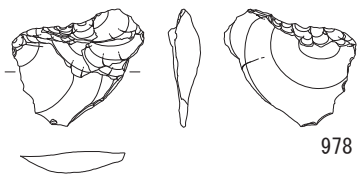

978

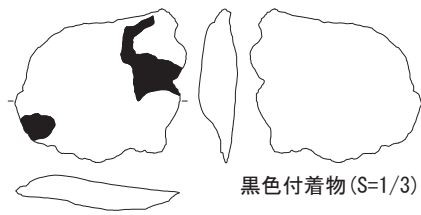

黑色付着物(S=1/3)

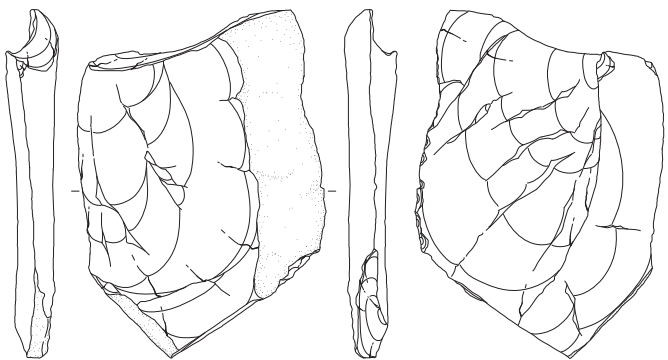

981

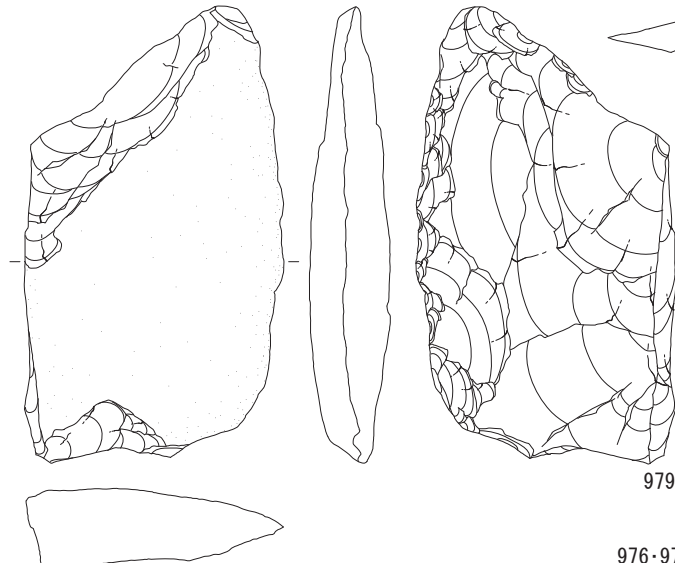

979



974・975・978・979

(2:3)

5 cm



976・977・980・981

(1:2)

10 cm

60 豎

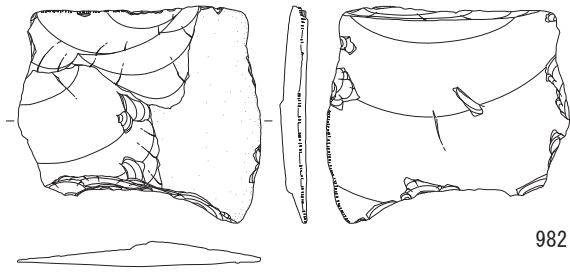

982

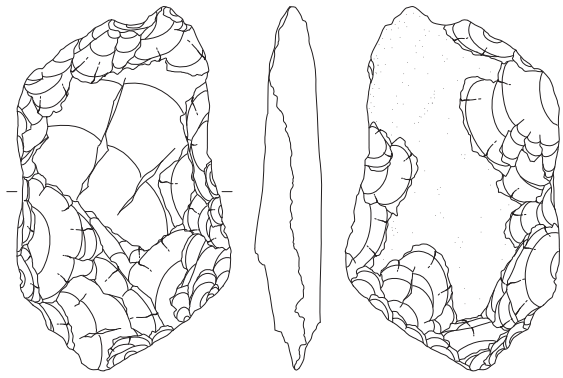

983

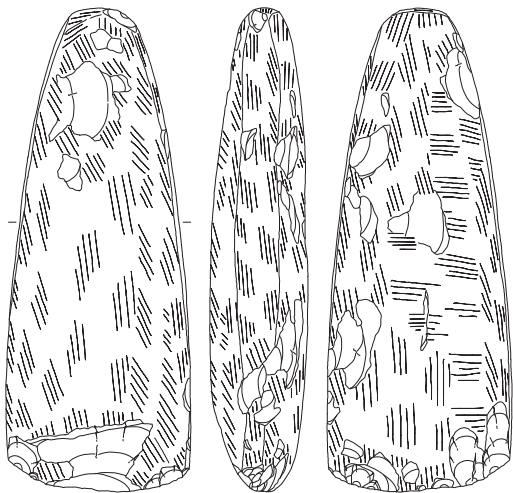

985

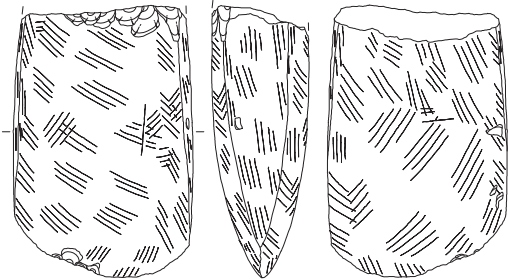
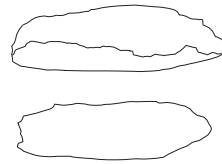

984

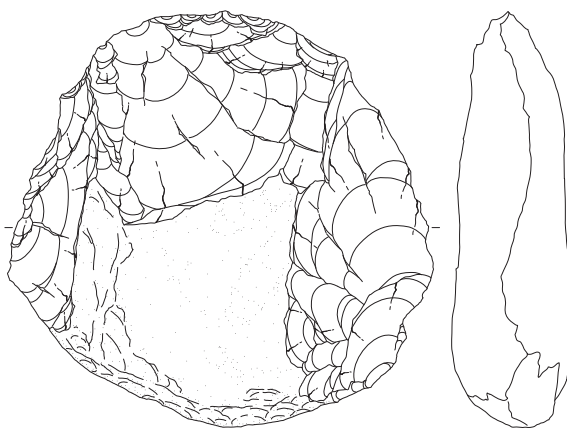
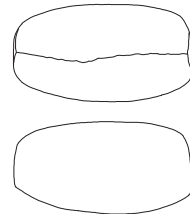
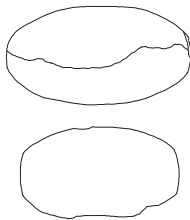

986

60 豎

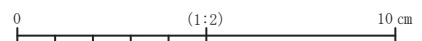

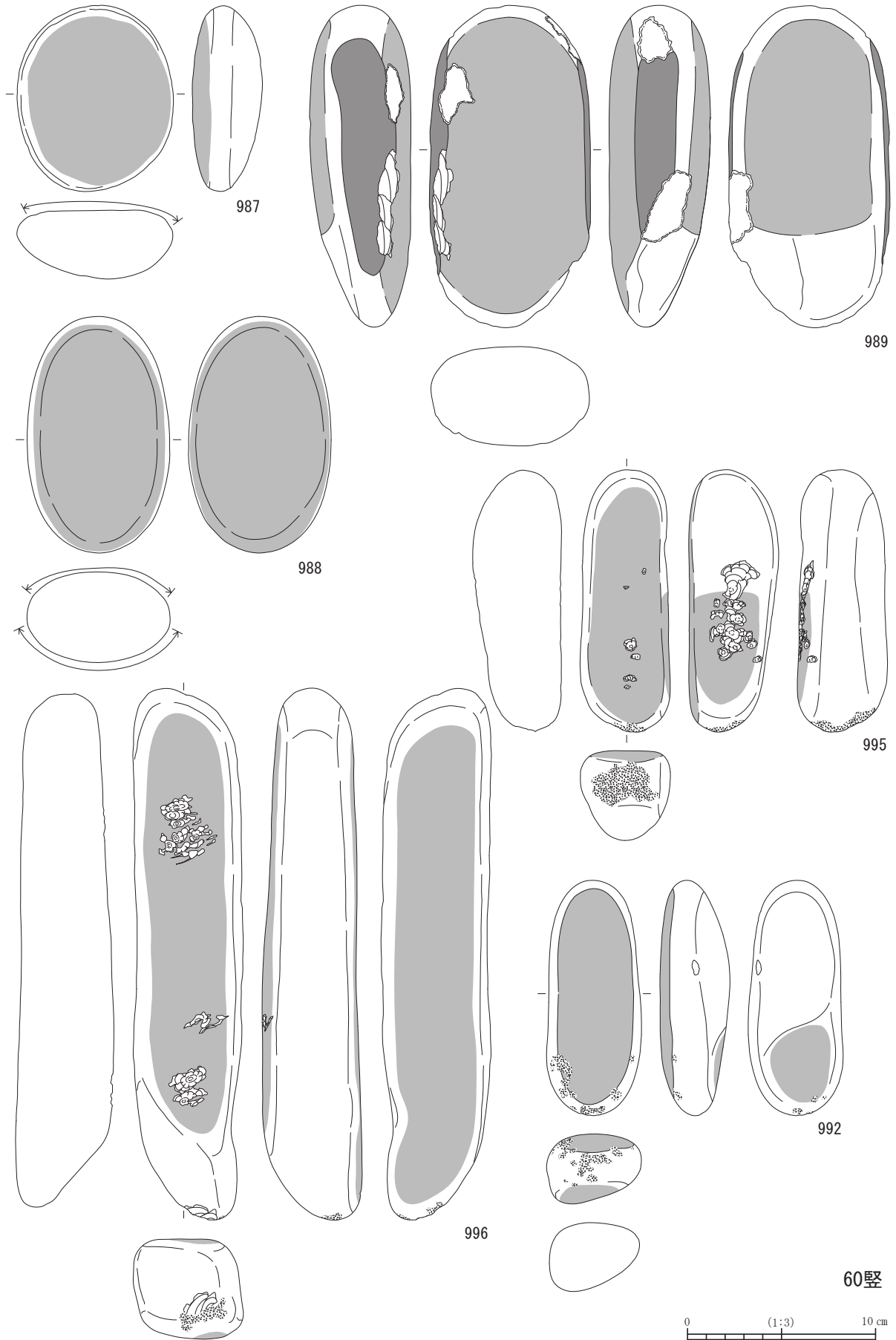

遺物図版134 縄文時代の遺物134

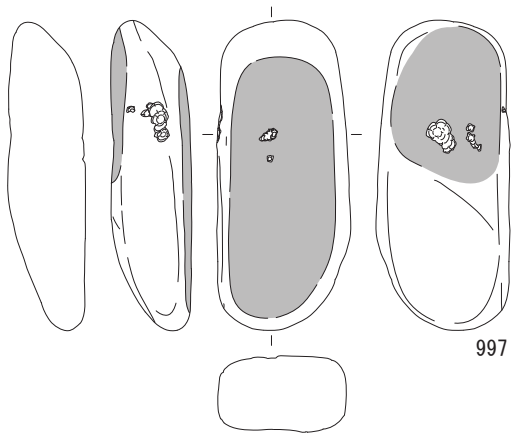

997

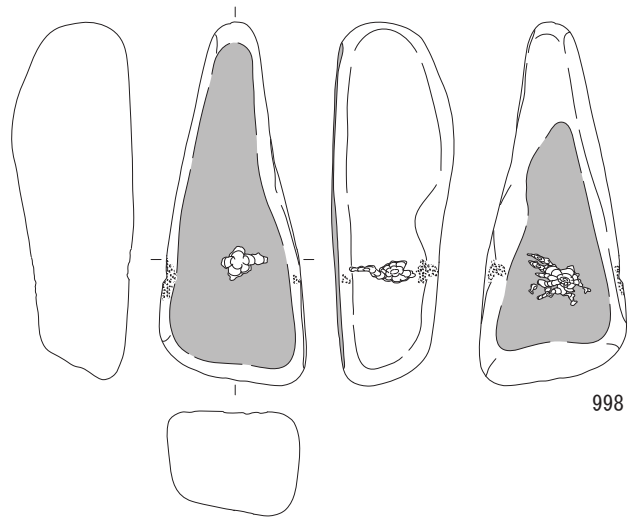

998

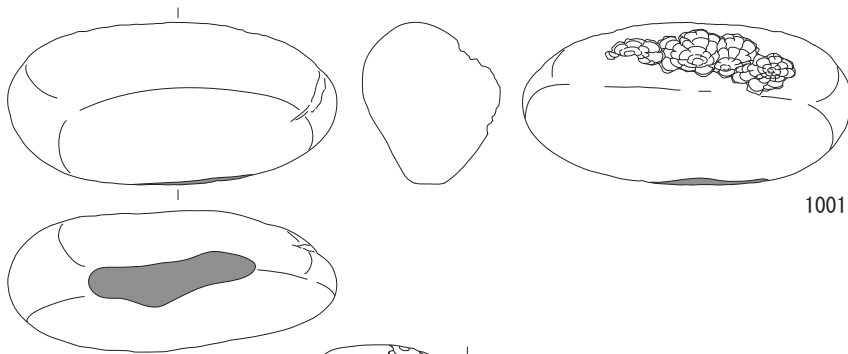

1001

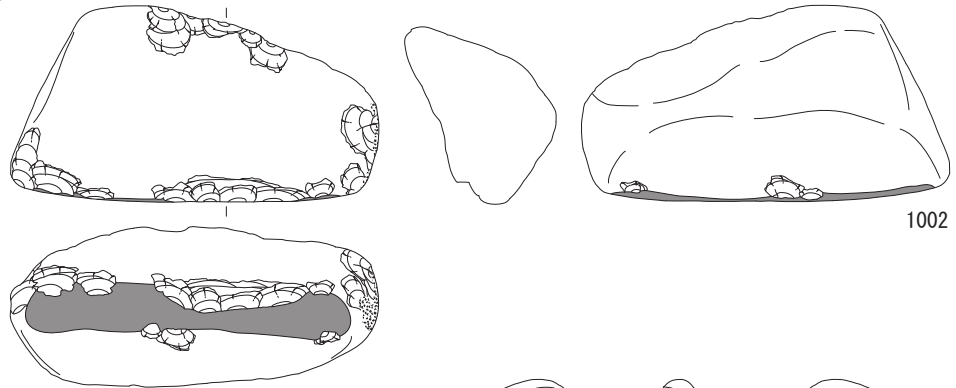

1002

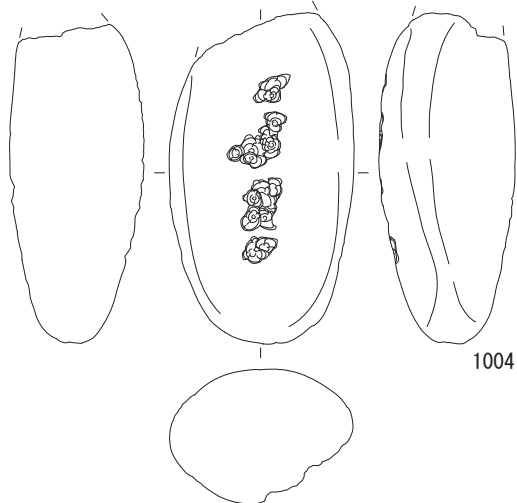

1004

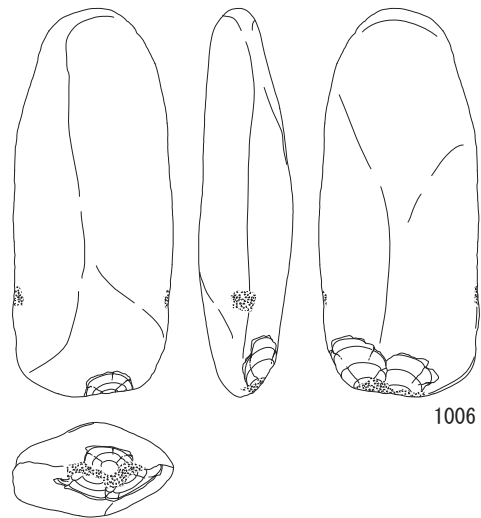

1006

60 豎

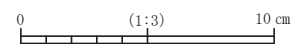

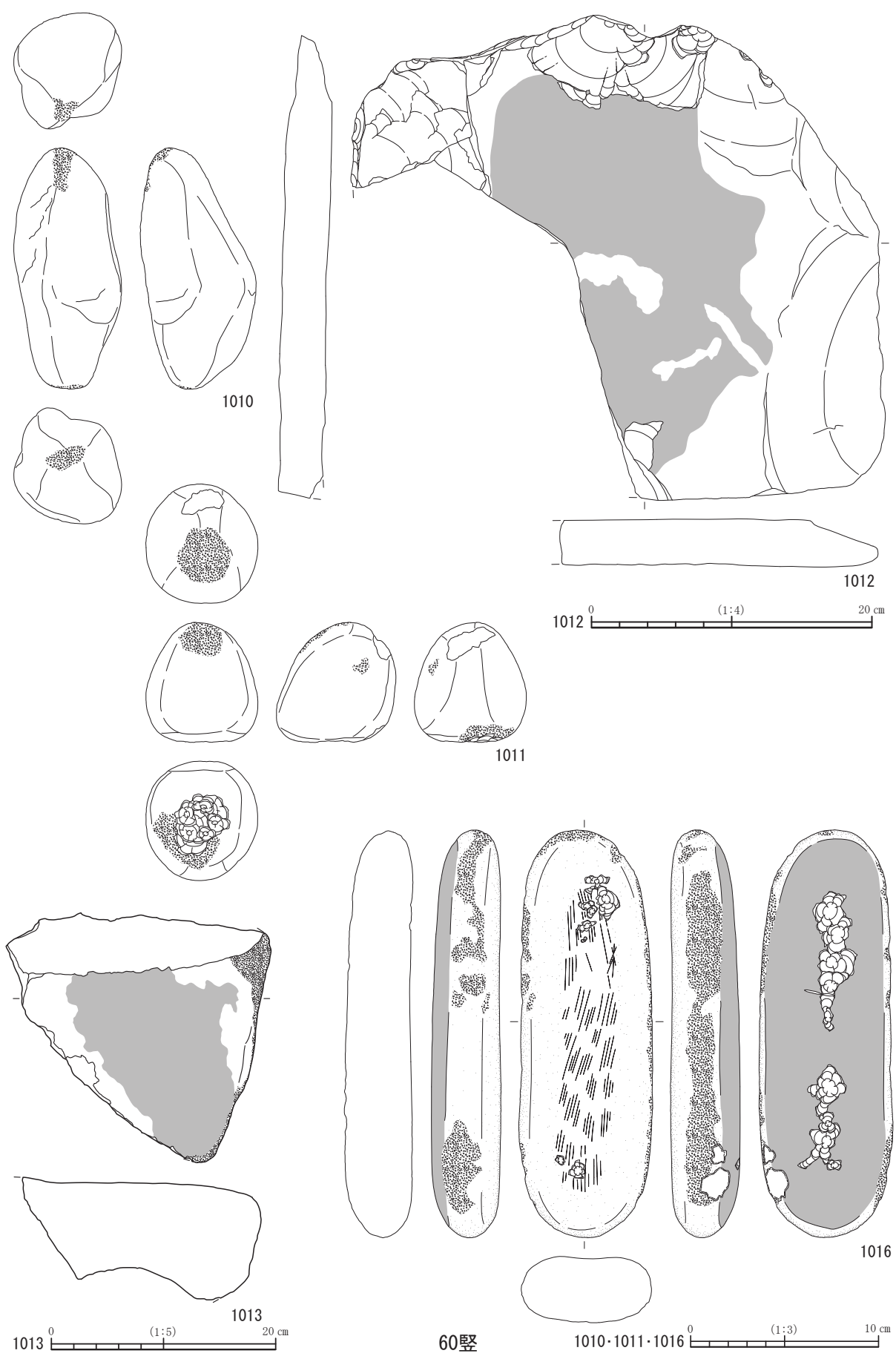

遺物図版136 縄文時代の遺物136

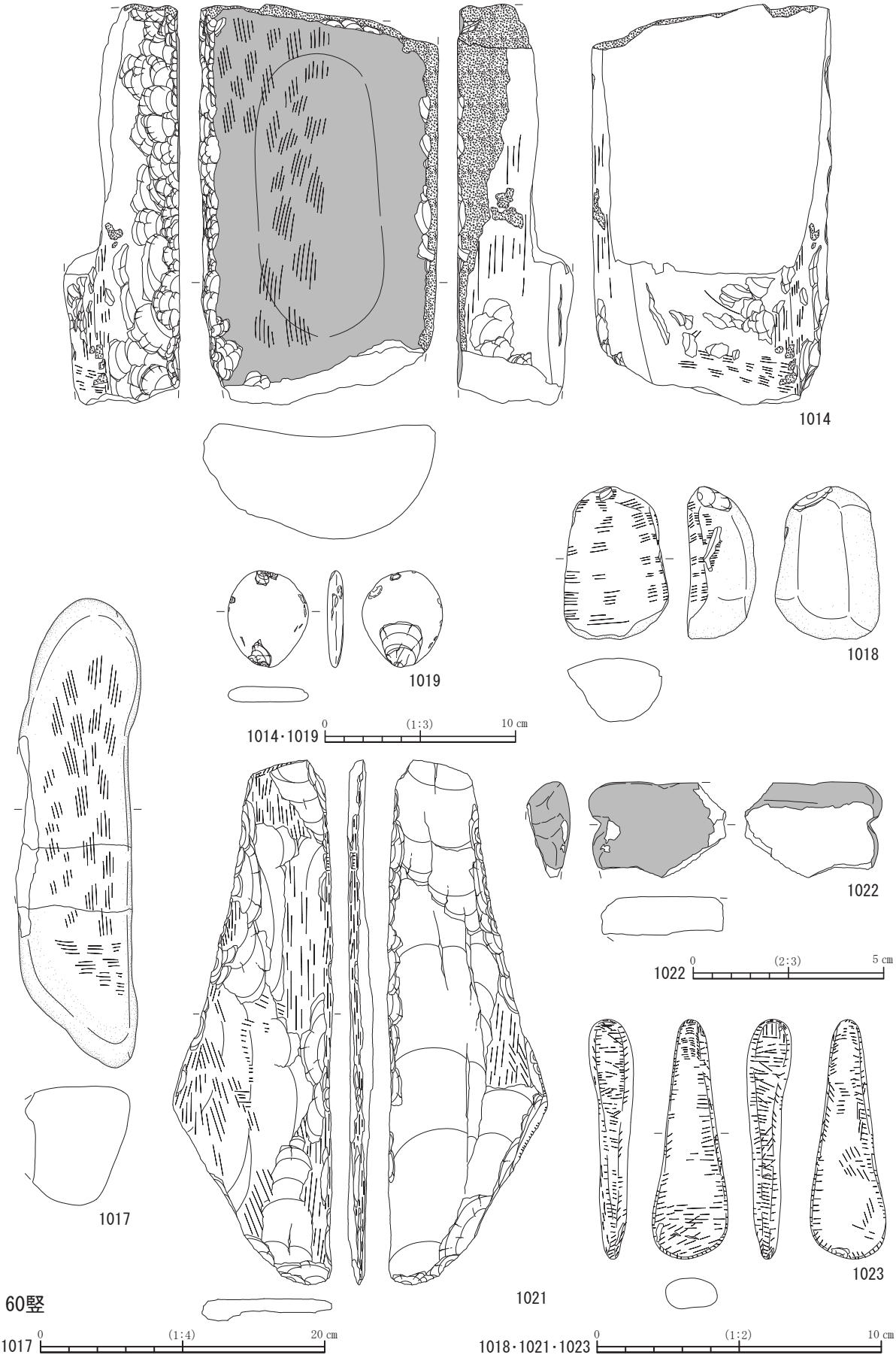

遺物図版137 縄文時代の遺物137

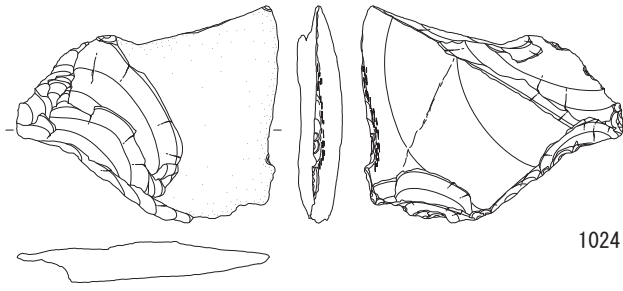

1024

61 豎

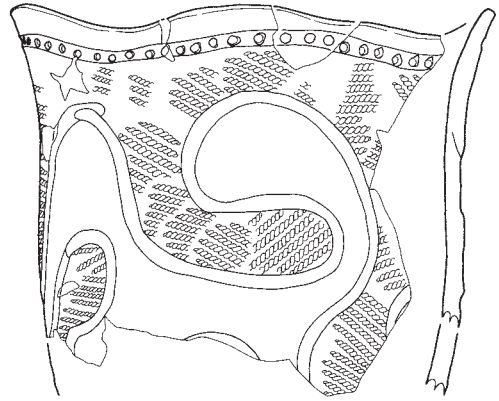
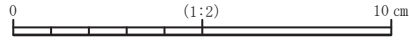

1027



1025

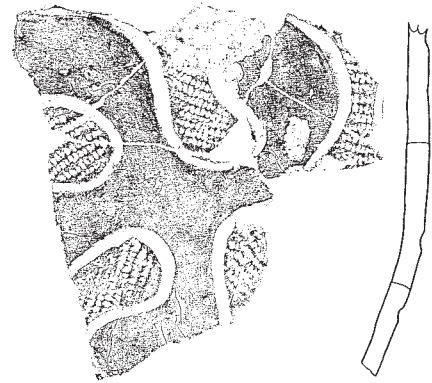

1028



1029

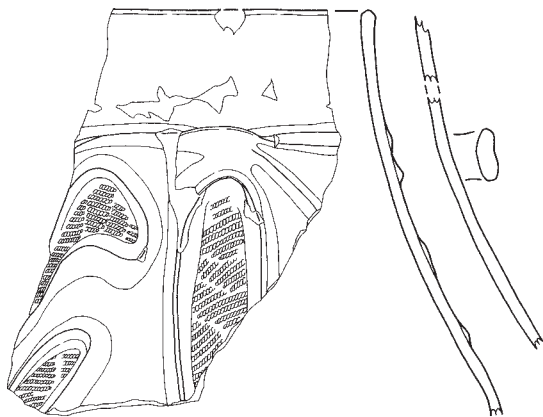

1026

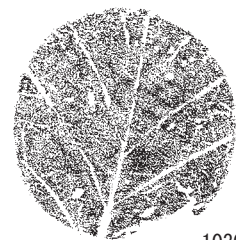
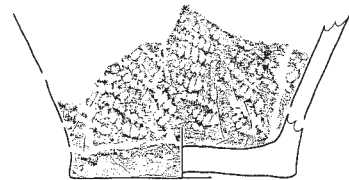
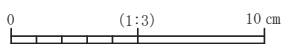

1030

62 豎

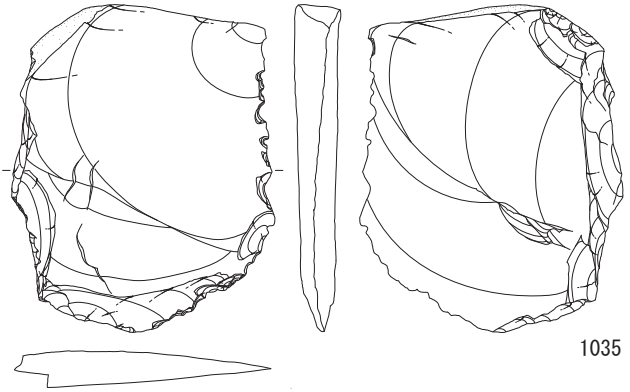
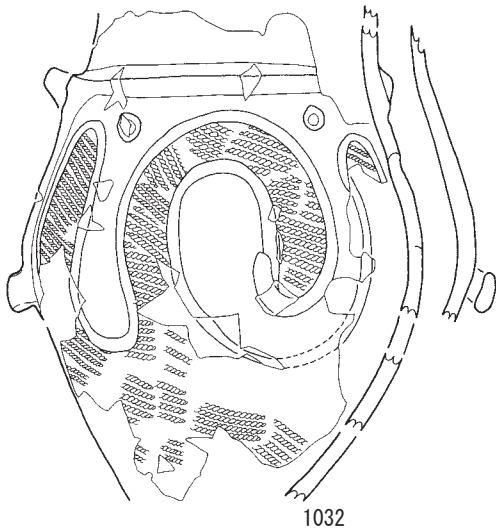
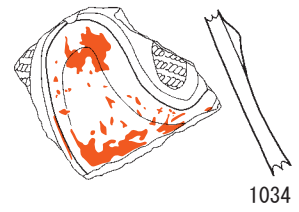

1034・1035 0 (1:2) 10 cm

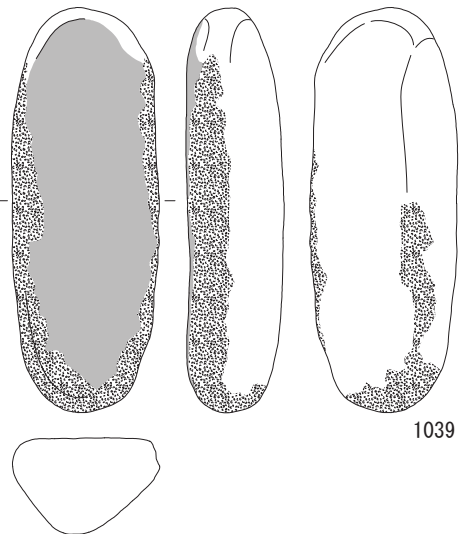
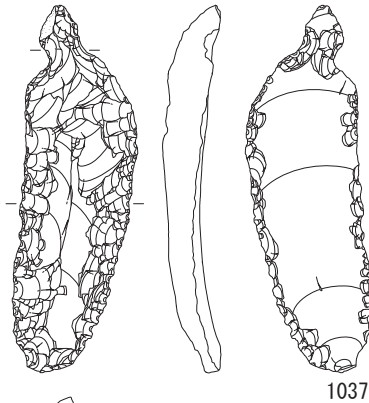
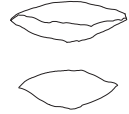
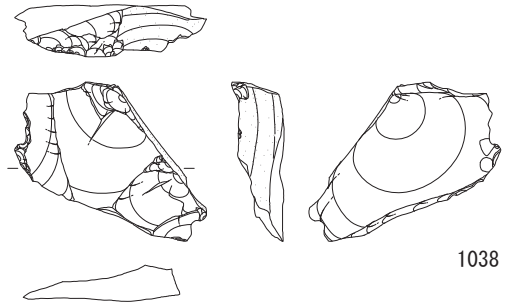
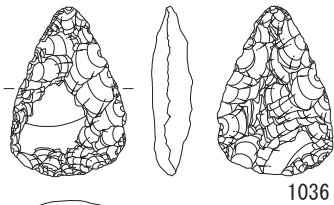

1036~1038 0 (2:3) 5 cm

1031~1033・1039 0 (1:3) 10 cm

62 豎

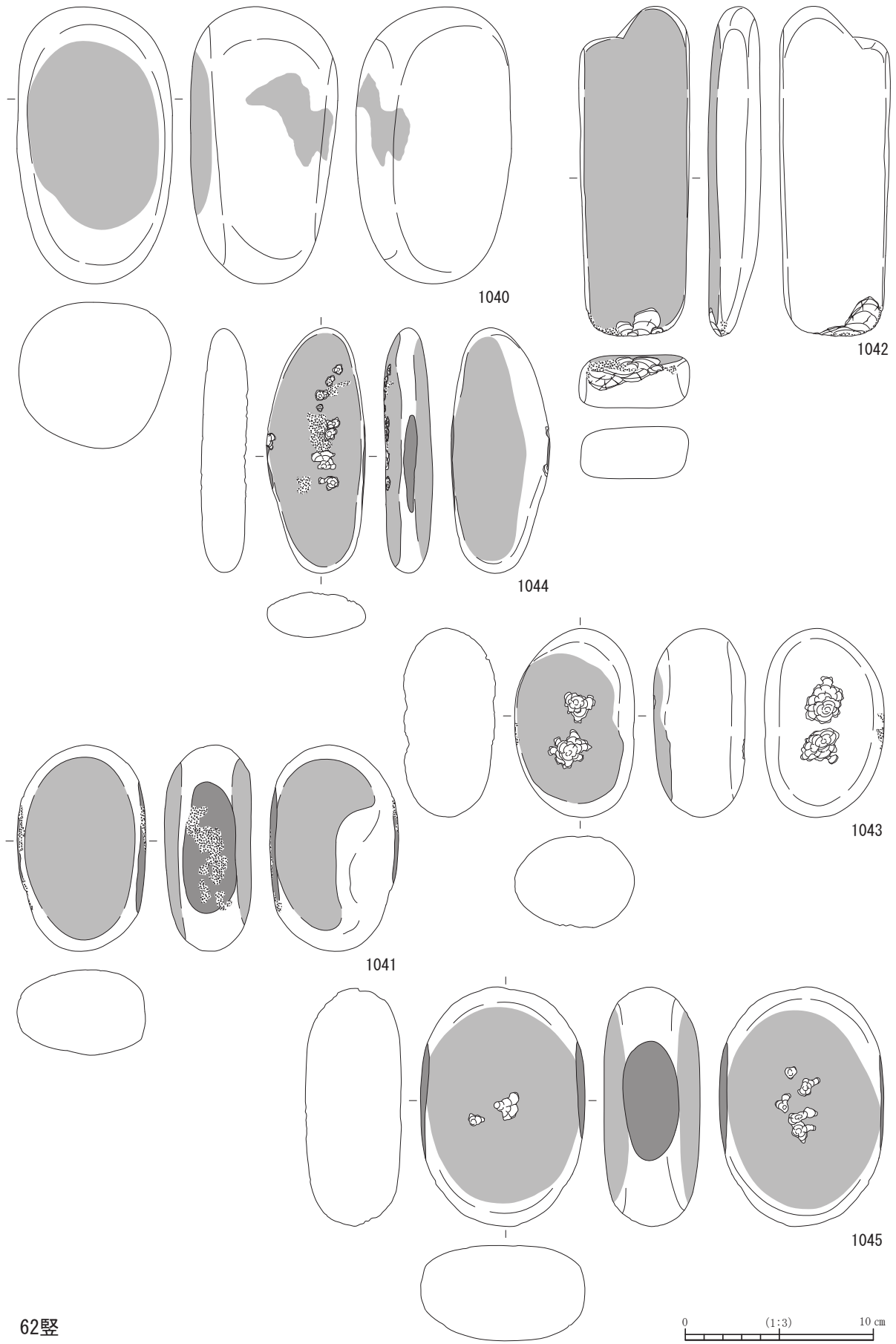

62 豎

遺物図版140 縄文時代の遺物140

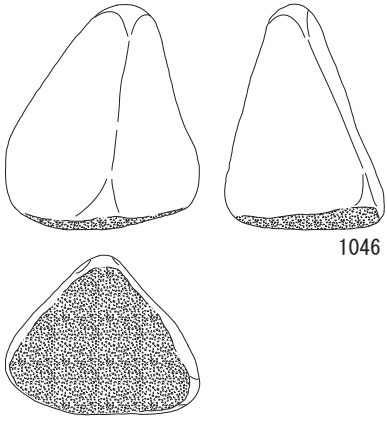

1046

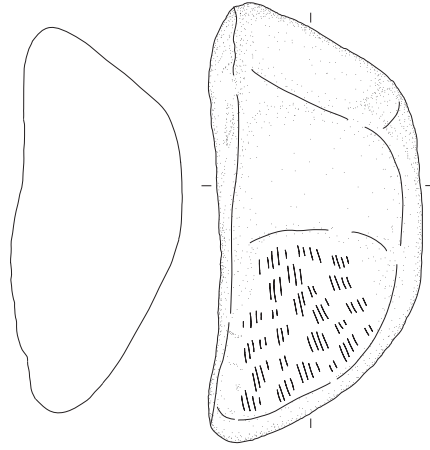

1052

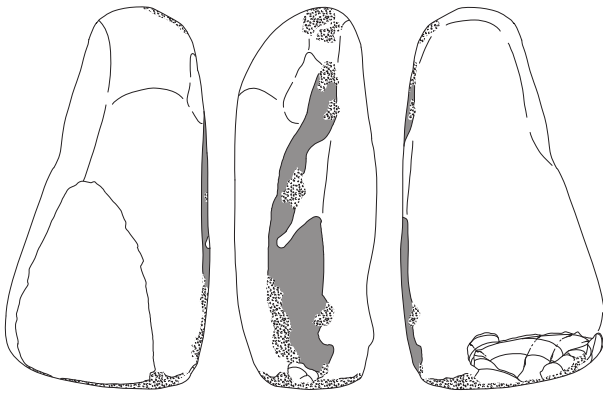

1047

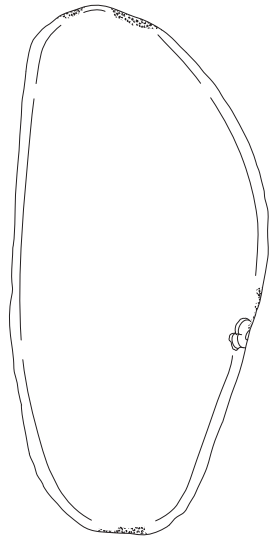
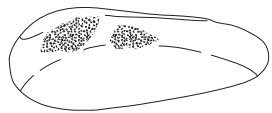
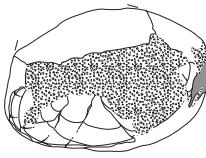

1048

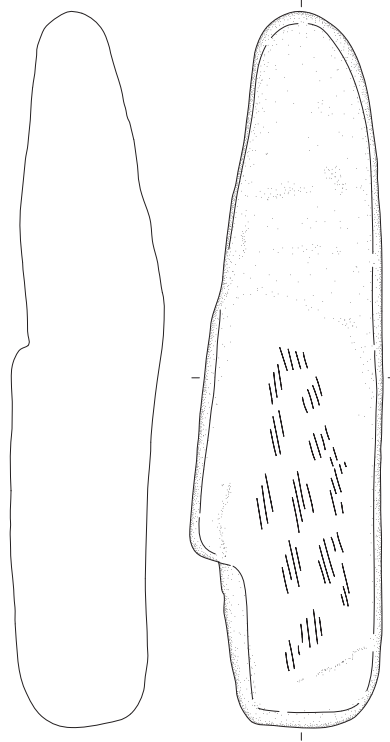
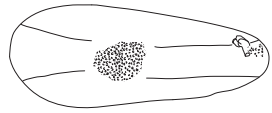

1051

62 豎

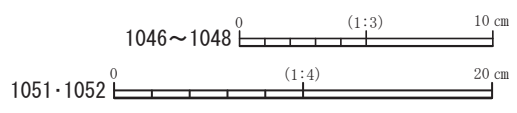

遺物図版141 縄文時代の遺物141

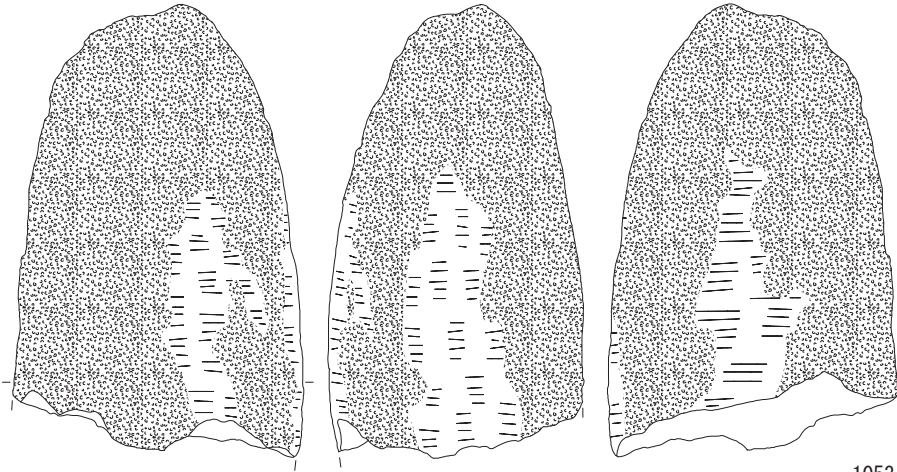

1053

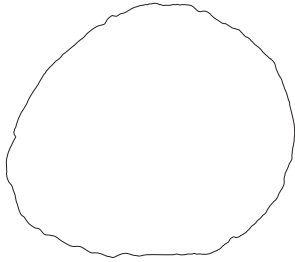

1053 0 (1:2) 10 cm

62 豎

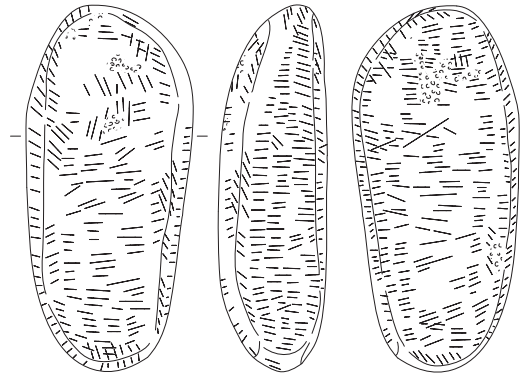

1055



1055 0 (2:3) 5 cm

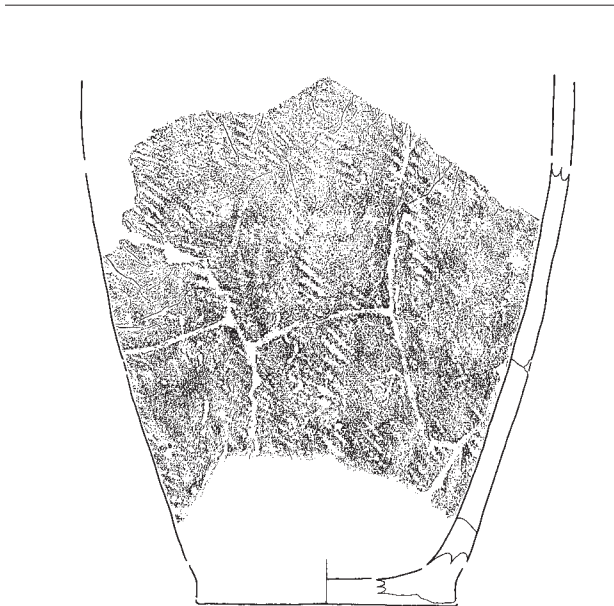

1056

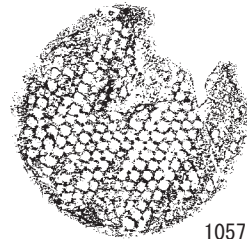
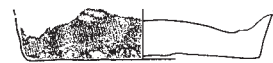

1057

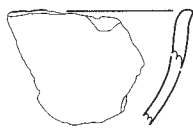

1059



1060

63 豎

0 (1:3) 10 cm

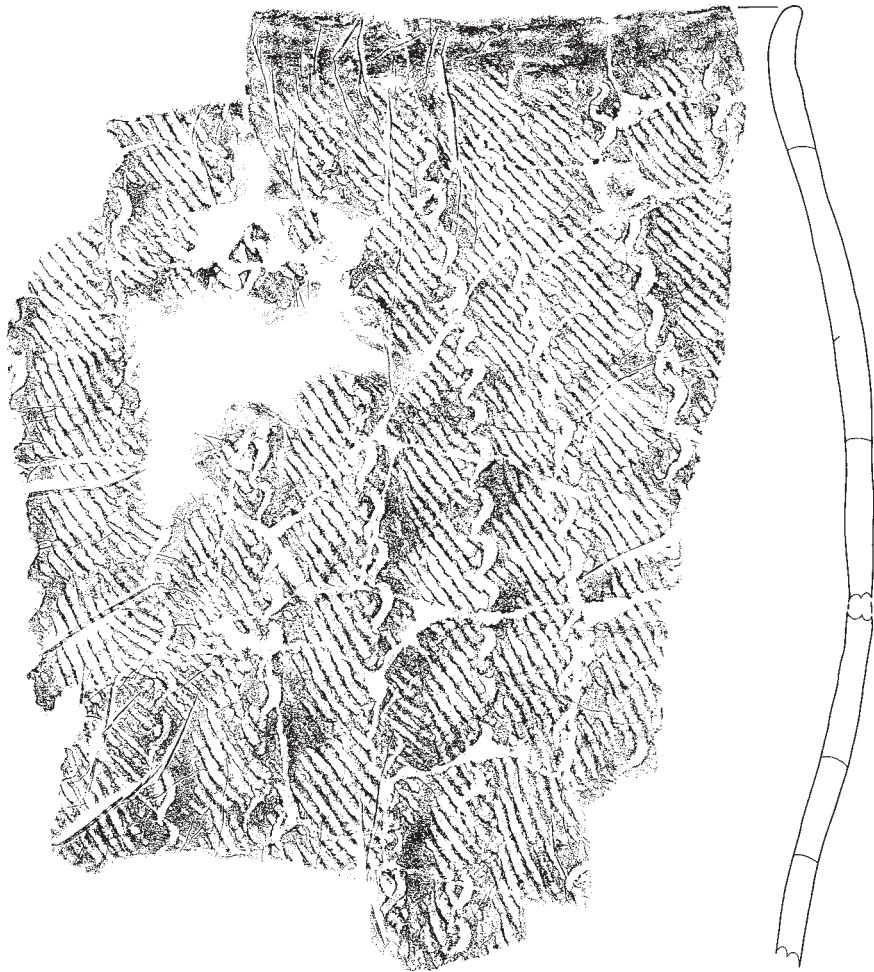

1058

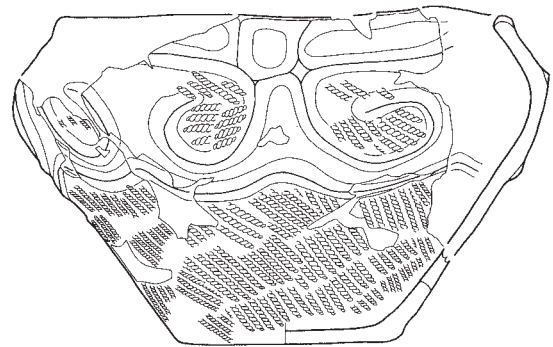
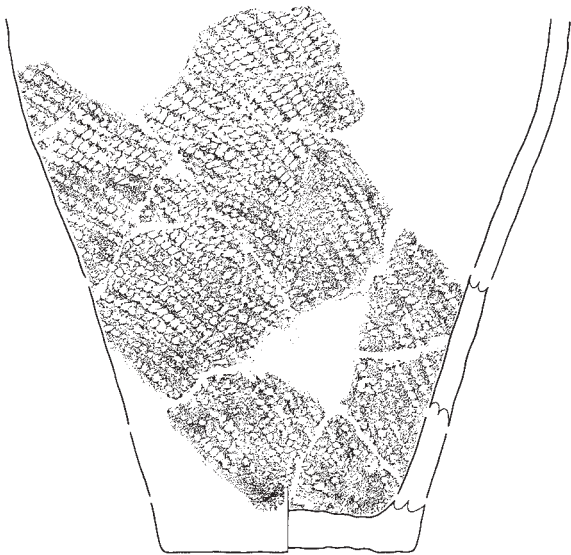

1062



1061



1064



1065

0 (1:2) 10 cm

1064 0 (1:3) 10 cm

63 豎

1058・1061・1062・1065

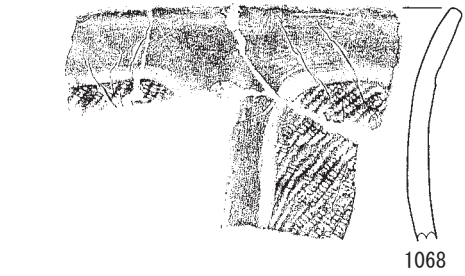
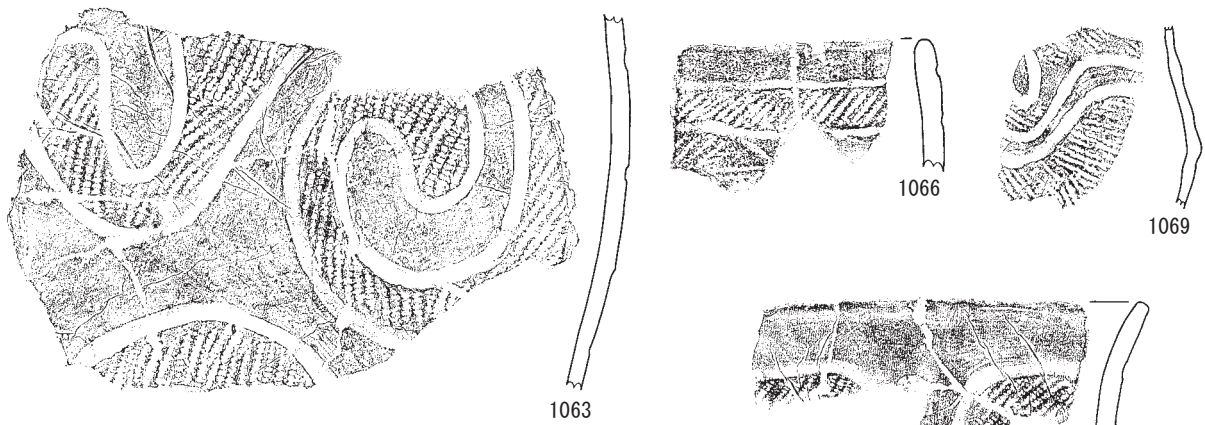

1063・1067~1070 (1:3) 0 10 cm

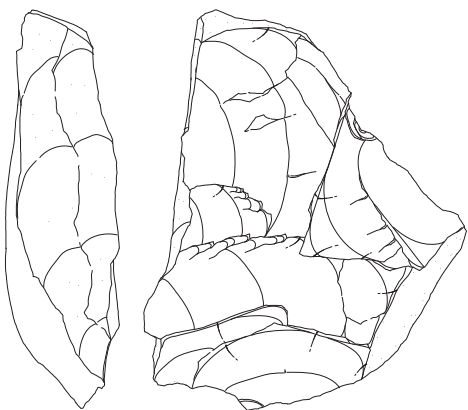
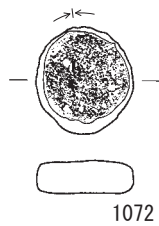
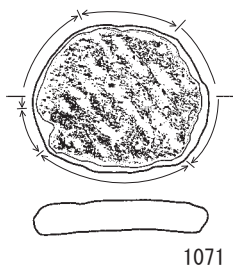
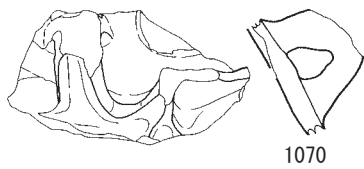
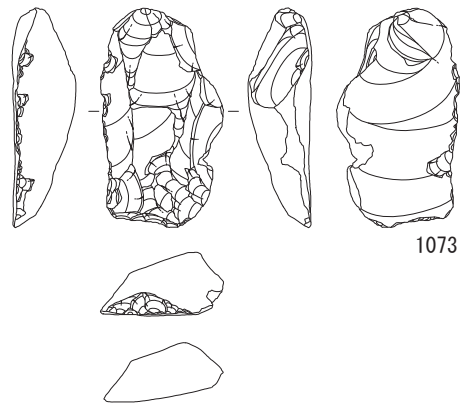

1066・1071・1072 (1:2) 0 10 cm

1073・1074 (2:3) 0 5 cm

63 豎

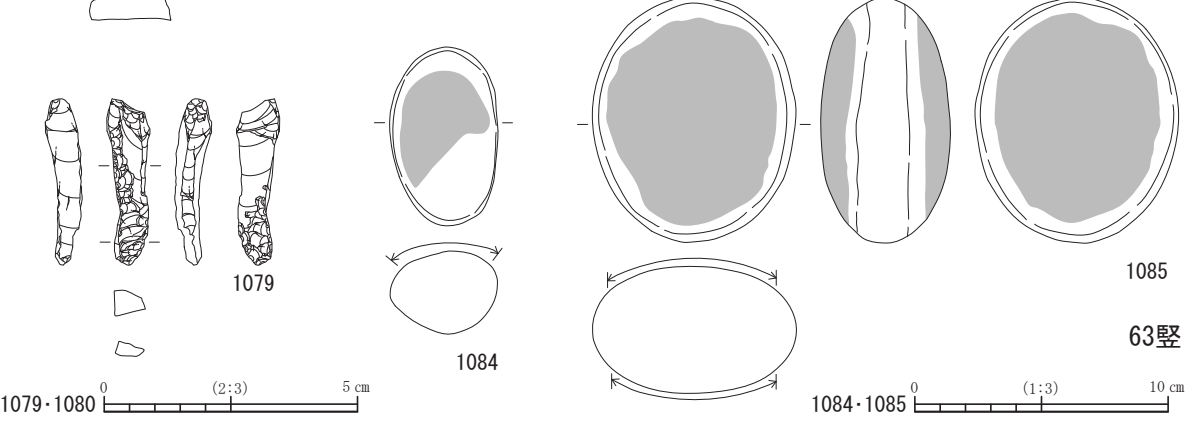
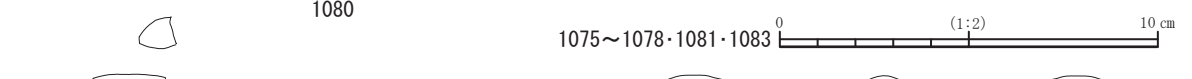
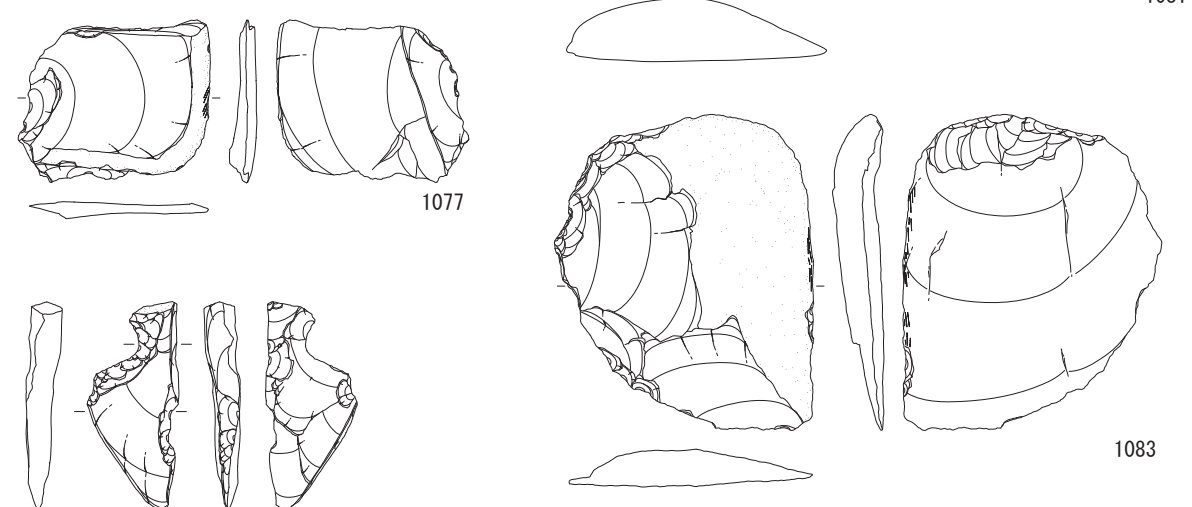
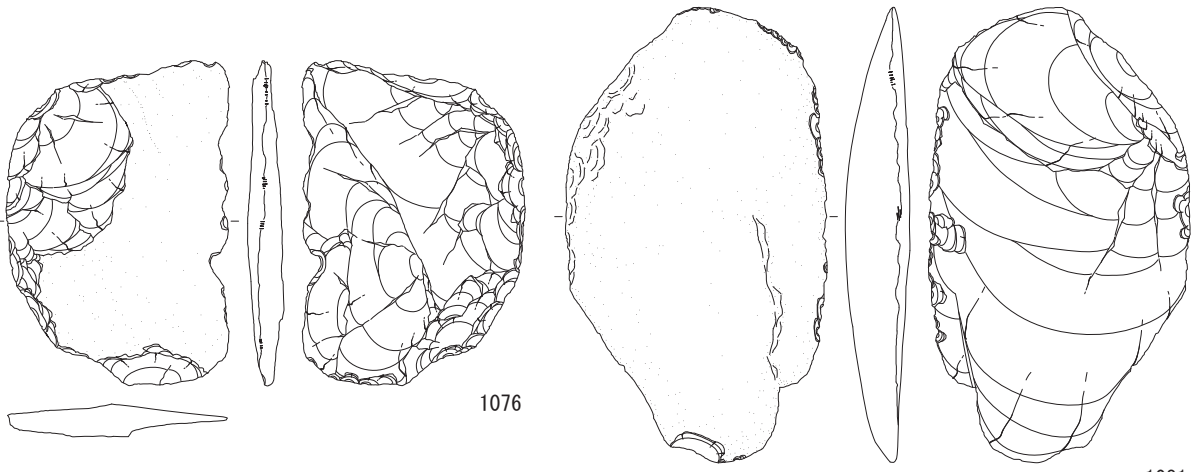
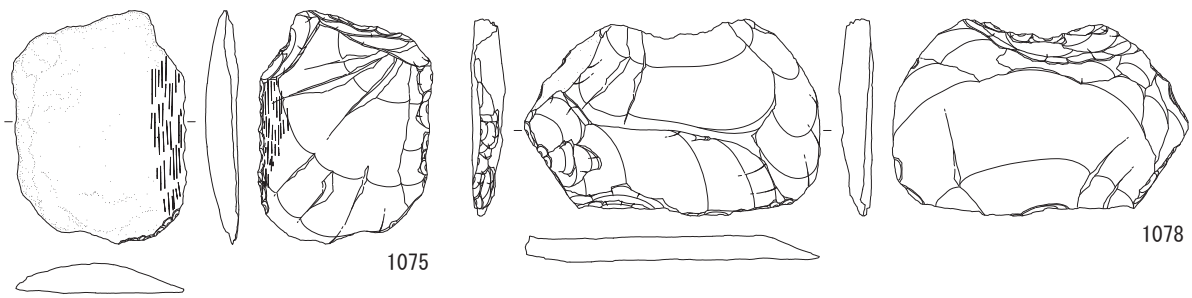

遺物図版145 縄文時代の遺物145

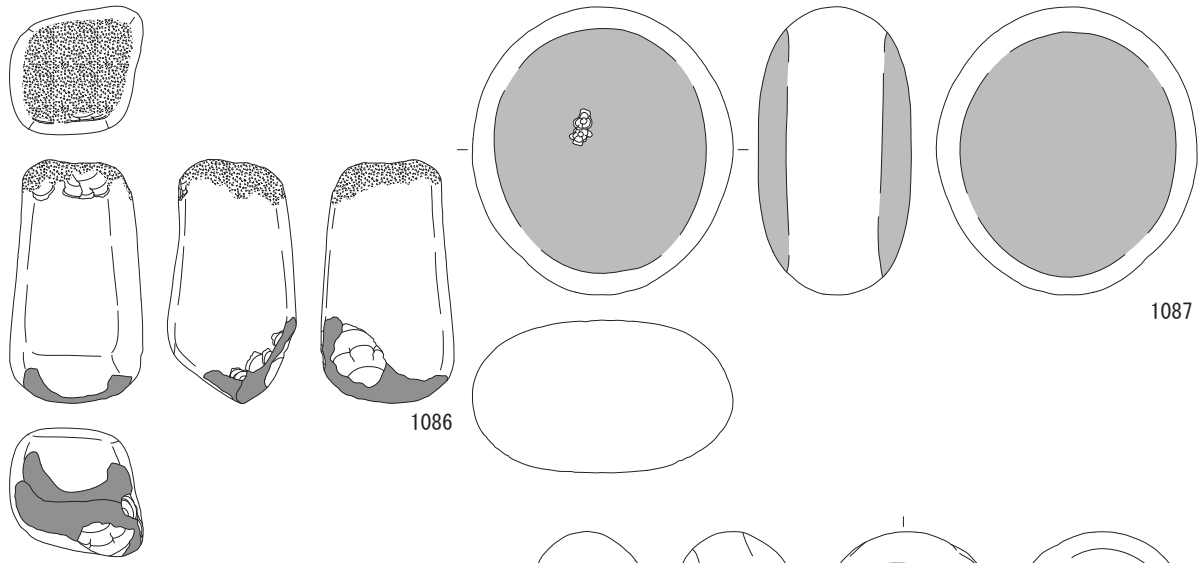

1086

1087

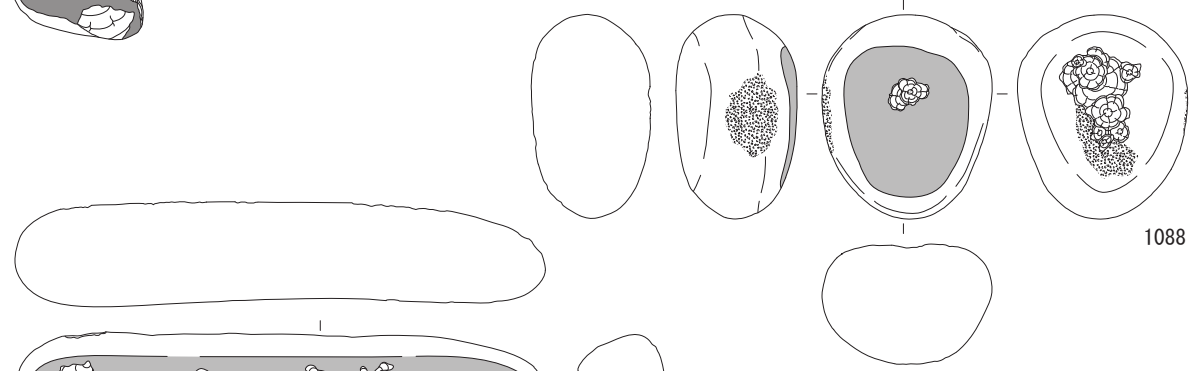

1088

1089

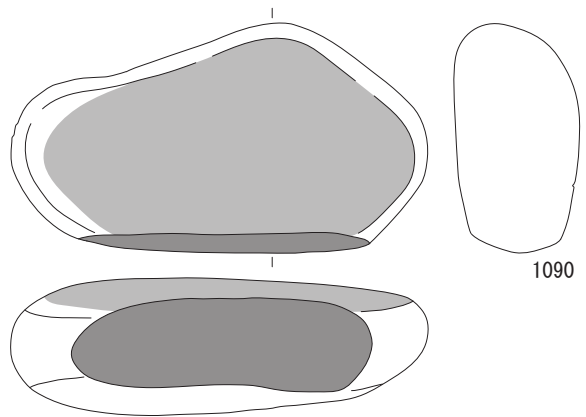
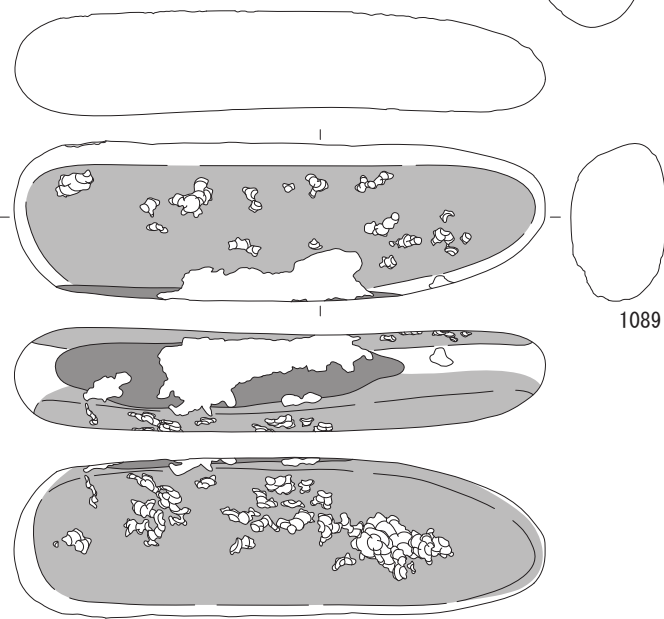

1090

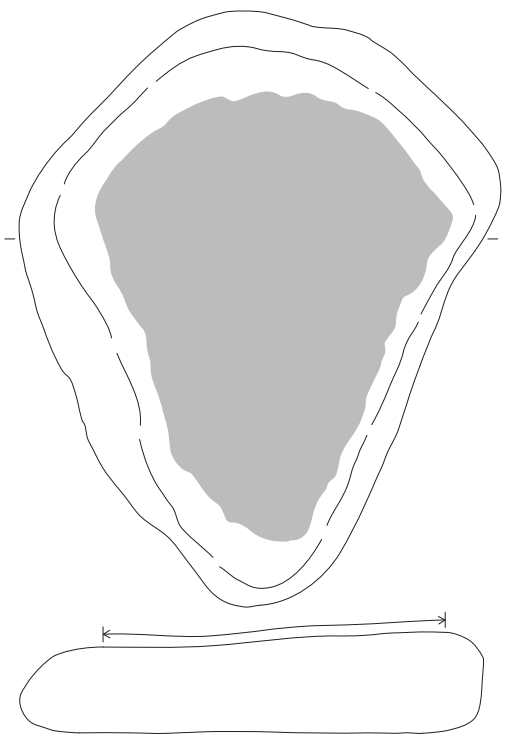

1091

1086~1090 0 (1:3) 10 cm

63 1091 0 (1:4) 20 cm

遺物図版146 縄文時代の遺物146

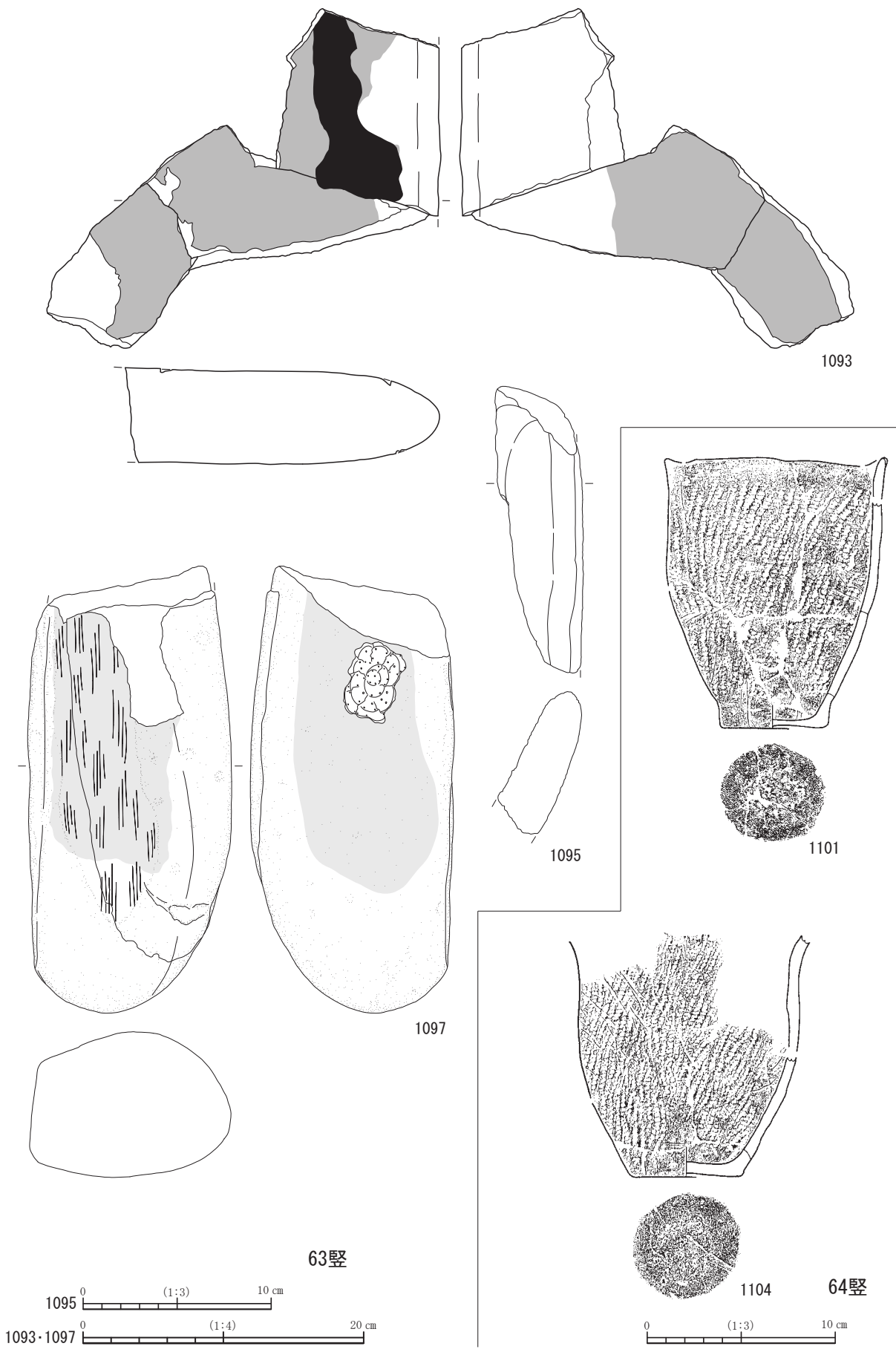

遺物図版147 縄文時代の遺物147

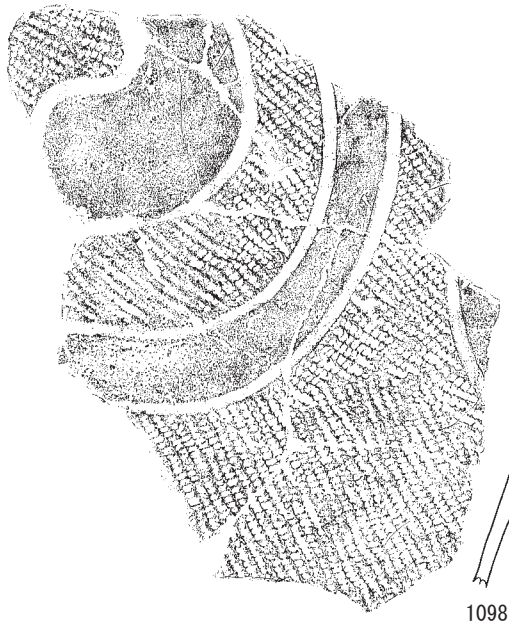

1098



1099

1099 0 (1:4) 20 cm

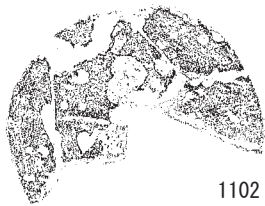
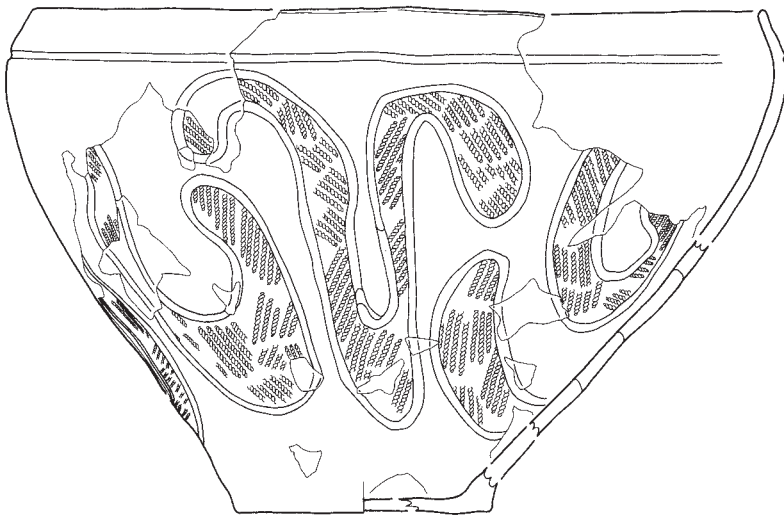

1102



1105

64 豎

1098・1102・1105 0 (1:3) 10 cm

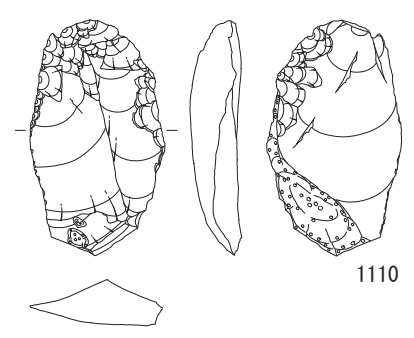
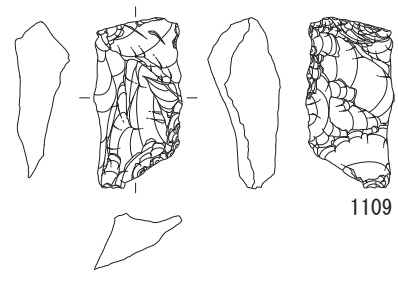
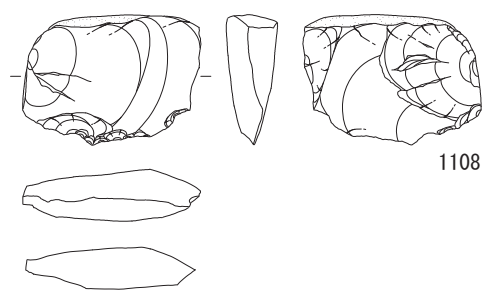
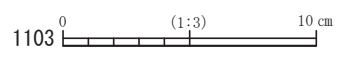
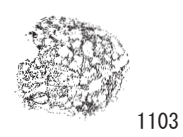
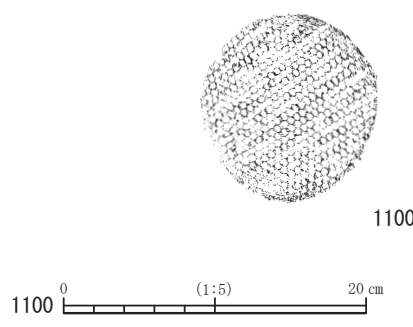
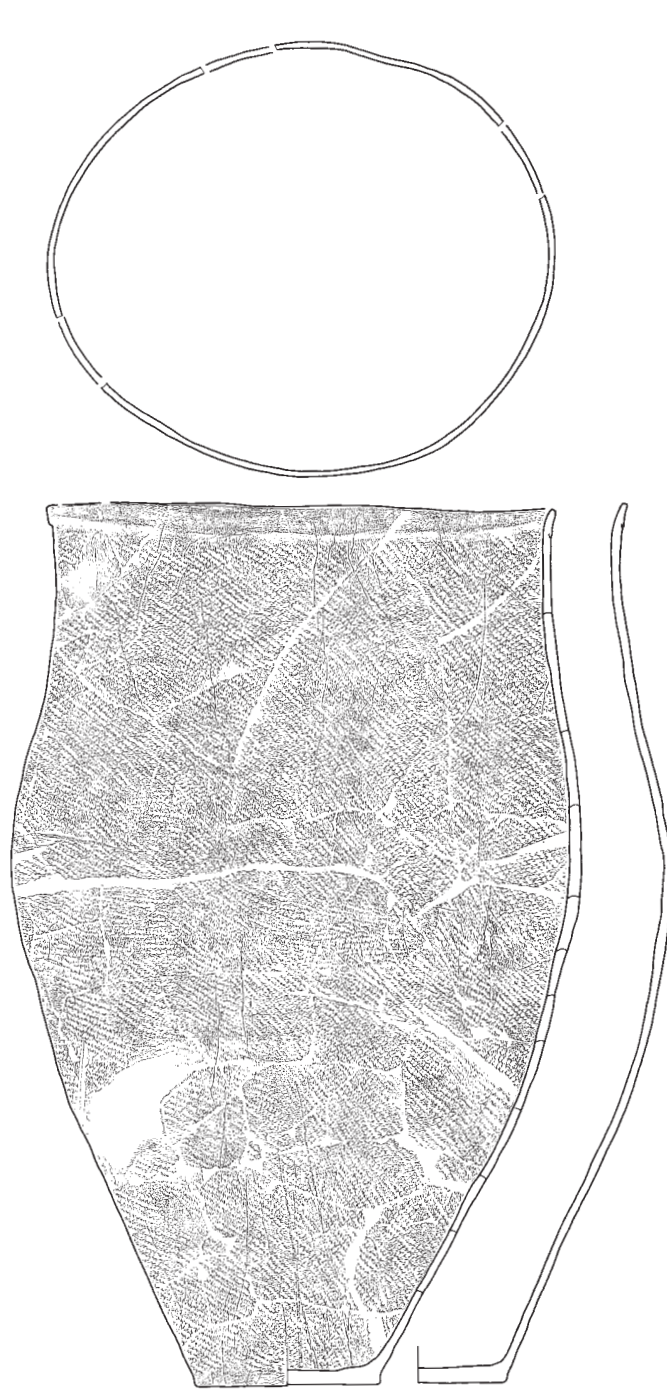

遺物図版149 縄文時代の遺物149

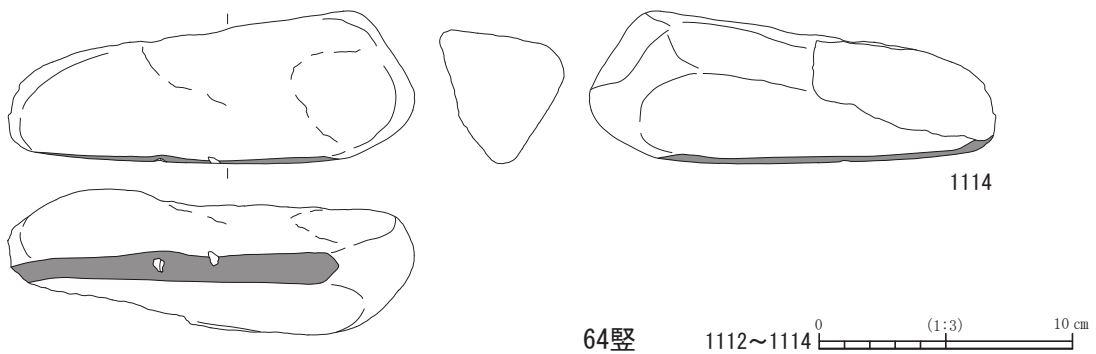
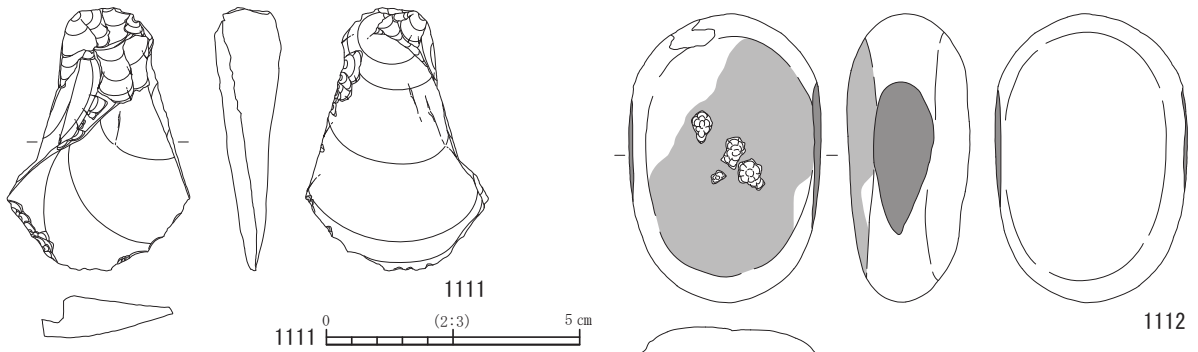

遺物図版150 縄文時代の遺物150

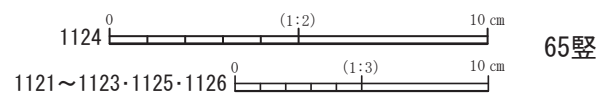
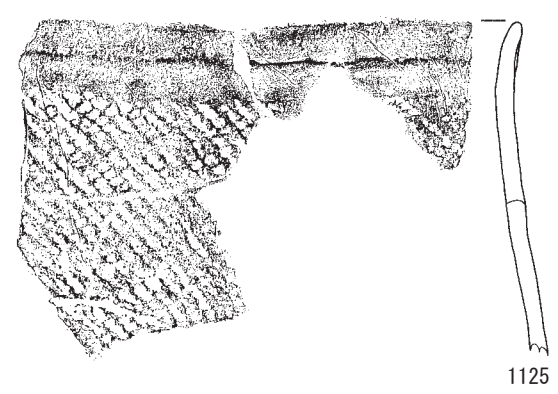
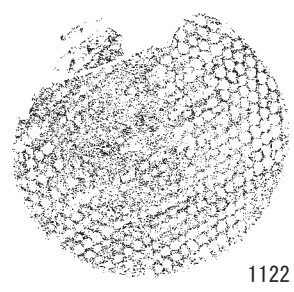
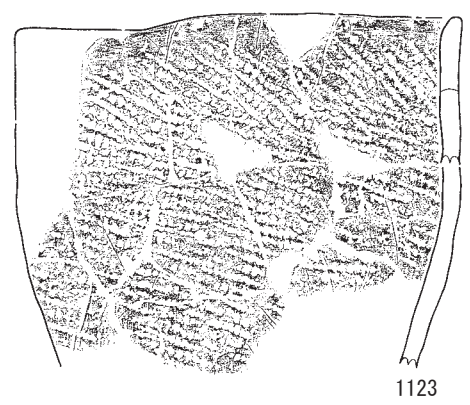
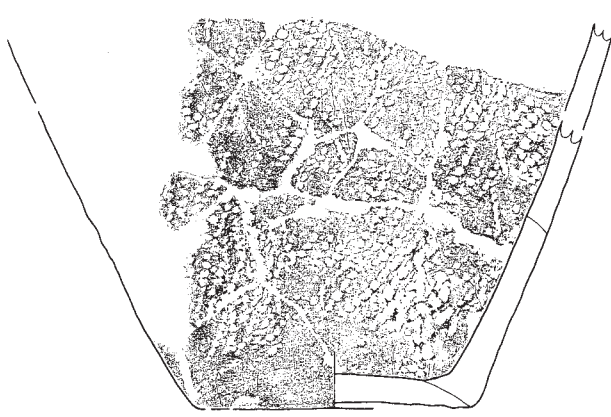
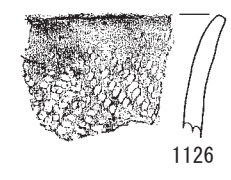
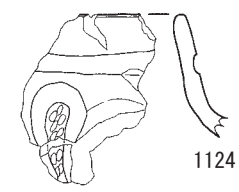
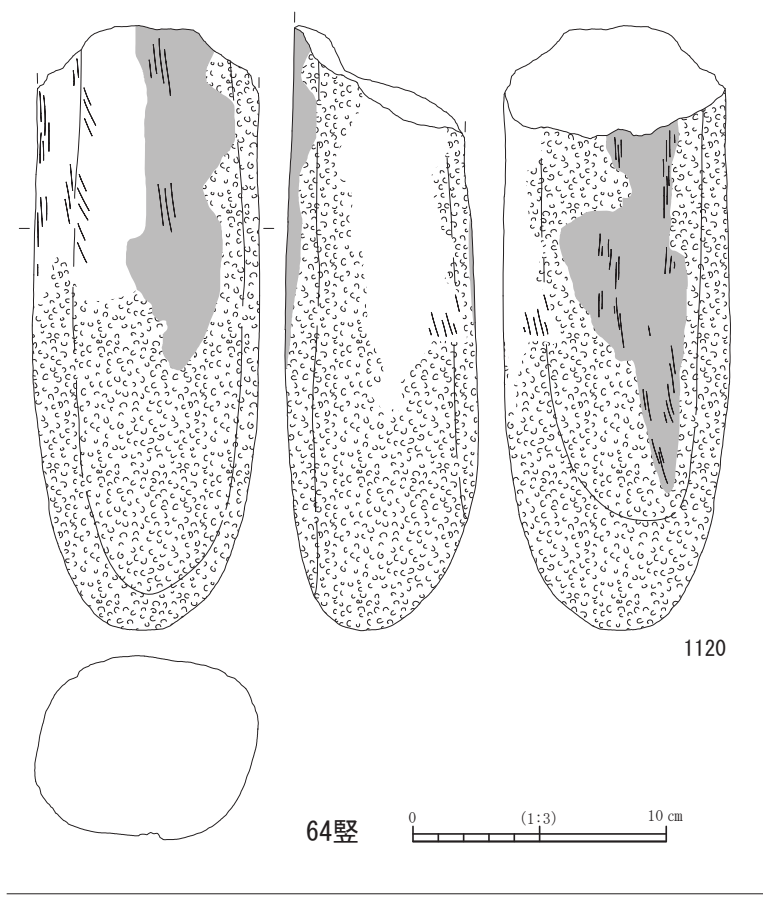

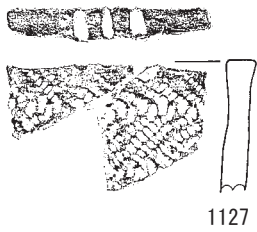

1127



1128

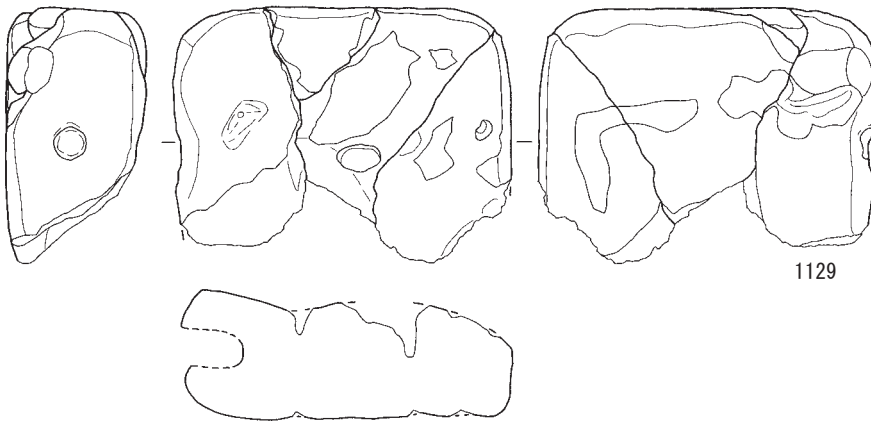

1129

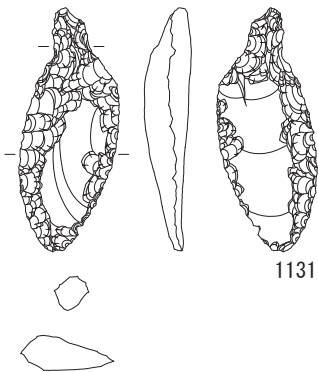

1131

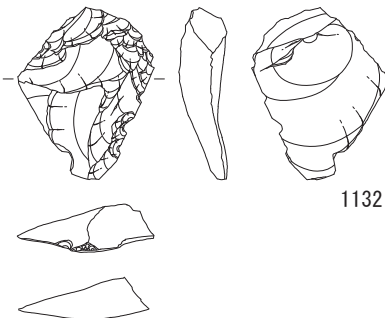

1132

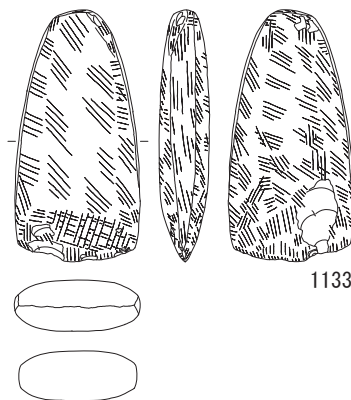

1133

1131-1132 0 (2:3) 5 cm

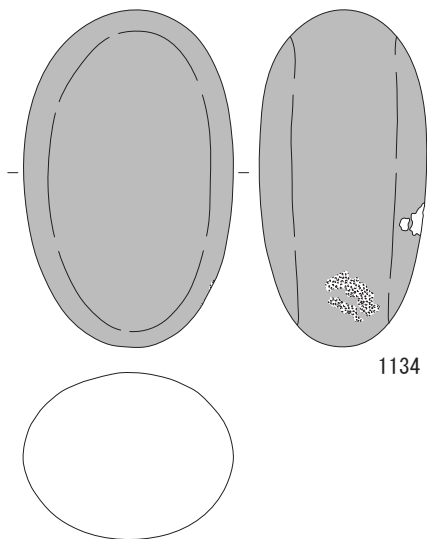

1134

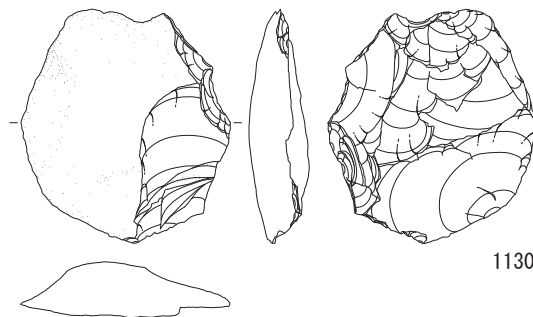

1130

1128-1134 0 (1:3) 10 cm

65 豎

1127-1129-1130-1133 0 (1:2) 10 cm

遺物図版152 縄文時代の遺物152

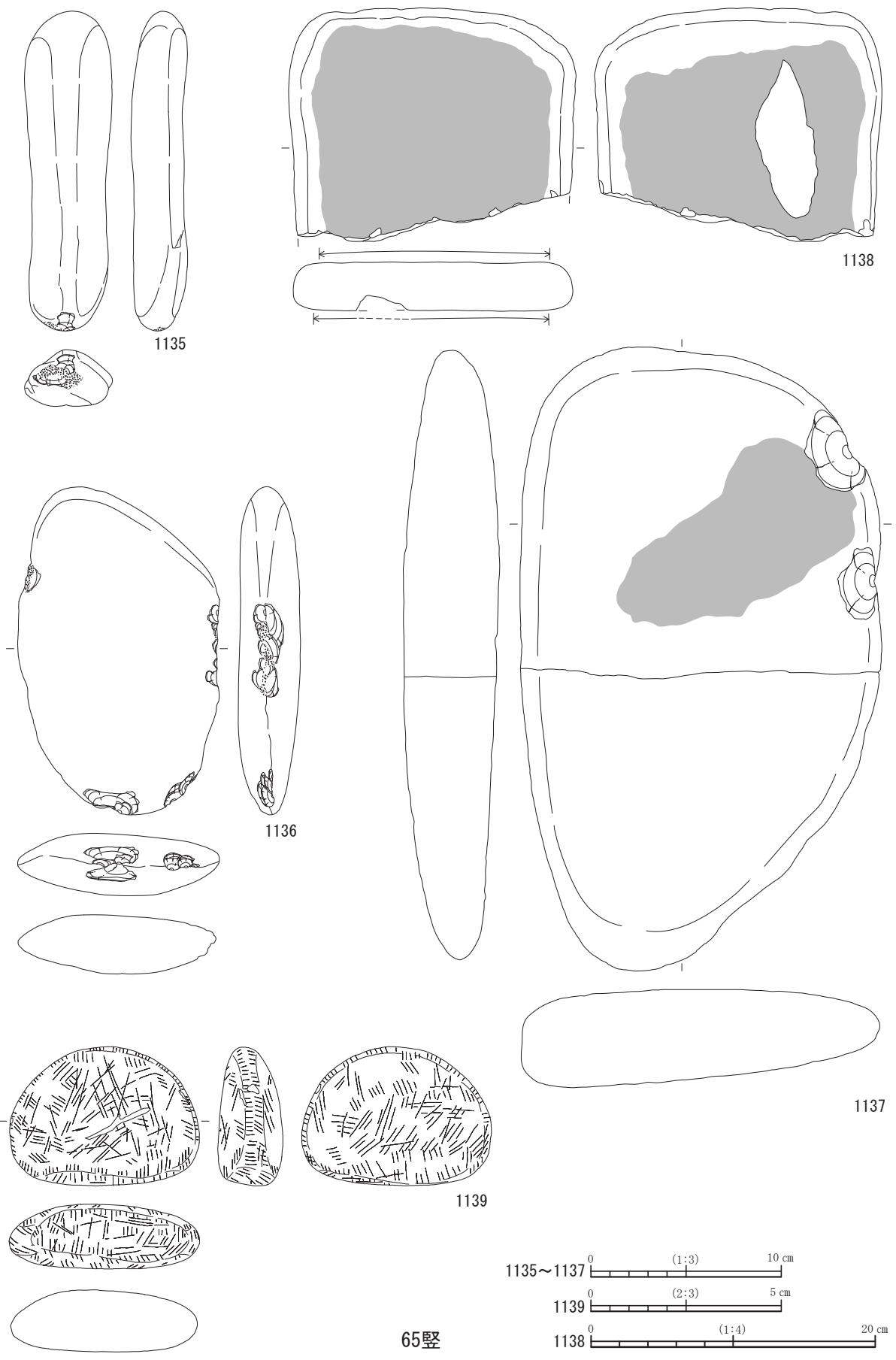

65 豎

遺物図版153 縄文時代の遺物153

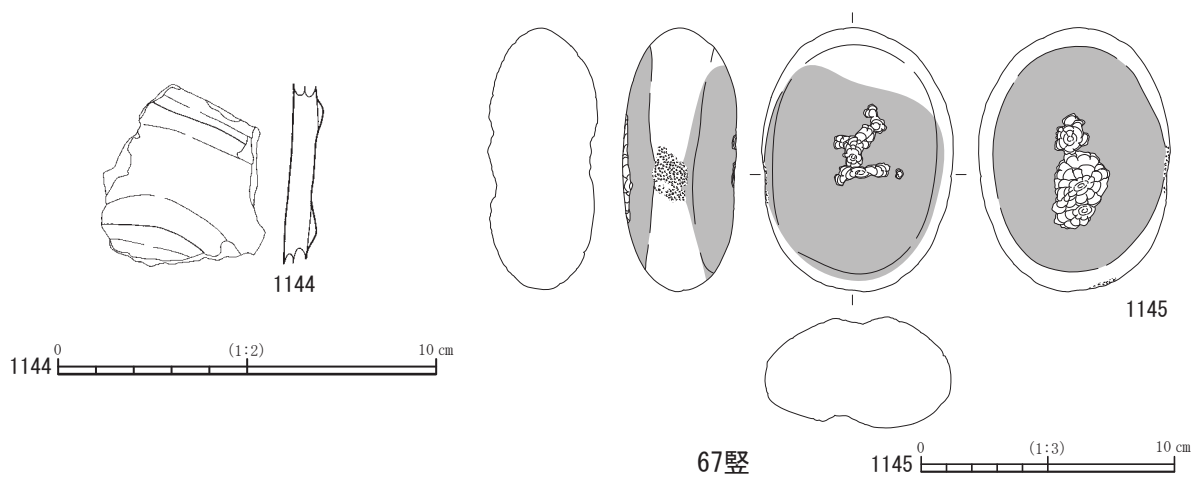
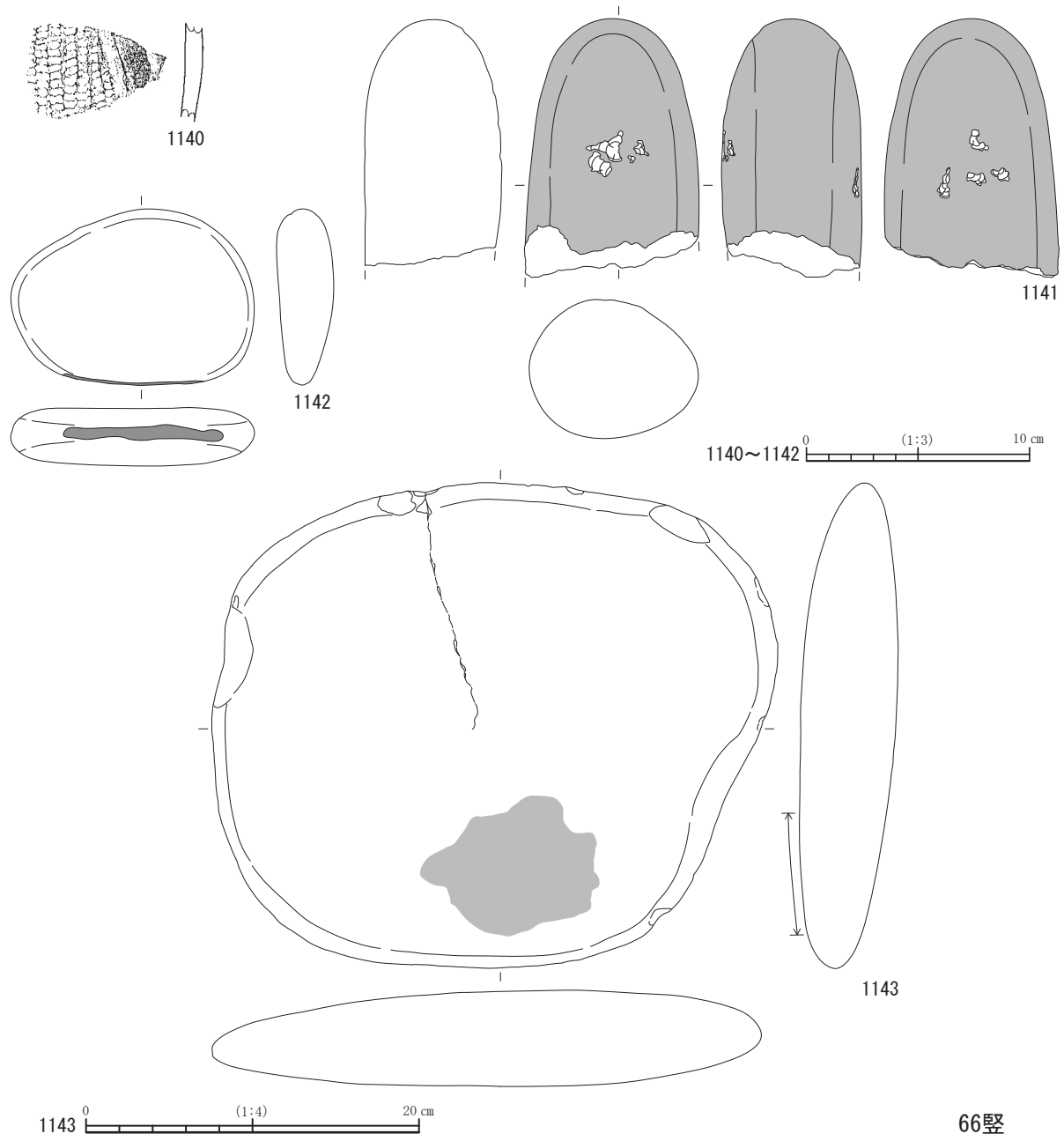

遺物図版154 縄文時代の遺物154

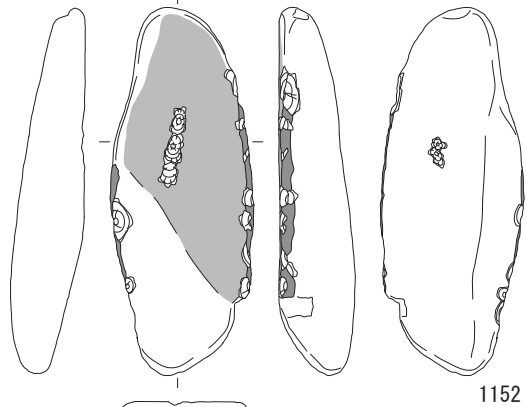
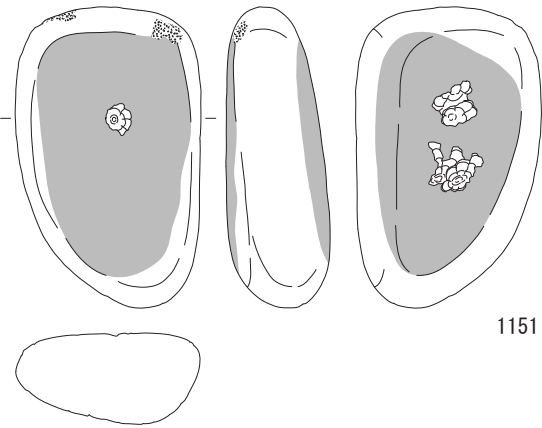
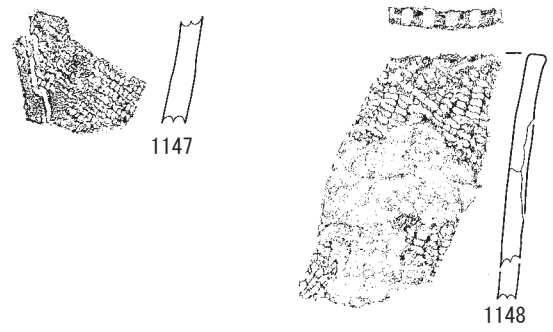
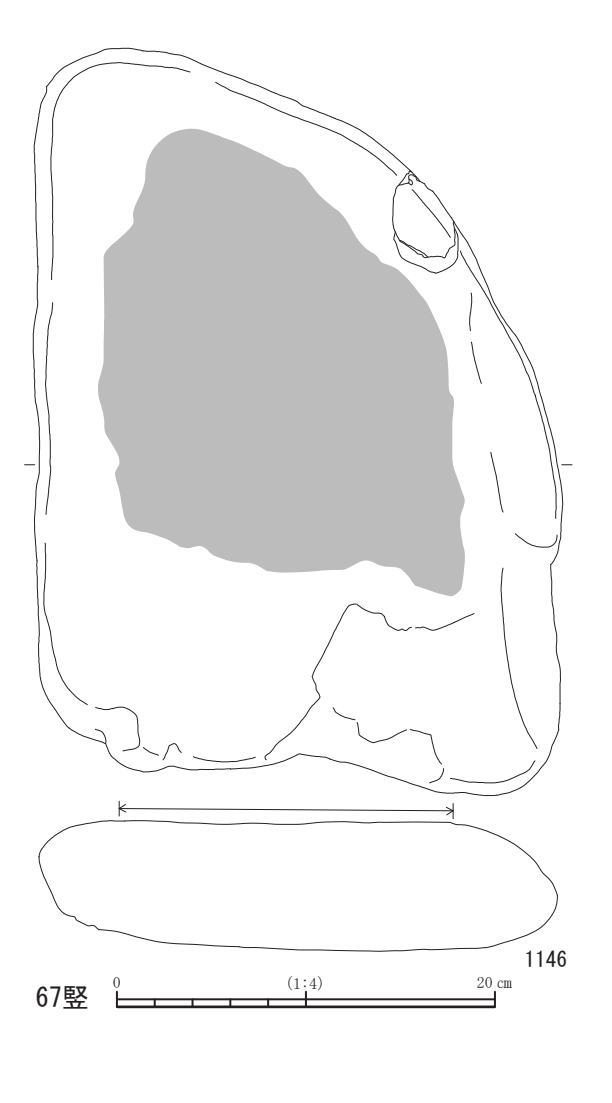

1147・1148・1151・1152 0 (1:3) 10 cm

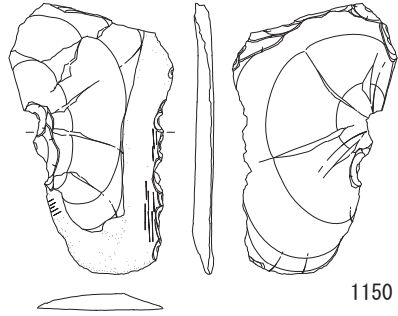
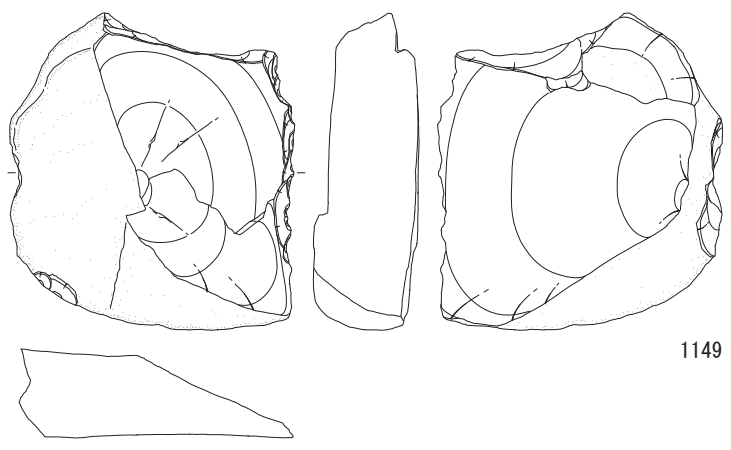

68 豎 1149・1150 0 (1:2) 10 cm

遺物図版155 縄文時代の遺物155

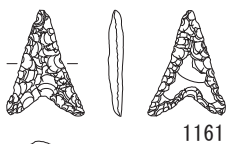
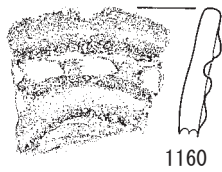
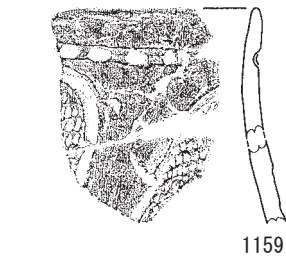
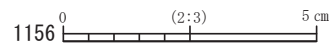
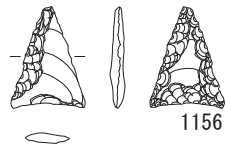
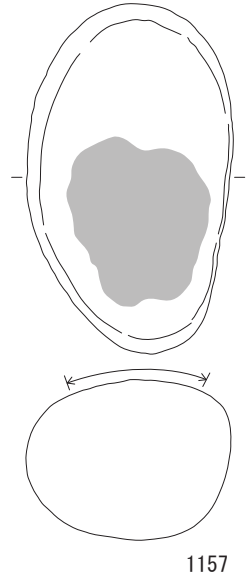
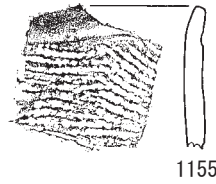
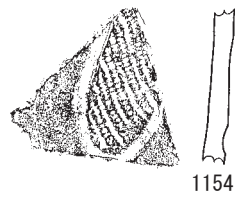
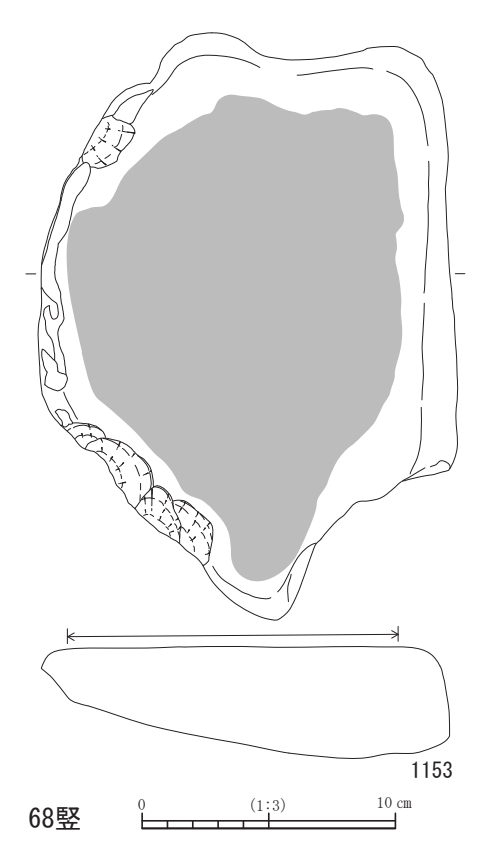

71 縦

黒色付着物

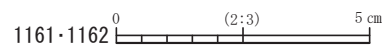
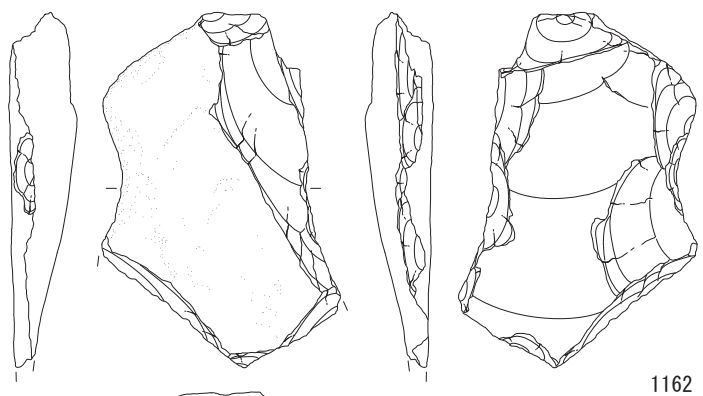
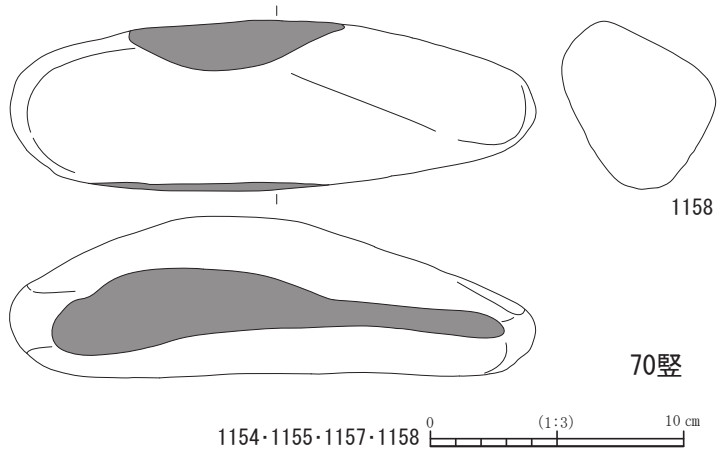

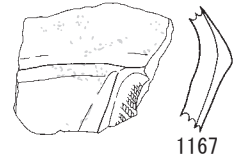
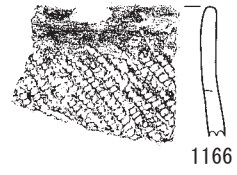
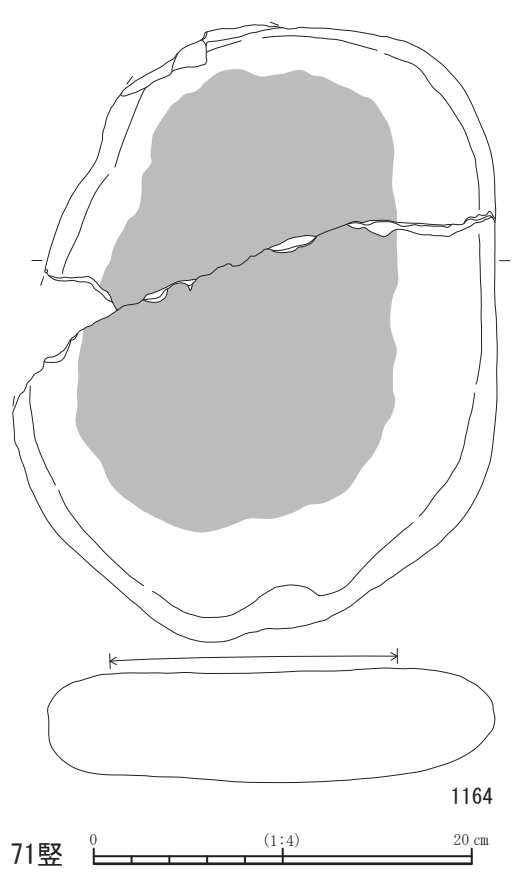

1165~1167 0 (1:3) 10 cm

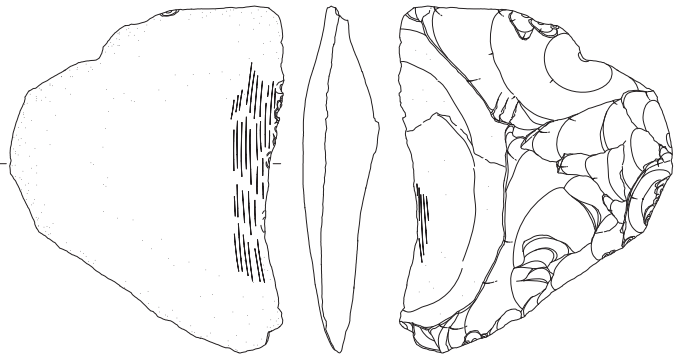

1171



1168·1169·1171 0 (1:2) 10 cm

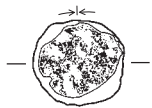

1168

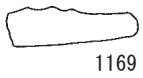
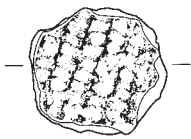

1169

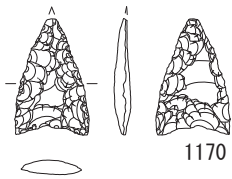

1170

72 縦

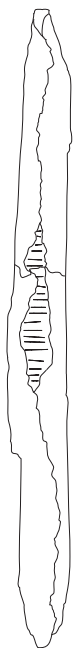

1172

1170·1172 0 (2:3) 5 cm

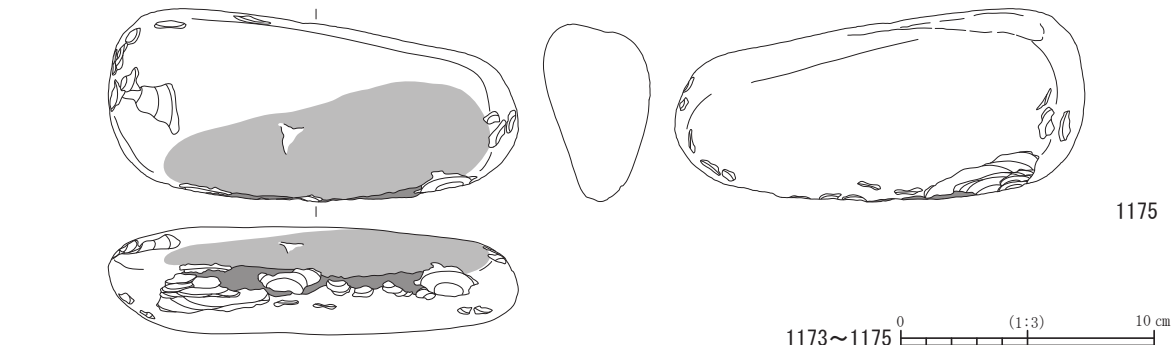

1175

1173~1175 0 (1:3) 10 cm

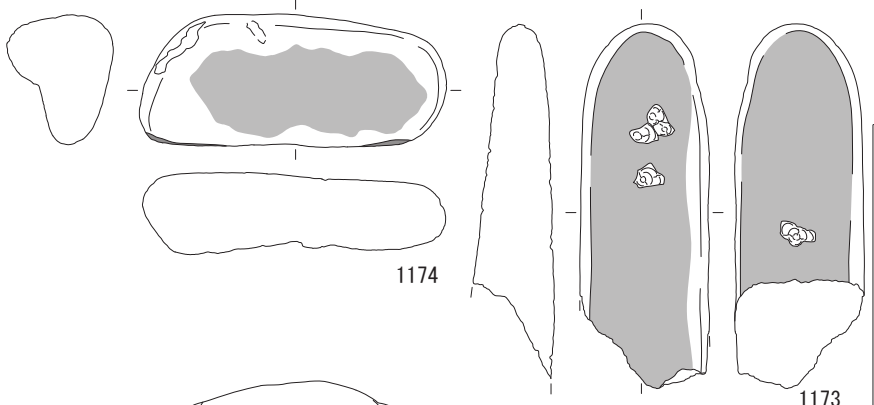

1174

1173

72 豎

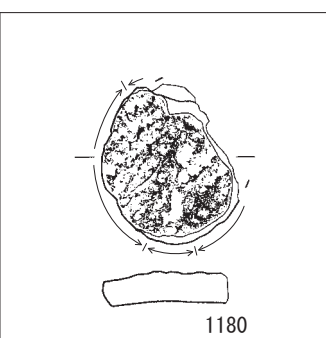

1180

1180 0 (1:2) 10 cm

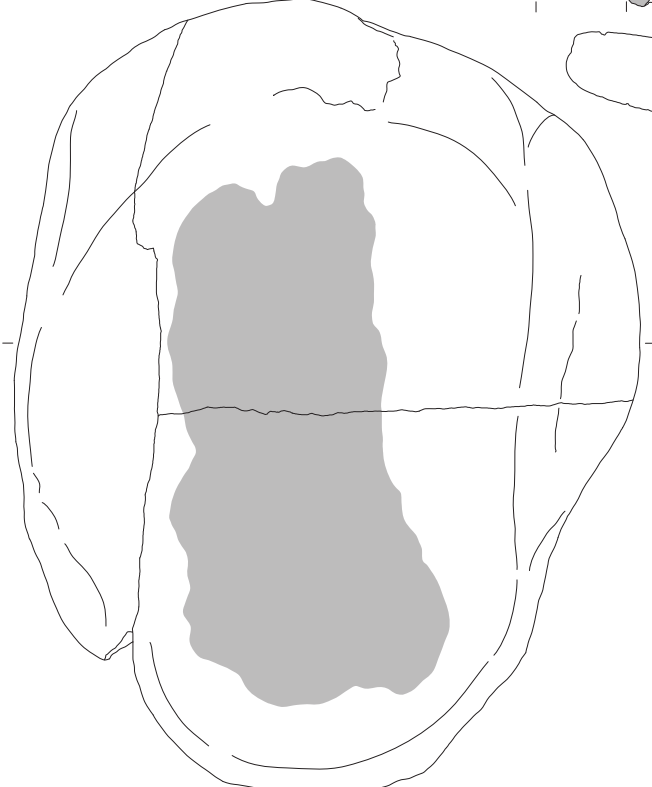

1176

1176 0 (1:5) 20 cm

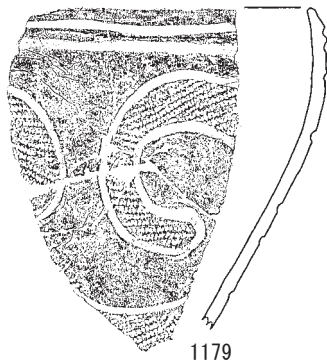

1179

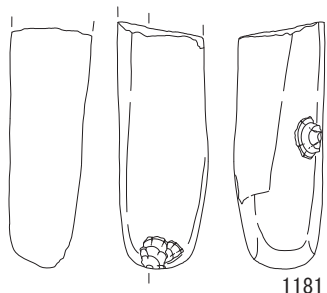

1181

73 豎

1179-1181 0 (1:3) 10 cm

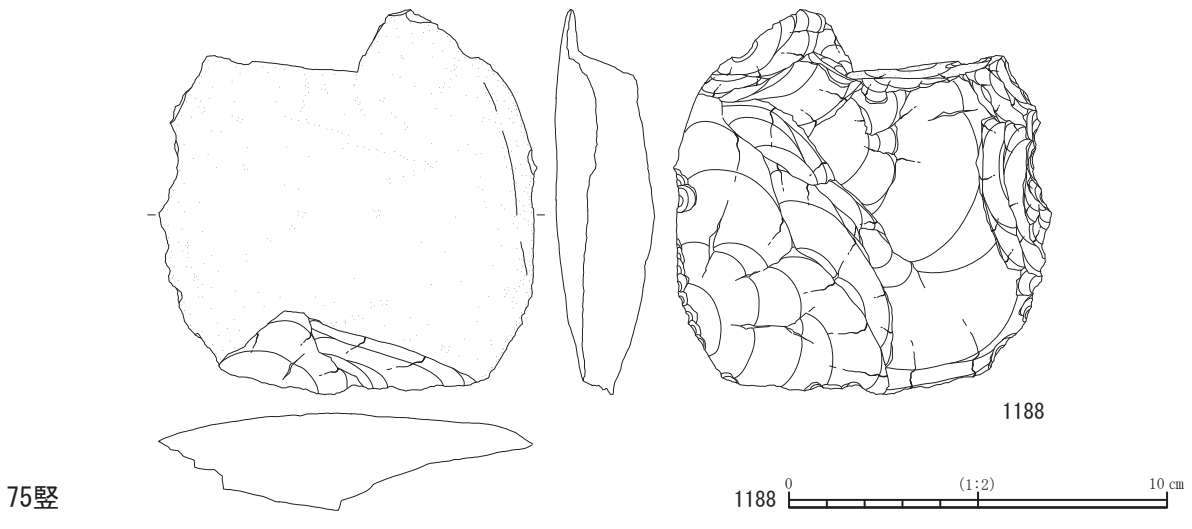
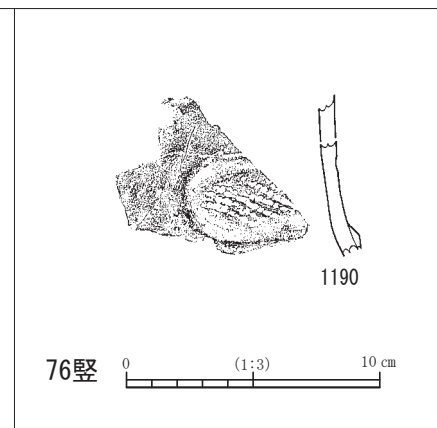
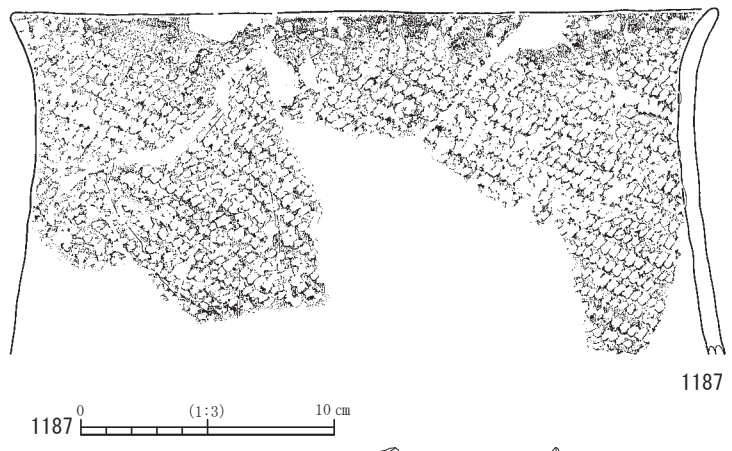
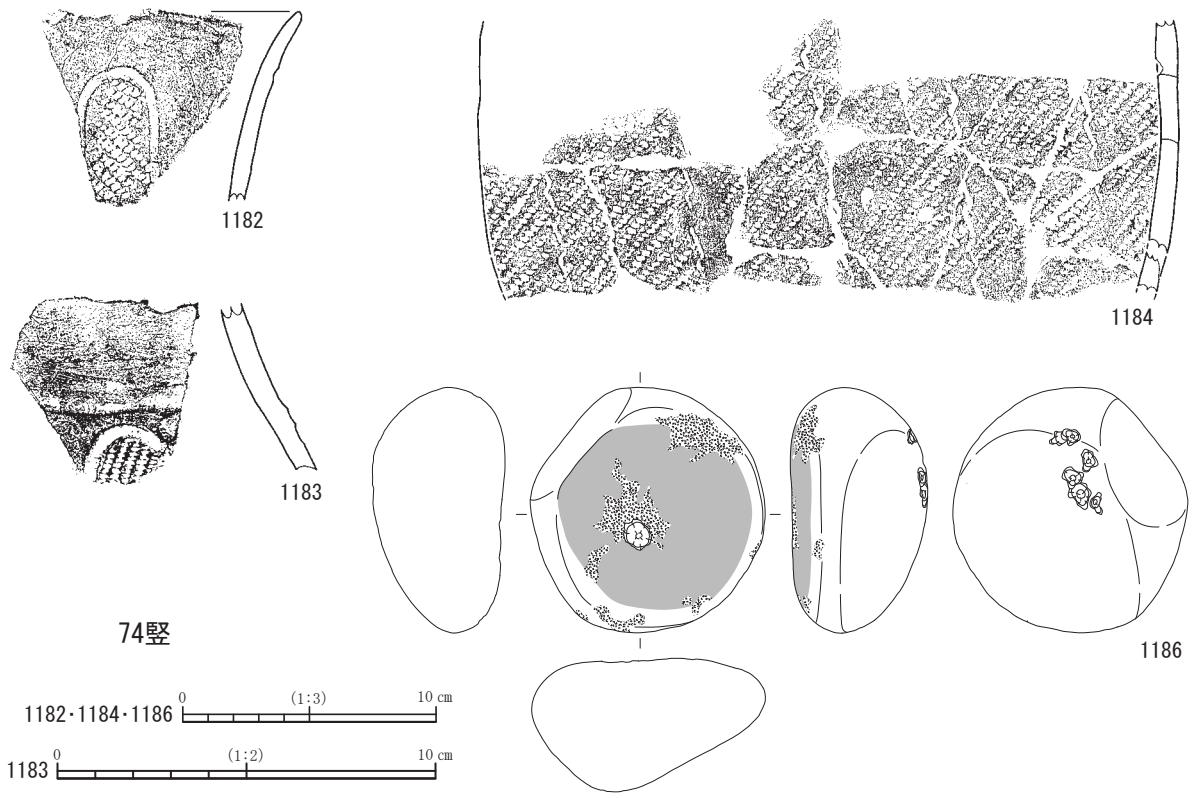

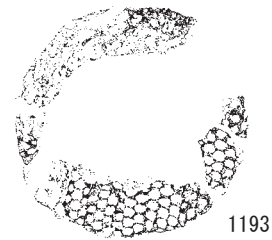
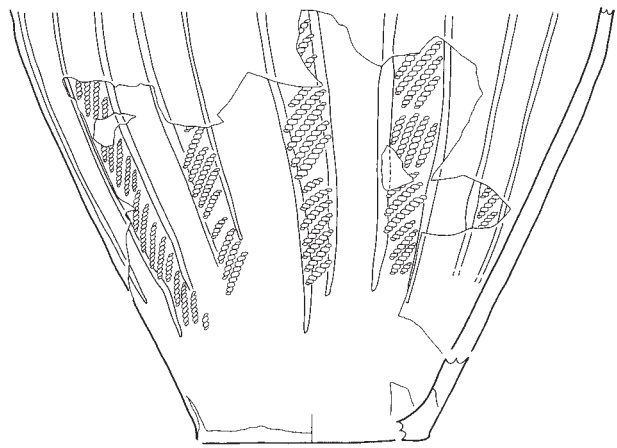
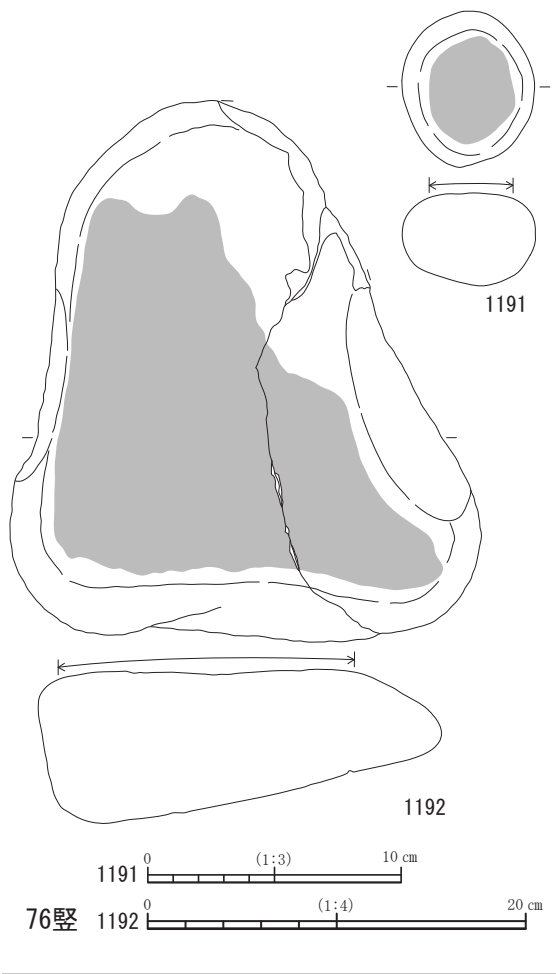

1194

1193-1194 0 (1:3) 10 cm

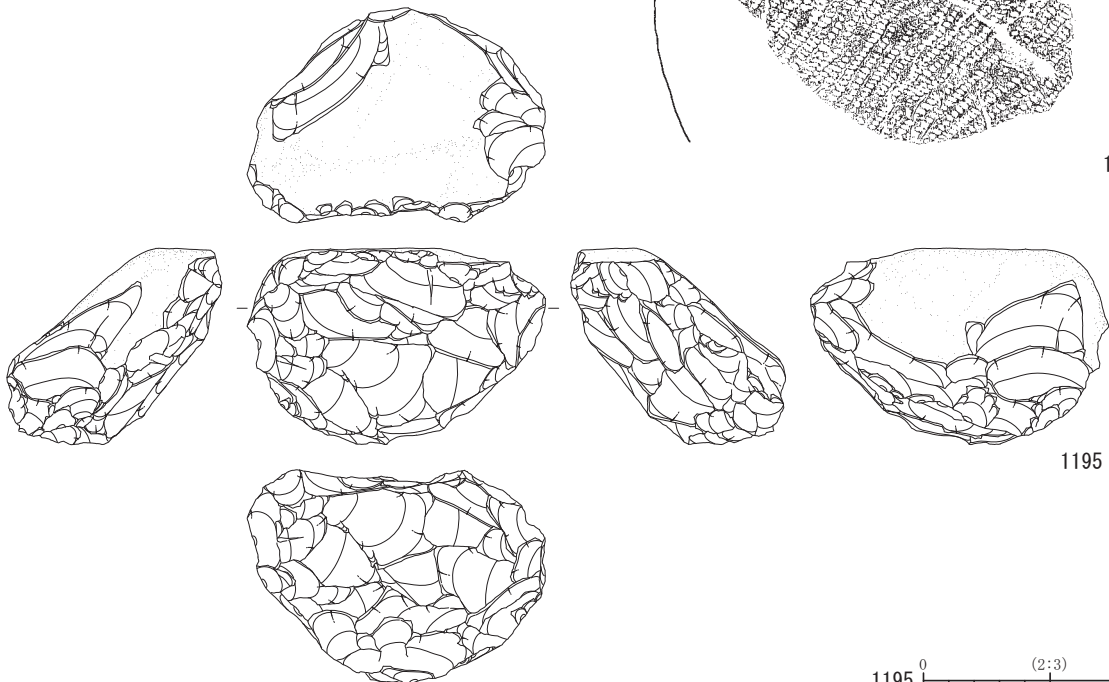

77 豎

1195 0 (2:3) 5 cm

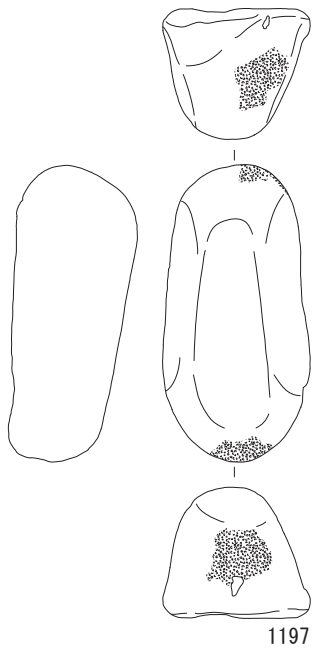

1197

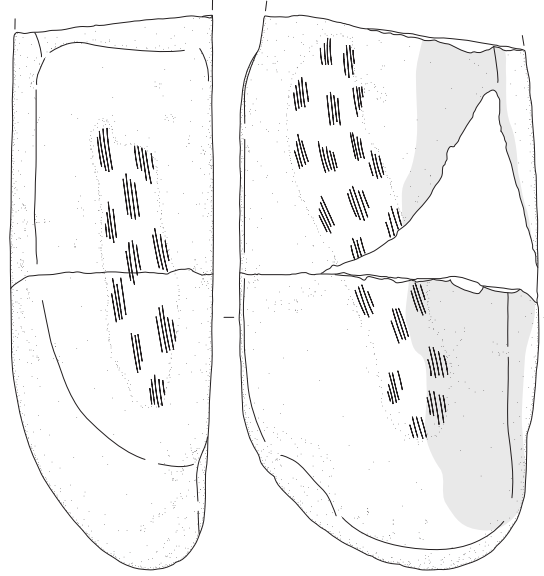
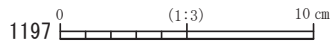

1199

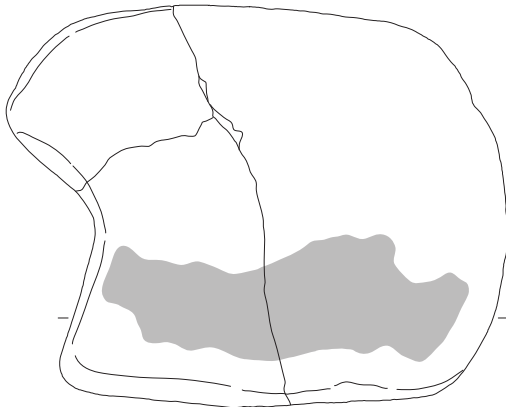
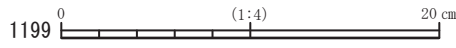

1198

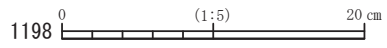

77 豎



1200

78 豎

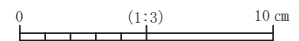



1201

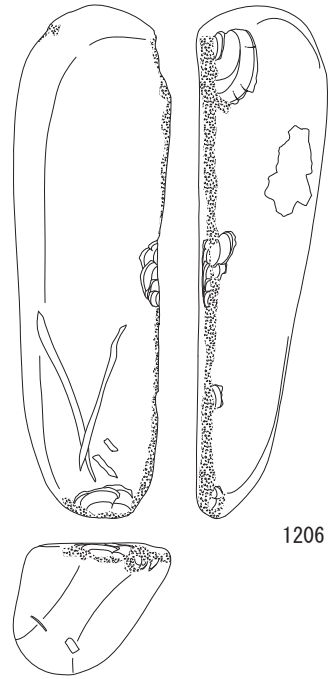

1206

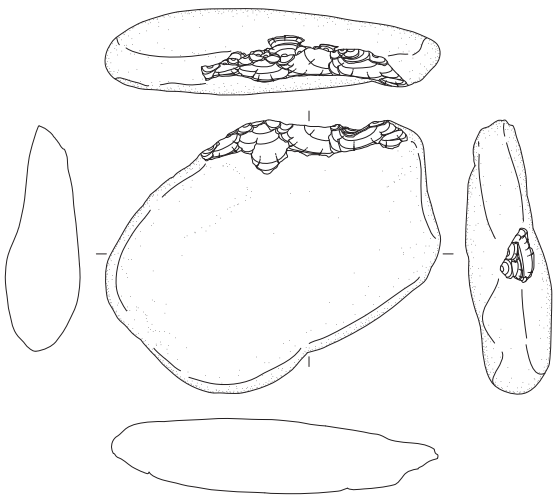

1202

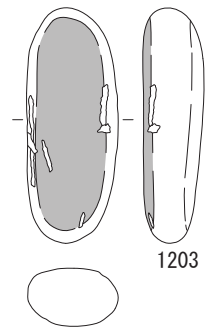

1203

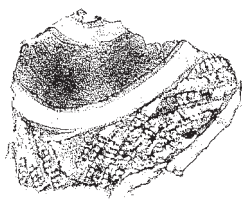

1208

79 豎

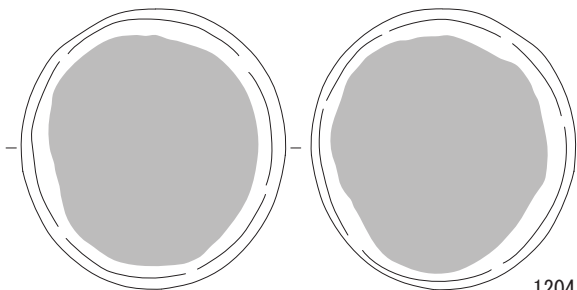
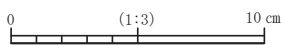

1204

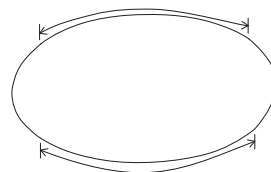

78 豎

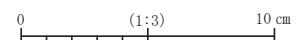

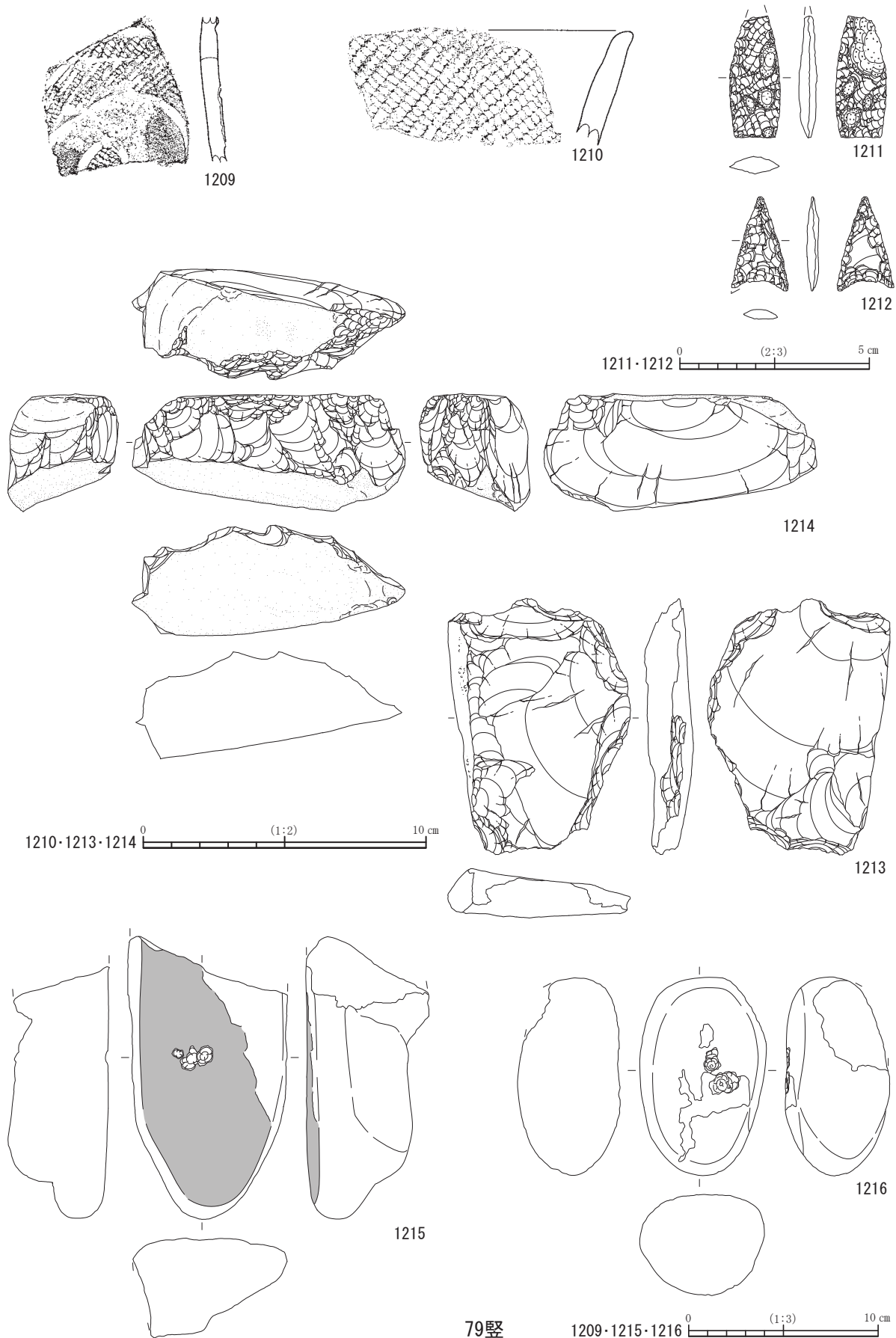

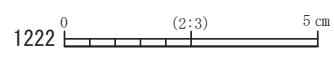
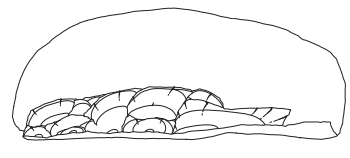
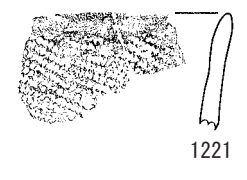
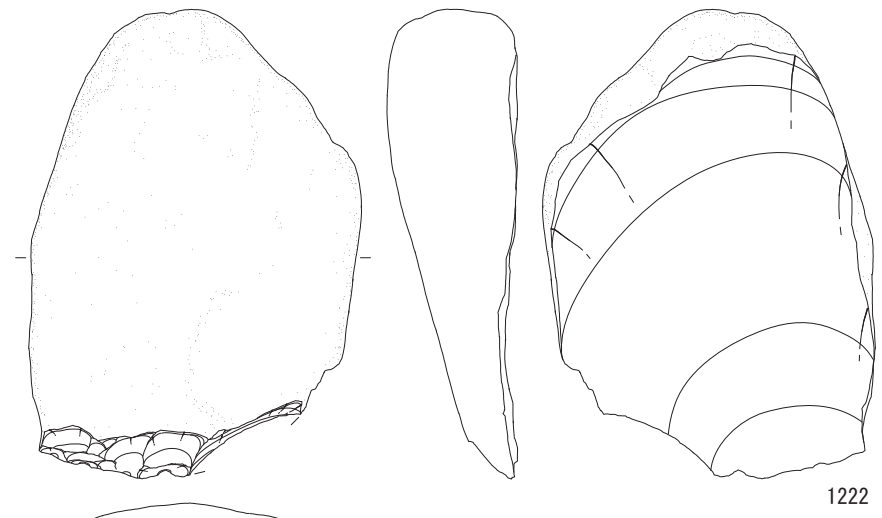
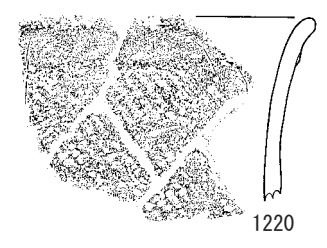
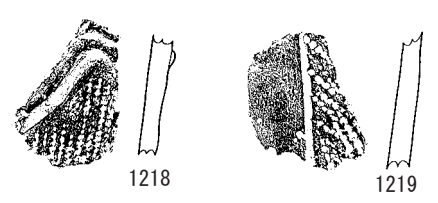
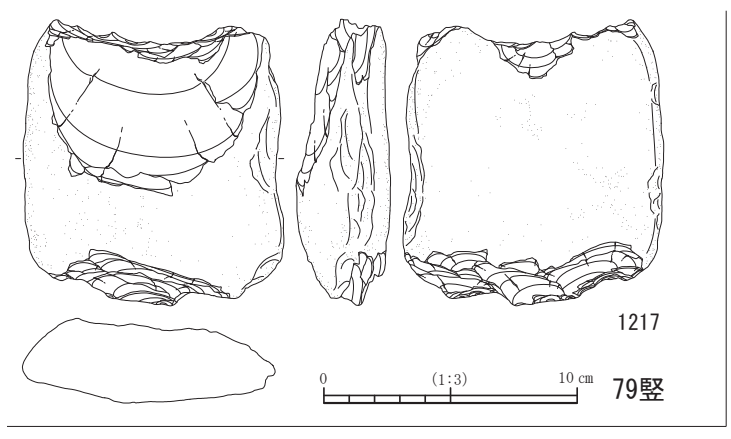

80 豎

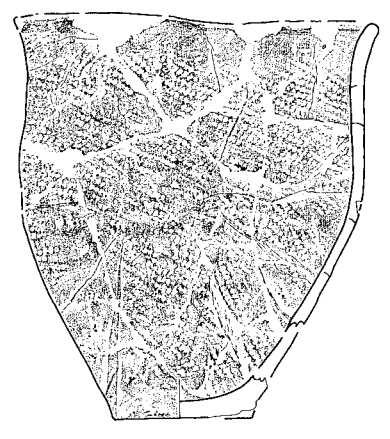
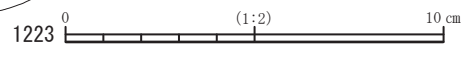
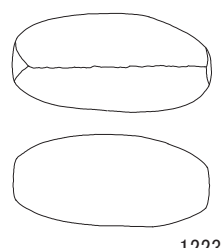
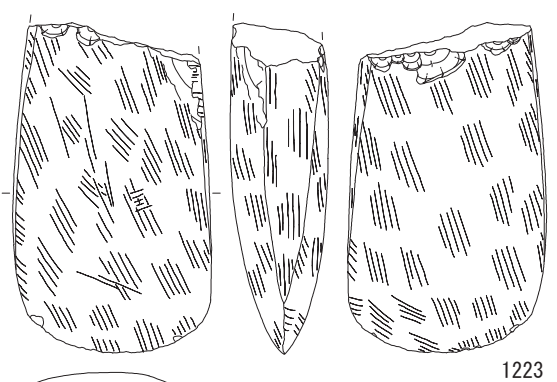

1224

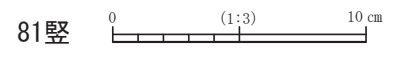

遺物図版164 縄文時代の遺物164

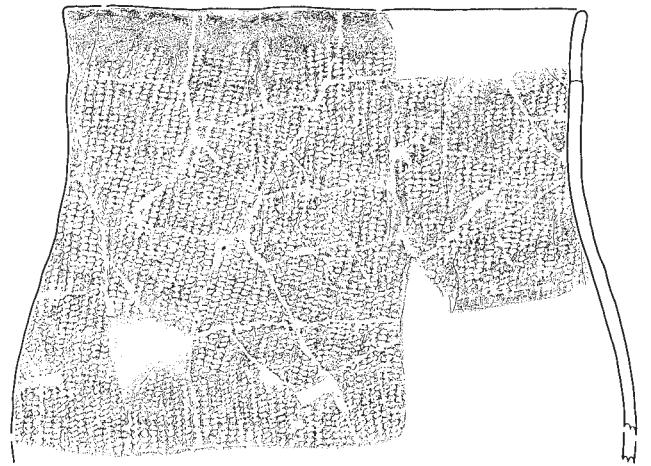

1225

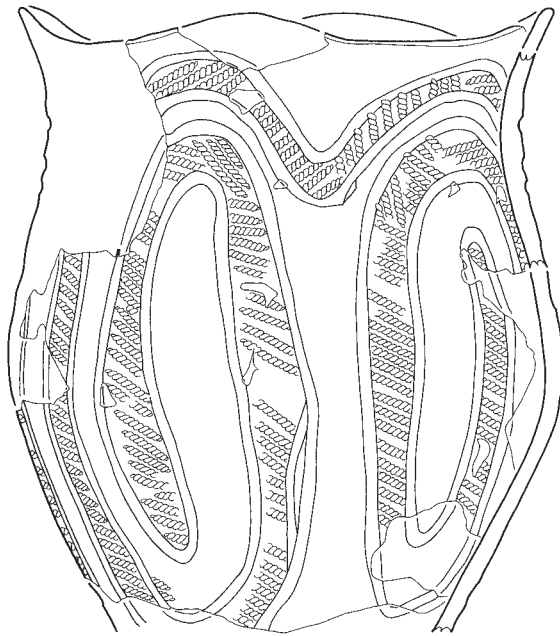
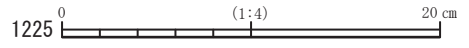

1226

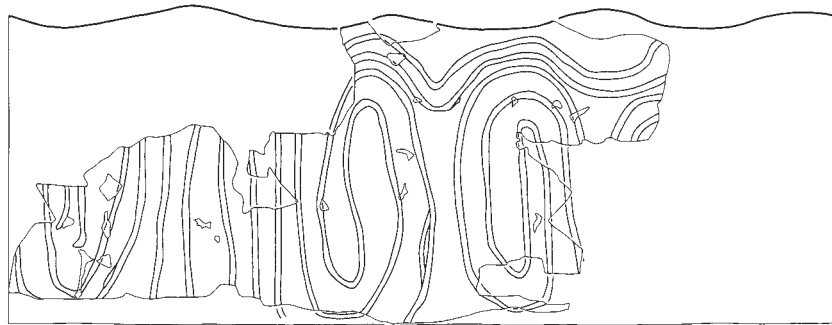

1226展開図

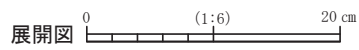

展開図

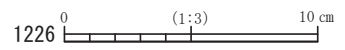

1226

81 豎

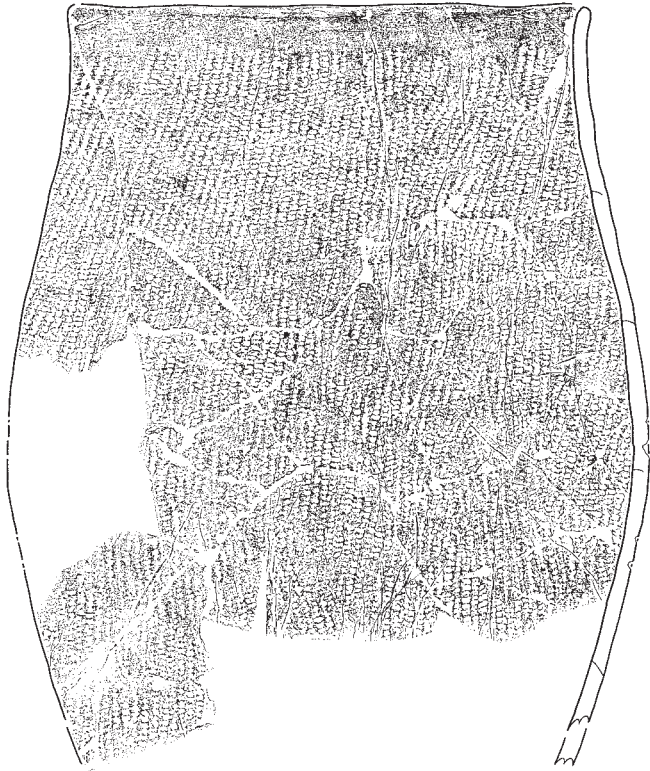

1227

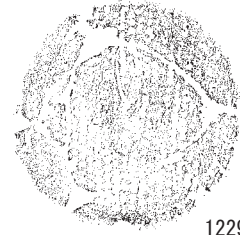
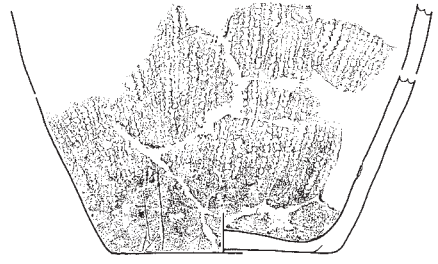

1229

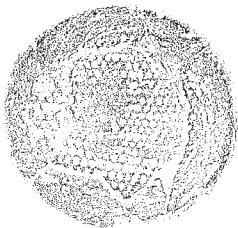

1230

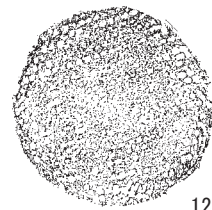
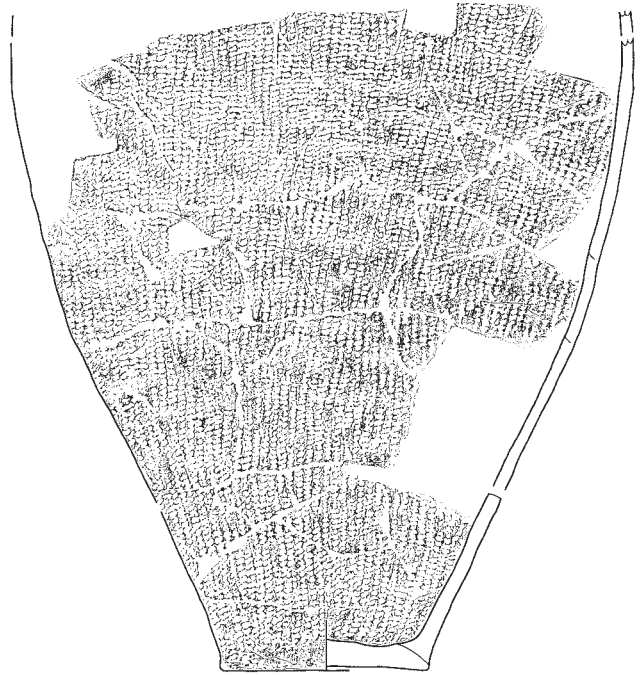

1228

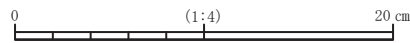

81 竖

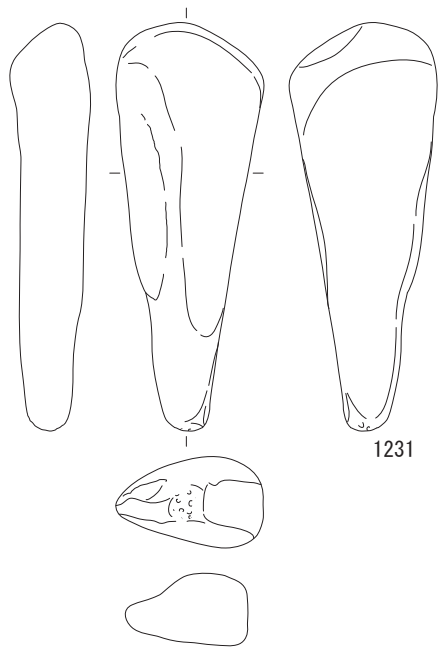

1231

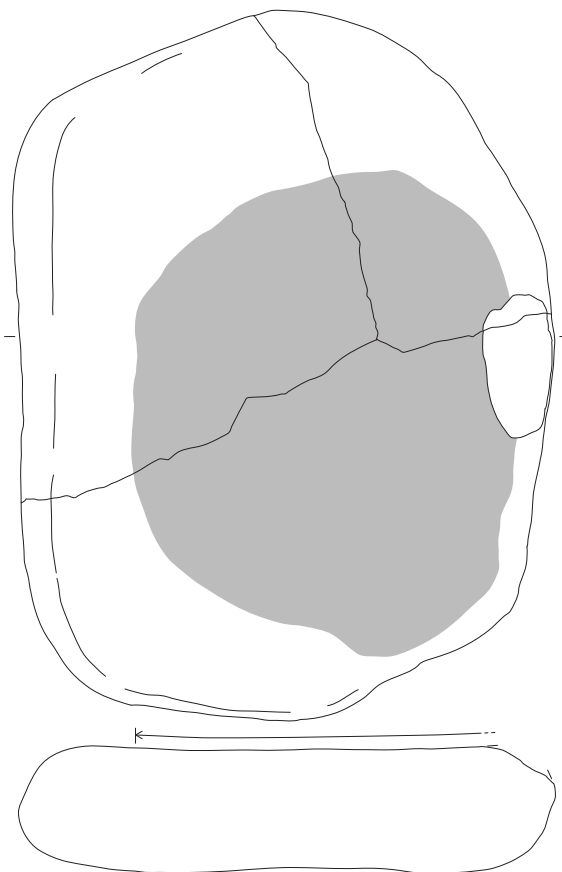

1232

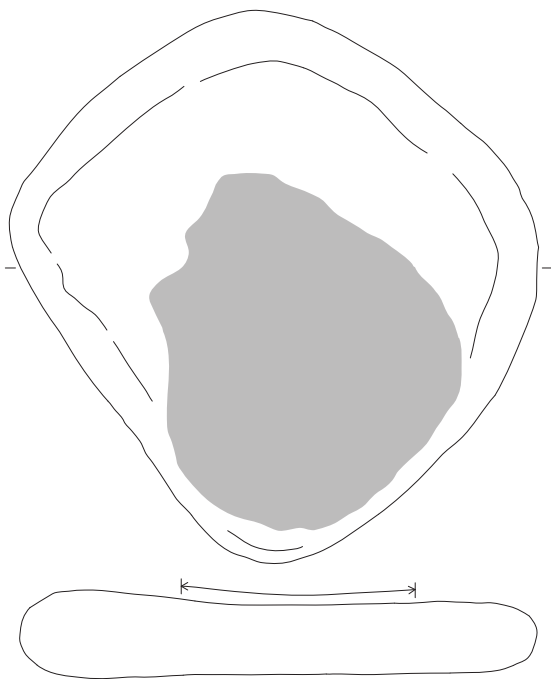

1233

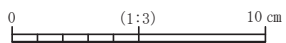
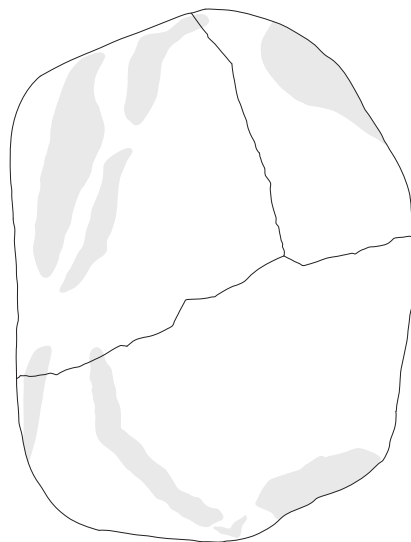

81 豎

被熱範囲 (S=1/4)

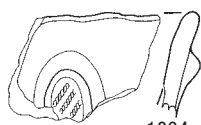

1234

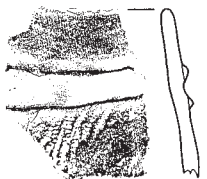

1235



1236

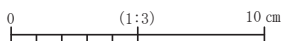

83 豎

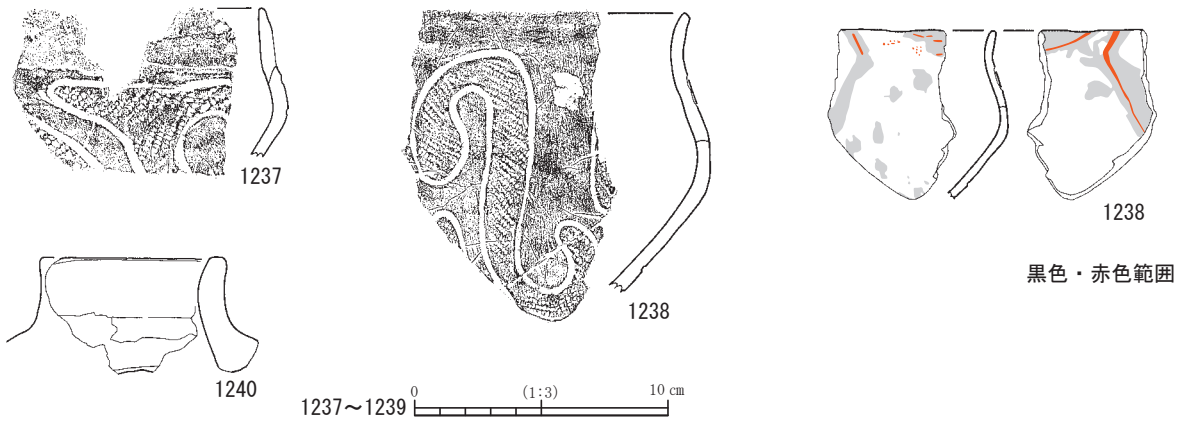

黒色・赤色範囲

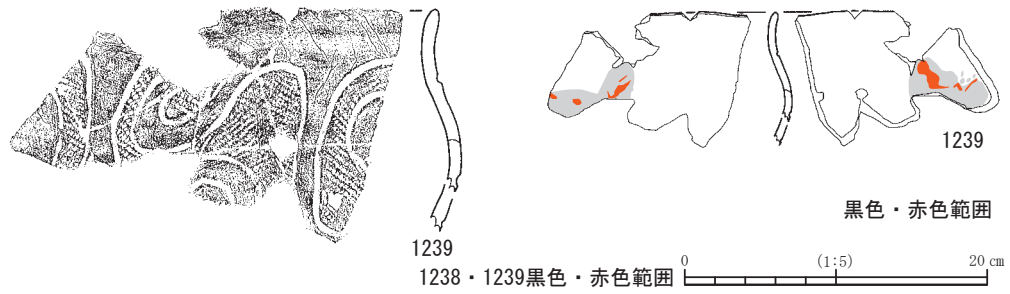

黒色・赤色範囲

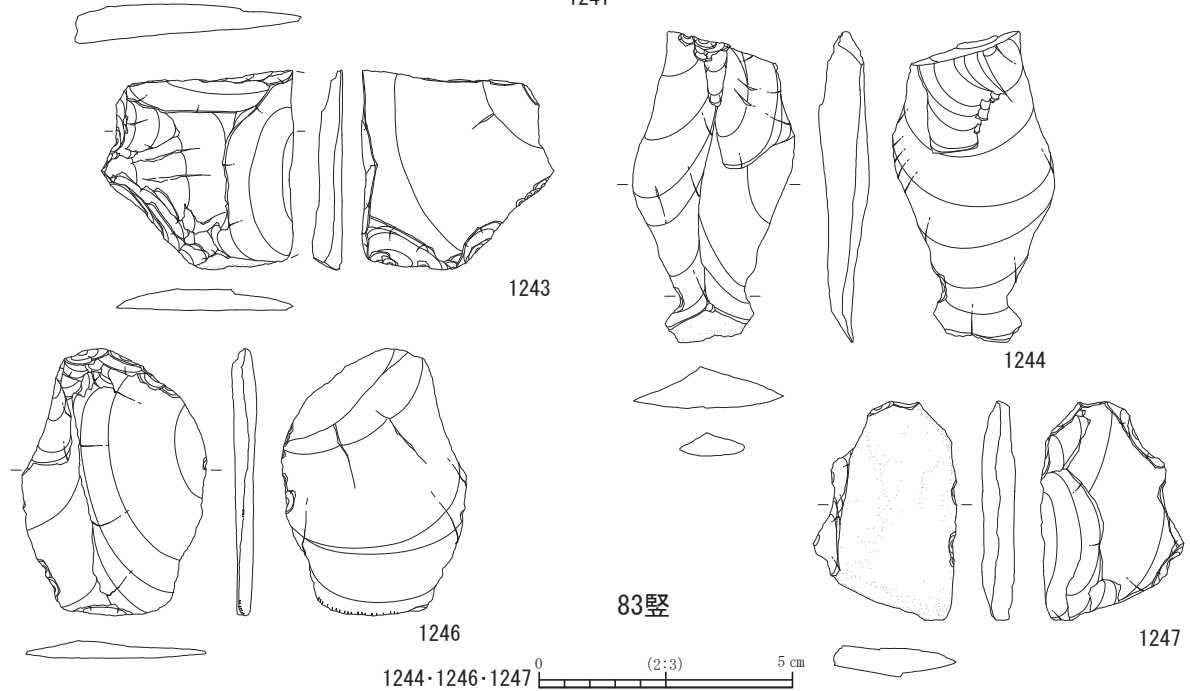
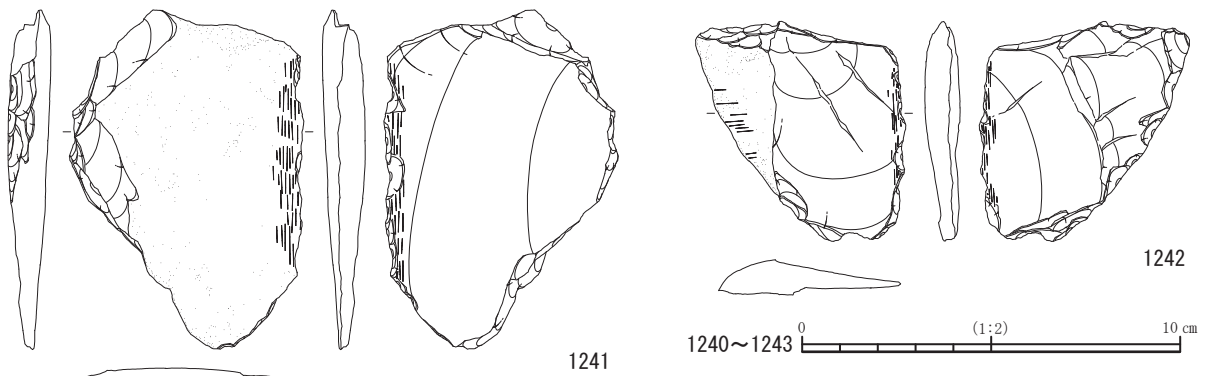

83 豎

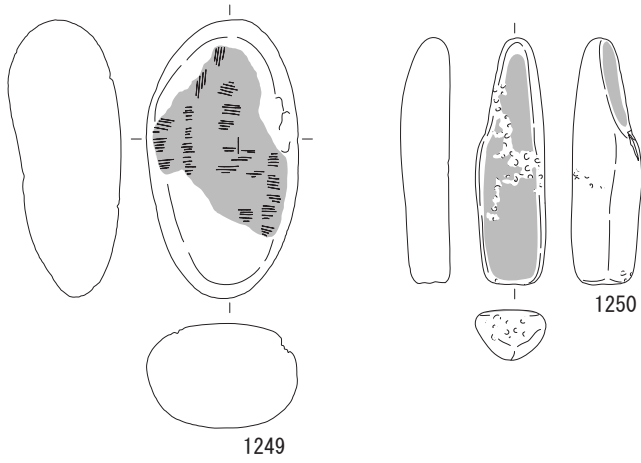

1249

1250



1254

1254 0 (1:2) 10 cm

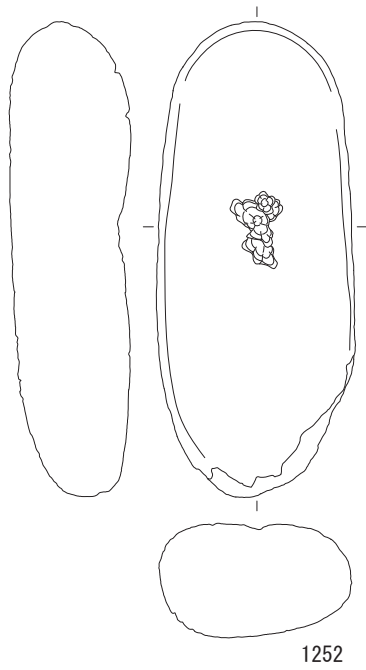

1252

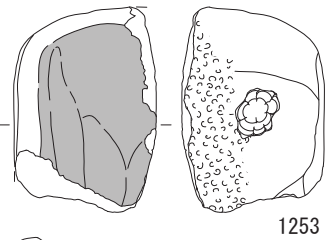

1253

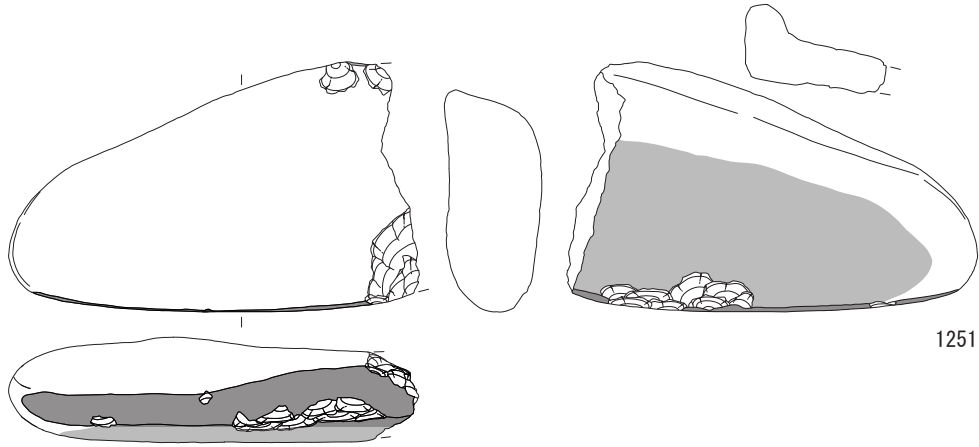

1251

83 豎
1249~1253 0 (1:3) 10 cm

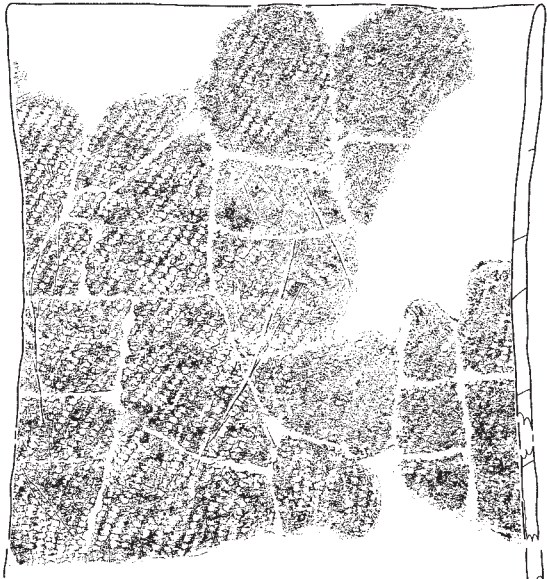

1255



1257

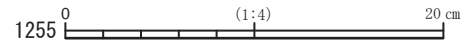

1256



1258

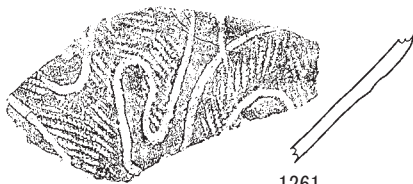

1261



1262

84 豎

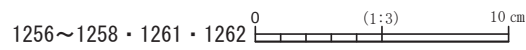



1259

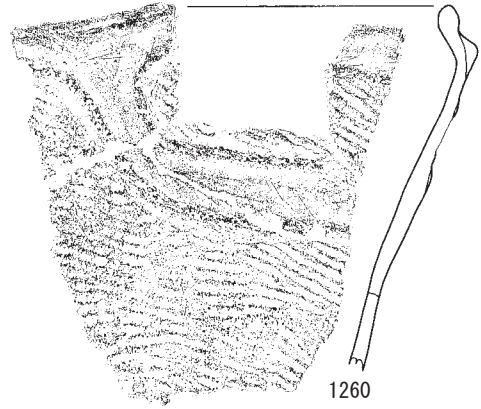

1260

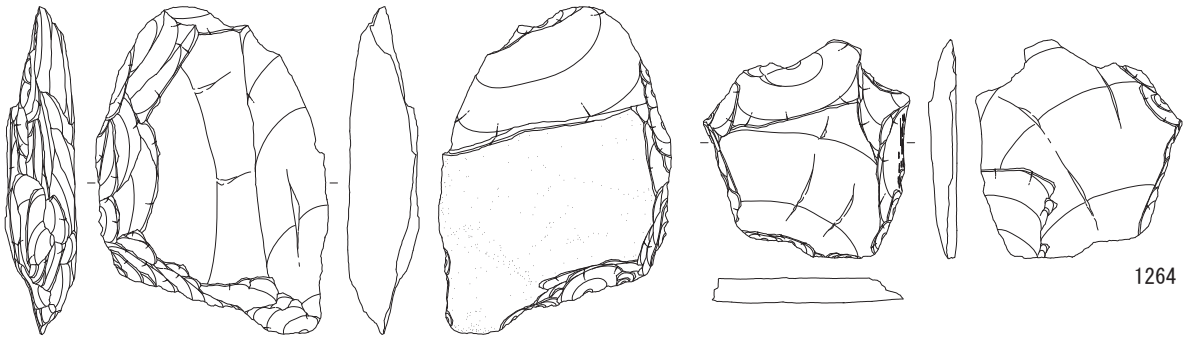

1263

1264

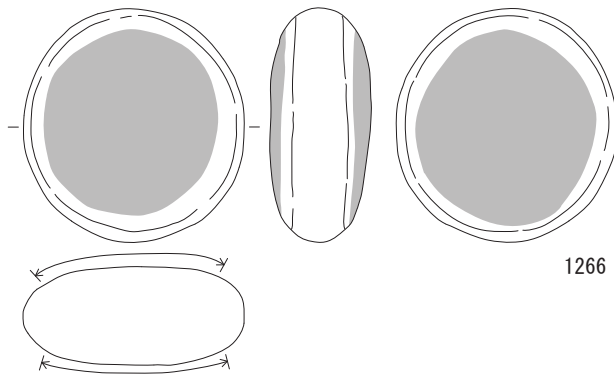

1266

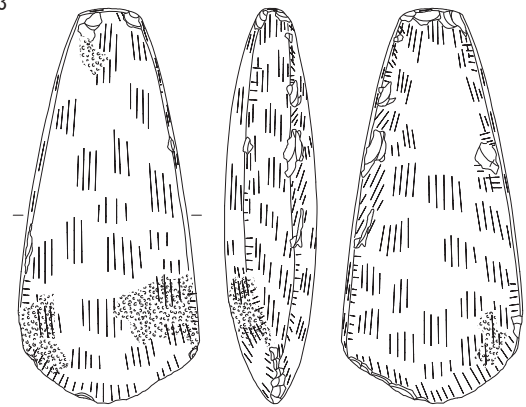

1265

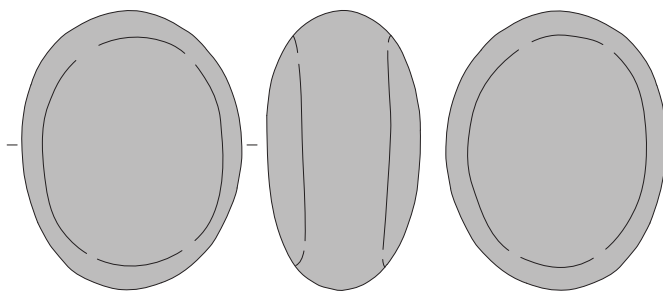

1267

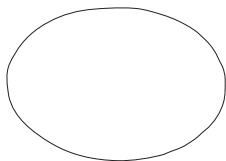

84 豎

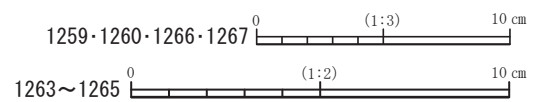

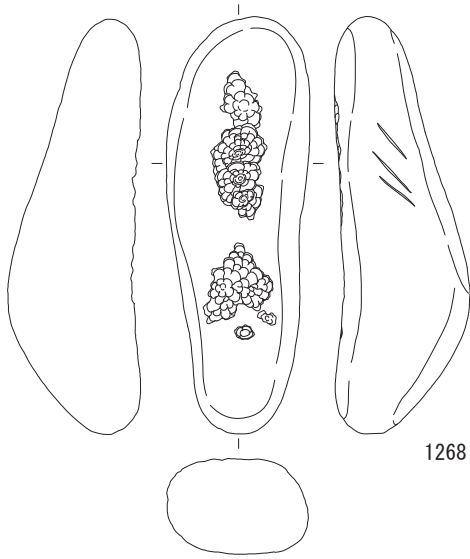

1268

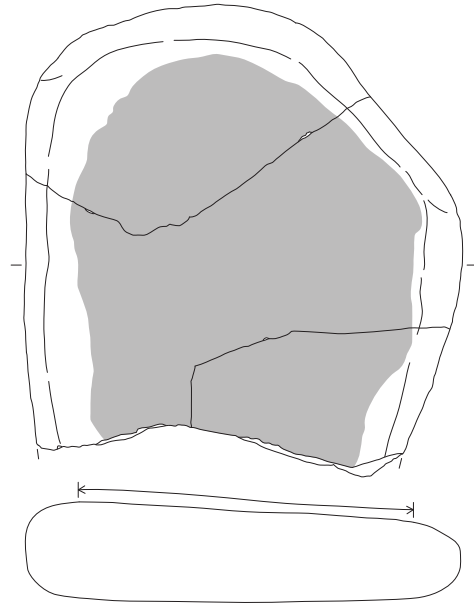

1269

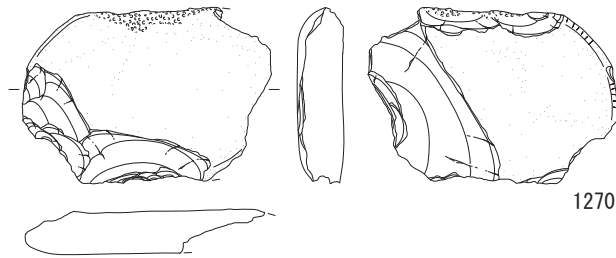

1270

84 豎

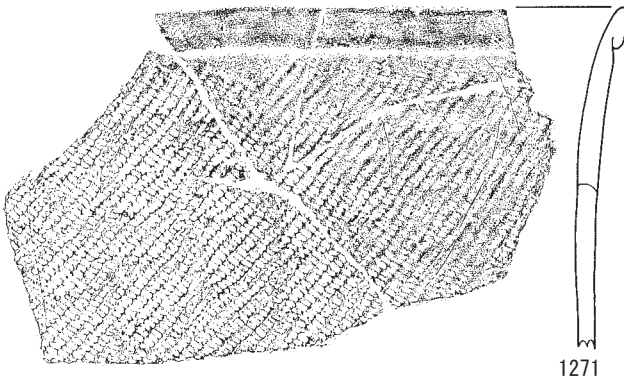
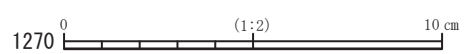
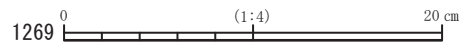
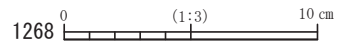

1271

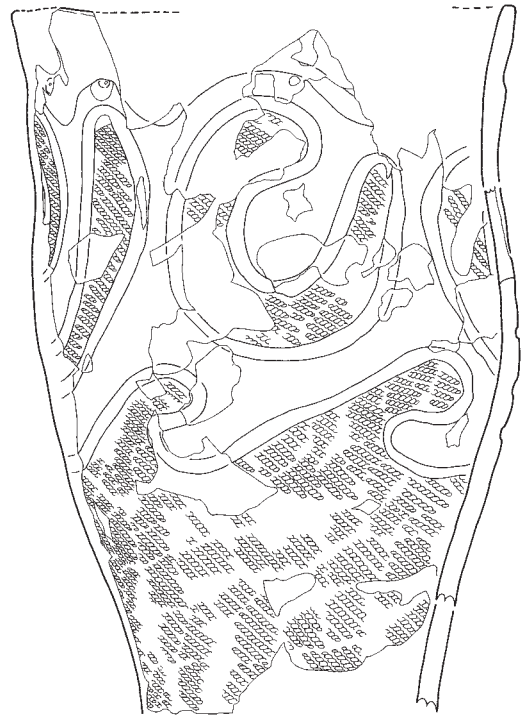

1272



1273

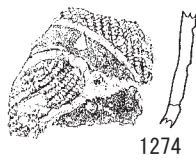

1274

85 豎

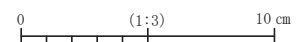

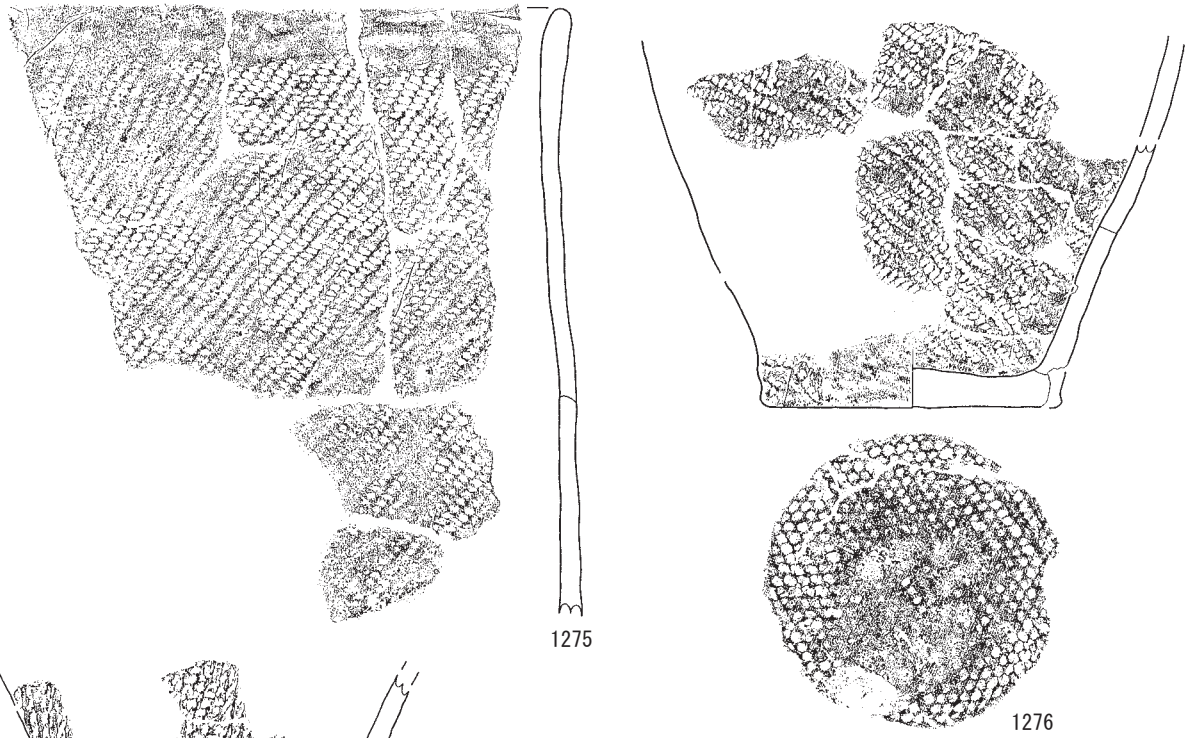

1275

1276

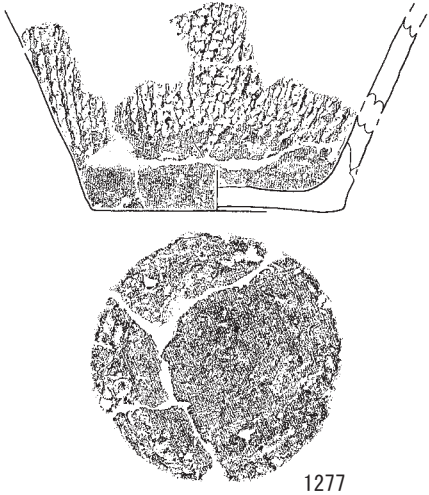

1277

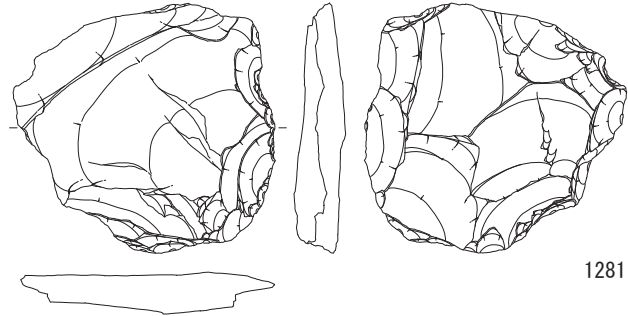

1281

1278・1281 0 (1:2) 10 cm

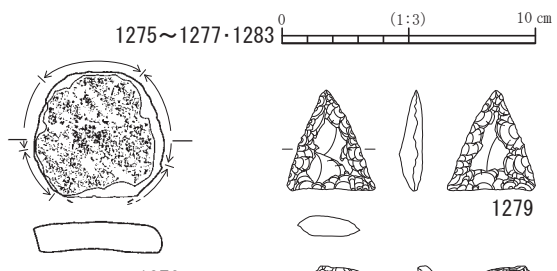

1275~1277・1283 0 (1:3) 10 cm

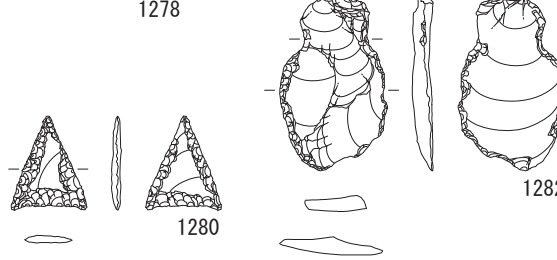

1279

1282

1280

1279・1280・1282 0 (2:3) 5 cm

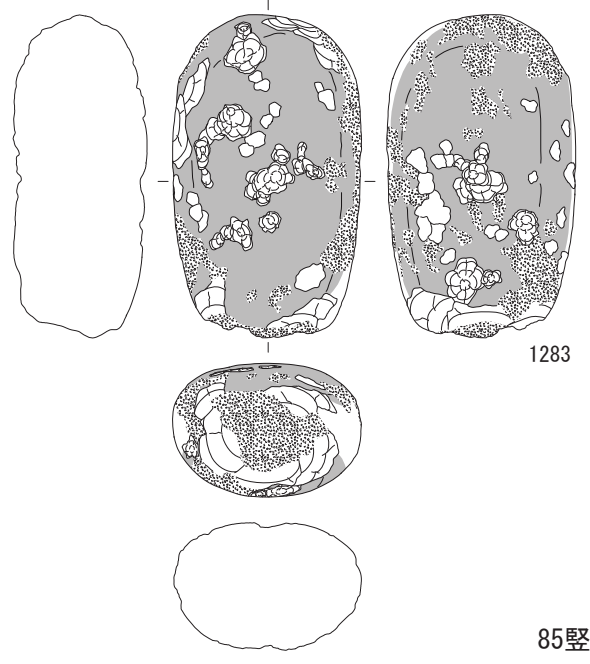

1283

85 豎

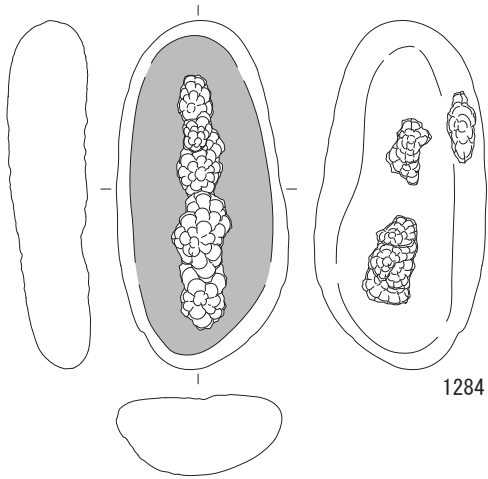

1284

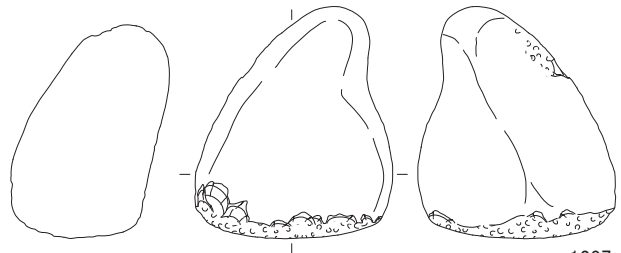

1287

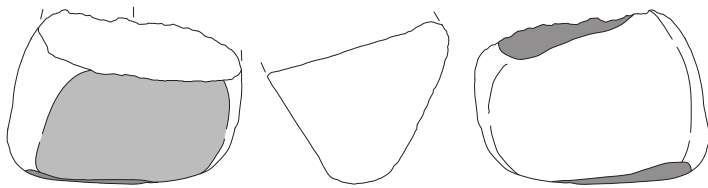

1285

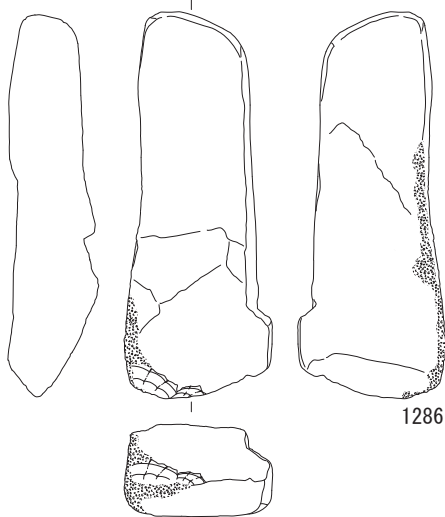
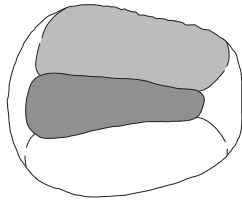

1286

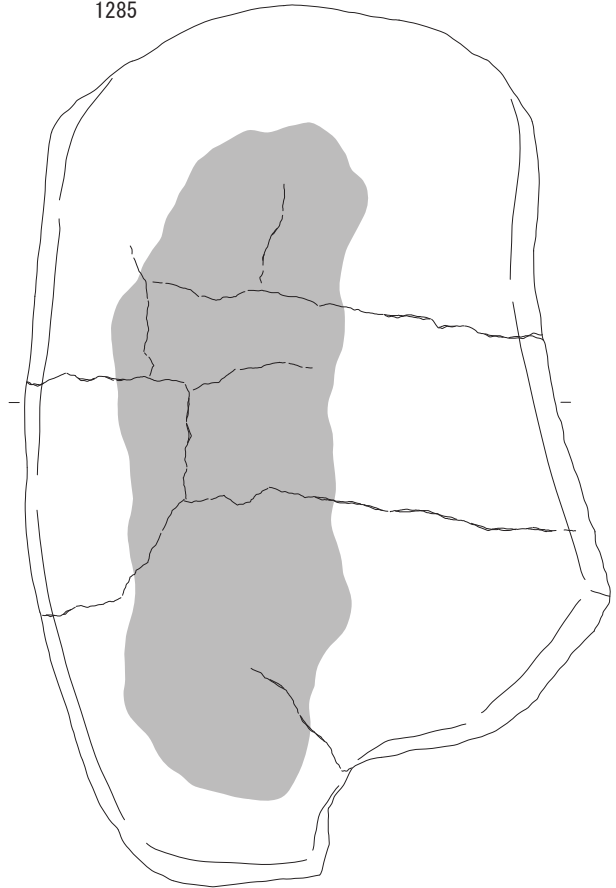

1288

85 豎

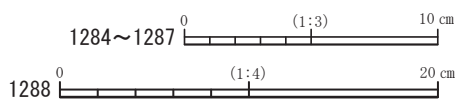

遺物図版174 縄文時代の遺物174

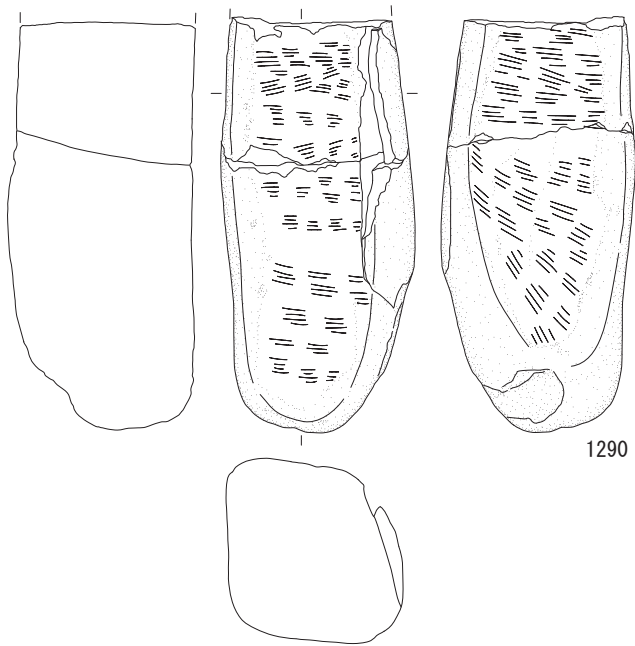

1290

1291

0 (1:3) 10 cm

85 豎

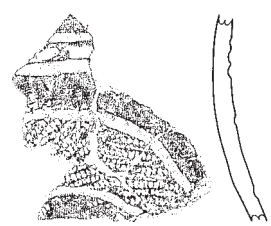

1293

1294



1292

1291・1292 0 (1:3) 10 cm

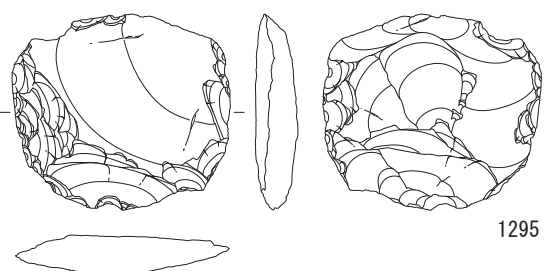

1295

1296

1293~1295 0 (2:3) 5 cm

86 豎

1296 0 (1:4) 20 cm



1298

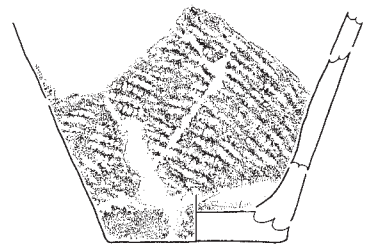

1299

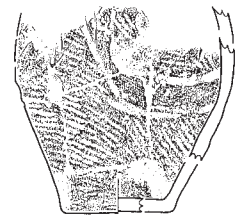
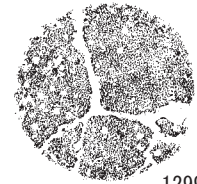

1301

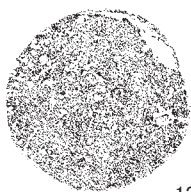
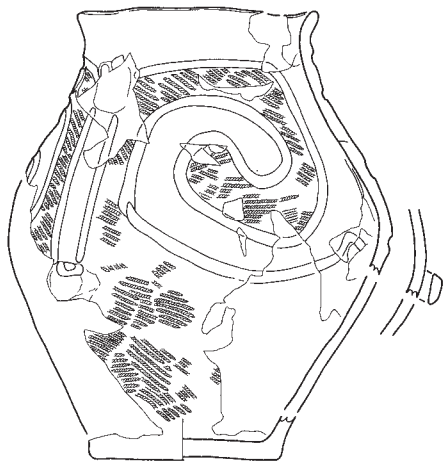

1300



1302

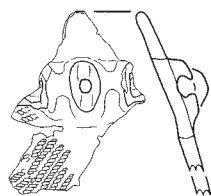

1304

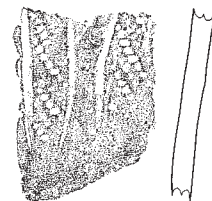

1303

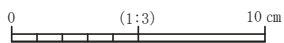

87 豎

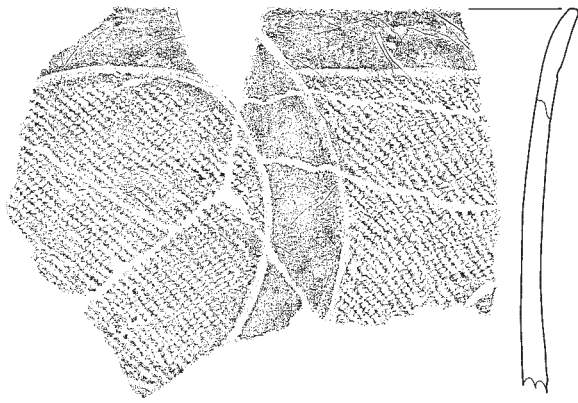

1305

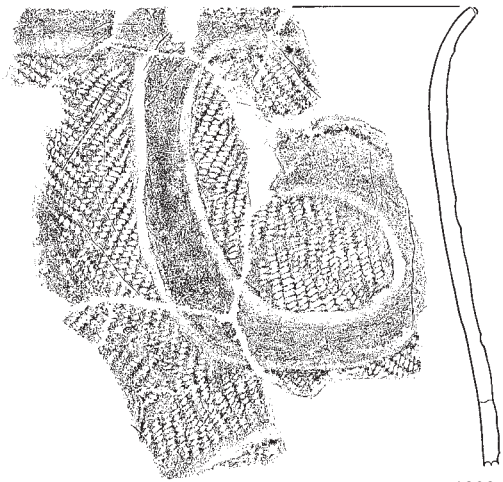

1308



1306

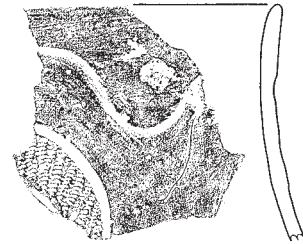

1309

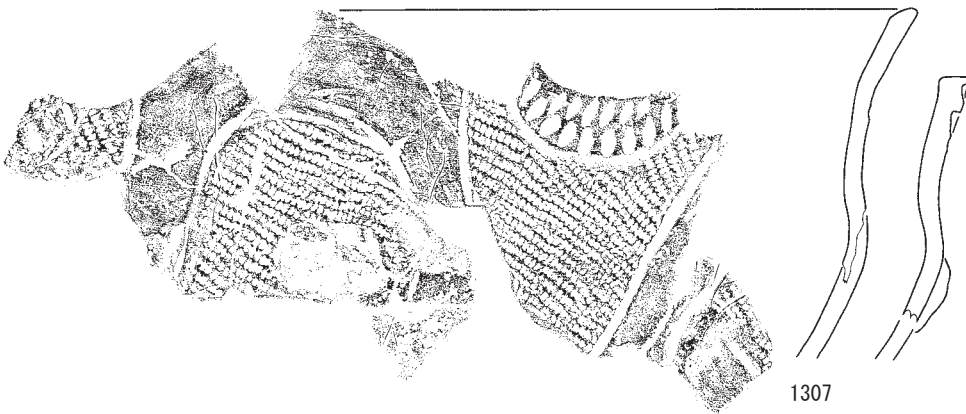

1307

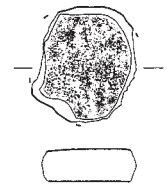

1310

1305~1309 0 (1:3) 10 cm

1310 0 (1:2) 10 cm

87 豎

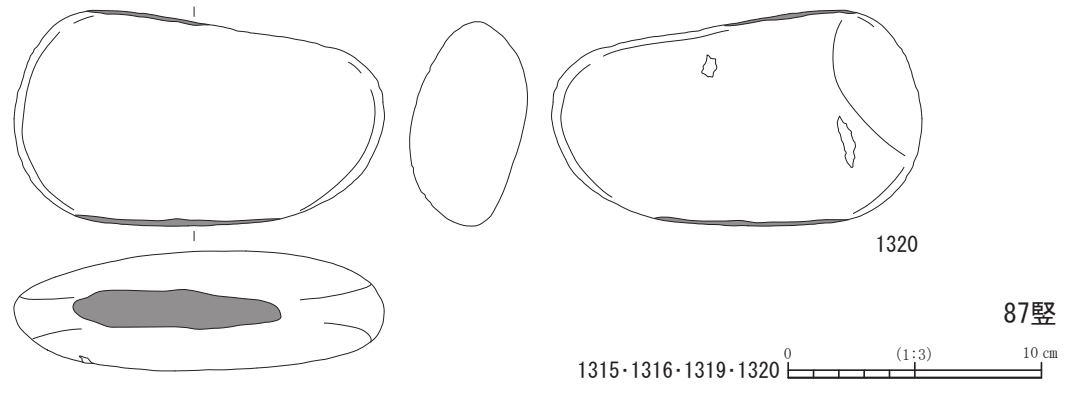
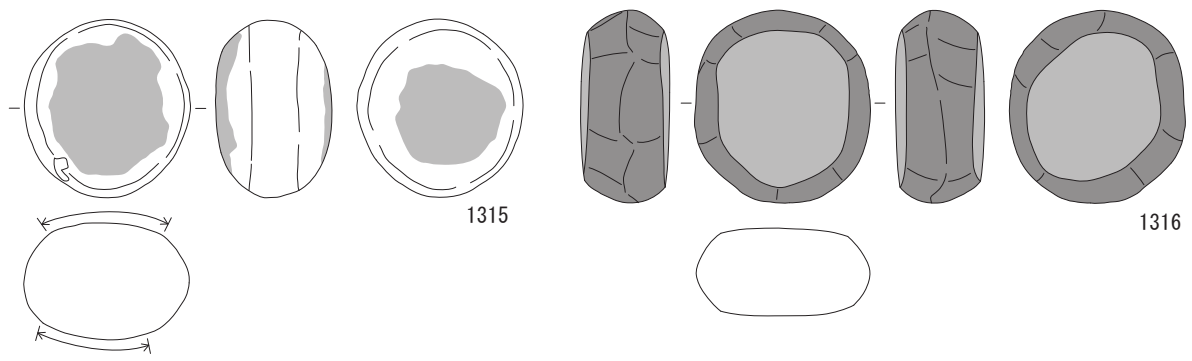
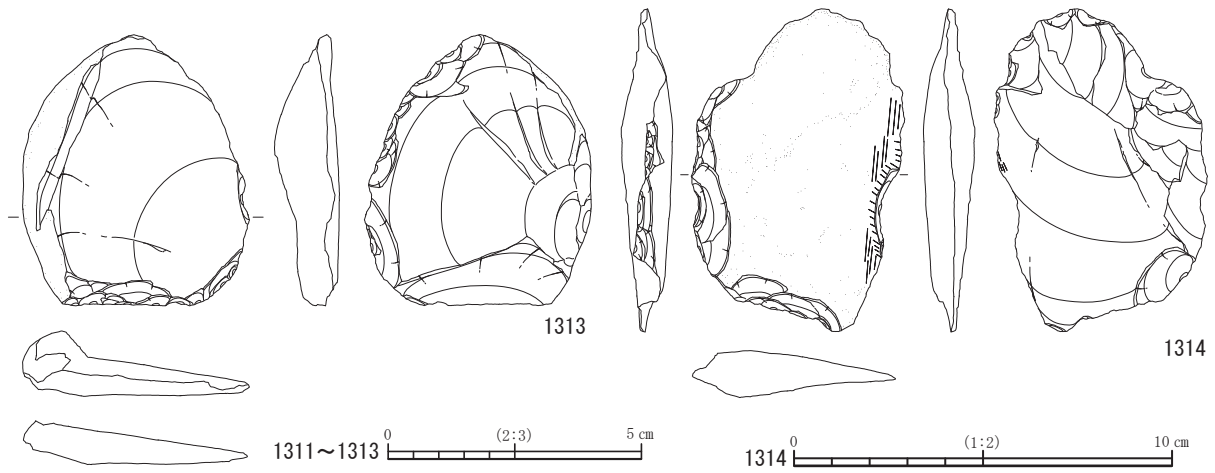
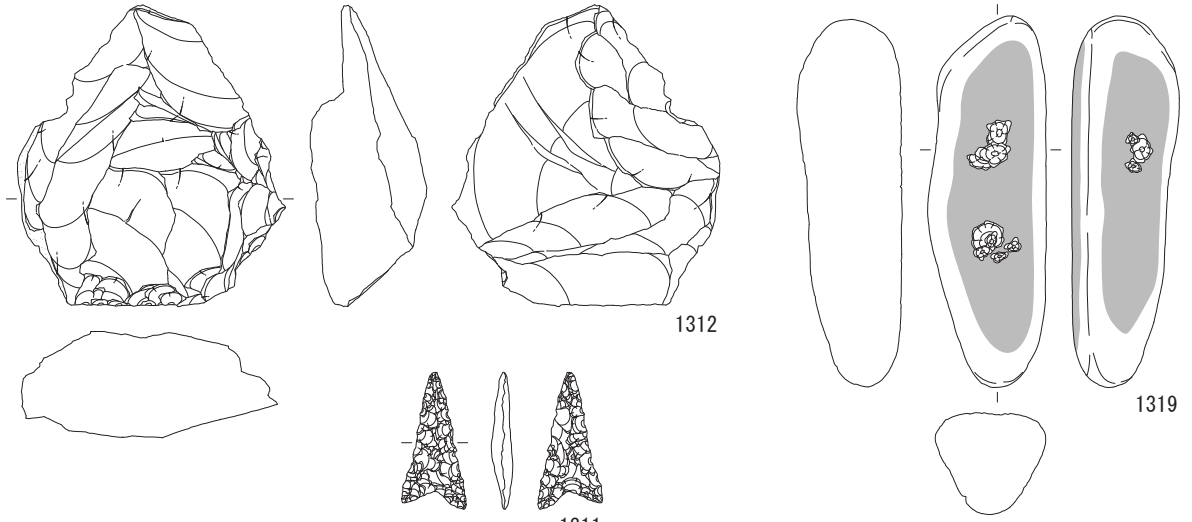

遺物図版178 縄文時代の遺物178

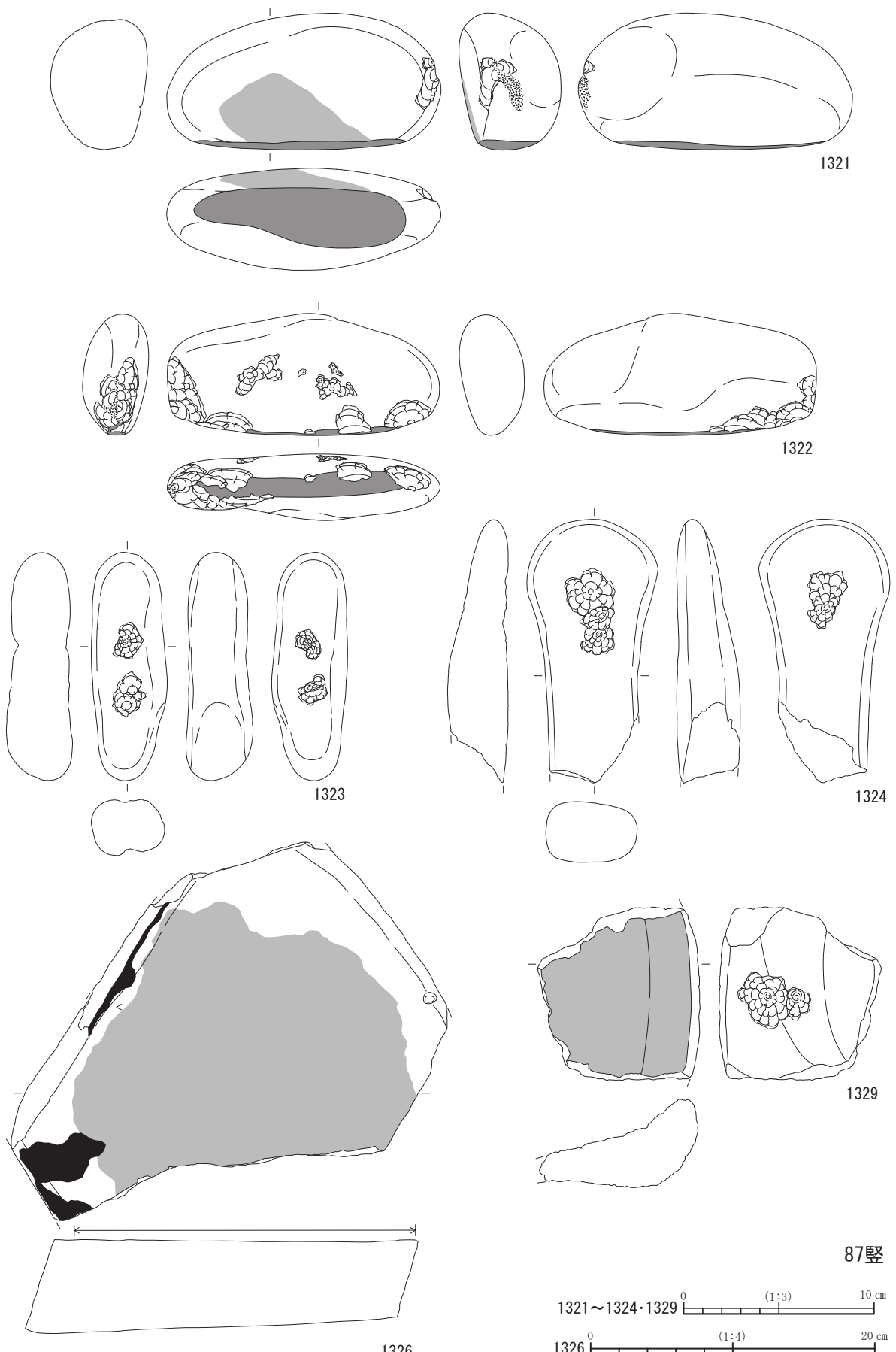

遺物図版179 縄文時代の遺物179

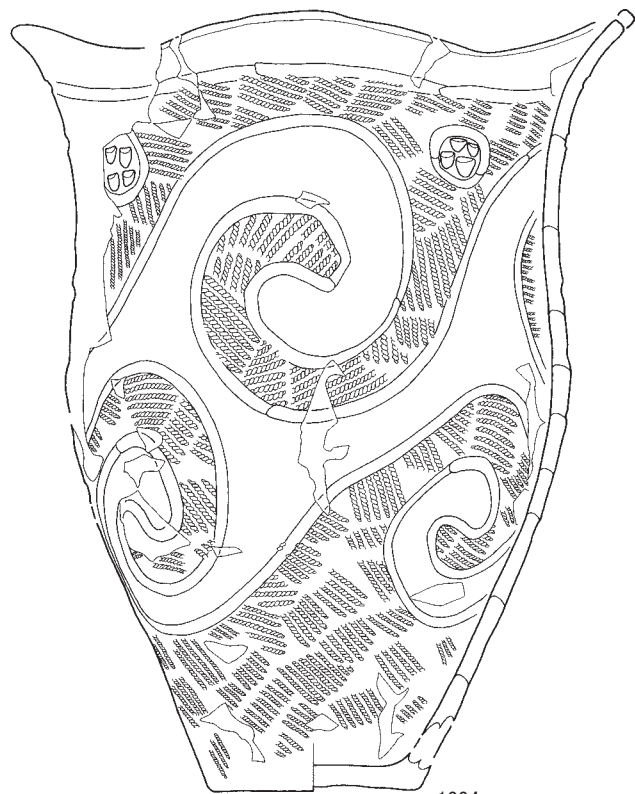
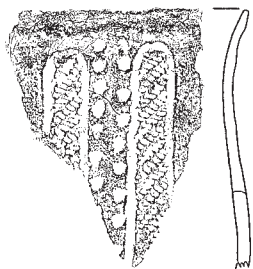
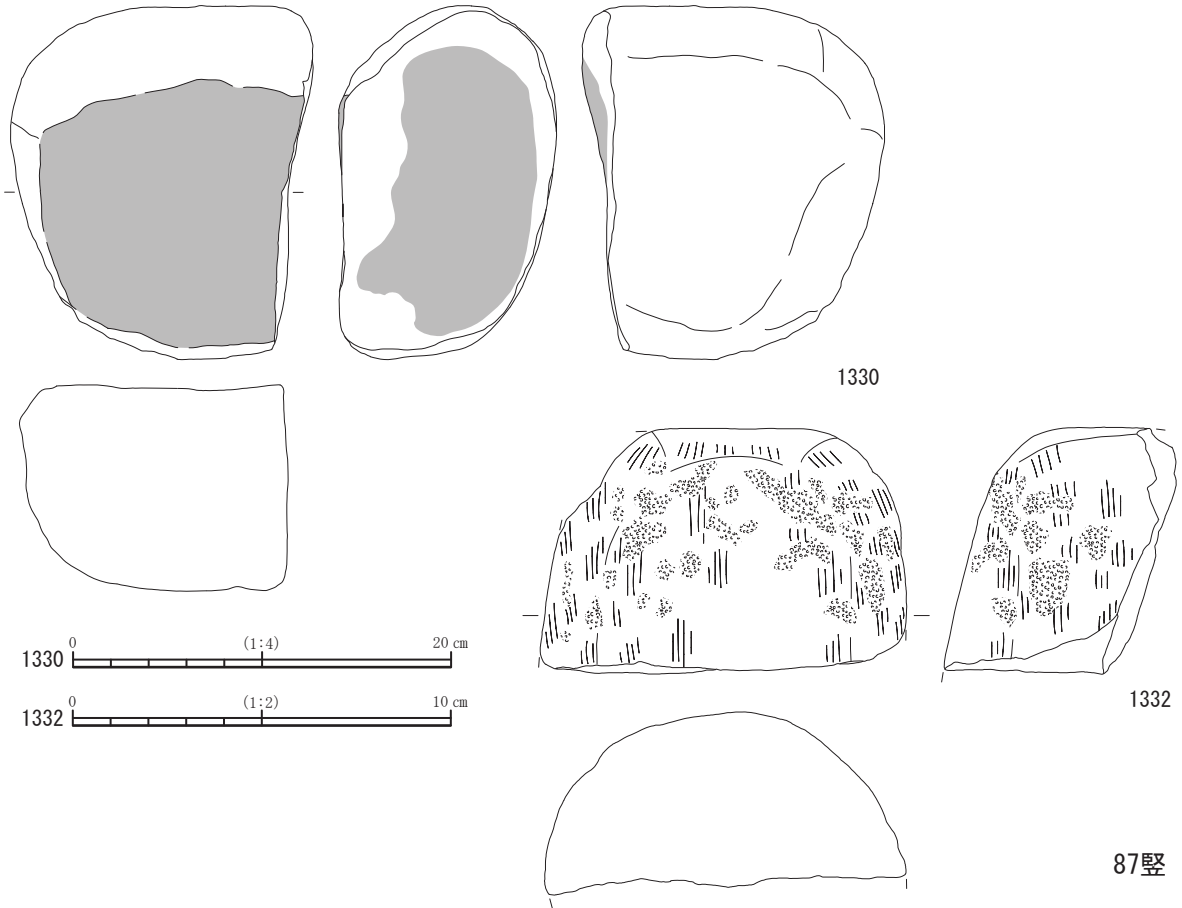

88 豎

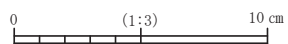

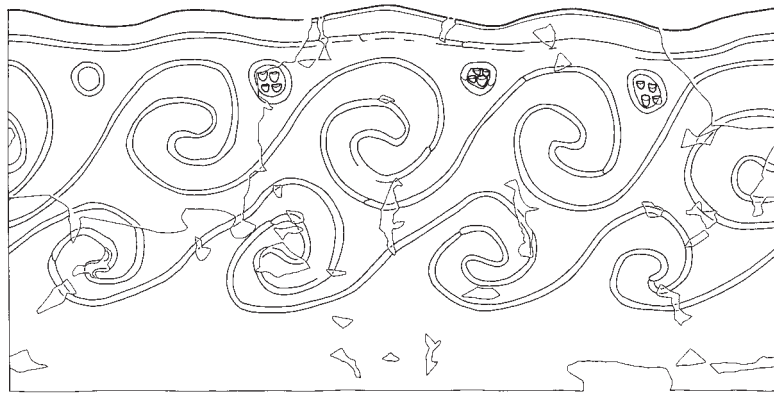

1334展開図

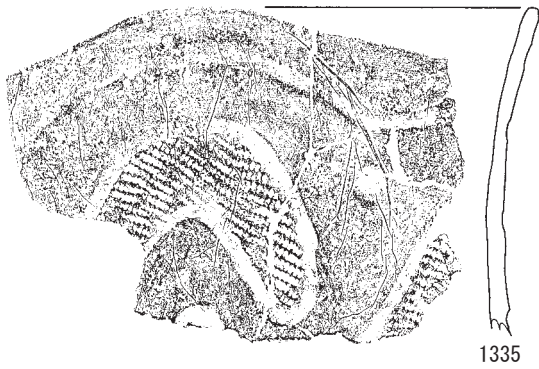
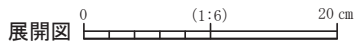

1335

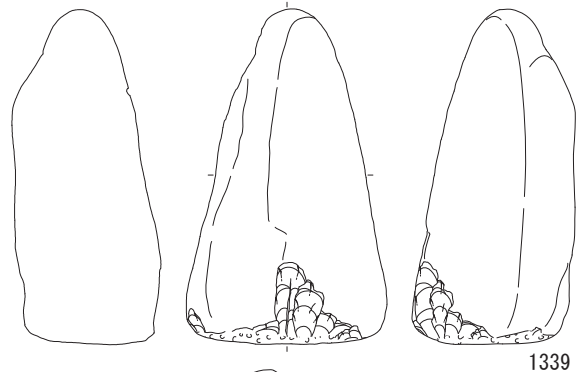

1339

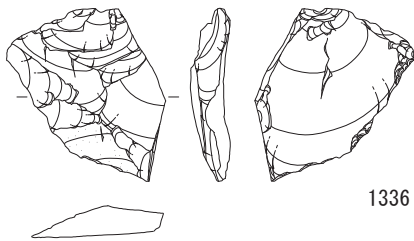
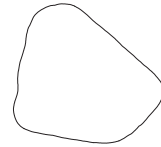
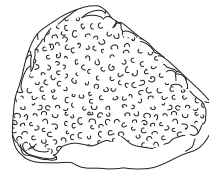

1336

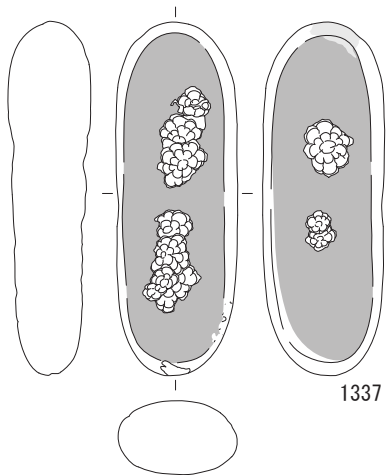
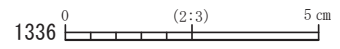

1337

88 豎

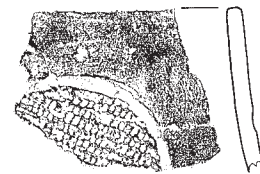

1342

89 豎

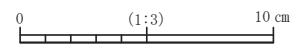

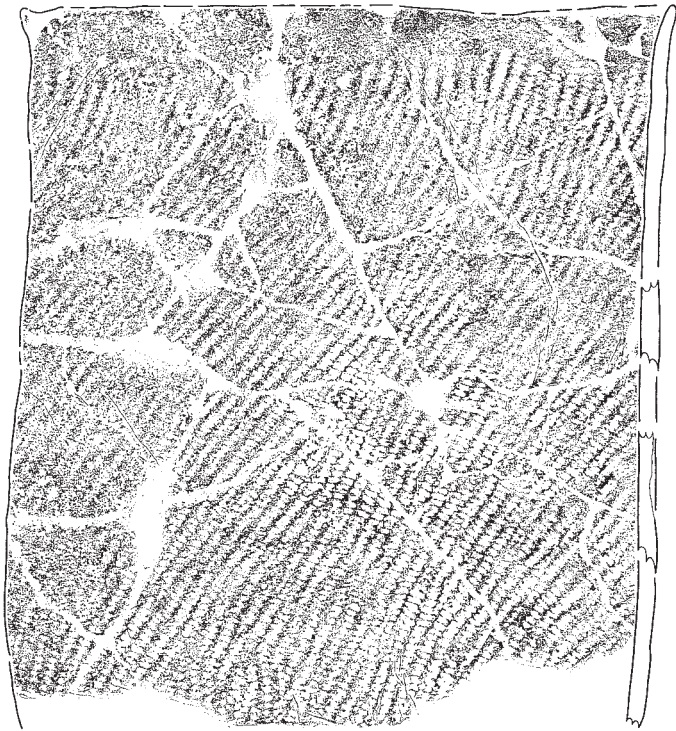

1341

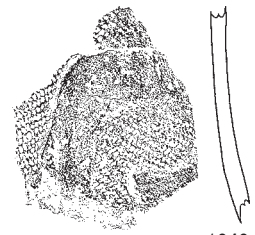

1343

1341・1343 0 (1:3) 10 cm

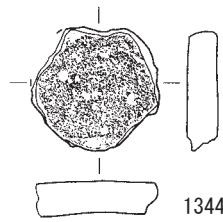

1344

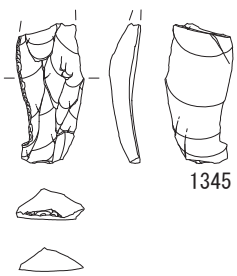

1345

1345 0 (2:3) 5 cm

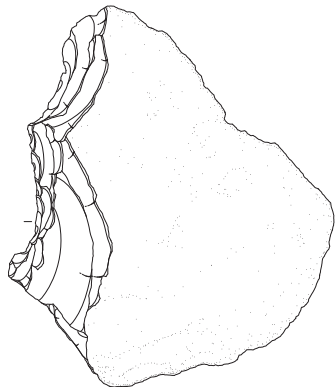

1348



1346

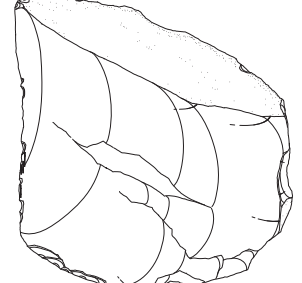
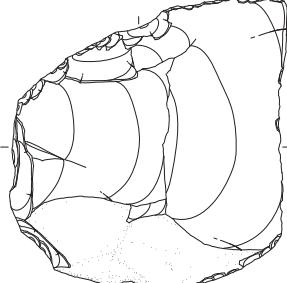
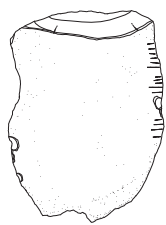

1347

89 豎

1344・1346~1348 0 (1:2) 10 cm

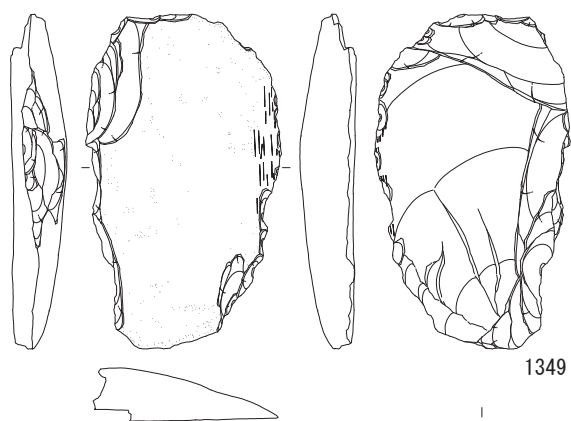

1349

1350

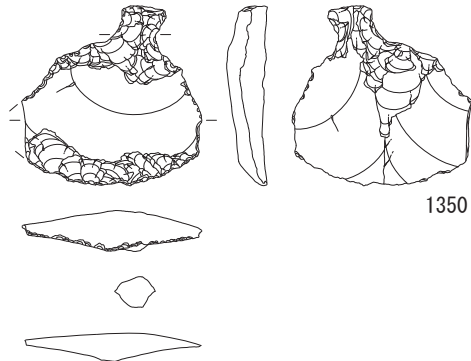

1350 0 (2:3) 5 cm

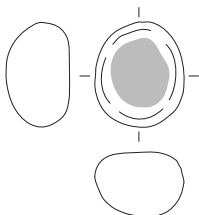

1351

1349・1351 0 (1:2) 10 cm

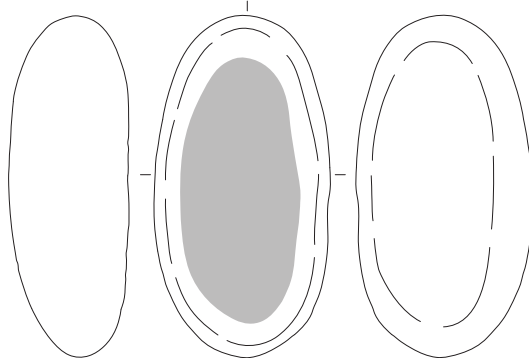

1352

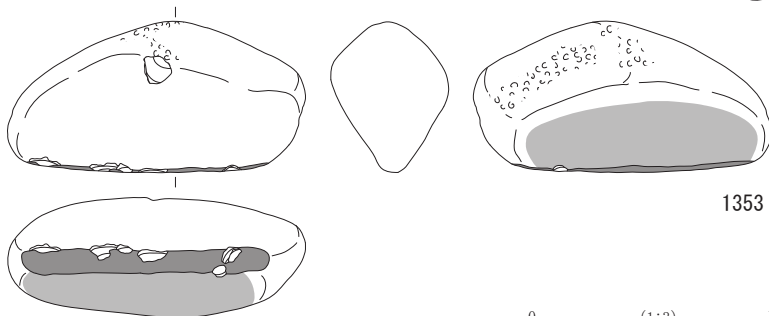

1353

1352・1353 0 (1:3) 10 cm

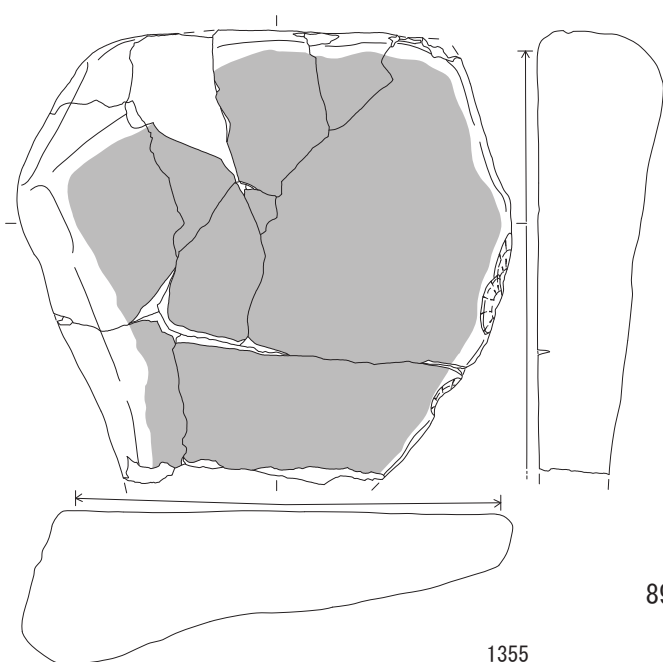

89 豎

1355

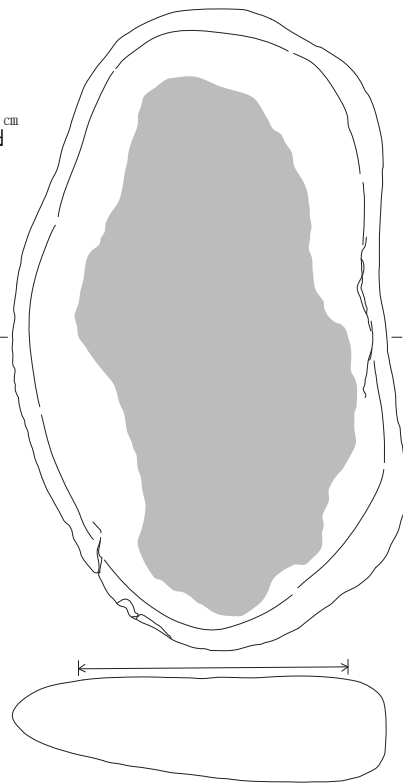

1354

1354・1355 0 (1:5) 20 cm

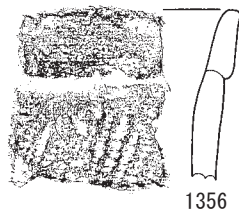

1356

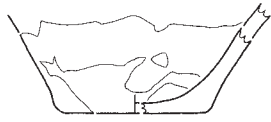

1357

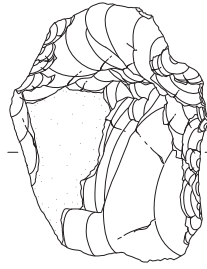
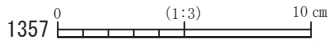

1358

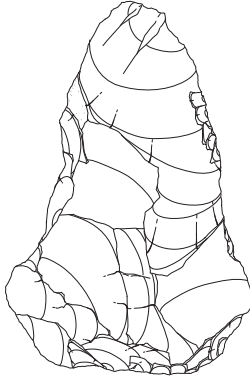
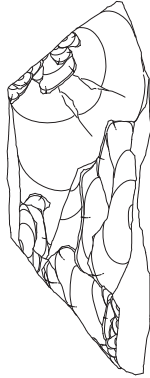

1359

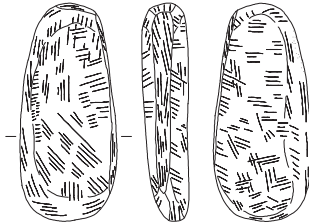
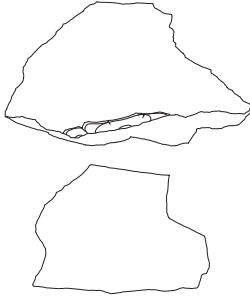

1363

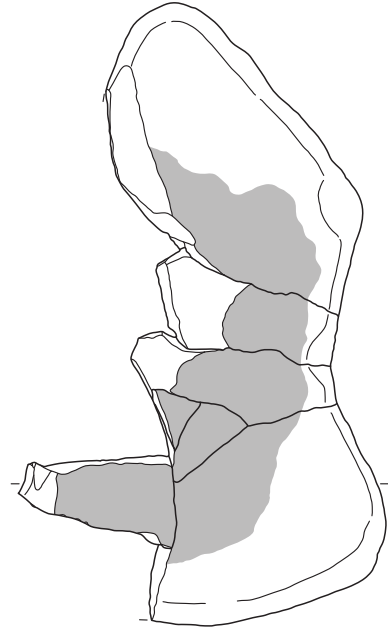

1360

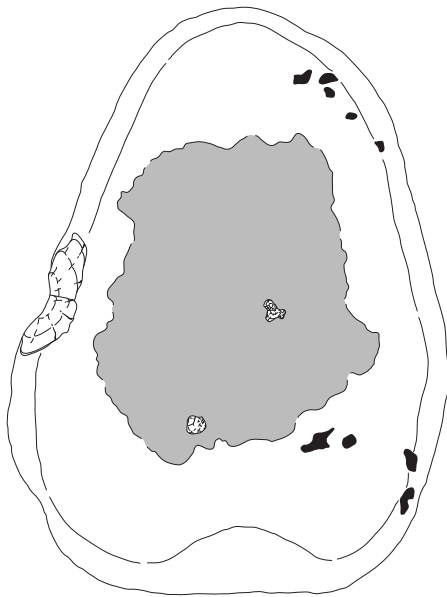
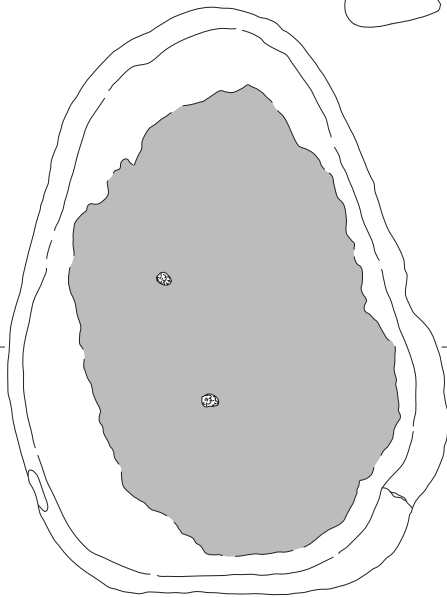

1361 90 豎



遺物図版184 縄文時代の遺物184

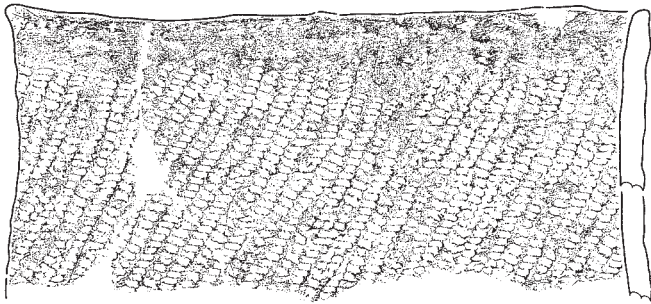

1364

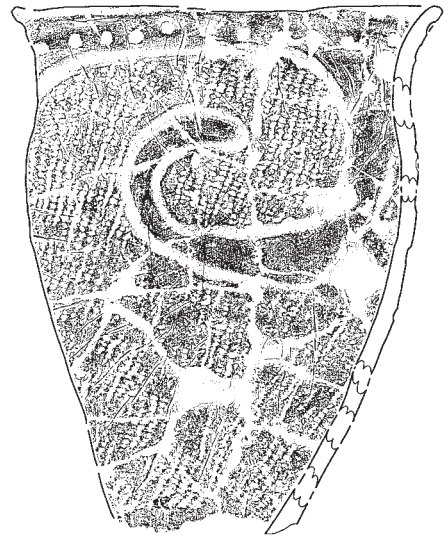

1365



1369

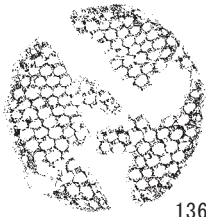

1367

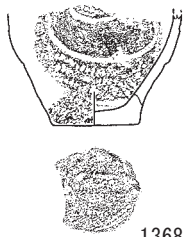

1368

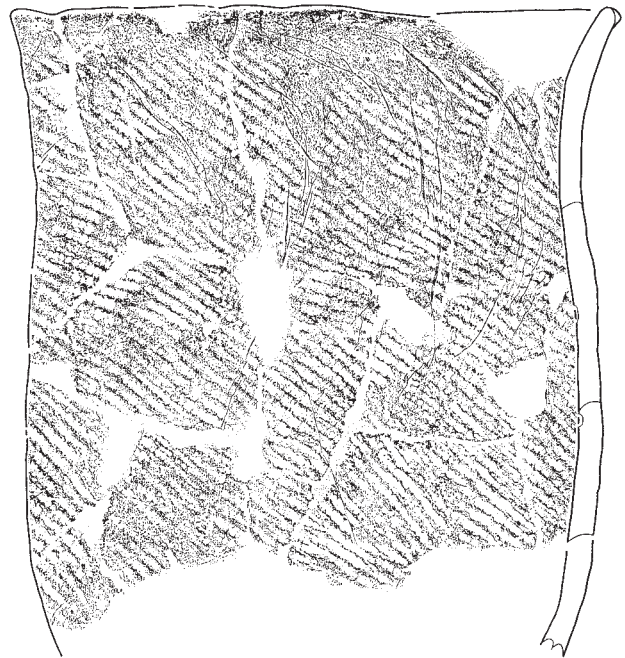

1366

91 豎

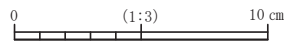

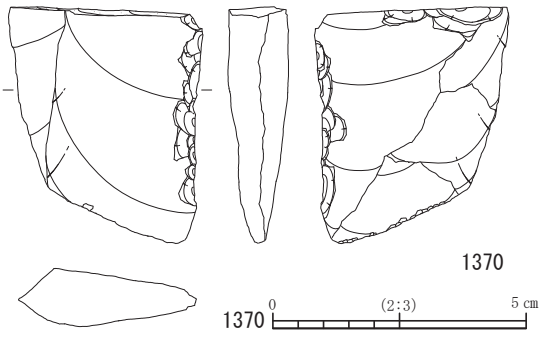

1370

1370 0 (2:3) 5 cm

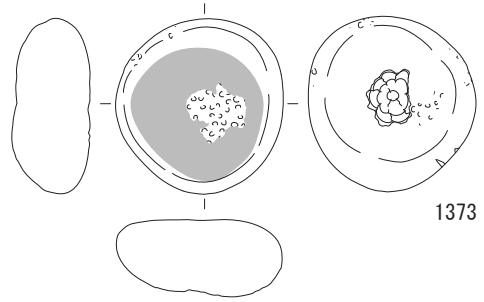

1373

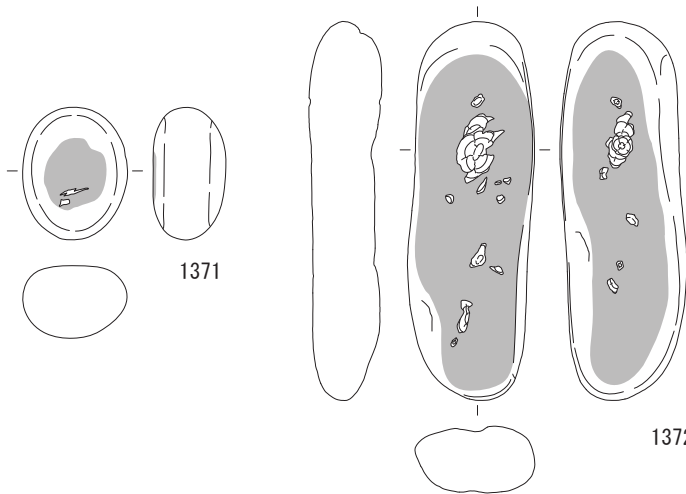

1371

1372

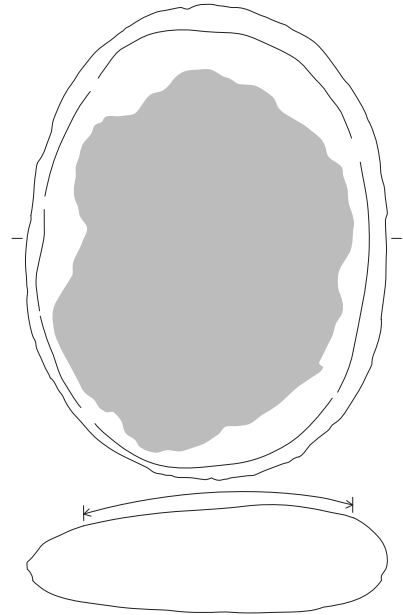

1375

1371~1373・1375 0 (1:3) 10 cm

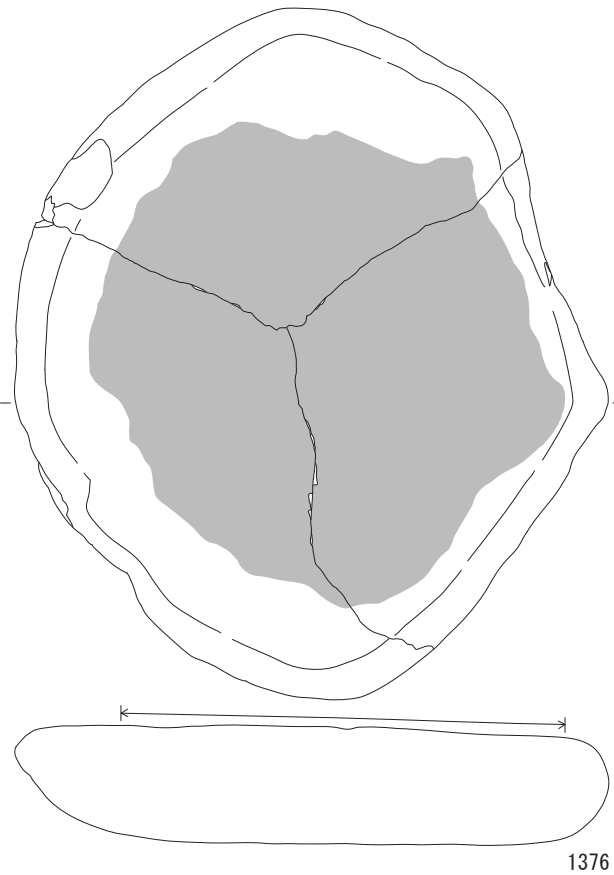

1376

1376 0 (1:4) 20 cm

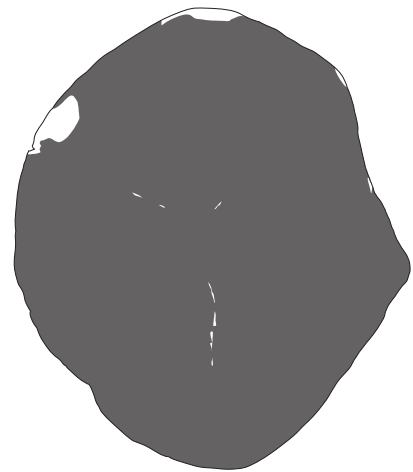

黒色範囲 (S=1/6)

91 豎

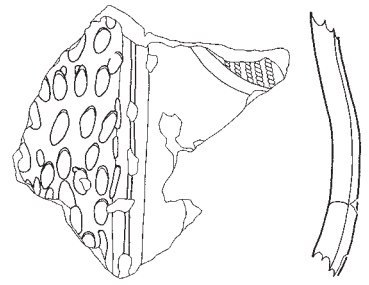

1378

1379

1378・1379 0 (1:3) 10 cm



1384

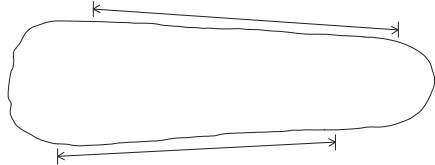

92 縦

1384 0 (1:4) 20 cm

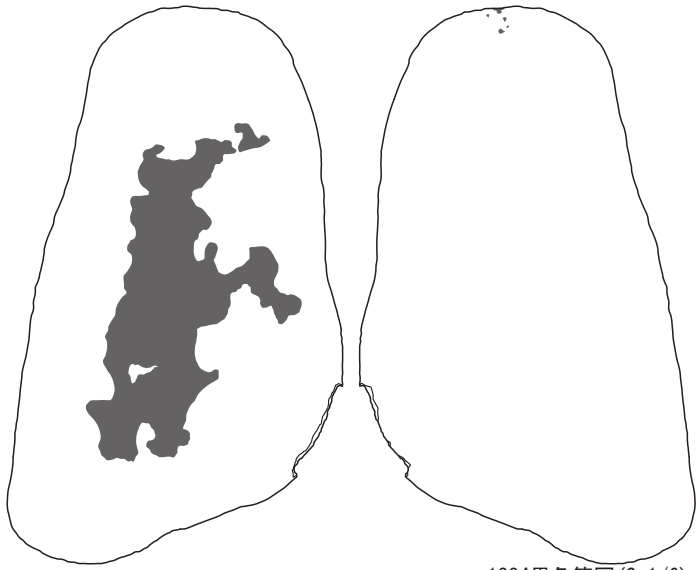

1384黒色範囲(S=1/6)

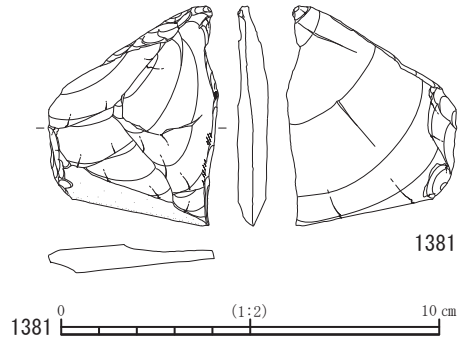

1381

1381 0 (1:2) 10 cm

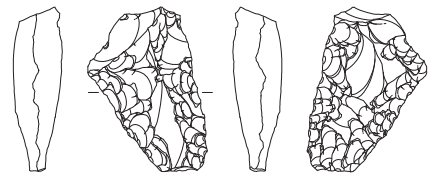

1380

1380 0 (2:3) 5 cm

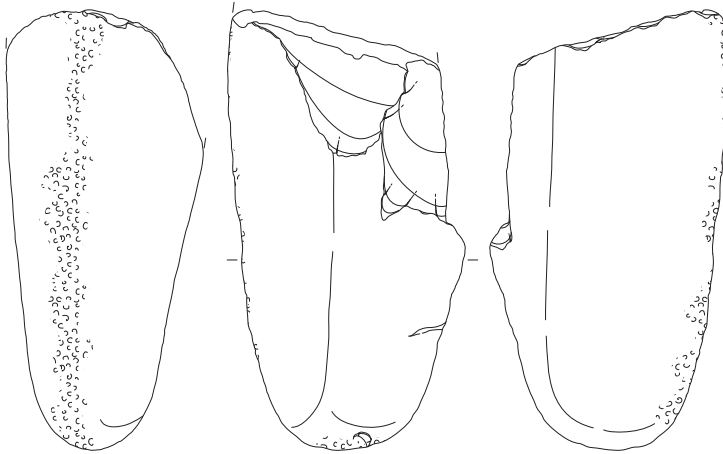

1382 0 (1:4) 20 cm

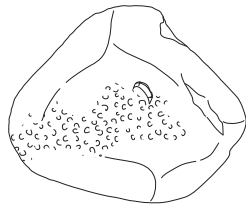

1382

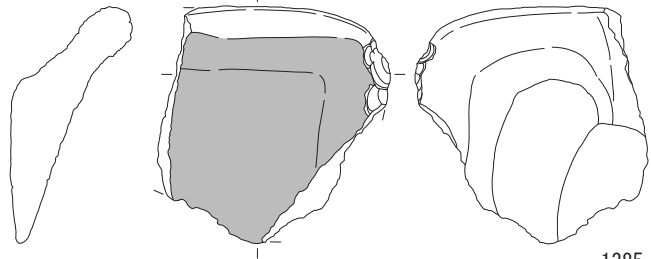

1385

92 豎

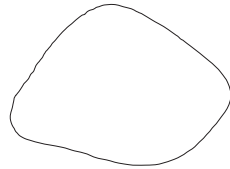

1385 0 (1:3) 10 cm

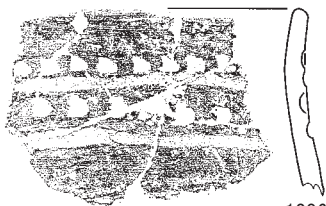

1386

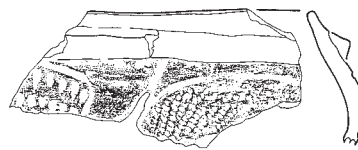

1388

93 豎

1386・1388 0 (1:3) 10 cm

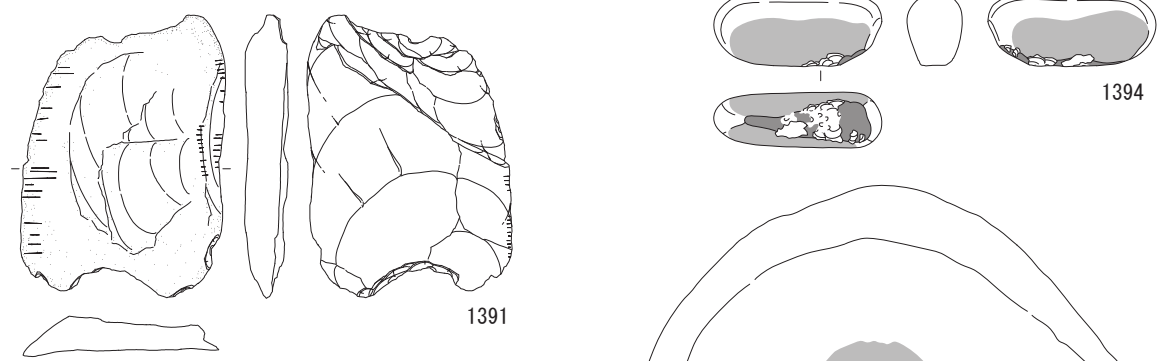
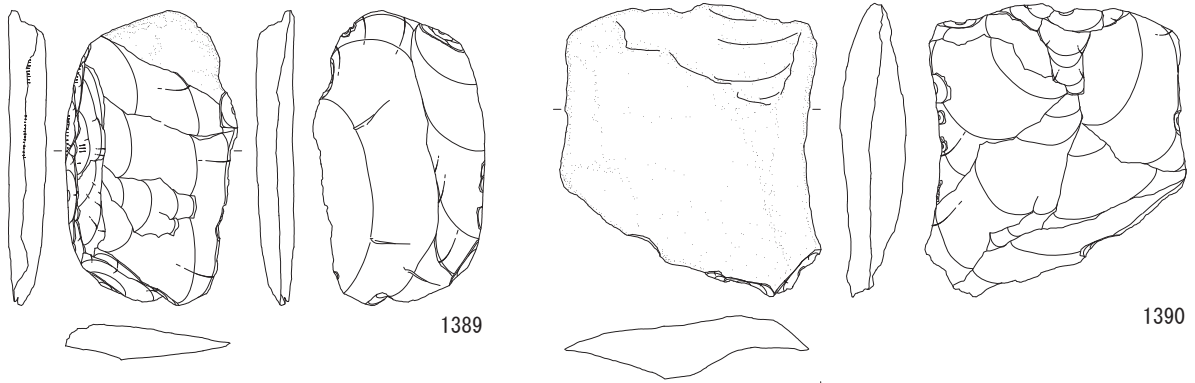
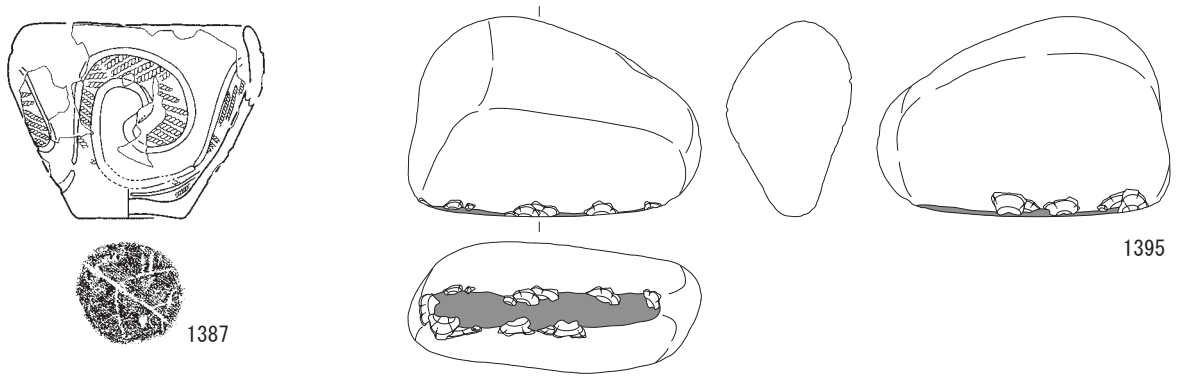

1389~1391 0 (1:2) 10 cm

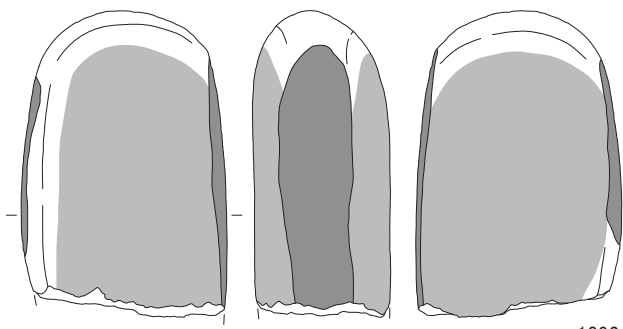

1392

1387・1392・1394・1395 0 (1:3) 10 cm

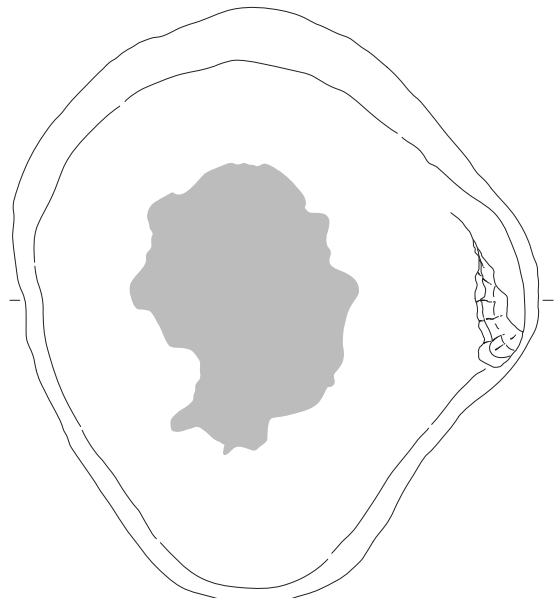

1396

0 (1:4) 20 cm

93 豎

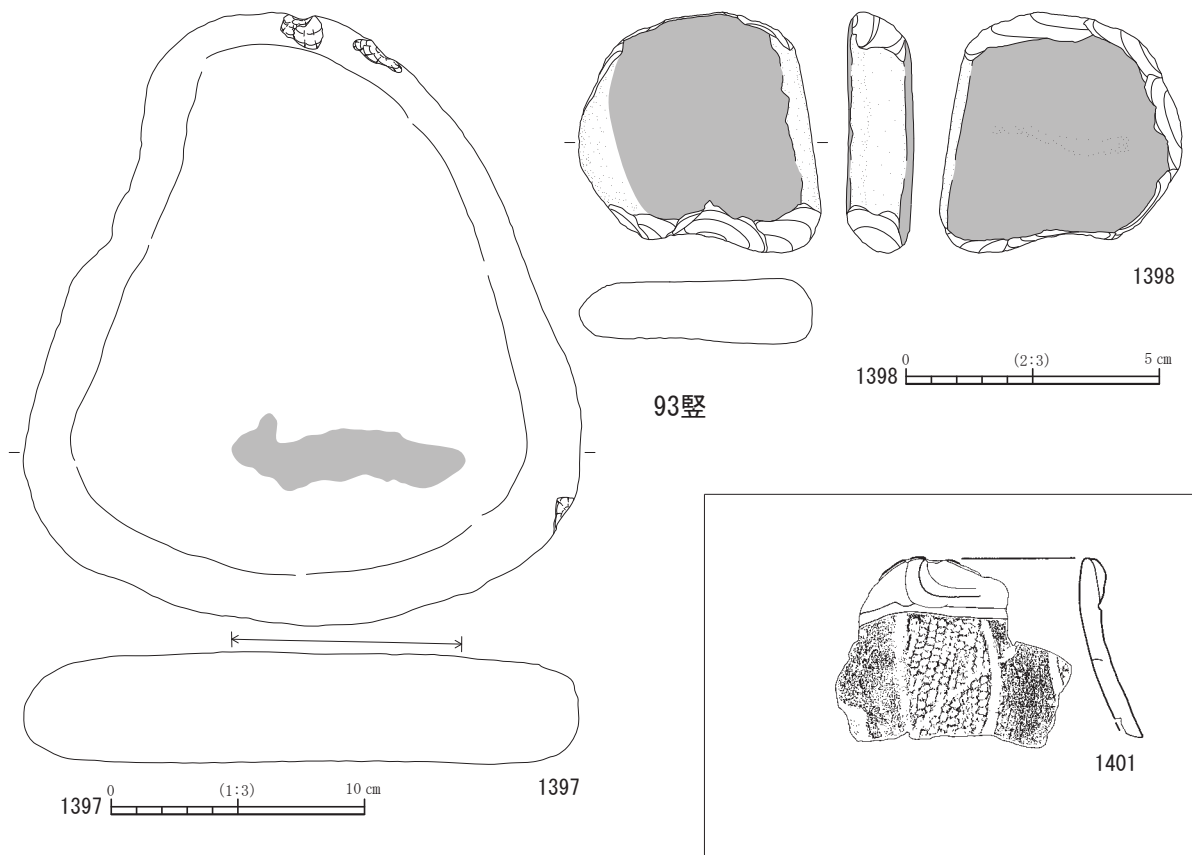

93 豎

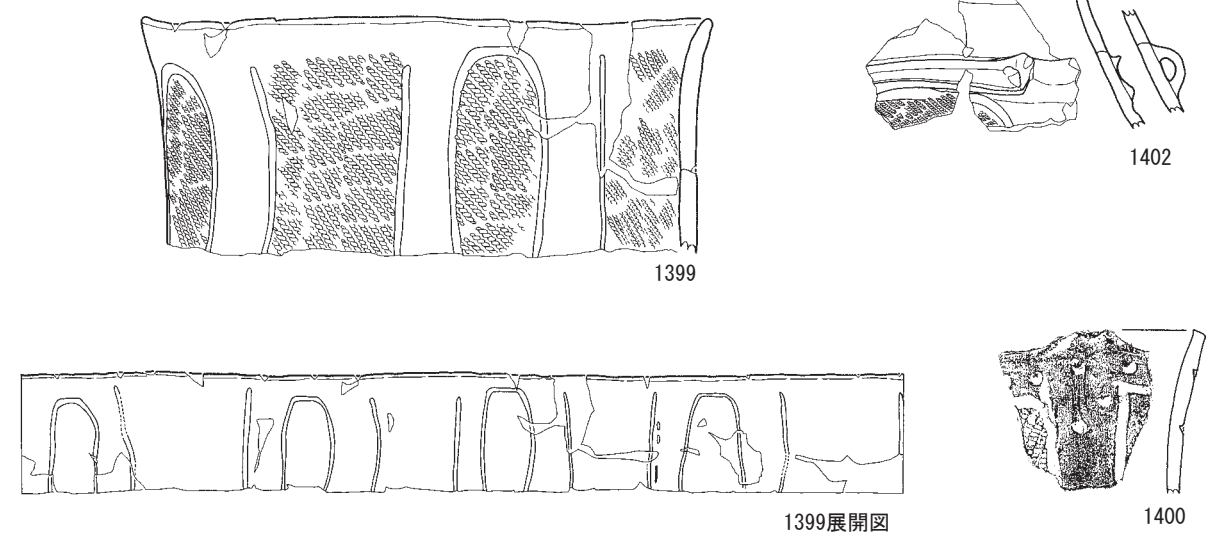

1399

1400

1399 展開図

展開図 0 (1:6) 20 cm

95 豎

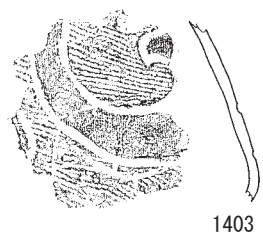

1403

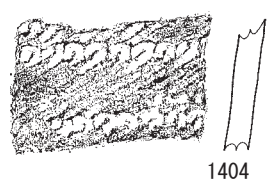

1404

0 (1:3) 10 cm

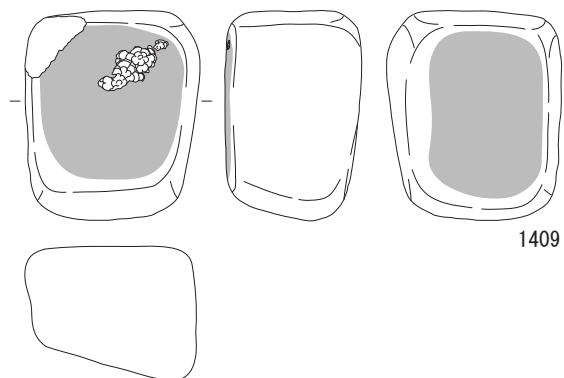
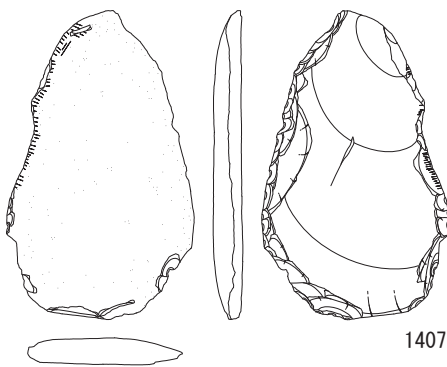
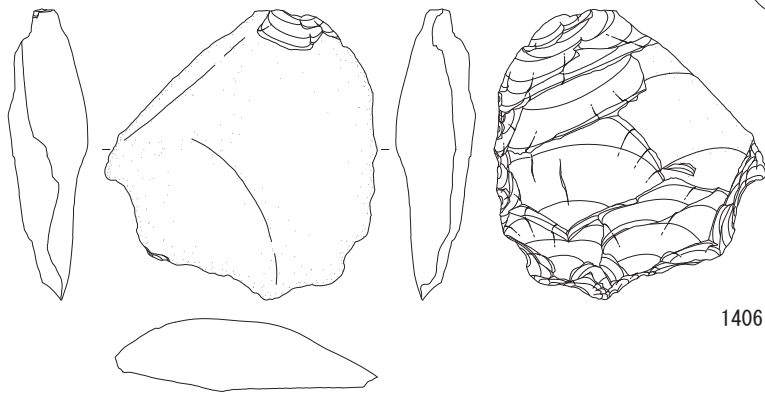
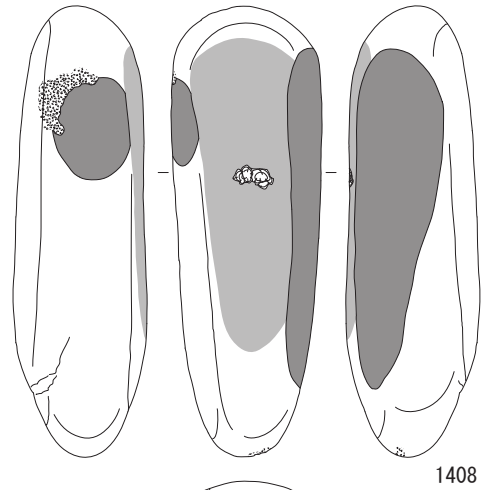
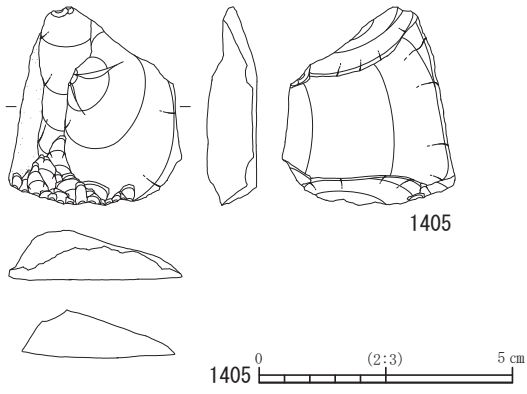

95 竖

1408~1410 0 (1:3) 10 cm

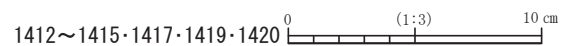
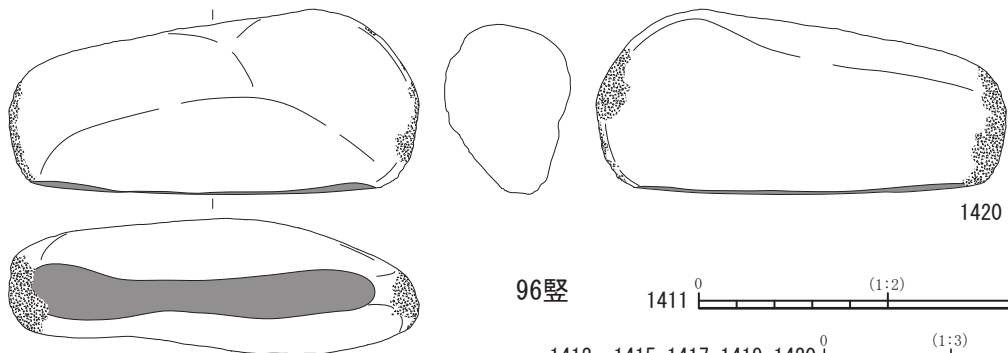
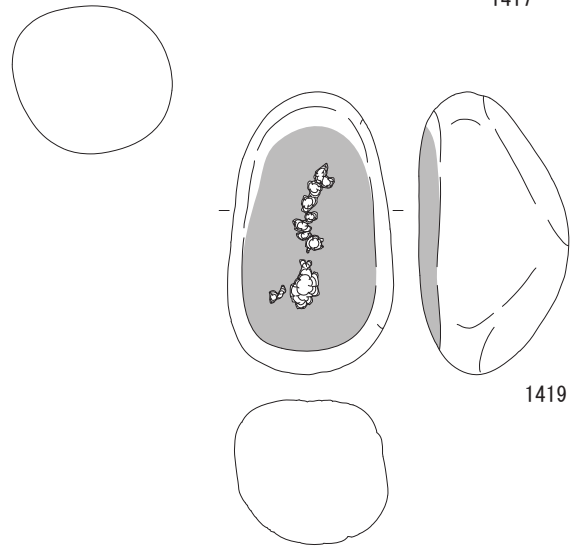
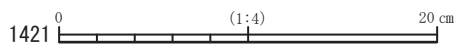
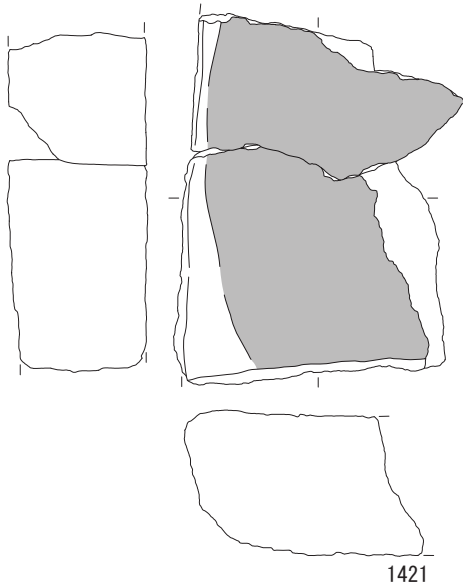
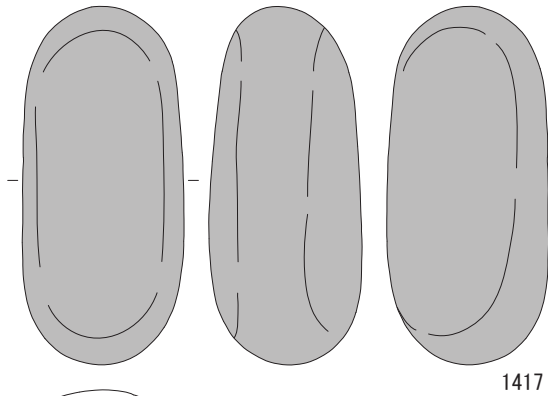
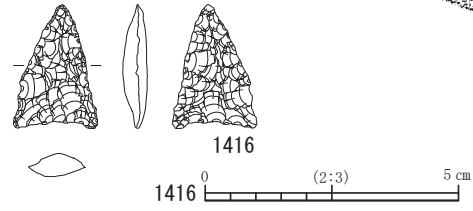
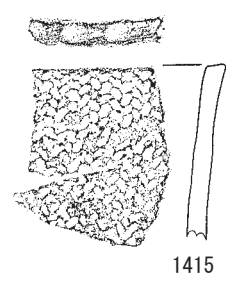
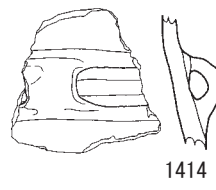

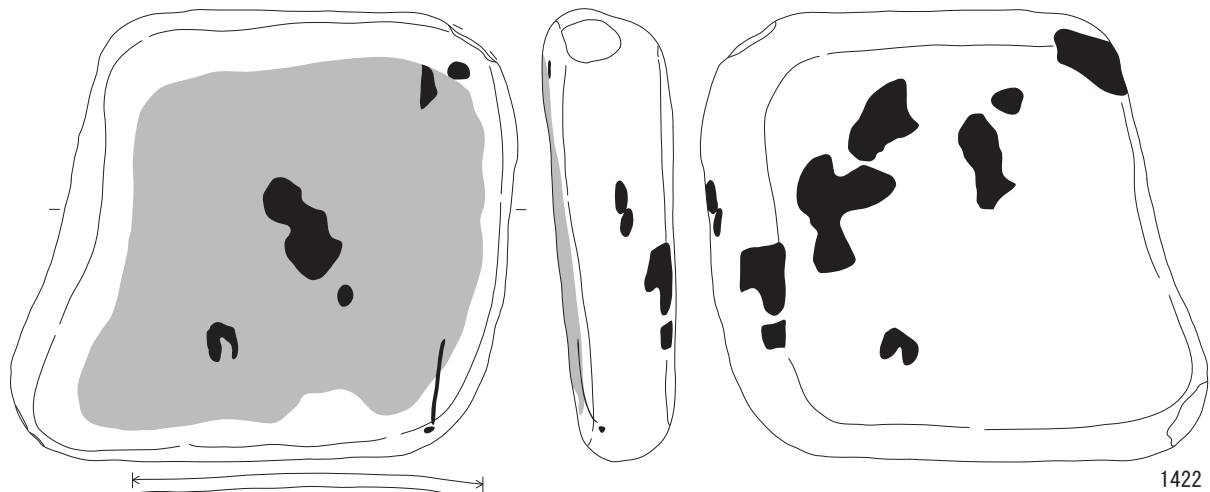

1422

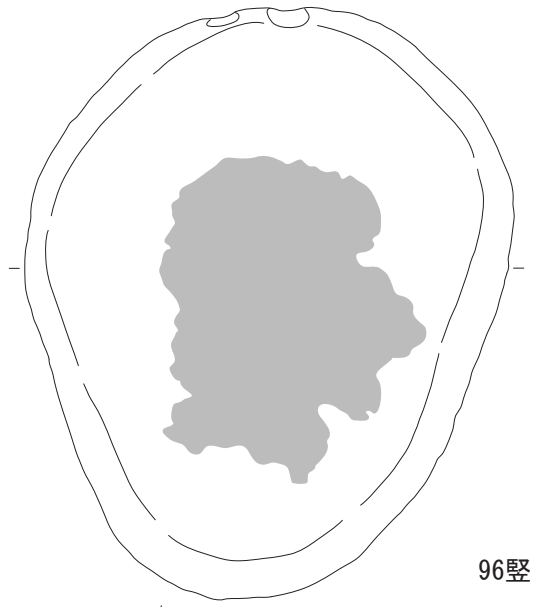
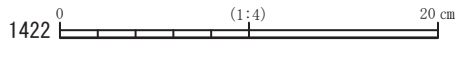

96 豎

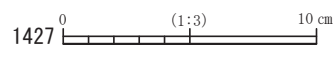
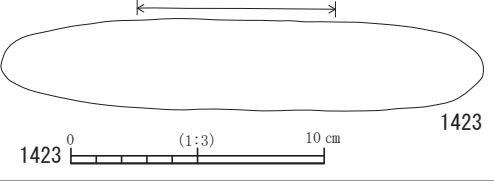

1427

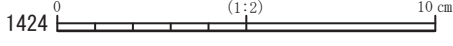
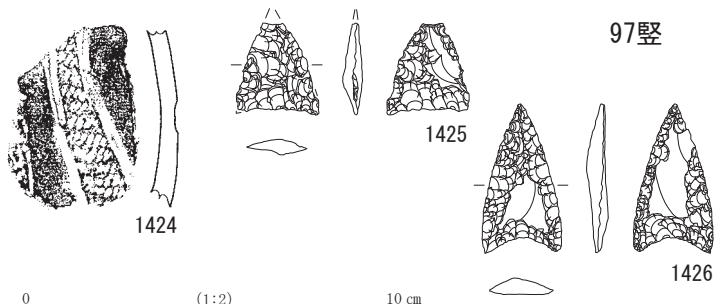

97 豎

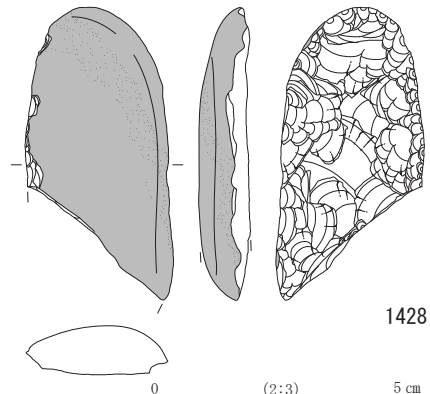

1428

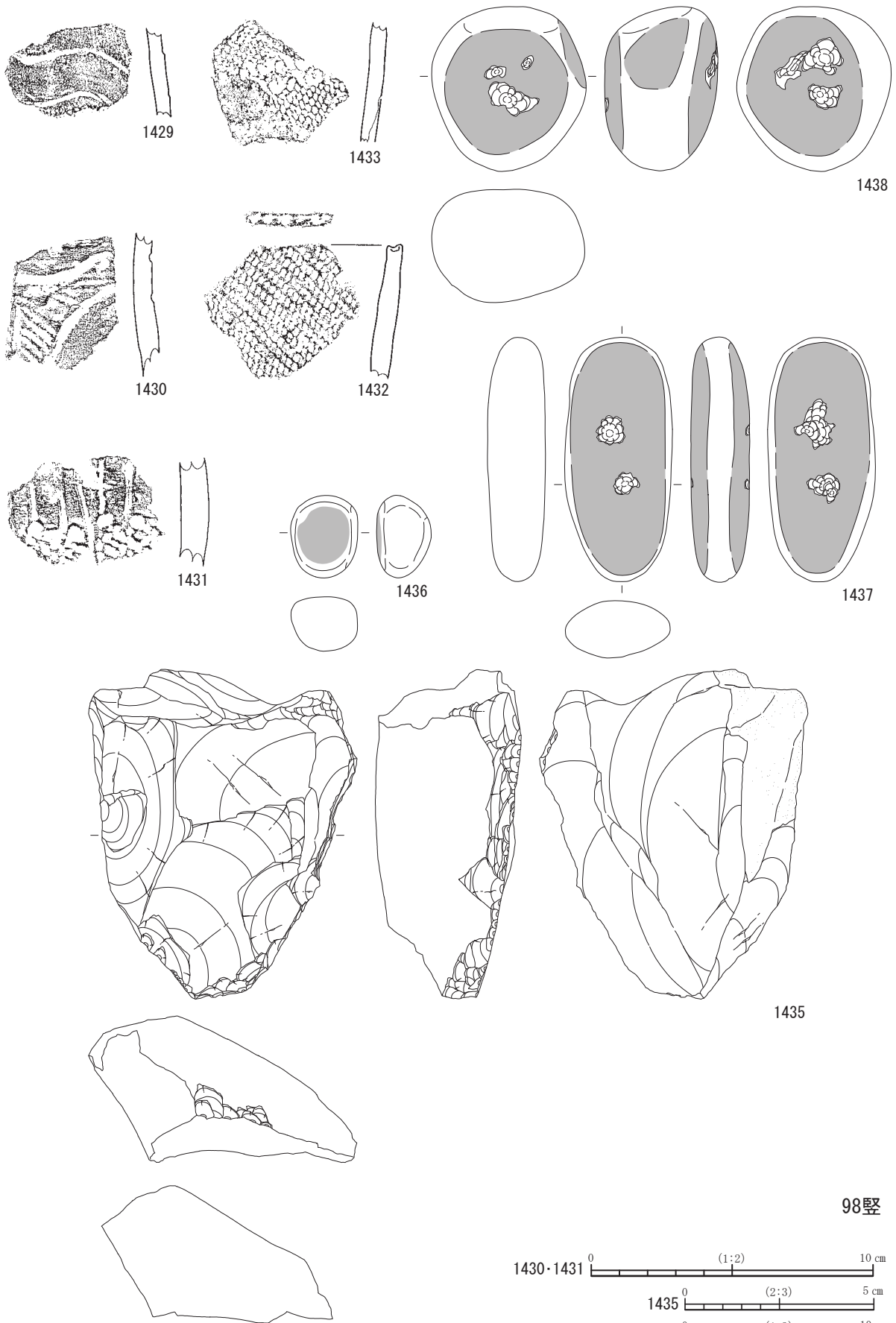

遺物図版194 縄文時代の遺物194

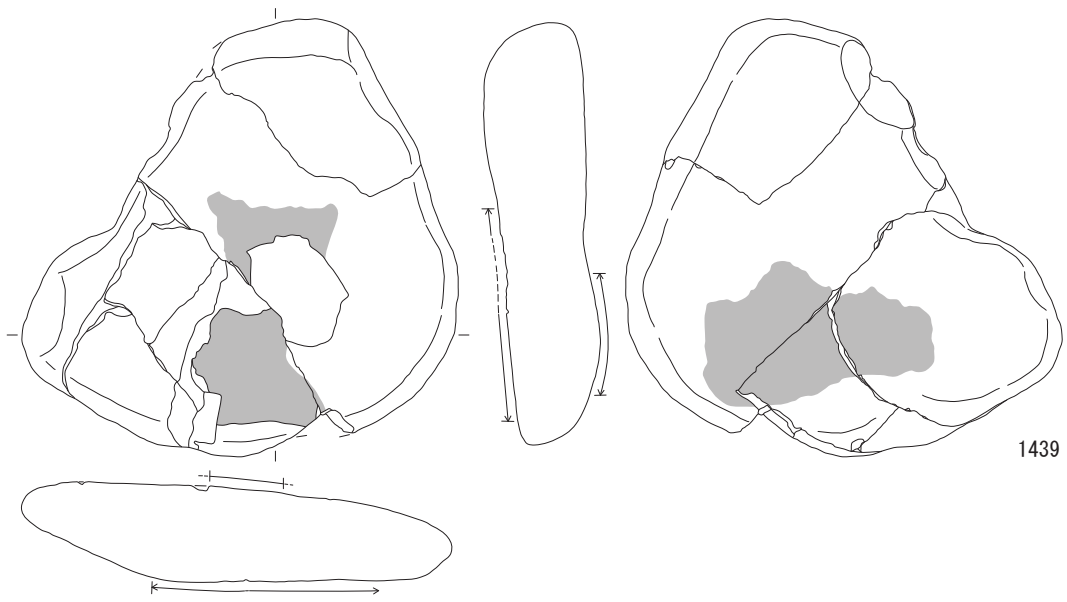

1439

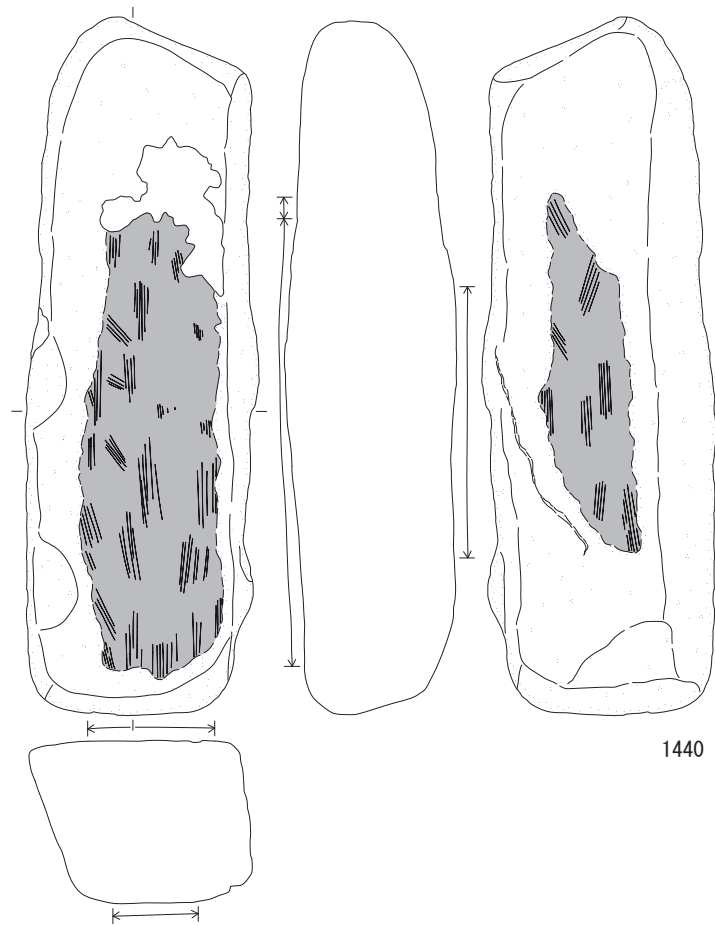

1440

98 豎

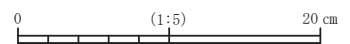



1441

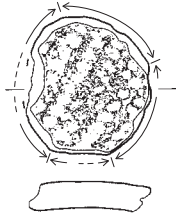

1443

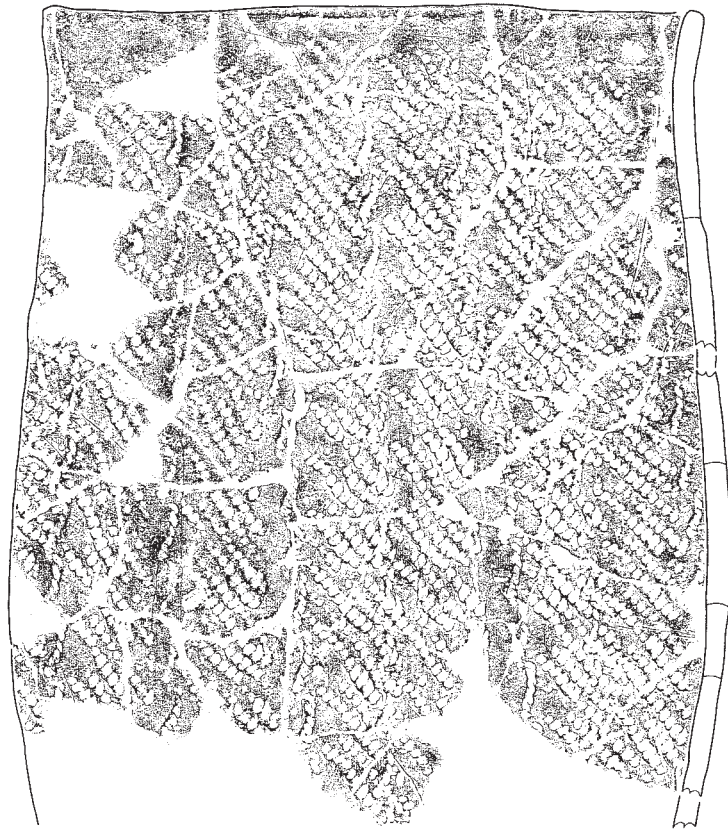

1442

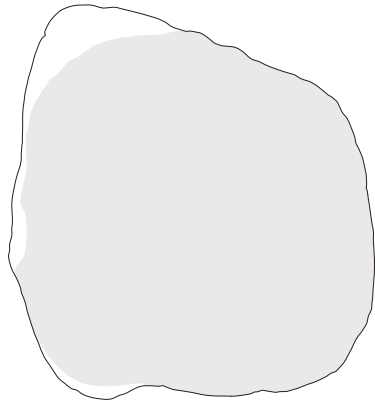

被熱範囲 (S=1/6)

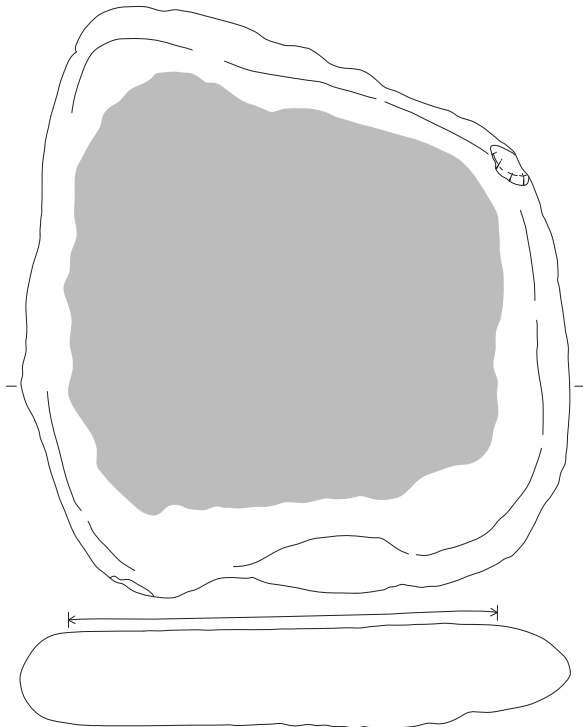

1445

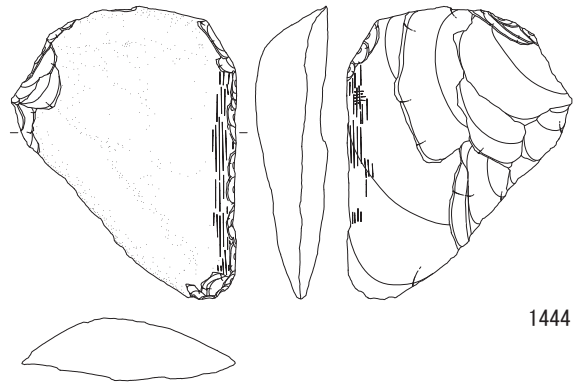

1444

99 豎

1441・1442 0 (1:3) 10 cm

1445 0 (1:4) 20 cm

1443・1444 0 (1:2) 10 cm

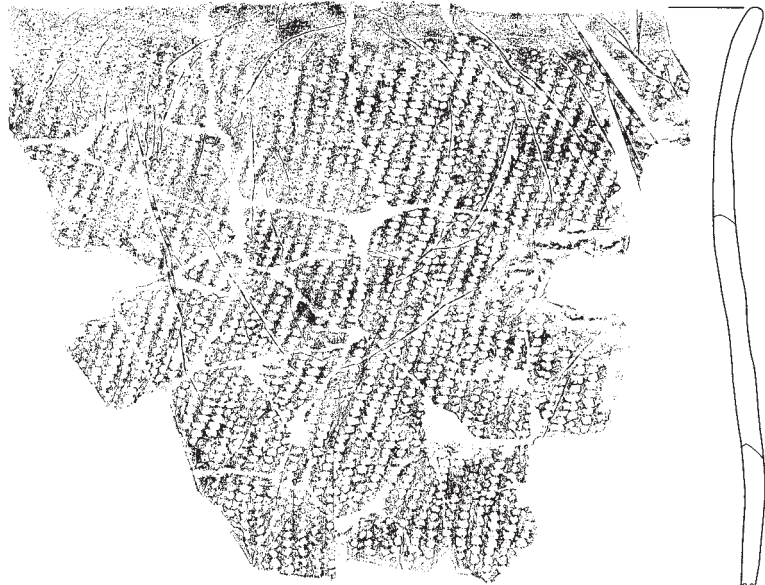

1446

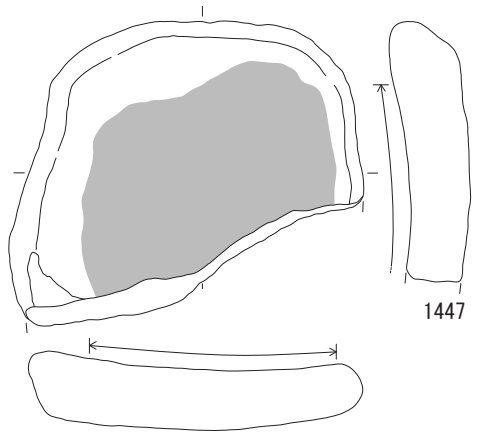

1447

100 豎

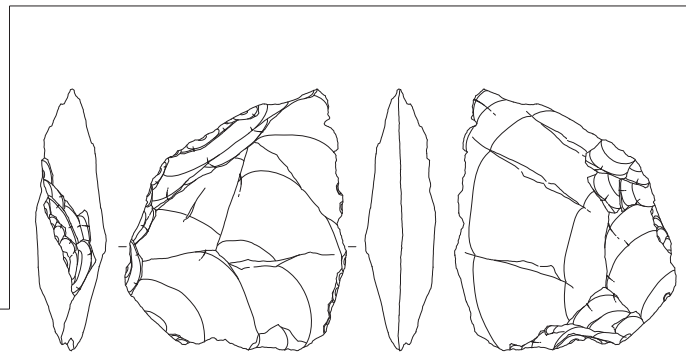
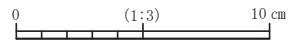

1451



1448

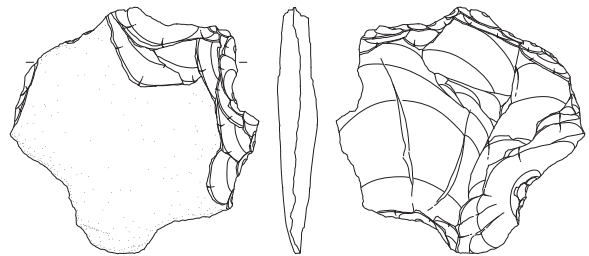

1452



1449

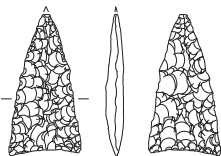

1450

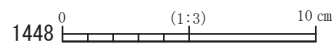

101 豎

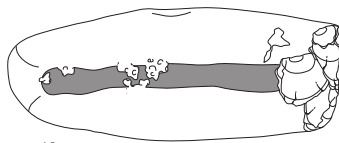
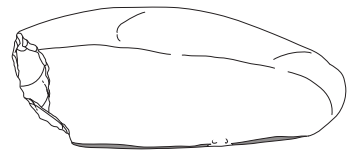
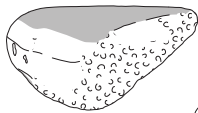
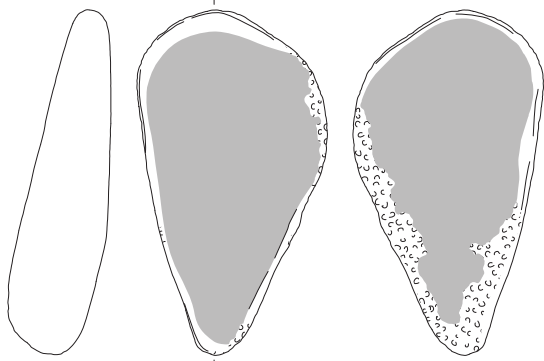
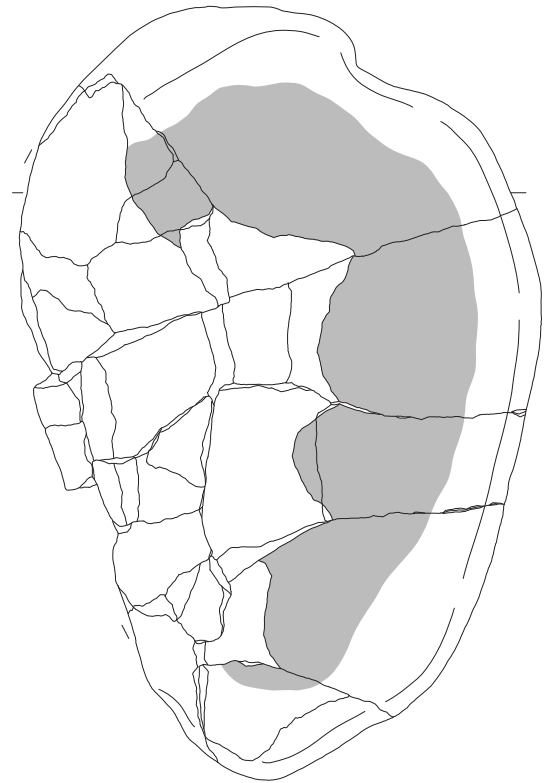
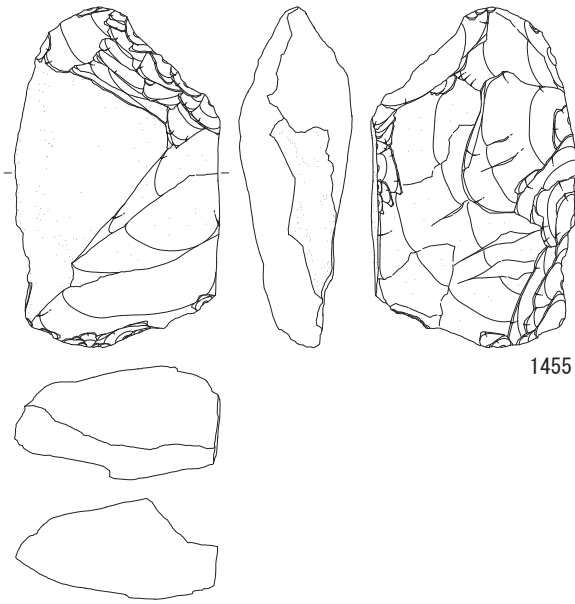
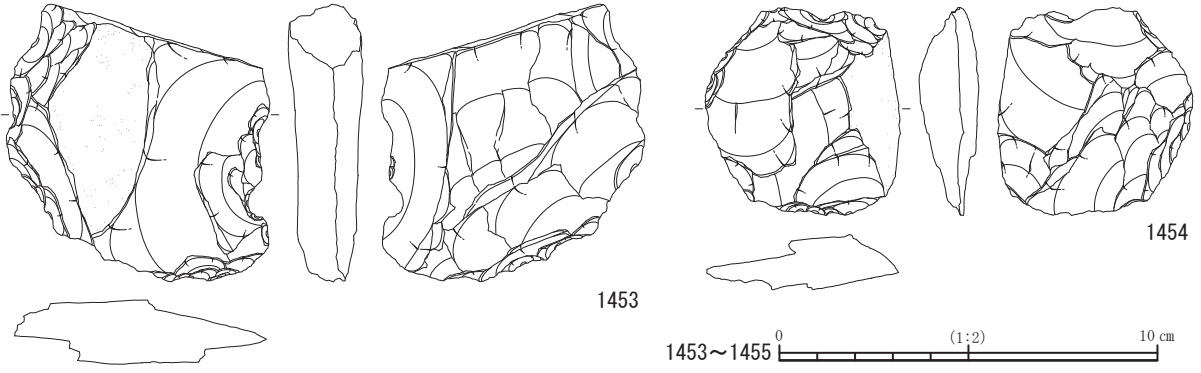

1457

101 豎

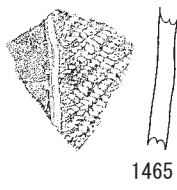
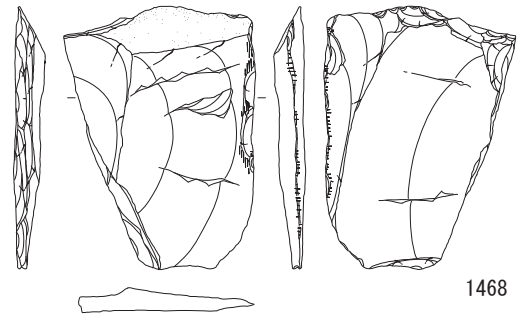
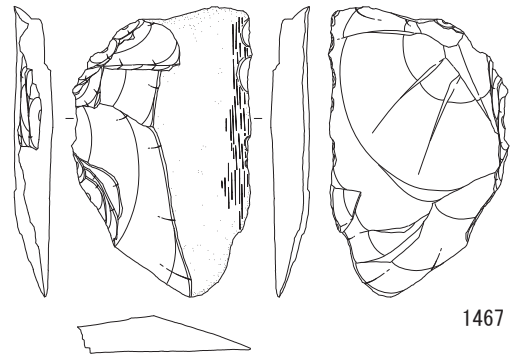
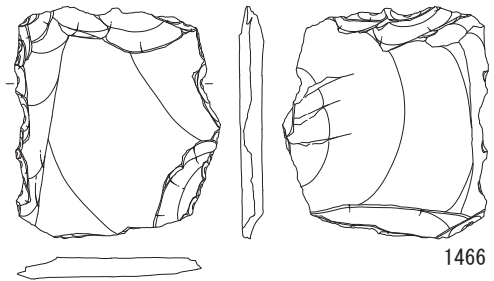
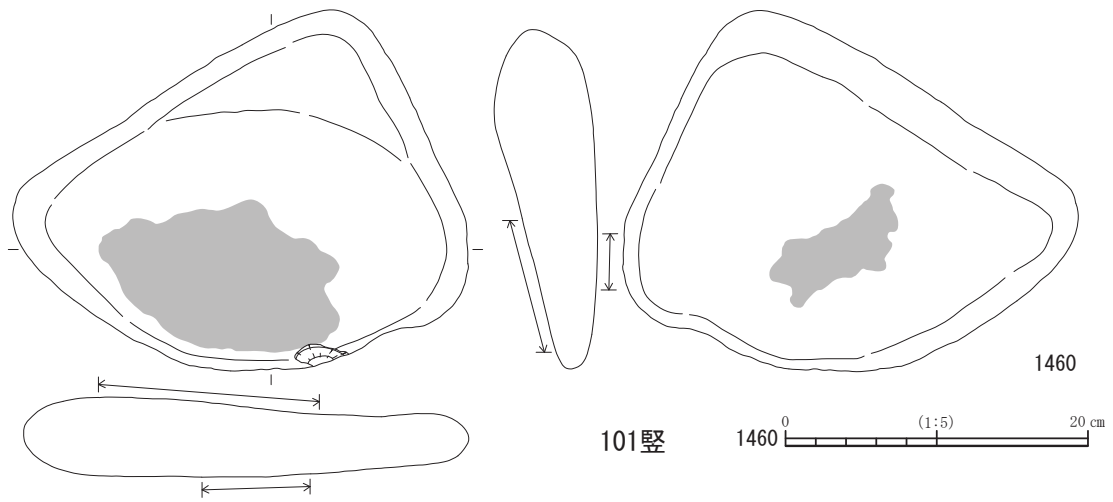

102 縦

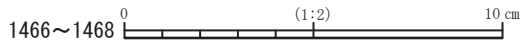



1470 0 (1:3) 10 cm



1473

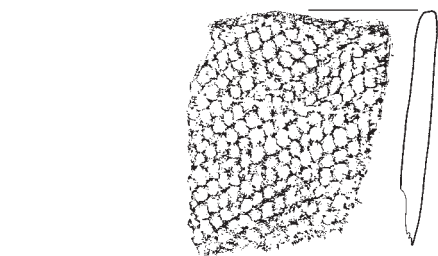
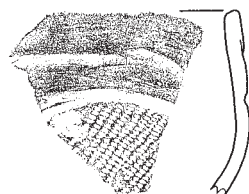

104 豎

1471 0 (1:2) 10 cm



105 豎

0 (1:3) 10 cm

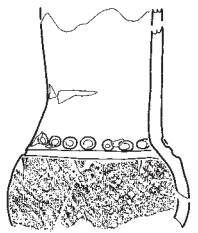

1481

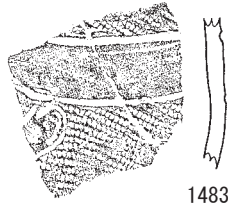

1483

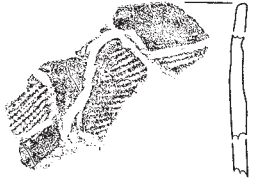

1484

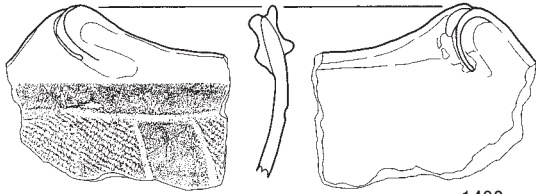

1482

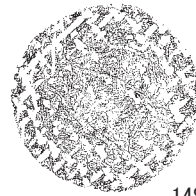

1480

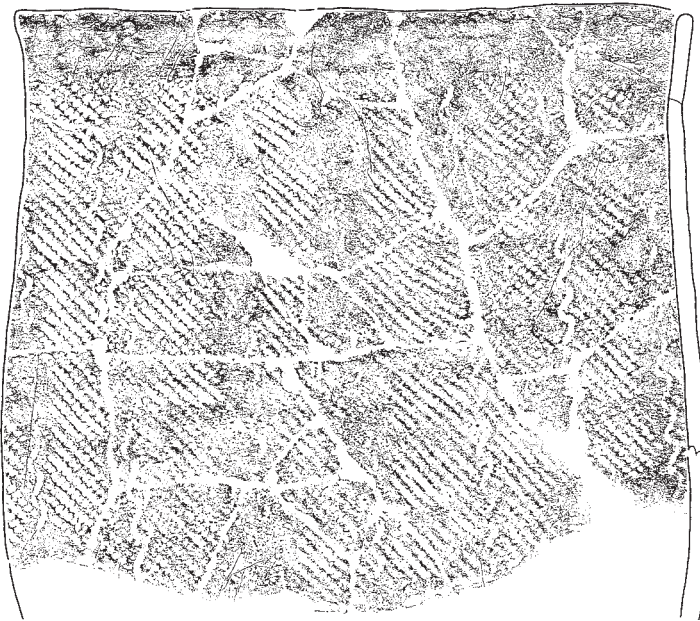
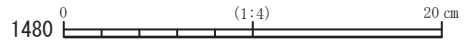

1479



1485

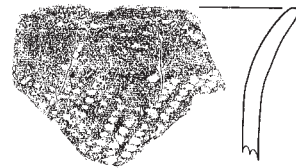

1486

105 豎



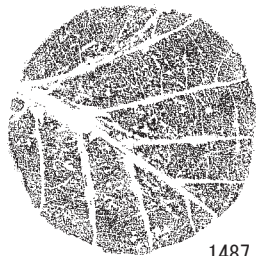

1487

1487 0 (1:3) 10 cm

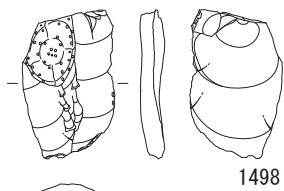

1498

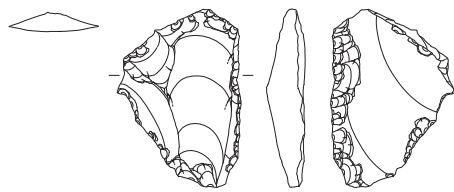

1497

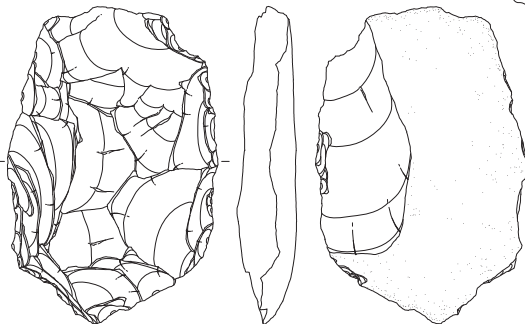

1501

105 豎

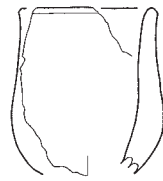

1488

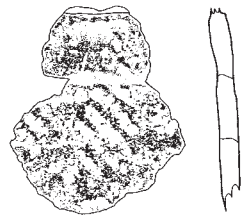

1489

1488・1489・1492~1498 0 (2:3) 5 cm

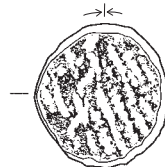

1490



1491



1492



1493



1496



1494



1495

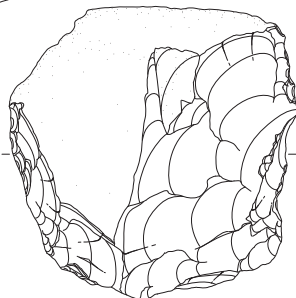

1499

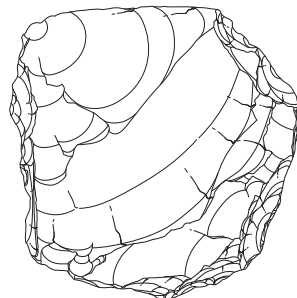

1500

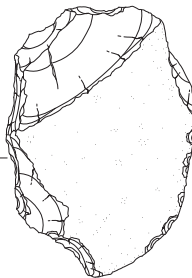

1490・1491・1499~1501 0 (1:2) 10 cm

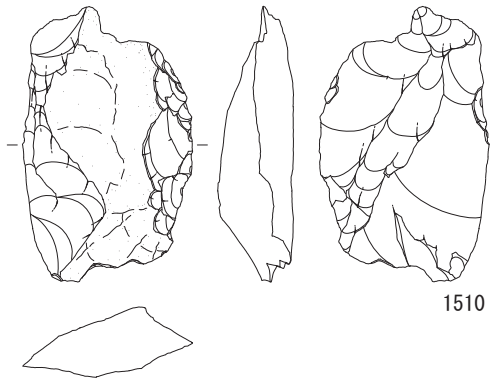
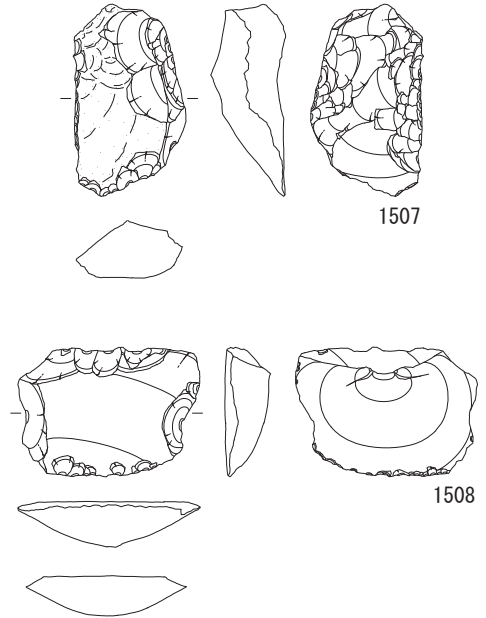
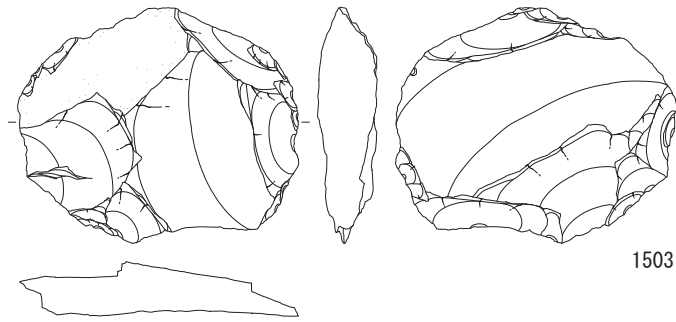
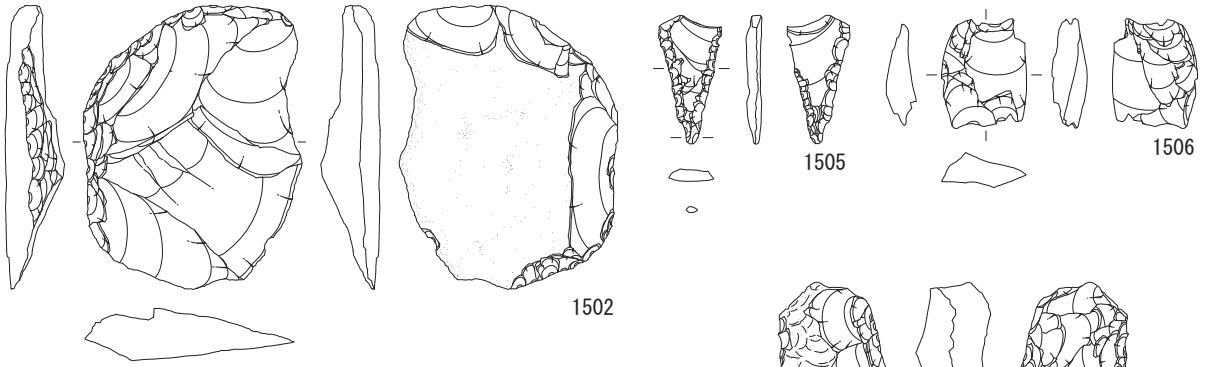

1505~1510 0 (2:3) 5 cm

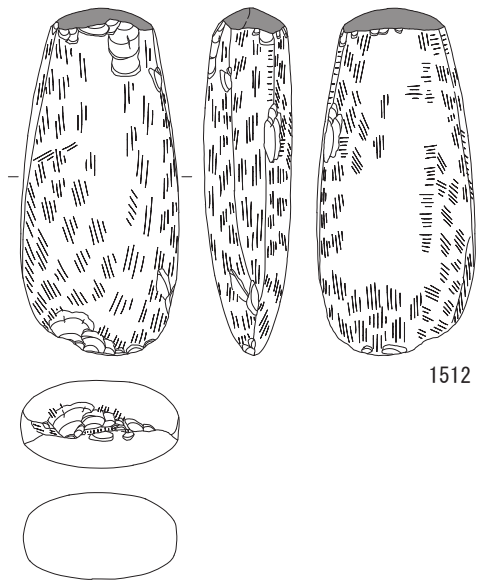
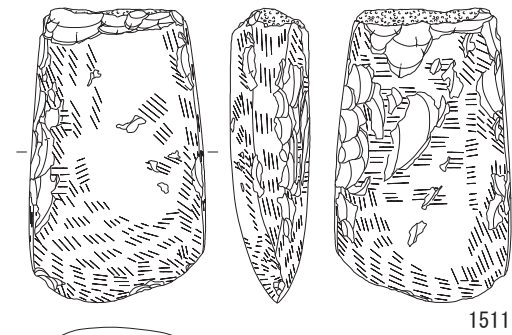

105 豎

1502・1503・1511・1512 0 (1:2) 10 cm

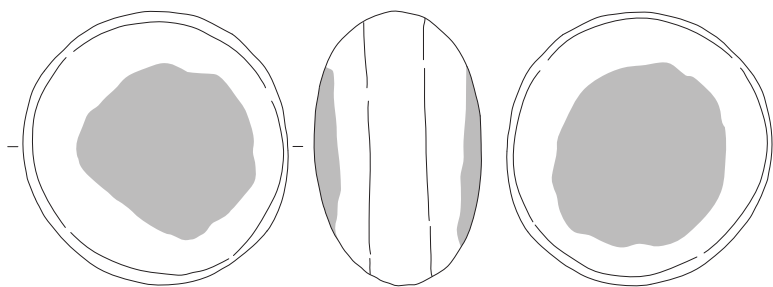

1513

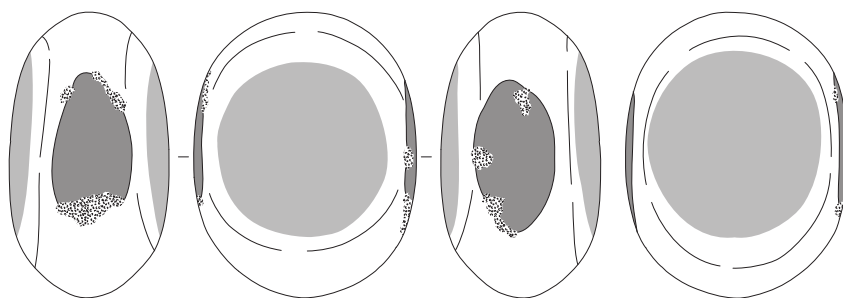
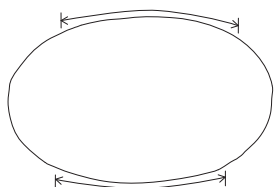

1514

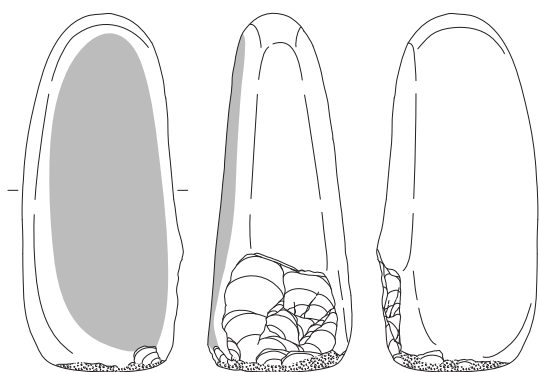
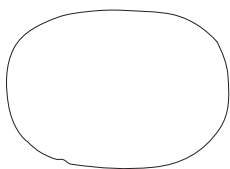

1515

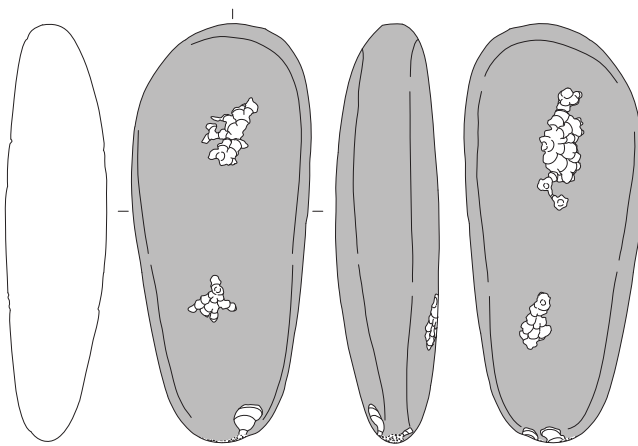
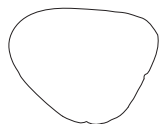
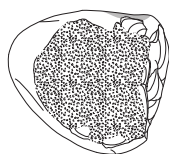

1516



105 豎

0 (1:3) 10 cm

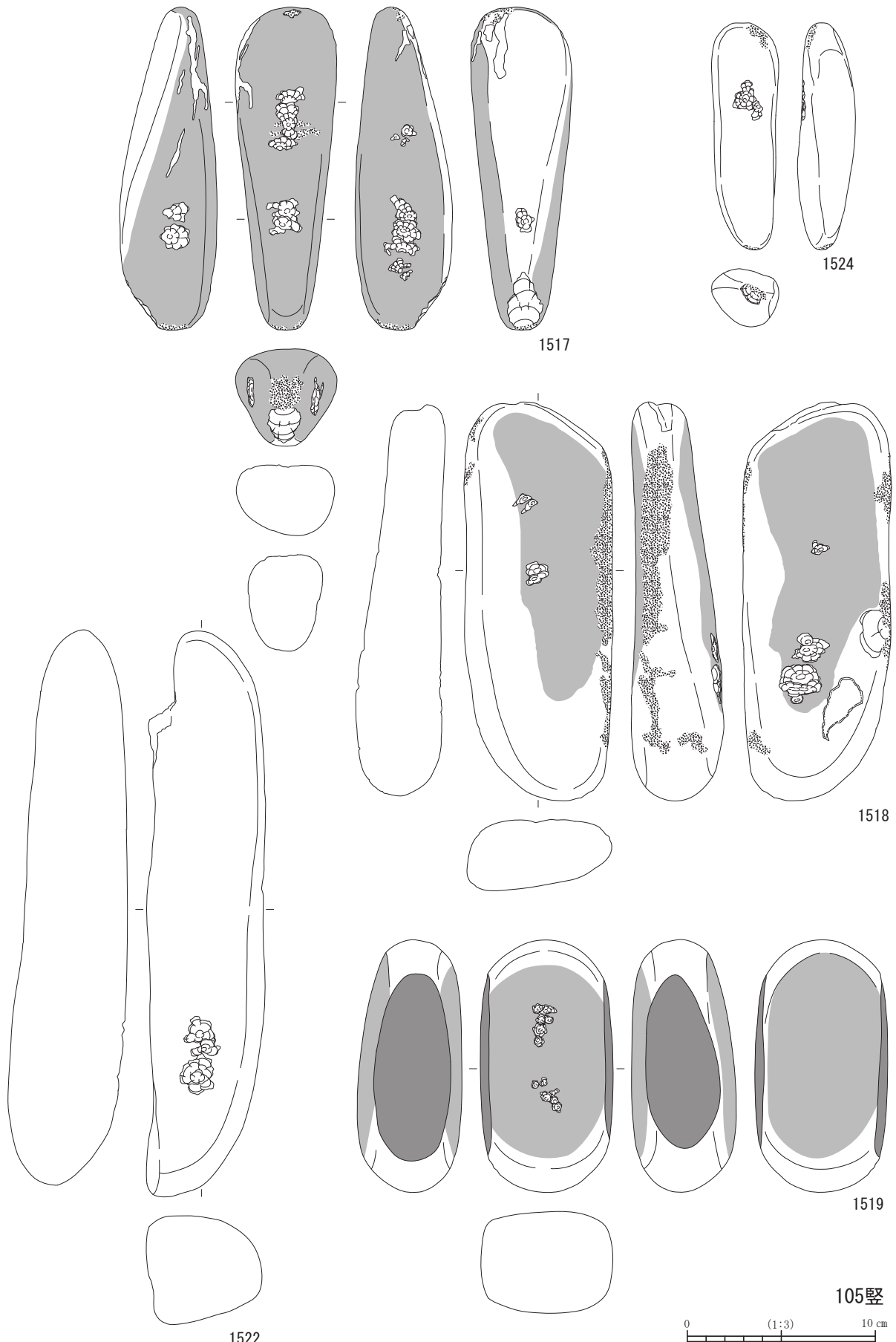

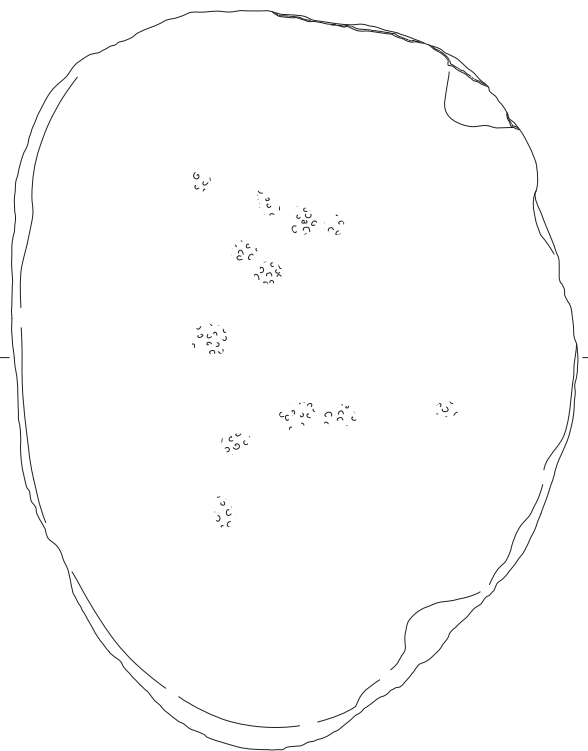

105 豎

0 (1:3) 10 cm

1528

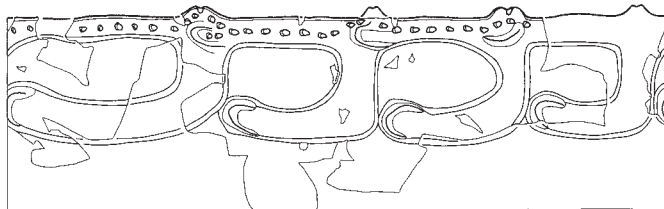

展開図 0 (1:6) 20 cm

1531 展開図

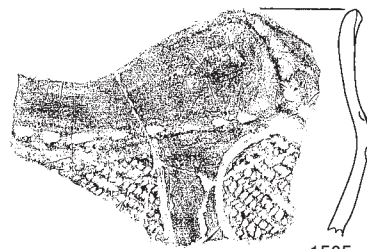

1535



1536

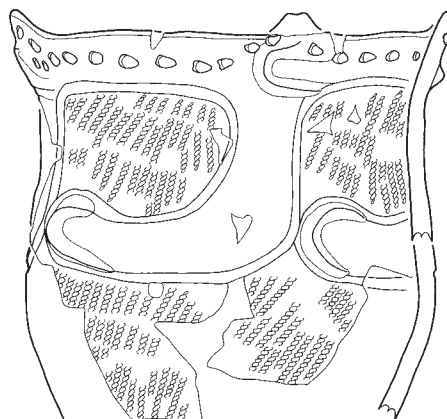

1531

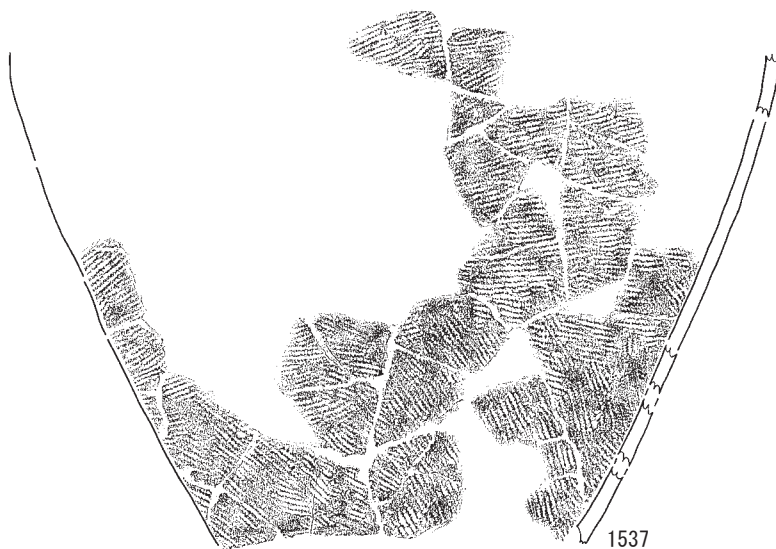

1537

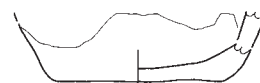

1532

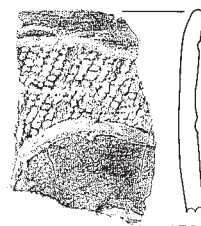

1534

106 豎

0 (1:3) 10 cm

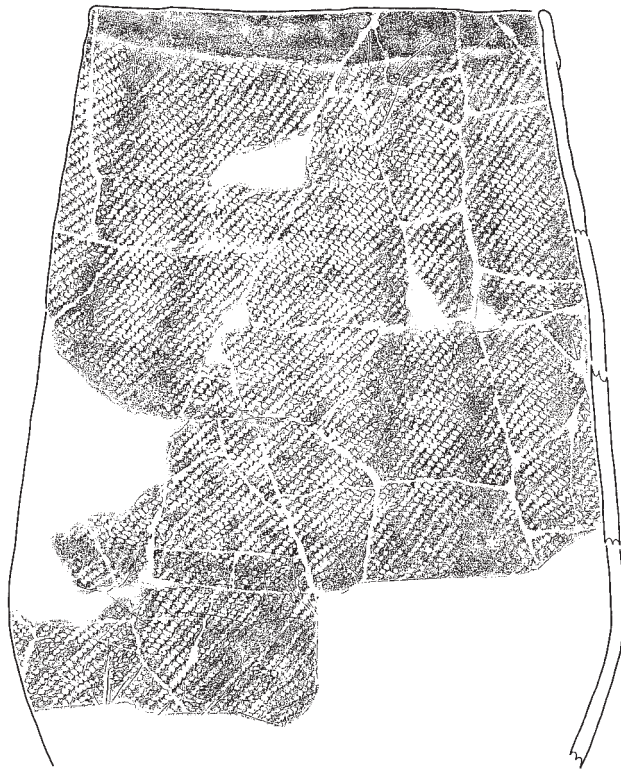

1533

1533 0 (1:4) 20 cm

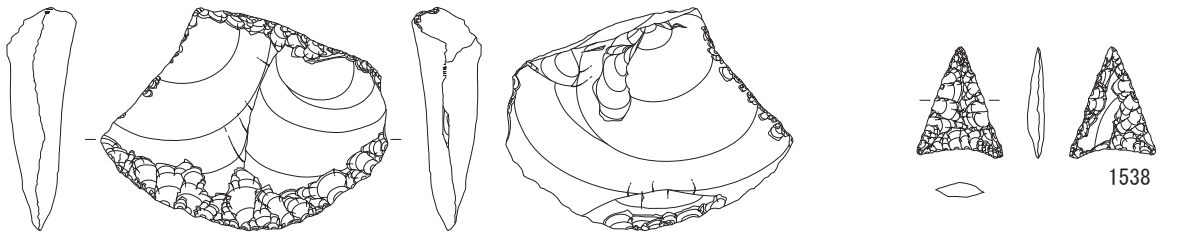

1539

1538

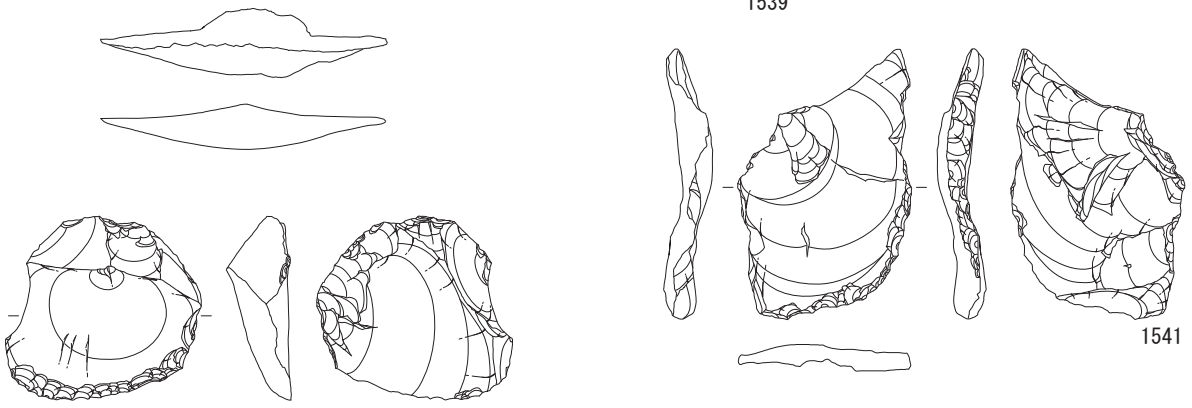

1540

1541

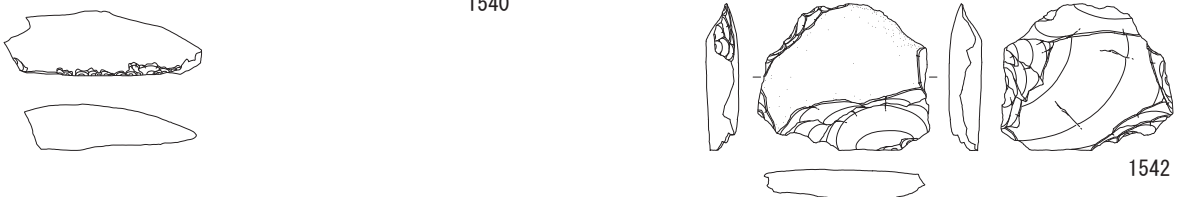

1542

1538~1541 0 (2:3) 5 cm

106 1542 0 (1:2) 10 cm

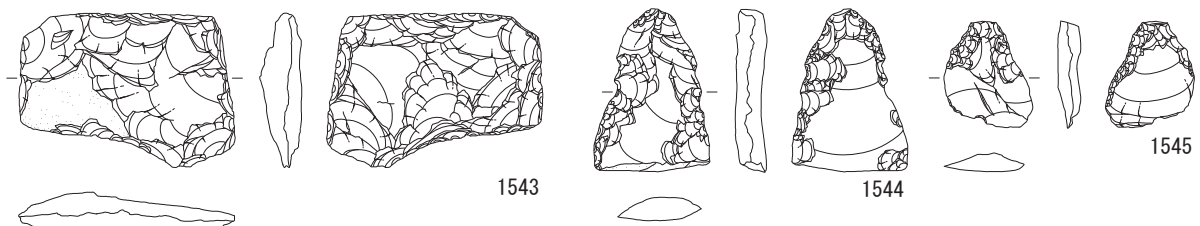

1543

1544

1545

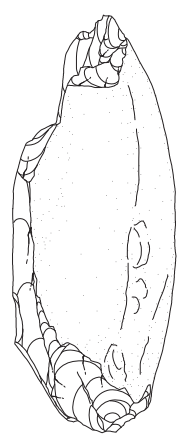
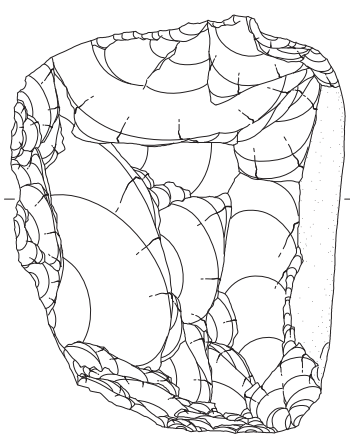
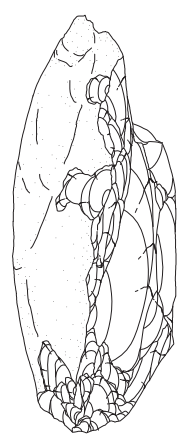
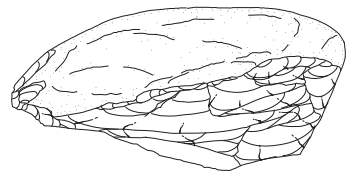
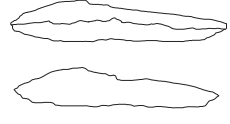

1546

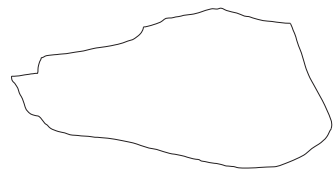
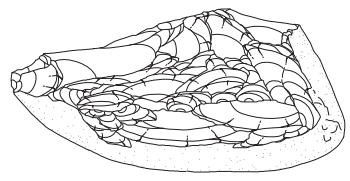

1543~1546 (2:3) 5 cm

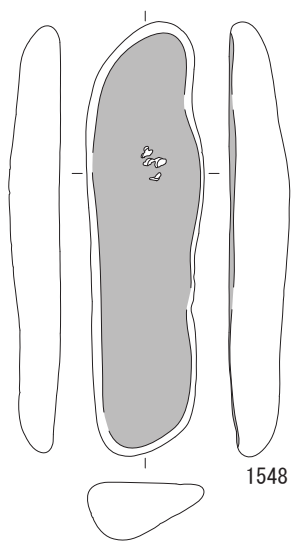

1548

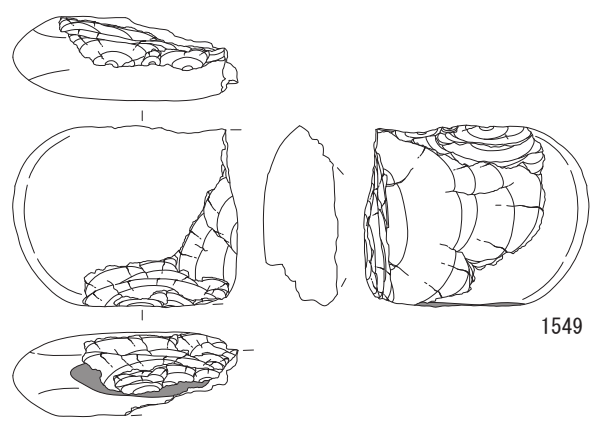

1549

106 豎

1548・1549 (1:3) 10 cm

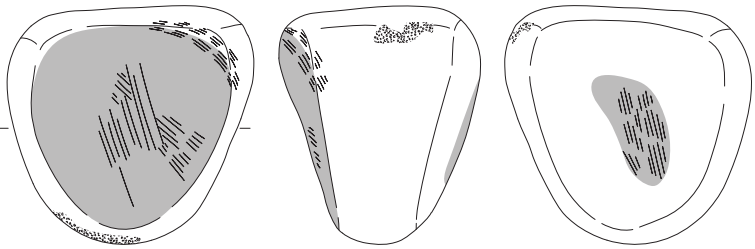

1547

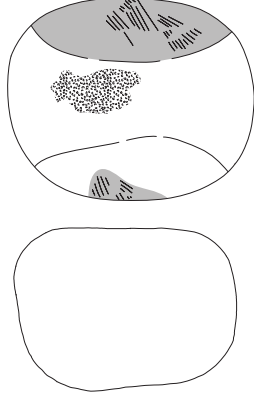
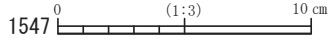

106 豎

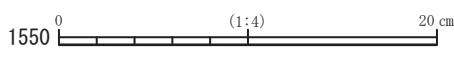

1550

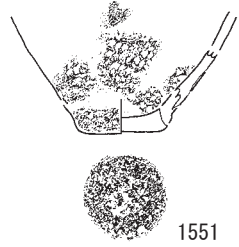

1551

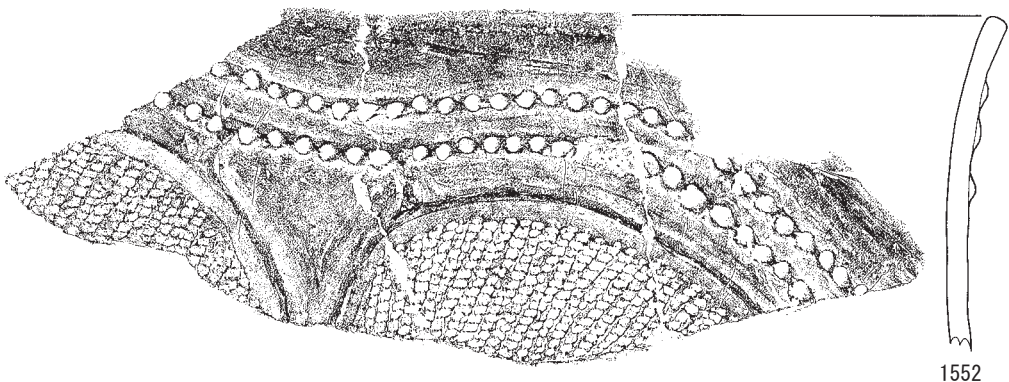

1552

107 豎

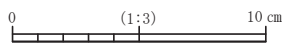

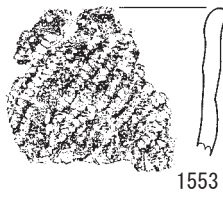

1553

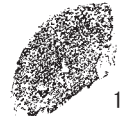
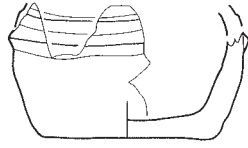

1554

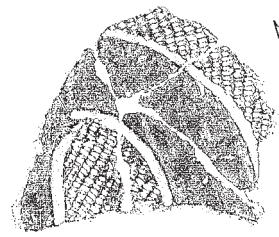

1555

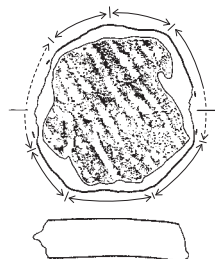

1556

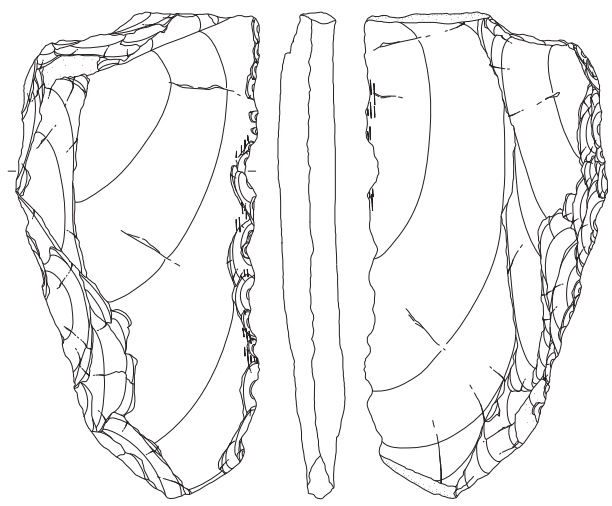

1558

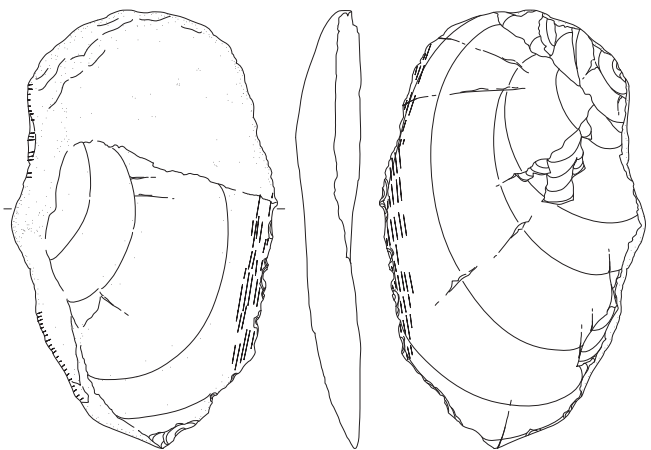

1560

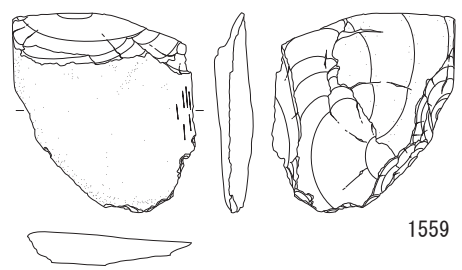

1559

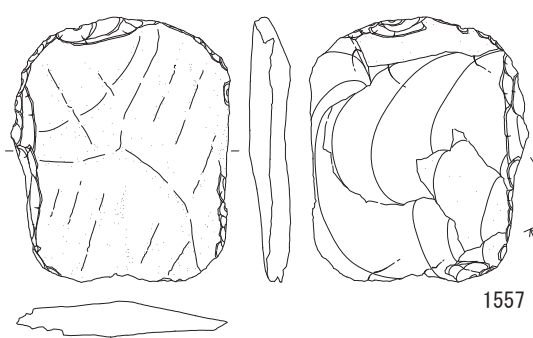

1557

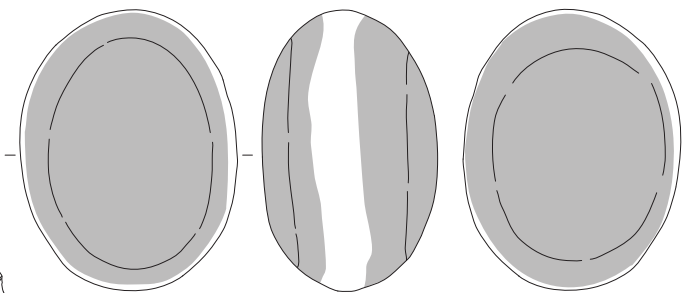

1561

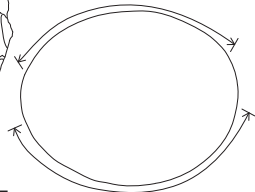

107 縦

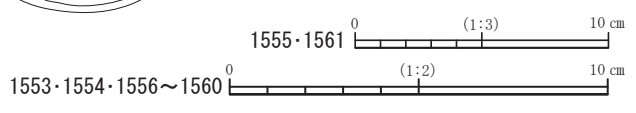

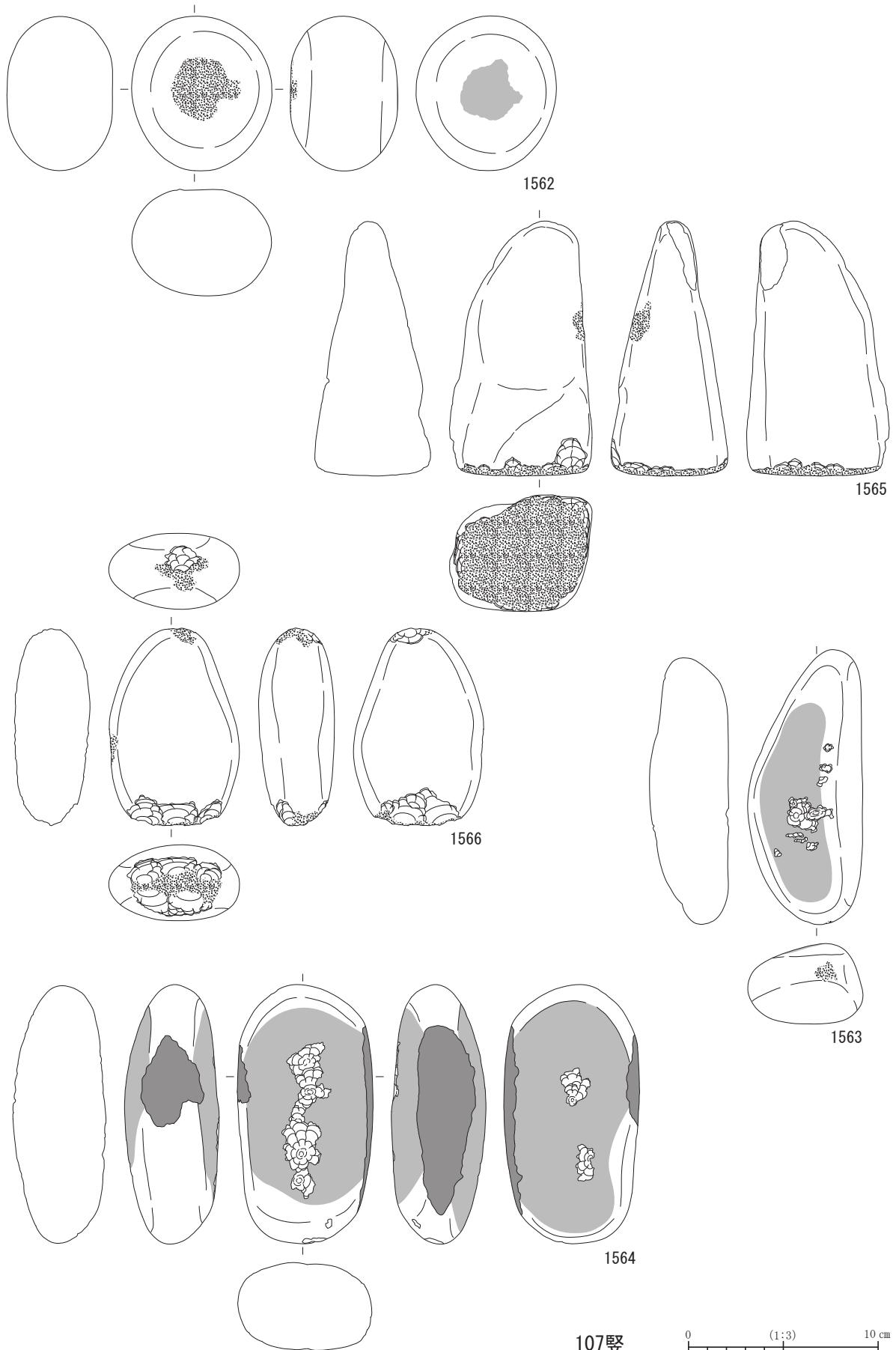

遺物図版211 縄文時代の遺物211

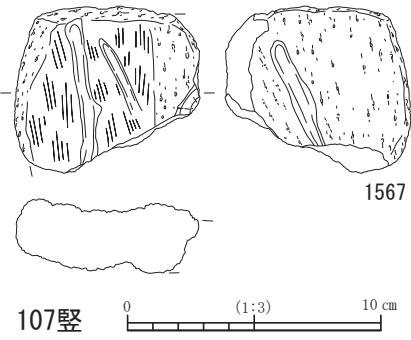

107 豎

1567

0 (1:3) 10 cm

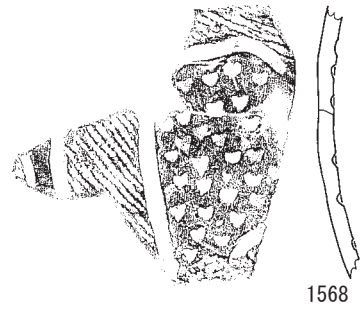

108 豎

1568

0 (1:3) 10 cm

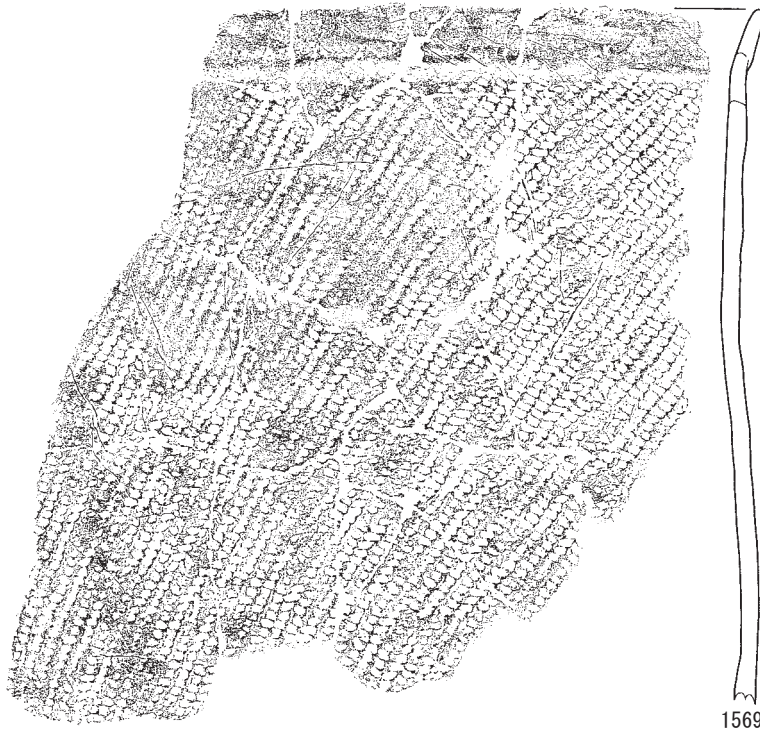

1569

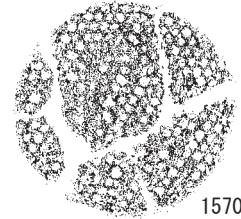

1570

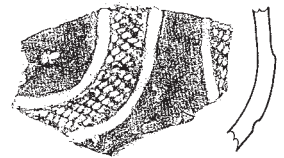

1571

1571 0 (1:2) 10 cm



1572

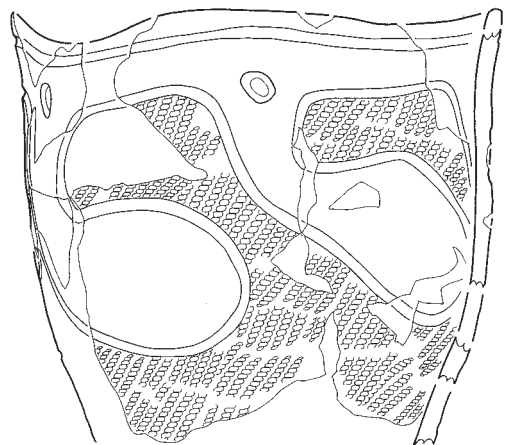

1573

1569・1570・1572・1573 0 (1:3) 10 cm

109 豎



1574

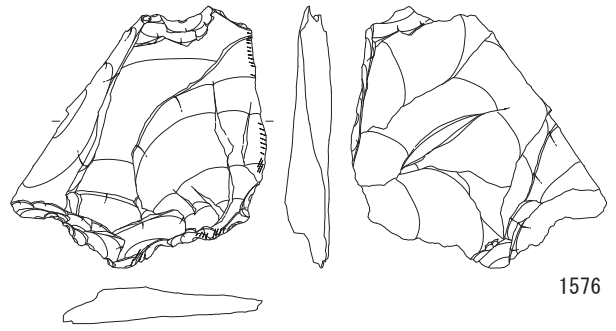

1576

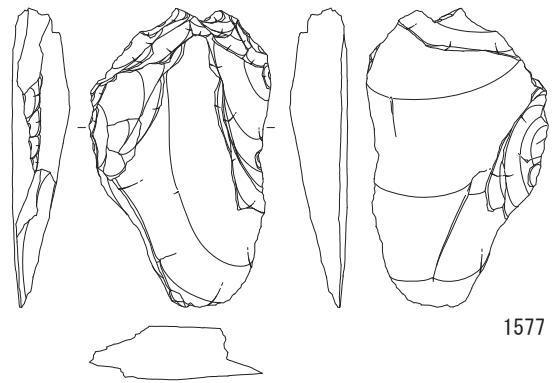

1577

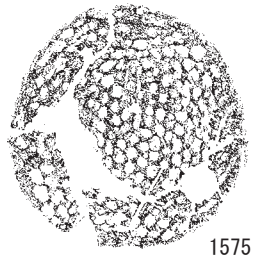

1575

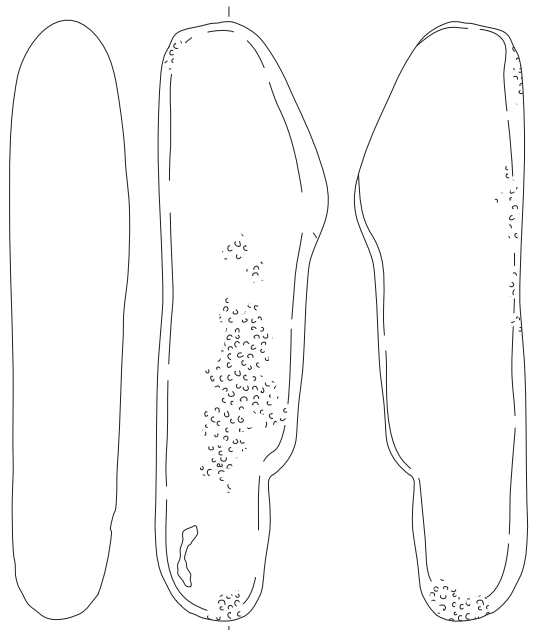

1580

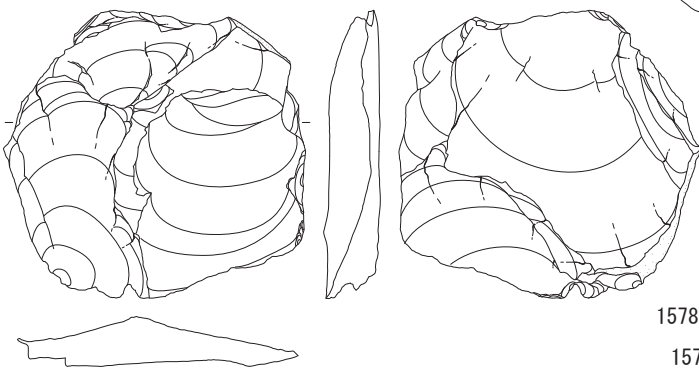

1578

109 豎



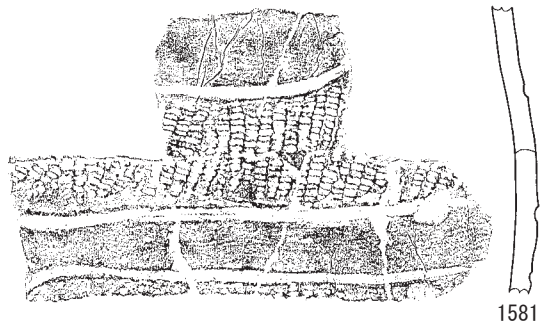

1581

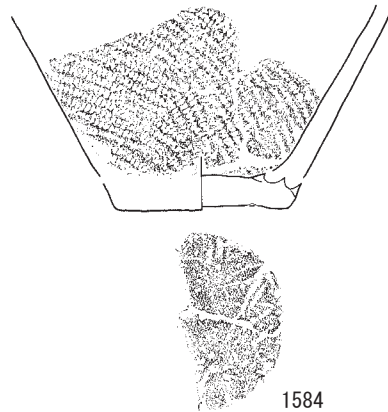

1584

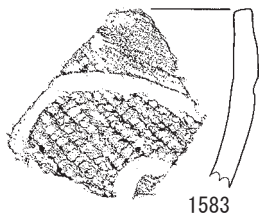

1583



1582

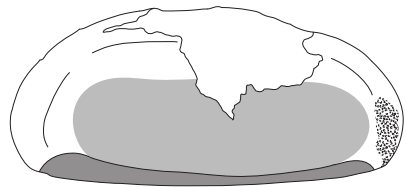
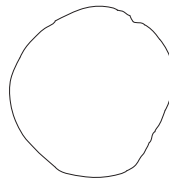
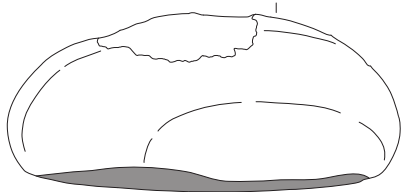

1585

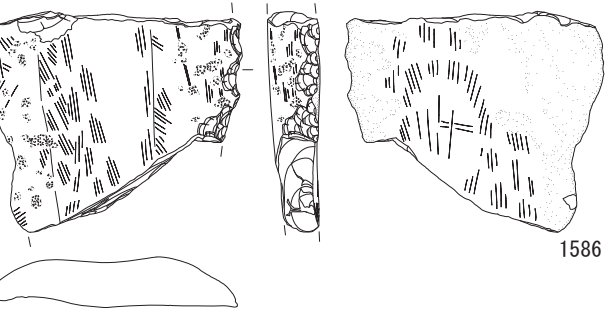
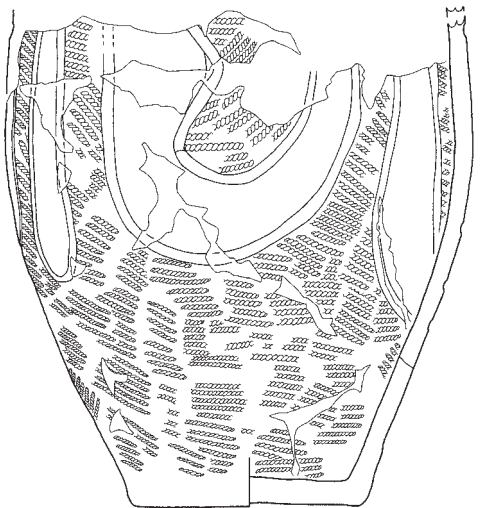
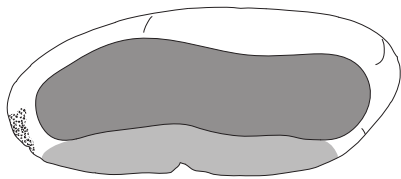

1586

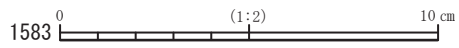

110 豎

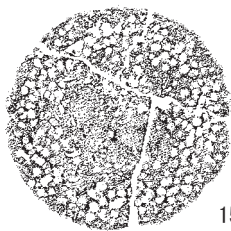
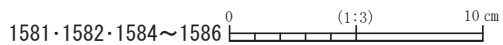

1587

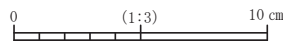

111 豎

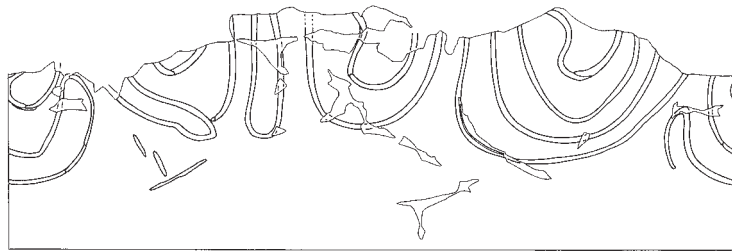

1587展開図

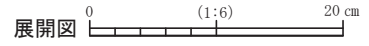

展開図

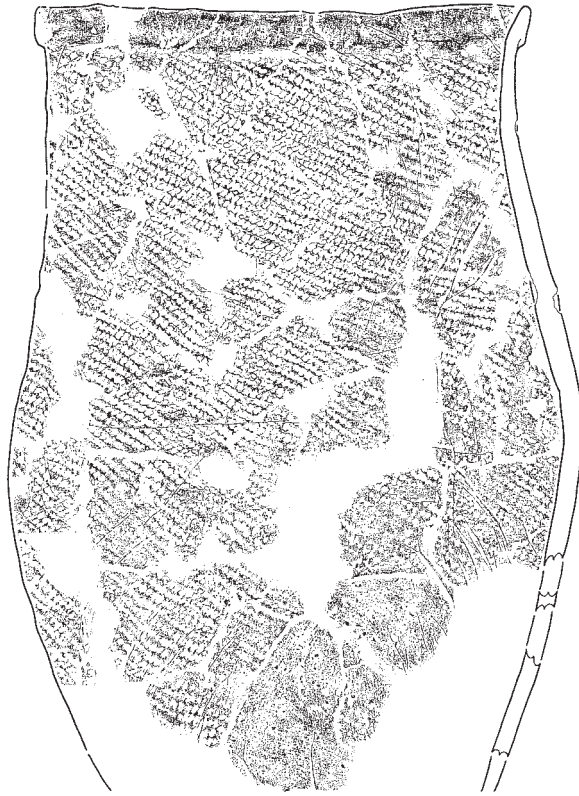

1588

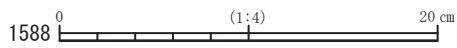

1588

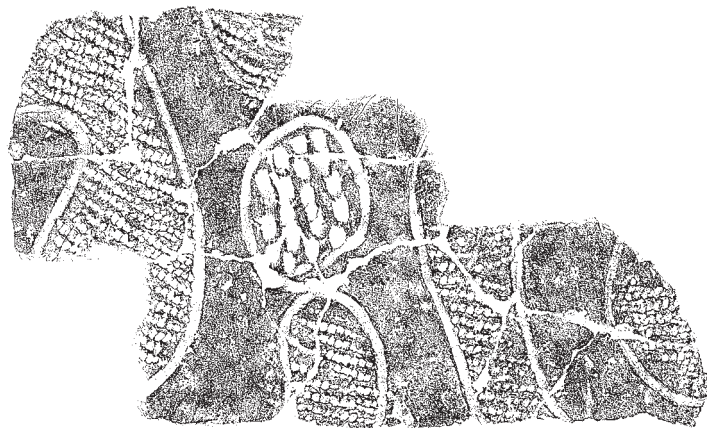

1589

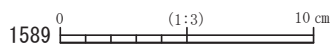

1589

111 豎

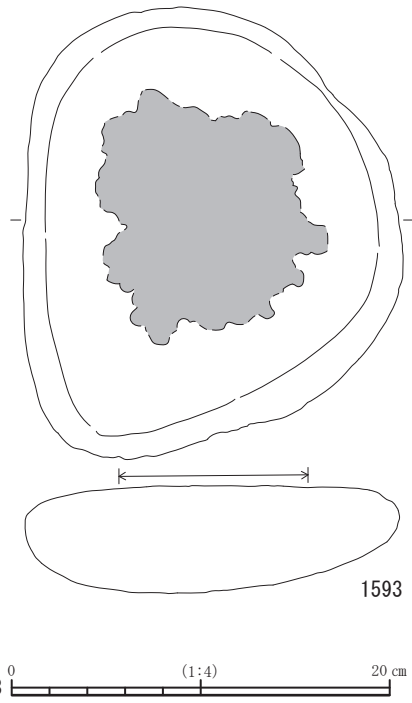
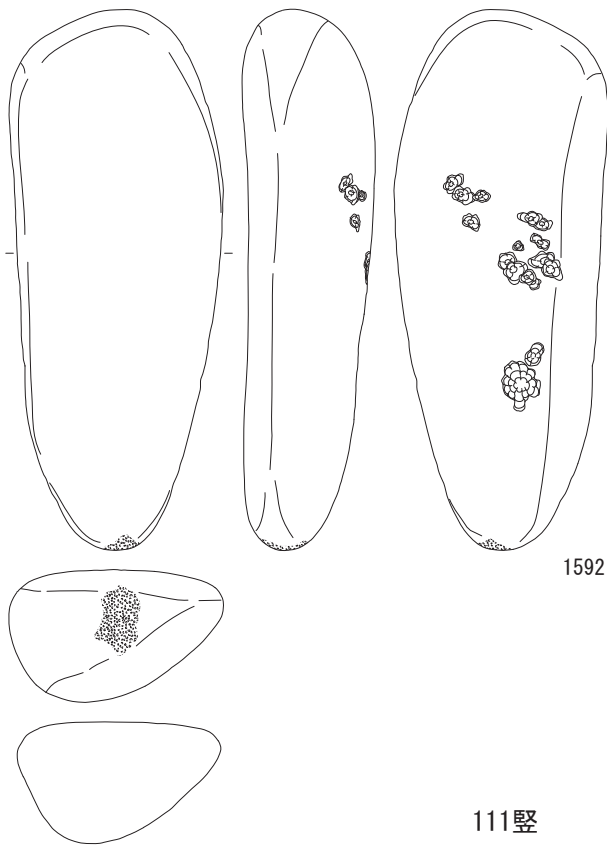
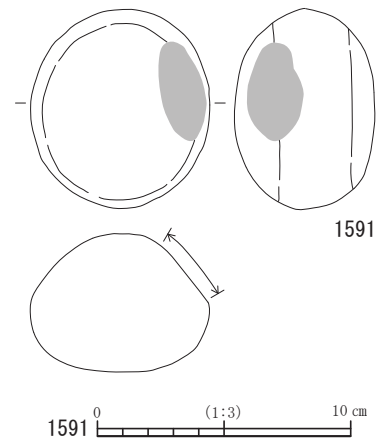
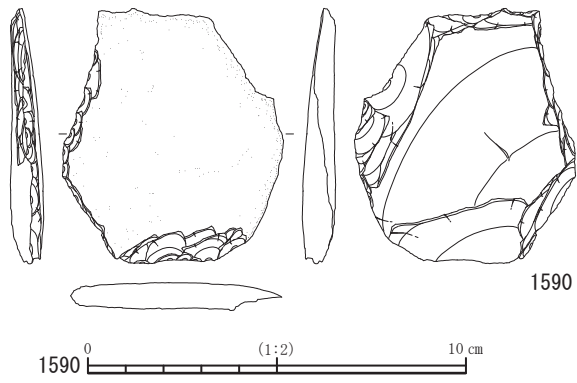

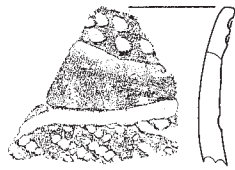

1596

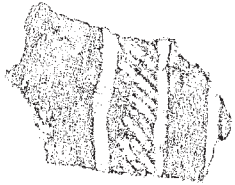

1597

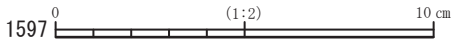

1600

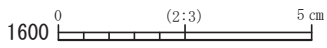

1598

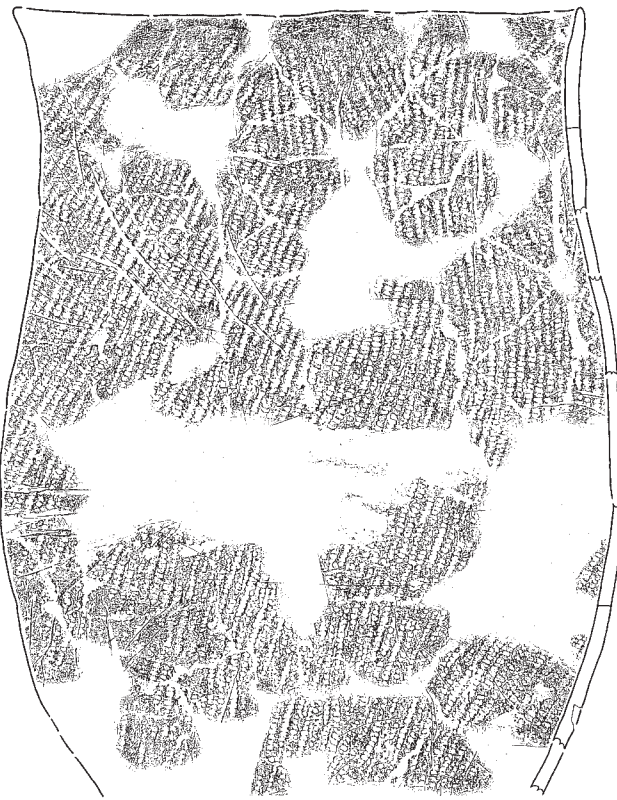
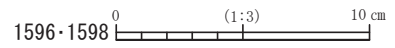

1599

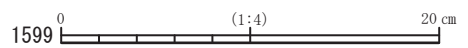

113 豎

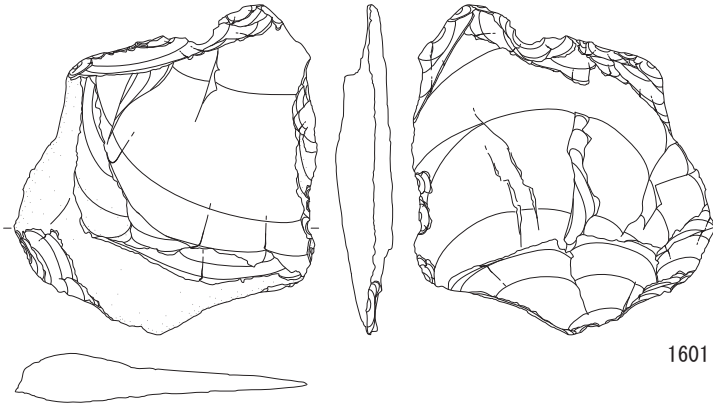

1601

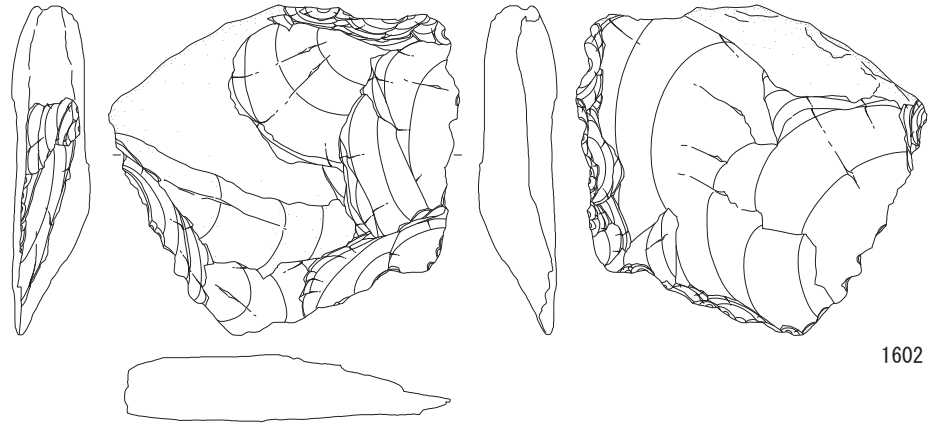

1602

1601・1602 0 (1:2) 10 cm

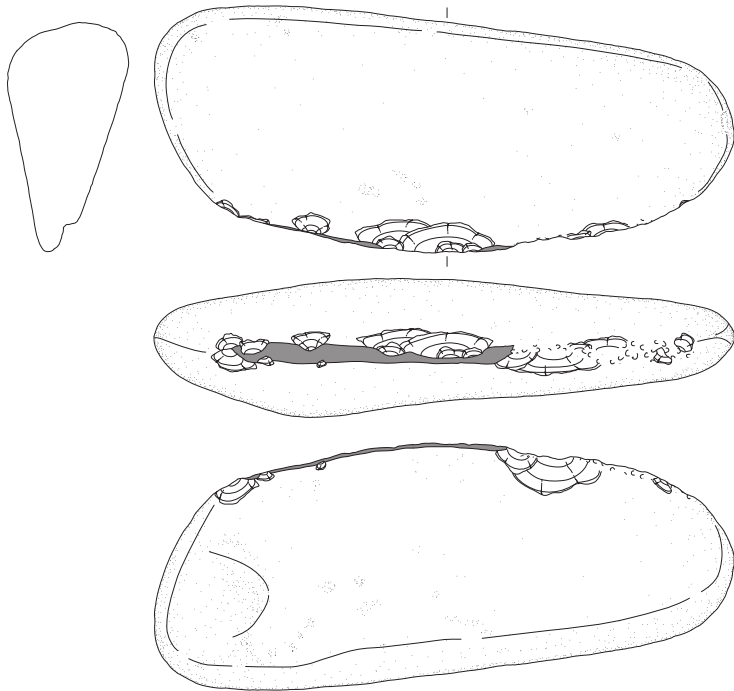

1603

113 豎

1603 0 (1:4) 20 cm

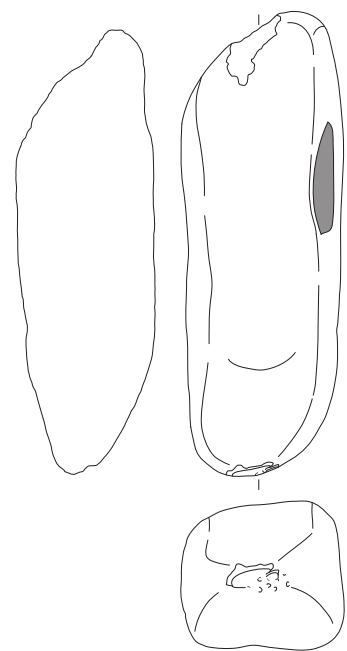

1604

1604 0 (1:3) 10 cm

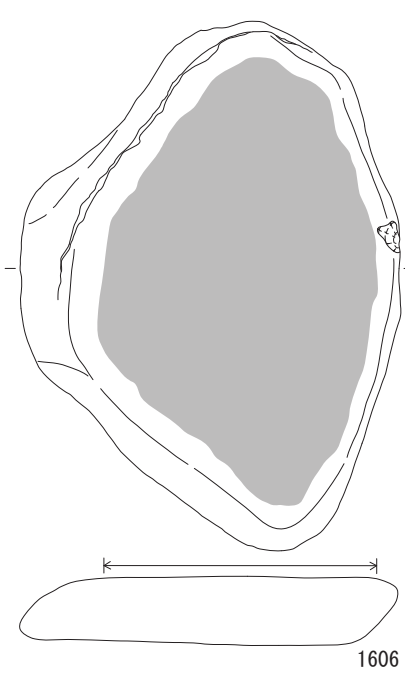

1606

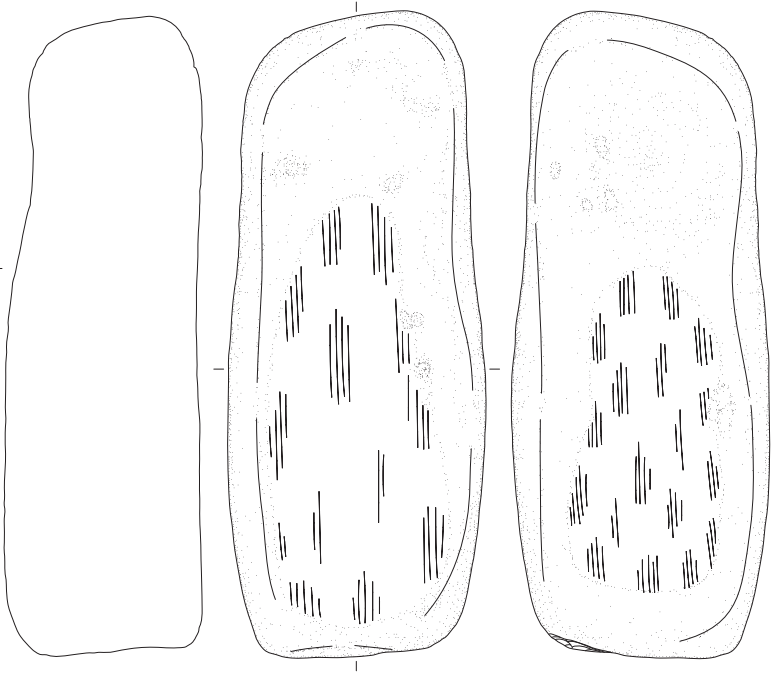

1607

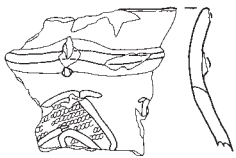

1609

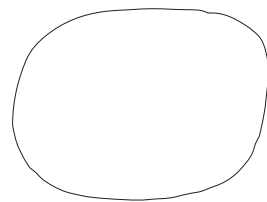

113 豎

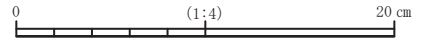

1608

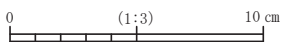

114 豎

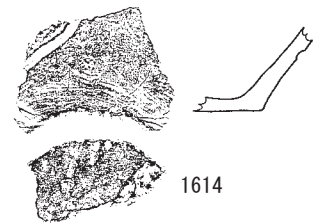
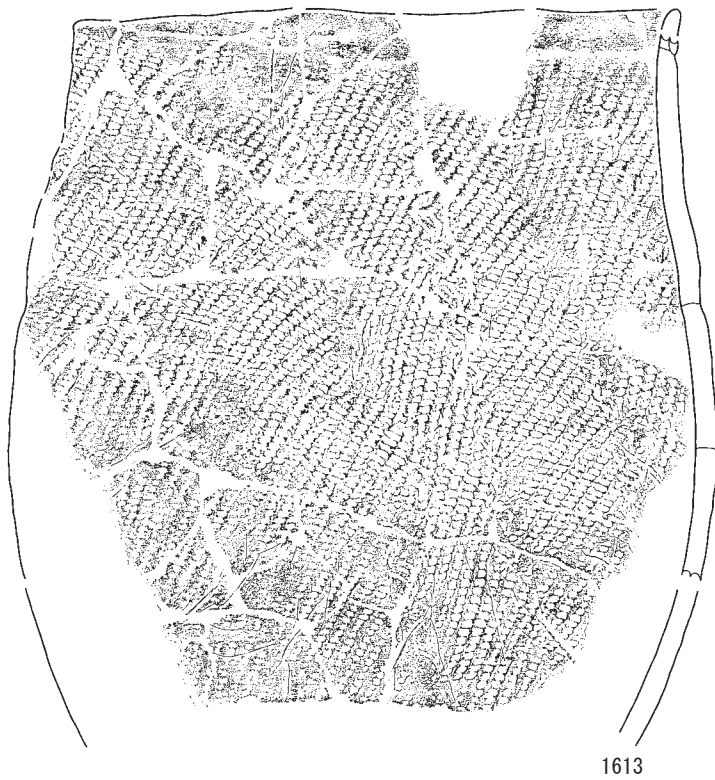
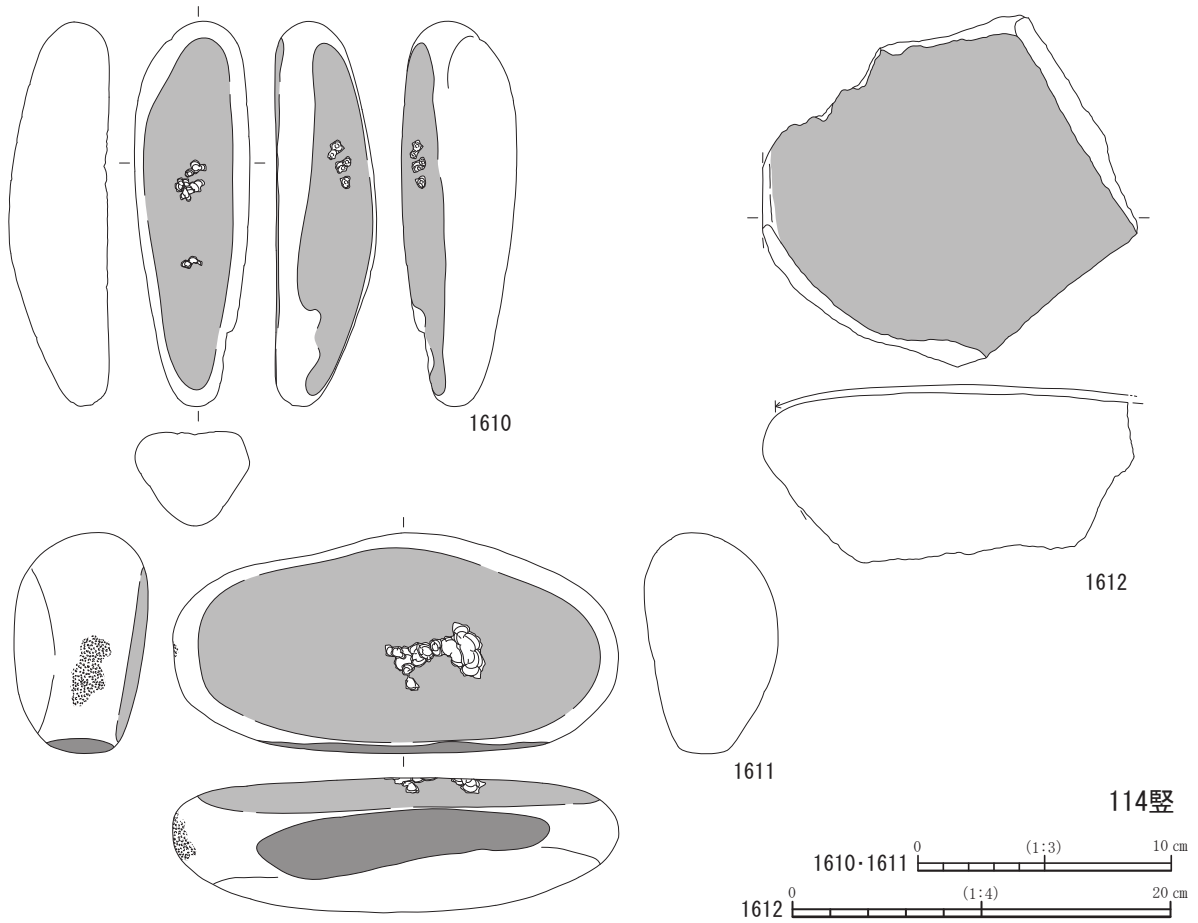

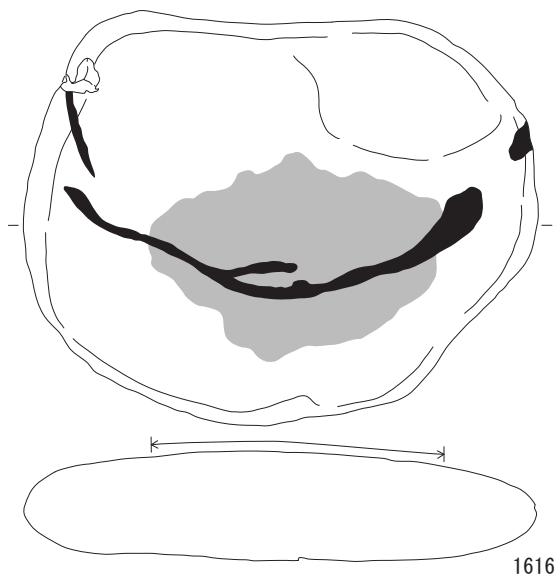

1616

115 豎

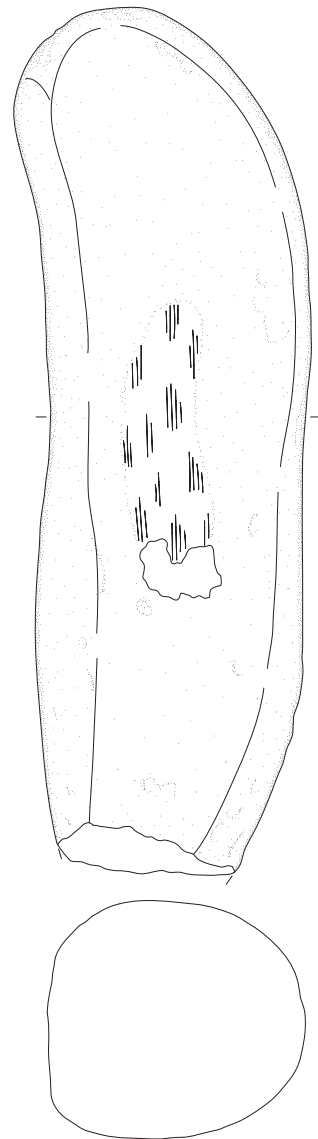

1617

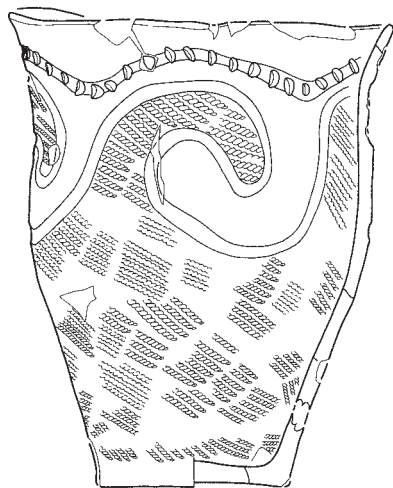

1619

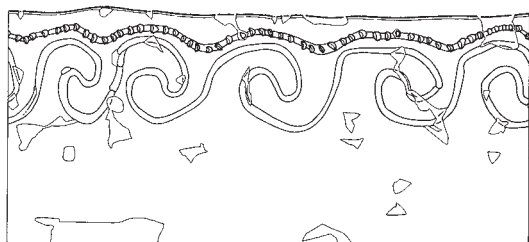

1619 展開図

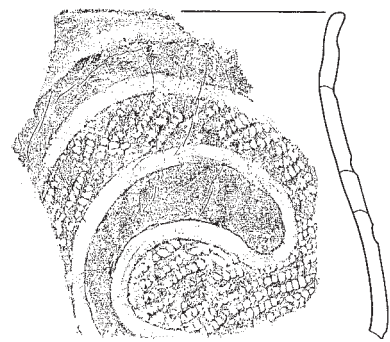
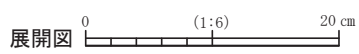

1621

116 豎

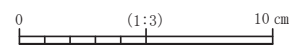

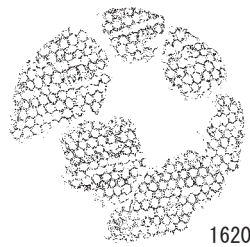
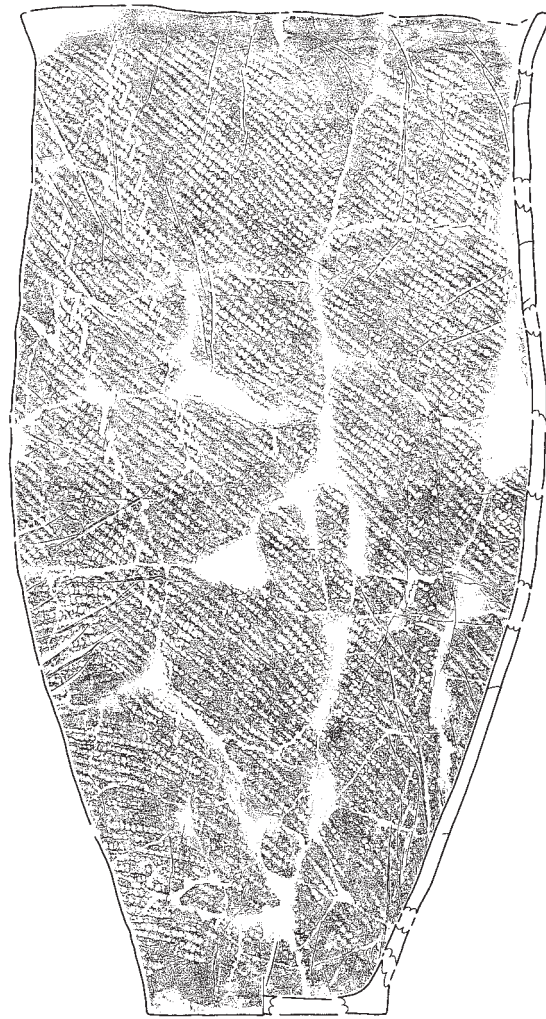

1620

1620 0 (1:4) 20 cm

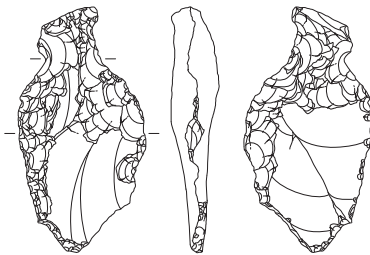

1622



1622 0 (2:3) 5 cm

116 豎

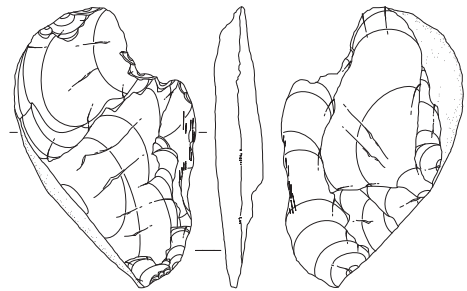

1623

1623 0 (1:2) 10 cm

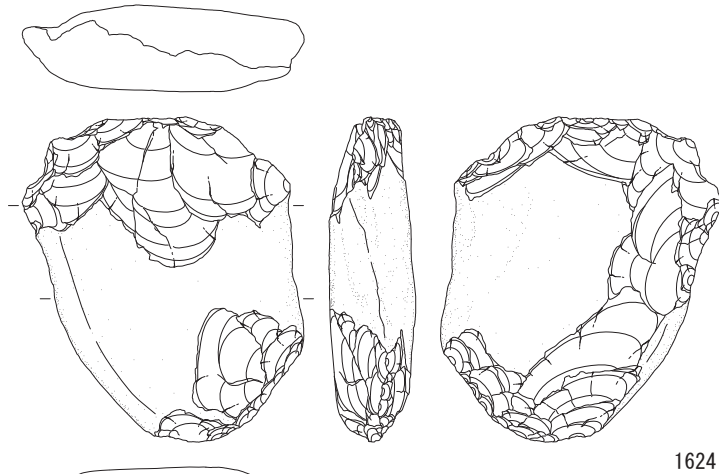

1624

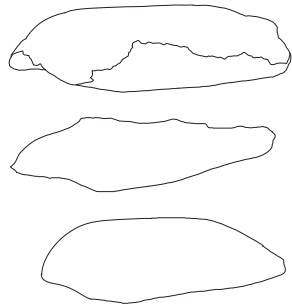

116 豎

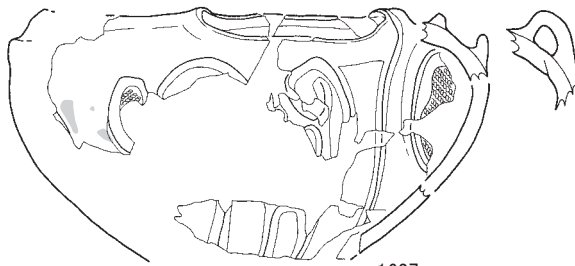
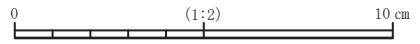

1627

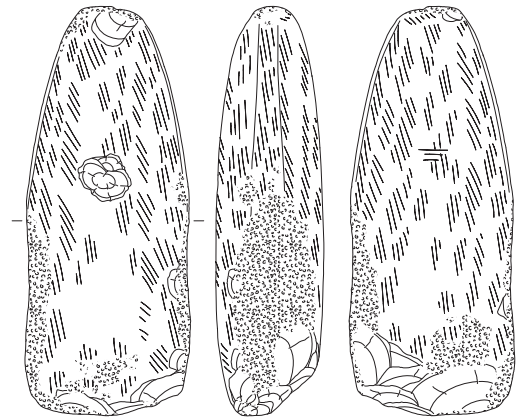
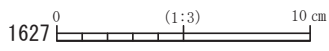

1629

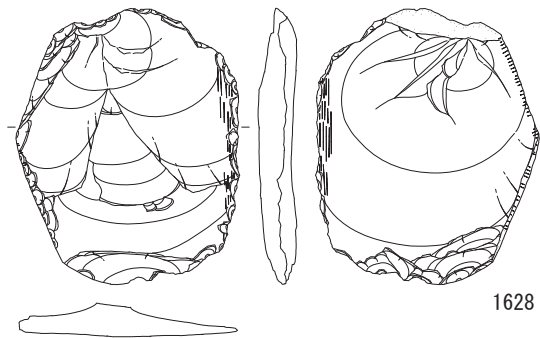

1628

117 豎





1630

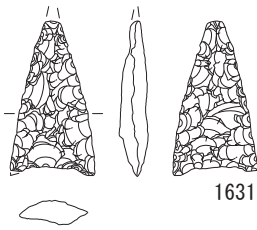

1631

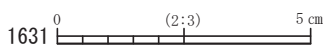

1631

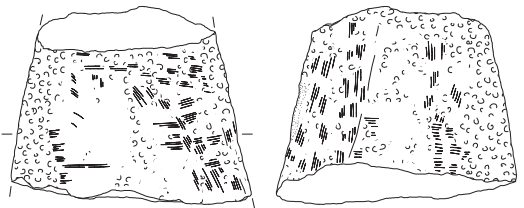

1637

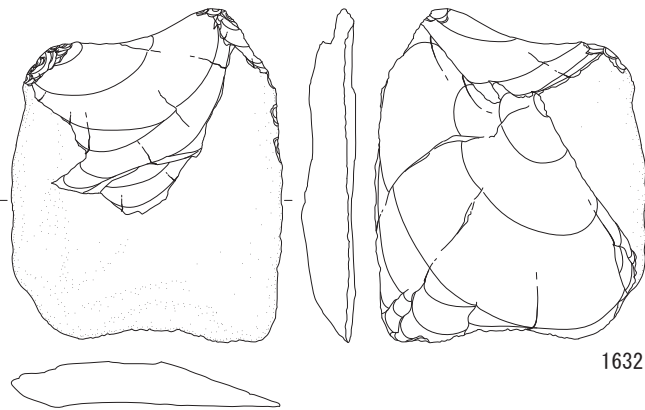
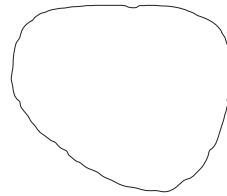

1632

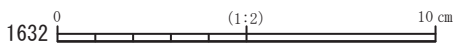

1632

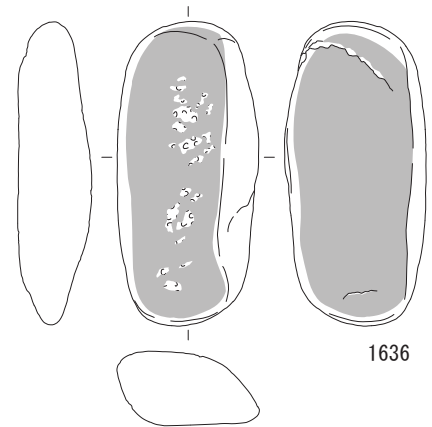

1636



1630・1636・1637

118 縦

遺物図版224 縄文時代の遺物224

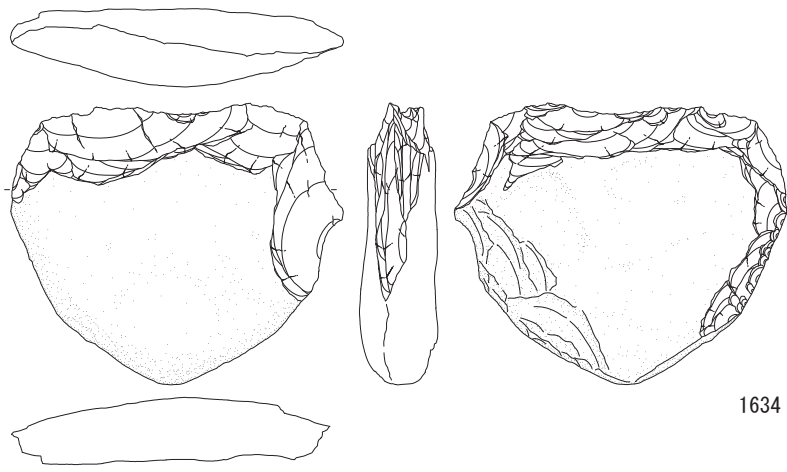

1634

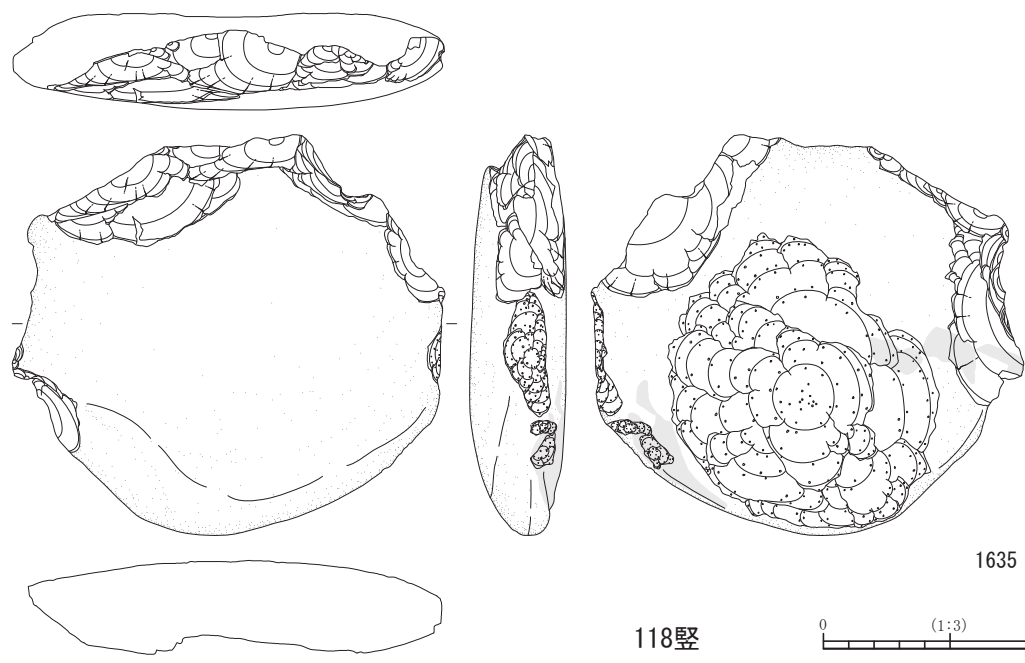

1635

118 豎

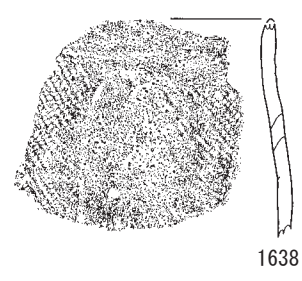
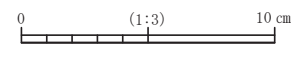

1638

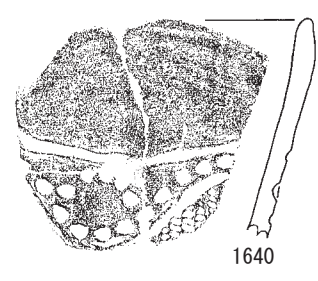

1640

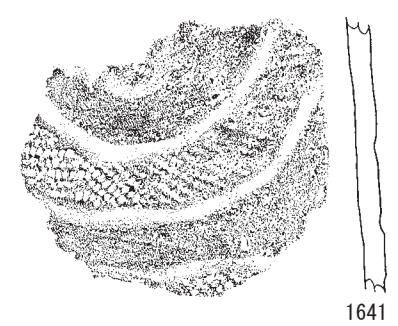

1641

119 豎

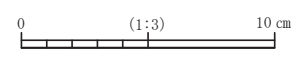

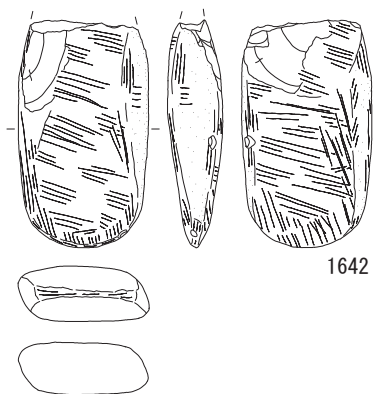

1642

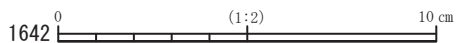

1639

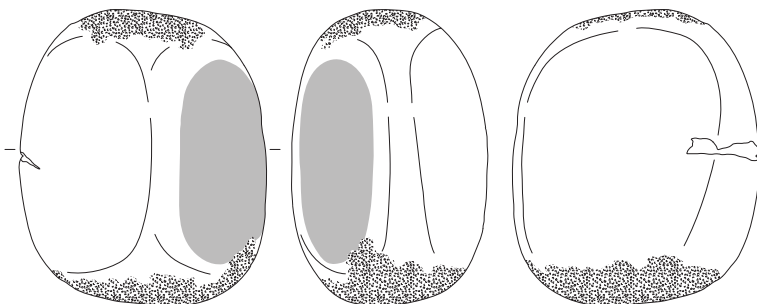
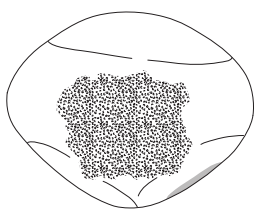

1643

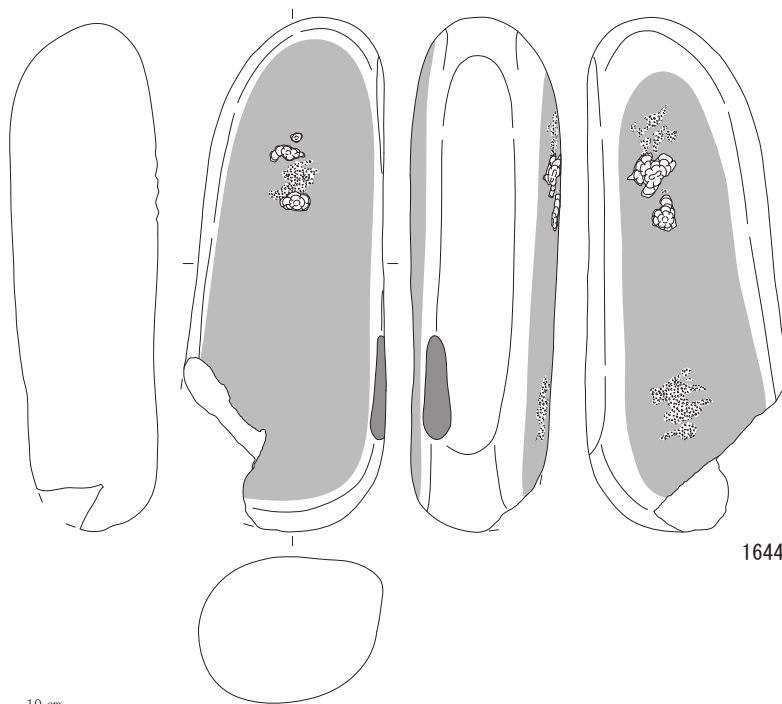
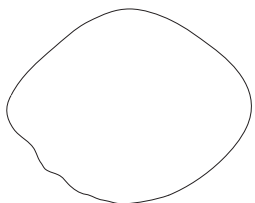
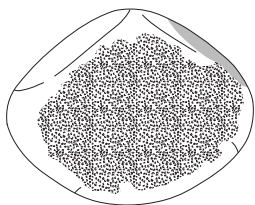

1644



119 豎

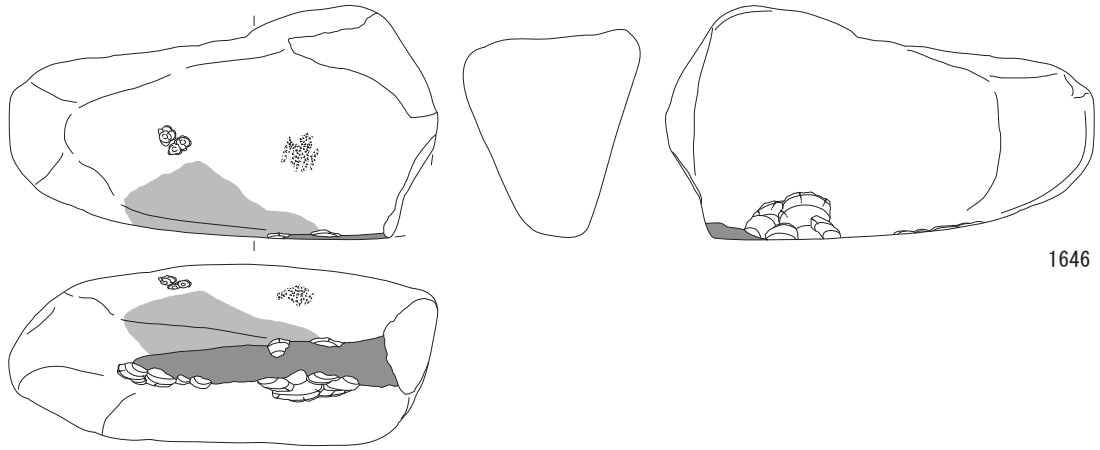

1646

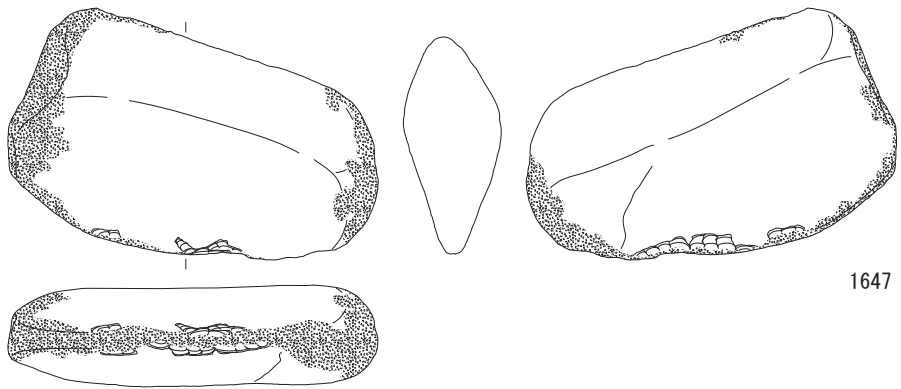

1647

1646・1647・1652 0 (1:3) 10 cm

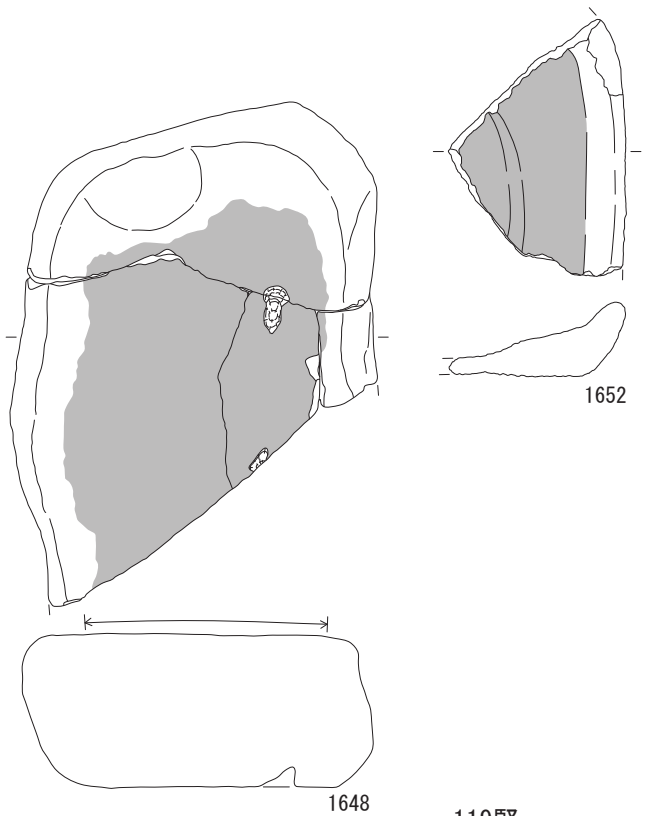

1648

1652

119 豎

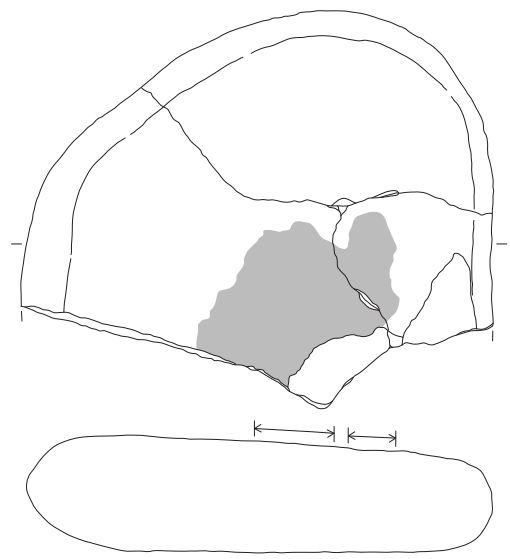

1649

1648・1649 0 (1:4) 20 cm



1653



1654

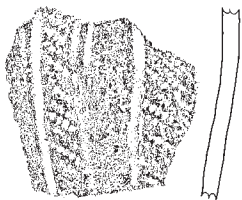

1655

120 豎

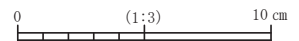

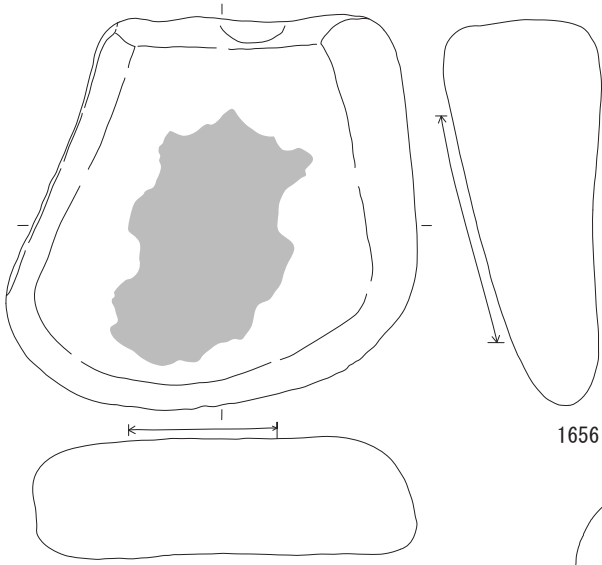

1656

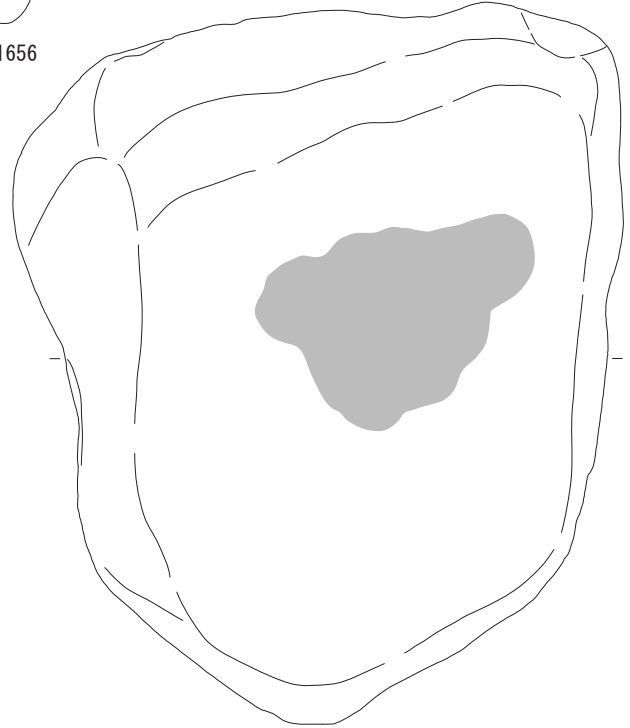

1657

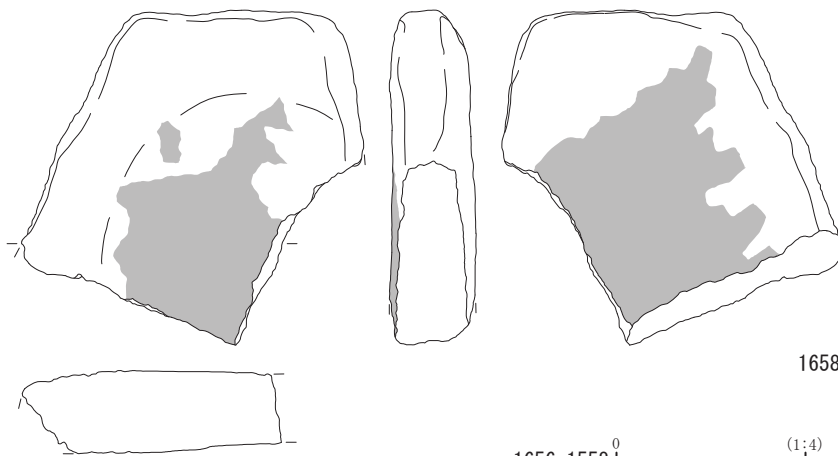
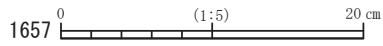

1658



120 豎

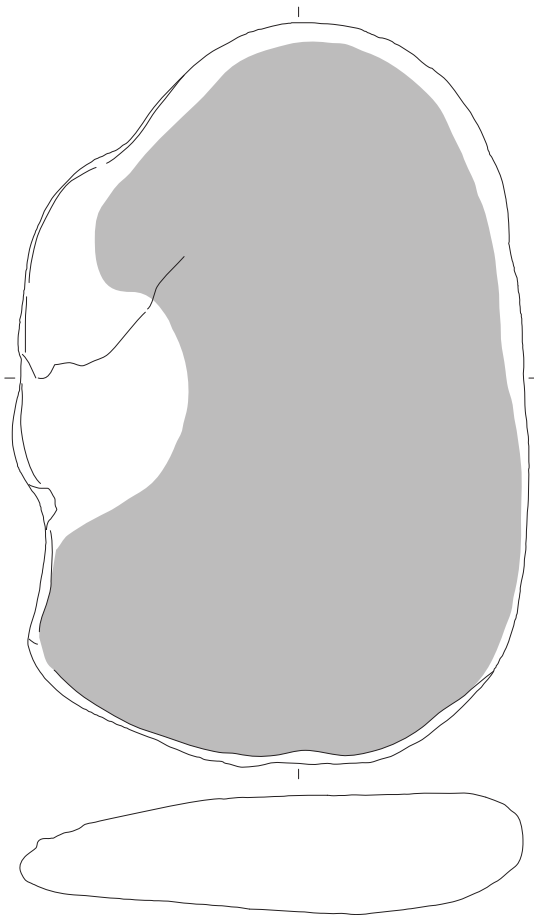
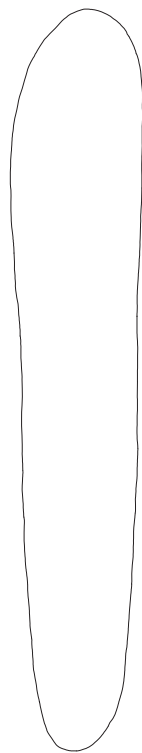
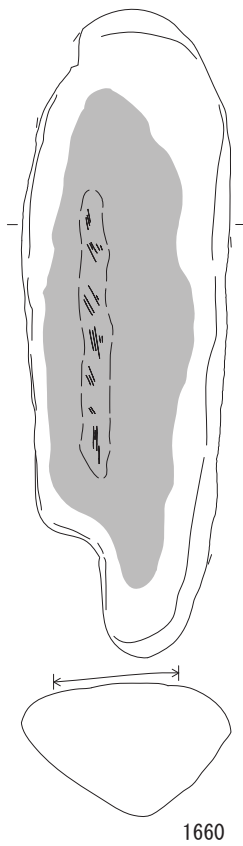
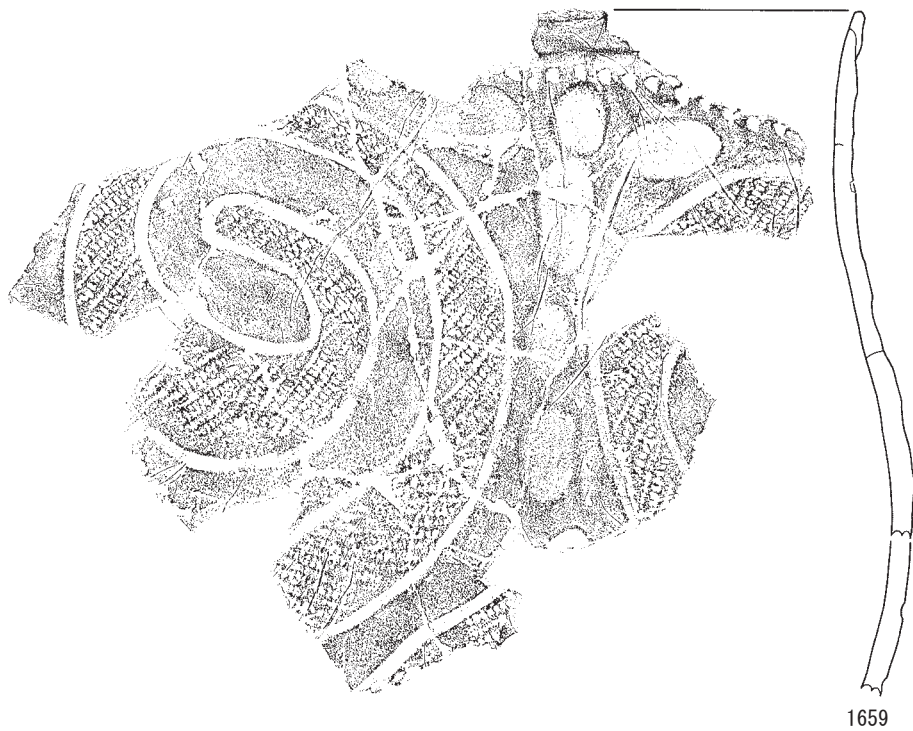

0 (1:3) 10 cm

121 豎

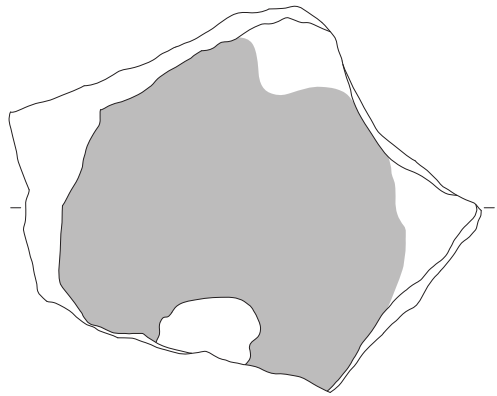

1662

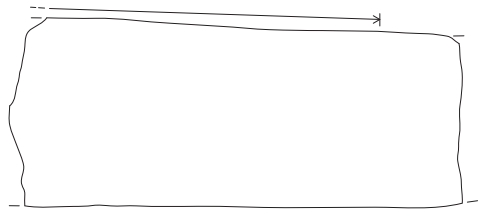

121 縦

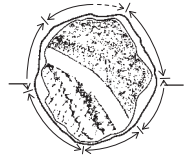
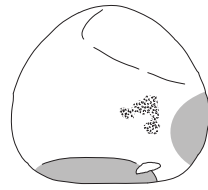
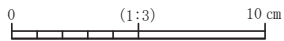

1666

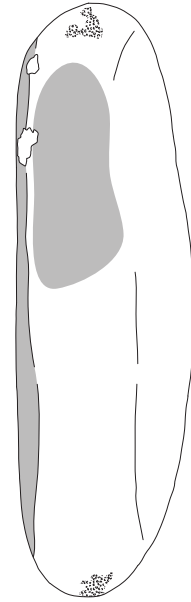
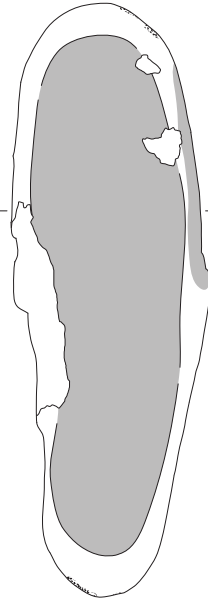

1667

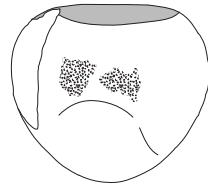

1665

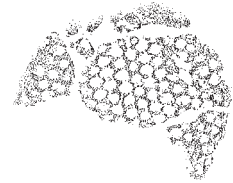
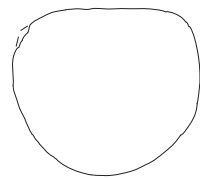

123 縦

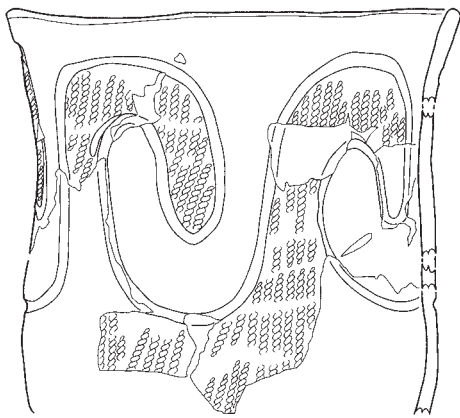
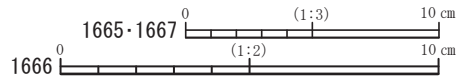

1664

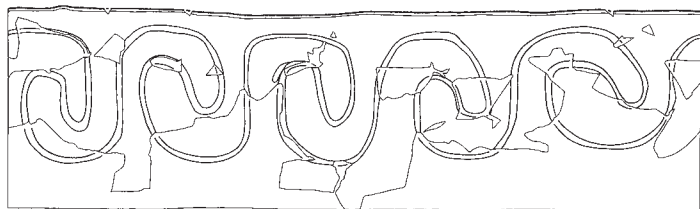

1664 展開図

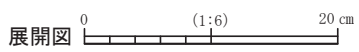

展開図

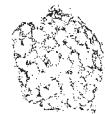

1663

122 縦

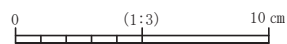

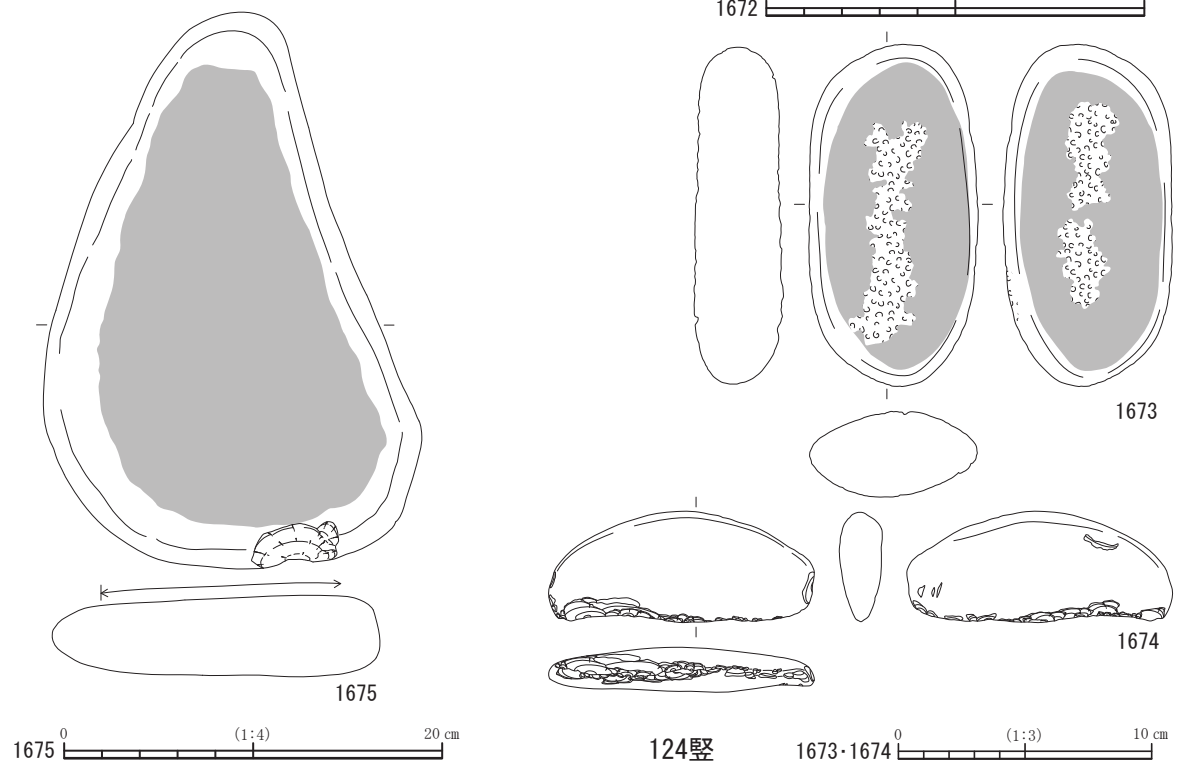
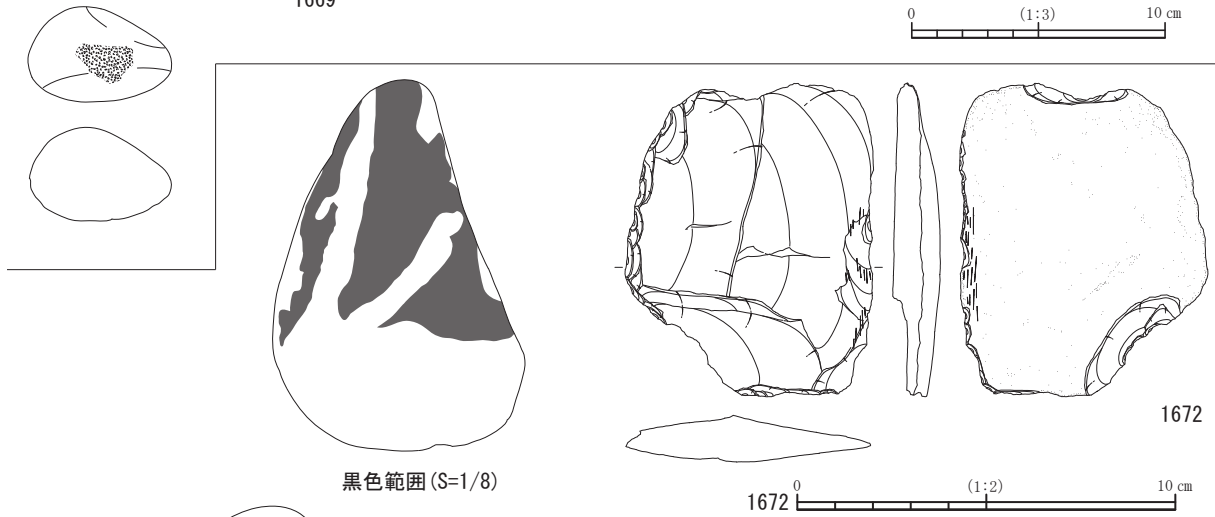

遺物図版232 縄文時代の遺物232

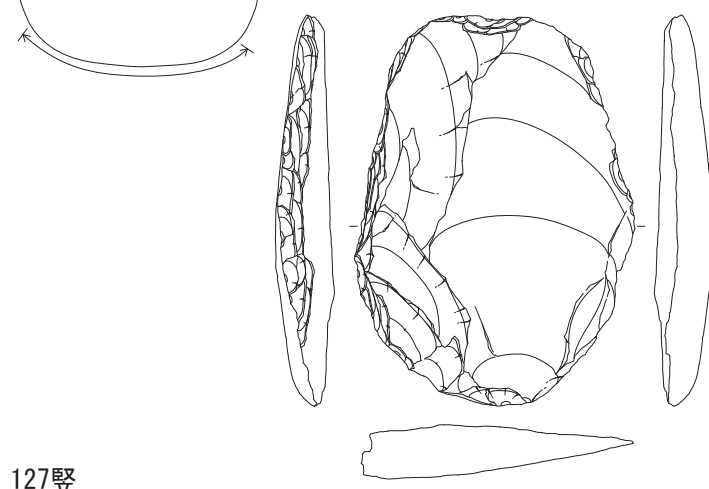
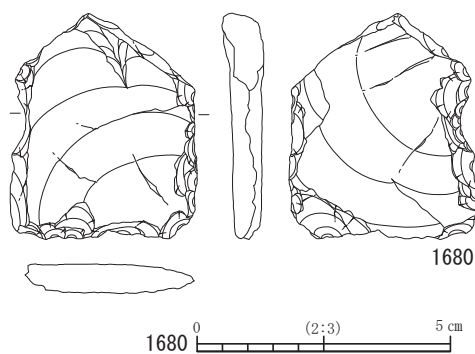
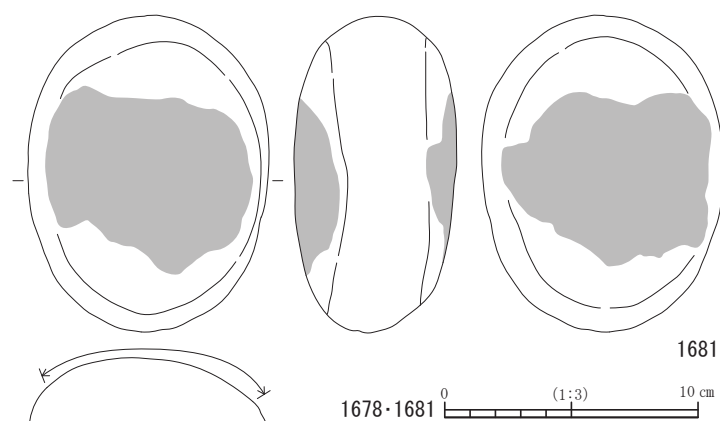
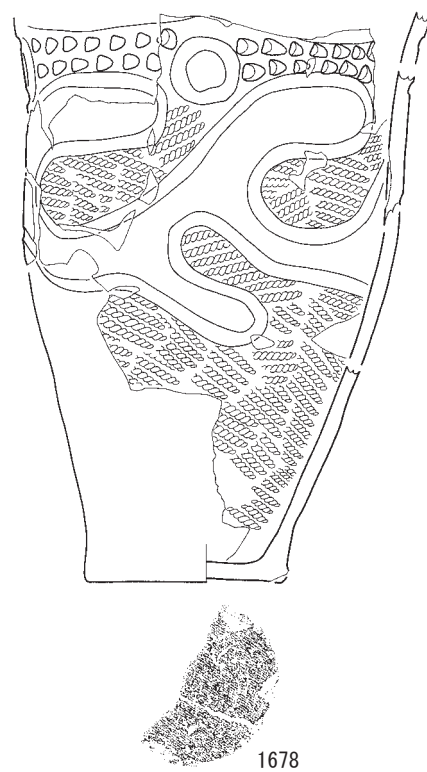
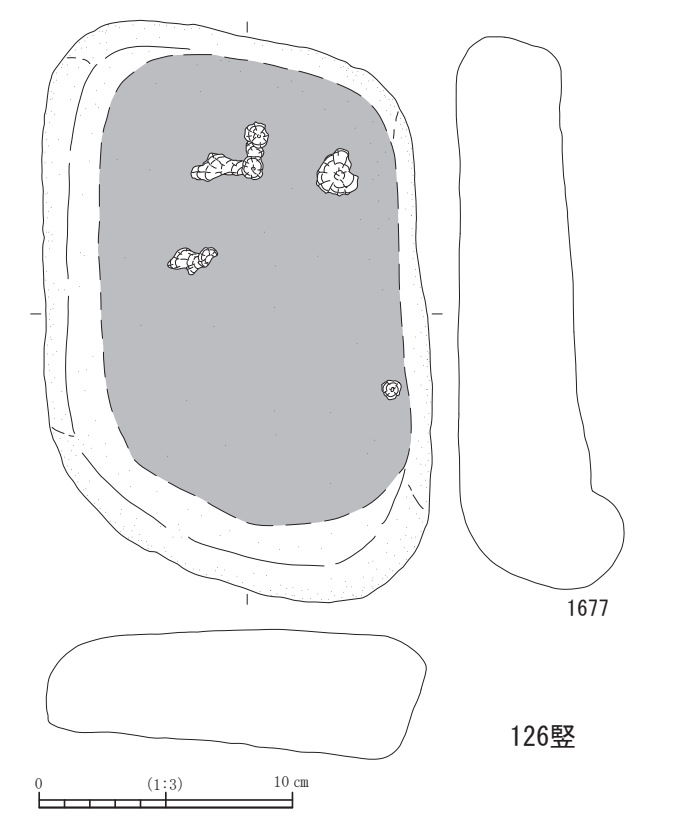

127 豎

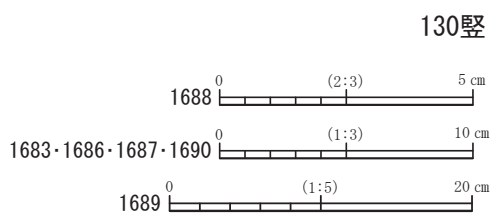
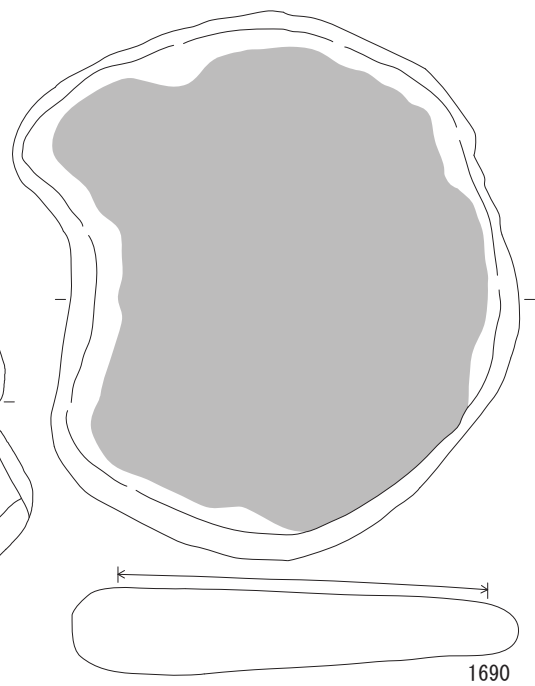
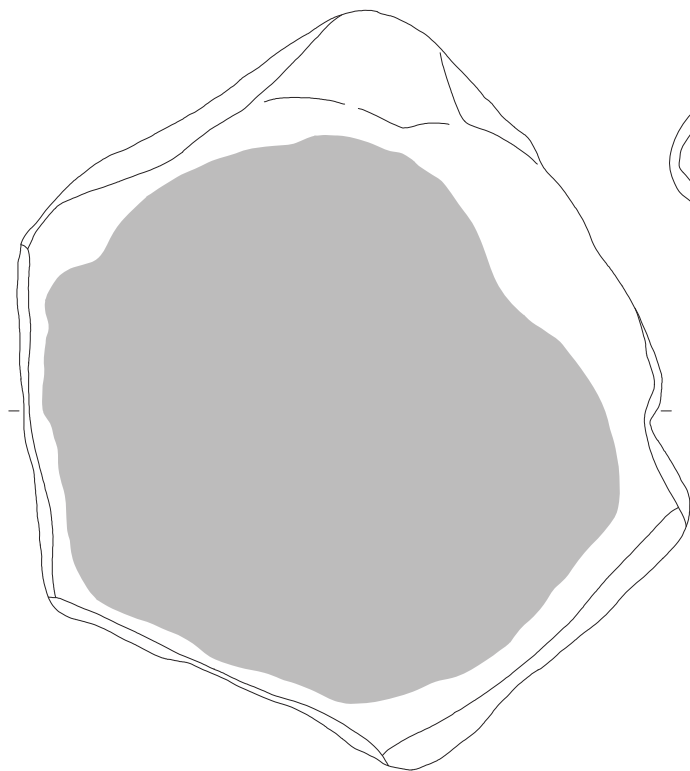
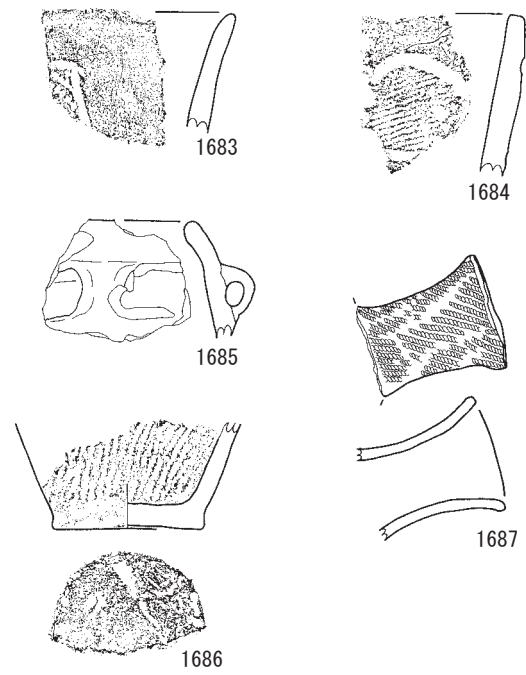
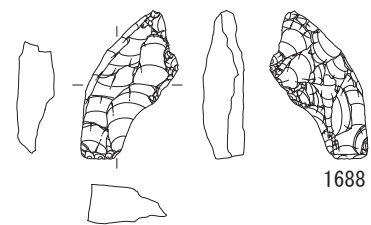
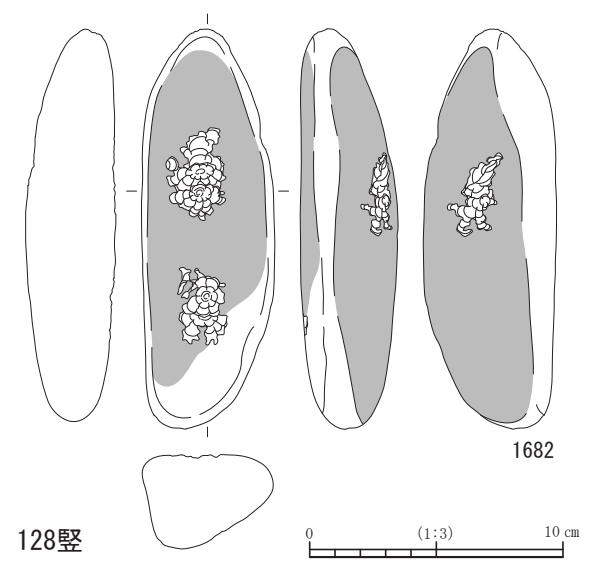

遺物図版234 縄文時代の遺物234

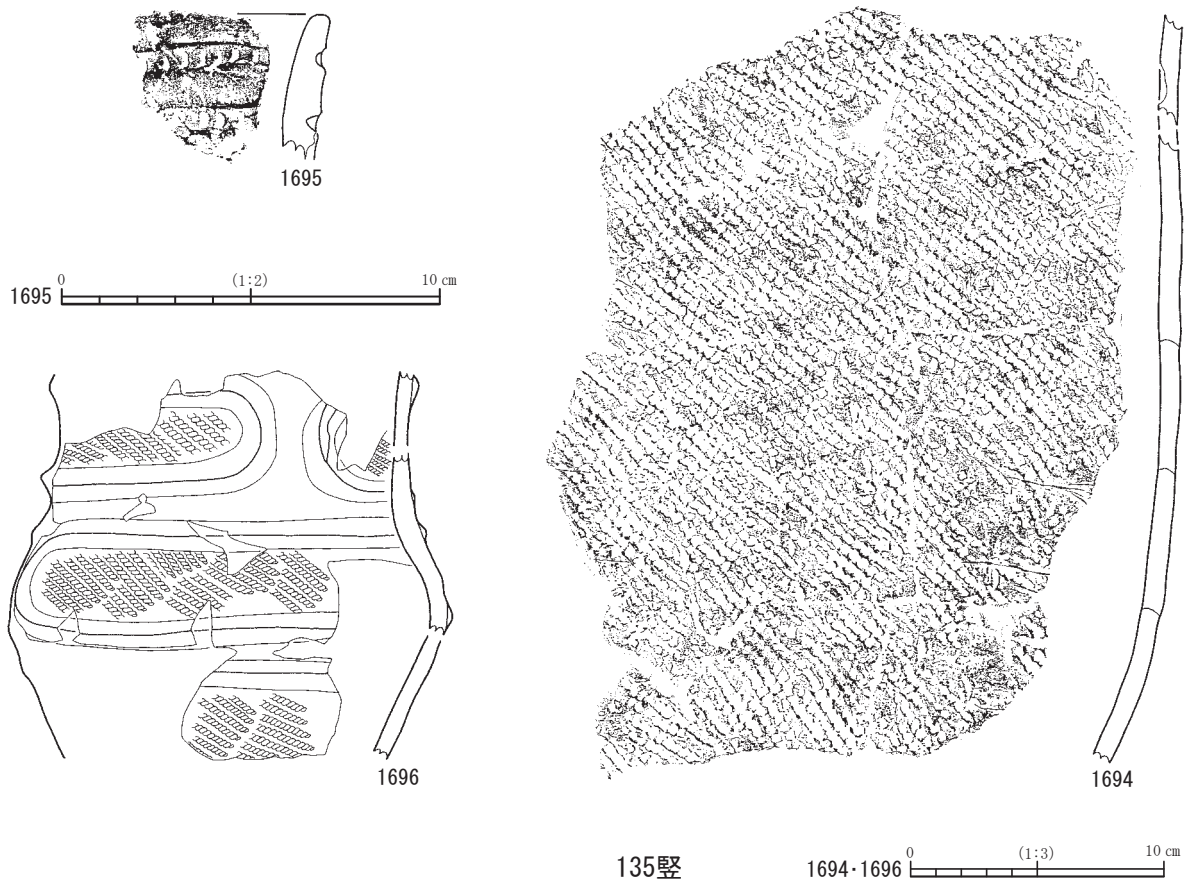
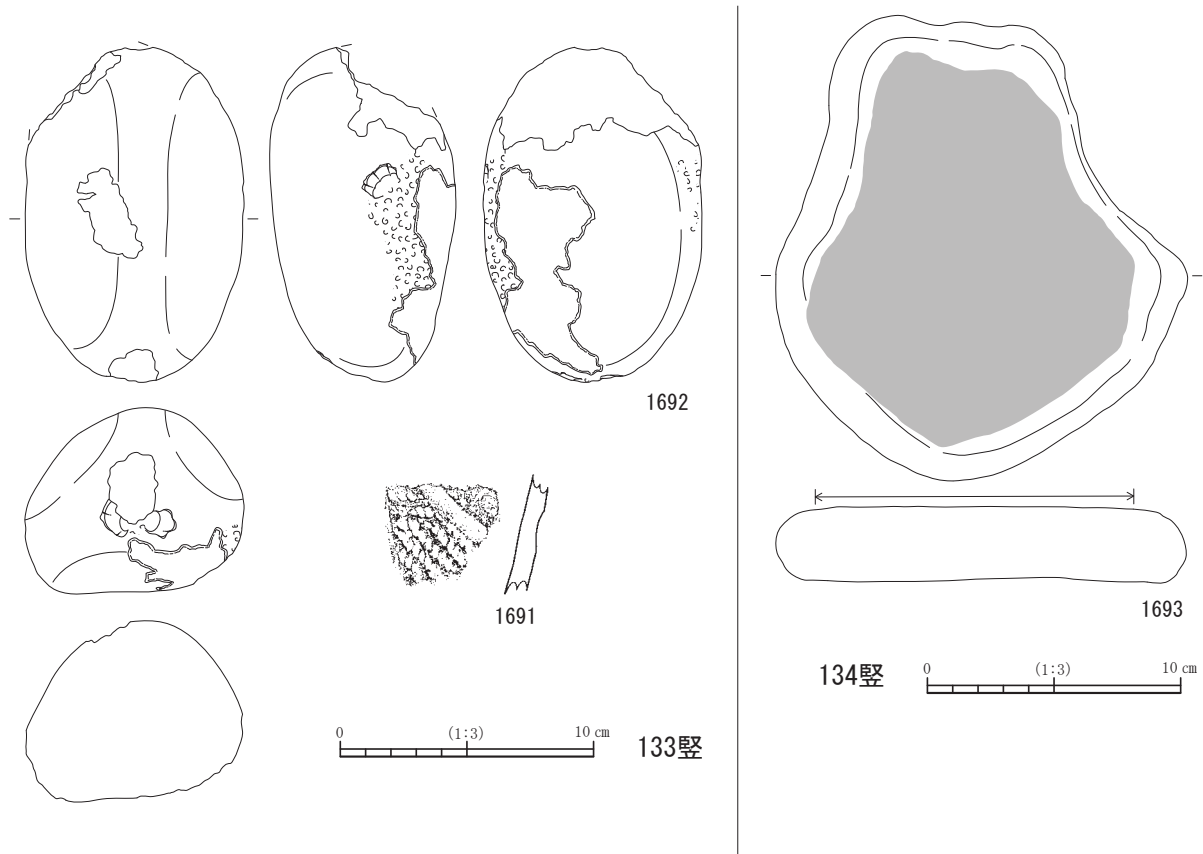

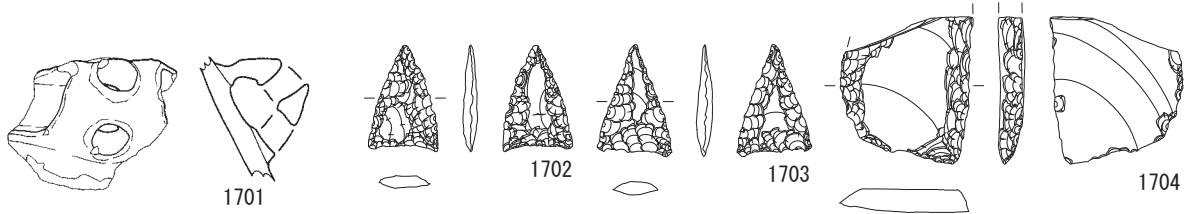
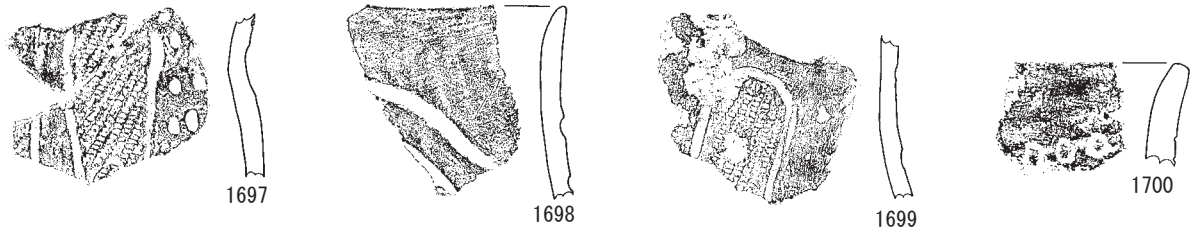

1697~1699·1701 0 (1:3) 10 cm

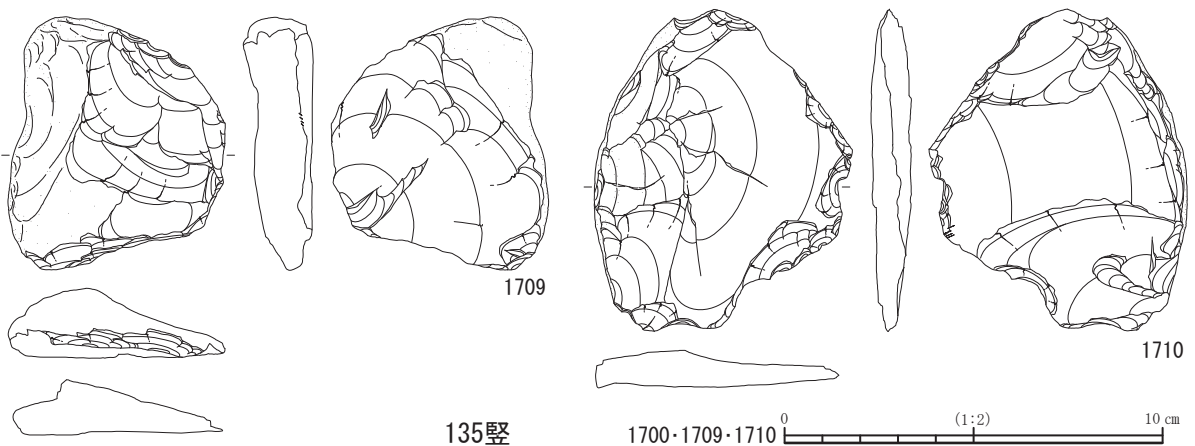
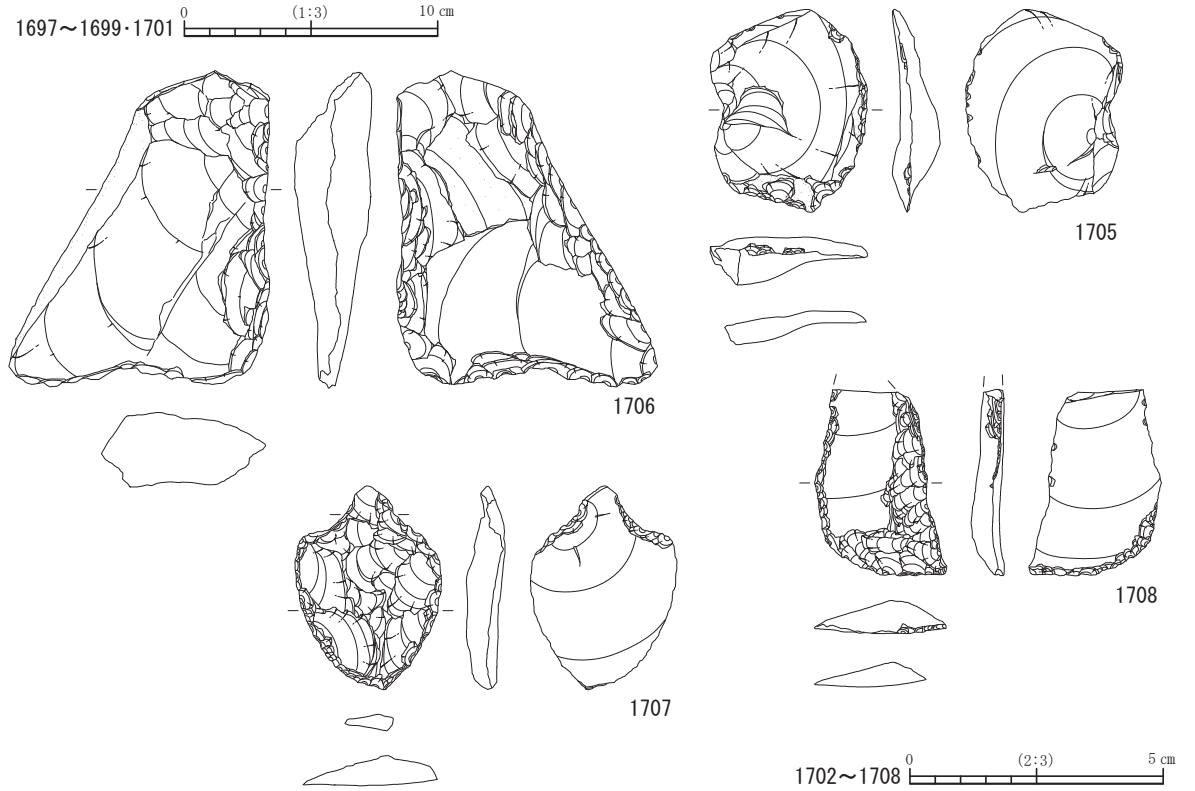

135 豎

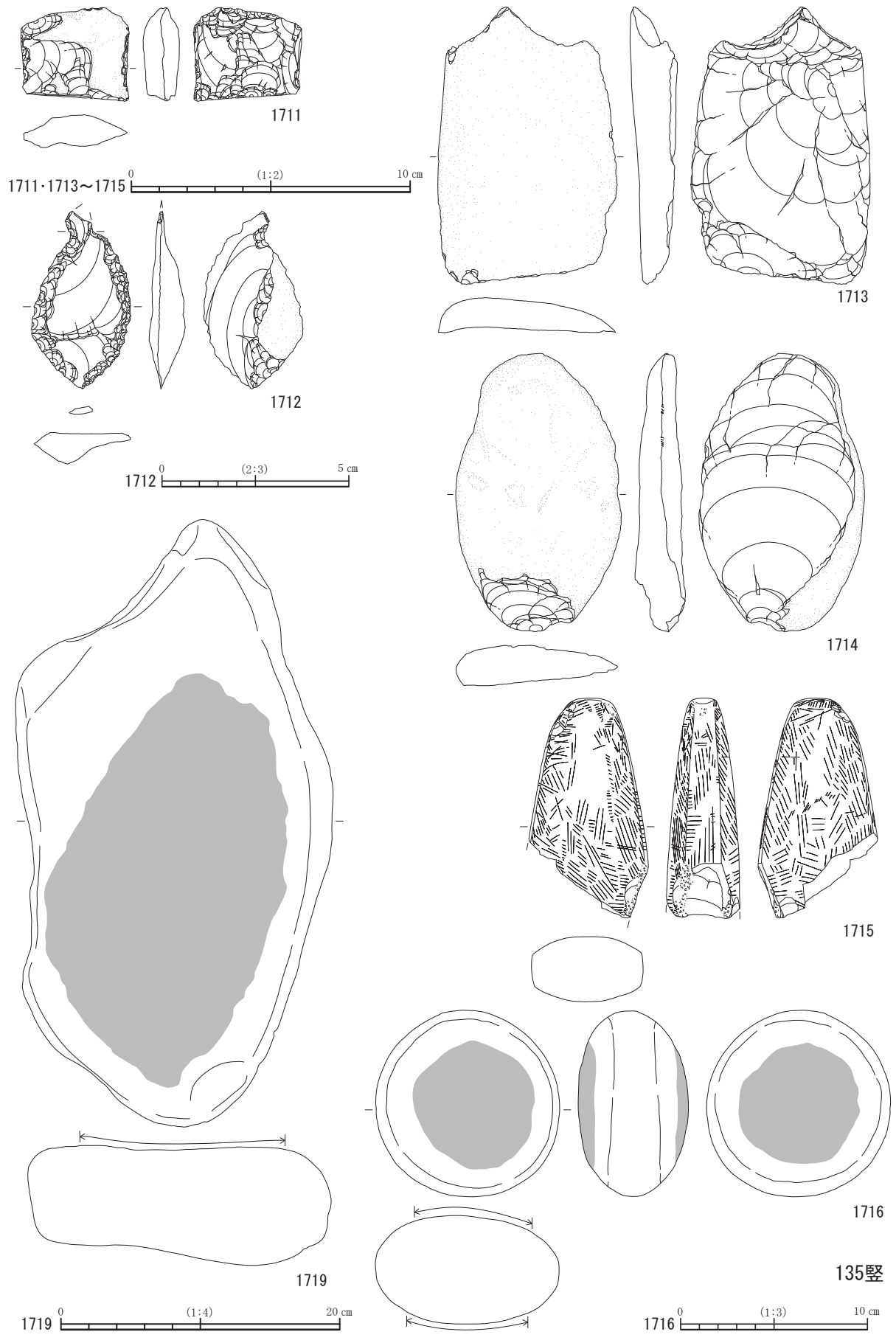

遺物図版237 縄文時代の遺物237

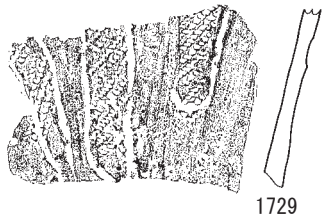

1729



1732

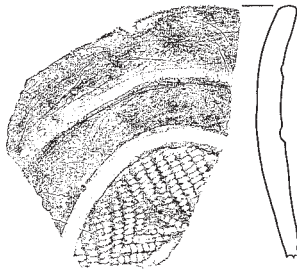

1733



1734

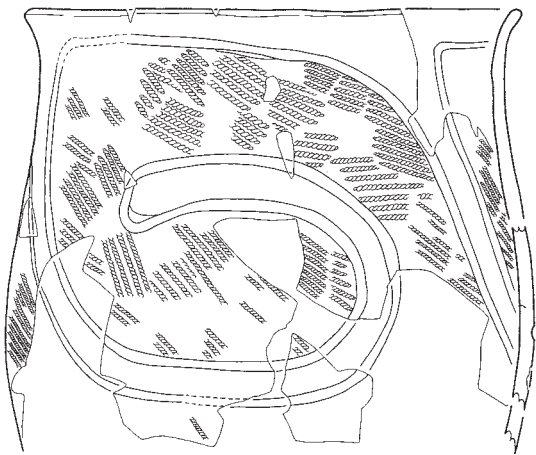
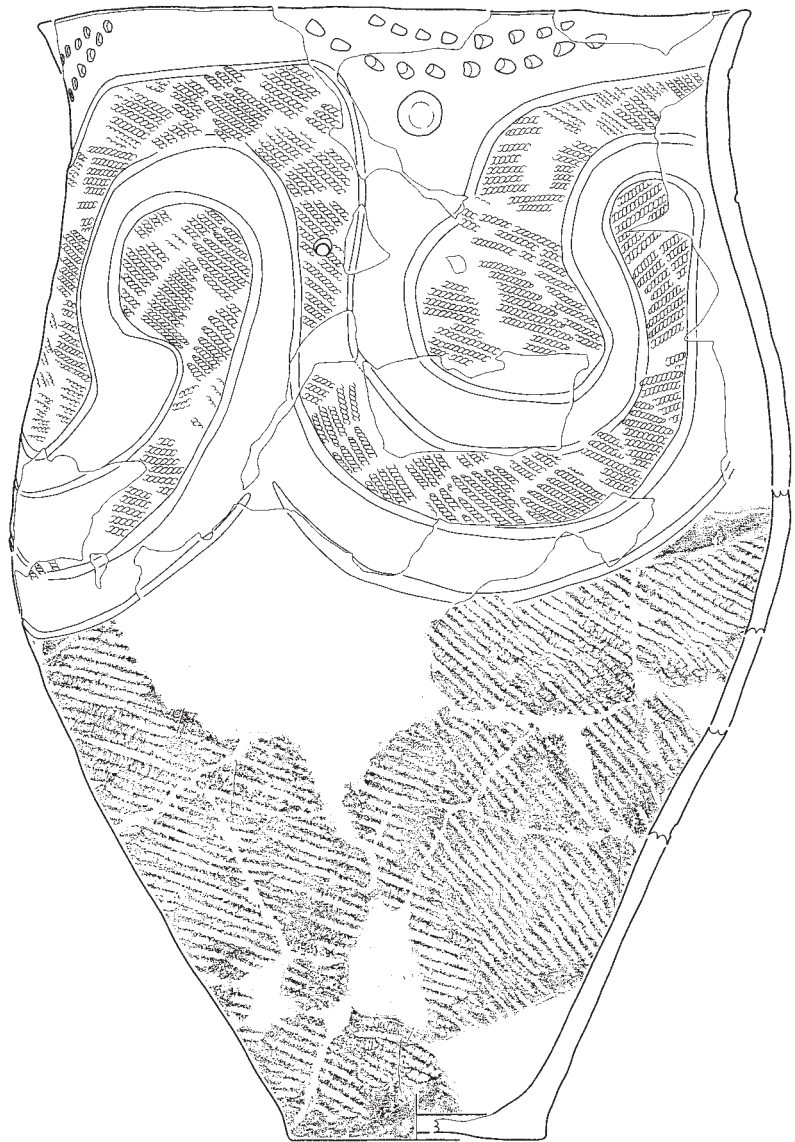

1731

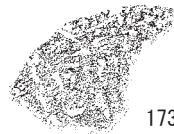

1730



1737

141 豎

