

山梨県埋蔵文化財センター調査報告第21集

釈迦堂 II

— 図 版 編 —

山梨県東山梨郡勝沼町三口神平地区

山梨県中央自動車道
埋蔵文化財包蔵地発掘調査報告書



1987. 3.

山梨県教育委員会
日本道路公団

釈迦堂 II

— 図 版 編 —

図版目次

- 図1 釈迦堂S—Ⅲ区・S—Ⅳ区・N—Ⅲ区・N—Ⅳ区 住居址土壌全体図
図2 釈迦堂S—Ⅲ区・S—Ⅳ区・N—Ⅲ区・N—Ⅳ区 住居址全体図
図3 釈迦堂S—Ⅲ区・S—Ⅳ区・N—Ⅲ区・N—Ⅳ区 土壌全体図
図4 釈迦堂遺構全体図
図5 釈迦堂S—Ⅲ区・S—Ⅳ区・N—Ⅲ区・N—Ⅳ区 グリッド配置図

釈迦堂S—Ⅲ区図版目次

- | | |
|---|-------------------------|
| 第6図 釈迦堂S—Ⅲ区SB—47—52 | 第31図 釈迦堂S—Ⅲ区SB—37 |
| 第7図 釈迦堂S—Ⅲ区SB—102 | 第32図 釈迦堂S—Ⅲ区SB—39—77 |
| 第8図 釈迦堂S—Ⅲ区SB—107 | 第33図 釈迦堂S—Ⅲ区SB—41—42 |
| 第9図 釈迦堂S—Ⅲ区SB—108 | 第34図 釈迦堂S—Ⅲ区SB—43 |
| 第10図 釈迦堂S—Ⅲ区SB—110 | 第35図 釈迦堂S—Ⅲ区SB—46 |
| 第11図 釈迦堂S—Ⅲ区SB—112 | 第36図 釈迦堂S—Ⅲ区SB—55 |
| 第12図 釈迦堂S—Ⅲ区SB—29—1・2 | 第37図 釈迦堂S—Ⅲ区SB—57 |
| 第13図 釈迦堂S—Ⅲ区SB—20—18—78—26—27 | 第38図 釈迦堂S—Ⅲ区SB—59—60 |
| 第14図 釈迦堂S—Ⅲ区SB—95 | 第39図 釈迦堂S—Ⅲ区SB—21—59—60 |
| 第15図 釈迦堂S—Ⅲ区SB—111 | 第40図 釈迦堂S—Ⅲ区SB—62 |
| 第16図 釈迦堂S—Ⅲ区SB—48—49—50—51—56—58 | 第41図 釈迦堂S—Ⅲ区SB—66 |
| 第17図 釈迦堂S—Ⅲ区SB—49—87 | 第42図 釈迦堂S—Ⅲ区SB—68—69 |
| 第18図 釈迦堂S—Ⅲ区SB—84 | 第43図 釈迦堂S—Ⅲ区SB—70 |
| 第19図 釈迦堂S—Ⅲ区SB—09 | 第44図 釈迦堂S—Ⅲ区SB—71 |
| 第20図 釈迦堂S—Ⅲ区SB—100—106 | 第45図 釈迦堂S—Ⅲ区SB—72 |
| 第21図 釈迦堂S—Ⅲ区SB—33 | 第46図 釈迦堂S—Ⅲ区SB—75—76 |
| 第22図 釈迦堂S—Ⅲ区SB—35—38 | 第47図 釈迦堂S—Ⅲ区SB—80 |
| 第23図 釈迦堂S—Ⅲ区SB—36 | 第48図 釈迦堂S—Ⅲ区SB—85—86 |
| 第24図 釈迦堂S—Ⅲ区SB—06—07—08—10—11—12—13—14—15—16—17 | 第49図 釈迦堂S—Ⅲ区SB—88—90—91 |
| 第25図 釈迦堂S—Ⅲ区SB—19—23—24—25—27—30—31—40—53 | 第50図 釈迦堂S—Ⅲ区SB—92—93 |
| 第26図 釈迦堂S—Ⅲ区SB—63—67—73—82—83—89 | 第51図 釈迦堂S—Ⅲ区SB—94—99 |
| 第27図 釈迦堂S—Ⅲ区SB—04 | 第52図 釈迦堂S—Ⅲ区SB—96 |
| 第28図 釈迦堂S—Ⅲ区SB—05 | 第53図 釈迦堂S—Ⅲ区SB—97—98 |
| 第29図 釈迦堂S—Ⅲ区SB—21 | 第54図 釈迦堂S—Ⅲ区SB—101—103 |
| 第30図 釈迦堂S—Ⅲ区SB—34 | 第55図 釈迦堂S—Ⅲ区SB—105 |
| | 第56図 釈迦堂S—Ⅲ区SB—105 |
| | 第57図 釈迦堂S—Ⅲ区SB—109 |

- 第 58 图 积迦堂 S—Ⅲ区 S B—113
- 第 59 图 积迦堂 S—Ⅲ区埋葬
- 第 60 图 积迦堂 S—Ⅲ区 S B—01—02
- 第 61 图 积迦堂 S—Ⅲ区 S B—03—14
- 第 62 图 积迦堂 S—Ⅲ区 S B—28
- 第 63 图 积迦堂 S—Ⅲ区 S B—01—68—14 出土遗物
- 第 64 图 积迦堂 S—Ⅲ区 S X—02—04—05 出土遗物
- 第 65 图 积迦堂 S—Ⅲ区 S K—01—02—03—04
- 第 66 图 积迦堂 S—Ⅲ区 S K—05—06—07—08—09—10—13—14—15
- 第 67 图 积迦堂 S—Ⅲ区 S K—17—18—21—23—25—28—90
- 第 68 图 积迦堂 S—Ⅲ区 S K—32—33—34—35—36
- 第 69 图 积迦堂 S—Ⅲ区 S K—38—40—41—42—43—44—45—47—48
- 第 70 图 积迦堂 S—Ⅲ区 S K—49—51—52—53—54—55—57—58—60—64—69
- 第 71 图 积迦堂 S—Ⅲ区 S K—70—72—73—74—79—80—81—88—89—97
- 第 72 图 积迦堂 S—Ⅲ区 S K—90—91—92—93—94—95
- 第 73 图 积迦堂 S—Ⅲ区 S K—99—100—101—102—103—104—105—106—107—109—111—48—67
- 第 74 图 积迦堂 S—Ⅲ区 S K—112—113—114—115—116—117—118—119—121—124—125—126—152—153—154—155—156
- 第 75 图 积迦堂 S—Ⅲ区 S K—120—123—128—129—82—83—144—149
- 第 76 图 积迦堂 S—Ⅲ区 S K—130—135—137—138—139—141—142—143—145—148—151—166
- 第 77 图 积迦堂 S—Ⅲ区 S K—156—157—160—169—171—172—176—115—120
- 第 78 图 积迦堂 S—Ⅲ区 S K—177—180—182—185—188—189
- 第 79 图 积迦堂 S—Ⅲ区 S K—190—191—192—193—194—195
- 第 80 图 积迦堂 S—Ⅲ区 S K—198—204—205—207—211—99—100
- 第 81 图 积迦堂 S—Ⅲ区 S K—216—217—218—221—222—223—224—235—237—240—241
- 第 82 图 积迦堂 S—Ⅲ区 S K—236—239—243—245—246—255—228
- 第 83 图 积迦堂 S—Ⅲ区 S K—247—248—251—252—254—256—259—274—286
- 第 84 图 积迦堂 S—Ⅲ区 S K—260—266—267—270—275
- 第 85 图 积迦堂 S—Ⅲ区 S K—271—276—279—280—287—290—260—275
- 第 86 图 积迦堂 S—Ⅲ区 S K—291—297—299—300—311—323—324—267—269
- 第 87 图 积迦堂 S—Ⅲ区 S K—304—308—309—313—316—317—318—319—328—329
- 第 88 图 积迦堂 S—Ⅲ区 S K—333—334—335—336—337—338—339—342
- 第 89 图 积迦堂 S—Ⅲ区 S K—340—341—346—349—350—355—356—357—360
- 第 90 图 积迦堂 S—Ⅲ区 S K—362—366—367—380—386—387—388—389—391—392—393—394—400
- 第 91 图 积迦堂 S—Ⅲ区土器すてば A
- 第 92 图 积迦堂 S—Ⅲ区 S B—47出土土器
- 第 93 图 积迦堂 S—Ⅲ区 S B—52出土土器
- 第 94 图 积迦堂 S—Ⅲ区 S B—110—102 出土土器
- 第 95 图 积迦堂 S—Ⅲ区 S B—107—108—112 出土土器
- 第 96 图 积迦堂 S—Ⅲ区 S B—29—1 出土土器
- 第 97 图 积迦堂 S—Ⅲ区 S B—20出土土器
- 第 98 图 积迦堂 S—Ⅲ区 S B—18—78—95 出土土器
- 第 99 图 积迦堂 S—Ⅲ区 S B—95出土土器 (2)
- 第 100 图 积迦堂 S—Ⅲ区 S B—95出土土器 (3)
- 第 101 图 积迦堂 S—Ⅲ区 S B—95出土土器 (4)
- 第 102 图 积迦堂 S—Ⅲ区 S B—111出土土器
- 第 103 图 积迦堂 S—Ⅲ区 S B—49—84—87出土土器
- 第 104 图 积迦堂 S—Ⅲ区 S B—84出土土器 (2)
- 第 105 图 积迦堂 S—Ⅲ区 S B—84出土土器 (3)
- 第 106 图 积迦堂 S—Ⅲ区 S B—84出土土器 (4)
- 第 107 图 积迦堂 S—Ⅲ区 S B—84出土土器 (5)
- 第 108 图 积迦堂 S—Ⅲ区 S B—84出土土器 (6)
- 第 109 图 积迦堂 S—Ⅲ区 S B—84出土土器 (7)
- 第 110 图 积迦堂 S—Ⅲ区 S B—100出土土器 (1)
- 第 111 图 积迦堂 S—Ⅲ区 S B—100—106出土土器
- 第 112 图 积迦堂 S—Ⅲ区 S B—09—26—27—29-2 出土土器
- 第 113 图 积迦堂 S—Ⅲ区 S B—29—2 出土土器 (2)
- 第 114 图 积迦堂 S—Ⅲ区 S B—33出土土器
- 第 115 图 积迦堂 S—Ⅲ区 S B—33出土土器
- 第 116 图 积迦堂 S—Ⅲ区 S B—35出土土器 (1)
- 第 117 图 积迦堂 S—Ⅲ区 S B—35出土土器 (2)
- 第 118 图 积迦堂 S—Ⅲ区 S B—35—38出土土器
- 第 119 图 积迦堂 S—Ⅲ区 S B—36出土土器 (1)
- 第 120 图 积迦堂 S—Ⅲ区 S B—36出土土器 (2)

- 第121图 积逊堂S—Ⅲ区S B—48出土土器(1)
- 第122图 积逊堂S—Ⅲ区S B—48出土土器(2)
- 第123图 积逊堂S—Ⅲ区S B—48出土土器(3)
- 第124图 积逊堂S—Ⅲ区S B—04出土土器
- 第125图 积逊堂S—Ⅲ区S B—05出土土器(1)
- 第126图 积逊堂S—Ⅲ区S B—05出土土器(2)
- 第127图 积逊堂S—Ⅲ区S B—05出土土器(3)
- 第128图 积逊堂S—Ⅲ区S B—05出土土器(4)
- 第129图 积逊堂S—Ⅲ区S B—06—07—08—13—15
出土土器
- 第130图 积逊堂S—Ⅲ区S B—17—21出土土器
- 第131图 积逊堂S—Ⅲ区S B—22—23—24—25
出土土器
- 第132图 积逊堂S—Ⅲ区S B—29 出土土器
- 第133图 积逊堂S—Ⅲ区S B—30—31—34—64
出土土器
- 第134图 积逊堂S—Ⅲ区S B—34—64出土土器
- 第135图 积逊堂S—Ⅲ区S B—37出土土器(1)
- 第136图 积逊堂S—Ⅲ区S B—37—39出土土器
- 第137图 积逊堂S—Ⅲ区S B—39出土土器(2)
- 第138图 积逊堂S—Ⅲ区S B—40出土土器
- 第139图 积逊堂S—Ⅲ区S B—41出土土器(1)
- 第140图 积逊堂S—Ⅲ区S B—41出土土器(2)
- 第141图 积逊堂S—Ⅲ区S B—41—42—43出土土器
- 第142图 积逊堂S—Ⅲ区S B—43出土土器(2)
- 第143图 积逊堂S—Ⅲ区S B—43出土土器(3)
- 第144图 积逊堂S—Ⅲ区S B—43—44出土土器
- 第145图 积逊堂S—Ⅲ区S B—44出土土器(2)
- 第146图 积逊堂S—Ⅲ区S B—46出土土器(1)
- 第147图 积逊堂S—Ⅲ区S B—47出土土器(2)
- 第148图 积逊堂S—Ⅲ区S B—49—50—51—56—58
出土土器(1)
- 第149图 积逊堂S—Ⅲ区S B—49—50—51—56—58
出土土器(2)
- 第150图 积逊堂S—Ⅲ区S B—49—50—51—56—58
—55出土土器
- 第151图 积逊堂S—Ⅲ区S B—55出土土器(2)
- 第152图 积逊堂S—Ⅲ区S B—55—57出土土器
- 第153图 积逊堂S—Ⅲ区S B—57出土土器(2)
- 第154图 积逊堂S—Ⅲ区S B—57出土土器(3)
- 第155图 积逊堂S—Ⅲ区S B—59—60出土土器
- 第156图 积逊堂S—Ⅲ区S B—76—80—85出土土器
- 第157图 积逊堂S—Ⅲ区S B—62出土土器(1)
- 第158图 积逊堂S—Ⅲ区S B—62出土土器(2)
- 第159图 积逊堂S—Ⅲ区S B—63—66出土土器
- 第160图 积逊堂S—Ⅲ区S B—69出土土器
- 第161图 积逊堂S—Ⅲ区S B—68—70—71出土土器
- 第162图 积逊堂S—Ⅲ区S B—71出土土器(2)
- 第163图 积逊堂S—Ⅲ区S B—71出土土器(3)
- 第164图 积逊堂S—Ⅲ区S B—72—75出土土器
- 第165图 积逊堂S—Ⅲ区S B—85出土土器(2)
- 第166图 积逊堂S—Ⅲ区S B—85出土土器(3)
- 第167图 积逊堂S—Ⅲ区S B—85—86出土土器
- 第168图 积逊堂S—Ⅲ区S B—88—91出土土器
- 第169图 积逊堂S—Ⅲ区S B—91—92—76—93
出土土器
- 第170图 积逊堂S—Ⅲ区S B—93出土土器(2)
- 第171图 积逊堂S—Ⅲ区S B—94出土土器(1)
- 第172图 积逊堂S—Ⅲ区S B—94出土土器(2)
- 第173图 积逊堂S—Ⅲ区S B—95出土土器(3)
- 第174图 积逊堂S—Ⅲ区S B—99—96出土土器
- 第175图 积逊堂S—Ⅲ区S B—96出土土器(2)
- 第176图 积逊堂S—Ⅲ区S B—96—97出土土器(2)
- 第177图 积逊堂S—Ⅲ区S B—97出土土器(2)
- 第178图 积逊堂S—Ⅲ区S B—97—103出土土器
- 第179图 积逊堂S—Ⅲ区S B—105出土土器(1)
- 第180图 积逊堂S—Ⅲ区S B—105出土土器(2)
- 第181图 积逊堂S—Ⅲ区S B—105出土土器(3)
- 第182图 积逊堂S—Ⅲ区S B—105出土土器(4)
- 第183图 积逊堂S—Ⅲ区S B—105出土土器(5)
- 第184图 积逊堂S—Ⅲ区S B—109出土土器(1)
- 第185图 积逊堂S—Ⅲ区S B—109—113出土土器
- 第186图 积逊堂S—Ⅲ区S K—01—02出土土器(1)
- 第187图 积逊堂S—Ⅲ区S K—03—07—08—09—19—
25—34出土土器(2)
- 第188图 积逊堂S—Ⅲ区S K—34—35—45—47—49—
51—64—72—84—90出土土器(3)
- 第189图 积逊堂S—Ⅲ区S K—92—101—102—106
109—129—130—141出土土器(4)
- 第190图 积逊堂S—Ⅲ区S K—188—190—194—
206—217—223—230—214出土土器(5)
- 第191图 积逊堂S—Ⅲ区S K—256—259—260—
275—289—266—267—276出土土器(6)
- 第192图 积逊堂S—Ⅲ区S K—278—279—280—
281—287—290—291—298—357—360—
371—397—36出土土器(7)

第193図	积迦堂S—Ⅲ区SK—埋甕	第232図	积迦堂S—Ⅲ区土偶	(15)
第194図	积迦堂S—Ⅲ区土器すてばA出土土器(1)	第233図	积迦堂S—Ⅲ区土偶	(16)
第195図	积迦堂S—Ⅲ区土器すてばA出土土器(2)	第234図	积迦堂S—Ⅲ区土偶	(17)
第196図	积迦堂S—Ⅲ区土器すてばA出土土器(3)	第235図	积迦堂S—Ⅲ区土偶	(18)
第197図	积迦堂S—Ⅲ区土器すてばA出土土器(4)	第236図	积迦堂S—Ⅲ区土偶	(19)
第198図	积迦堂S—Ⅲ区土器すてばA出土土器(5)	第237図	积迦堂S—Ⅲ区土偶	(20)
第199図	积迦堂S—Ⅲ区土器すてばA出土土器(6)	第238図	积迦堂S—Ⅲ区土偶	(21)
第200図	积迦堂S—Ⅲ区土器すてばA出土土器(7)	第239図	积迦堂S—Ⅲ区土偶	(22)
第201図	积迦堂S—Ⅲ区土器すてばA出土土器(8)	第240図	积迦堂S—Ⅲ区土偶	(23)
第202図	积迦堂S—Ⅲ区グリッド出土土器(1)	第241図	积迦堂S—Ⅲ区土偶	(24)
第203図	积迦堂S—Ⅲ区グリッド出土土器(2)	第242図	积迦堂S—Ⅲ区土偶	(25)
第204図	积迦堂S—Ⅲ区グリッド出土土器(3)	第243図	积迦堂S—Ⅲ区土偶	(26)
第205図	积迦堂S—Ⅲ区グリッド出土土器(4)	第244図	积迦堂S—Ⅲ区土偶	(27)
第206図	积迦堂S—Ⅲ区グリッド出土土器(5)	第245図	积迦堂S—Ⅲ区土偶	(28)
第207図	积迦堂S—Ⅲ区グリッド出土土器(6)	第246図	积迦堂S—Ⅲ区土偶	(29)
第208図	积迦堂S—Ⅲ区グリッド出土土器(7)	第247図	积迦堂S—Ⅲ区土偶	(30)
第209図	积迦堂S—Ⅲ区グリッド出土土器(8)	第248図	积迦堂S—Ⅲ区土偶	(31)
第210図	积迦堂S—Ⅲ区グリッド出土土器(9)	第249図	积迦堂S—Ⅲ区土偶	(32)
第211図	积迦堂S—Ⅲ区グリッド出土土器(10)	第250図	积迦堂S—Ⅲ区土偶	(33)
第212図	积迦堂S—Ⅲ区把手(1)	第251図	积迦堂S—Ⅲ区土偶	(34)
第213図	积迦堂S—Ⅲ区把手(2)	第252図	积迦堂S—Ⅲ区土偶	(35)
第214図	积迦堂S—Ⅲ区S—Ⅳ区把手(3)	第253図	积迦堂S—Ⅲ区土偶	(36)
第215図	积迦堂S—Ⅲ区把手(4)	第254図	积迦堂S—Ⅲ区土偶	(37)
第216図	积迦堂S—Ⅲ区把手(5)	第255図	积迦堂S—Ⅲ区土偶	(38)
第217図	积迦堂S—Ⅲ区把手(6)	第256図	积迦堂S—Ⅲ区土偶	(39)
第218図	积迦堂S—Ⅲ区土偶(1)	第257図	积迦堂S—Ⅲ区土偶	(40)
第219図	积迦堂S—Ⅲ区土偶(2)	第258図	积迦堂S—Ⅲ区土偶	(41)
第220図	积迦堂S—Ⅲ区土偶(3)	第259図	积迦堂S—Ⅲ区土偶	(42)
第221図	积迦堂S—Ⅲ区土偶(4)	第260図	积迦堂S—Ⅲ区土偶	(43)
第222図	积迦堂S—Ⅲ区土偶(5)	第261図	积迦堂S—Ⅲ区土偶	(44)
第223図	积迦堂S—Ⅲ区土偶(6)	第262図	积迦堂S—Ⅲ区土偶	(45)
第224図	积迦堂S—Ⅲ区土偶(7)	第263図	积迦堂S—Ⅲ区土偶	(46)
第225図	积迦堂S—Ⅲ区土偶(8)	第264図	积迦堂S—Ⅲ区土偶	(47)
第226図	积迦堂S—Ⅲ区土偶(9)	第265図	积迦堂S—Ⅲ区土偶	(48)
第227図	积迦堂S—Ⅲ区土偶(10)	第266図	积迦堂S—Ⅲ区土偶	(49)
第228図	积迦堂S—Ⅲ区土偶(11)	第267図	积迦堂S—Ⅲ区土偶	(50)
第229図	积迦堂S—Ⅲ区土偶(12)	第268図	积迦堂S—Ⅲ区土偶	(51)
第230図	积迦堂S—Ⅲ区土偶(13)	第269図	积迦堂S—Ⅲ区土偶	(52)
第231図	积迦堂S—Ⅲ区土偶(14)	第270図	积迦堂S—Ⅲ区土偶	(53)
		第271図	积迦堂S—Ⅲ区土偶	(54)

- 第272图 积逊堂S—Ⅲ区土偶 (55)
- 第273图 积逊堂S—Ⅲ区土偶 (56)
- 第274图 积逊堂S—Ⅲ区土偶 (57)
- 第275图 积逊堂S—Ⅲ区S B土製円盤 (1)
- 第276图 积逊堂S—Ⅲ区S B土製円盤 (2)
- 第277图 积逊堂S—Ⅲ区S B・S K土製円盤
- 第278图 积逊堂S—Ⅲ区土製円盤 (1)
- 第279图 积逊堂S—Ⅲ区土製円盤 (2)
- 第280图 积逊堂S—Ⅲ区土製円盤 (3)
- 第281图 积逊堂S—Ⅲ区土製円盤 (4)
- 第282图 积逊堂S—Ⅲ区土製円盤 (5)
- 第283图 积逊堂S—Ⅲ区土製円盤 (6)
- 第284图 积逊堂S—Ⅲ区土製円盤 (7)
- 第285图 积逊堂S—Ⅲ区土製円盤 (8)
- 第286图 积逊堂S—Ⅲ区土製円盤 (9)
- 第287图 积逊堂S—Ⅲ区土製円盤 (10)
- 第288图 积逊堂S—Ⅲ区土製円盤 (11)
- 第289图 积逊堂S—Ⅲ区土製円盤 (12)
- 第290图 积逊堂S—Ⅲ区N—Ⅲ区土製匙
- 第291图 积逊堂S—Ⅲ区S—Ⅳ区N—Ⅲ区N—Ⅳ区耳栓・珠状耳飾
- 第292图 积逊堂N—Ⅳ区S—Ⅱ区耳栓・珠状耳飾
- 第293图 积逊堂S—Ⅱ区S—Ⅳ区N—Ⅲ区N—Ⅳ区S—Ⅱ区土製薄円盤
- 第294图 积逊堂S—Ⅲ区N—Ⅲ区土鈴 (1)
- 第295图 积逊堂S—Ⅳ区N—Ⅳ区土鈴 (2)
- 第296图 积逊堂S—Ⅲ区S—Ⅳ区N—Ⅳ区土製品
- 第297图 积逊堂S—Ⅲ区土器片錘・軽石
- 第298图 积逊堂S—Ⅲ区原石

S—Ⅳ区図版目次

- 第299图 积逊堂S—Ⅳ区S B—57—34
- 第300图 积逊堂S—Ⅳ区S B—54—59
- 第301图 积逊堂S—Ⅳ区S B—47—48—49—51
- 第302图 积逊堂S—Ⅳ区S B—73
- 第303图 积逊堂S—Ⅳ区S B—73
- 第304图 积逊堂S—Ⅳ区S B—53
- 第305图 积逊堂S—Ⅳ区S B—68—69—80—81
- 第306图 积逊堂S—Ⅳ区S B—52
- 第307图 积逊堂S—Ⅳ区S B—32
- 第308图 积逊堂S—Ⅳ区S B—32
- 第309图 积逊堂S—Ⅳ区S B—18
- 第310图 积逊堂S—Ⅳ区S B—60
- 第311图 积逊堂S—Ⅳ区S B—83
- 第312图 积逊堂S—Ⅳ区S B—01—02—03—04
- 第313图 积逊堂S—Ⅳ区S B—05—08—09—24—25
31—44—61
- 第314图 积逊堂S—Ⅳ区S B—07—23
- 第315图 积逊堂S—Ⅳ区S B—10
- 第316图 积逊堂S—Ⅳ区S B—11
- 第317图 积逊堂S—Ⅳ区S B—14—17
- 第318图 积逊堂S—Ⅳ区S B—20
- 第319图 积逊堂S—Ⅳ区S B—12—21
- 第320图 积逊堂S—Ⅳ区S B—21
- 第321图 积逊堂S—Ⅳ区S B—28—30
- 第322图 积逊堂S—Ⅳ区S B—33—41
- 第323图 积逊堂S—Ⅳ区S B—50—77
- 第324图 积逊堂S—Ⅳ区S B—55
- 第325图 积逊堂S—Ⅳ区S B—56
- 第326图 积逊堂S—Ⅳ区S B—62
- 第327图 积逊堂S—Ⅳ区S B—63
- 第328图 积逊堂S—Ⅳ区S B—64
- 第329图 积逊堂S—Ⅳ区S B—65
- 第330图 积逊堂S—Ⅳ区S B—67
- 第331图 积逊堂S—Ⅳ区S B—66—70—71—72
- 第332图 积逊堂S—Ⅳ区S B—75
- 第333图 积逊堂S—Ⅳ区S B—78
- 第334图 积逊堂S—Ⅳ区S B—77 B—82
- 第335图 积逊堂S—Ⅳ区埋甕
- 第336图 积逊堂S—Ⅳ区S X—01—03
- 第337图 积逊堂S—Ⅳ区土器すてばC
- 第338图 积逊堂S—Ⅳ区S K—01—04—05
- 第339图 积逊堂S—Ⅳ区S K—06—07—08
- 第340图 积逊堂S—Ⅳ区S K—09—11—12—21—22—23

- 第341图 积迦堂S—IV区SK—25—26—27—28—32—33—34—36—37
- 第342图 积迦堂S—IV区SK—20—29—31—40—46—47—48—52
- 第343图 积迦堂S—IV区SK—53—75—78
- 第344图 积迦堂S—IV区SK—76—77—81—87—88
- 第345图 积迦堂S—IV区SK—89—90—91—107—114—121—122—123—126—127
- 第346图 积迦堂S—IV区SK—128
- 第347图 积迦堂S—IV区SK—131—132—133—135—137—138—139
- 第348图 积迦堂S—IV区SK—140—141—142—143—144—136—171
- 第349图 积迦堂S—IV区SK—145—148—149—150—151—152—153—156—157—158—159—160—163—164—165—166—167—169
- 第350图 积迦堂S—IV区SK—173—174—175—176—178—183—184
- 第351图 积迦堂S—IV区SK—185—186—187—188—189—190—191—192—203
- 第352图 积迦堂S—IV区SK—195—196—197—198—199—200—202—203—204—205—206—207—208—209—210—211—212—213—214—215—218—219
- 第353图 积迦堂S—IV区SK—219—220—221—223—224—225—226—227—228—229—230—231—232—234—235
- 第354图 积迦堂S—IV区SK—241—242—243—344—345—346—347—349—378
- 第355图 积迦堂S—IV区SK—342—349—351—362—382—383—384—385—395—107
- 第356图 积迦堂S—IV区SK—353—354—355—356—357—358—359—360—361—362—363—364—365—366—367—368—369—370—371—372—373—374—375—395—397—398
- 第357图 积迦堂S—IV区SK—376—380—381—383—384—385—386—396
- 第358图 积迦堂S—IV区SB—57出土土器
- 第359图 积迦堂S—IV区SB—41—48—51出土土器
- 第360图 积迦堂S—IV区SB—06—73出土土器
- 第361图 积迦堂S—IV区SB—73出土土器(2)
- 第362图 积迦堂S—IV区SB—73出土土器(3)
- 第363图 积迦堂S—IV区SB—73出土土器(4)
- 第364图 积迦堂S—IV区SB—73出土土器(5)
- 第365图 积迦堂S—IV区SB—73出土土器(6)
- 第366图 积迦堂S—IV区SB—73出土土器(7)
- 第367图 积迦堂S—IV区SB—73出土土器(8)
- 第368图 积迦堂S—IV区SB—73出土土器(9)
- 第369图 积迦堂S—IV区SB—53出土土器(1)
- 第370图 积迦堂S—IV区SB—53出土土器(2)
- 第371图 积迦堂S—IV区SB—53出土土器(3)
- 第372图 积迦堂S—IV区SB—53出土土器(4)
- 第373图 积迦堂S—IV区SB—53出土土器(5)
- 第374图 积迦堂S—IV区SB—53出土土器(6)
- 第375图 积迦堂S—IV区SB—53出土土器(7)
- 第376图 积迦堂S—IV区SB—53出土土器(8)
- 第377图 积迦堂S—IV区SB—53出土土器(9)
- 第378图 积迦堂S—IV区SB—53出土土器(10)
- 第379图 积迦堂S—IV区SB—69出土土器(1)
- 第380图 积迦堂S—IV区SB—69—80—81出土土器
- 第381图 积迦堂S—IV区SB—32出土土器(1)
- 第382图 积迦堂S—IV区SB—32出土土器(2)
- 第383图 积迦堂S—IV区SB—32出土土器(3)
- 第384图 积迦堂S—IV区SB—32出土土器(4)
- 第385图 积迦堂S—IV区SB—32出土土器(5)
- 第386图 积迦堂S—IV区SB—32出土土器(6)
- 第387图 积迦堂S—IV区SB—52出土土器(1)
- 第388图 积迦堂S—IV区SB—52出土土器(2)
- 第389图 积迦堂S—IV区SB—52出土土器(3)
- 第390图 积迦堂S—IV区SB—52出土土器(4)
- 第391图 积迦堂S—IV区SB—52出土土器(5)
- 第392图 积迦堂S—IV区SB—52出土土器(6)
- 第393图 积迦堂S—IV区SB—18—34出土土器
- 第394图 积迦堂S—IV区SB—34出土土器(2)
- 第395图 积迦堂S—IV区SB—40出土土器
- 第396图 积迦堂S—IV区SB—60出土土器(1)
- 第397图 积迦堂S—IV区SB—60出土土器(2)
- 第398图 积迦堂S—IV区SB—83出土土器(1)
- 第399图 积迦堂S—IV区SB—83出土土器(2)
- 第400图 积迦堂S—IV区SB—83出土土器(3)
- 第401图 积迦堂S—IV区SB—01出土土器
- 第402图 积迦堂S—IV区SB—02出土土器
- 第403图 积迦堂S—IV区SB—03出土土器
- 第404图 积迦堂S—IV区SB—04出土土器(1)
- 第405图 积迦堂S—IV区SB—04—05—07出土土器
- 第406图 积迦堂S—IV区SB—07—10出土土器
- 第407图 积迦堂S—IV区SB—10出土土器(2)

- 第408図 釈迦堂S—IV区SB—10出土土器 (3)
- 第409図 釈迦堂S—IV区SB—11出土土器 (1)
- 第410図 釈迦堂S—IV区SB—11出土土器 (2)
- 第411図 釈迦堂S—IV区SB—12出土土器 (1)
- 第412図 釈迦堂S—IV区SB—12出土土器 (2)
- 第413図 釈迦堂S—IV区SB—17出土土器 (1)
- 第414図 釈迦堂S—IV区SB—17出土土器 (2)
- 第415図 釈迦堂S—IV区SB—17出土土器 (3)
- 第416図 釈迦堂S—IV区SB—20出土土器 (1)
- 第417図 釈迦堂S—IV区SB—20出土土器 (2)
- 第418図 釈迦堂S—IV区SB—20出土土器 (3)
- 第419図 釈迦堂S—IV区SB—20出土土器 (4)
- 第420図 釈迦堂S—IV区SB—21出土土器 (1)
- 第421図 釈迦堂S—IV区SB—21出土土器 (2)
- 第422図 釈迦堂S—IV区SB—23—24—25出土土器
- 第423図 釈迦堂S—IV区SB—28—30出土土器 (1)
- 第424図 釈迦堂S—IV区SB—28—30—31—33
出土土器
- 第425図 釈迦堂S—IV区SB—33—44出土土器
- 第426図 釈迦堂S—IV区SB—50出土土器 (1)
- 第427図 釈迦堂S—IV区SB—50出土土器 (2)
- 第428図 釈迦堂S—IV区SB—55出土土器 (1)
- 第429図 釈迦堂S—IV区SB—55出土土器 (2)
- 第430図 釈迦堂S—IV区SB—55出土土器 (3)
- 第431図 釈迦堂S—IV区SB—56出土土器 (1)
- 第432図 釈迦堂S—IV区SB—56出土土器 (2)
- 第433図 釈迦堂S—IV区SB—56出土土器 (3)
- 第434図 釈迦堂S—IV区SB—56出土土器 (4)
- 第435図 釈迦堂S—IV区SB—56出土土器 (5)
- 第436図 釈迦堂S—IV区SB—61—62—63出土土器
- 第437図 釈迦堂S—IV区SB—63出土土器 (2)
- 第438図 釈迦堂S—IV区SB—63出土土器 (3)
- 第439図 釈迦堂S—IV区SB—63出土土器 (4)
- 第440図 釈迦堂S—IV区SB—64出土土器 (1)
- 第441図 釈迦堂S—IV区SB—64出土土器 (2)
- 第442図 釈迦堂S—IV区SB—65出土土器
- 第443図 釈迦堂S—IV区SB—66—67出土土器
- 第444図 釈迦堂S—IV区SB—67出土土器 (2)
- 第445図 釈迦堂S—IV区SB—70—71—75出土土器
- 第446図 釈迦堂S—IV区SB—76—77—78出土土器
- 第447図 釈迦堂S—IV区SB—78出土土器 (1)
- 第448図 釈迦堂S—IV区SB—78—82出土土器
- 第449図 釈迦堂S—IV区SK—01—04—05—08
出土土器 (1)
- 第450図 釈迦堂S—IV区SK—05出土土器 (2)
- 第451図 釈迦堂S—IV区SK—06—11—33—40—46
出土土器 (3)
- 第452図 釈迦堂S—IV区SK—52—53出土土器 (4)
- 第453図 釈迦堂S—IV区SK—53出土土器 (5)
- 第454図 釈迦堂S—IV区SK—48—75—78—83—86—
87—88—出土土器 (6)
- 第455図 釈迦堂S—IV区SK—128出土土器 (7)
- 第456図 釈迦堂S—IV区SK—128—114—132—
137—138—139—155—156出土土器 (8)
- 第457図 釈迦堂S—IV区SK—159—175—178—
198—226—232出土土器 (9)
- 第458図 釈迦堂S—IV区SK—344—354—367—
369—372—376—395—351—345—395—
396 (10)
- 第459図 釈迦堂S—IV区埋甕
- 第460図 釈迦堂S—IV区埋甕
- 第461図 釈迦堂S—IV区土器すてばC
出土土器 (1)
- 第462図 釈迦堂S—IV区土器すてばC
出土土器 (2)
- 第463図 釈迦堂S—IV区土器すてばC
出土土器 (3)
- 第464図 釈迦堂S—IV区土器すてばC
出土土器 (4)
- 第465図 釈迦堂S—IV区グリッド出土土器 (1)
- 第466図 釈迦堂S—IV区グリッド出土土器 (2)
- 第467図 釈迦堂S—IV区グリッド出土土器 (3)
- 第468図 釈迦堂S—IV区グリッド出土土器 (4)
- 第469図 釈迦堂S—IV区グリッド出土土器 (5)
- 第470図 釈迦堂S—IV区グリッド出土土器 (6)
- 第471図 釈迦堂S—IV区グリッド出土土器 (7)
- 第472図 釈迦堂S—IV区グリッド出土土器 (8)
- 第473図 釈迦堂S—IV区グリッド出土土器 (9)
- 第474図 釈迦堂S—IV区グリッド出土土器 (10)
- 第475図 釈迦堂S—IV区グリッド出土土器 (11)
- 第476図 釈迦堂S—IV区グリッド出土土器 (12)
- 第477図 釈迦堂S—IV区把手 (1)
- 第478図 釈迦堂S—IV区把手 (2)
- 第479図 釈迦堂S—IV区把手 (3)
- 第480図 釈迦堂S—IV区把手 (4)

- | | | | |
|-------|----------------|-------|-------------------|
| 第481図 | 积迦堂S—IV区土偶(1) | 第511図 | 积迦堂S—IV区土偶(31) |
| 第482図 | 积迦堂S—IV区土偶(2) | 第512図 | 积迦堂S—IV区土偶(32) |
| 第483図 | 积迦堂S—IV区土偶(3) | 第513図 | 积迦堂S—IV区土偶(33) |
| 第484図 | 积迦堂S—IV区土偶(4) | 第514図 | 积迦堂S—IV区土偶(34) |
| 第485図 | 积迦堂S—IV区土偶(5) | 第515図 | 积迦堂S—IV区土偶(35) |
| 第486図 | 积迦堂S—IV区土偶(6) | 第516図 | 积迦堂S—IV区土偶(36) |
| 第487図 | 积迦堂S—IV区土偶(7) | 第517図 | 积迦堂S—IV区土偶(37) |
| 第488図 | 积迦堂S—IV区土偶(8) | 第518図 | 积迦堂S—IV区土偶(38) |
| 第489図 | 积迦堂S—IV区土偶(9) | 第519図 | 积迦堂S—IV区土偶(39) |
| 第490図 | 积迦堂S—IV区土偶(10) | 第520図 | 积迦堂S—IV区土偶(40) |
| 第491図 | 积迦堂S—IV区土偶(11) | 第521図 | 积迦堂S—IV区土偶(41) |
| 第492図 | 积迦堂S—IV区土偶(12) | 第522図 | 积迦堂S—IV区土偶(42) |
| 第493図 | 积迦堂S—IV区土偶(13) | 第523図 | 积迦堂S—IV区土偶(43) |
| 第494図 | 积迦堂S—IV区土偶(14) | 第524図 | 积迦堂S—IV区動物土偶ほか |
| 第495図 | 积迦堂S—IV区土偶(15) | 第525図 | 积迦堂S—IV区SB土製円盤(1) |
| 第496図 | 积迦堂S—IV区土偶(16) | 第526図 | 积迦堂S—IV区SB土製円盤(2) |
| 第497図 | 积迦堂S—IV区土偶(17) | 第527図 | 积迦堂S—IV区SB土製円盤(3) |
| 第498図 | 积迦堂S—IV区土偶(18) | 第528図 | 积迦堂S—IV区SB土製円盤(4) |
| 第499図 | 积迦堂S—IV区土偶(19) | 第529図 | 积迦堂S—IV区SK土製円盤 |
| 第500図 | 积迦堂S—IV区土偶(20) | 第530図 | 积迦堂S—IV区土製円盤(1) |
| 第501図 | 积迦堂S—IV区土偶(21) | 第531図 | 积迦堂S—IV区土製円盤(2) |
| 第502図 | 积迦堂S—IV区土偶(22) | 第532図 | 积迦堂S—IV区土製円盤(3) |
| 第503図 | 积迦堂S—IV区土偶(23) | 第533図 | 积迦堂S—IV区土製円盤(4) |
| 第504図 | 积迦堂S—IV区土偶(24) | 第534図 | 积迦堂S—IV区土製円盤(5) |
| 第505図 | 积迦堂S—IV区土偶(25) | 第535図 | 积迦堂S—IV区土製円盤(6) |
| 第506図 | 积迦堂S—IV区土偶(26) | 第536図 | 积迦堂S—IV区土製円盤(7) |
| 第507図 | 积迦堂S—IV区土偶(27) | 第537図 | 积迦堂S—IV区土製円盤(8) |
| 第508図 | 积迦堂S—IV区土偶(28) | 第538図 | 积迦堂S—IV区土製円盤(9) |
| 第509図 | 积迦堂S—IV区土偶(29) | 第539図 | 积迦堂S—IV区土製円盤(10) |
| 第510図 | 积迦堂S—IV区土偶(30) | 第540図 | 积迦堂S—IV区土製円盤(11) |

N—III区図版目次

- | | | | |
|-------|----------------------------|-------|------------------------|
| 第541図 | 积迦堂N—III区SB—01—02 | 第546図 | 积迦堂N—III区SB—02出土土器 |
| 第542図 | 积迦堂N—III区SB—03 | 第547図 | 积迦堂N—III区SB—03出土土器 |
| 第543図 | 积迦堂N—III区SK—01—02—03—04—05 | 第548図 | 积迦堂N—III区SK—03ほか出土土器 |
| 第544図 | 积迦堂N—III区土器すてばB | 第549図 | 积迦堂N—III区土器すてばB出土土器(1) |
| 第545図 | 积迦堂N—III区SB—01出土土器 | 第550図 | 积迦堂N—III区土器すてばB出土土器(2) |

第551図 积迦堂N—Ⅲ区土器すてばB出土土器 (3)
第552図 积迦堂N—Ⅲ区把手
第553図 积迦堂N—Ⅲ区土偶 (1)
第554図 积迦堂N—Ⅲ区土偶 (2)
第555図 积迦堂N—Ⅲ区土偶 (3)
第556図 积迦堂N—Ⅲ区土偶 (4)
第557図 积迦堂N—Ⅲ区土偶 (5)
第558図 积迦堂N—Ⅲ区土偶 (6)
第559図 积迦堂N—Ⅲ区土偶 (7)
第560図 积迦堂N—Ⅲ区土偶 (8)

第561图 积迦堂N—Ⅲ区土偶 (9)
第562图 积迦堂N—Ⅲ区土偶 (10)
第563图 积迦堂N—Ⅲ区土偶 (11)
第564图 积迦堂N—Ⅲ区土偶 (12)
第565图 积迦堂N—Ⅲ区土製円盤 (1)
第566图 积迦堂N—Ⅲ区土製円盤 (2)
第567图 积迦堂N—Ⅲ区土製円盤 (3)
第568图 积迦堂N—Ⅲ区土製円盤 (4)
第569图 积迦堂N—Ⅲ区土製円盤 (5)

N—Ⅳ区図版目次

第570图 积迦堂N—Ⅳ区S B—01—02 S K—01—02—03—04—05—06—07—09—10
第571图 积迦堂N—Ⅳ区土器すてばB
第572图 积迦堂N—Ⅳ区S K—01—02—04—06 S B—03出土土器
第573图 积迦堂N—Ⅳ区土器すてばB出土土器 (1)
第574图 积迦堂N—Ⅳ区土器すてばB出土土器 (2)
第575图 积迦堂N—Ⅳ区土器すてばB出土土器 (3)
第576图 积迦堂N—Ⅳ区土器すてばB出土土器 (4)
第577图 积迦堂N—Ⅳ区土器すてばB出土土器 (5)
第578图 积迦堂N—Ⅳ区土器すてばB出土土器 (6)
第579图 积迦堂N—Ⅳ区土器すてばB出土土器 (7)
第580图 积迦堂N—Ⅳ区土器すてばB出土土器 (8)
第581图 积迦堂N—Ⅳ区土器すてばB出土土器 (9)
第582图 积迦堂N—Ⅳ区土器すてばB出土土器 (10)
第583图 积迦堂N—Ⅳ区土器すてばB出土土器 (11)
第584图 积迦堂N—Ⅳ区土器すてばB出土土器 (12)
第585图 积迦堂N—Ⅳ区土器すてばB出土土器 (13)
第586图 积迦堂N—Ⅳ区土器すてばB出土土器 (14)
第587图 积迦堂N—Ⅳ区把手 (1)
第588图 积迦堂N—Ⅳ区把手 (2)
第589图 积迦堂N—Ⅳ区土偶 (1)
第590图 积迦堂N—Ⅳ区土偶 (2)
第591图 积迦堂N—Ⅳ区土偶 (3)
第592图 积迦堂N—Ⅳ区土偶 (4)
第593图 积迦堂N—Ⅳ区土偶 (5)
第594图 积迦堂N—Ⅳ区土偶 (6)

第595图 积迦堂N—Ⅳ区土偶 (7)
第596图 积迦堂N—Ⅳ区土偶 (8)
第597图 积迦堂N—Ⅳ区土偶 (9)
第598图 积迦堂N—Ⅳ区土偶 (10)
第599图 积迦堂N—Ⅳ区土偶 (11)
第600图 积迦堂N—Ⅳ区土偶 (12)
第601图 积迦堂N—Ⅳ区土偶 (13)
第602图 积迦堂N—Ⅳ区土偶 (14)
第603图 积迦堂N—Ⅳ区土偶 (15)
第604图 积迦堂N—Ⅳ区土偶 (16)
第605图 积迦堂N—Ⅳ区土偶 (17)
第606图 积迦堂N—Ⅳ区土偶 (18)
第607图 积迦堂N—Ⅳ区土偶 (19)
第608图 积迦堂N—Ⅳ区土偶 (20)
第609图 积迦堂N—Ⅳ区土偶 (21)
第610图 积迦堂N—Ⅳ区土偶 (22)
第611图 积迦堂N—Ⅳ区土偶 (23)
第612图 积迦堂N—Ⅳ区土偶 (24)
第613图 积迦堂N—Ⅳ区土偶 (25)
第614图 积迦堂N—Ⅳ区土偶 (26)
第615图 积迦堂N—Ⅳ区土偶 (27)
第616图 积迦堂N—Ⅳ区土偶 (28)
第617图 积迦堂N—Ⅳ区土偶 (29)
第618图 积迦堂N—Ⅳ区土偶 (30)
第619图 积迦堂N—Ⅳ区土偶 (31)
第620图 积迦堂N—Ⅳ区土偶 (32)

- | | | | |
|-------|---------------------------------|-------|-------------------|
| 第621図 | 积迦堂N—IV区土偶 (33) | 第632図 | 积迦堂N—IV区土製円盤 (6) |
| 第622図 | 积迦堂N—IV区土偶 (34) | 第633図 | 积迦堂N—IV区土製円盤 (7) |
| 第623図 | 积迦堂N—IV区土偶 (35) | 第634図 | 积迦堂N—IV区土製円盤 (8) |
| 第624図 | 积迦堂S—II区S—V区—土偶 | 第635図 | 积迦堂N—IV区土製円盤 (9) |
| 第625図 | 积迦堂S—III区S—IV区N—III区N—IV区
土偶 | 第636図 | 积迦堂N—IV区土製円盤 (10) |
| 第626図 | 积迦堂S—III区S—IV区N—III区N—IV区
土偶 | 第637図 | 积迦堂N—IV区土製円盤 (11) |
| 第627図 | 积迦堂N—IV区土製円盤 (1) | 第638図 | 积迦堂N—IV区土製円盤 (12) |
| 第628図 | 积迦堂N—IV区土製円盤 (2) | 第639図 | 积迦堂N—IV区土製円盤 (13) |
| 第629図 | 积迦堂N—IV区土製円盤 (3) | 第640図 | 积迦堂S—III区土器すてばA |
| 第630図 | 积迦堂N—IV区土製円盤 (4) | 第641図 | 积迦堂N—III区土器すてばB |
| 第631図 | 积迦堂N—IV区土製円盤 (5) | 第642図 | 积迦堂N—IV区土器すてばB |

凡 例

1. 本書の遺構図の方位は特に図化してない場合は、北が上である。
2. 本書のSBは住居址、SKは土壙、SXは不明遺構の略号である。
3. 本書の図面はSBが(1:60)、SKが(1:40)を原則とした。例外は特に表示した。
4. 土器の実測図は(1:6)、拓影は(1:3)を原則とした。土偶・土製円盤・土製品は(1:2)とした。例外は特に表示した。
5. 土器の実測は従来の方法に従い、文様等の関係上左側断面としたものもある。土偶・土製品等は第3角法とした。ただし把手は表示上いずれかを採用し、土製円盤は第1角法となり「釈迦堂I」とは異なる。
6. 遺構・遺物はそれぞれ地区別に図化した。特に少量の遺物については、それぞれの地区にまとめたものもある。また既報告地区の未掲載資料についても、いずれかの地区にまとめた。
7. 遺構・遺物の配列は地区別、時代別であるが、例外もある。
8. SB図のスクリーントーンは焼土を示し、柱穴脇の数値は深さを示す。
9. 「土器すてば」の呼称には概念既定は特になく、発掘時の暫定的な呼称である。
10. 土偶の割口のスクリーントーンは、下図のとおりである。

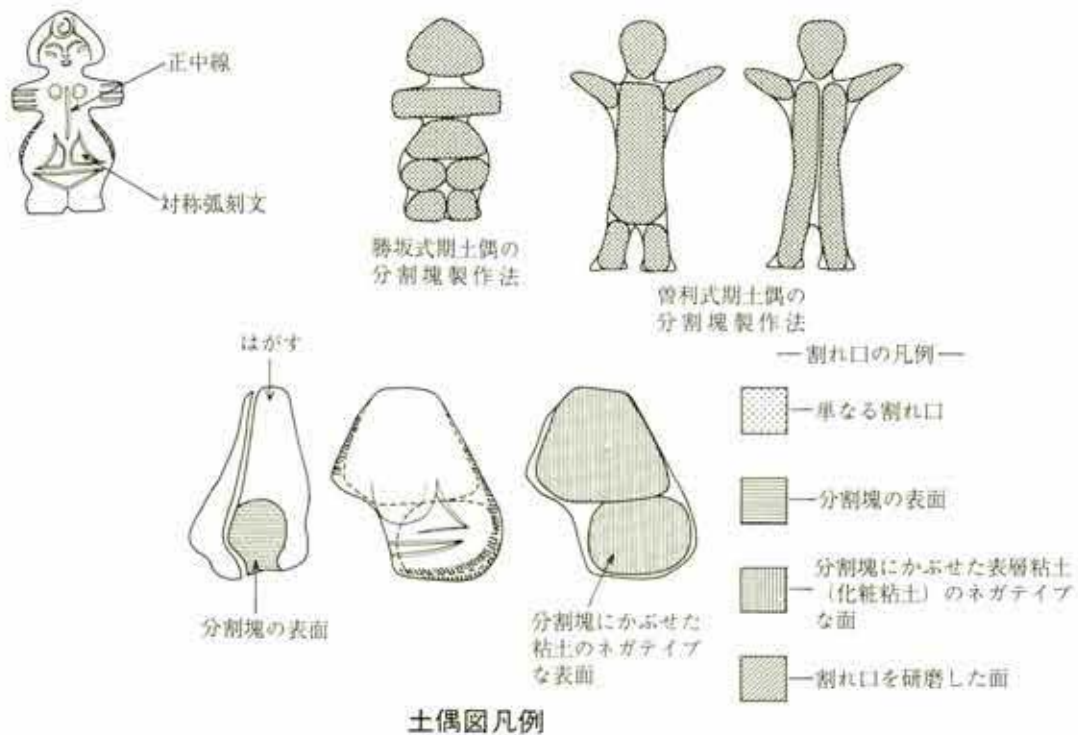

土偶図凡例

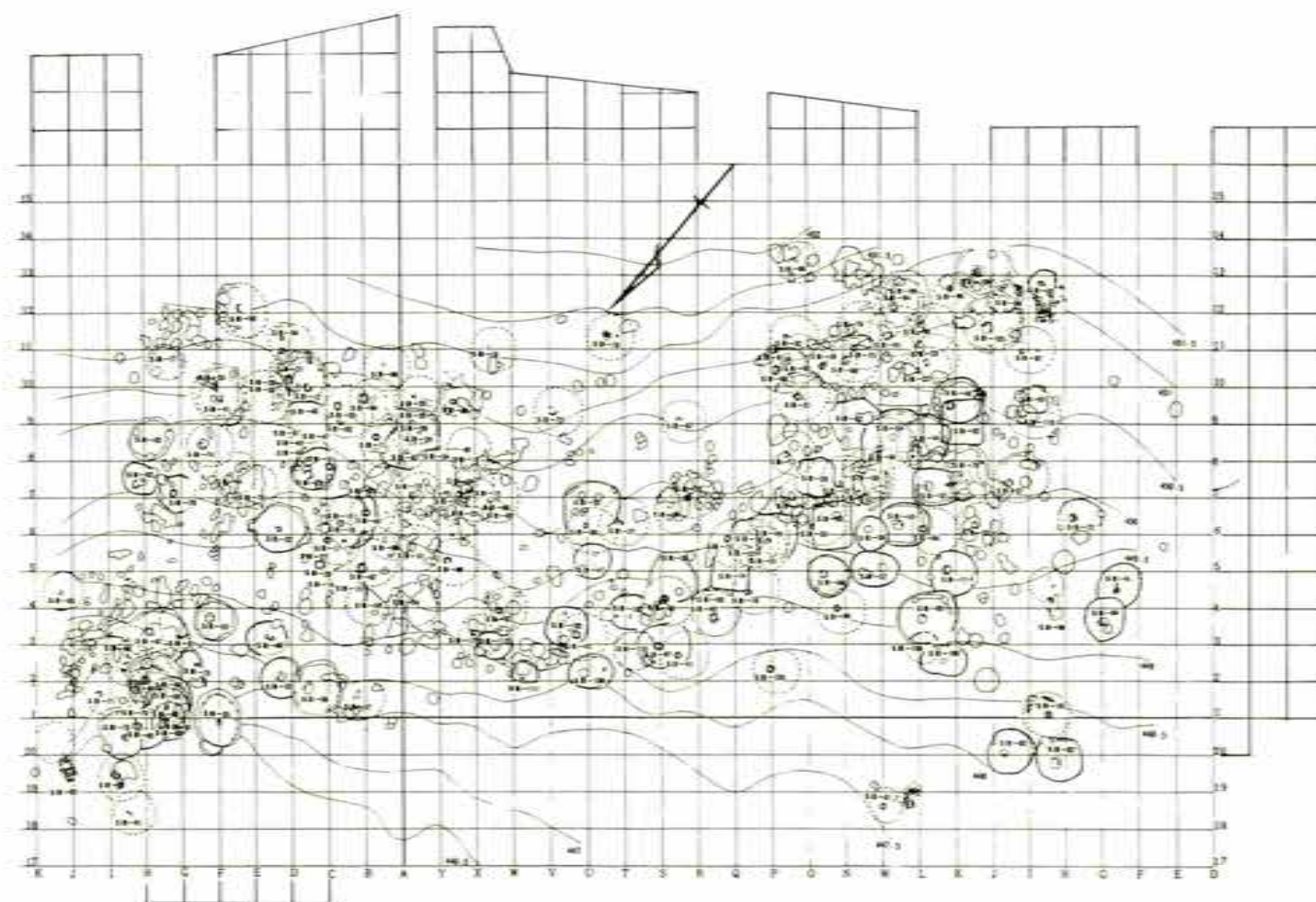

第 1 图 积迦堂 S-III 区 S-IV 区 N-III 区 N-IV 区 住居址・土壤全体图

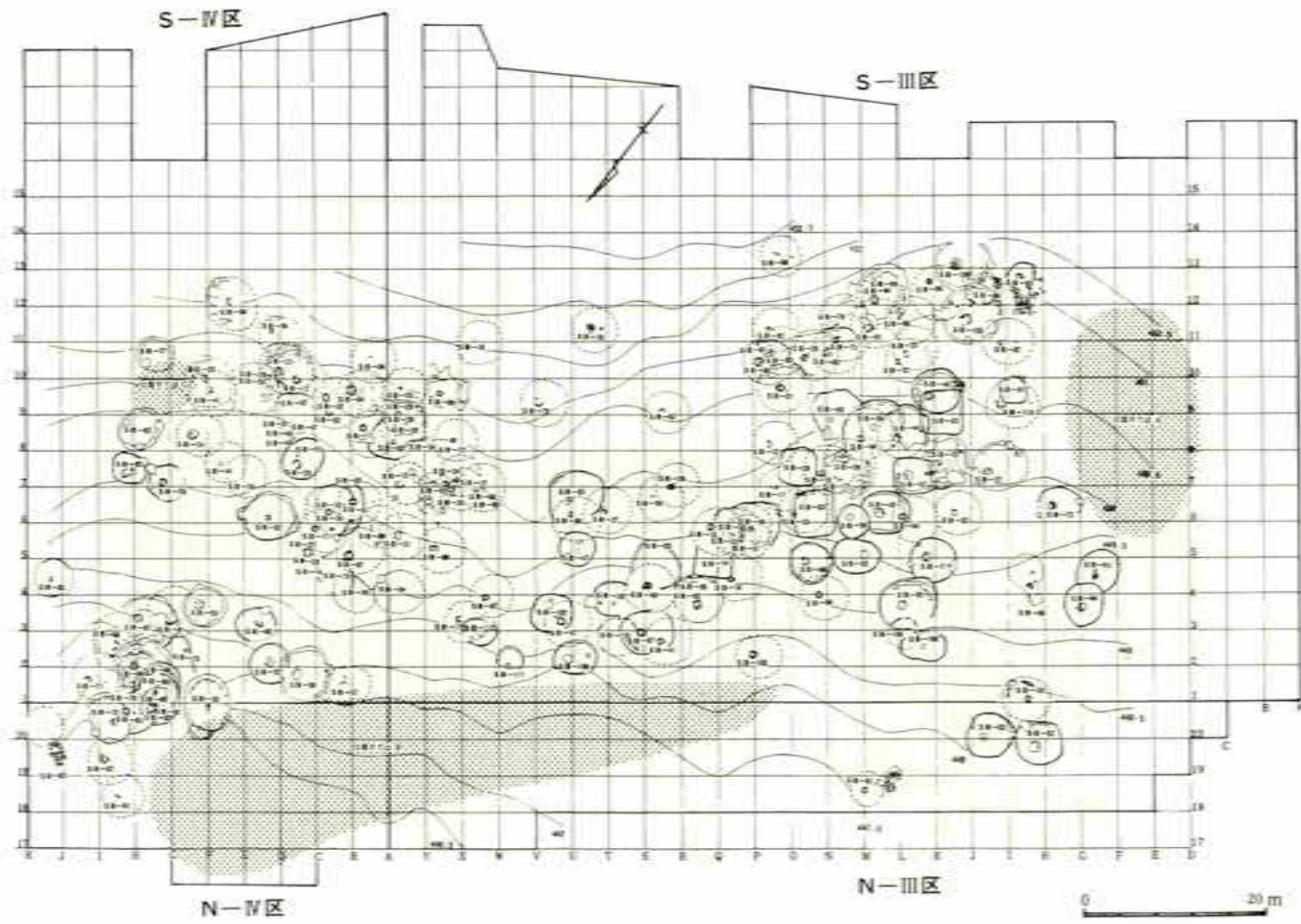

第 2 图 积善堂 S-III 区 S-IV 区 N-III 区 N-IV 区 住居址全体图

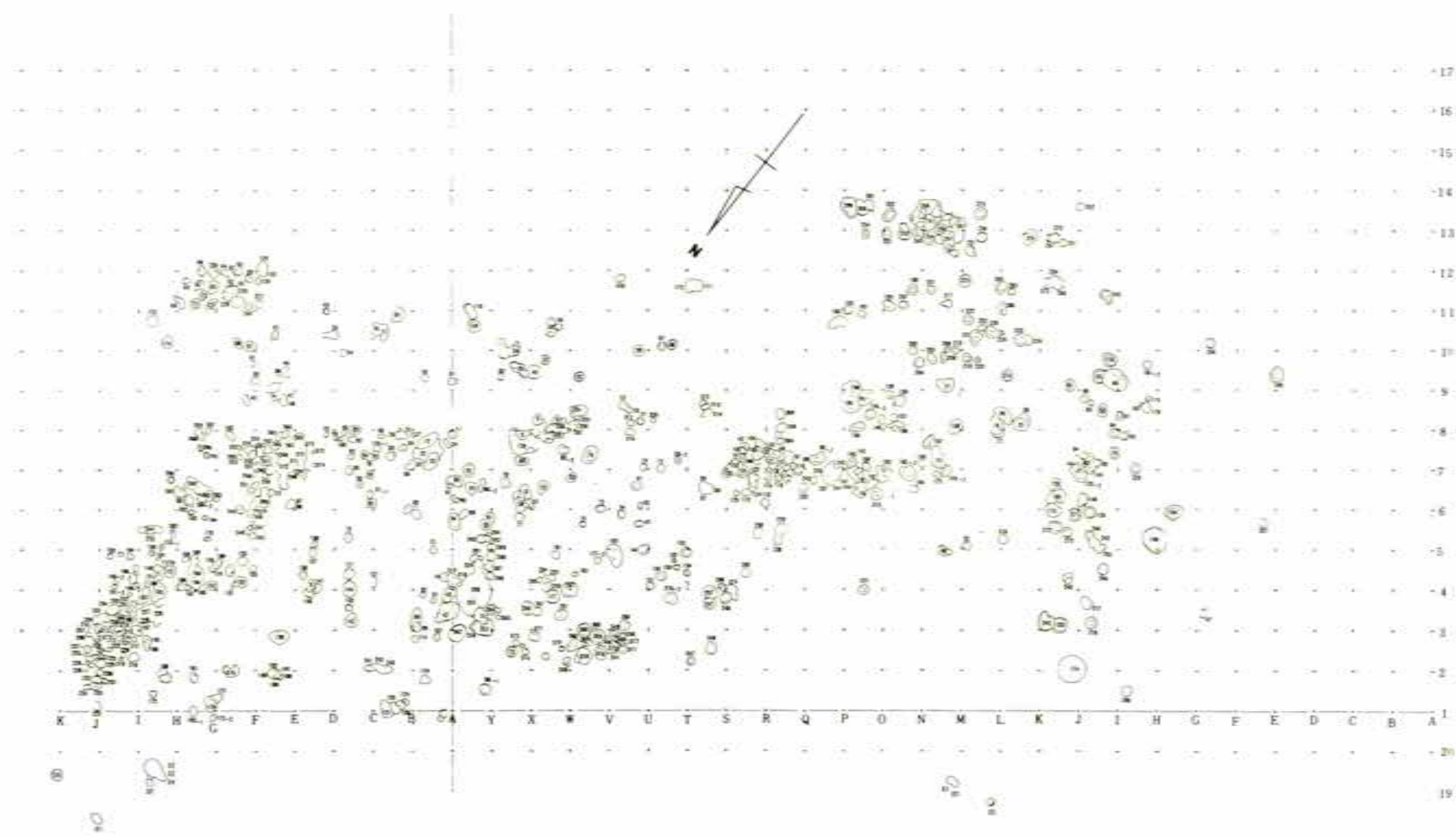

第 3 图 积迦堂 S-III 区 S-IV 区 N-III 区 N-IV 区 土壤全体图

20 m

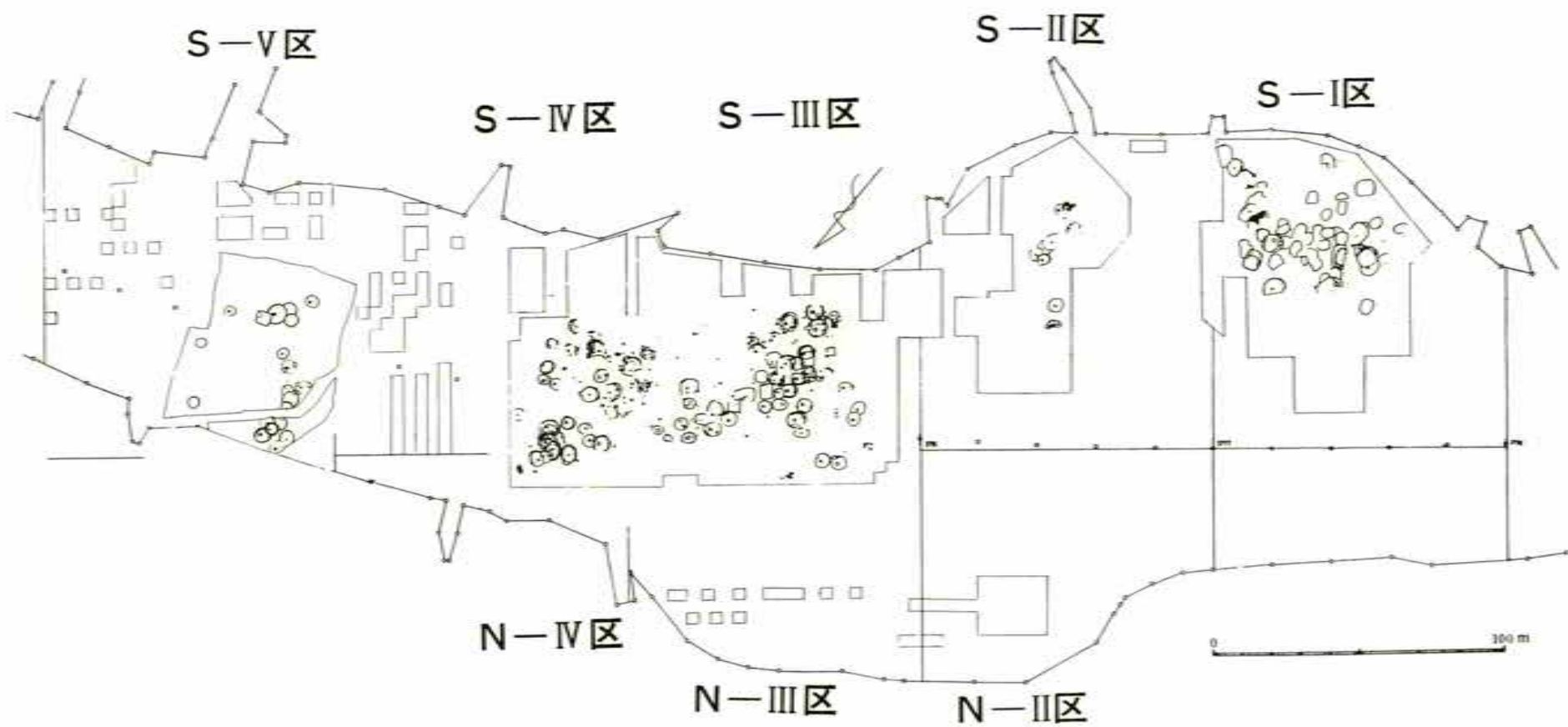

第 4 图 积逊堂遗址群总平面图

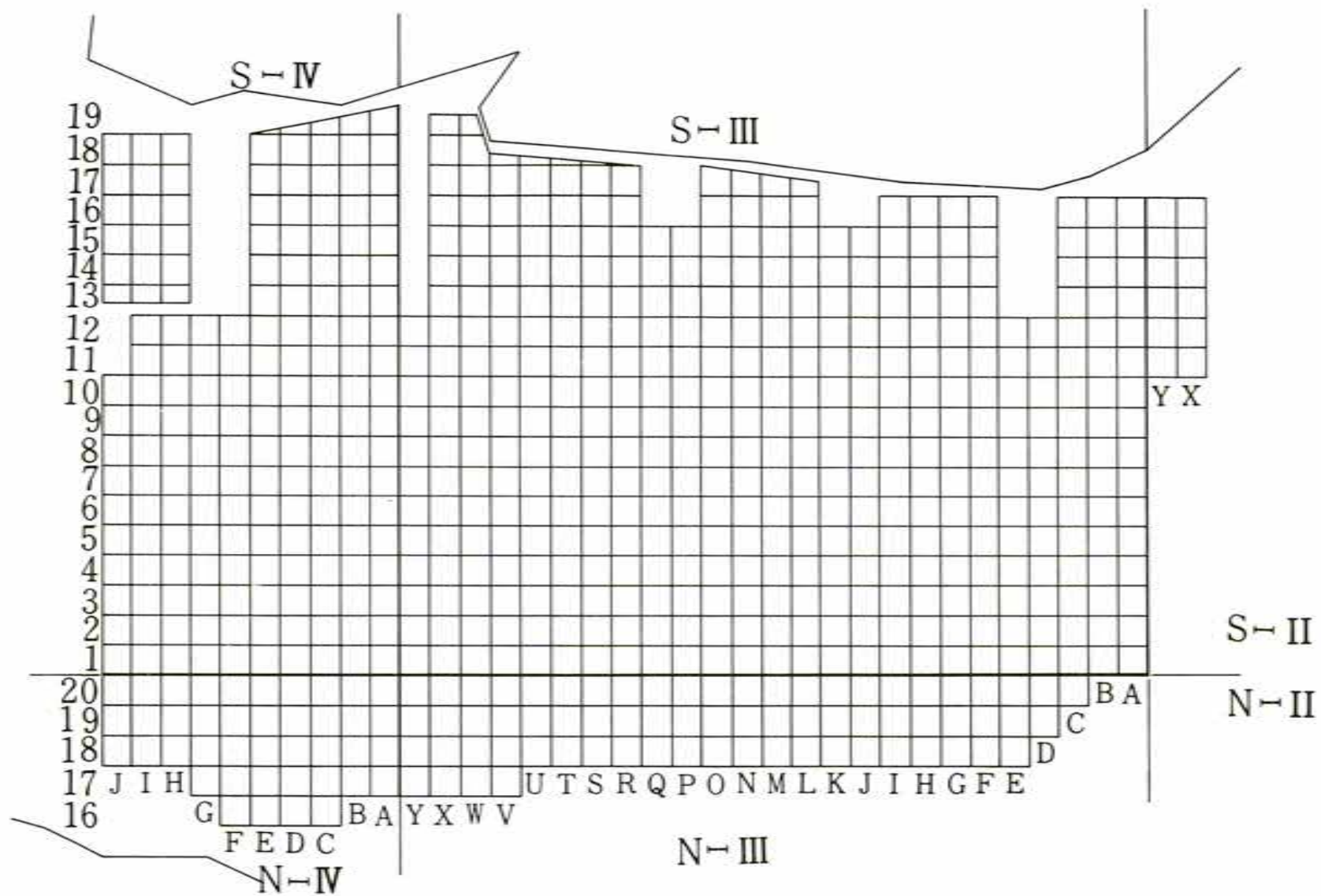

第 5 図 釈迦堂S-III区S-IV区N-III区N-IV区 グリッド配置図

积迦堂 S-III 区

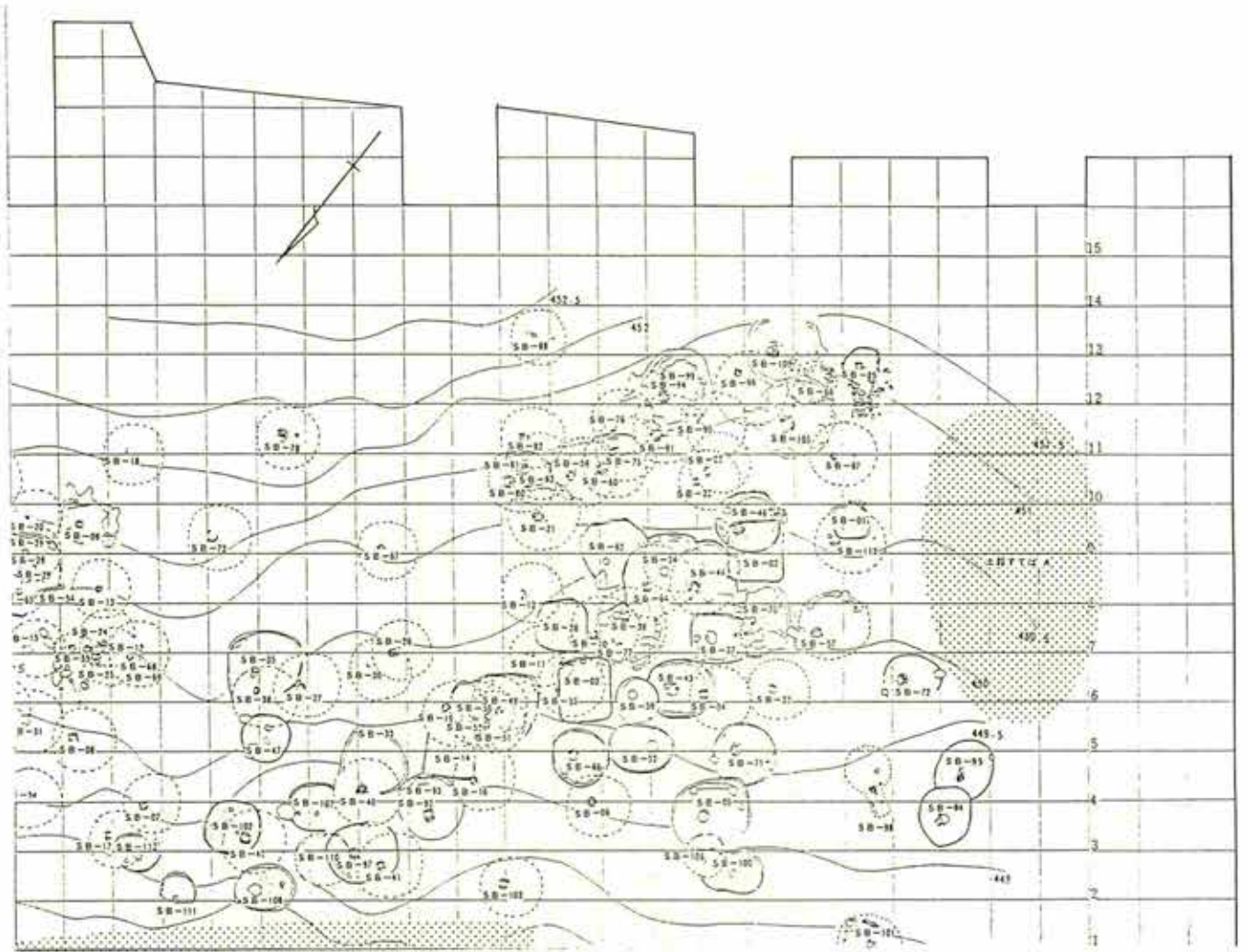

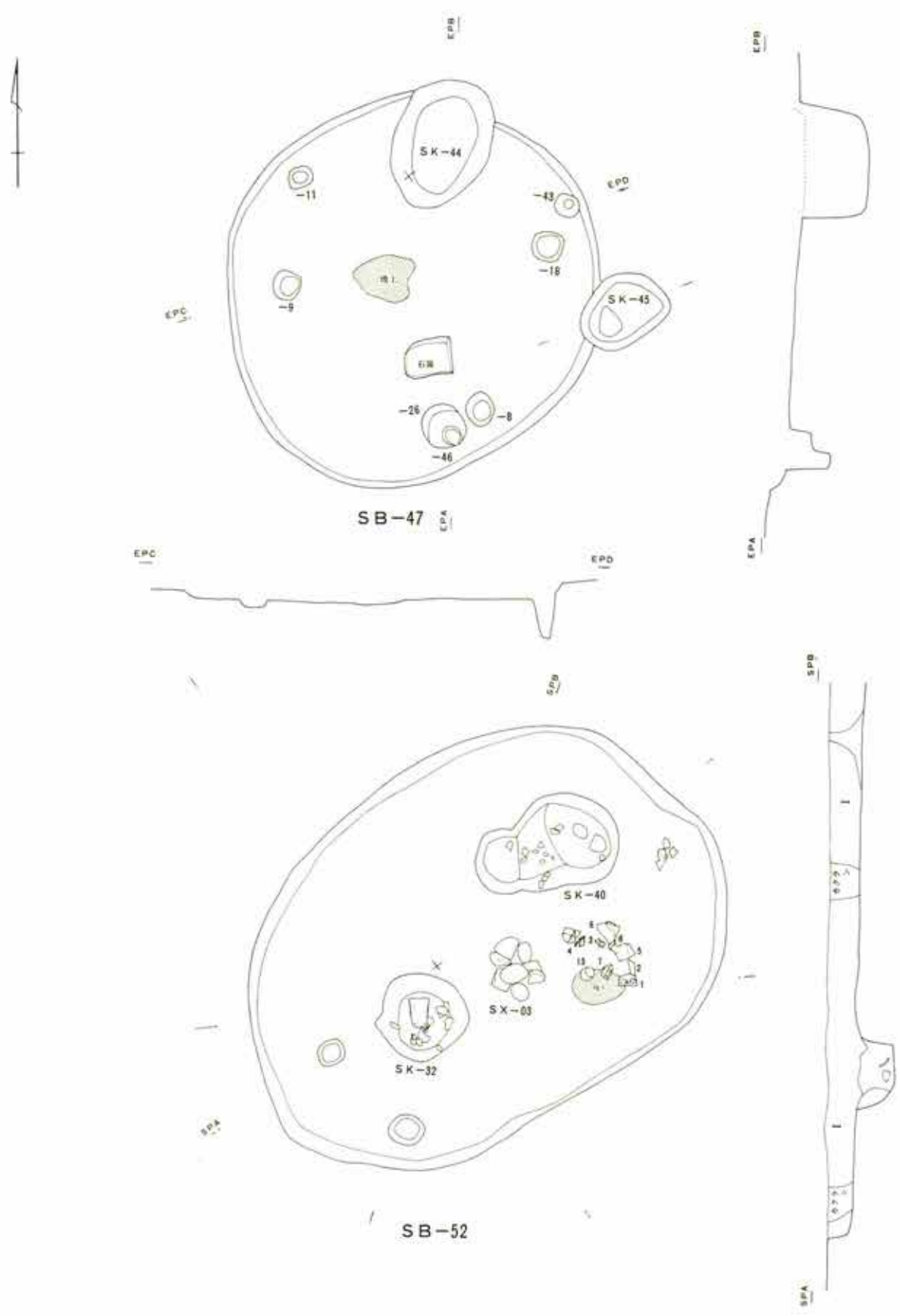

第 6 图 积迦堂S—III区 SB-47 -52

(1:60)

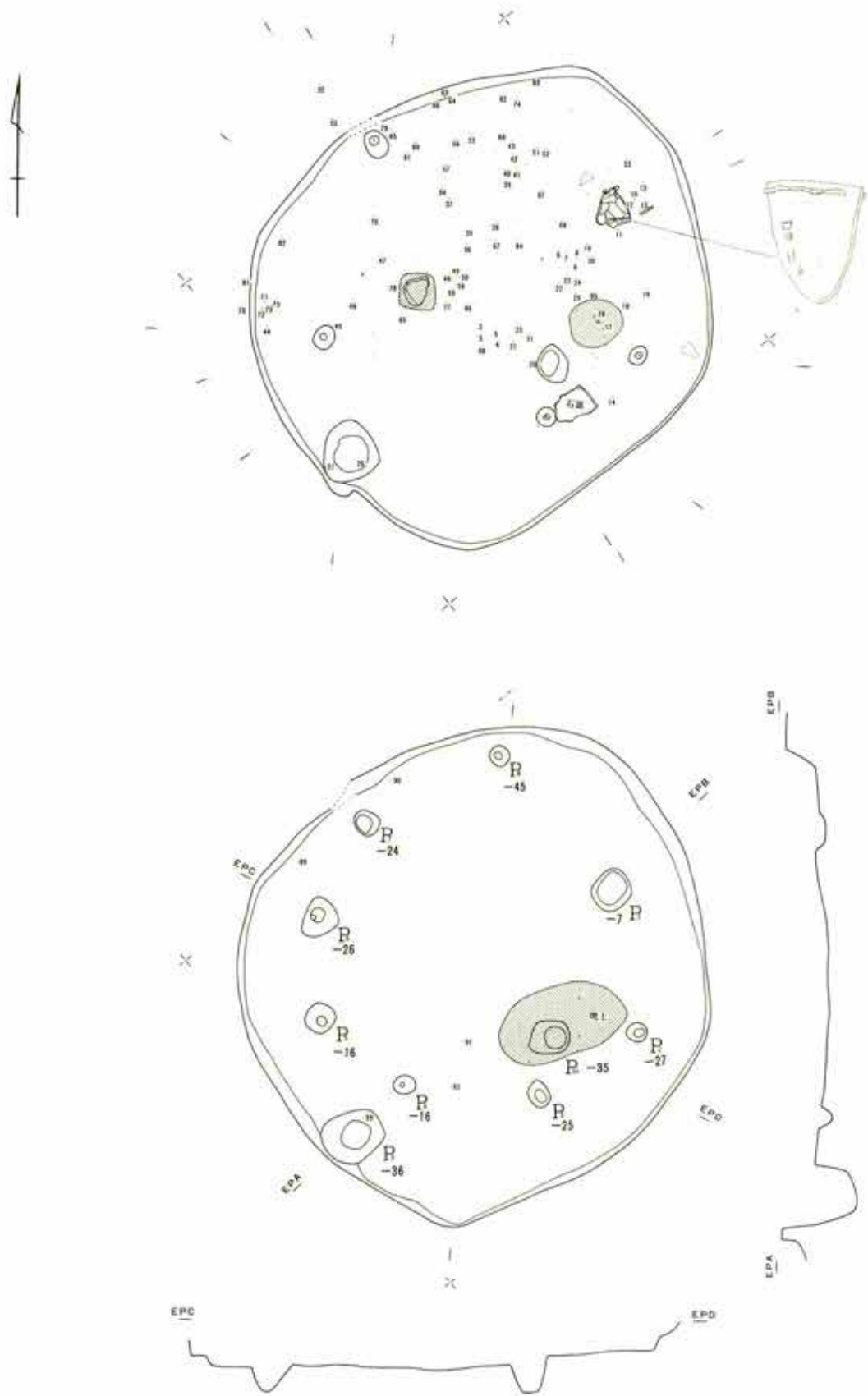

第 7 图 积善堂 S-III 区 SB-102

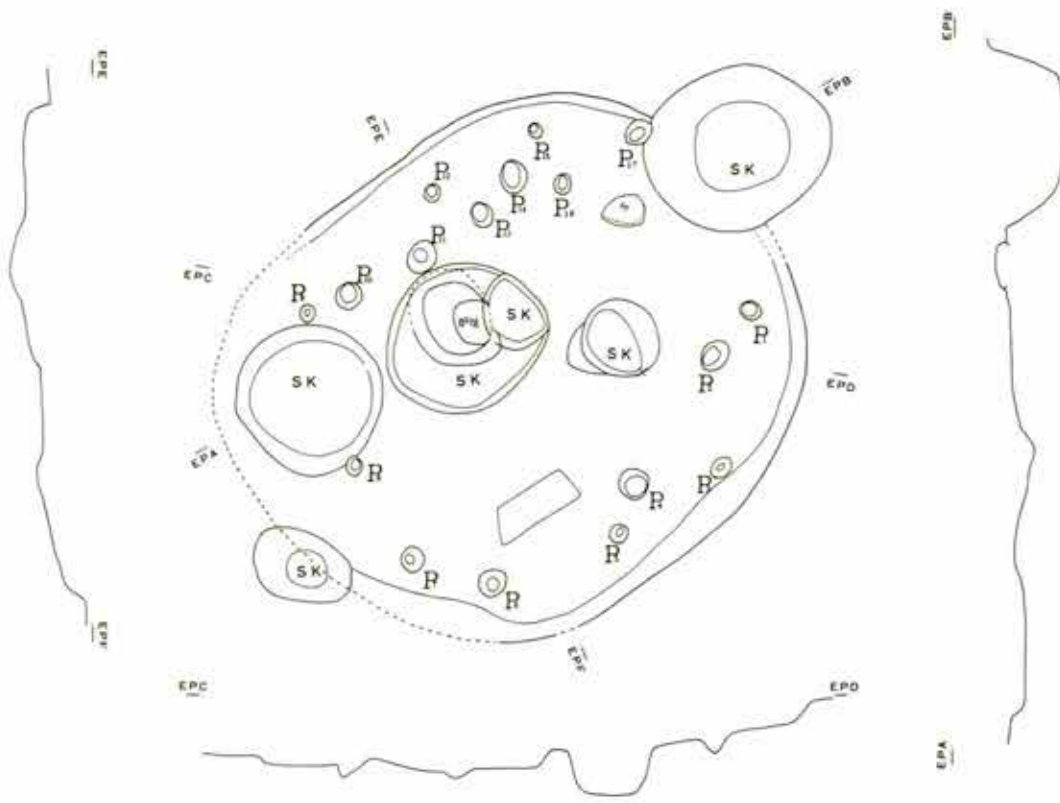
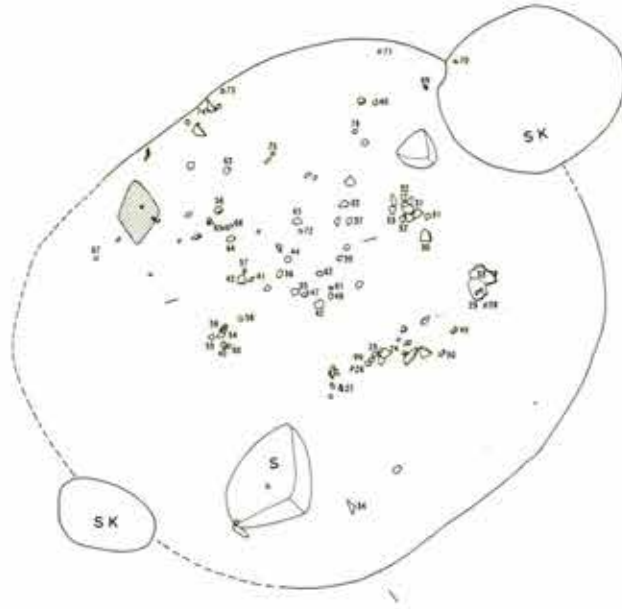

第 8 図 釈迦堂S-III区 SB-107

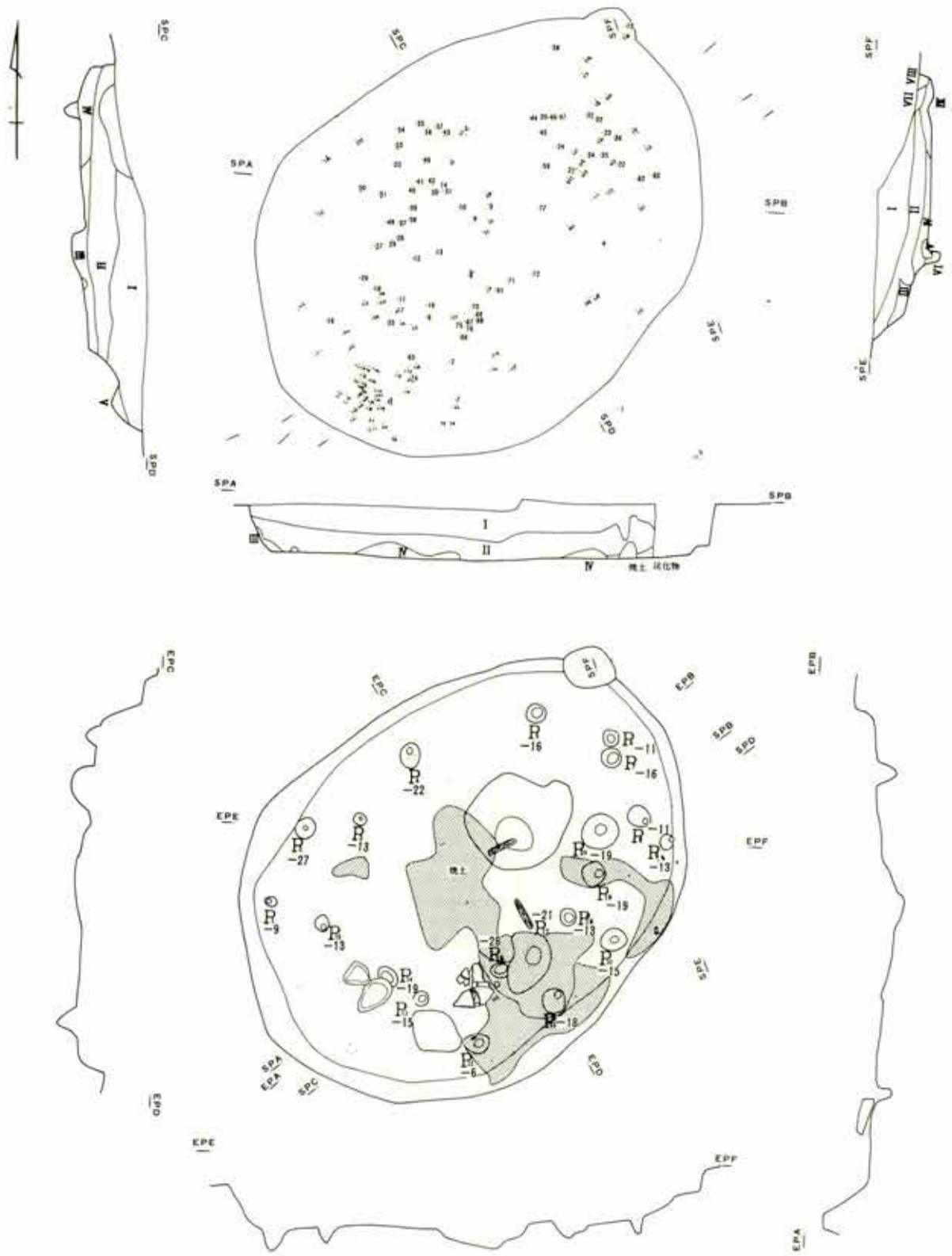

第 9 图 积迦堂 S-III 区 SB-108

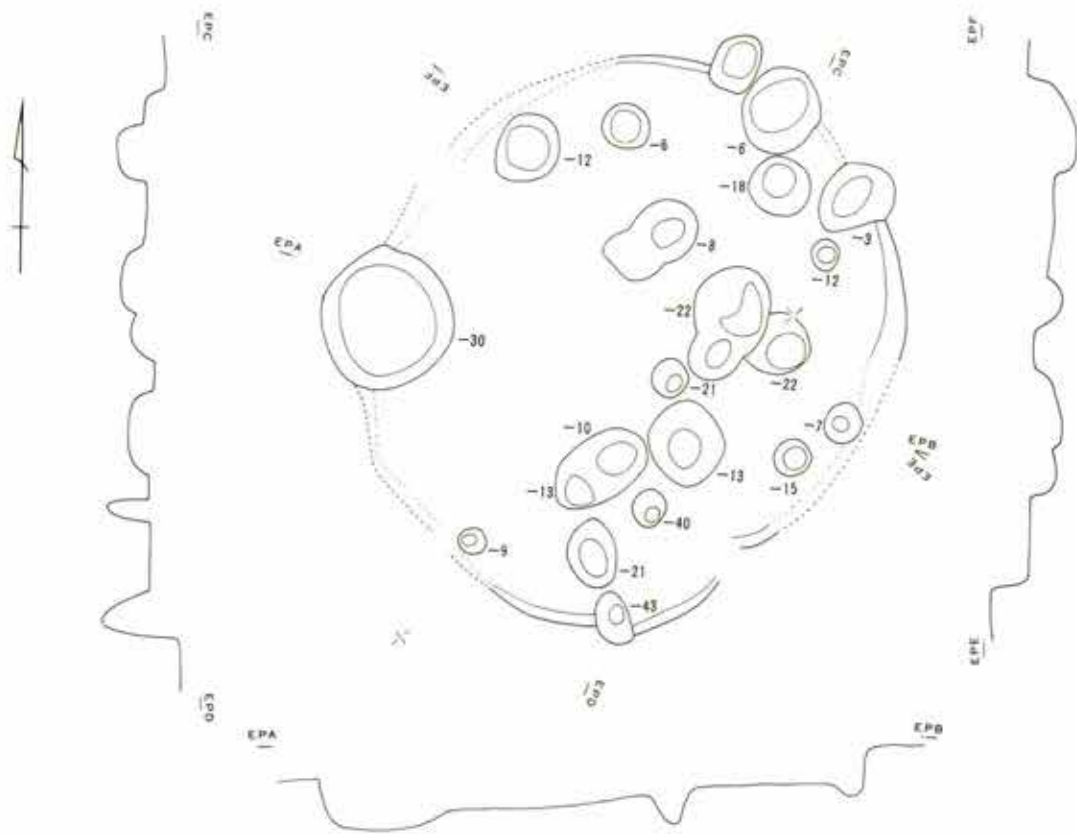

第 10 图 积逊堂 S-III 区 SB-110

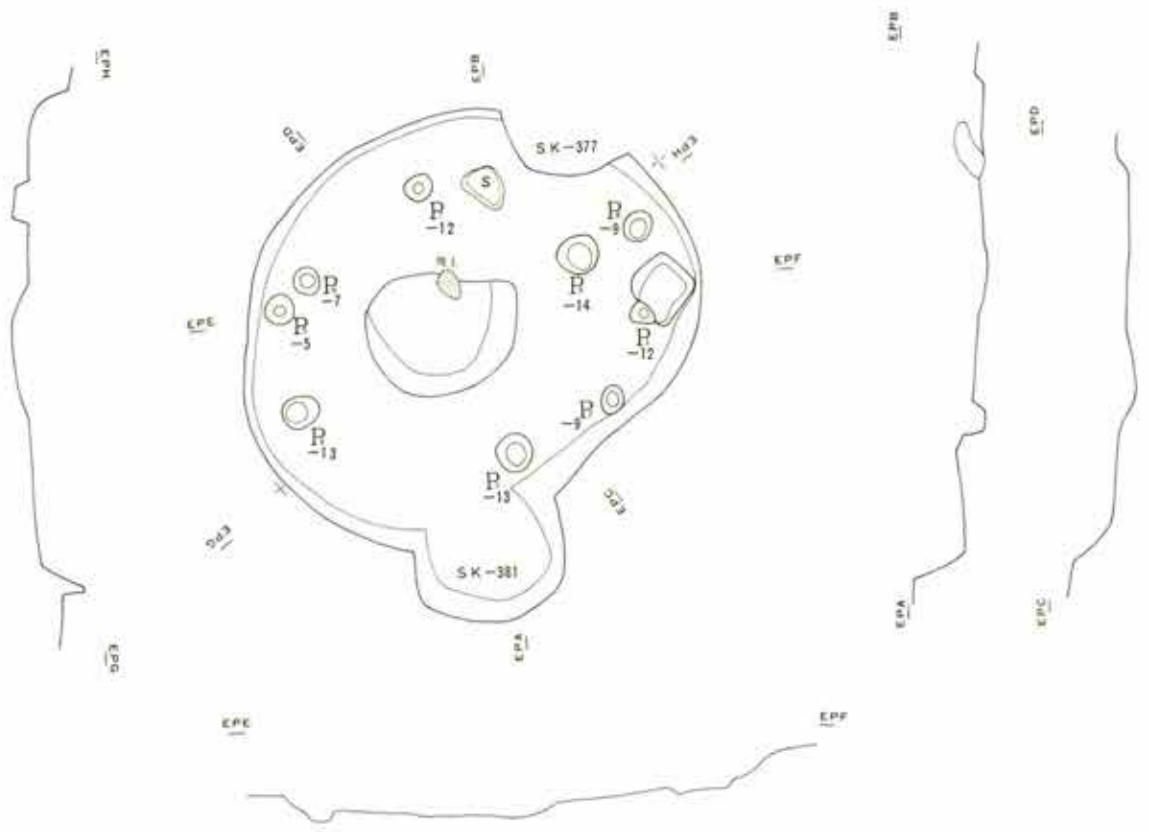
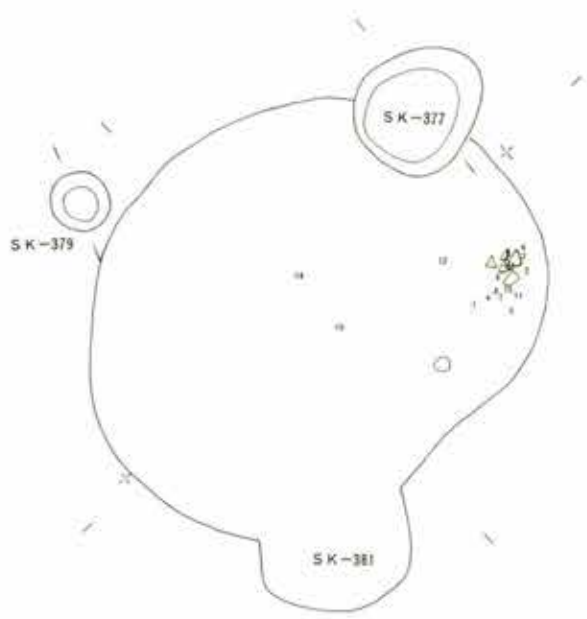

第 11 区 积迦堂 S-III 区 SB-112



第 12 图 积善堂 S-III 区 SB-29-1.2

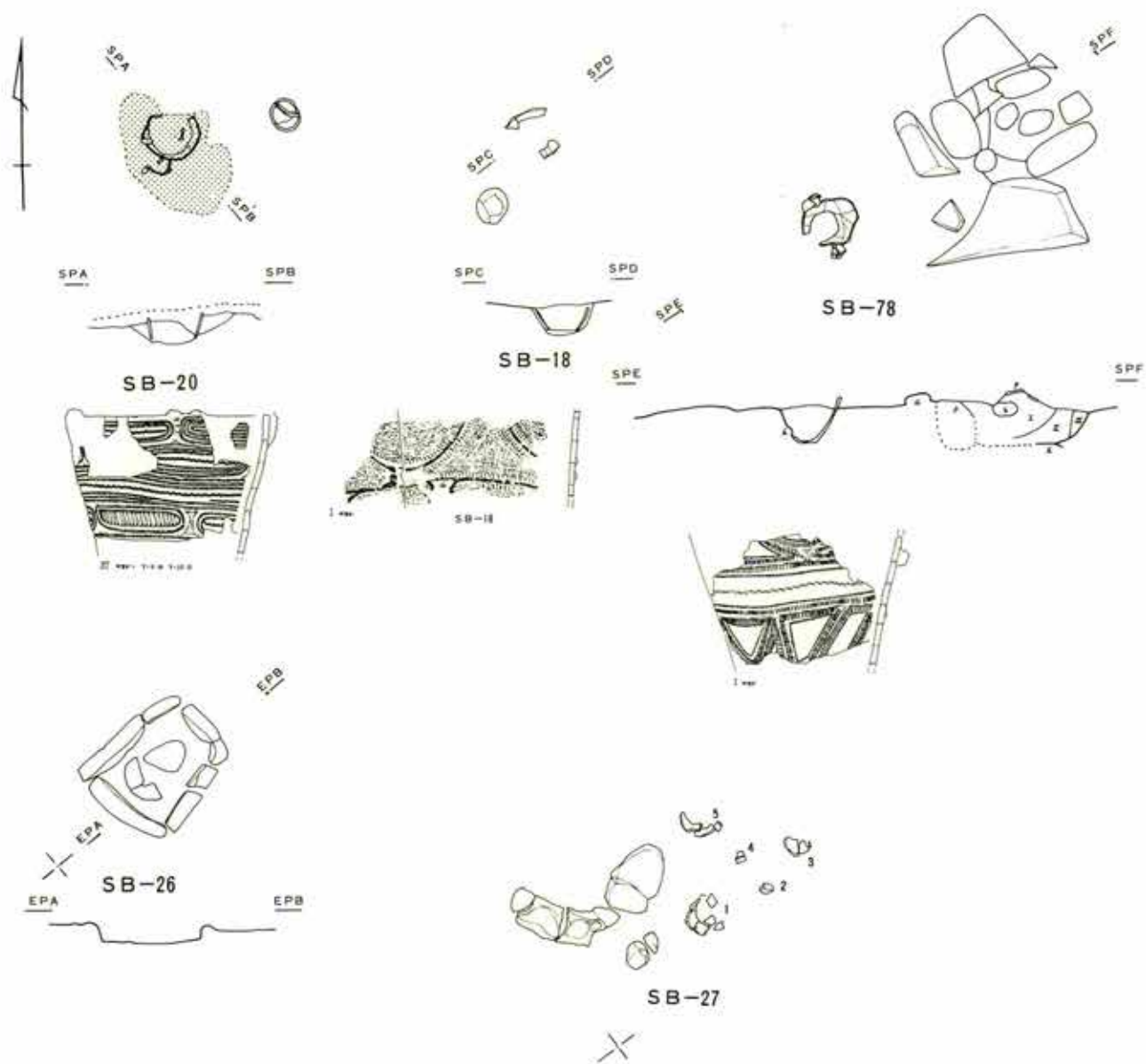

第 13 图 积迦堂 S-III 区 SB-20 -18 -78 -26 -27

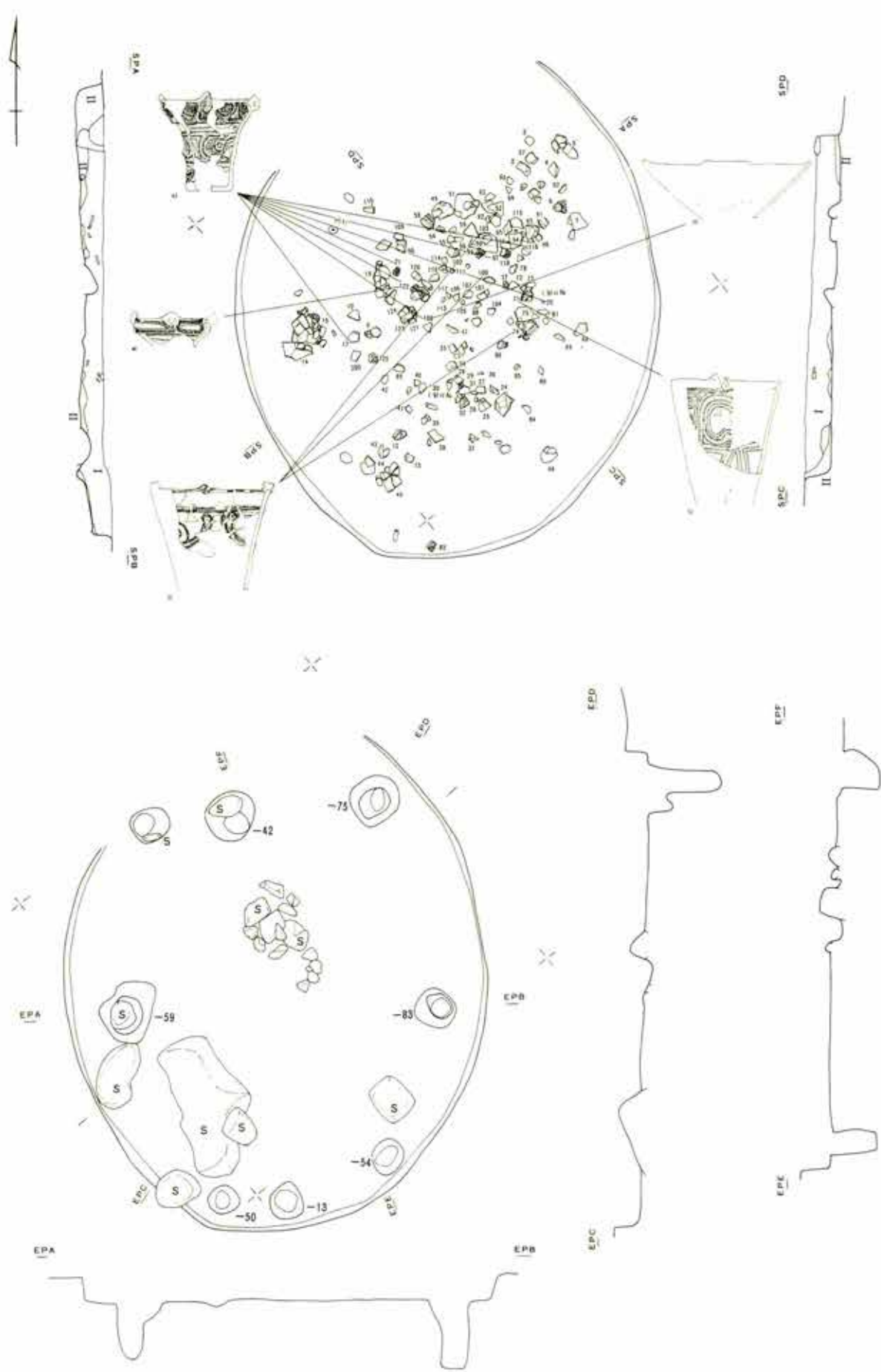

第 14 图 积逊堂 S-III 区 SB-95

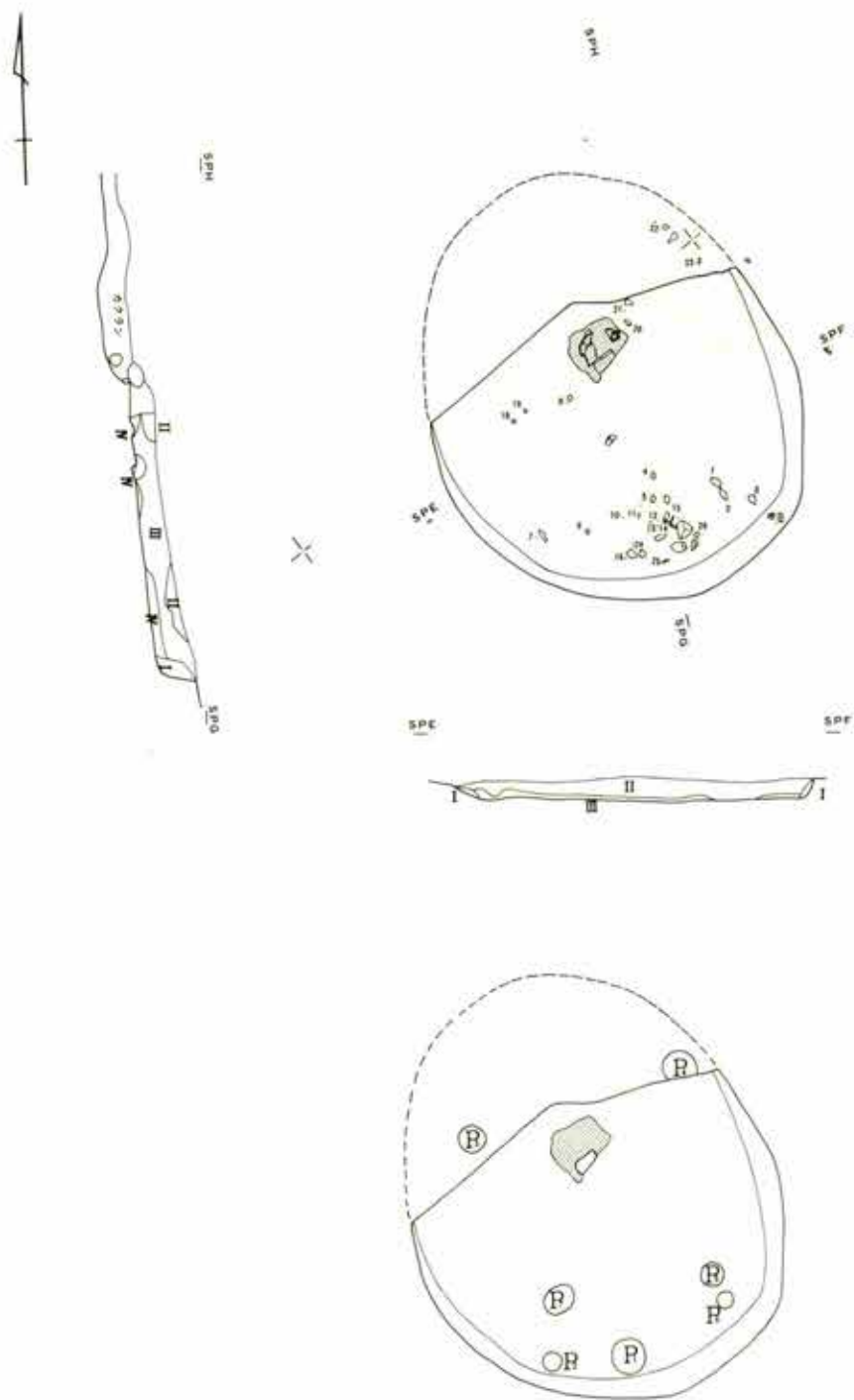

第 15 图 积迦堂 S-III 区 SB-111

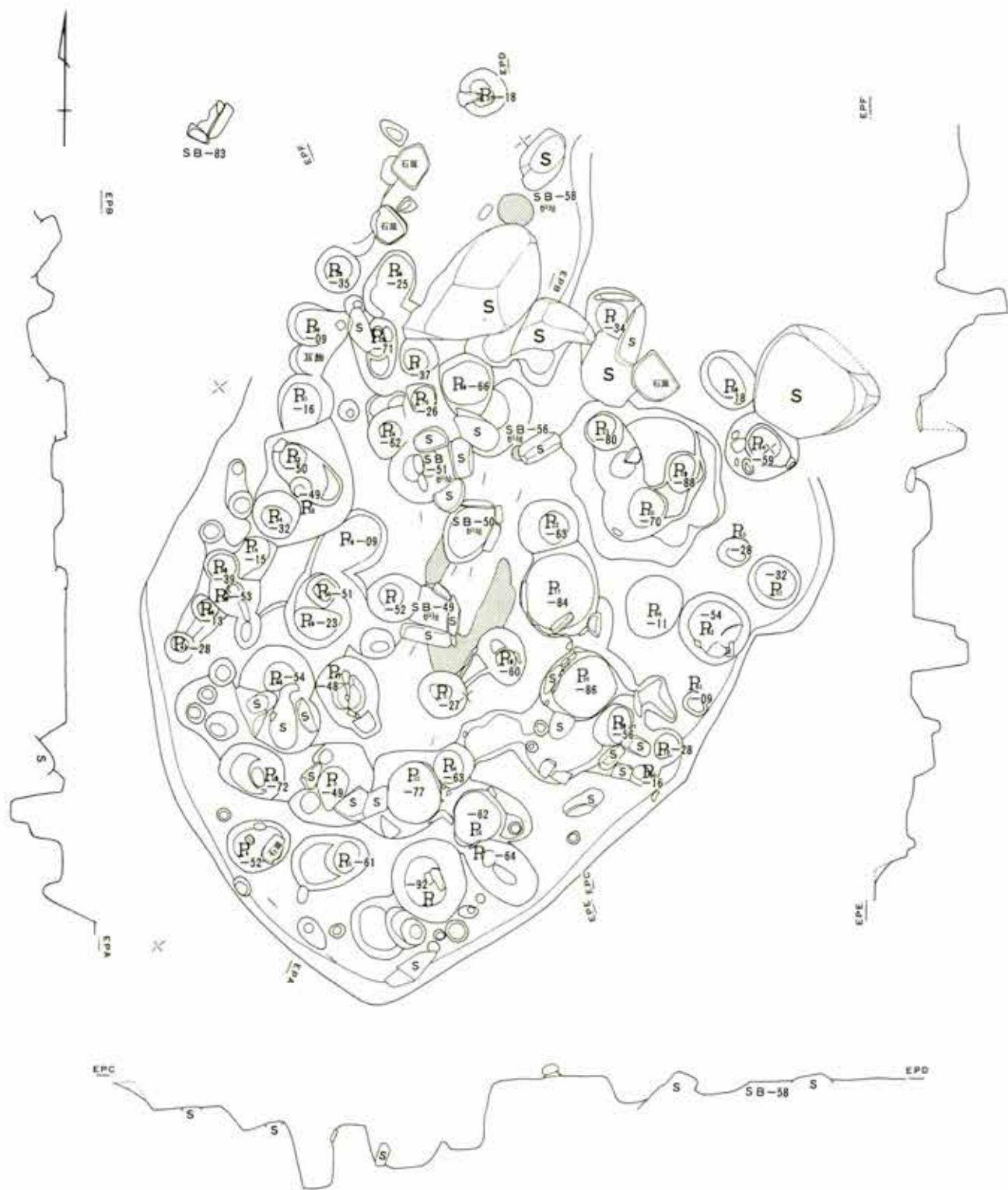

第 16 图 积迦堂 S-III 区 SB-48-49-50-51-56-58

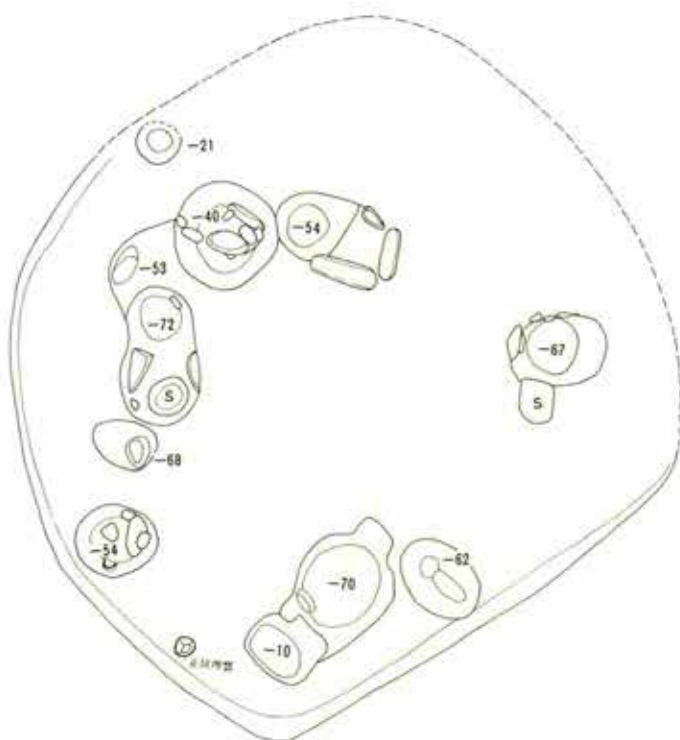

SB-49

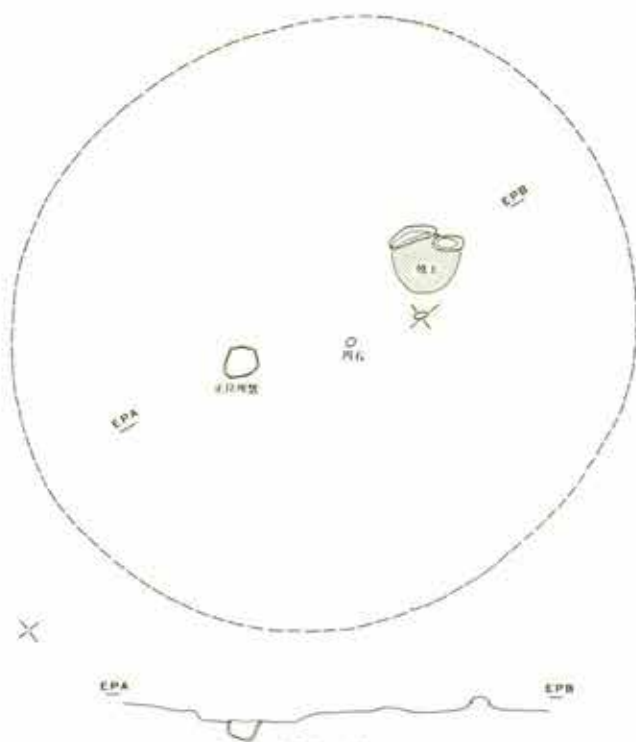

SB-87

第 17 图 积逊堂 S-III 区 SB-49-87

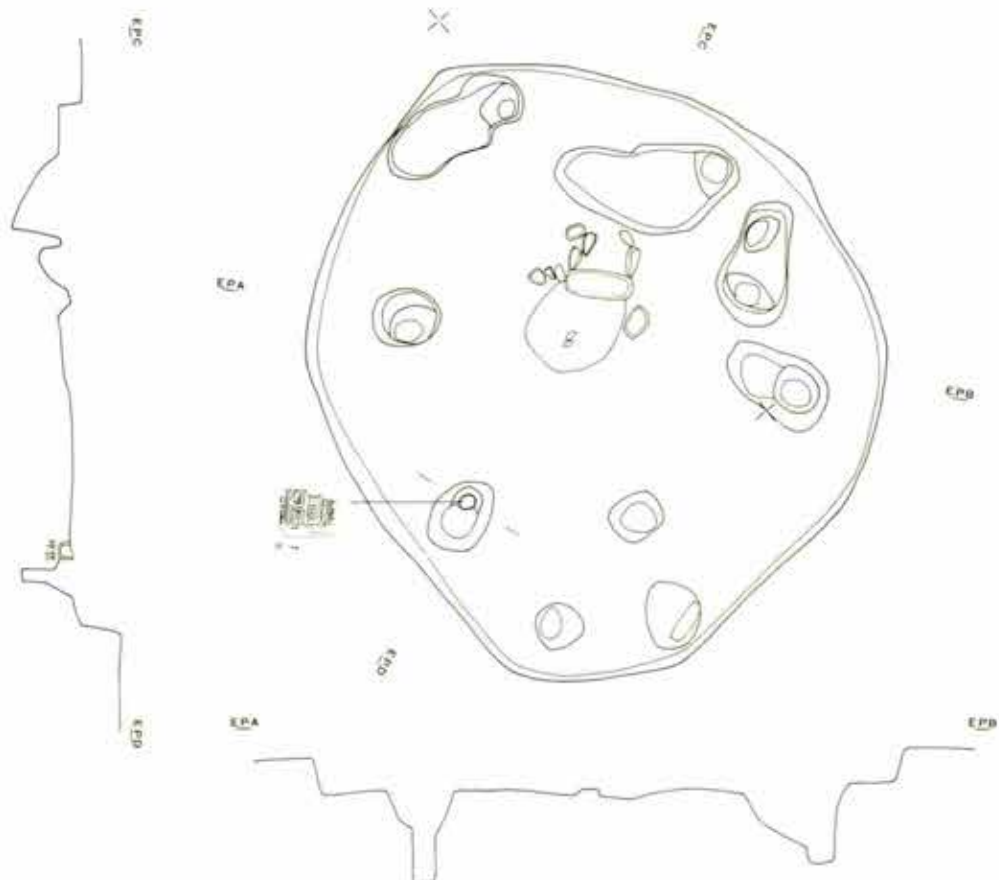
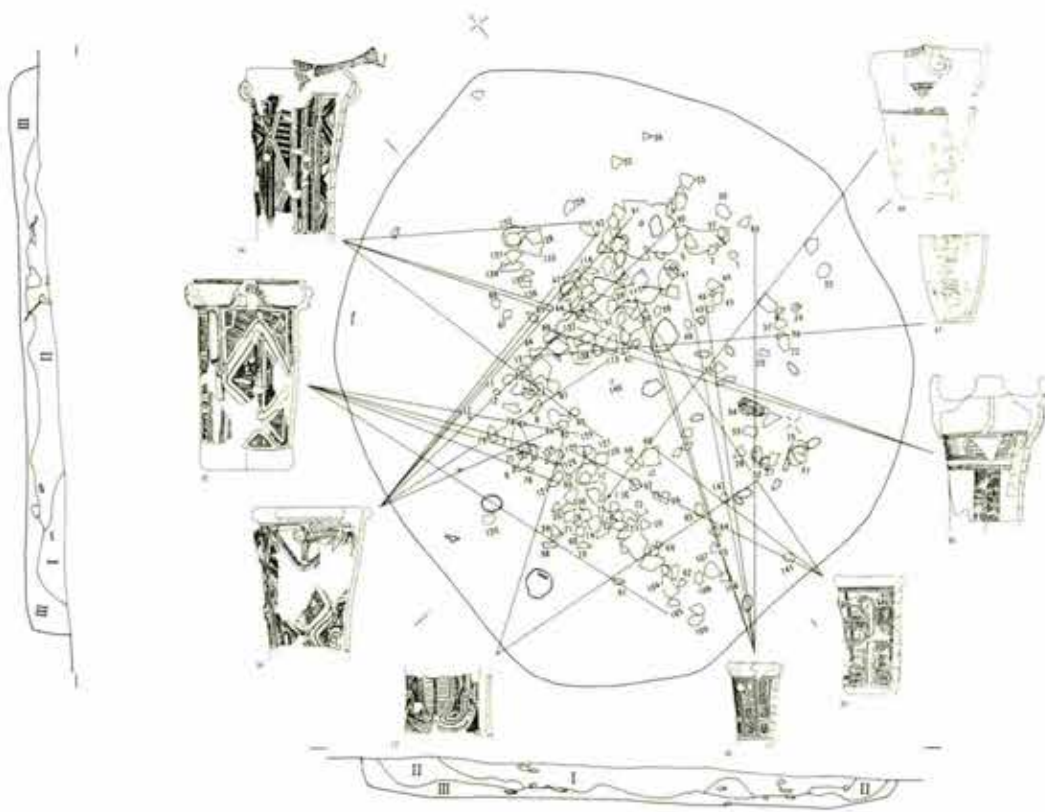

第 18 图 积迦堂S-III区 SB-84

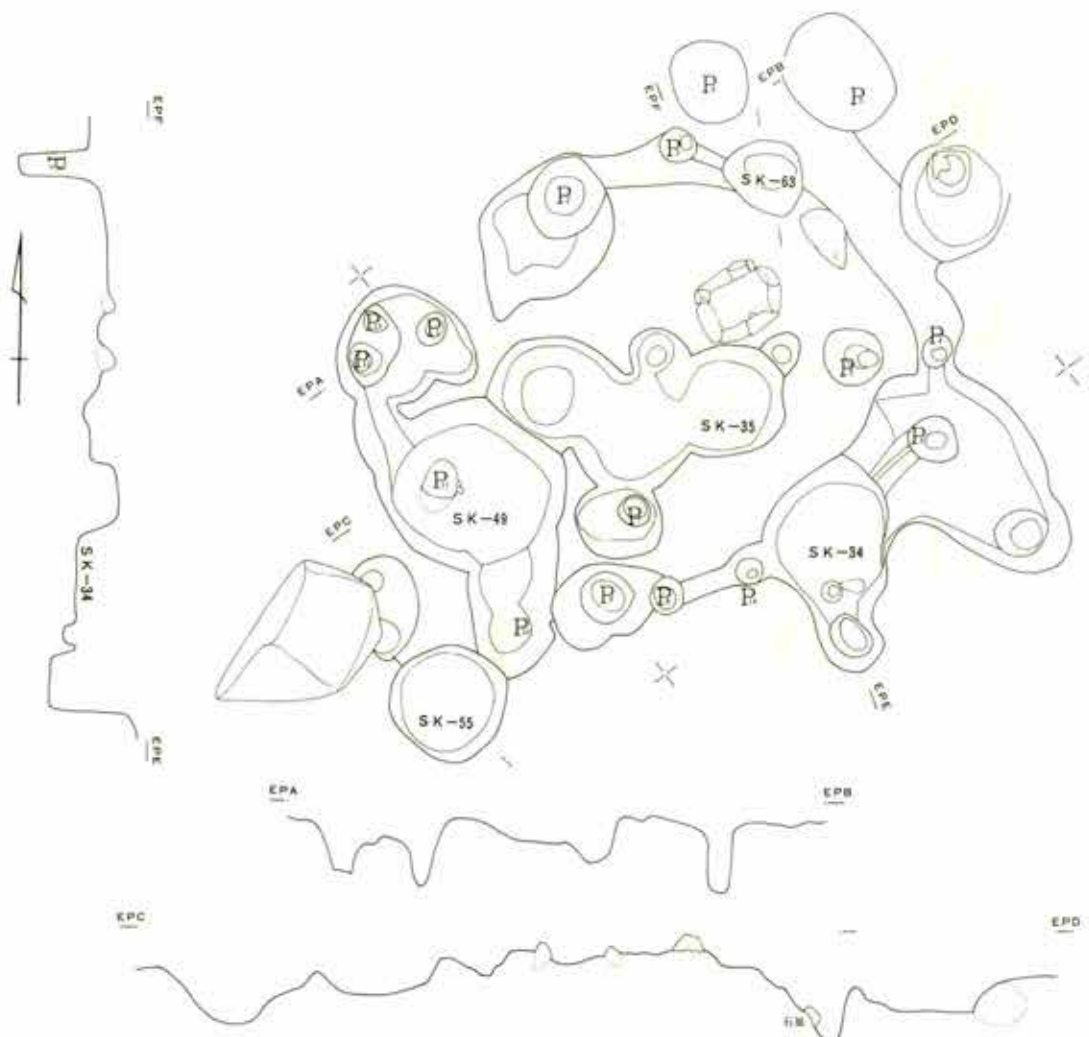

第 19 图 积迦堂 S-III 区 SB-09

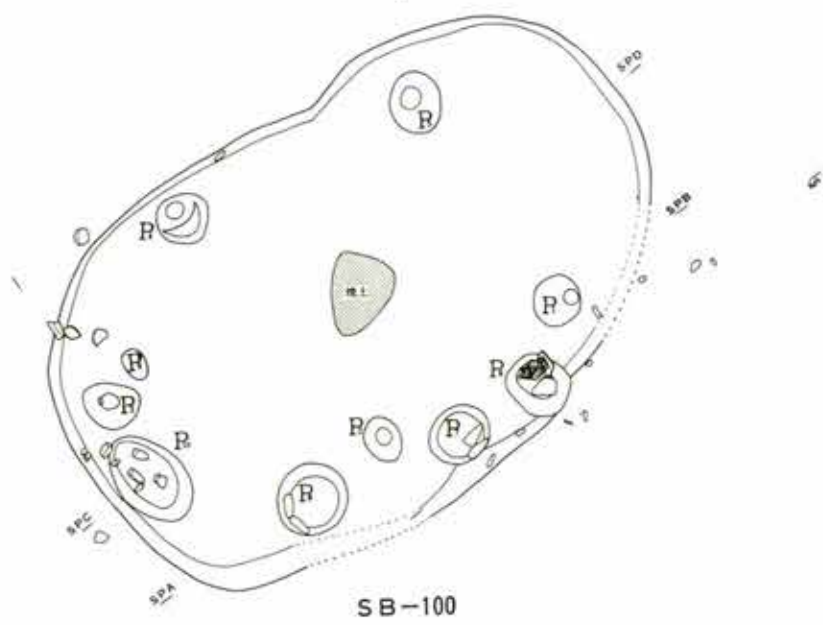

SB-100

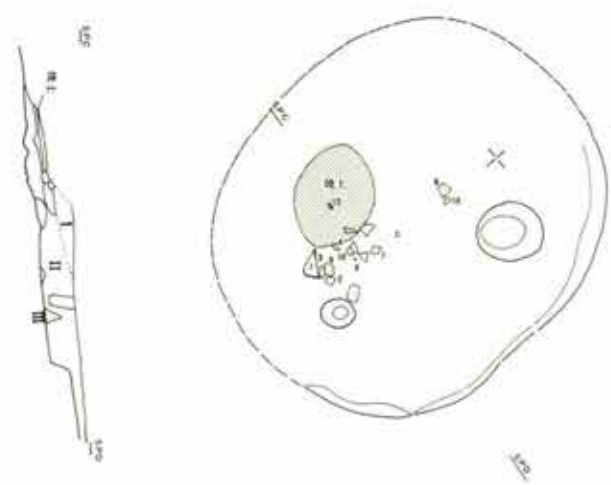
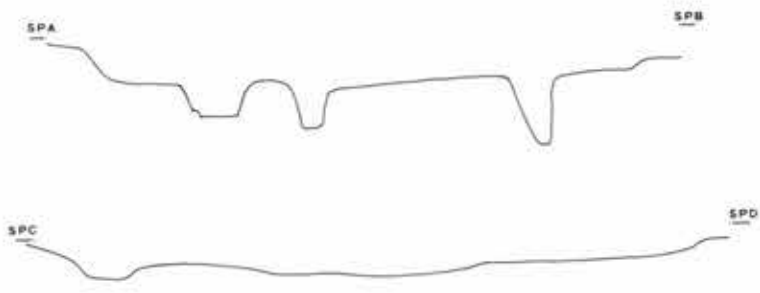

SB-106

第 20 图 积迦堂S-III区 SB-100-106

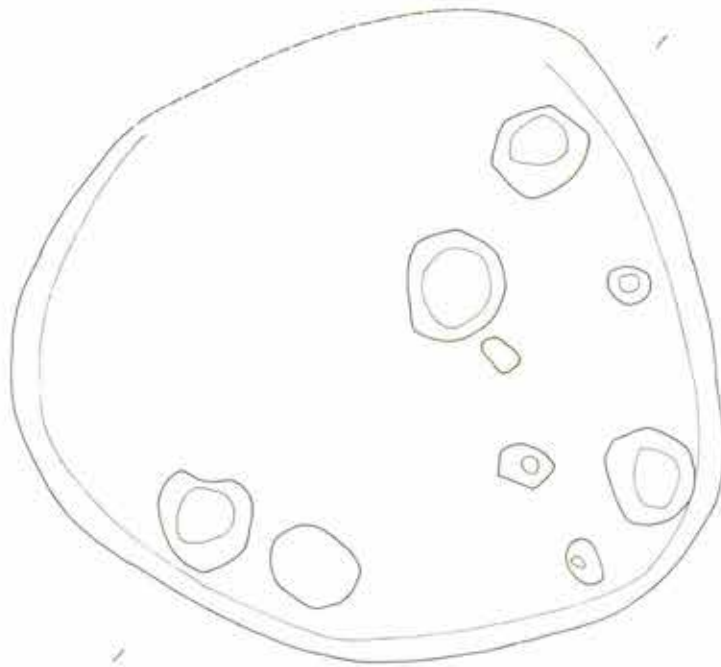
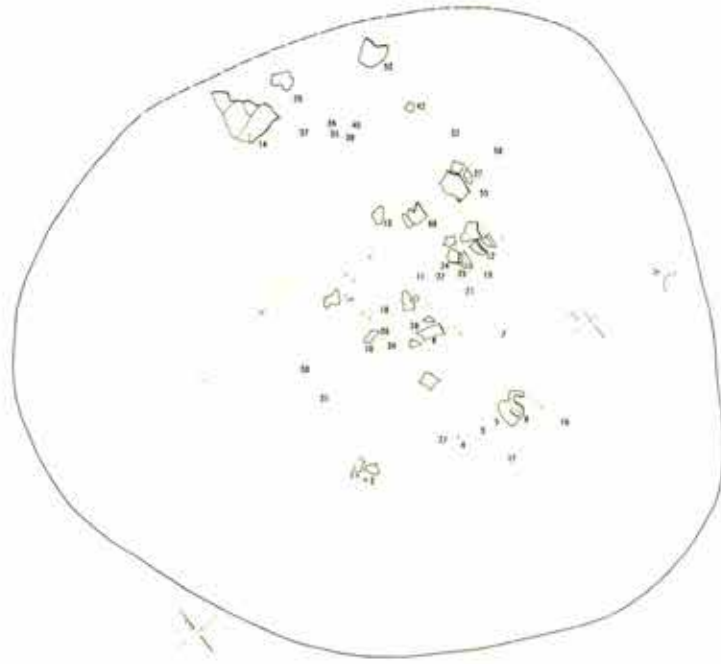

第 21 图 积迦堂 S-III 区 SB-33

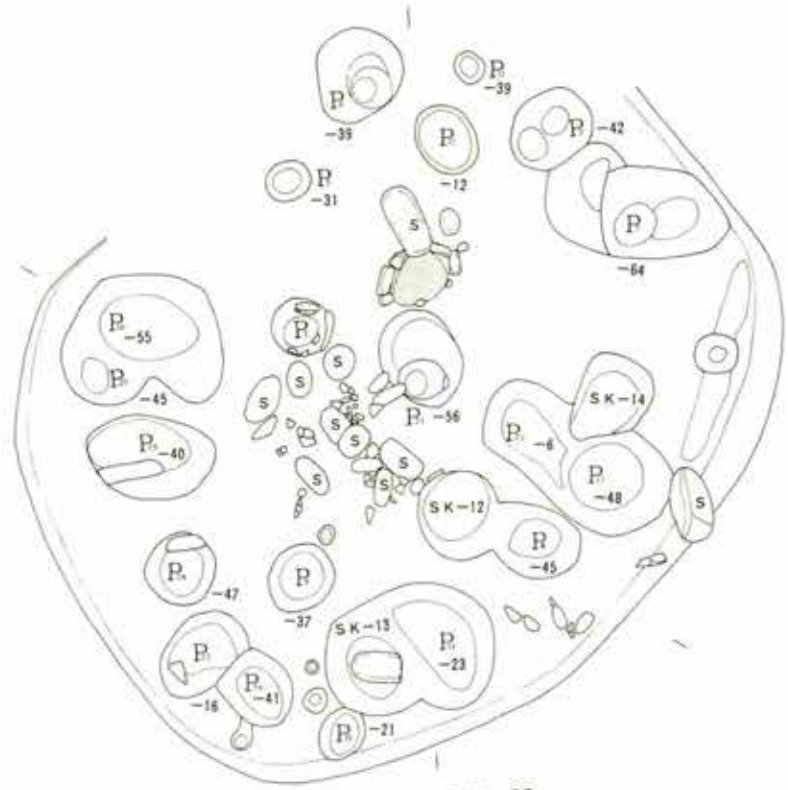

SB-35

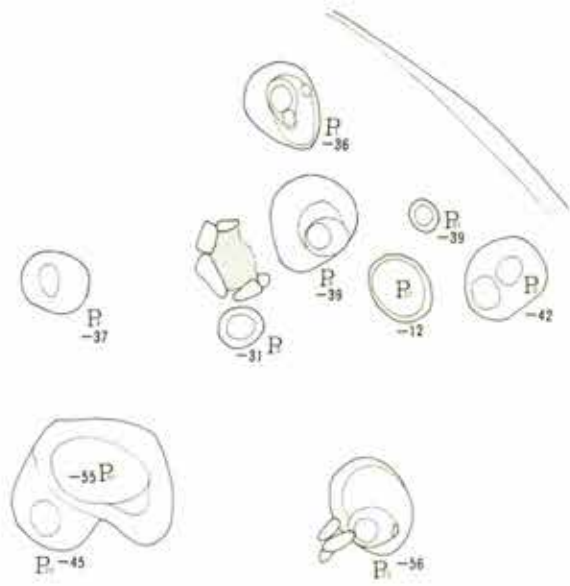

SB-38

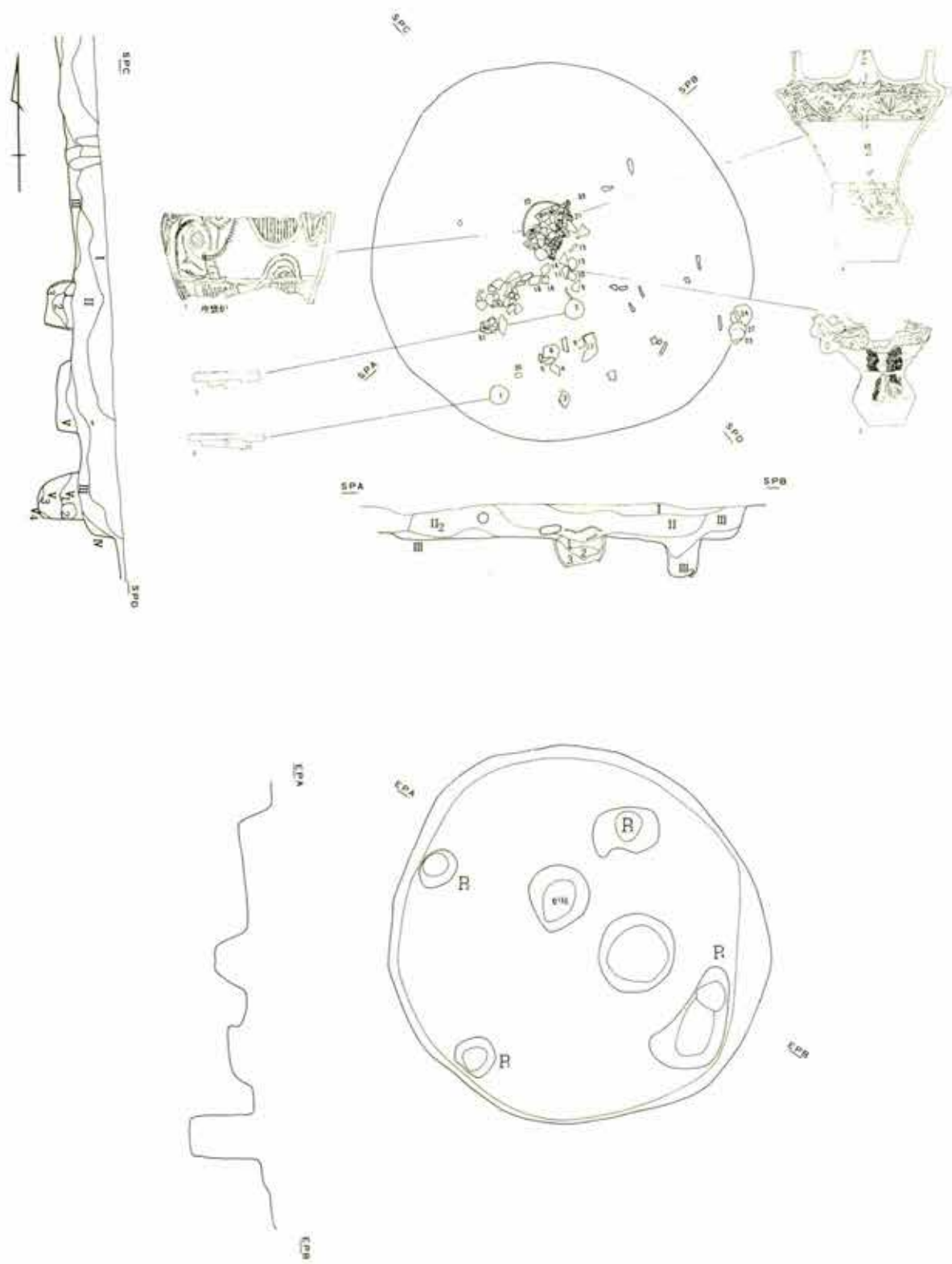

第 23 图 积迦堂 S-III 区 SB-36

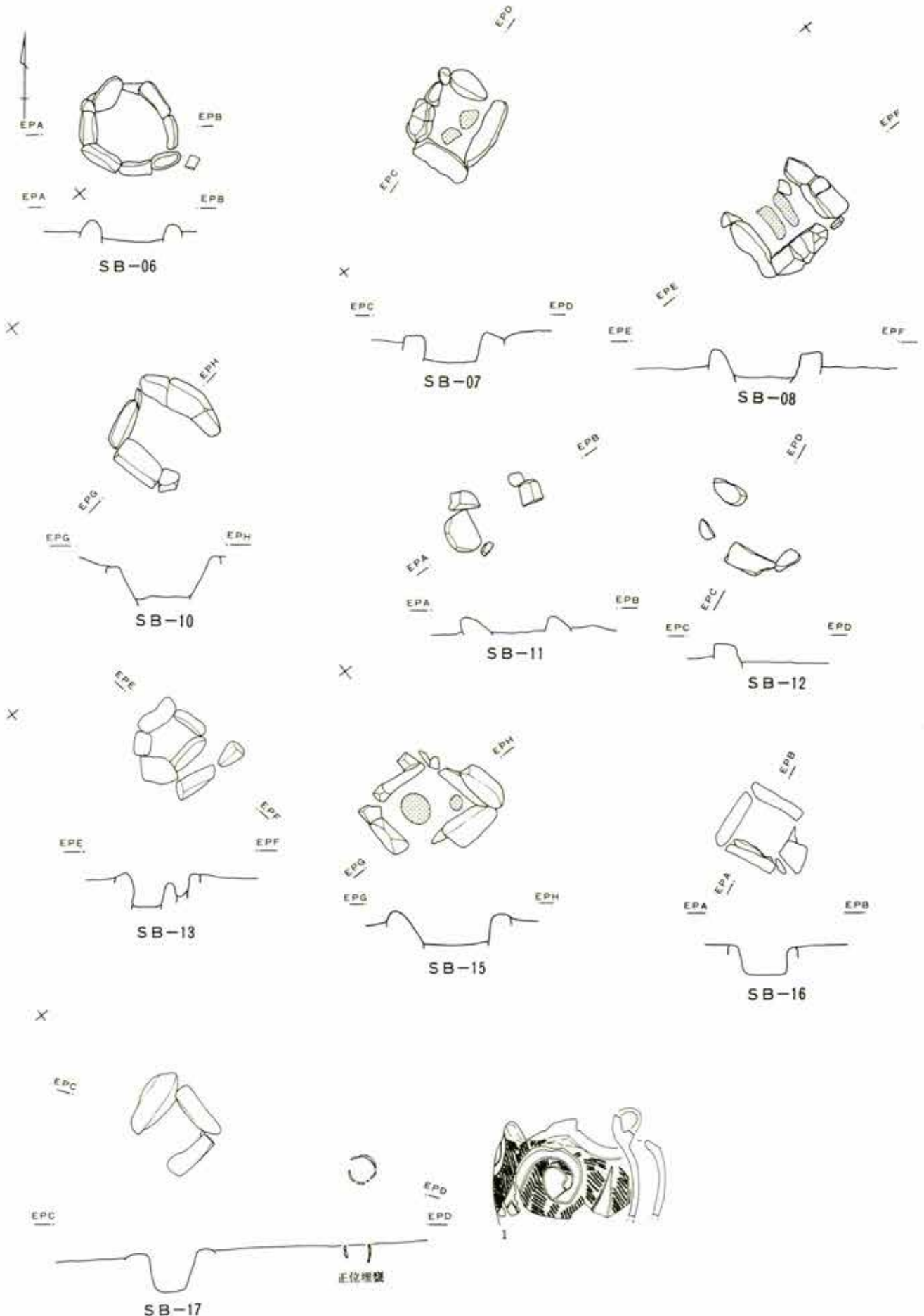

第 24 图 积迦堂 S-III 区 SB-06 -07 -08 -10 -11 -12 -13 -15 -16 -17

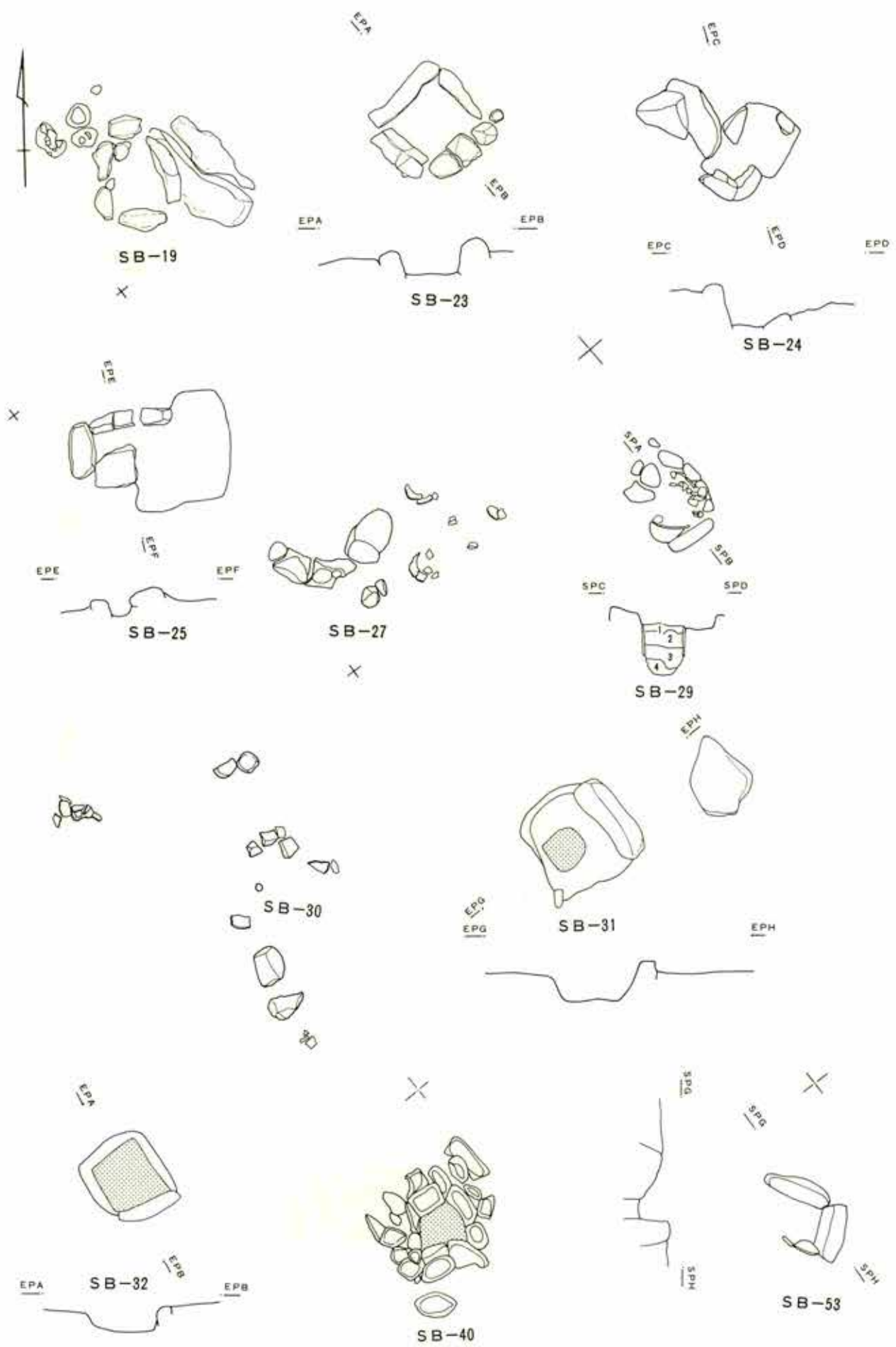

第 25 图 积迦堂 S-III 区 SB-19 -23 -24 -25 -27 -30 -31 -32 -40 -53

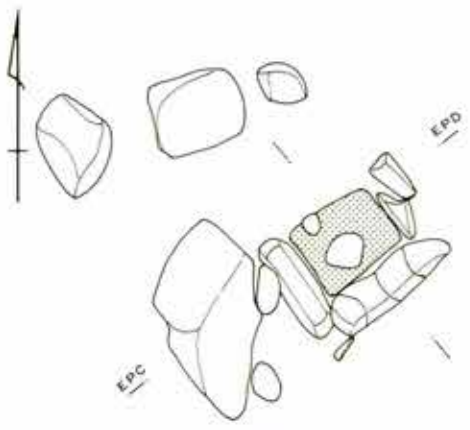

SB-63



SB-67



SB-73

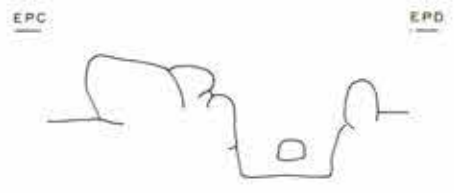

SB-83

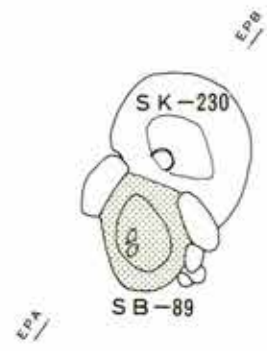

SB-89



SB-63

SK-192

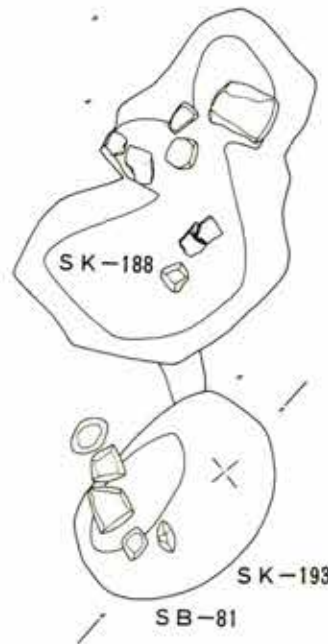

SK-188

SK-193

SB-81

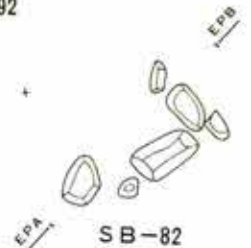

SB-82



第 26 图 积迦堂 S-III 区 SB-63 -67 -73 -82 -83 -89



第 27 图 积逊堂 S-III 区 SB-04

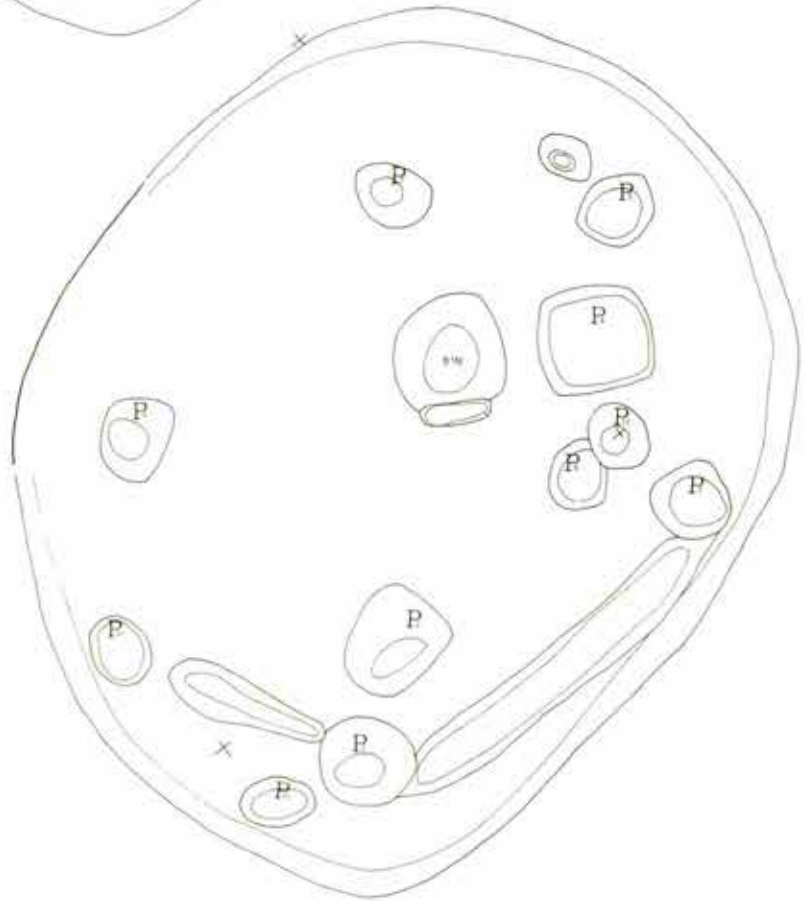
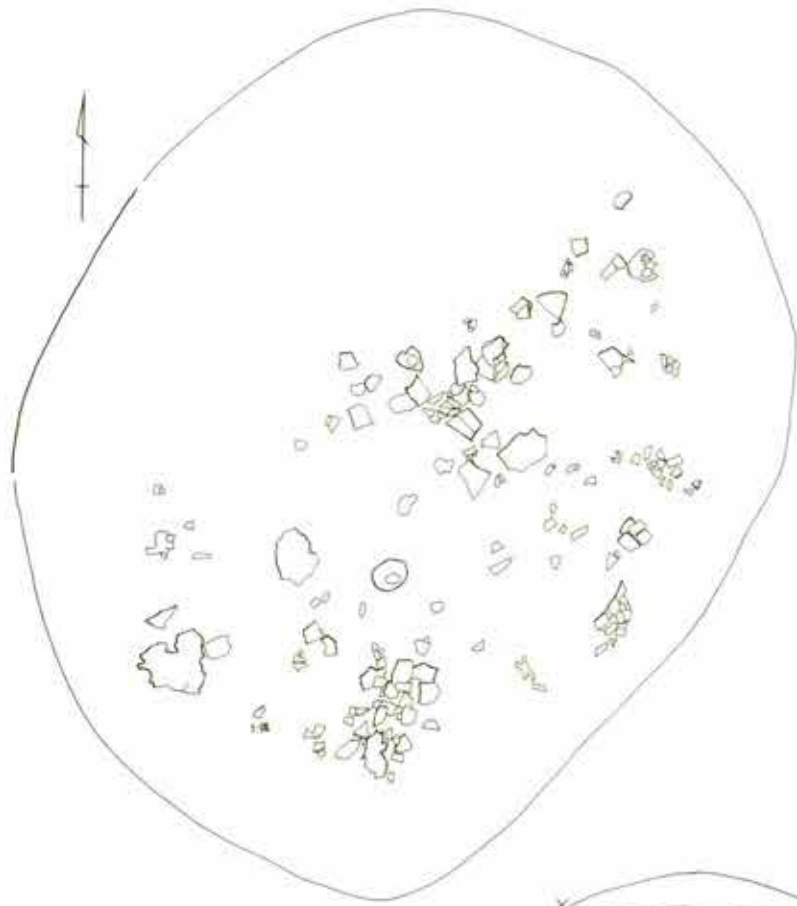

第 28 图 积迦堂 S-III 区 SB-05

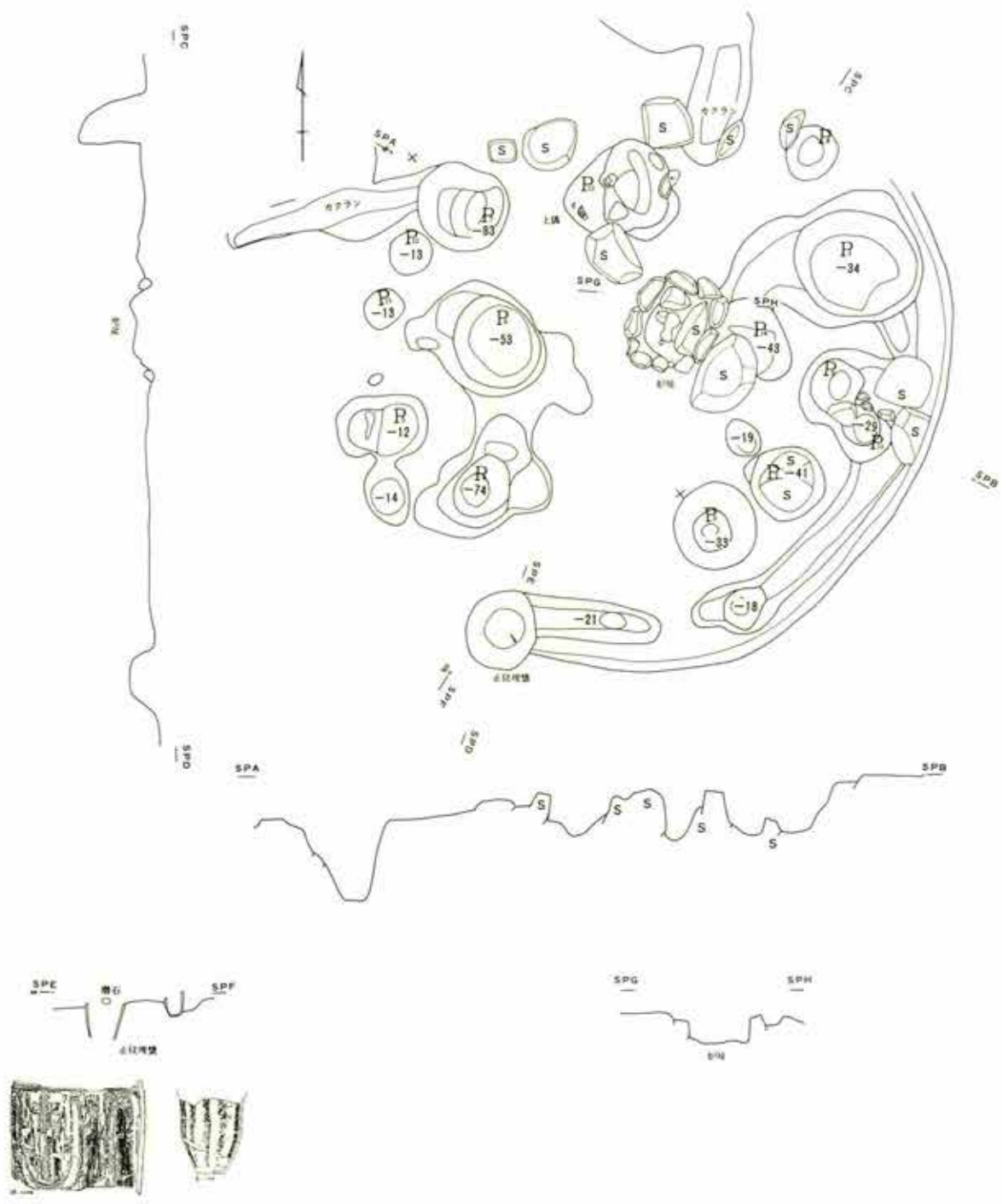

第 29 图 积迦堂 S-III 区 SB-21

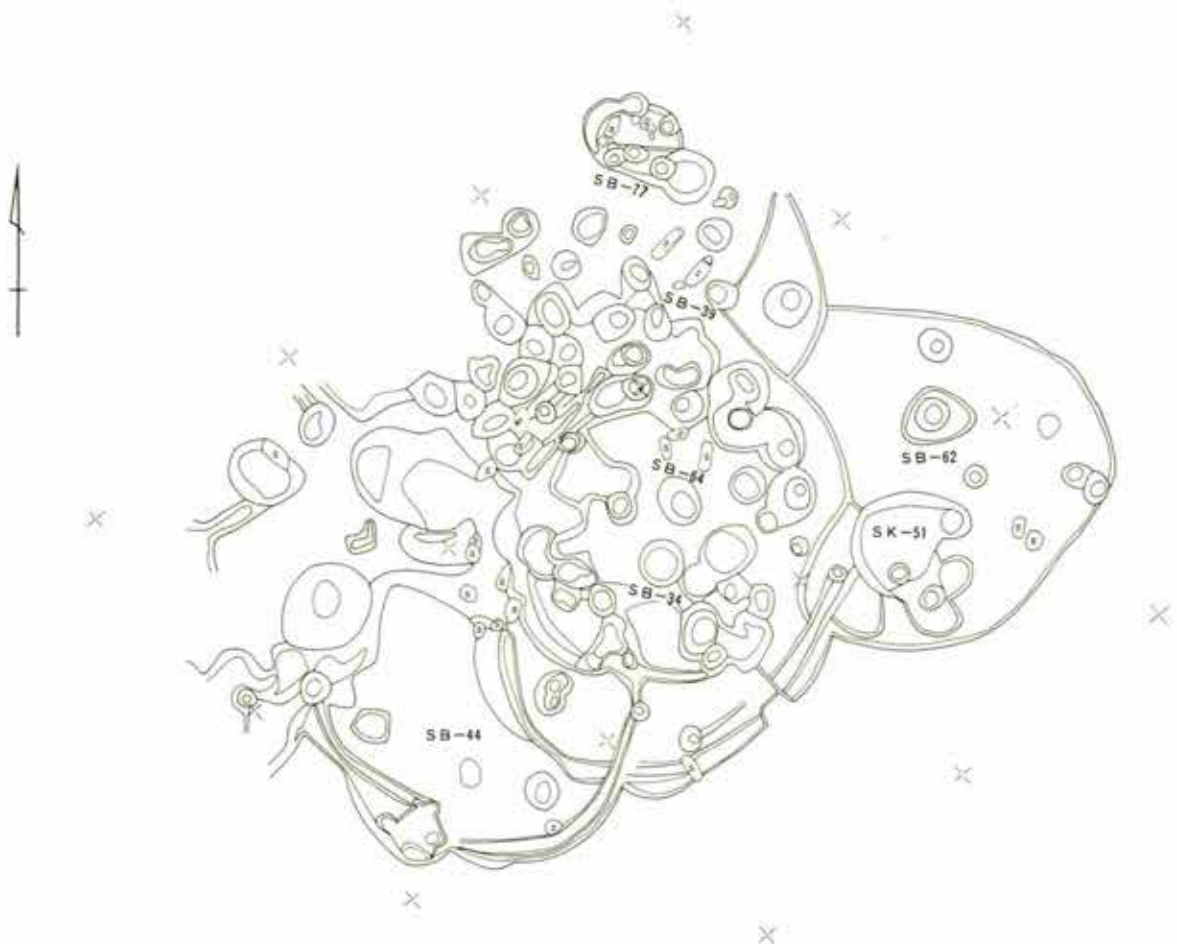

SB-34 -44 -39 -62 -72 (1:120)

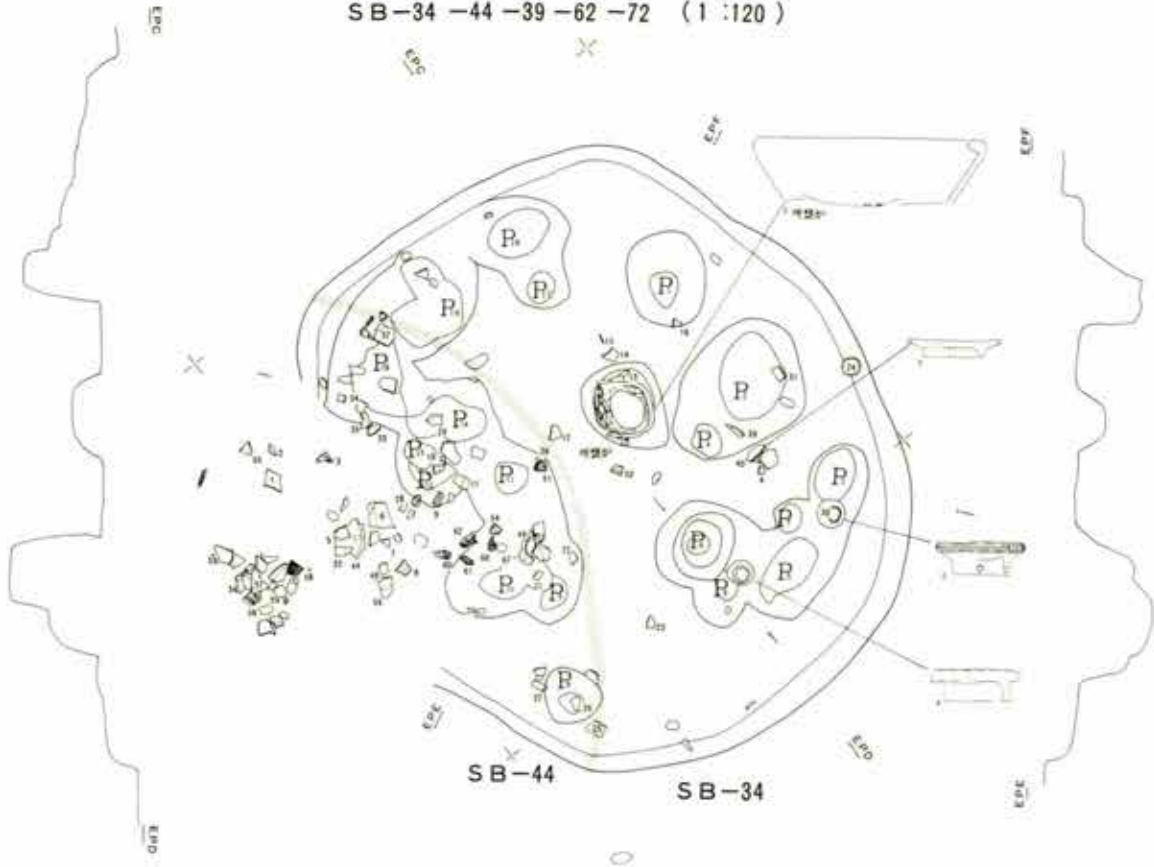

第 30 图 积道堂S-III区 SB-34

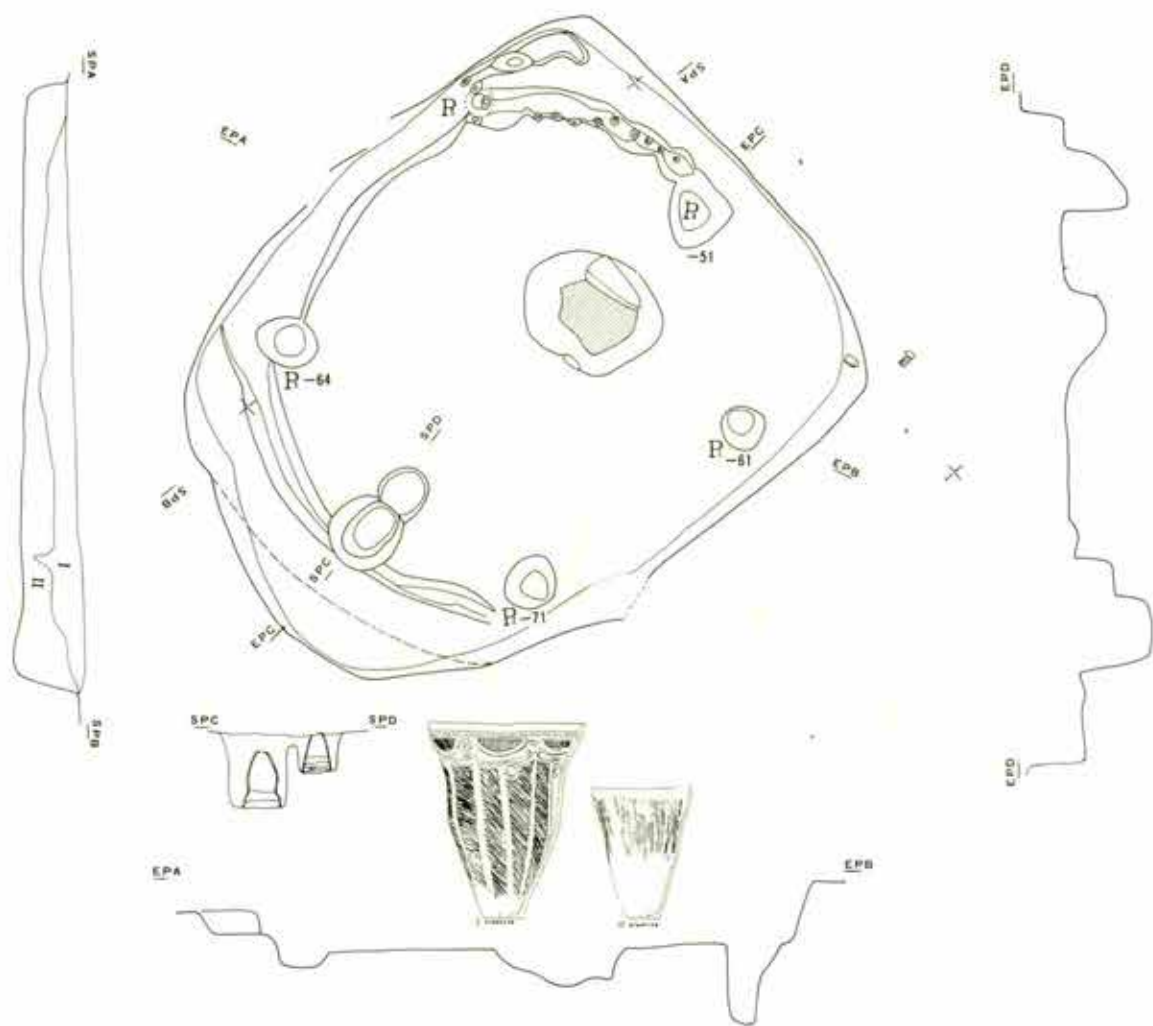
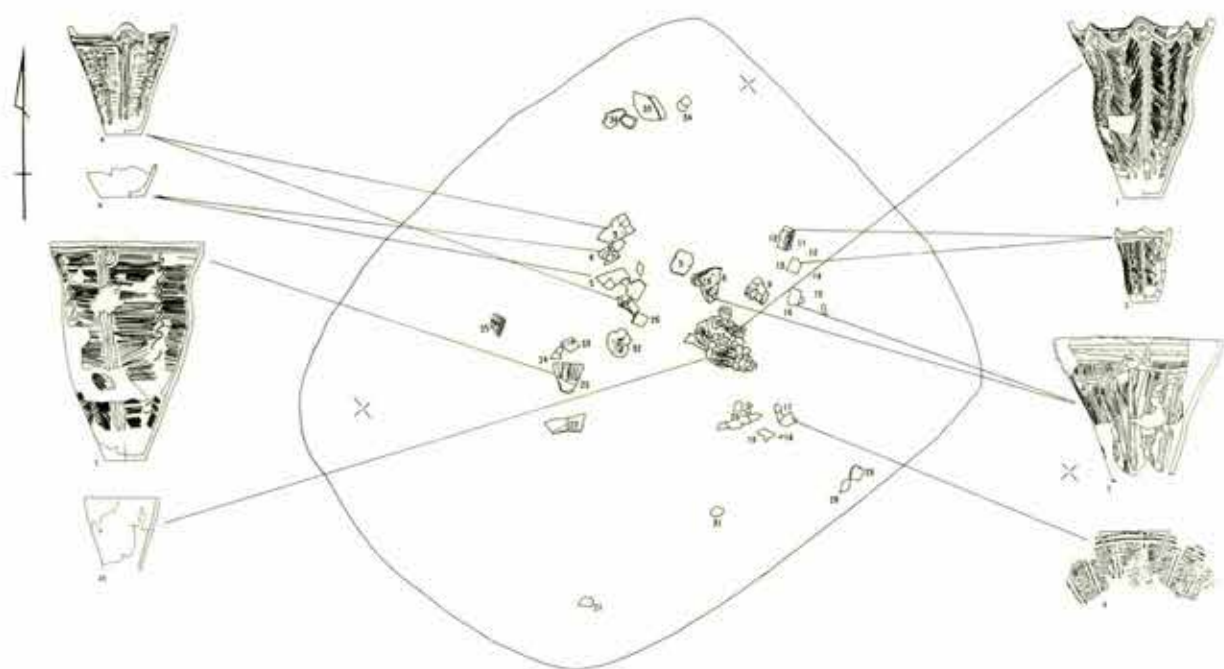

第 31 图 积迦堂 S-III 区 SB-37

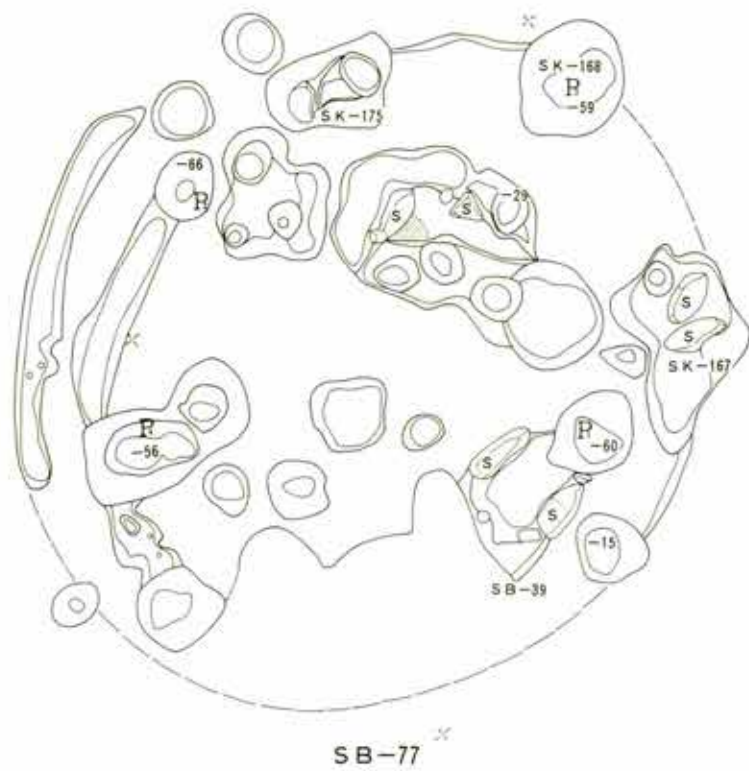
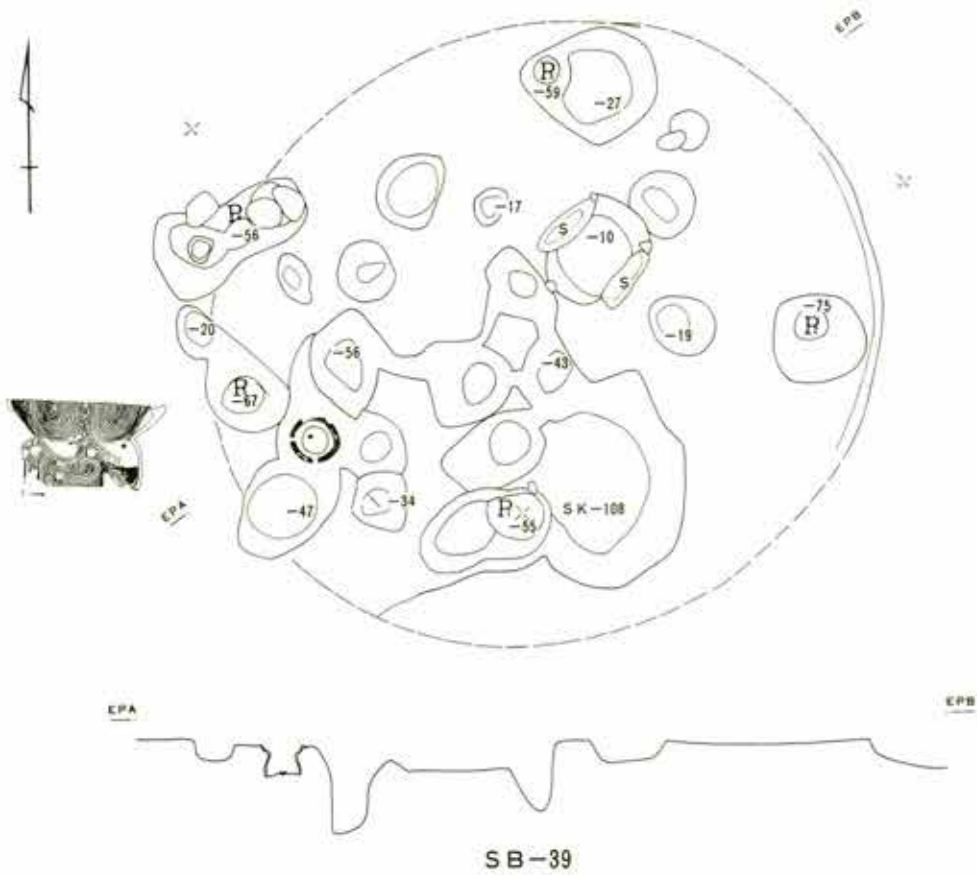

第 32 图 积造堂 S-III 区 SB-39-77



SB-41



SB-42

第 33 图 积迦堂S-III区 SB-41-42

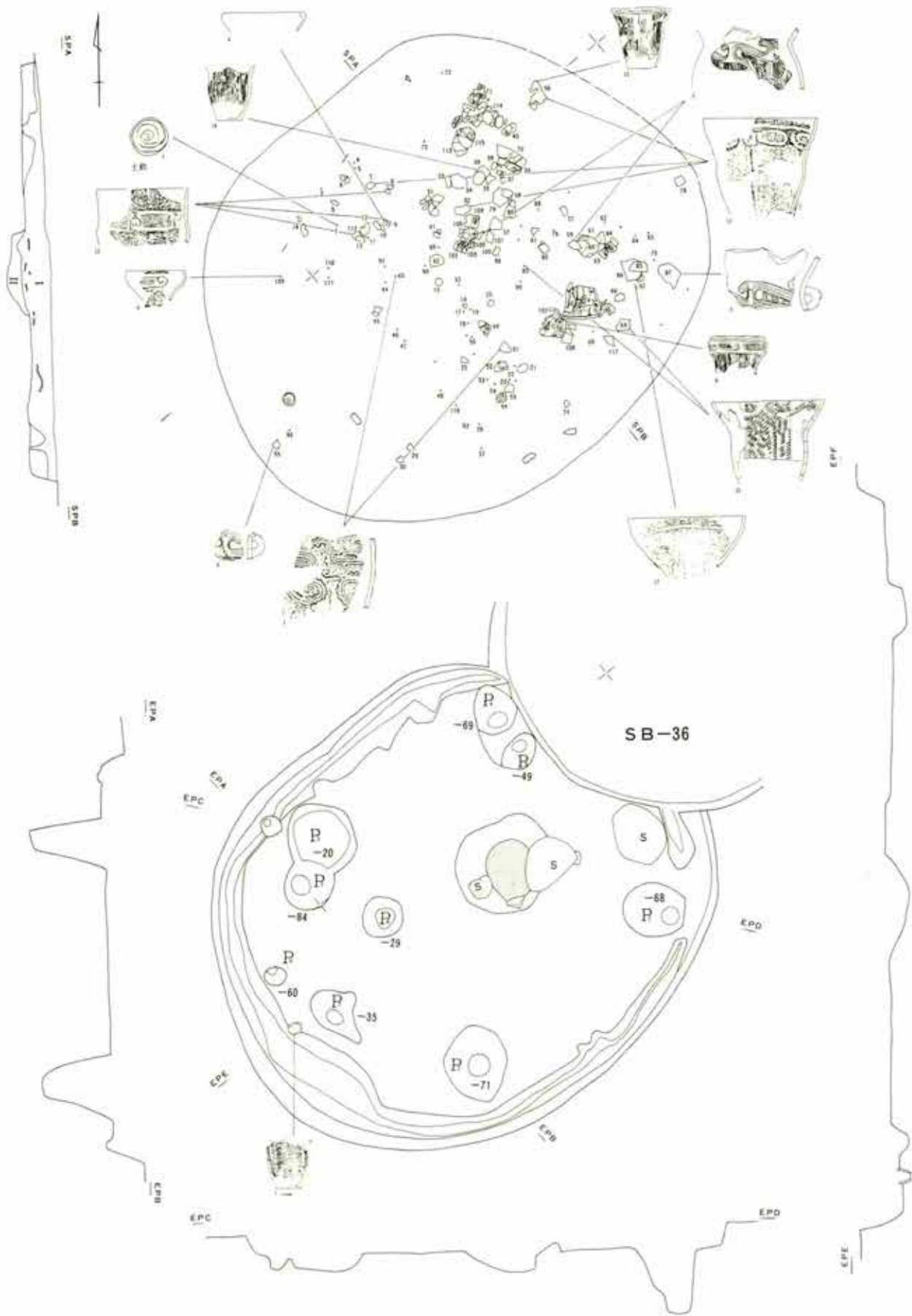

第 34 图 积迦堂 S-III 区 SB-43

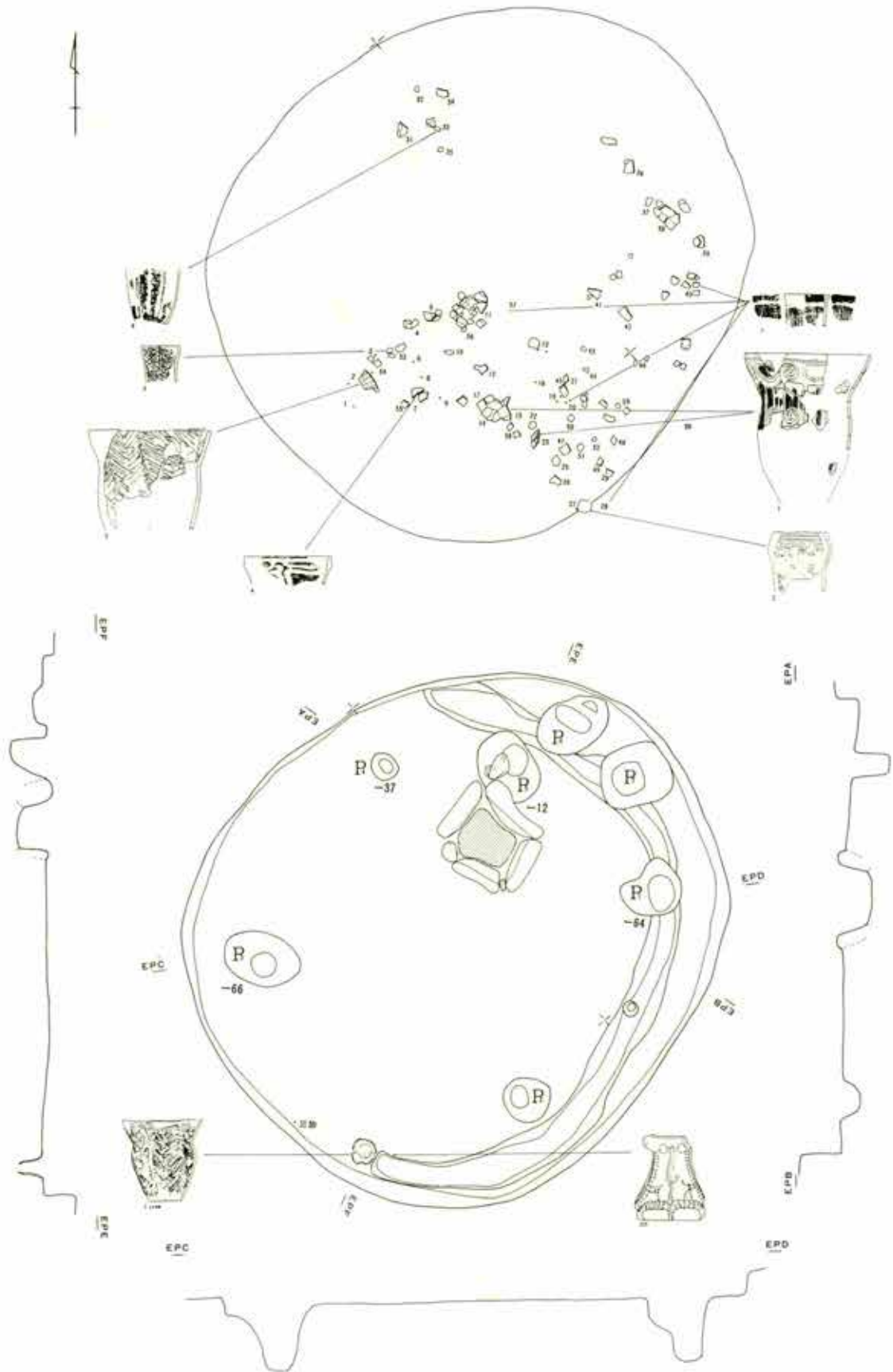

第 35 图 积迦堂 S-III 区 SB-46

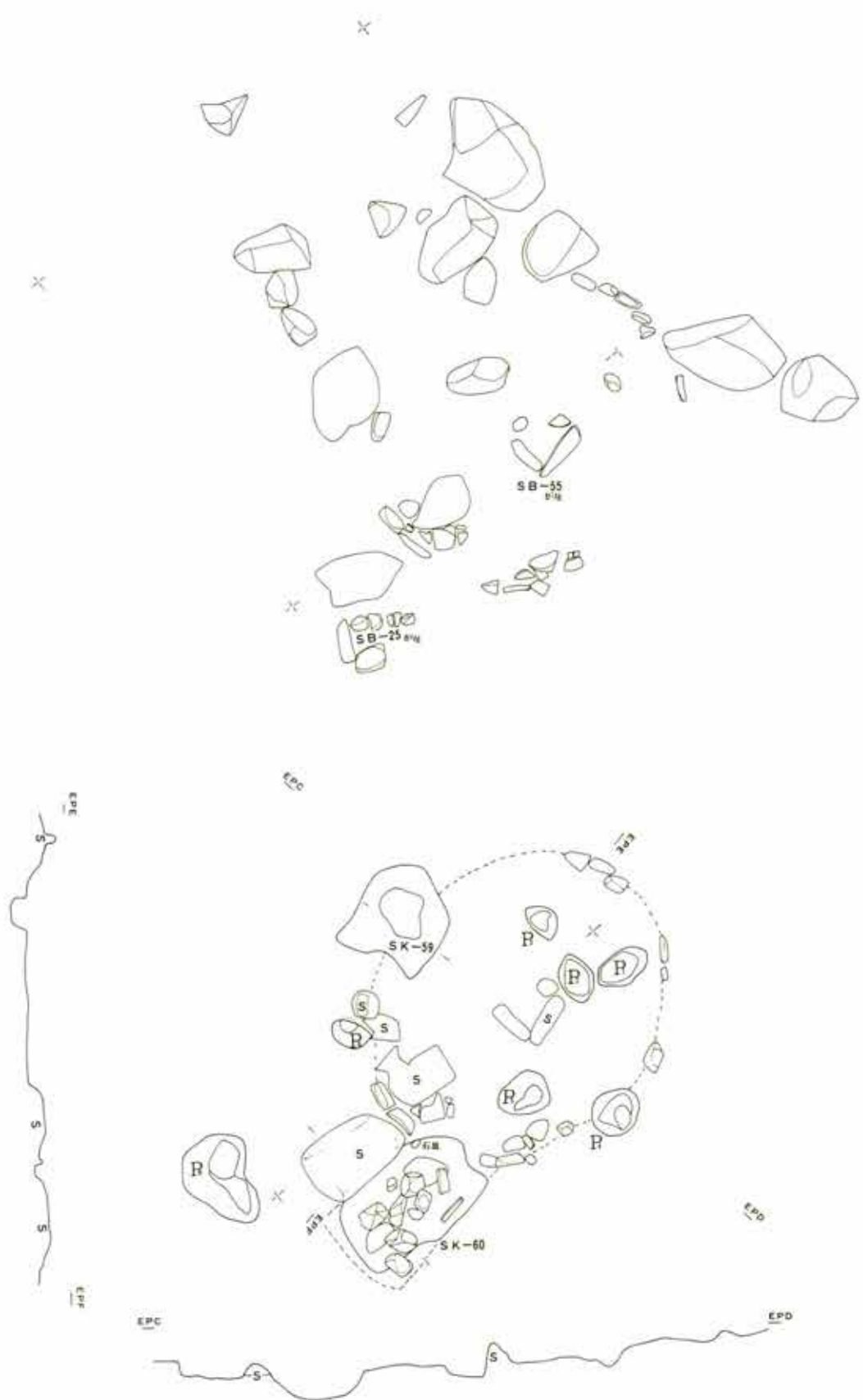

第 36 图 积迦堂S-III区 SB-55

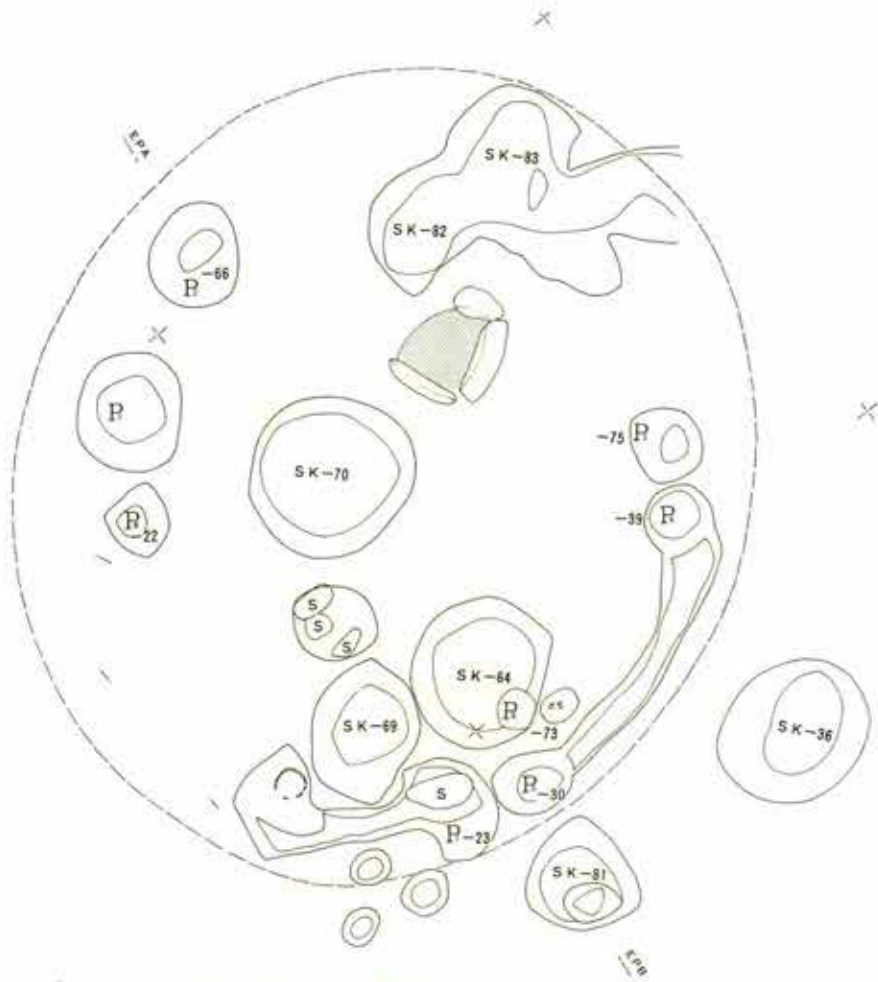
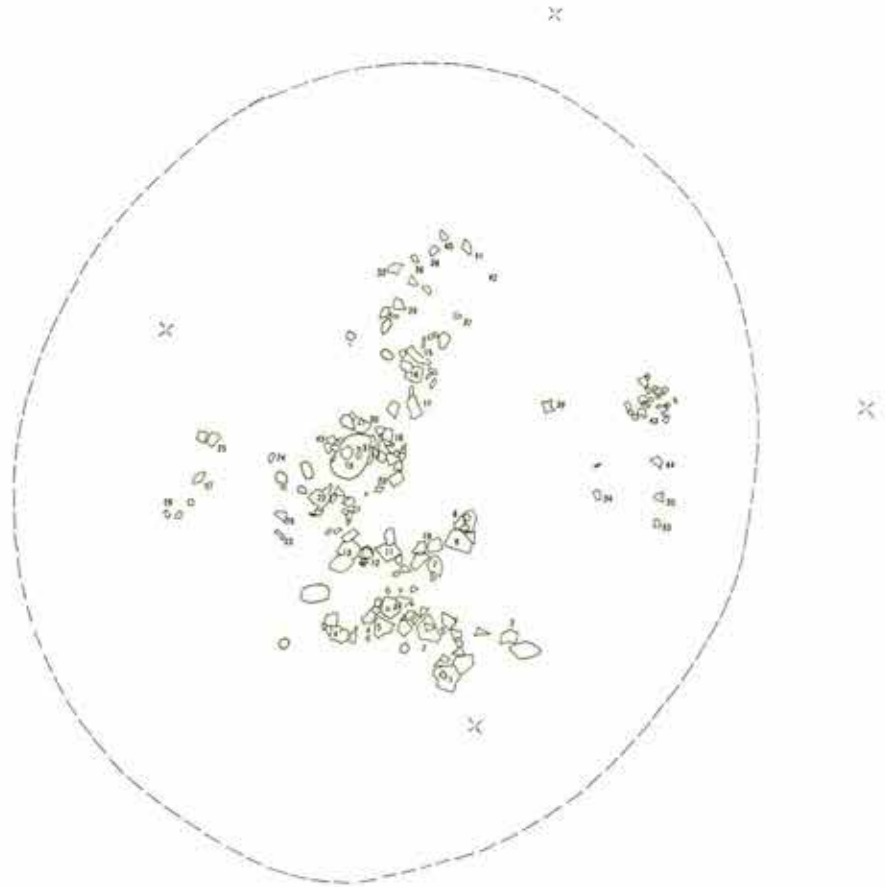

第 37 图 积迦堂 S-III 区 SB-57

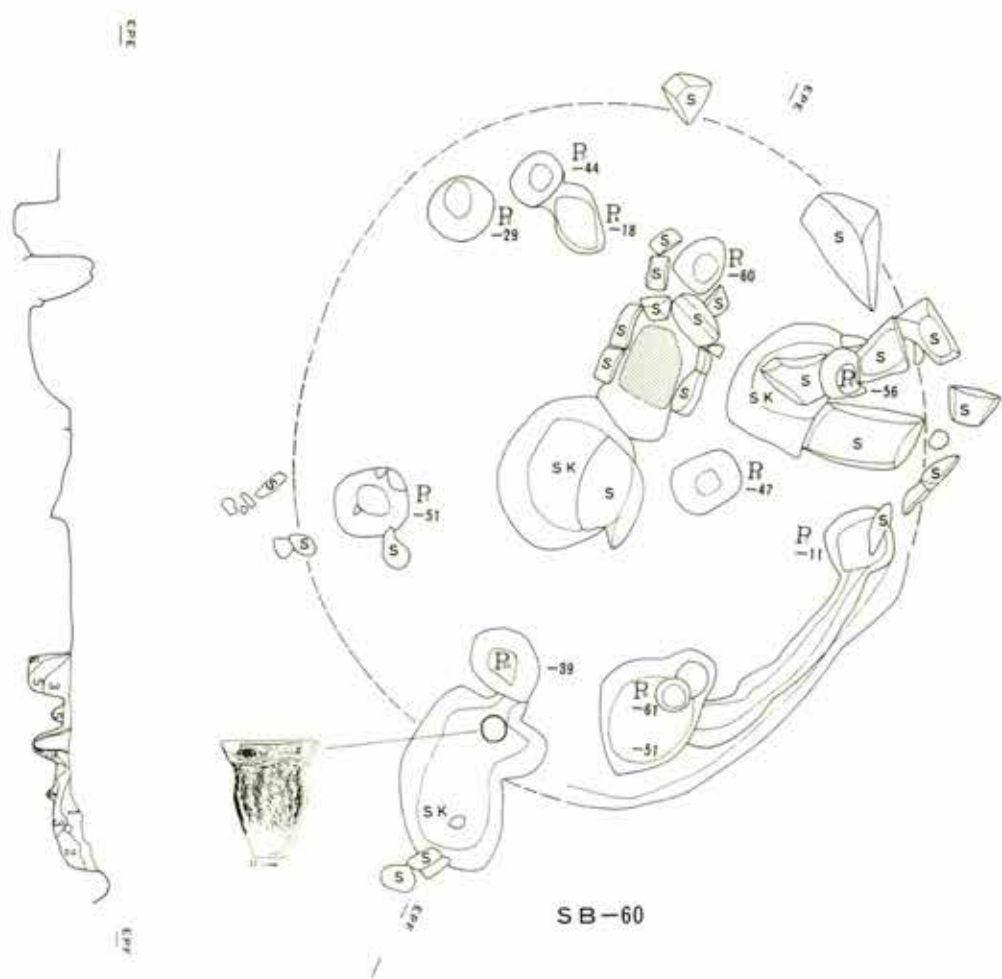
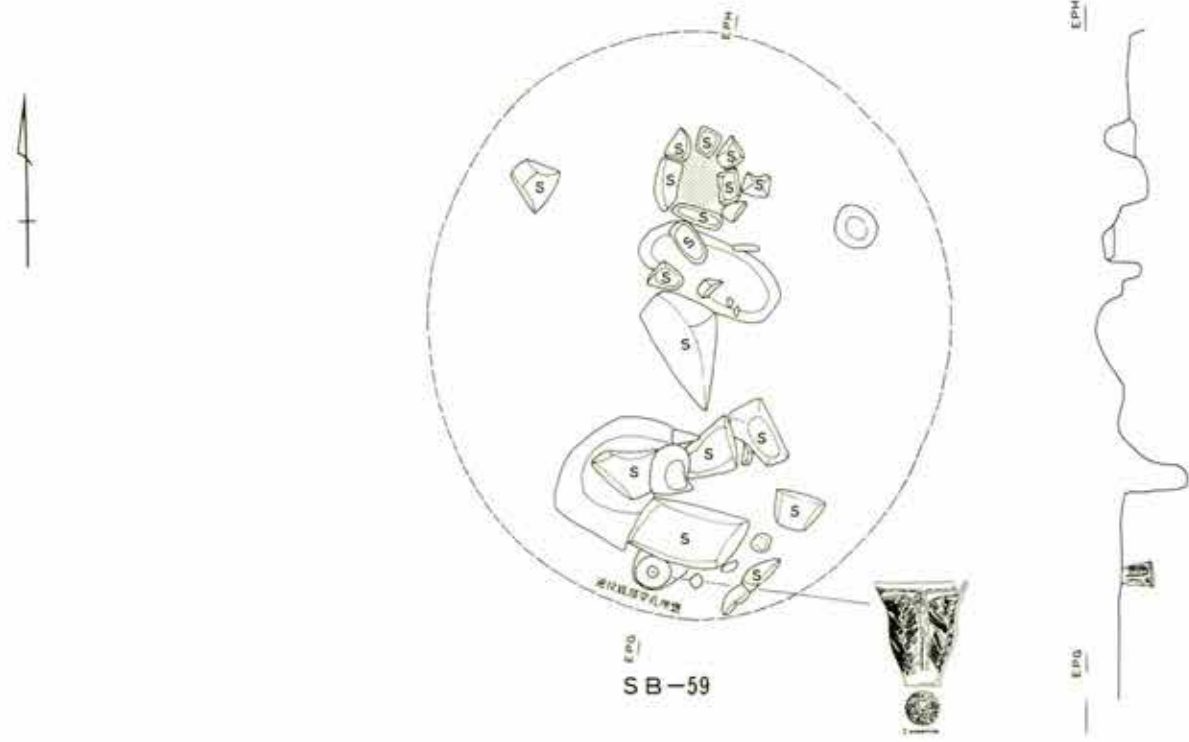

第 38 图 积逊堂 S-III 区 SB-59 -60

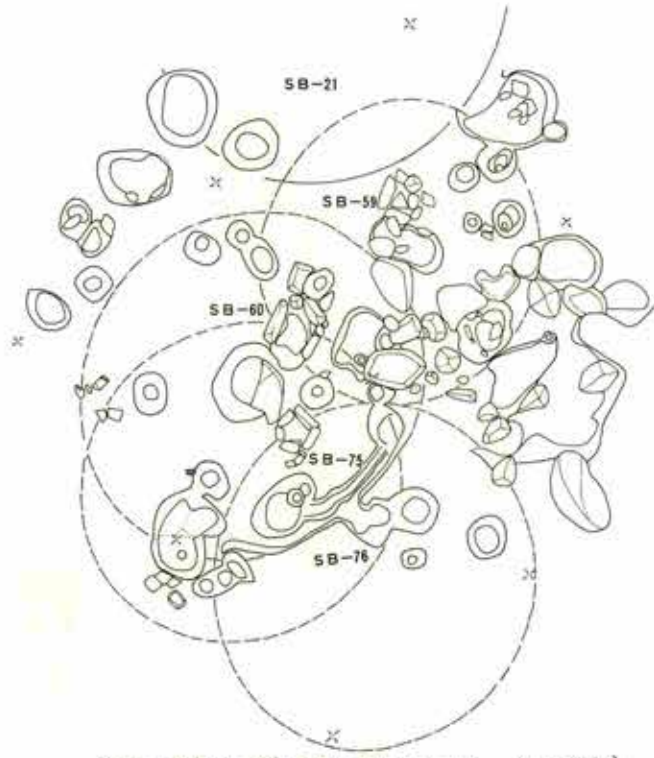

SB-59 SB-60 SB-75 SB-76 (1:120)

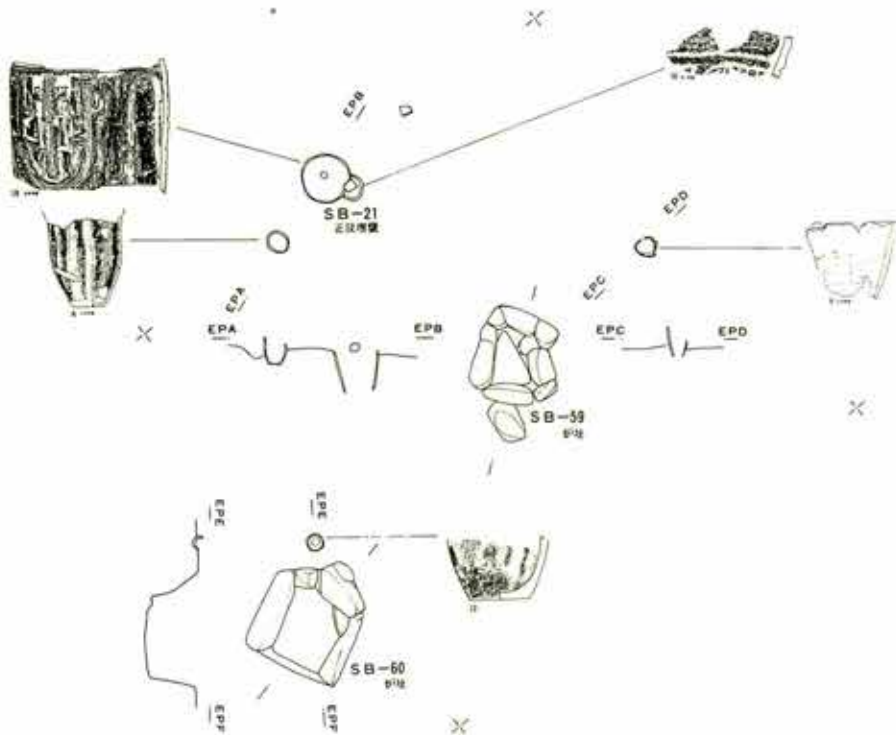
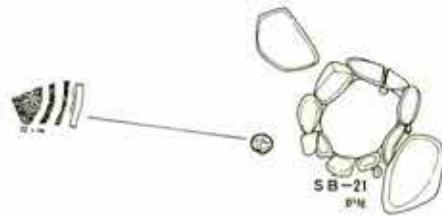

第 39 图 积迦堂 S-III 区 SB-21-59-60

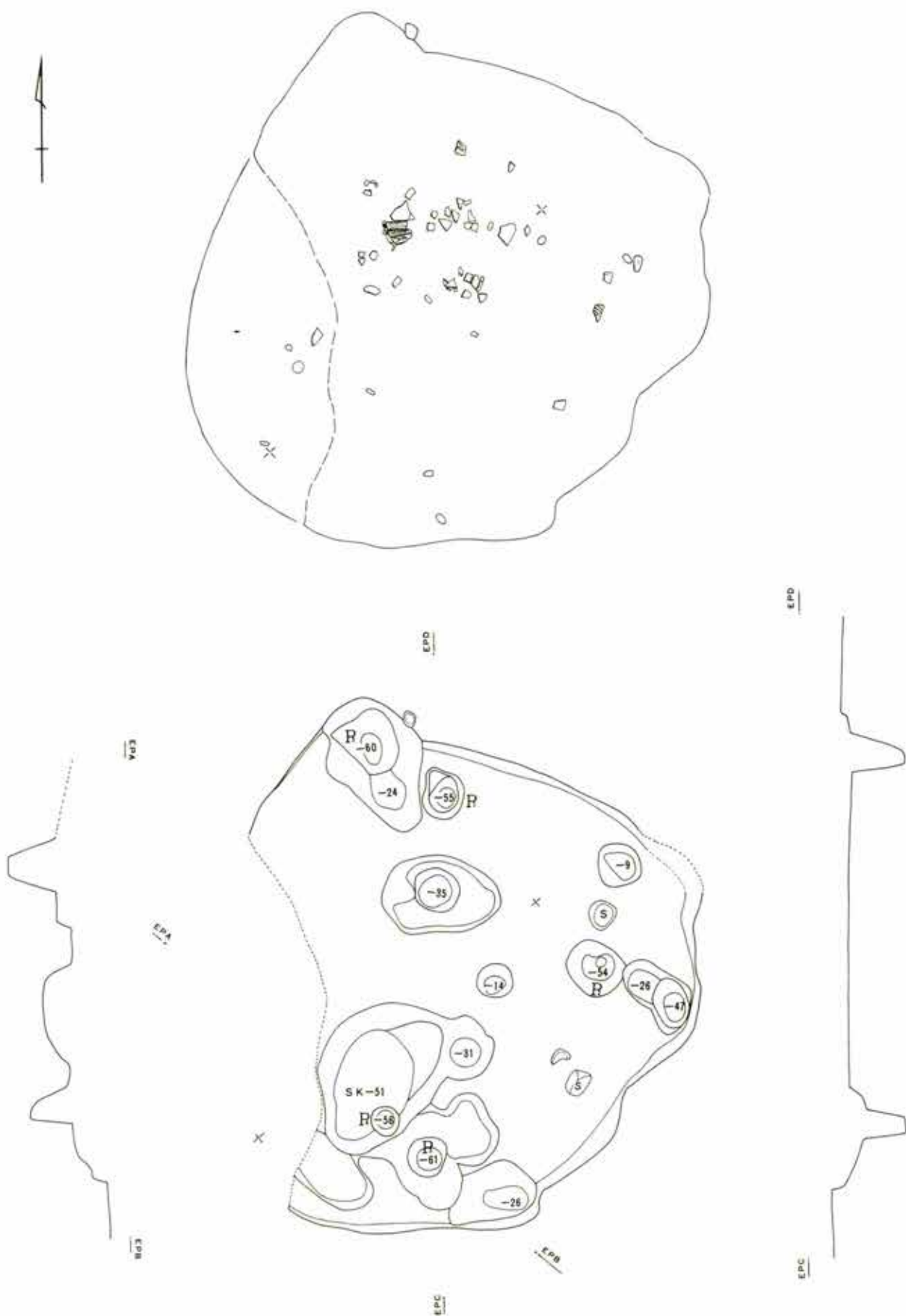

第 40 图 积逊堂 S-III 区 SB-62

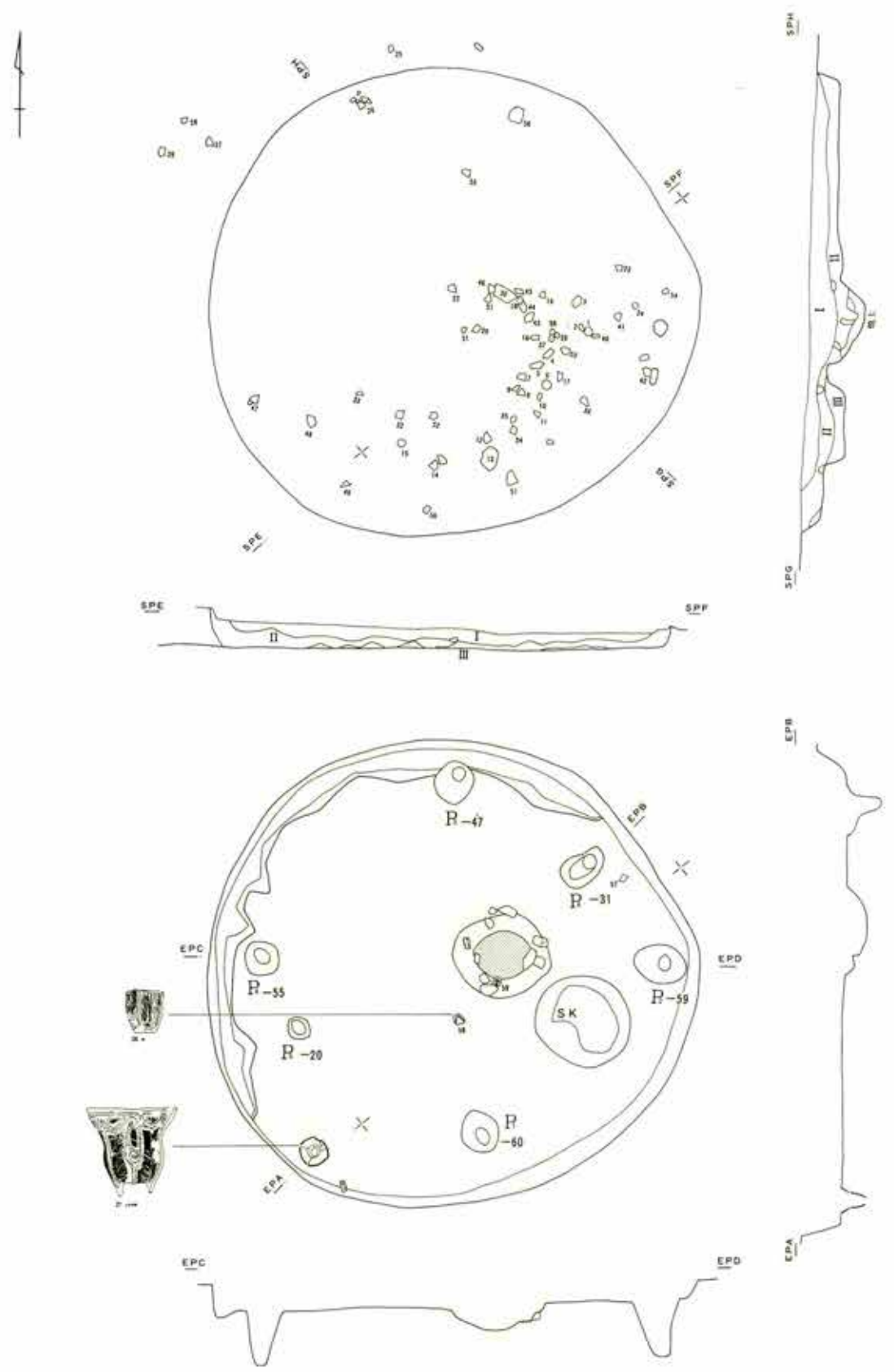

第 41 图 积迦堂 S-III 区 SB-66

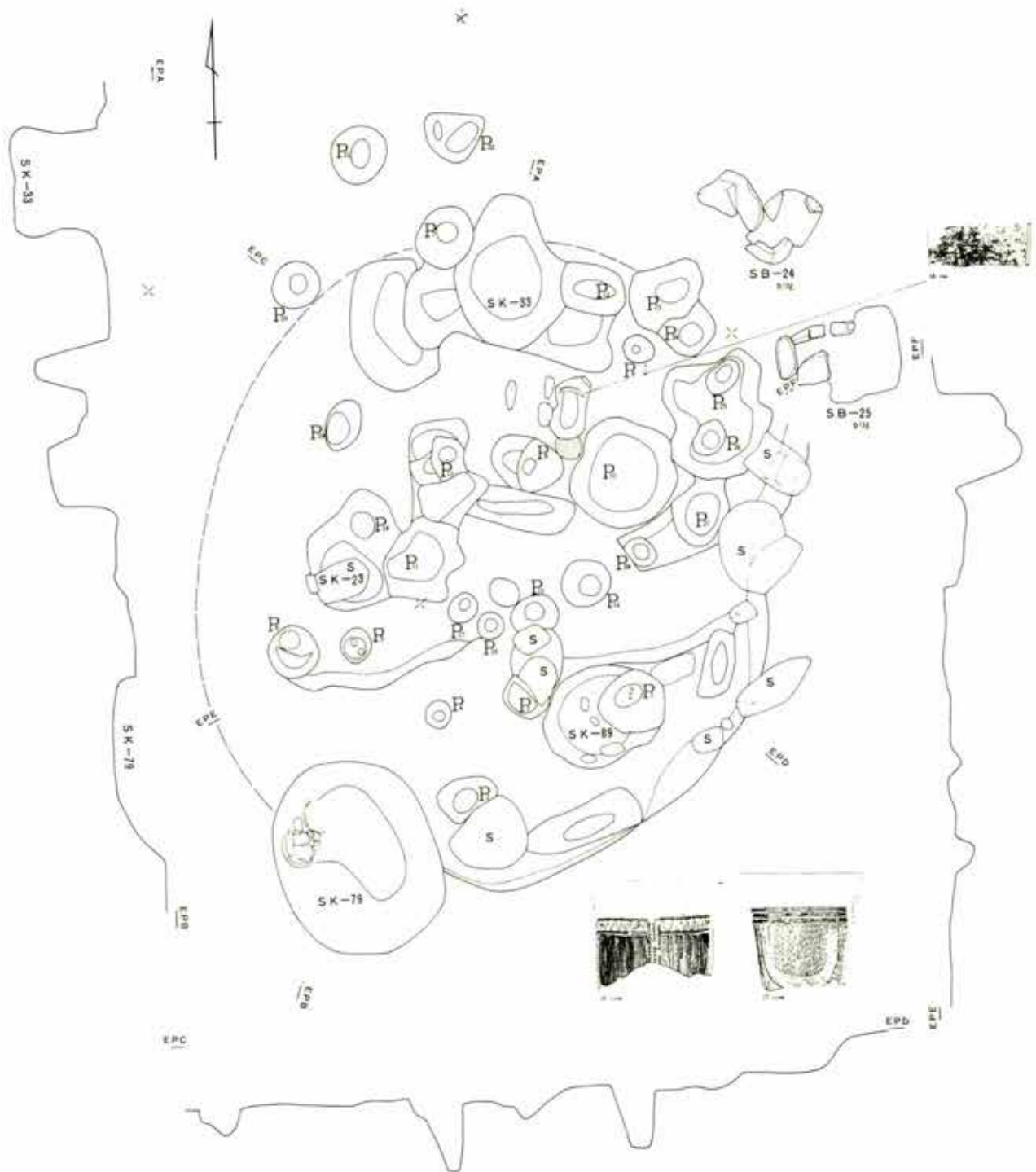

第 42 图 积迦堂 S-III 区 SB-68-69

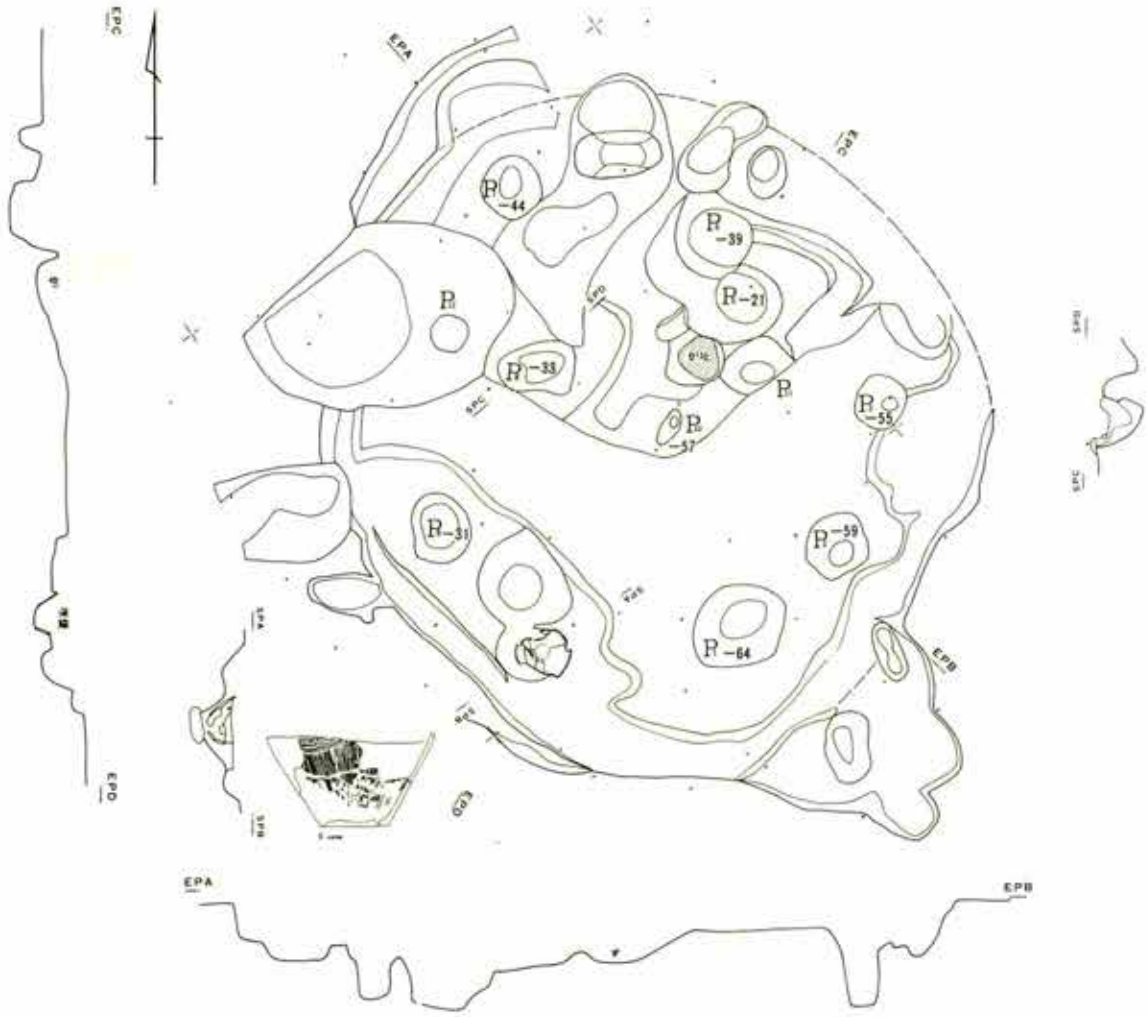

第 43 图 积迦堂 S-III 区 SB-70

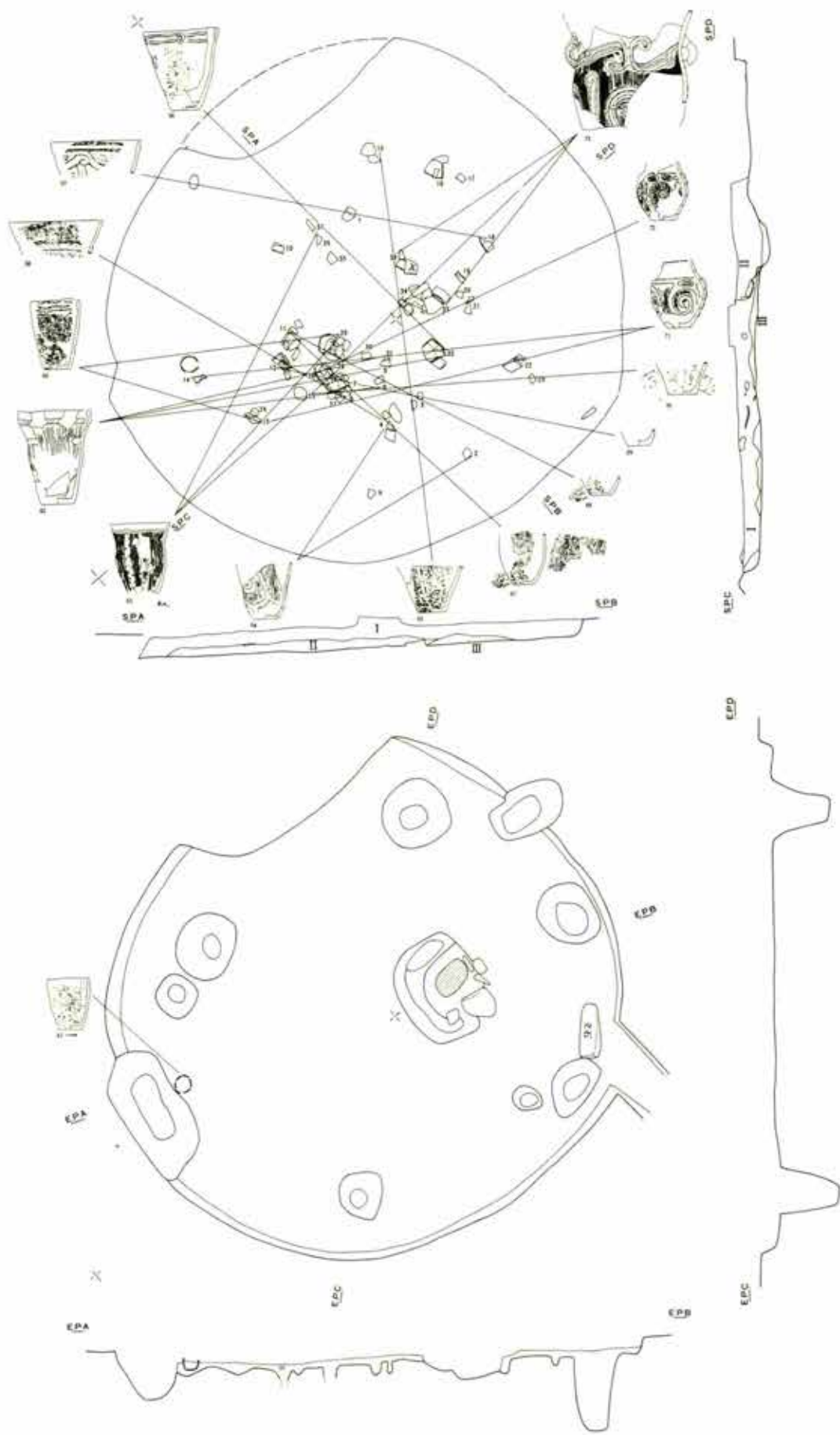

第 44 图 积通堂 S-III 区 SB-71

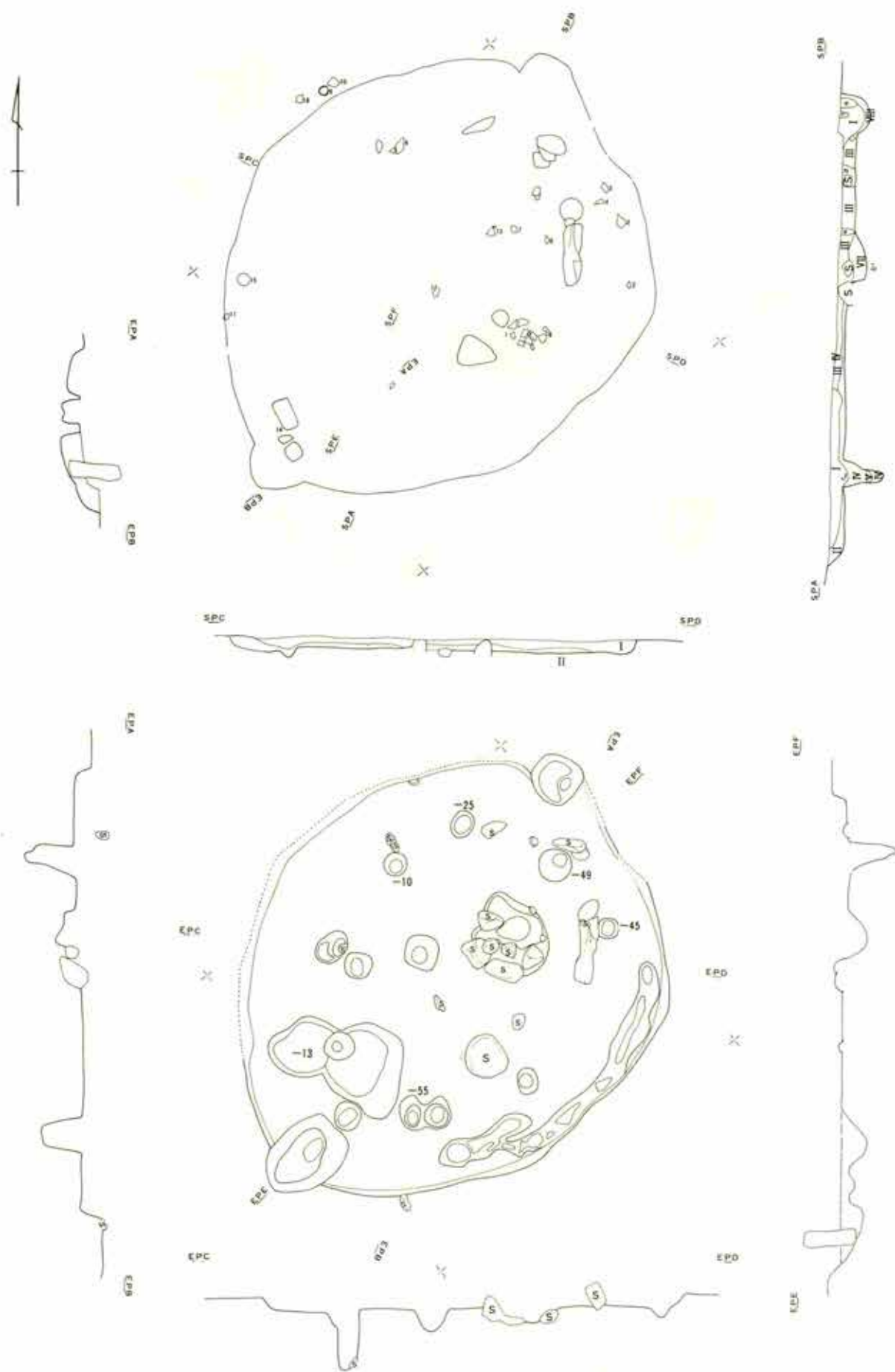

第 45 图 积逸堂 S-III 区 SB-72

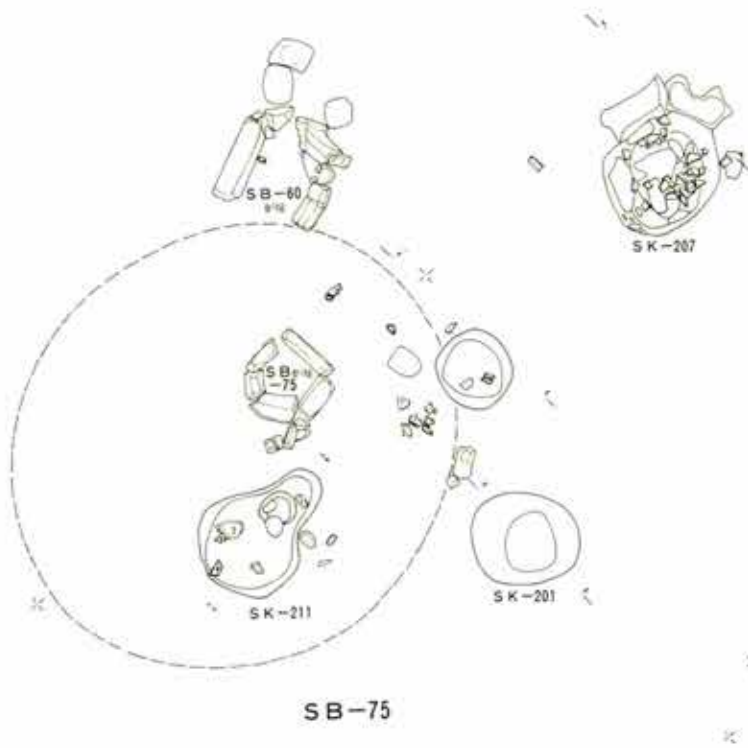

SB-75

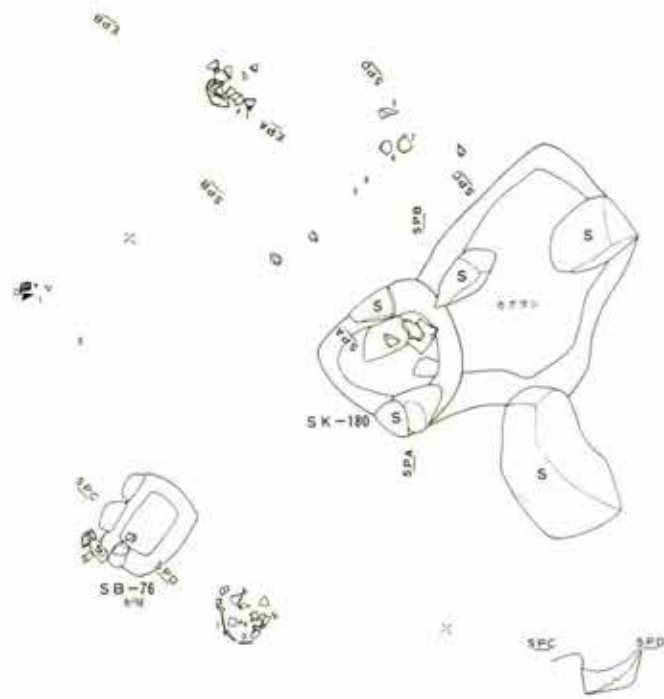

SB-76

第 46 图 积迦堂S-III区 SB-75-76

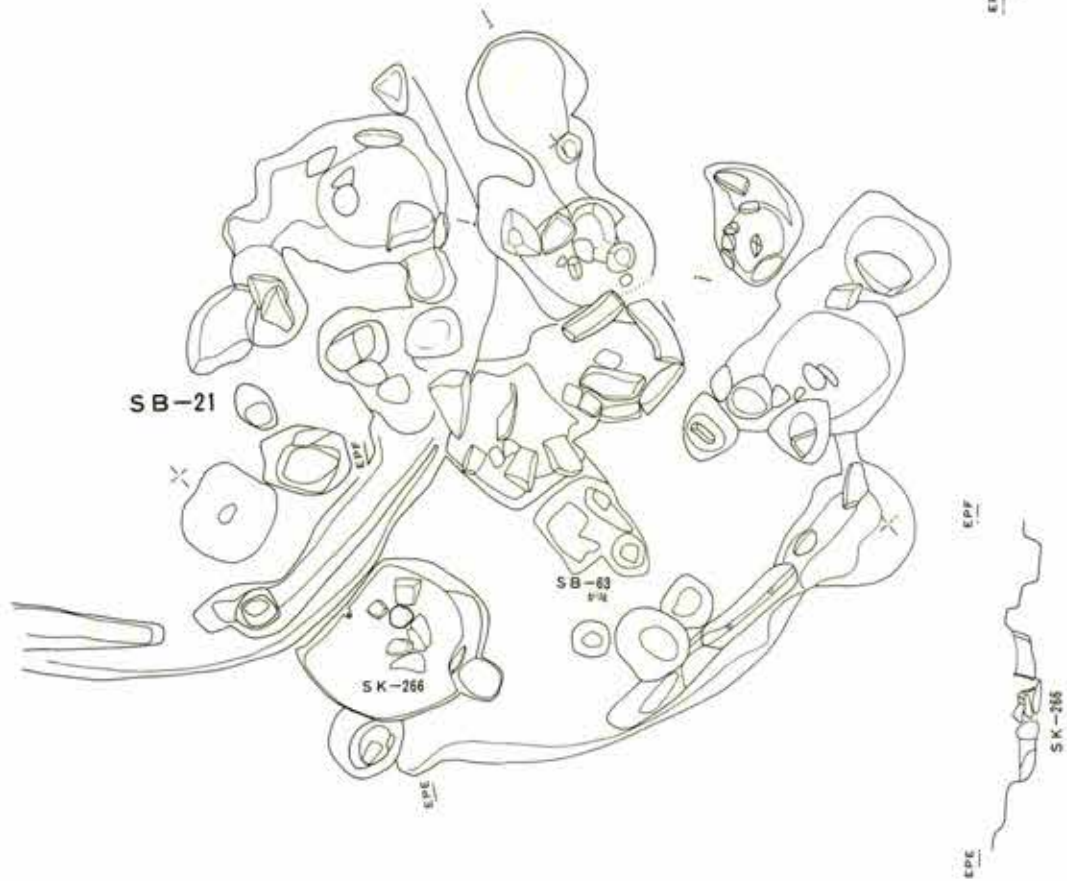
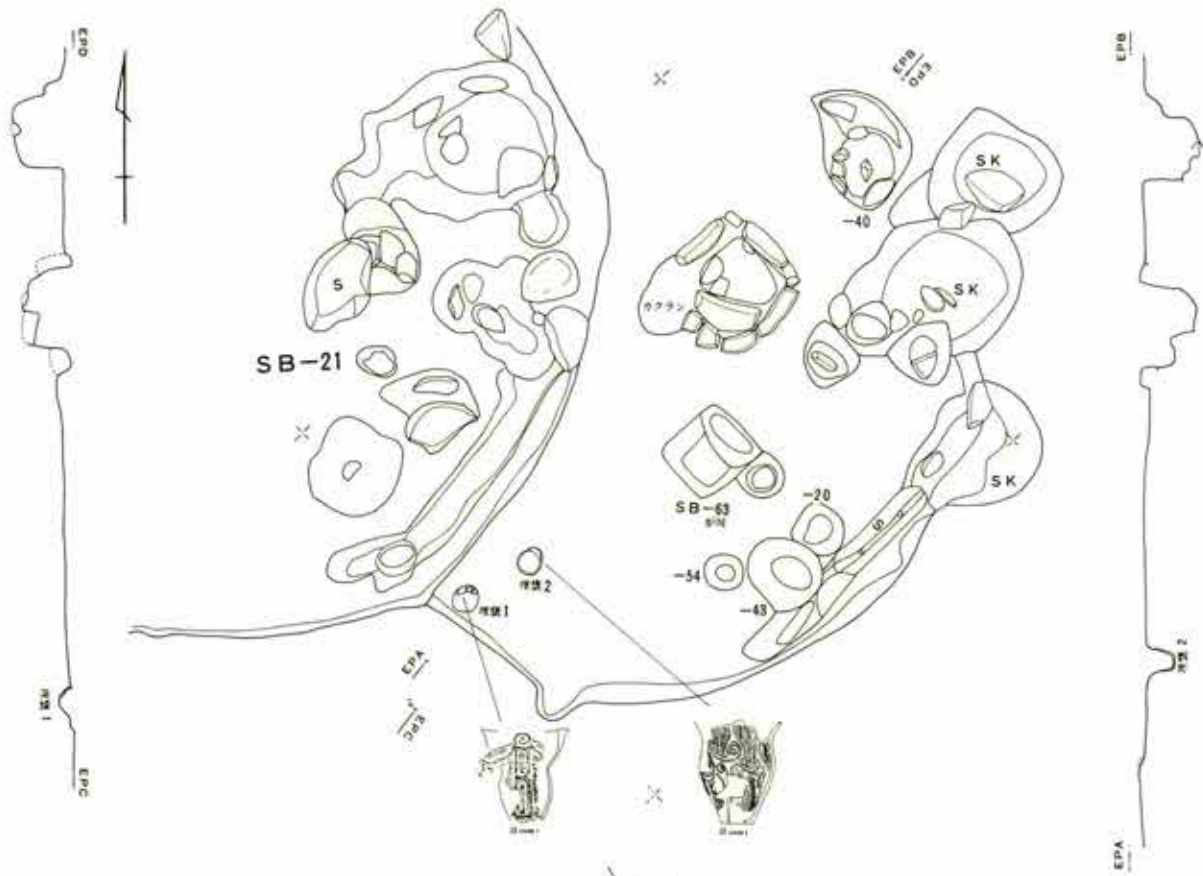

第 47 图 积迦堂 S-III 区 SB-80

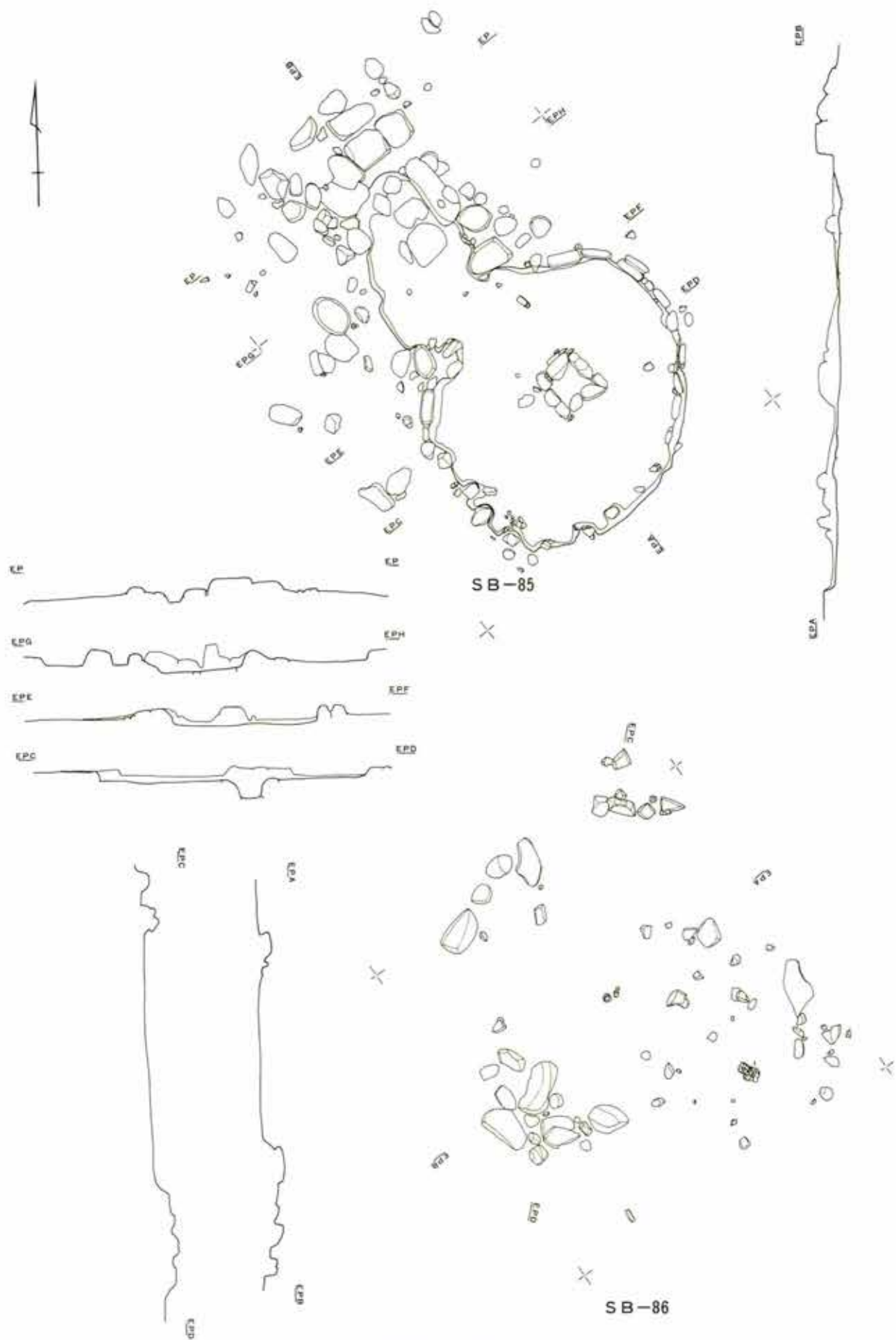

第 48 图 积迦堂 S-III 区 SB-85-86

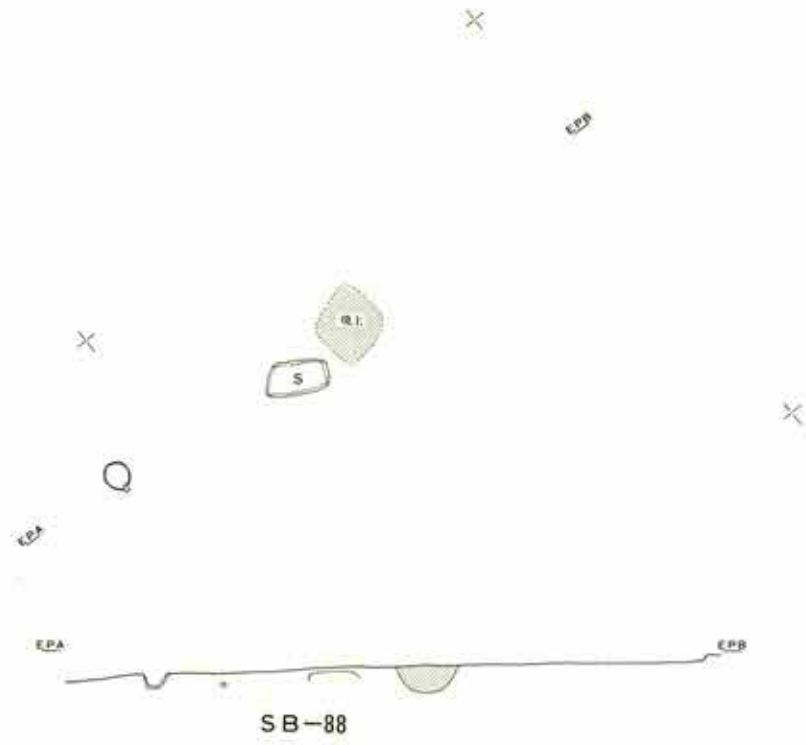

SB-90 SB-91
第 49 图 积迦堂S-III区 SB-88 -90 -91

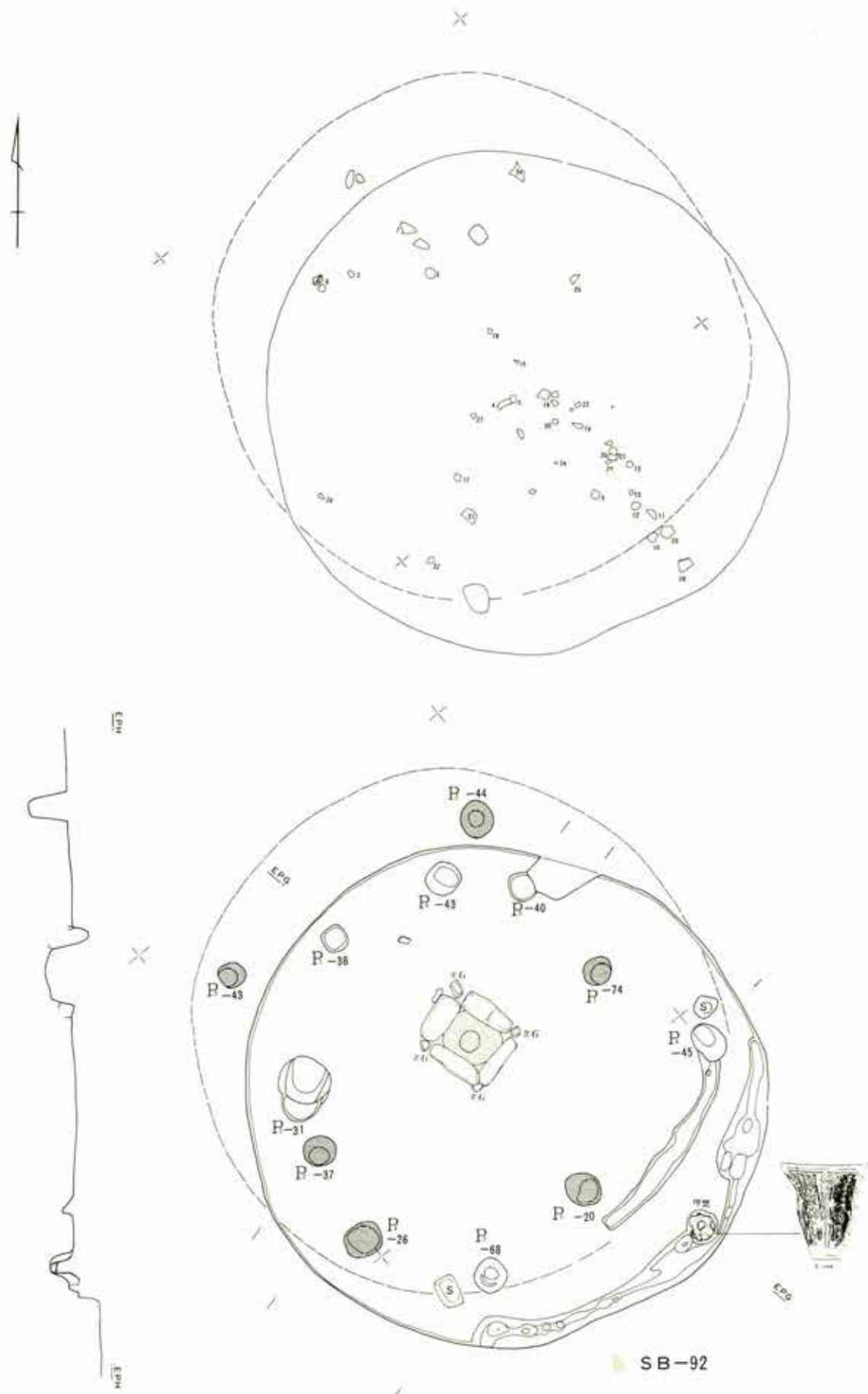

第 50 图 积边堂 S-III 区 SB-92 -93

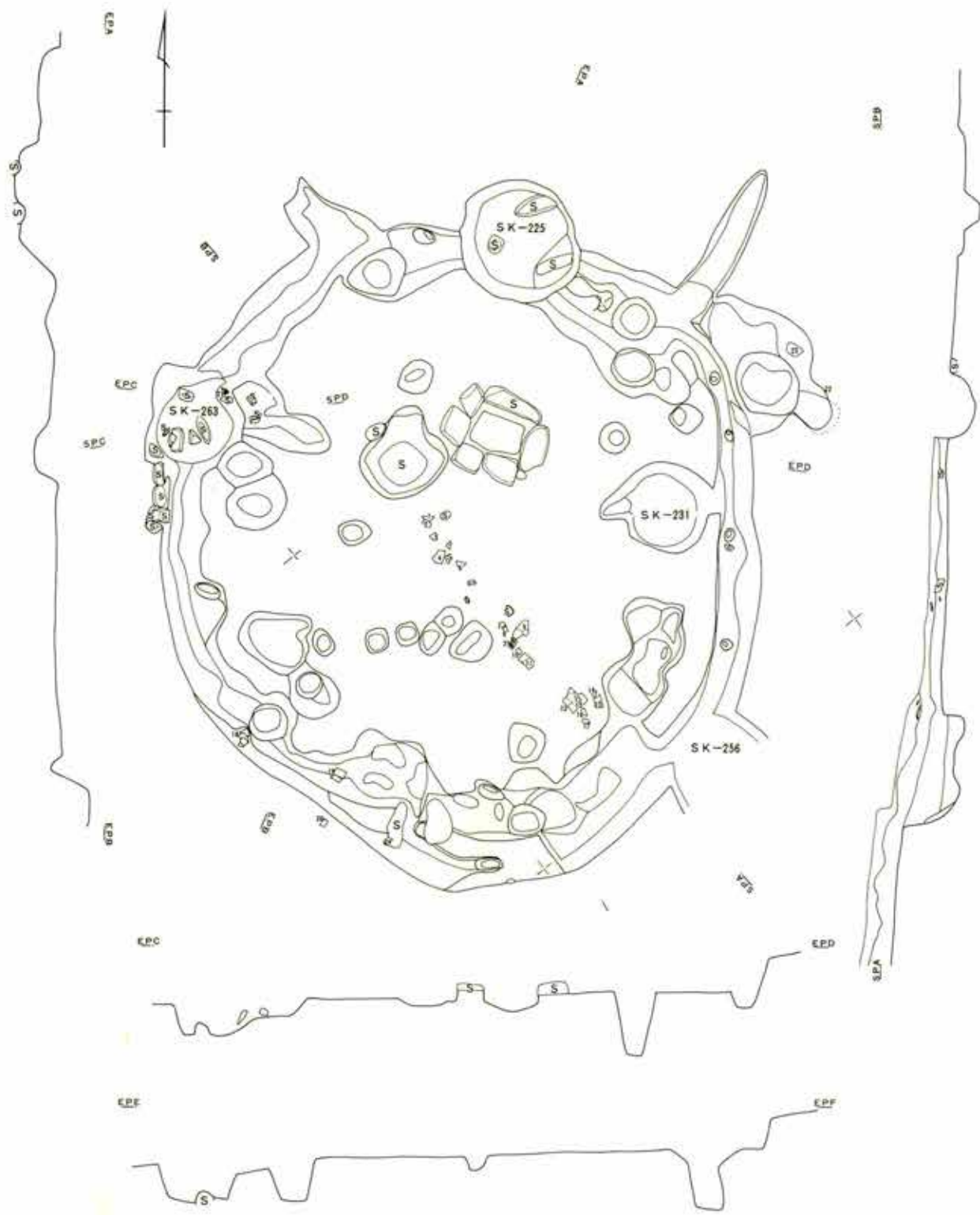

第 51 图 积迦堂 S-III 区 SB-94-99

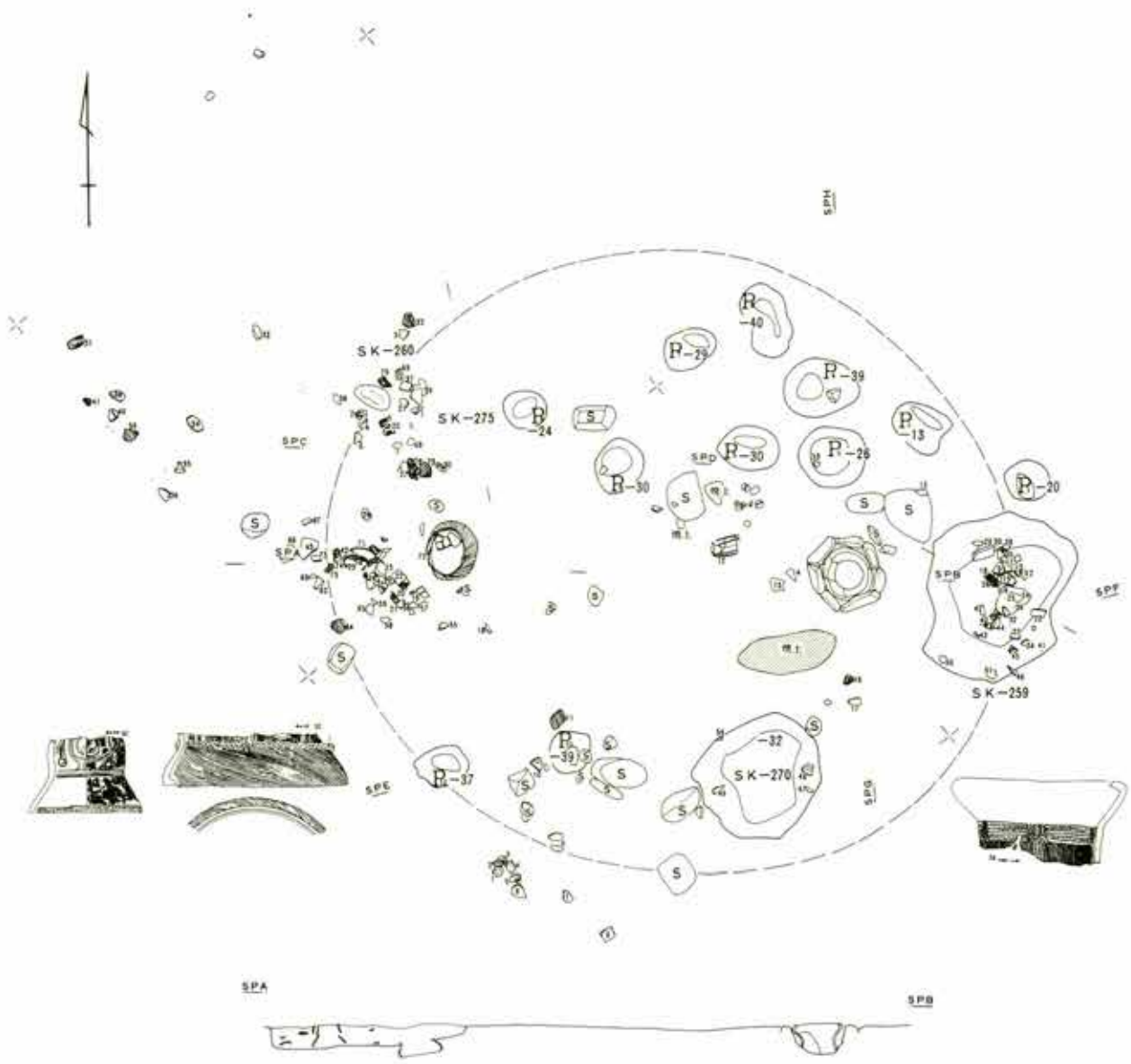

第 52 图 积迦堂 S-III 区 SB-96

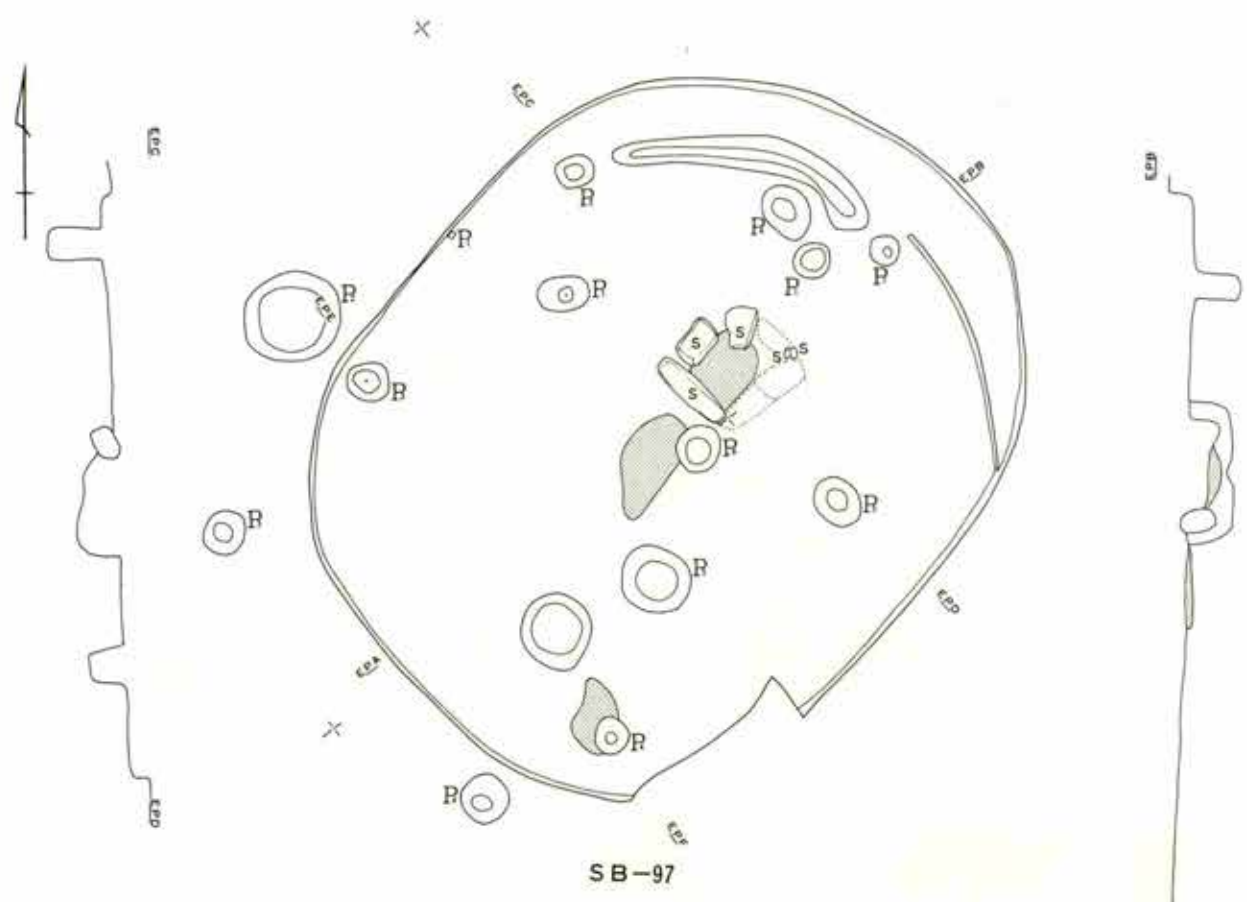

第 53 图 积迦堂 S-III 区 SB-97 -98

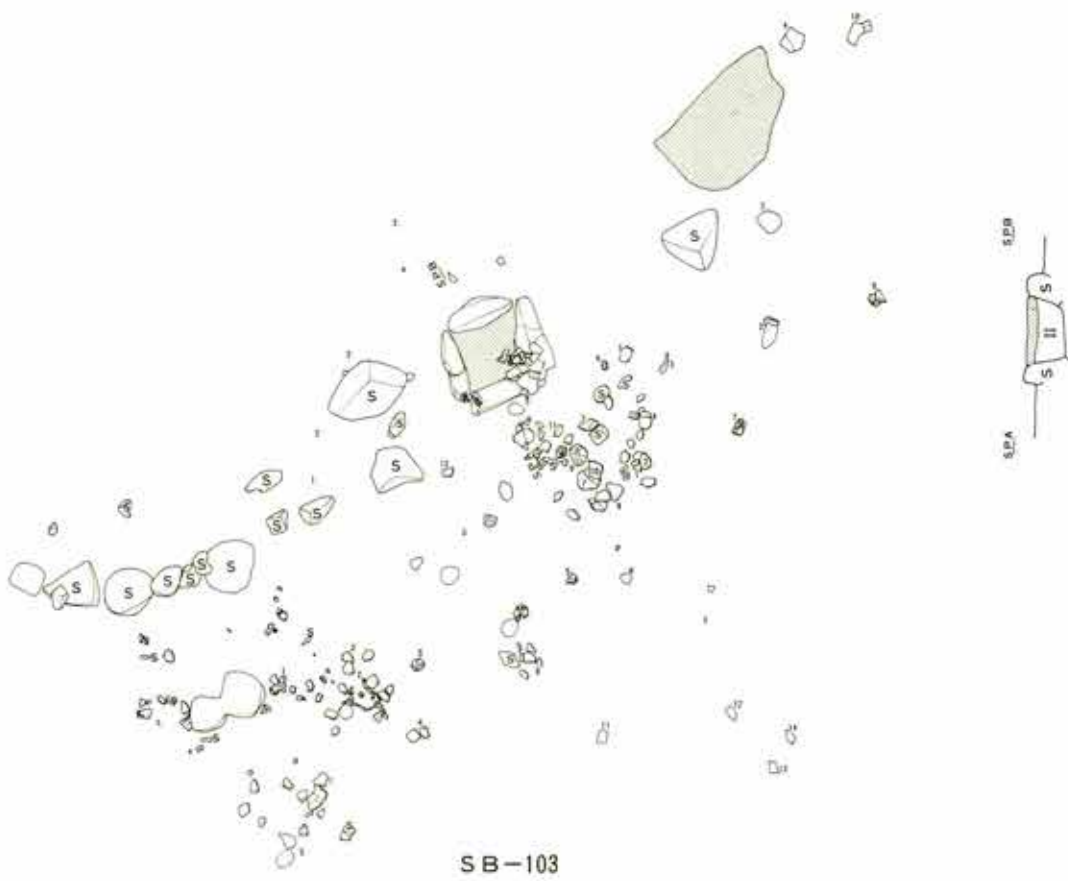
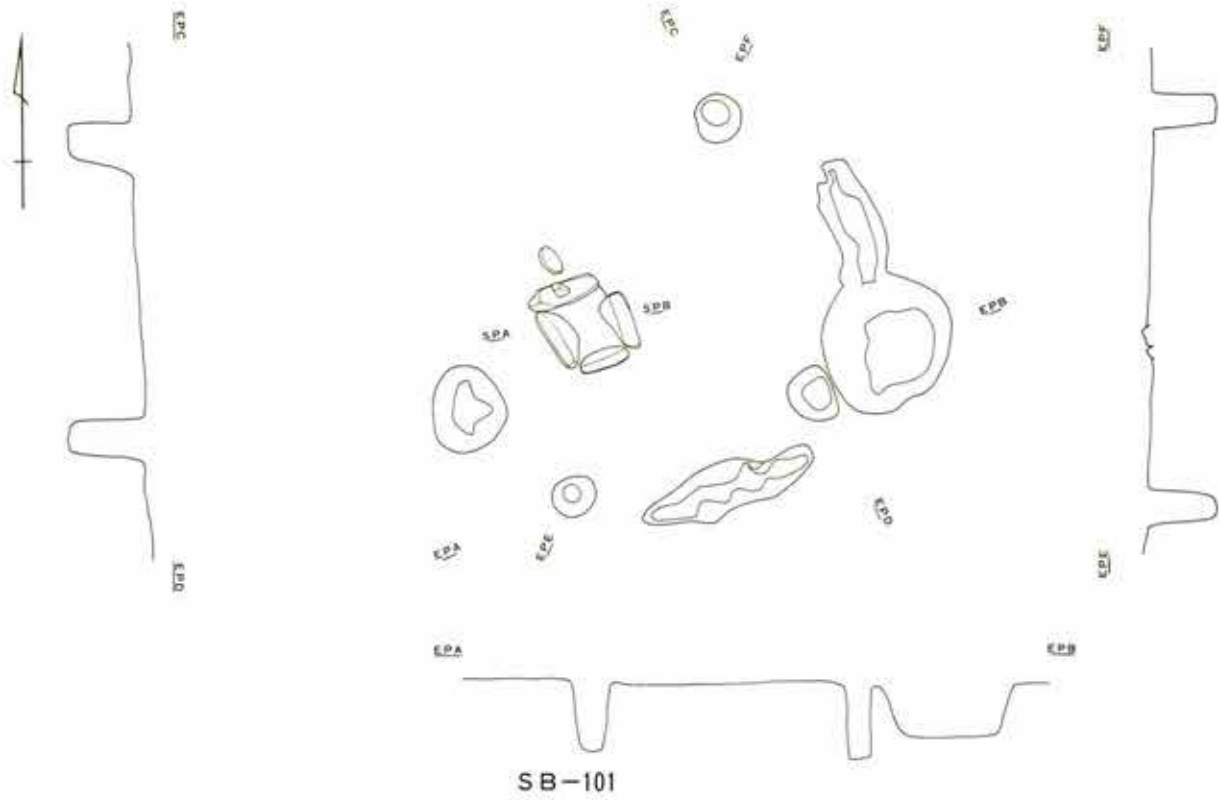

第 54 图 积造堂 S-III 区 SB-101-103

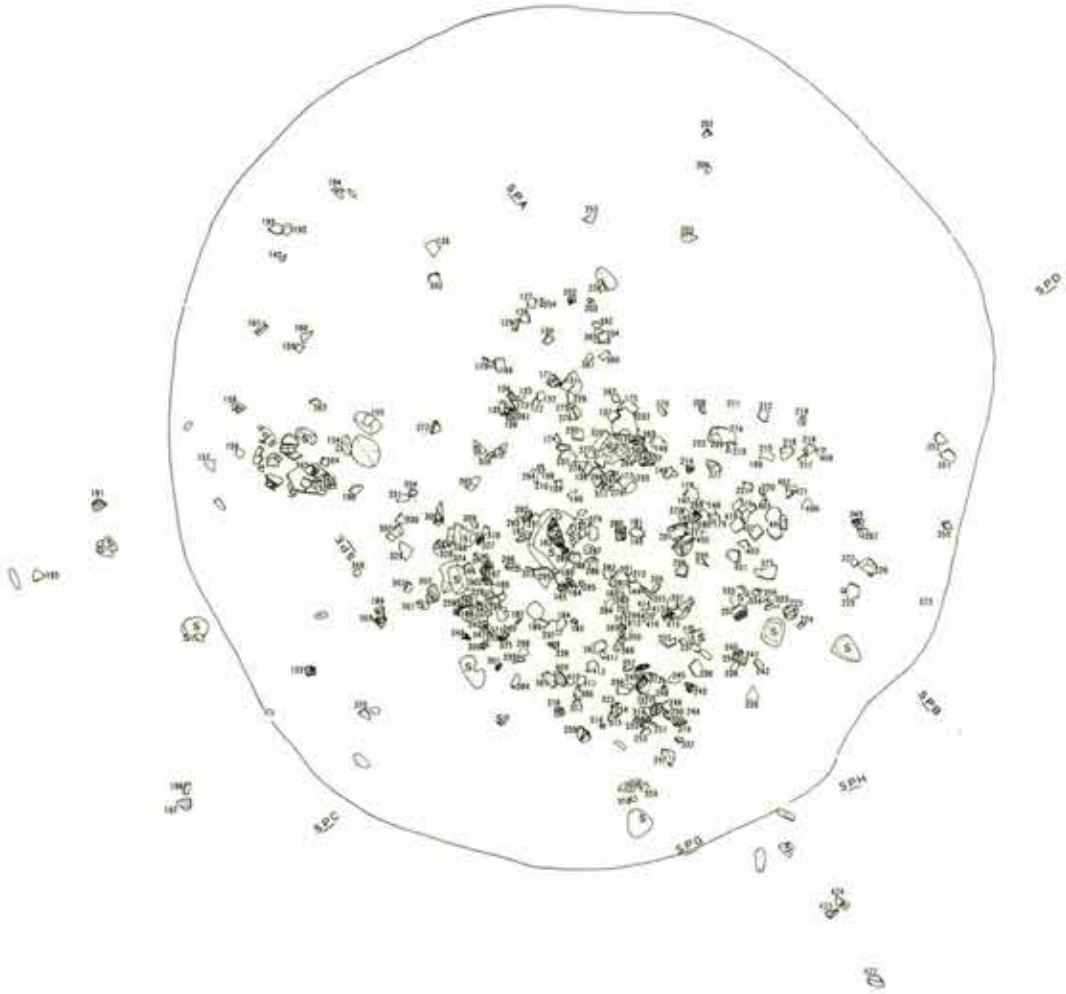

第 55 图 积迦堂 S-IV 区 SB-105

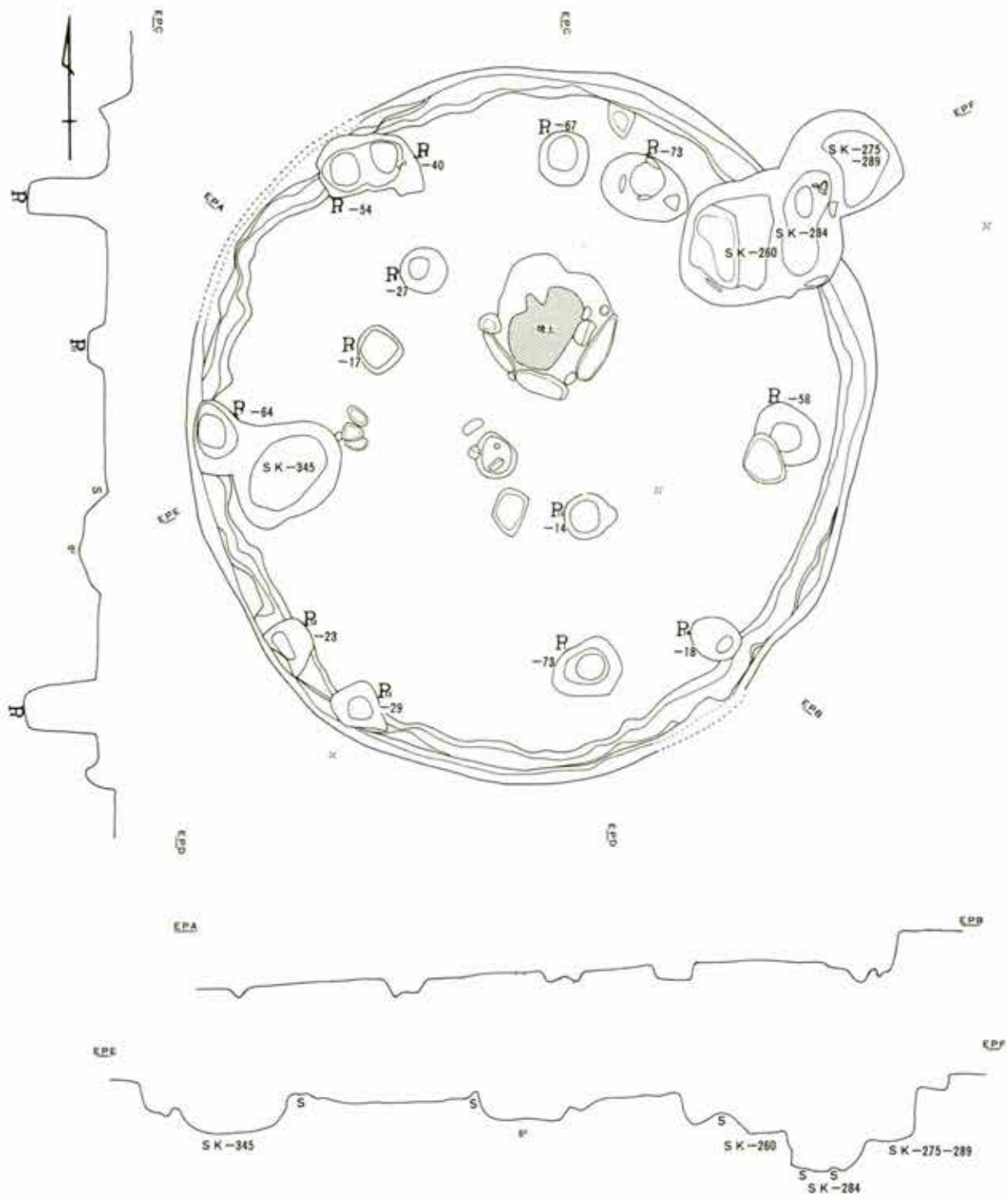

第 56 图 积迦堂 S-III 区 SB-105

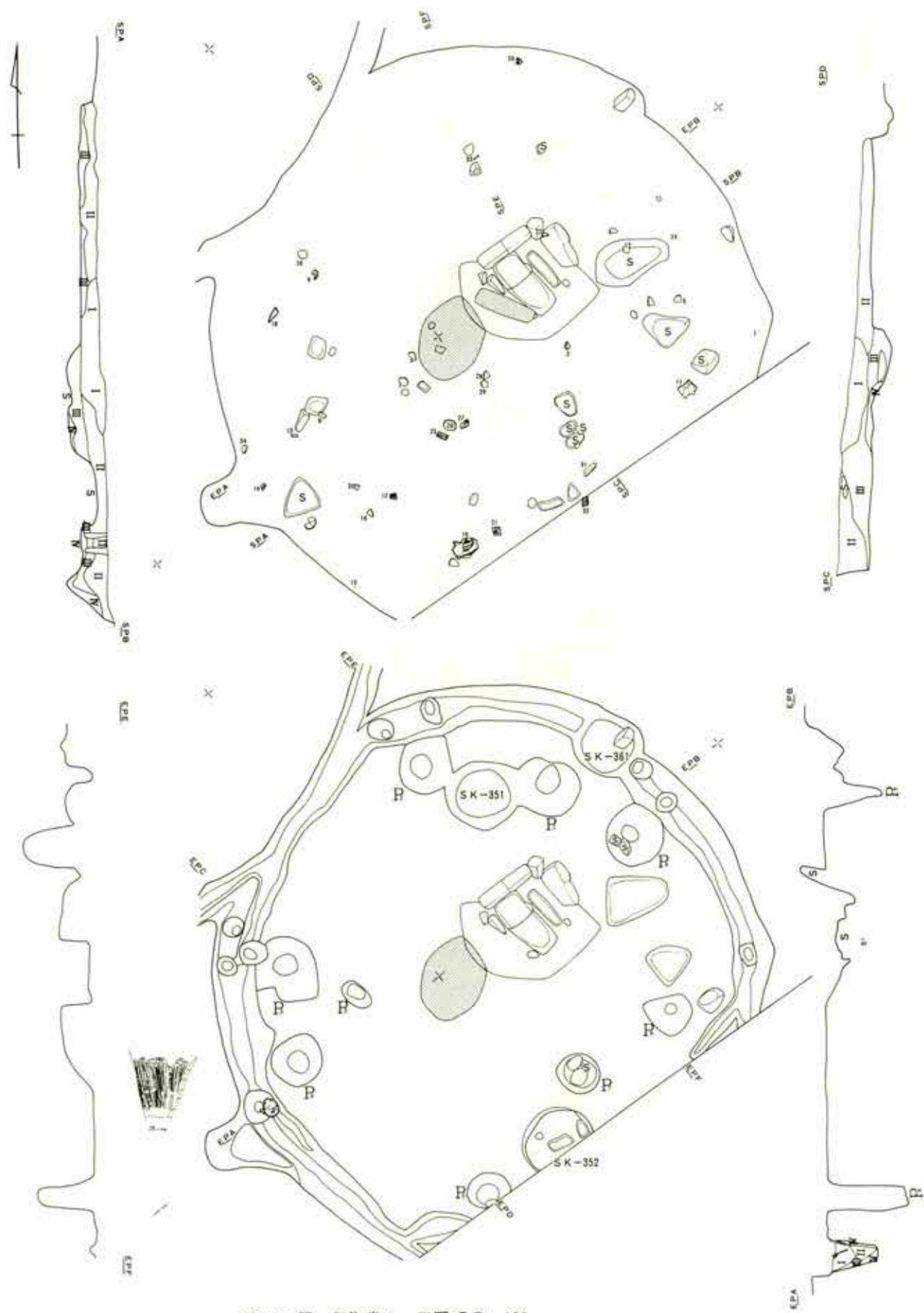

第 57 图 积迦堂S-III区 SB-109

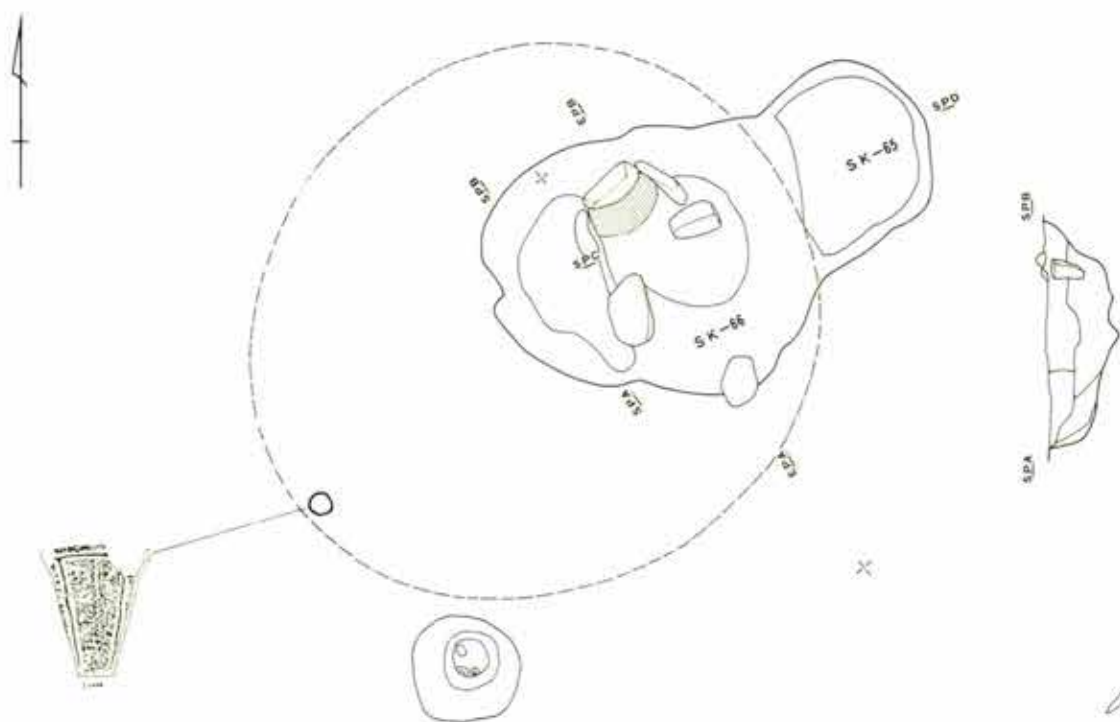

第 58 图 积迦堂 S-III 区 SB-113

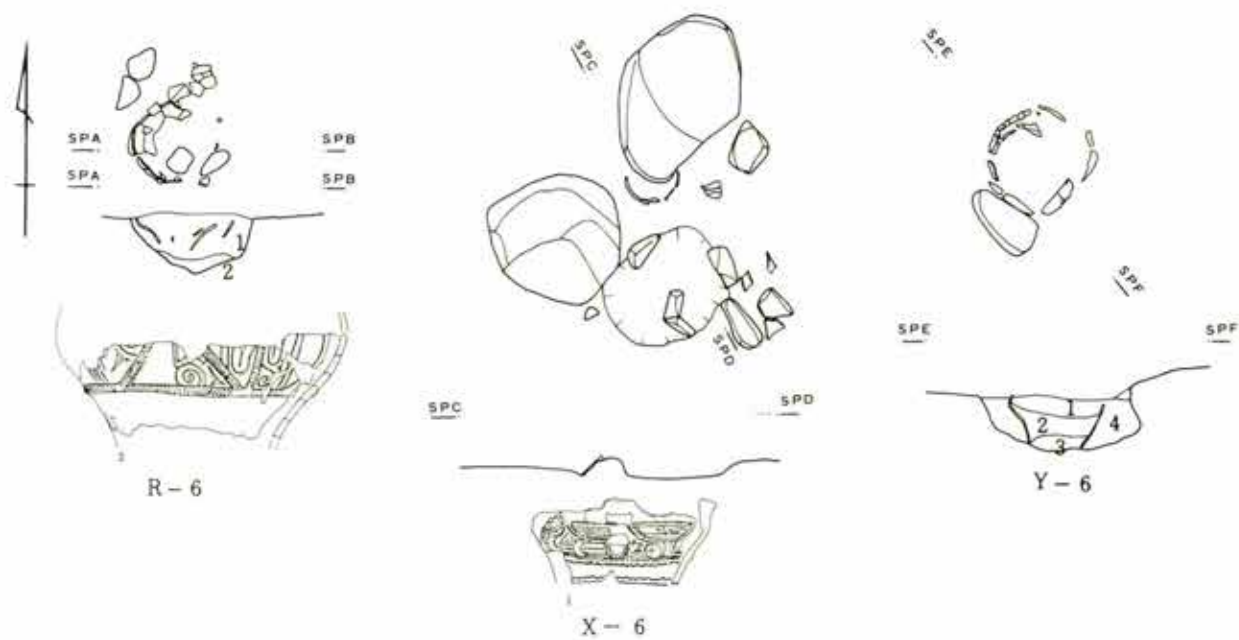

第 59 图 积迦堂 S-III 区埋甕

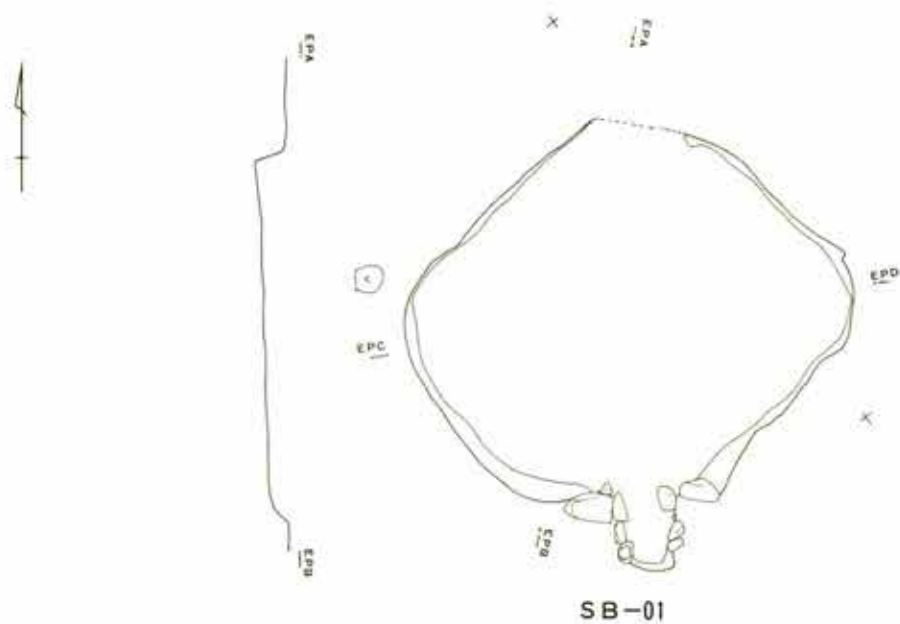

SB-01



SB-02

第 60 图 积逊堂 S-III 区 SB-01-02 (1)



(1 : 60)

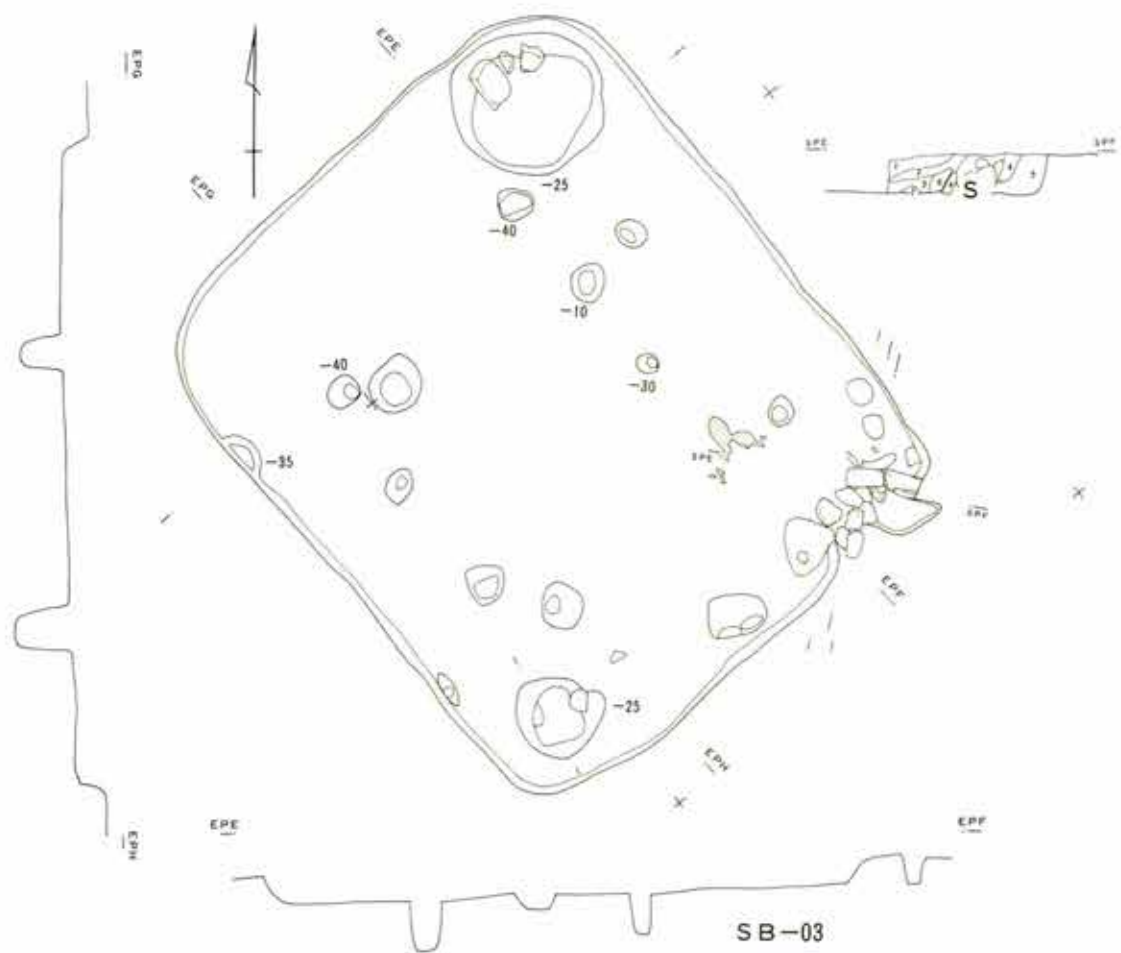

第 61 图 积迦堂S-III区SB-03-14

(2) (1:60)



第 62 图 积迦堂 S-III 区 SB-28

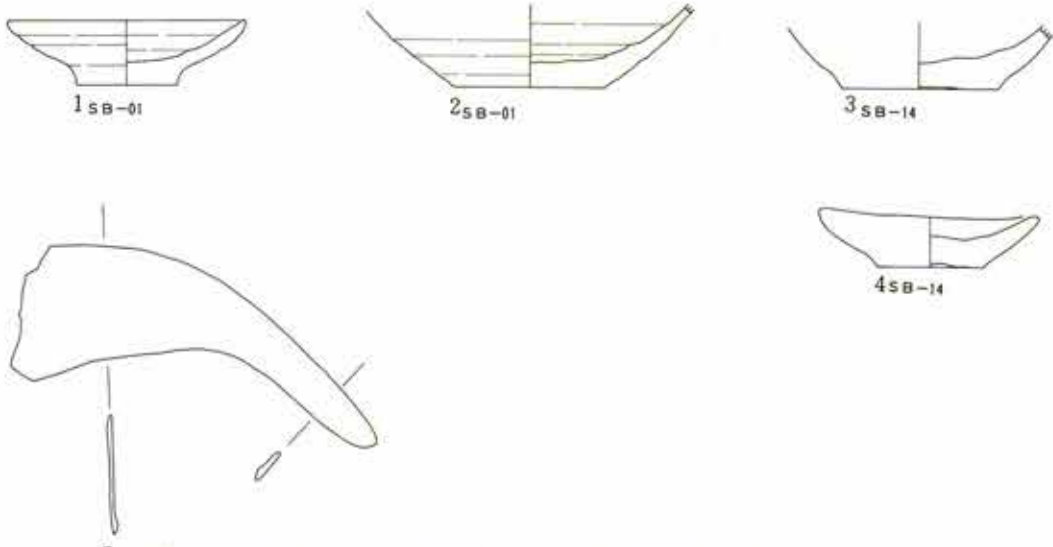

第 63 图 积迦堂 S-III 区 SB-01 -08 -14 出土遗物 (1:3)

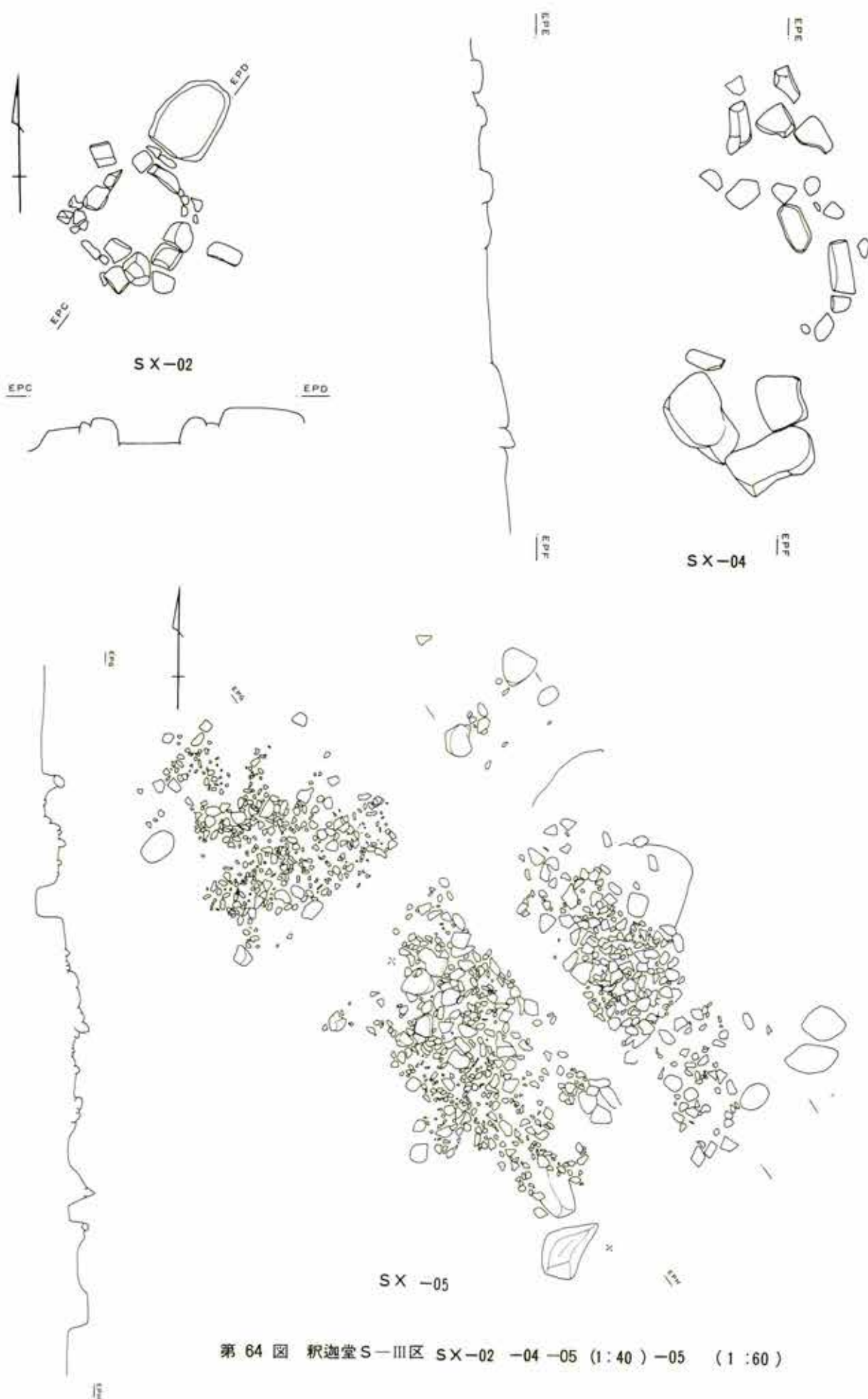

第 64 图 积迦堂 S-III 区 SX-02 -04 -05 (1:40) -05 (1:60)

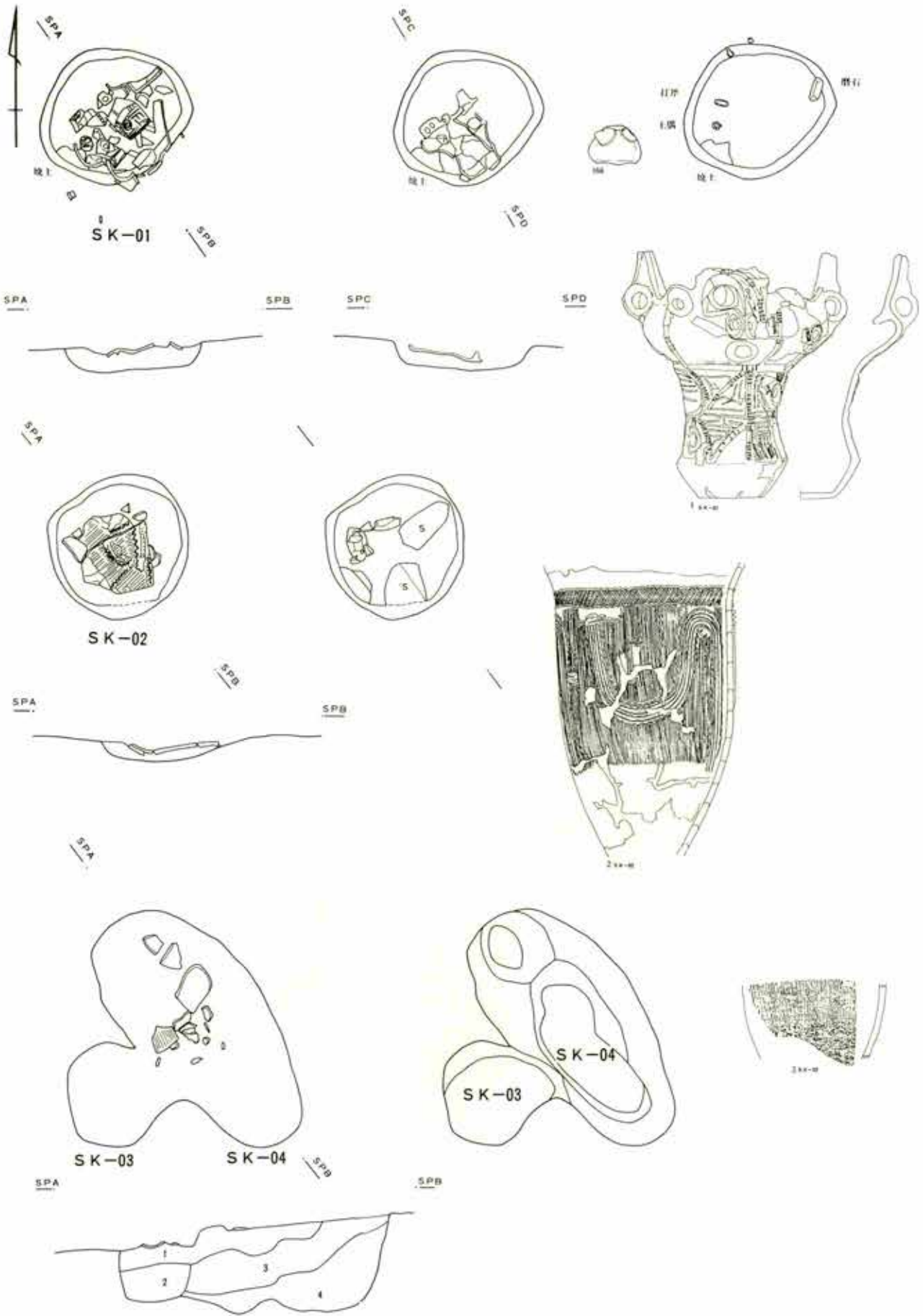

第 65 图 积迦堂 S-III 区 SK-01 -02 -03 -04 (1:40) (1)

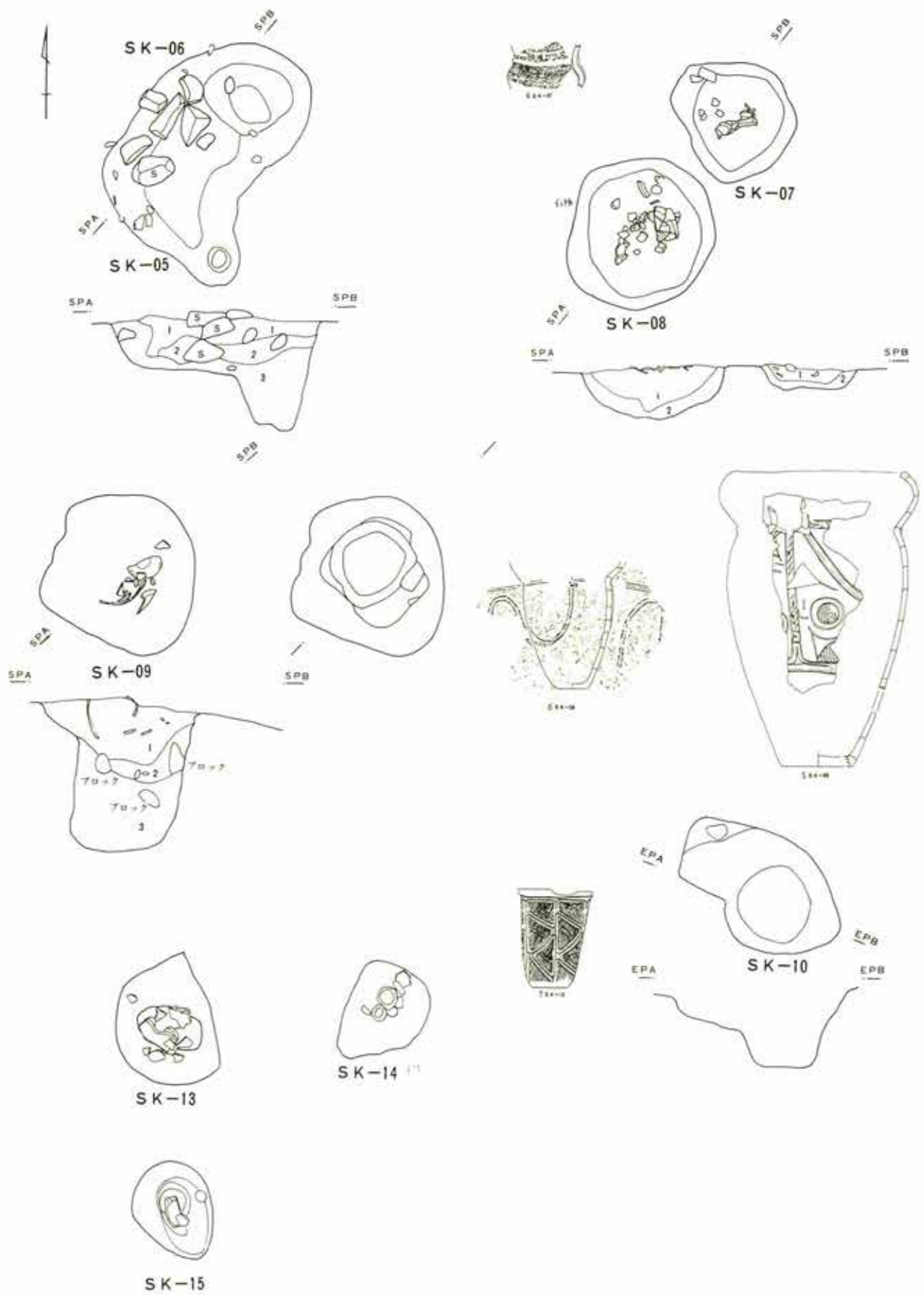

第 66 图 积迦堂 S-III 区 SK-05-06-07-08-09-10-13-14-15 (1:40) (2)

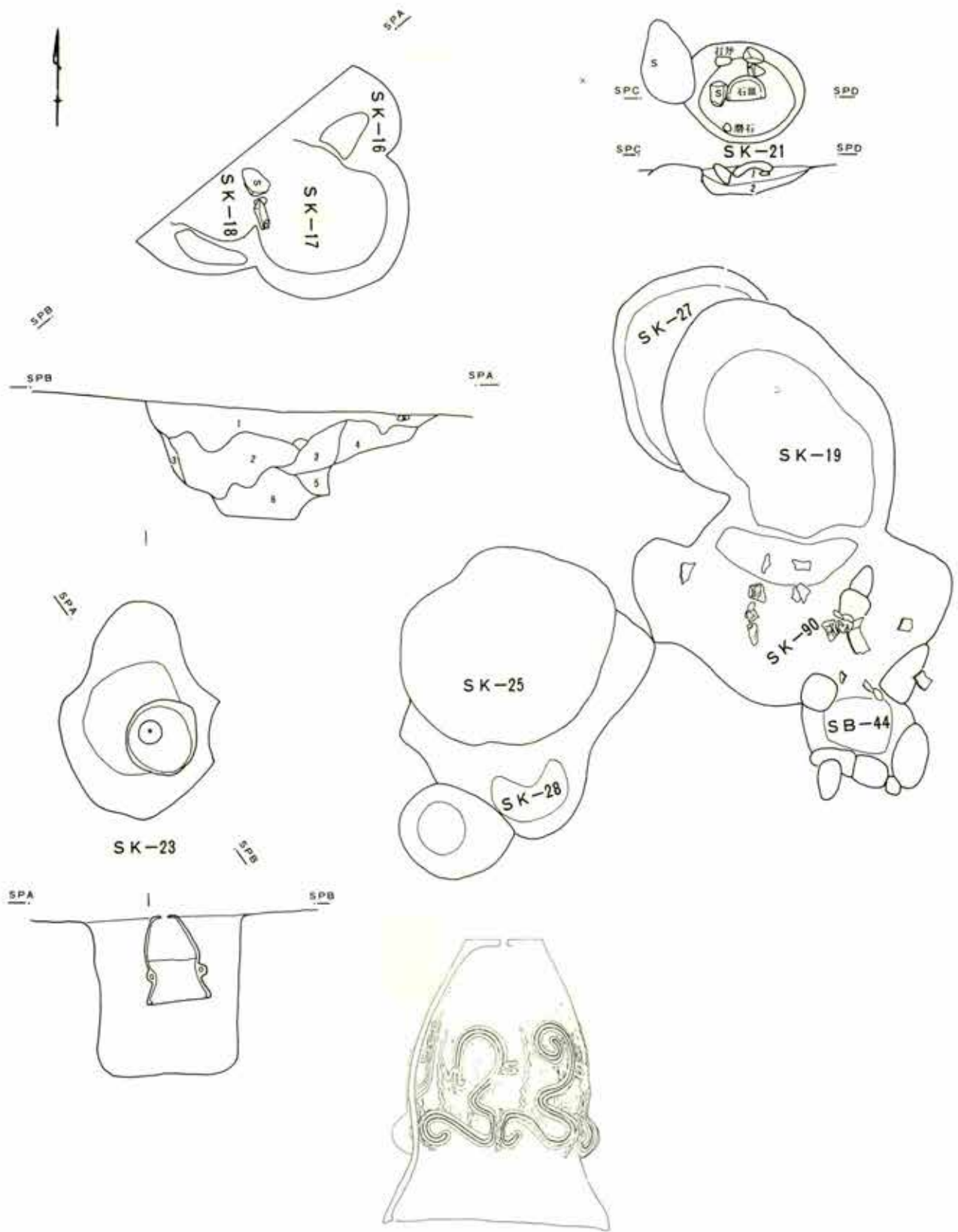

第 67 图 积善堂S-III区 SK-17-18-21-23-25-27-28-90 (1:40) (3)

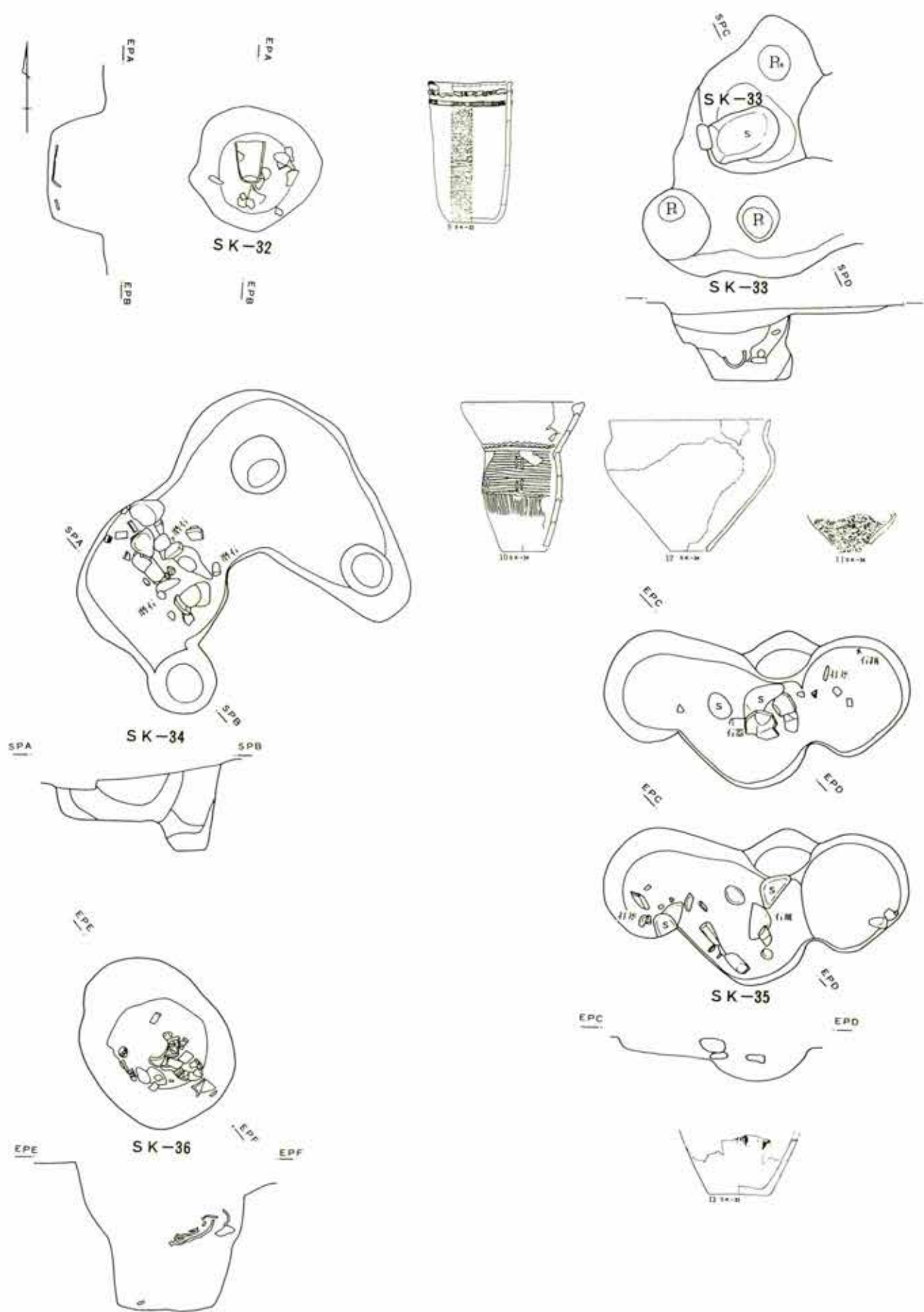

第 68 图 积迦堂 S-III 区 SK-32 -33 -34 -35 -36 (1:40) (4)

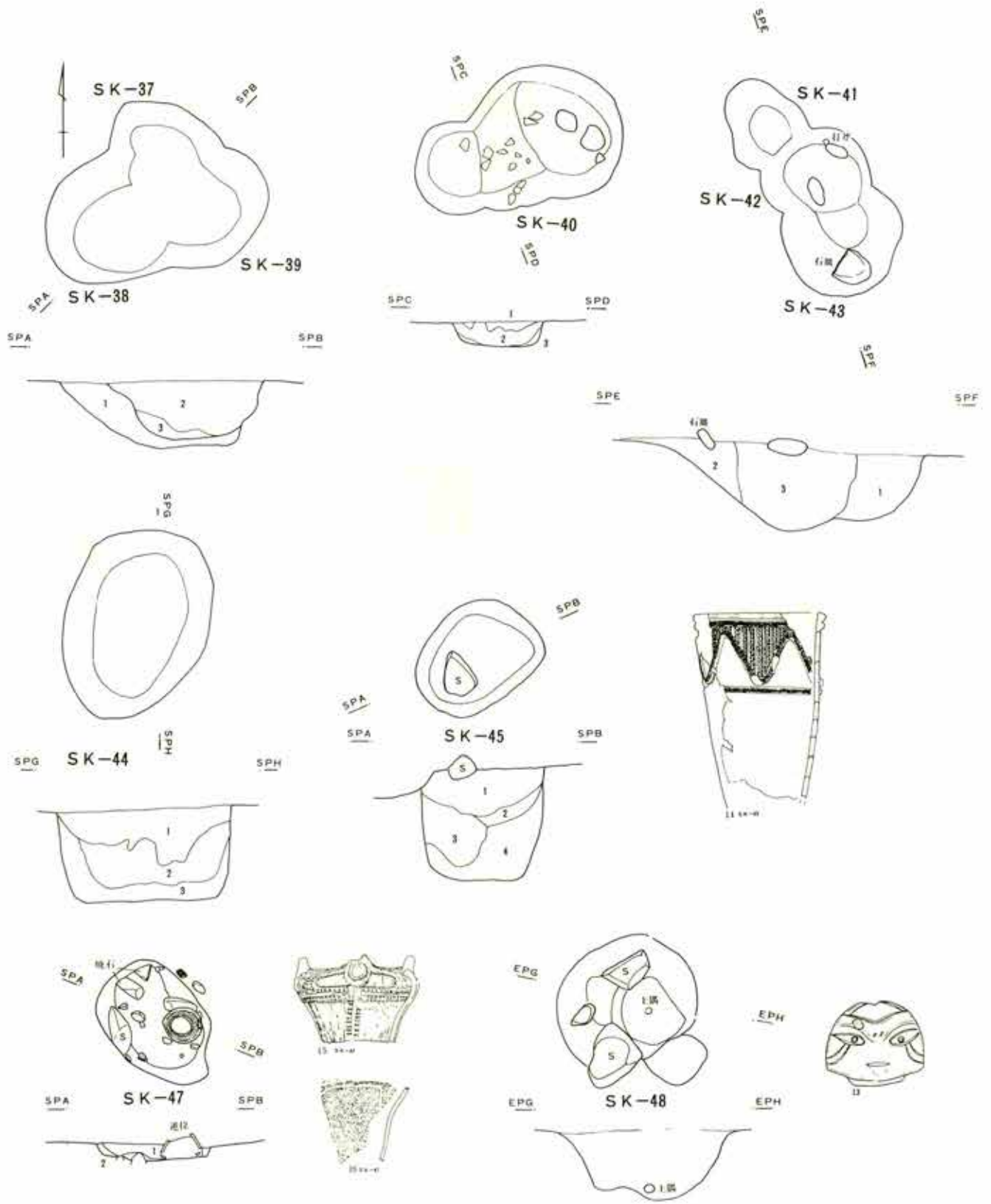

第 69 图 积迦堂S-III区SK-38-40-41-42-43-44-45-47-48 (1:40) (5)

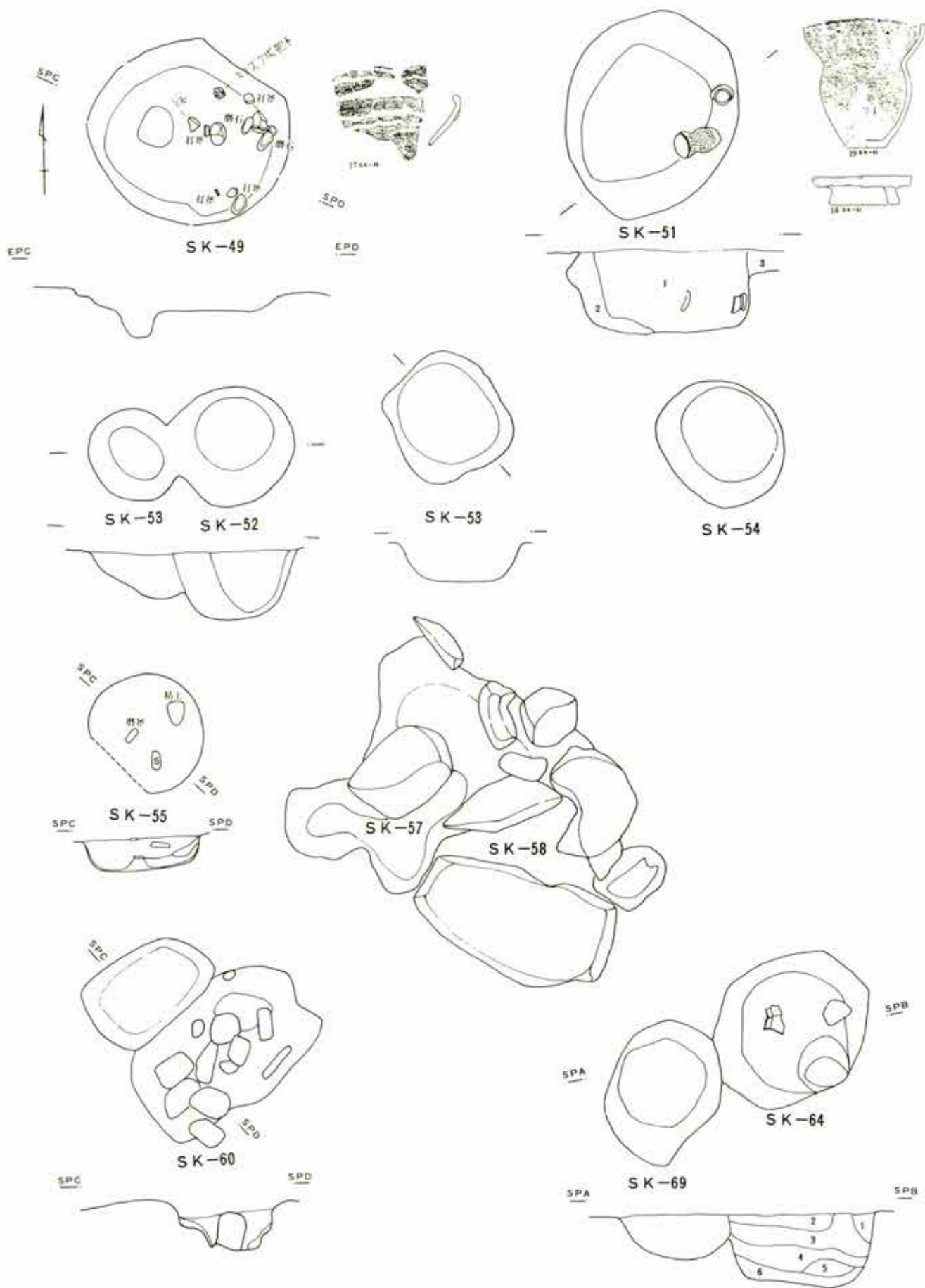

第 70 图 积迦堂 S-III 区 SK-49-51-52-53-54-55-57-58-60-64-69 (1:40) (6)

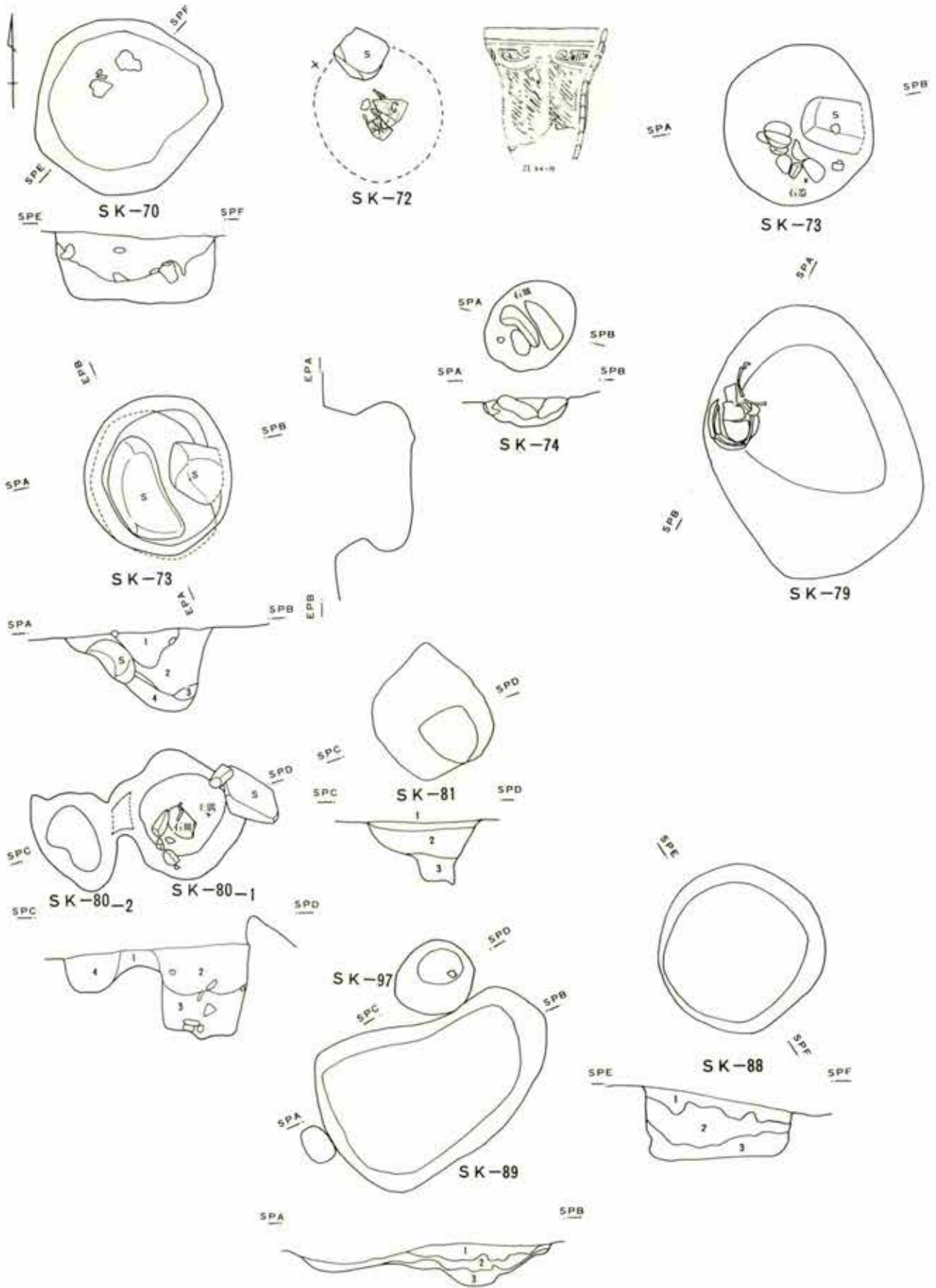

第 71 图 积迦堂 S-III 区 SK-70-72-73-74-79-80-81-88-89-97 (1:40) (7)

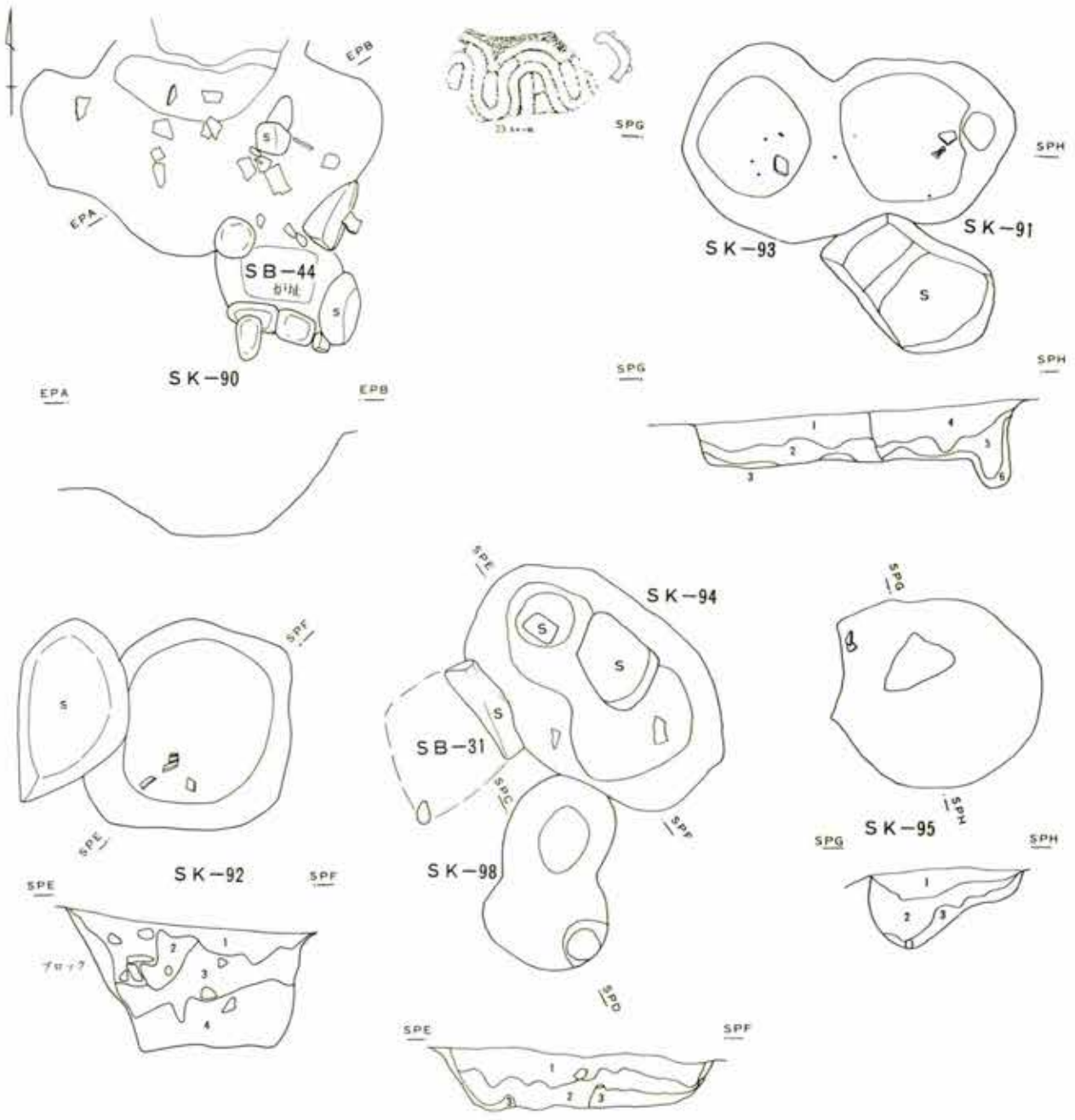

第 72 图 积道堂 S-III 区 SK-90-91-92-93-94-95 (1:40) (8)

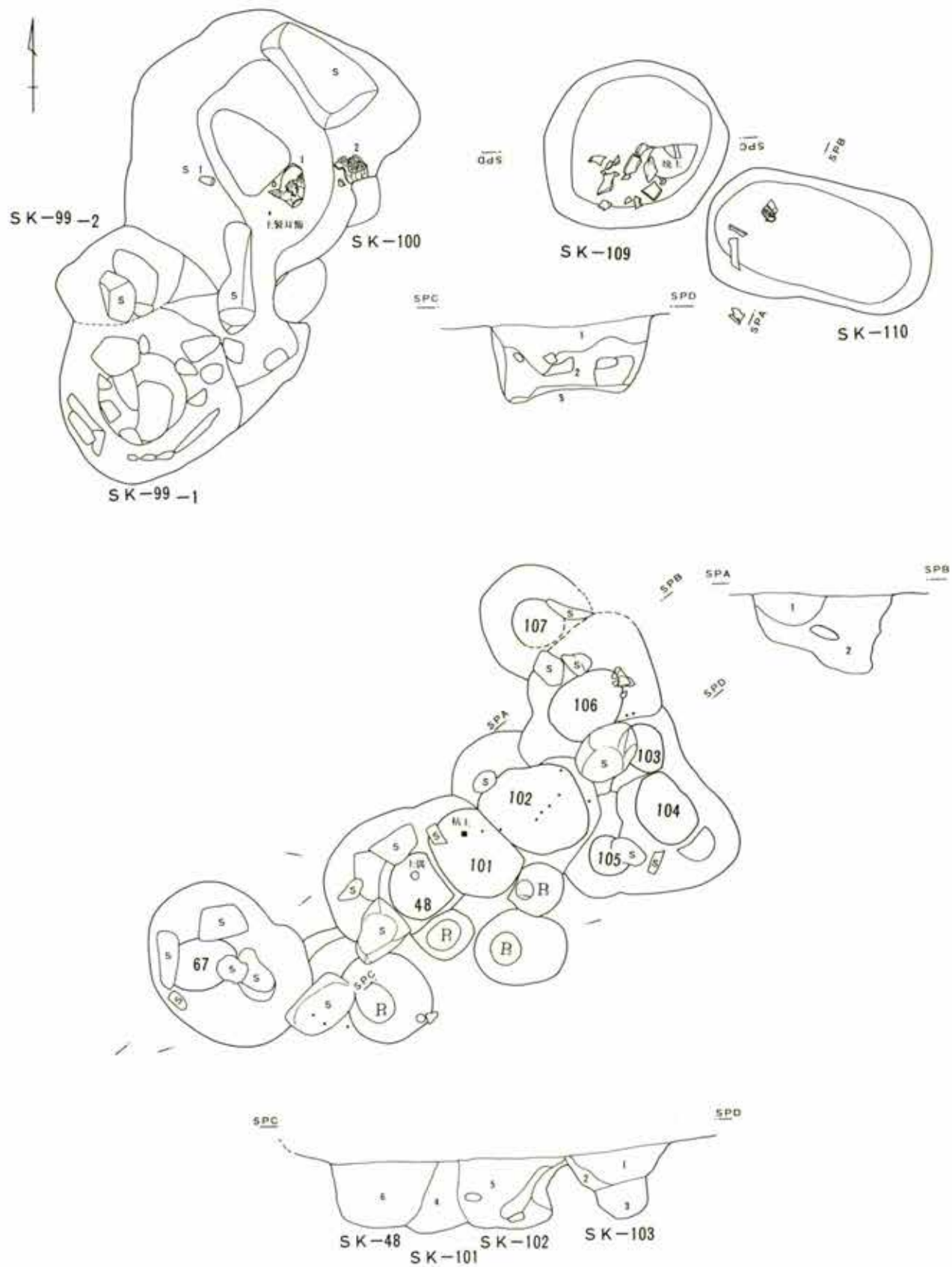

第 73 图 积道堂 S-III 区 SK-99-100-101-102-103-104-105-106
-107-109-111-48-67(1:40) (9)

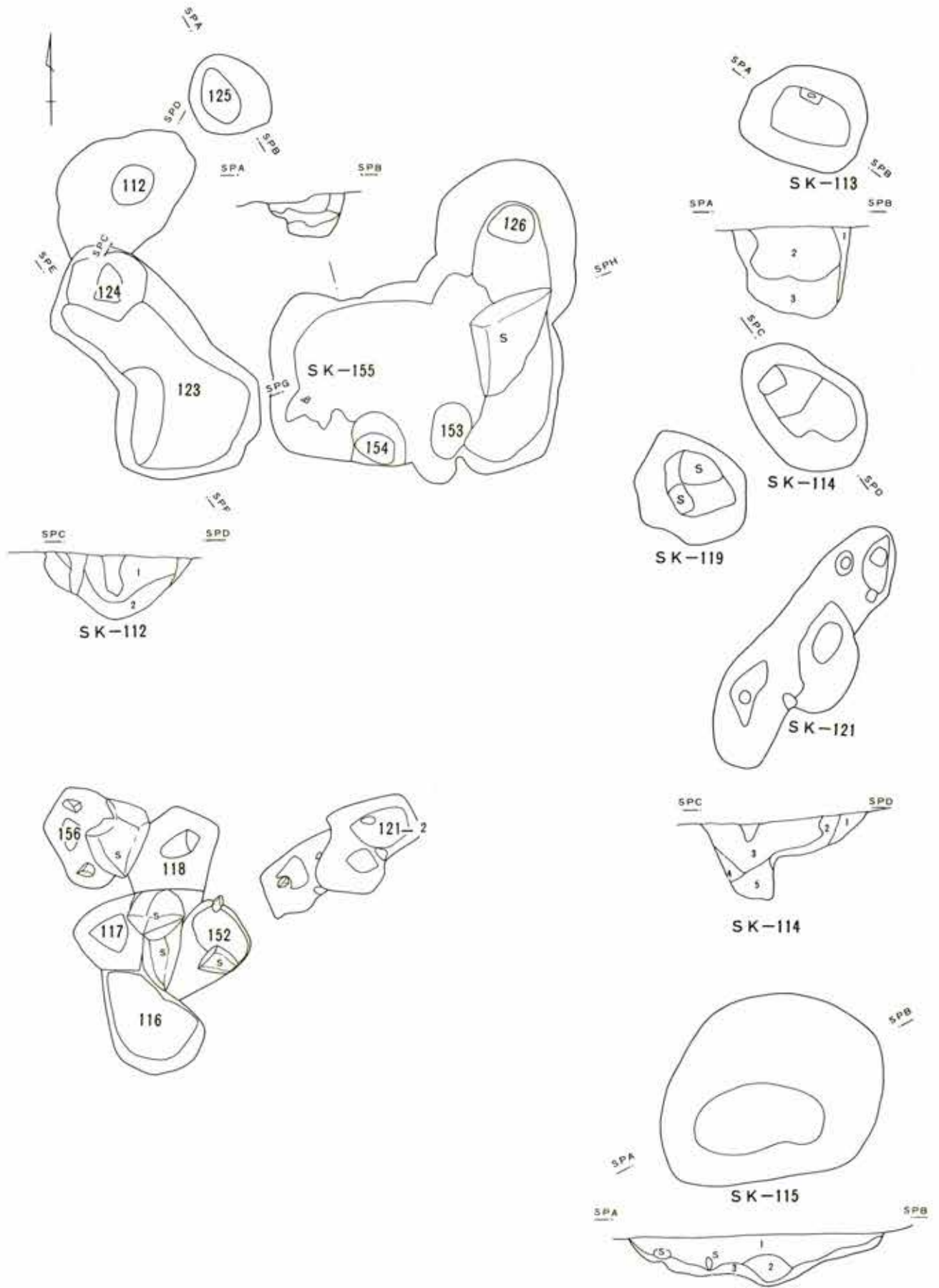

第 74 图 积迦堂S-III区 SK-112-113-114-115-116
 -117-118-119-121-124-125-126-152-153-154
 -155-156 (1:40)

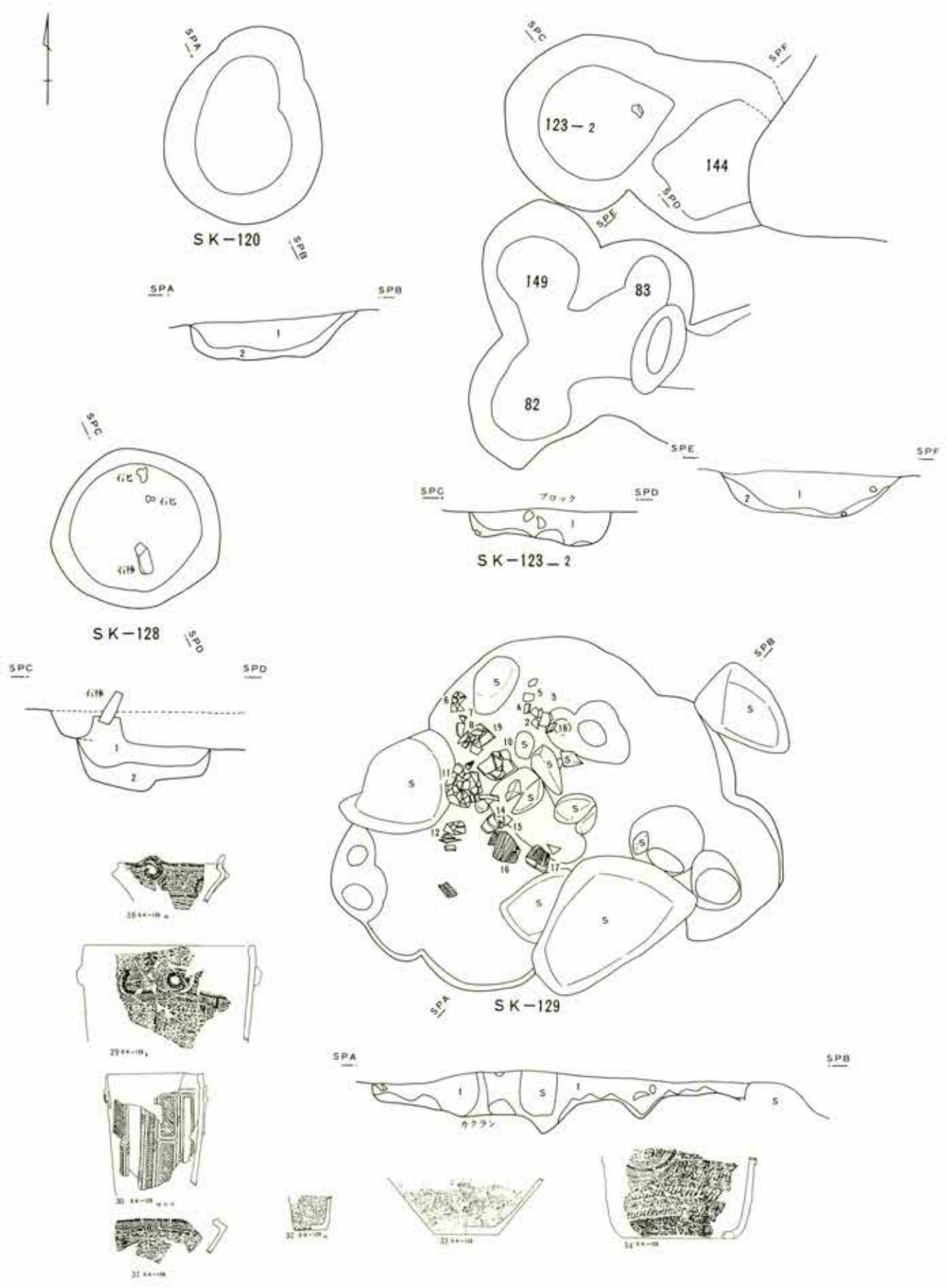

第 75 図 釈迦堂 S-III 区 SK-120-123-128-129-82-83-144-149
(1:40) (11)

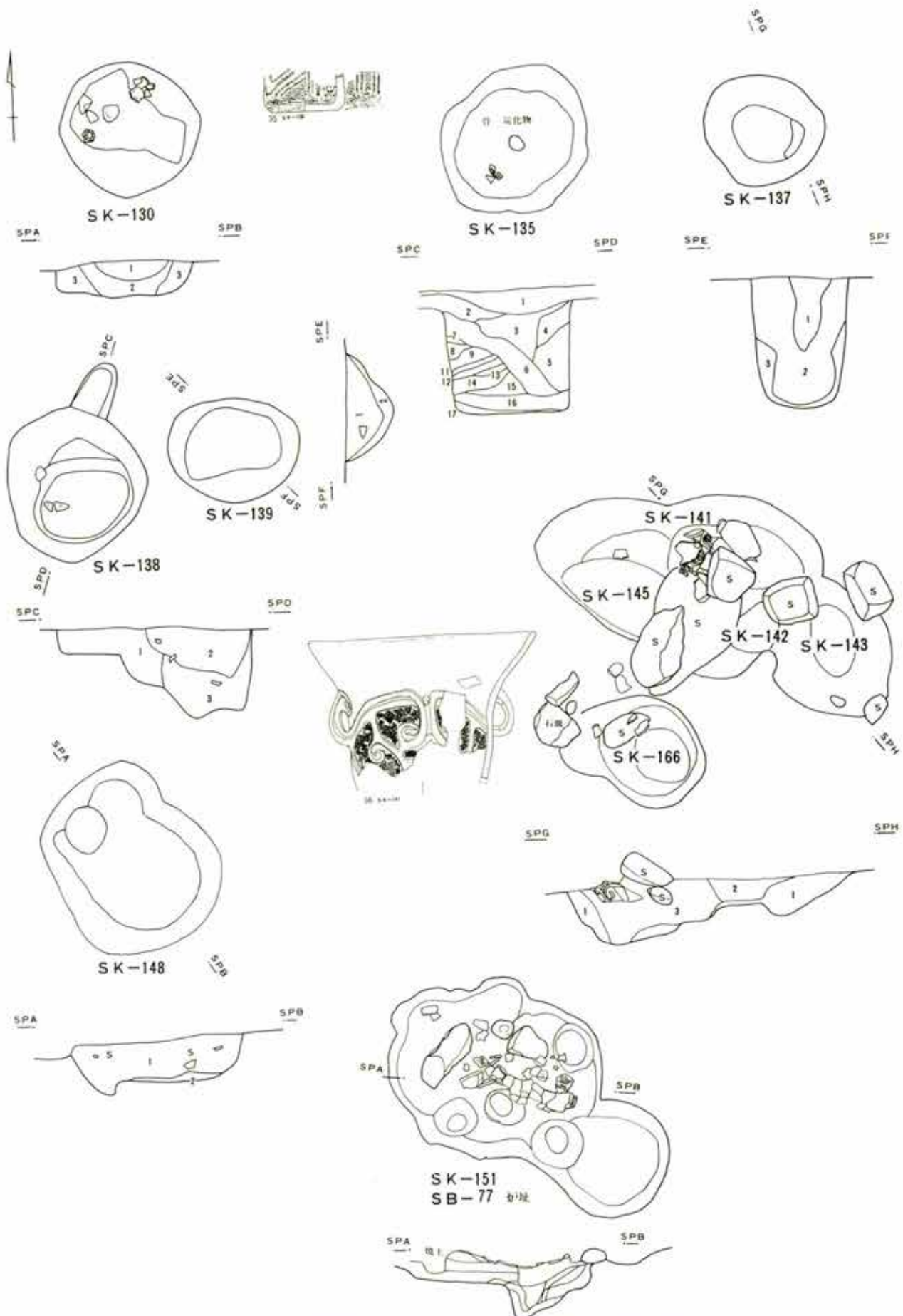

第 76 图 积道堂 S-III 区 SK-130-135-137-138-139-141-142-143-145
-148-151-166 (1:40) (12)

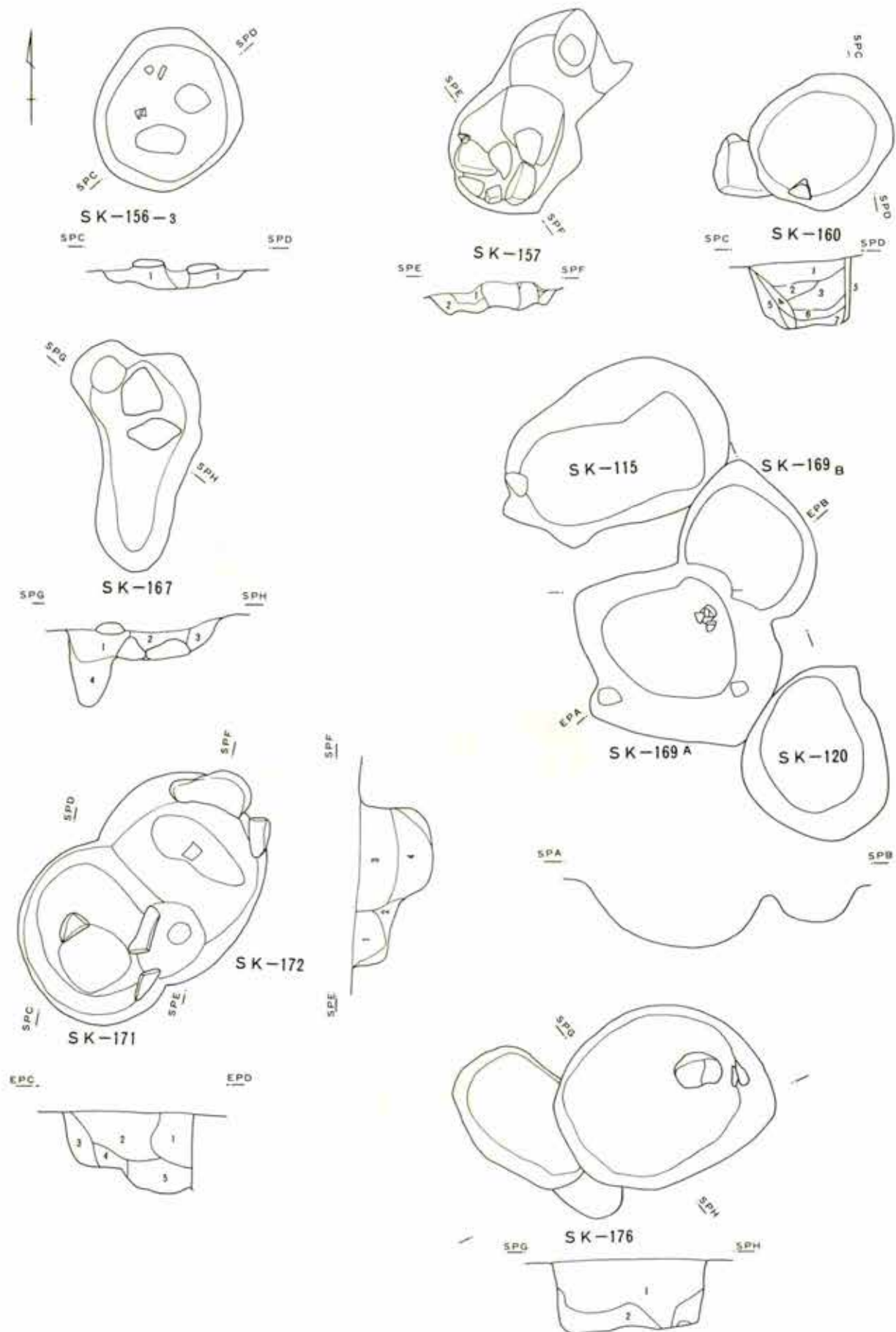

第 77 图 积逊堂 S-III 区 SK-156-157-160-167-169-171-172
-176-115-120 (1:40) (13)

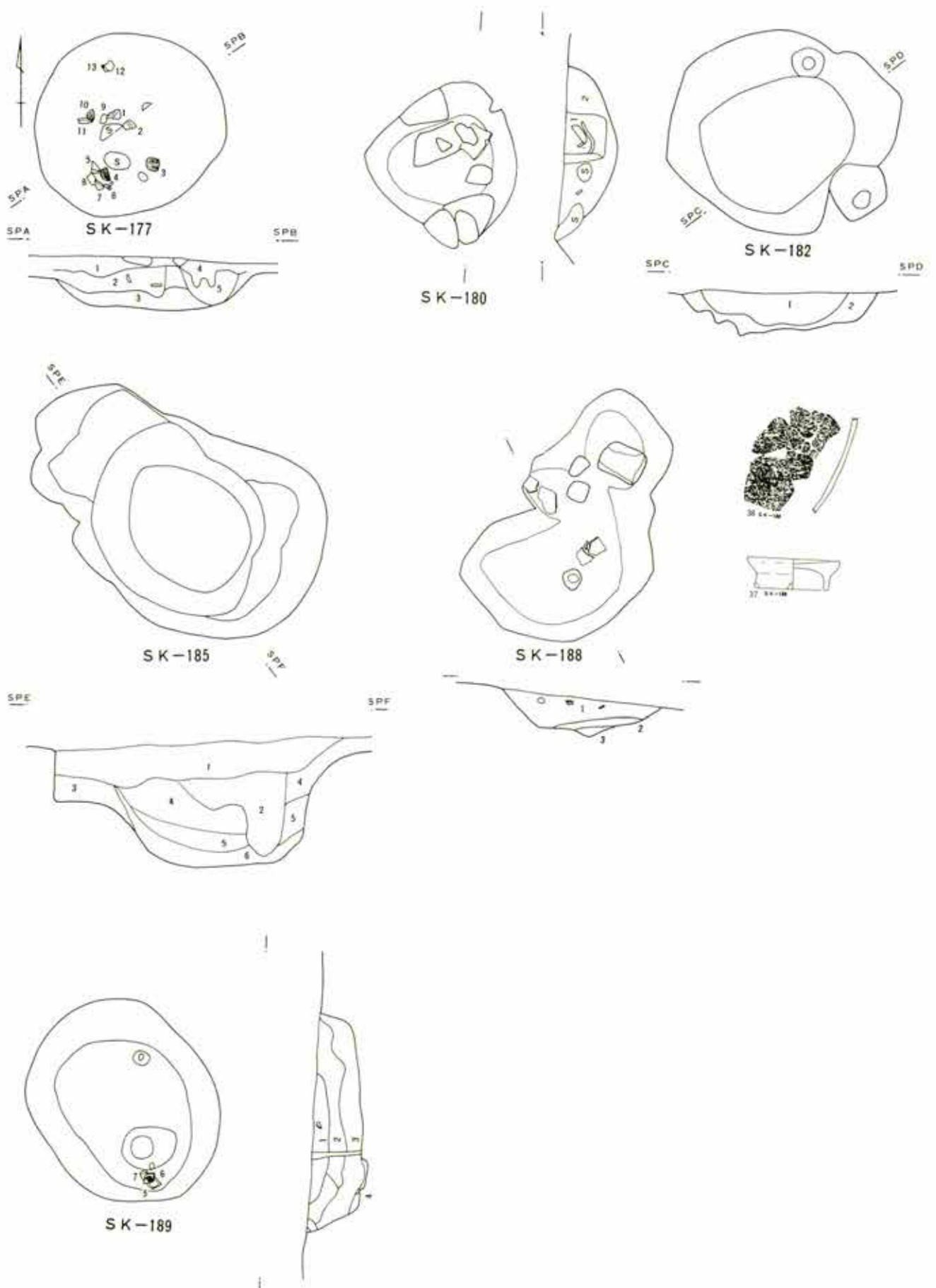

第 78 图 积造堂 S-III 区 SK-177-180-182-185-188-189
(1:40) (14)

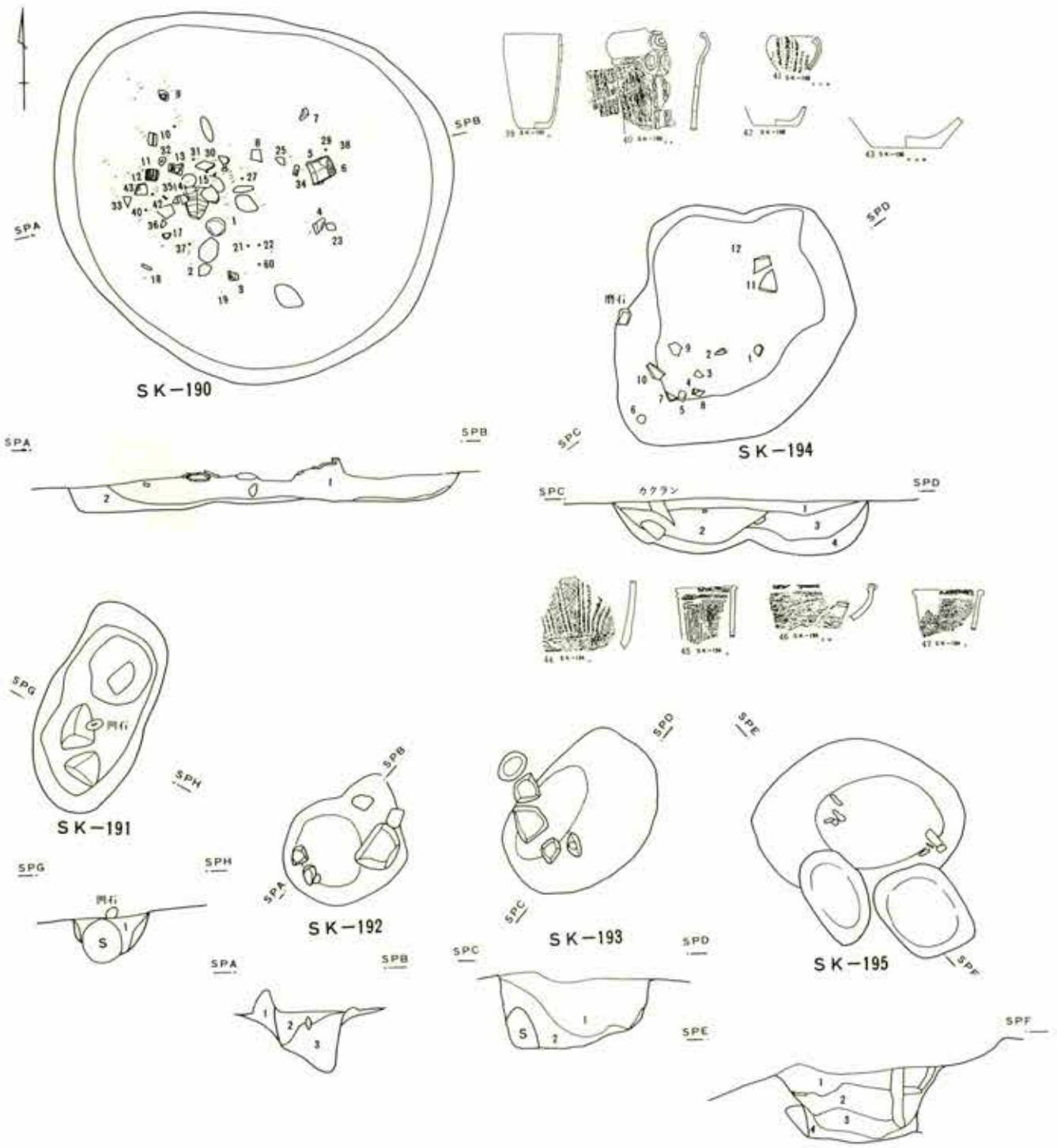

第 79 图 积迦堂 S-III 区 SK-190-191-192-193-194-195
(1:40) (15)

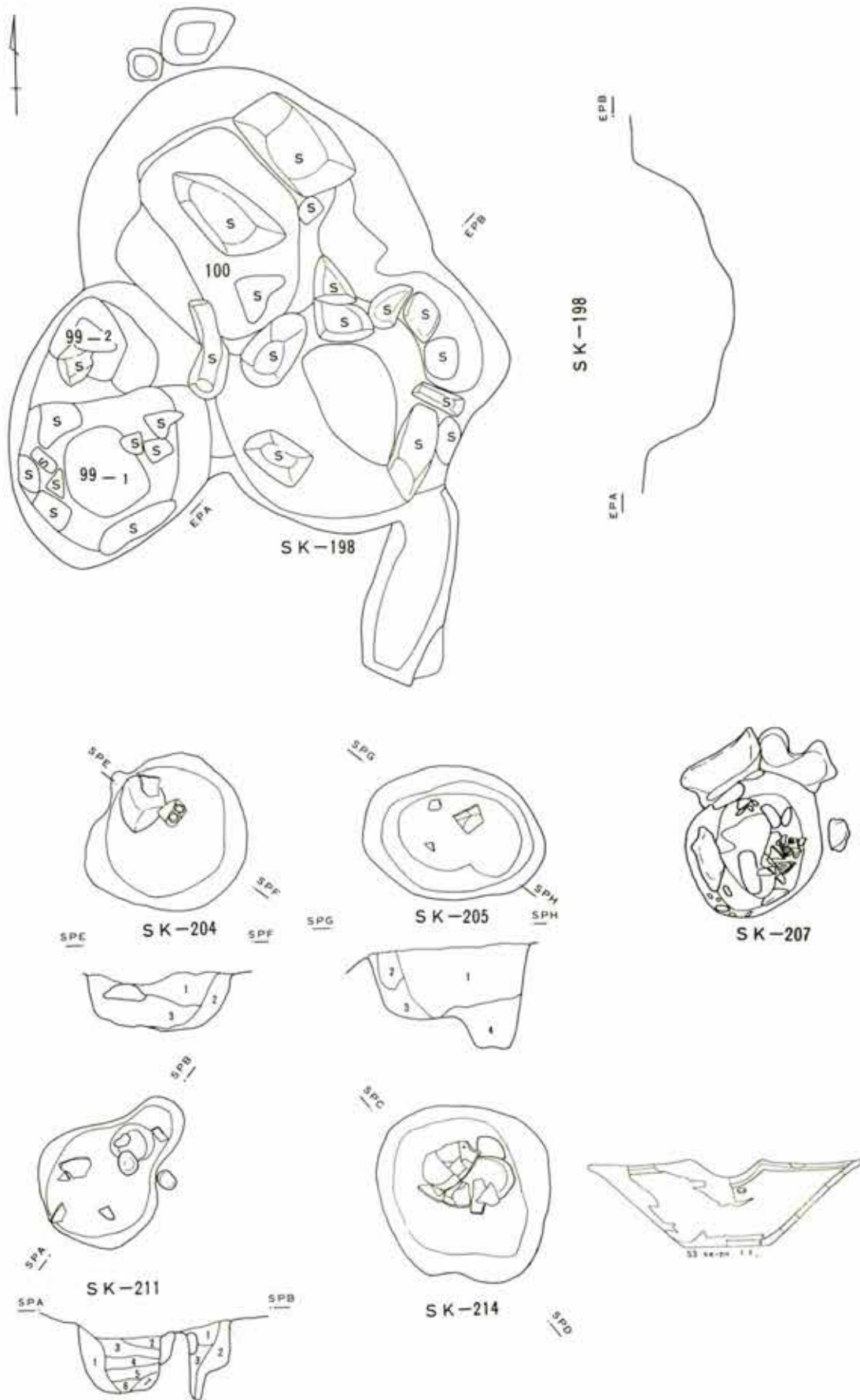

第 80 图 积迦堂 S-III 区 SK-198-204-205-207-211-214-99-100 (1:40) (16)

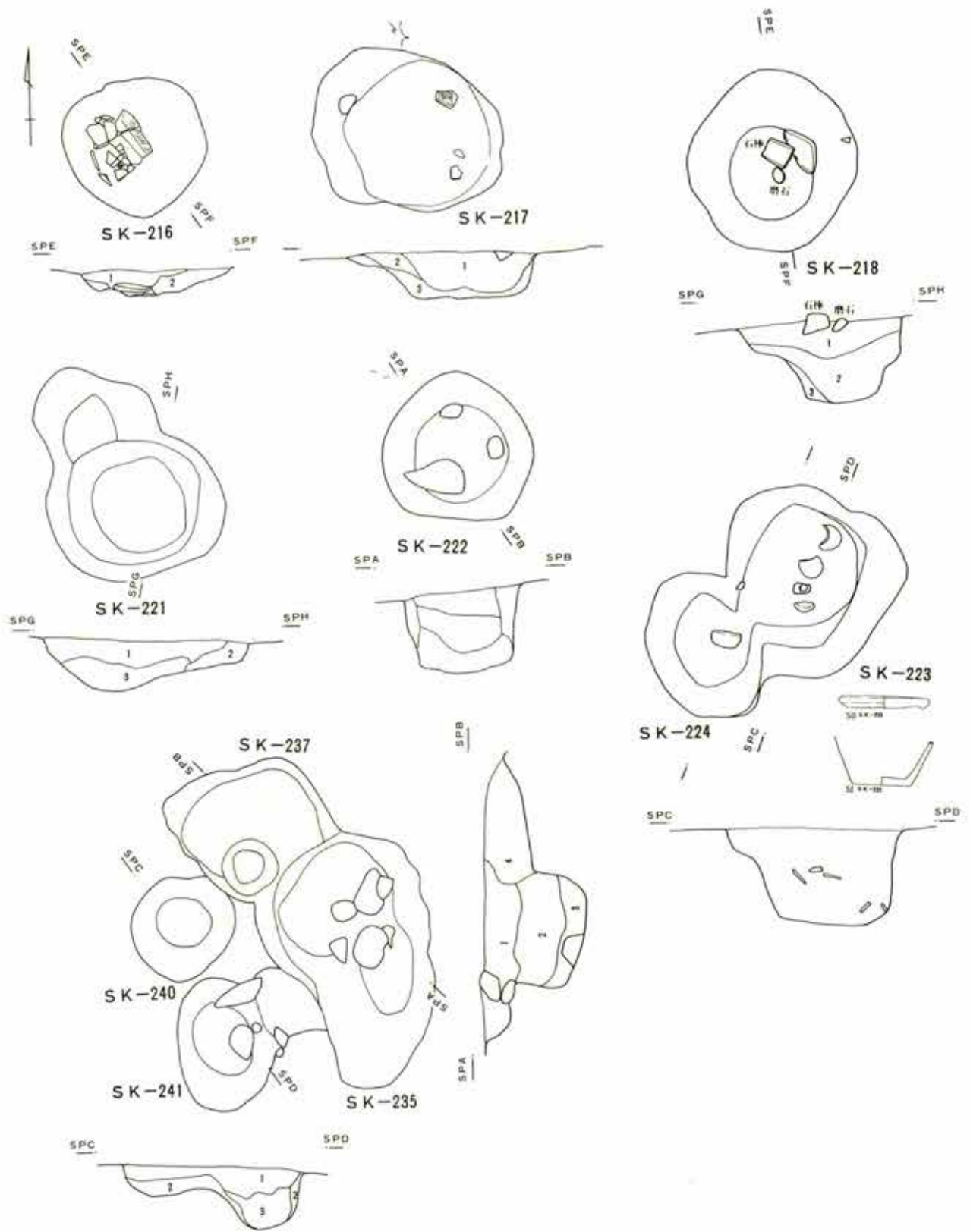

第 81 图 积迦堂 S-III 区 SK-216 -217 -218 -221 -222 -223 -224 -235 -237
-240 -241 (1:40) (17)

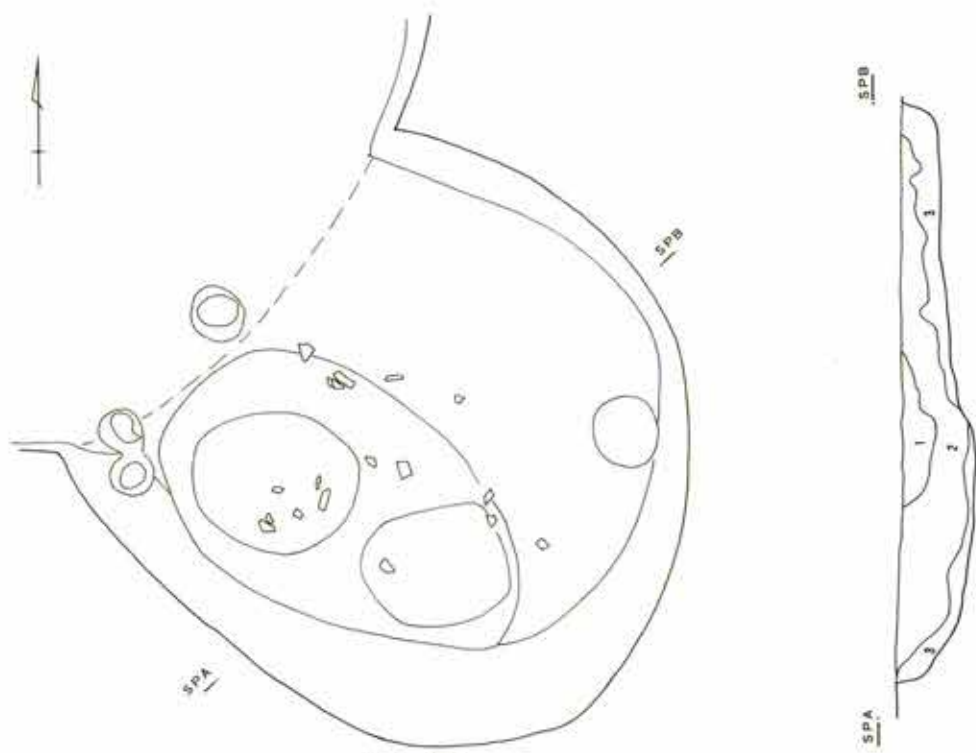

SK-236

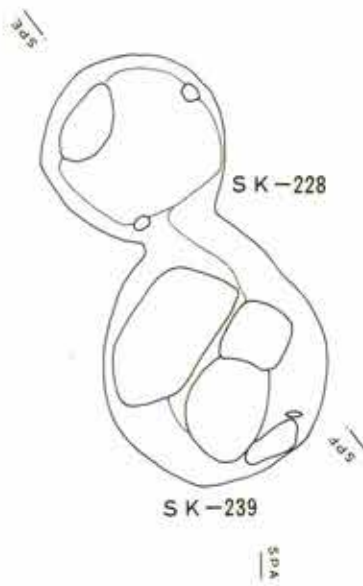

SK-228

SK-239

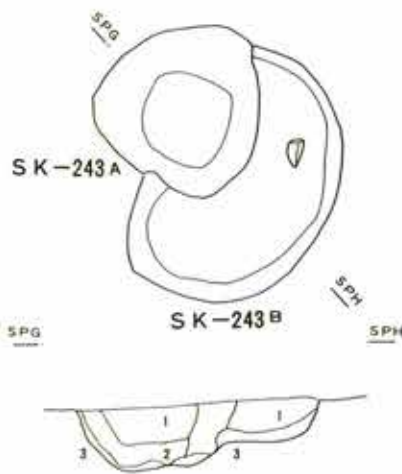
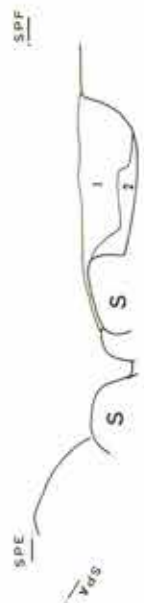

SK-243A

SK-243B



Bds

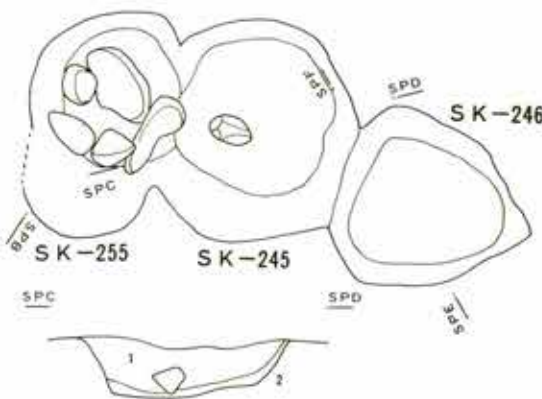

SK-255

SK-245

SK-246



SPE

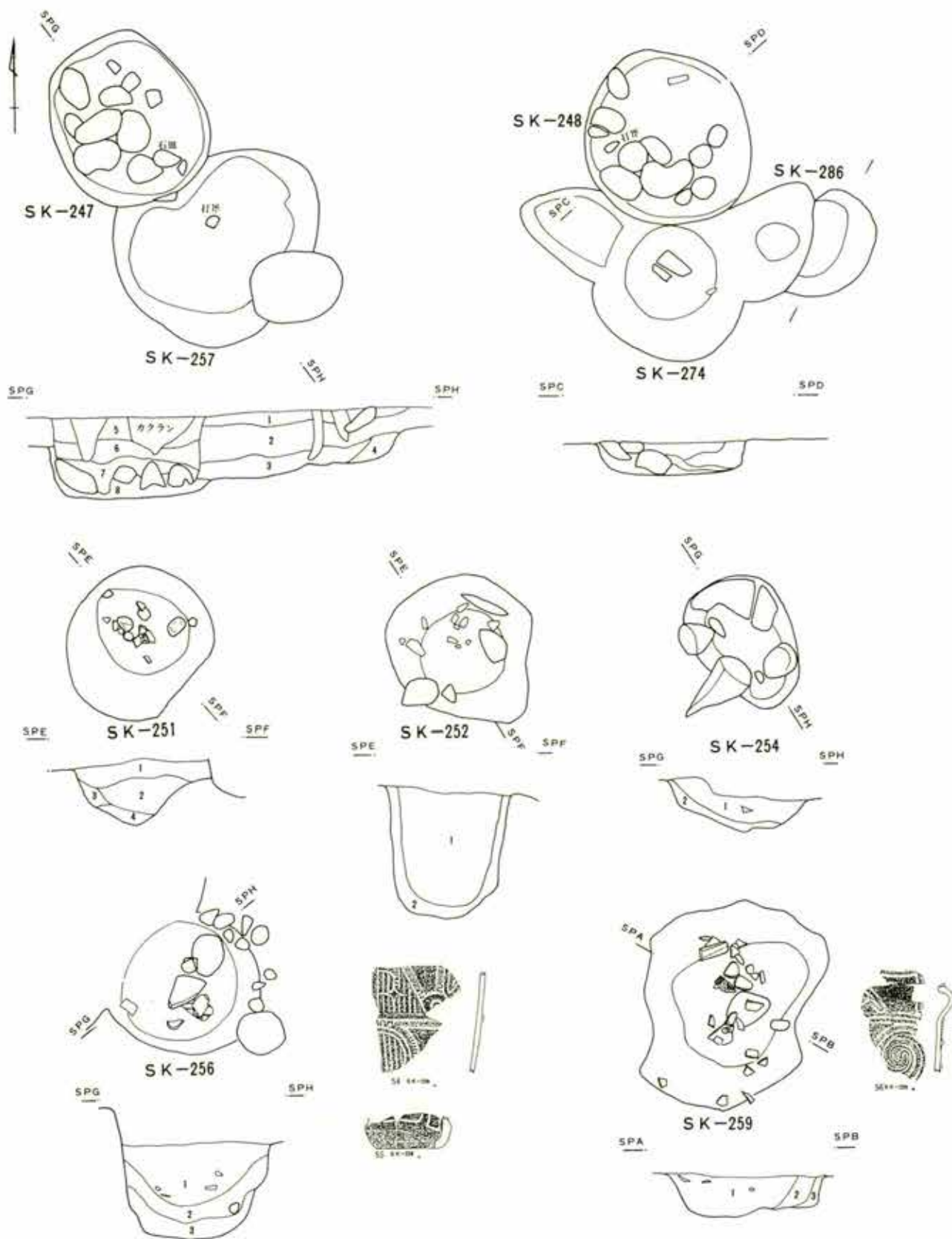

第 83 图 积迦堂 S-III 区 SK-247-248-251-252-254-256-259
 -274-286 (1:40) (19)

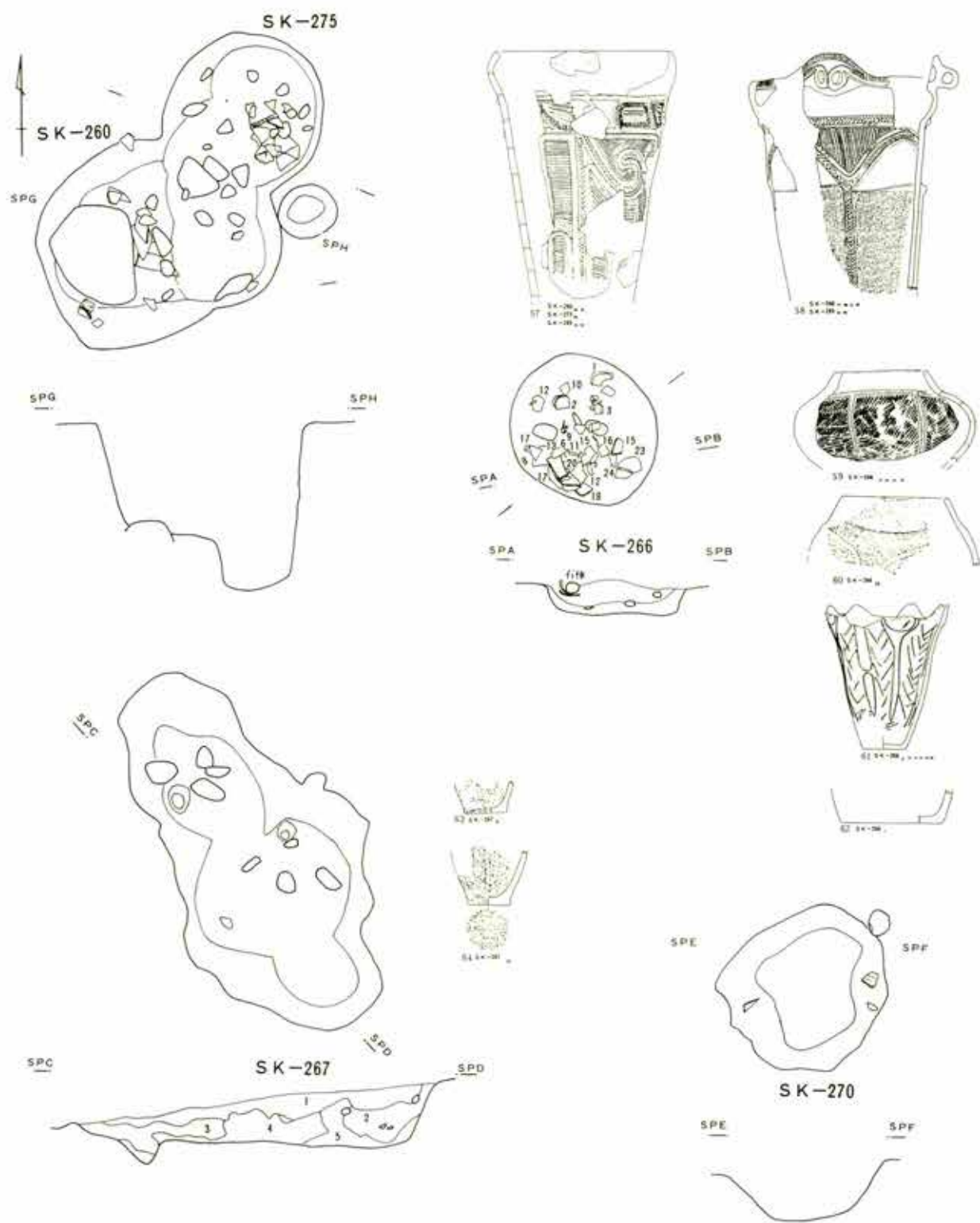

第 84 图 积迦堂 S-III 区 SK-260-266-267-270-275 (1:40) (20)

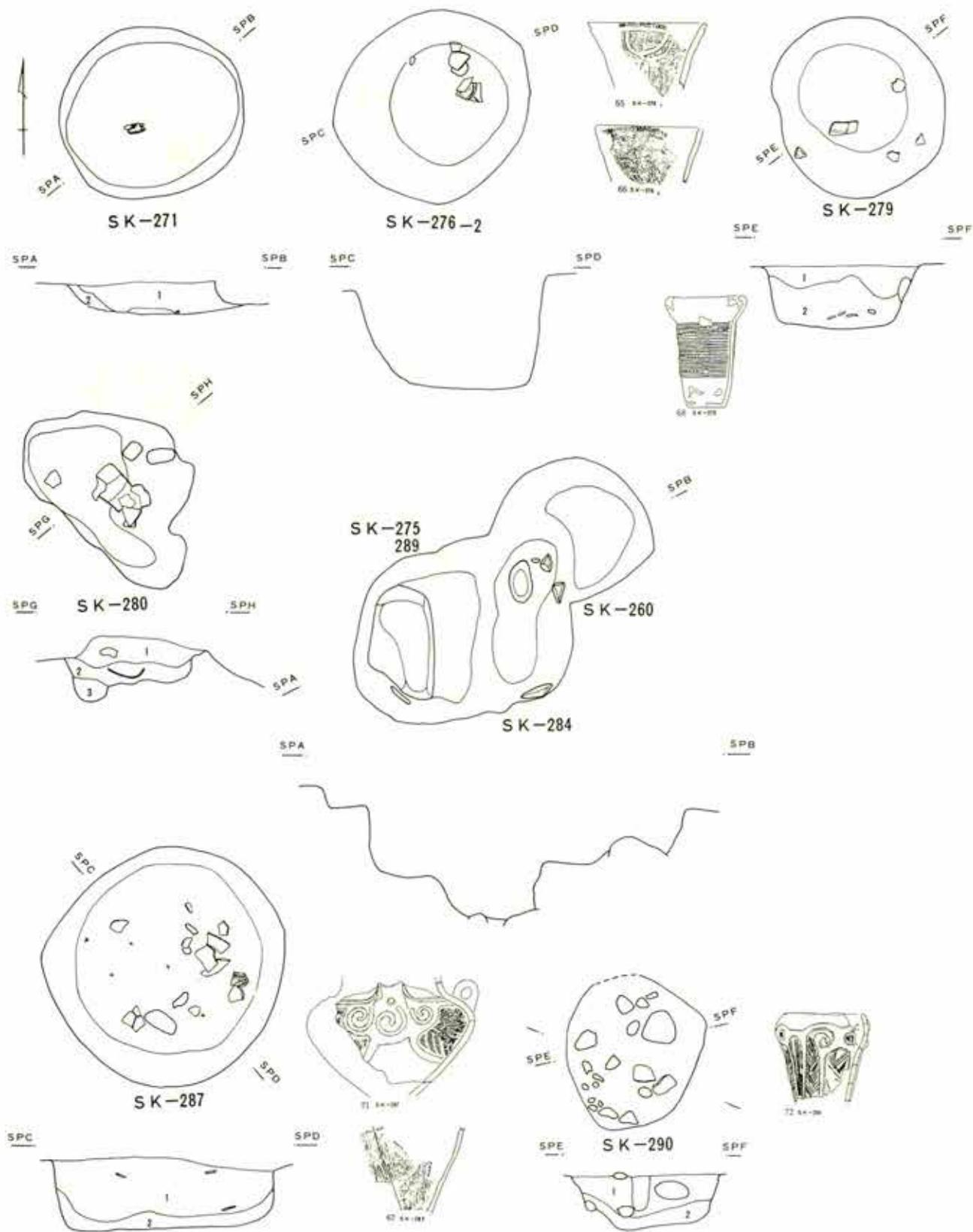

第 85 图 积逊堂 S-III 区 SK-271-276-279-280-287-290-260-275 (1:40) (21)



第 86 图 积迦堂 S-III 区 SK-291-297-299-300-311-323-324-267-269
(1:40) (22)

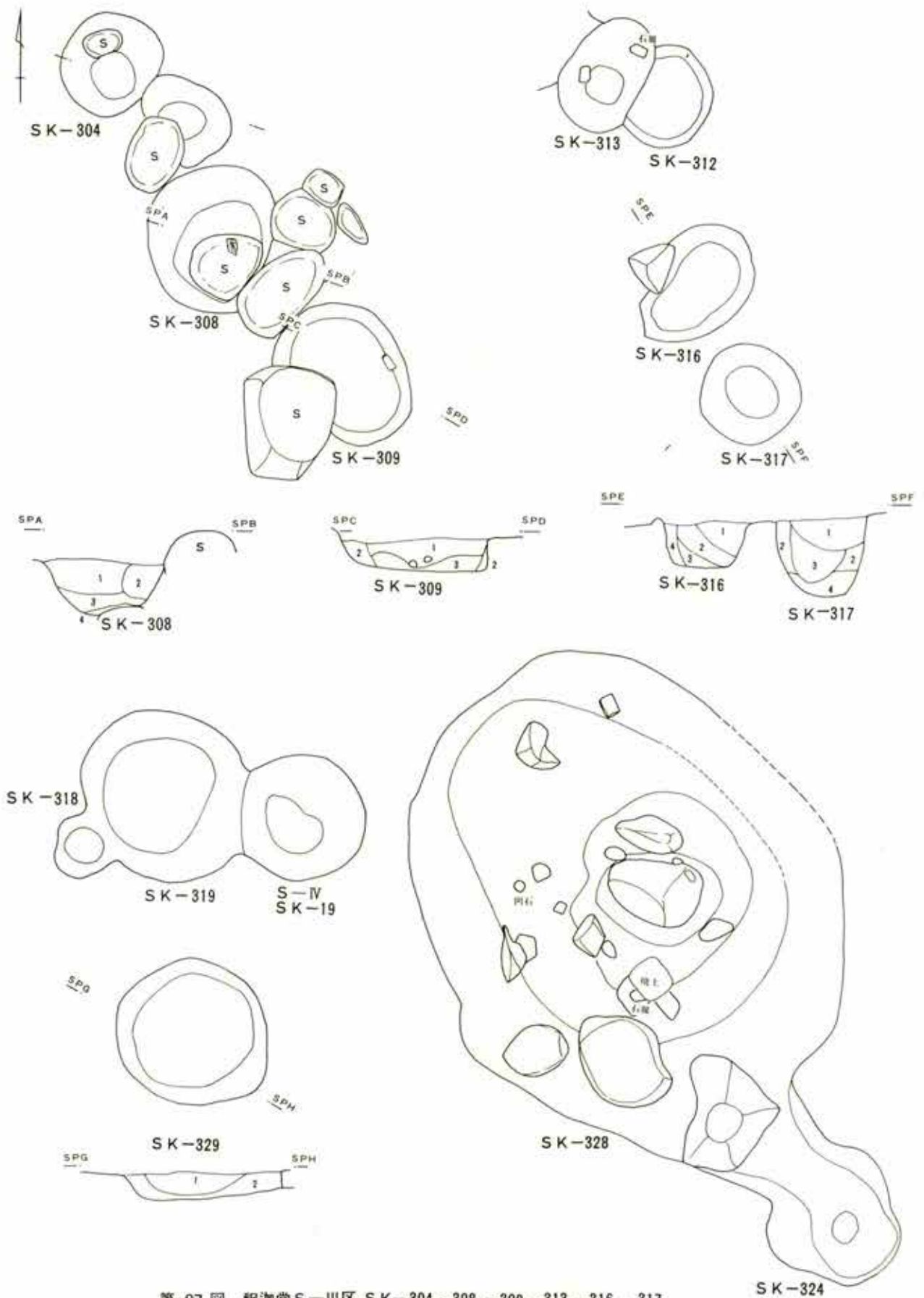

第 87 图 积迦堂 S-III 区 SK-304 - 308 - 309 - 313 - 316 - 317
318 - 319 - 328 - 329 (1:40) (23)

SK-324

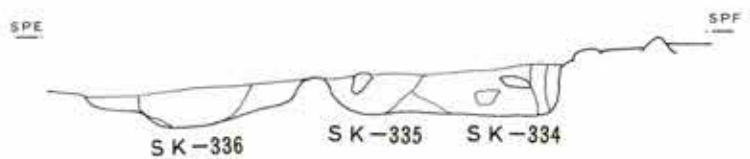
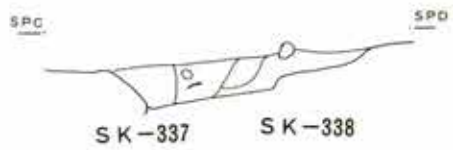
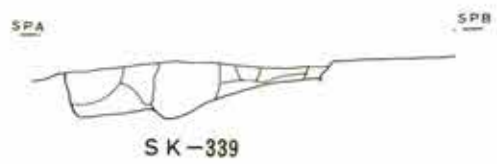
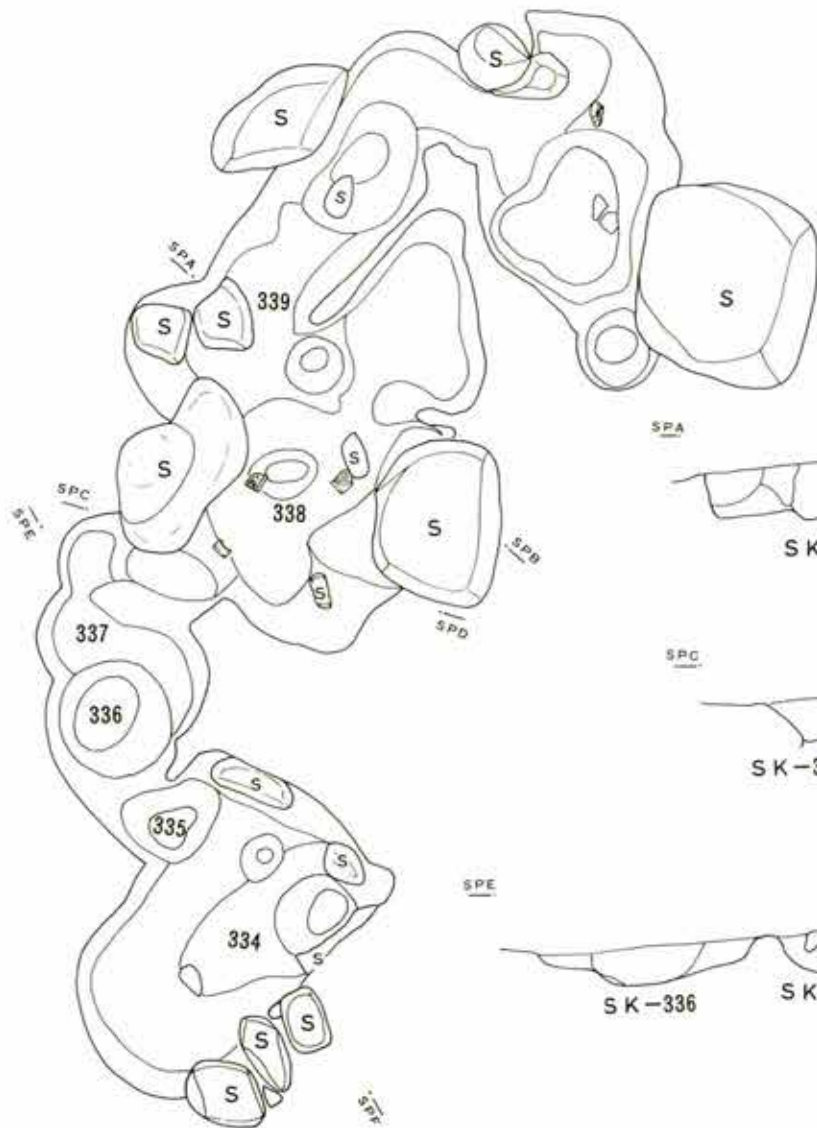
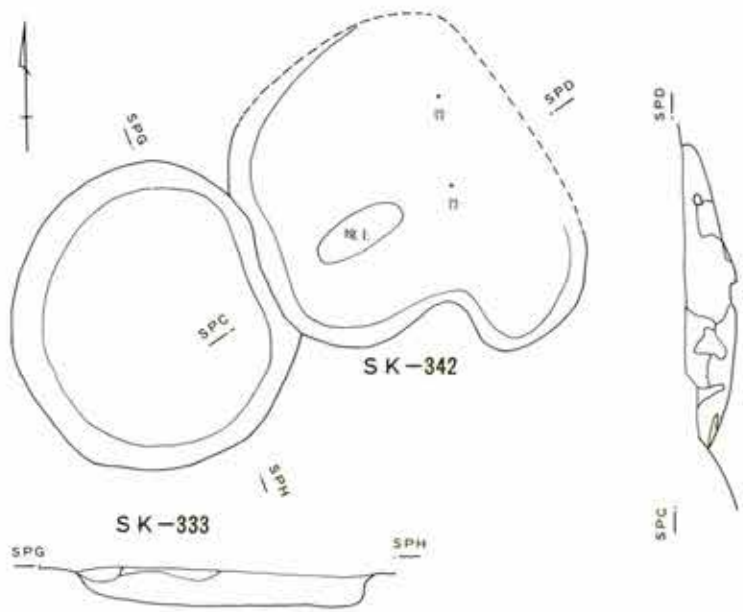

第 88 图 积迦堂 S-III 区 SK-333 -334 -335 -336 -337 -338 -339 -342(1:40) (24)

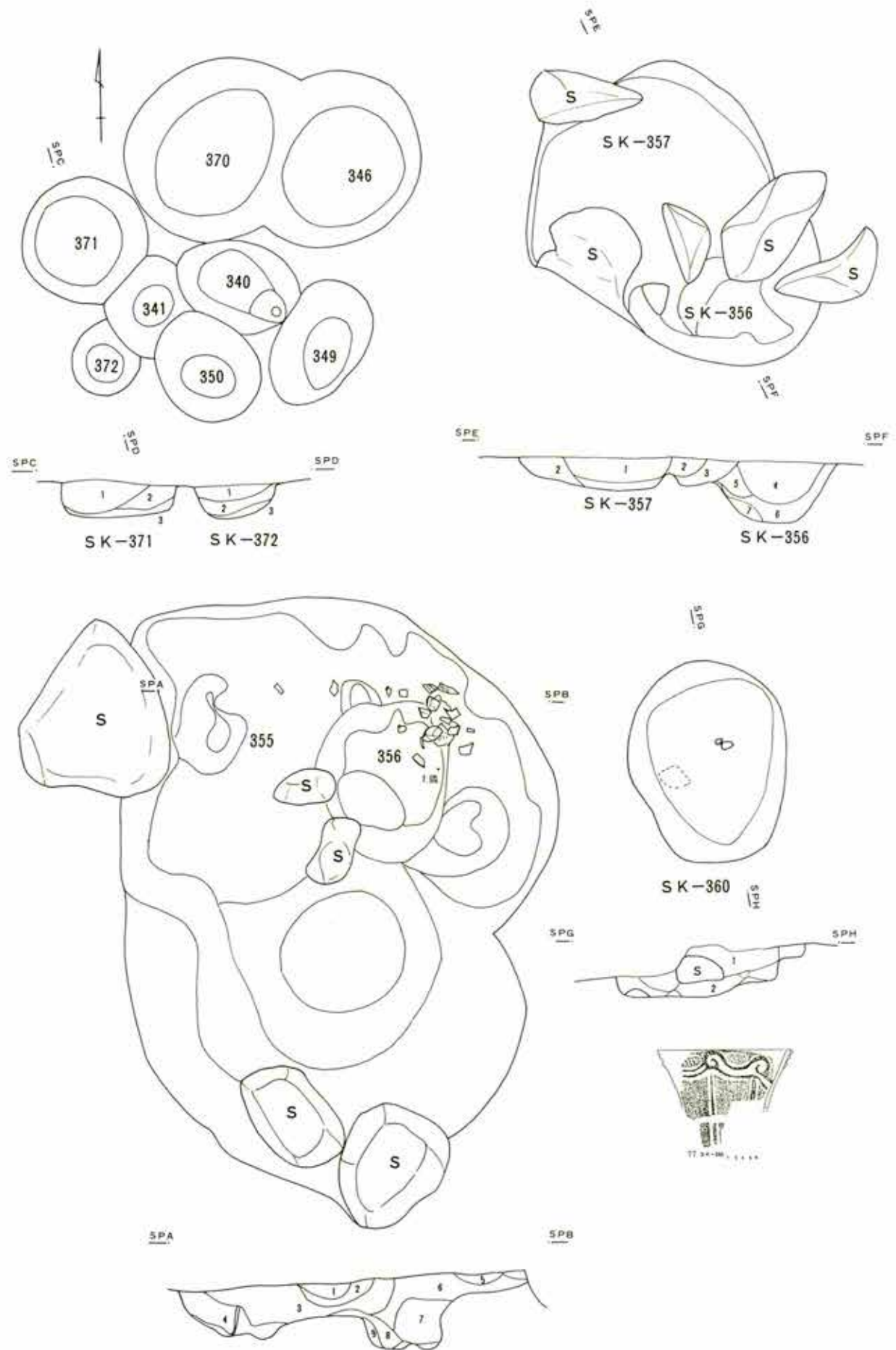

第 89 图 积迦堂 S-III 区 SK-340-341-346-349-350-355-356-357-360 (1:40) (25)

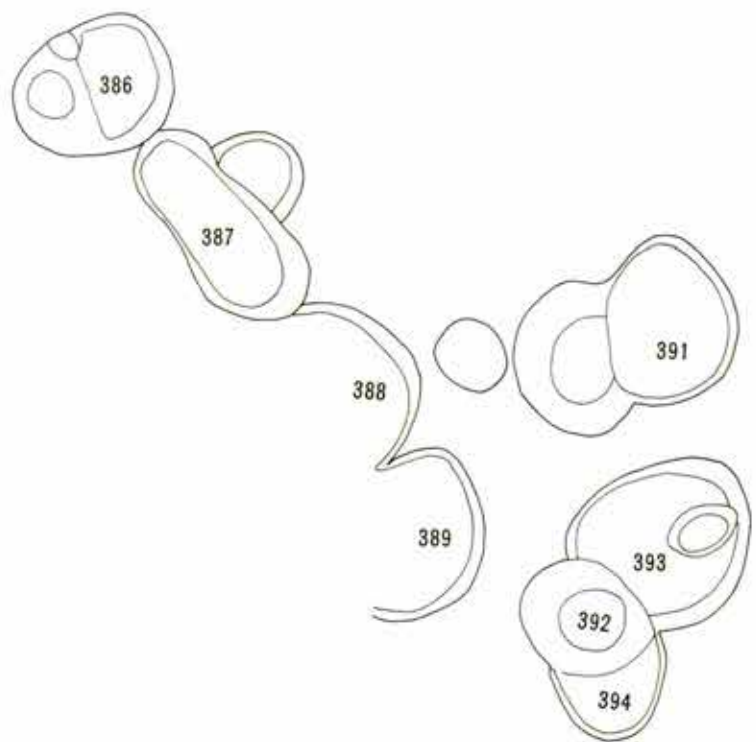
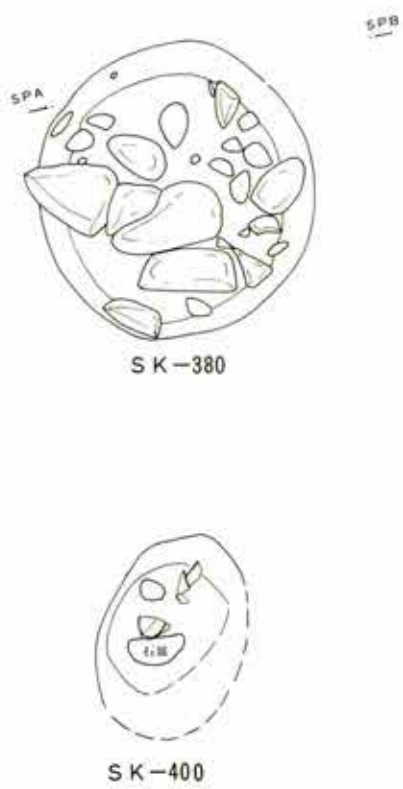
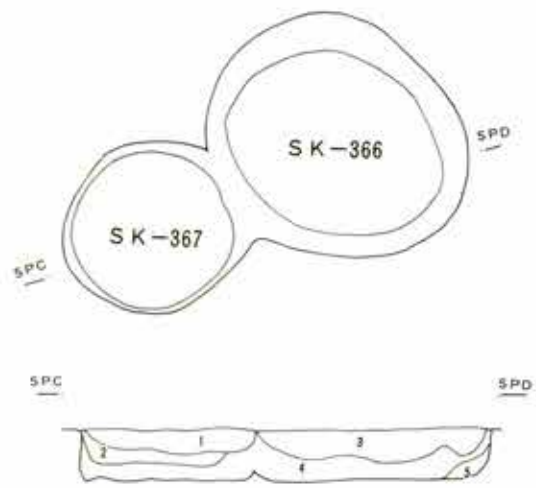

第 90 图 积迦堂 S-III 区 SK-362 -366 -367 -380 -386 -387
 -388 -389 -391 -392 -393 -394
 -400 (1:40) (26)

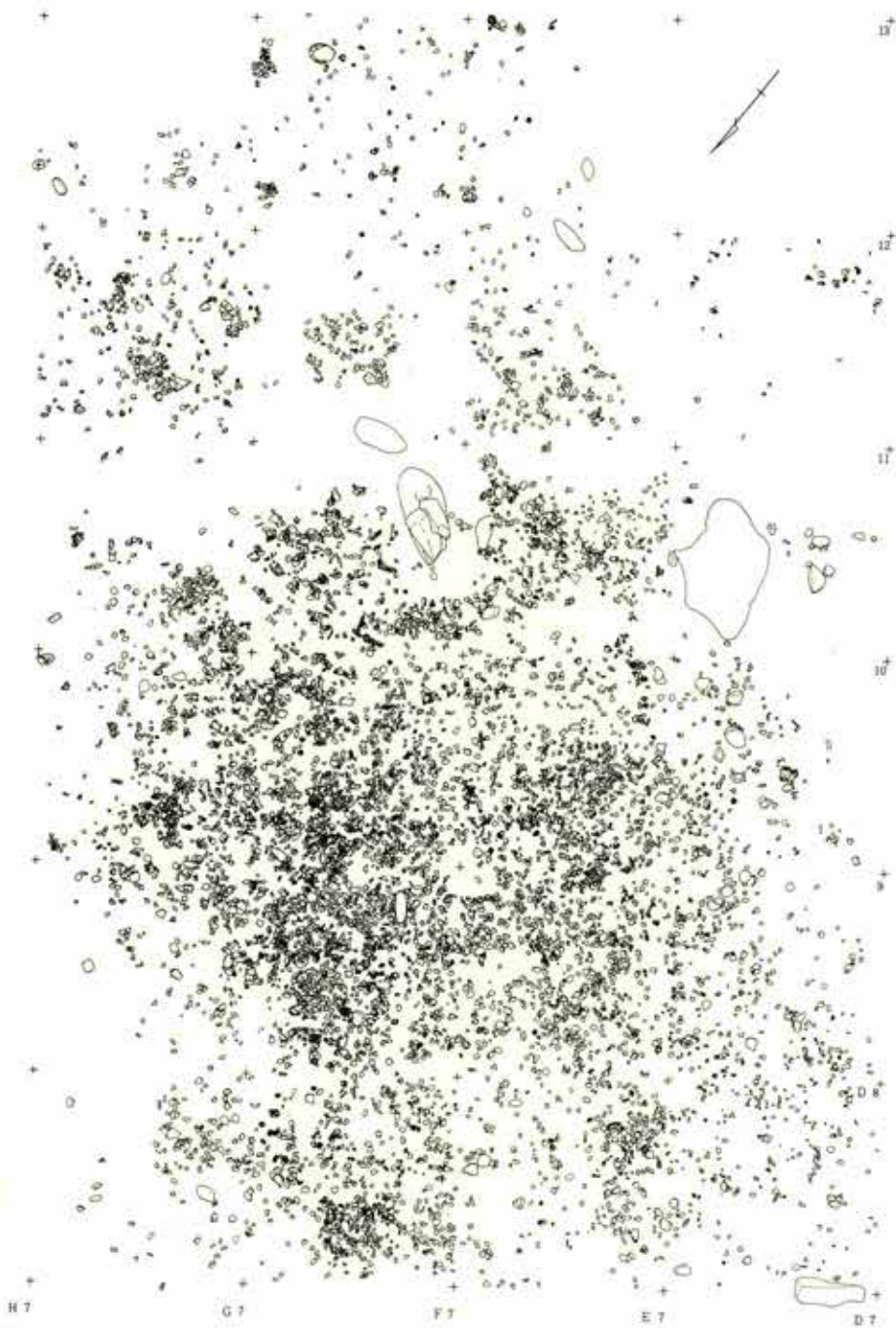

第 91 図 釈迦堂 S-III 区 土器すてば A

4m

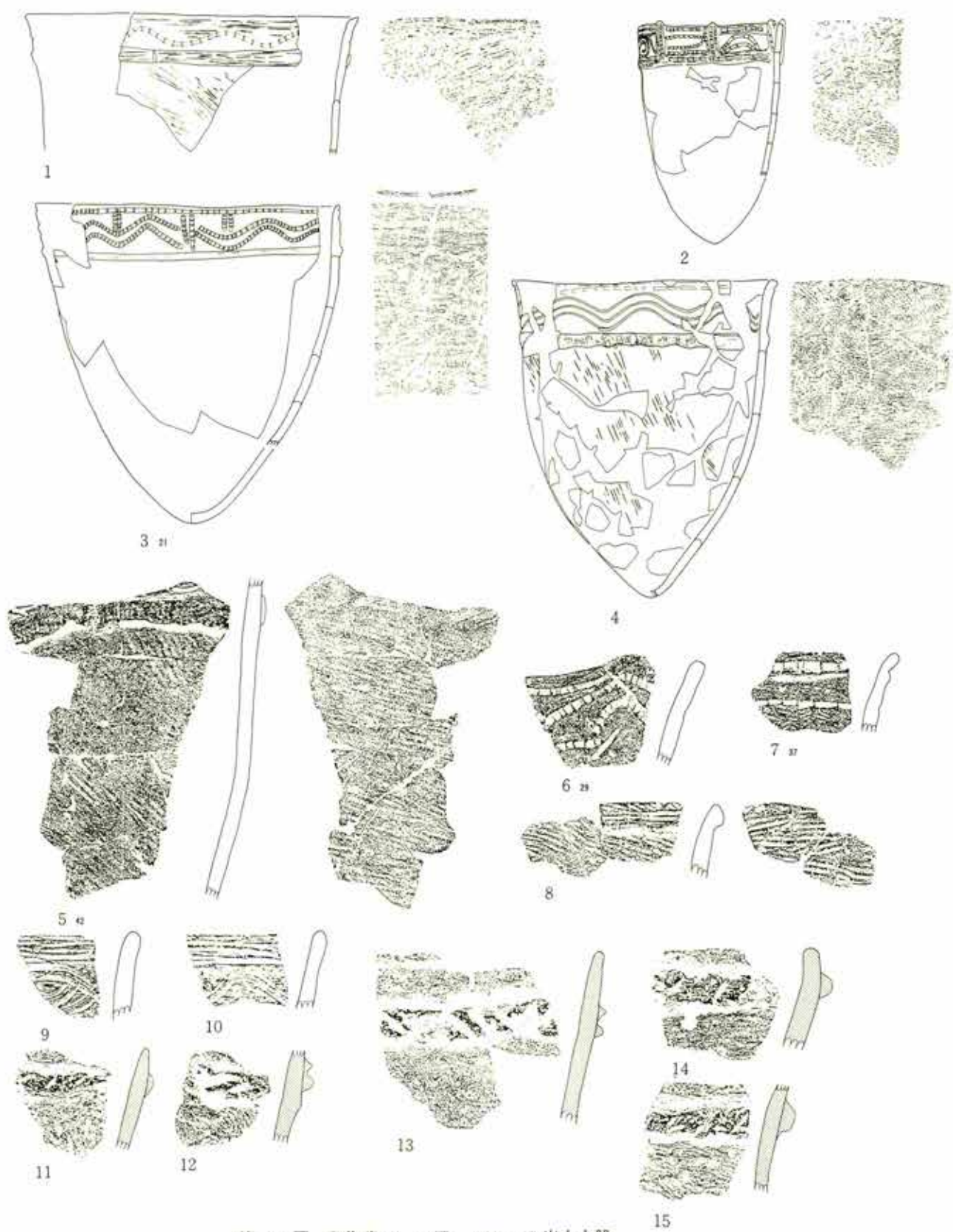

第 92 图 积逊堂 S-III 区 SB-47 出土土器

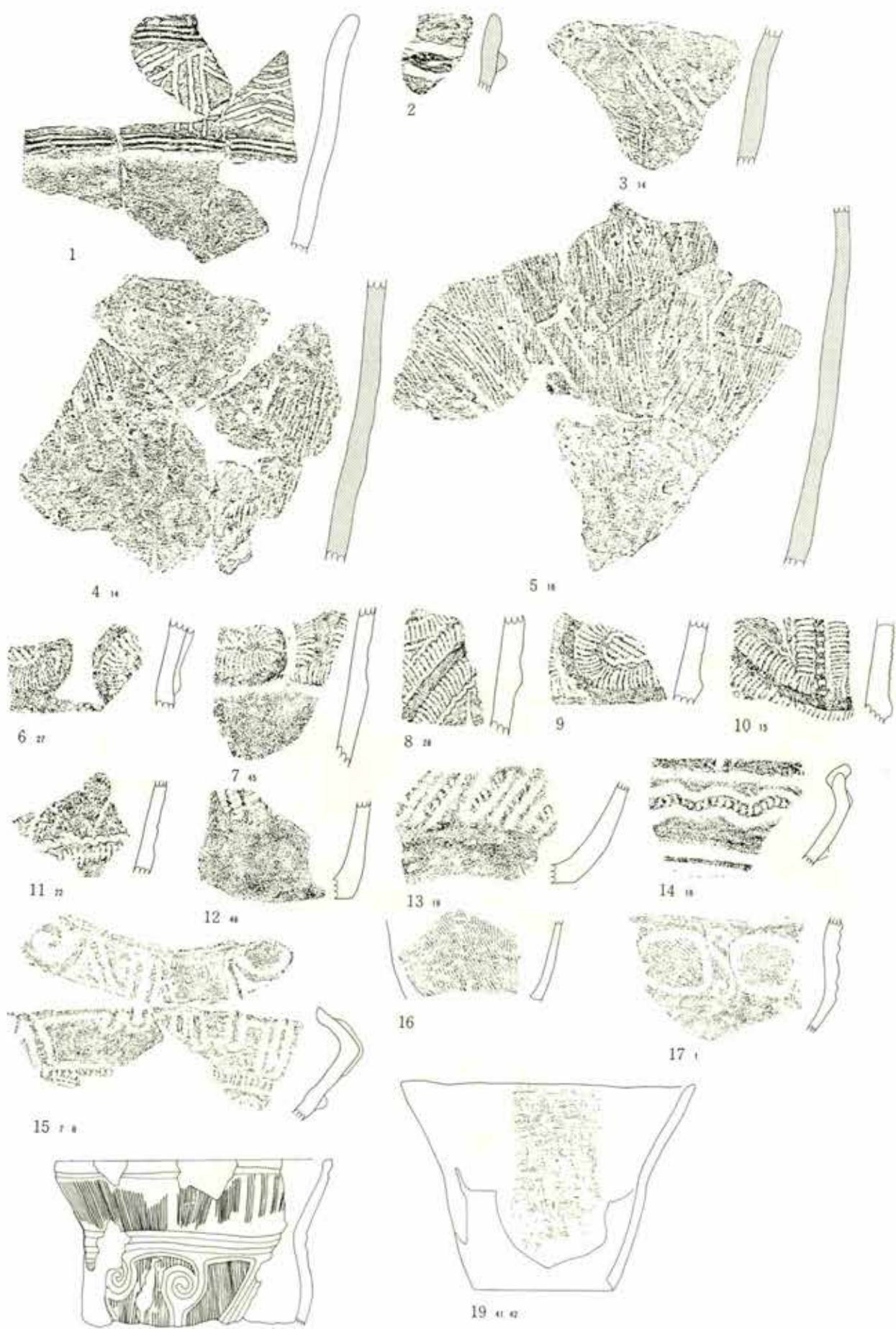

18 z

第 93 图 积迦堂 S-III 区 SB-52 出土土器 (15.16.17.18.19. 1 : 6)

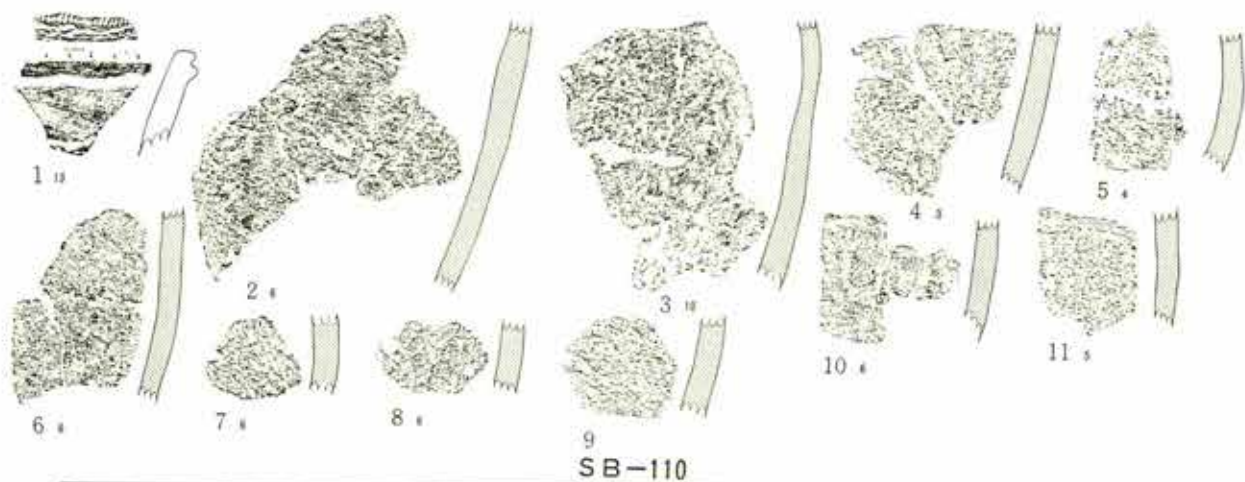

第 94 图 积迦堂 S-III 区 SB-110-102 出土土器 (7: 1: 6)

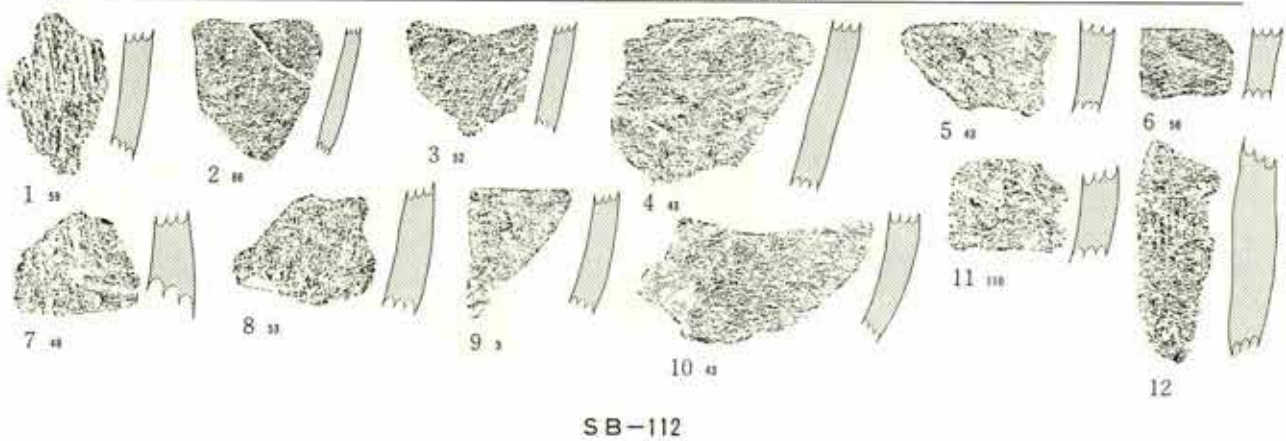
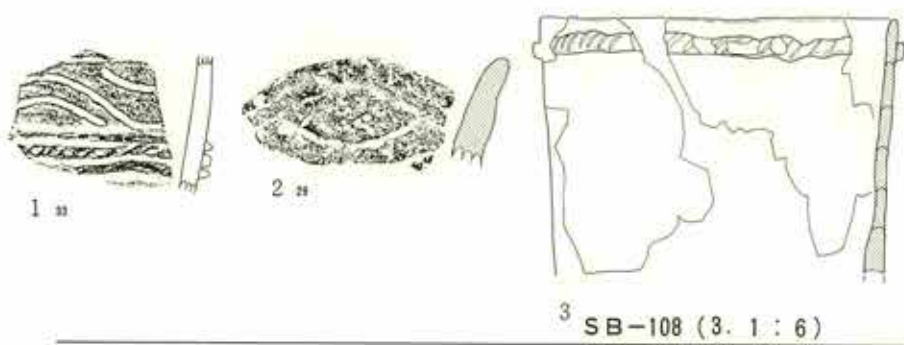
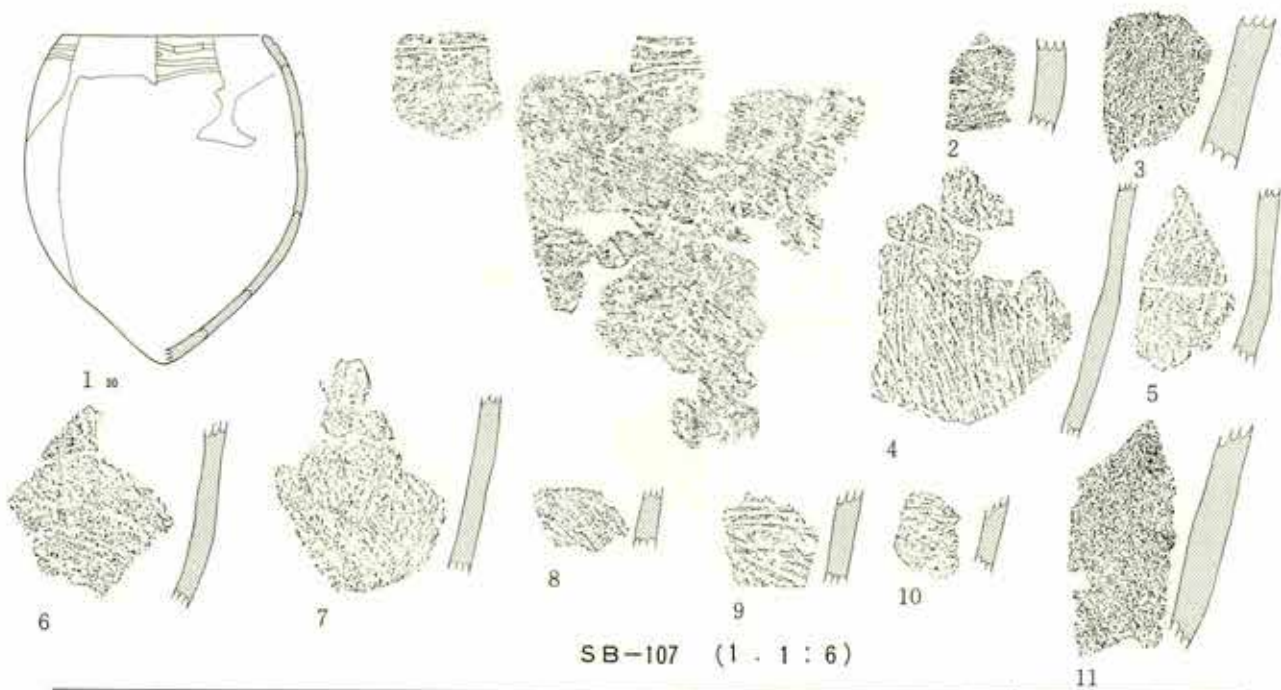

第 95 图 积逊堂 S-III 区 SB-107 - 108 - 112 出土土器

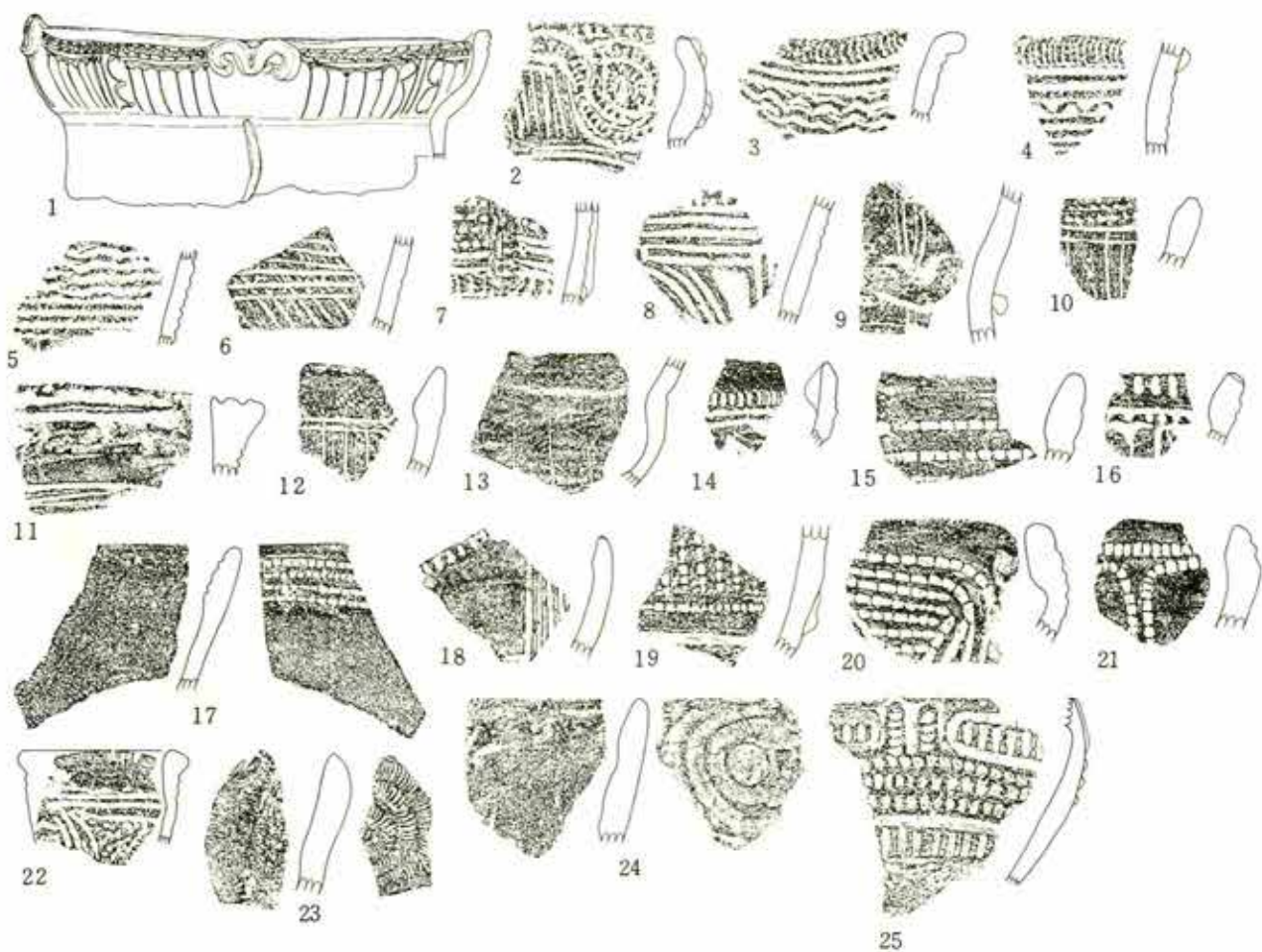

第 96 图 积迦堂S-III区 SB-29-1 出土土器

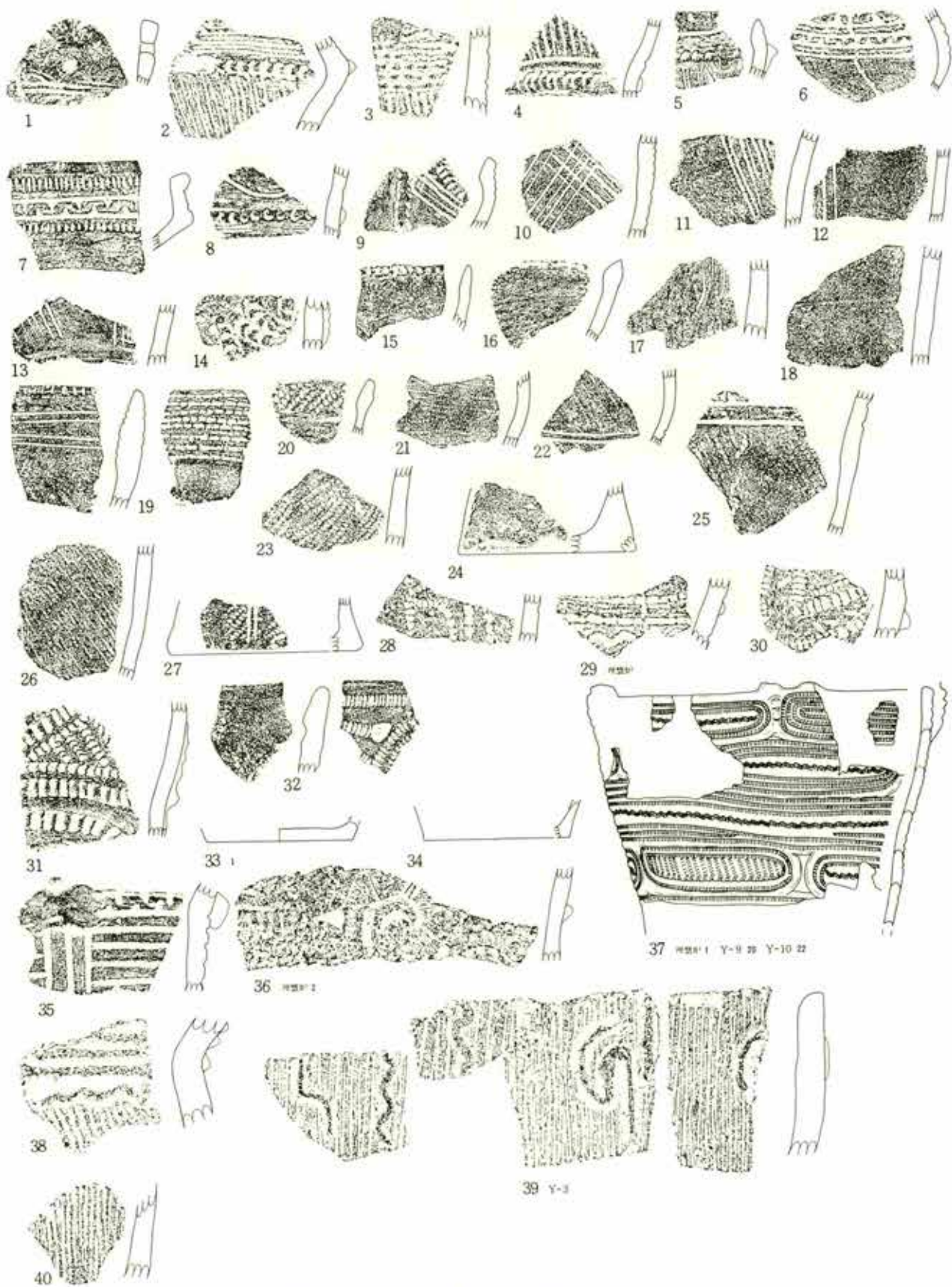

第 97 图 积逊堂 S-III 区 SB-20 出土土器
(33.34.37. 1 : 6)

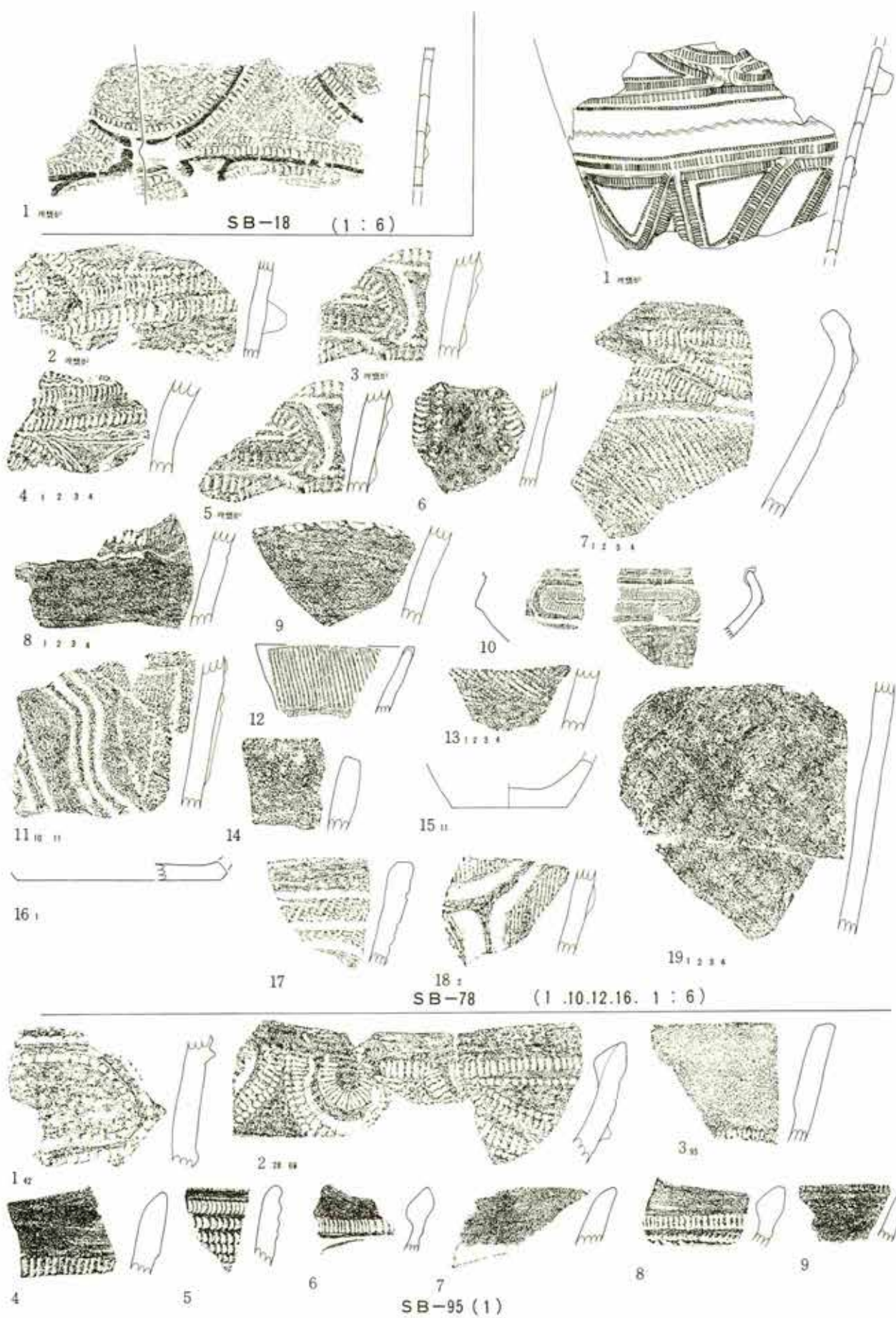

第 98 图 积迦堂 S—III 区 SB-18 -78 -95 出土土器

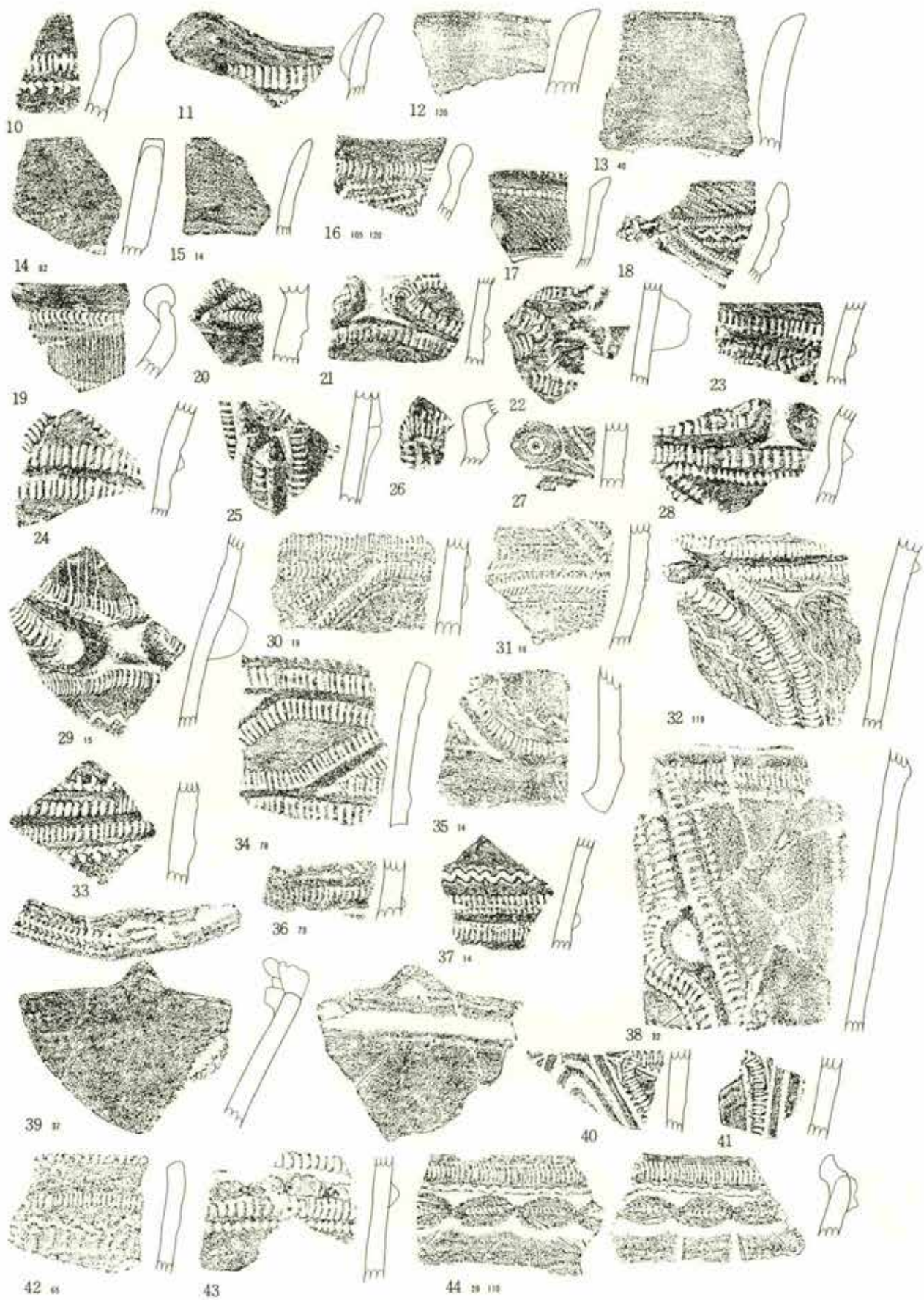

第 99 图 积迦堂 S-III 区 SB-95 出土土器 (2)



45



46



48

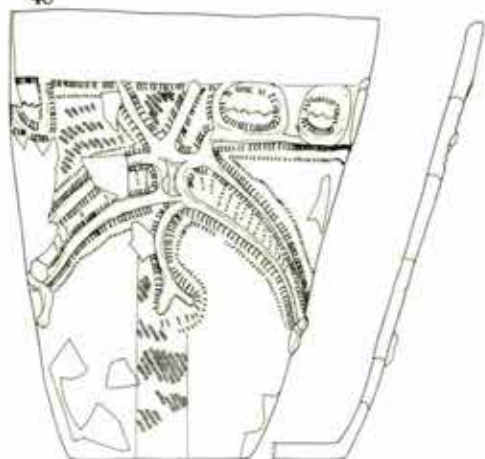

50



52



47



49

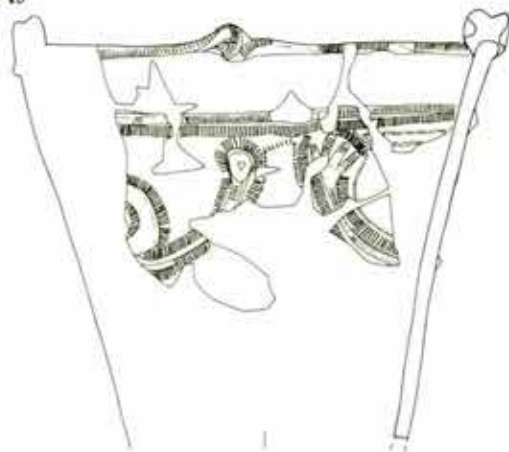

51



53

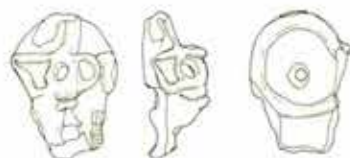

54



55

第 100 图 积迦堂 S-III 区 SB-95 出土土器 (3)

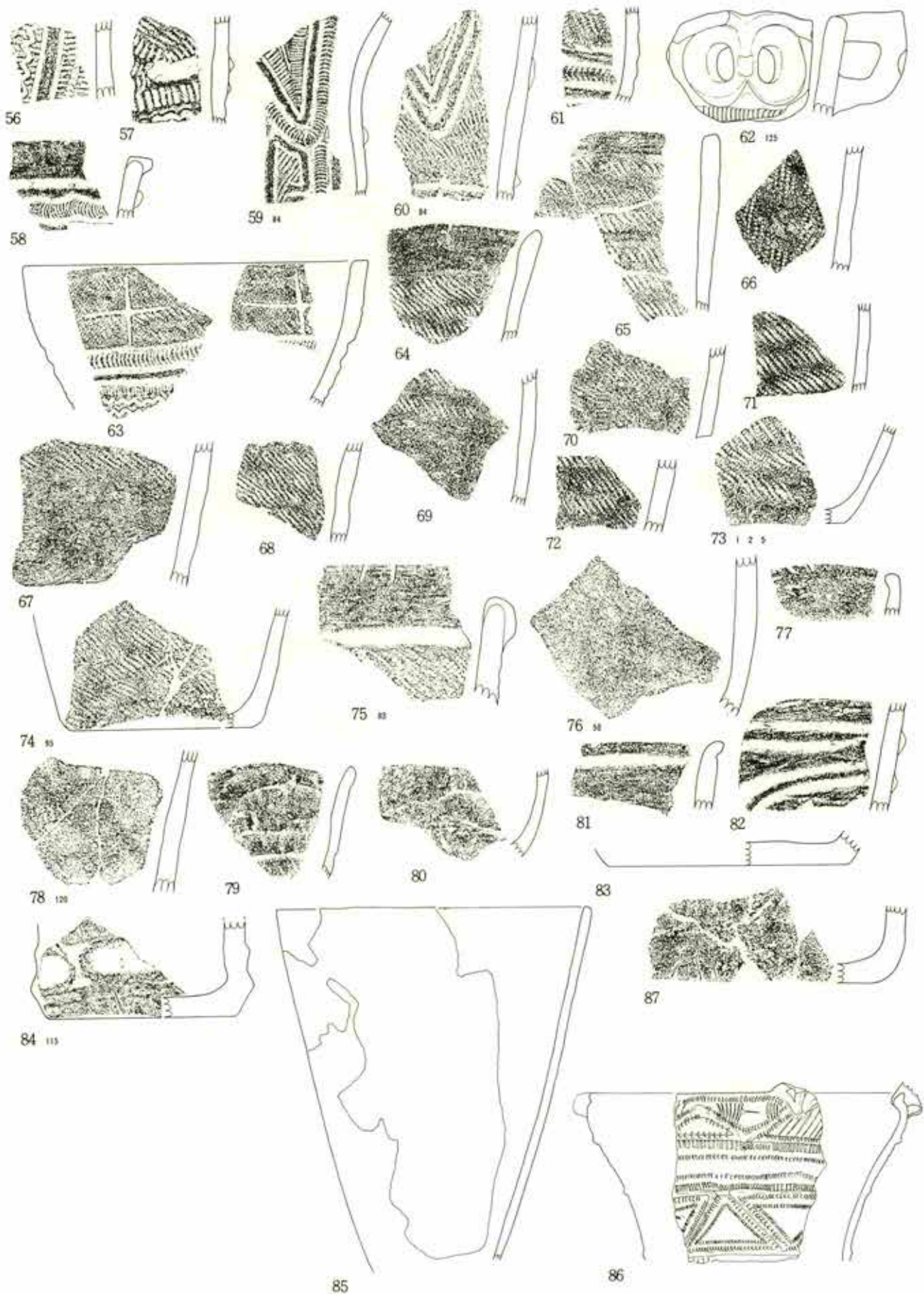

第101图 积迦堂S-III区 SB-95 出土土器(4)

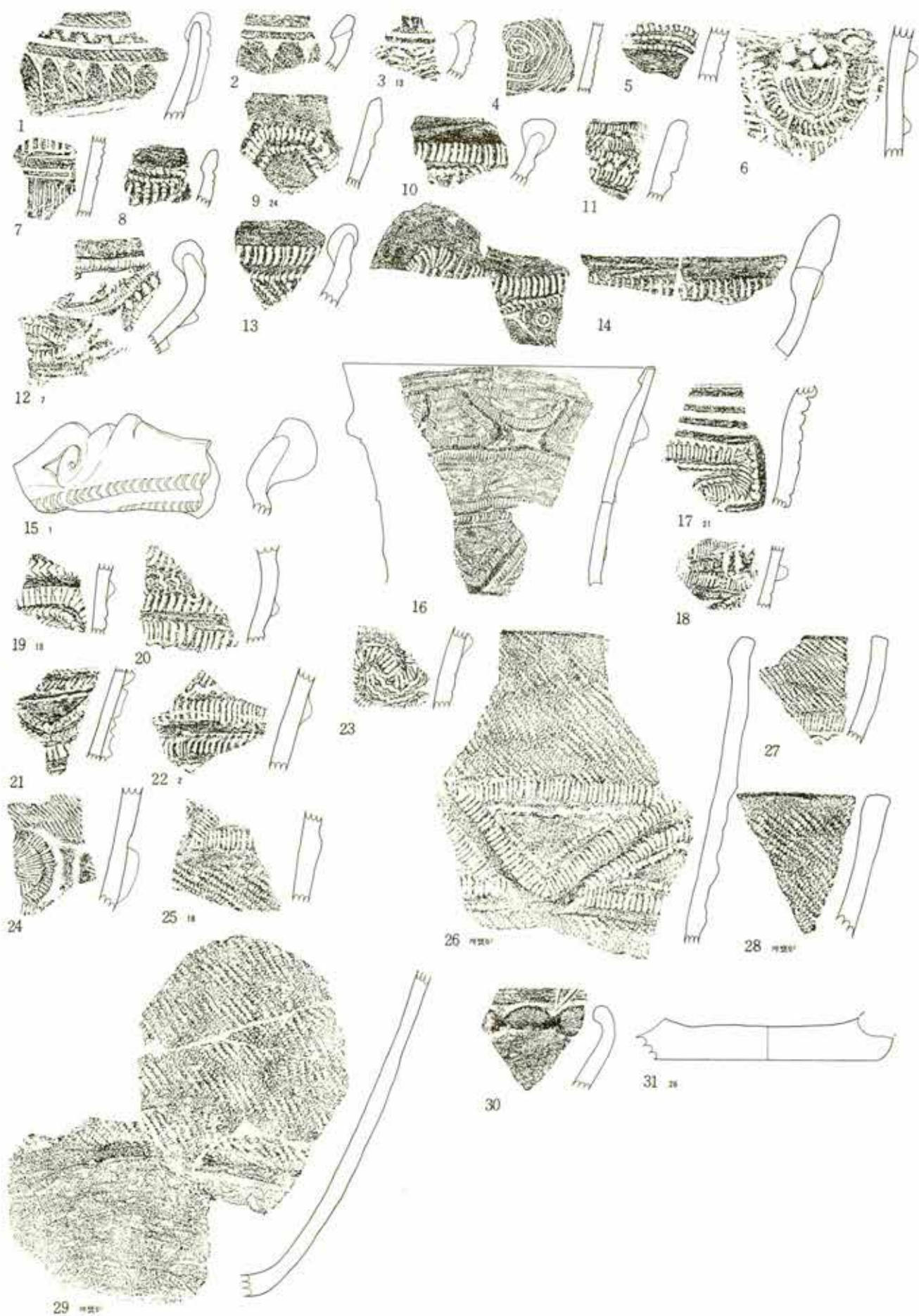

第 102 图 积迦堂 S-III 区 SB-111 出土土器

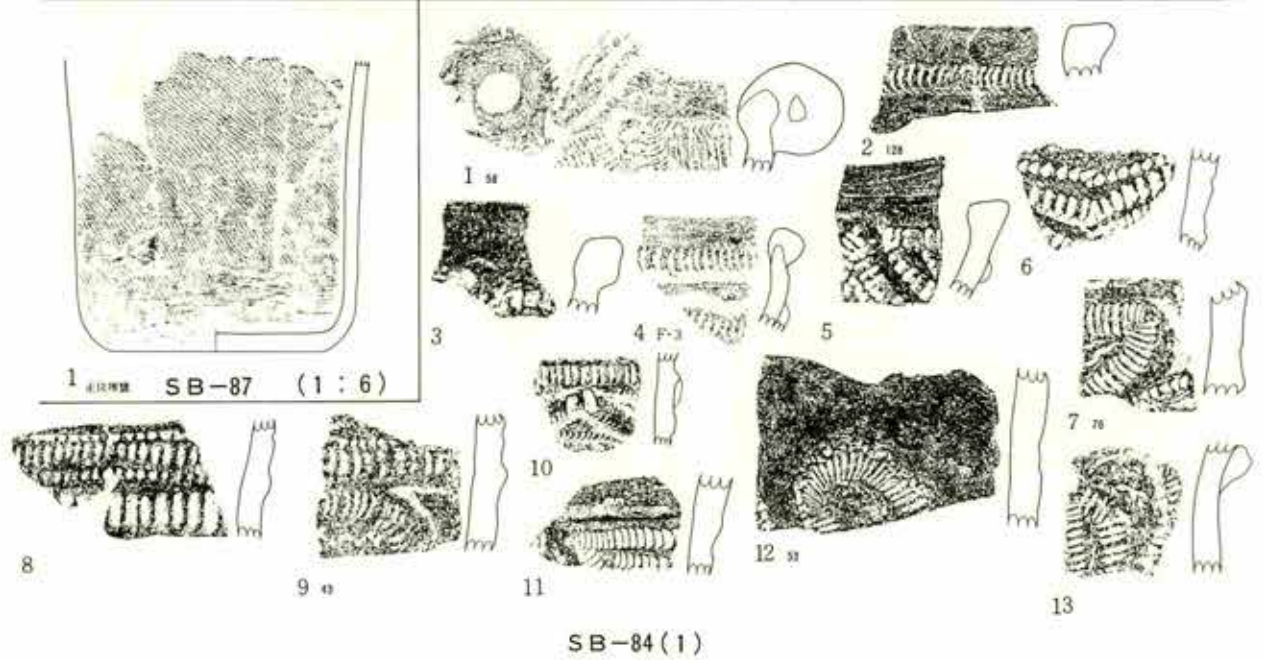
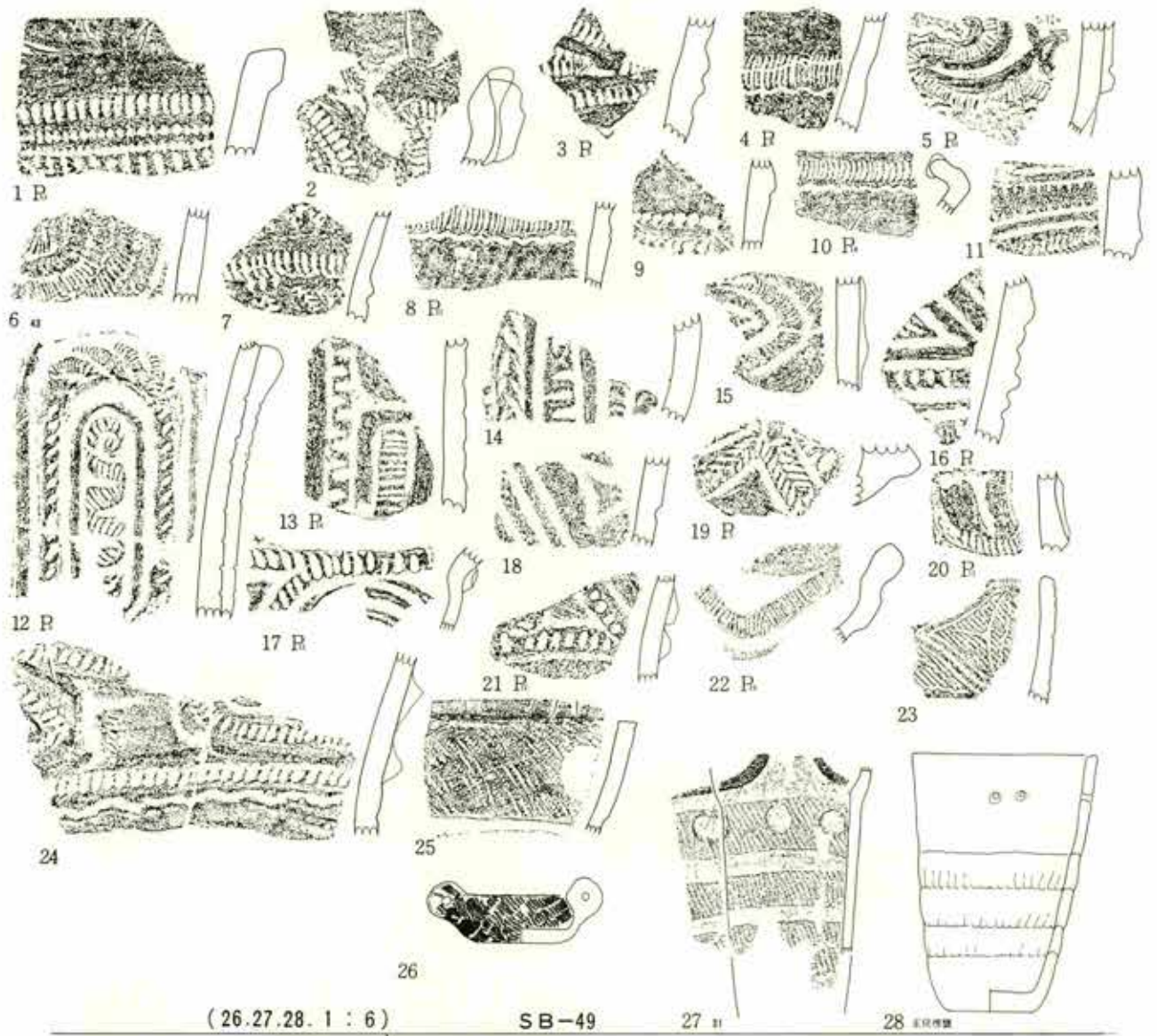

第103图 积逊堂S-III区 SB-49-84-87 出土土器

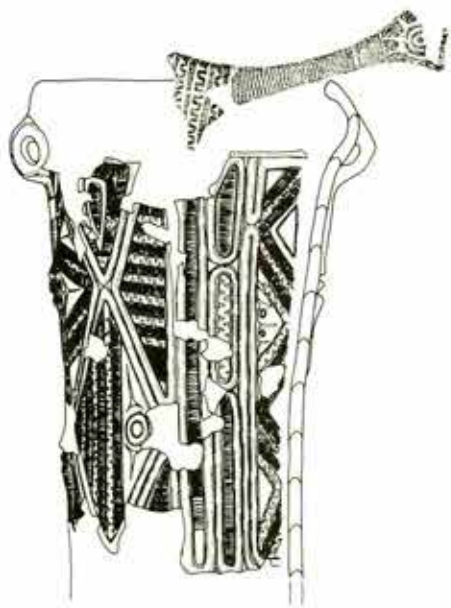

14

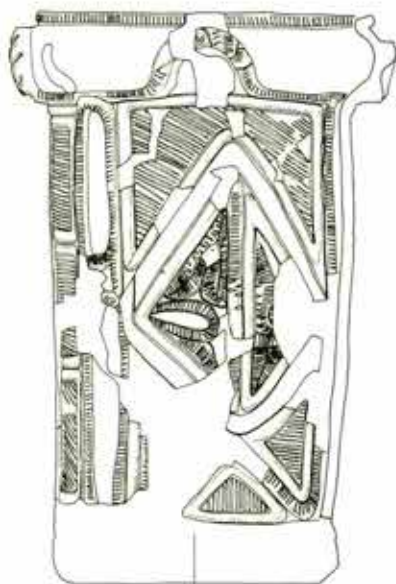

15

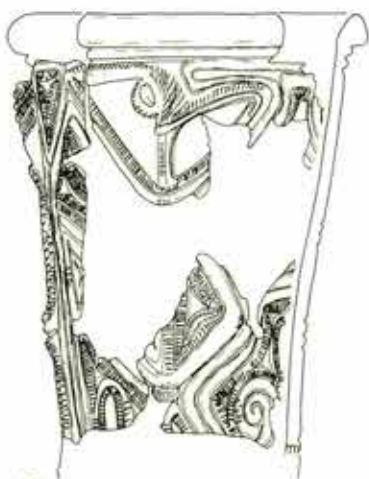

16



17



18



19 宽沿陶器



20

第 104 图 积迦堂 S—III 区 SB—84 出土土器 (2)

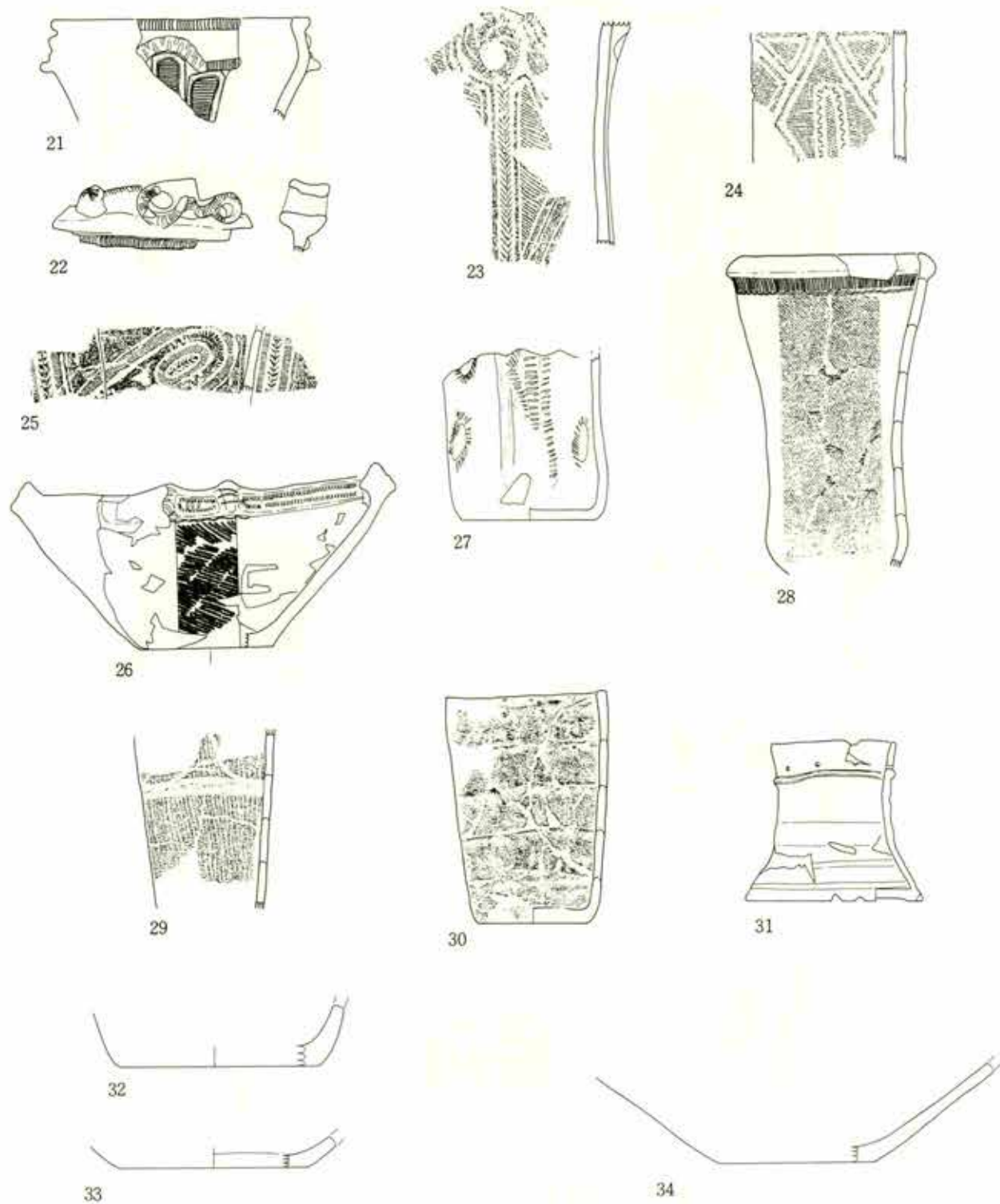

第105图 积迦堂S-III区 SB-84 出土土器(3)

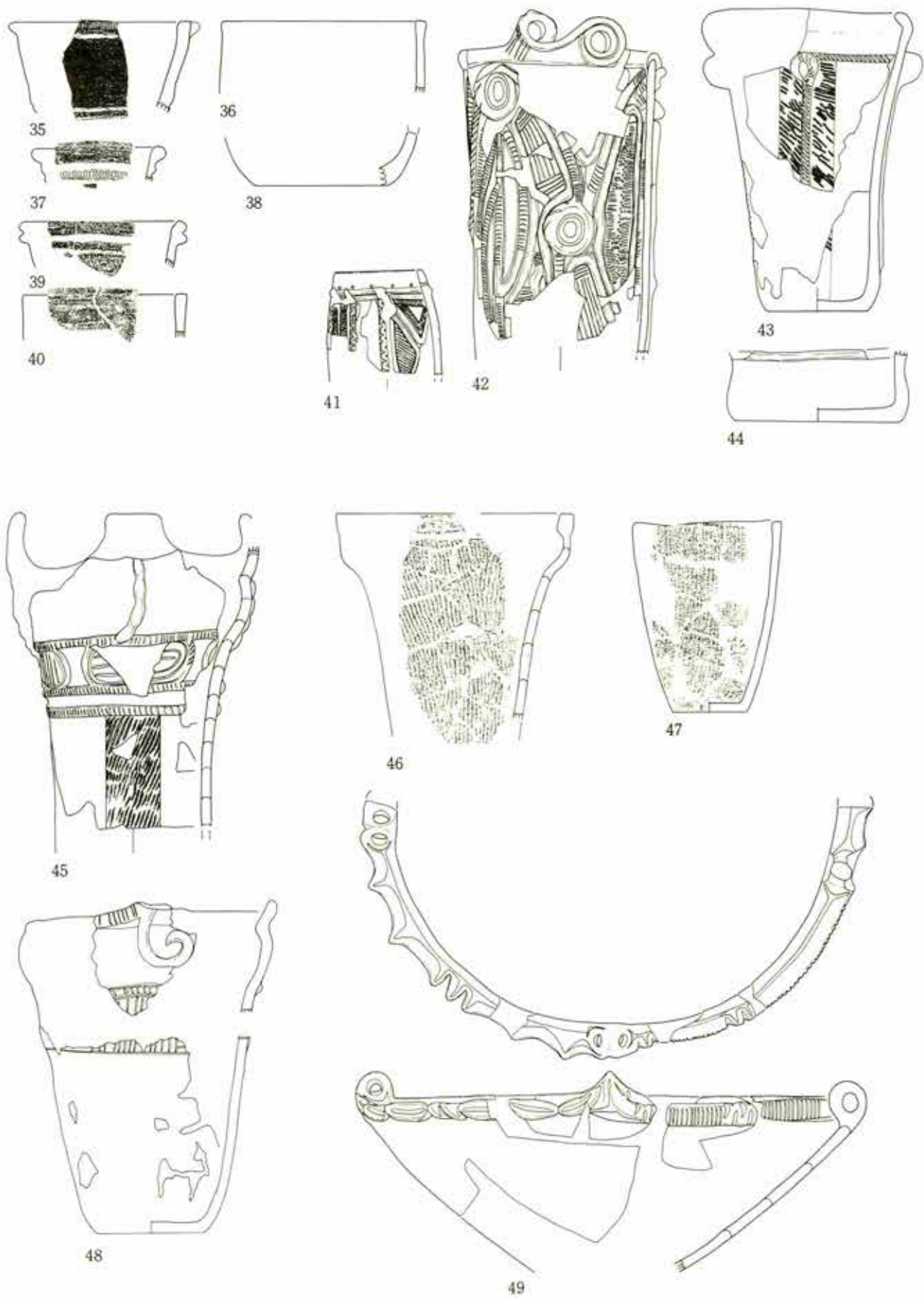

第 106 图 积迦堂 S-III 区 SB-84 出土土器 (4)



第 107 图 积迦堂 S-III 区 SB-84 出土土器 (5)

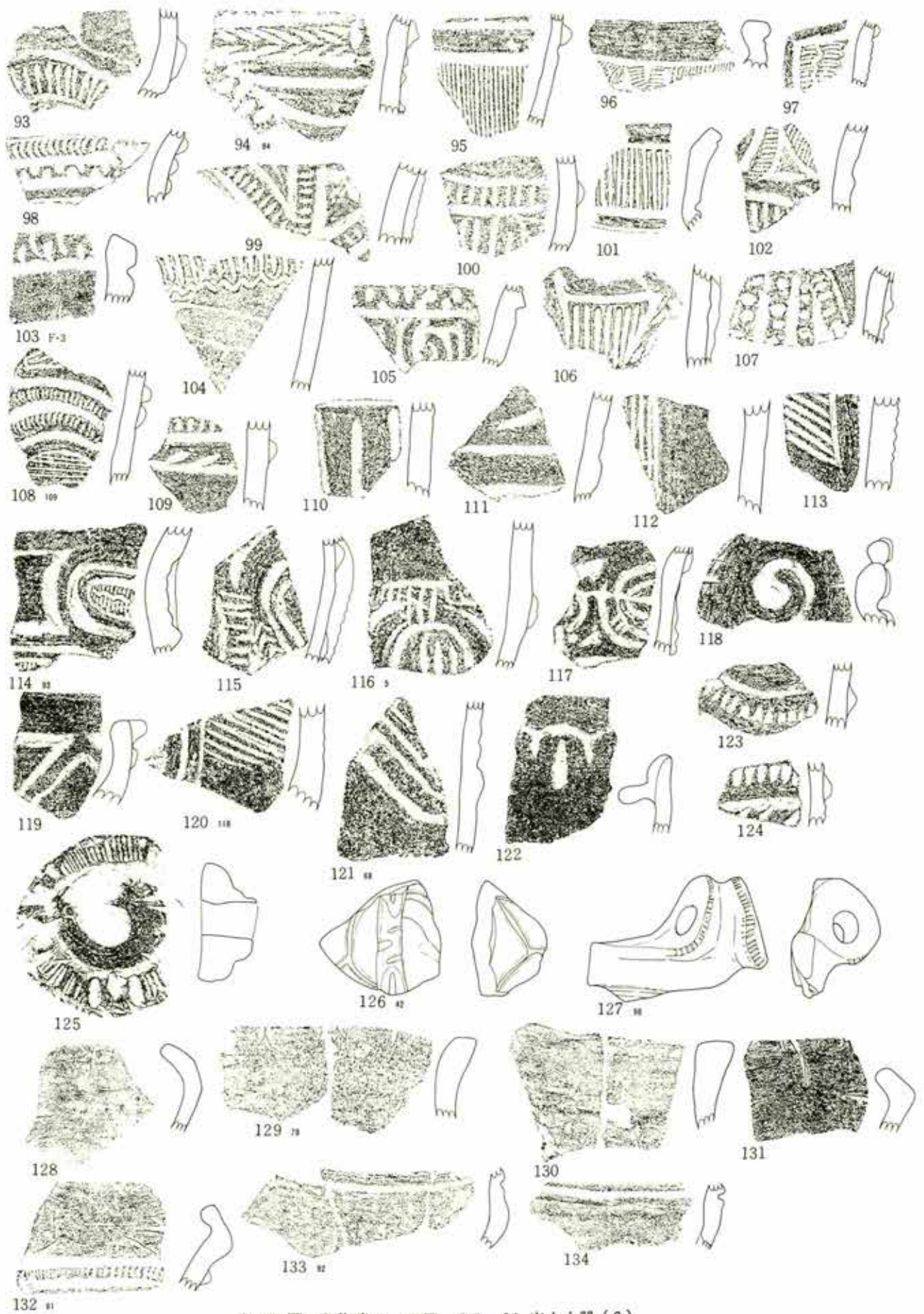

第 108 图 积逊堂 S-III 区 SB-84 出土土器 (6)

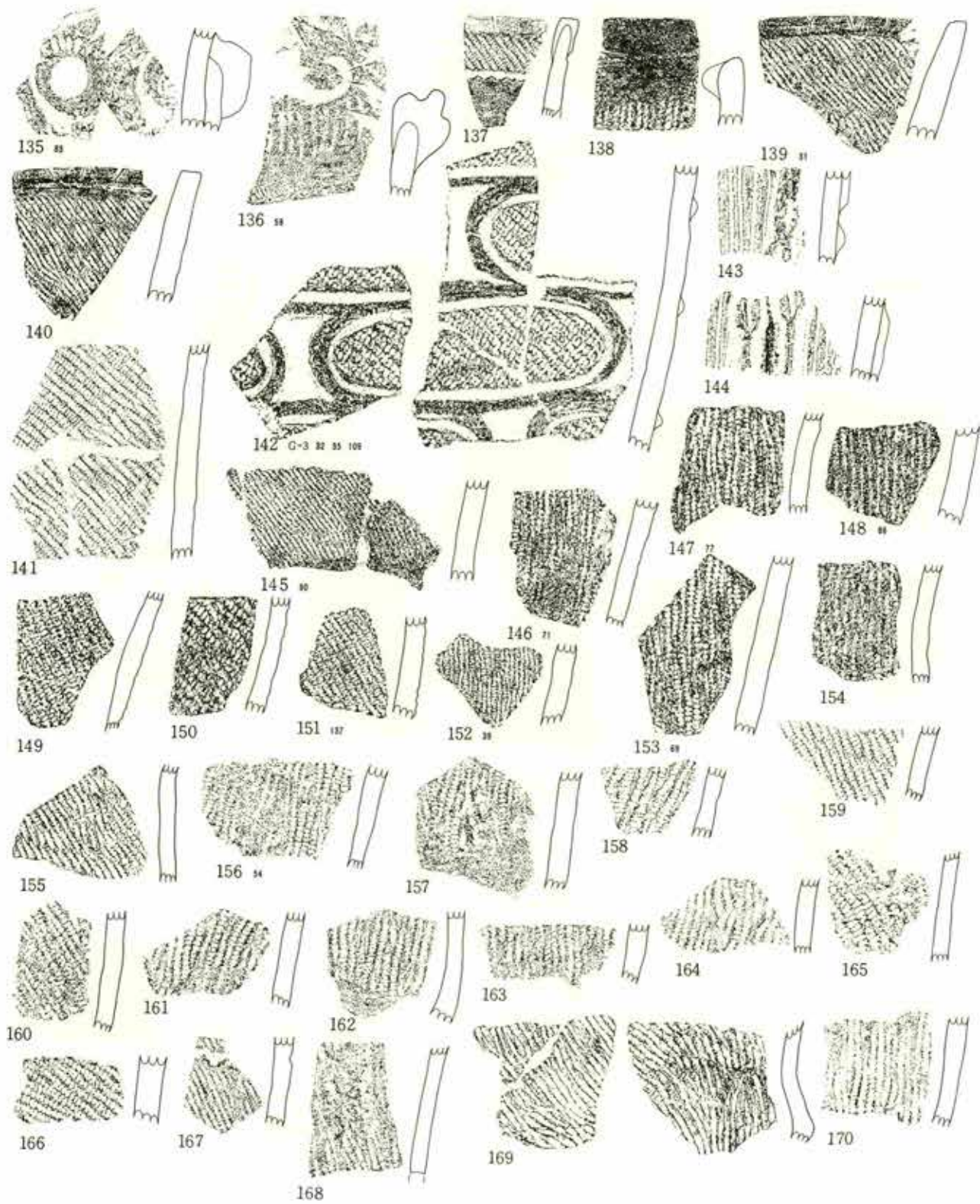

第109图 积迦堂S-III区 SB-84 出土土器(7)

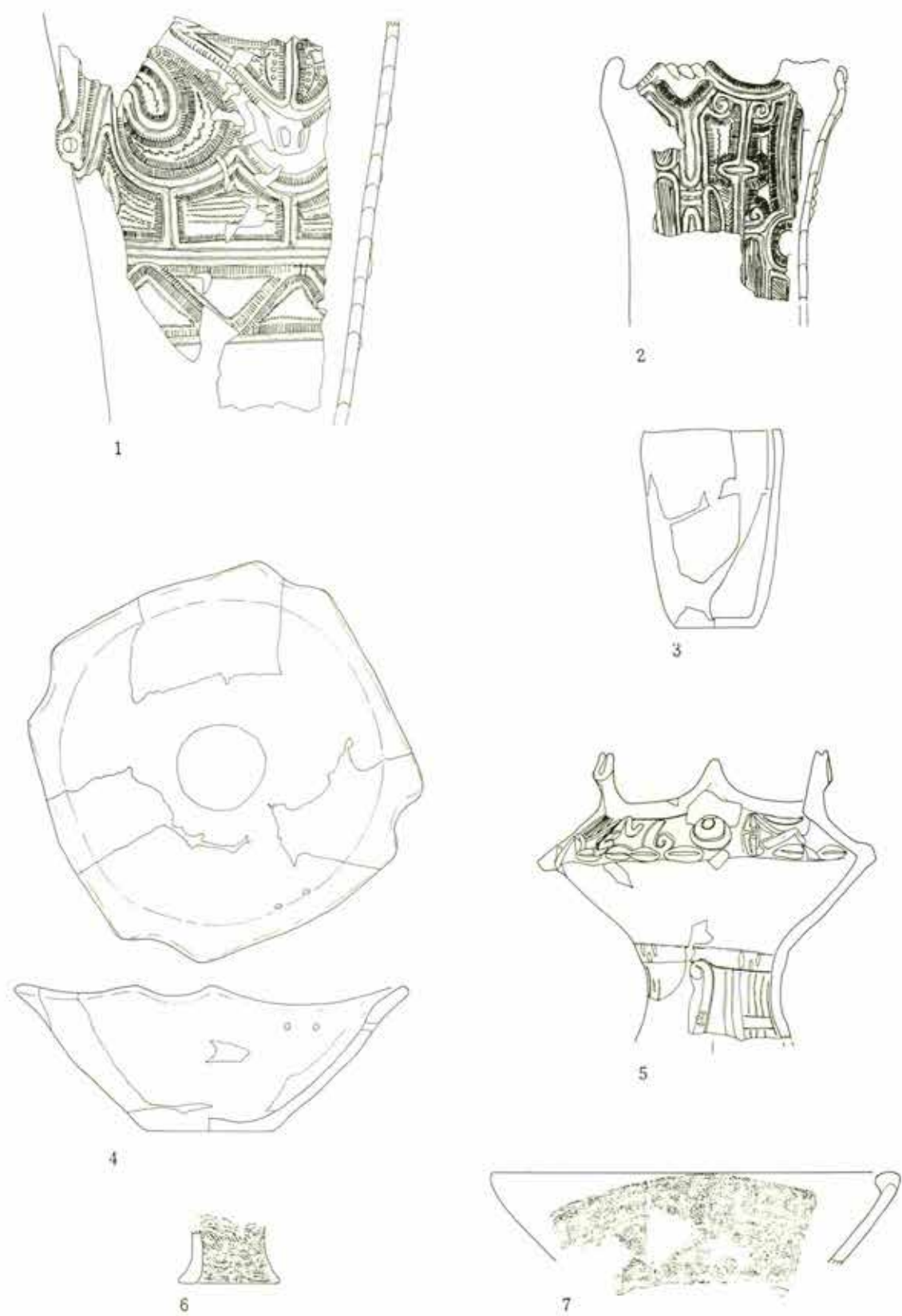

第 110 图 积逊堂 S-III 区 SB-100 出土土器 (1)

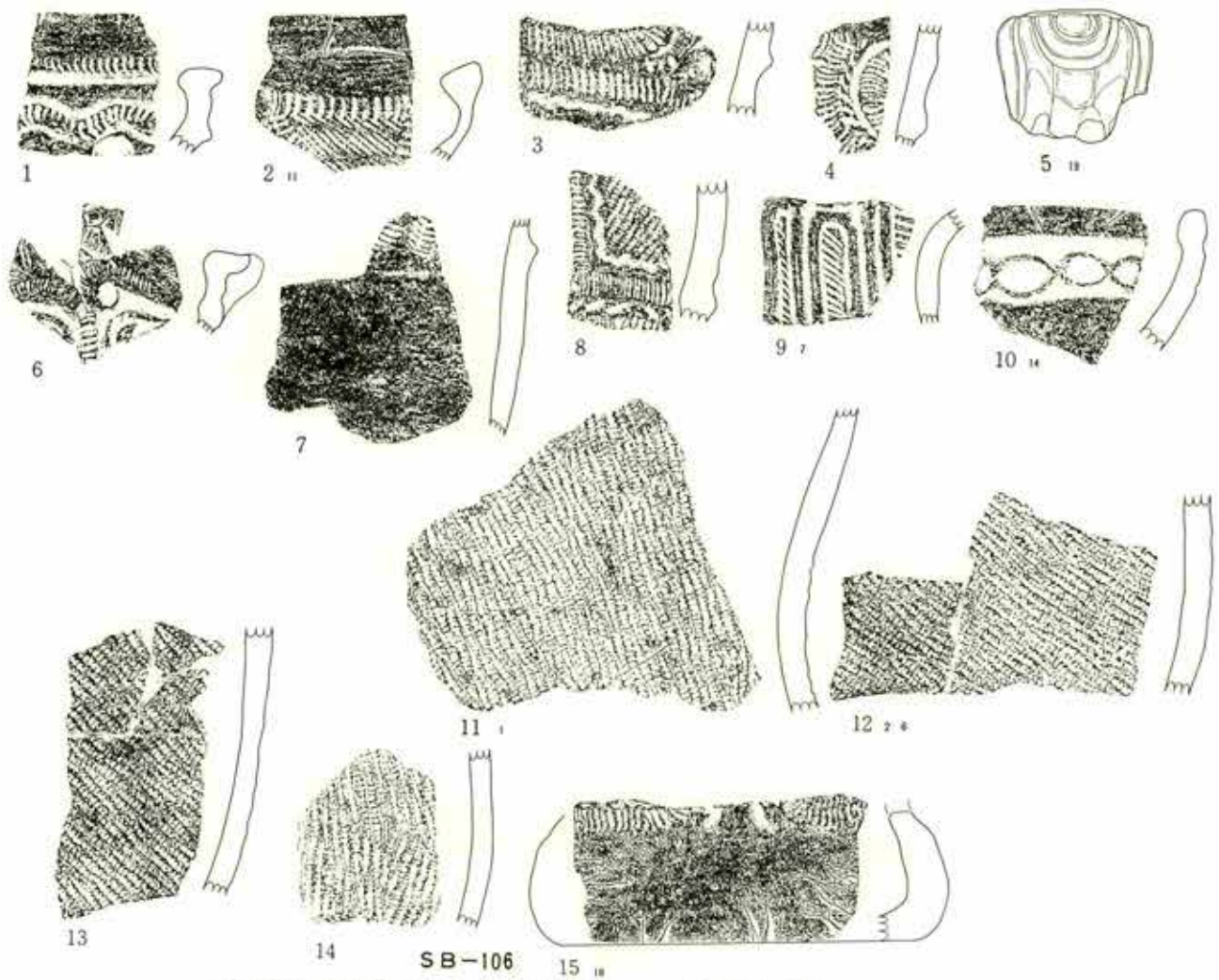
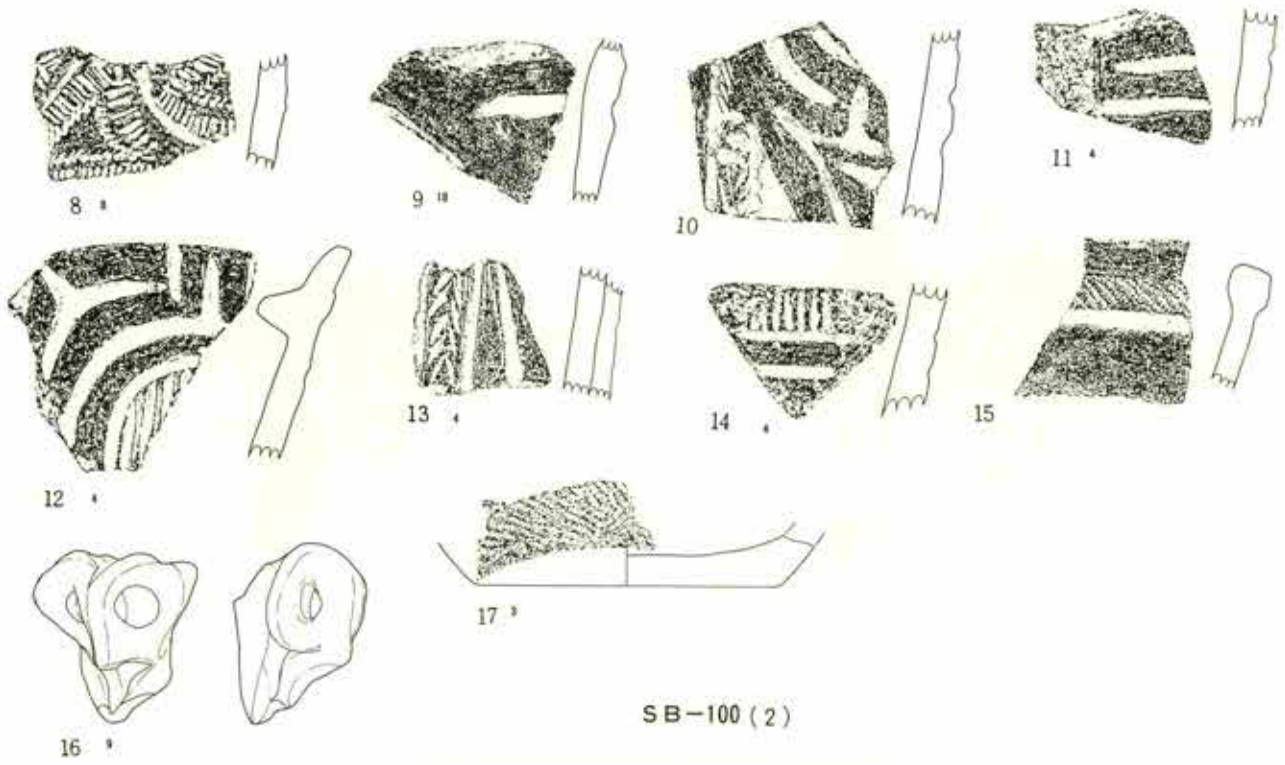

第 111 图 积迦堂 S-III 区 SB-100 -106 出土土器

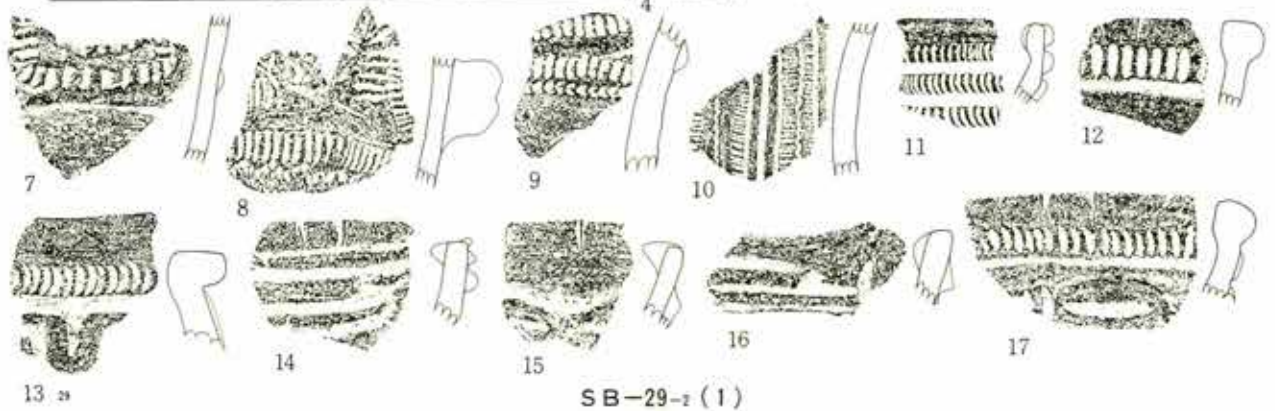
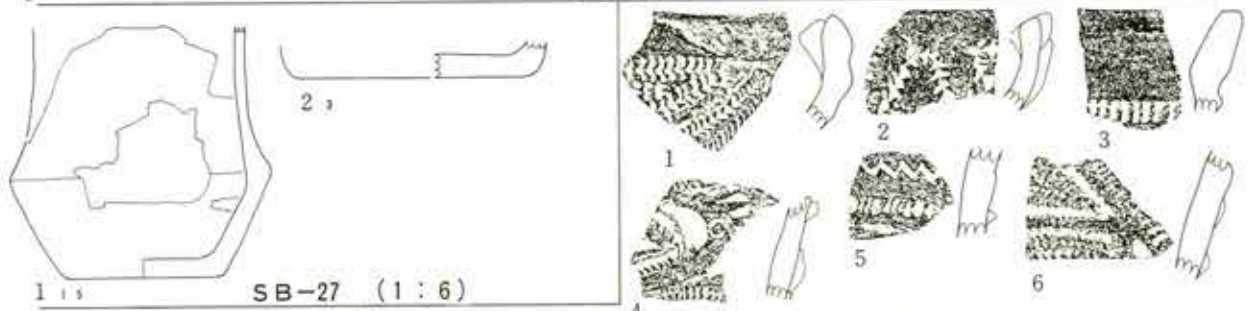
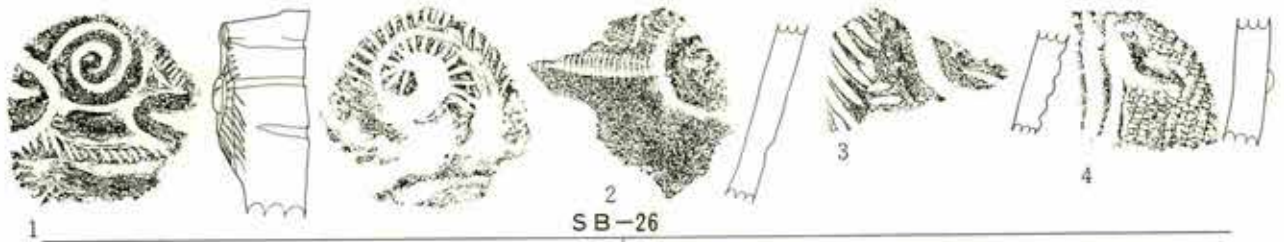
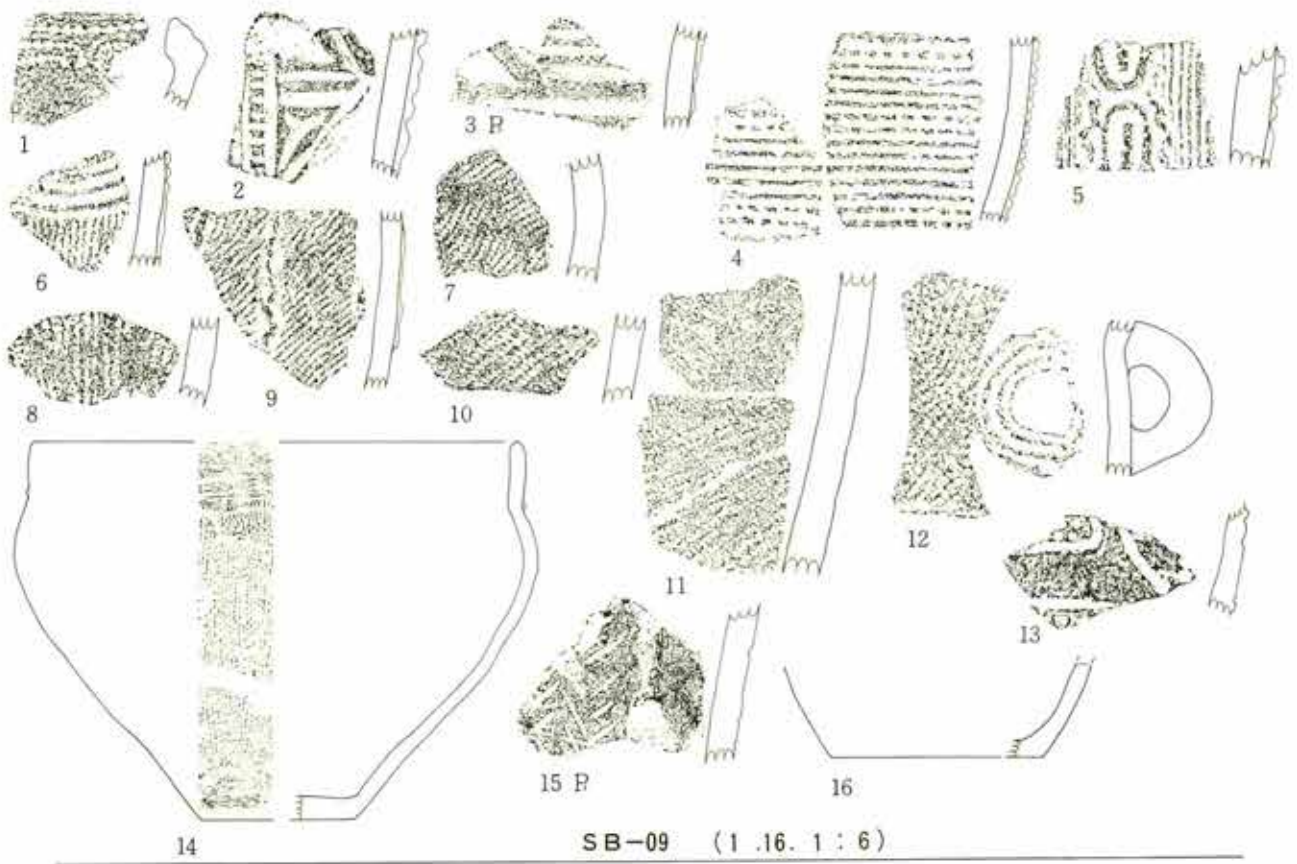

第 112 图 积逊堂 S-III 区 SB-09-26-27-29 出土土器

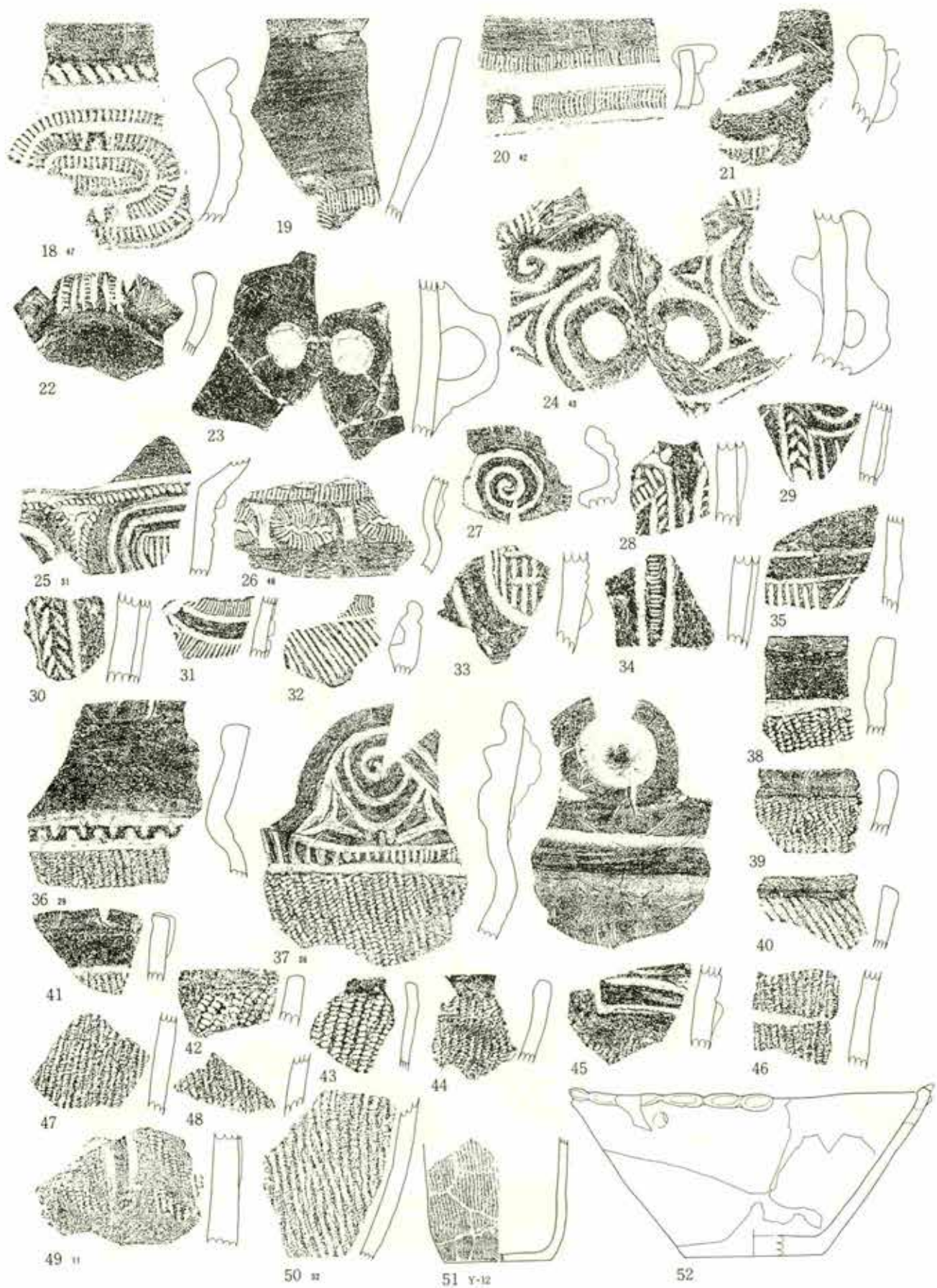

第113图 积迦堂S-III区 SB-29-2 出土土器(2)
(51.52. 1:6)

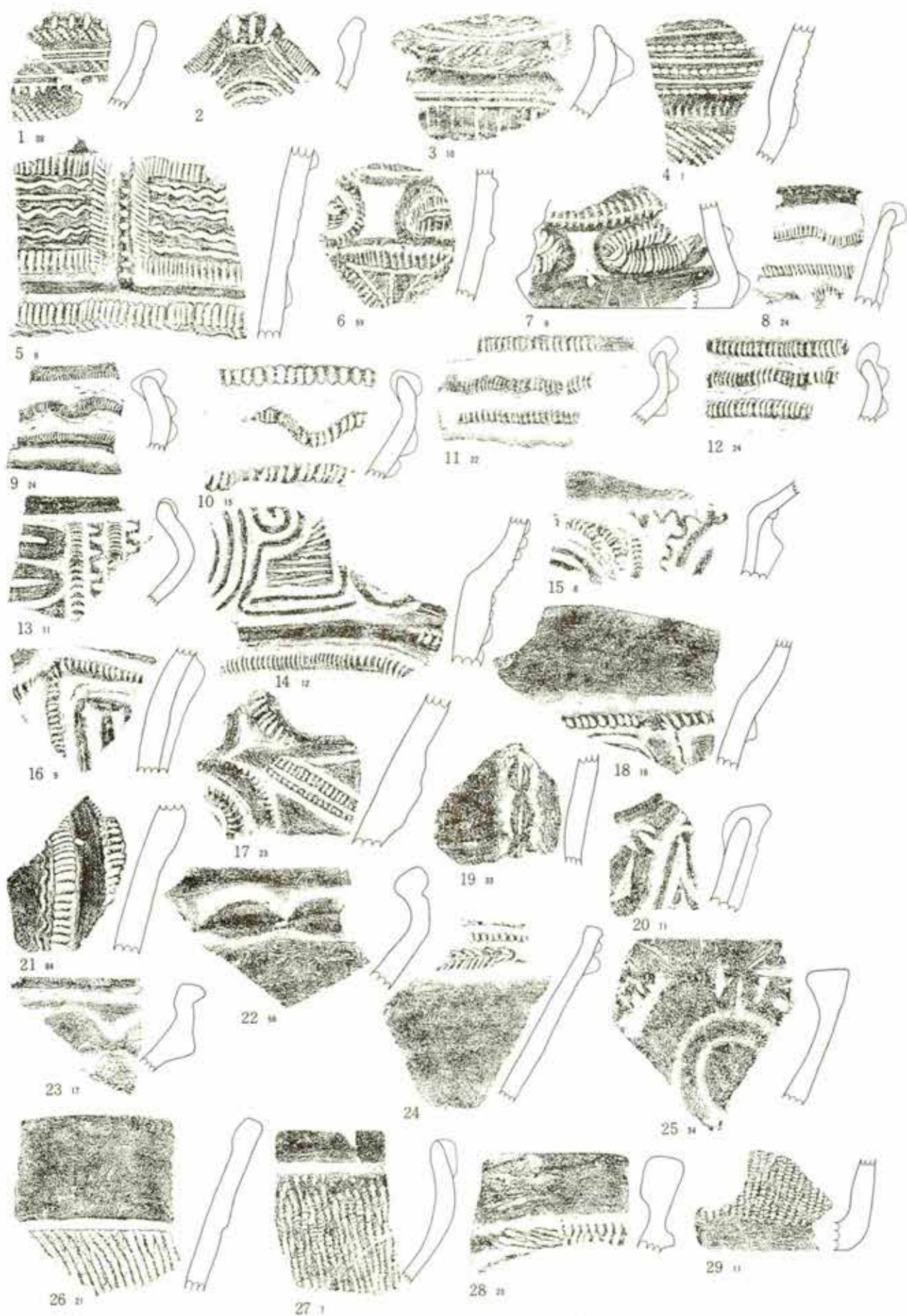

第114图 积迦堂S-III区 SB-33 出土土器



第115图 积迤堂S-III区 SB-33 出土土器
 (30.31.32.33.34.35.36.37.38.39.40.41.48.49. 1:6)



第116图 积逊堂S-III区 SB-35 出土土器(1)

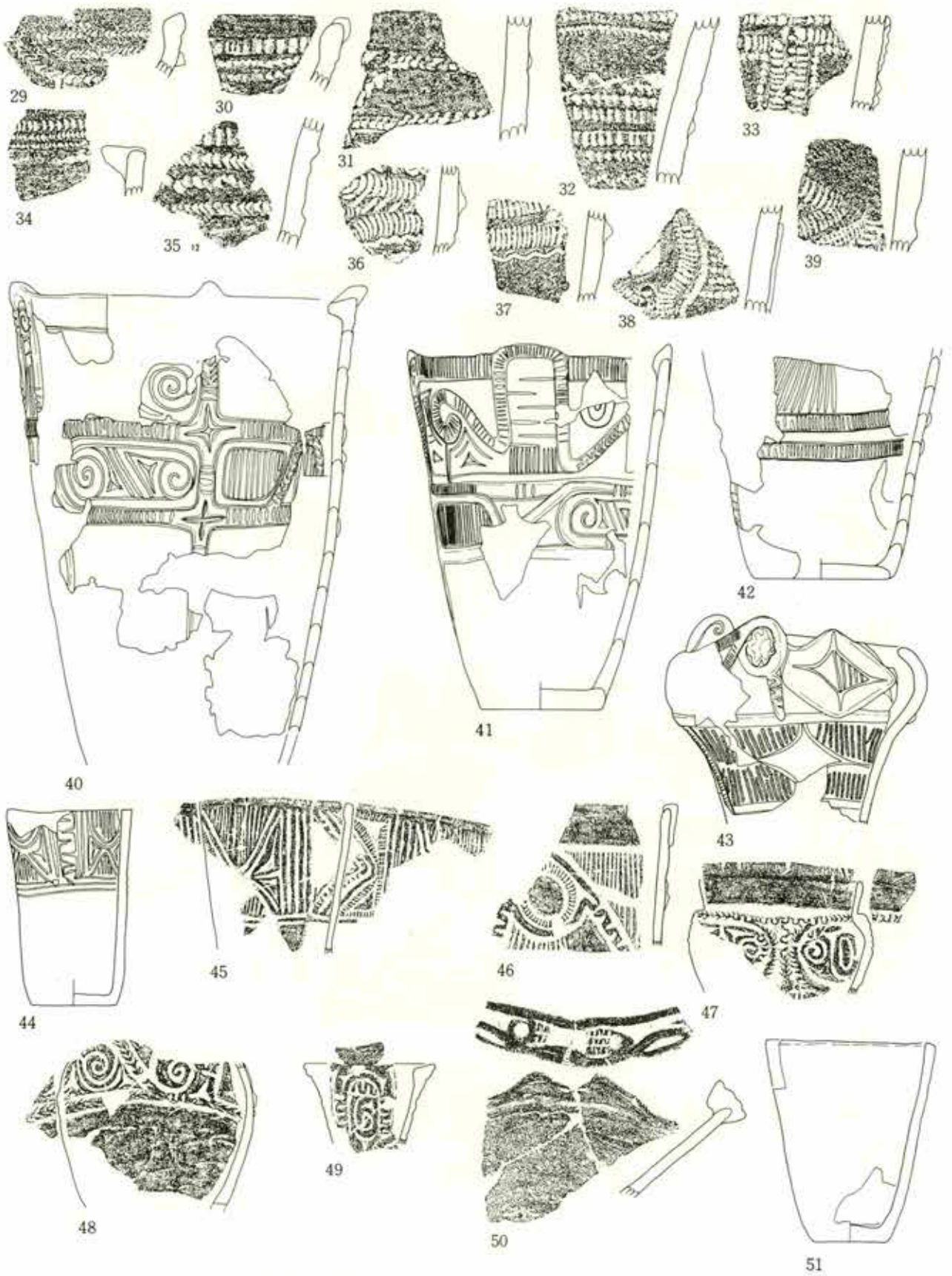

第117图 积迦堂S-III区 SB-35出土土器(2)

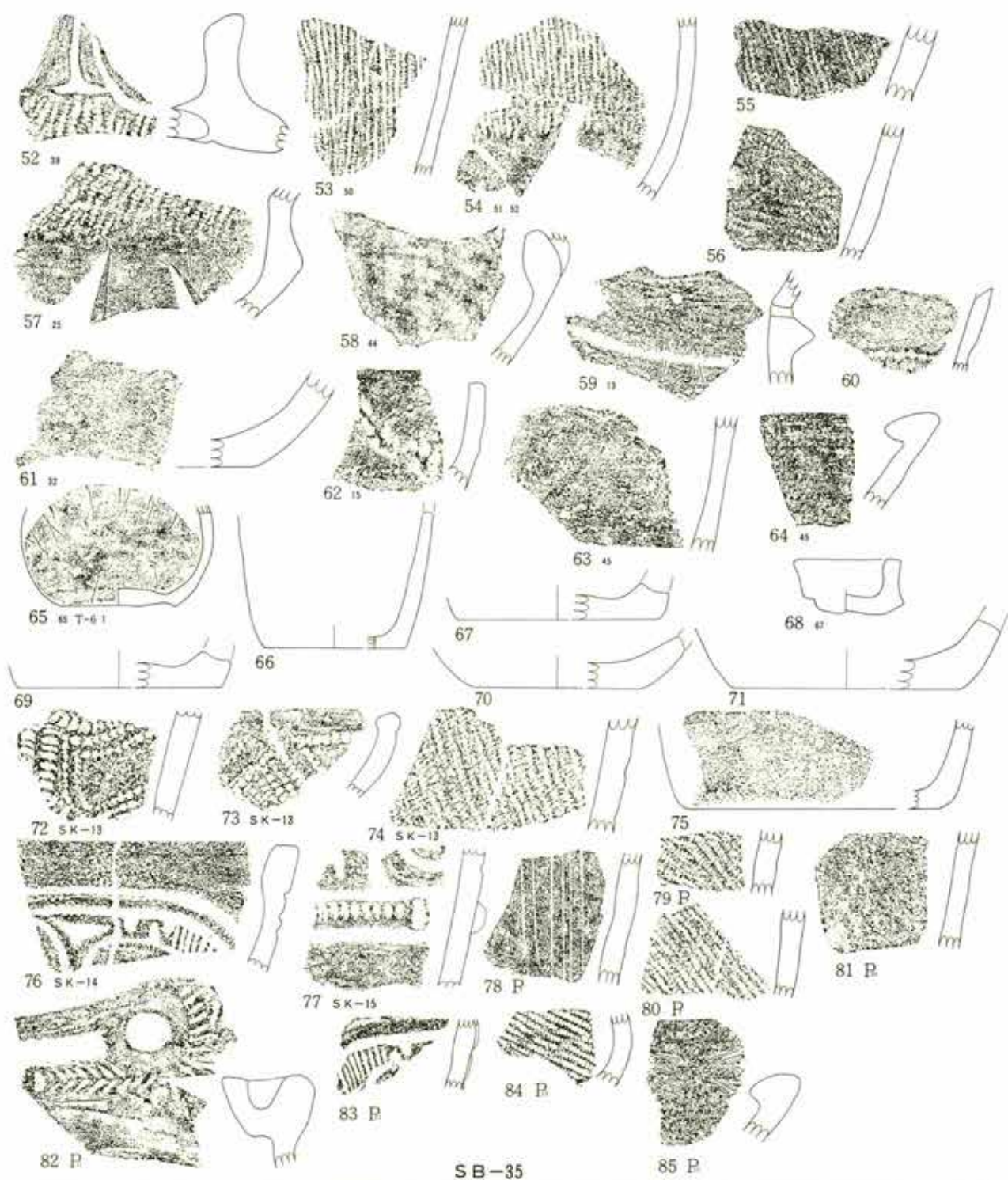

SB-35

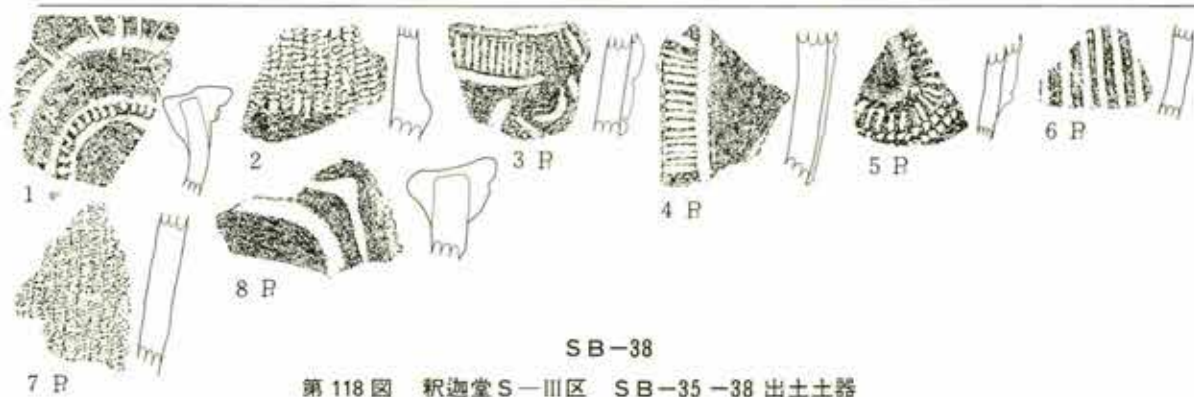

SB-38

第118图 积迦堂S-III区 SB-35-38 出土土器

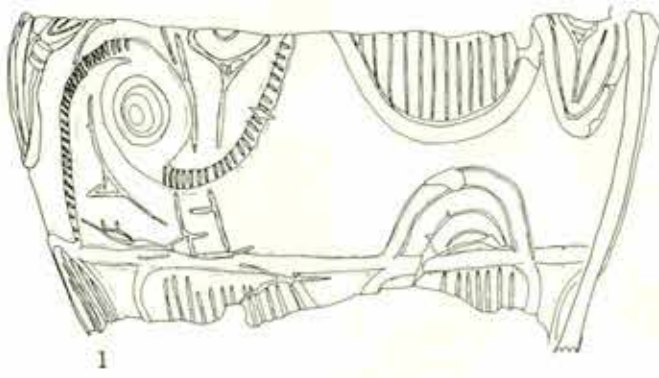

1



2

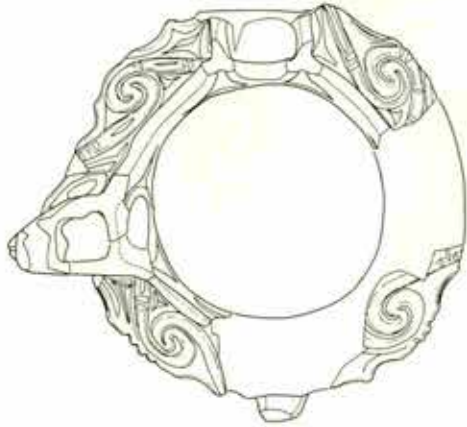

3

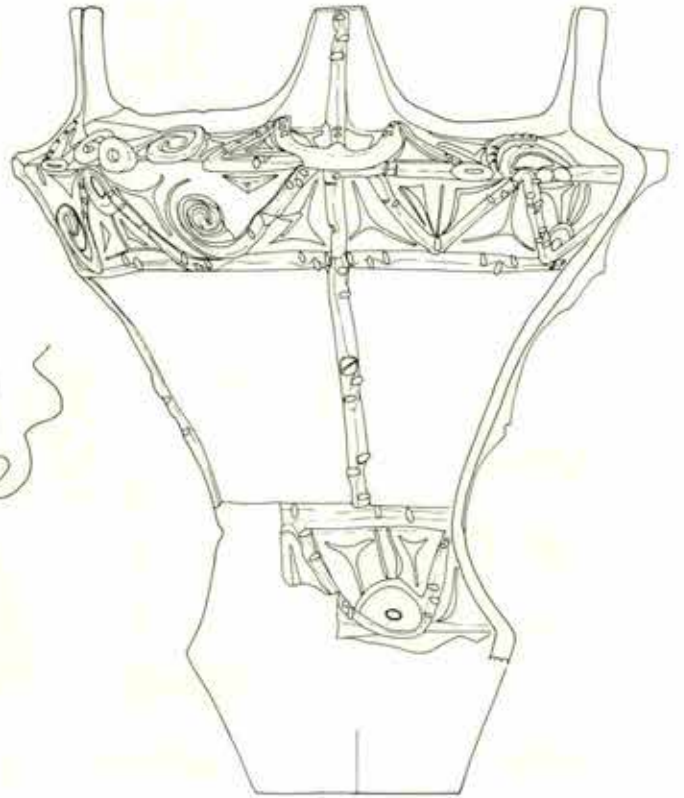

4

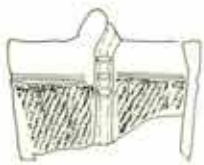
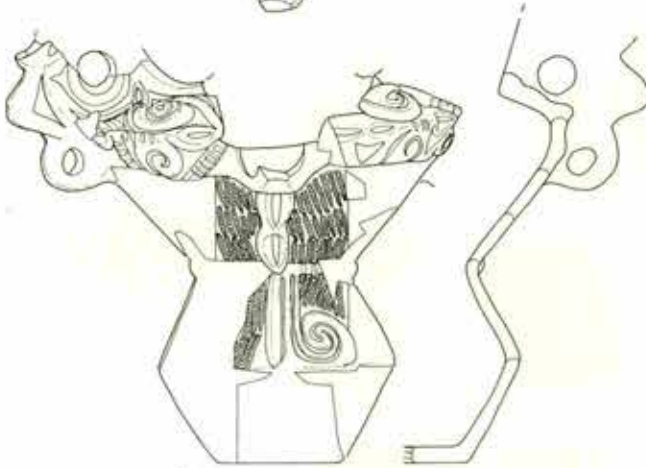

5

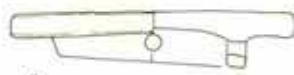

6



7

第 119 图 积迦堂 S-III 区 SB-36 出土土器 (1)

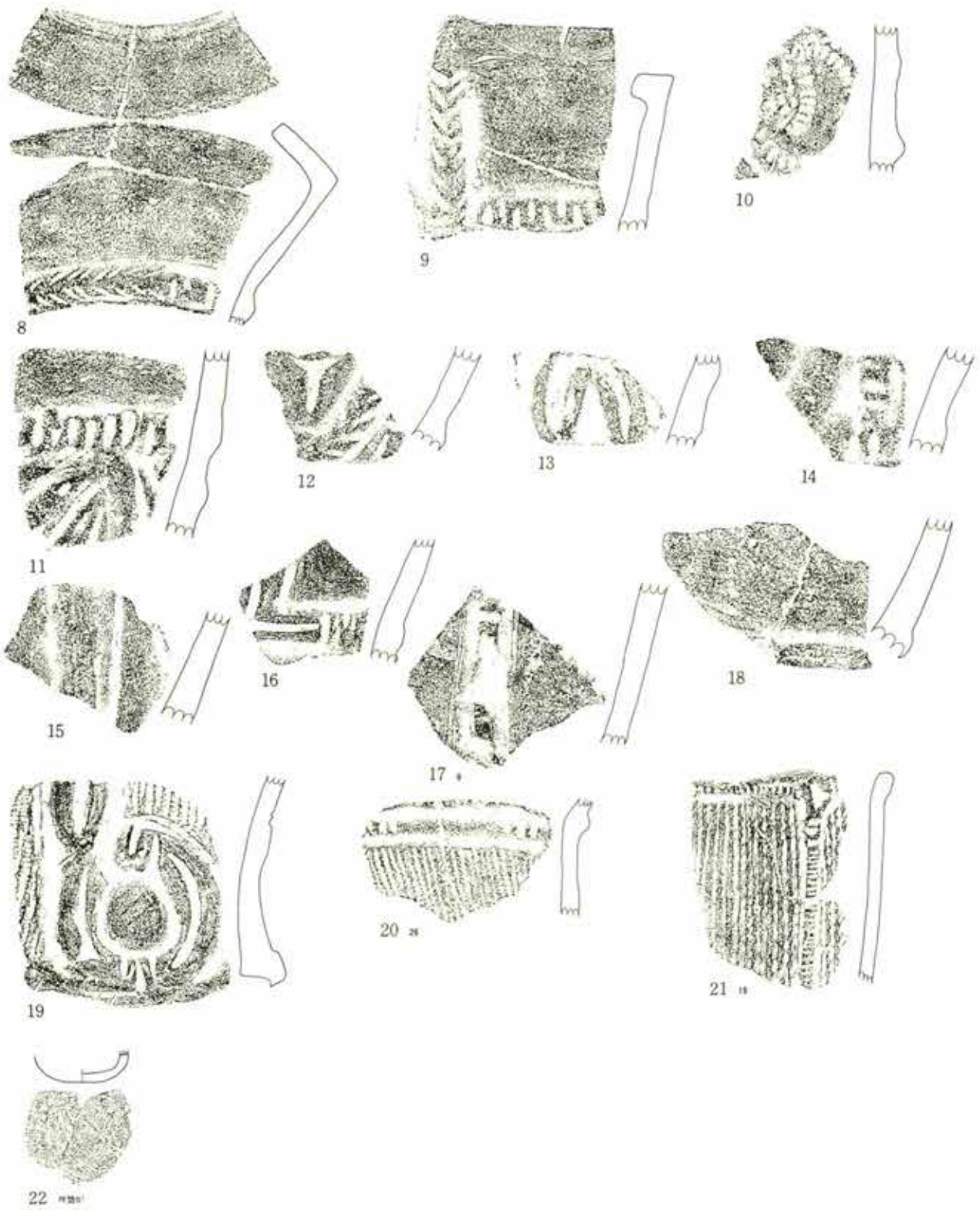

第 120 图 积迳堂 S-III 区 SB-36 出土土器 (2)

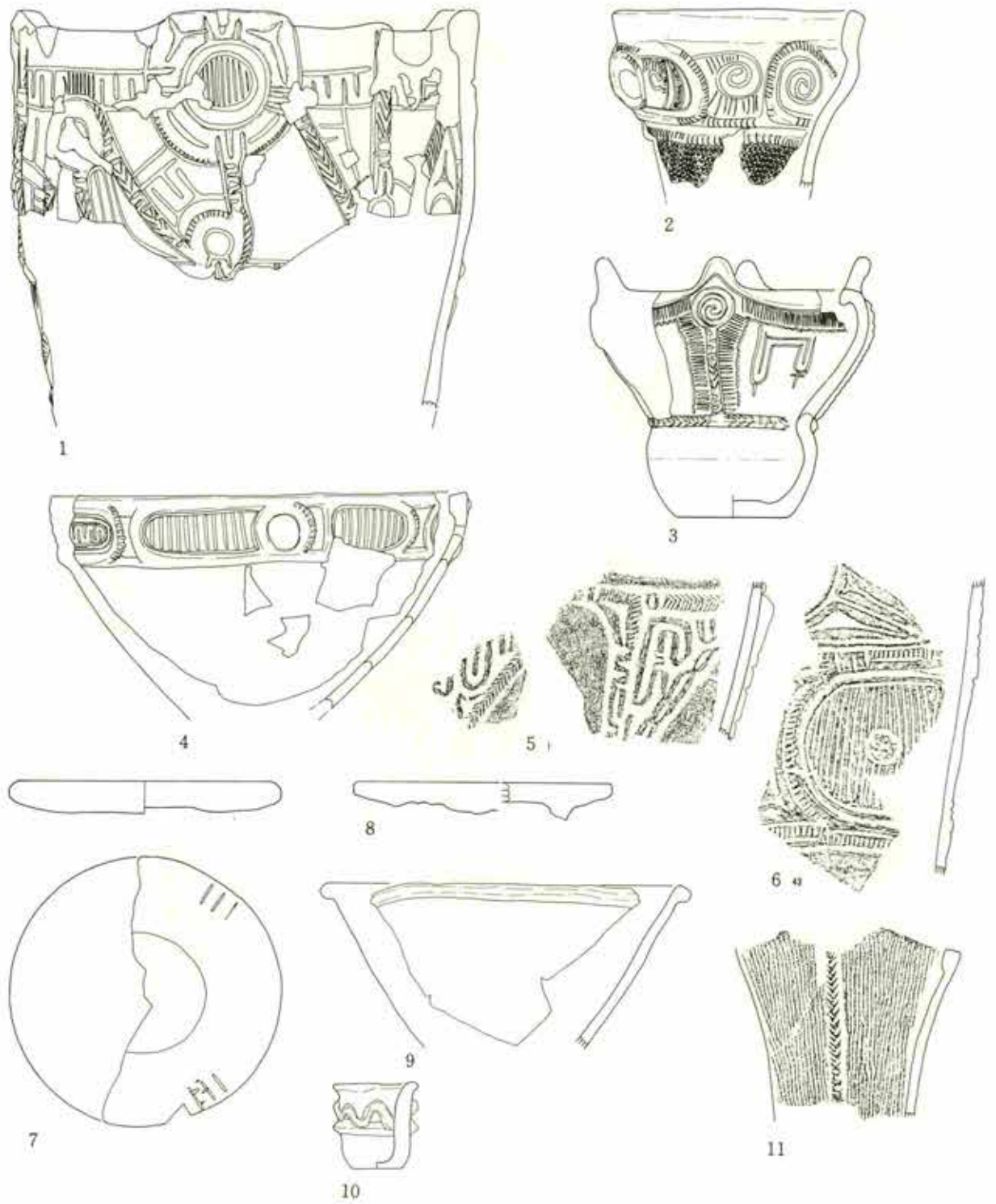

第 121 图 积迦堂 S-III 区 SB-48 出土土器 (1)

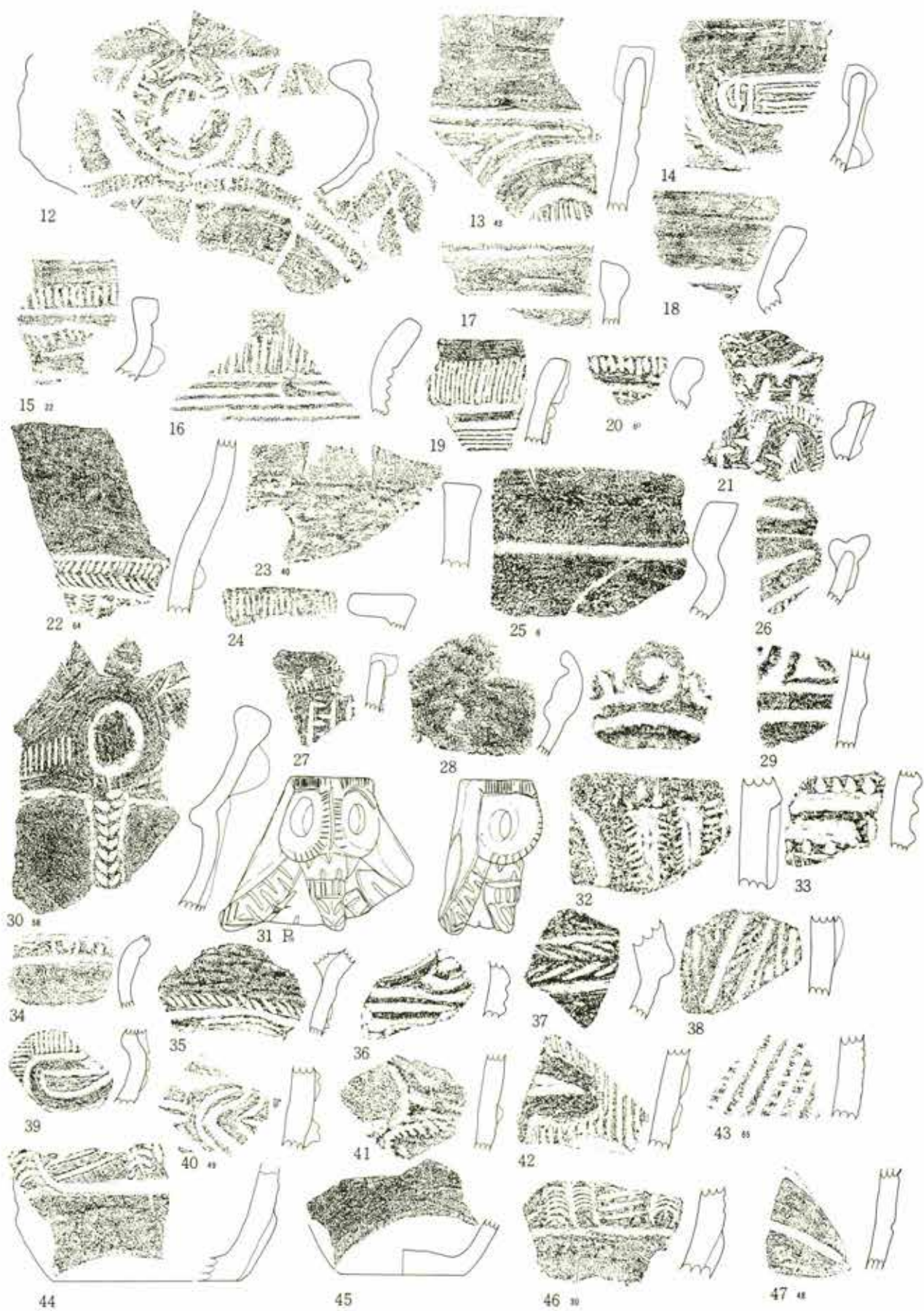

第122图 积迦堂S-III区 SB-48出土土器(2)
(1:1:6)

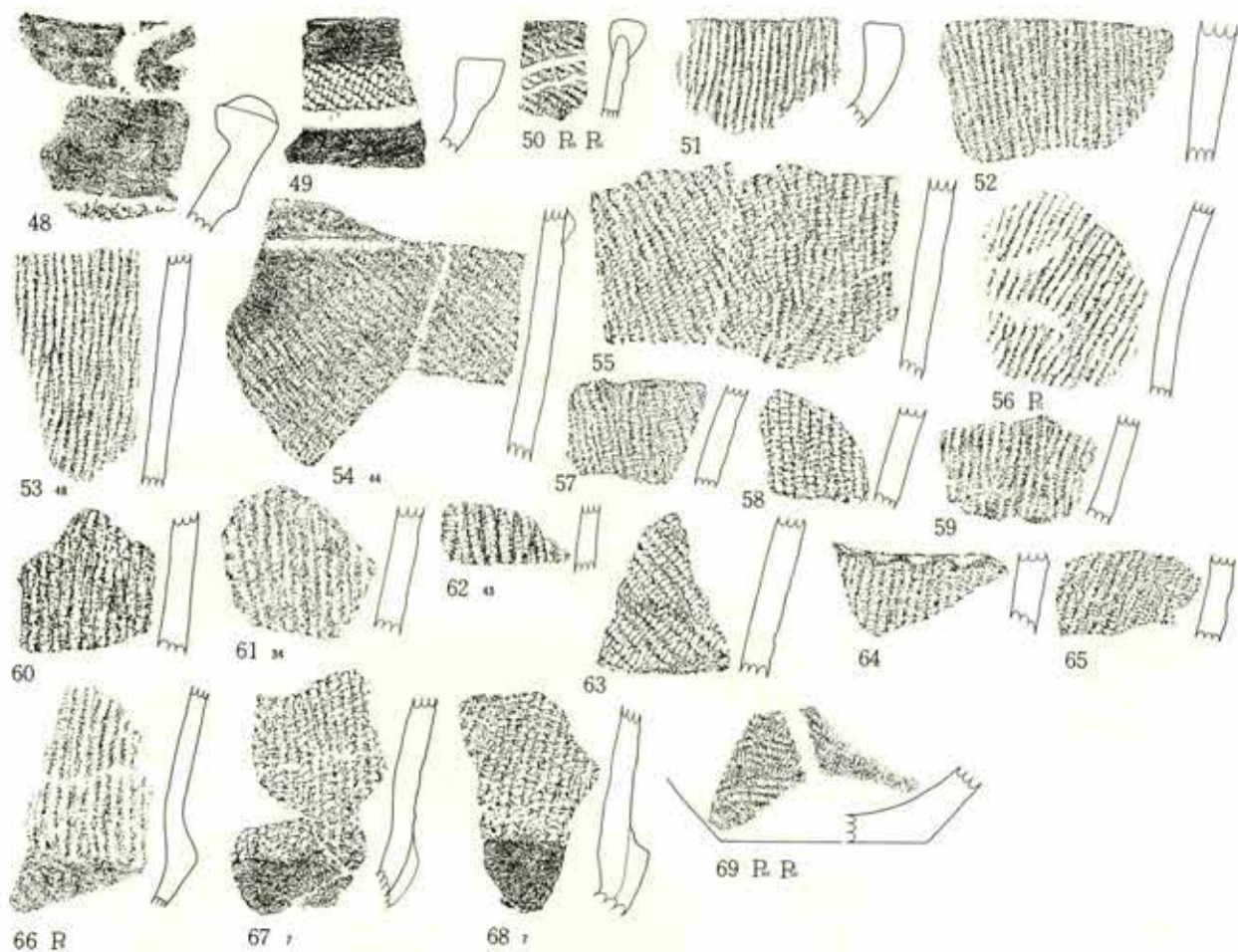

第 123 图 积迦堂 S-III 区 SB-48 出土土器 (3)

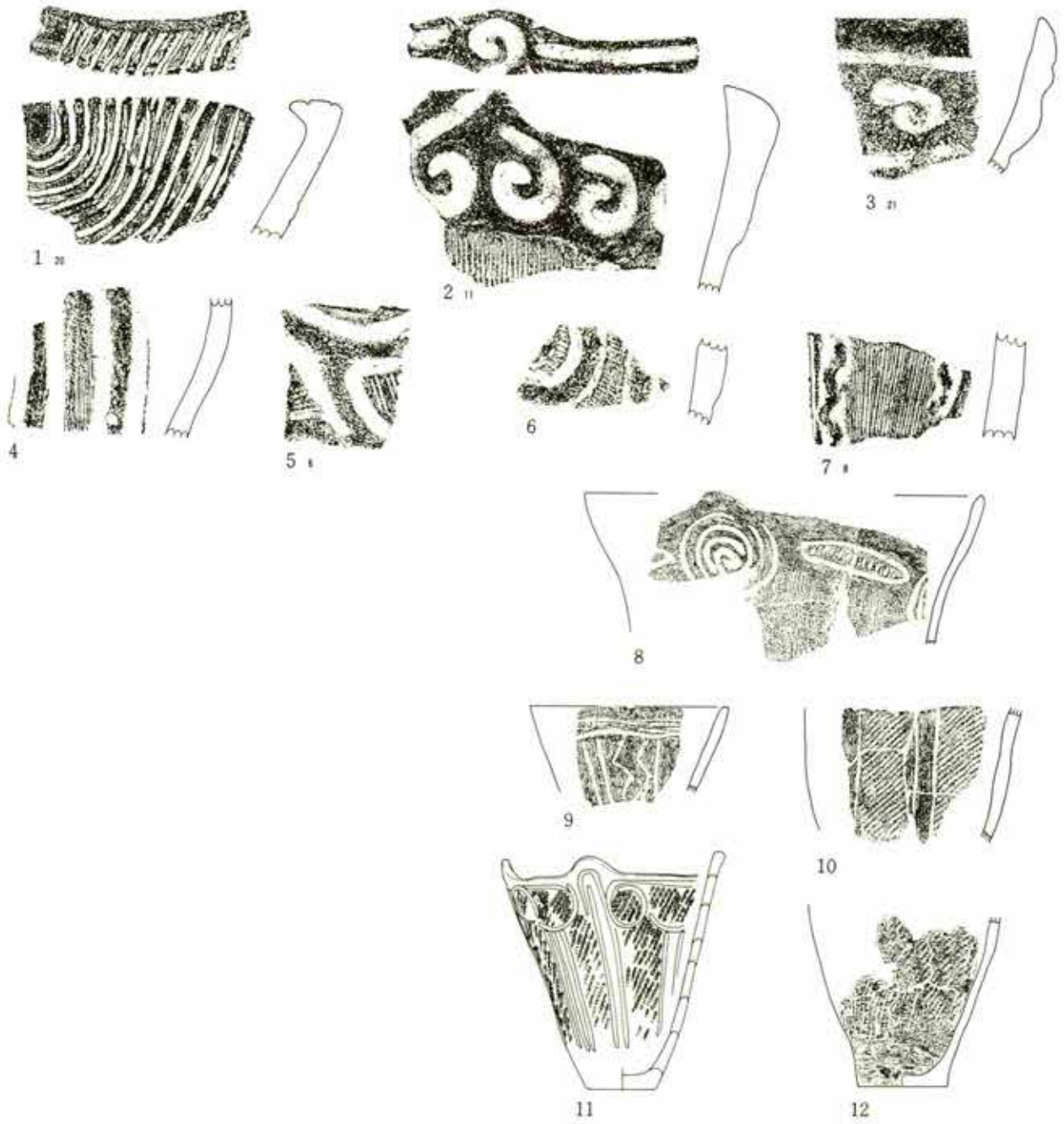

第 124 图 积逊堂 S-III 区 SB-04 出土土器

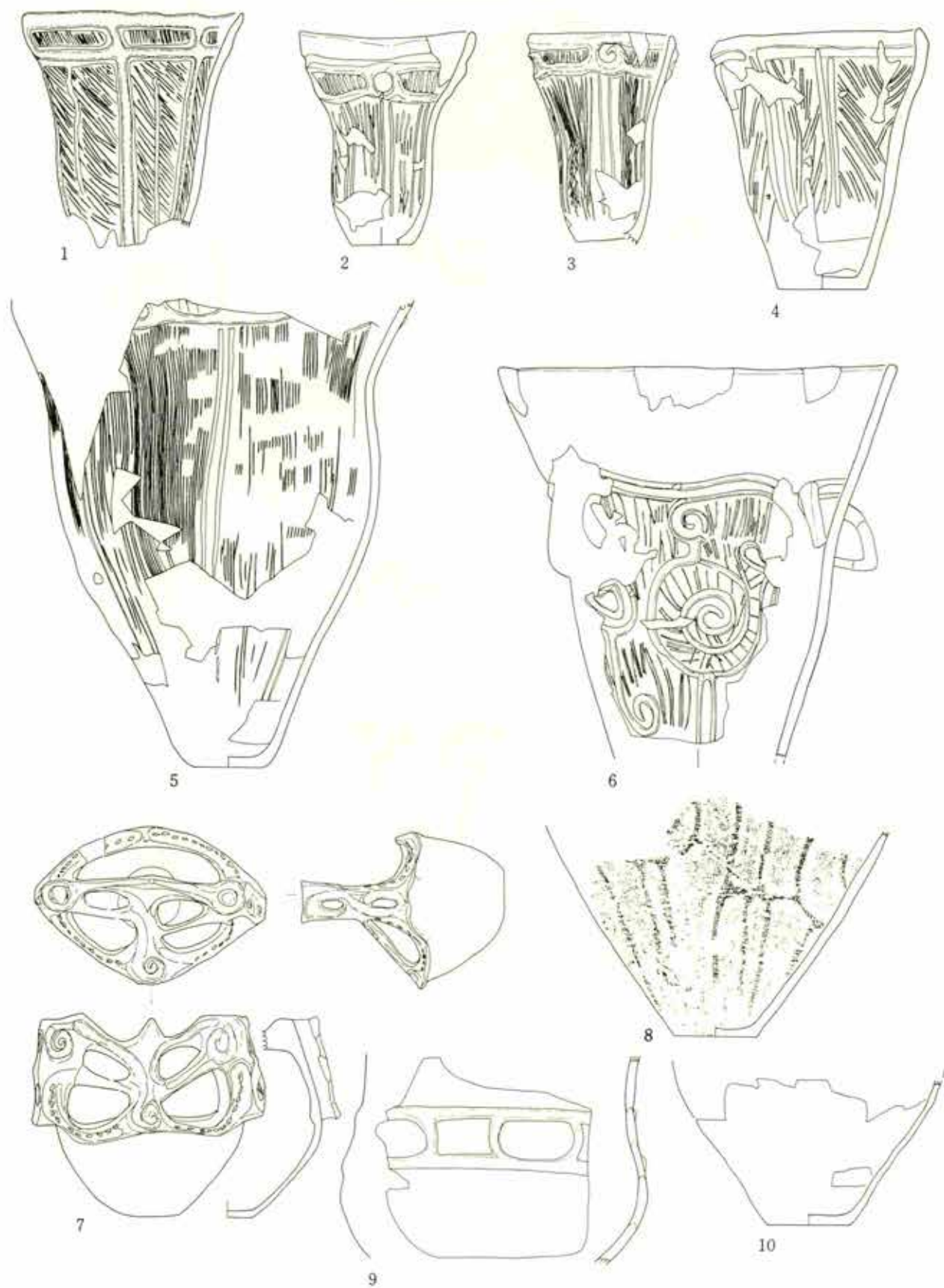

第125图 积逊堂S-III区 SB-05 出土土器(1)

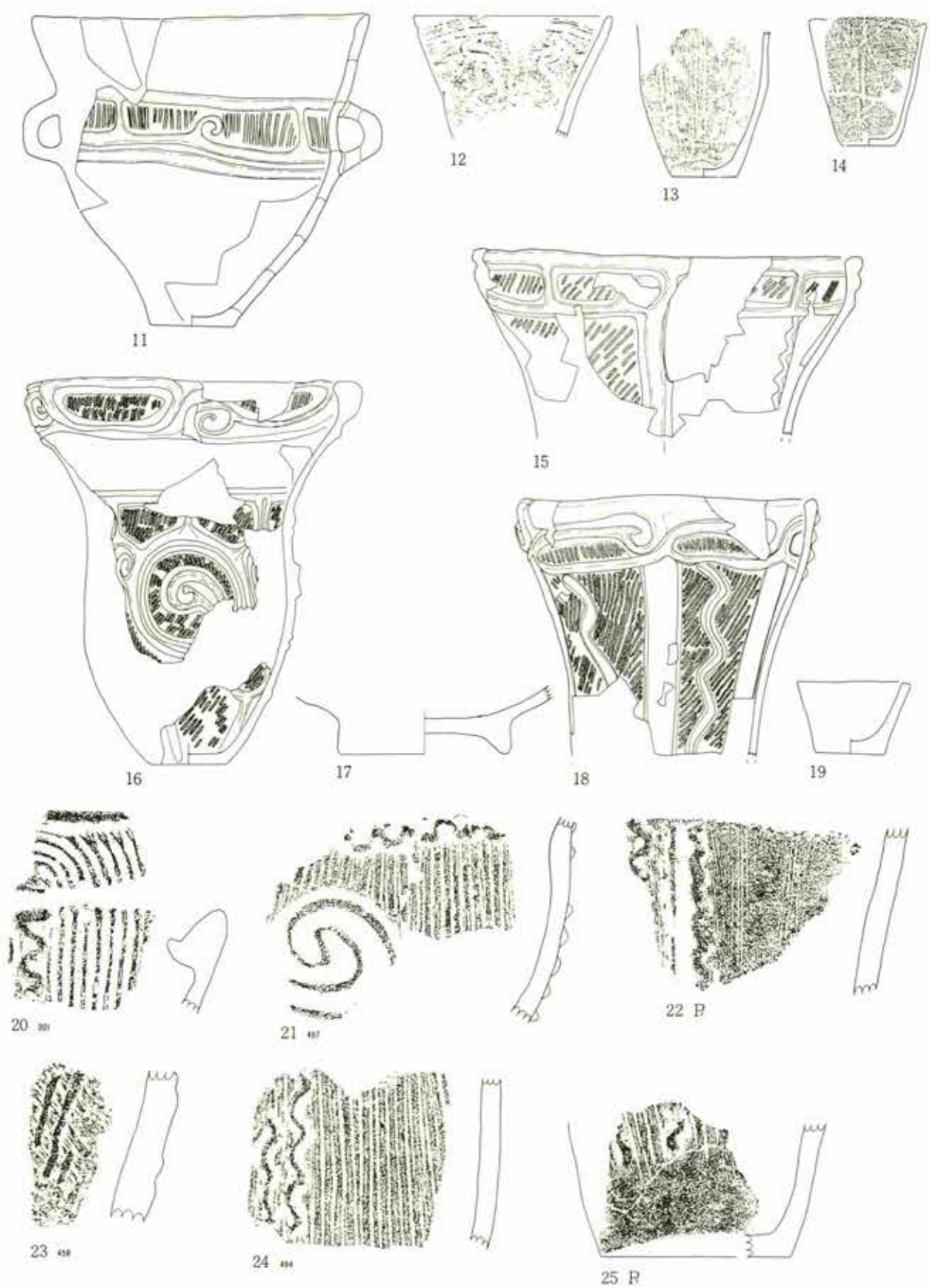

第126图 积迦堂S-III区 SB-05 出土土器 (2)

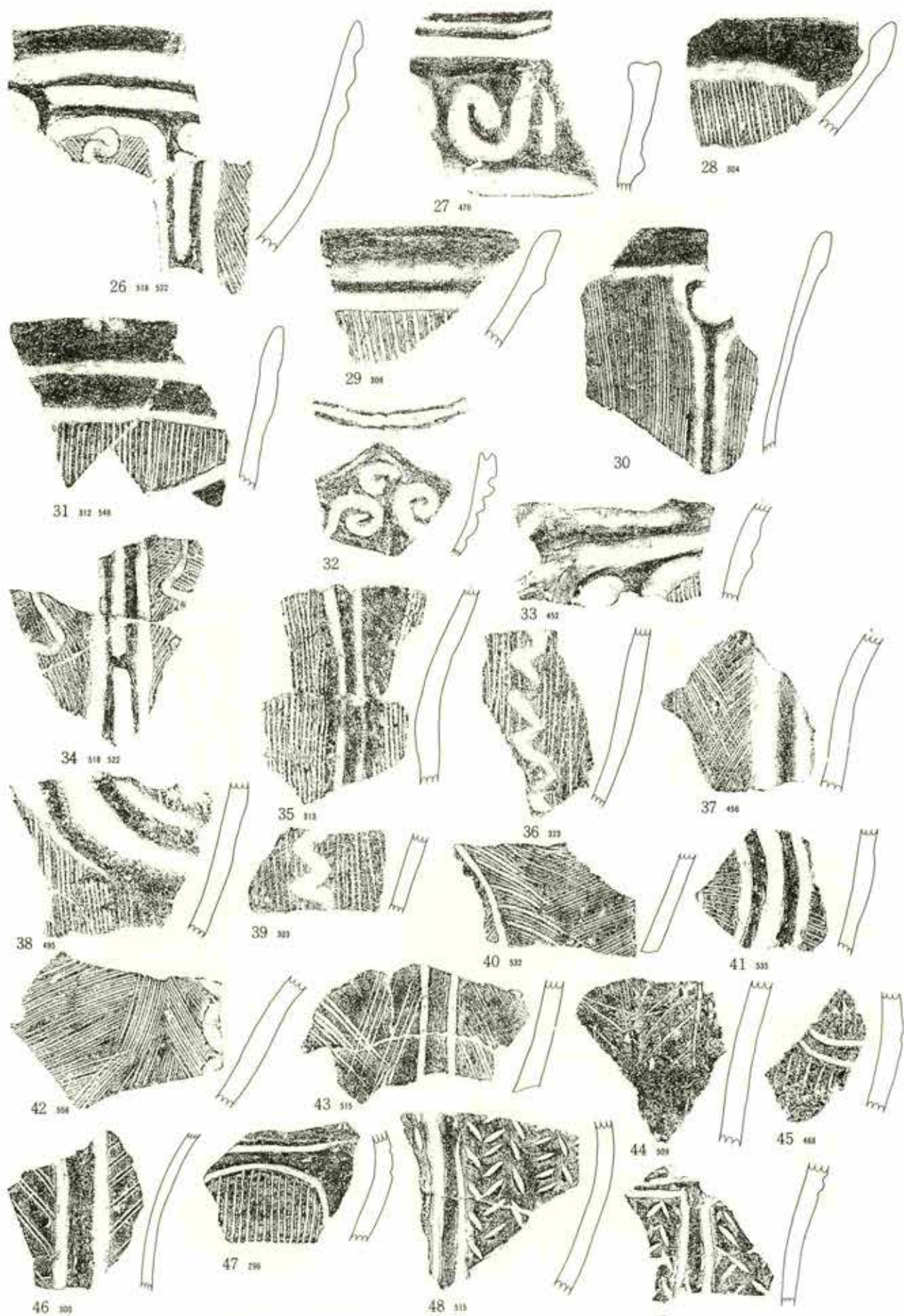

第127图 积迦堂S-III区 SB-05 出土土器(3)

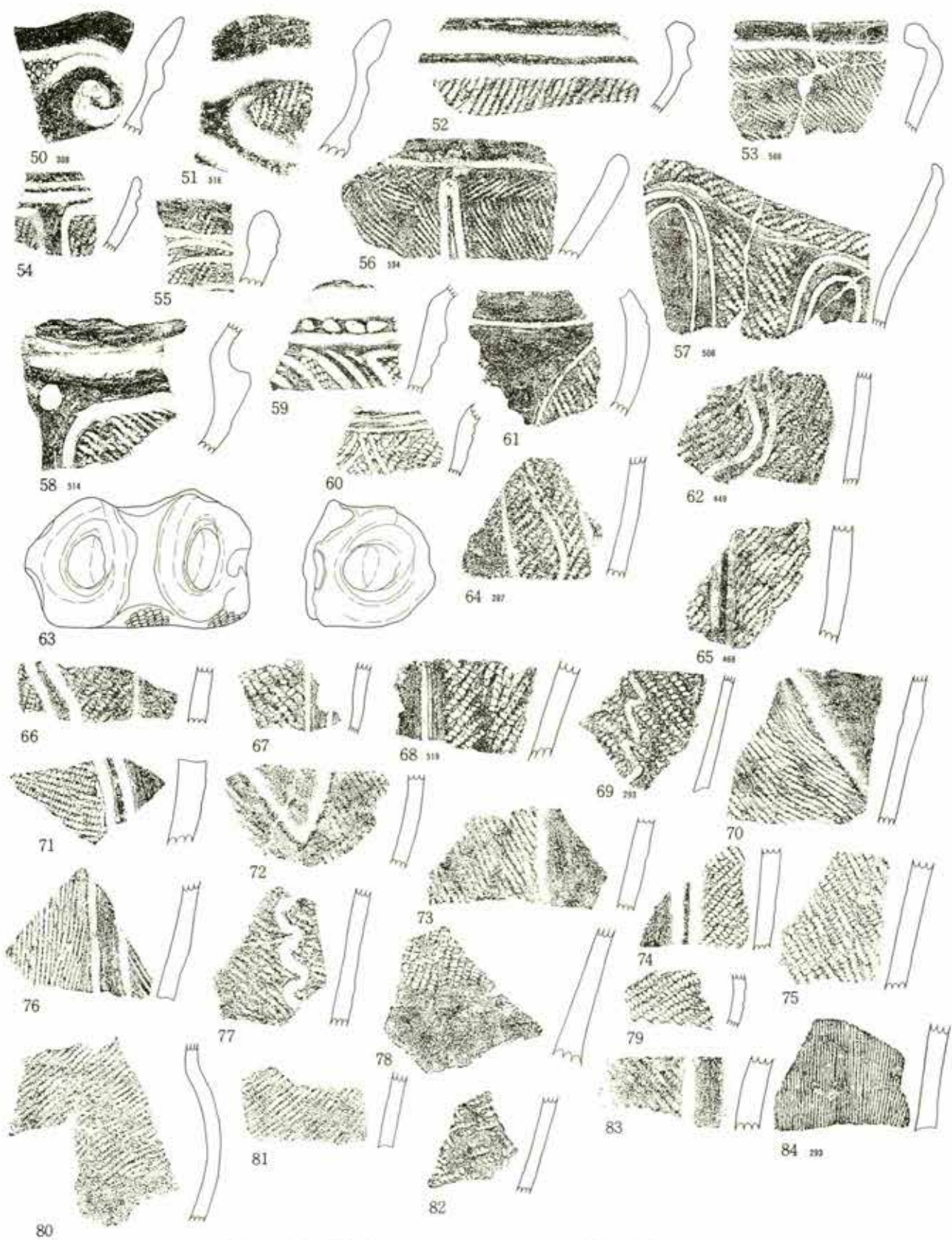

第128图 积迦堂S-III区 SB-05 出土土器 (4)

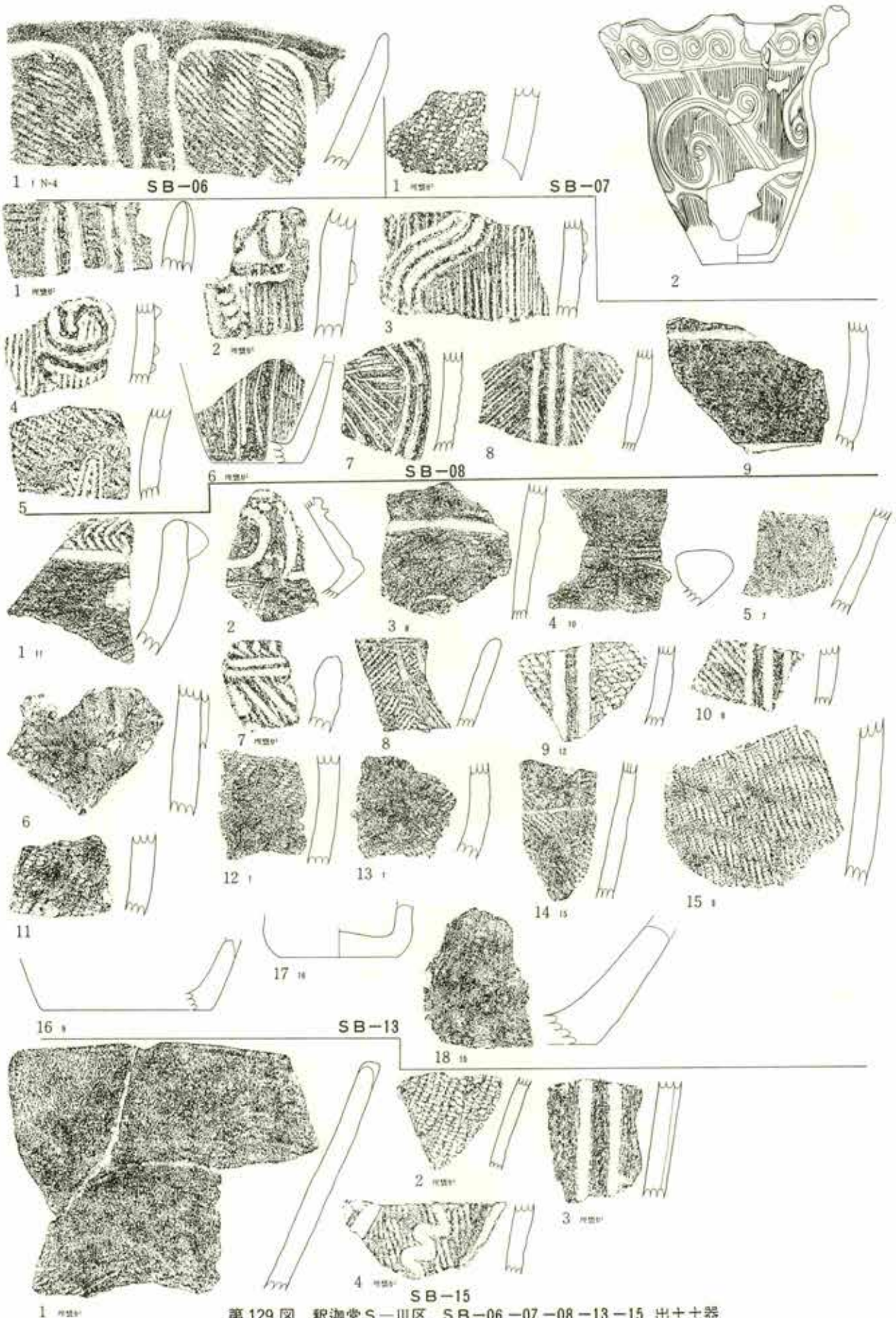

第129图 积逊堂S-III区 SB-06-07-08-13-15 出土土器



第130图 积逊堂S-III区 SB-17-21 出土土器 (18.19. 1:6)

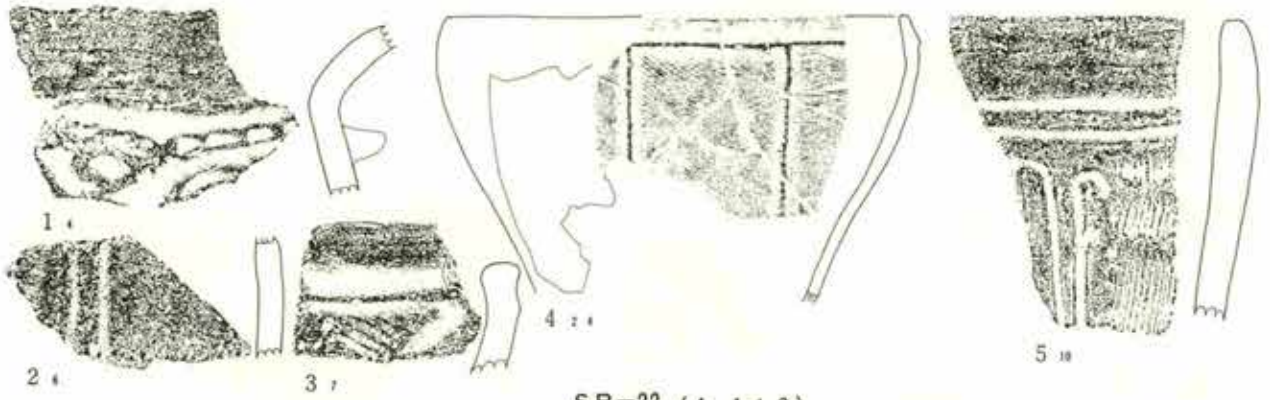

SB-22 (4. 1 : 6)

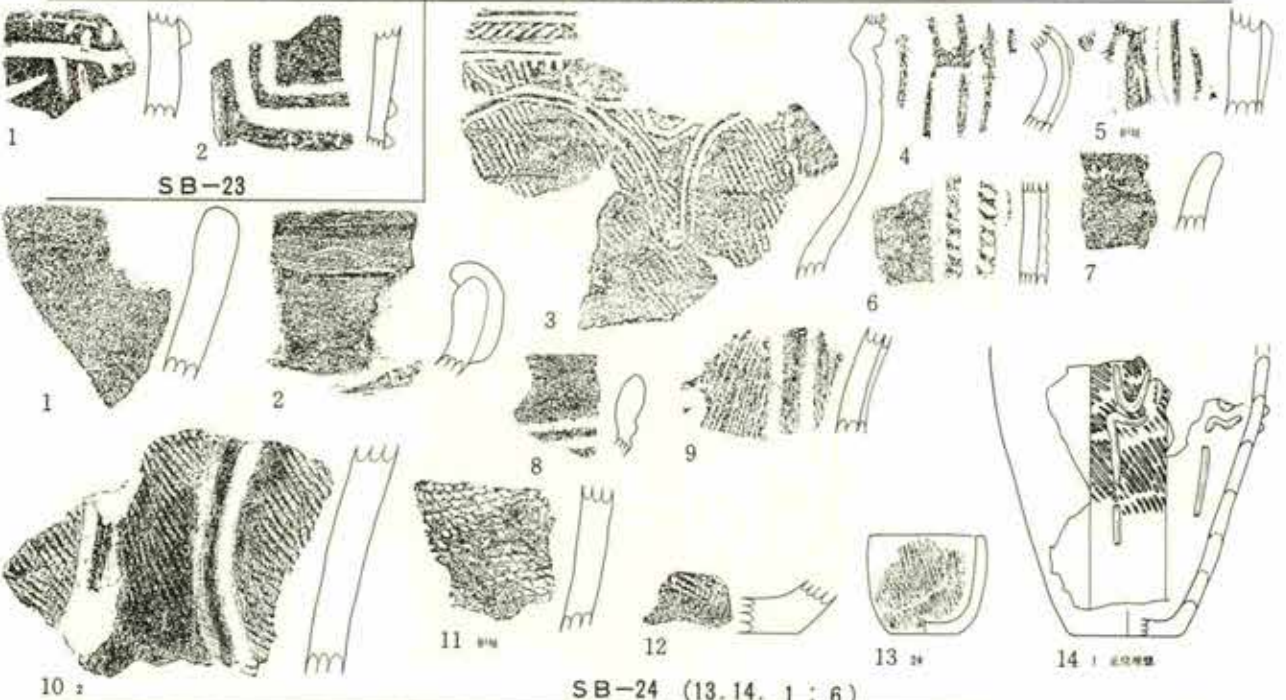

SB-24 (13. 14. 1 : 6)

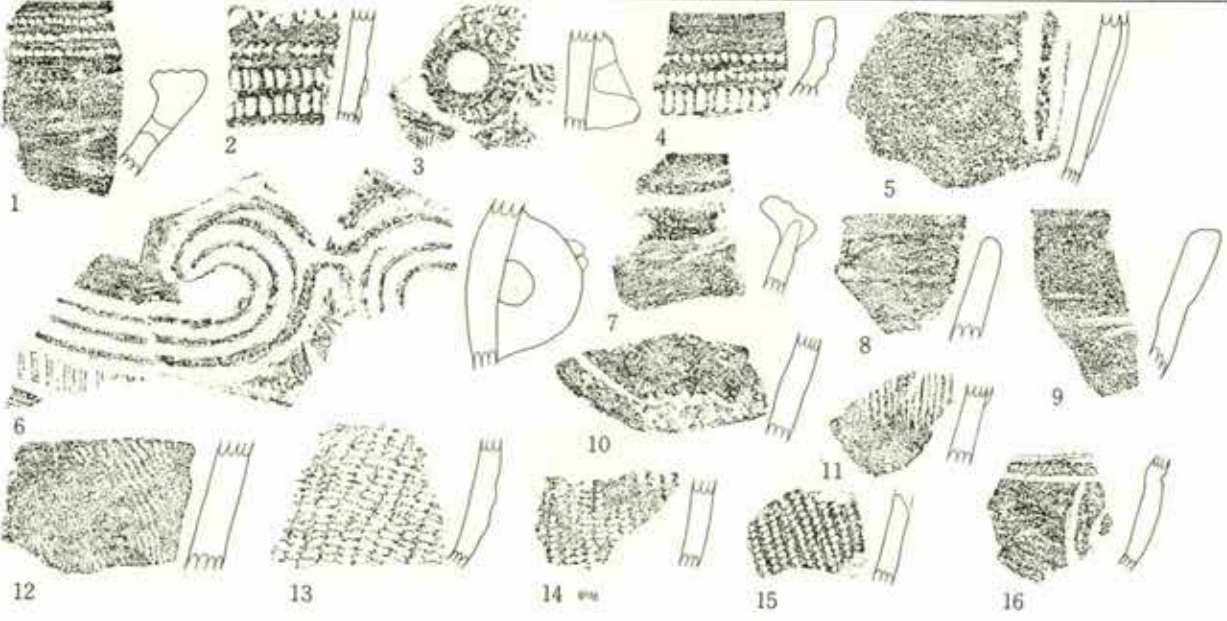

SB-25

第 131 图 积迦堂 S-III 区 SB-22-23-24-25 出土土器

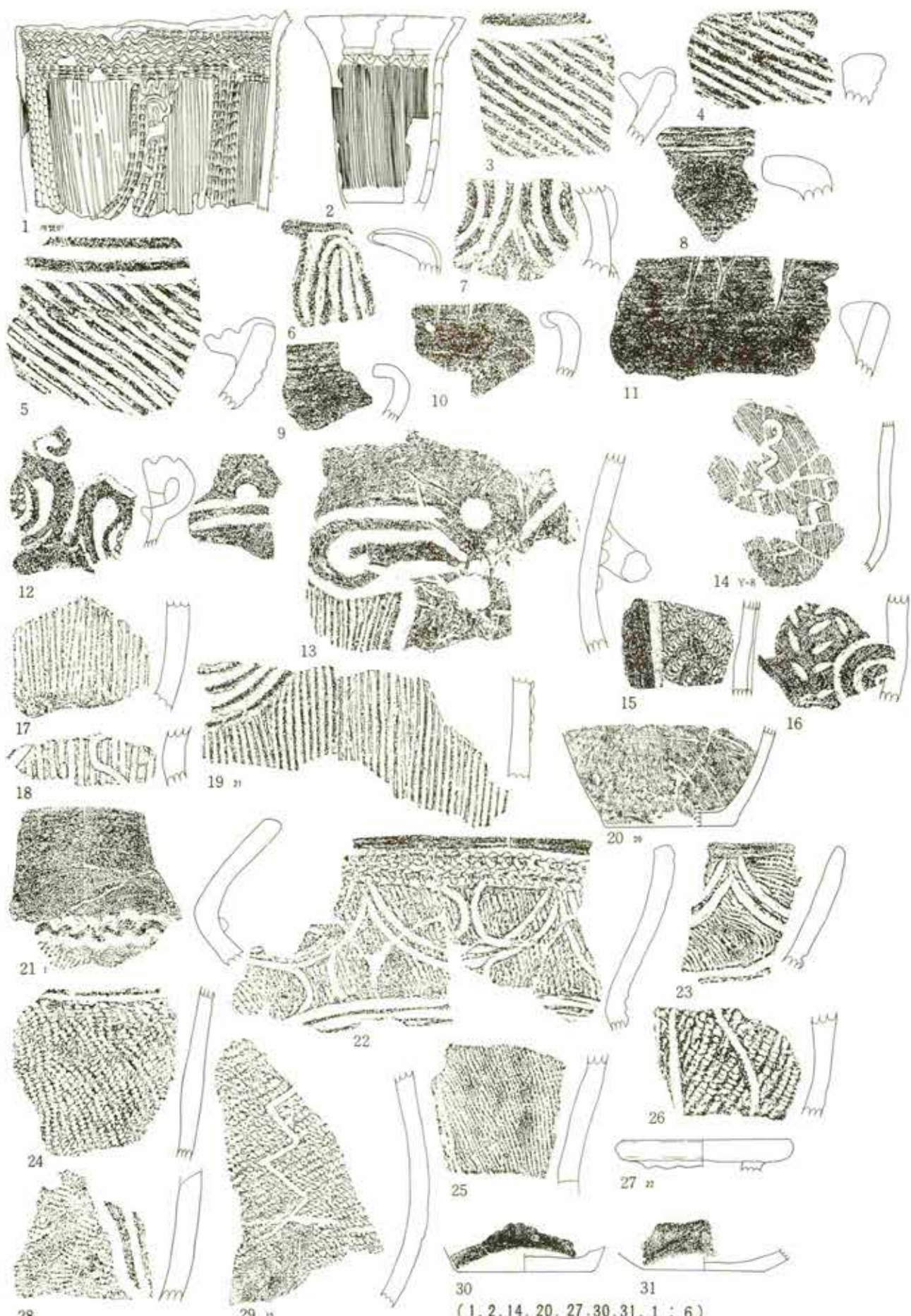

第132图 积逊堂S-III区 SB-29-3 出土土器
 (1. 2. 14. 20. 27. 30. 31. 1 : 6)

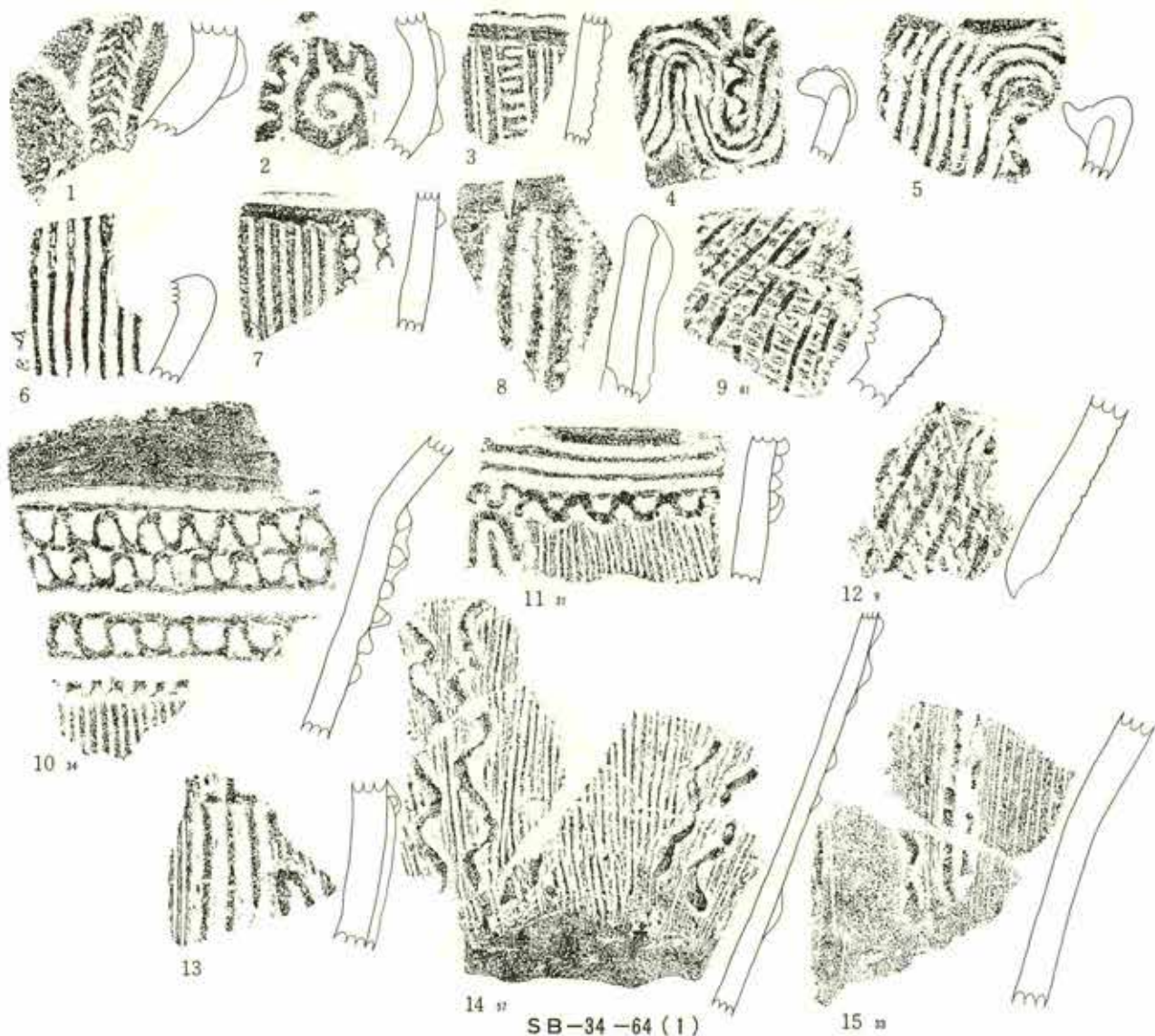
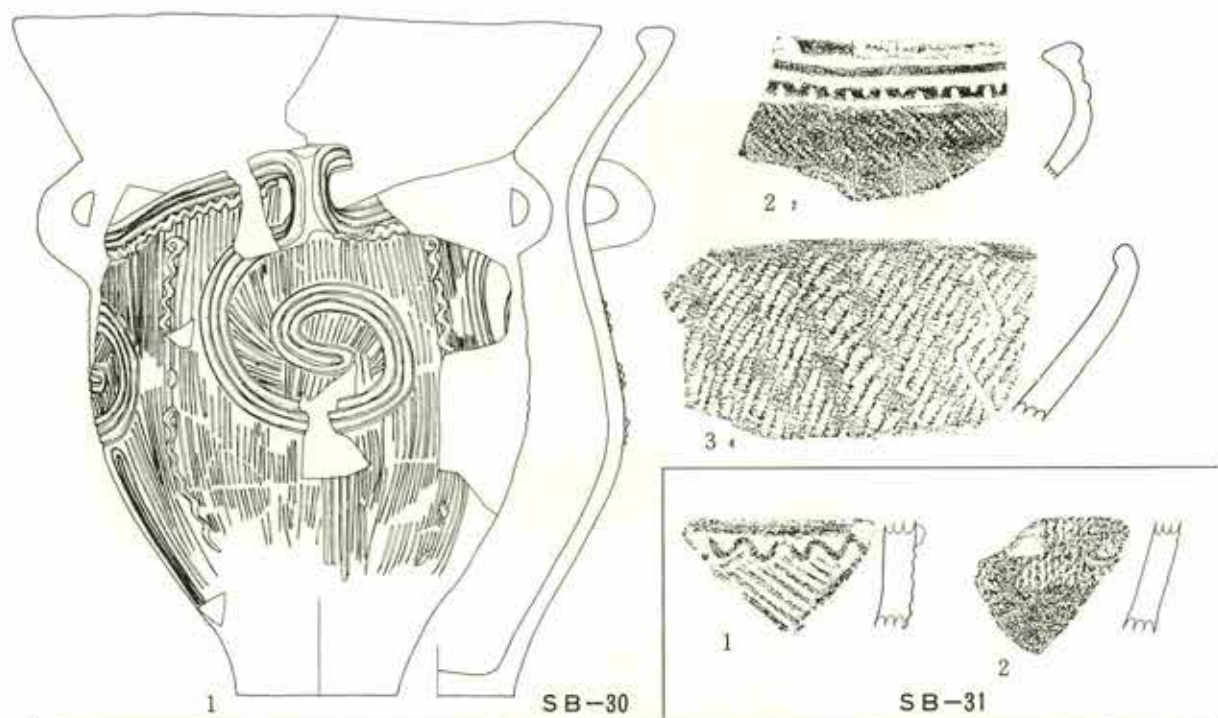

第133图 积迦堂S-III区 SB-30-31-34-64 出土土器

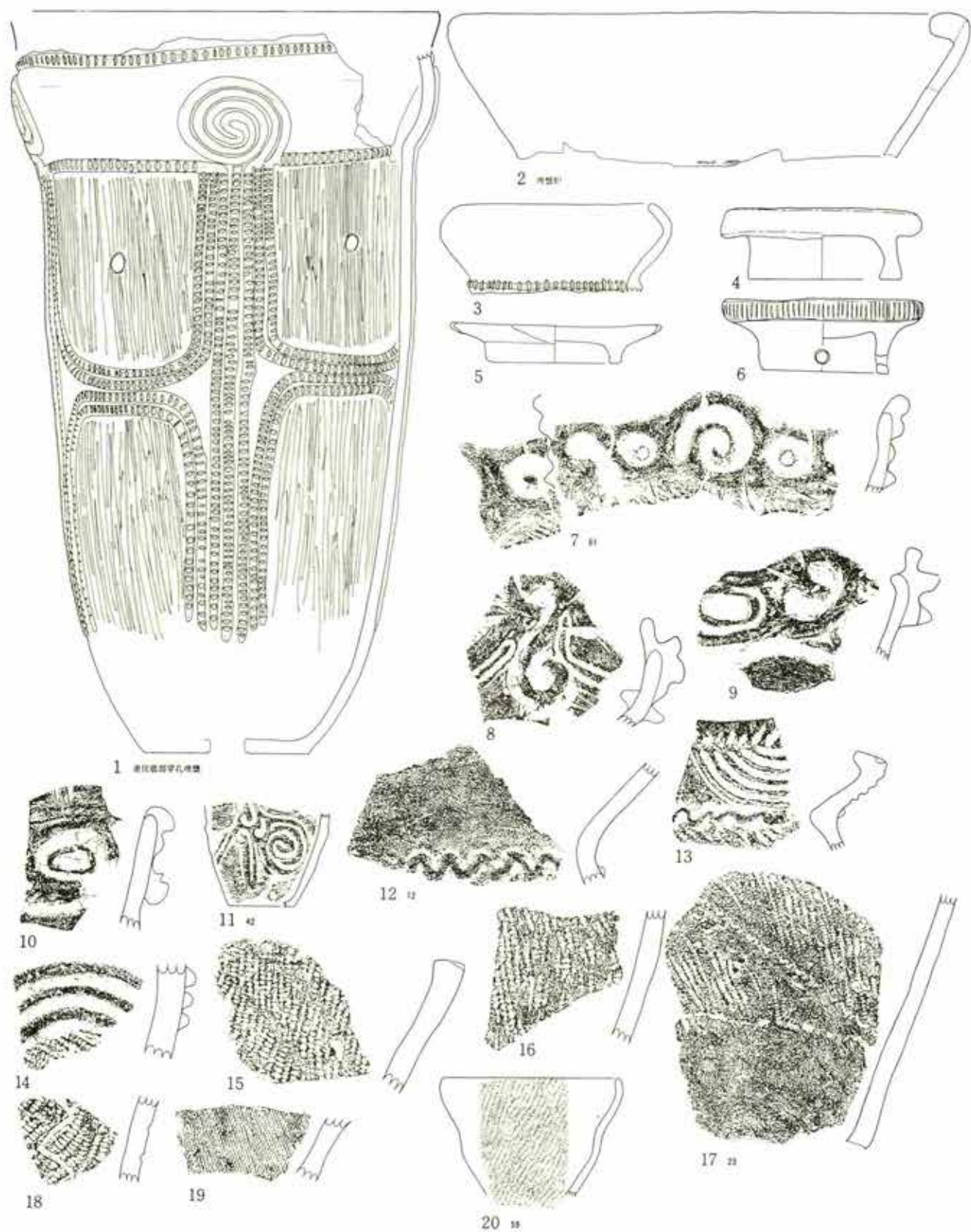

第 134 图 积迦堂 S-III 区 SB-34-64 出土土器 (2)
 (1. 2. 3. 4. 5. 6. 11. 20. 1 : 6)

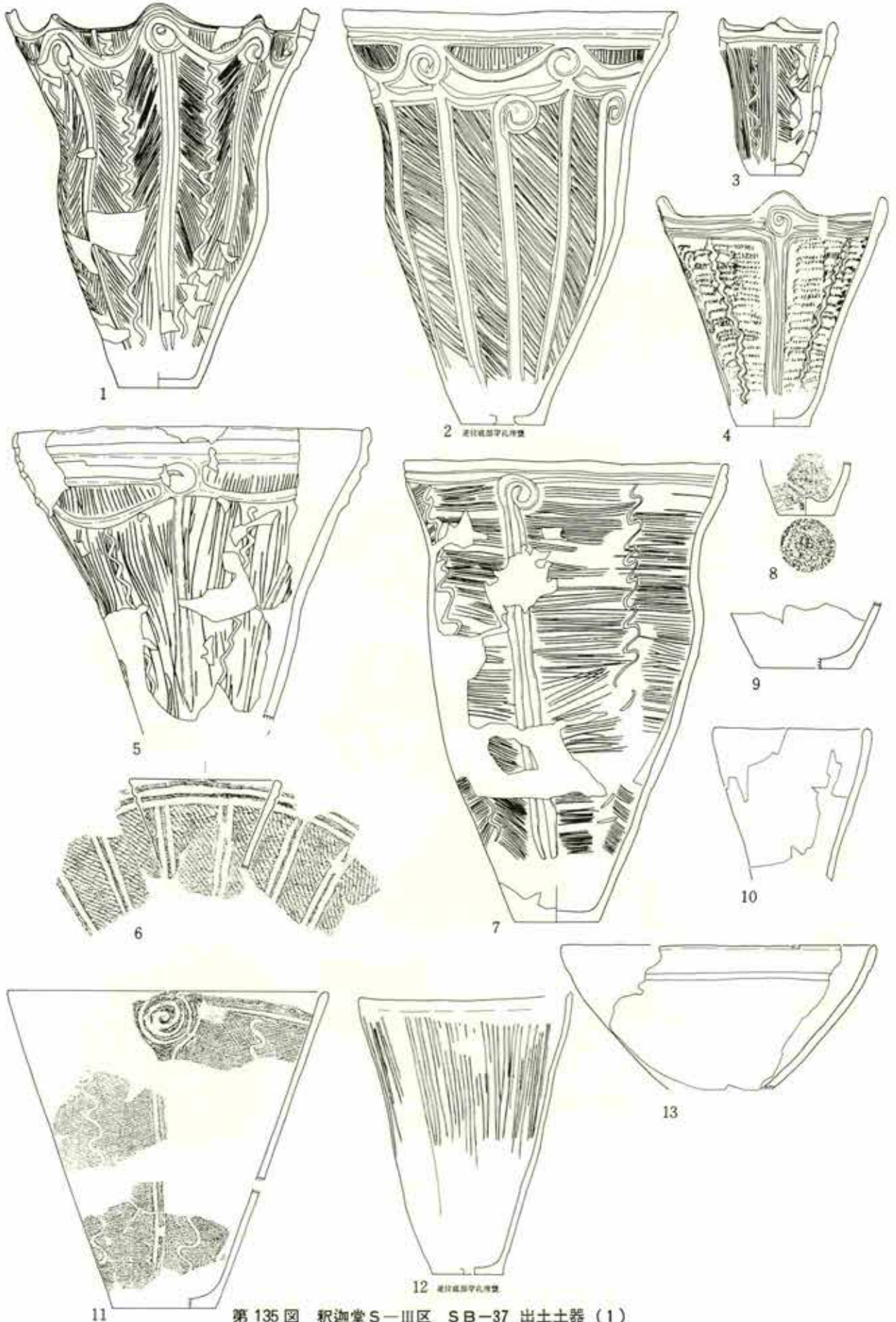

11

第 135 图 积迦堂 S-III 区 SB-37 出土土器 (1)

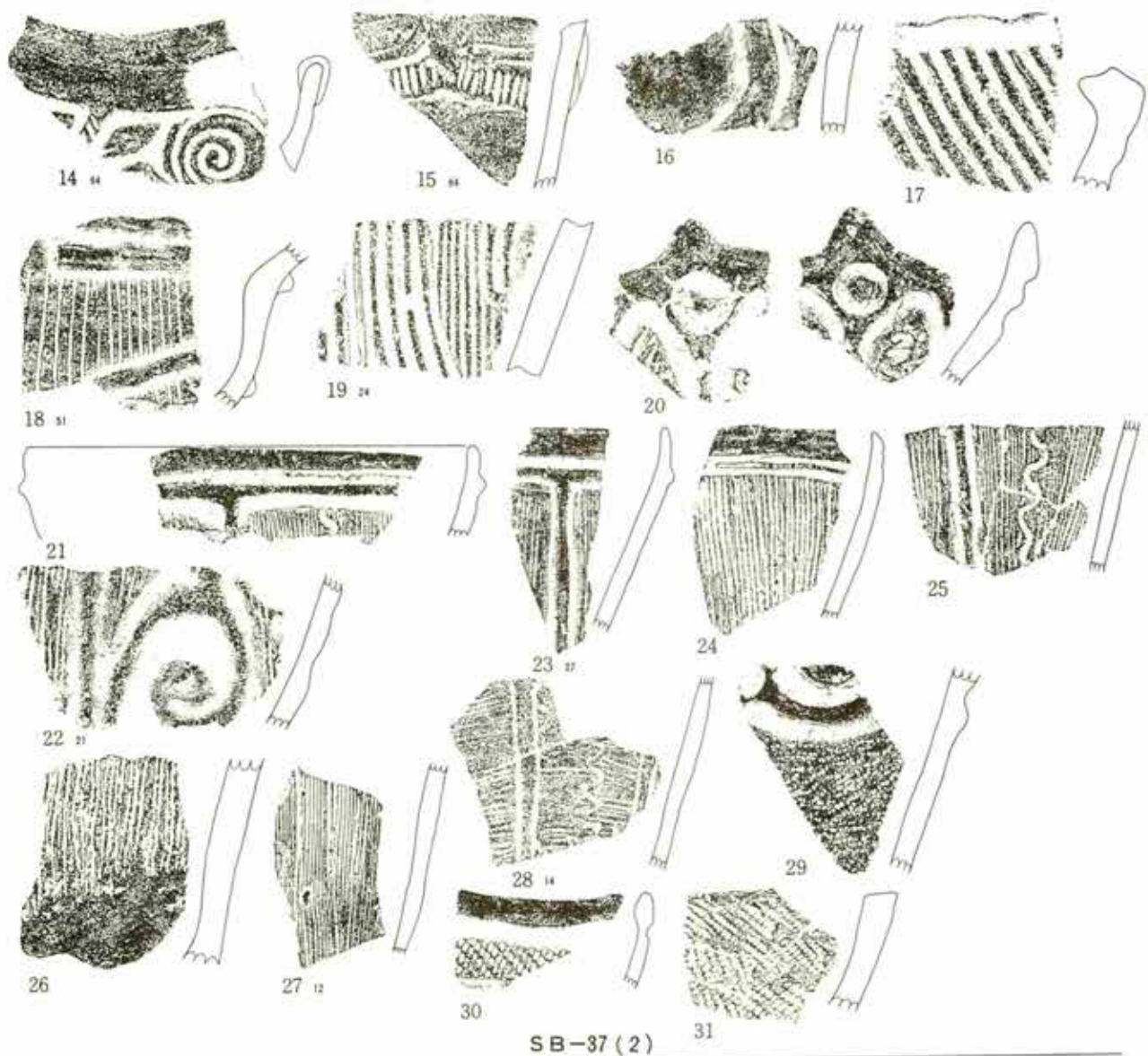

SB-37(2)

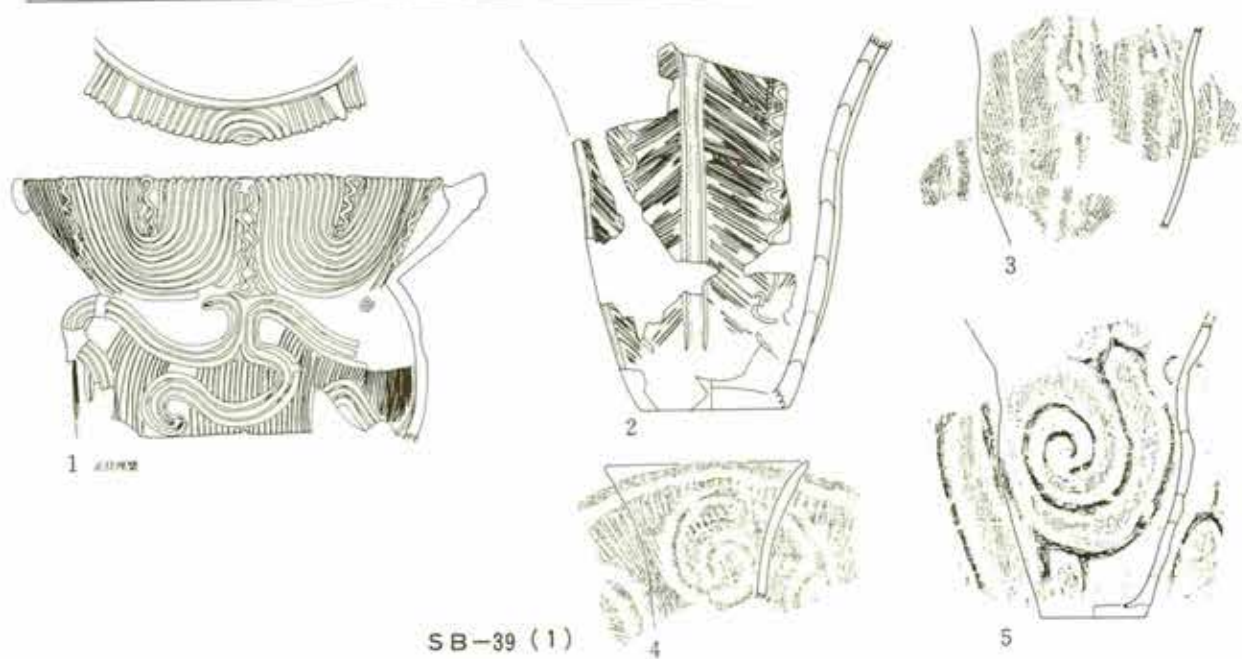

SB-39(1)

第136图 积迦堂S-III区 SB-37-39 出土土器



第137图 积迦堂S-III区 SB-39出土土器 (2)

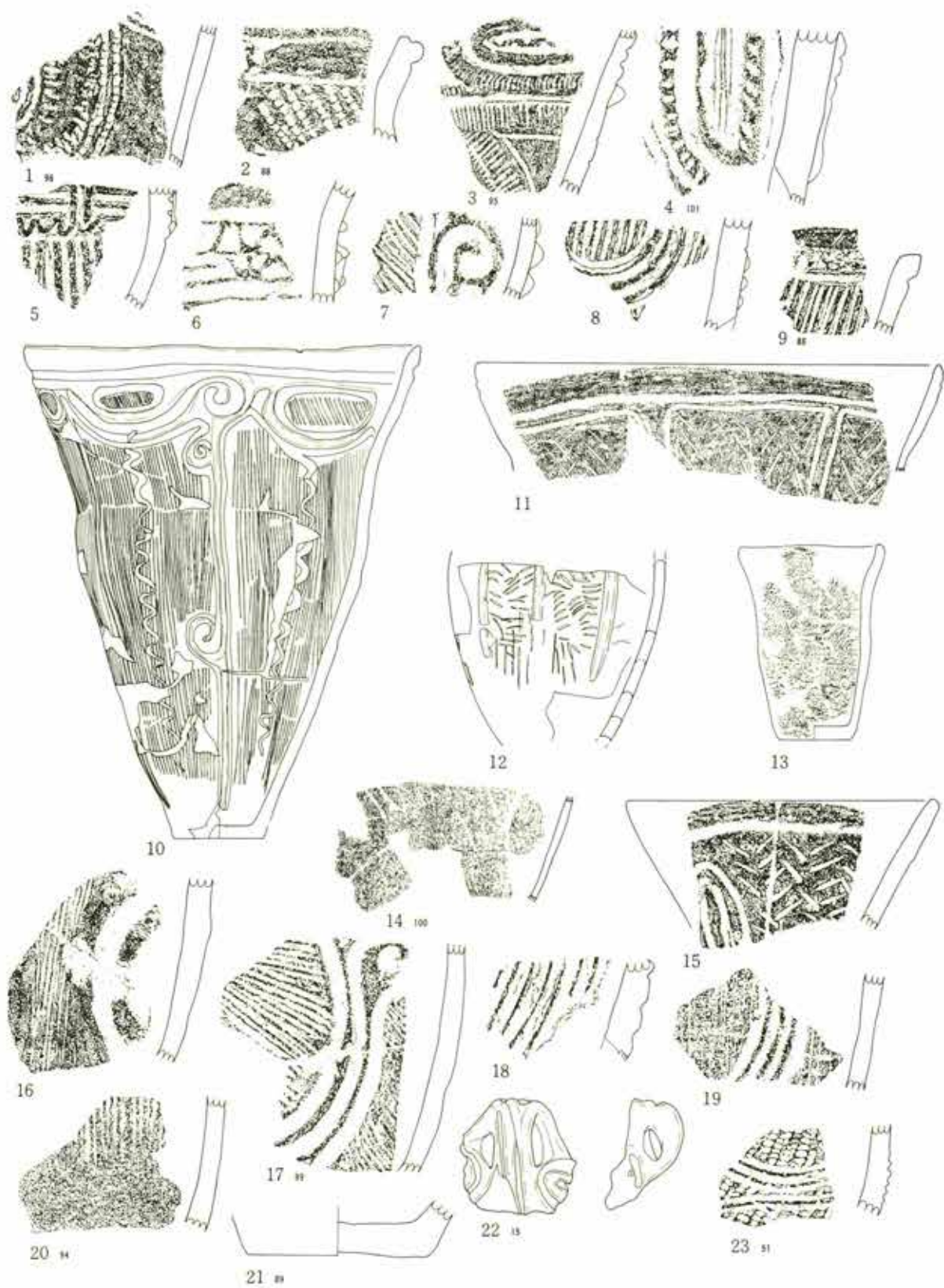

第138图 积迦堂S-III区 SB-40 出土土器
(10. 11. 12. 13. 14. 1 ; 6)



第139图 积逊堂S-III区 SB-41出土土器(1)

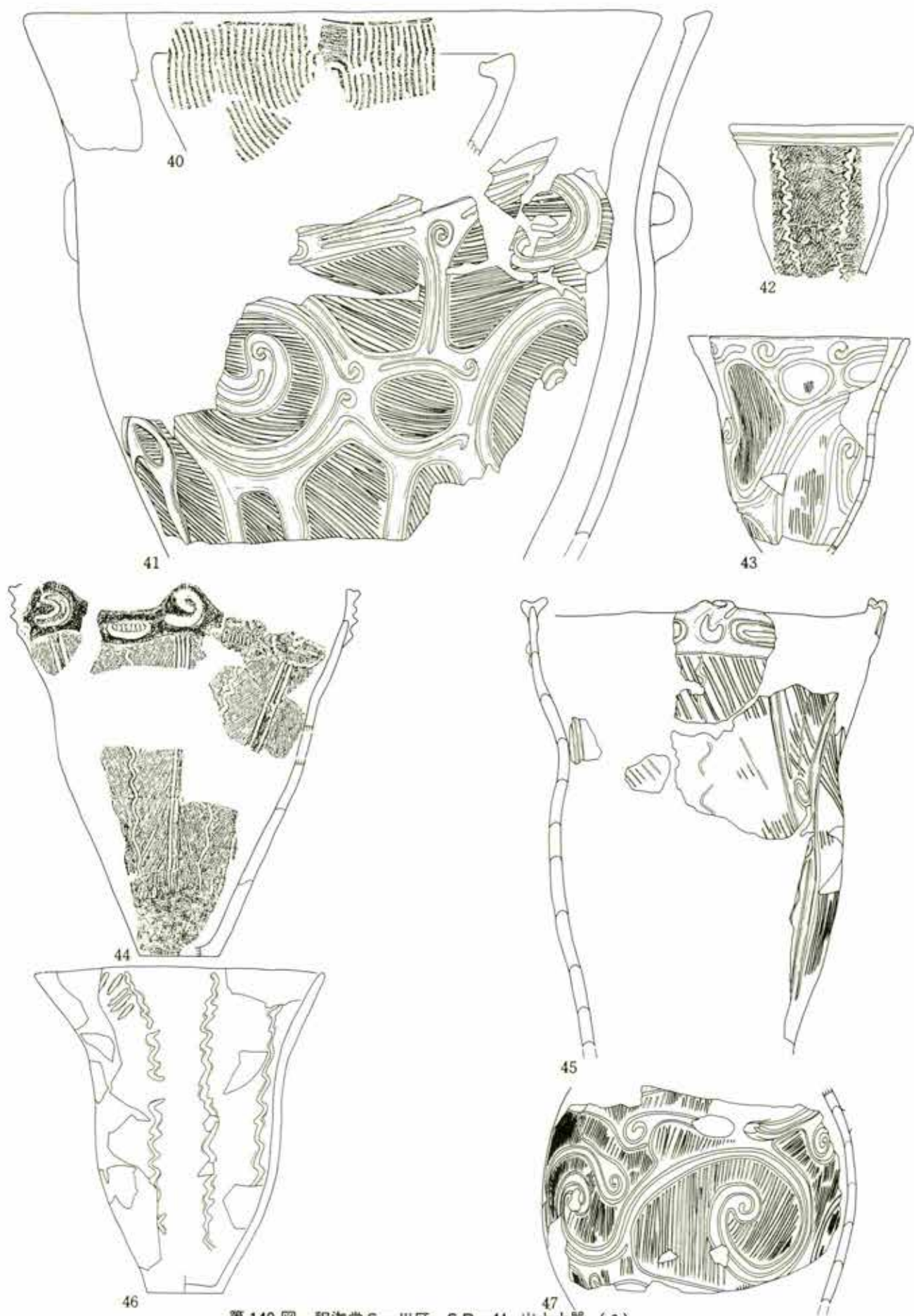

第 140 图 积逊堂 S-III 区 SB-41 出土土器 (2)

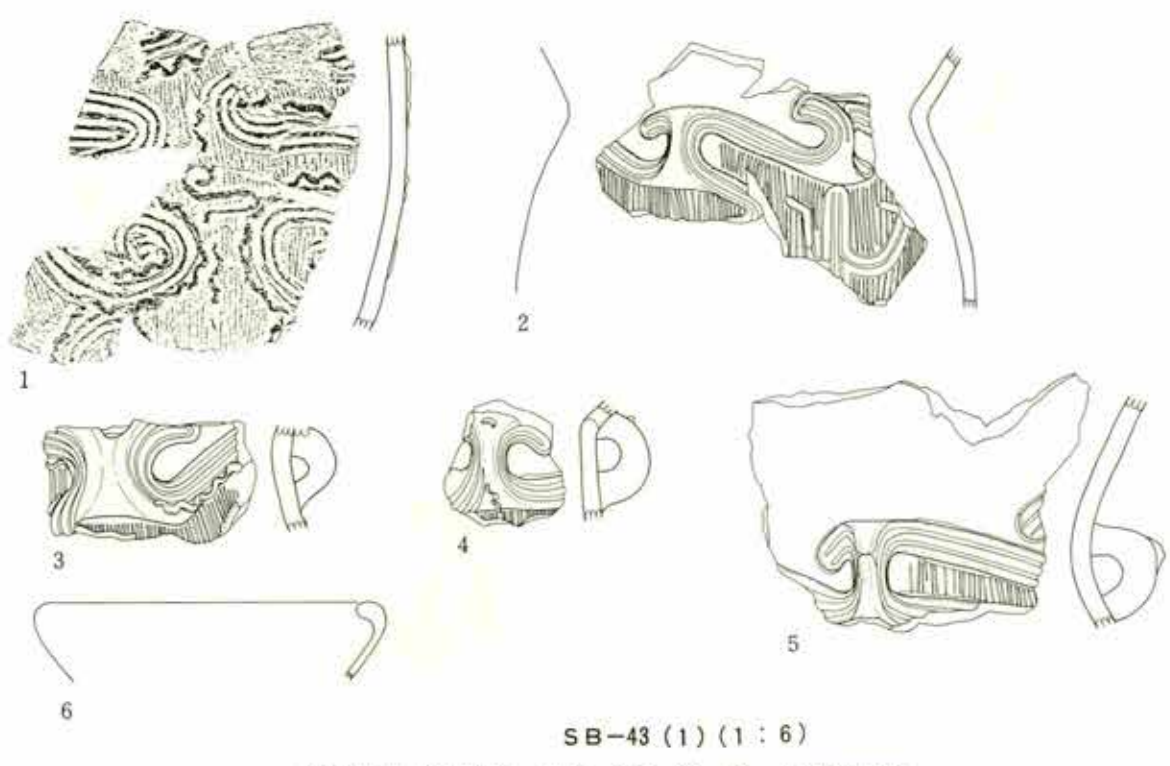
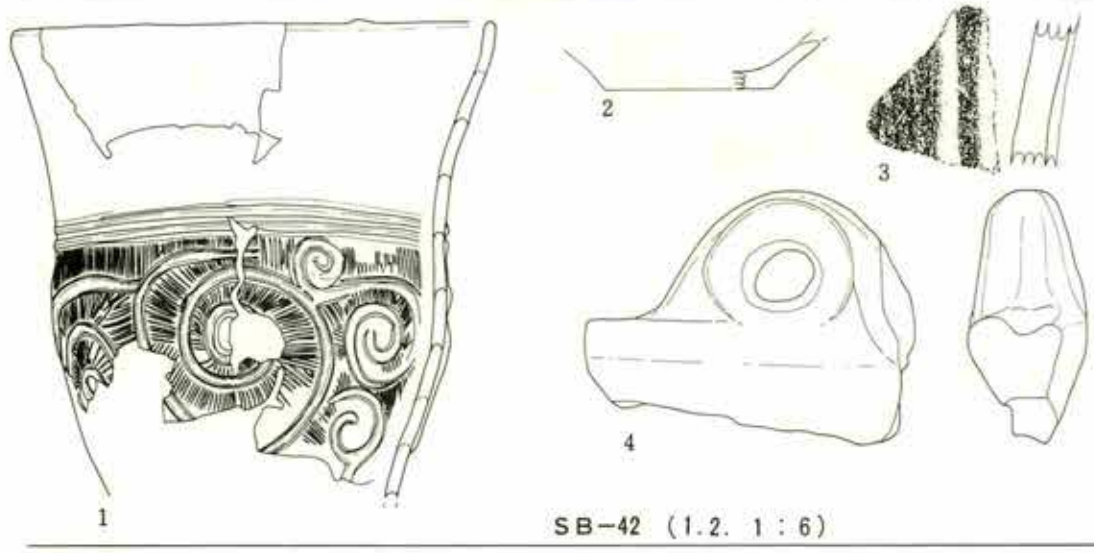
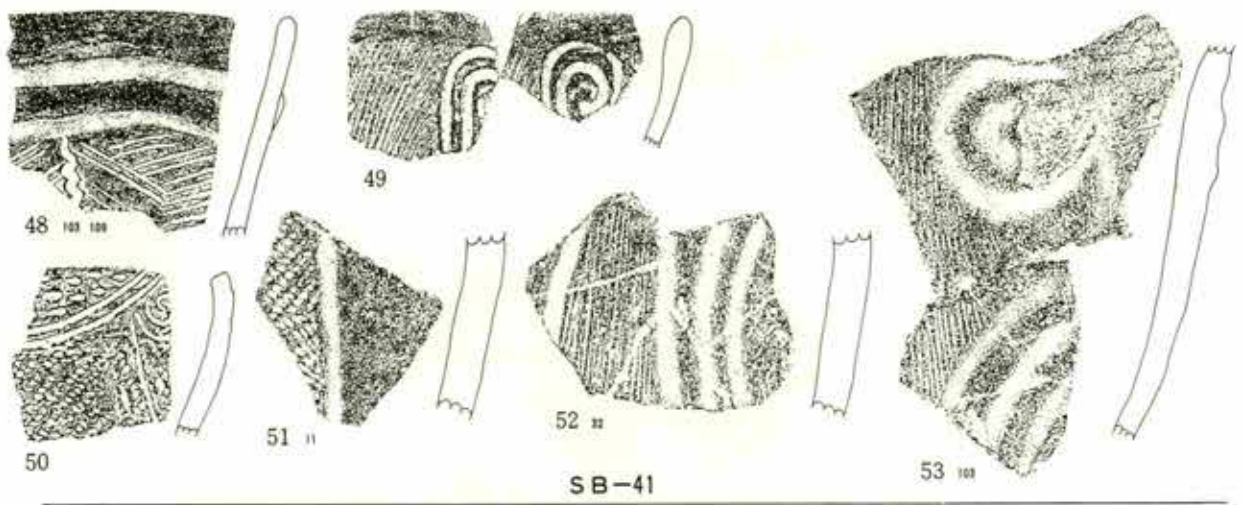

第141图 积迦堂S-III区 SB-41-42-43 出土土器

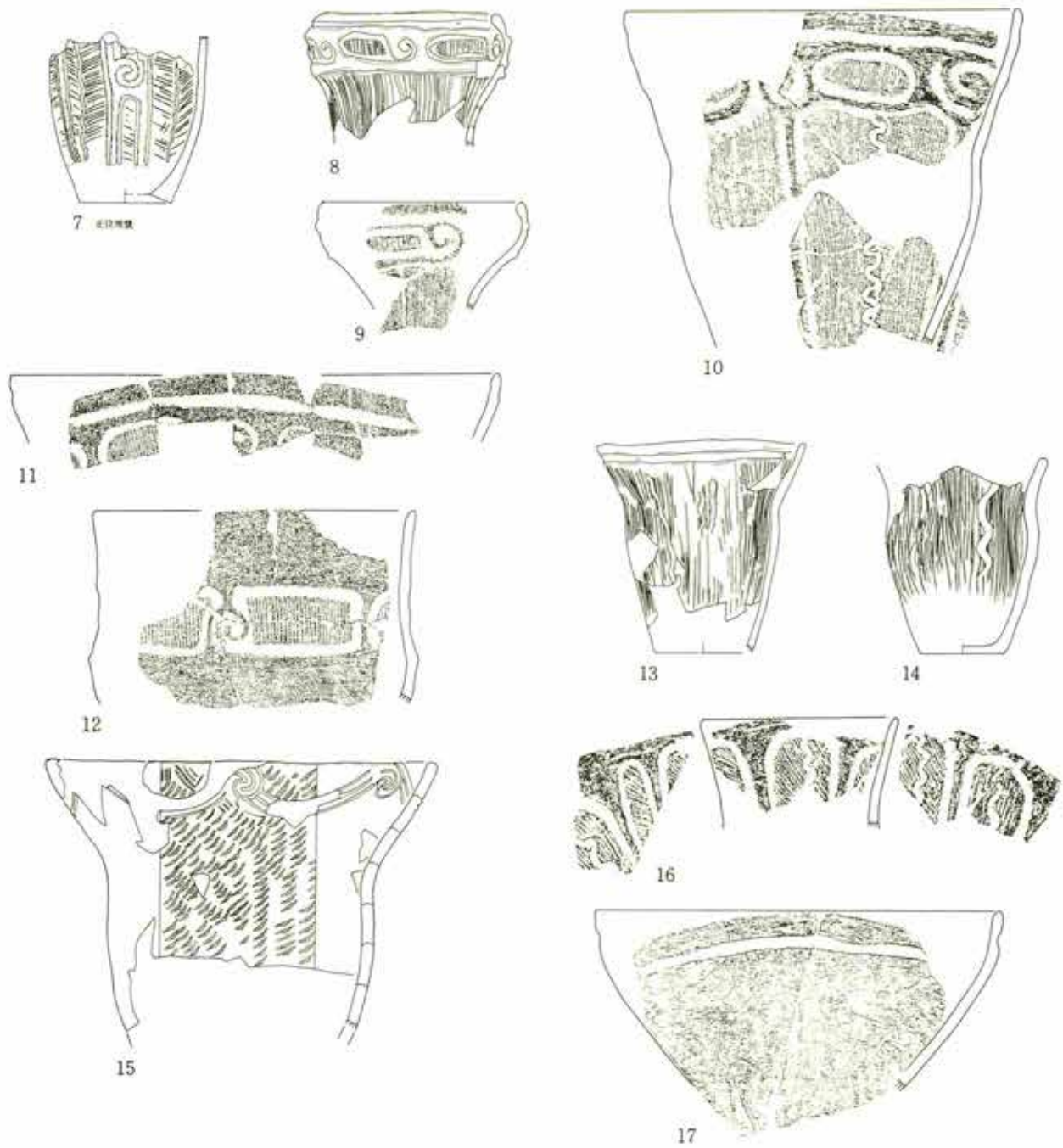

第 142 图 积逊堂 S-III 区 SB-43 出土土器 (2)



第 143 图 积逊堂 S-III 区 SB-43 出土土器 (3)

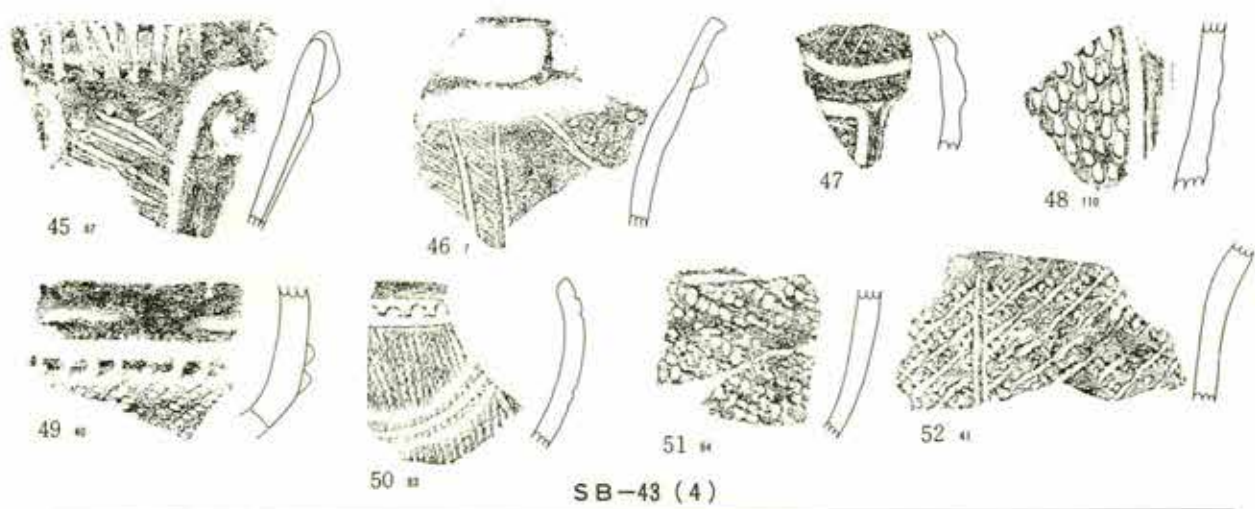

SB-43 (4)

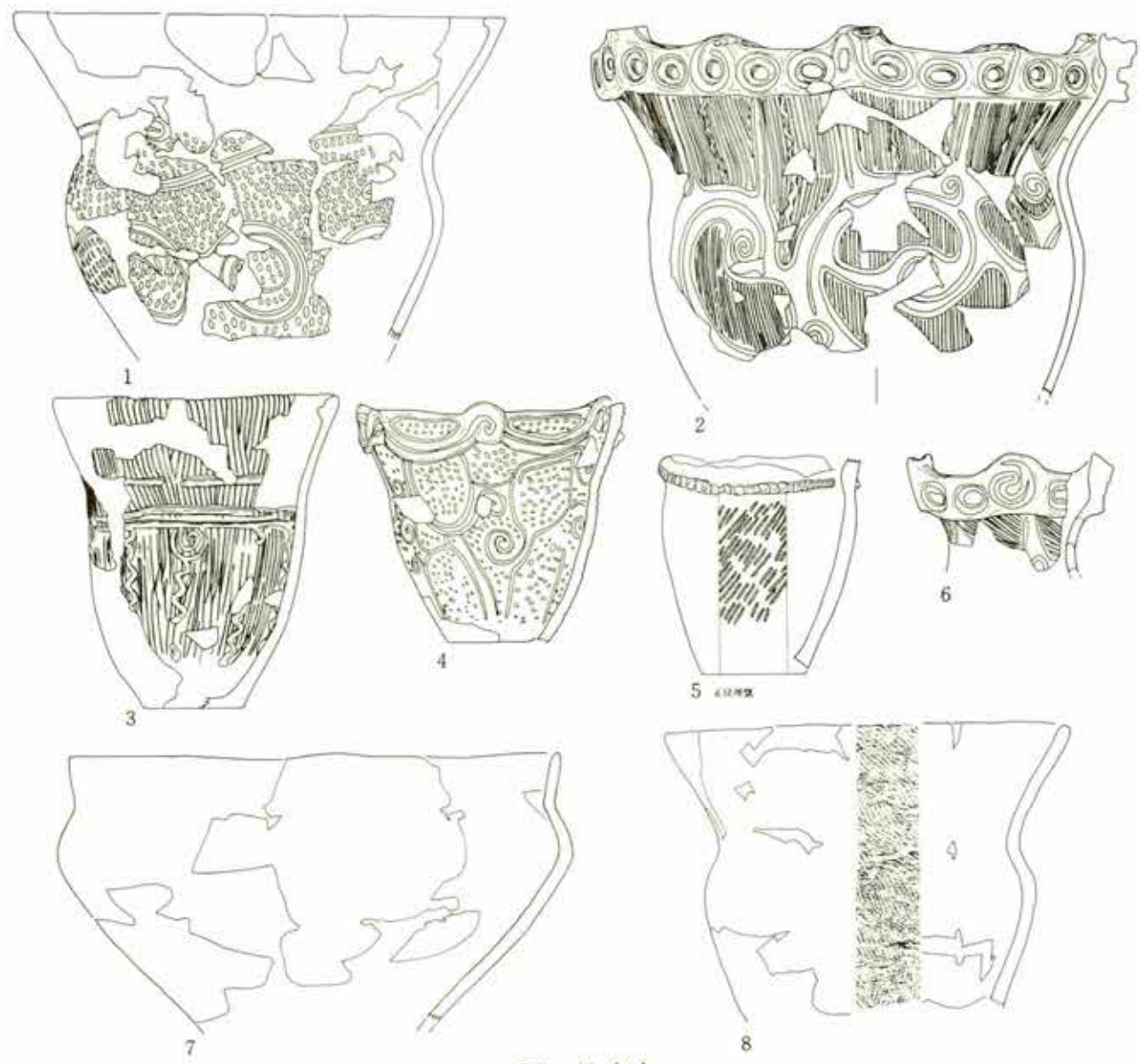

SB-44 (1)

第 144 图 积逊堂 S-III 区 SB-43-44 出土土器

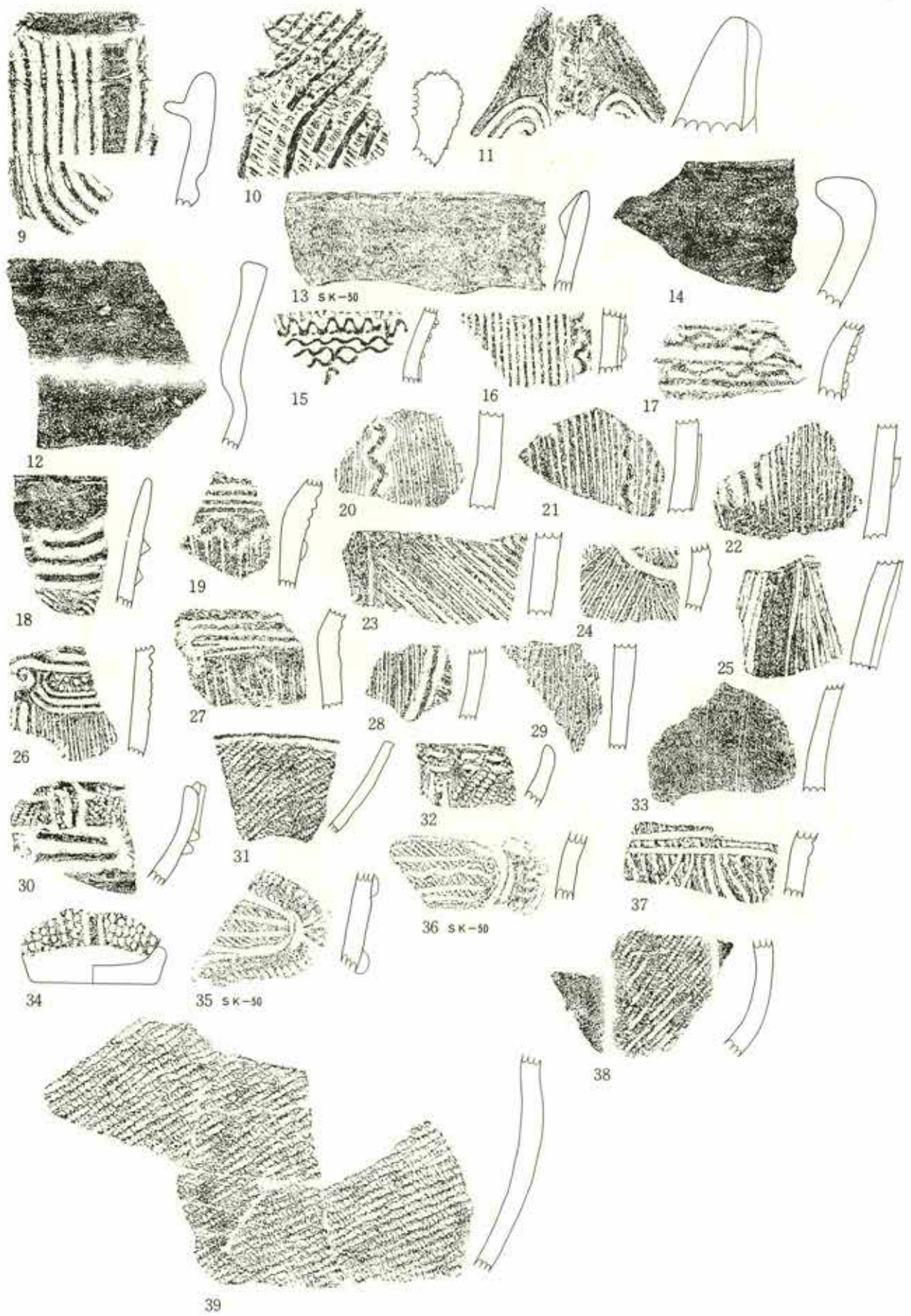

第 145 图 积迦堂 S-III 区 SB-44 出土土器 (2)

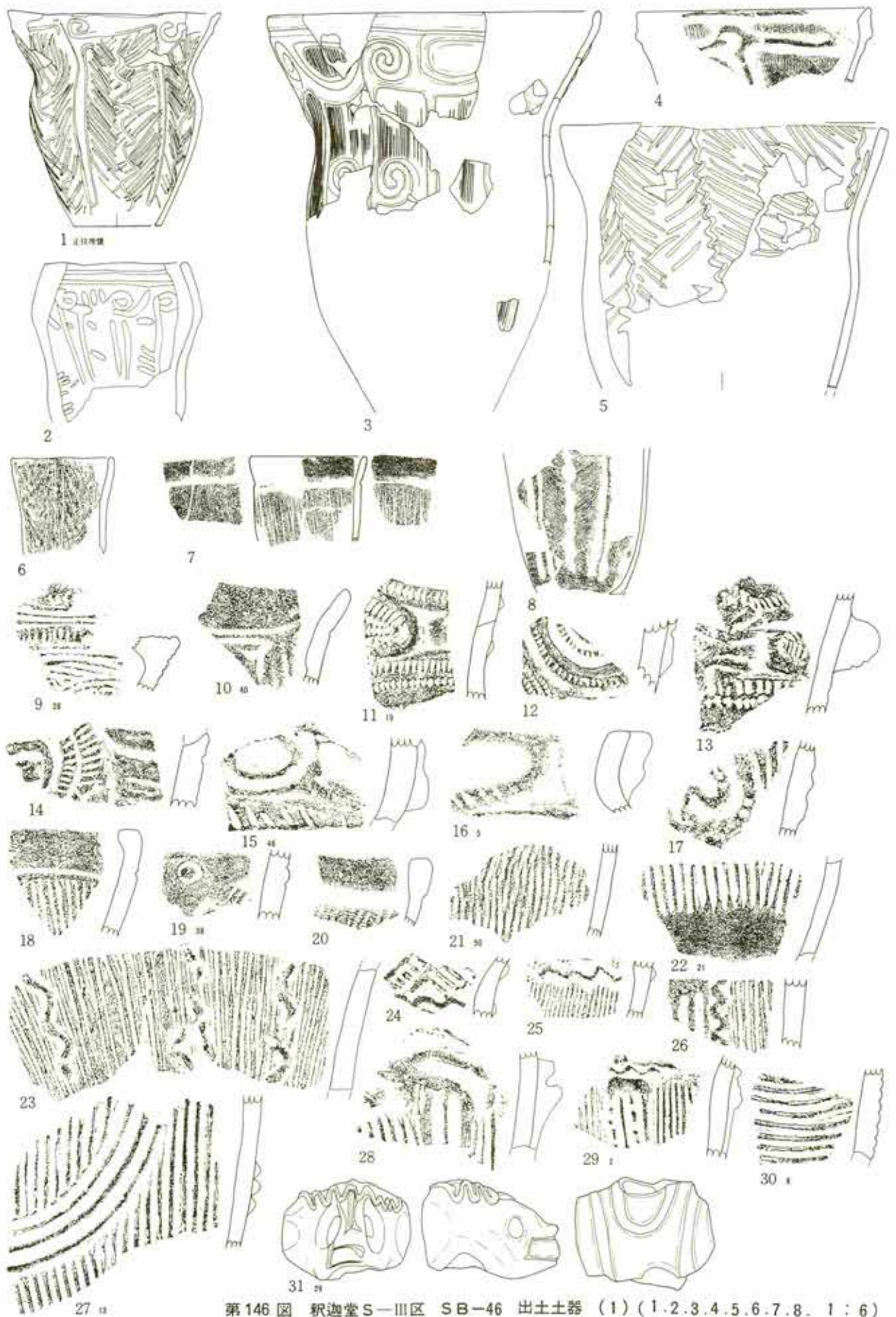

第146图 积迦堂S-III区 SB-46 出土土器 (1) (1.2.3.4.5.6.7.8. 1:6)

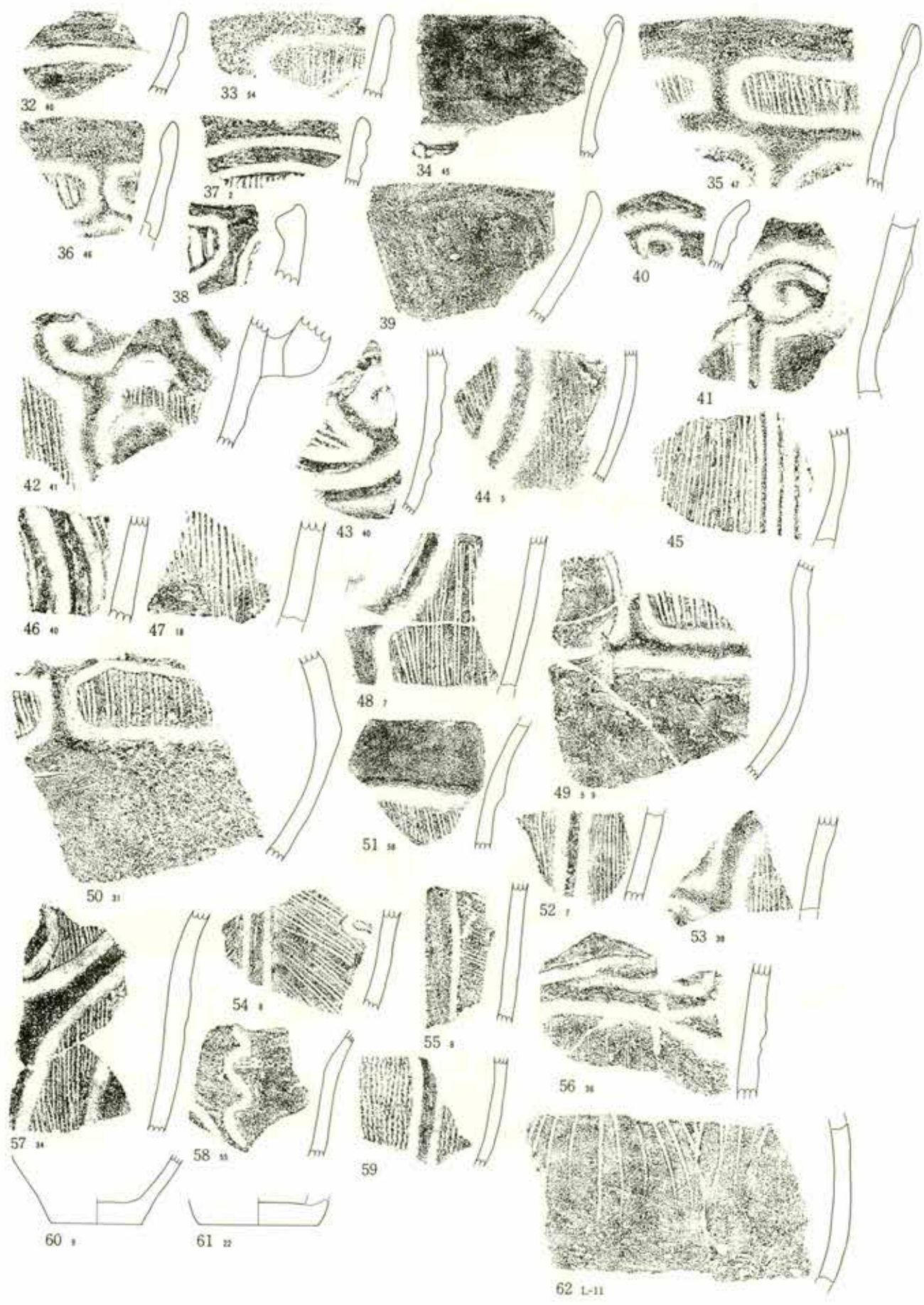

第147图 积迦堂S-III区 SB-46 出土土器(2)

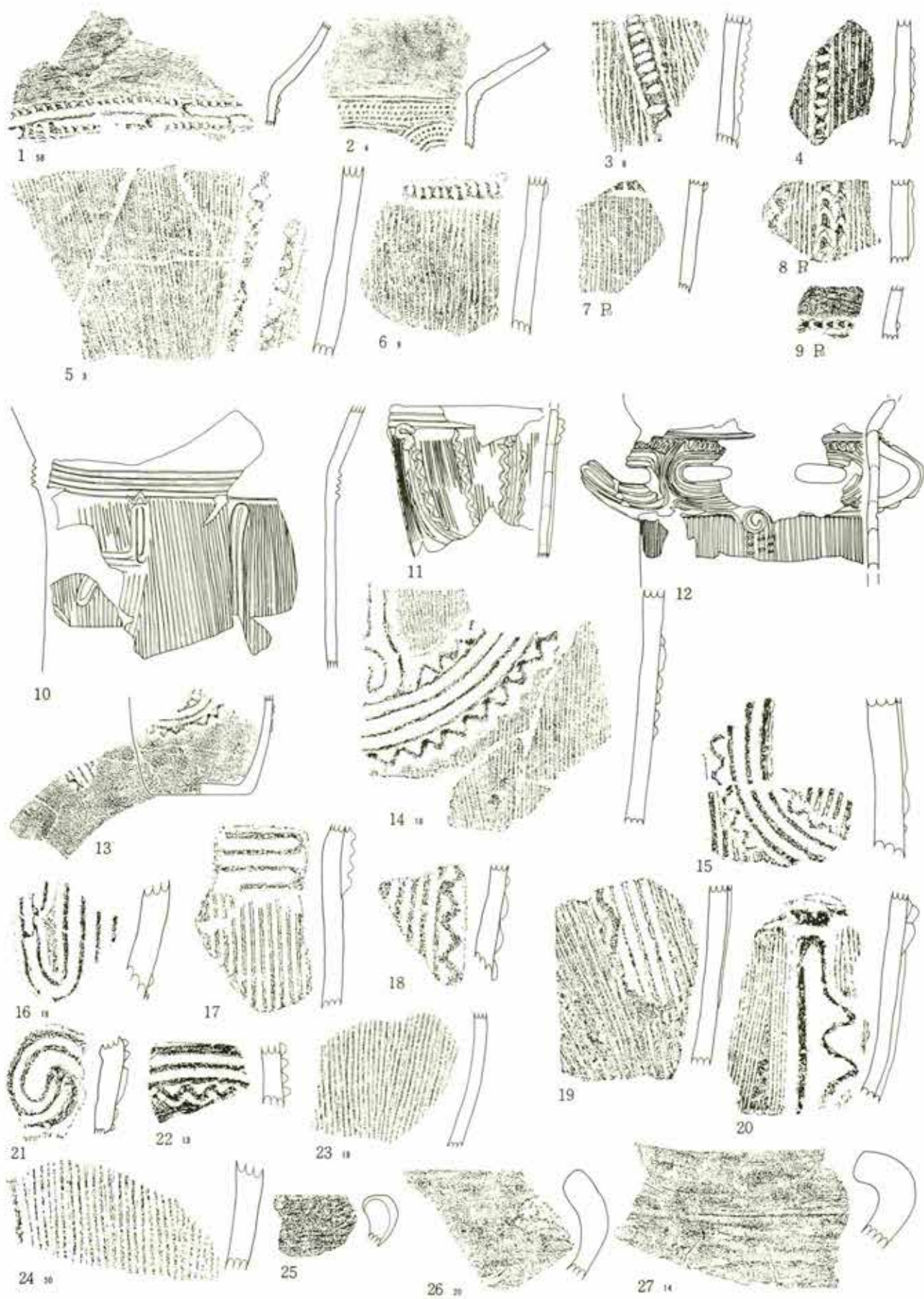

第148图 积迦堂S-III区 SB-49-50-51-56-58 出土土器(1)
 (1.2.10.11.12.13. 1:6)

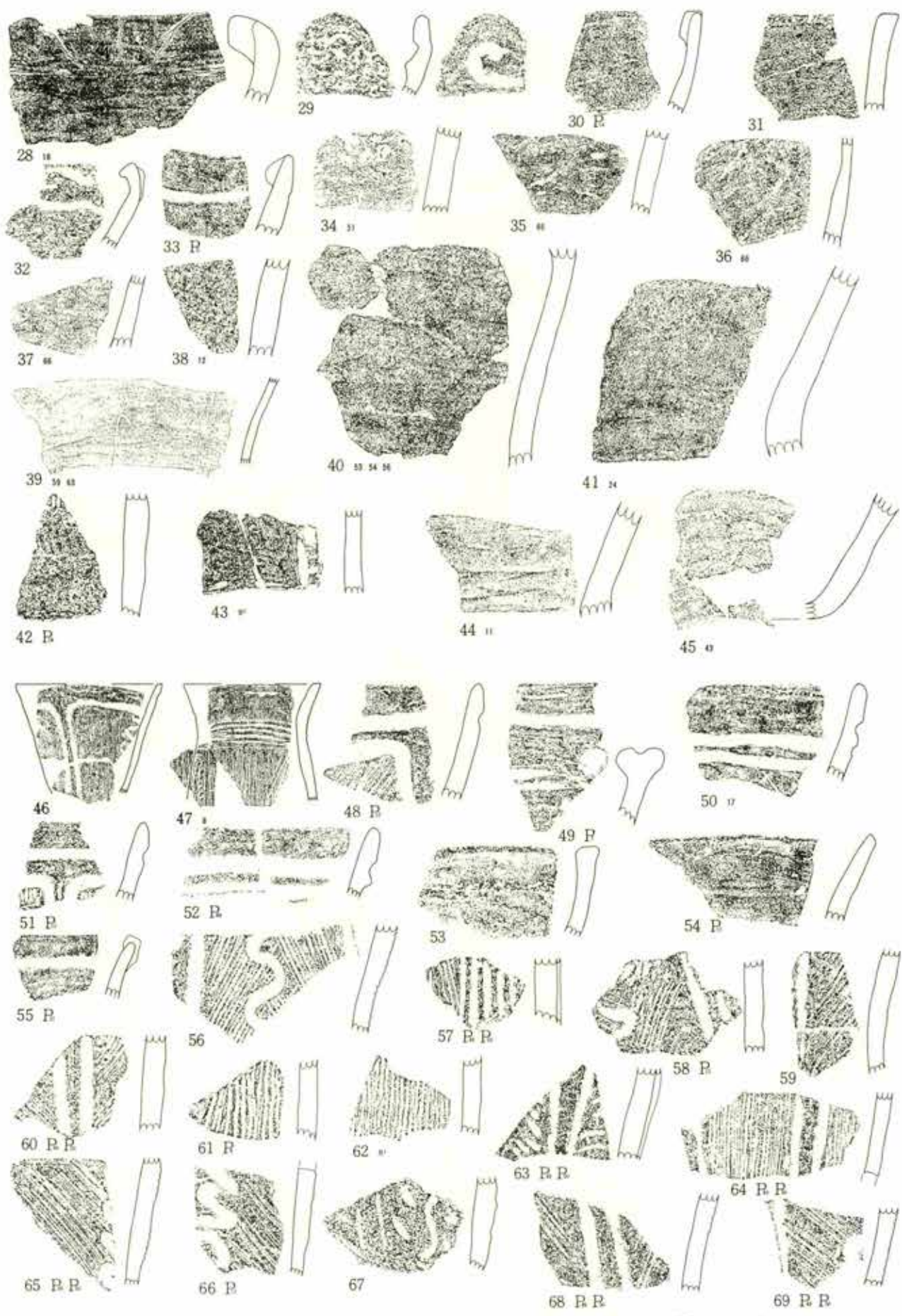

第 149 图 积迦堂 S-III 区 SB-49-50-51-56-58 出土土器 (2) (46.47. 1:6)

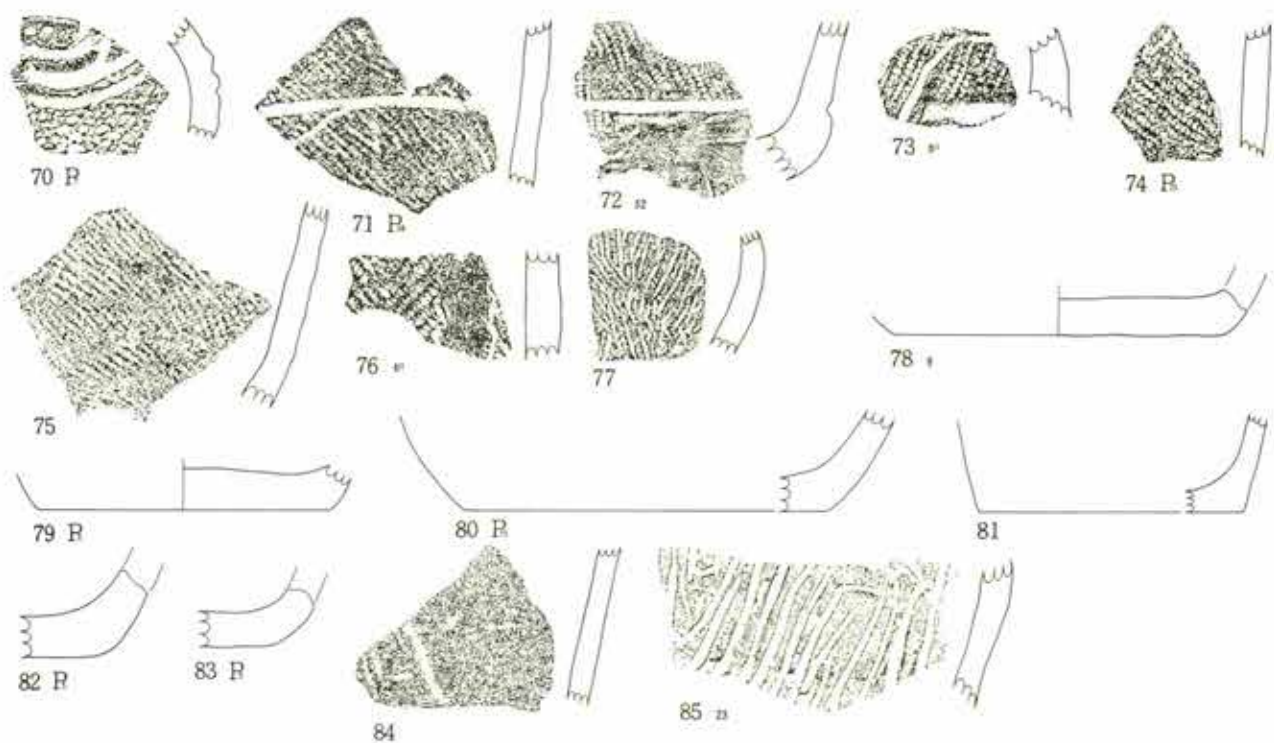

SB-49-50-51-56-58 (3)

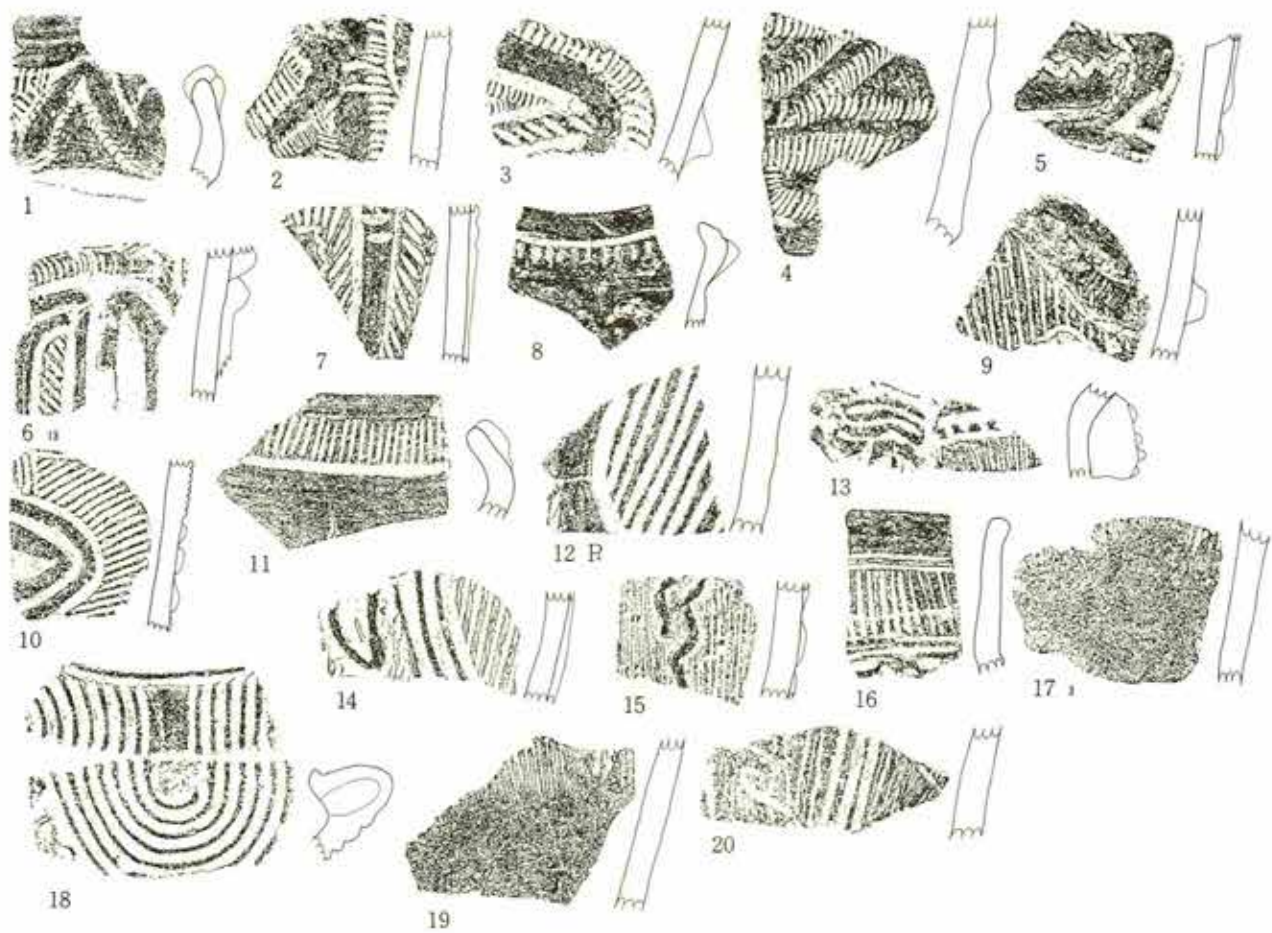

SB-55 (1)

第150图 积迦堂S-III区 SB-49-50-51-56-58-55 出土土器

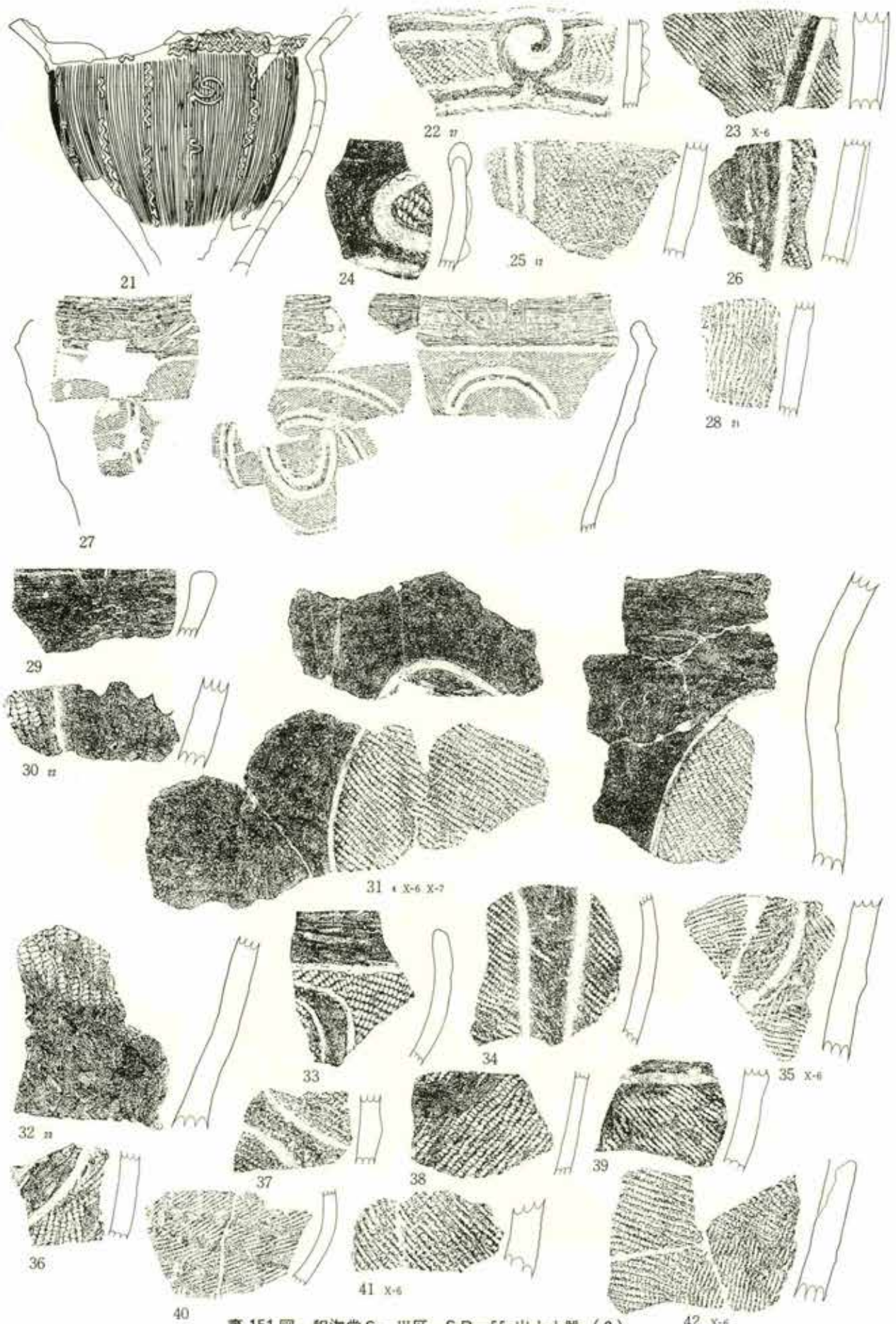

第151图 积迦堂S-III区 SB-55 出土土器 (2) 40 42 x-6

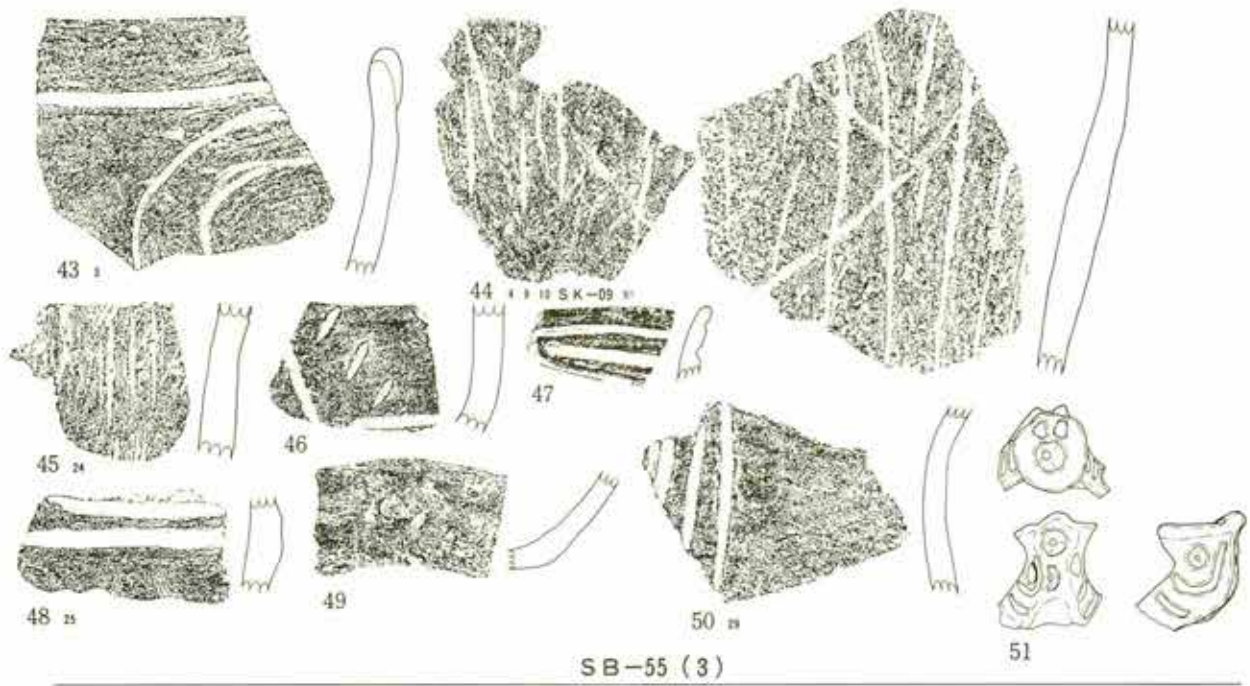

第152图 积逊堂S-III区 SB-55-57 出土土器

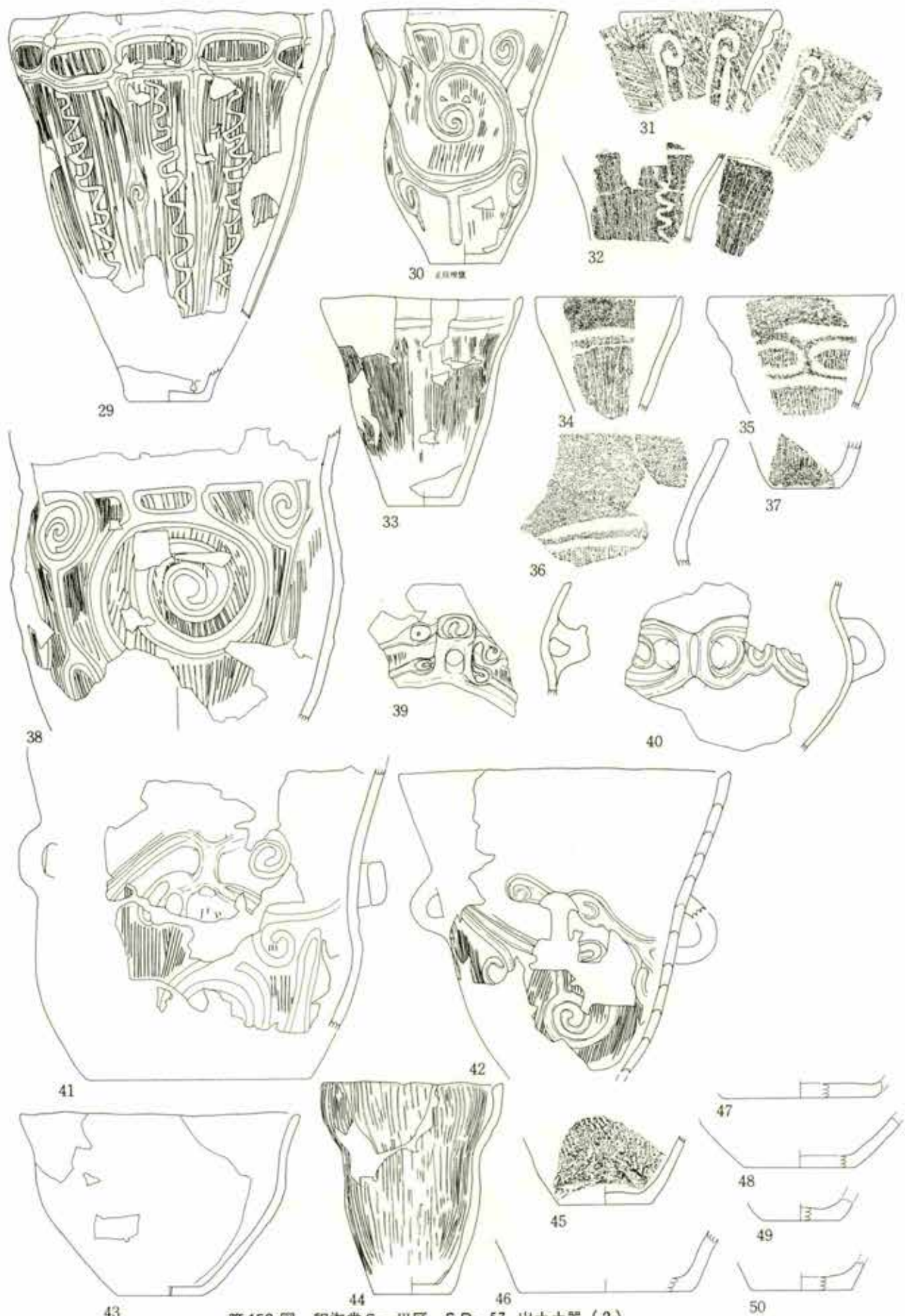

第153图 积逊堂S-III区 SB-57 出土土器(2)



第154图 积迦堂S-III区 SB-57 出土土器(3)

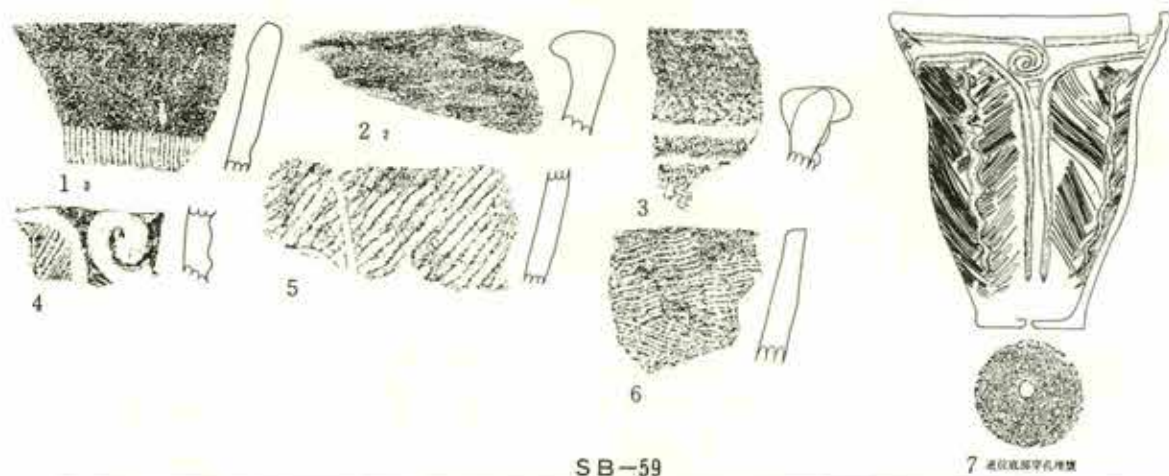

SB-59

7 底面穿孔陶片

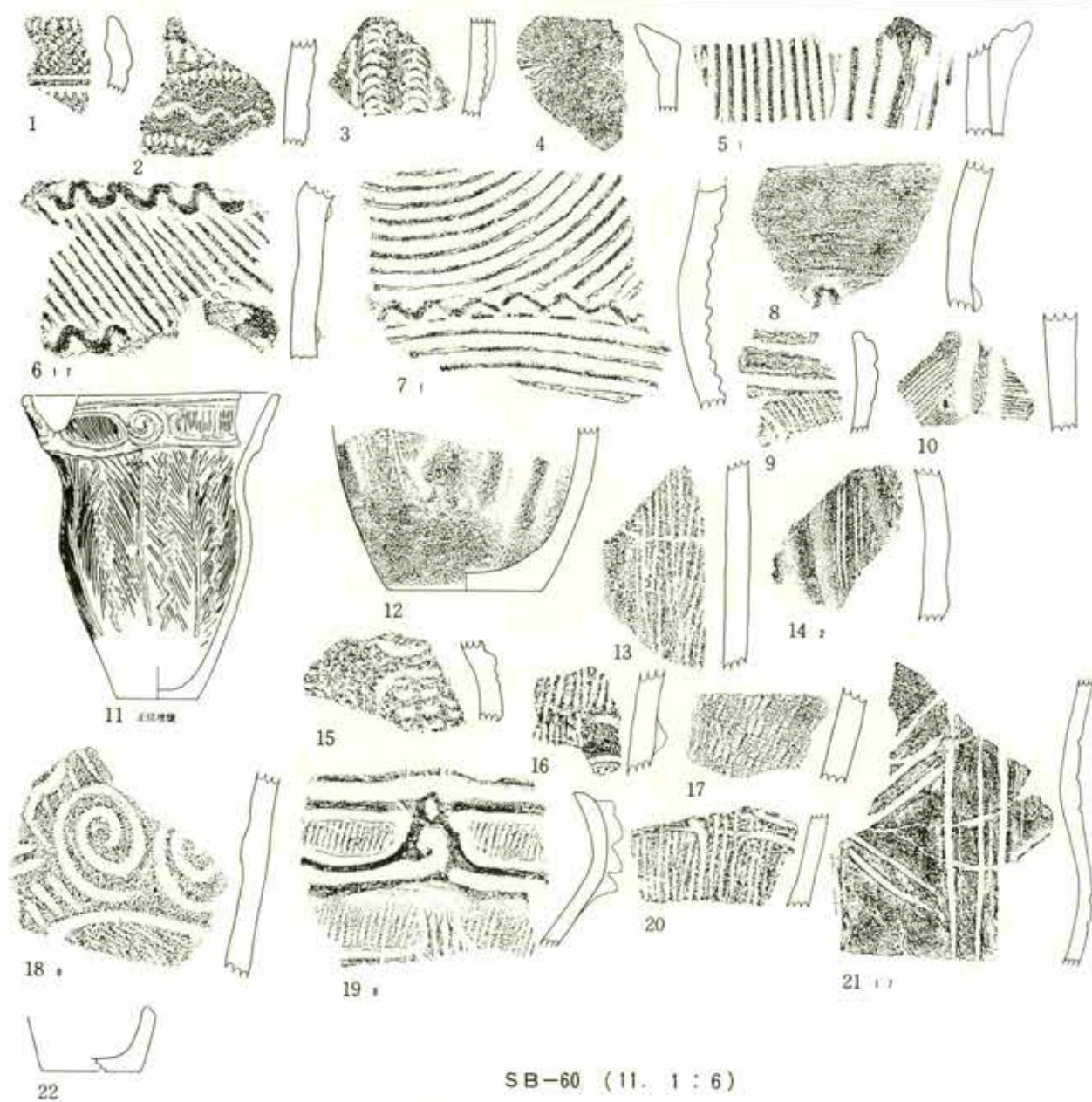

SB-60 (11. 1 : 6)

第155图 积迦堂S-III区 SB-59-60 出土土器



SB-76

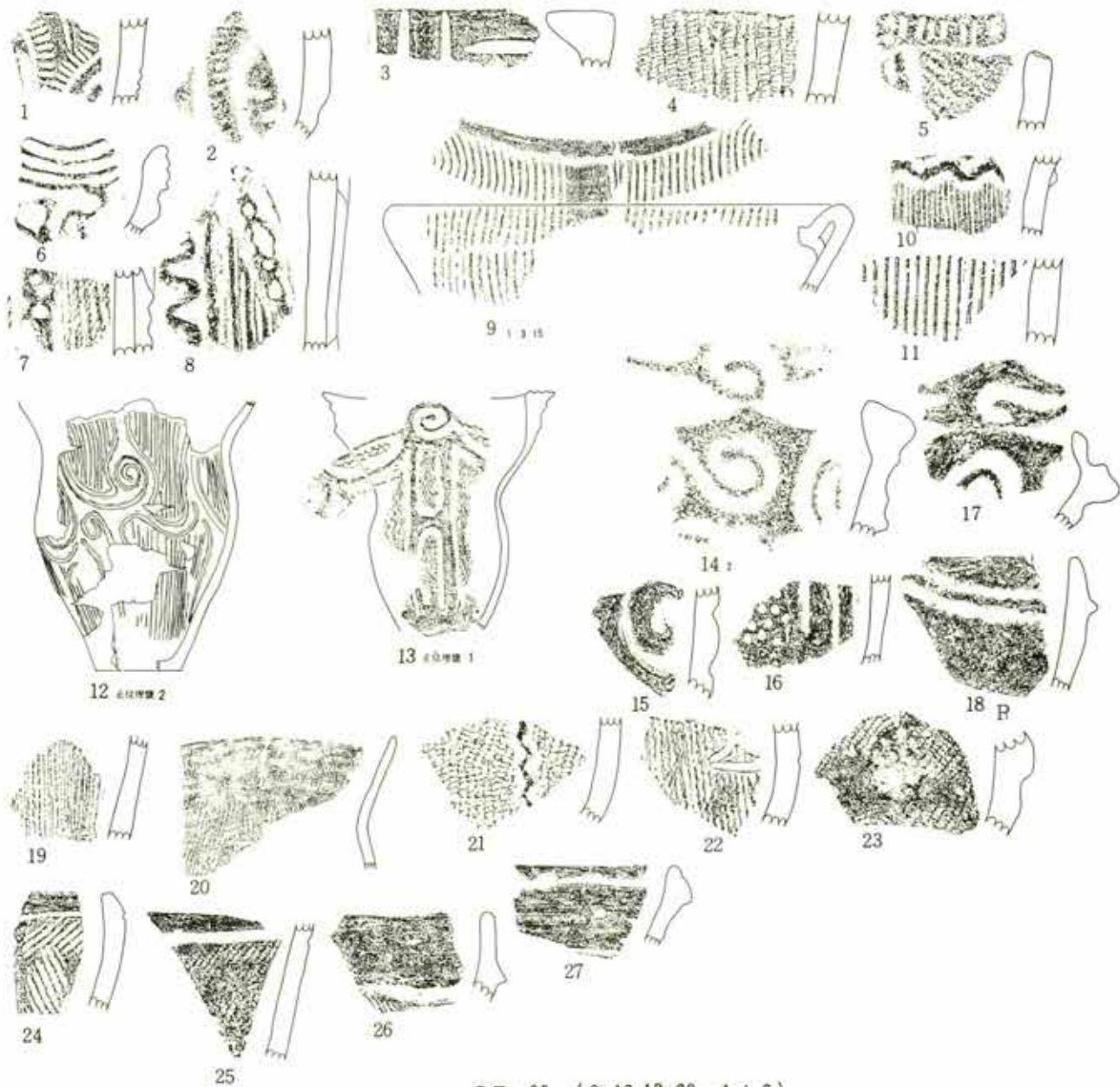

SB-80 (9.12.13.20. 1 : 6)



SB-85 (1)

第 156 图 积迦堂 S-III 区 SB-76 -80 -85 出土土器

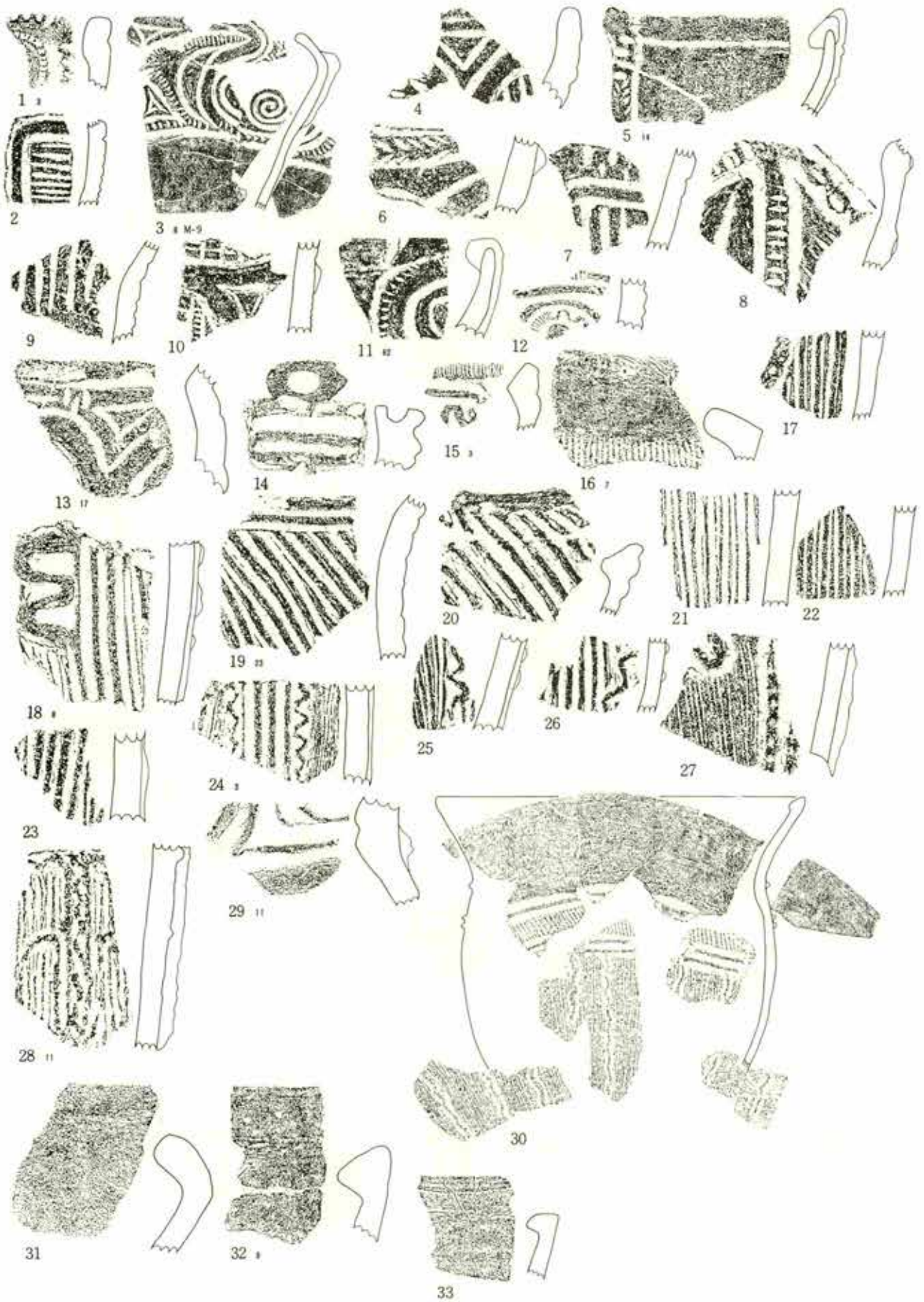

第157图 积迦堂S-III区 SB-62 出土土器(1) (3.30. 1:6)

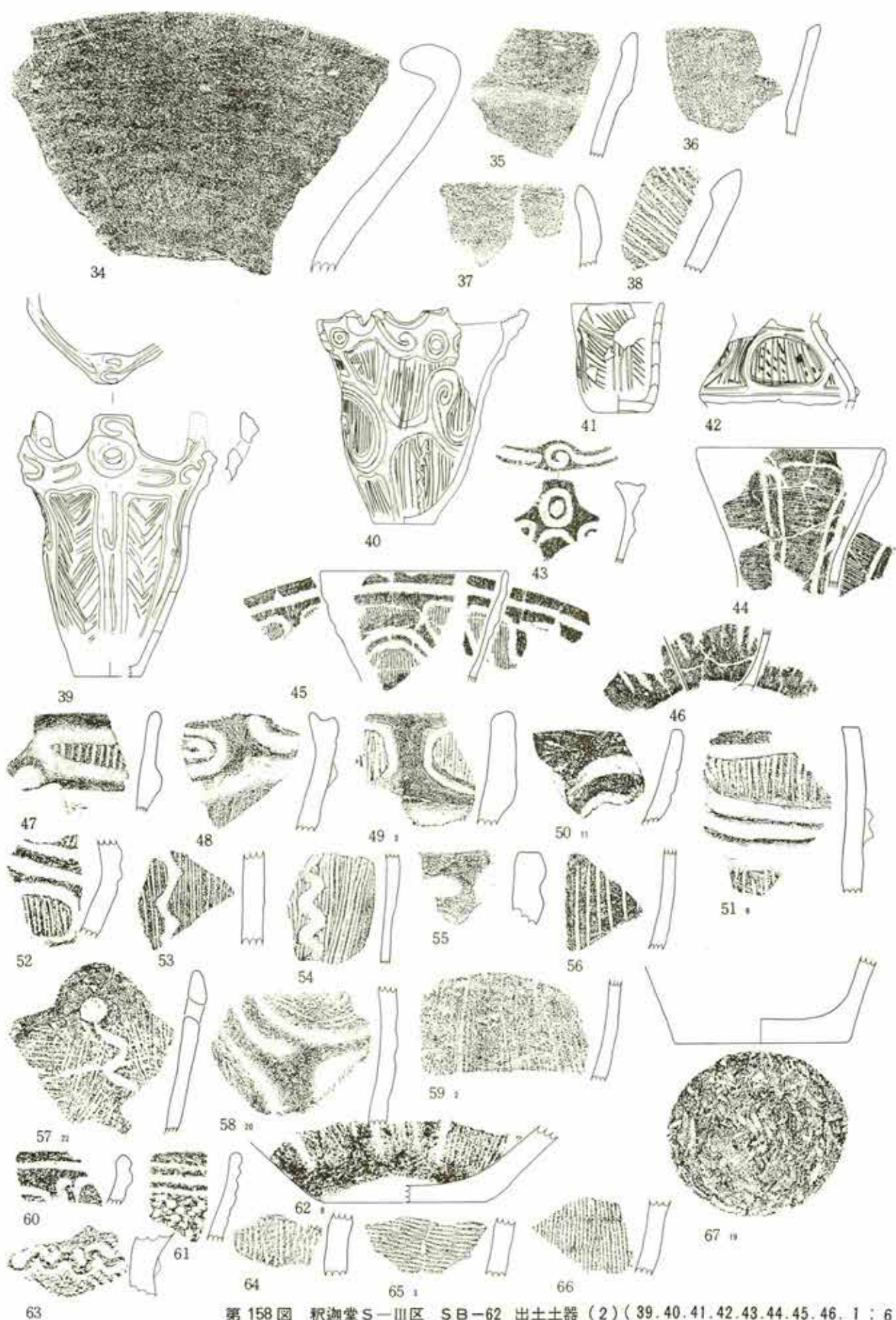

第 158 图 积迦堂 S-III 区 SB-62 出土土器 (2) (39.40.41.42.43.44.45.46. 1 : 6)



SB-63

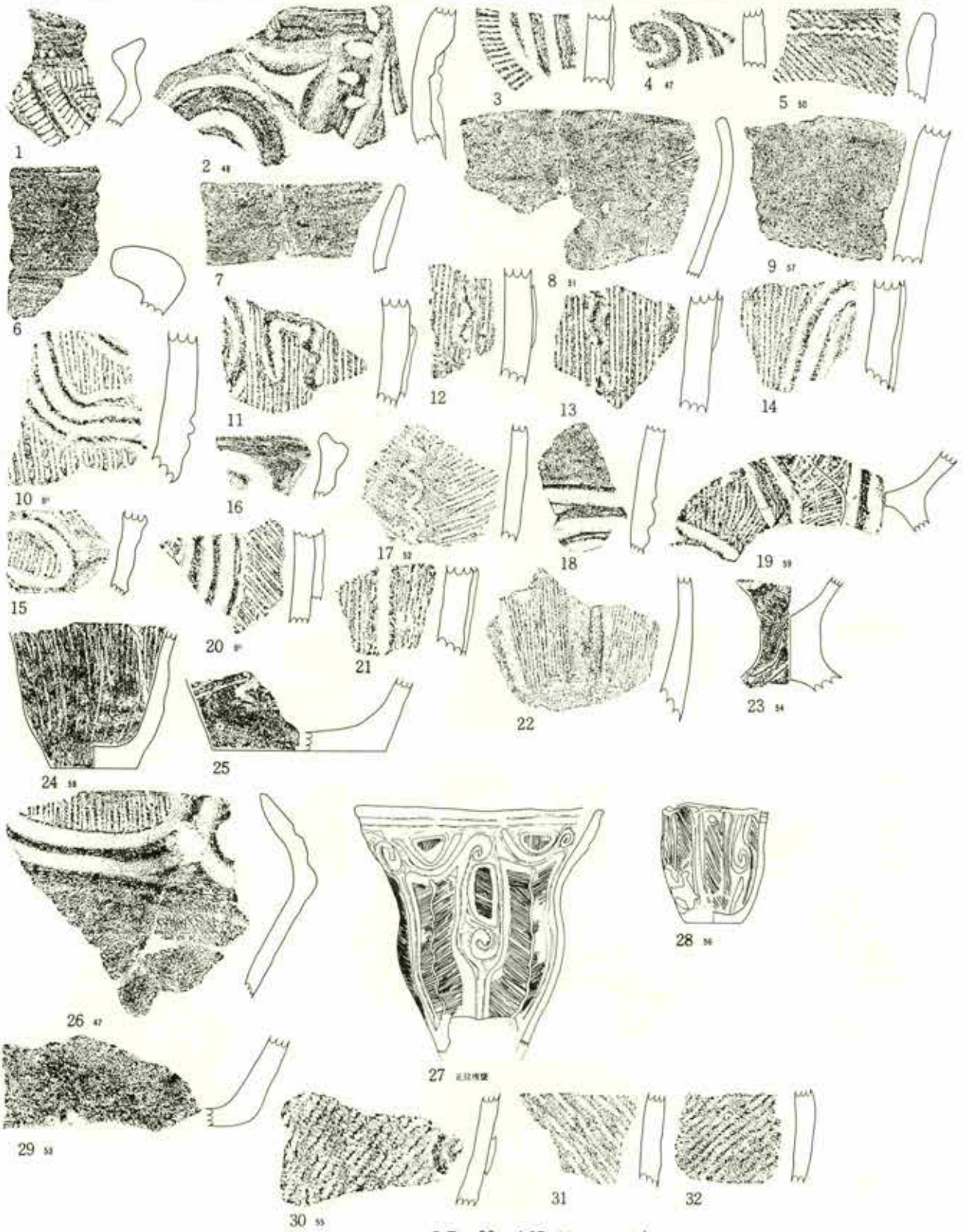

SB-66 (27.28. 1:6)

第159图 积逊堂S-III区 SB-63-66 出土土器

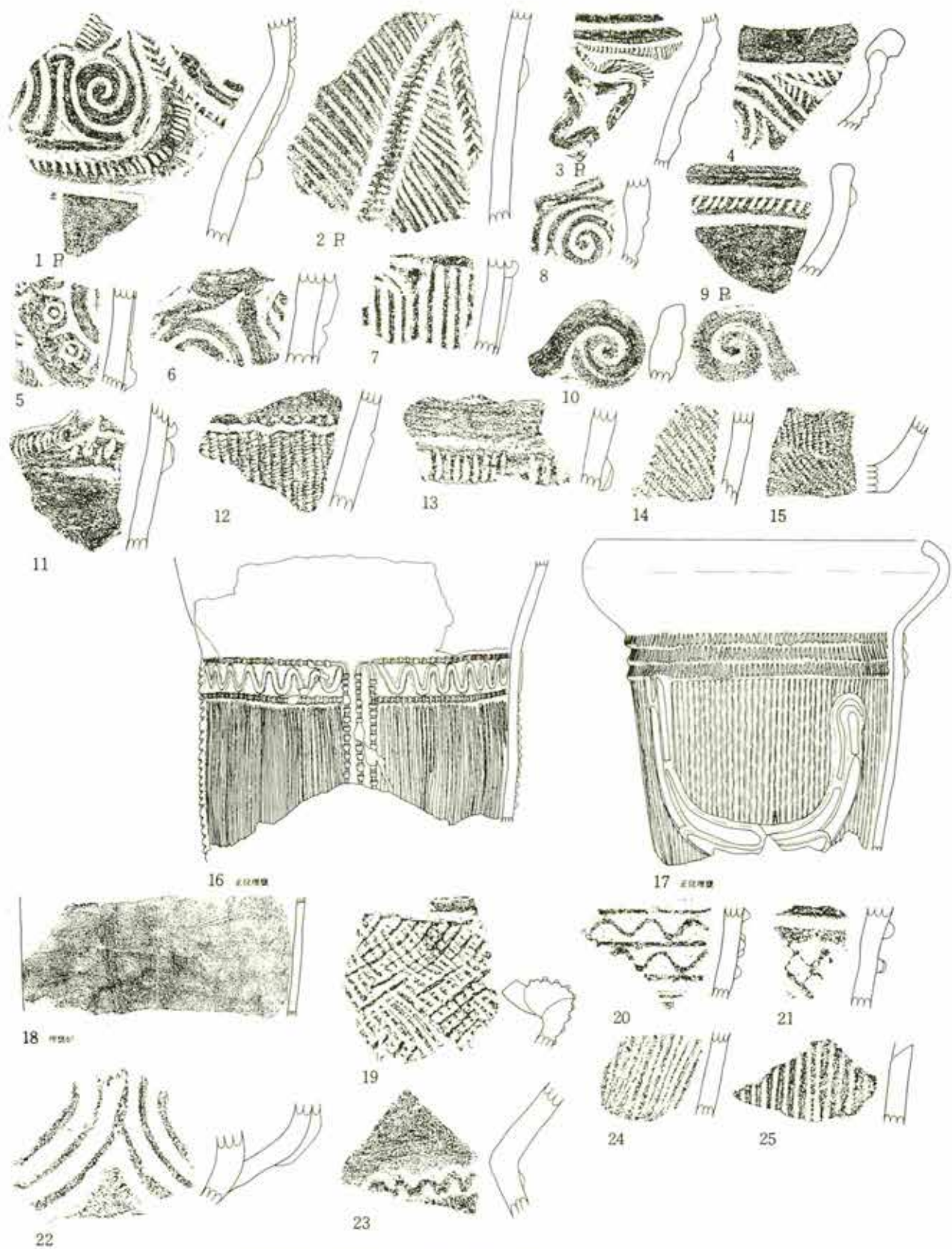

第 160 图 积逊堂 S-III 区 SB-69 出土土器

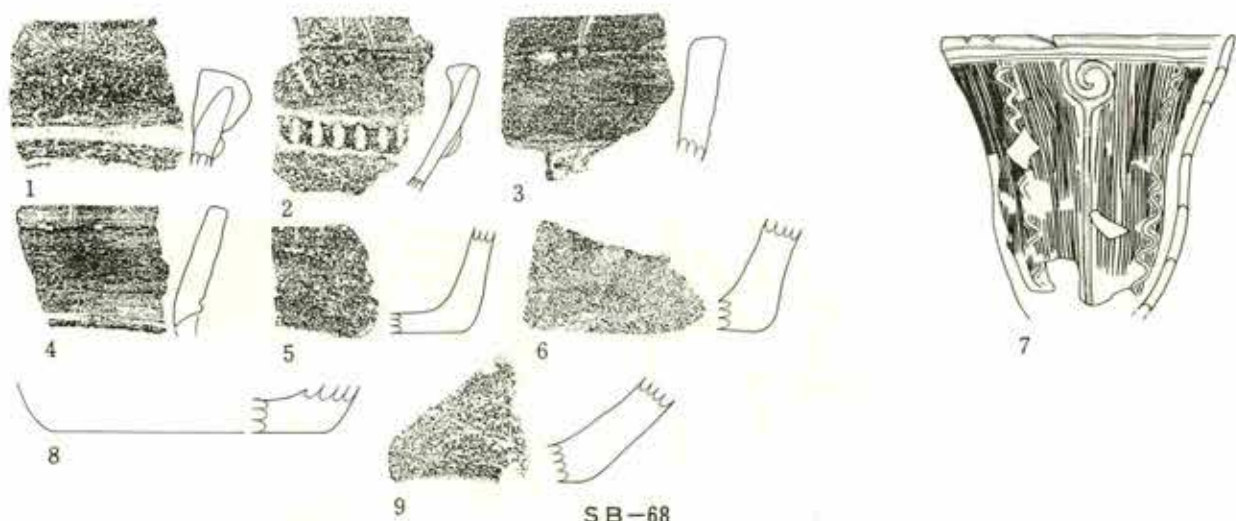

SB-68

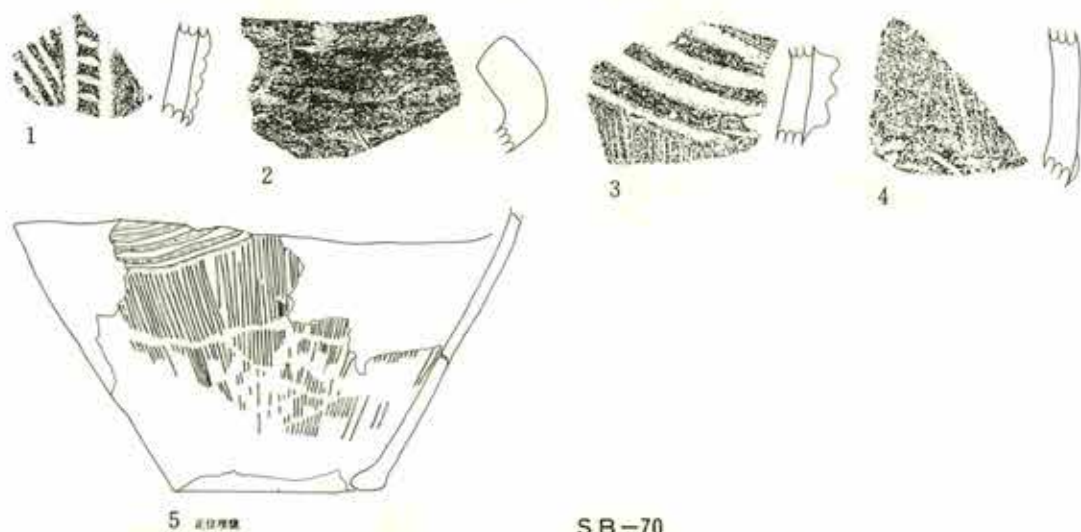

SB-70

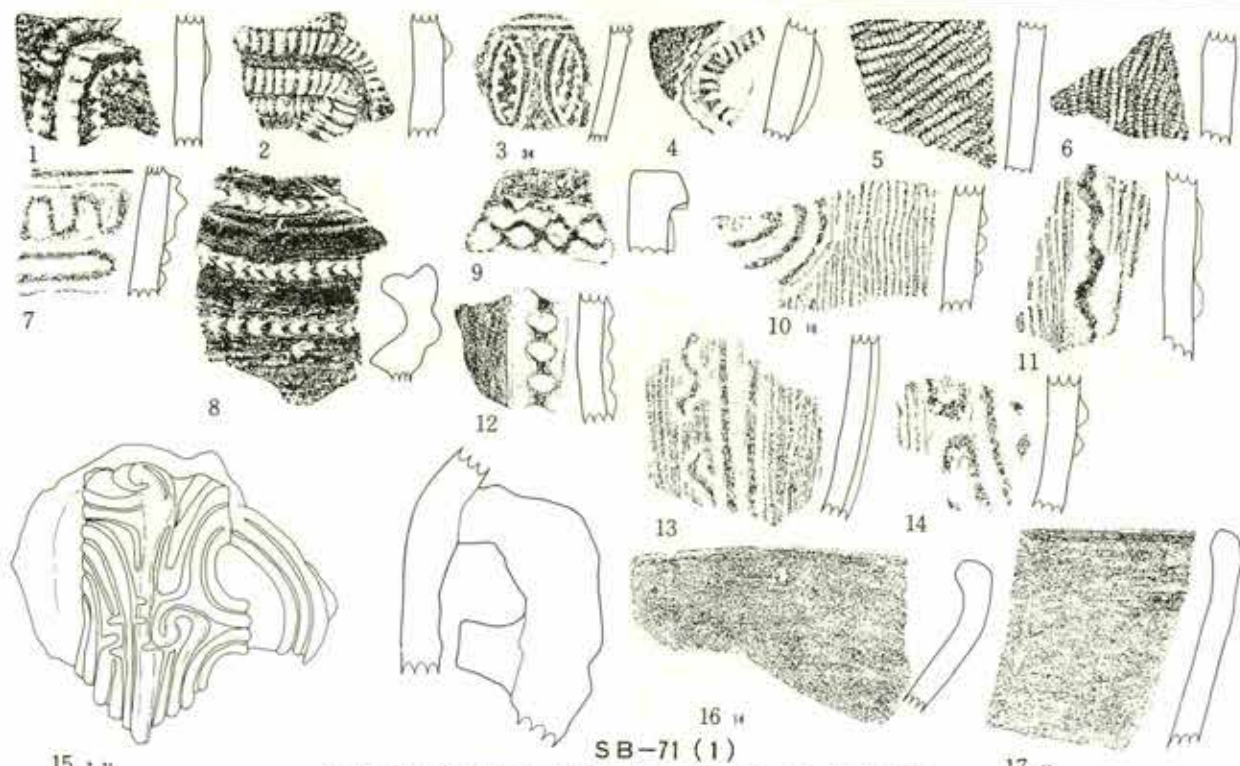

SB-71 (1)

15 11

第161图 积迦堂S-III区 SB-68-70-71 出土土器

17 20

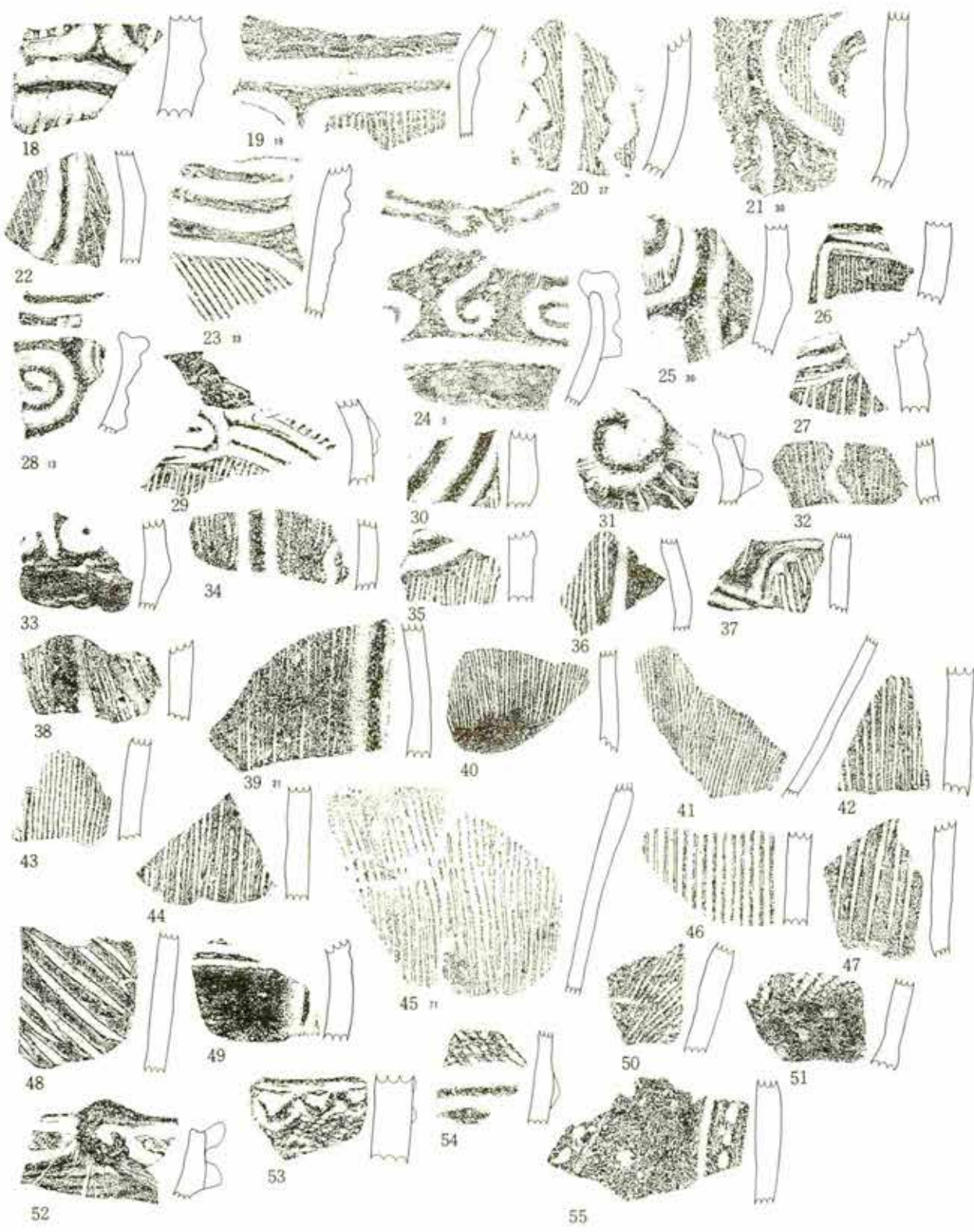

第 162 图 积逊堂 S-III 区 SB-71 出土土器 (2)

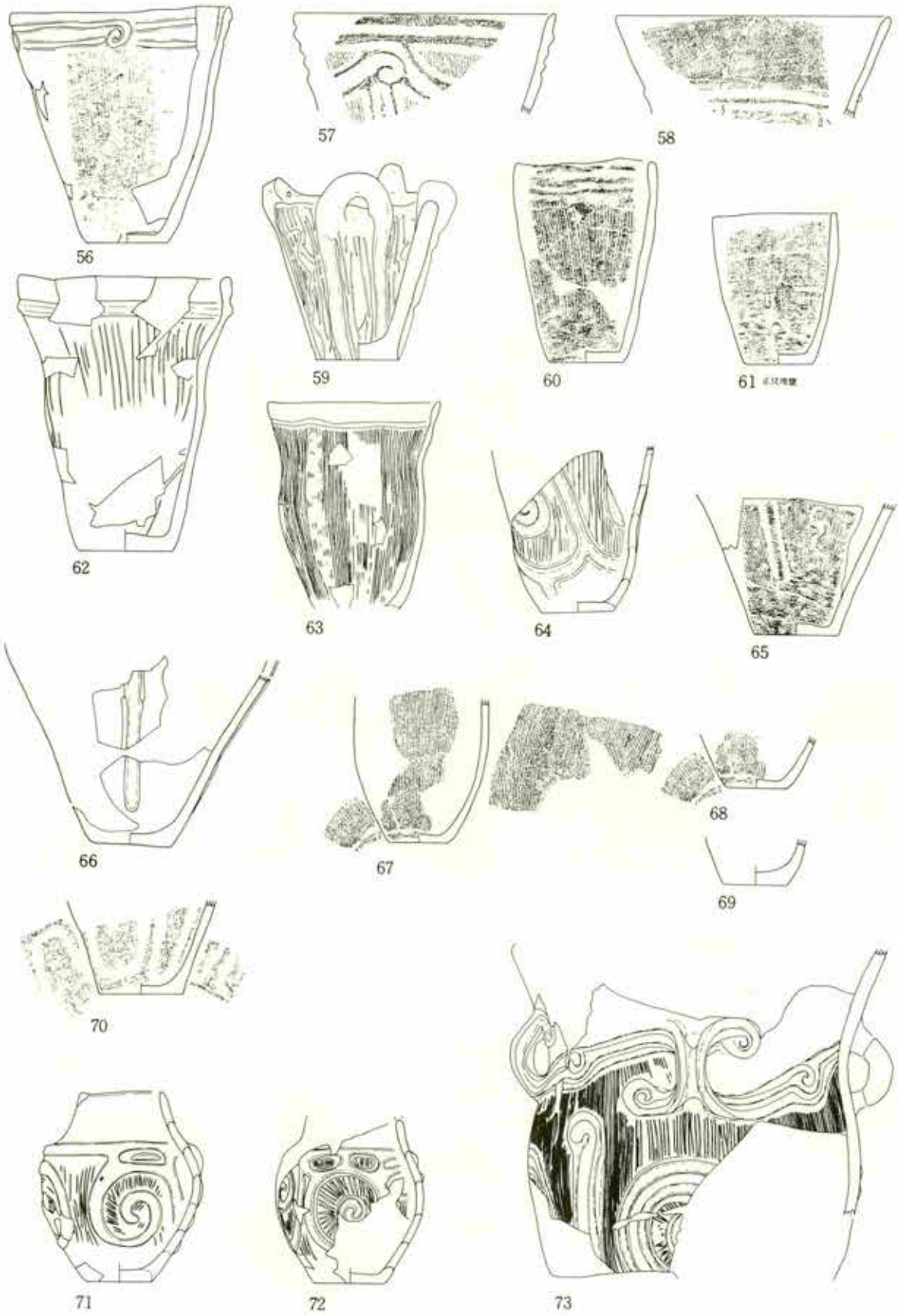

第163图 积迦堂S-III区 SB-71 出土土器(3)
(59. 1:3)

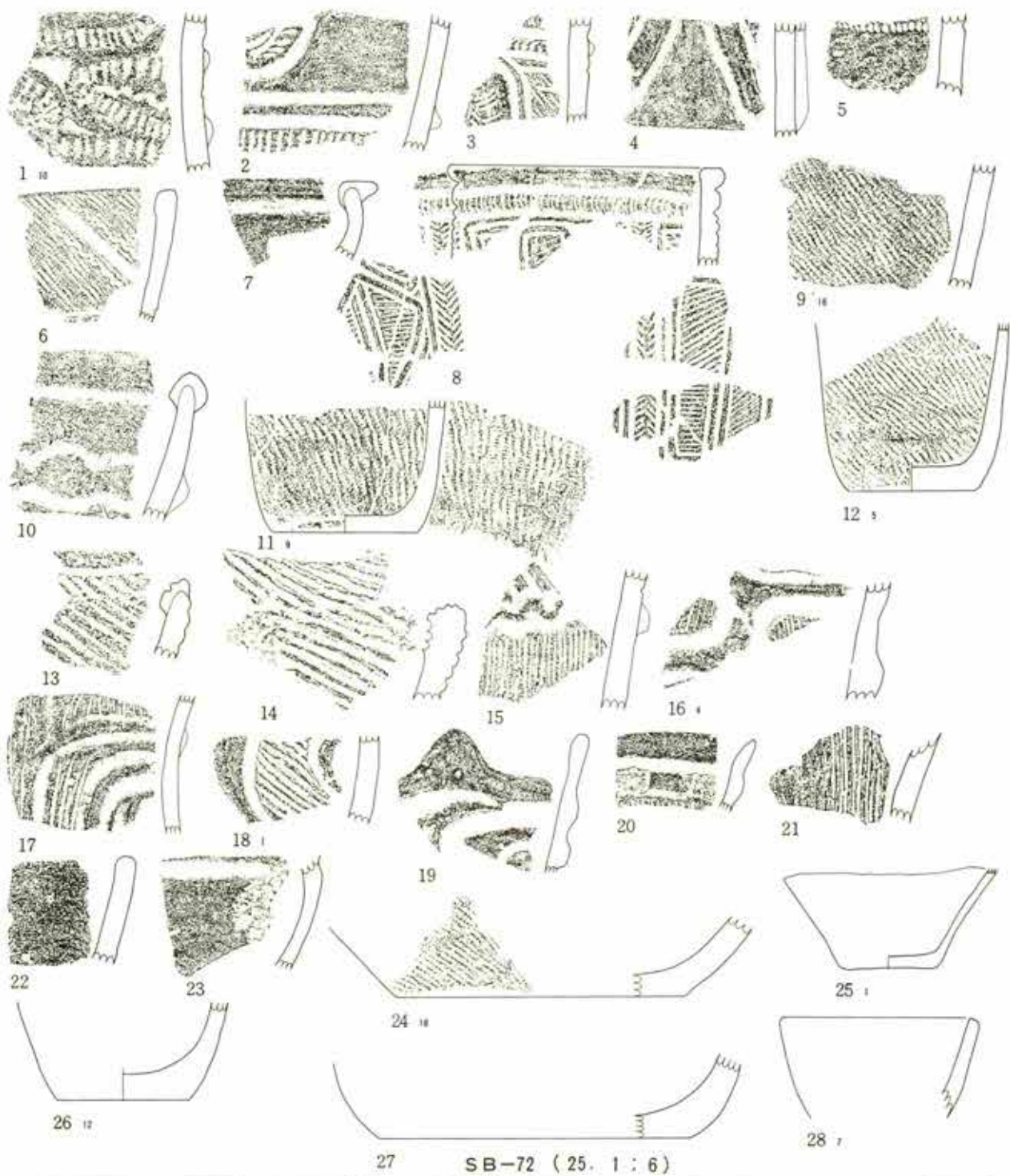

SB-72 (25. 1 : 6)

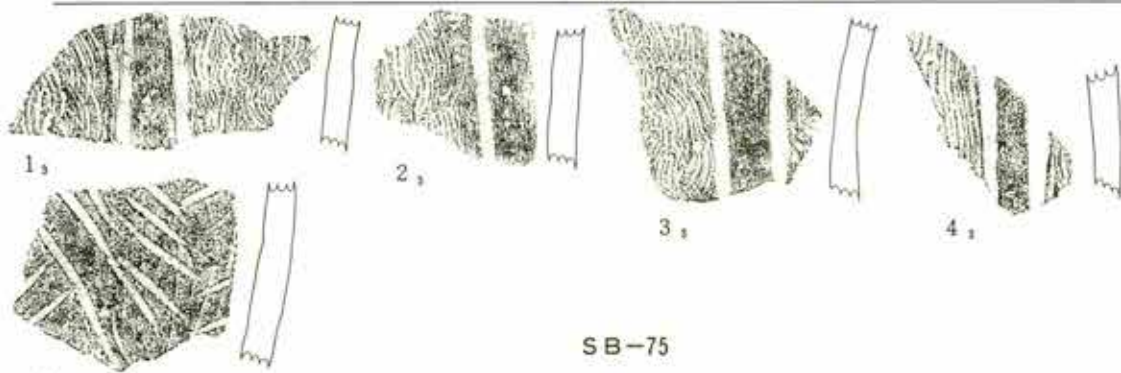

SB-75

5 M-11

第164图 积迦堂S-III区 SB-72-75 出土土器



第165图 积迦堂S-III区SB-85出土土器 (2)

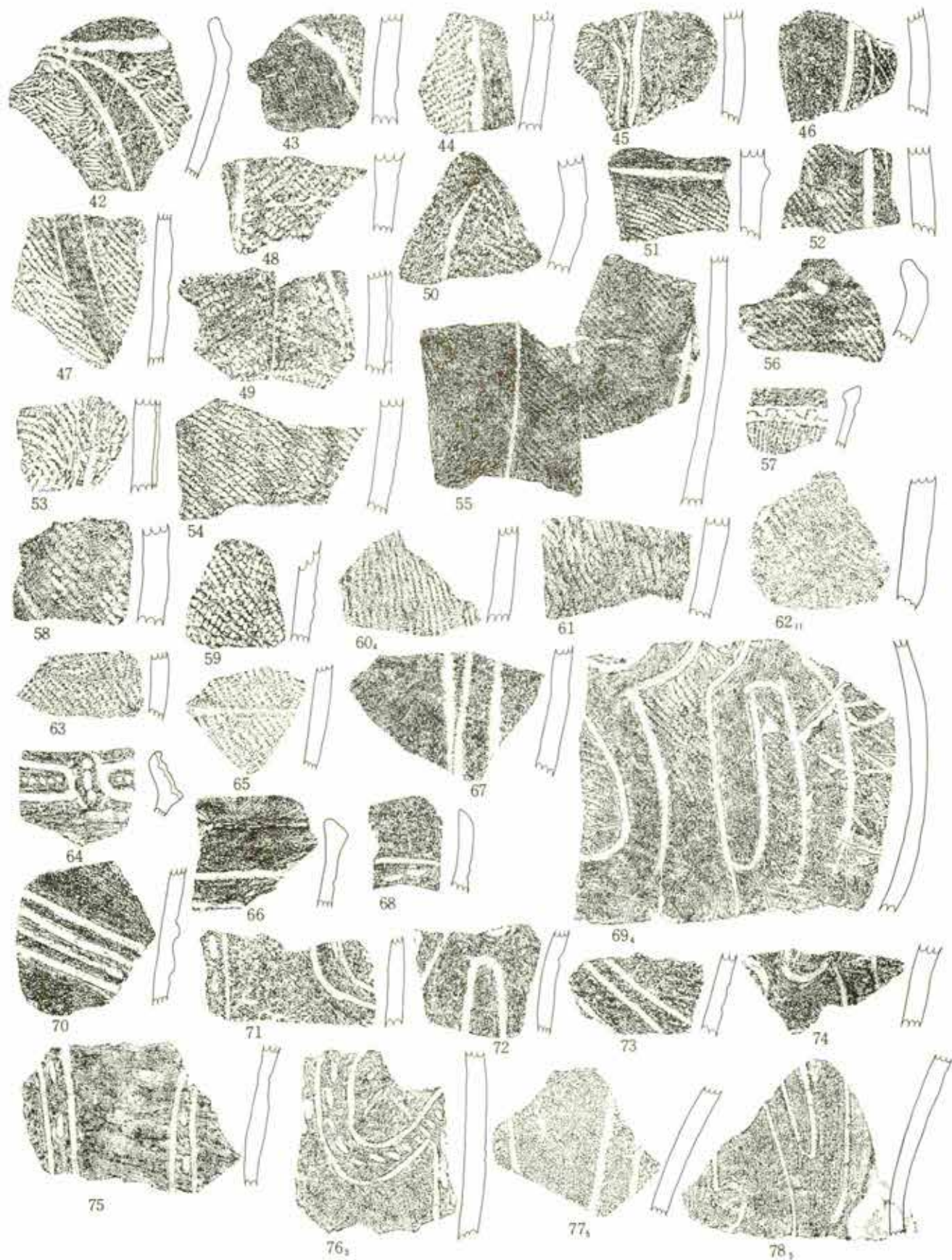

第166图 积迦堂S-III区 SB-85 出土土器 (3)

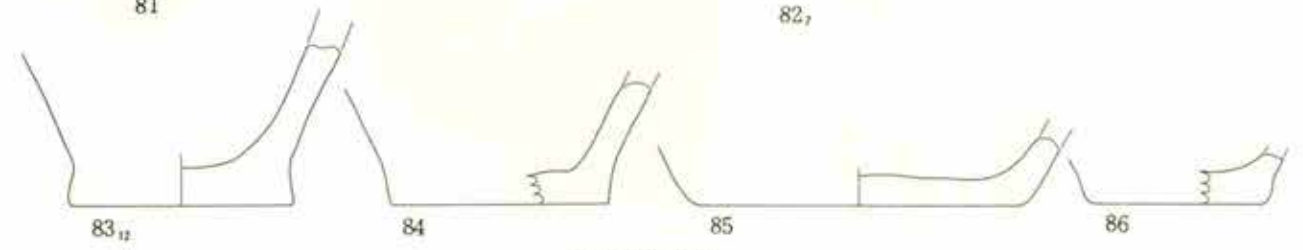
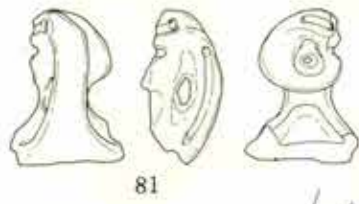
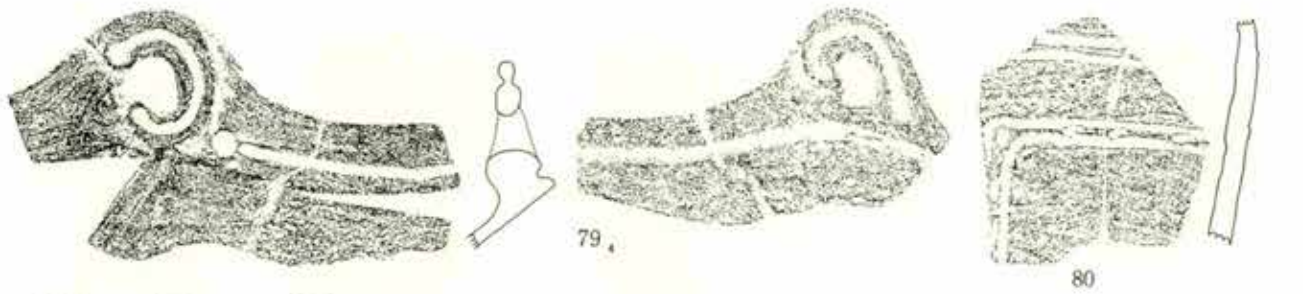

SB-85 (4)

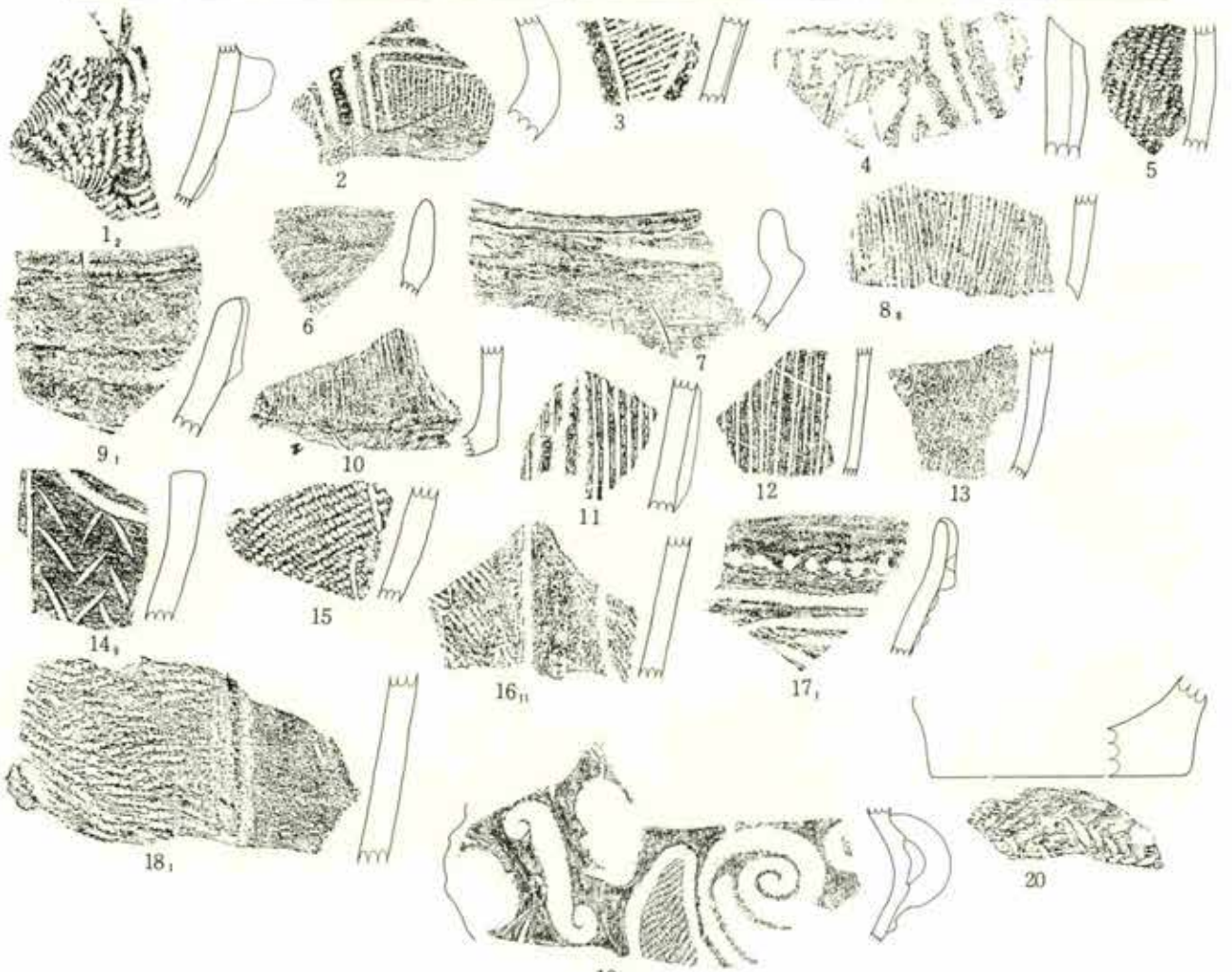

19
SB-86

第 167 图 积迦堂 S-III 区 SB-85 -86 出土土器

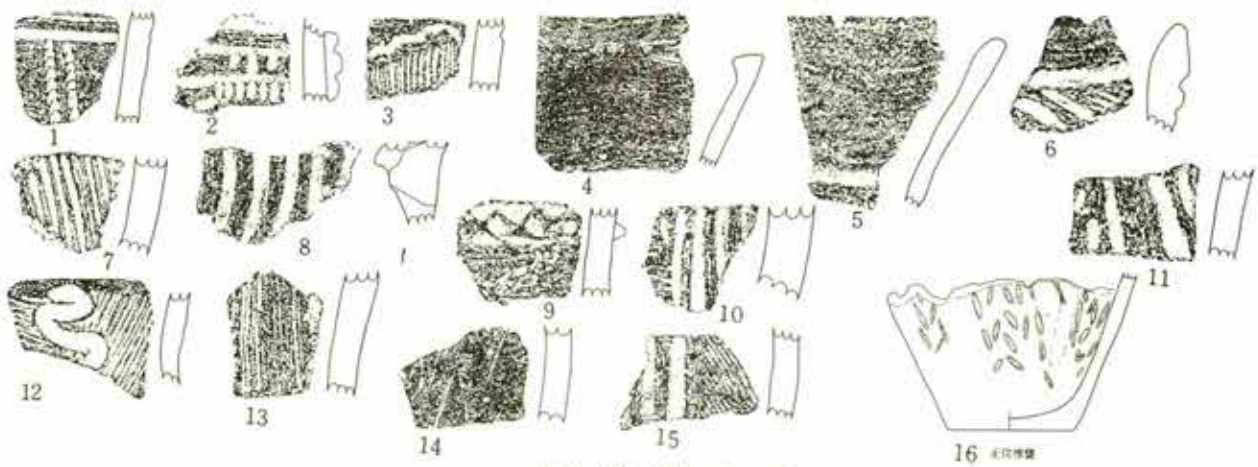

SB-88 (16. 1 : 6)

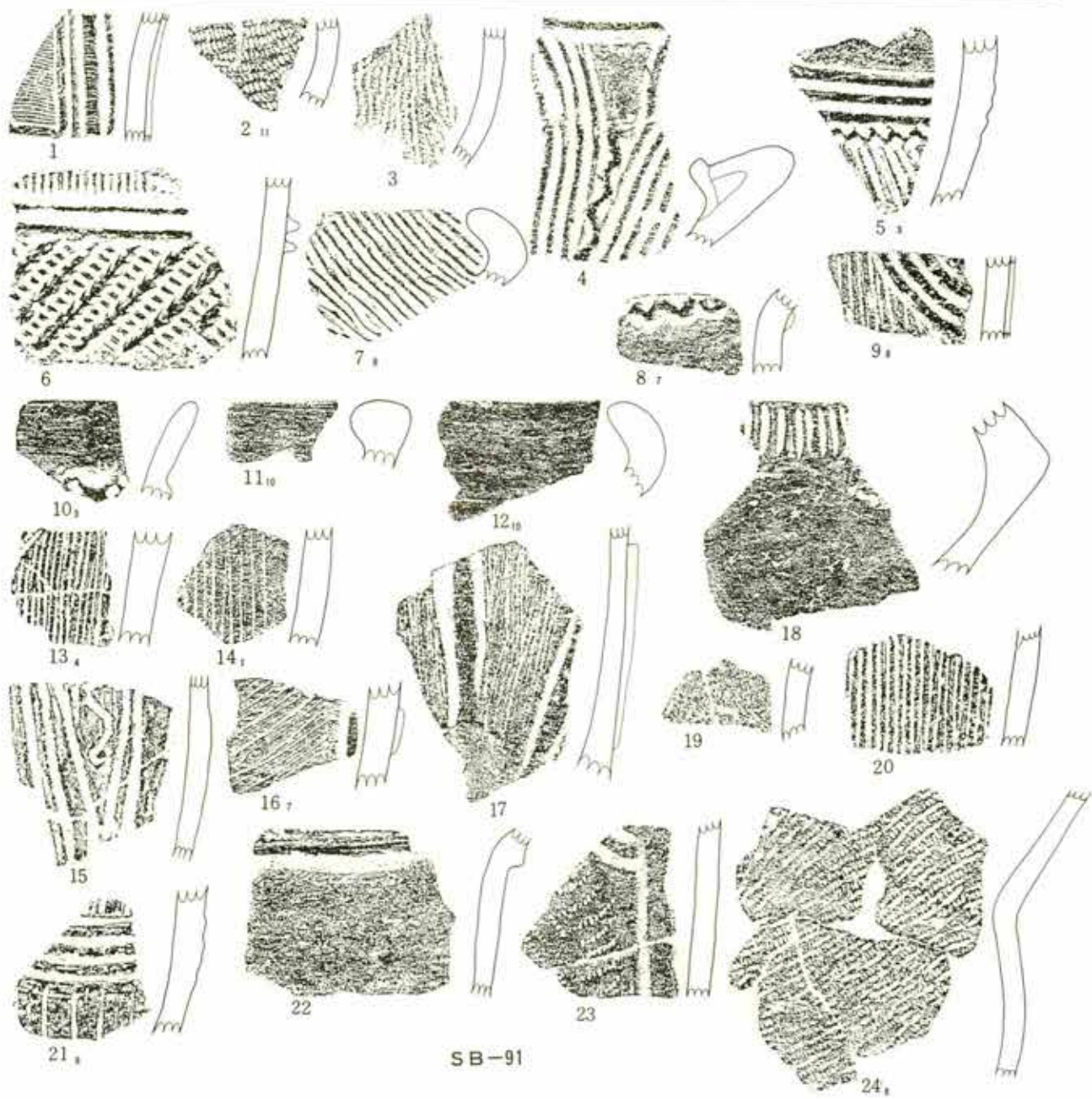

SB-91

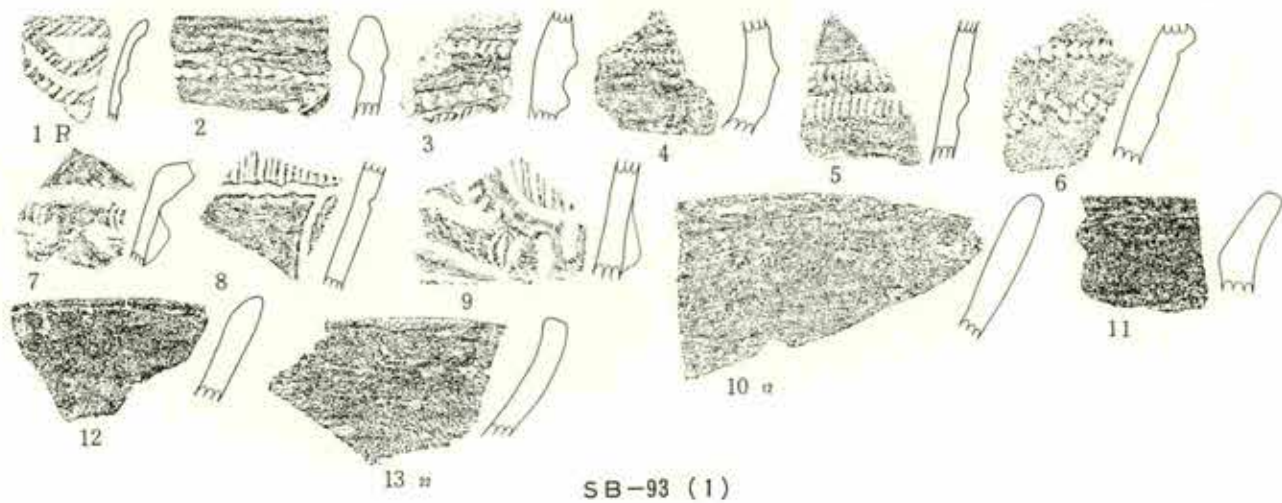
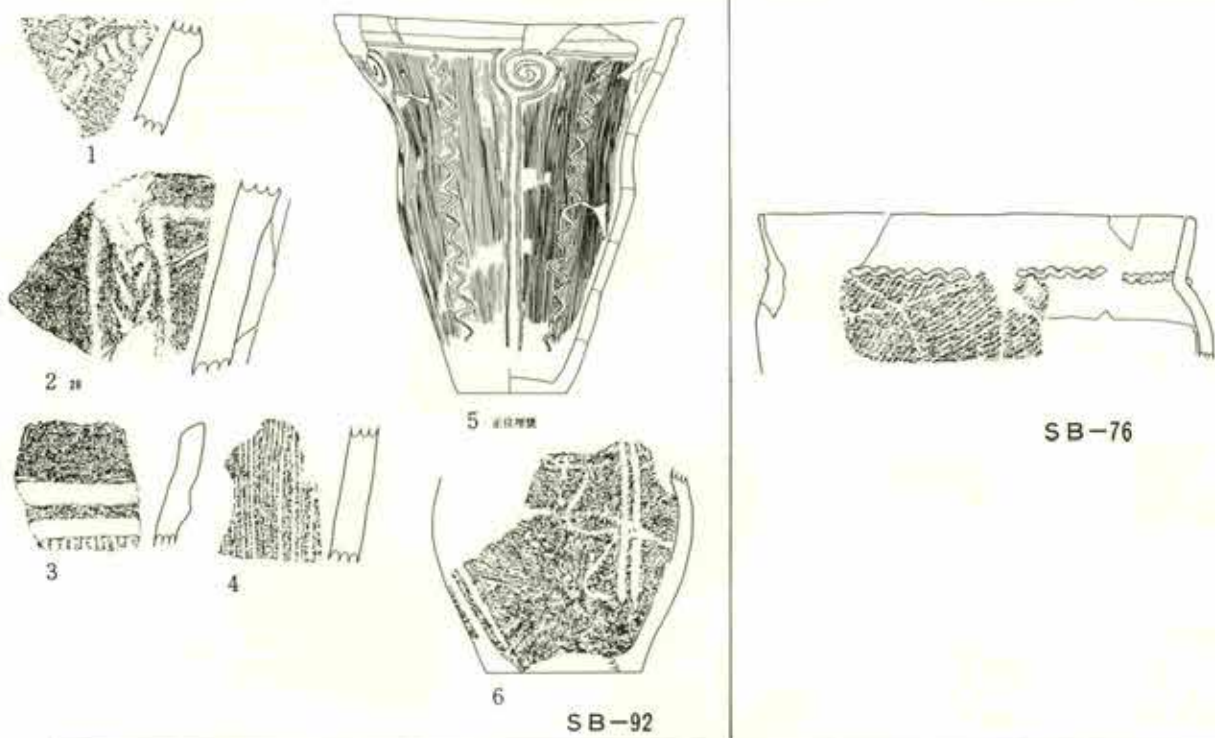
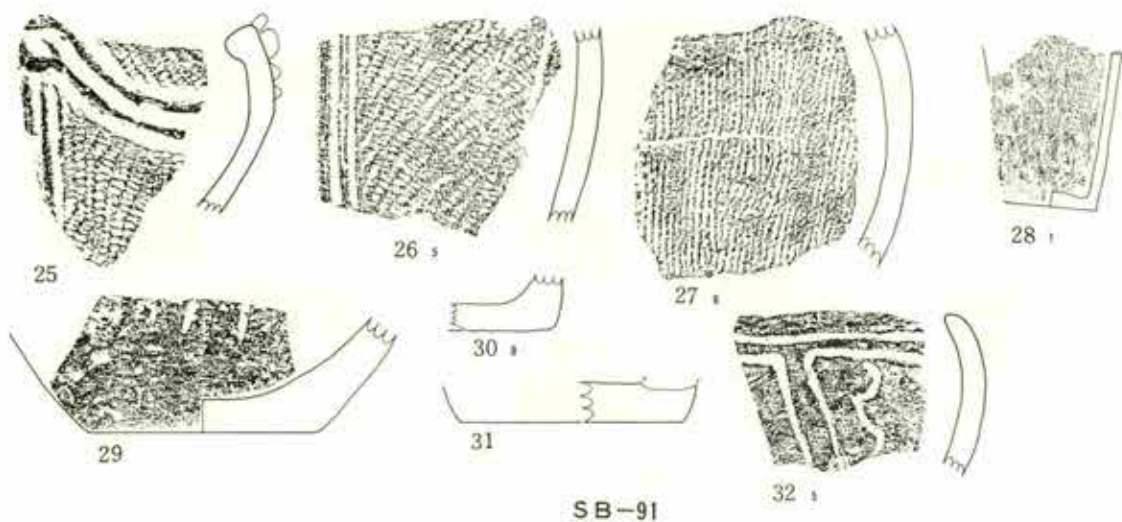

第169图 积迦堂S-III区 SB-91 -92 -76-93 出土土器

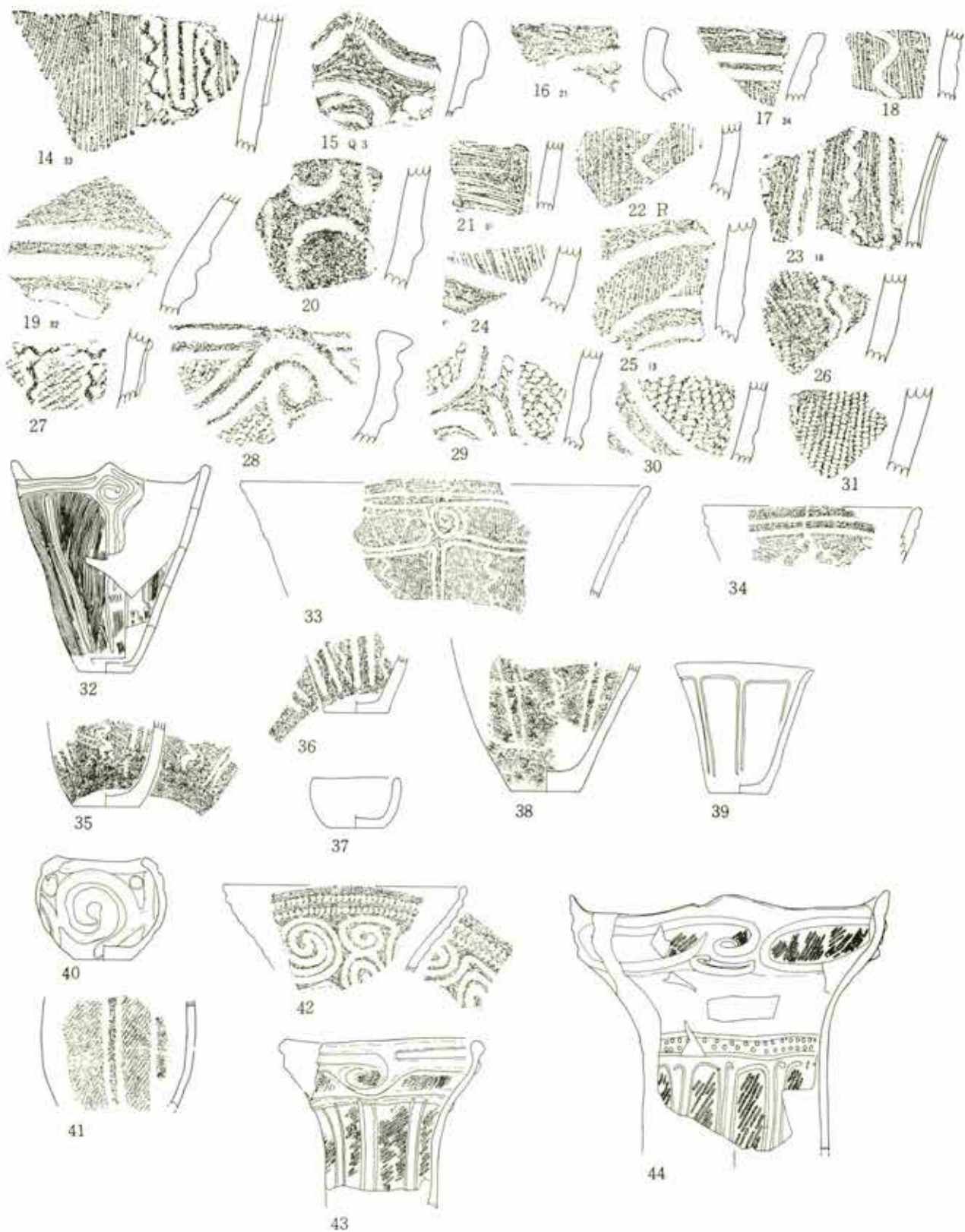

第 170 图 积迦堂 S-III 区 SB-93 出土土器 (2)

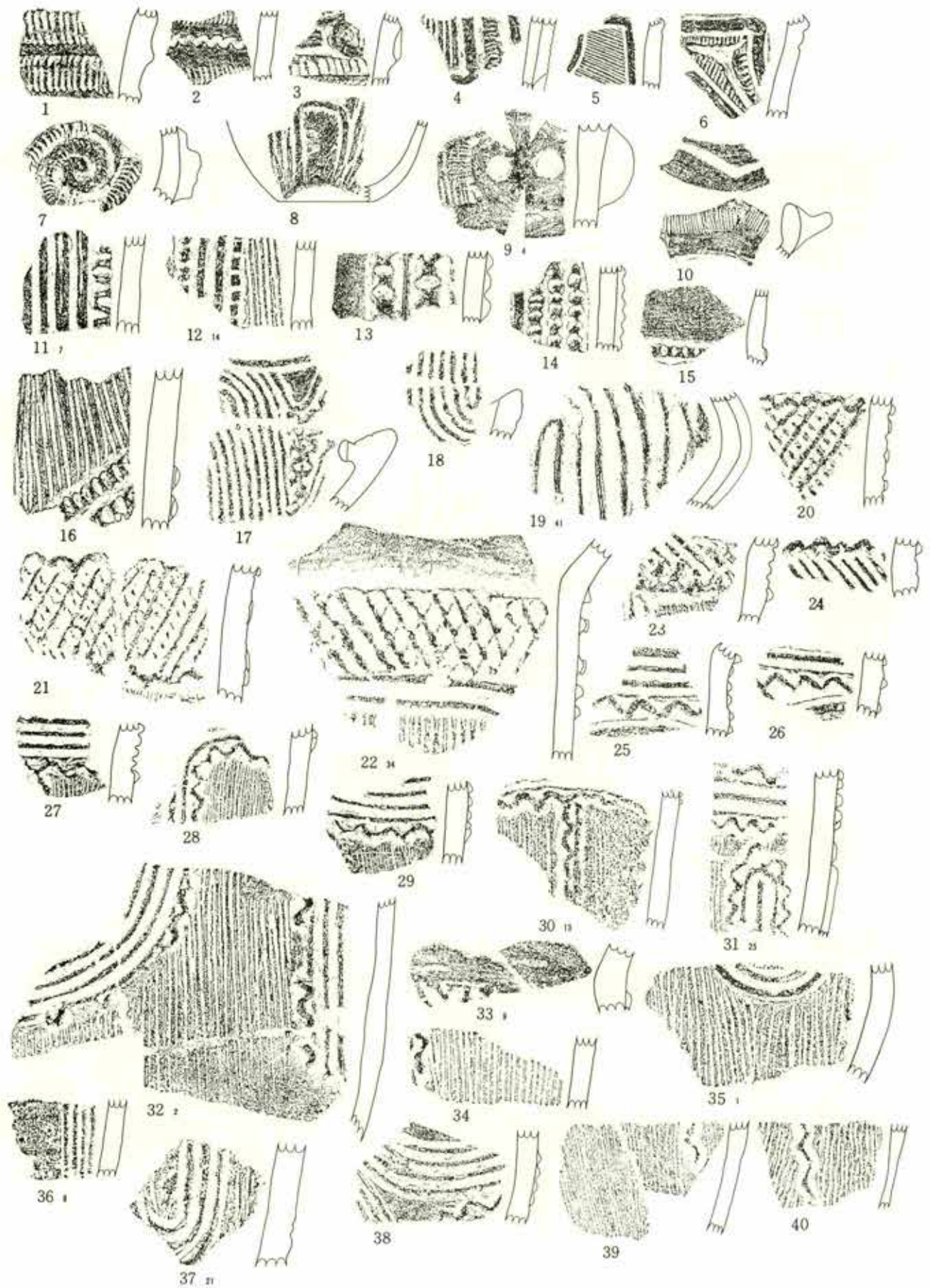

第 171 图 积逊堂 S-III 区 SB-94 出土土器 (1)

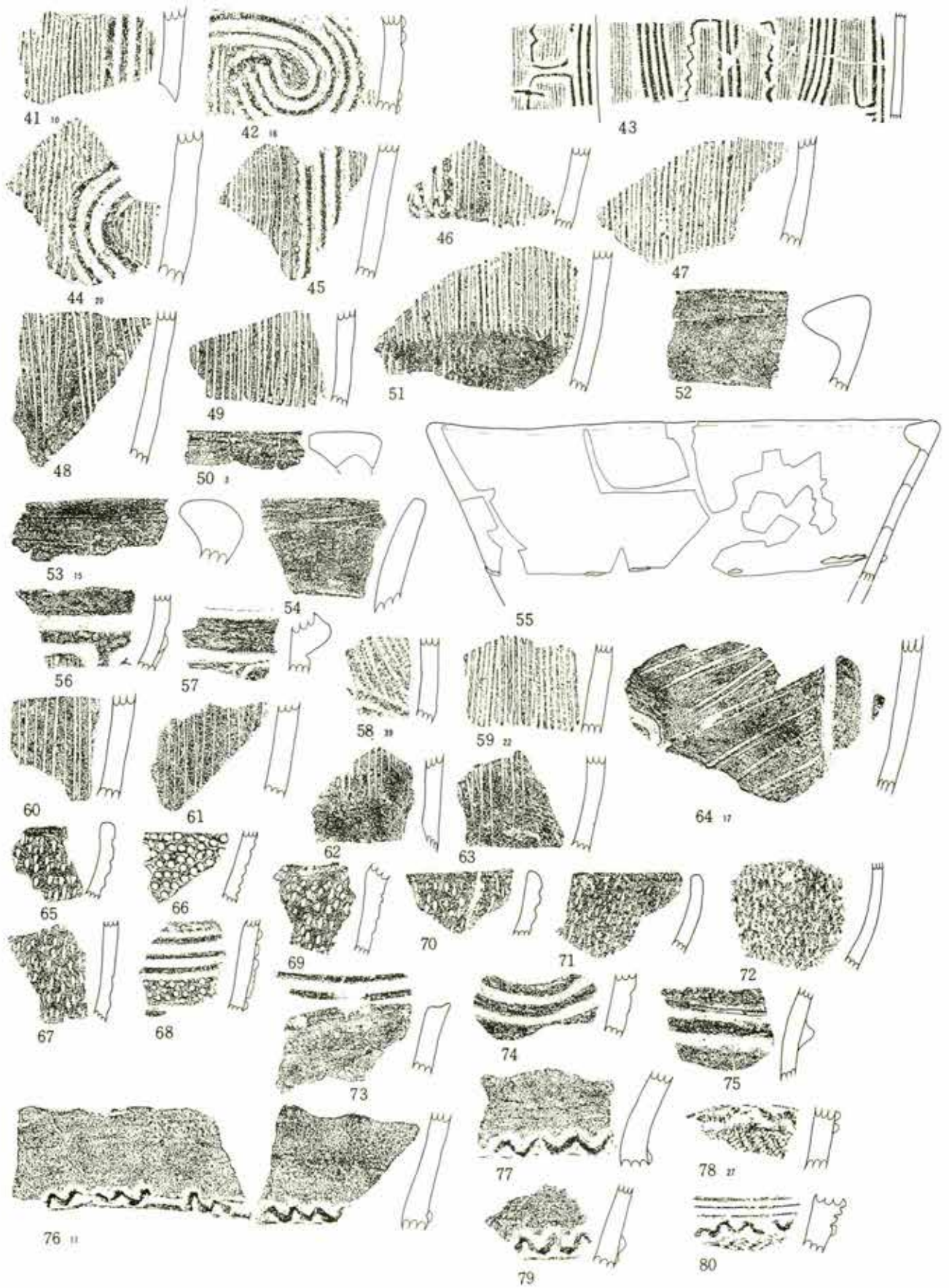

第 172 图 积迦堂 S-III 区 SB-94 出土土器 (2)

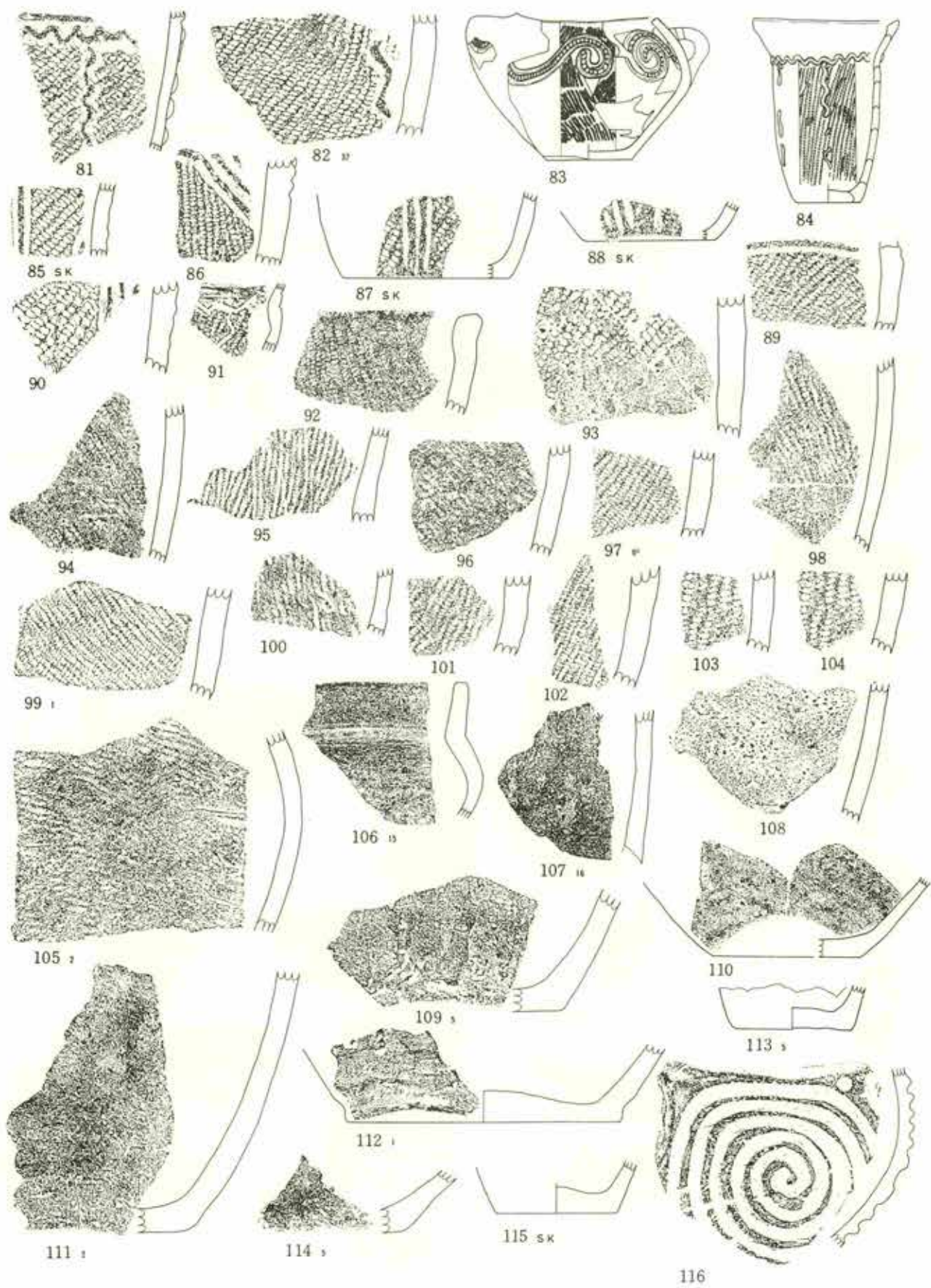

第173图 积迦堂S-III区 SB-94 出土土器(3)
 (83.84. 1:6)

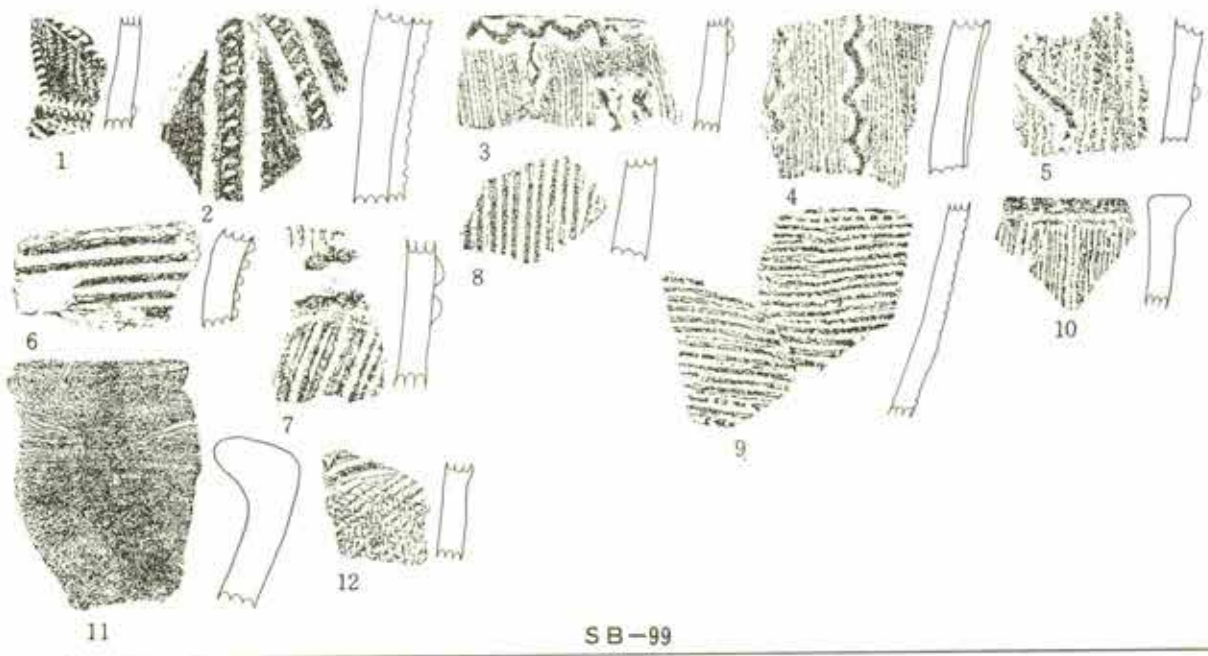

SB-99

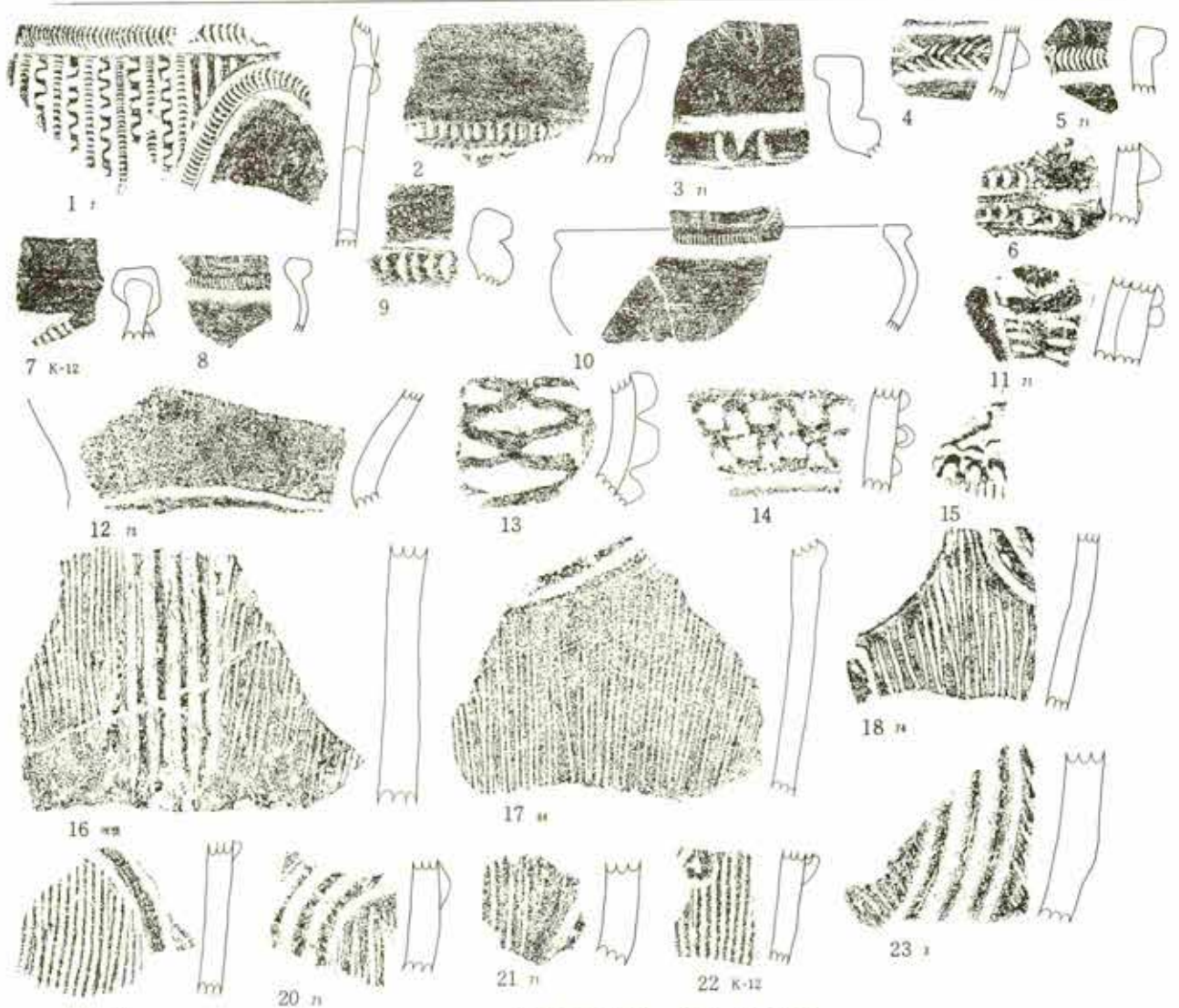

SB-96 (1) (10. 1 : 6)

第174图 积迦堂S-III区 SB-99 -96 出土土器

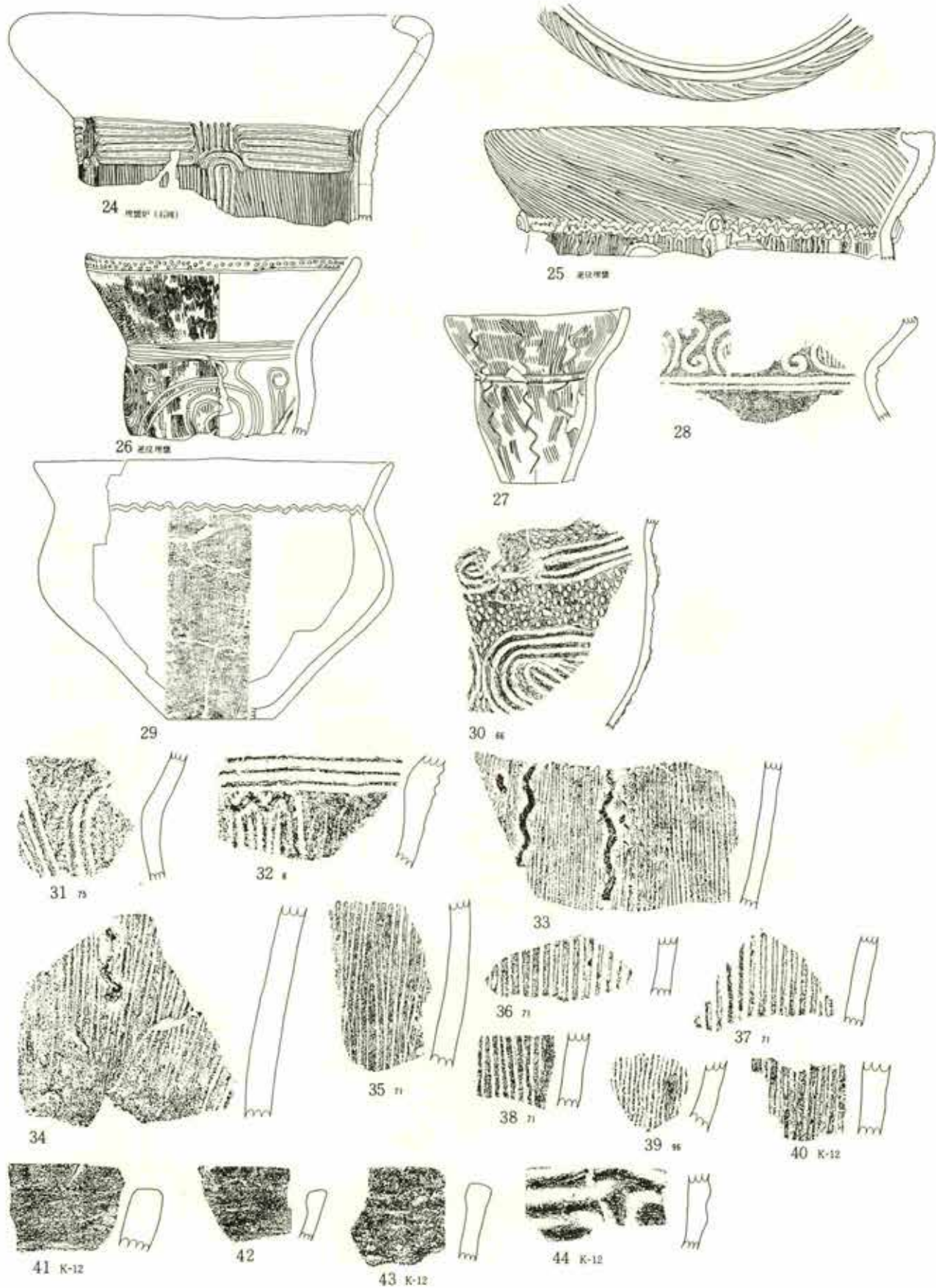

第 175 图 积迦堂S-III区 SB-96 出土土器 (2)
 (24. 25. 26. 27. 28. 29. 30. 1 : 6)

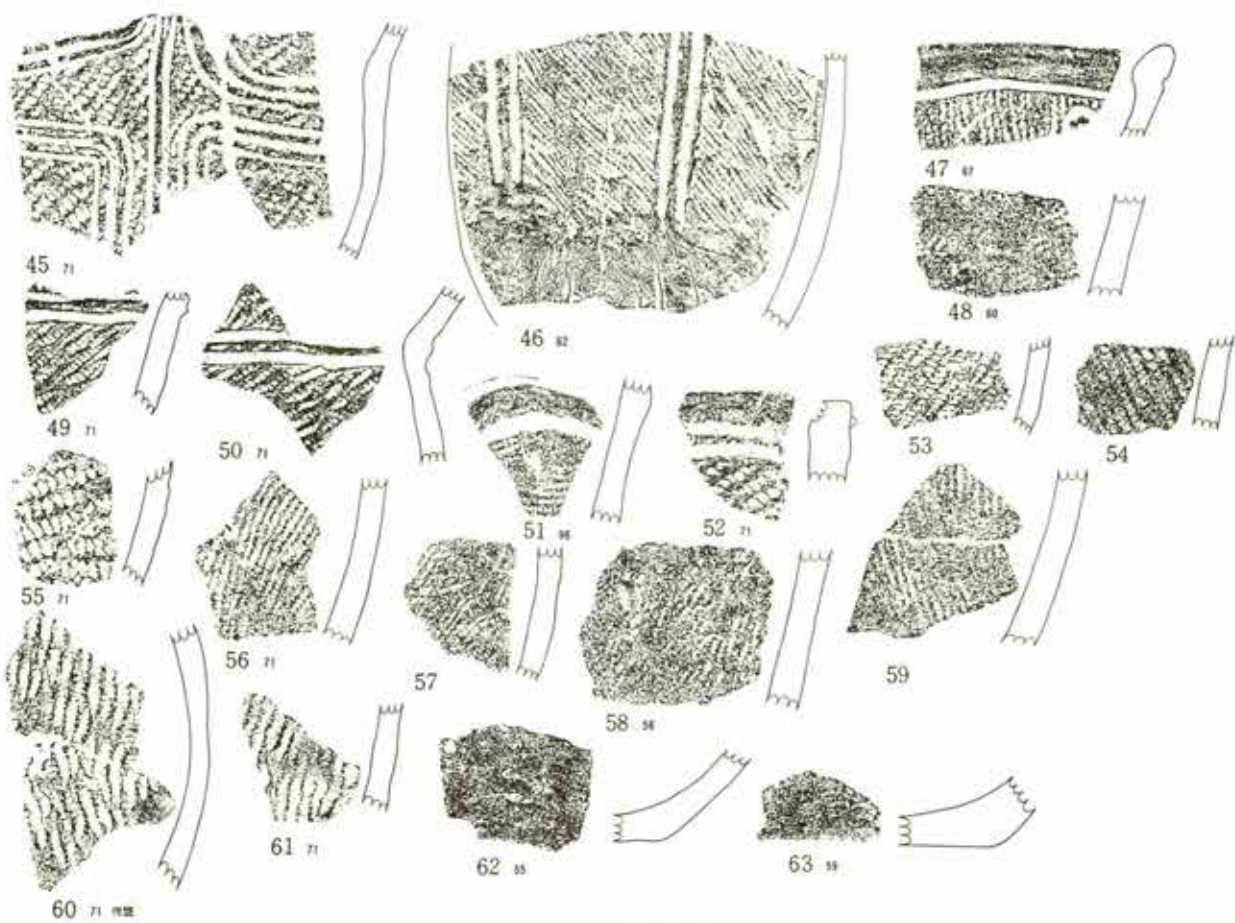

SB-96 (3)

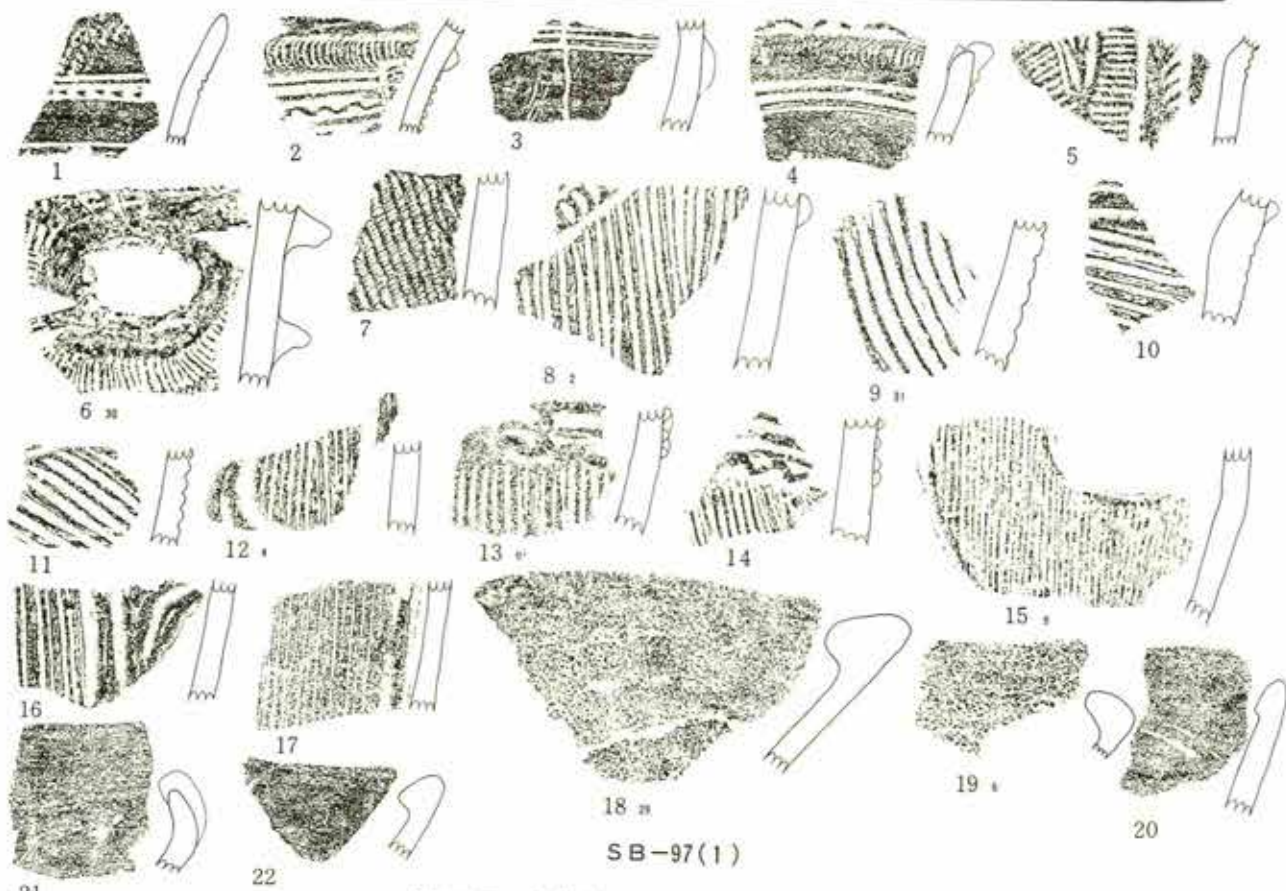

SB-97(1)

第 176 图 积迦堂 S-III 区 SB-96 -97 出土土器

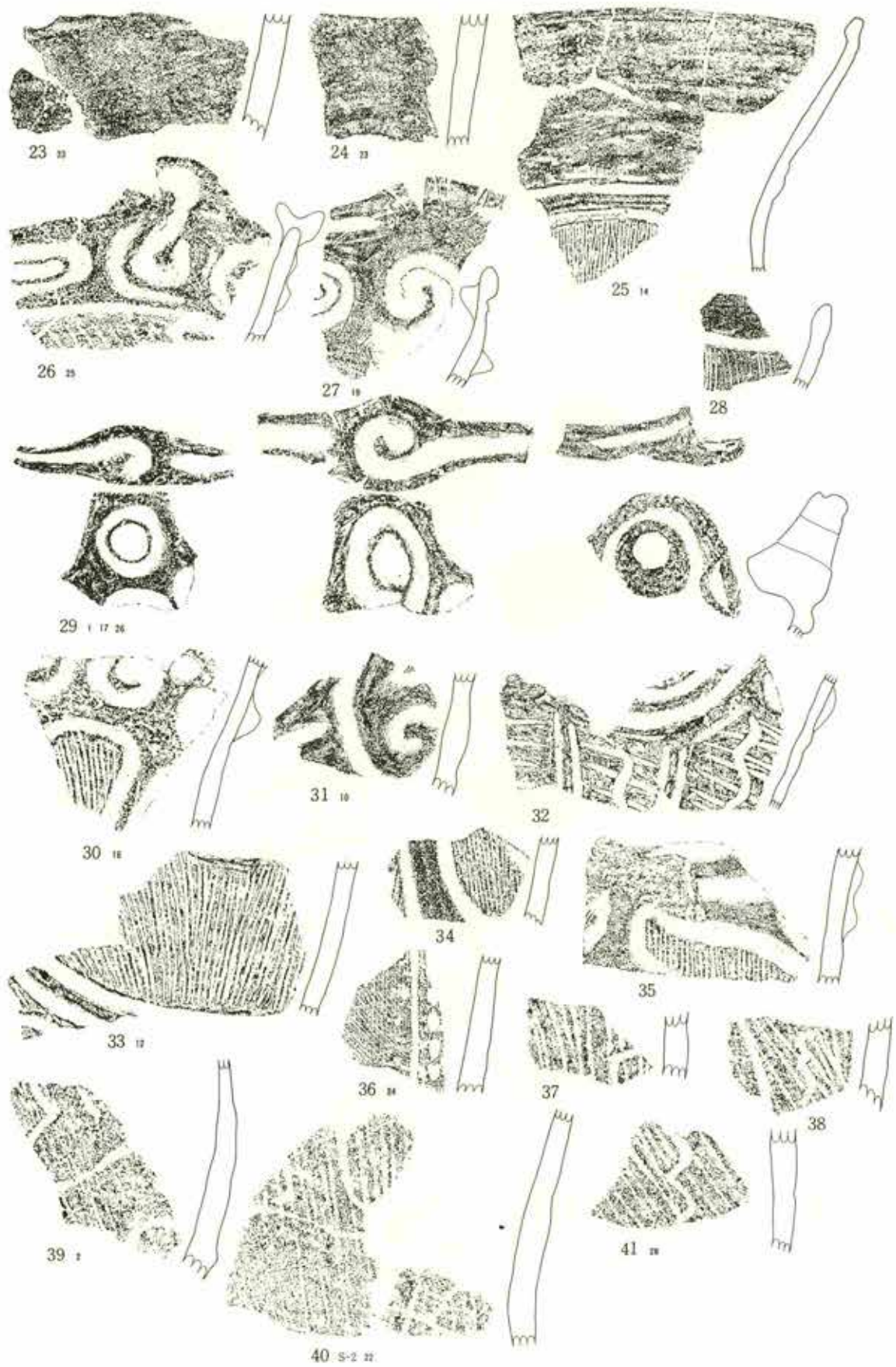

第177图 积迦堂S-III区 SB-97 出土土器(2)

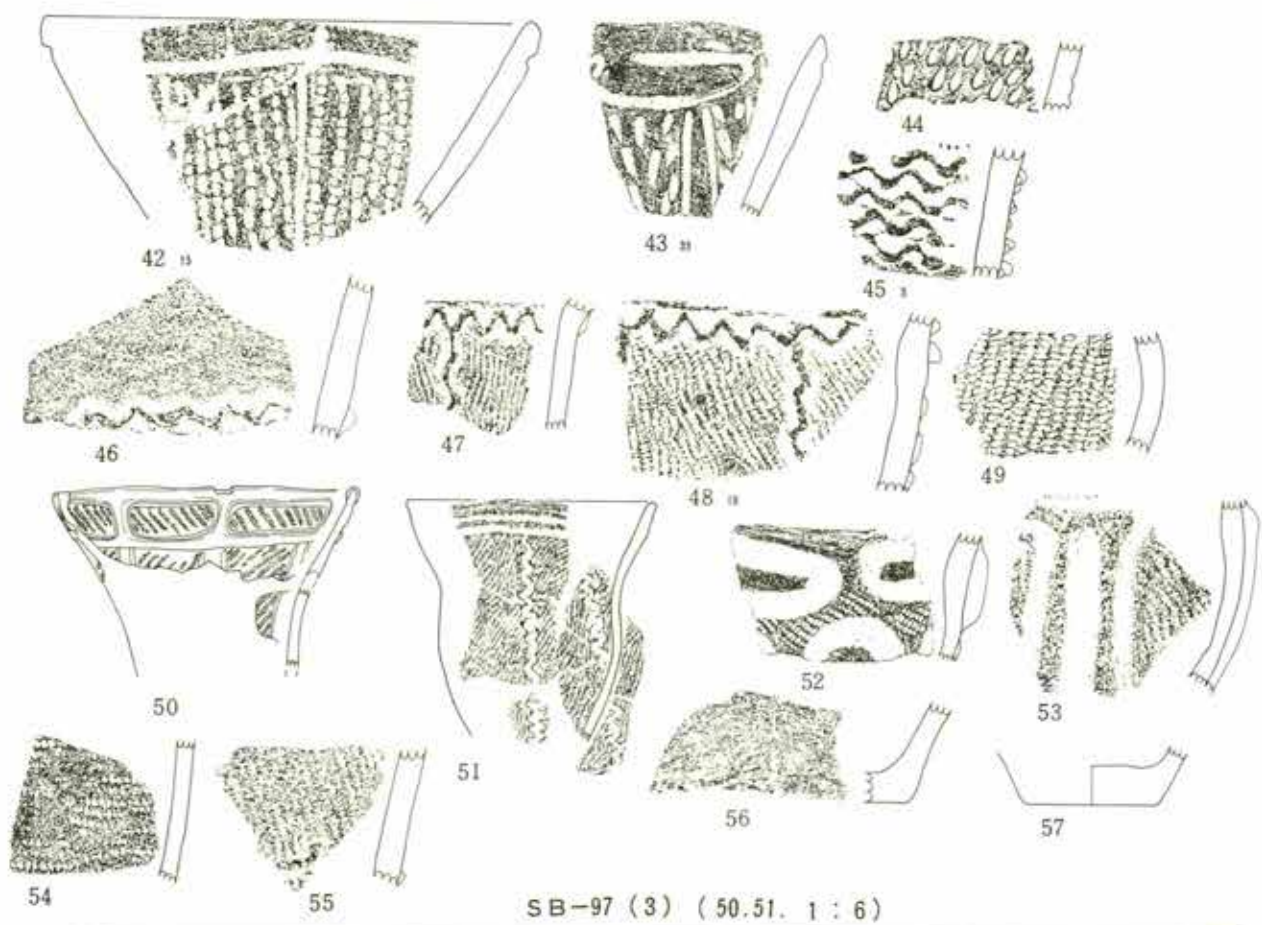

SB-97 (3) (50.51. 1:6)



SB-103 (2. 1:3)

第178图 积迦堂S-III区 SB-97-103 出土土器

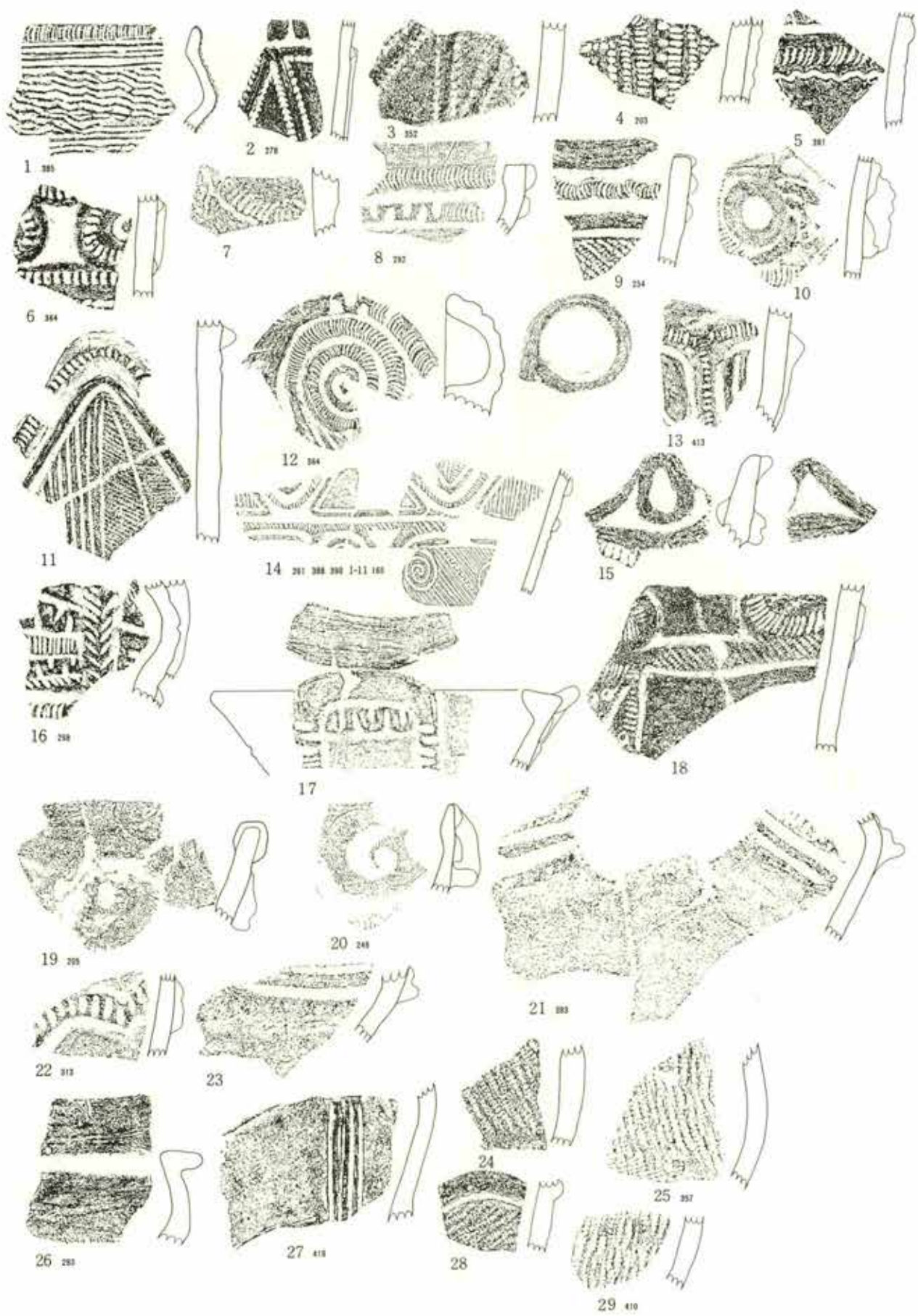

第179图 积迦堂S-III区 SB-105 出土土器 (1)
(14. 1 : 6)

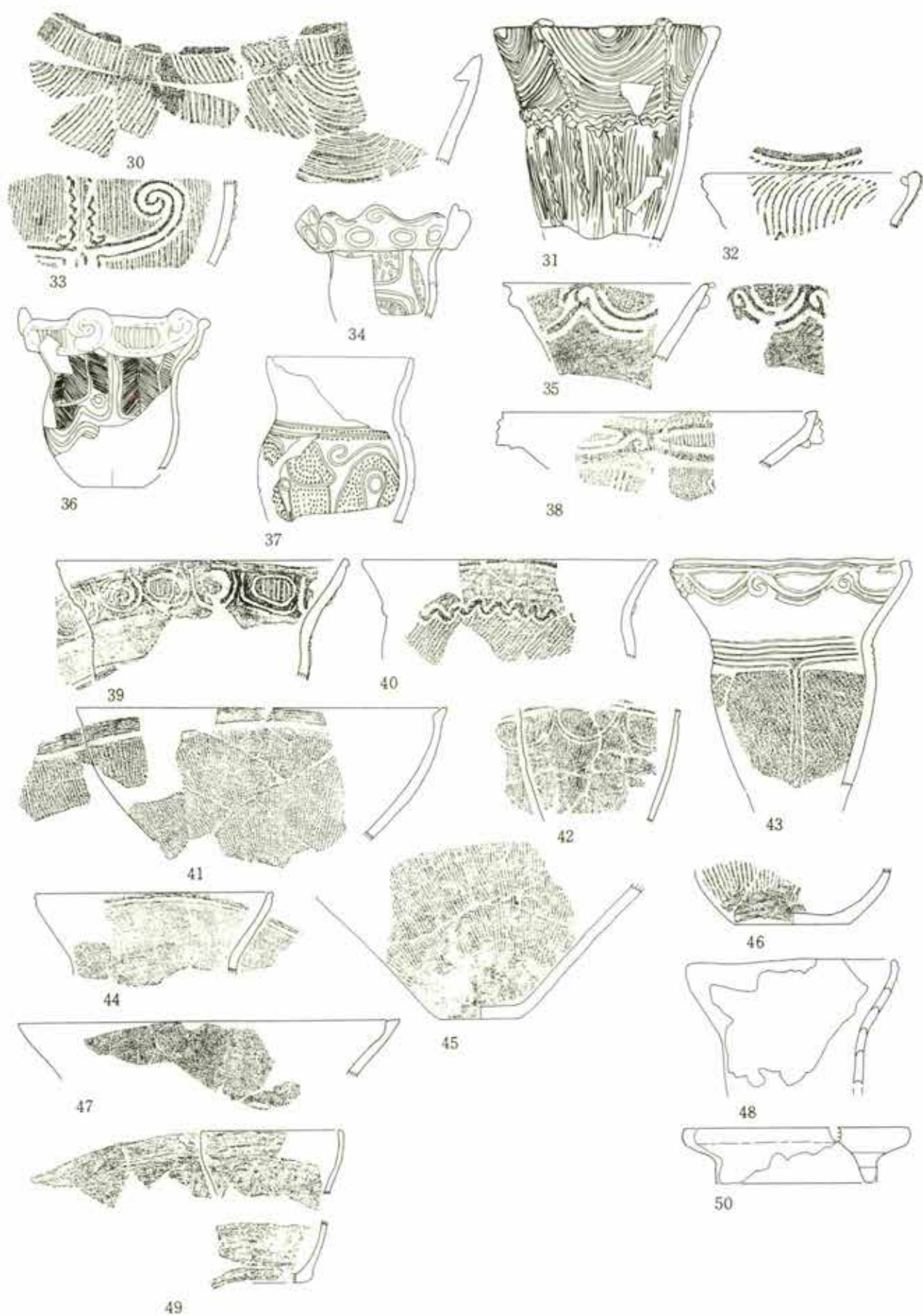

第 180 图 积逊堂 S-III 区 SB-105 出土土器 (2)
(1:6)

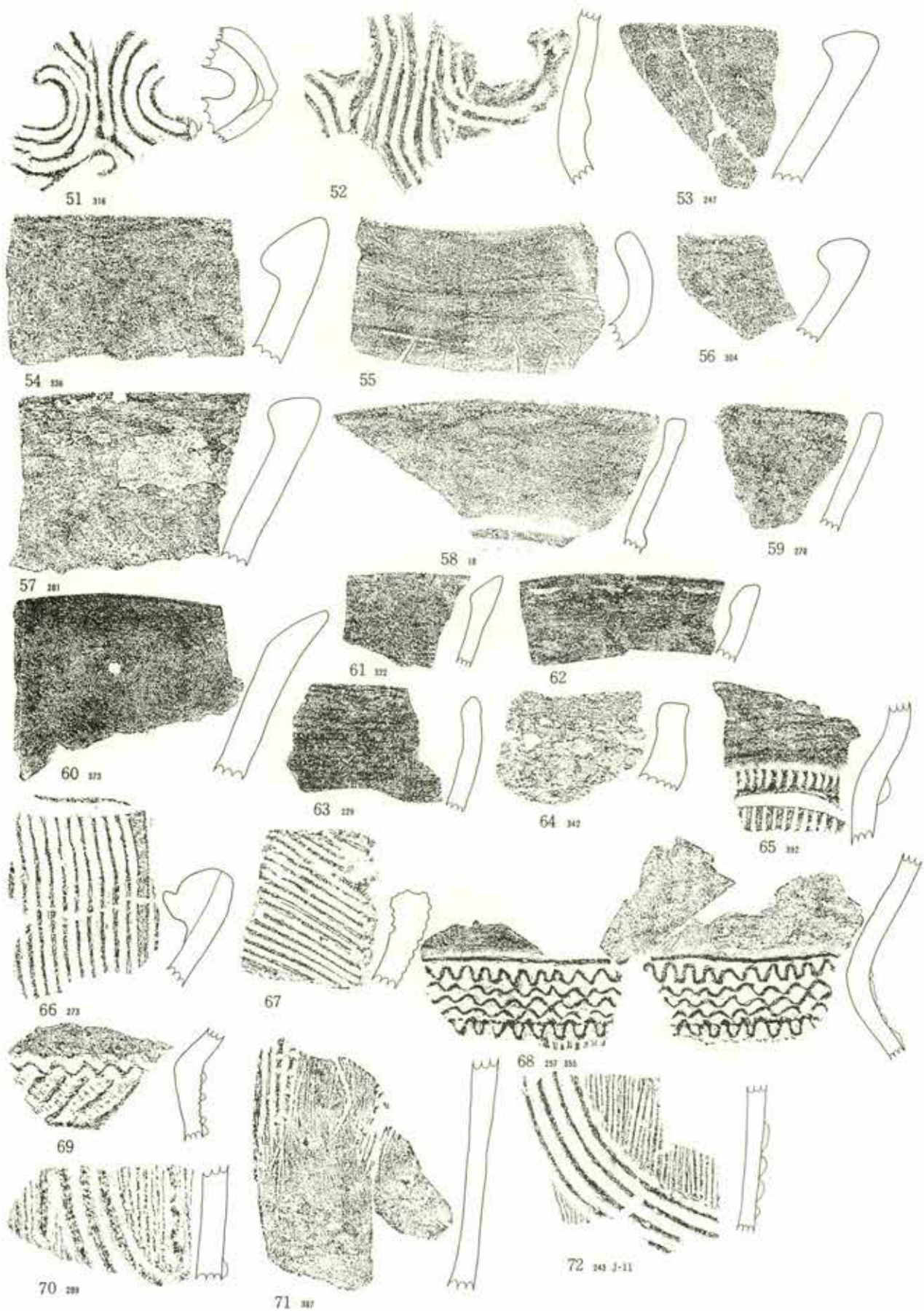

第 181 图 积逊堂 S-III 区 SB-105 出土土器 (3)

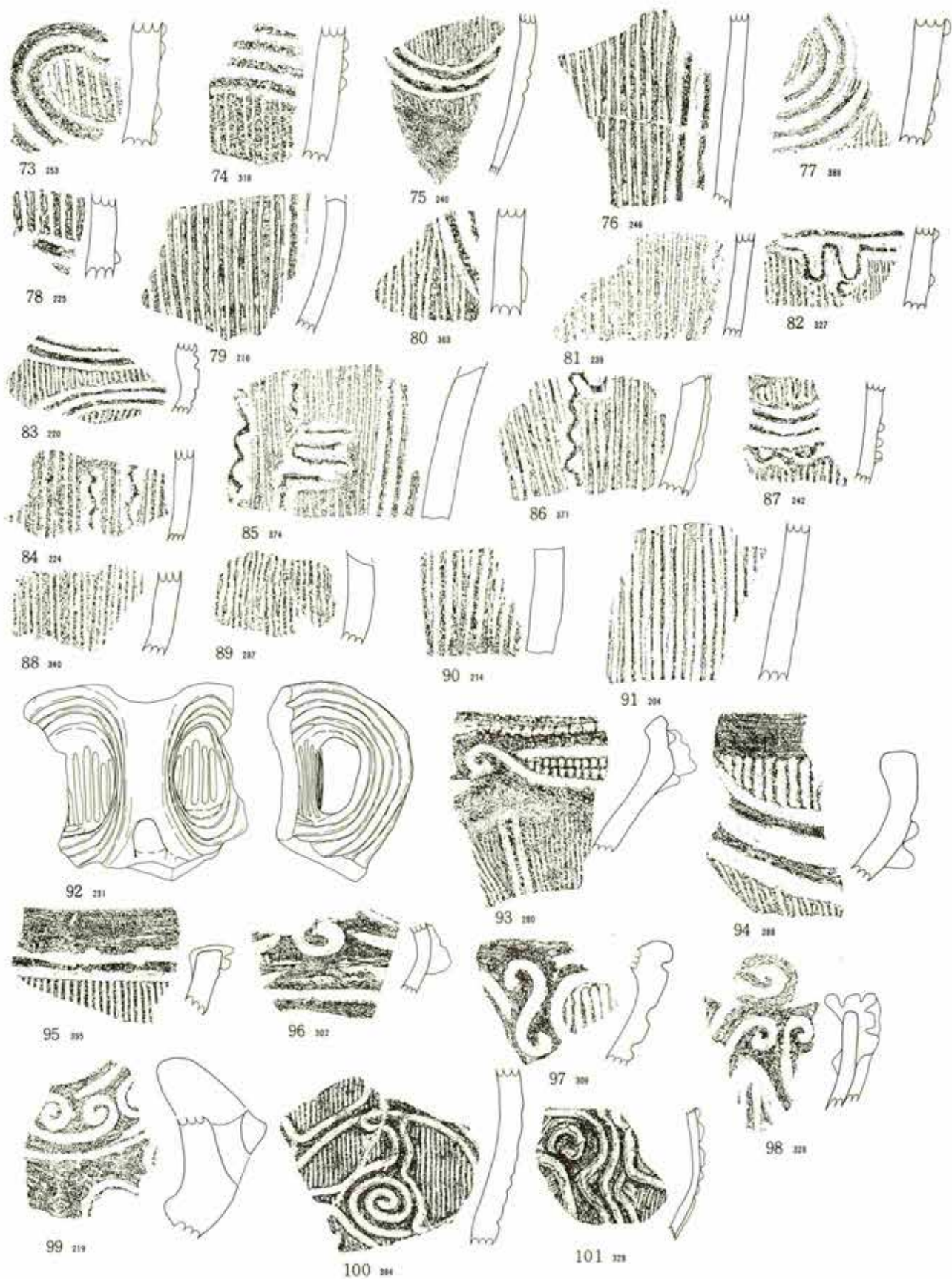

第182图 积迦堂S-III区 SB-105 出土土器 (4)

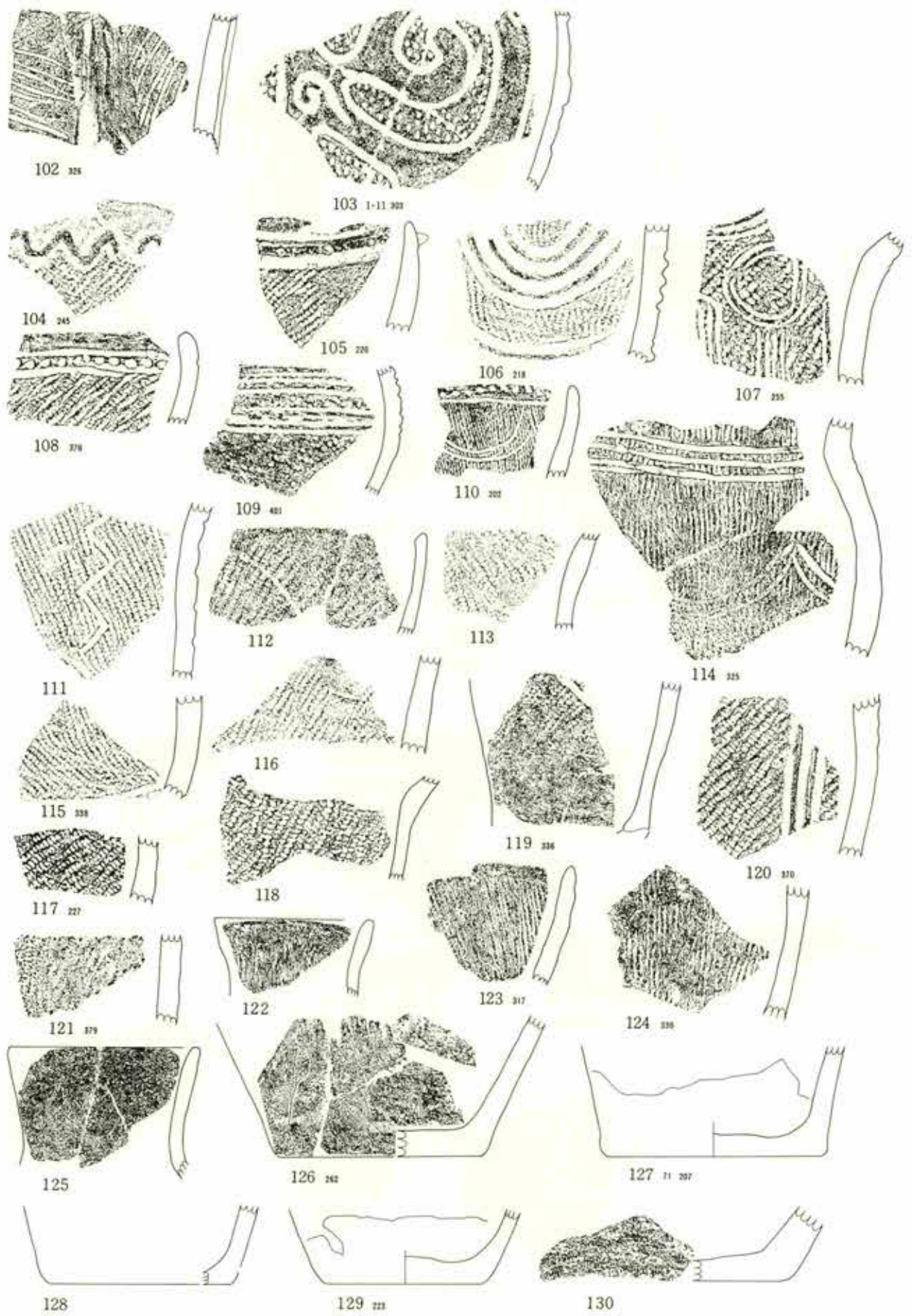

第 183 图 积迦堂 S-III 区 SB-105 出土土器 (5)



第 184 图 积逊堂 S-III 区 SB-109 出土土器 (1)



27

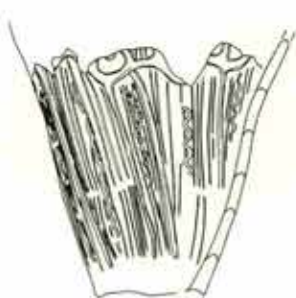

28 正位残片

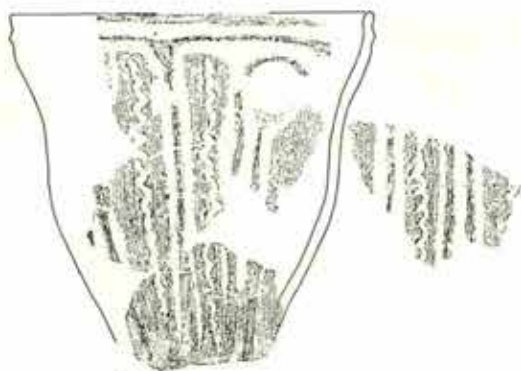

29



30

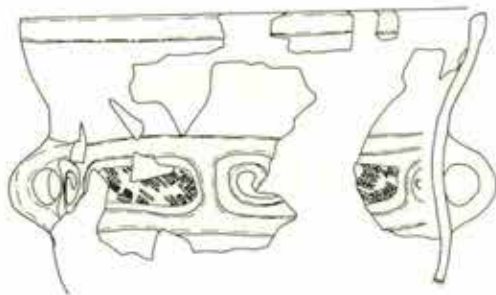

31

SB-109 (2)

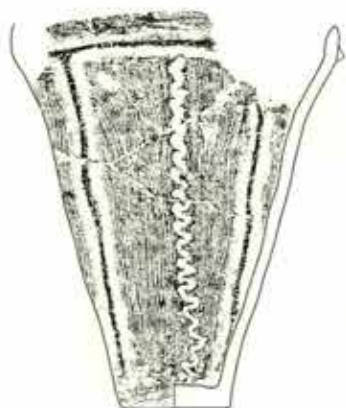

1 正位残片



2

SB-113 (2. 1 : 2)

第185图 积迦堂S-III区 SB-109 -113 出土土器

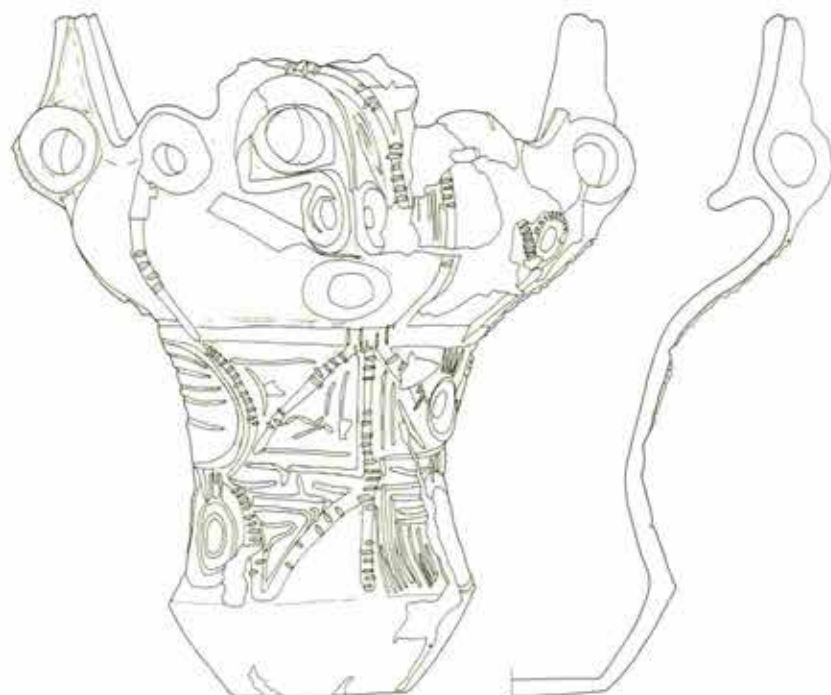

1 SK-01

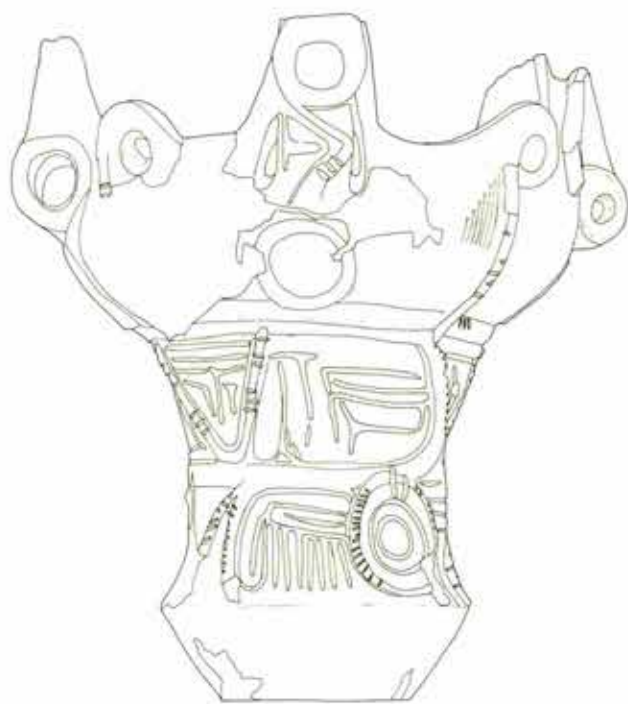

1b SK-01

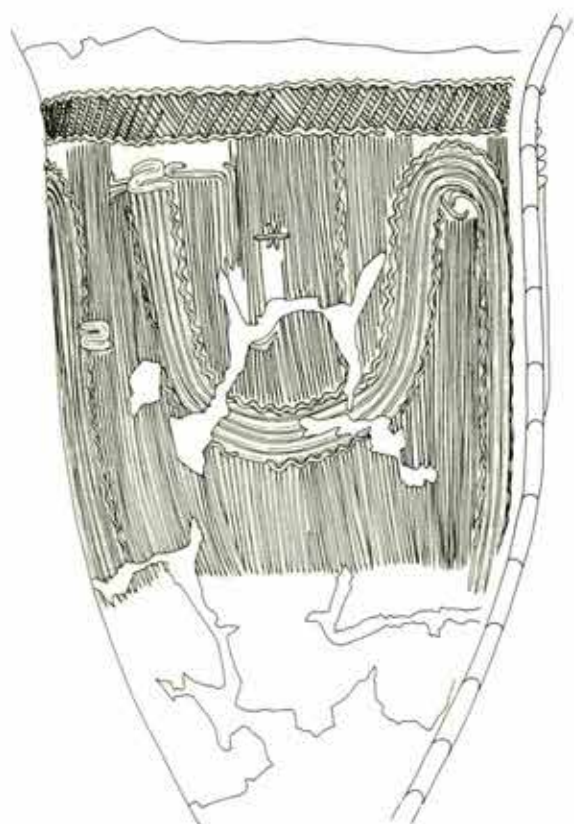

2 SK-02

第186图 积迦堂S-III区 SK-01 -02 出土土器

(1)

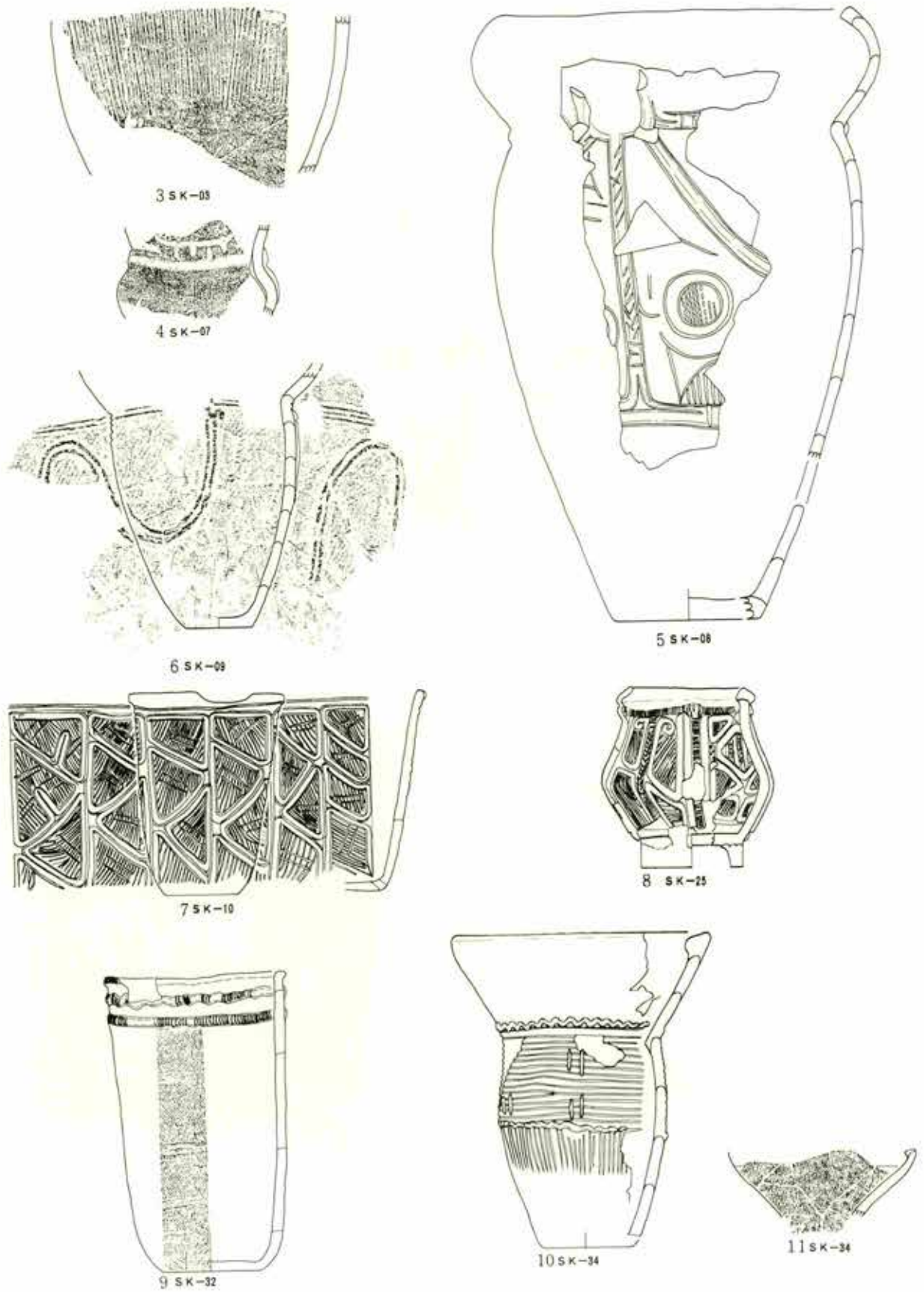

第 187 图 积逊堂 S-III 区 SK-03-07-08-09-10-25-34 出土土器 (2)

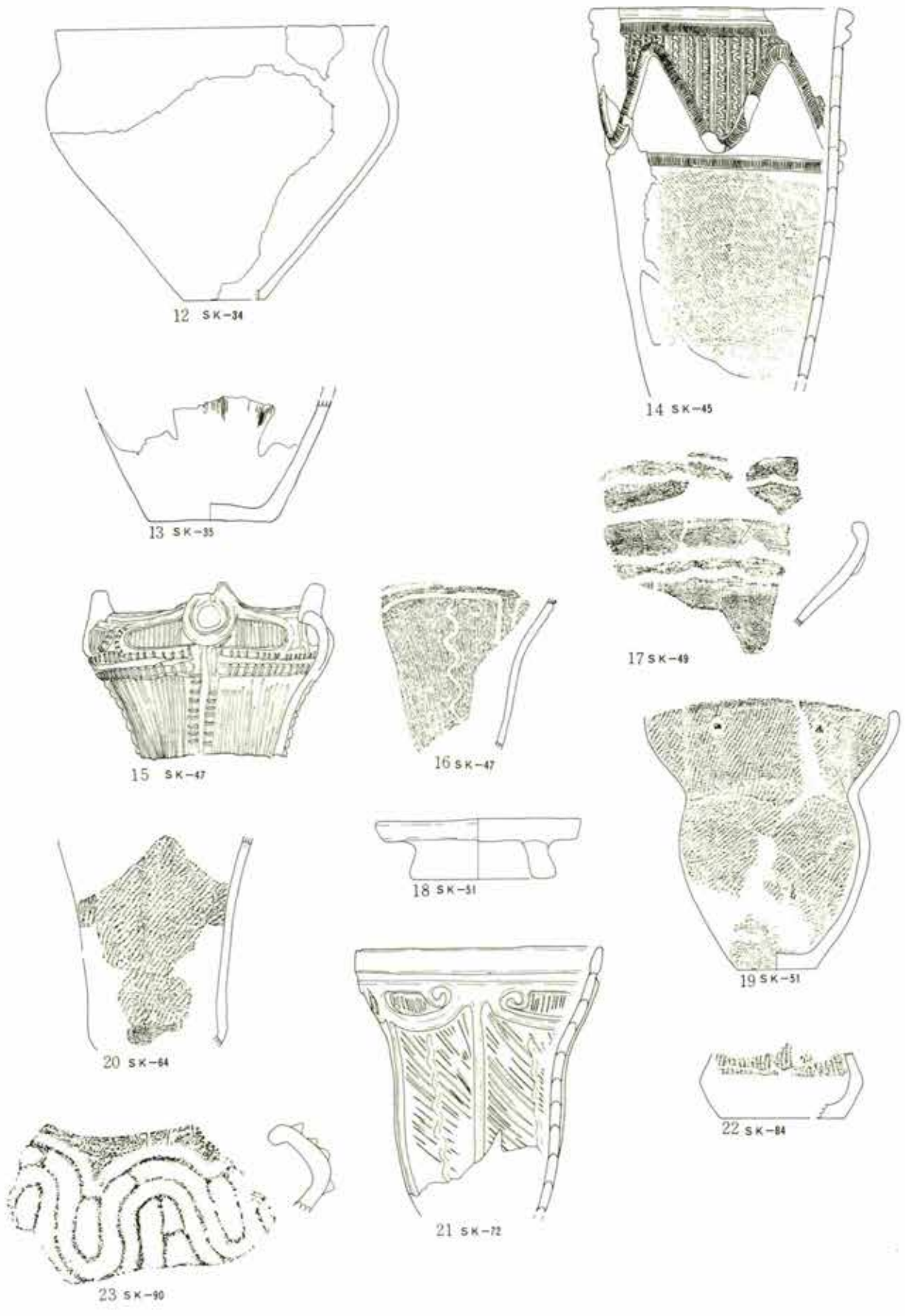

第188图 积迦堂S-III区 SK-34-35-45-47-49-51-64-72-84-90 出土土器(3)

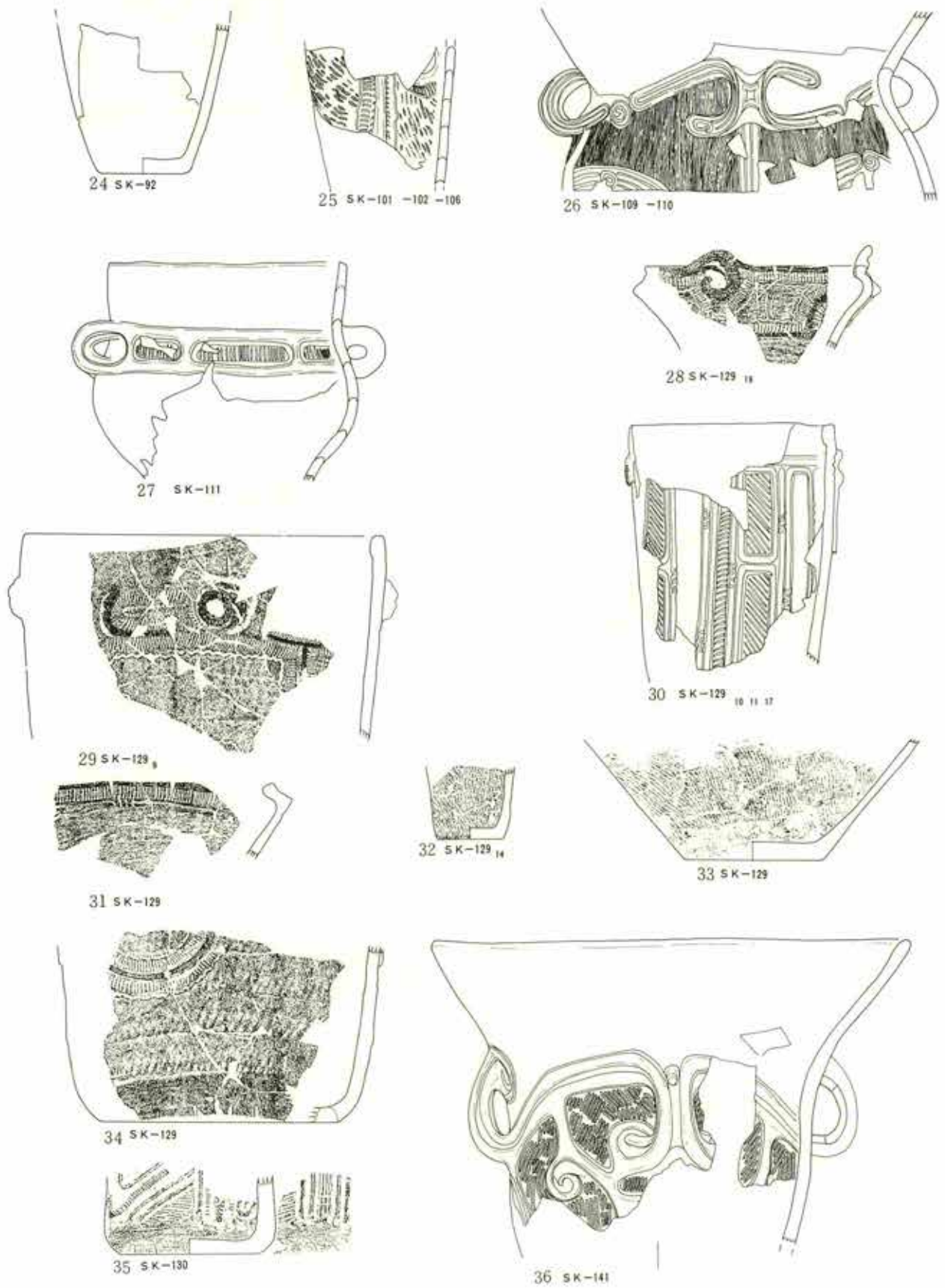

第189图 积逊堂S-III区 SK-92-101-102-106-109-129-130-141出土土器(4)

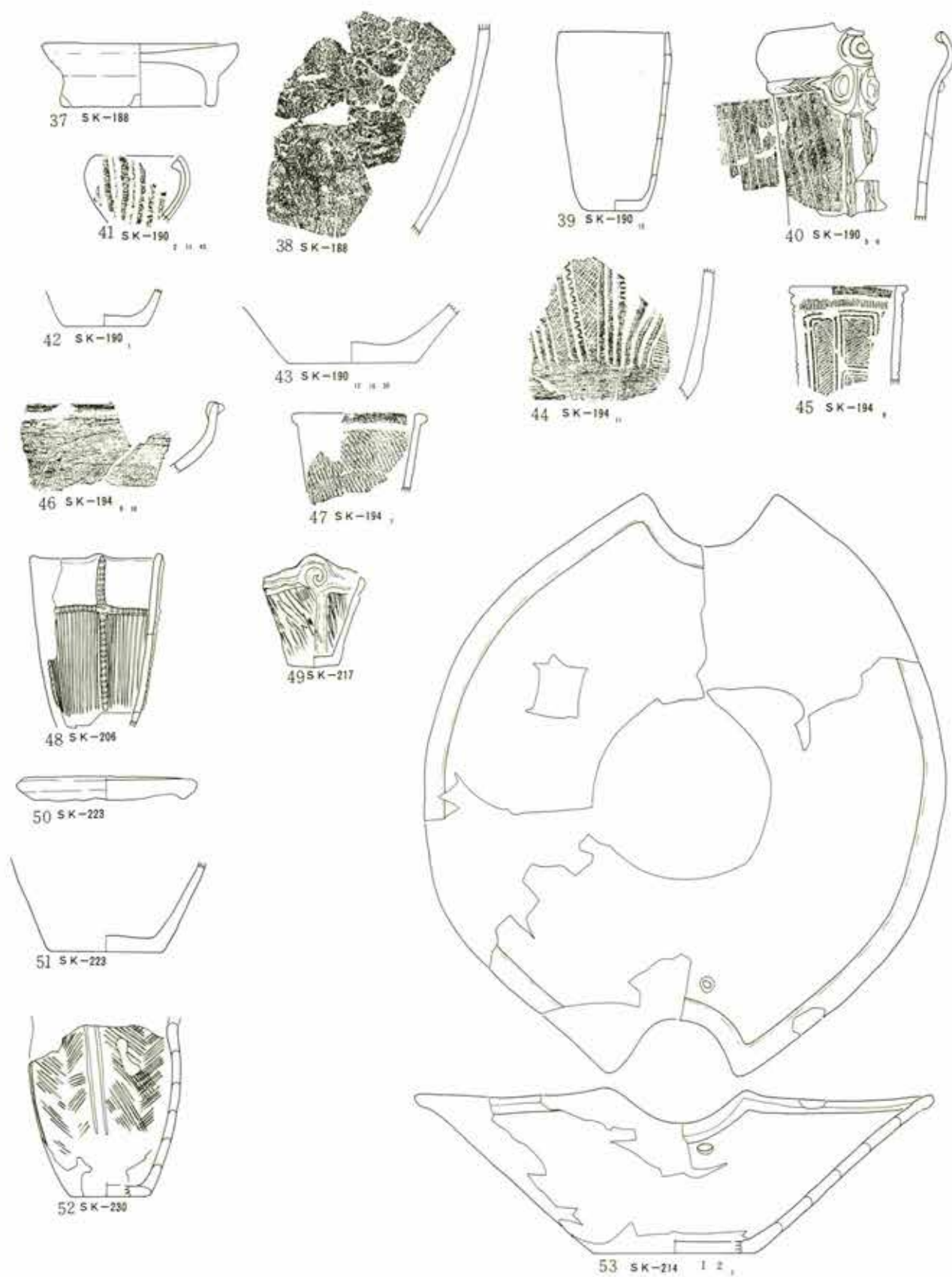

第 190 图 积迦堂 S-III 区 SK-188-190-194-206-217-223-230-214
出土土器 (5)



54 SK-256₁



55 SK-256₂



56 SK-259₁

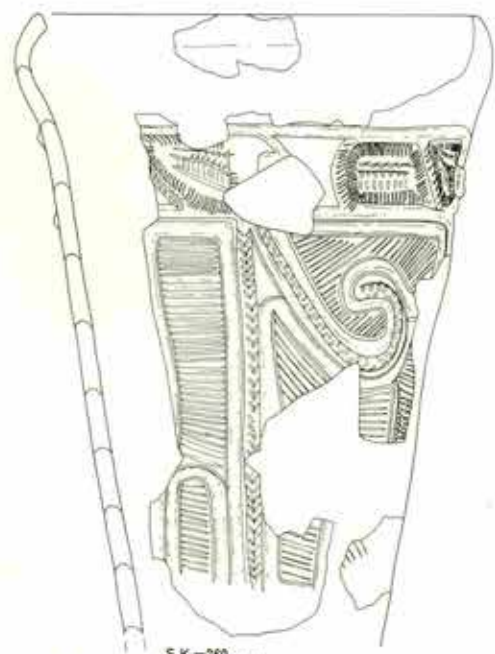

57 SK-260₁ 11
SK-275₁ 11
SK-289₁ 11

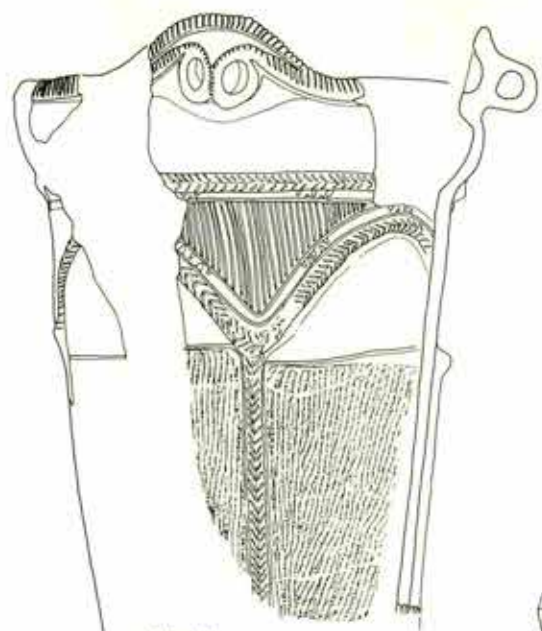

58 SK-260₁ 11 11 11
SK-289₁ 11 11



59 SK-266₁ 11 11 11 11



60 SK-266₂



61 SK-266₃ 11 11 11 11



62 SK-266₄



63 SK-267₁



64 SK-267₂



65 SK-276₁



66 SK-276₂

第191图 积迦堂S-III区 SK-256 -259 -260 -275 -289 -266 -267 -276
出土土器 (6)

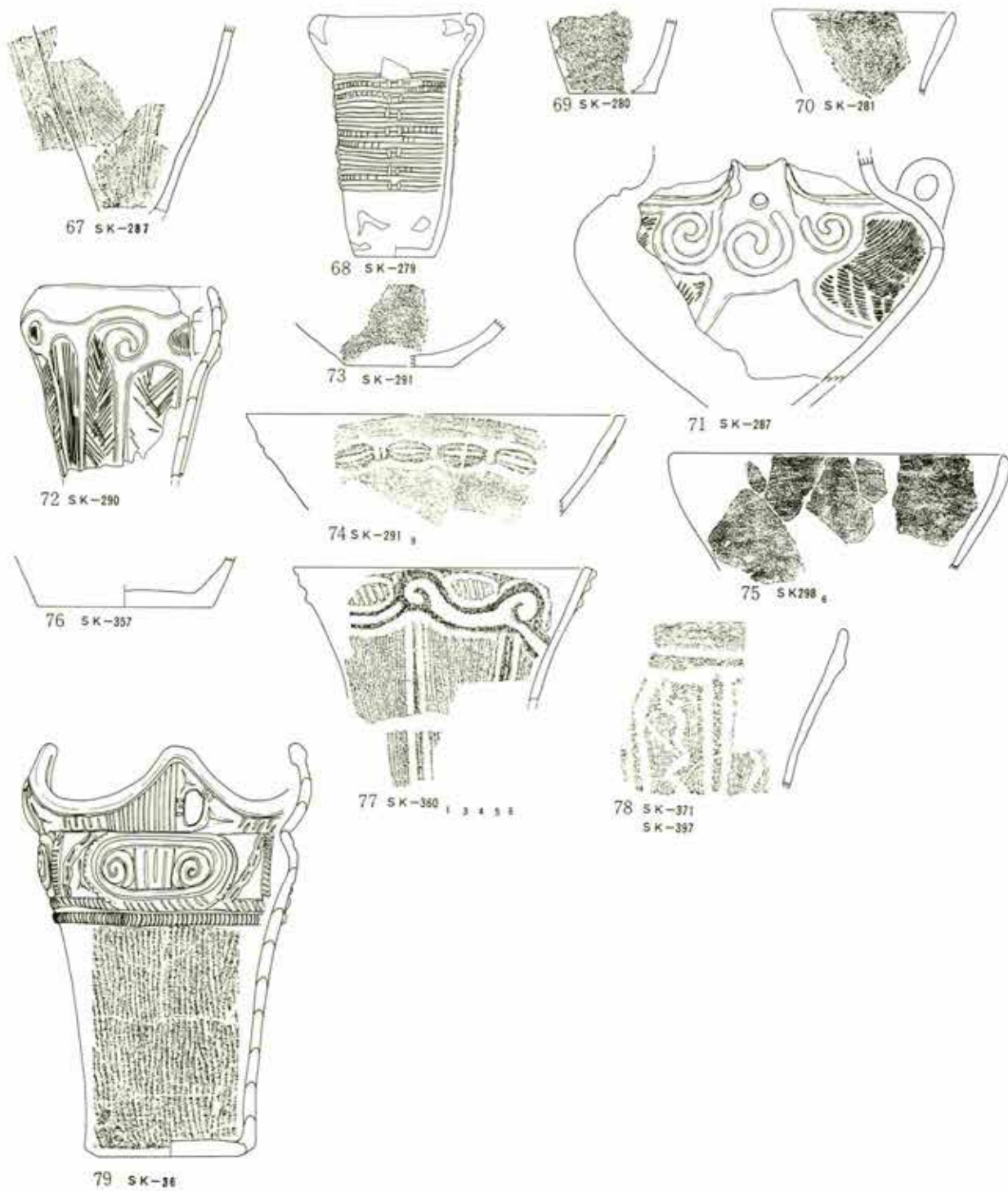

第192图 积迦堂S-III区 SK-287 -279 -280 -281 -287 -290 -291 -298
-357 -360 -371 -397 出土土器 SK-36 (7)

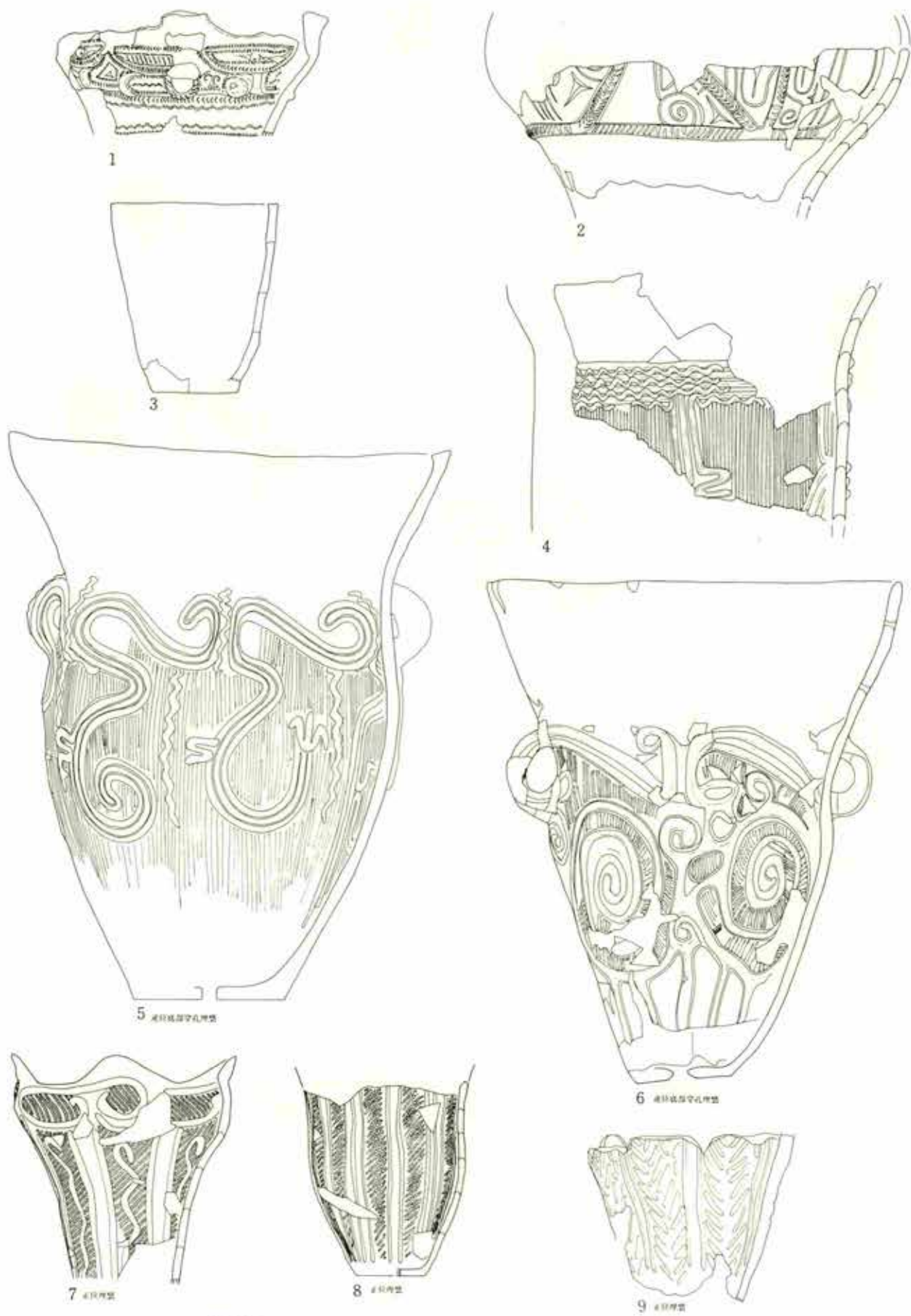

第 193 图 积逊堂 S-III 区 埋藏

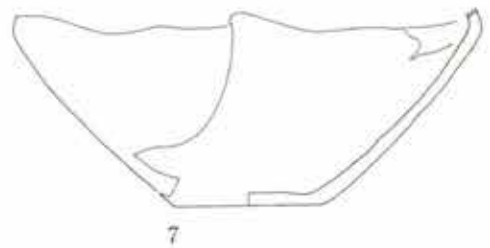
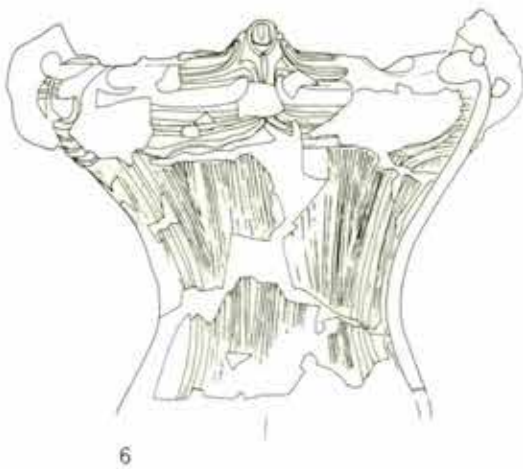
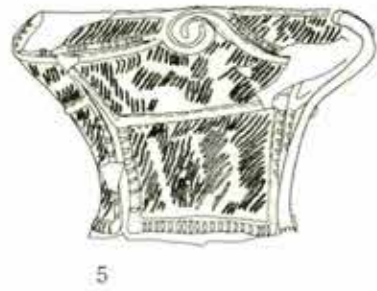
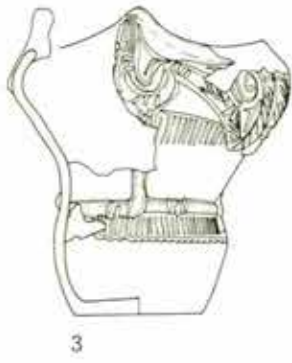
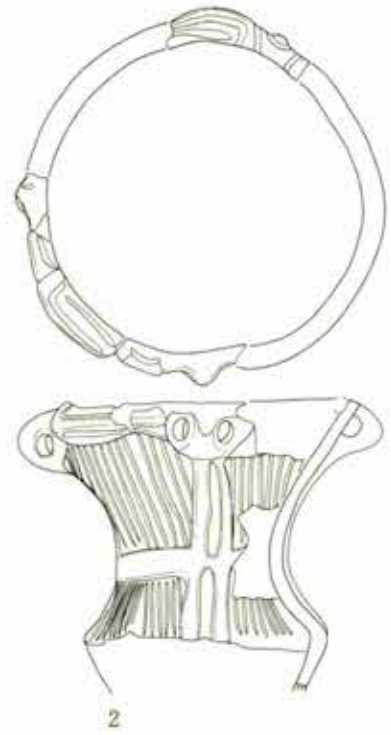
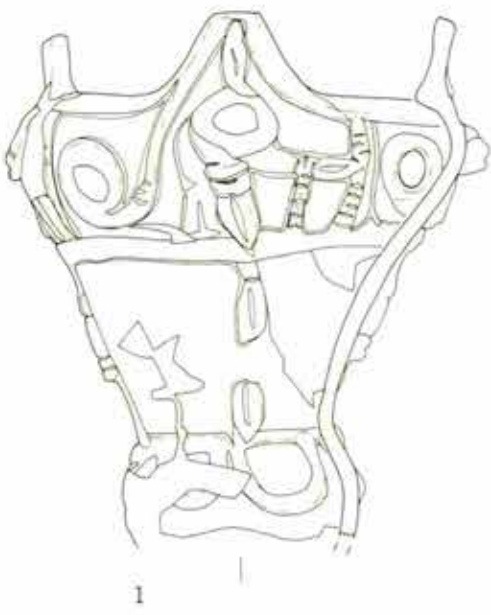

第 194 図 积迦堂 S-III 区 土器すてば A 出土土器 (1)

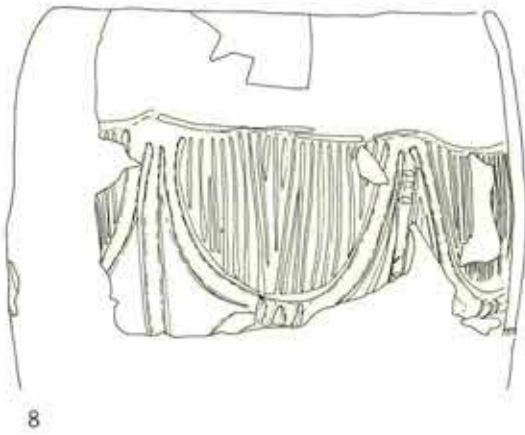

8

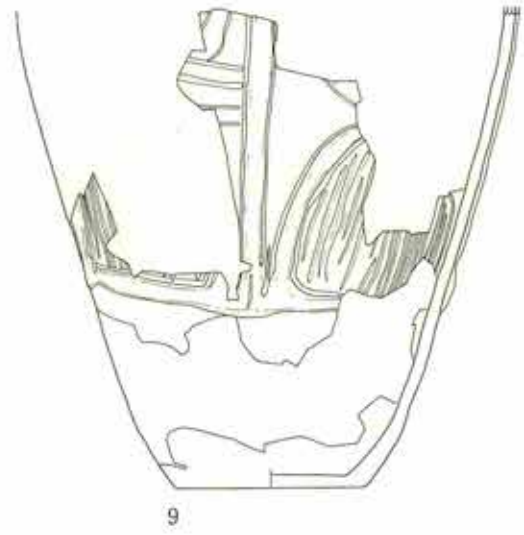

9



10

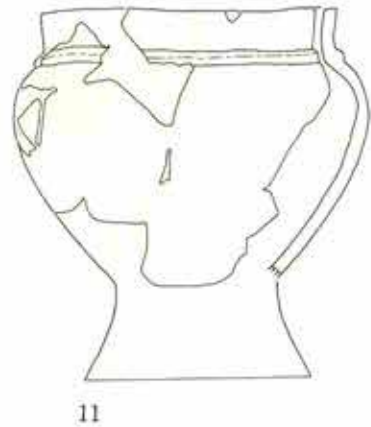

11

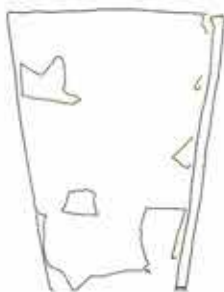

12

第195図 釈迦堂S-III区 土器すてばA 出土土器(2)

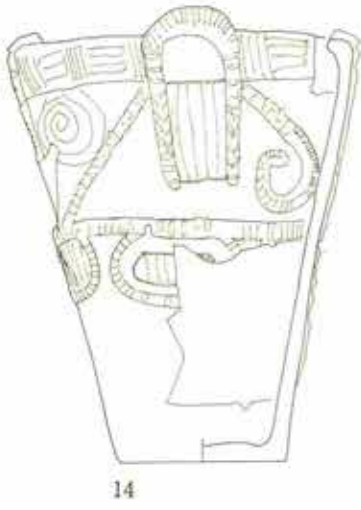
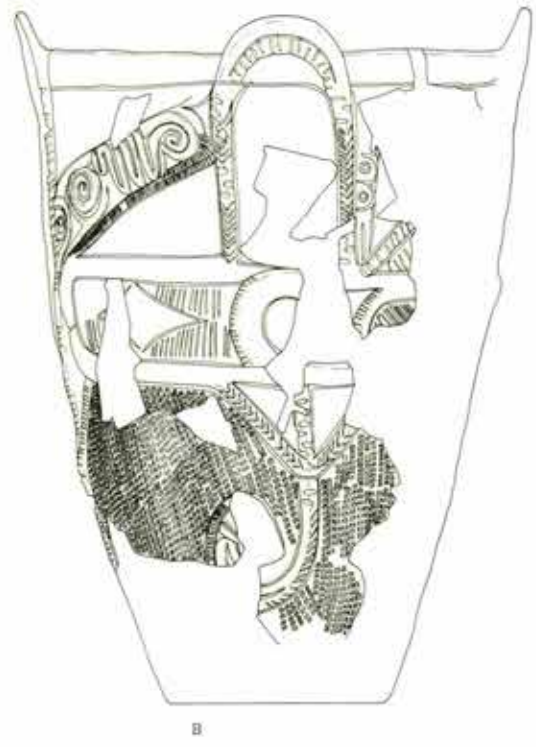
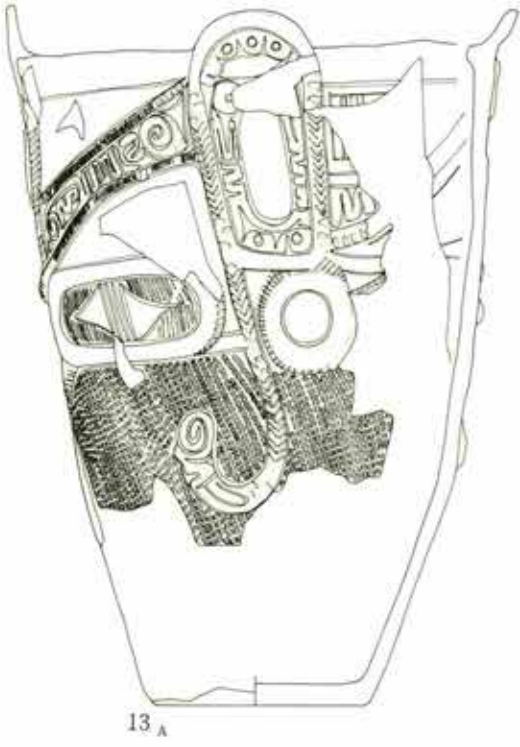

第 196 図 釈迦堂 S-III 区 土器すてば A 出土土器 (3)

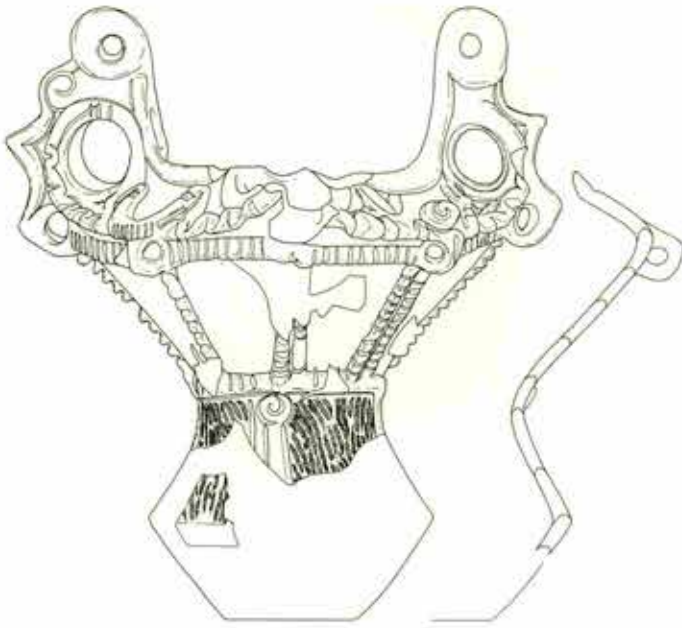

16

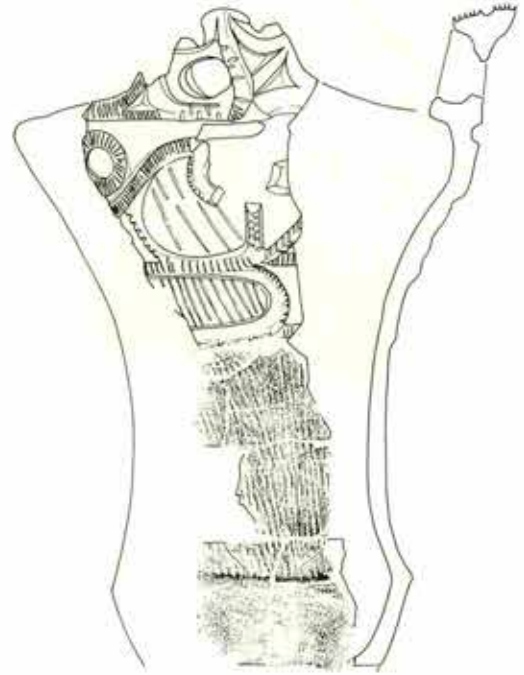

17

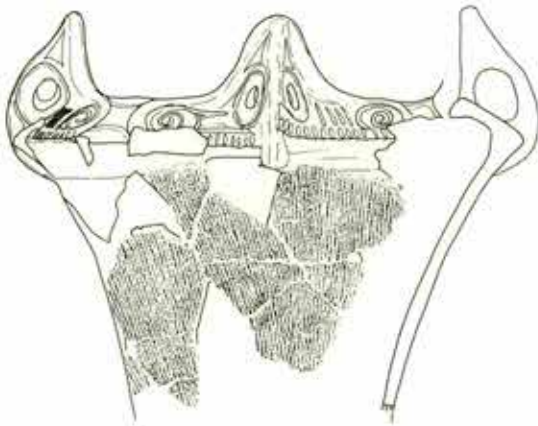

18

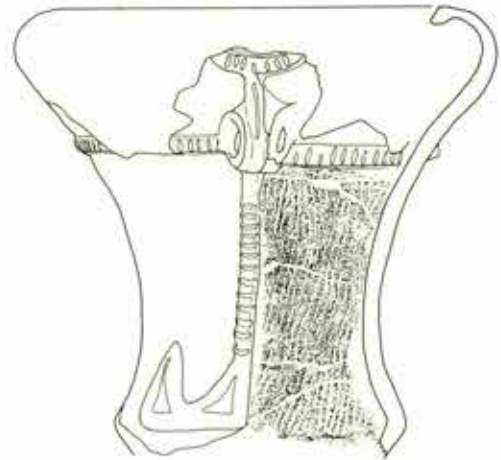

19



20

第197図 釈迦堂S-III区 土器すてば A 出土土器(4)



21



22



23

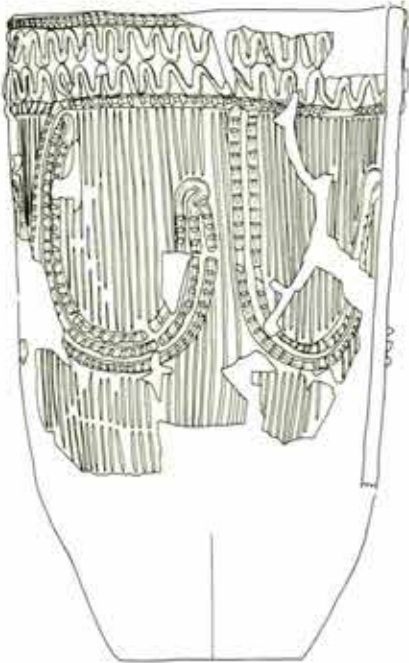

24

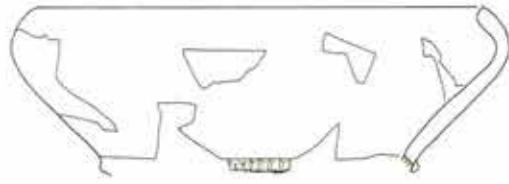

25

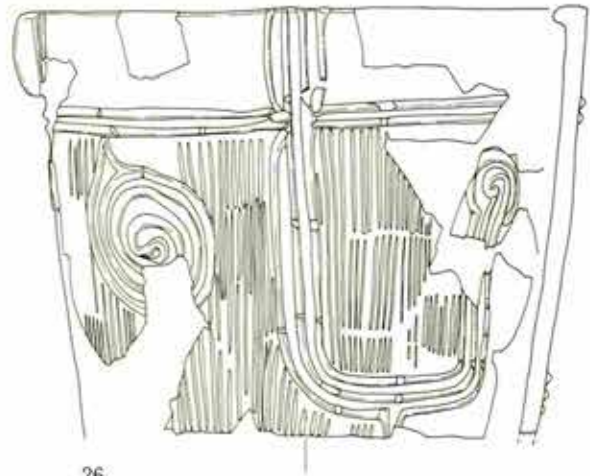

26



27



28

第198図 釈迦堂S-III区 土器すてばA 出土土器(5)



29



30



31



32



33

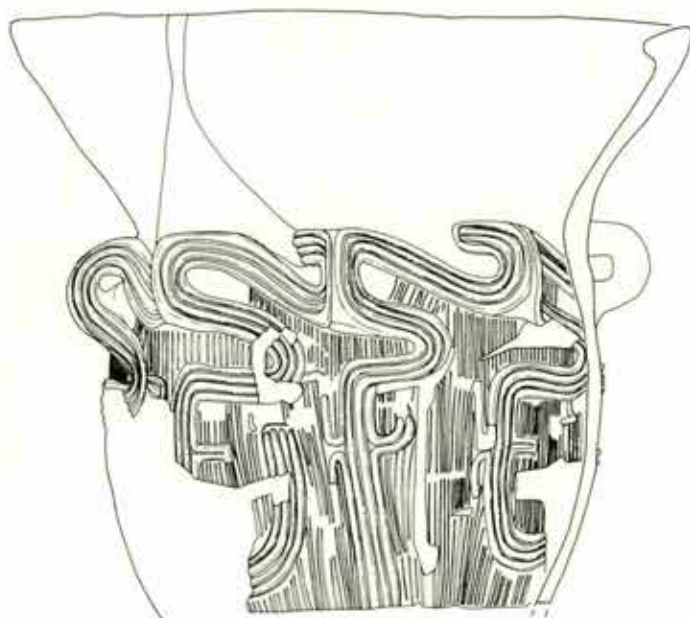

34



35



36



37

第199図 釈迦堂S-III区 土器すてばA 出土土器 (6)

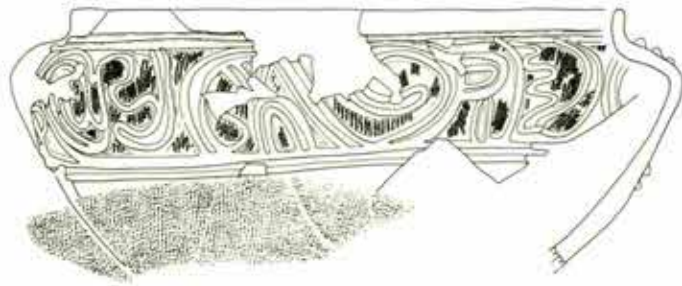

38

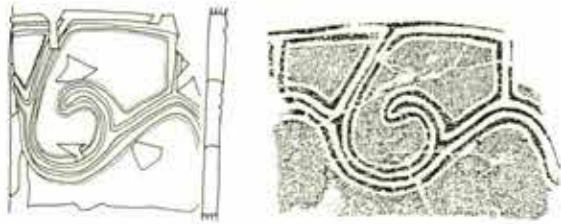

39

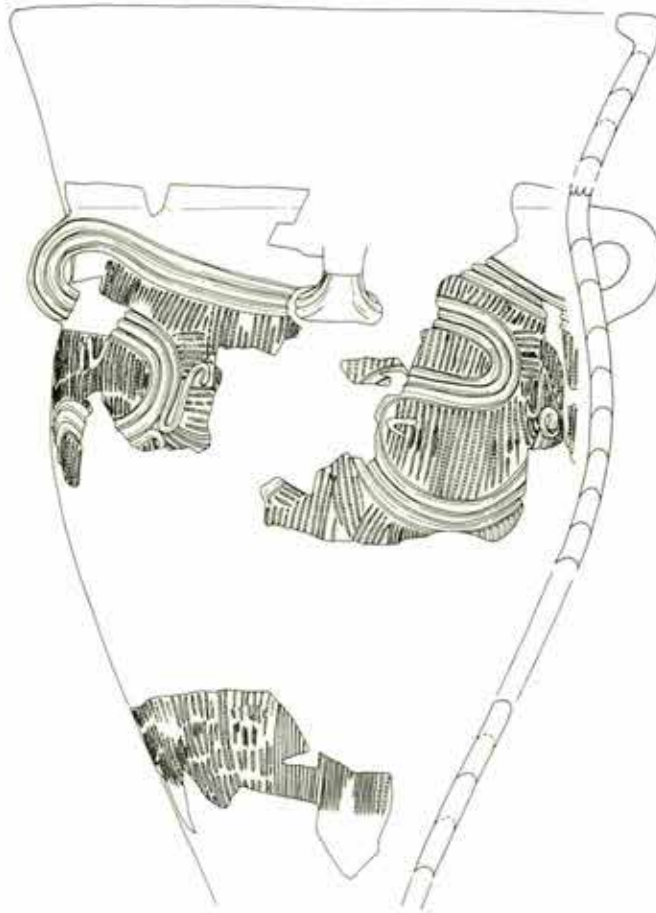

40

第 200 図 釈迦堂 S-III 区 土器すてば A 出土土器 (7)



41

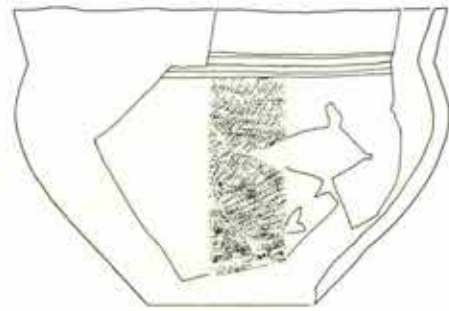

42



43



44



45



46



47



48

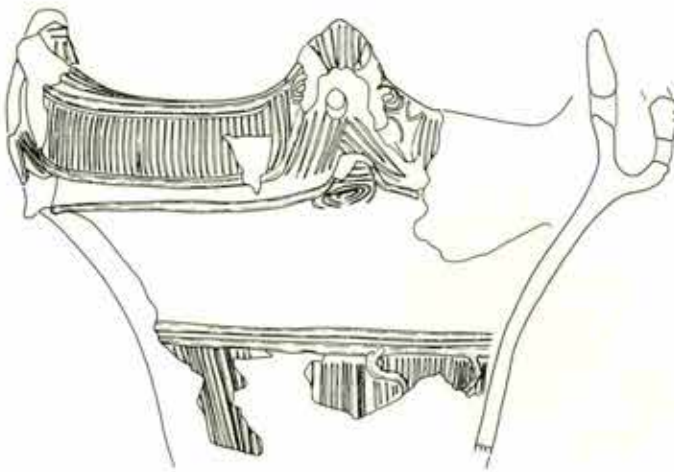

49

第201図 釈迦堂S-III区 土器すてばA 出土土器 (8)

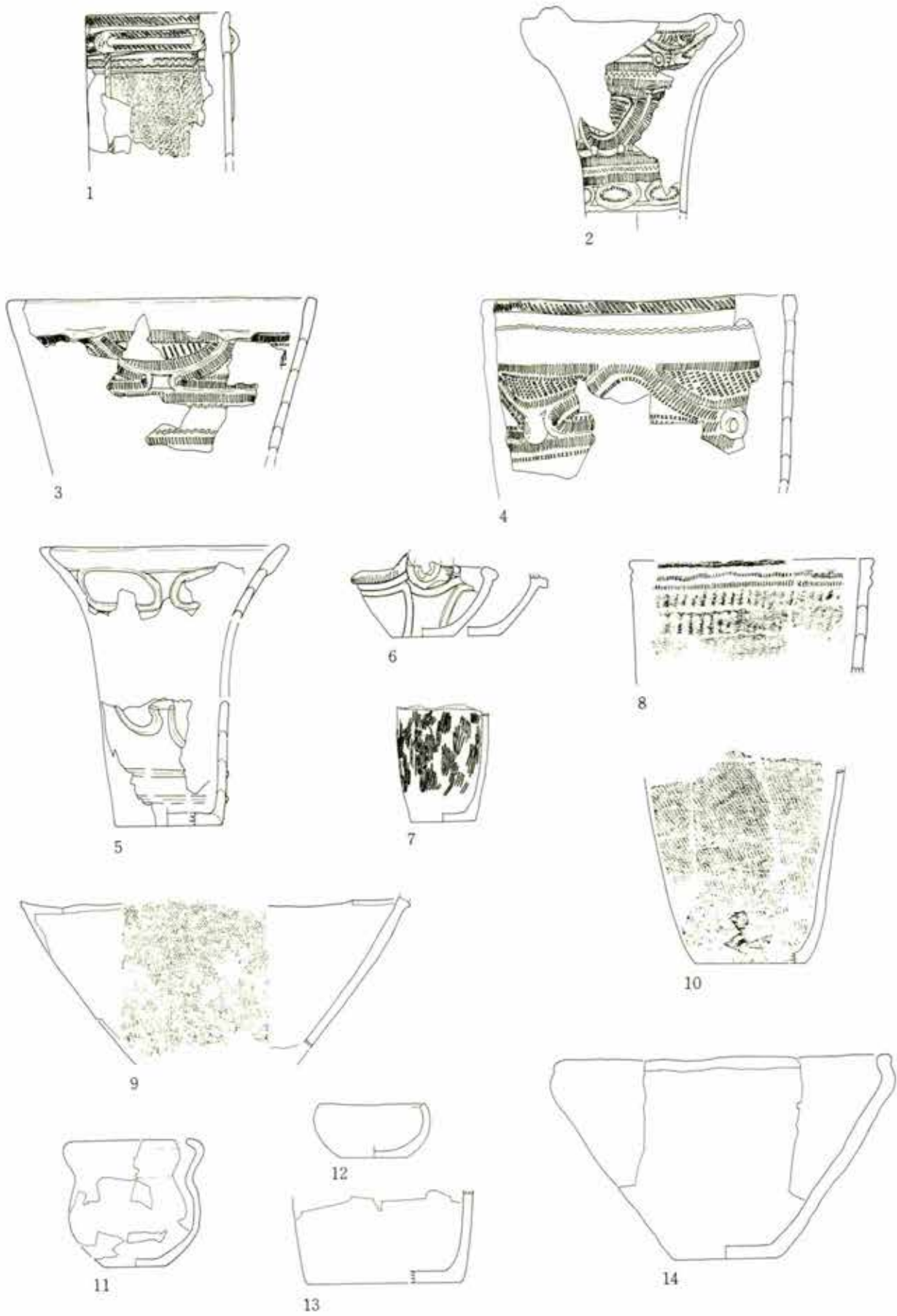

第 202 図 釈迦堂S-III区 グリッド 出土土器 (1)



15

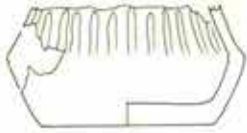

16



17

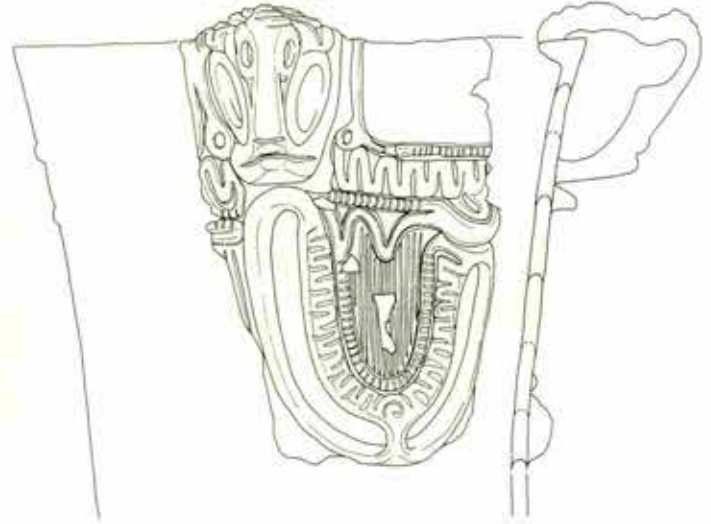

18

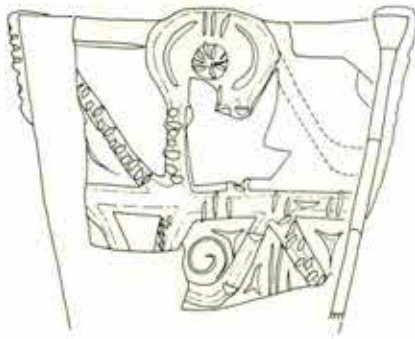

19

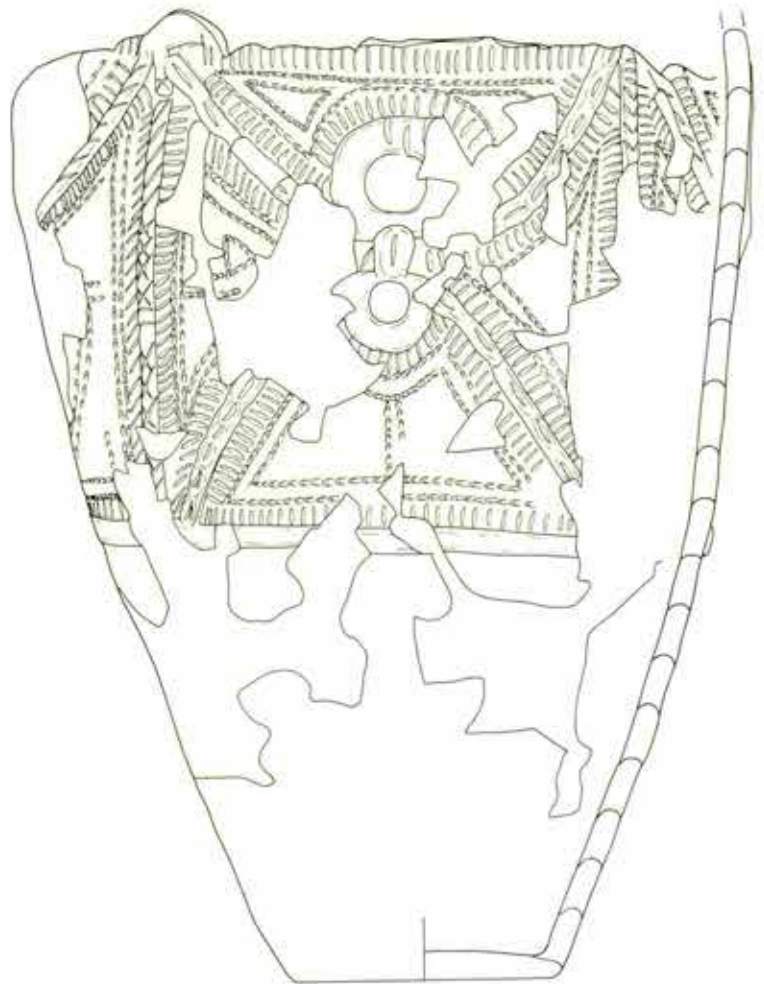

20

第 203 図 釈迦堂 S-III 区 グリッド 出土土器 (2)

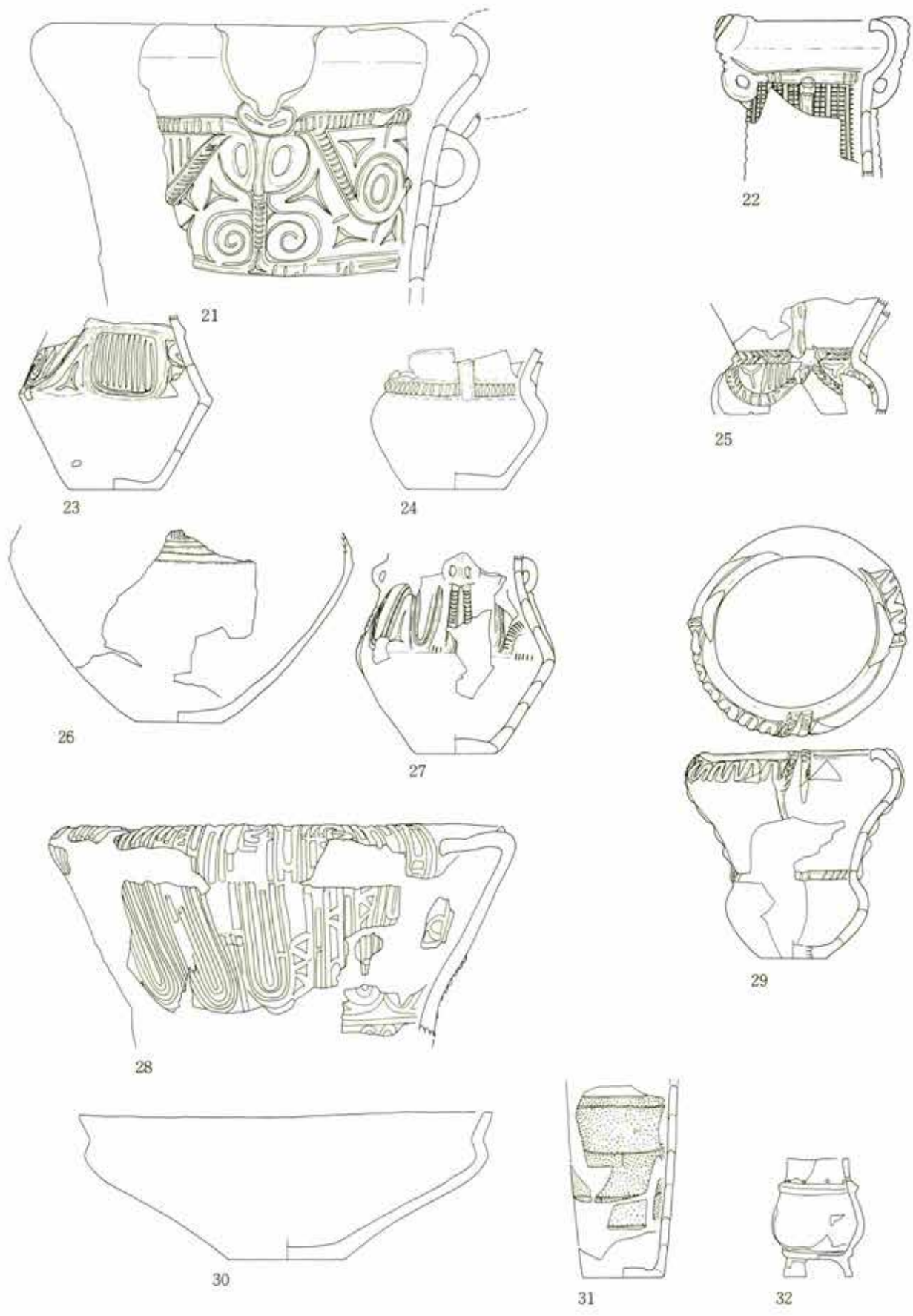

第 204 図 釈迦堂 S-III 区 グリッド 出土土器 (3)

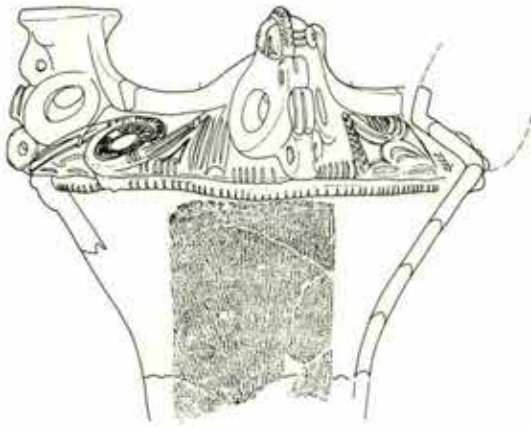

33

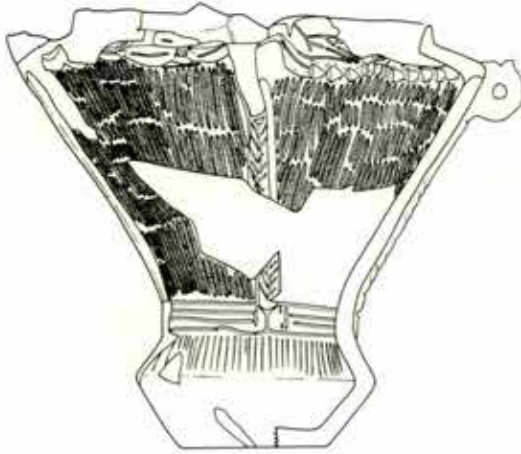
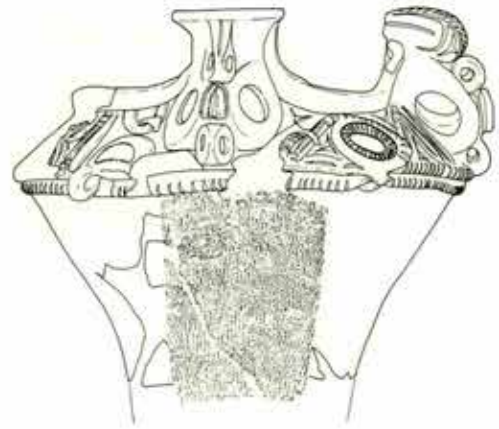

34

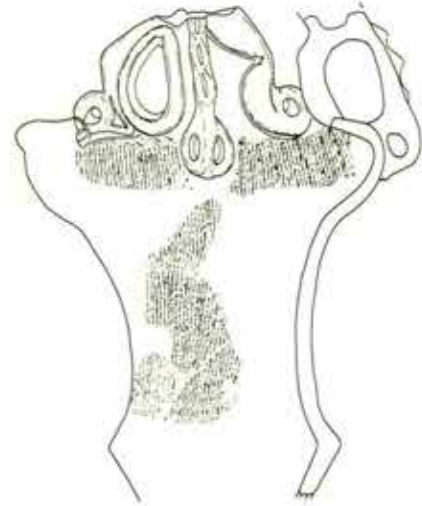

35

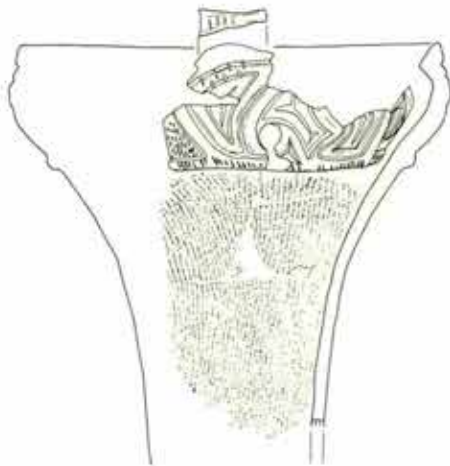

36



37



38

第 205 図 釈迦堂 S-III 区 グリッド 出土土器 (4)



39

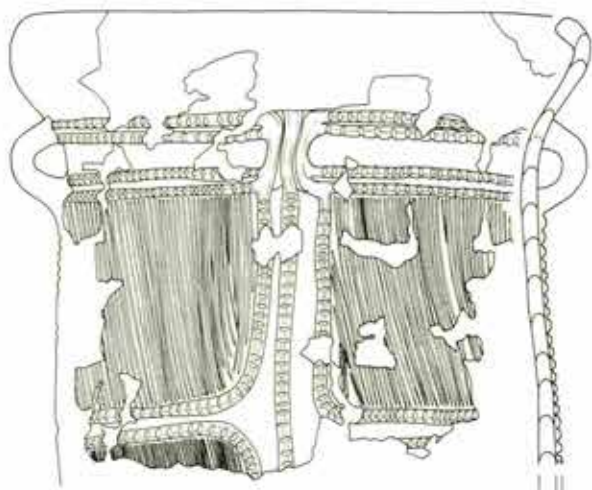

40

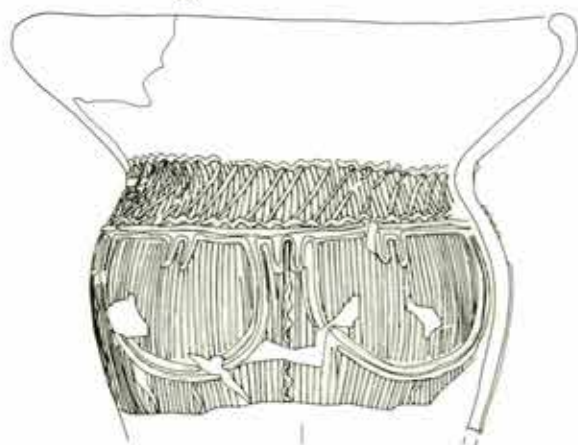

41



42

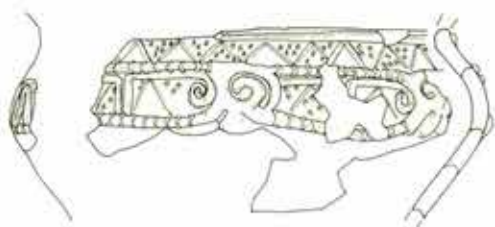

43



45

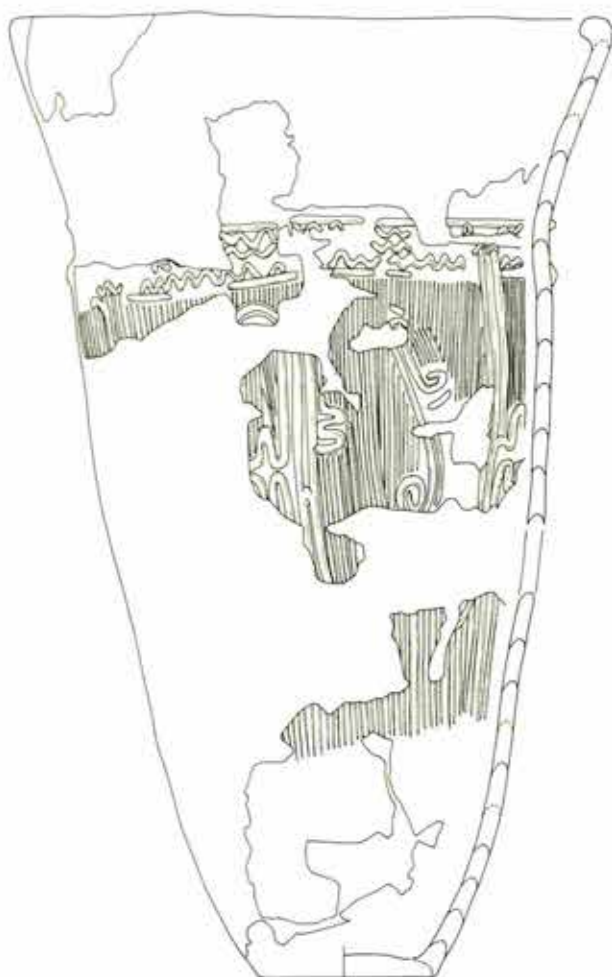

44



(5) 46

第206図 釈迦堂S-III区 グリッド 出土土器



47



48



49



50

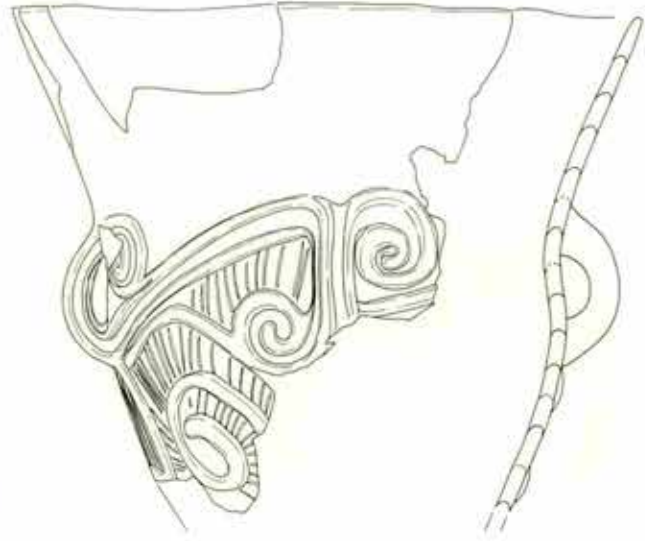

51

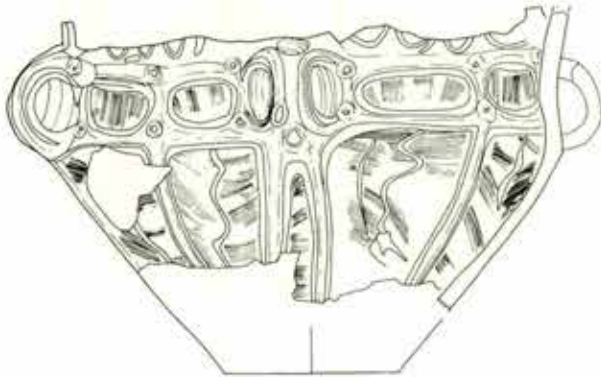

52

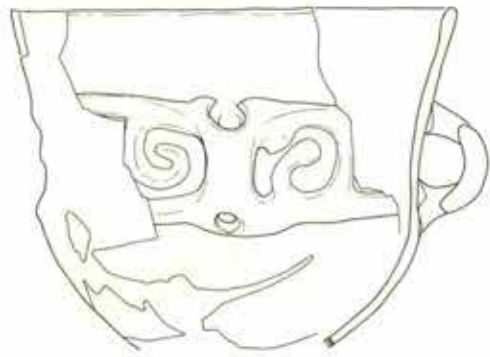

53



54

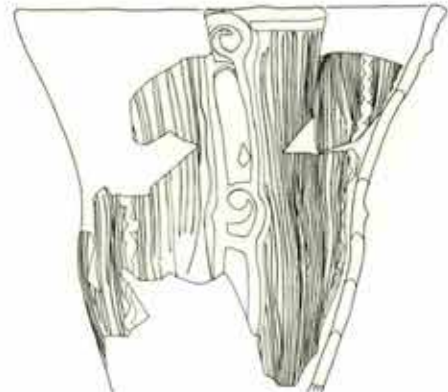

55

第 207 図 釈迦堂 S-III 区 グリッド 出土土器 (6)



第 208 図 釈迦堂 S-III 区 グリッド 出土土器 (7)



71



72

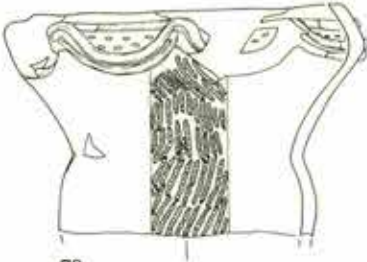

73

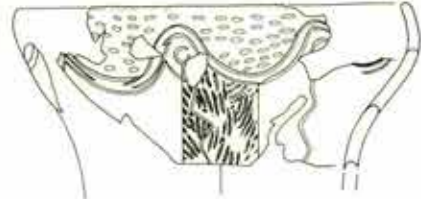

74

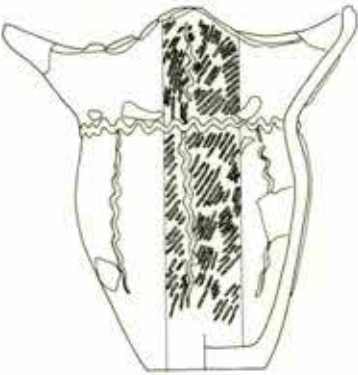

75



76



77



78

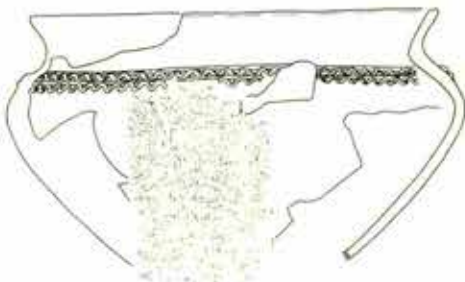

79

第209図 釈迦堂S-III区 グリッド 出土土器 (8)

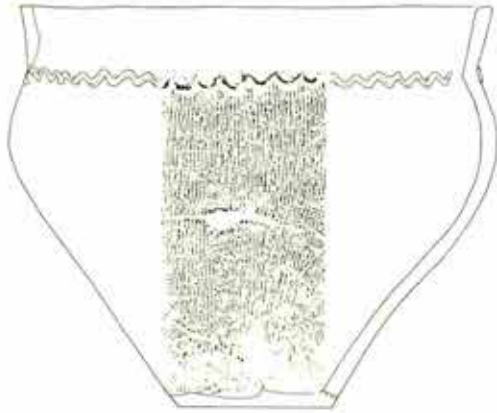

80



81



82



84

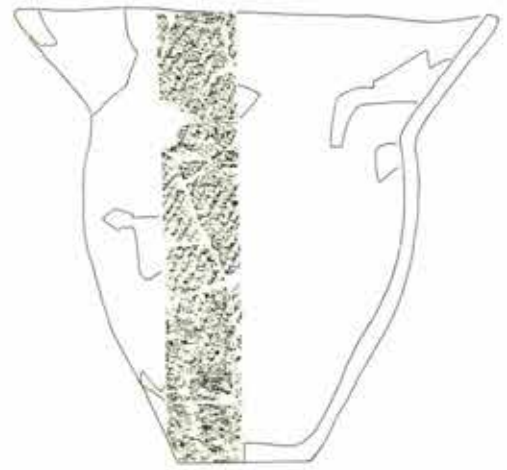

83

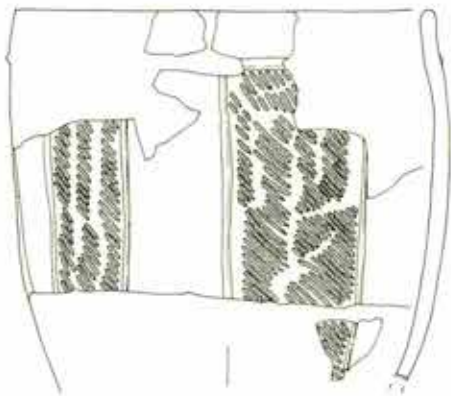

85

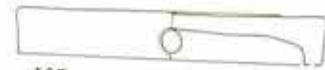

105



106



107

第 210 図 釈迦堂S-III区 グリッド 出土土器 (9)

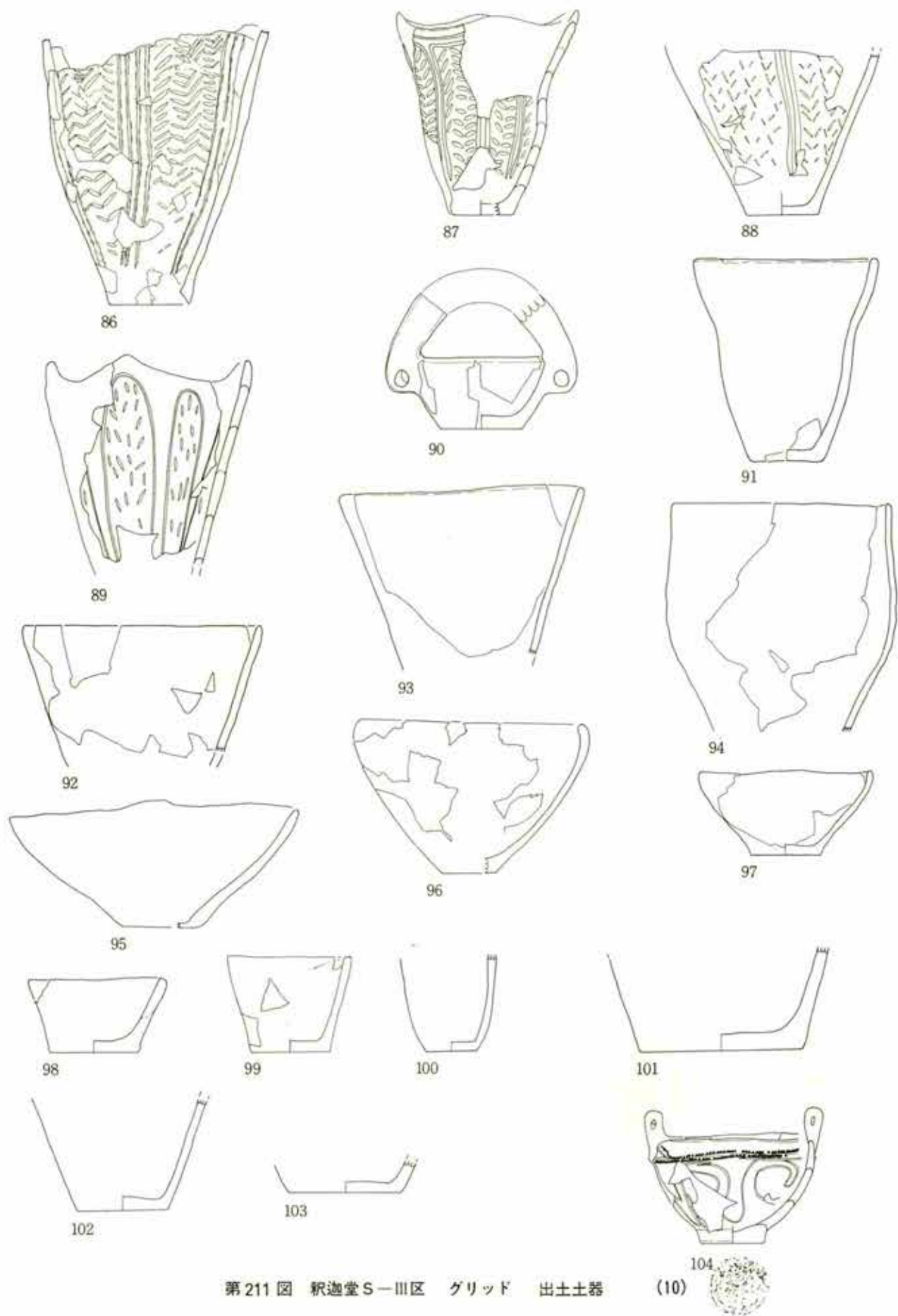

第211図 釈迦堂S-III区 グリッド 出土土器

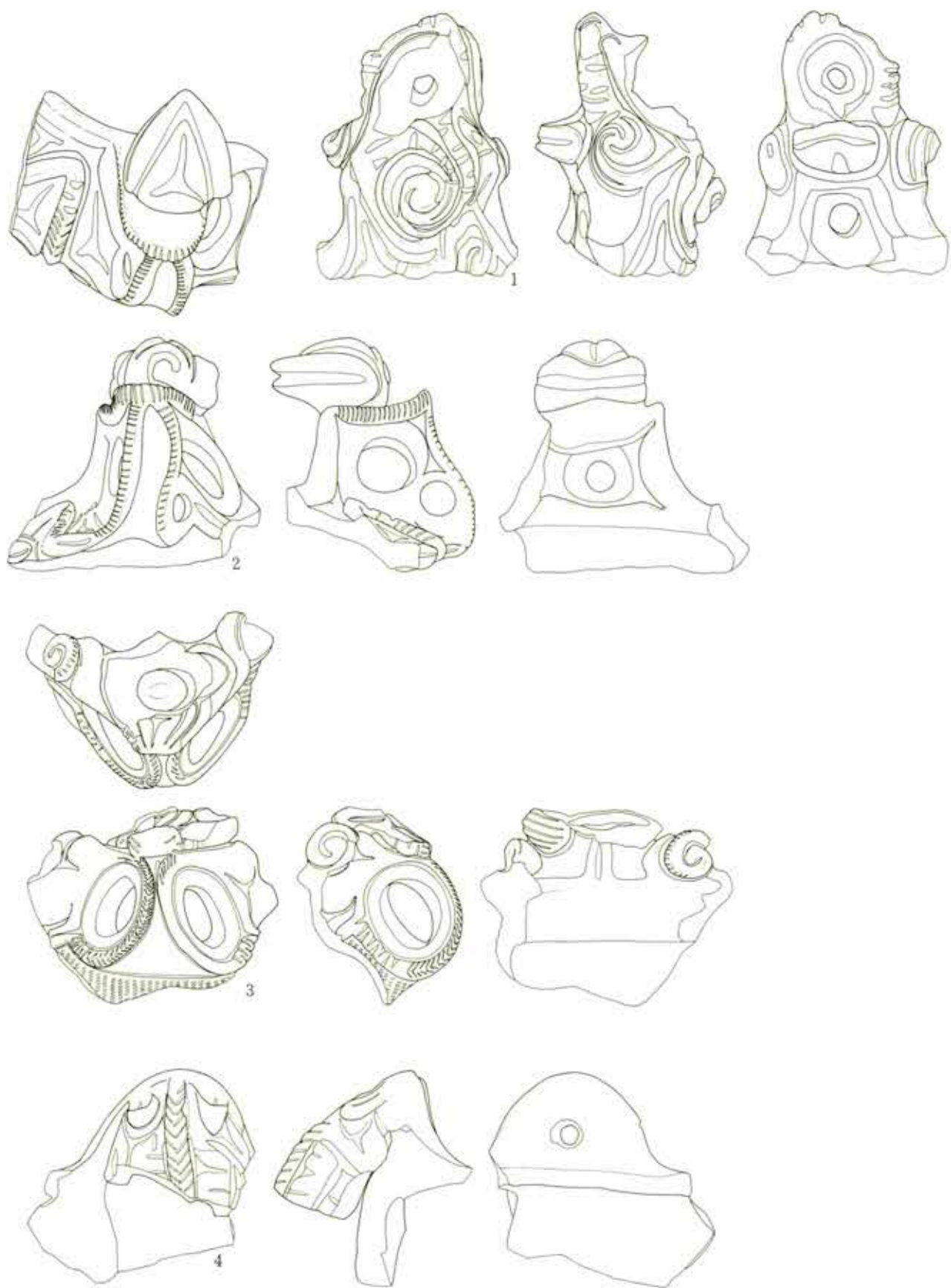

第212图 积逊堂S—III区把手

(1) (1:3)

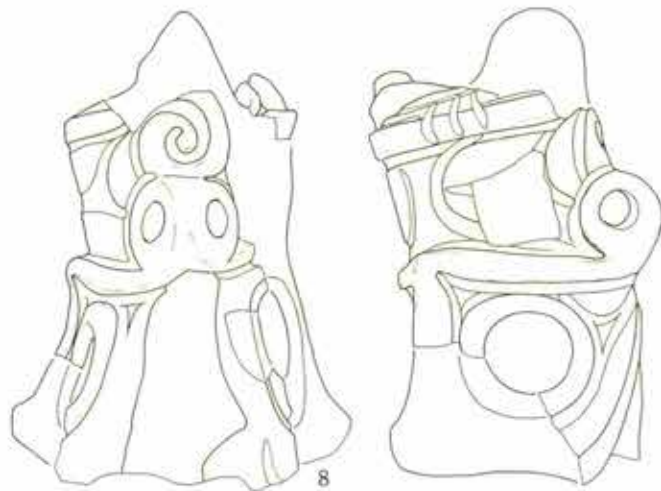
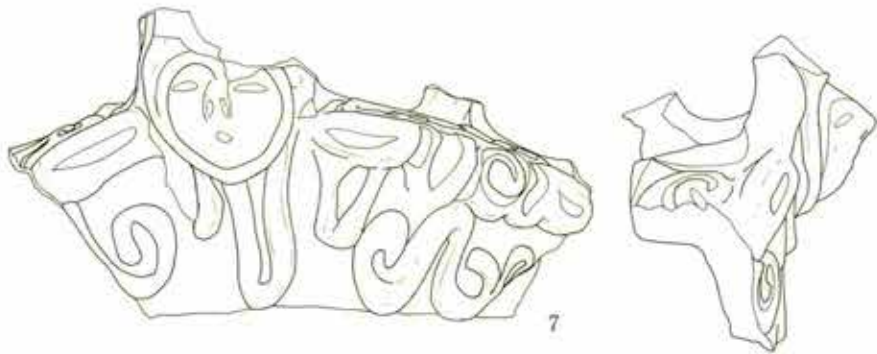
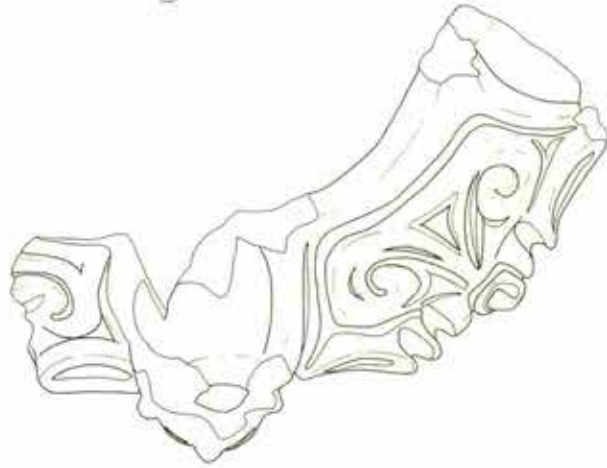
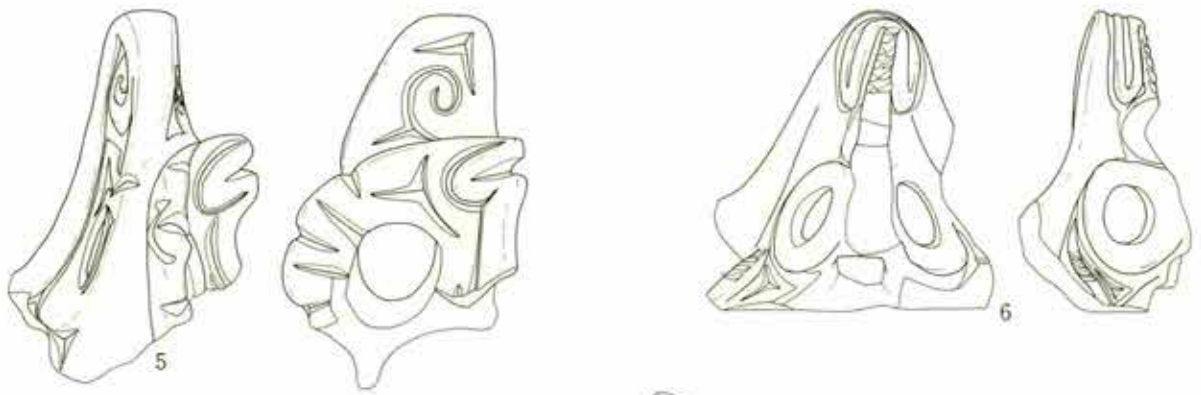

第 213 图 积逊堂 S—III 区把手

(2) (1:3)

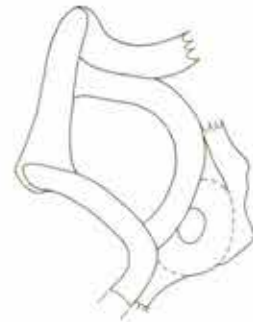
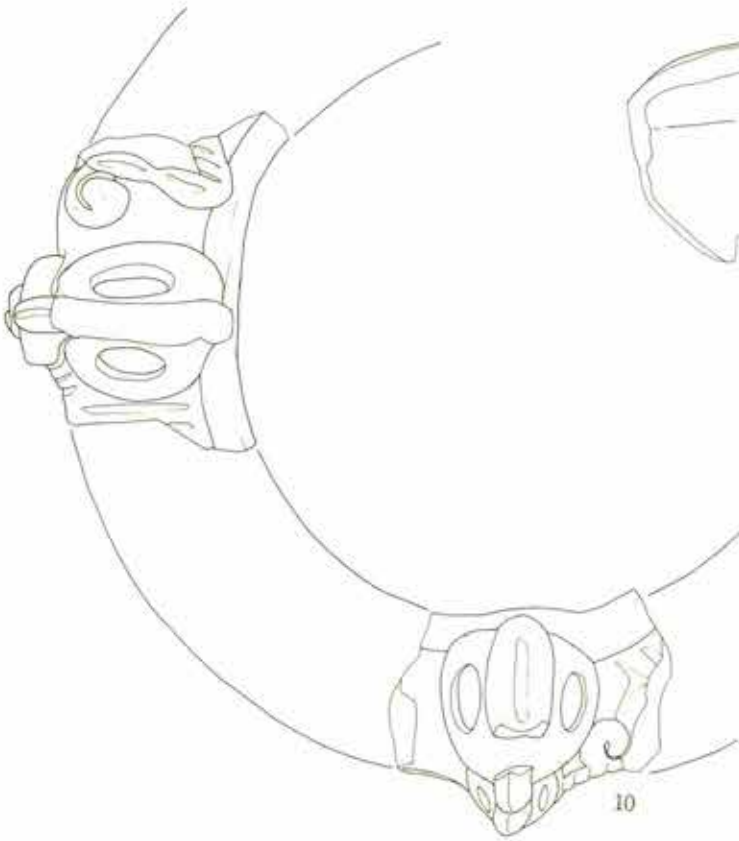
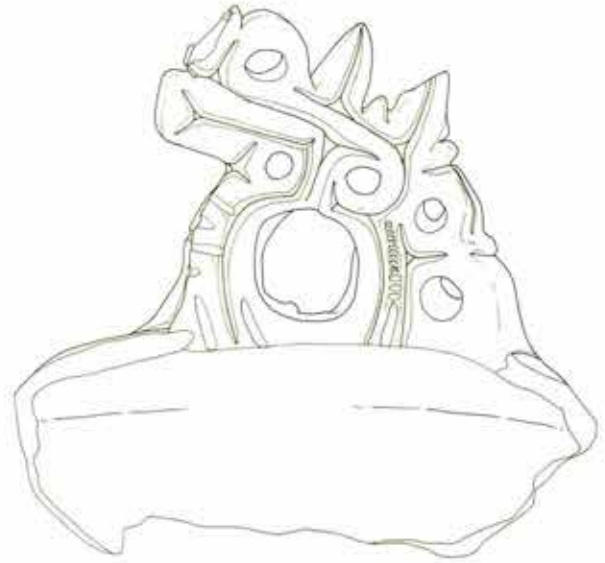
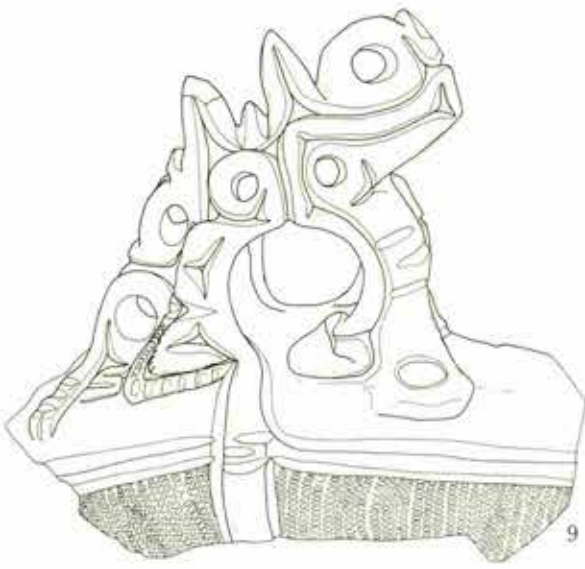

第 214 图 积迦堂 S-III 区 S-IV 区把手

(3) (1:3)

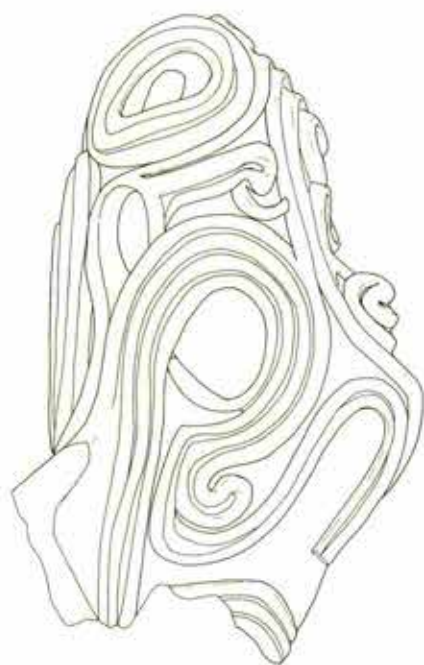
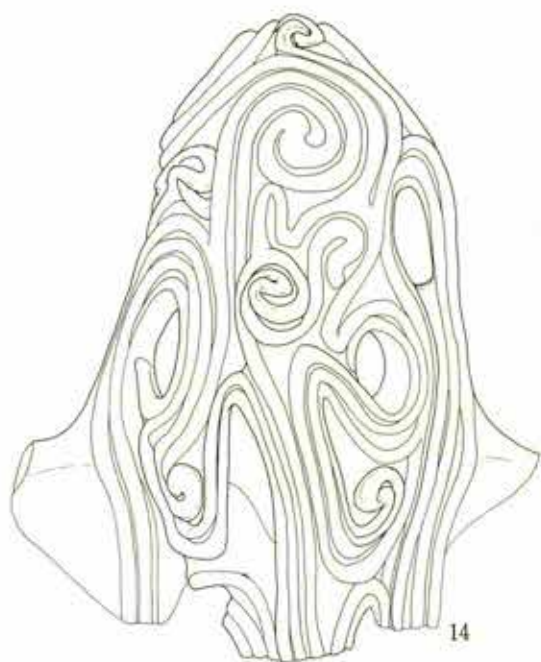
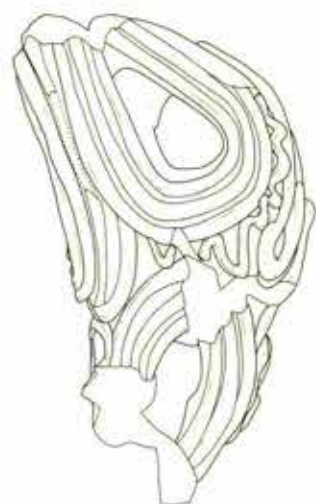
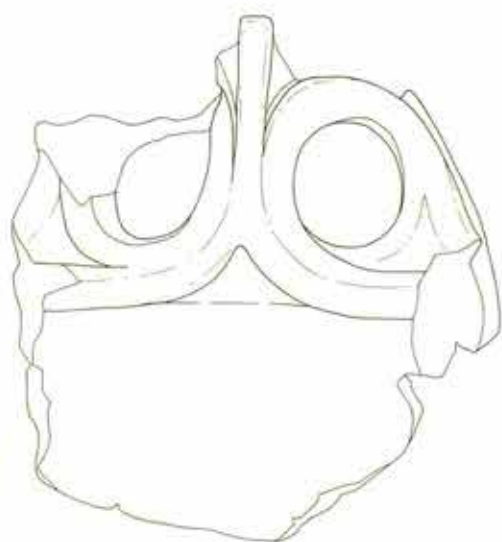
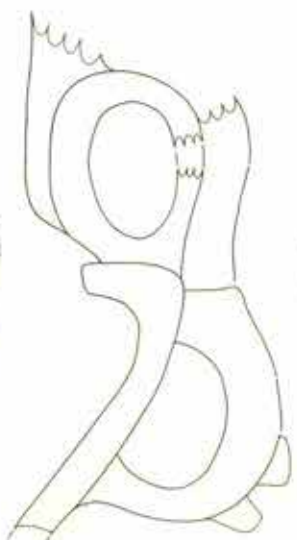

第 215 图 积迦堂 S—III 区把手

(4) (1:3)

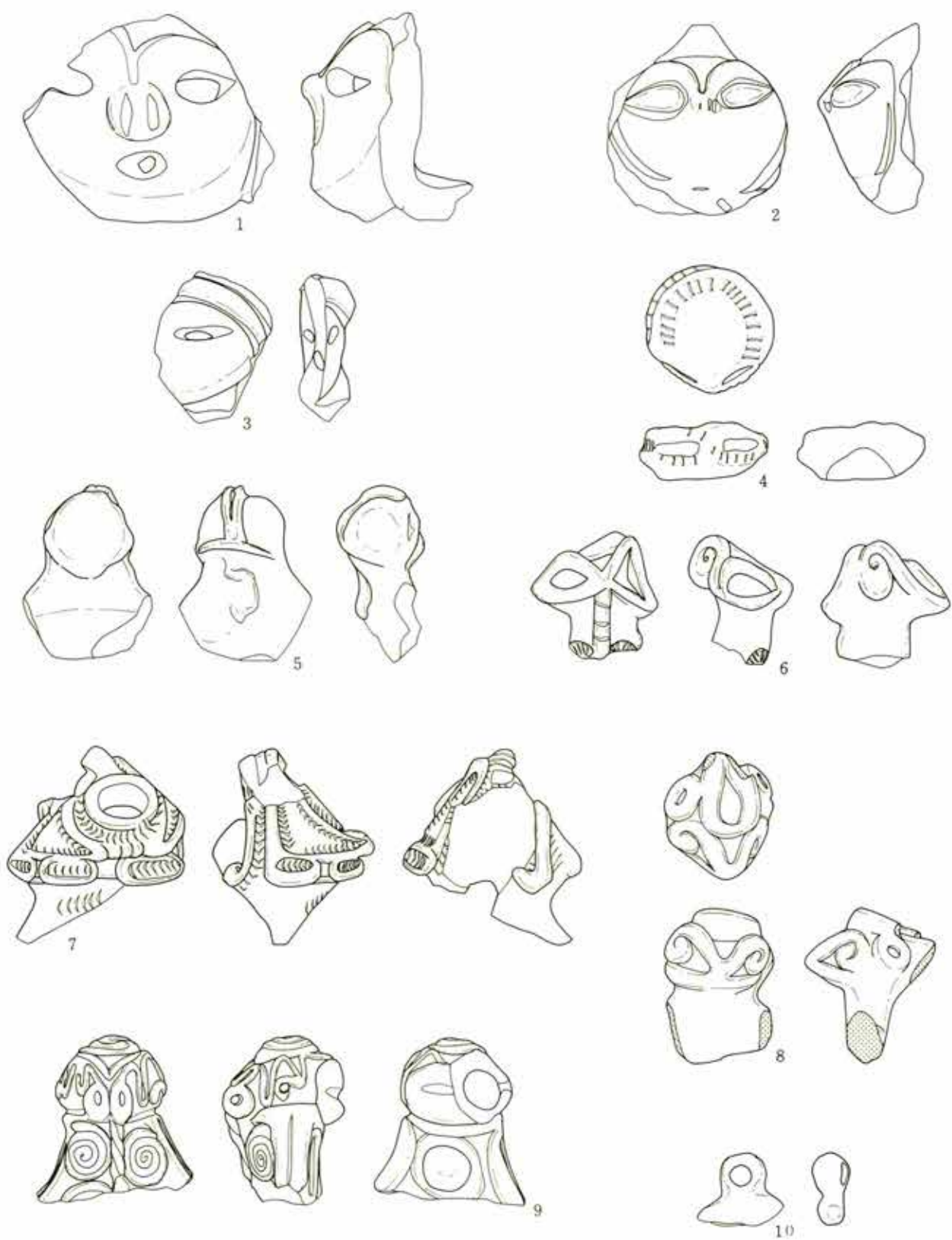

第216图 积逊堂S-III区把手

(5) (1:2)

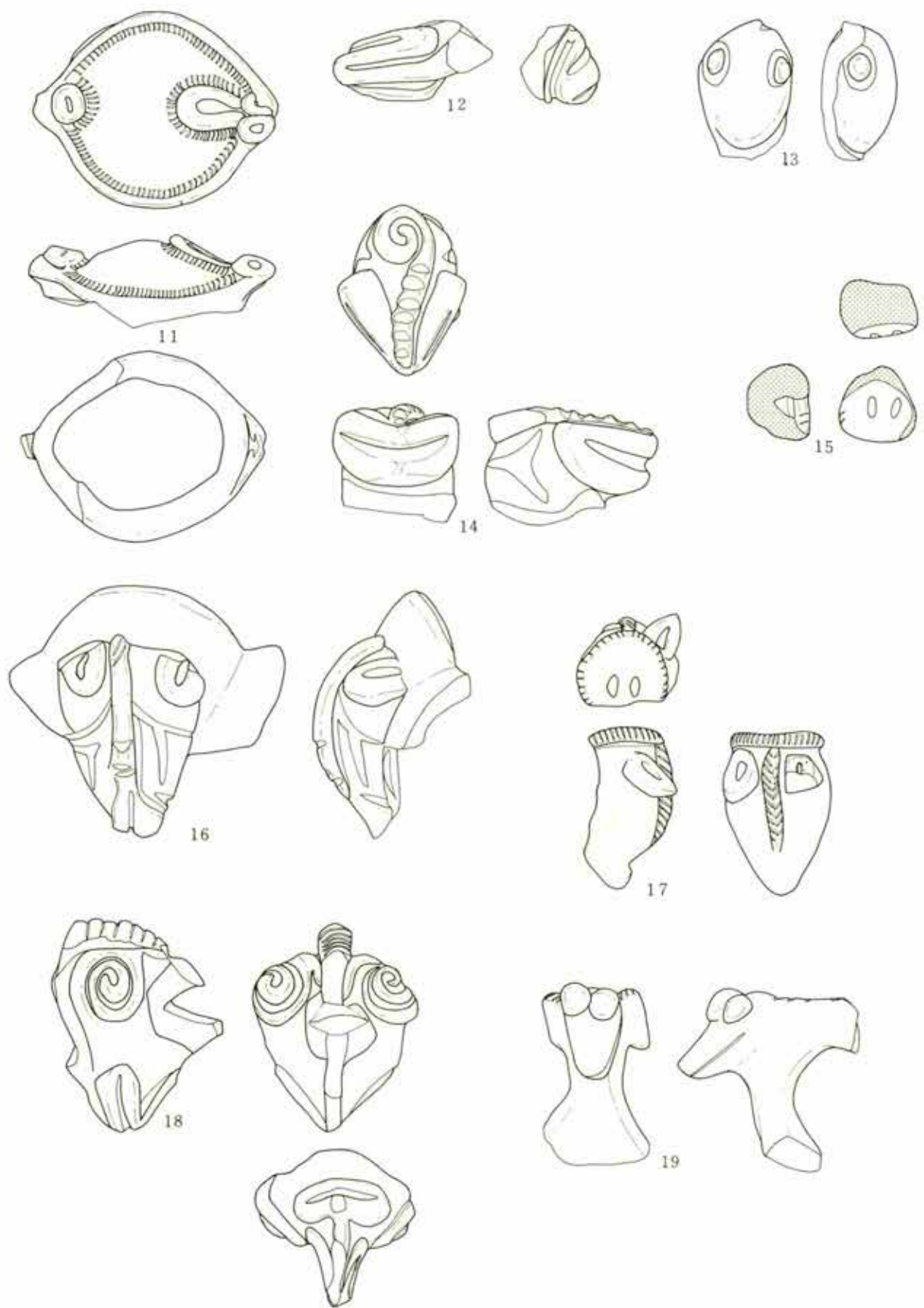

第217图 积迺堂S—III区把手

(6) (1:2)

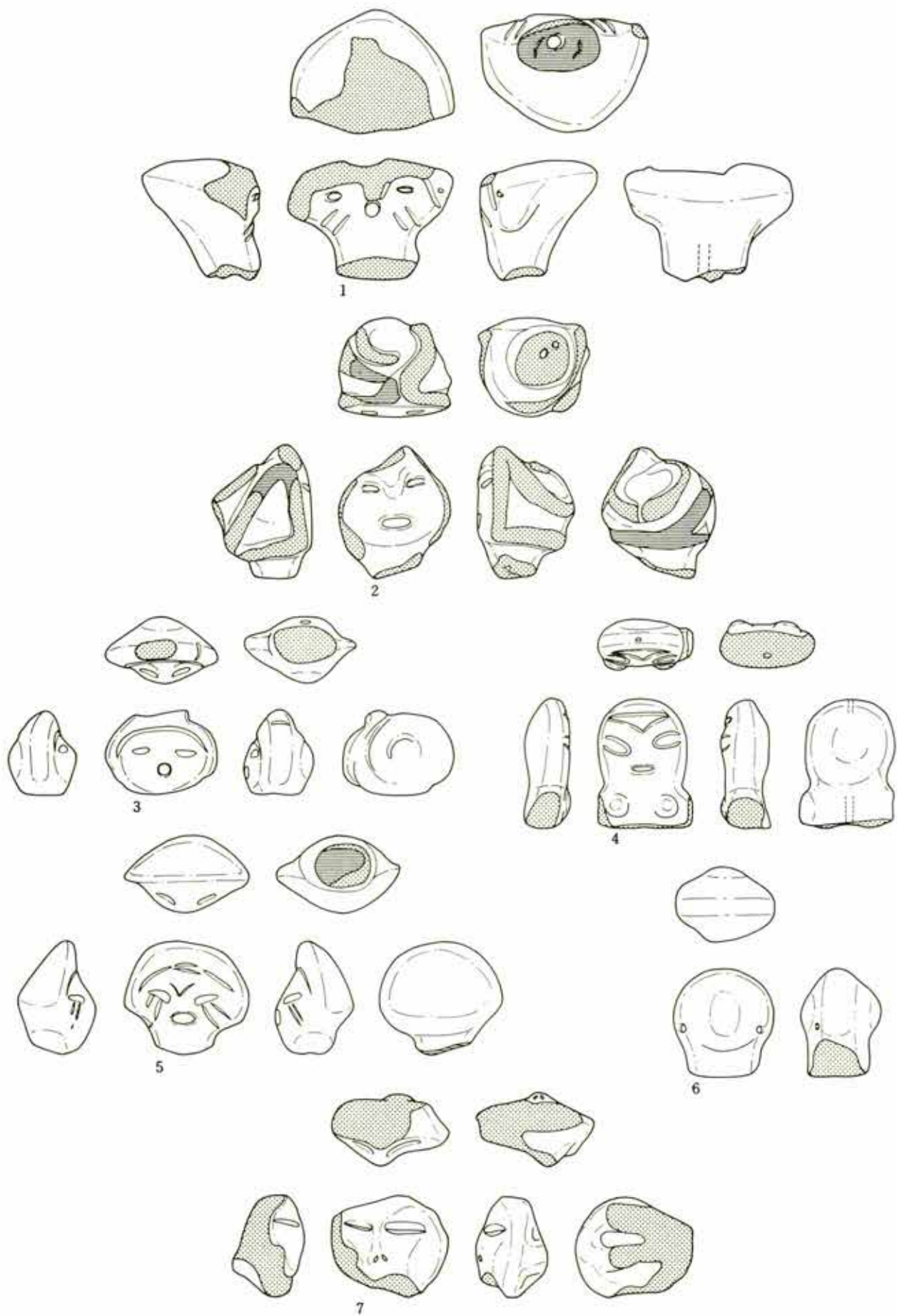

第 218 图 积逊堂 S-III 区 土偶 (1)



第 219 图 积逊堂 S-III 区 土偶 (2)

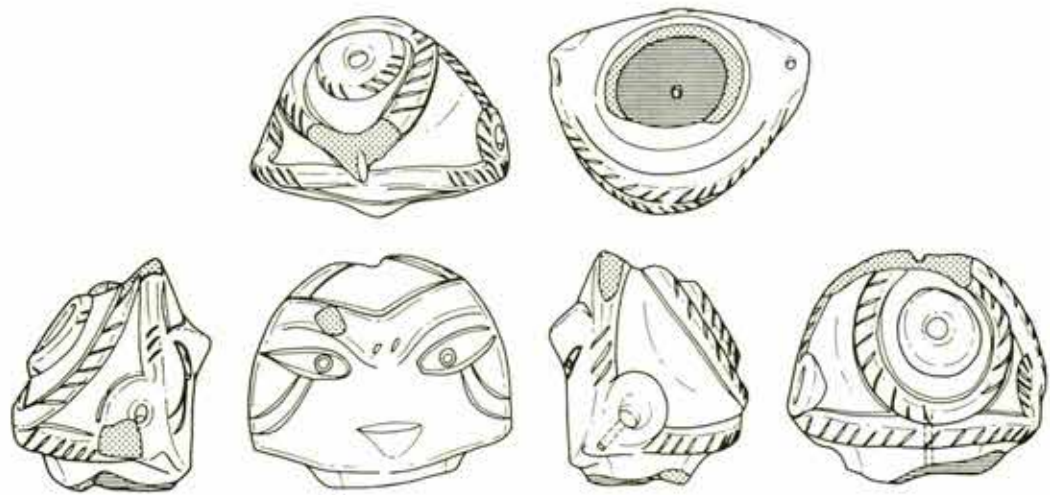

13

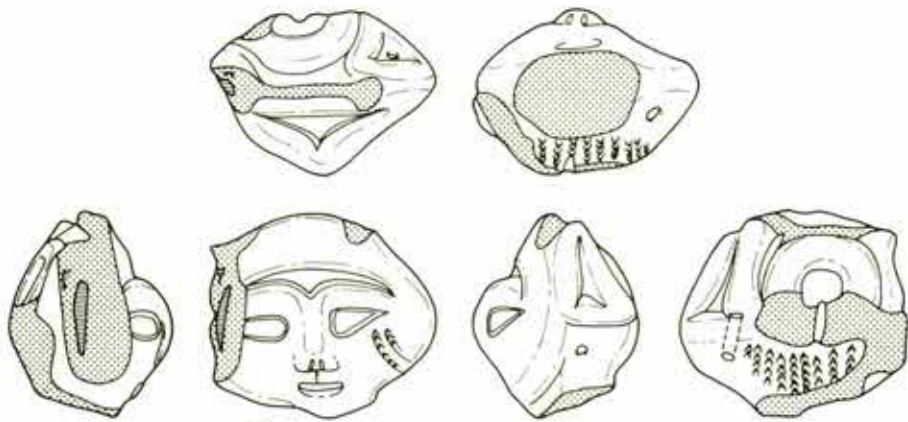

14



15

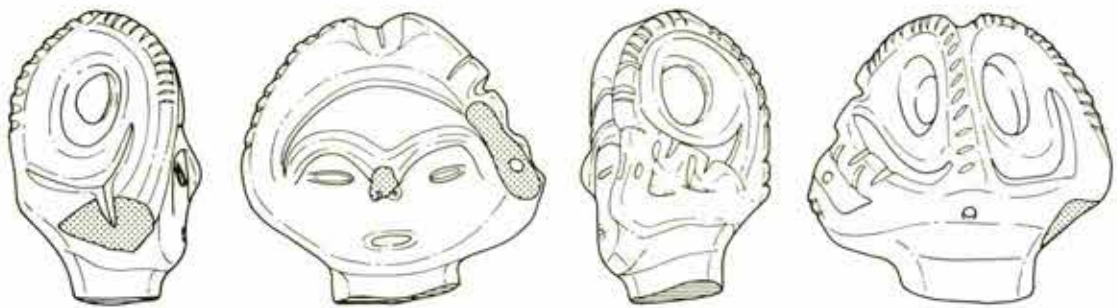

16

第 220 图 积迦堂 S—III 区 土偶 (3)



第 221 图 积逊堂 S—III 区 土偶 (4)

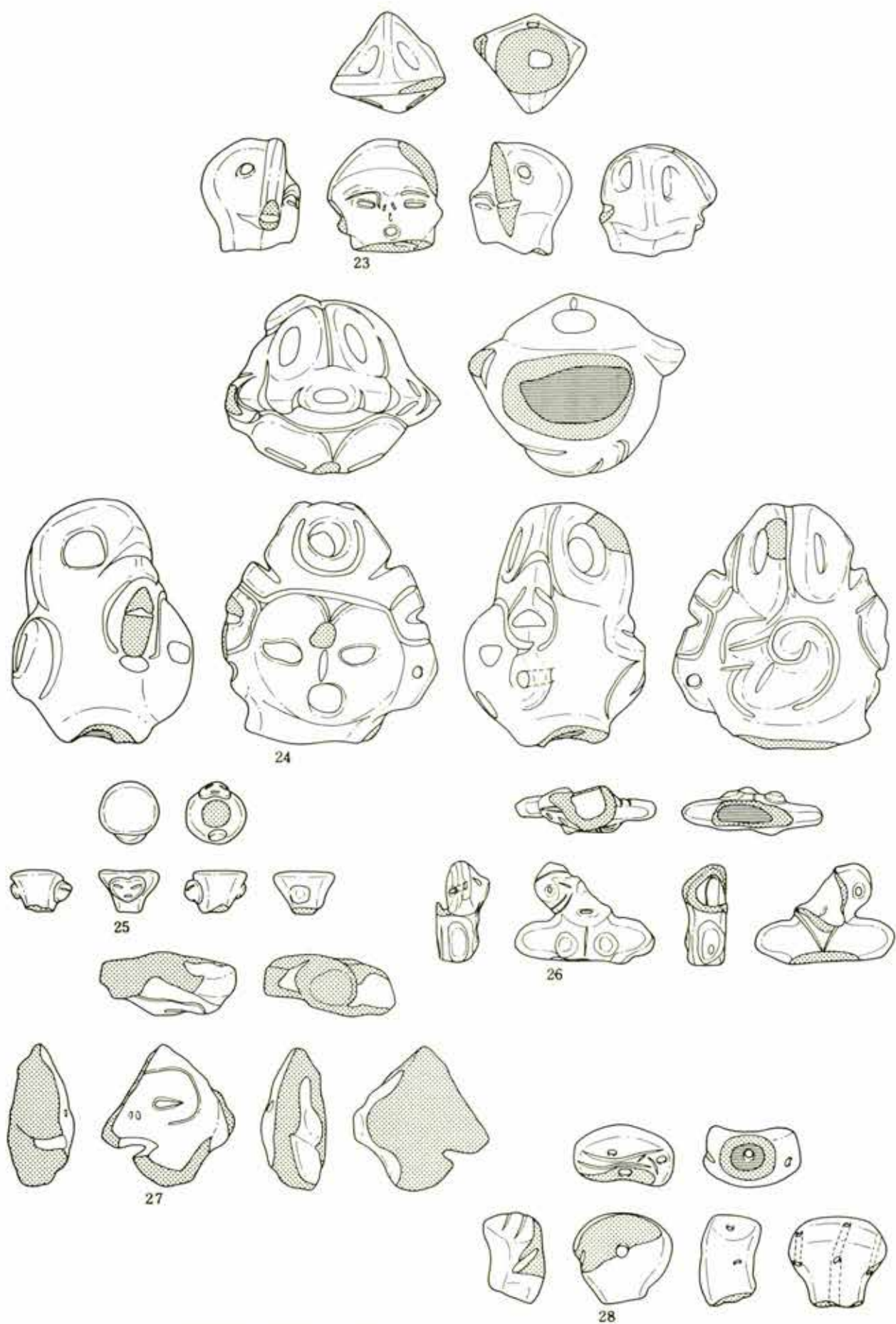

第222图 积逊堂S-III区 土偶 (5)



第 223 图 积迳堂 S-III 区 土偶 (6)



第224图 积逊堂S-III区 土偶 (7)

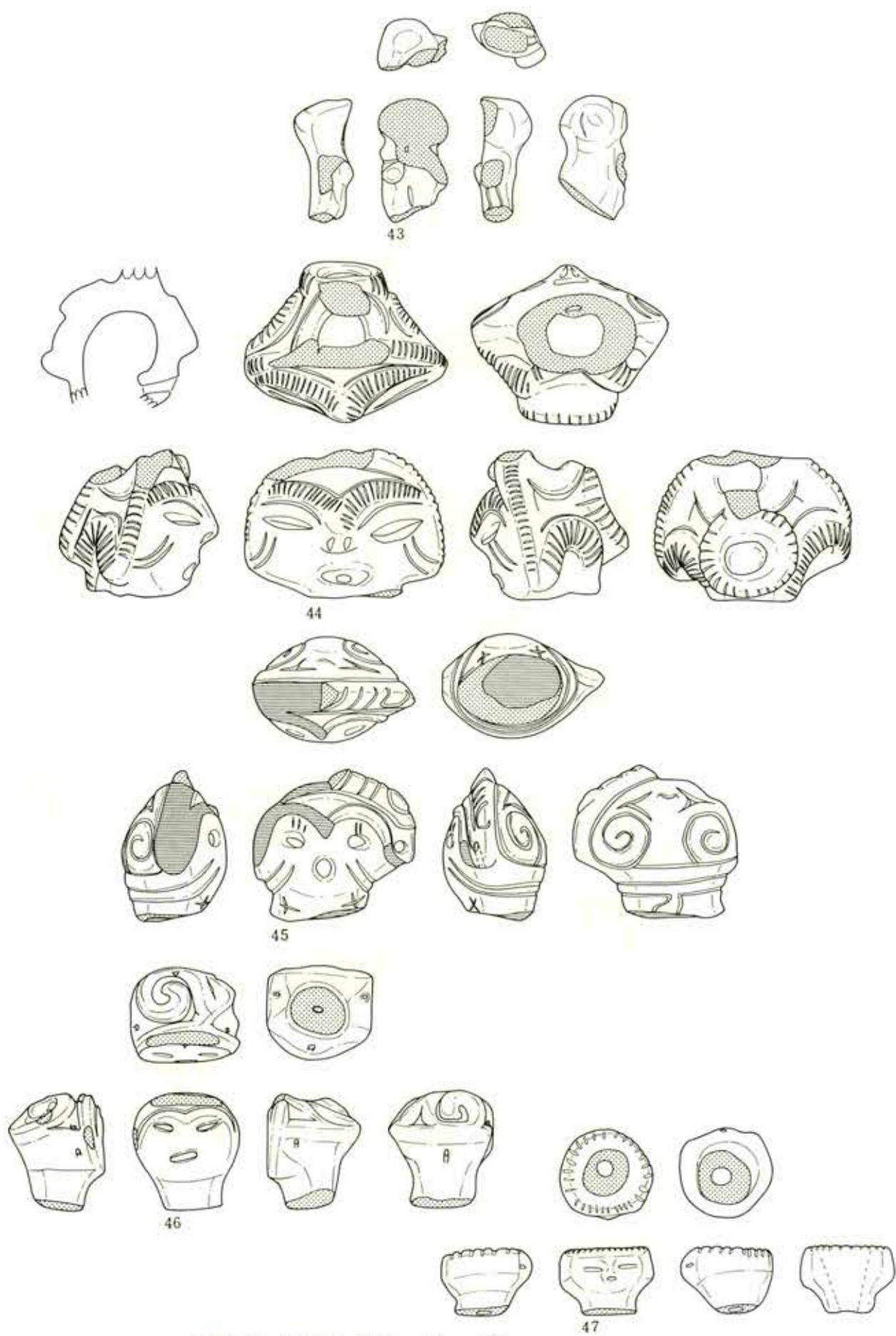

第225图 积逊堂S-III区 土偶 (8)

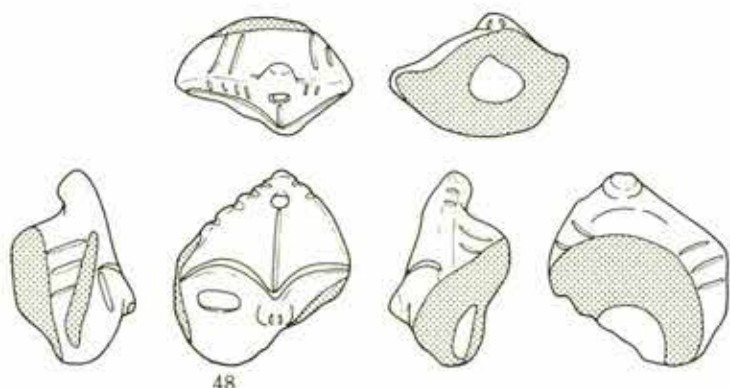

48

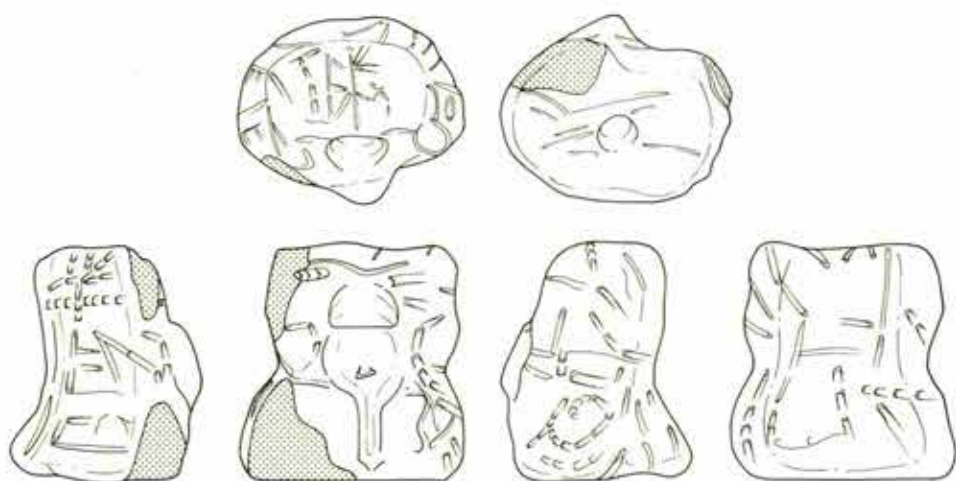

49

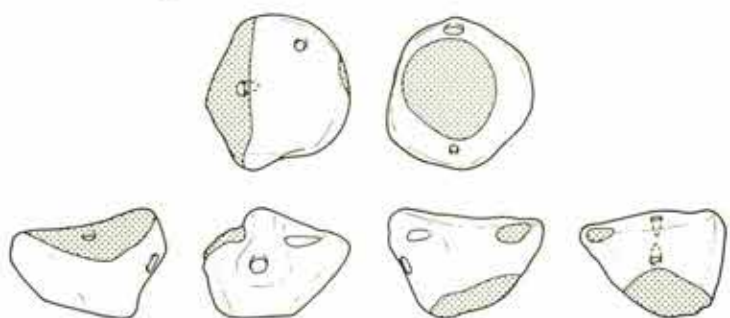

50

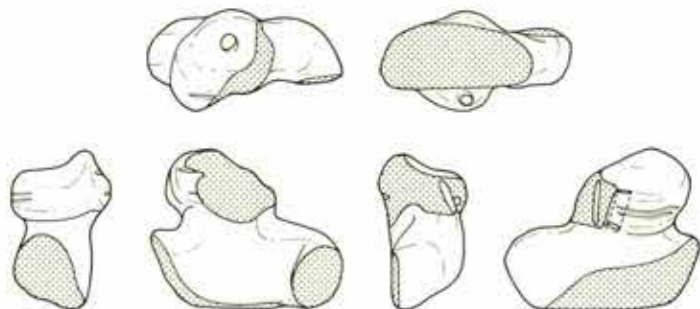

51

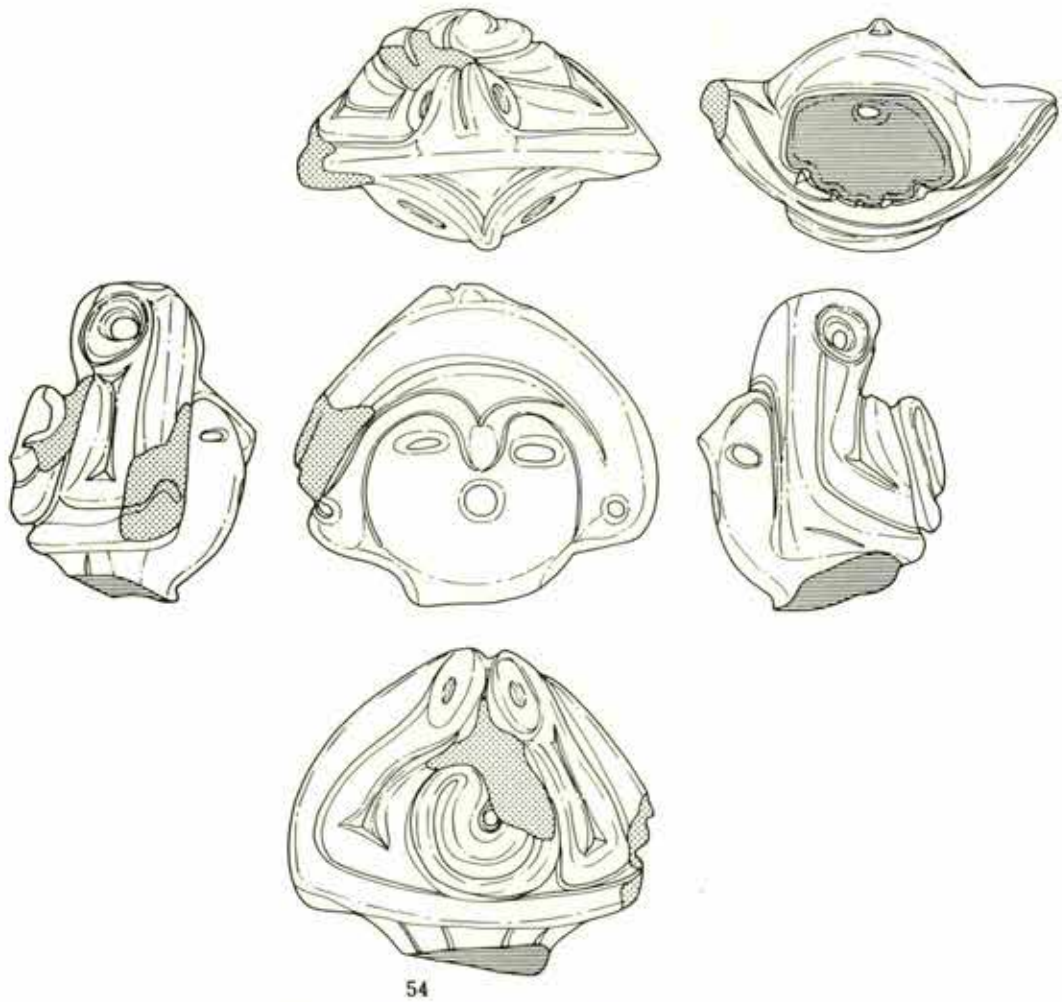
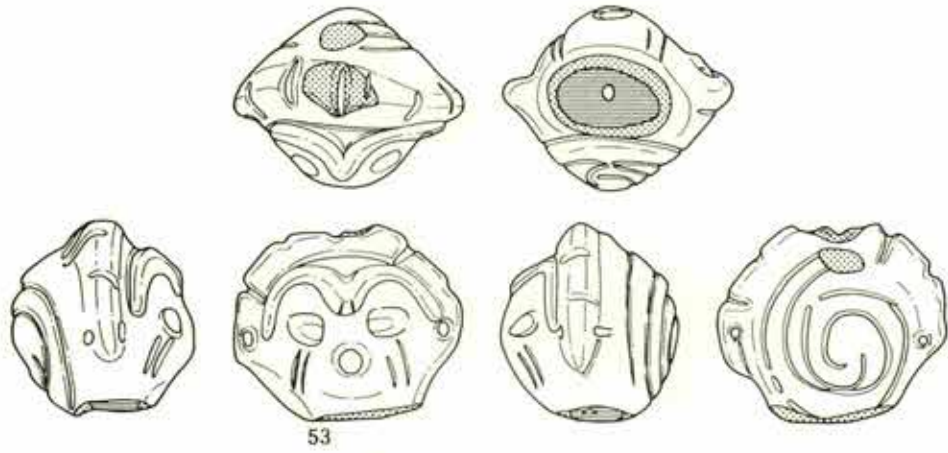
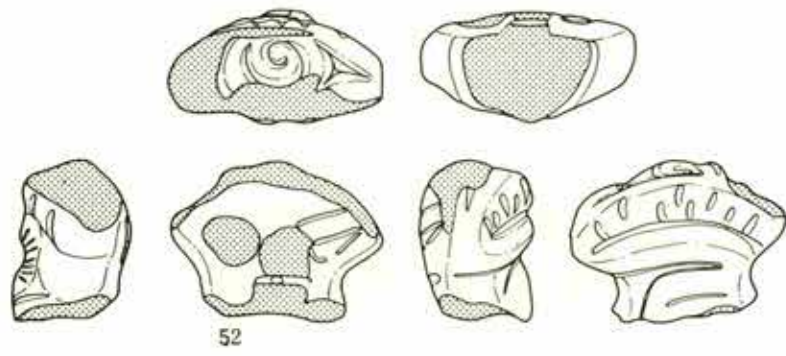

第 227 图 积迦堂 S-III 区 土偶 (10)

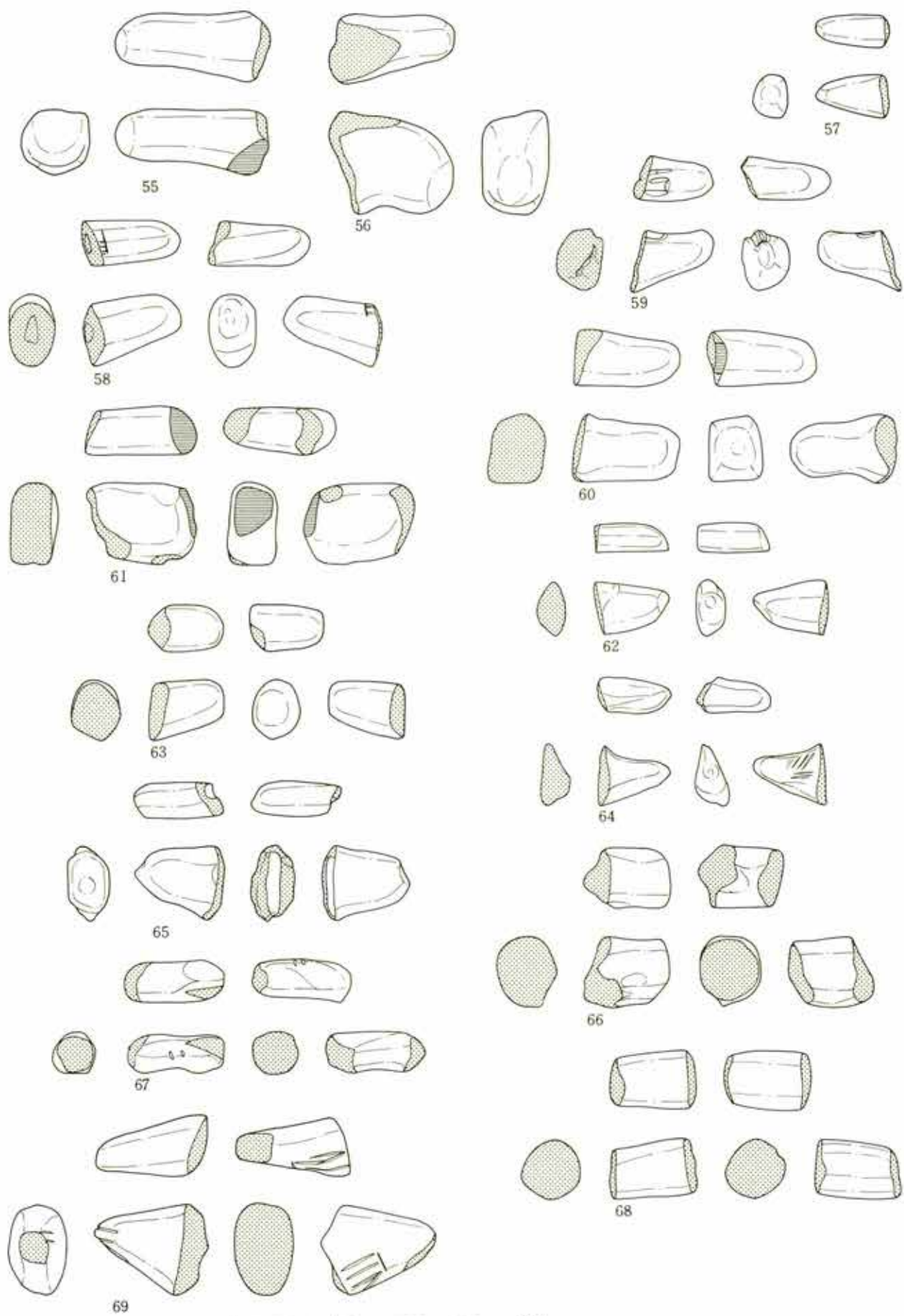

第 228 图 积迳堂 S—III 区 土偶 (11)

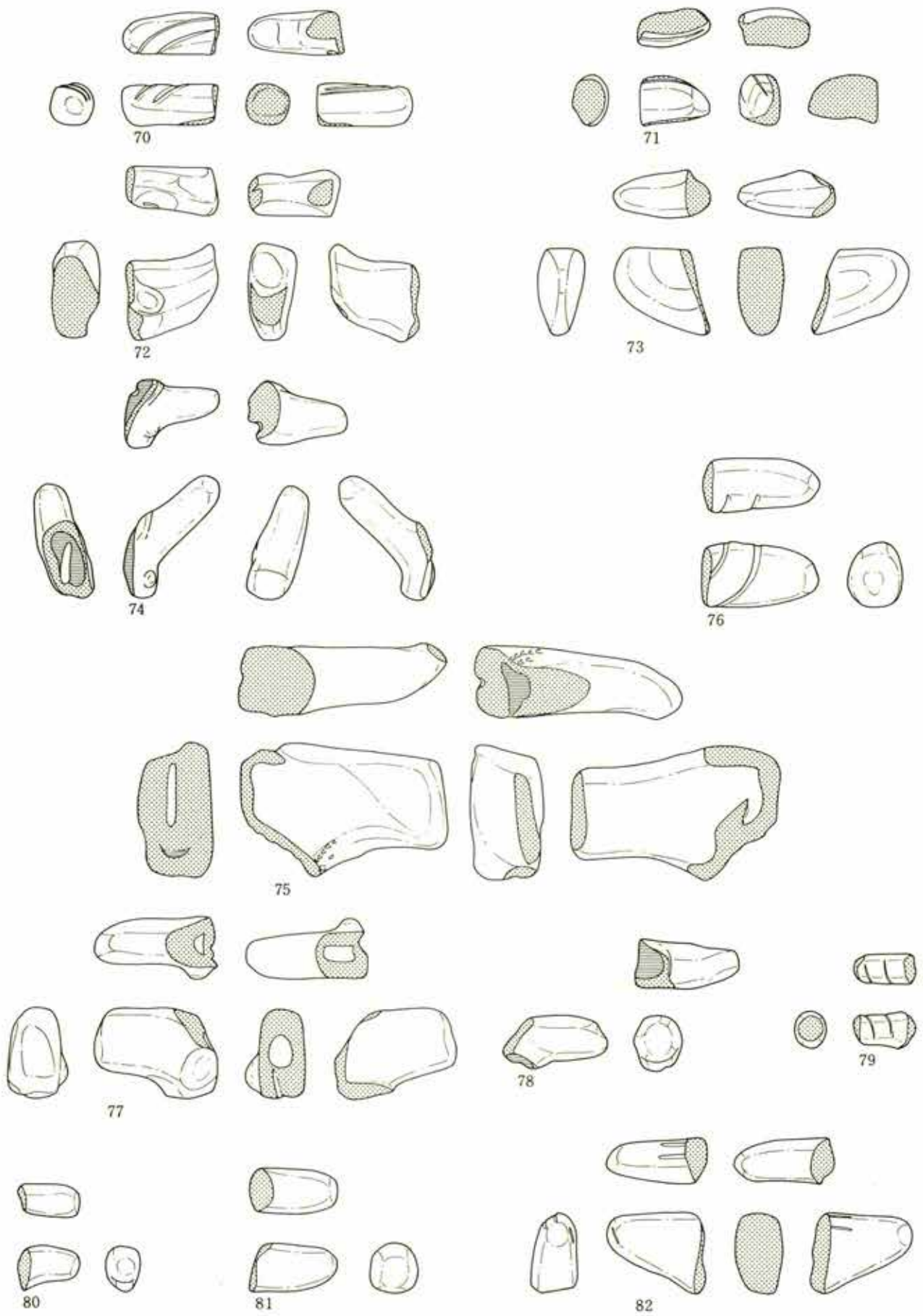

第 229 图 积善堂 S-III 区 土偶 (12)

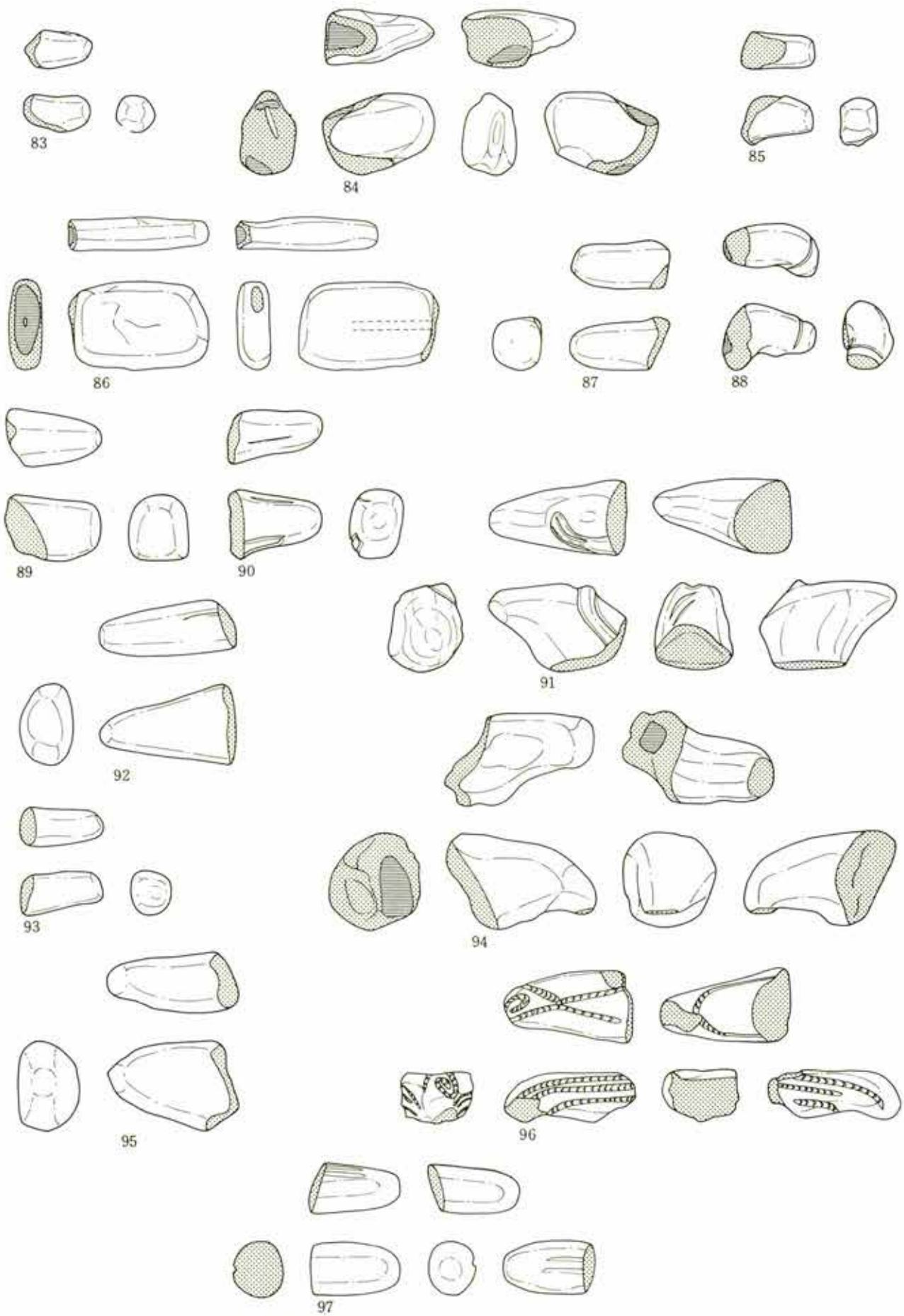

第 230 图 积迳堂 S-III 区 土偶 (13)

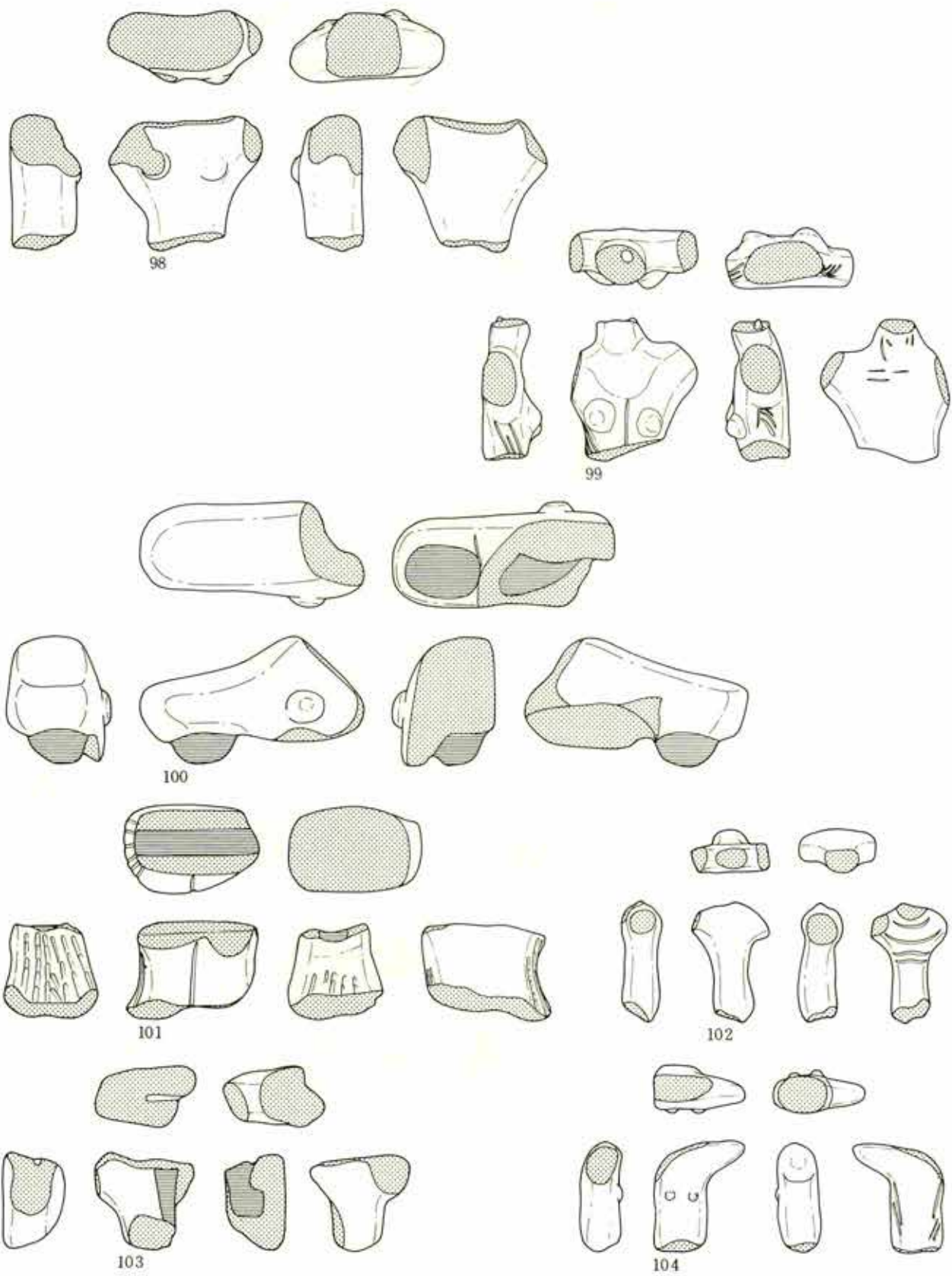

第 231 图 积逊堂 S—III 区 土偶 (14)

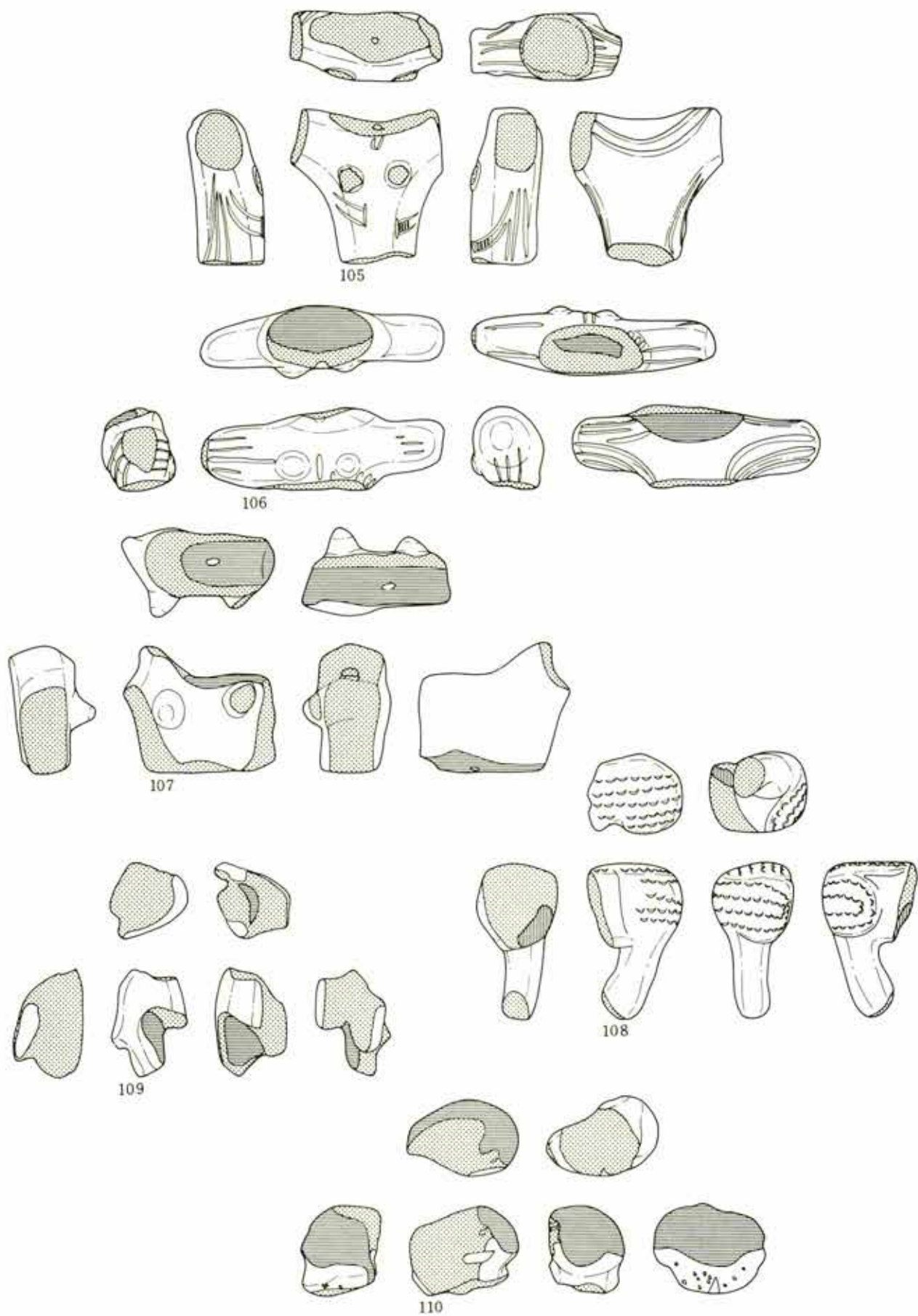

第 232 图 积迦堂 S—III 区 土偶 (15)

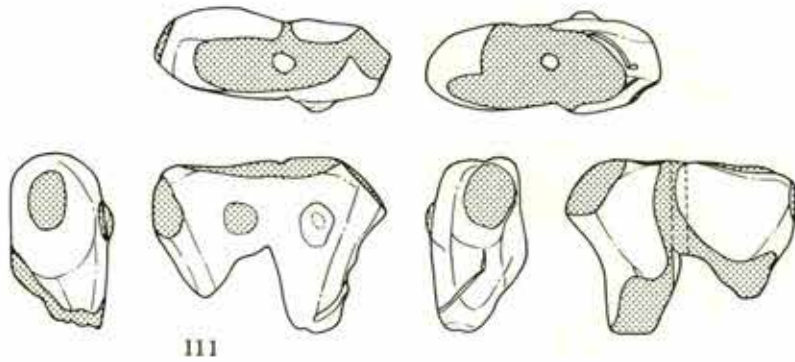

111

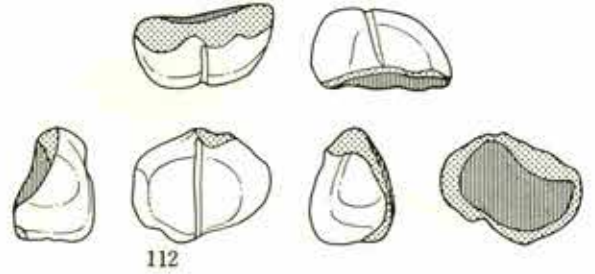

112

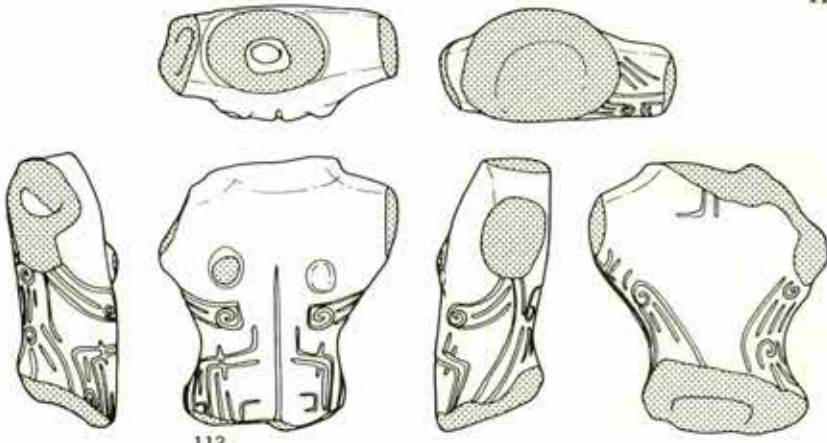

113

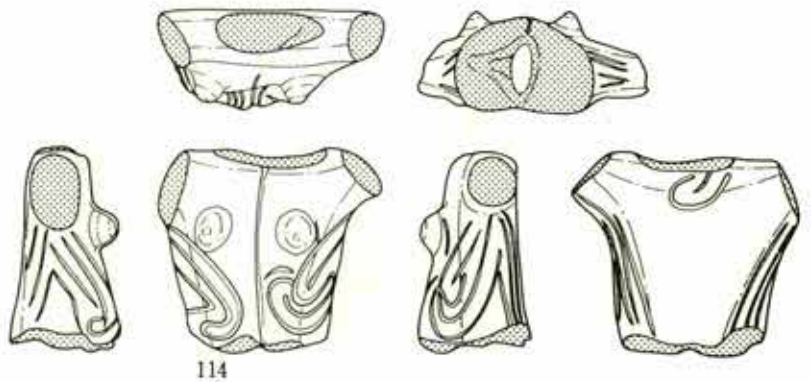

114

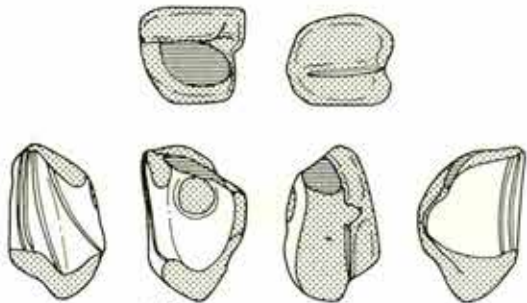

115

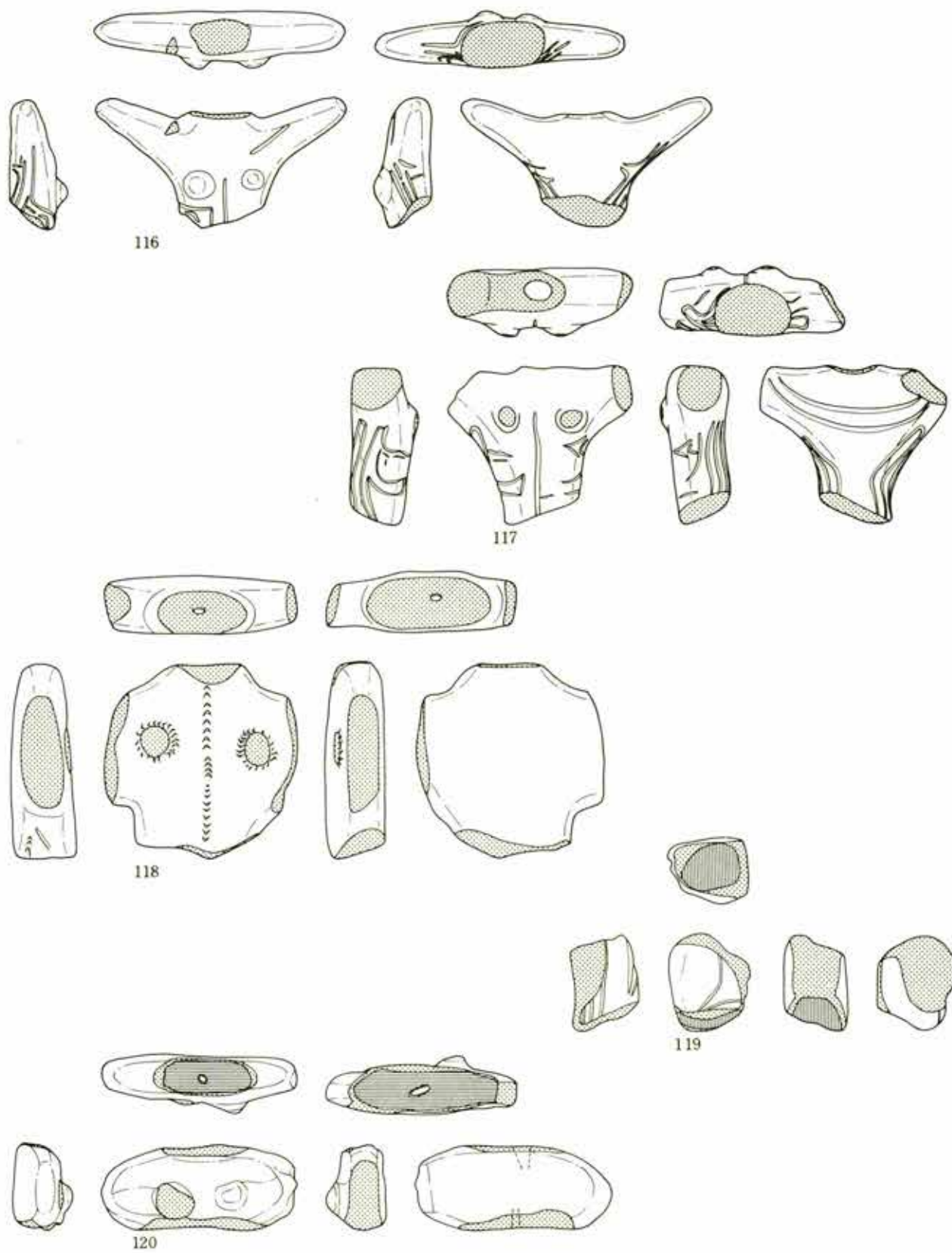

第 234 图 积逊堂 S-III 区 土偶 (17)

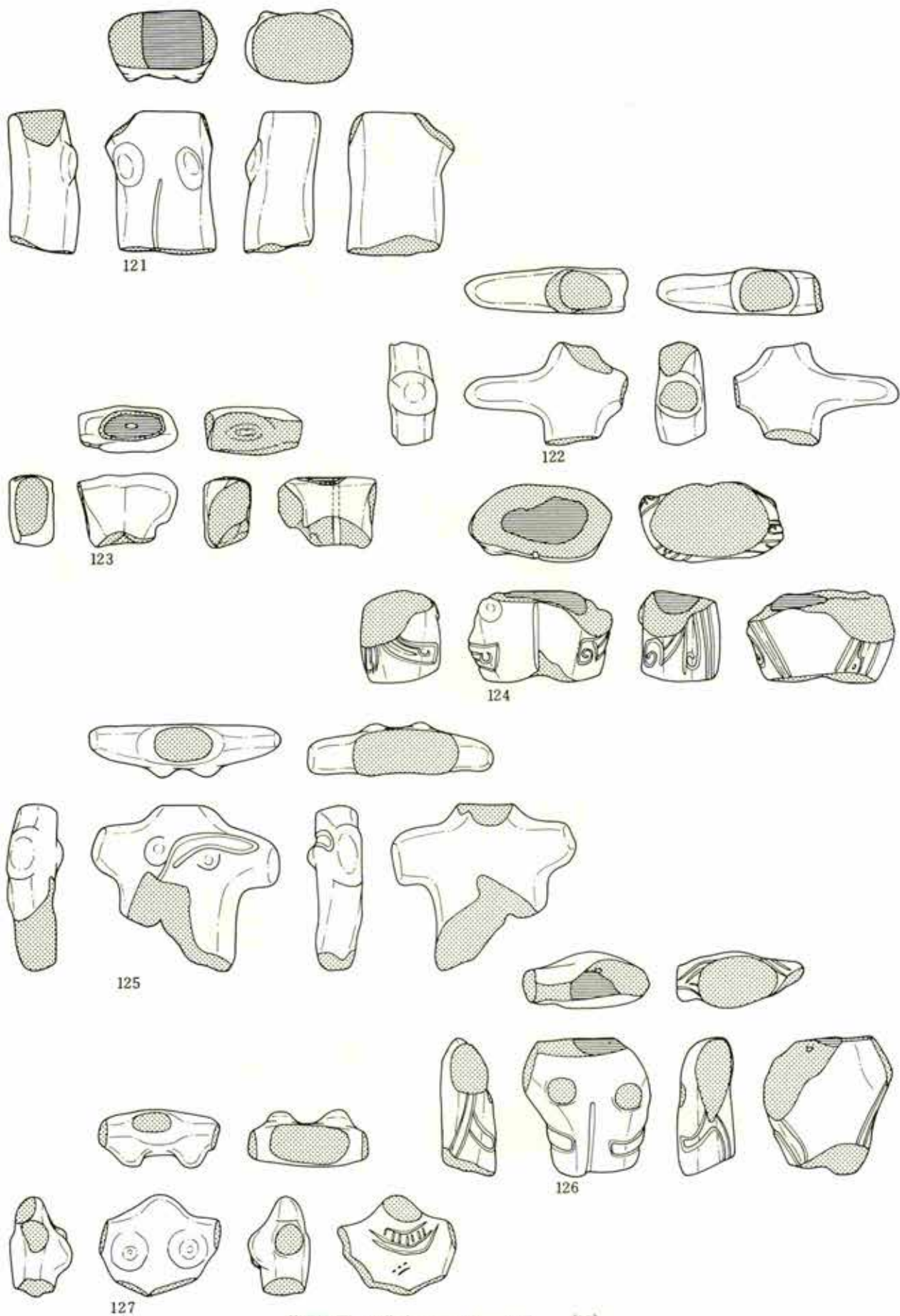

第235图 积逊堂S-III区 土偶 (18)

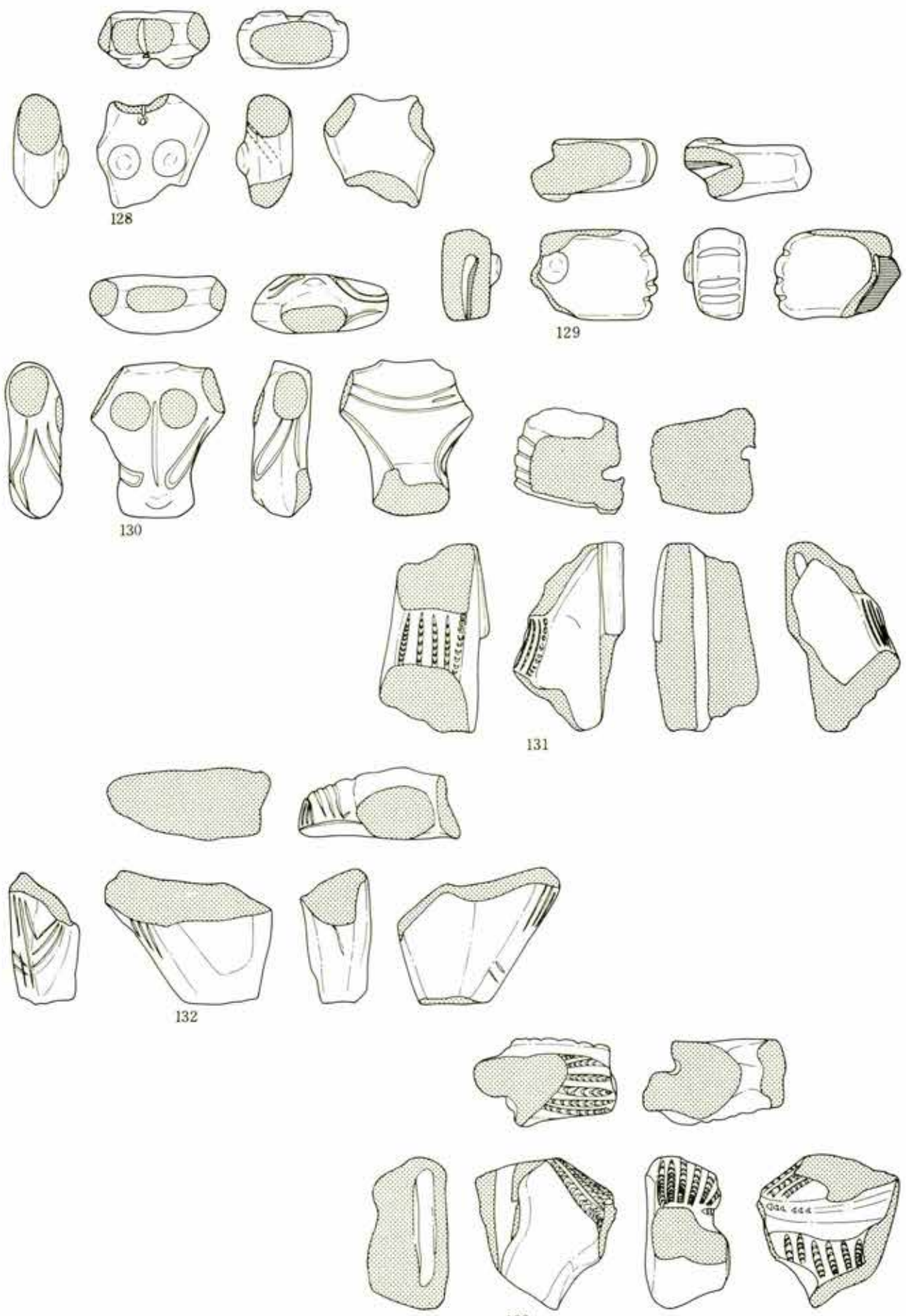

第 236 图 积迦堂 S-III 区 土偶 (19)

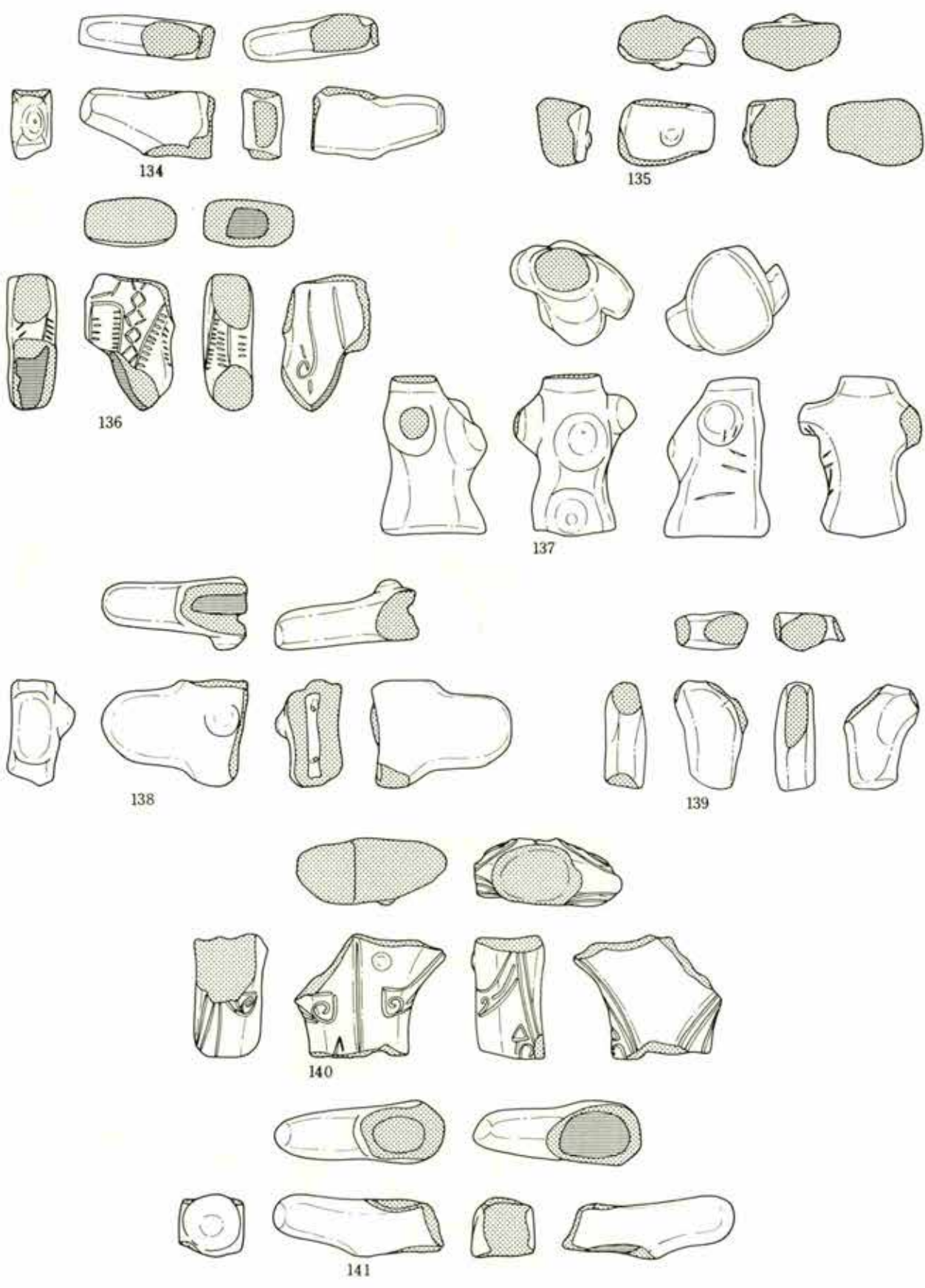

第237图 积迳堂S-III区 土偶 (20)

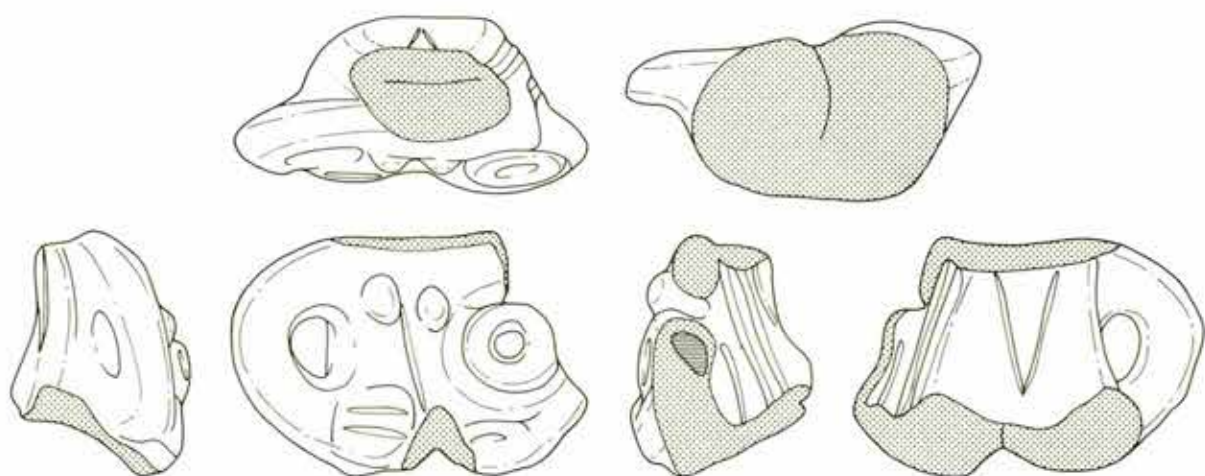

142

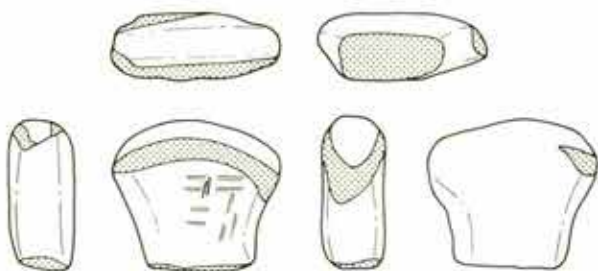

143

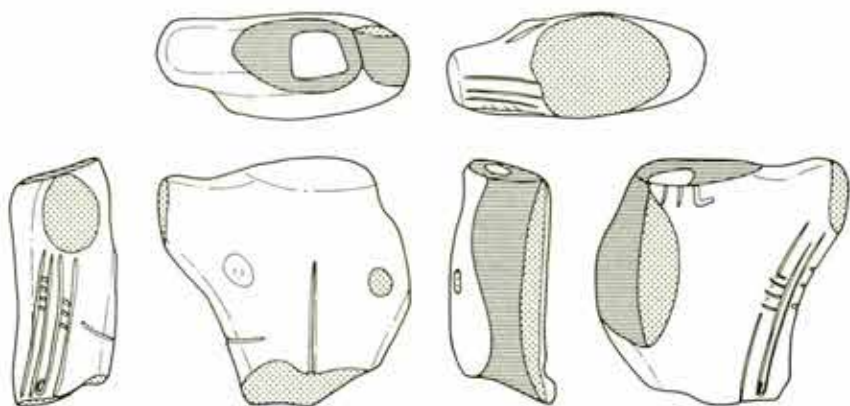

144

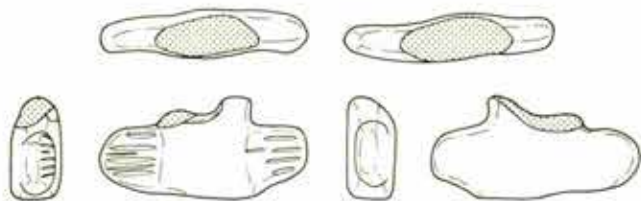

145



146

第 238 图 积逸堂 S—III 区 土偶 (21)

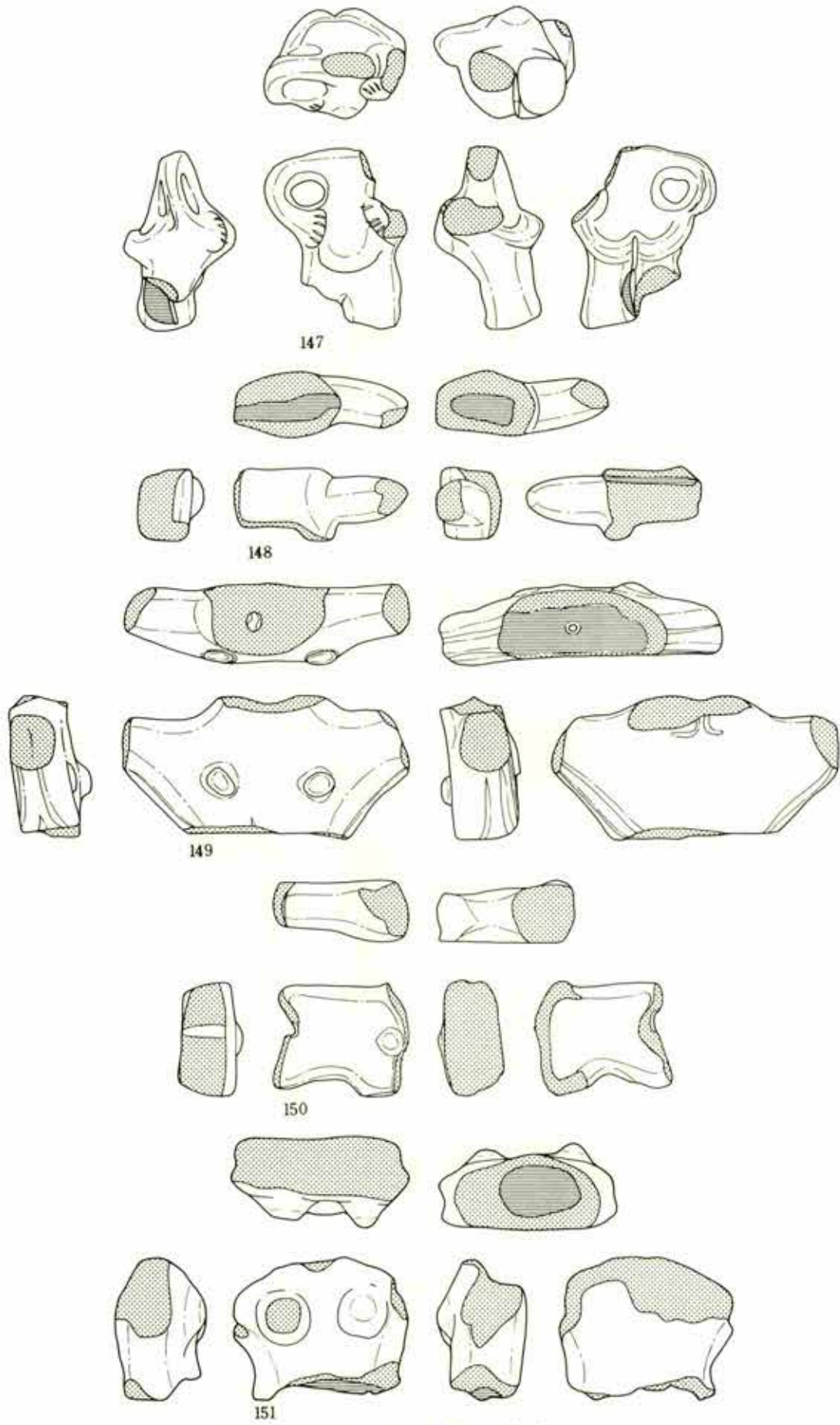

第 239 图 积逊堂 S-III 区 土偶 (22)

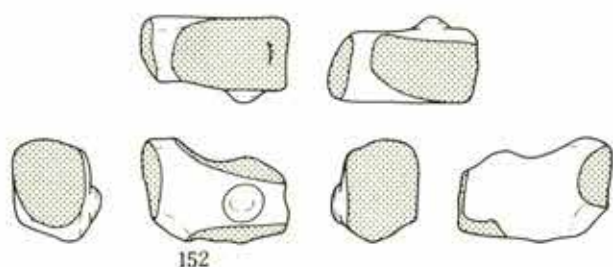

152

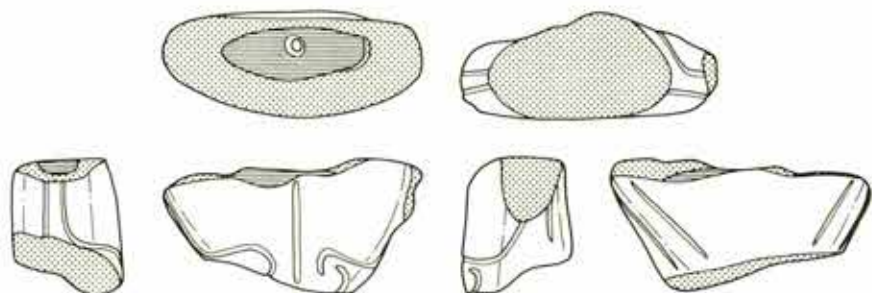

153

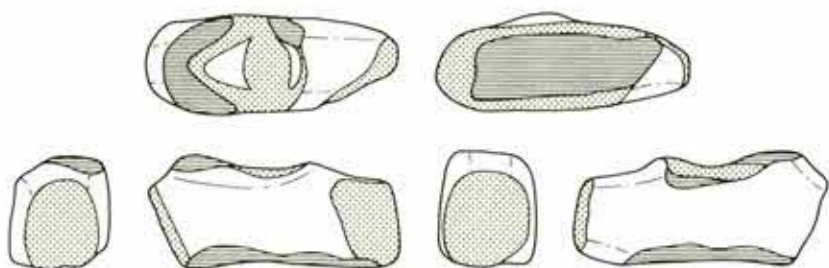

154

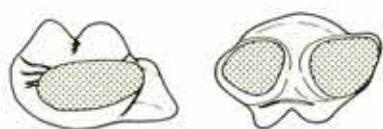

155

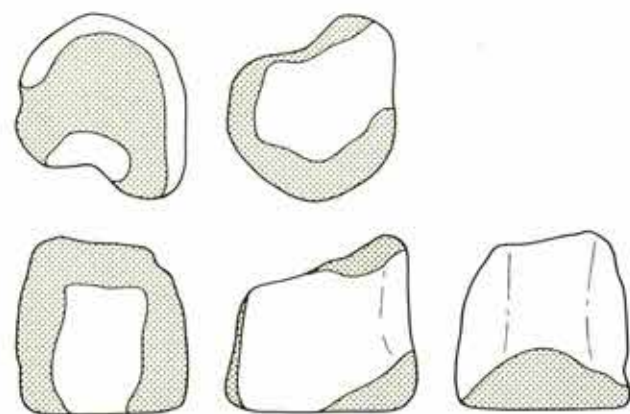

156

第 240 图 积逊堂 S-III 区 土偶 (23)

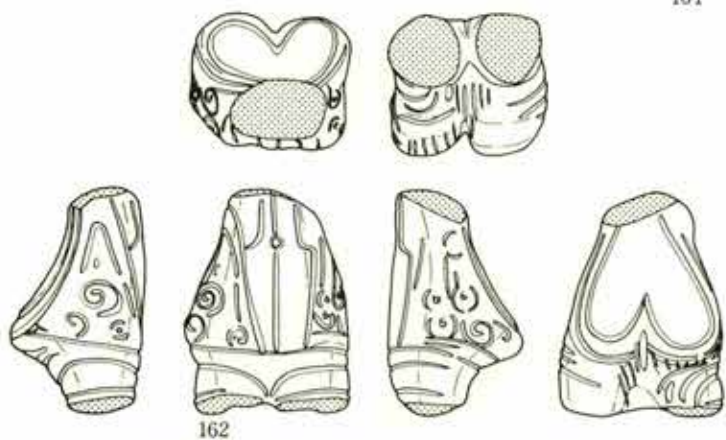
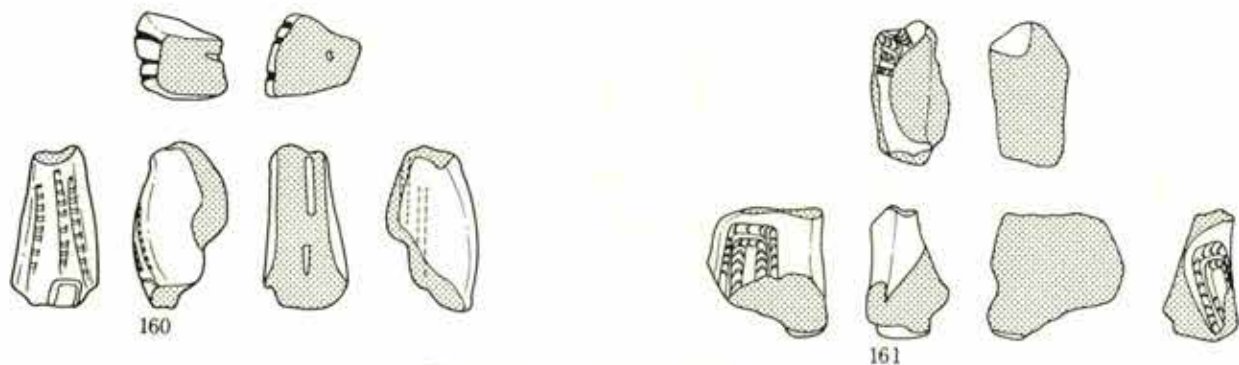
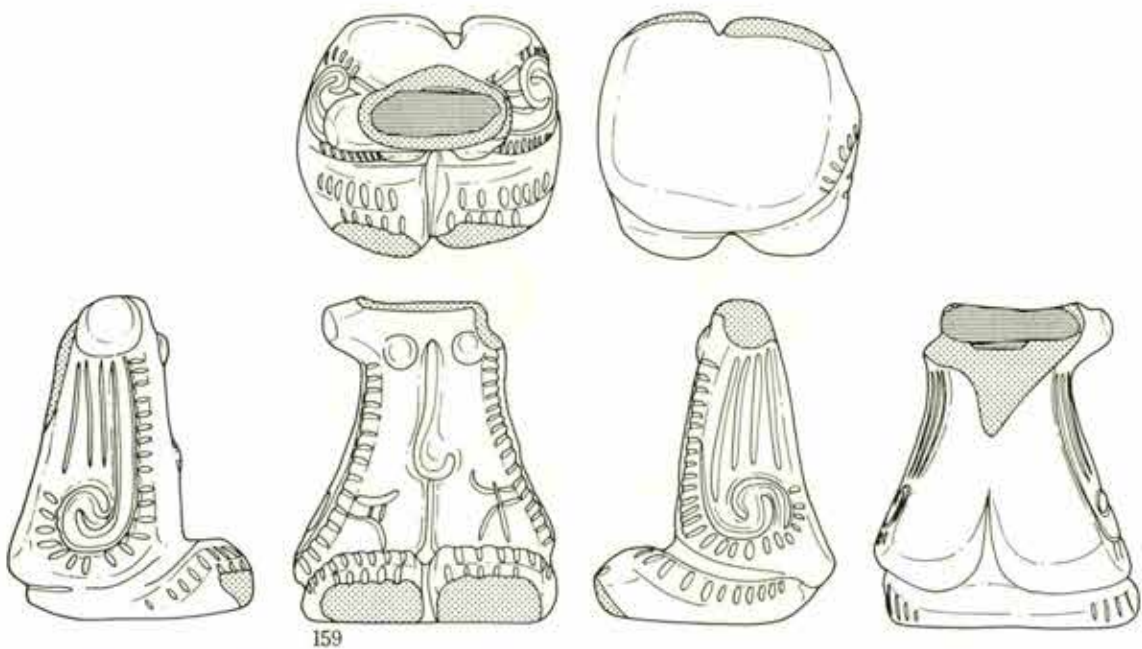
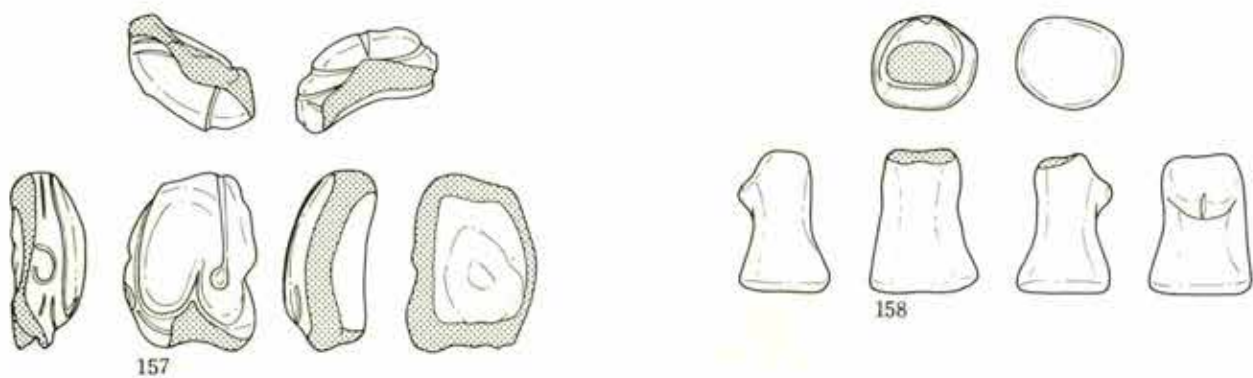

第 241 图 积逊堂 S-III 区 土偶 (24)

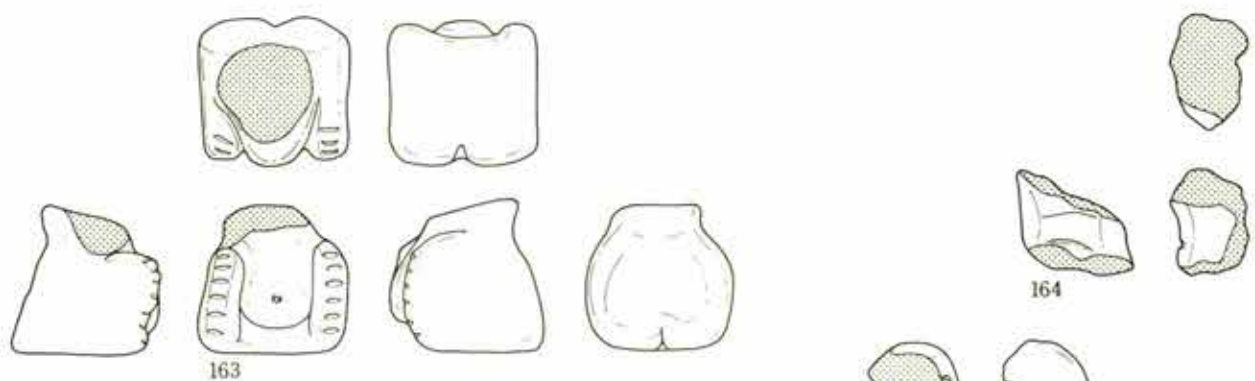

163

164

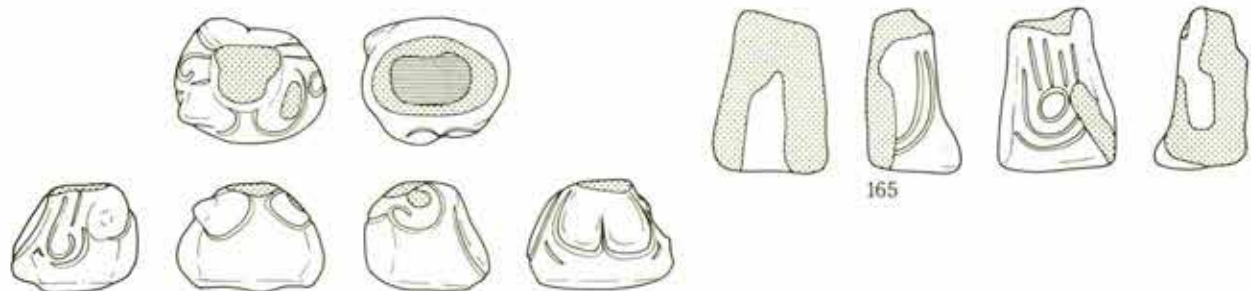

165

166

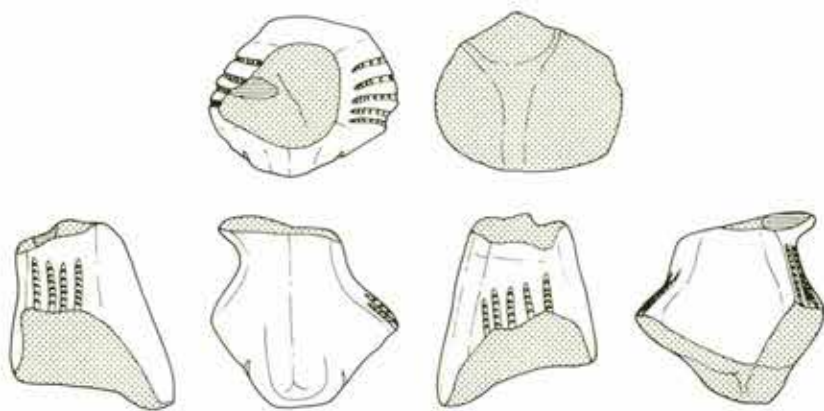

167

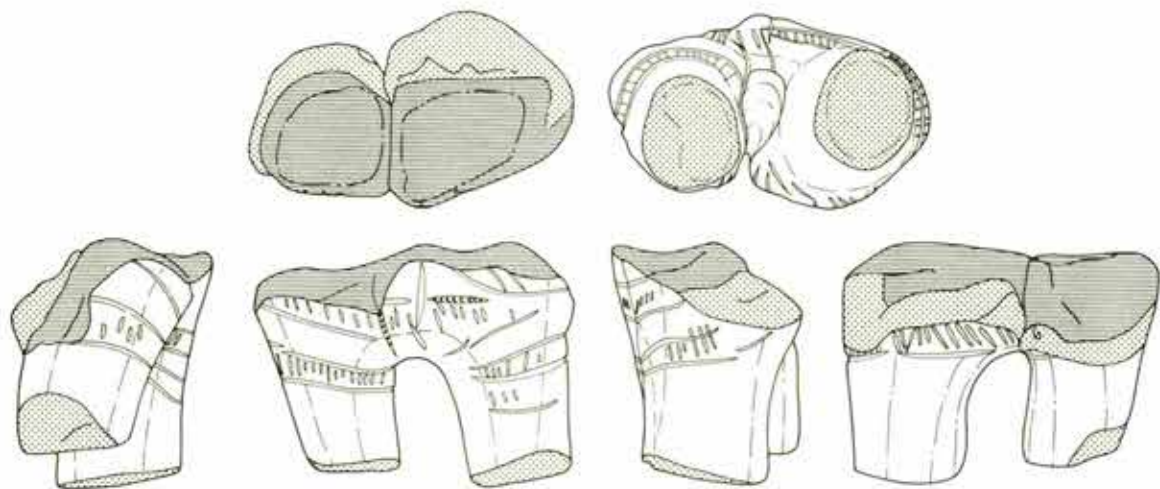

168

第 242 图 积逊堂 S—III 区 土偶 (25)

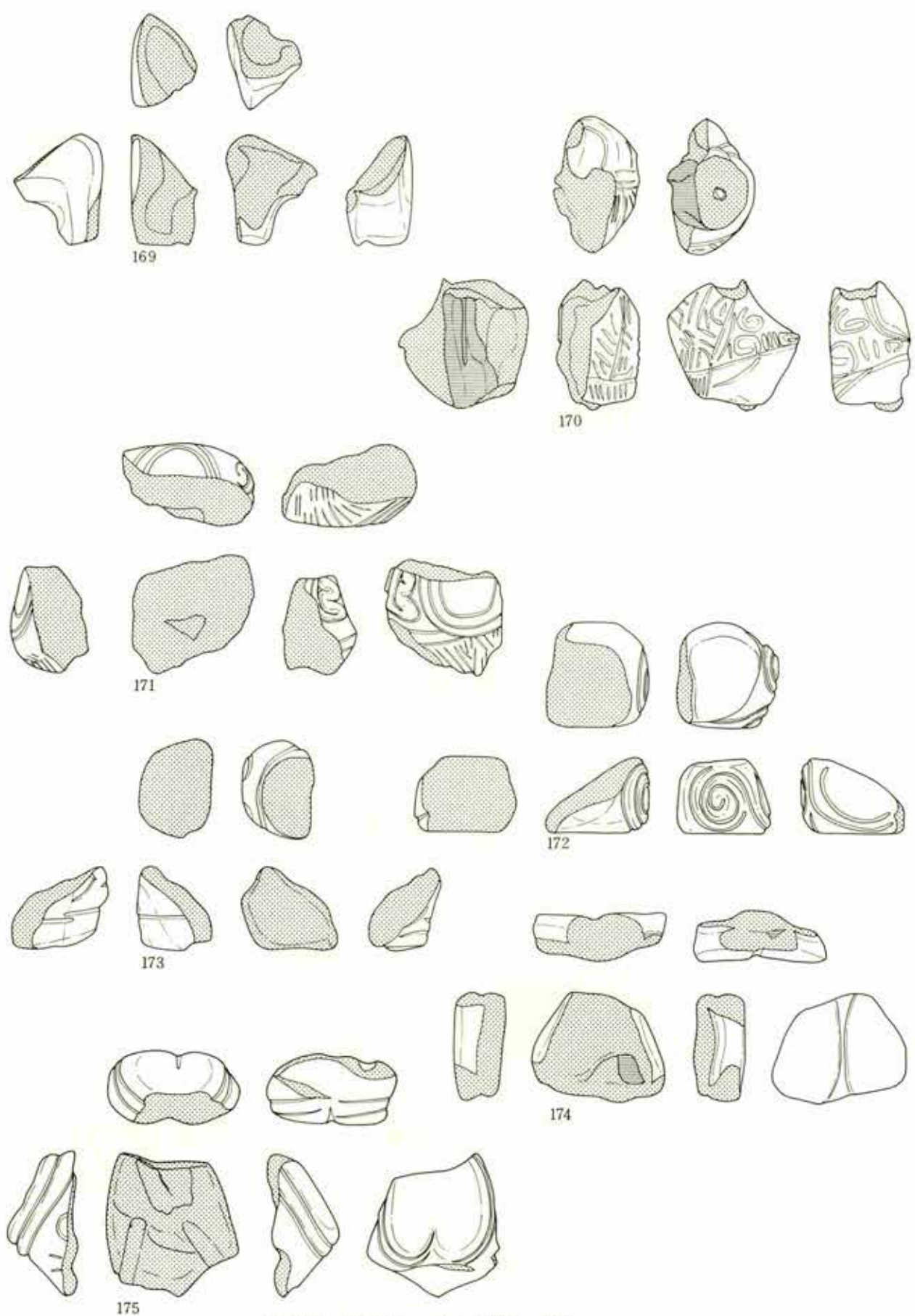

第 243 图 积逊堂 S-III 区 土偶 (26)

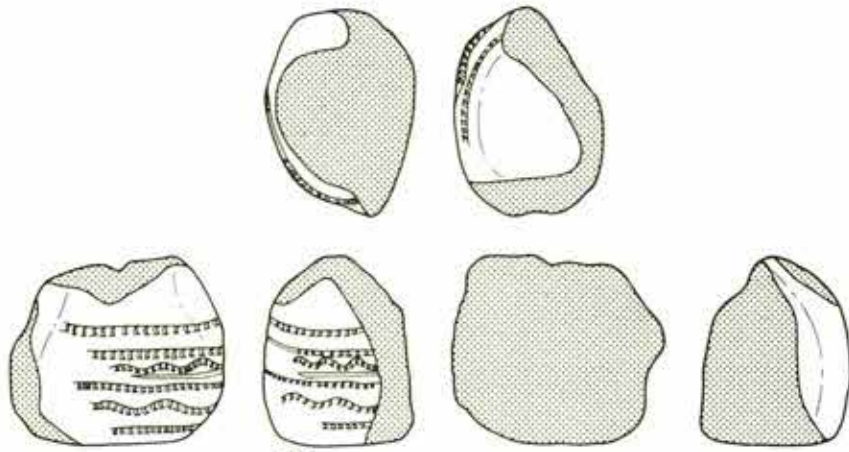

176

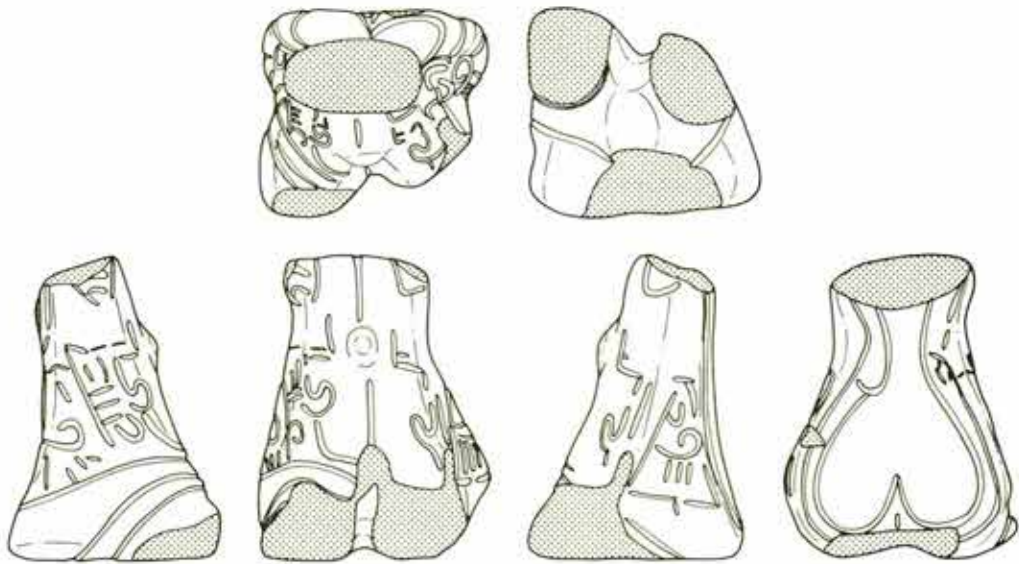

177

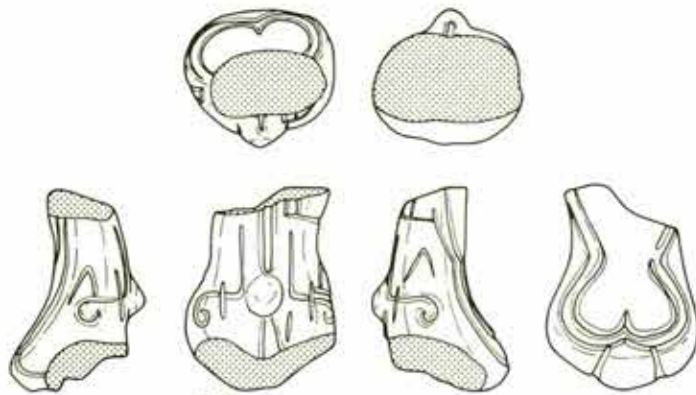

178



第 245 图 积逊堂 S—III 区 土偶 (28)

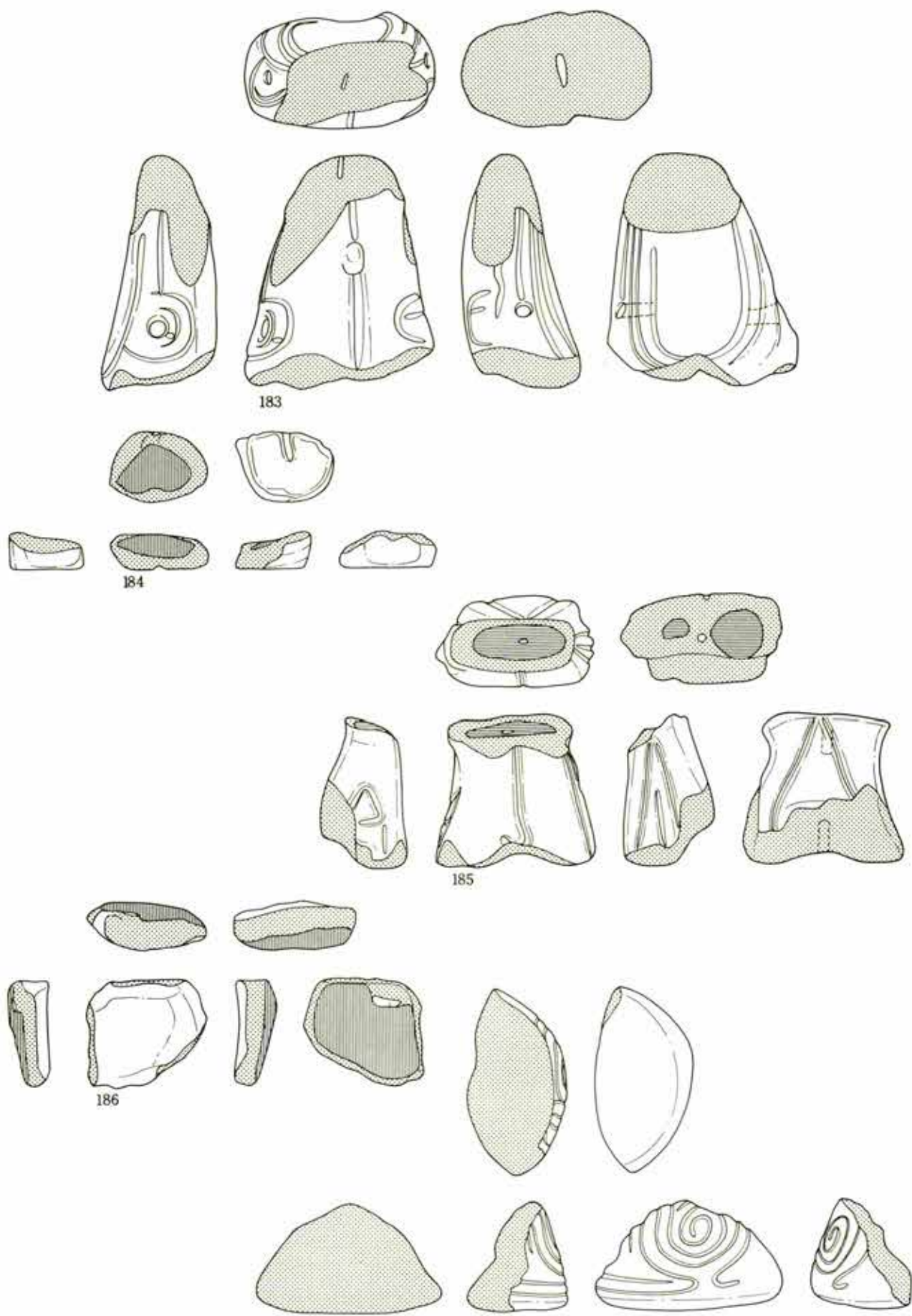

第246图 积逊堂S-III区 土偶 (29)

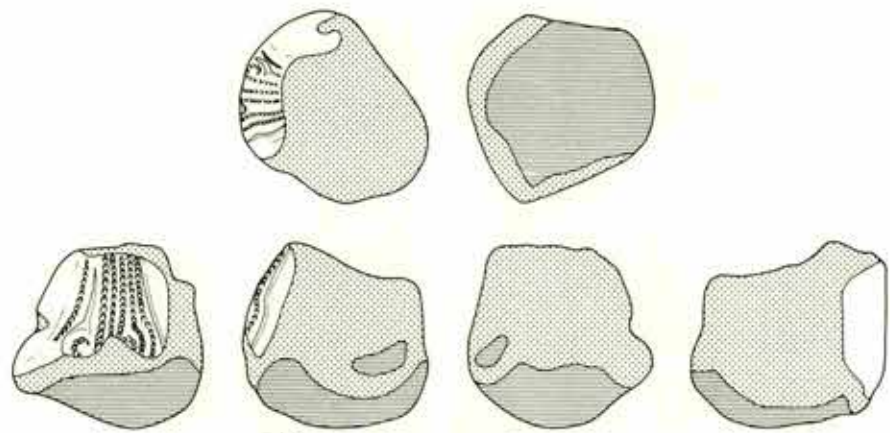

188

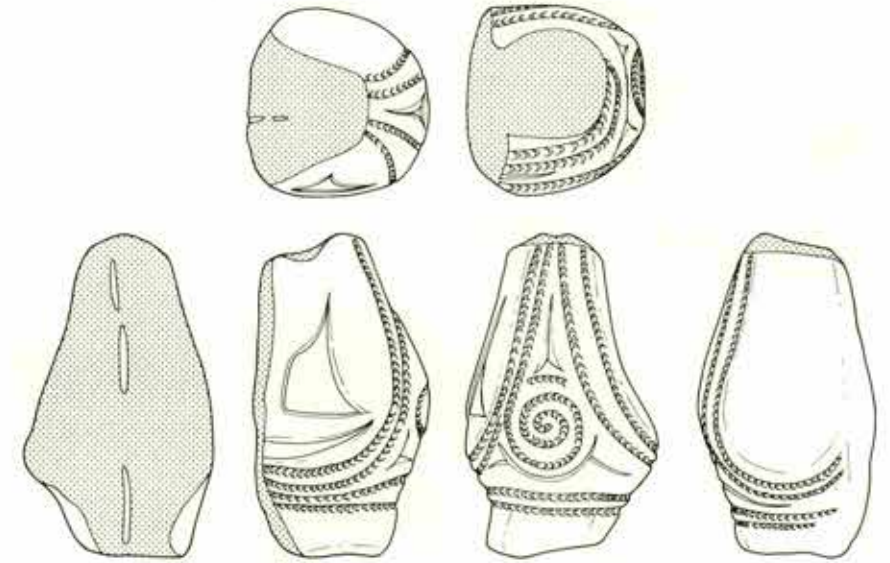

189

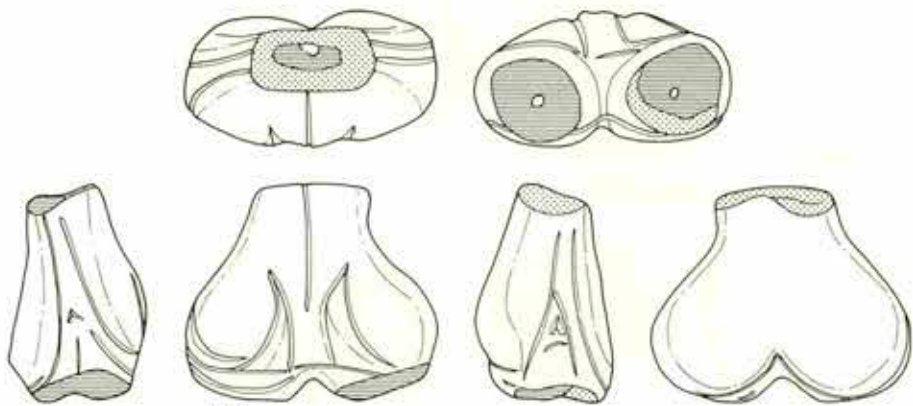

190

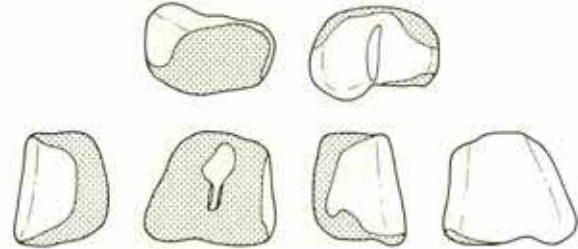

191

第247图 积逊堂S-III区 土偶 (30)

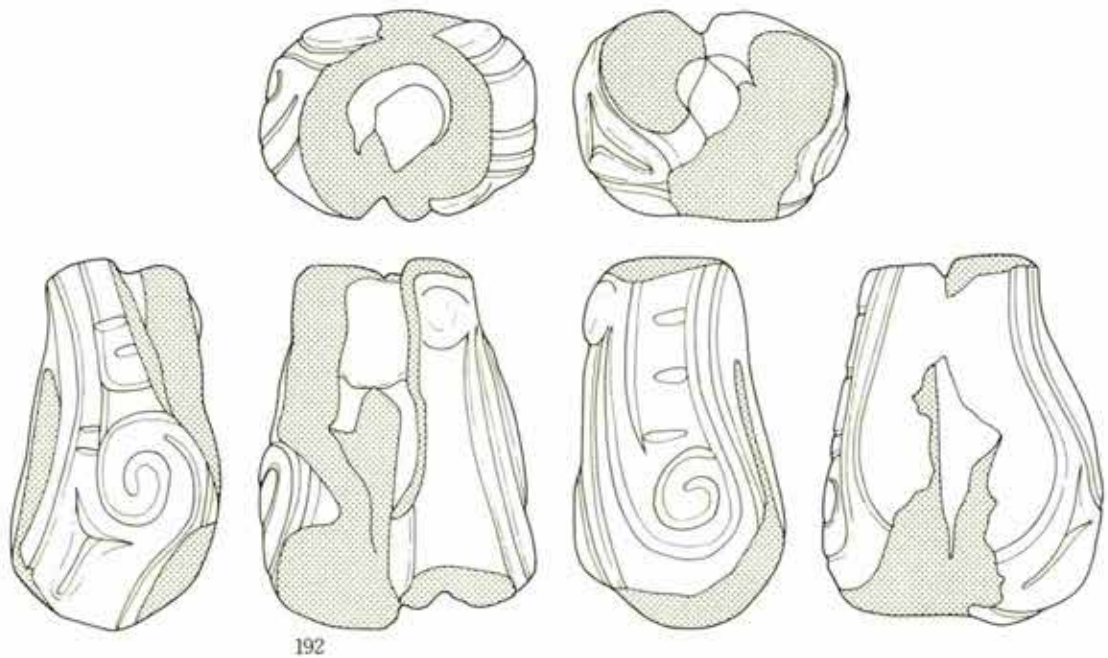

192

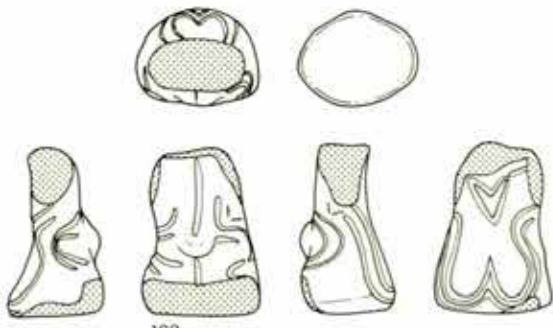

193

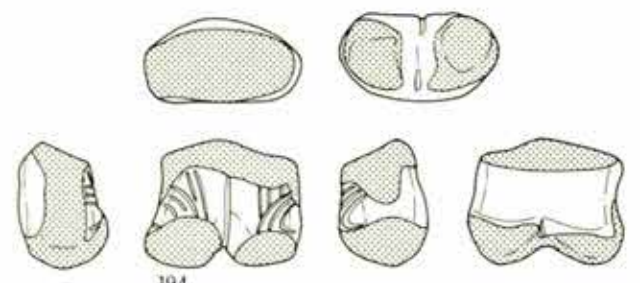

194

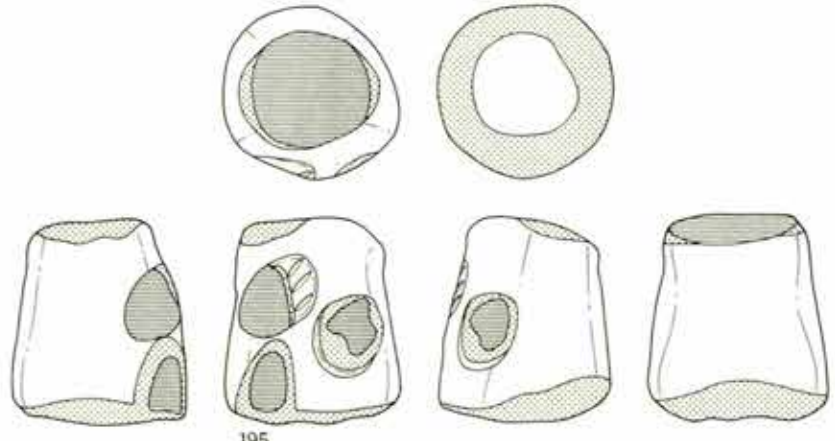

195

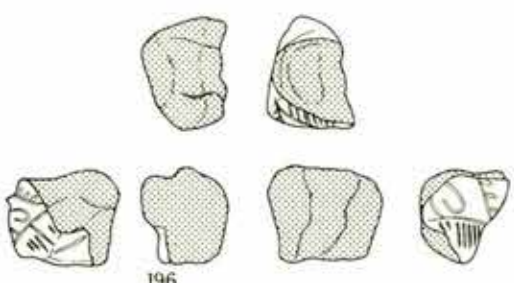

196

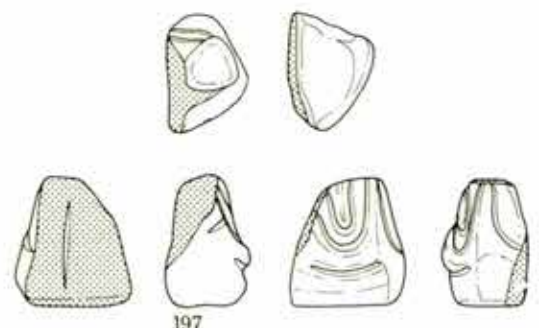

197

第248图 积迦堂S—III区 土偶 (31)

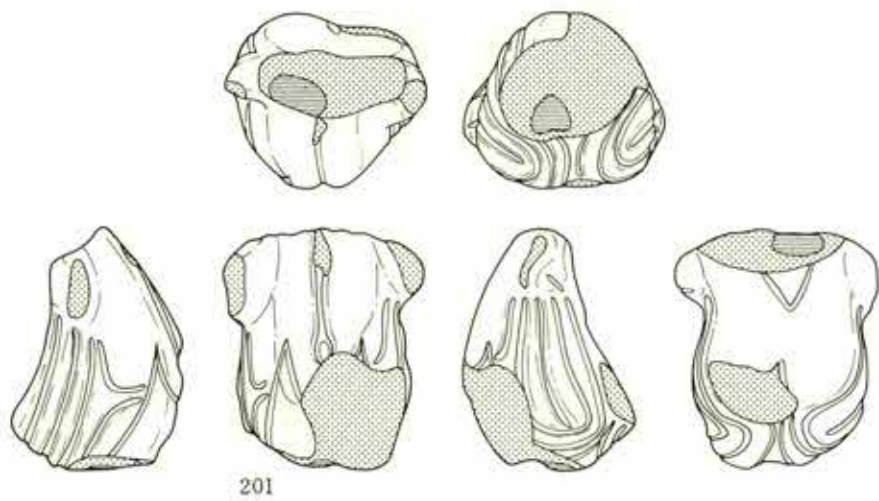
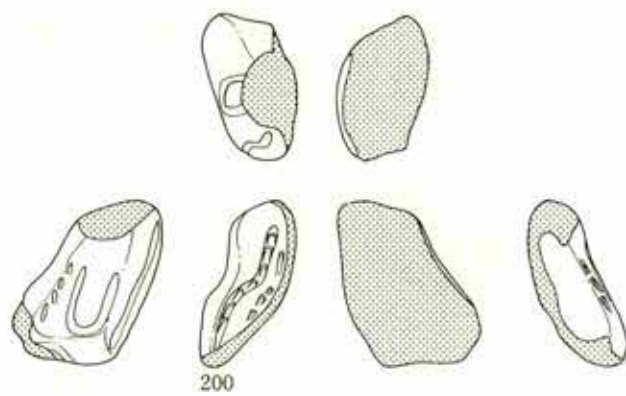
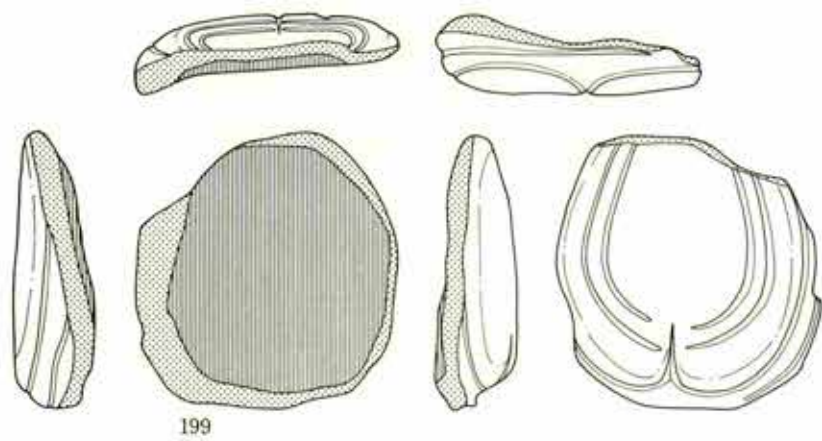
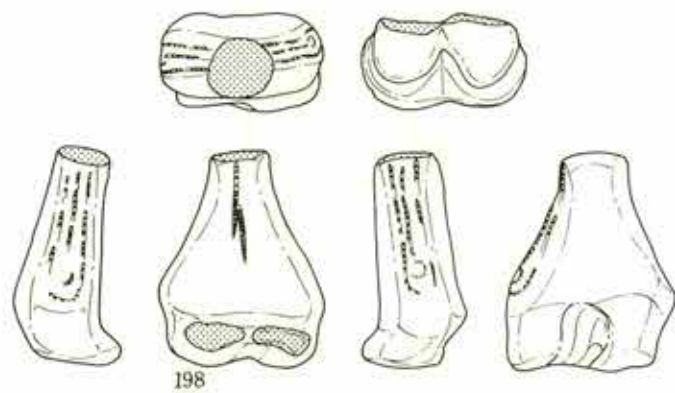

第249图 积迦堂S-III区 土偶 (32)

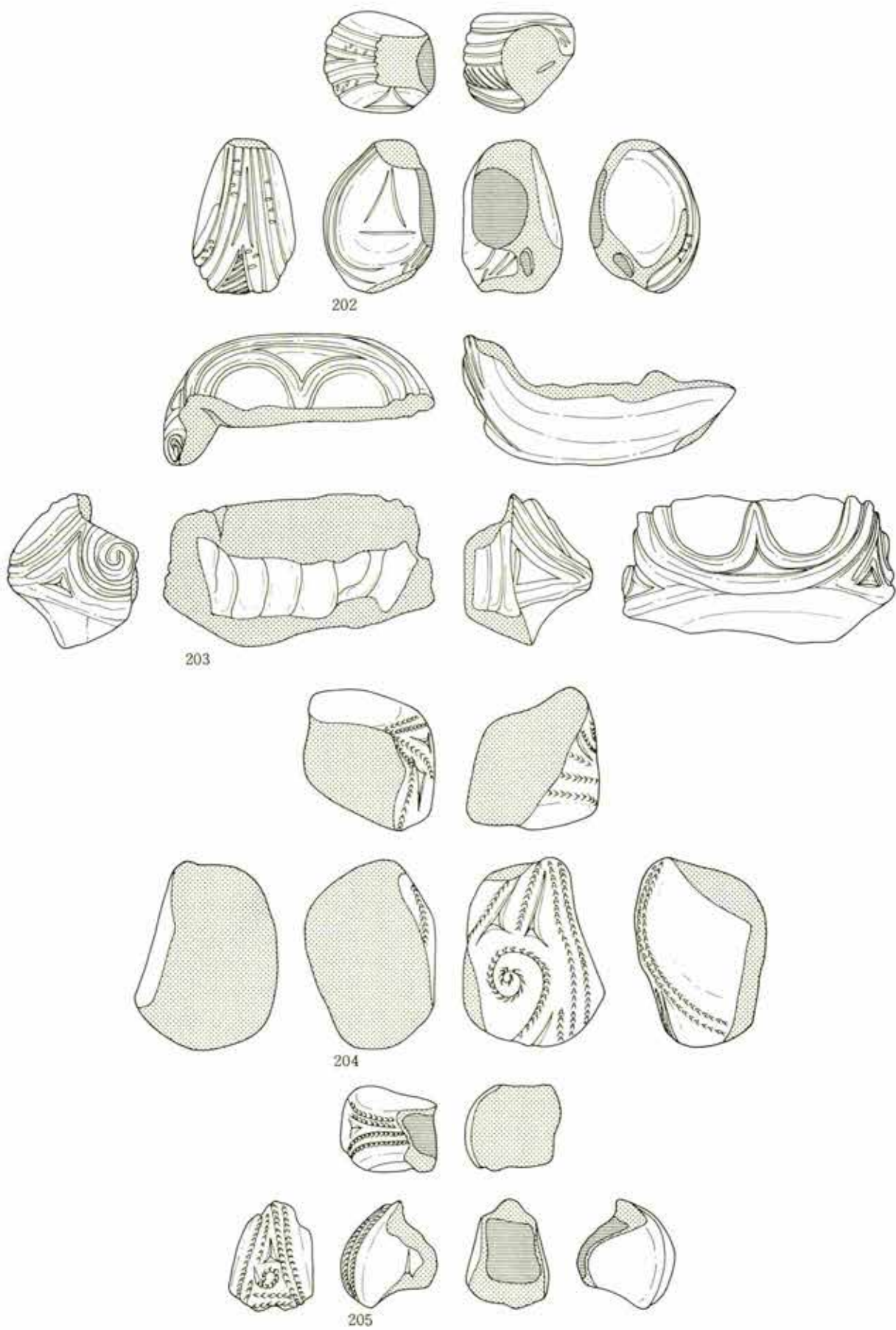

第250图 积迦堂S—III区 土偶 (33)



第251图 积逊堂S-III区 土偶 (34)

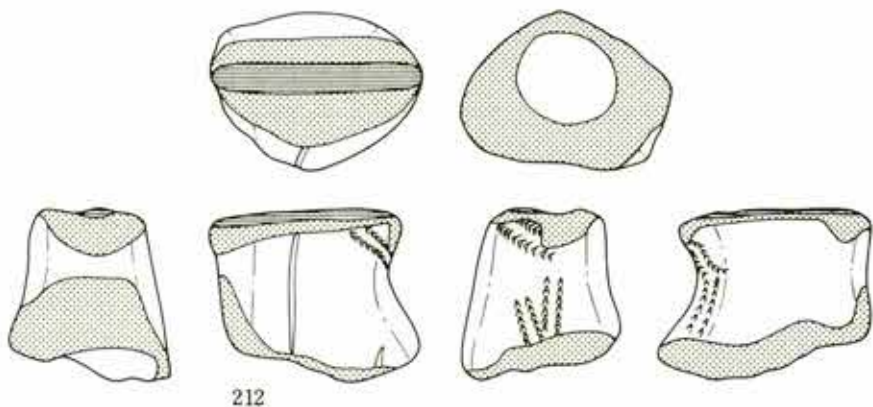

212

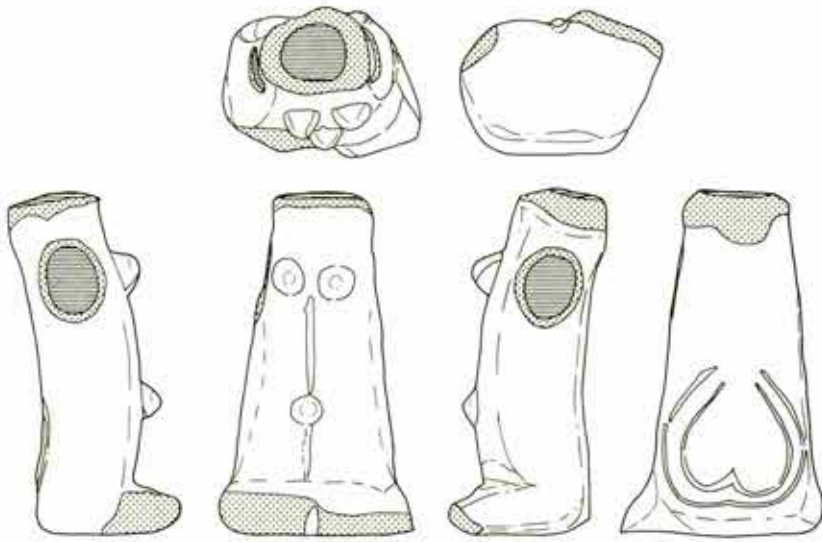

213

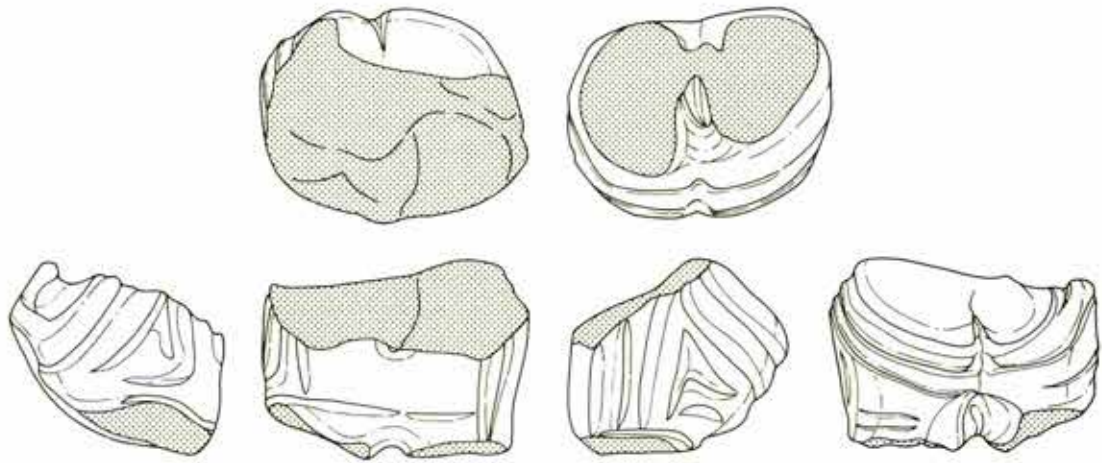

214

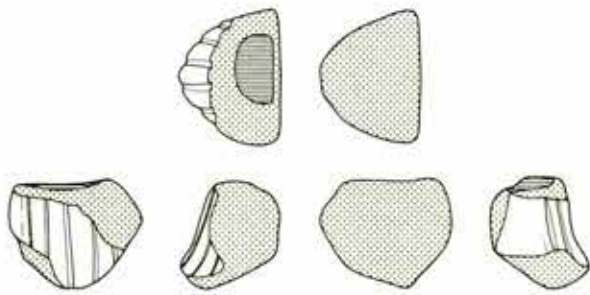

215

第 252 图 积逊堂 S-III 区 土偶 (35)

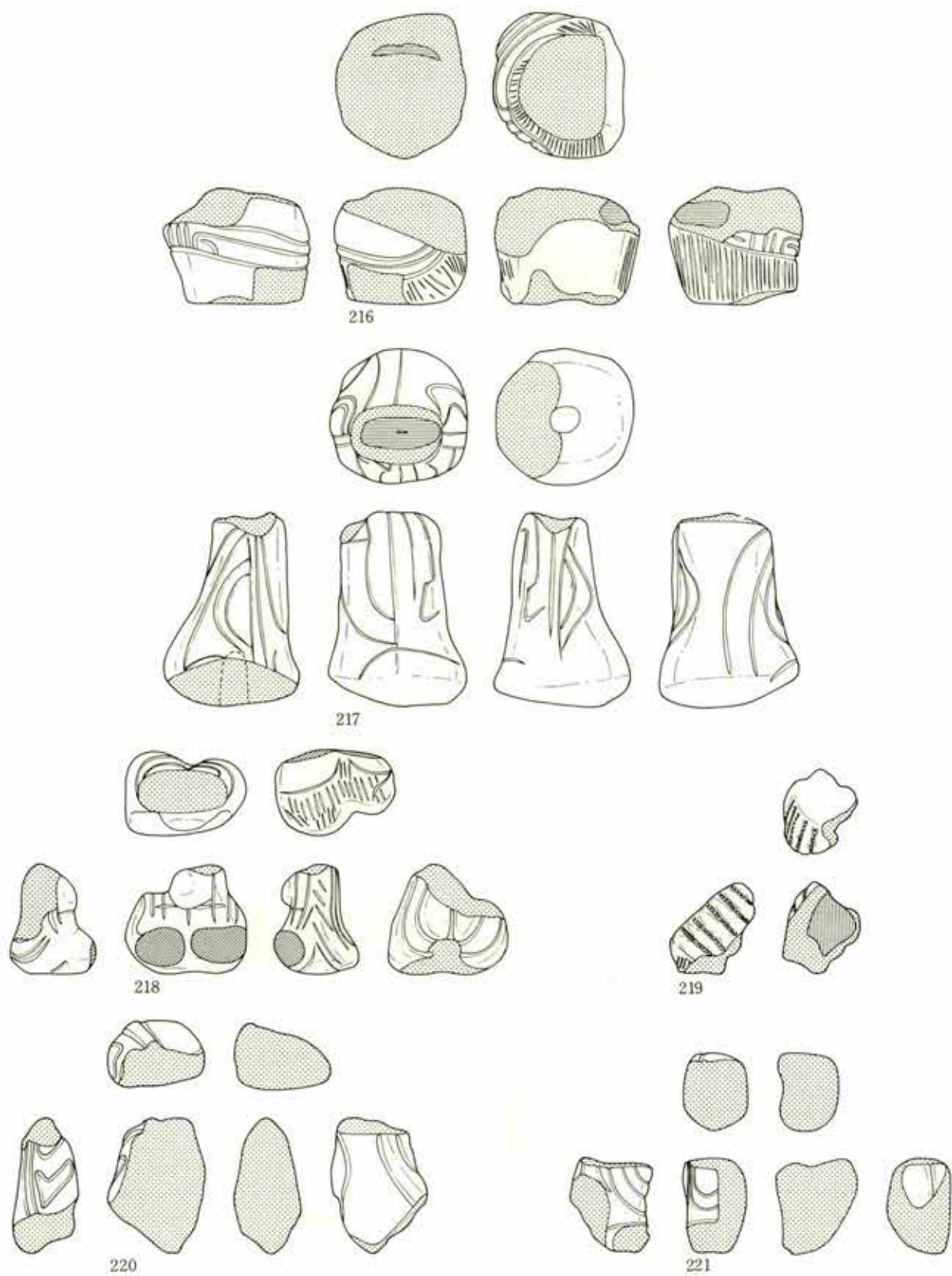

第253图 积逊堂S—III区 土偶 (36)

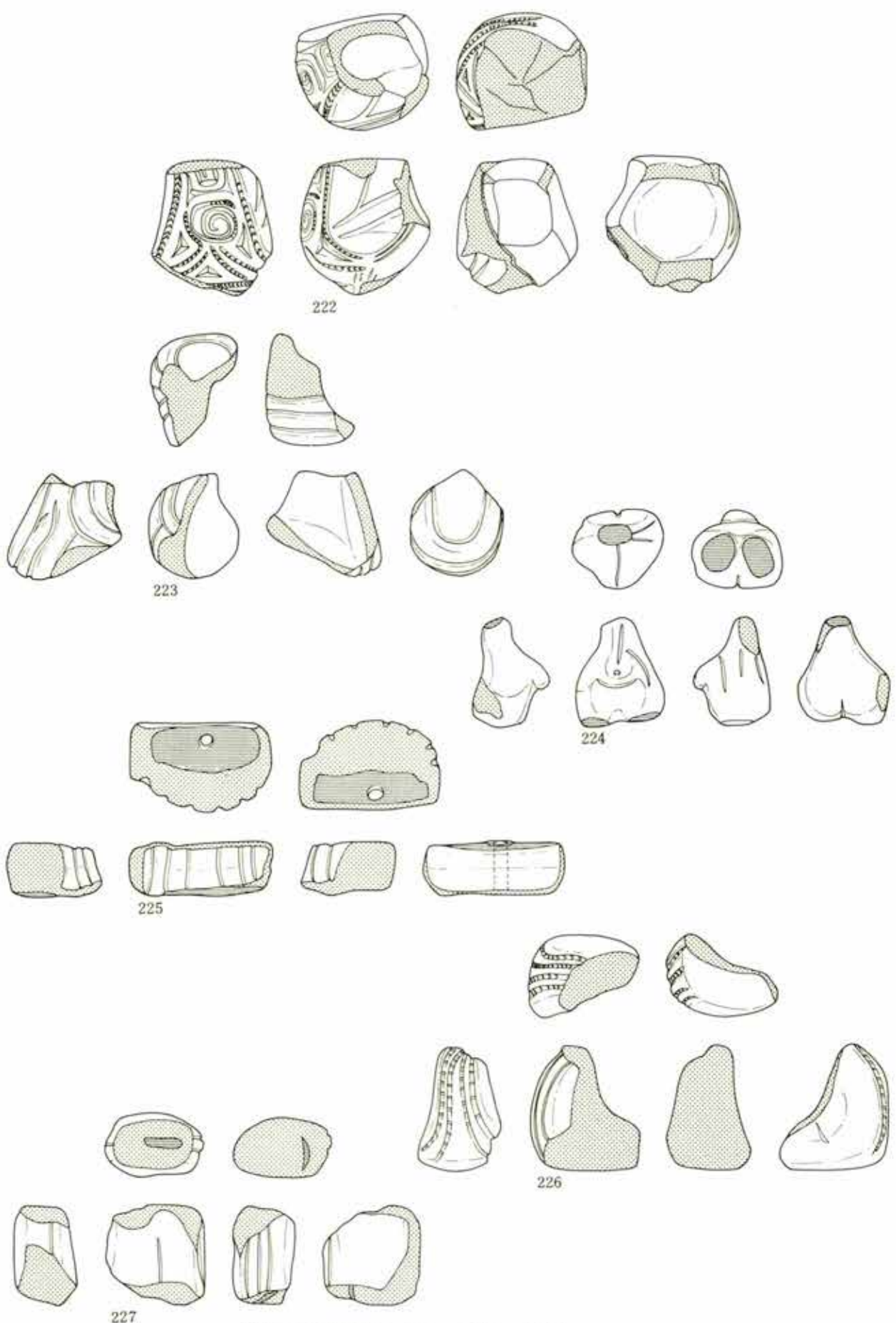

第 254 图 积逊堂 S-III 区 土偶 (37)

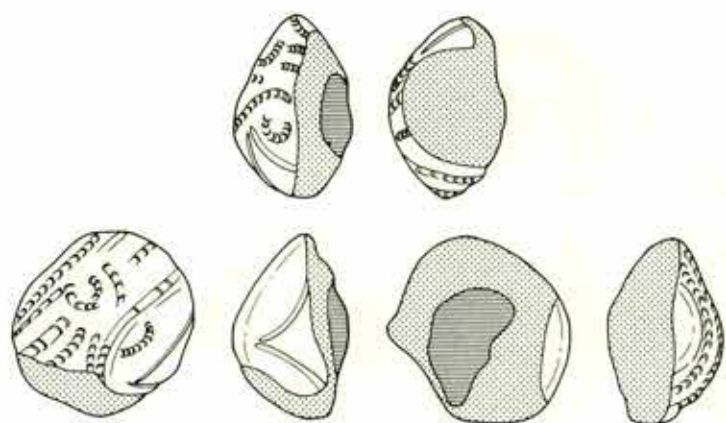

228

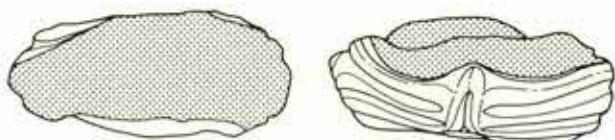

229

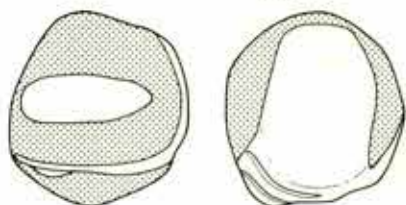
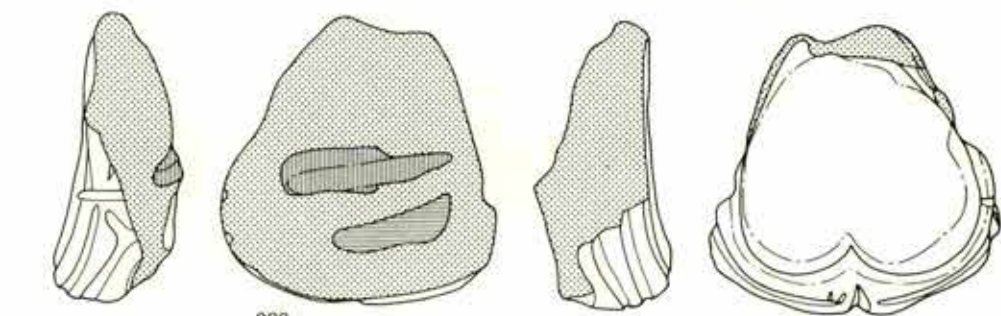

230

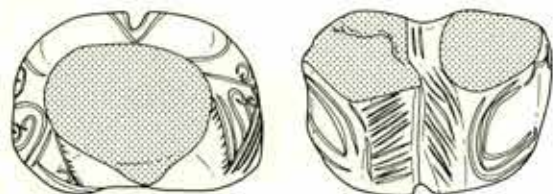
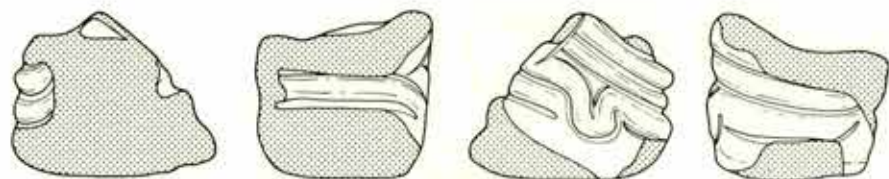

231

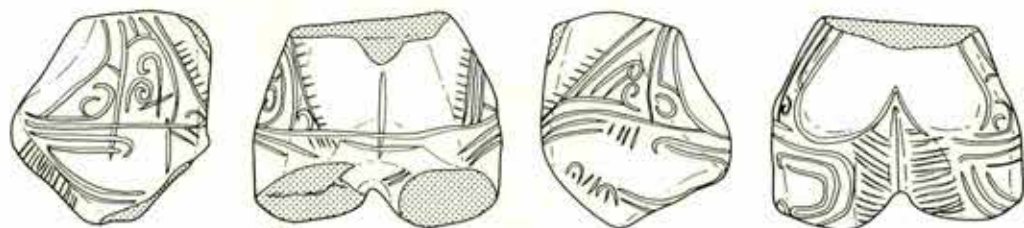

第 255 图 积迦堂 S—III 区 土偶 (38)

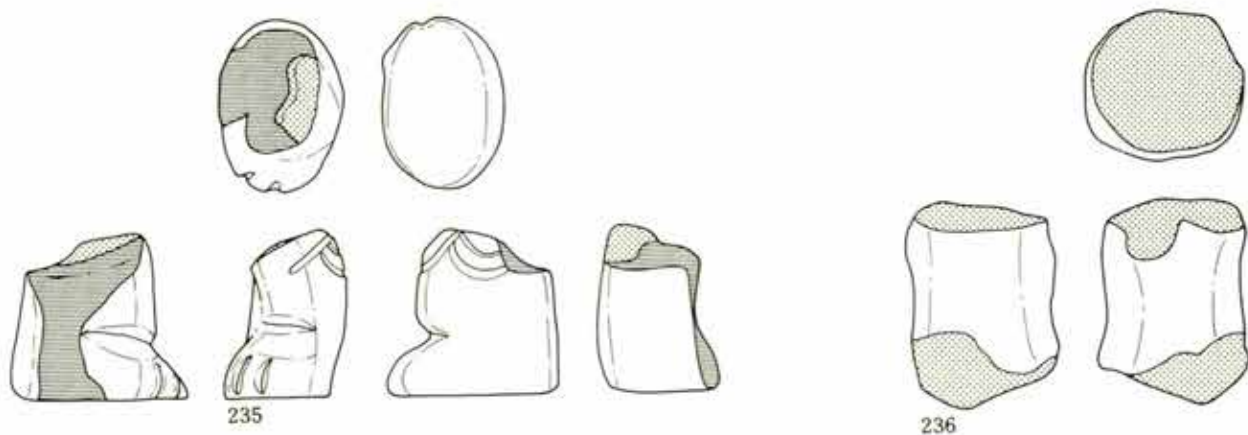
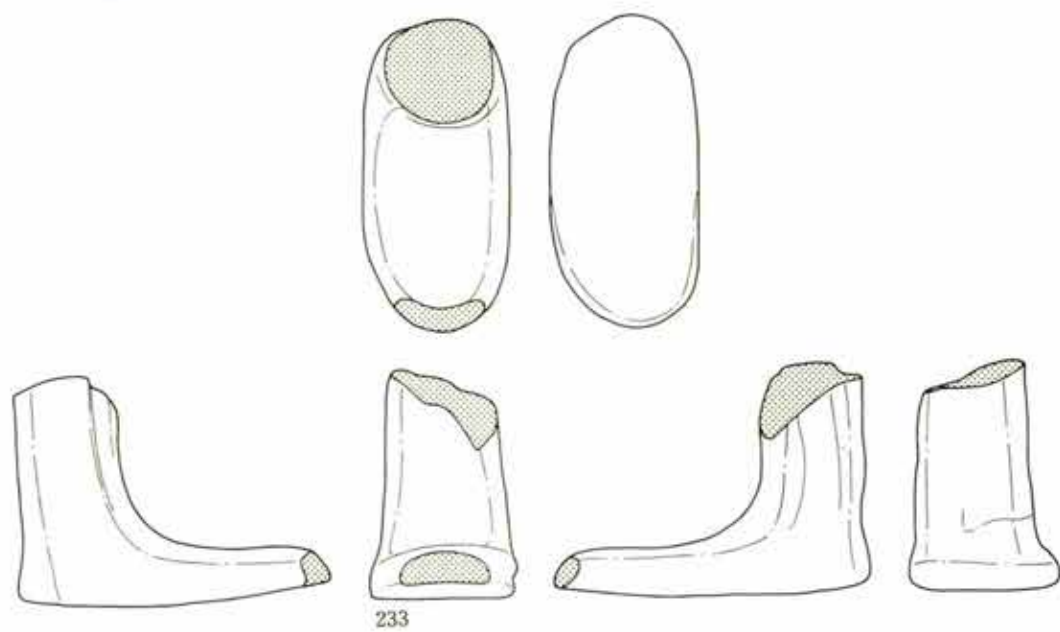
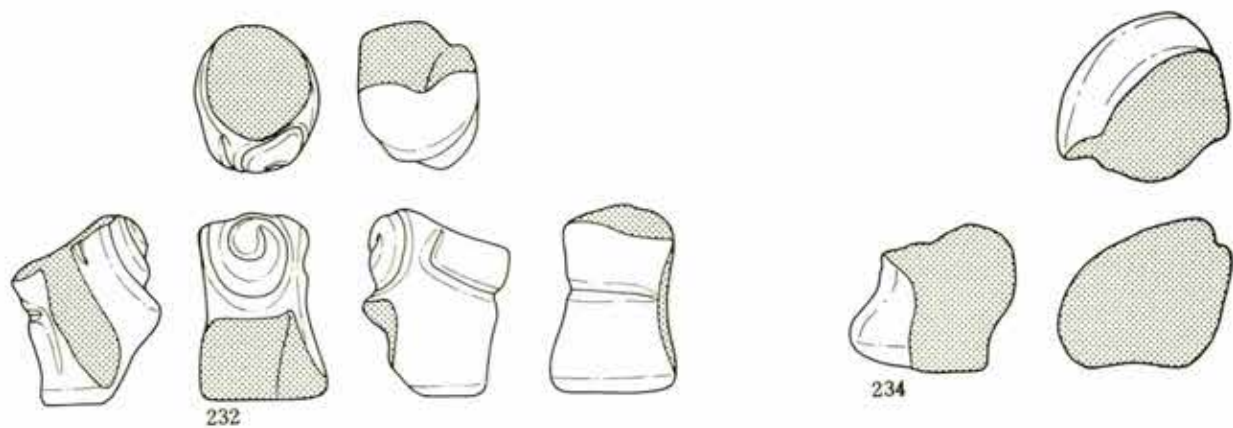

第 256 图 积逊堂 S-III 区 土偶 (39)



第257图 积逊堂S-III区 土偶 (40)

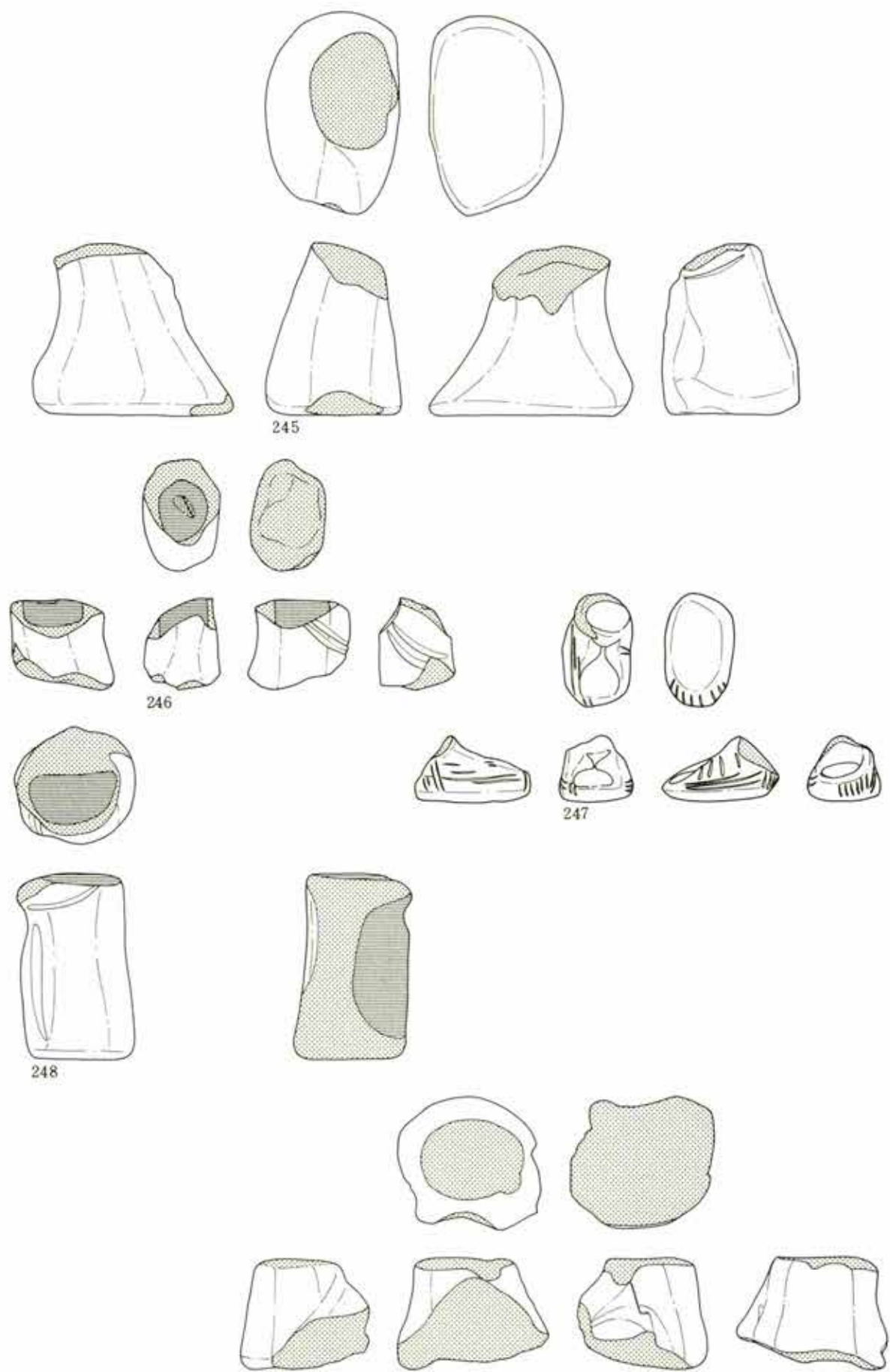

第258图 积迺堂S-III区 土偶 (41)

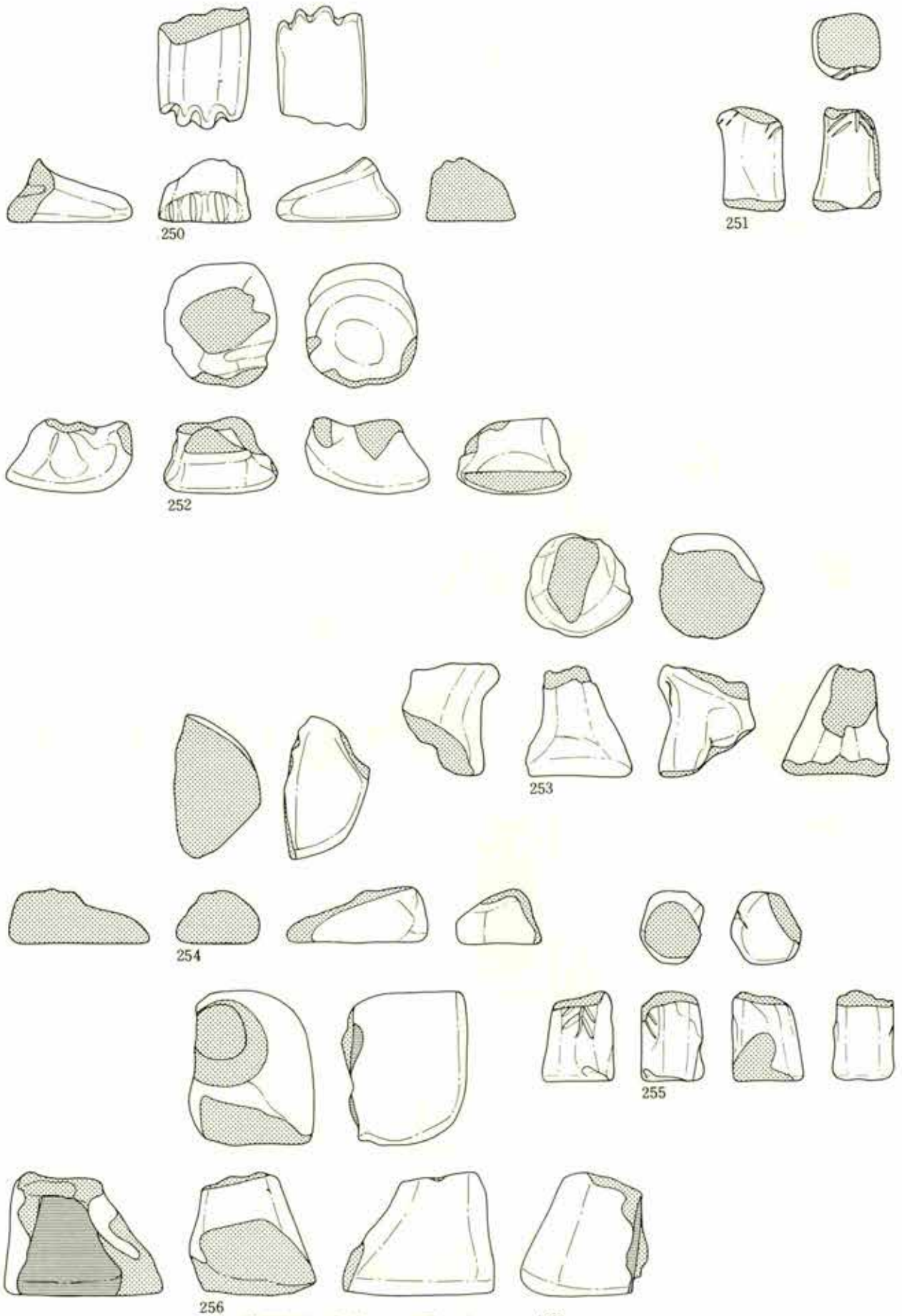

第 259 图 积迦堂 S-III 区 土偶 (42)

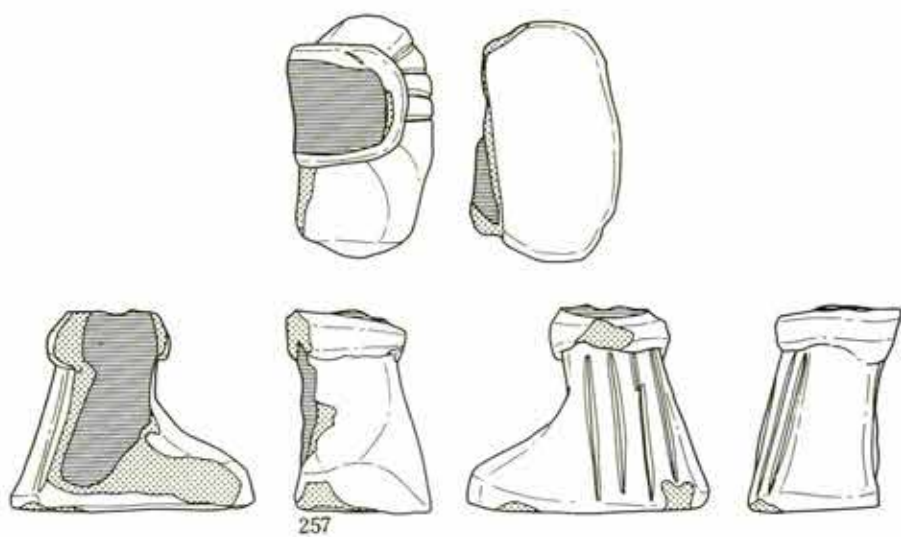

257

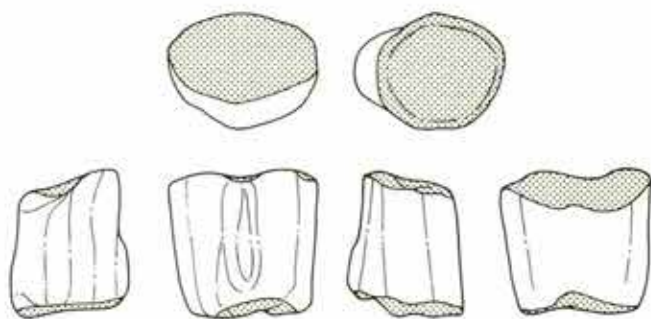

258

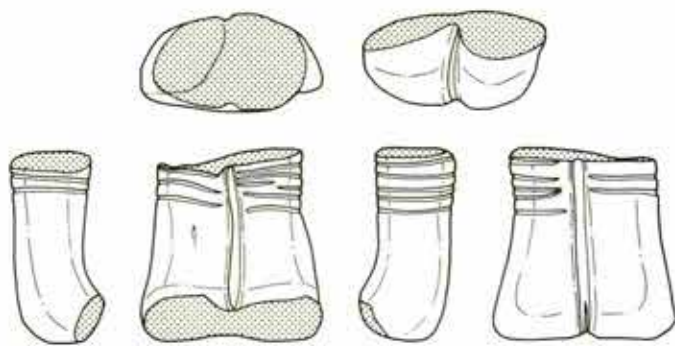

259

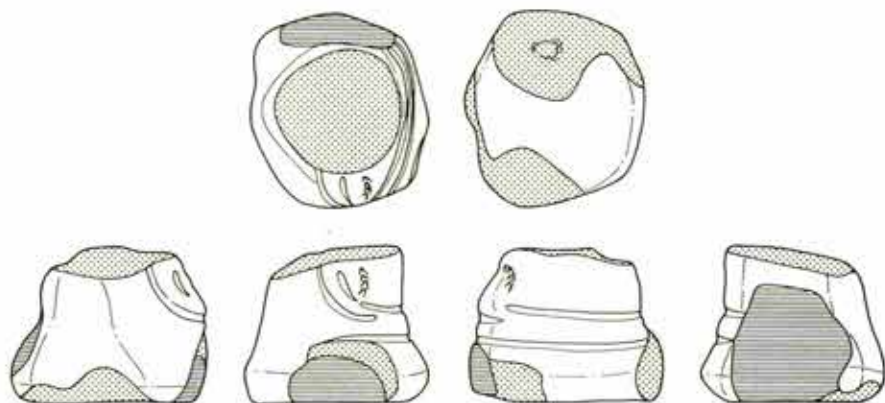

260

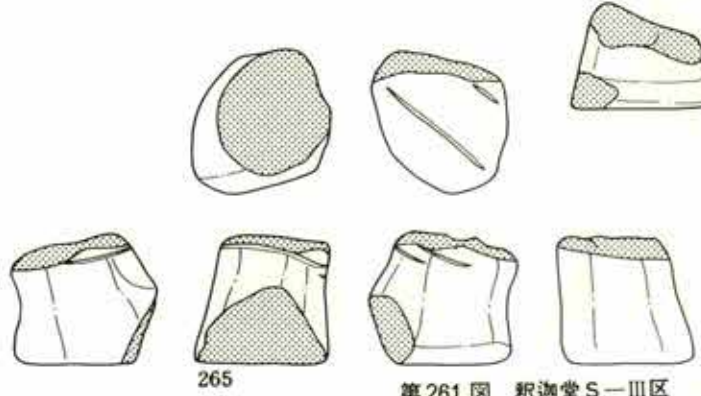
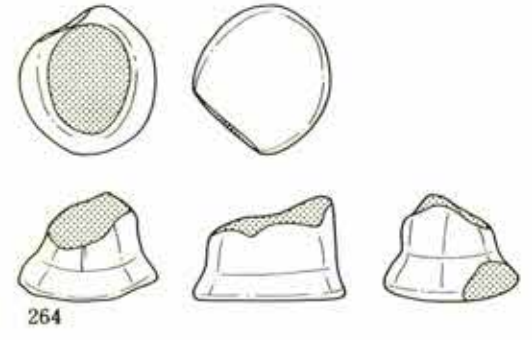
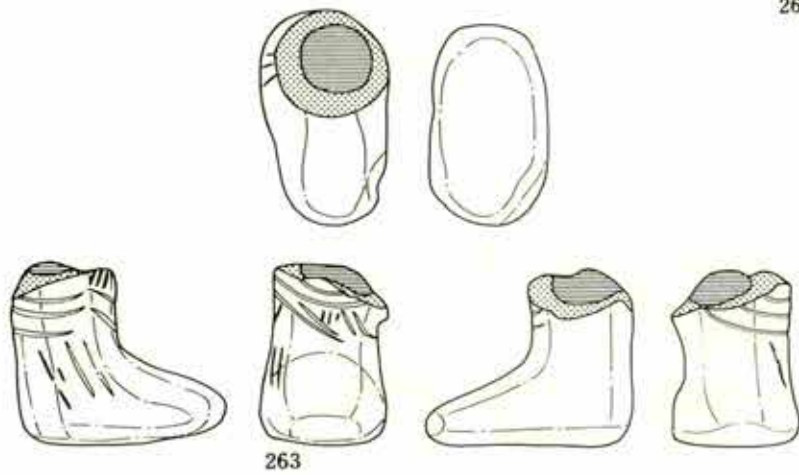
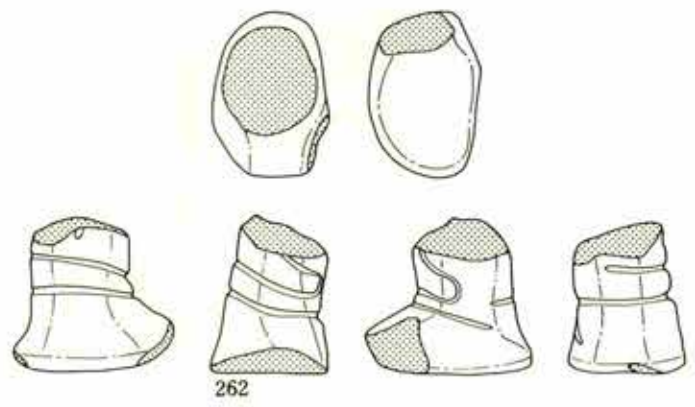
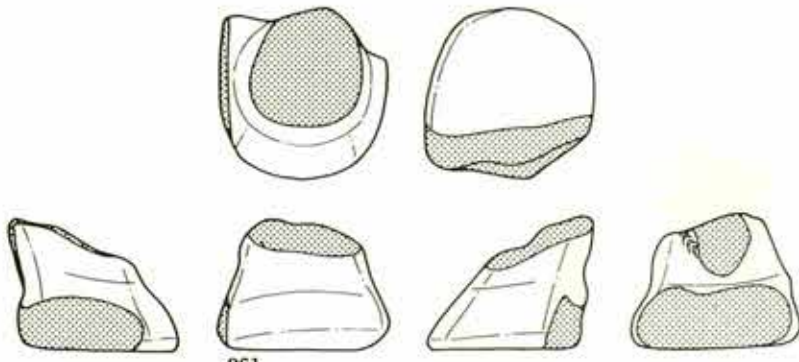

第261图 积逊堂S-III区 土偶 (44)

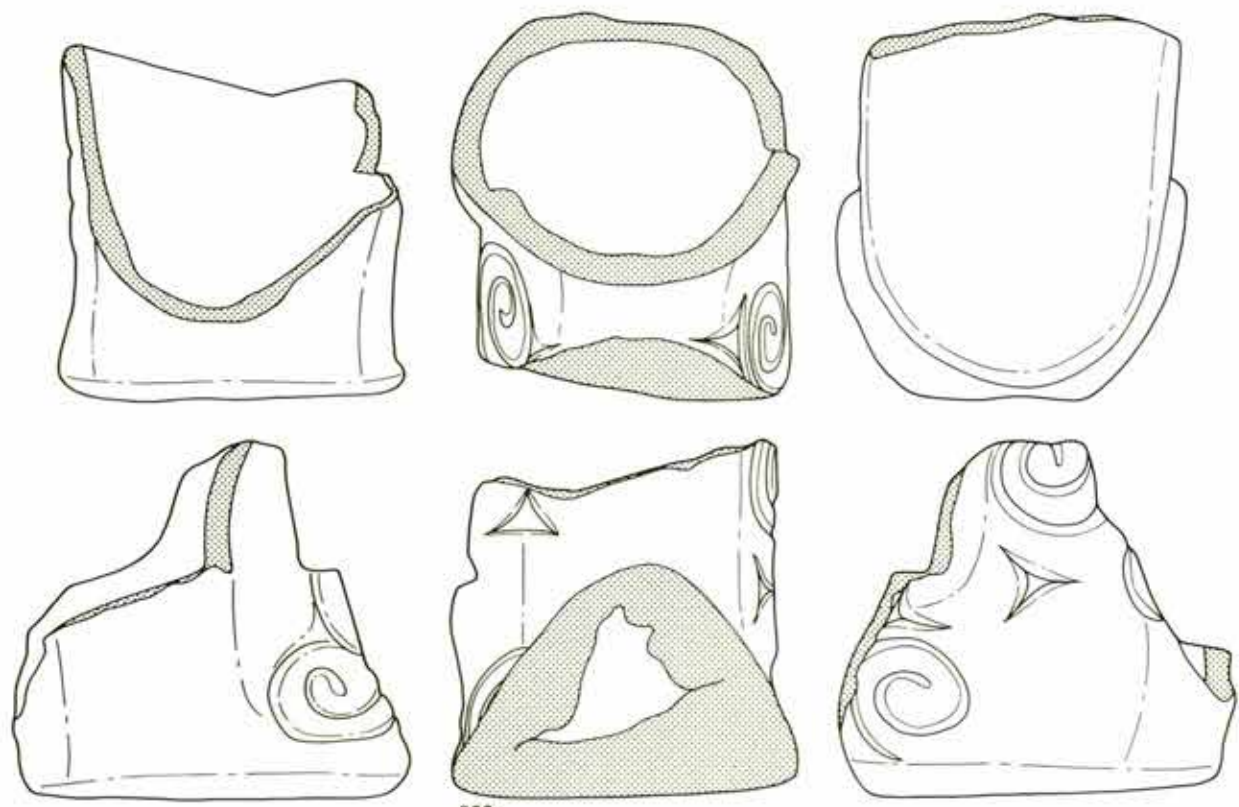

266

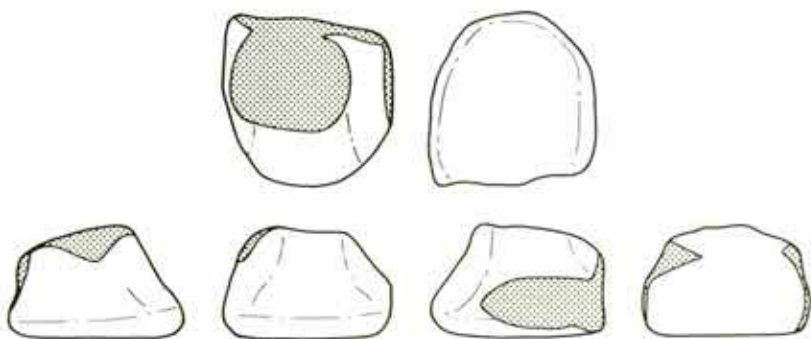

267



268

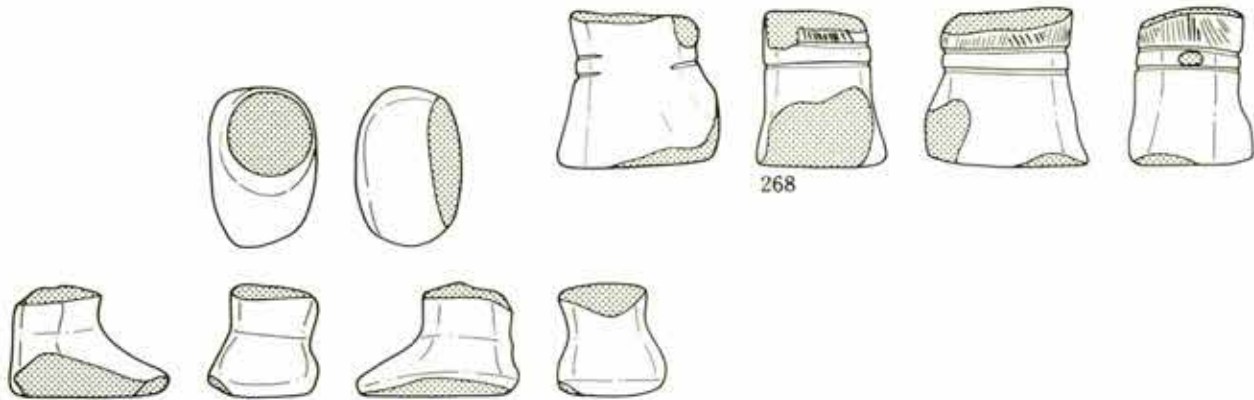

269

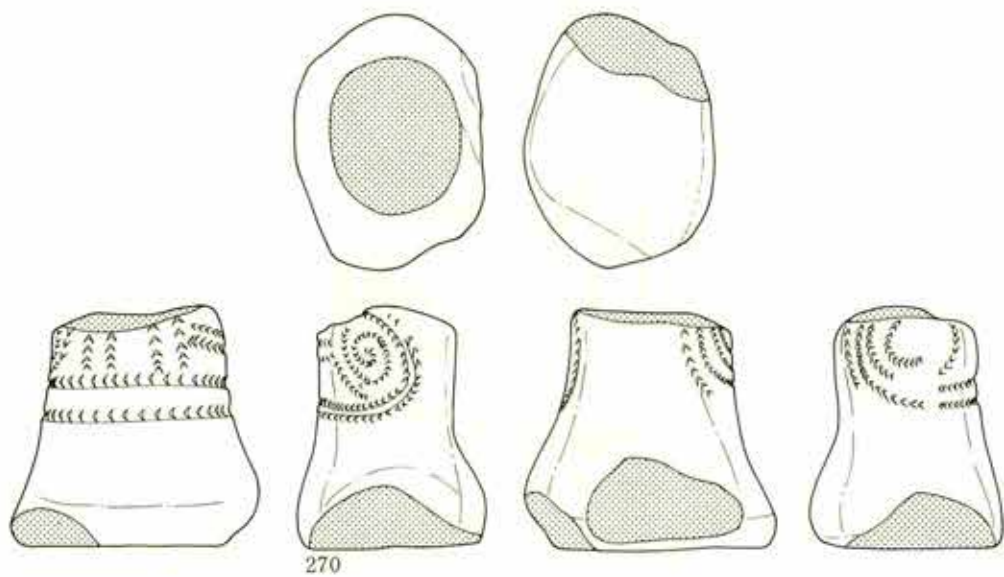

270

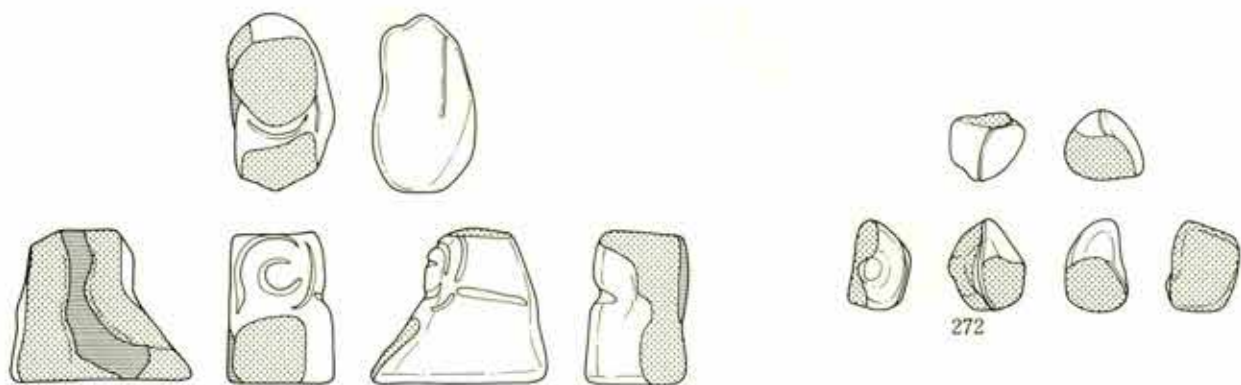

271

272

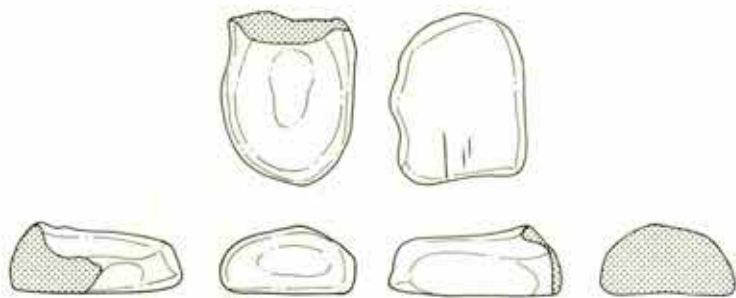

273

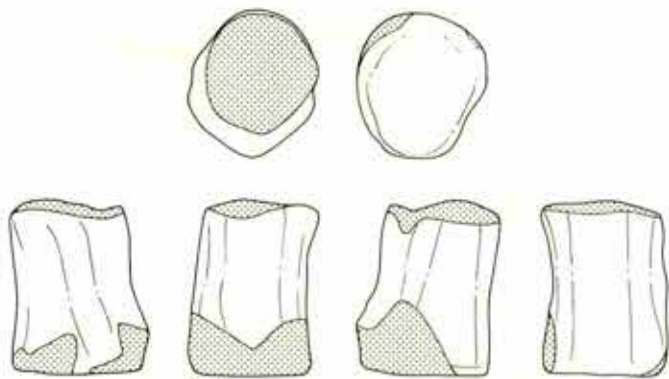

274

第 263 图 积逊堂 S-III 区 土偶 (46)

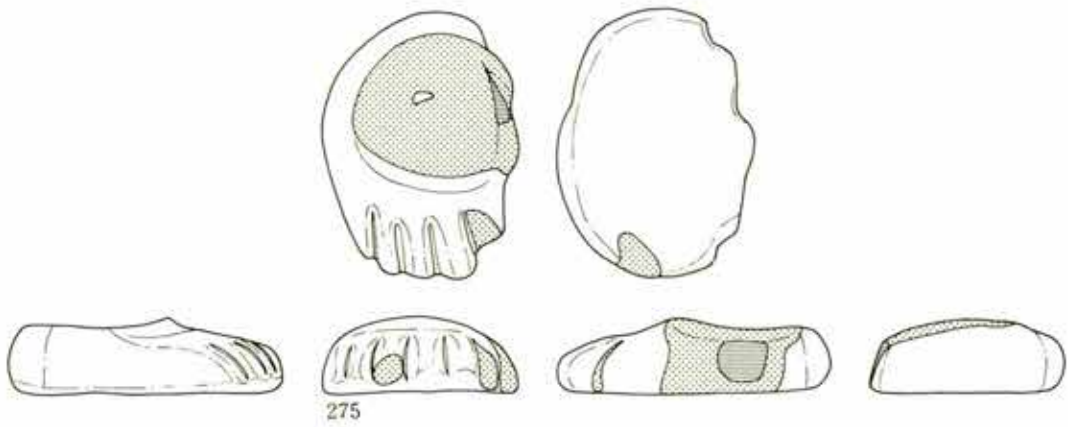

275

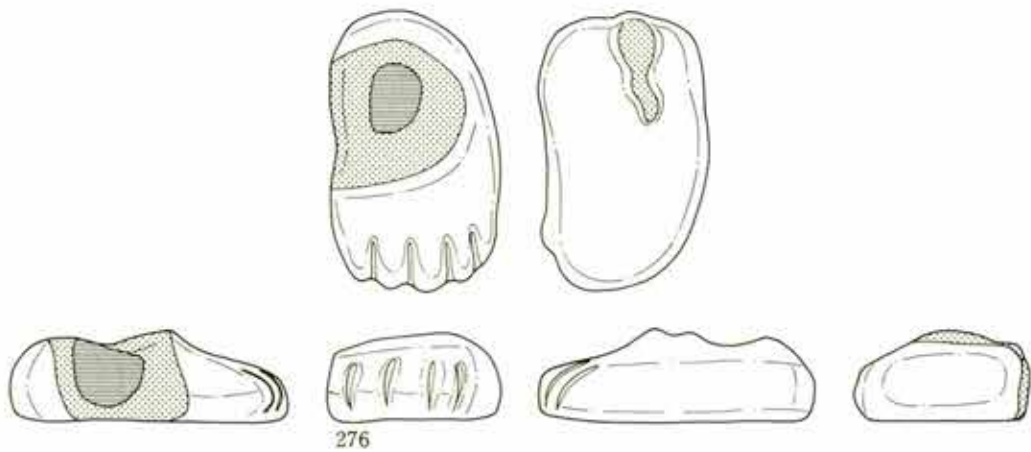

276



277



278

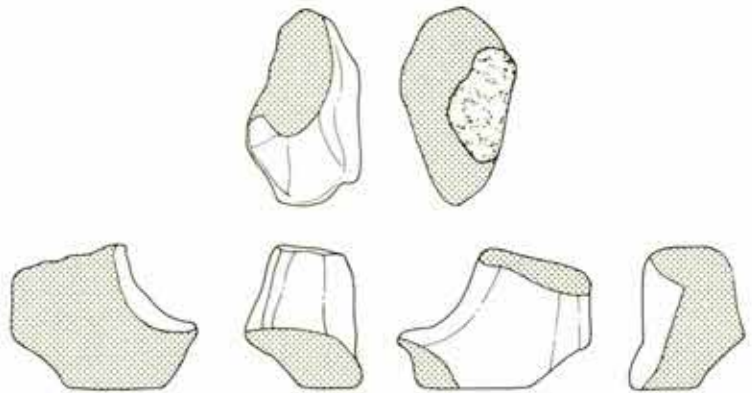

279
(47)

第 264 图 积迦堂 S-III 区 土偶

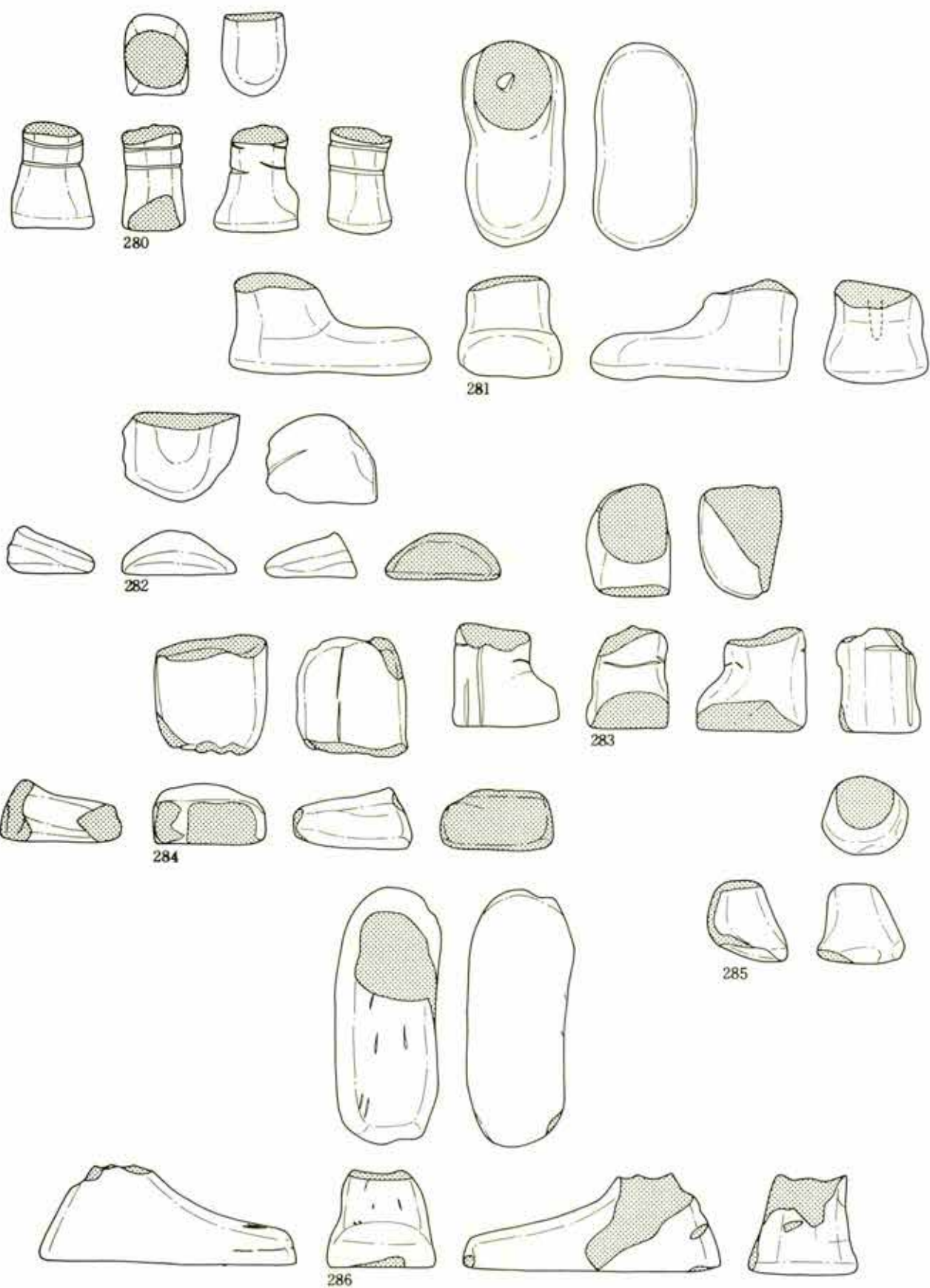

第265图 积逊堂S-III区 土偶 (48)



第 266 图 积逊堂 S—III 区 土偶 (49)

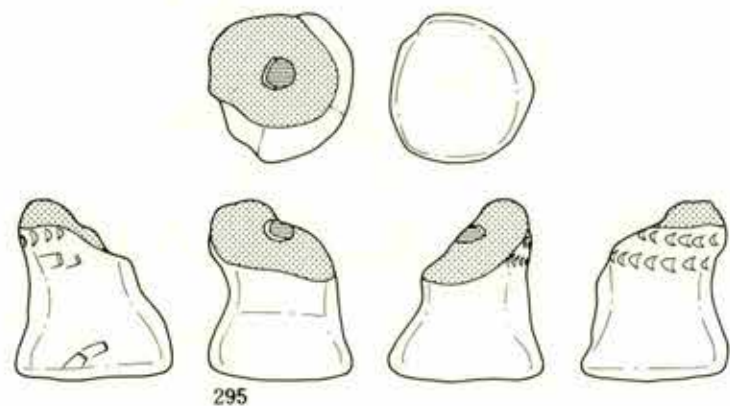

295

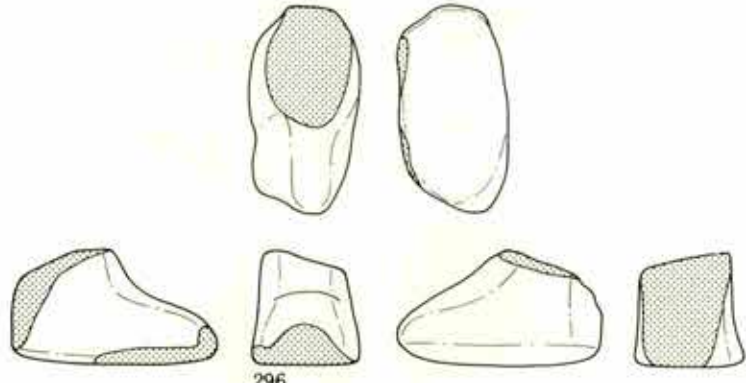

296

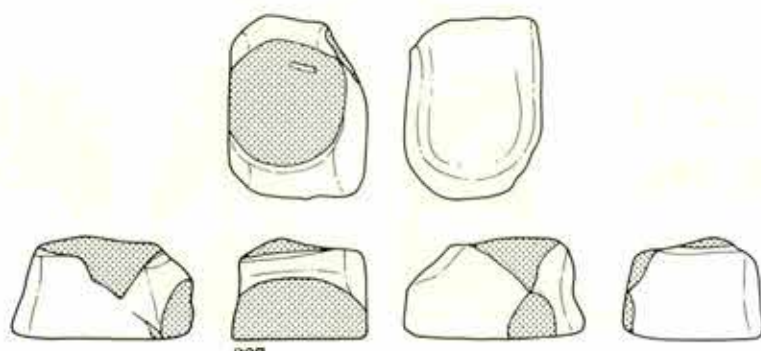

297

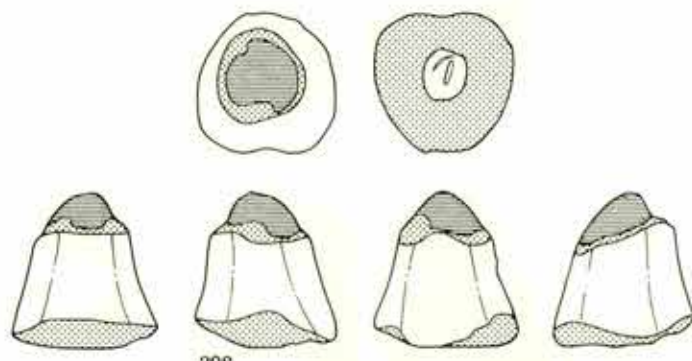

298

第 267 图 积迦堂 S-III 区 土偶 (50)

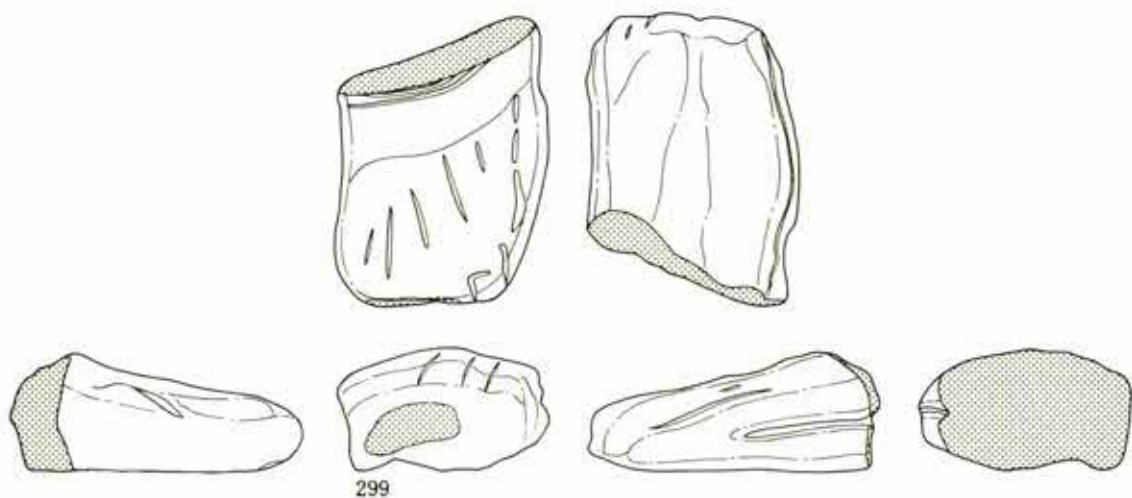

299

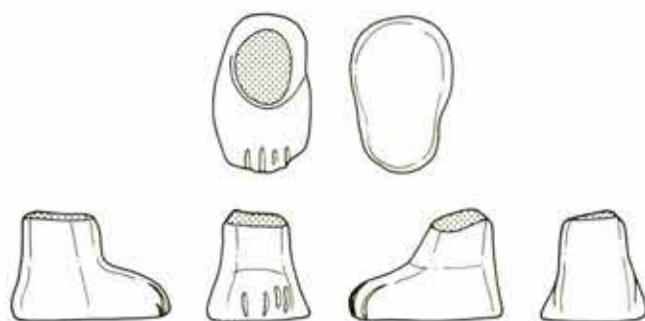

300

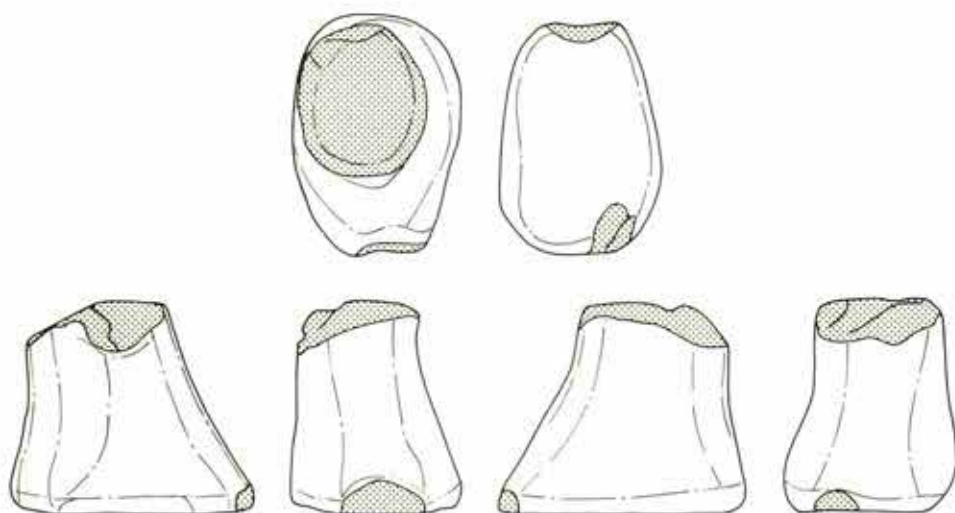

301

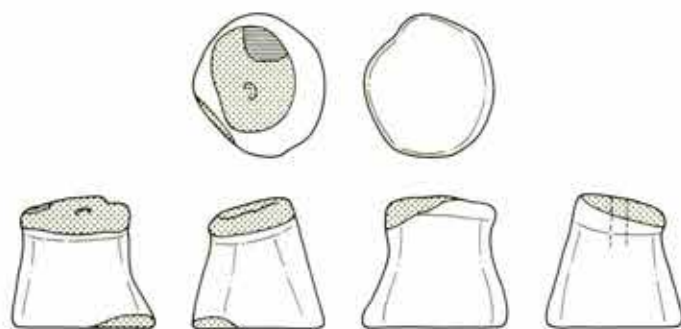

302

第 268 图 积逊堂 S-III 区 土偶 (51)

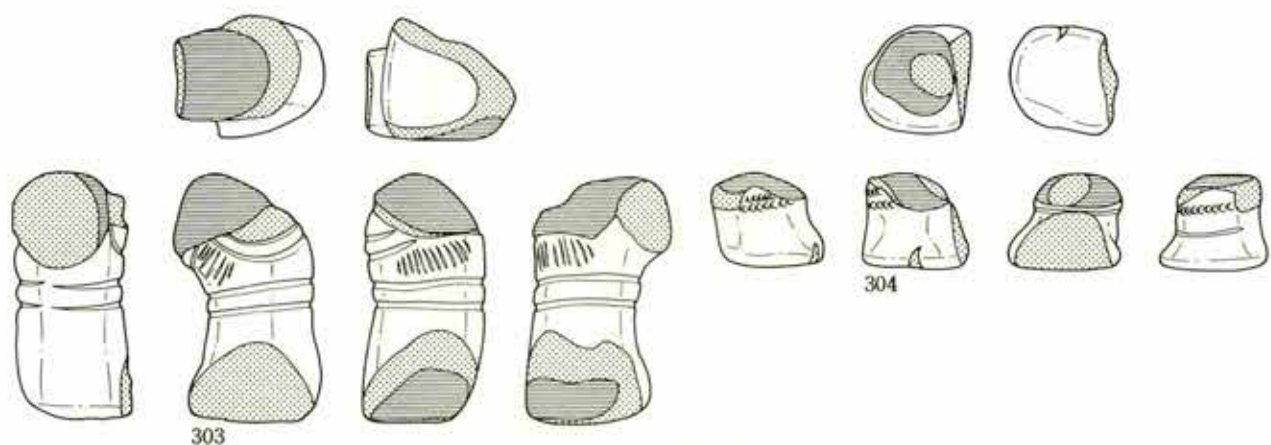

303

304

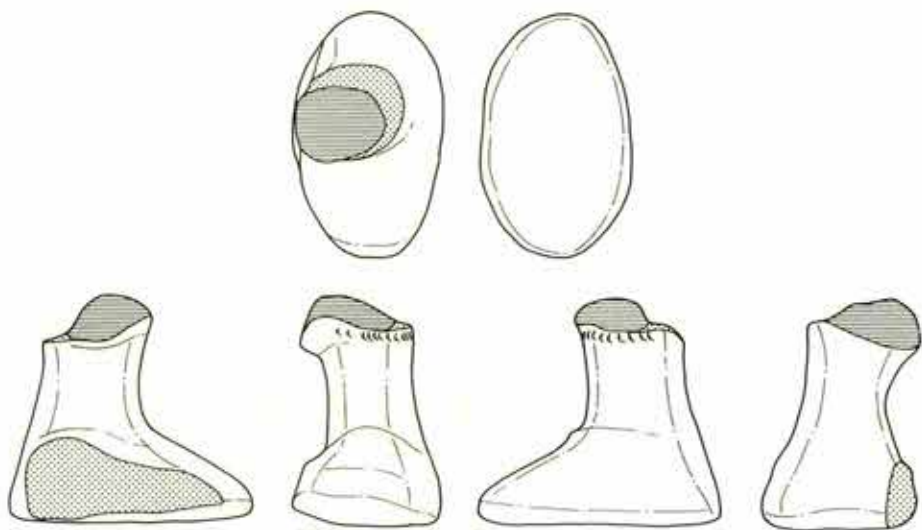

305

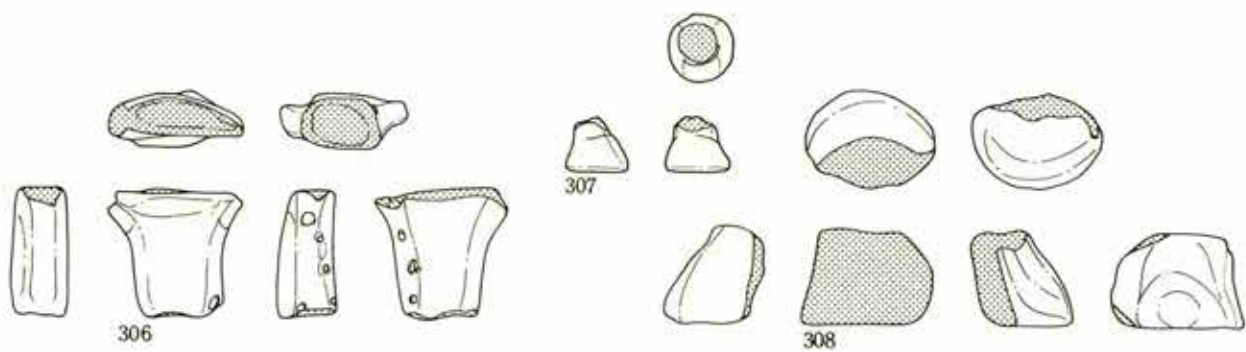

306

307

308

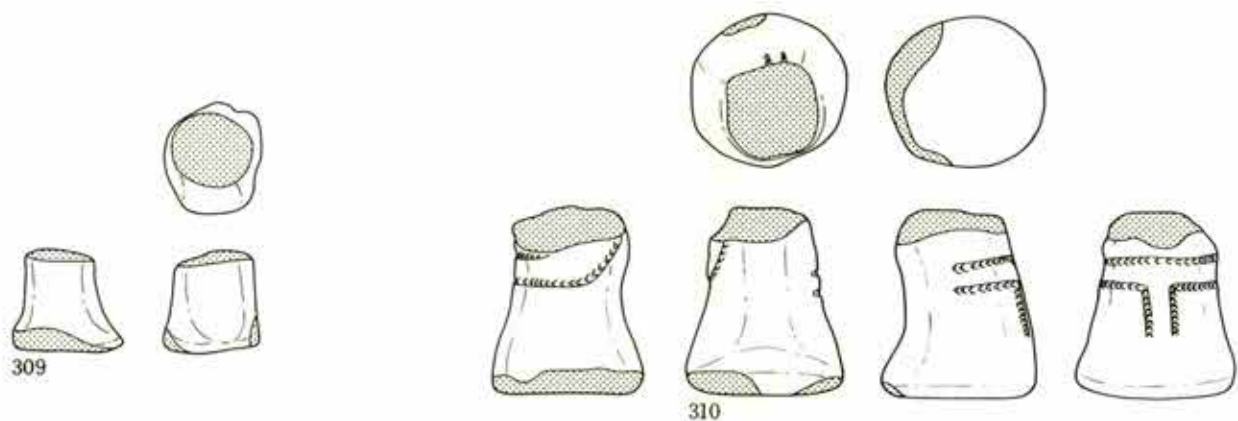

309

310

第 269 图 积逊堂 S-III 区 土偶 (52)

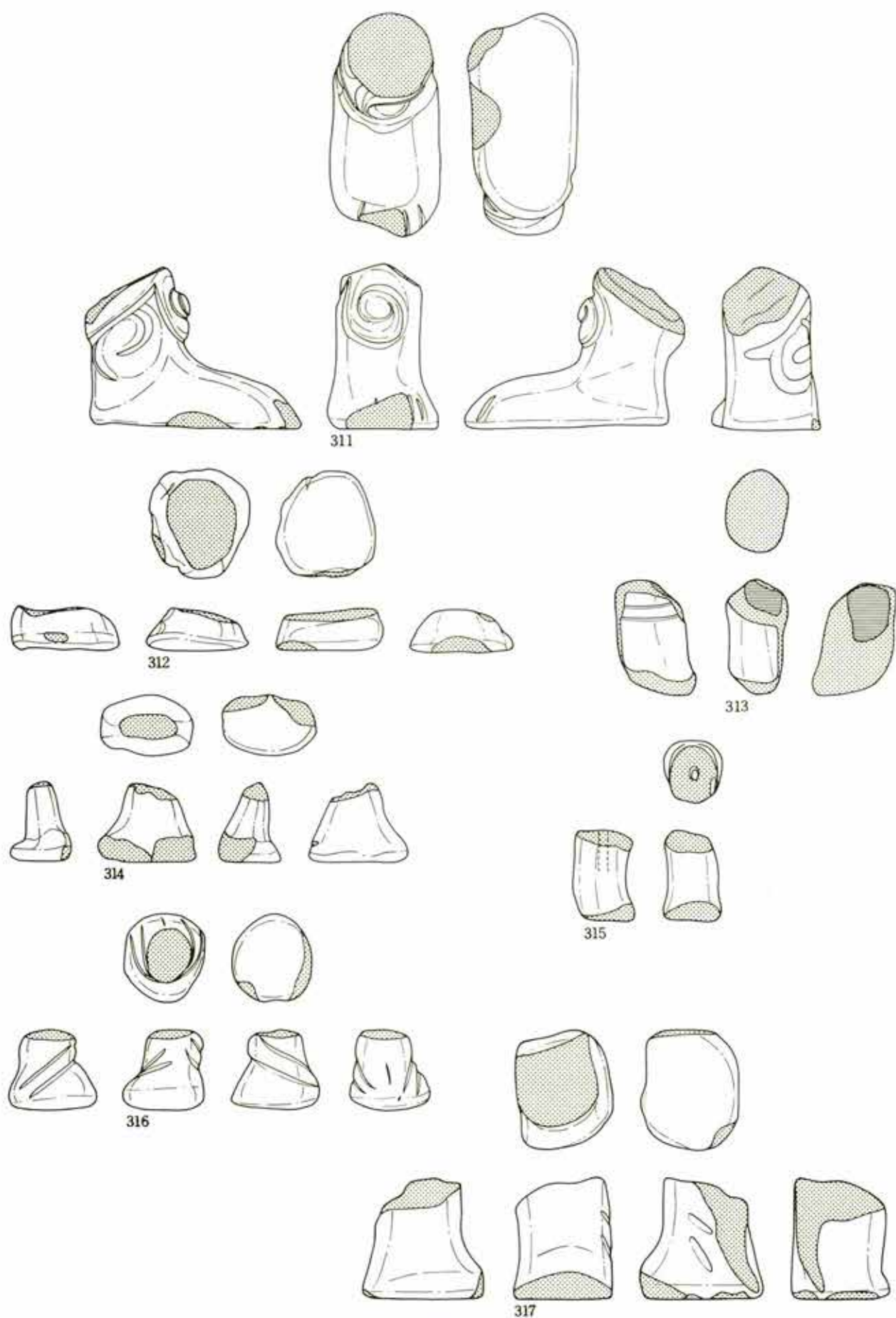

第270图 积善堂S-III区 土偶 (53)

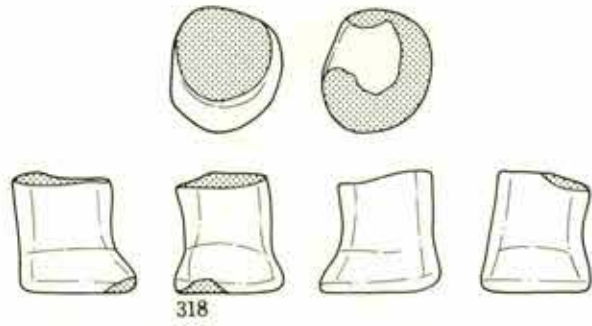

318

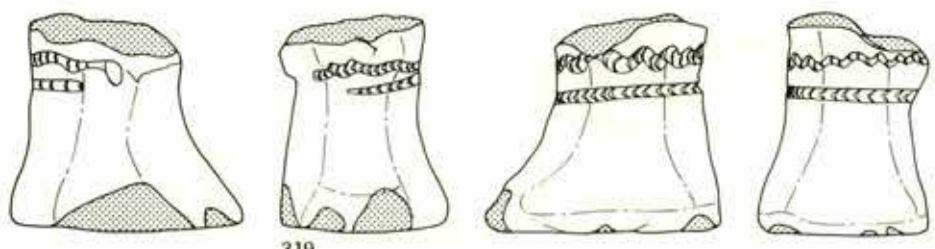
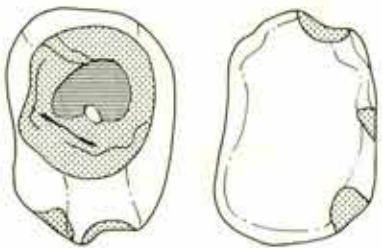

319

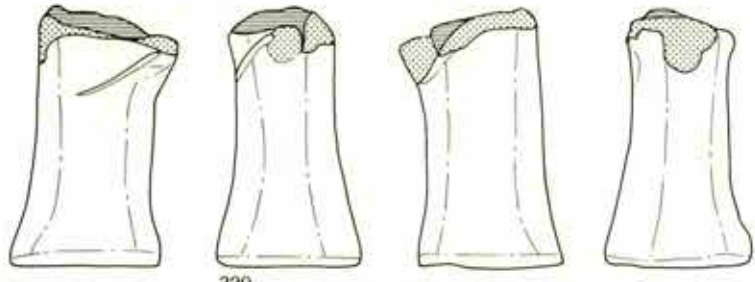
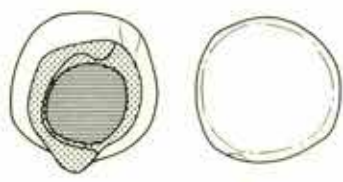

320

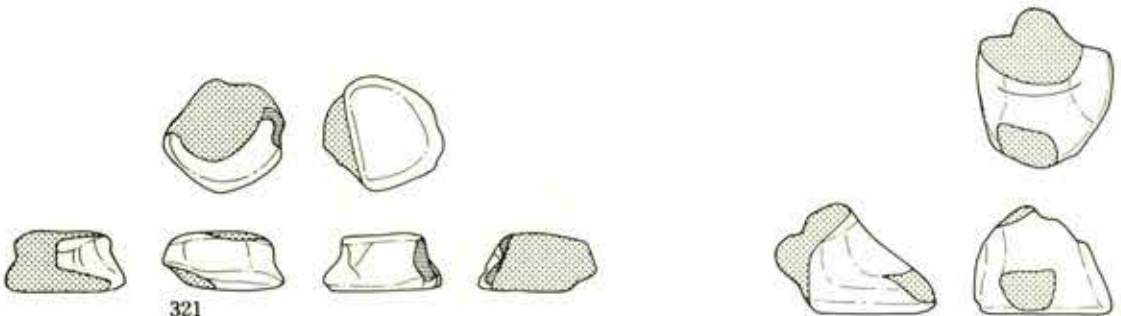

321

322

第271图 积逊堂S-III区 土偶 (54)

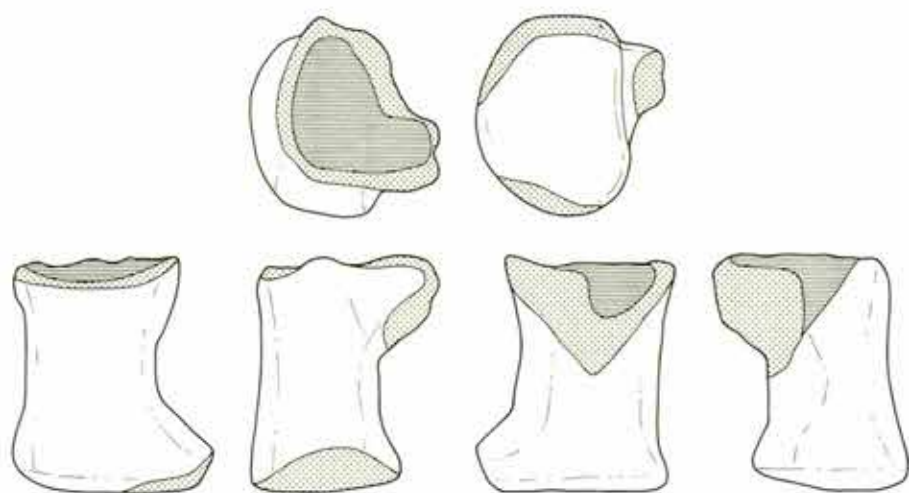

323



325

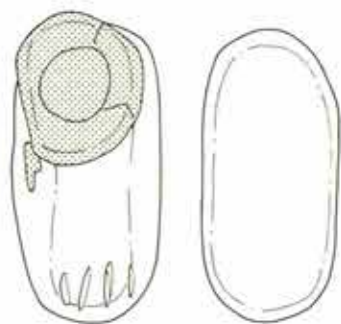

324

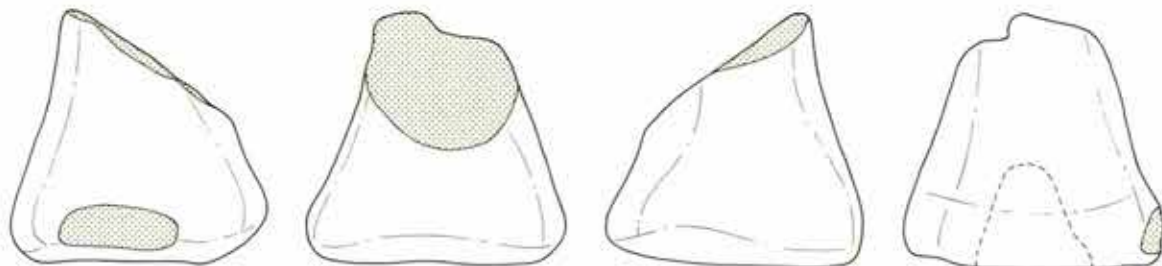
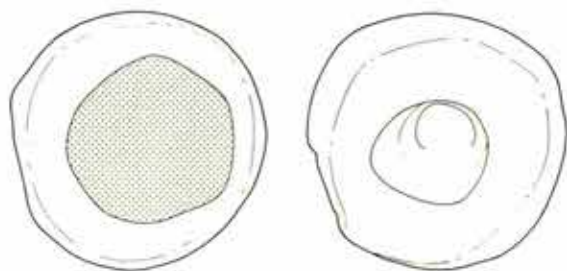

326



第273图 积逊堂S-III区 土偶 (56)

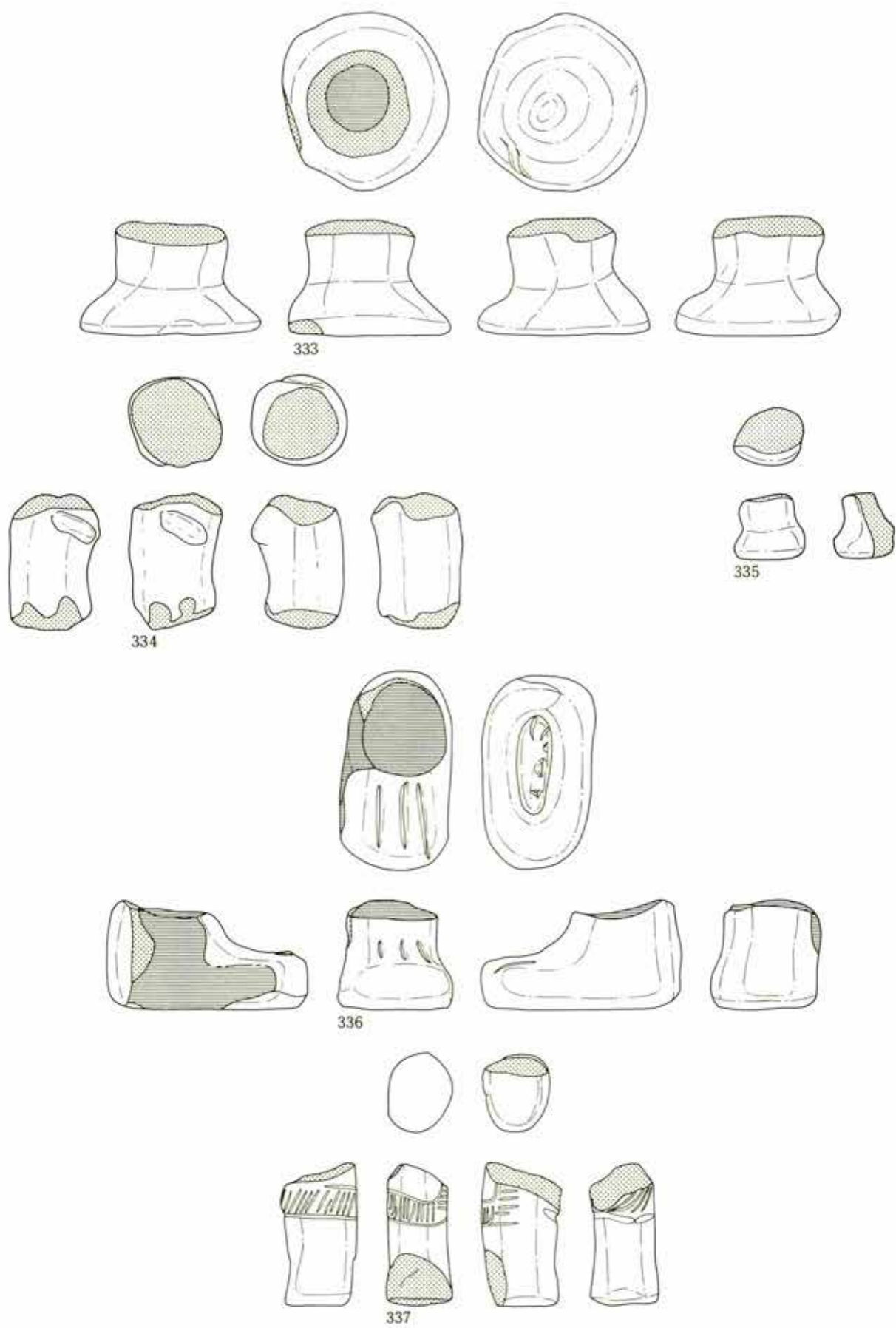

第 274 图 积逊堂 S-III 区 土偶 (57)

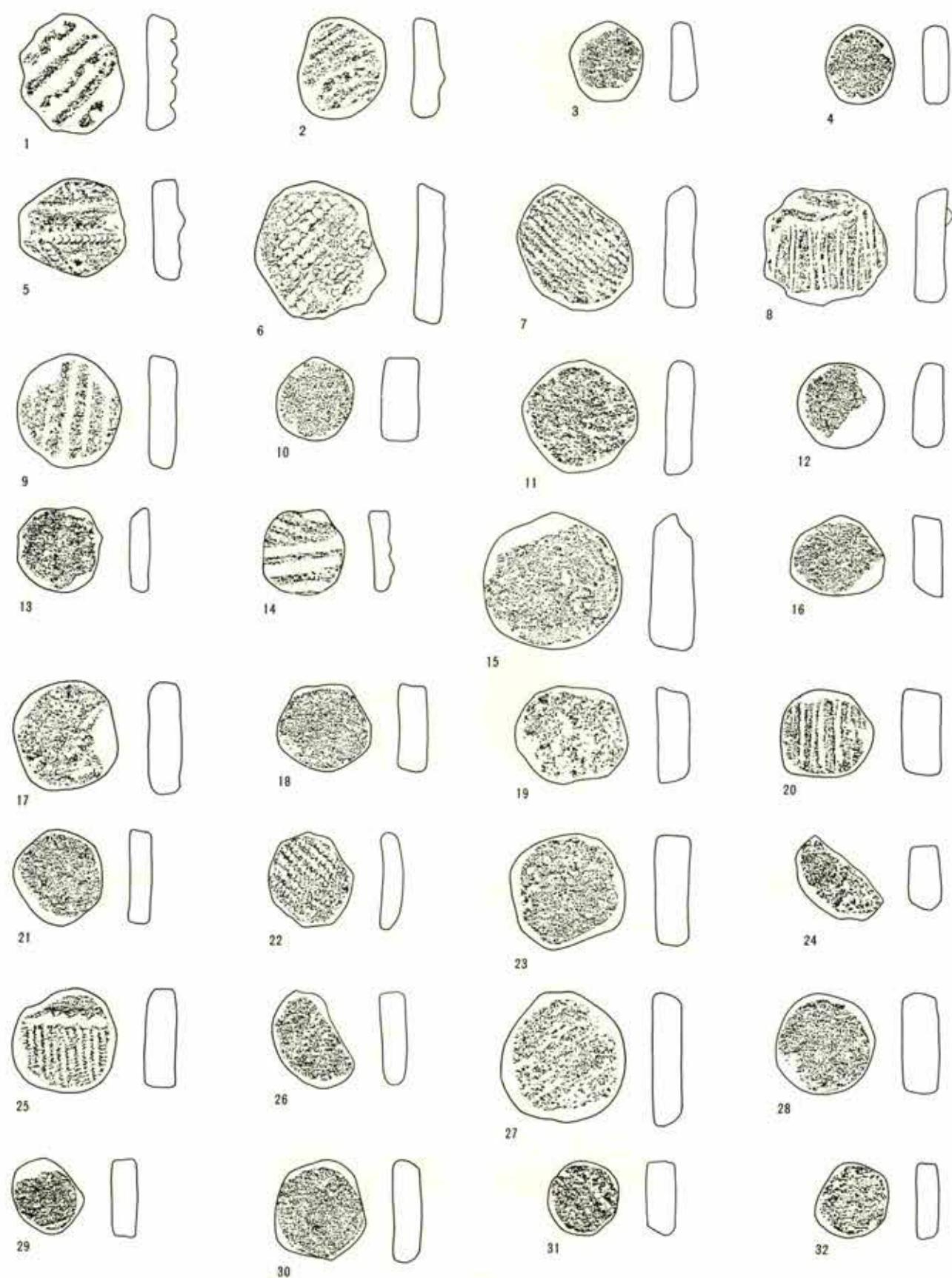

第275图 积迦堂S-III区 SB土製円盤

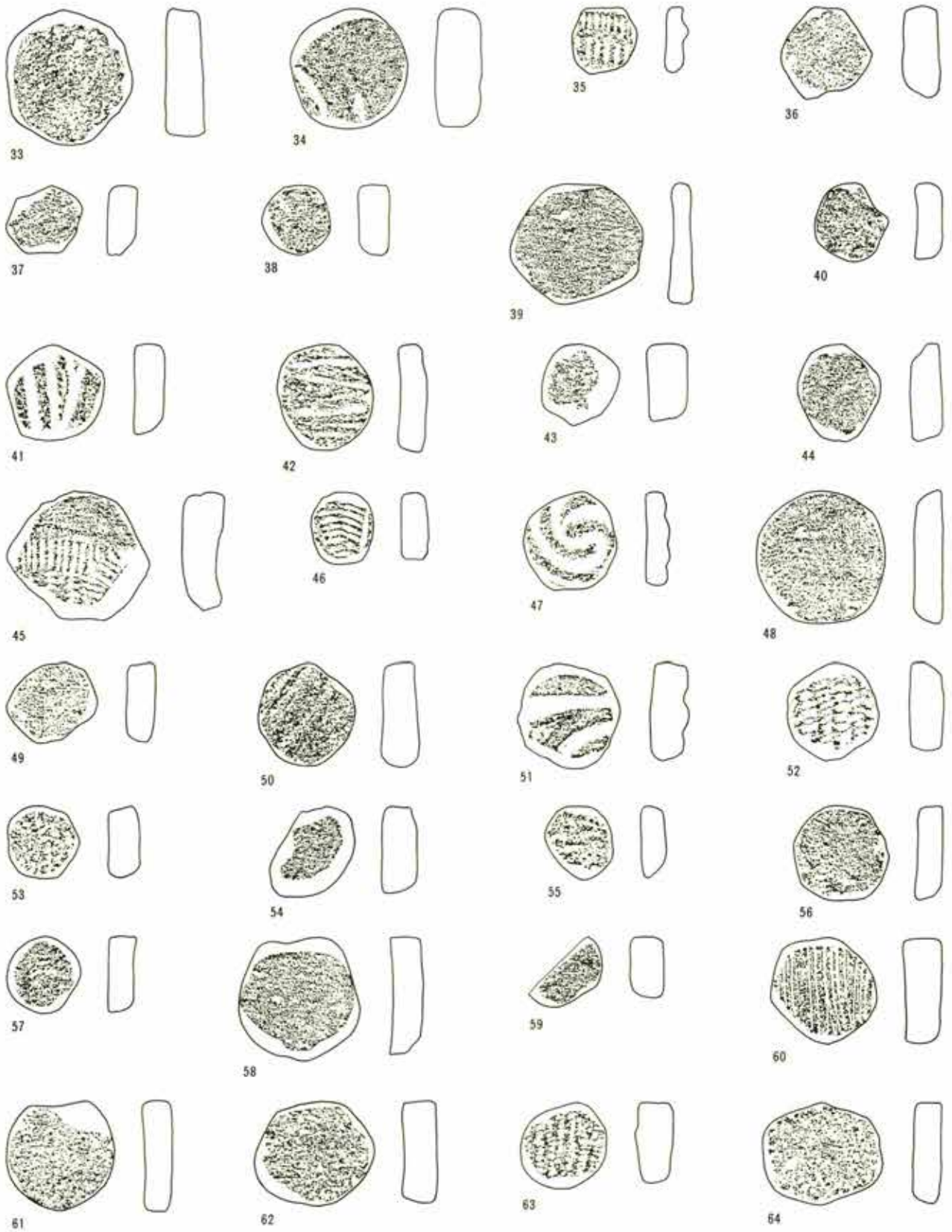

第 276 图 积迦堂 S—III 区 SB 土製円盤

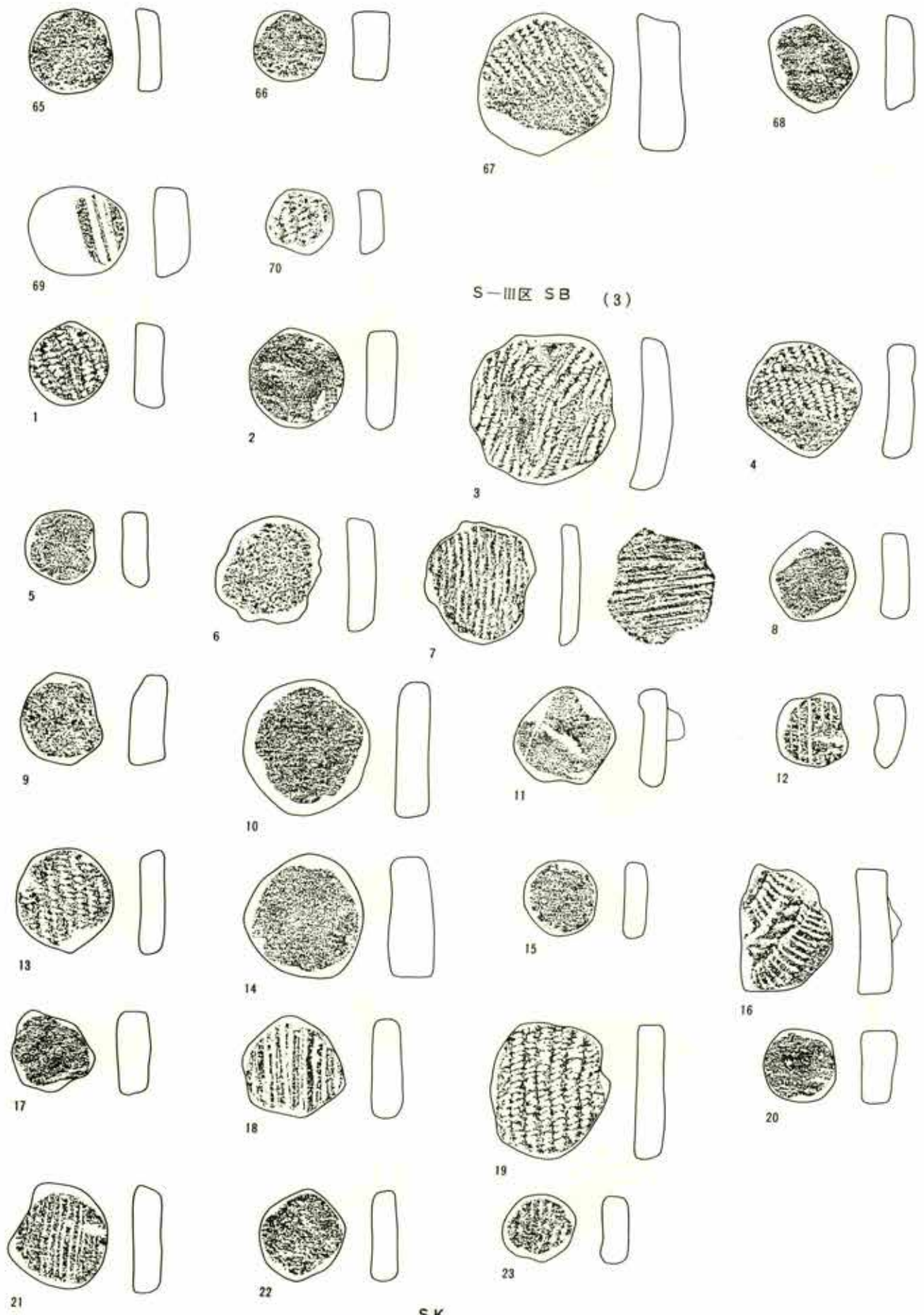

SK

第277图 积逊堂S-III区 SB SK 土製円盤



第 278 图 积边堂 S-III 区 土製円盤

(1)



第 279 图 积边堂 S-III 区 土製円盤 (2)

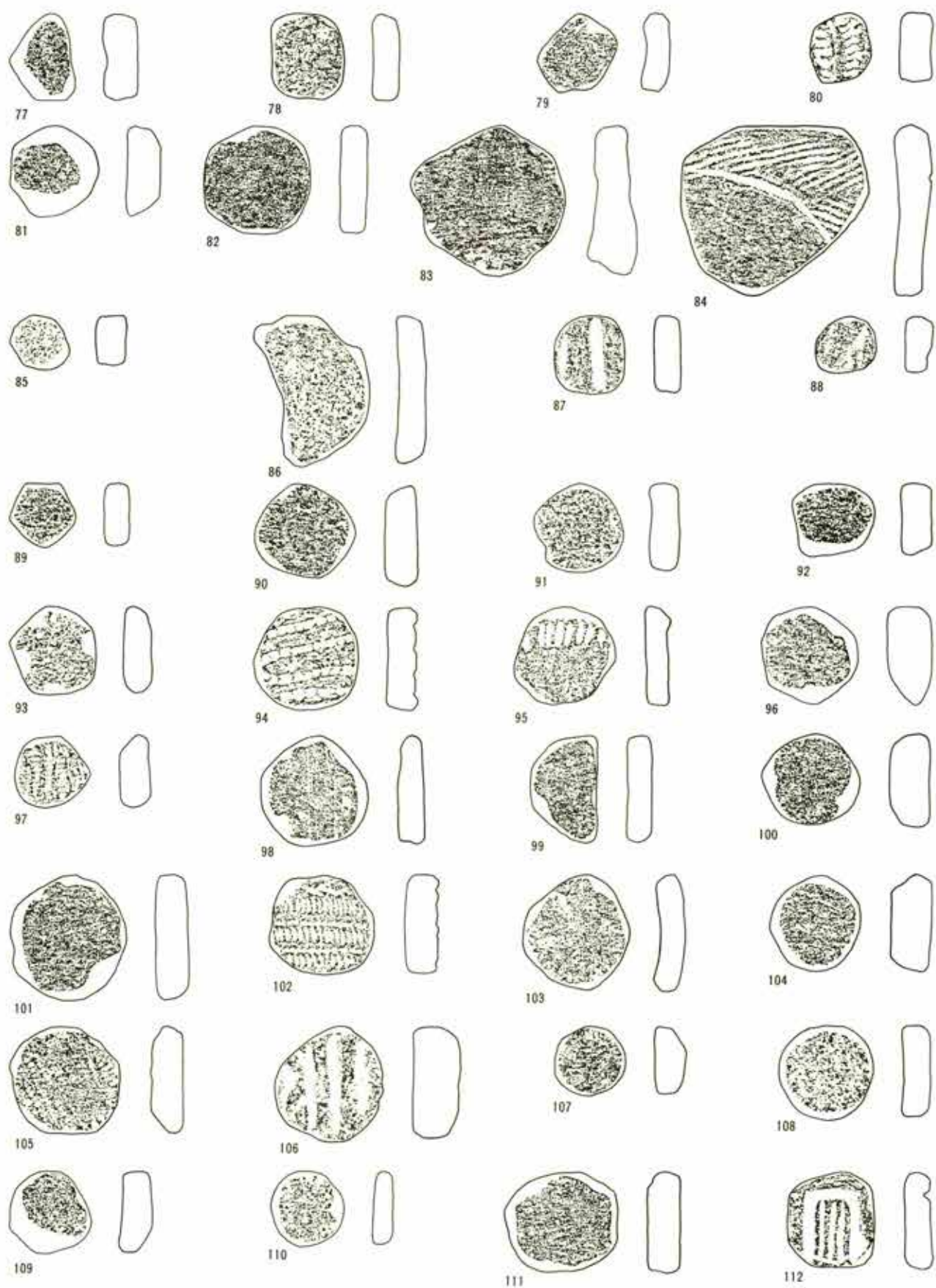

第 280 图 积逊堂 S-III 区土製円盤

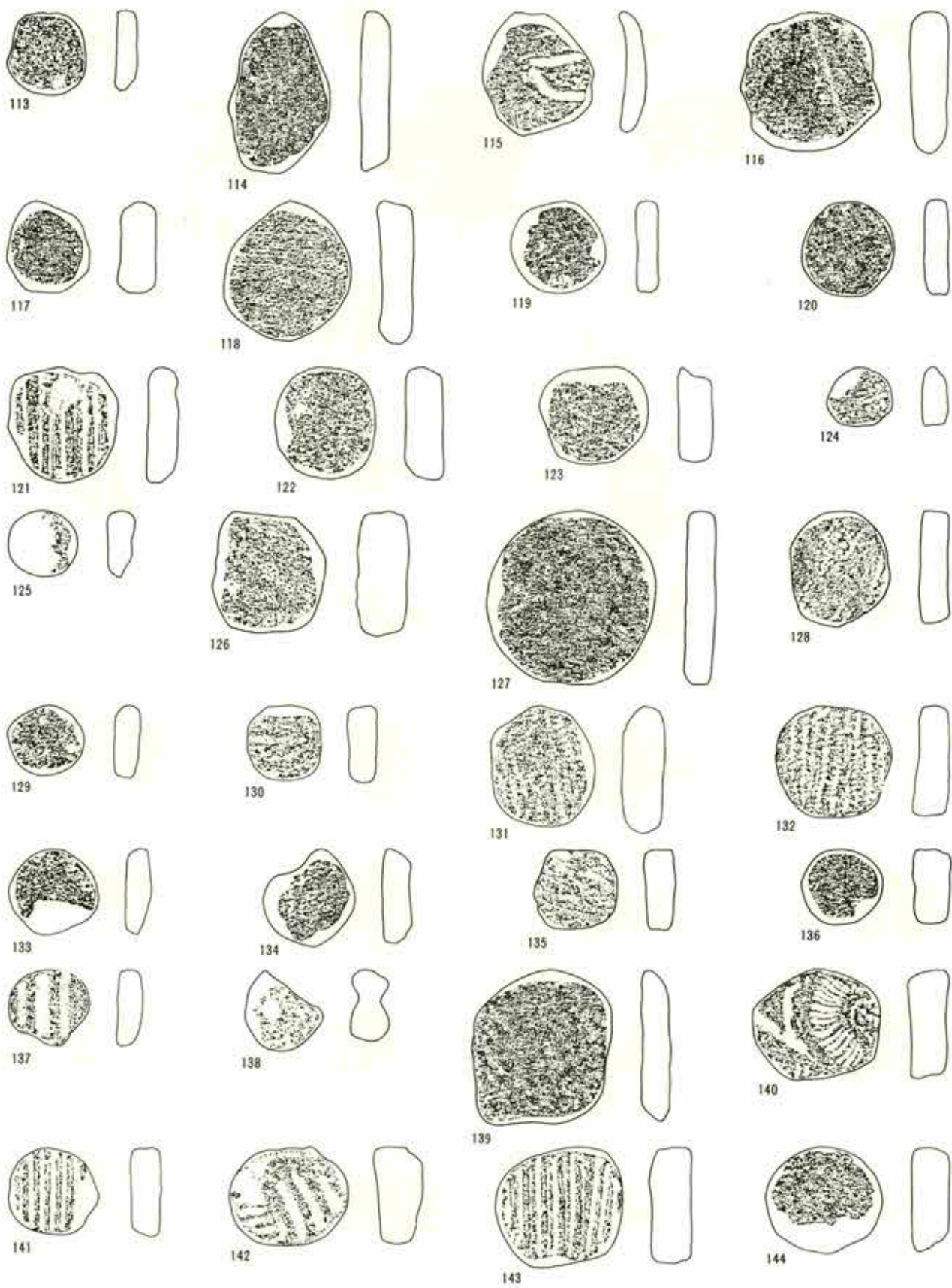

第281图 积造堂S-III区土製円盤

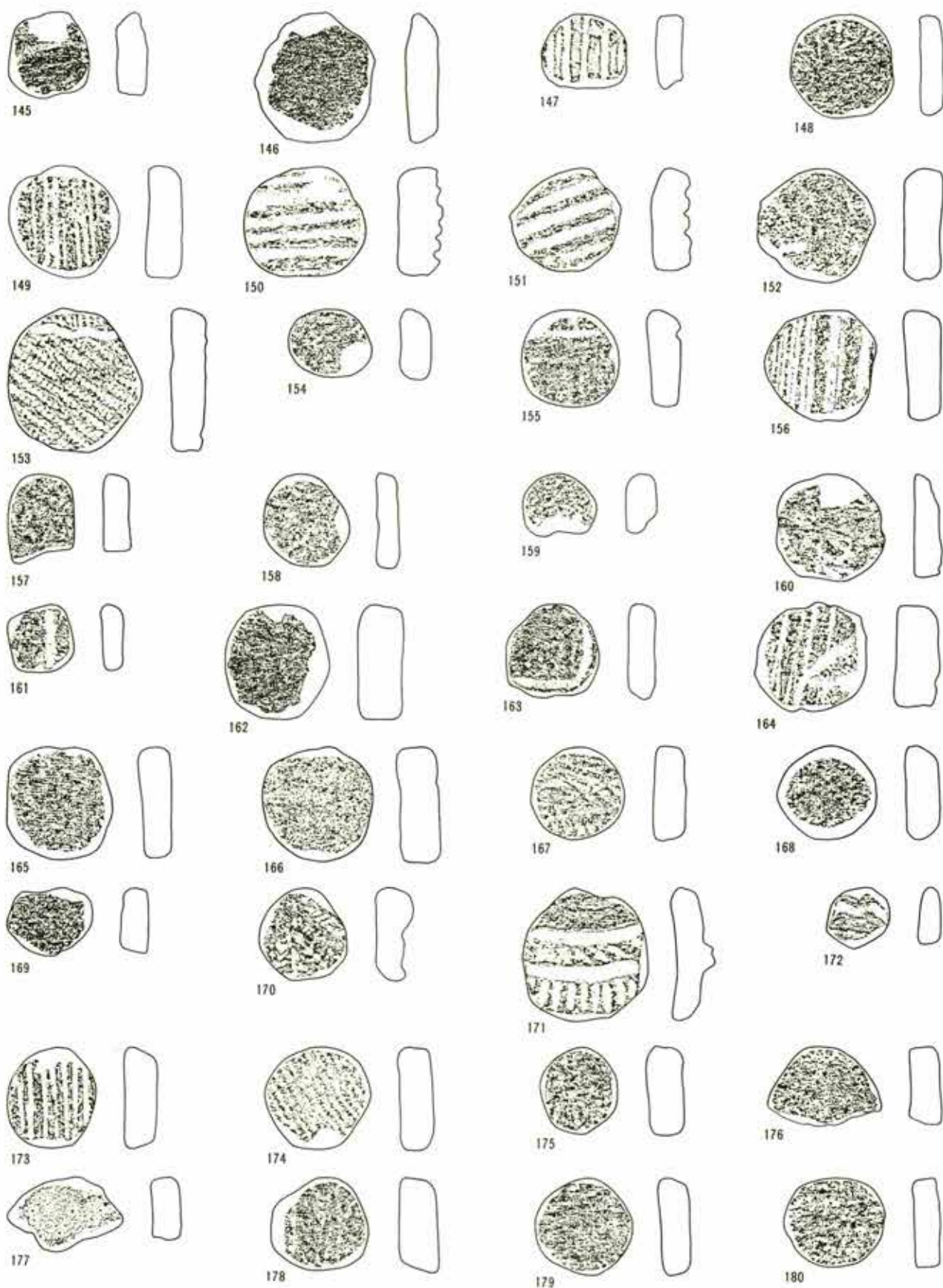

第282图 积迦堂S-III区土製円盤

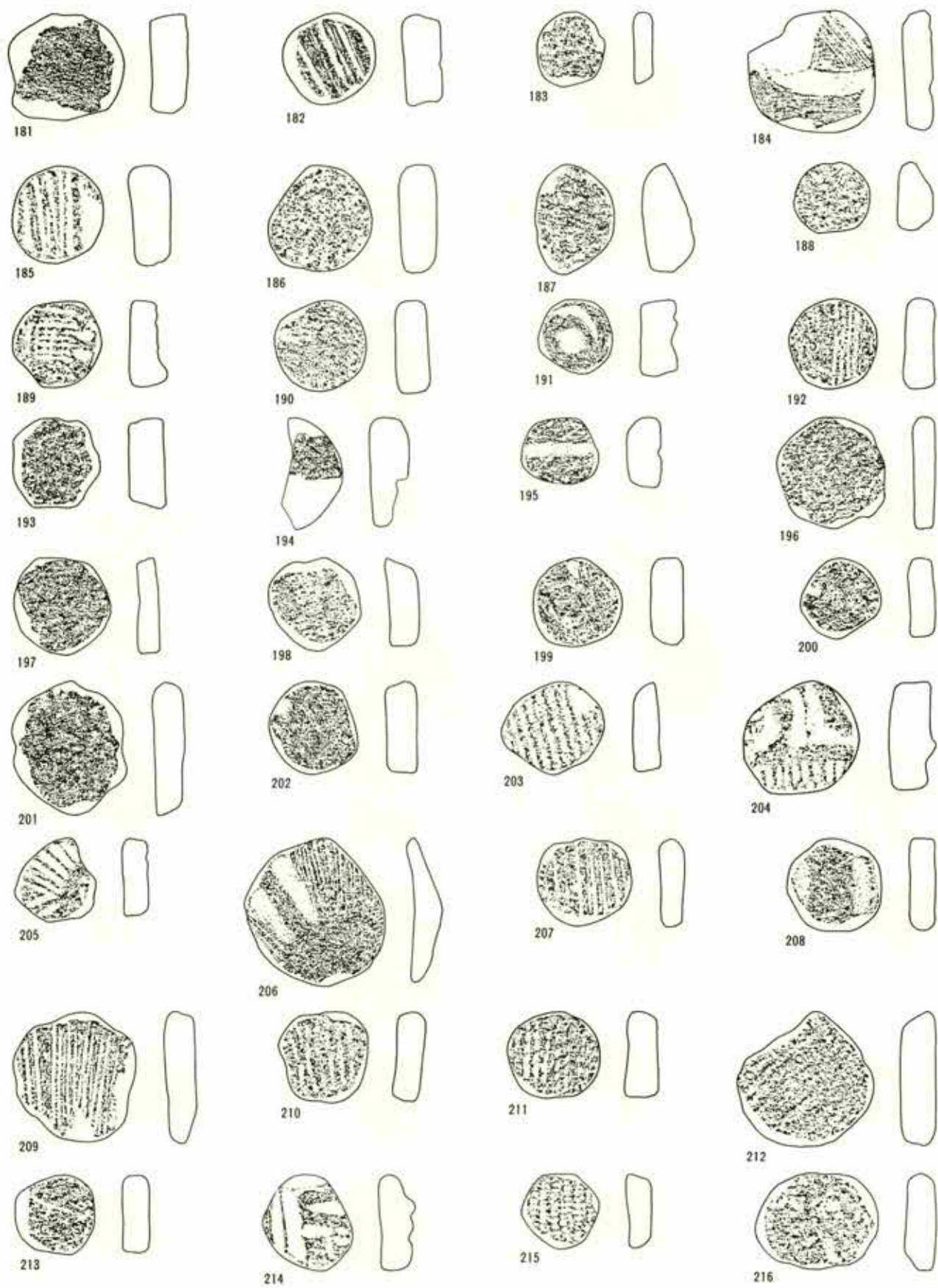

第283图 积造堂S-III区土製円盤 (6)



第 284 图 积迦堂 S-III 区 土製円盤

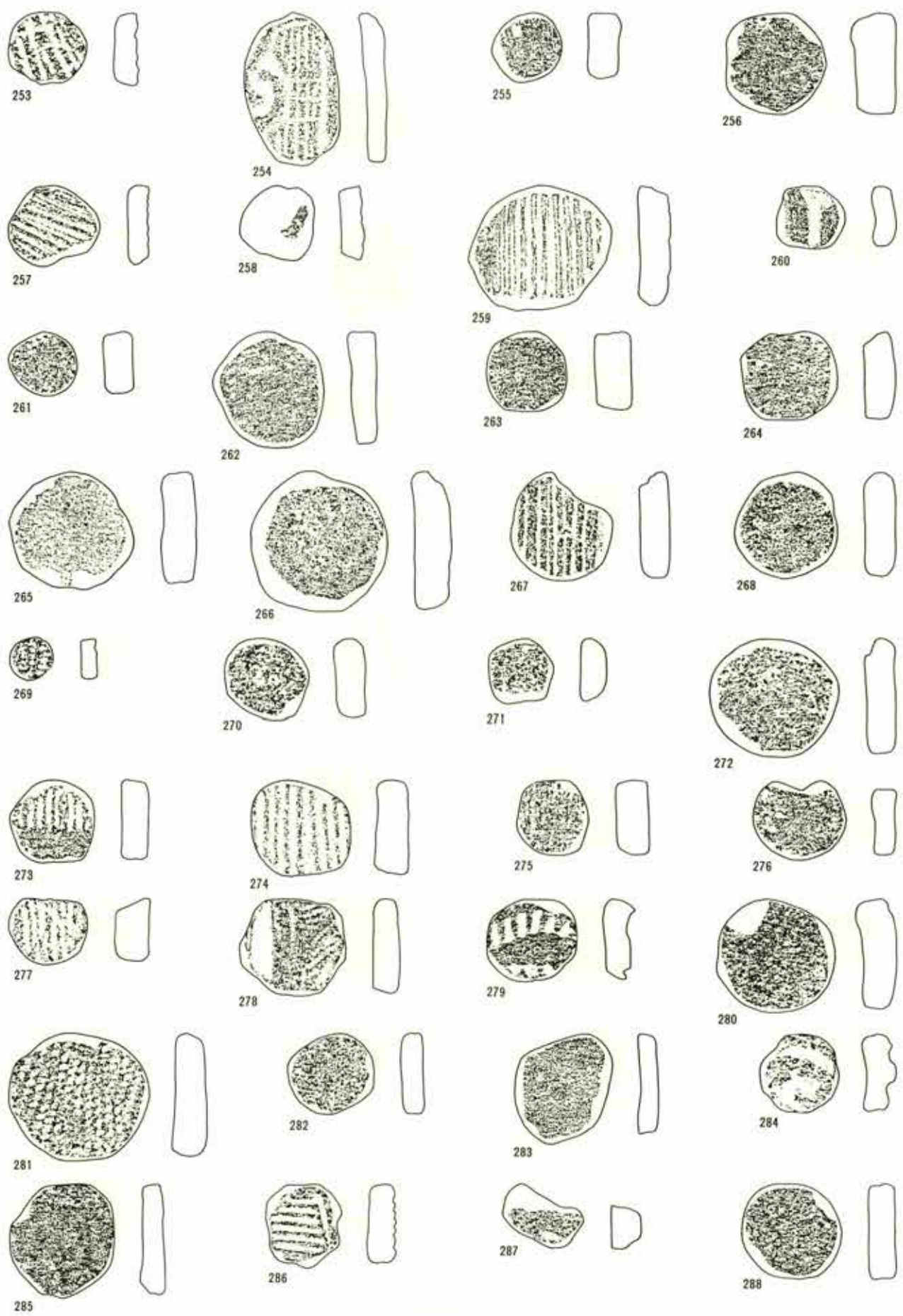

第285图 积道堂S-III区土製円盤 (8)

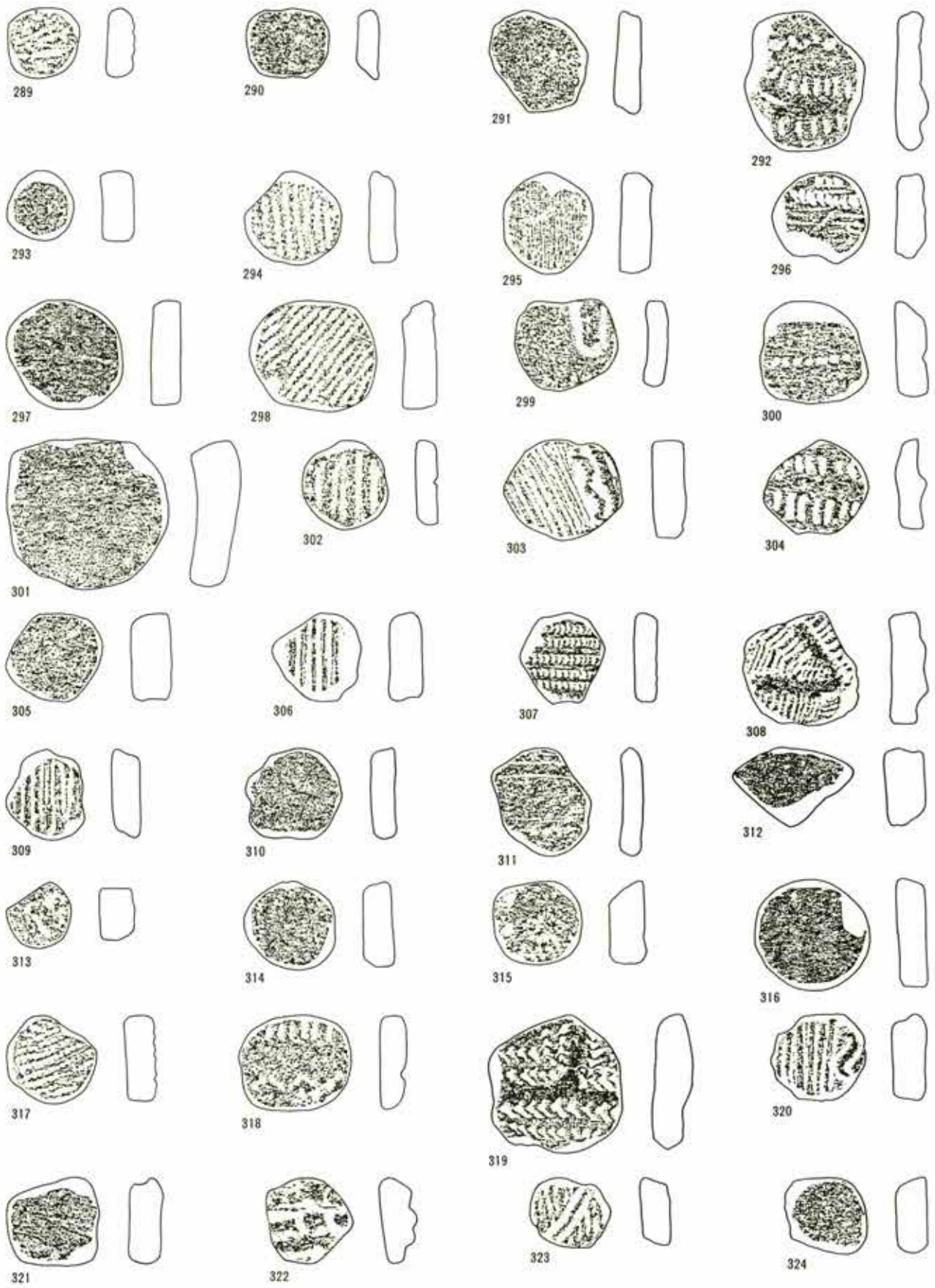

第 286 図 釈迦堂 S-III 区 土製円盤

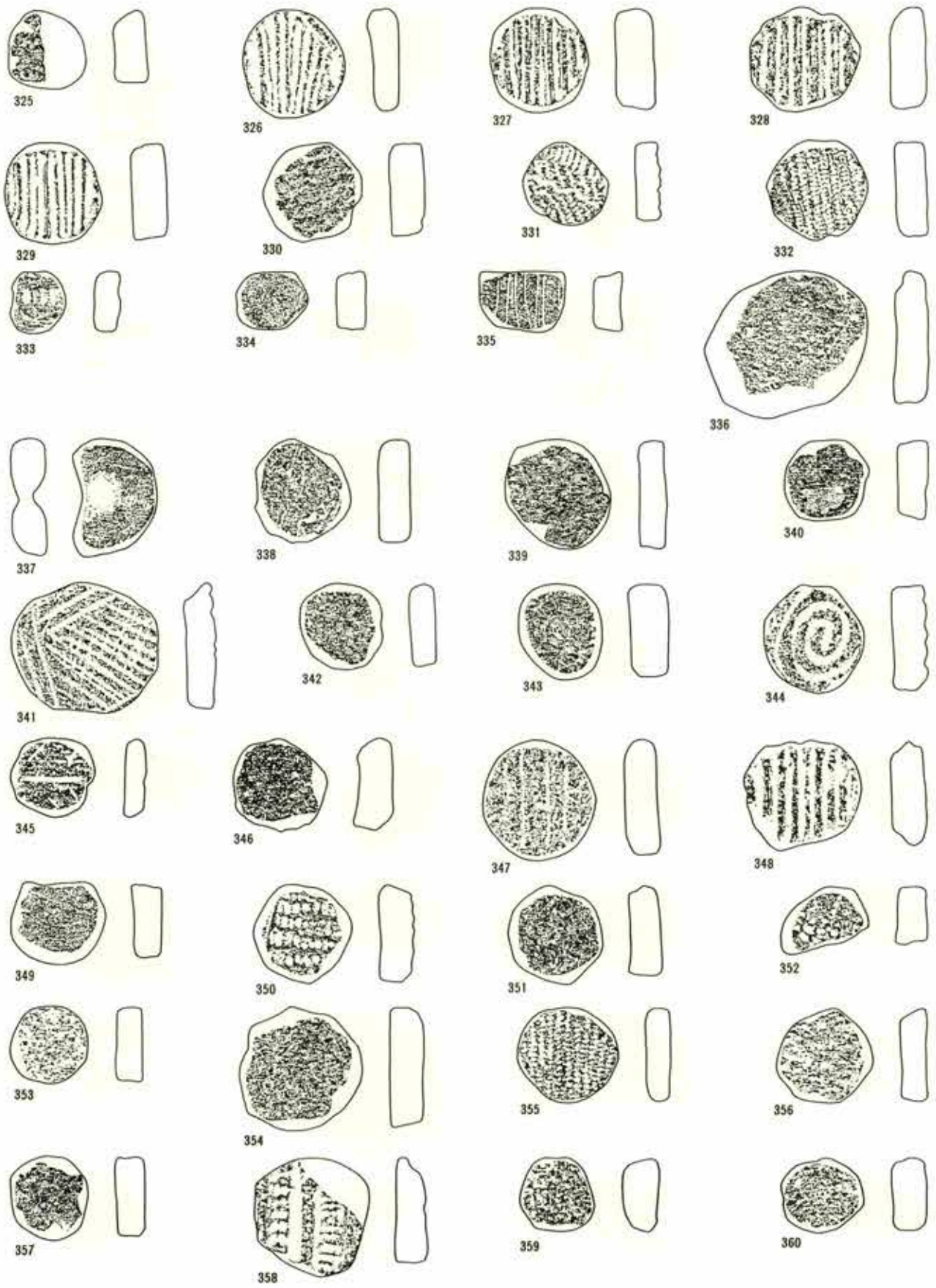

第 287 图 积逊堂 S-III 区土製円盤

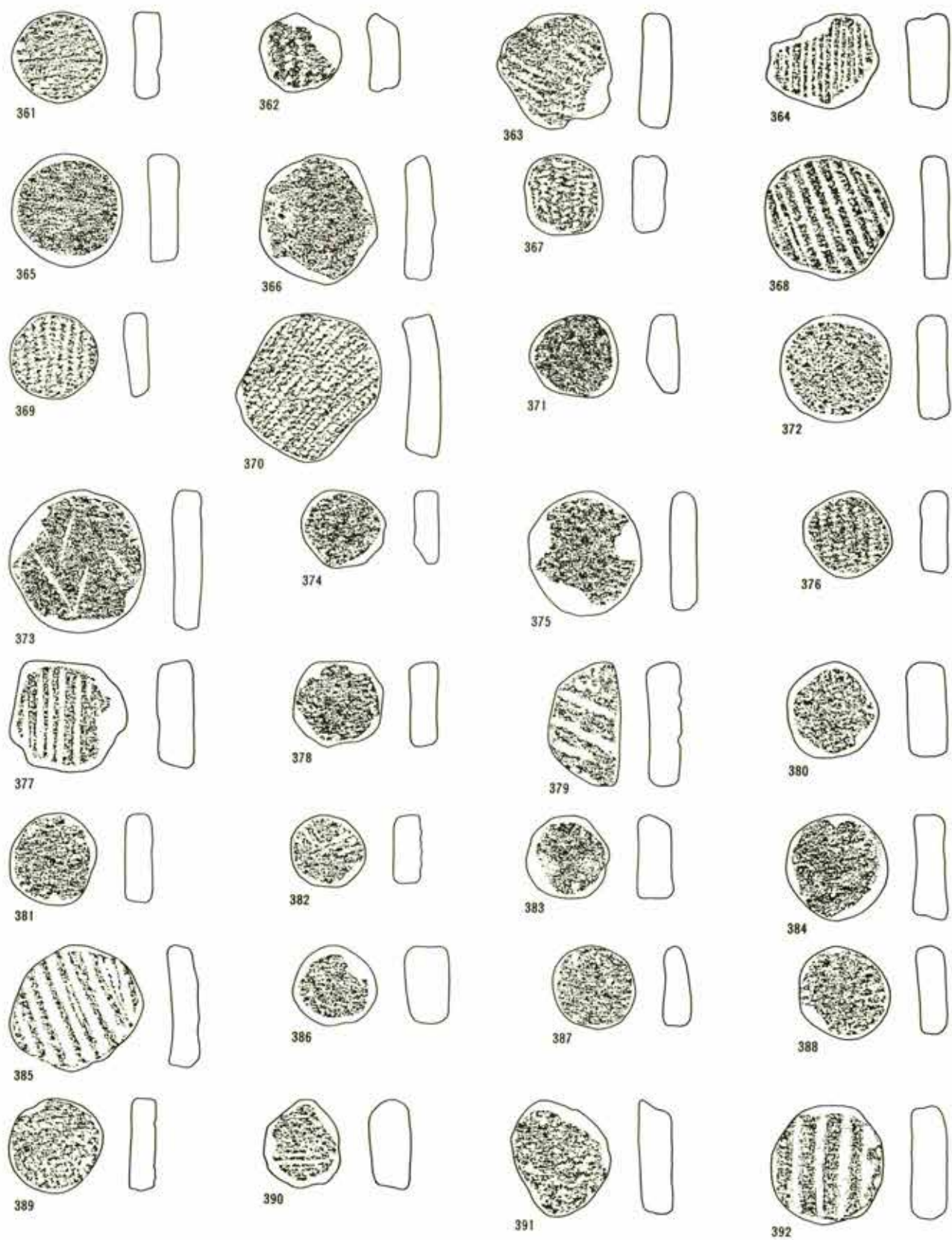

第288图 积逊堂S-III区土製円盤

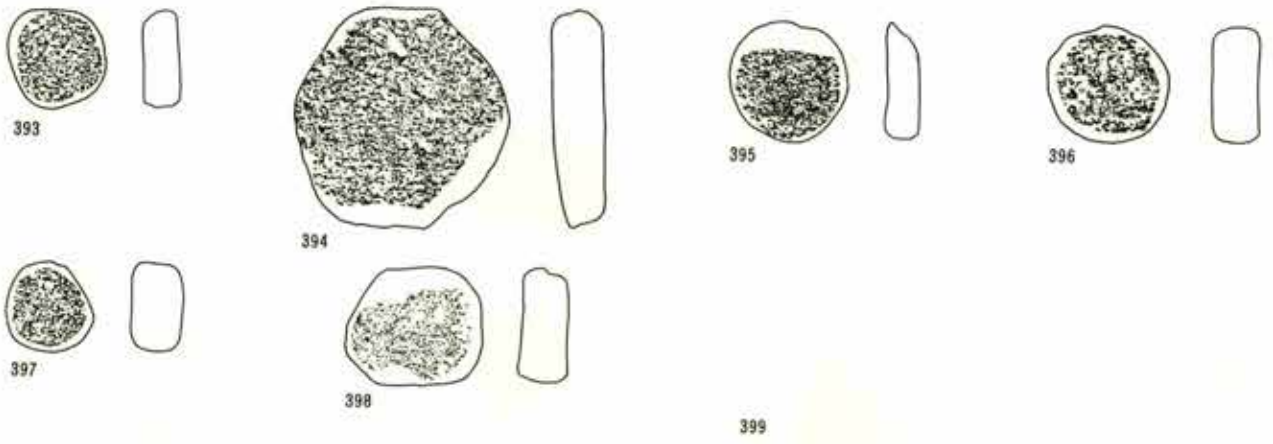

第 289 图 积逊堂 S—III 区土製円盤 (12)

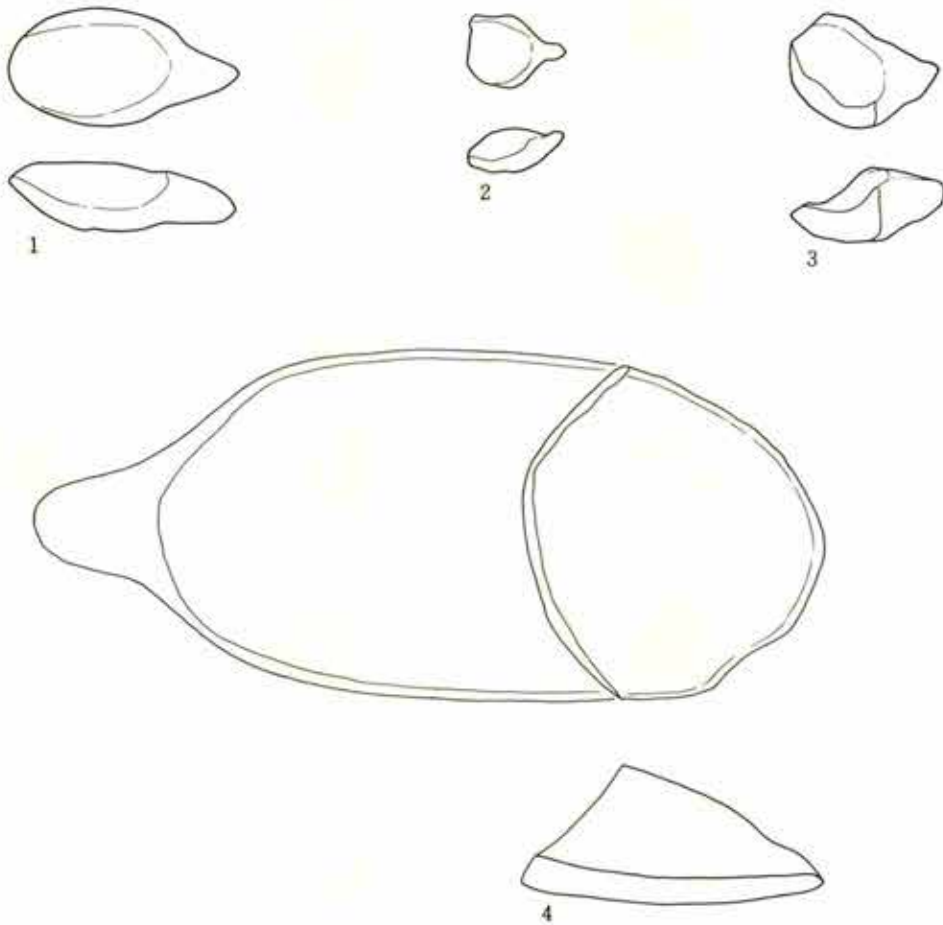

第 290 图 积逊堂 S—III 区 N—III 区土製匙

(1:2)

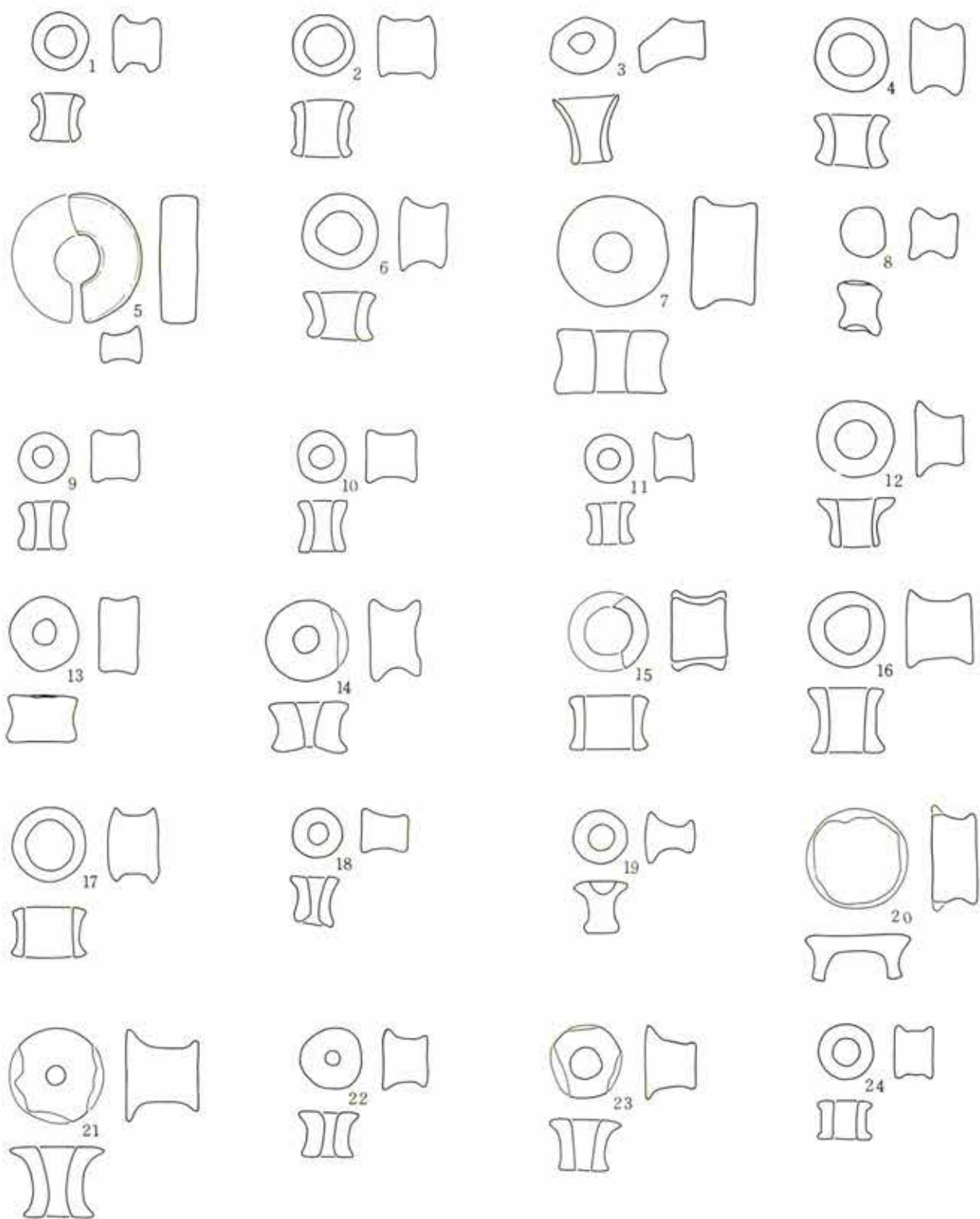

第291图 积迦堂S-III区S-IV区N-III区N-IV区耳栓·球状耳饰

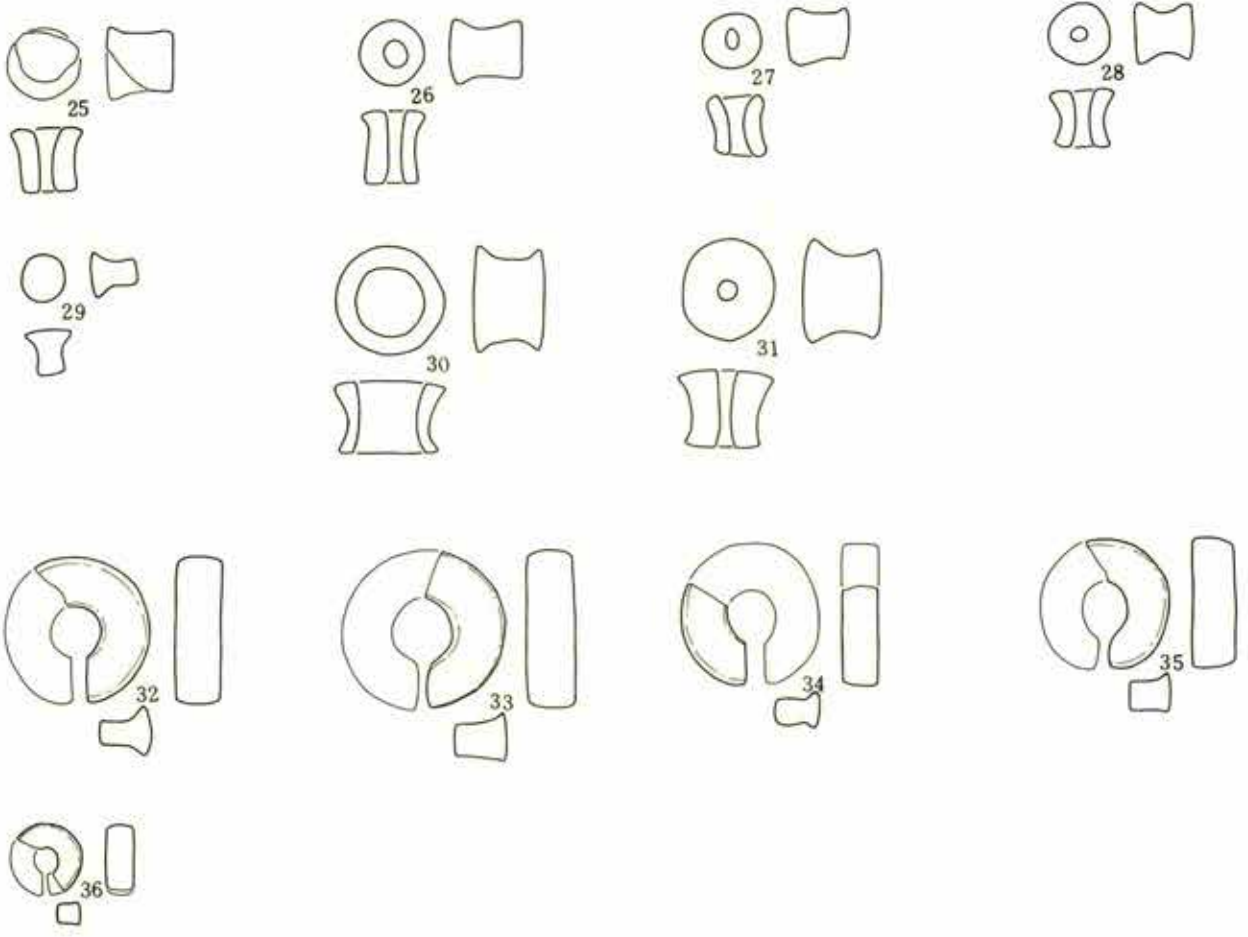

第 292 图 积迦堂 N-IV 区 S-II 区 耳栓·块状耳饰

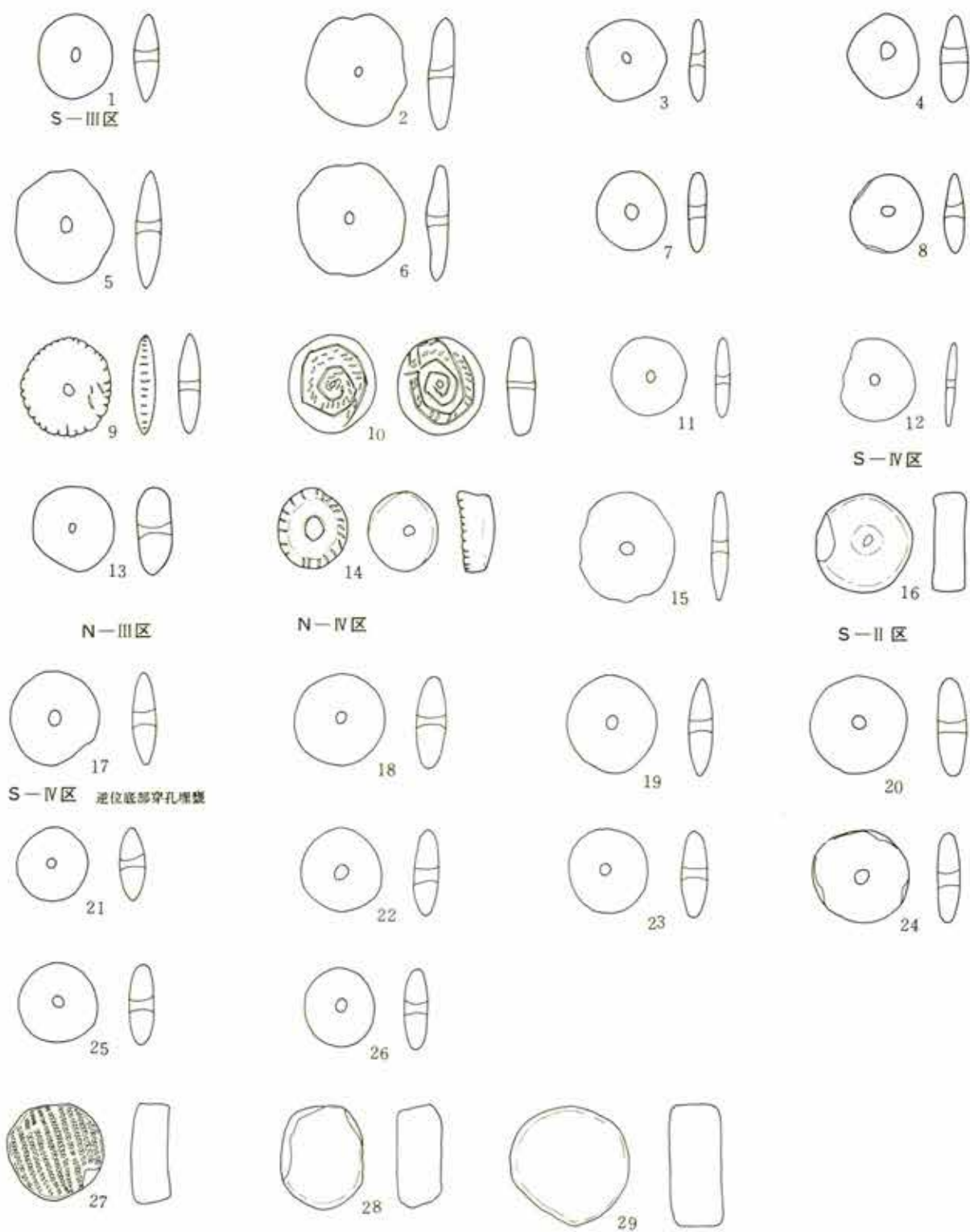

第 293 图 积迦堂 S-III区 S-IV区 N-III区 N-IV区 S-II区 土製薄円盤(1:2)

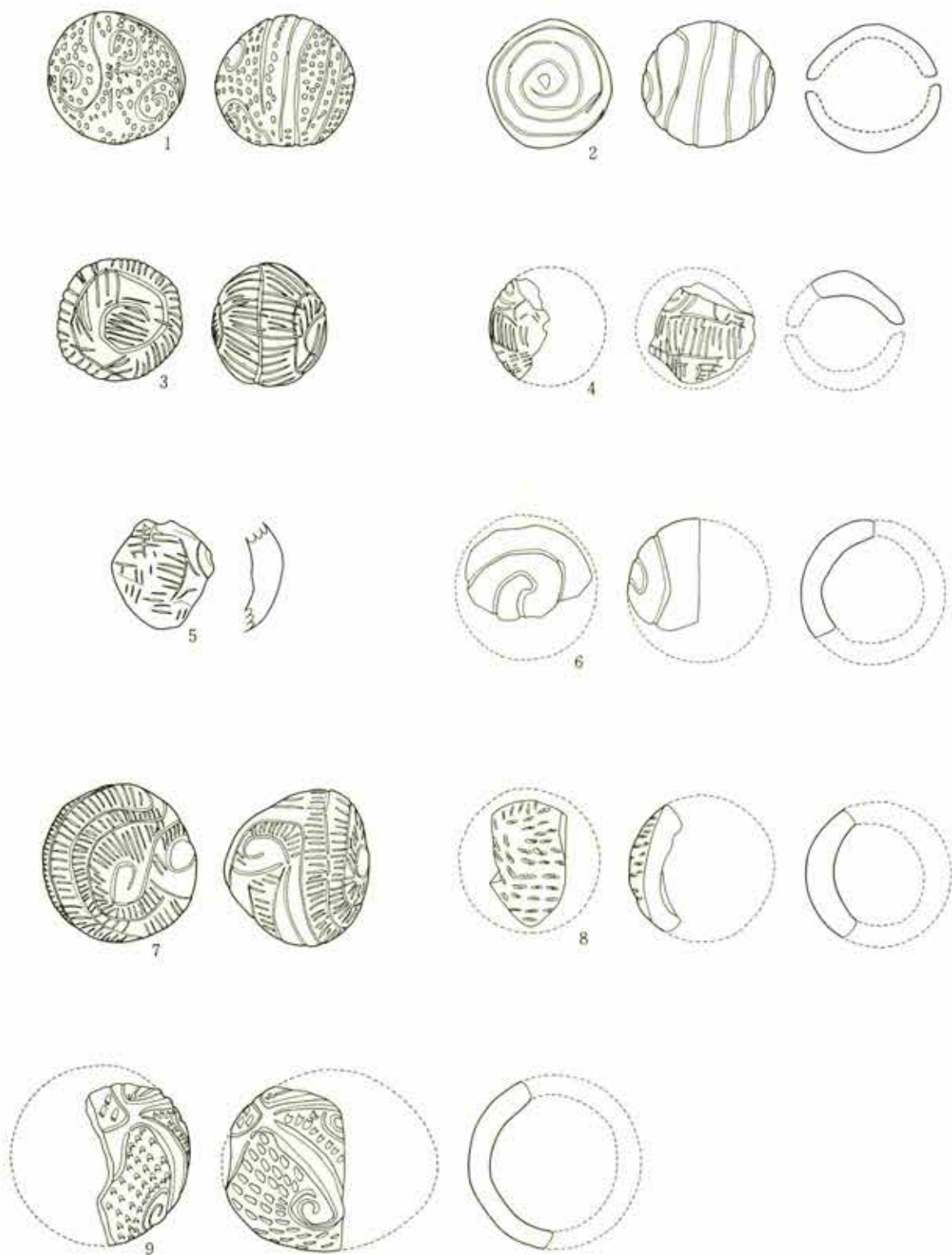

第294图 积迺堂S—III区N—III区土铃

(1) (1:2)

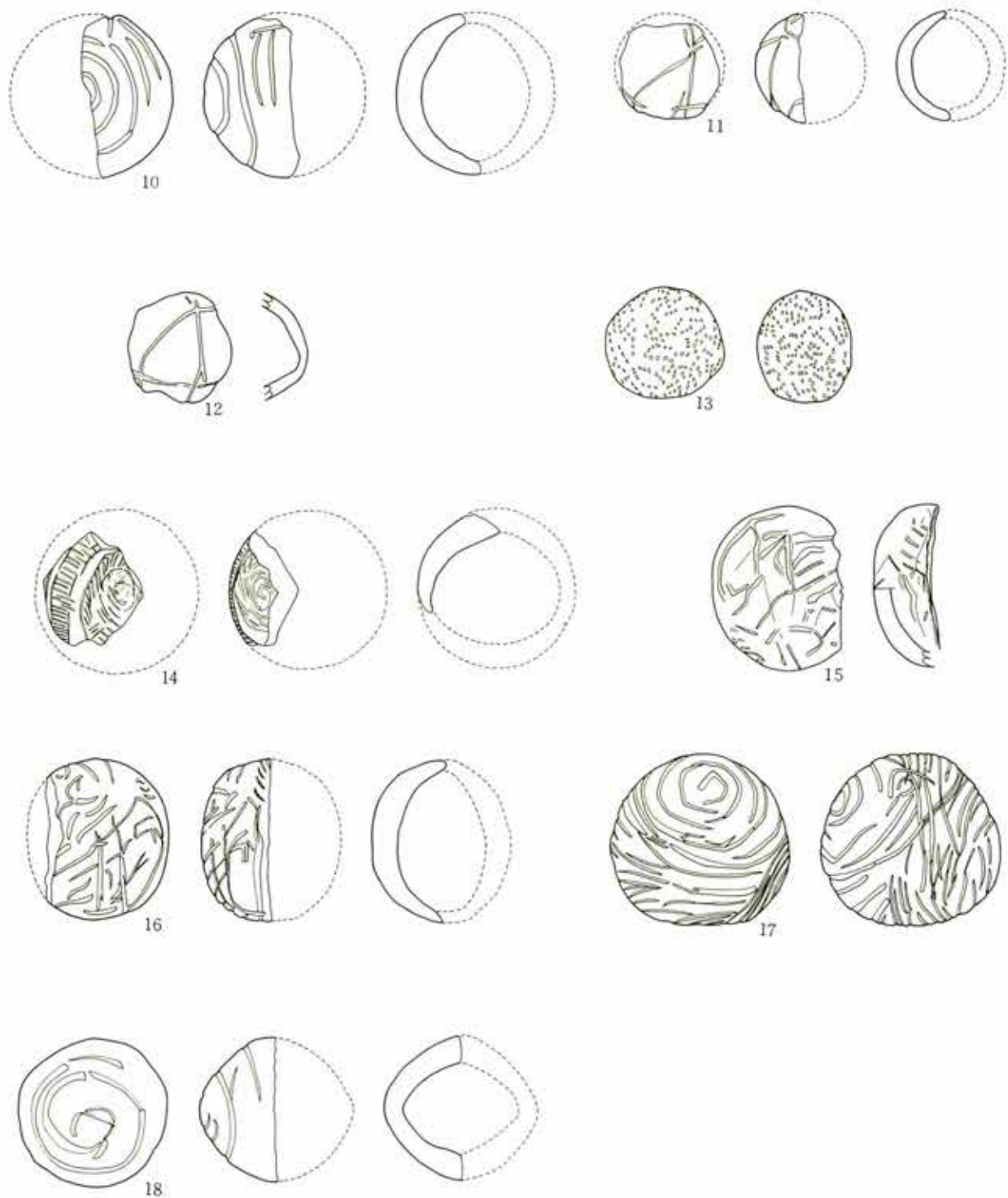

第 295 图 积逊堂 S-IV 区 N-IV 区土鈴

(2) (1:2)

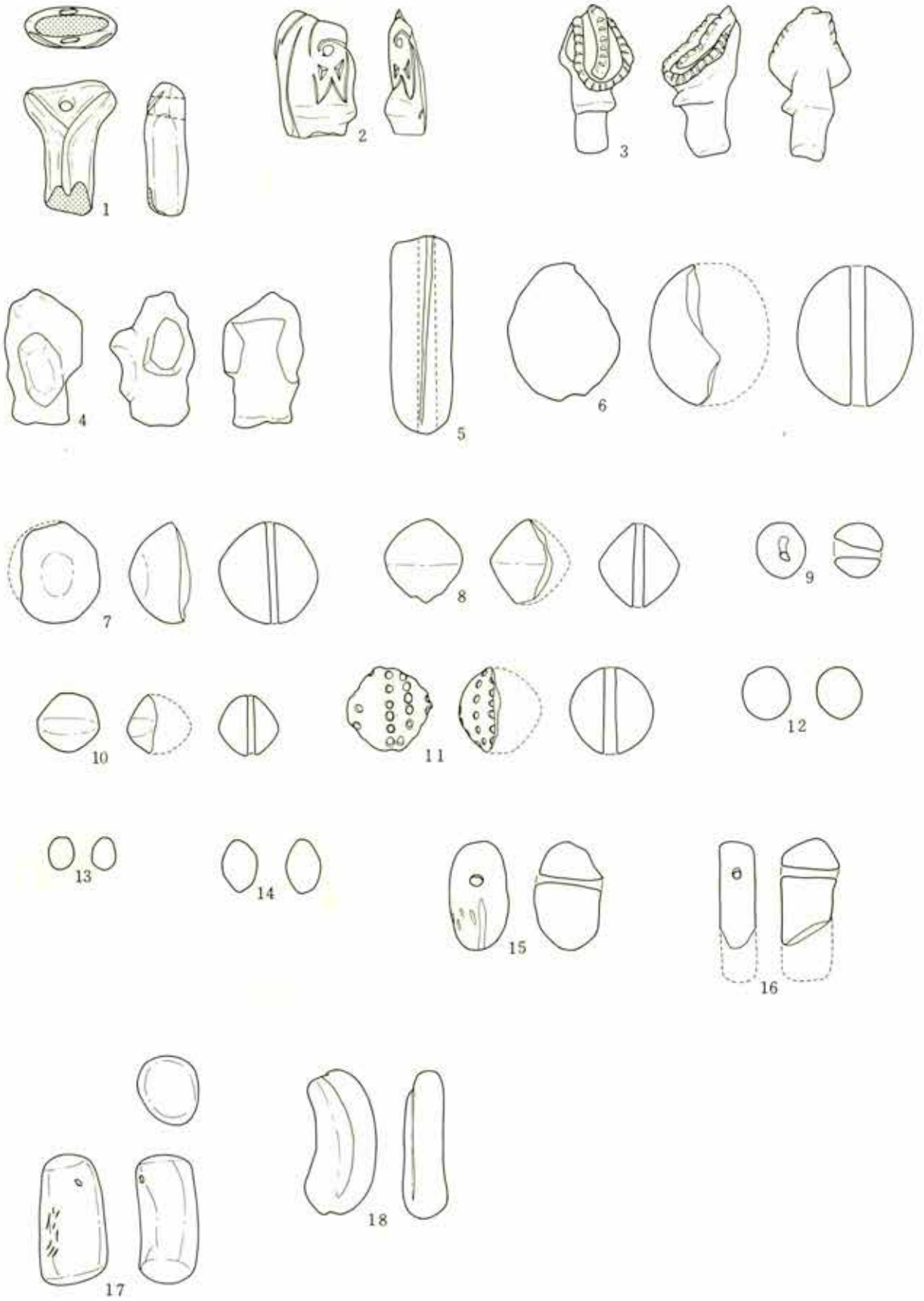

第296图 积逊堂S-III区 S-IV区 N-IV区土製品

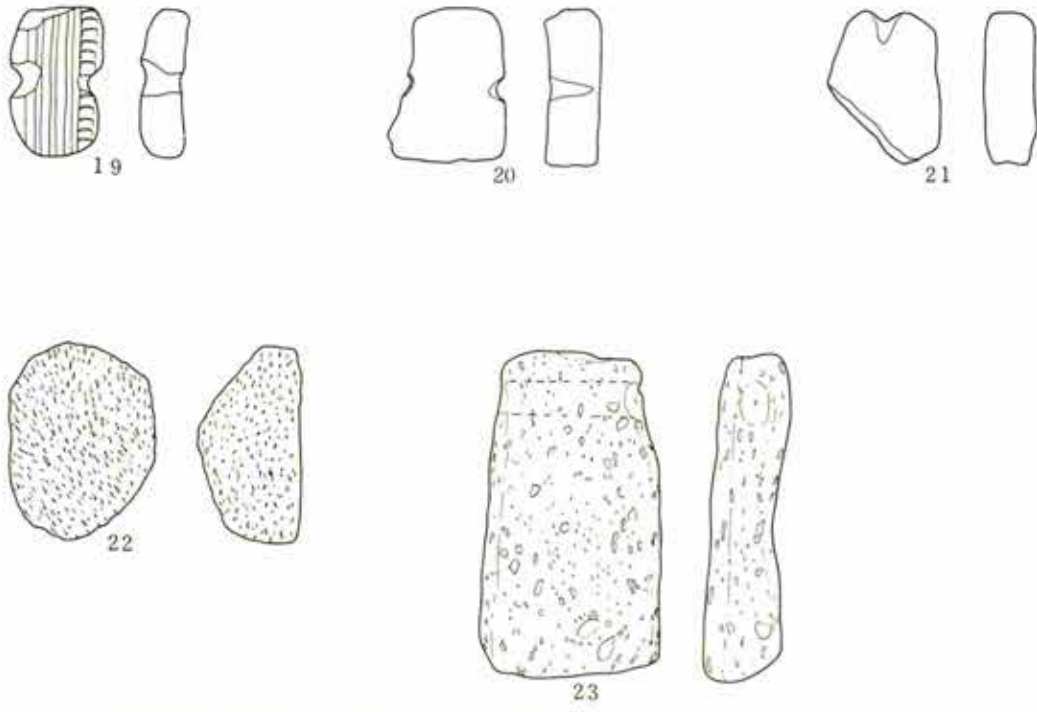

第 297 图 积逊堂 S—III 区 土器片锤・軽石 (1:2)

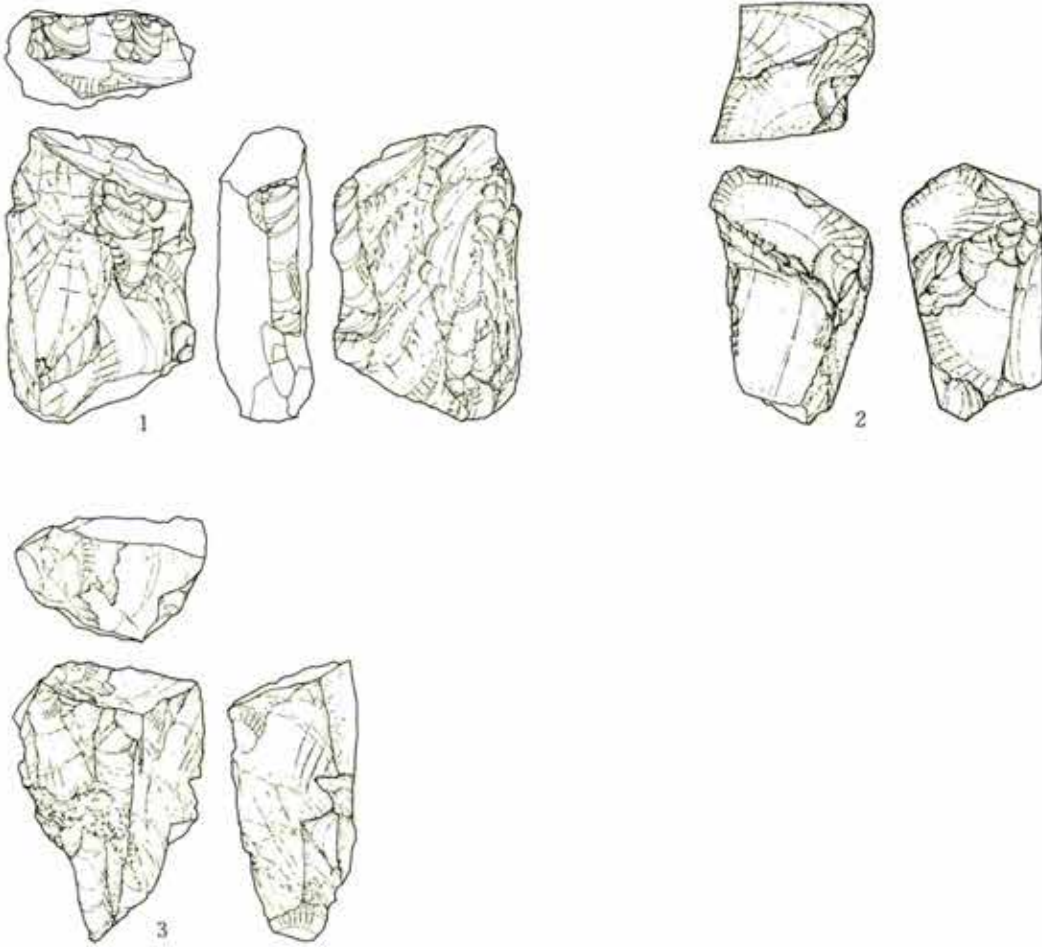

第 298 图 积逊堂 S—III 区 原石

(1:2)

积迦堂 S—IV 区

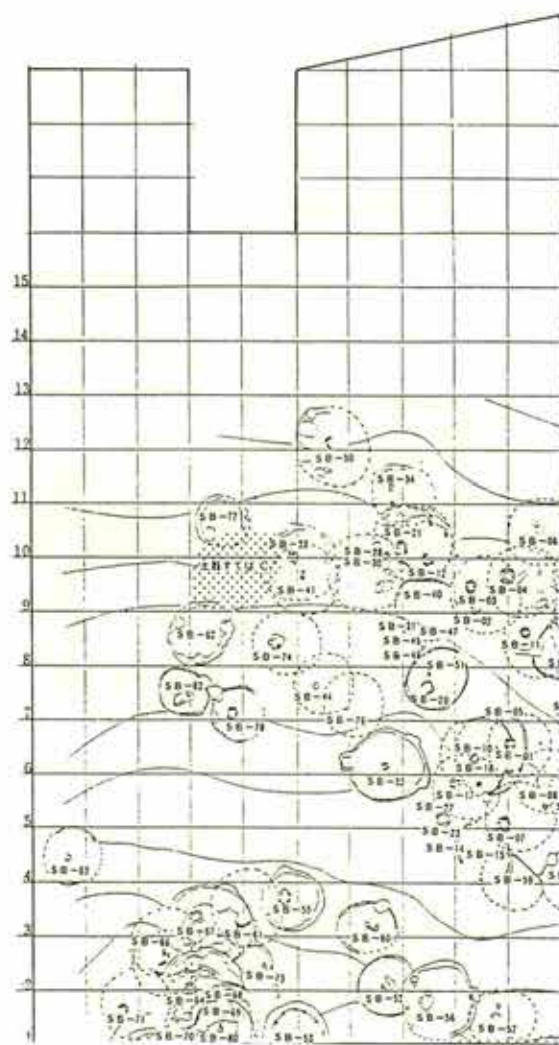

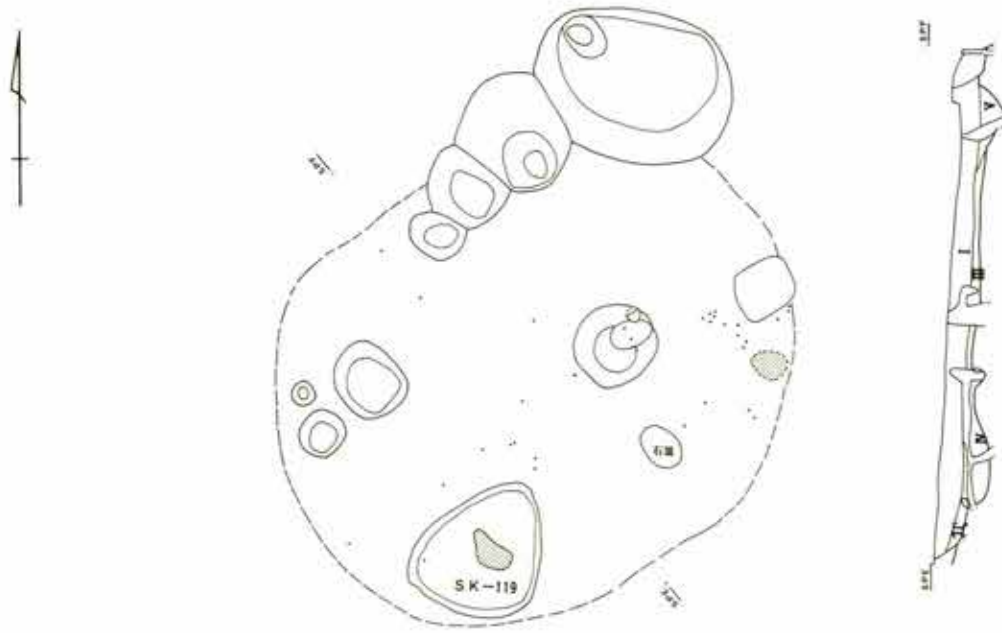

SB-57

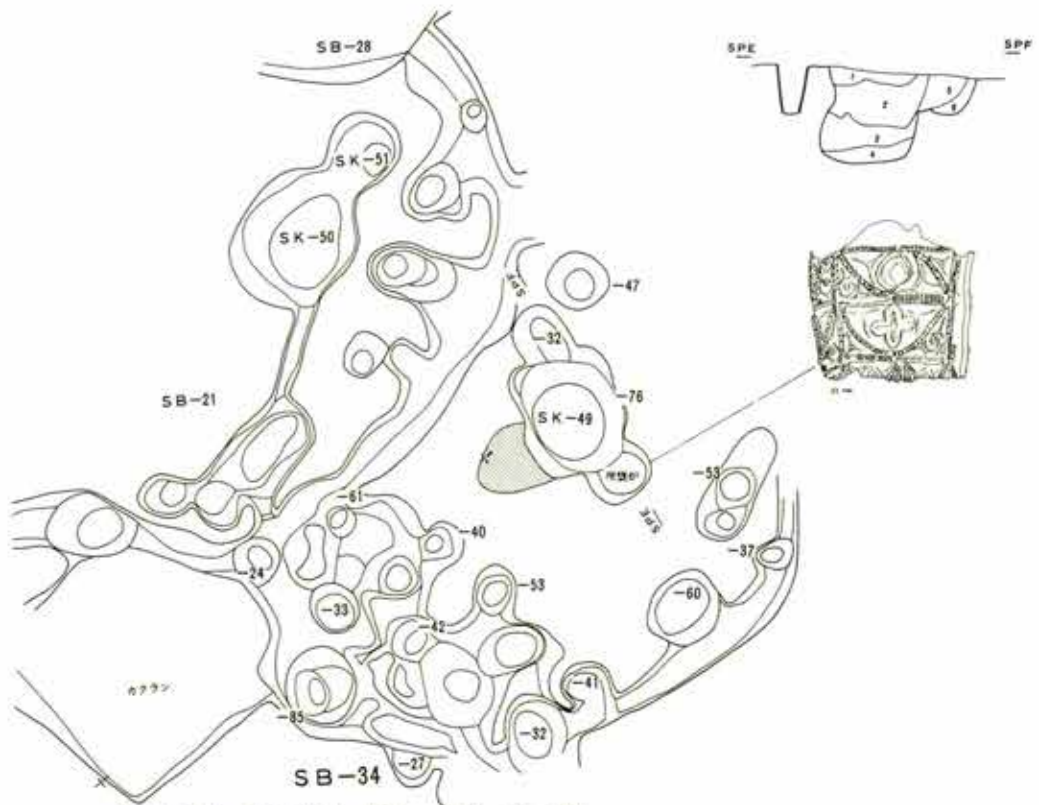

第 299 图 积迦堂 S-IV 区 SB-57 -34

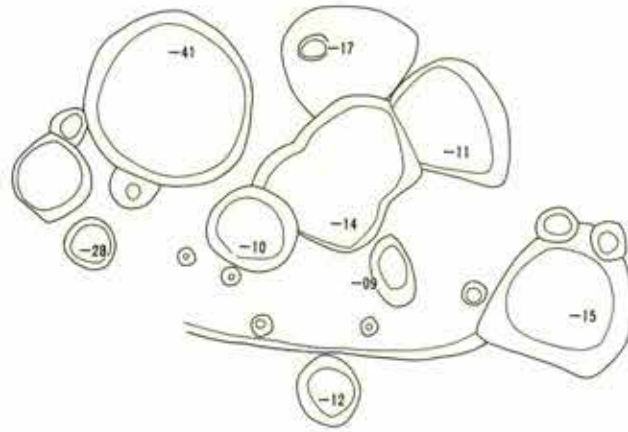

SB-54

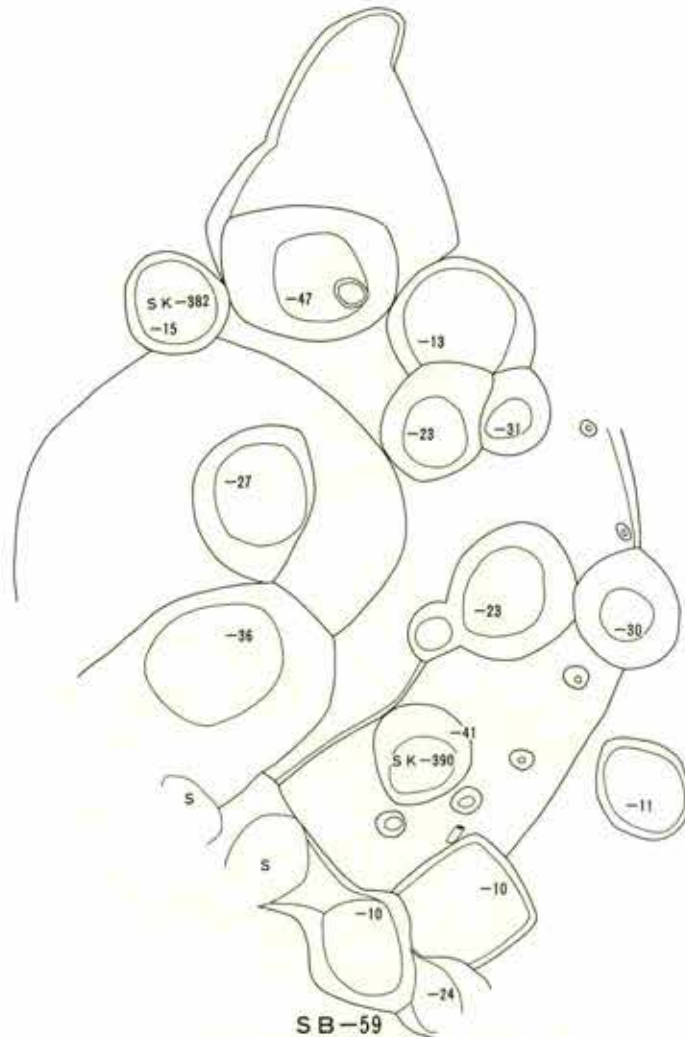

SB-59

第 300 图 积迦堂 S-IV 区 SB-54 -59

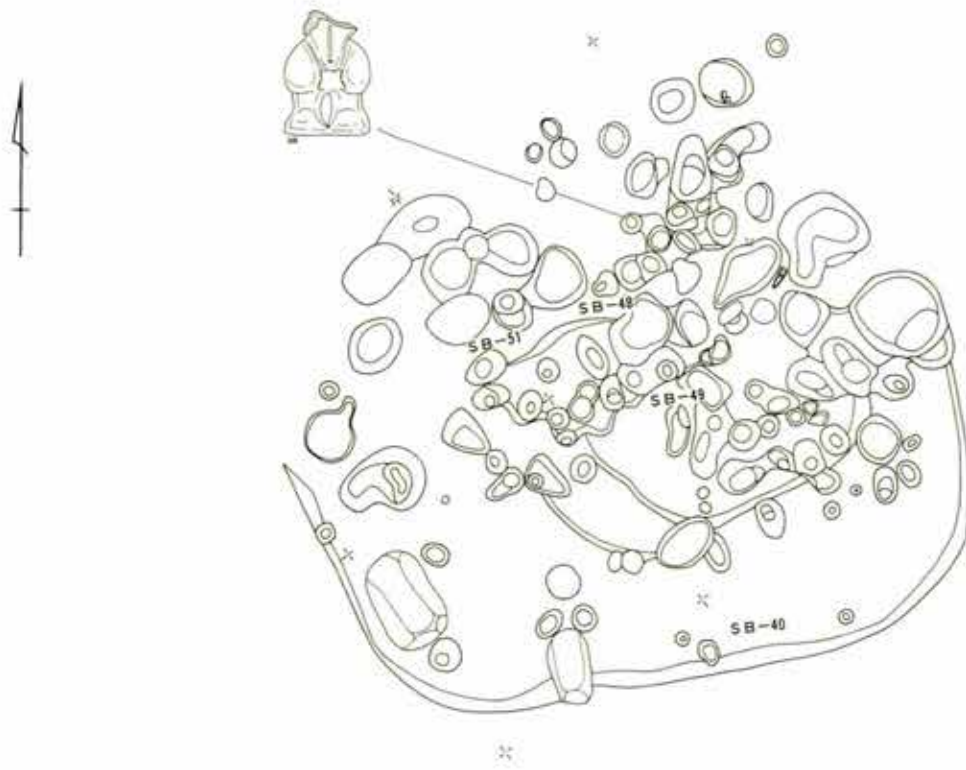

积迦堂S—IV区

(1 : 120)



(1 : 30)

第 301 图 积迦堂S—IV区 SB-47-48-49-51

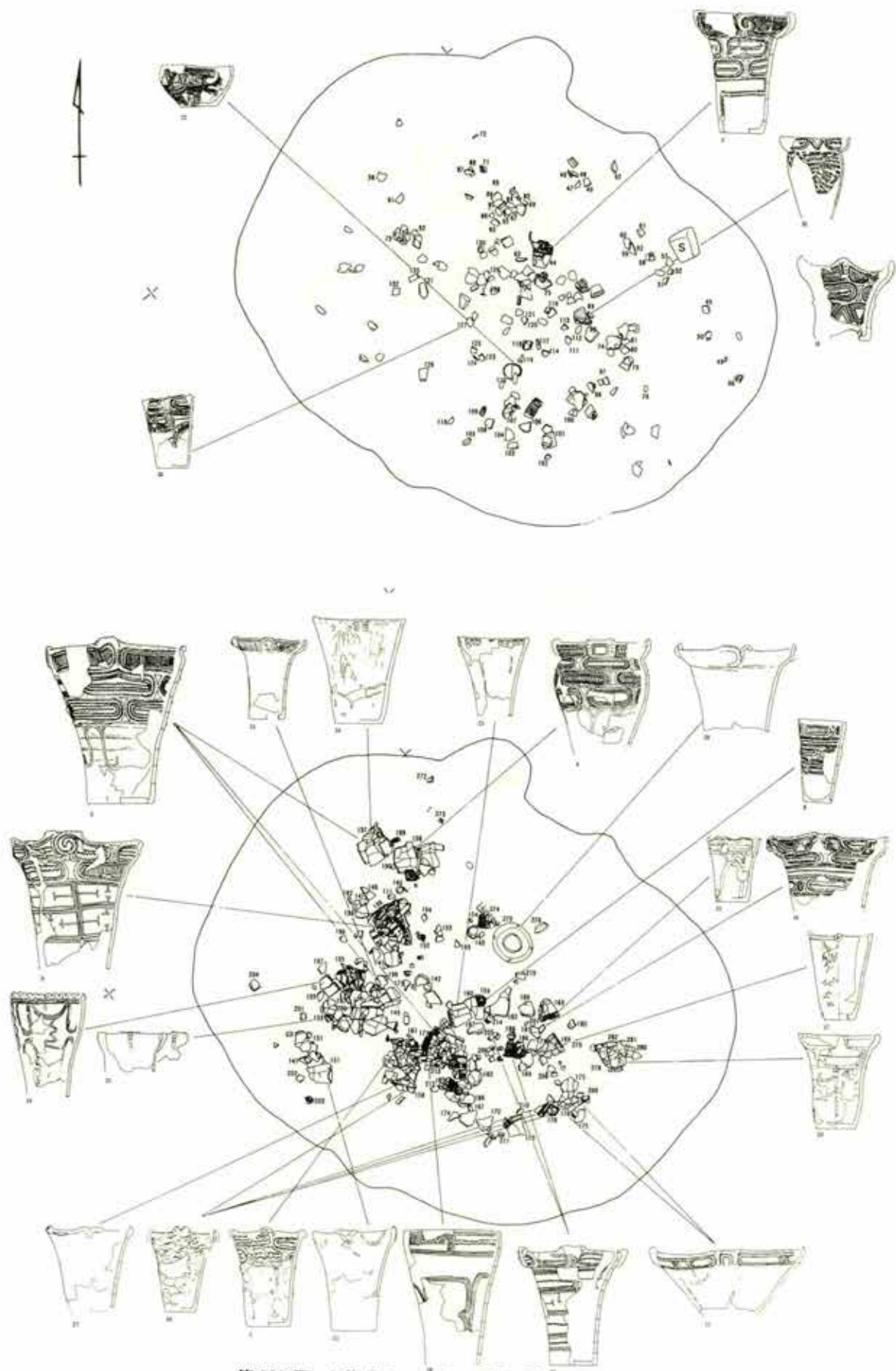

第 302 图 积迦堂 S-N 区 SB-73

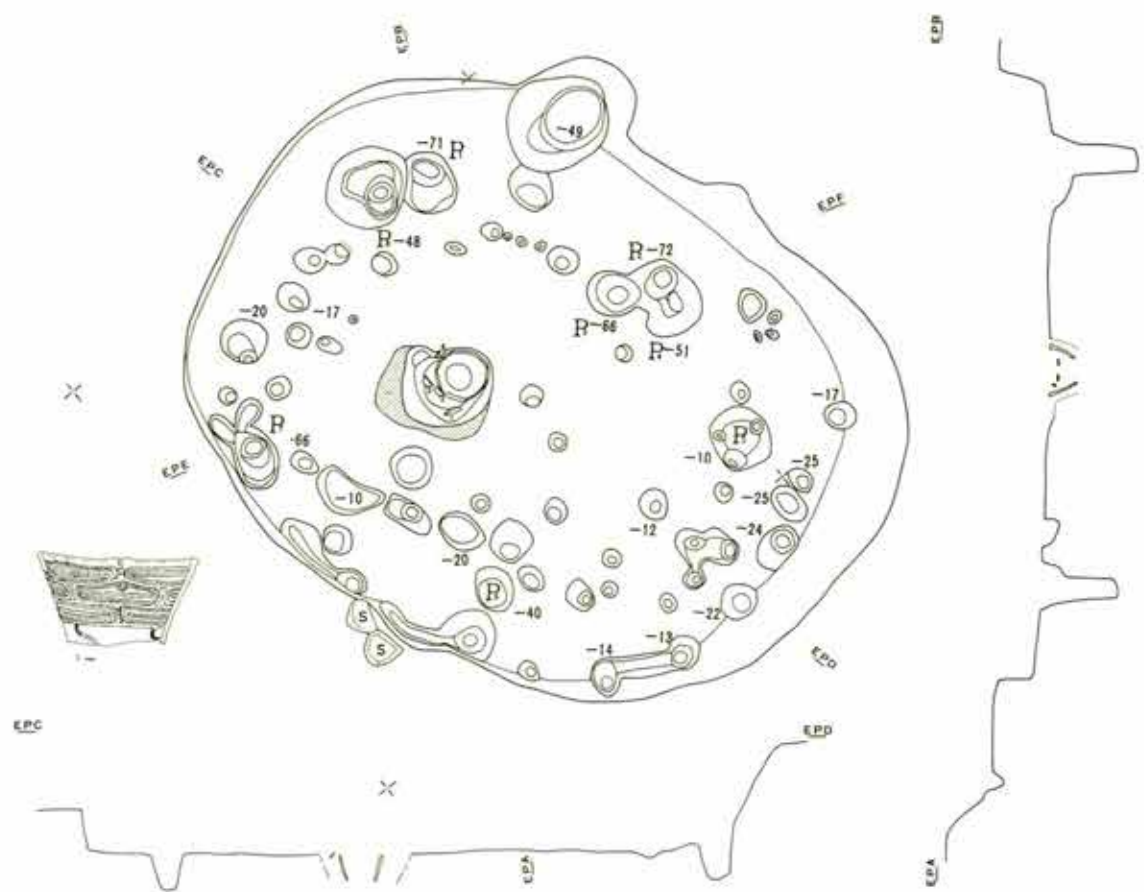
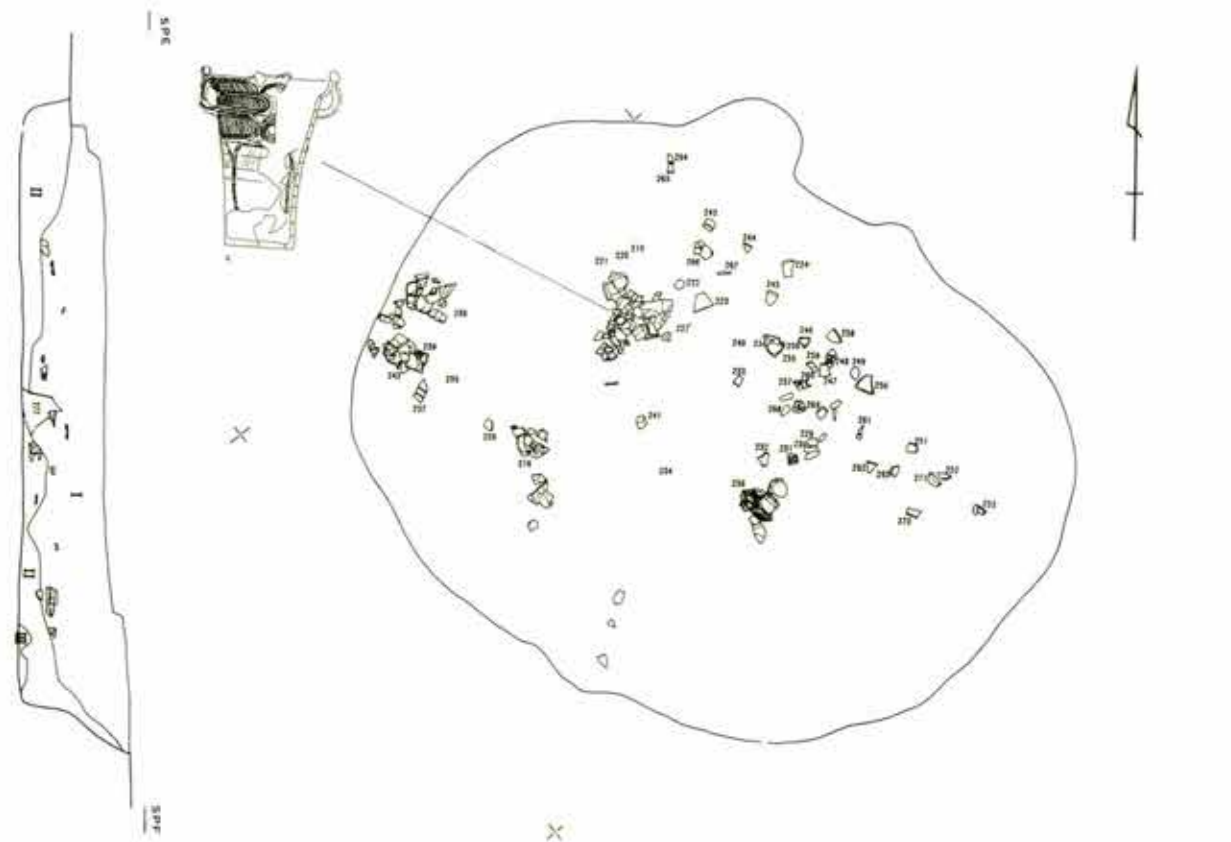

第 303 图 积迦堂 S-IV 区 SB-73

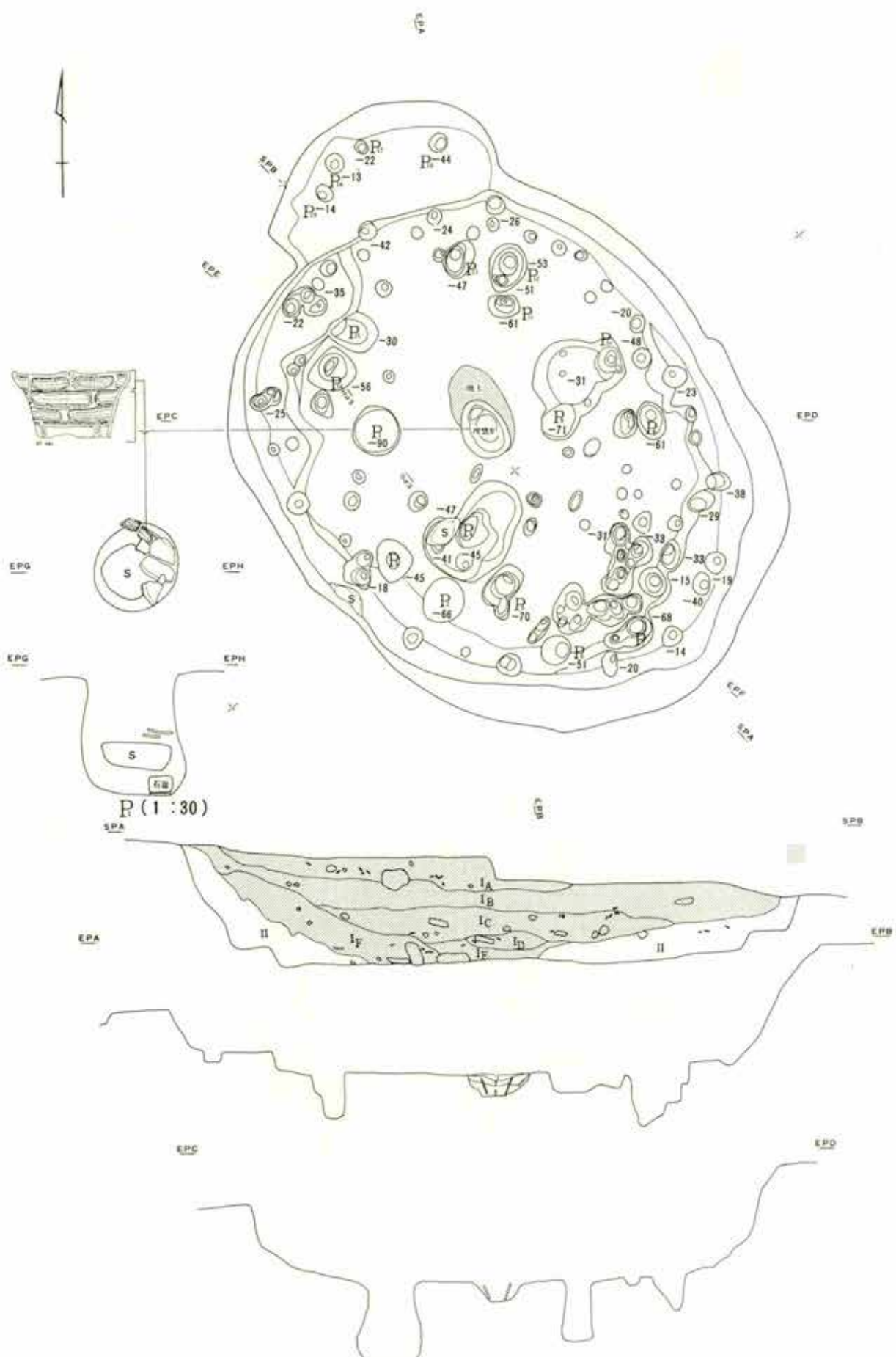

第 304 图 积逊堂 S-IV 区 SB-53

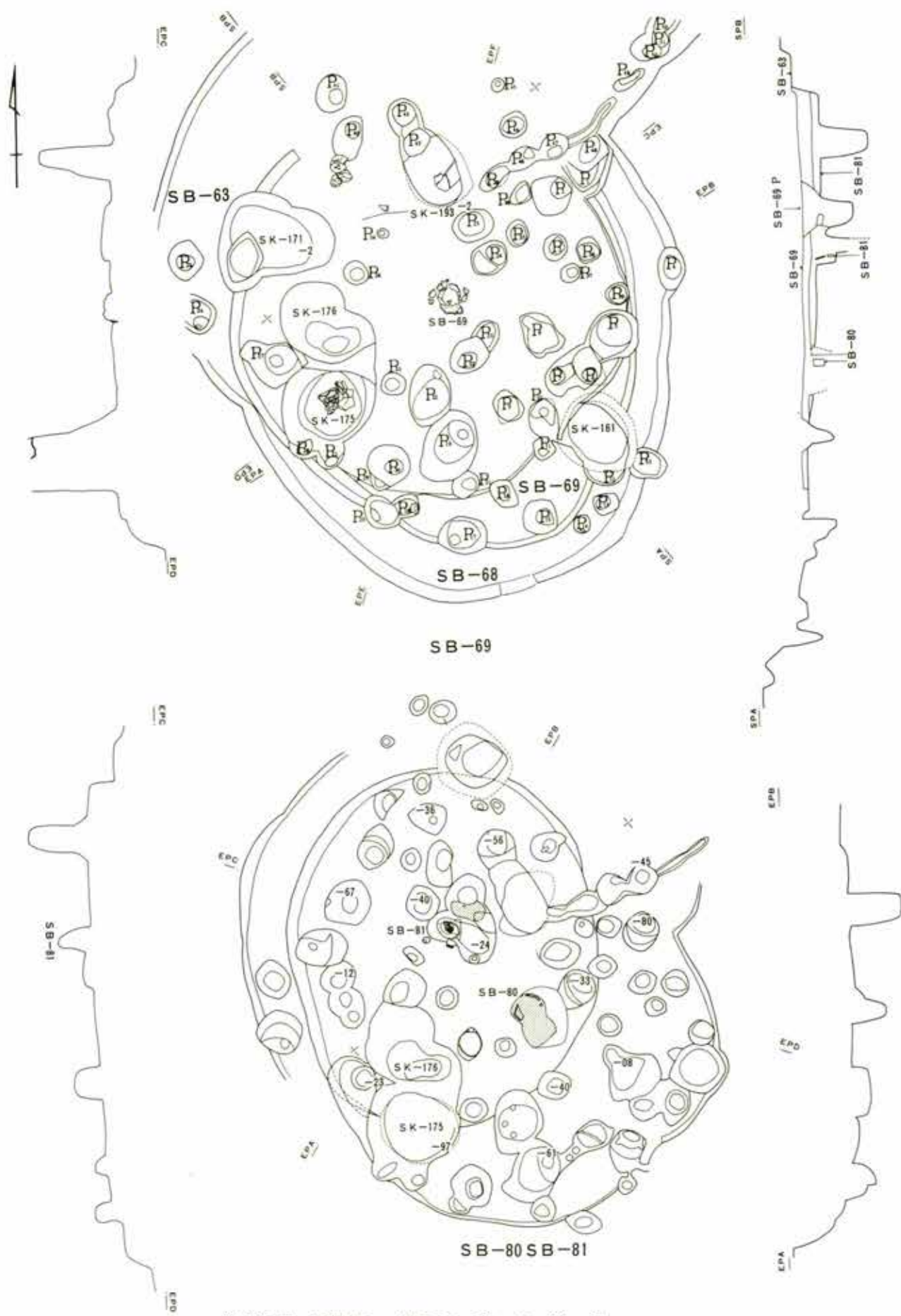

第 305 图 积迦堂 S-IV 区 SB-68-69-80-81

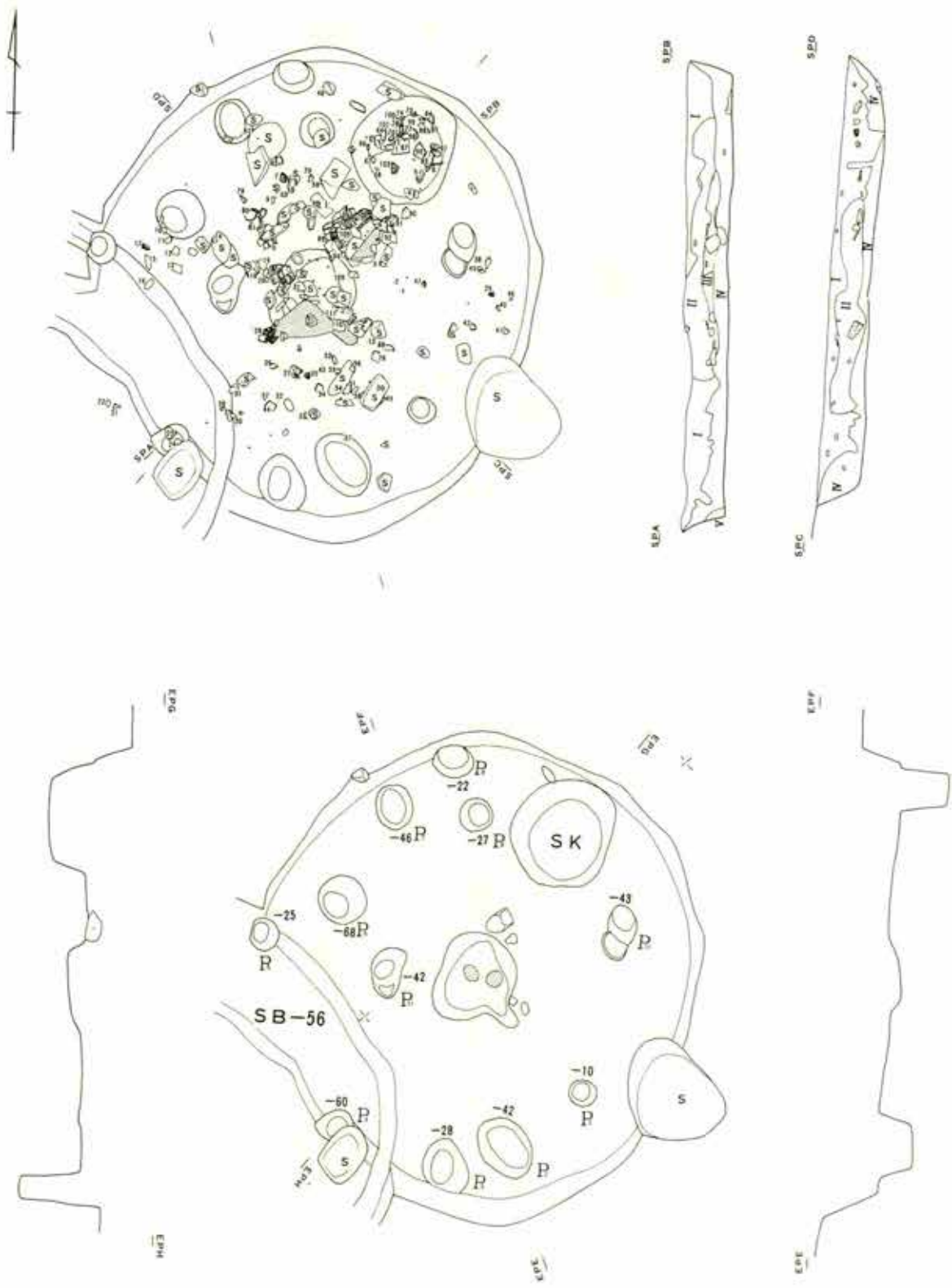

第306图 积迦堂S-IV区 SB-52

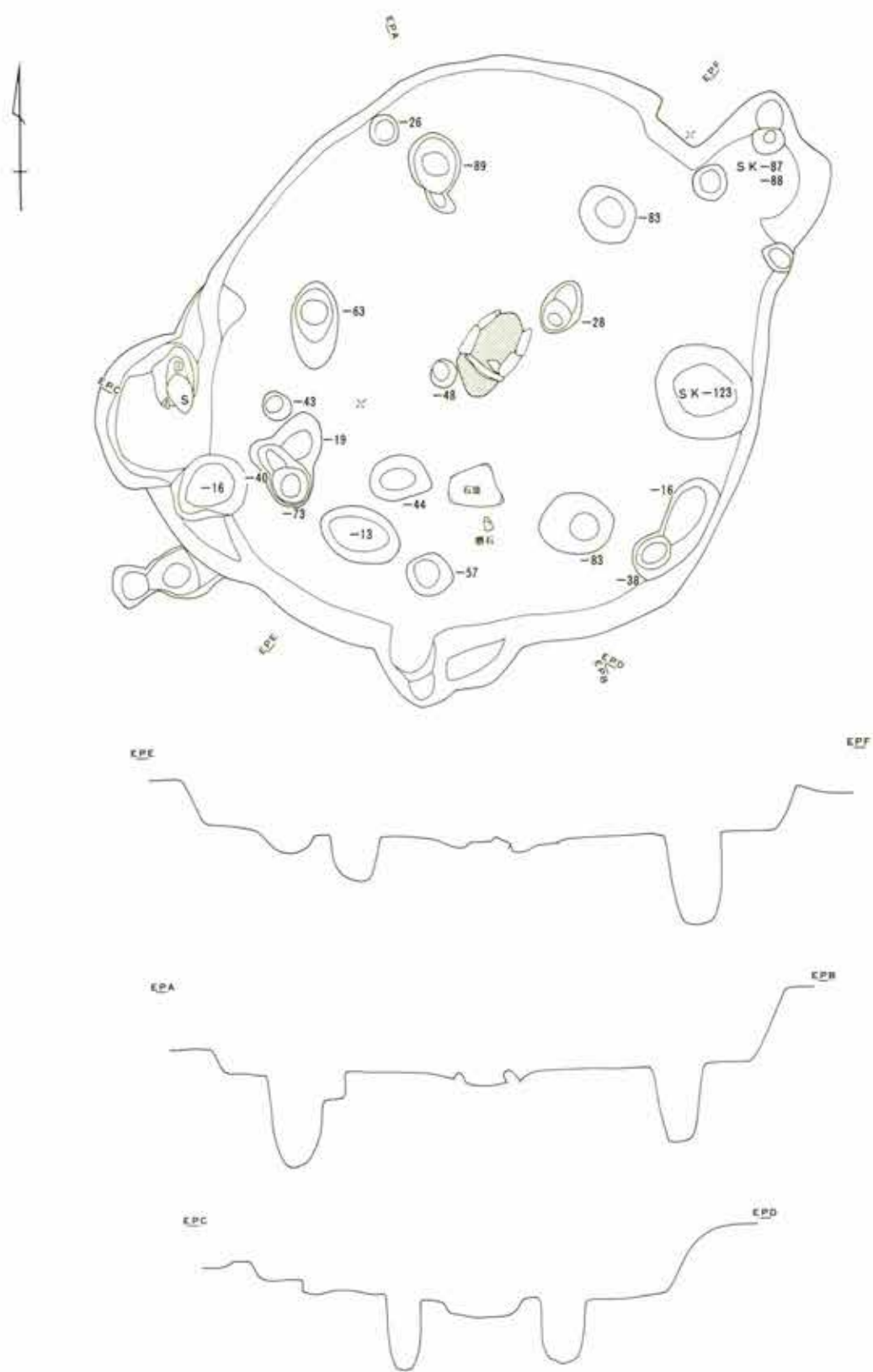

第 307 图 积迦堂 S-IV 区 SB-32

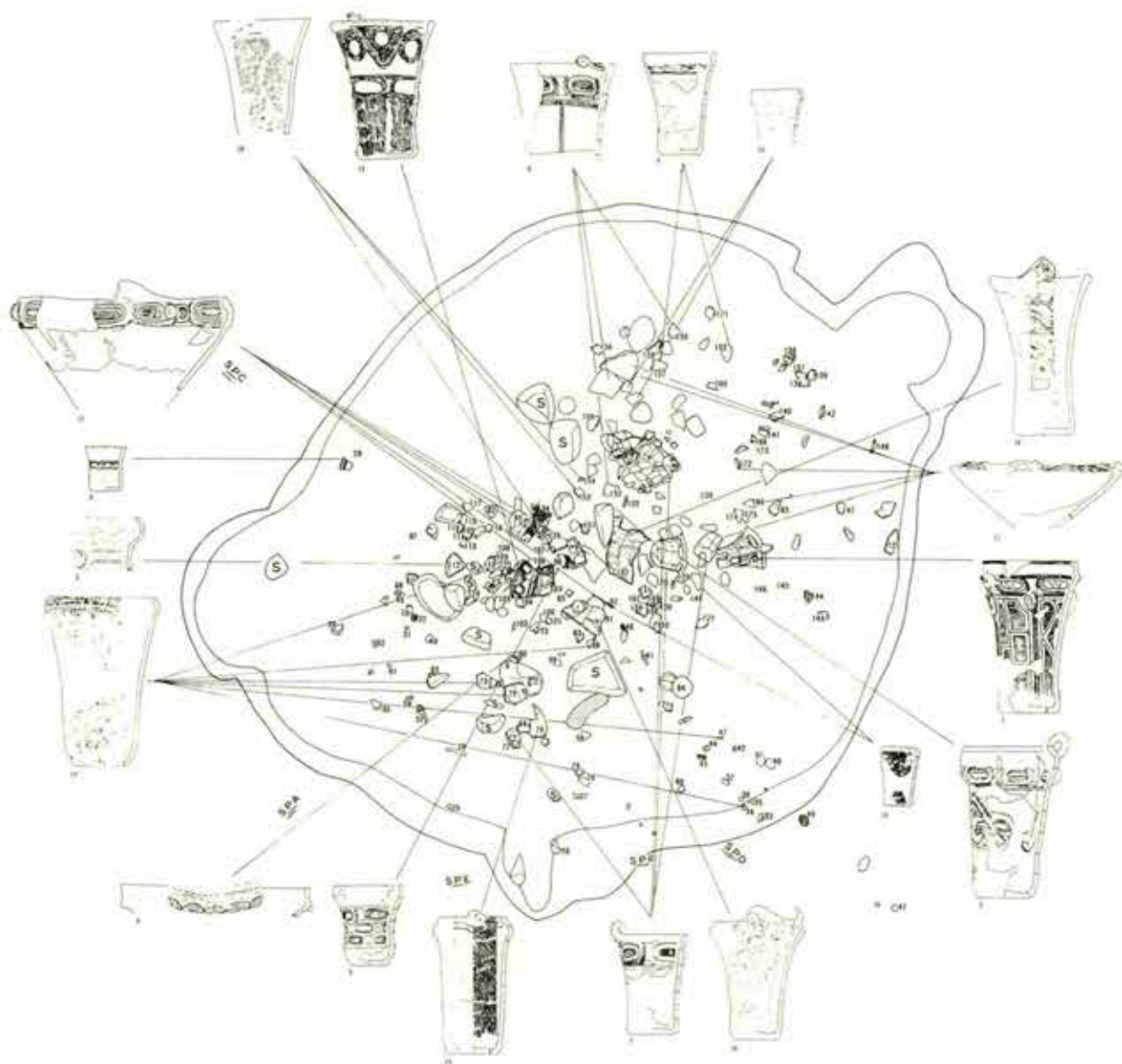

第 308 图 积迦堂 S-IV 区 SB-32

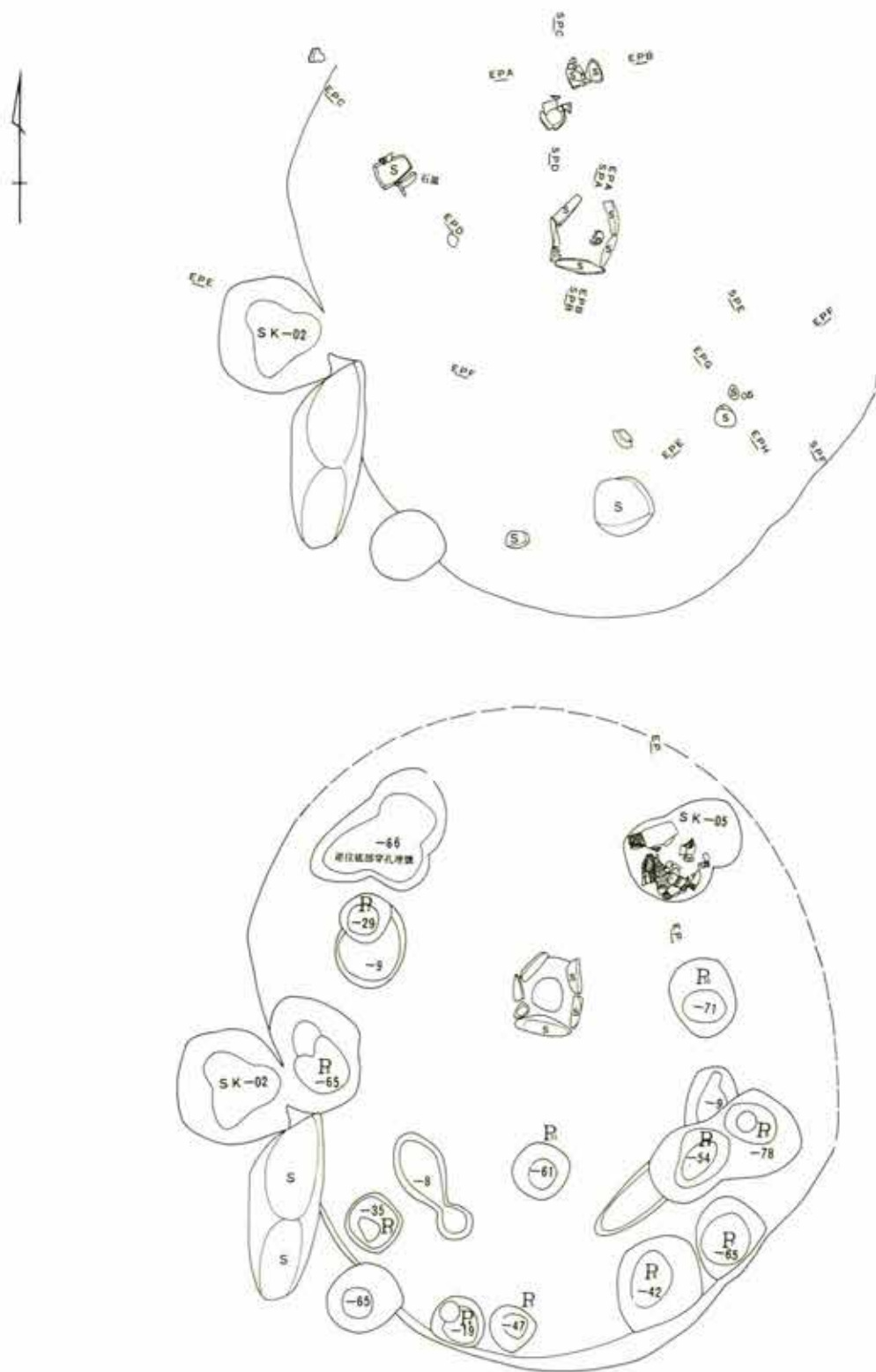

第 309 图 积迦堂 S-IV 区 SB-18

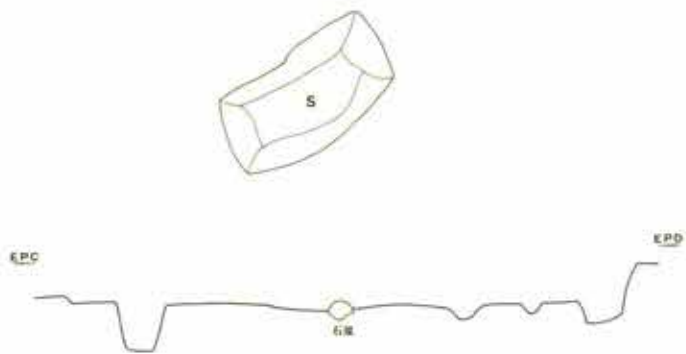
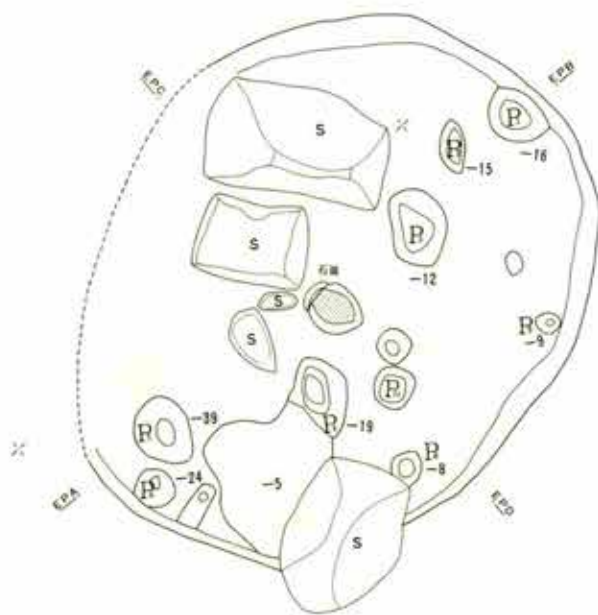
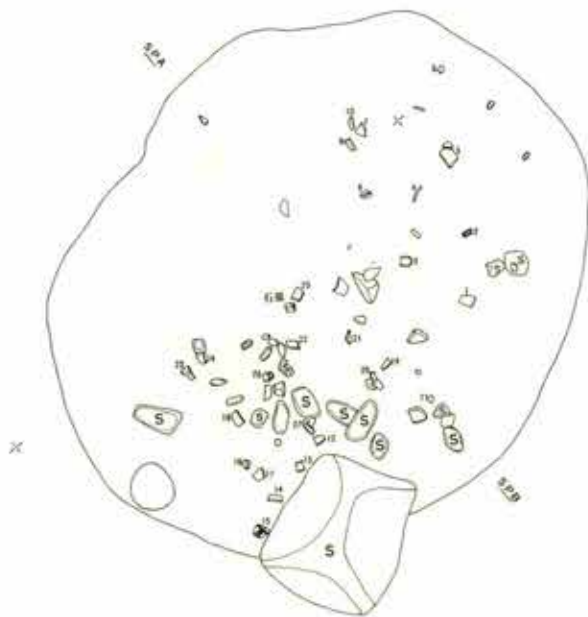

第 310 图 积迦堂 S—IV 区 SB-60

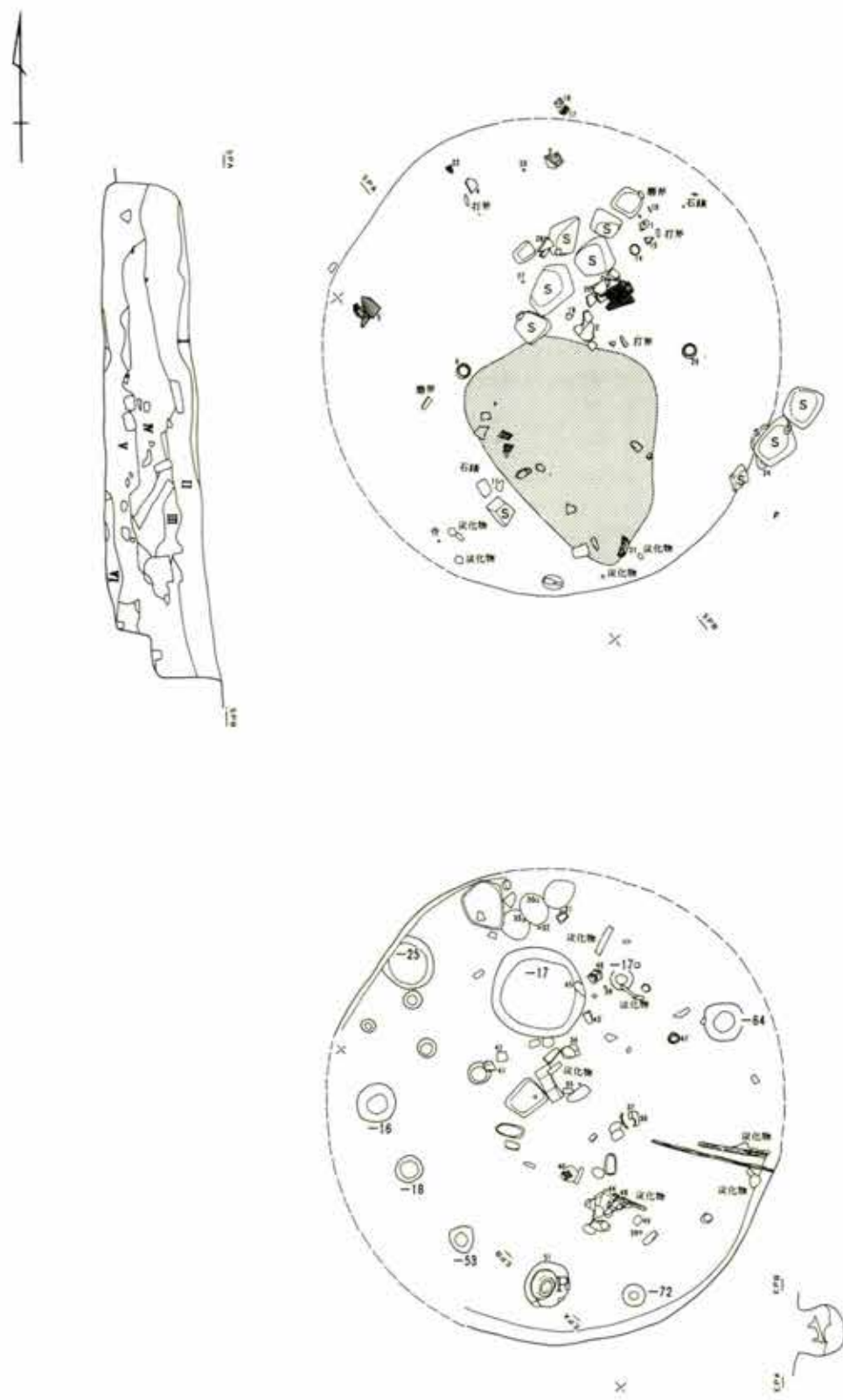

第311图 积迦堂S-IV区 SB-83

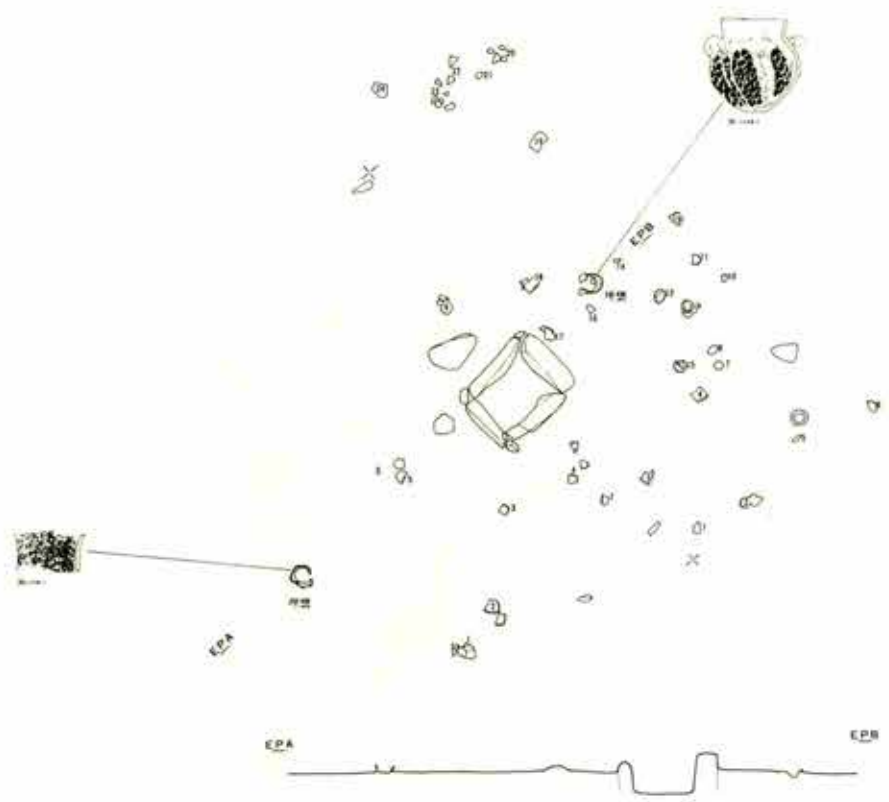

SB-01

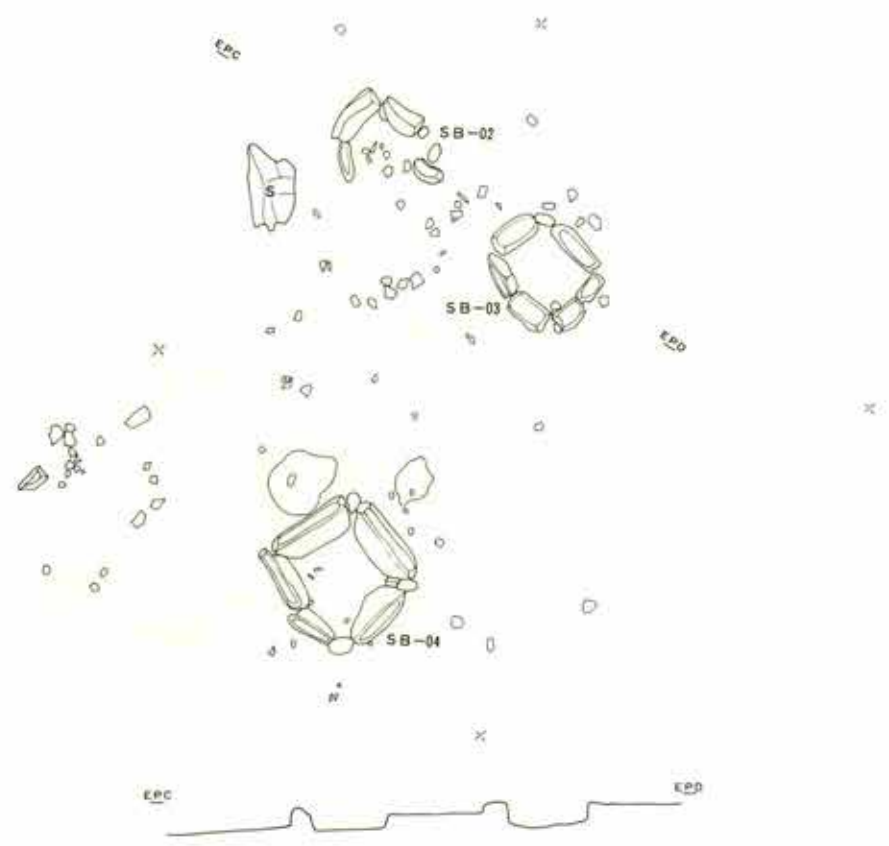

SB-02 SB-03 SB-04

第 312 图 积迦堂 S-IV 区 SB-01 -02 -03 -04

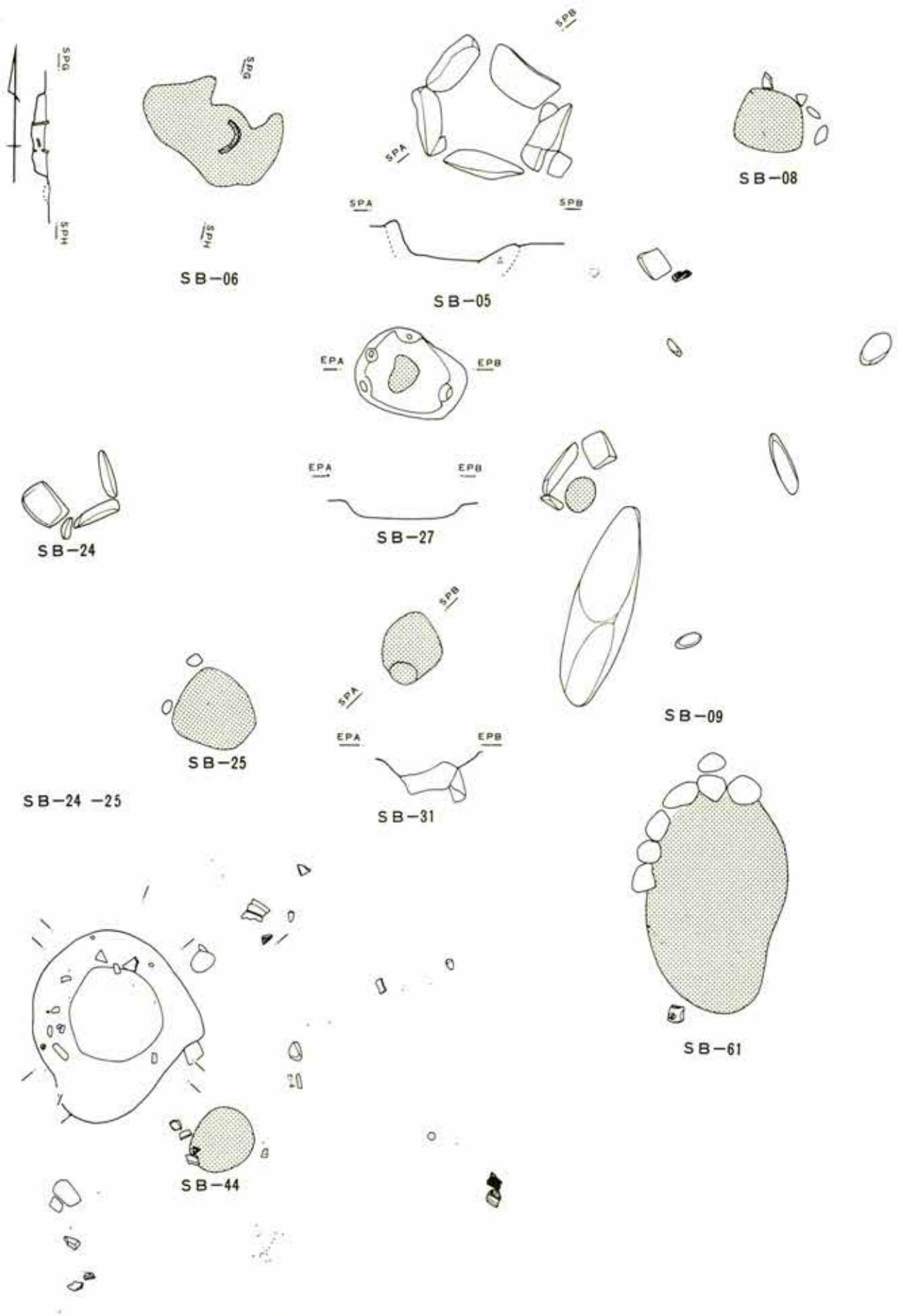

SB-44

第313图 积逊堂S-IV区SB-05-08-09-24-25-31-44-61

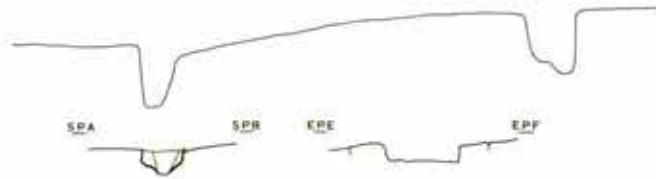
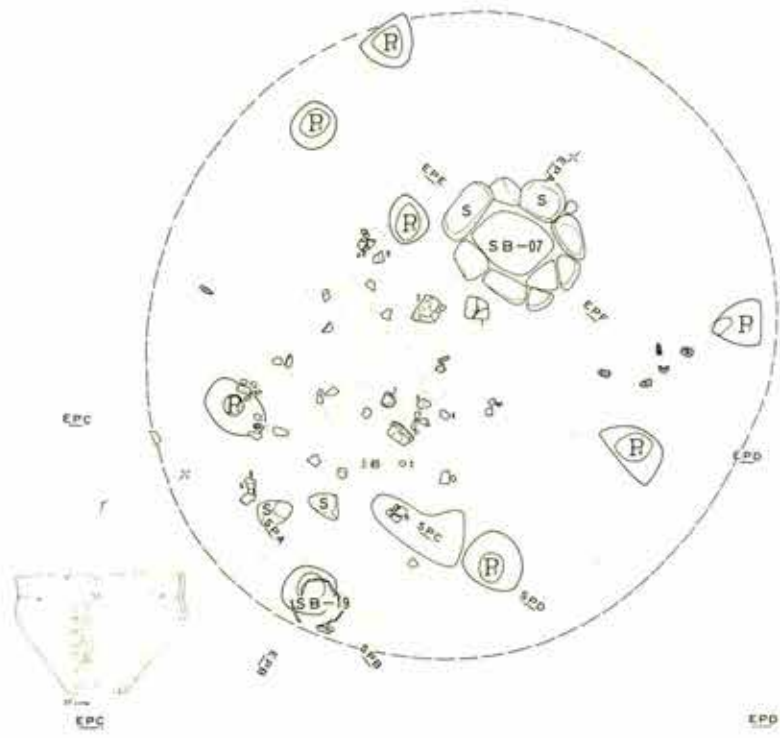

SB-07

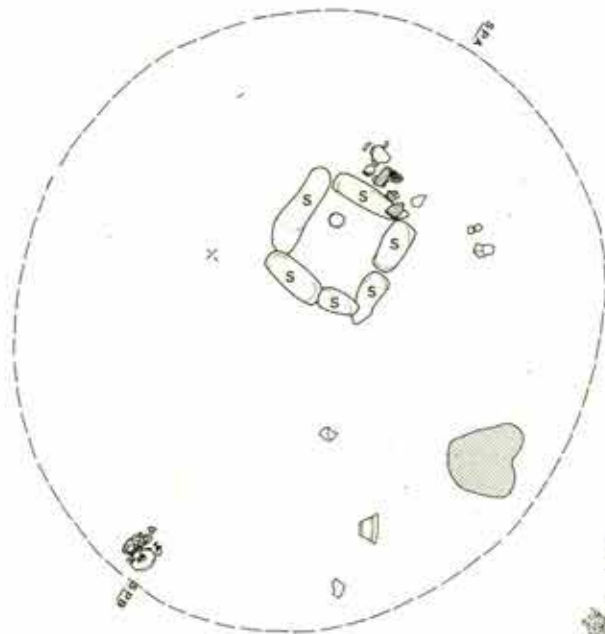

SB-23



第 314 图 积迦堂S-N区 SB-07 -23

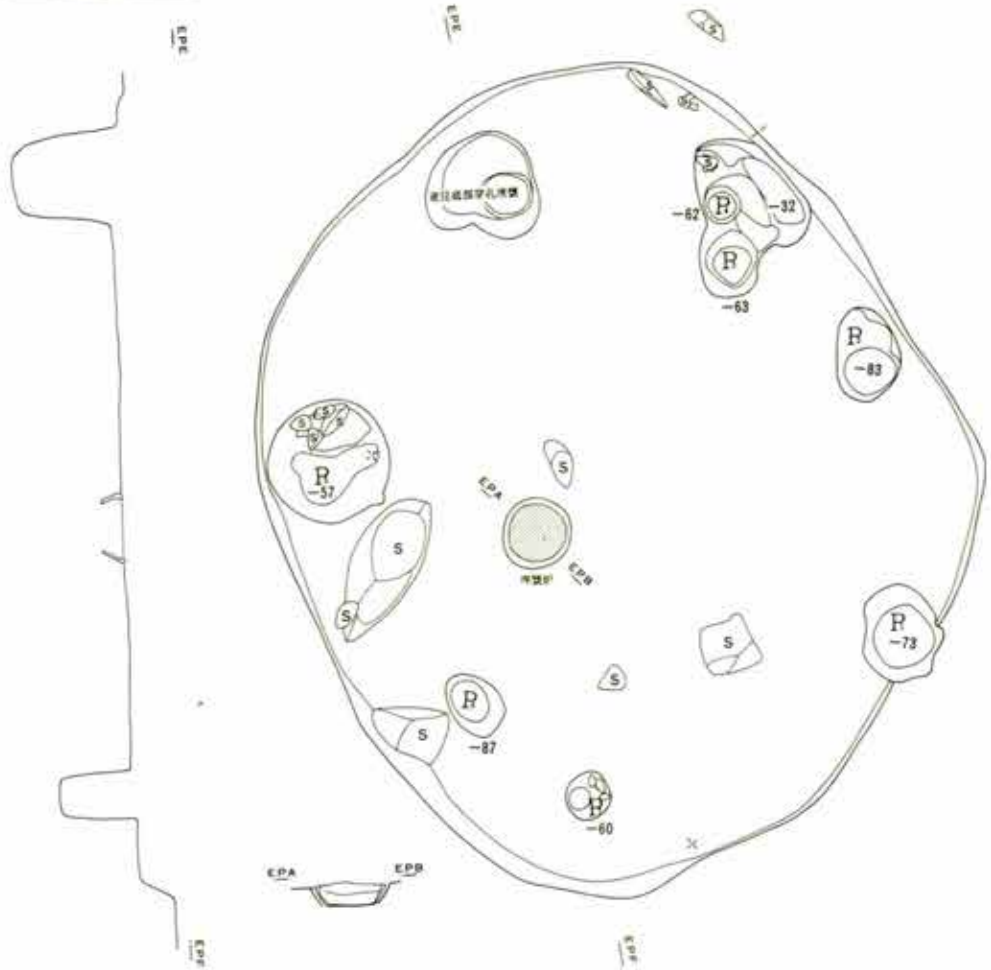
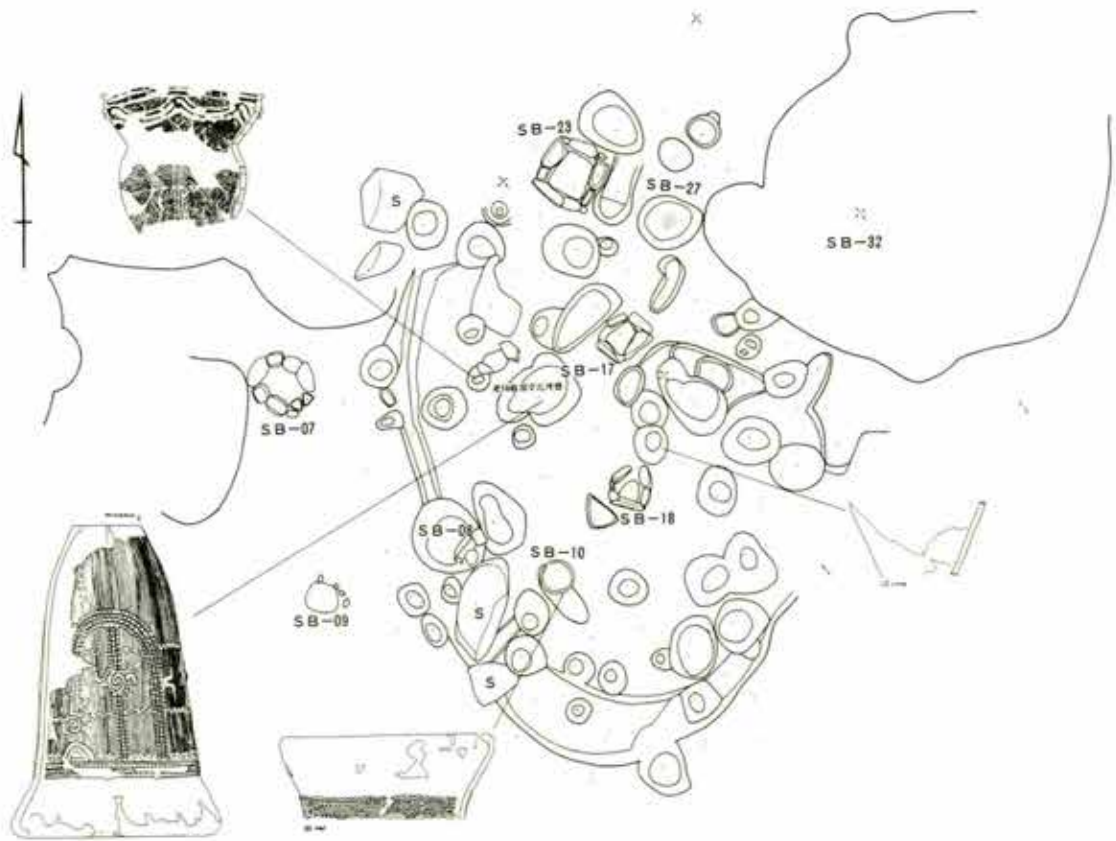

第315图 积迦堂S-IV区 SB-10

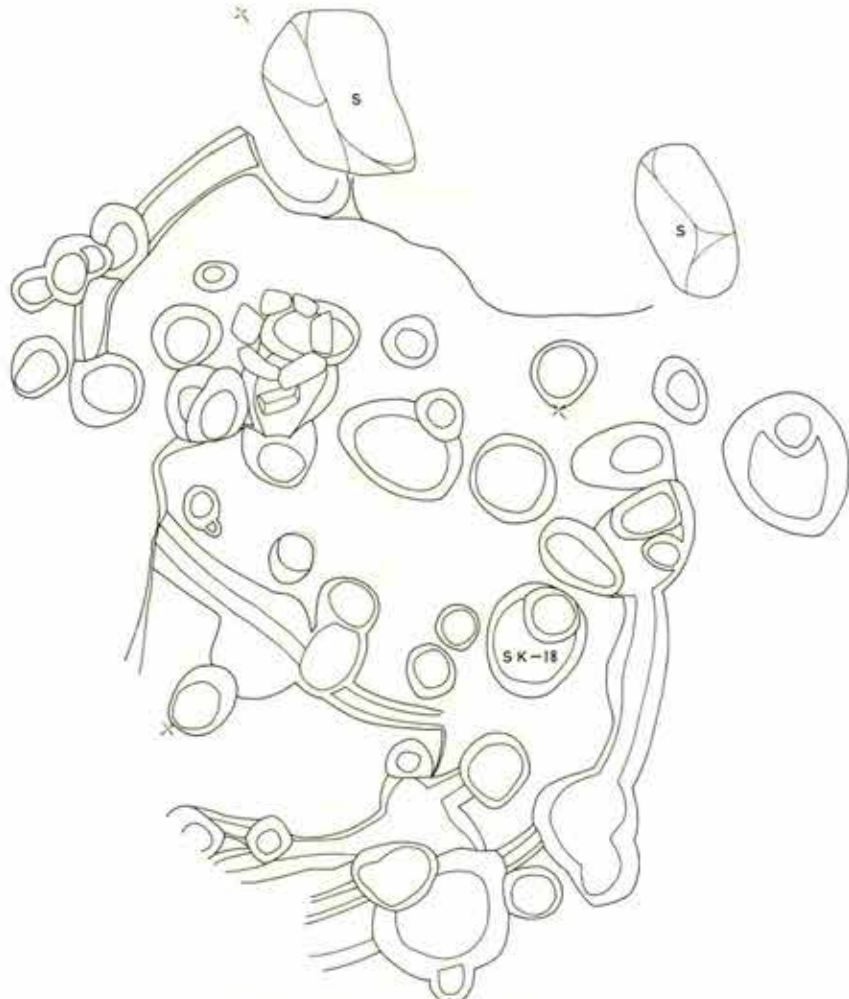
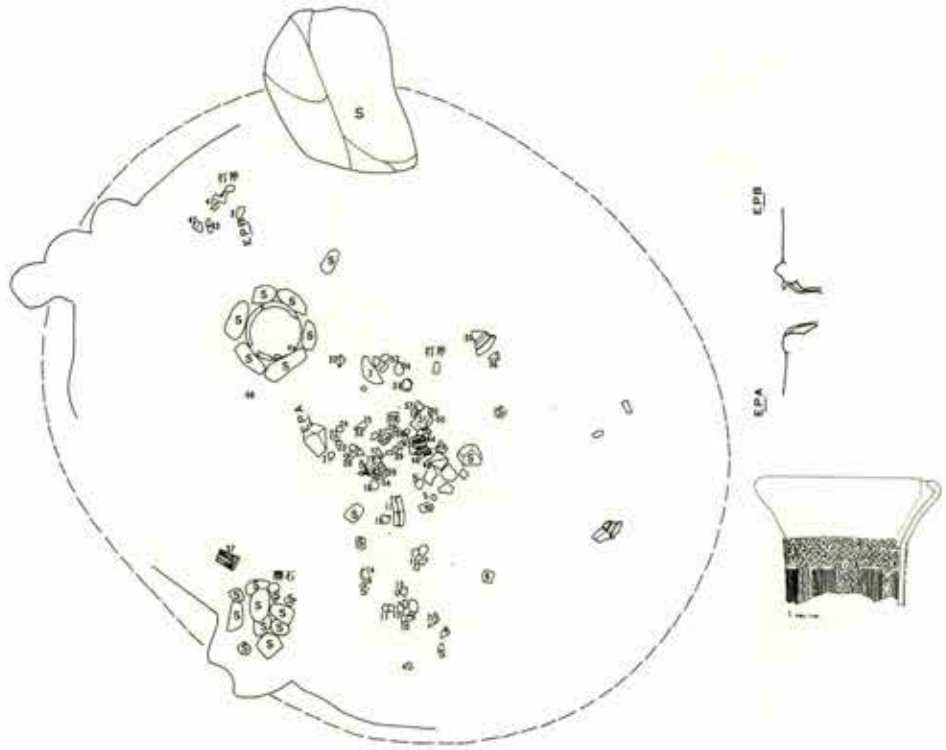

第 316 图 积迦堂 S-IV 区 SB-11



第 317 图 积迦堂 S-IV 区 SB-14 -17



第 318 图 积迦堂 S-IV 区 SB-20

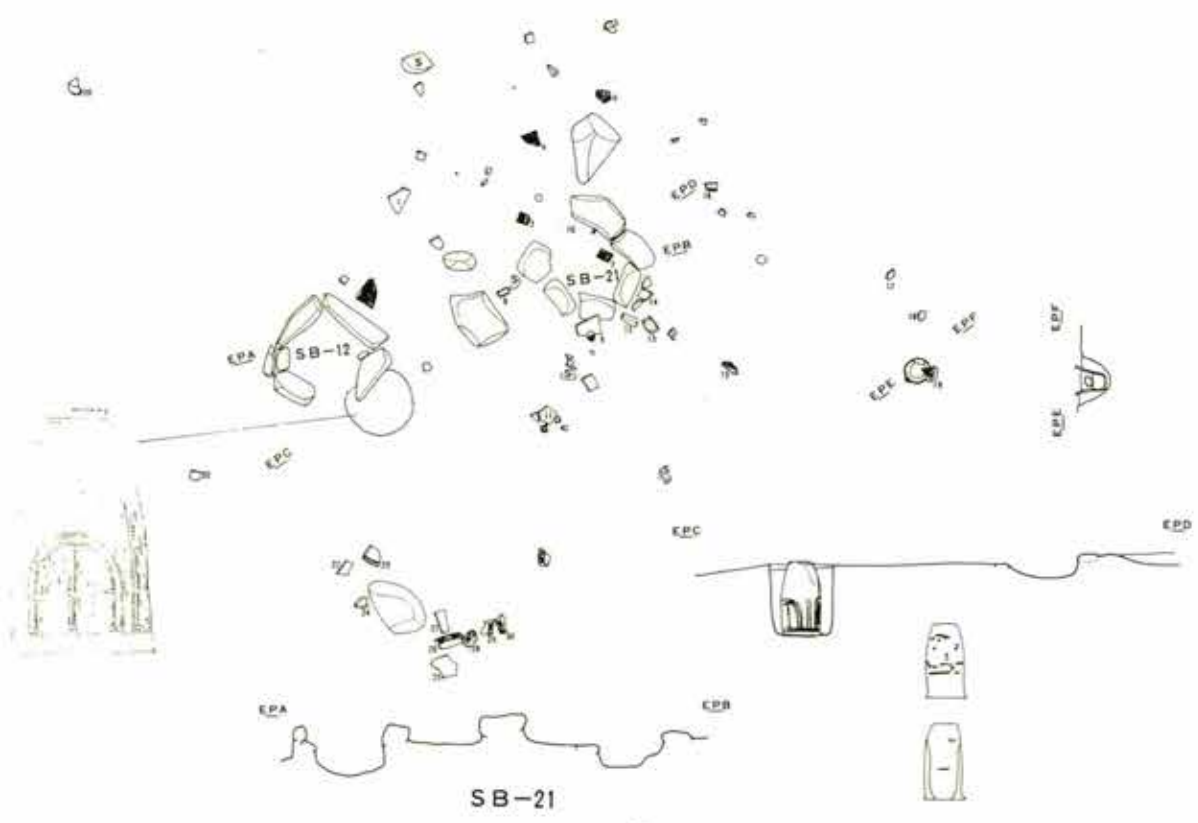
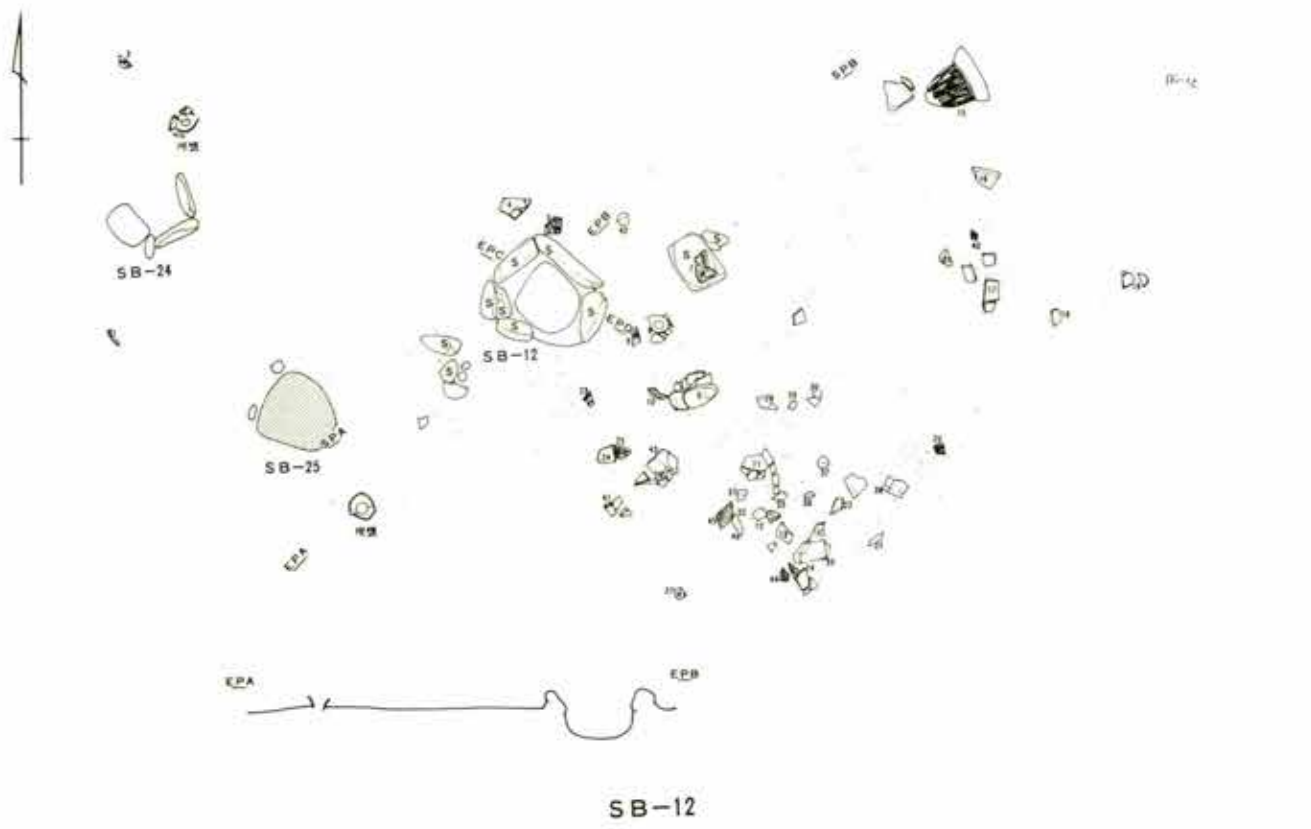

第 319 图 积迦堂 S-IV 区 SB-12 -21

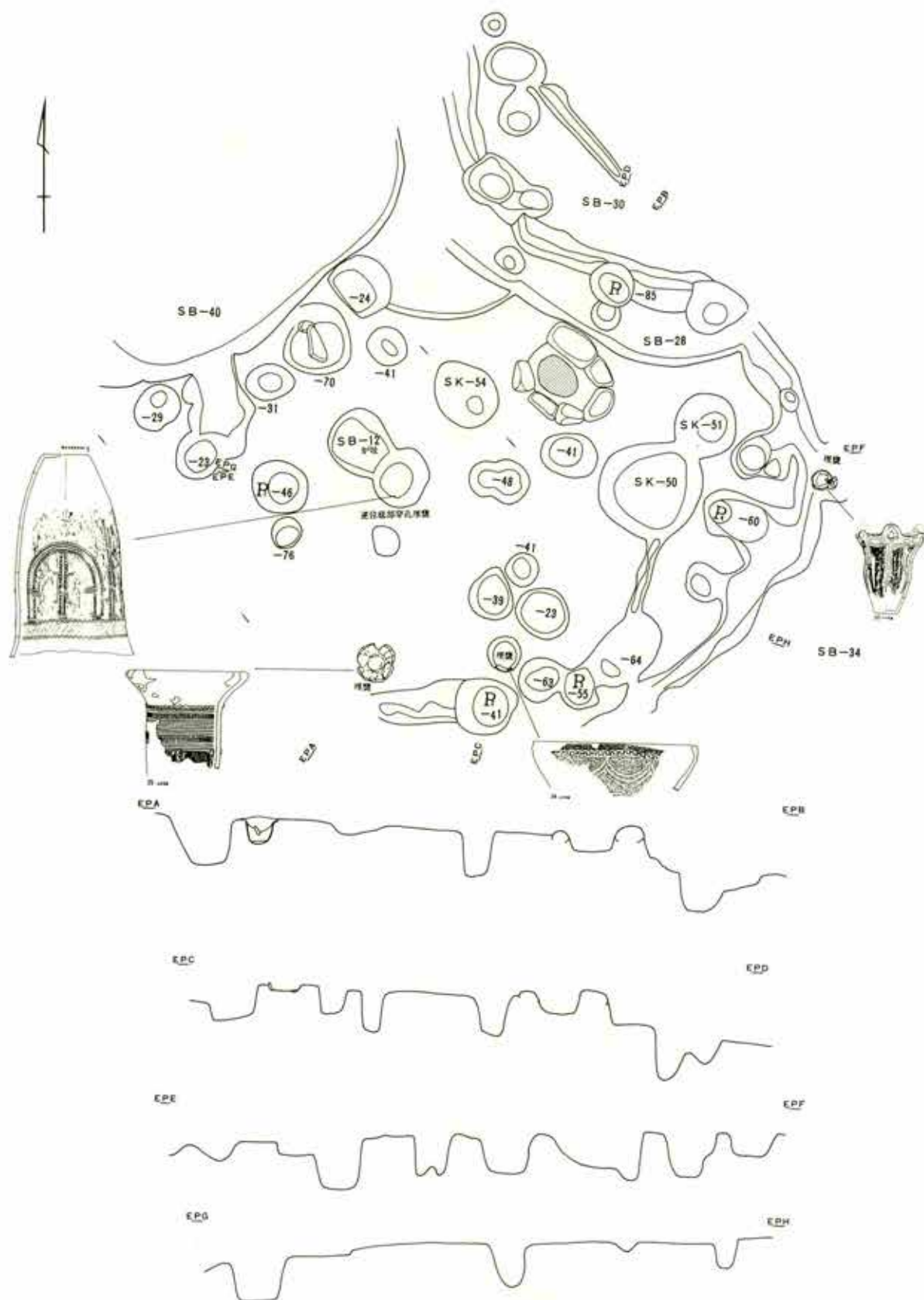

第 320 图 积迦堂 S-IV 区 SB-21

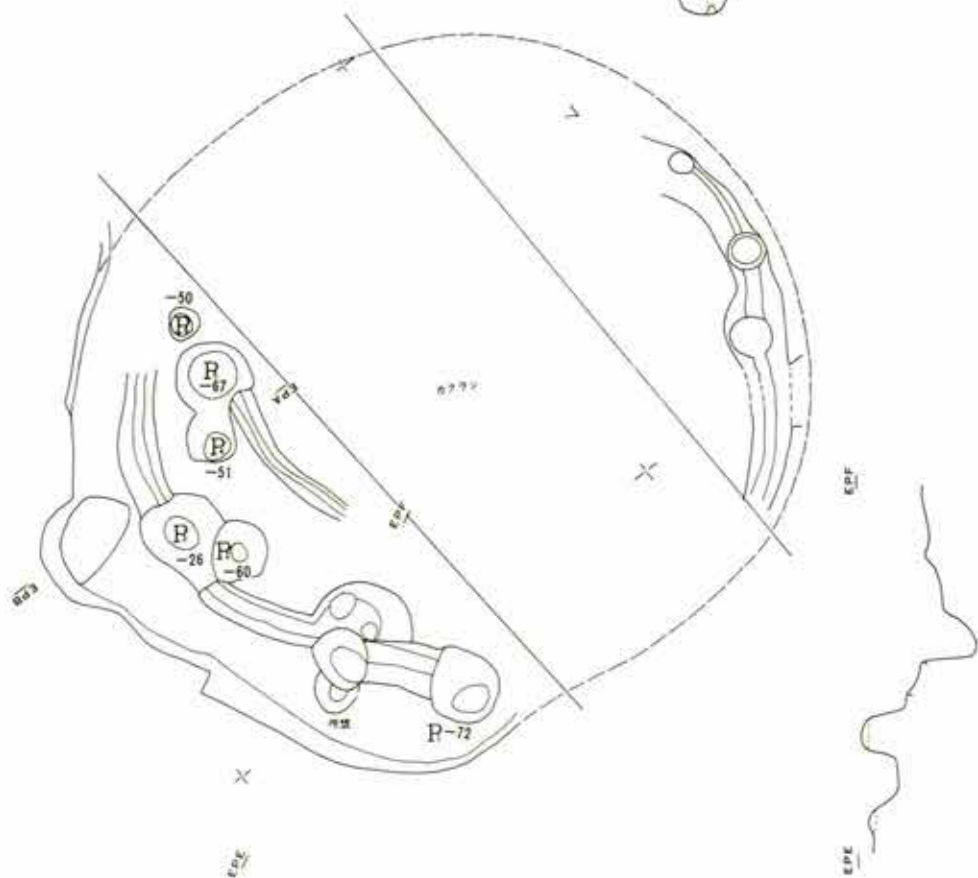
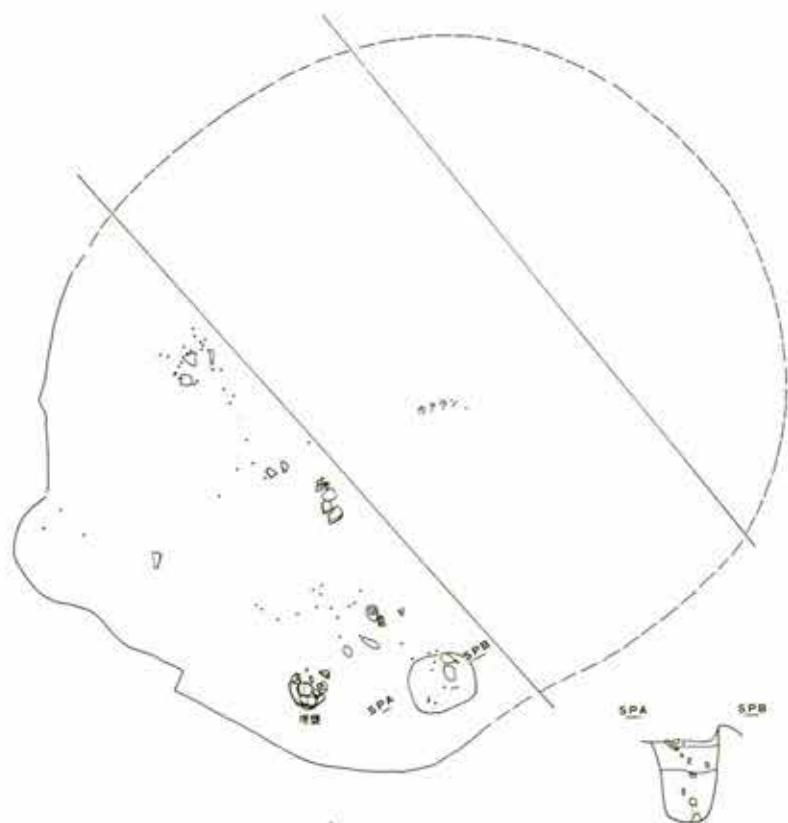

第 321 图 积迦堂 S-IV 区 SB-28-30

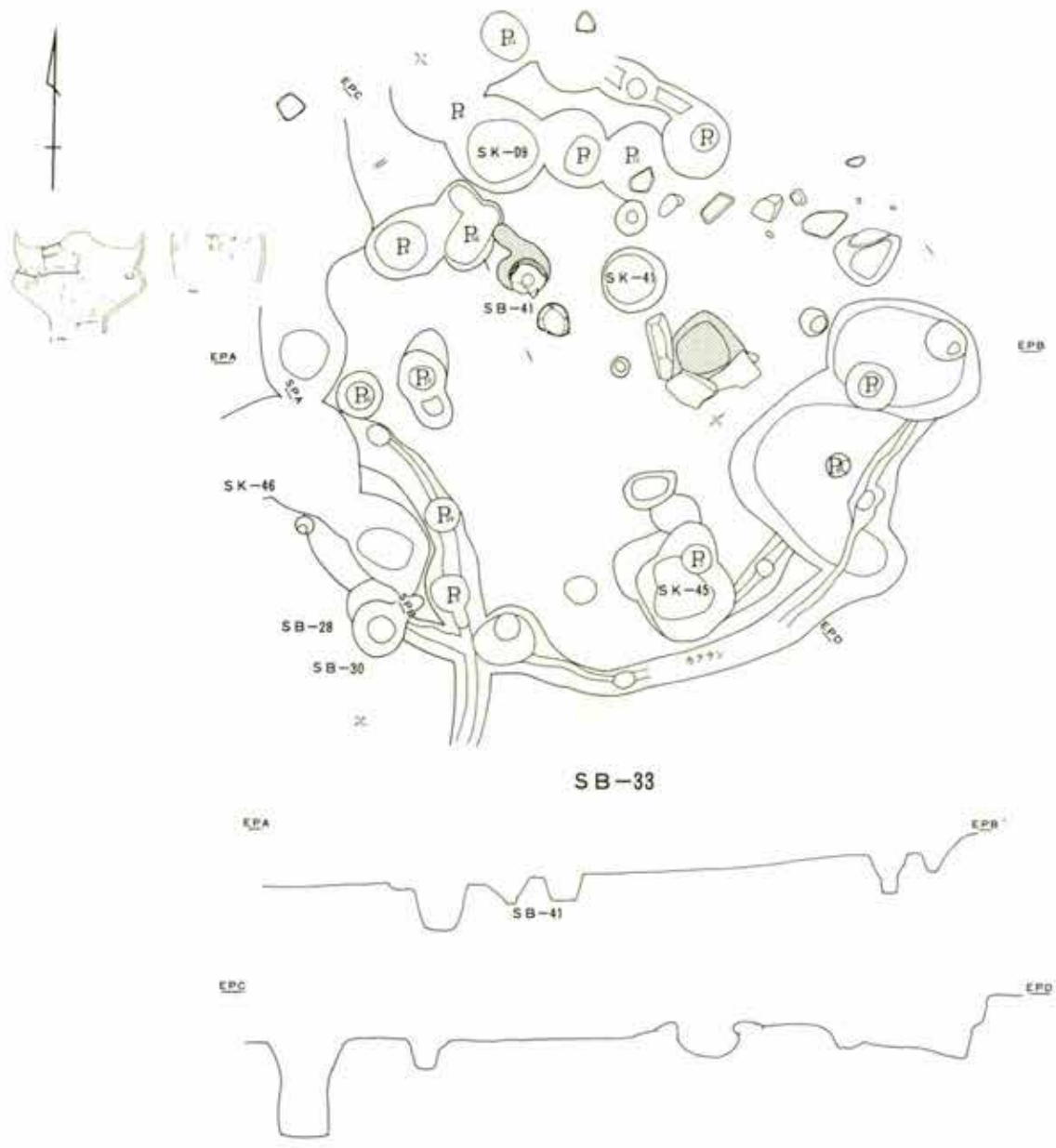

第 322 图 积迦堂 S-IV 区 SB-33-41

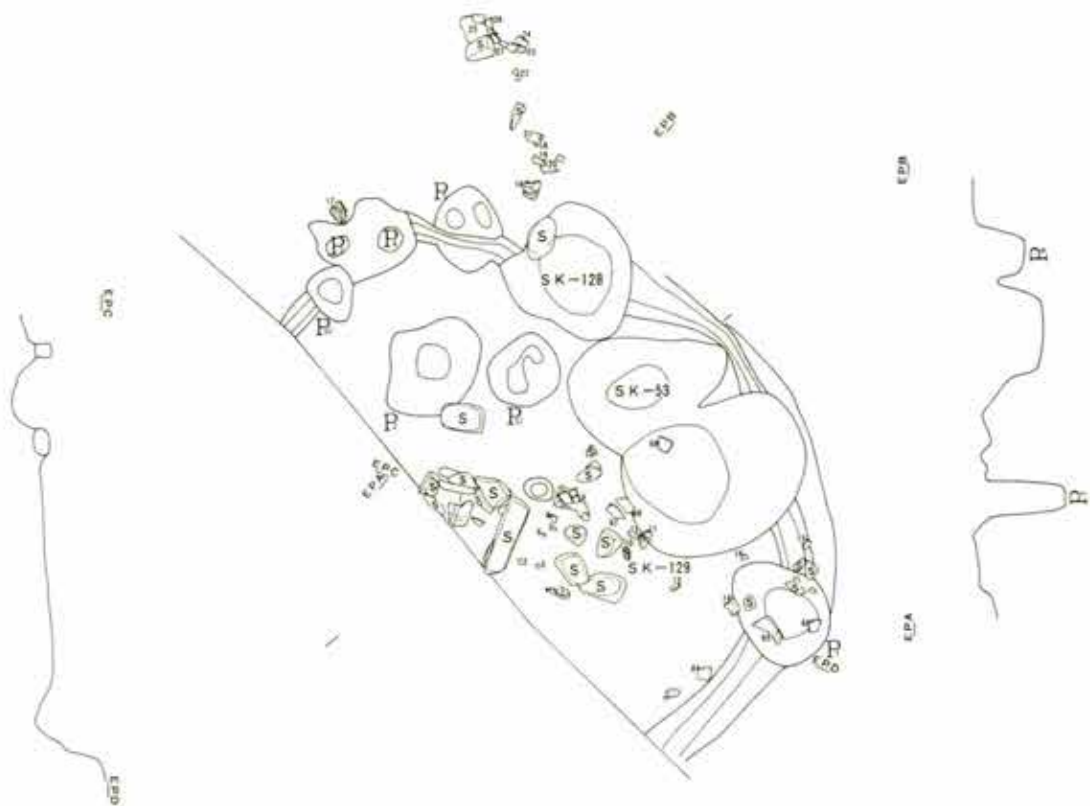

SB-50

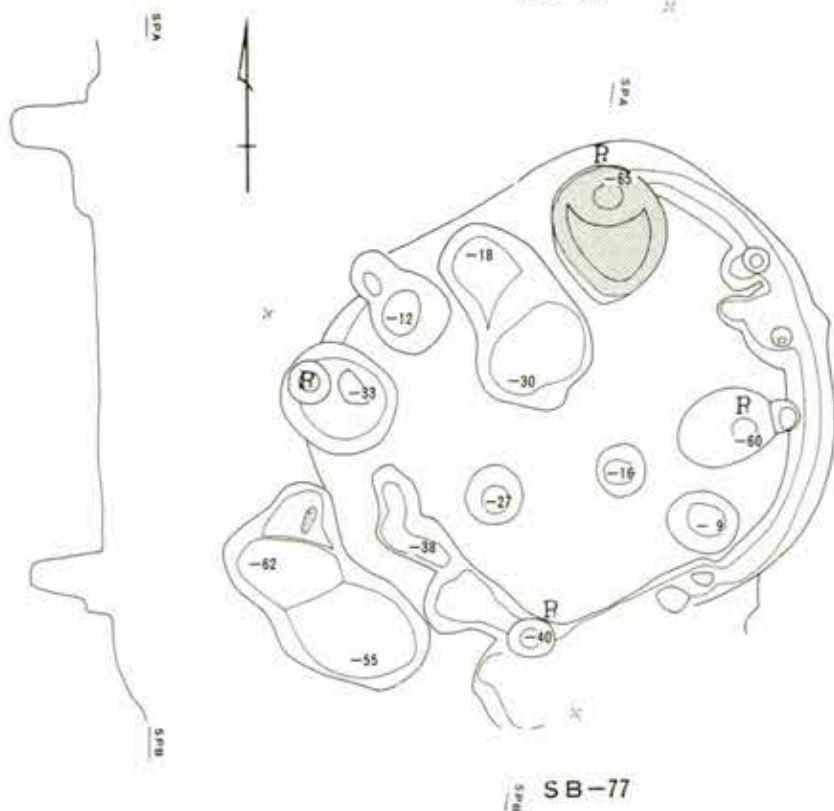

SB-77

第323图 积迦堂S-IV区 SB-50 -77

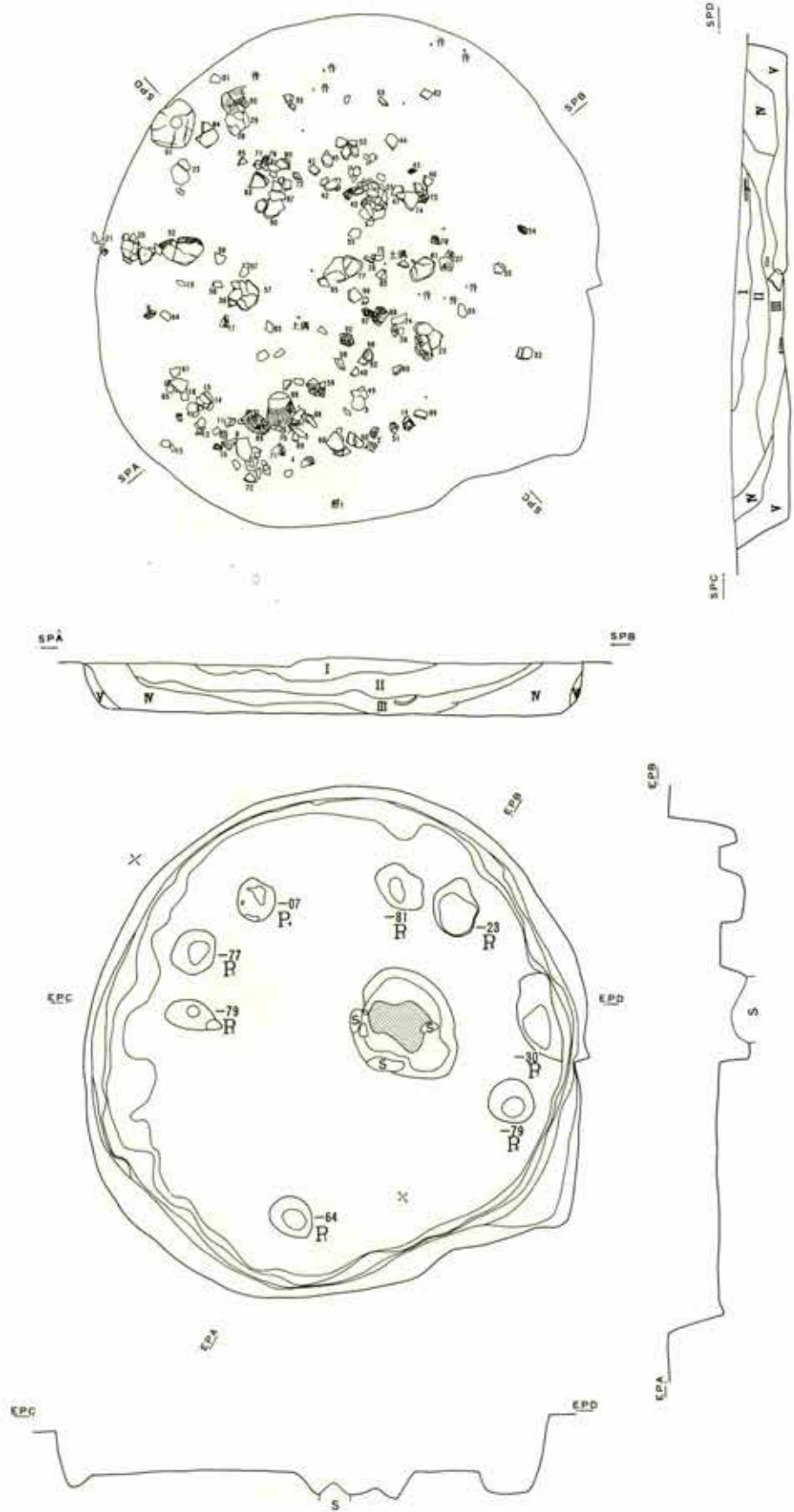

第 324 图 积逊堂 S-IV 区 SB-55

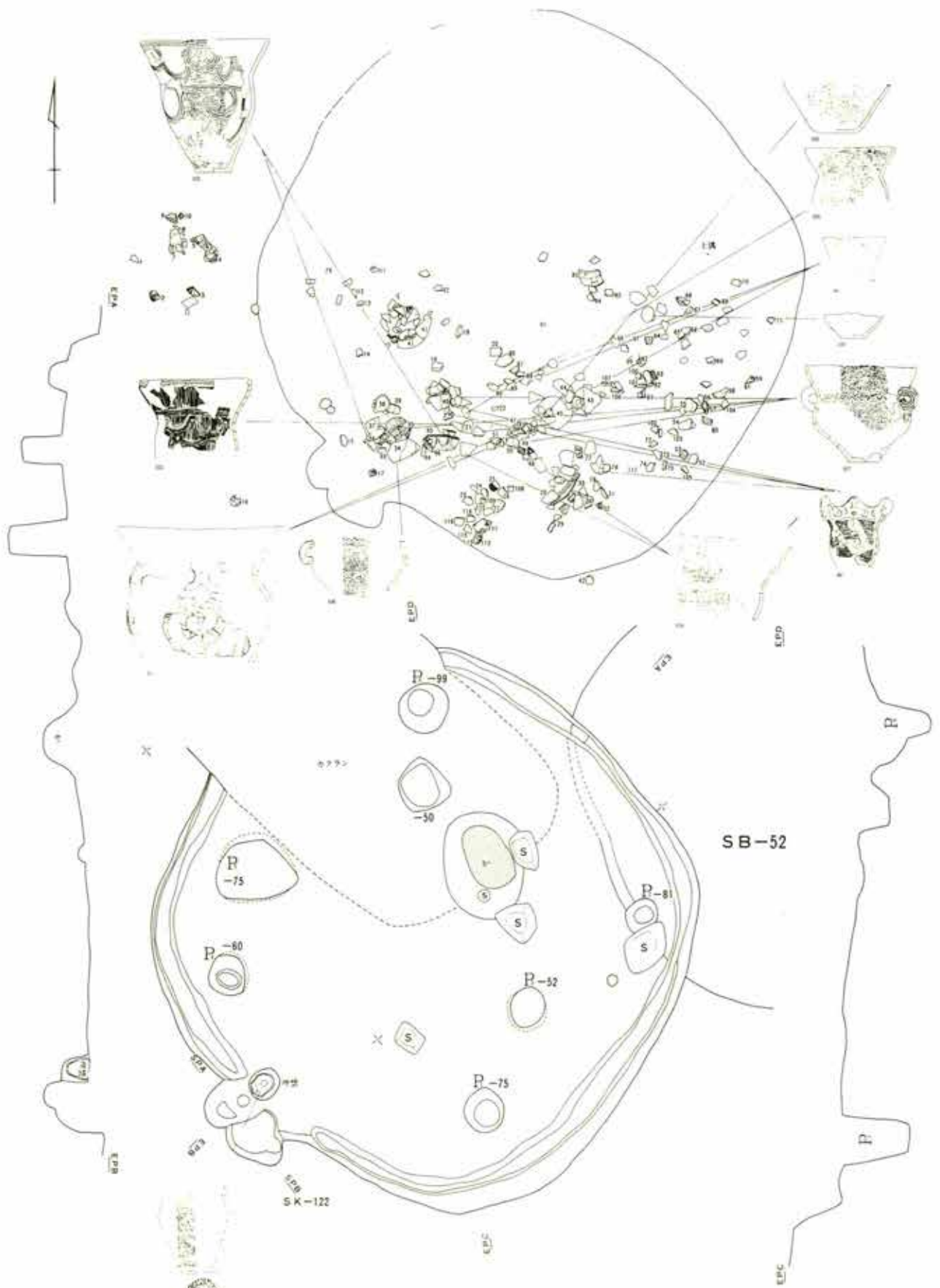

第 325 图 积迺堂 S-IV 区 SB-56

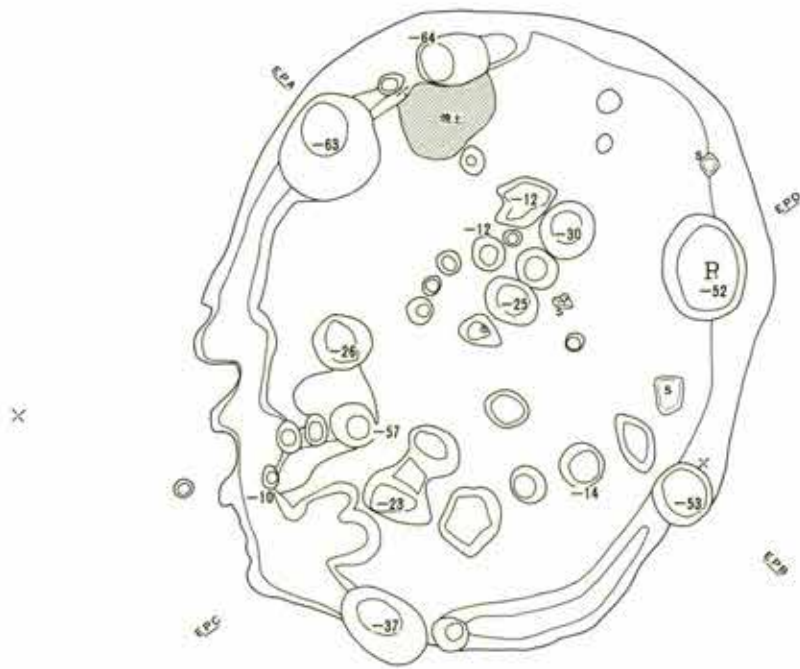
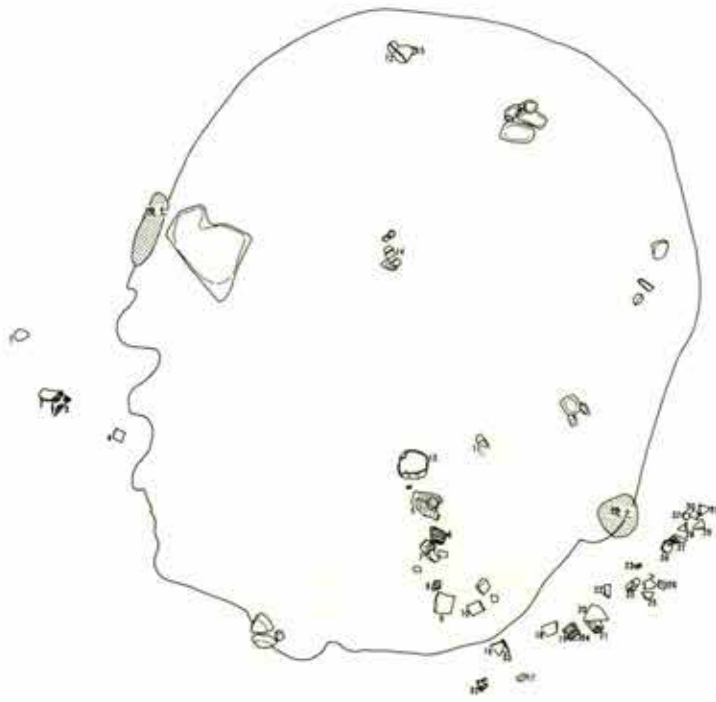

第 326 图 积迦堂 S-IV 区 SB-62

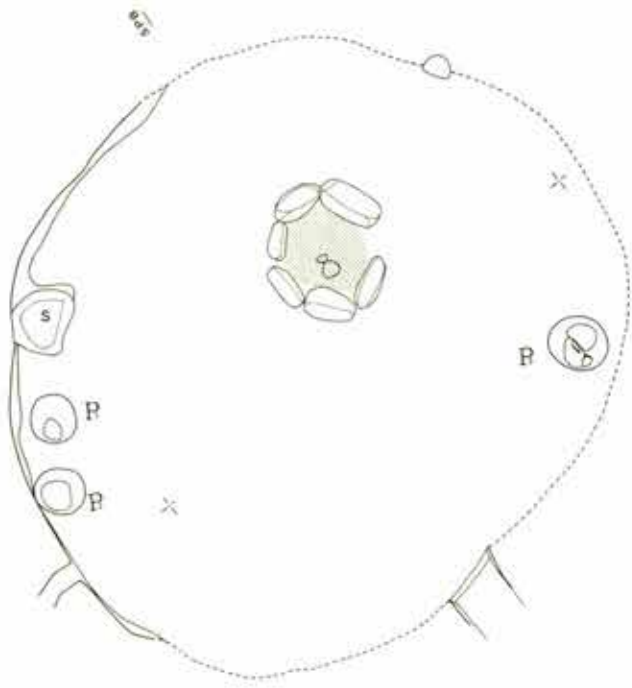
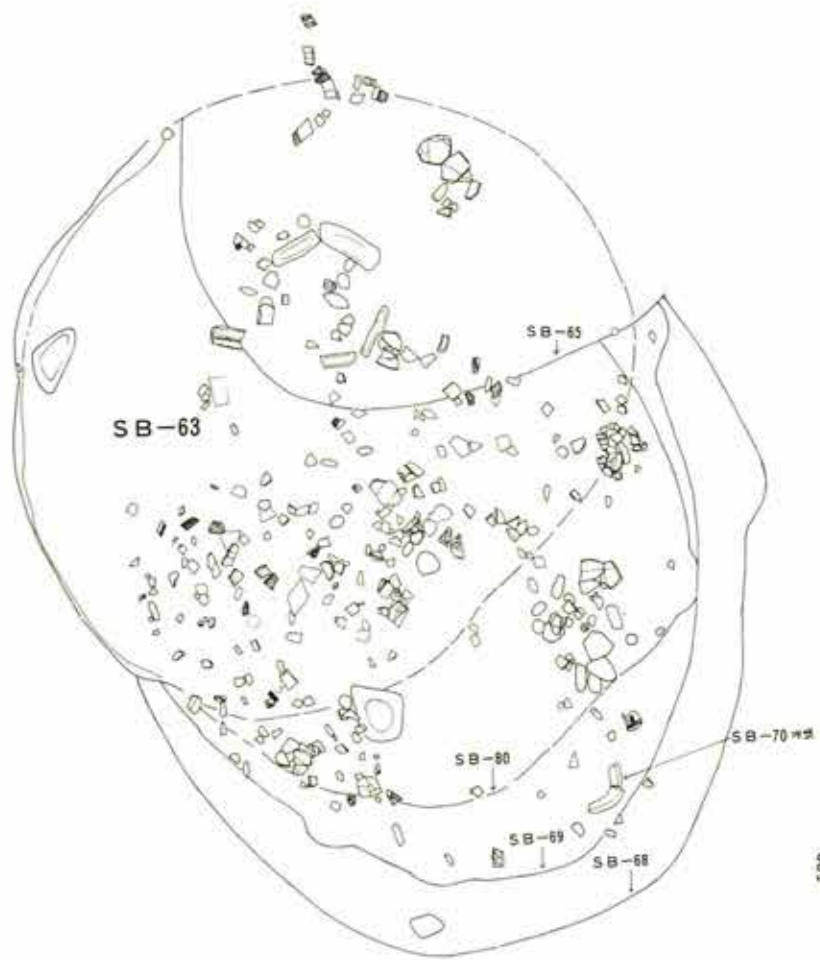

第 327 图 积迦堂 S-IV 区 SB-63

1/50

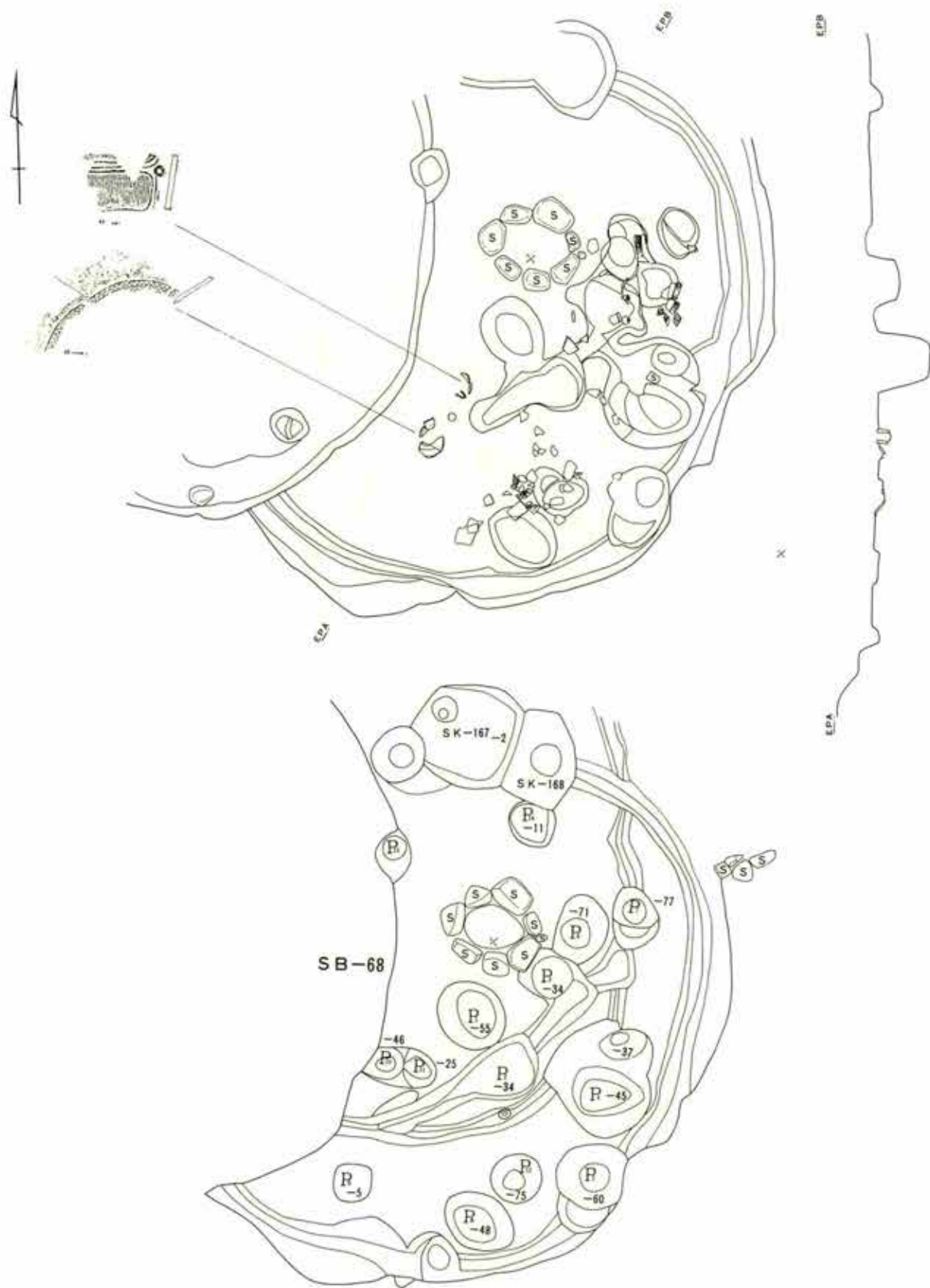

第 328 图 积迦堂 S-V 区 SB-64

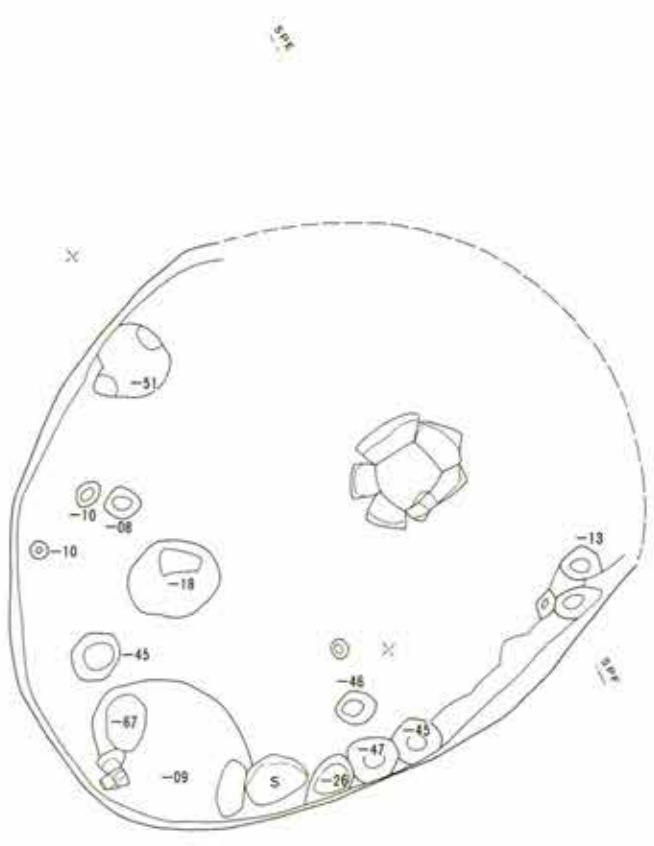
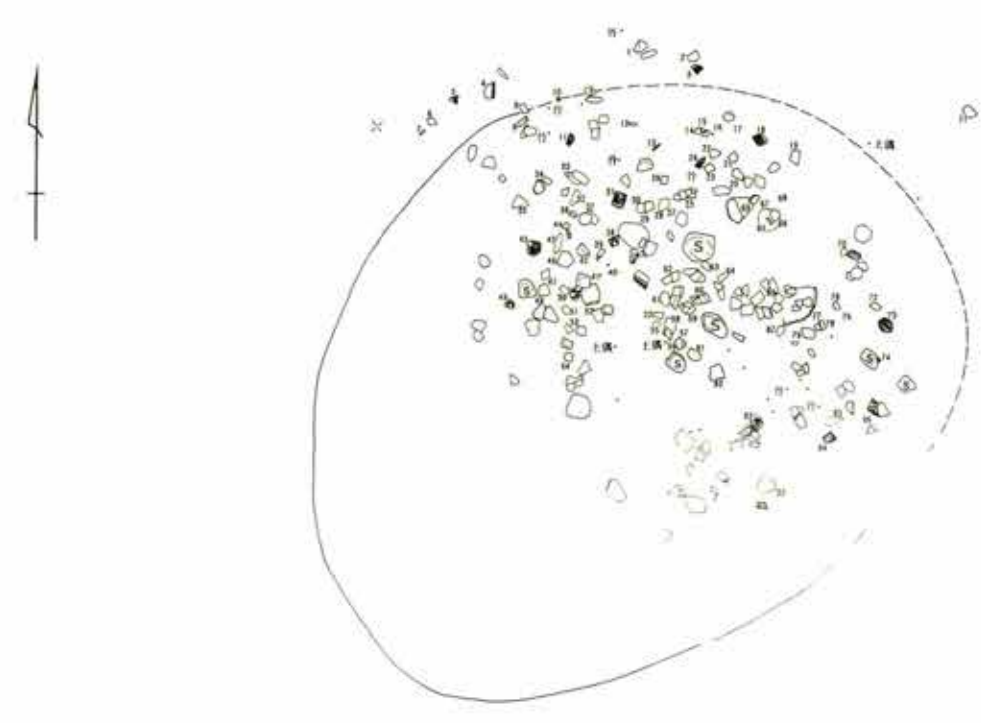

第 329 图 积迦堂 S—IV 区 SB—65

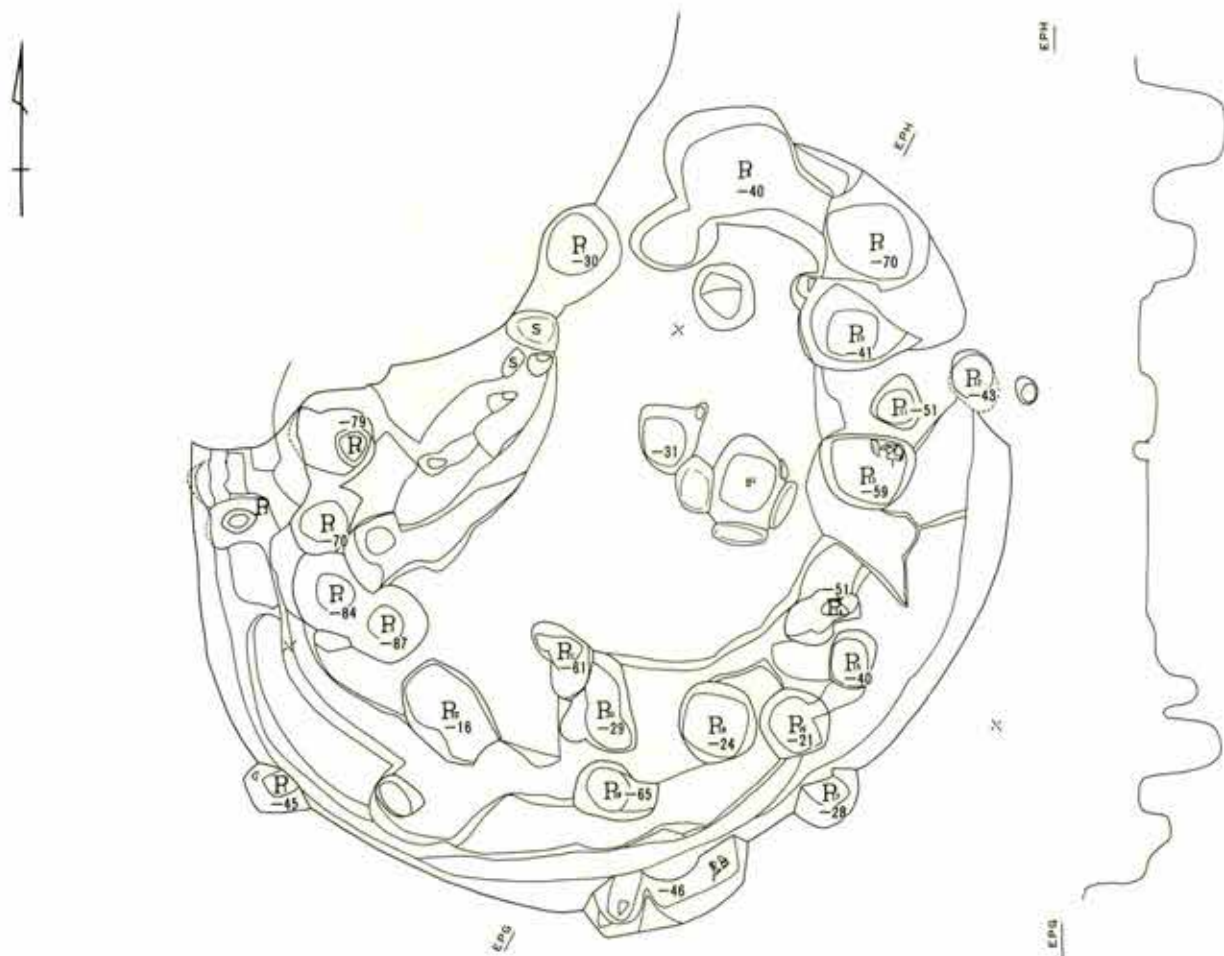

第 330 图 积迦堂 S-IV 区 SB-67



第331图 积迦堂S-IV区 SB-66-70-71-72

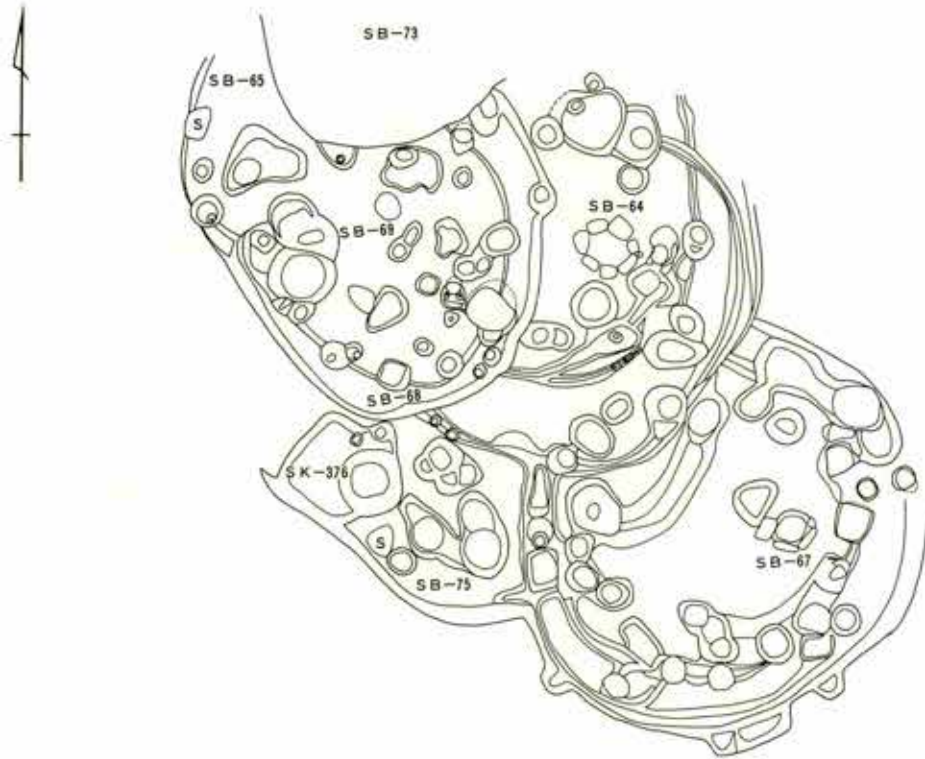

积迦堂S-IV区 SB-64 -67 -68 -75 (1 : 120)

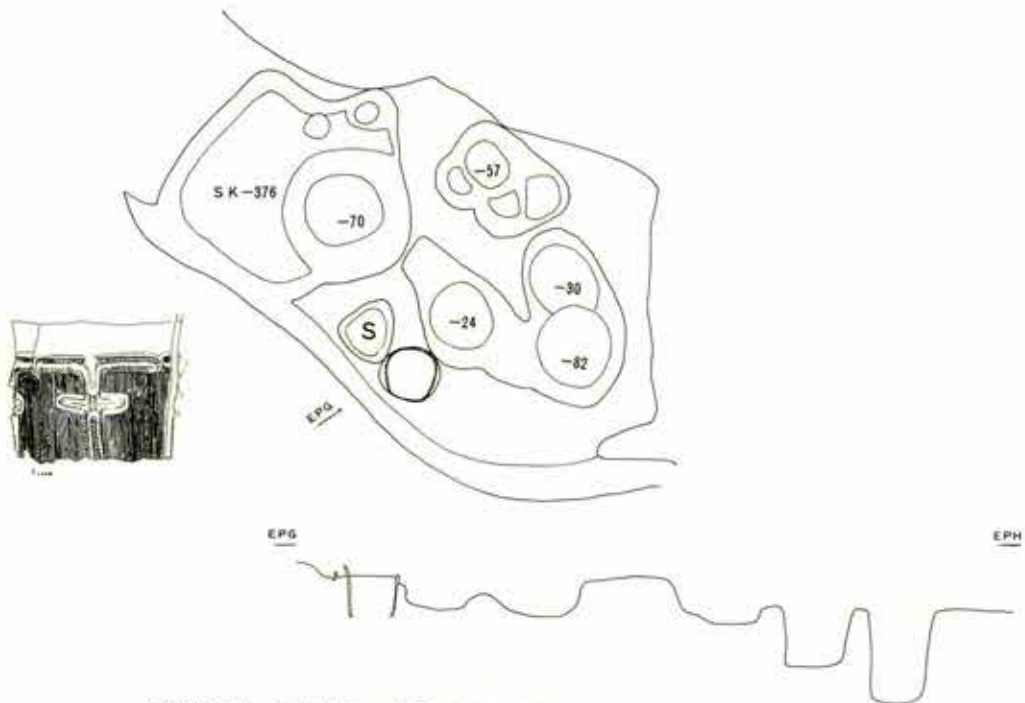

第 332 图 积迦堂S-IV区 SB-75

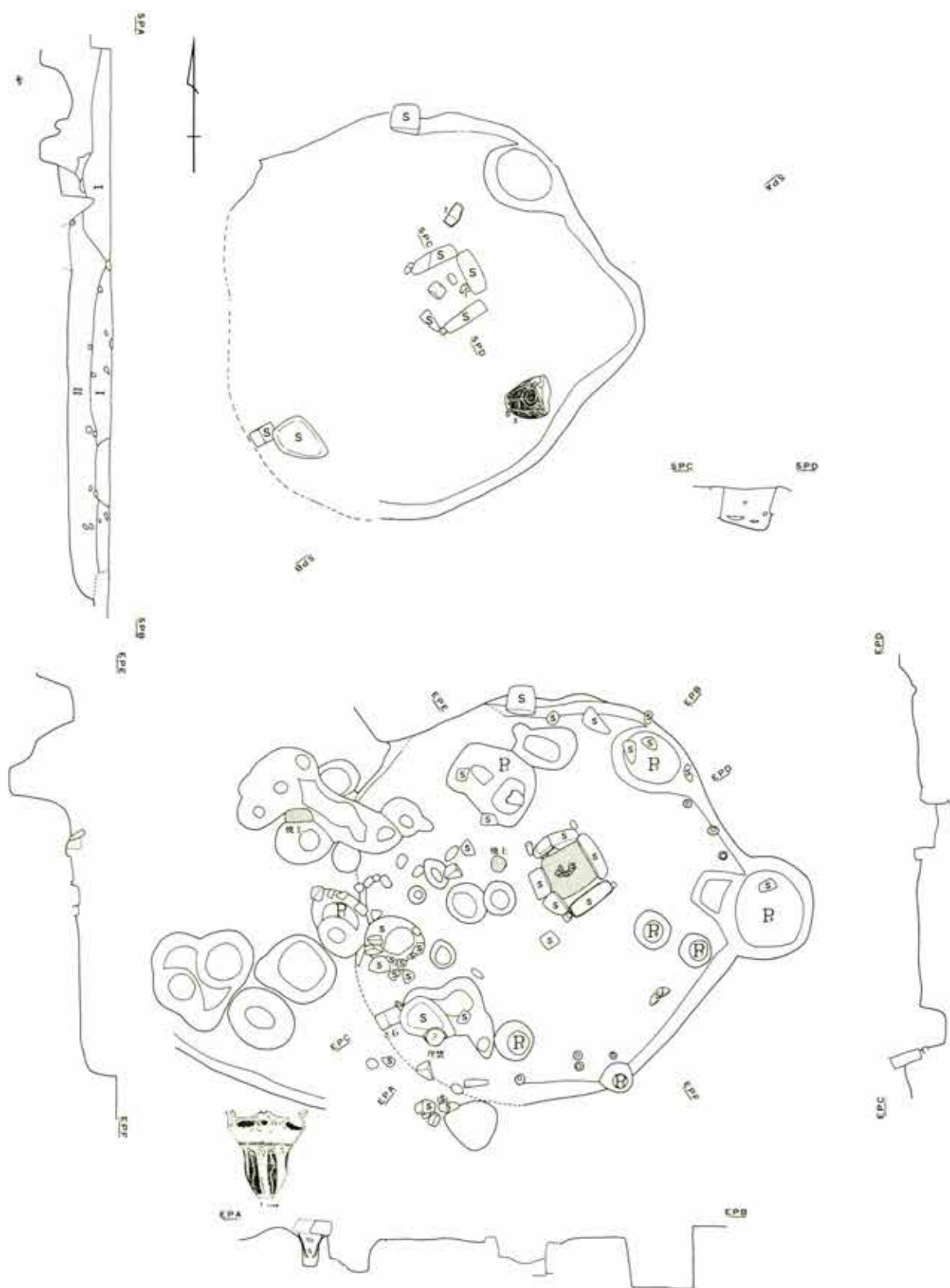

第 333 図 積迦堂 S-IV 区 SB-78

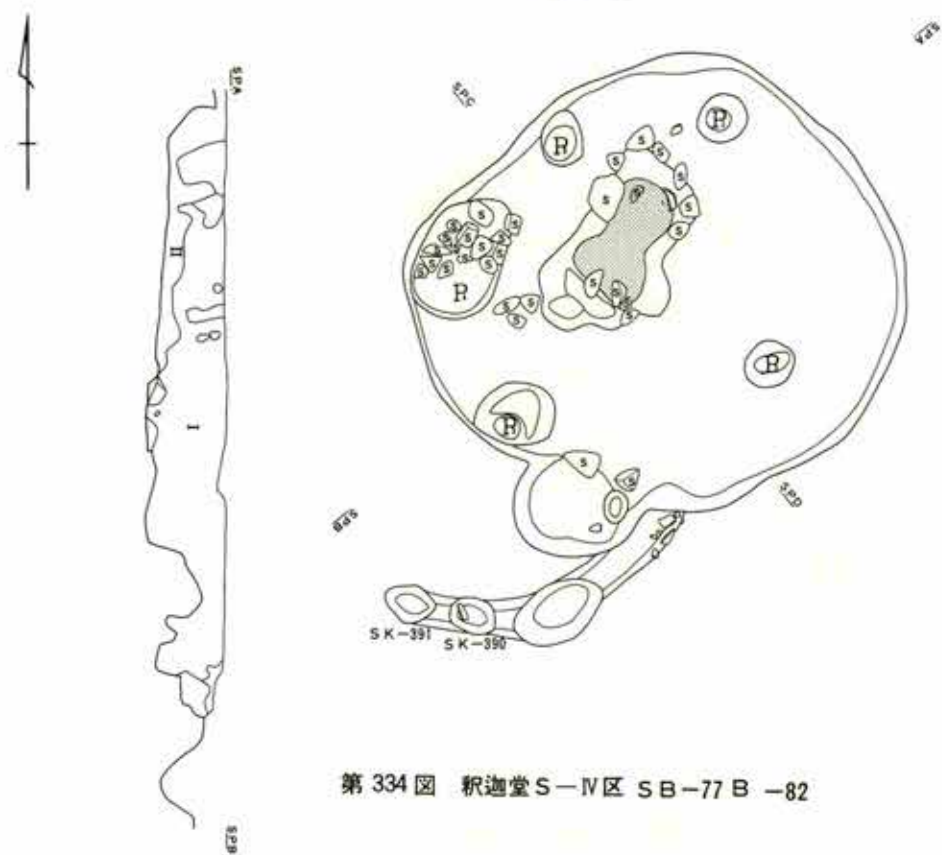
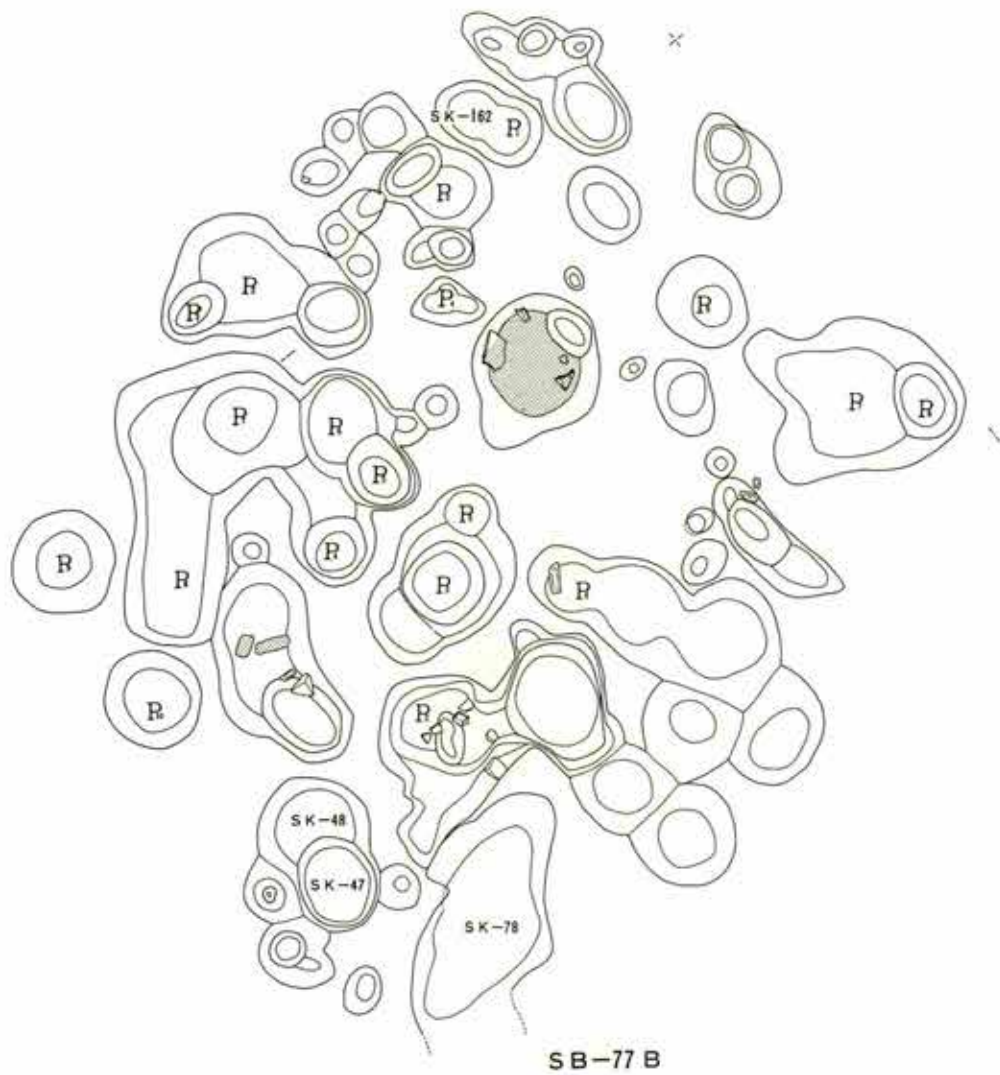

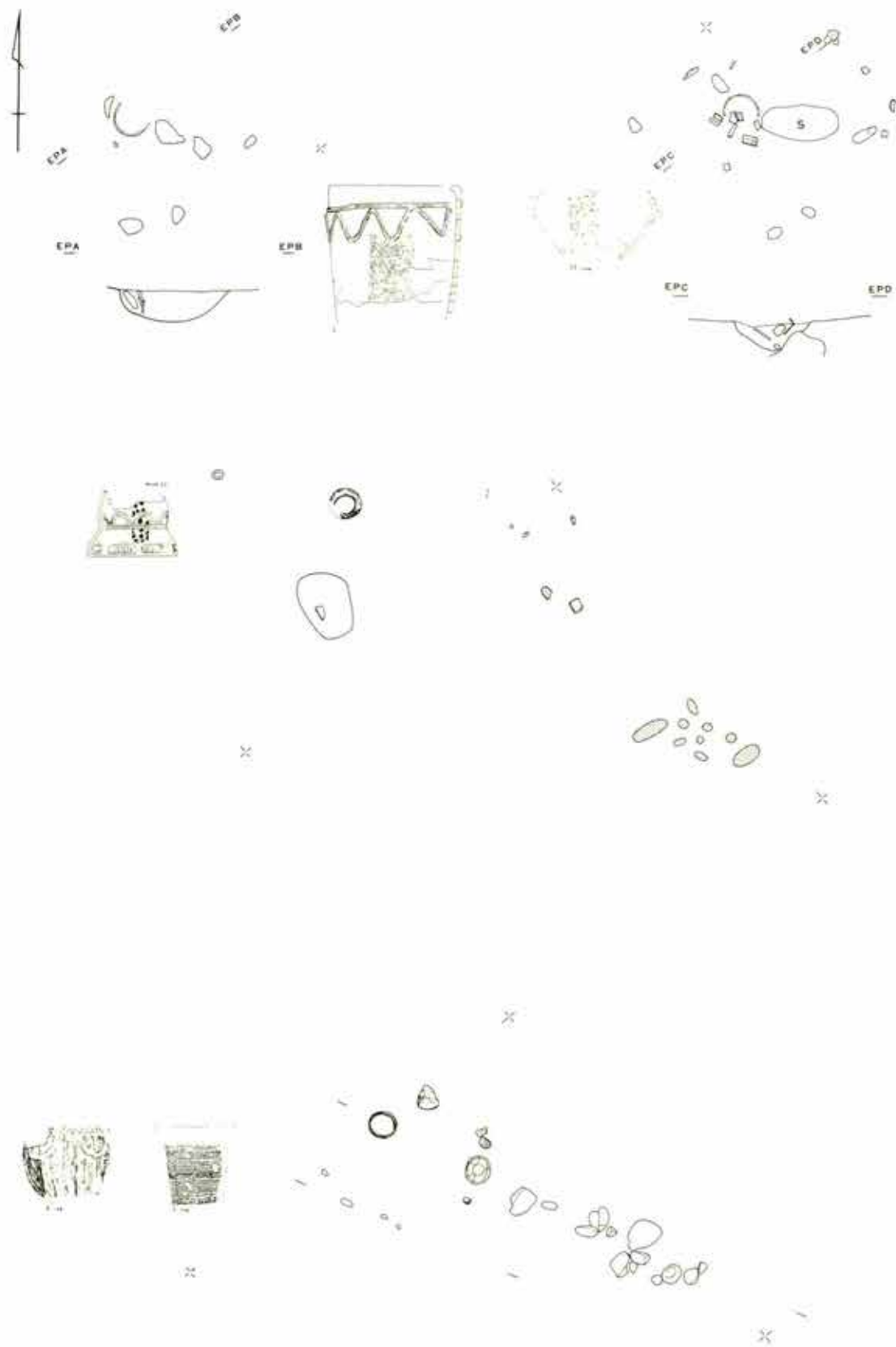

第 335 图 积逊堂 S-IV 区埋坑

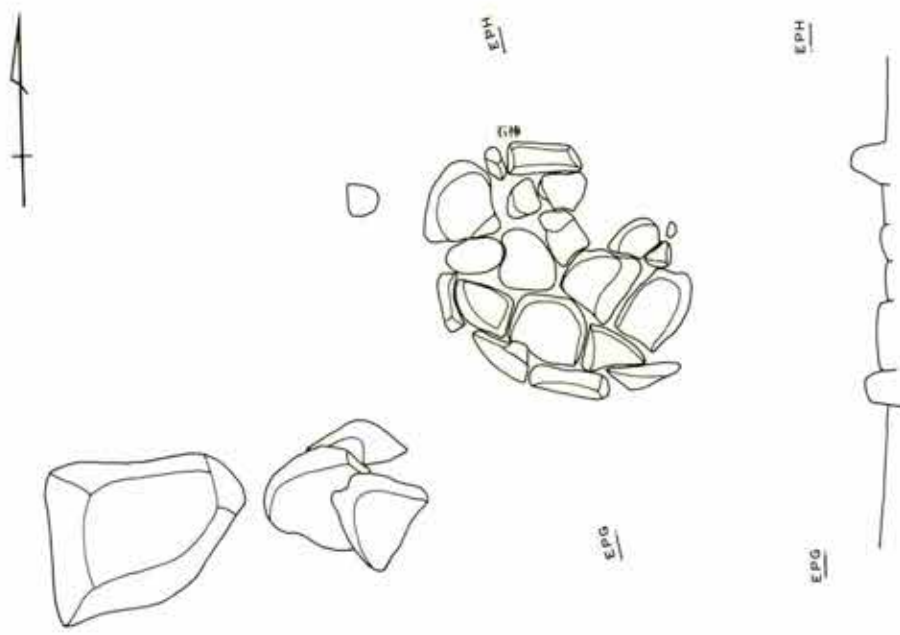

SX-01

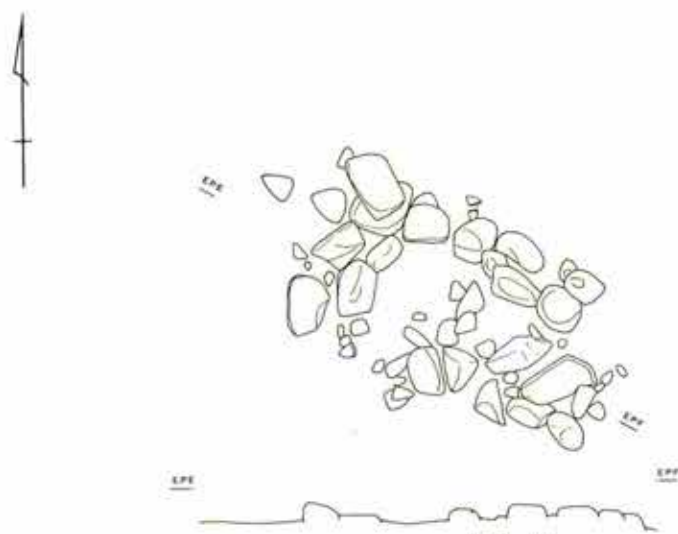

SX-03

第 336 图 积迦堂 S-IV 区 SX-01 -03 (1 : 60)

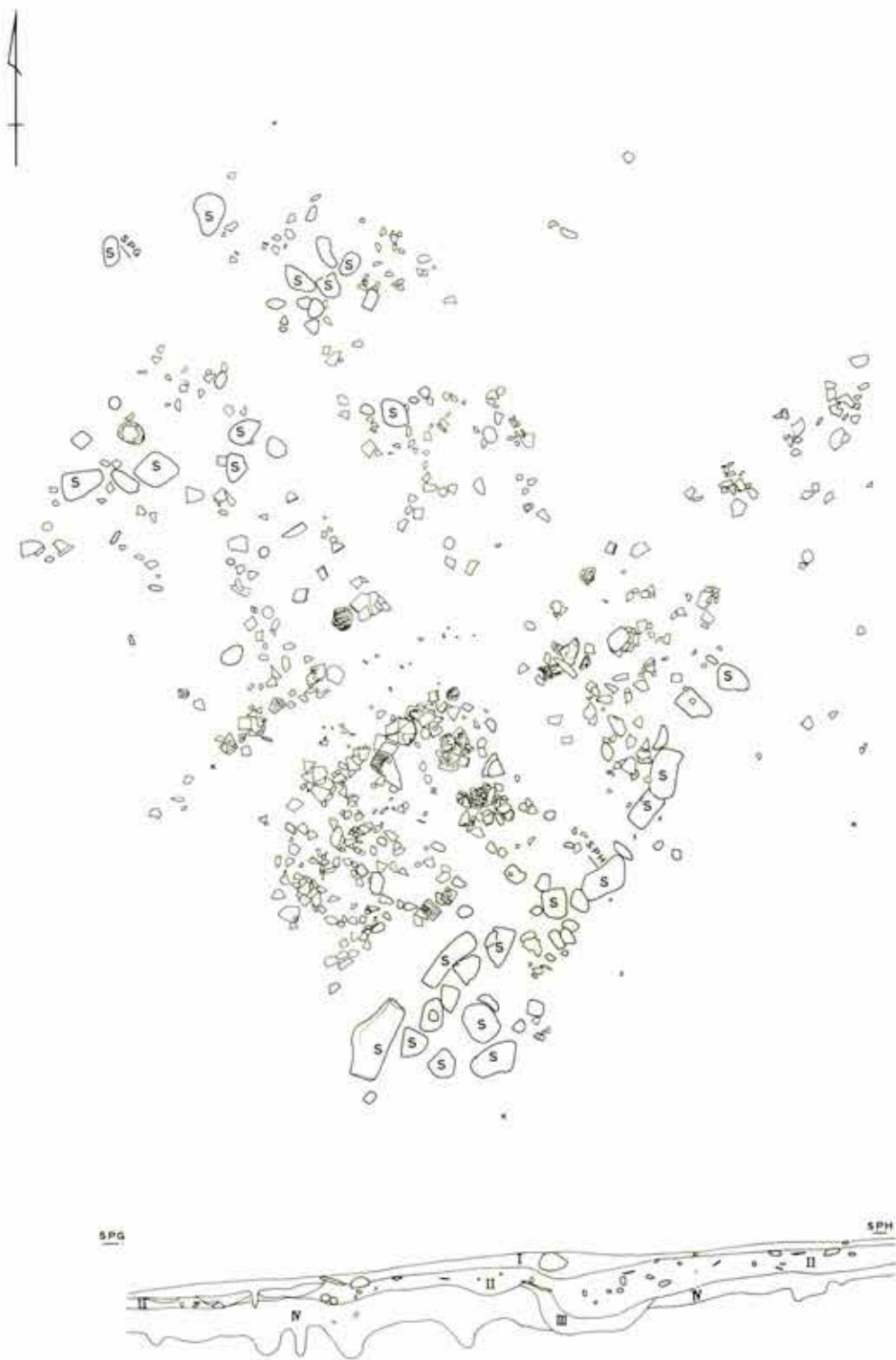

第 337 図 积迦堂 S-IV 区 土器すてば C (1 : 60)

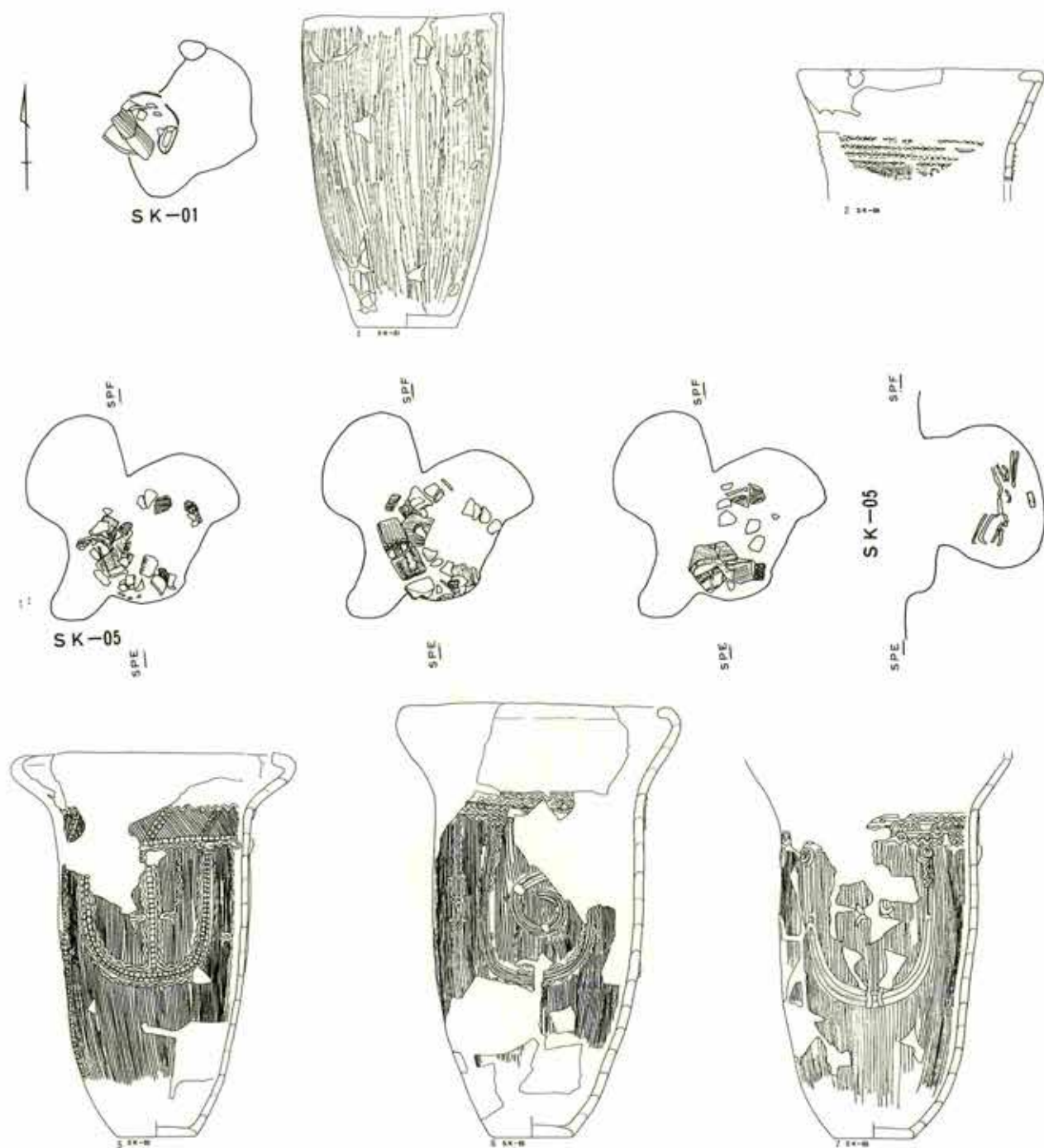

第 338 图 积迪堂 S-IV 区 SK-01-04-05

(1:40) (1)

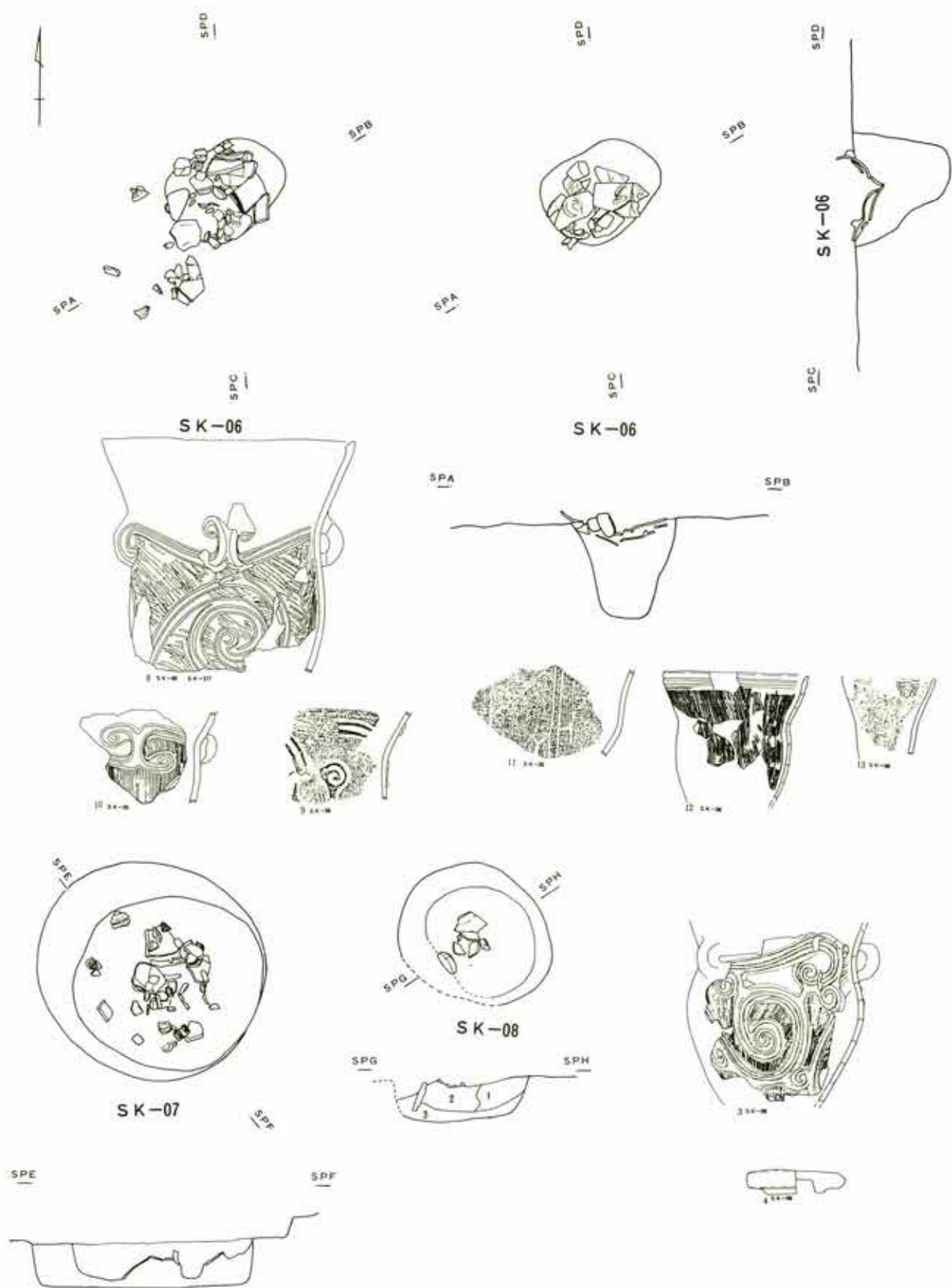

第 339 图 积迦堂 S-IV 区 SK-06-07-08

(1:40)

(2)

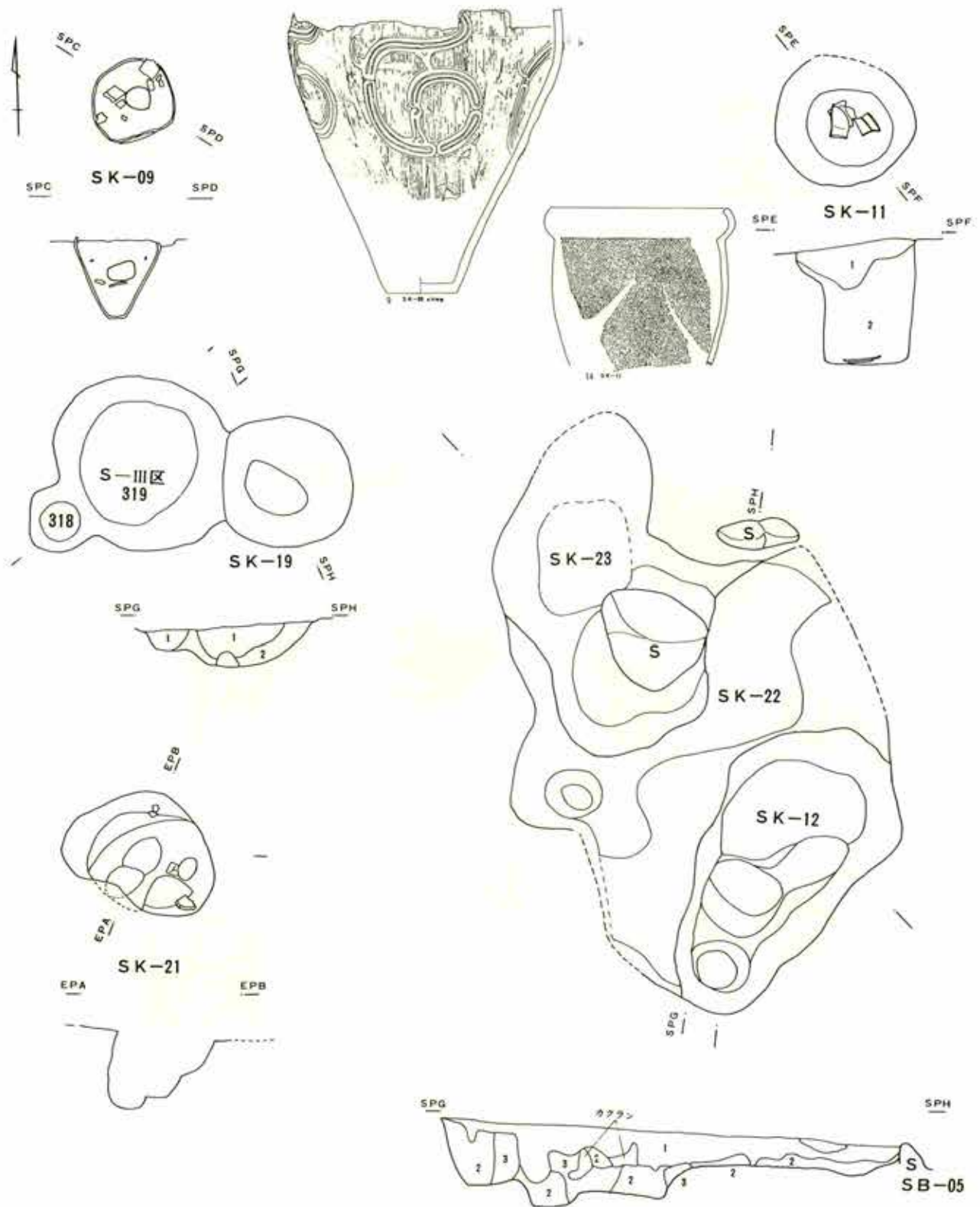

第 340 图 积迦堂 S-IV 区 SK-09 -11-12-19 -21-22-23 (1:40) (3)

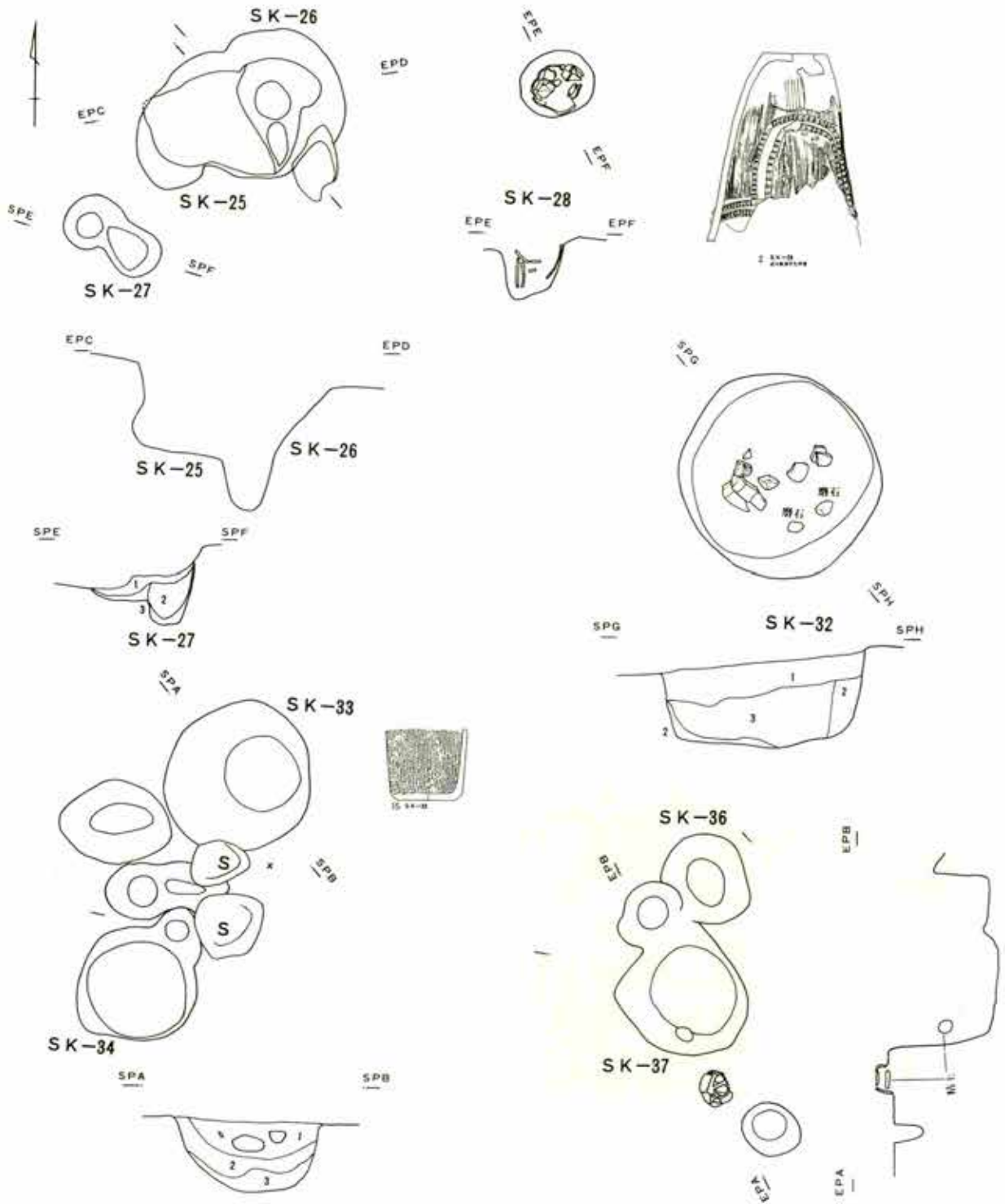

第341图 积迦堂S-IV区 SK-25-26-27-28-32-33-34-36-37 (1:40) (4)

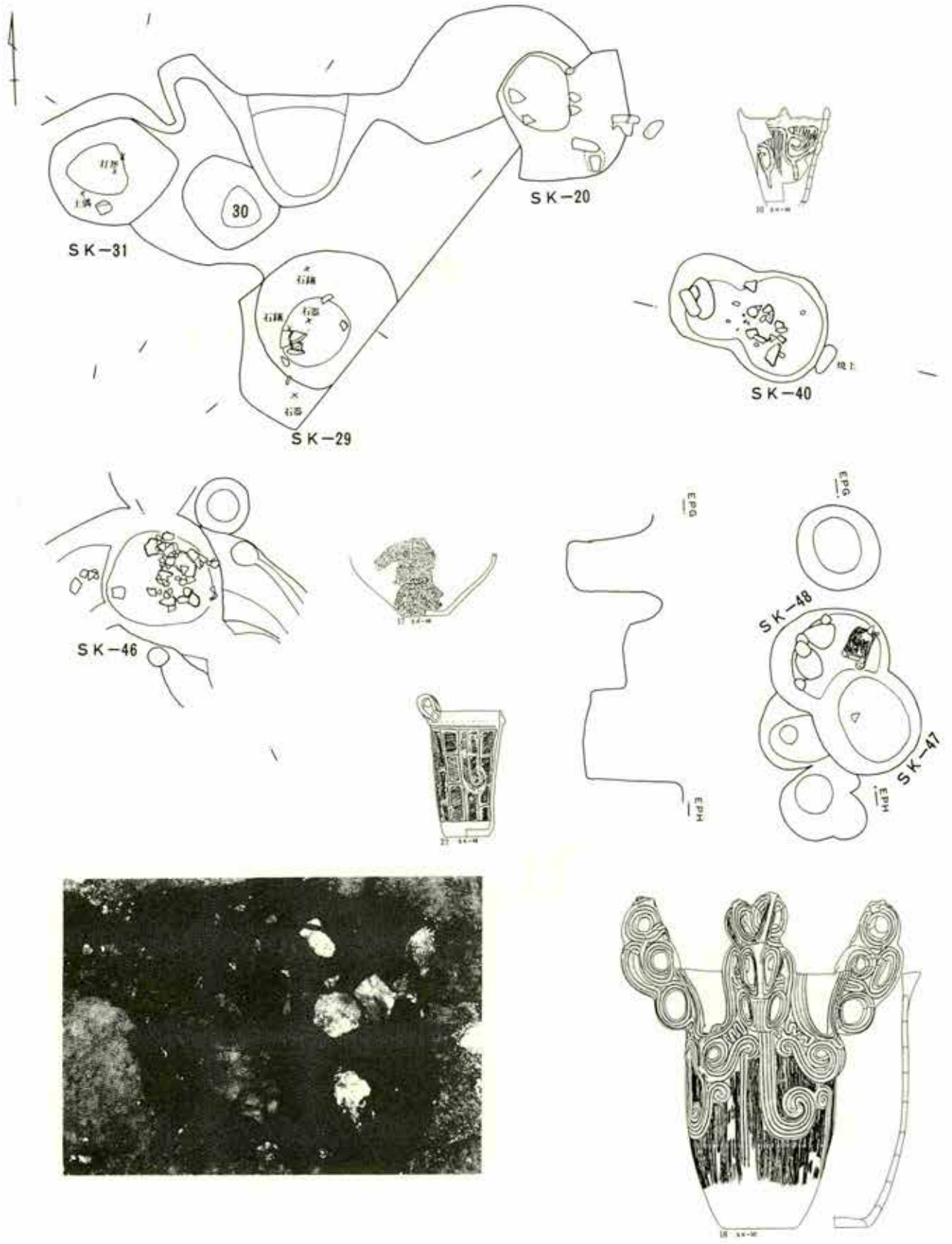

第342图 积逊堂S-IV区 SK-20-29-31-40-46-47-48-52(1:40)

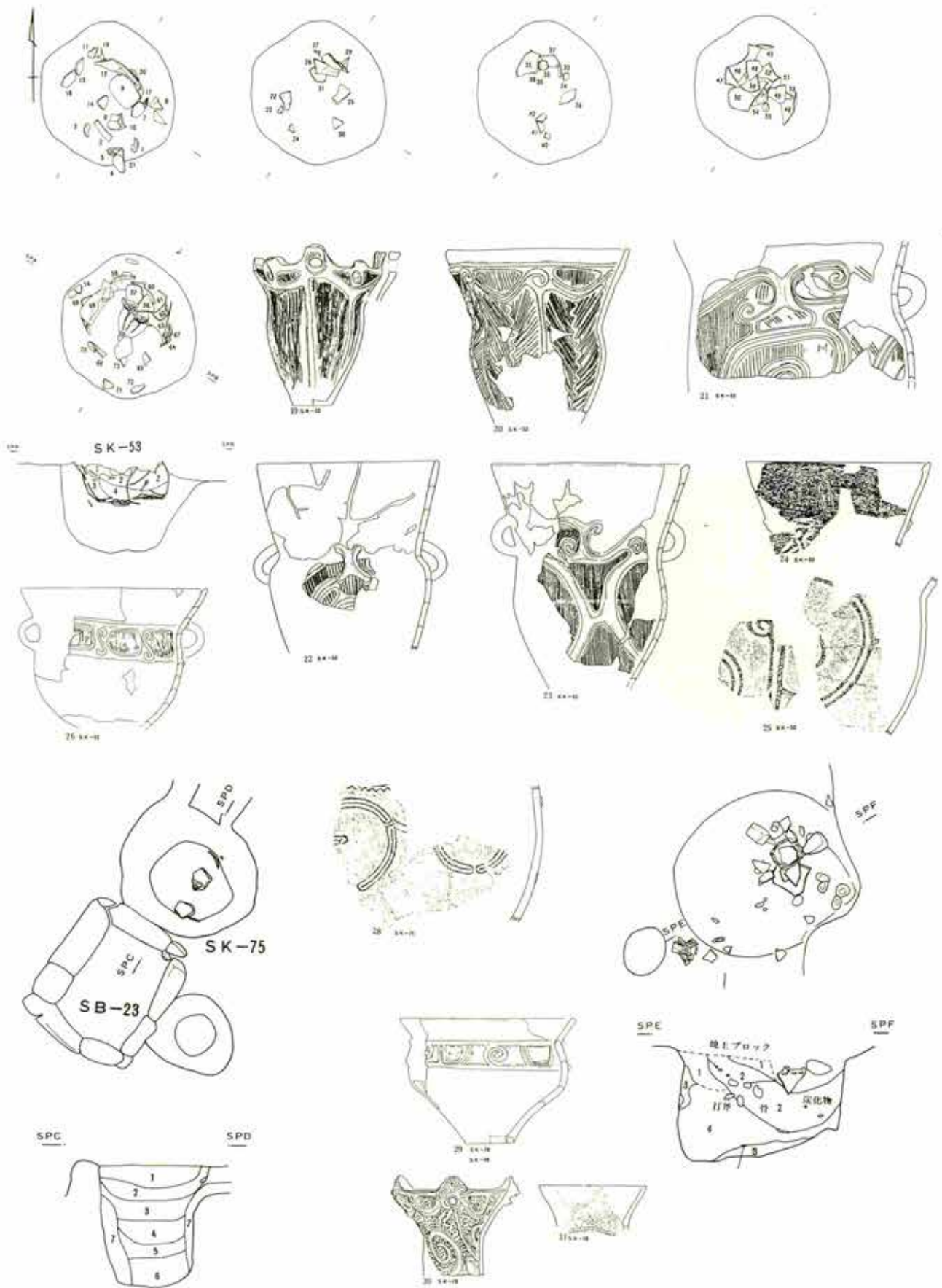

第343图 积逊堂S-IV区 SK-53-75-78

(1:40)

(6)

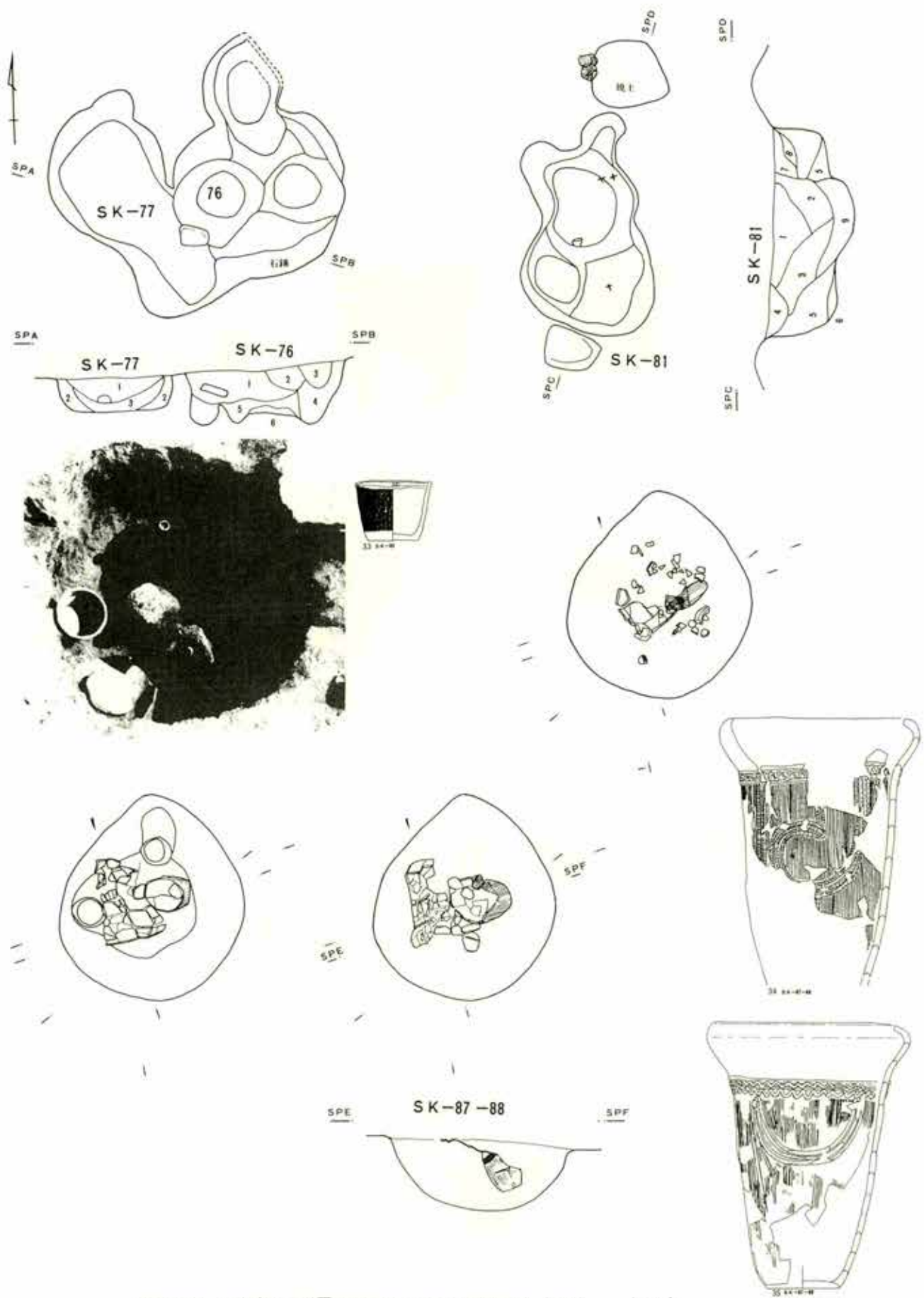

第 344 图 积迦堂 S-IV 区 SK-76-77-81-87-88 (1:40) (7)

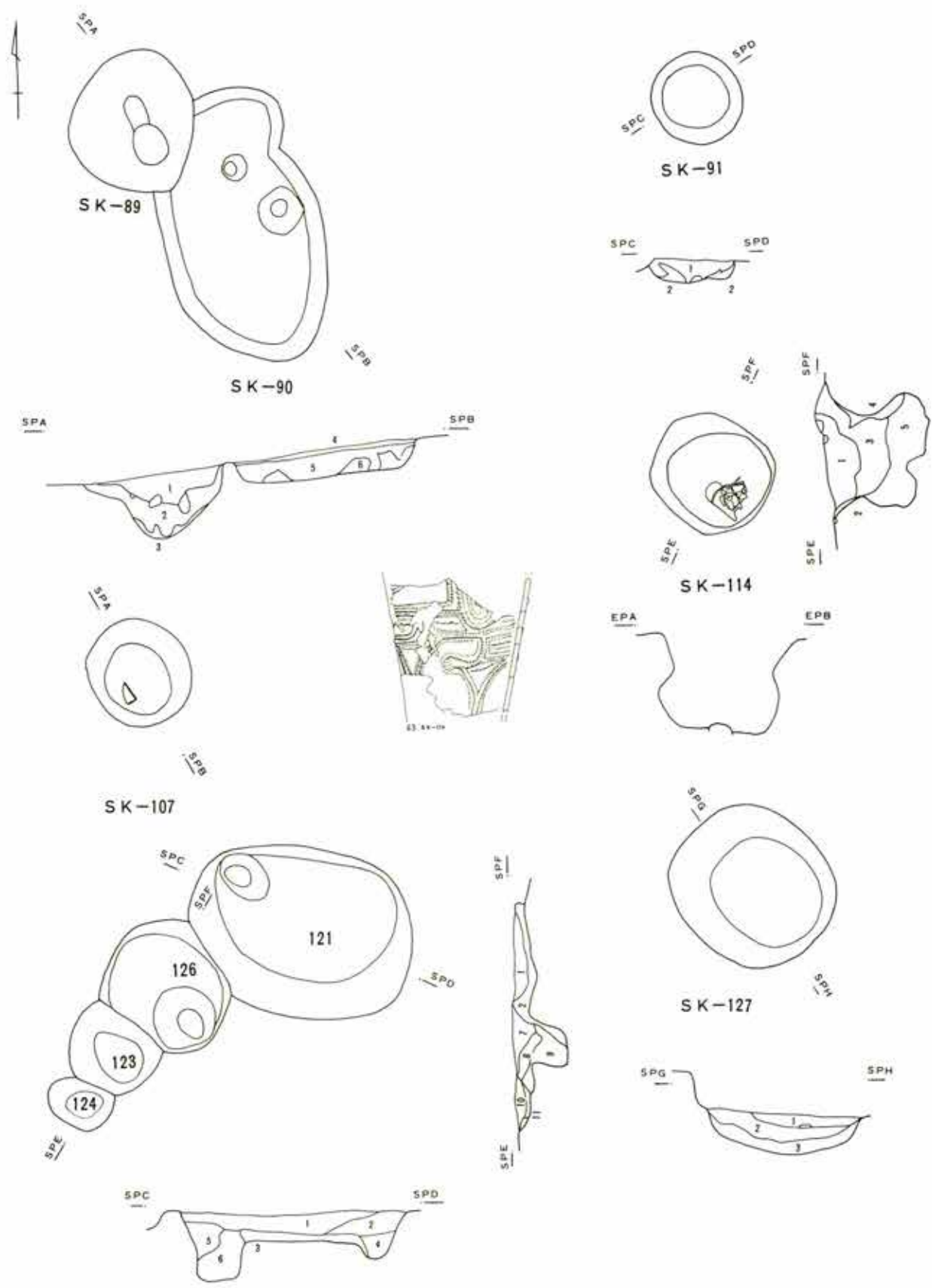

第 345 图 积逊堂 S-IV 区 SK-89-90-91-107-114-121
 -122-123-124-126-127 (1:40) (8)

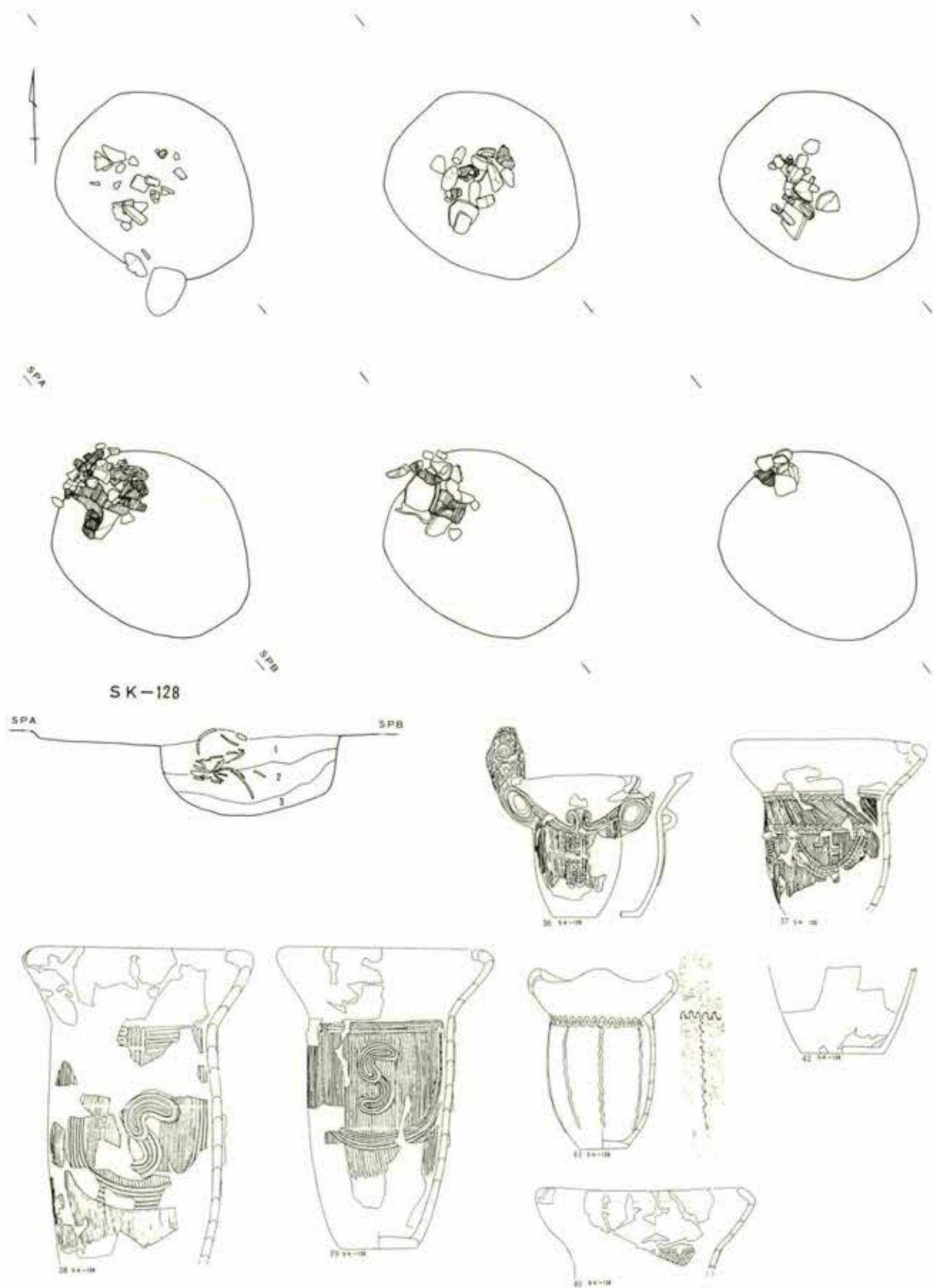

第 346 图 积迦堂 S-IV 区 SK-128

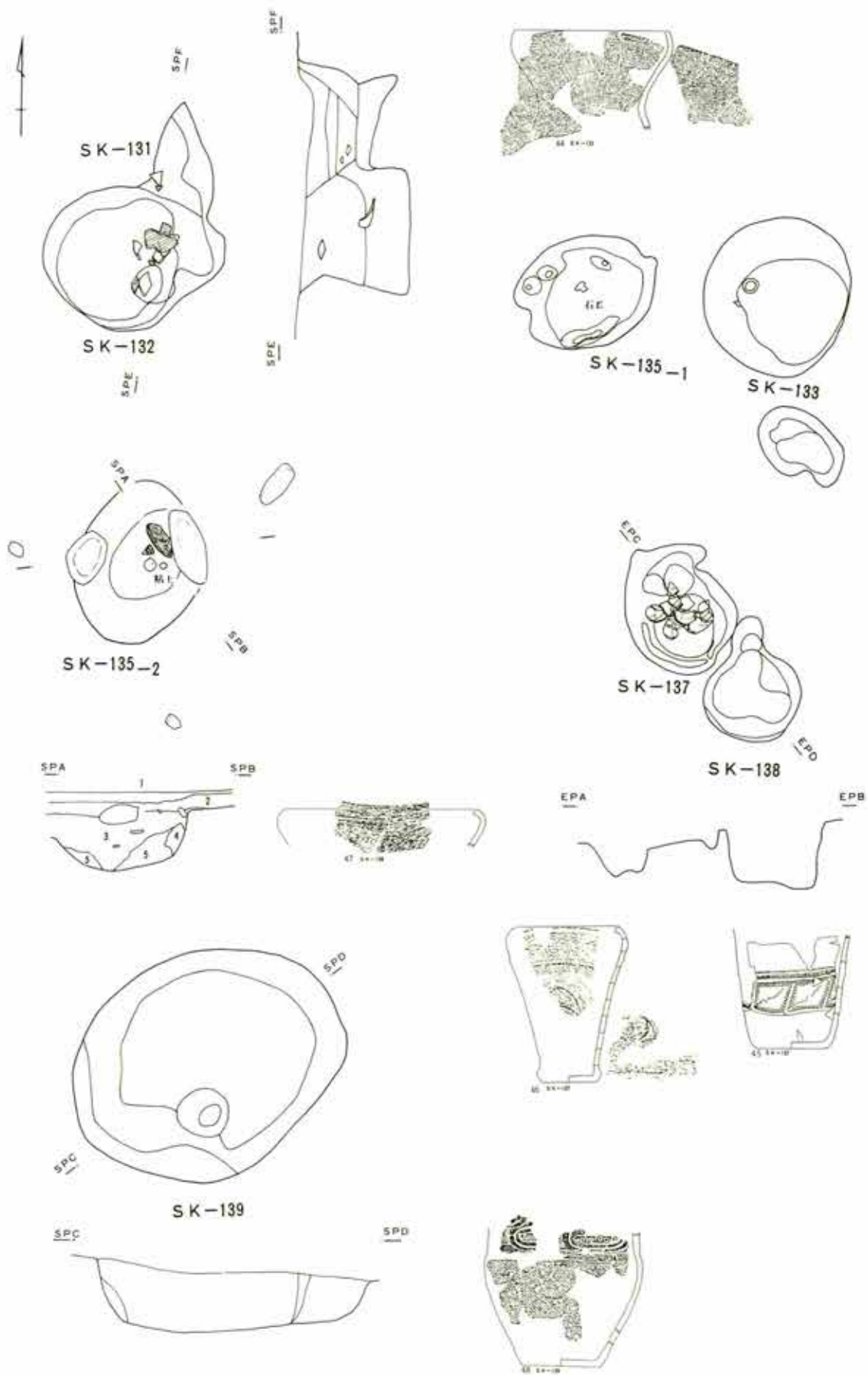

第 347 图 积逊堂 S-IV 区 SK-131 -132 -133 -135 -137 -138 -139 (1:40)

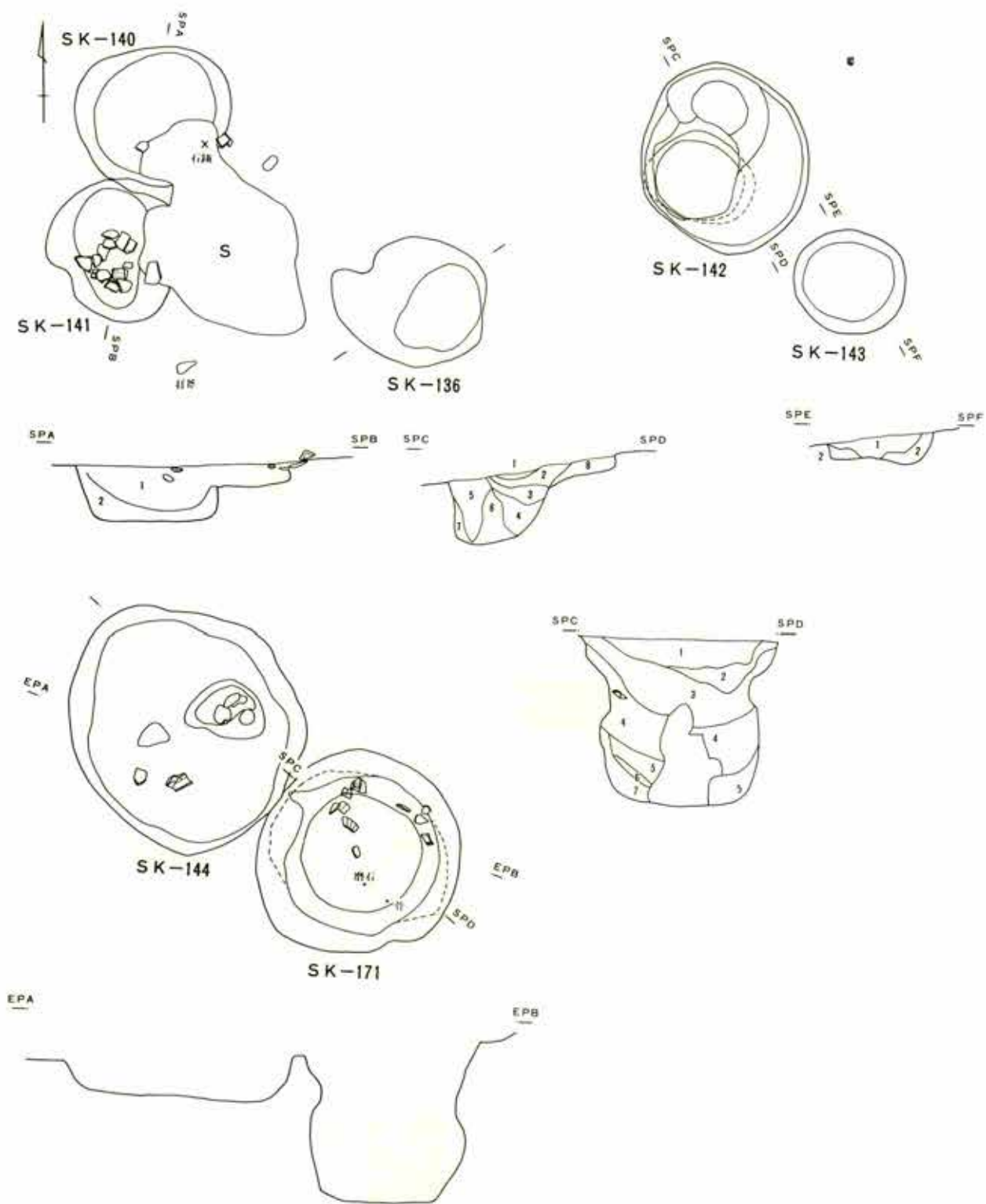

第 348 图 积道堂 S-IV 区 SK-140-141-142-143-144-136-171 (1:40)

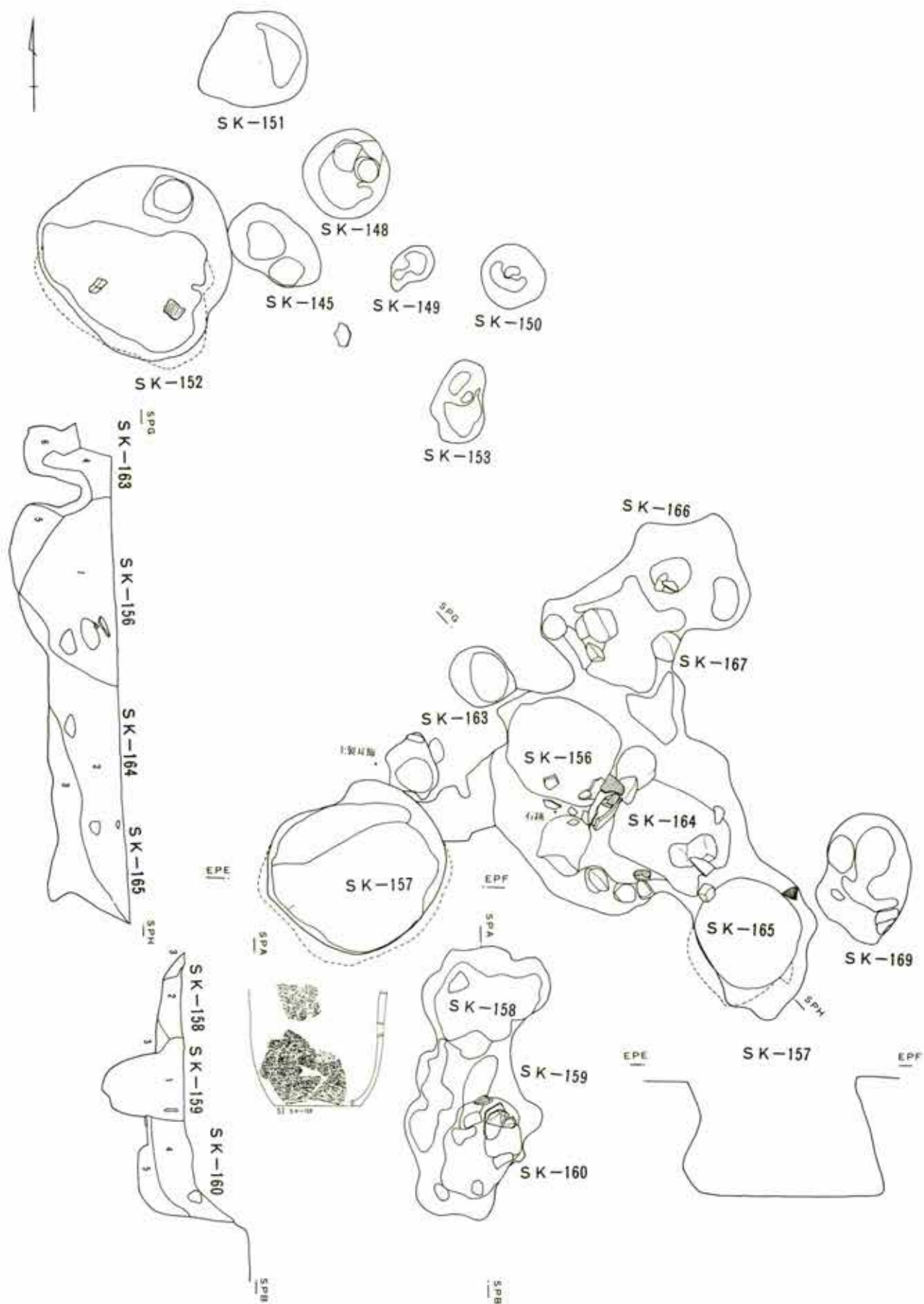

第349图 积道堂S-IV区 SK-145-148-149-150-151-152-153-156-157-158 (1:40) (12)
 -159-160-163-164-165-166-167-169

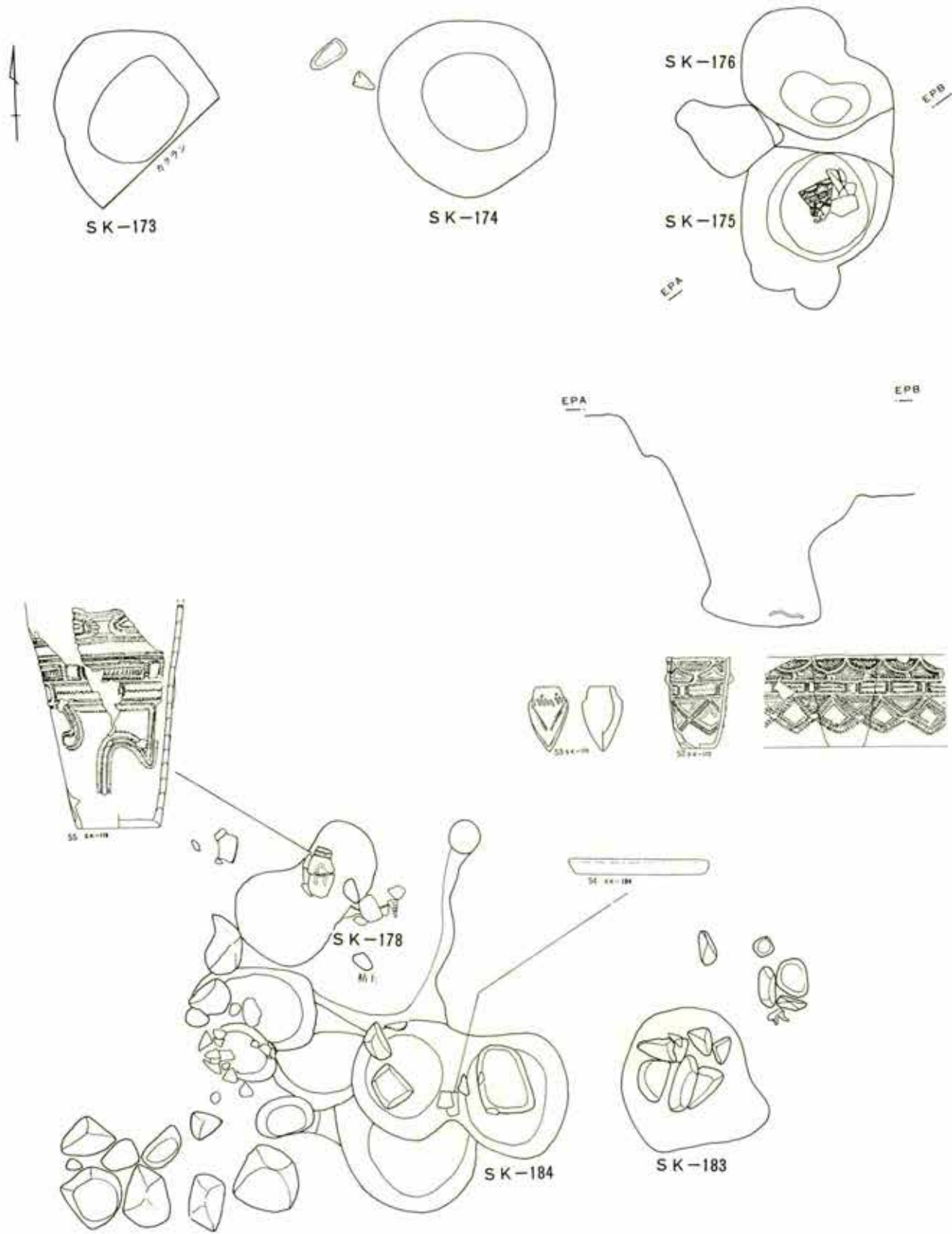

第 350 图 积逊堂 S-IV 区 SK-173-174-175-176-178-183-184 (1:40)

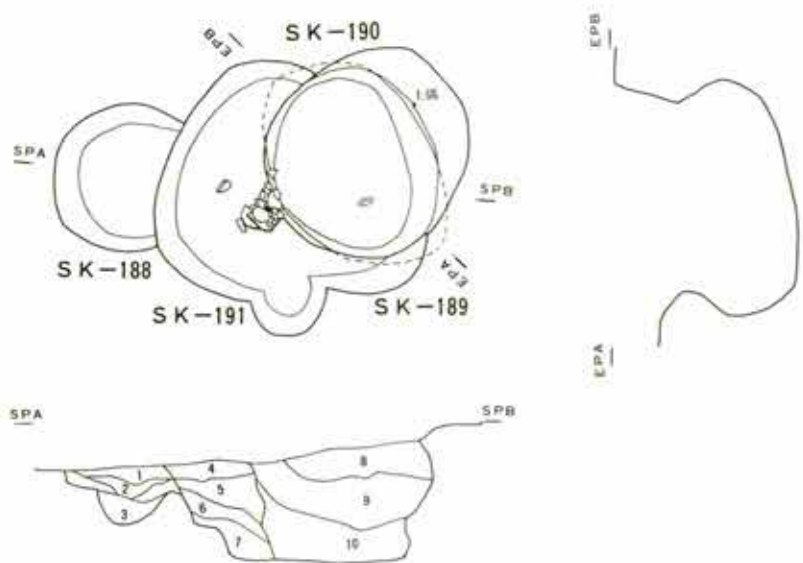
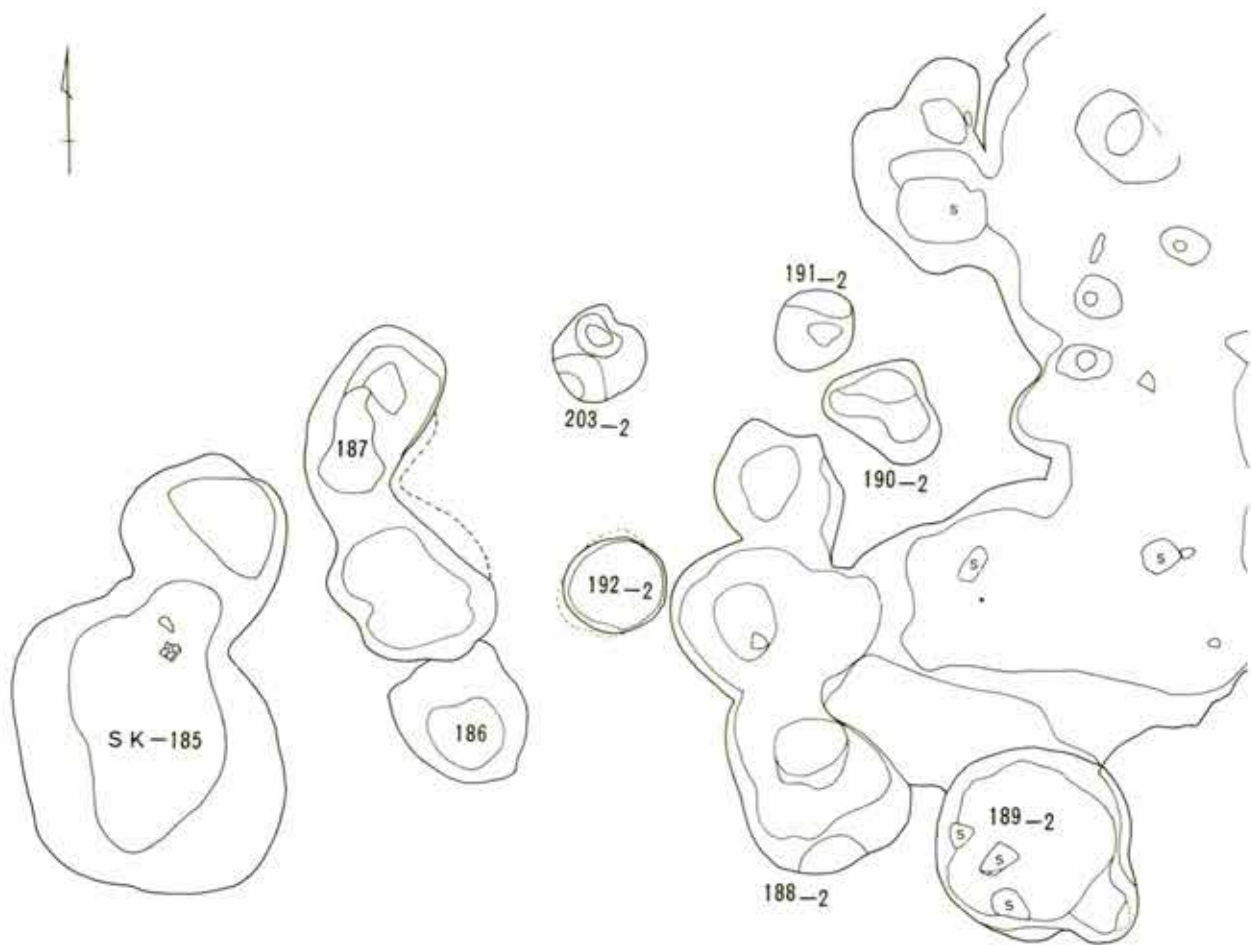

第351图 积善堂S-IV区 SK-185 -186 -187 -188 -189 -190 -191 -192
-203 (1:40) (14)

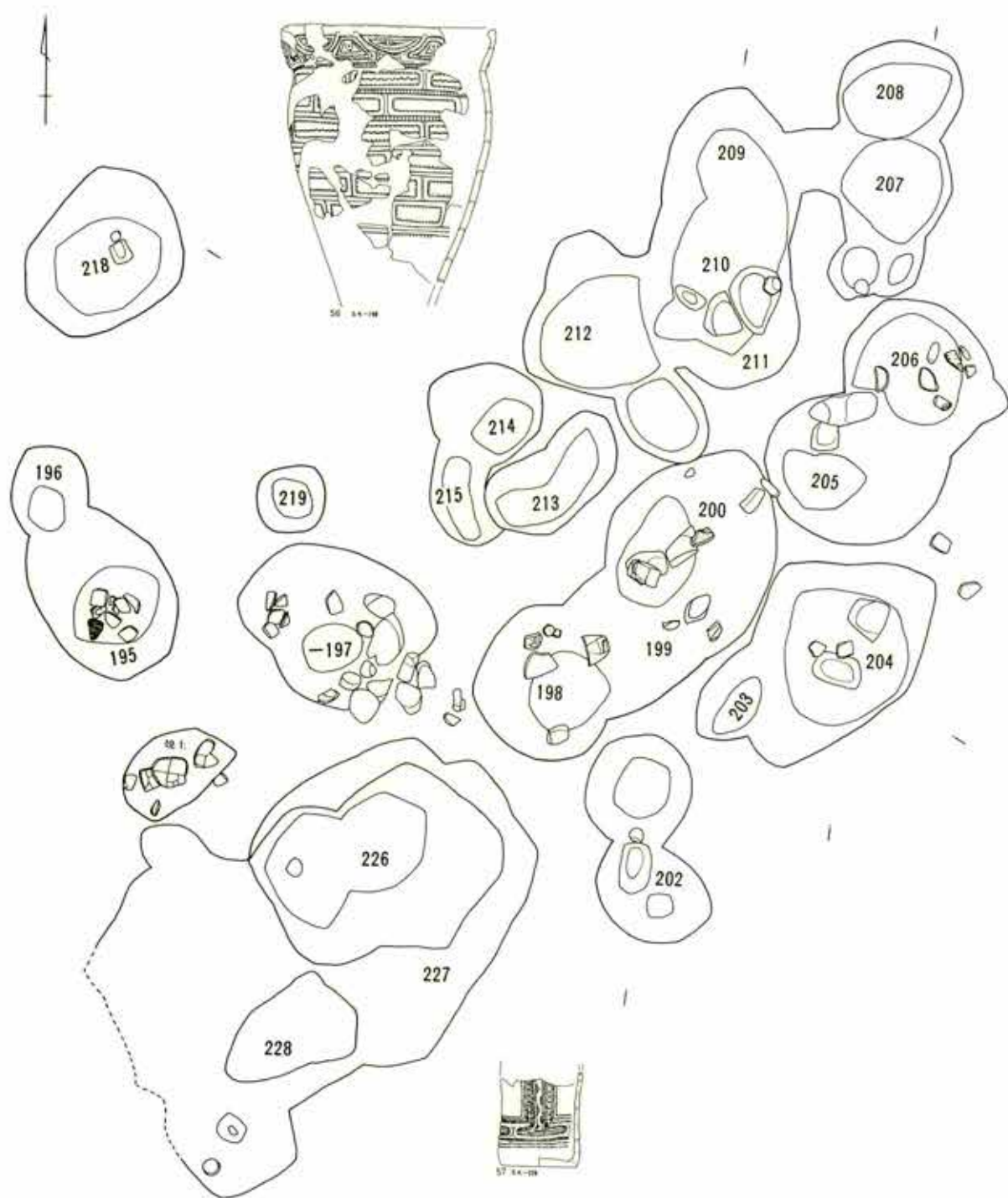

第 352 图 积迦堂 S-IV 区 SK-195 -196 -197 -198 -199 -200 -202 -203
 -204 -205 -206 -207 -208 -209 -210 -211
 -212 -213 -214 -215 -218 -219 (1:40) (15)

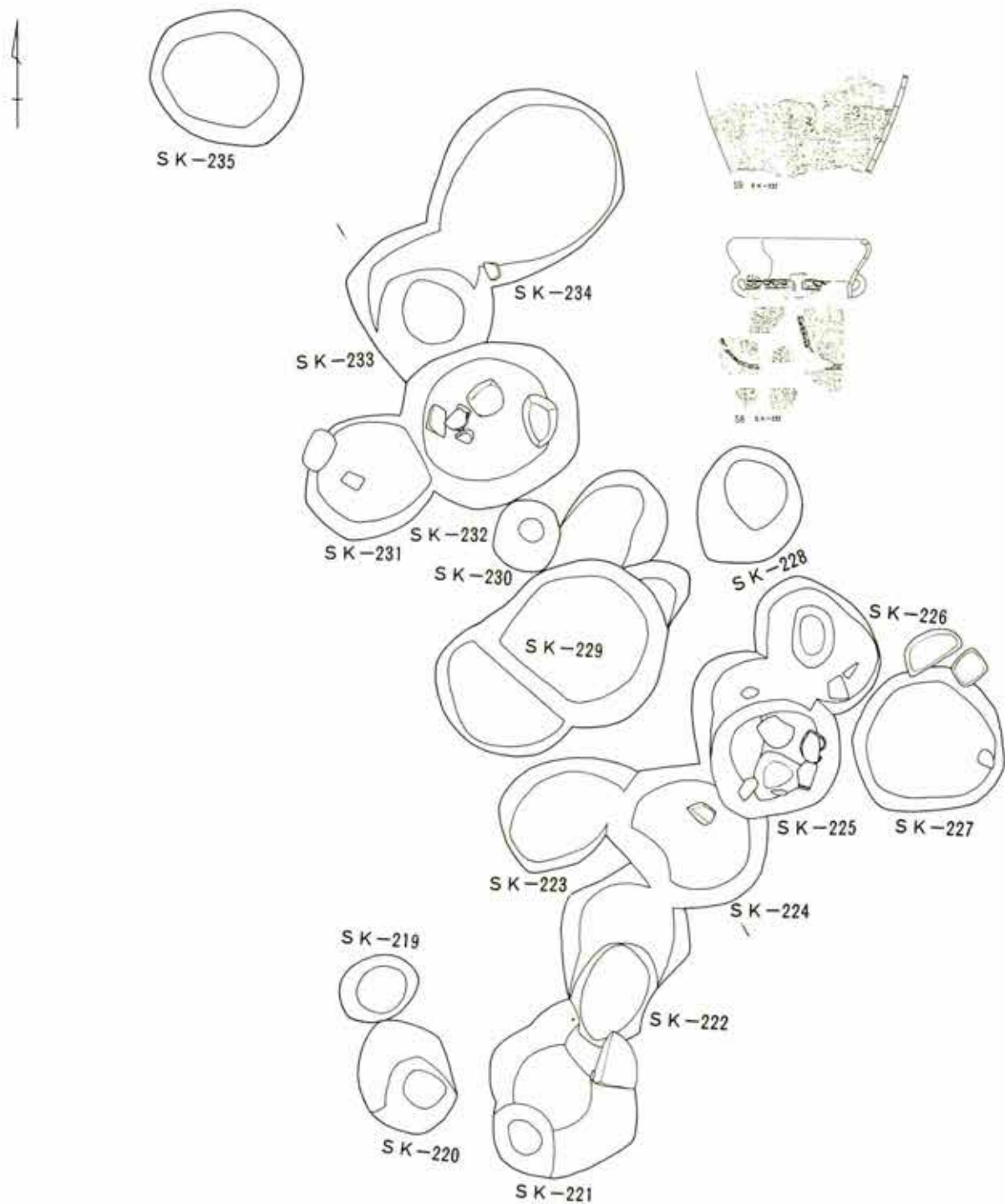

第 353 图 积迦堂 S-IV 区 SK-219-220-221-222-223-224-225-226-227 (1:40) (16)
 -228-229-230-231-232-233-234-235

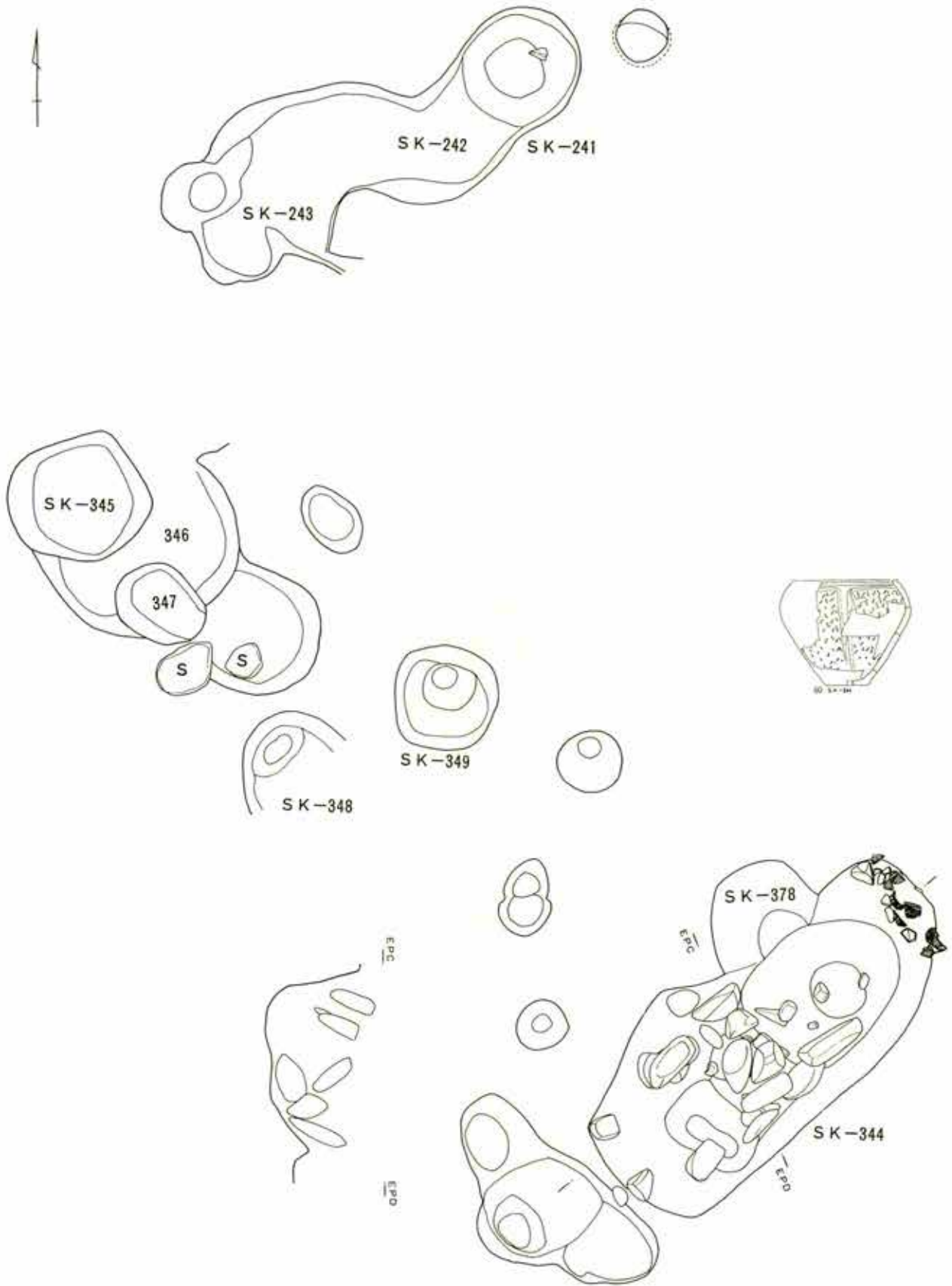

第354图 积迦堂S-IV区 SK-241-242-243-344-345-346-347-348-349-378 (1:40) (17)

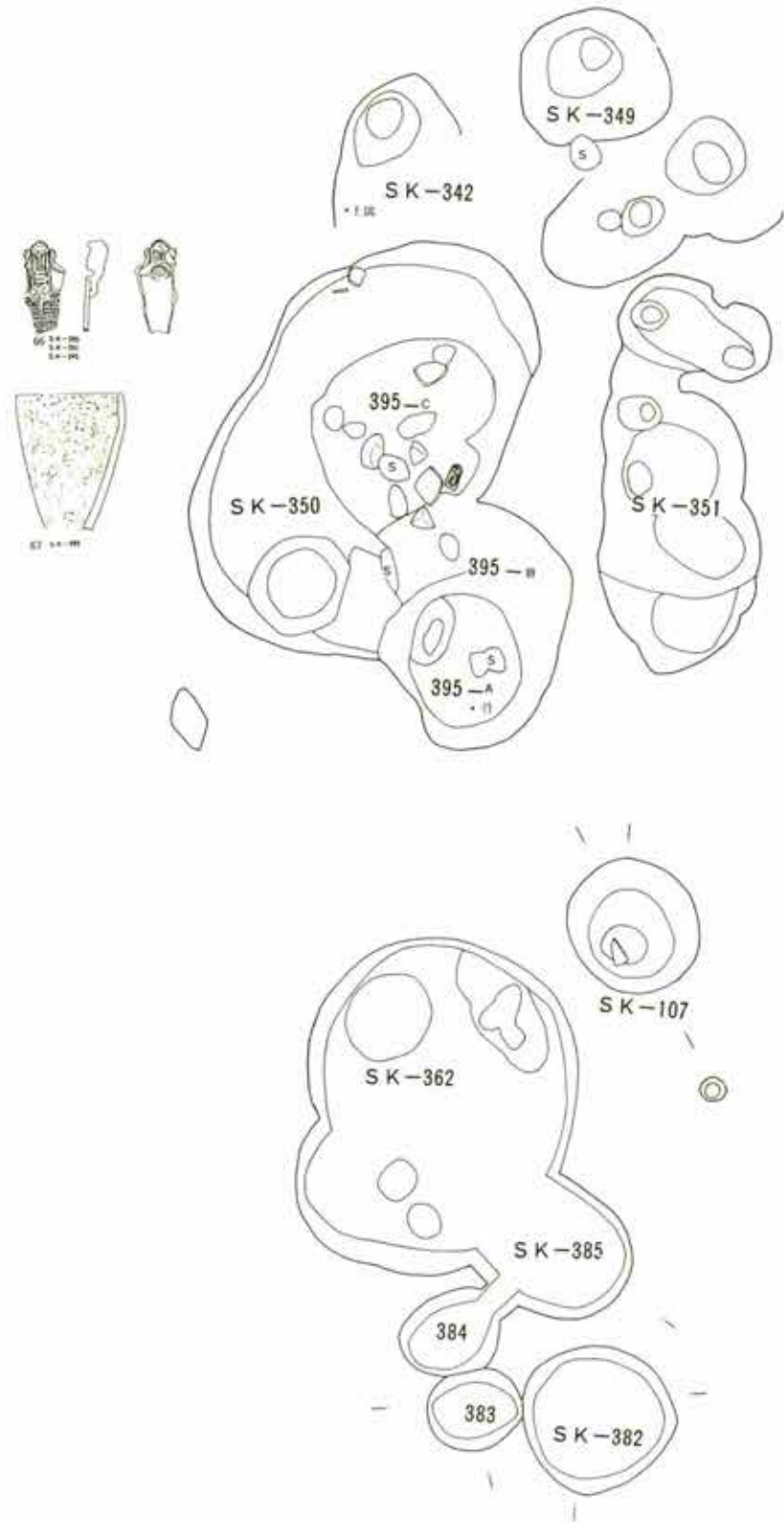

第355图 积迦堂S-IV区SK-342-349-350-351-362-382-383-384-385-395(1:40) (18)
-107

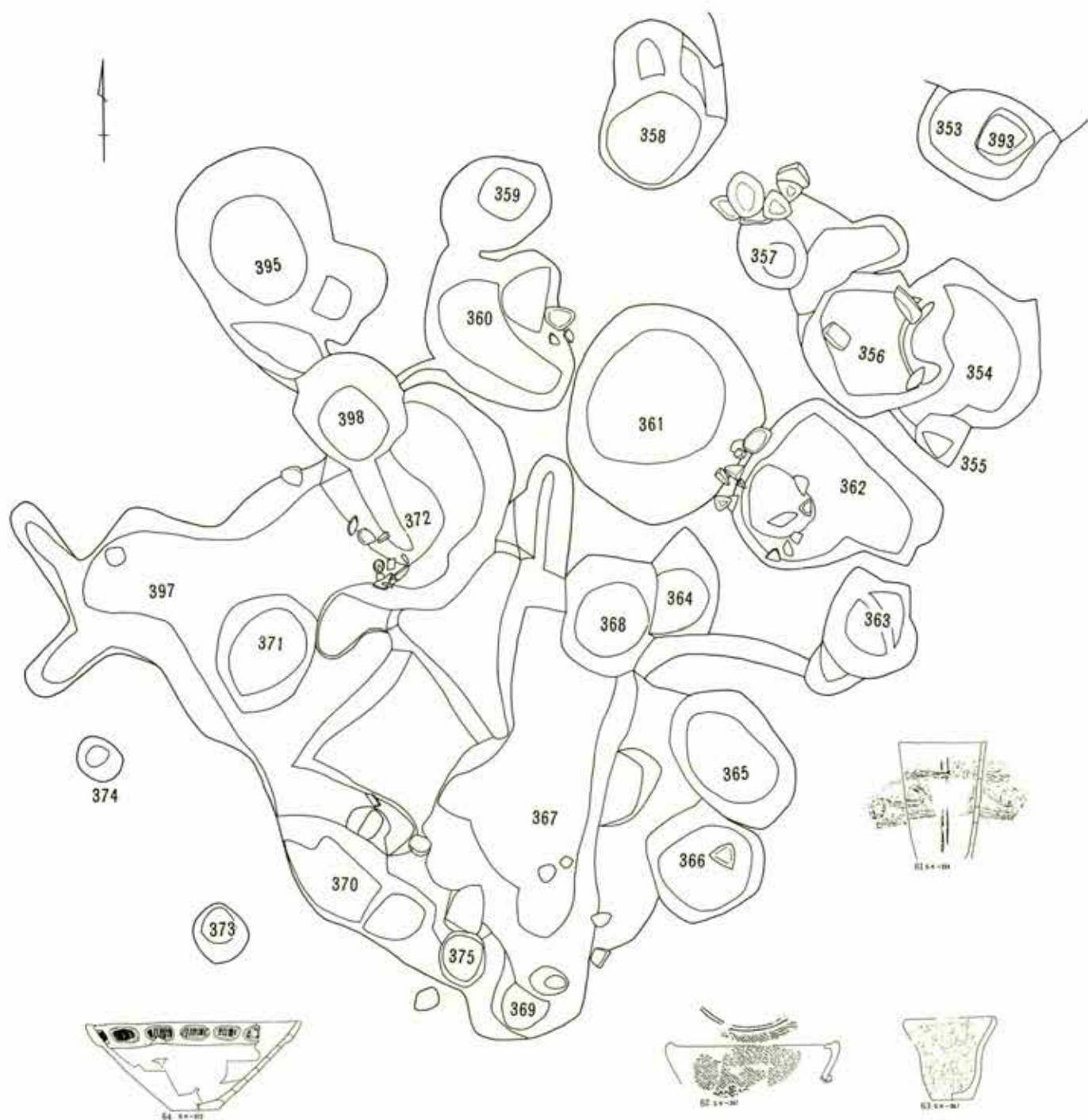

第 356 图 积迦堂 S—IV 区 SK—353—354—355—356—357—358—359—360—361—362 (1:40) (19)
 —363—364—365—366—367—368—369—370—371—372
 —373—374—375—393—395—397—398

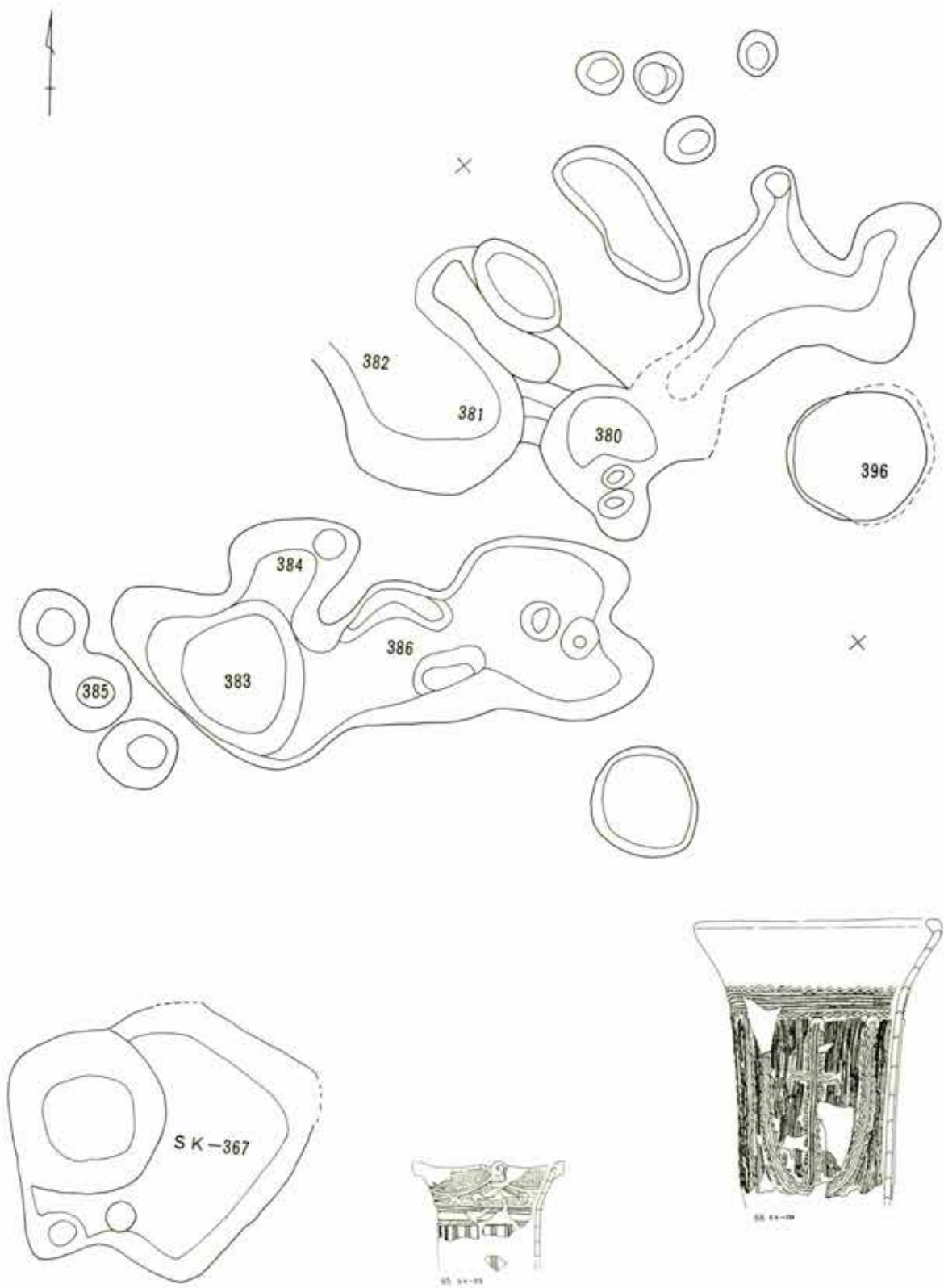

第 357 图 积迦堂 S-IV 区 SK-376 -380 -381 -382 -383 -384 -385 -386 -396 (1:40) (20)



第358图 积迦堂S-IV区 SB-57 出土土器

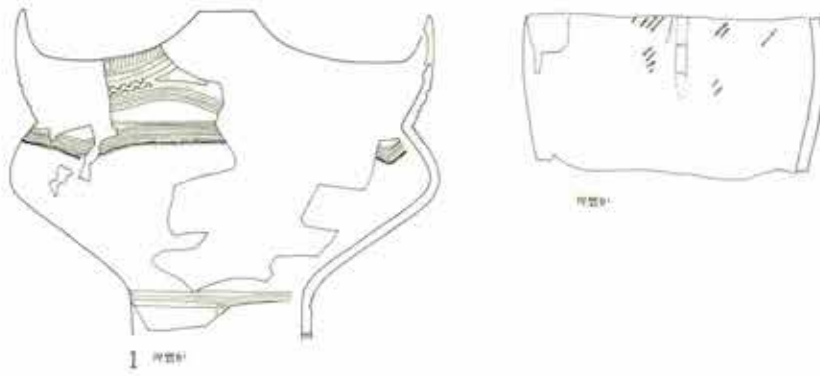

SB-41 (1 : 6)

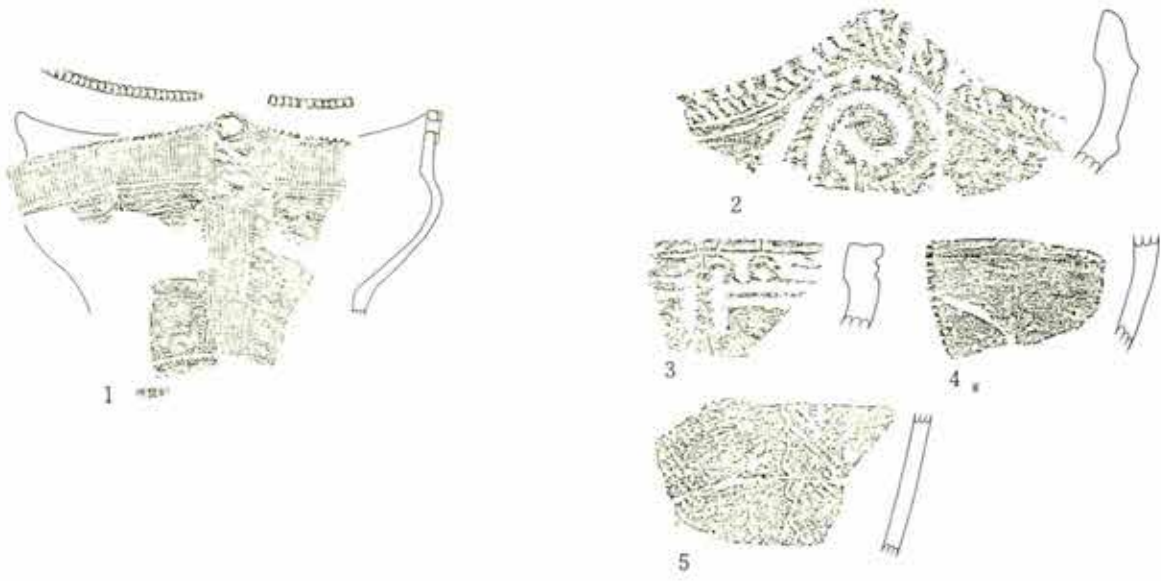

SB-48 (1 : 6)

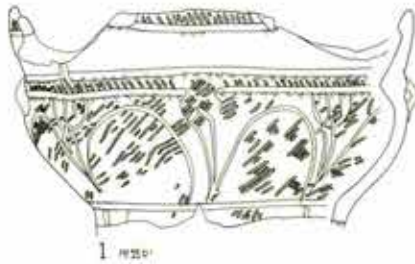

SB-51 (1 : 6)

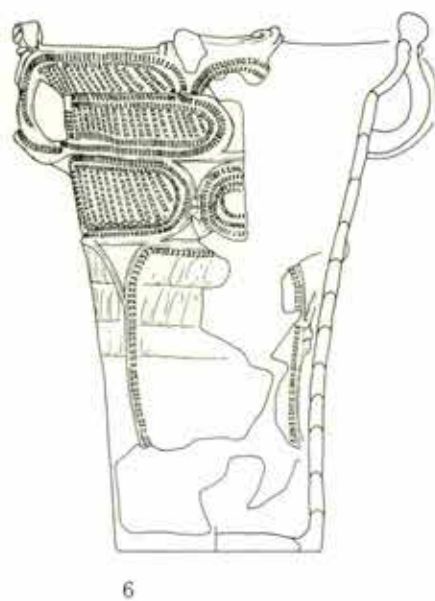
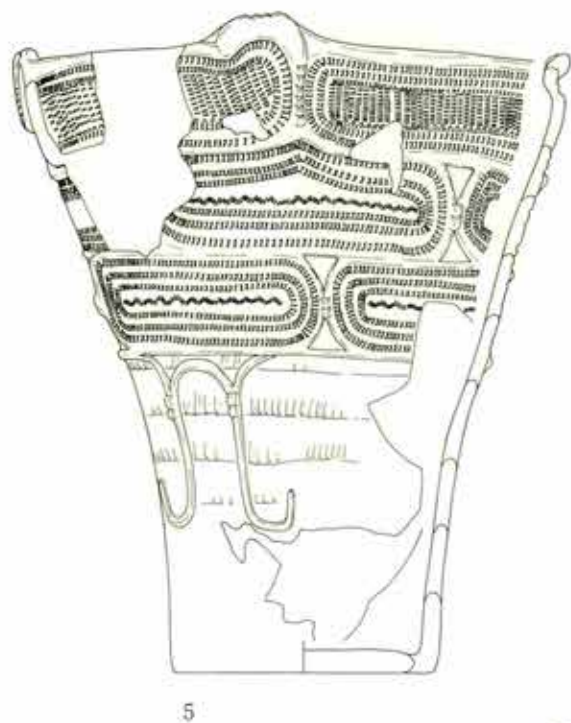
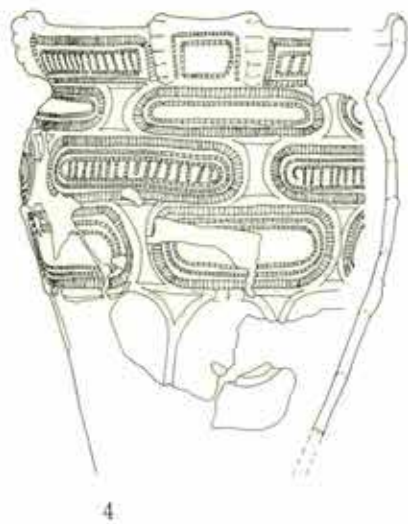
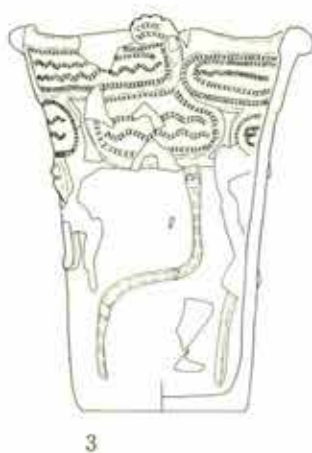
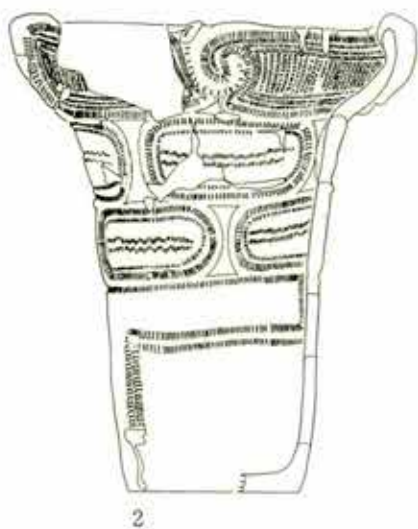
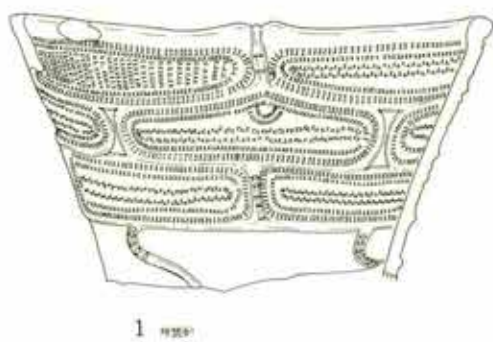
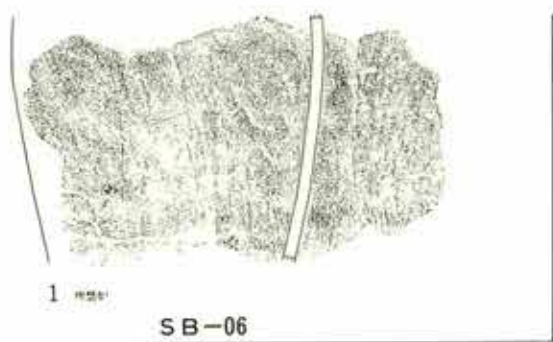

SB-73 (1)

第 360 图 积迦堂 S-IV 区 SB-06-73 出土土器

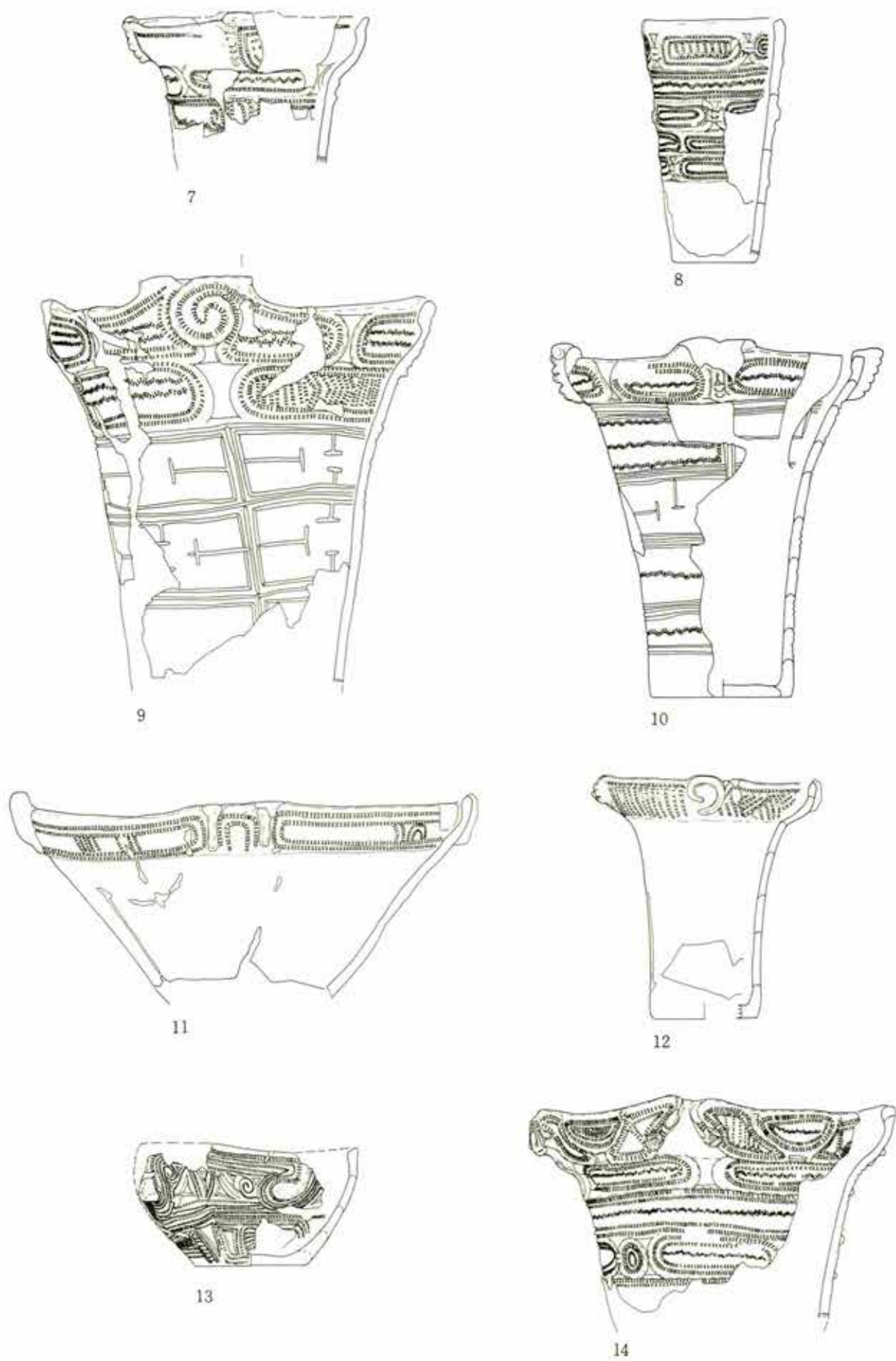

第 361 图 积逊堂 S—IV 区 SB-73 出土土器 (2)



15

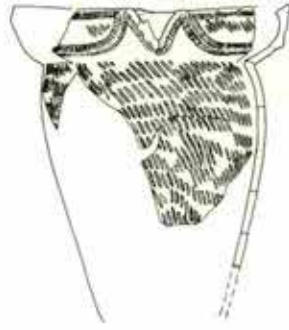

16

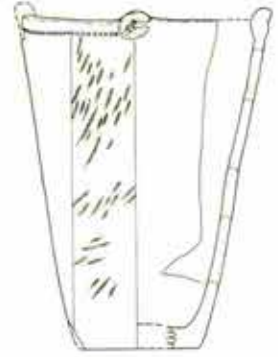

17

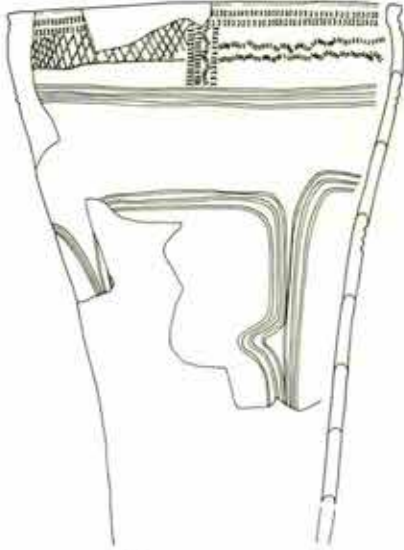

18

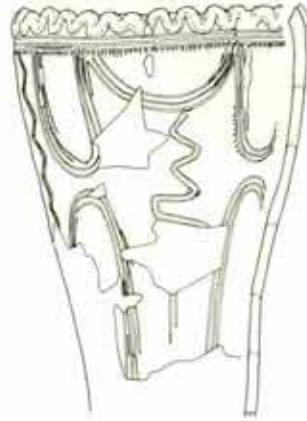

19

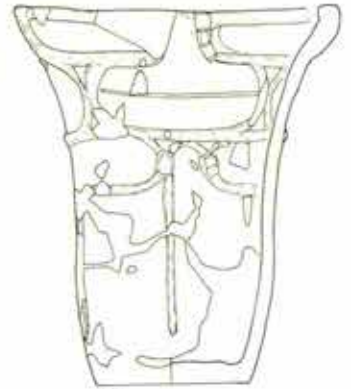

20

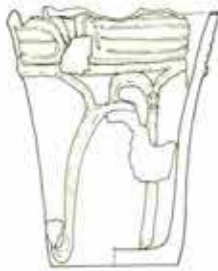

21



22



23

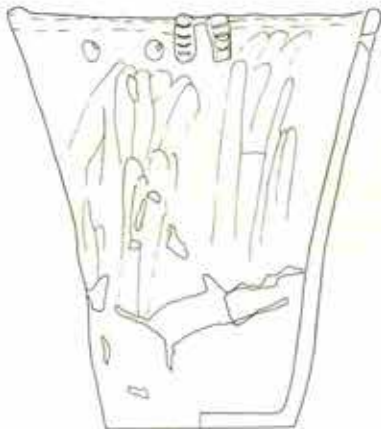

24



25



26

第 362 图 积迦堂 S—IV 区 SB-73 出土土器 (3)

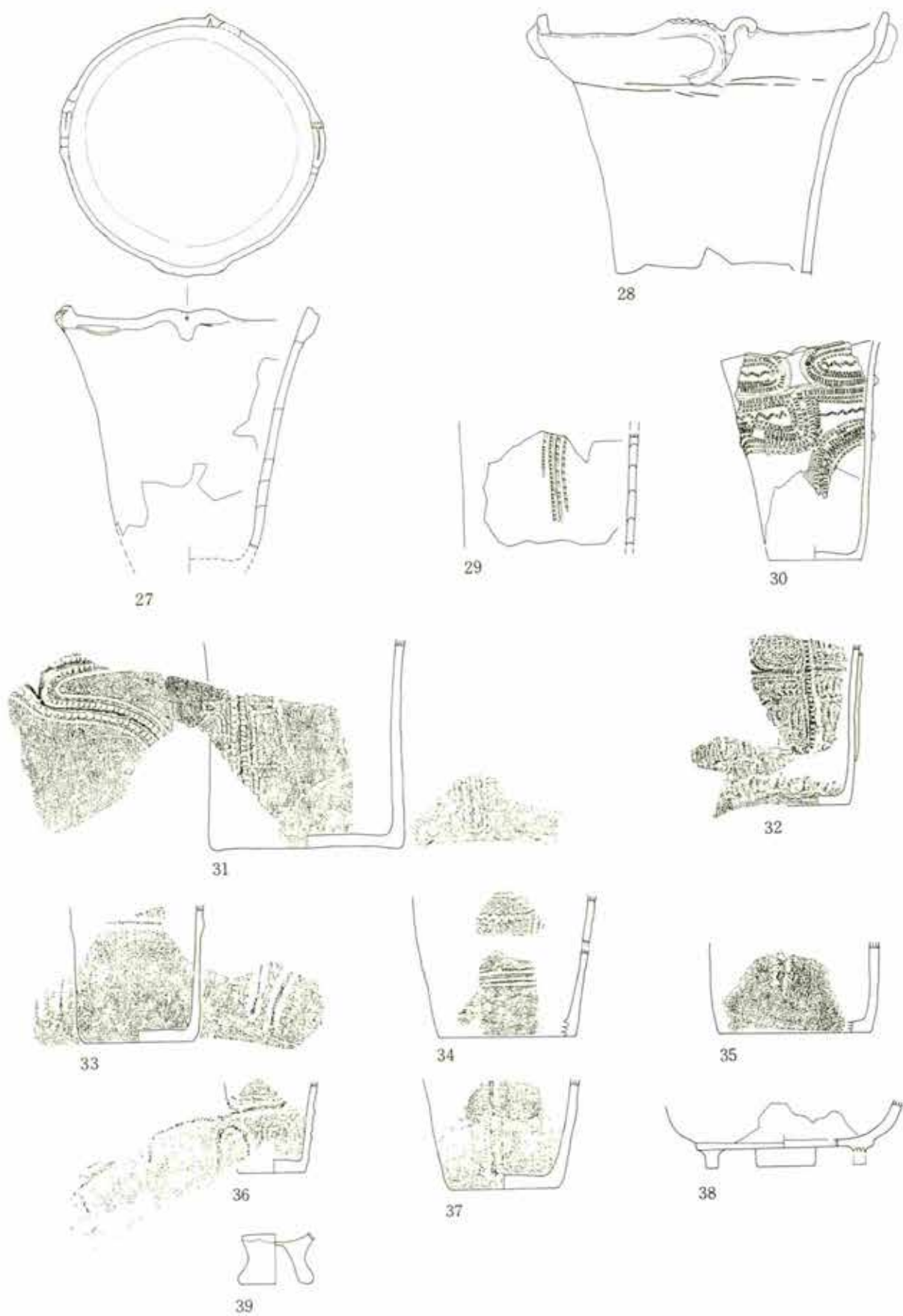

第 363 图 积迦堂 S—IV 区 SB-73 出土土器 (4)

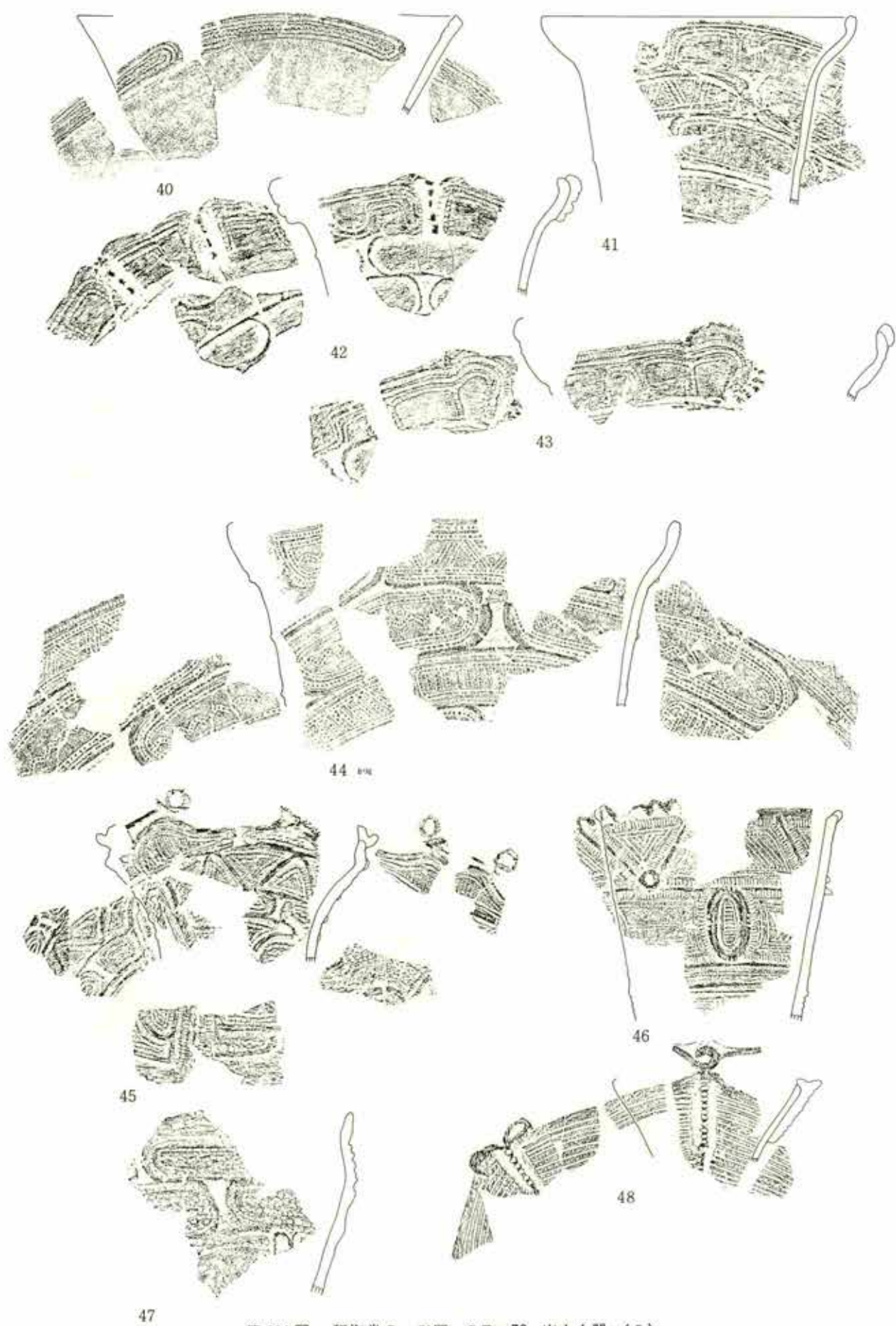

第 364 图 积逊堂 S—IV 区 SB—73 出土土器 (5)



第 365 图 积逊堂 S—IV 区 SB-73 出土土器 (6)

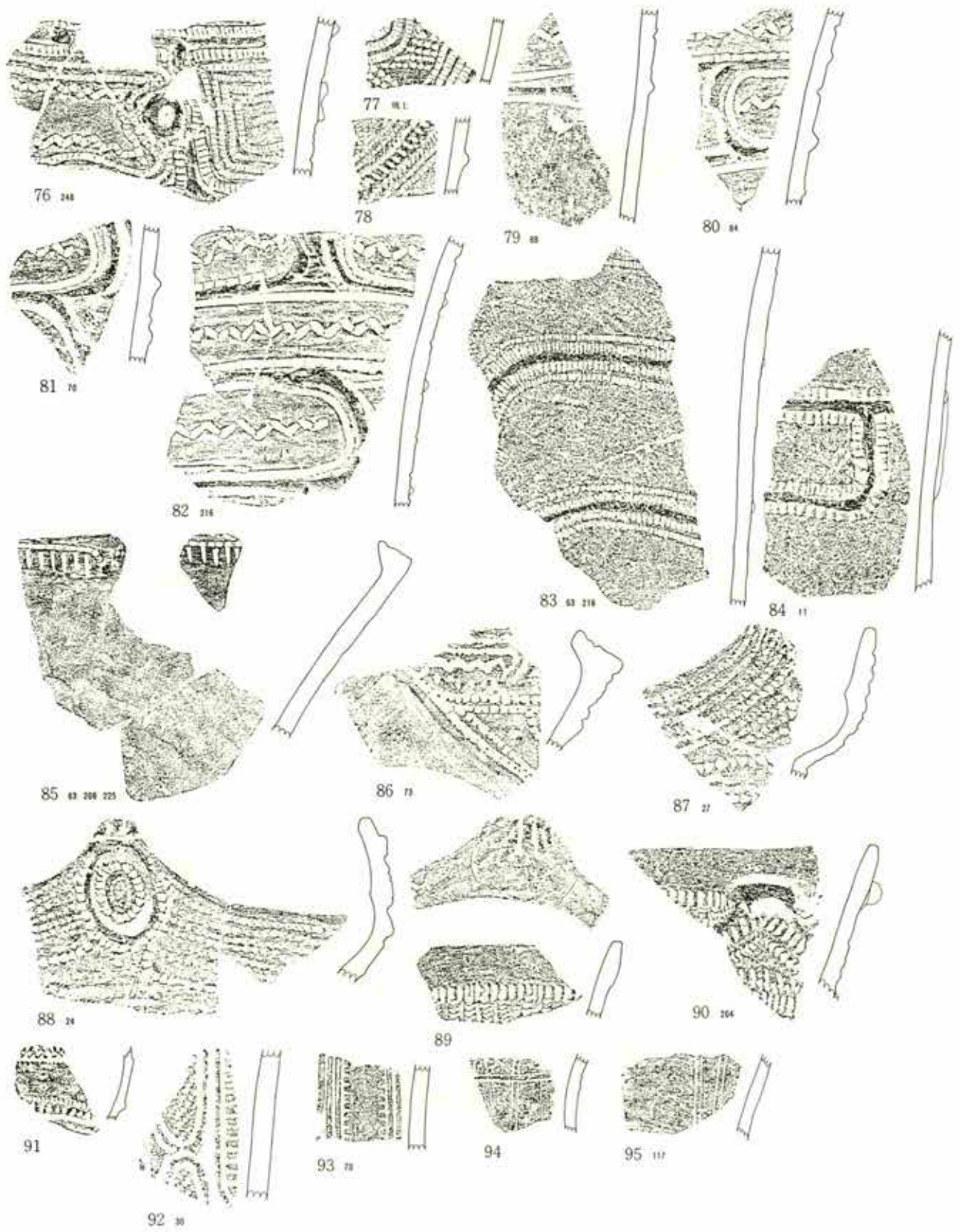

第 366 图 积迦堂 S-IV 区 SB-73 出土土器 (7)

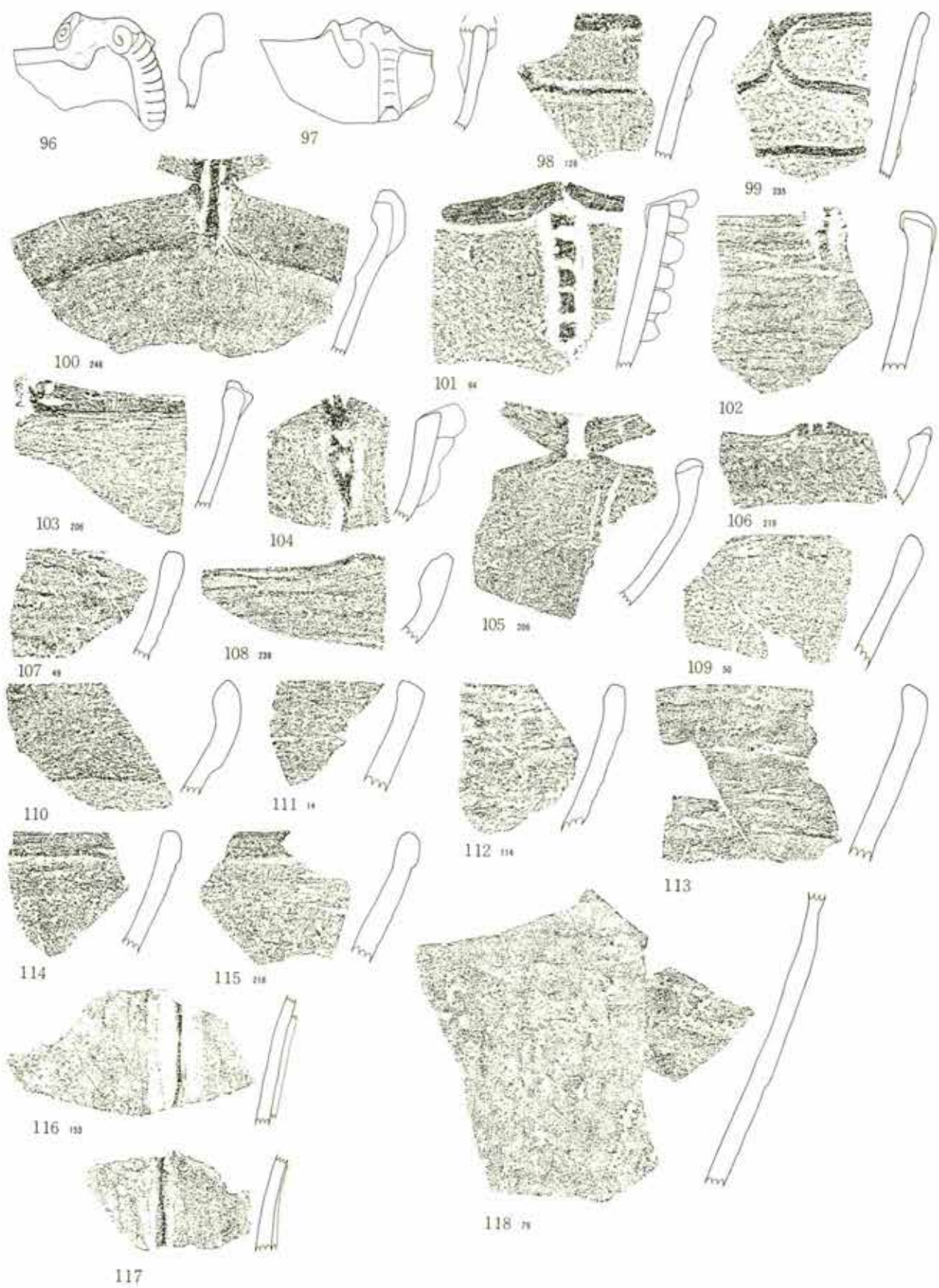

第 367 图 积迦堂 S-IV 区 SB-73 出土土器 (8)

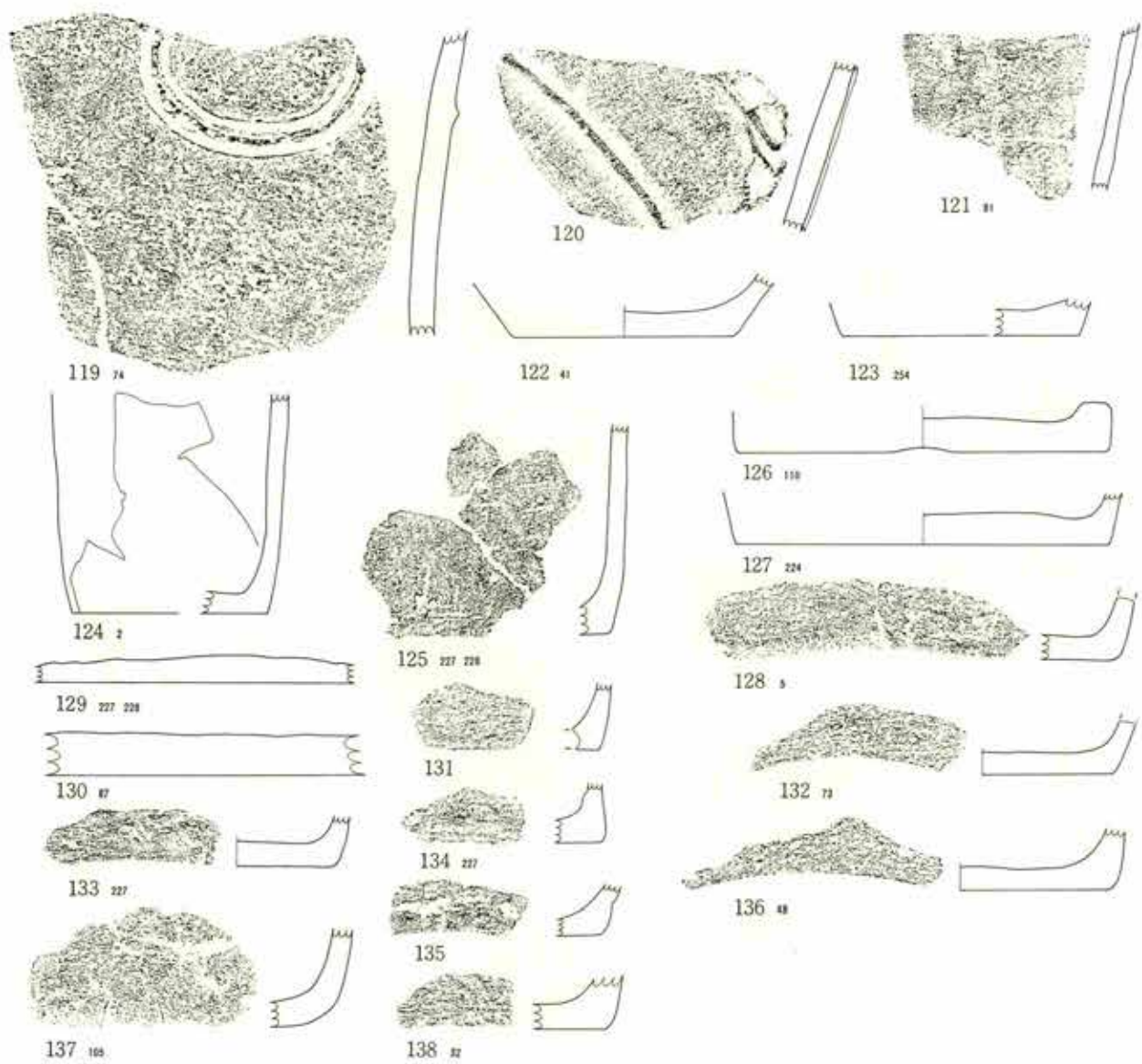

第 368 图 积迦堂 S—IV 区 SB-73 出土土器 (9)

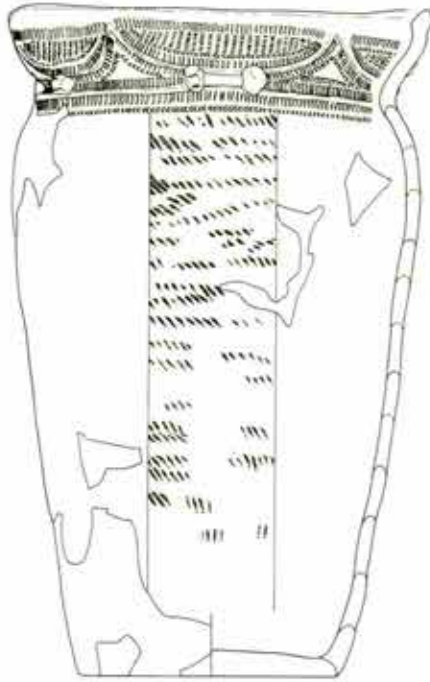

1

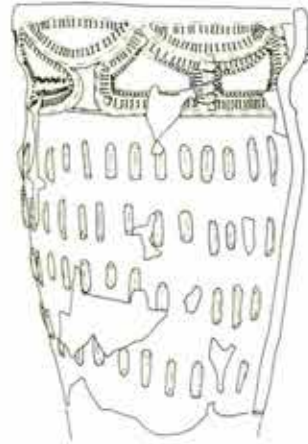

2

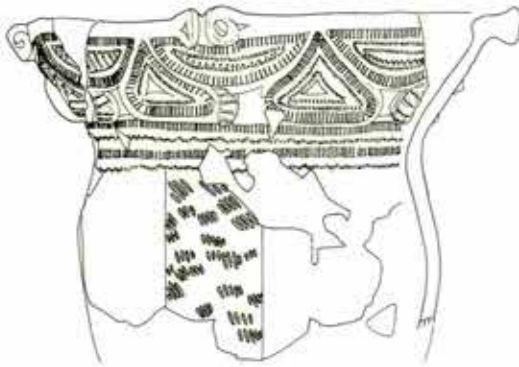

3

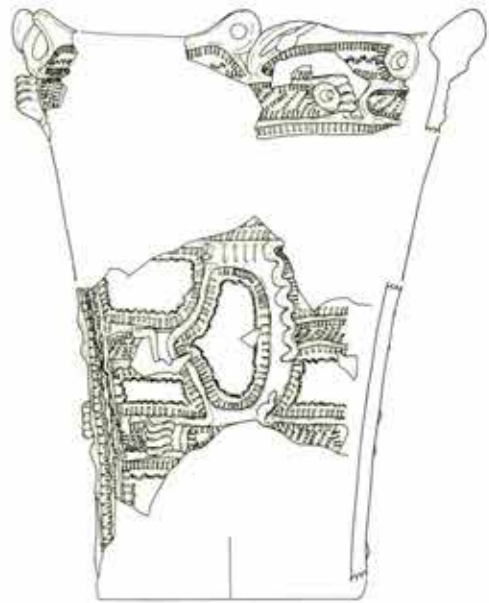

4



5

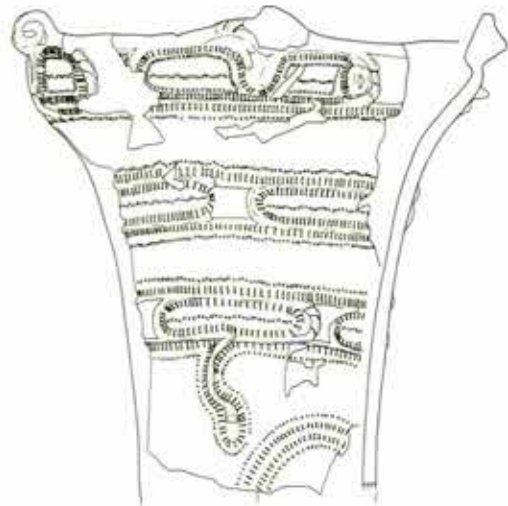

6

第 369 图 积逊堂 S-IV 区 SB-53 出土土器 (1)

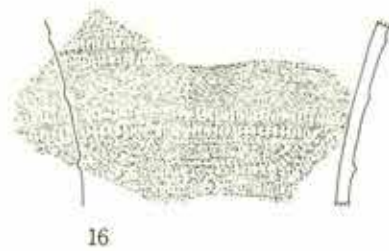
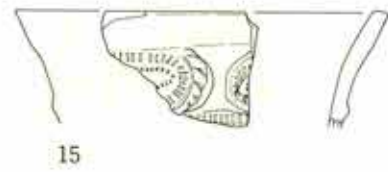
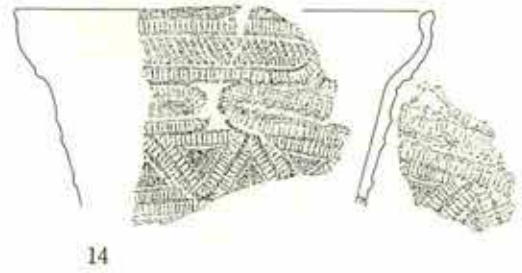
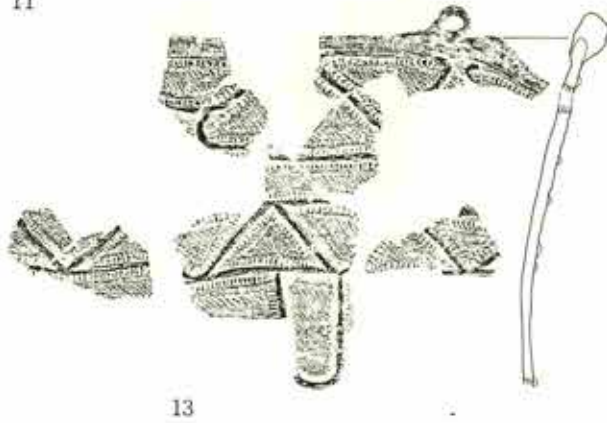
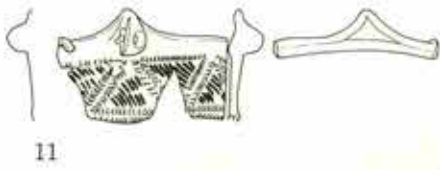
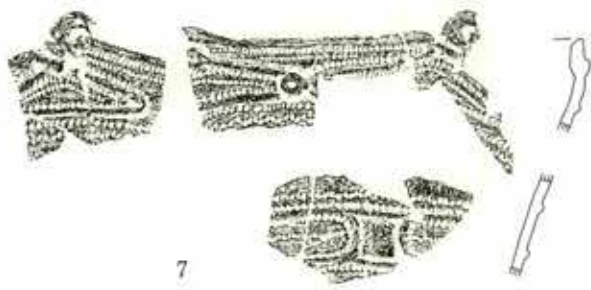

第 370 图 积迦堂 S-IV 区 SB-53 出土土器 (2)



第 371 图 积迦堂 S-IV 区 SB-53 出土土器 (3)

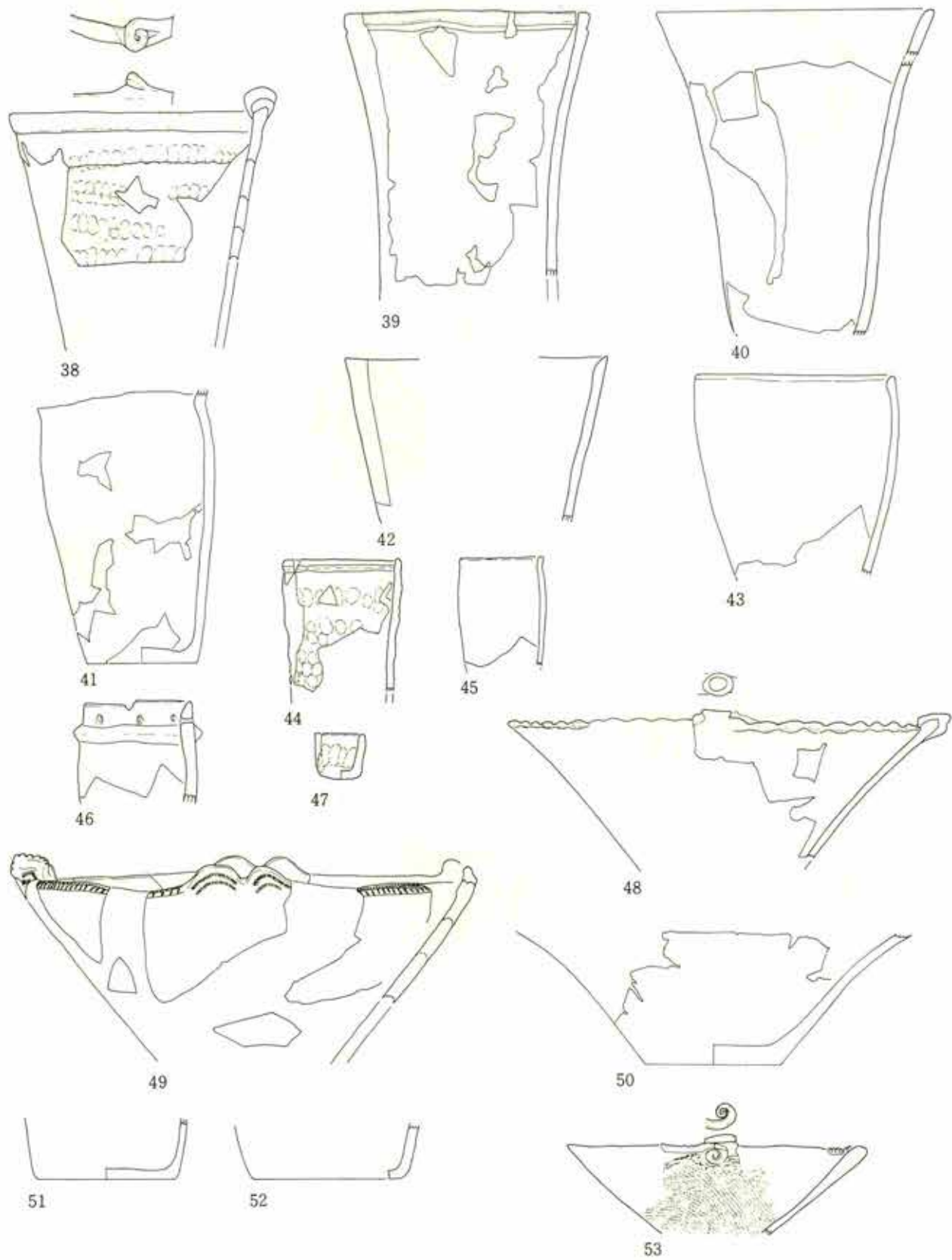

第 372 图 积迦堂 S-IV 区 SB-53 出土土器 (4)
 (46. 1 : 3)



第 373 图 积迦堂 S-IV 区 SB-53 出土土器 (5)

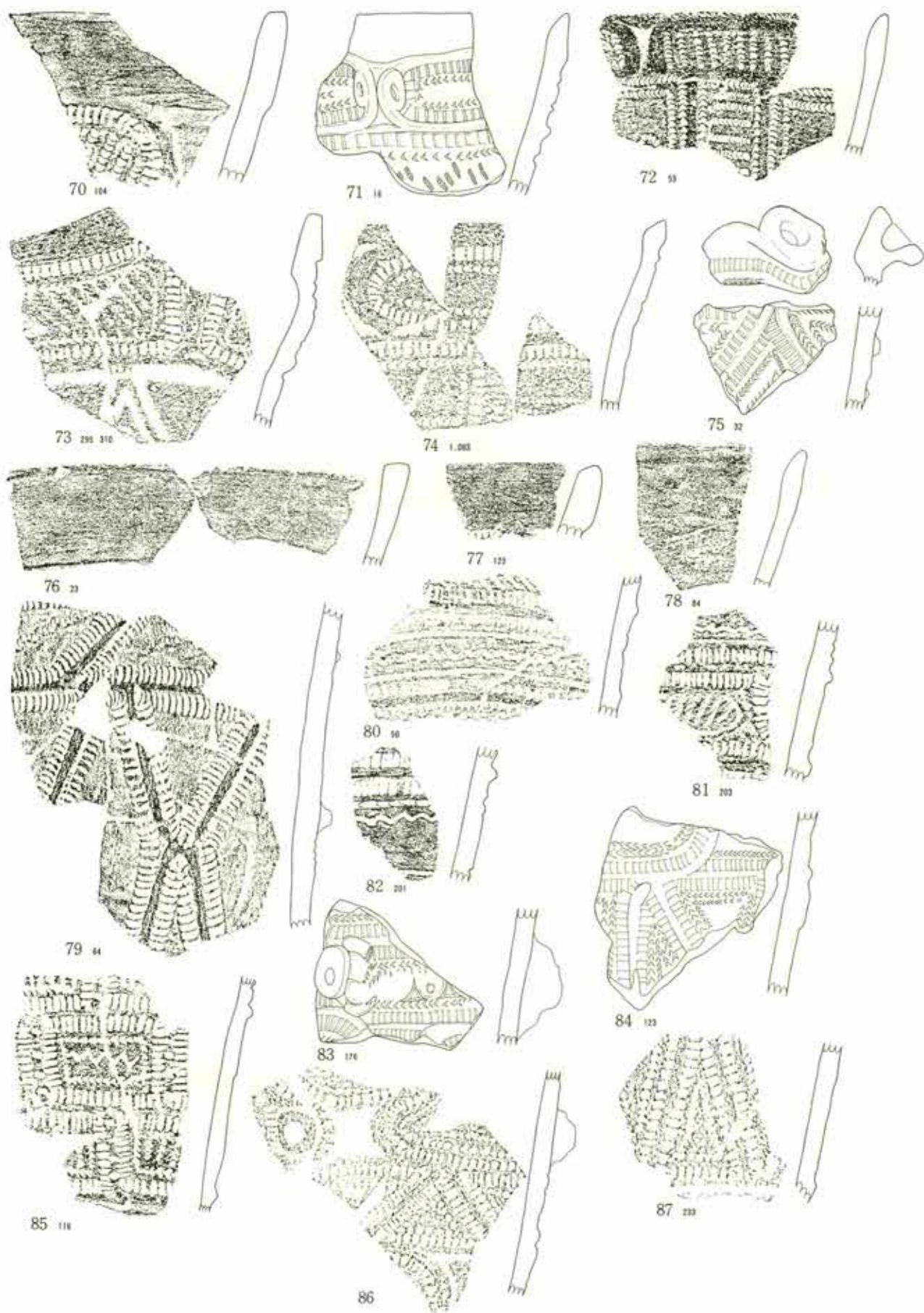

第 374 图 积迦堂 S—IV 区 SB—53 出土土器 (6)

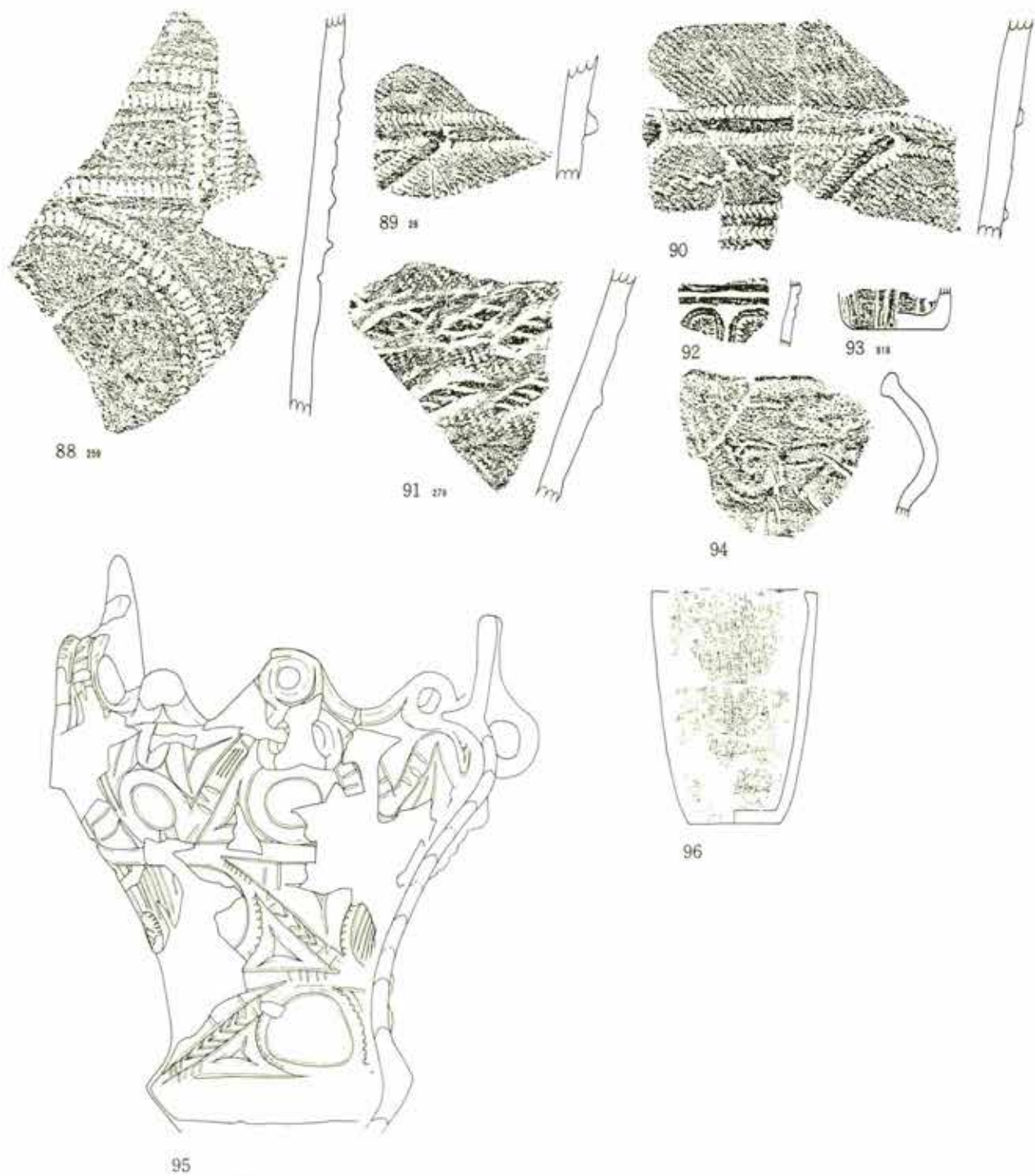

第 375 图 积迦堂 S—IV 区 SB—53 出土土器 (7)

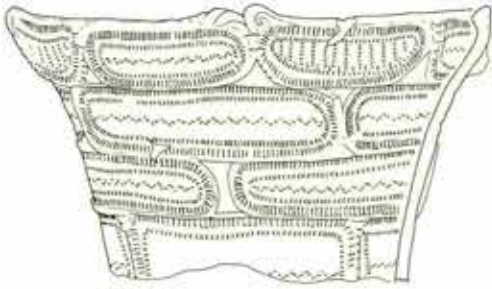

97

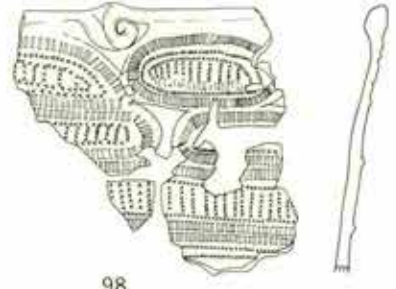

98



99

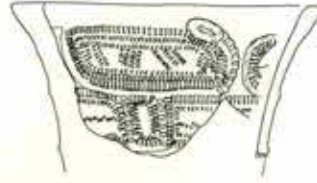

100



101



102



103



104

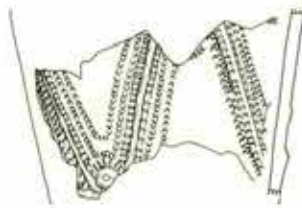

105



106



107



108

第 376 图 积迦堂 S-IV 区 SB-53 出土土器 (8)

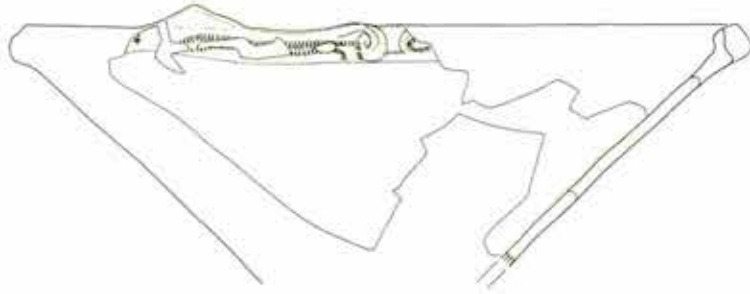

109

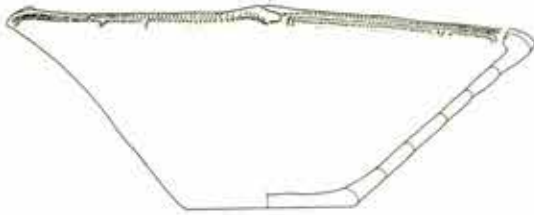

110

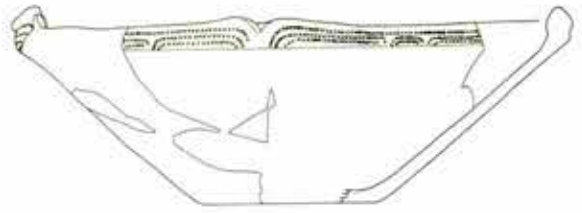

111



112



113



114

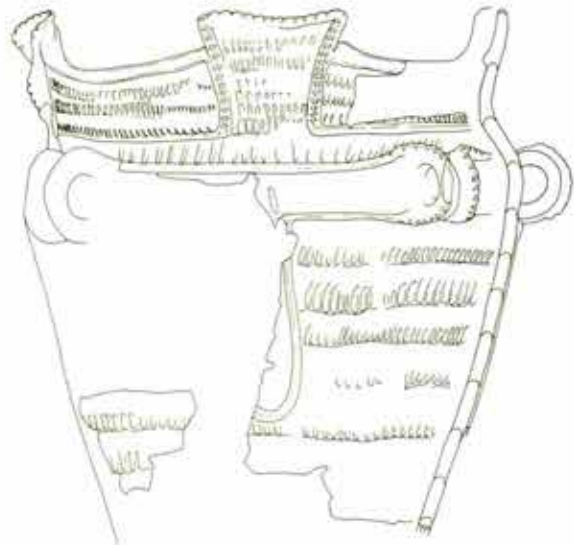

115

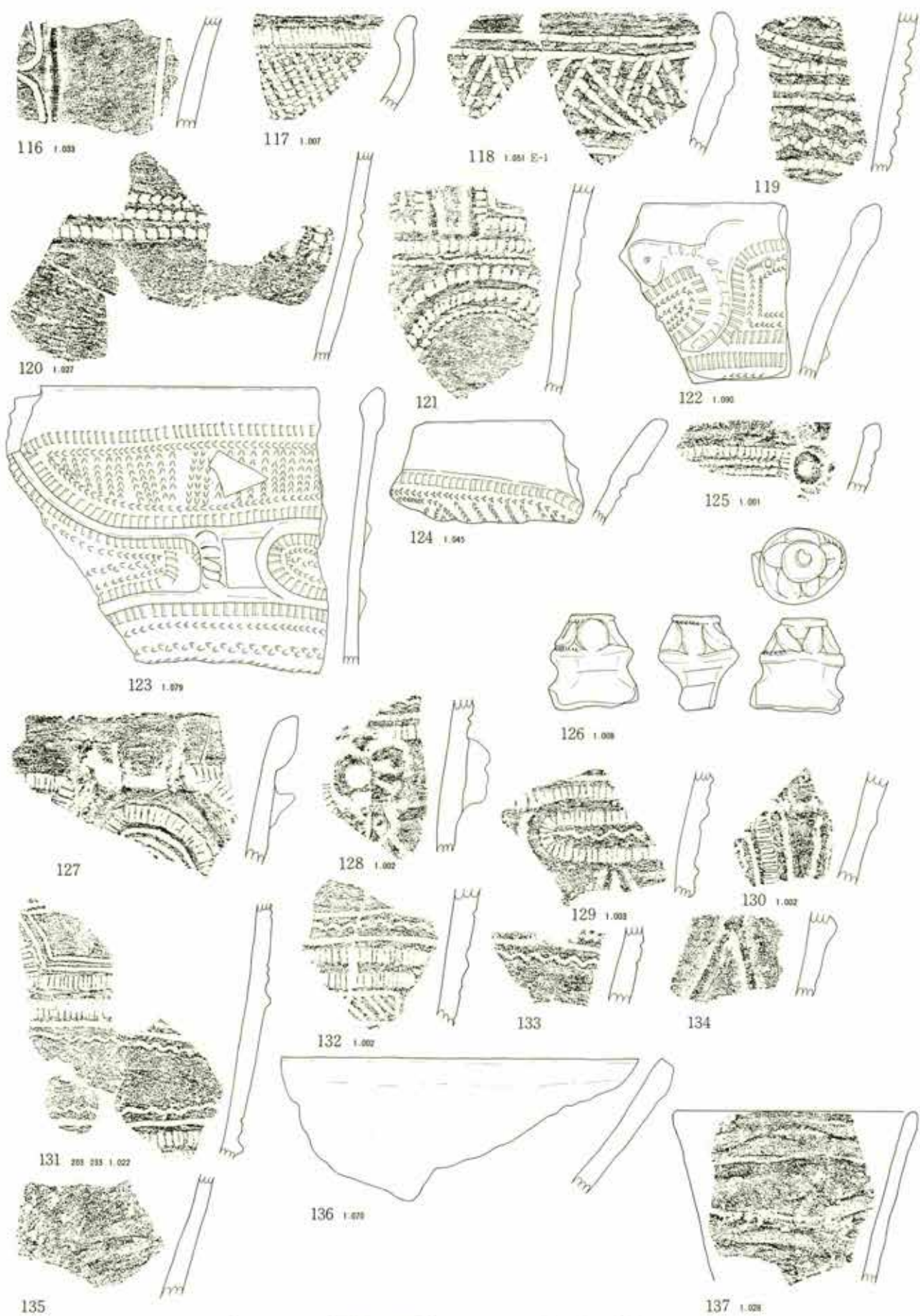

第378图 积迦堂S-IV区 SB-53 出土土器 (10)

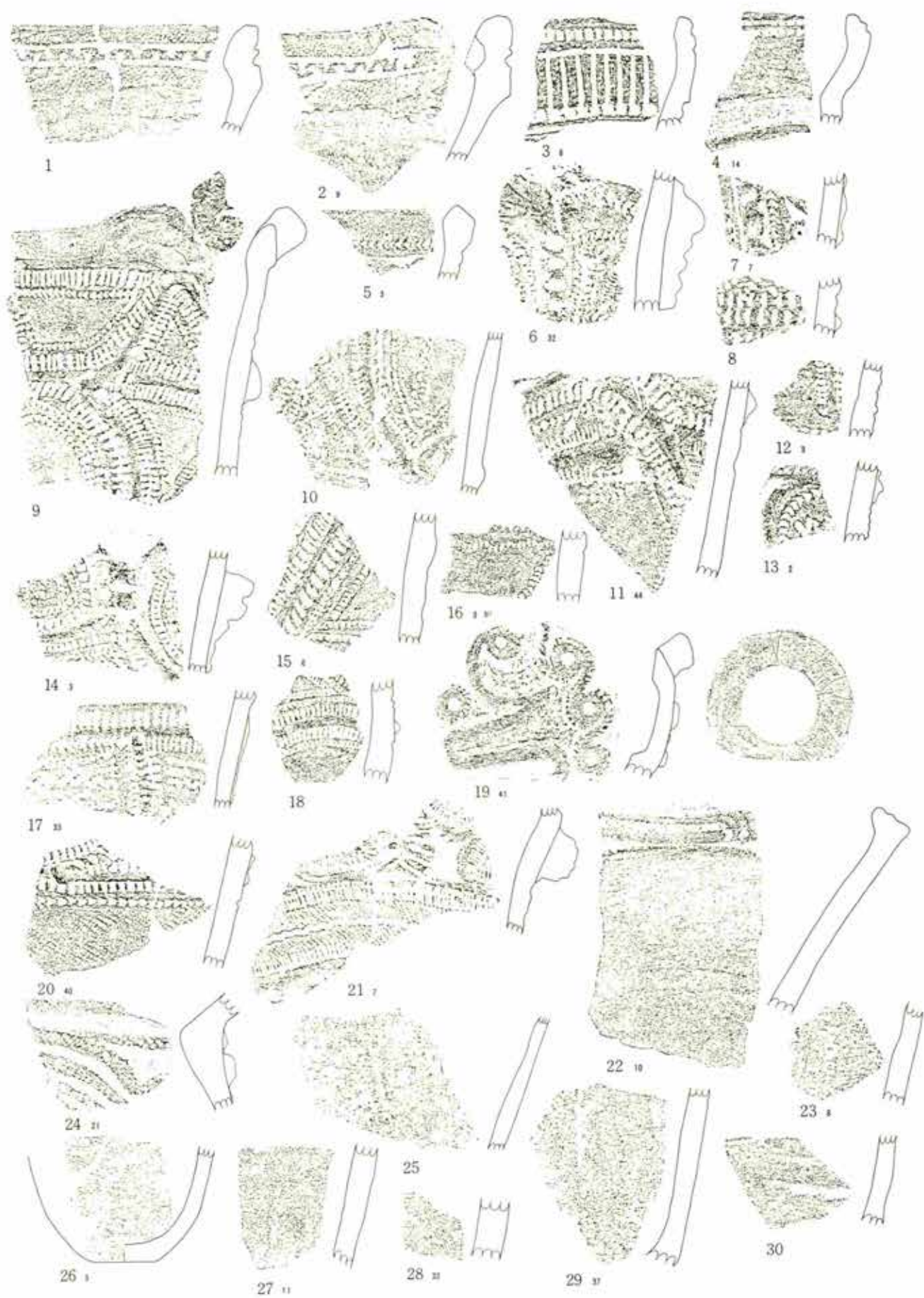

第379图 积迦堂S-IV区 SB-69 出土土器(1)

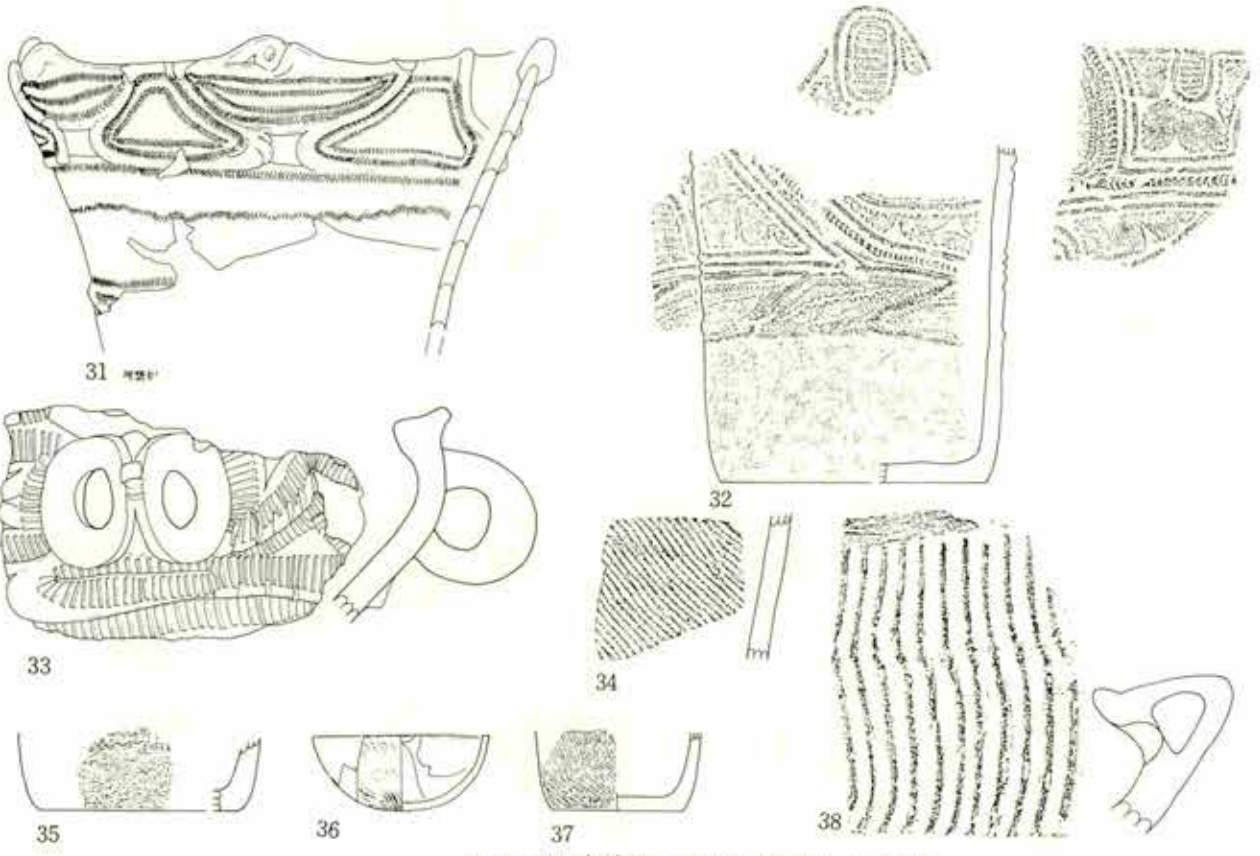

SB-69 (2) (31.32.35.36.37. 1 : 6)

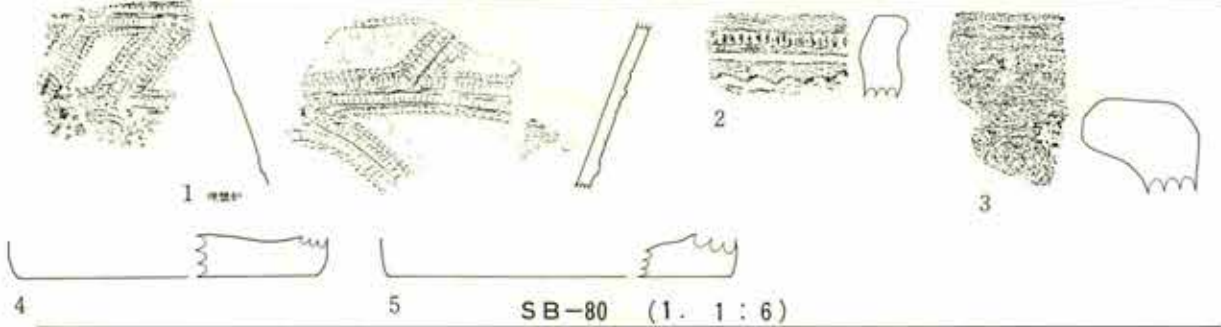

SB-80 (1. 1 : 6)

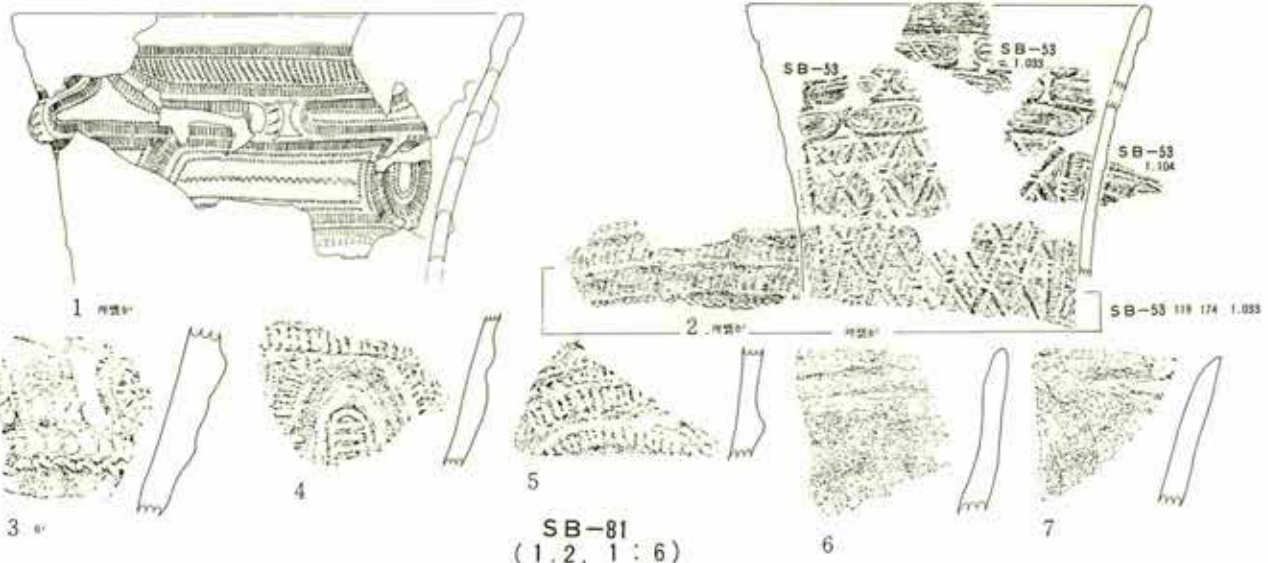

SB-81 (1.2. 1 : 6)

第 380 图 积迦堂 S-IV 区 SB-69-80-81 出土土器

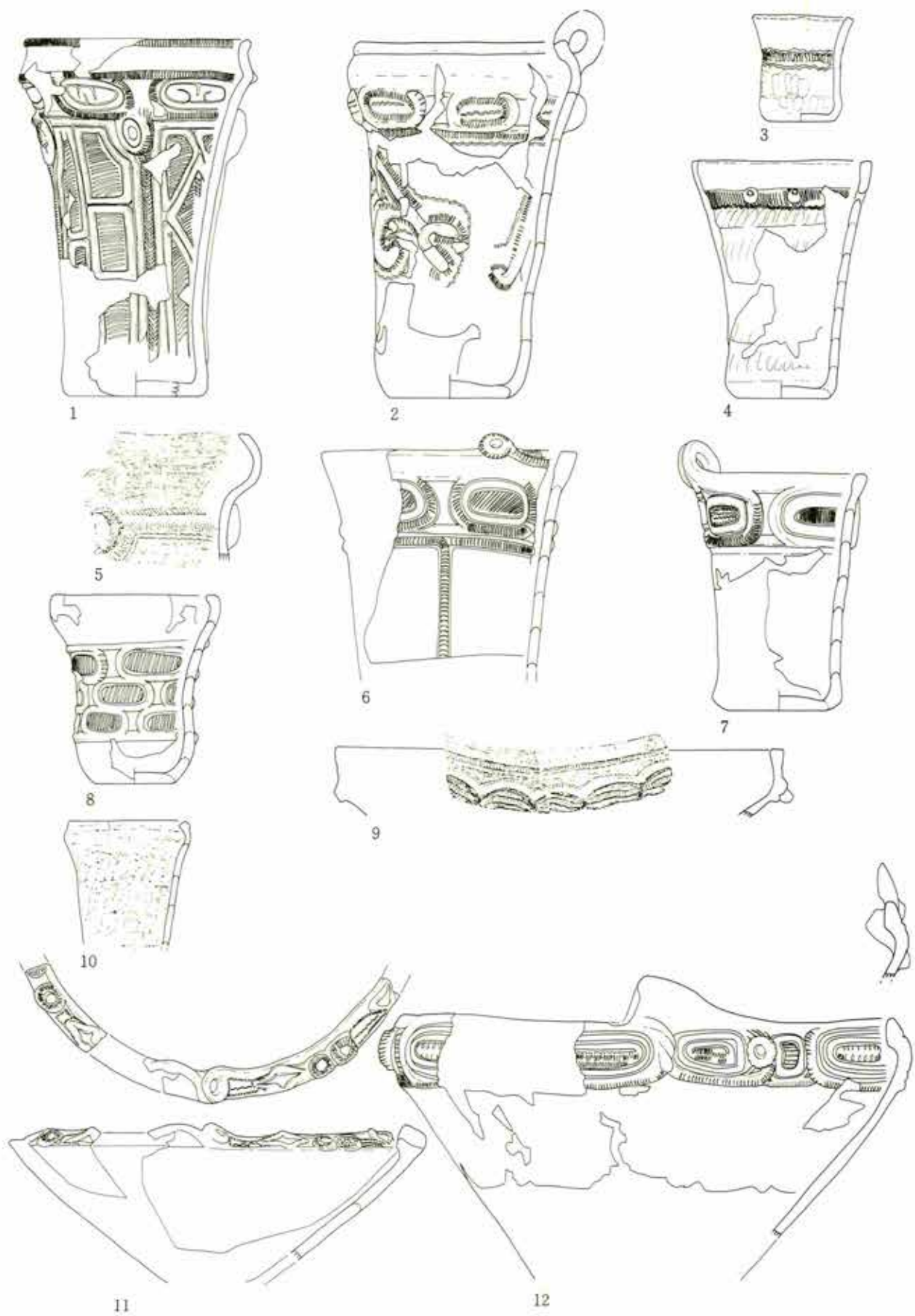

第 381 图 积迦堂 S-IV 区 SB-32 出土土器 (1)

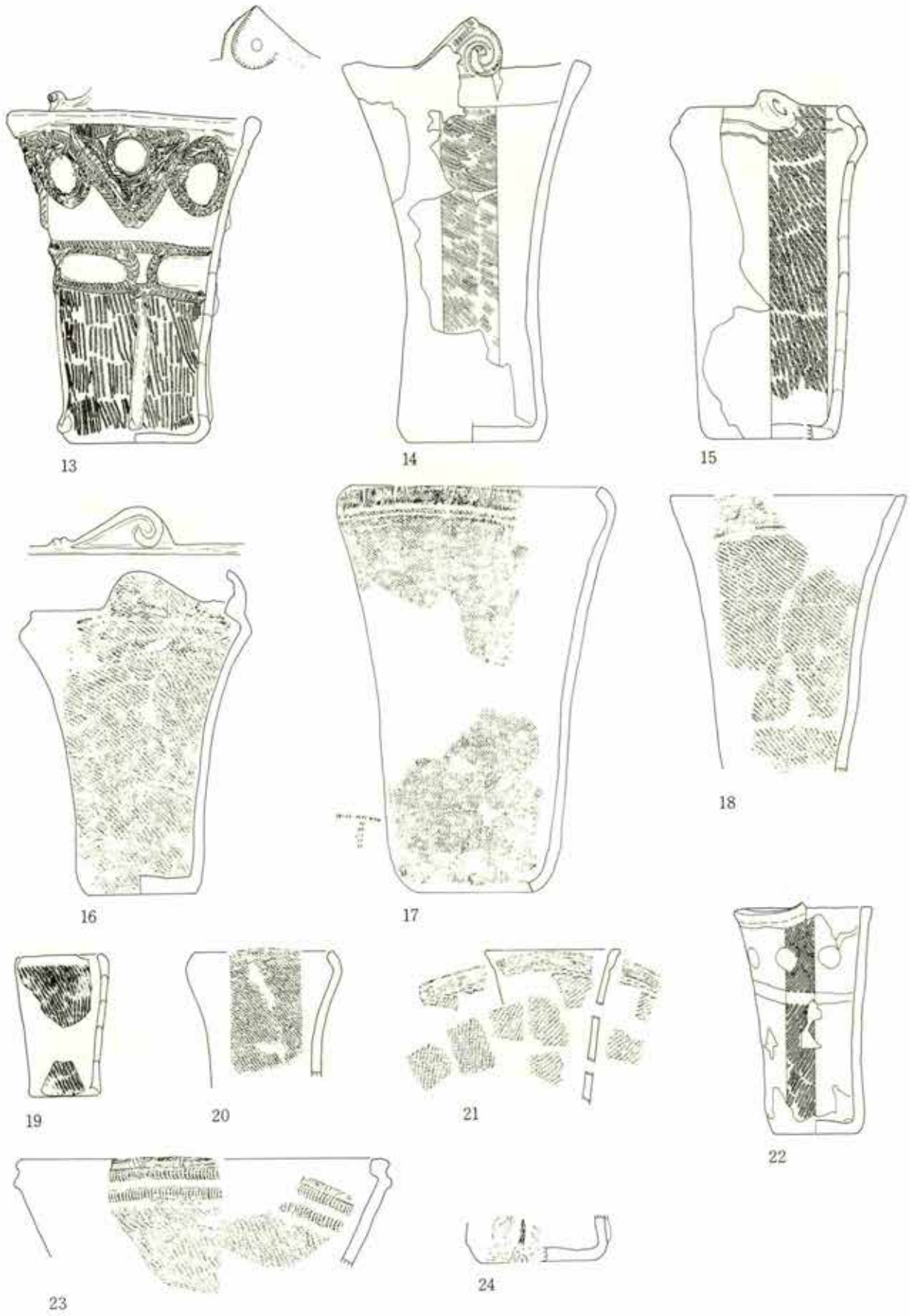

第 382 图 积迦堂 S—IV 区 SB-32 出土土器

(2)

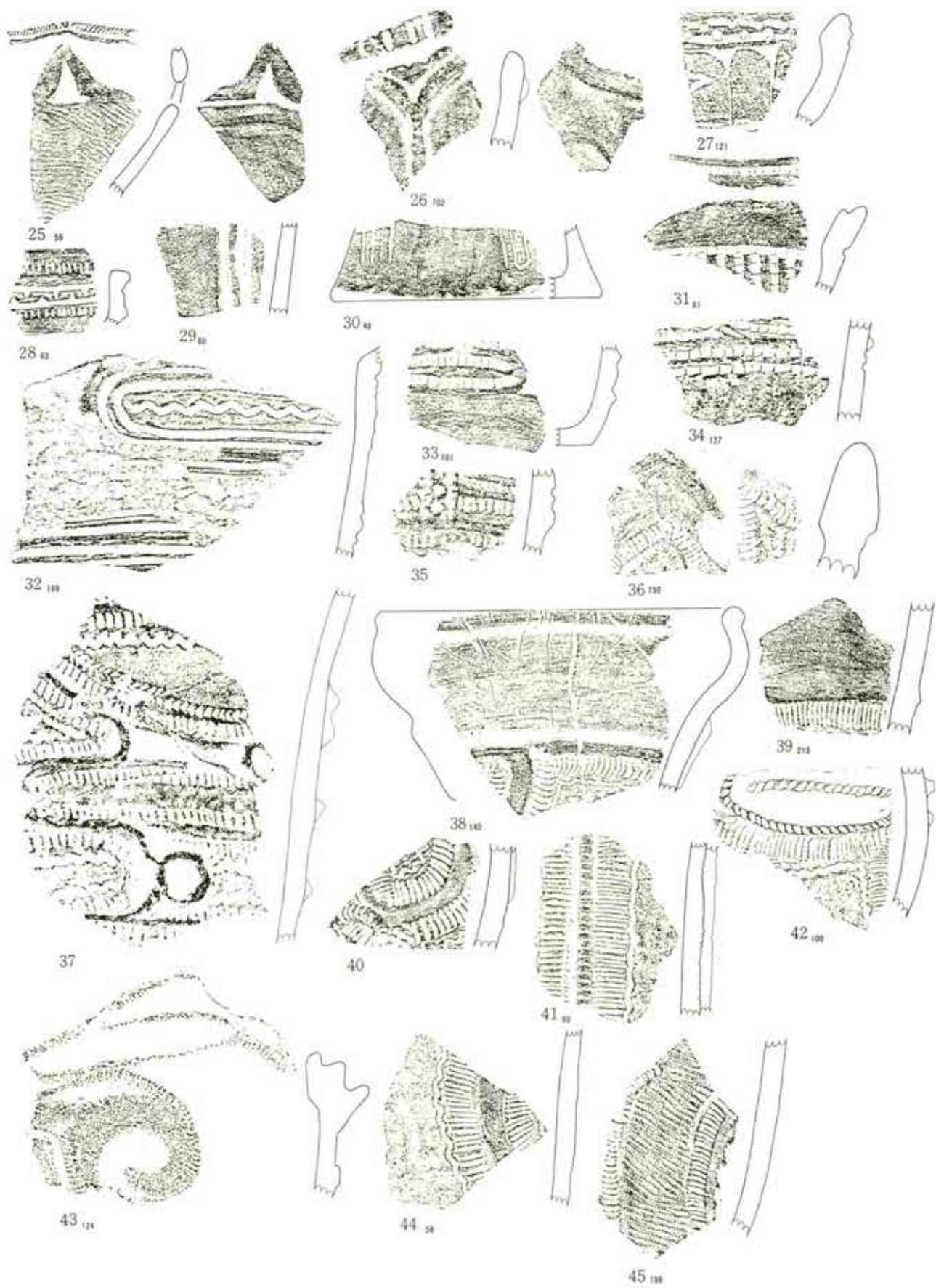

第 383 图 积迦堂 S-N 区 SB-32 出土土器

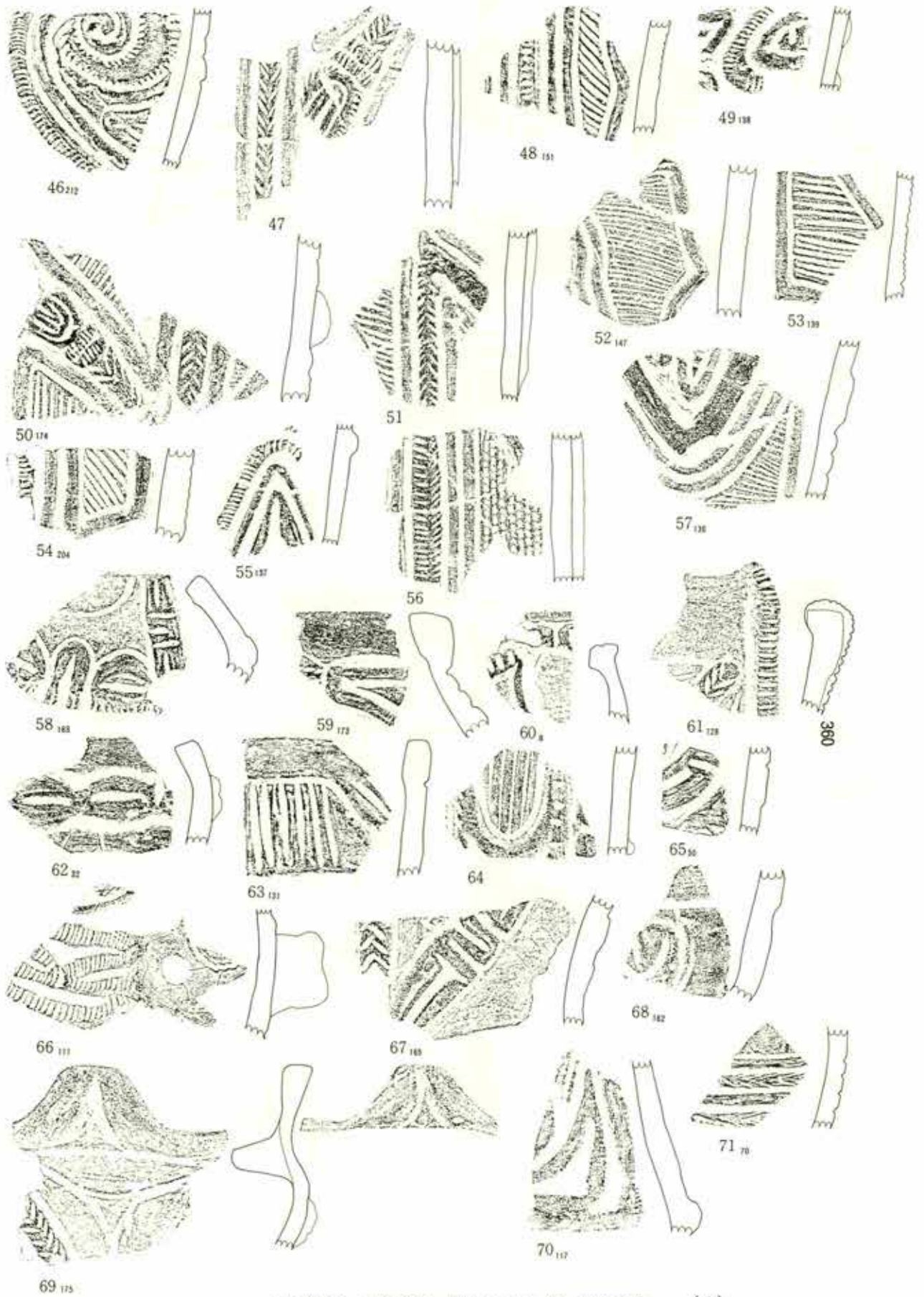

第 384 图 积迦堂 S-IV 区 SB-32 出土土器 (4)

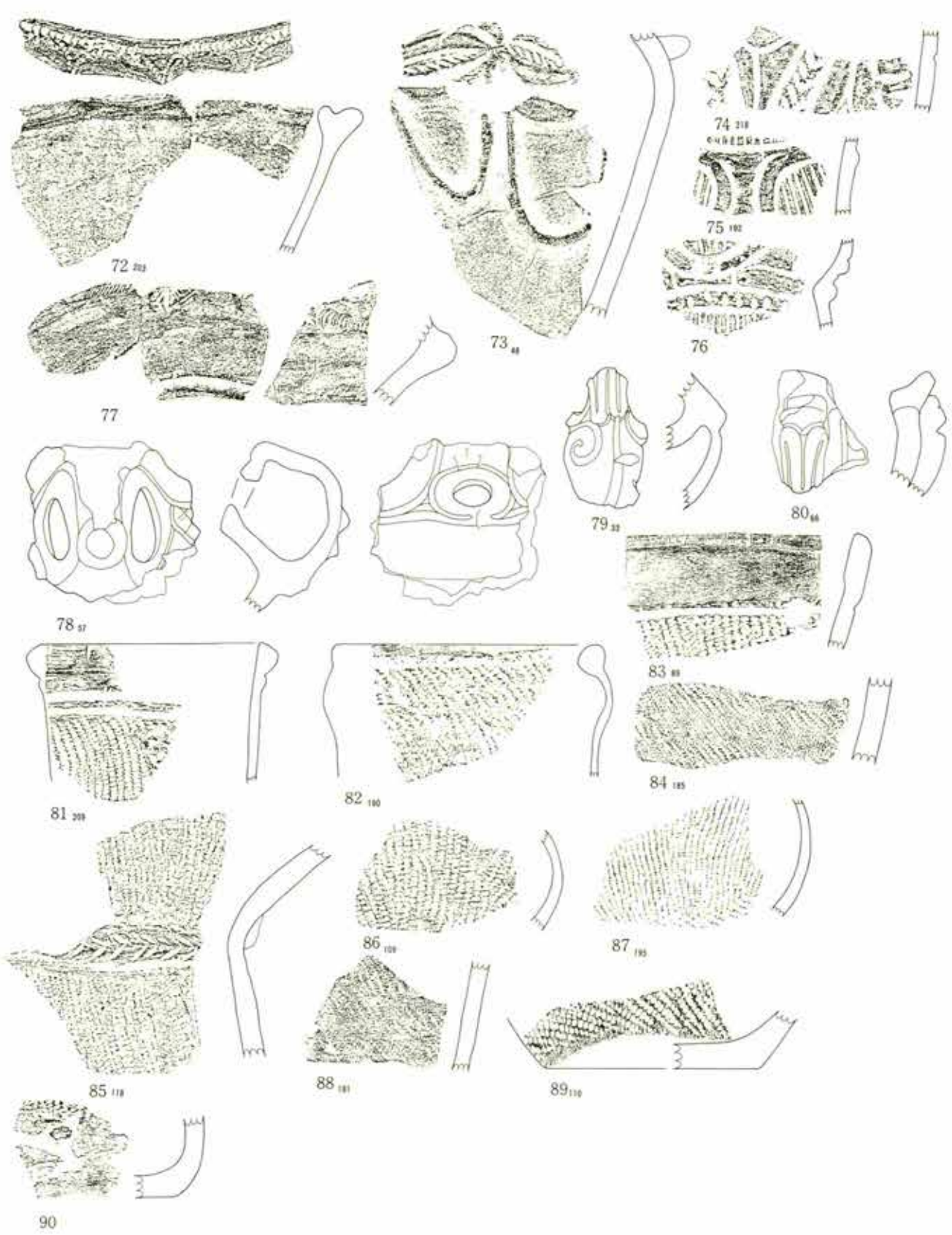

第 385 图 积逊堂 S-IV 区 SB-32 出土土器 (72.81.82.96.97. 1:6) (5)

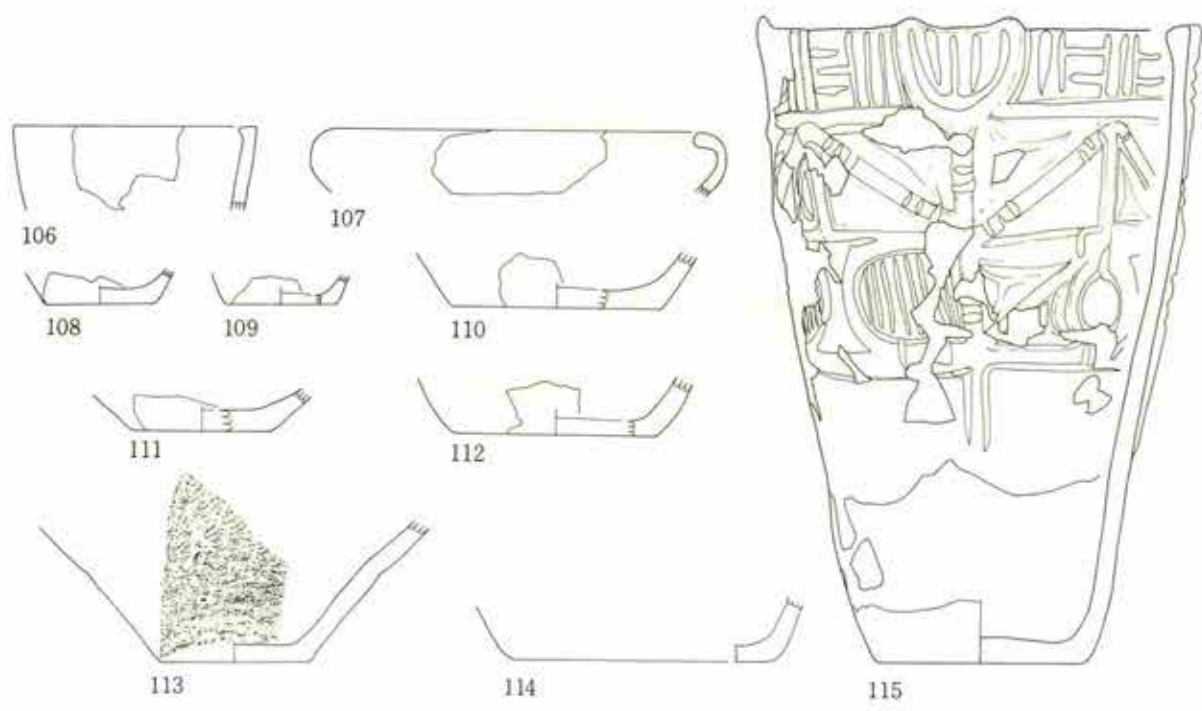
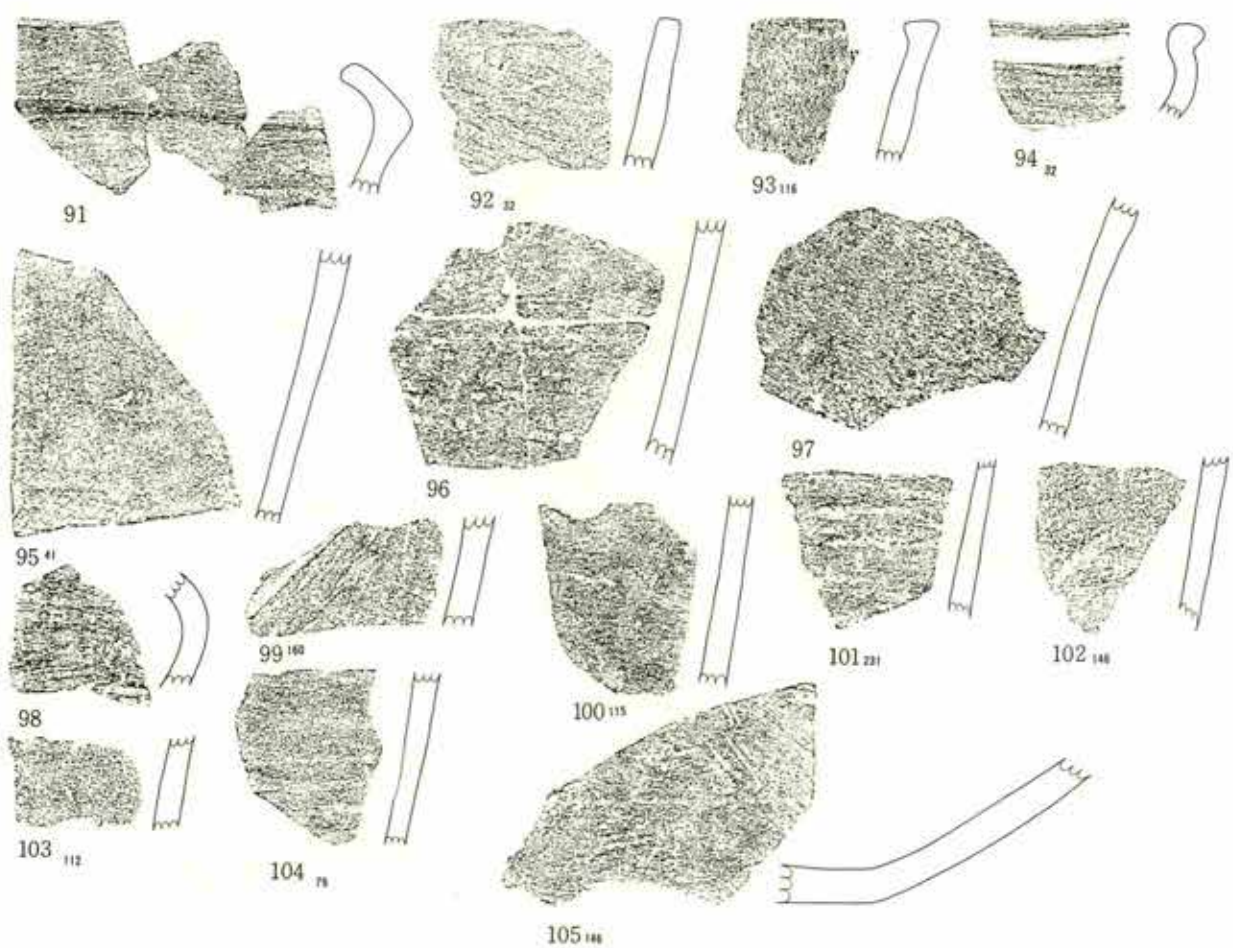

第 386 图 积迦堂 S-IV 区 SB-32 出土土器 (6) (106-115. 1 : 6)



第 387 图 积迦堂 S-IV 区 SB-52 出土土器

(1)

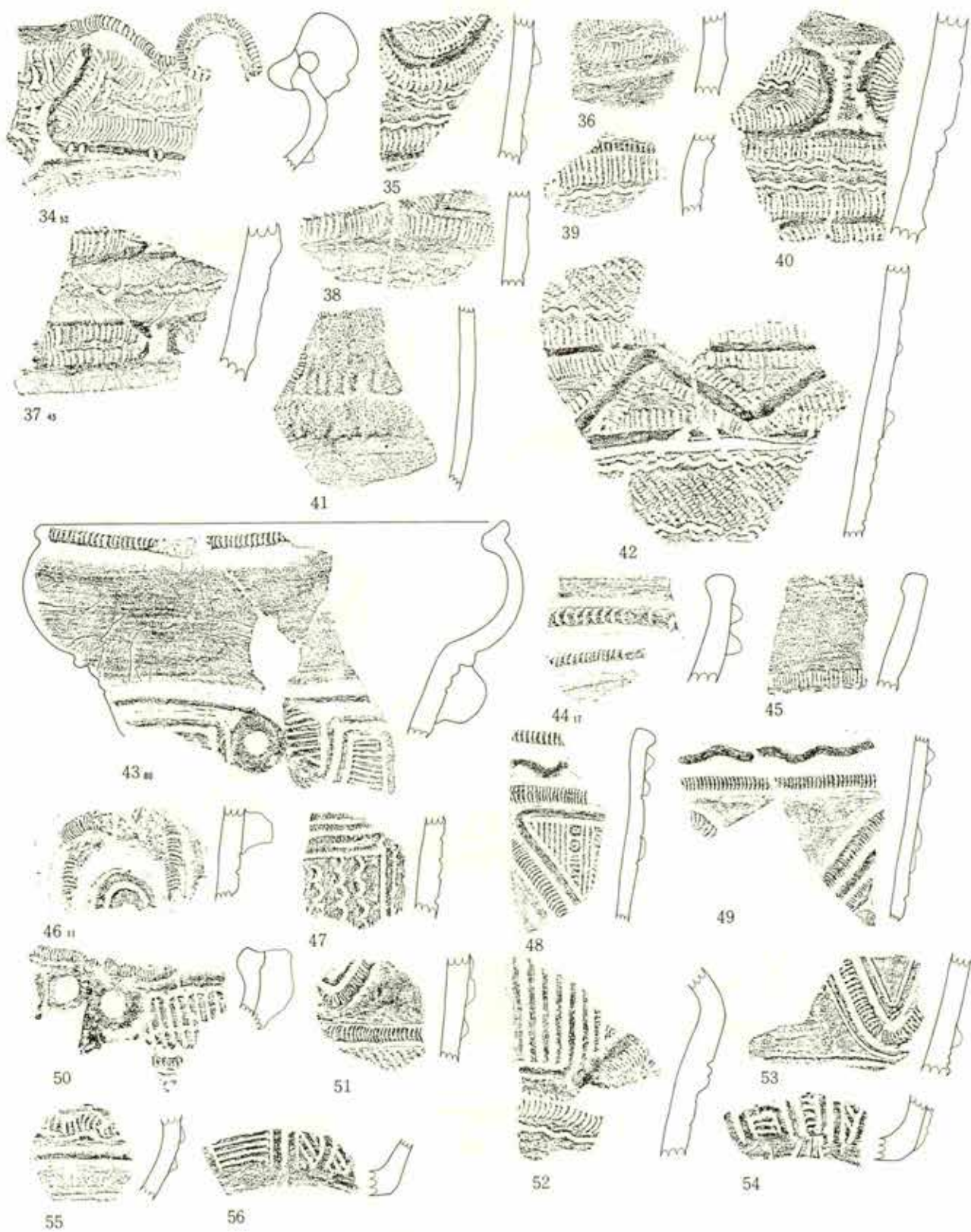

第 388 图 积迦堂 S-IV 区 SB-52 出土土器 (2)

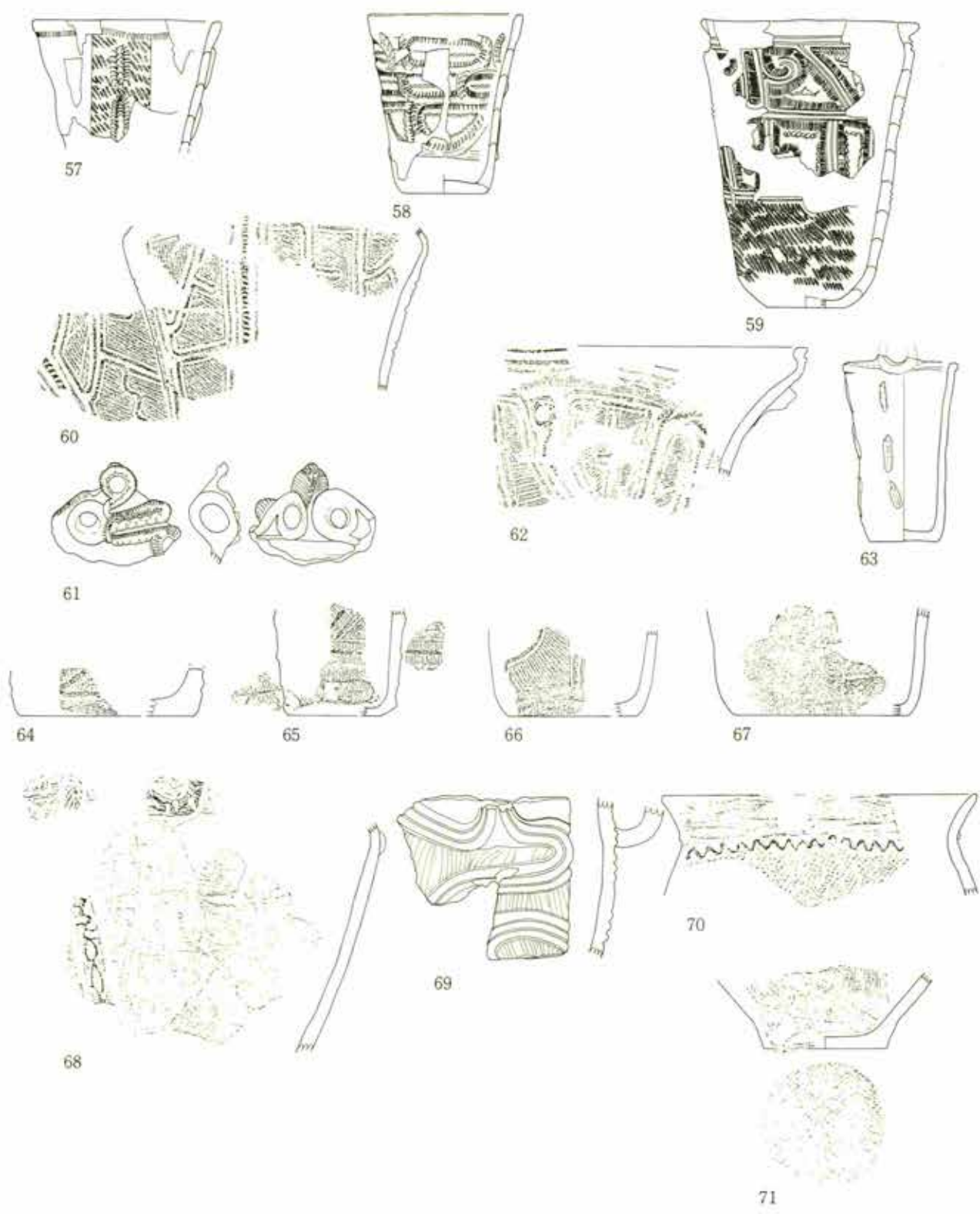

第 389 图 积迦堂 S—IV 区 SB—52 出土土器

(3) (1:6)



第 390 图 积迦堂 S-IV 区 SB-52 出土土器 (4)



第 391 图 积迦堂 S-IV 区 SB-52 出土土器 (5)

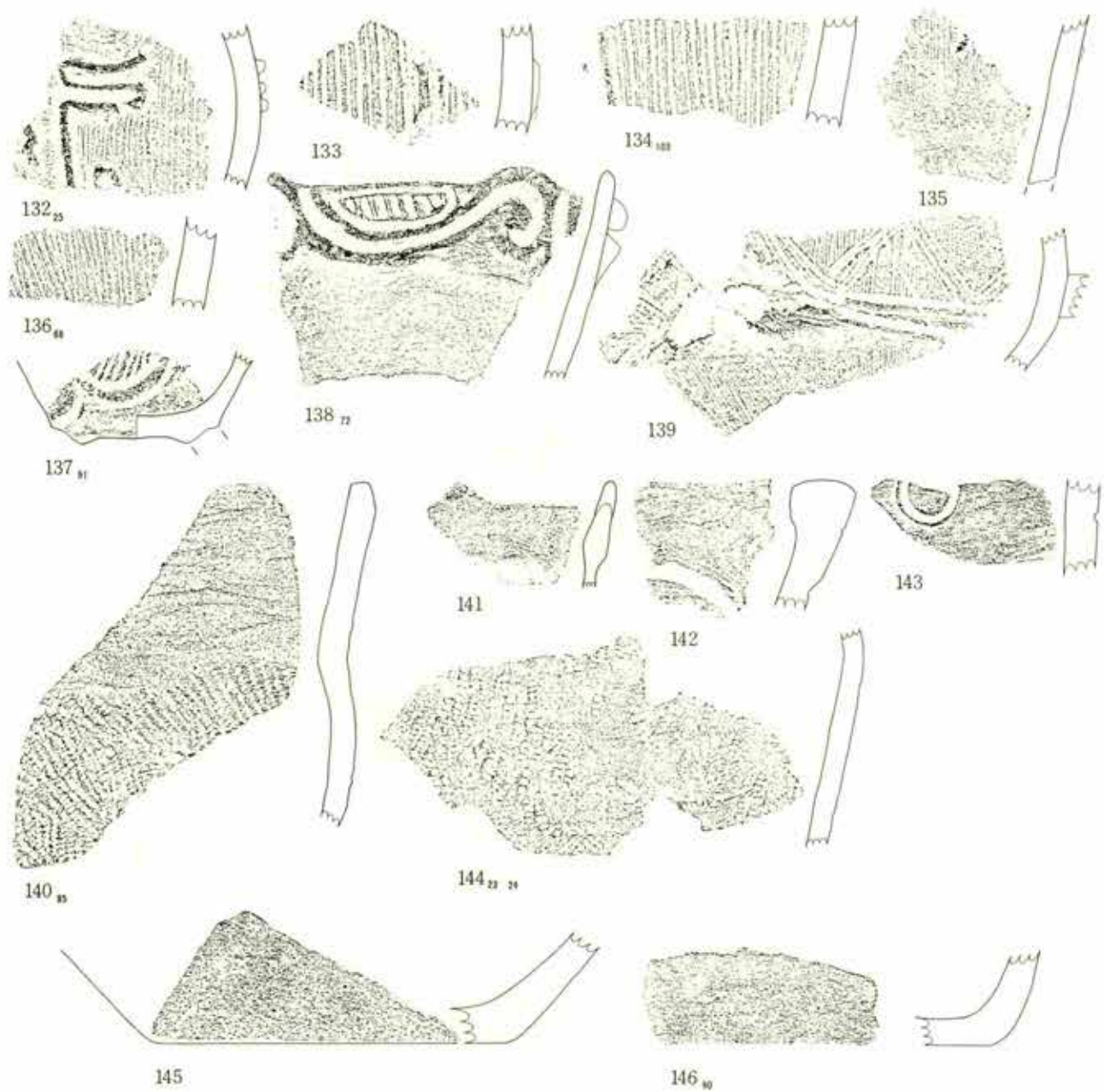

第 392 图 积迦堂 S-IV 区 SB-52 出土土器 (6)

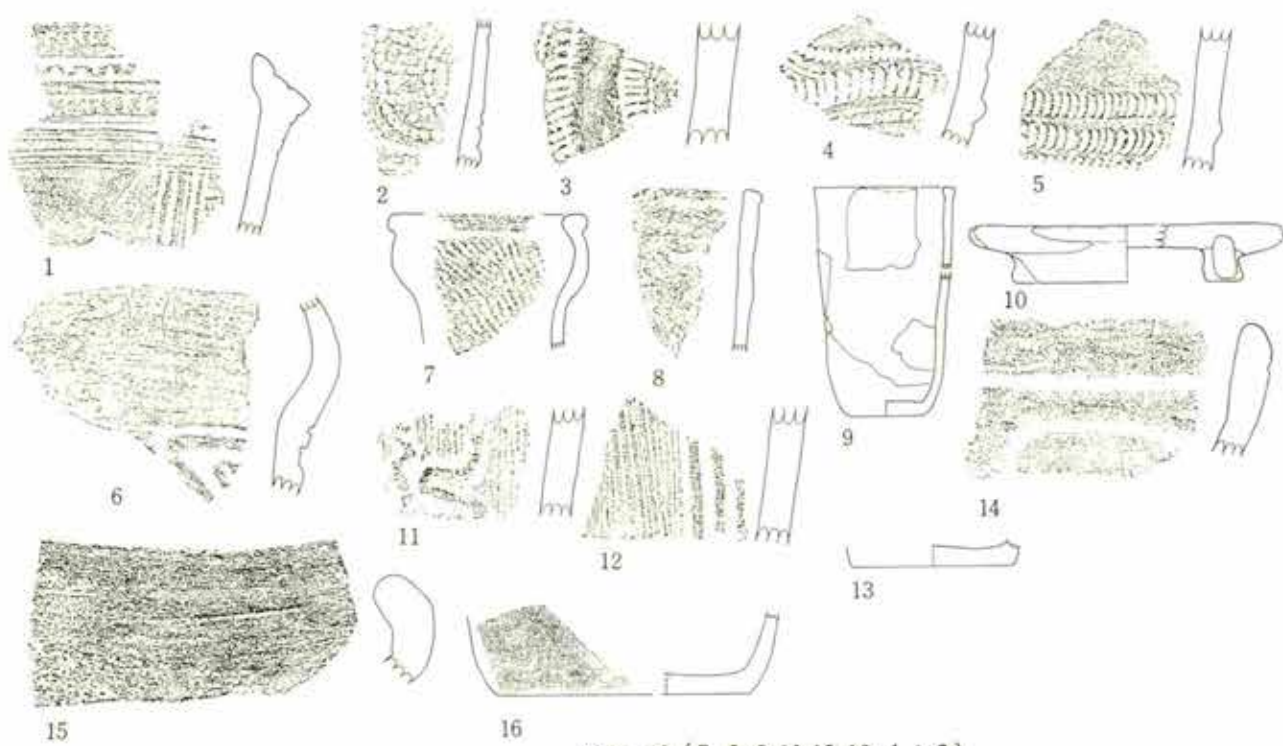

SB-18 (7.8.9.10.13.16. 1 : 6)

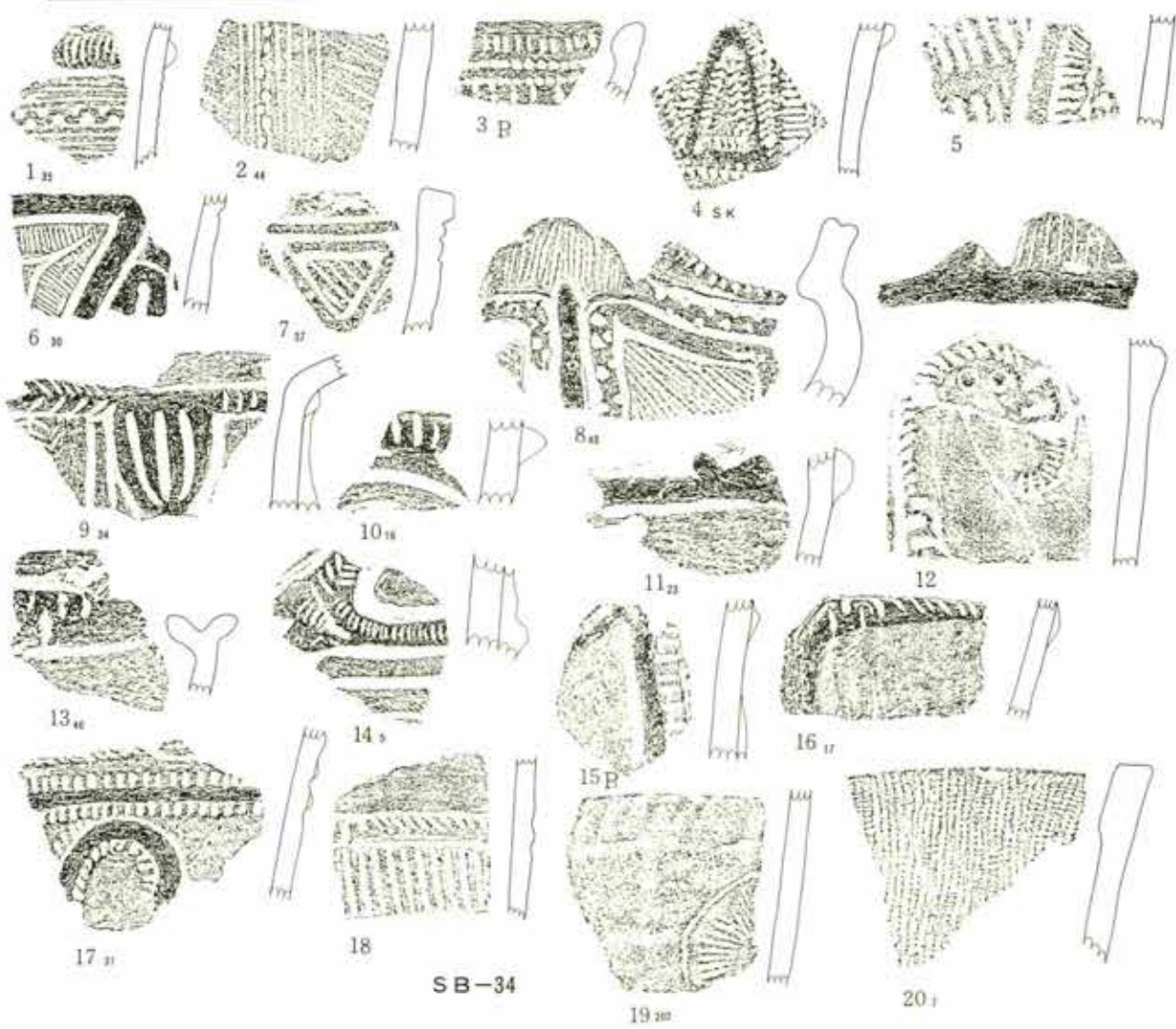

SB-34

第393图 积逊堂S-IV区 SB-18-34 出土土器

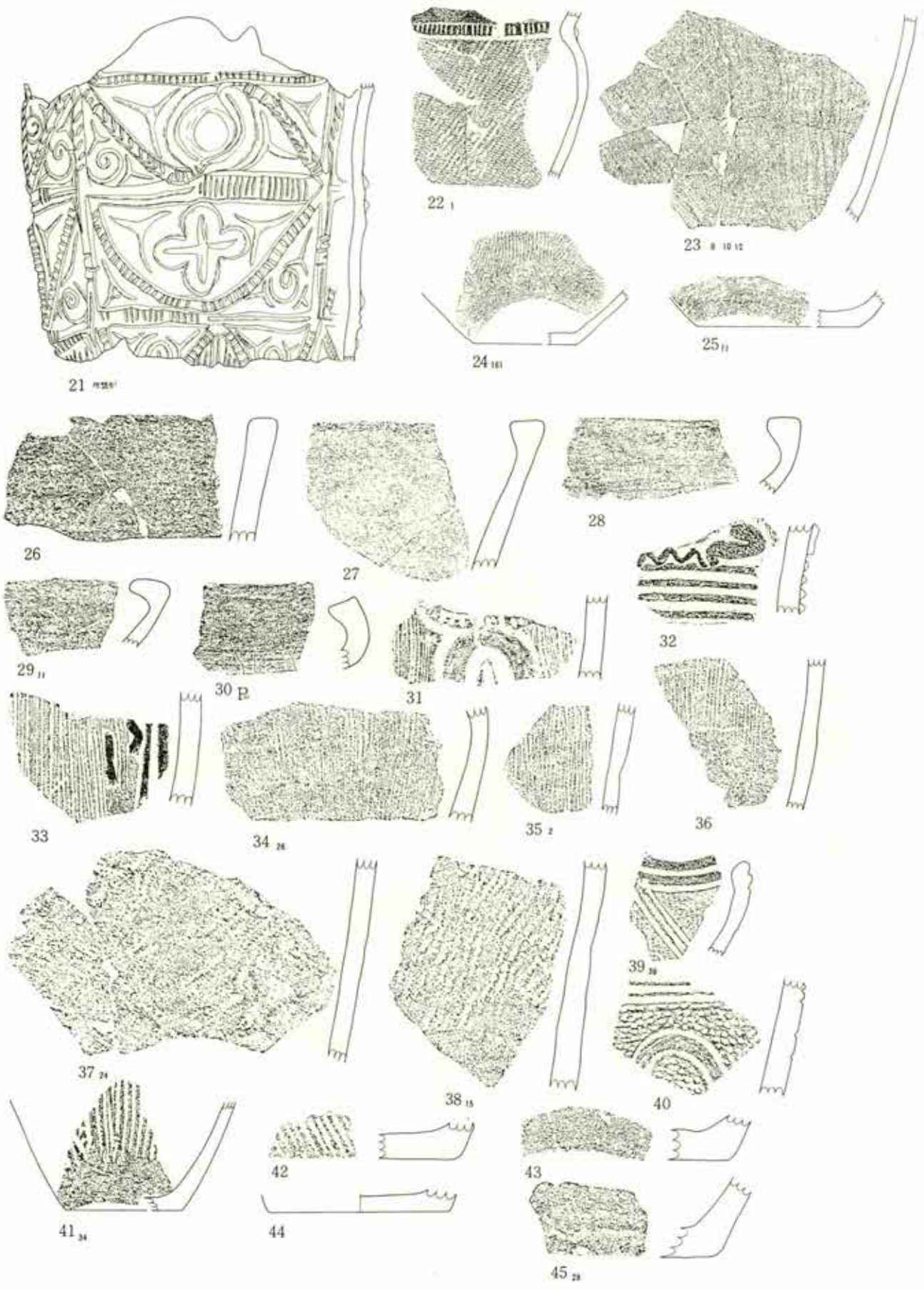

第 394 图 积迦堂 S-IV 区 SB-34 出土土器 (21-25. 1:6)



第 395 图 积迦堂 S-IV 区 SB-40 出土土器 (5.10.1 : 6)



第 396 图 积迦堂 S—IV 区 SB-60 出土土器

(1)

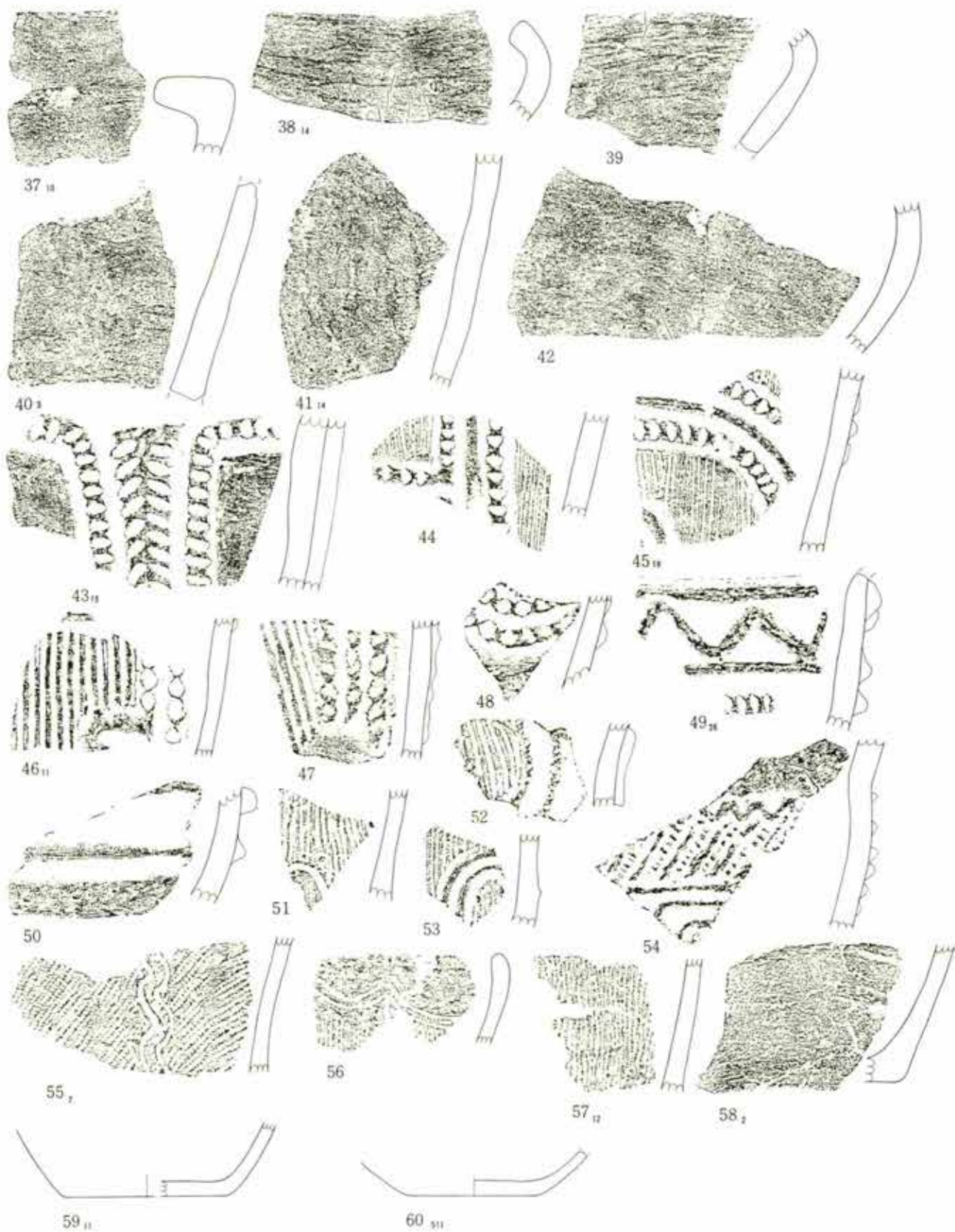

第397图 积迦堂S-IV区 SB-60 出土土器
 (59.60.1:6)

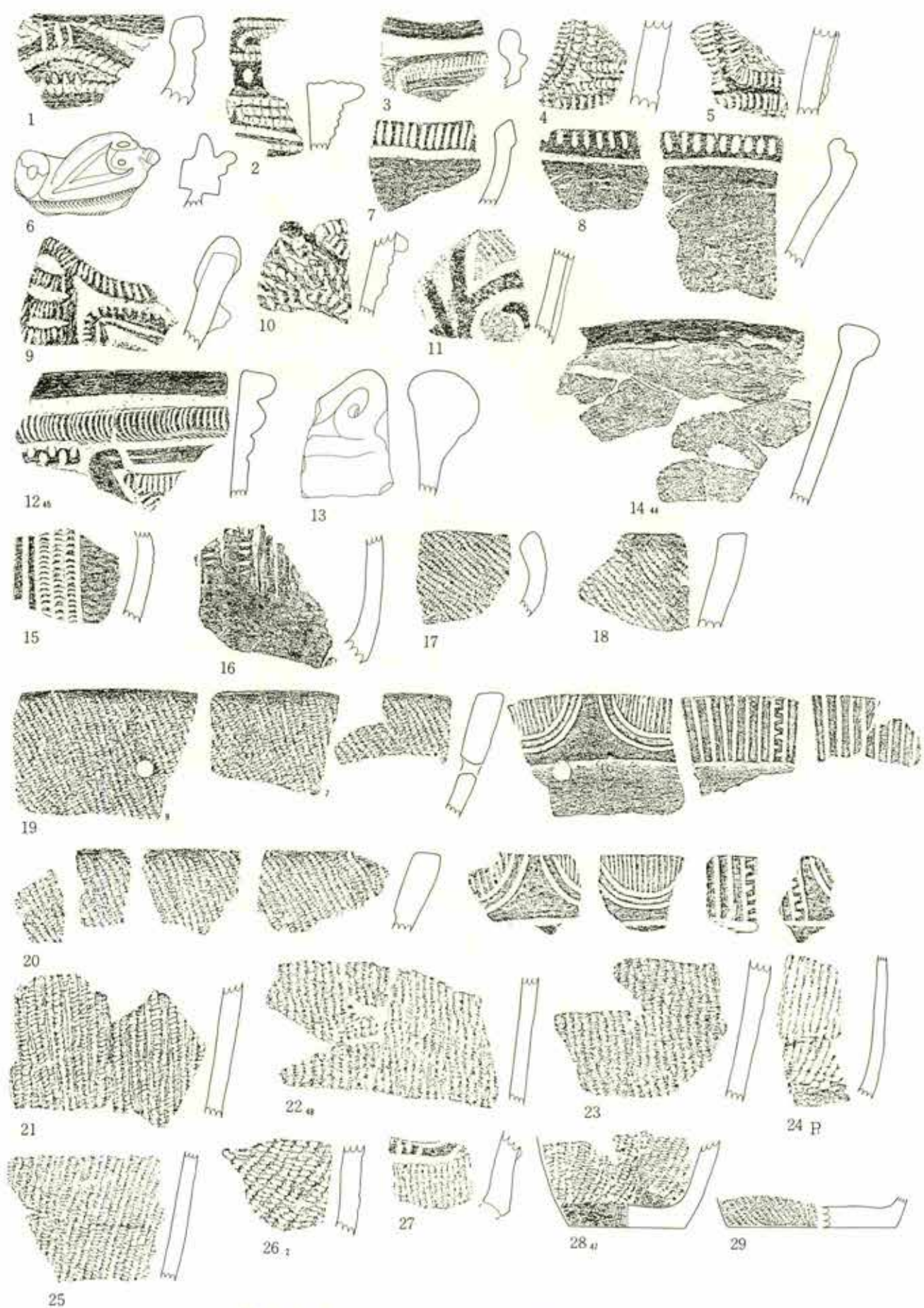

第 398 图 积迦堂 S—IV 区 SB-83 出土土器 (1)

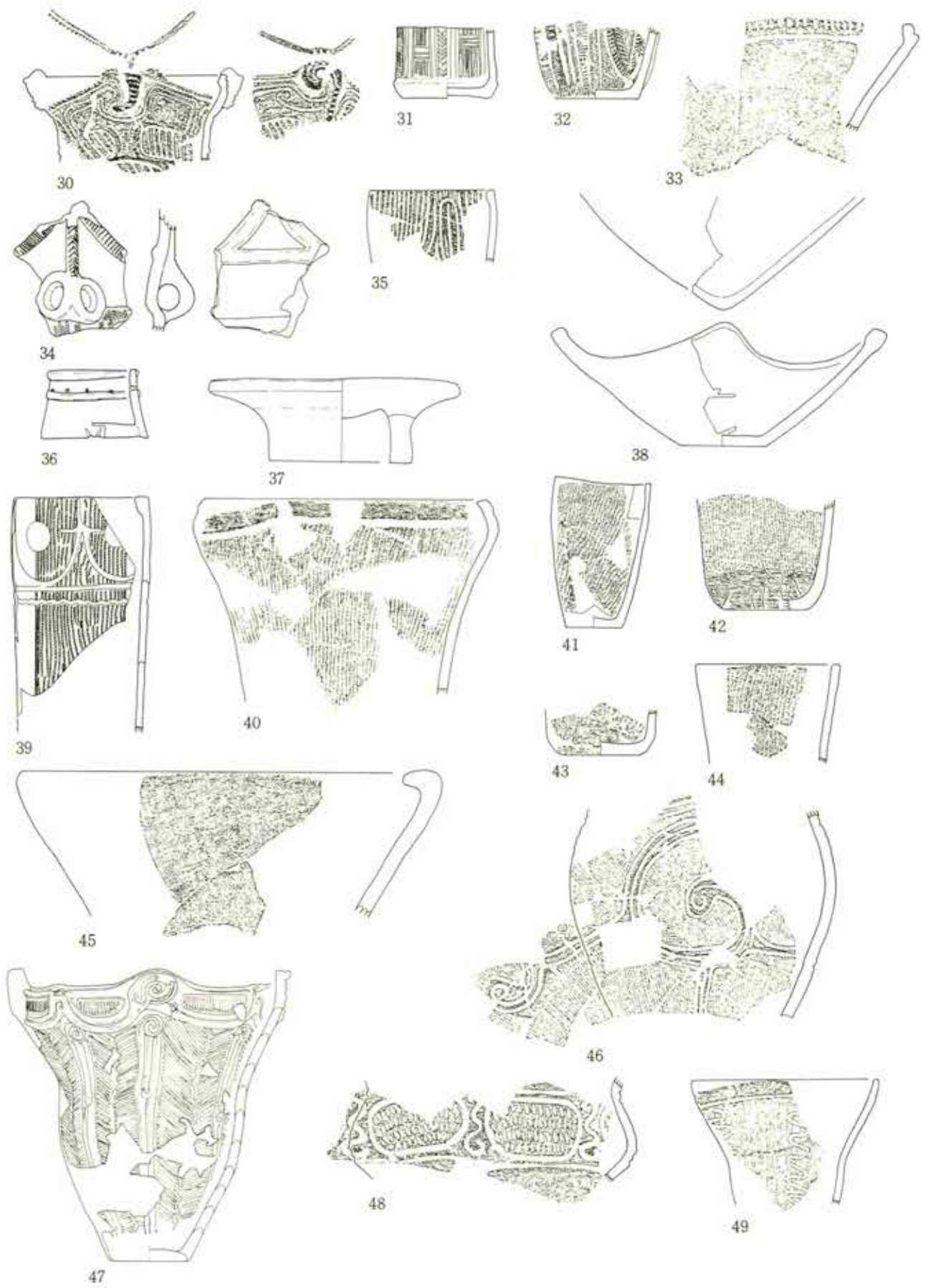

第 399 图 积迦堂 S-IV 区 SB-83 出土土器

(2) (1:6)

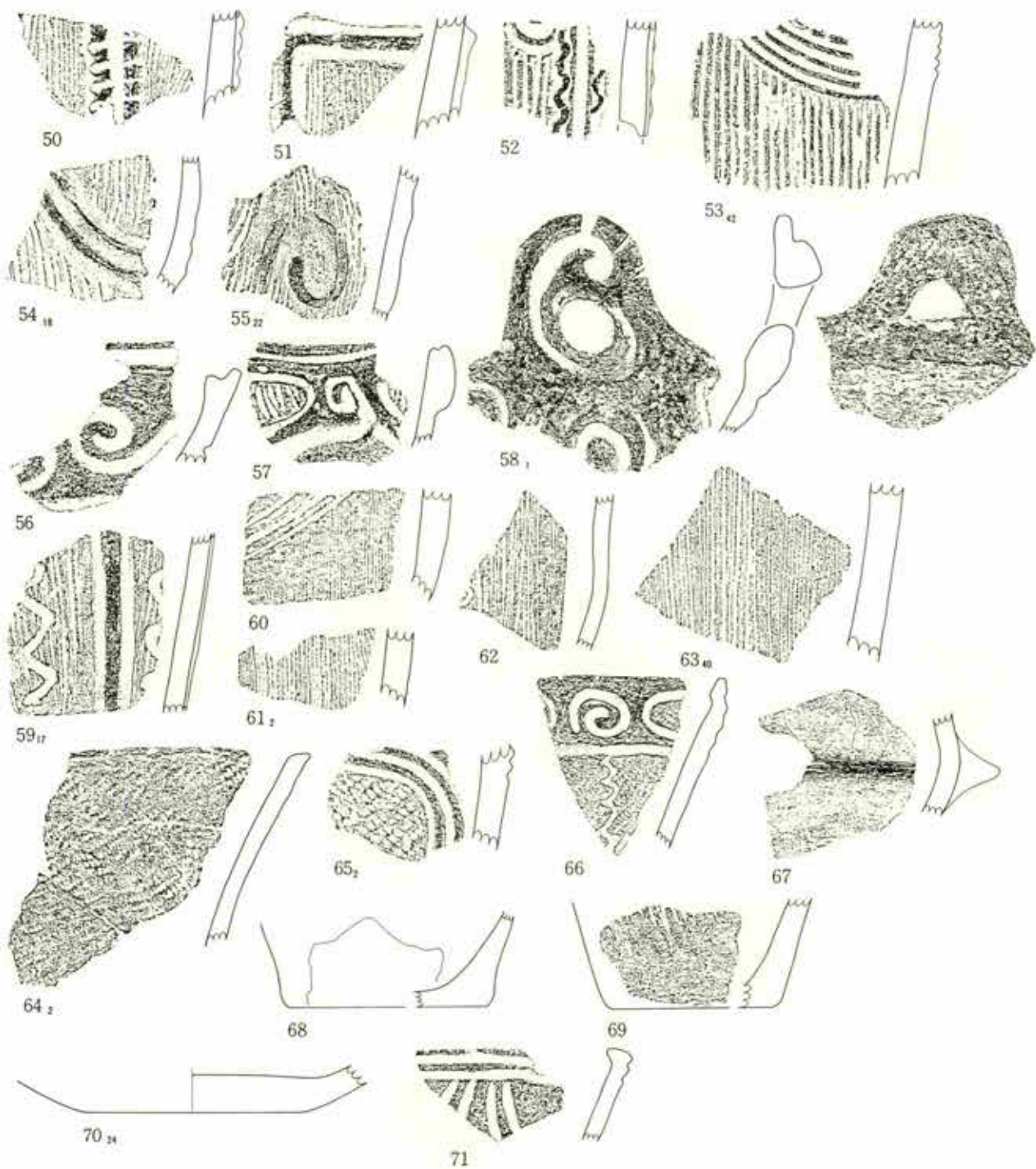

第400图 积迦堂S-IV区 SB-83 出土土器 (3)

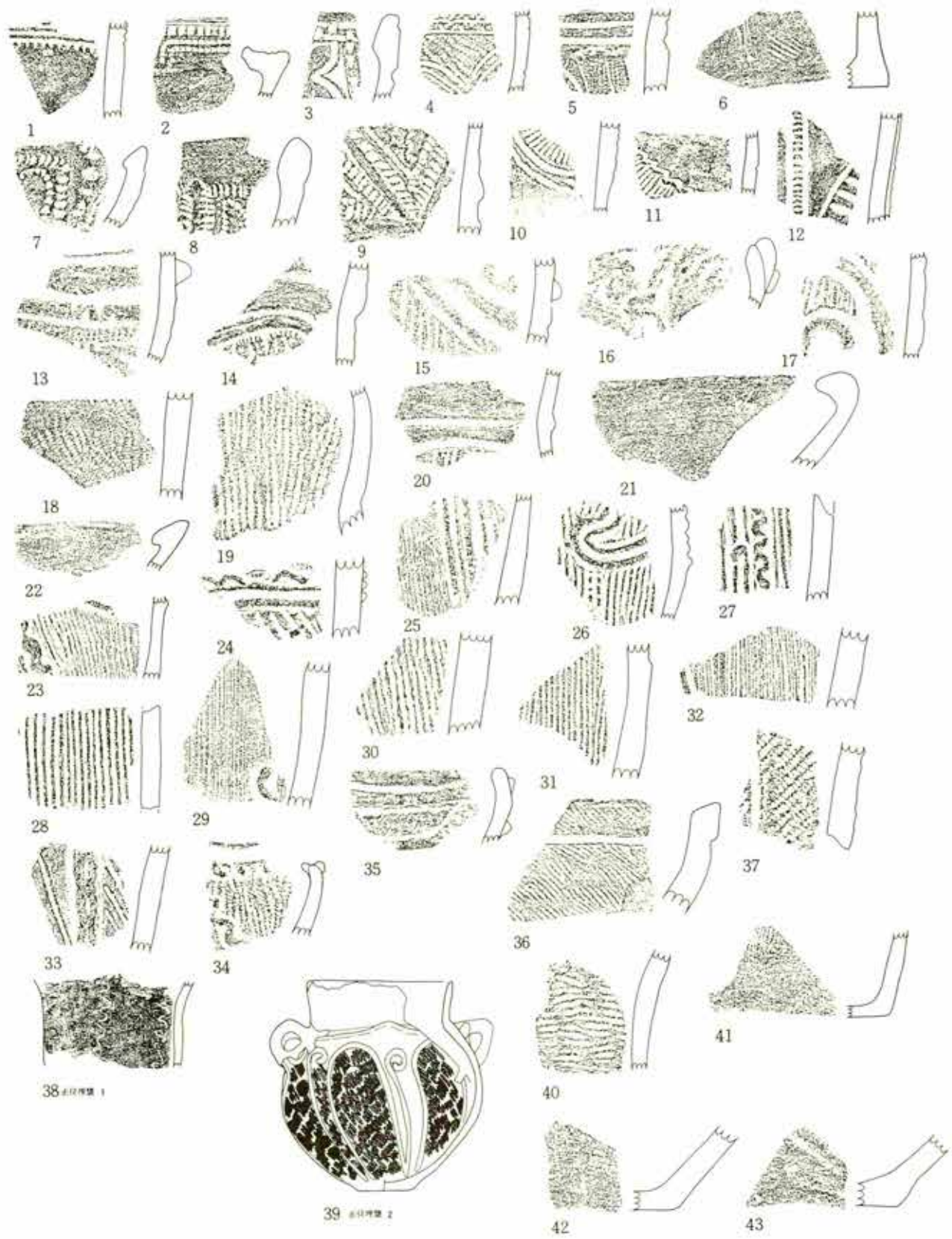

第 401 图 积逊堂 S—IV 区 SB-01 出土土器
(38.39. 1 : 6)



第 402 图 积迺堂 S-IV 区 SB-02 出土土器

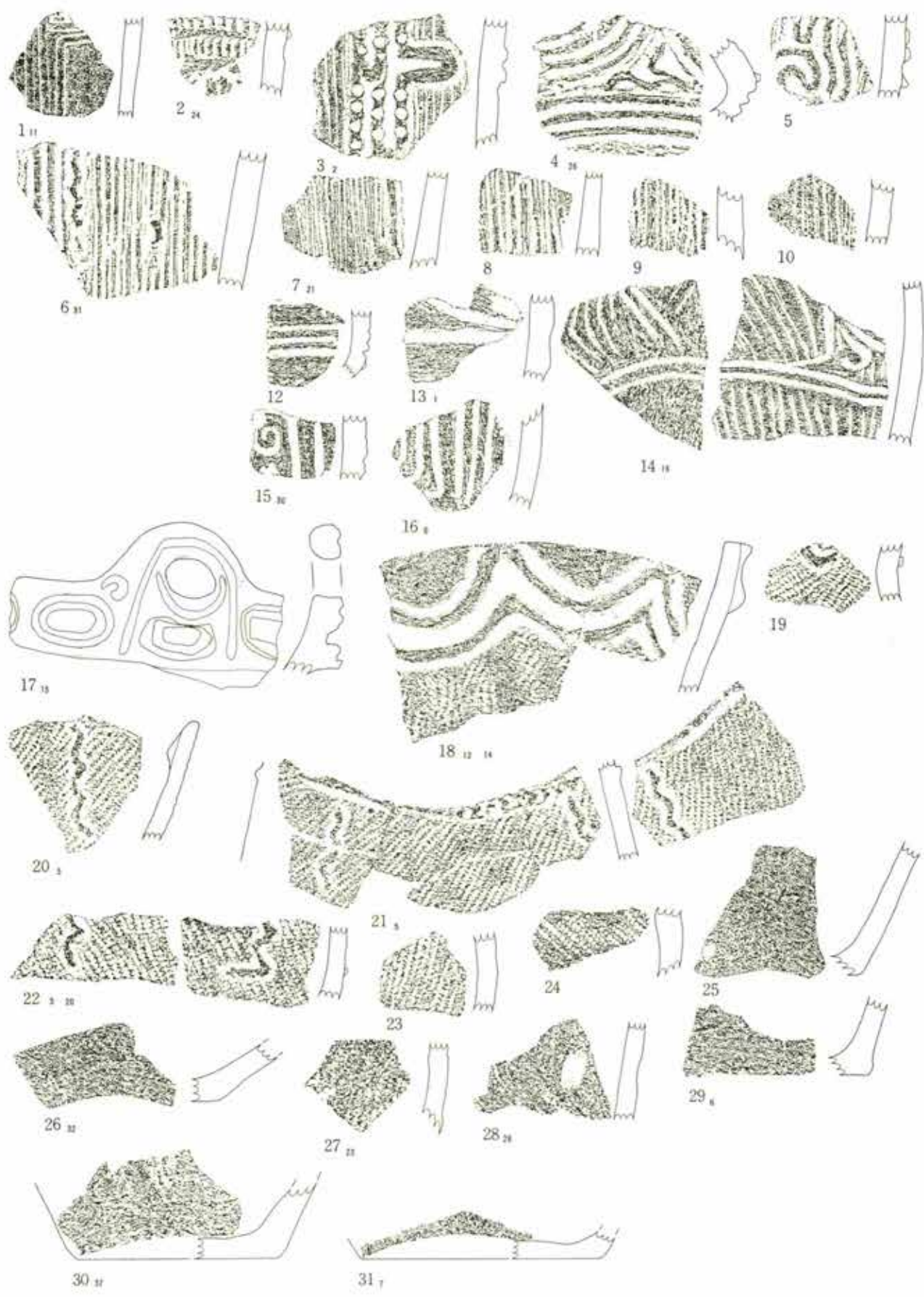

第 403 图 积迦堂 S-IV 区 SB-03 出土土器

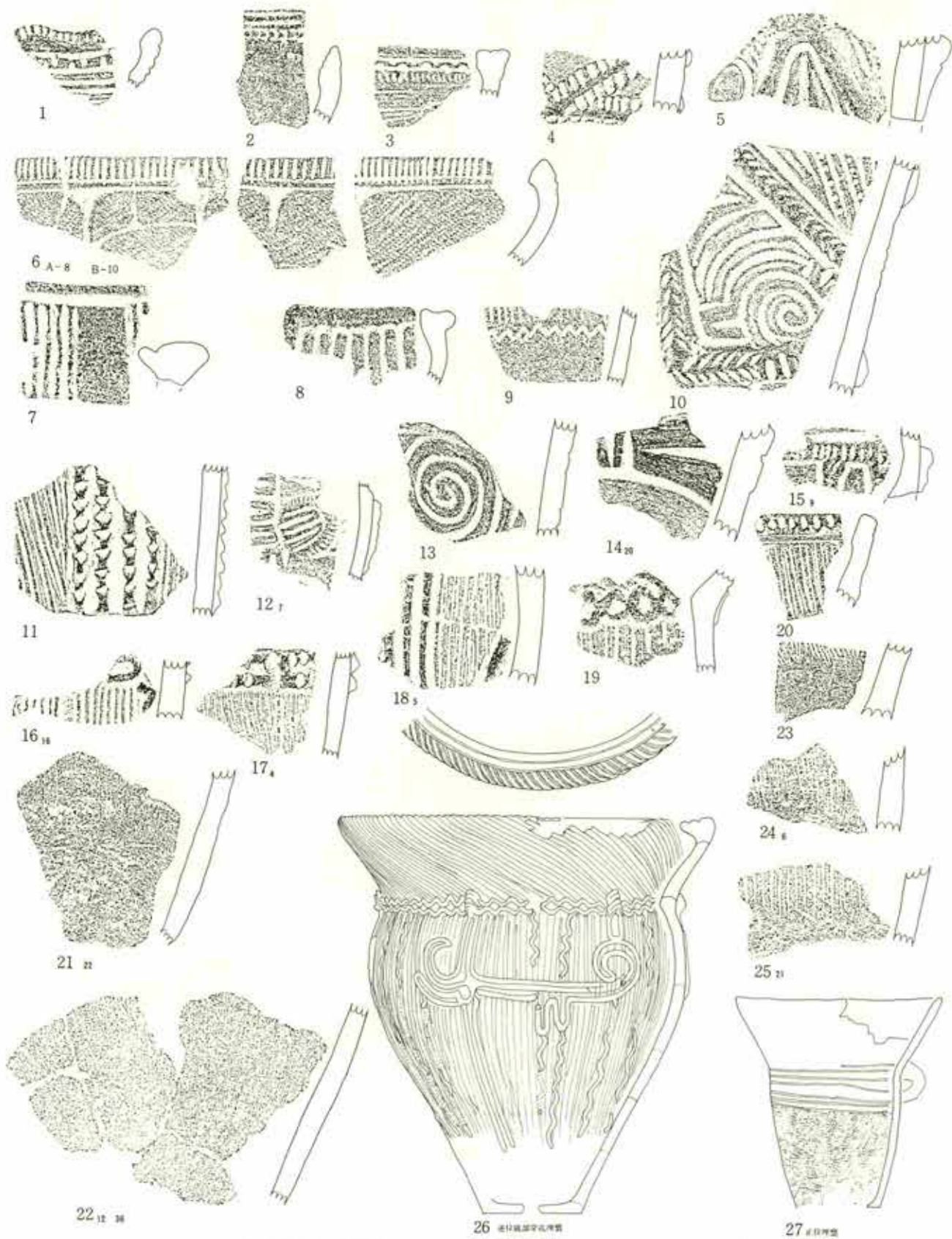

第404图 积逊堂S-IV区 SB-04 出土土器 (1) (25.26. 1:6)

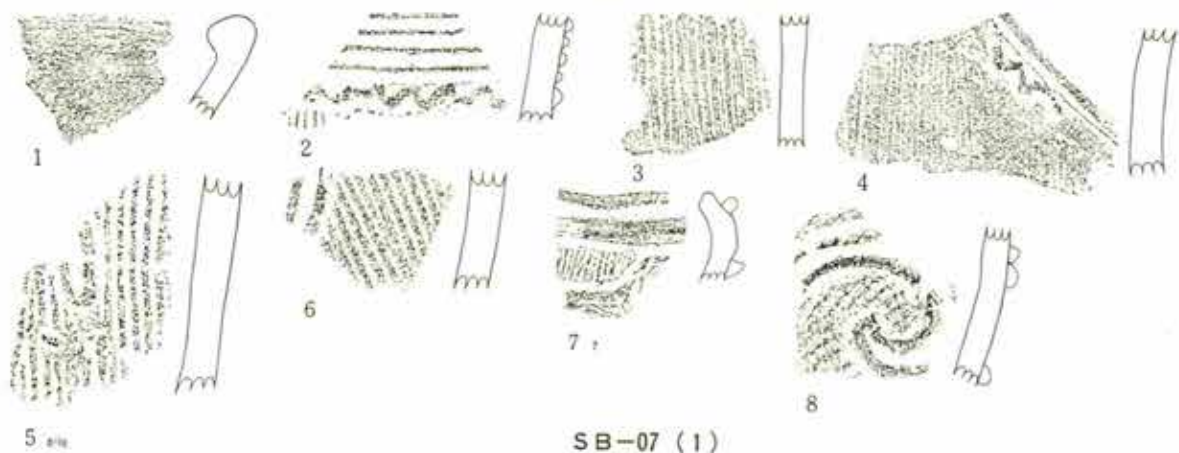
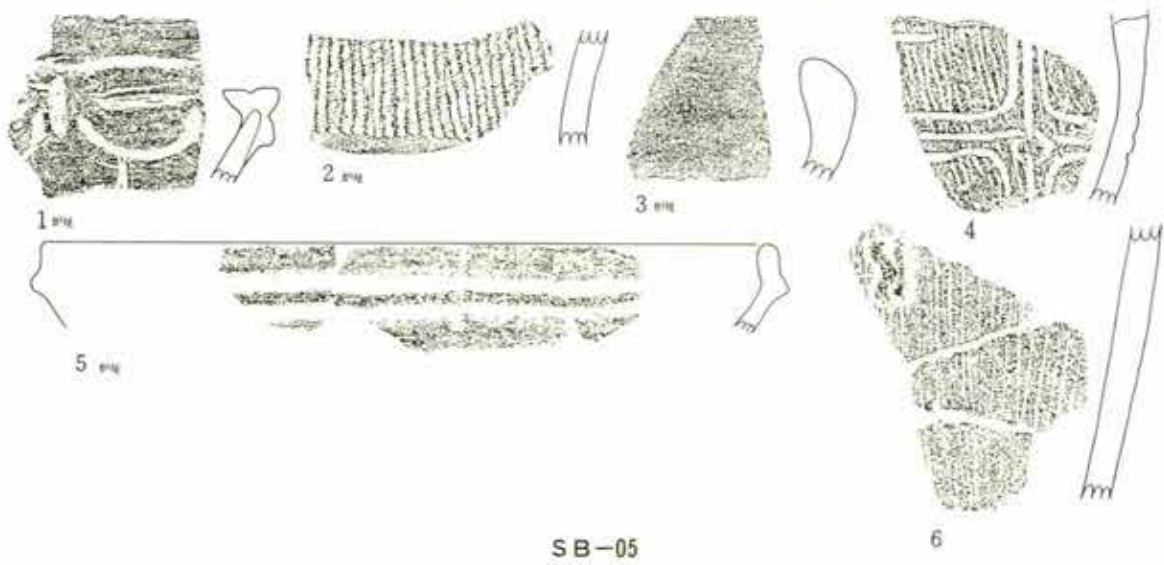
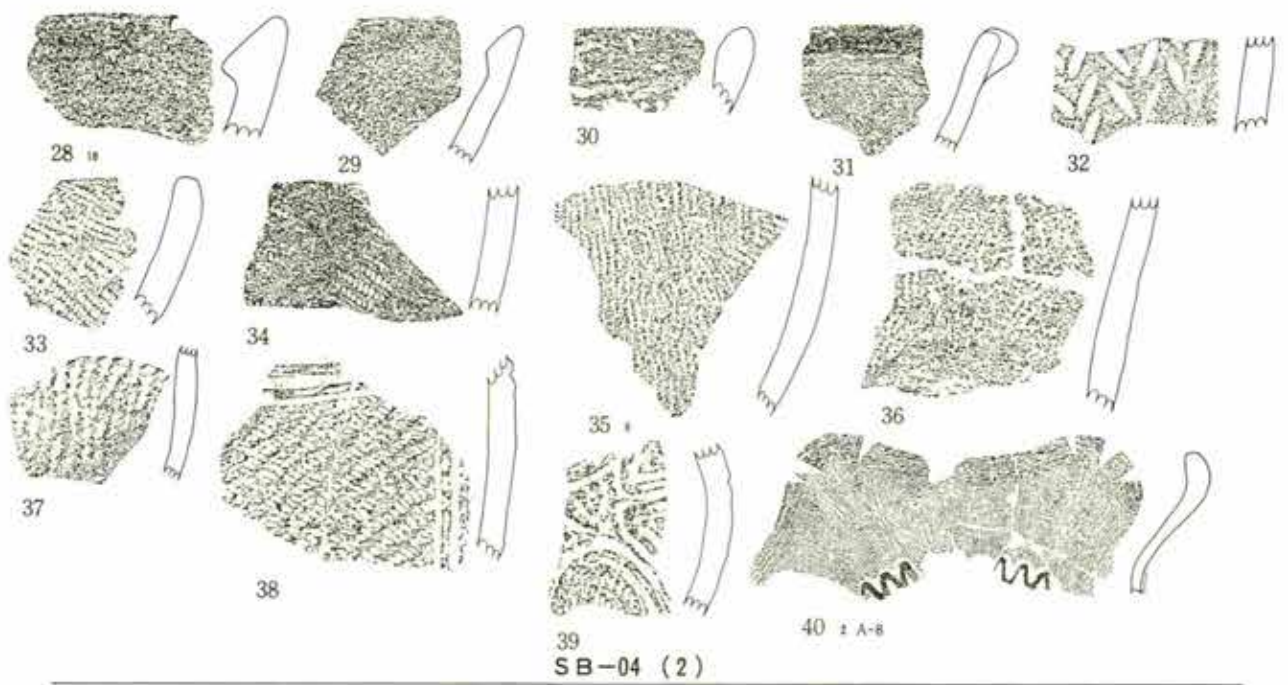

第405图 积逊堂S-IV区 SB-04 -05 -07 出土土器

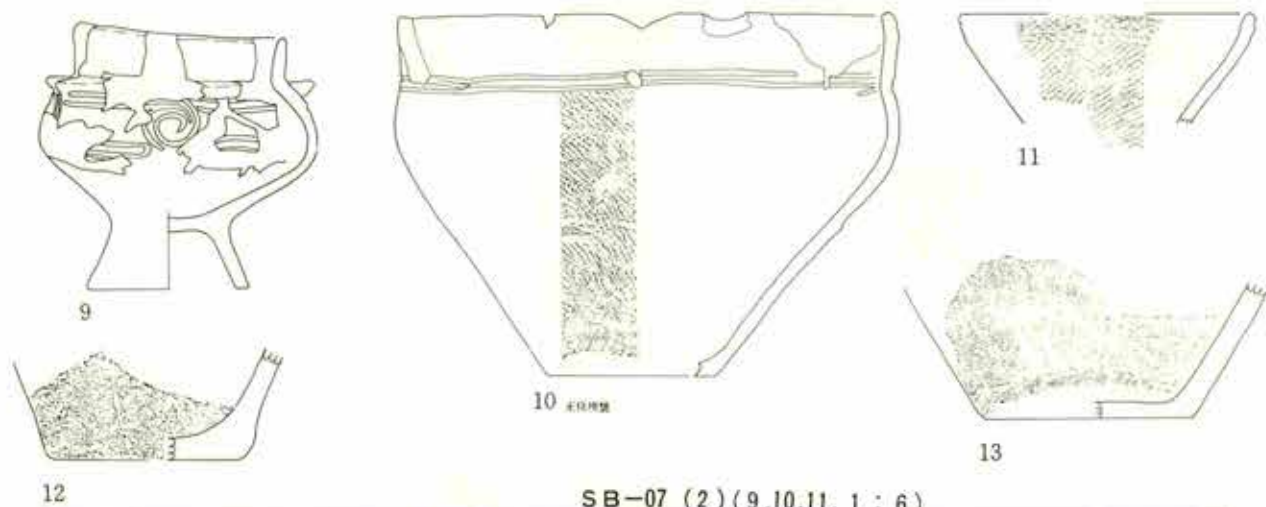

SB-07 (2) (9.10.11. 1 : 6)

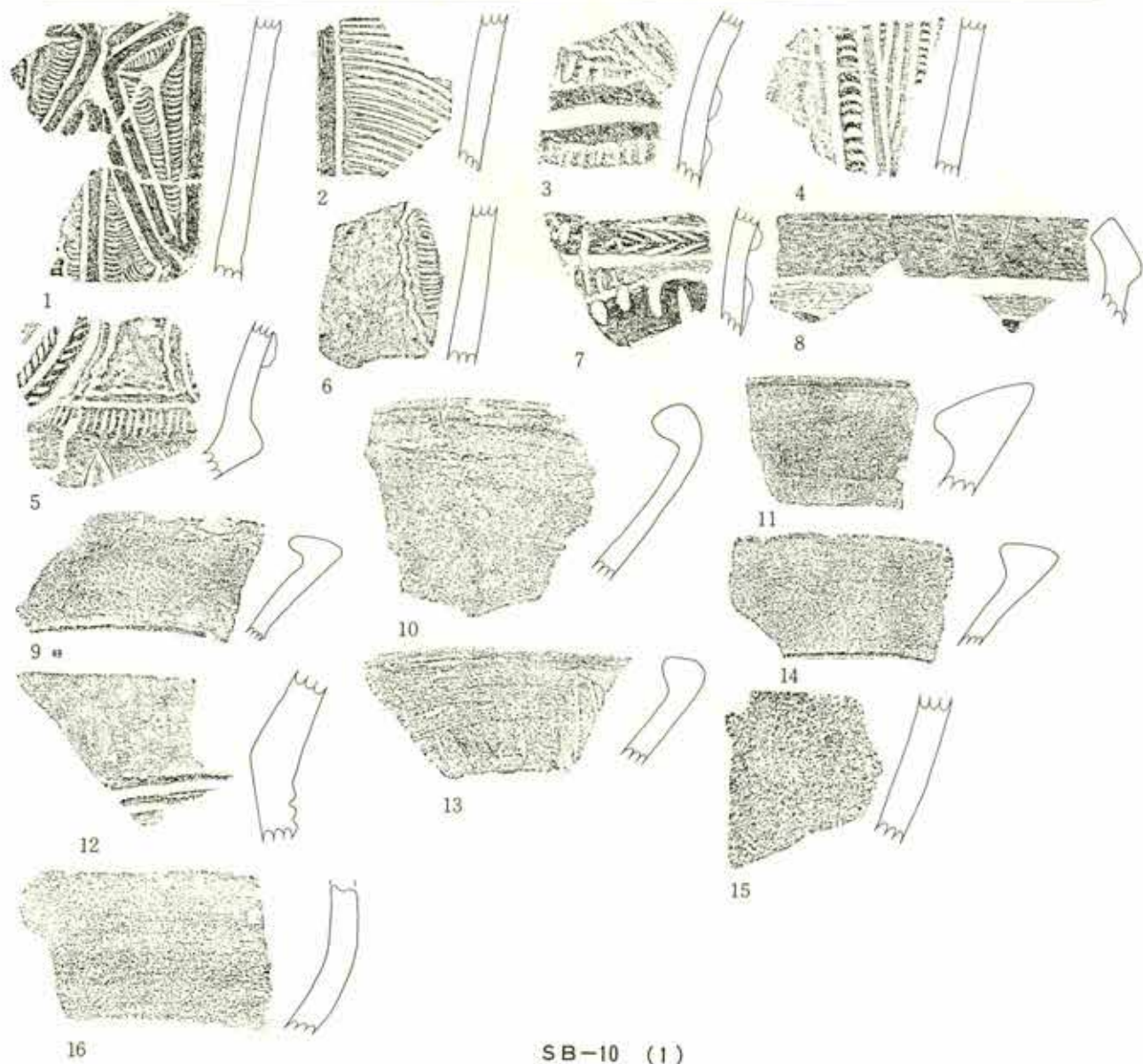

SB-10 (1)

第406图 积逊堂S-IV区 SB-07 -10 出土土器

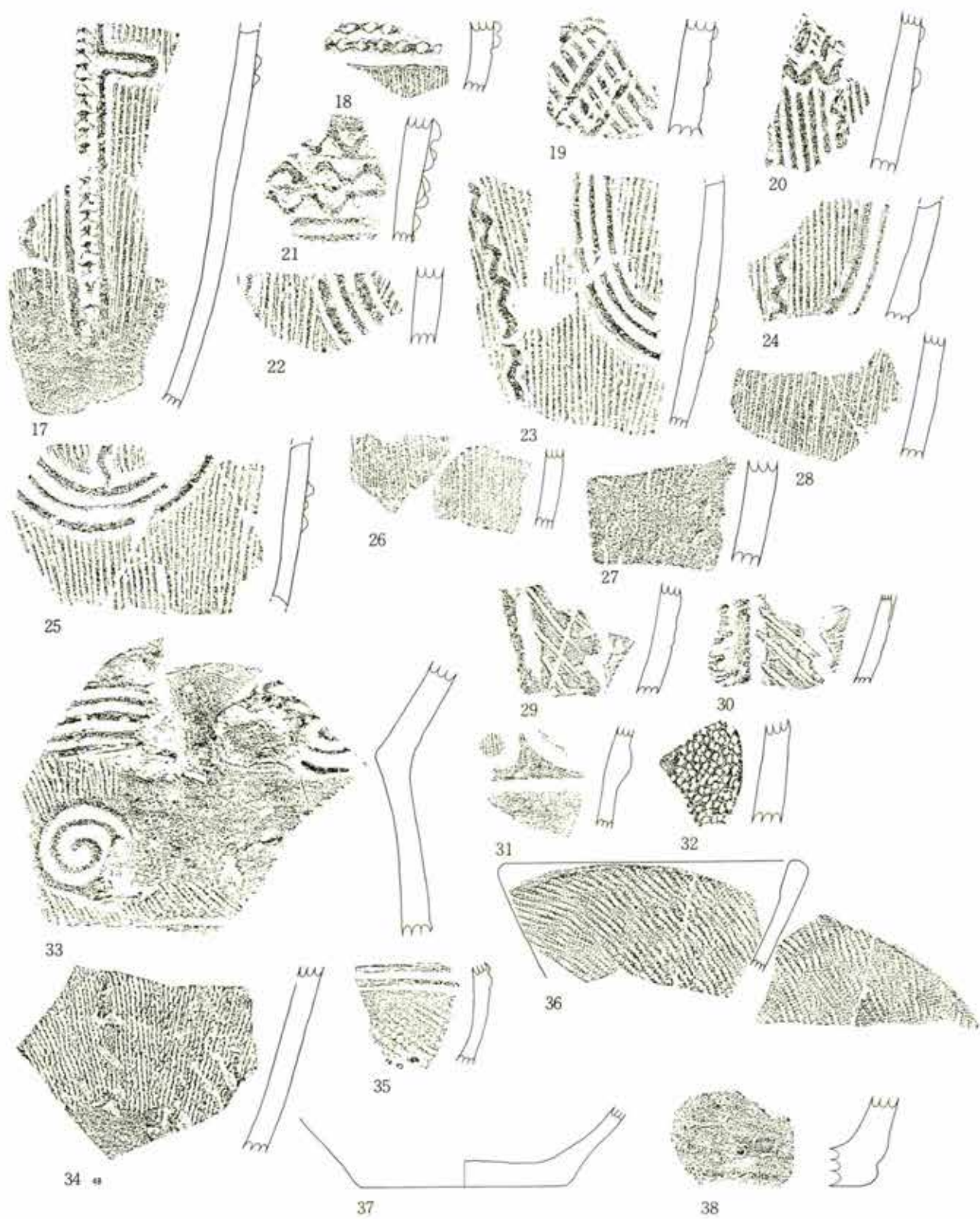

第 407 图 积迦堂S-IV区 SB-10 出土土器

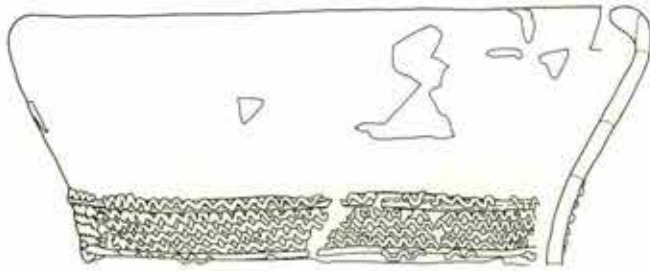

39

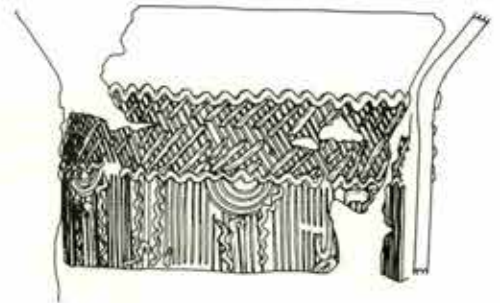

40

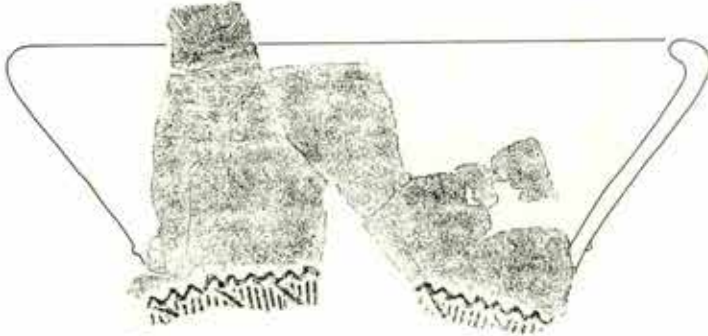

41



42



43



44



45



46



47

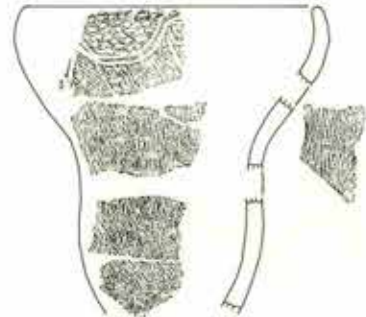

48

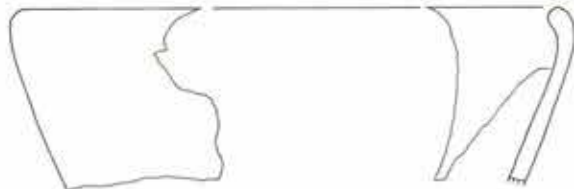

49

第 408 图 积迦堂 S-IV 区 SB-10 出土土器 (3) (1:6)

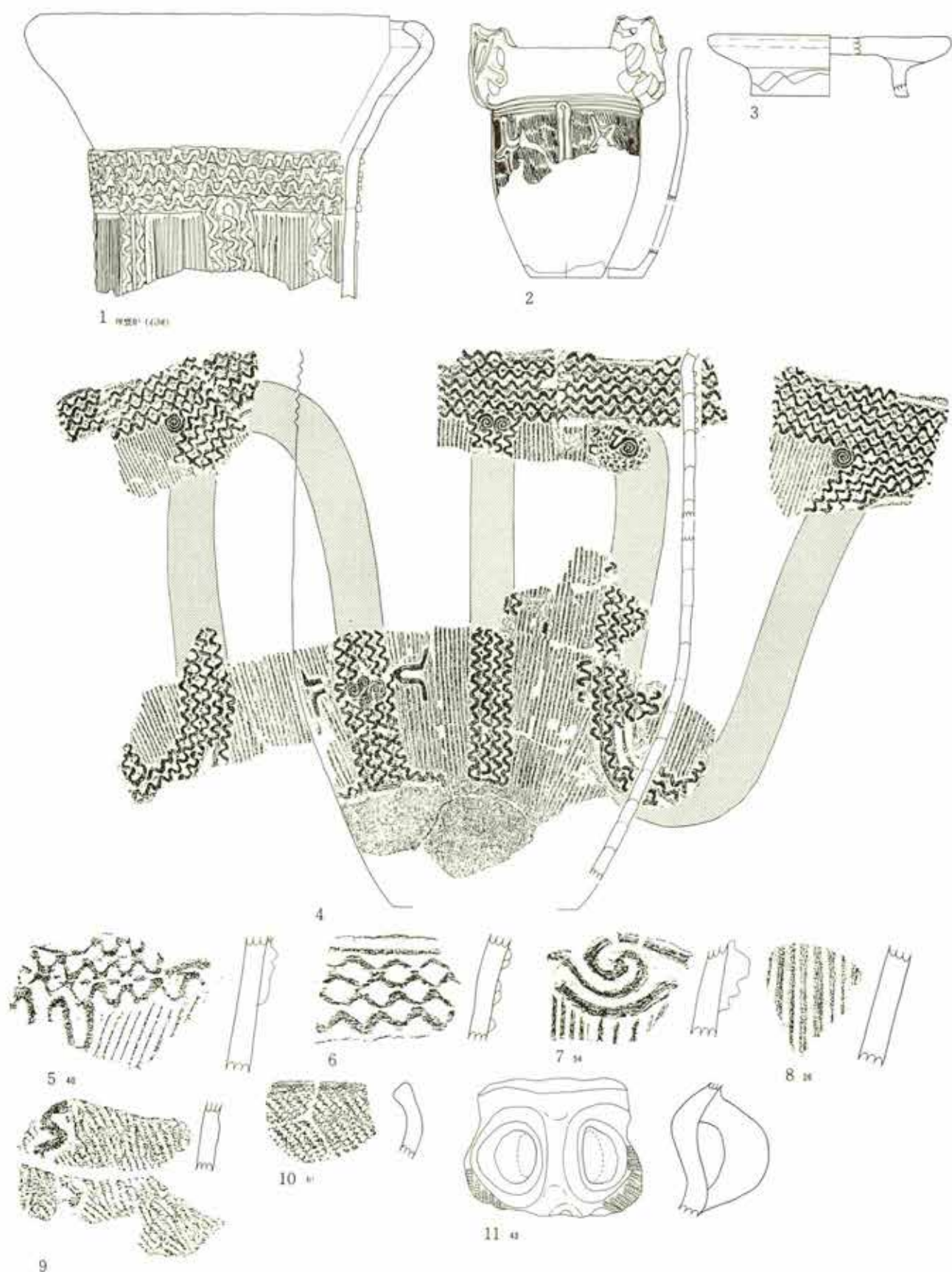

第 409 图 积迦堂 S-IV 区 SB-11 出土土器 (1)
(1.2.3.4. 1:6)



第 410 图 积迦堂S-N区 SB-11 出土土器 (2)
 (28.29.35. 40. 1 : 6)



第411图 积逊堂S-IV区SB-12出土土器

(1)

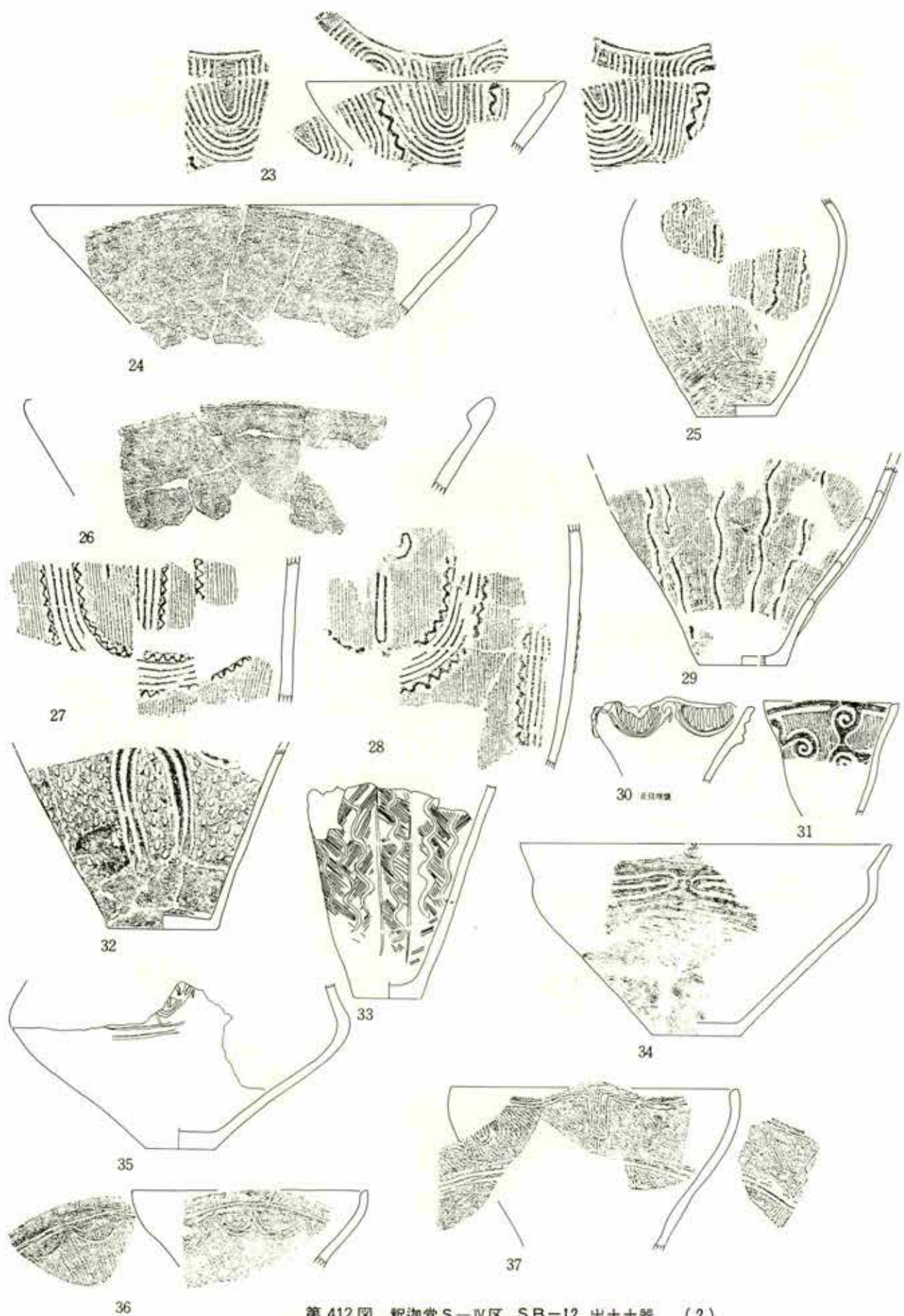

第 412 图 积迦堂 S-IV 区 SB-12 出土土器 (2)



第 413 图 积逊堂 S-IV 区 SB-17 出土土器 (1)

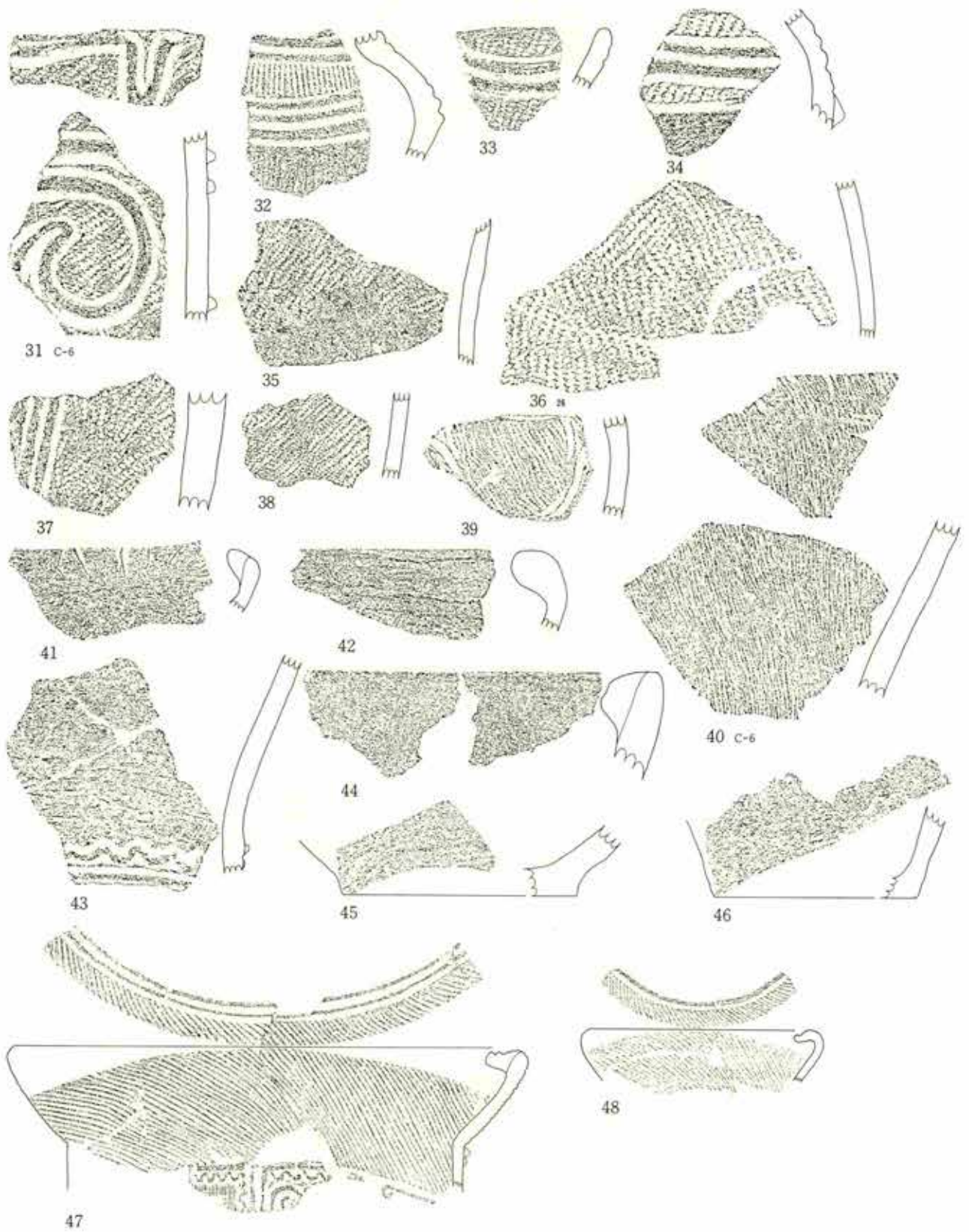

第414图 积迦堂S-IV区SB-17出土土器(2)
(47.48. 1:6)

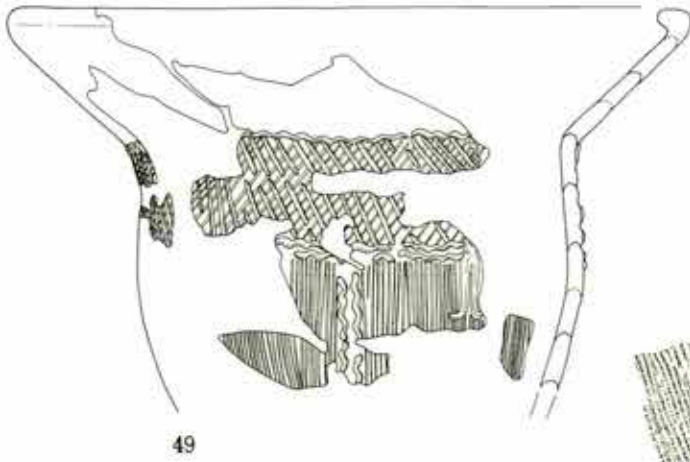

49

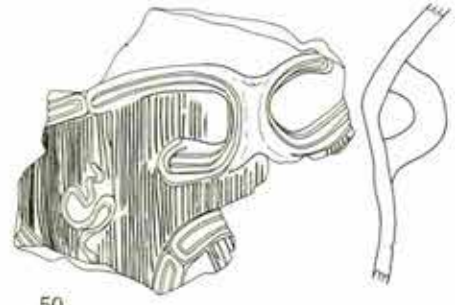

50



51



52

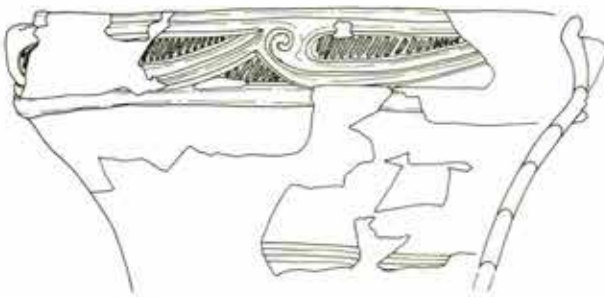

53



54



55



56

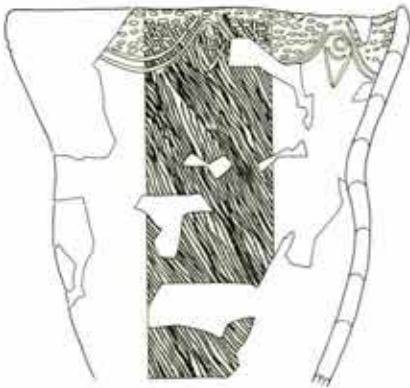

57

第 415 图 积迦堂 S—IV 区 SB—17 出土土器 (3)

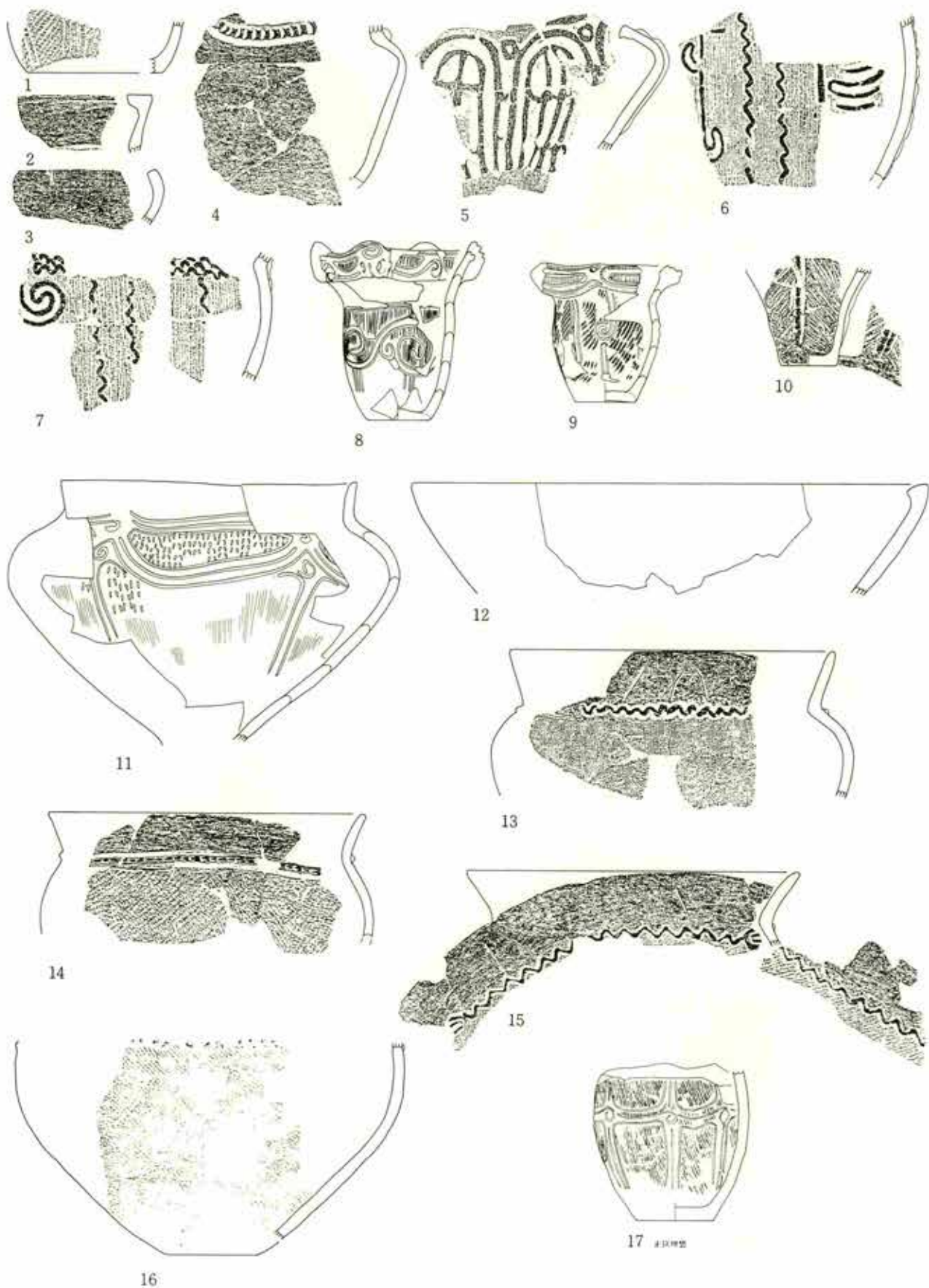

第 416 图 积迦堂 S—IV 区 SB-20 出土土器 (1) (1 : 6)



第 417 图 积迦堂 S-IV 区 SB-20 出土土器 (2)
(54 1:6)



第418图 积迦堂S-IV区 SB-20 出土土器 (3)

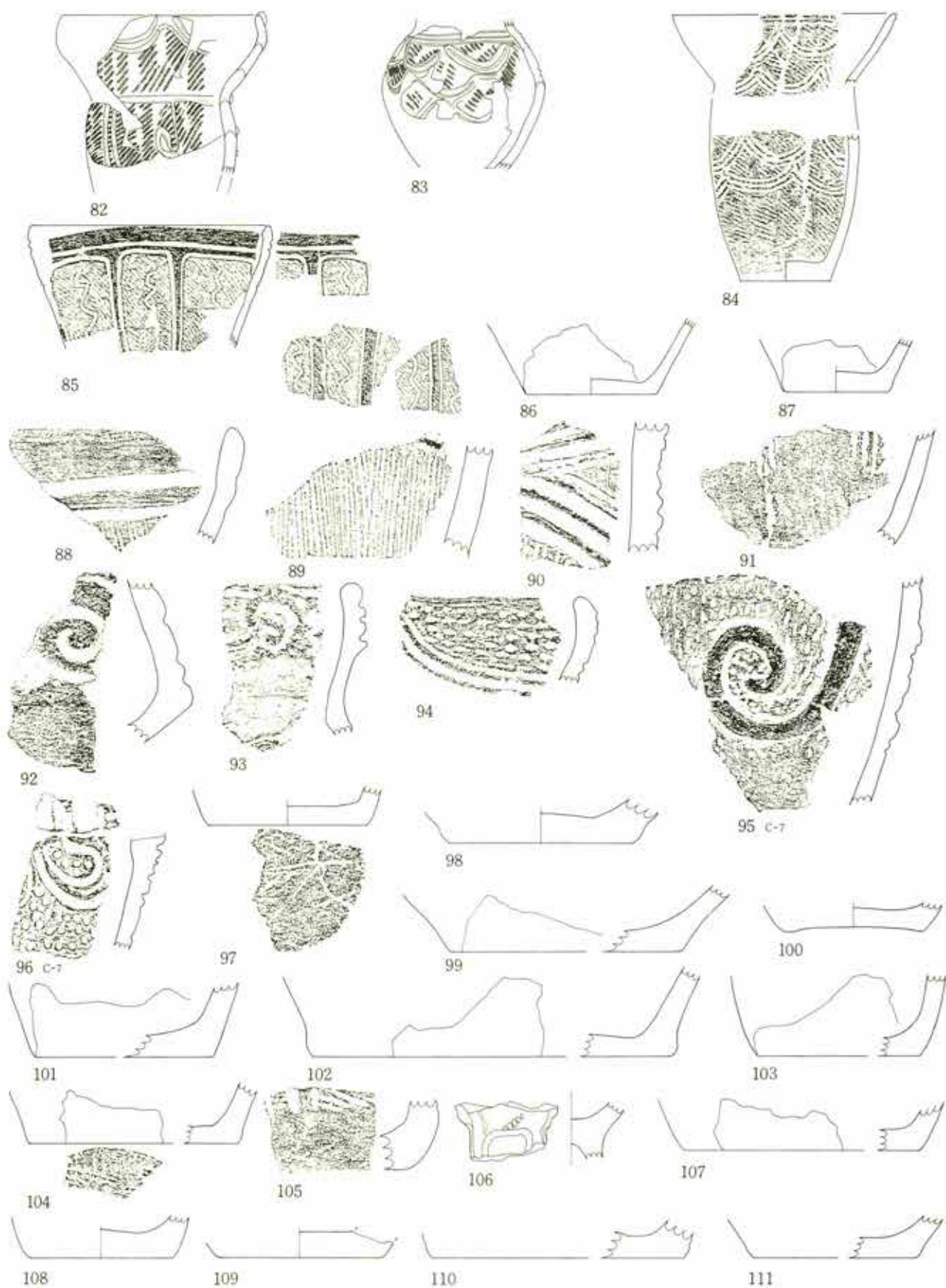

第419图 积迦堂S-IV区SB-20出土土器
 (82.83.84.85.86.87. 1:6)

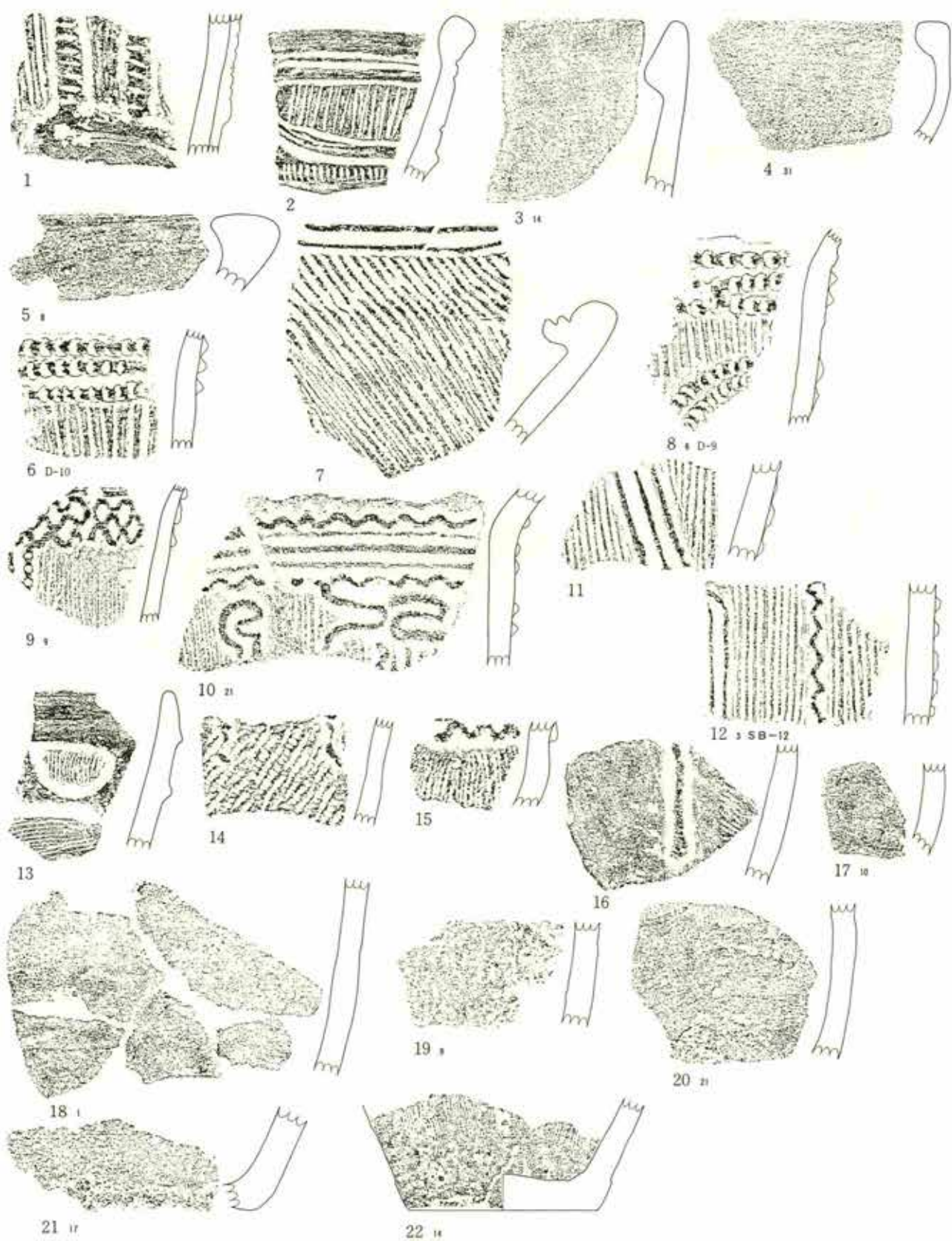

第 420 图 积逊堂 S-IV 区 SB-21 出土土器 (1)

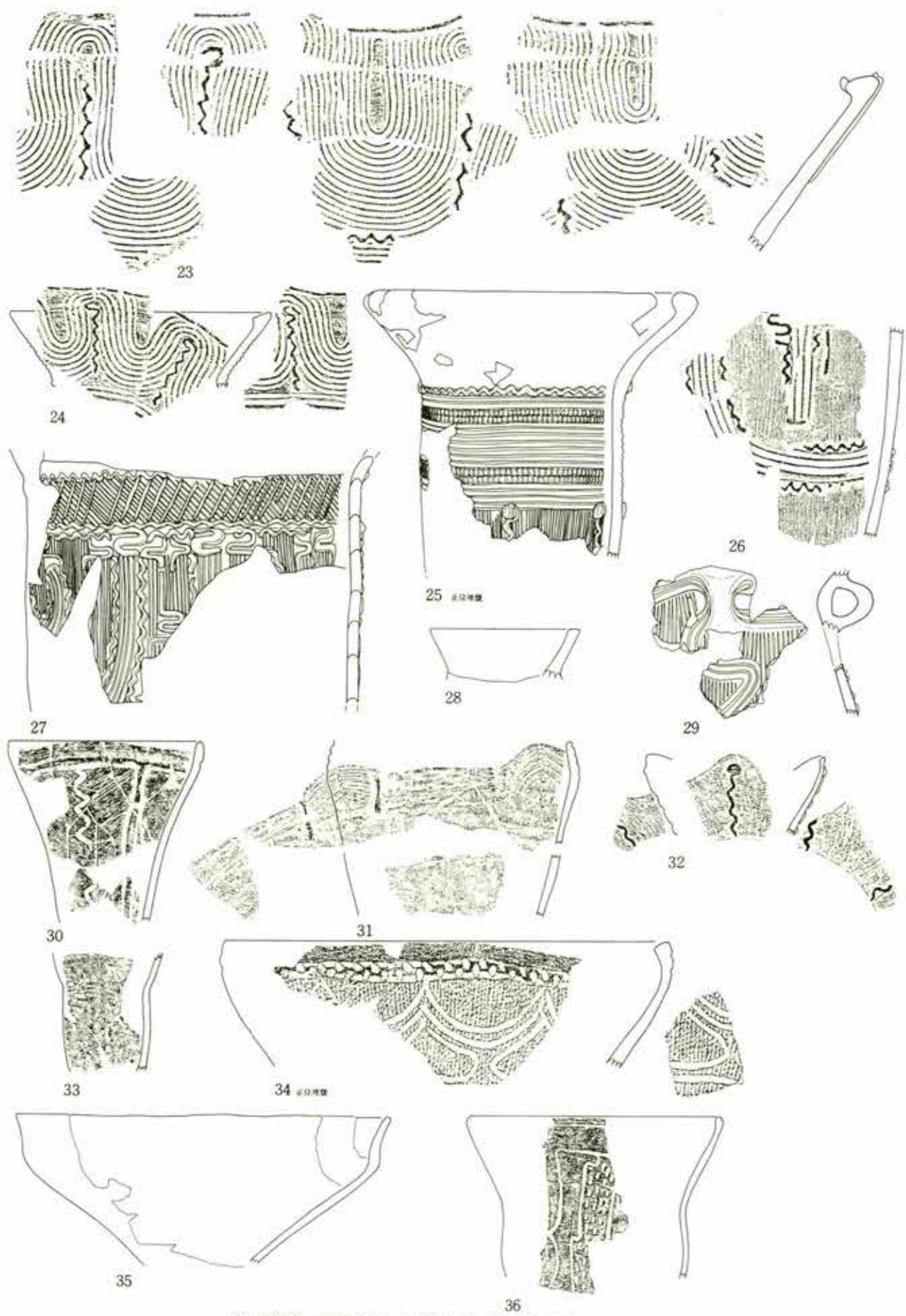

第 421 图 积迦堂 S-IV 区 SB-21 出土土器 (2) (1:6)

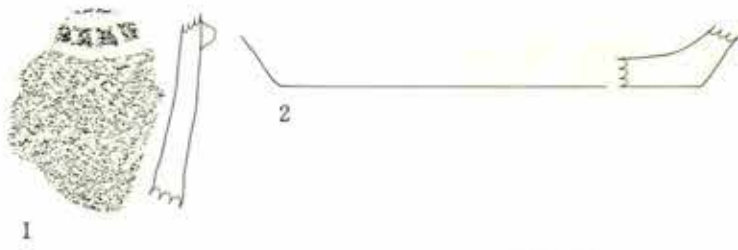
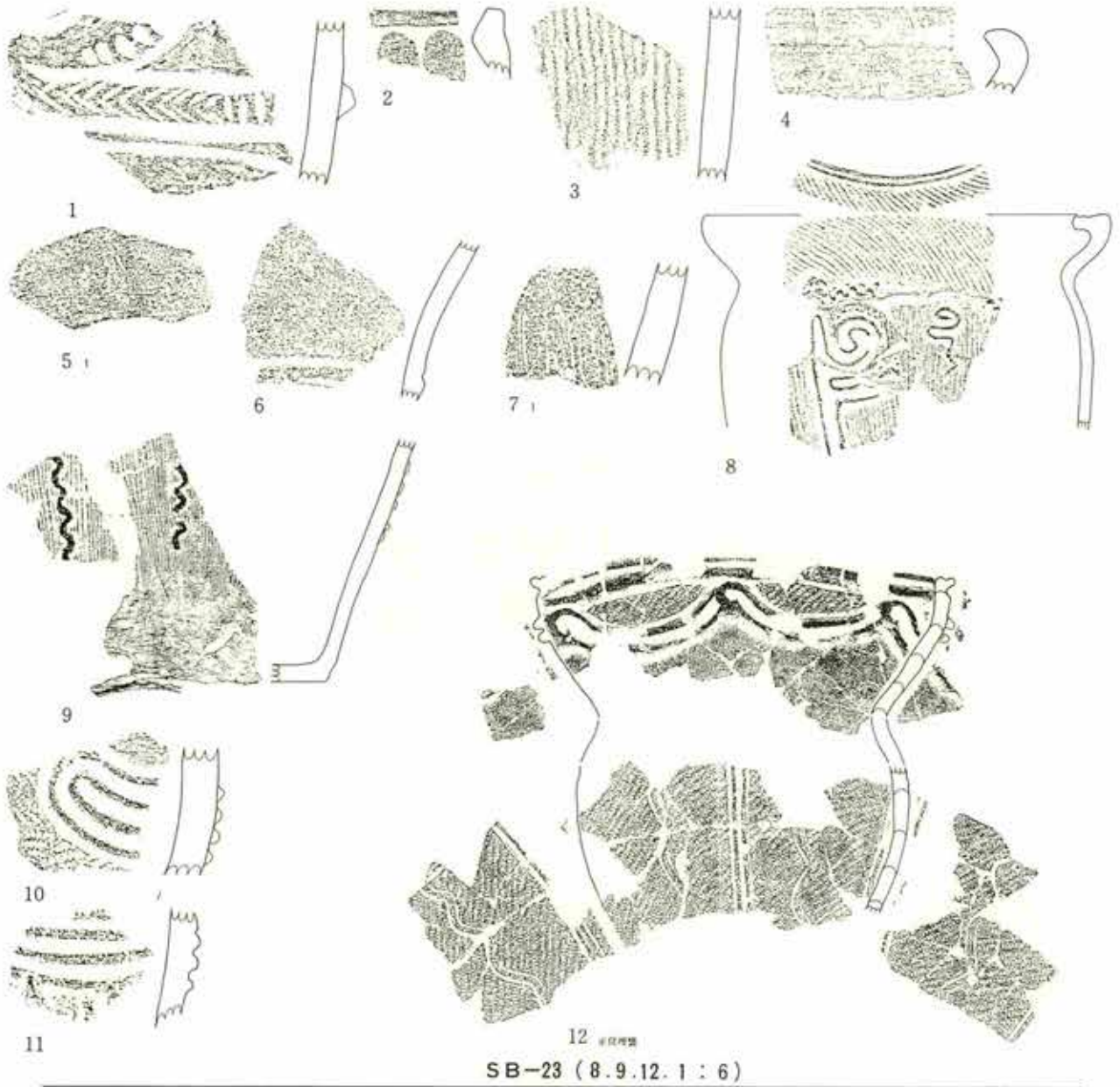

SB-24

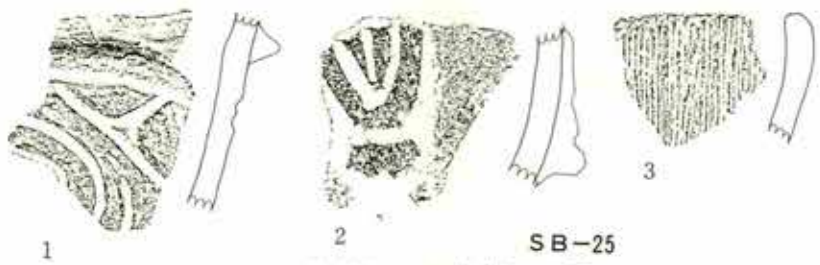

SB-25



第423图 积逊堂S-N区 SB-28 SB-30 出土土器 (1)
(22. 1 : 6)

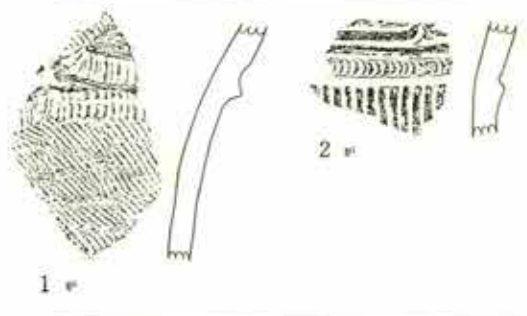
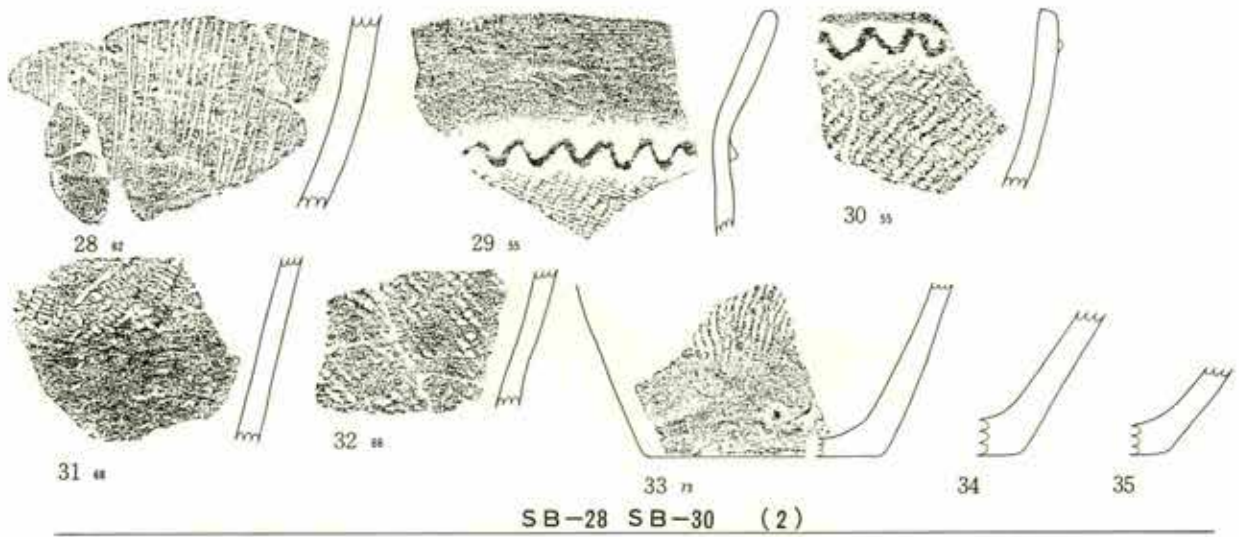

第 424 图 积逊堂 S-IV 区 SB-28 -30 -31 -33 出土土器

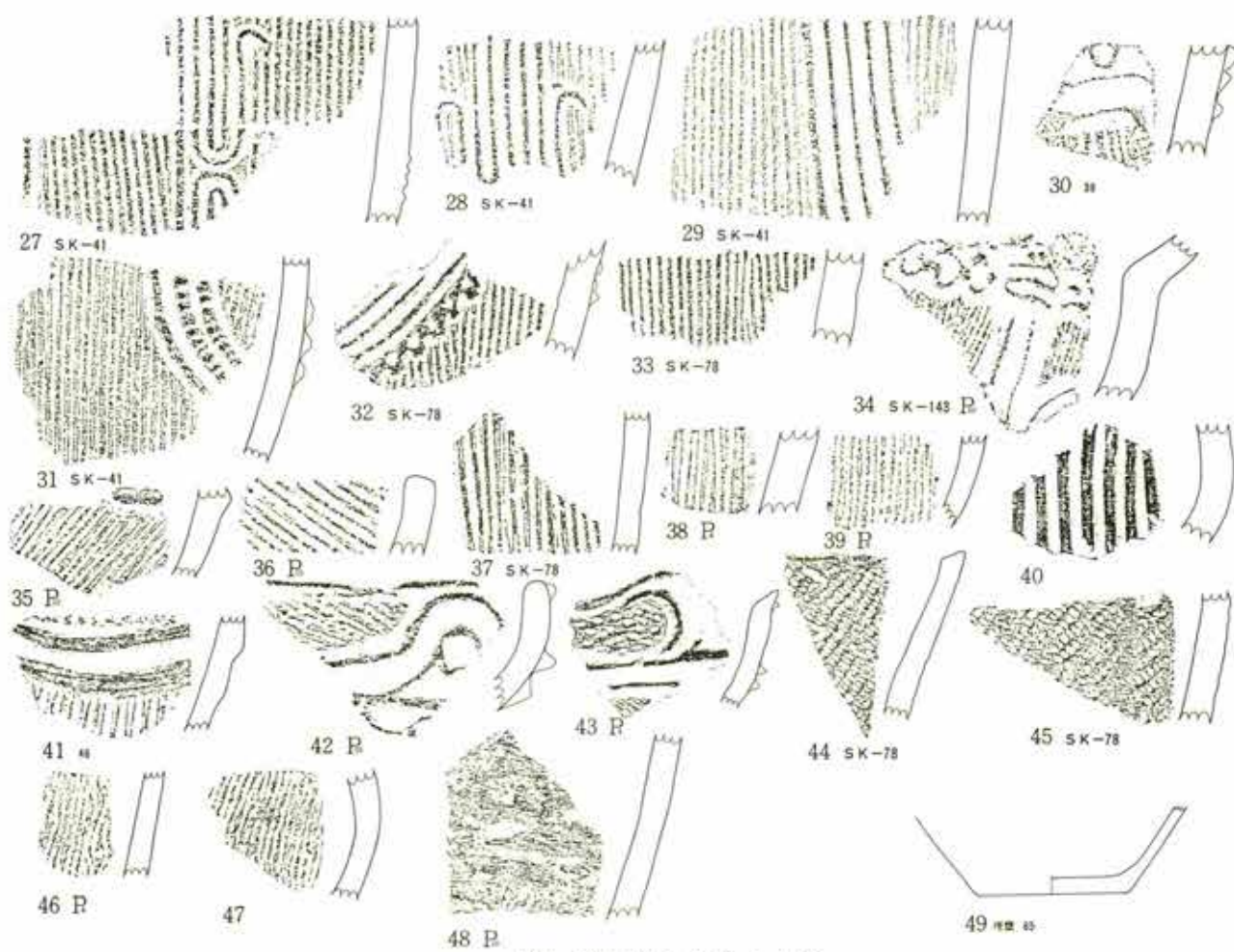

SB-33 (2) (49. 1 : 6)

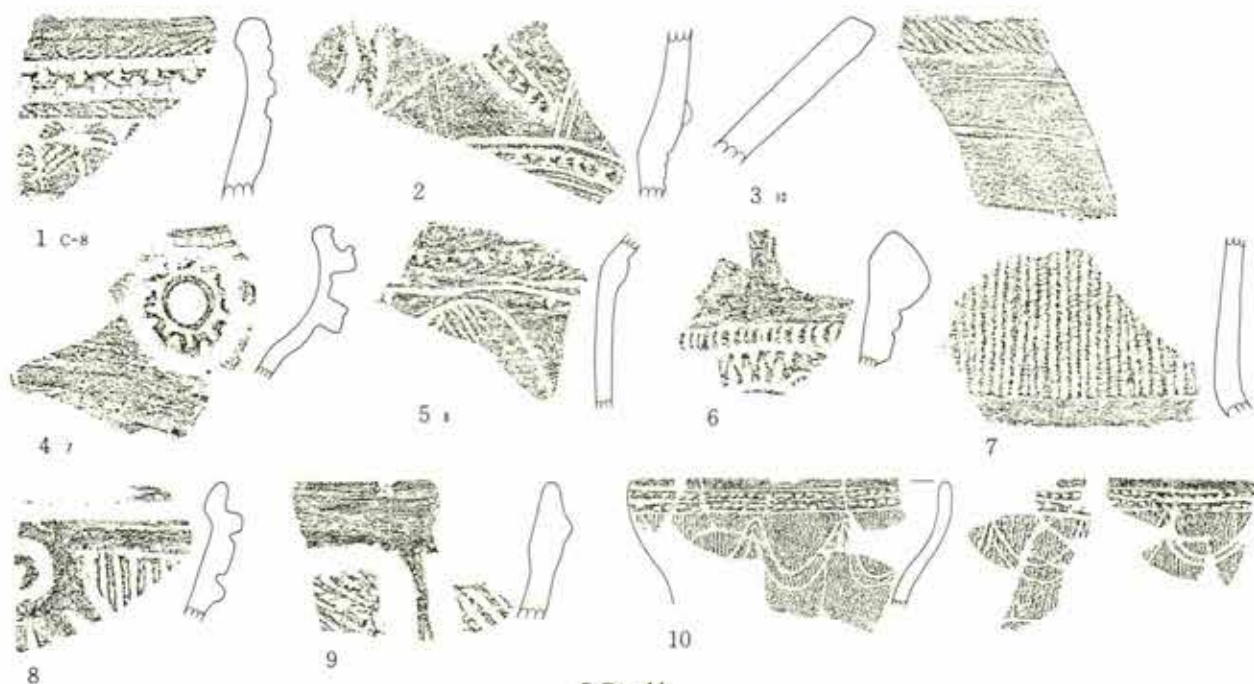

SB-44

第425图 积迦堂S-IV区 SB-33 -44 出土土器 (10. 1 : 6)



第 426 图 积迦堂 S-IV 区 SB-50 出土土器

(1)

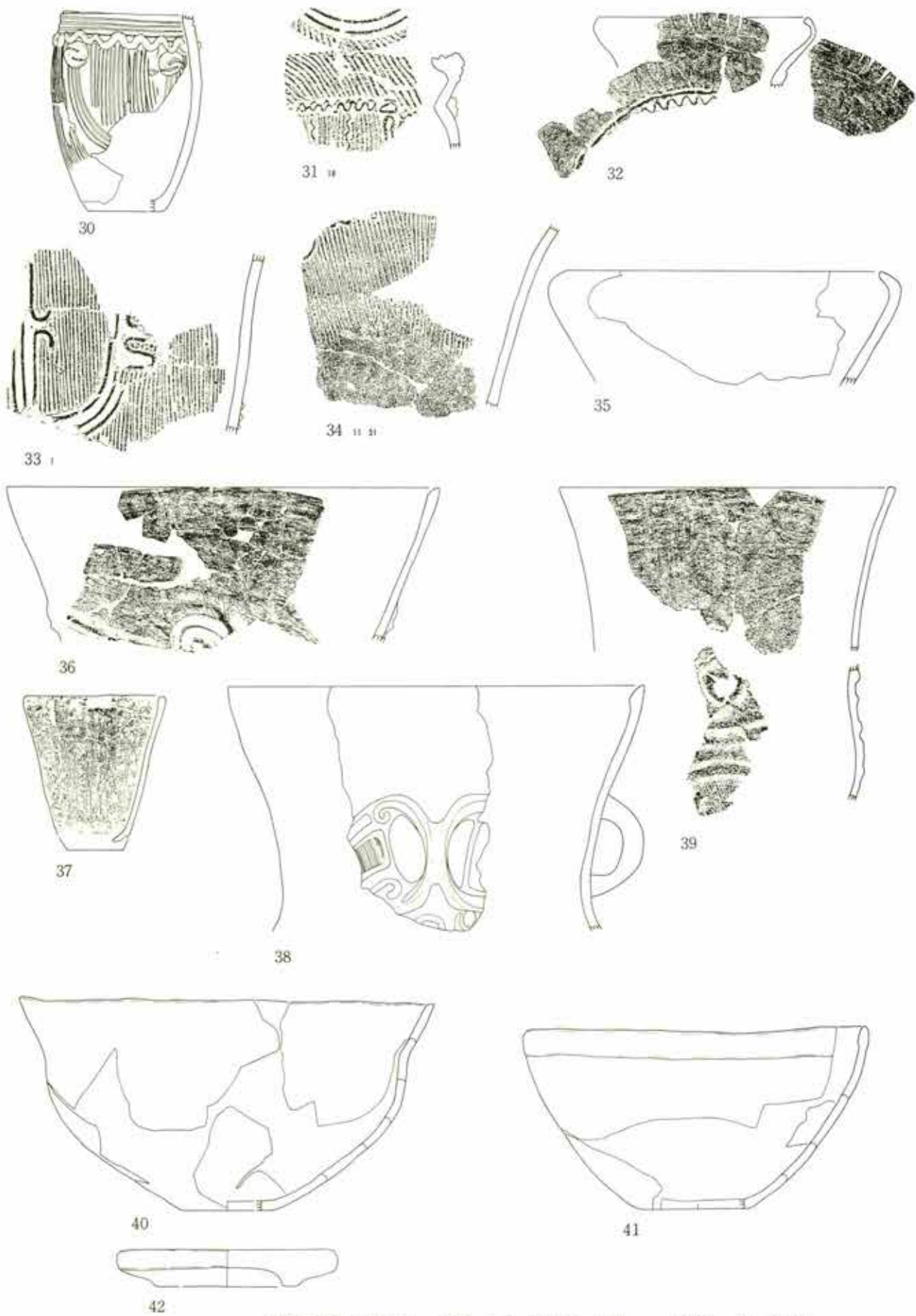

第427图 积迦堂S-IV区 SB-50 出土土器 (2) (1:6)

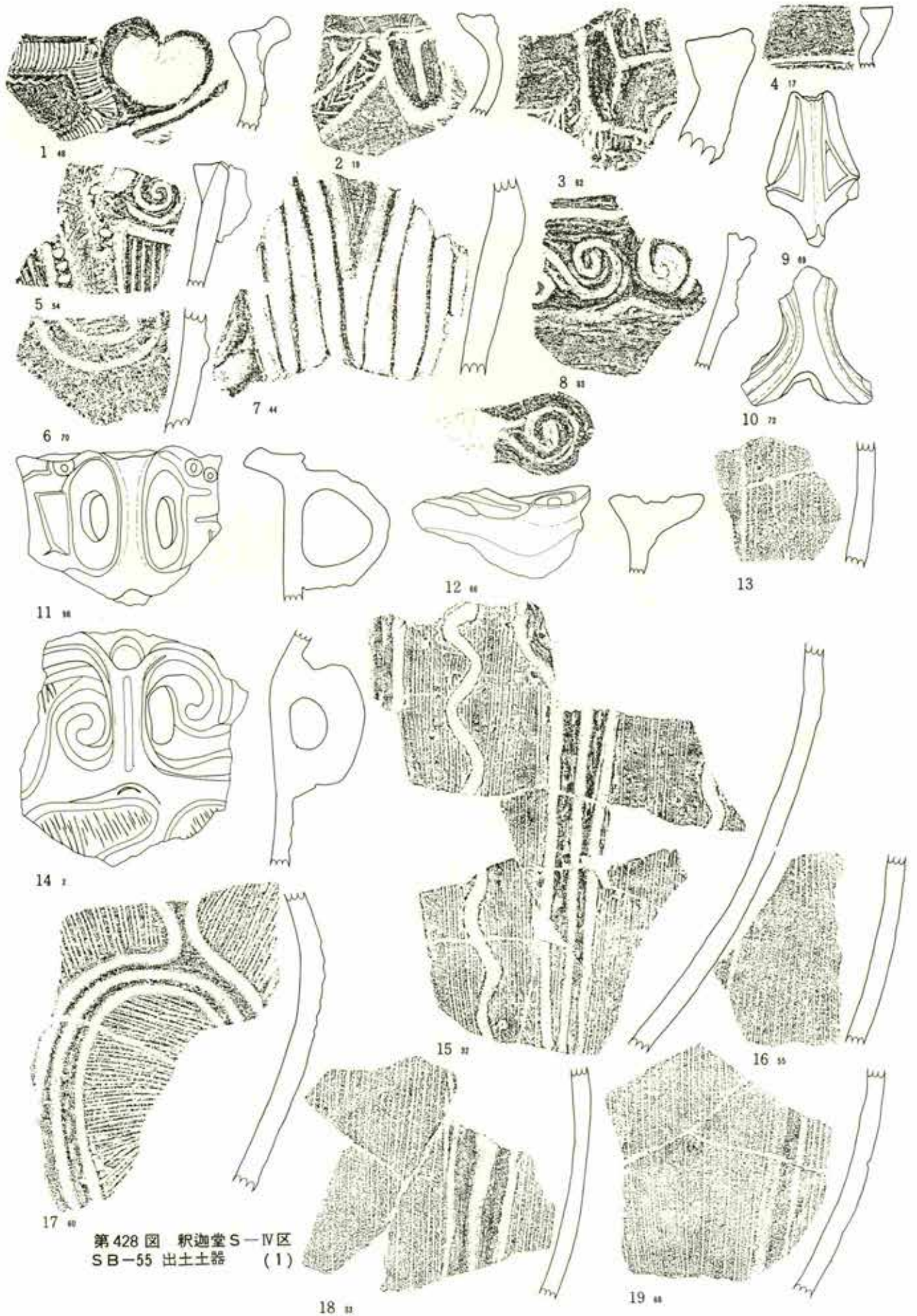

第428图 积迦堂S-IV区
 SB-55 出土土器 (1)

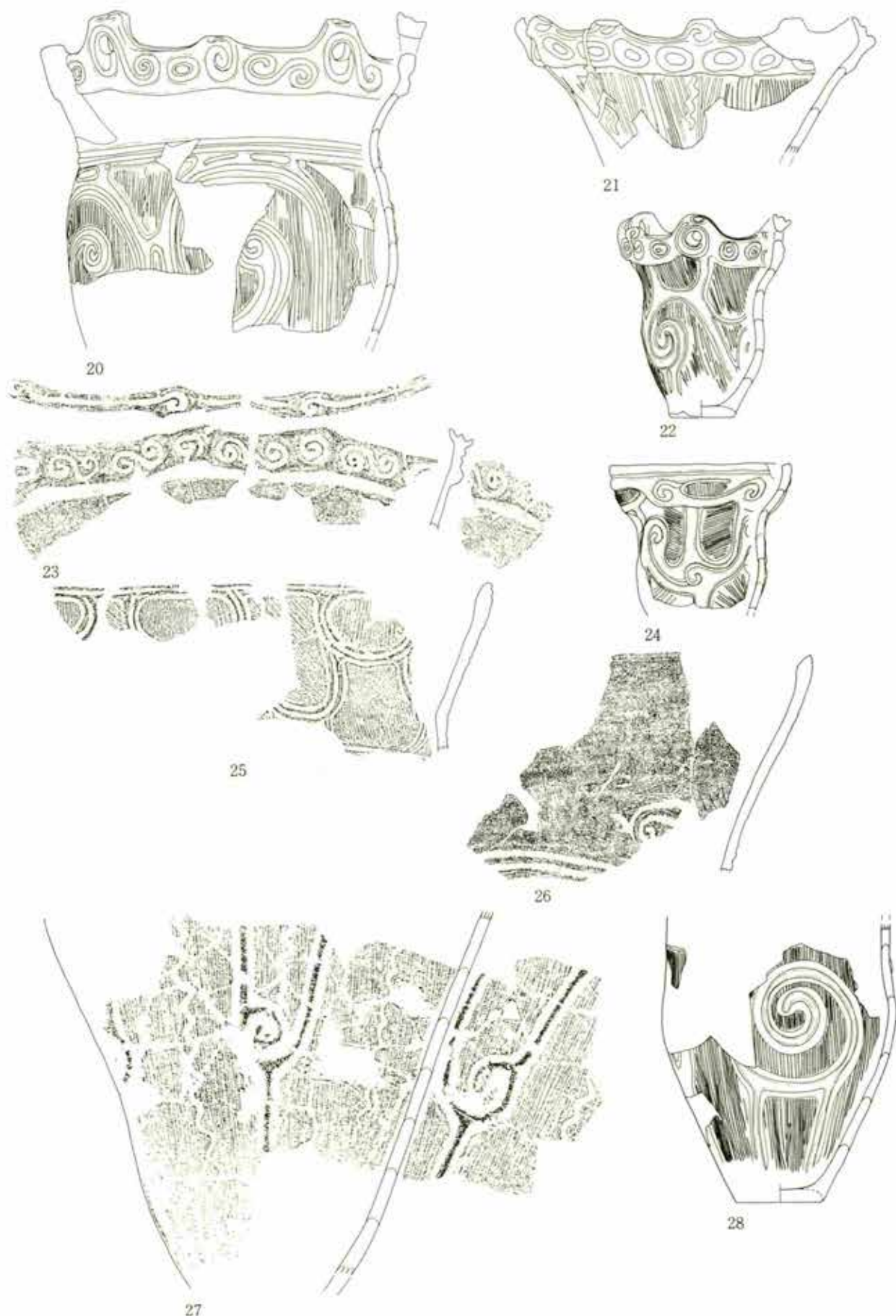

第 429 图 积迦堂 S-IV 区 SB-55 出土土器

(2) (1:6)

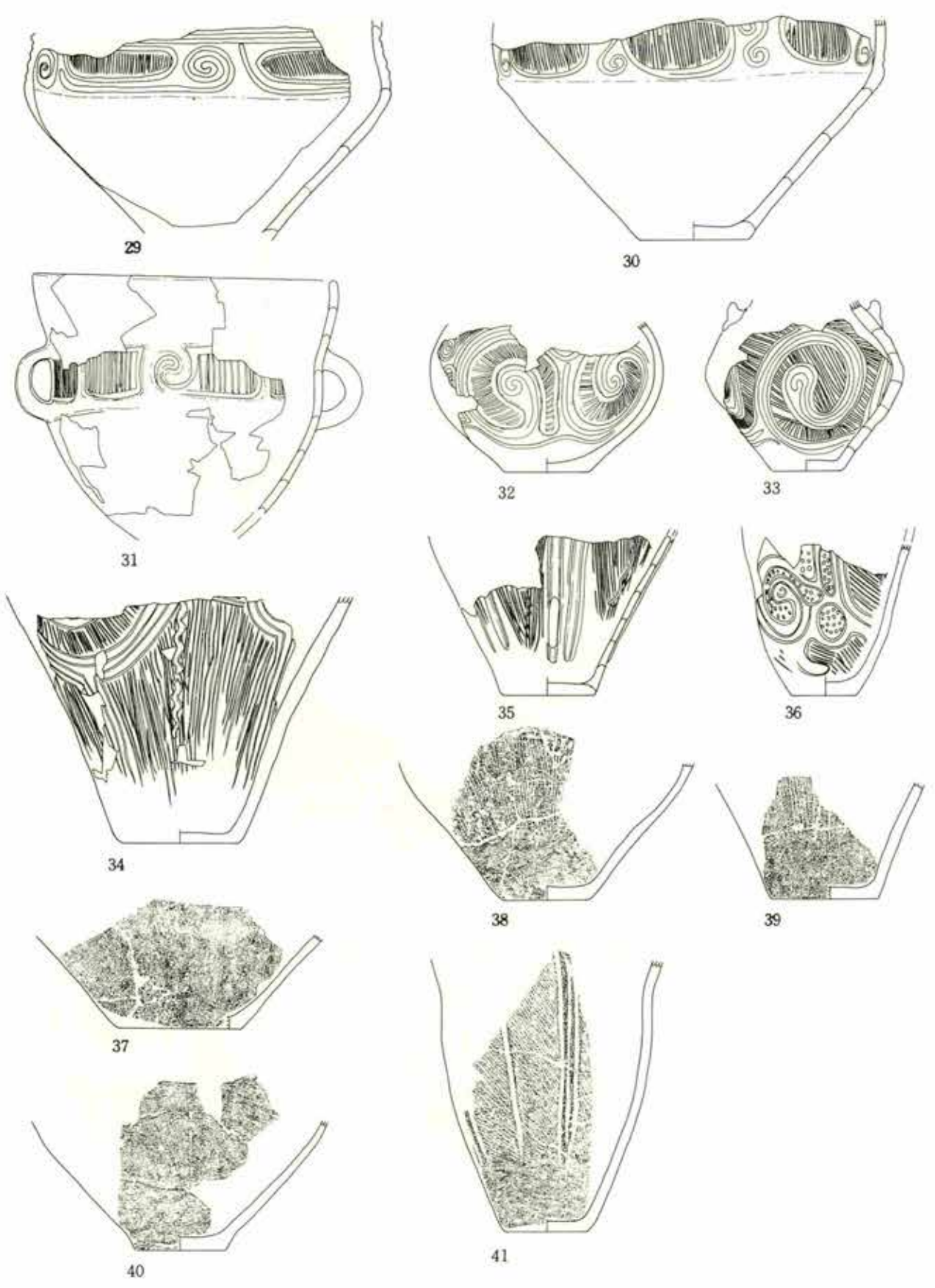

第430图 积迦堂S-IV区 SB-55 出土土器 (3) (1:6)



第431图 积迦堂S—IV区SB-56出土土器

(1)

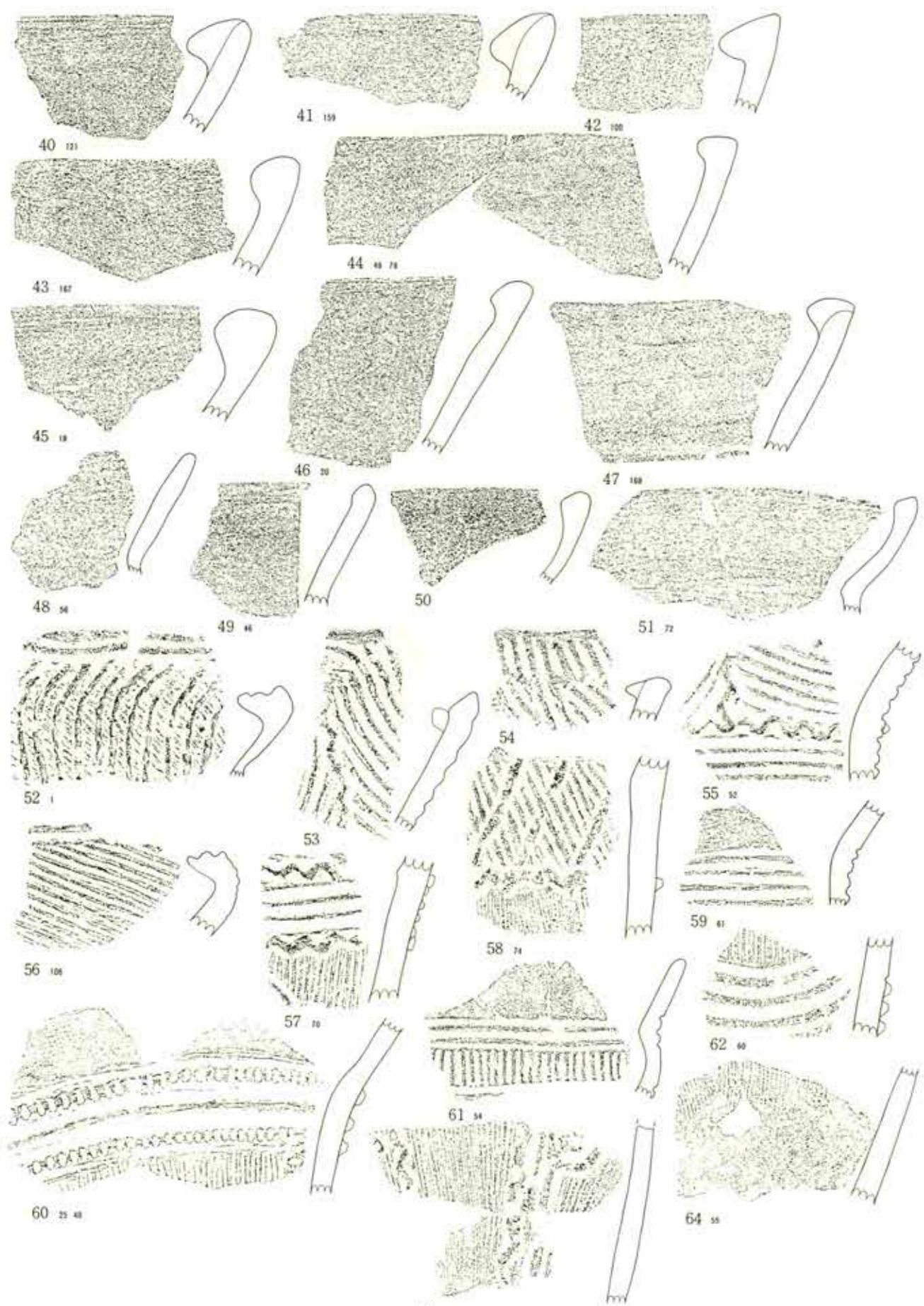

第432图 积迦堂S-IV区 SB-56 出土土器 (2)

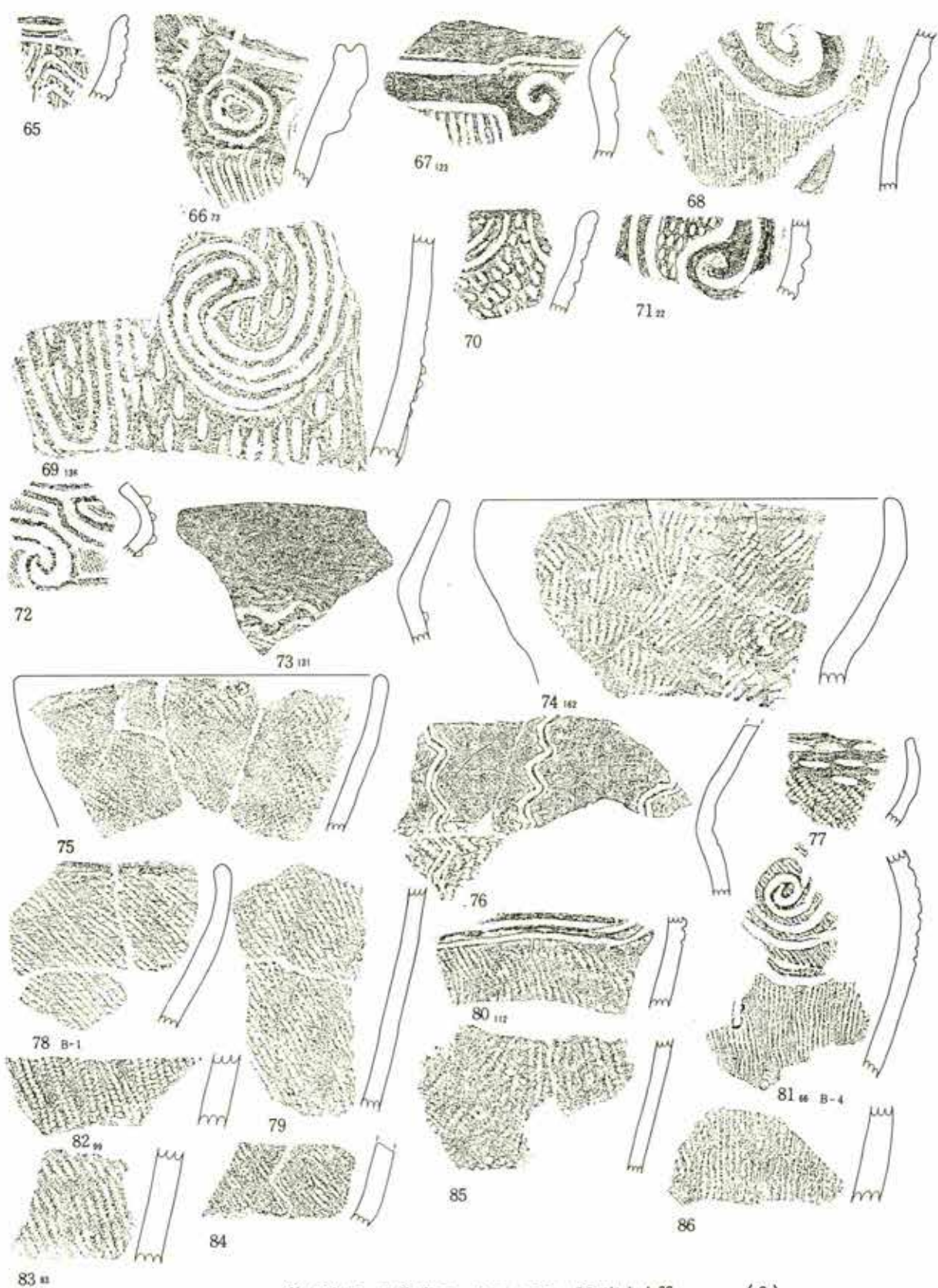

第 433 图 积迦堂 S-IV 区 SB-56 出土土器



87



88



89



91



92



90

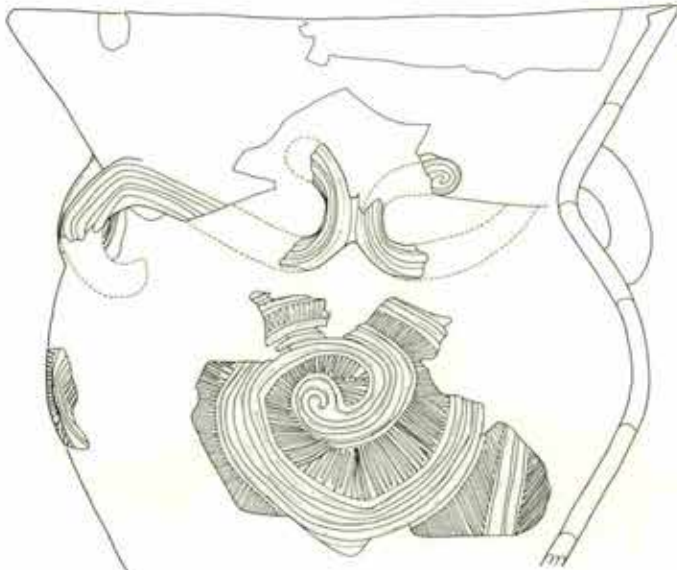

93

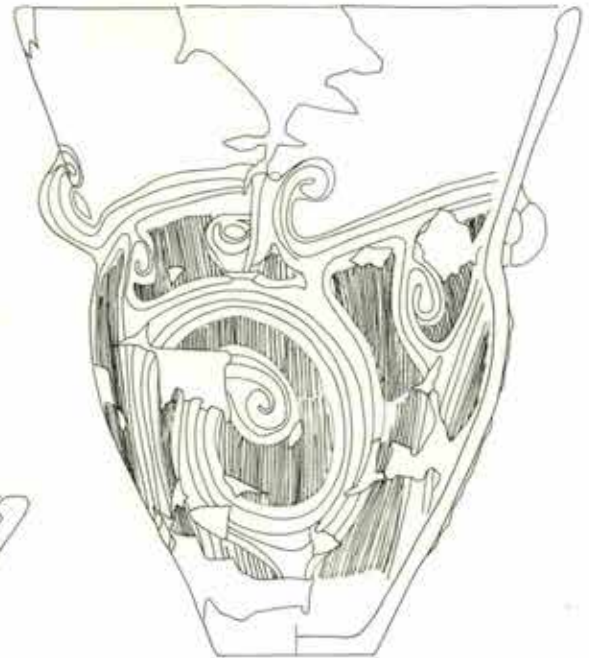

95



94



96



97



98



99



100



101

第 434 图 积迦堂 S-IV 区 SB-56 出土土器

(4) (87-95. 1:6)

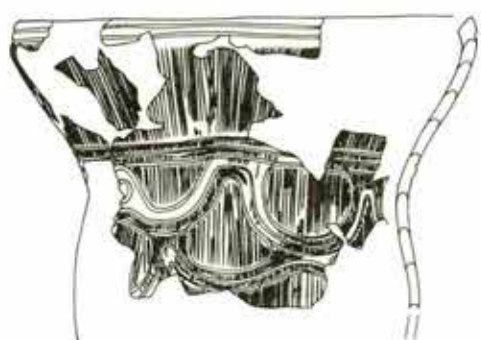

102

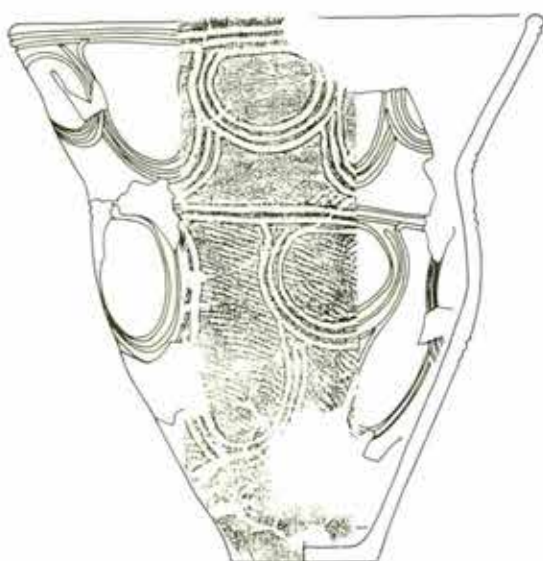

103



104 正位残片



105



106

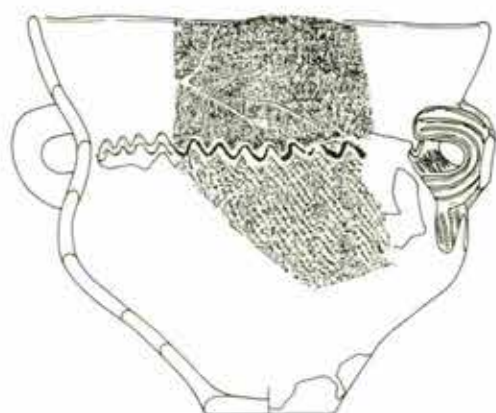

107

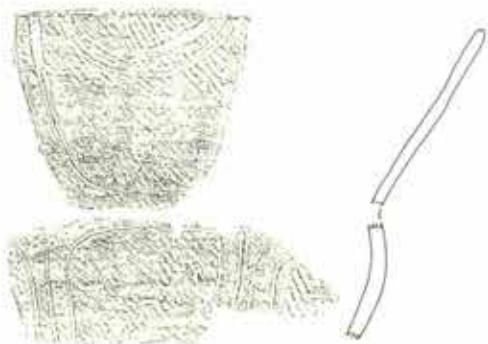

108



109



110

第 435 图 积迦堂 S-IV 区 SB-56 出土土器 (5)

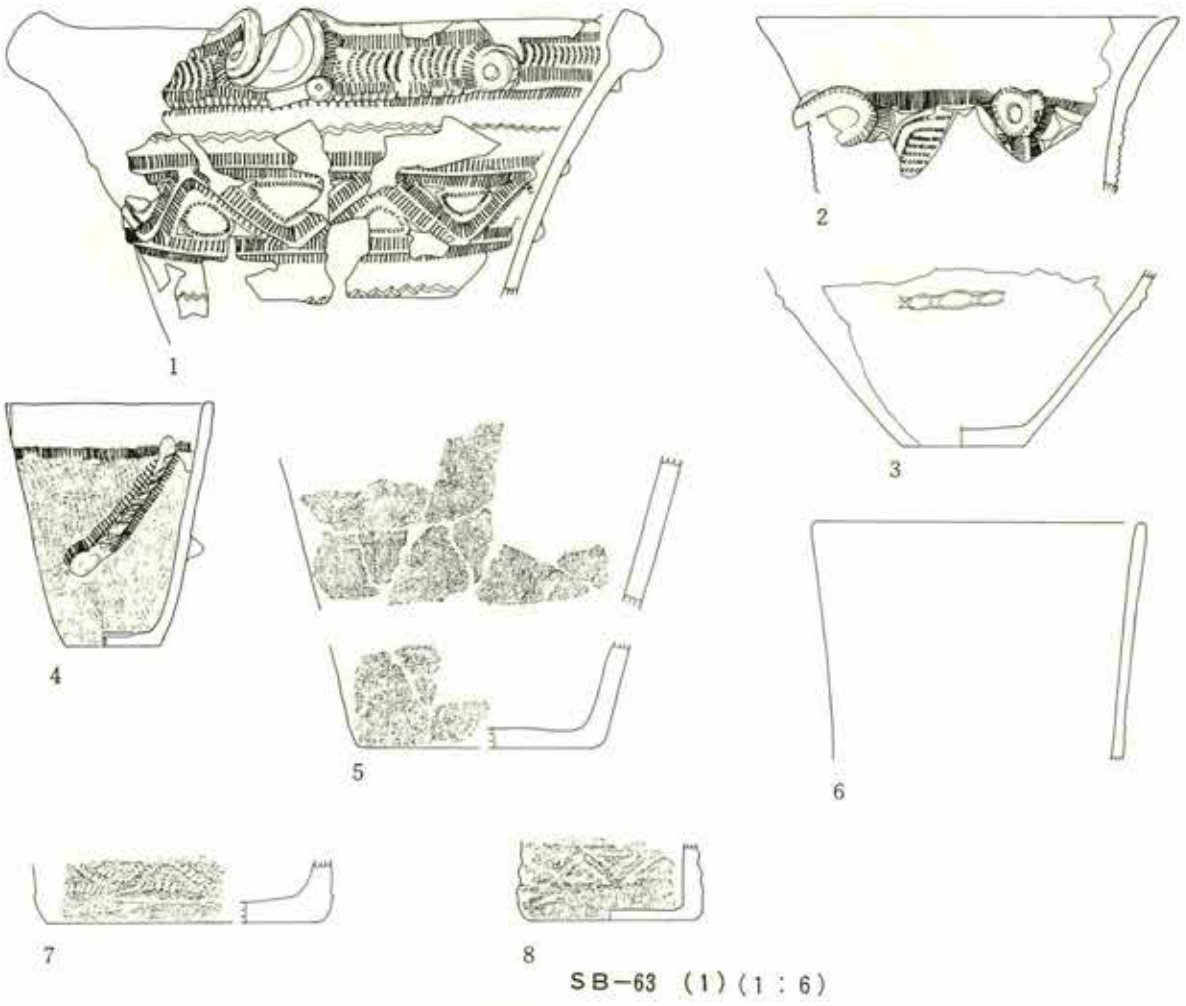
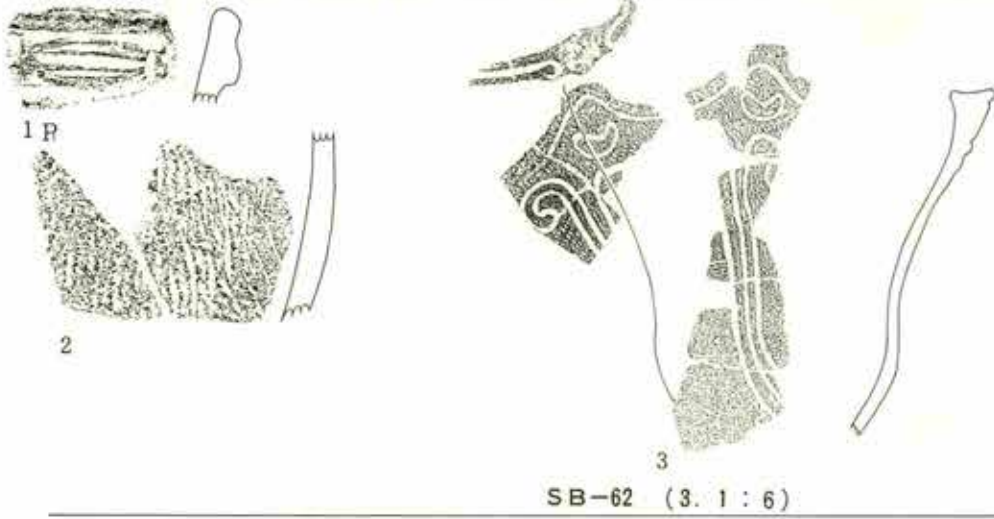
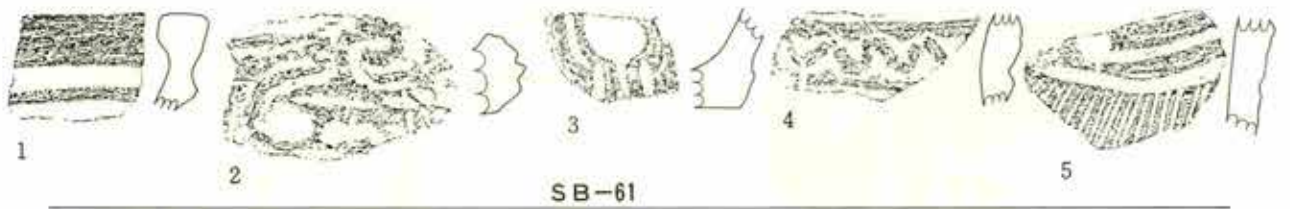

第436图 积迦堂S-IV区 SB-61 -62 -63 出土土器



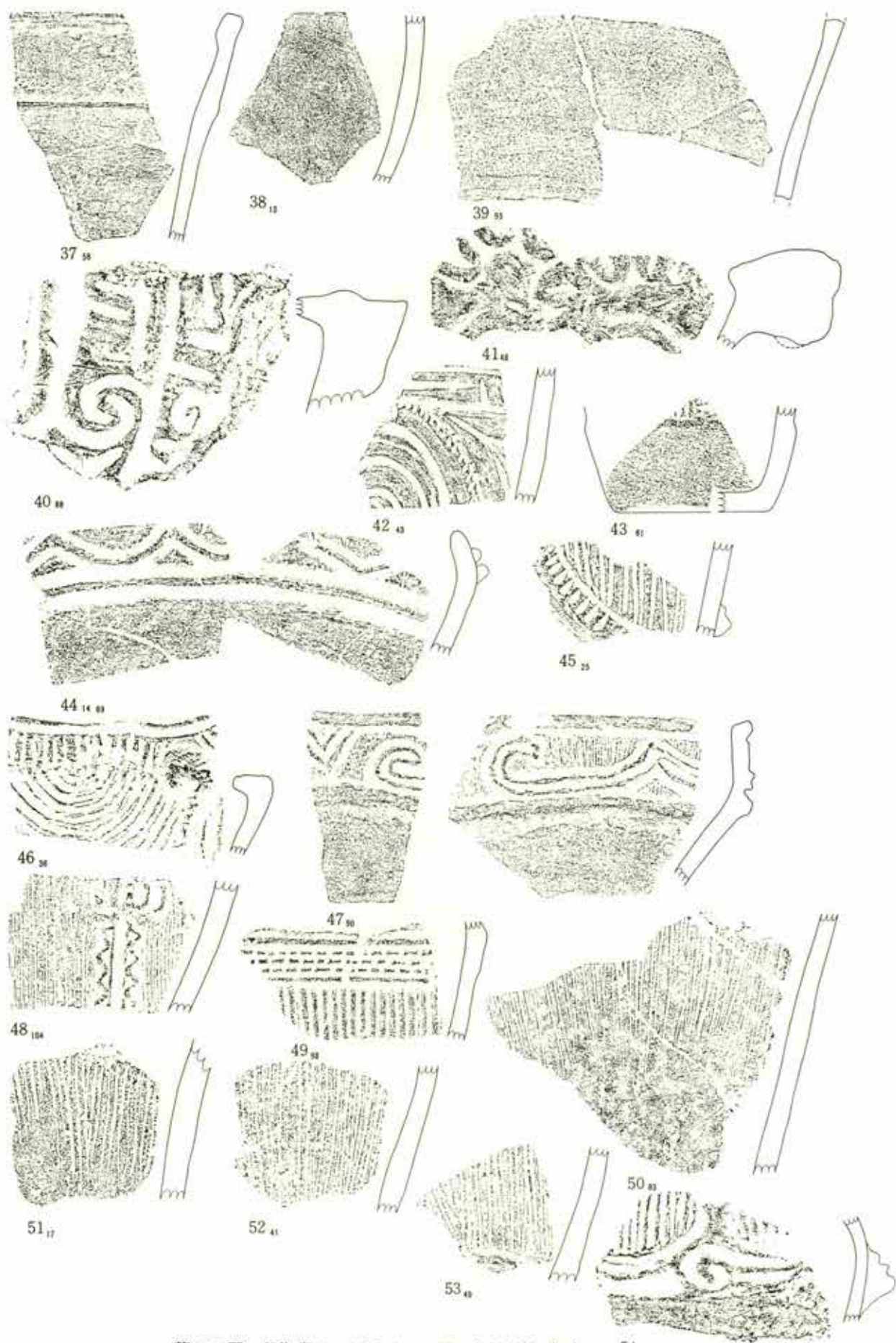

第438图 积迦堂S-IV区 SB-63 出土土器 (3)

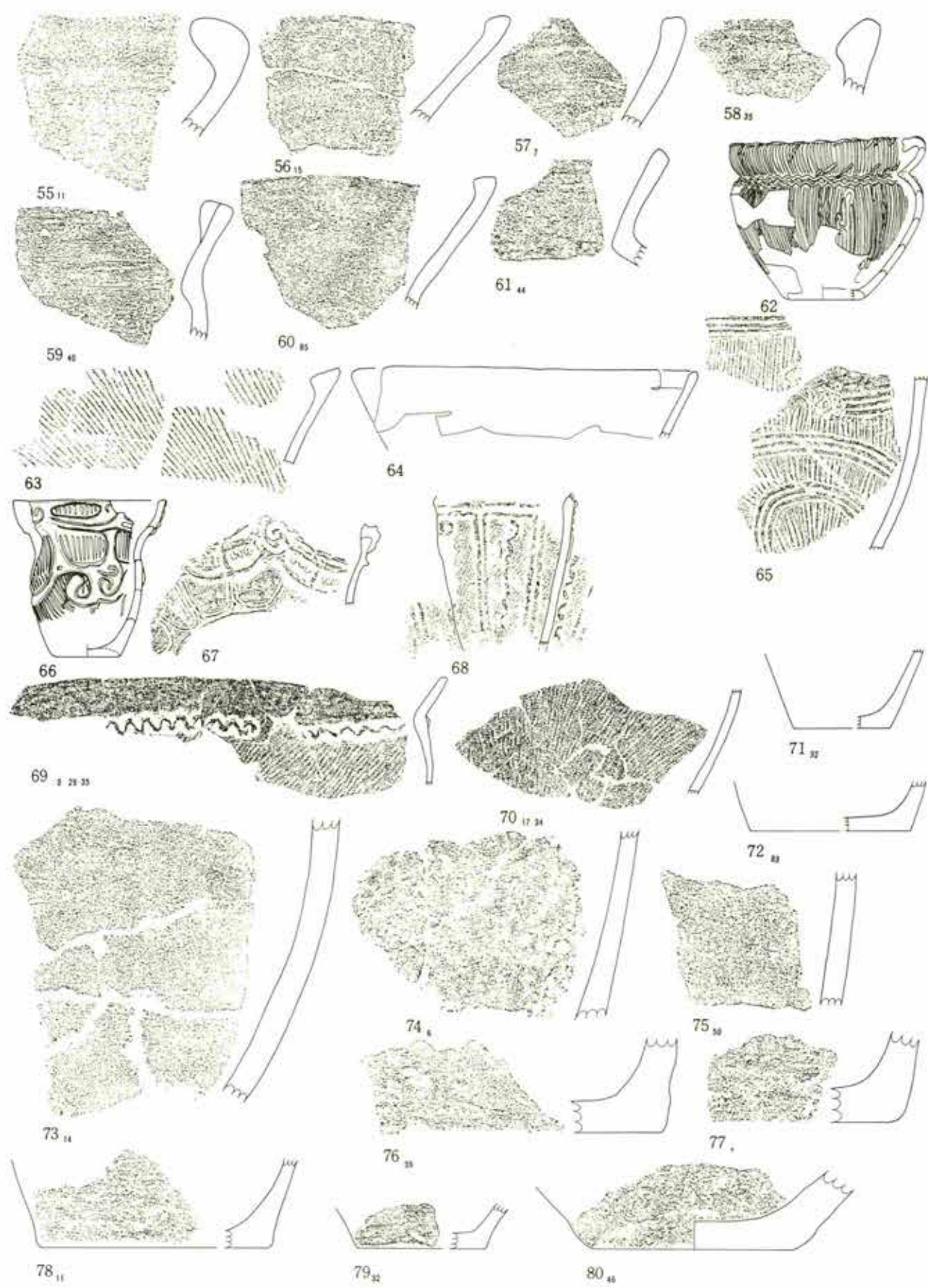

第 439 图 积迦堂 S-IV 区 SB-63 出土土器 (4) (62-72. 1:6)

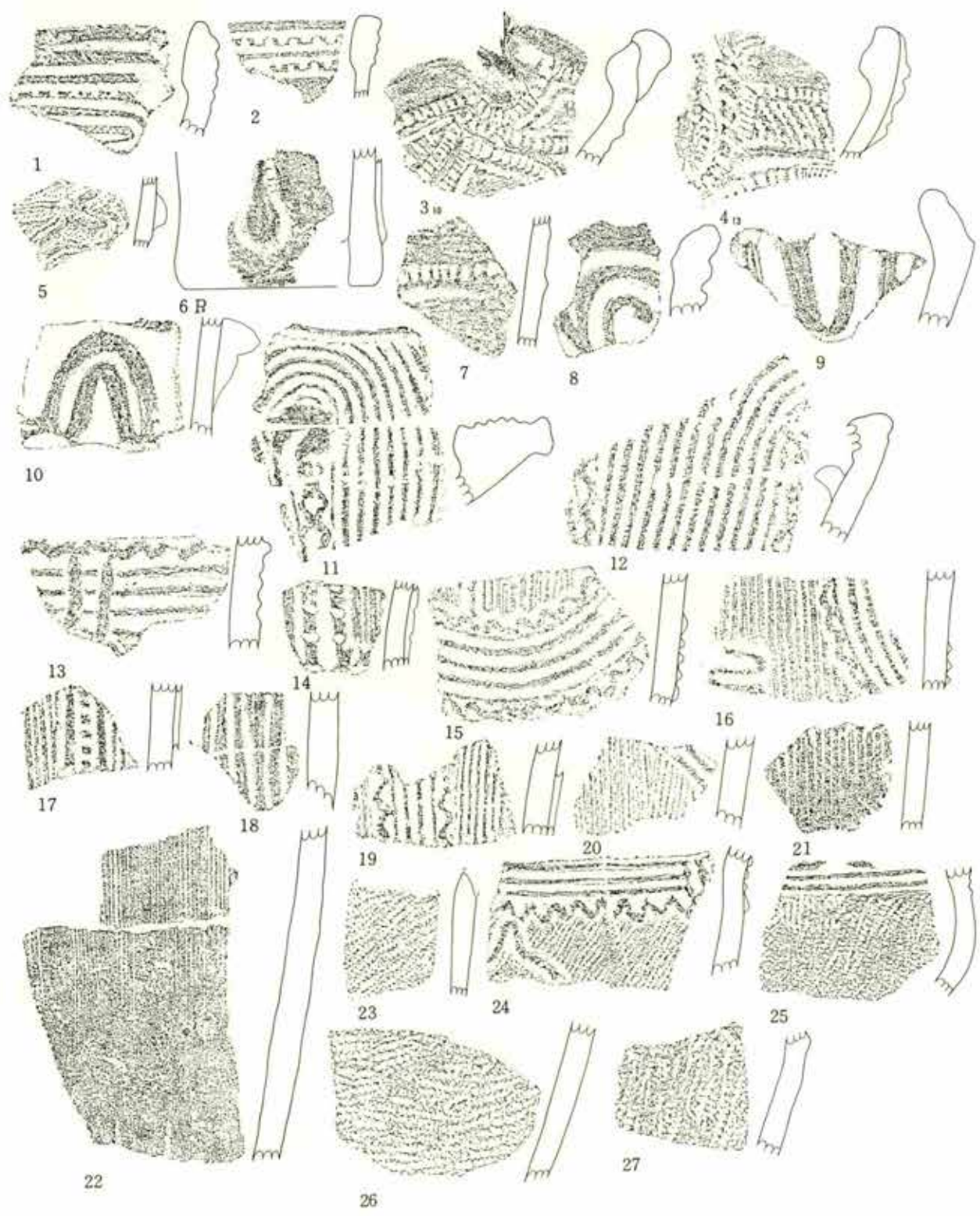

第 440 图 积迦堂 S-IV 区 SB-64 出土土器

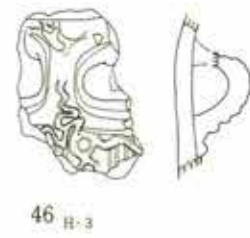
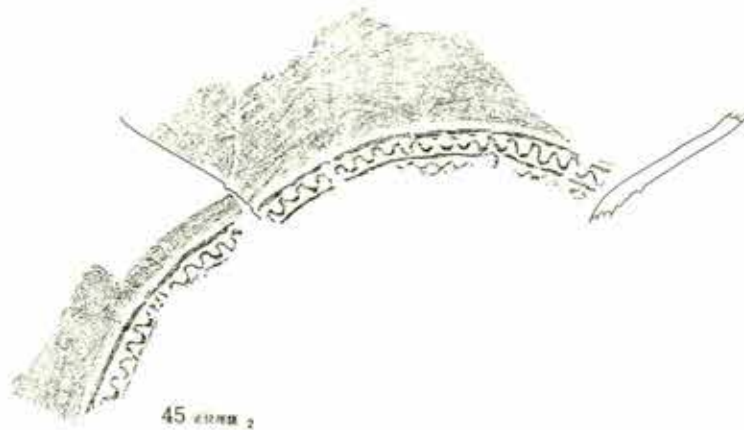
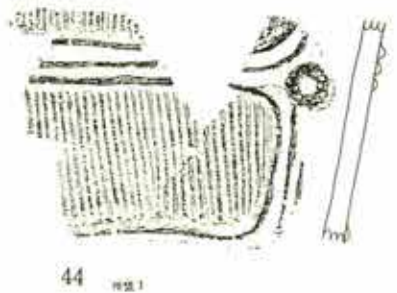
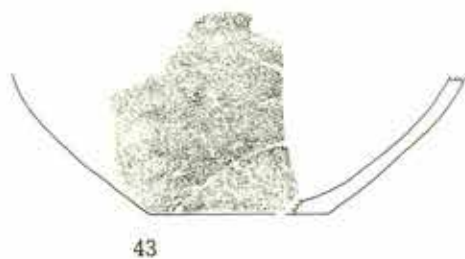
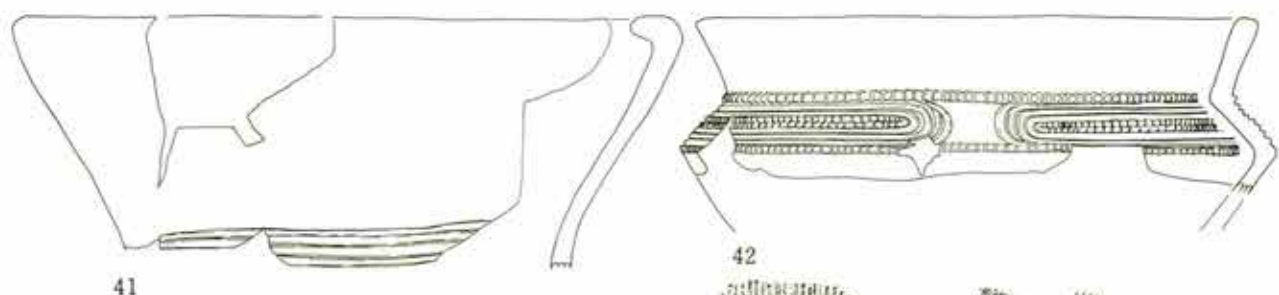
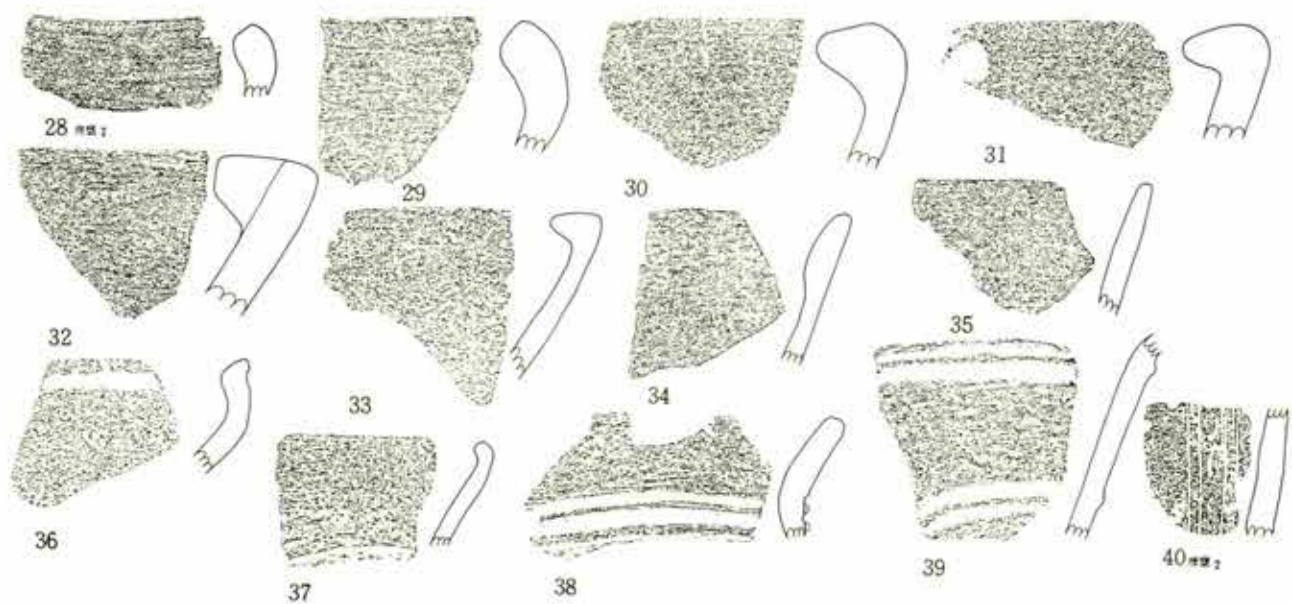

第441图 积迦堂S-IV区 SB-64 出土土器(2) (41-46. 1:6)

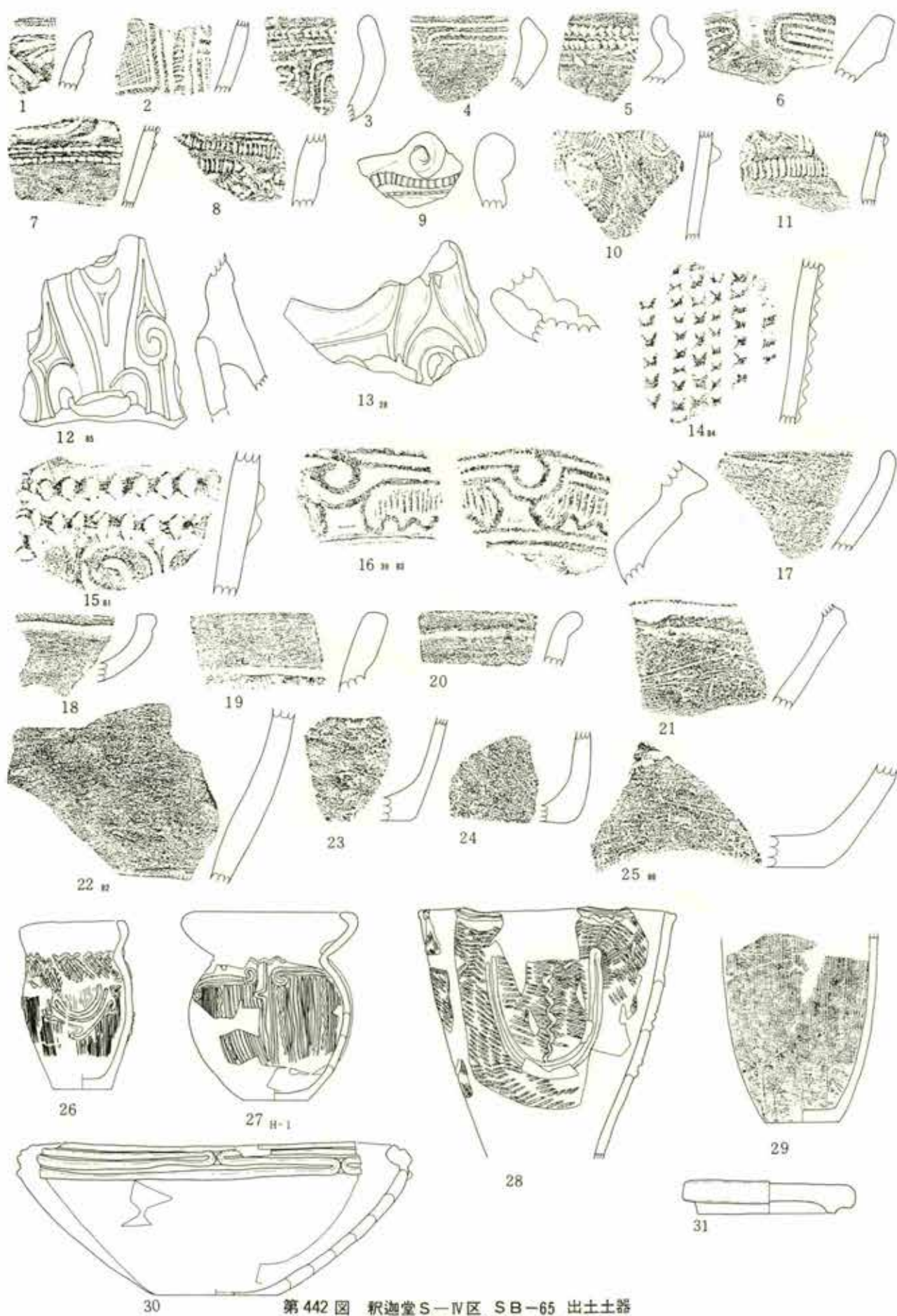

第442图 积迦堂S-IV区 SB-65 出土土器
 (26.27.28.29.30.31. 1 : 6)



1

SB-66 (1 : 6)

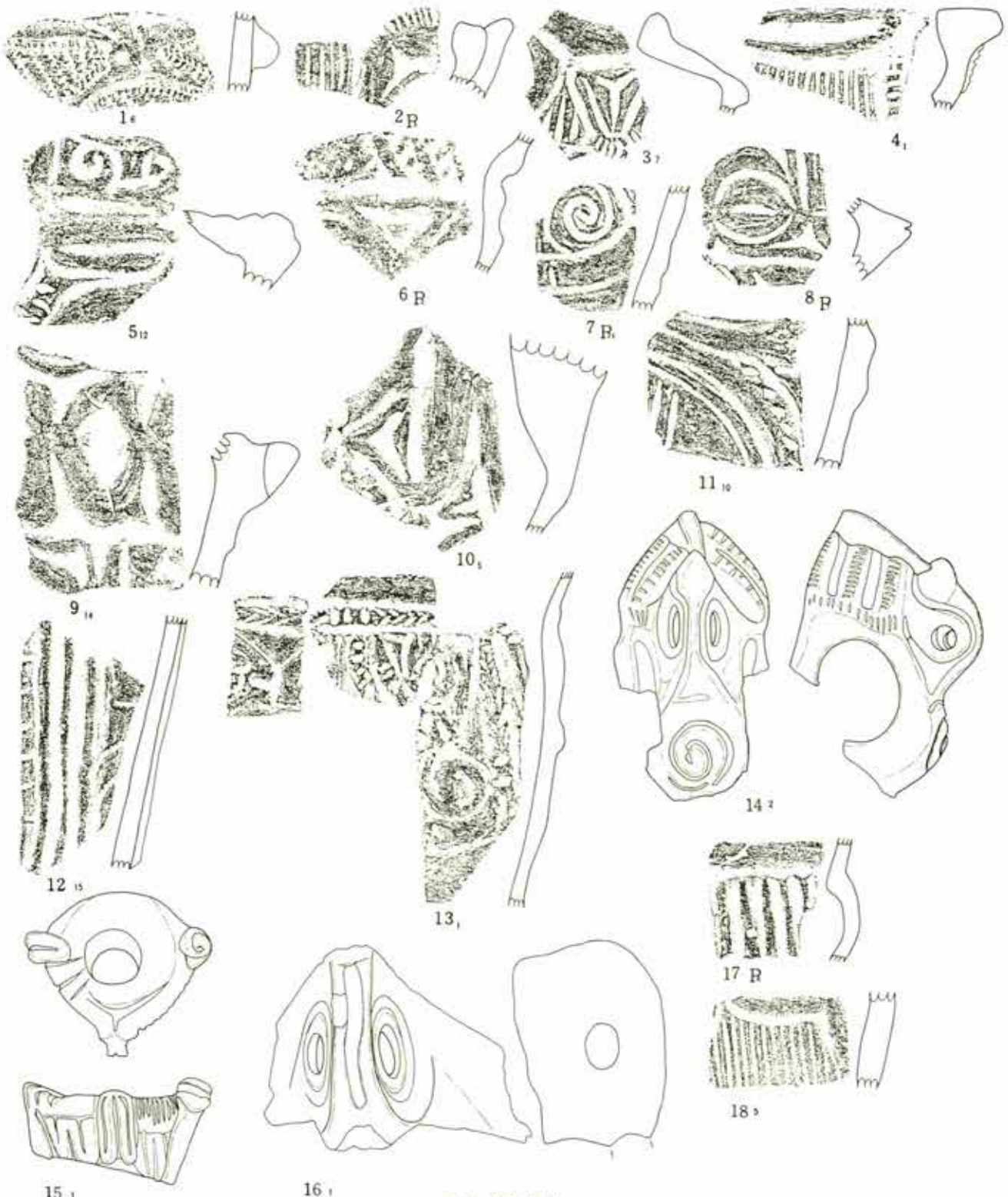

SB-67 (1)

第443图 积逊堂S-IV区 SB-66 -67 出土土器

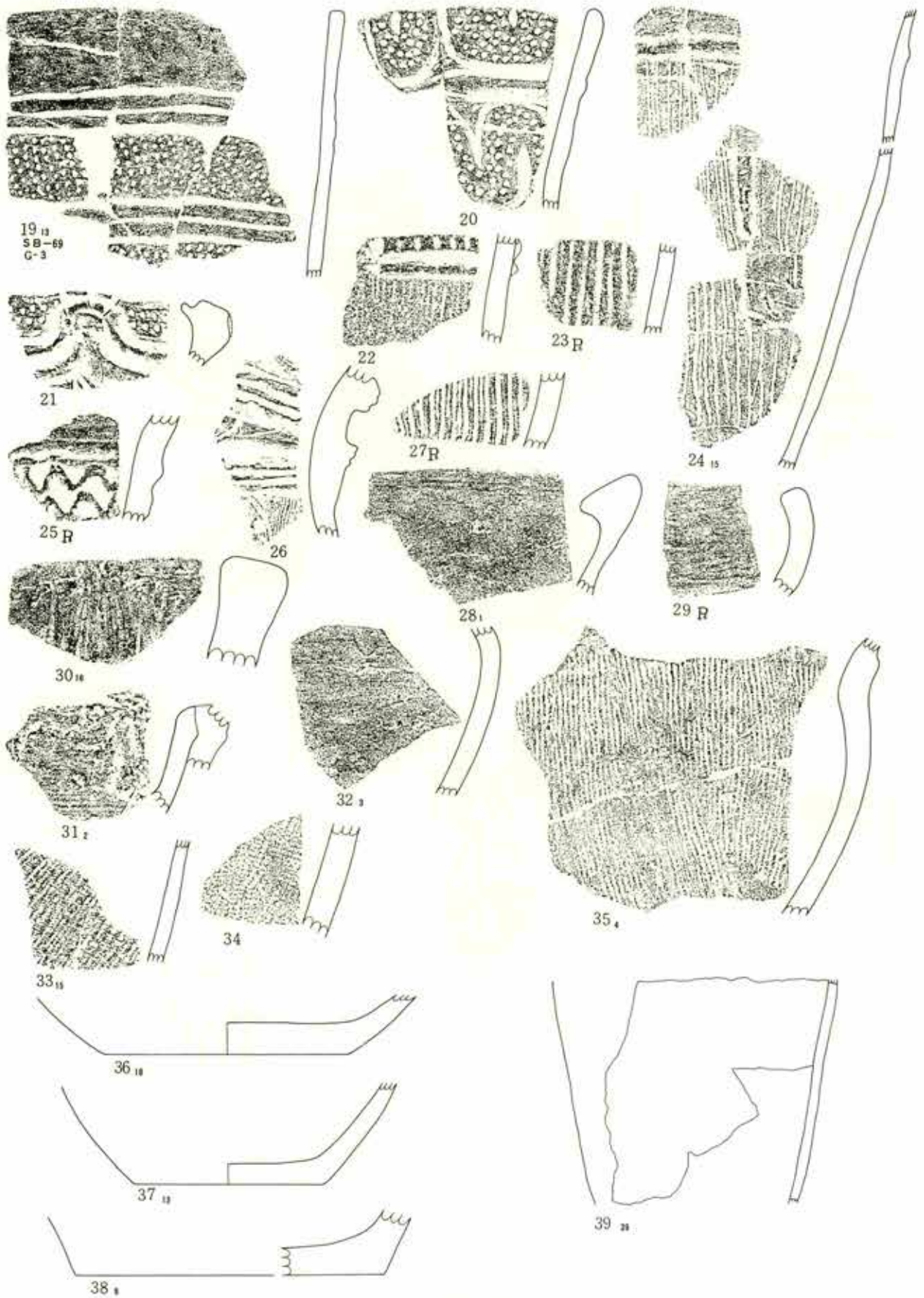

第444图 积迦堂S-IV区SB-67出土土器 (2) (40.1:6)

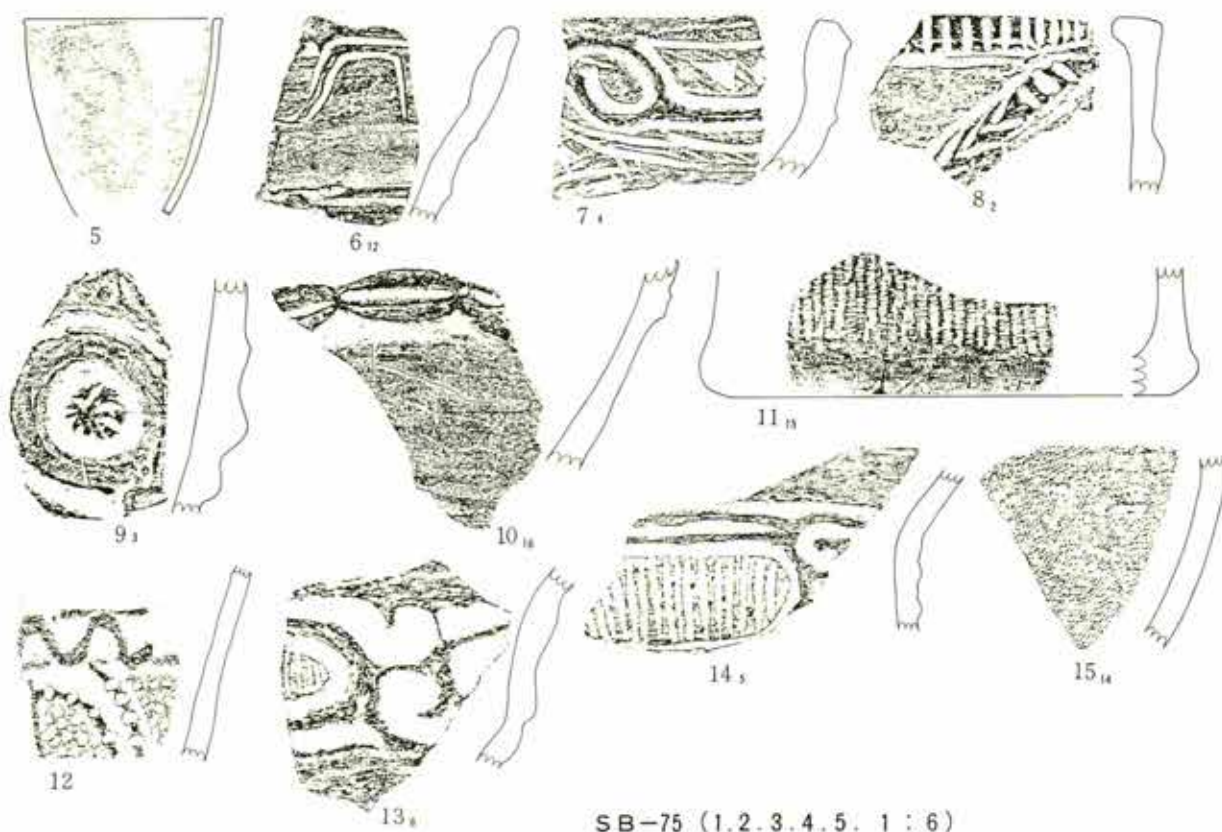
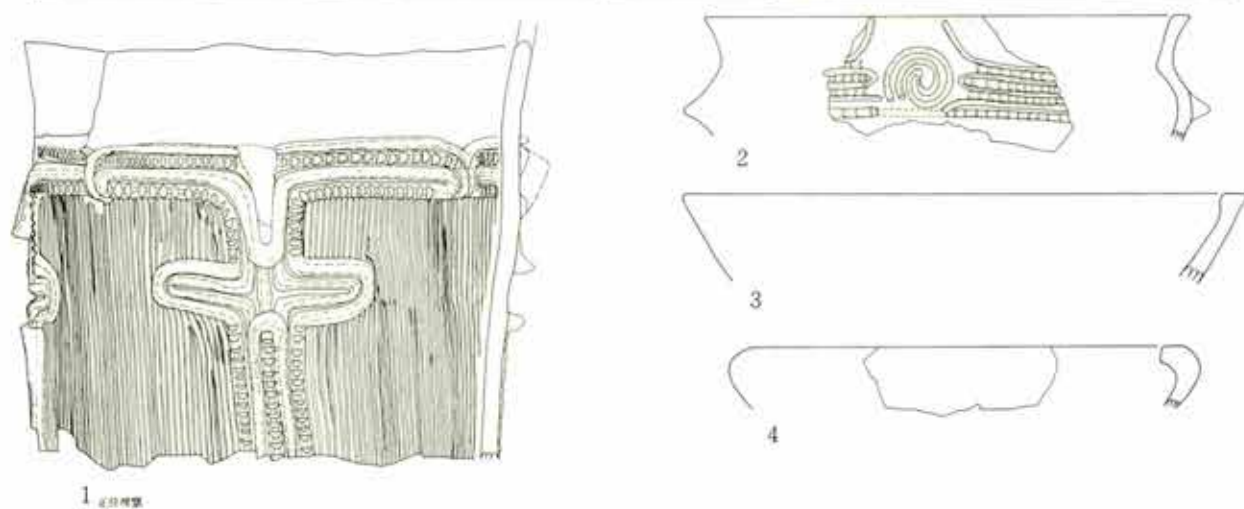
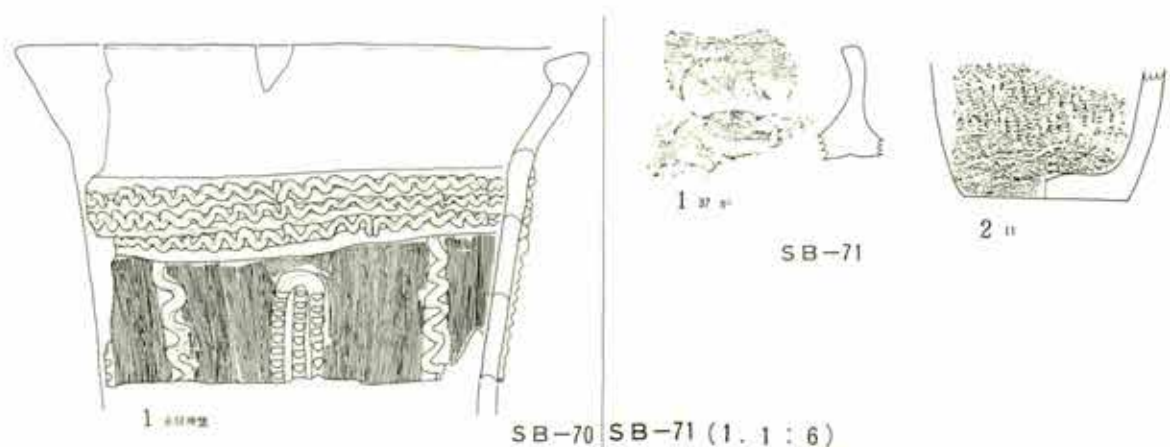

第445图 积逊堂S-IV区 SB-70 -71 -75 出土土器

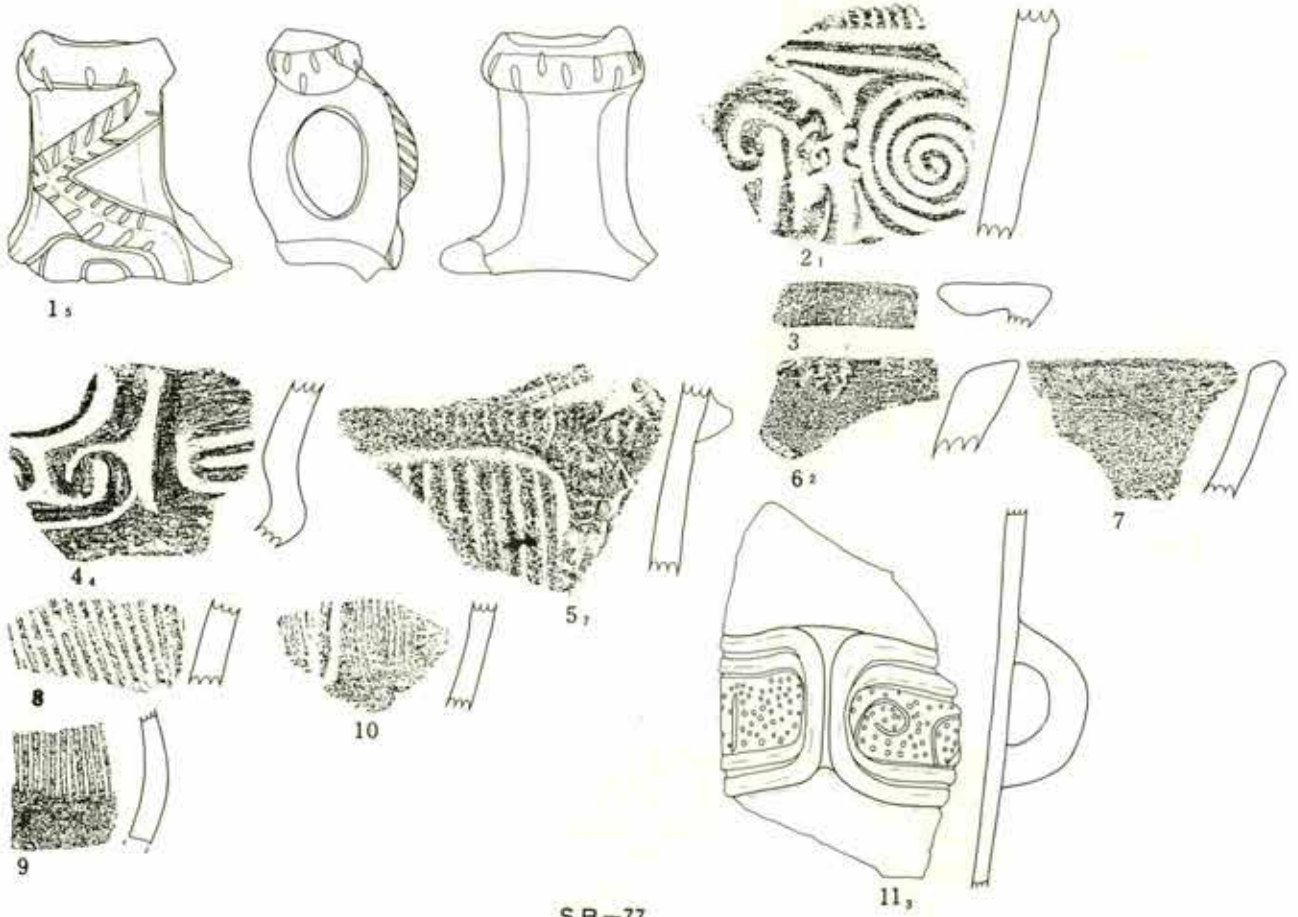

SB-77

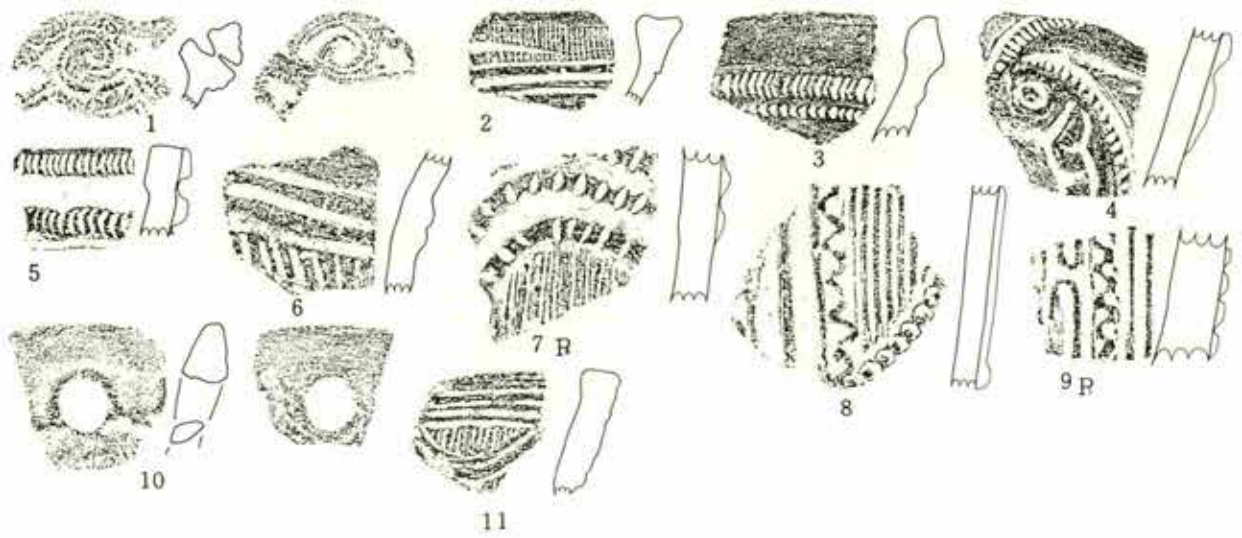

SB-78

第 446 图 积逊堂 S-IV 区 SB-77-78 出土土器



1

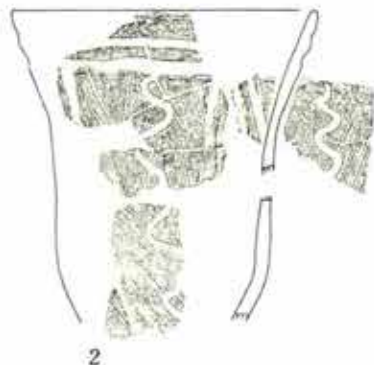

2

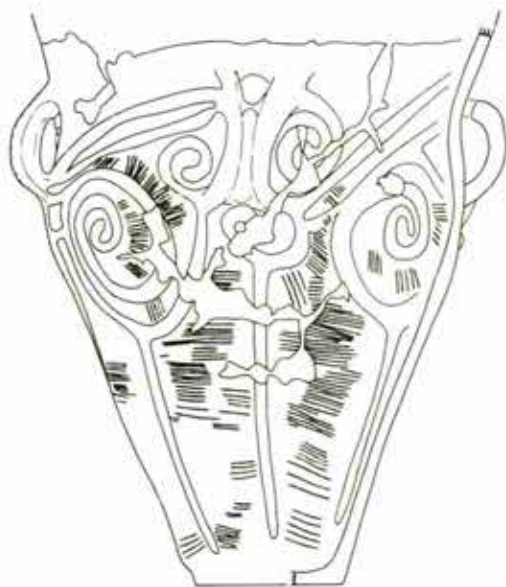

3



4



5



6



7 龙纹碗



8

第 447 图 积迦堂 S—IV 区 SB-78 出土土器 (1)

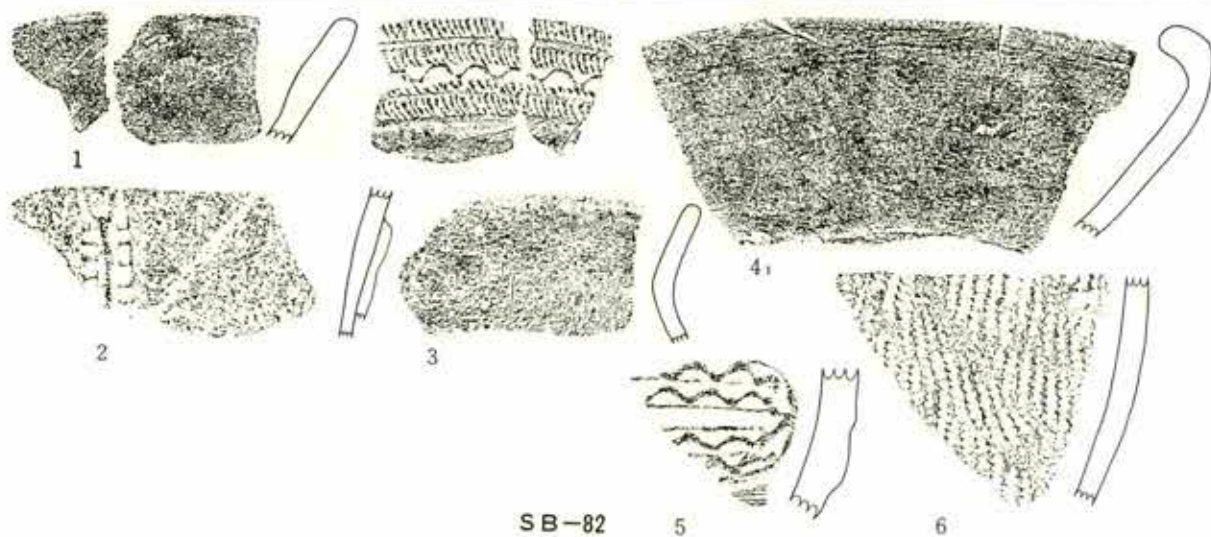

第 448 图 积迦堂 S-IV 区 SB-78 -82 出土土器

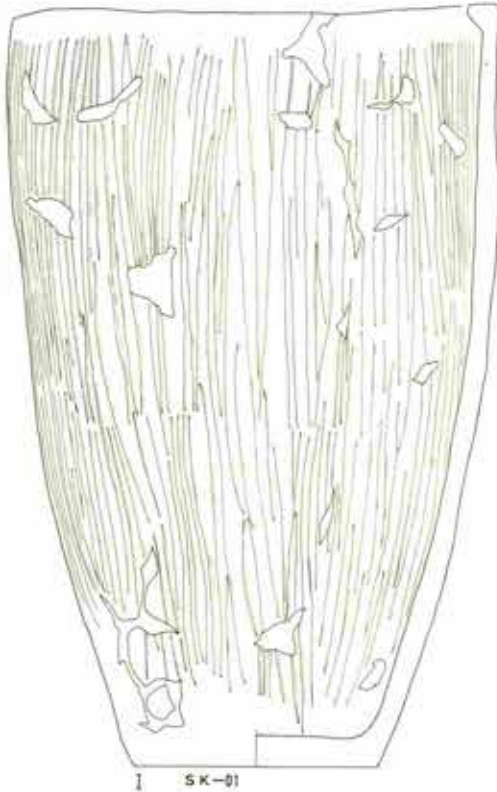

1 SK-01

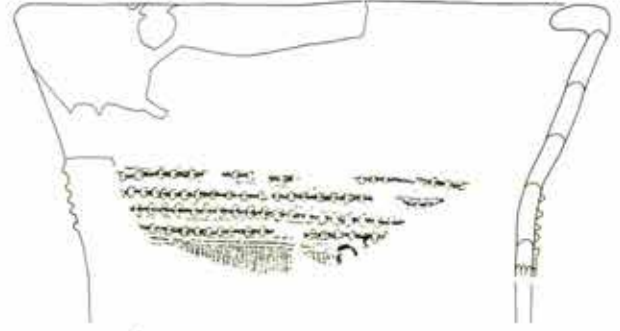

2 SK-04



3 SK-08

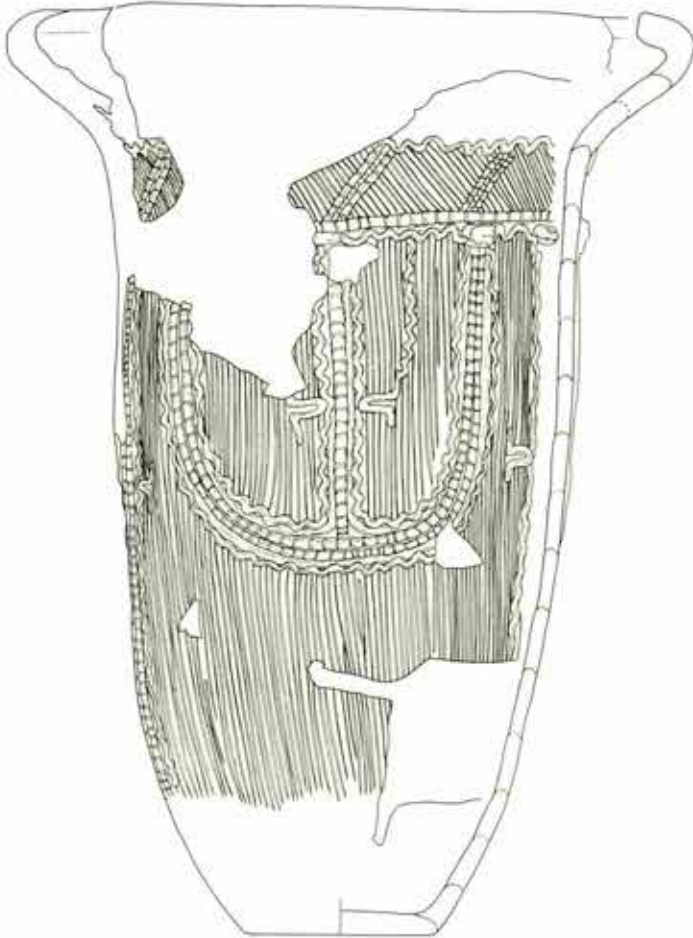

5 SK-05

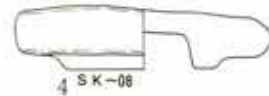

4 SK-08

第 449 图 积迦堂 S-IV 区 SK-01 -04 -05 -08 出土土器 (1)

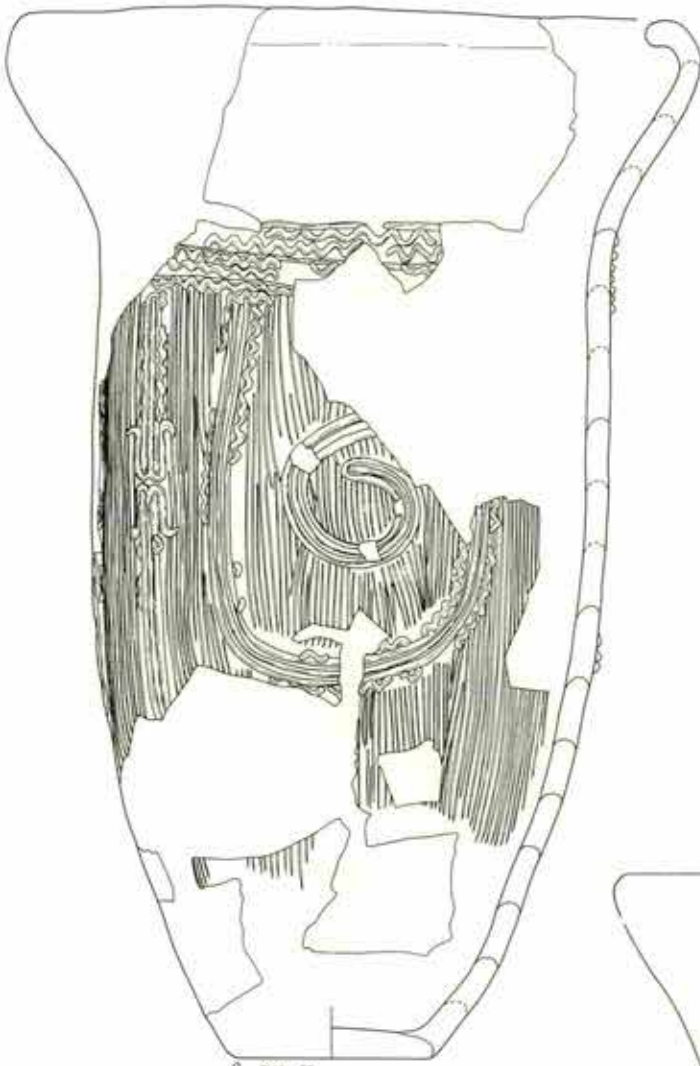

6 SK-05

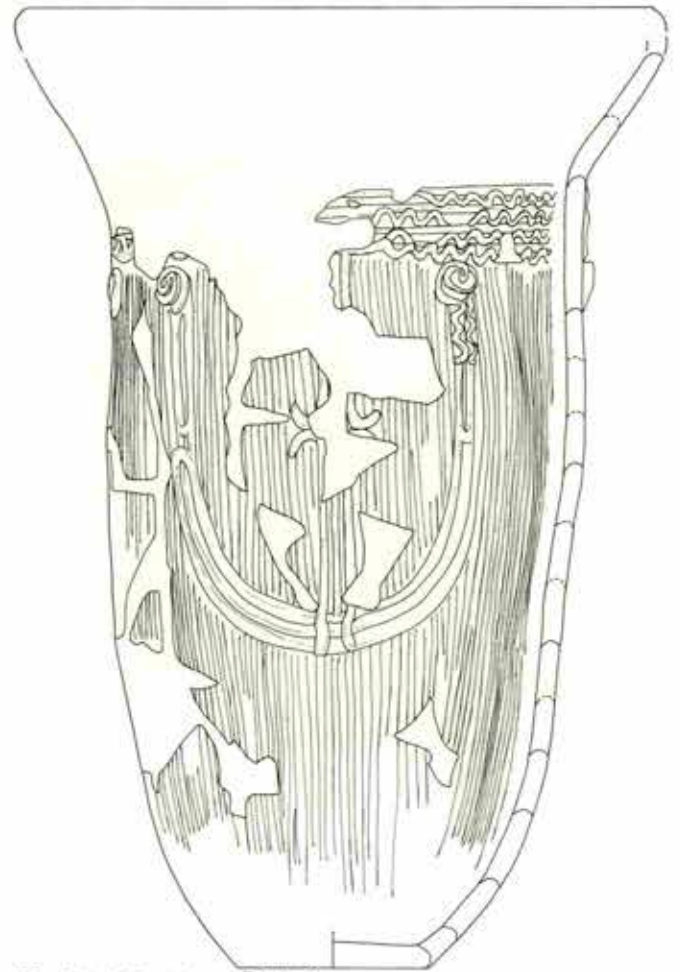

7 SK-05

第450图 积迦堂S-IV区 SK-05 出土土器(2)

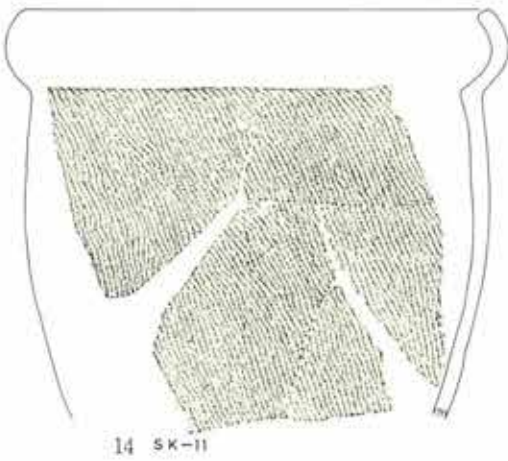
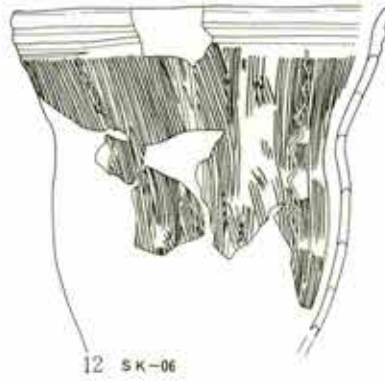
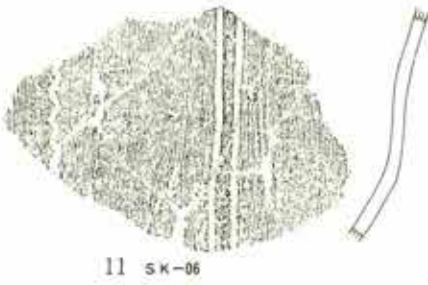
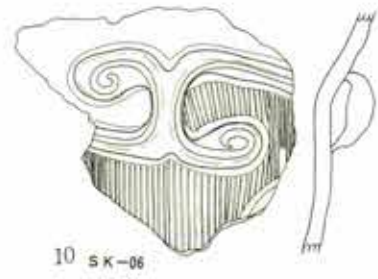
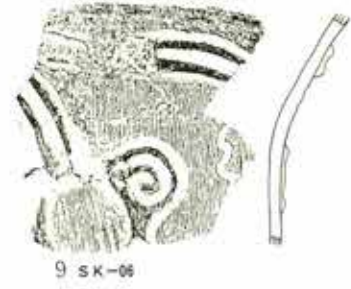

第451图 积迦堂S-IV区 SK-06 -11-33 -40 -46 出土土器 (3)

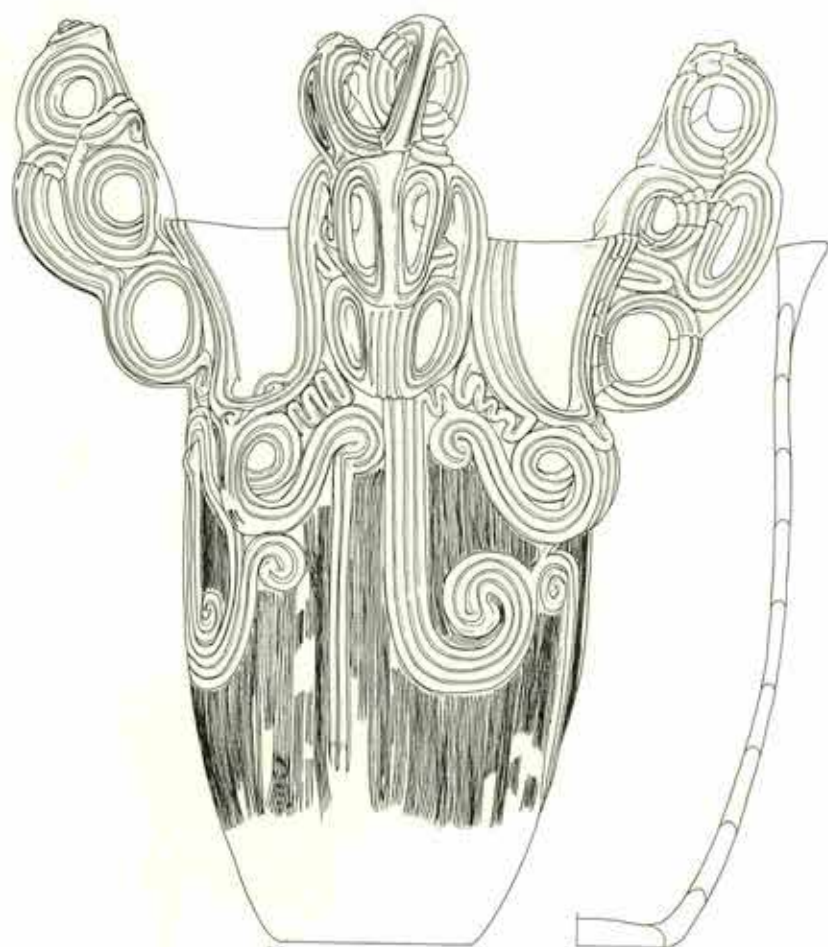

18 SK-52

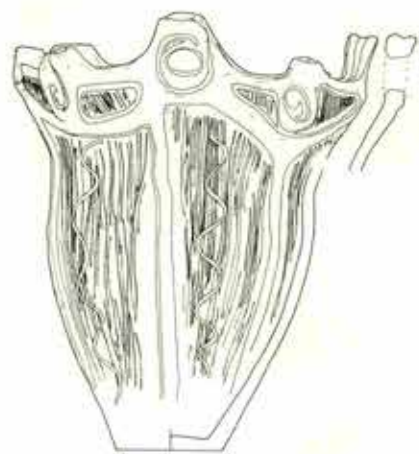

19 SK-53



20 SK-53

第452图 积迦堂S-IV区 SK-52-53 出土土器 (4)



21 SK-53

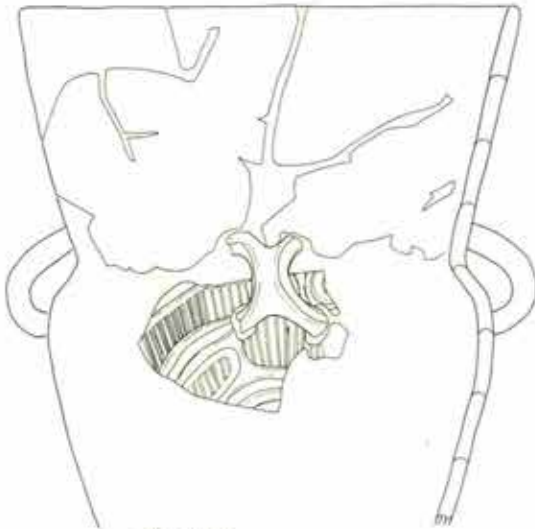

22 SK-53

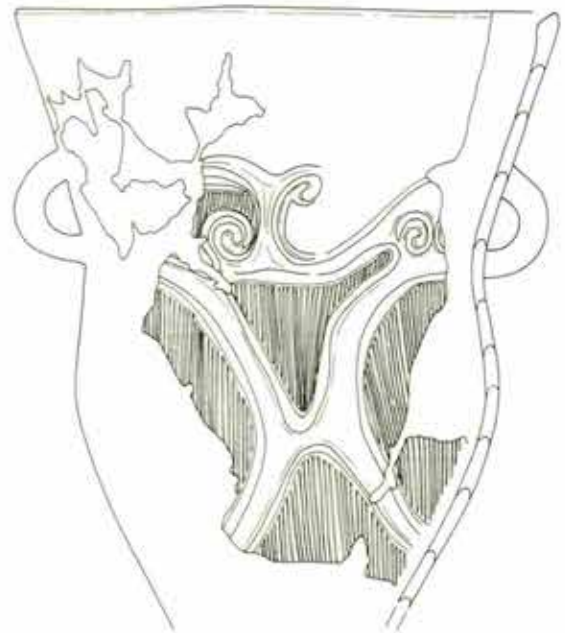

23 SK-53



24 SK-53



25 SK-53

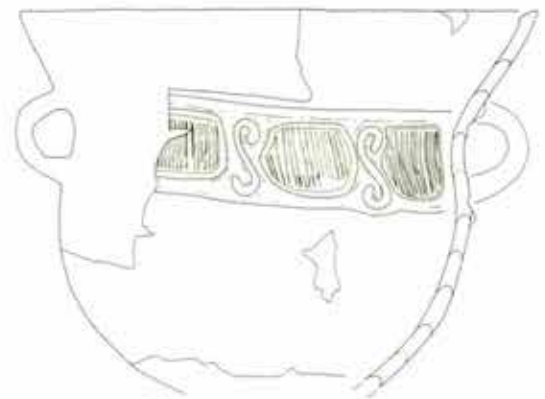

26 SK-53

第453图 积迦堂S-IV区 SK-53 出土土器 (5)

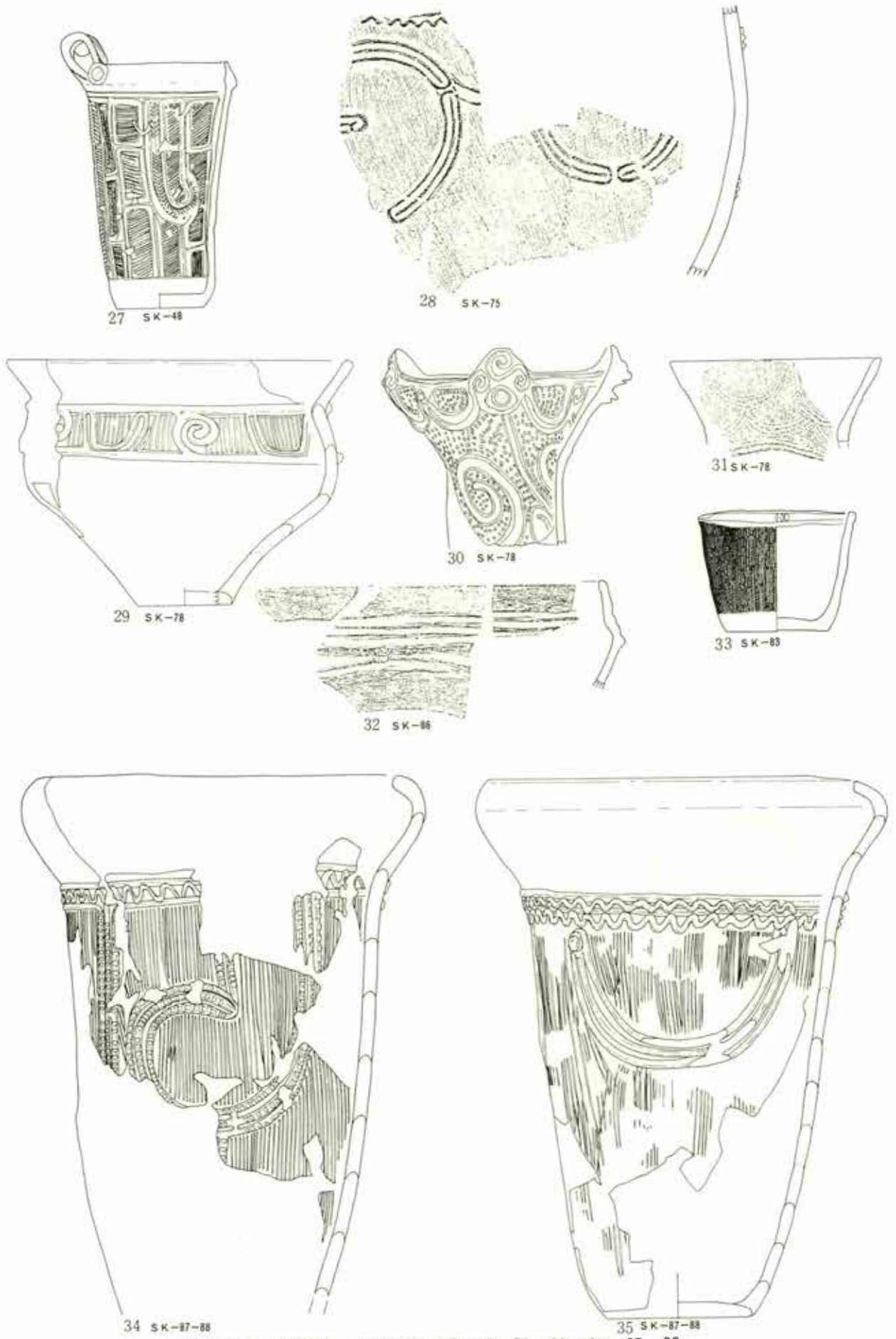

第454图 积迦堂S-IV区 SK-48-75-78-83-86-87-88
出土土器 (6)

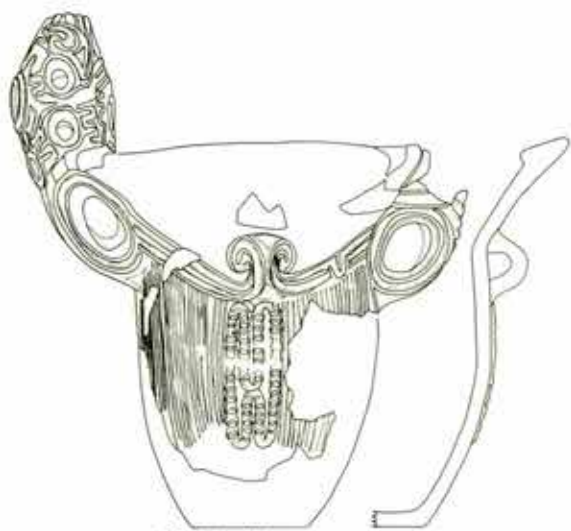

36 SK-128

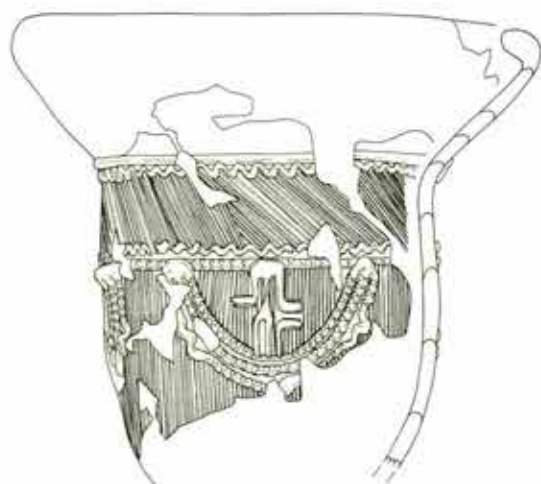

37 SK-128



38 SK-128

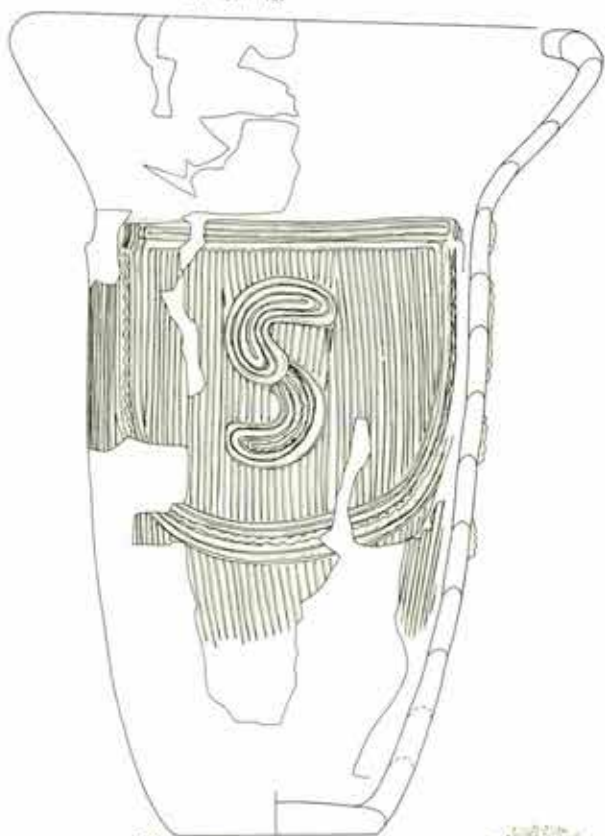

39 SK-128



40 SK-128

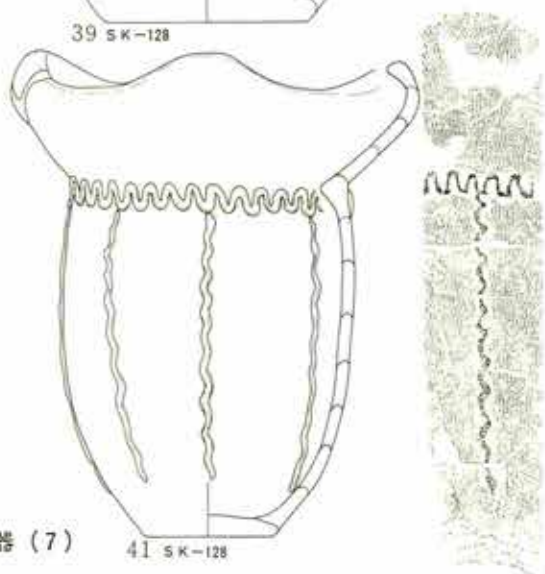

41 SK-128

第455图 积迦堂S-IV区SK-128出土土器(7)

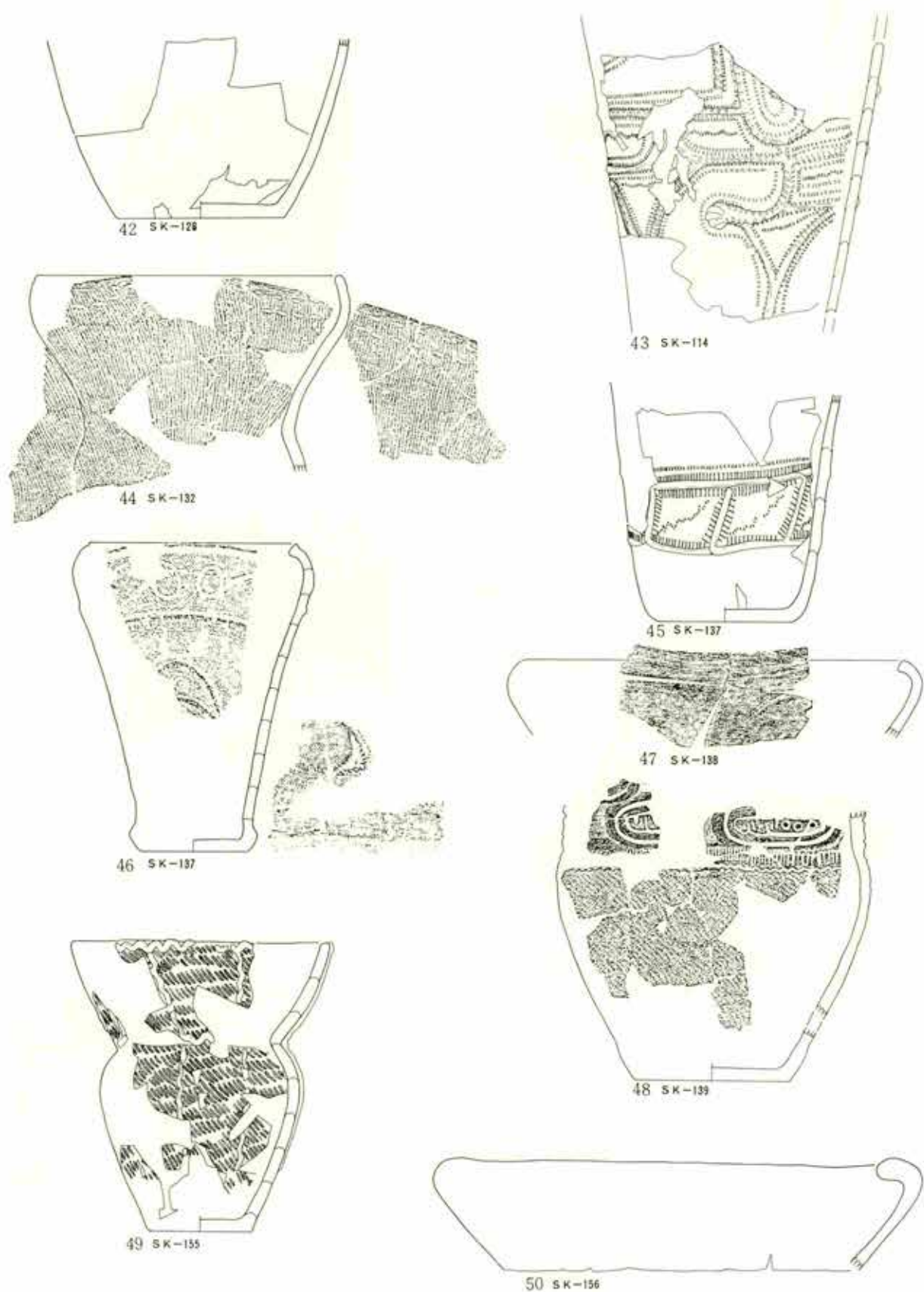

第456图 积迦堂S-IV区 SK-128 -114 -132 -137 -138 -139 -155
-156 出土土器(8)



51 SK-159



52 SK-175

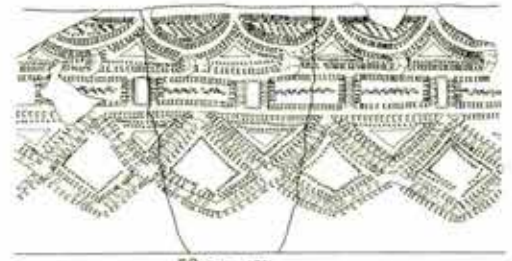

53 SK-175



54 SK-178

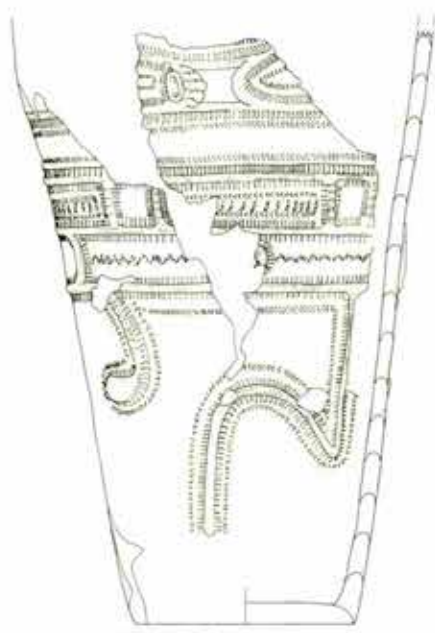

55 SK-178

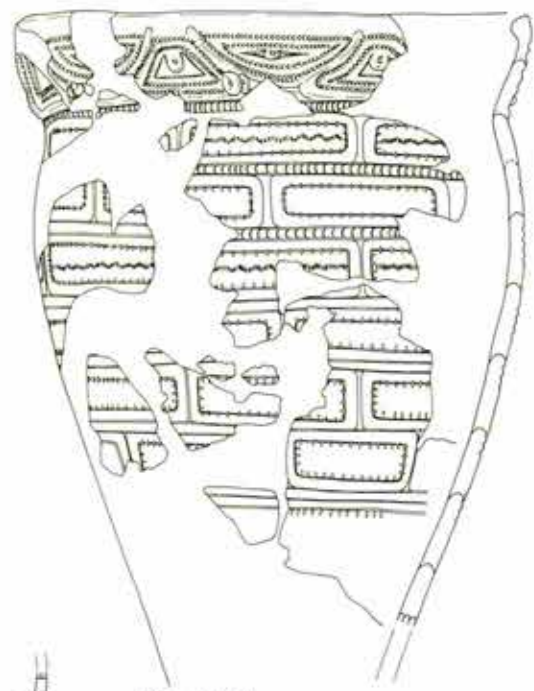

56 SK-198

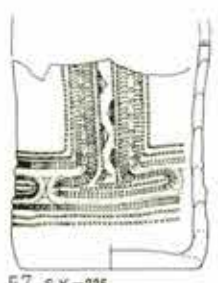

57 SK-226



58 SK-232



59 SK-232

第457图 积迦堂S-IV区 SK-159-175-178-198-226-232 出土土器(9)



第 458 图 积迦堂 S-IV 区 SK-344 -354 -367 -369 -372 -376 -395
-351 -345 -395 -396 出土土器 (10)

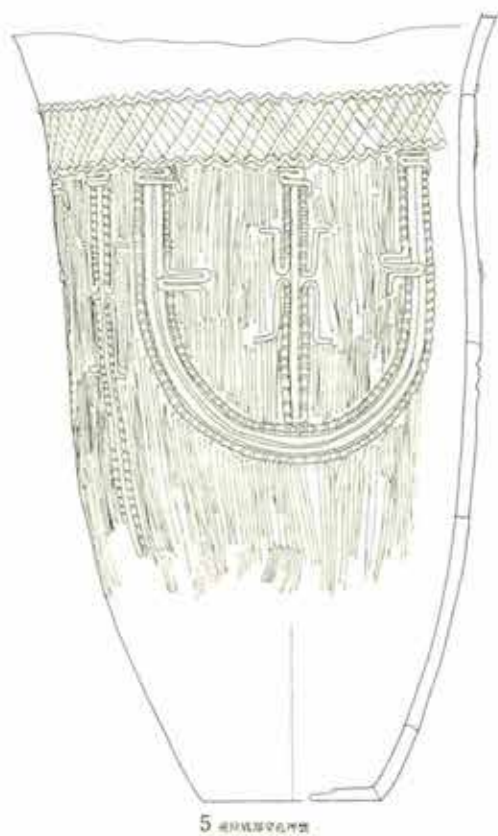
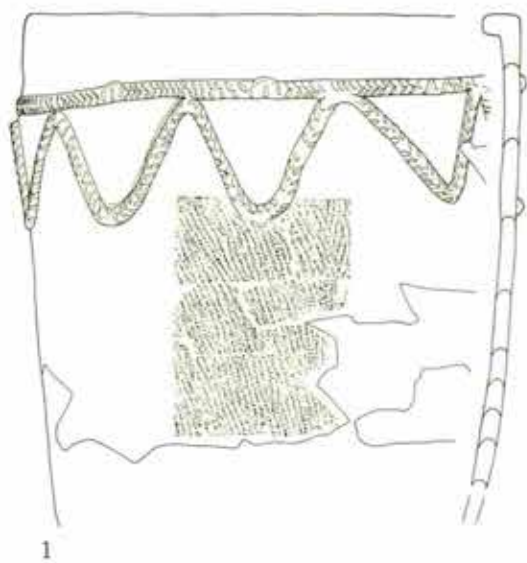

第 459 图 积逊堂 S-IV 区 埋壁



6 灰白陶片



7 灰白陶片



8 灰白陶片

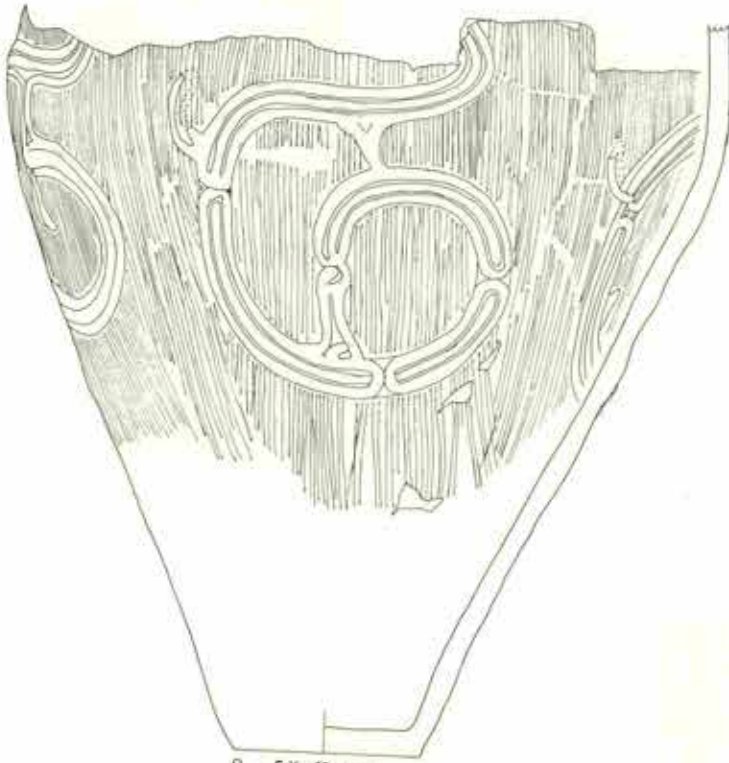

9 SK-09 灰白陶片



10 灰白陶片

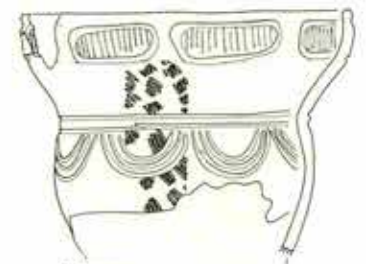

11 灰白陶片

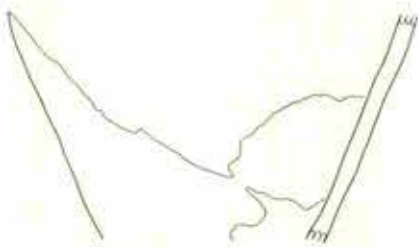

12 灰白陶片

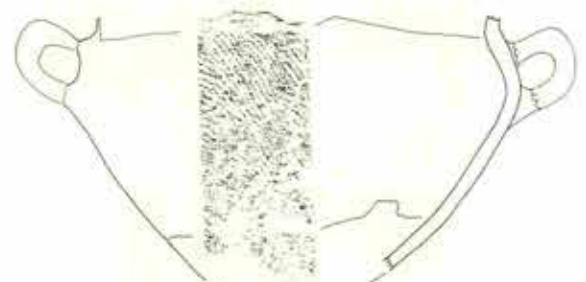

13 灰白陶片



14

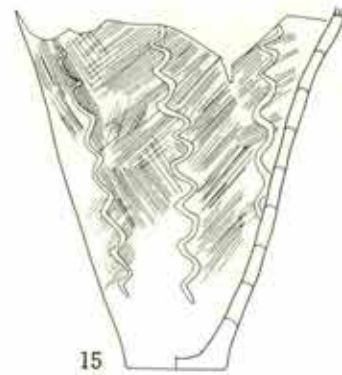

15

第 460 图 积迦堂 S-IV 区 埋残

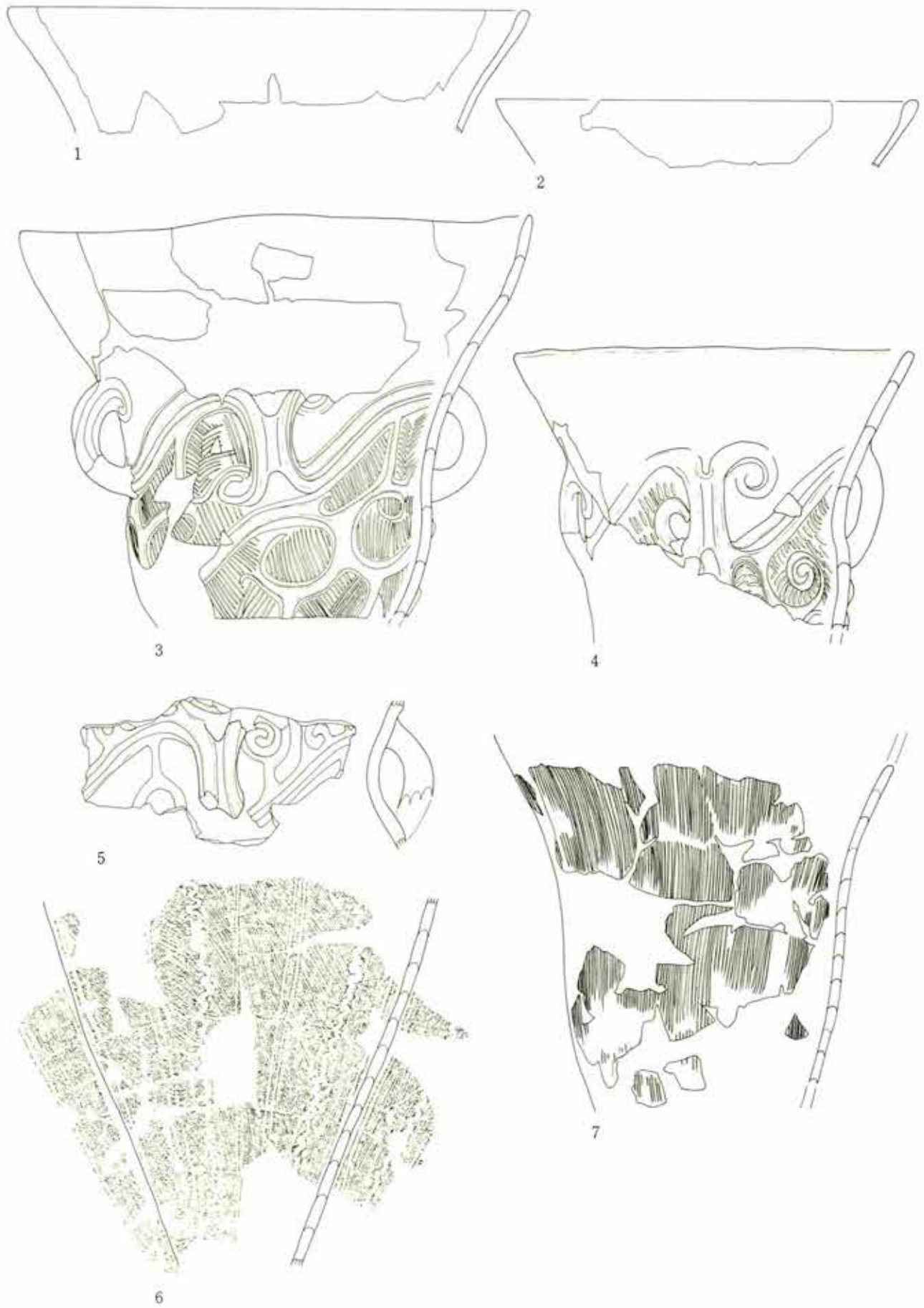

第 461 図 釈迦堂 S-IV 区 土器すてば C 出土土器 (1)

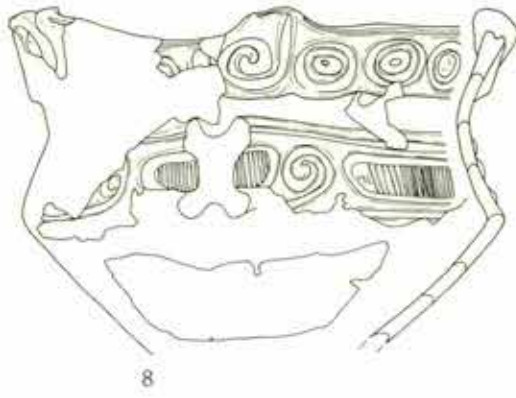

8

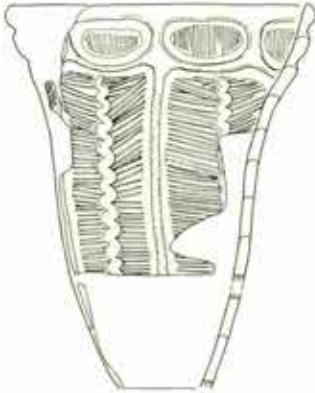

10



13



15



9



11



12



14



16

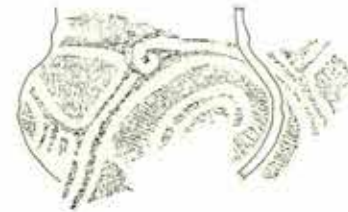

17

第462図 釈迦堂S-IV区 土器すてばC 出土土器 (2)

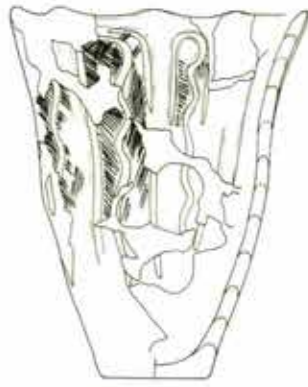

18



19



20



21



23



22



24



25

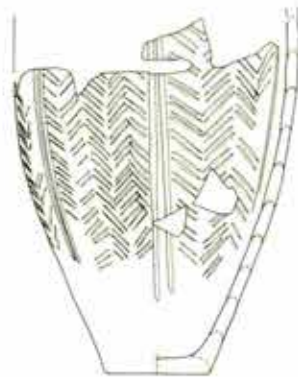

26



27

第463図 釈迦堂S-IV区 土器すてばC 出土土器 (3)



第 464 図 釈迦堂 S-IV 区 土器すてば C 出土土器 (4)

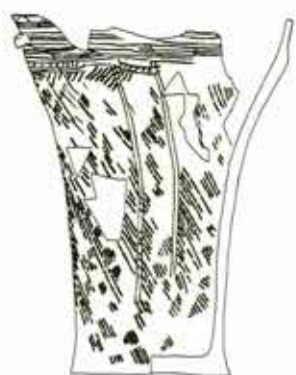

1



2

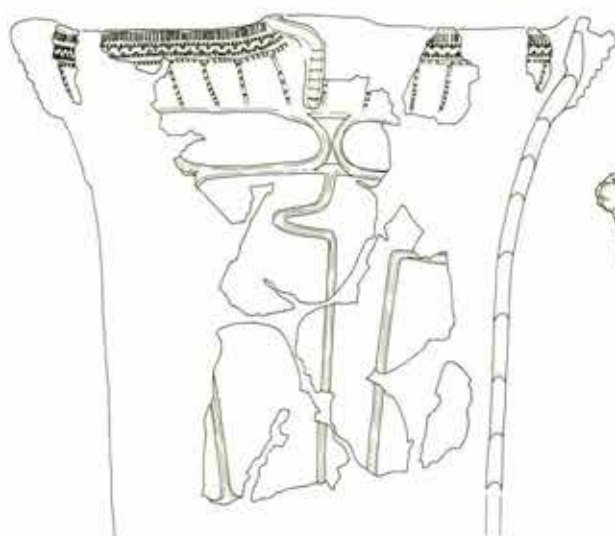

3



4



5

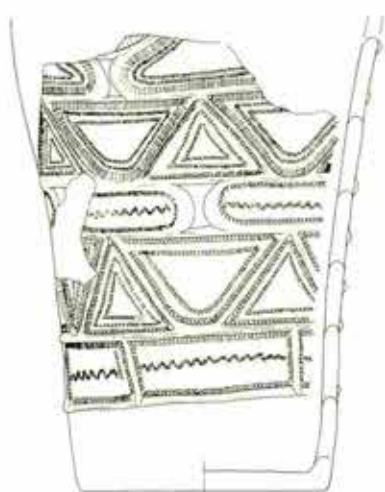

6



7



8



9

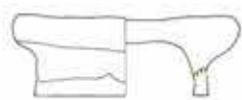

10

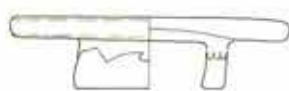

11



12

第465図 釈迦堂S-IV区 グリッド 出土土器 (1)



13



14



15



16



17



18



19

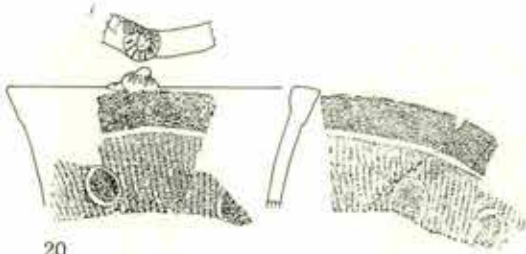

20



21

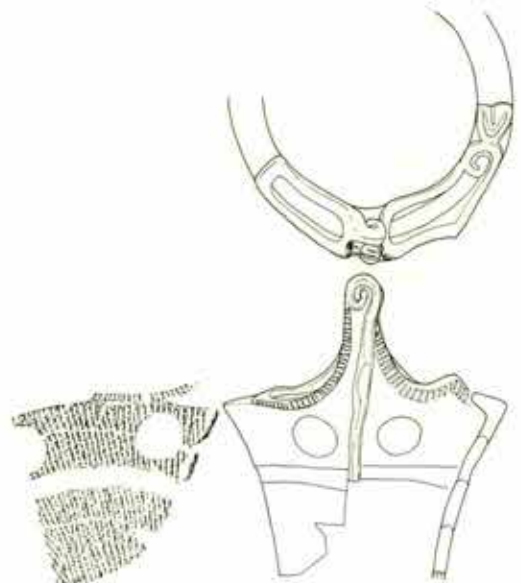

22

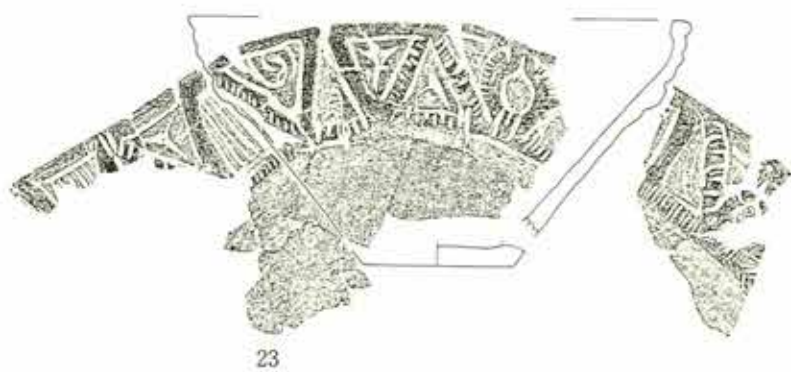

23

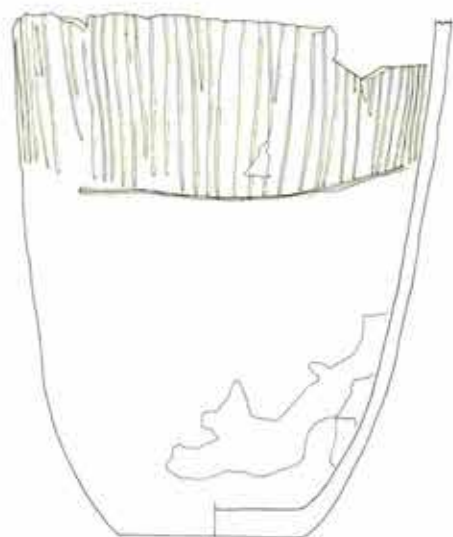

25



24



26

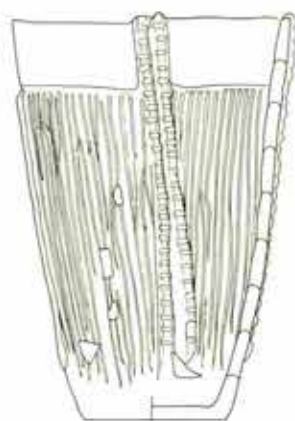

27

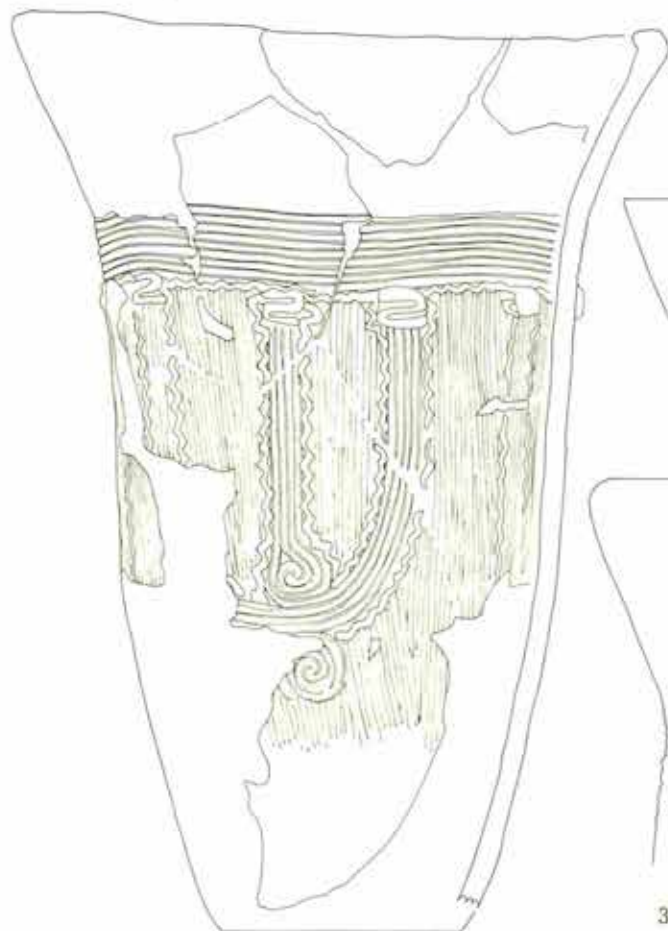

28



29



30

第467図 釈迦堂S-IV区 グリッド 出土土器

(3)



31

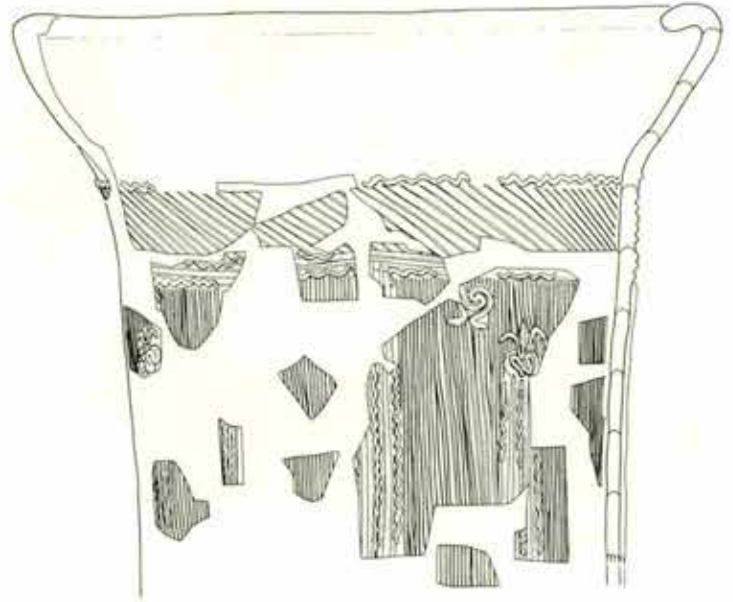

32

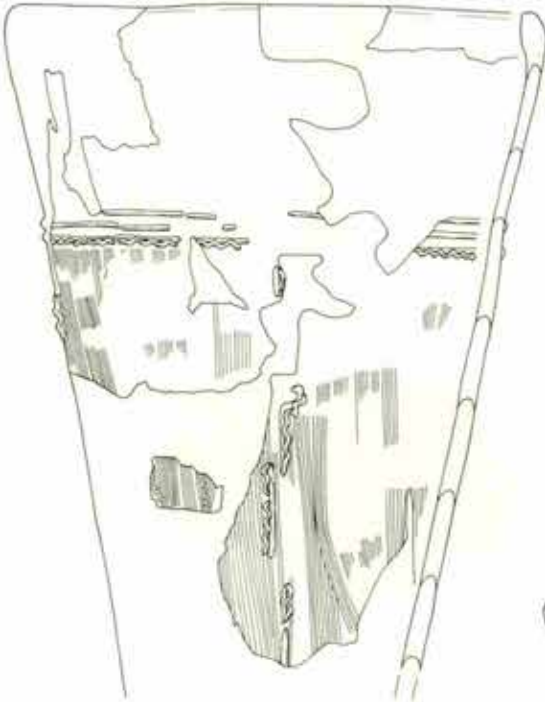

33



34



35

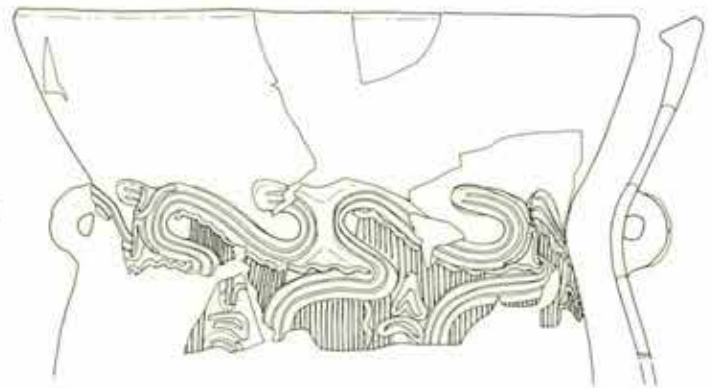

36

第468図 釈迦堂S-IV区 グリッド 出土土器 (4)

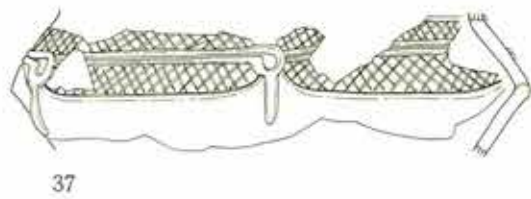

37



38



39



40



41



42



43



44

第469図 釈迦堂S-IV区 グリッド 出土土器 (5)

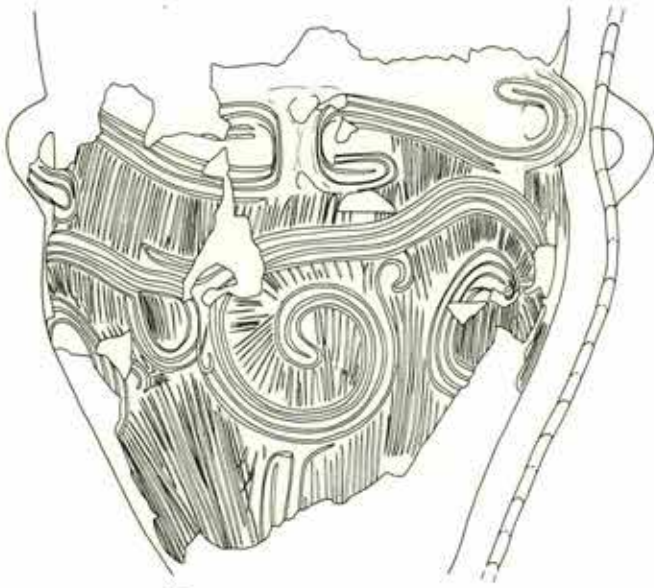

45



46

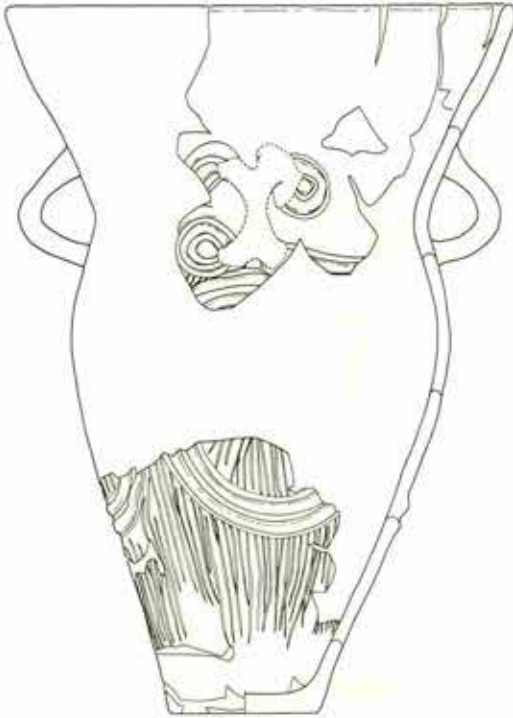

47

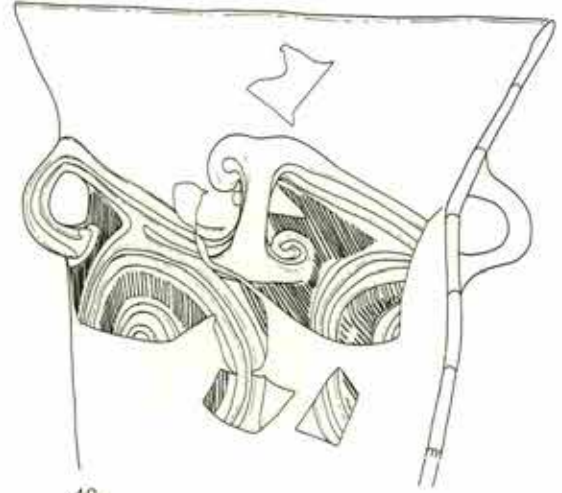

48

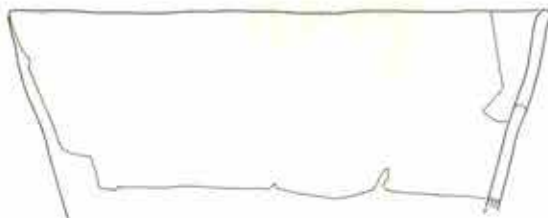

49

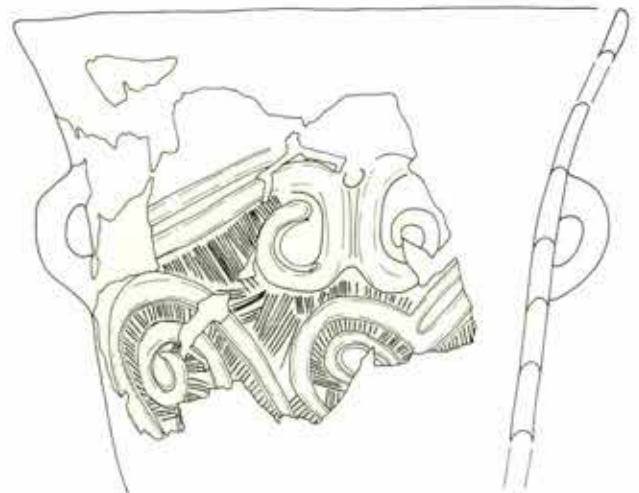

50

第470図 釈迦堂S-IV区 グリッド 出土土器 (6)



51

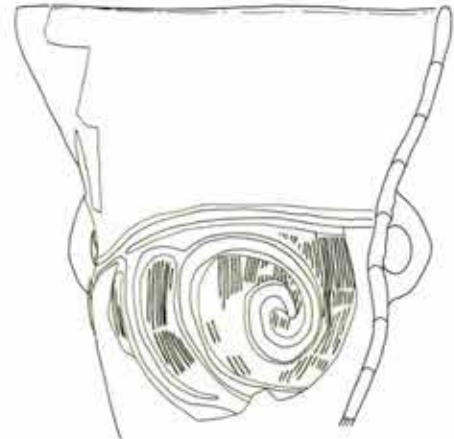

52

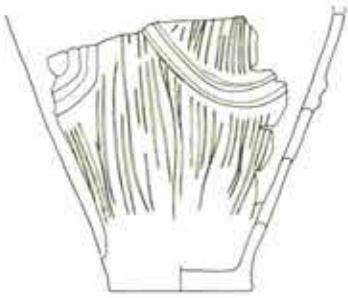

54

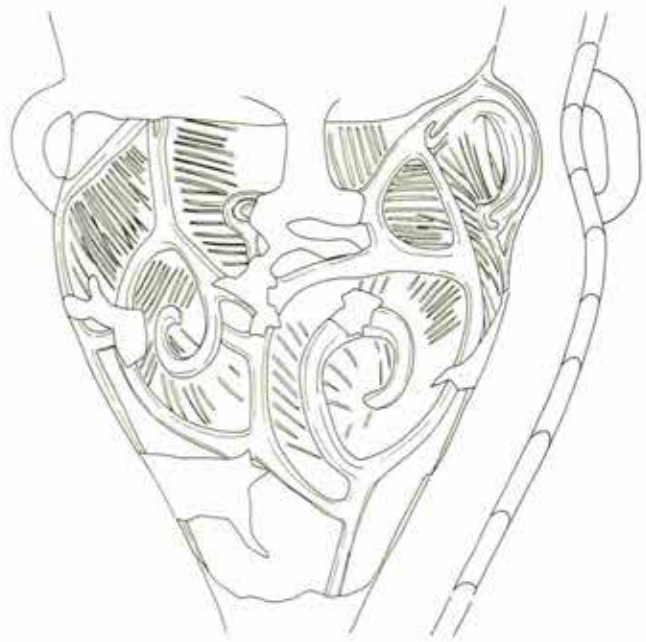

55

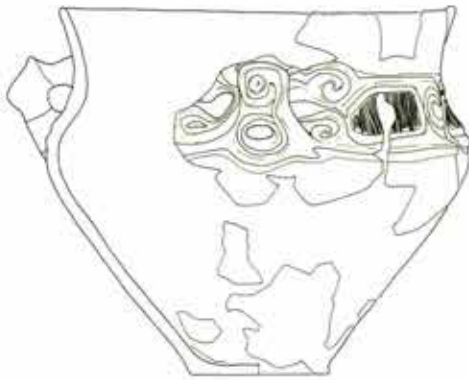

56

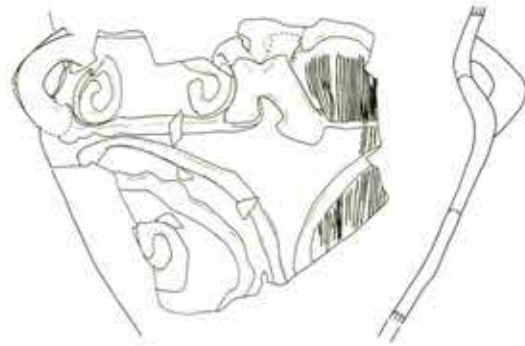

57

第471図 釈迦堂S-IV区 グリッド 出土土器 (7)



58



59

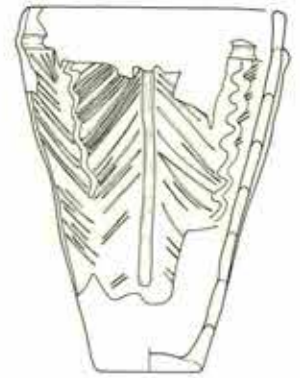

60



61



62



63

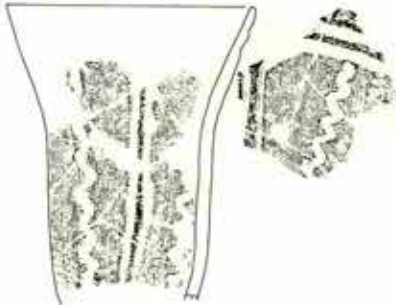

64

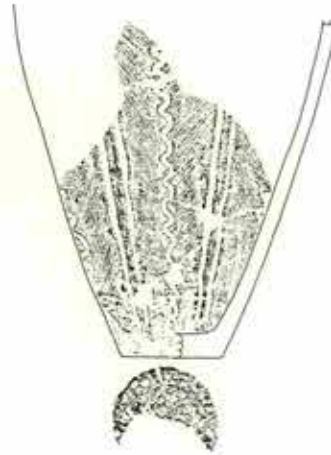

65



66



67



68



69



70



71

第472図 釈迦堂S-N区 グリッド 出土土器 (8)



72



73



74



75



76

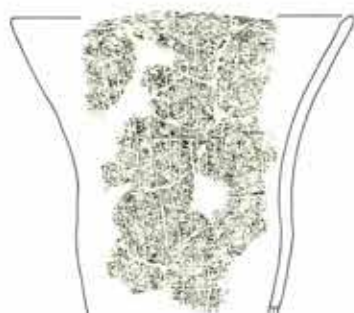

77



78

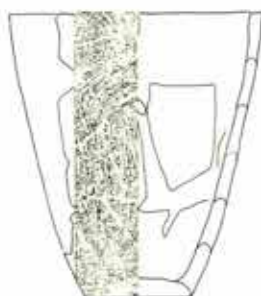

79



80



81



82



83



84



85



86

第473図 釈迦堂S-IV区 グリッド 出土土器 (9)



第474図 釈迦堂S-IV区 グリッド 出土土器 (10)



98

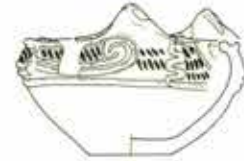

99



100



101



103

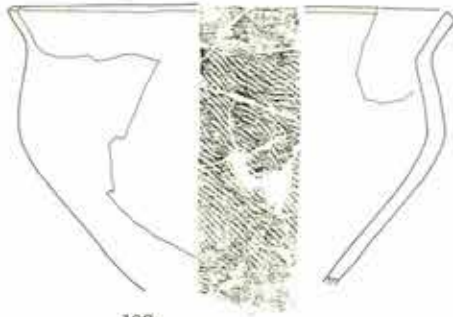

102



105



108

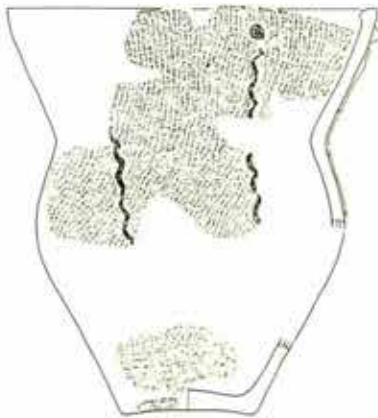

104



107



106



109

第475図 釈迦堂S-IV区 グリッド 出土土器

(11)

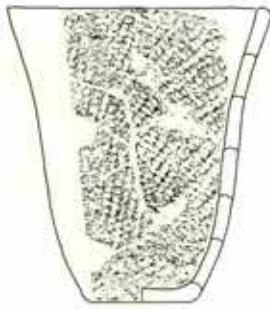

110



111

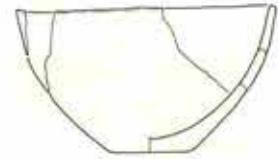

112



113



114



115



116



117



118

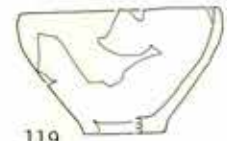

119

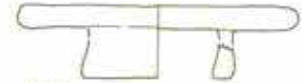

120

第476図 釈迦堂S-IV区 グリッド 出土土器

(12)

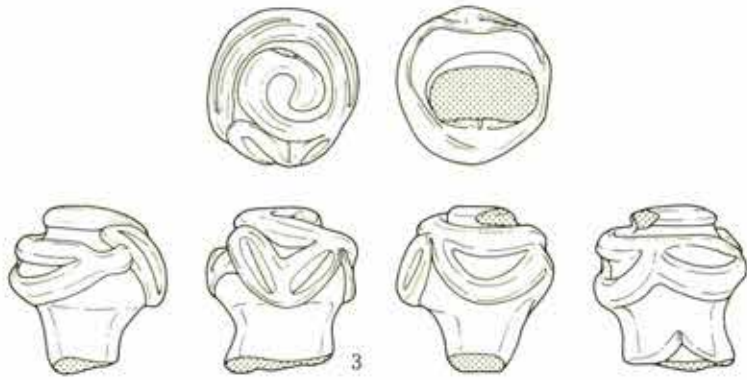

1.008

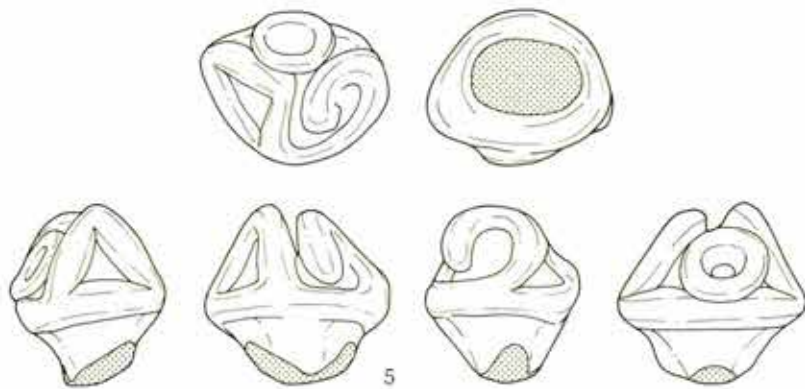

第477图 积迦堂S—IV区把手

(1) (1:2)

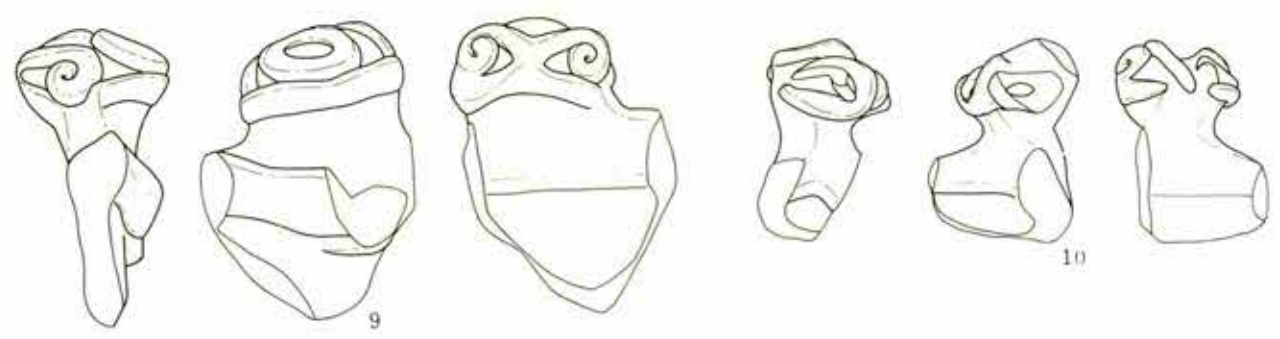
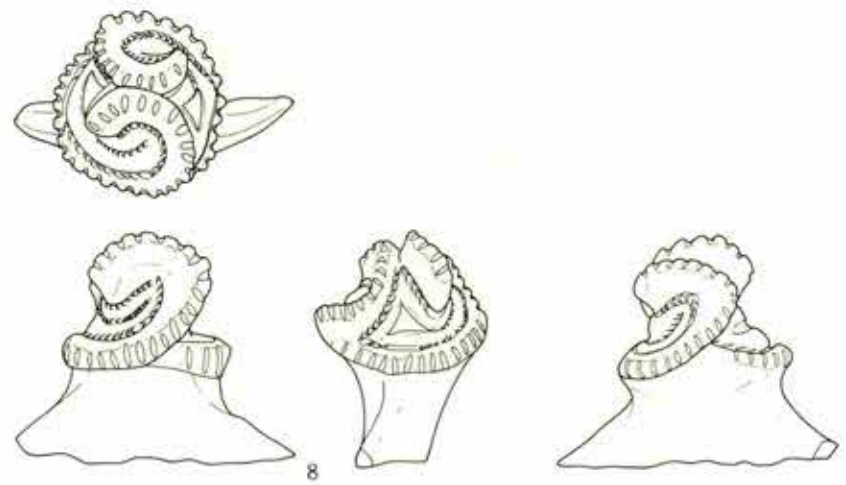
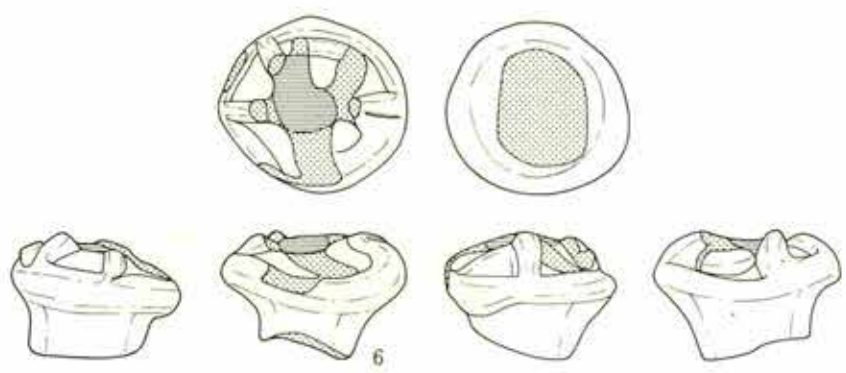

第 478 图 积迦堂 S—IV 区把手

(2) (1:2)

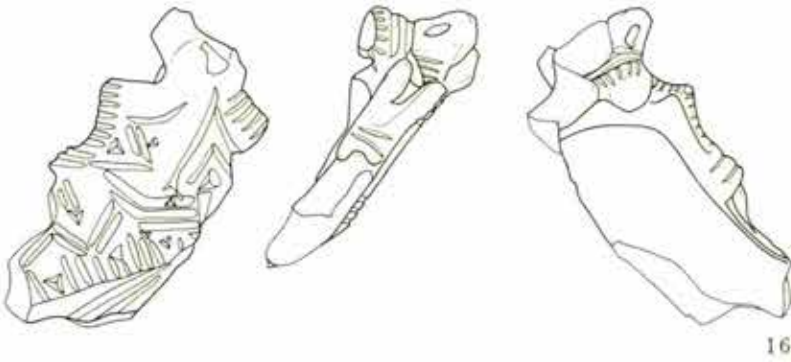
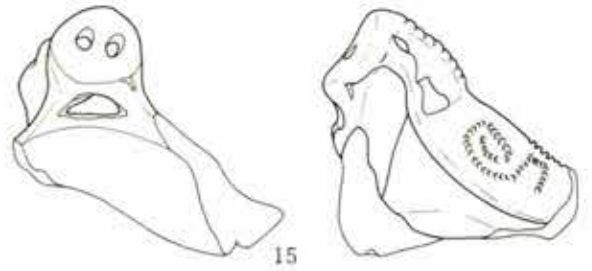
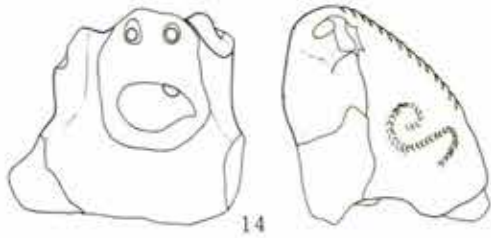
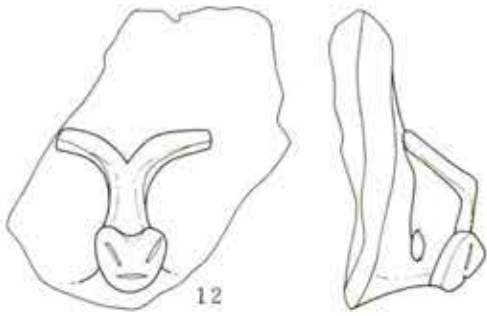
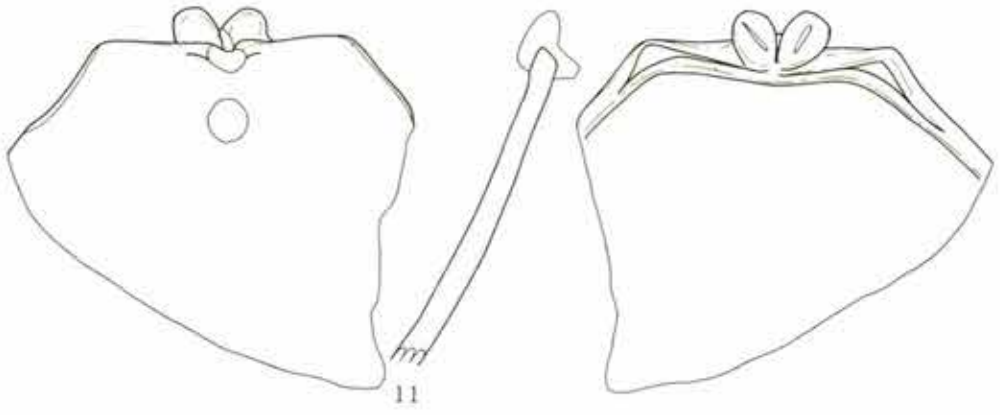

第 479 图 积迦堂 S-IV 区 把手

(3) (1:2)

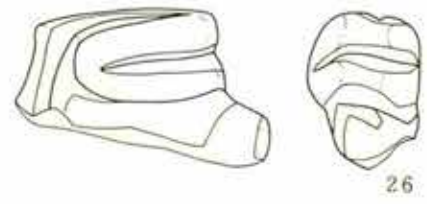
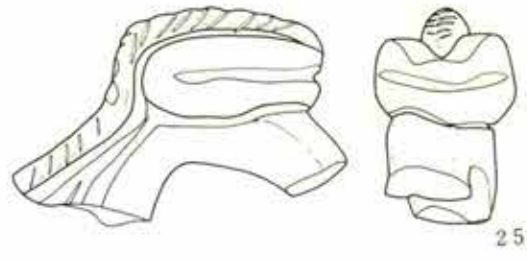
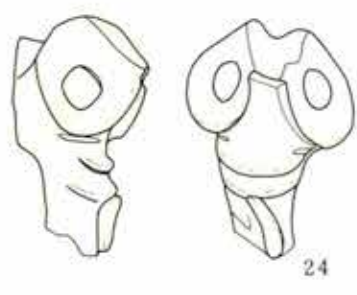
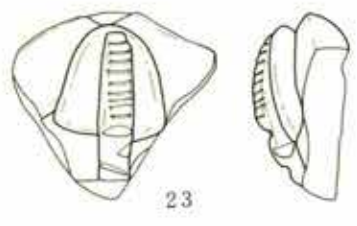
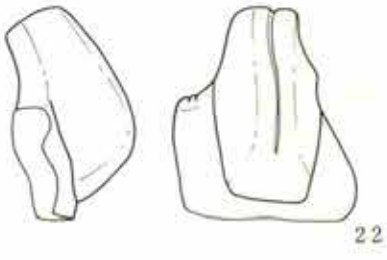
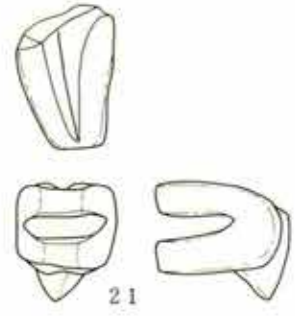
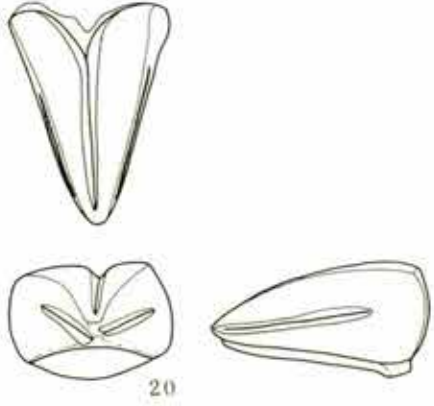
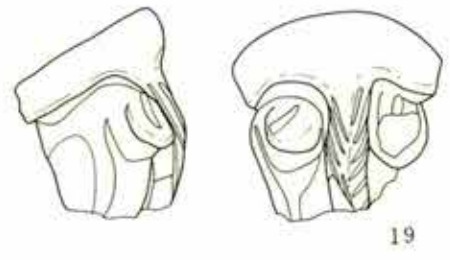
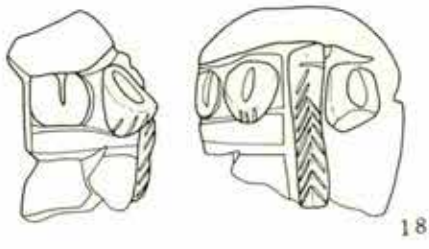

第 480 图 积迦堂 S—IV 区把手

(4) (1:2)

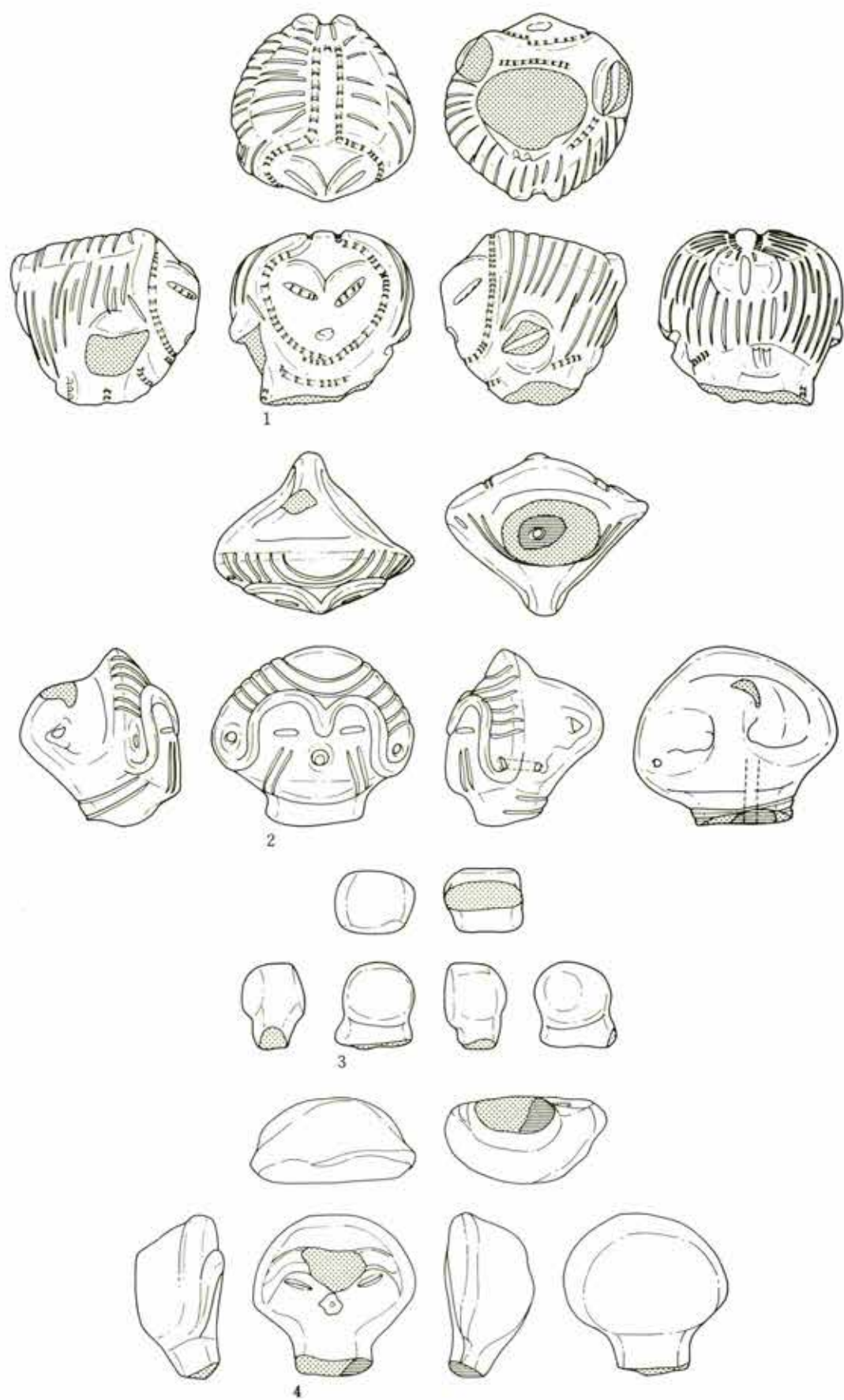

第481图 积逊堂S-IV区 土偶 (1)

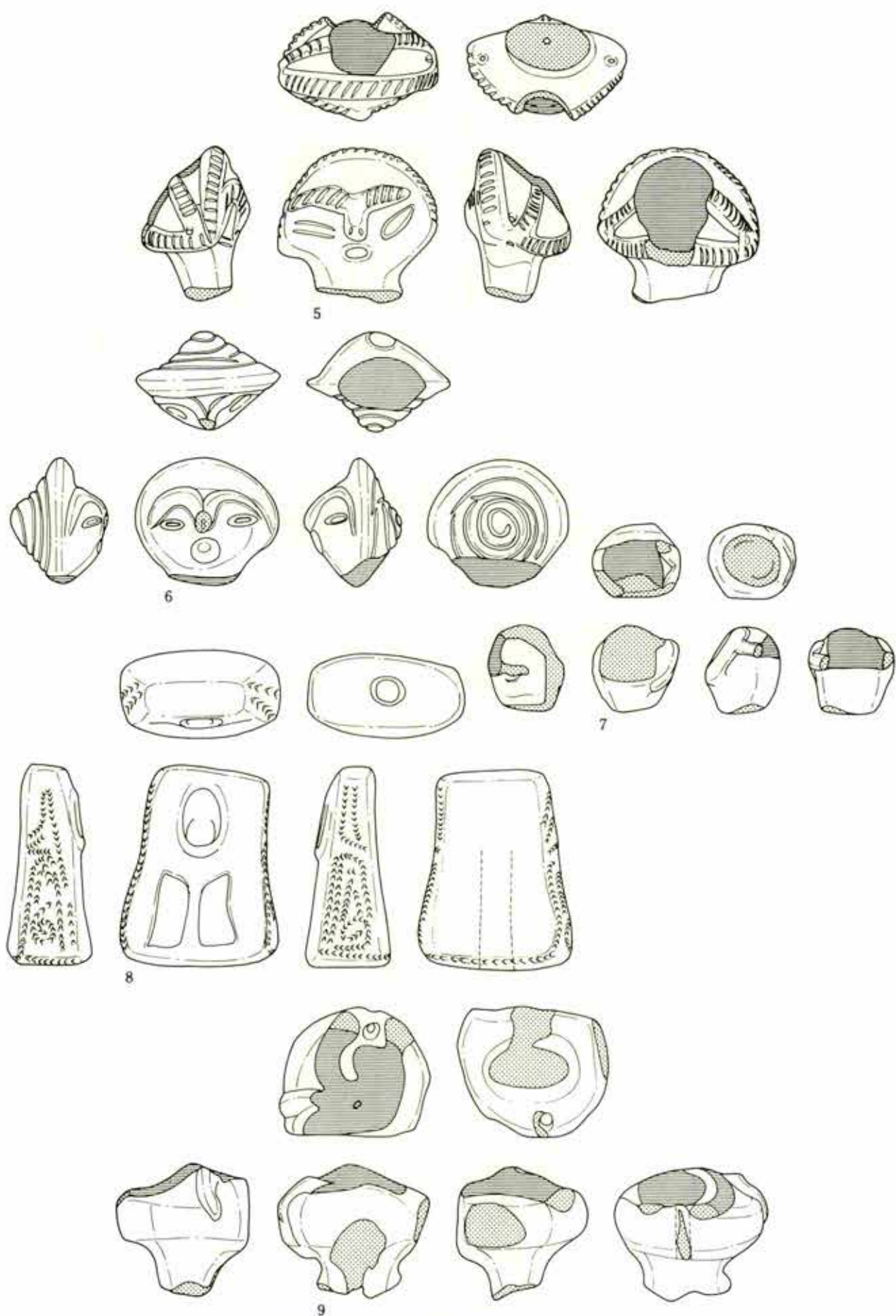

第482图 积逊堂S—IV区 土偶 (2)

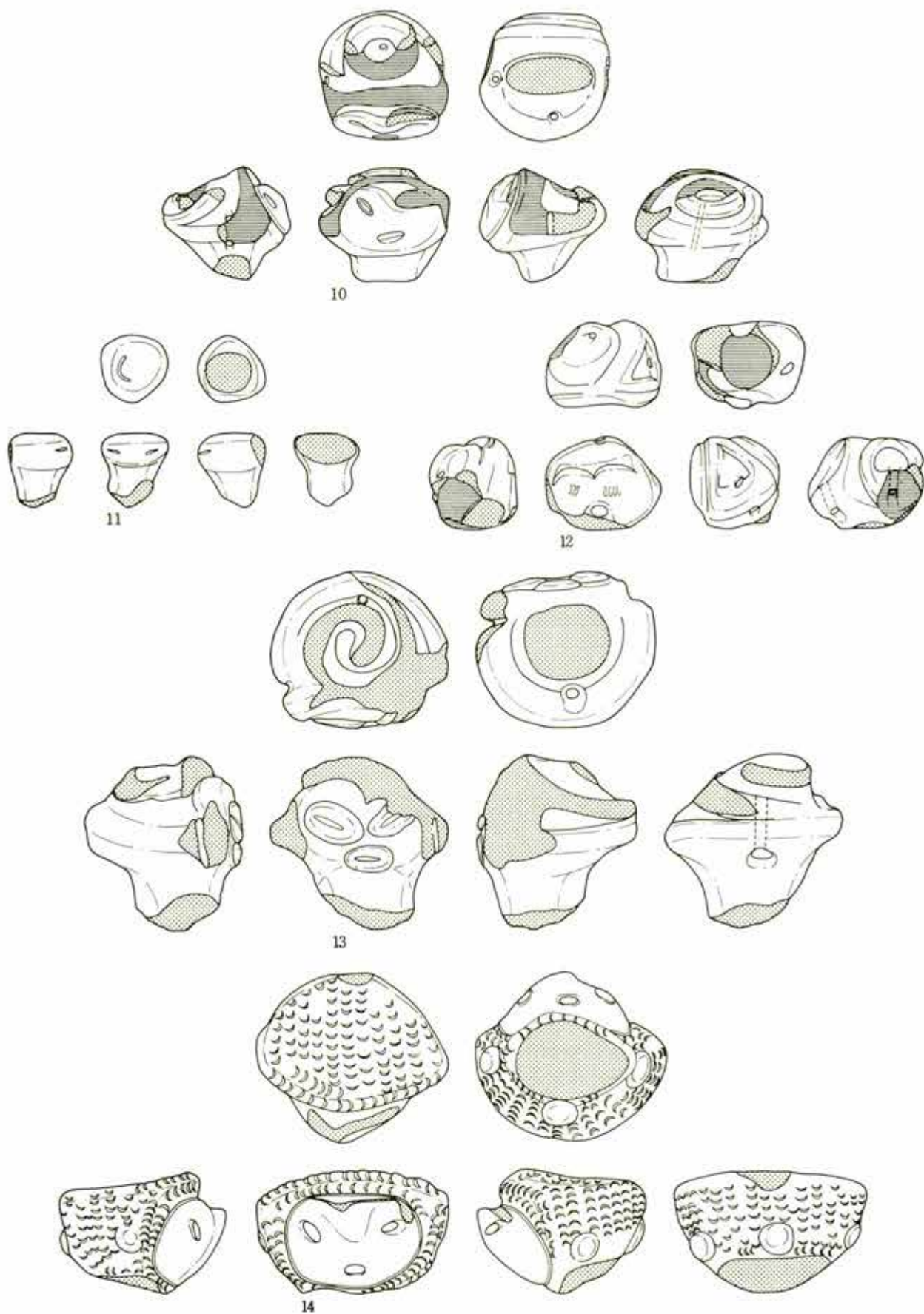

第483图 积迦堂S-IV区 土偶 (3)

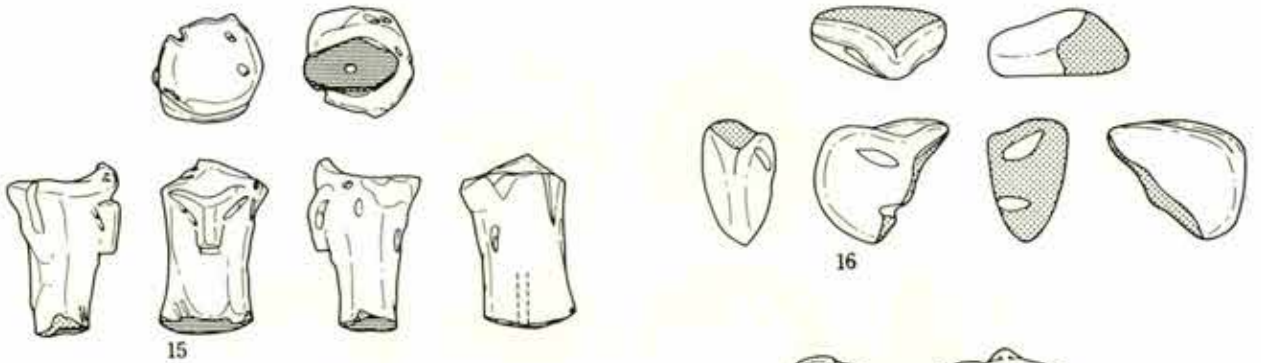

15

16



17

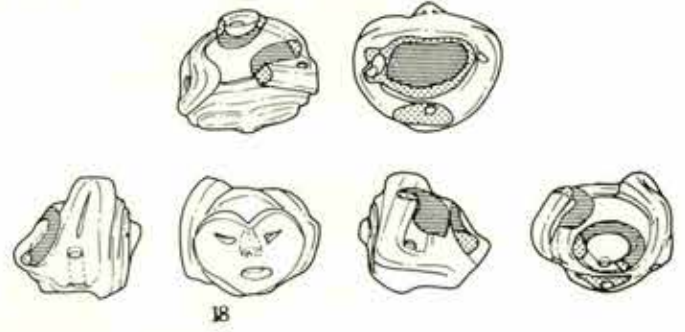

18

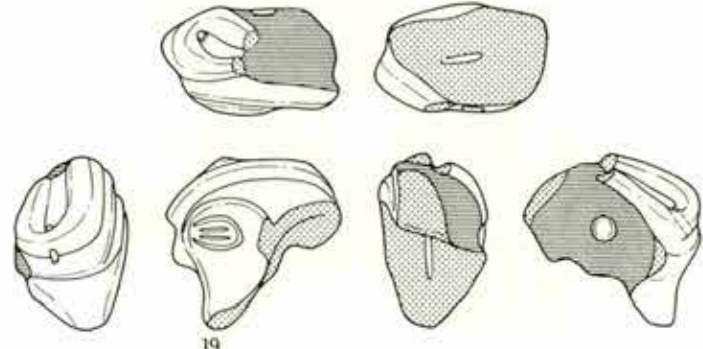

19

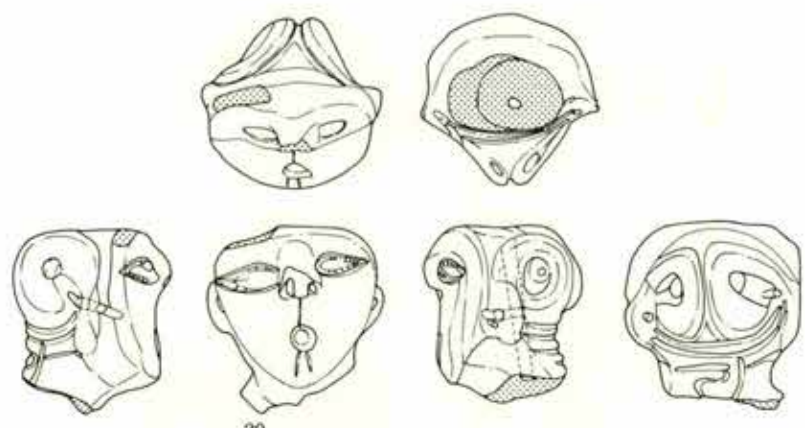

20

第484图 积迦堂S-IV区 土偶 (4)

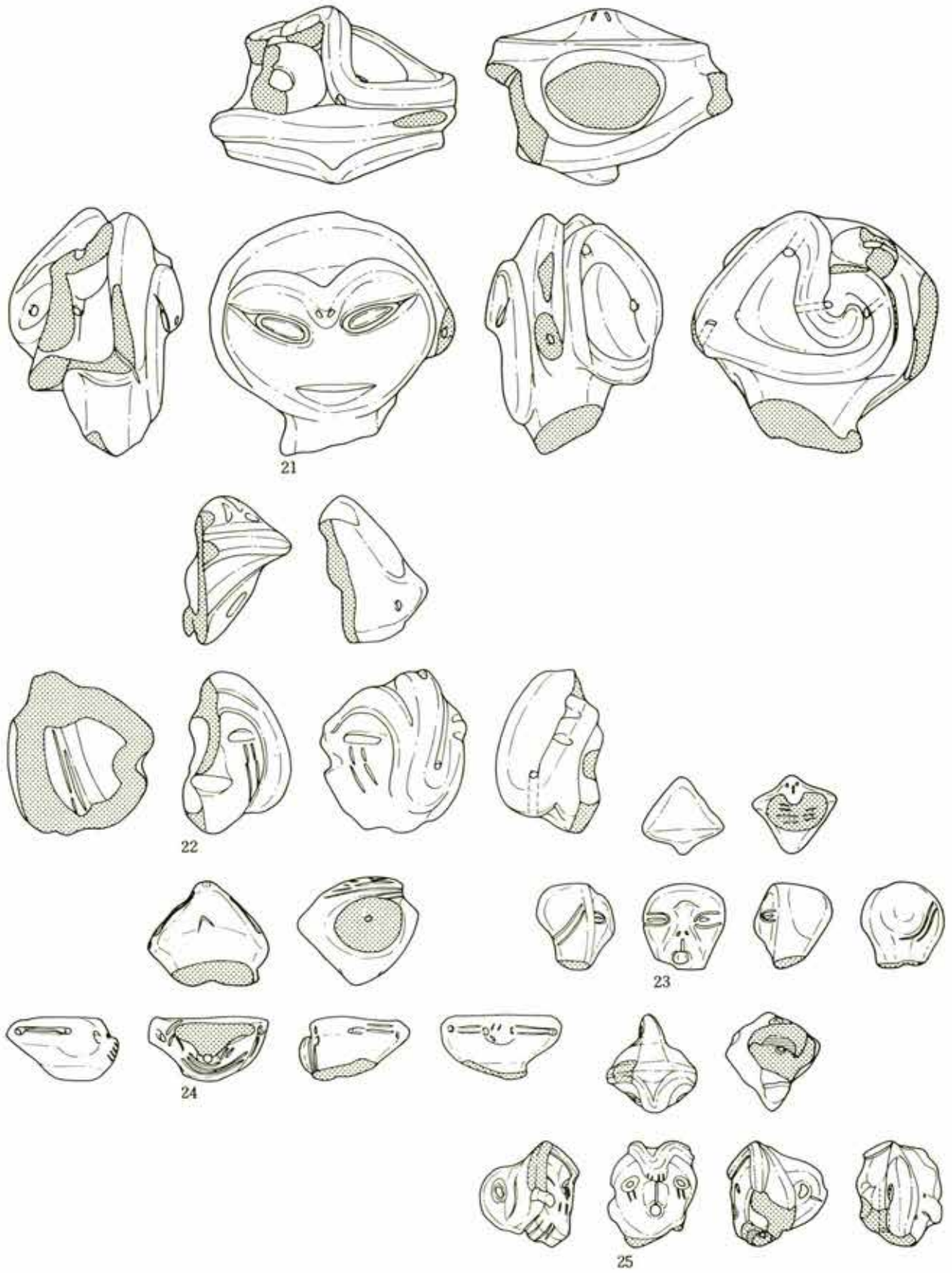

第485图 积逊堂S-IV区 土偶 (5)



第486图 积逊堂S-IV区 土偶 (6)

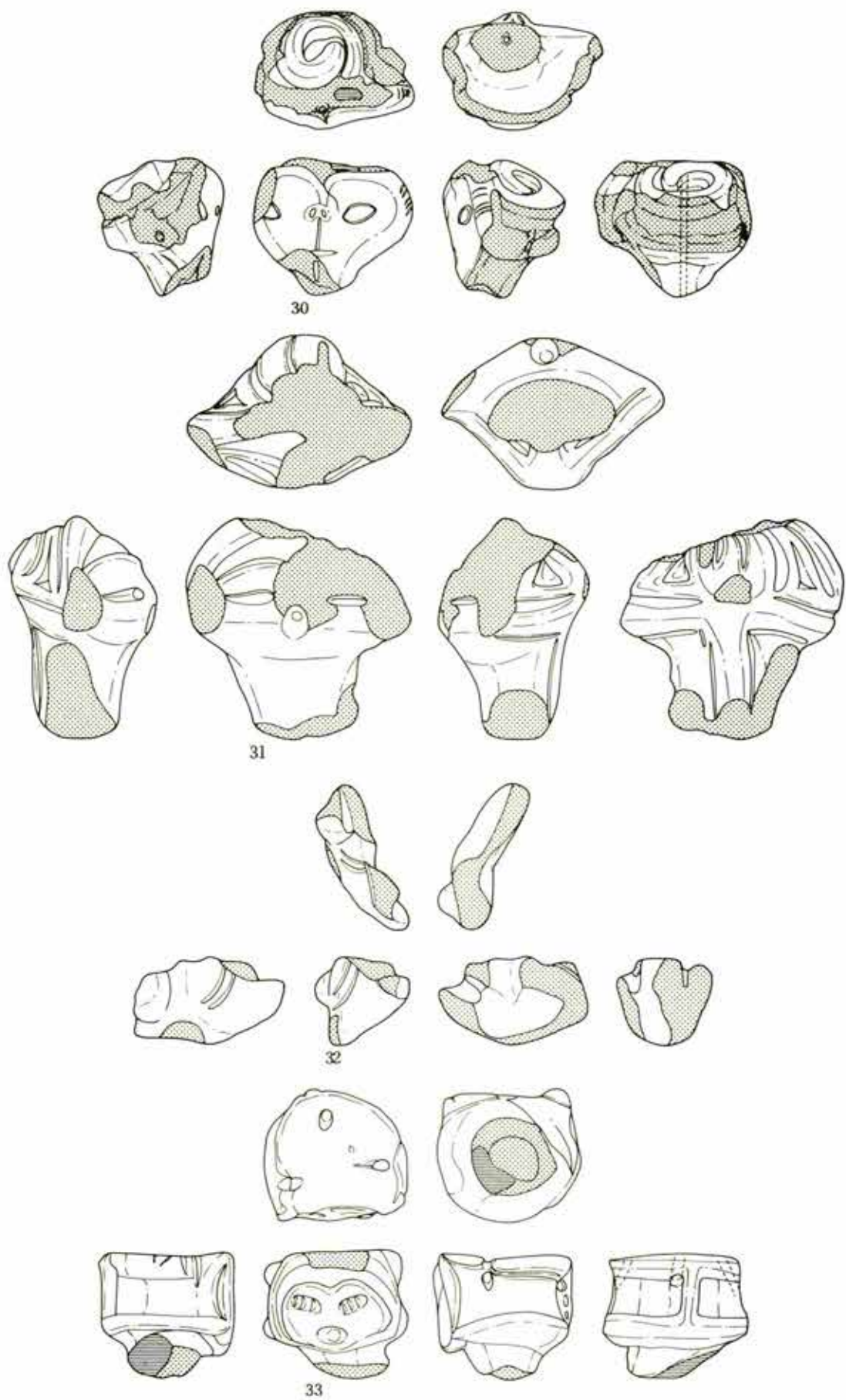

第 487 图 积逊堂 S—IV 区 土偶 (7)

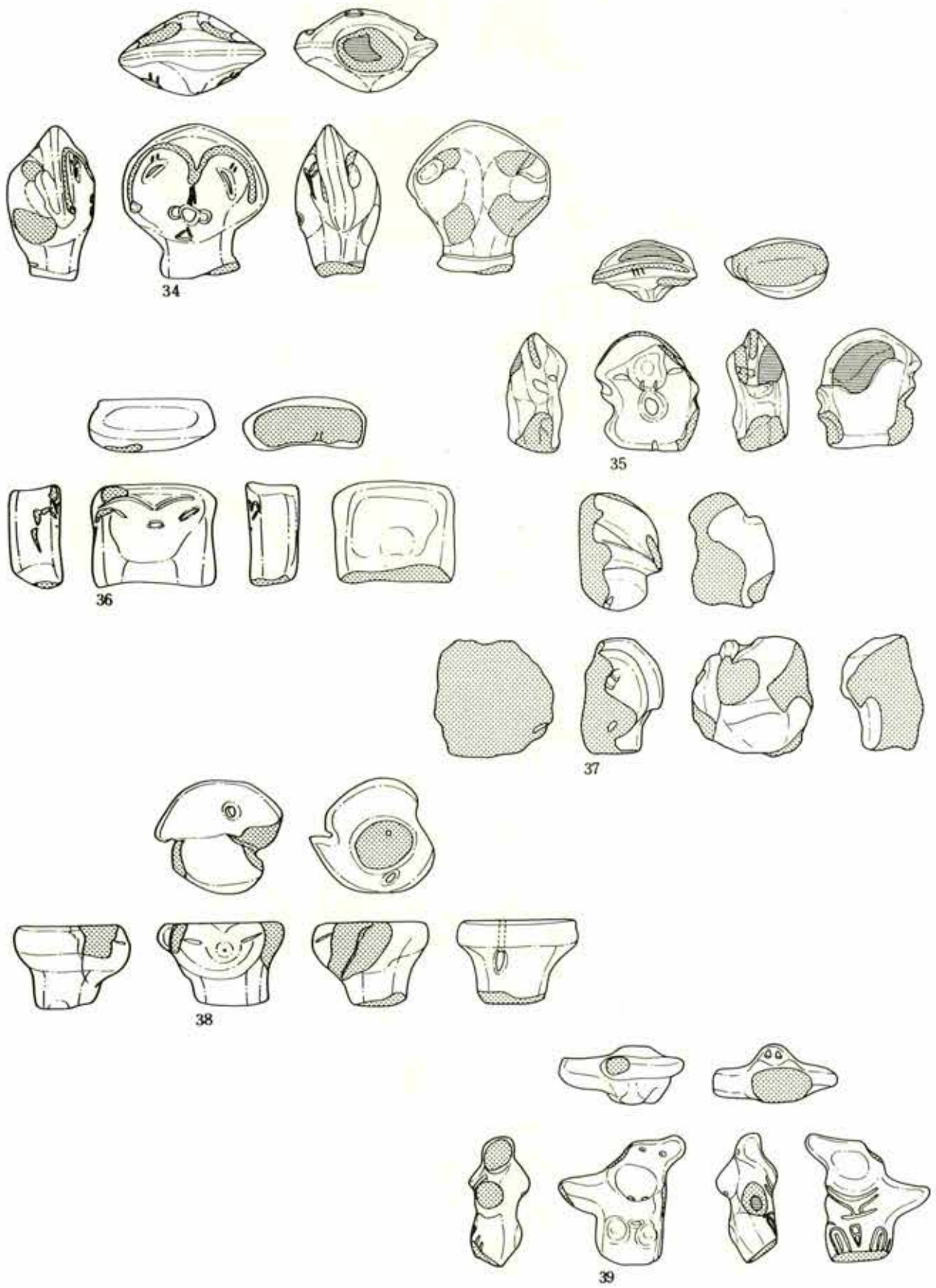

第488图 积逊堂S—V区 土偶 (8)

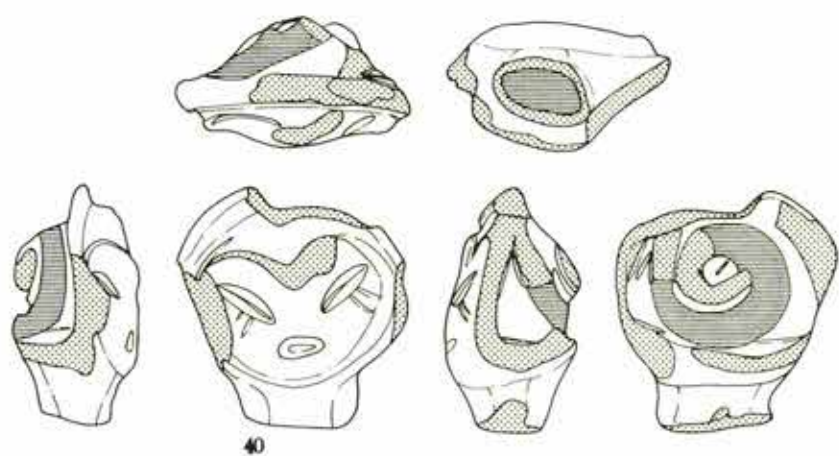

40

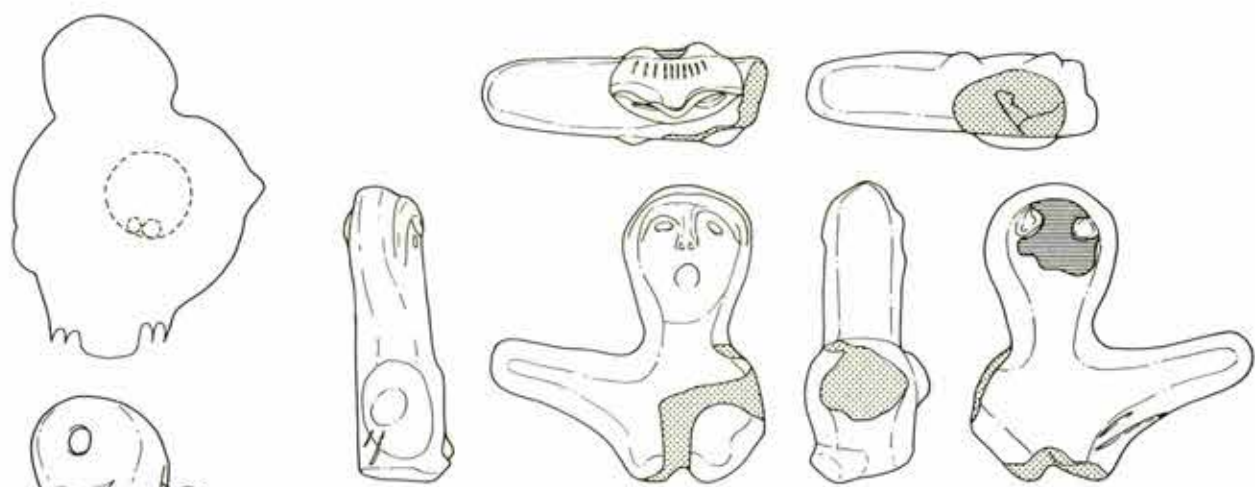

41

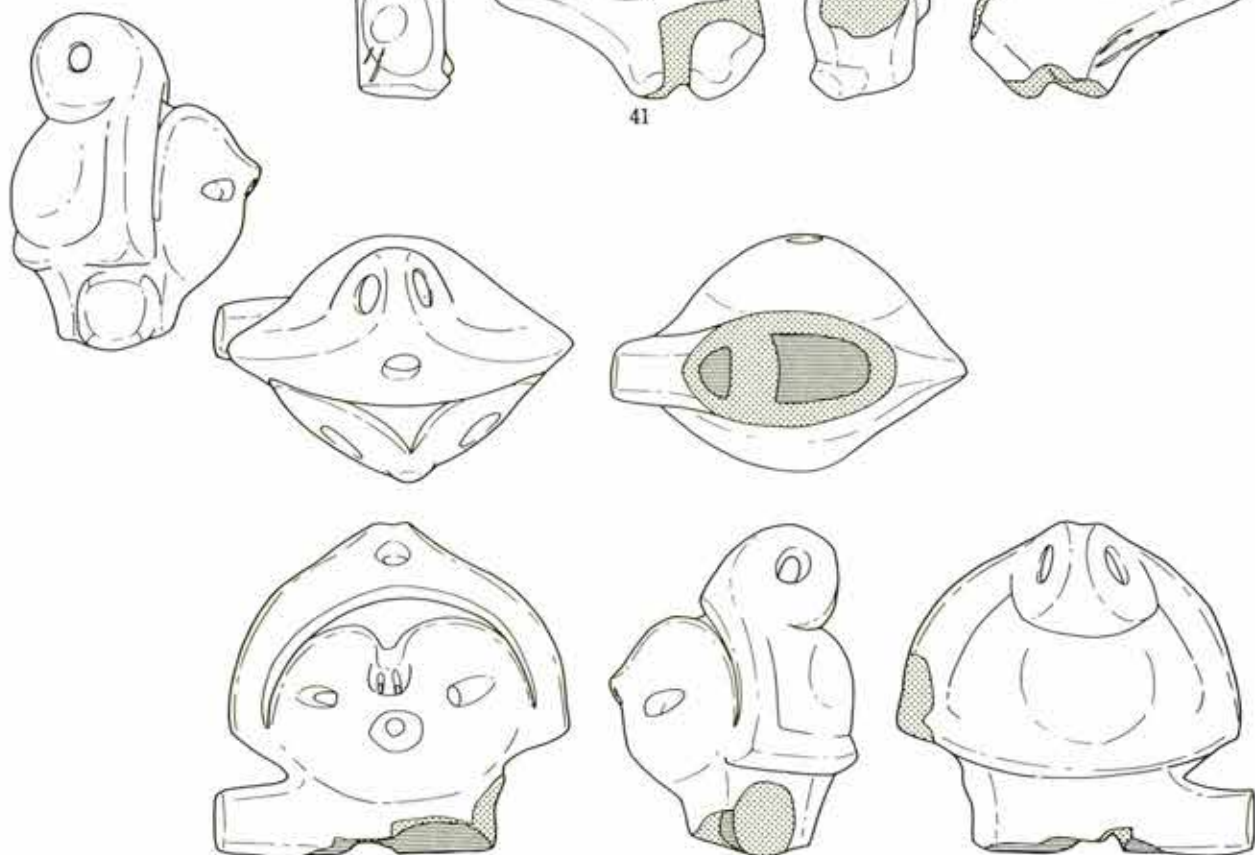

42

第 489 图 积逊堂 S—IV 区 土偶 (9)

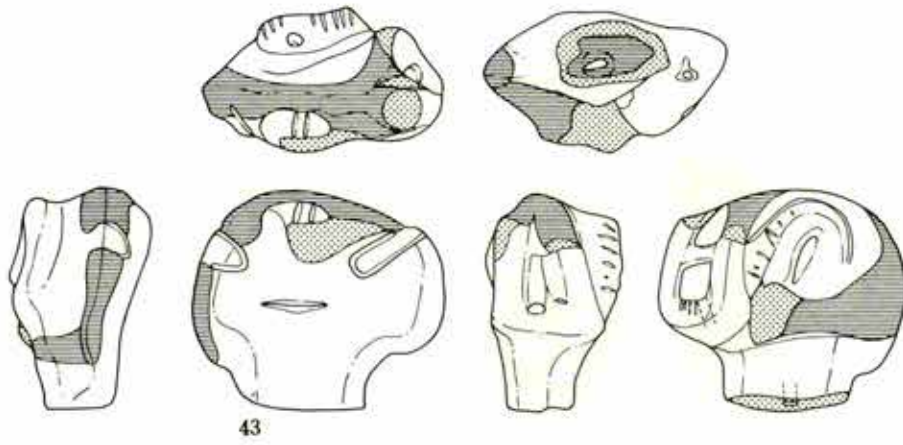

43

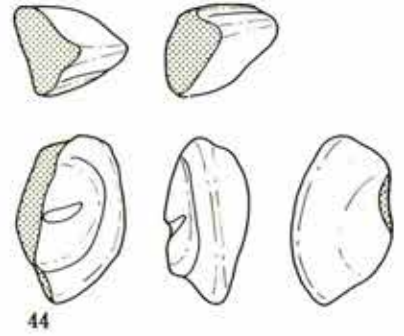

44



45

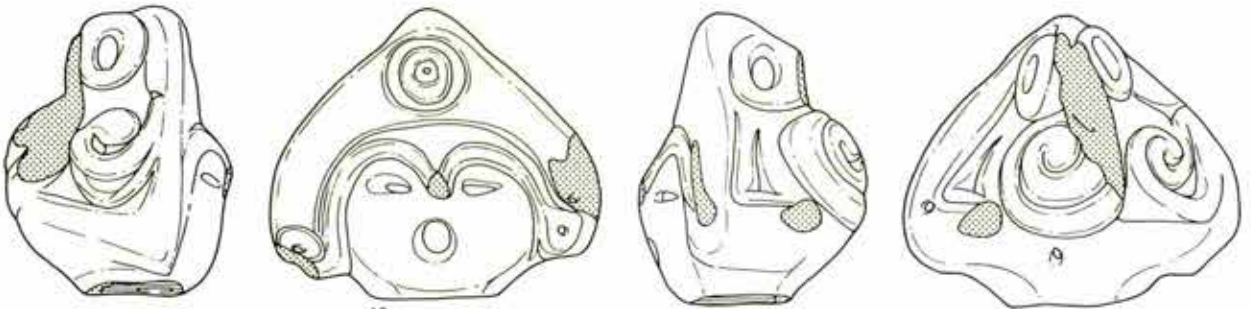
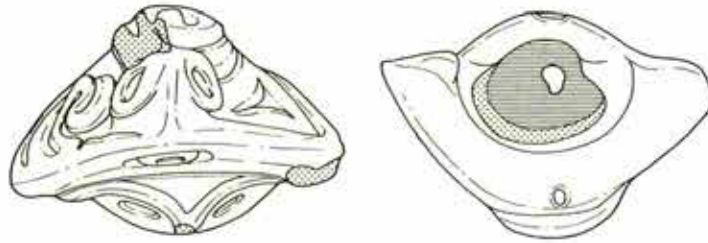

46

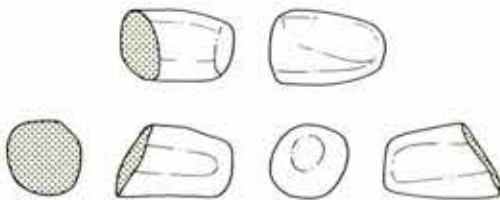

47

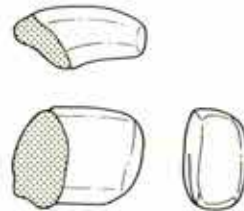

48

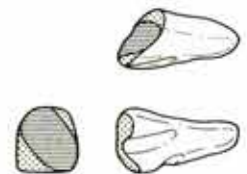

49

第490图 积逊堂S-N区 土偶 (10)

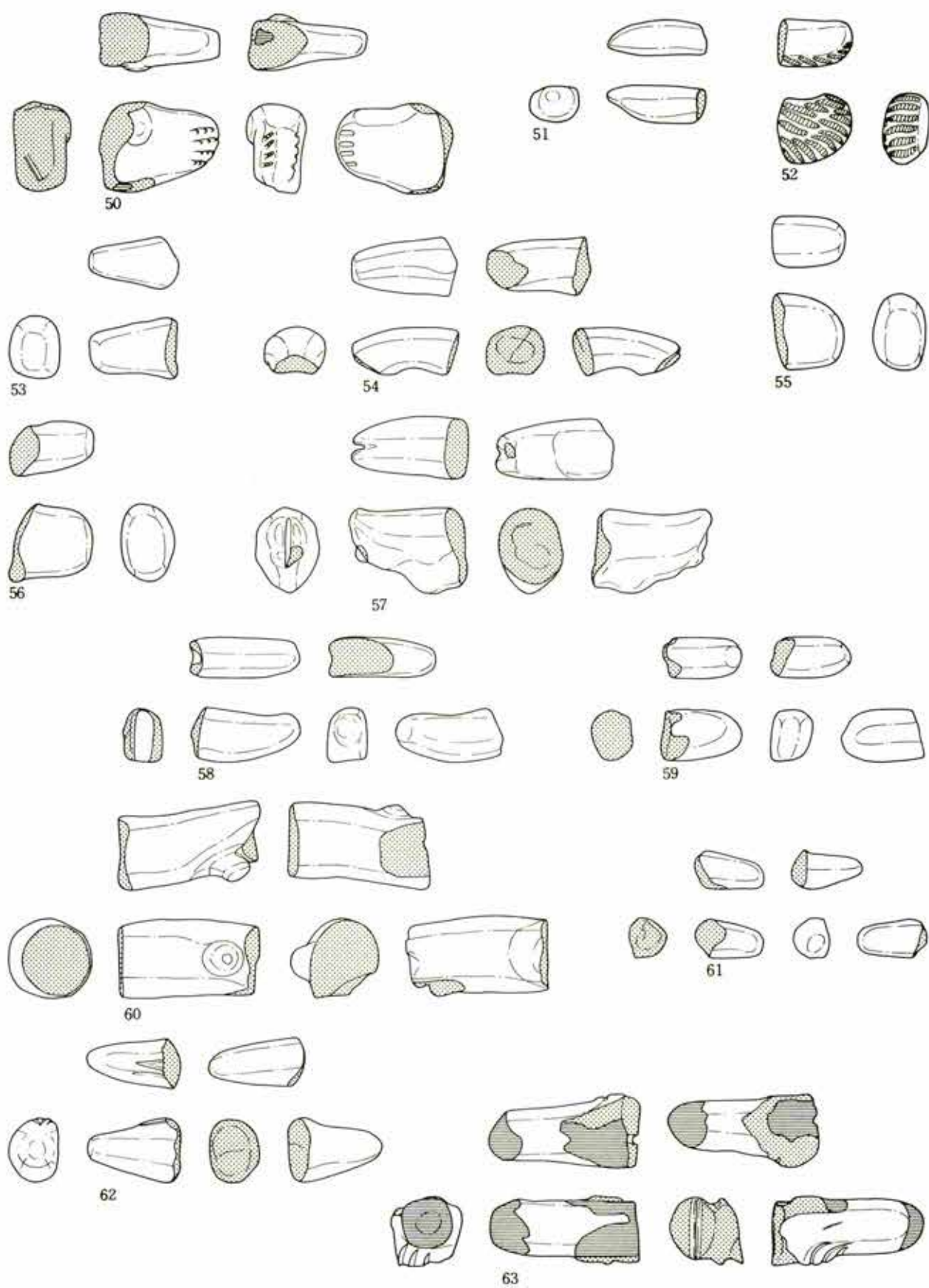

第 491 图 积逊堂 S-IV 区 土偶 (11)

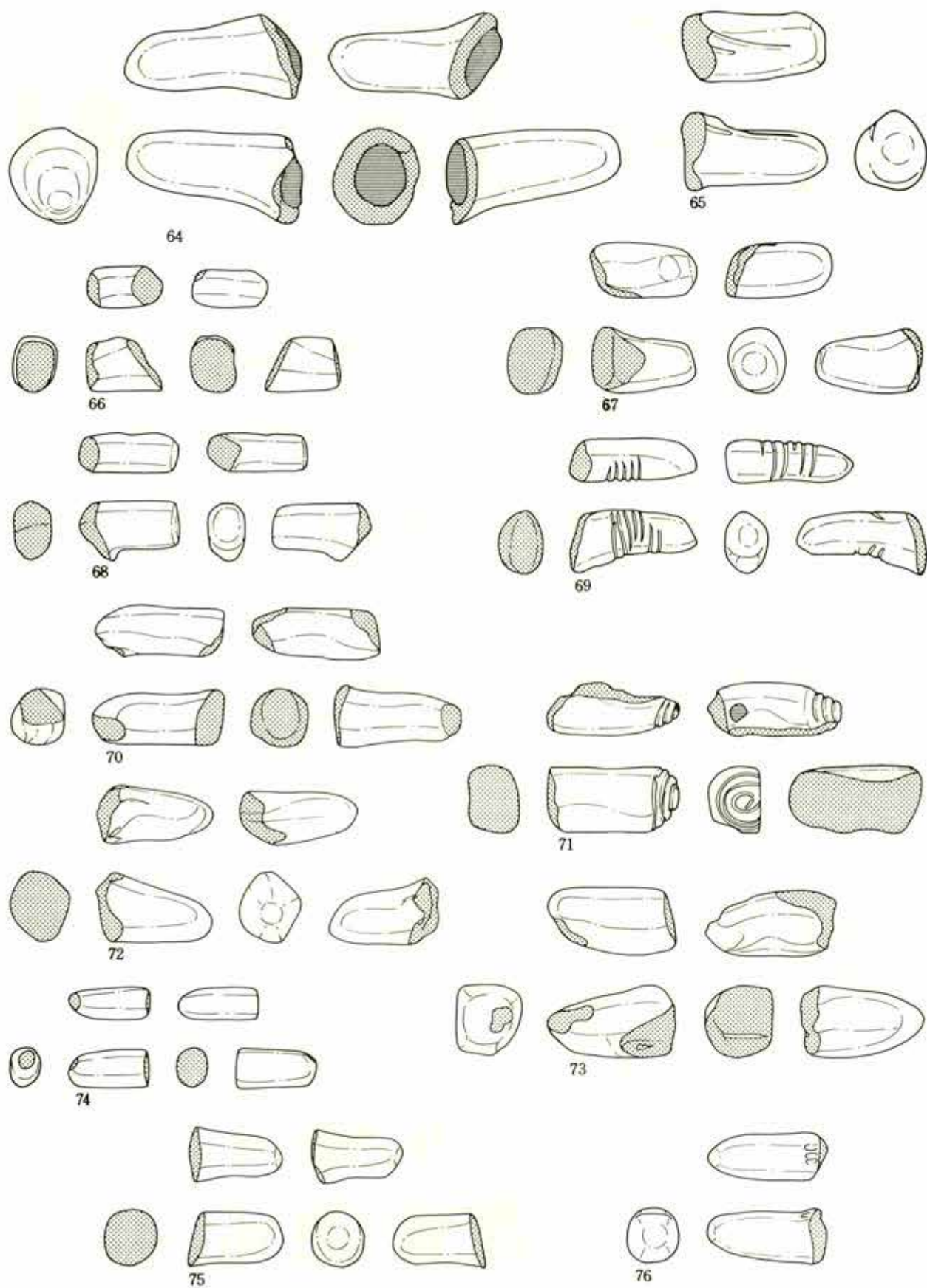

第 492 图 积迦堂 S—IV 区 土偶 (12)

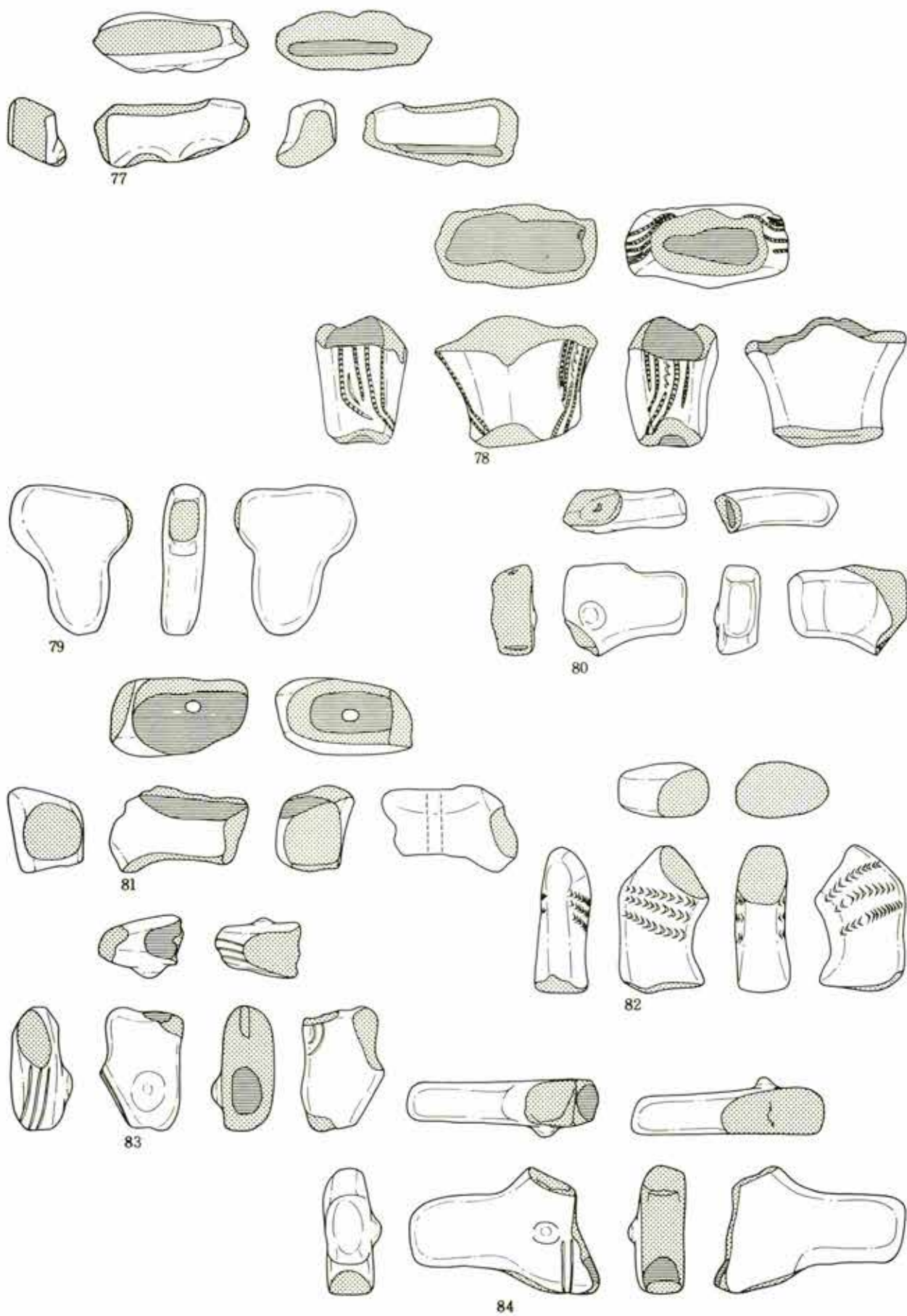

第 493 图 积逊堂 S-IV 区 土偶 (13)

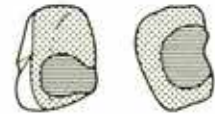
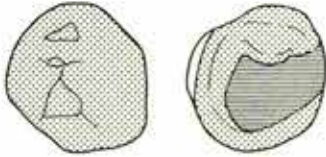
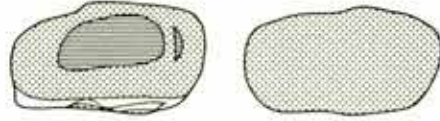
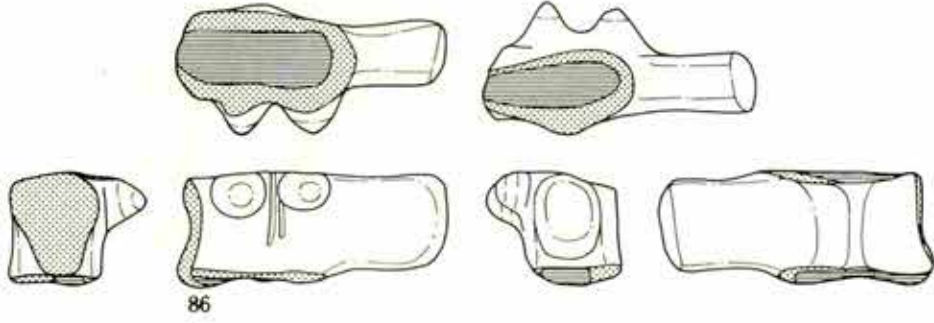
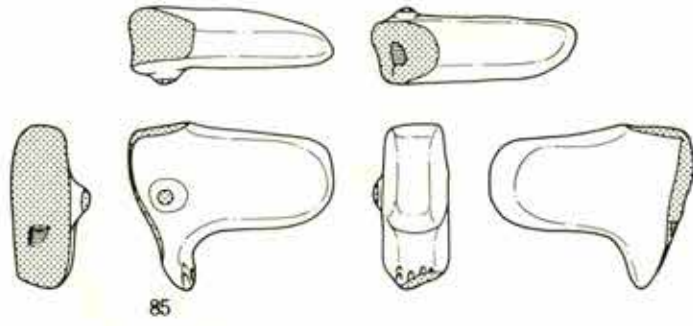

第 494 图 积逊堂 S-IV 区 土偶 (14)

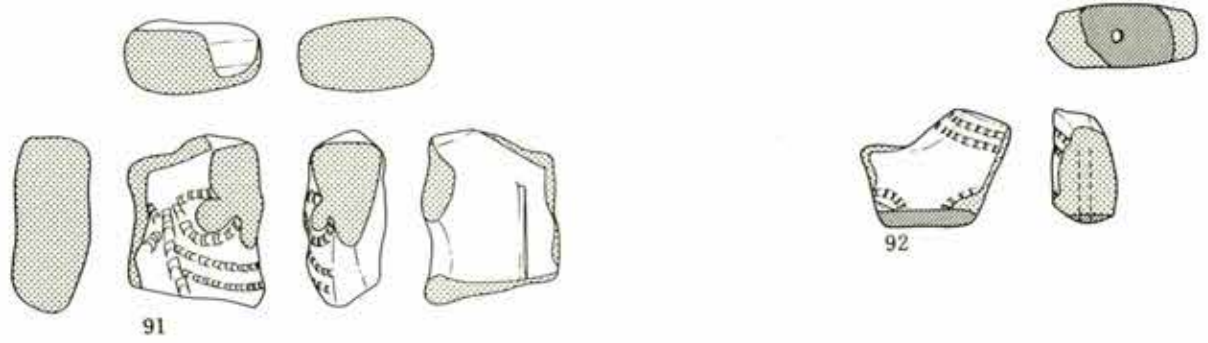

91

92

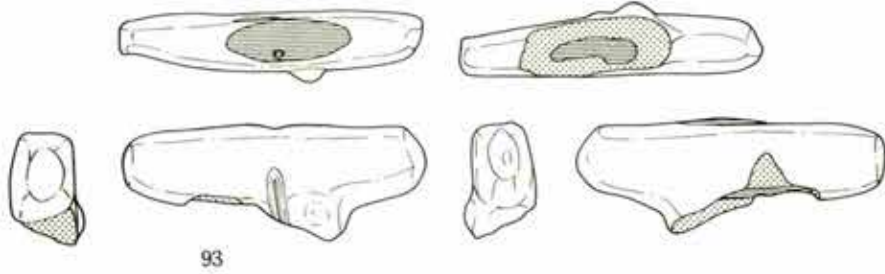

93

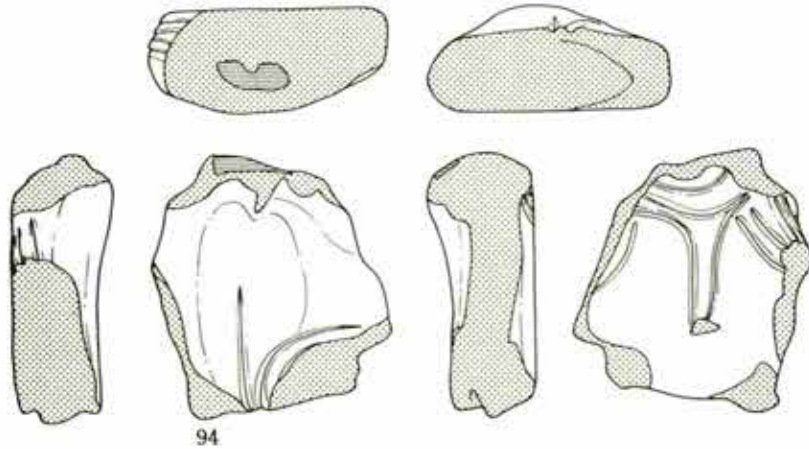

94

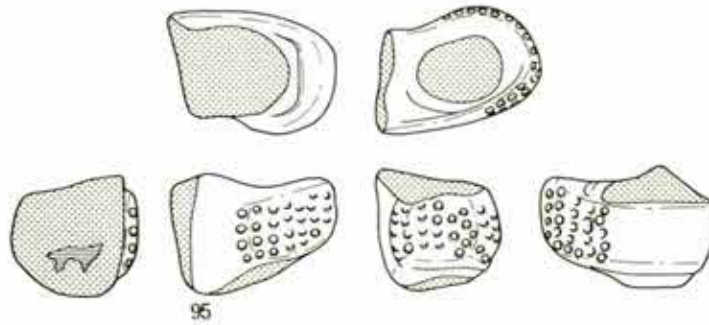

95

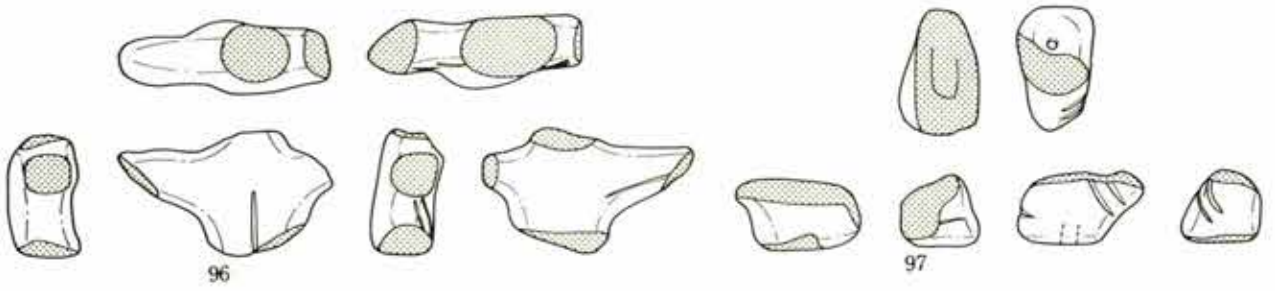

96

97

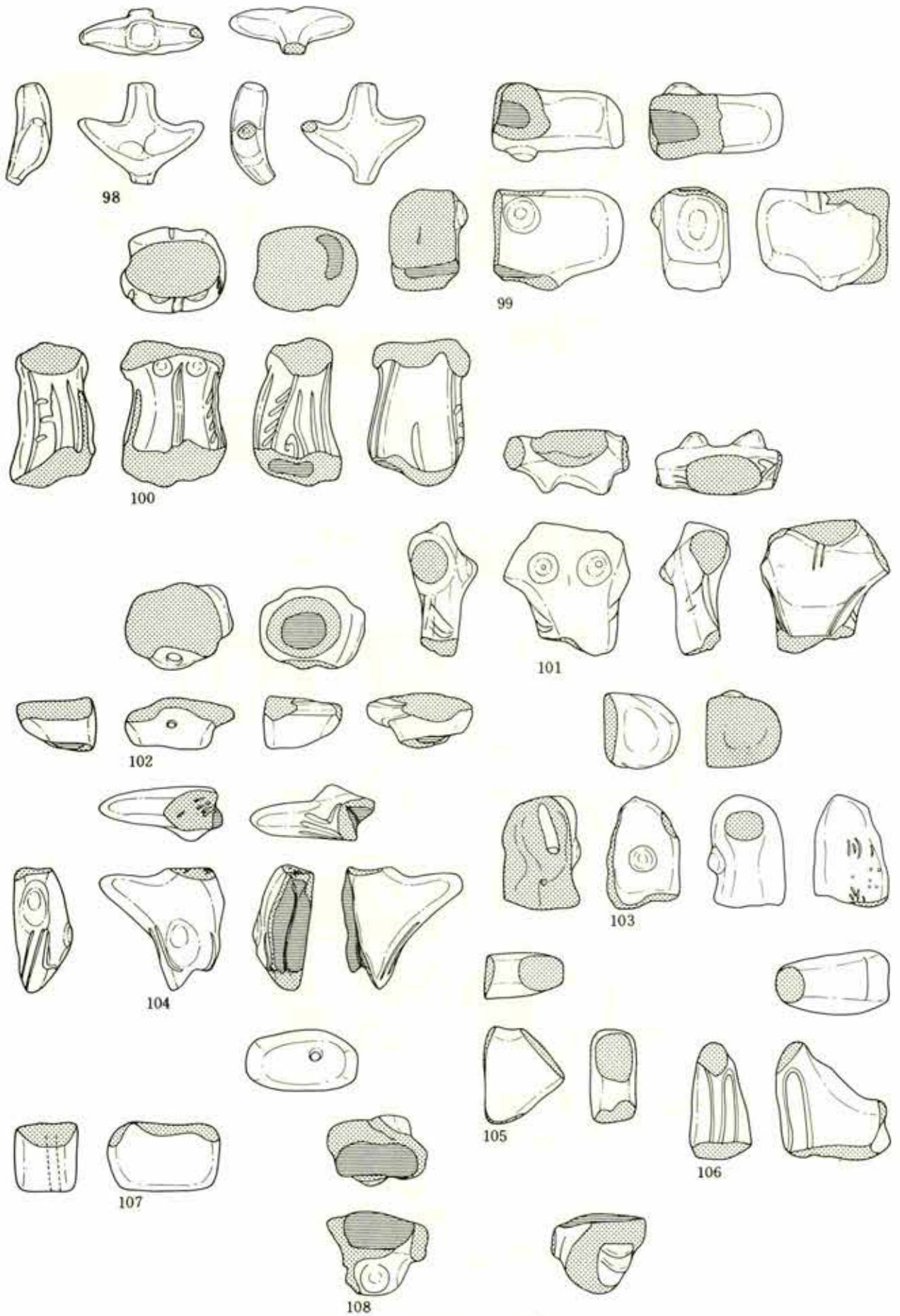

第 496 图 积逊堂 S-IV 区 土偶 (16)

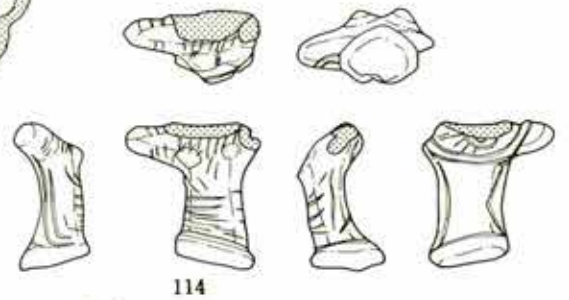
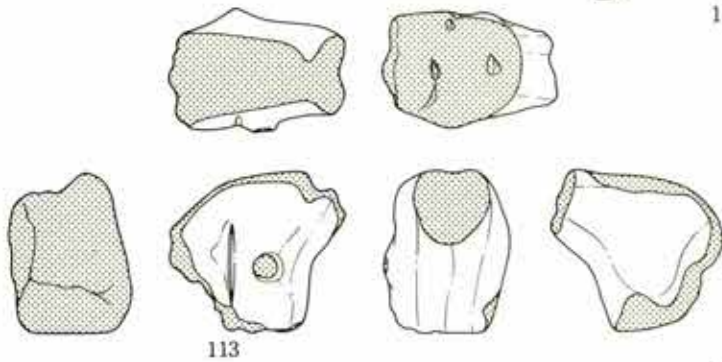
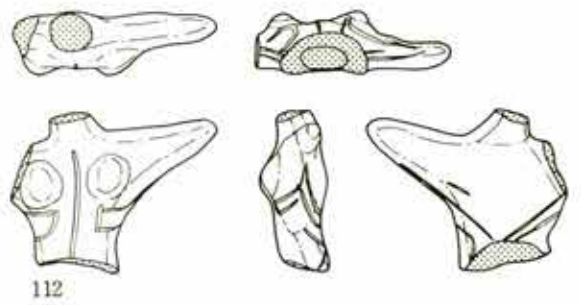
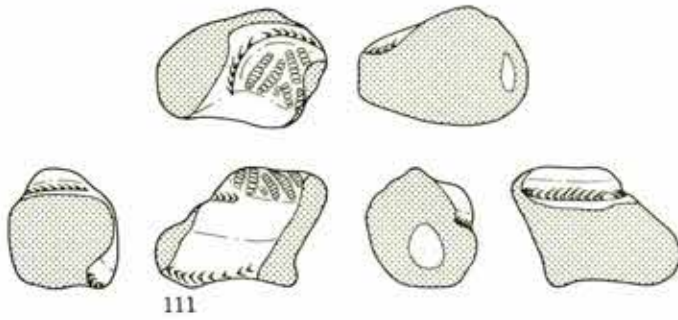
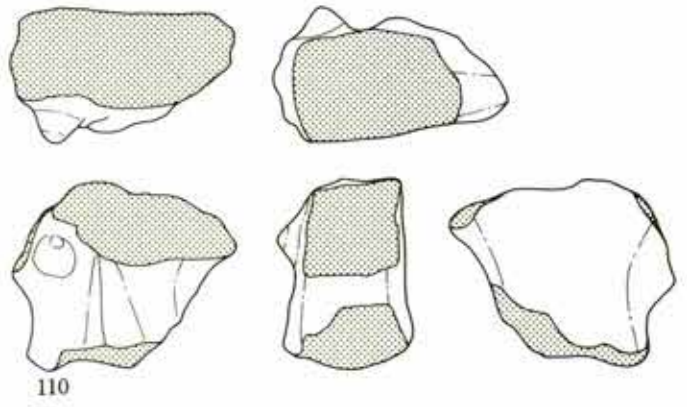
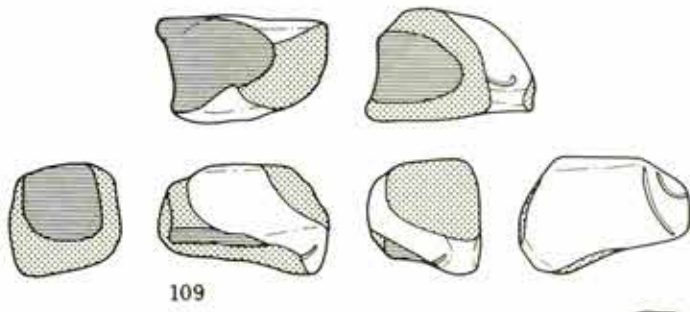

第497图 积迦堂S—IV区 土偶 (17)

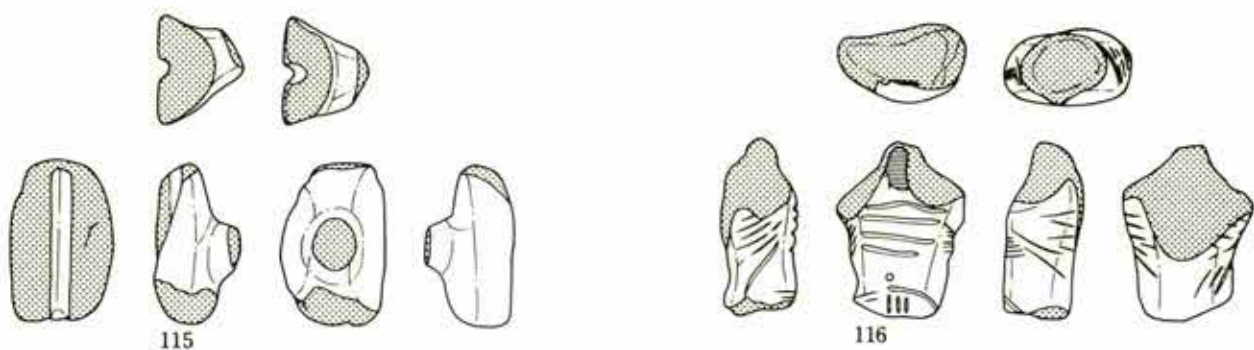

115

116

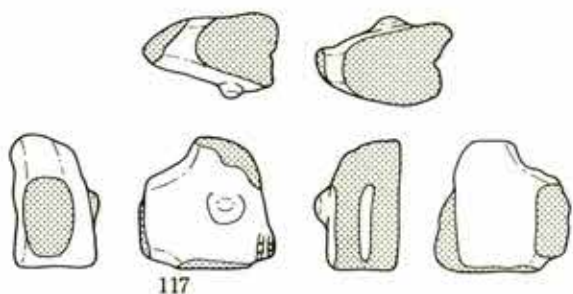

117

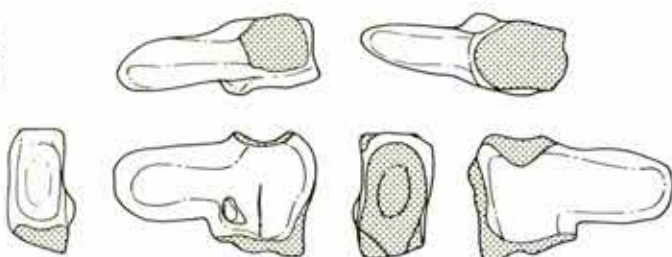

118

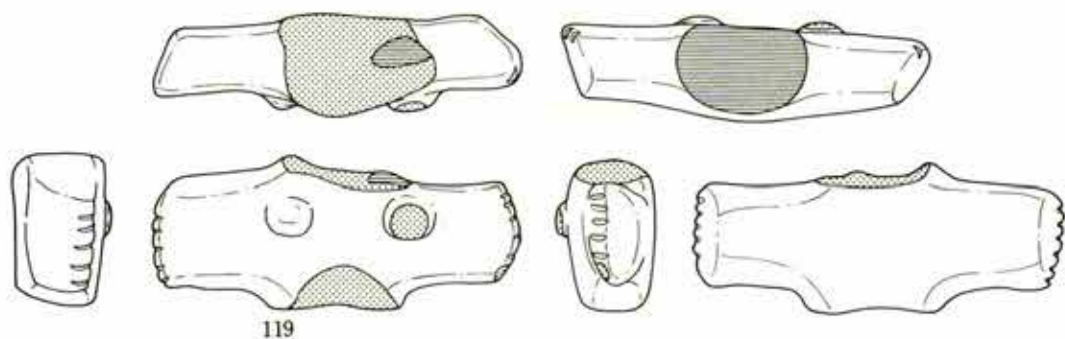

119

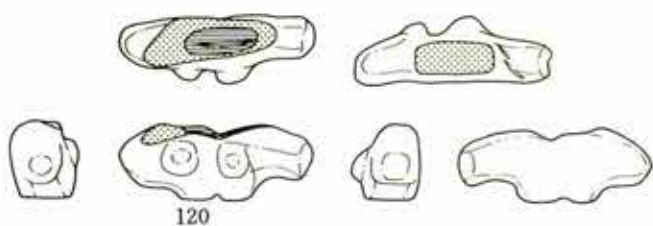

120

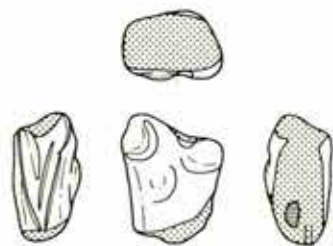

121

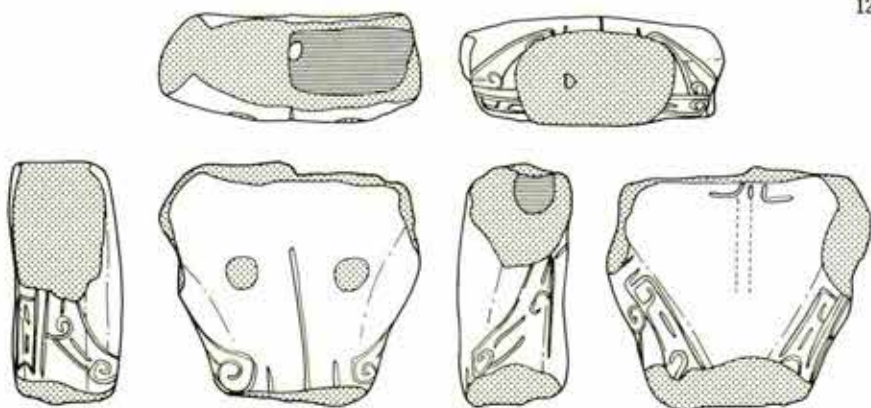

122

第498图 积逊堂S-IV区土偶 (18)

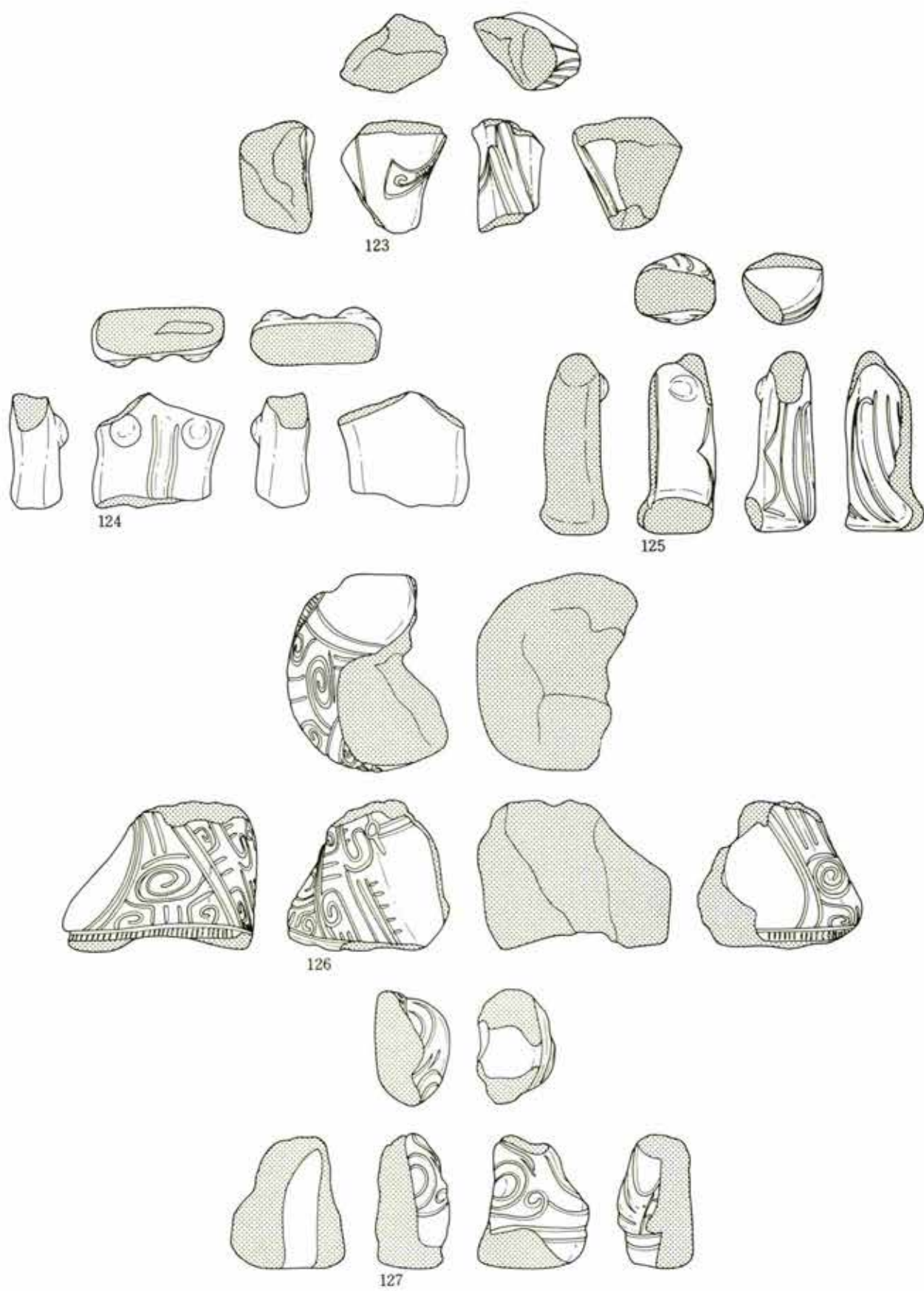

第 499 图 积逊堂 S-IV 区 土偶

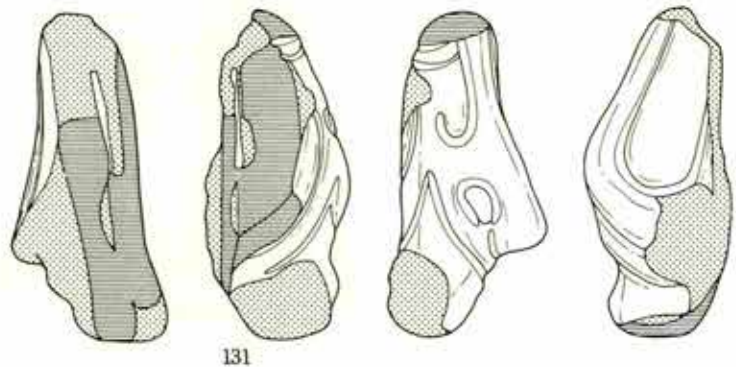
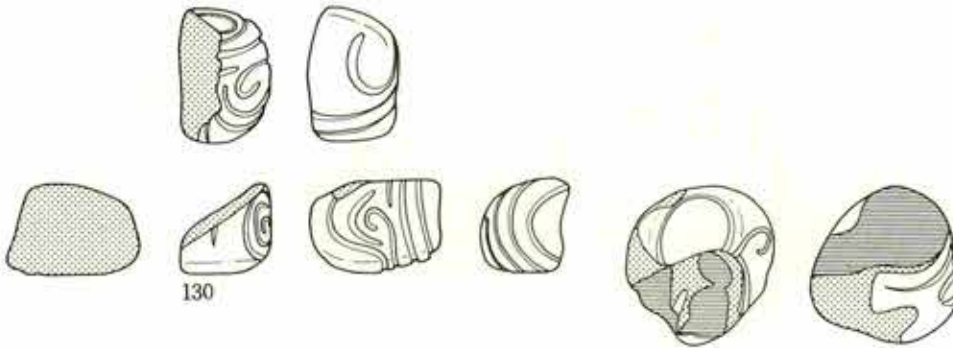
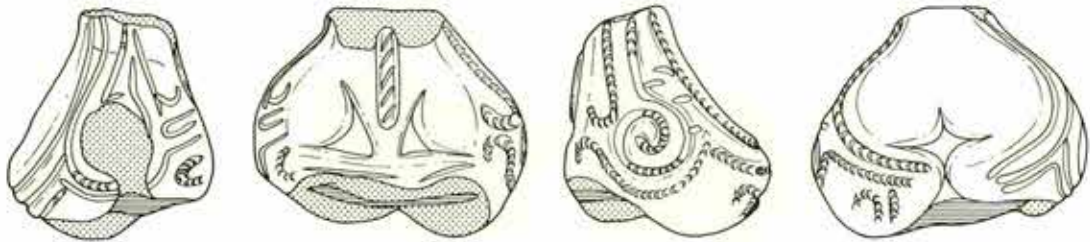
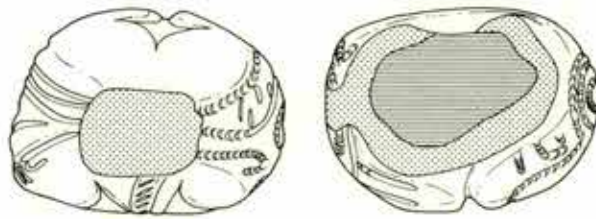
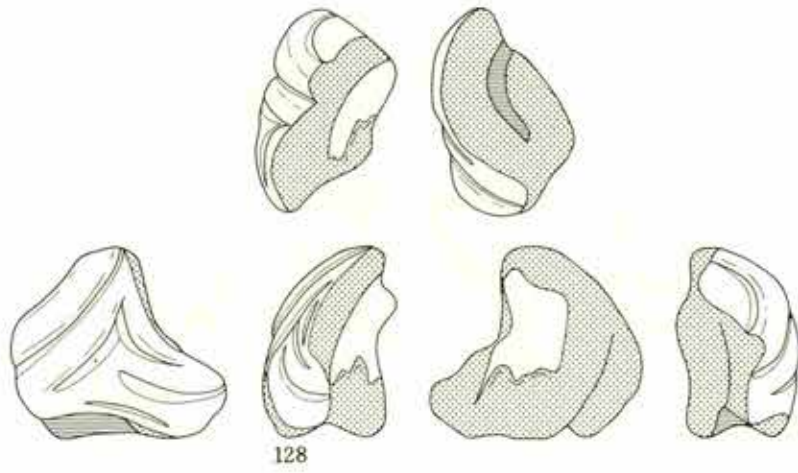

第 500 图 积逊堂 S—IV 区 土偶 (20)

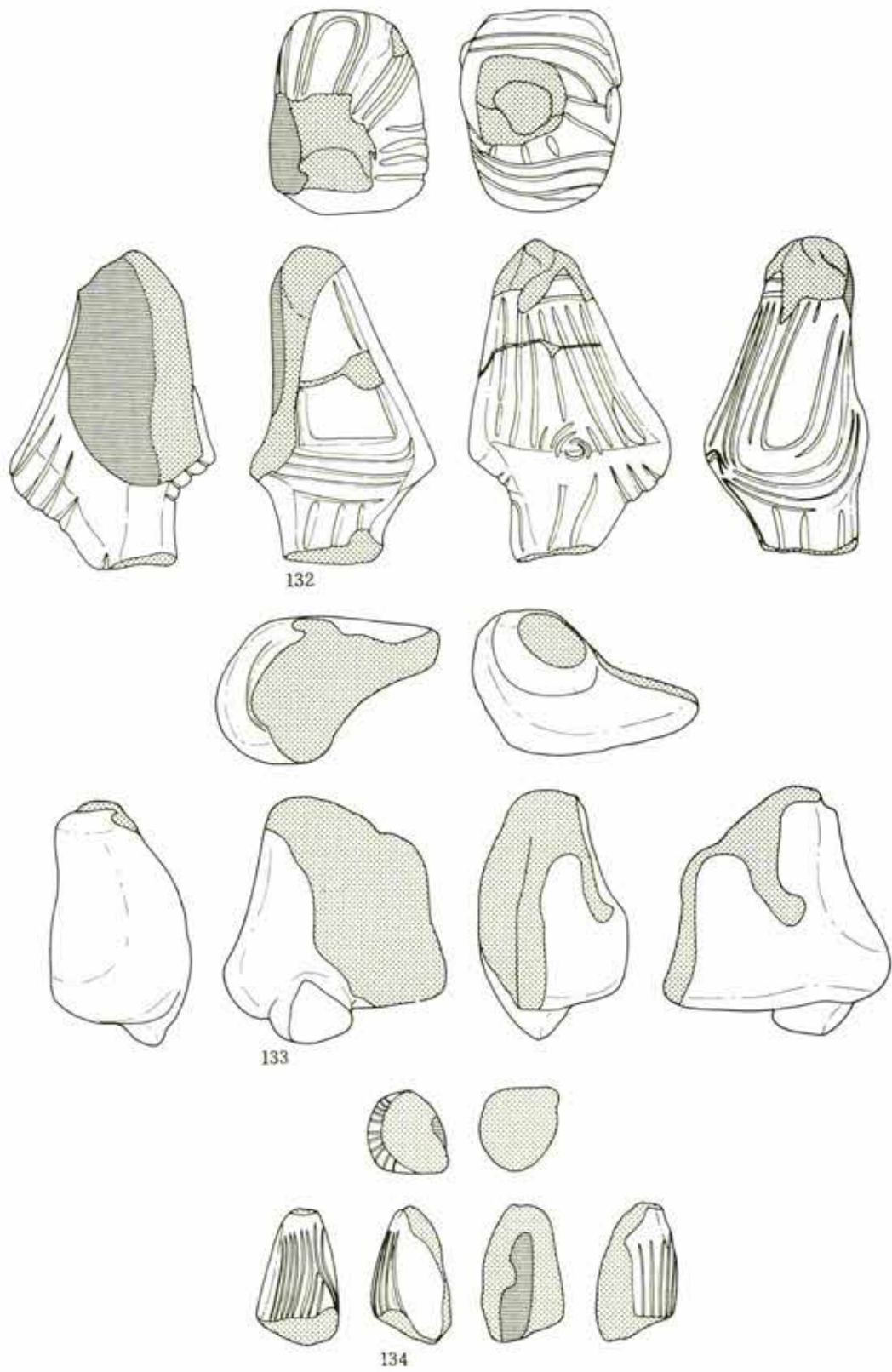

第 501 图 积迳堂 S-IV 区 土偶 (21)

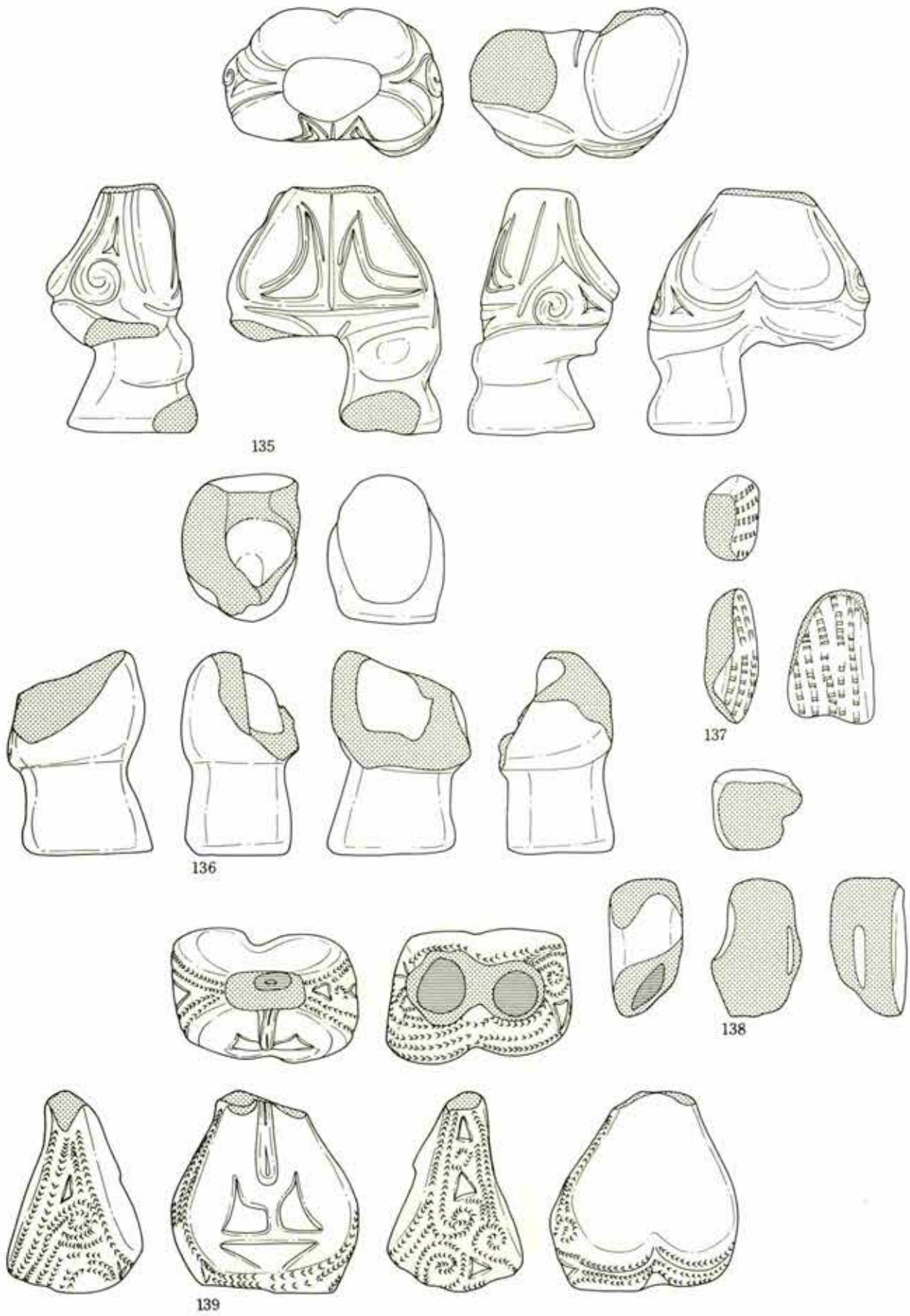

第 502 图 积逊堂 S—IV 区 土偶 (22)

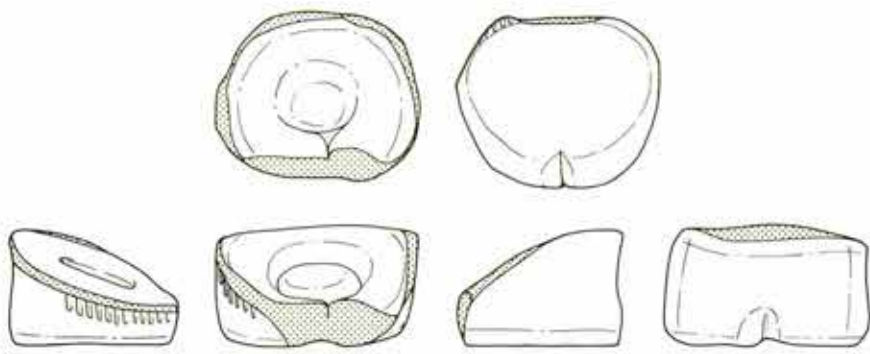

140

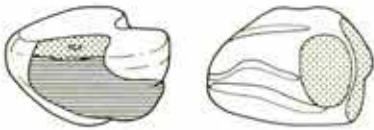

141

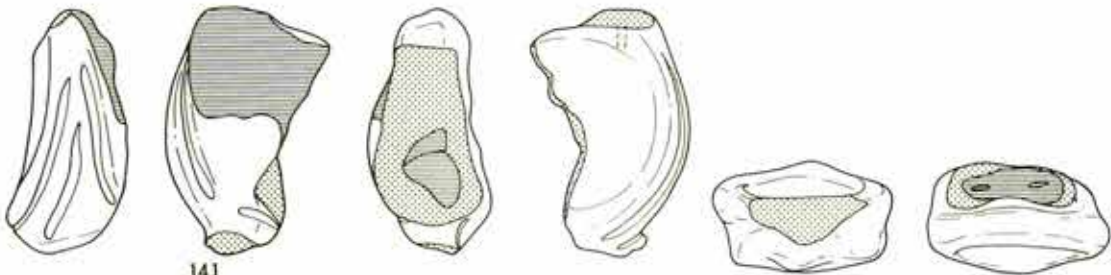

142

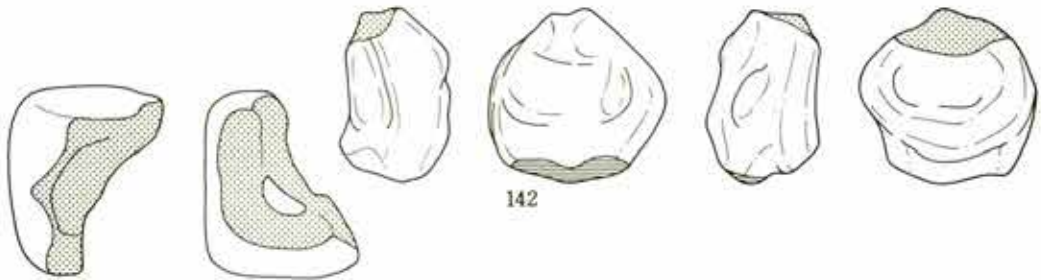

143

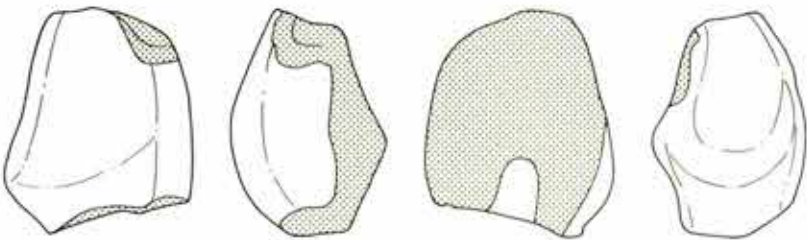

144

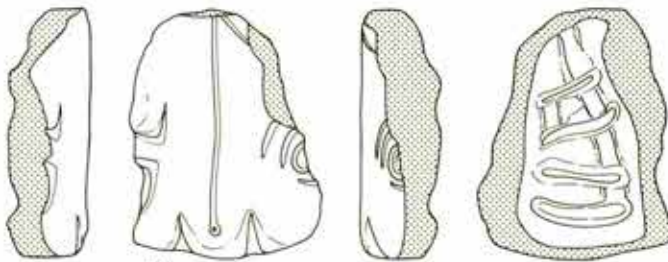
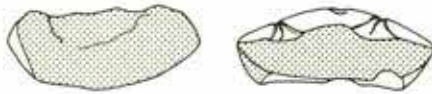

第 503 图 积迦堂 S-IV 区 土偶 (23)



第 504 图 积逊堂 S—IV 区 土偶 (24)

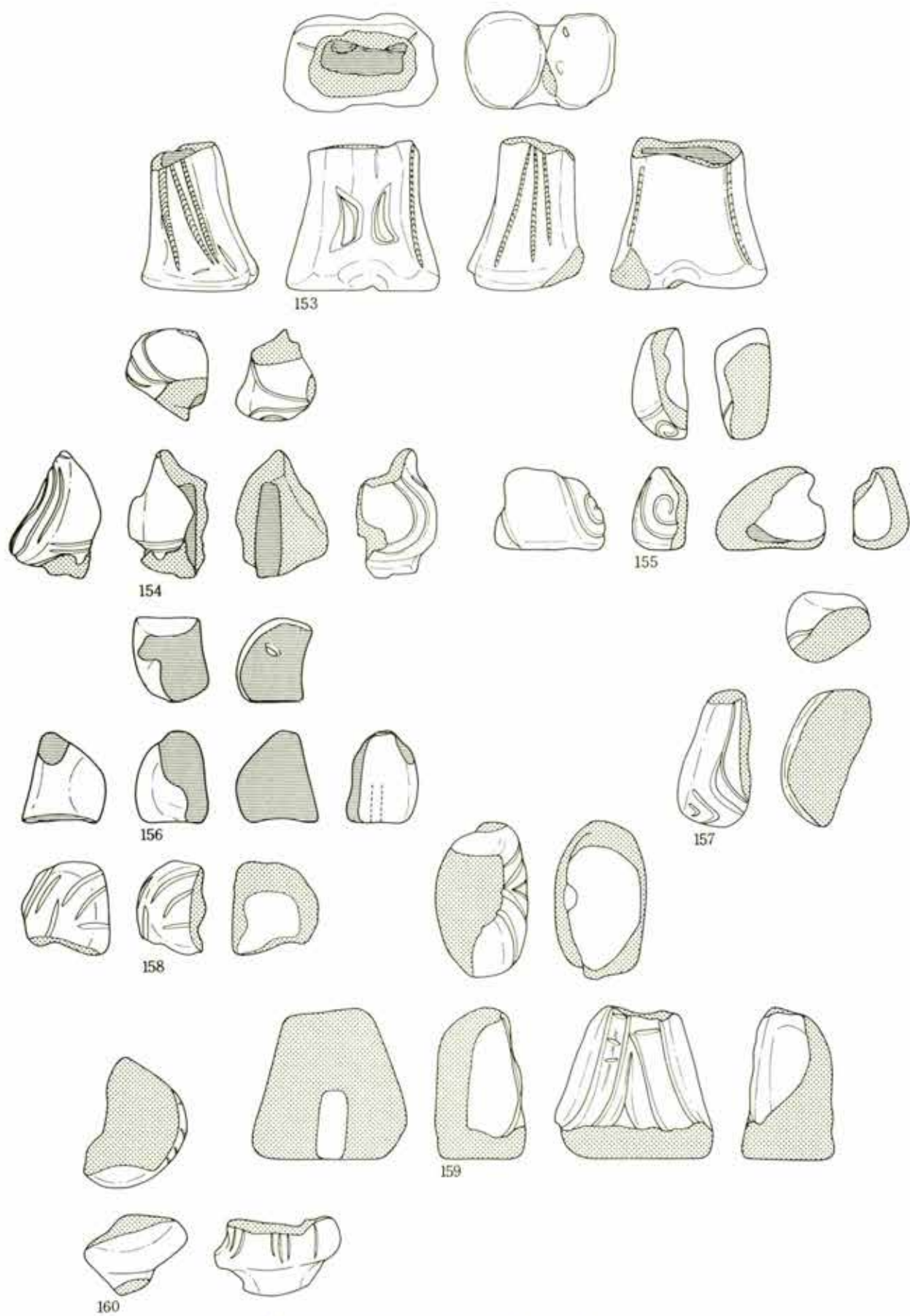

第 505 图 积迳堂 S—IV 区 土偶 (25)

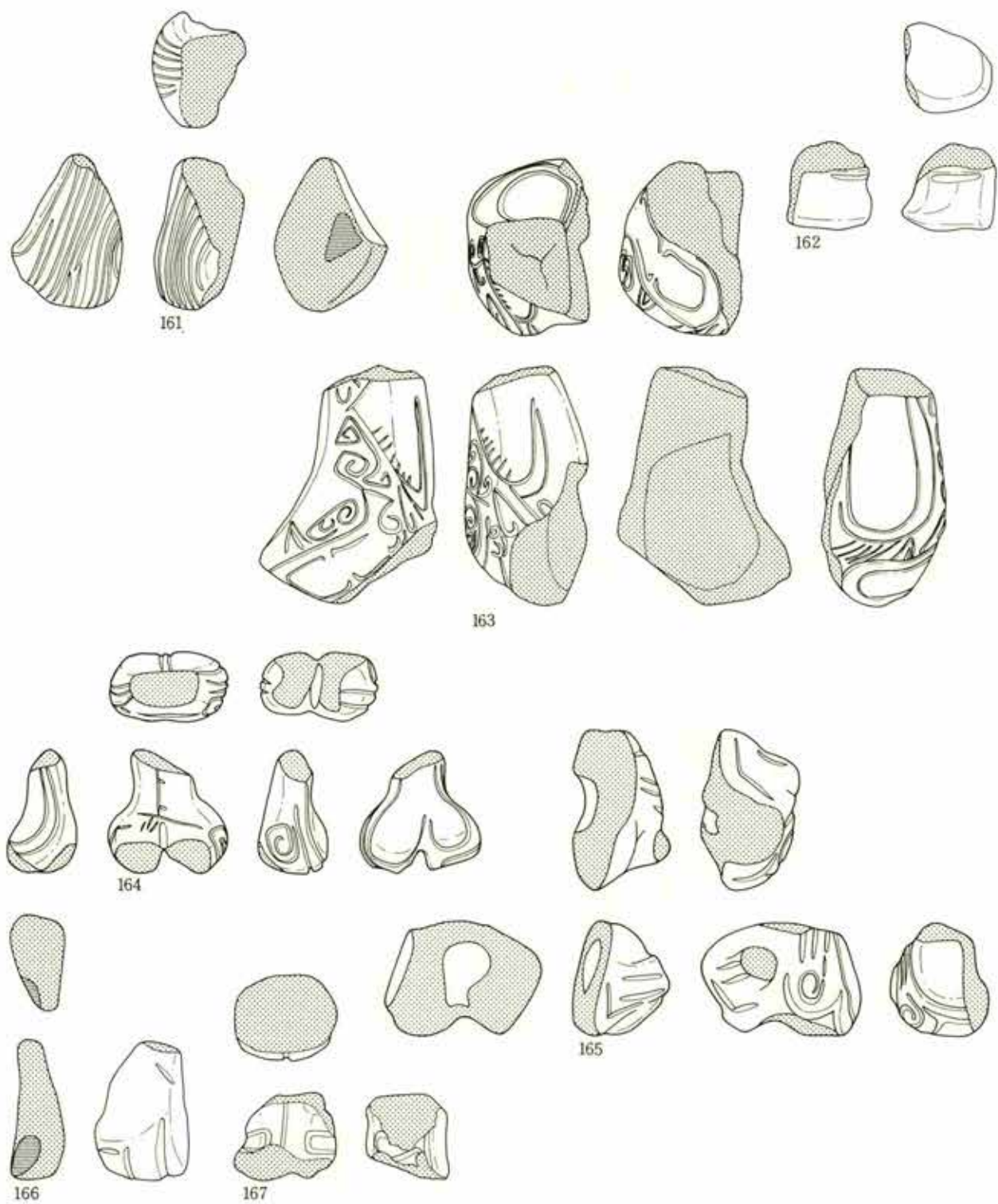

第 506 图 积迳堂 S—IV 区 土偶 (26)



第 507 图 积迺堂 S—IV 区 土偶 (27)

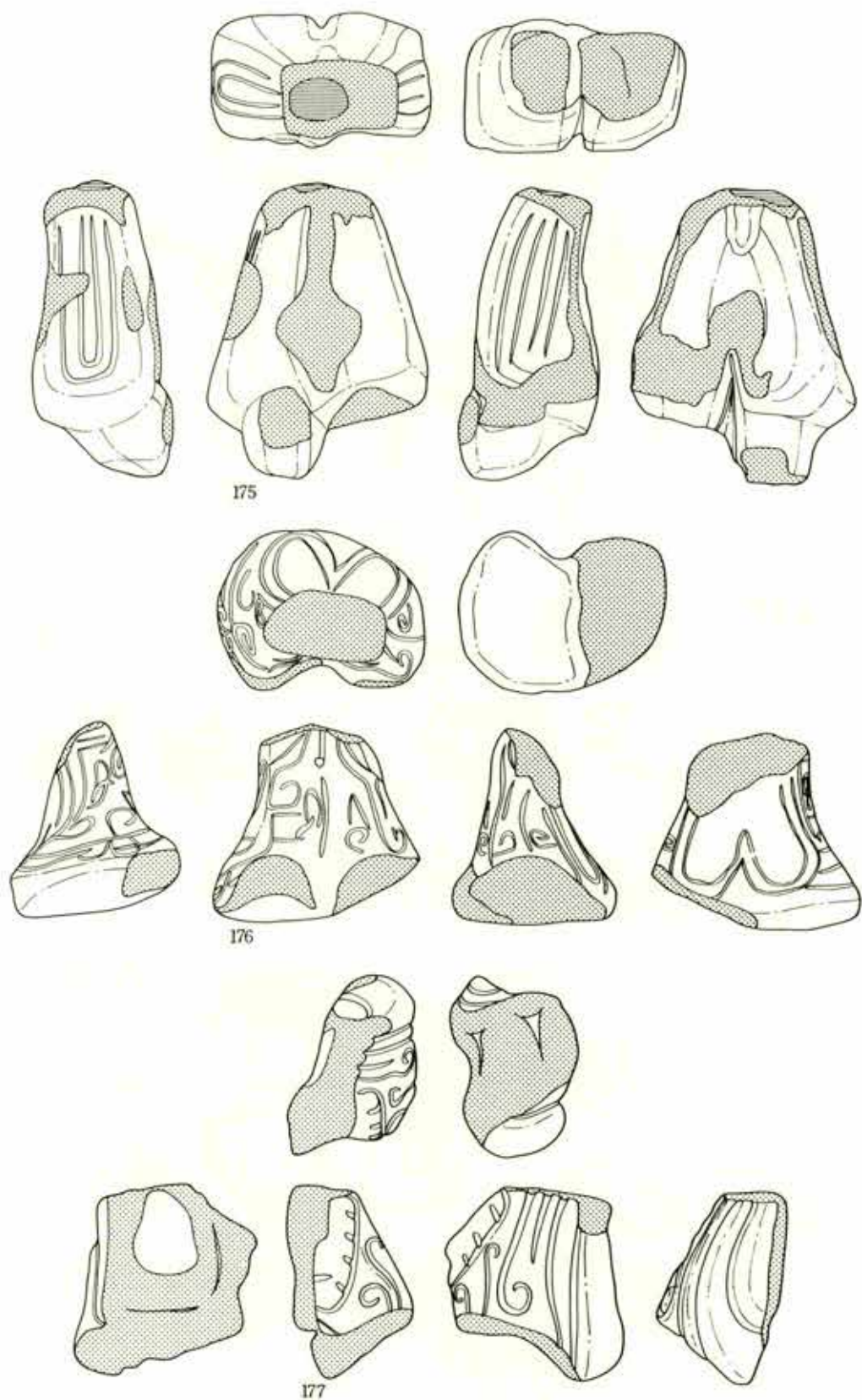

第 508 图 积逊堂 S—IV 区 土偶 (28)

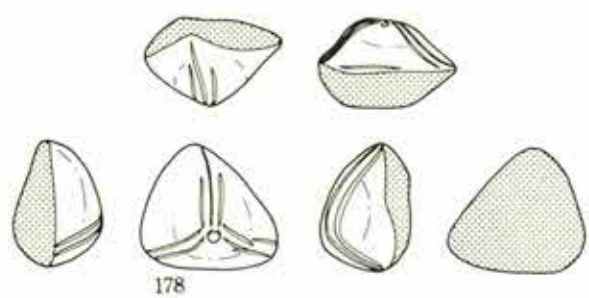

178

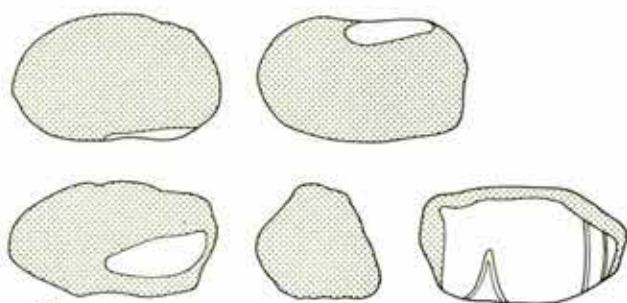

179

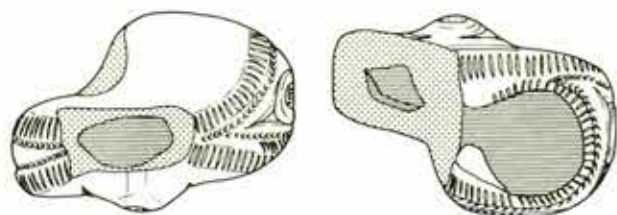

180

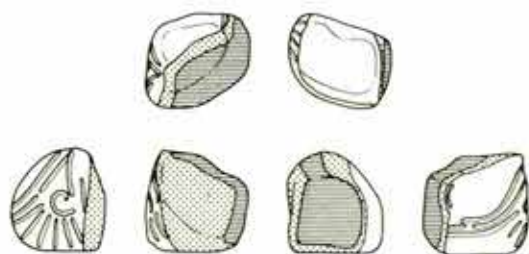
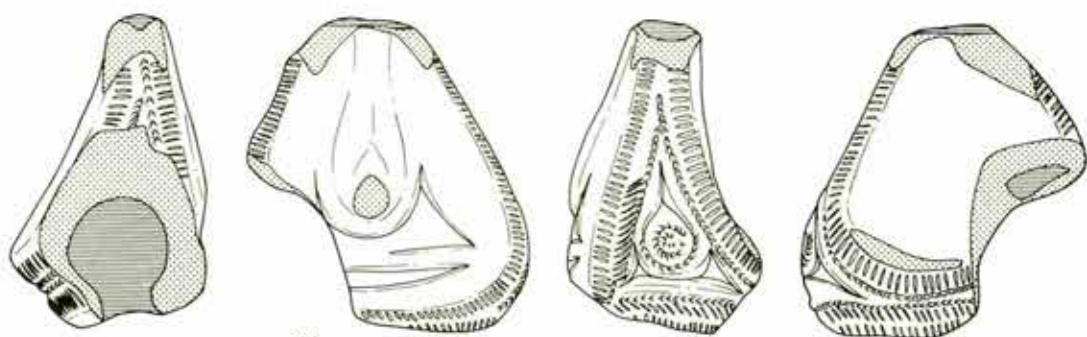

181



182

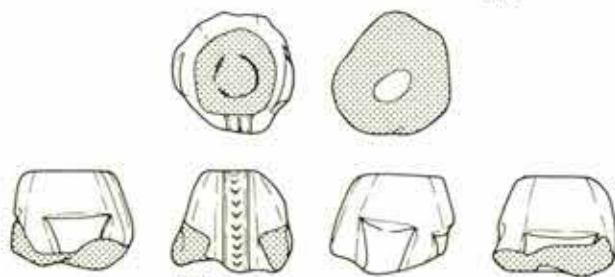

183

第 509 图 积逊堂 S-IV 区 土偶 (29)



第510图 积逊堂S-IV区 土偶 (30)

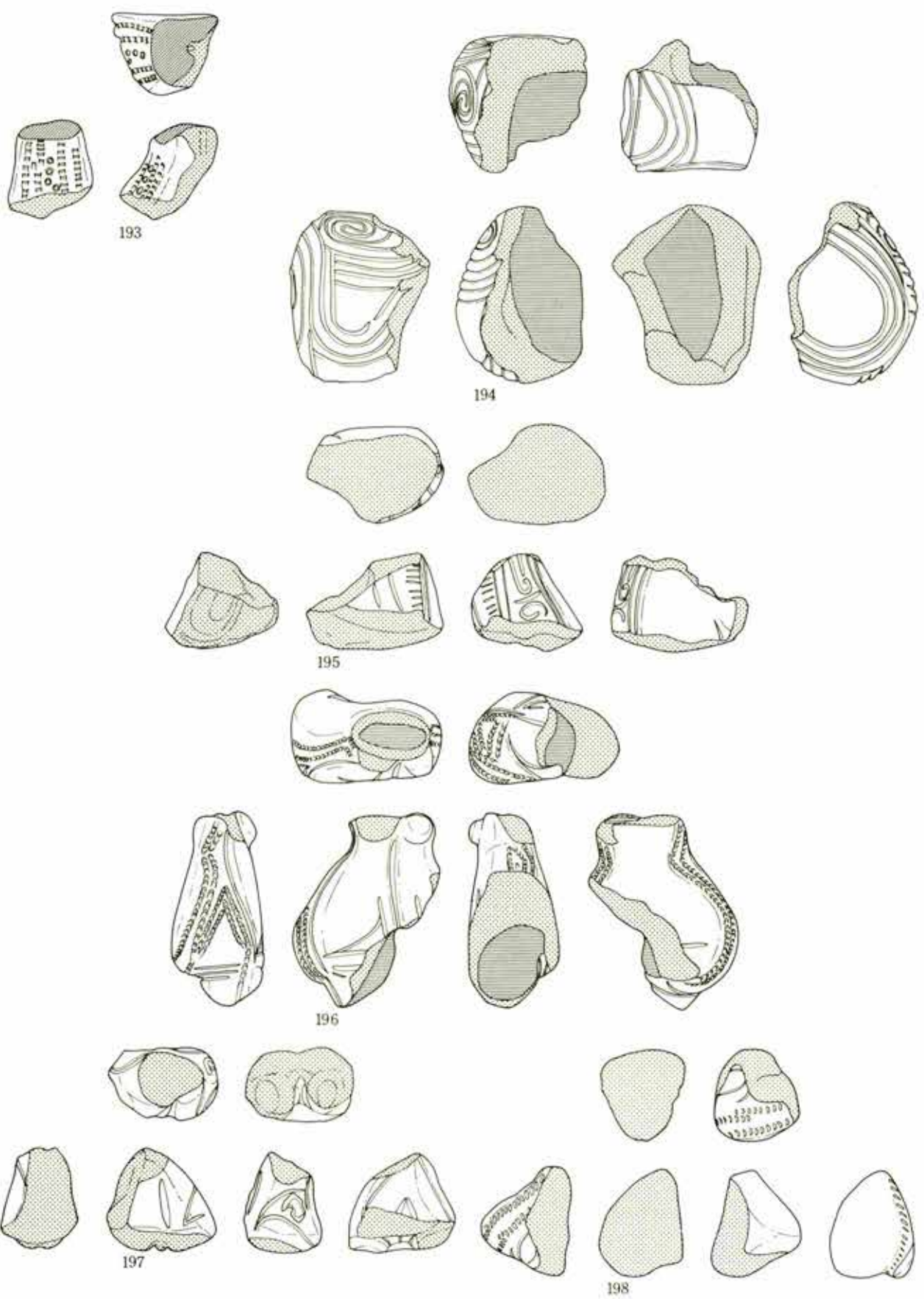

第 511 图 积迦堂 S—IV 区 土偶 (31)

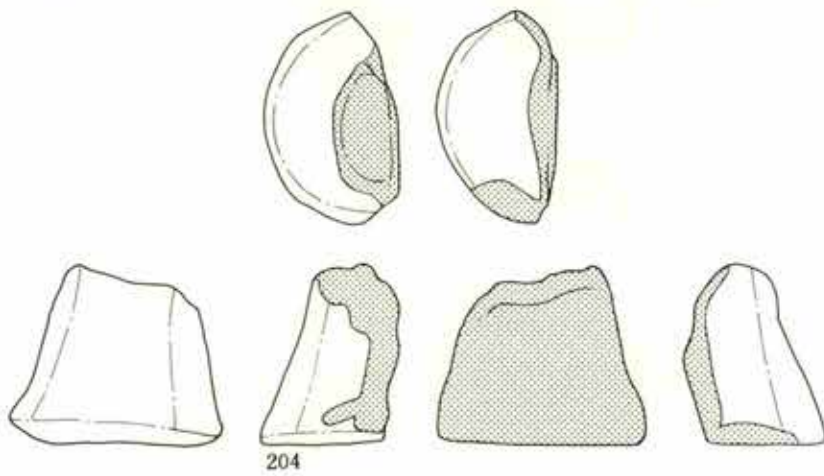
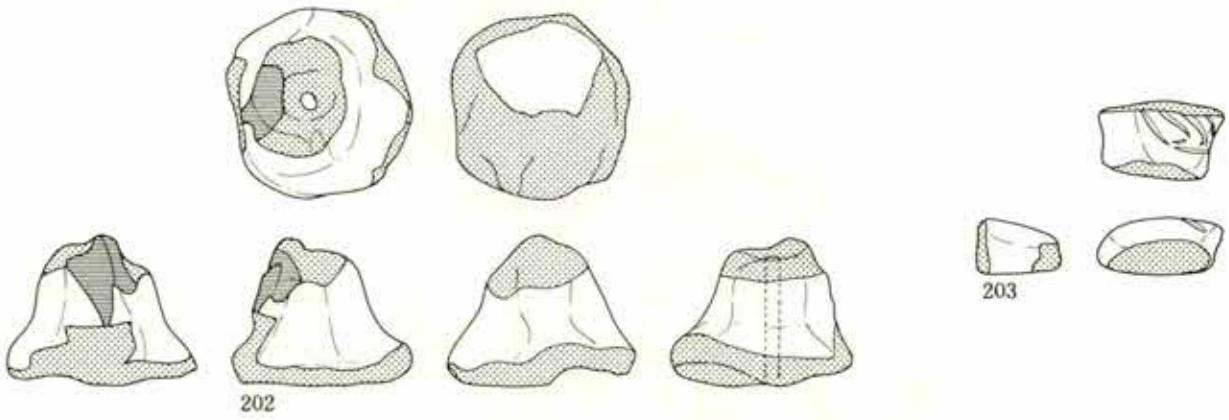
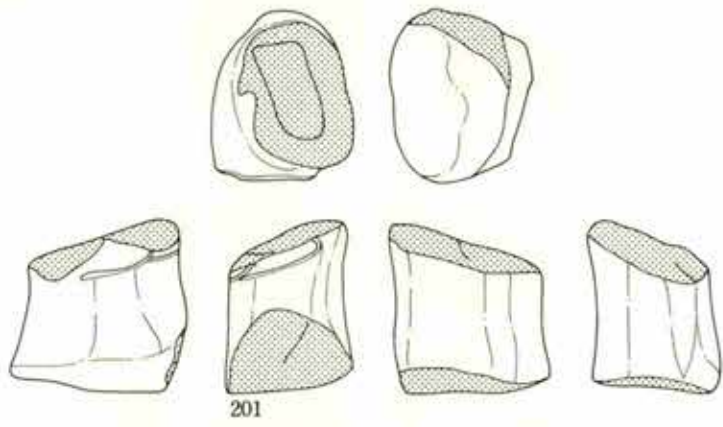
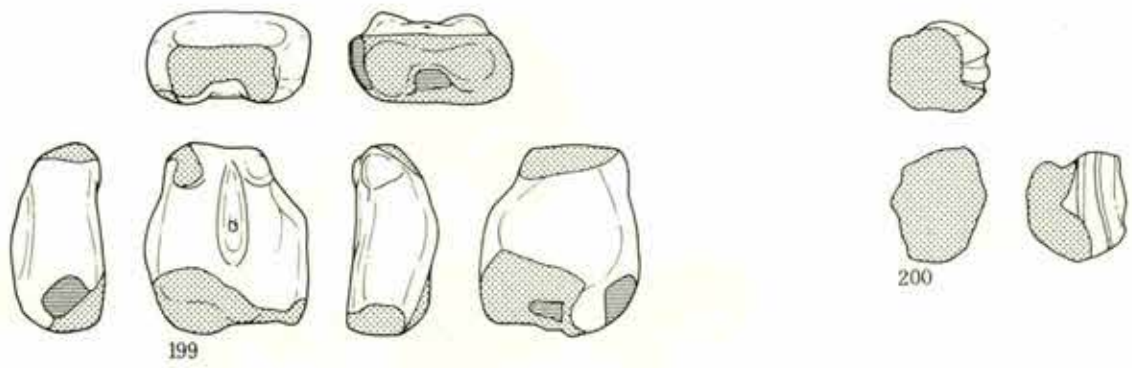

第512图 积逊堂S—IV区 土偶 (32)

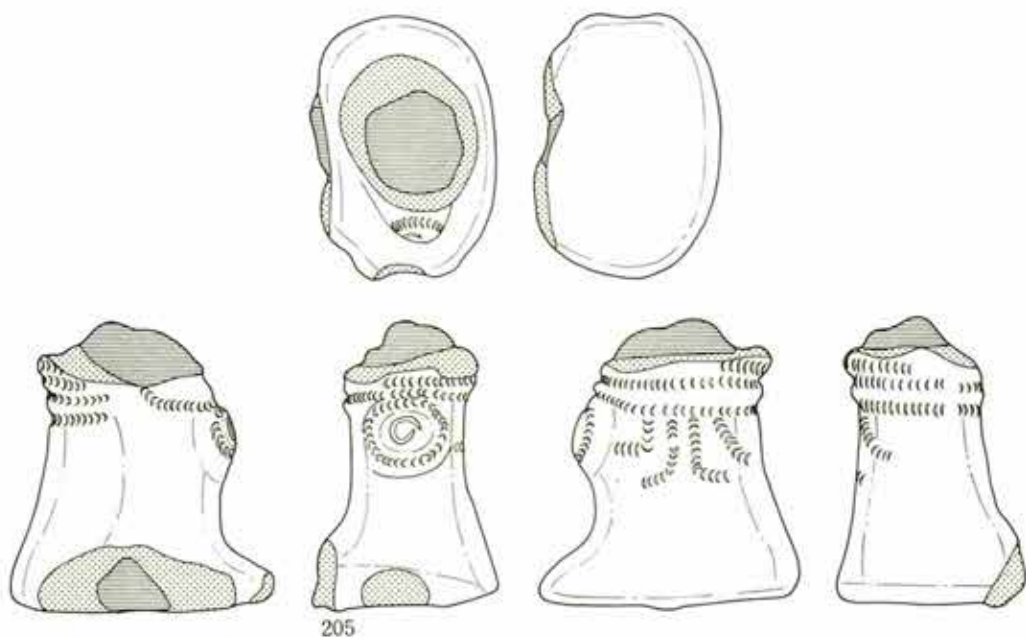

205

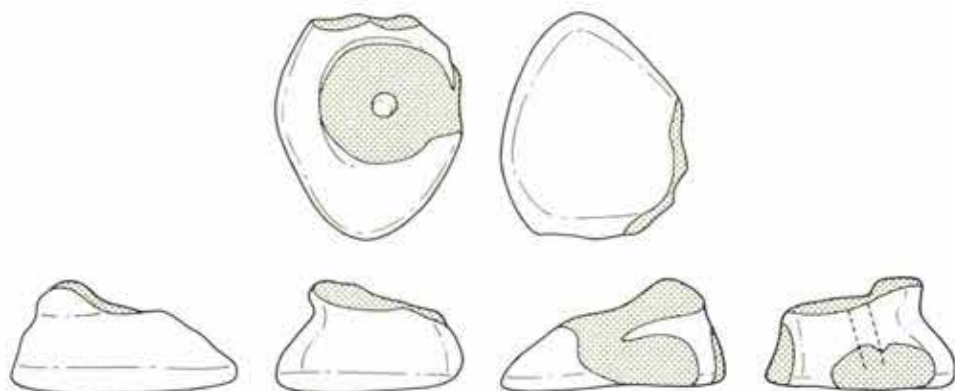

206

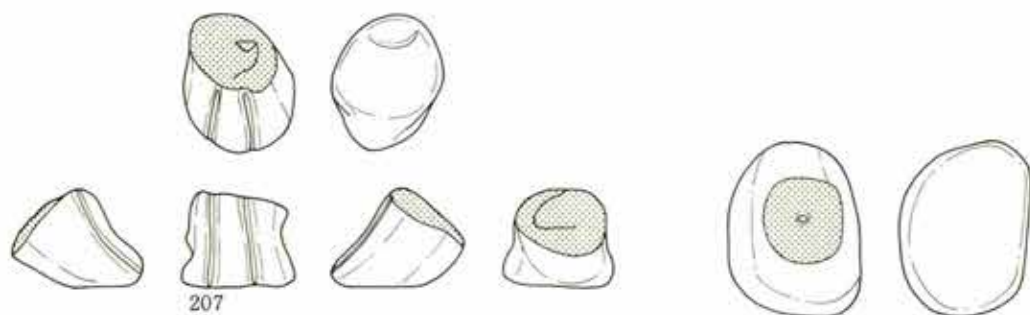

207



208



209

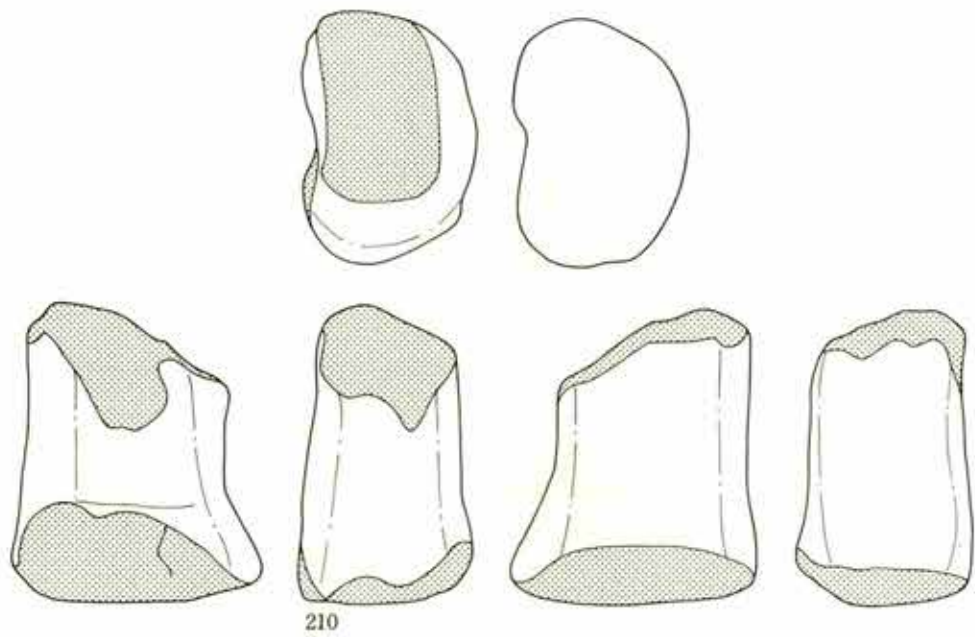

210

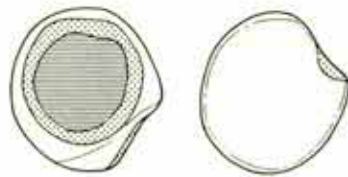

211

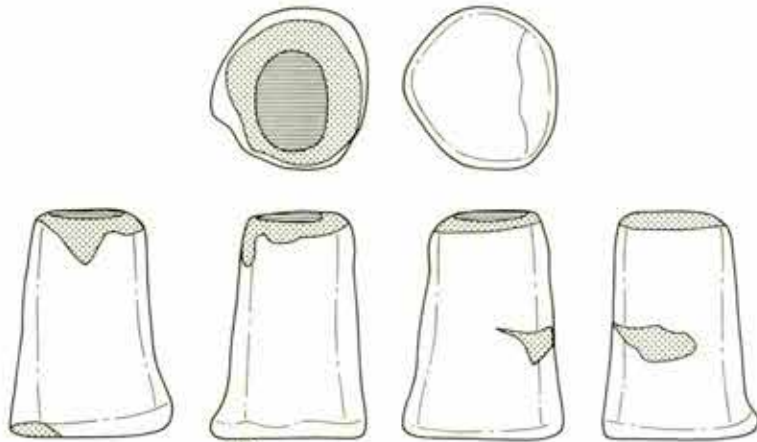

212

第514图 积迦堂S—IV区 土偶 (34)

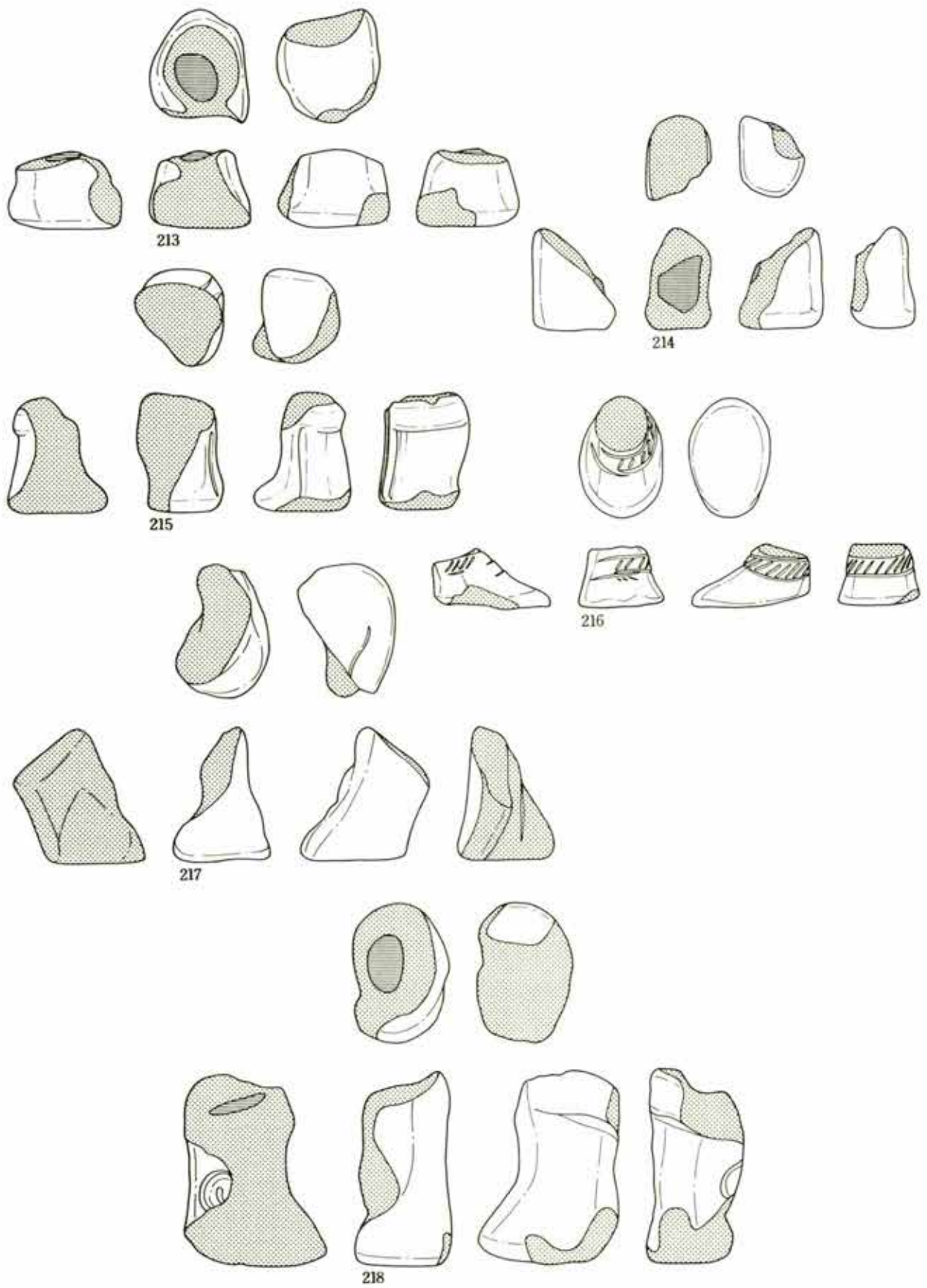

第 515 图 积迦堂 S—IV 区 土偶 (35)

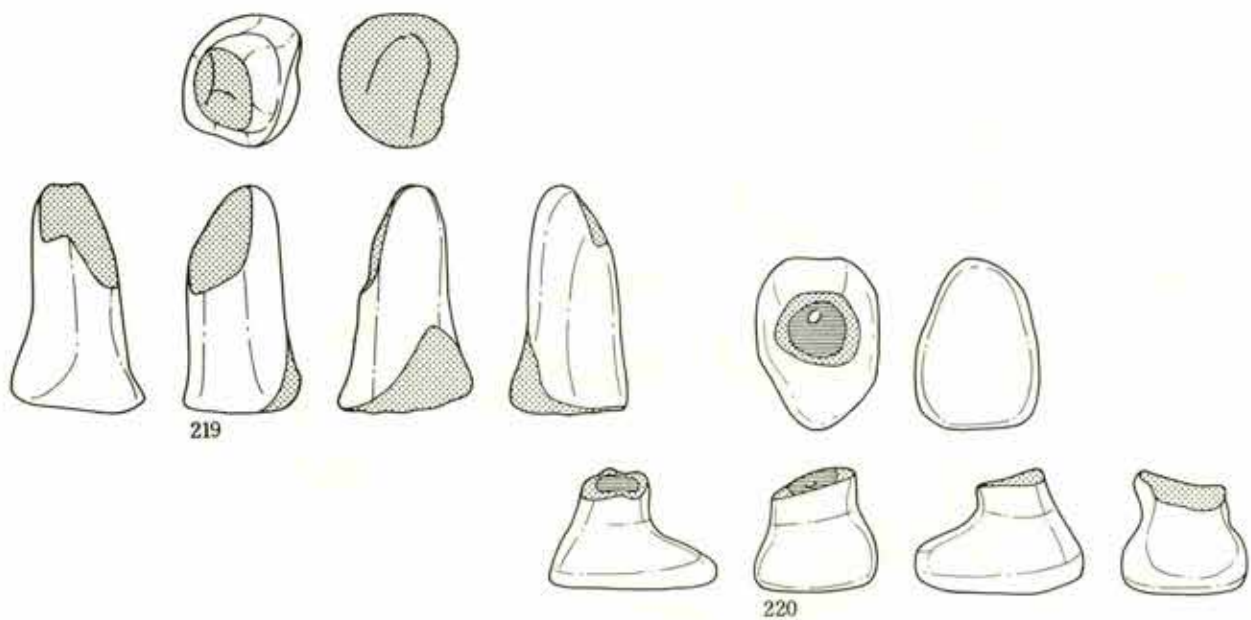

219

220

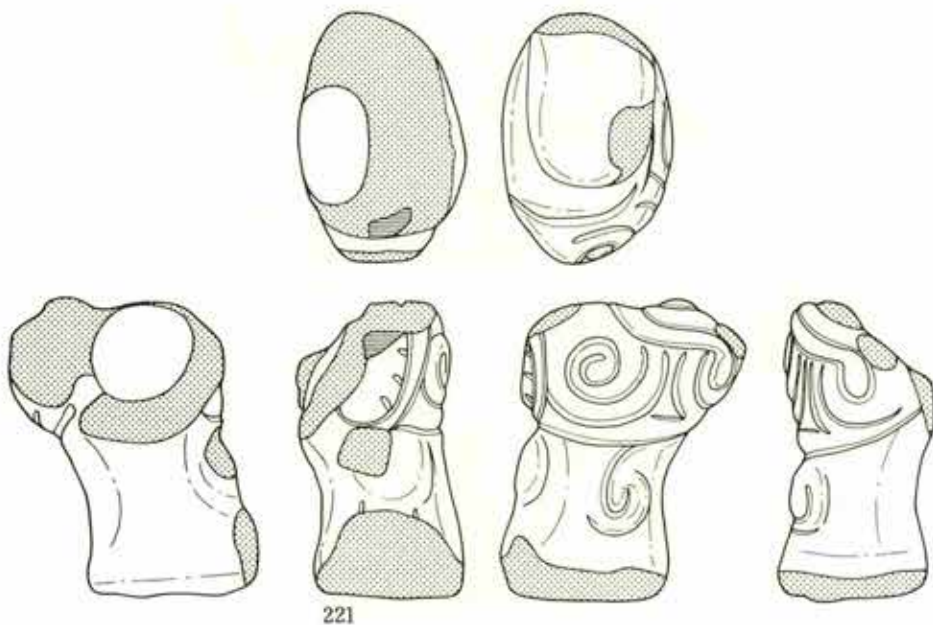

221

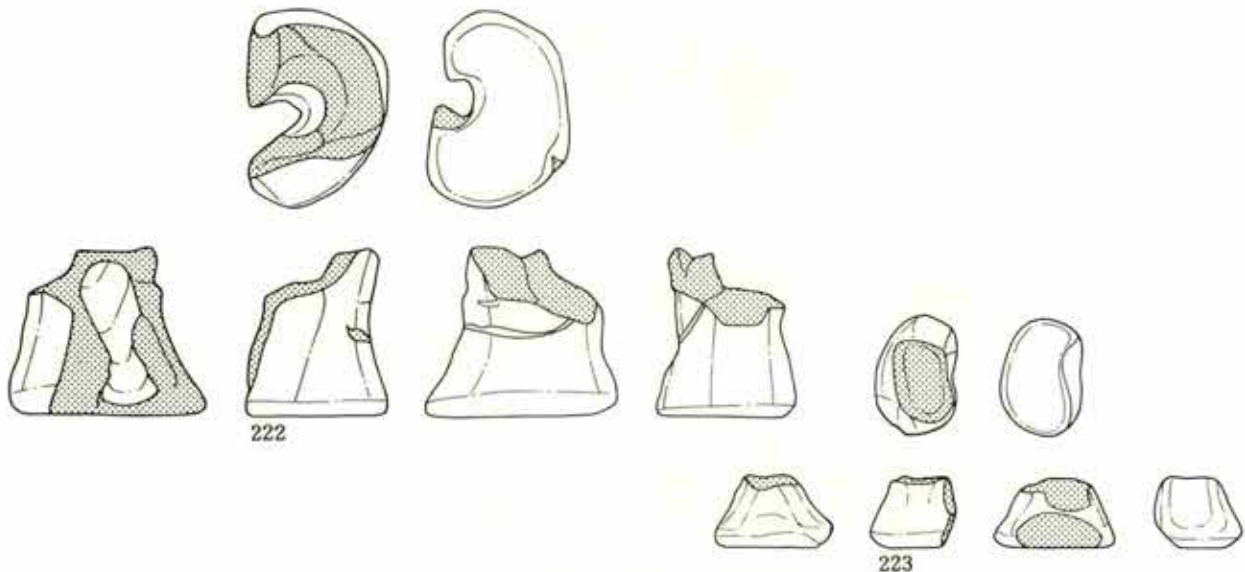

222

223

第516图 积逊堂S-IV区 土偶 (36)

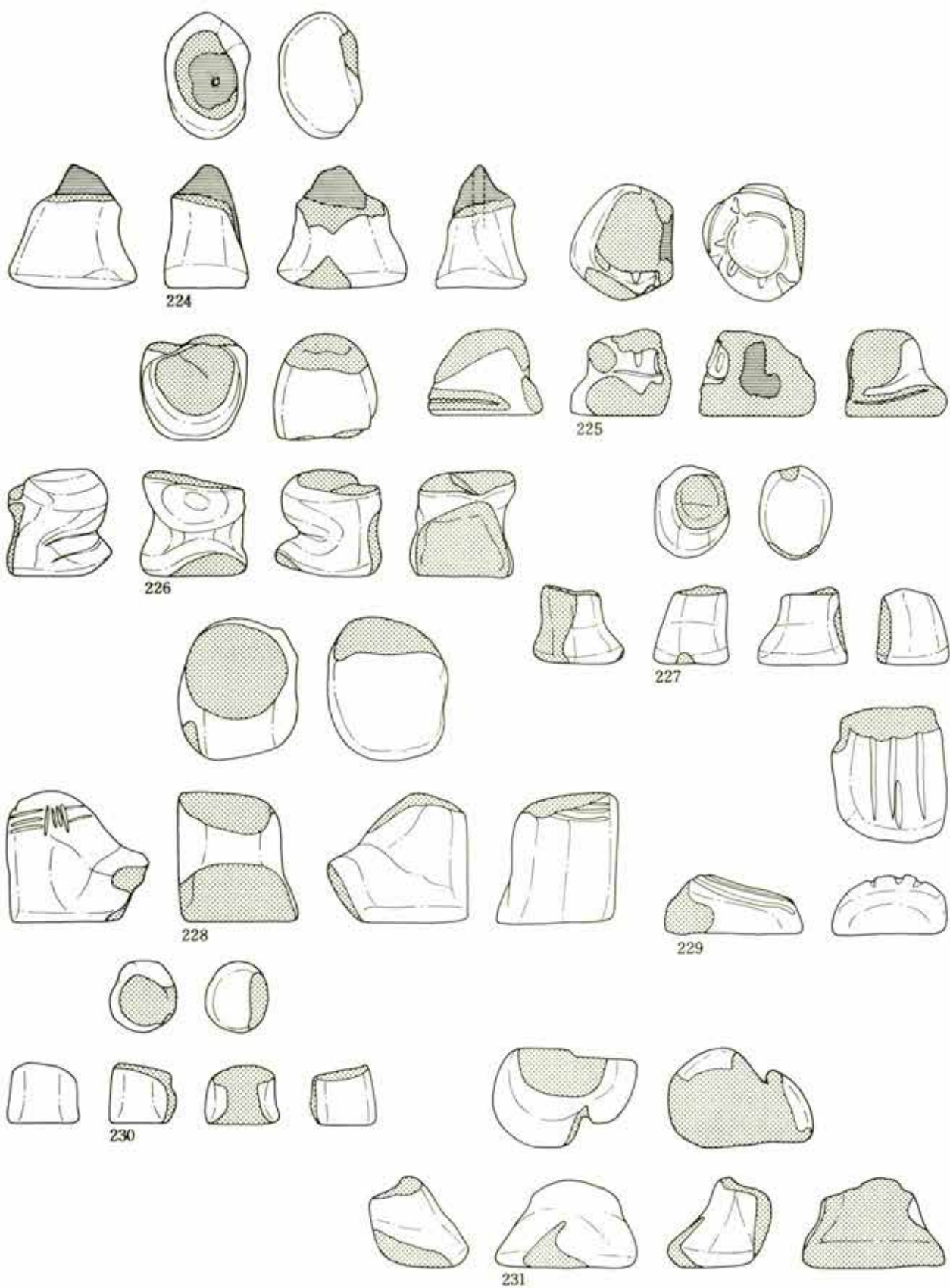

第517图 积逊堂S-IV区 土偶 (37)



第518图 积逊堂S-IV区 土偶 (38)

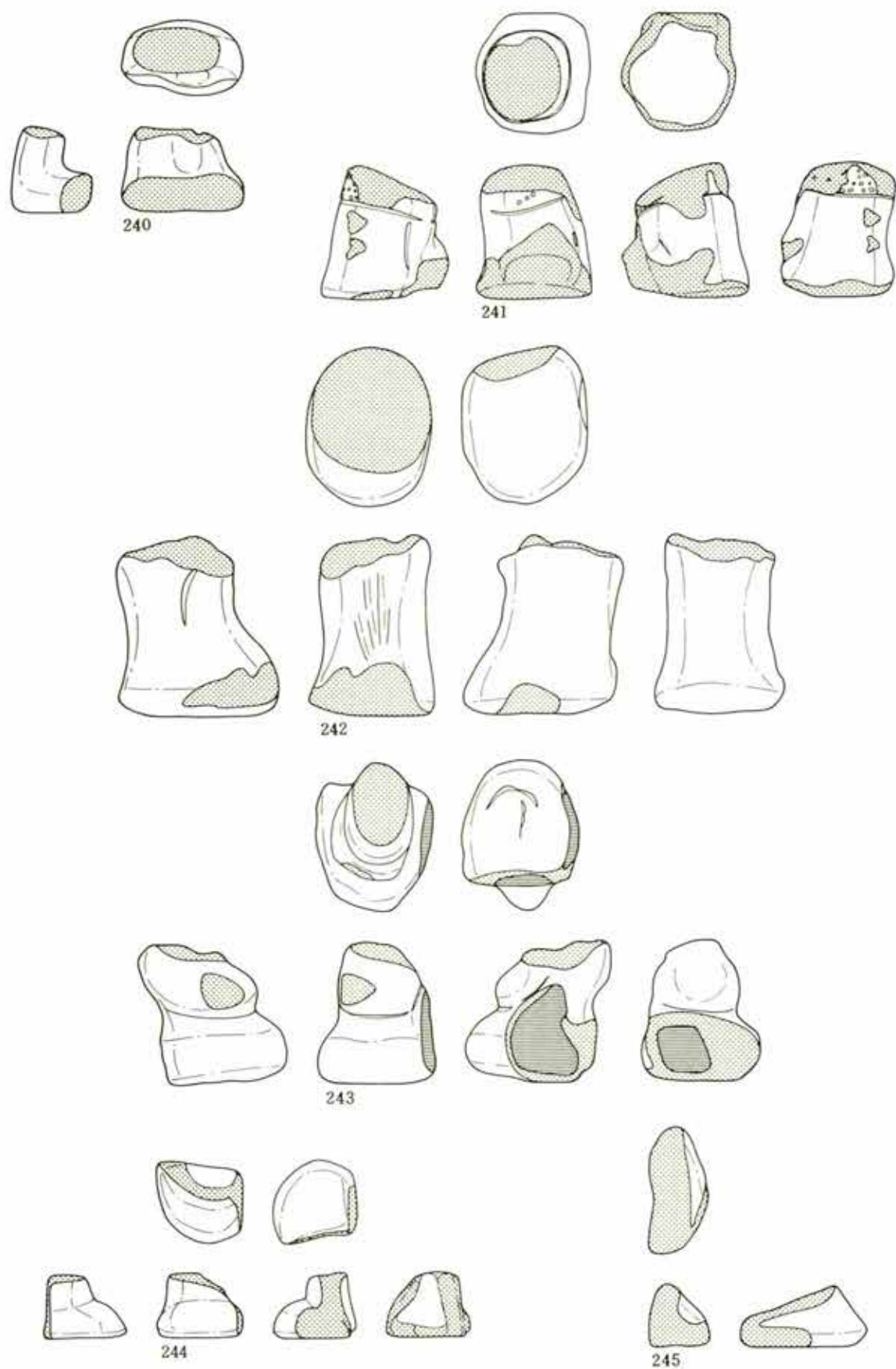

第519图 积道堂S-IV区土偶 (39)

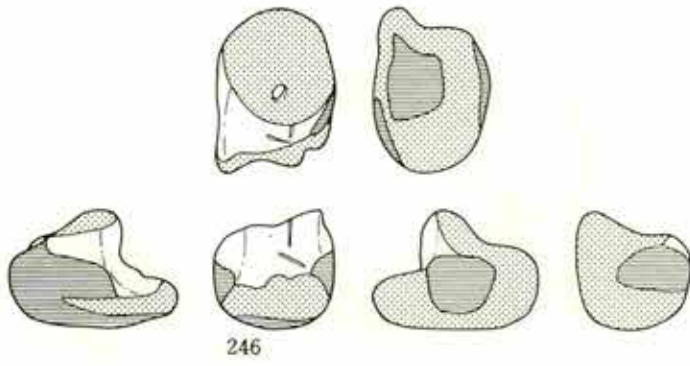

246

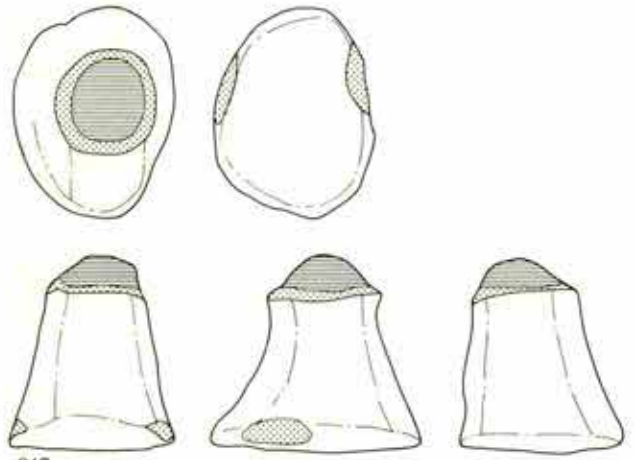

247



248

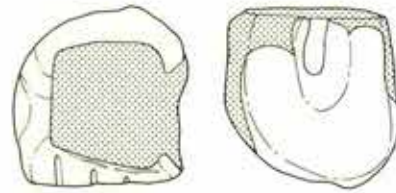

249

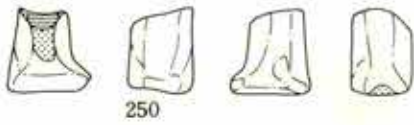

250

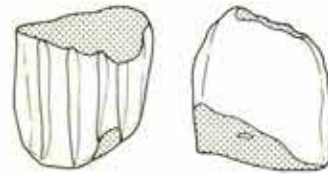

251

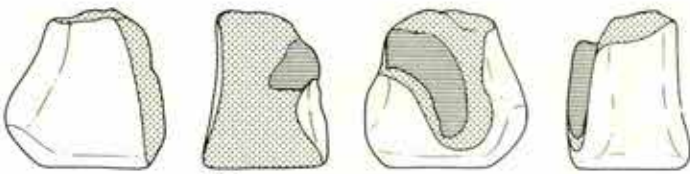

252

第520图 积迦堂S-IV区 土偶 (40)

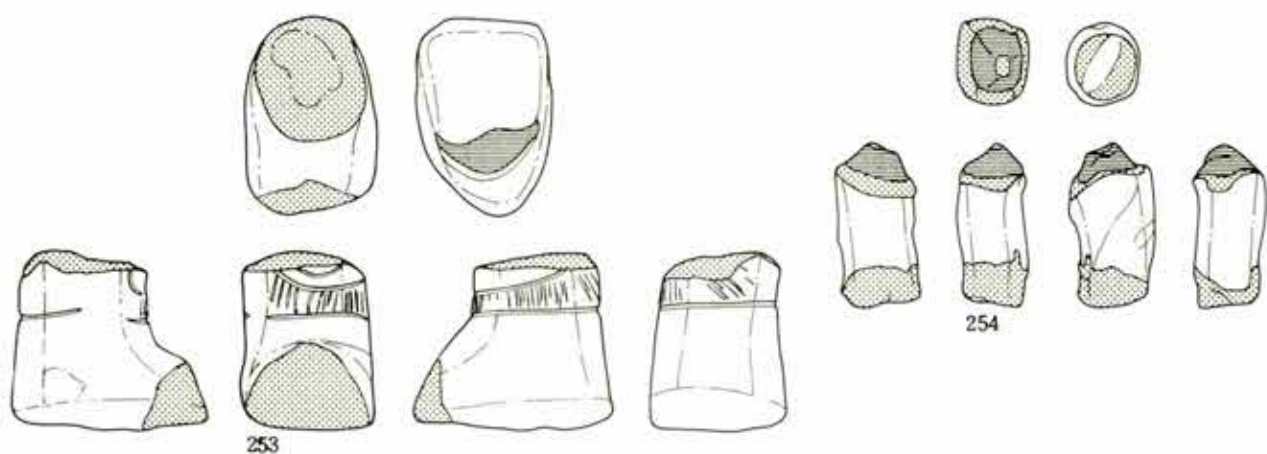

253

254

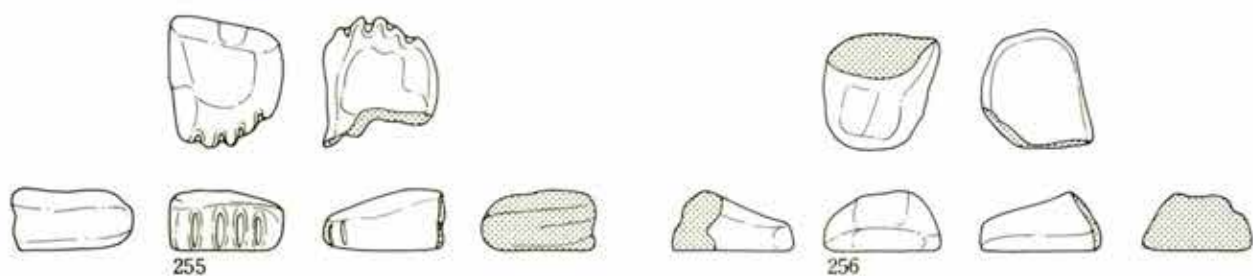

255

256

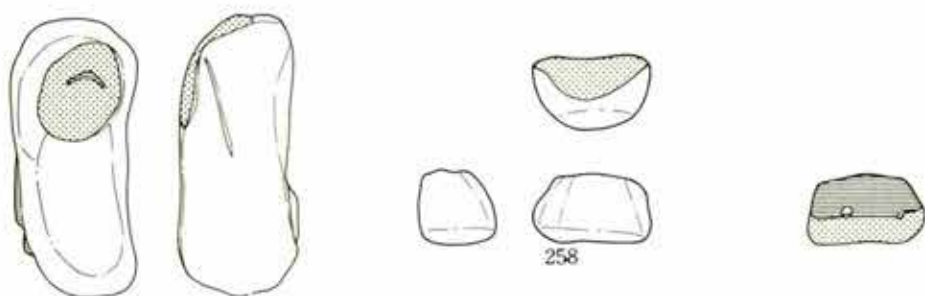

258



257

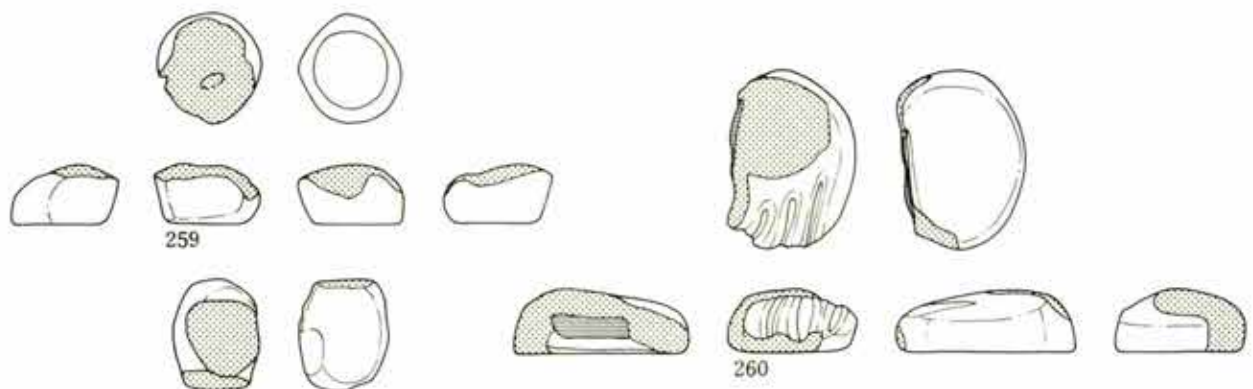

259

260



261

第 521 图 积迦堂 S—IV 区 土偶 (41)

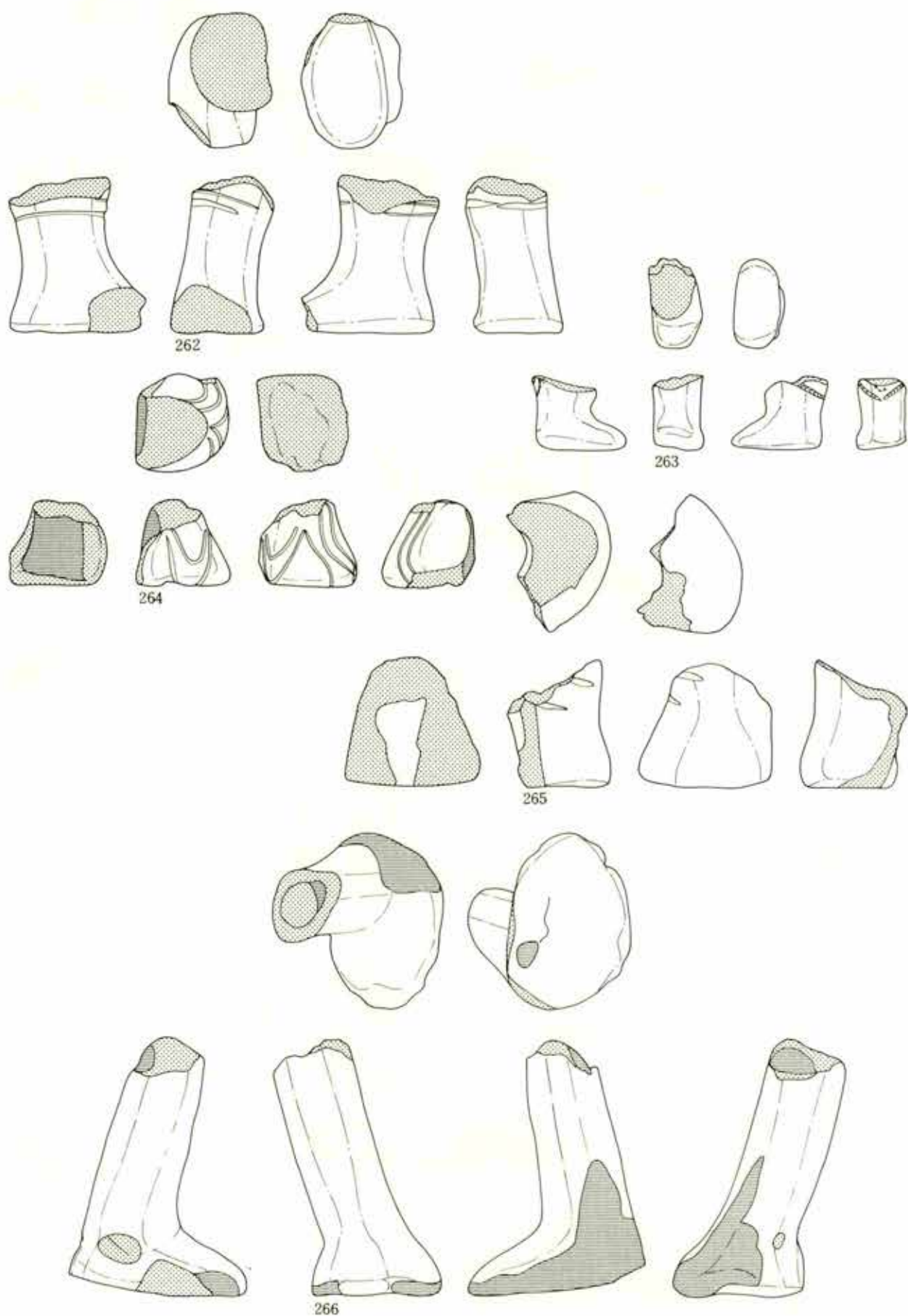

第522图 积迦堂S—IV区 土偶 (42)



第523图 积逊堂S-IV区 土偶 (43)

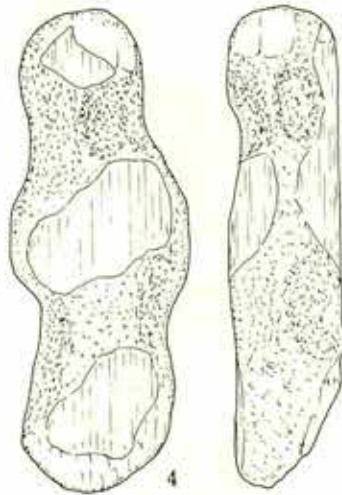
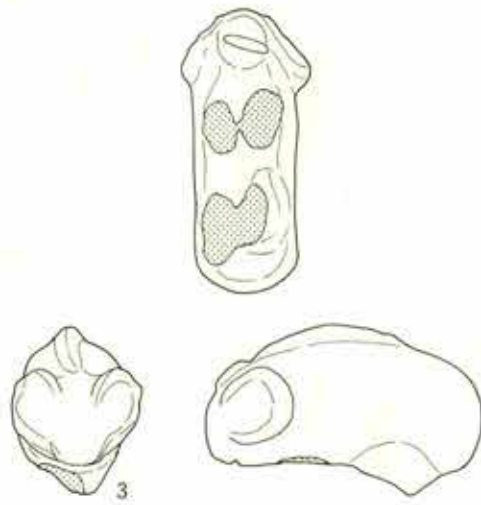
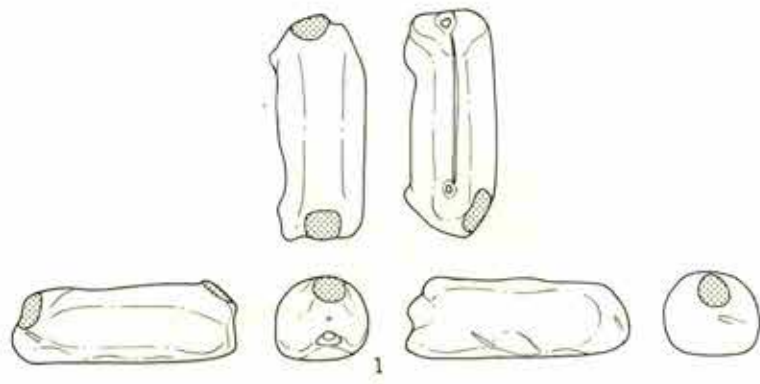

第 524 図 釈迦堂 S-IV 区 動物土偶ほか



第 525 图 积逊堂 S-IV 区 SB 土製円盤

(1)

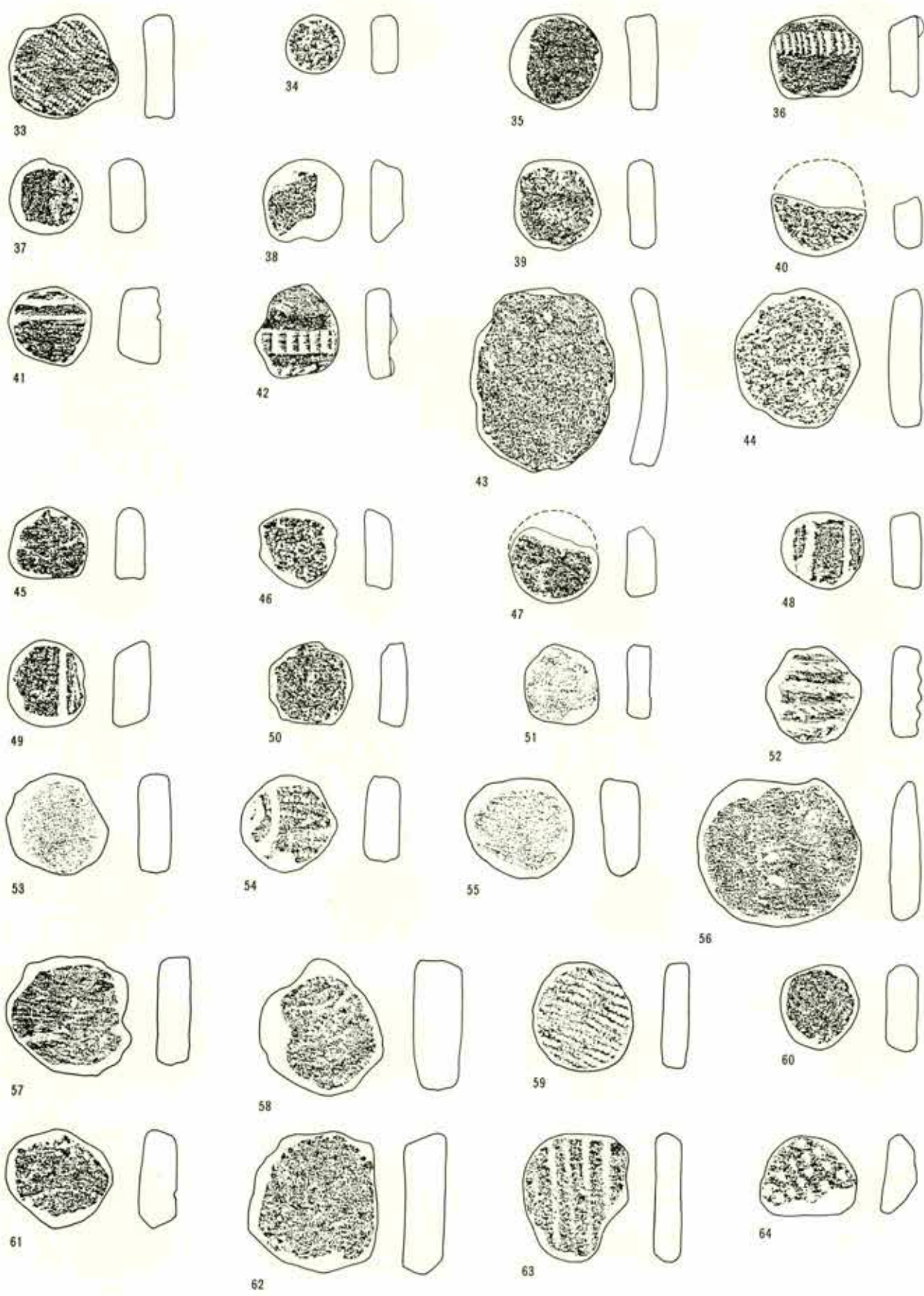

第 526 图 积迦堂 S-IV 区 SB 土製円盤



第 527 图 积逊堂 S—IV 区 SB 土製円盤

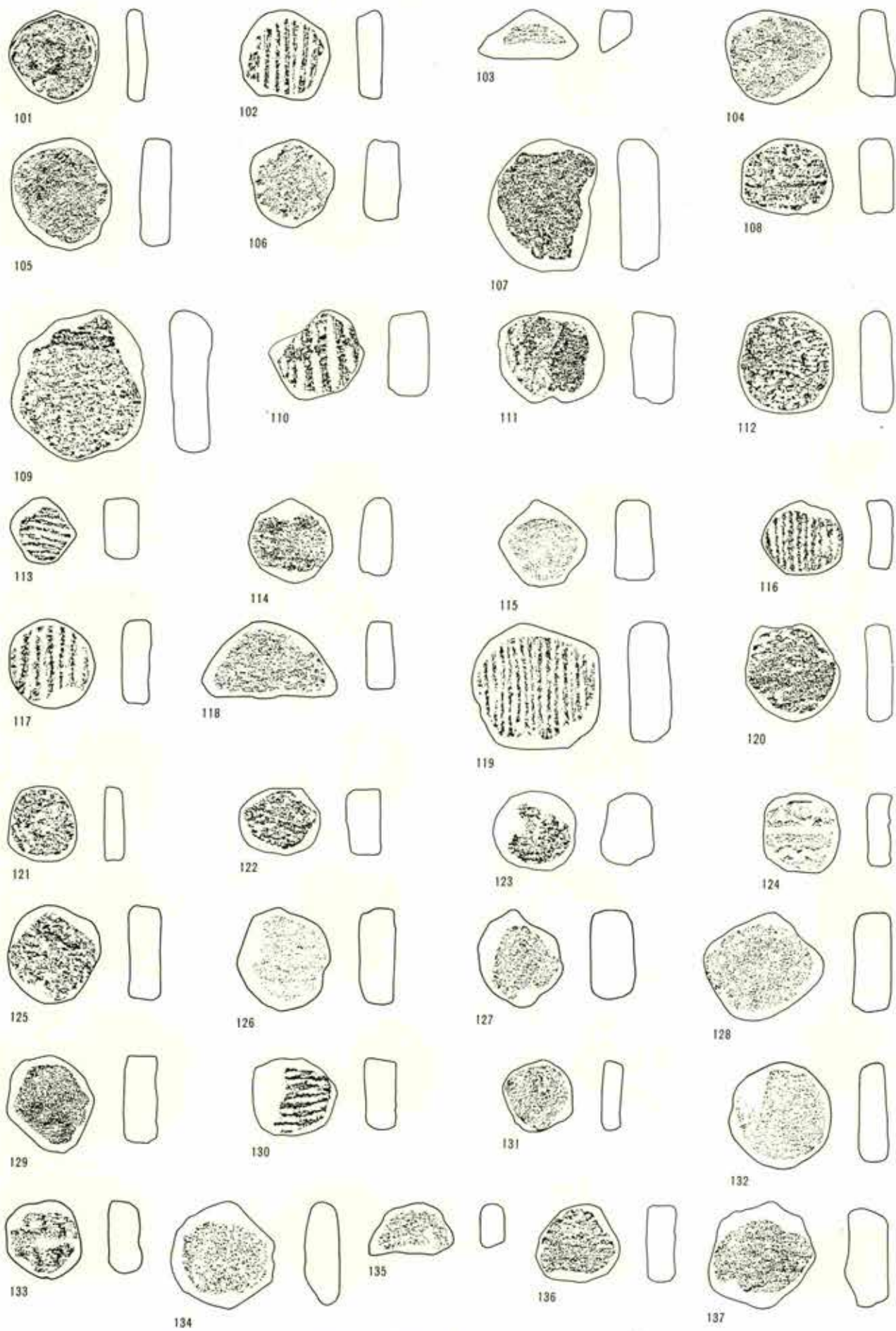

第 528 图 积逊堂 S-IV 区 SB 土製円盤

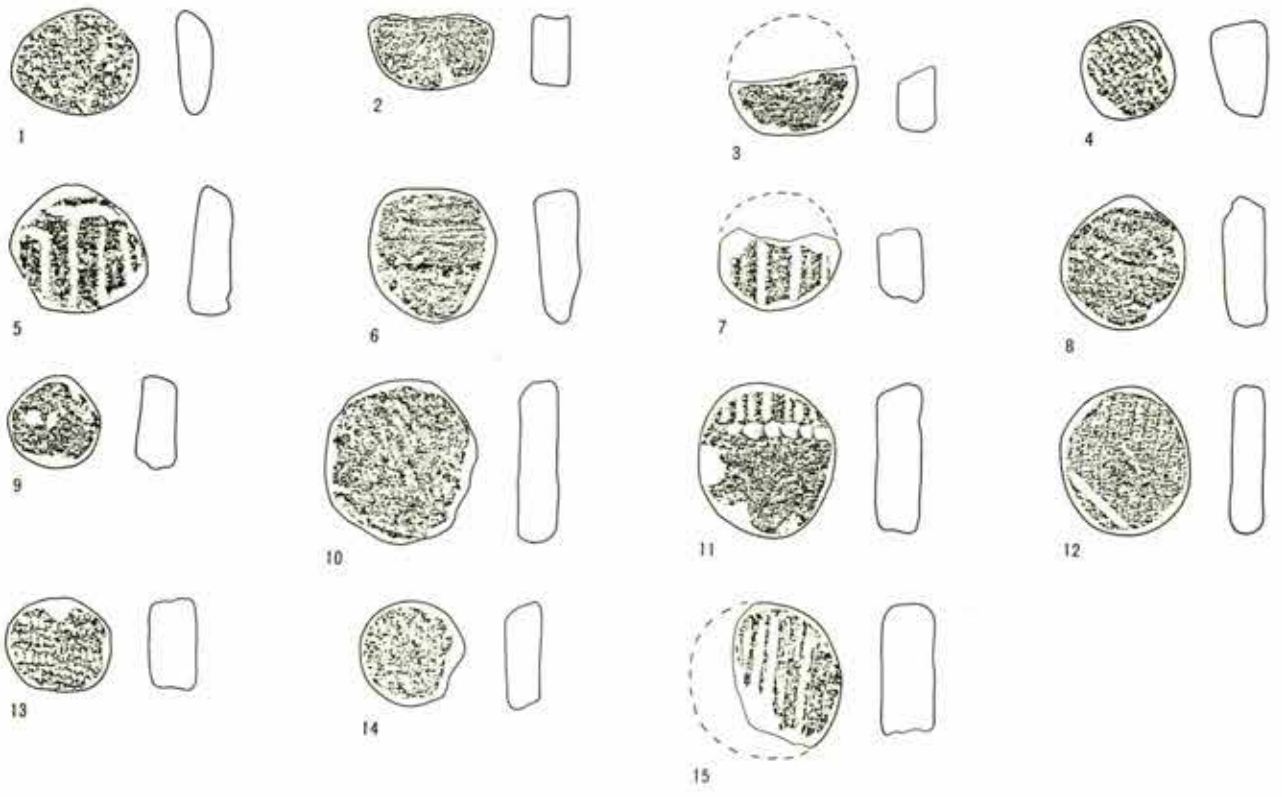

第 529 图 积迦堂 S—IV 区 SK 土製円盤

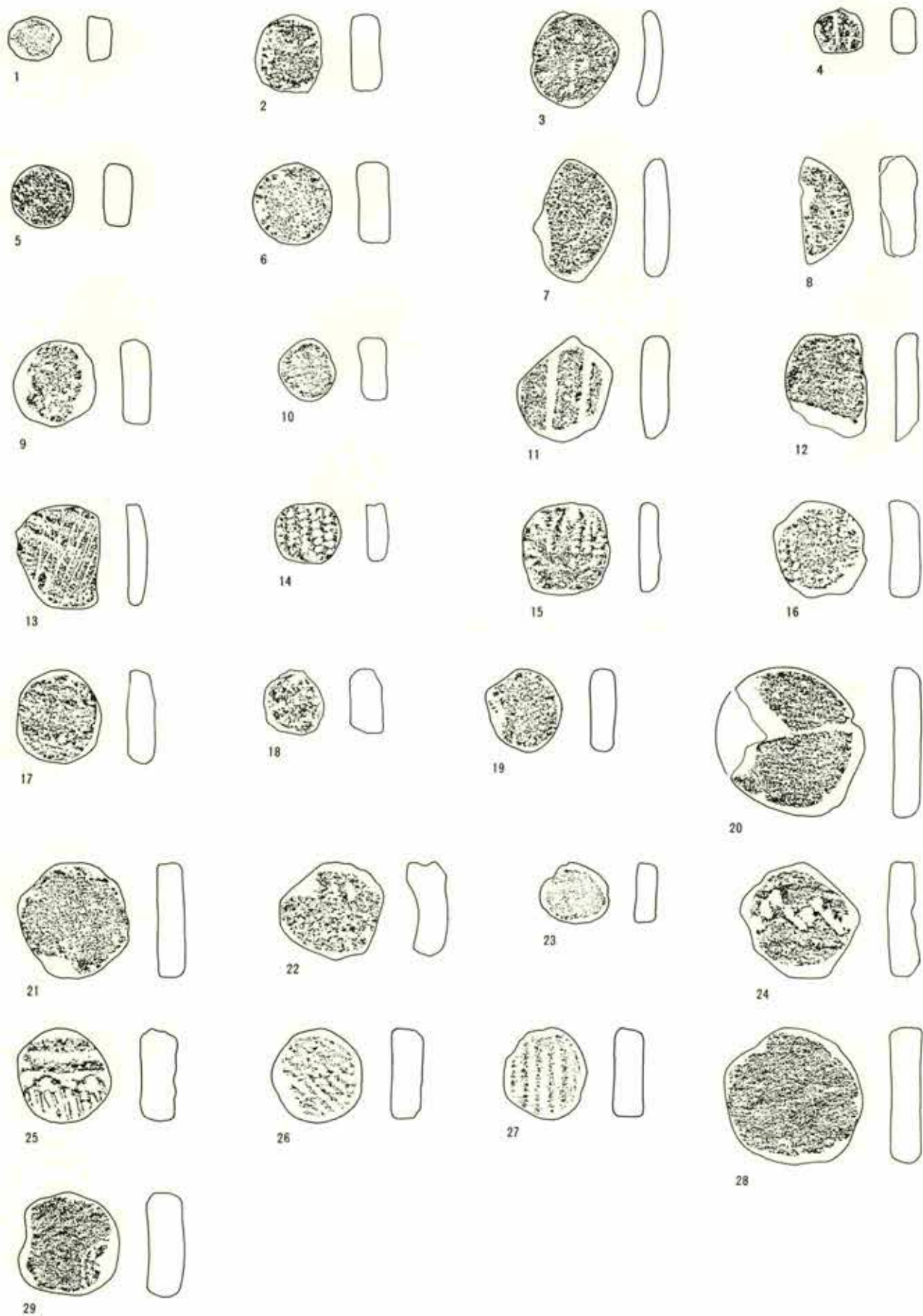

第 530 图 积逊堂 S—N 区 土製円盤

(1)

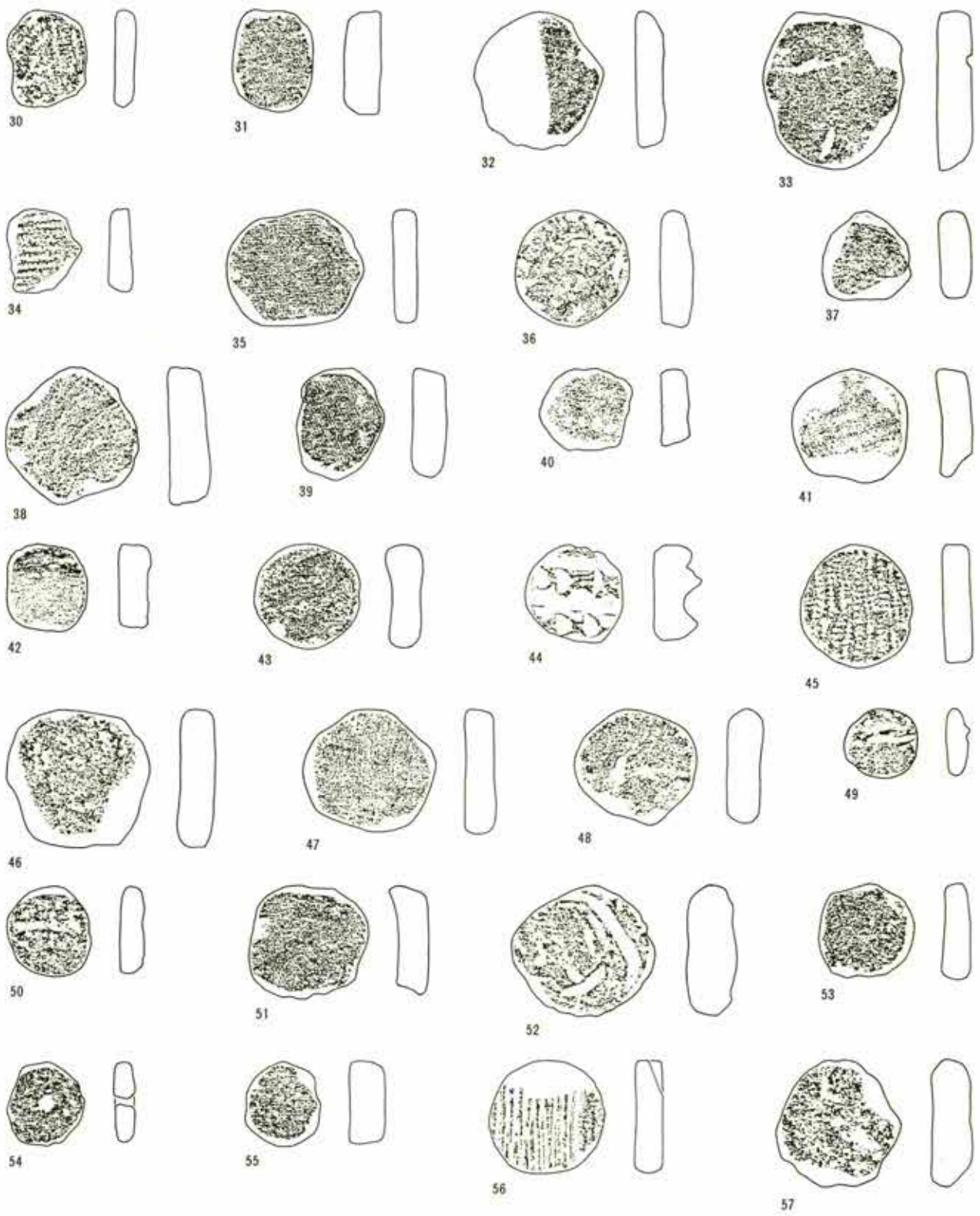

第 531 图 积迦堂 S-IV 区 土製円盤

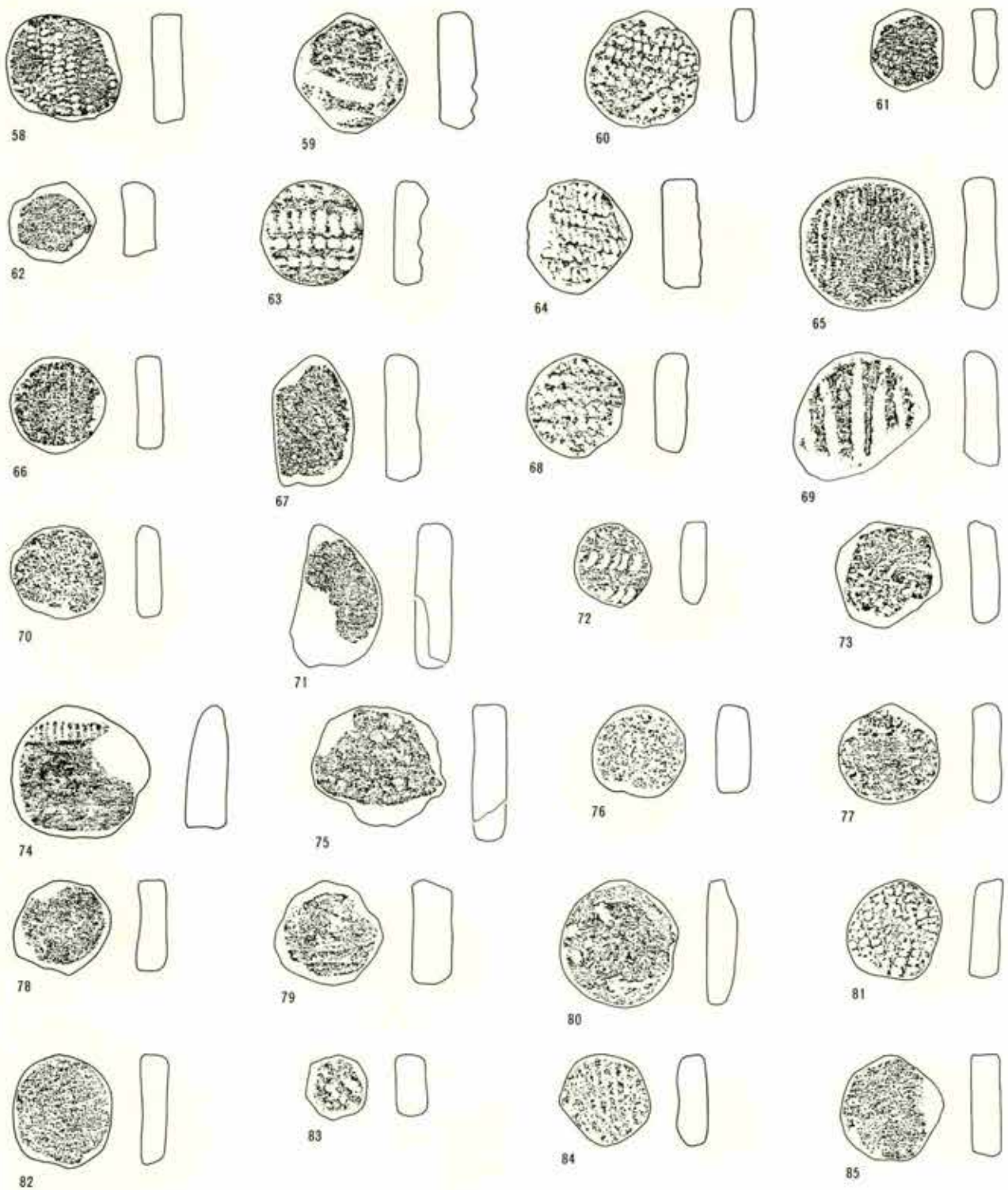

第 532 图 积逊堂 S-IV 区土製円盤

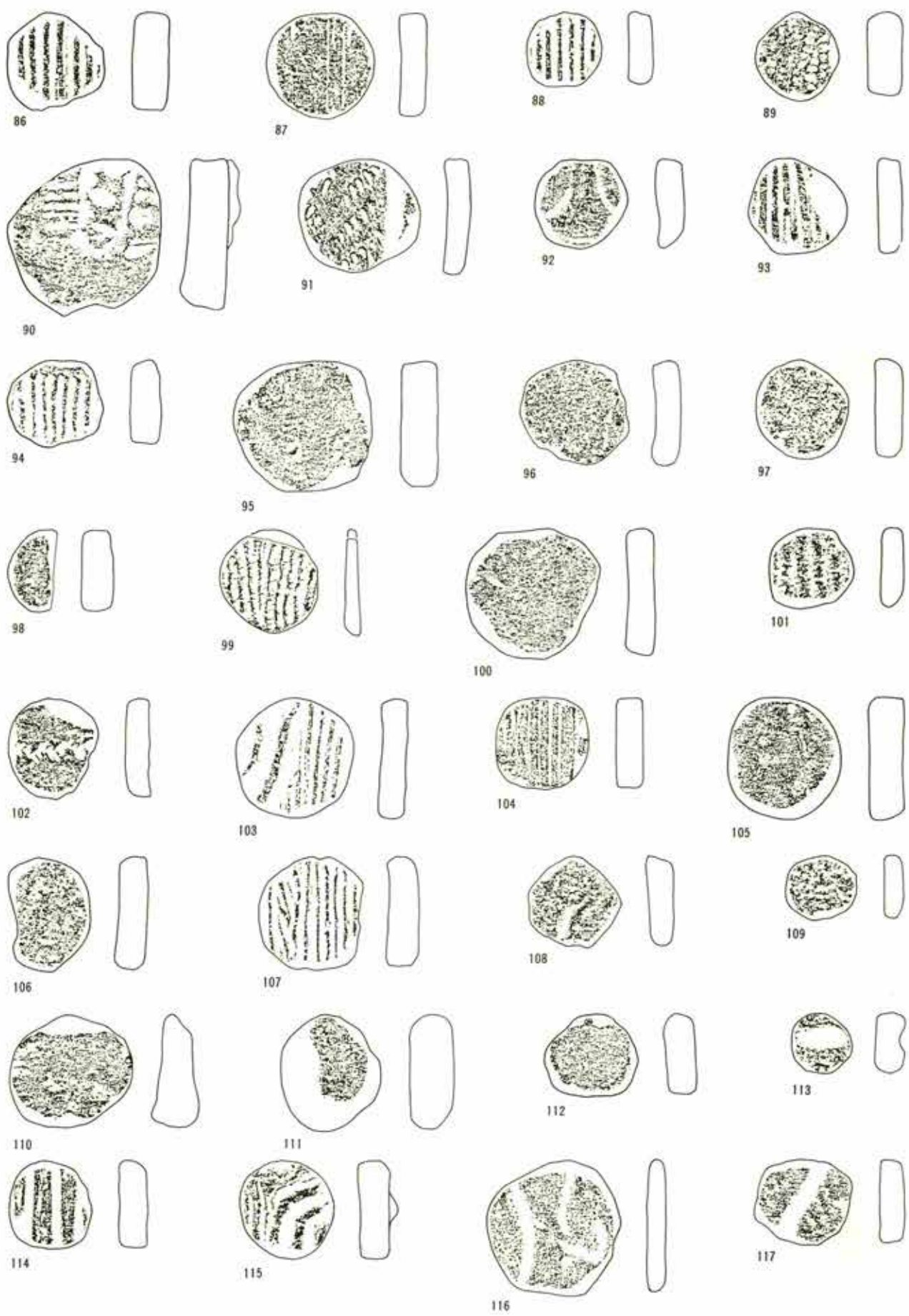

第 533 图 积逊堂 S—IV 区 土製円盤

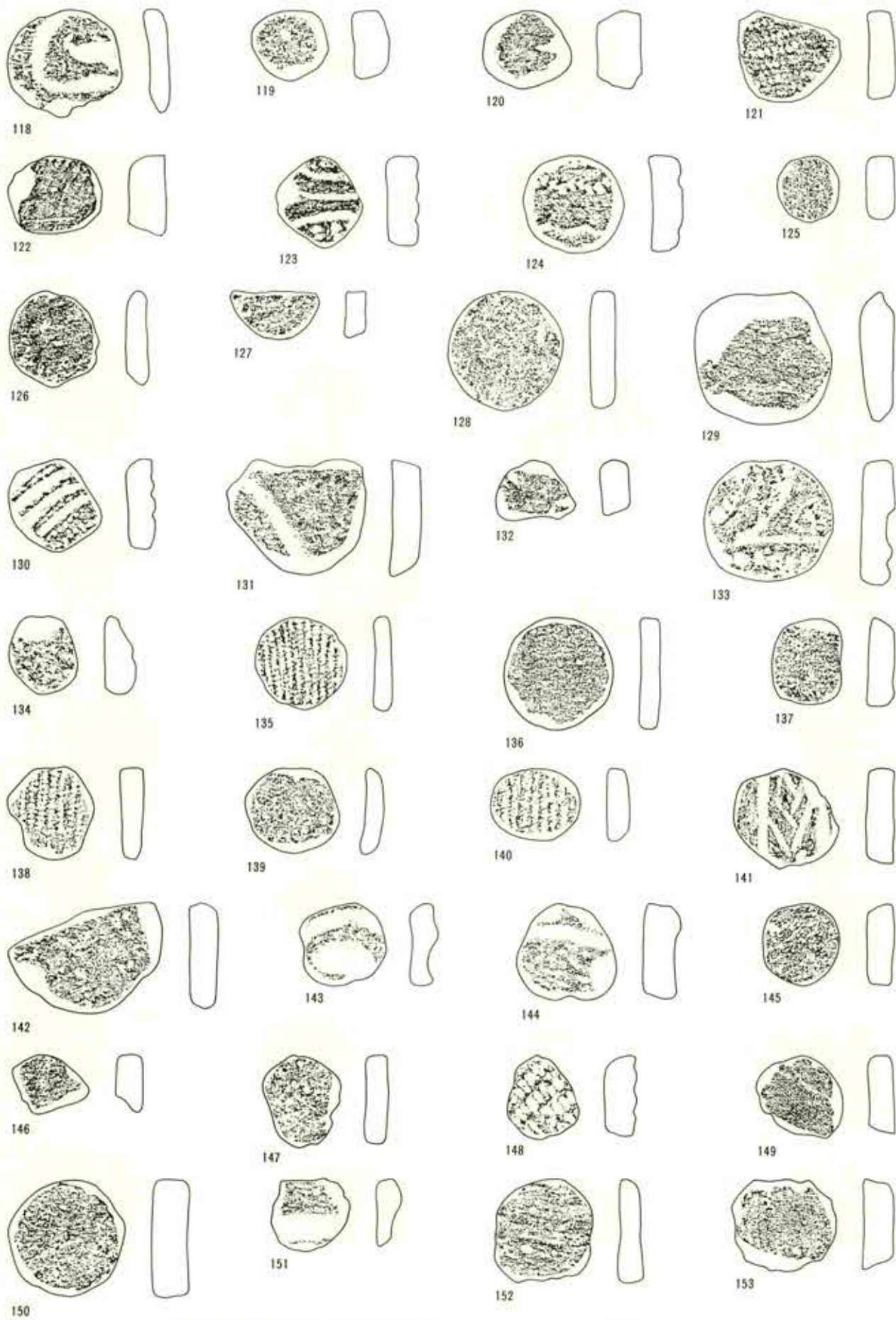

第534图 积迦堂S-IV区土製円盤

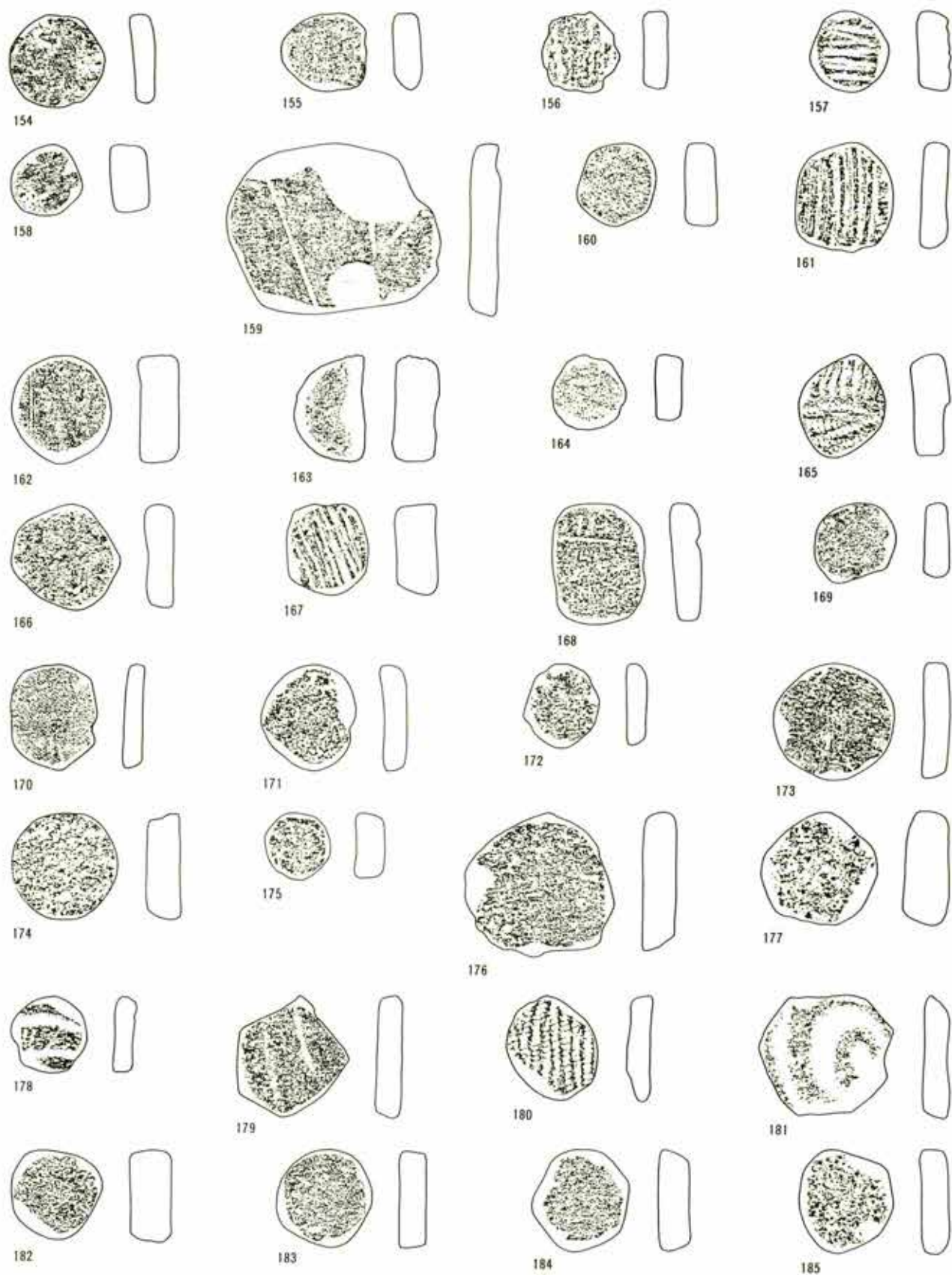

第535图 积迦堂S-IV区土製円盤

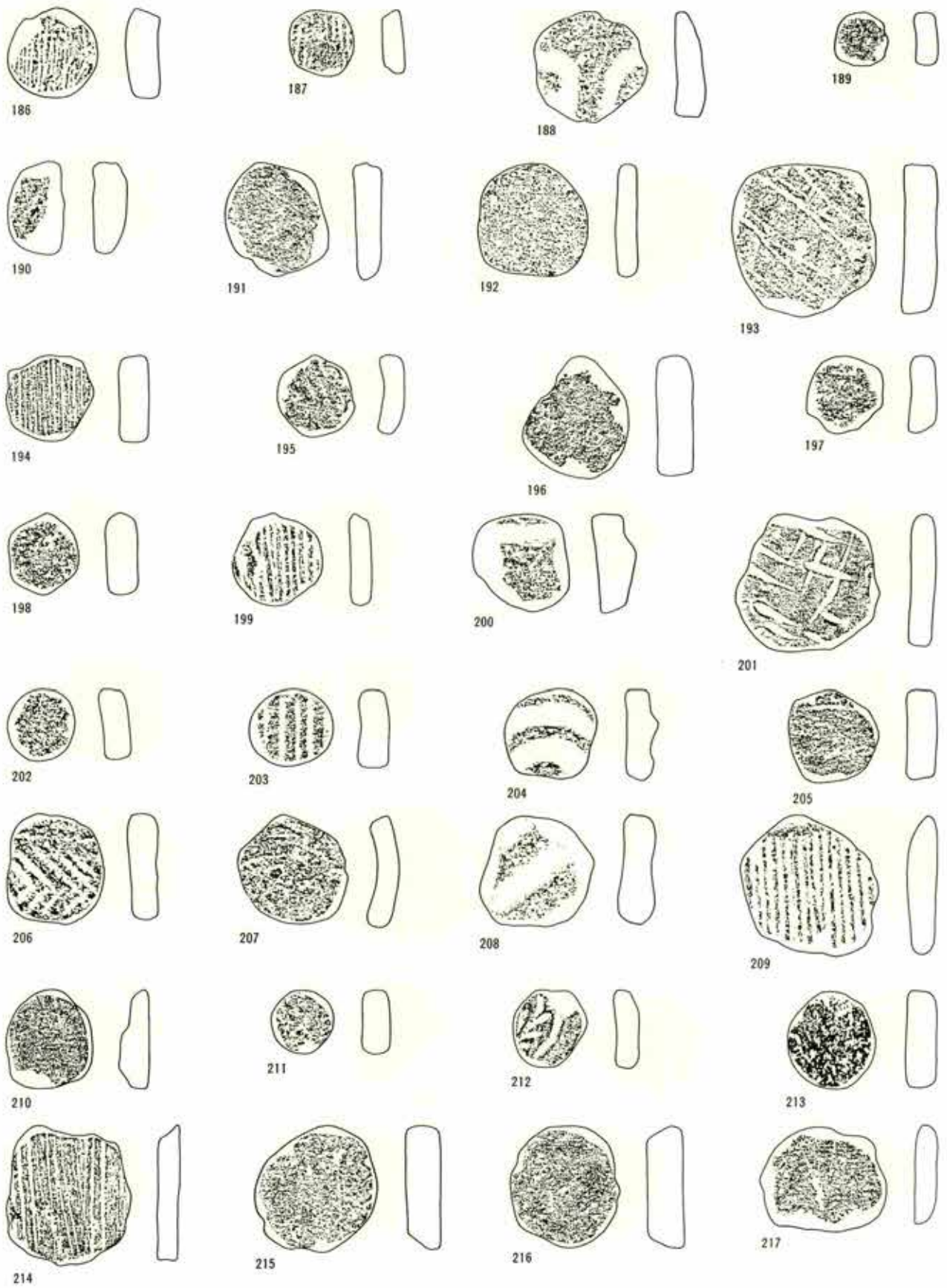

第 536 图 积逊堂 S-N 区 土製円盤

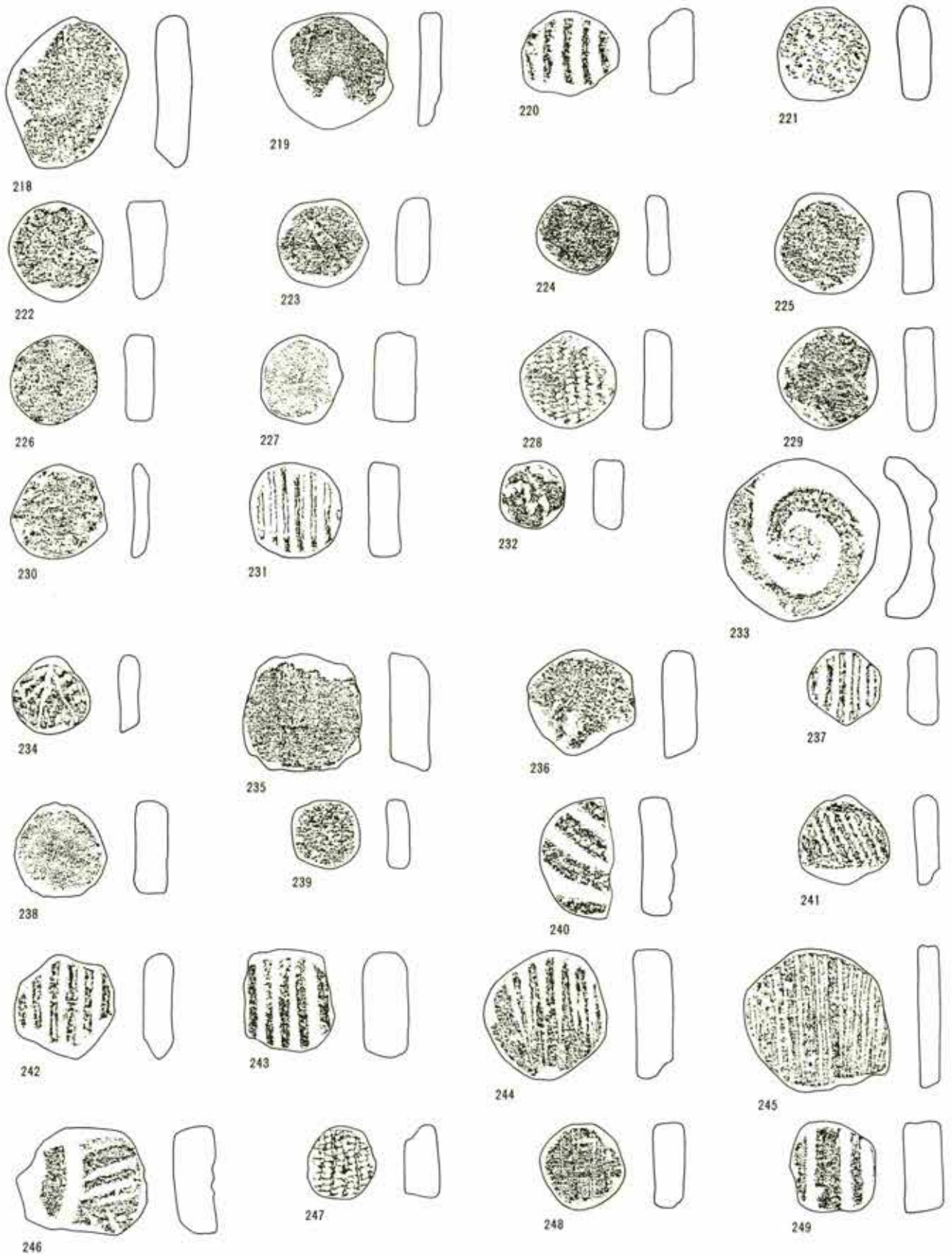

第537图 积逊堂S-IV区土製円盤

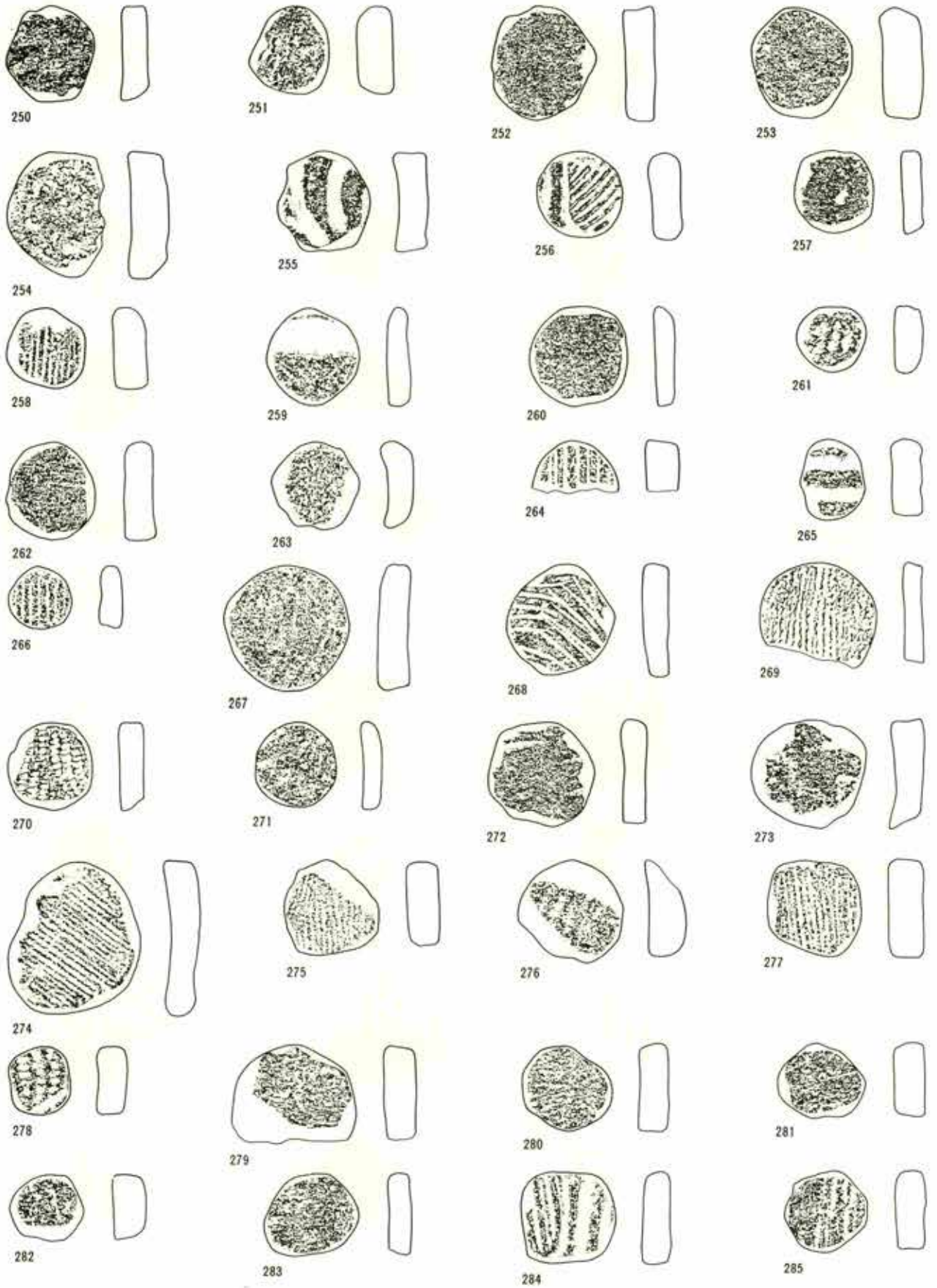

第 538 图 积逊堂 S—IV 区土裂円盤



第 539 图 积迦堂 S-IV 区土製丹盤

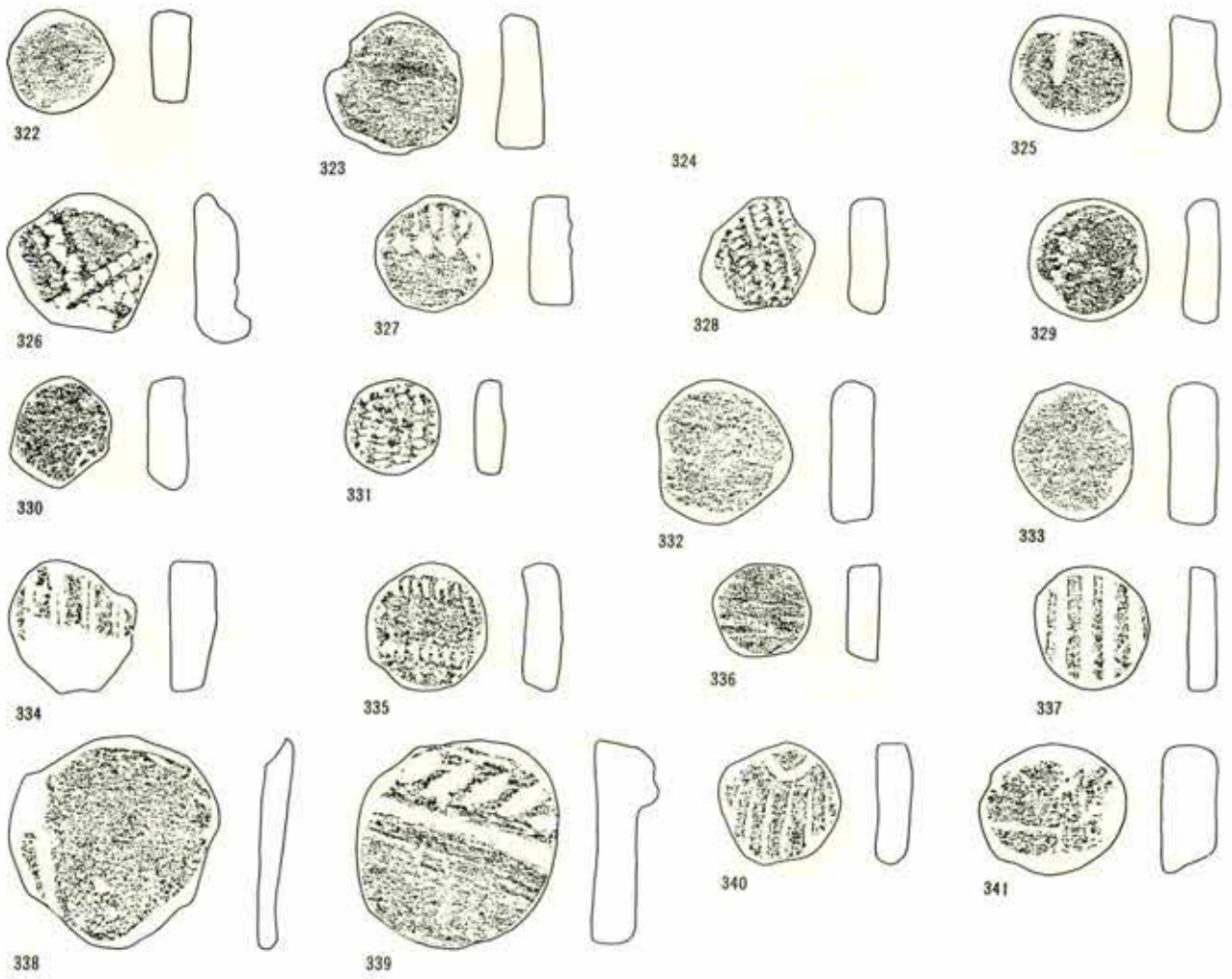

第 540 图 积逊堂 S—N 区土製内盆

积迦堂 N—III 区

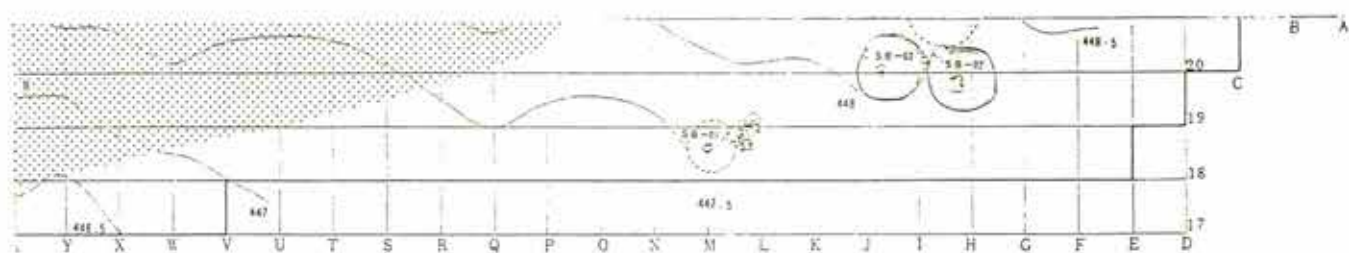

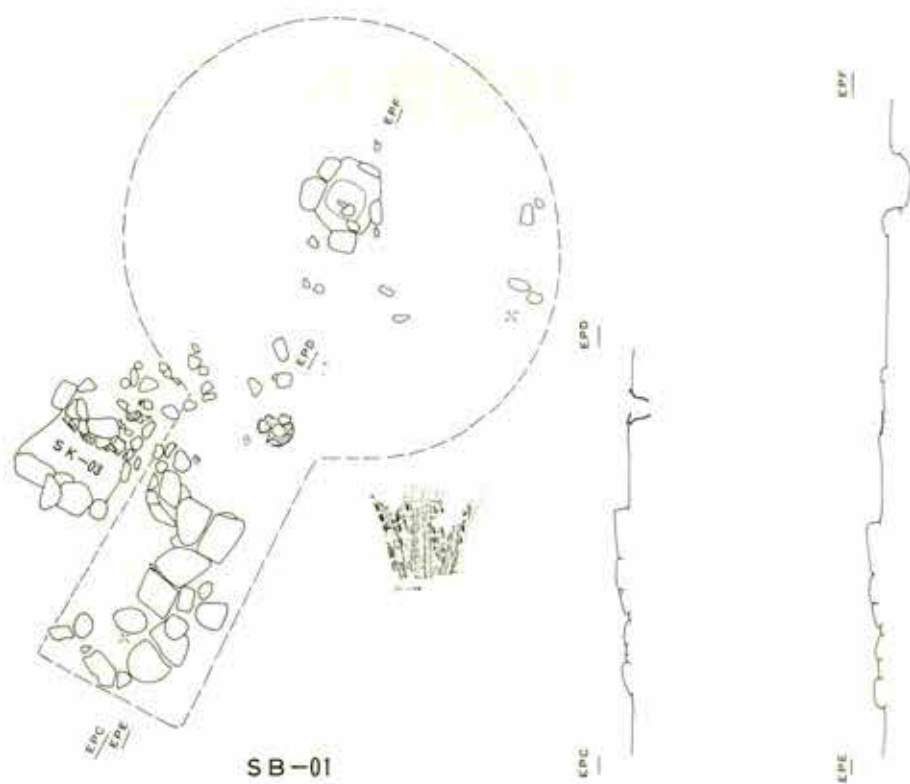

SB-01

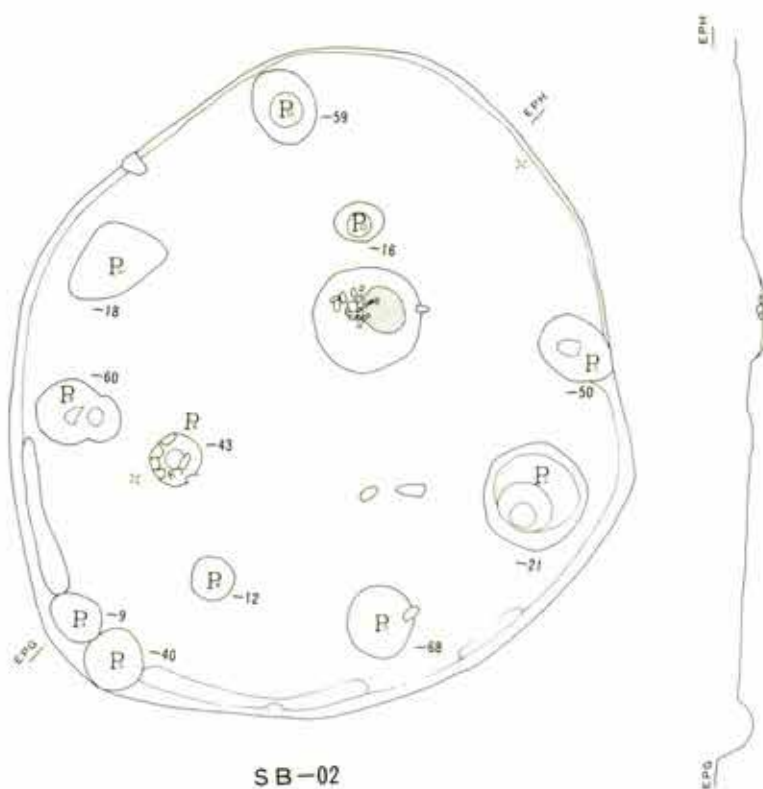

SB-02

第 541 图 积迦堂N-III区 SB-01-02

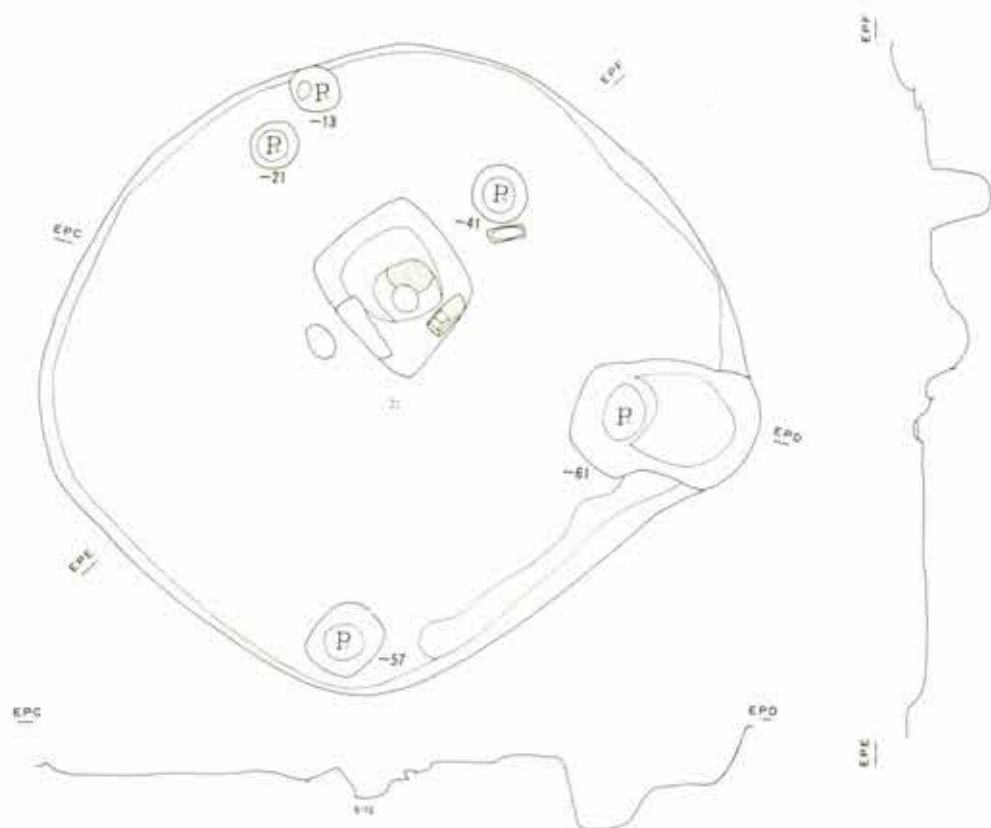

第 542 图 积善堂N-III区 SB-03

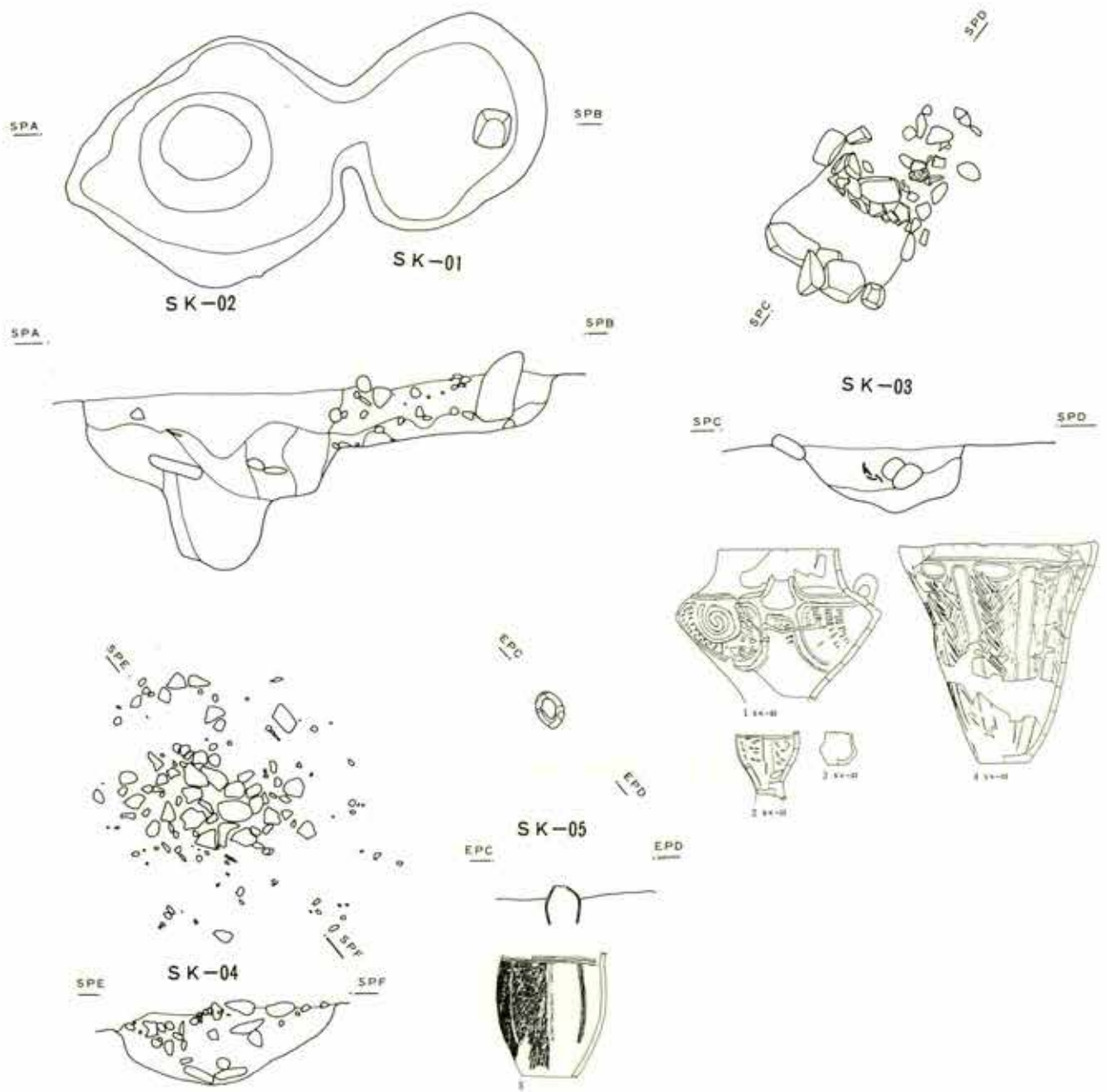

第543图 积逊堂N—III区 SK-01 -02 -03 -04 -05

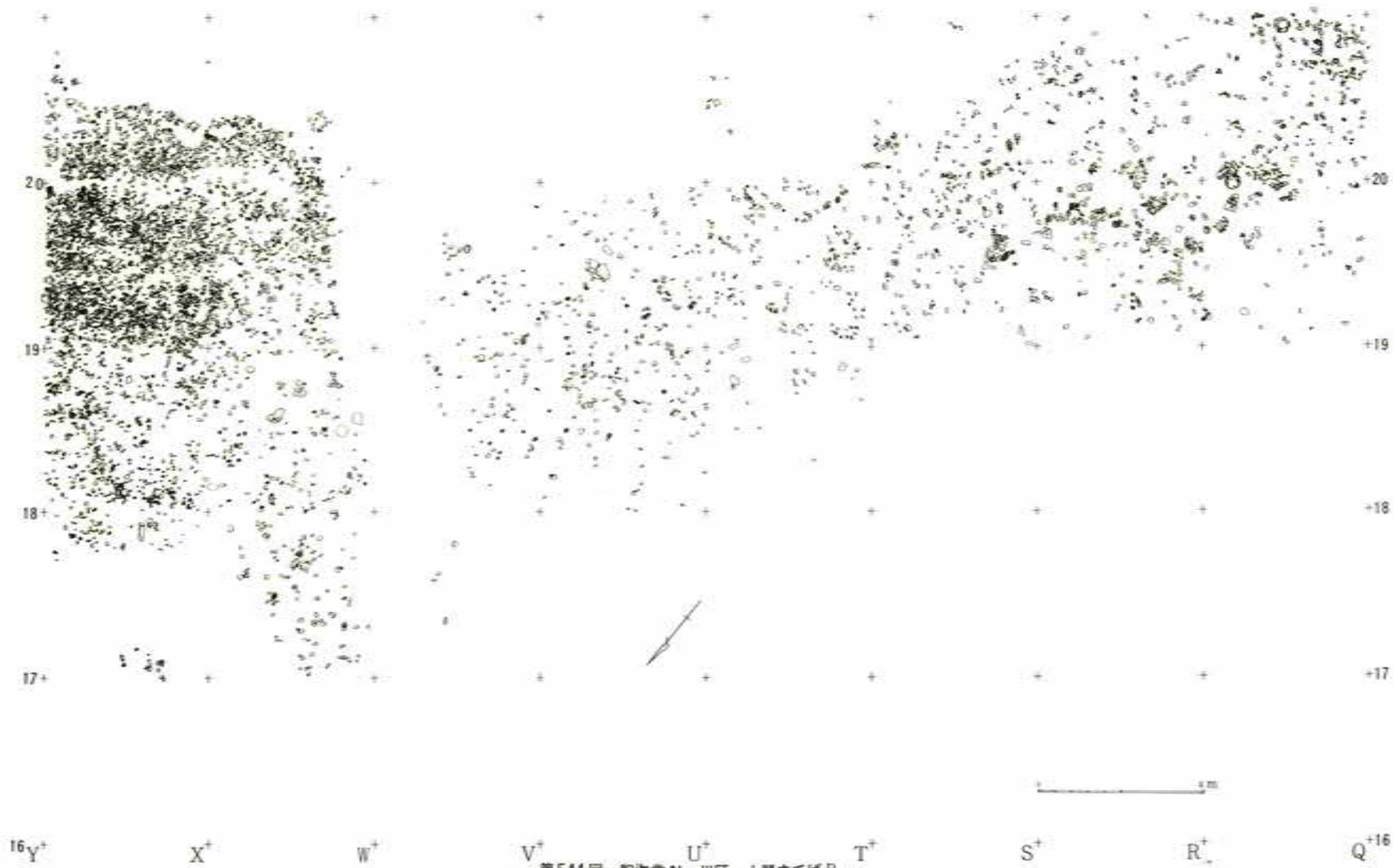

第544図 釈迦堂N-III区 土器すてばB

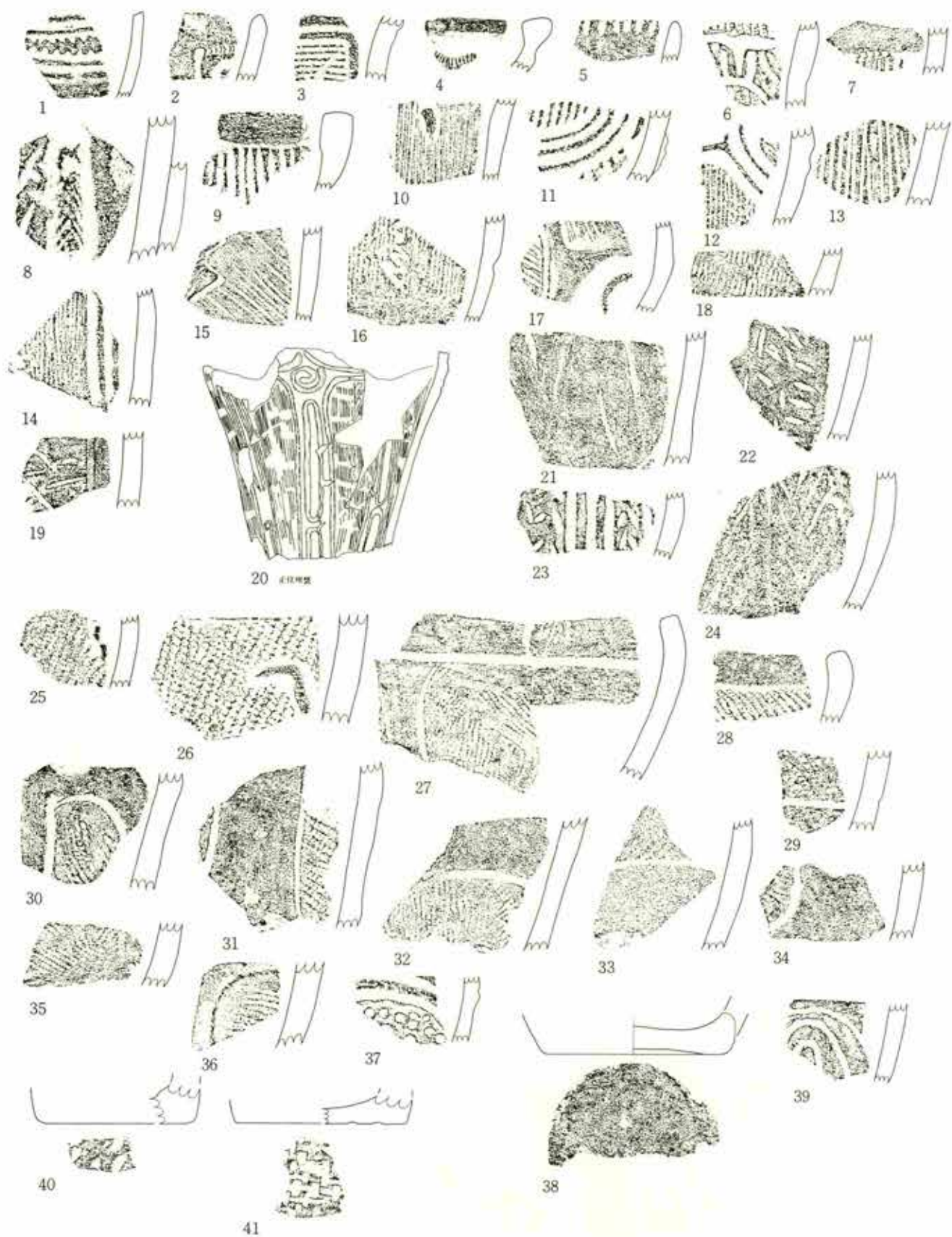

第 545 图 积迦堂 N-III 区 SB-01 出土土器

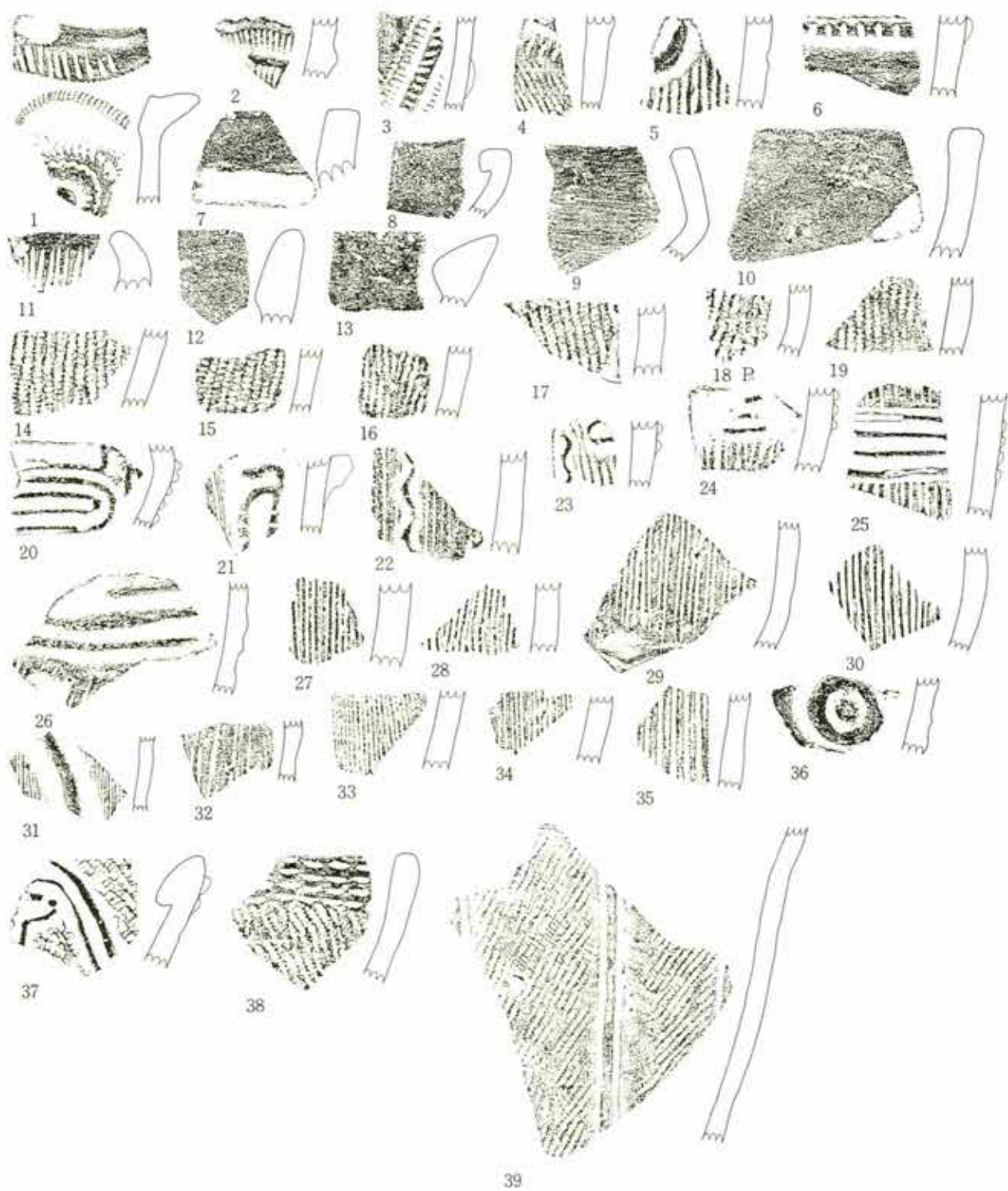

第 546 图 积逊堂 N-III 区 SB-02 出土土器

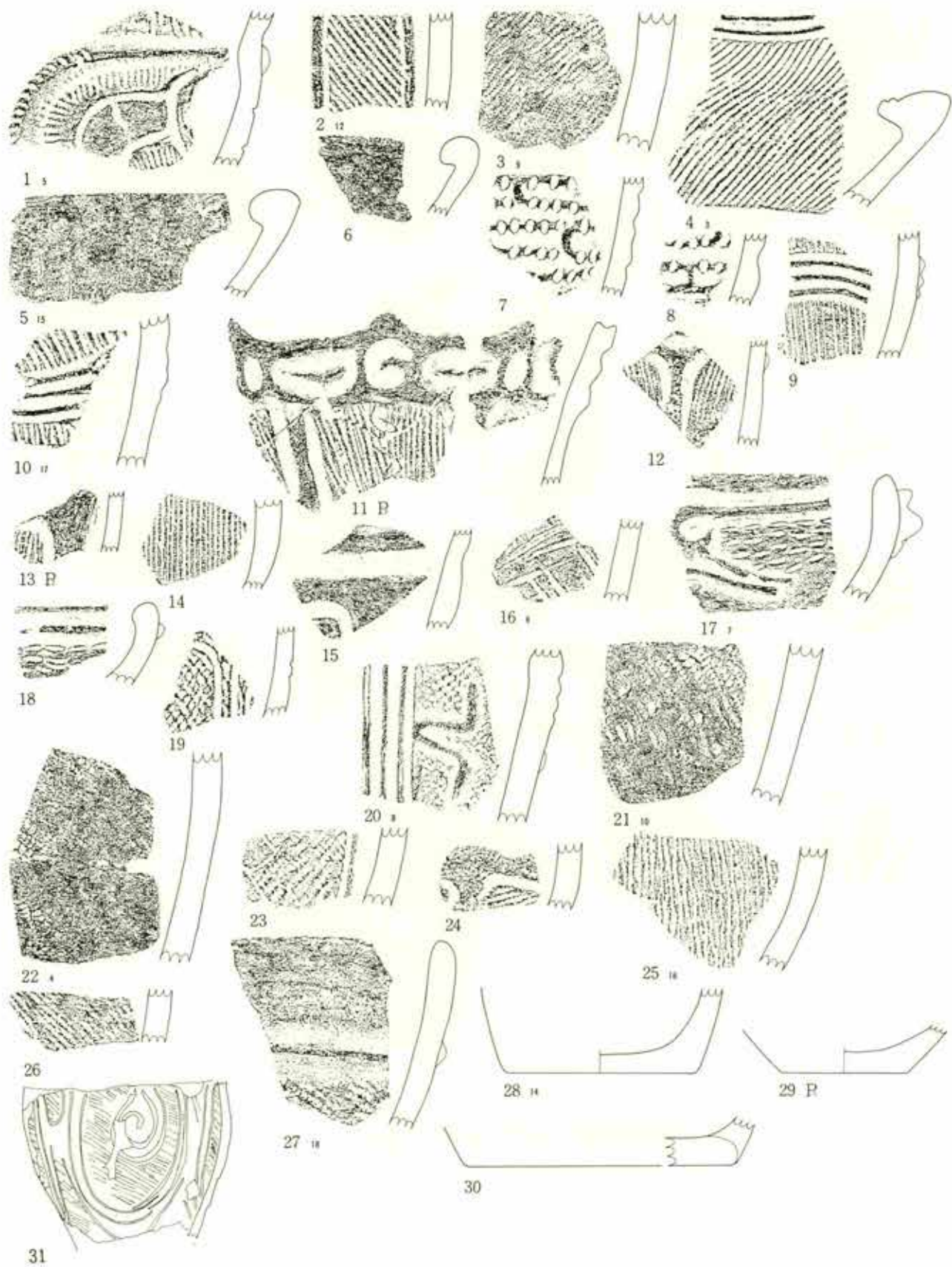

第 547 图 积迦堂N-III区 SB-03 出土土器

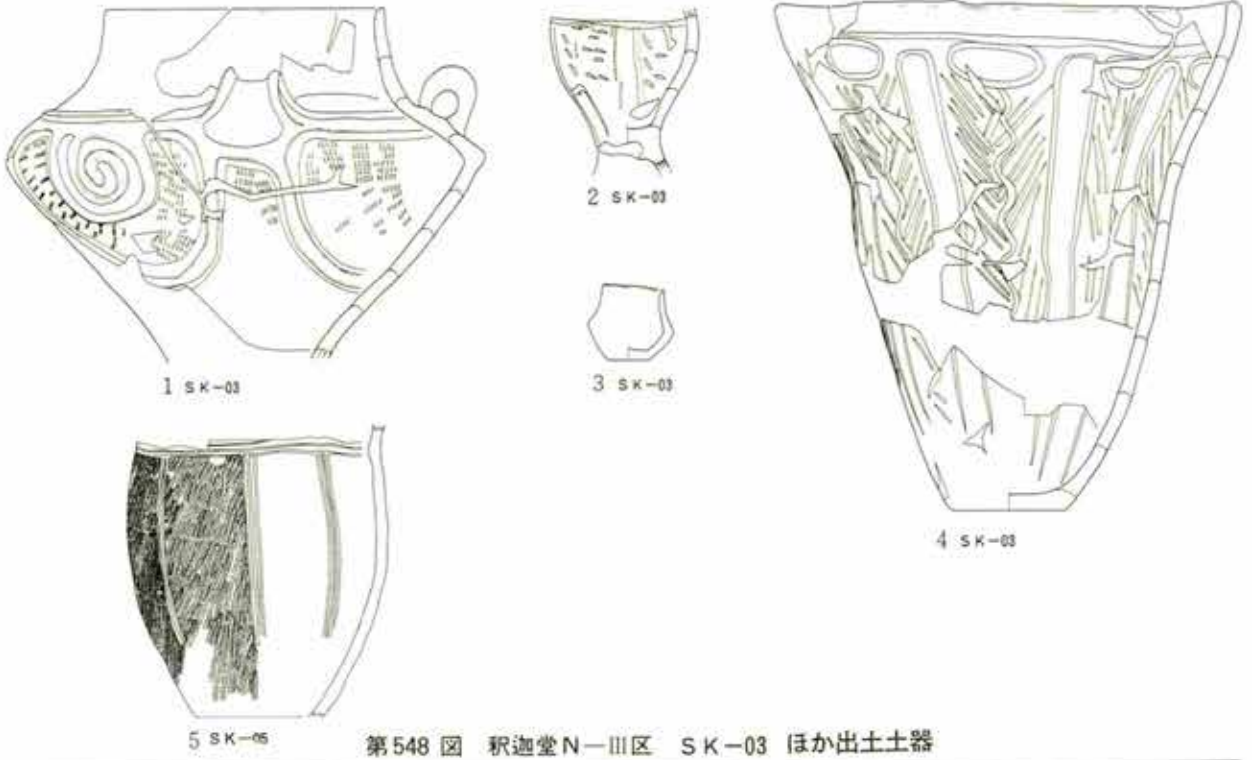

第548 図 积迦堂N-III区 SK-03 ほか出土土器

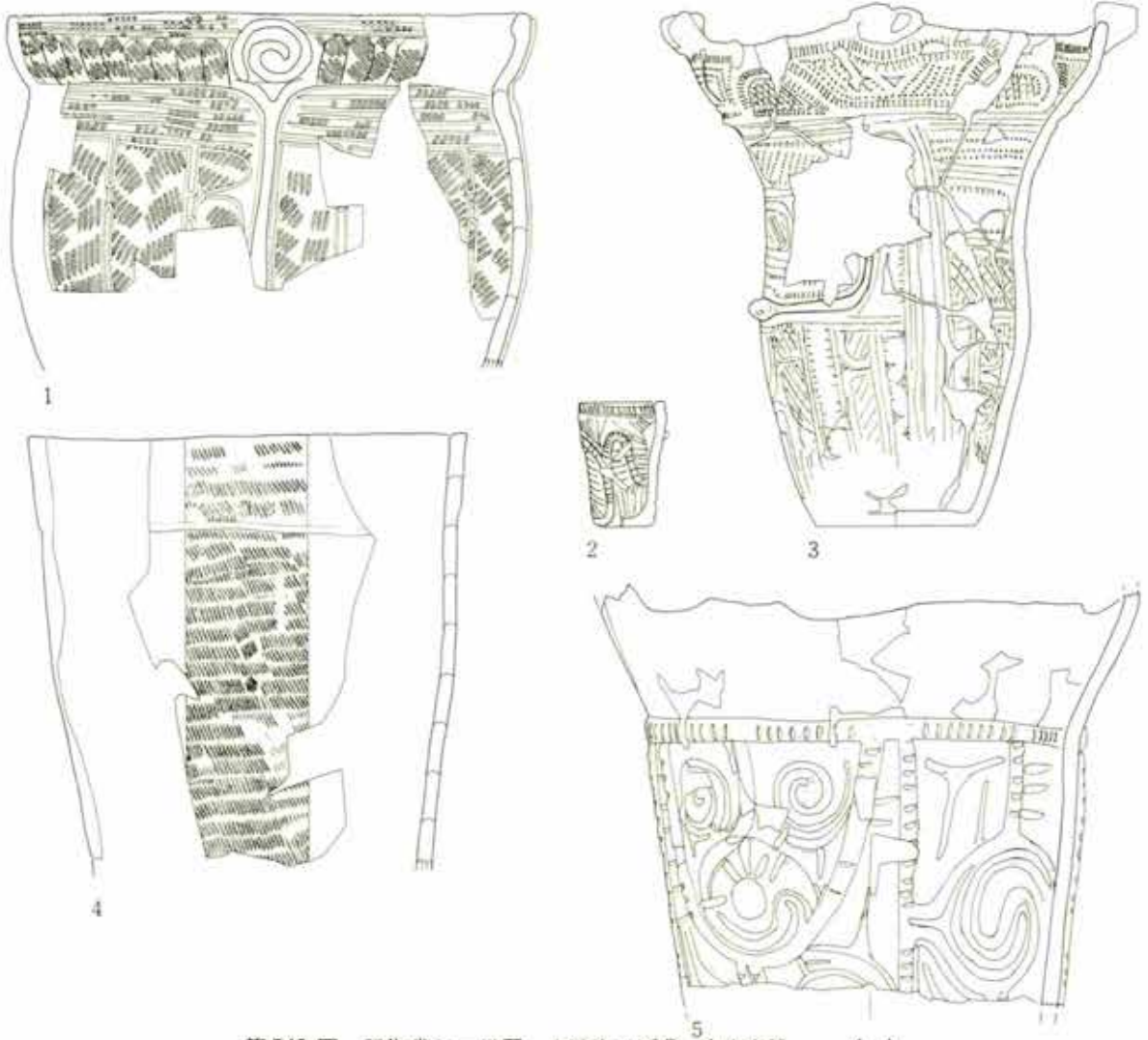

第549 図 积迦堂N-III区 土器すてばB 出土土器 (1)

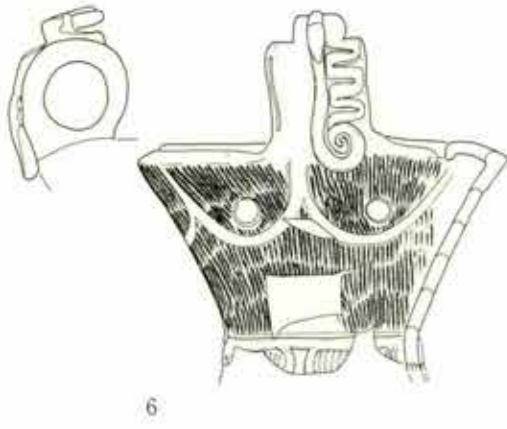

6



7

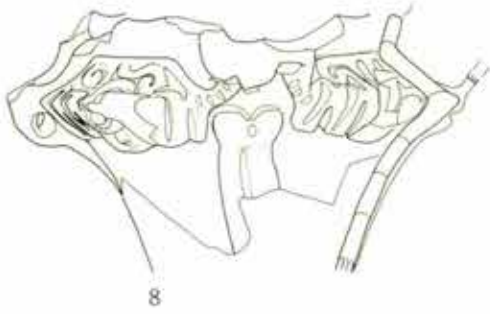

8



9

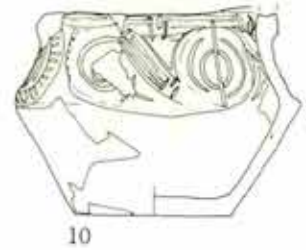

10

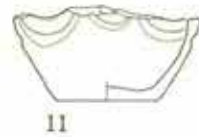

11



12



16



13

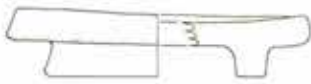

14

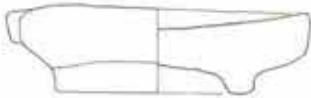

15



第 550 図 积迦堂N-III区 土器すてば B 出土土器 (2)

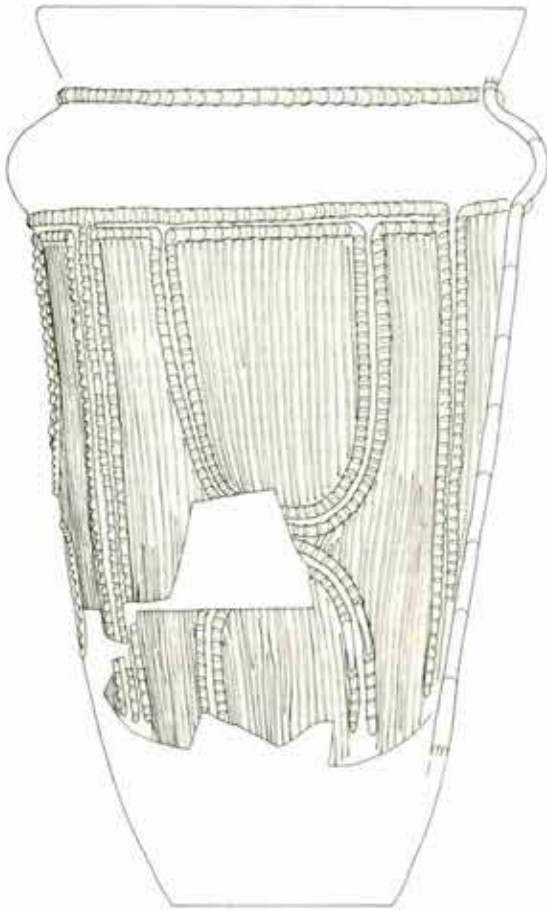

17

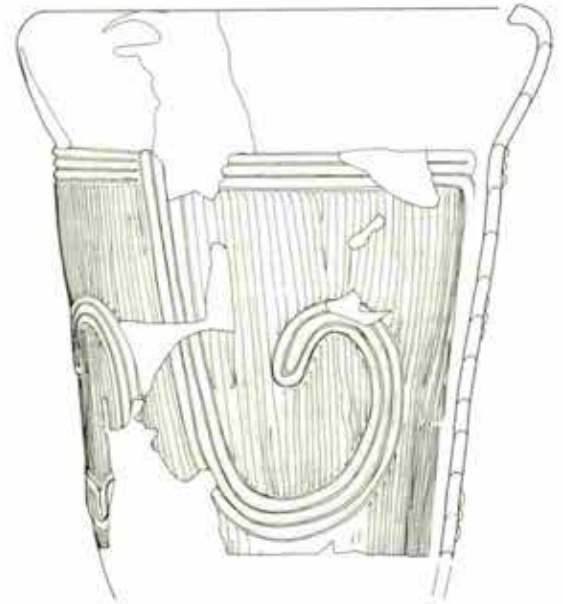

18



19



20



21



22



23

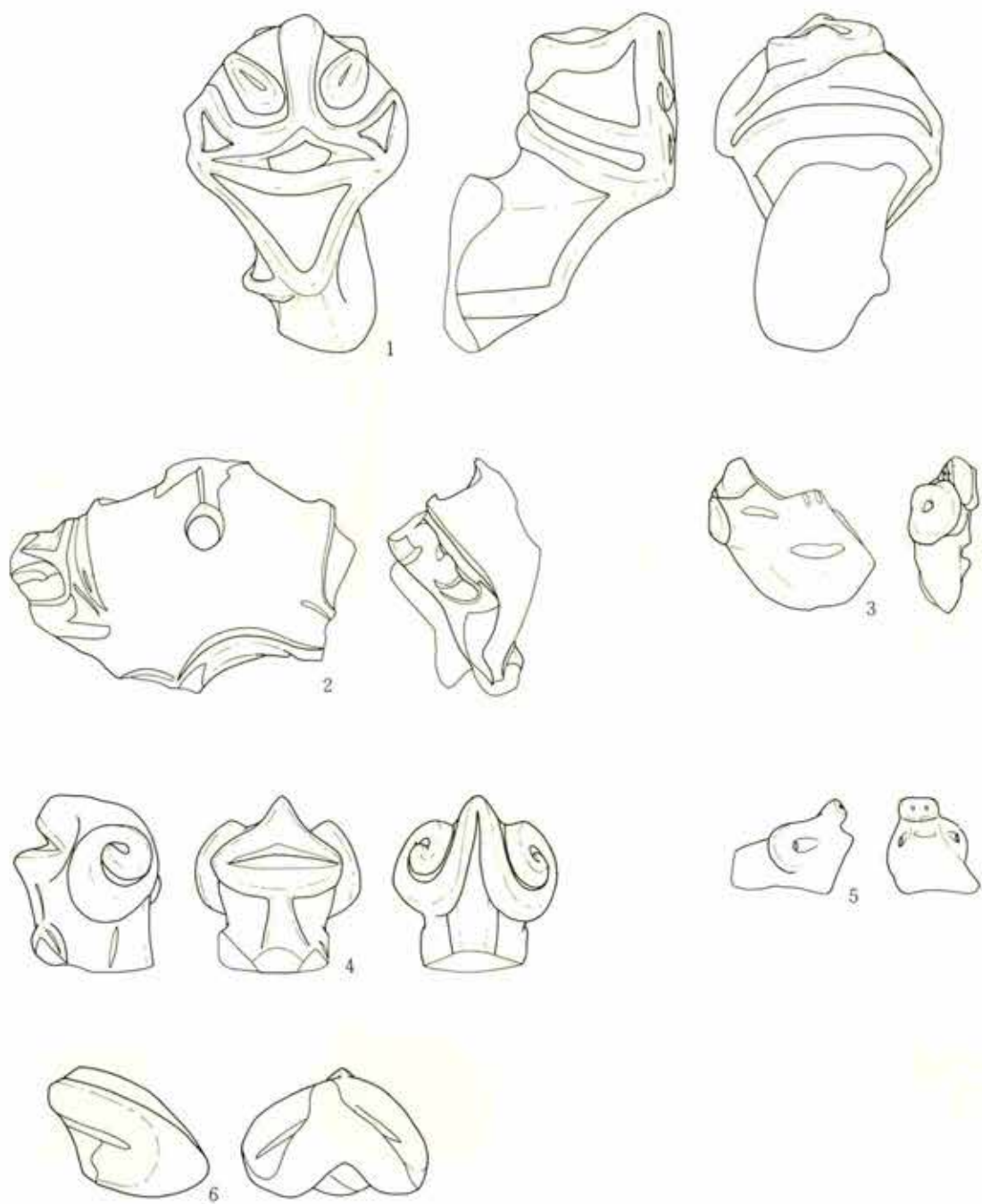

第 552 图 积迦堂N-III区 把手

(1:2)

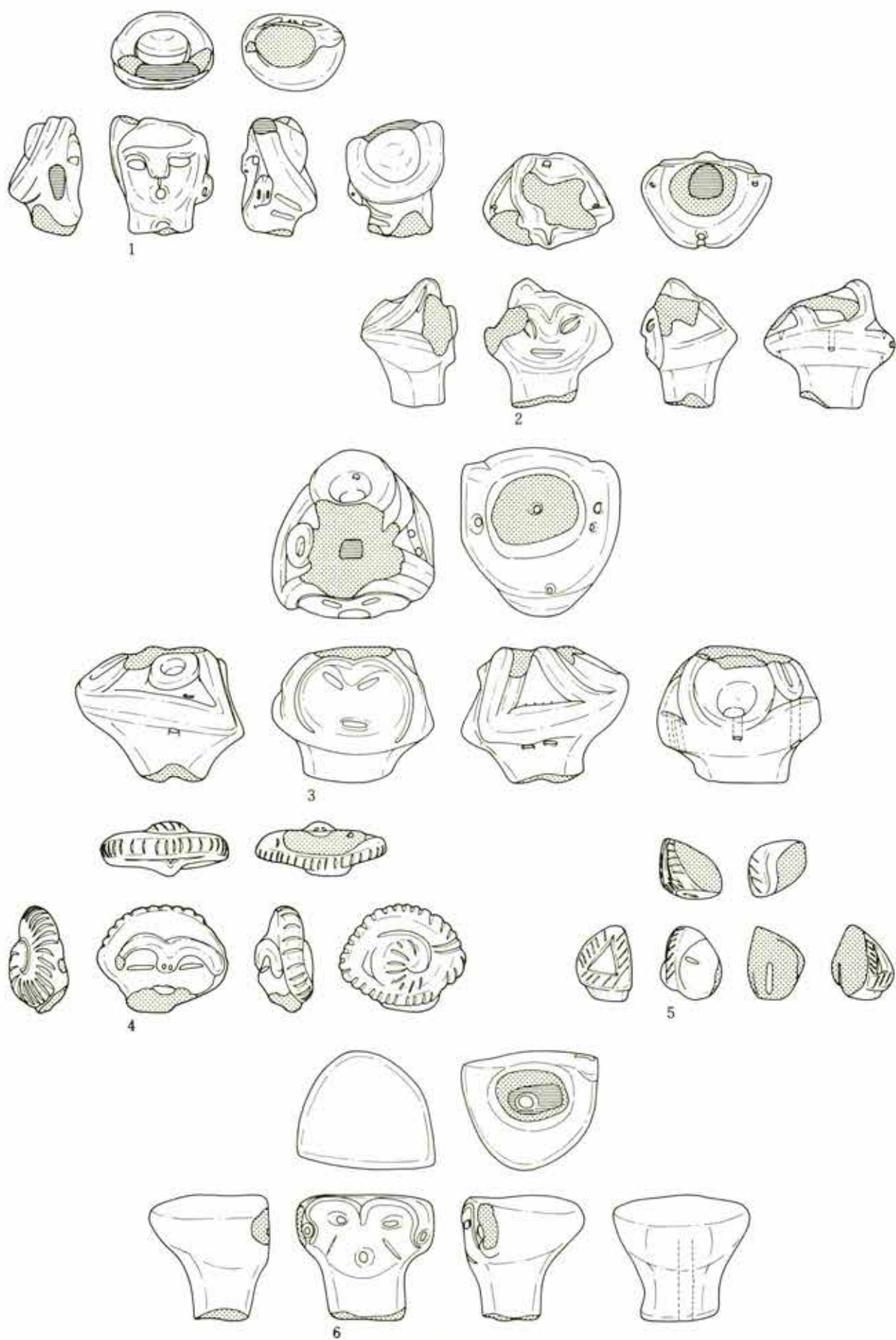

第 553 图 积迦堂 N-III 区 土偶 (1)

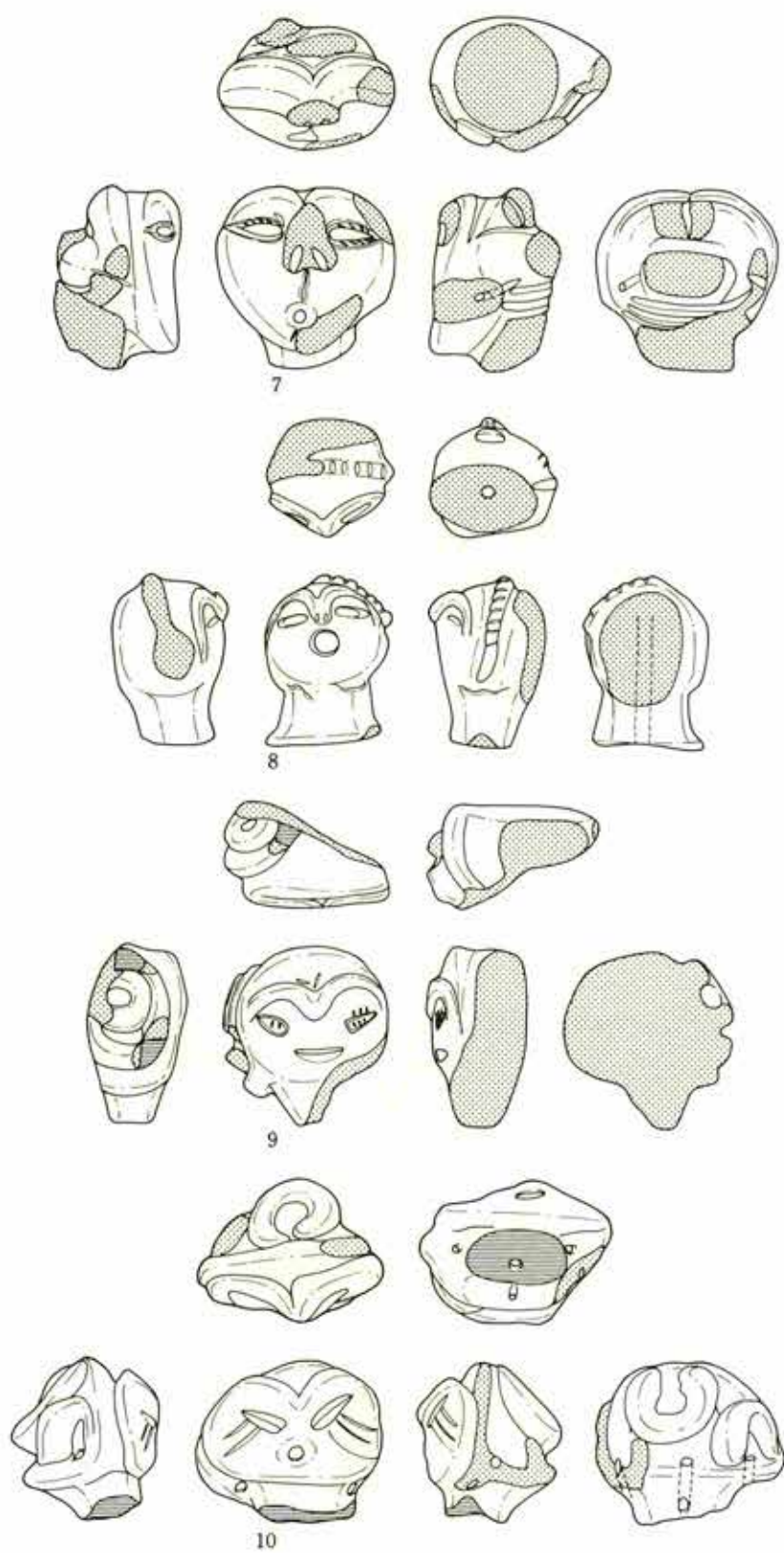

第 554 图 积逊堂 N-III 区 土偶 (2)

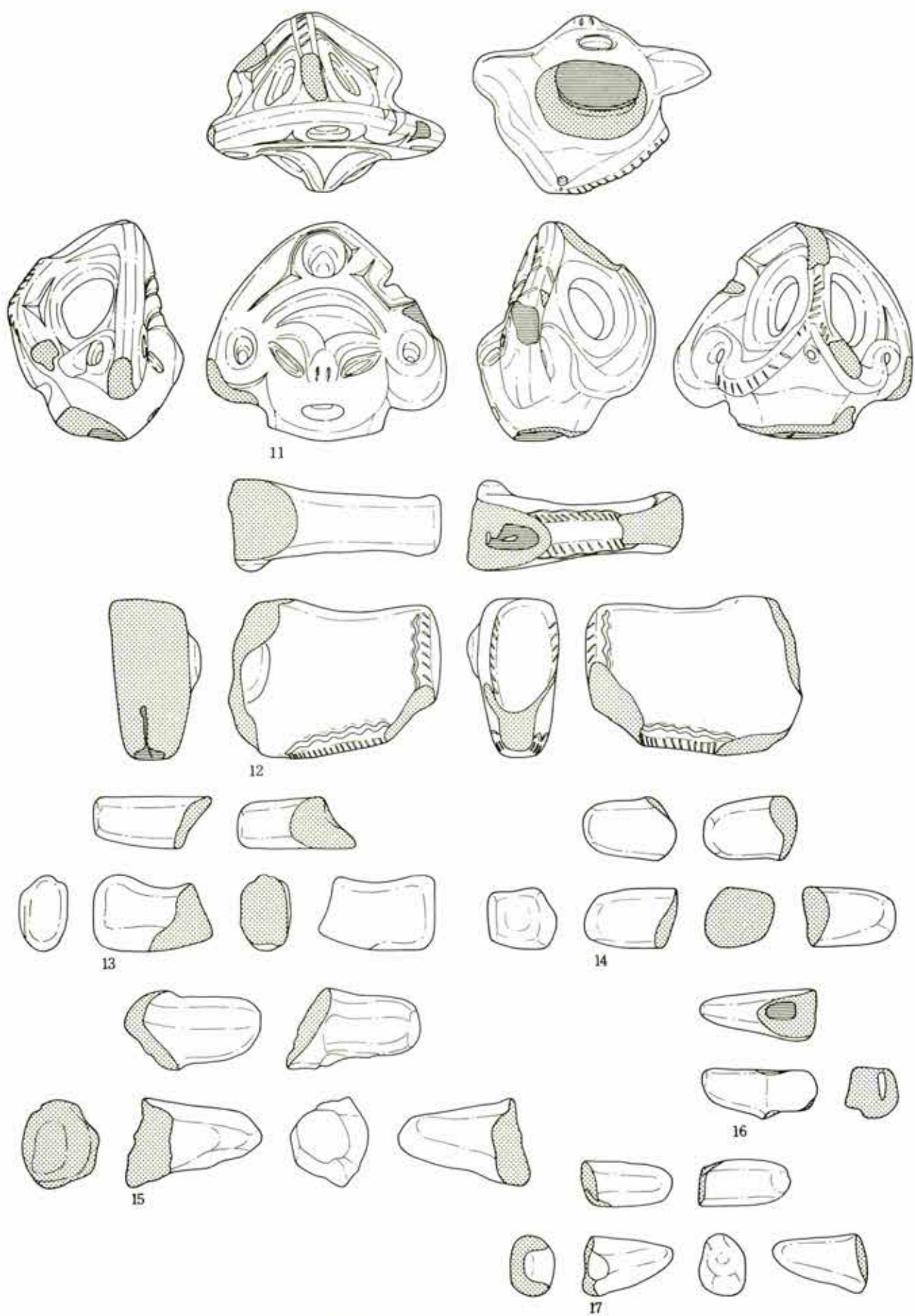

第 555 图 积逊堂 N-III 区 土偶 (3)



18

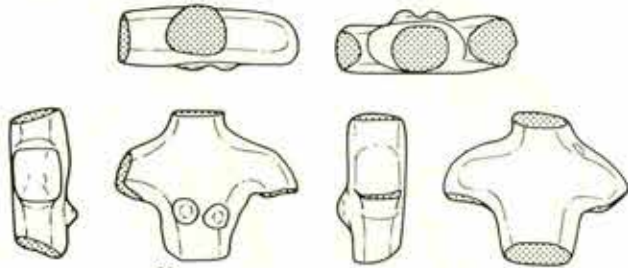

19

20

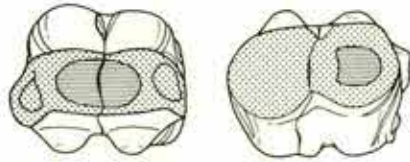

21

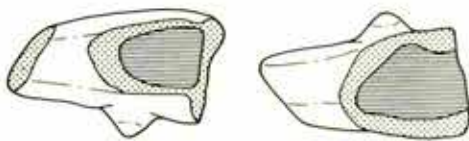
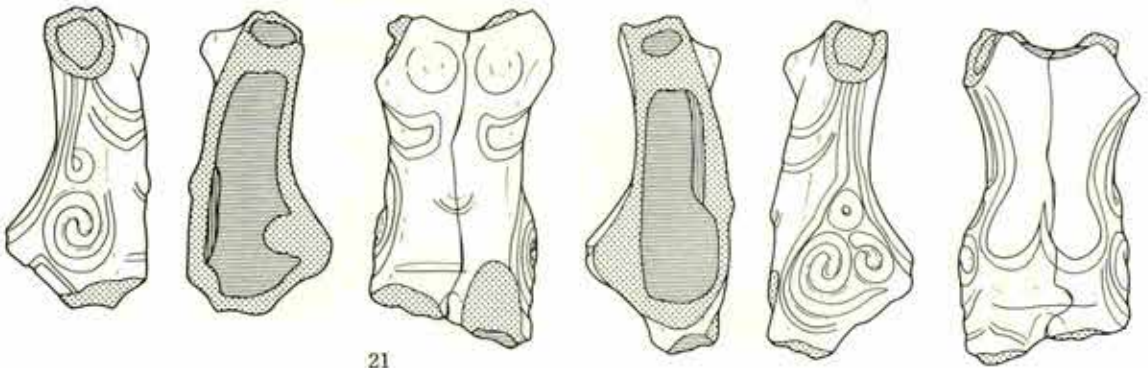

23

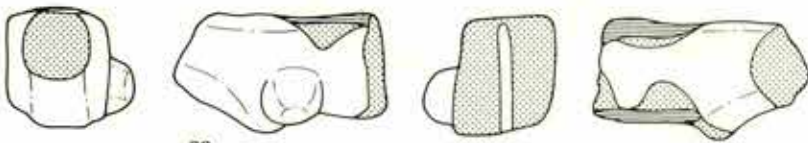

22

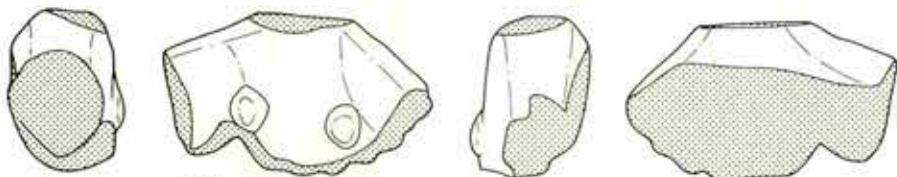
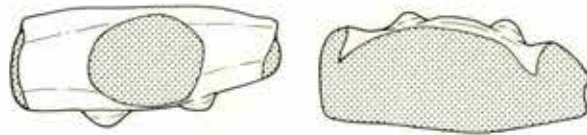

24

第 556 图 积逊堂 N-III 区 土偶 (4)

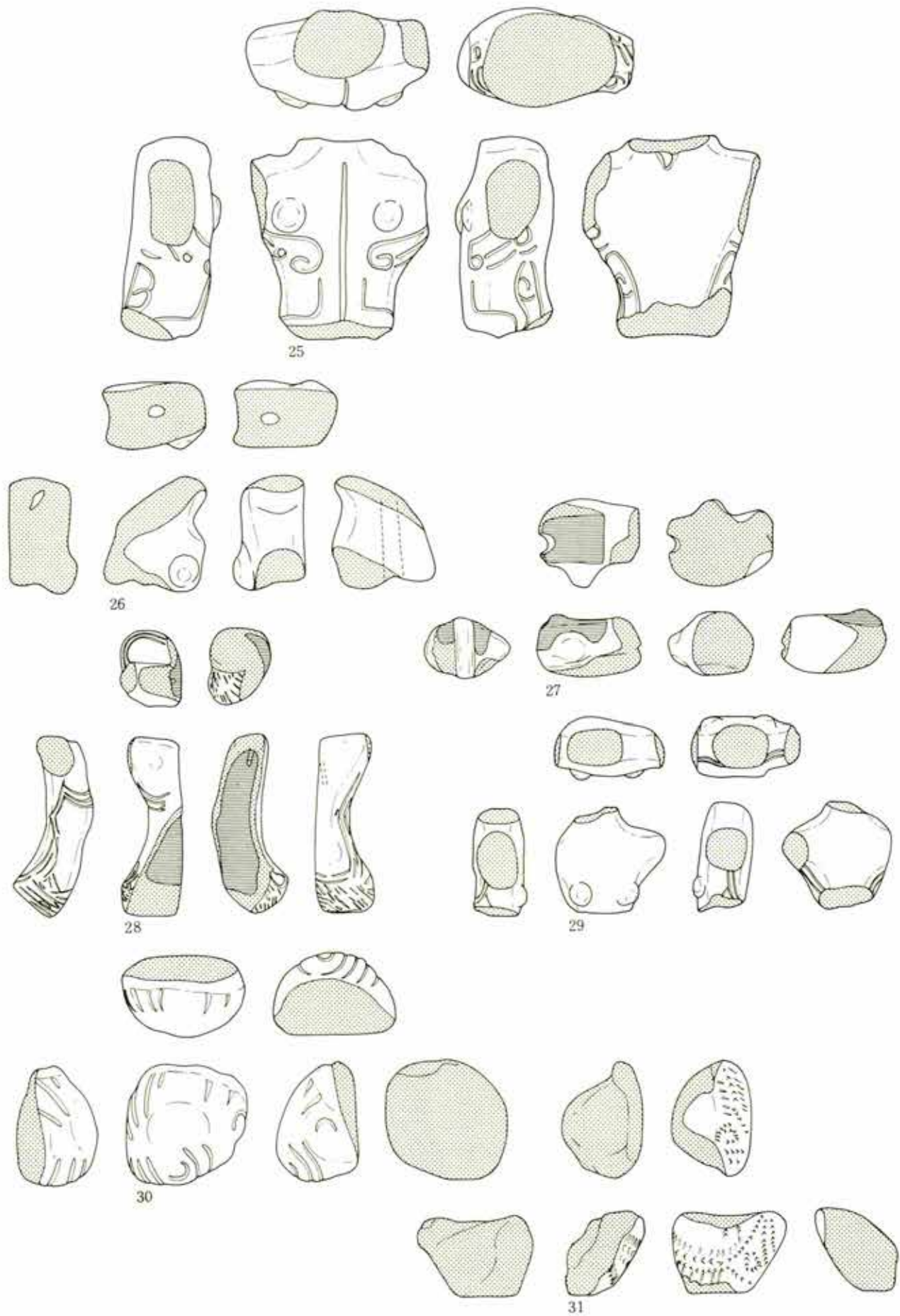

第557图 积逊堂N-III区 土偶 (5)

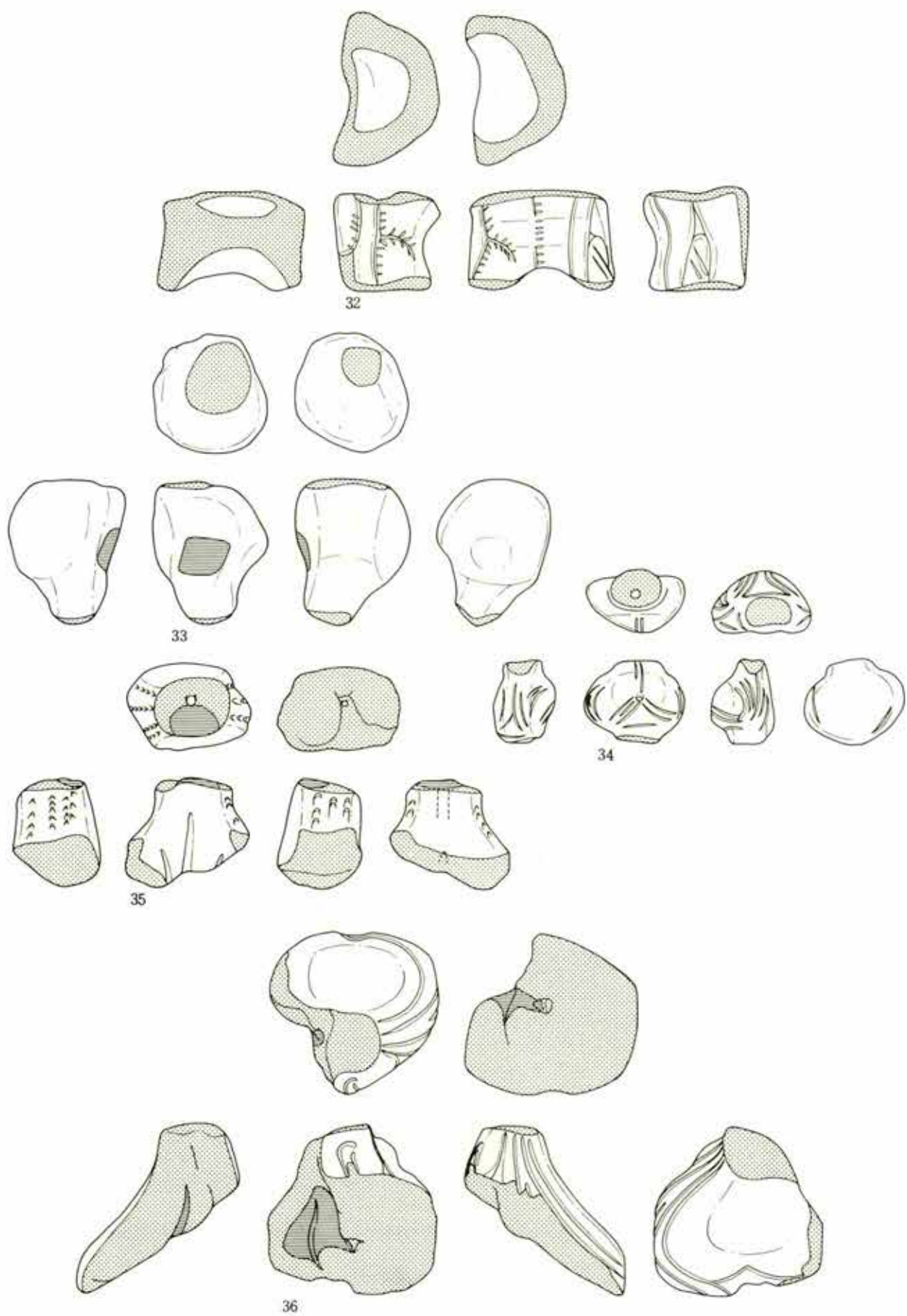

第558图 积逊堂N—III区 土偶 (6)

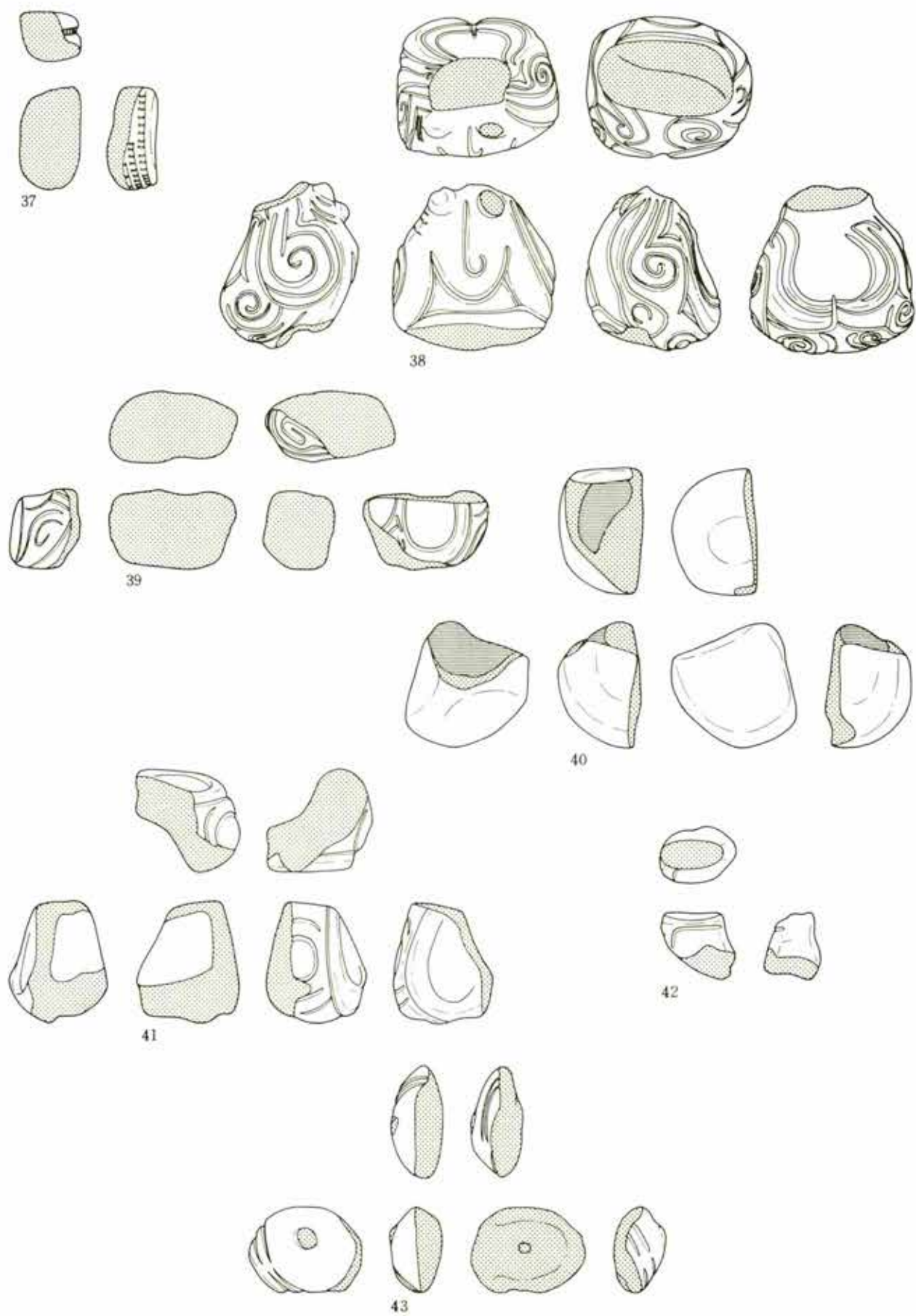

第 559 图 积逊堂 N-III 区 土偶 (7)

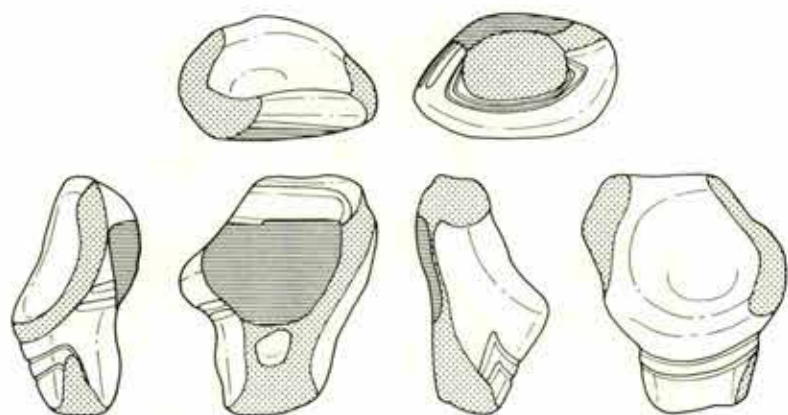

44

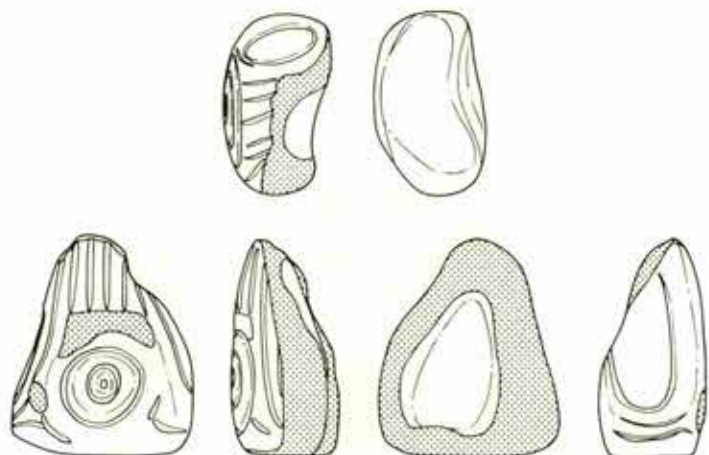

45

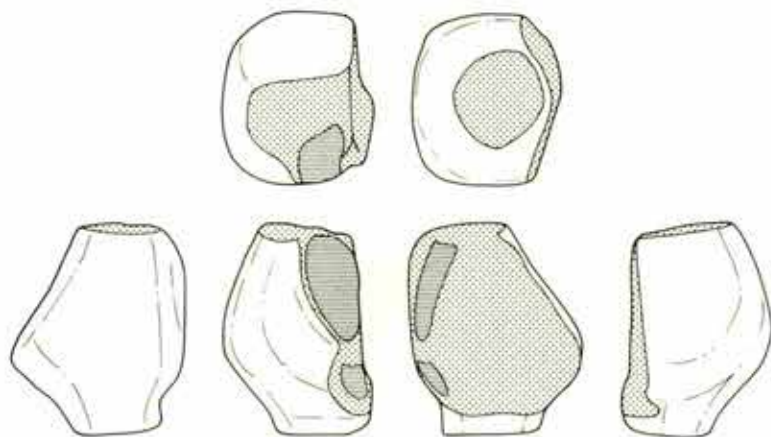

46

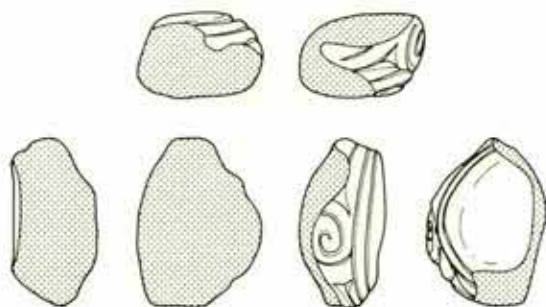

47

第560图 积迦堂N-III区 土偶 (8)

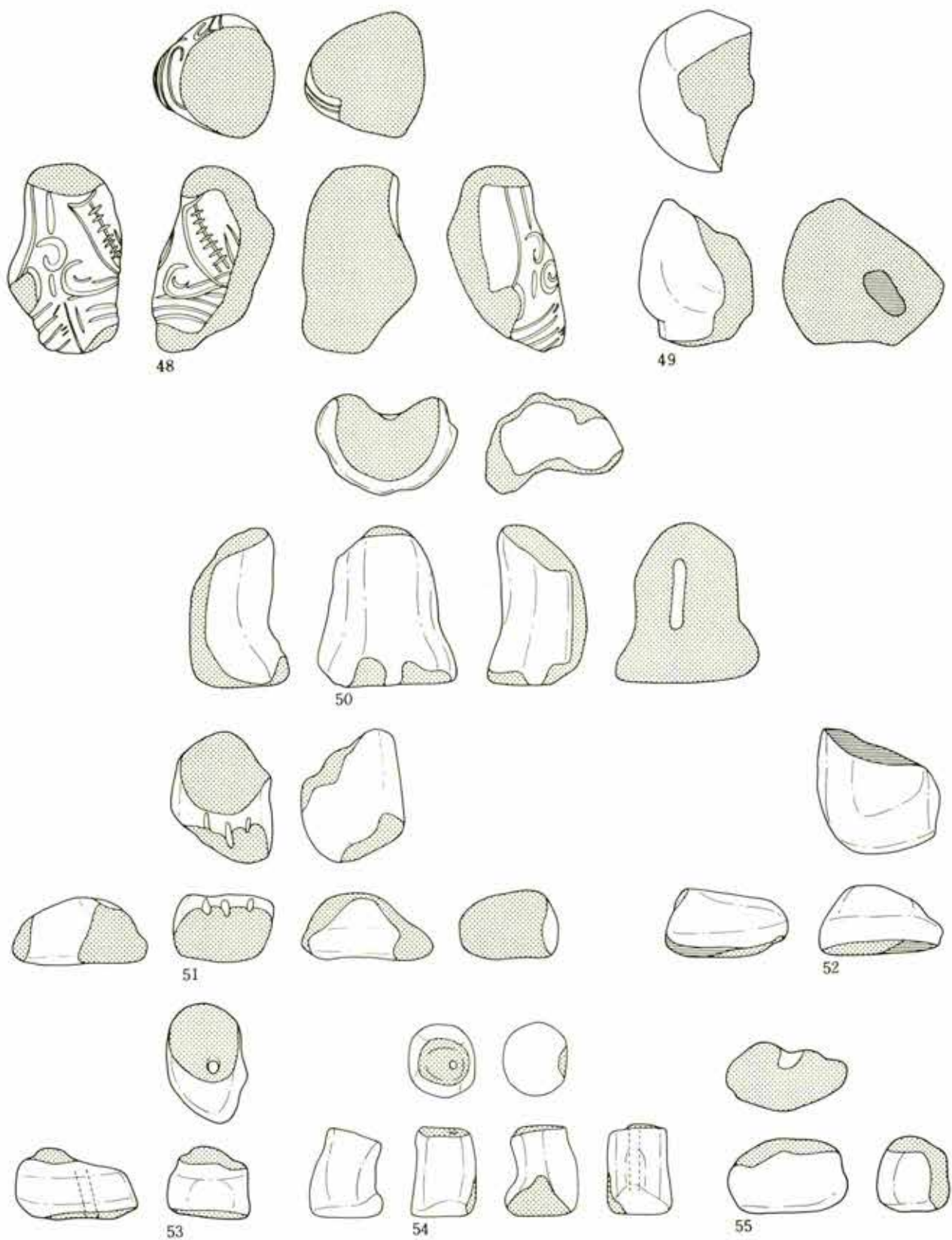

第561图 积道堂N-III区 土偶 (9)



第 562 图 积逊堂 N-III 区 土偶 (10)



第 563 图 积逊堂N-III区 土偶 (11)

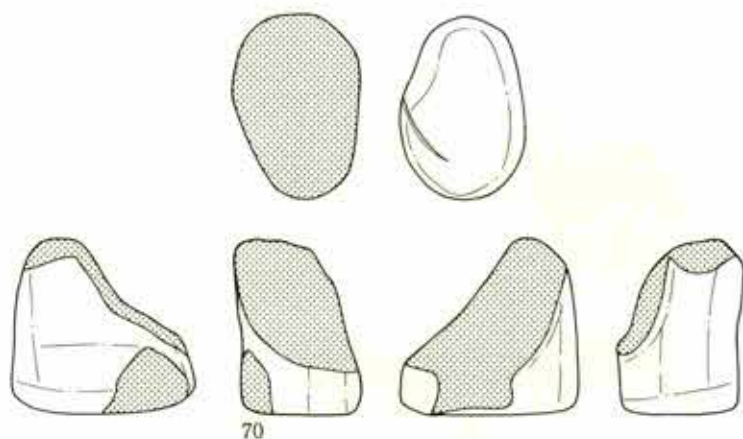

70

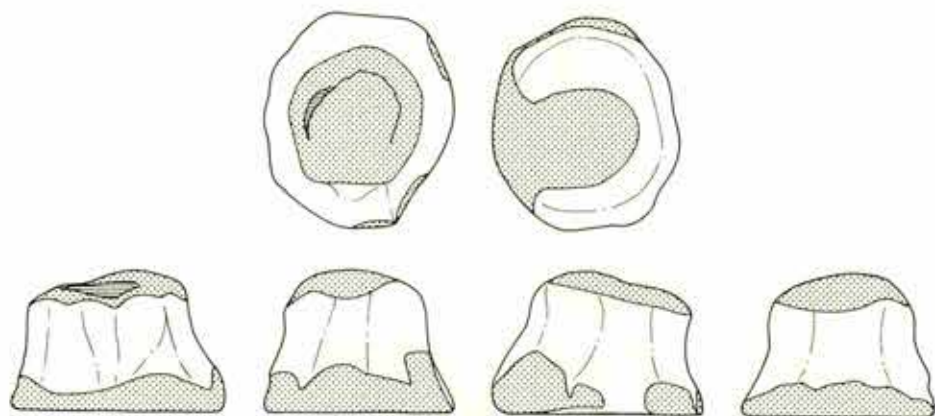

71

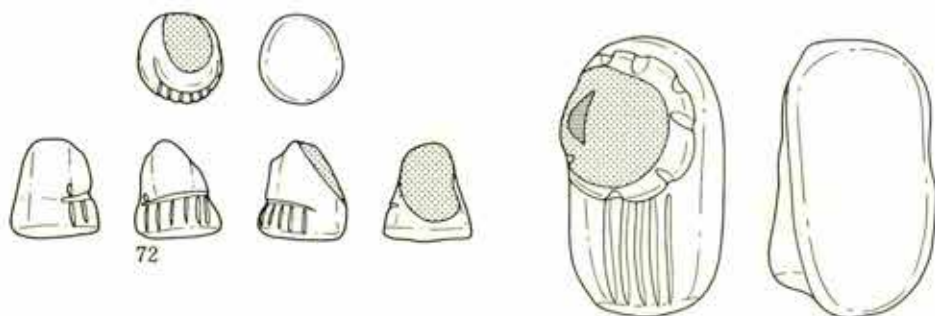

72



73

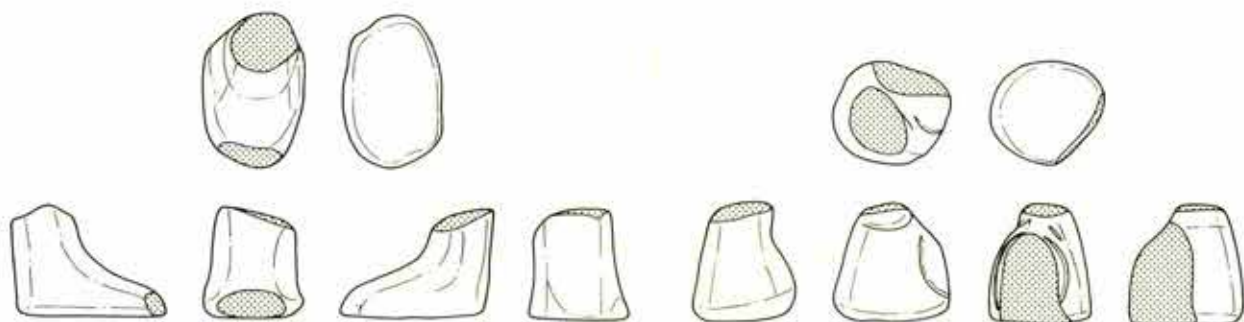

74

75

第 564 图 积迦堂 N-III 区 土偶 (12)



第 565 图 积迦堂 N-III 区 土製円盤

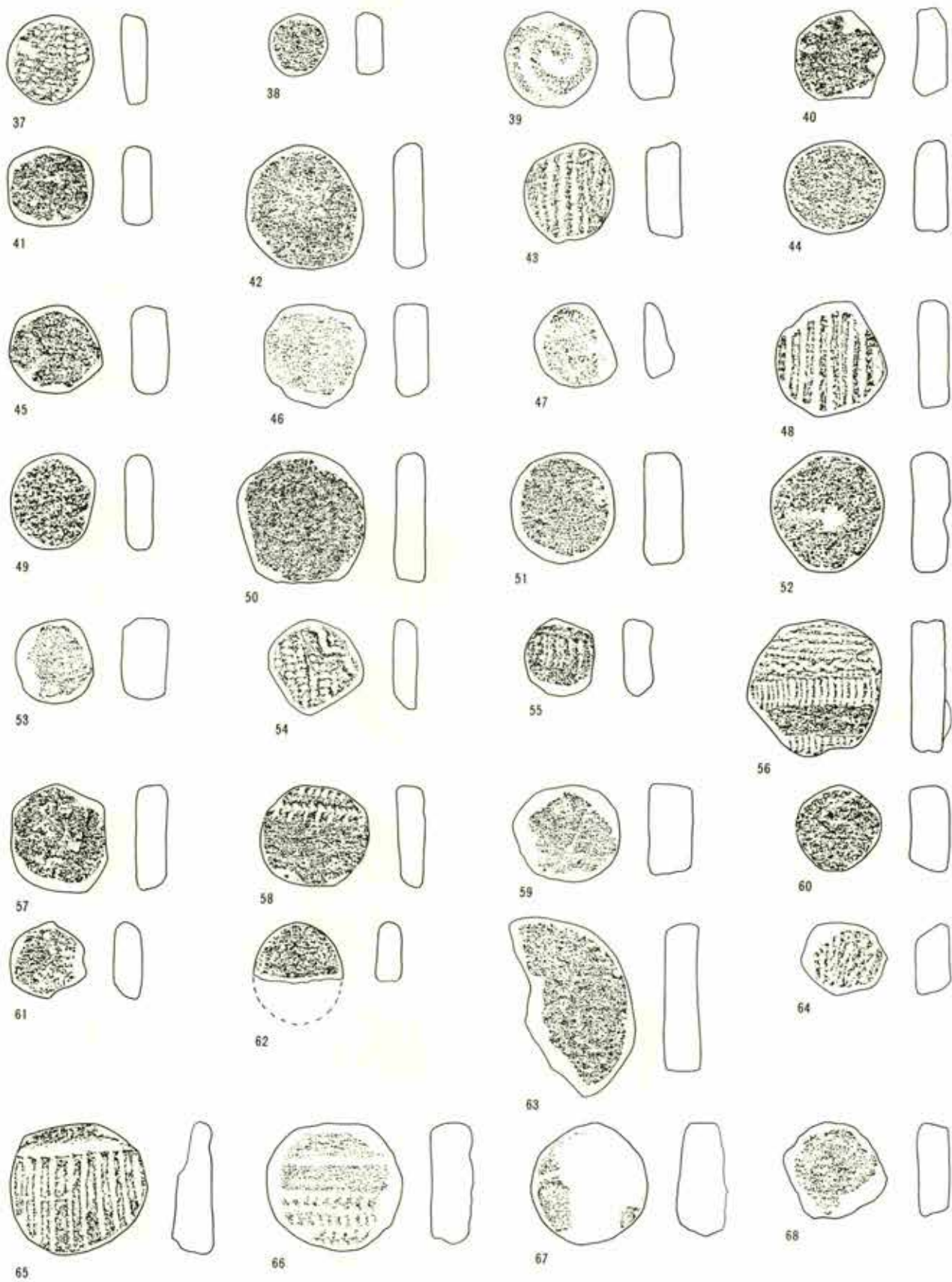

第 566 图 积逊堂 N-III 区 土製円盤

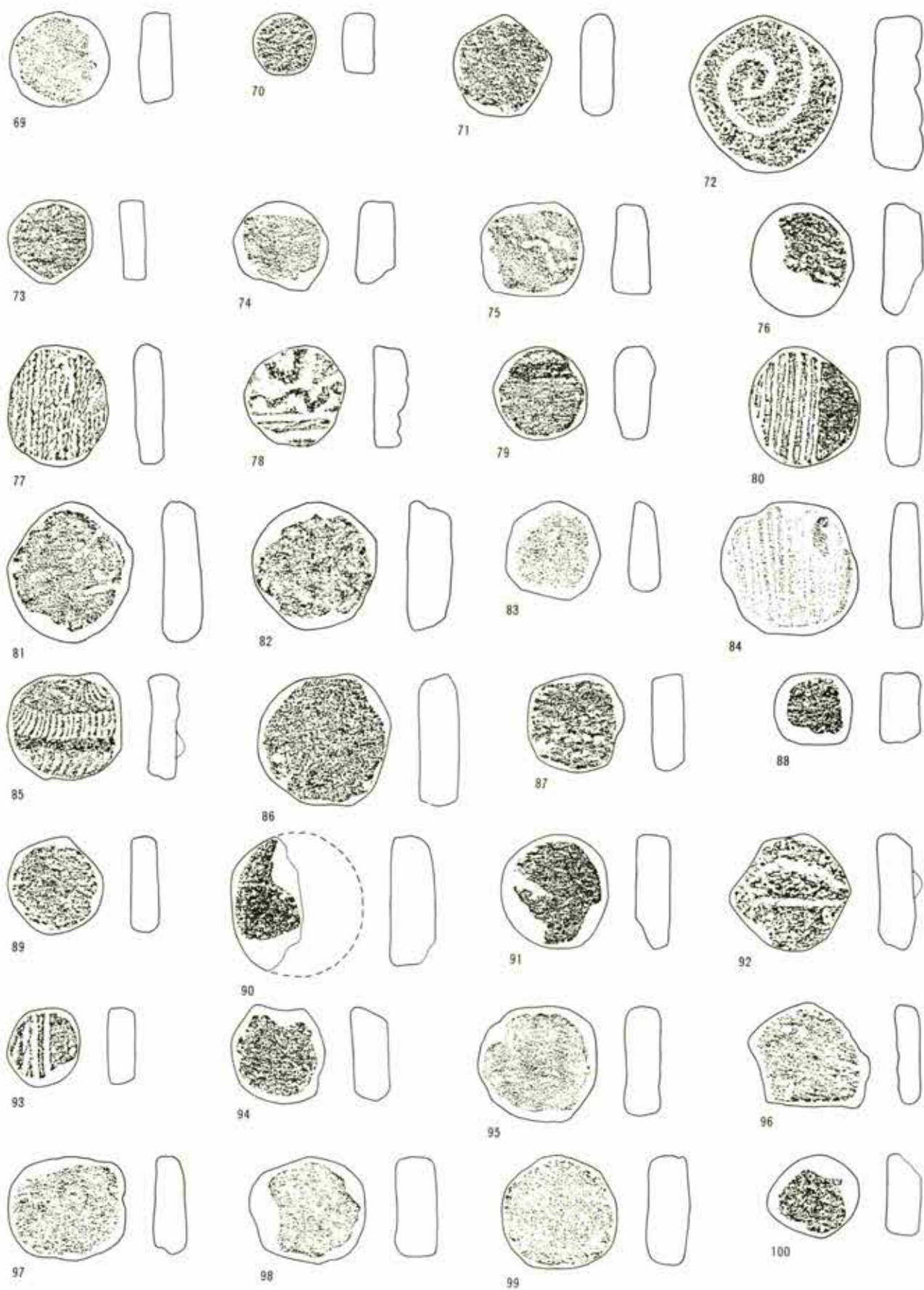

第 567 图 积迦堂 N-III 区 土製円盤

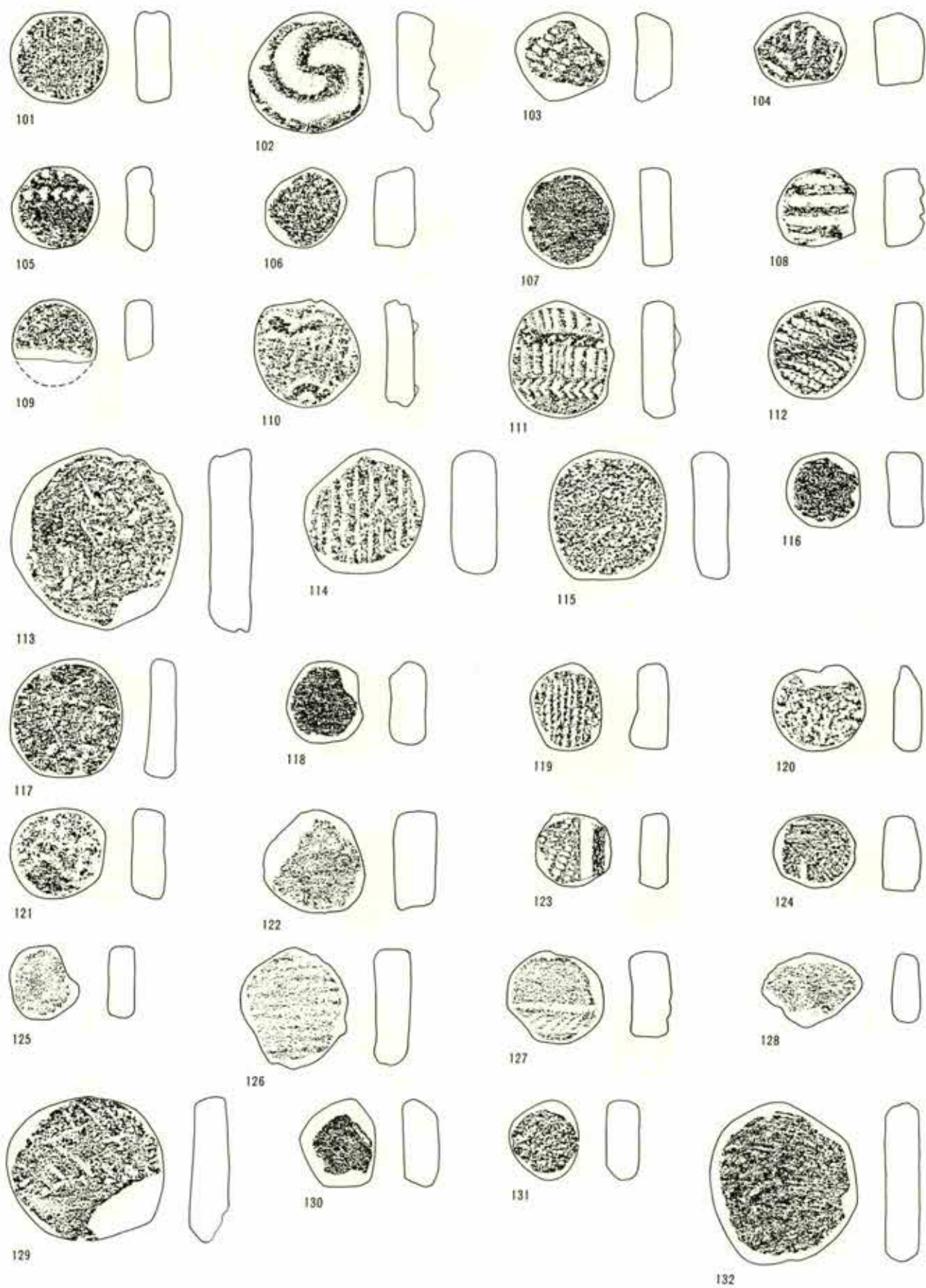

第 568 图 积迺堂 N-III 区 土製円盤

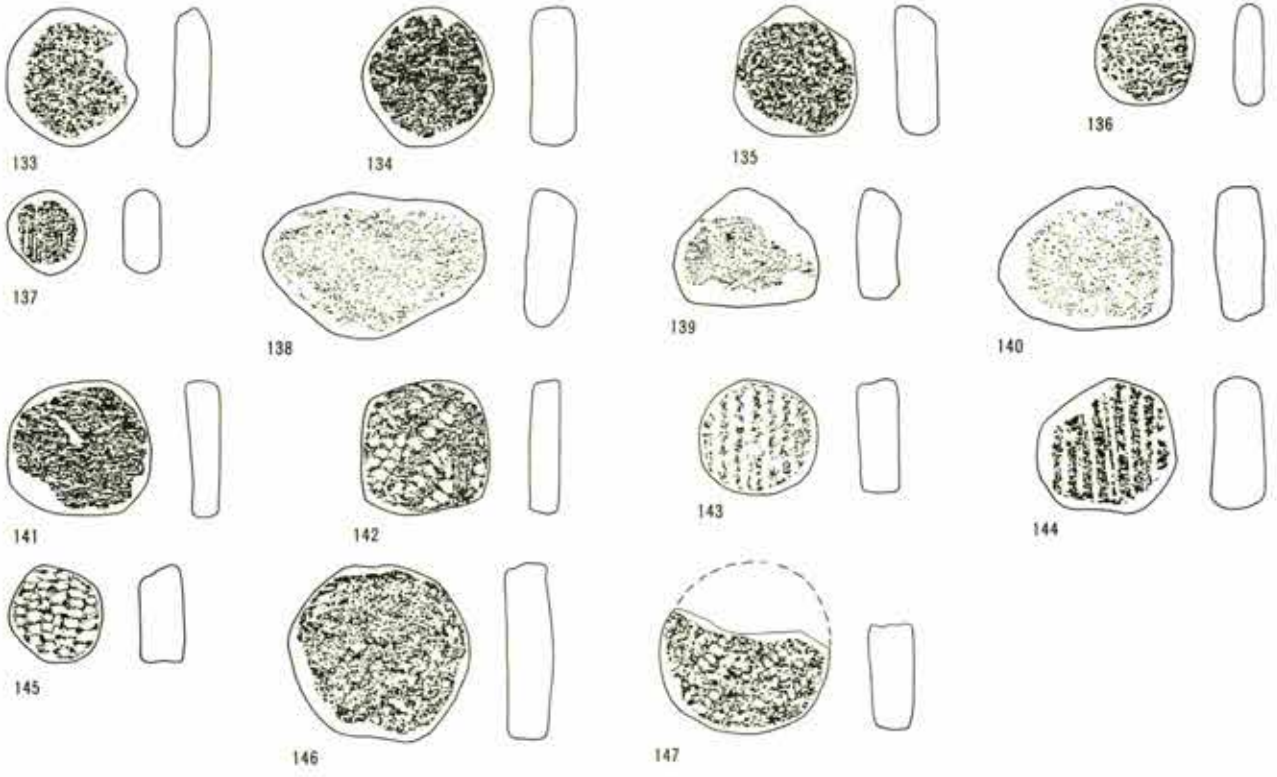

积迦堂N-III区 土製円盤

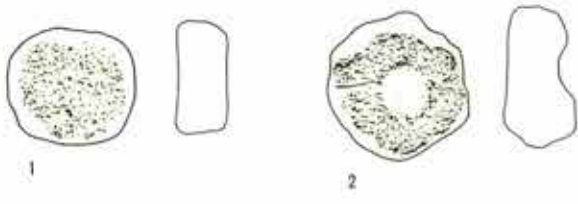

N-III区 SB

第569图 N-III区 土製円盤 (5)

积迦堂 N—IV 区

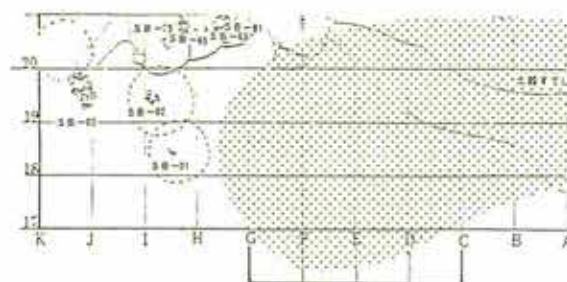

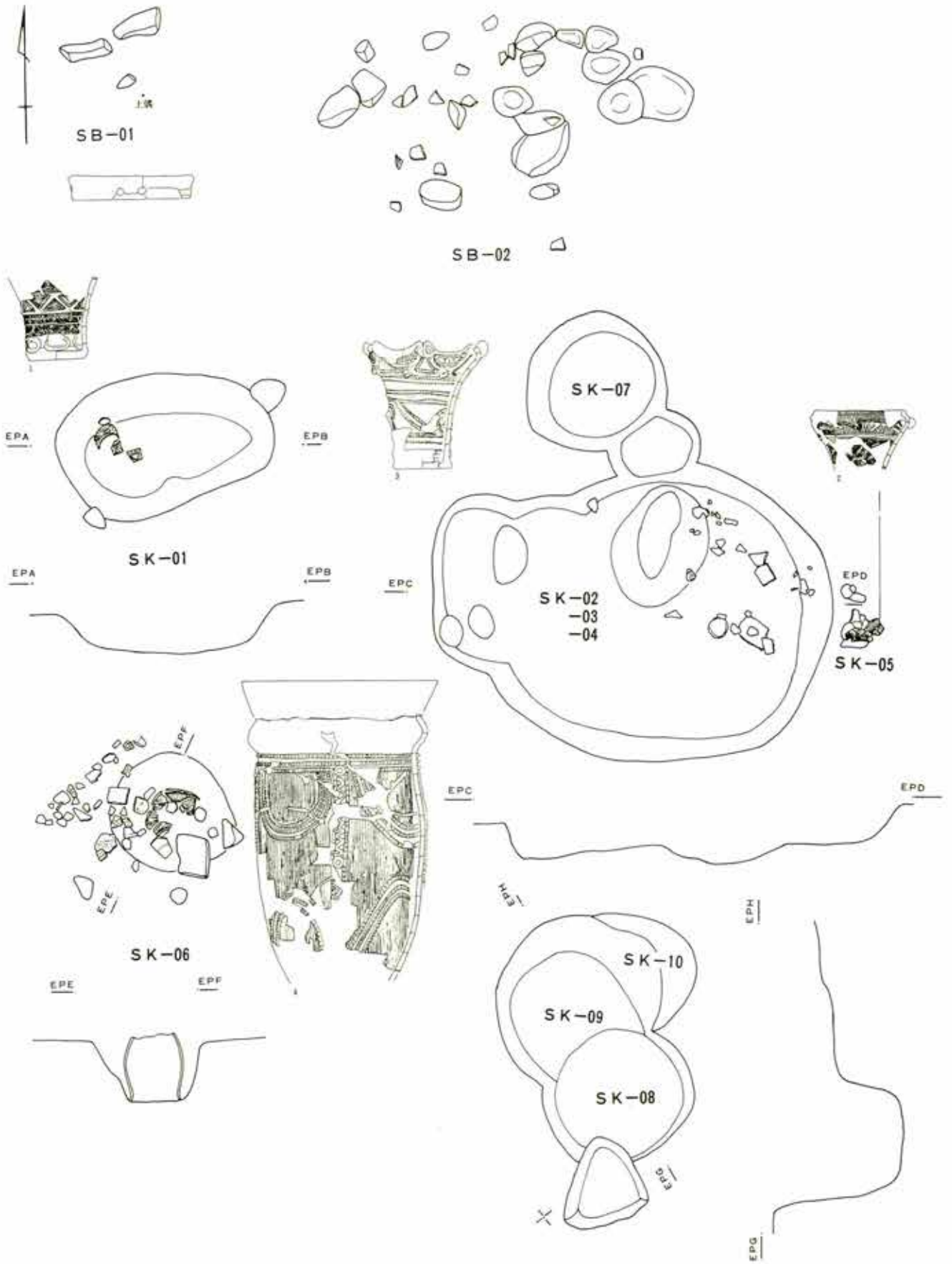

第570图 积迦堂N-IV区 SB-01-02

SK-01-02-03-04-05-06-07-08-09-10

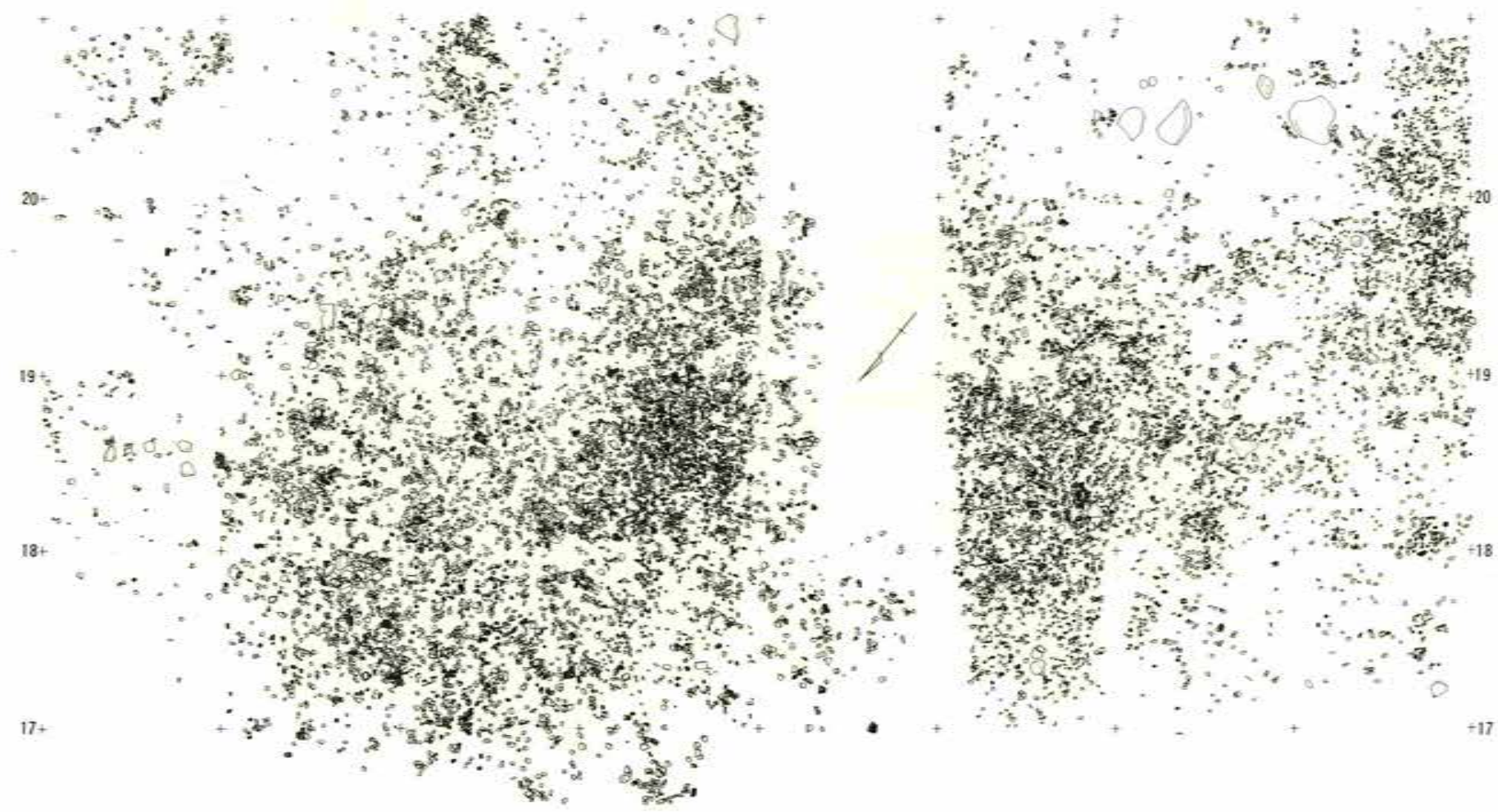

16^+ H⁺ G⁺ F⁺ E⁺ N-IV区 D⁺ C⁺ B⁺ A⁺ N-III区 Y¹⁶

第571図 釈迦堂N-W区 土器すてば B



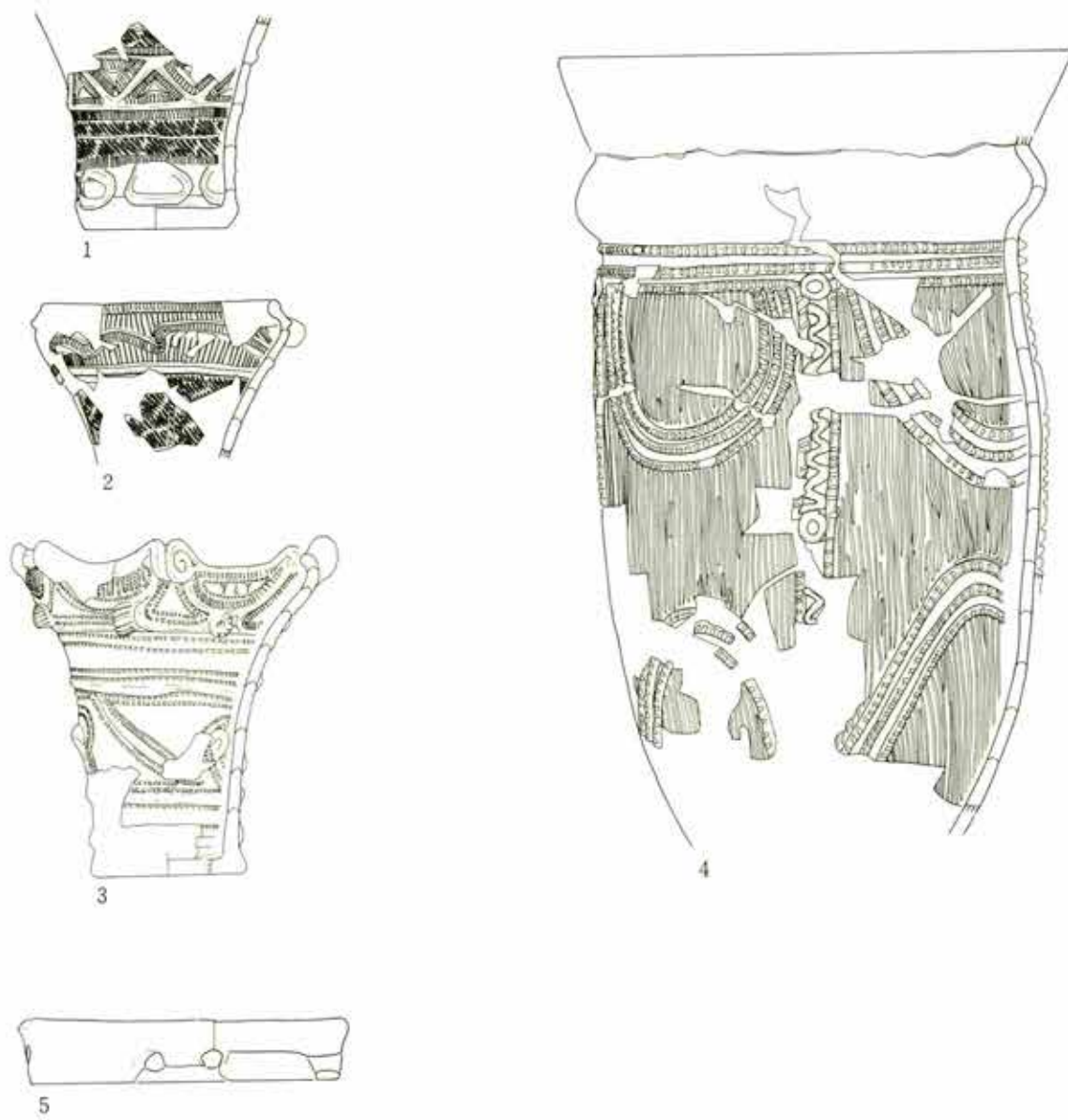

第 572 图 积迦堂 N-IV 区 SK-01 -02 -04 -06 出土土器
SB-03

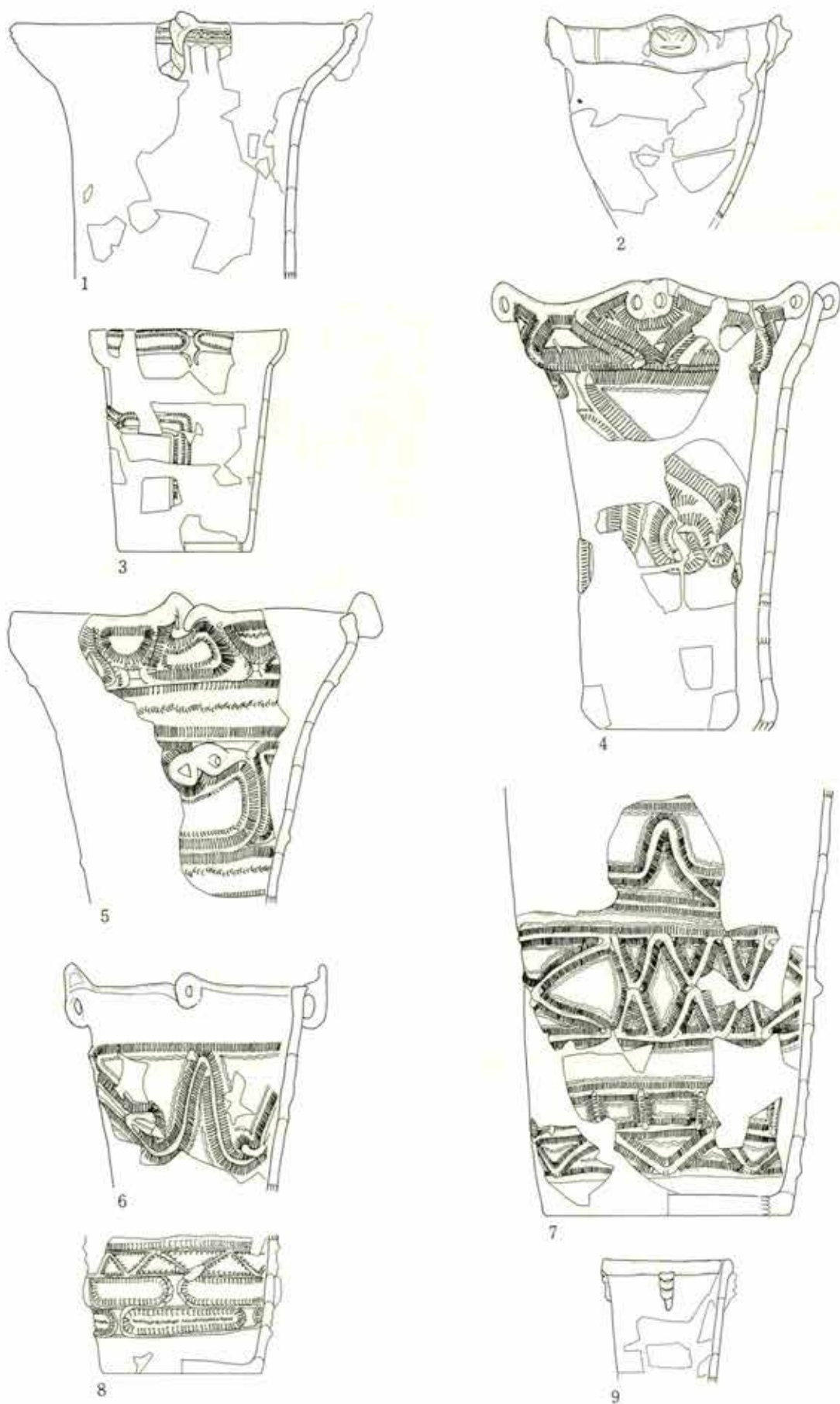

第573図 釈迦堂N—IV区 土器すてばB 出土土器 (1)

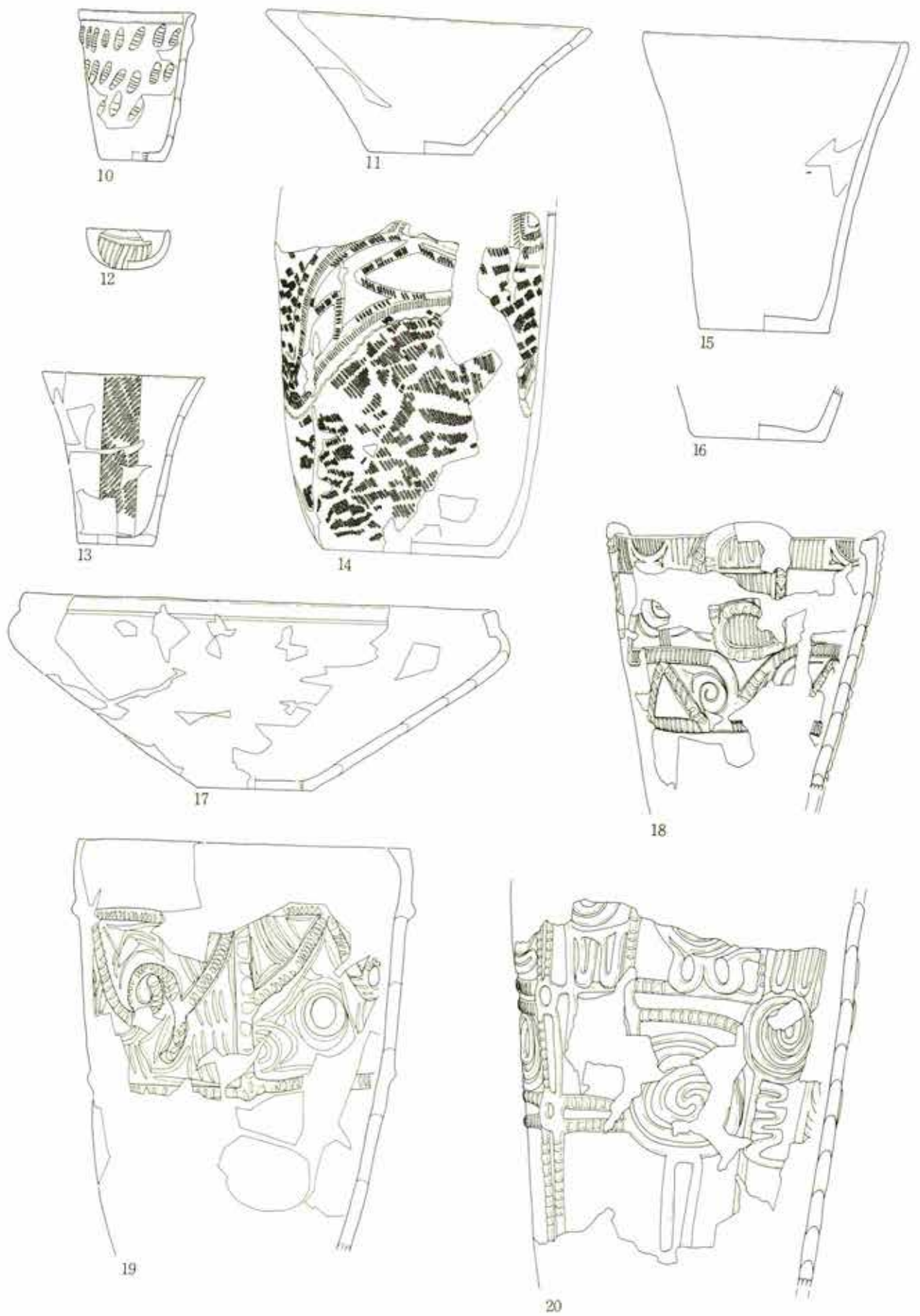

第 574 図 积迦堂N-IV区 土器すてば B 出土土器 (2)

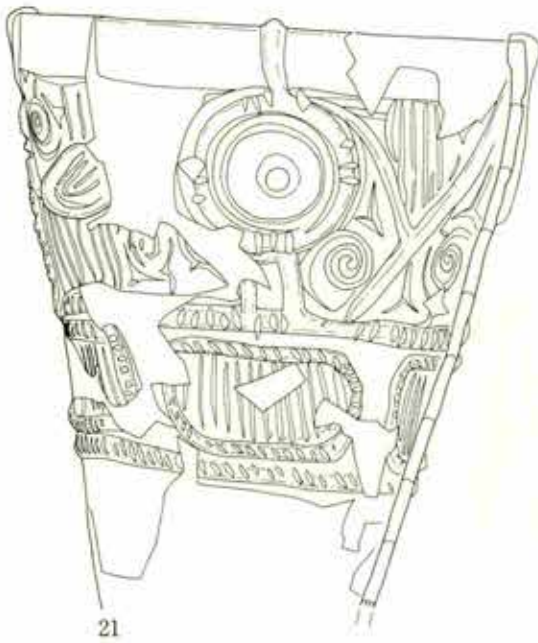

21

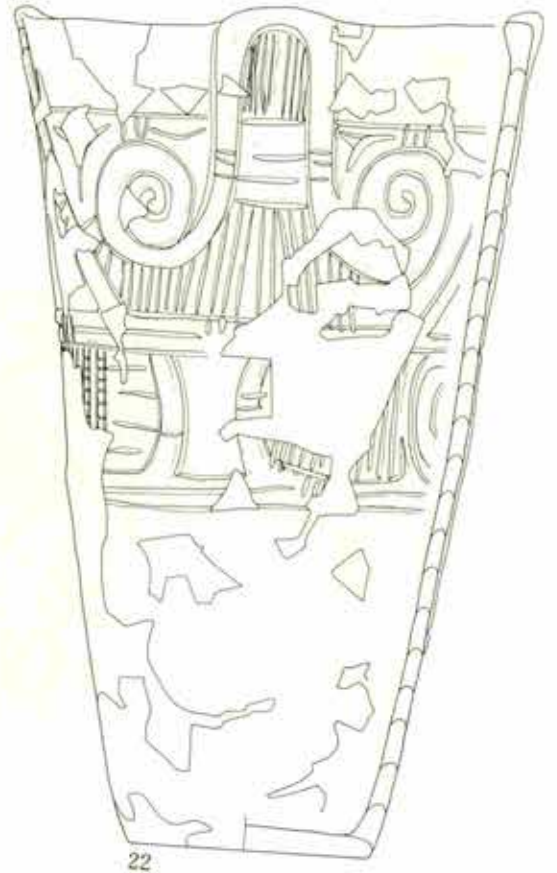

22



23

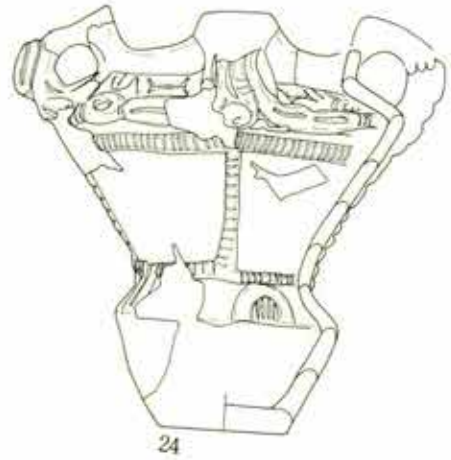

24

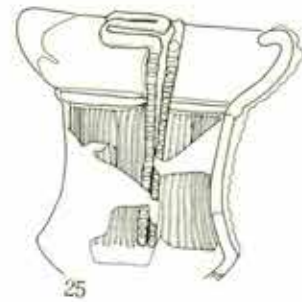

25

第 575 図 釈迦堂N-IV区 土器すてばB 出土土器 (3)

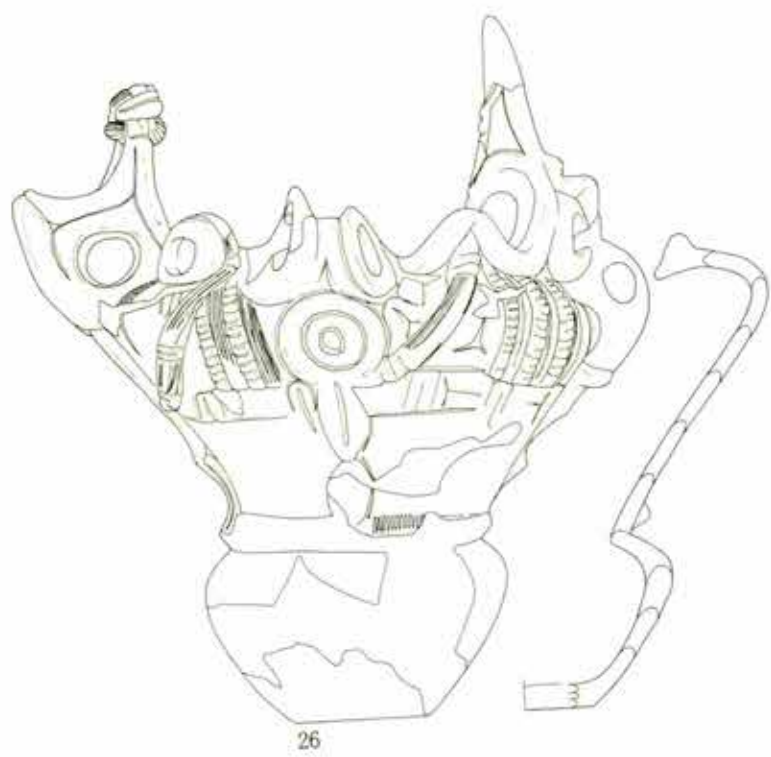

26

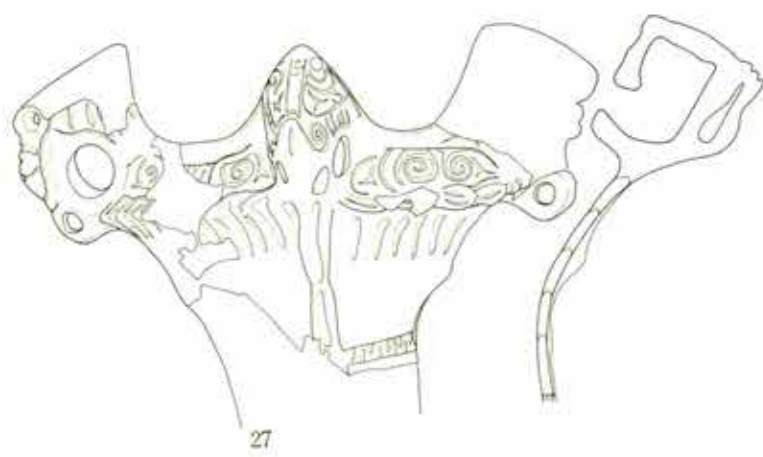

27

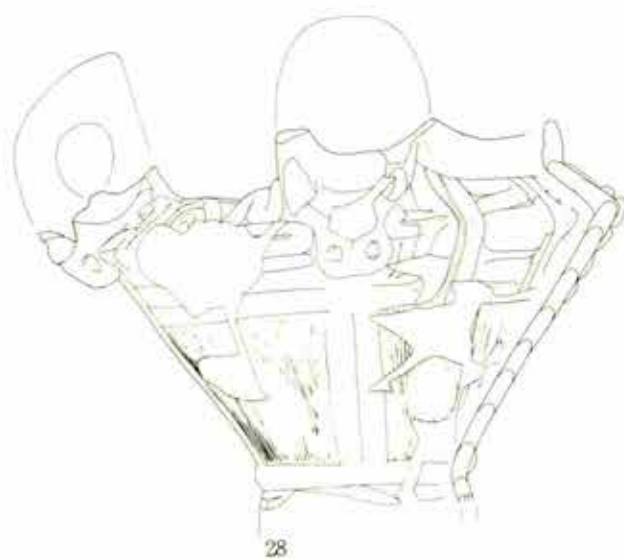

28

第 576 図 积迦堂 N-V 区 土器すてば B 出土土器 (4)



29



30

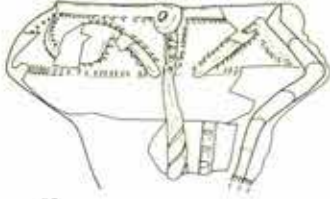

31

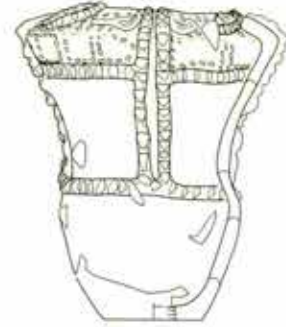

32



33

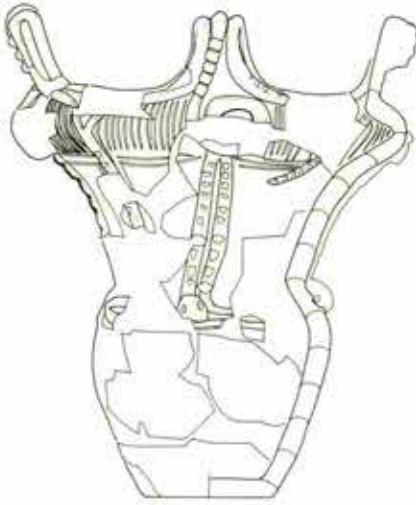

34



35



36

第 577 図 釈迦堂N-IV区 土器すてば B 出土土器 (5)

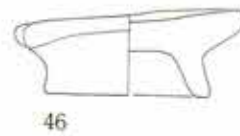
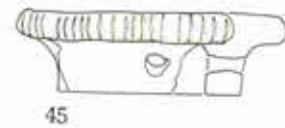
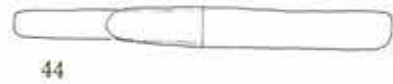
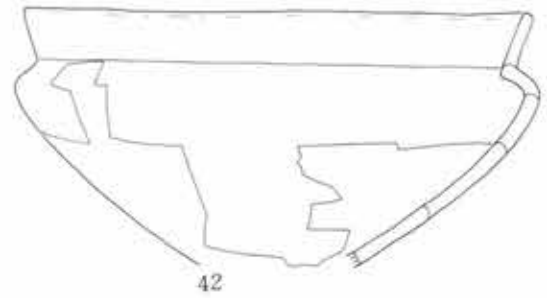
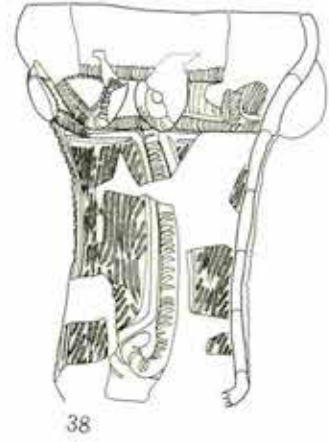
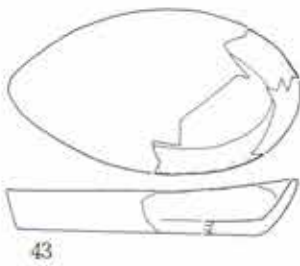
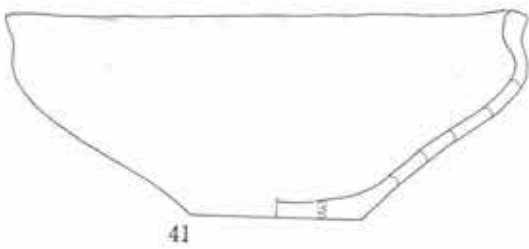
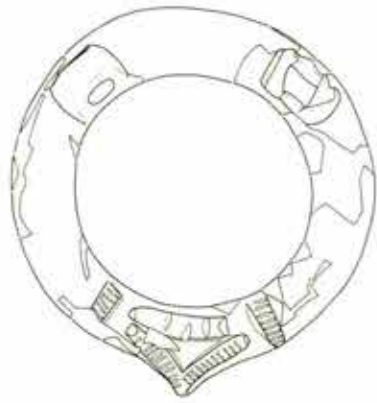

第 578 図 釈迦堂N-IV区 土器すてば B 出土土器 (6)



47

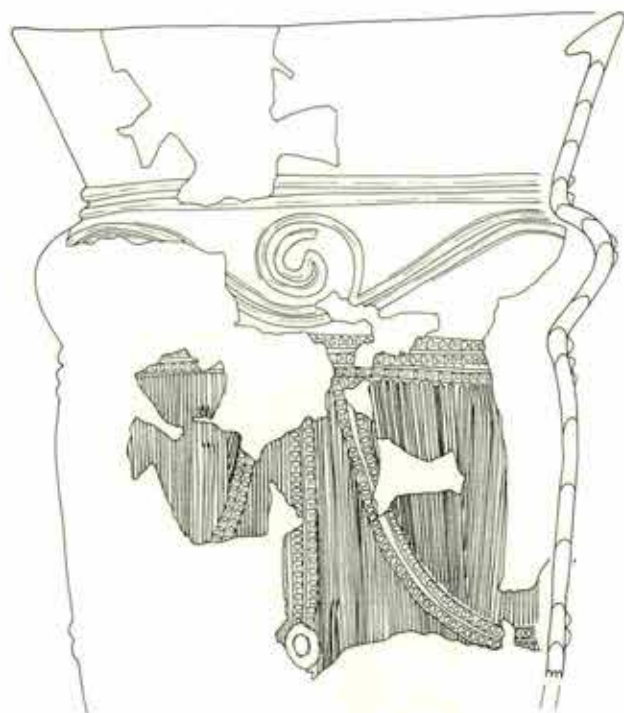

48

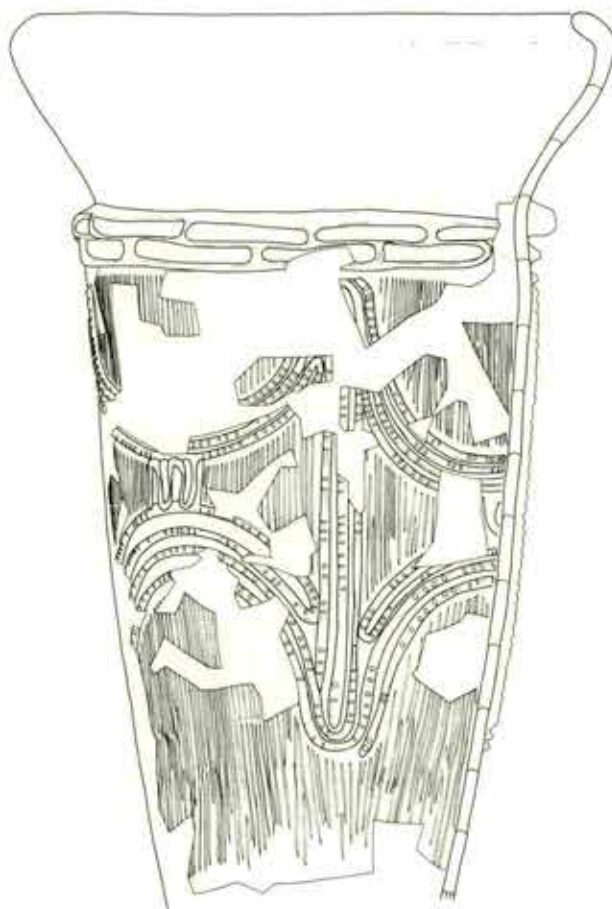

49

第 579 図 釈迦堂N-IV区 土器すてば B 出土土器 (7)

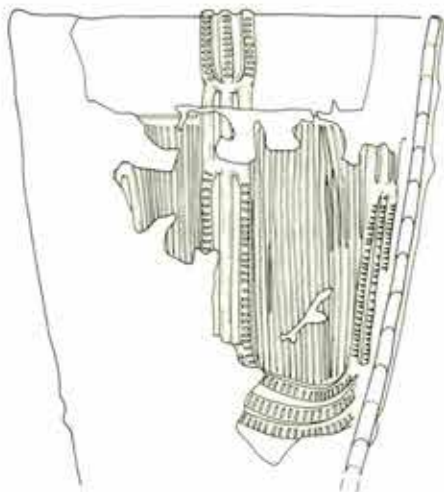

50

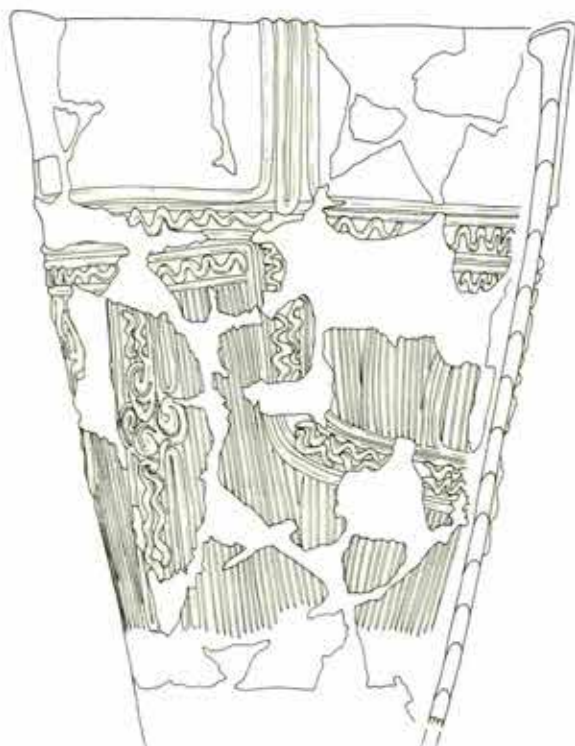

51



52

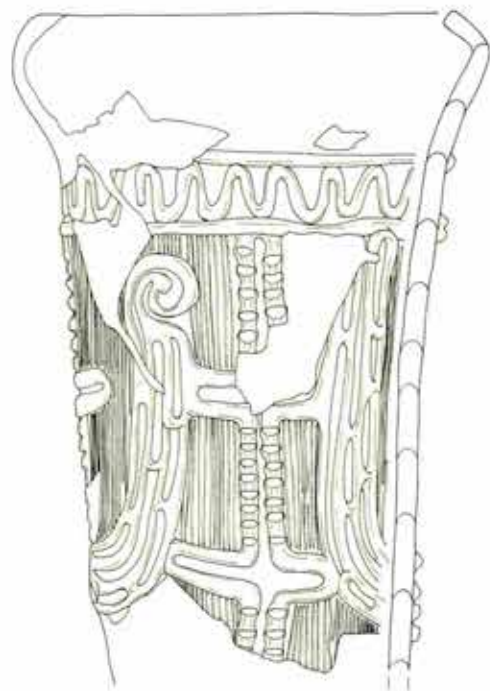

53

第 580 図 釈迦堂N-IV区 土器すてば B 出土土器 (8)



54

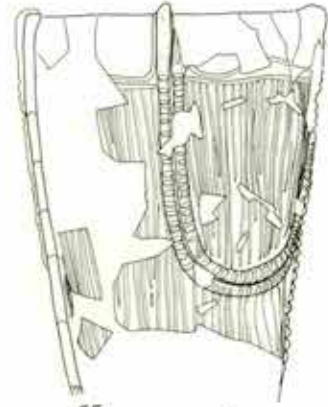

55

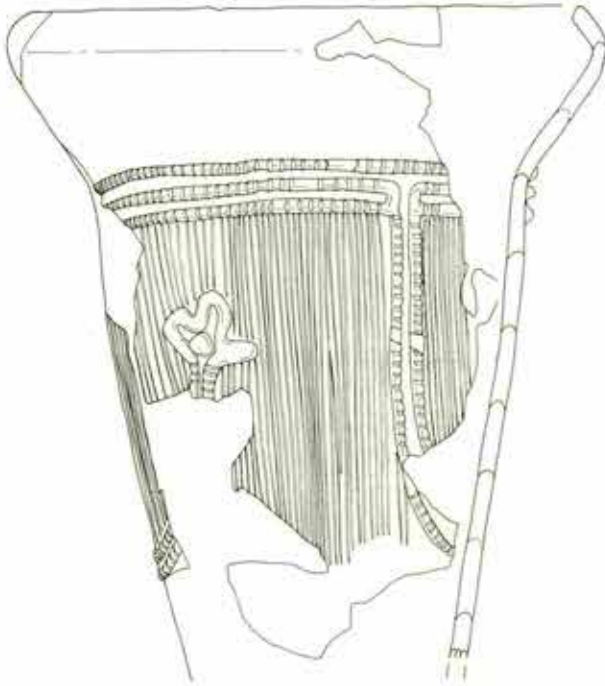

56

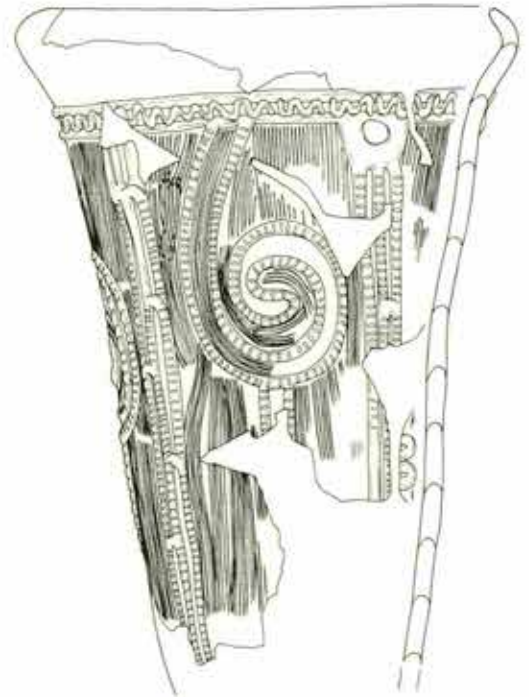

57

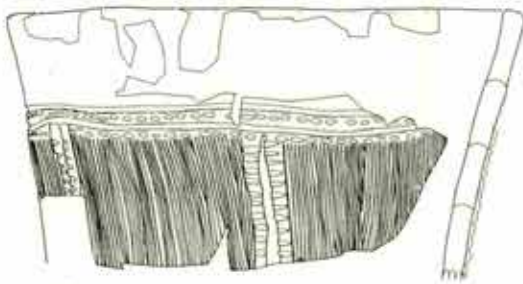

58



59



60

第 581 図 釈迦堂N-IV区 土器すてばB 出土土器 (9)

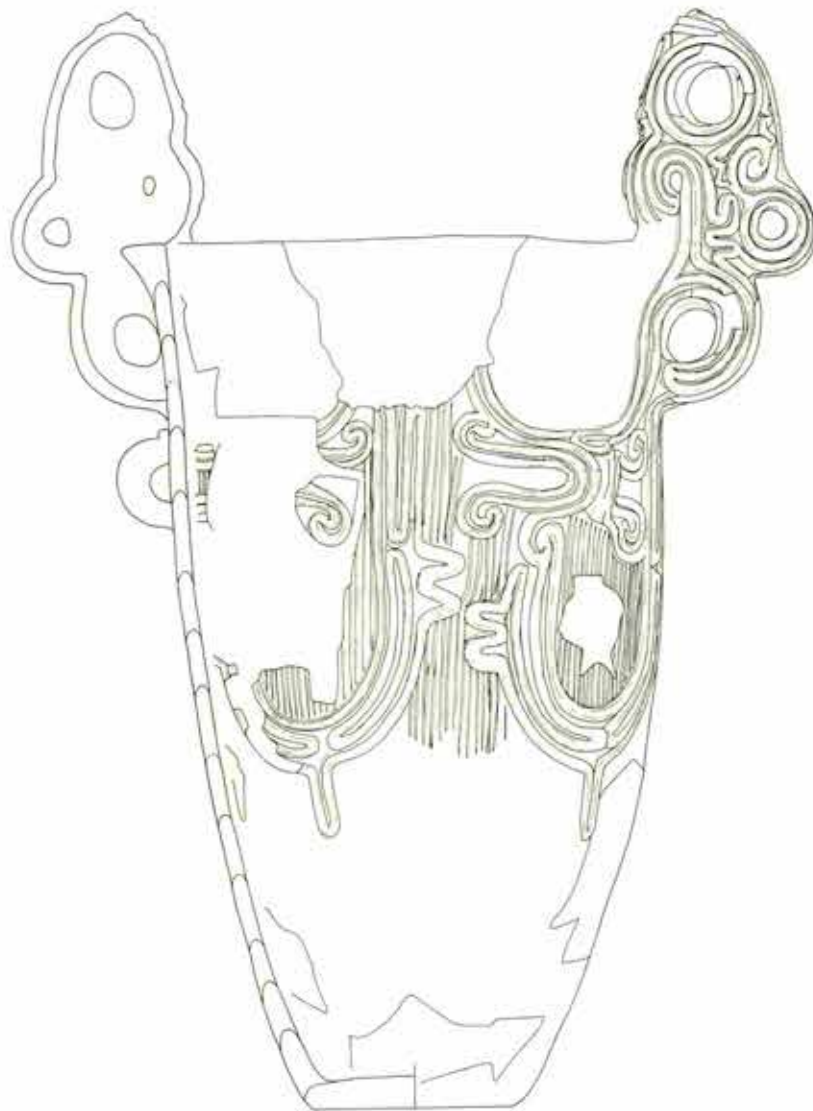

61



62

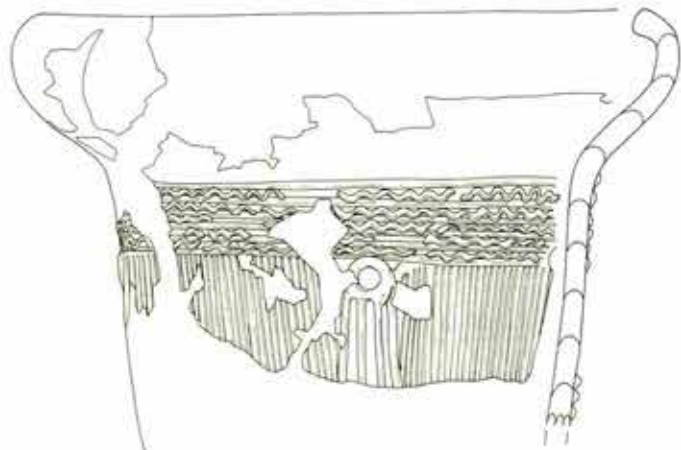

63

第582図 釈迦堂N-IV区 土器すてばB 出土土器 (10)

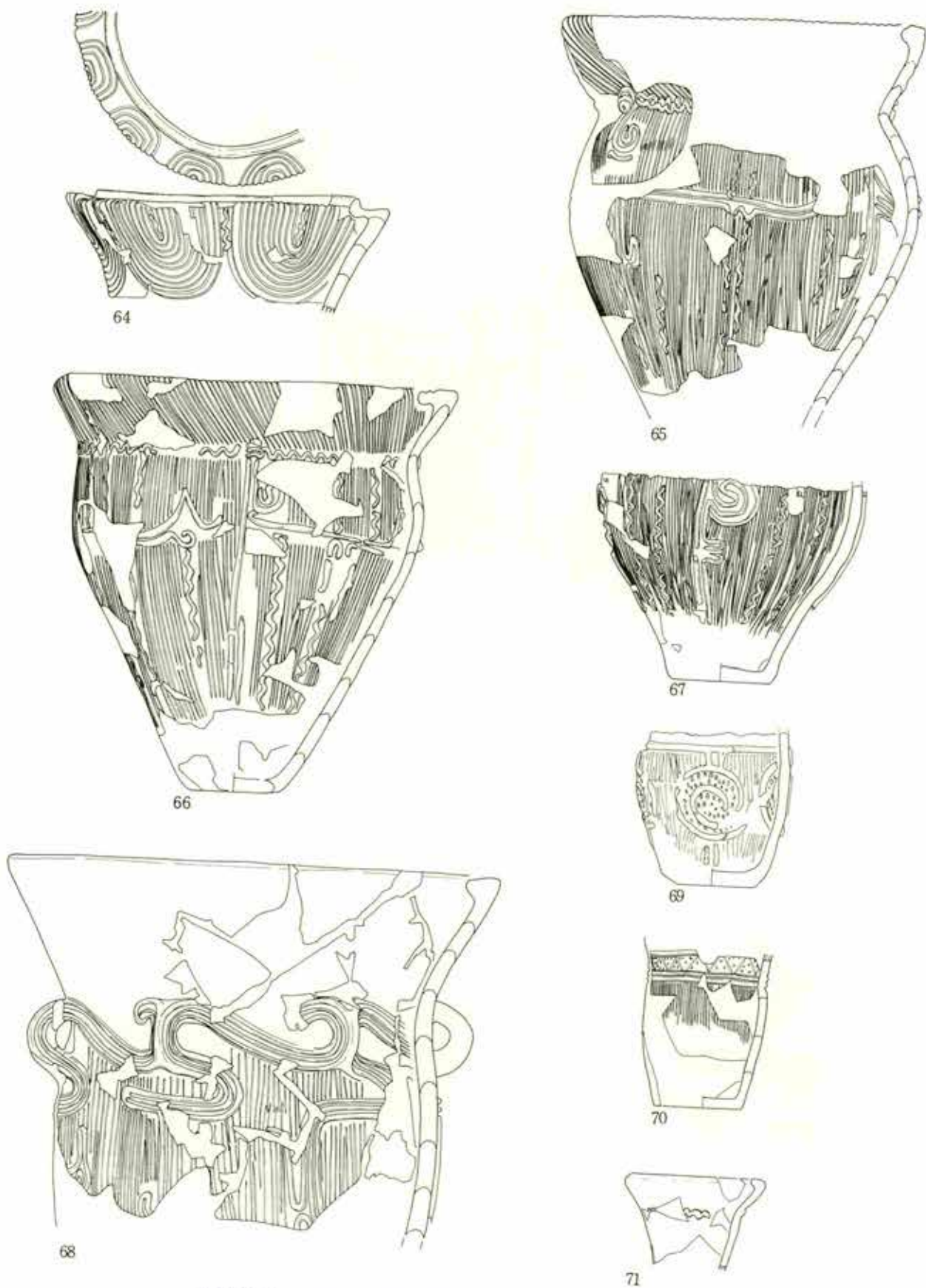

第 583 図・釈迦堂N-IV区 土器すてば B 出土土器

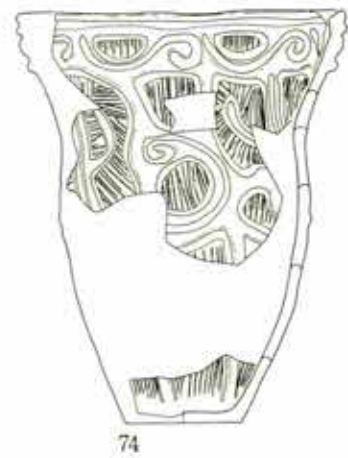
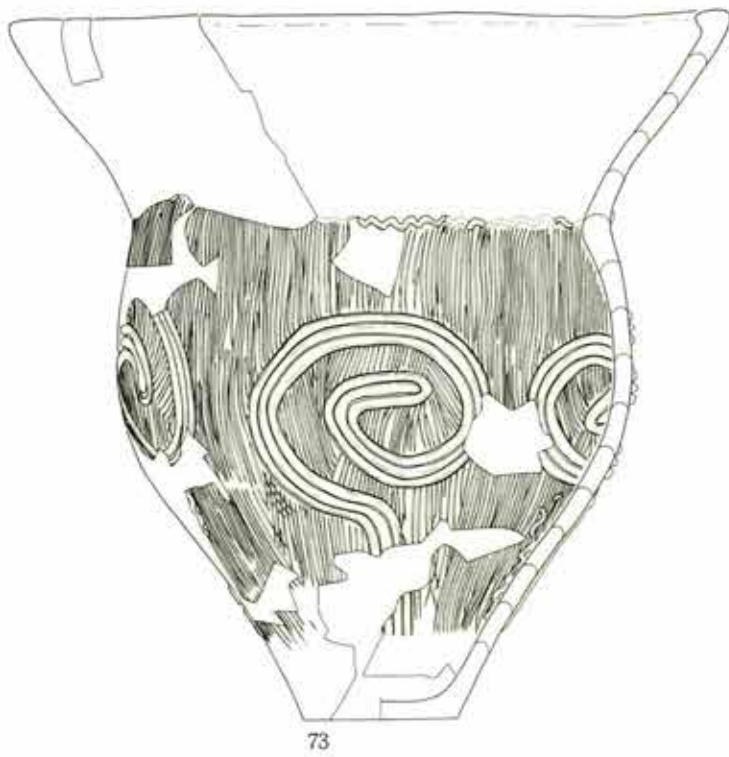
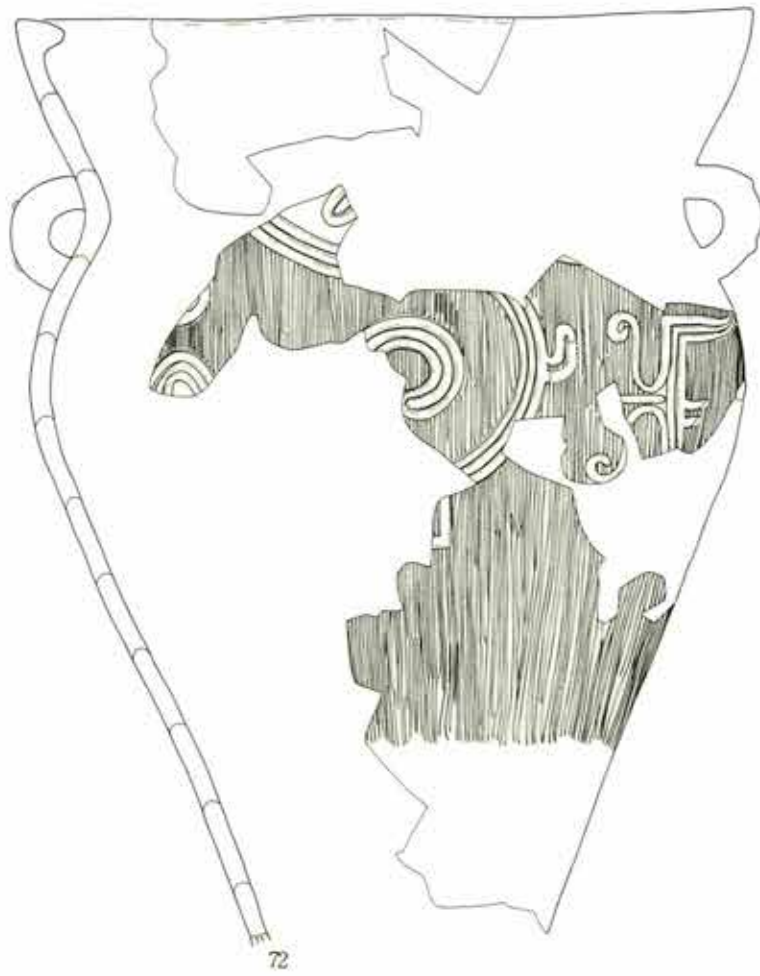

第 584 図 釈迦堂 N-IV 区 土器すてば B 出土土器 (12)

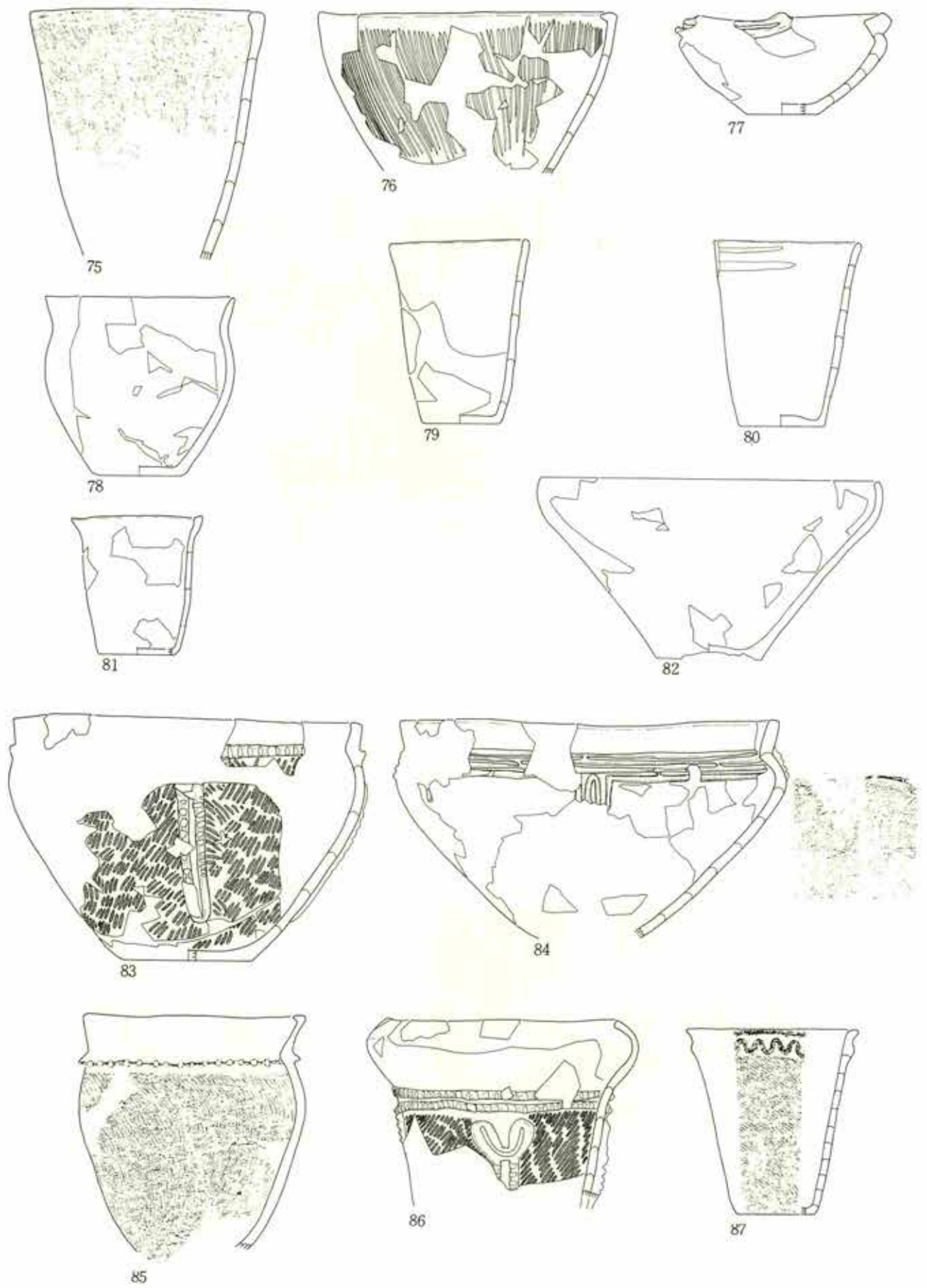

第 585 図 釈迦堂N-IV区 土器すてば B 出土土器 (13)

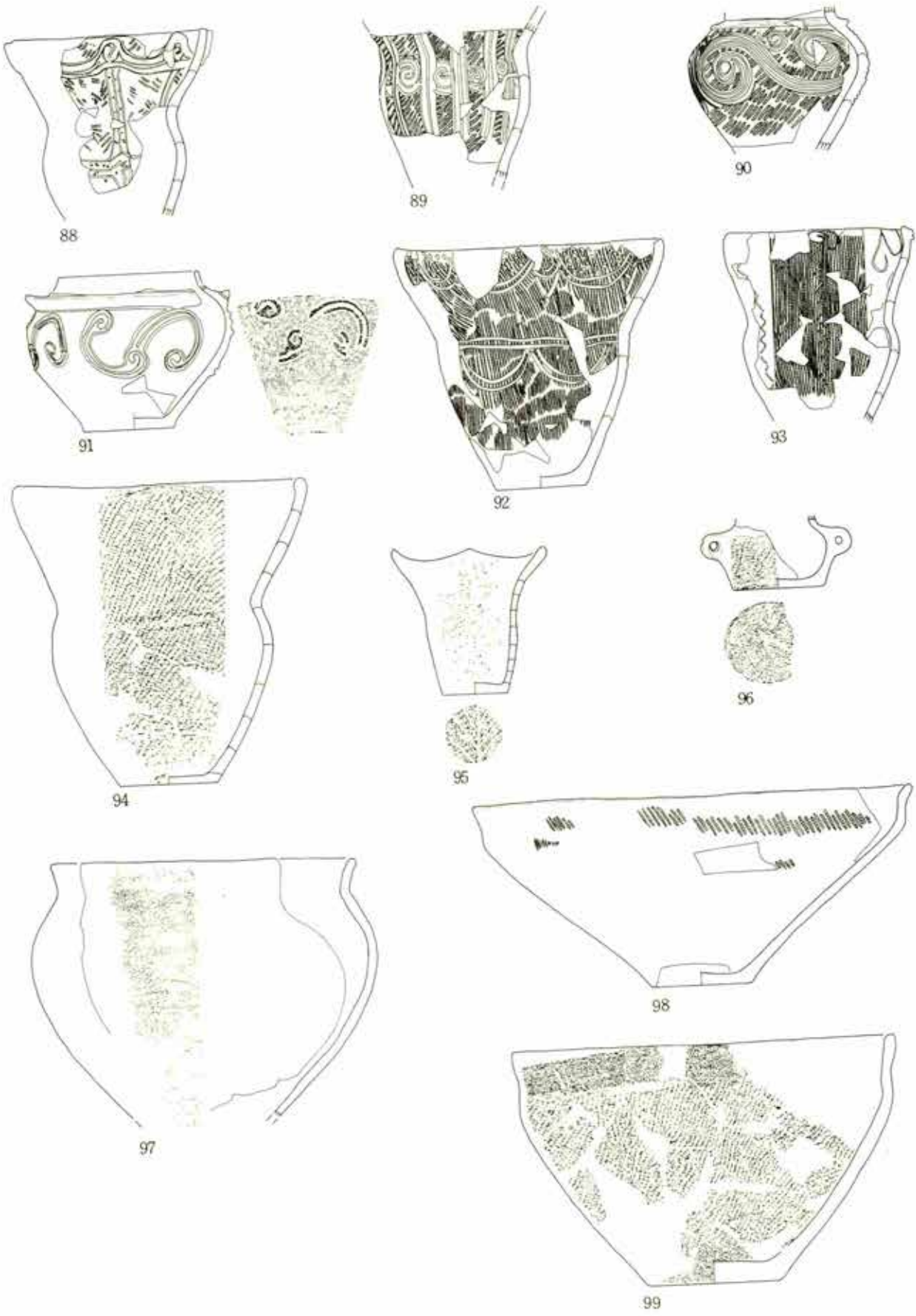

第 586 図 釈迦堂 N-IV 区 土器すてば B 出土土器 (14)

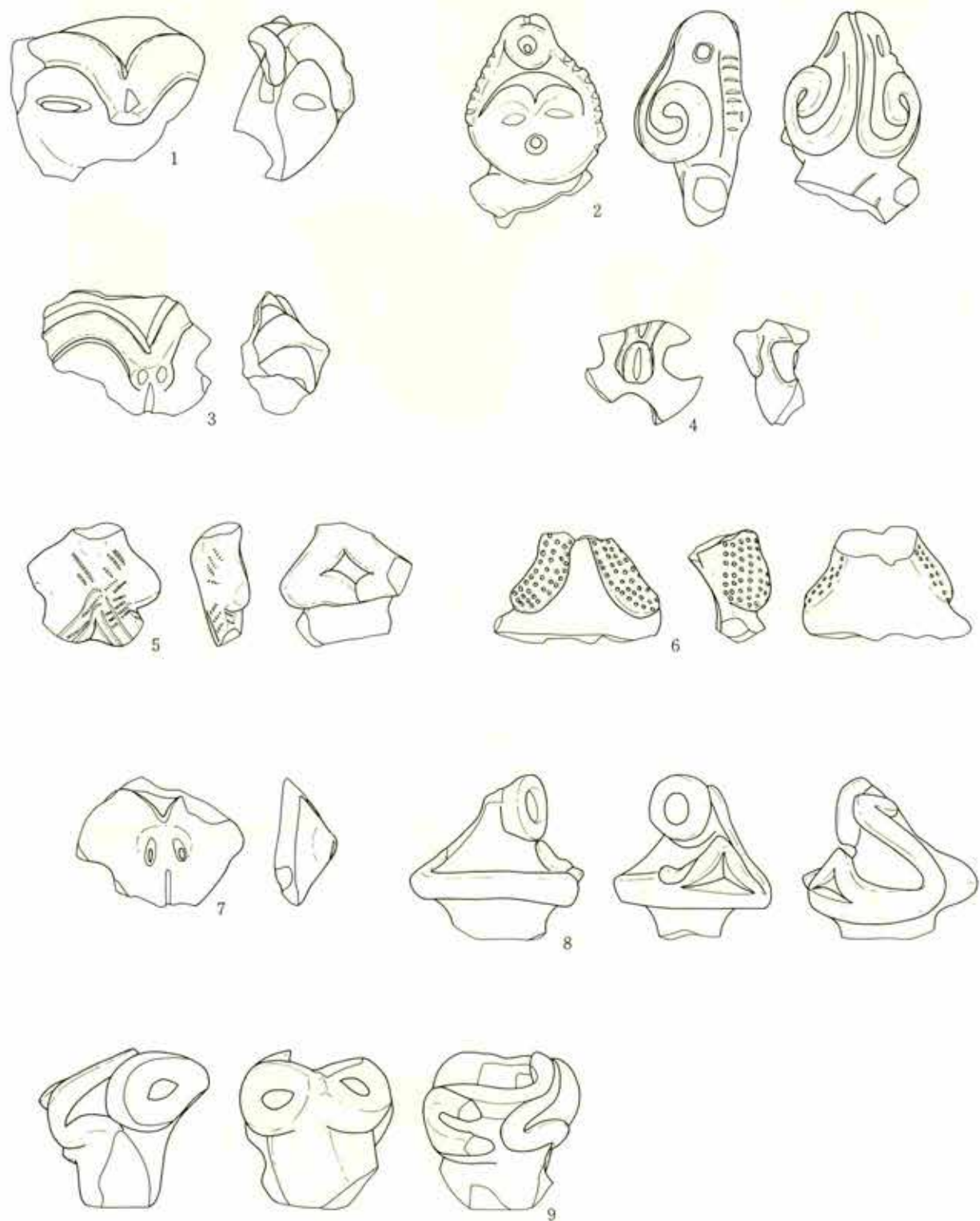

第 587 图 积逊堂N—IV区 把手

(1) (1:2)

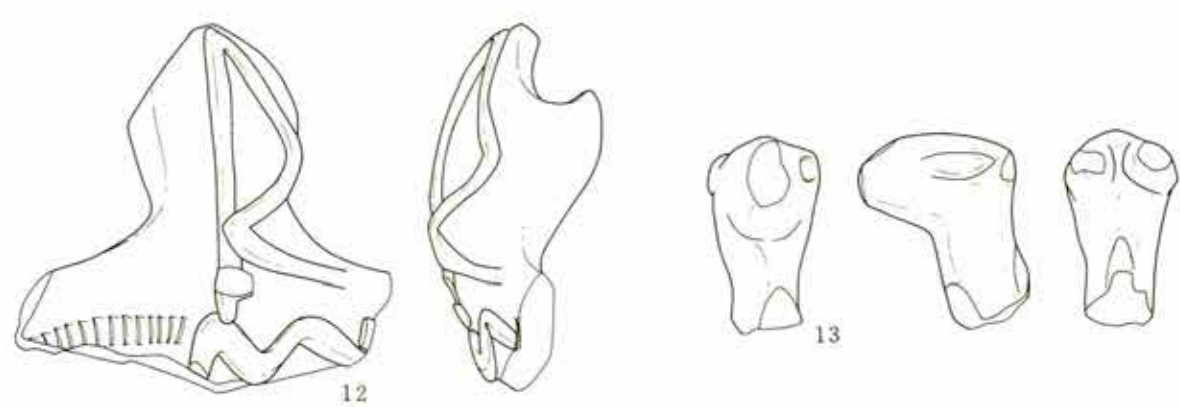
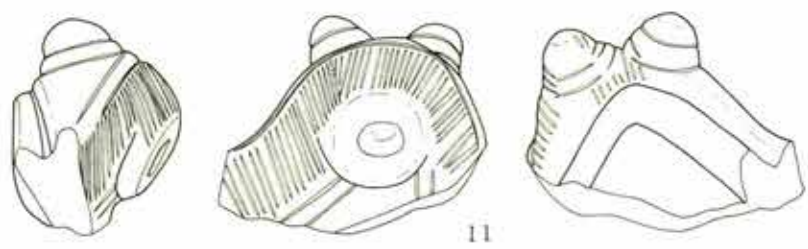
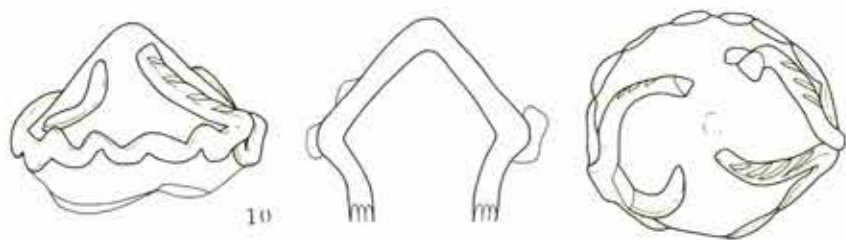

第 588 图 积逊堂N—IV区 把手

(2) (1:2)

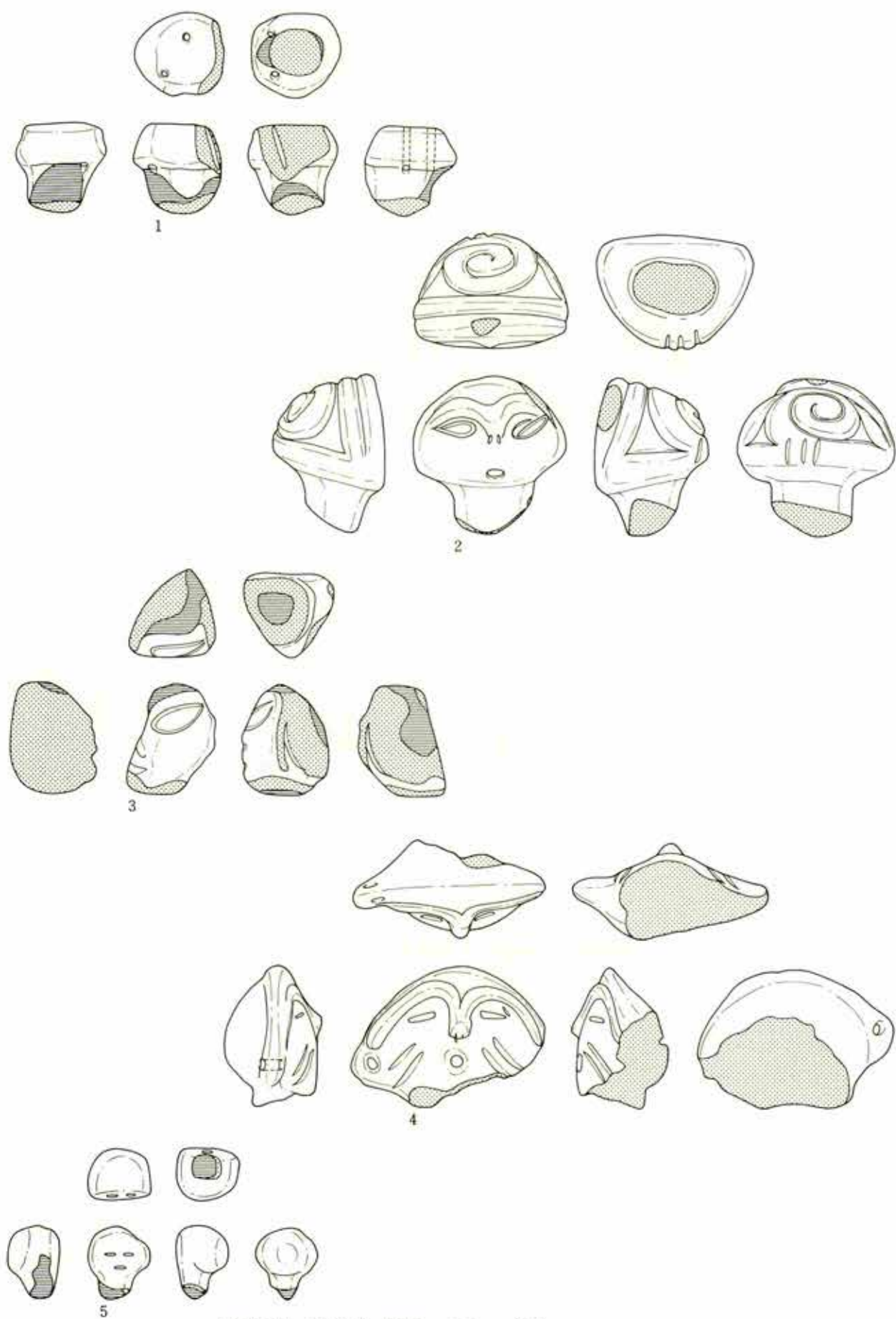

第 589 图 积逊堂N—IV区 土偶 (1)

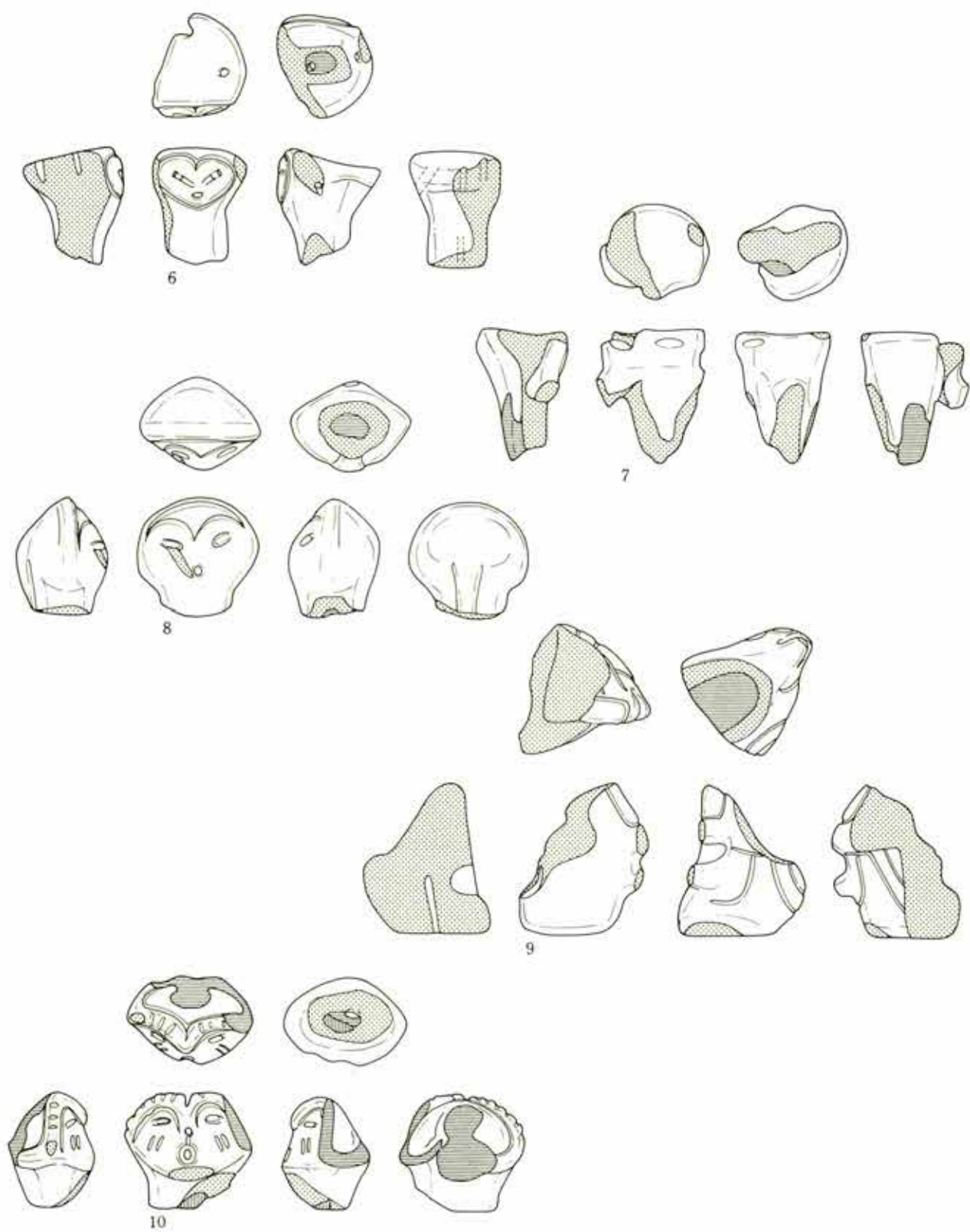

第 590 图 积迦堂 N-IV 区 土偶 (2)

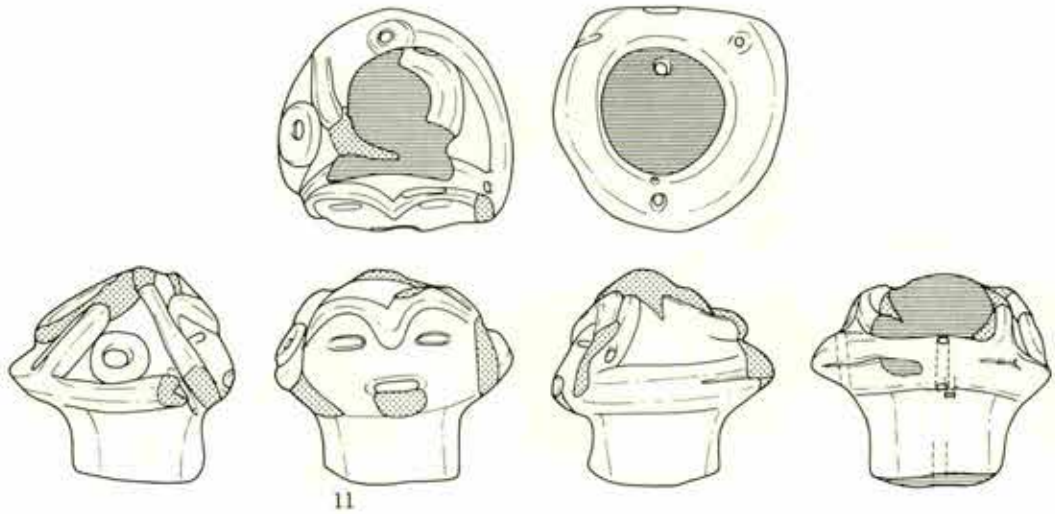

11

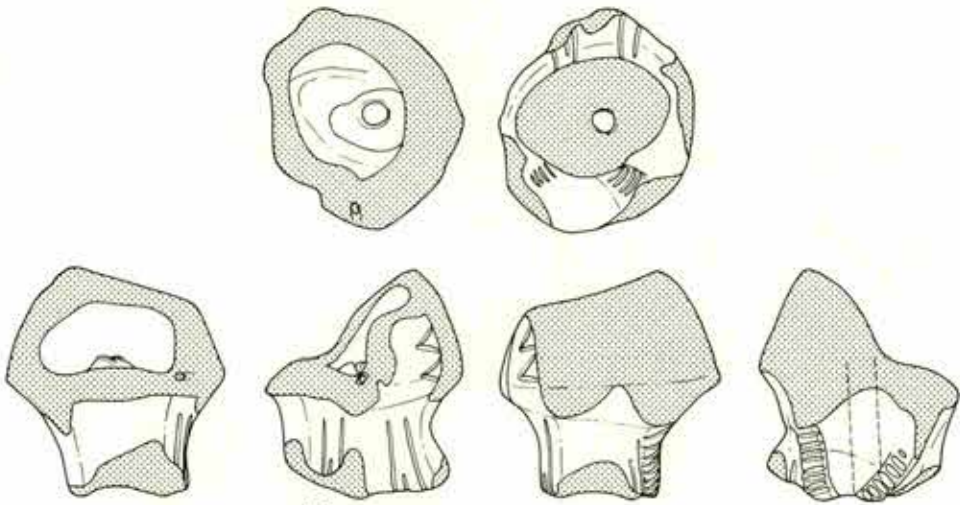

12

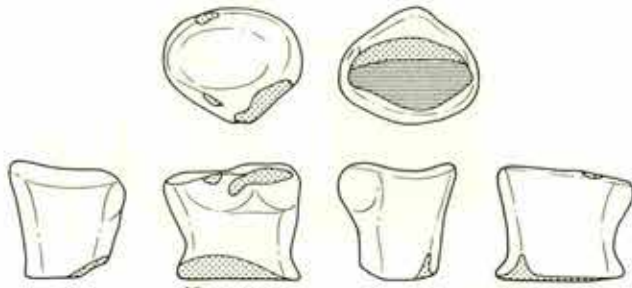

13

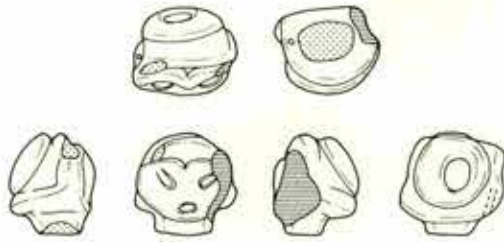

14

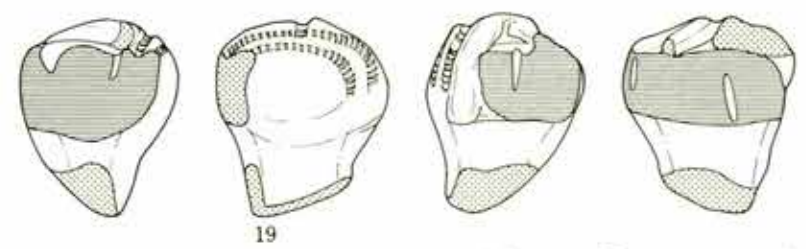
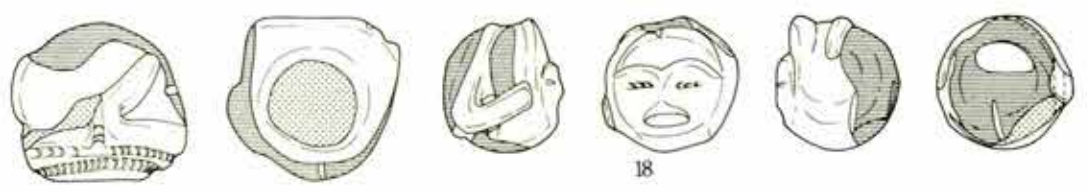
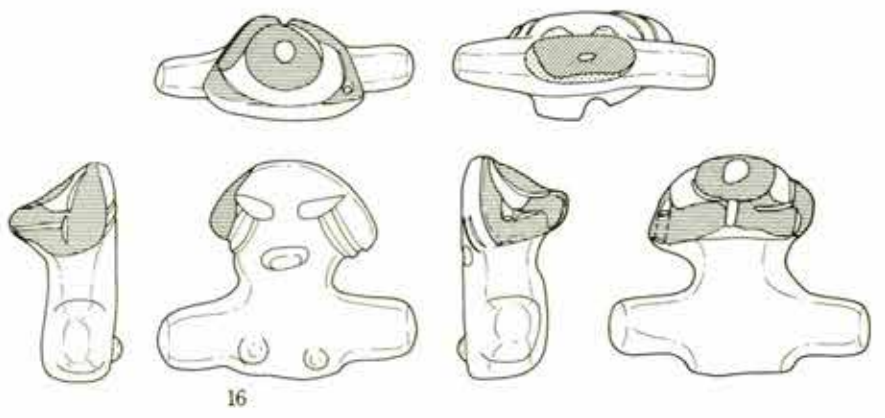
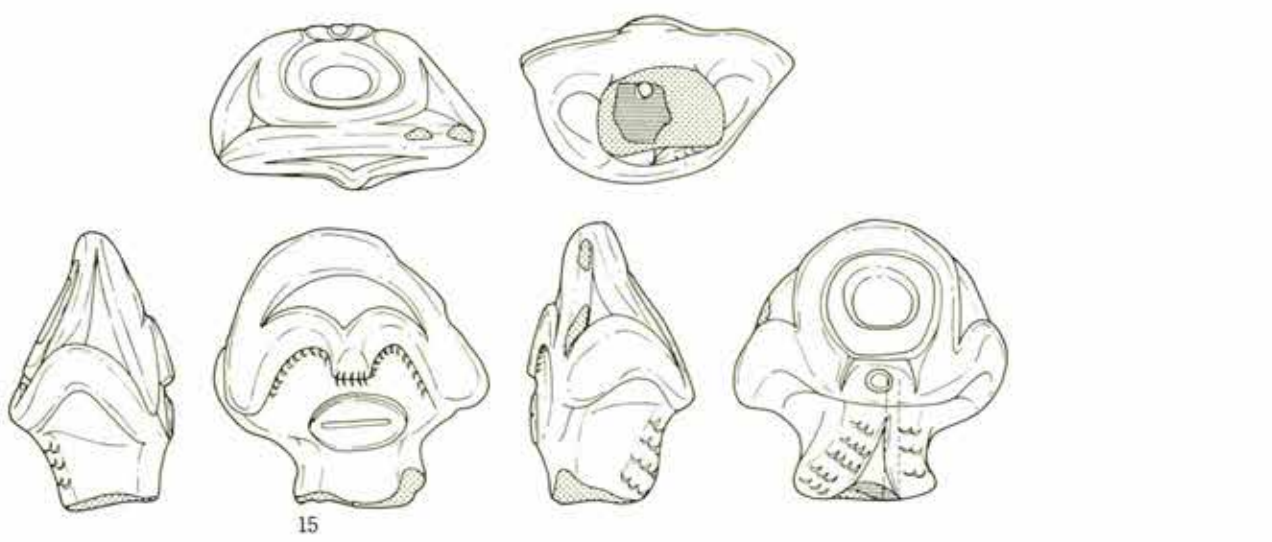

第 592 图 积逊堂 N—IV 区 土偶 (4)

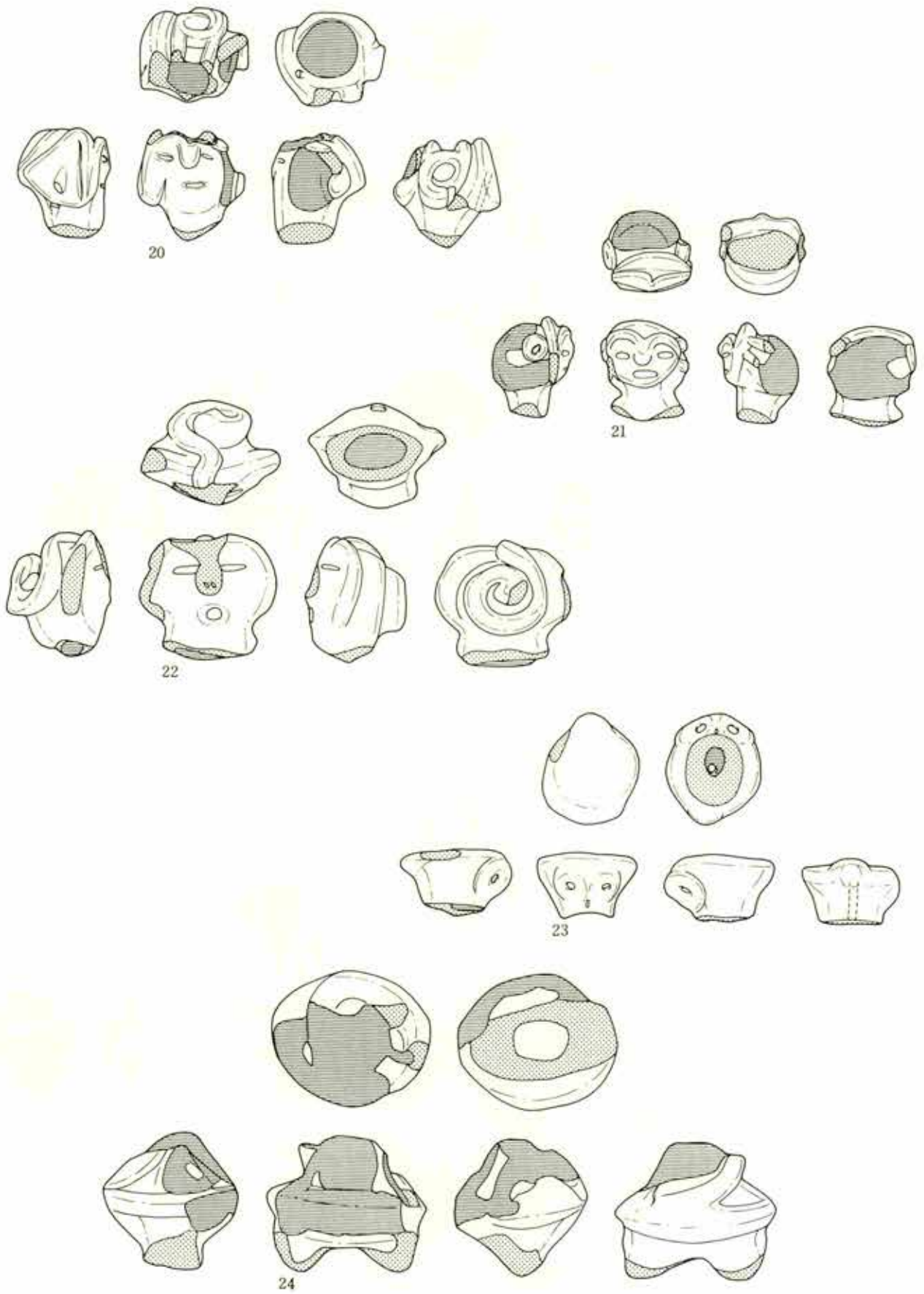

第 593 图 积道堂 N-IV 区 土偶 (5)

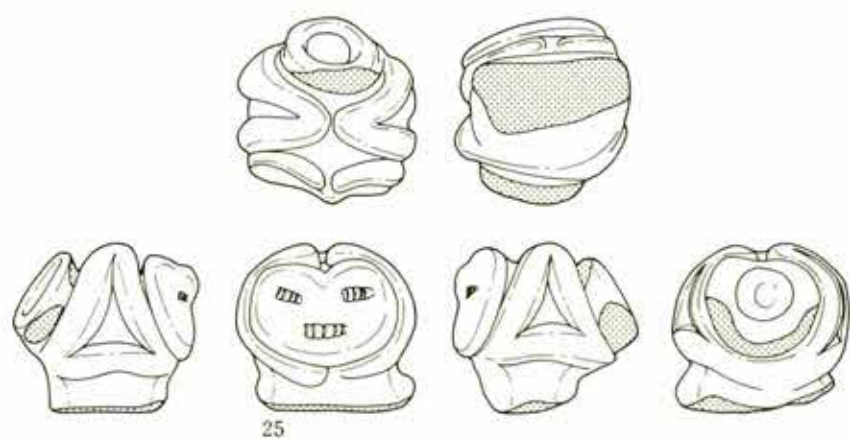

25

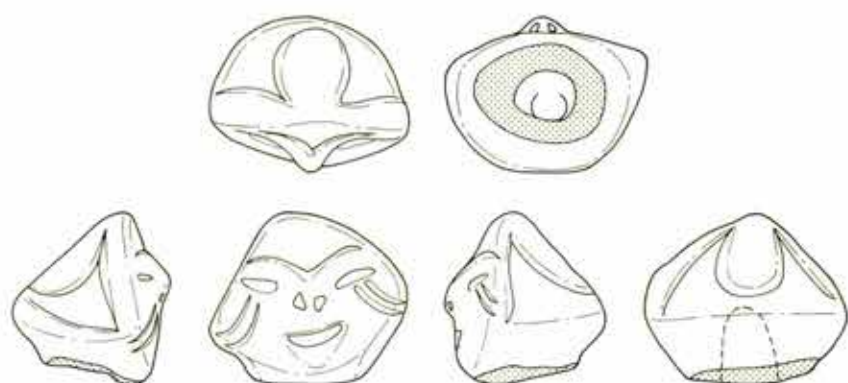

26

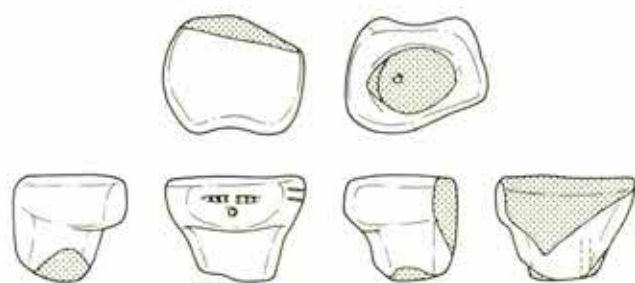

27

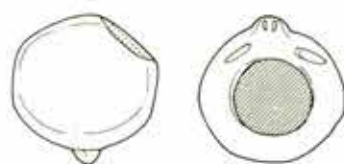

28

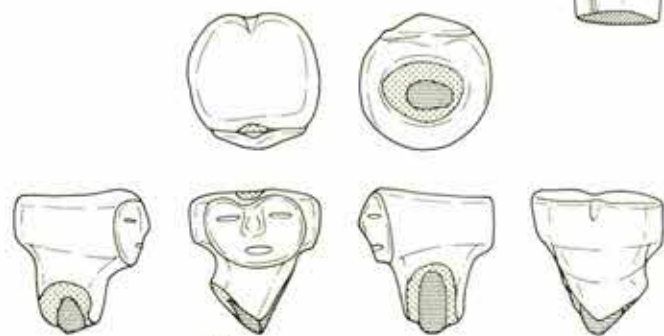

29

第 594 图 积迦堂 N—IV 区 土偶 (6)

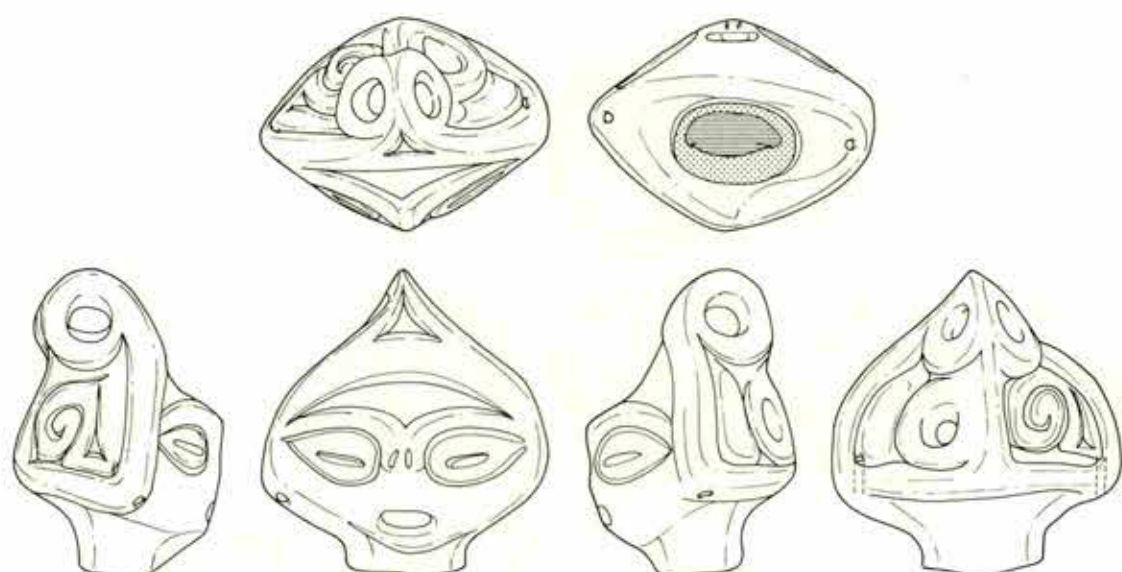

30

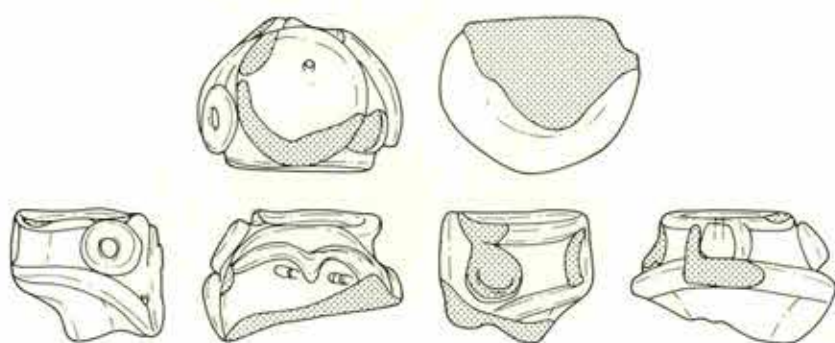

31

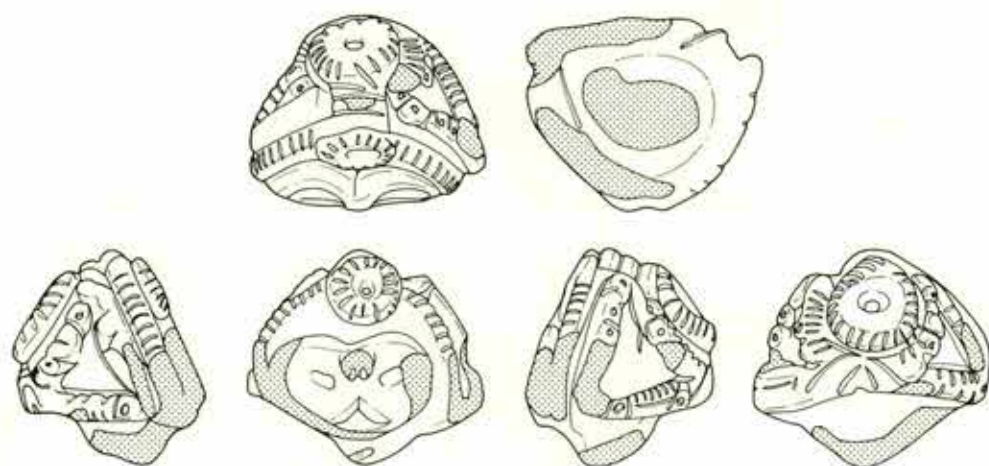

32

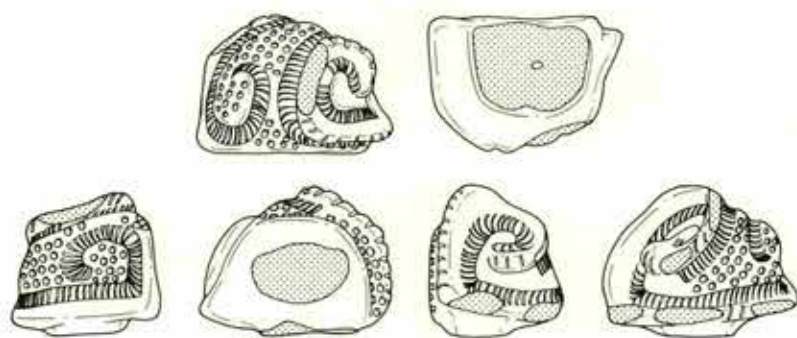

33

第 595 图 积逊堂 N—IV 区 土偶 (7)

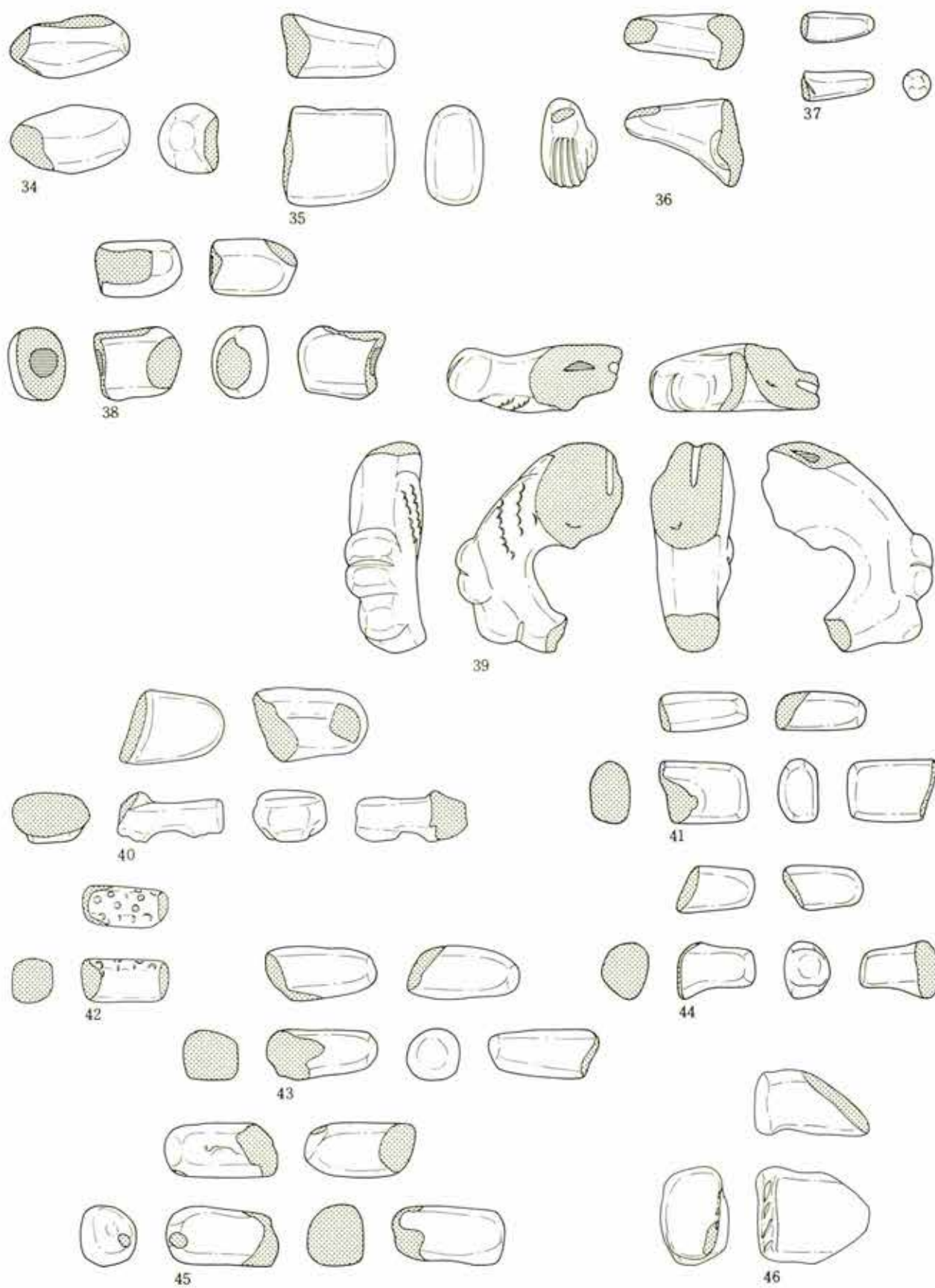

第 596 图 积迦堂 N-IV 区 土偶 (8)

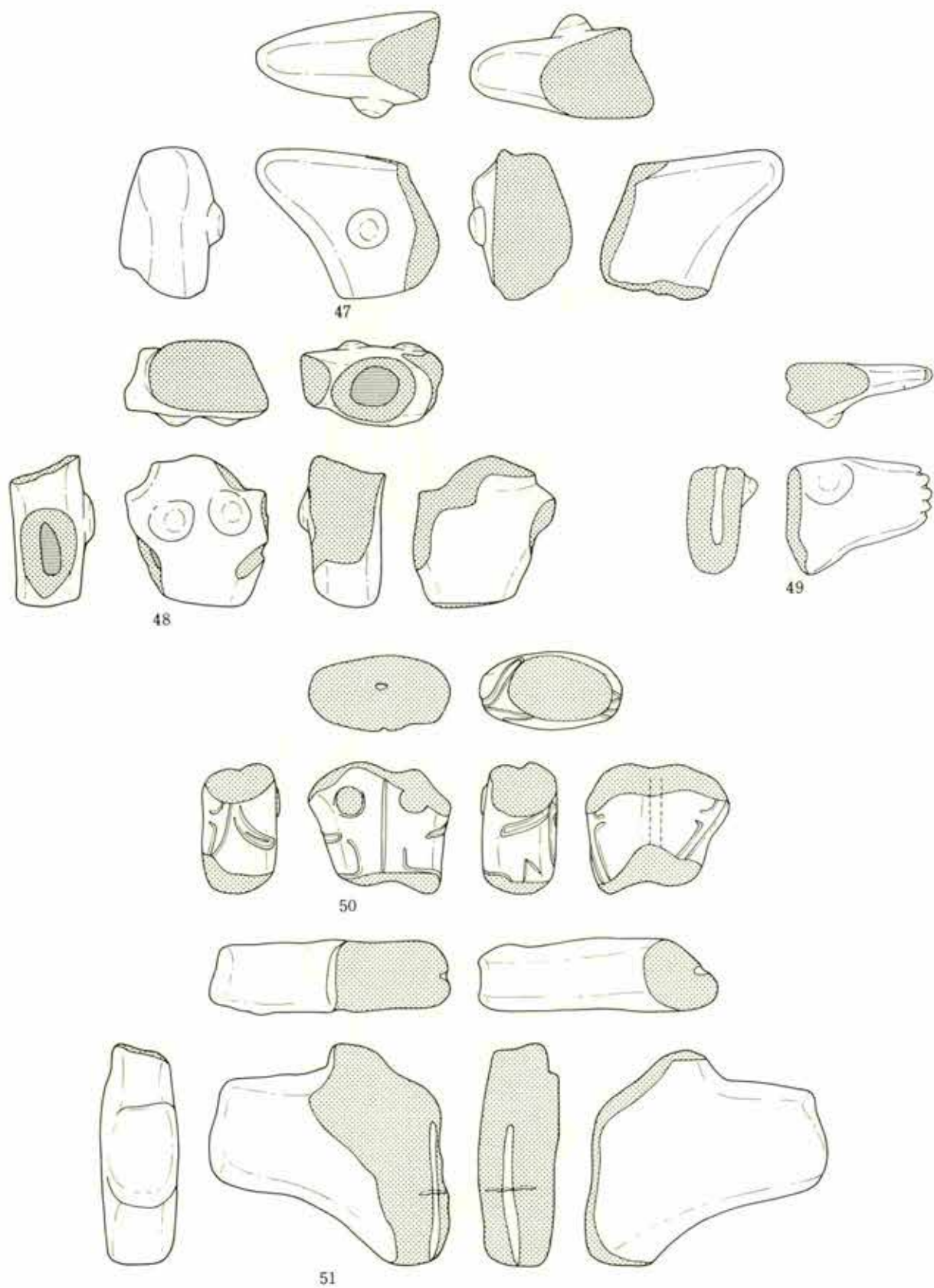

第 597 图 积逊堂 N-IV 区 土偶 (9)

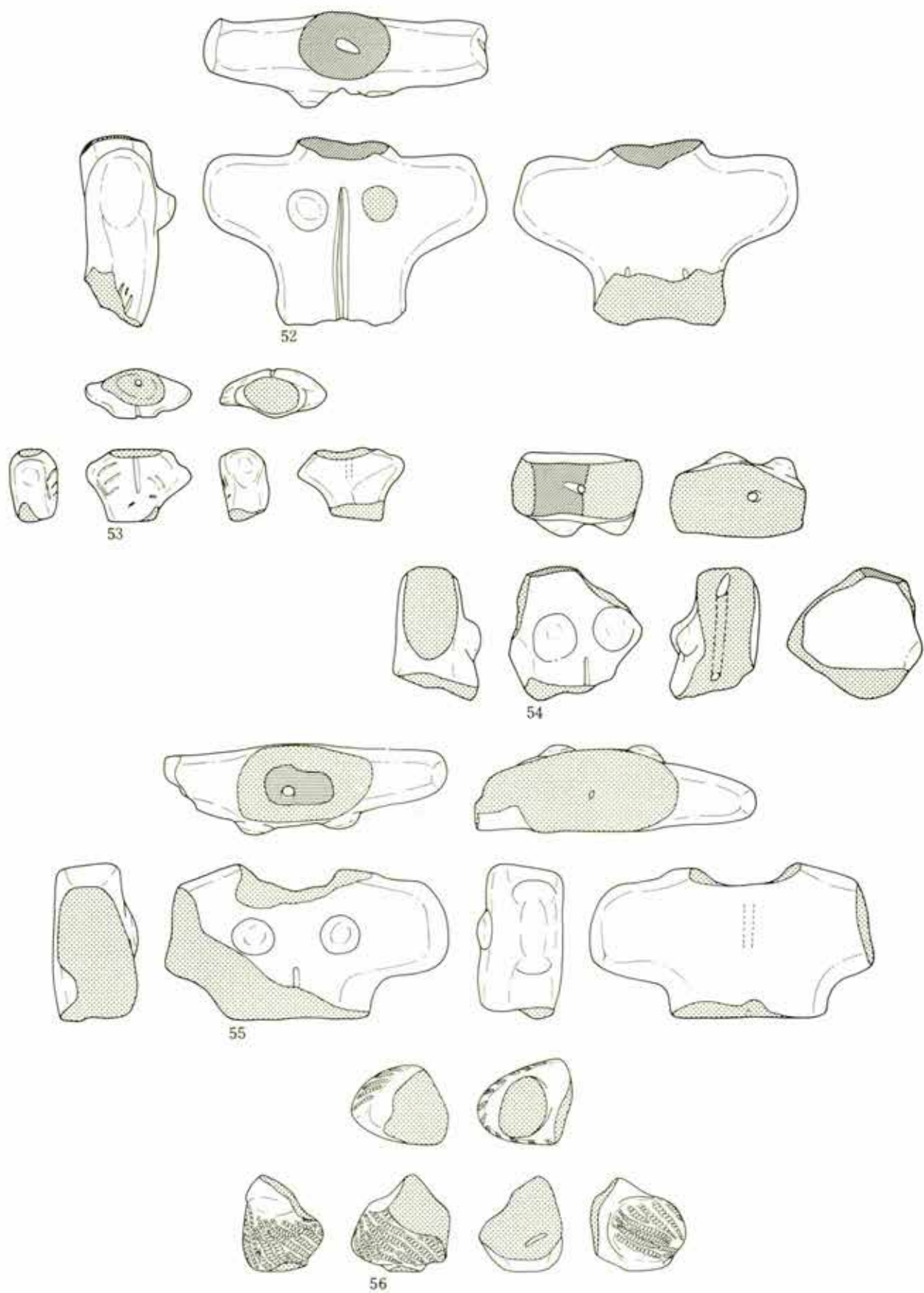

第 598 图 积逊堂 N—IV 区 土偶 (10)

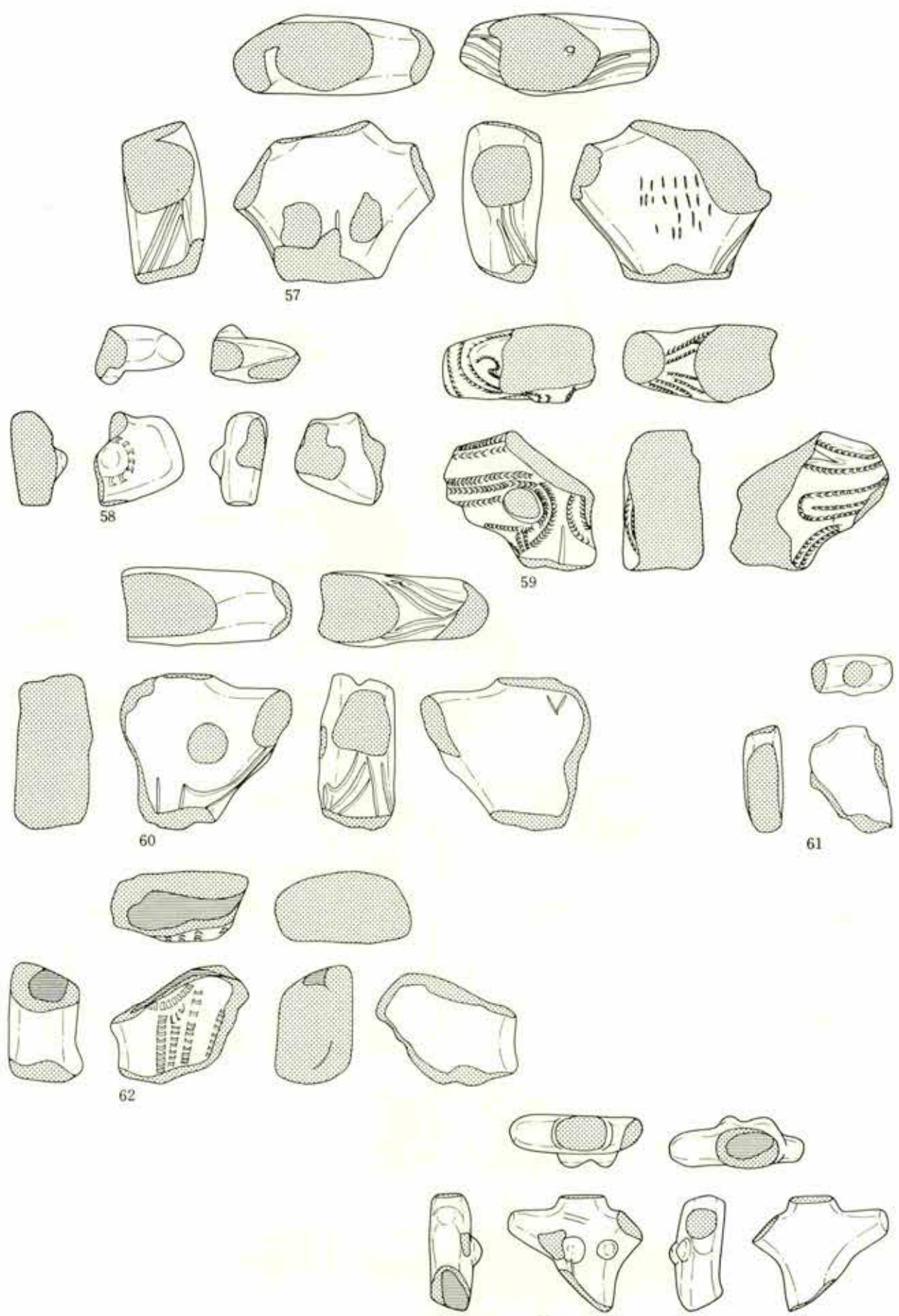

第 599 图 积逊堂 N-IV 区 土偶 (11)

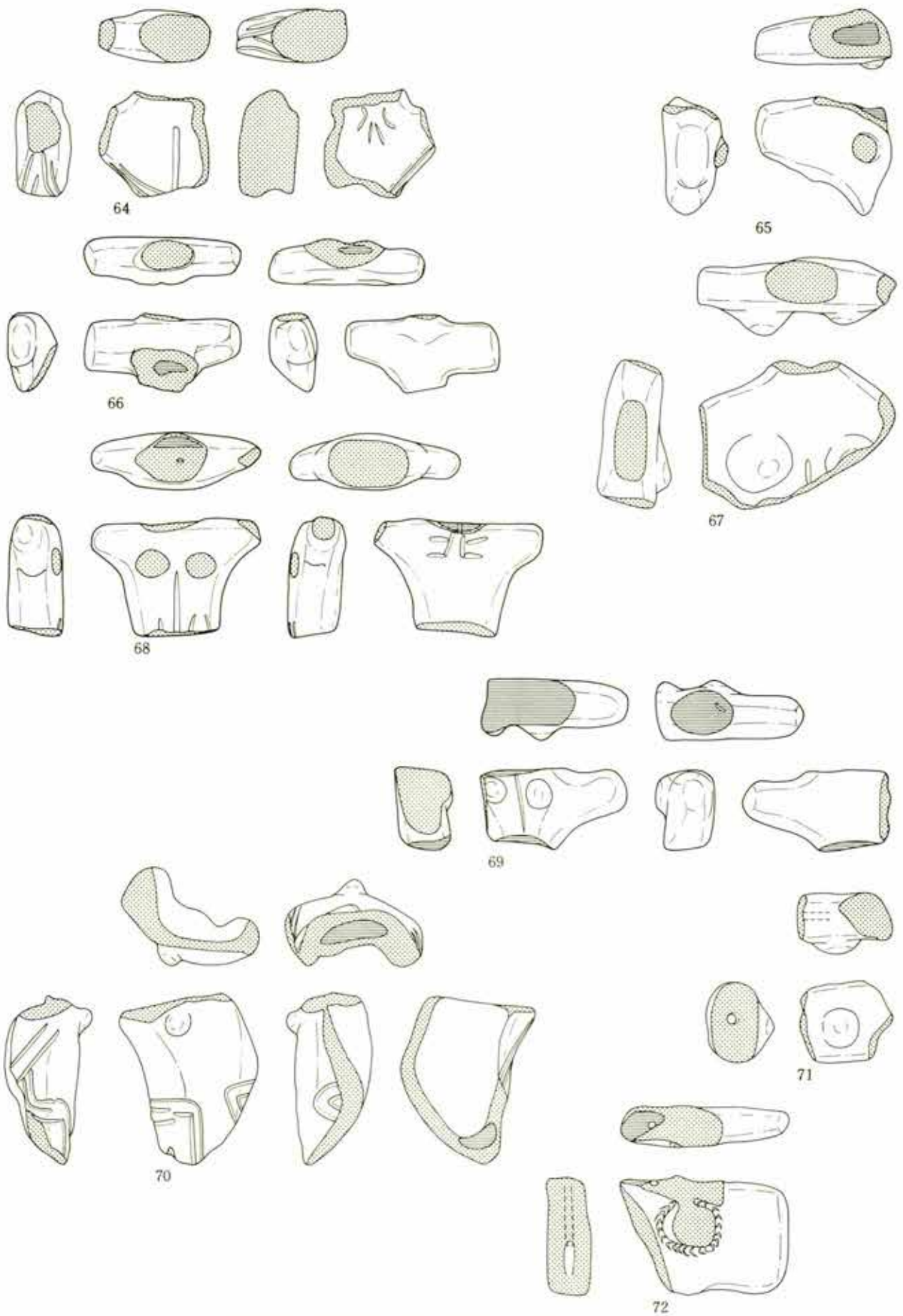

第 600 图 积迦堂 N-IV 区 土偶 (12)

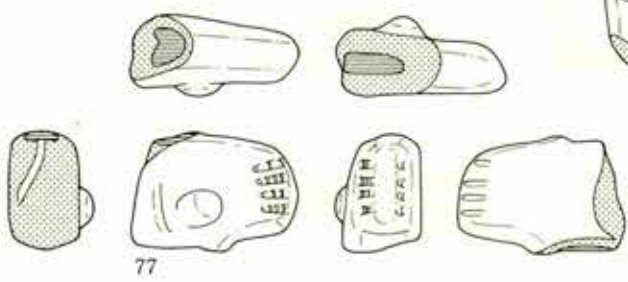
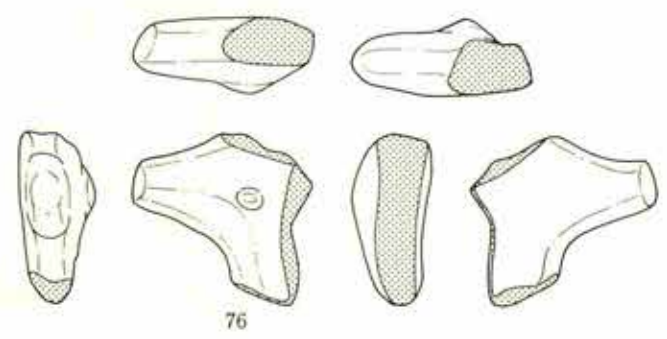
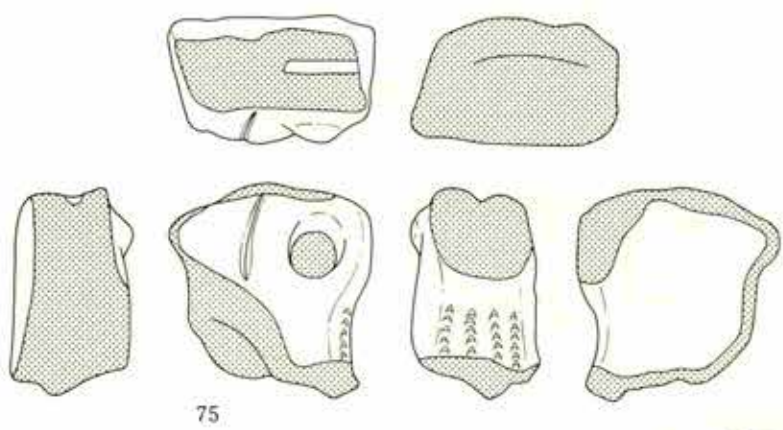
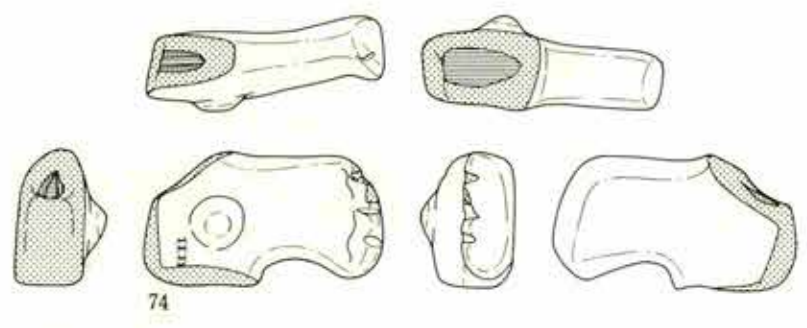
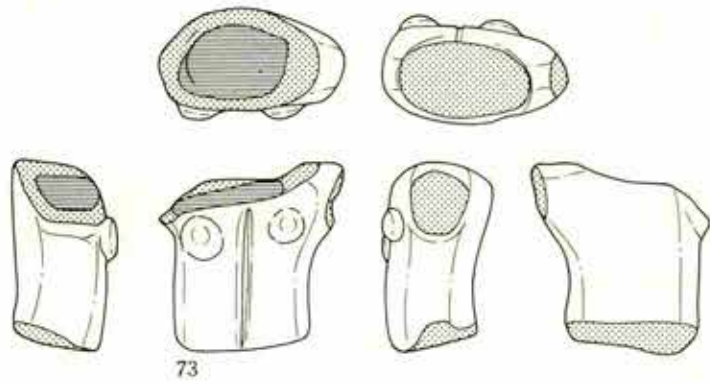

第 601 图 积逊堂 N-IV 区 土偶 (13)

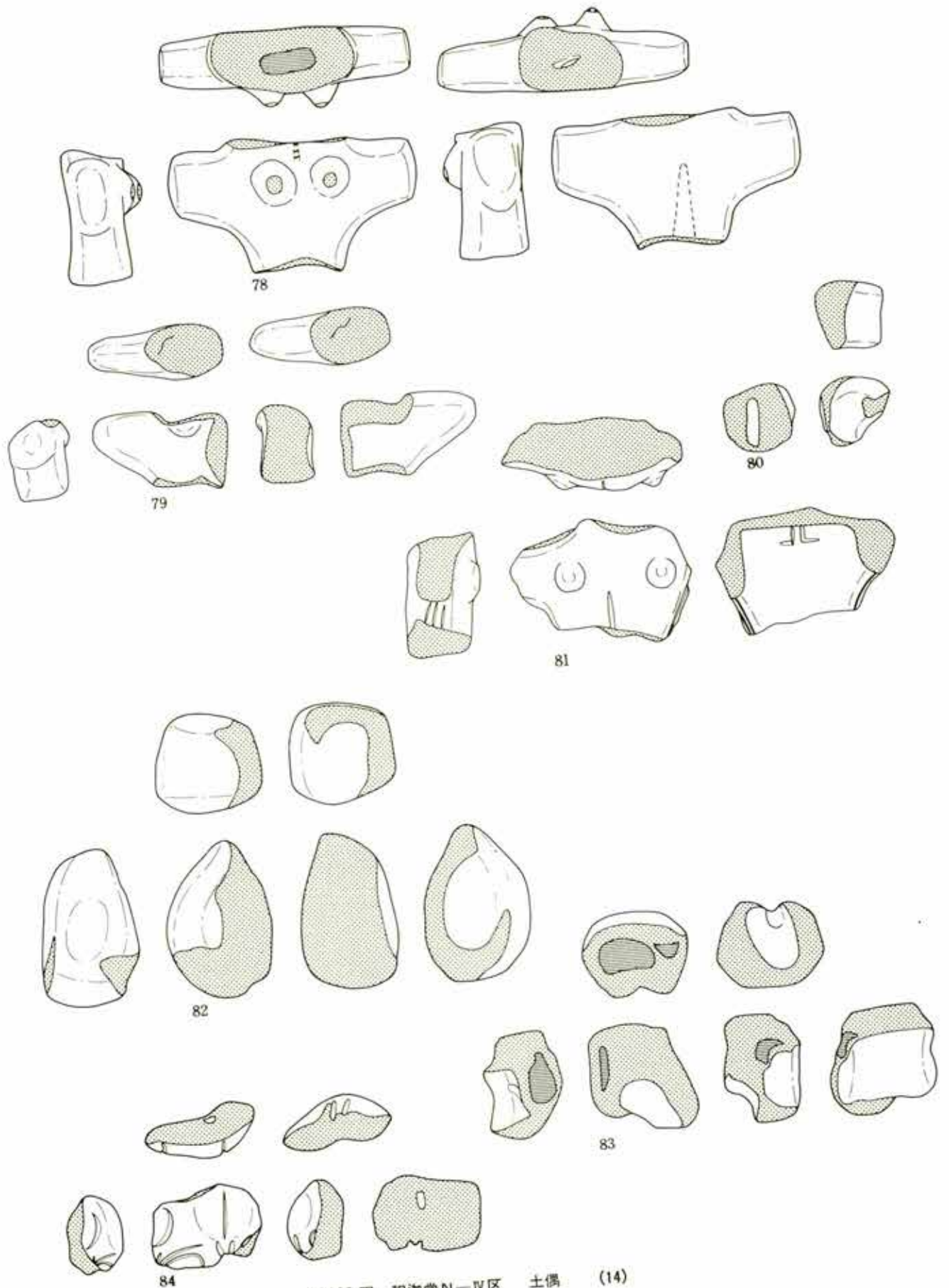

第602图 积道堂N-IV区 土偶 (14)

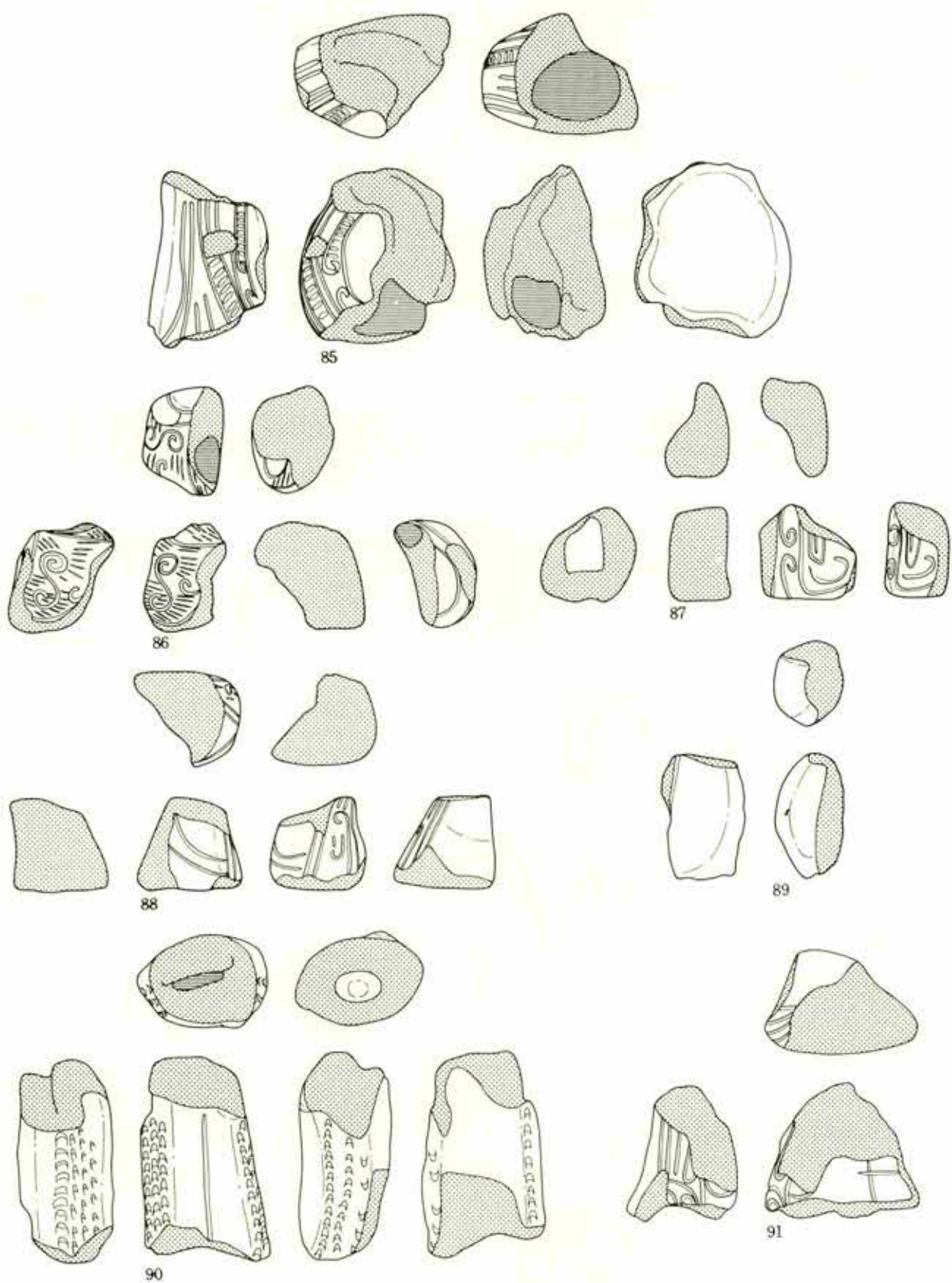

第 603 图 积逊堂 N—IV 区 土偶 (15)

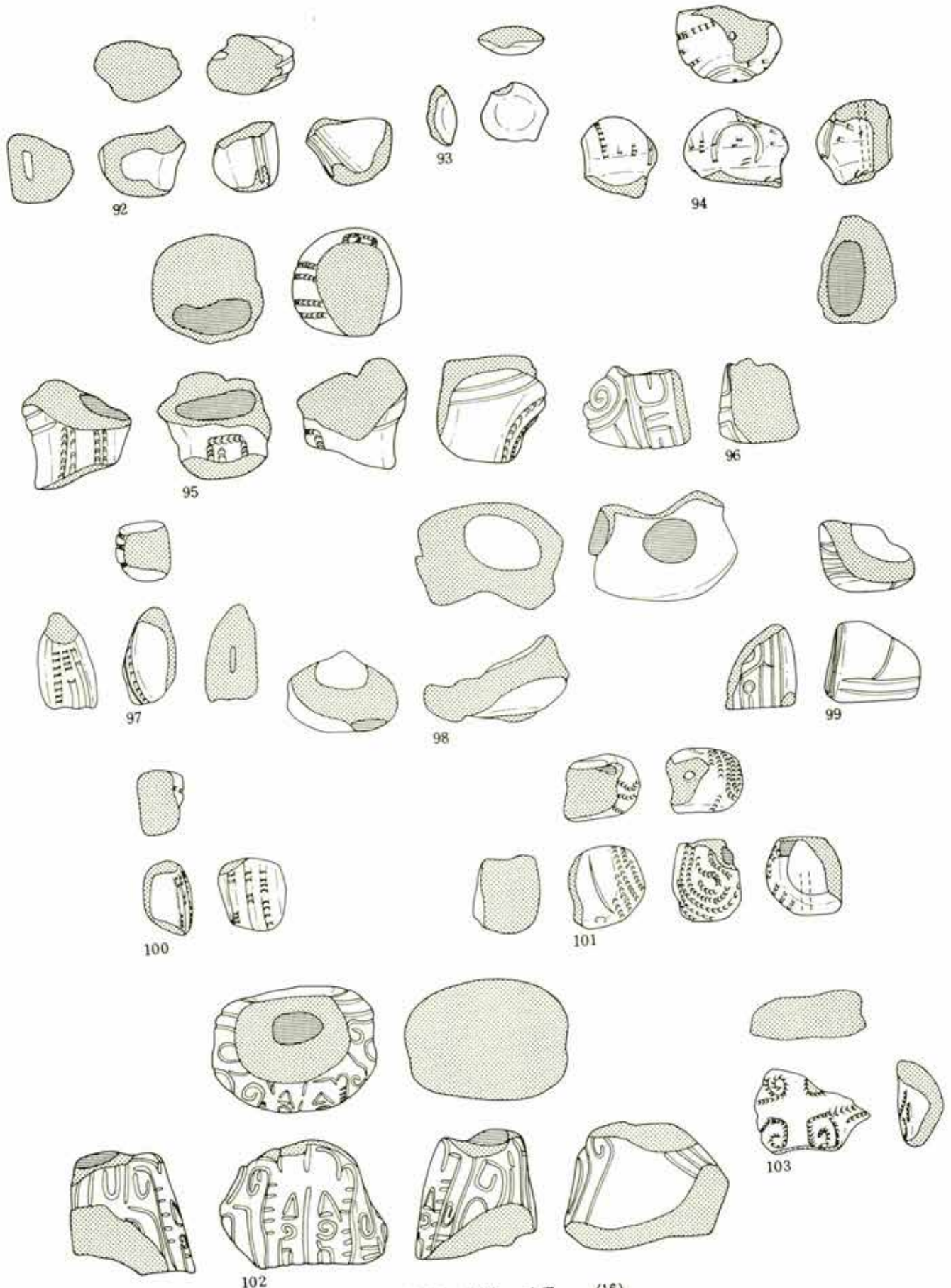

第 604 图 积善堂 N—IV 区 土偶 (16)

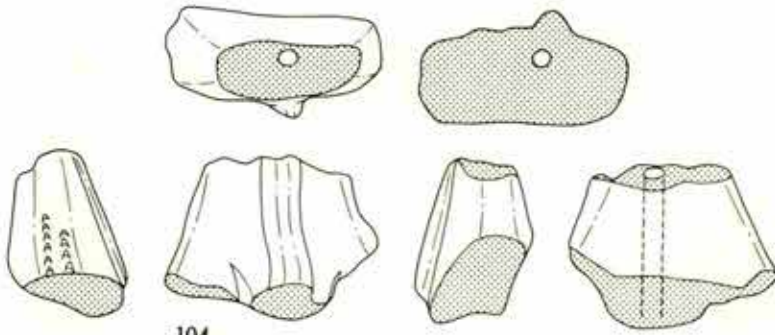

104

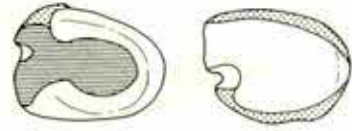

105

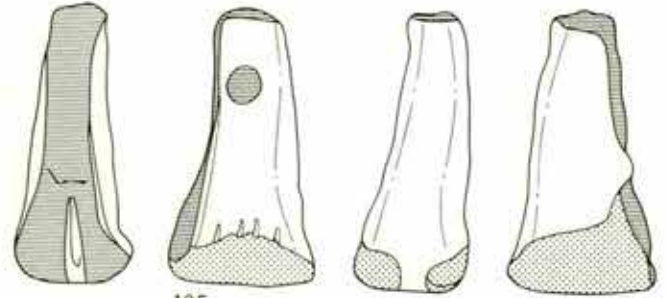

106

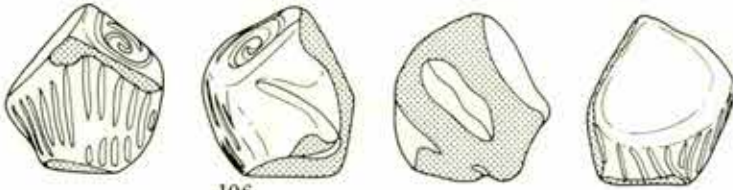

107

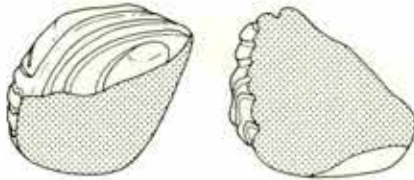
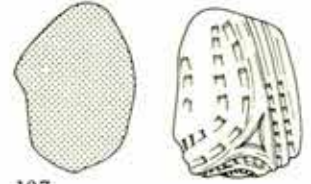

108

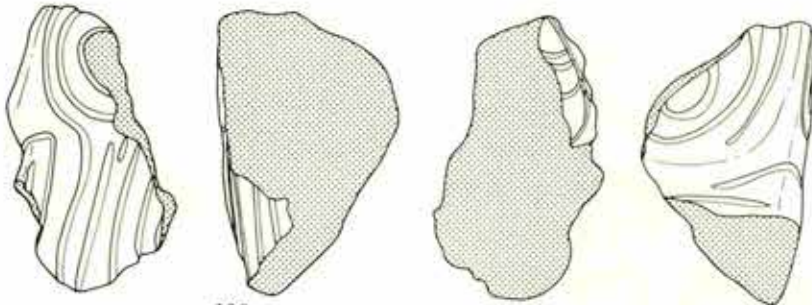

109



第 605 图 积逊堂 N—IV 区 土偶 (17)

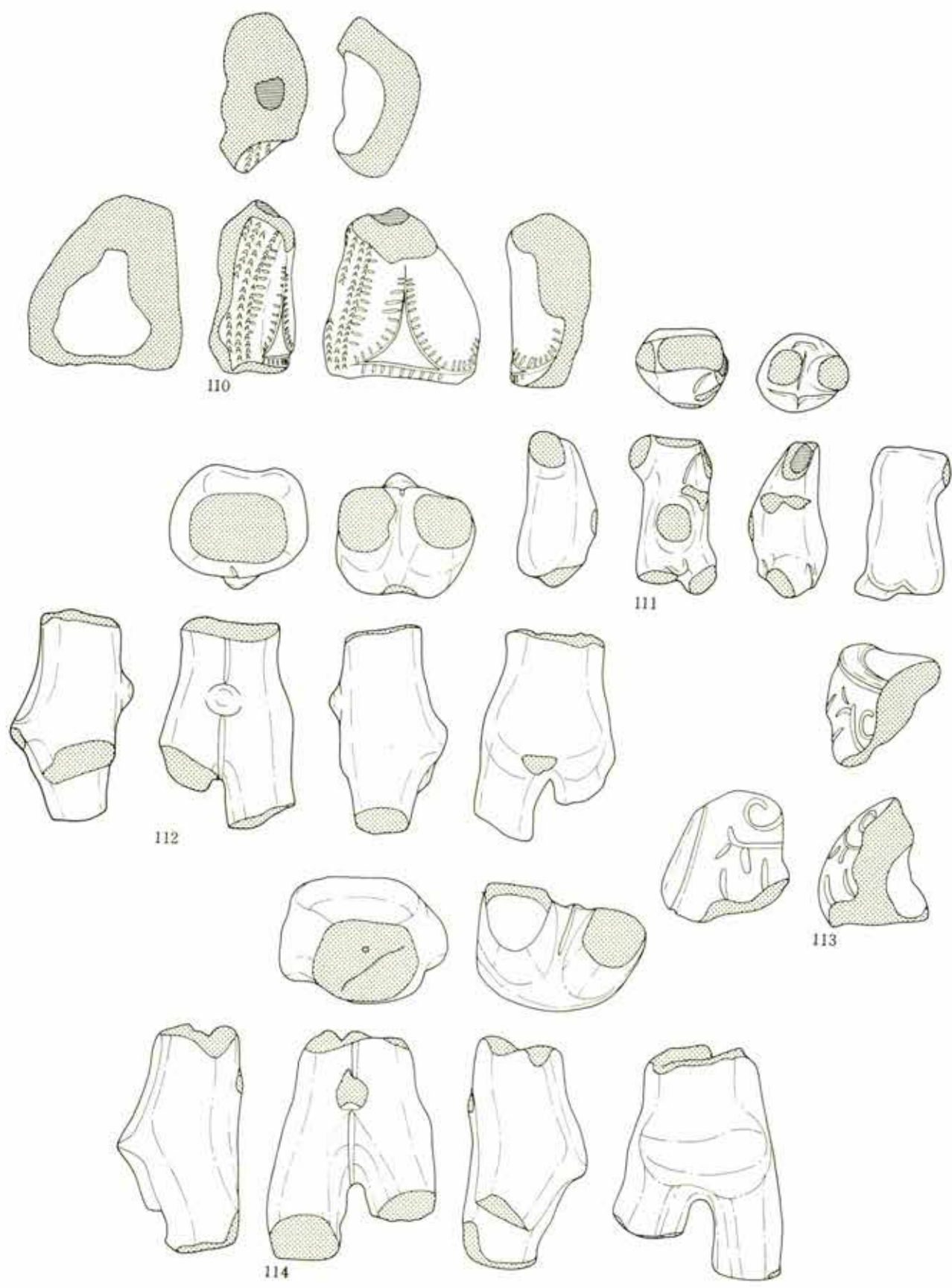

第 606 图 积逊堂 N-IV 区 土偶 (18)

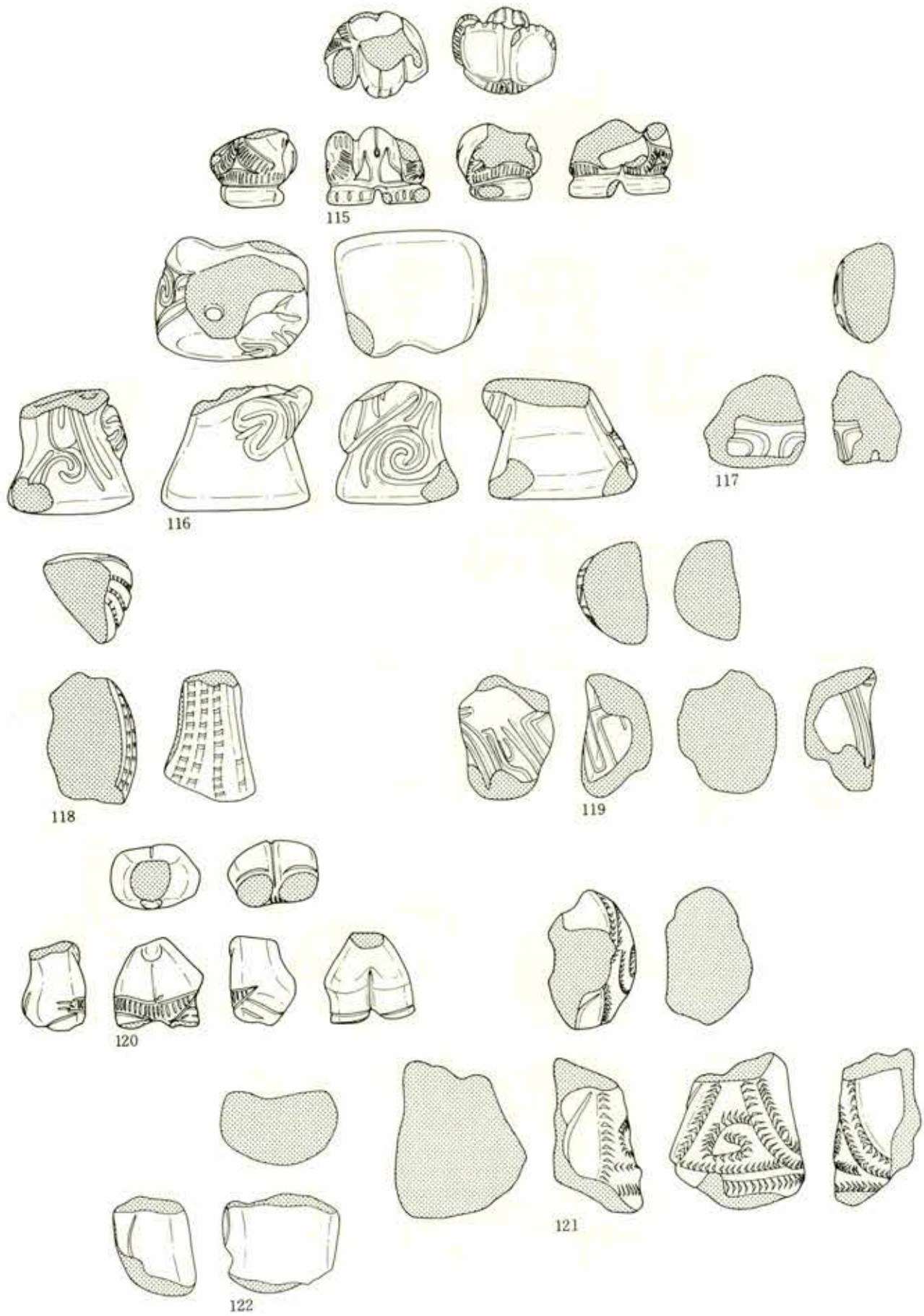

第 607 图 积逊堂 N-IV 区 土偶 (19)

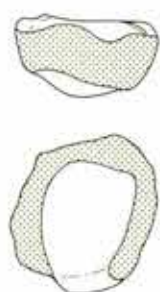

123

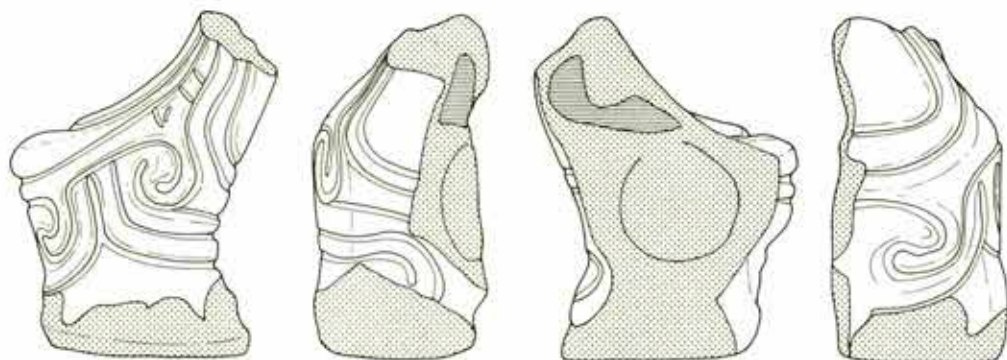

124

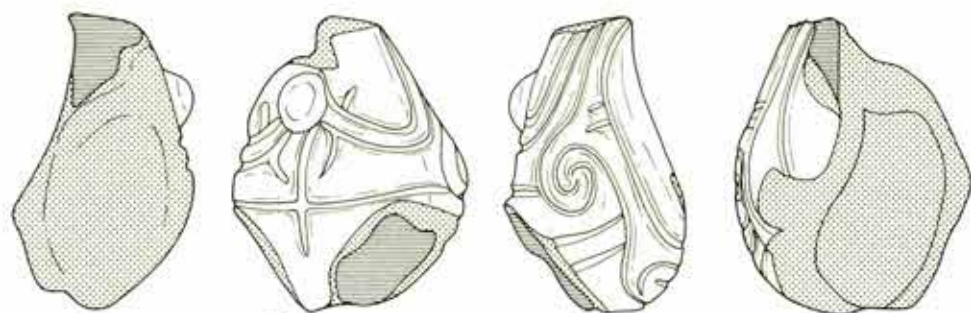
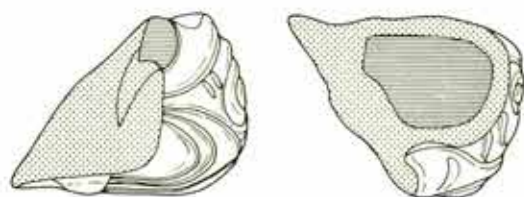

125

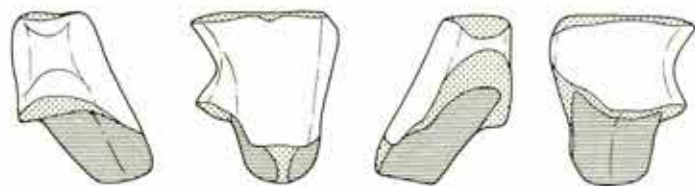

126

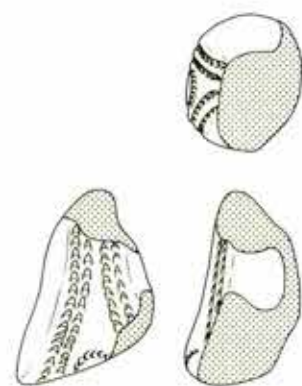

127

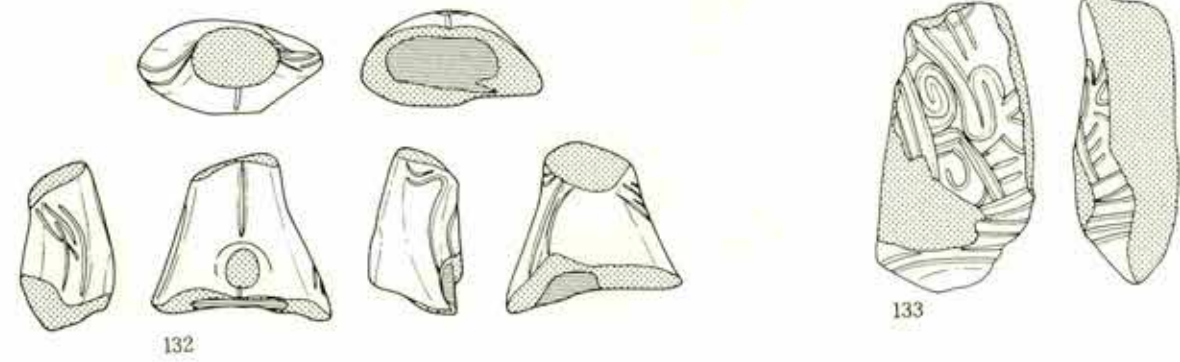
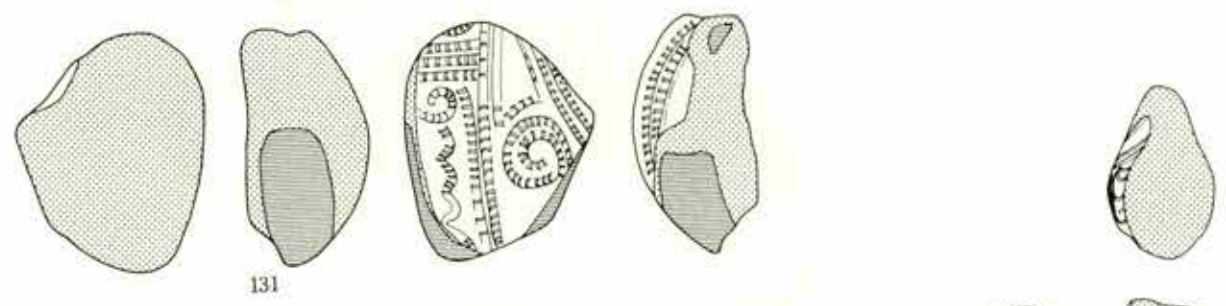
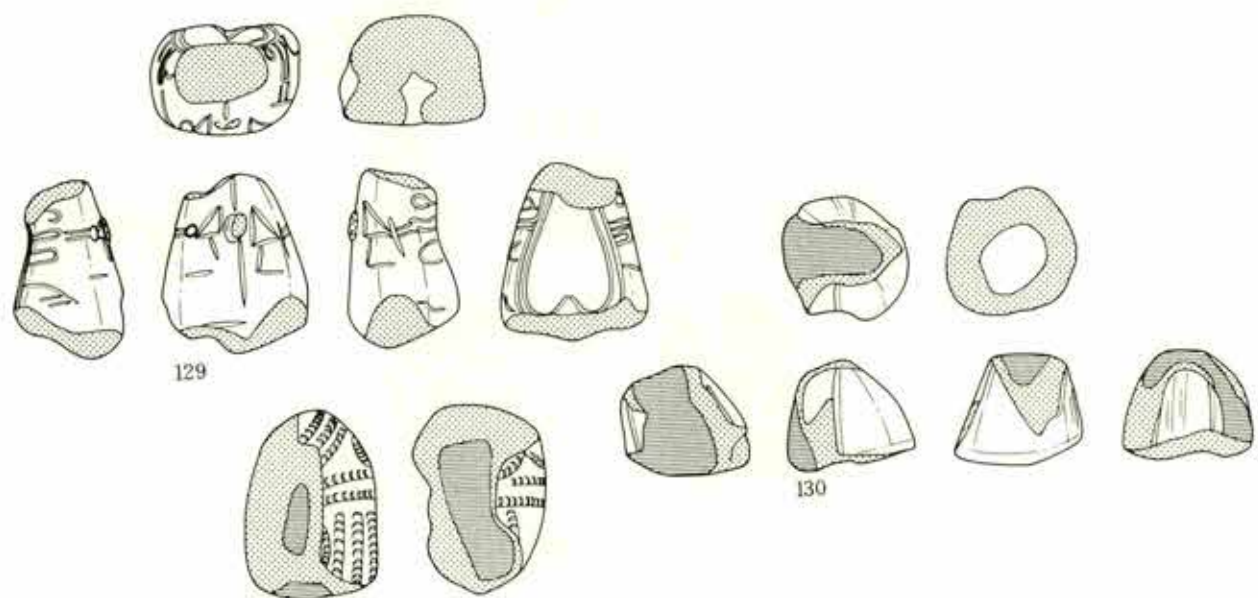
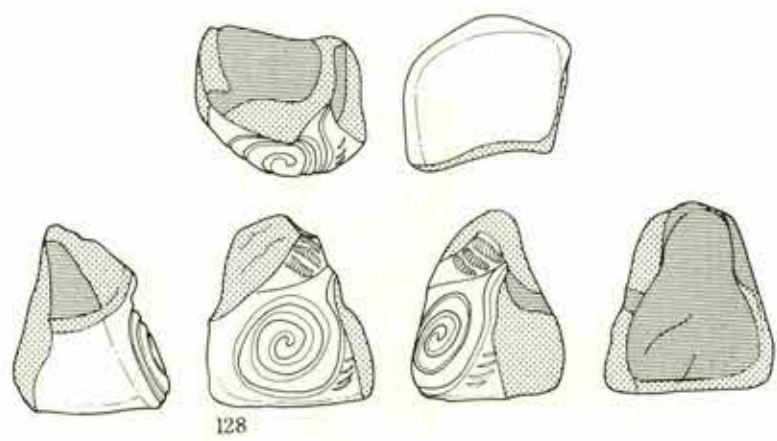

第 609 图 积逊堂 N—IV 区 土偶 (21)

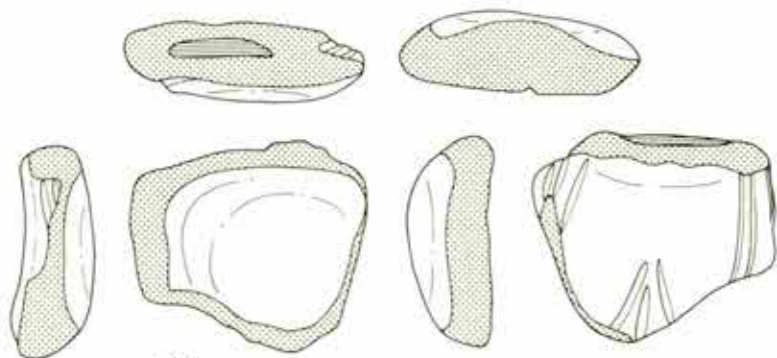

134

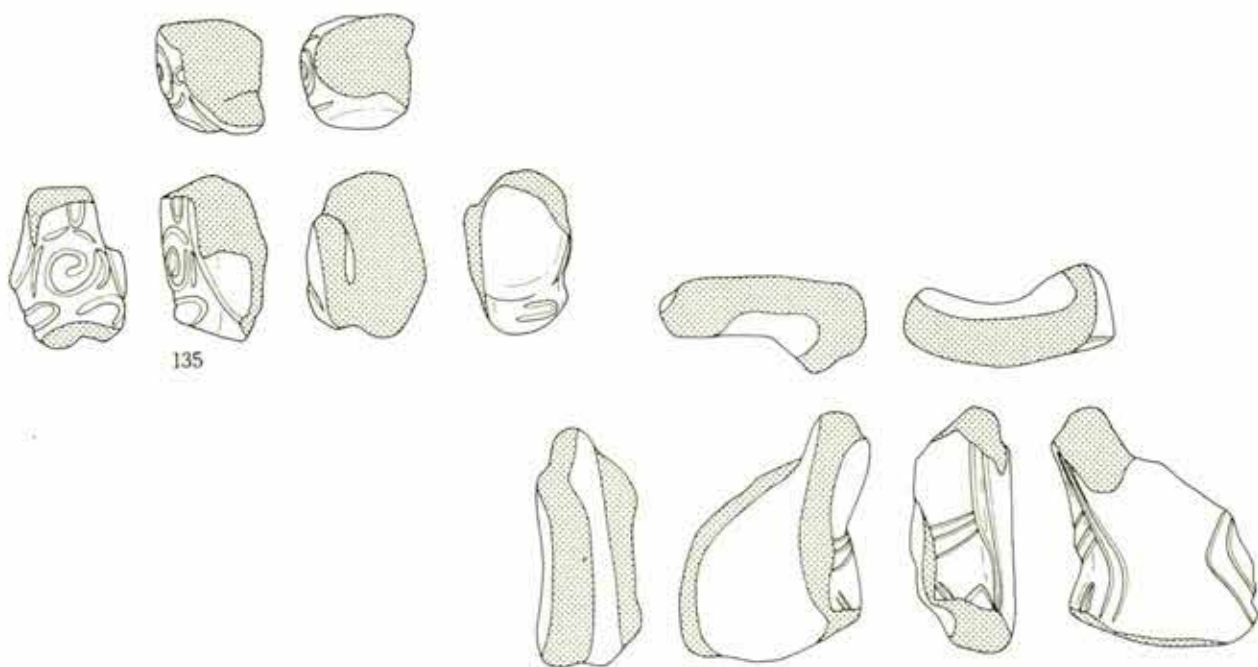

135

136

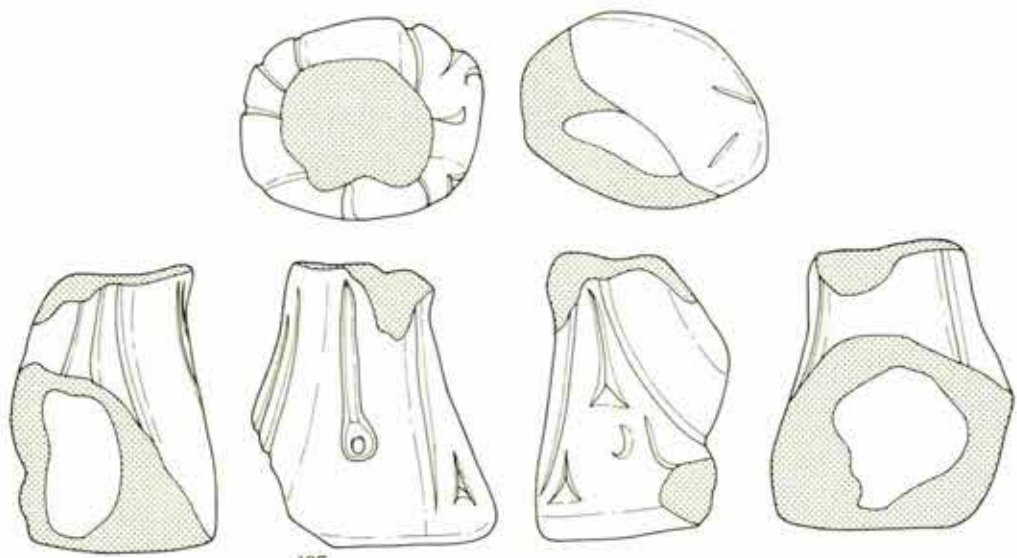

137

第 610 图 积迦堂N—IV区 土偶 (22)



第 611 图 积迳堂 N-IV 区 土偶 (23)

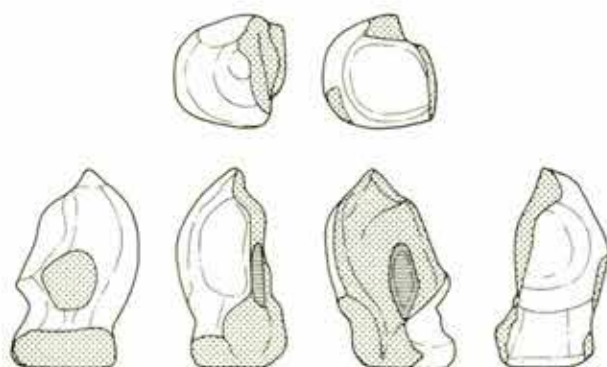

145

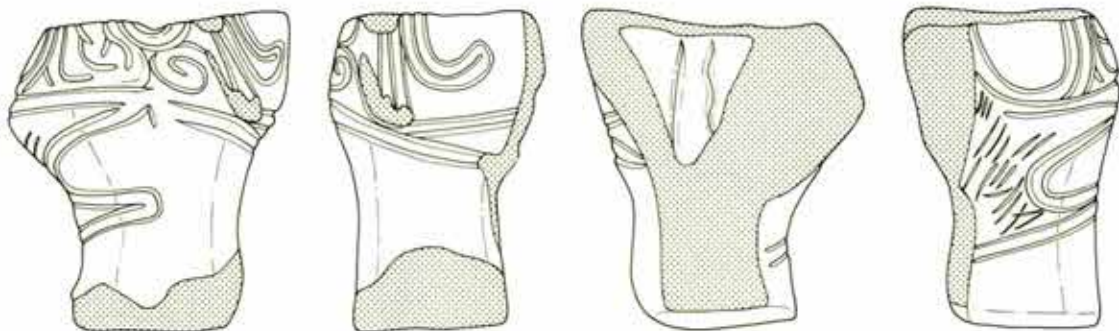
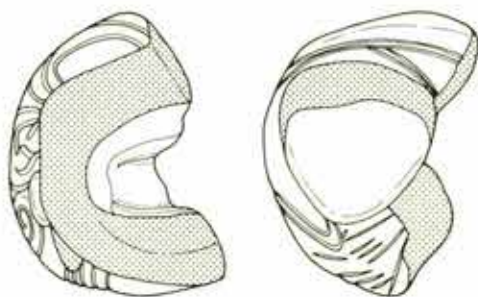

146

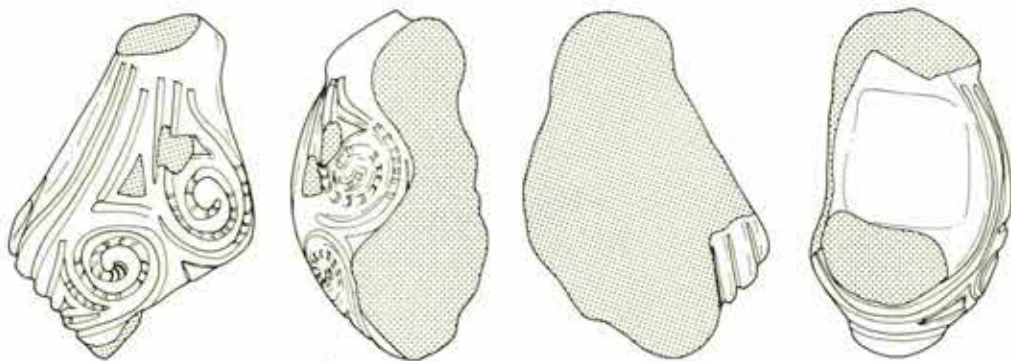
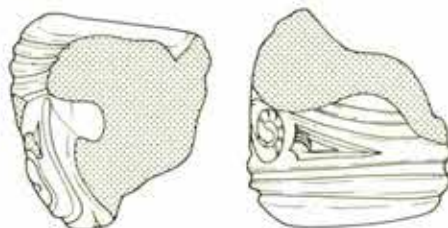

147



第613图 积逊堂N-I区 土偶 (25)

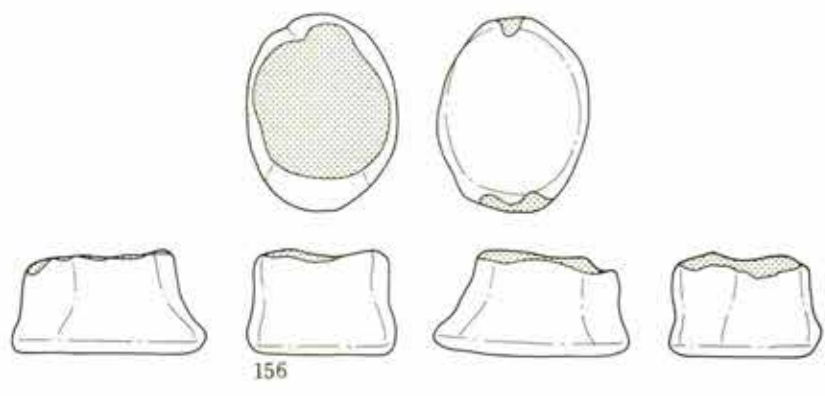

156

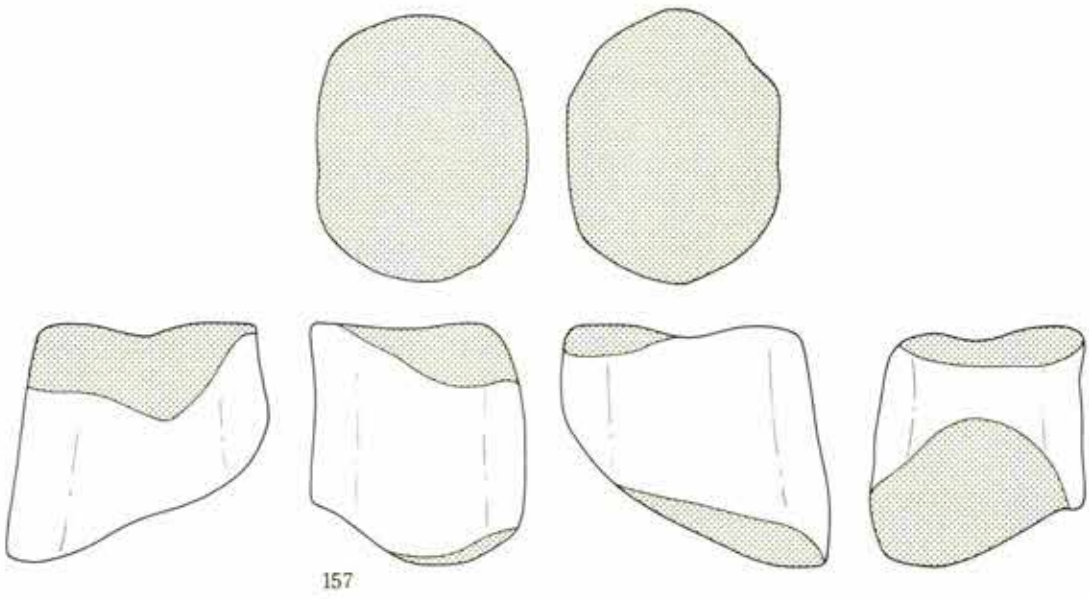

157

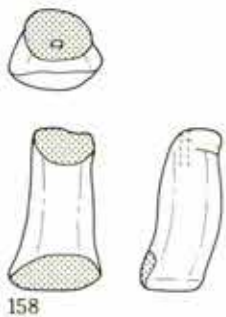

158

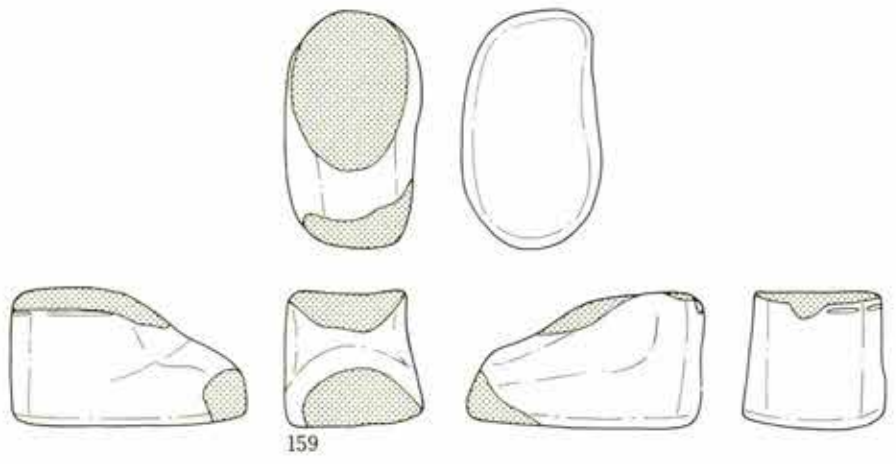

159

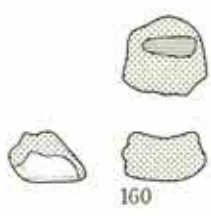

160

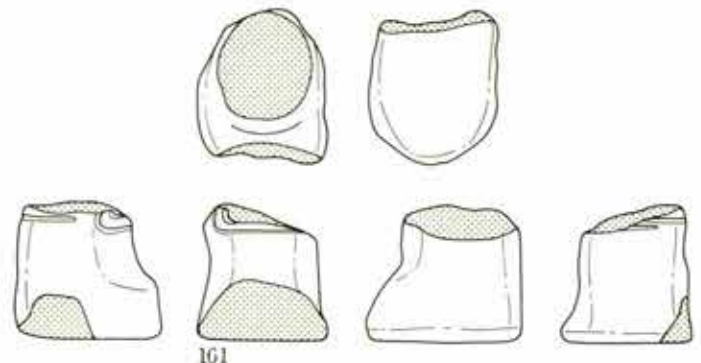

161

第 614 图 积迦堂 N-IV 区 土偶 (26)

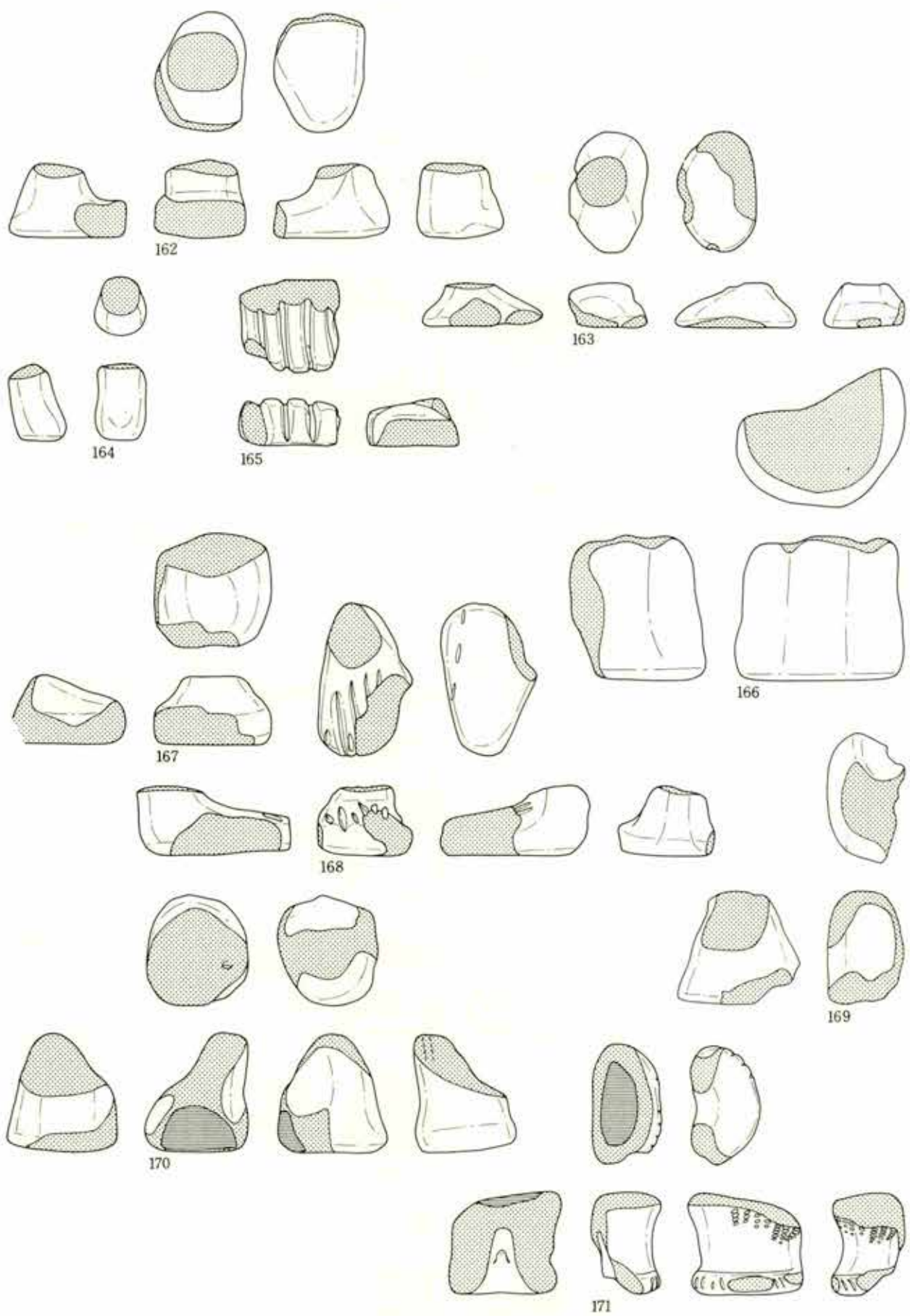

第615图 积迎堂N—IV区 土偶 (27)

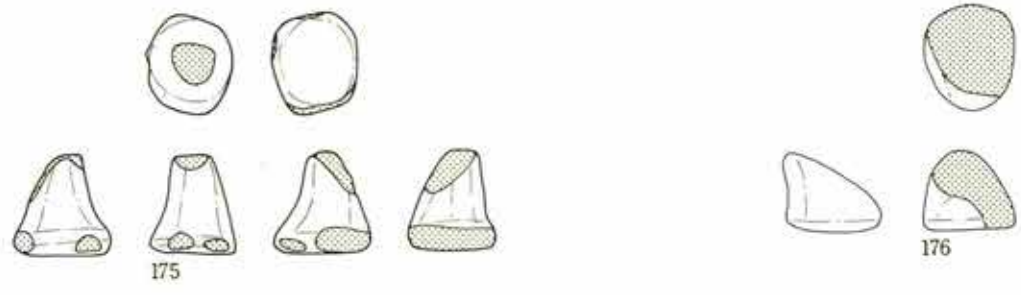
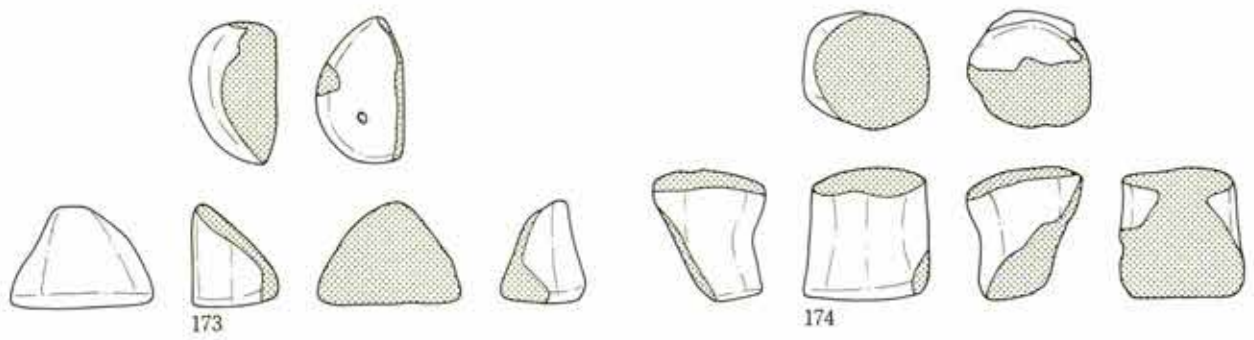
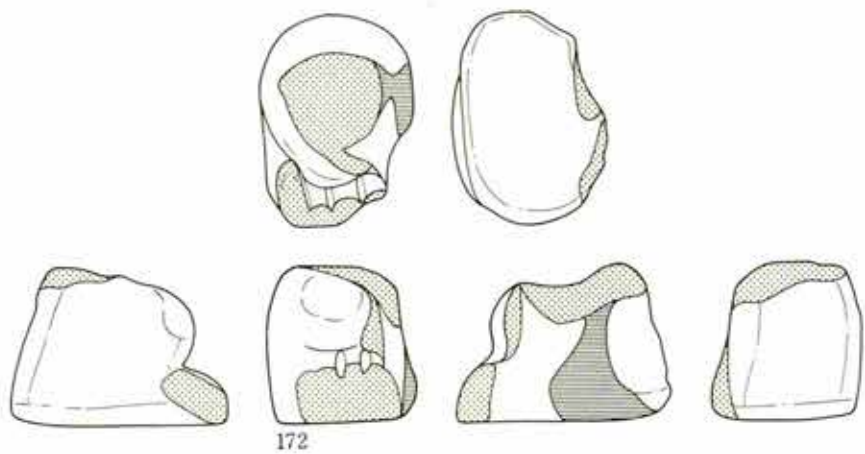

第 616 图 积迦堂 N-IV 区 土偶 (28)

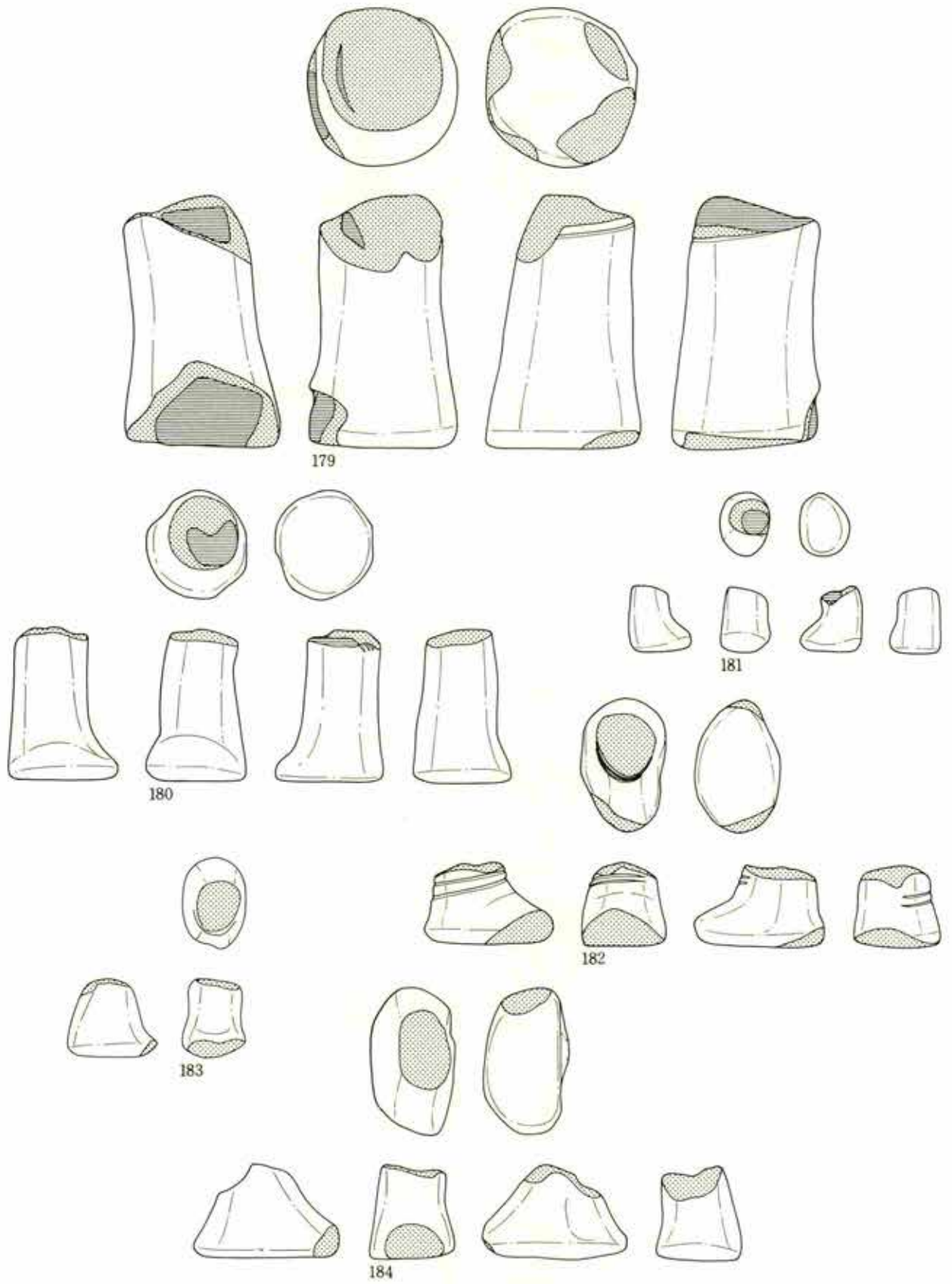

第 617 图 积逊堂 N—IV 区 土偶 (29)

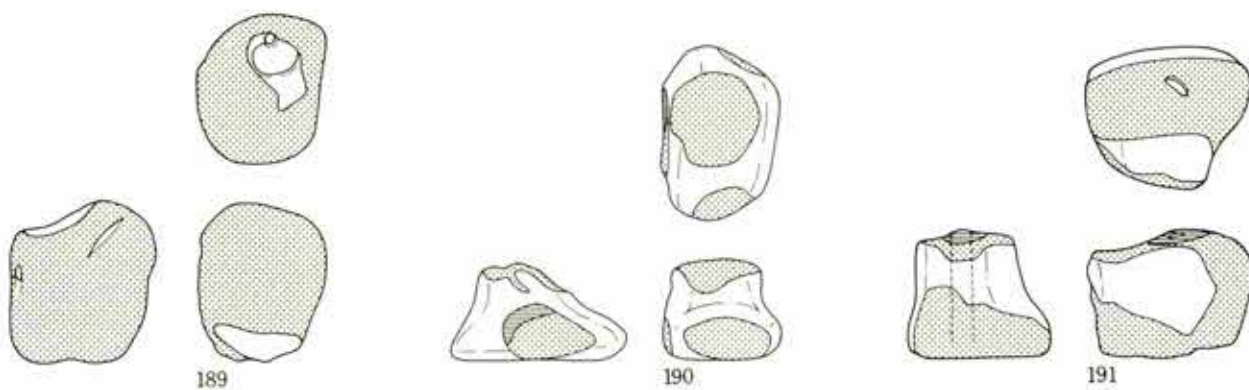
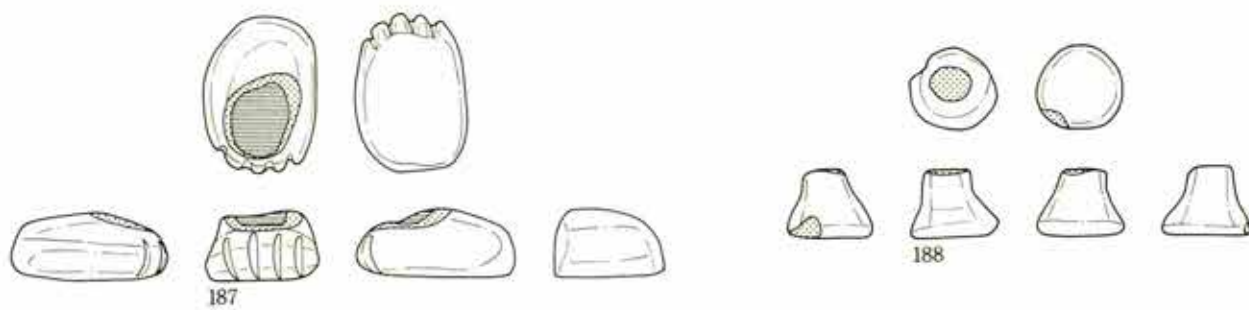
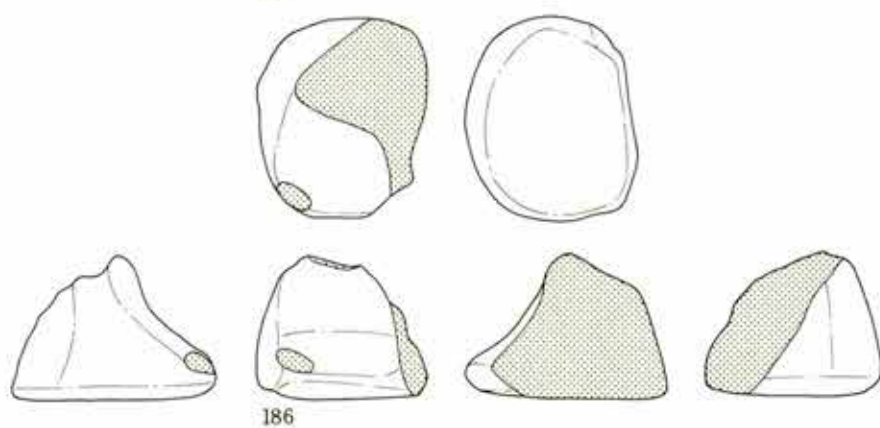
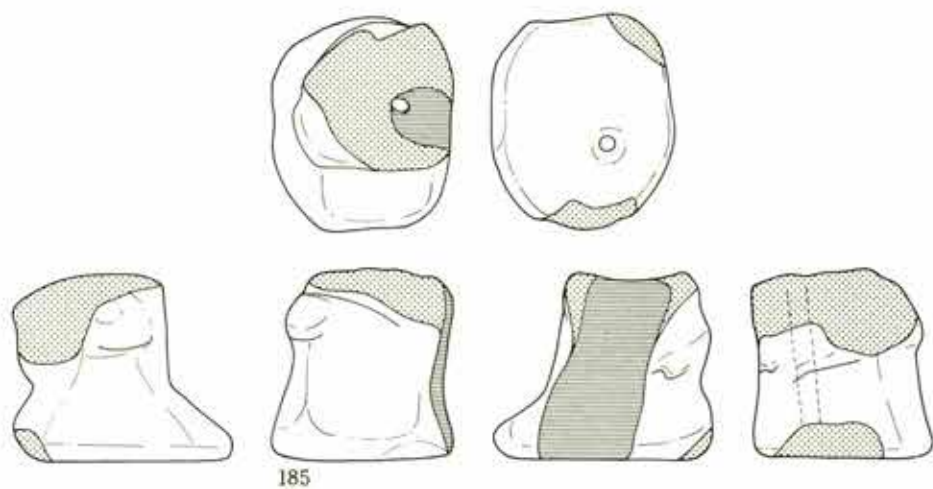

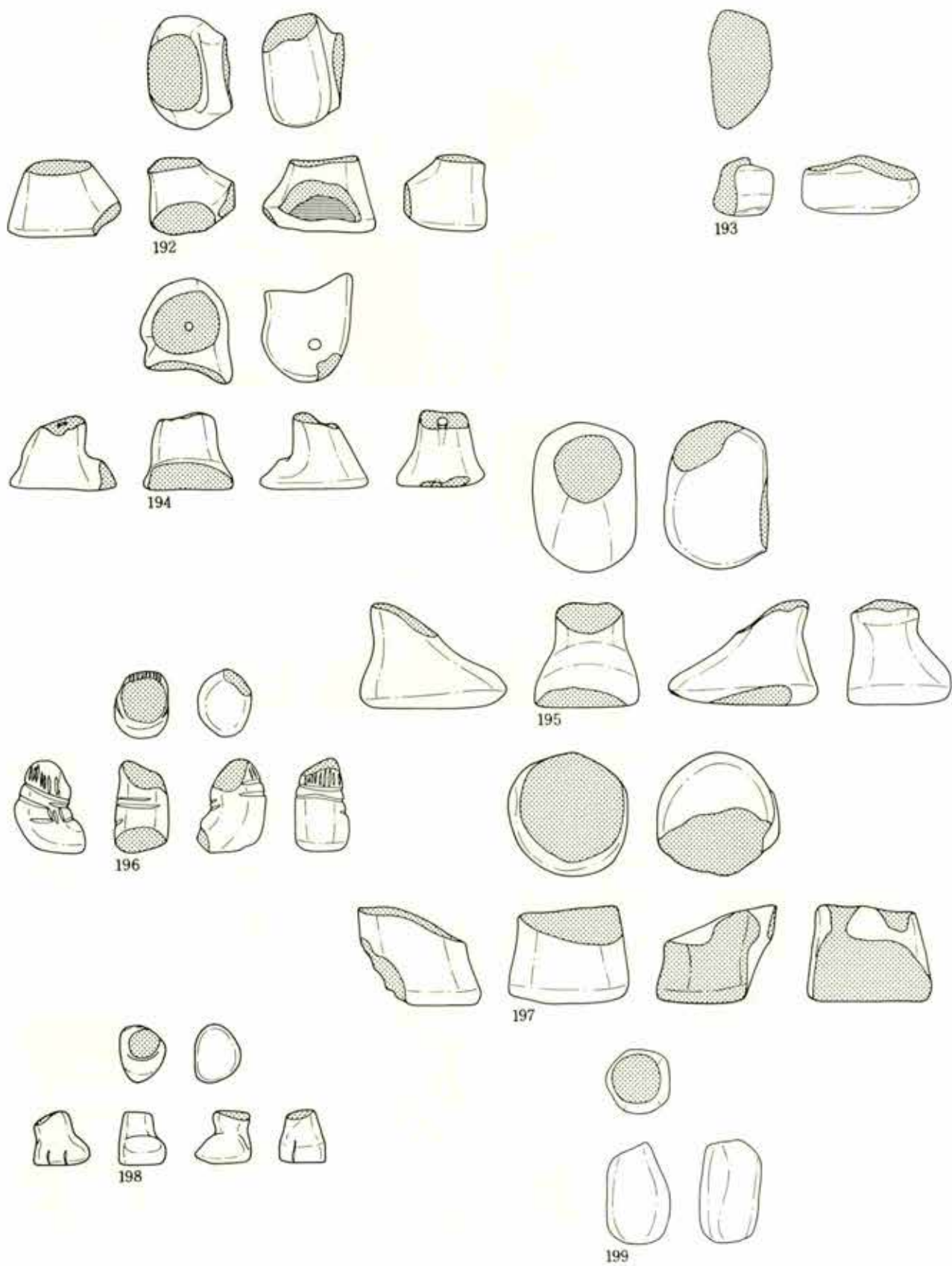

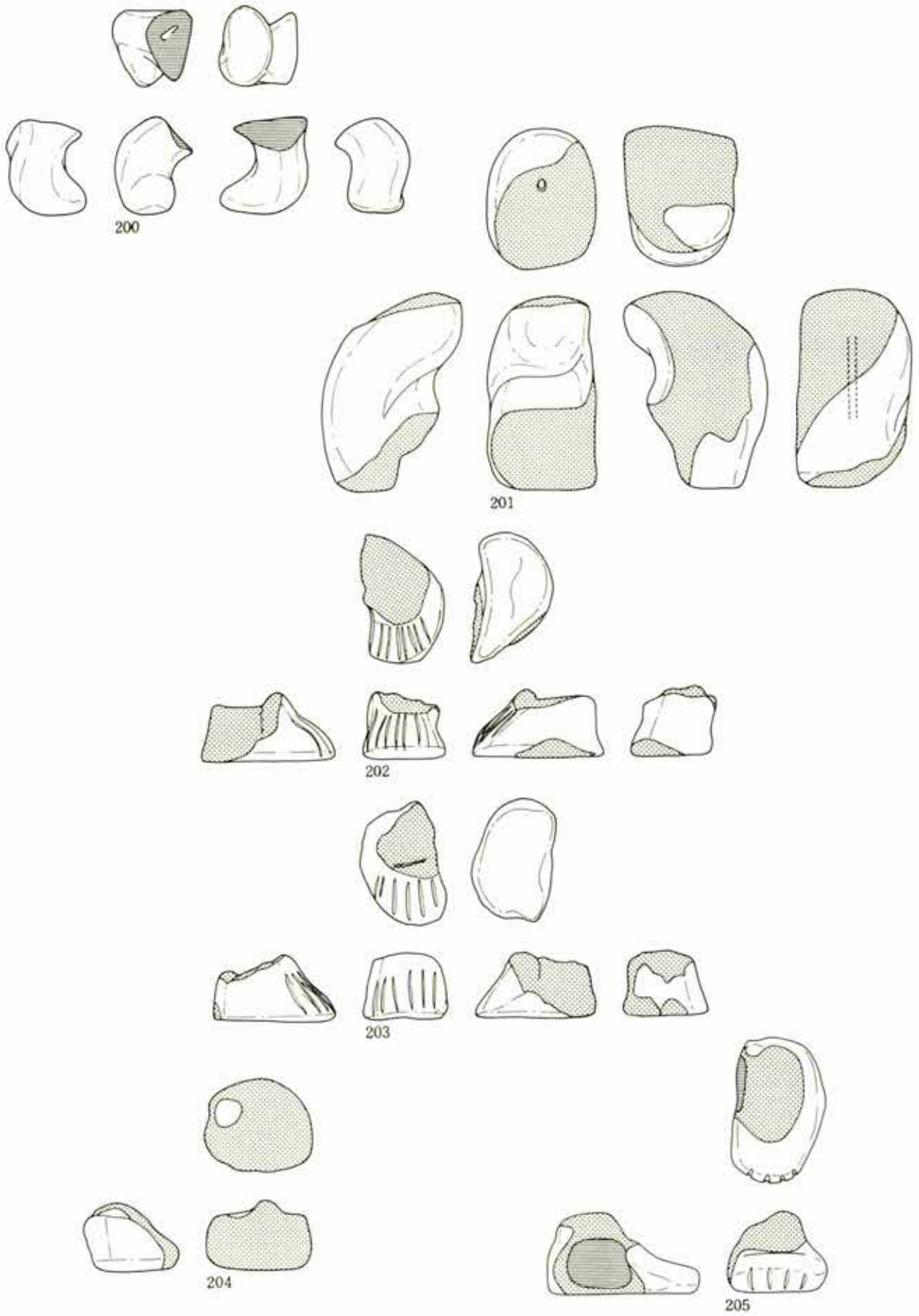

第 620 图 积迦堂 N-IV 区 土偶 (32)

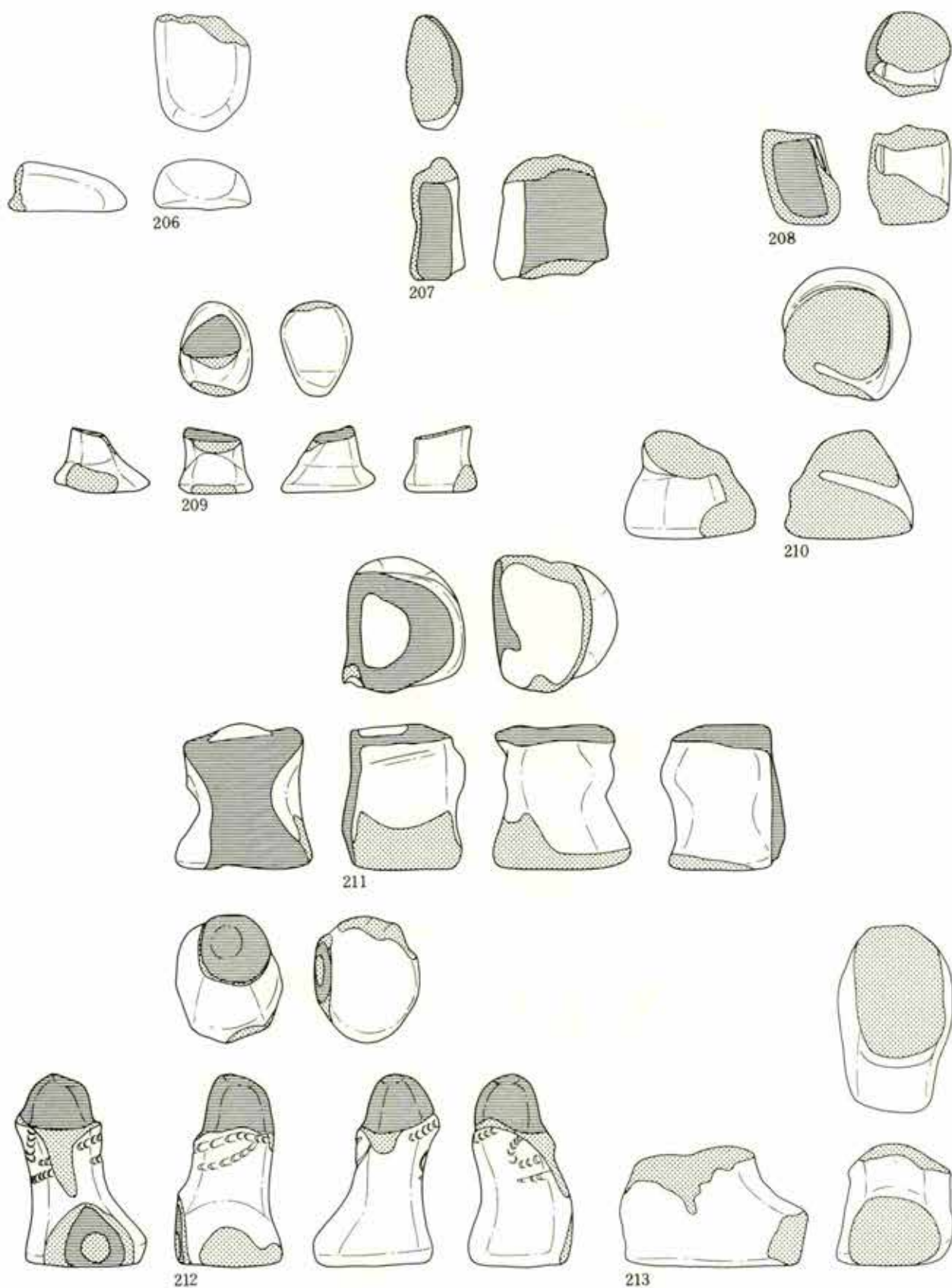

第 621 图 积逊堂 N-IV 区 土偶 (33)

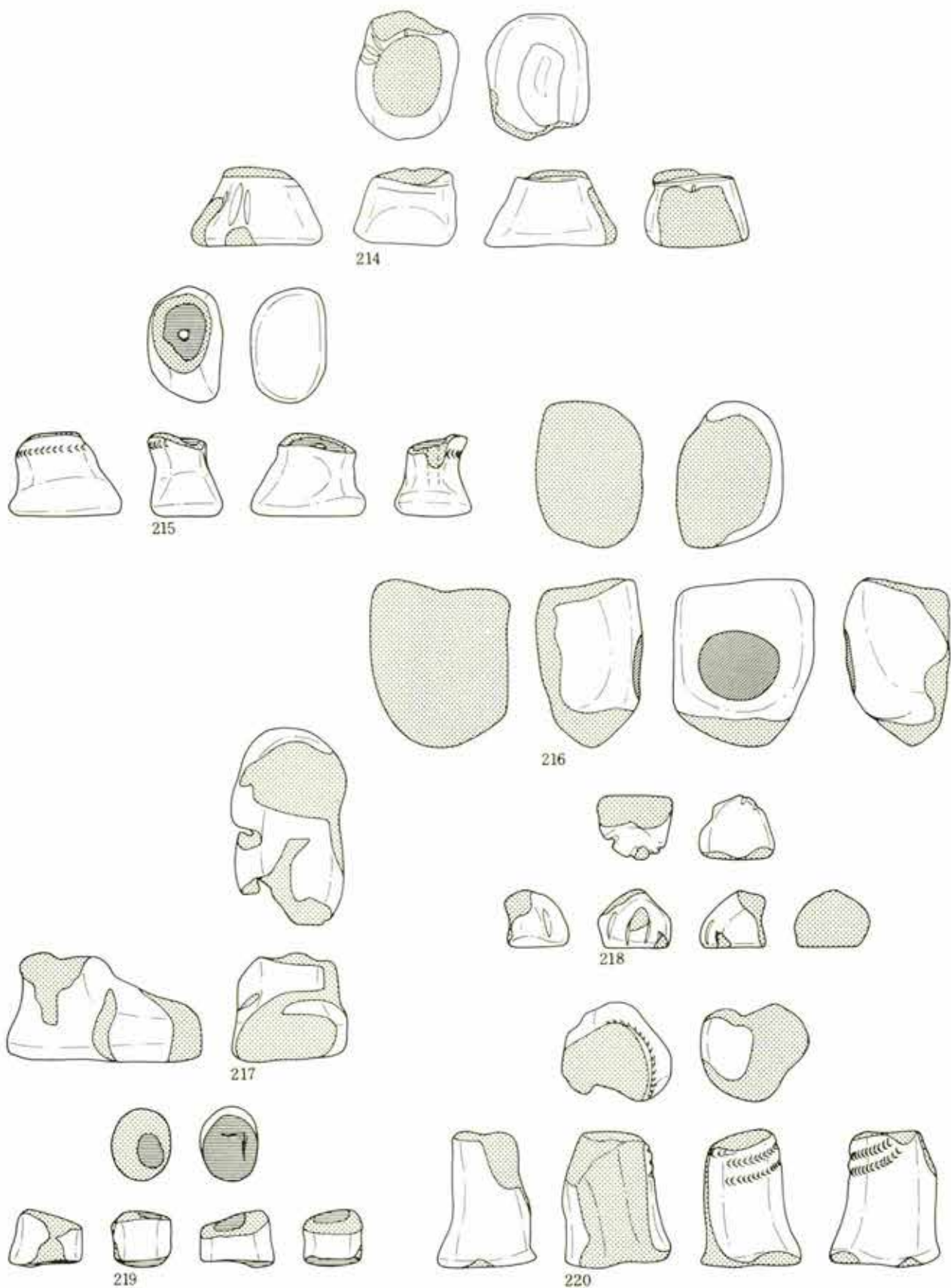

第 622 图 积逊堂 N—IV 区 土偶 (34)

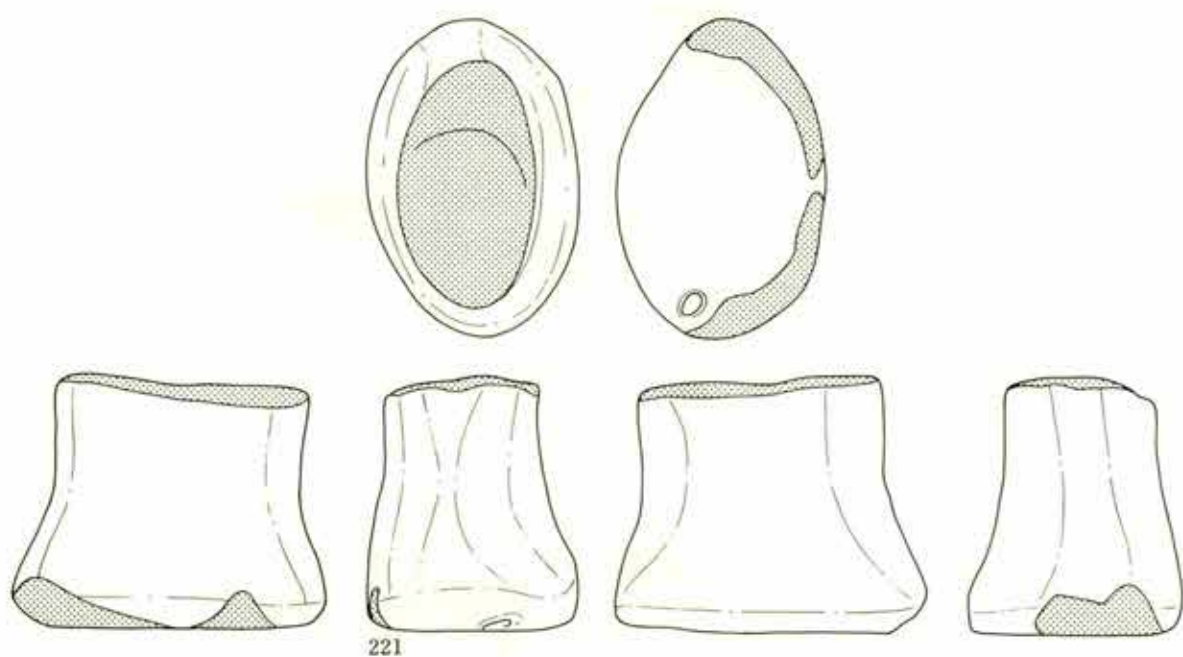

221

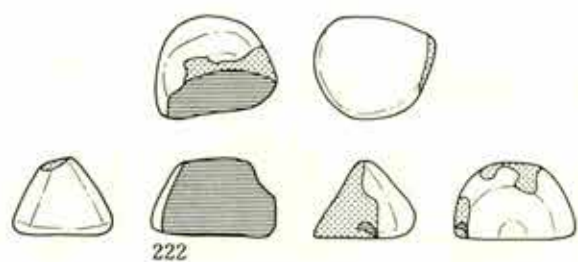

222

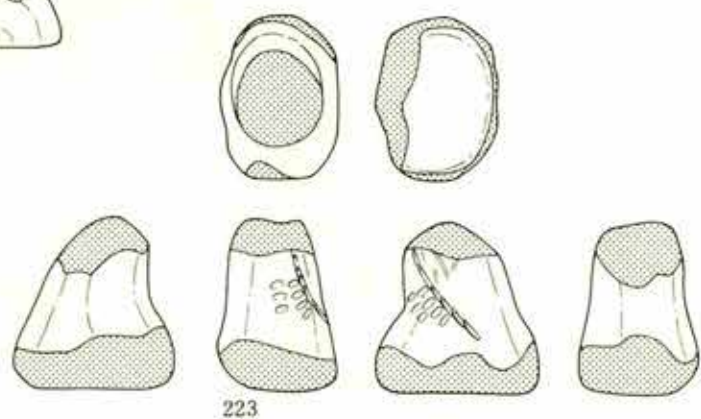

223

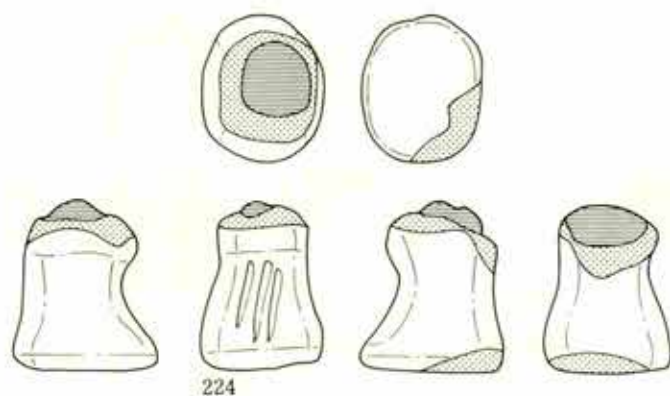

224

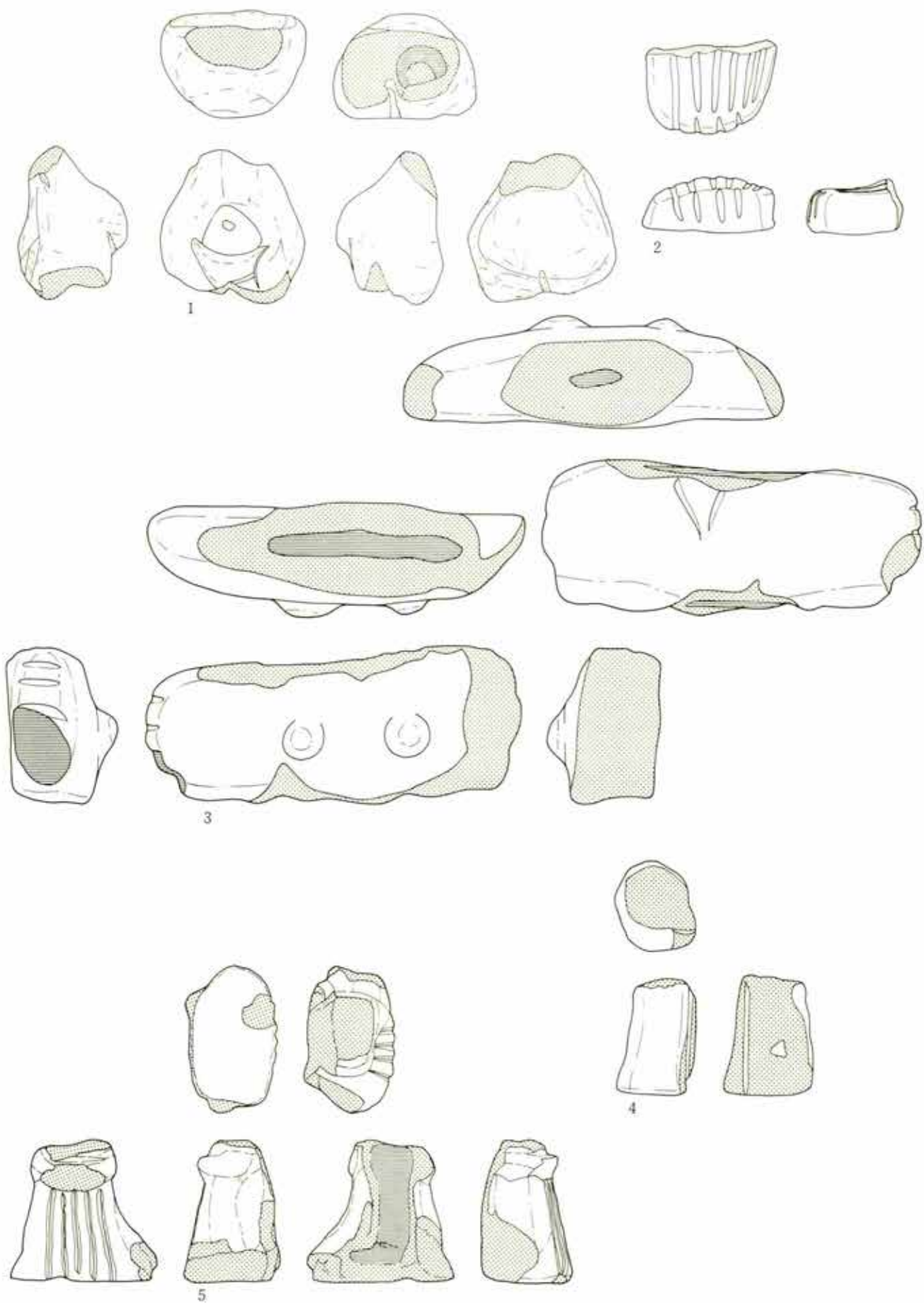

第 624 图 积逊堂 S—II 区 S—V 区 土偶



第 625 图 积逊堂 S-III 区 S-IV 区 N-III 区 N-IV 区

土偶

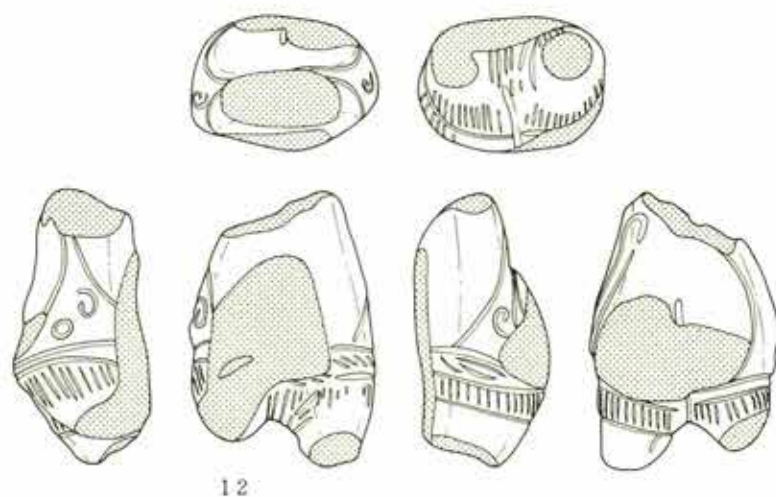
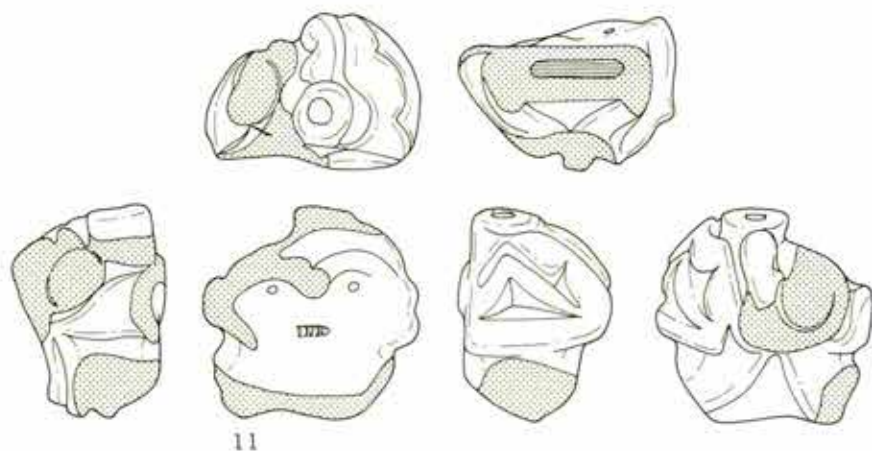
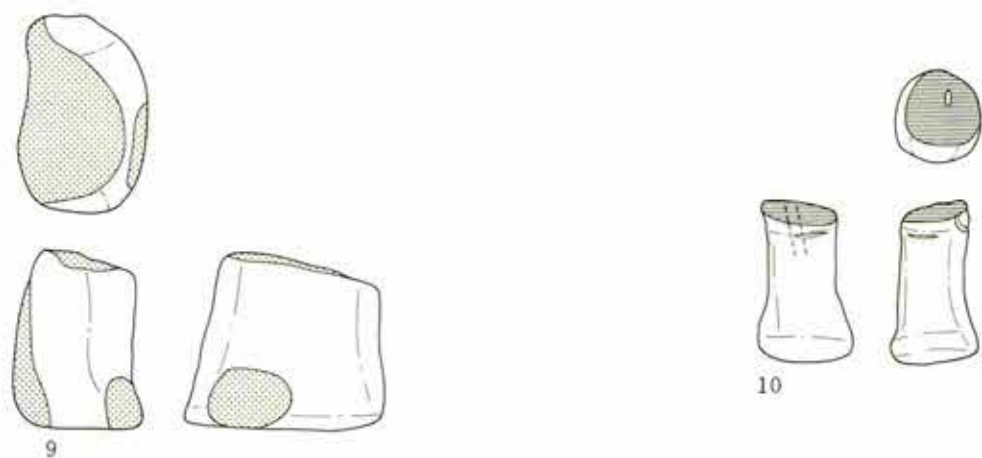

第626图 积逊堂S-III区S-IV区N-III区N-IV区

土偶



第627图 积迦堂N-IV区 土製円盤

(1)

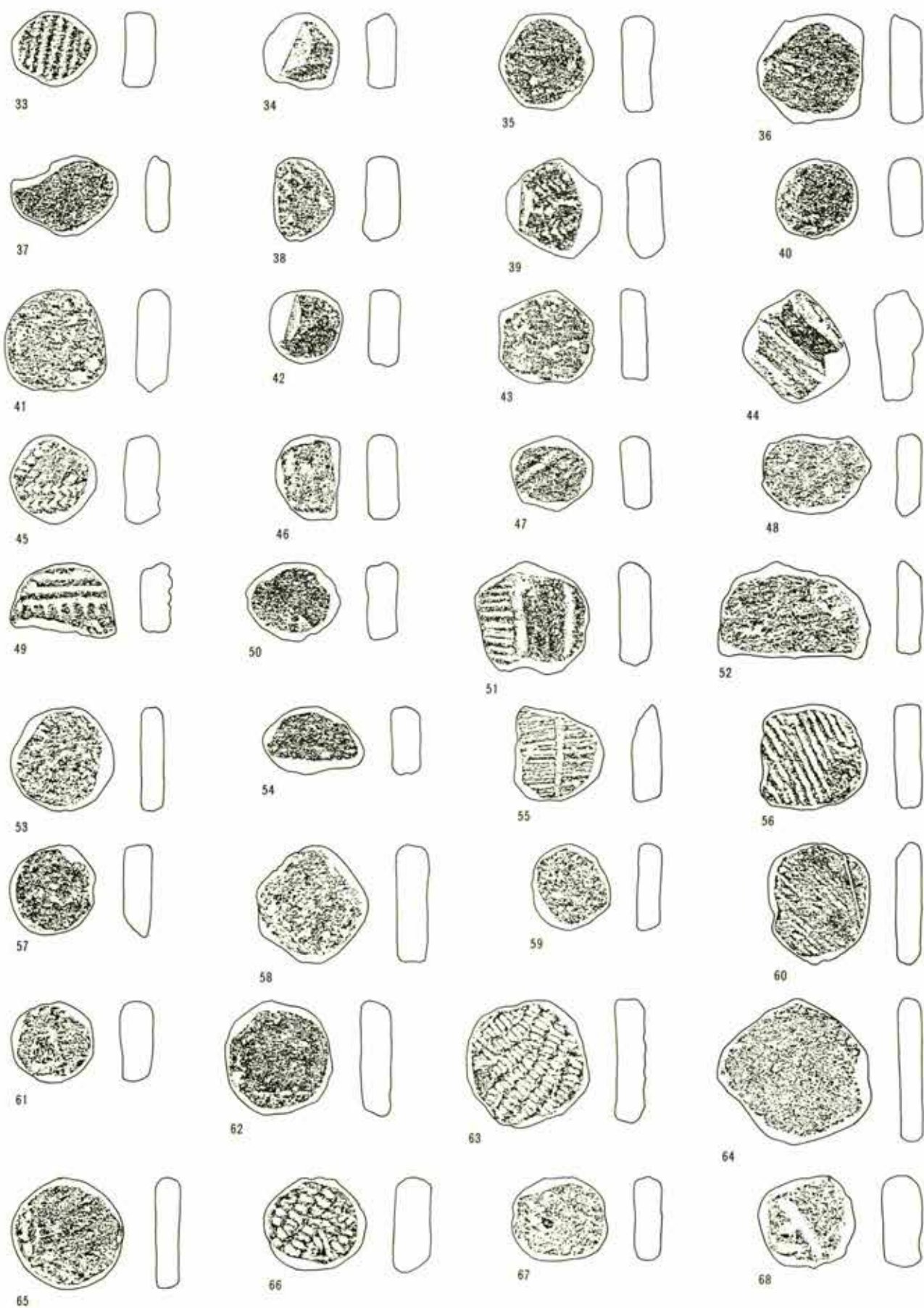

第 628 图 积逊堂 N—IV 区 土製円盤

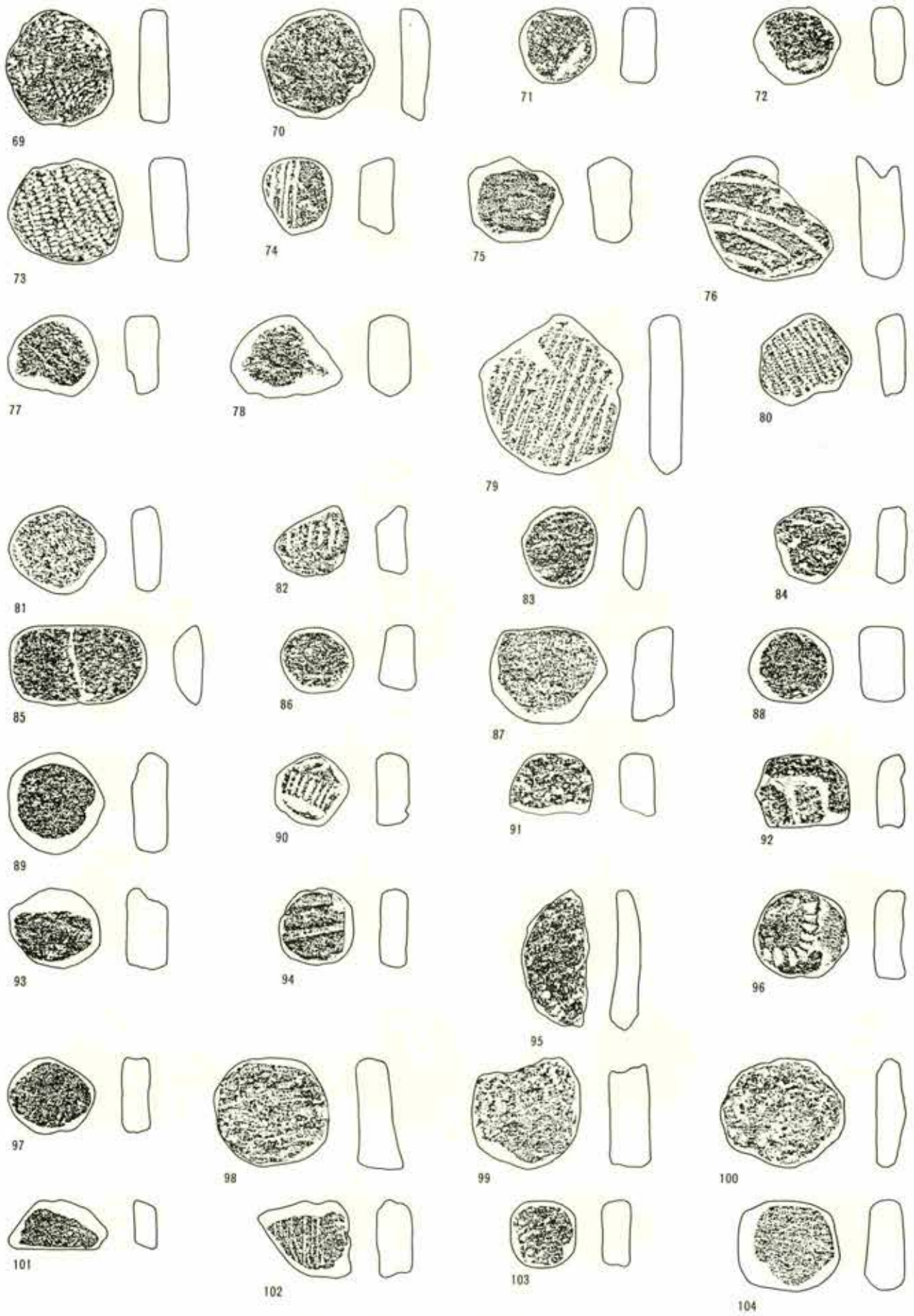

第 629 图 积逊堂 N-IV 区 土製円盤

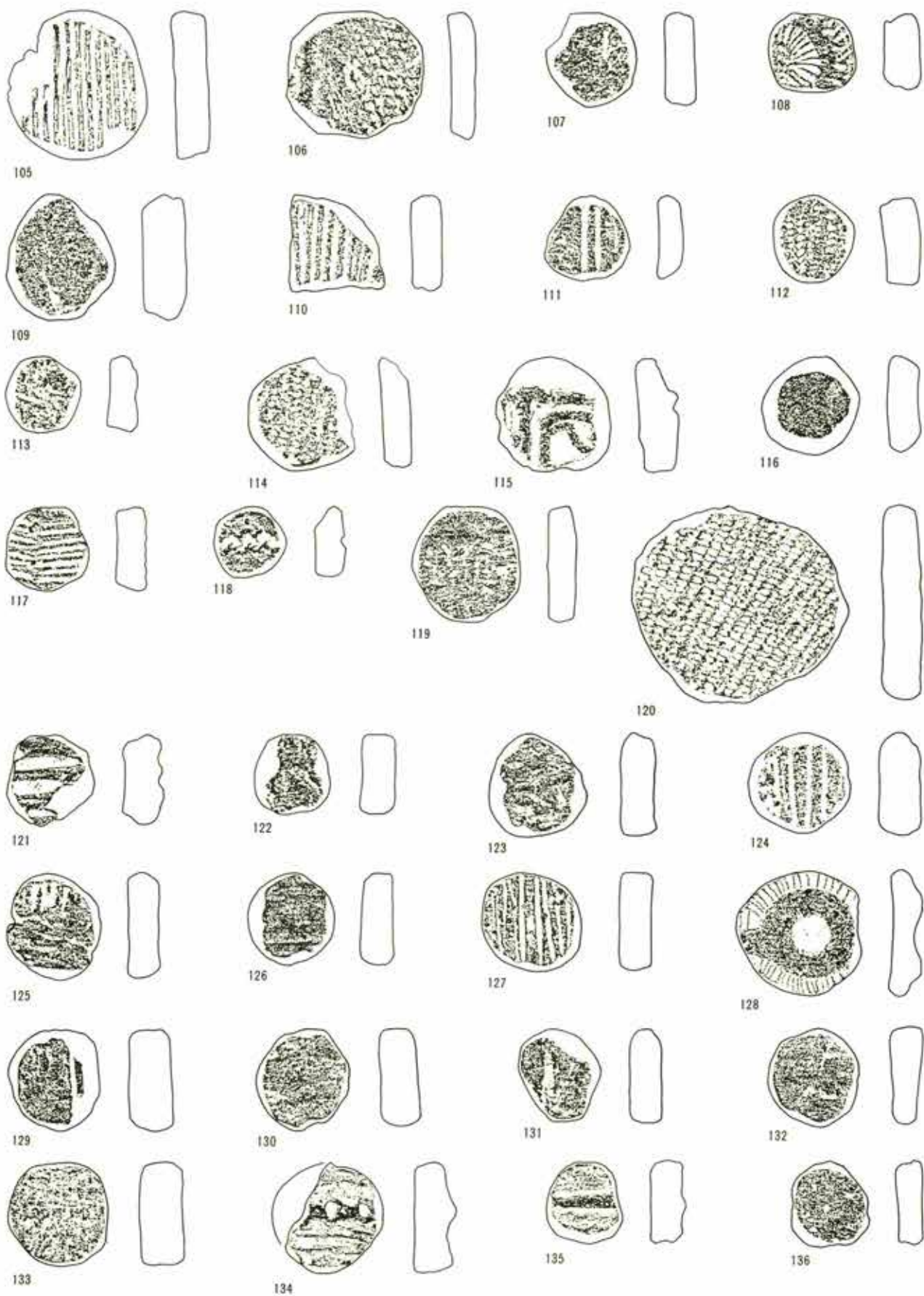

第 630 图 积迦堂 N—IV 区 土製円盤

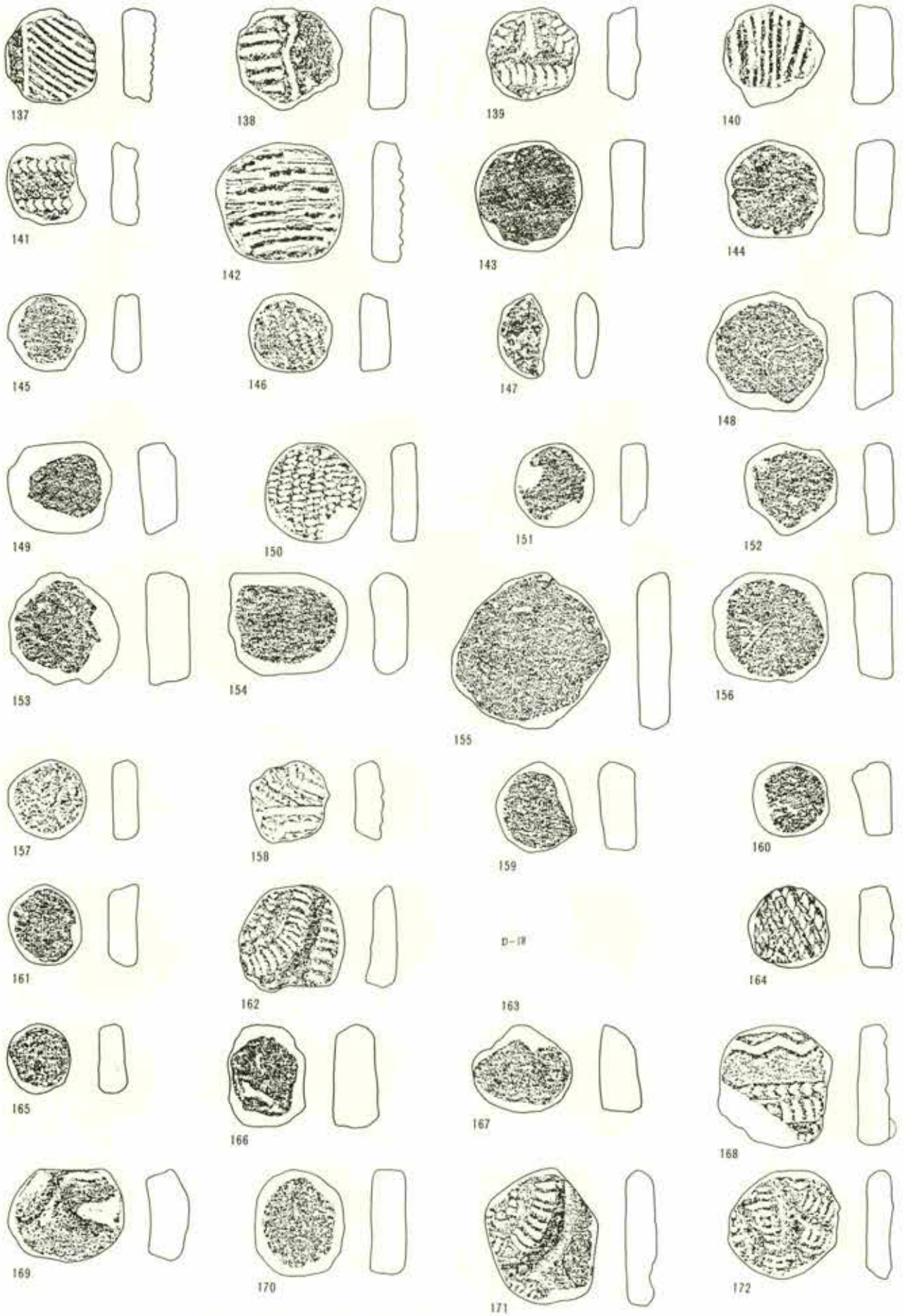

第 631 图 积逊堂 N—IV 区 土製円盤

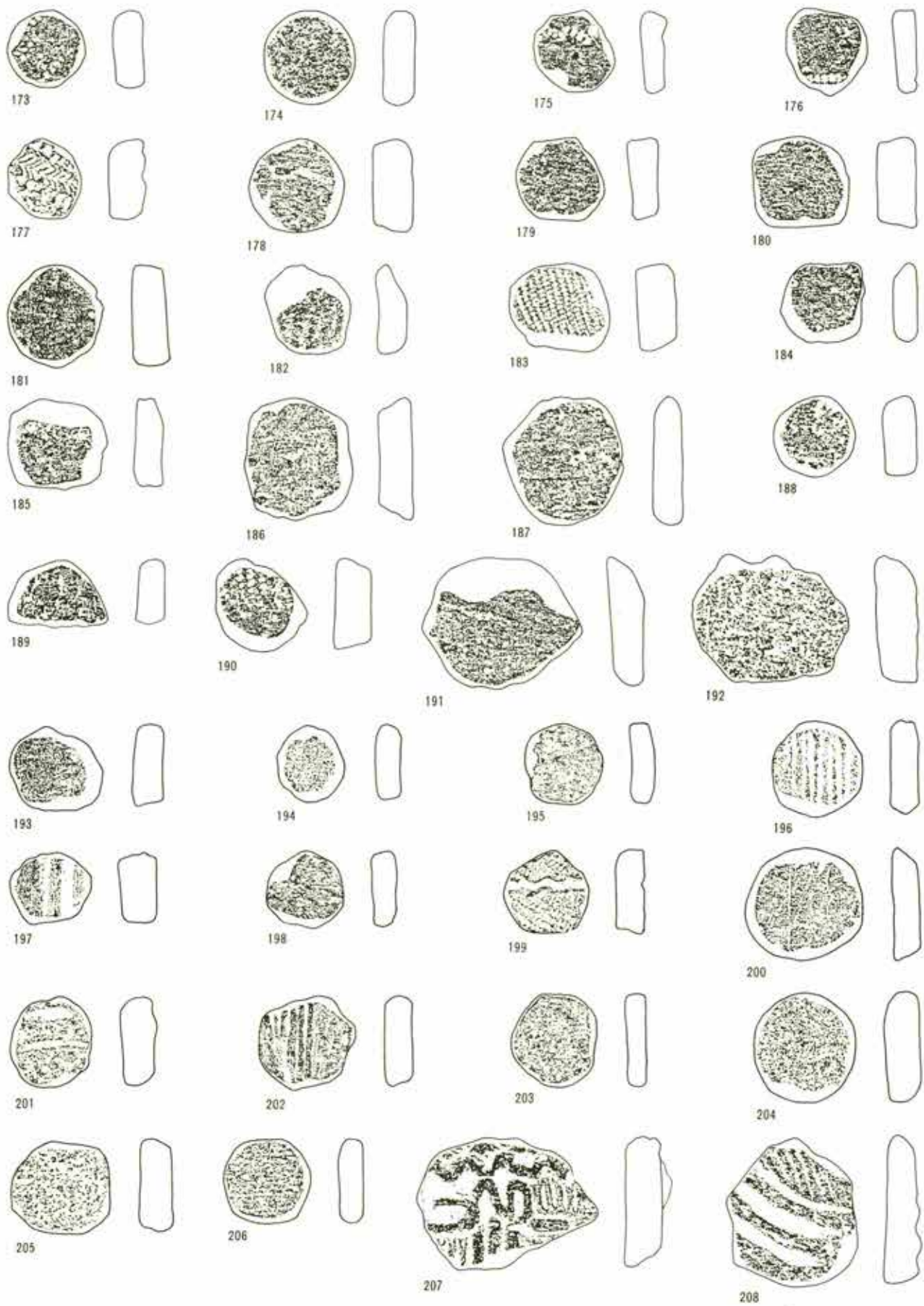

第 632 图 积逊堂 N-IV 区 土製円盤

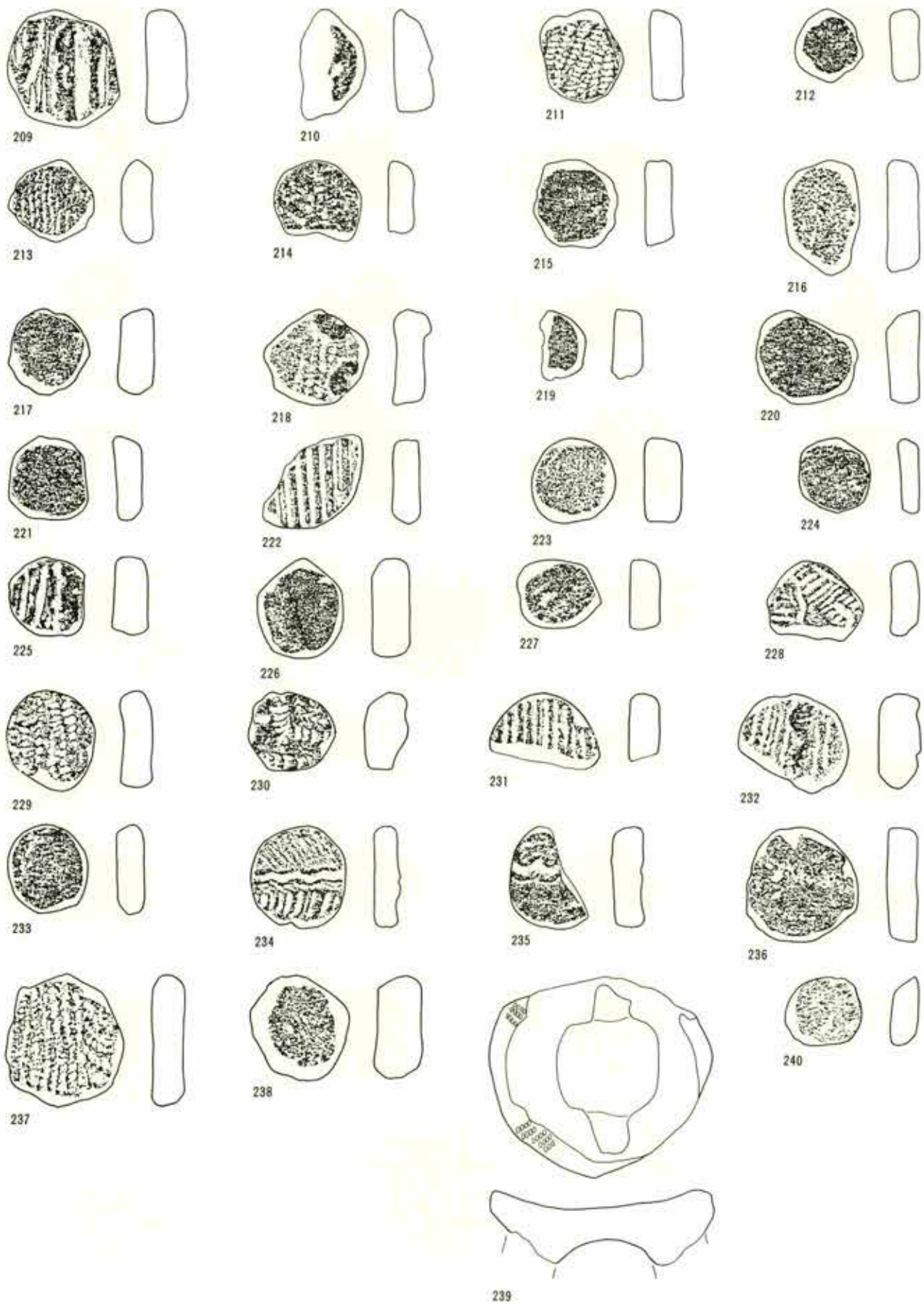

第 633 图 积逊堂 N—IV 区 土製円盤



第 634 图 积迦堂N—IV区 土製円盤

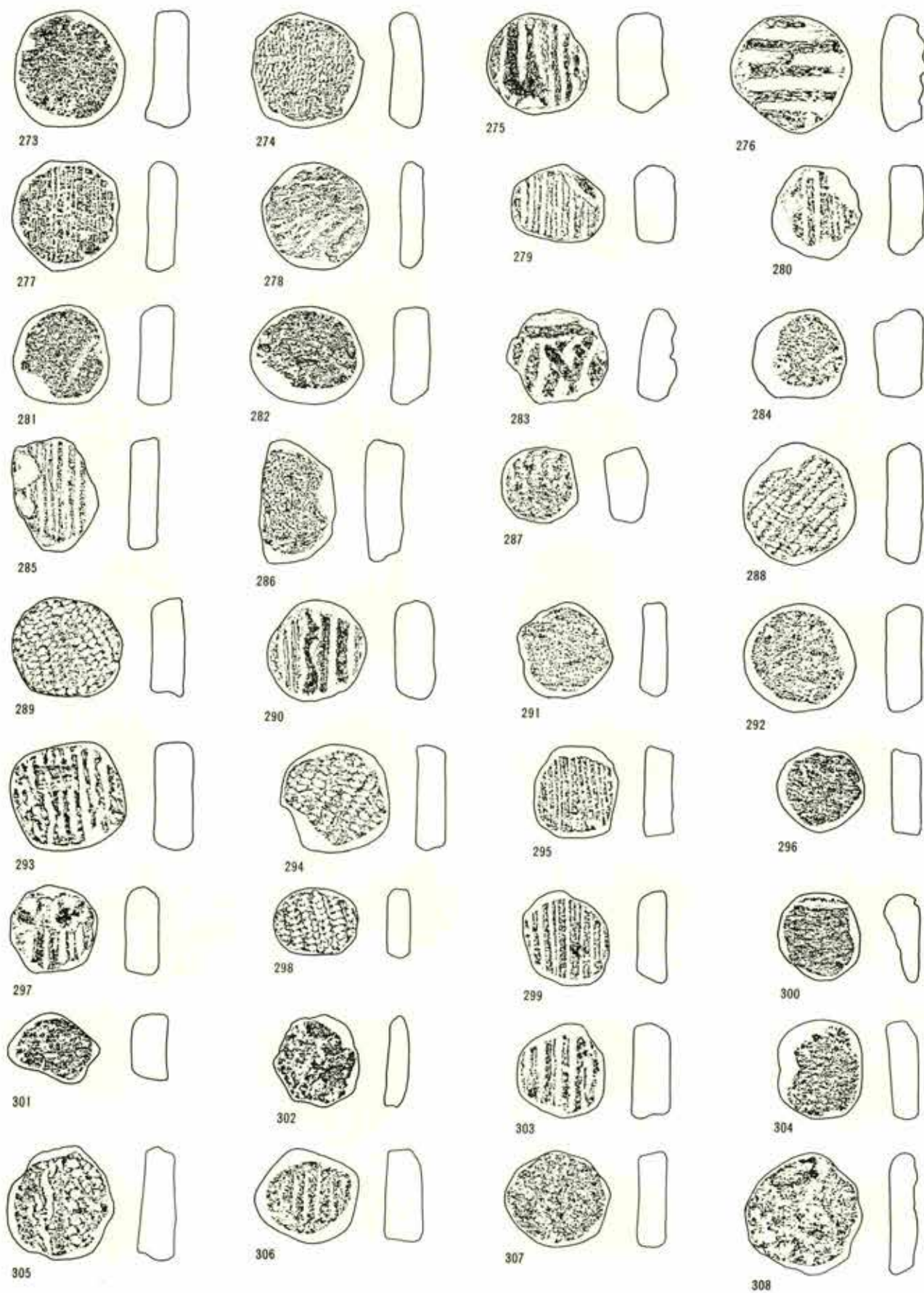

第635图 积逊堂N-IV区 土製円盤



第 636 图 积逊堂 N—IV 区 土製円盤

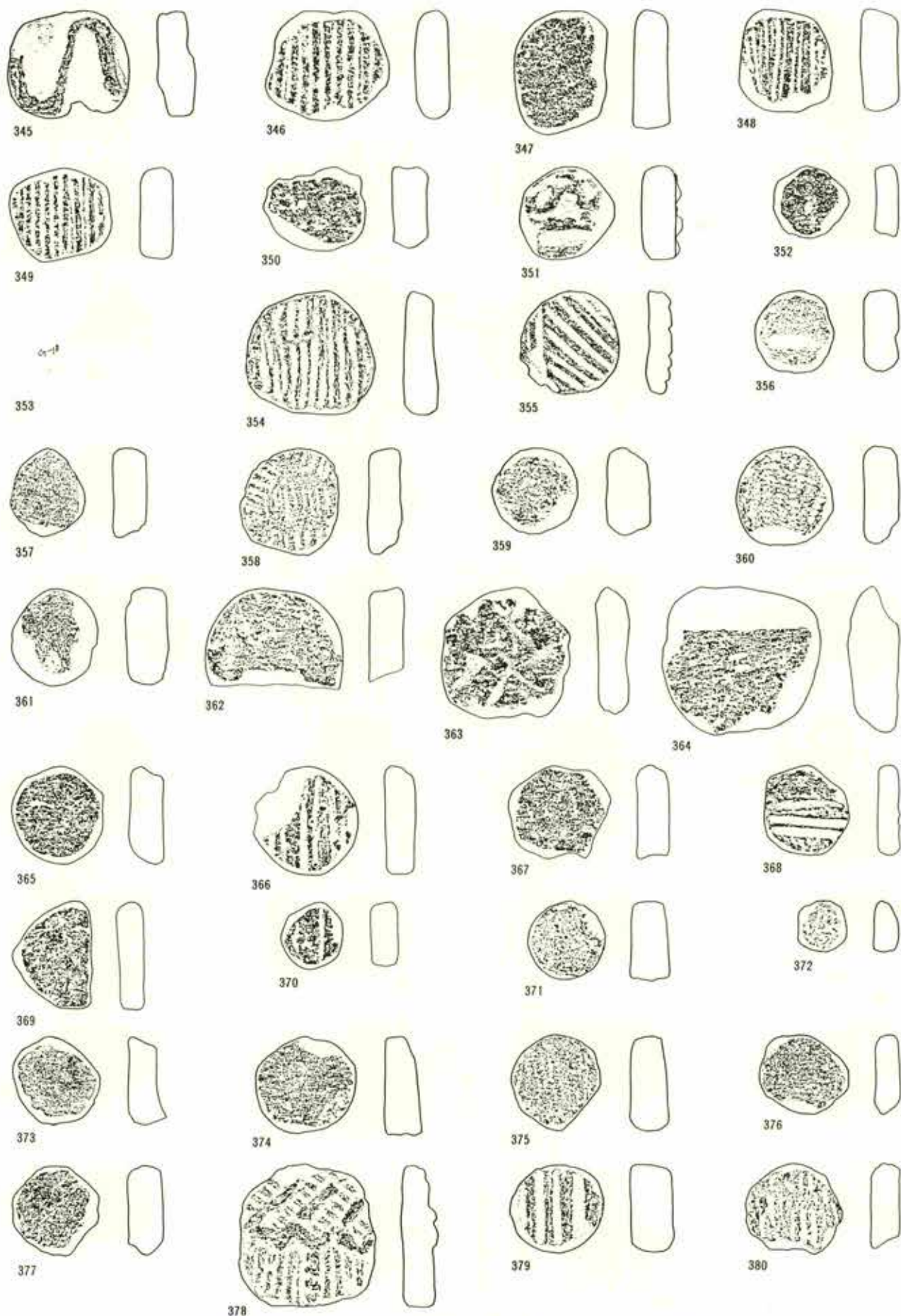

第637图 积逊堂N—IV区 土质丹钱

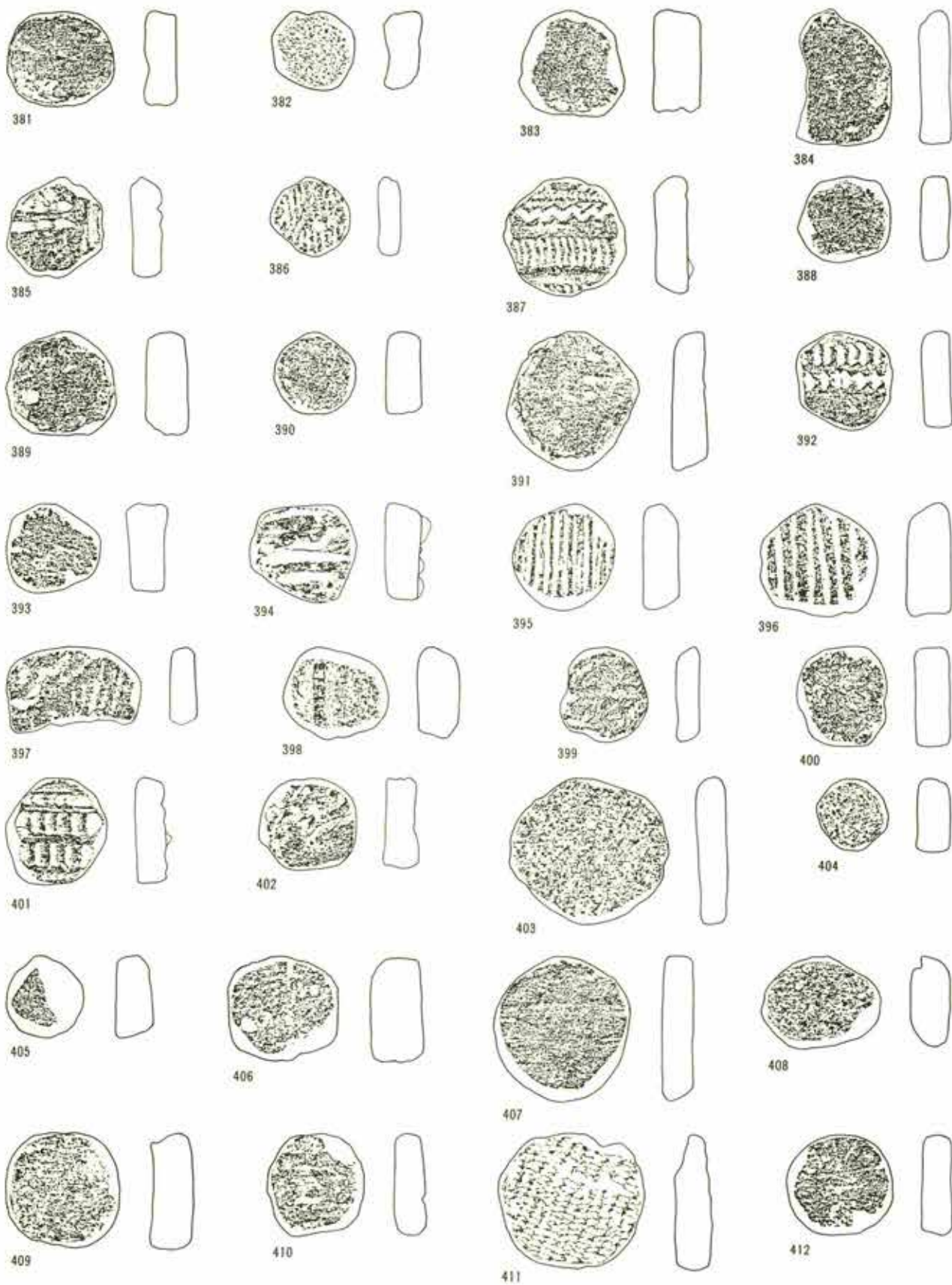

第 638 图 积迥堂 N-IV 区 土製円盤

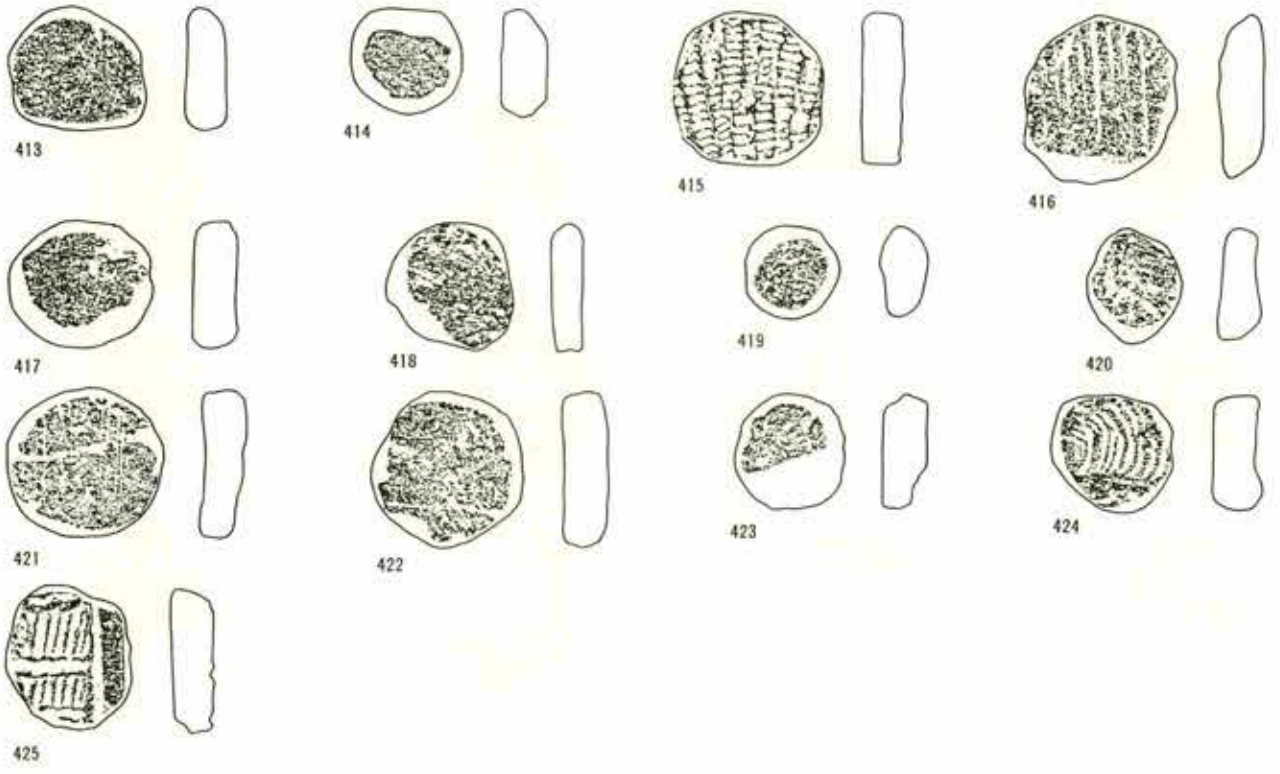

第 639 图 积迦堂 N—IV 区 土製円盤



第 640 図 釈迦堂 S-III 区 土器すてば A

0 4 m

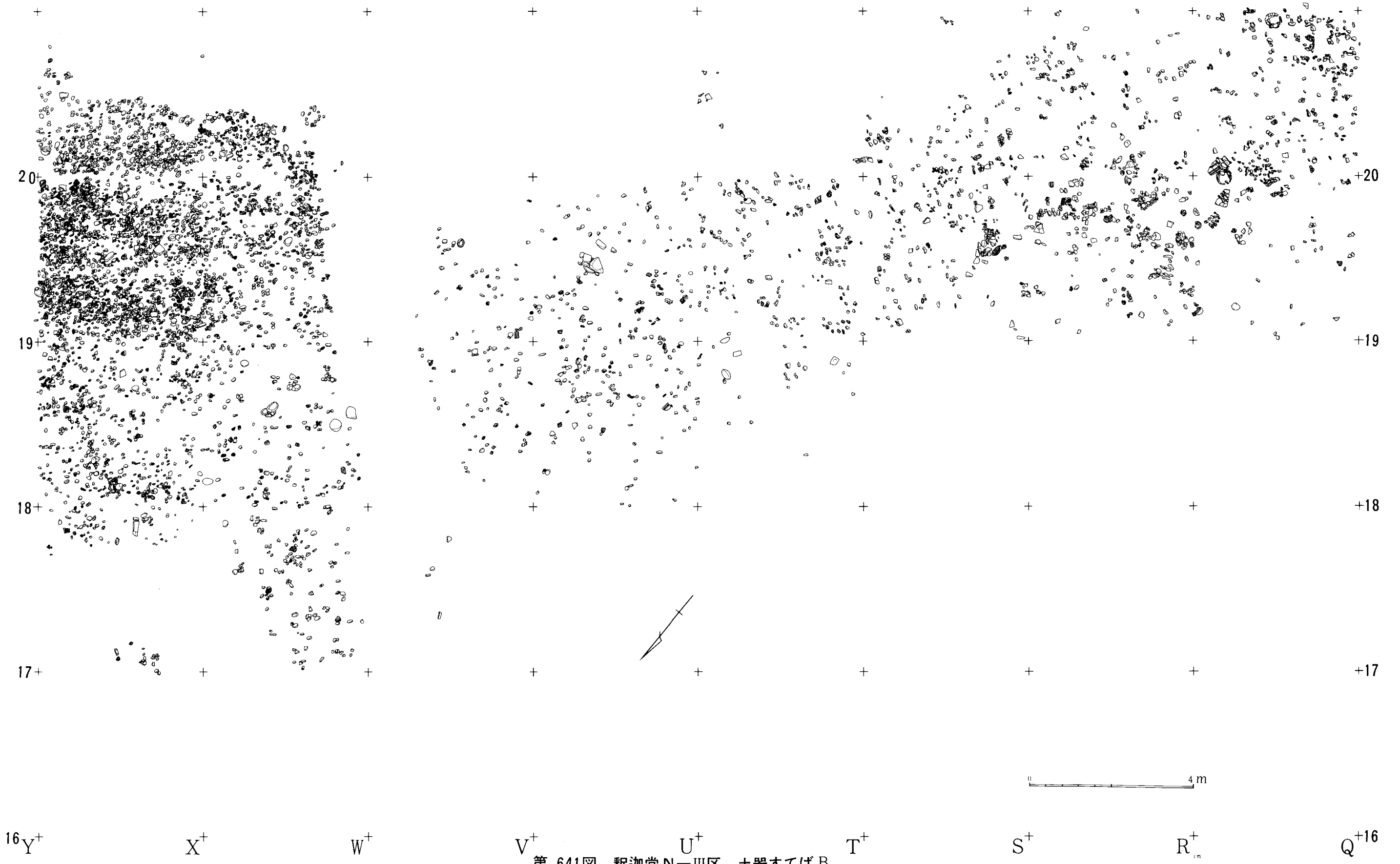

第 641 図 釈迦堂 N-III 区 土器すてば B

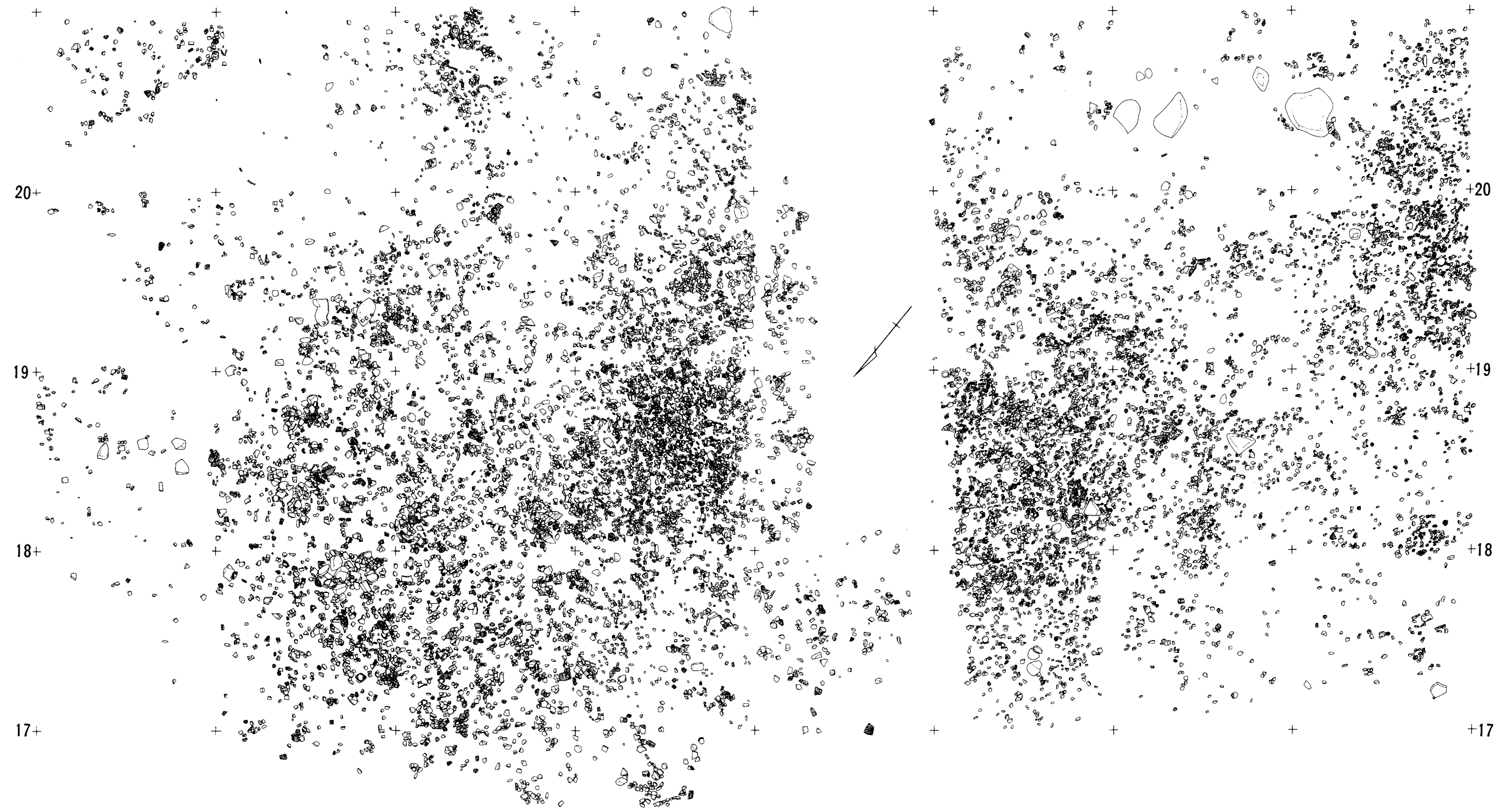

$16H^+$ G^+ F^+ E^+ D^+ C^+ B^+ A^+ Y^{16}
 N-IV区 N-III区

第 642 図 积迦堂N-IV区 土器すてば B

0 4m

山梨県埋蔵文化財センター調査報告書

釈迦堂 II

山梨県東山梨郡勝沼町三口神平地区

印刷 1987. 3. 25

発行 1987. 3. 30

山梨県中央自動車道
埋蔵文化財包蔵地発掘調査報告書

発行 山梨県教育委員会

日本道路公団

印刷所 合資会社 ヨネヤ印刷

