

# 上信越自動車道

## 埋蔵文化財発掘調査報告書 19

—小諸市内 3—

三子塚遺跡群 三田原遺跡群 岩下遺跡 石神遺跡群  
郷土遺跡 東丸山遺跡 西丸山遺跡 深沢遺跡群

図 版 編

2000

日 本 道 路 公 団  
長 野 県 教 育 委 員 会  
長 野 県 埋 蔵 文 化 財 セ ン タ ー

# 上信越自動車道

## 埋蔵文化財発掘調査報告書 19

—小諸市内 3—

三子塚遺跡群 三田原遺跡群 岩下遺跡 石神遺跡群  
郷土遺跡 東丸山遺跡 西丸山遺跡 深沢遺跡群

図 版 編

2000

日 本 道 路 公 団  
長 野 県 教 育 委 員 会  
長 野 県 埋 蔵 文 化 財 セ ン タ ー



## 例 言

- 1 本書は上信越自動車道建設工事及びそれに関連する小諸市道拡幅工事に伴い発掘調査された小諸市内に所在する8遺跡（三子塚遺跡群、三田原遺跡群、岩下遺跡、石神遺跡群、郷土遺跡、東丸山遺跡、西丸山遺跡、深沢遺跡群）の発掘調査報告書の図版編である。郷土遺跡の図版の一部と、各遺跡の写真図版を収録してある。
- 2 調査に至る経緯や結果については、本文編を併読願いたい。
- 3 遺物の展開写真は小川忠博氏に撮影していただいた。
- 4 航空写真は、(株)写真測図研究所に委託して撮影した。
- 5 本書の作成にかかる分担は下記の通りである  
桜井秀雄 郷土遺跡の図版、郷土遺跡と深沢遺跡群の写真図版作成  
宇賀神誠司 三子塚遺跡群、三田原遺跡群、岩下遺跡、石神遺跡群、東丸山遺跡、西丸山遺跡の写真図版作成  
贅田明 郷土遺跡の写真図版の一部作成  
田村彬 遺物写真撮影・現像・焼き付け  
西嶋力 同上
- 6 本書に掲載した遺物写真の縮尺は、原則として下記の通りである。  
小形土器1：4、大形土器1：6、土器破片1：3、小形石器1：2～1：3、大形石器1：6、

## 目 次

### 図版

郷土遺跡割付図の配置	図版	1
遺構割付図	図版	2～ 21
縄文中期の土坑	図版	22～ 78
出土土器	図版	79～210
出土石器	図版	211～276
出土土製品・石製品	図版	277～283
石器表		1～ 5

### 写真図版（P L）

三子塚遺跡群	P L	1～ 9
三田原遺跡群	P L	10～ 36
岩下遺跡	P L	37～ 65
石神遺跡群	P L	66～ 72
郷土遺跡	P L	73～226
東丸山遺跡	P L	227～232
西丸山遺跡	P L	233～234
深沢遺跡群	P L	235～236

# 実測図版

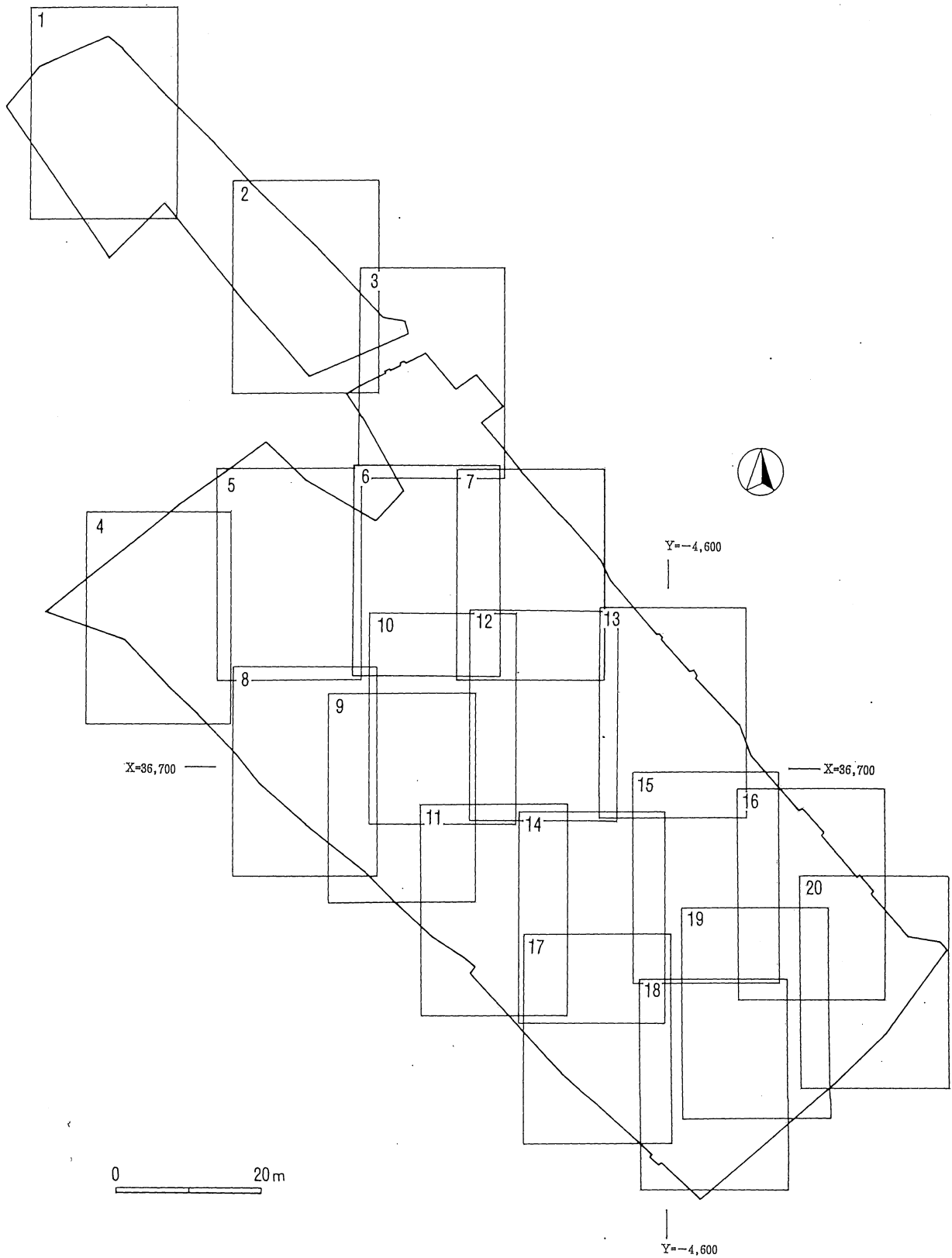

図版1 割付図の配置 1 : 800

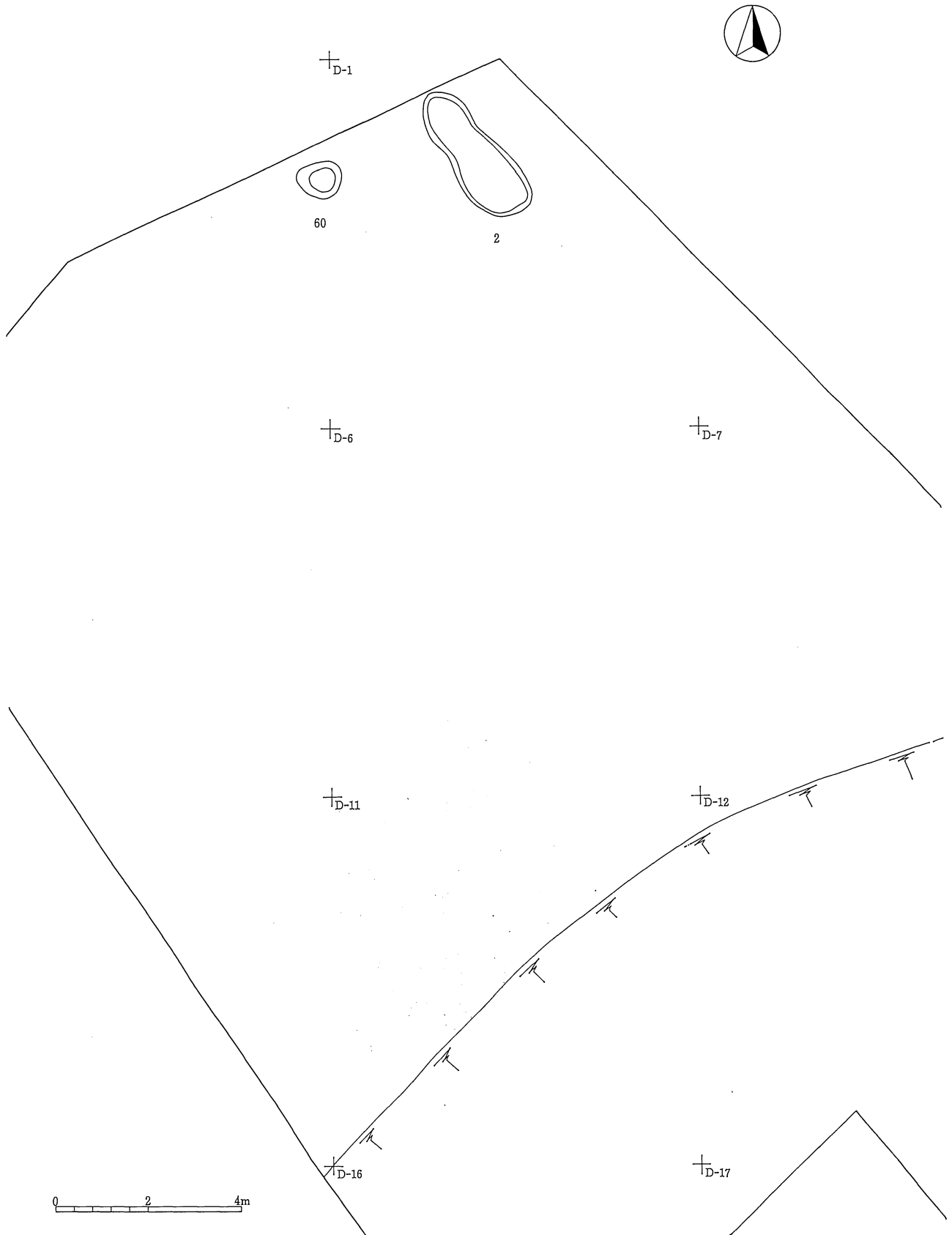

図版 2 遺構割付図(1) 1 : 120

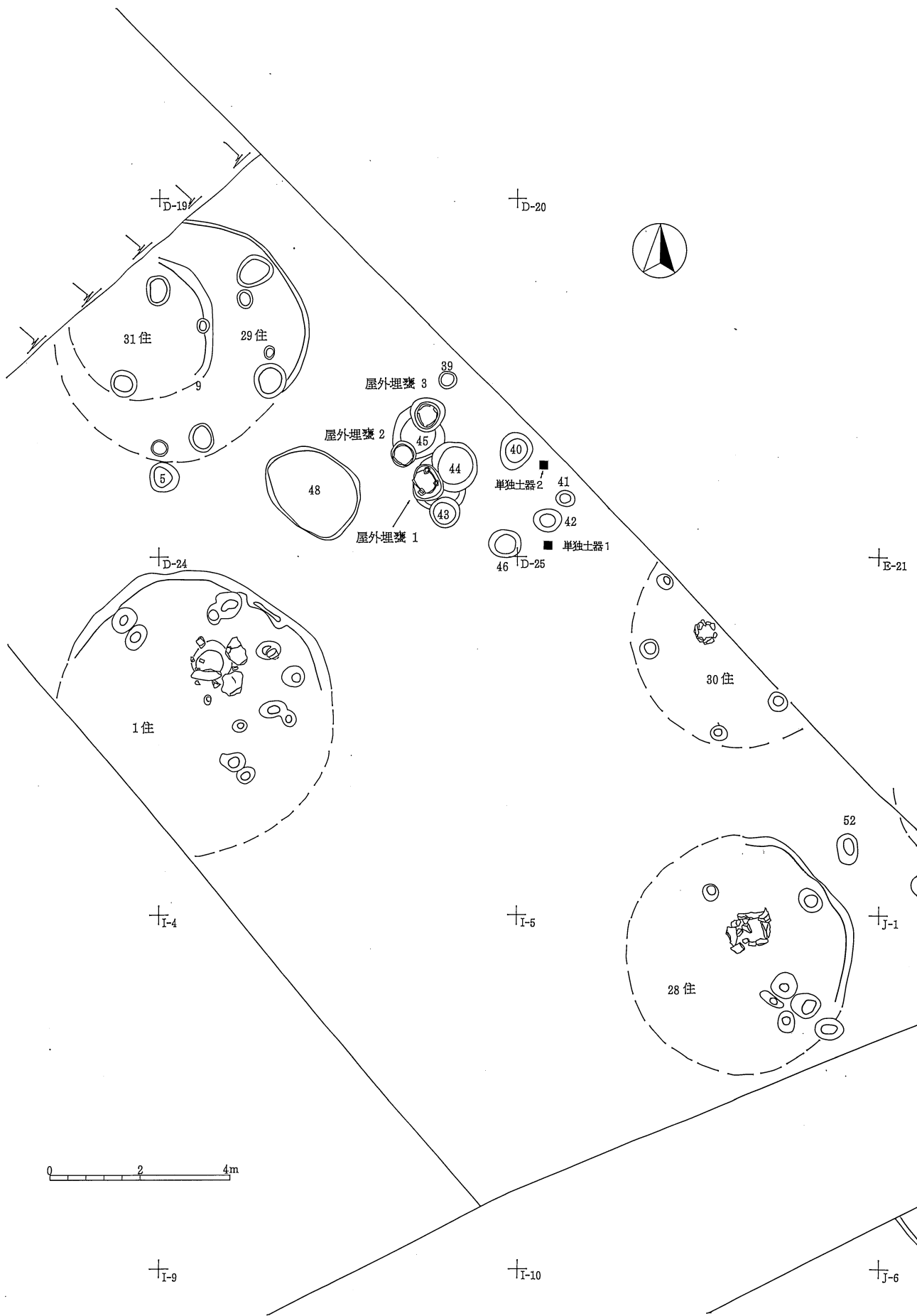

図版 3 遺構割付図(2) 1 : 120

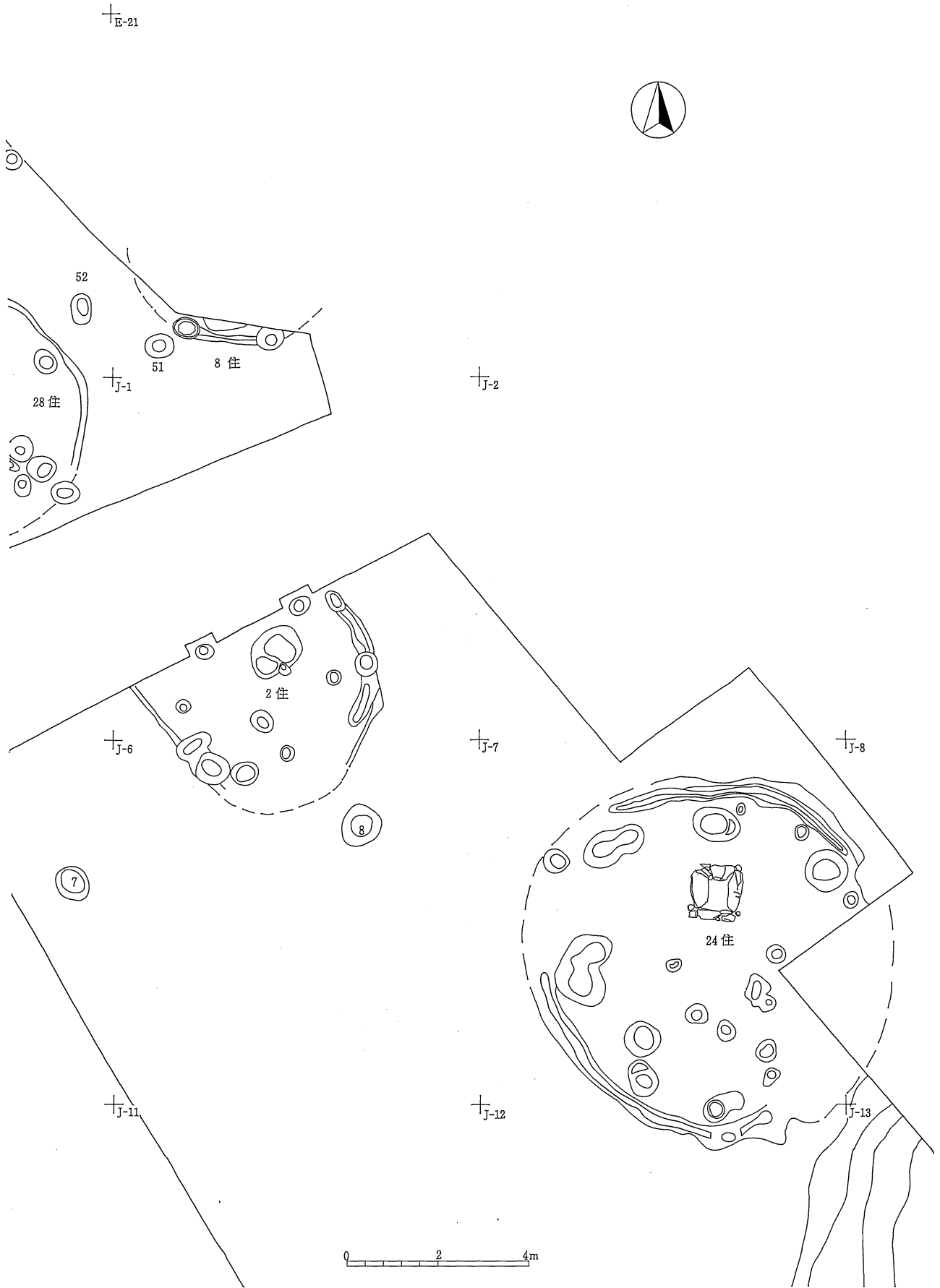

図版4 遺構割付図(3) 1:120

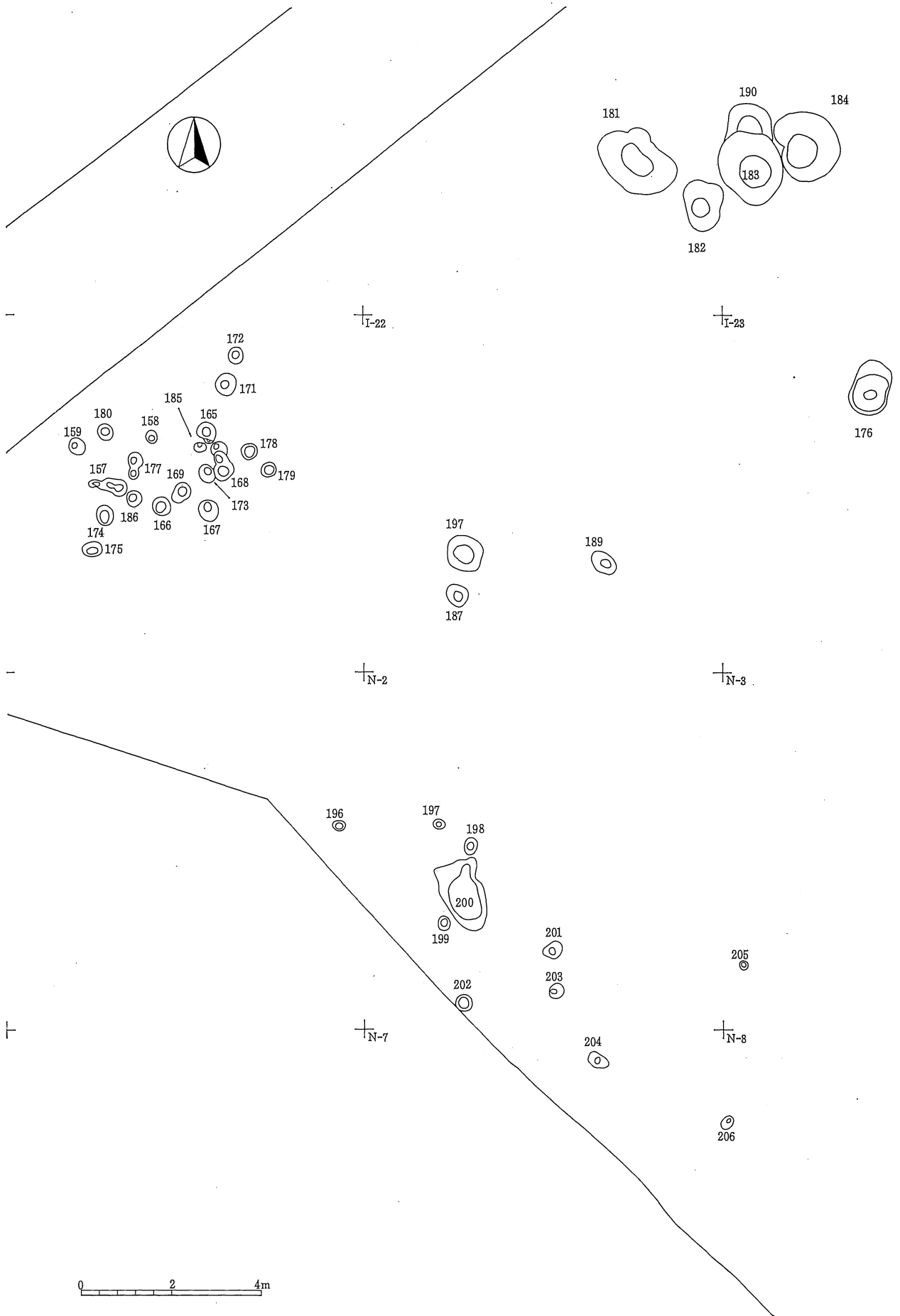

図版 5 遺構割付図(4) 1 : 120



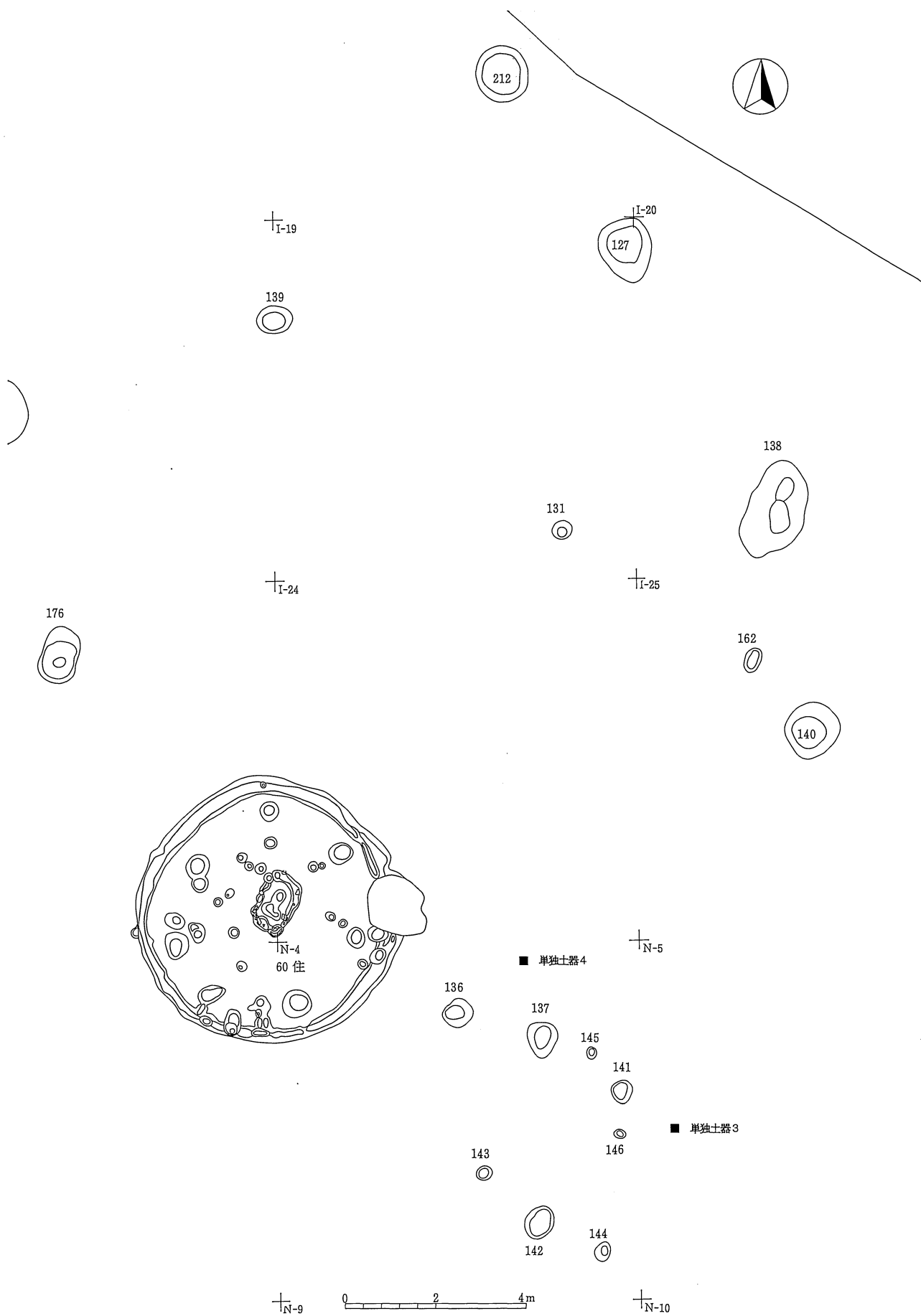

図版 6 遺構割付図(5) 1 : 120

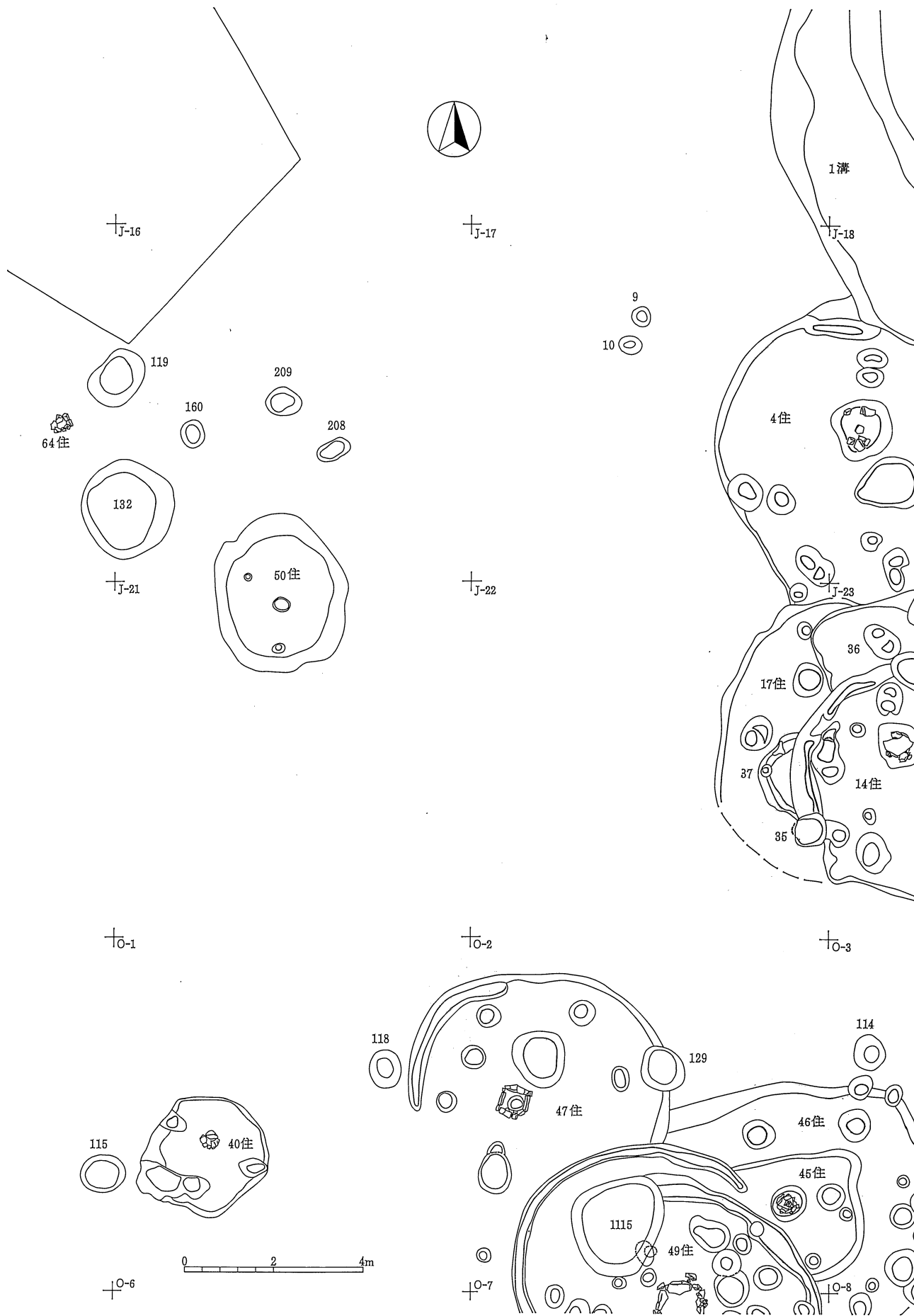

図版7 遺構割付図(6) 1 : 120



図版 8 遺構割付図(7) 1 : 120

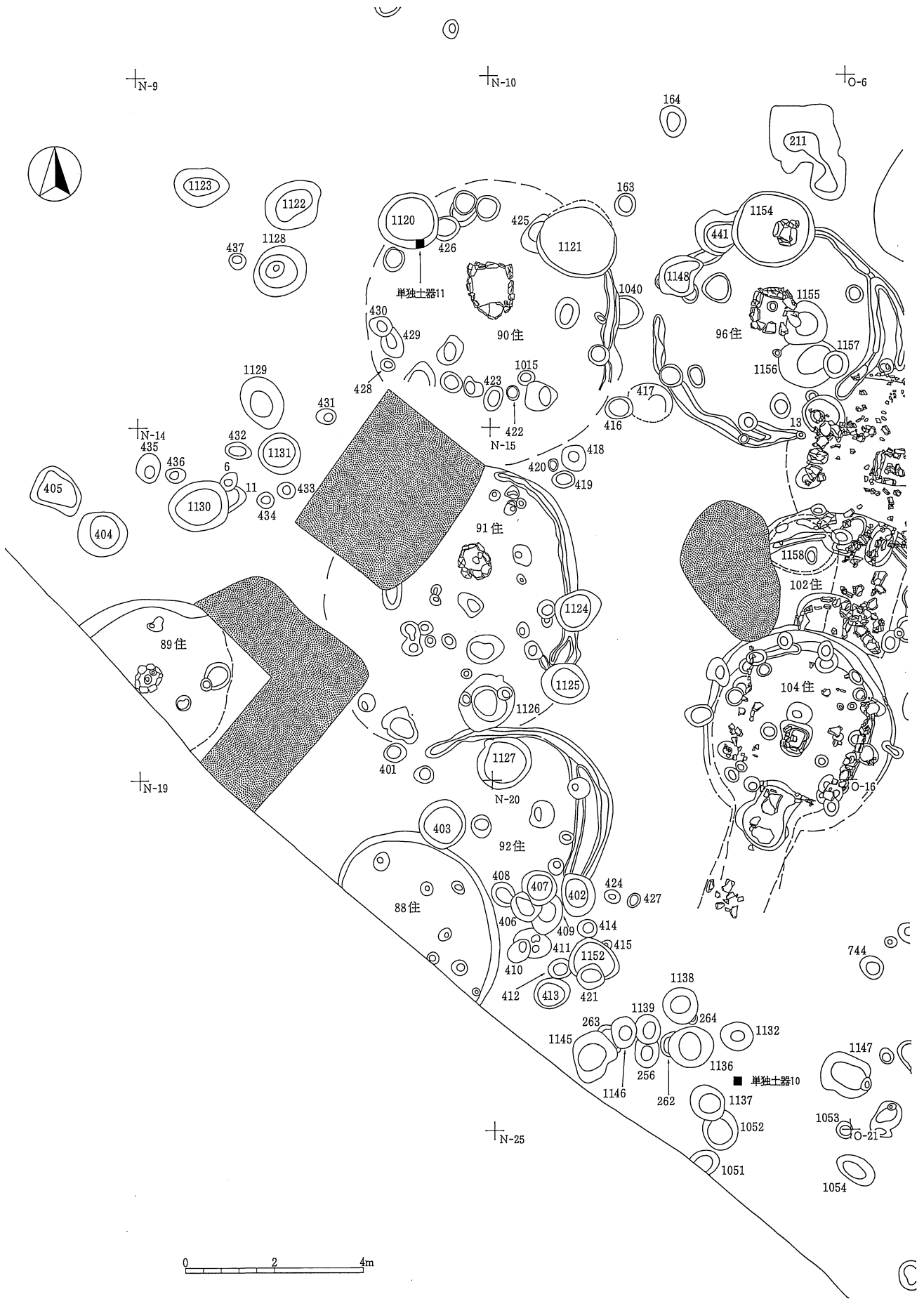

図版9 遺構割付図(8) 1 : 120







図版12 遺構割付図(1) 1 : 120



図版13 遺構割付図(12) 1 : 120



郷土遺跡



図版14 遺構割付図(13) 1 : 120

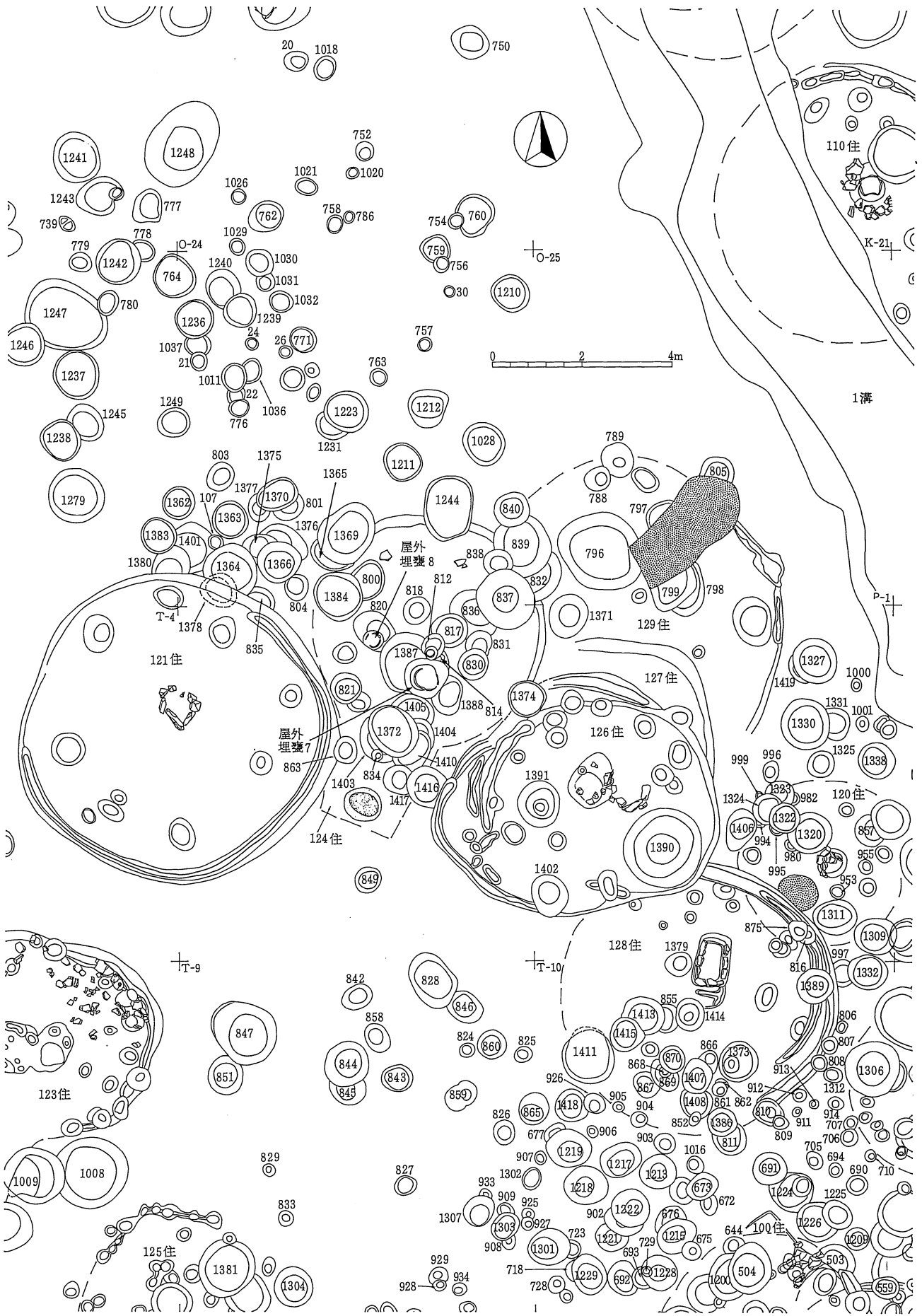

図版15 遺構割付図(14) 1 : 120



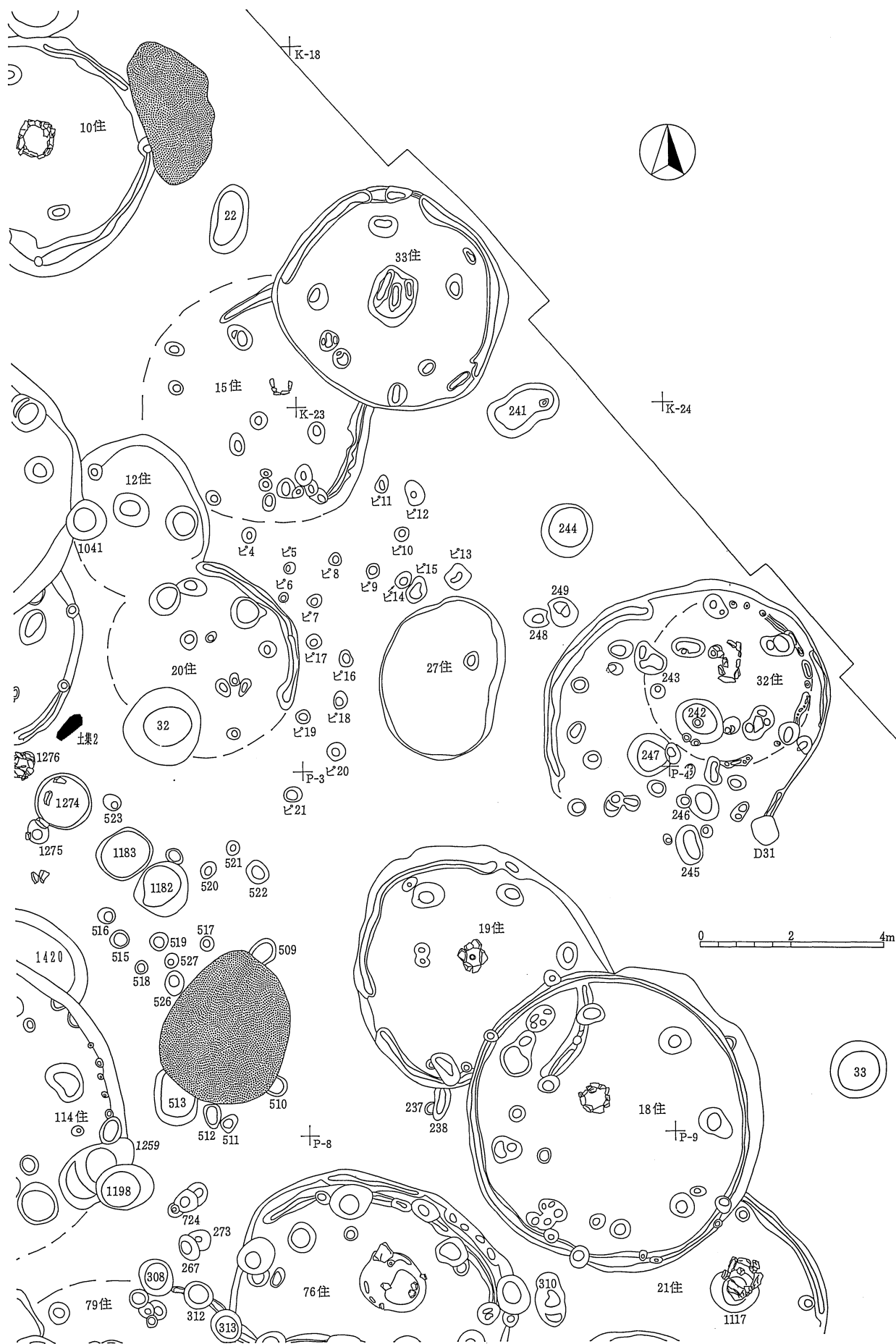

図版17 遺構割付図(16) 1 : 120

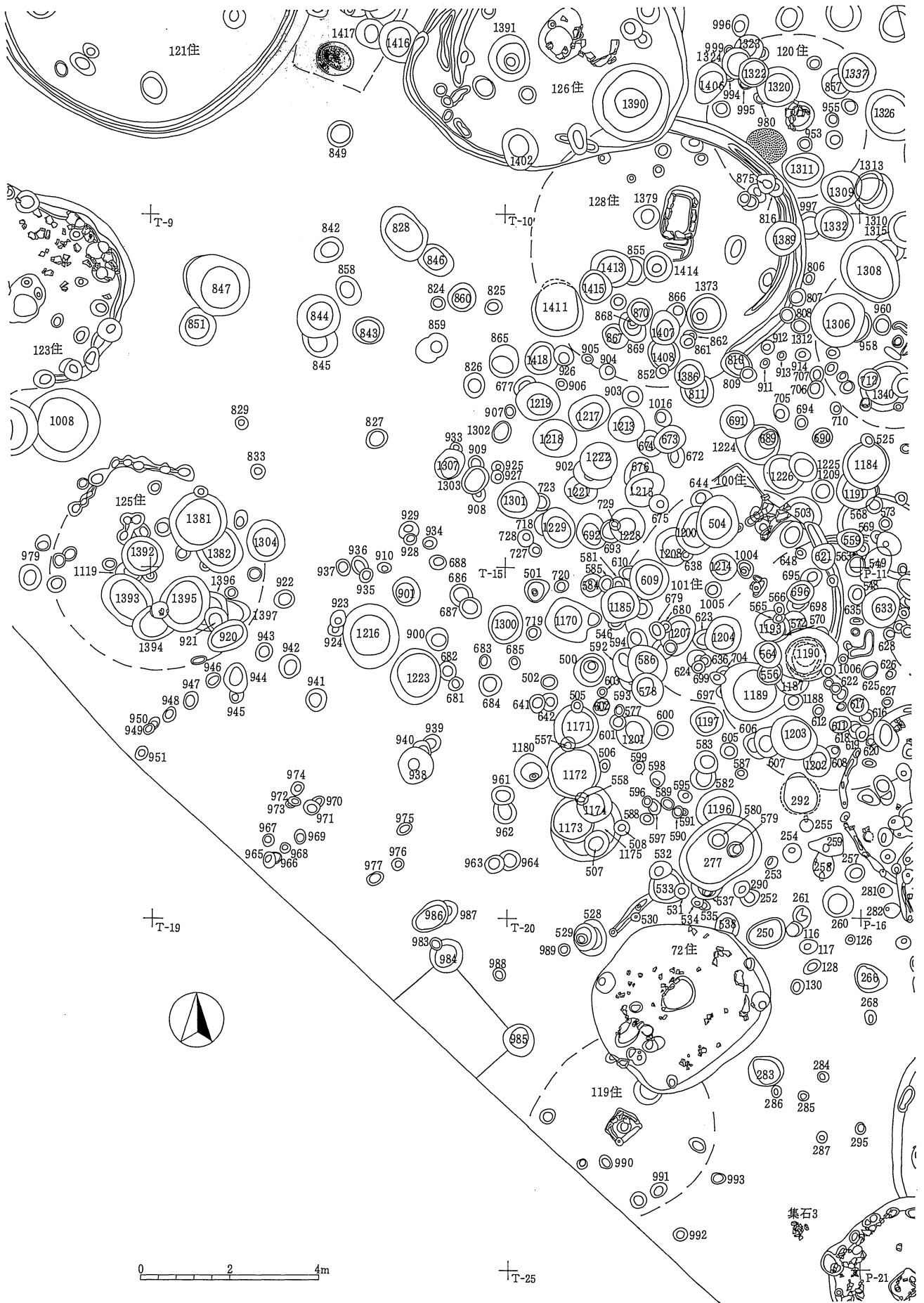

図版18 遺構割付図(17) 1 : 120



図版19 遺構割付図(18) 1 : 120

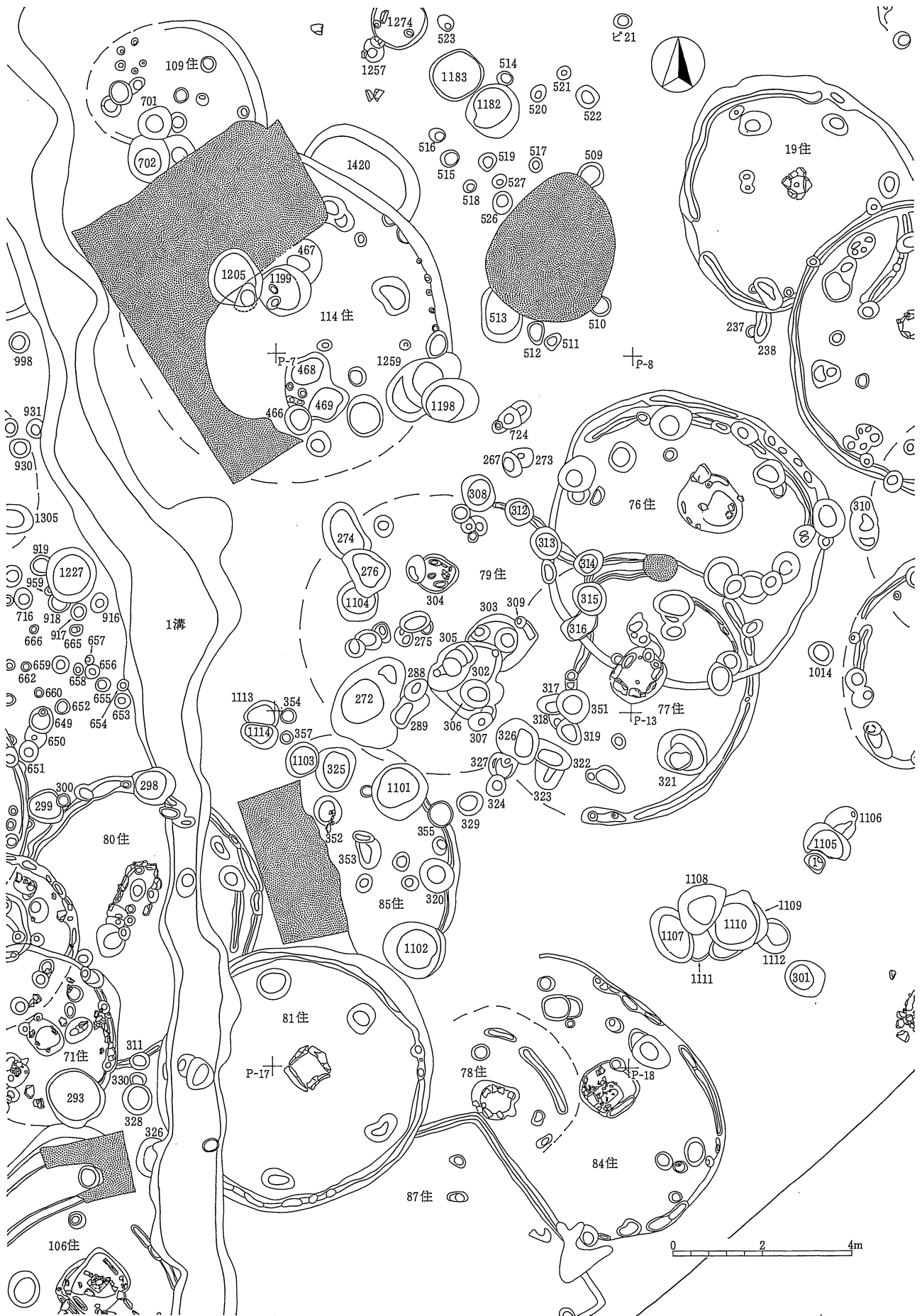

図版20 遺構割付図(19) 1 : 120

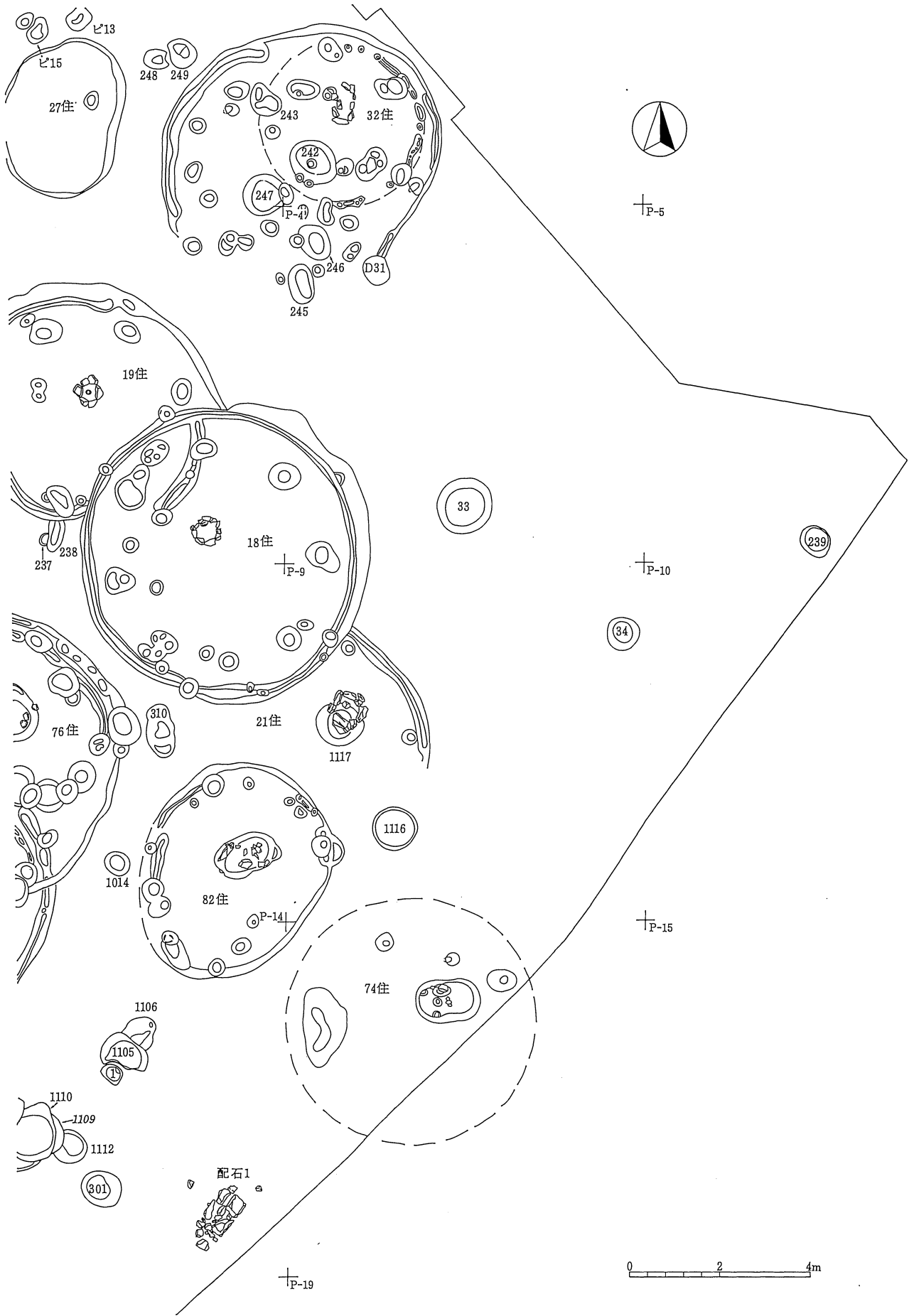

図版21 遺構割付図(20) 1 : 120



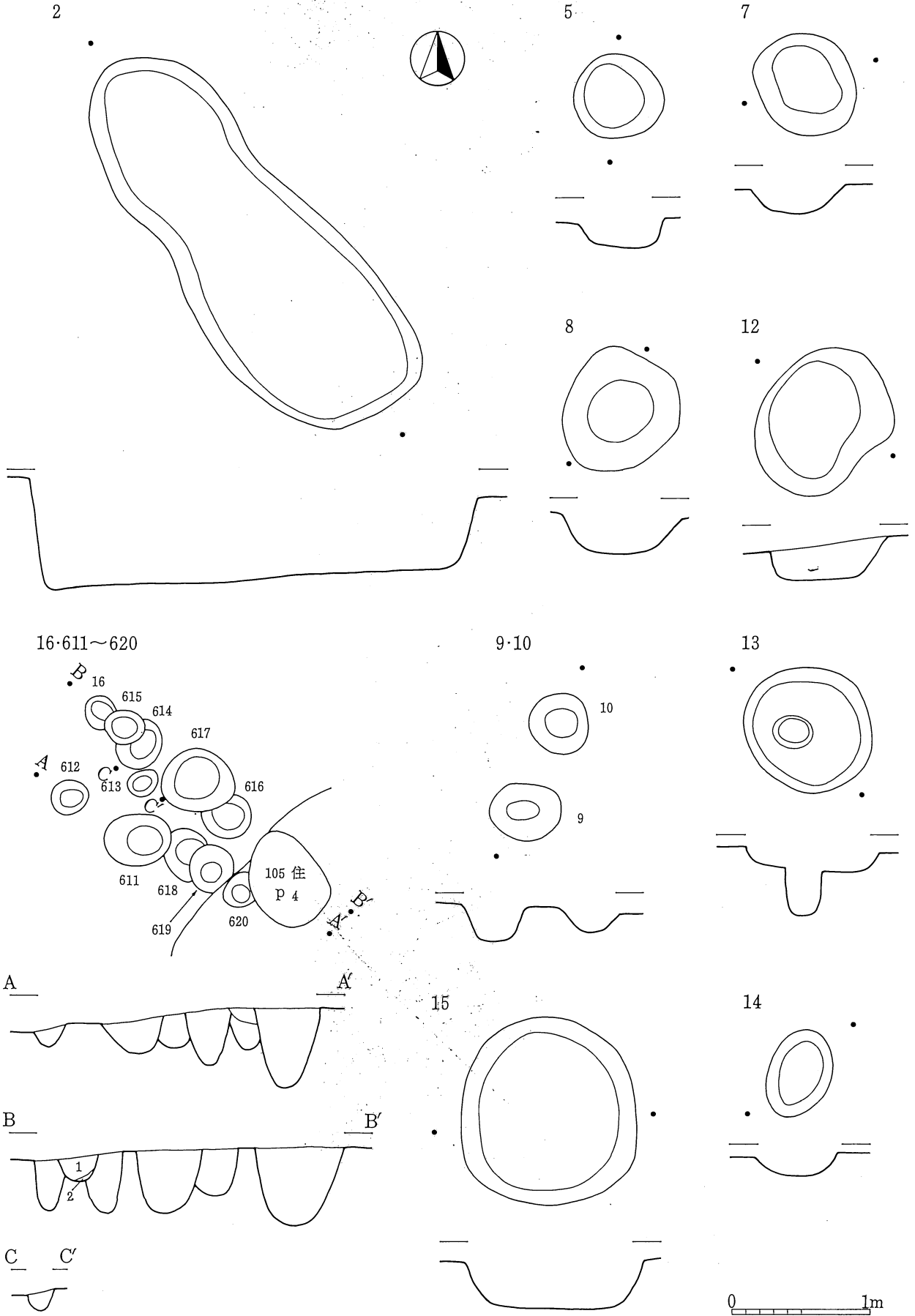

図版22 縄文中期の土坑(1) 1 : 40

18

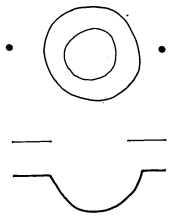

20

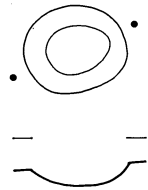

22

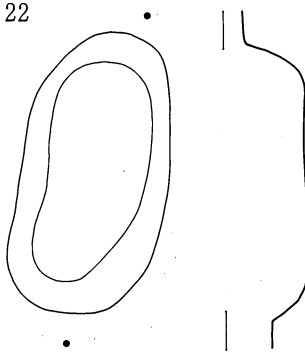

23-776-1011-1036

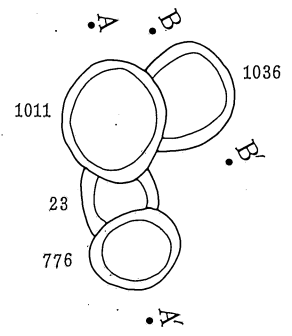

24

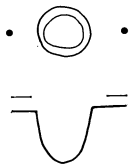

25

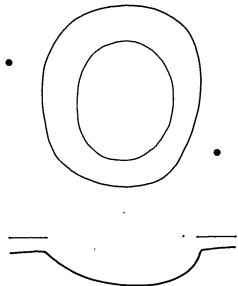

26-771

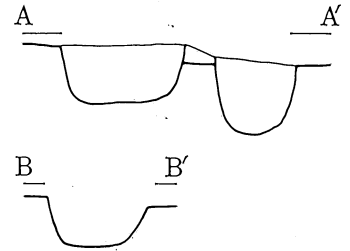
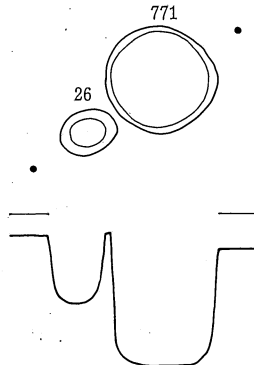

27-774

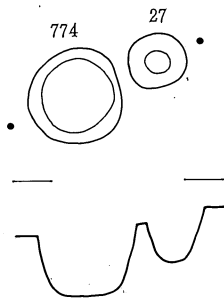

28

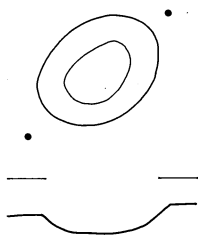

29



30



31

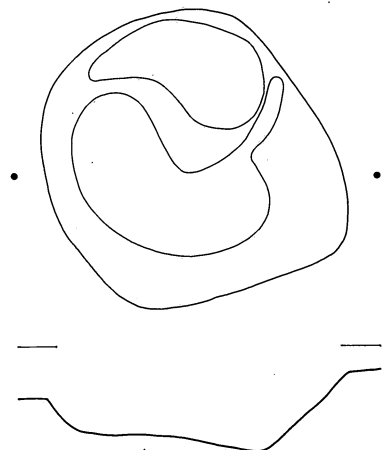

32

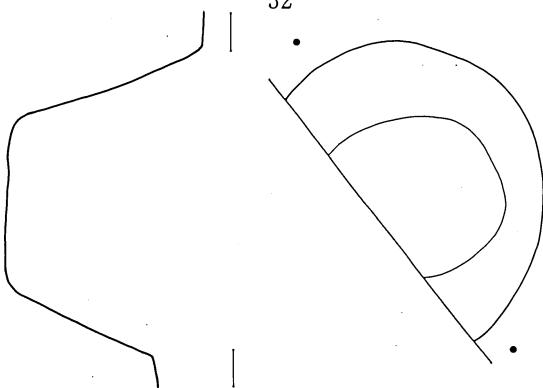

33

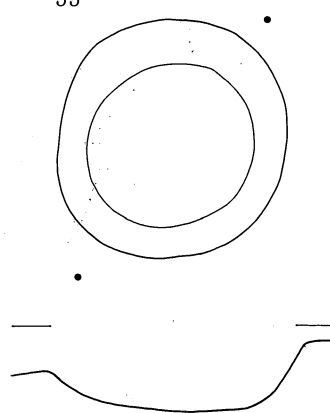

34

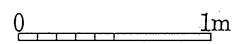
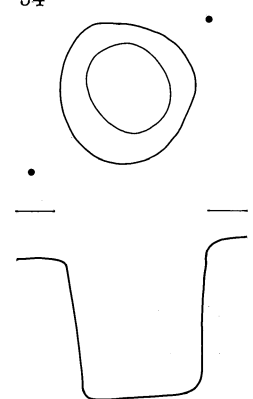

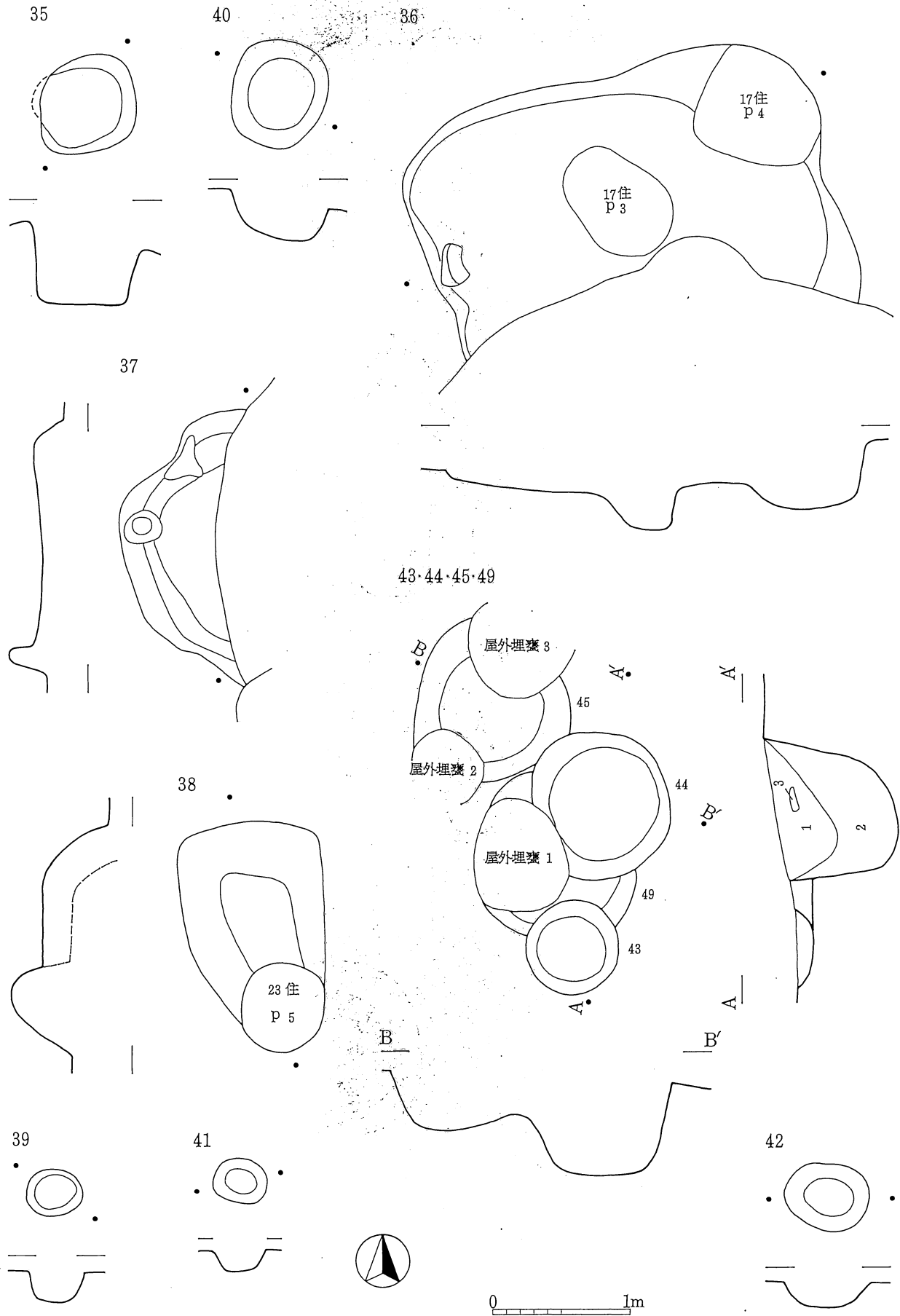

図版24 縄文中期の土坑(3) 1 : 40

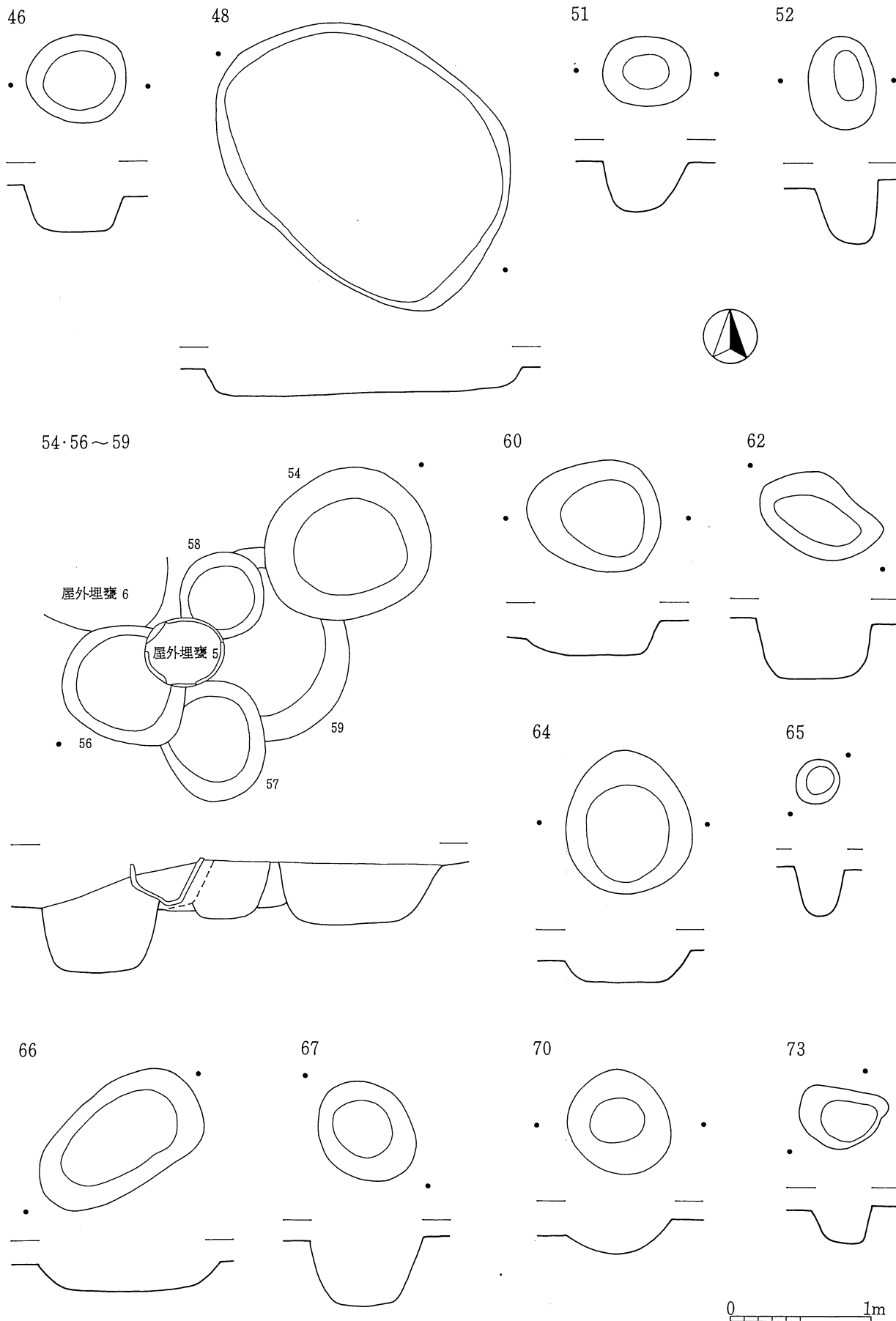

図版25 縄文中期の土坑(4) 1 : 40

71-148

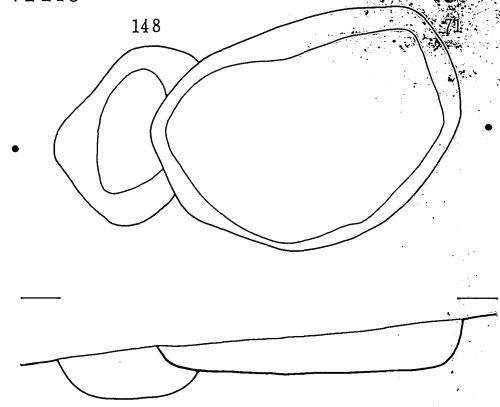

76

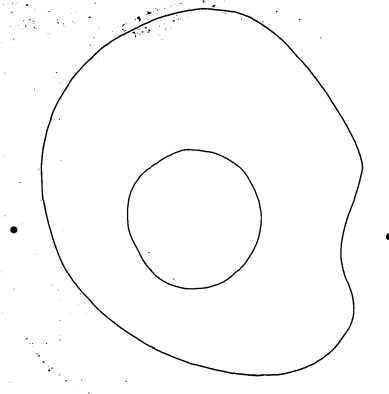

78

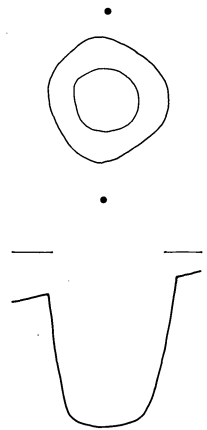

79

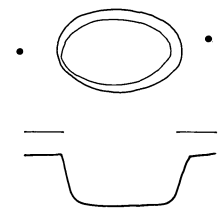

81

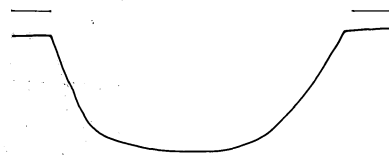
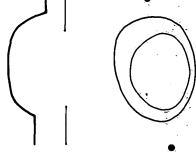

86-87



96

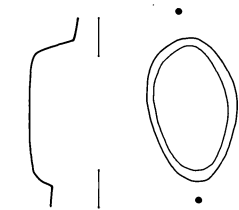

97

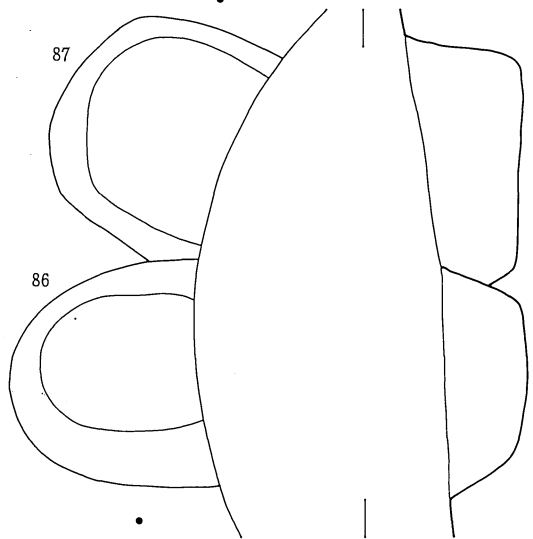
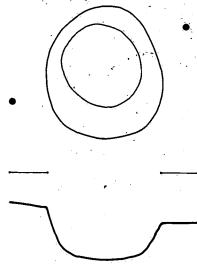

98

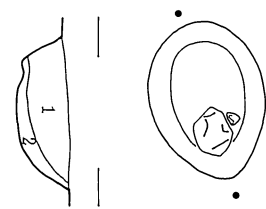

99



100

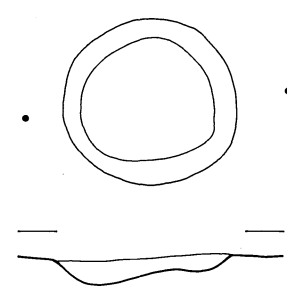

101

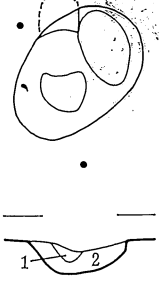

102



103

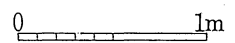
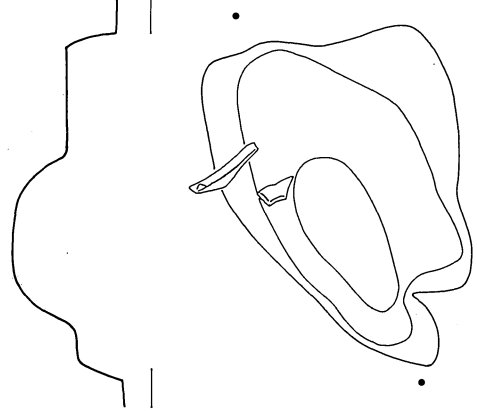

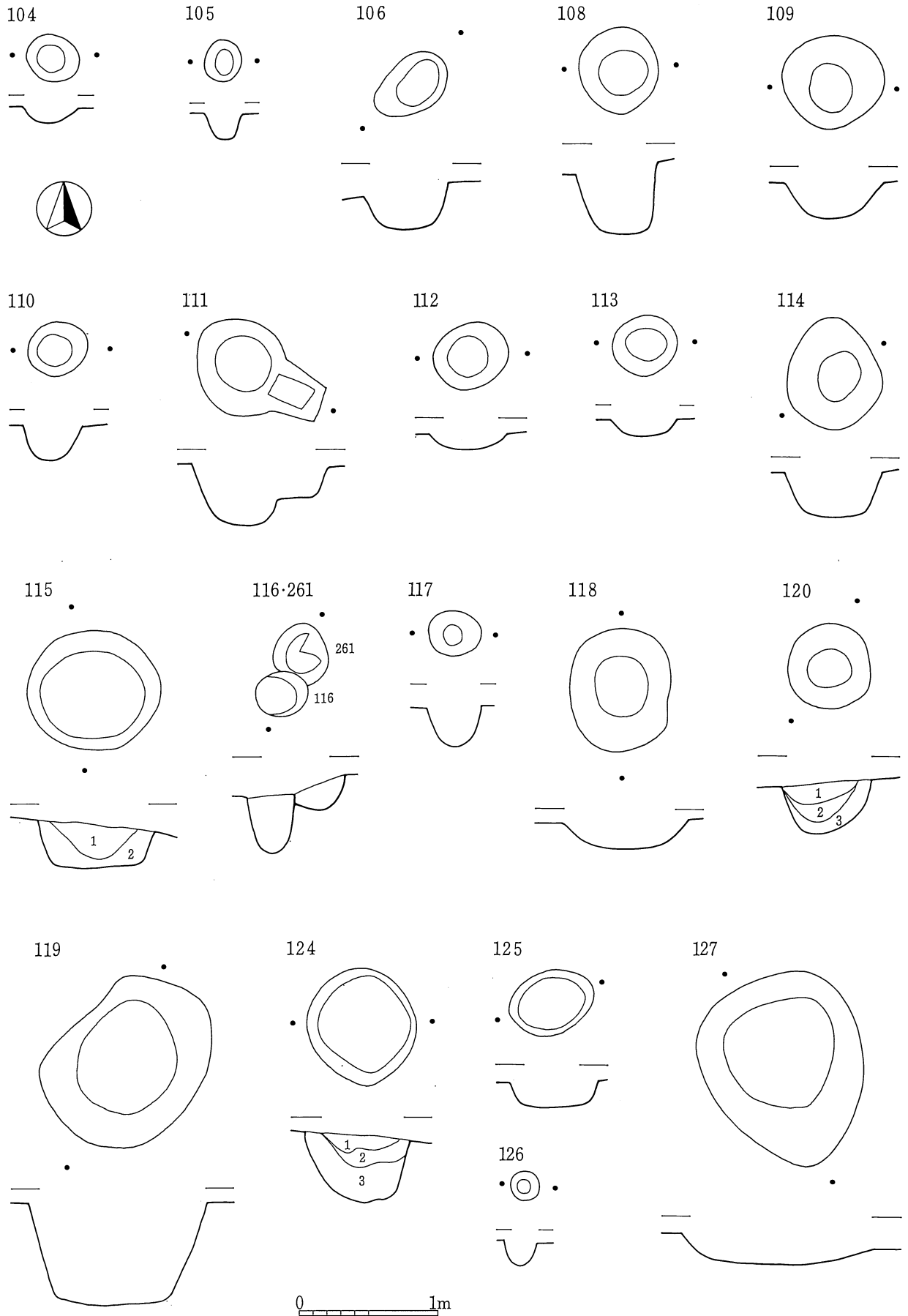

図版27 縄文中期の土坑(6) 1 : 40

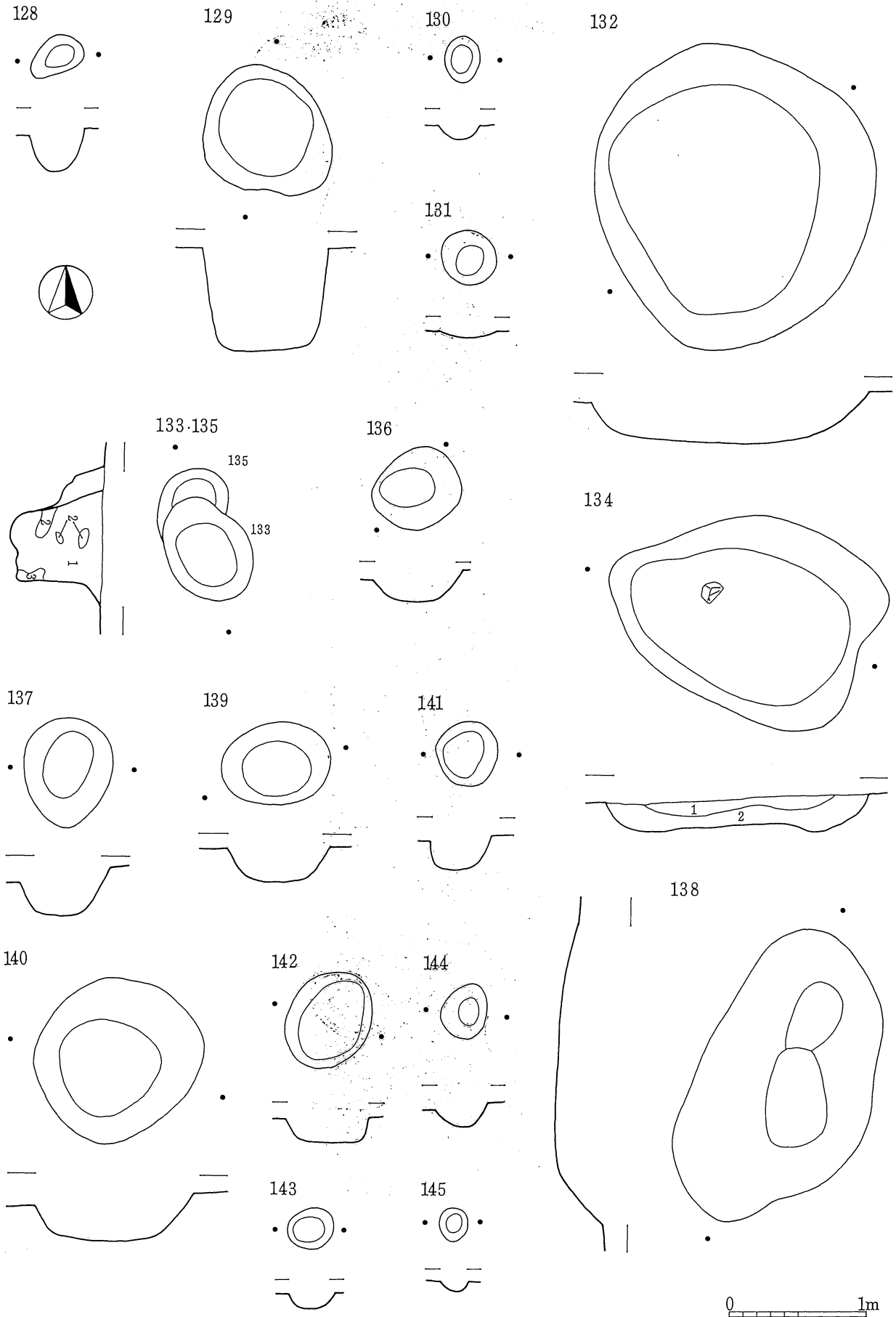

図版28 縄文中期の土坑(7) 1:40

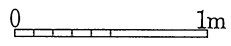
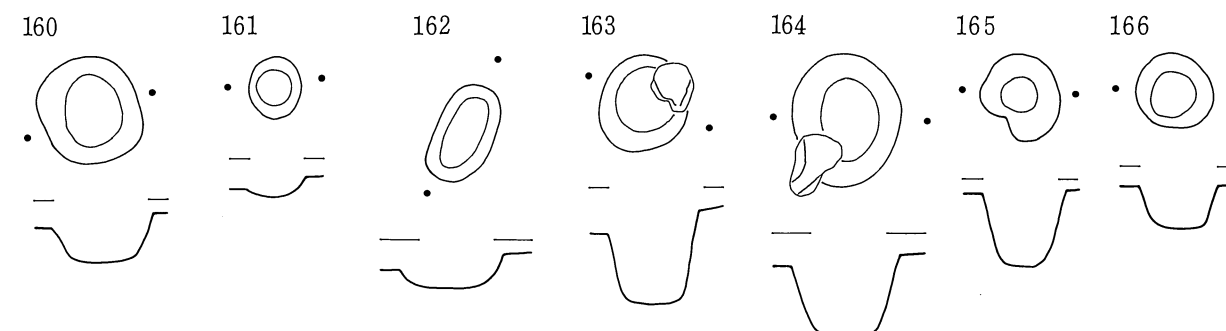
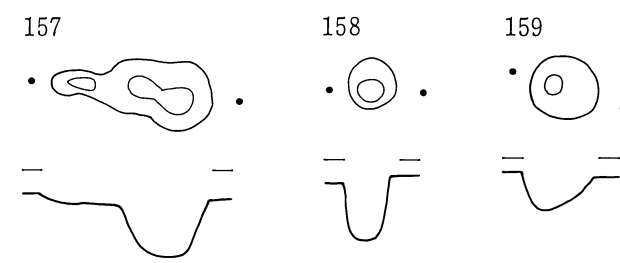
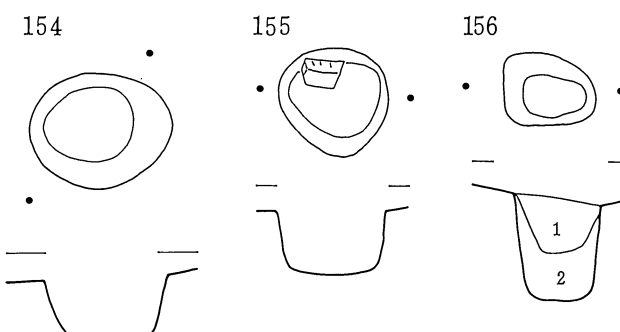
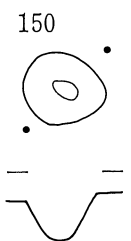
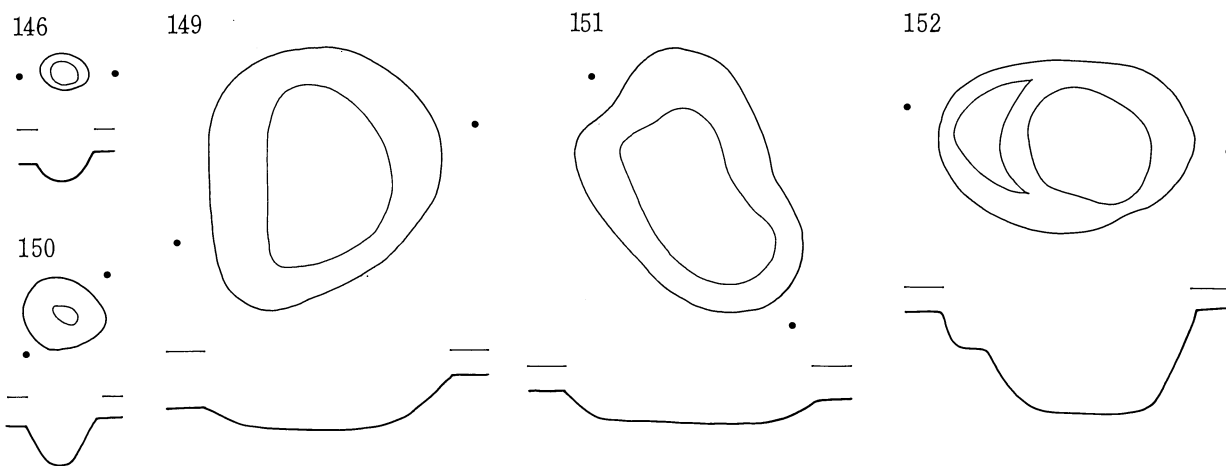

図版29 縄文中期の土坑(8) 1 : 40



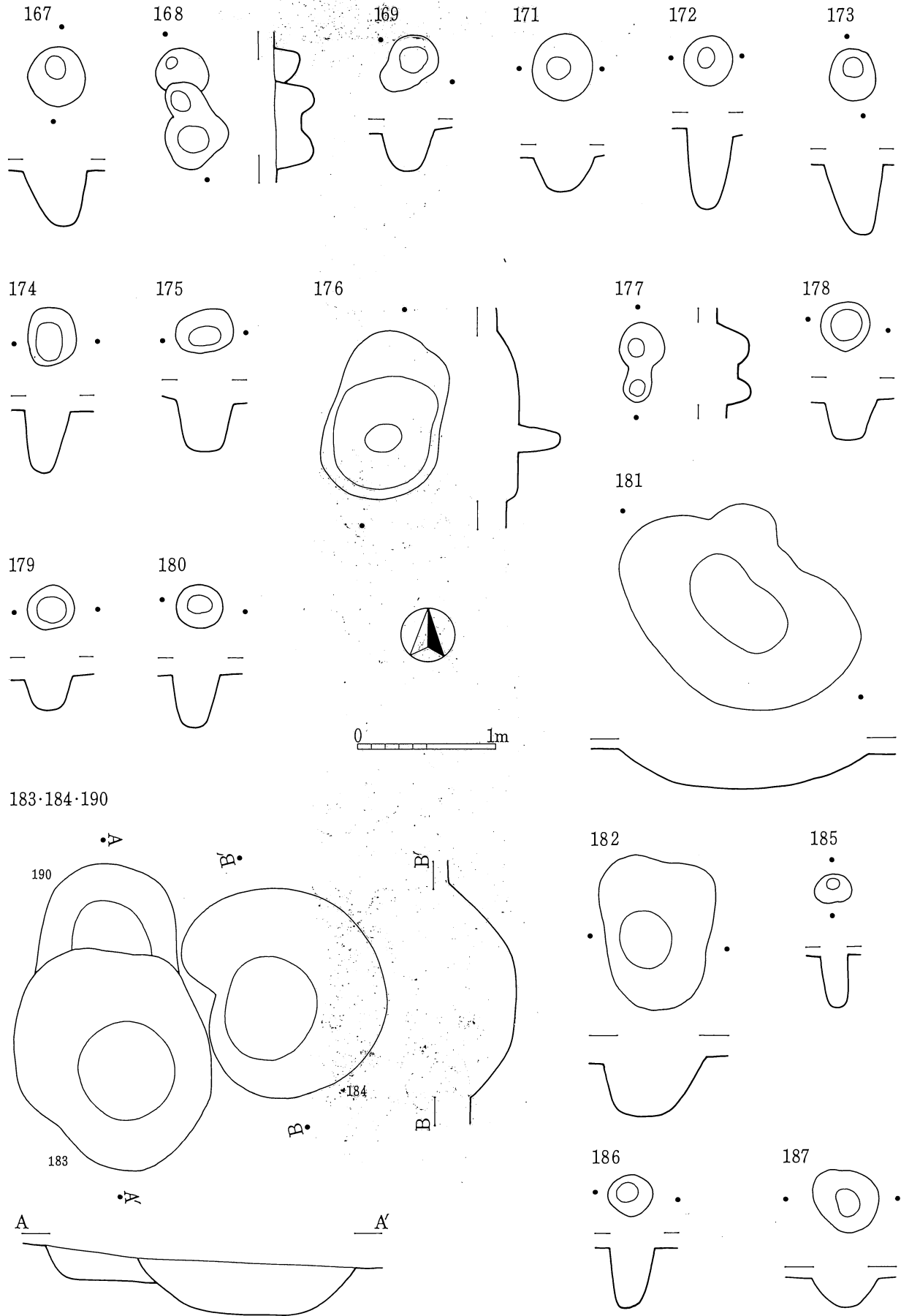

図版30 縄文中期の土坑(9) 1 : 40

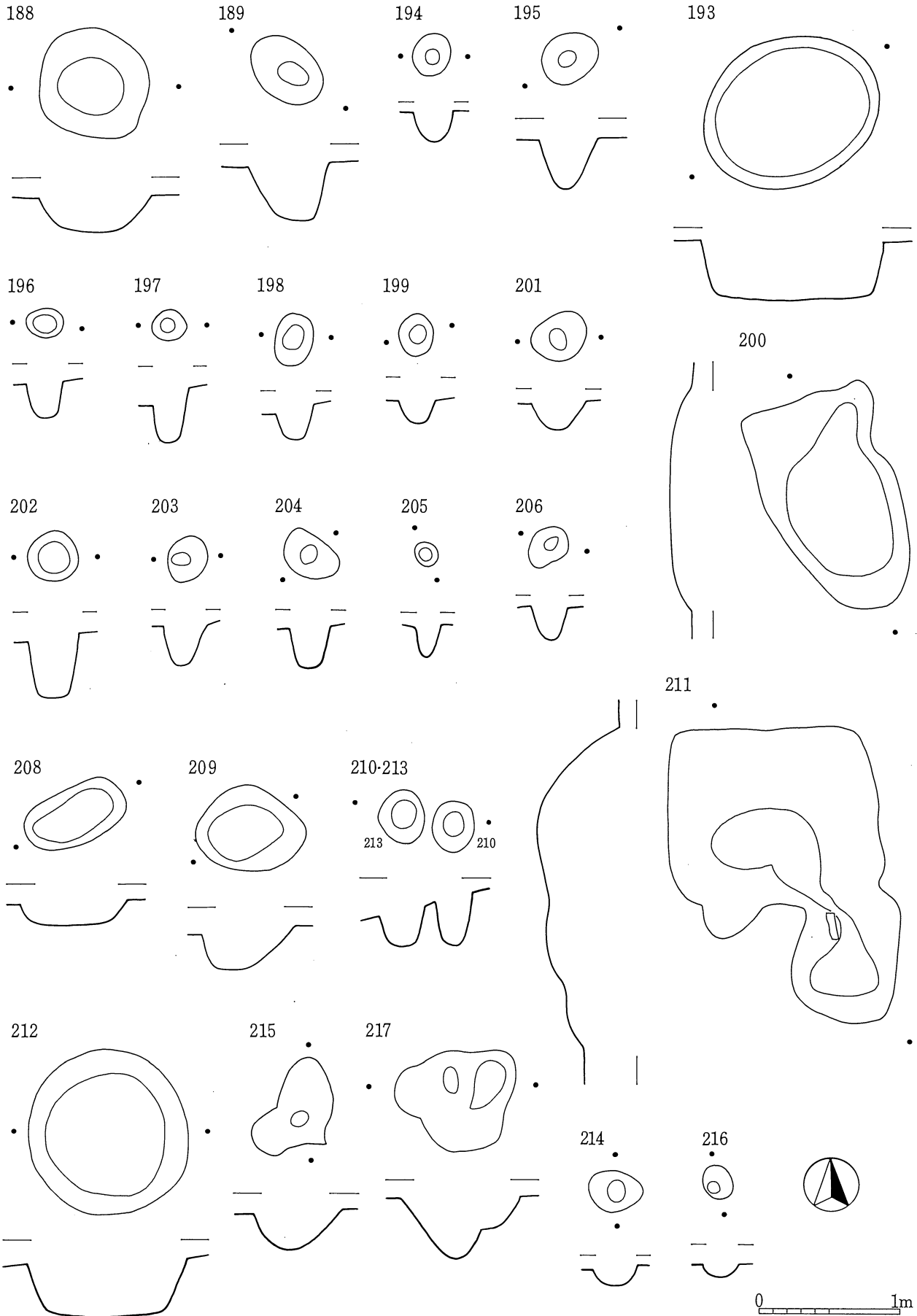

図版31 縄文中期の土坑(10) 1 : 40

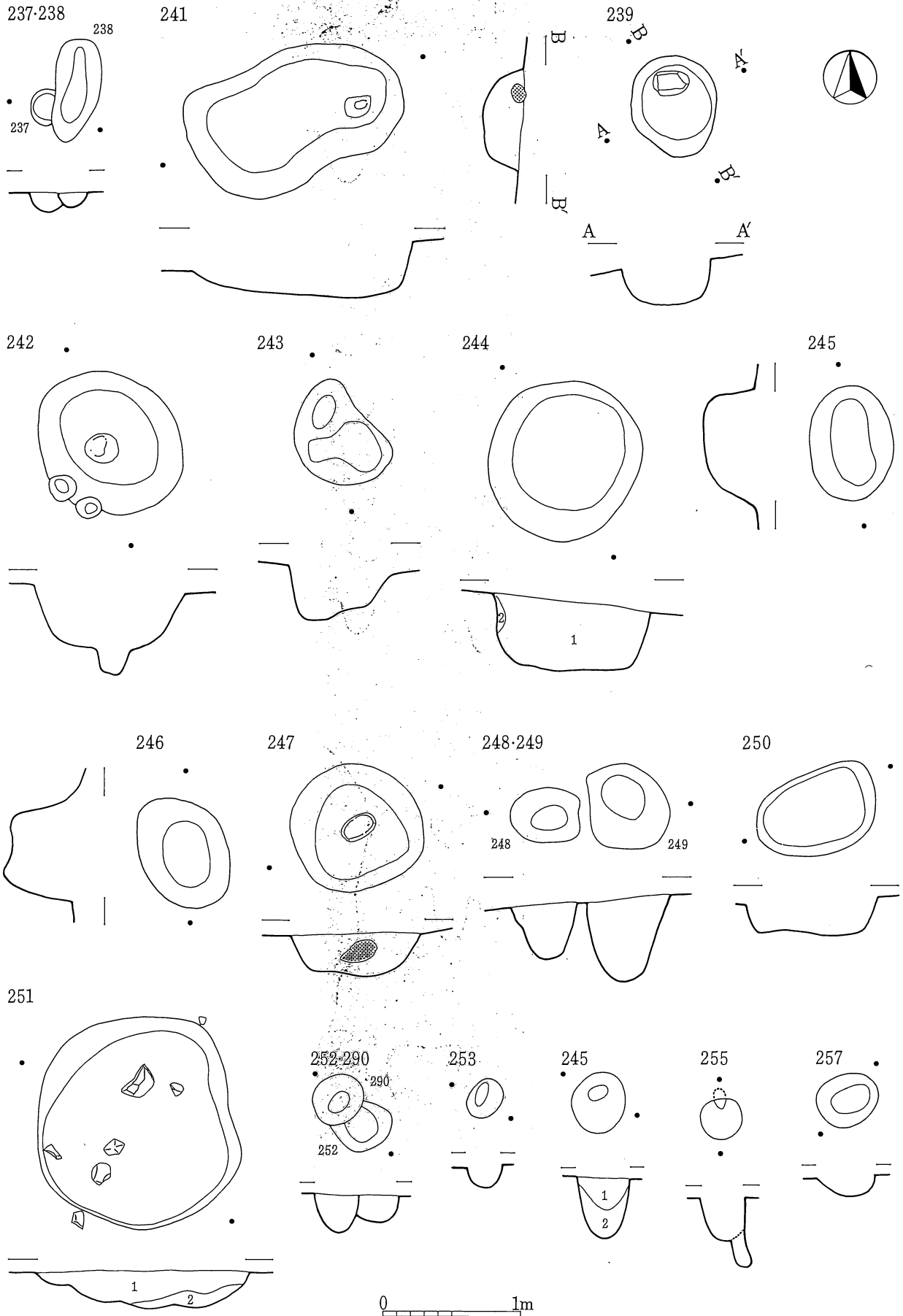

図版32 縄文中期の土坑(1) 1 : 40

258・259

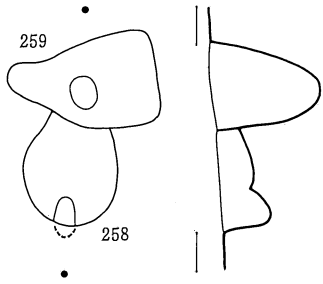

260

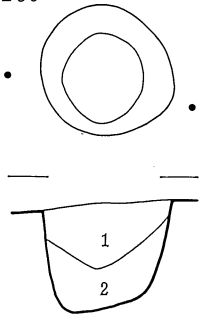

265

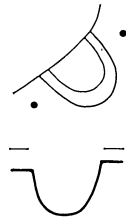

266

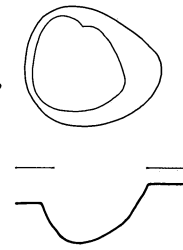

268

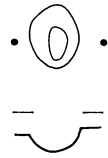

269

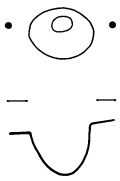

270

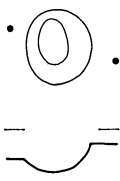

271

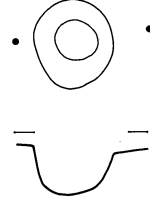

267・273

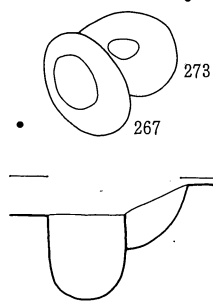

275

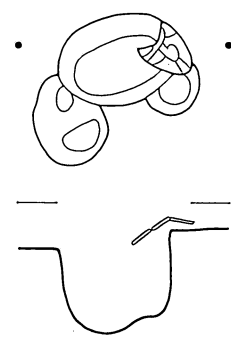

272・288・289

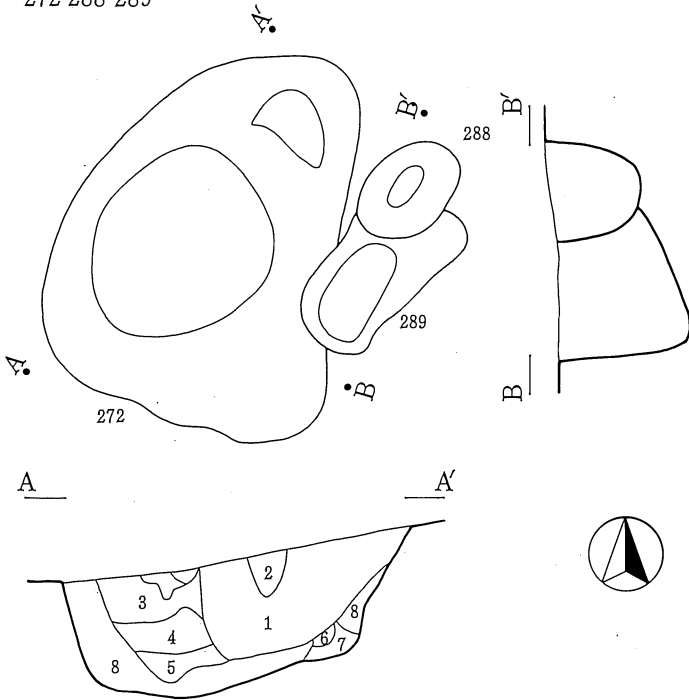

274・276

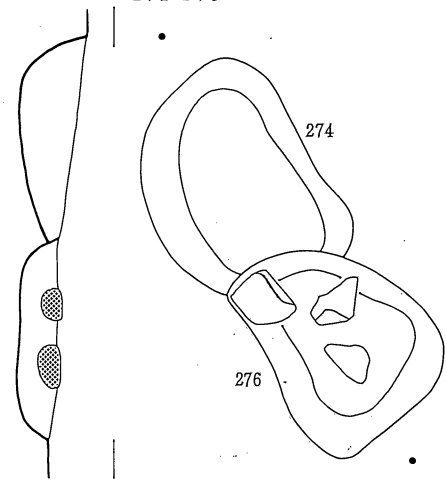

278・279・280

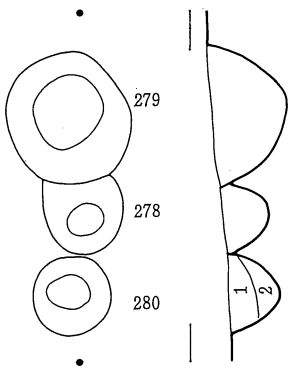

281

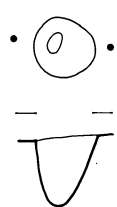

282



283

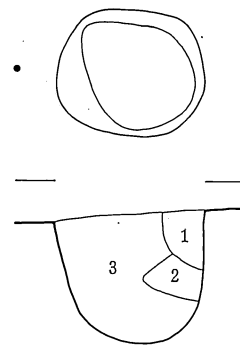

284

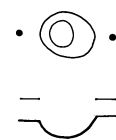

286

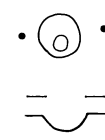

285

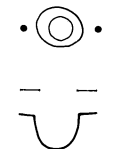

287

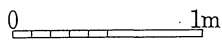
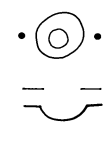

図版33 縄文中期の土坑(12) 1 : 40

292

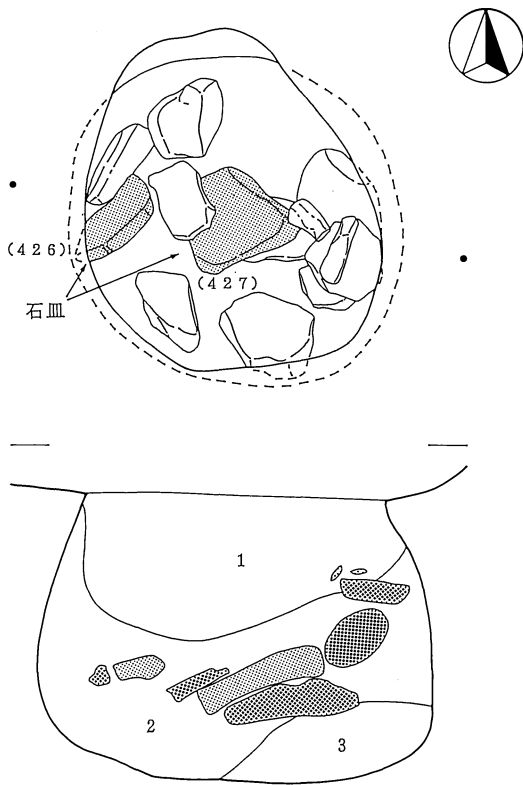

293

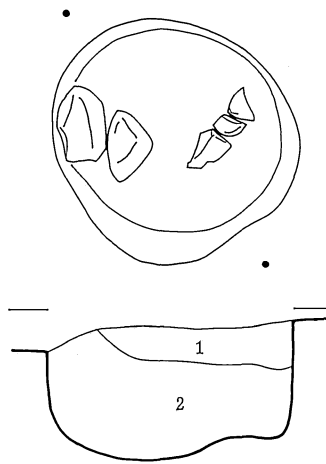

294

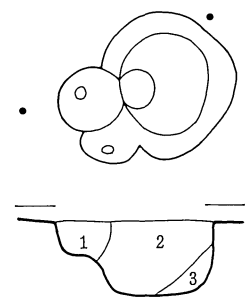

298

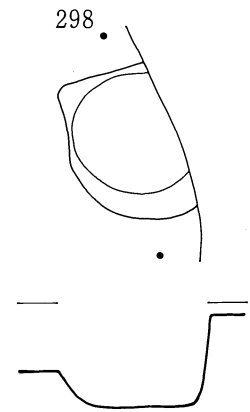

295



302·303·305·306·307·309

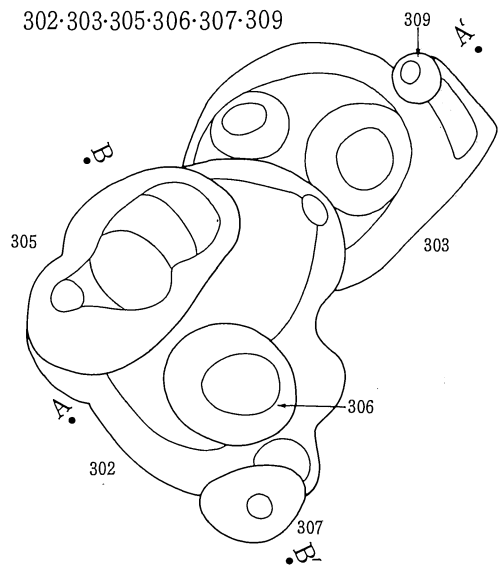

299·300

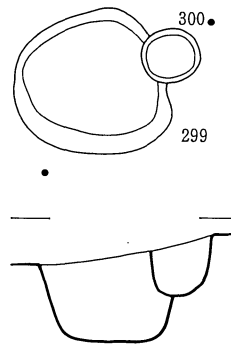

301

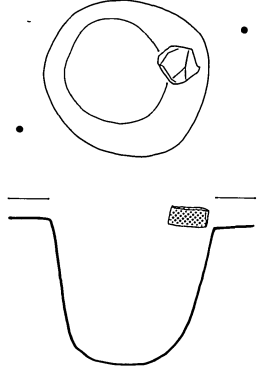

304

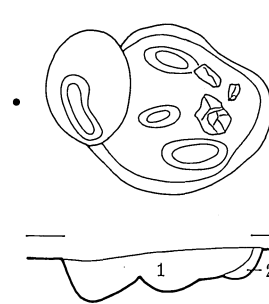

308

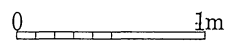
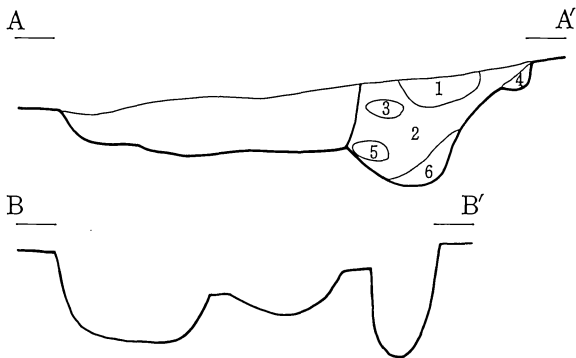
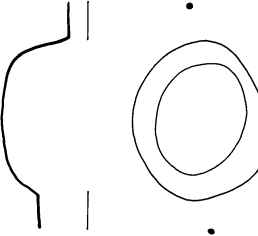

図版34 縄文中期の土坑(13) 1 : 40

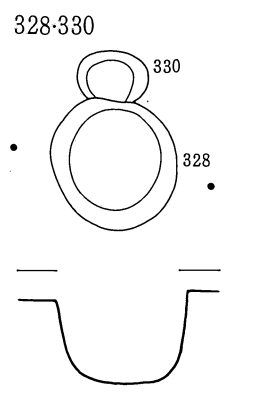
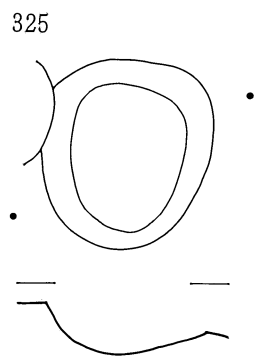
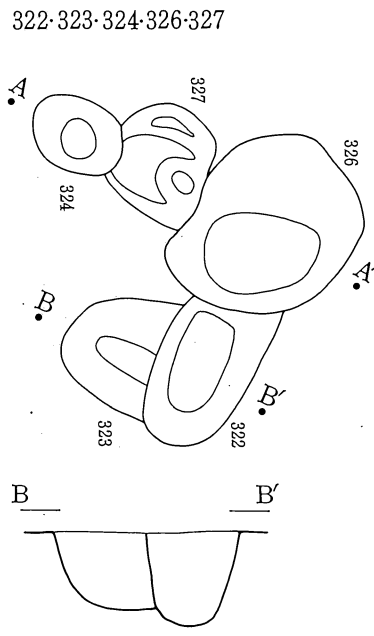
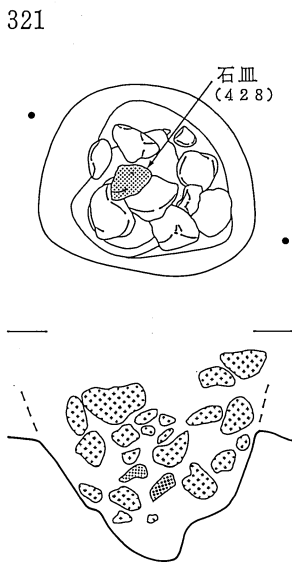
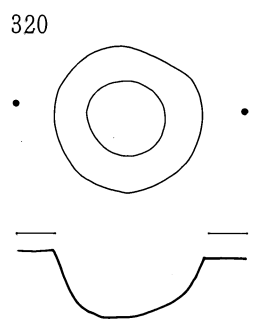
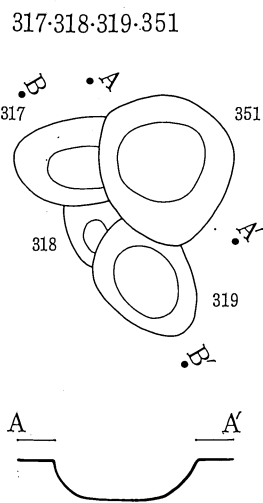
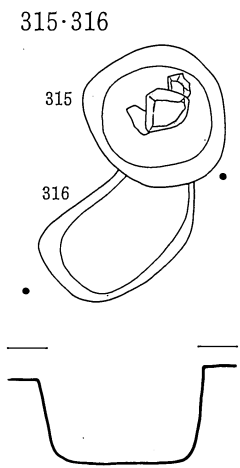
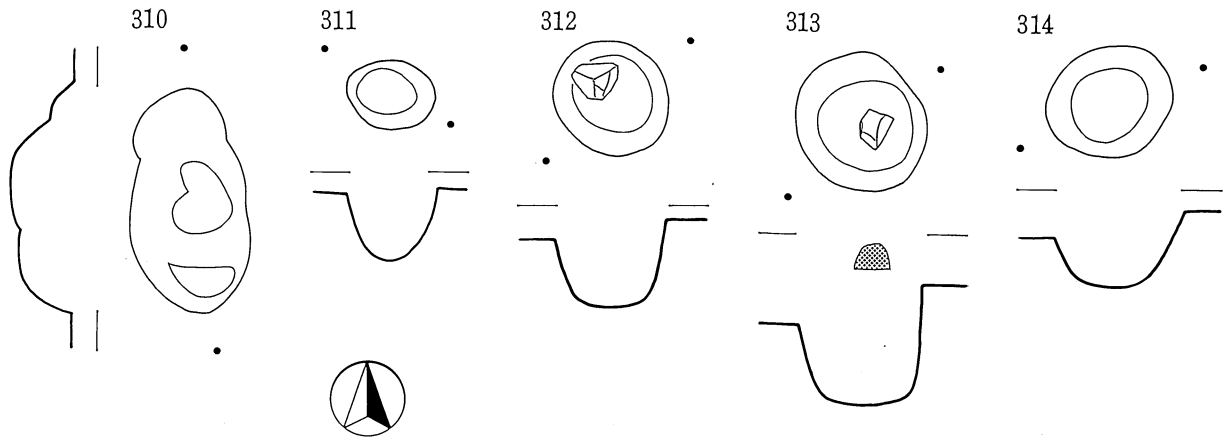

図版35 縄文中期の土坑(14) 1 : 40

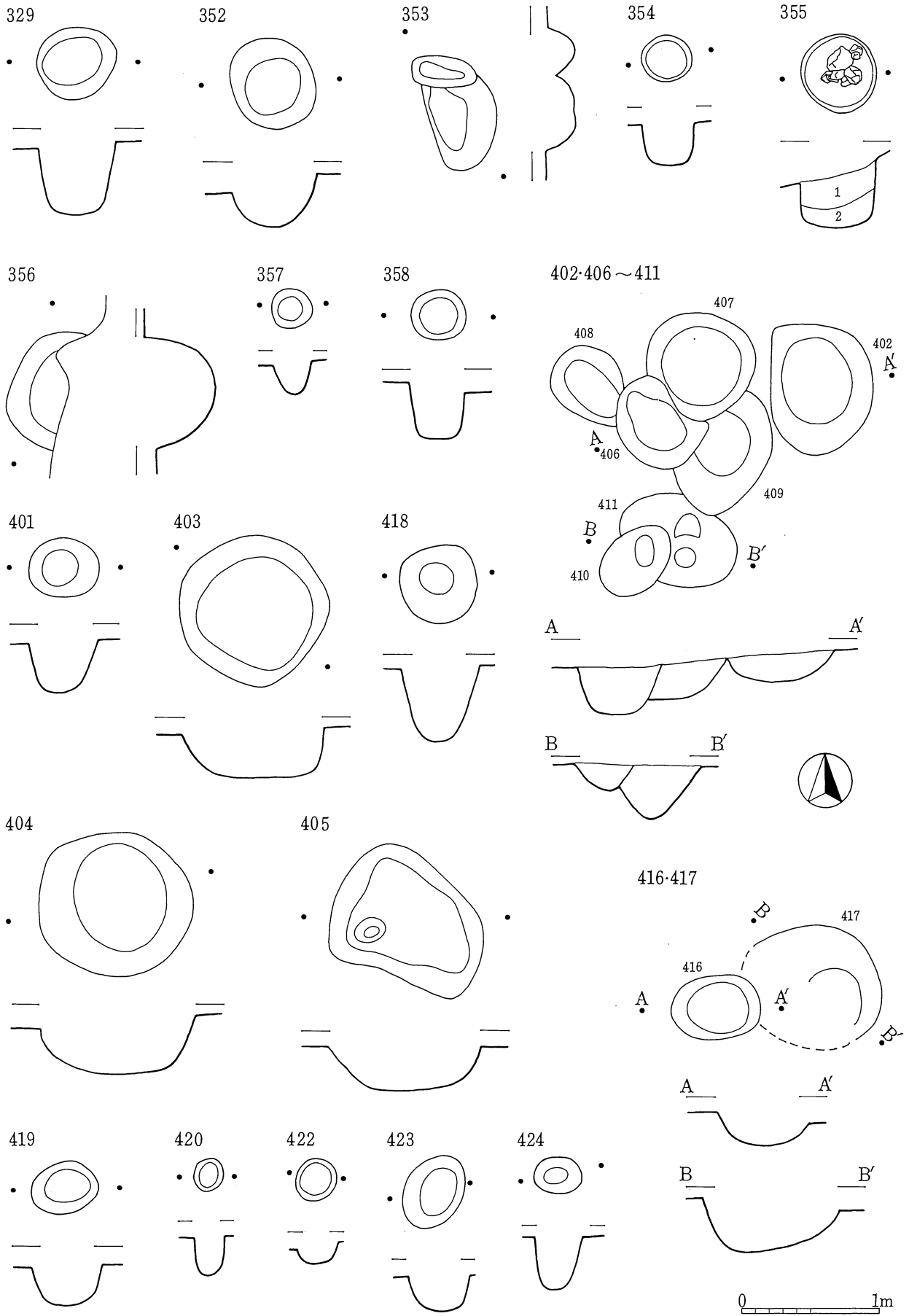

図版36 縄文中期の土坑(15) 1 : 40

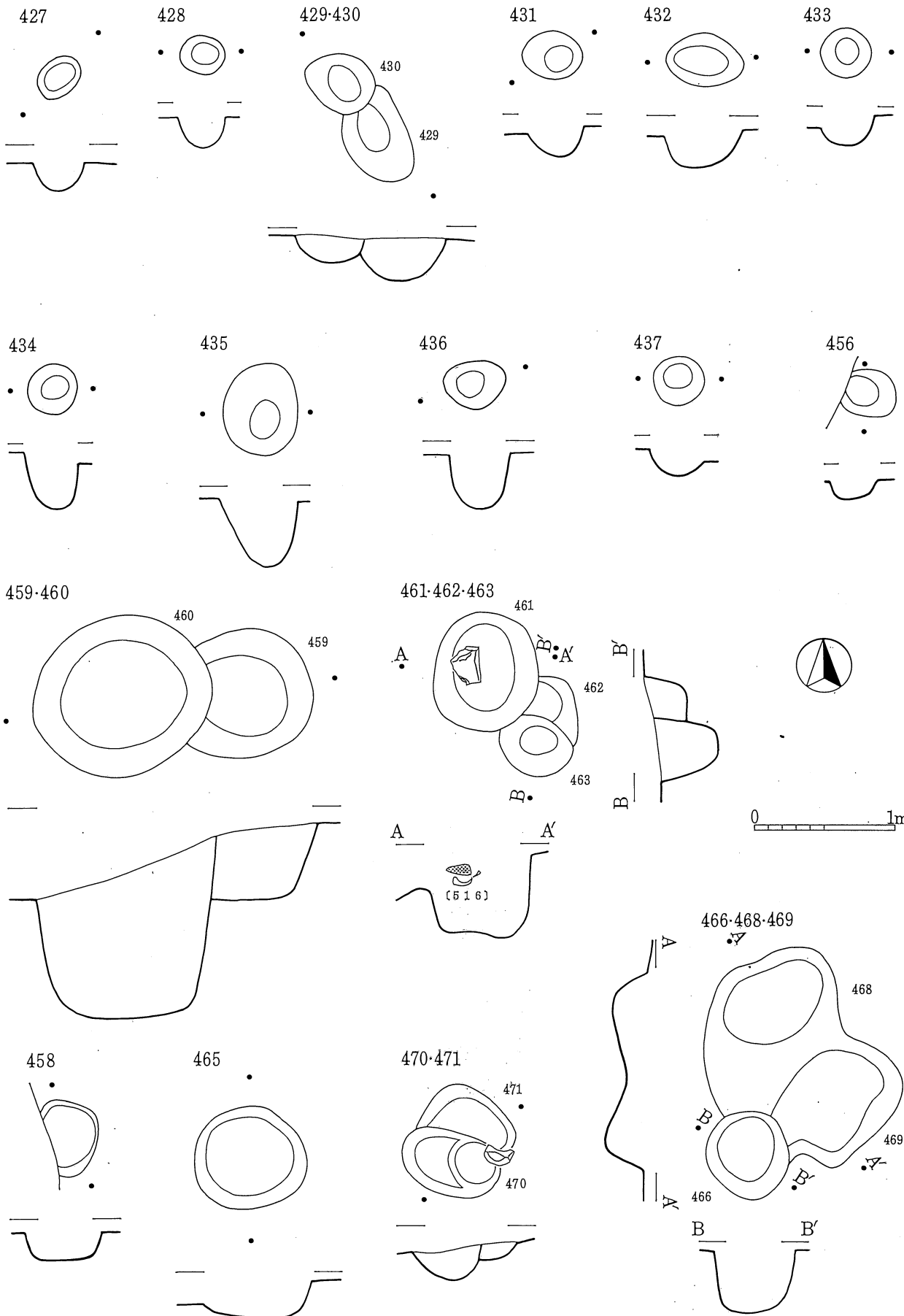

図版37 縄文中期の土坑(16) 1:40



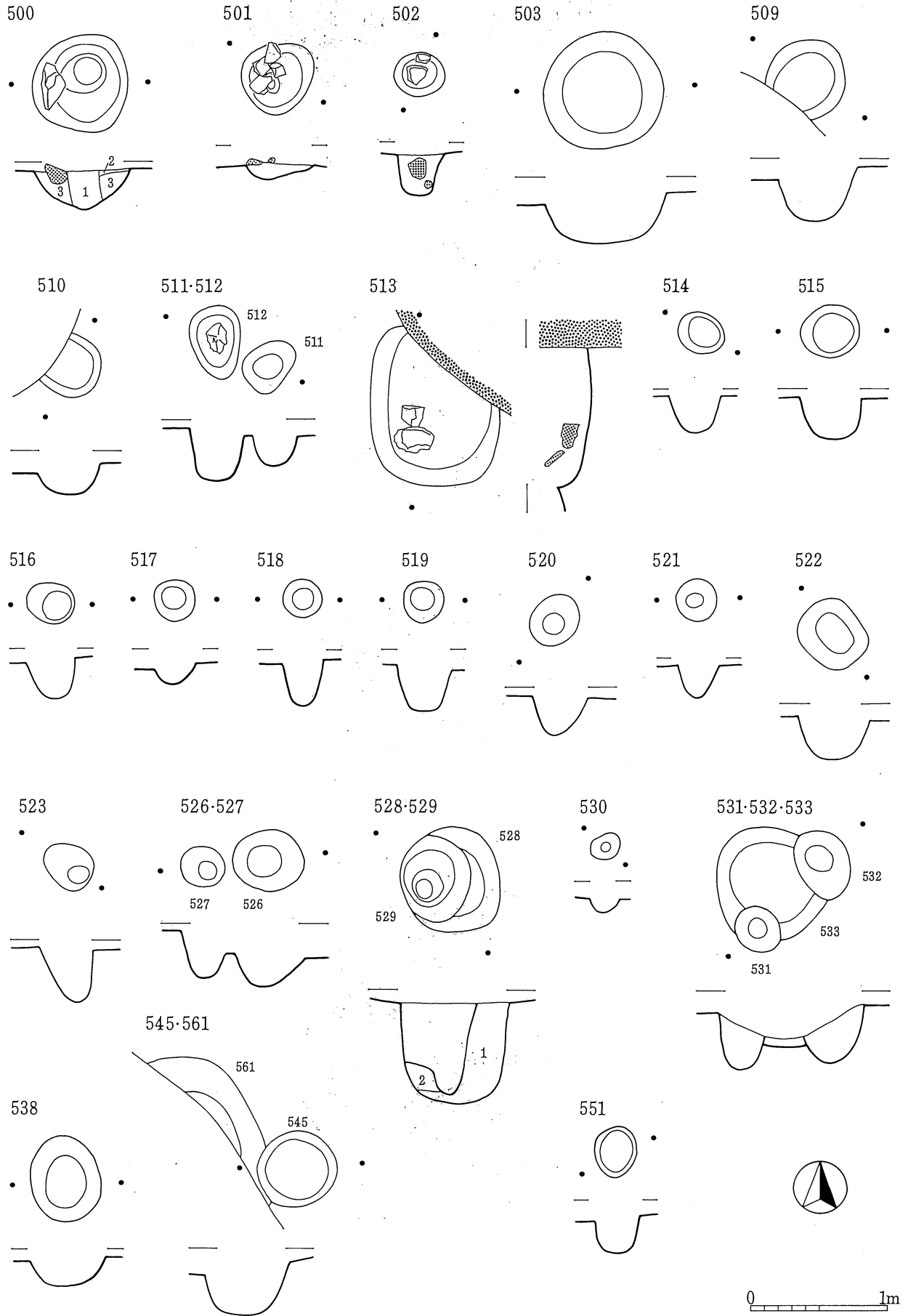

図版38 縄文中期の土坑(7) 1 : 40

554

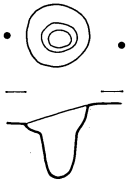

582-583

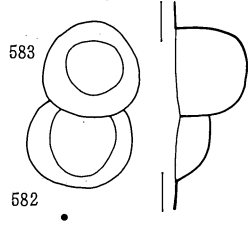

587



588



589



590-591

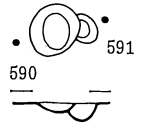

595

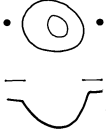

596-597

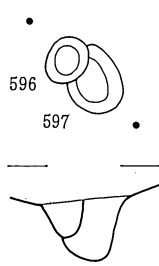

598-599

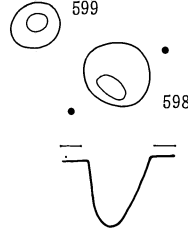

600

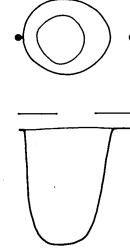

602-603

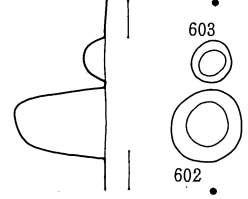

605

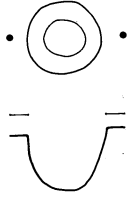

621

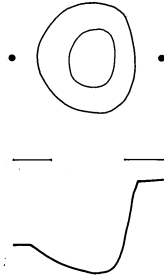

624-636

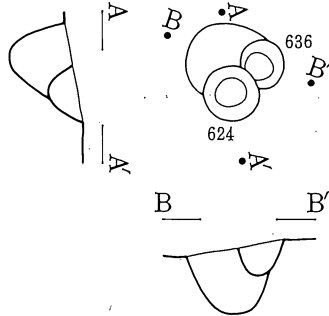

625

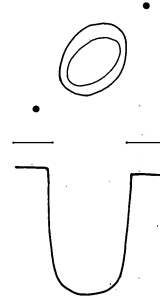

626

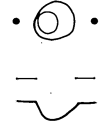

627

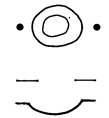

628-629-633-634-635

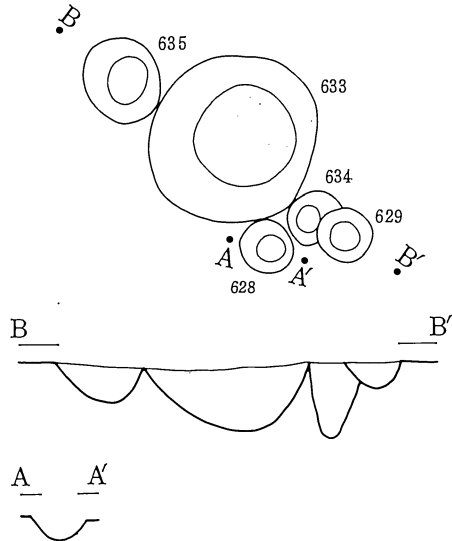

630-631-668-669

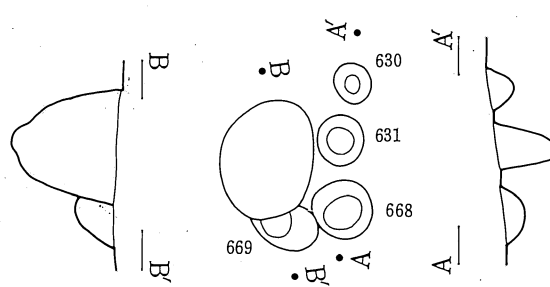

0 1m

641-642

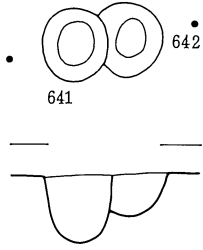

646-647

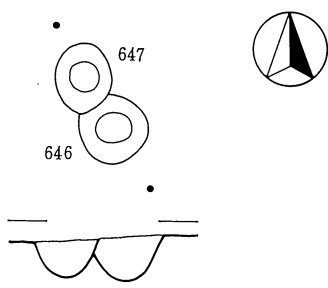

648

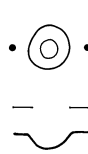

649-650-651

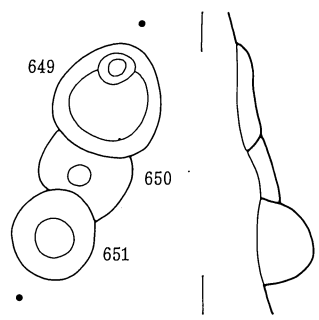

652



653-654

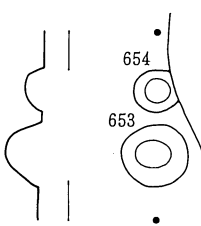

655-656

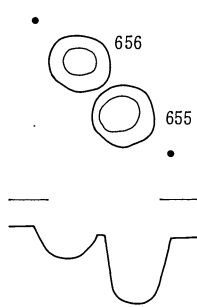

657-658

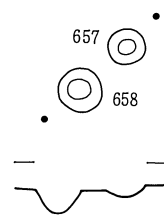

659

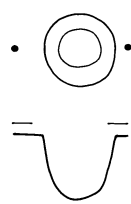

660

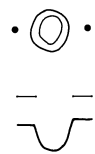

661

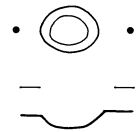

662-663

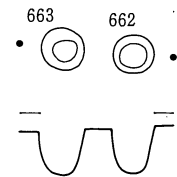

664-665

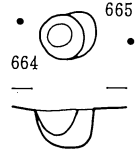

666

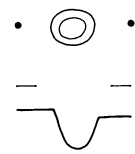

667



671



683

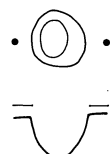

684

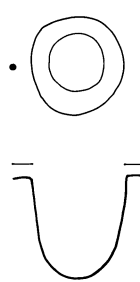

685

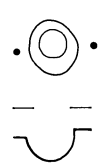

686-687

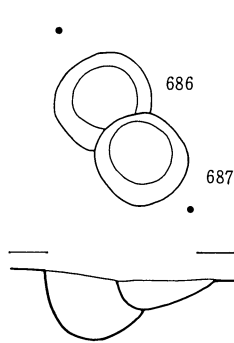

688

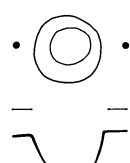

690

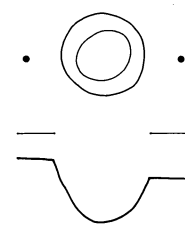

694



705

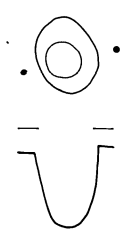

706-707

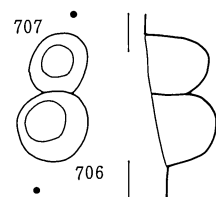

710

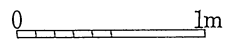
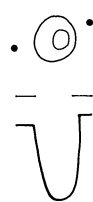

700

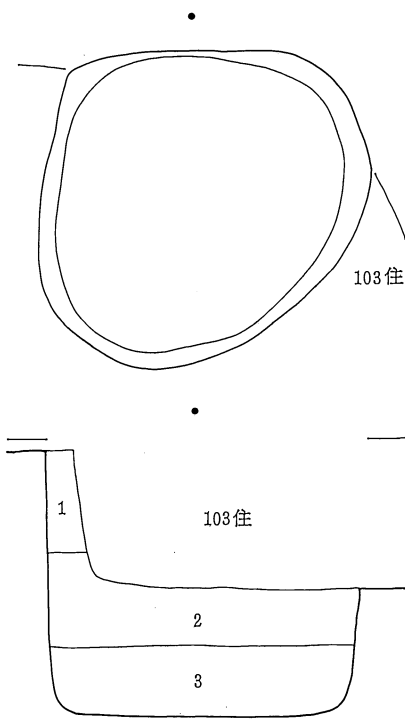

701・702・721

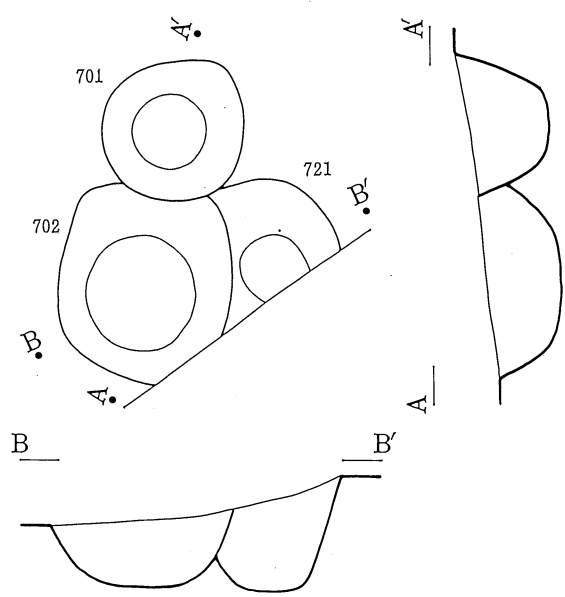

714

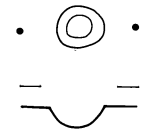

715

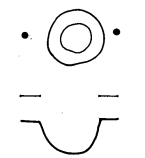

716

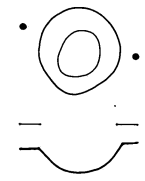

717

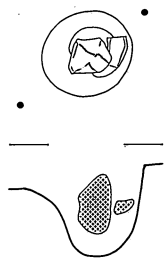

719

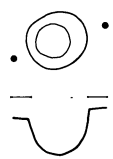

720

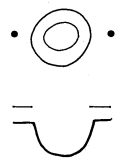

724

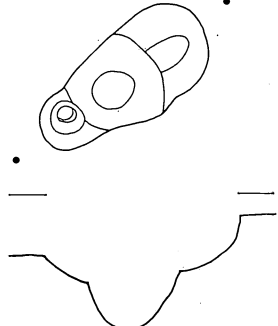

727・728

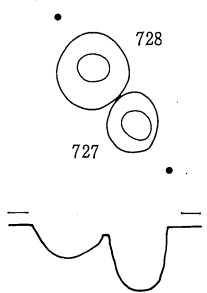

703

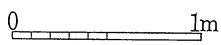
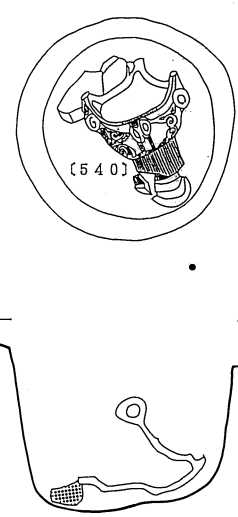

図版41 縄文中期の土坑(2) 1:40

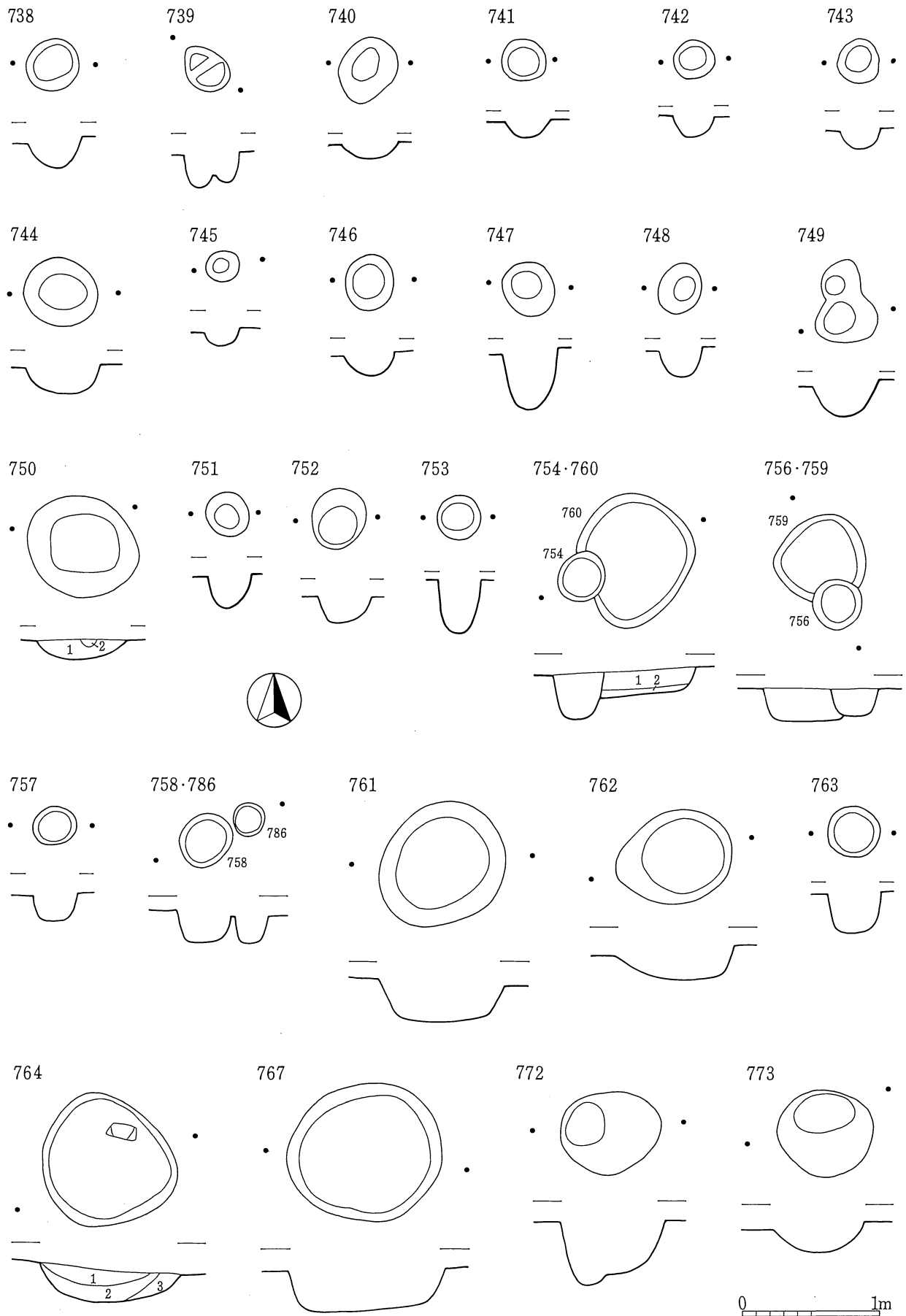

図版42 縄文中期の土坑(2) 1 : 40

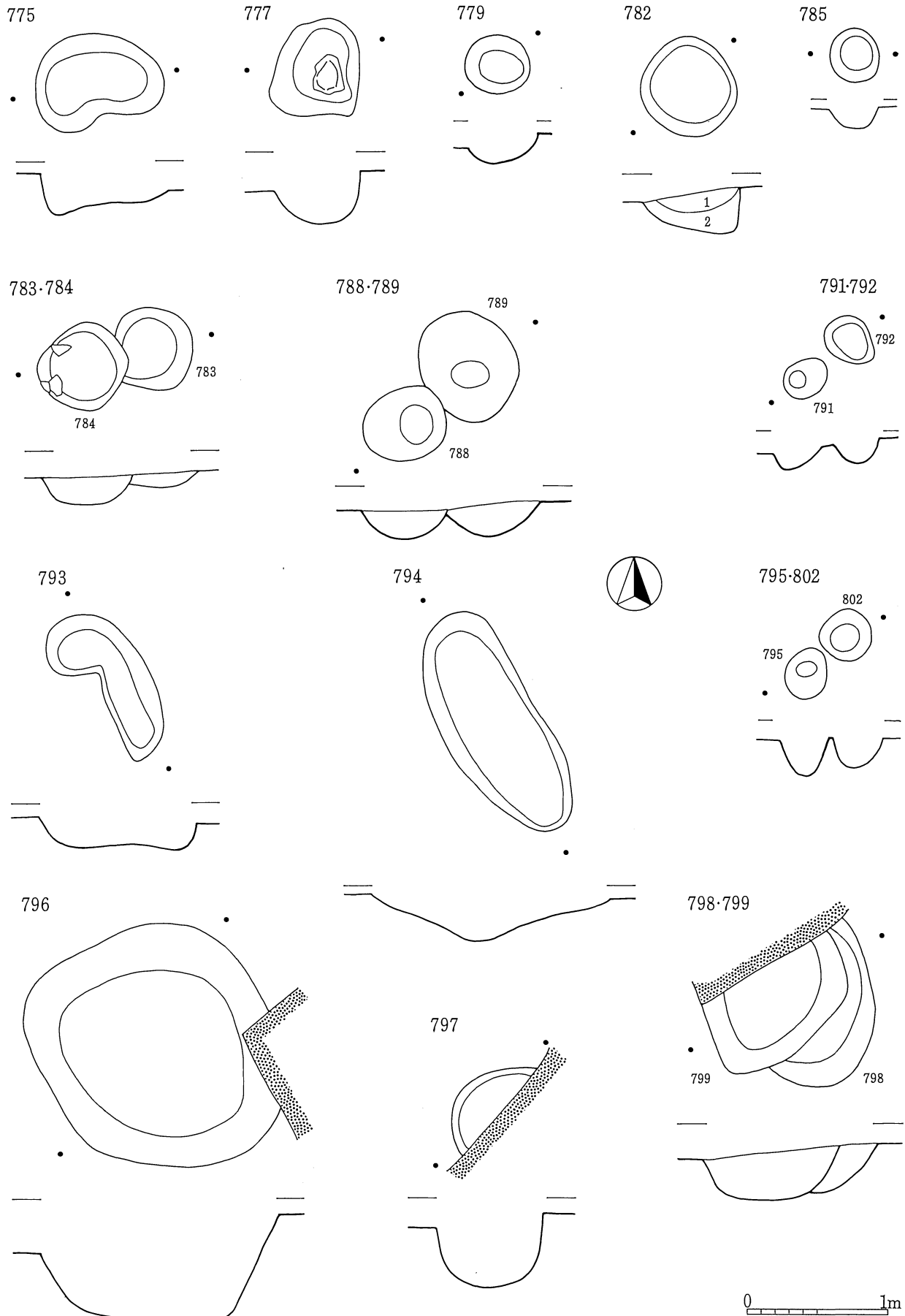

図版43 縄文中期の土坑(2) 1 : 40

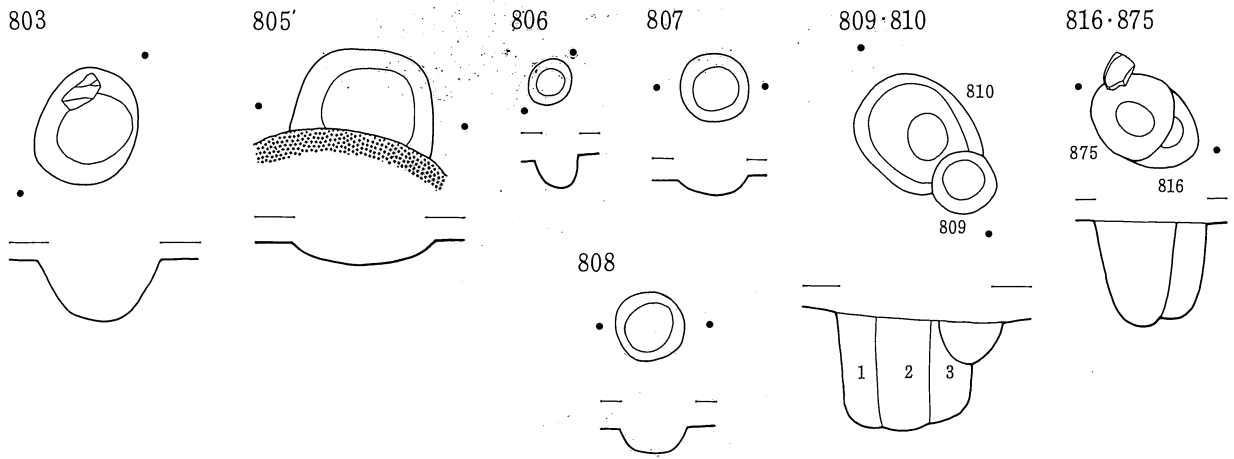

817-830-831-832-836~840

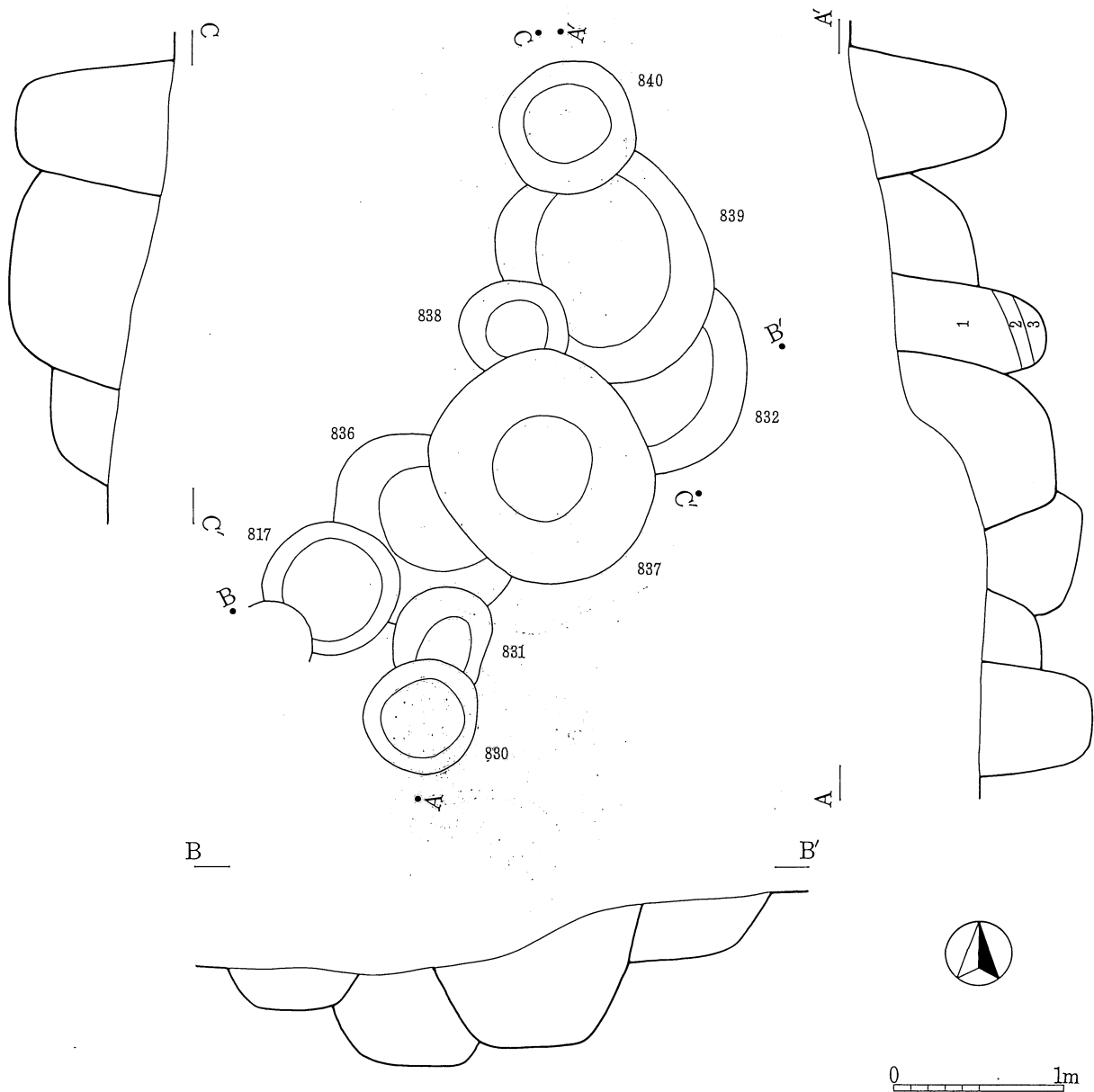

図版44 縄文中期の土坑(2) 1:40

818

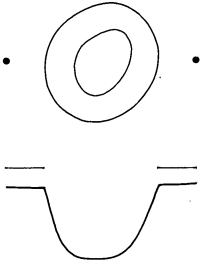

821

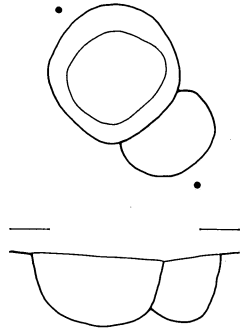

824



825

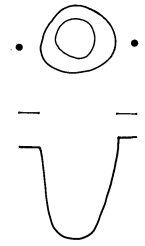

826

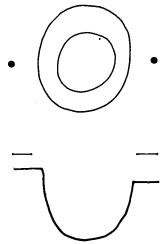

828・846

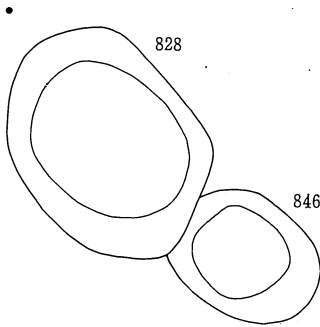

829



842

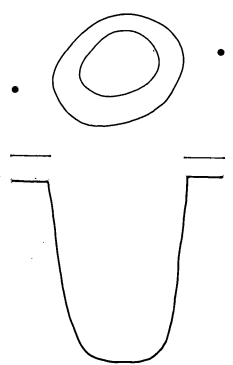

827

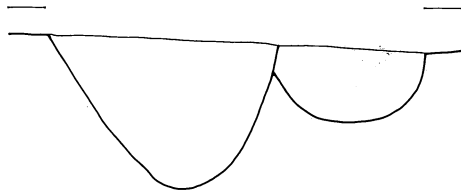
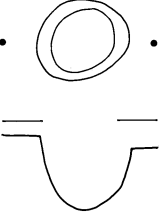

833

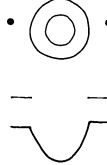

847・851

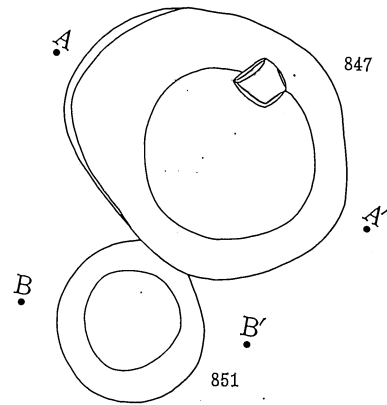

843

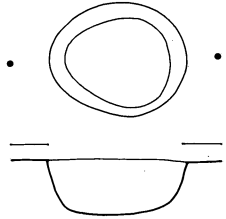

844・845

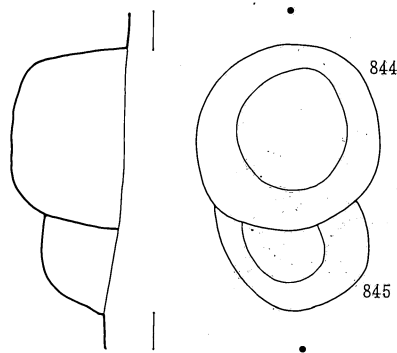

849

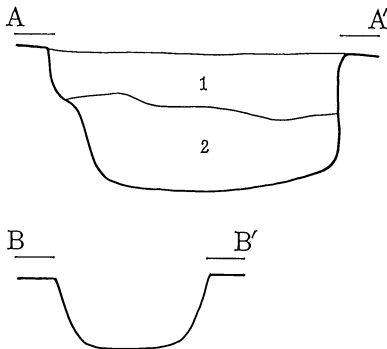
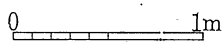
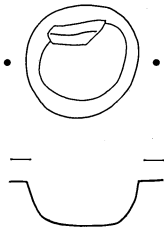

図版45 縄文中期の土坑(2) 1 : 40



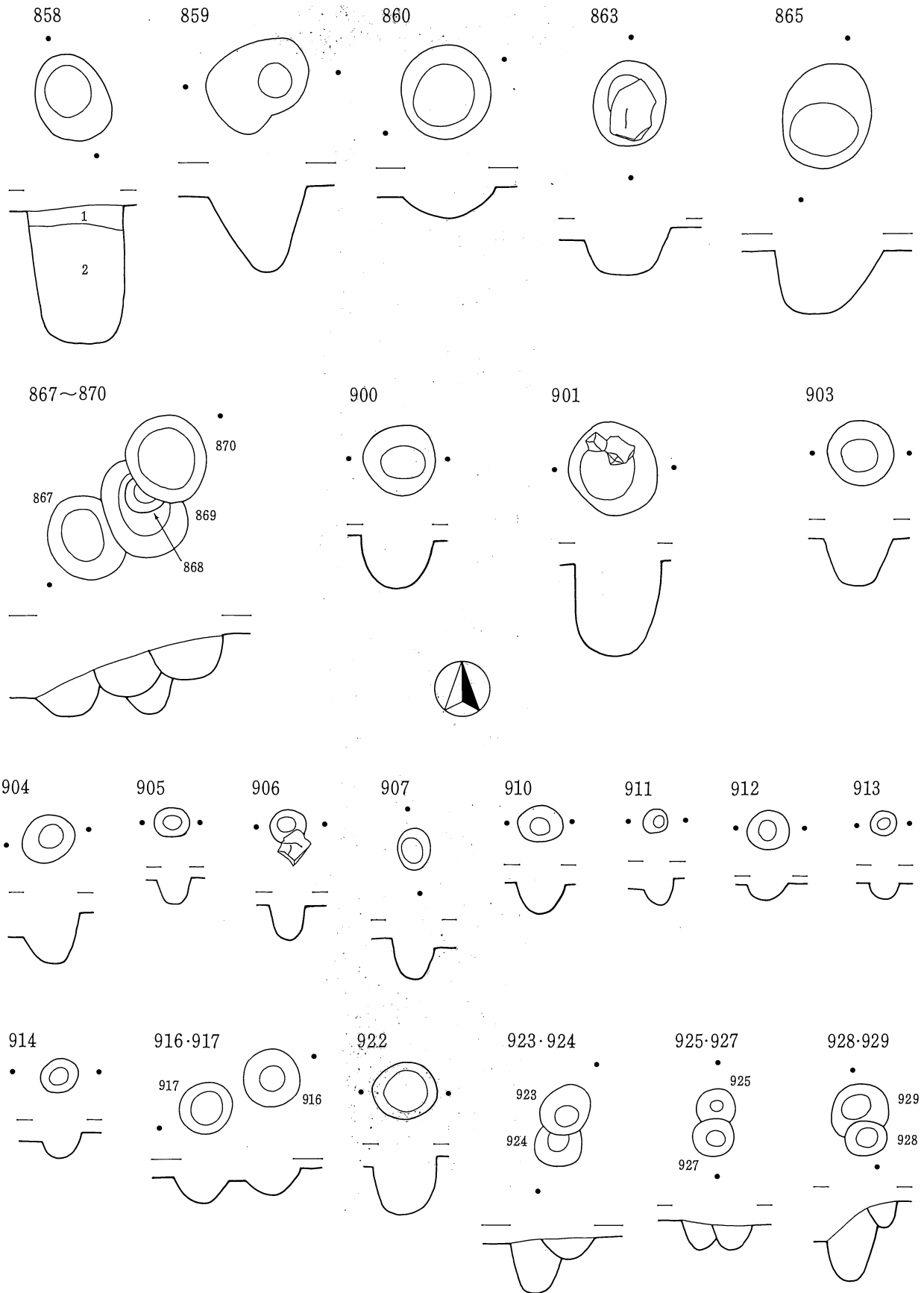

0 1m

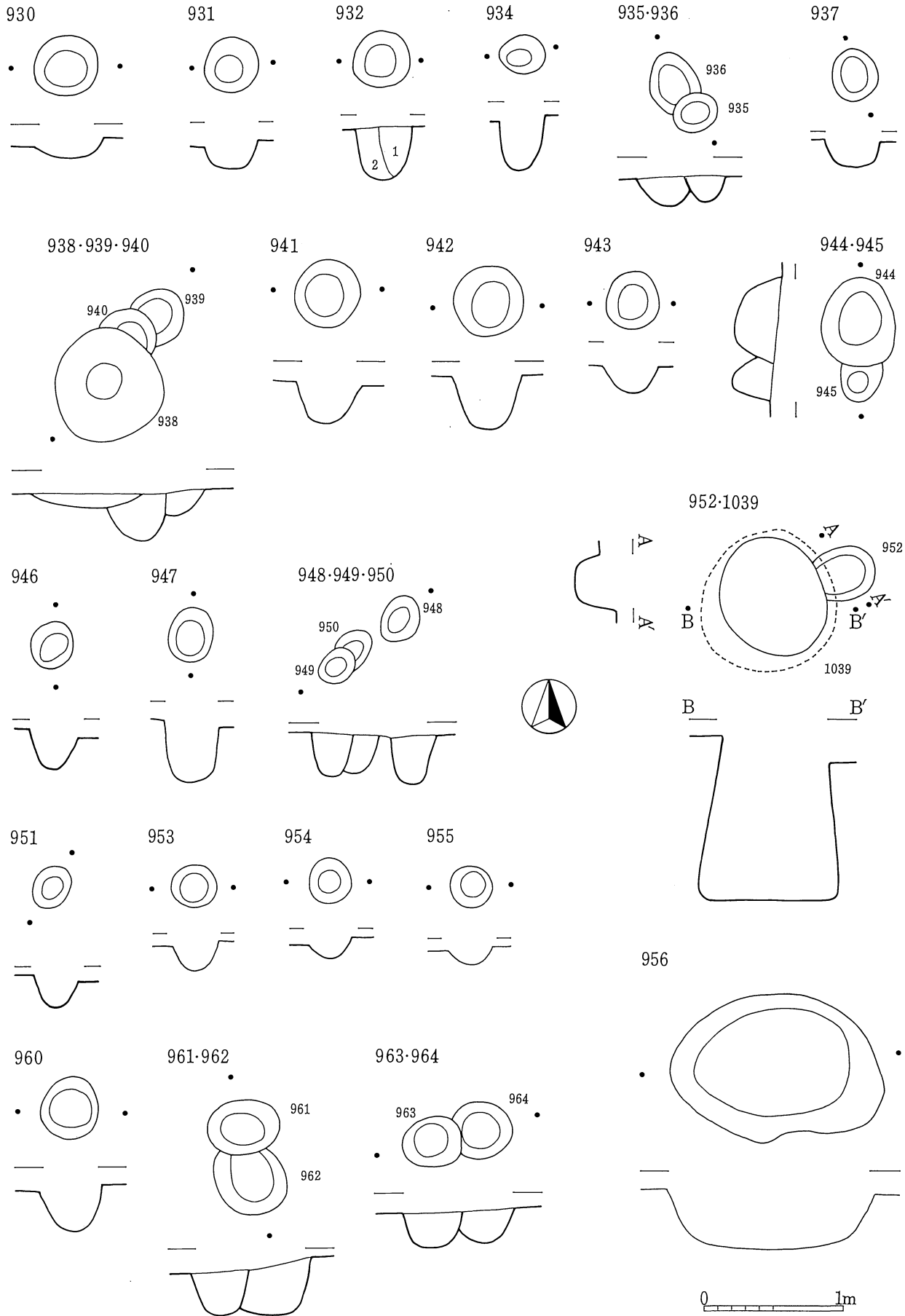

図版47 縄文中期の土坑(26) 1 : 40

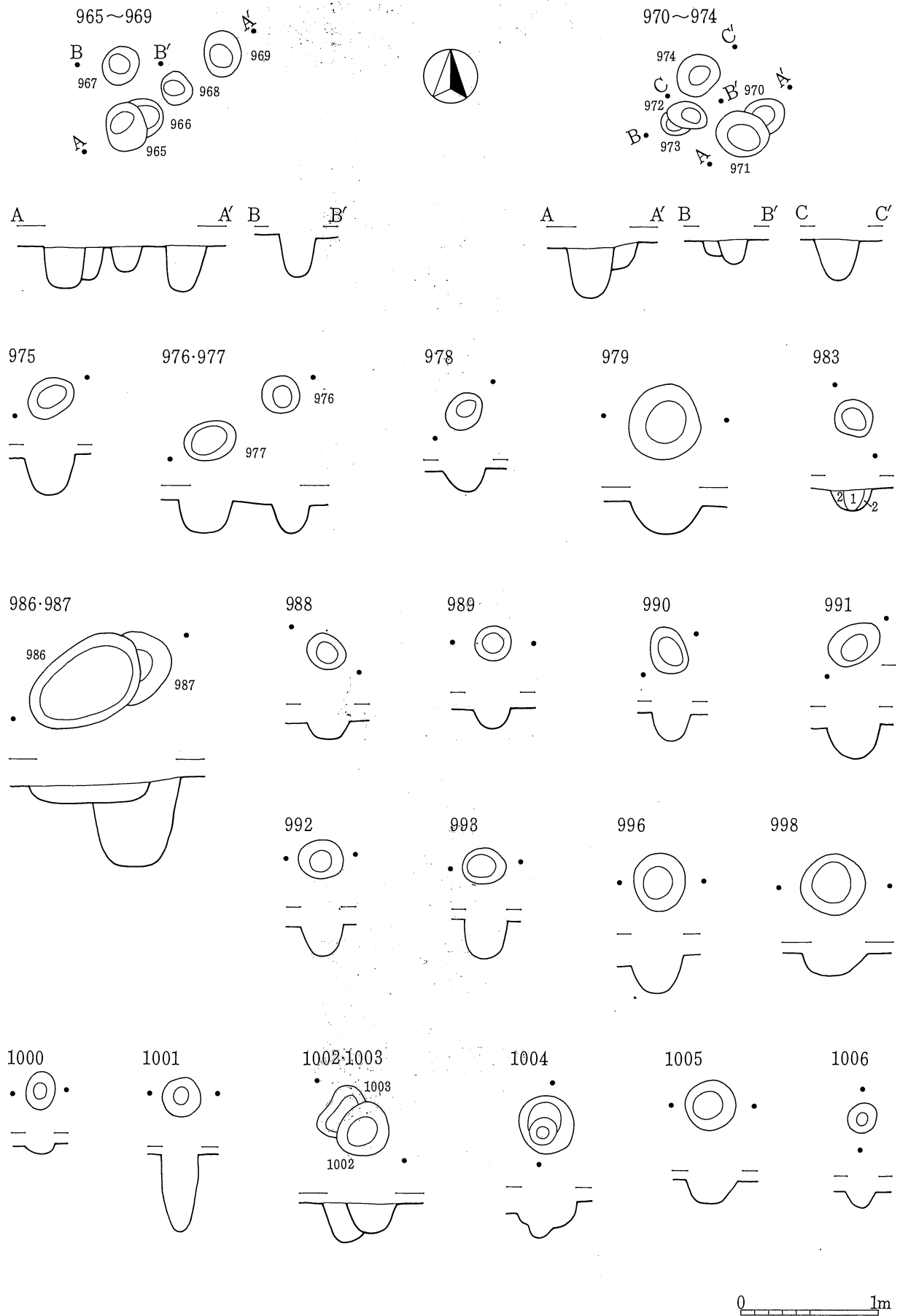

図版48 縄文中期の土坑(27) 1:40

1008・1009

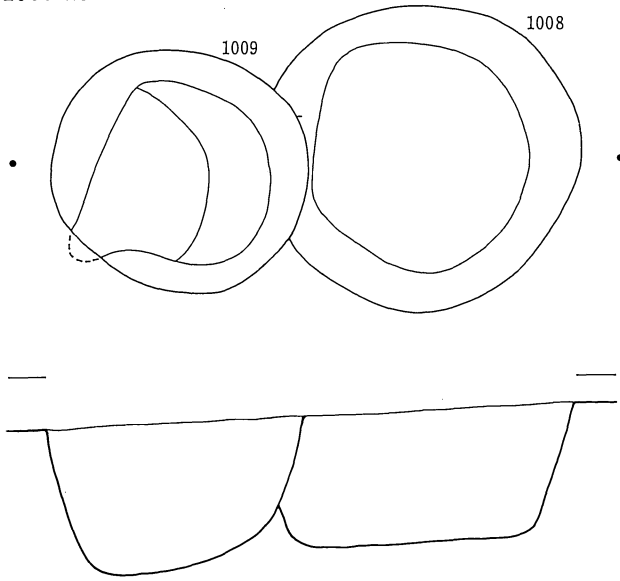

1010

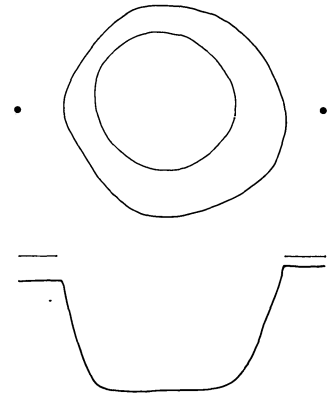

1012

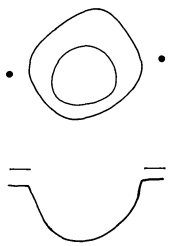

1013

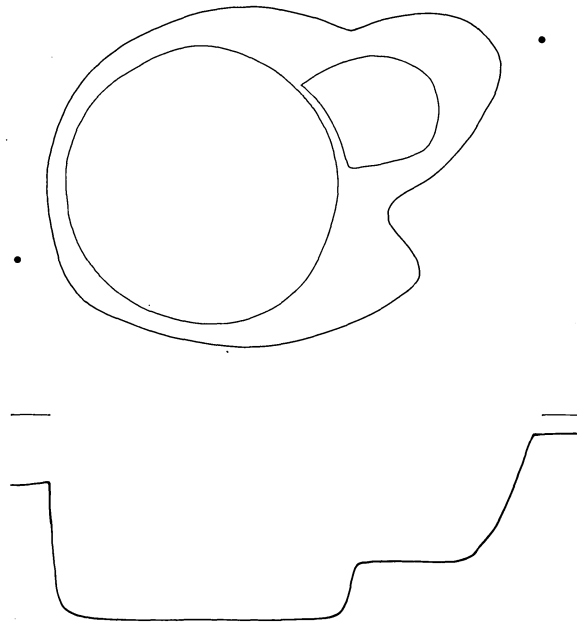

1014

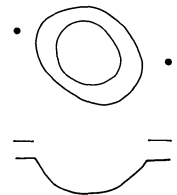

1015

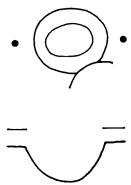

1016

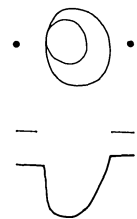

1017

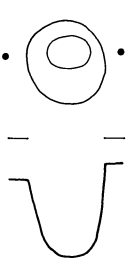

1018

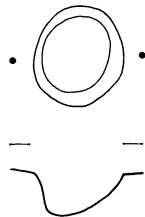

1019

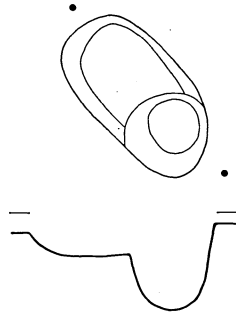

1020

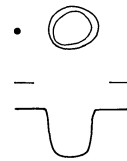

1021

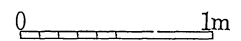
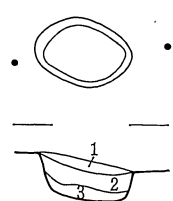

1022

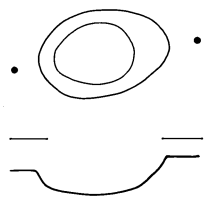

1023

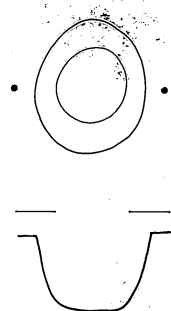

1024

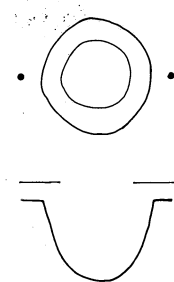

1025

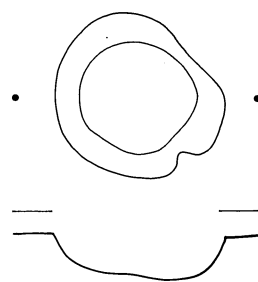

1026

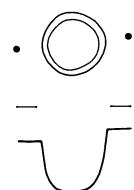

1028

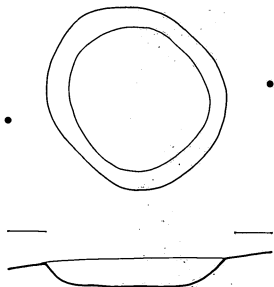

1029

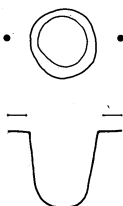

1030-1031

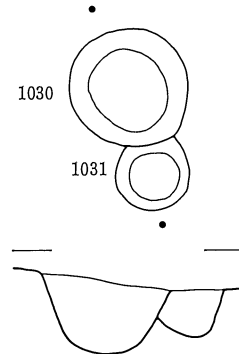

1032

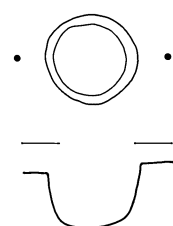

1034

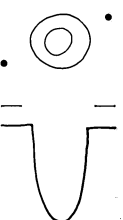

1035

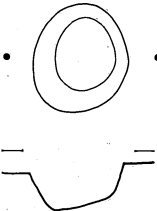

1042

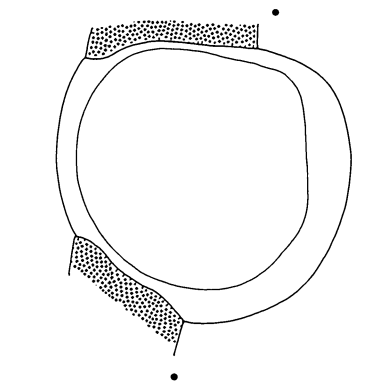

1038

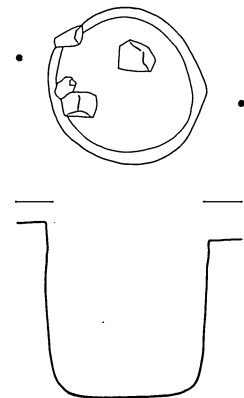

1040

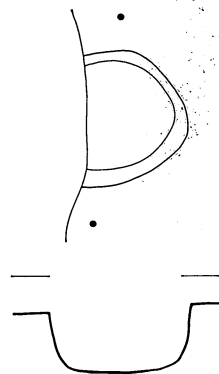

1041

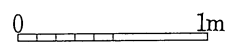
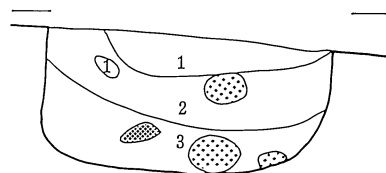
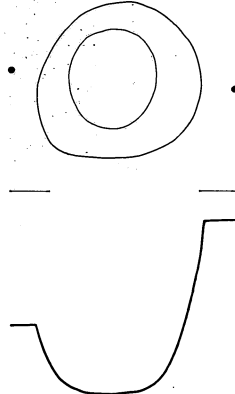

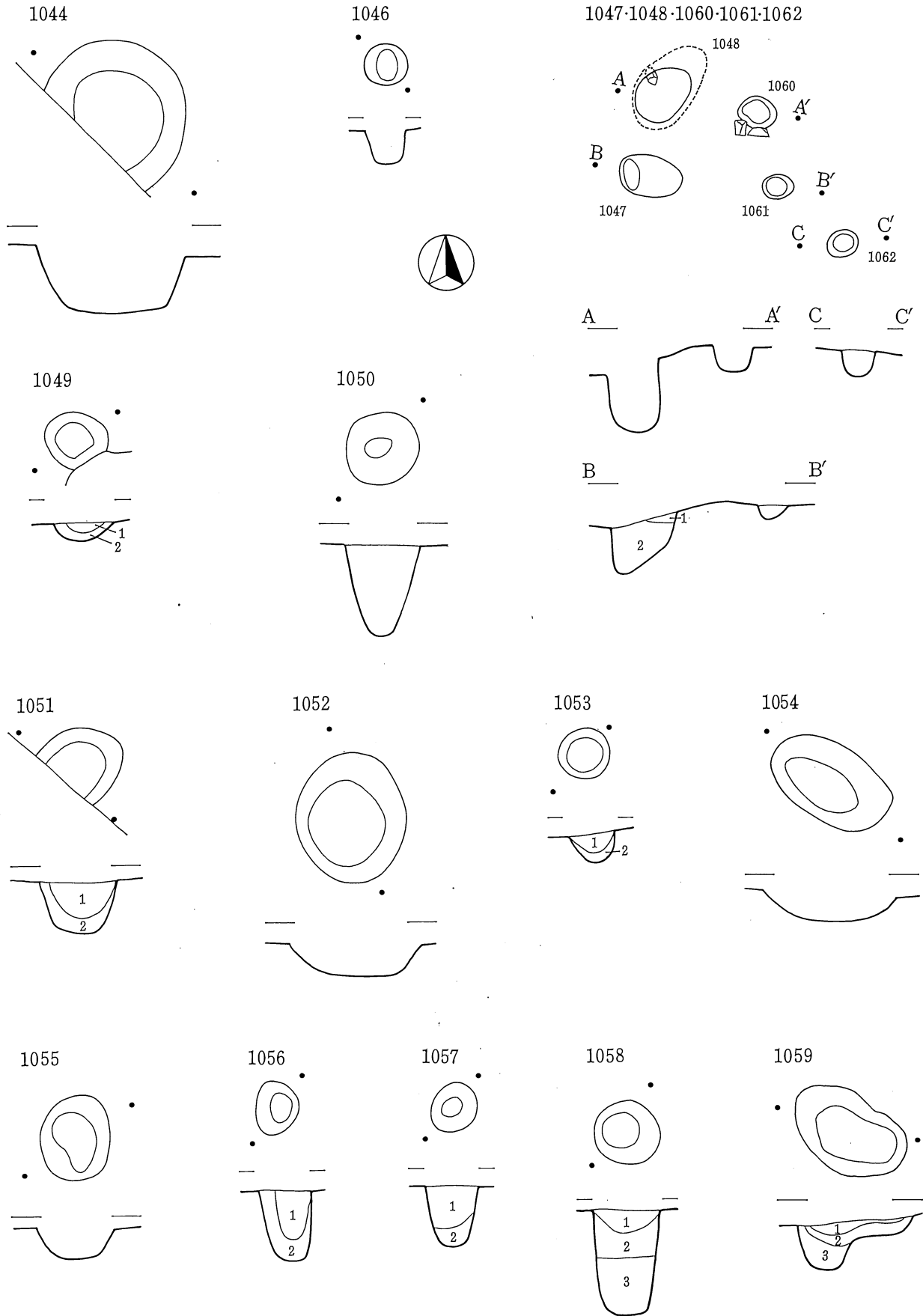

図版51 縄文中期の土坑(30) 1 : 40

1063~1068

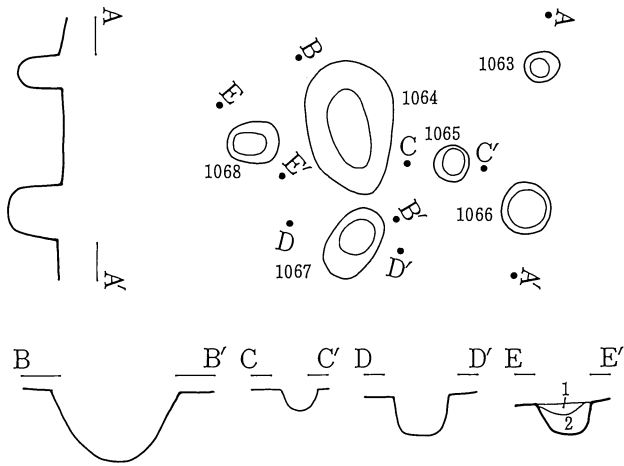

1072

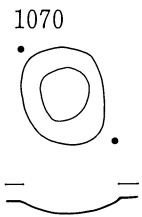
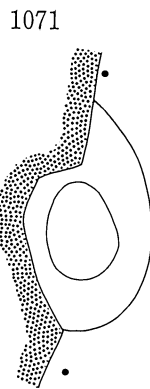
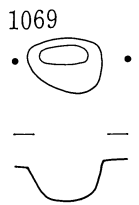
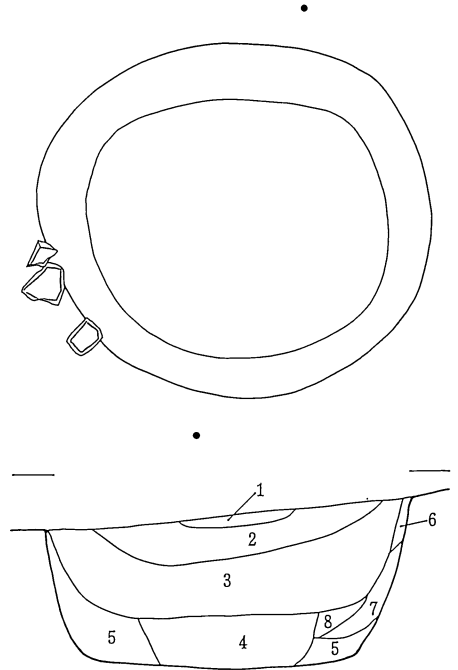

1075

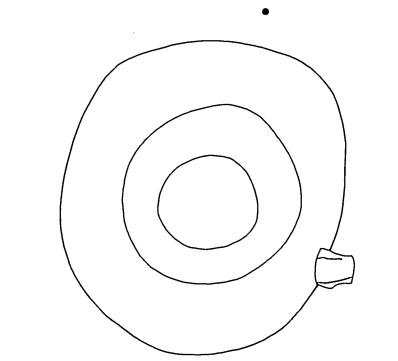

1073·1074·1076

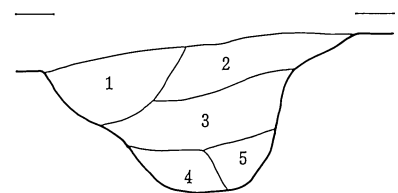
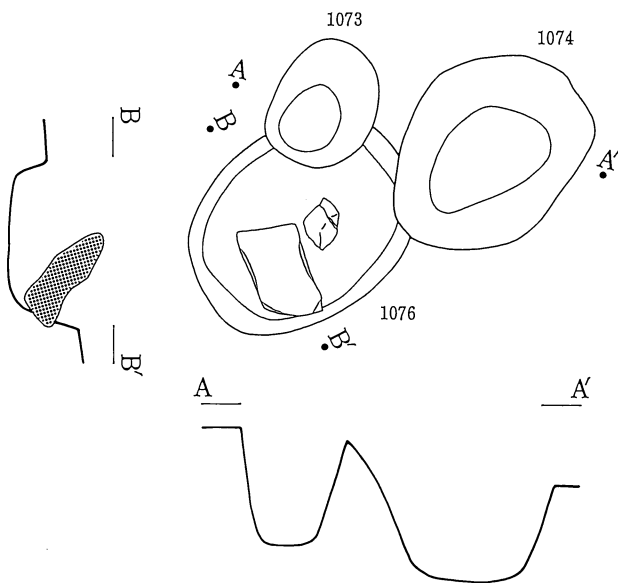

0 1m

図版52 縄文中期の土坑(31) 1 : 40

1101

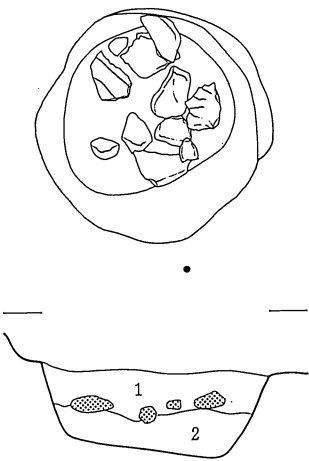

1102

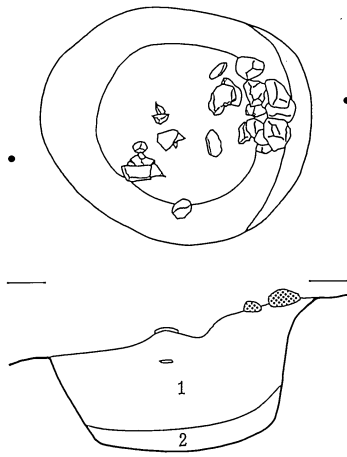

1103

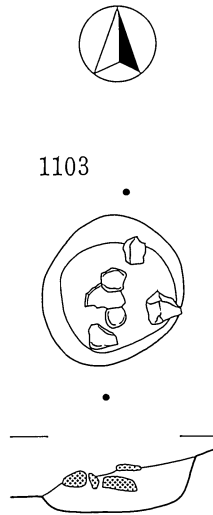

1104

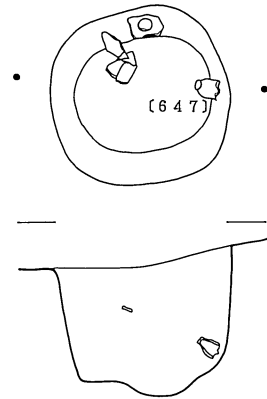

1107 ~ 1112

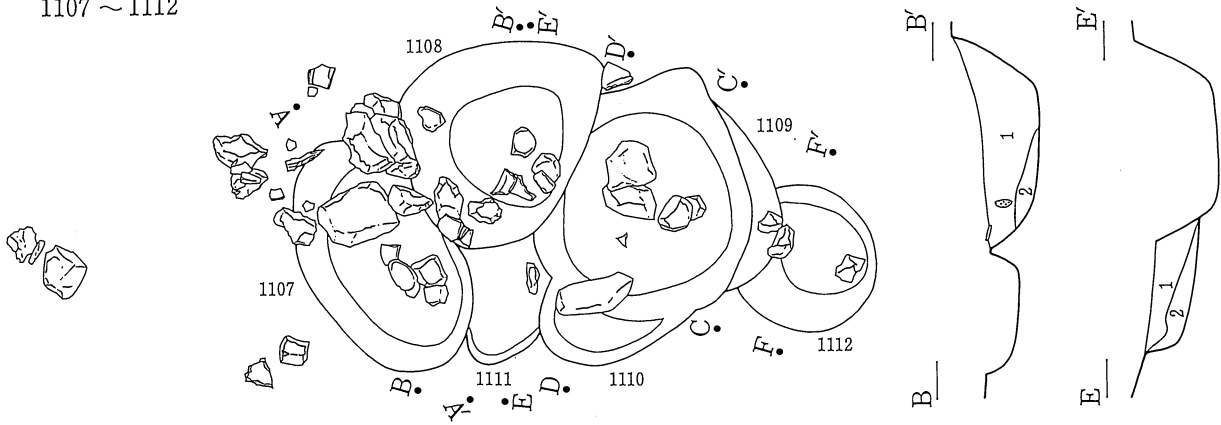

1. 1105. 1106

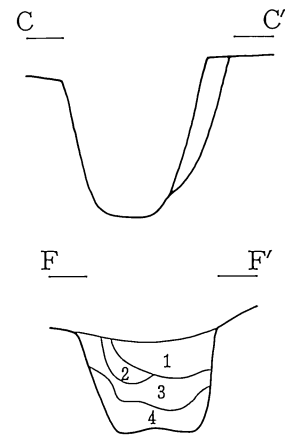
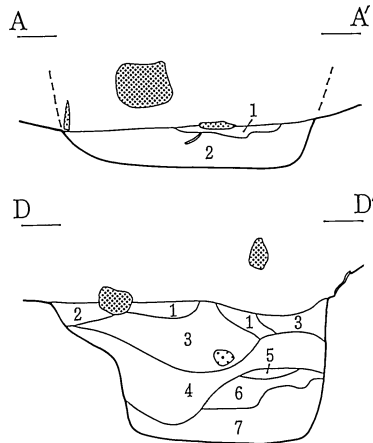
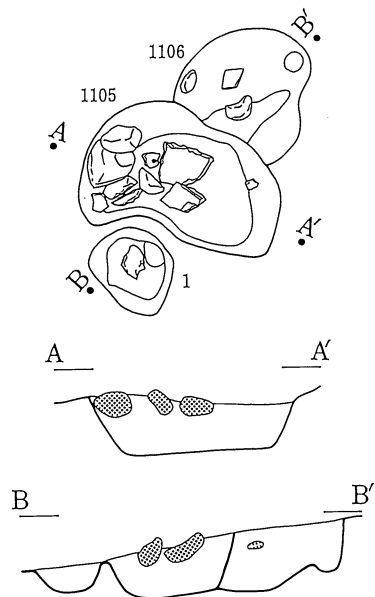

0 1m

図版53 縄文中期の土坑(2) 1 : 40



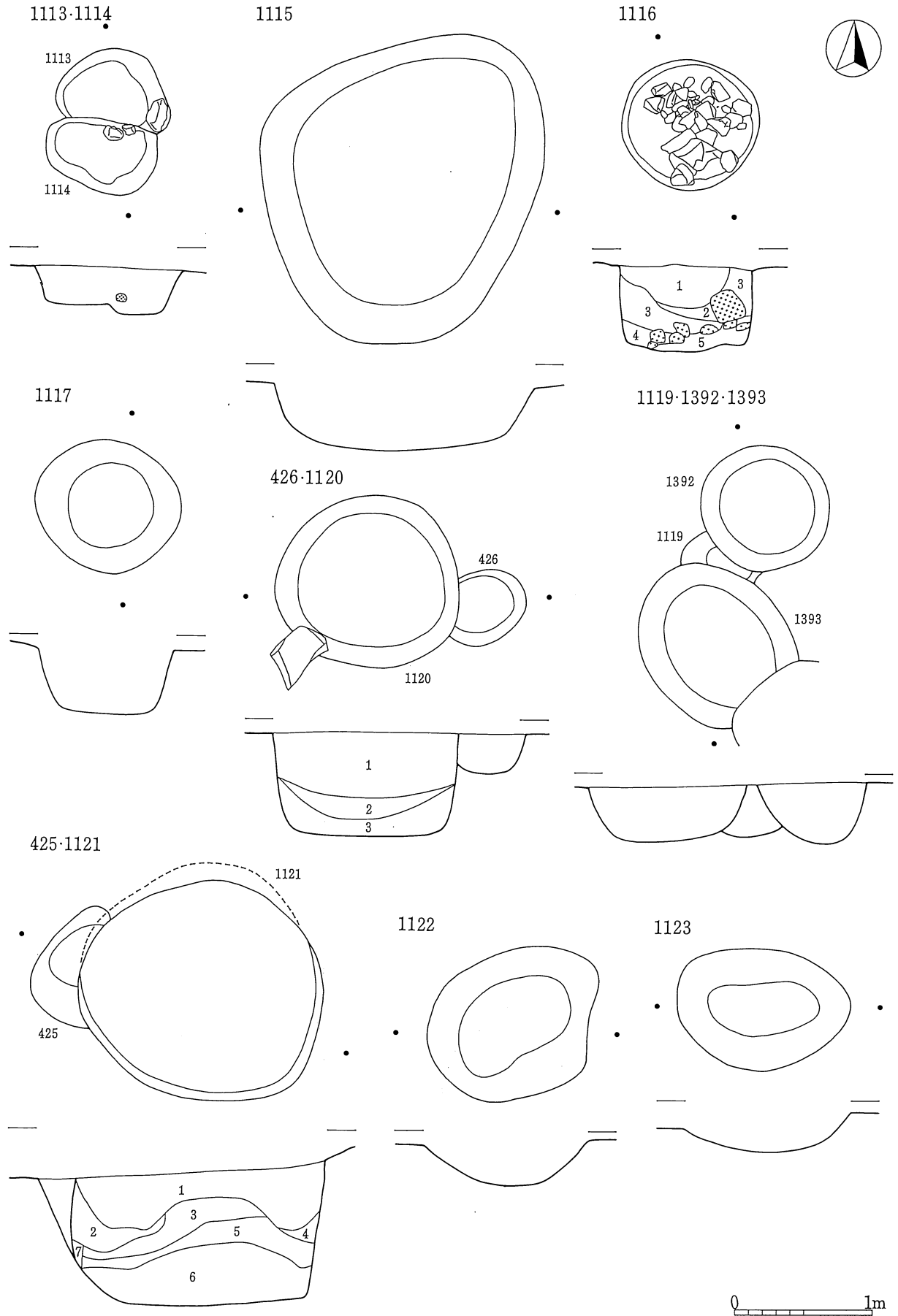

図版54 縄文中期の土坑(3) 1 : 40

1124

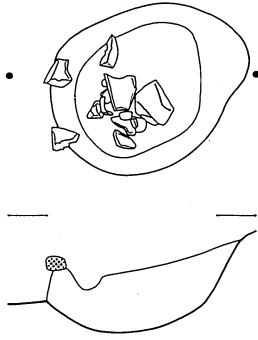

1125

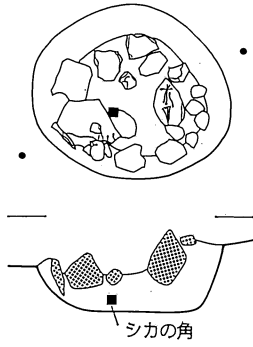

1126

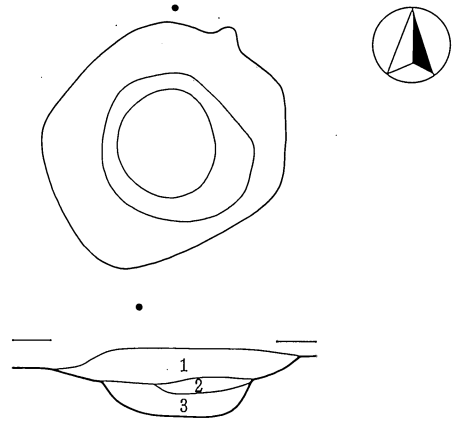

1127

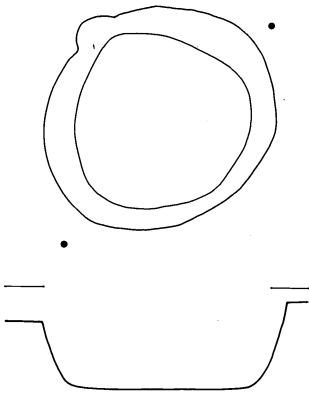

1128

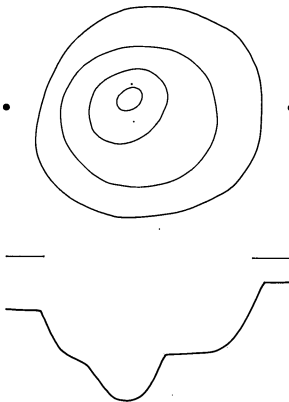

6·11·1130

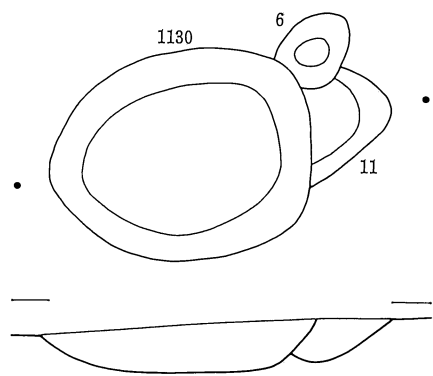

1129

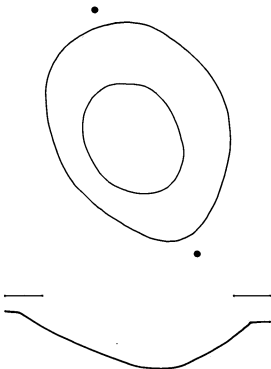

1131

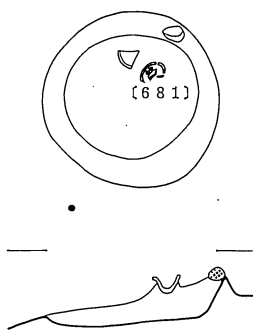

1132

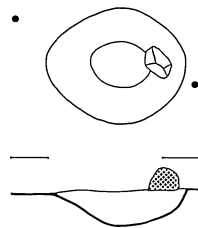

1133

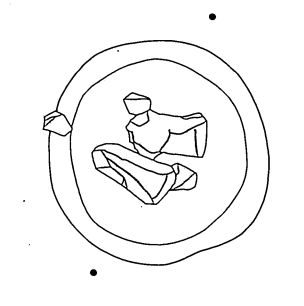

1134

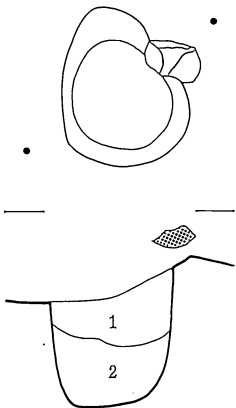

1135·1140

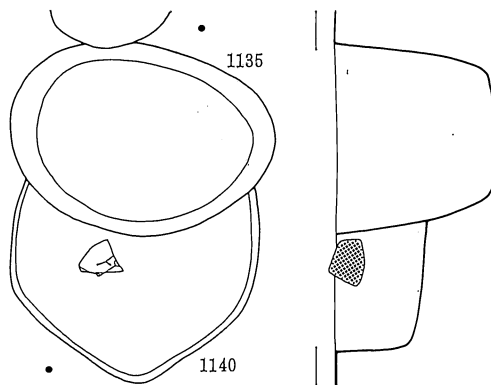

1140

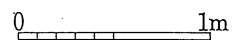
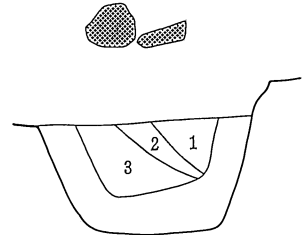

図版55 縄文中期の土坑(4) 1 : 40

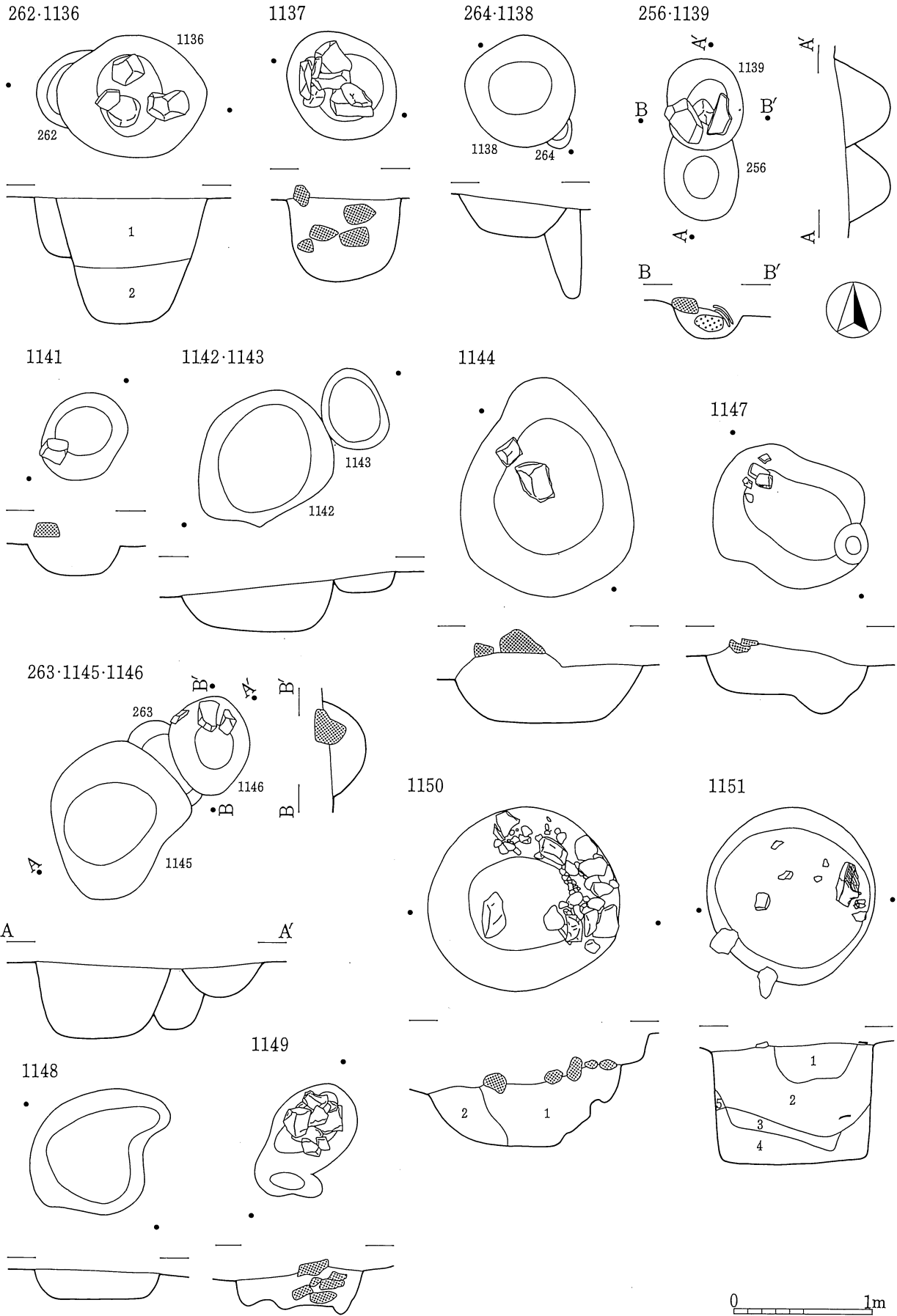

図版56 縄文中期の土坑(35) 1:40

412 ~ 415 · 421 · 1152

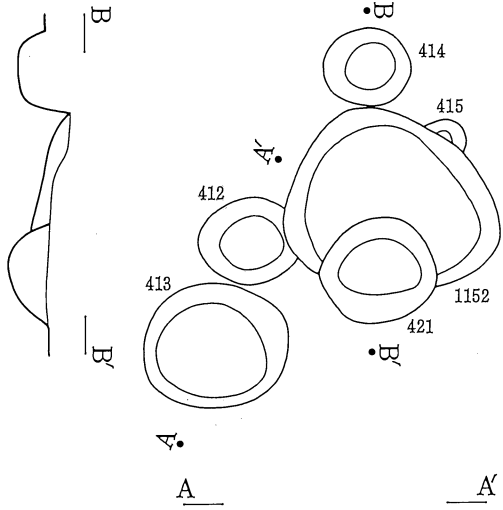

457 · 1153

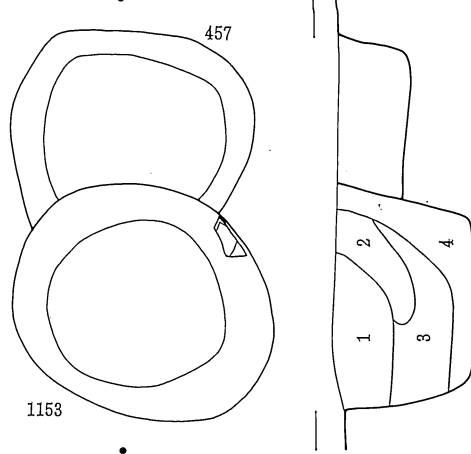

1155 ~ 1157

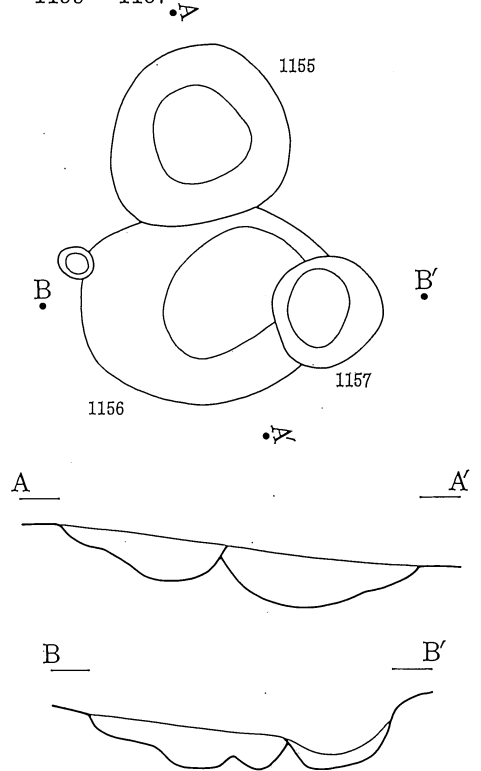

441 · 1154

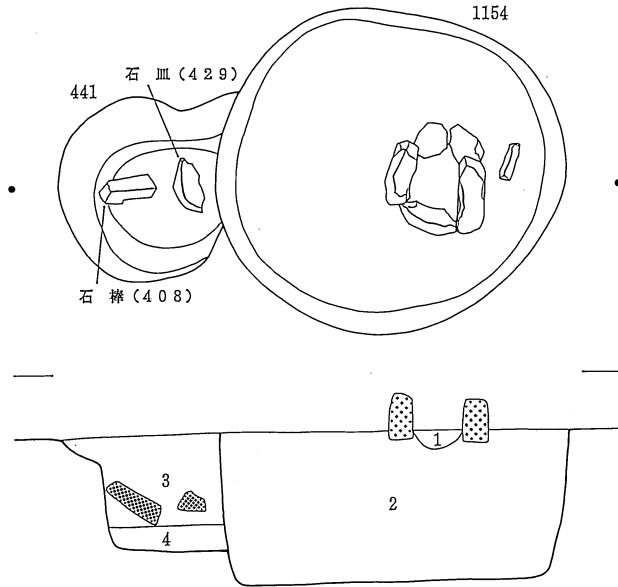

1158

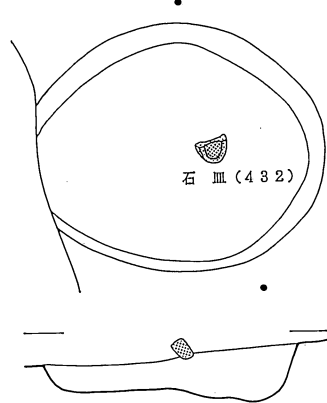

1178

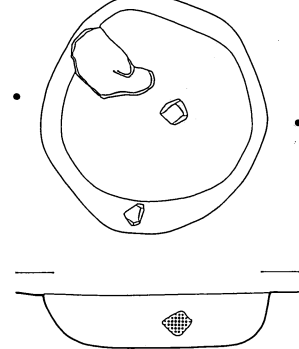

1170

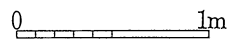
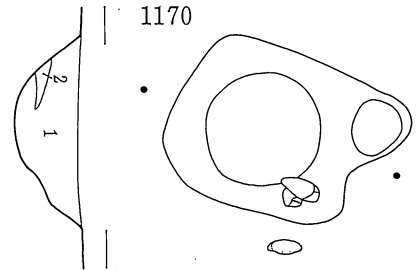

図版57 縄文中期の土坑(30) 1 : 40

556・564～566・570・572・622・695～699・704  
1176・1187～1190・1193・1220

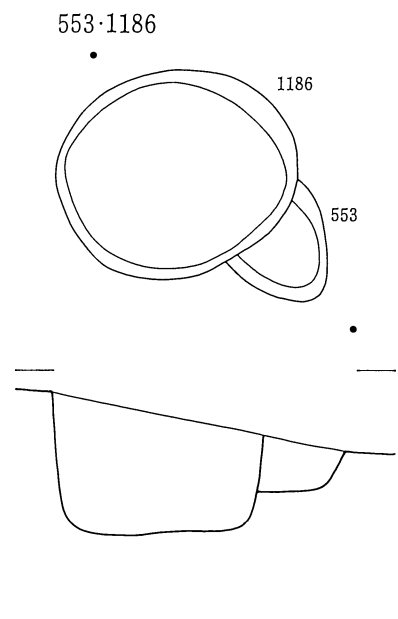
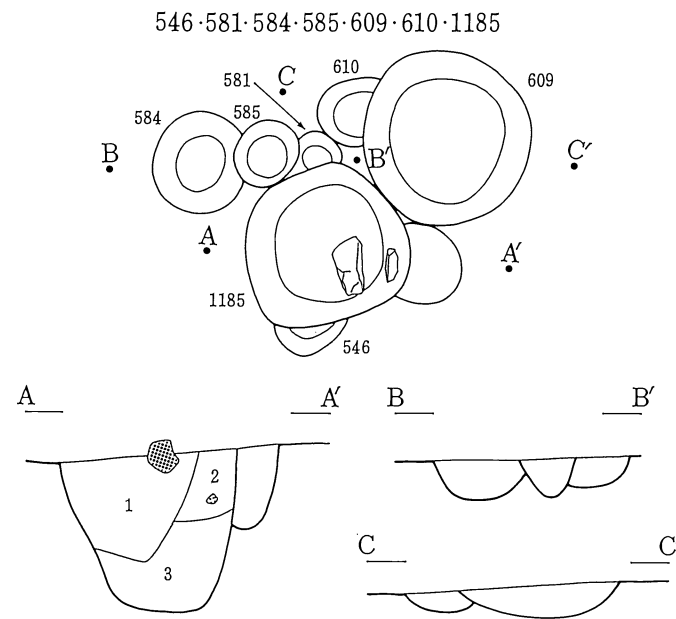
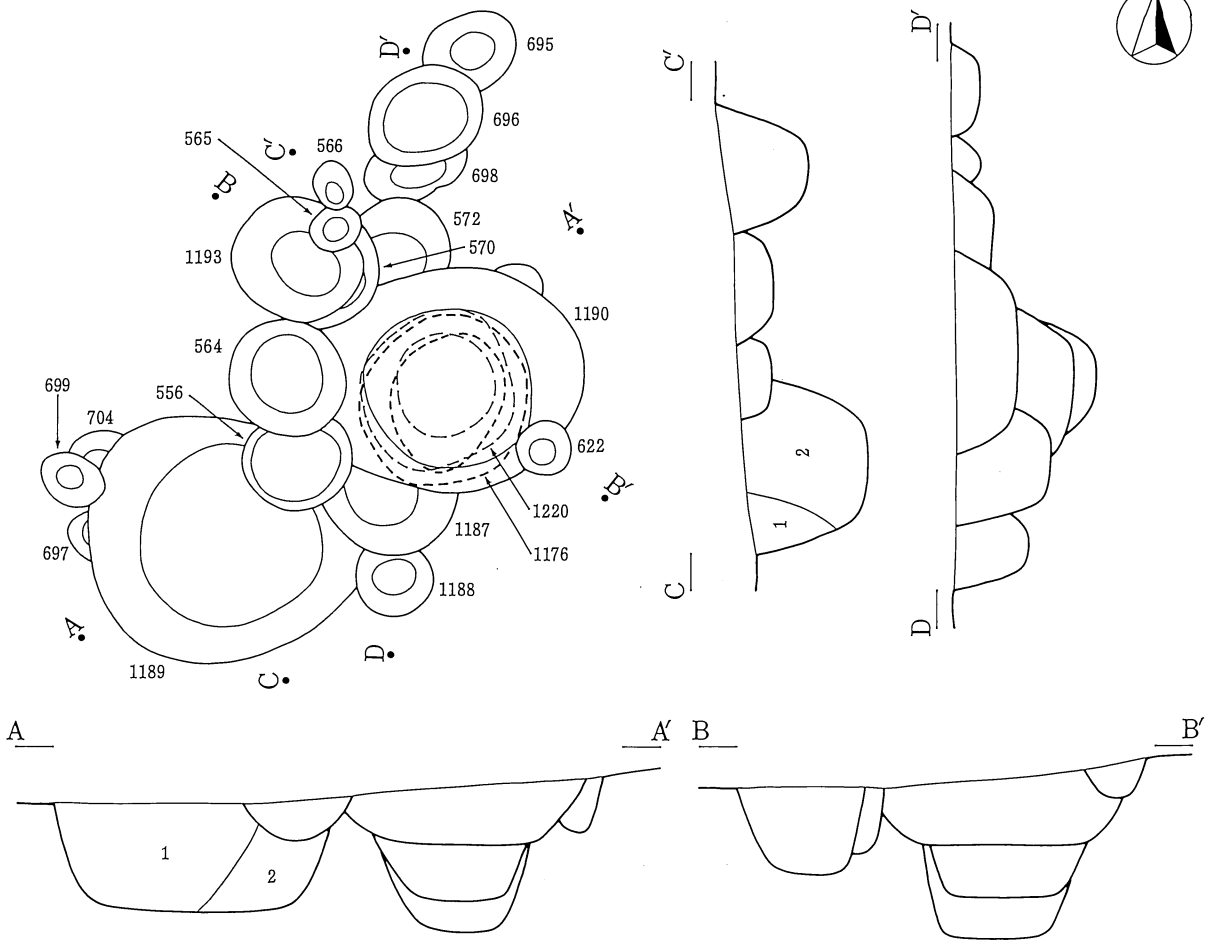

0 1m

図版58 縄文中期の土坑(7) 1 : 40

505 ~ 508 · 557 · 558 · 1171 ~ 1175 · 1180

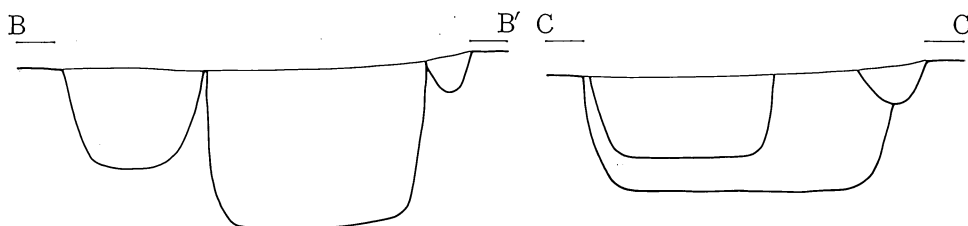
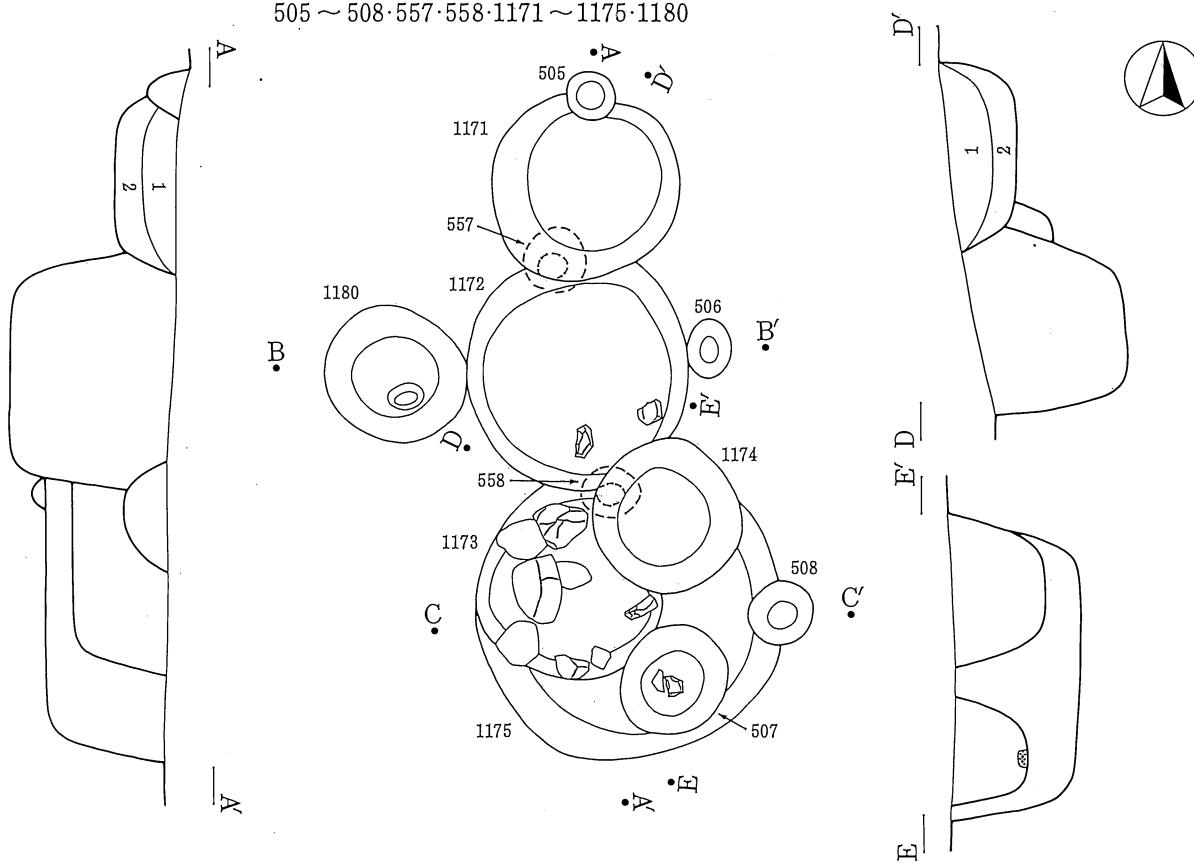

1179

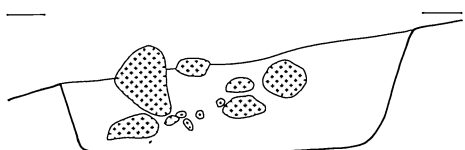

1181

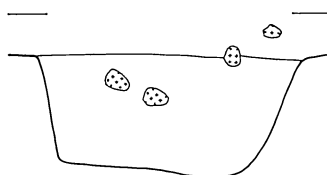
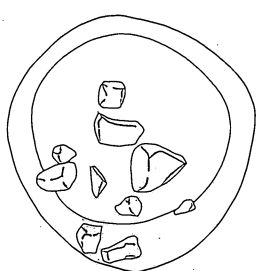

1183

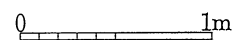
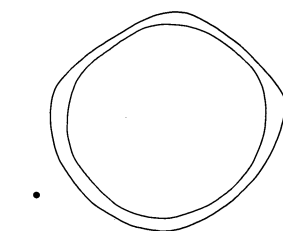

図版59 縄文中期の土坑(8) 1 : 40

525・539～541・544・548・549・559・563  
567～569・573～576・632・1184・1191

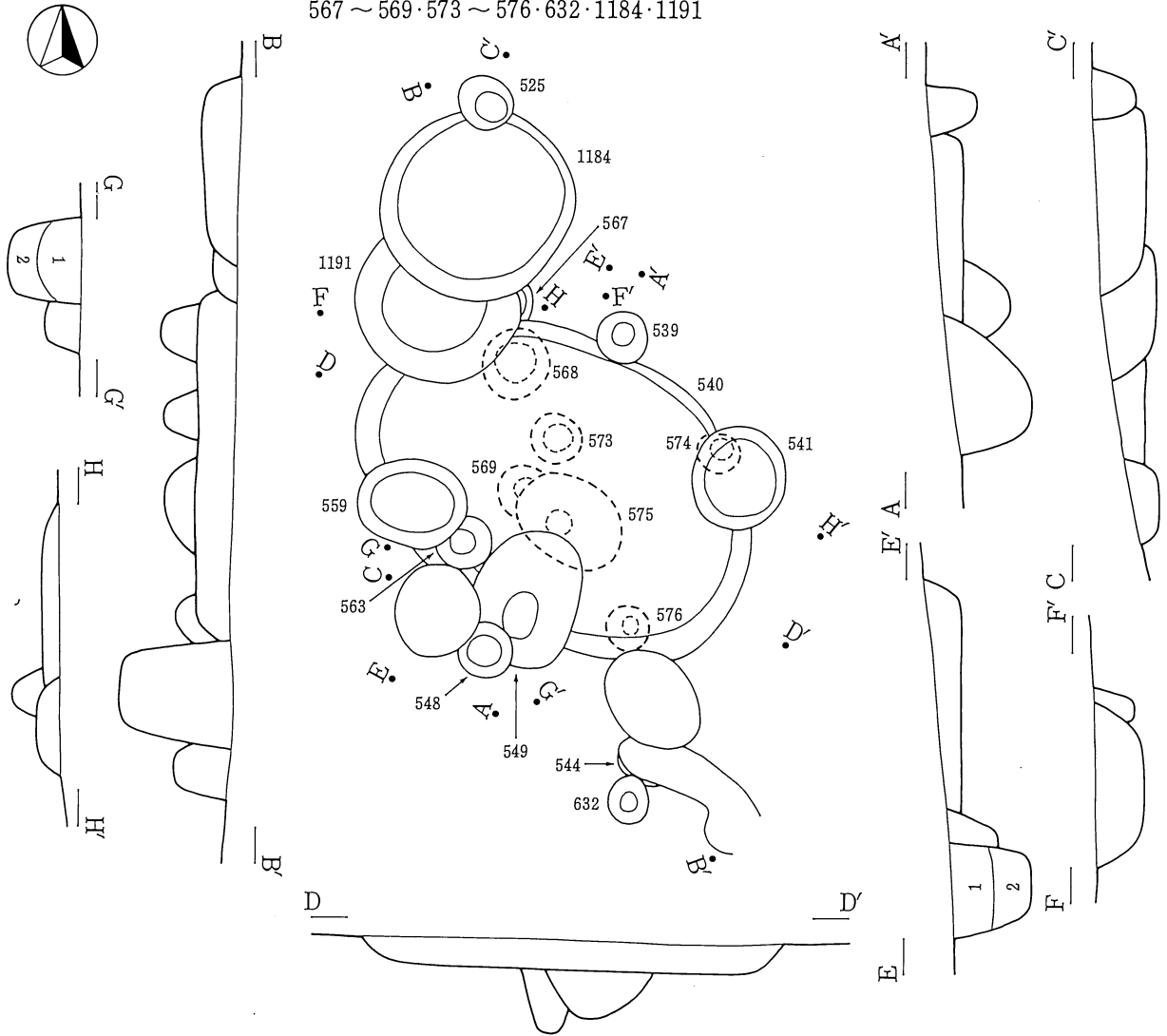

277・534・535・537・579・580・1196

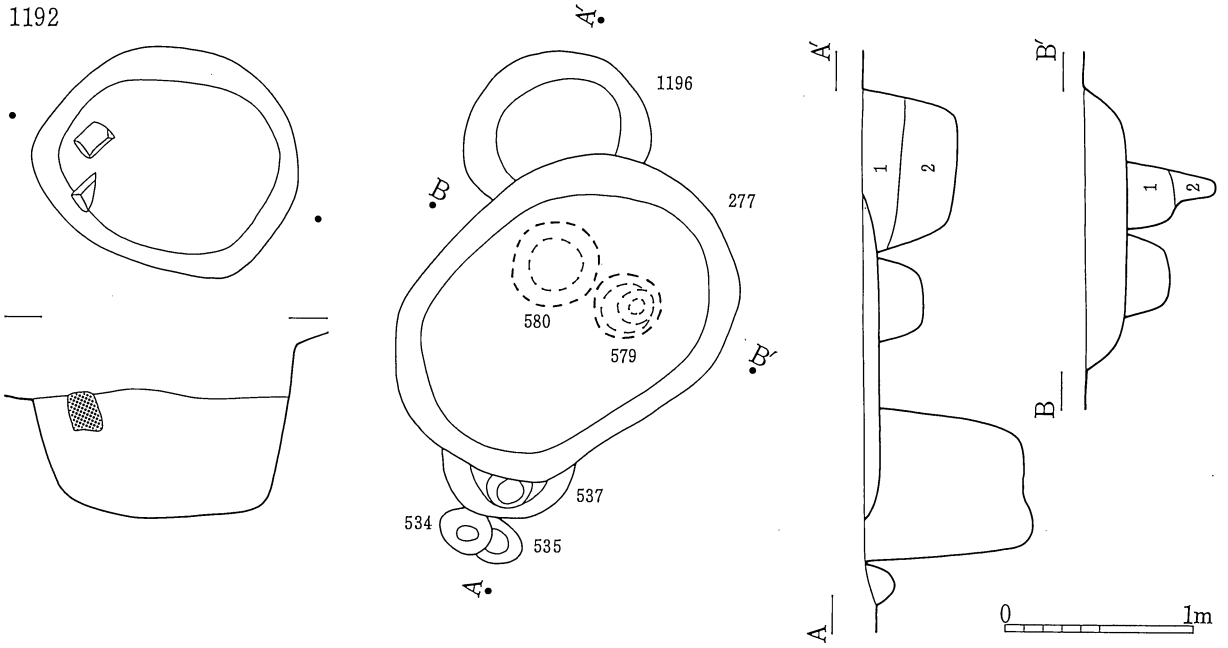

図版60 縄文中期の土坑(9) 1 : 40

1198・1259



1197

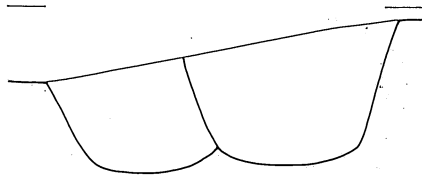
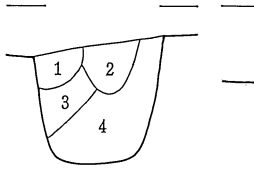
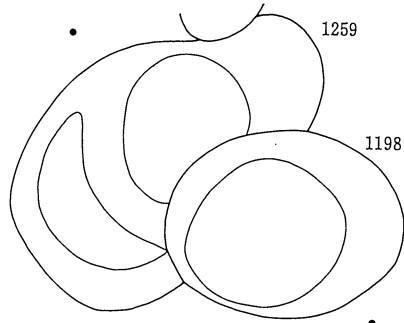
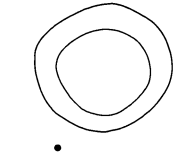

467・1199・1205

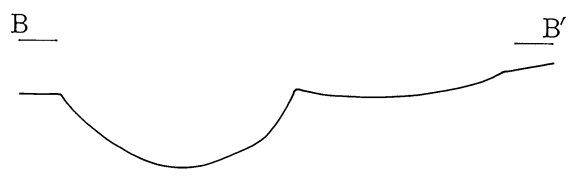
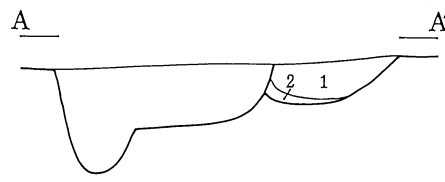
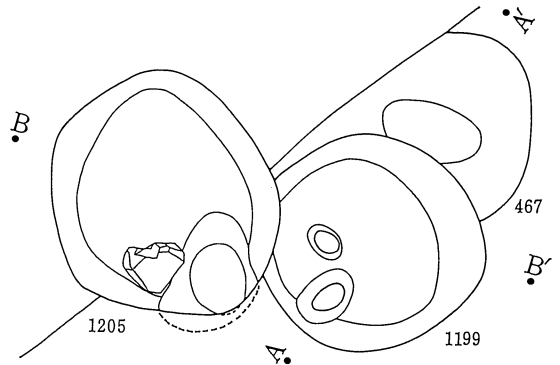

504・638・644・645・1200・1208

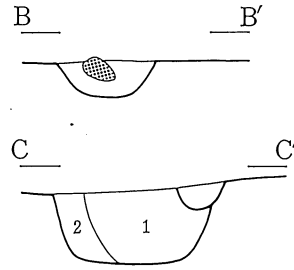
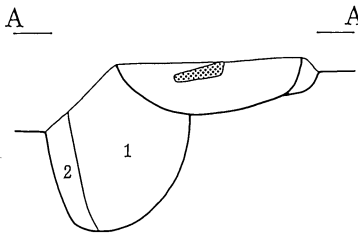
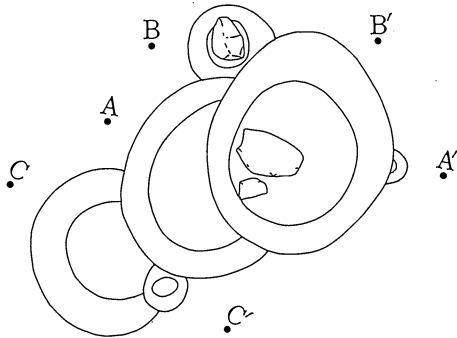

606・607・608・1202・1203

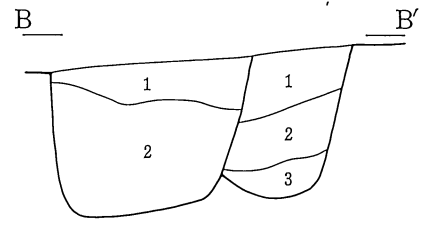
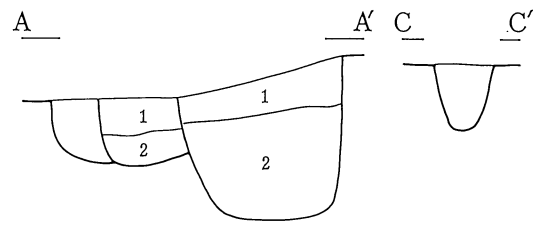
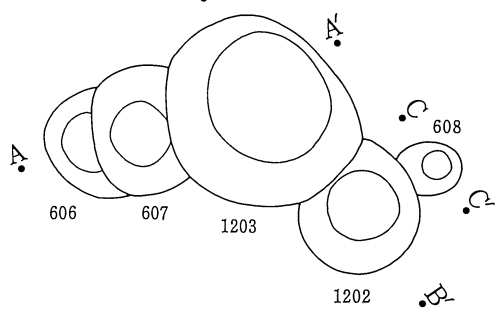

577・601・1201

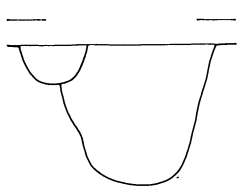
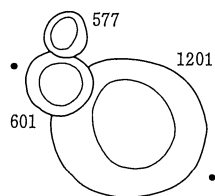

623・1204

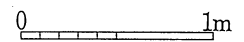
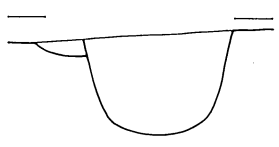
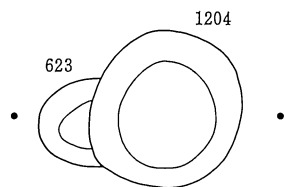

図版61 縄文中期の土坑(40) 1:40



578・586・592 ~ 594・639・640  
679・680・1207

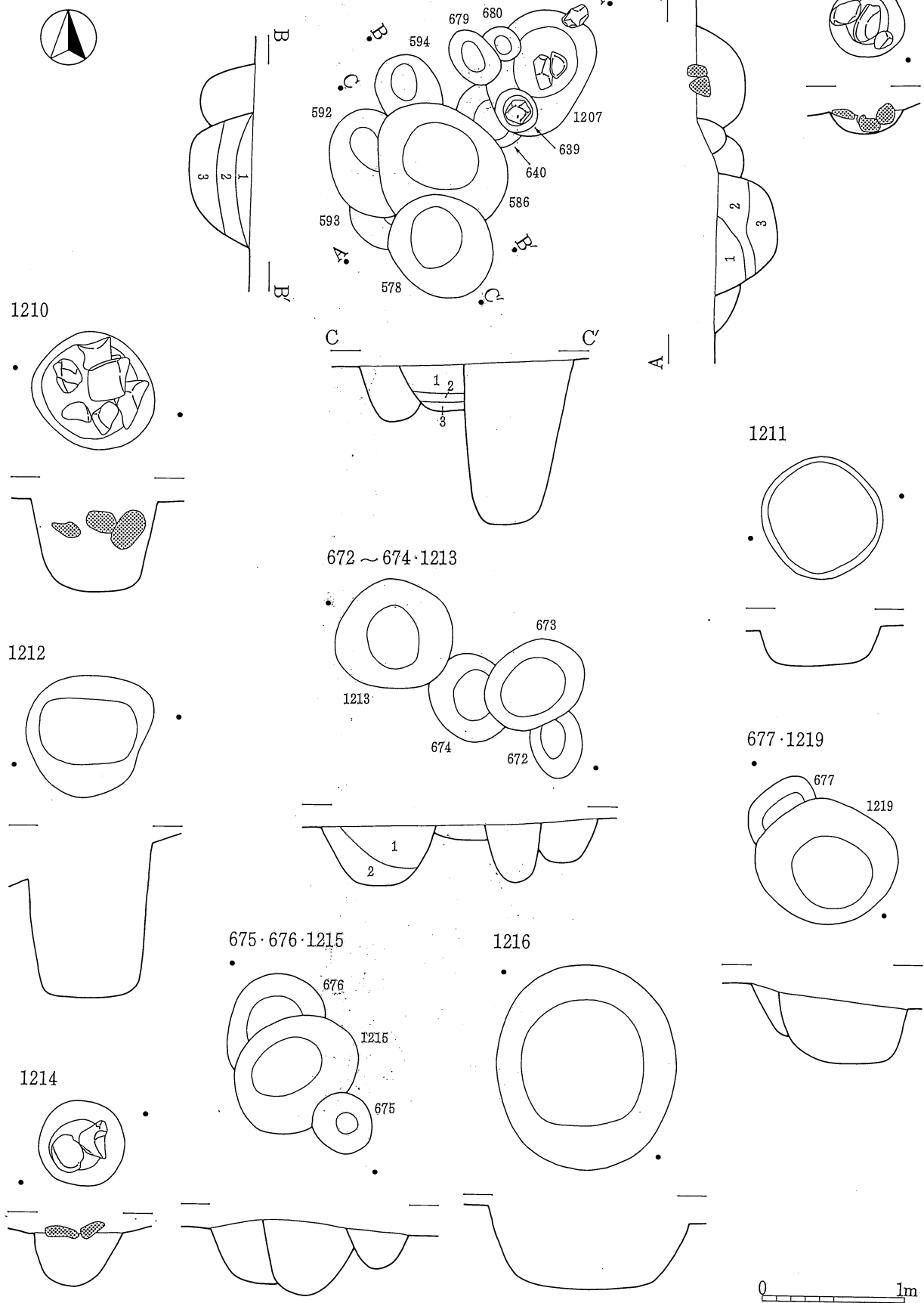

図版62 縄文中期の土坑(4) 1 : 40

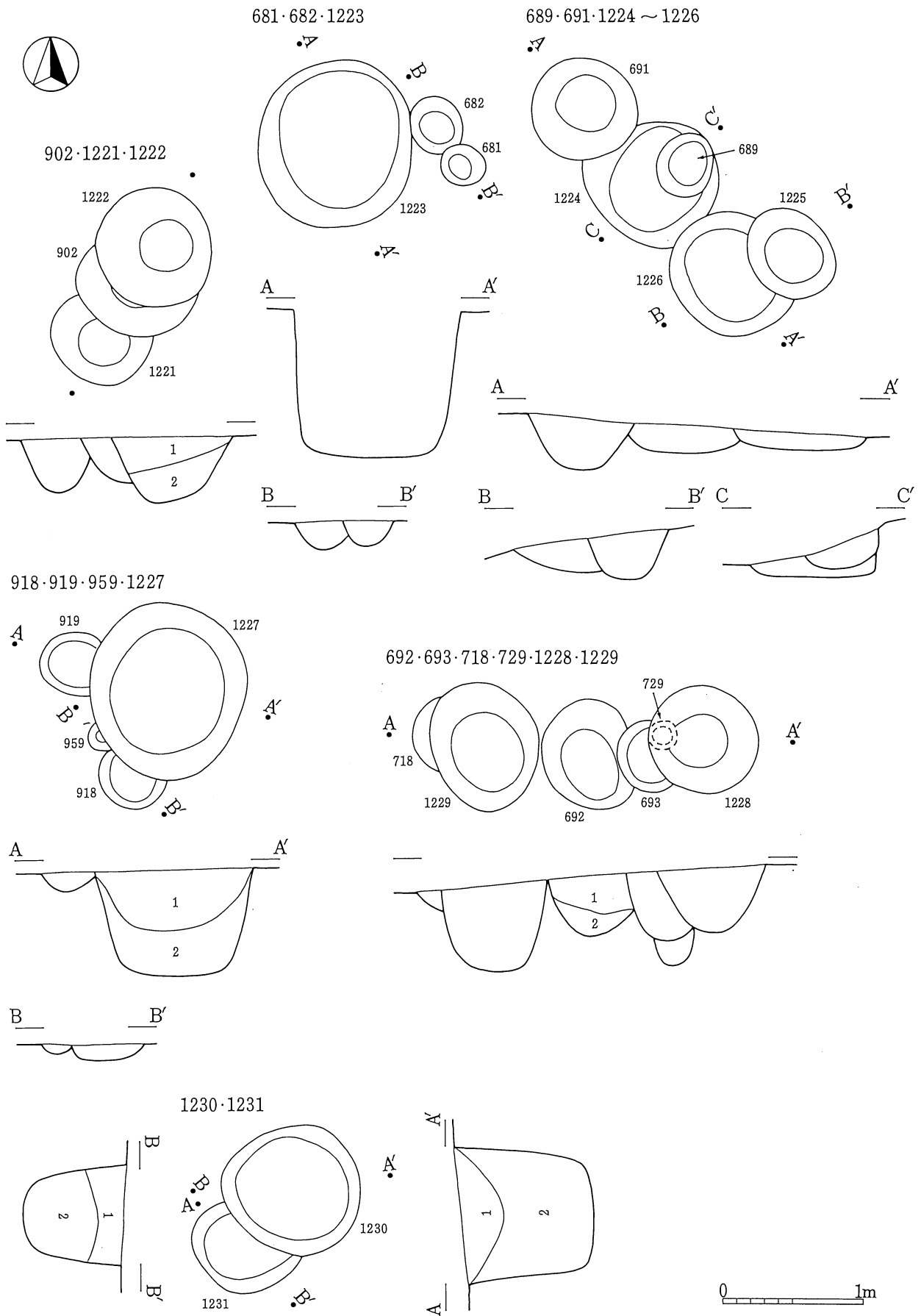

図版63 縄文中期の土坑(42) 1 : 40

1233・1234

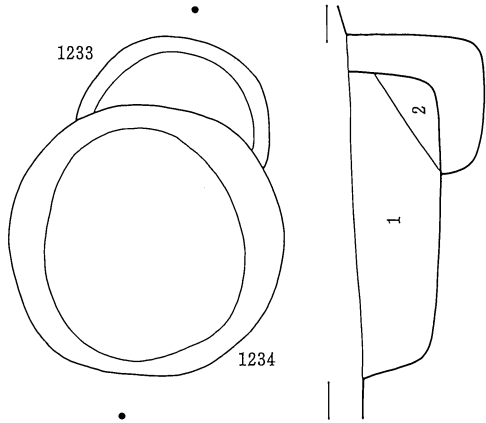

21・1037・1236

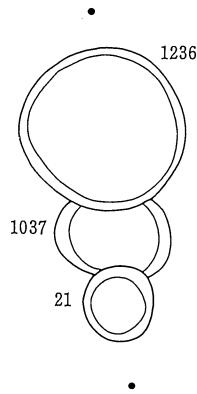

1237

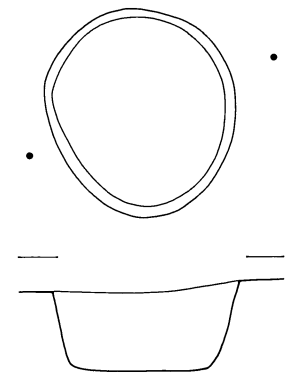

1238・1245

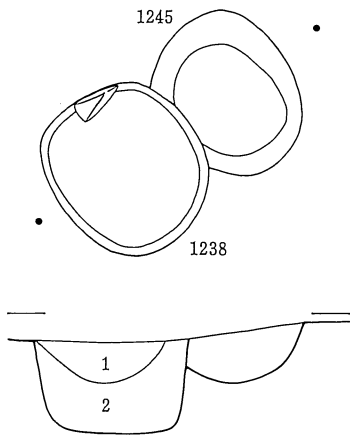

1239・1240

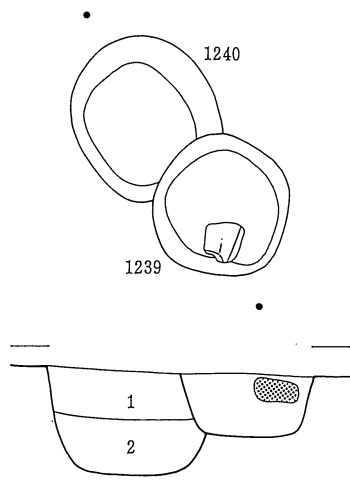

1241

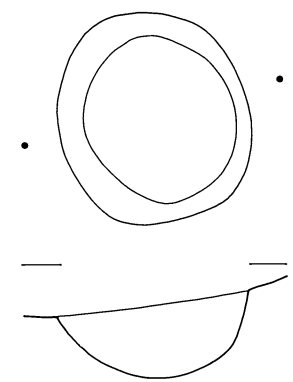

778・1242

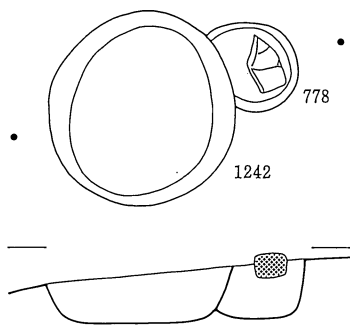

1243

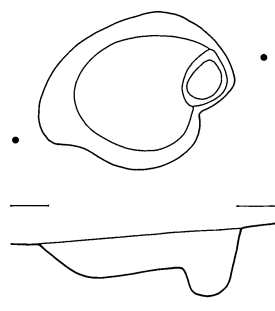

1244

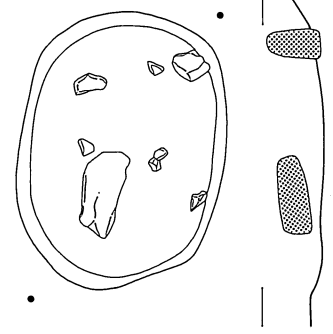

1249

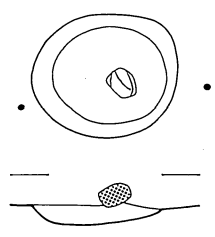

1251

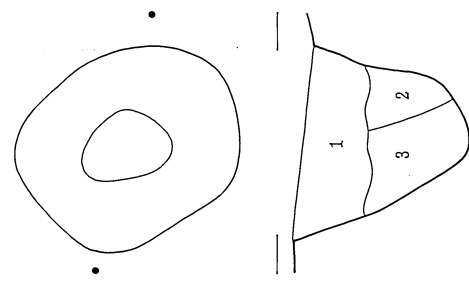

780・1246・1247

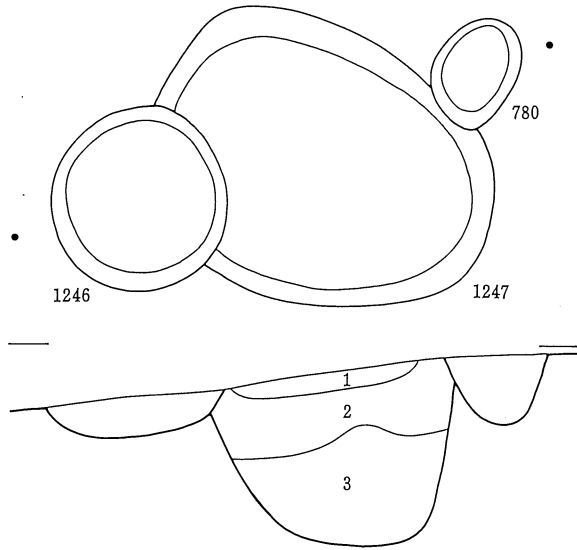

1248

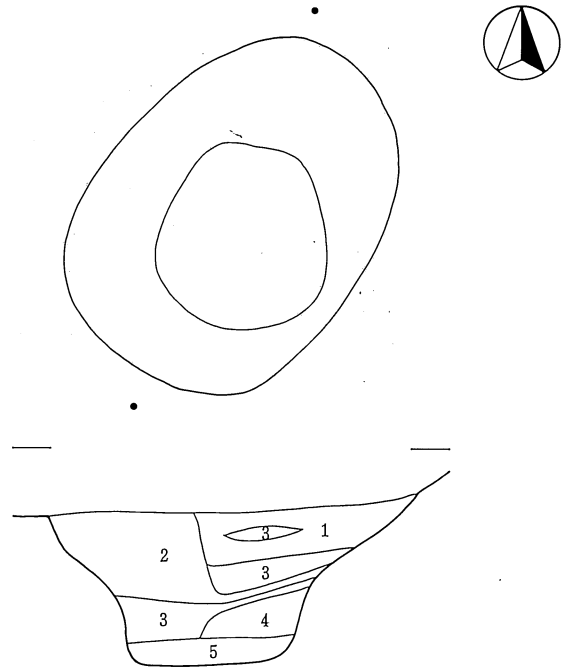

1252・1253

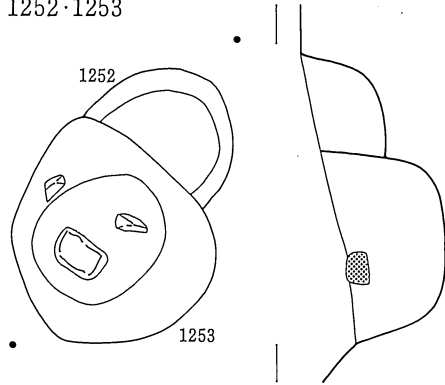

1255

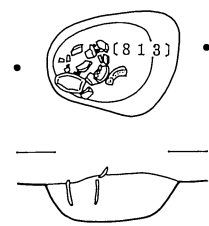

1254

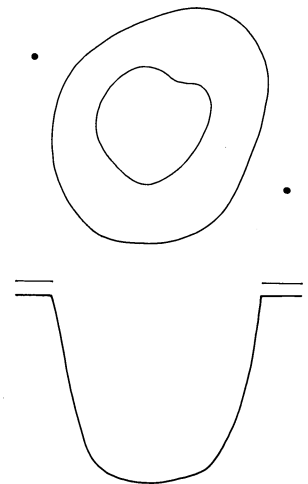

1256・1257

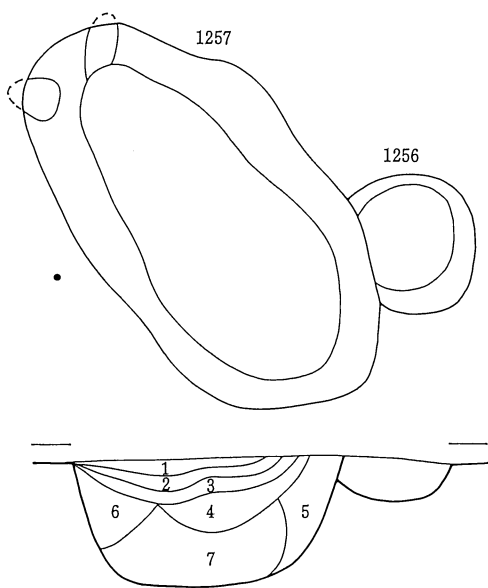

1027・1260

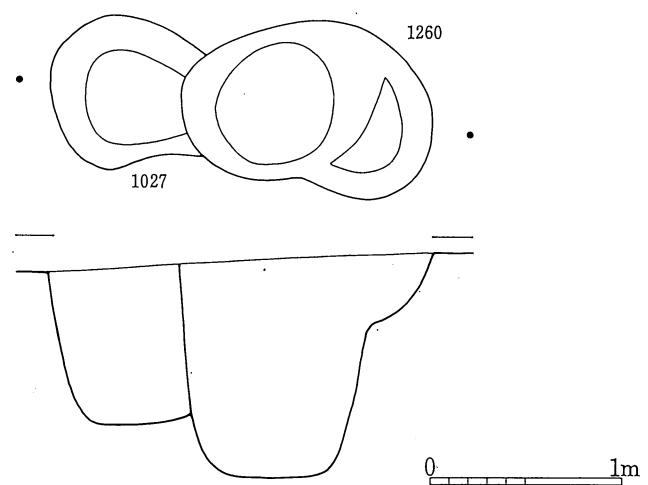

図版65 縄文中期の土坑(4) 1 : 40

69・72・74・75・77・787・1043・1045・1250・1258・1291・1292・1296・1328・1329・1335・1336・1339

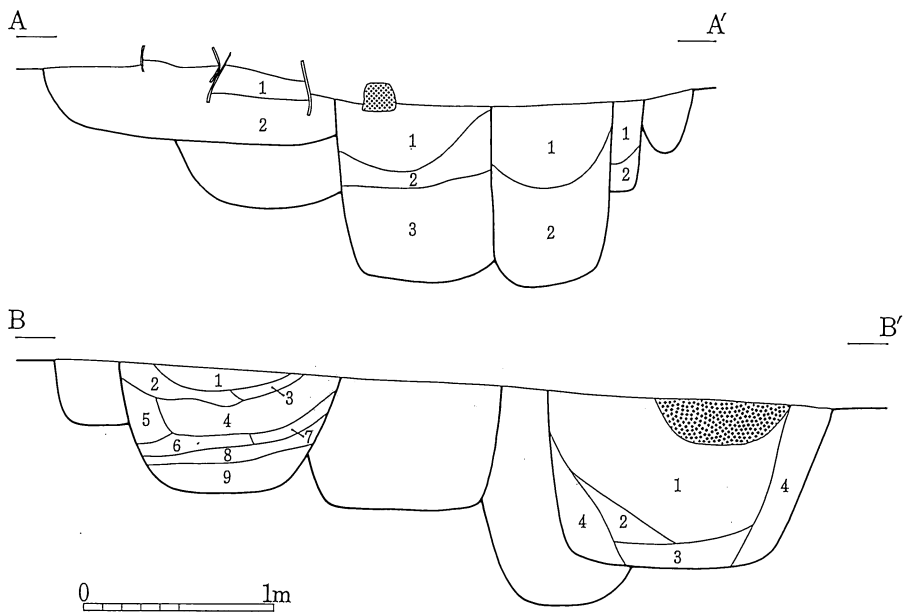
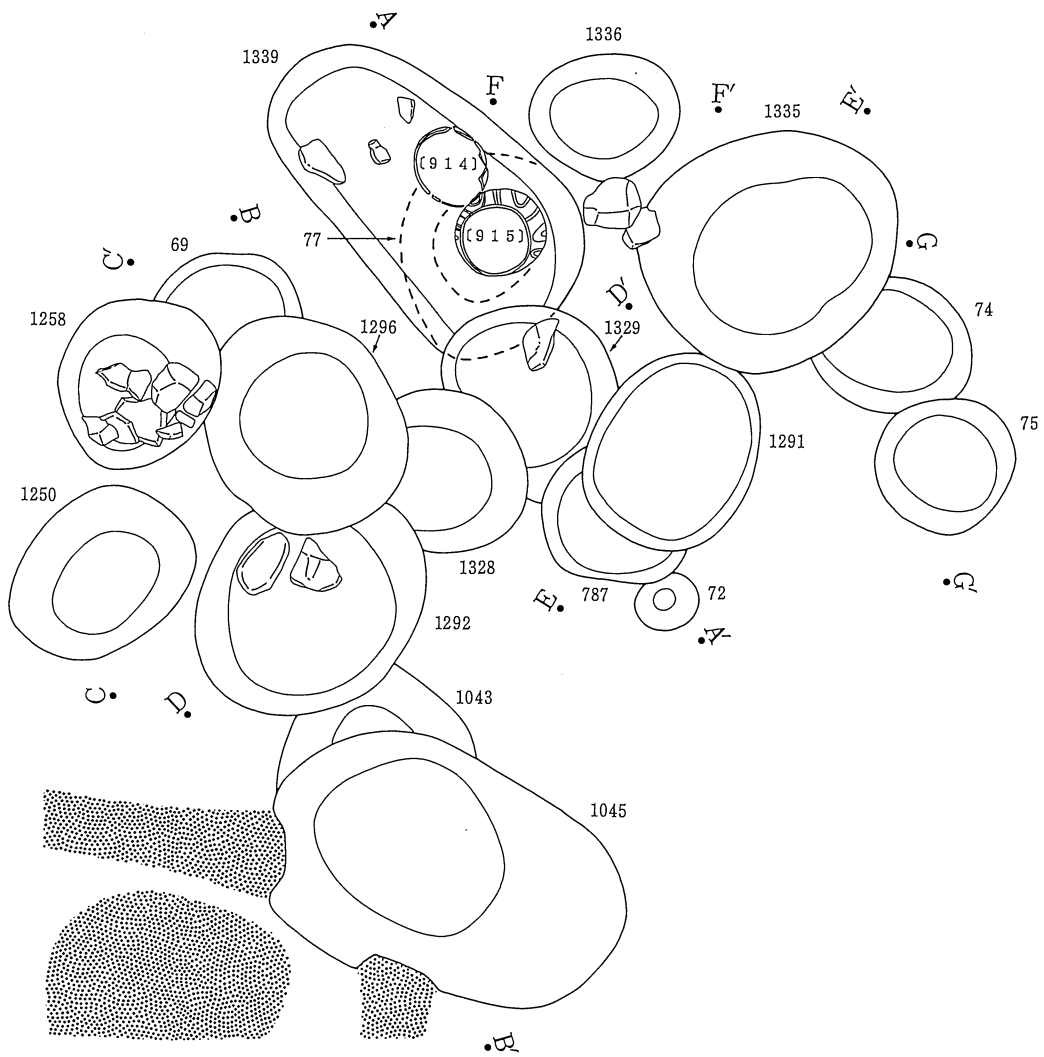

図版66 縄文中期の土坑(45) 1:40

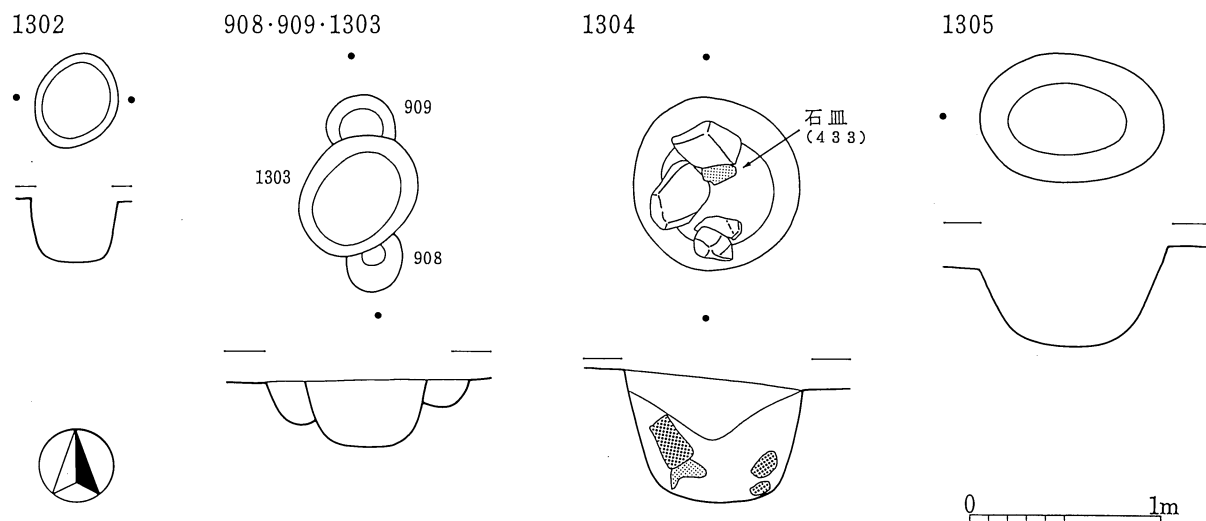
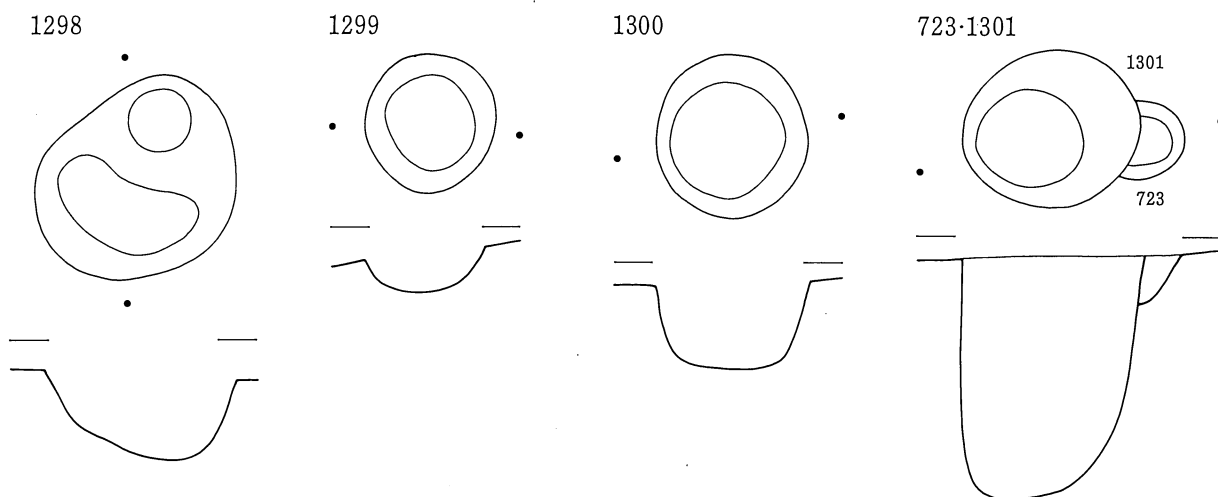
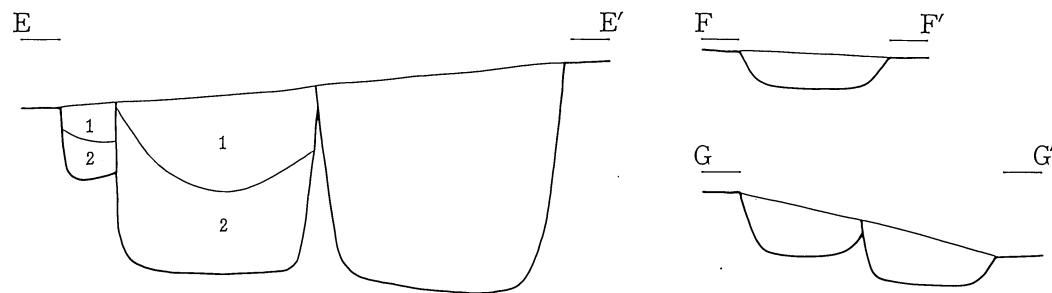
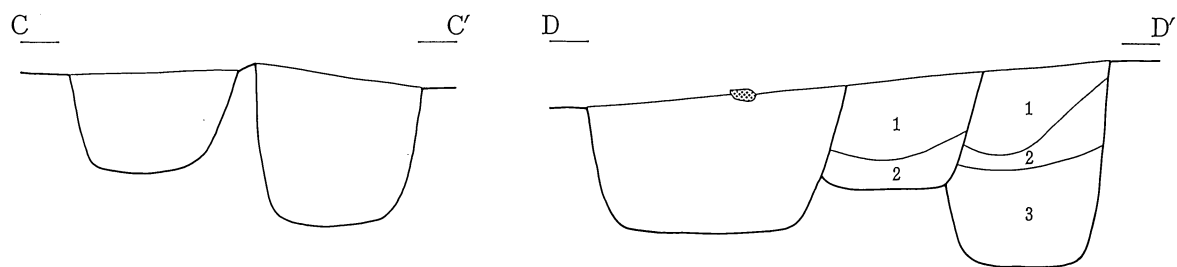

図版67 縄文中期の土坑(46) 1:40

1262・1263・1266

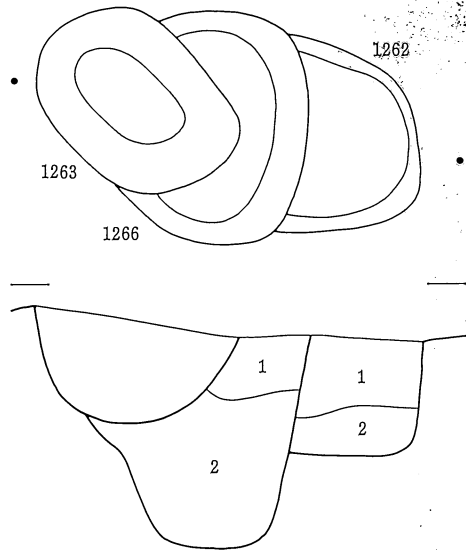

1264・1265

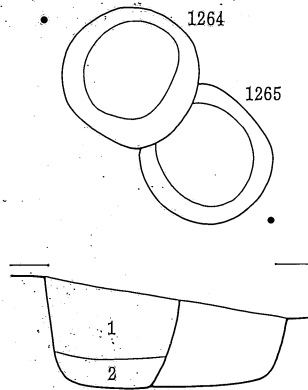

1267

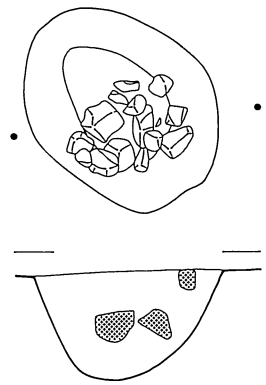

755・1268

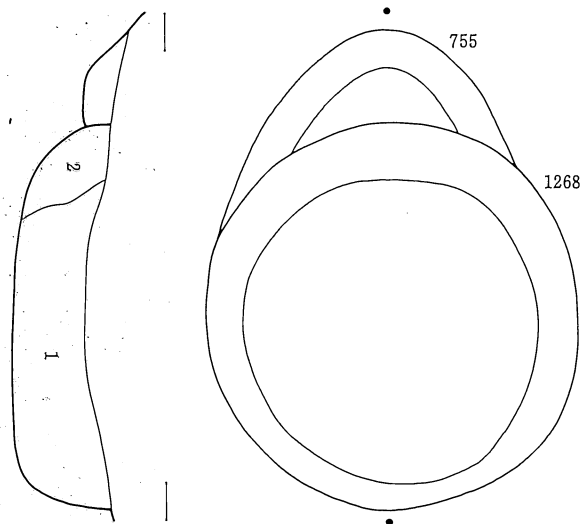

1269

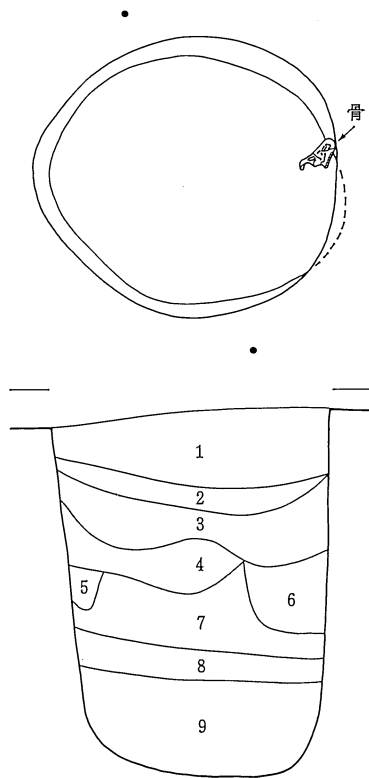

1270

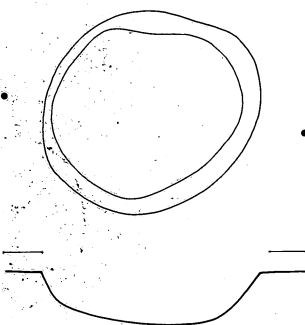

1279

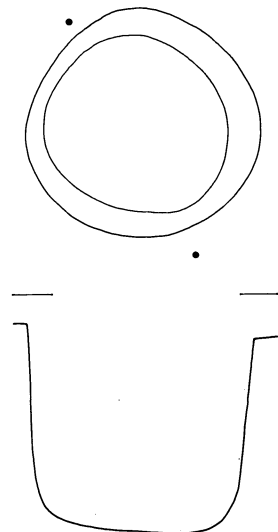

0 1m

68・766・781・1277・1278・1317～1319・1321

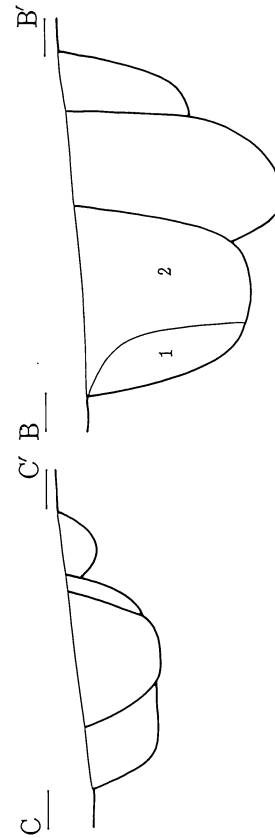
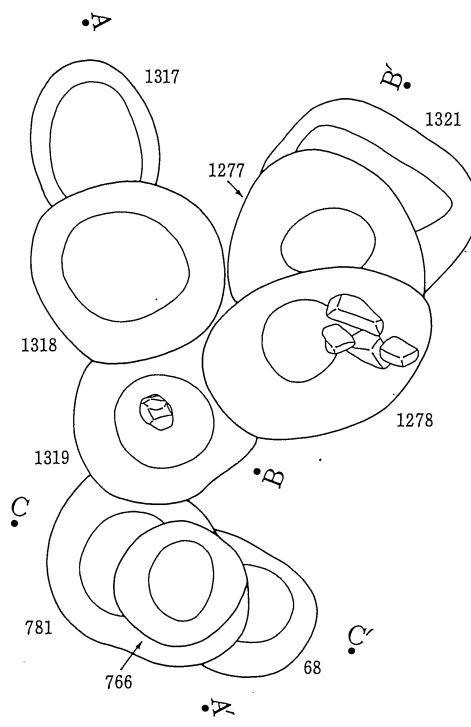
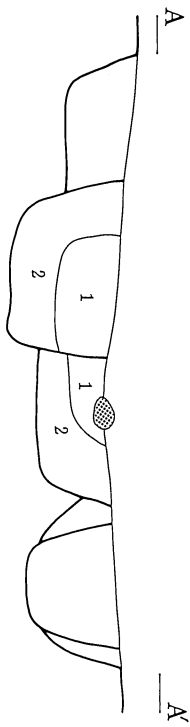

147・768・769・1280・1281

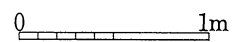
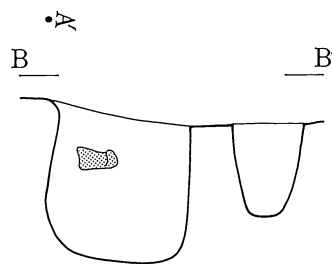
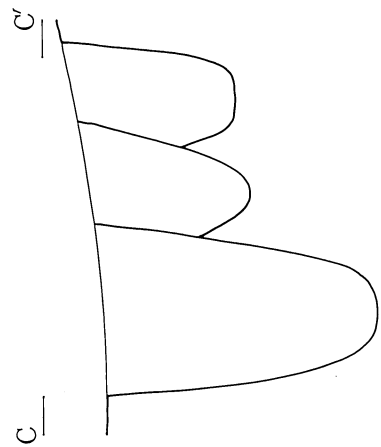
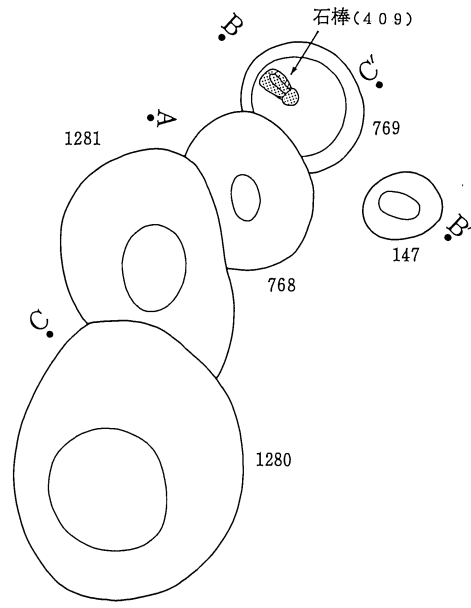
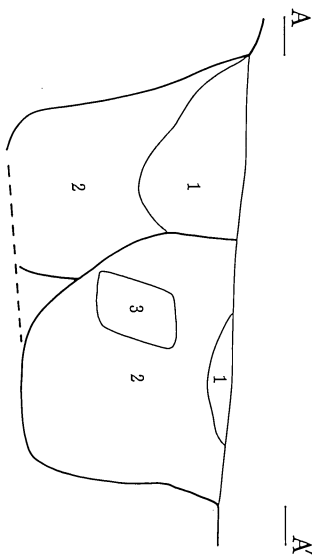

図版69 縄文中期の土坑(48) 1 : 40



770・1033・1272・1273・1293

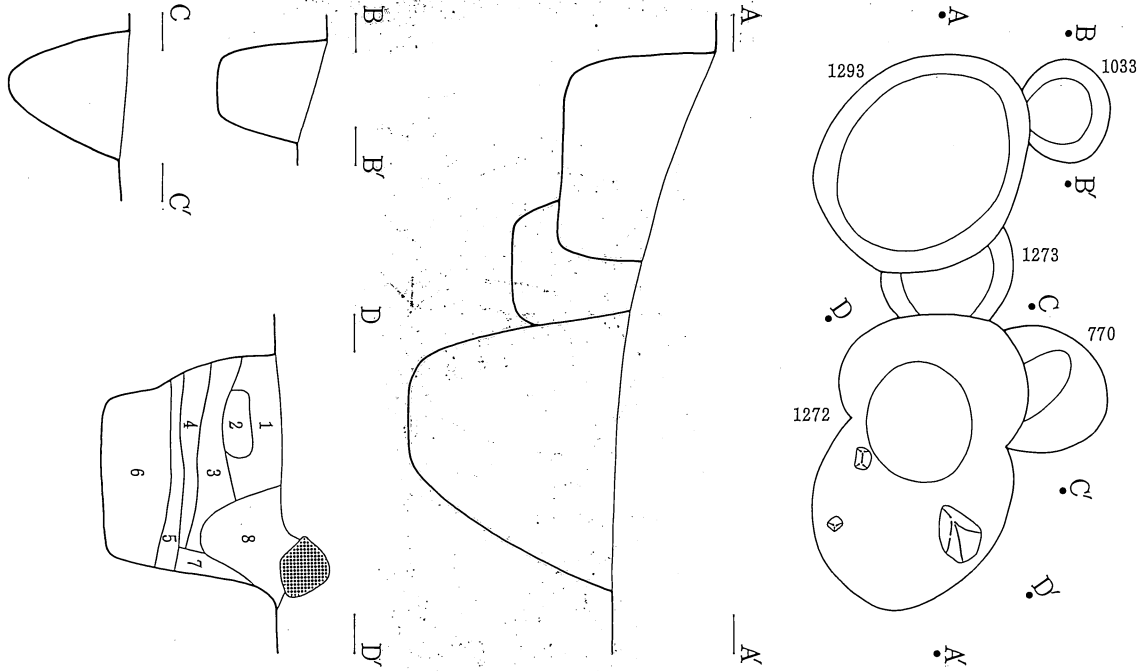

1274 ~ 1276

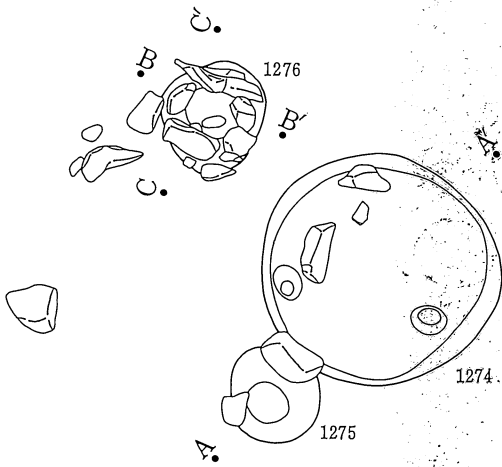

1282

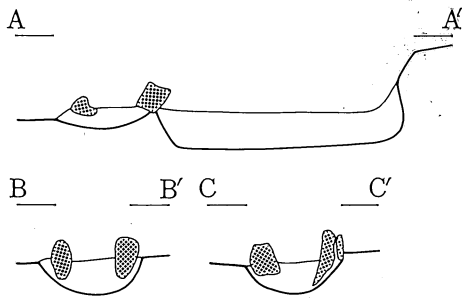
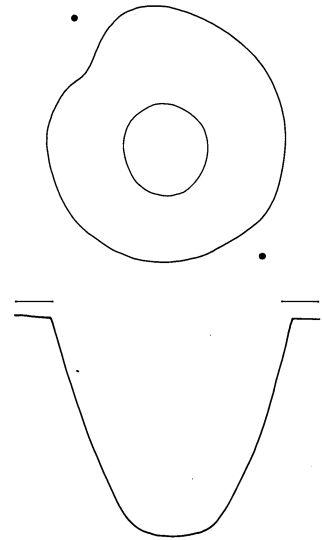

0 1m



958・1306

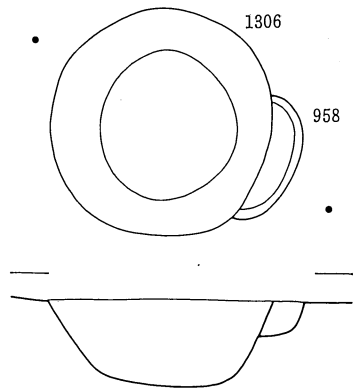

983・1307

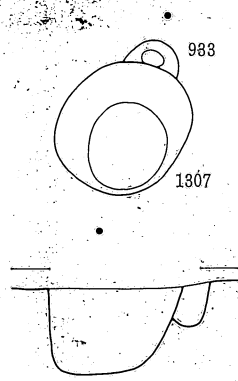

1308・1315・1316

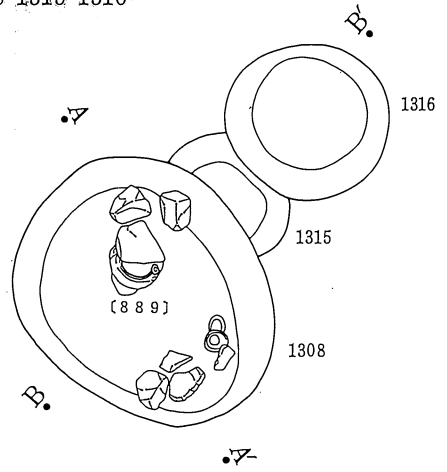

1309・1310・1313

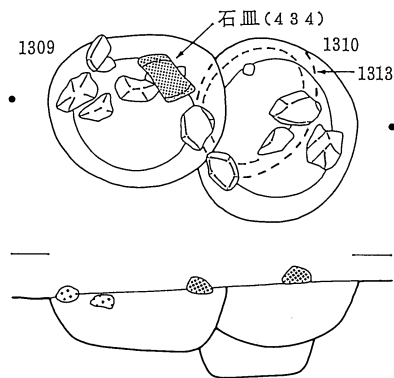

1312

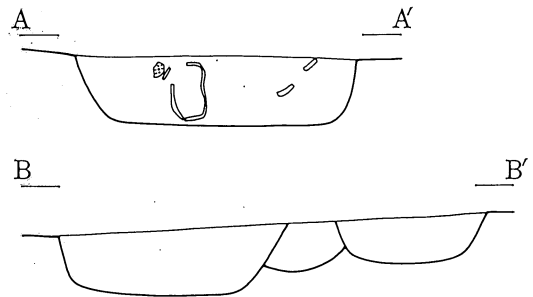
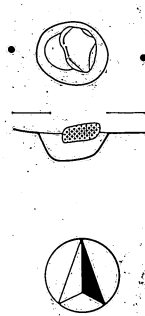

980・982・994・995・999・1320・1322 ~ 1324

1311

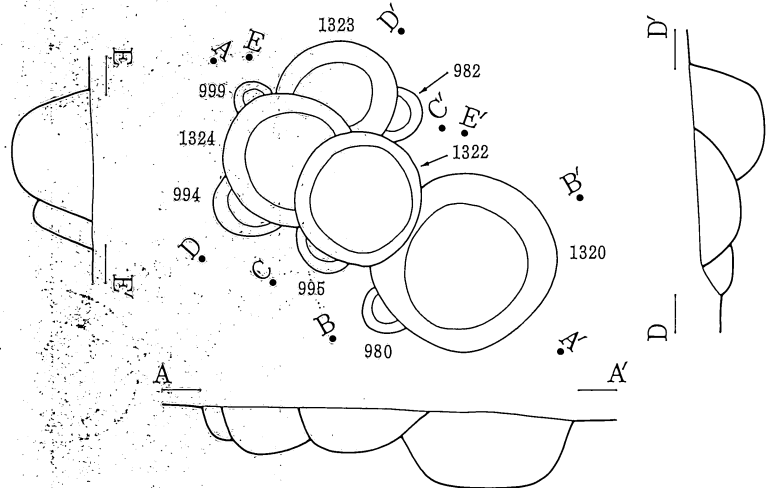
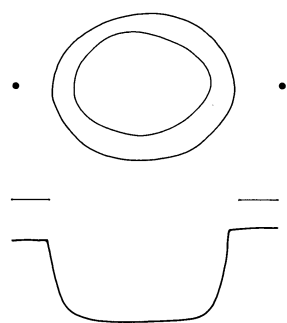

1325

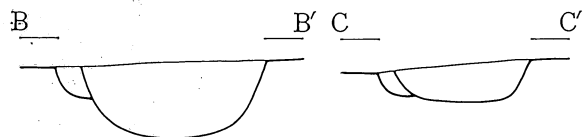
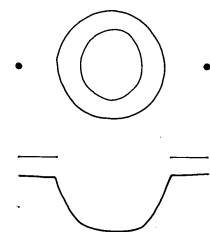

0 1m

571-1326

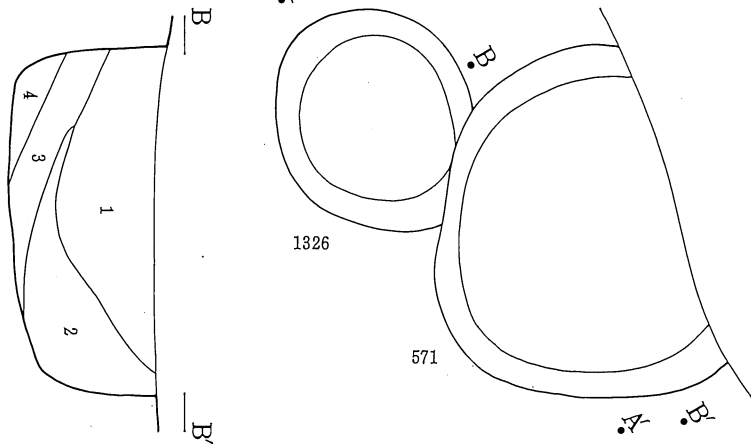

1327-1419

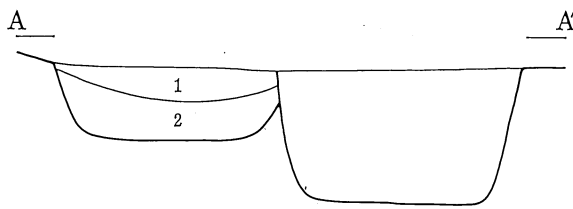
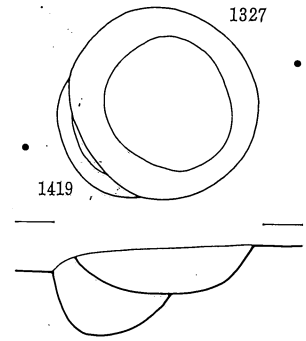

1330-1331

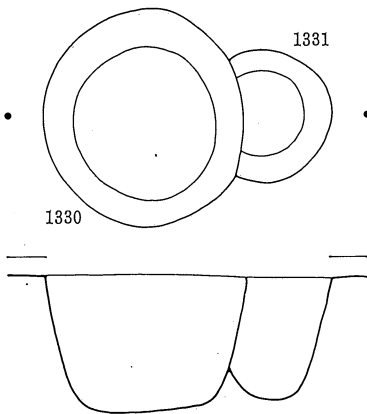

997-1332-1389

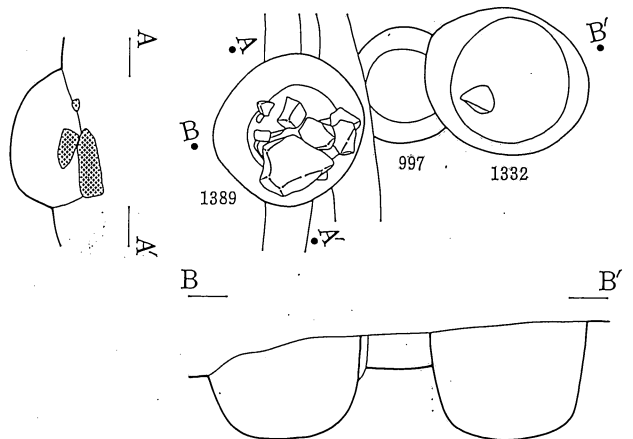

1333

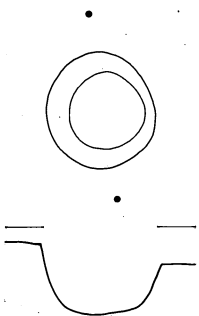

1334

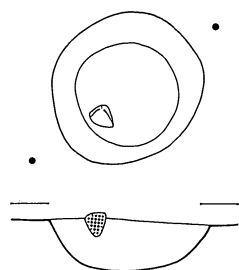

957-1337

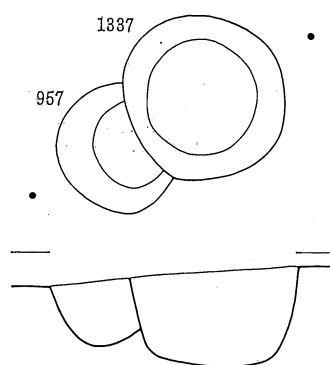

1338

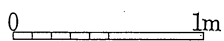
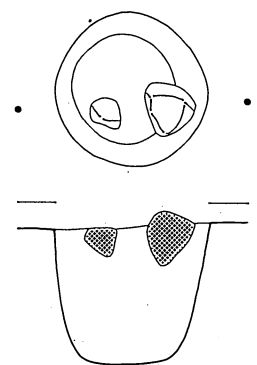

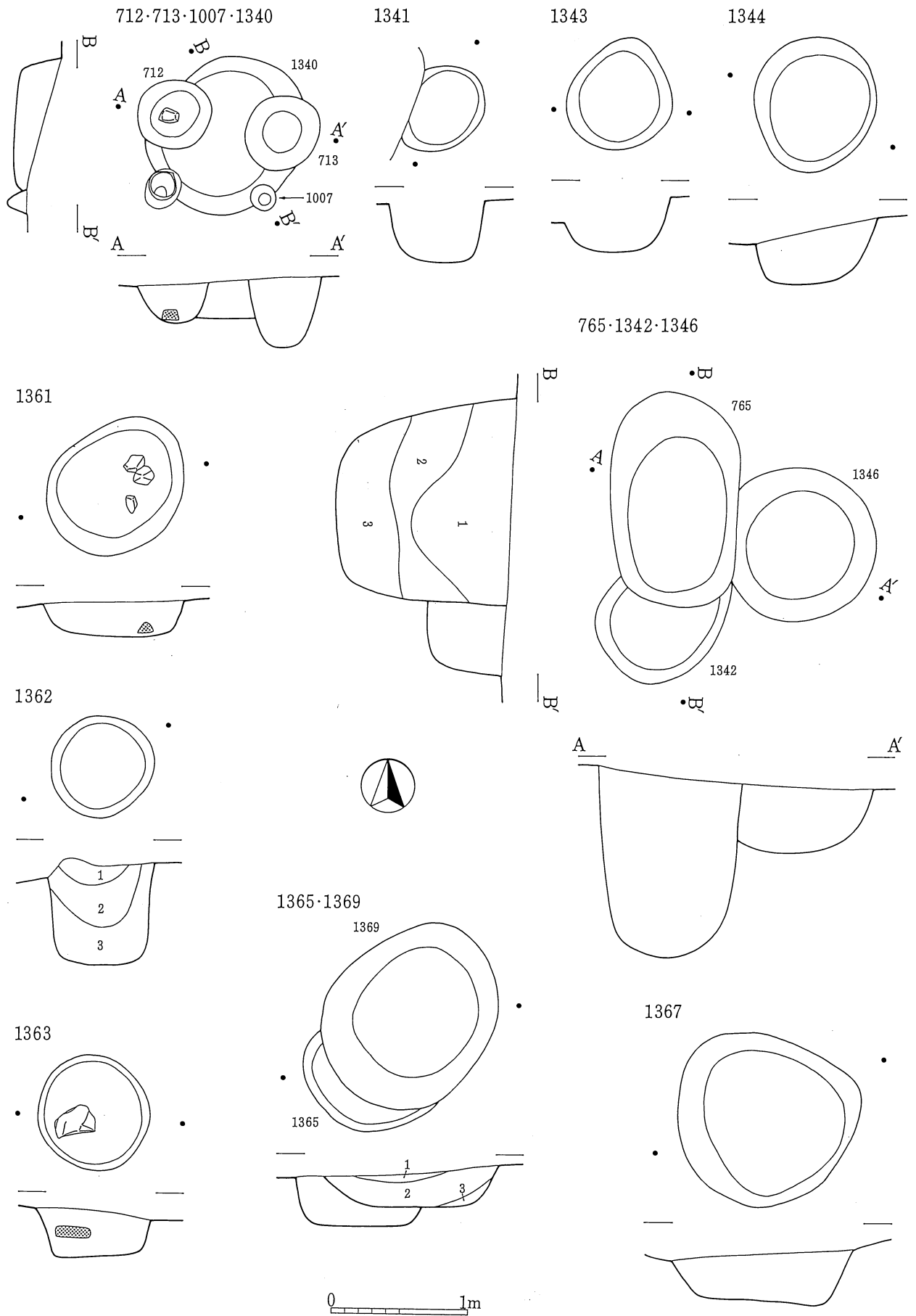

図版74 縄文中期の土坑(53) 1 : 40

107・804・835・1364・1366・1375・1376・1378・1380・1383・1401

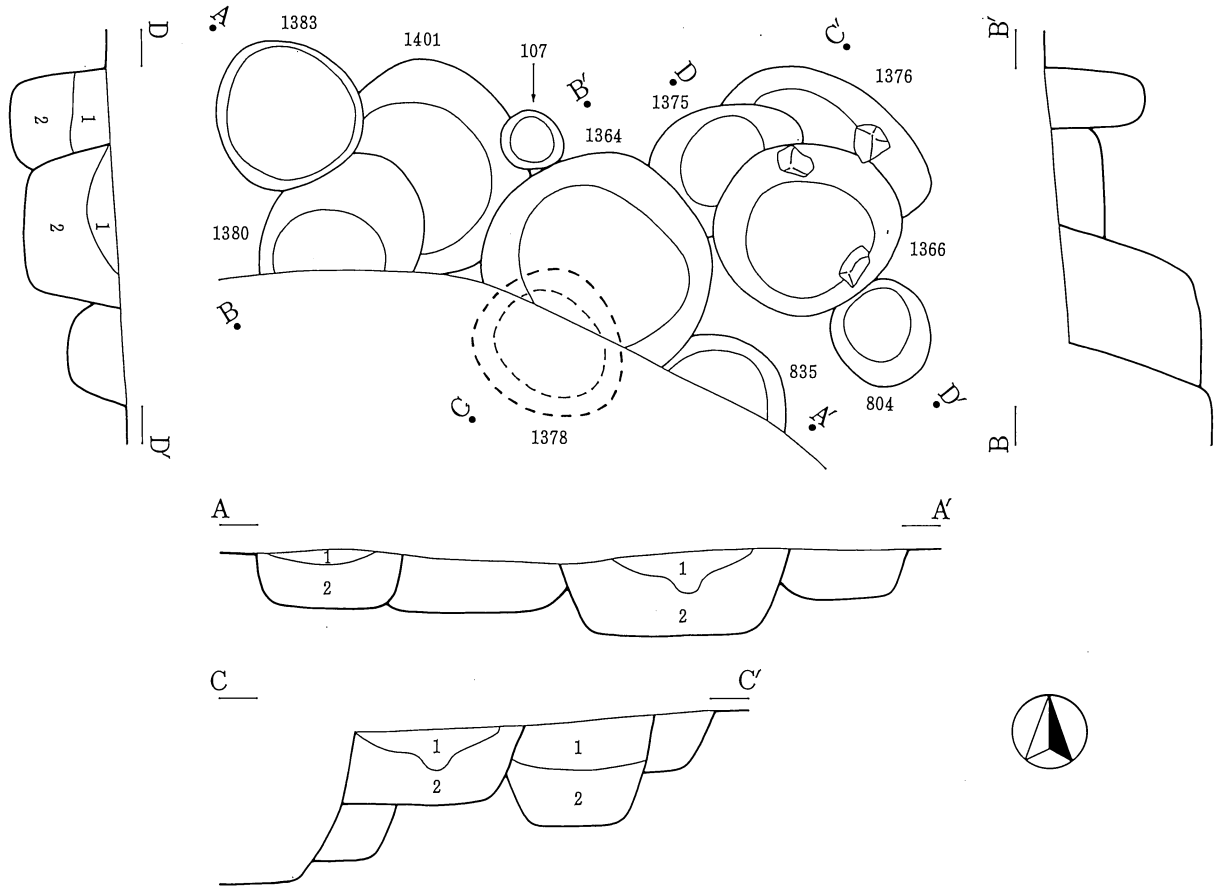

801・1370・1377

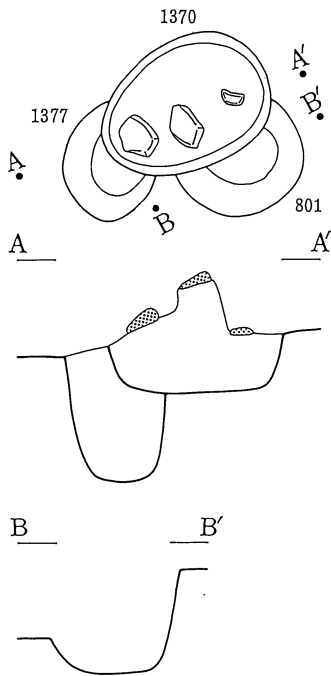

834・1372・1403~1405・1410・1416・1417

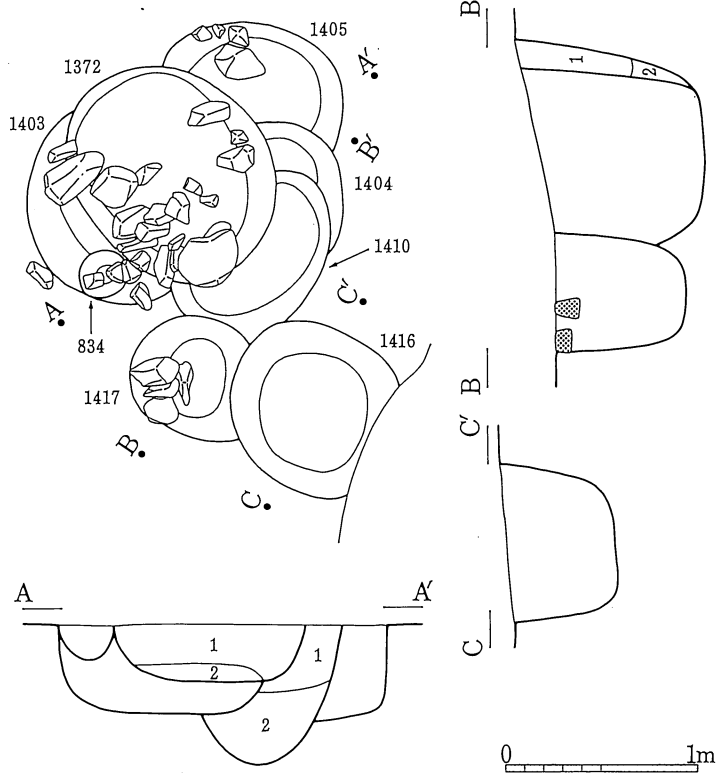

図版75 縄文中期の土坑(64) 1 : 40

1371

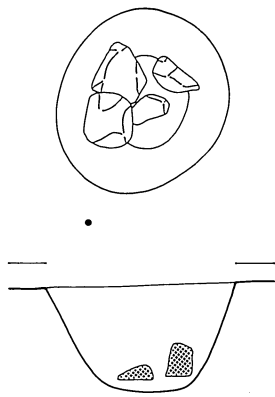

861・862・1373

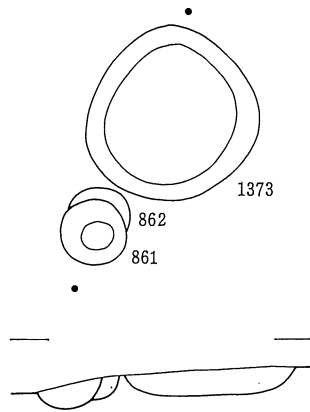

1374

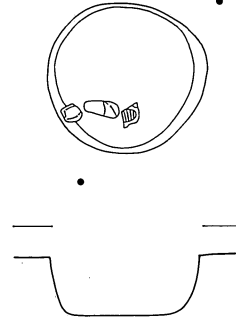

1379

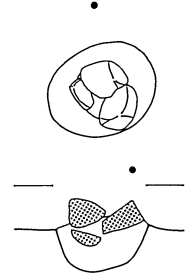

1381・1382

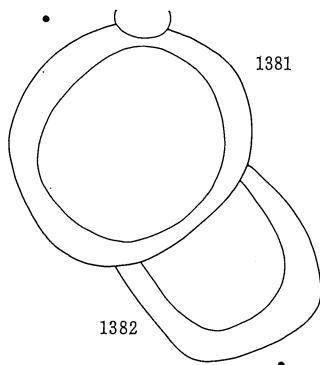

811・1386

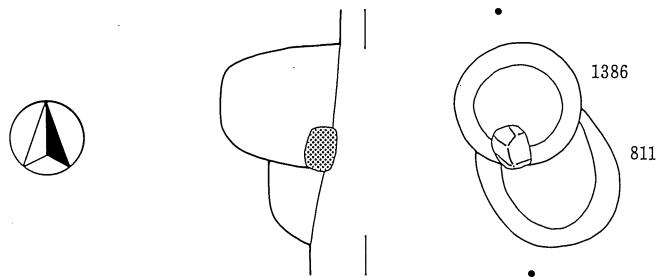

812・814・820・1387・1388

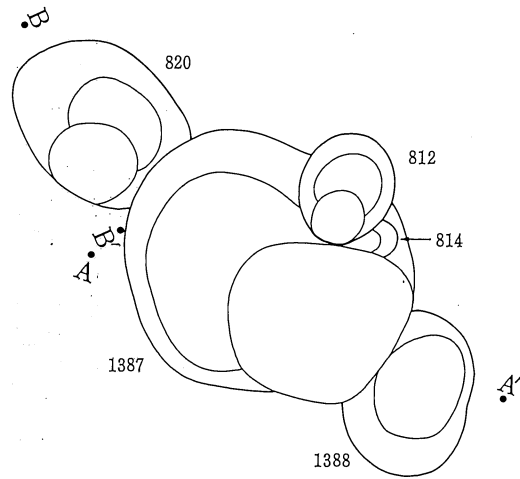
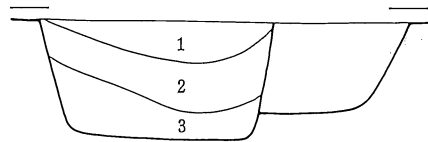

800・1384

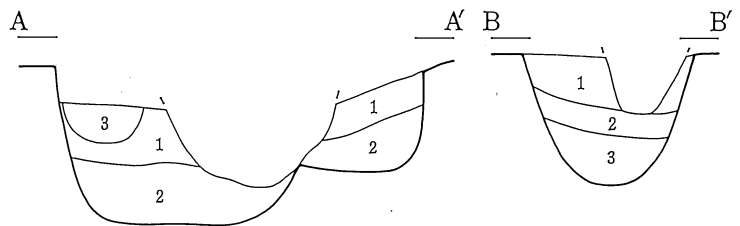
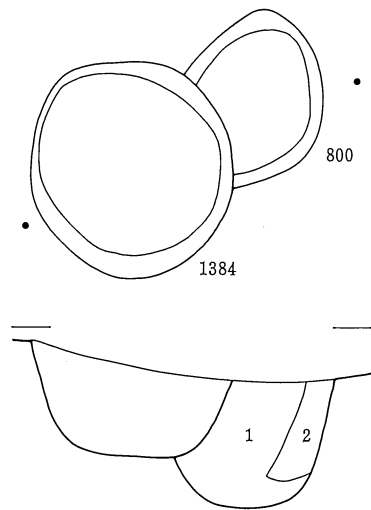

0 1m

920・921・1394～1397

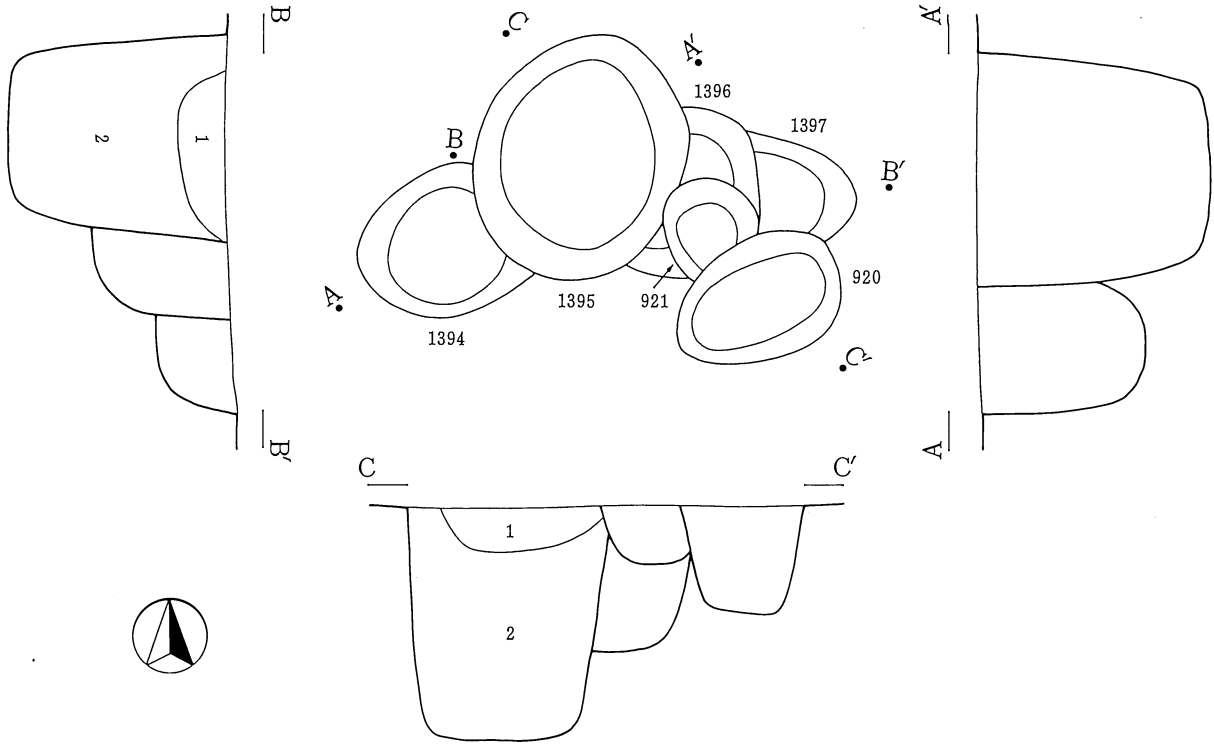

1390

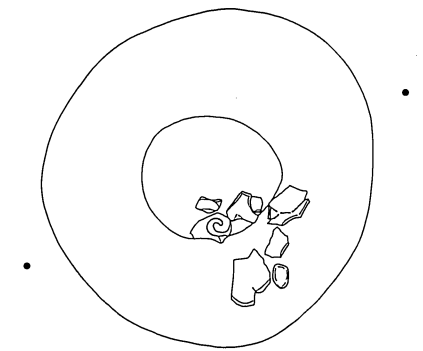

1391

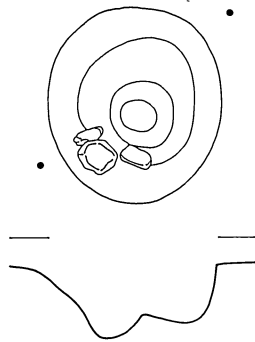

1402

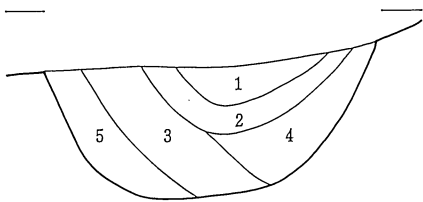
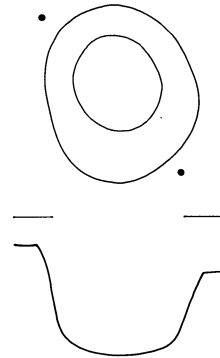

1406

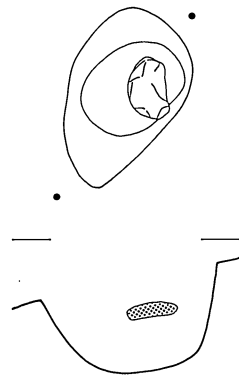

852・866・1407・1408

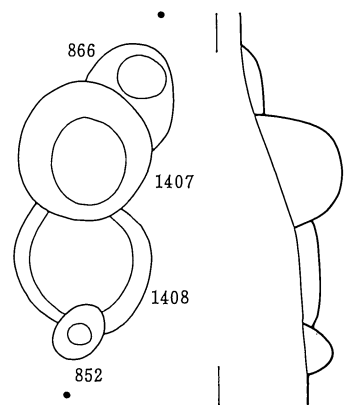

0 1m

図版77 縄文中期の土坑(6) 1:40



1411

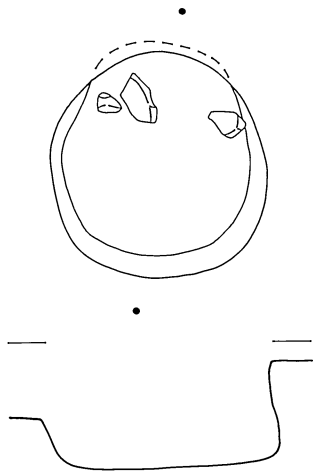

855・1413～1415

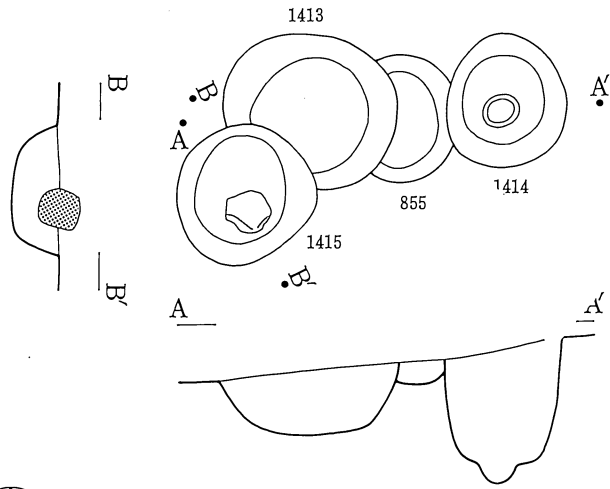

926・1418

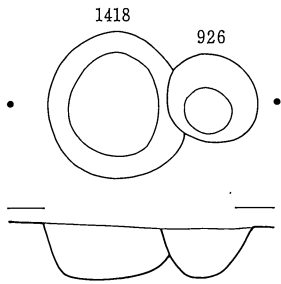

1420

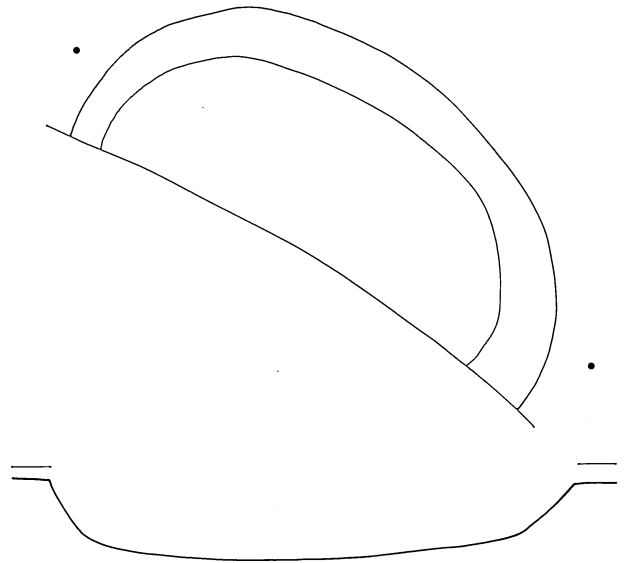

1217・1218

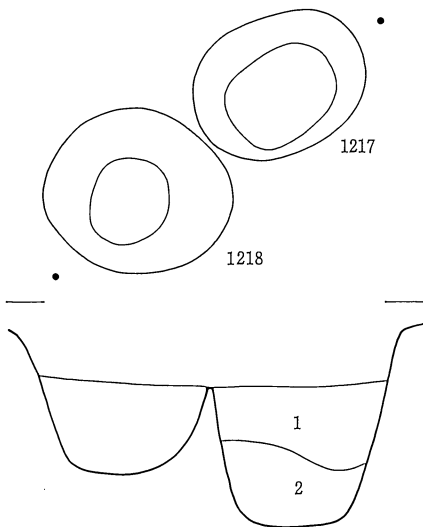

0 1m

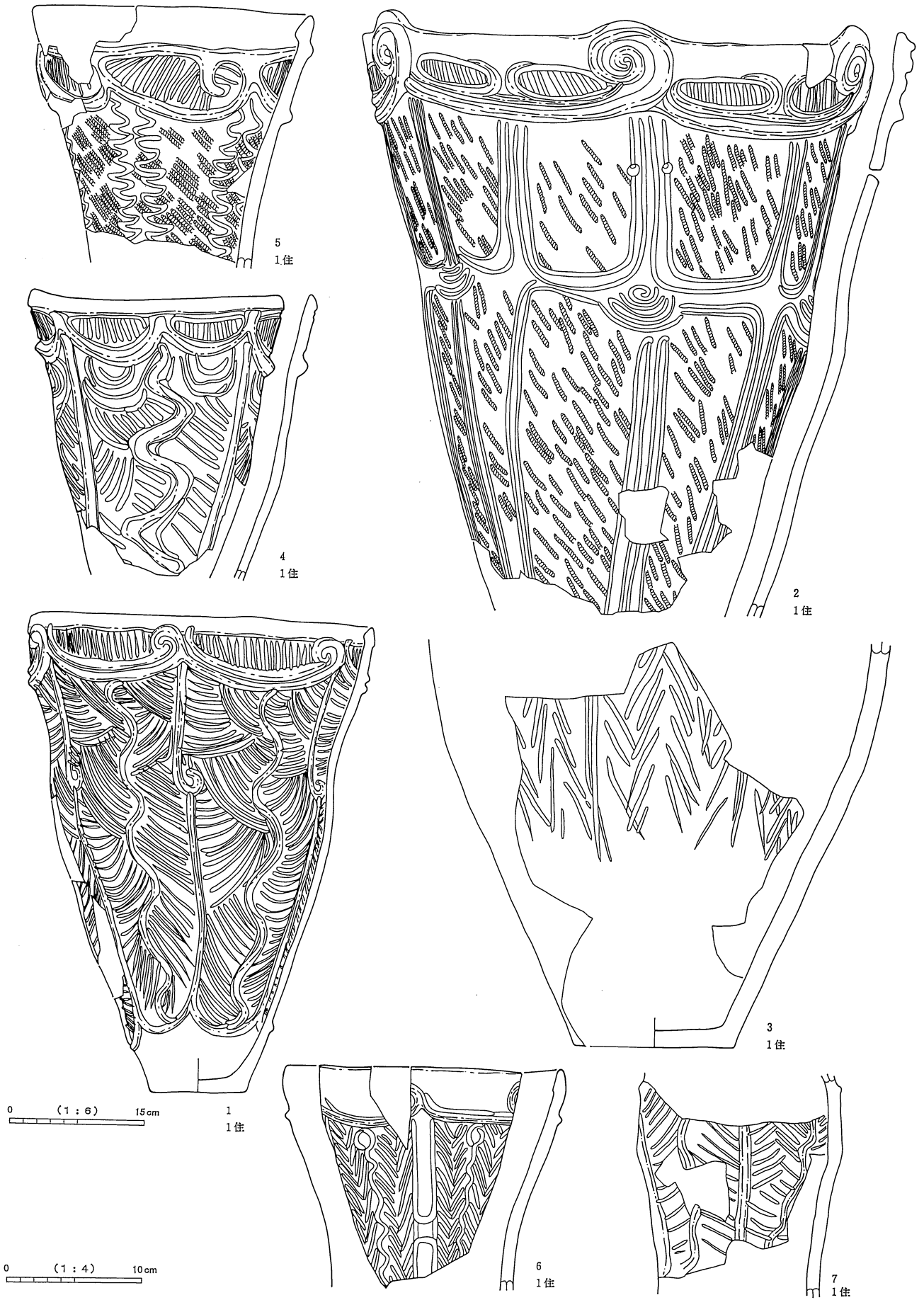

図版79 1号竖穴住居跡出土土器 (1 1:6、他 1:4)

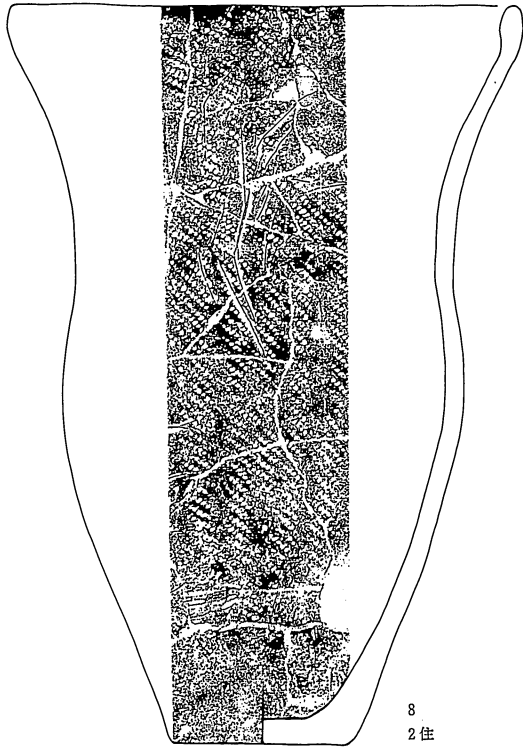

8  
2 住

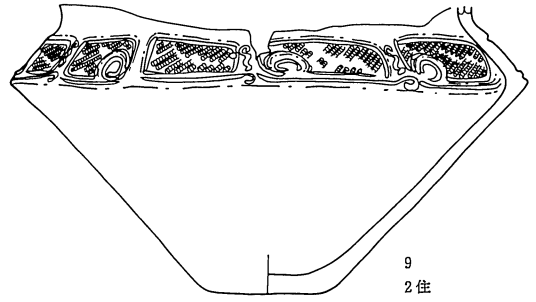

9  
2 住

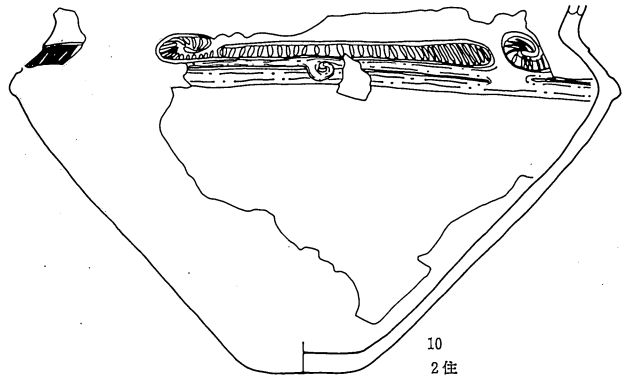

10  
2 住

0 (1 : 6) 15cm

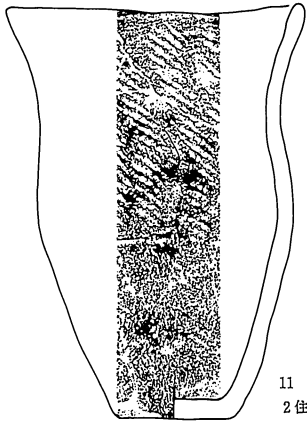

11  
2 住

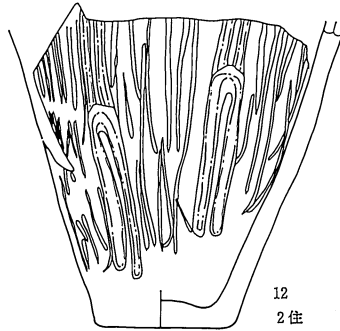

12  
2 住

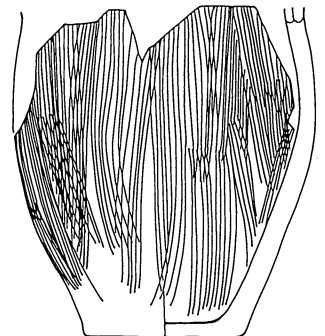

13  
2 住

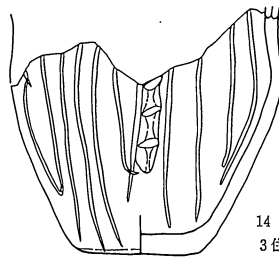

14  
3 住

0 (1 : 4) 10cm

图版80 2号、3号竖穴住居跡出土土器 (9・10 1 : 6、他 1 : 4)

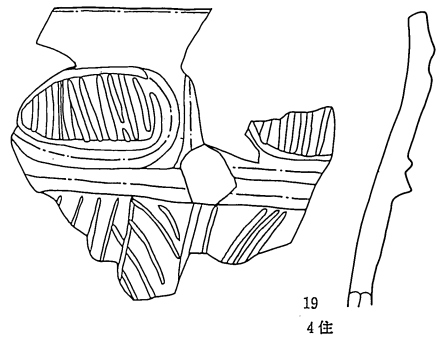
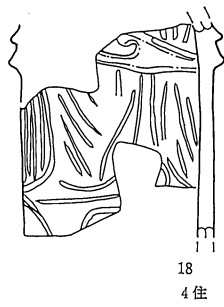
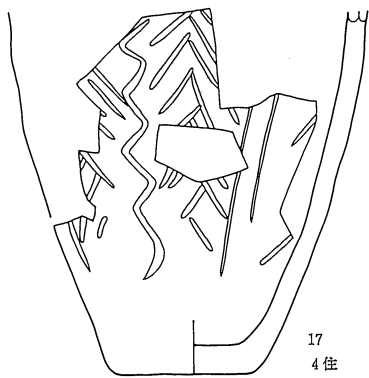
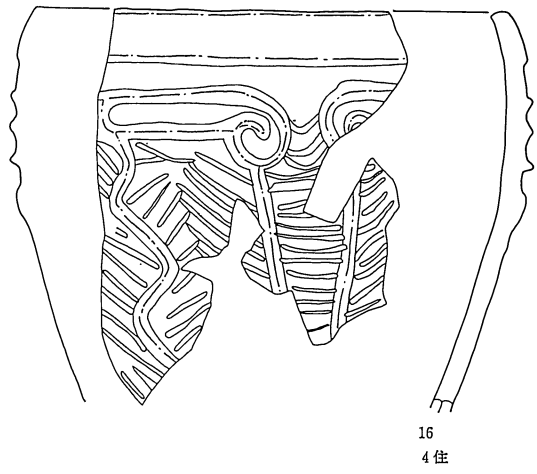
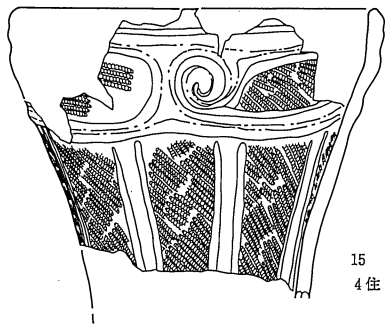

0 (1:4) 10cm

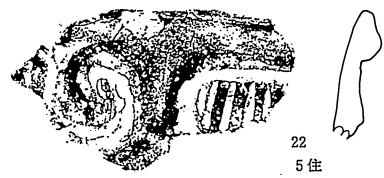
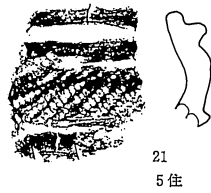
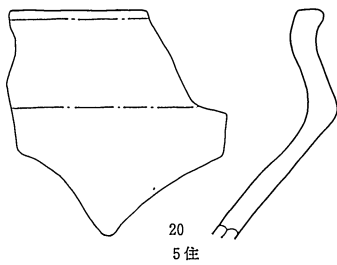

0 (1:3) 10cm

図版81 4号、5号竪穴住居跡出土土器 (20~22 1:3、他1:4)

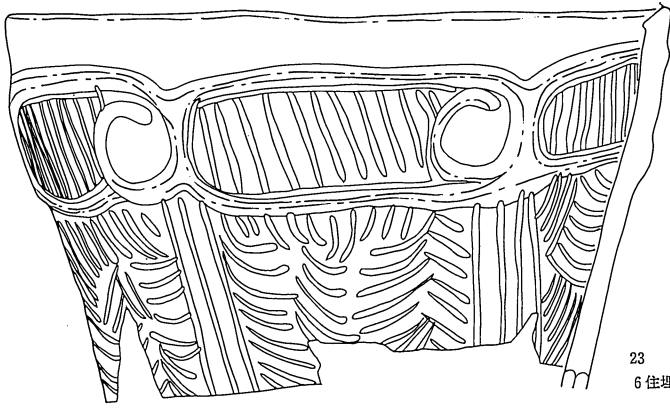

23  
6住埋甕

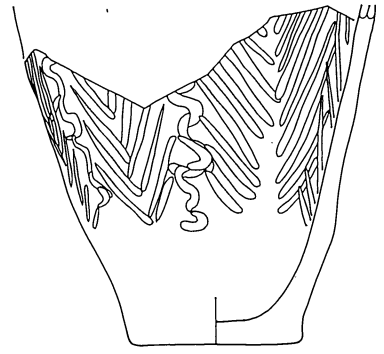

24  
6住埋甕内

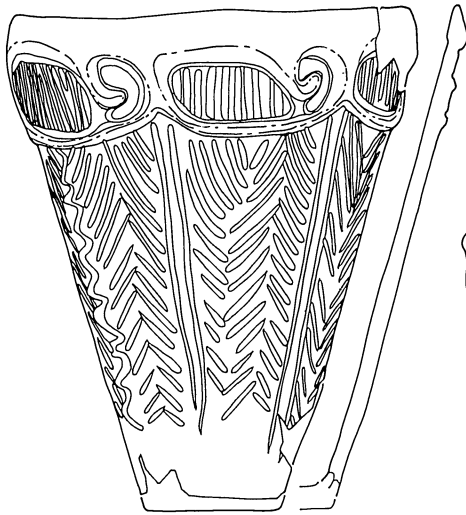

25  
6住

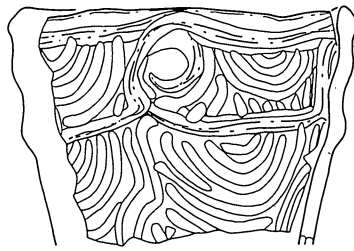

26  
6住

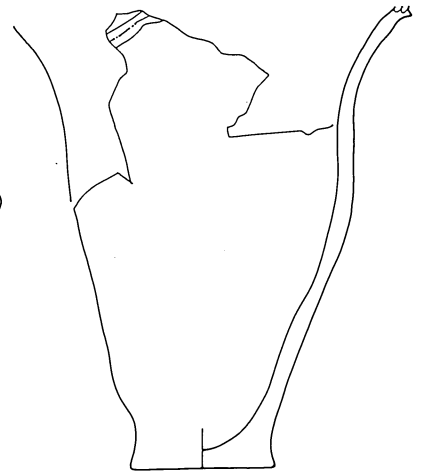

27  
6住



28  
7住

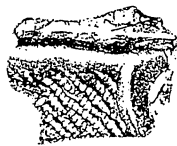

29  
7住



30  
7住



31  
7住

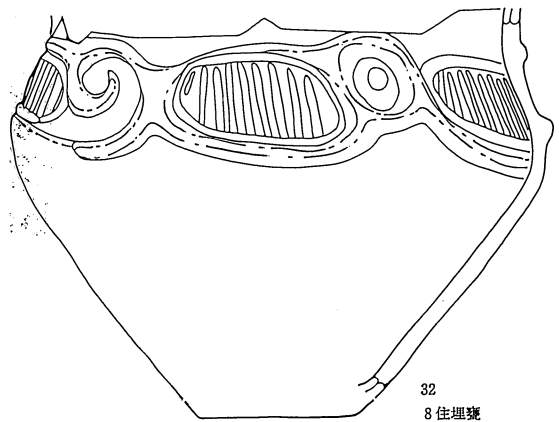

32  
8住埋甕

0 (1:3) 10cm

0 (1:4) 10cm

図版82 6号~8号竪穴住居跡出土土器 (28~31 1:3、他 1:4)

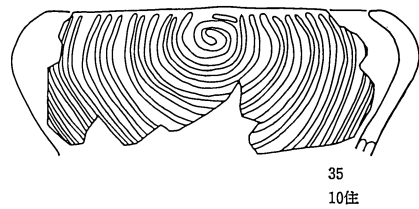
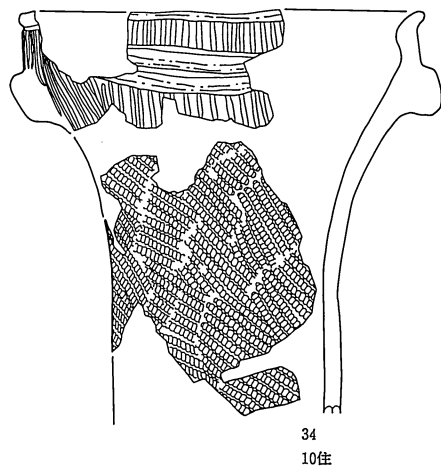
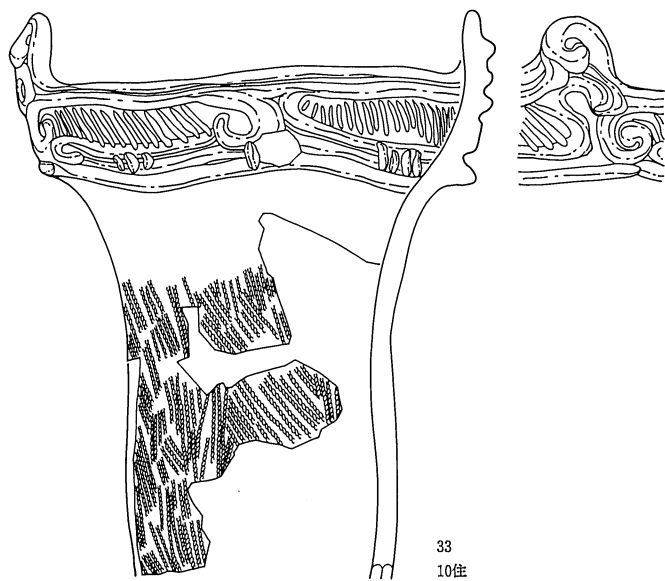

0 (1:4) 10cm

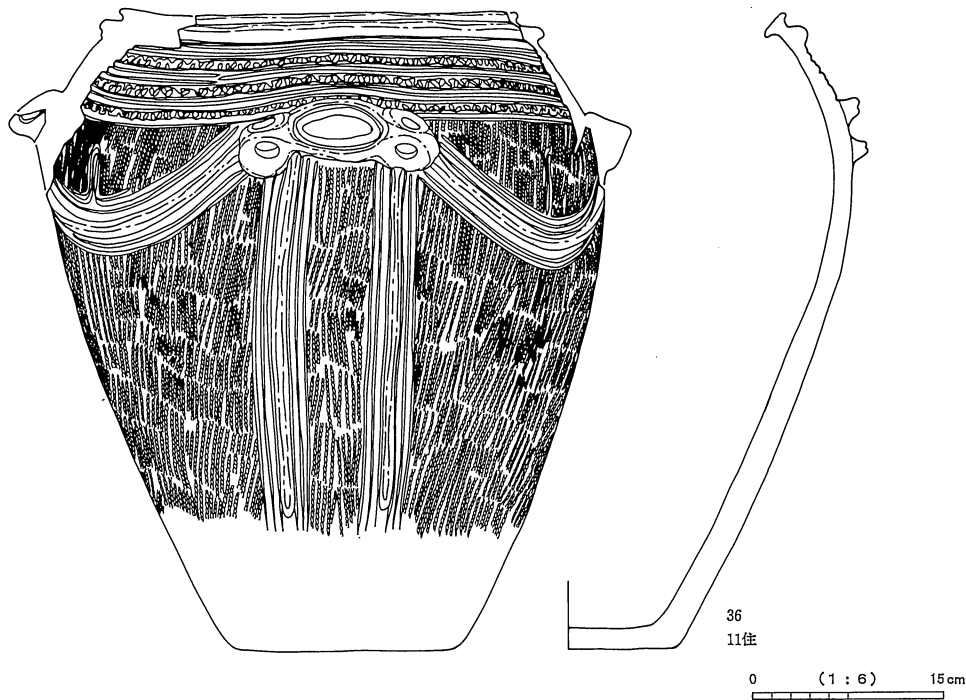

0 (1:6) 15cm

図版83 10号、11号竖穴住居跡出土土器 (36 1:6、他 1:4)

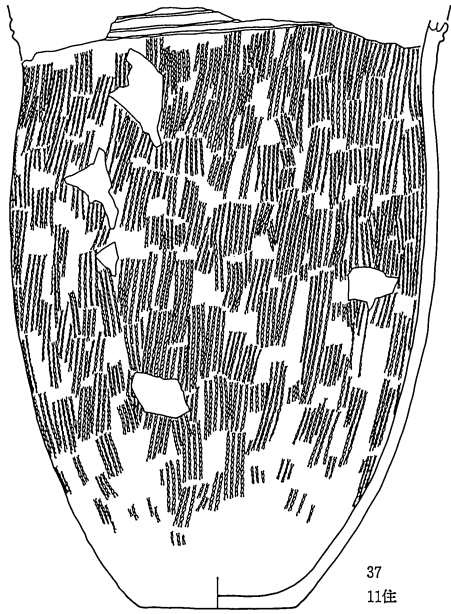

37  
11住

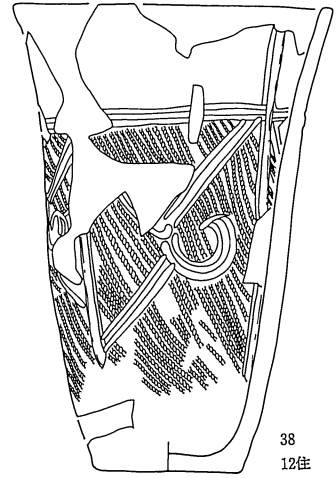

38  
12住

0 (1 : 6) 15 cm

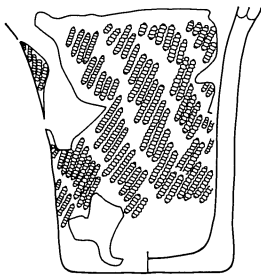

39  
12住

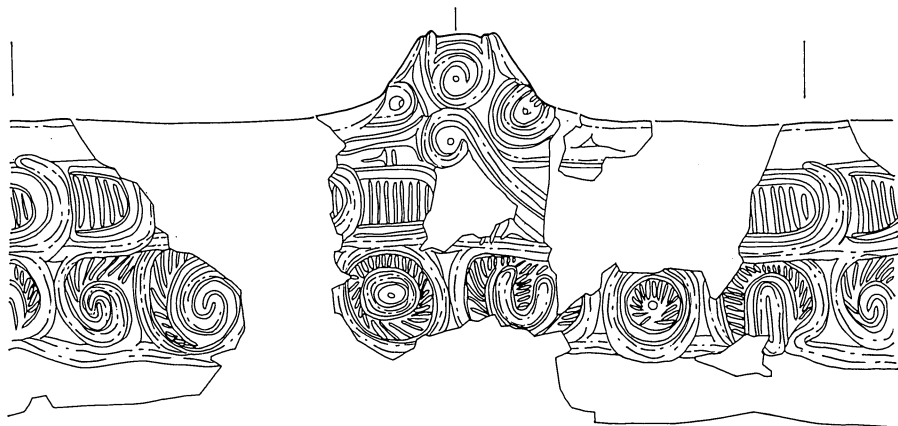
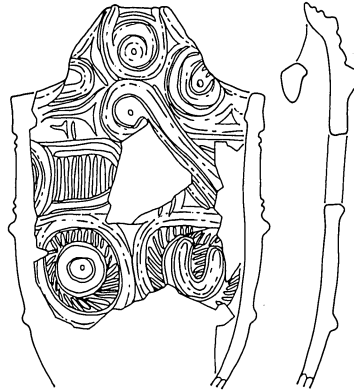

40  
12住

0 (1 : 4) 10 cm

図版84 11号、12号竪穴住居跡出土土器 (37 1 : 6、他 1 : 4)

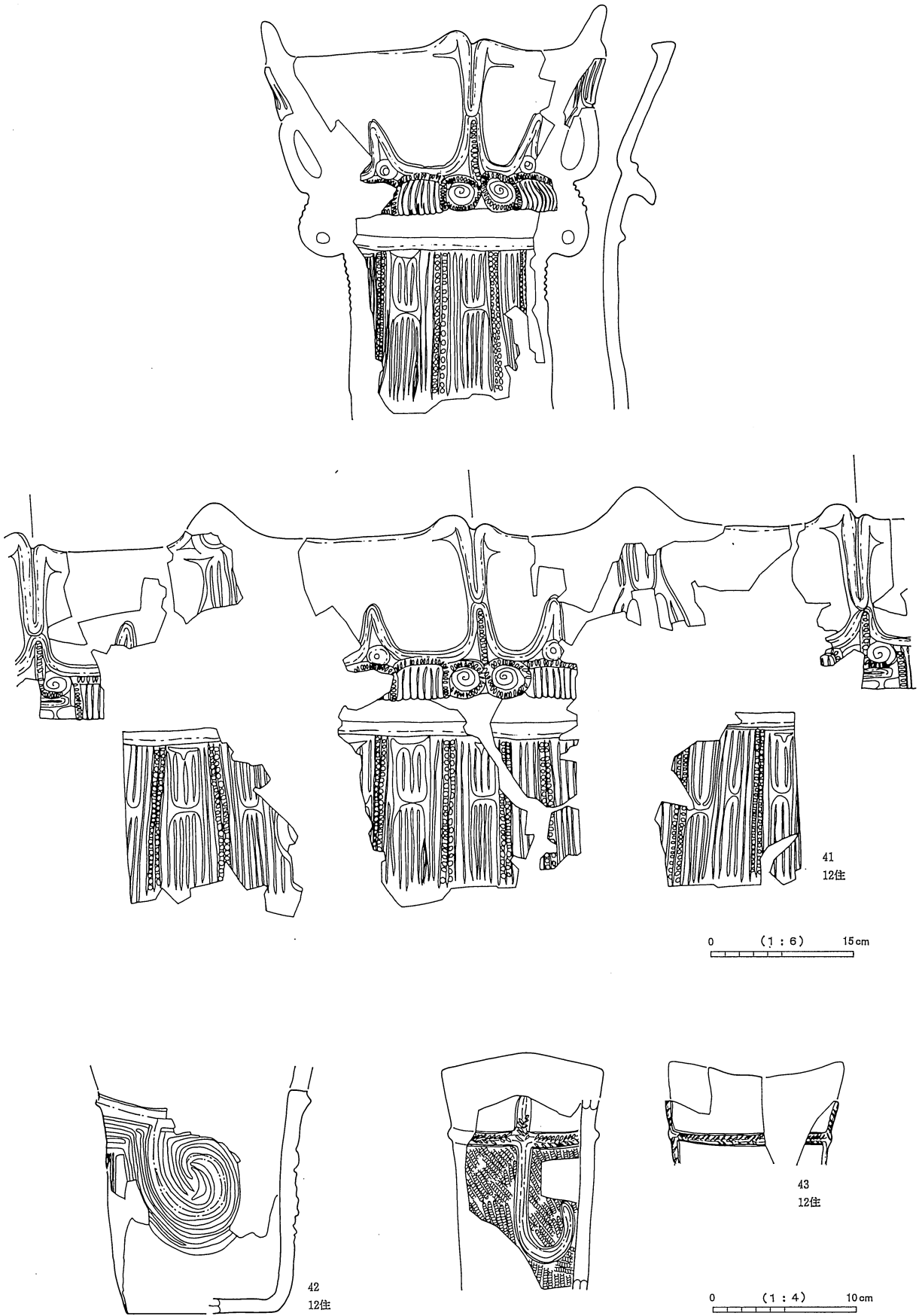

図版85 12号竖穴住居跡出土土器 (41 1:6、他 1:4)



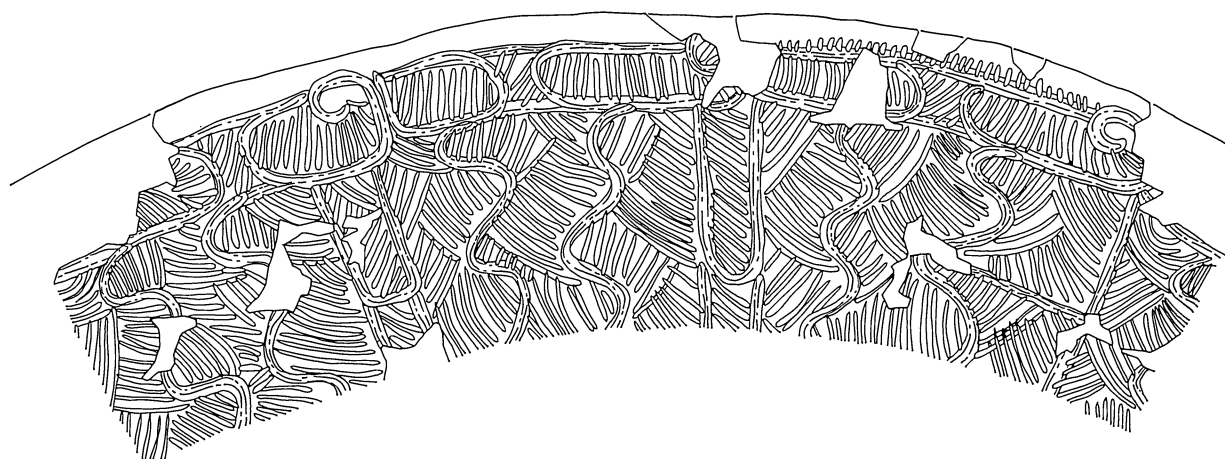

0 (1 : 6) 15 cm

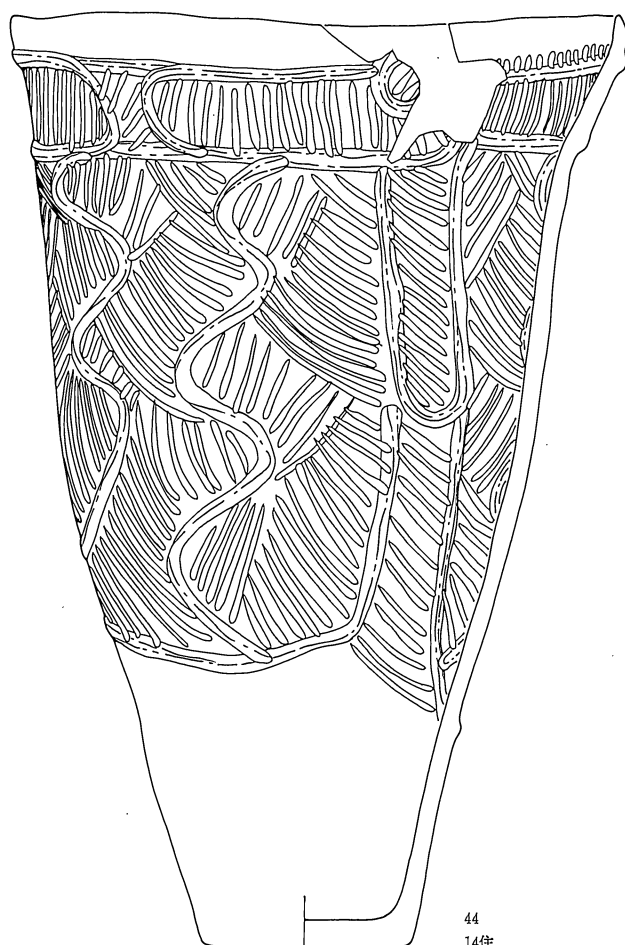

44  
14住

0 (1 : 4) 10 cm

図版86 14号竪穴住居跡出土土器 (1 : 4)

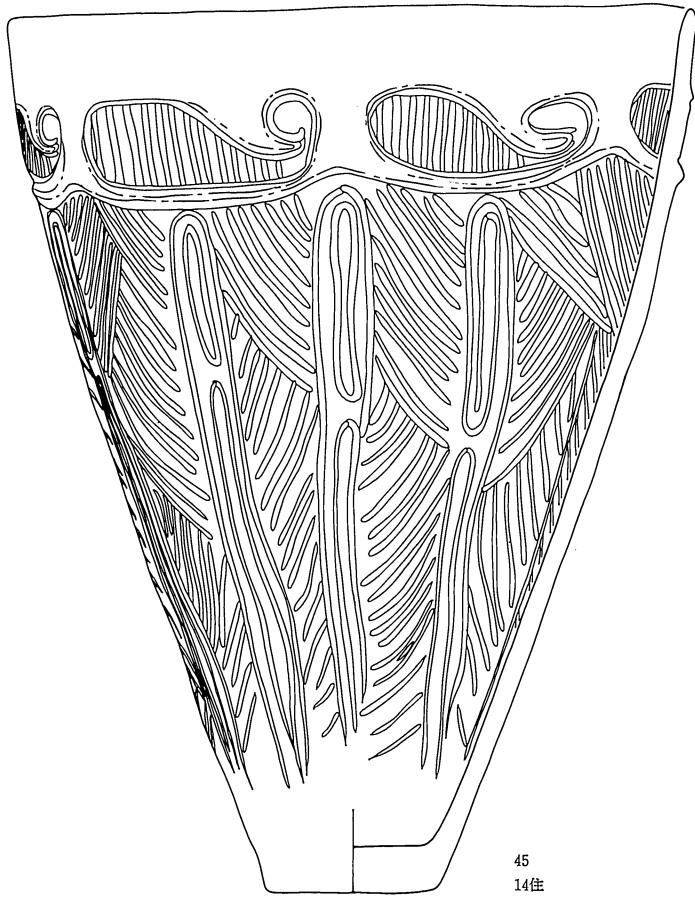

45  
14住

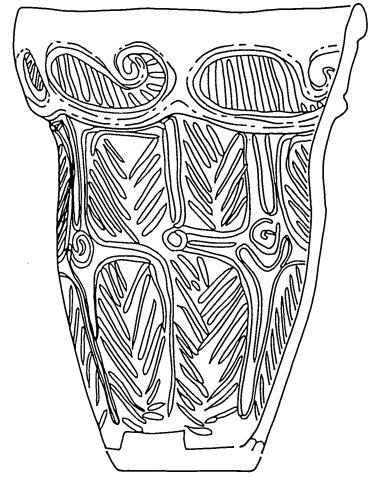

47  
14住



46  
14住

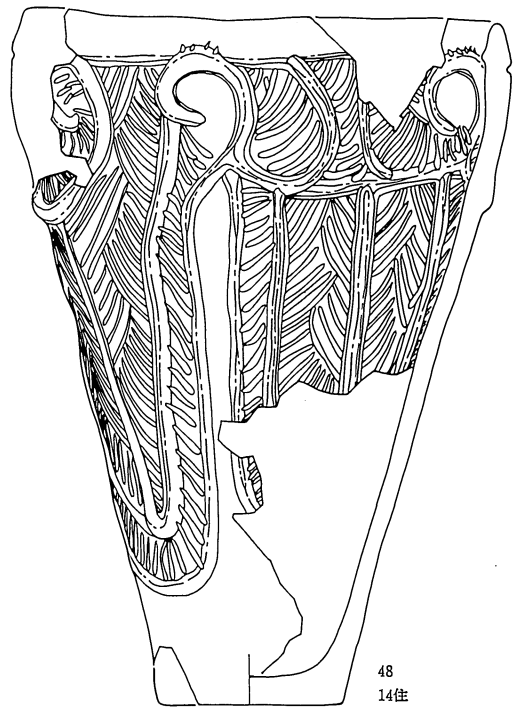

48  
14住

0 (1 : 4) 10cm

図版87 14号竪穴住居跡出土土器 (1 : 4)

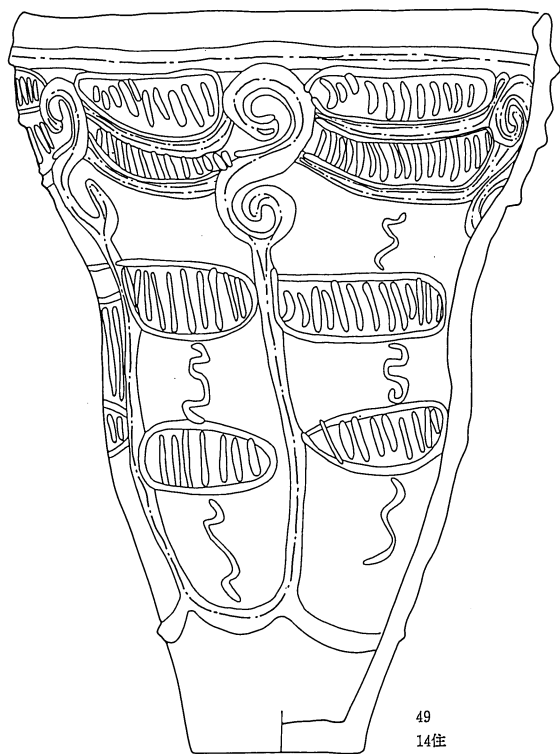

49  
14住

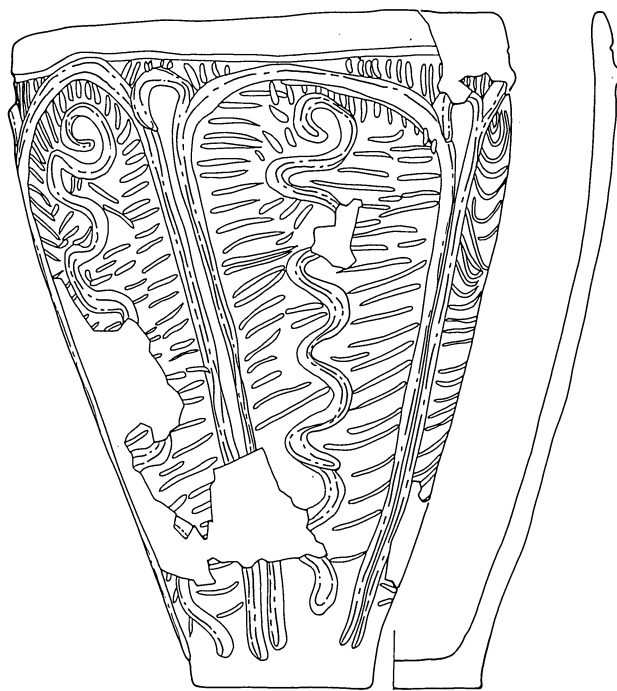

51  
14住

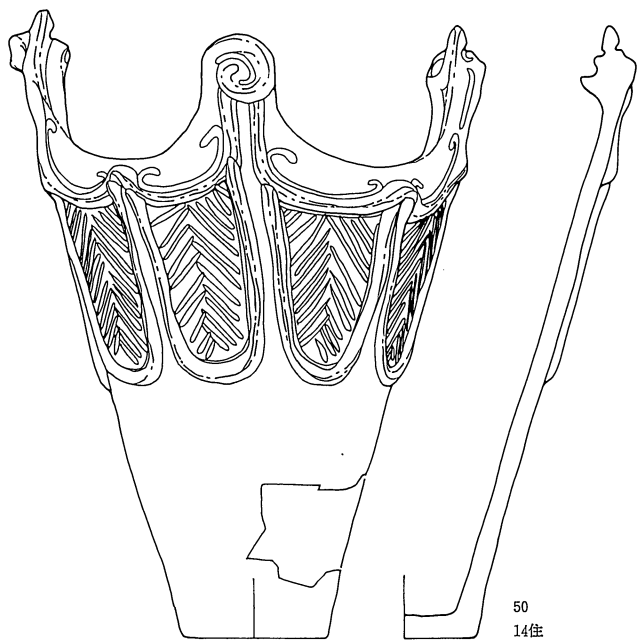

50  
14住

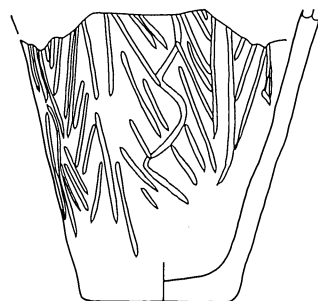

52  
14住

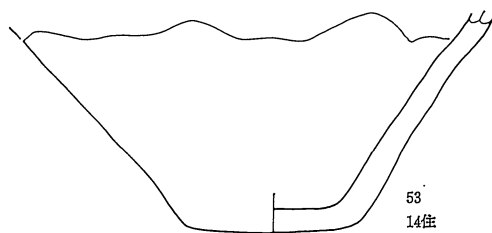

53  
14住

0 (1 : 4) 10cm

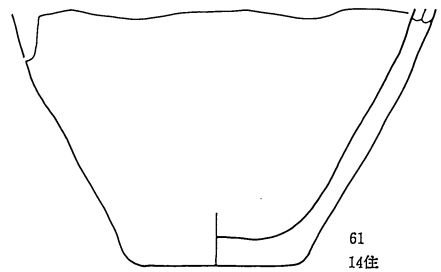
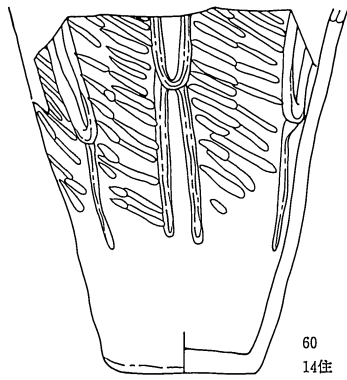
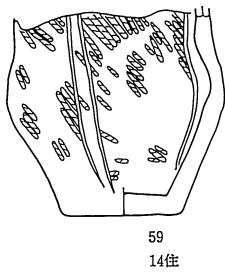
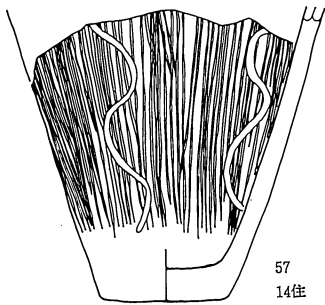
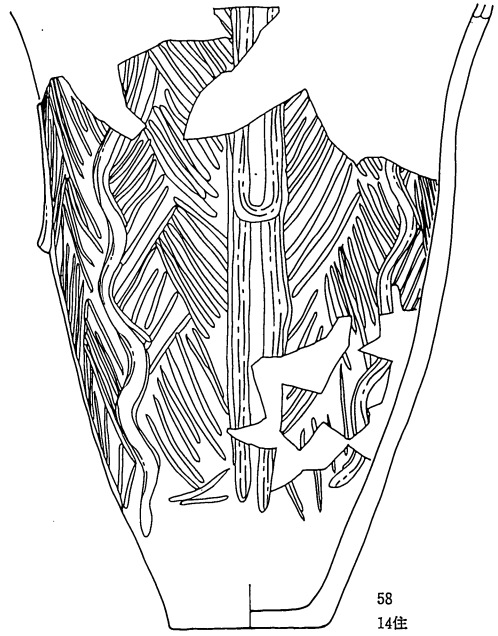
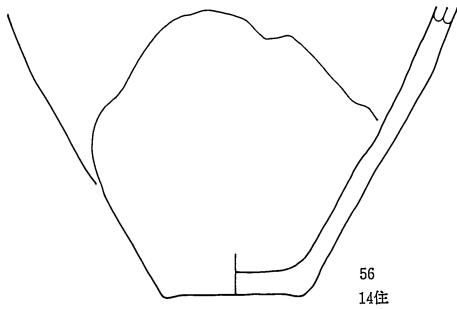
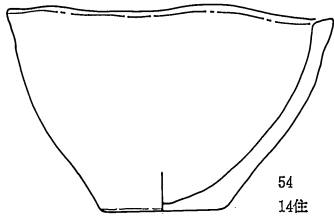

0 (1 : 4) 10cm

図版89 14号竖穴住居跡出土土器 (1 : 4)

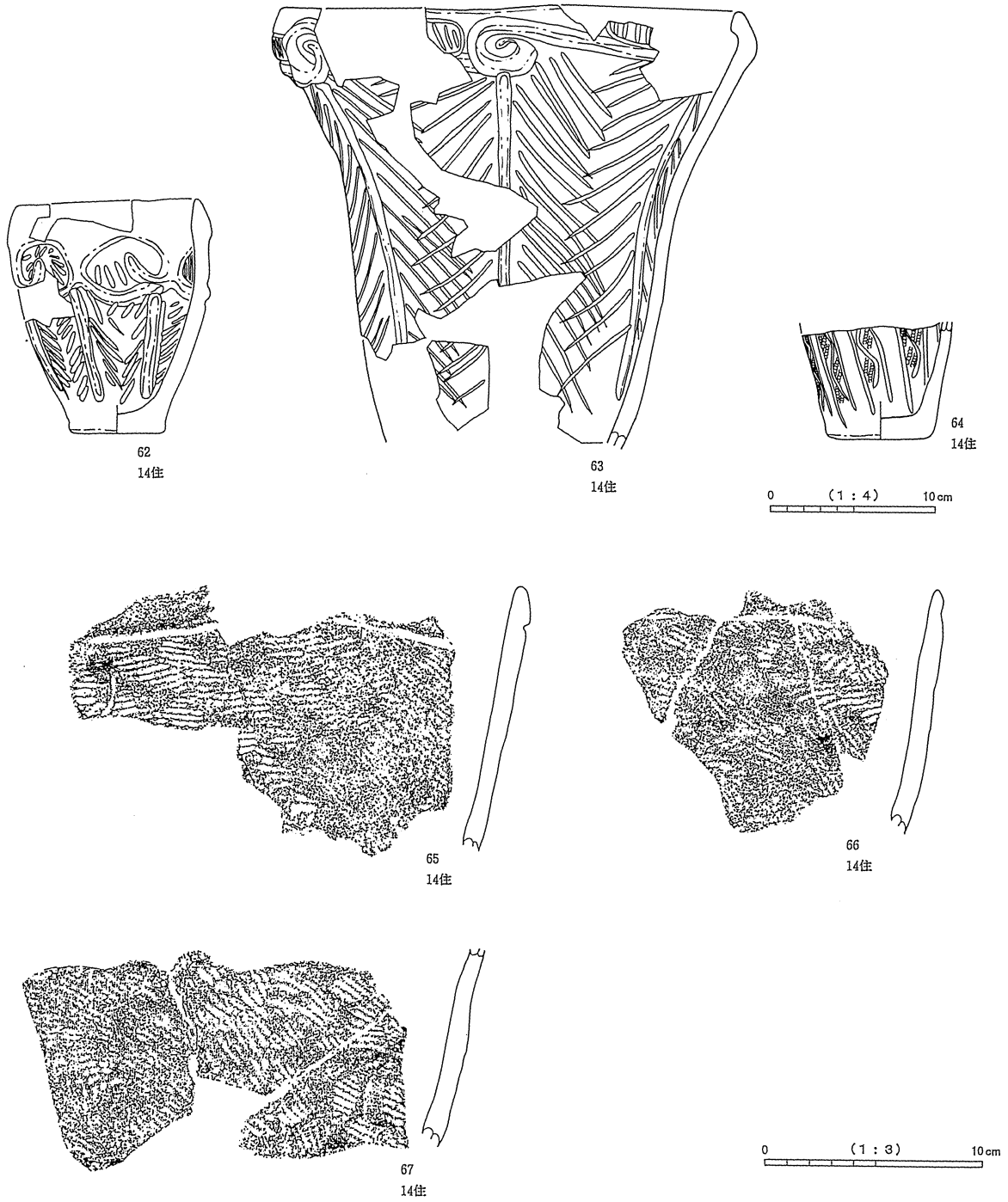

図版90 14号竪穴住居跡出土土器 (62~64 1:4、他 1:3)

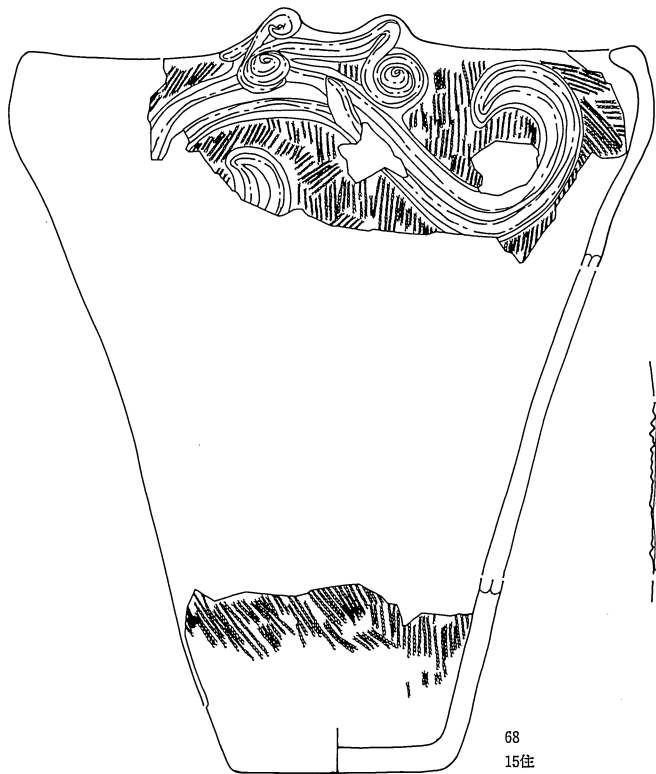

68  
15住

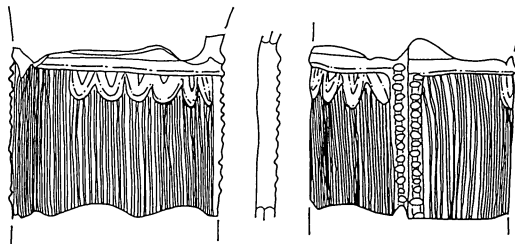

69  
15住

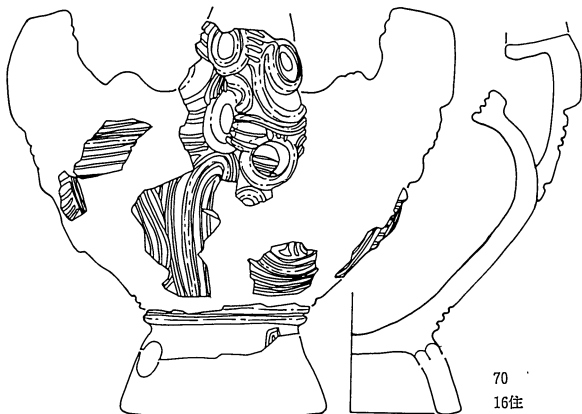

70  
16住



73  
16住

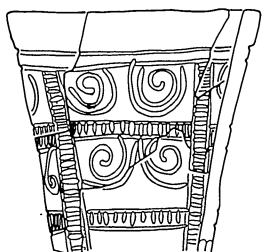

71  
16住

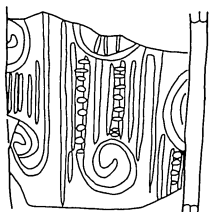

72  
16住



74  
16住

0 (1 : 4) 10 cm

図版91 15号、16号竪穴住居跡出土土器 (1 : 4)

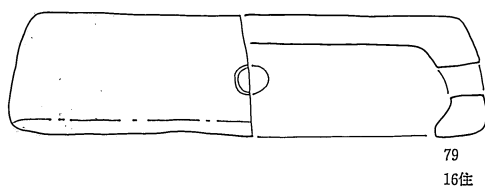
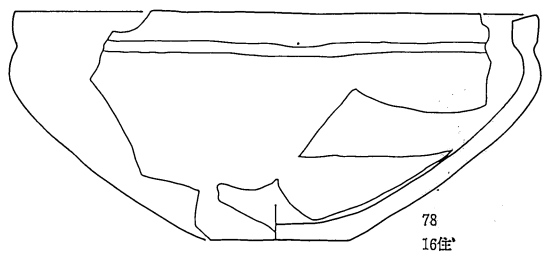
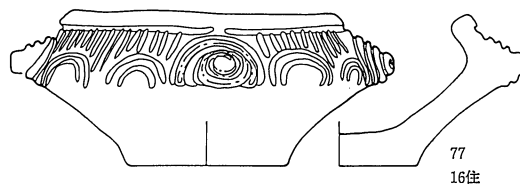
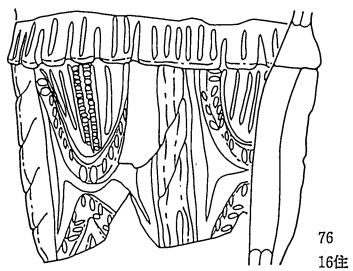
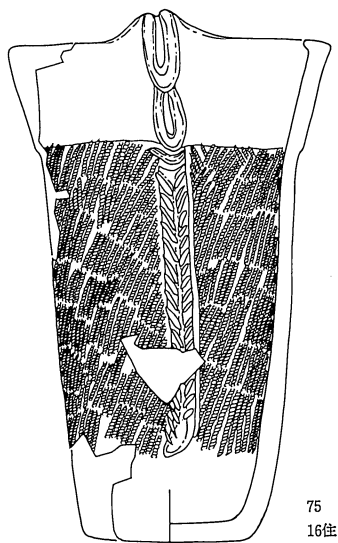

0 (1 : 4) 10 cm

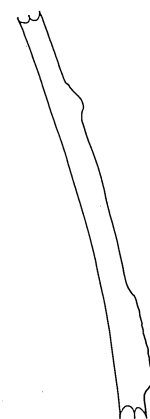
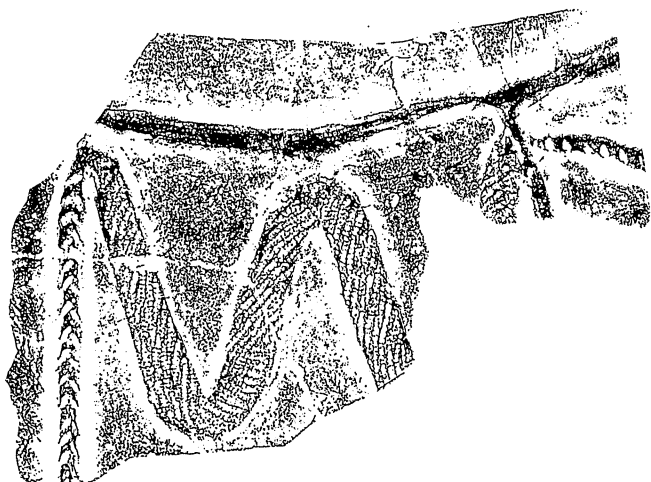

0 (1 : 3) 10 cm

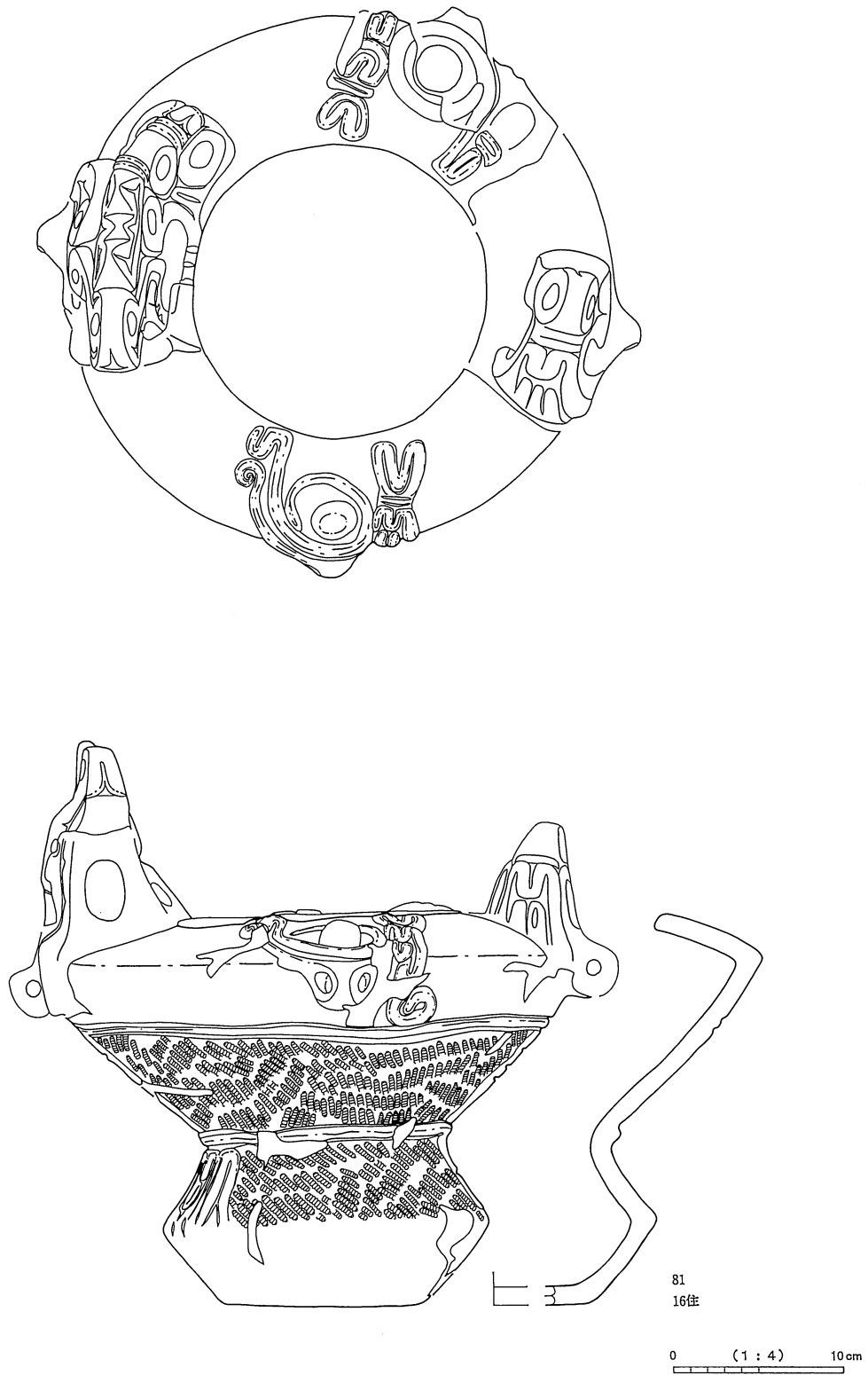

図版93 16号竖穴住居跡出土土器 (1:4)



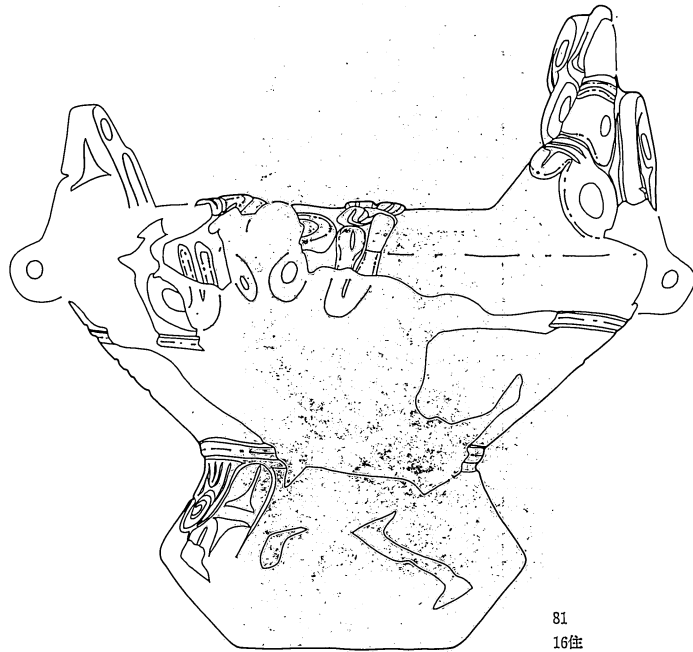
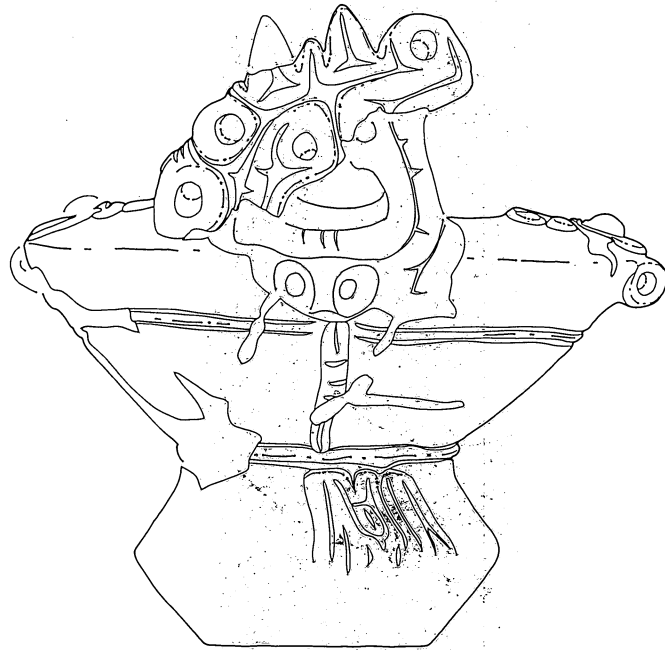

81  
16住

0 (1 : 4) 10cm

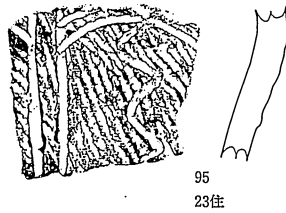
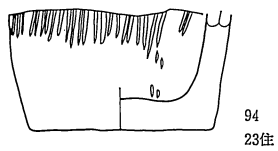
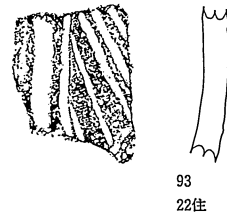
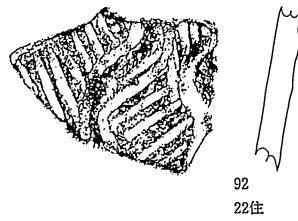
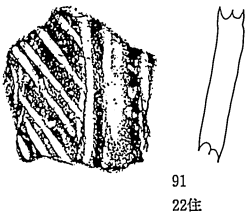
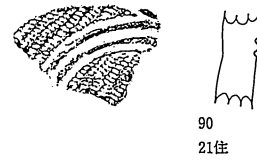
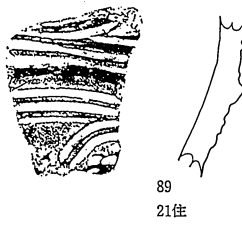
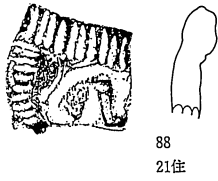
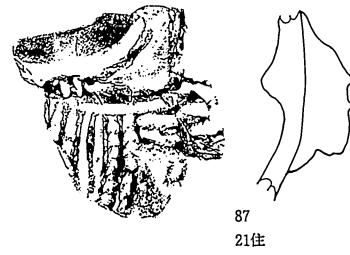
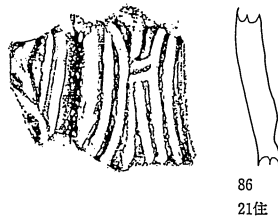
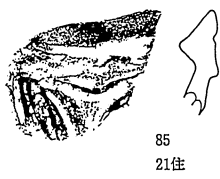
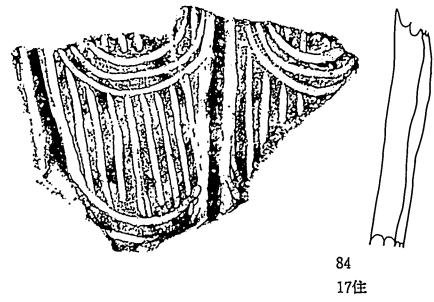
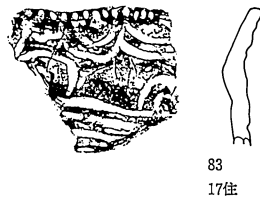
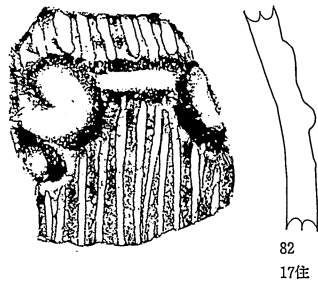

0 (1:4) 10 cm

0 (1:3) 10 cm

図版95 17号、21号~23号竪穴住居跡出土土器 (94 1:4、他 1:3)

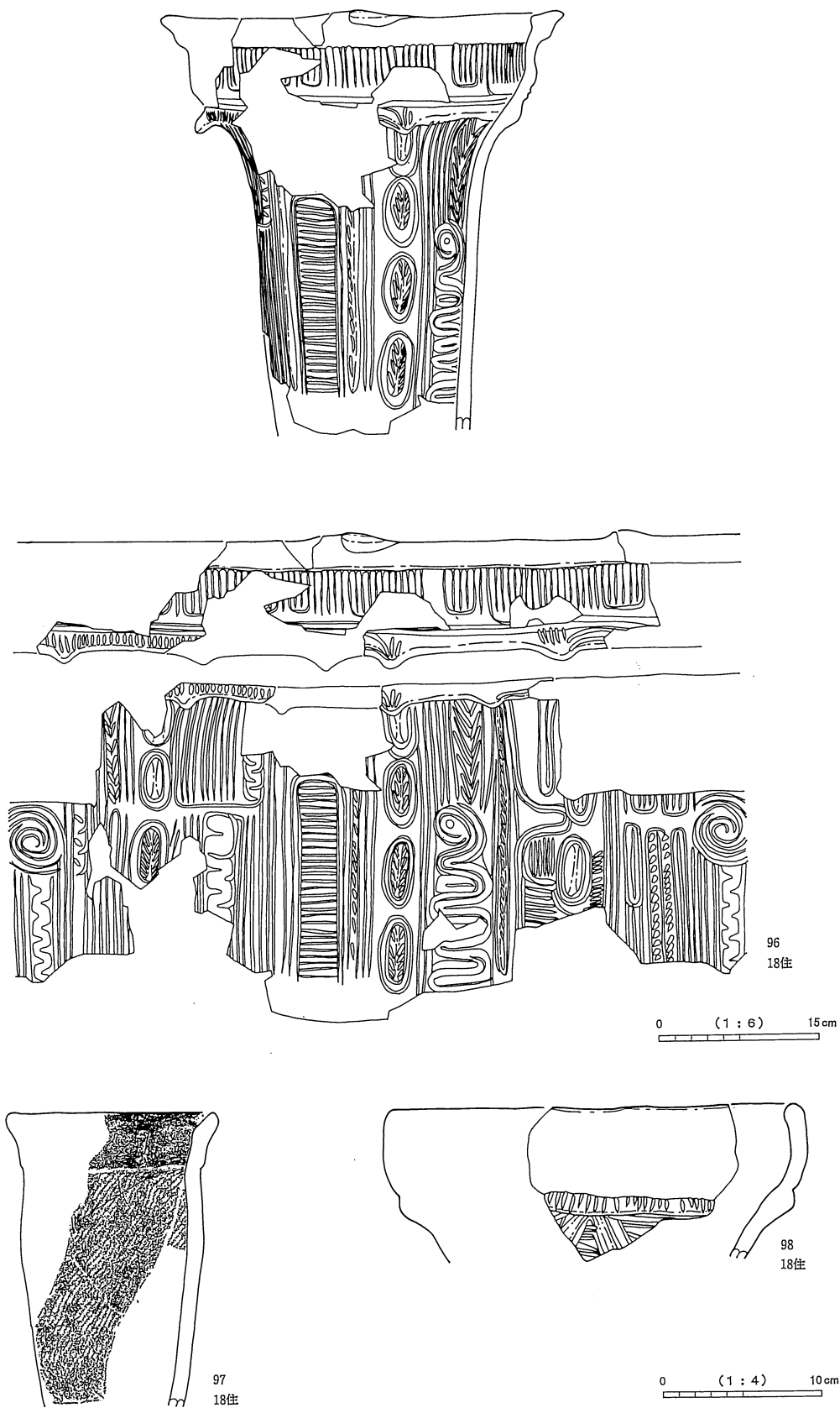

図版96 18号竪穴住居跡出土土器 (96 1 : 6、他 1 : 4)

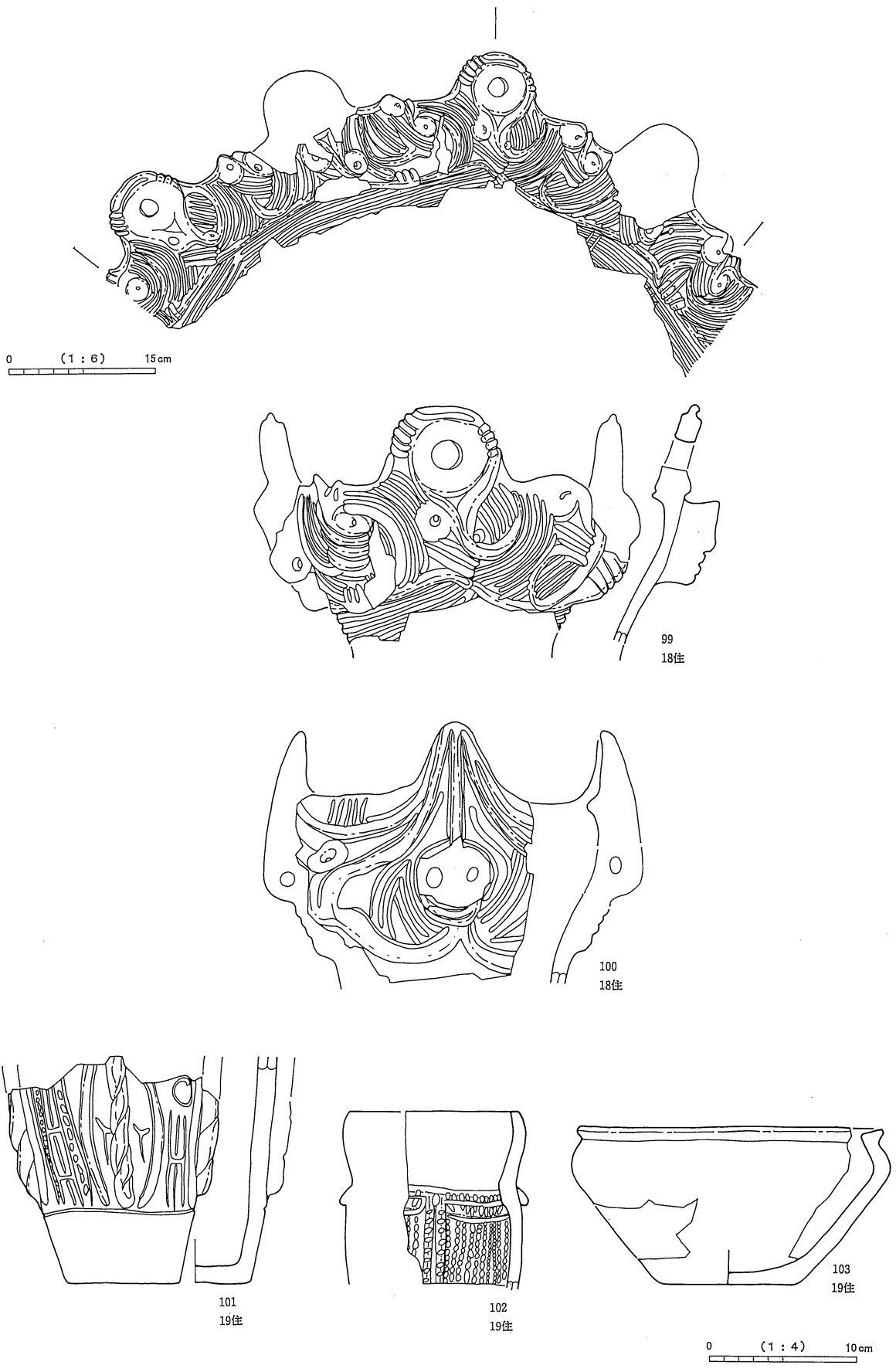

図版97 18号、19号竪穴住居跡出土土器 (1 : 4)

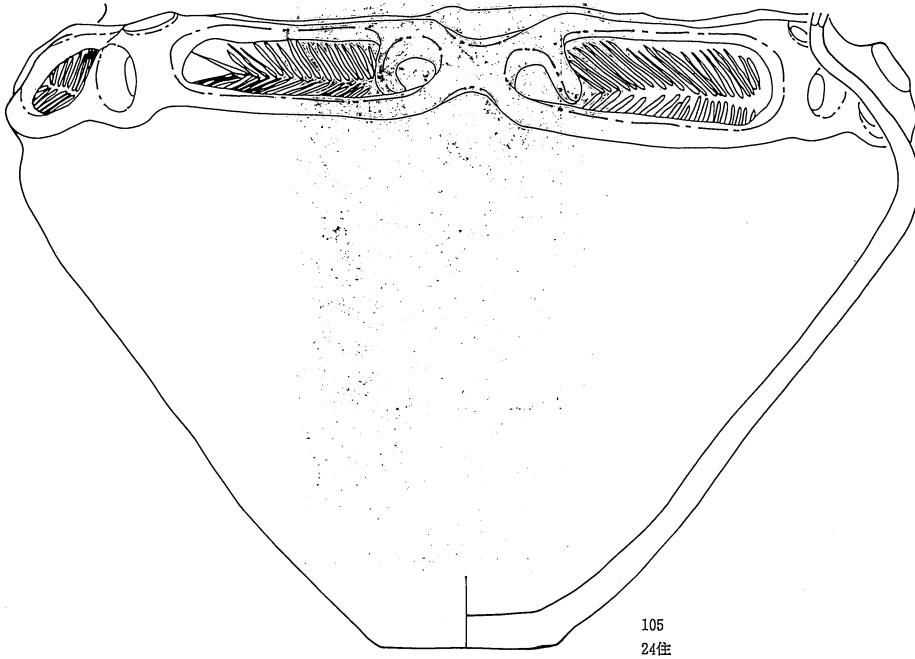
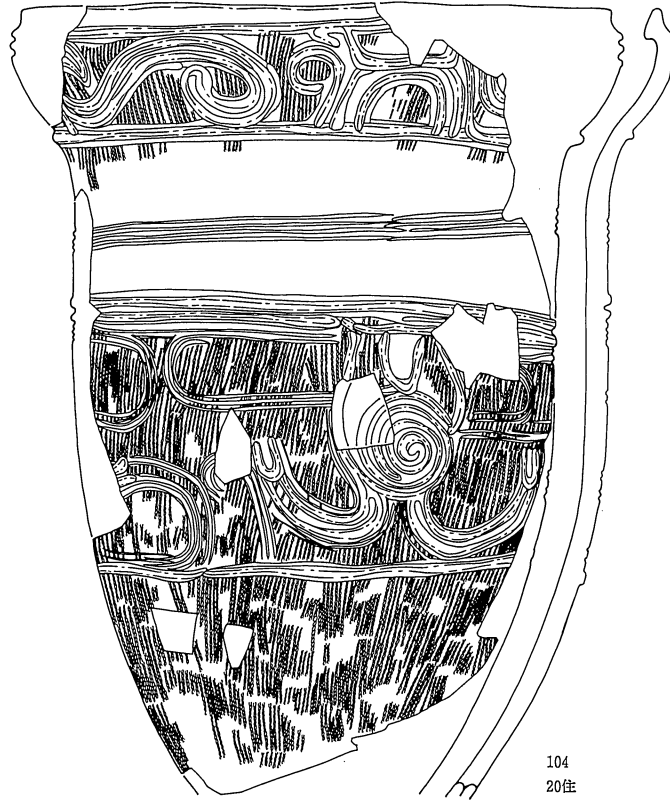

0 (1 : 6) 15 cm

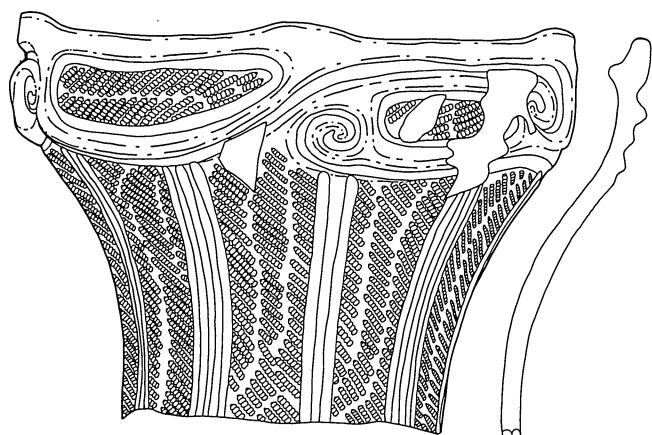

106  
24住

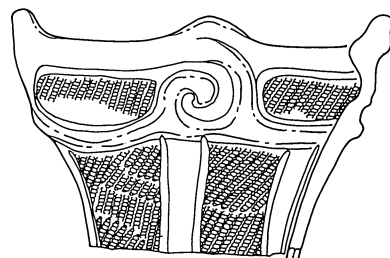

108  
24住

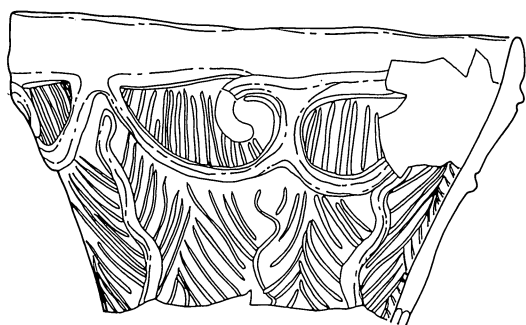

107  
24住

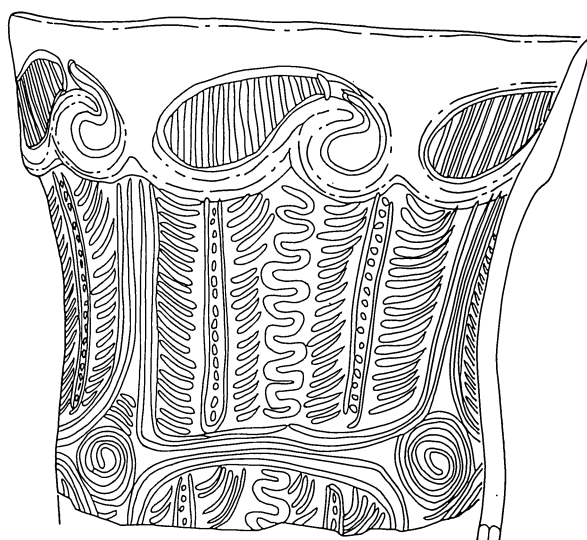

109  
24住

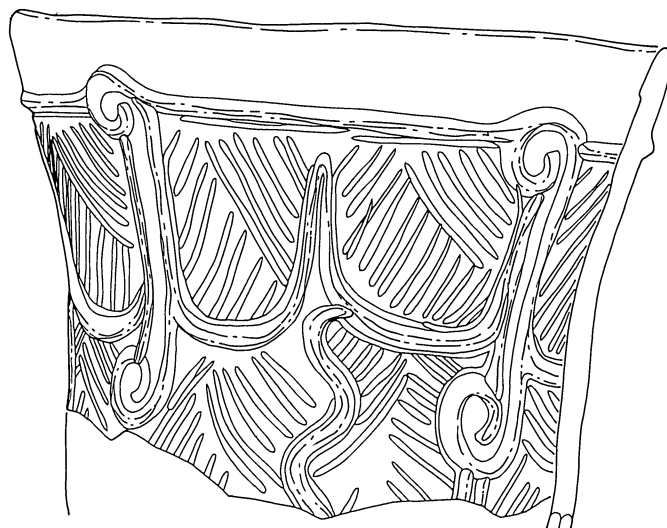

110  
24住

0 (1:4) 10cm

圖版99 24号竪穴住居跡出土土器 (1:4)

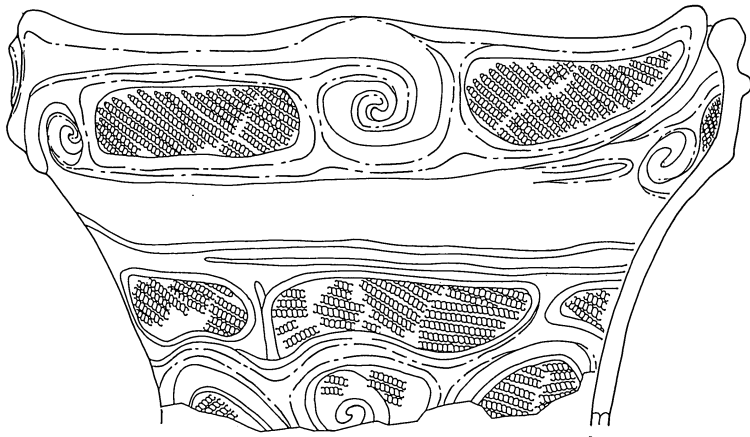

111  
24住

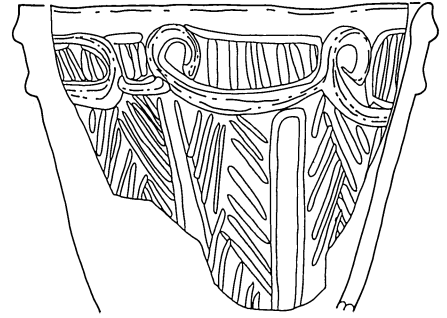

114  
24住

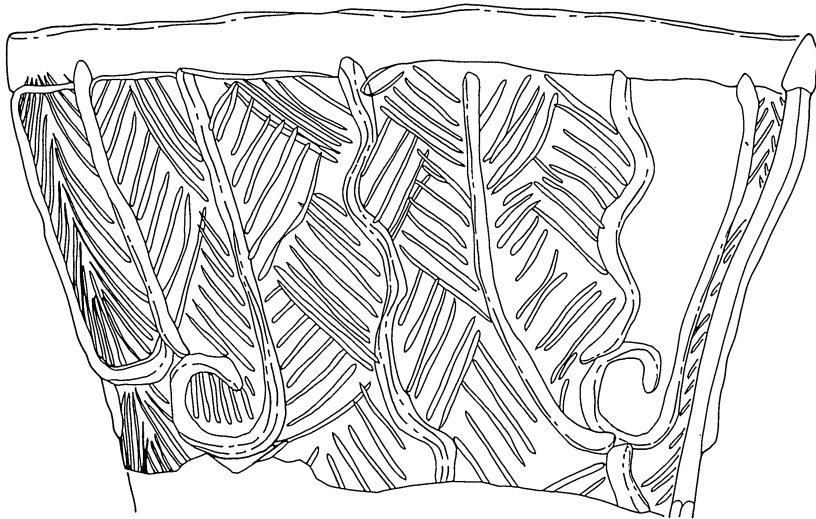

112  
24住埋甕

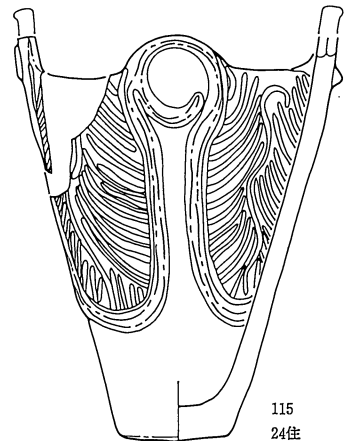

115  
24住

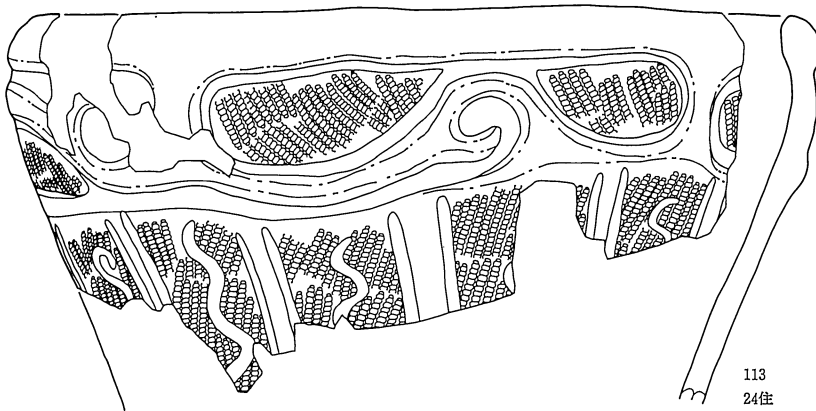

113  
24住

0 (1:4) 10cm

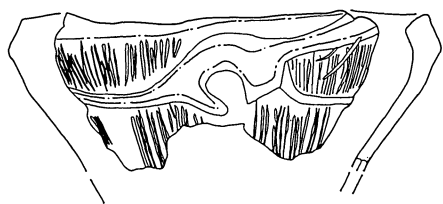

116  
24住

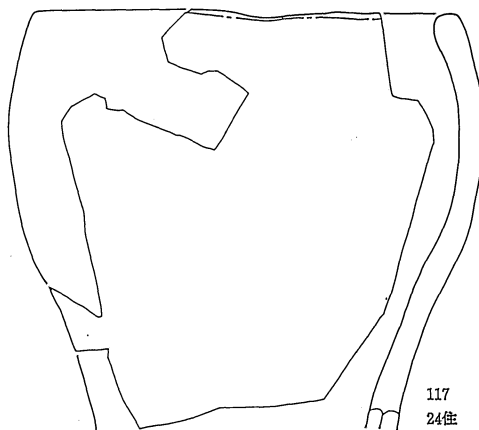

117  
24住

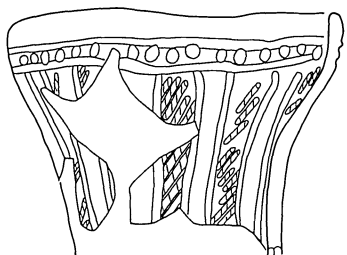

118  
24住



119  
24住

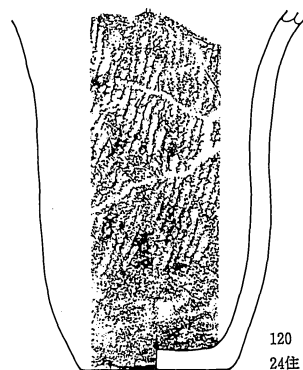

120  
24住



121  
24住

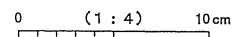

· 図版101 24号竪穴住居跡出土土器 (1:4)





0 (1:6) 15cm

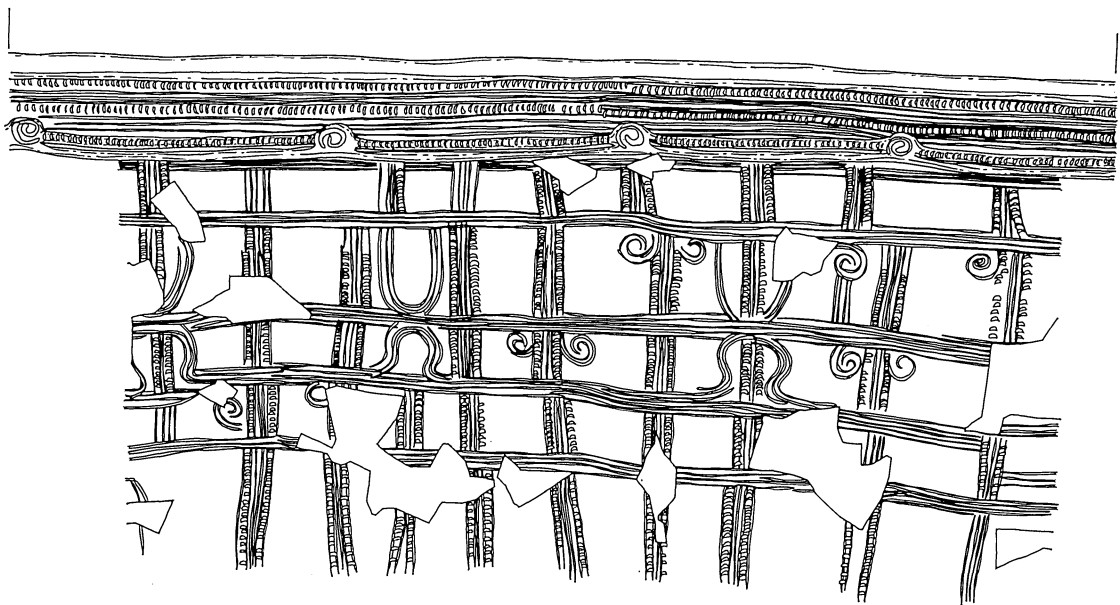

0 (1:8) 20cm

図版102 25号竪穴住居跡出土土器 (1:6)

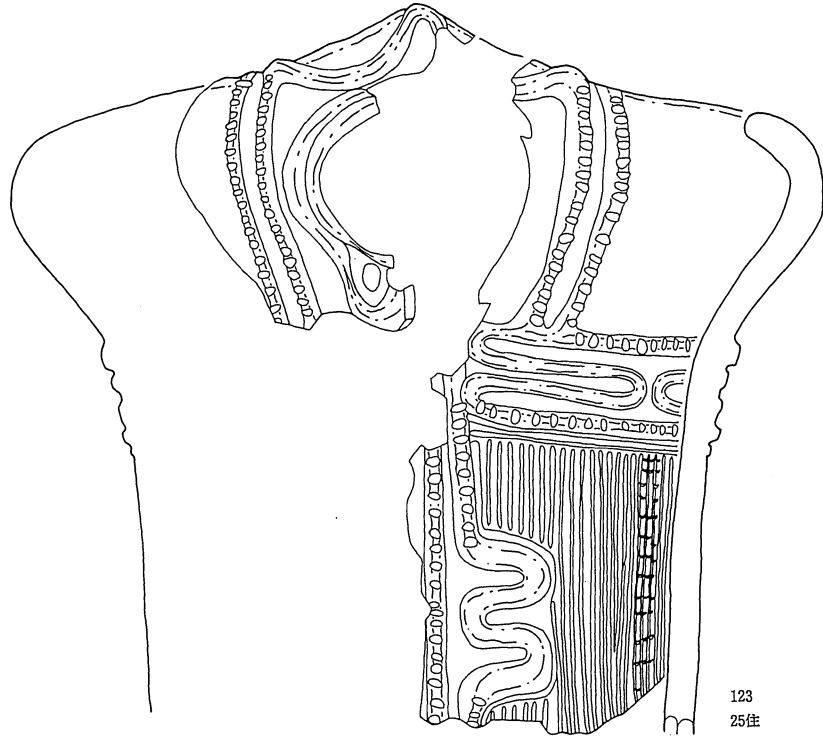

123  
25住

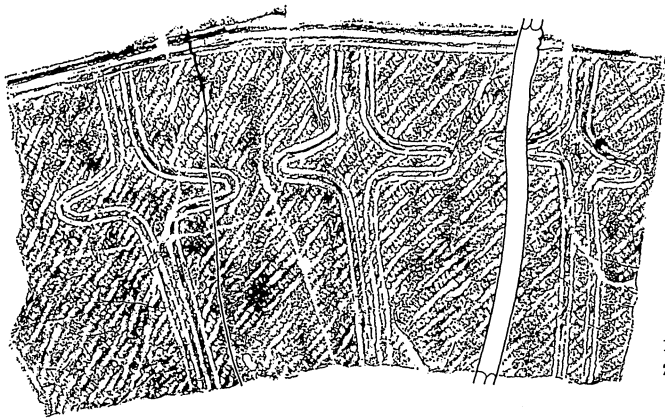

124  
25住

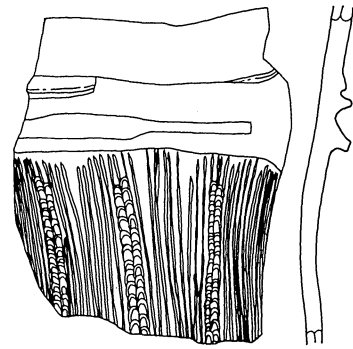

125  
25住

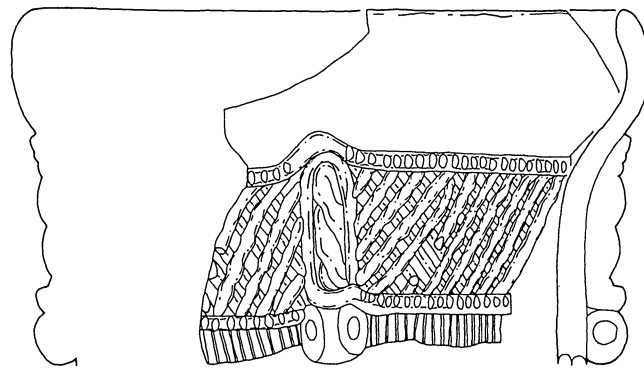

126  
25住

0 (1 : 4) 10cm

圖版103 25号竪穴住居跡出土土器 (1 : 4)

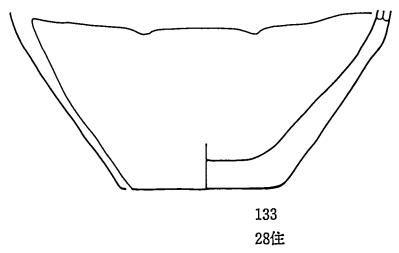
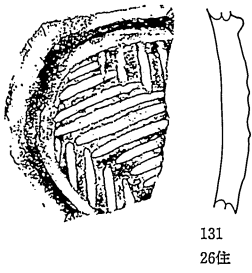
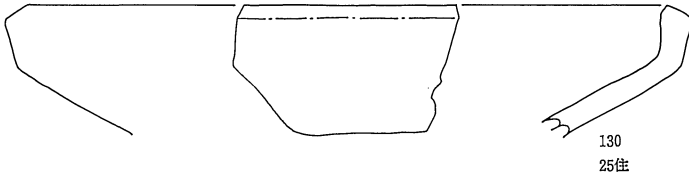
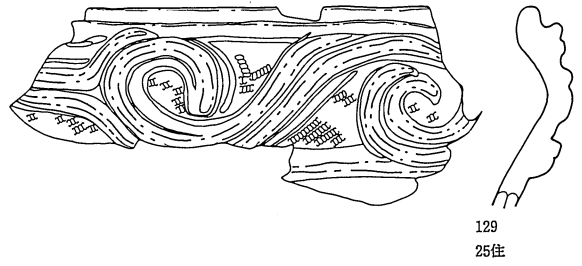
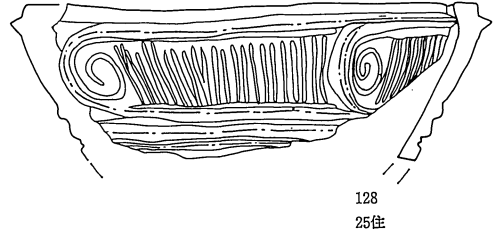
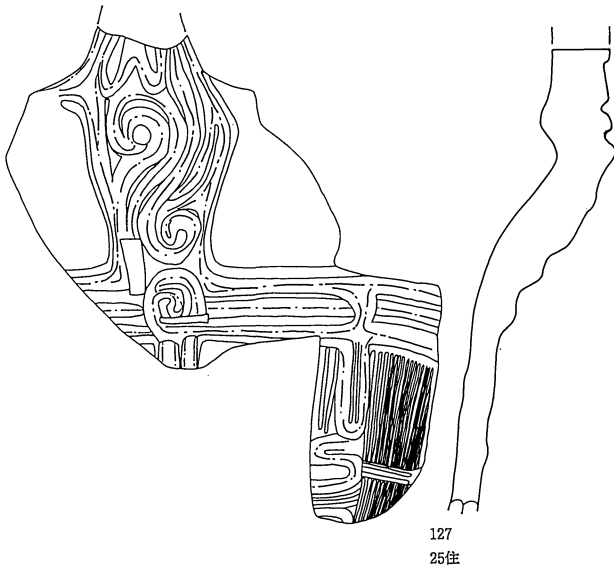

0 (1:3) 10cm

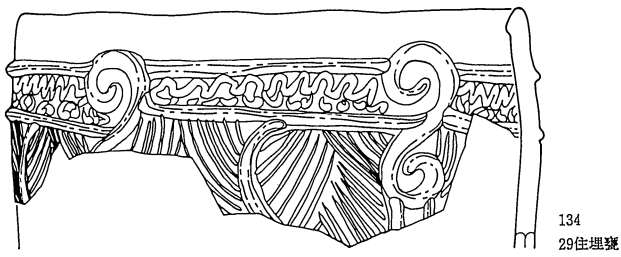

0 (1:4) 10cm

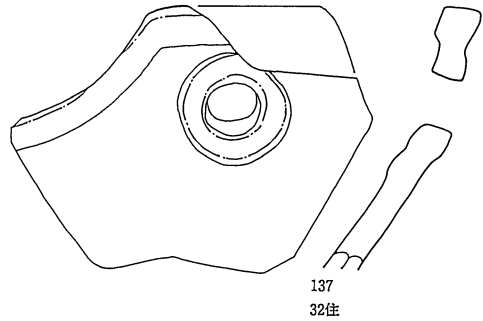
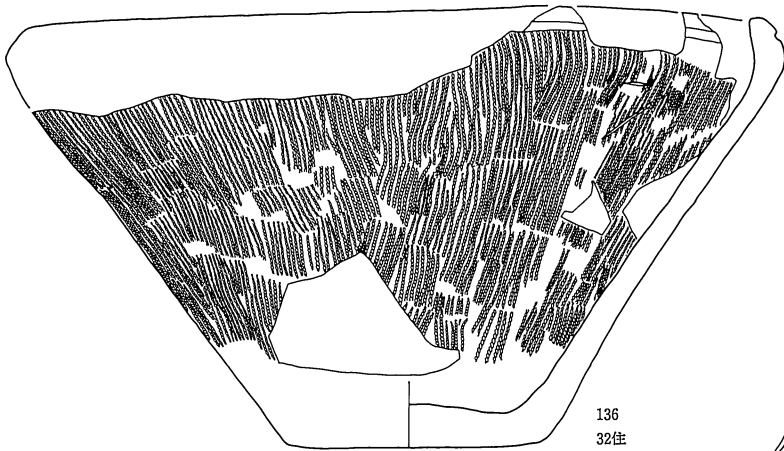
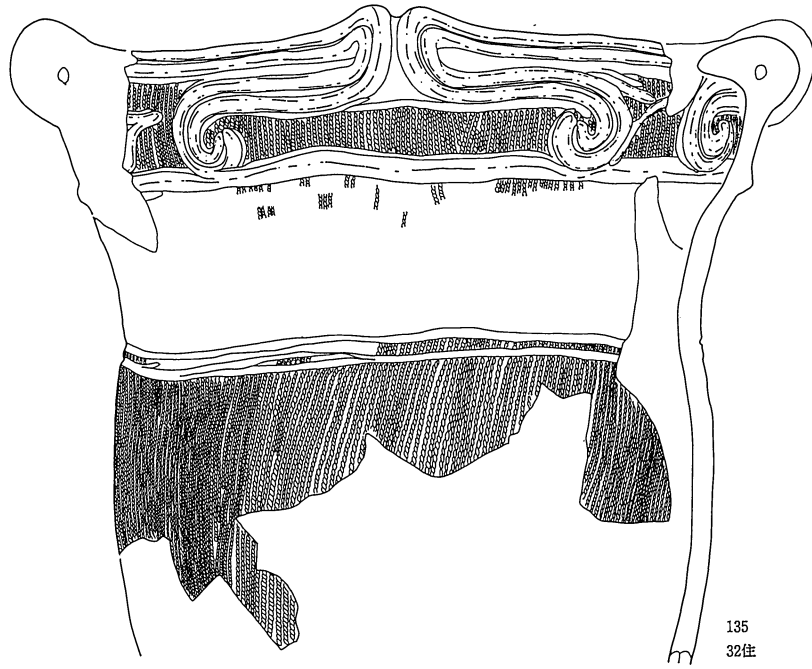

0 (1 : 4) 10 cm

図版105 32号竖穴住居跡出土土器 (1 : 4)

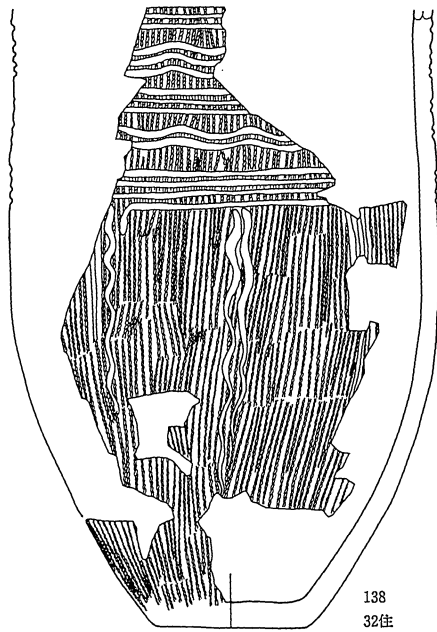

138  
32住

0 (1:4) 10 cm



139  
32住



140  
32住

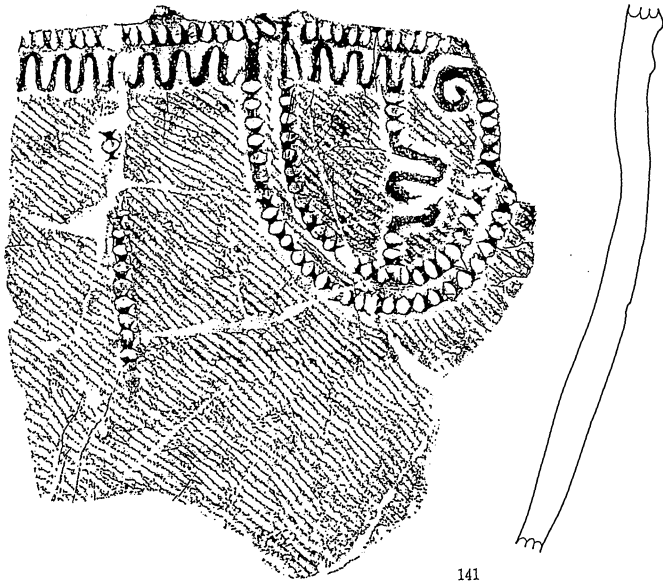

141  
32住

0 (1:3) 10 cm

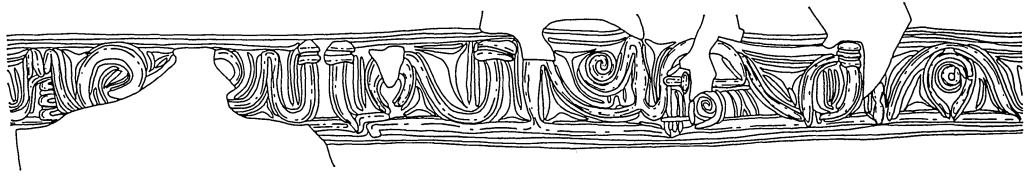

0 (1 : 8) 20 cm

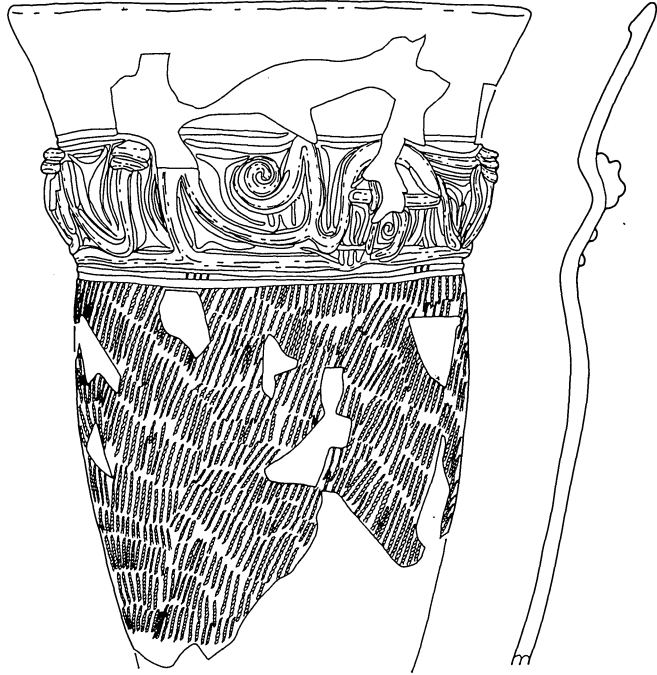

0 (1 : 6) 15 cm

142  
33住

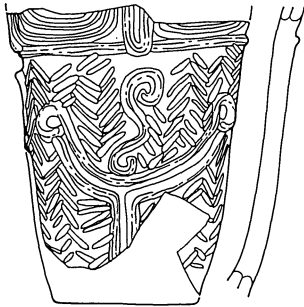

143  
33住

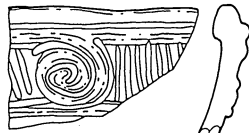

144  
33住

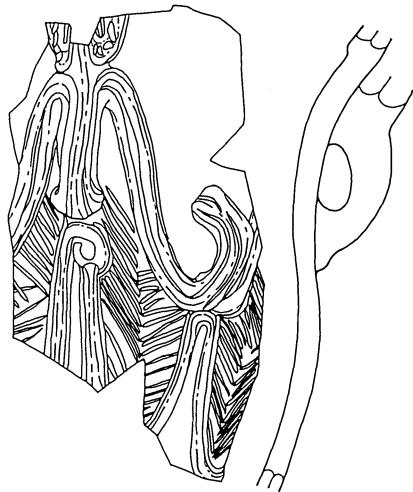

145  
33住

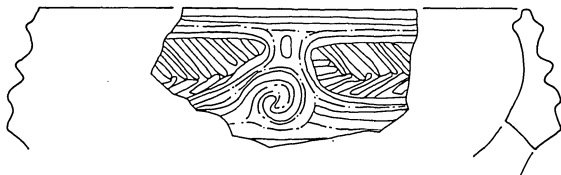

146  
33住

0 (1 : 4) 10 cm

図版107 33号竪穴住居跡出土土器 (142 1 : 6、他 1 : 4)

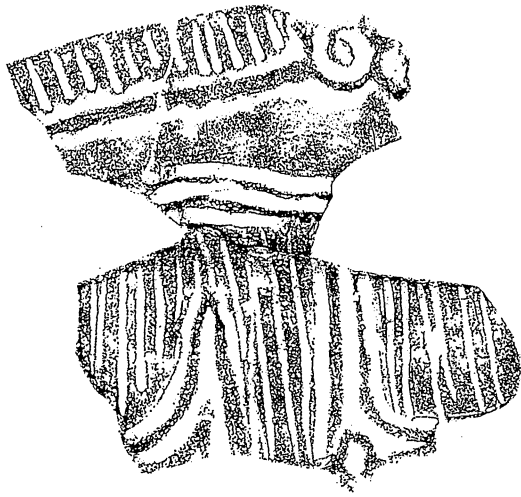

147  
37住



148  
40住



149  
40住



150  
40住



151  
40住

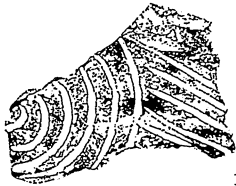

152  
45住

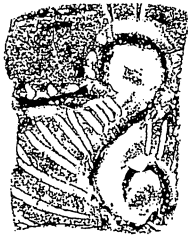

153  
45住

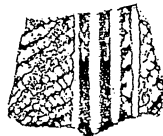

154  
45住



155  
45住



156  
48住



157  
48住



158  
48住

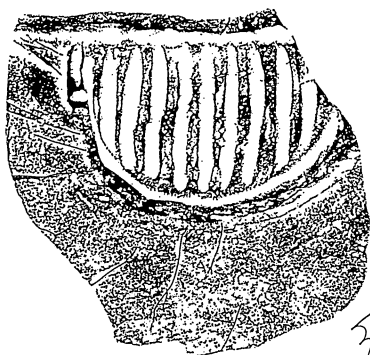

159  
50住

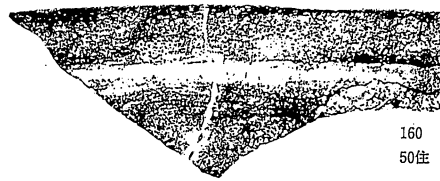

160  
50住



161  
50住



0 (1:3) 10cm

図版108 37号、40号、45号、48号、50号竖穴住居跡出土土器 (1:3)

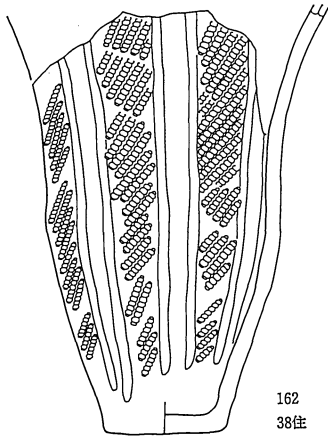

162  
38住

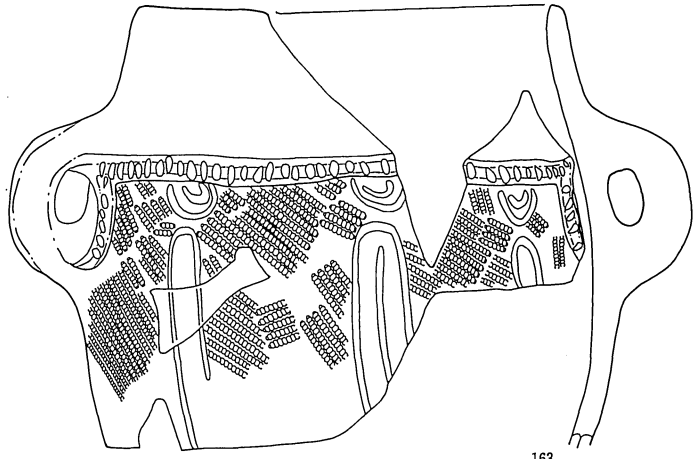

163  
39住

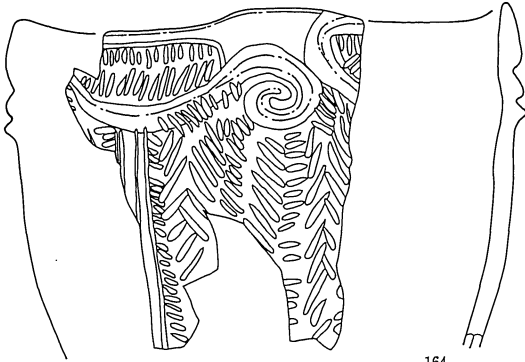

164  
39住

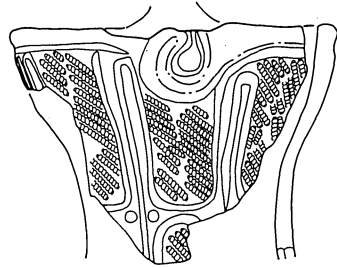

165  
39住

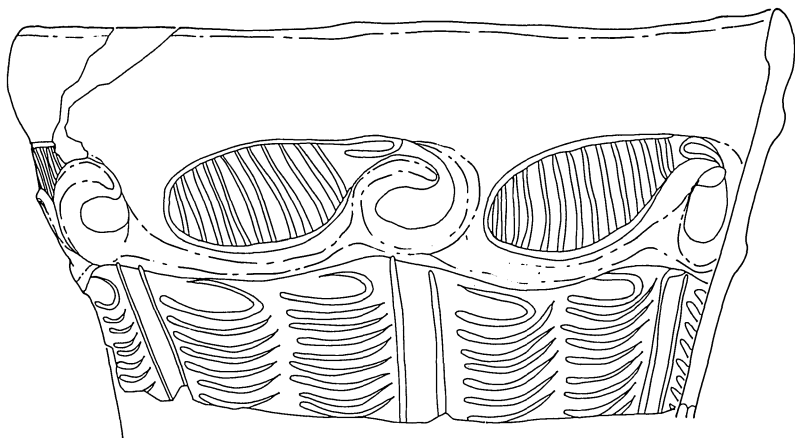

166  
39住埋藏

0 (1 : 4) 10 cm



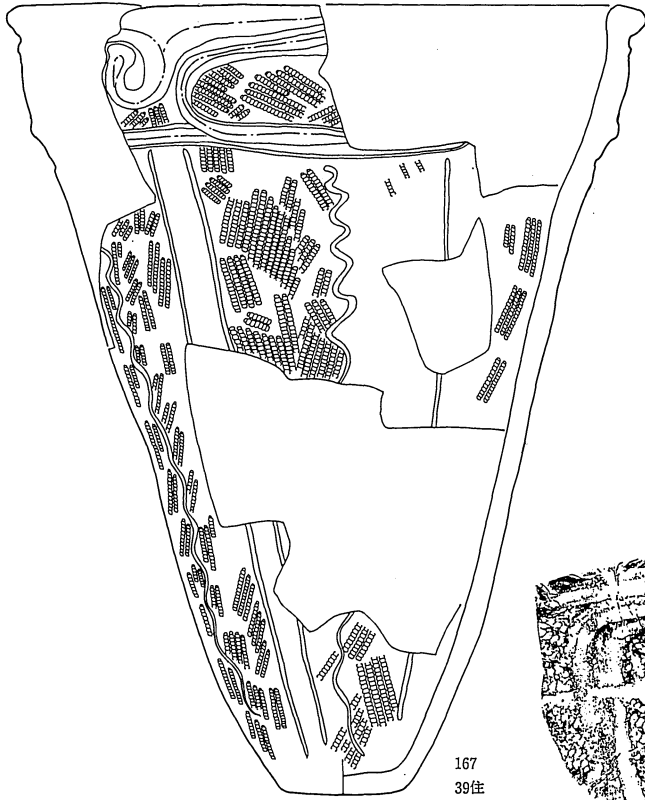

167  
39住

0 (1:6) 15cm

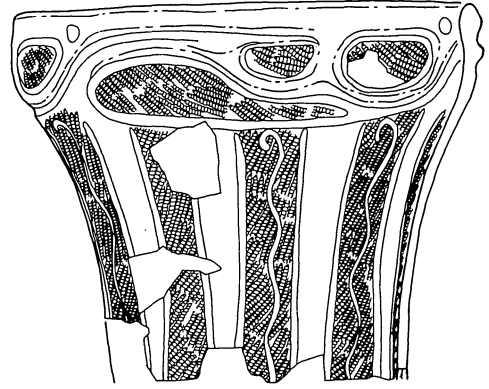

168  
39住

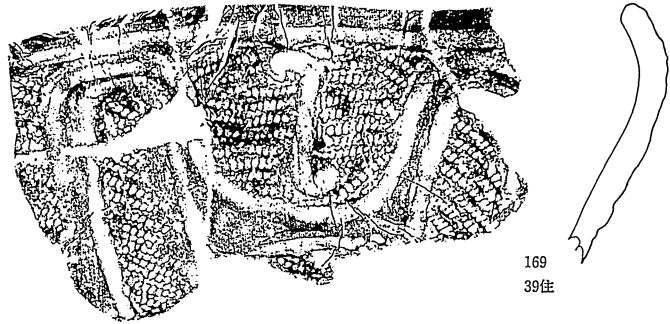

169  
39住

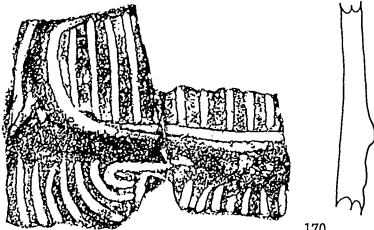

170  
39住

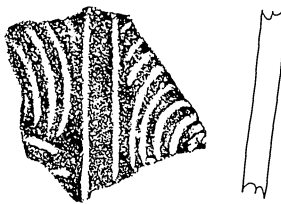

171  
39住

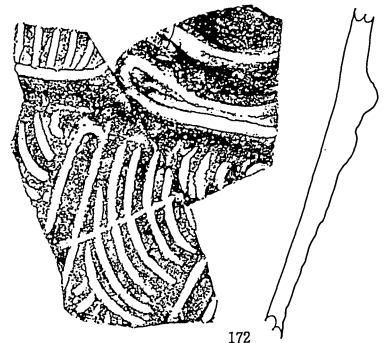

172  
39住

0 (1:3) 10cm

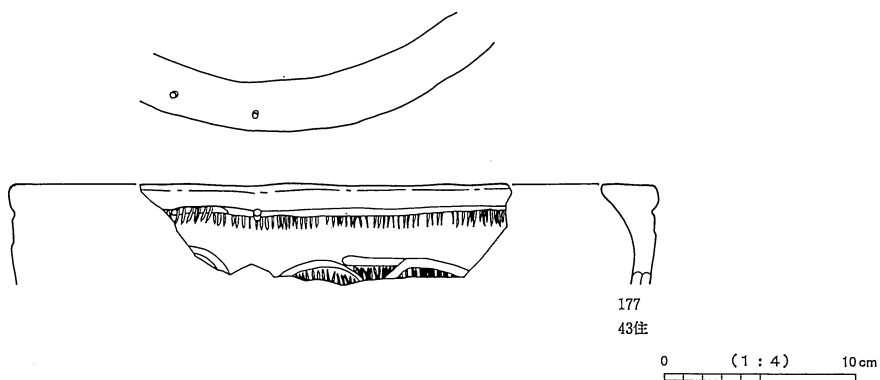
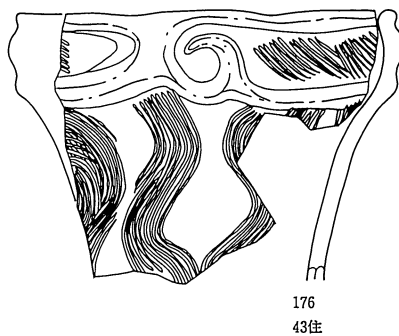
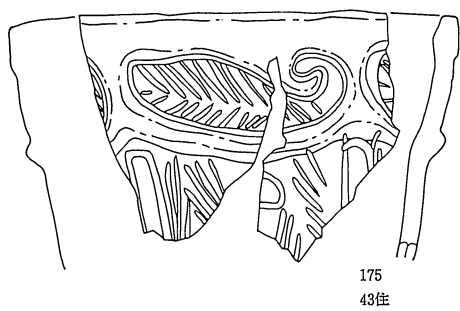
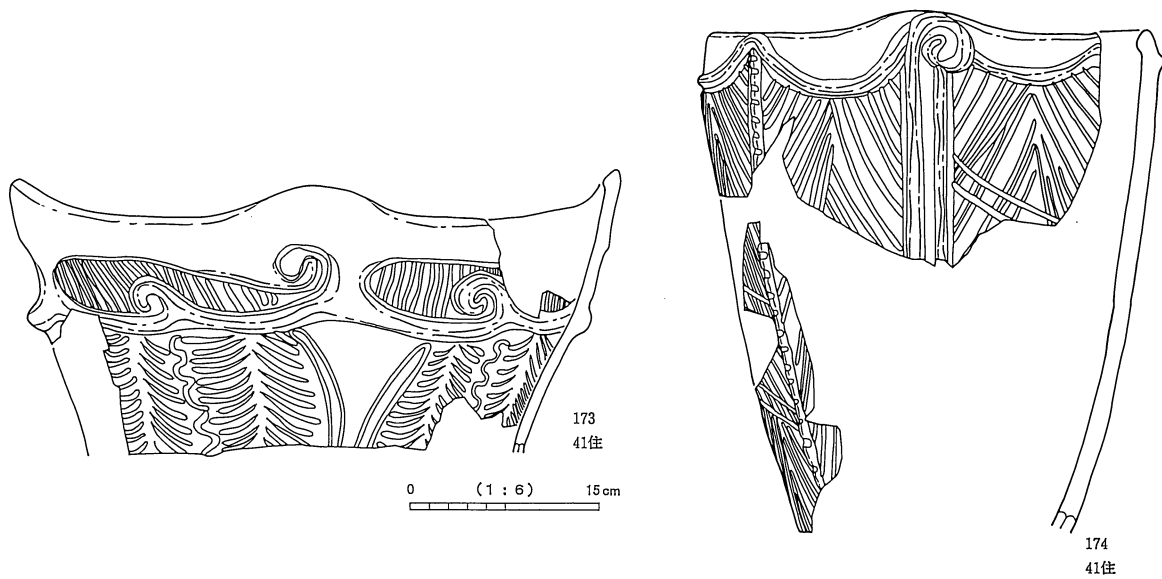

図版111 41号、43号竪穴住居跡出土土器 (173 1:6、他 1:4)

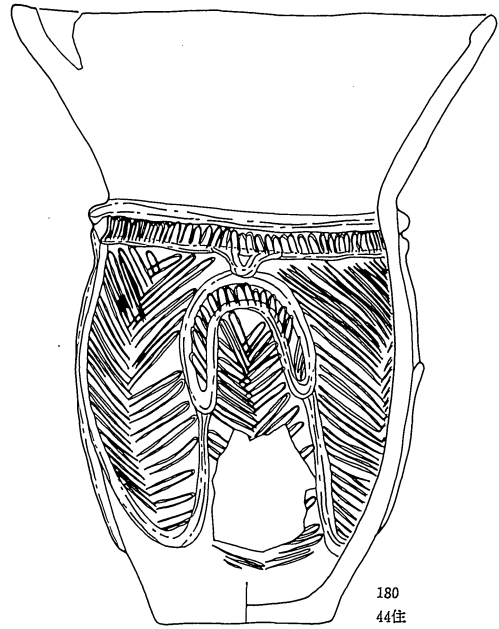
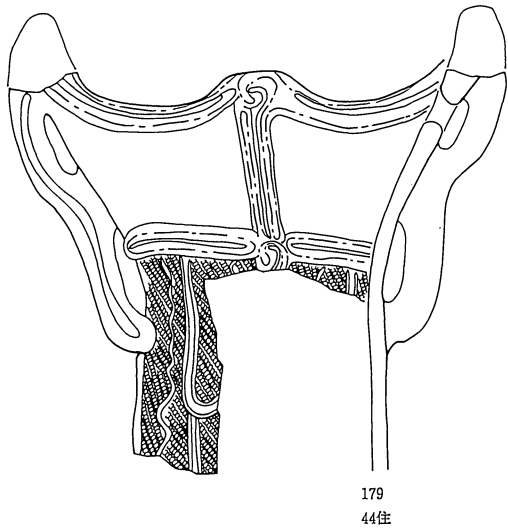
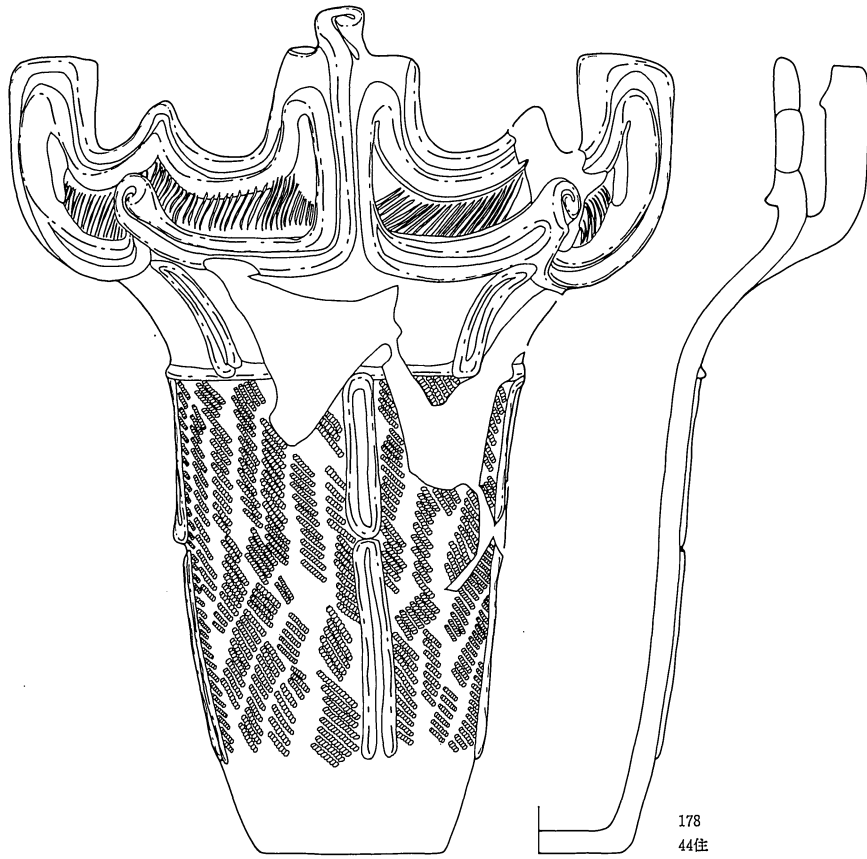

0 (1 : 4) 10 cm

図版112 44号竪穴住居跡出土土器 (1 : 4)

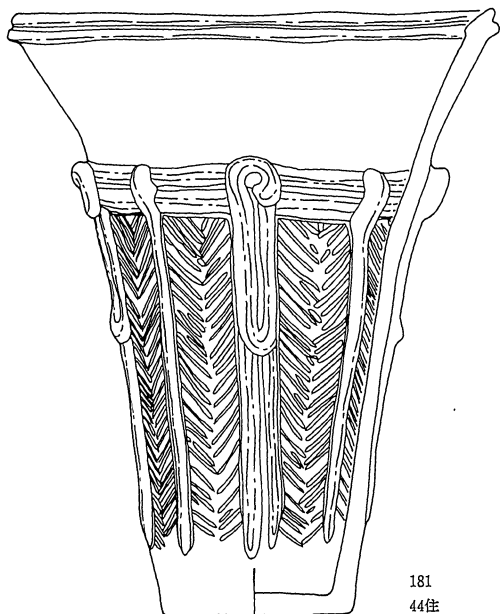

181  
44住

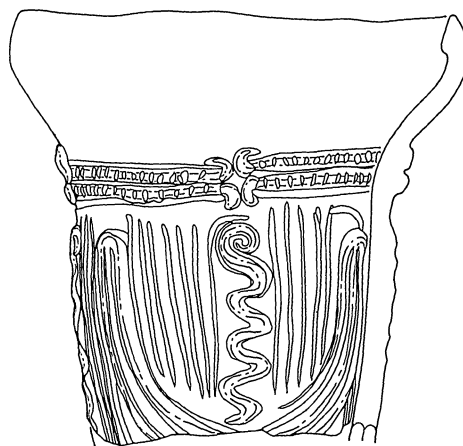

182  
44住

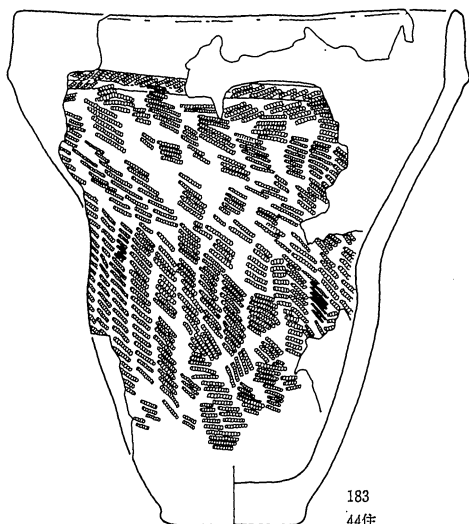

183  
44住

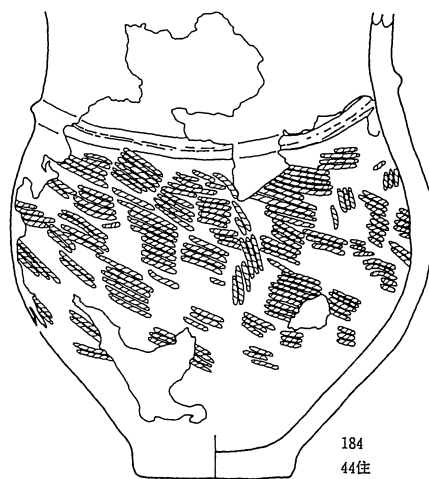

184  
44住

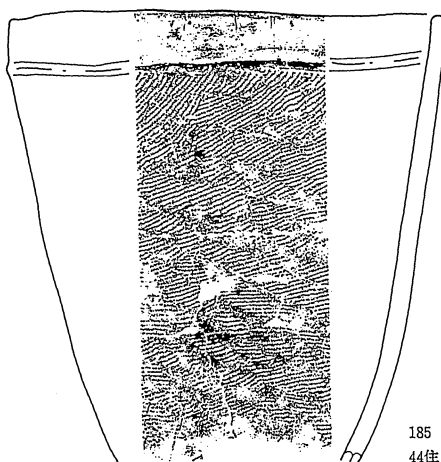

185  
44住

0 (1:4) 10cm

0 (1:6) 15cm

図版113 44号竪穴住居跡出土土器 (185 1:6、他 1:4)

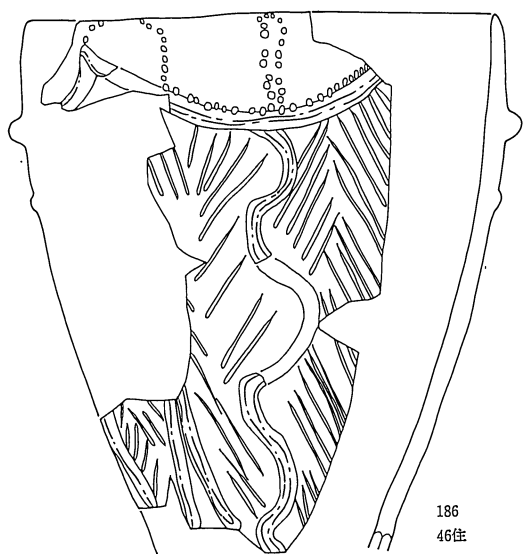

186  
46住

0 (1:6) 15 cm

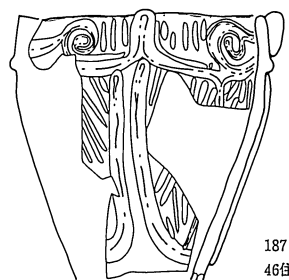

187  
46住

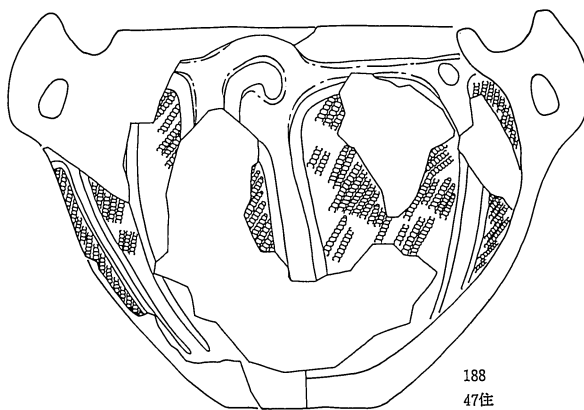

188  
47住

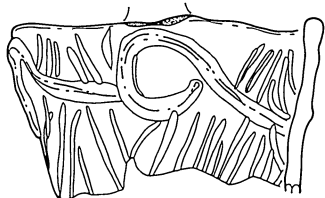

189  
47住

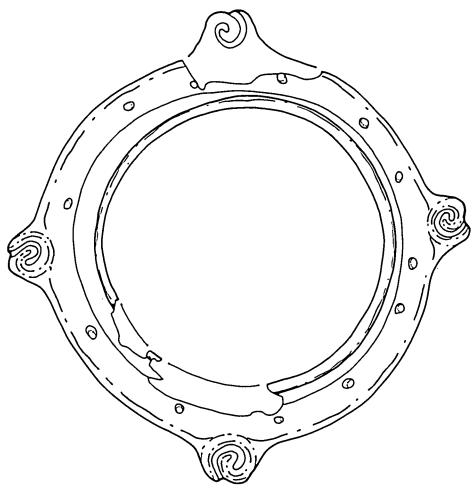

190  
47住

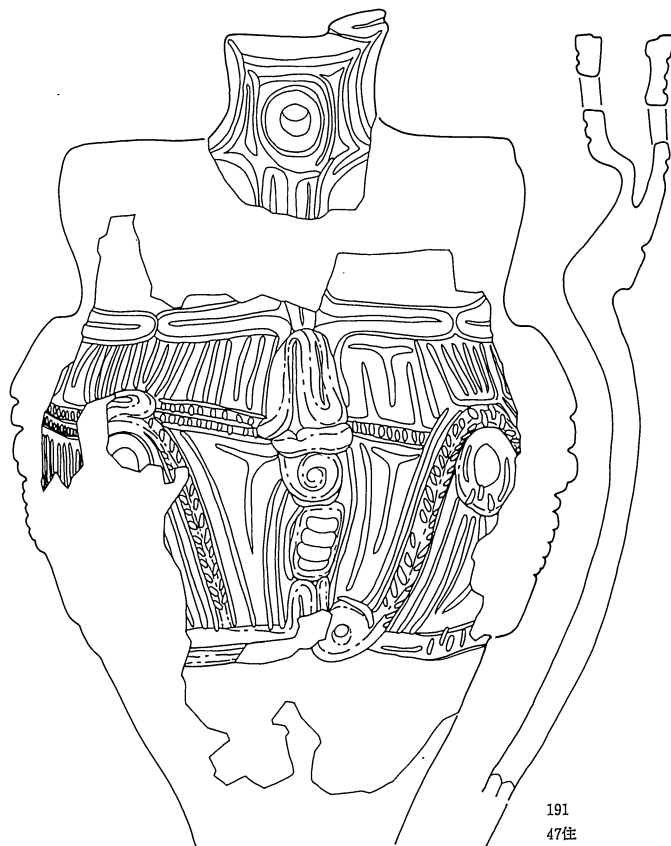

191  
47住

0 (1:4) 10 cm

図版114 46号、47号竪穴住居跡出土土器 (186 1:6、他 1:4)

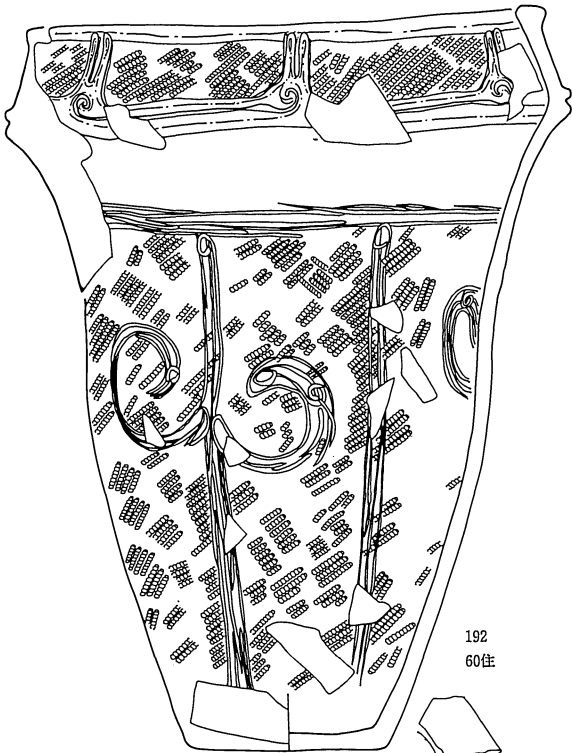

192  
60住

0 (1:6) 15cm

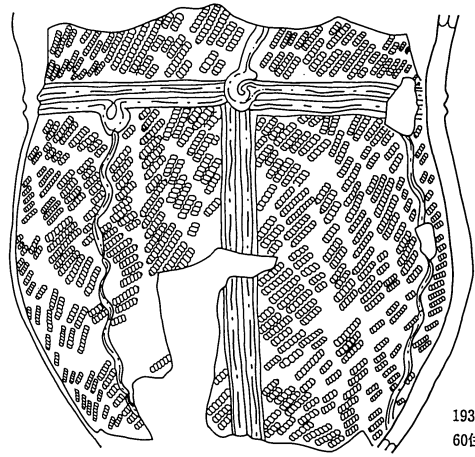
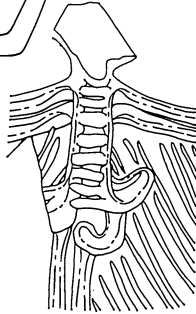

193  
60住

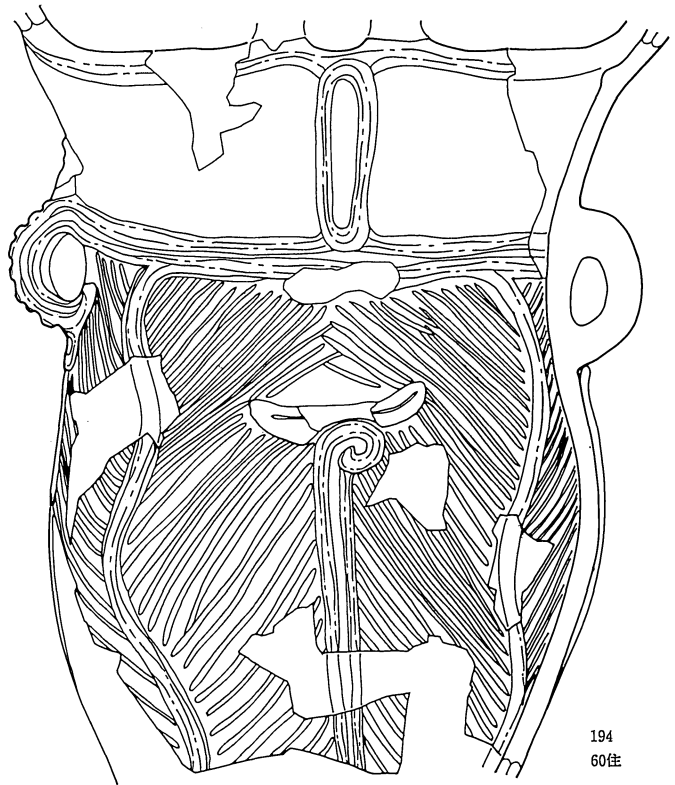

194  
60住

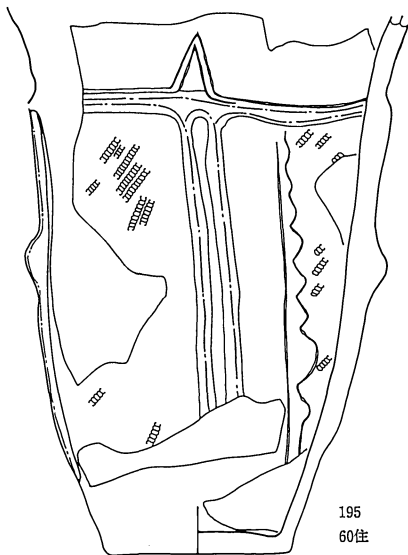

195  
60住

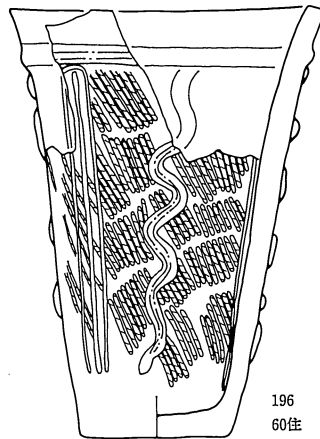

196  
60住

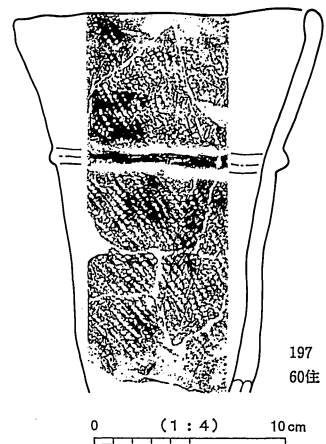

197  
60住

0 (1:4) 10cm

図版115 60号竪穴住居跡出土土器 (192・193 1:6、他 1:4)

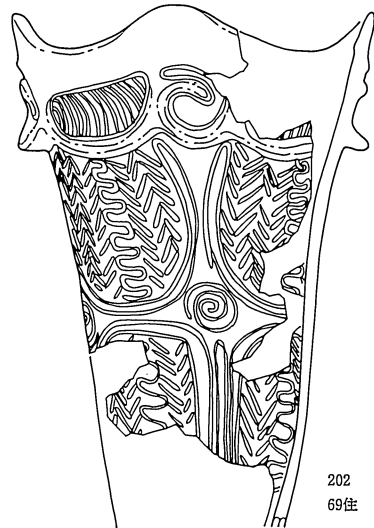
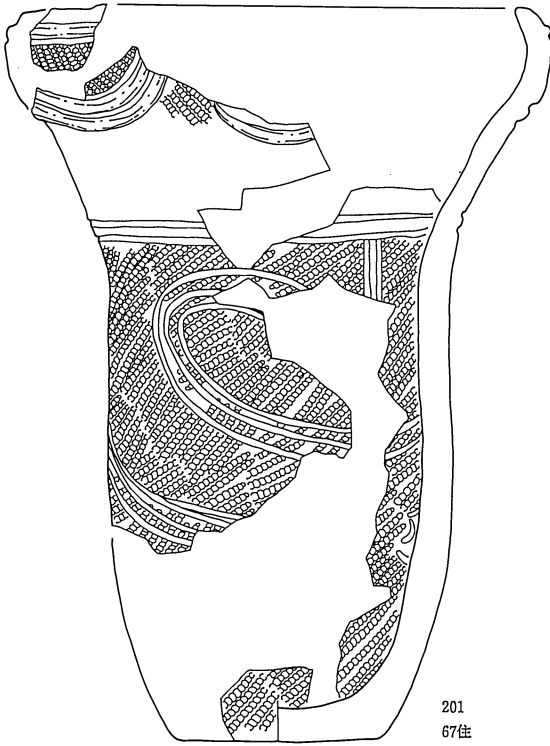
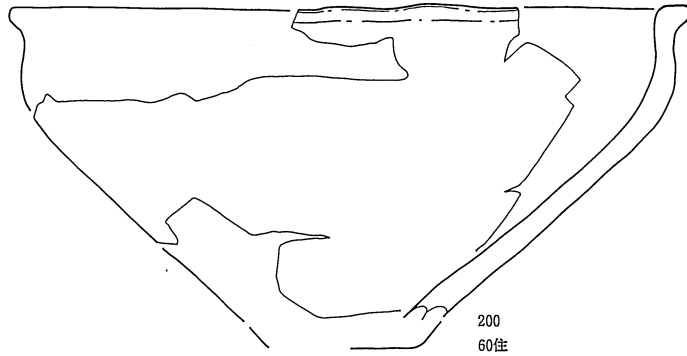
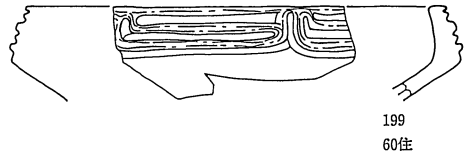
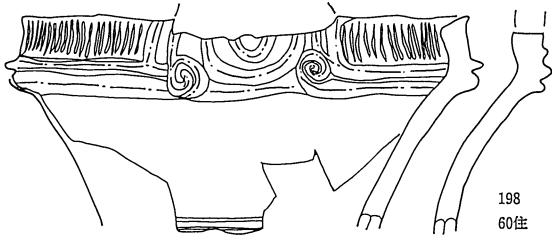

0 (1:6) 15cm

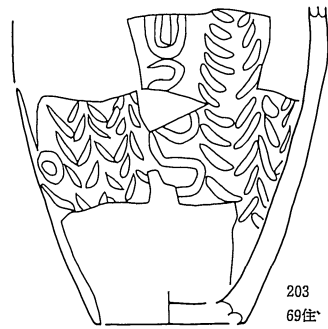

0 (1:4) 10cm

図版116 60号、67号、69号竪穴住居跡出土土器 (202 1:6、他 1:4)

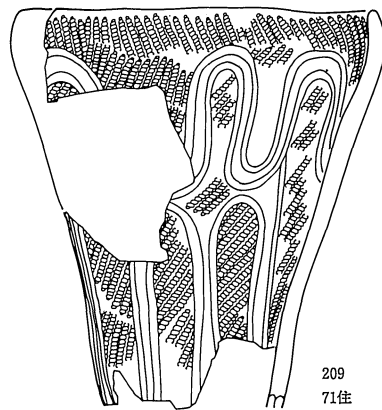
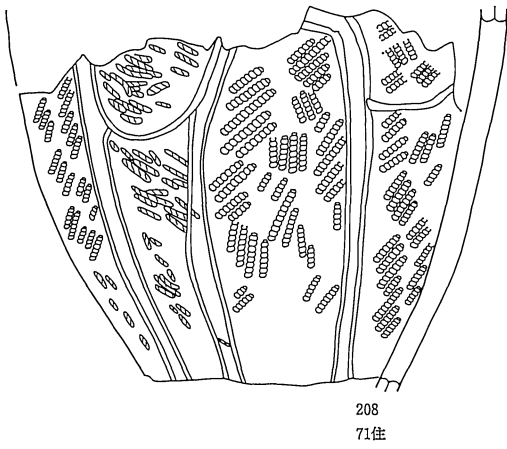
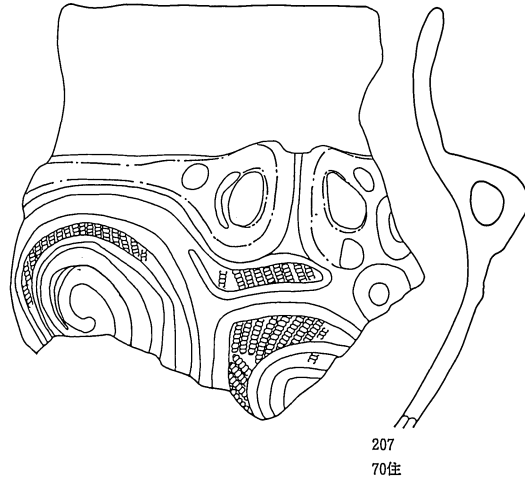
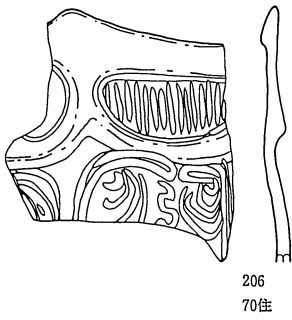
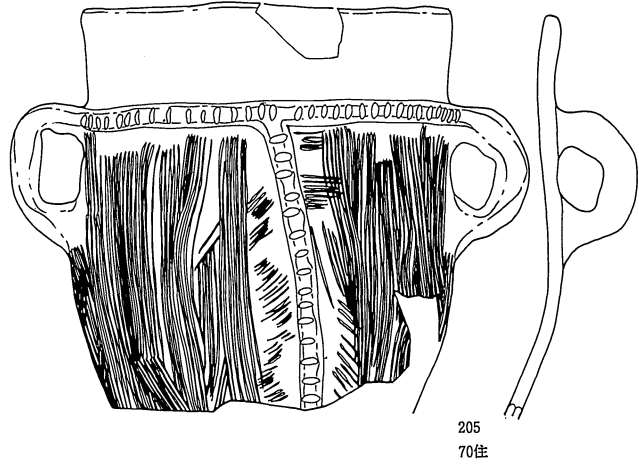
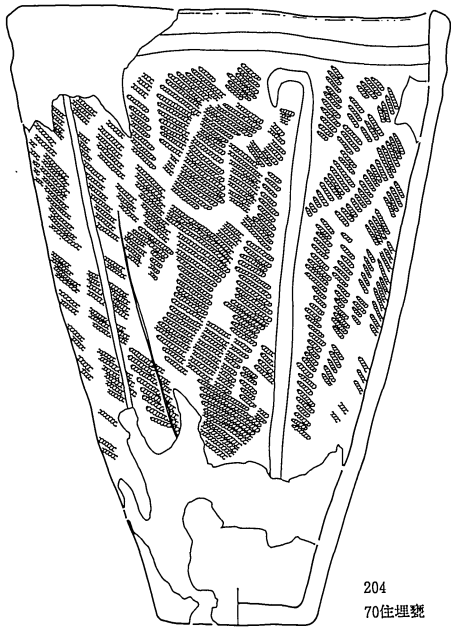

0 (1 : 4) 10cm



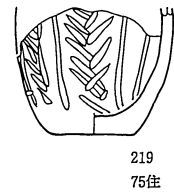
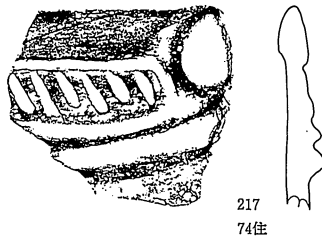
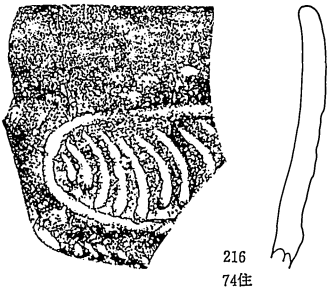
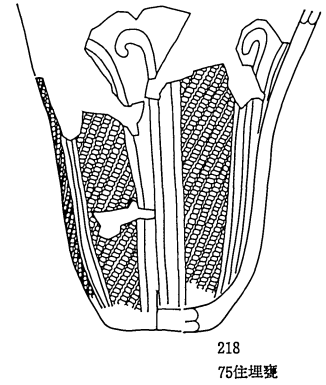
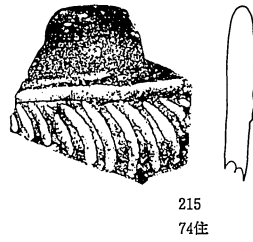
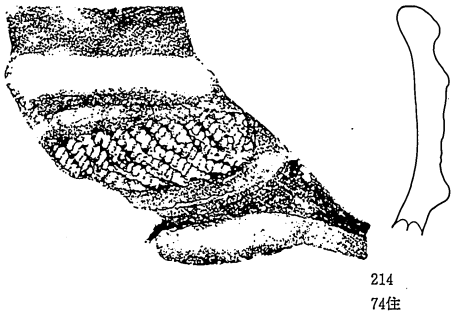
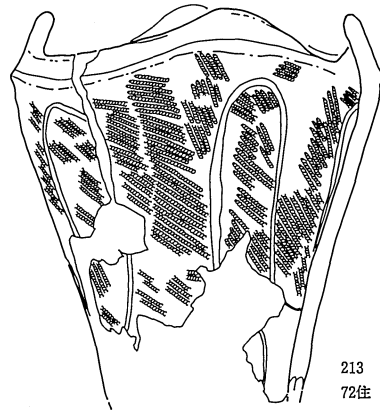
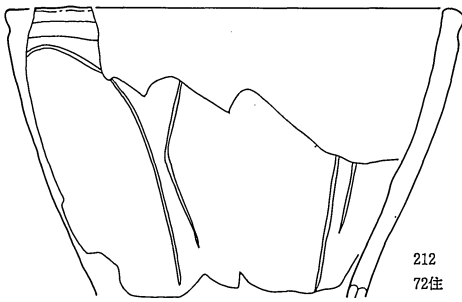
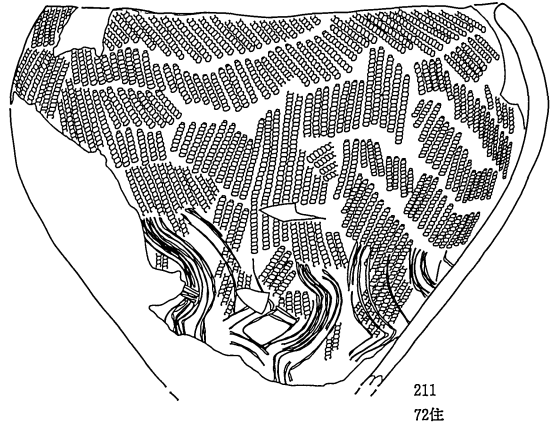
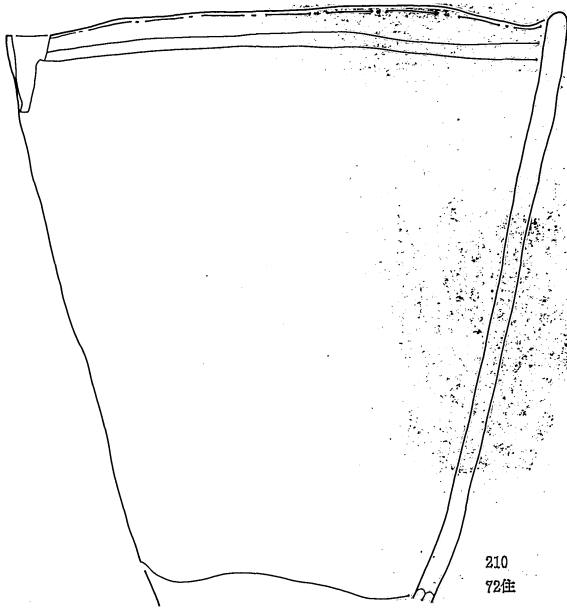

0 (1 : 3) 10cm

0 (1 : 4) 10cm

図版118 72号、74号、75号竪穴住居跡出土土器 (214~217 1 : 3、他 1 : 4)

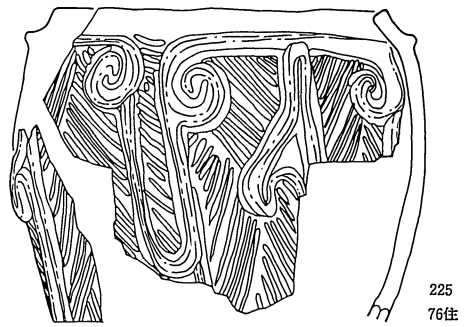
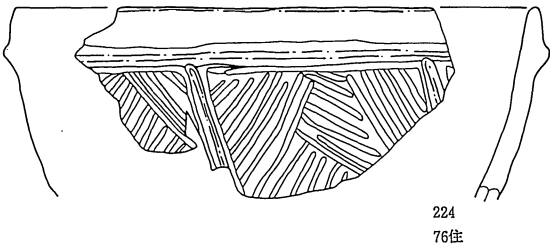
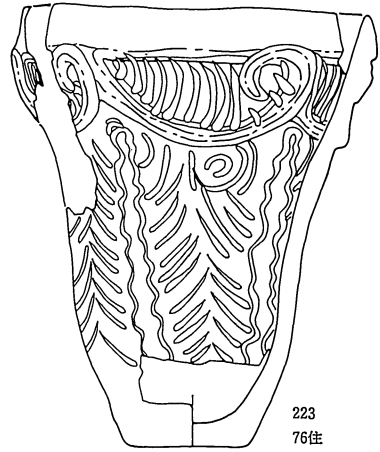
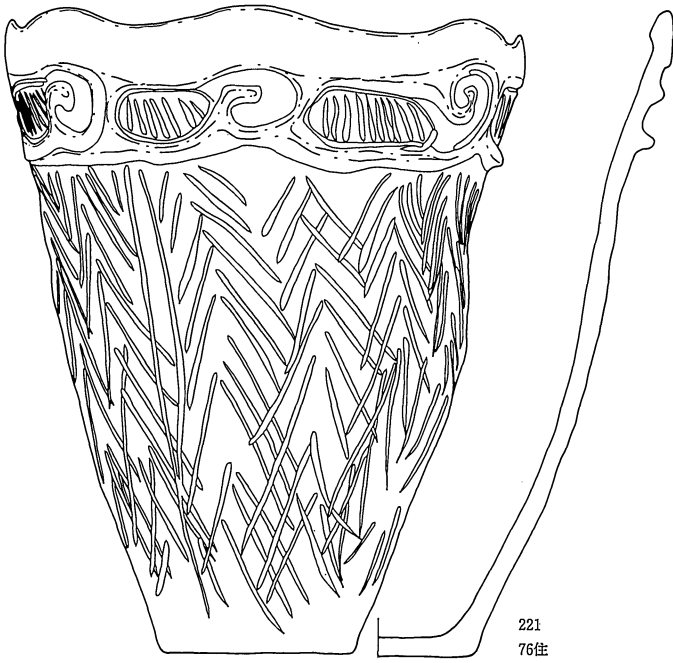
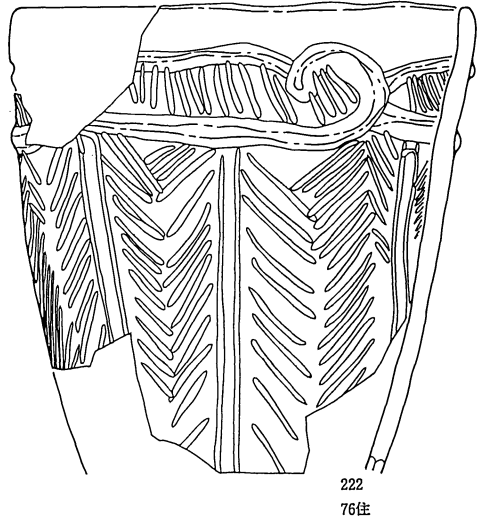
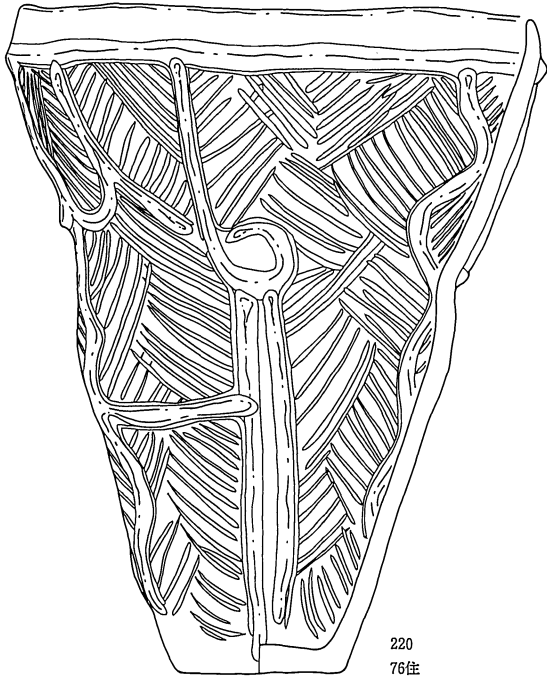

0 (1:4) 10cm

図版119 76号竖穴住居跡出土土器 (1:4)

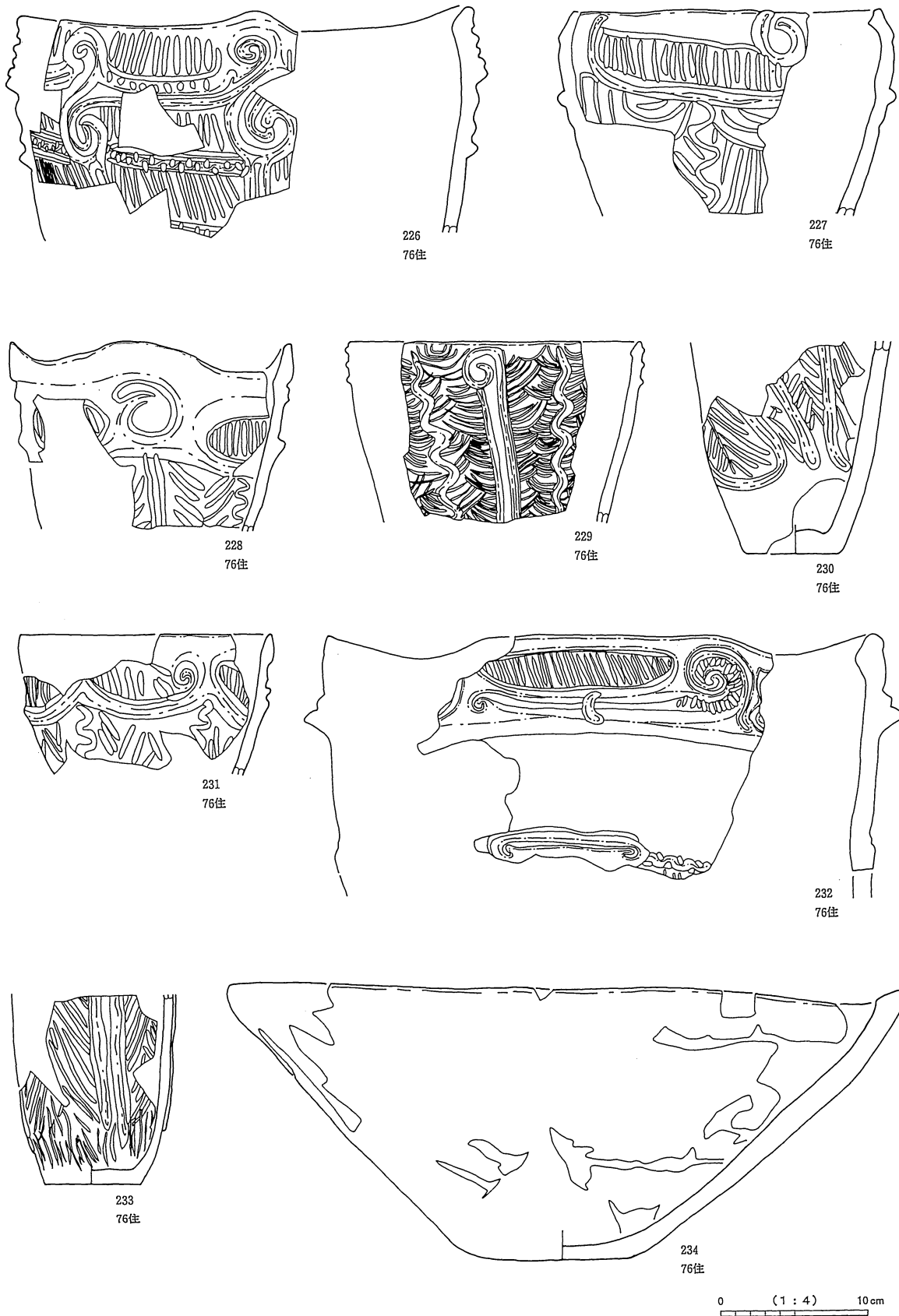

圖版120 76号竖穴住居跡出土土器 (1 : 4)

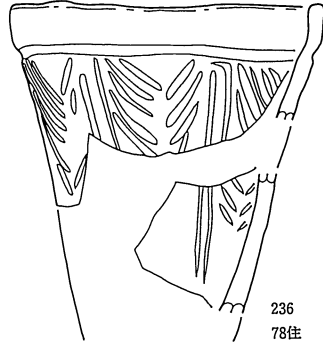
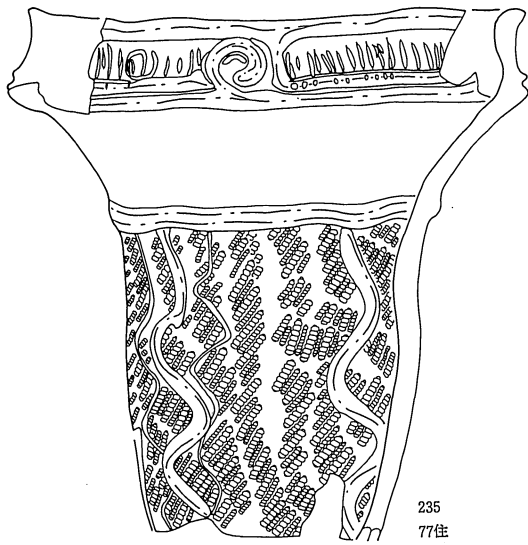

0 (1 : 4) 10 cm

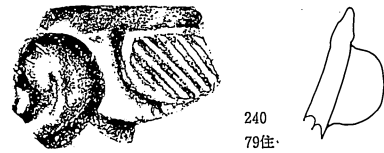
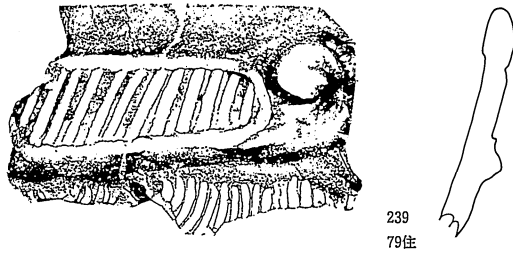
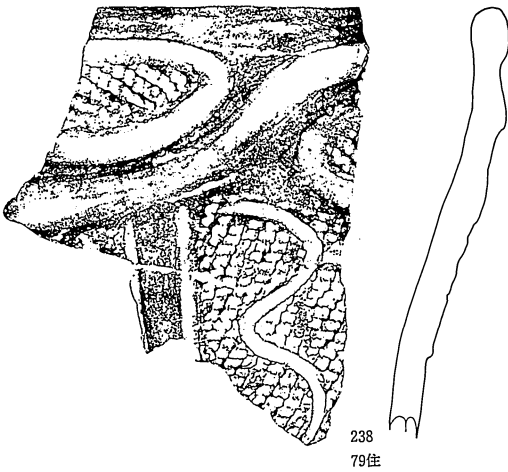

0 (1 : 3) 10 cm

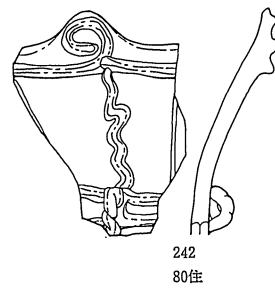
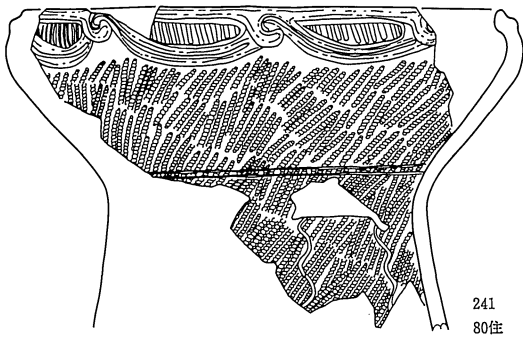

0 (1 : 6) 15 cm

0 (1 : 4) 10 cm

図版121 77号~80号竪穴住居跡出土土器 (235~237・242 1 : 4、241 1 : 6、他 1 : 3)

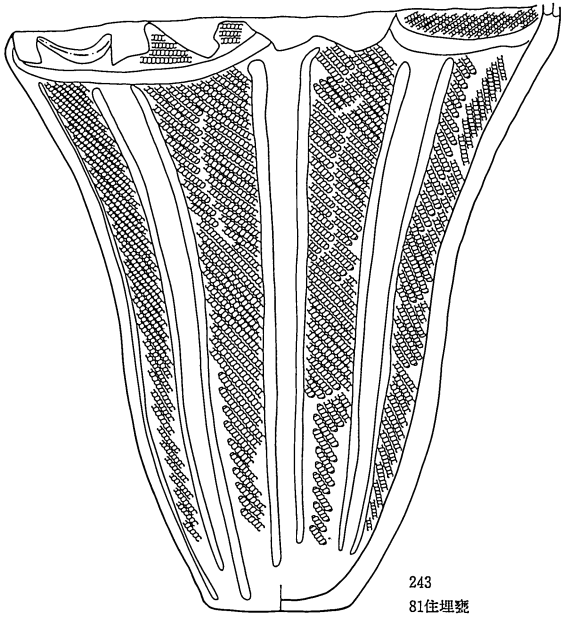

243  
81住埋藏

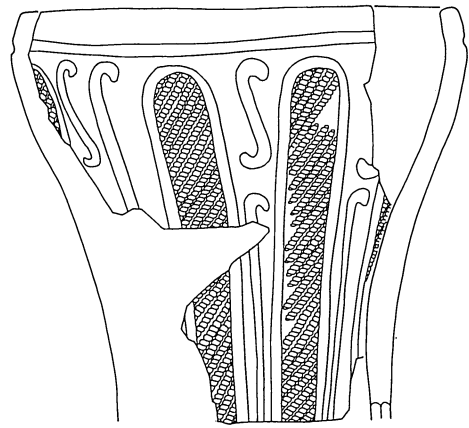

244  
81住

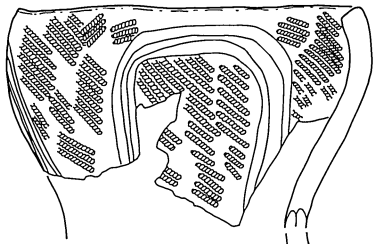

245  
81住

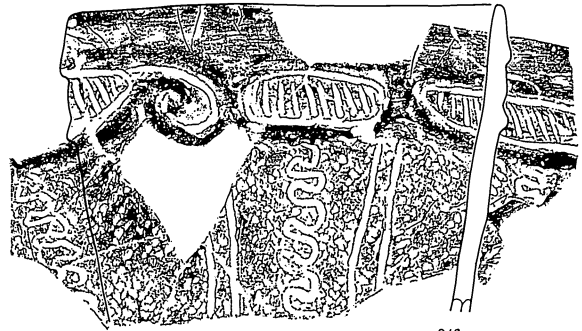

246  
81住

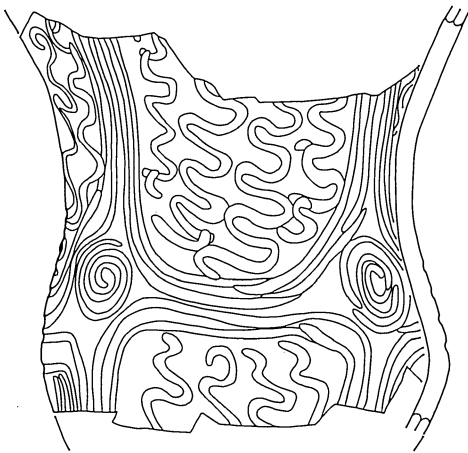

247  
82住埋藏

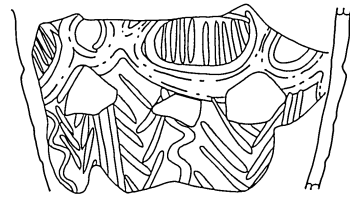

248  
82住



249  
82住

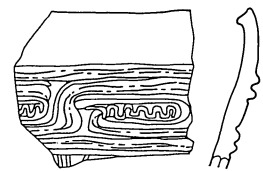

250  
82住

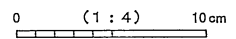

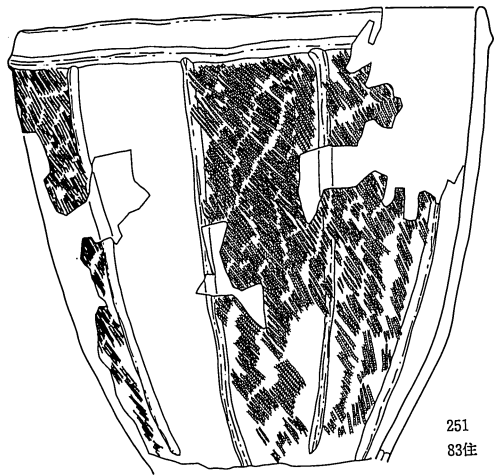

251  
83住

0 (1:6) 15cm

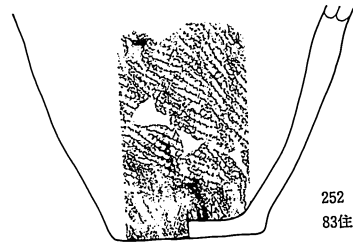

252  
83住埋甕

0 (1:4) 10cm

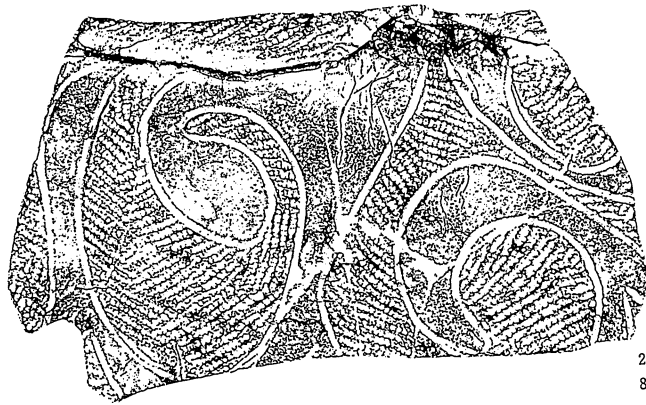

253  
83住

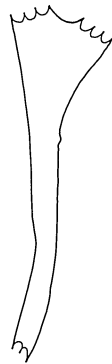

254  
83住

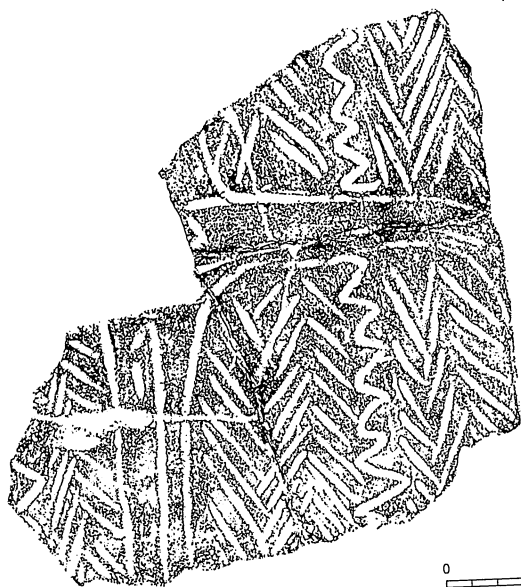

255  
84住

0 (1:3) 10cm

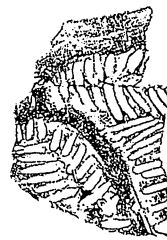

256  
84住



257  
84住

0 (1:4) 10cm

図版123 83号、84号竪穴住居跡出土土器 (251 1:6、252・257 1:4、他 1:3)

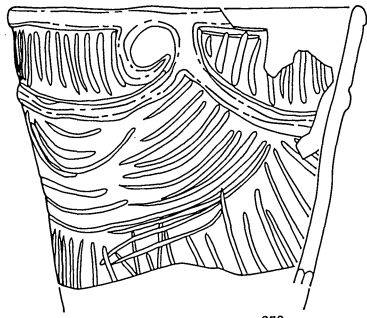

258  
85住

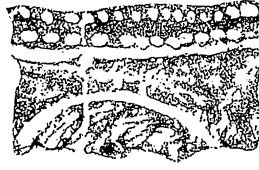

259  
85住

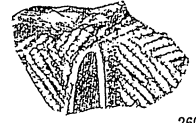

260  
85住

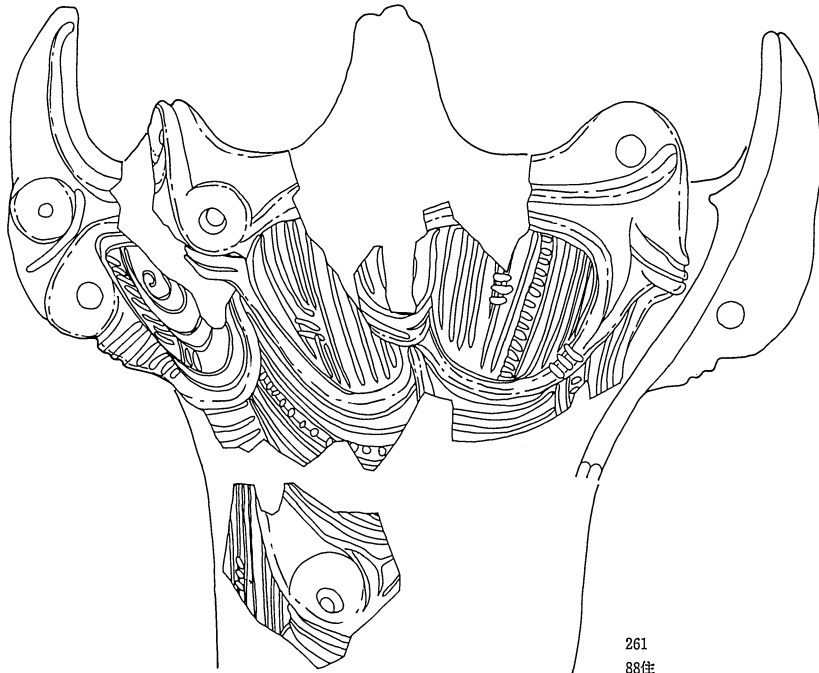

261  
88住

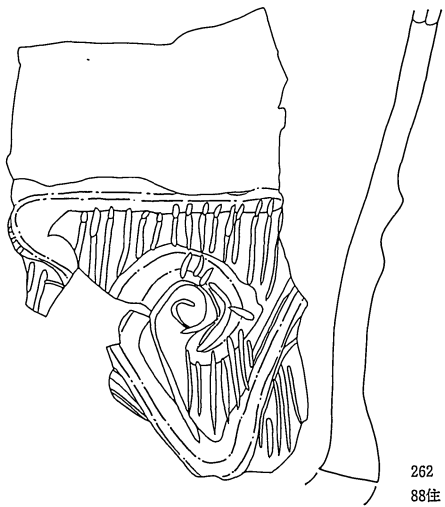

262  
88住

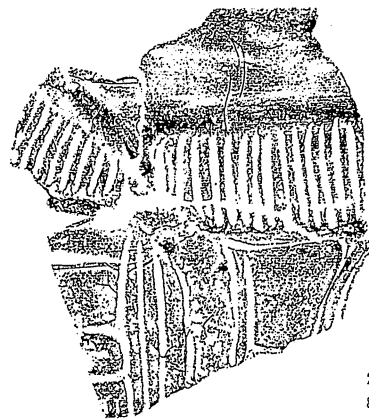

263  
88住

0 (1:4) 10 cm

0 (1:3) 10 cm

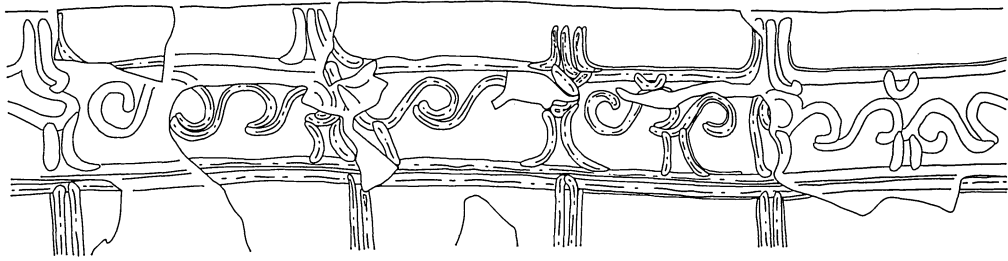

0 (1:8) 20 cm

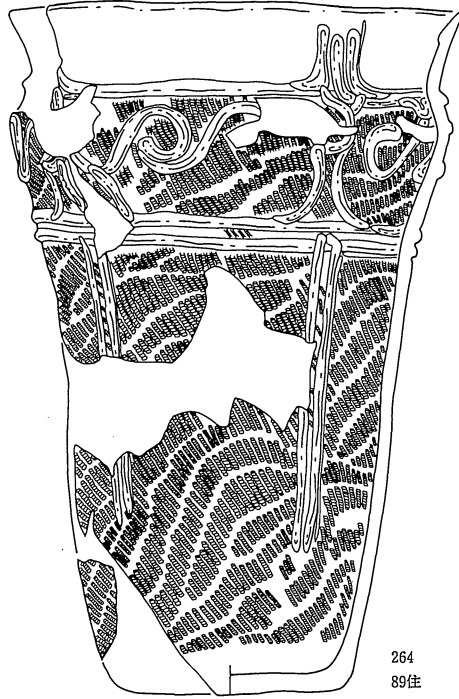

264  
89住

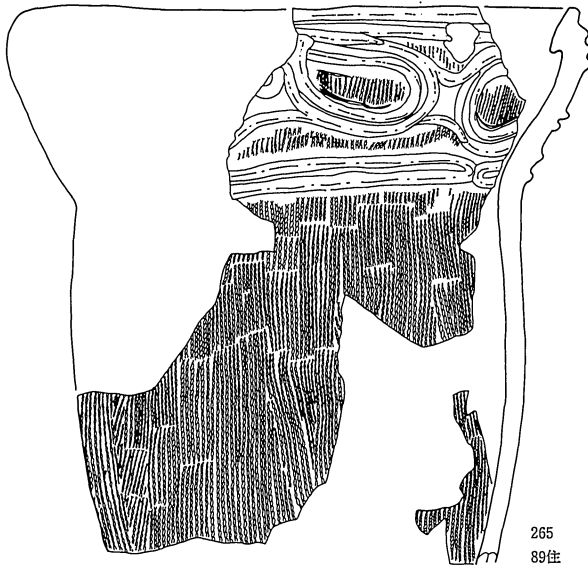

265  
89住

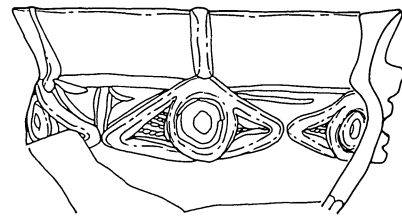

266  
89住

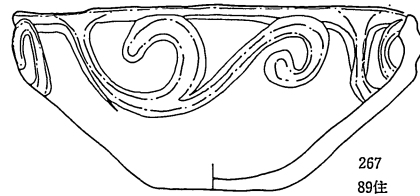

267  
89住

0 (1:6) 15 cm

0 (1:4) 10 cm

図版125 89号竪穴住居跡出土土器 (264・265 1:6、他 1:4)



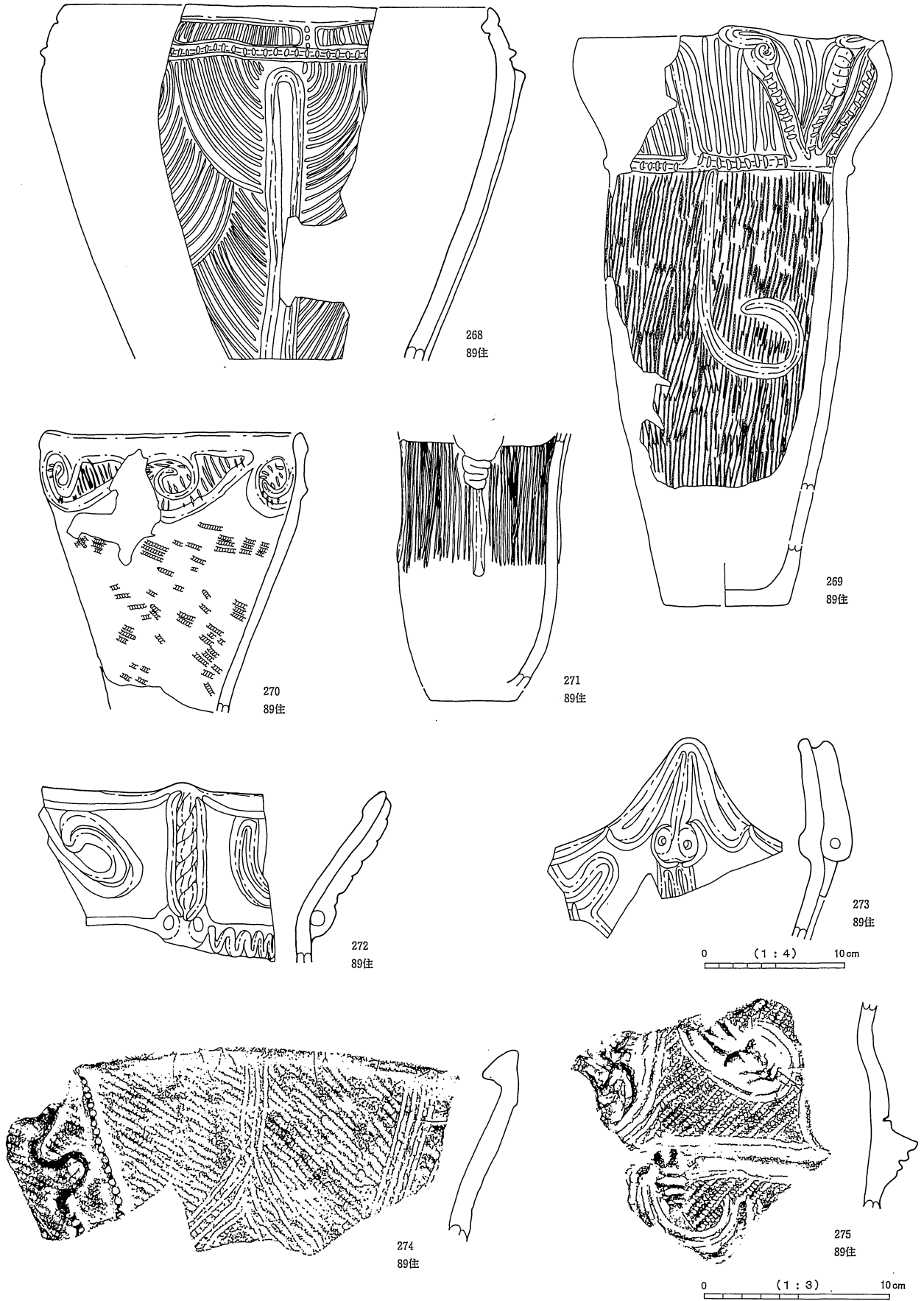

圖版126 89号竖穴住居跡出土土器 (274·275 1:3、他 1:4)

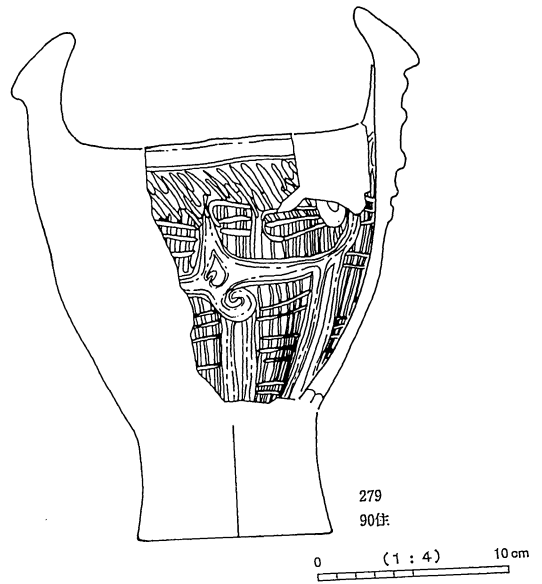
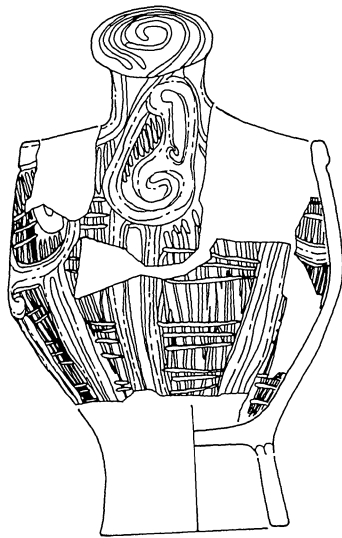
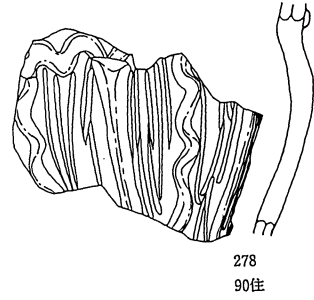
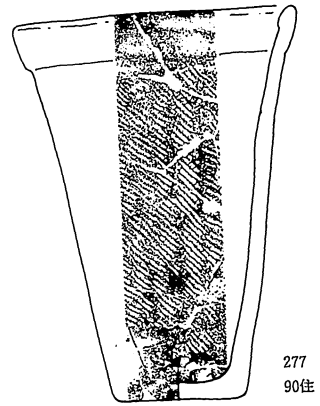
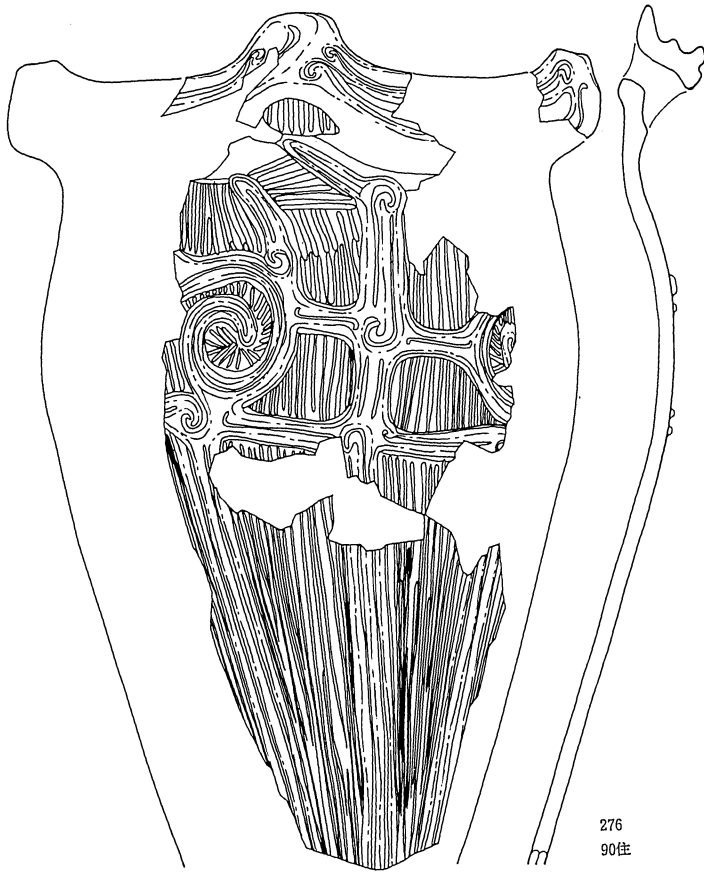

図版127 90号竪穴住居跡出土土器 (276 1 : 6、他 1 : 4)

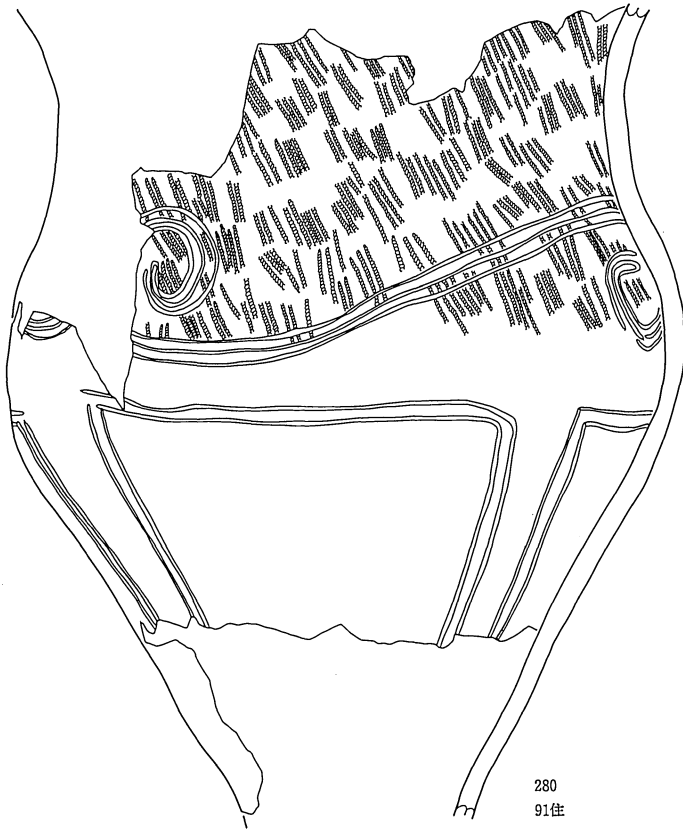

280  
91住

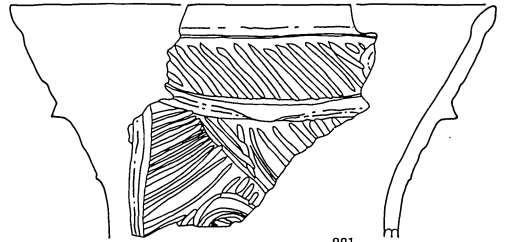

281  
91住

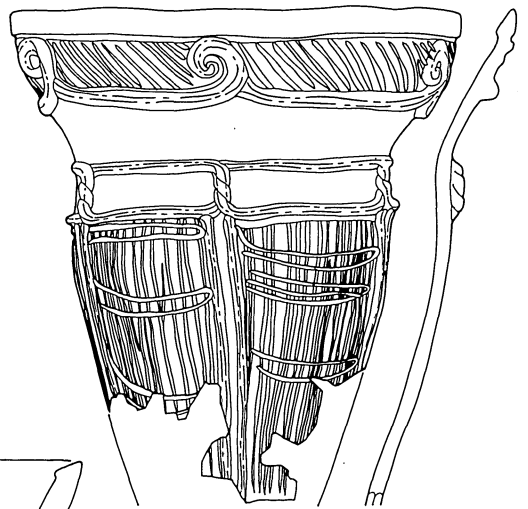

282  
91住

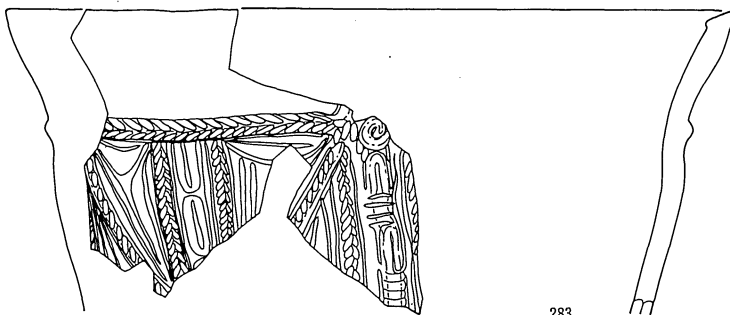

283  
91住

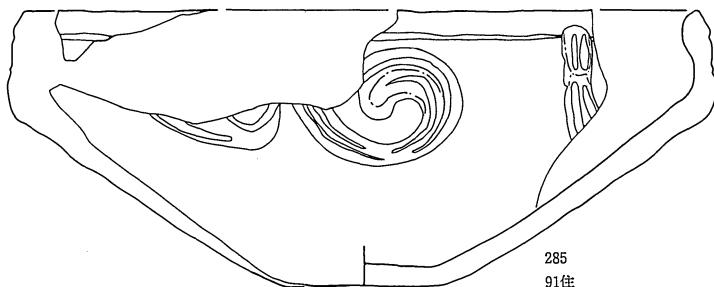

285  
91住

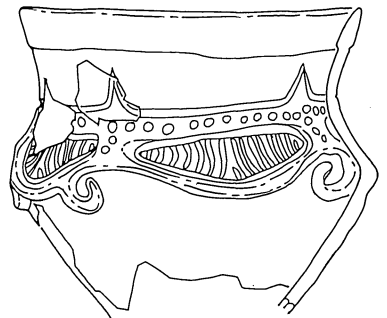

284  
91住

0 (1 : 4) 10cm

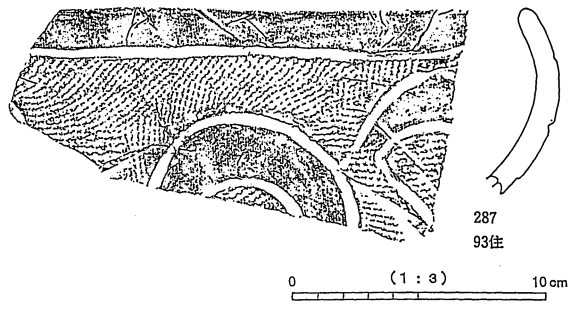
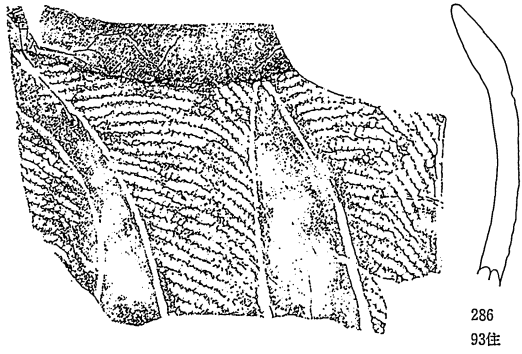

0 (1:3) 10cm

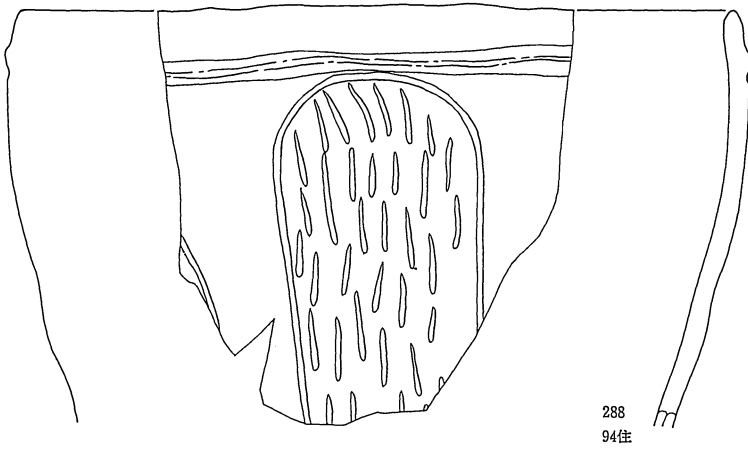

0 (1:4) 10cm

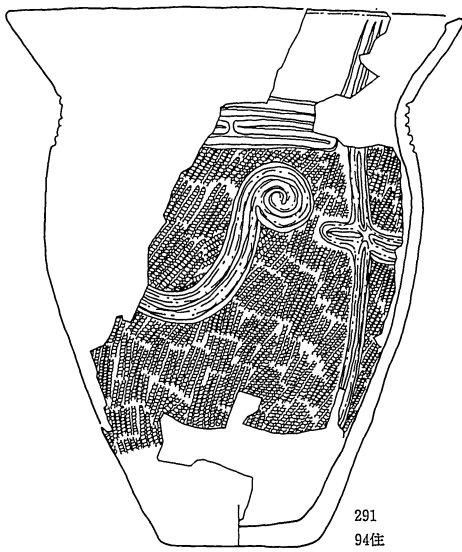

0 (1:6) 15cm

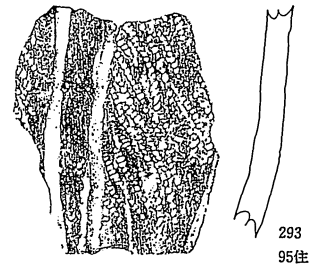
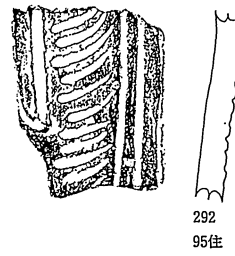

0 (1:3) 10cm

図版129 93号~95号竪穴住居跡出土土器 (288~290 1:4、291 1:6、他 1:3)

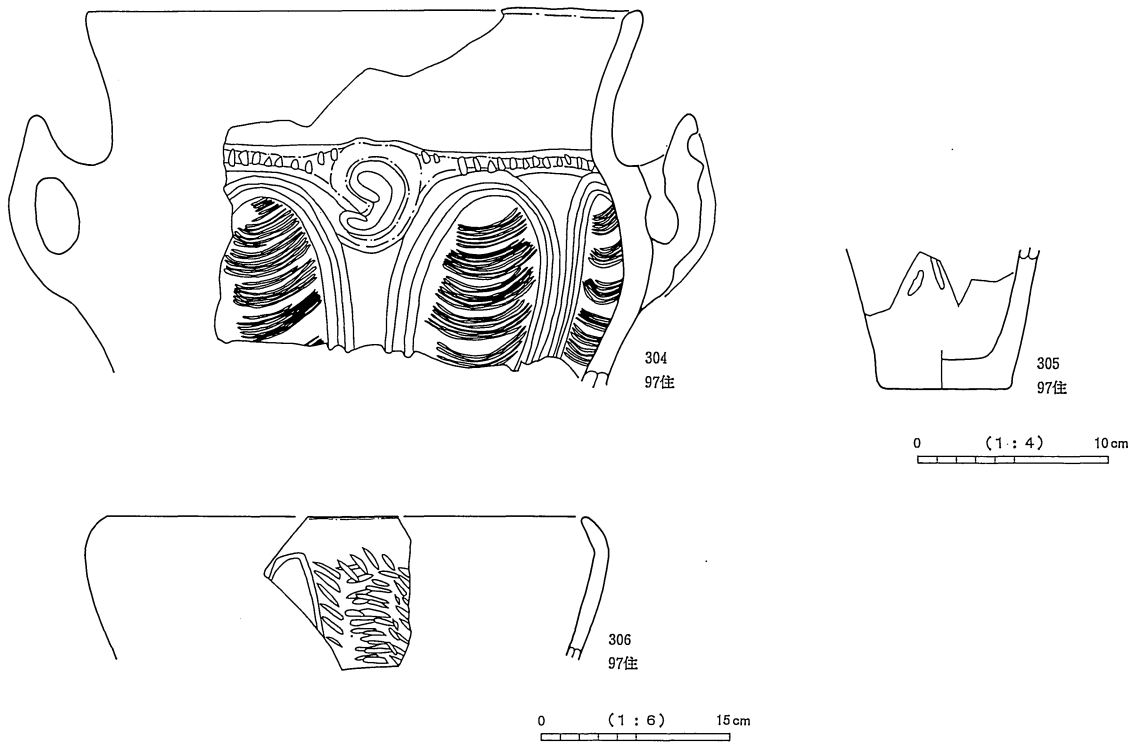
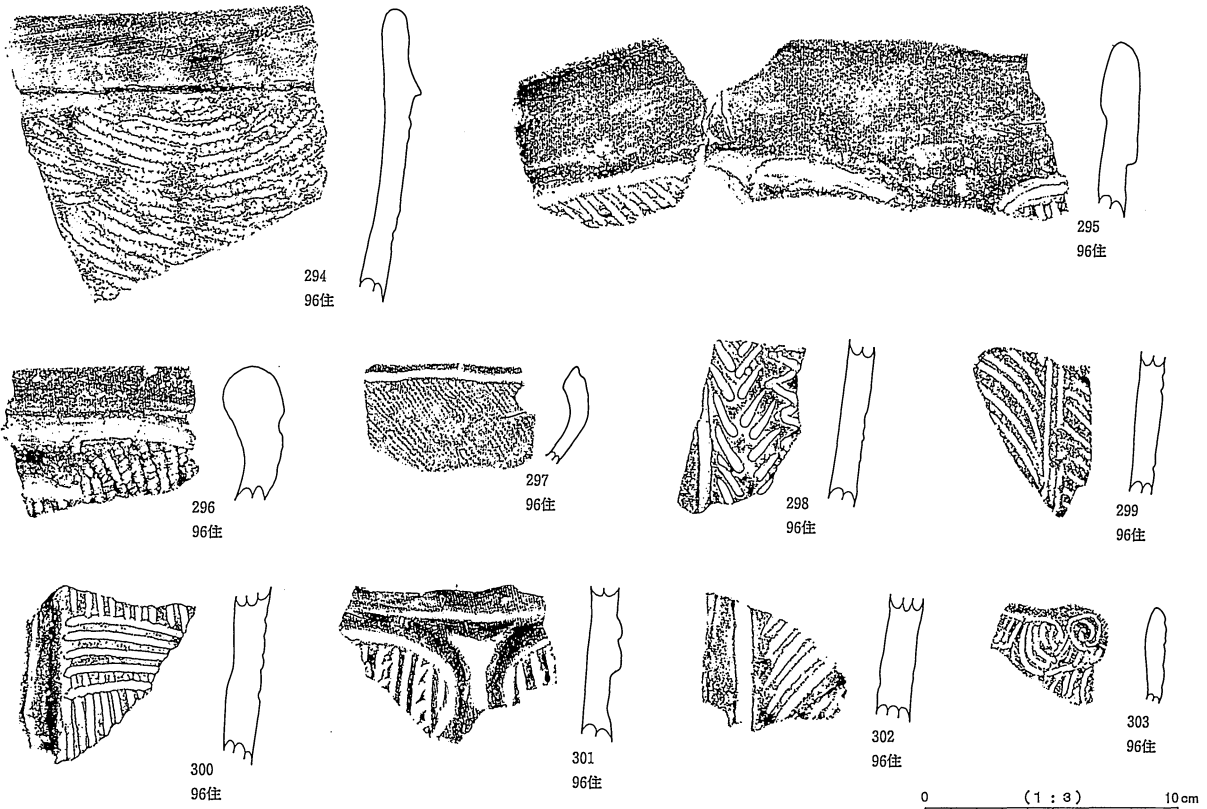

図版130 96号、97号竪穴住居跡出土土器 (294~303 1:3、306 1:6、他 1:4)

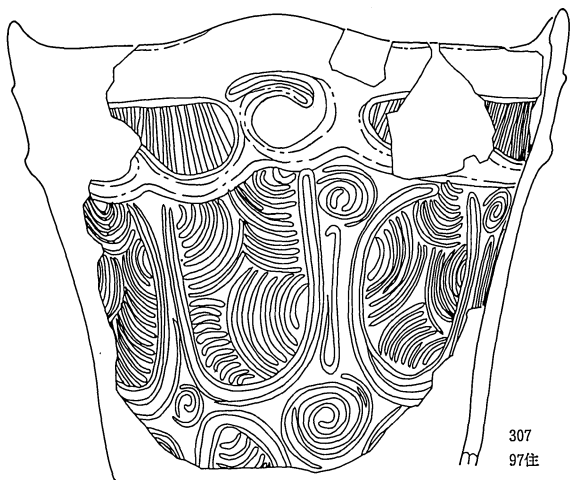

307  
97住

0 (1:6) 15cm

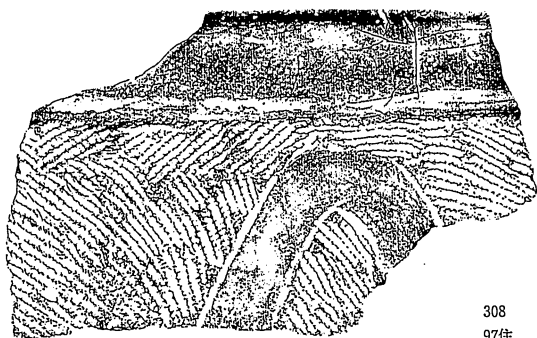

308  
97住

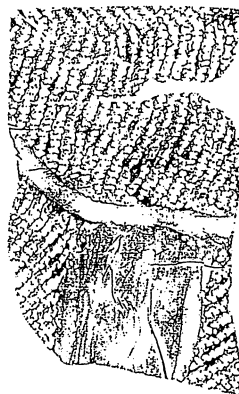

309  
97住

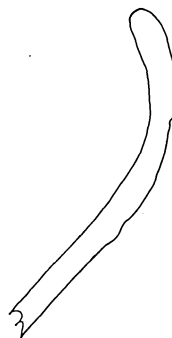

310  
97住

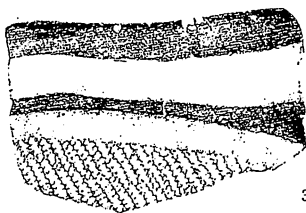

311  
97住



312  
97住



0 (1:3) 10cm

図版131 97号竪穴住居跡出土土器 (307 1:6、他 1:3)

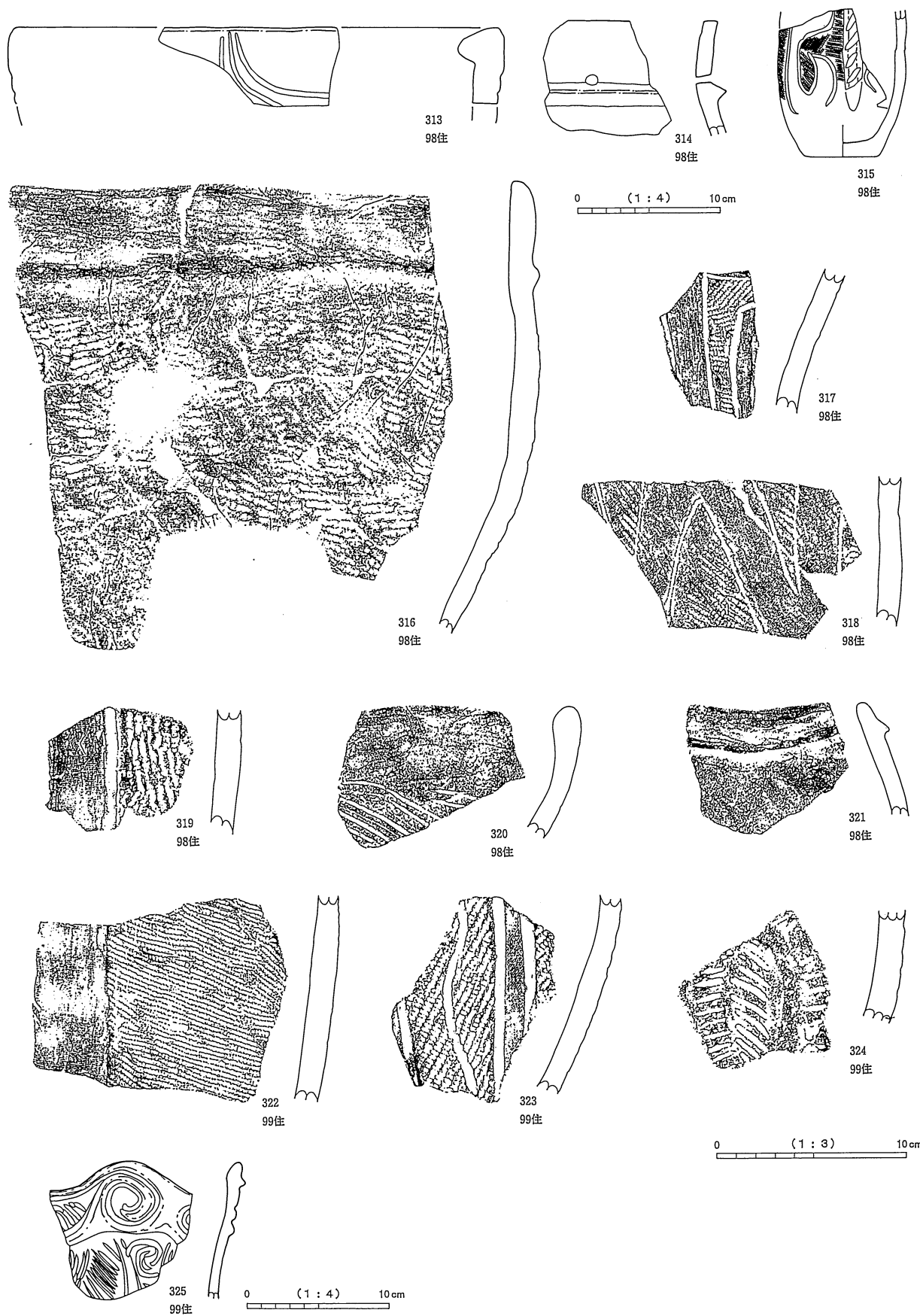

図版132 98号、99号竪穴住居跡出土土器 (313~315・325 1:4、他 1:3)

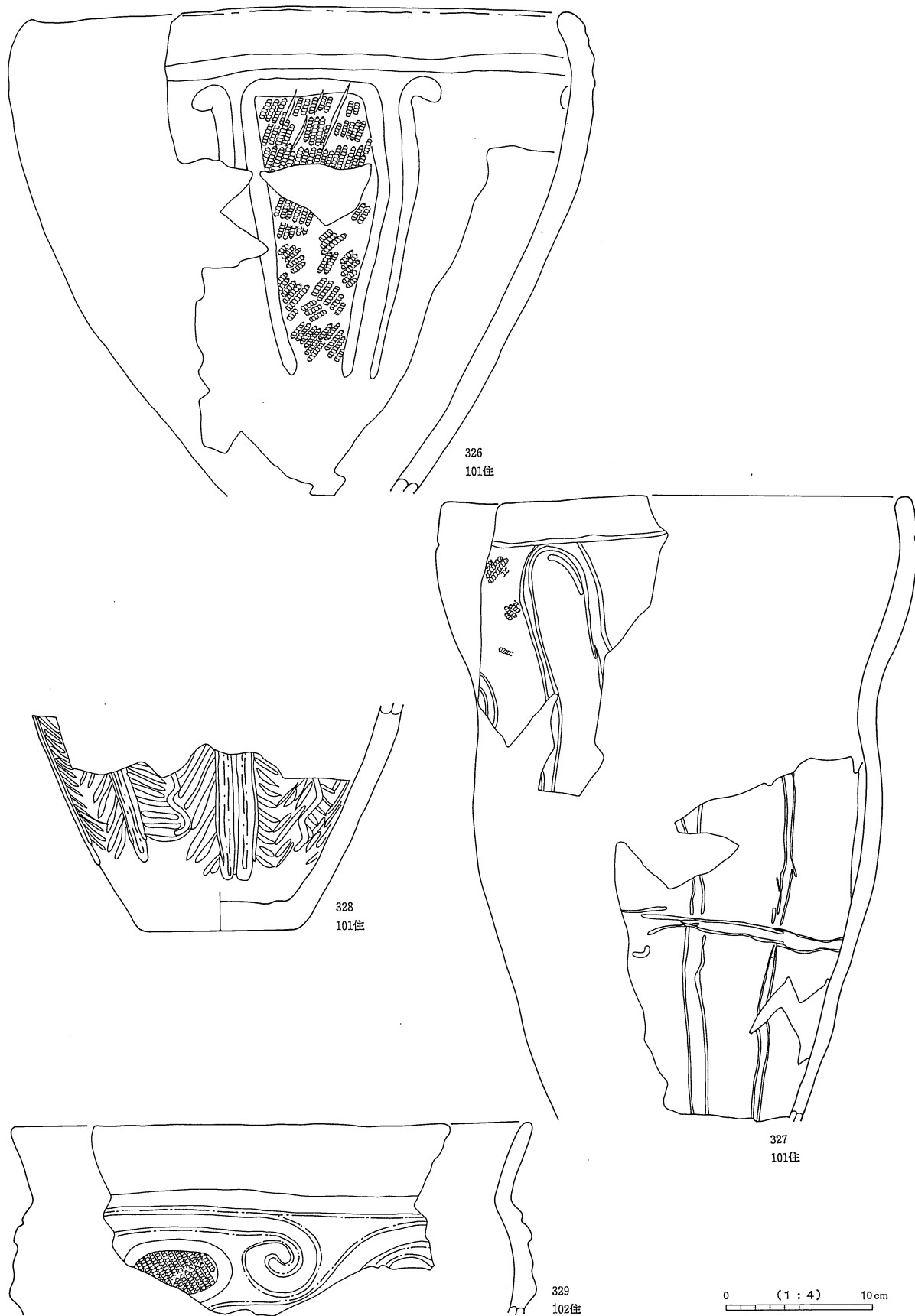

図版133 101号、102号竖穴住居跡出土土器 (1:4)



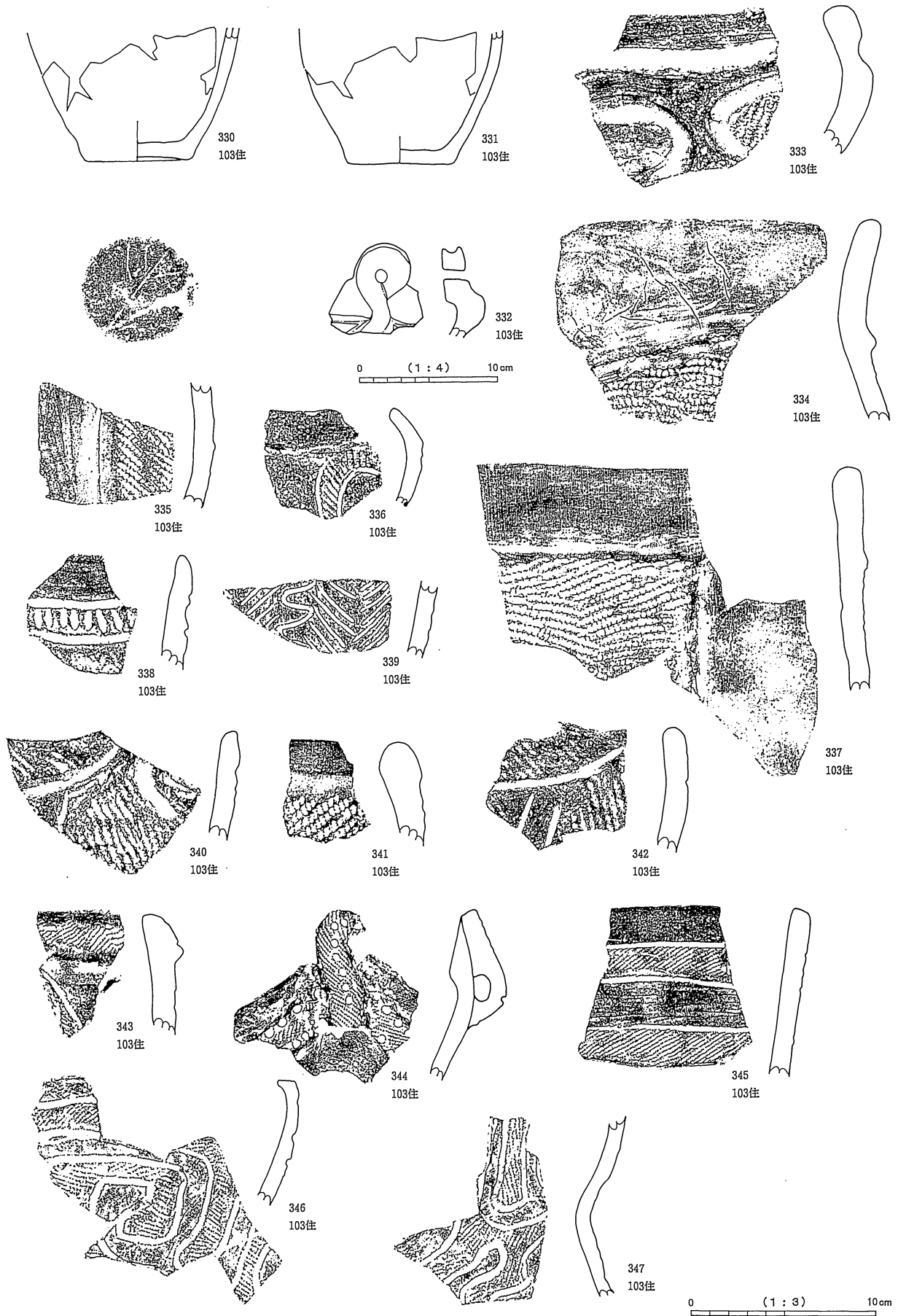

図版134 103号竪穴住居跡出土土器 (330~332 1:4、他 1:3)

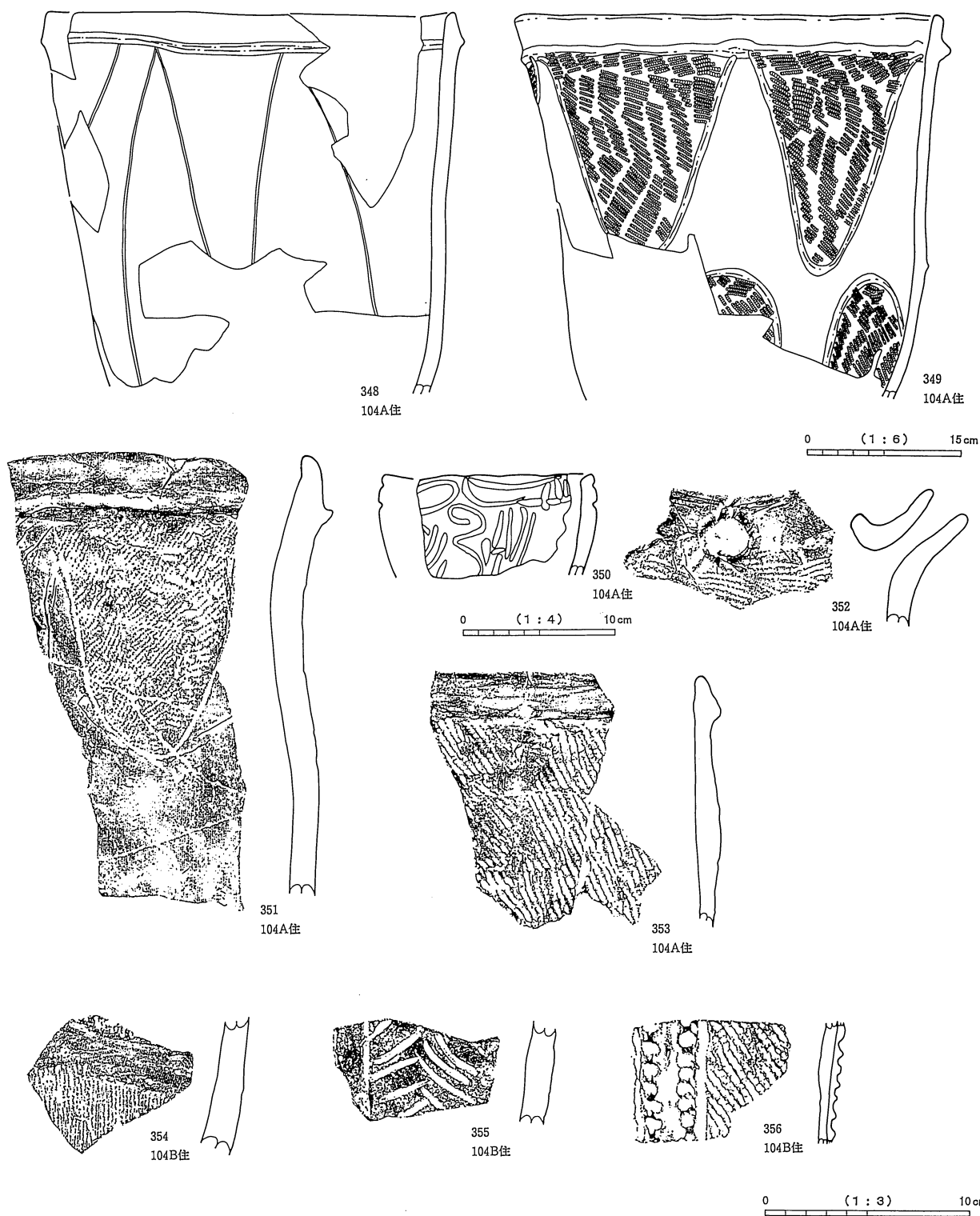

図版135 104A号、104B号竖穴住居跡出土土器 (348・349 1:6、350 1:4、他 1:3)

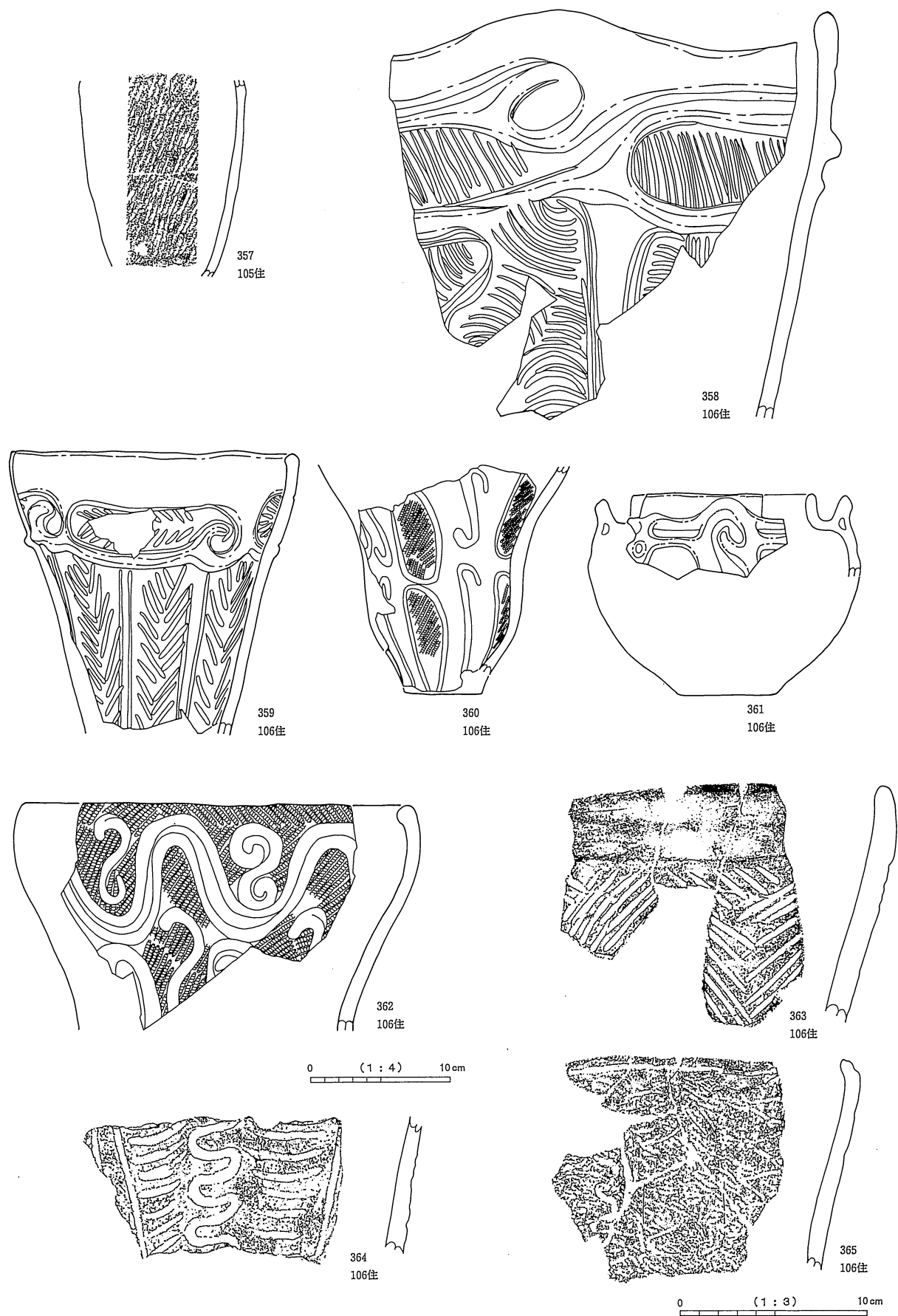

図版136 105号、106号竪穴住居跡出土土器 (357~362 1:4、他 1:3)

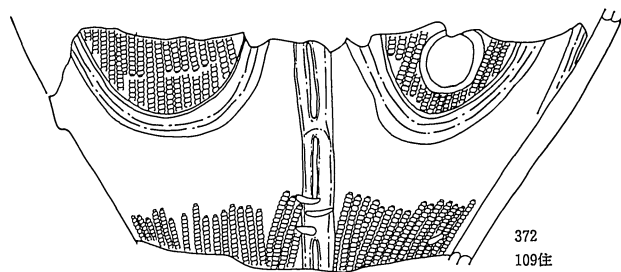
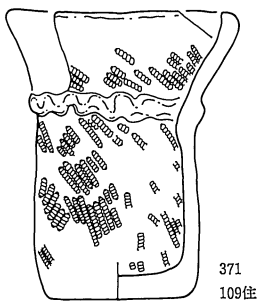
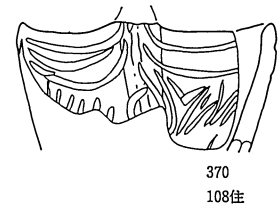
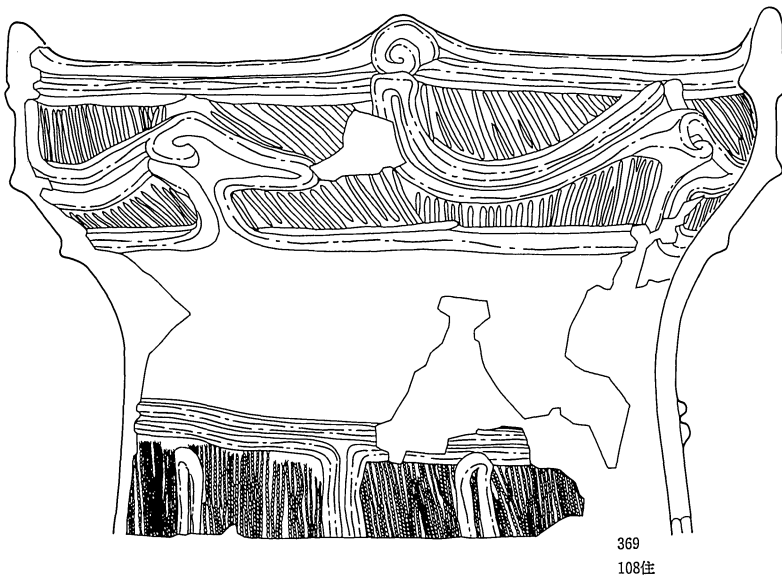
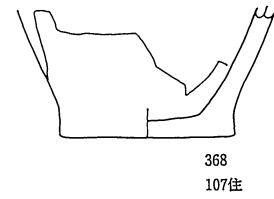
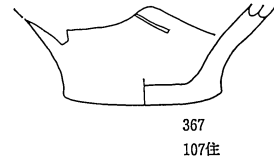
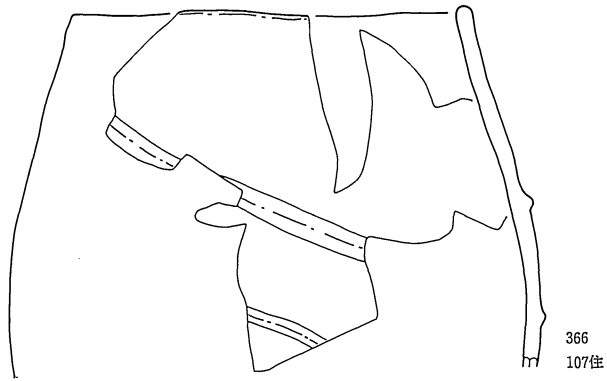

0 (1 : 4) 10 cm

図版137 107号~109号竪穴住居跡出土土器 (1 : 4)

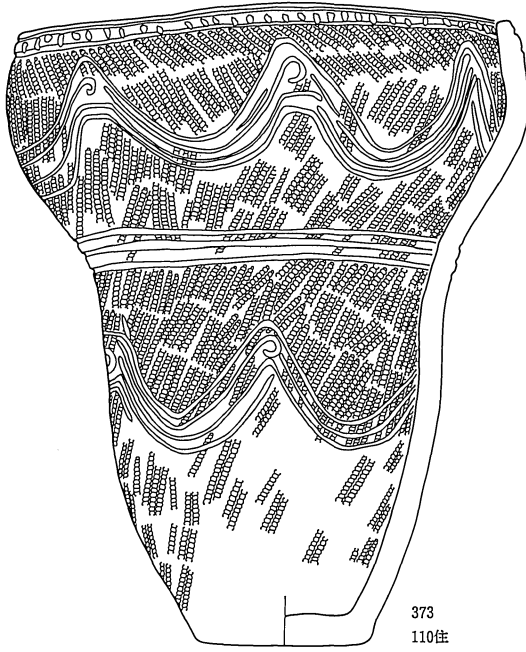

373  
110住

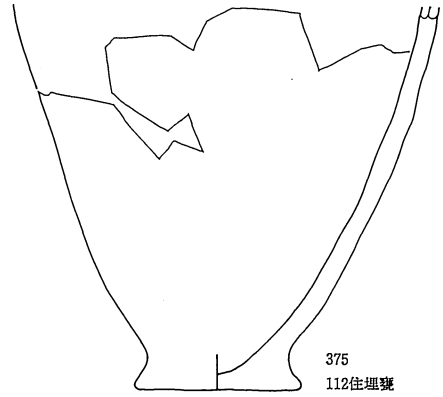

375  
112住埋甕

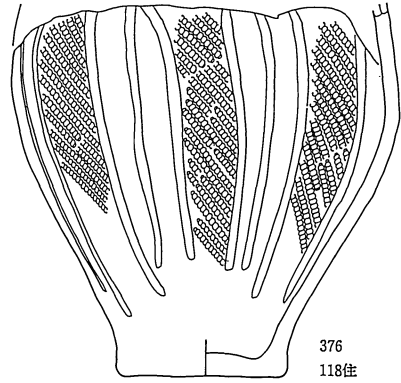

376  
118住

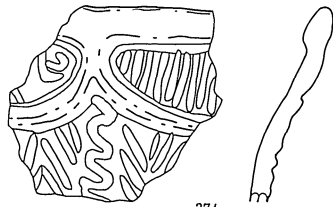

374  
110住

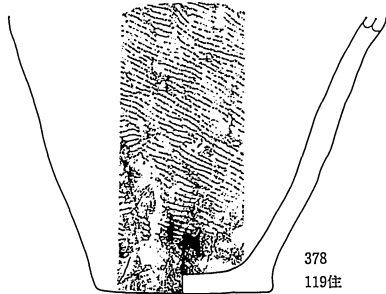

378  
119住

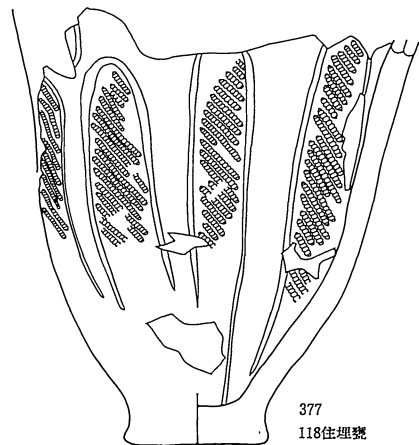

377  
118住埋甕

0 (1 : 4) 10 cm

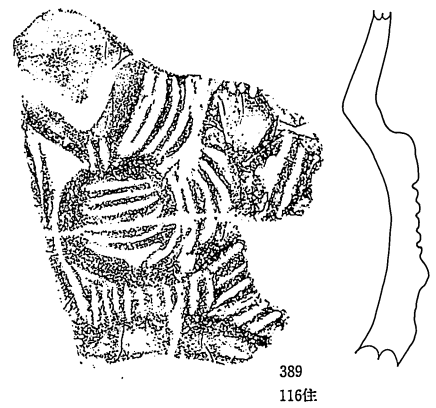
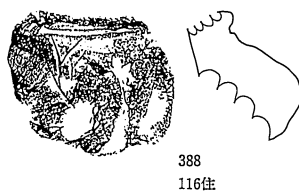
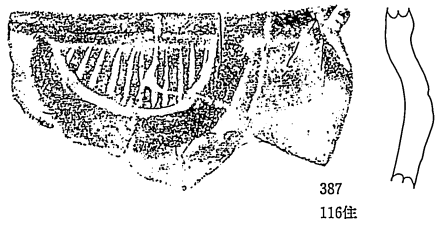
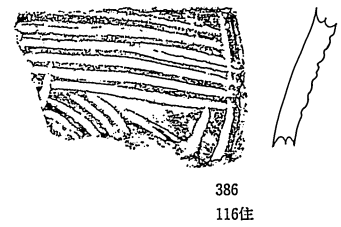
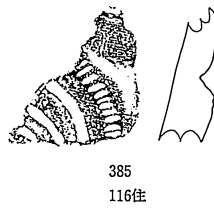
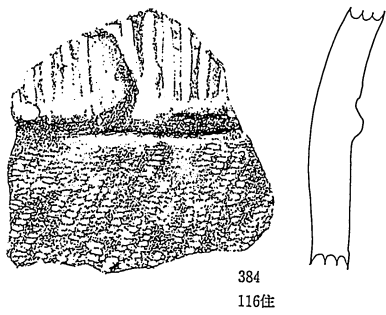
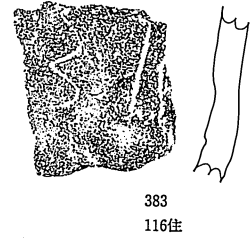
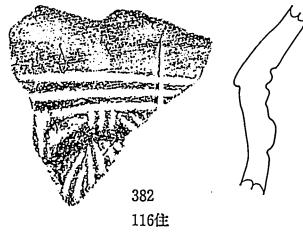
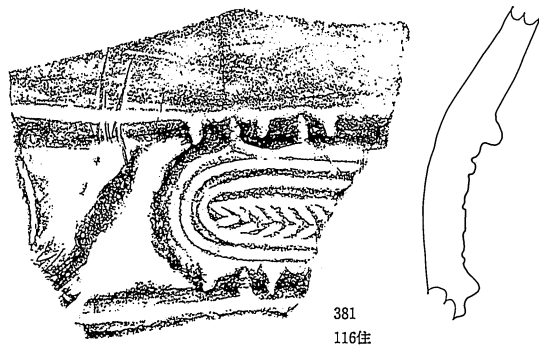
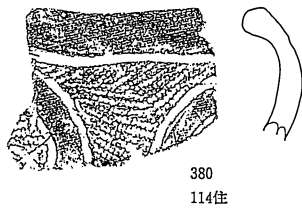
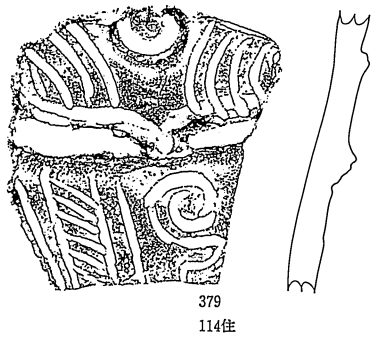

0 (1 : 3) 10cm

図版139 114号、116号竪穴住居跡出土土器 (1 : 3)

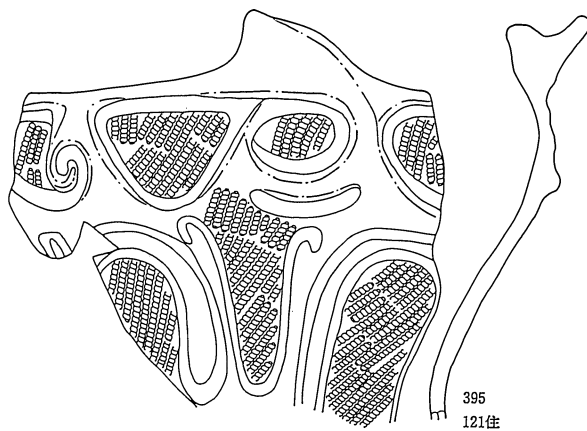
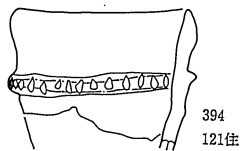
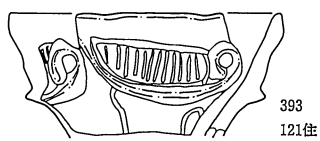
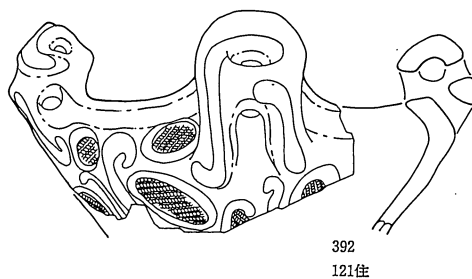
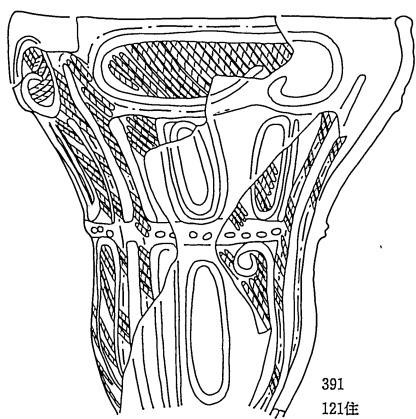
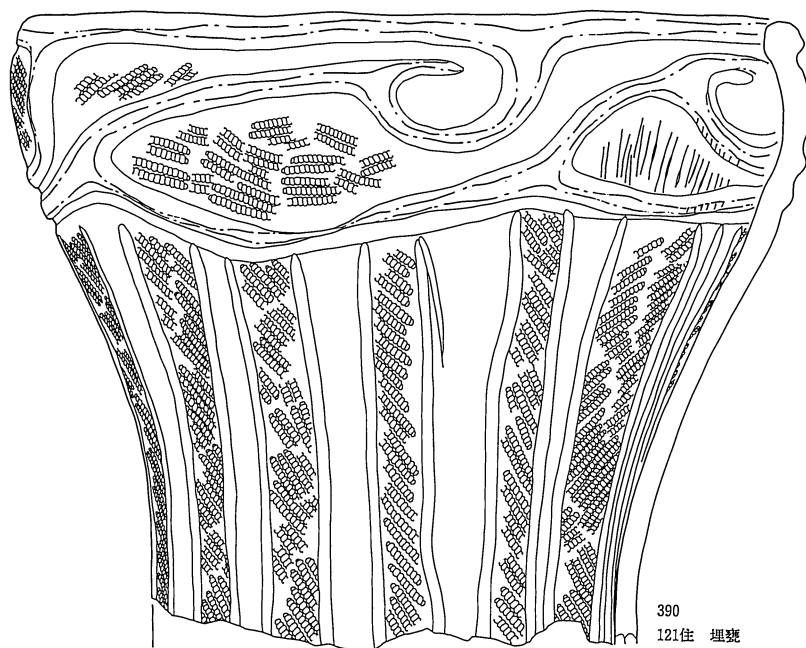

0 (1 : 4) 10 cm

図版140 121号竖穴住居跡出土土器 (1 : 4)

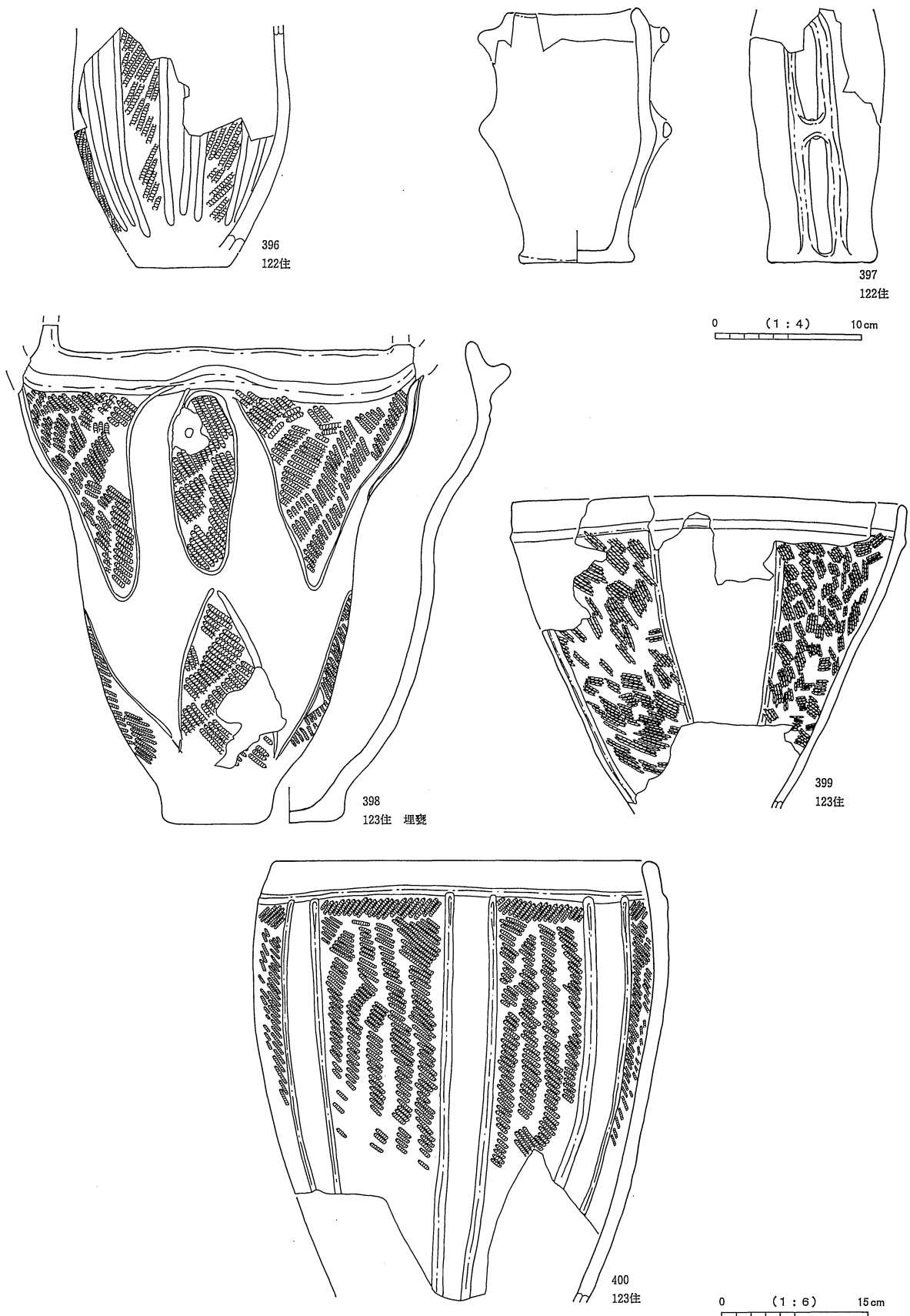

図版141 122号、123号竪穴住居跡出土土器 (396・397 1:4、398~400 1:6)



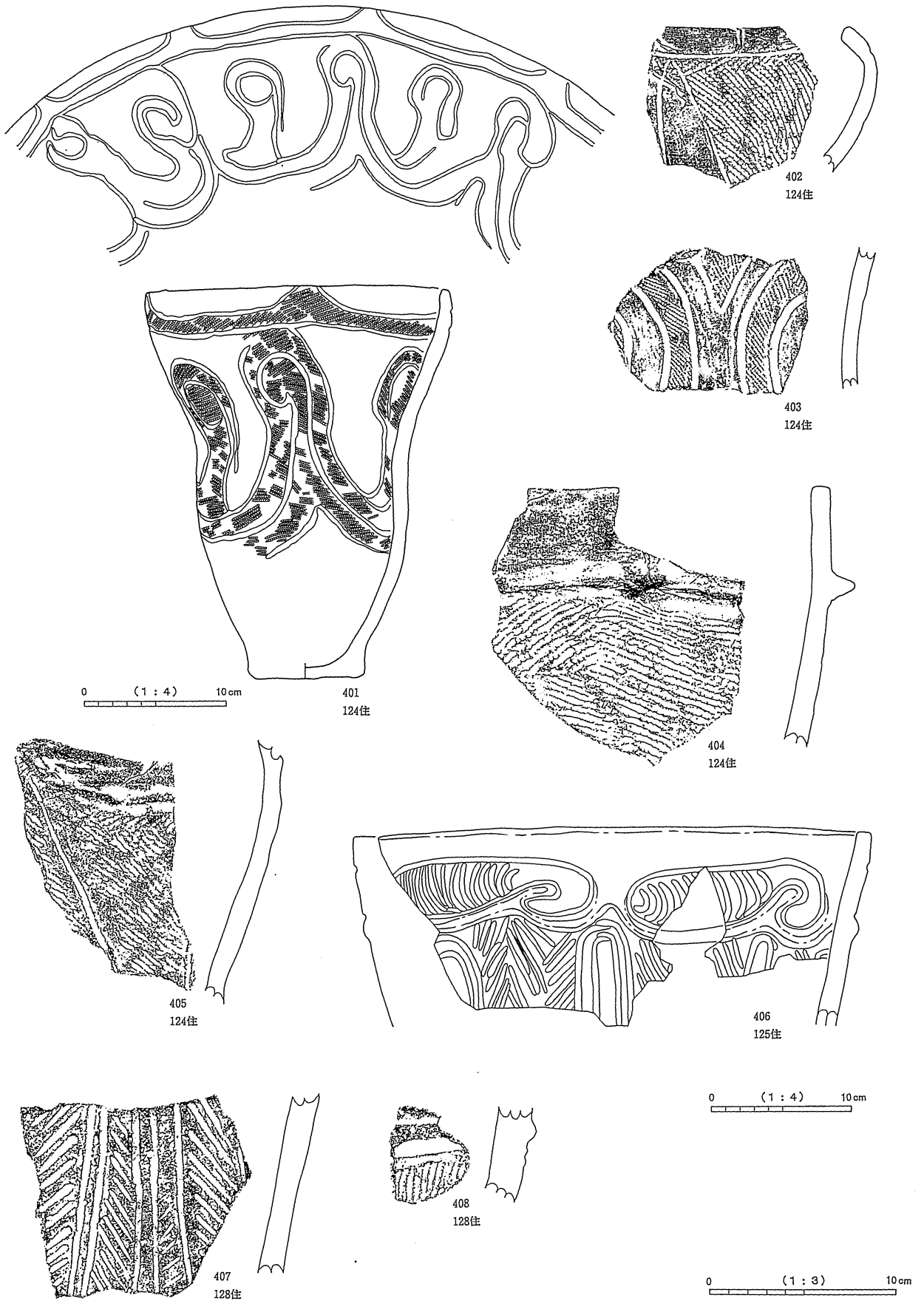

図版142 124号、125号、128号竪穴住居跡出土土器 (401・406 1:4、他 1:3)

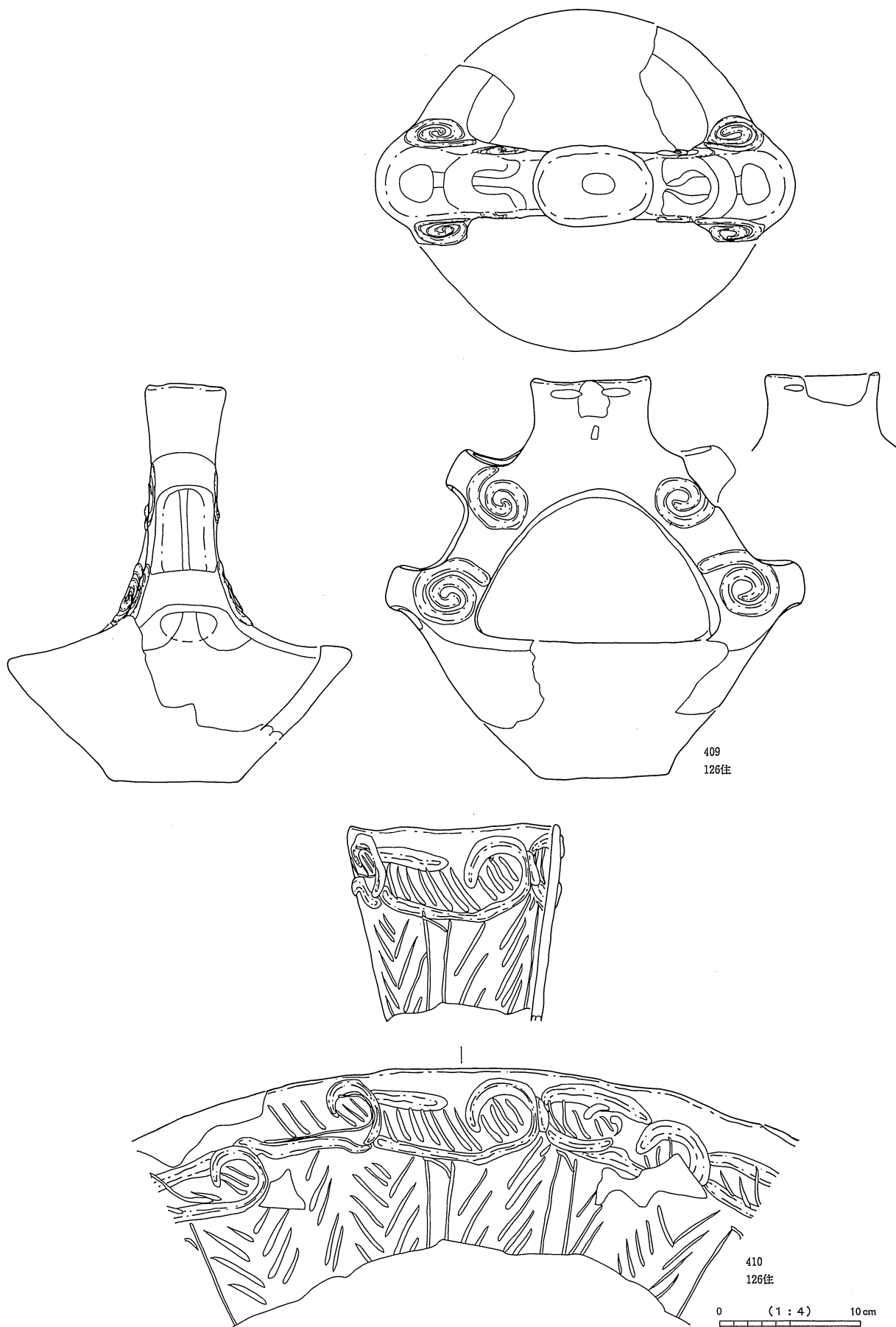

図版143 126号竪穴住居跡出土土器 (1 : 4)

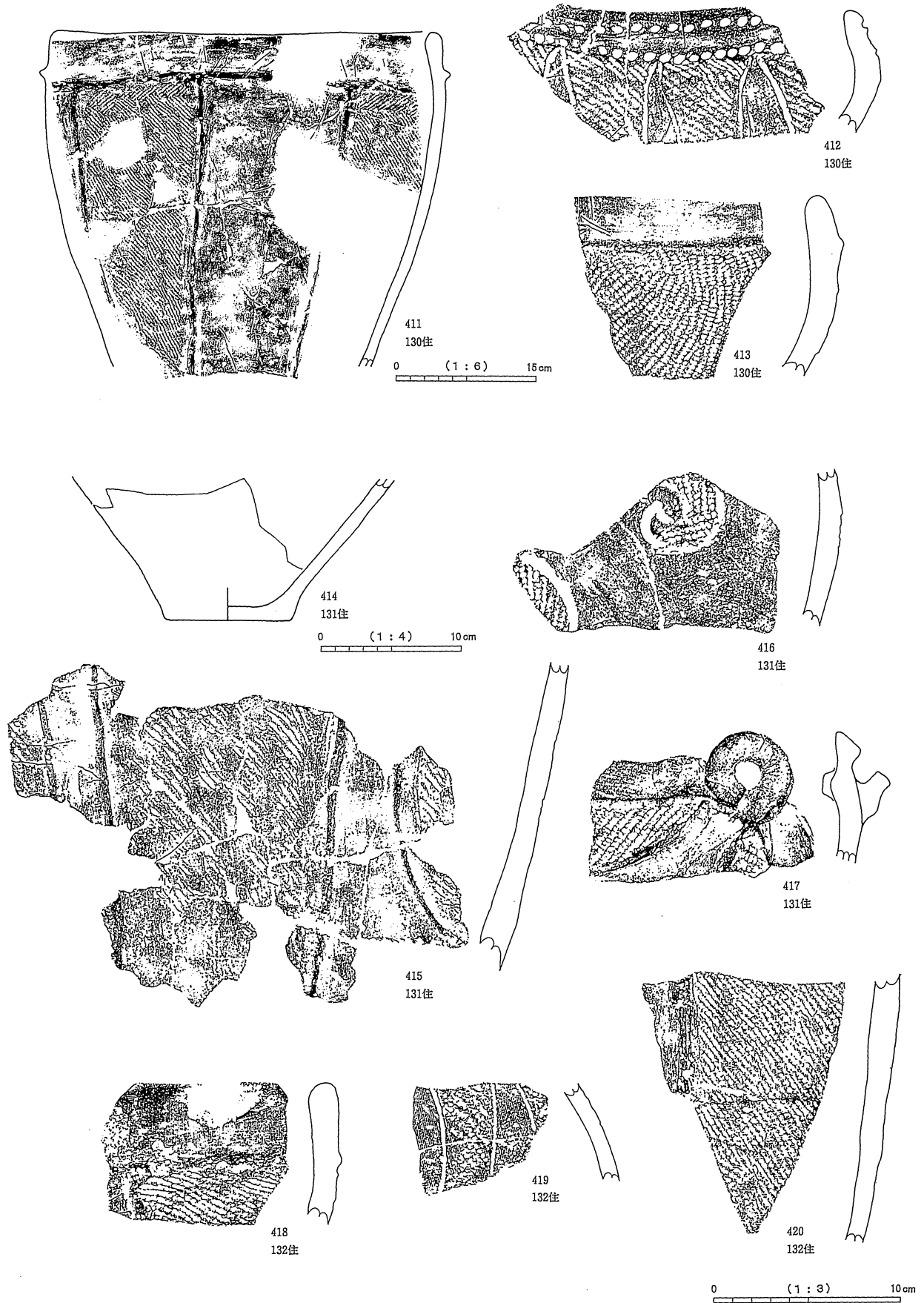

図版144 130号~132号竖穴住居跡出土土器 (411 1:6、414 1:4、他 1:3)

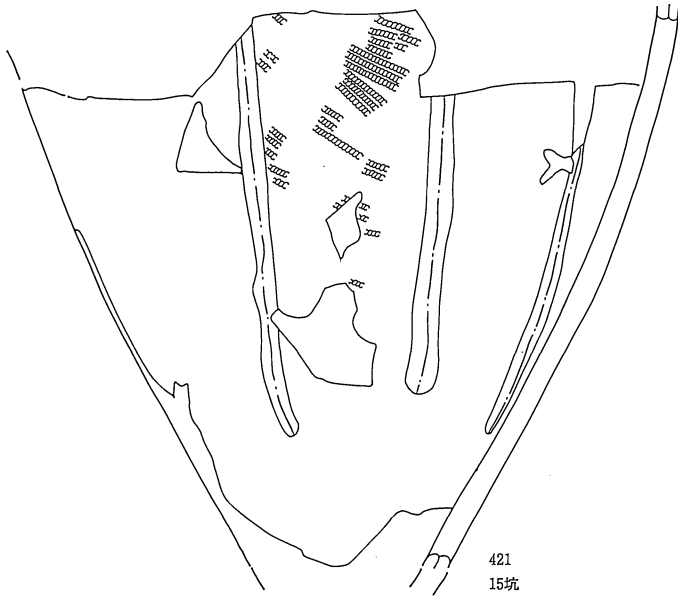

421  
15坑

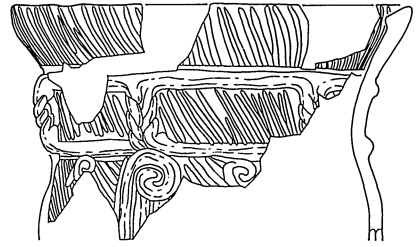

422  
31坑

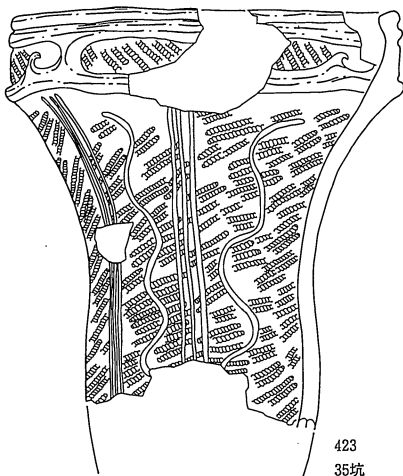

423  
35坑

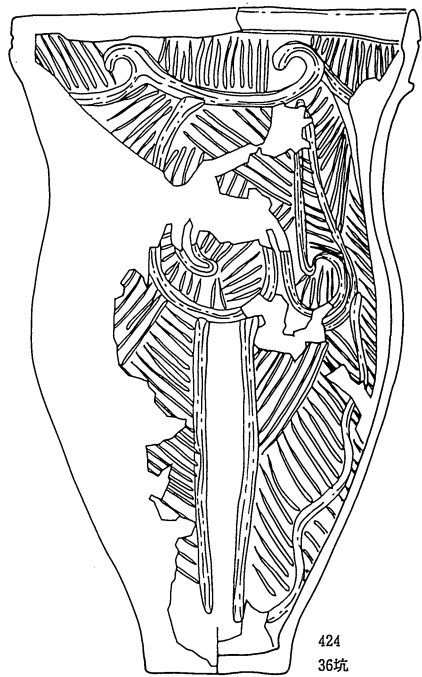

424  
36坑

0 (1:6) 15cm

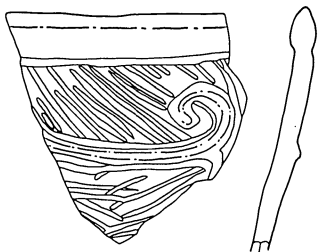

425  
40坑

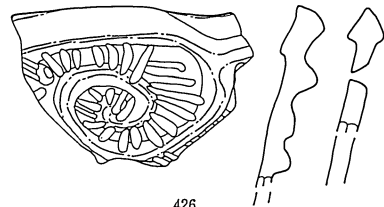

426  
40坑

0 (1:4) 10cm

図版145 土坑出土土器(1) (424 1:6、他 1:4)

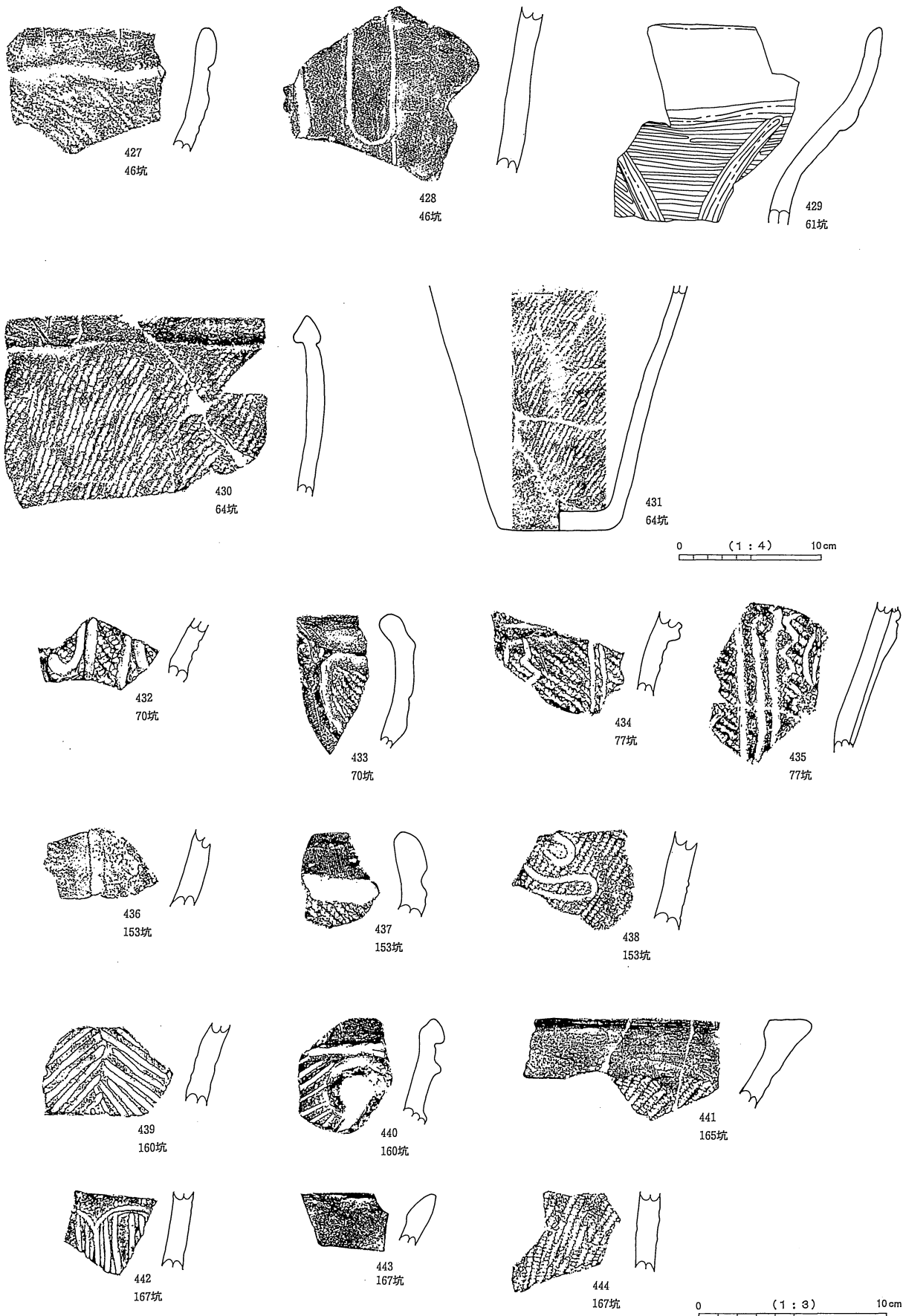

圖版146 土坑出土土器(2) (429·431 1:4、他 1:3)



図版147 土坑出土土器(3) (449・450 1:4、他 1:3)

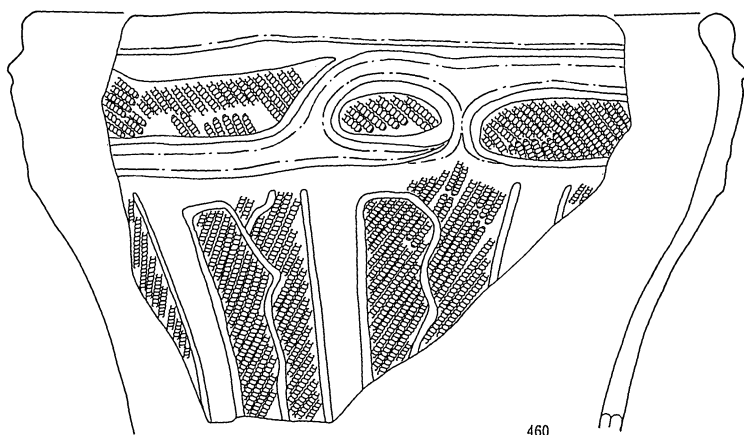

460  
275坑

0 (1:4) 10cm

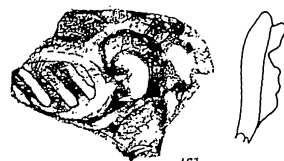

461  
276坑

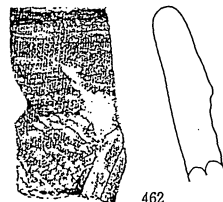

462  
277坑



463  
278坑

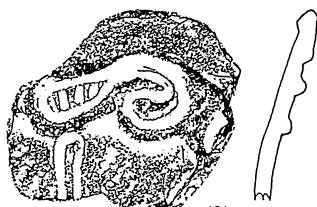

464  
292坑



465  
292坑

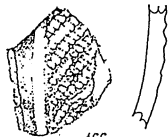

466  
292坑

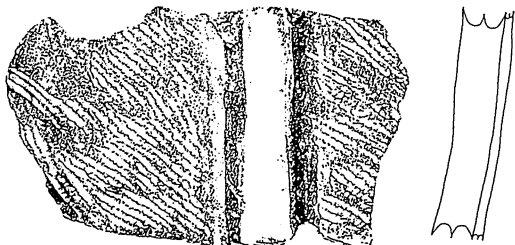

467  
293坑

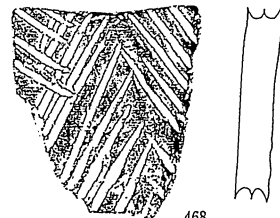

468  
293坑

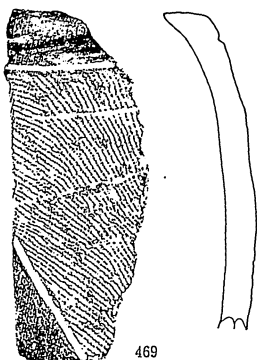

469  
301坑

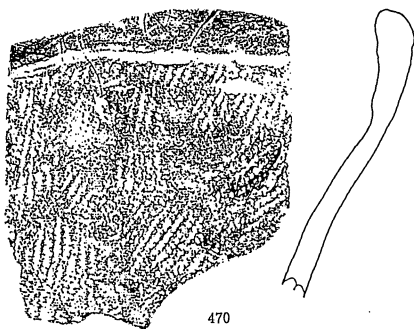

470  
301坑



471  
301坑



472  
301坑

0 (1:3) 10cm

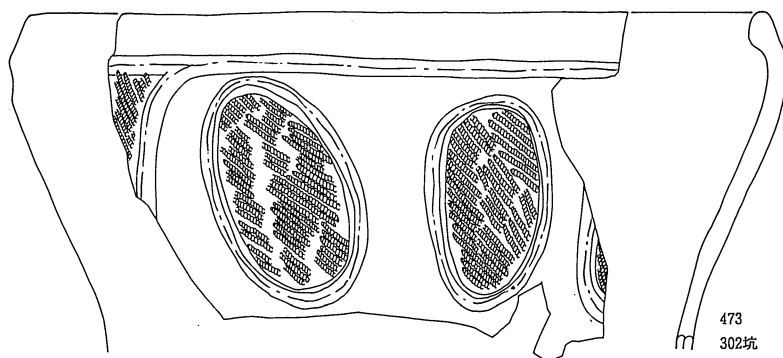

473  
302坑

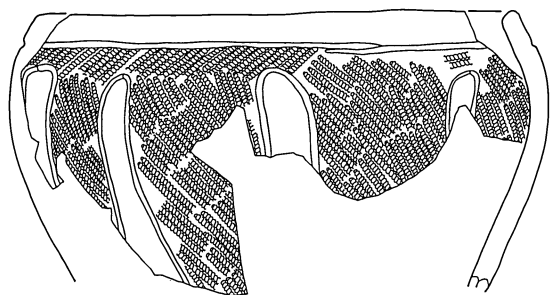

474  
302坑

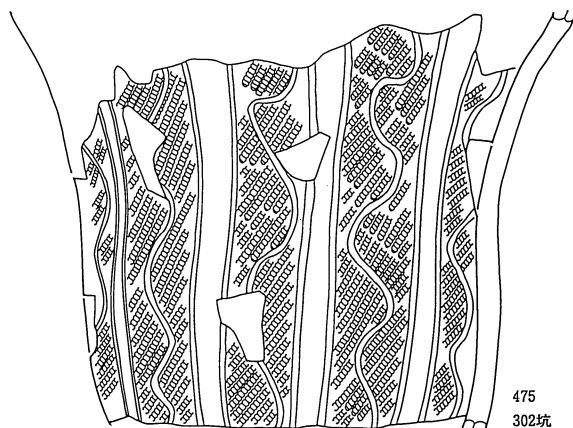

475  
302坑

0 (1:4) 10cm



476  
303坑

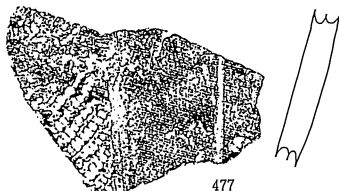

477  
303坑

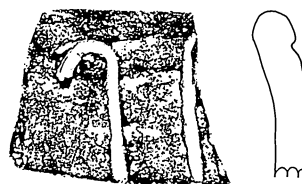

478  
303坑

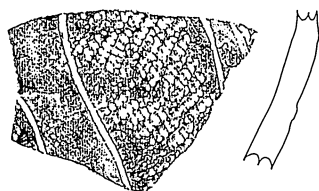

479  
303坑

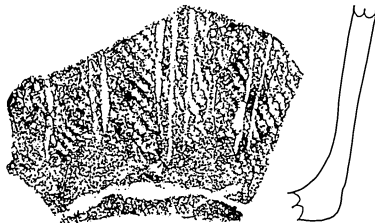

480  
304坑

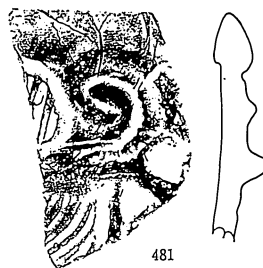

481  
304坑

0 (1:3) 10cm

圖版149 土坑出土土器(5) (473~475 1:4、他 1:3)



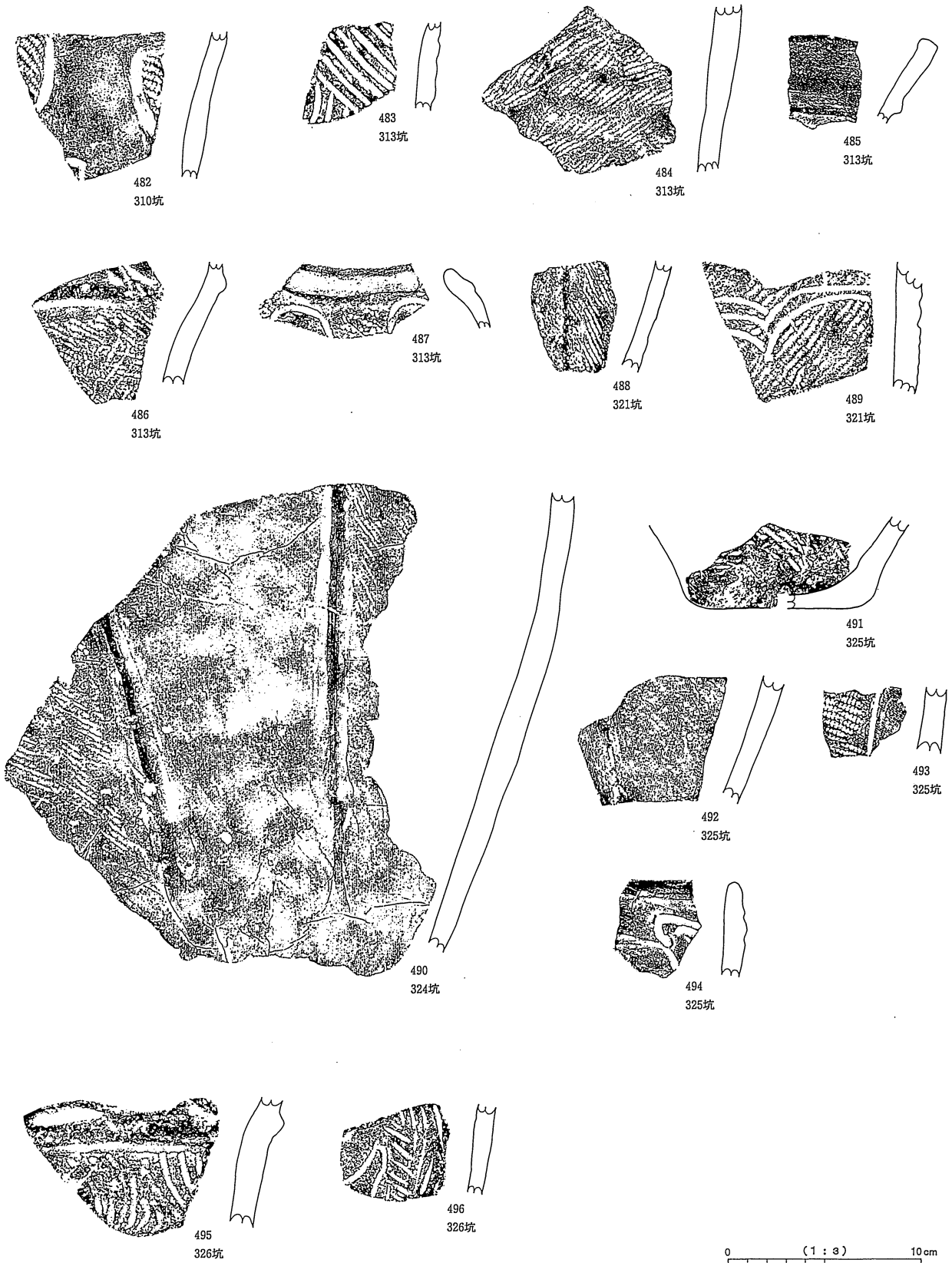

圖版150 土坑出土土器(6) (1:3)

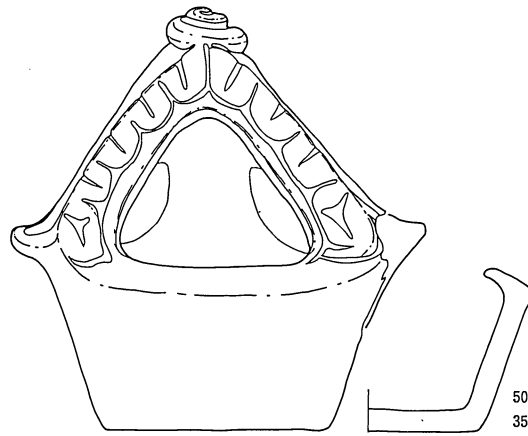
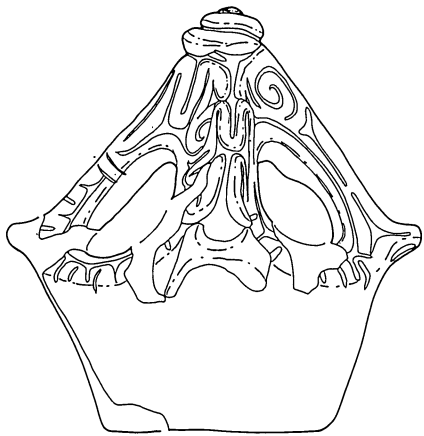
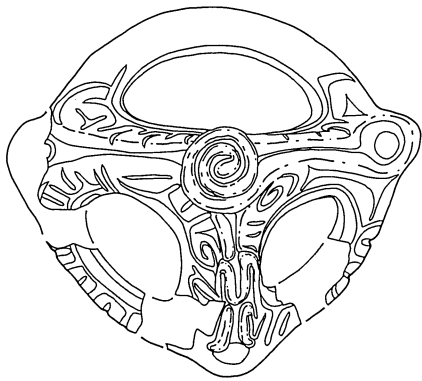
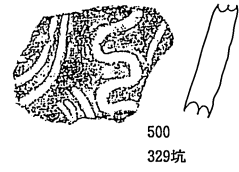
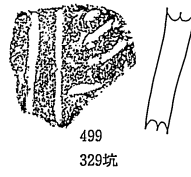
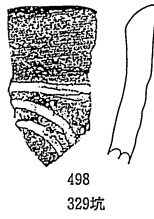
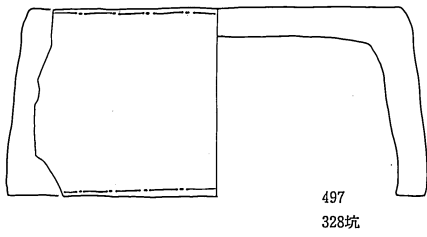

0 (1:4) 10 cm

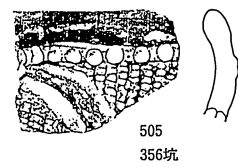
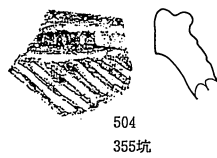
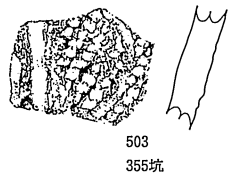
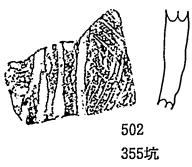

0 (1:3) 10 cm

圖版151 土坑出土土器(7) (497·501 1:4、他 1:3)

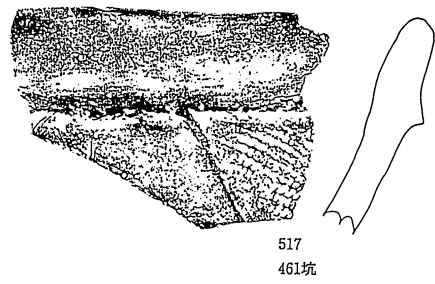
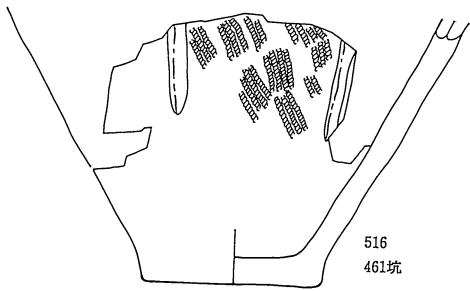
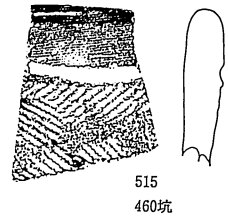
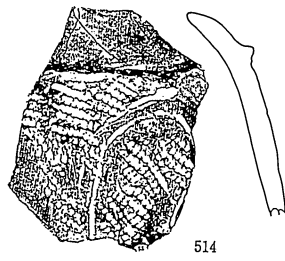
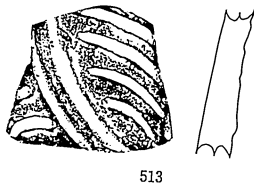
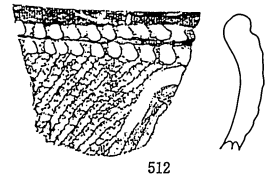
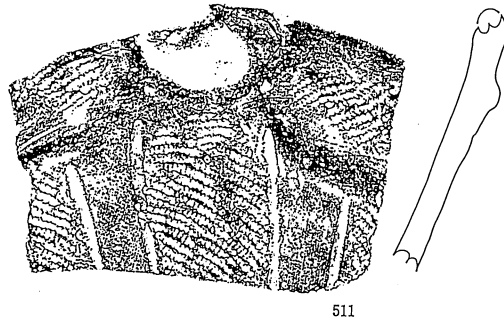
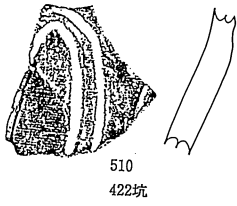
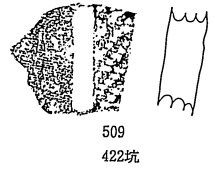
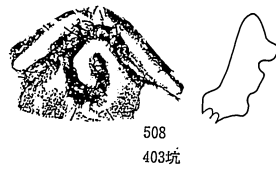
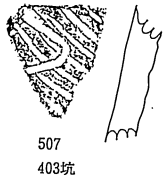
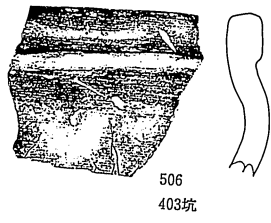

0 (1 : 4) 10 cm

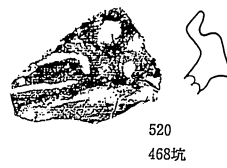
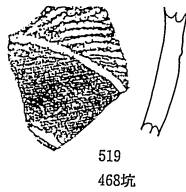
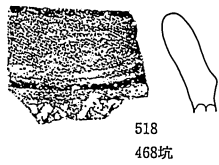

0 (1 : 3) 10 cm

図版152 土坑出土土器(8) (516 1 : 4、他 1 : 3)

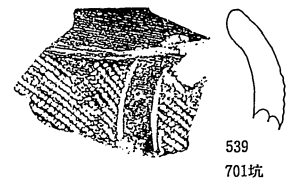
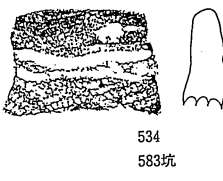
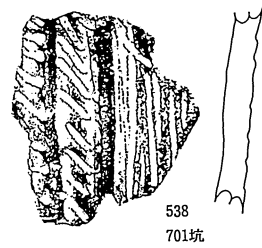
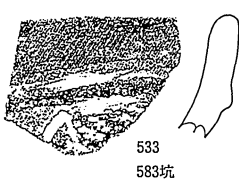
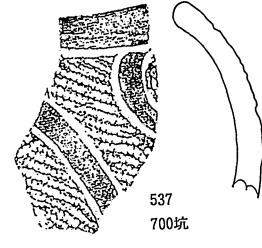
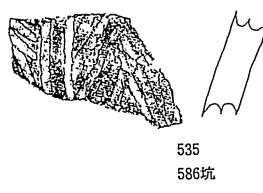
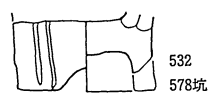
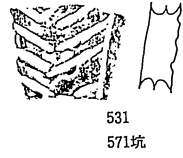
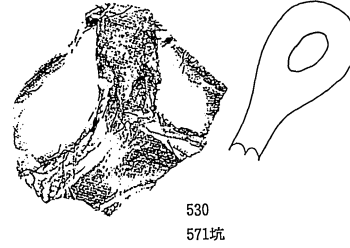
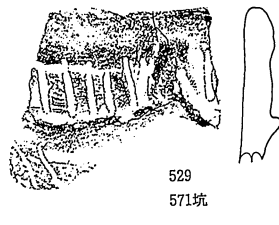
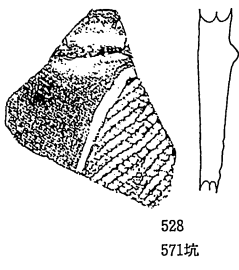
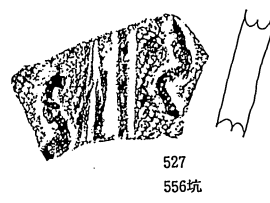
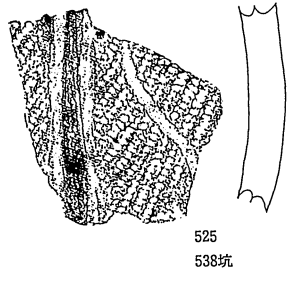
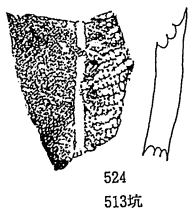
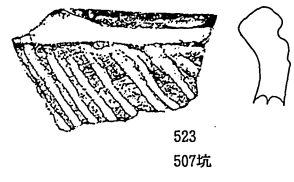
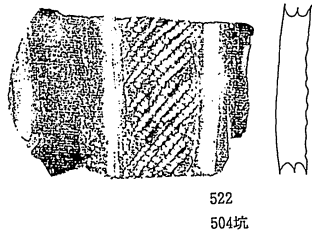
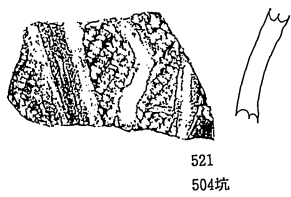

0 (1:4) 10 cm

0 (1:3) 10 cm

圖版153 土坑出土土器(9) (532 1:4、他 1:3)

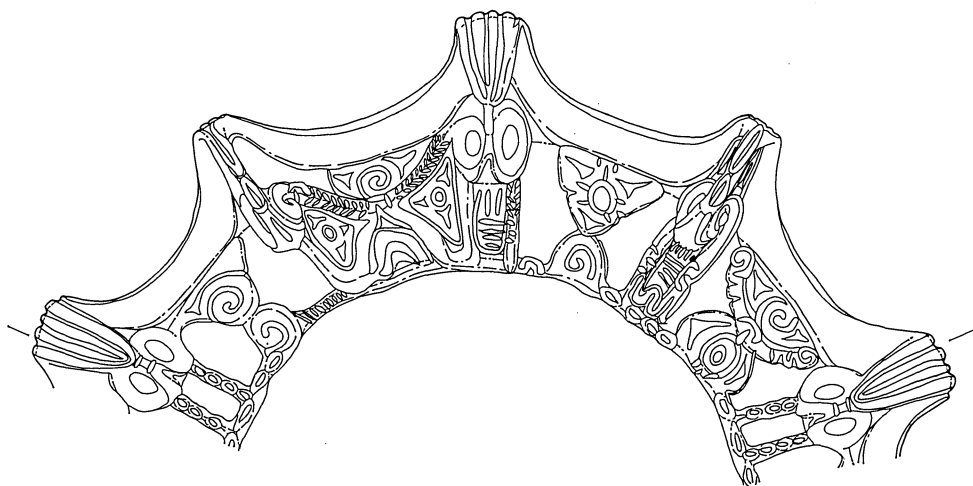

0 (1:6) 15cm

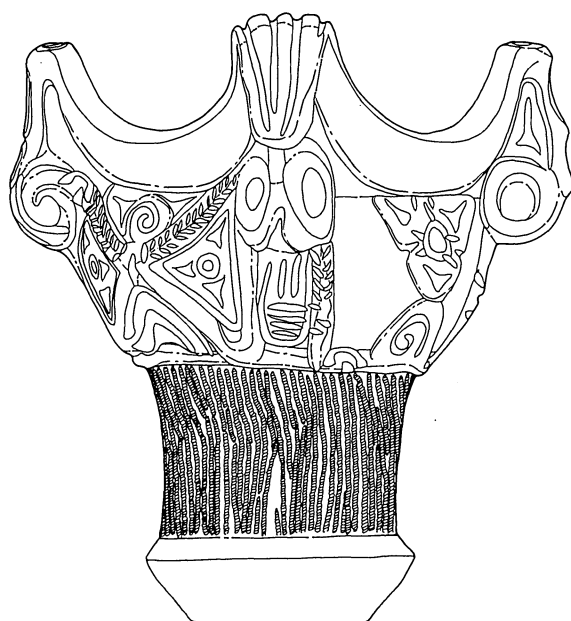

500  
703坑

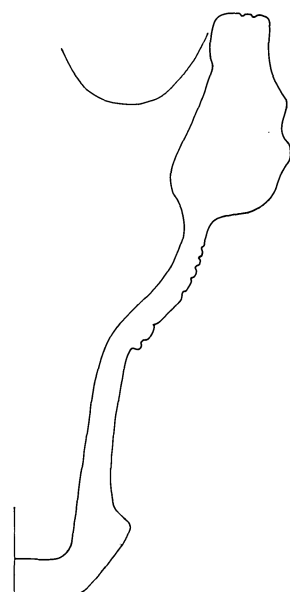

0 (1:4) 10cm

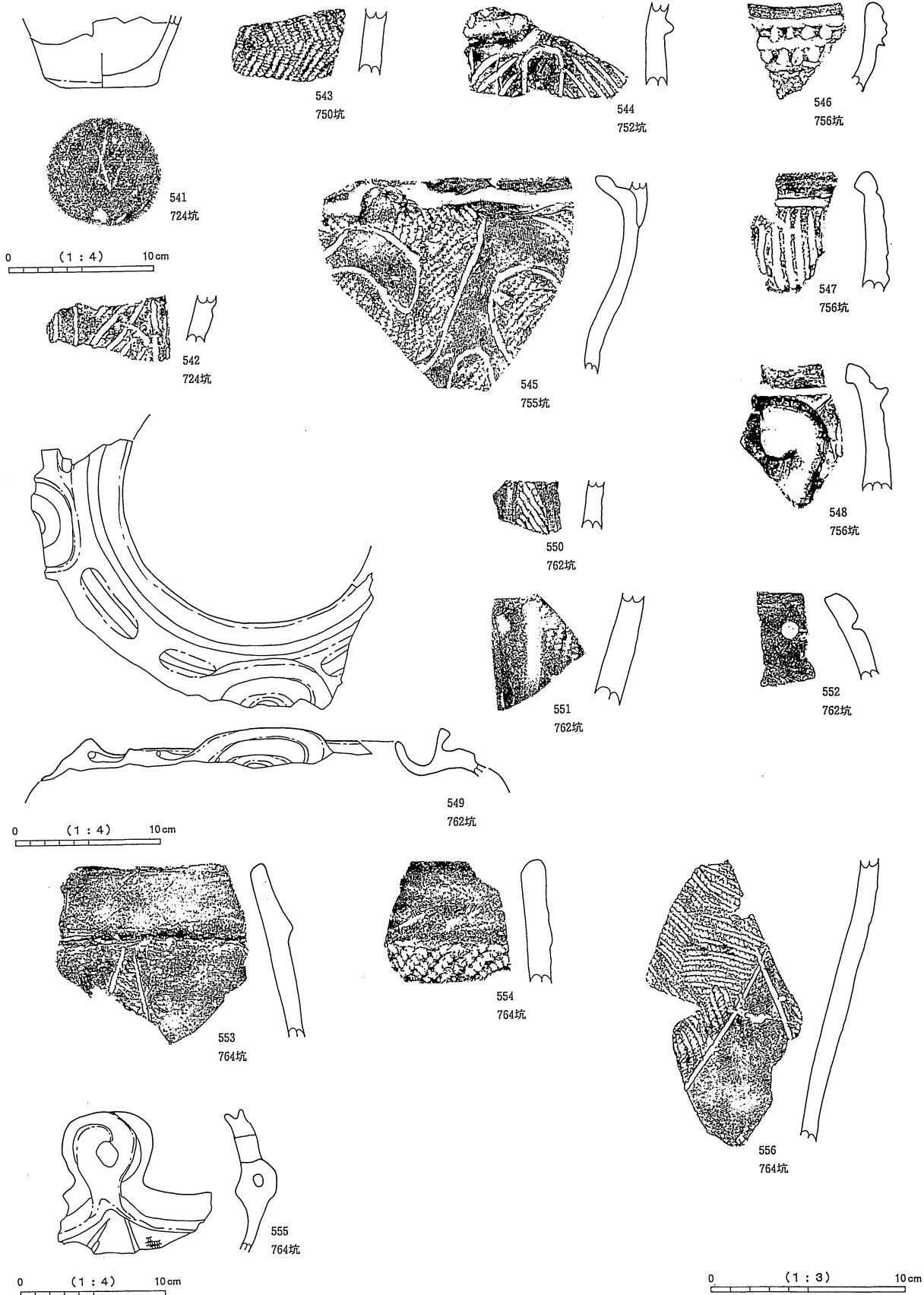

圖版155 土坑出土土器(1) (541·549·555 1:4、他 1:3)

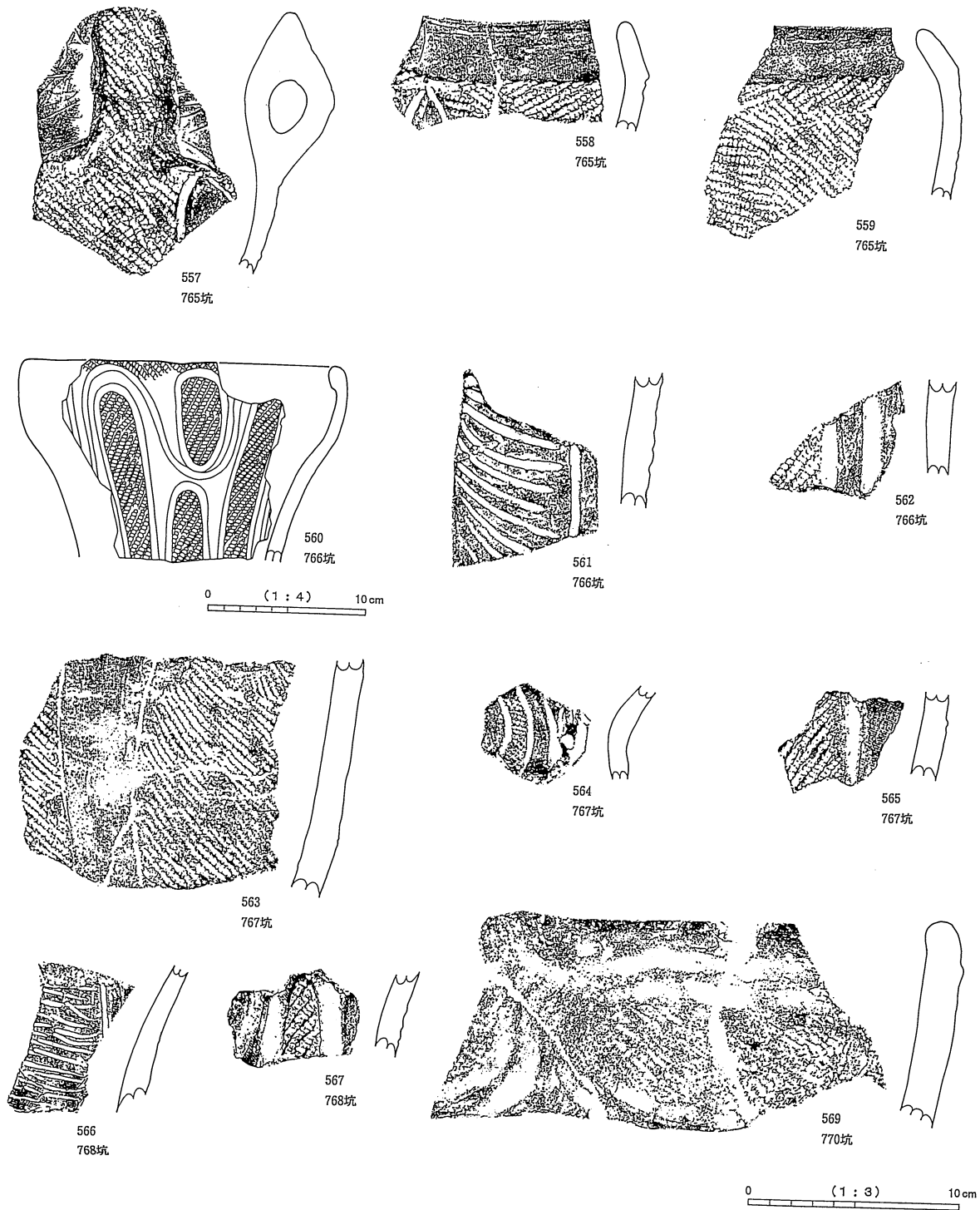

図版156 土坑出土土器(12) (560 1 : 4、他 1 : 3)

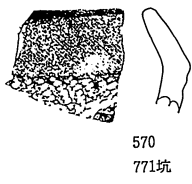

570  
771坑

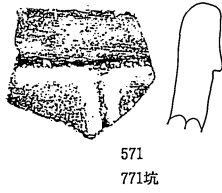

571  
771坑

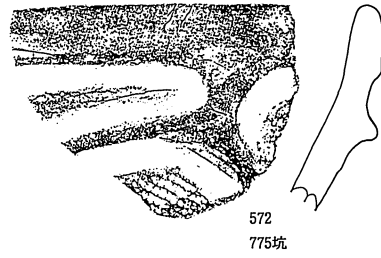

572  
775坑

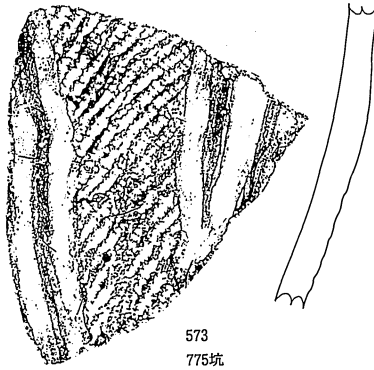

573  
775坑

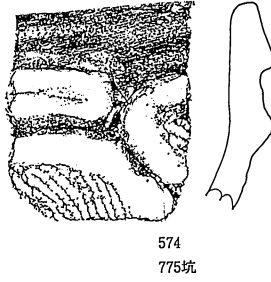

574  
775坑

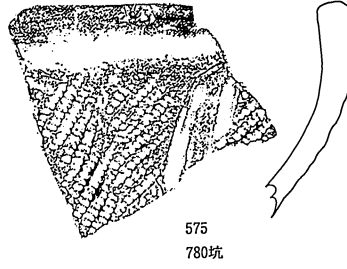

575  
780坑

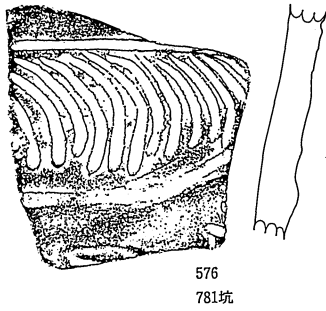

576  
781坑

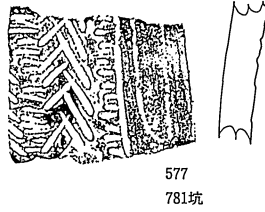

577  
781坑

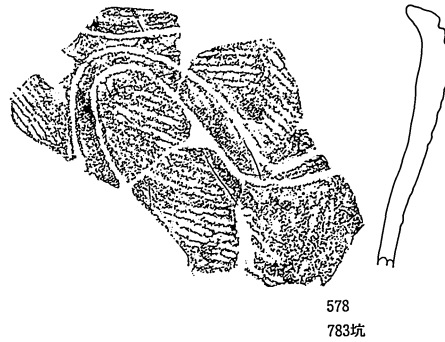

578  
783坑

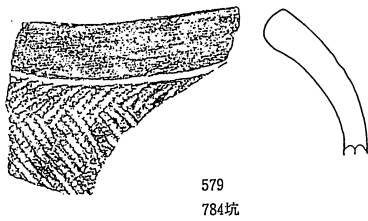

579  
784坑

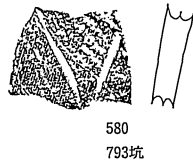

580  
793坑

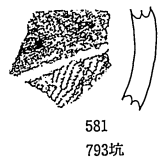

581  
793坑

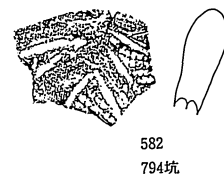

582  
794坑

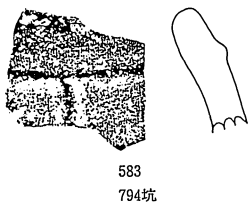

583  
794坑

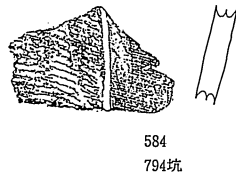

584  
794坑

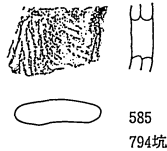

585  
794坑

0 (1 : 3) 10 cm

圖版157 土坑出土土器(13) (1 : 3)



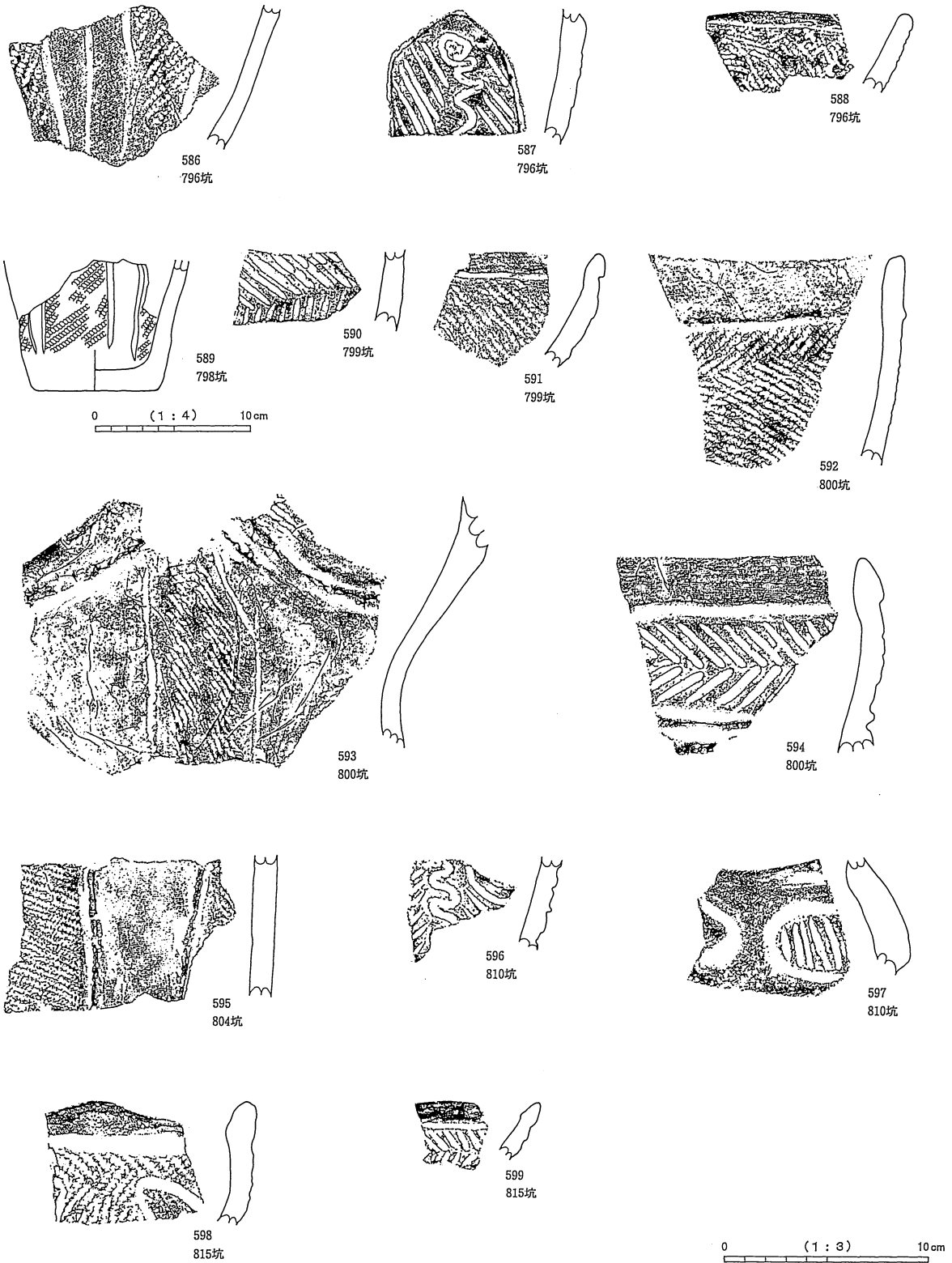

圖版158 土坑出土土器(14) (589 1 : 4、他 1 : 3)

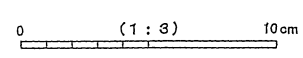
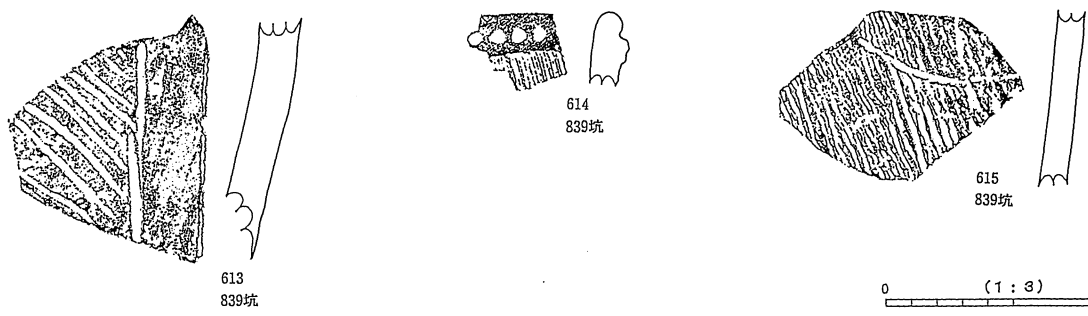
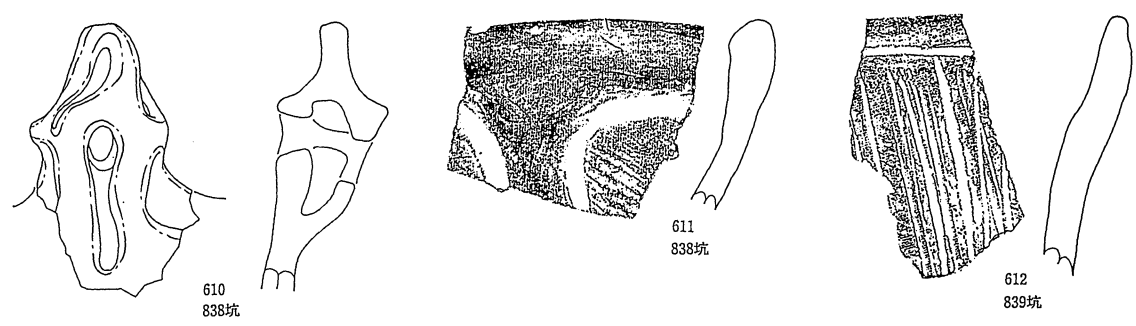
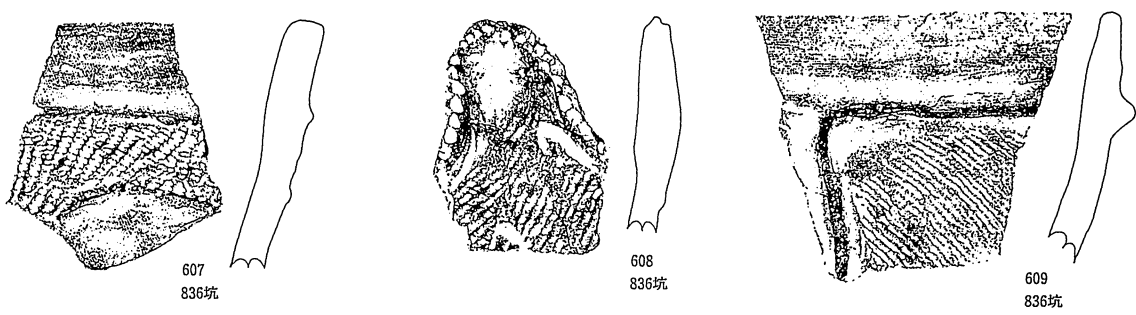
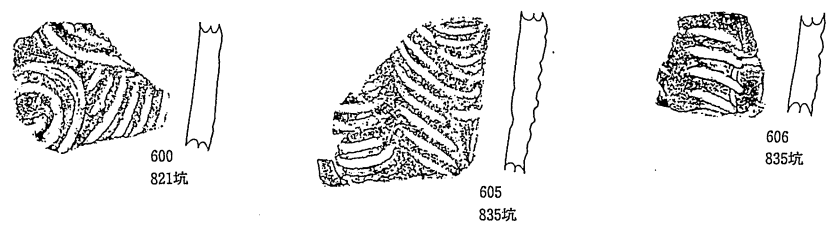
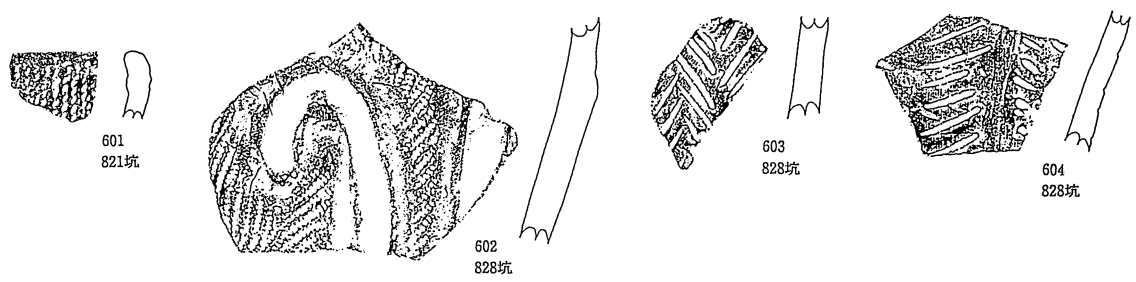

圖版159 土坑出土土器(15) (1 : 3)

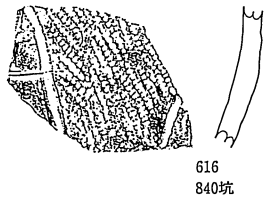

616  
840坑

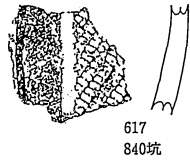

617  
840坑

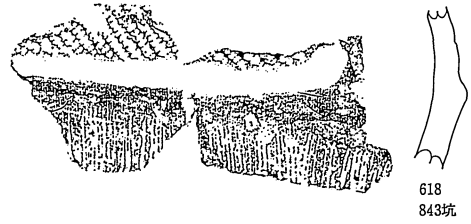

618  
843坑

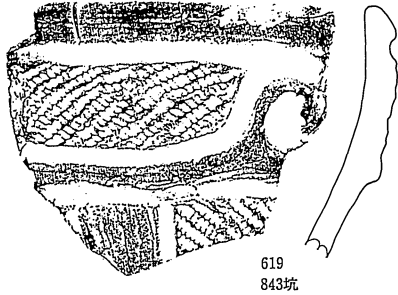

619  
843坑

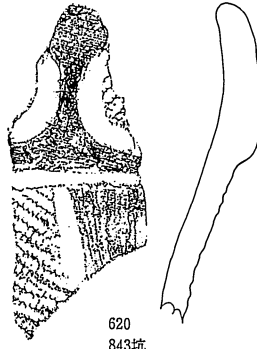

620  
843坑

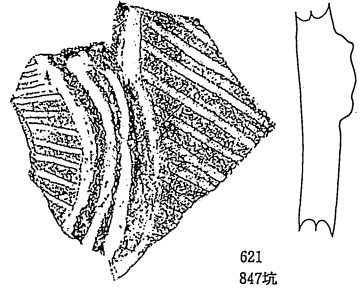

621  
847坑

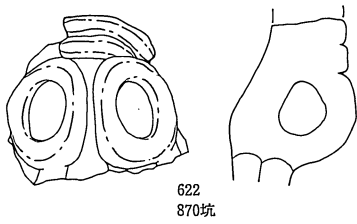

622  
870坑

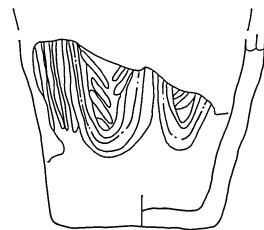

623  
958坑



625  
1011坑

0 (1 : 4) 10 cm

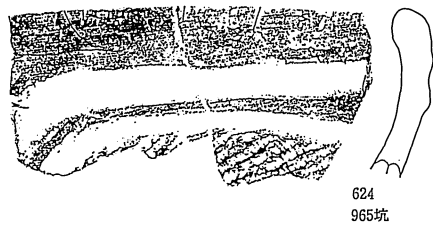

624  
965坑

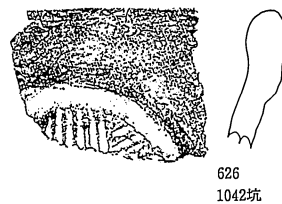

626  
1042坑

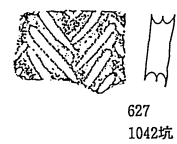

627  
1042坑

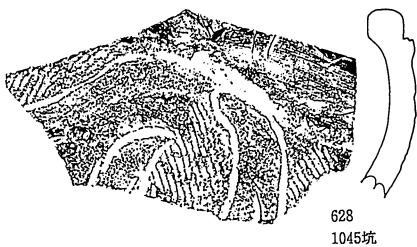

628  
1045坑

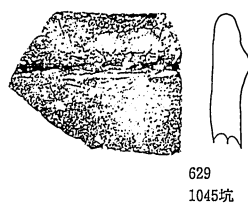

629  
1045坑

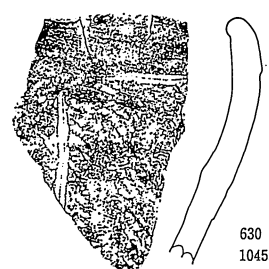

630  
1045坑

0 (1 : 3) 10 cm

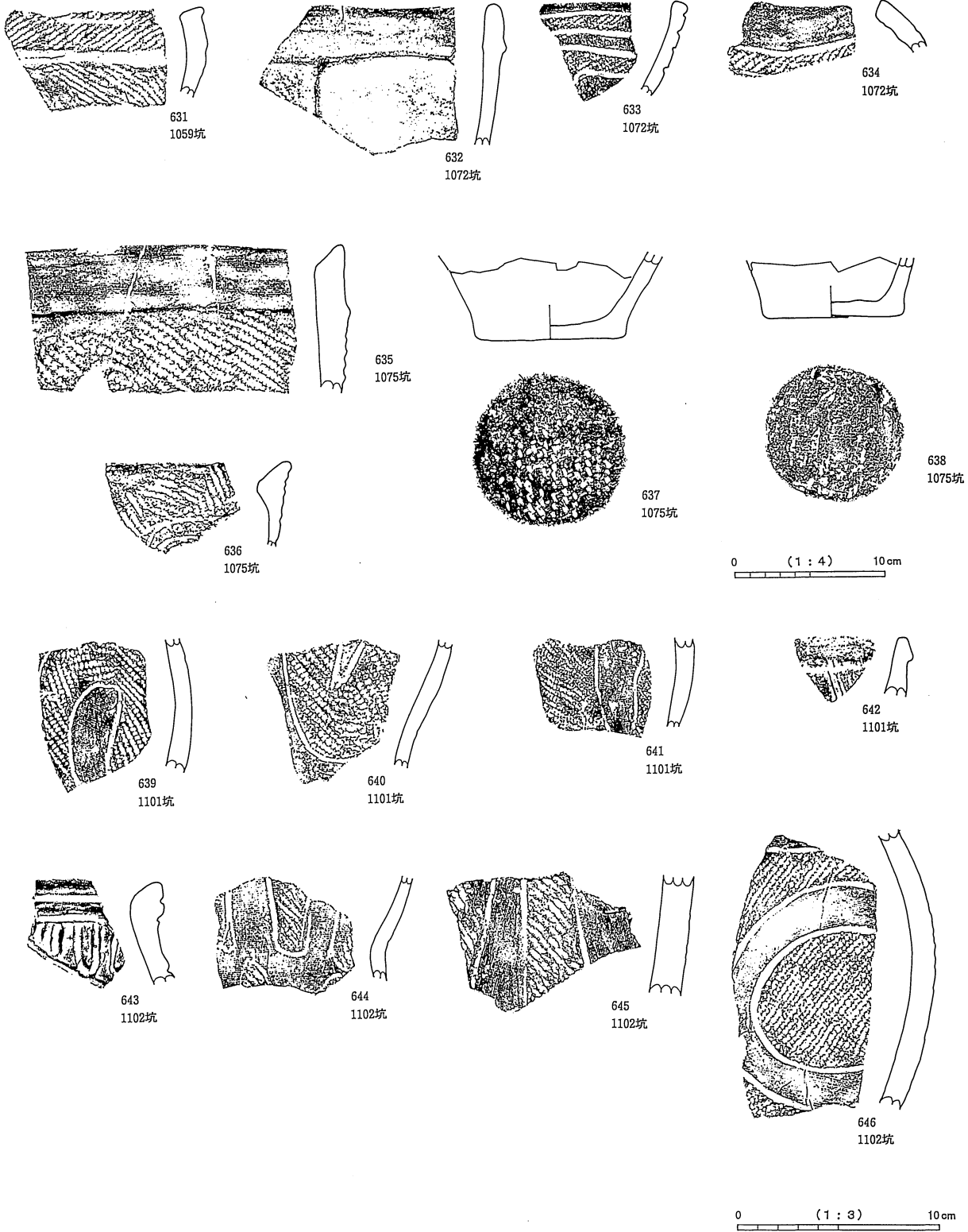

図版161 土坑出土土器(17) (637・638 1:4、他 1:3)

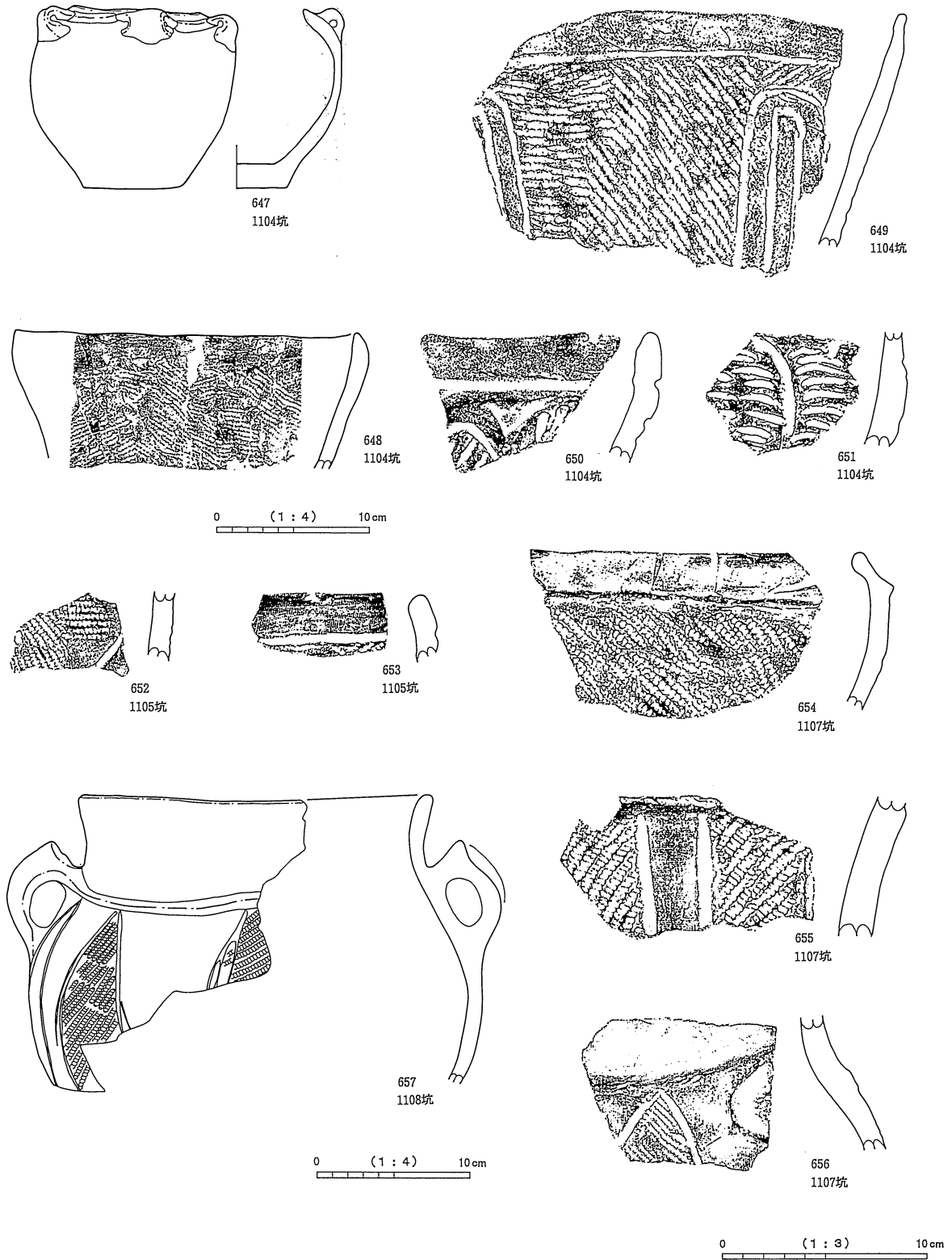

圖版162 土坑出土土器(18) (647·648·657 1:4、他 1:3)

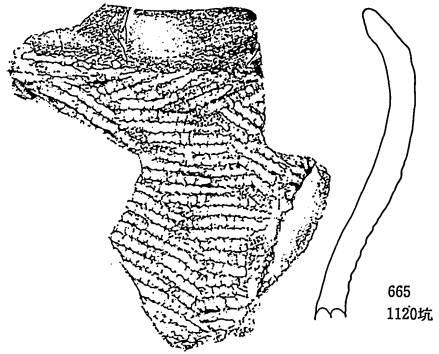
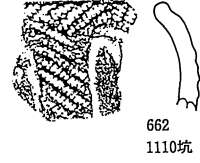
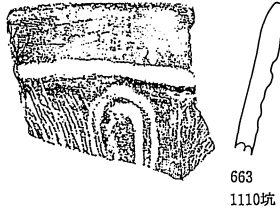
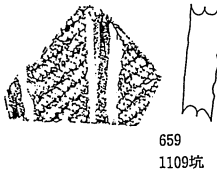
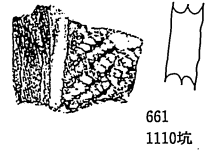
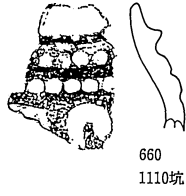
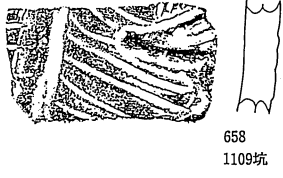

0 (1:3) 10cm

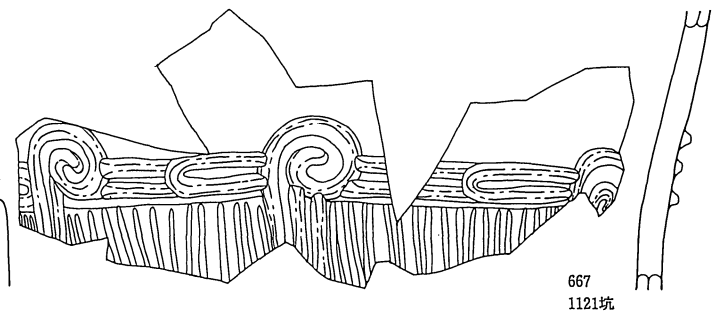
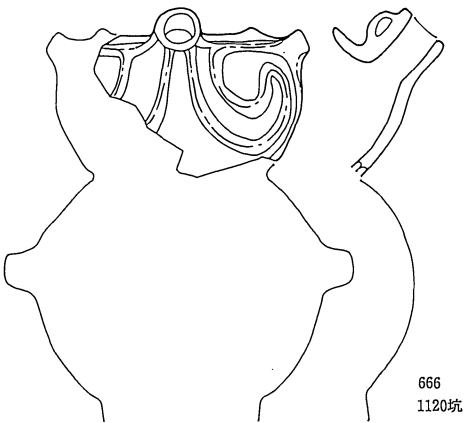

0 (1:4) 10cm

圖版163 土坑出土土器(19) (666·667 1:4、他 1:3)

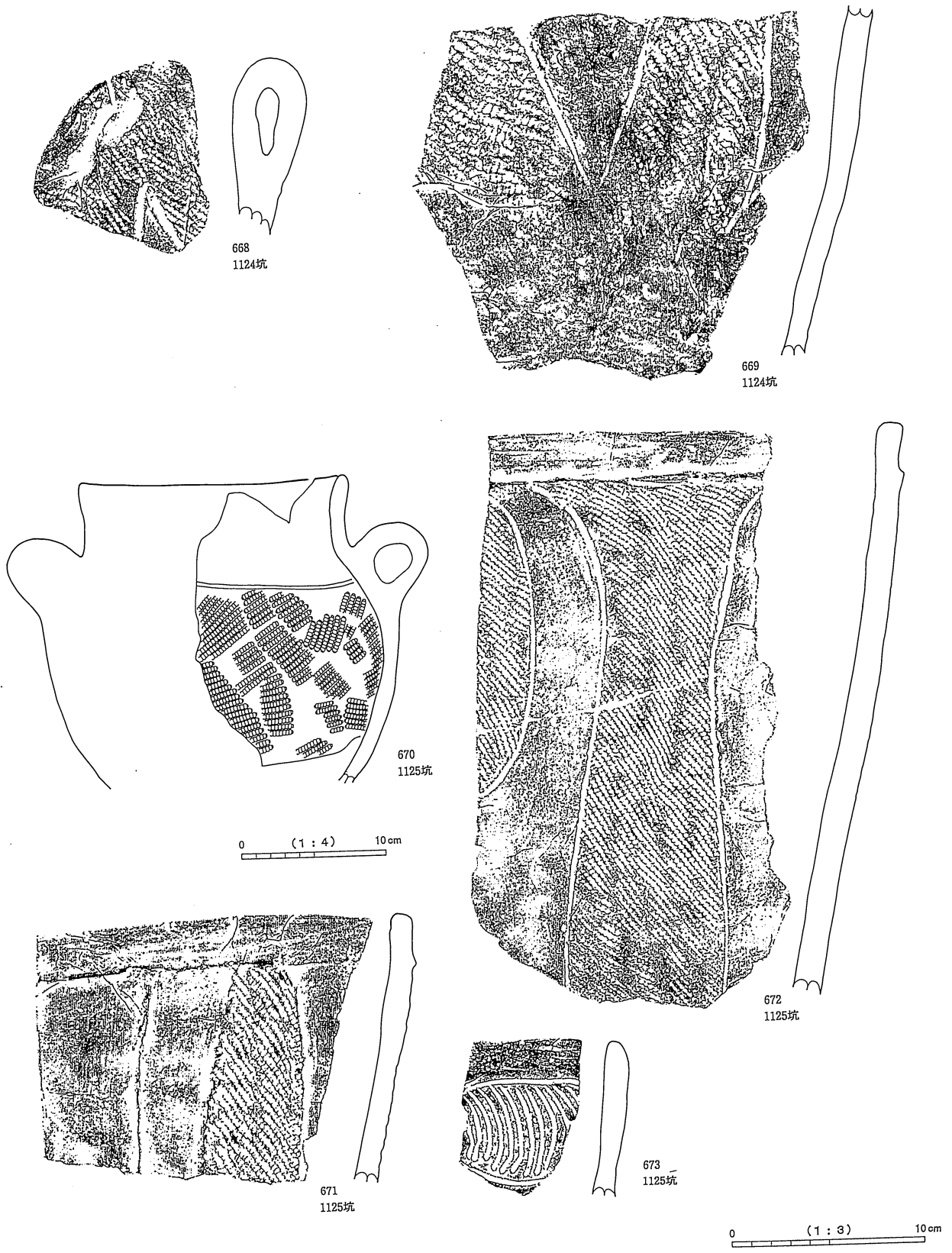

図版164 土坑出土土器(20) (670 1 : 4、他 1 : 3)

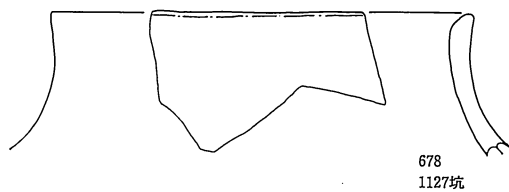
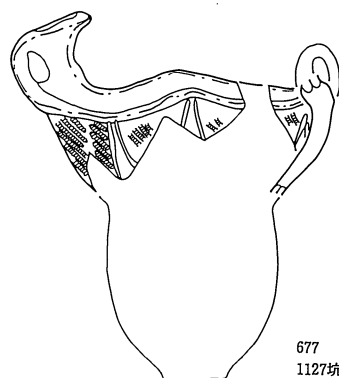
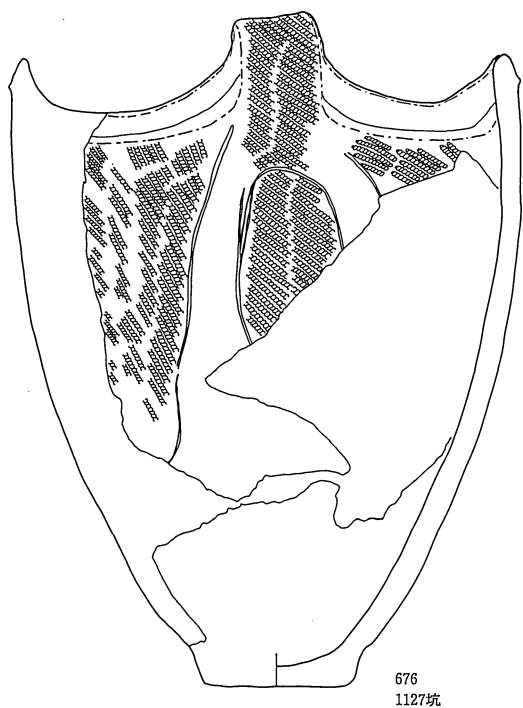
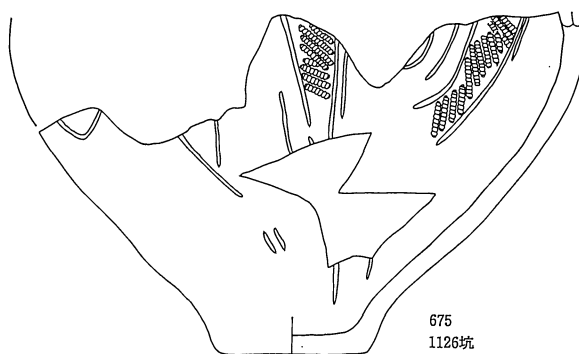
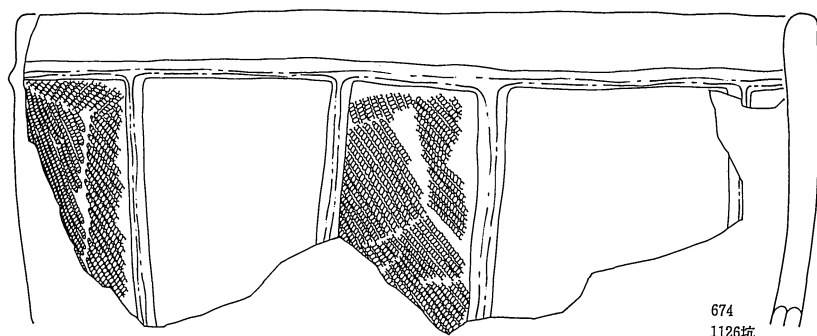

0 (1 : 4) 10cm

圖版165 土坑出土土器(1) (1 : 4)



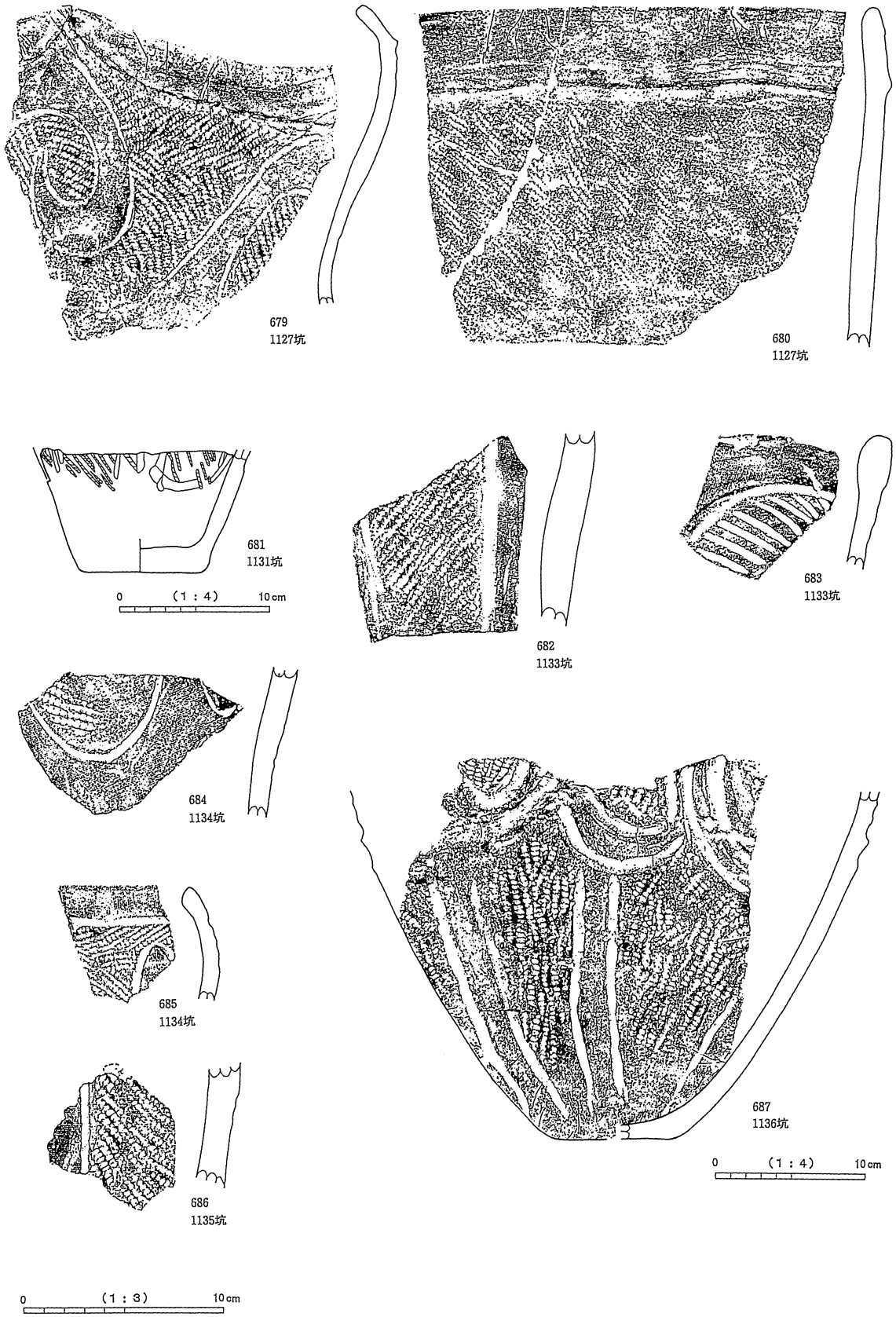

圖版166 土坑出土土器(2) (681·687 1:4、他 1:3)

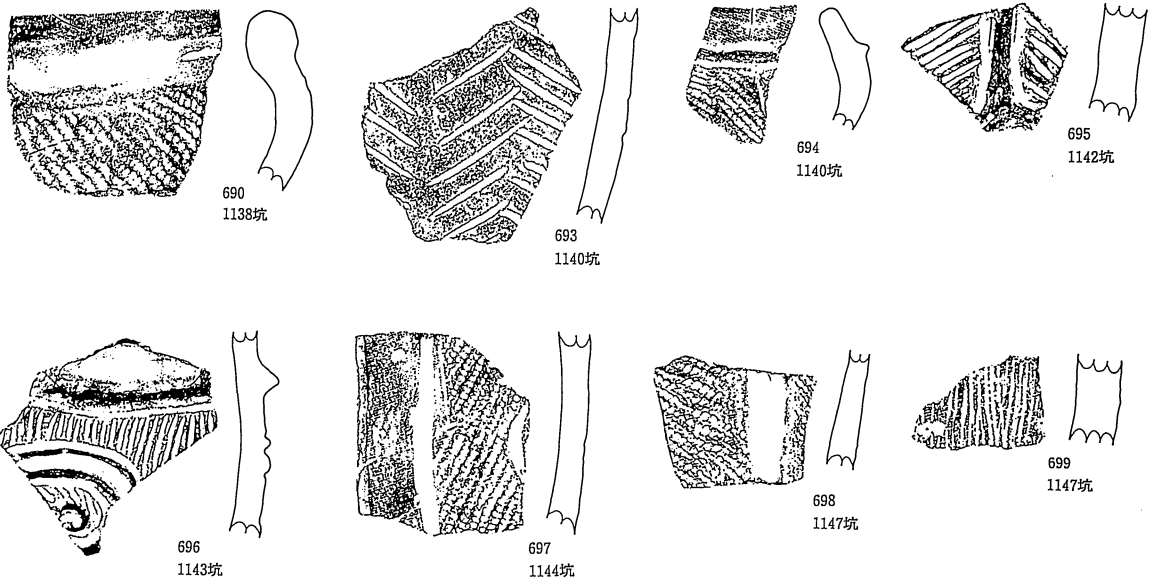
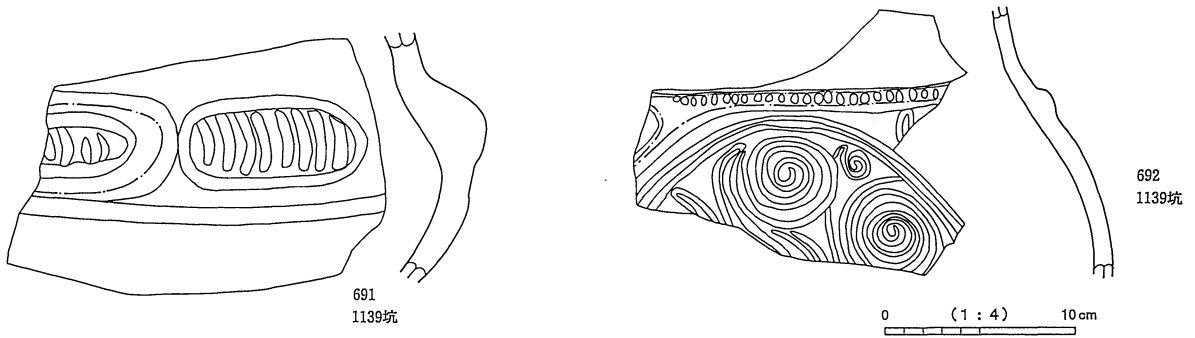
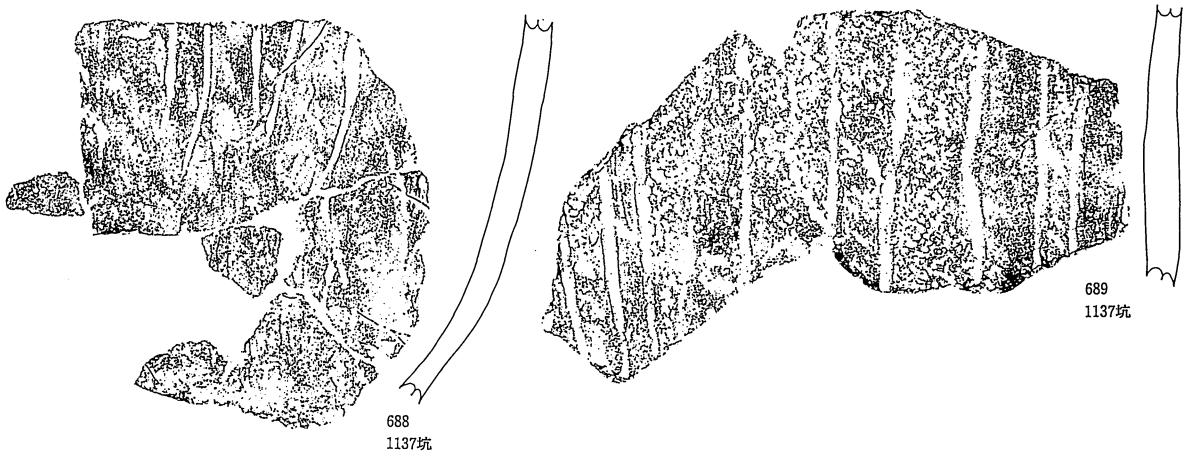

0 (1 : 3) 10 cm

圖版167 土坑出土土器(23) (691·692 1 : 4、他 1 : 3)

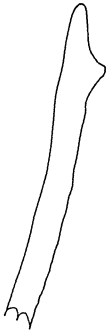

700  
1148坑

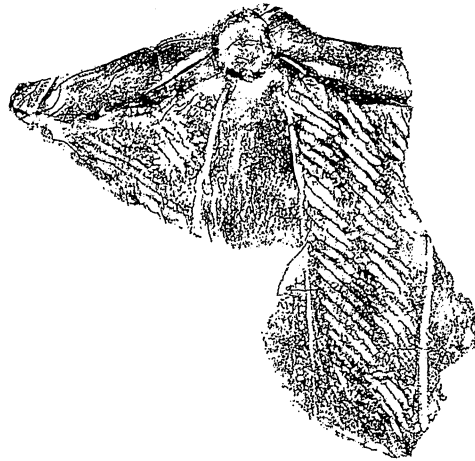

701  
1148坑

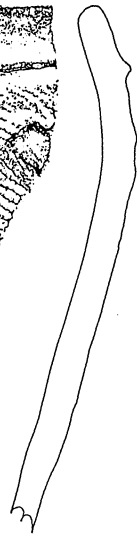
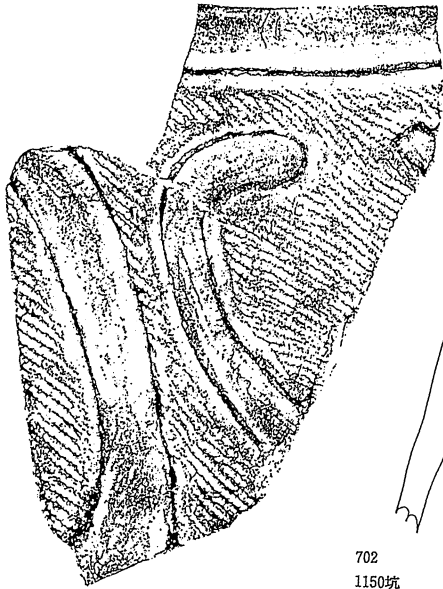

702  
1150坑

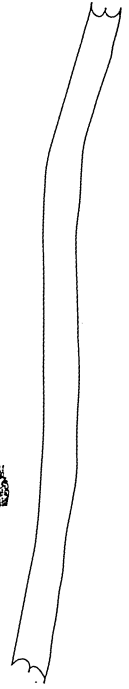
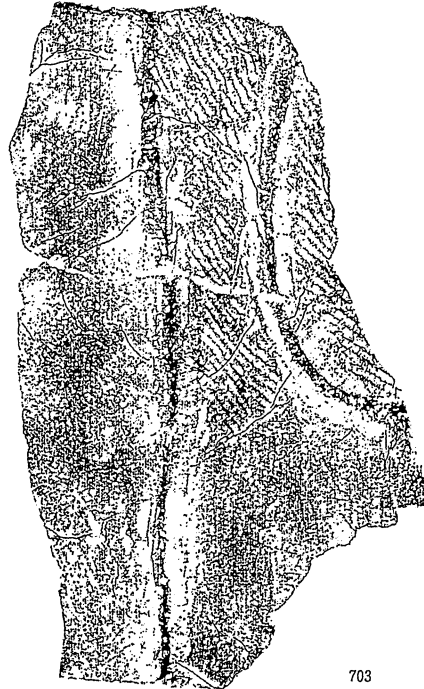

703  
1151坑

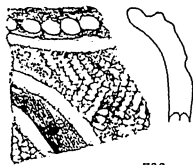

706  
1152坑

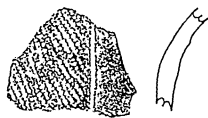

707  
1152坑



704  
1151坑



705  
1151坑

0 (1 : 3) 10cm

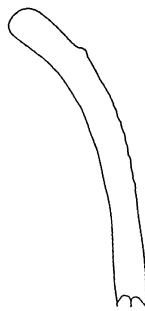
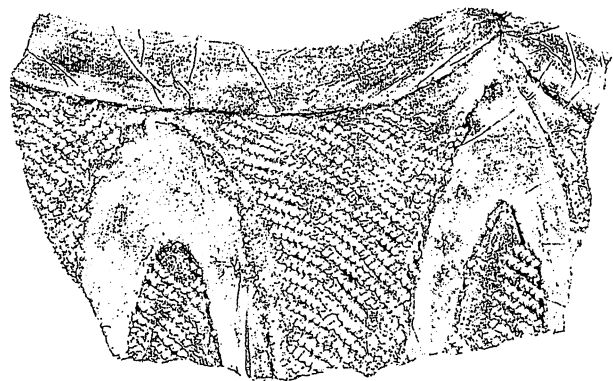

708  
1153坑

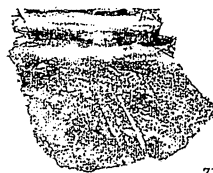

710  
1154坑

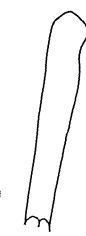
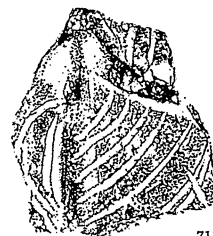

711  
1154坑

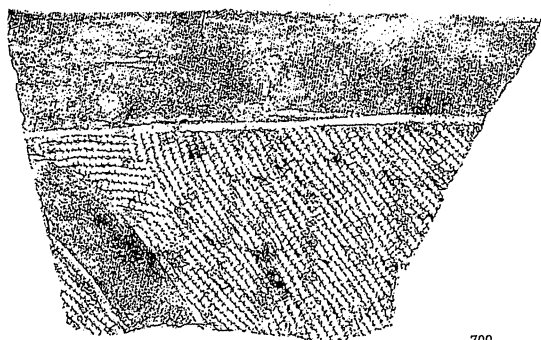

709  
1153坑



712  
1154坑



713  
1154坑



716  
1158坑

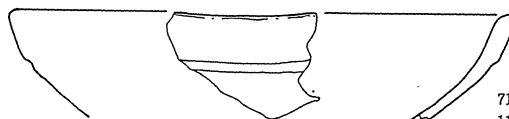

714  
1154坑

0 (1:4) 10cm



715  
1158坑

0 (1:4) 10cm



717  
1158坑



718  
1170坑

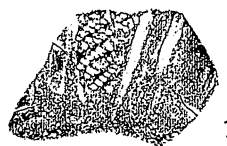

719  
1172坑

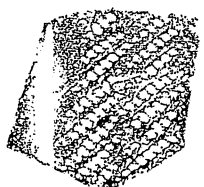

720  
1172坑

0 (1:3) 10cm

圖版169 土坑出土土器(25) (714·715 1:4、他 1:3)

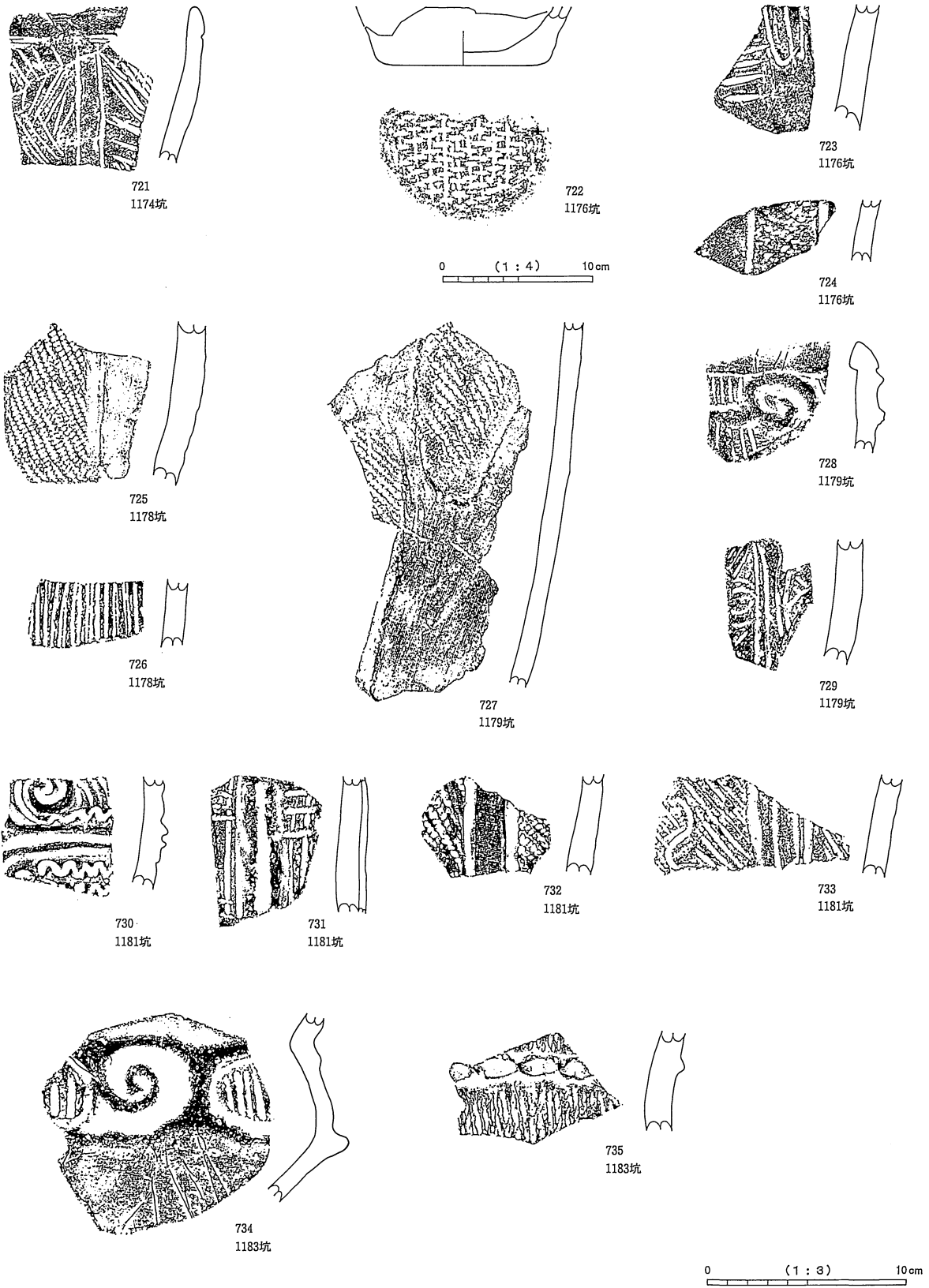

圖版170 土坑出土土器(26) (722 1:4、他 1:3)

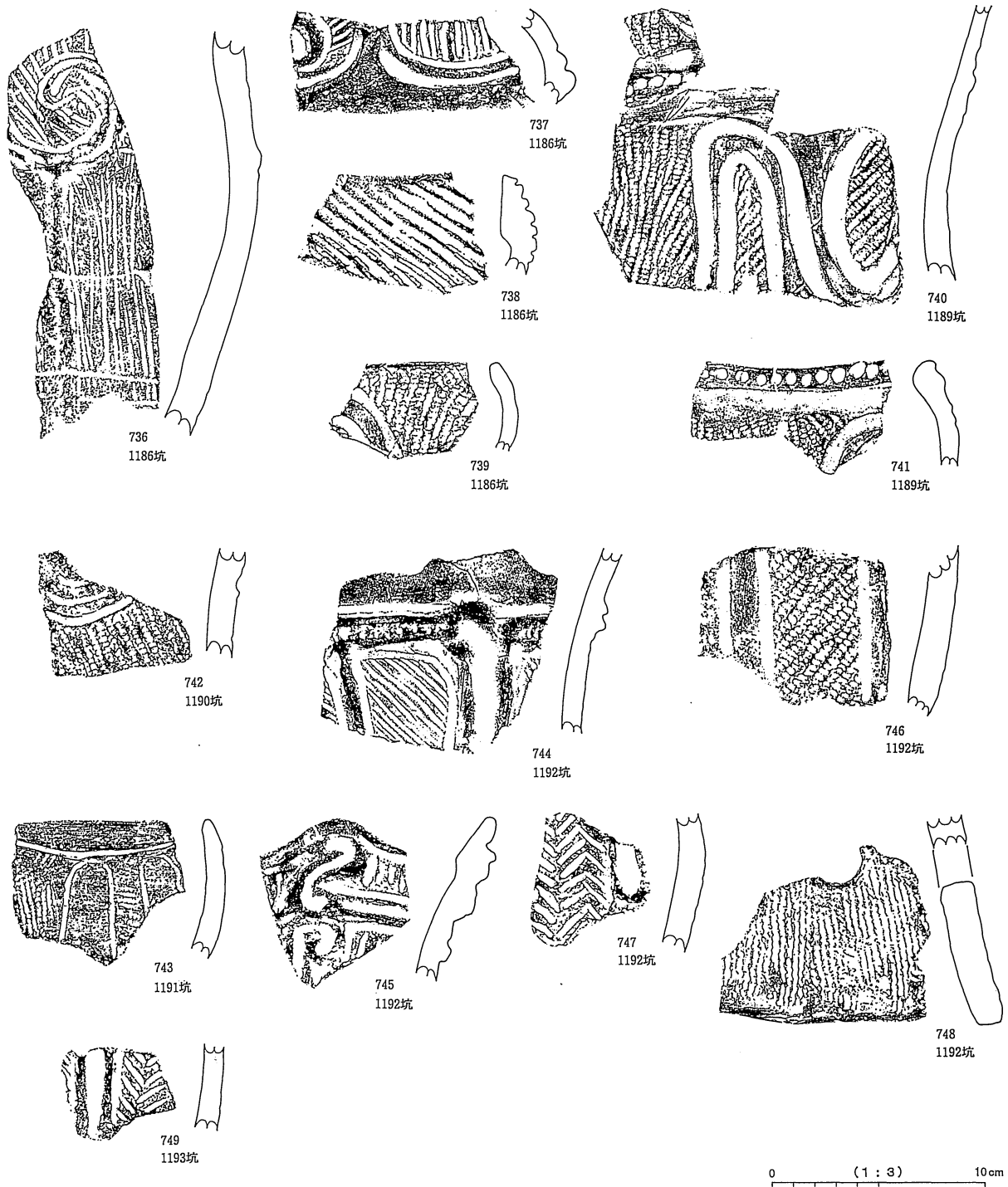

図版171 土坑出土土器(27) (1 : 3)

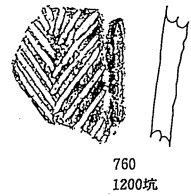
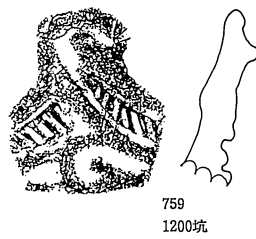
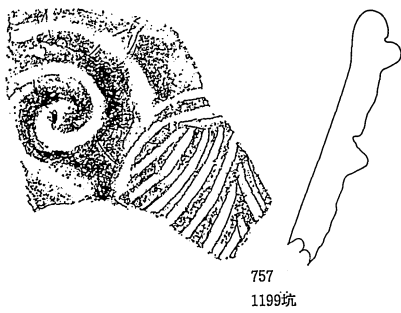
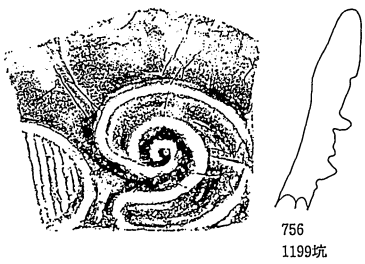
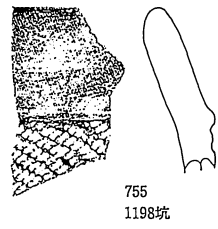
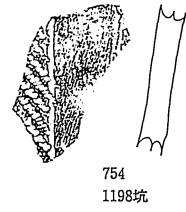
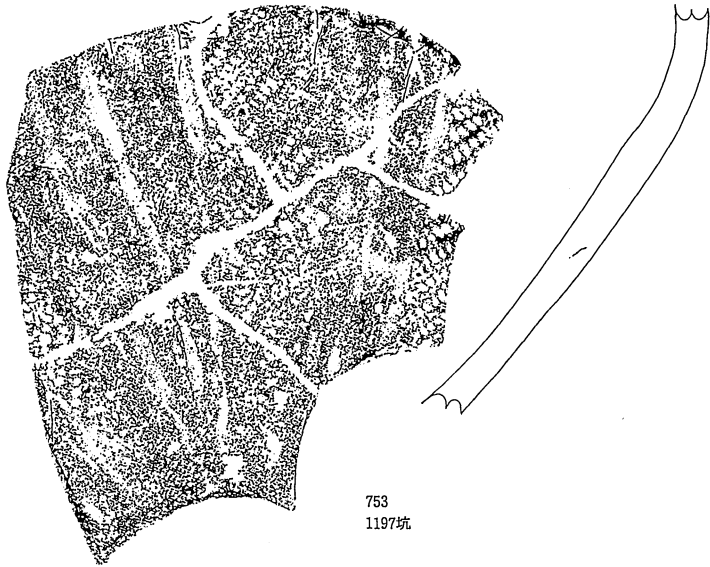
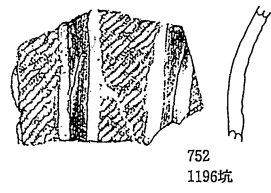
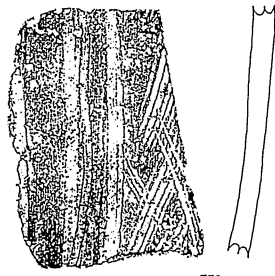
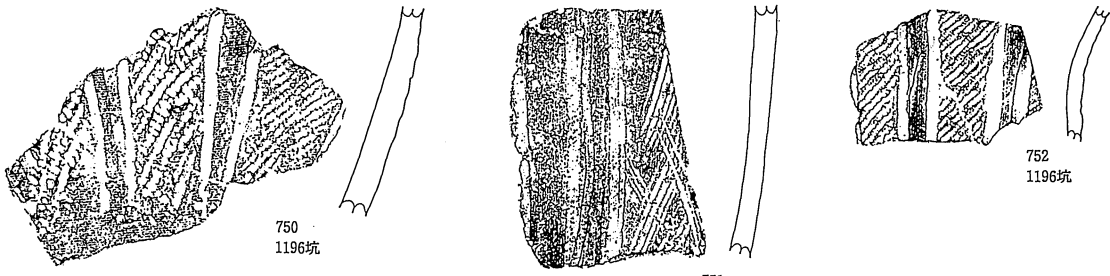

0 (1:3) 10 cm

圖版172 土坑出土土器(28) (1:3)

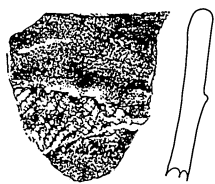

761  
1205坑



762  
1205坑

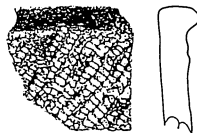

763  
1205坑



764  
1205坑

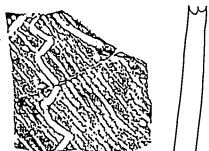

765  
1211坑

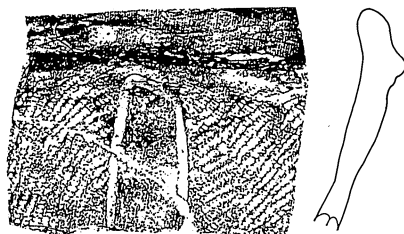

766  
1212坑



767  
1215坑



768  
1216坑



769  
1216坑



770  
1216坑



771  
1219坑



772  
1219坑

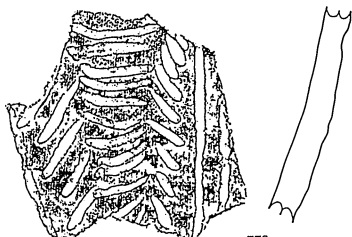

773  
1220坑

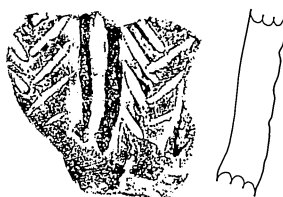

774  
1220坑

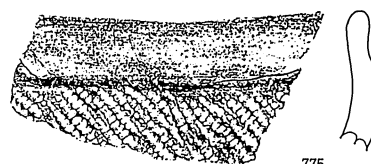

775  
1227坑

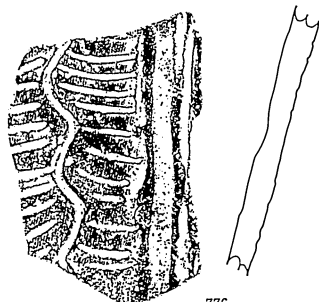

776  
1277坑

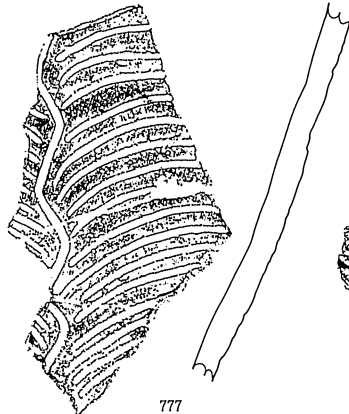

777  
1227坑

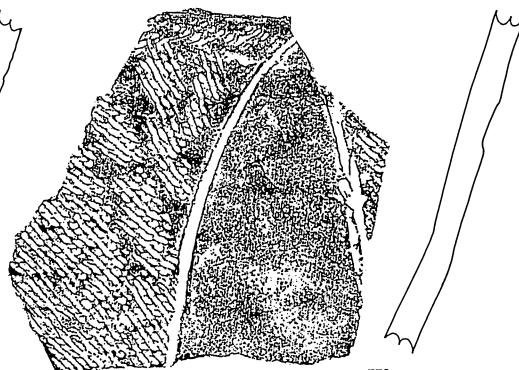

778  
1227坑

0 (1:3) 10cm

図版173 土坑出土土器(29) (1:3)



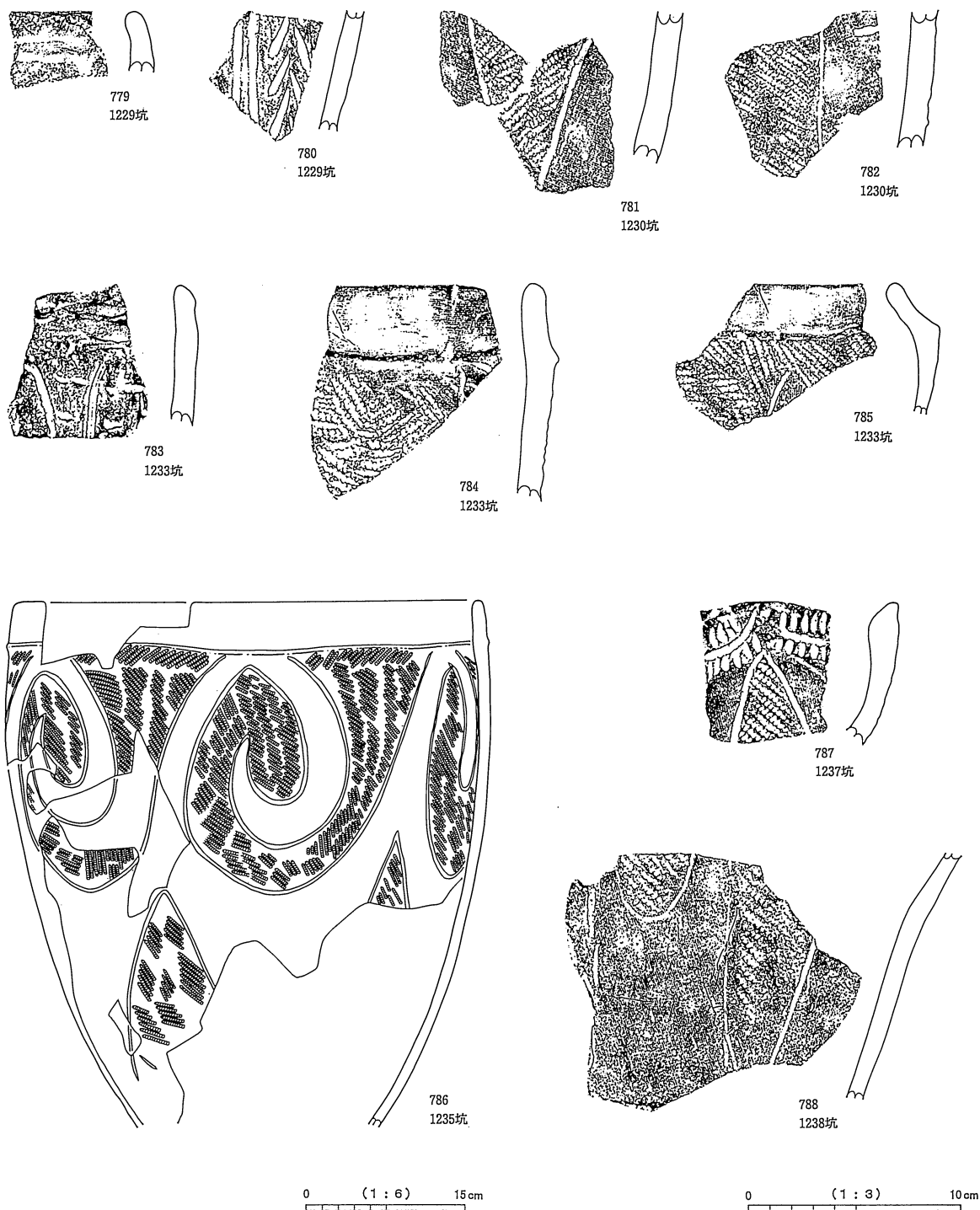

図版174 土坑出土土器(30) (786 1:6、他 1:3)

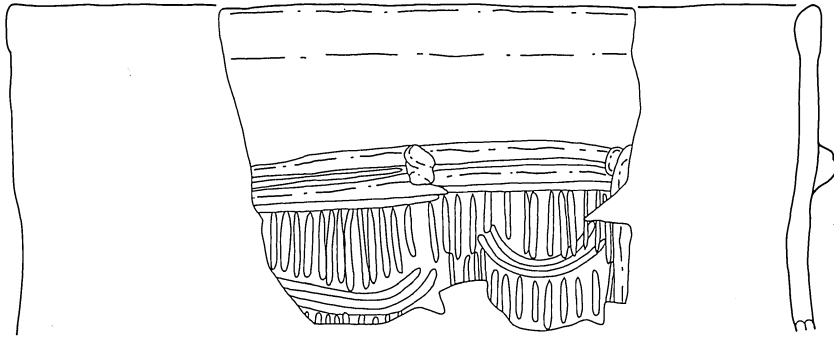

789  
1240坑

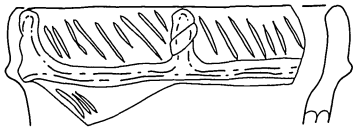

790  
1240坑

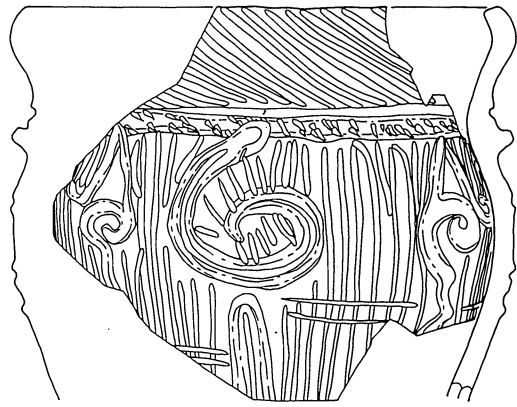

791  
1240坑

0 (1:4) 10 cm

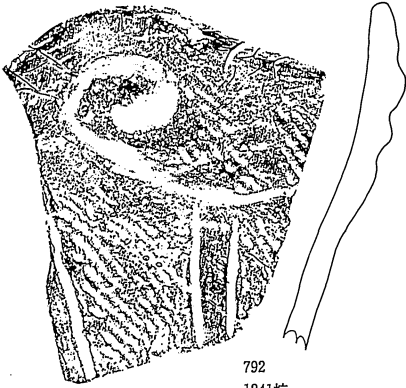

792  
1241坑

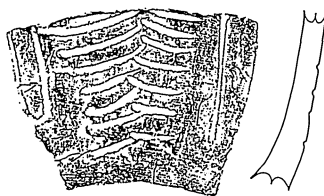

793  
1244坑

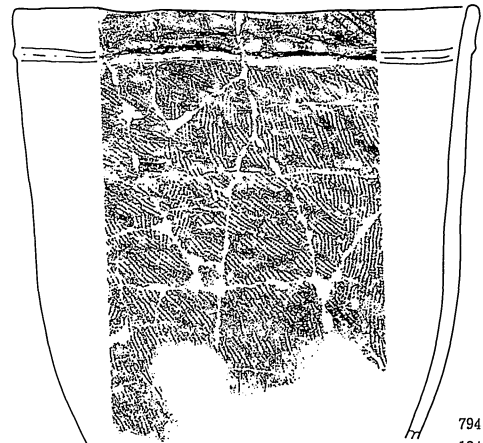

794  
1244坑

0 (1:6) 15 cm

0 (1:3) 10 cm

圖版175 土坑出土土器(81) (789~791 1:4、794 1:6、他 1:3)

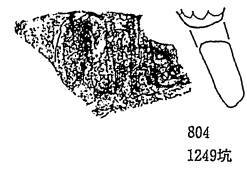
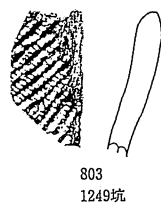
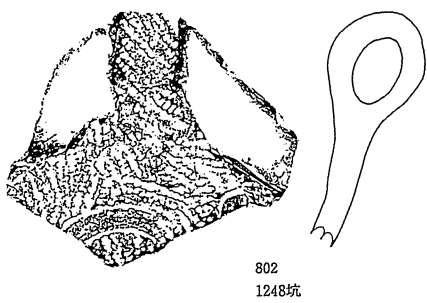
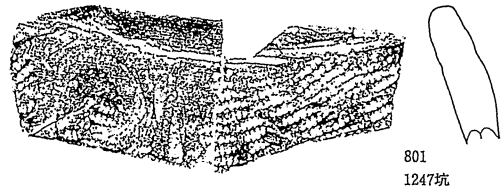
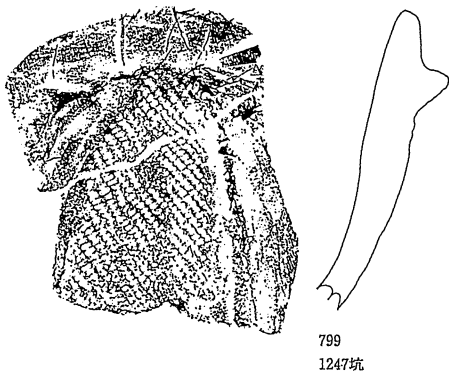
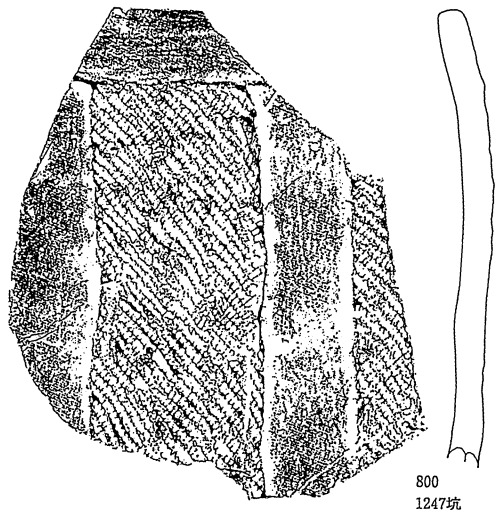
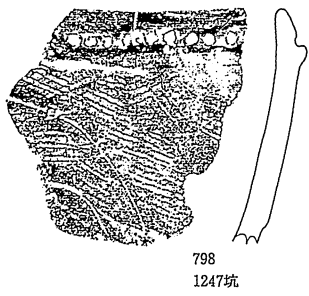
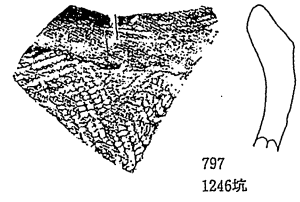
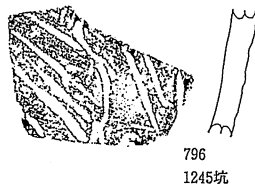
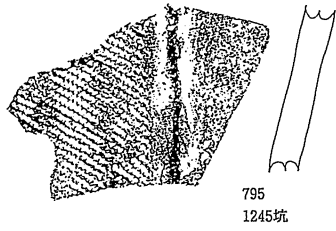

0 (1 : 3) 10 cm

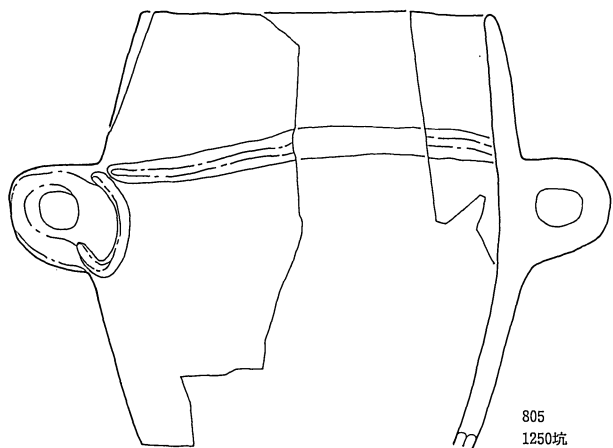

805  
1250坑

0 (1:4) 10cm

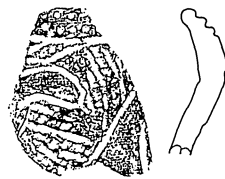

806  
1251坑



807  
1251坑



808  
1252坑

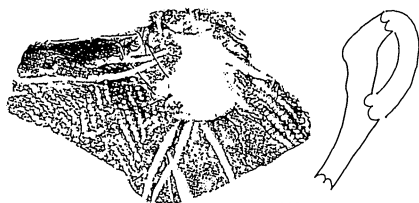

809  
1253坑

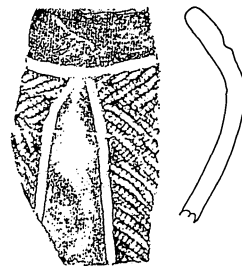

810  
1253坑

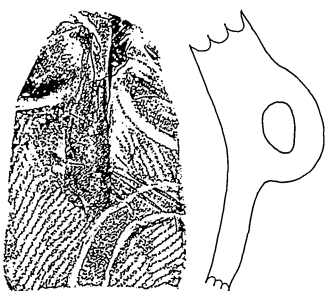

811  
1254坑

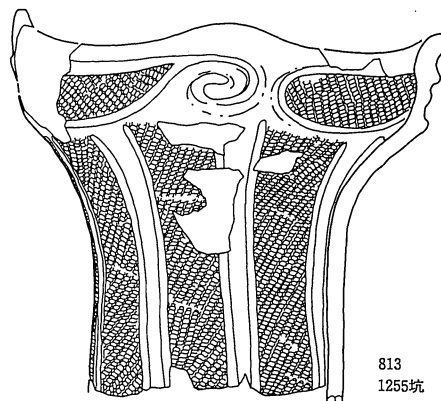

813  
1255坑

0 (1:4) 10cm



812  
1254坑

0 (1:3) 10cm

圖版177 土坑出土土器(3) (805、813 1:4、他 1:3)

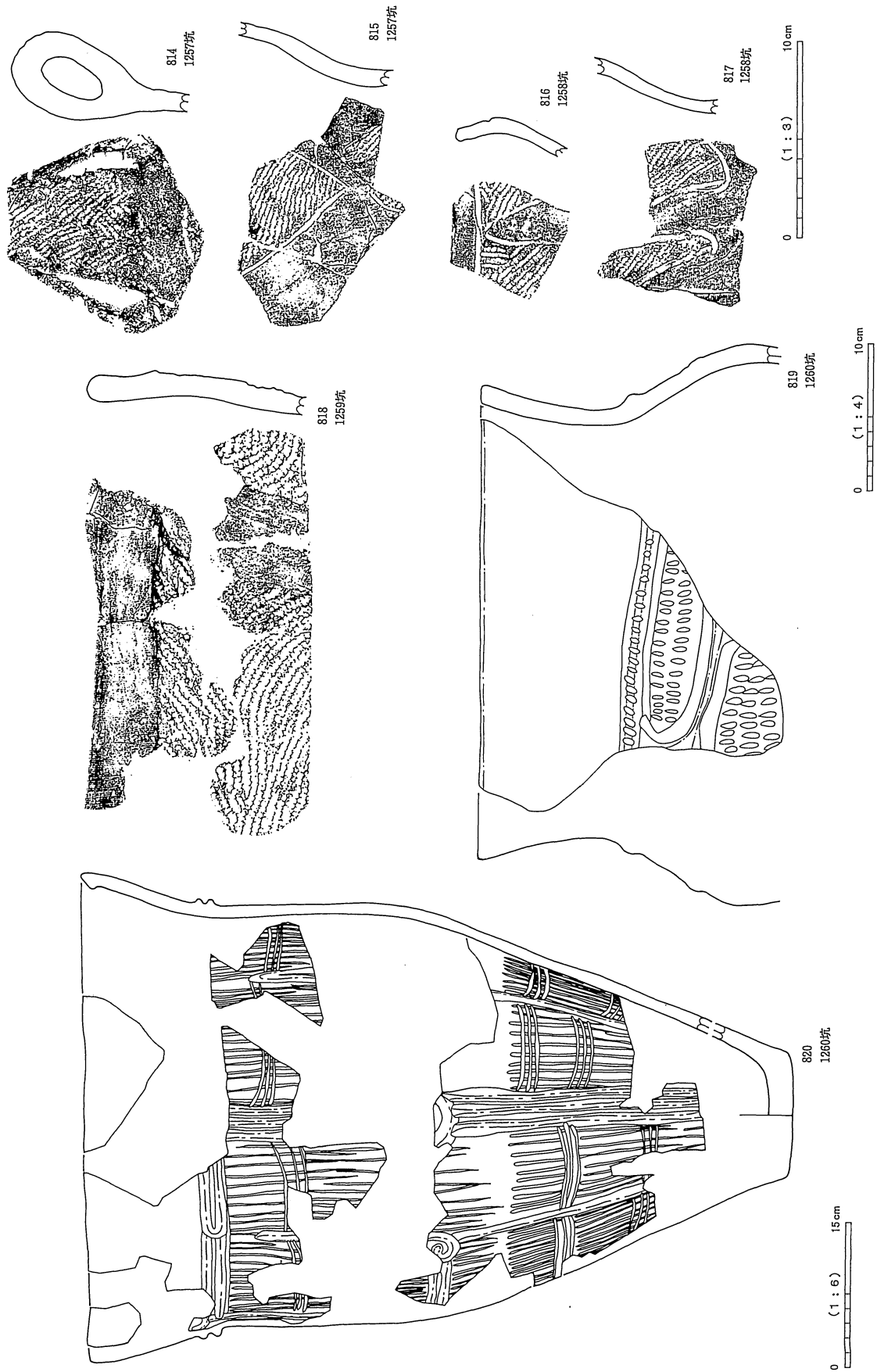

図版178 土坑出土土器(34) (819 1:4、820 1:6、他 1:3)

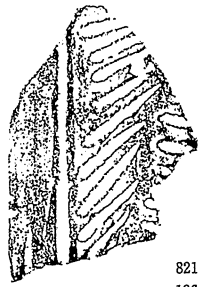

821  
1262坑

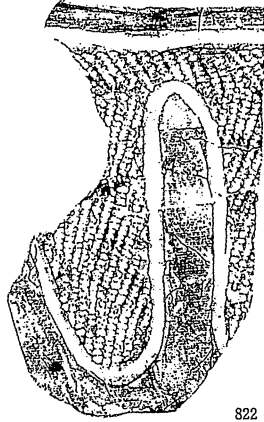

822  
1263坑

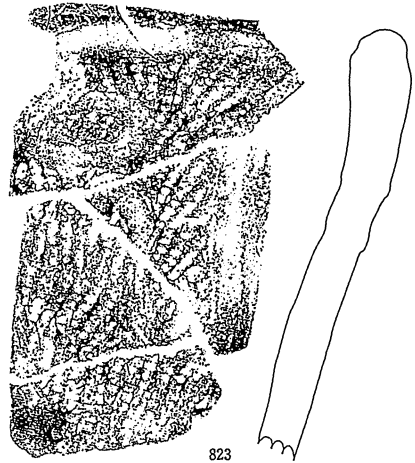

823  
1264坑



824  
1264坑

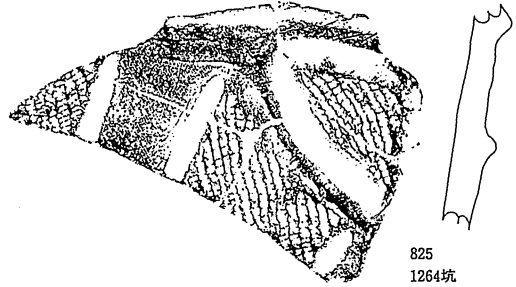

825  
1264坑

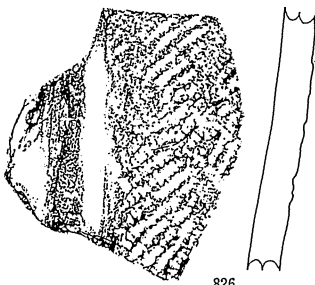

826  
1265坑

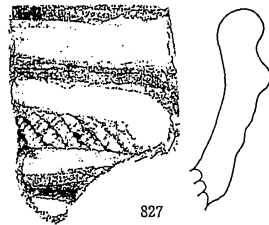

827  
1265坑

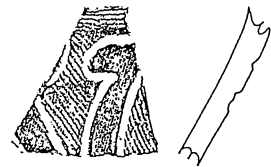

828  
1265坑



829  
1266坑



830  
1266坑

0 (1:3) 10cm

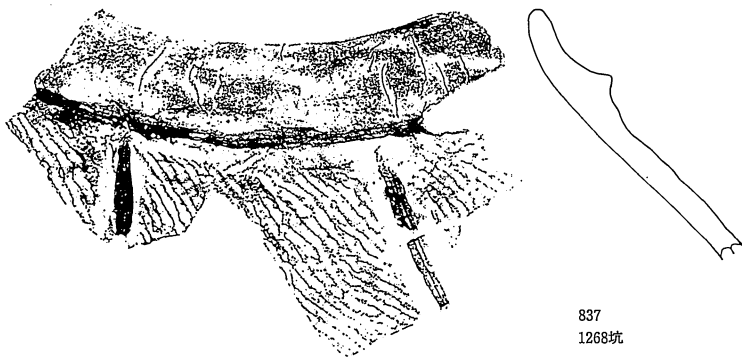
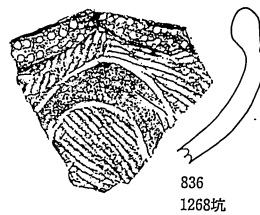
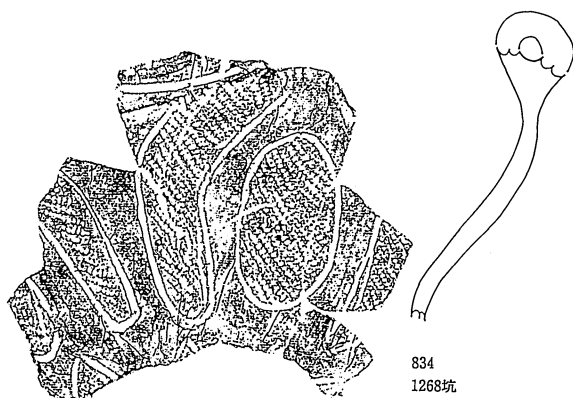
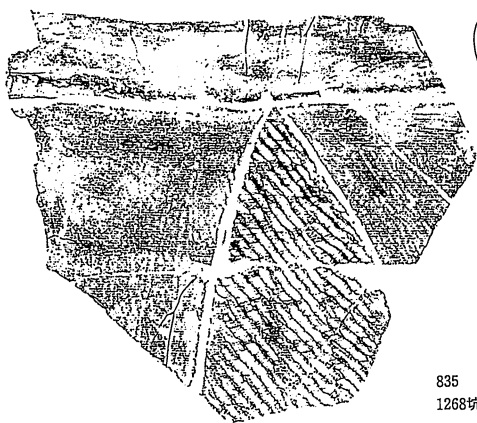
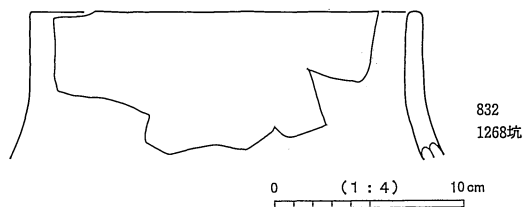
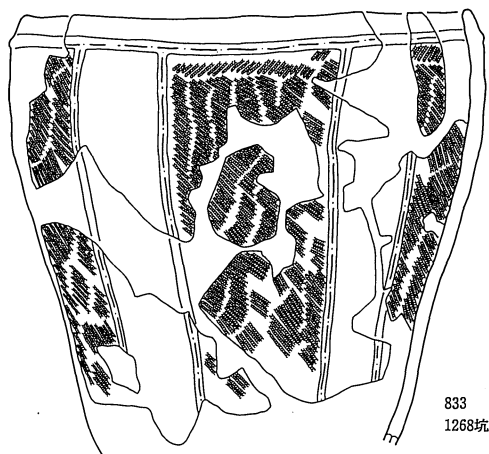
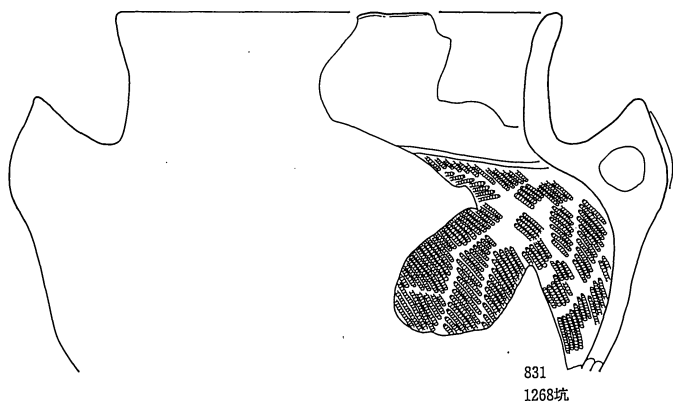

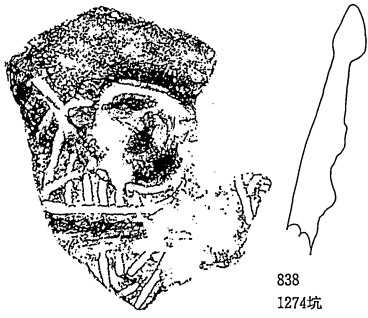

838  
1274坑

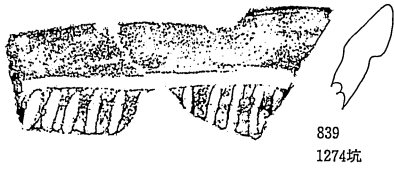

839  
1274坑

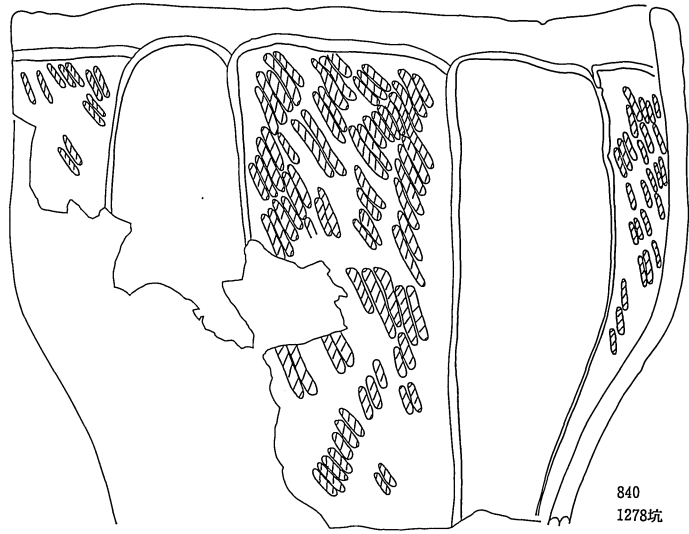

840  
1278坑

0 (1 : 4) 10 cm

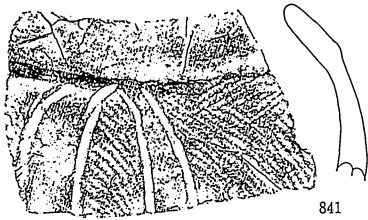

841  
1279坑

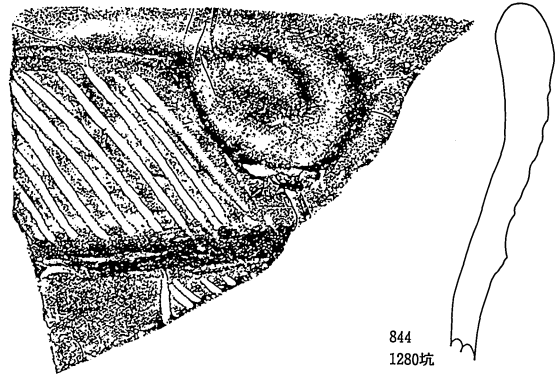

844  
1280坑

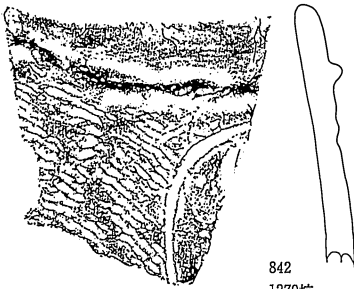

842  
1279坑

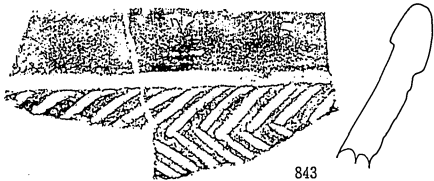

843  
1279坑

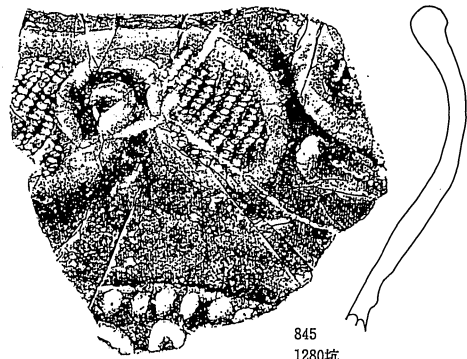

845  
1280坑

0 (1 : 3) 10 cm

図版181 土坑出土土器⑦ (840 1 : 4、他 1 : 3)



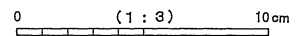
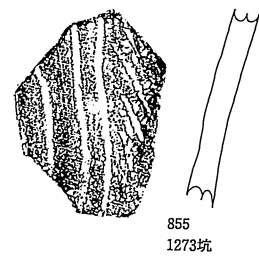
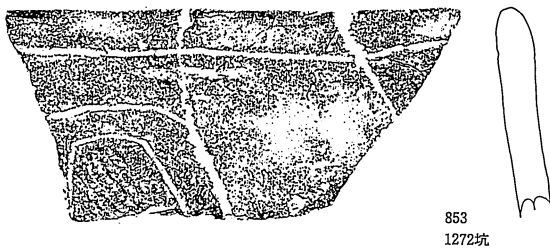
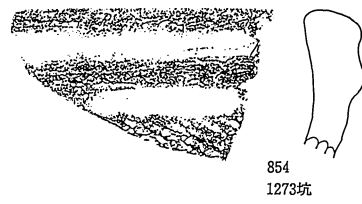
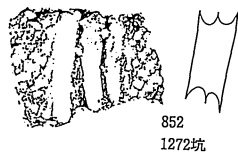
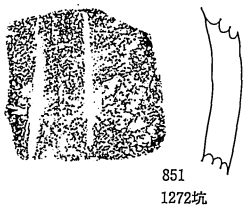
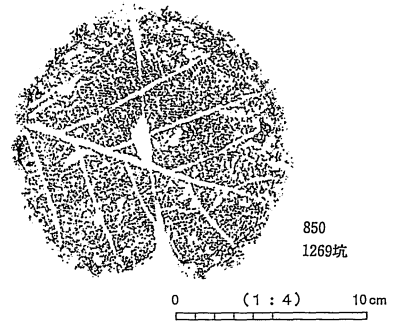
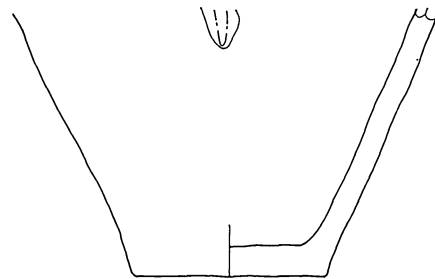
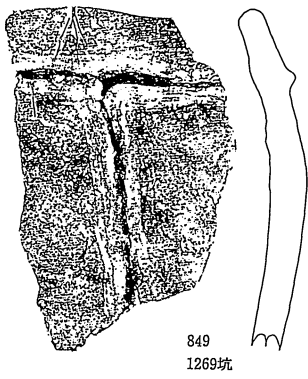
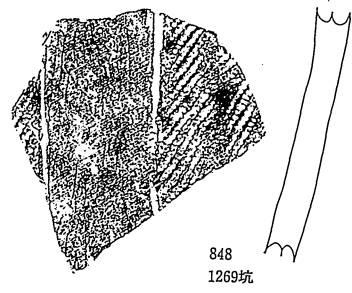
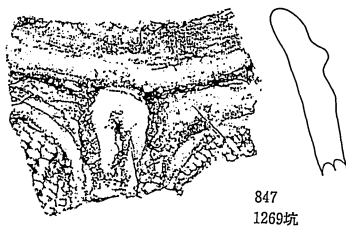
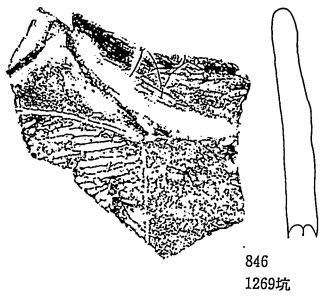

圖版182 土坑出土土器(8) (850 1 : 4、他 1 : 3)

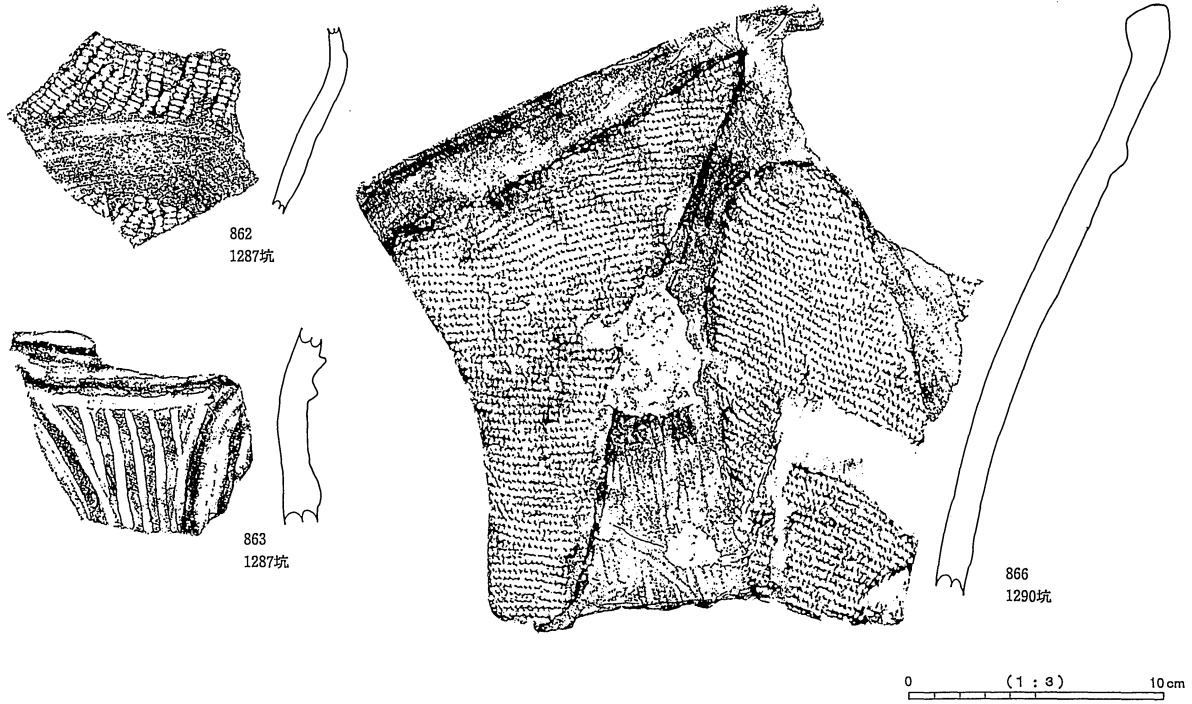
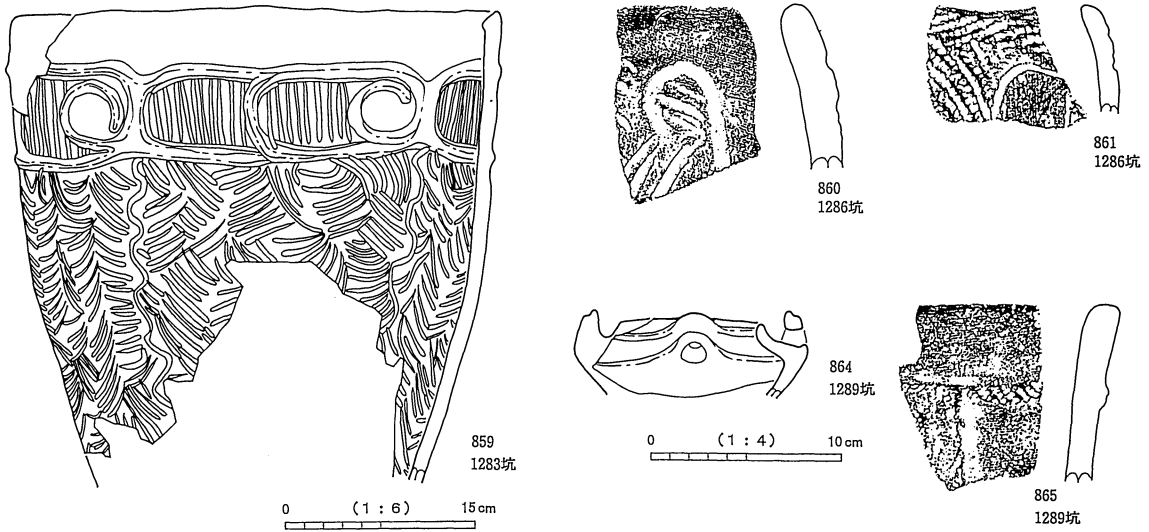
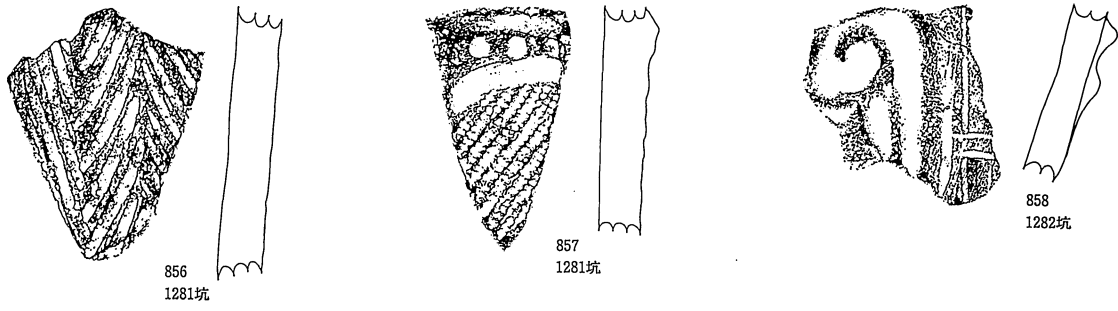

圖版183 土坑出土土器(39) (859 1:6、864 1:4、他 1:3)

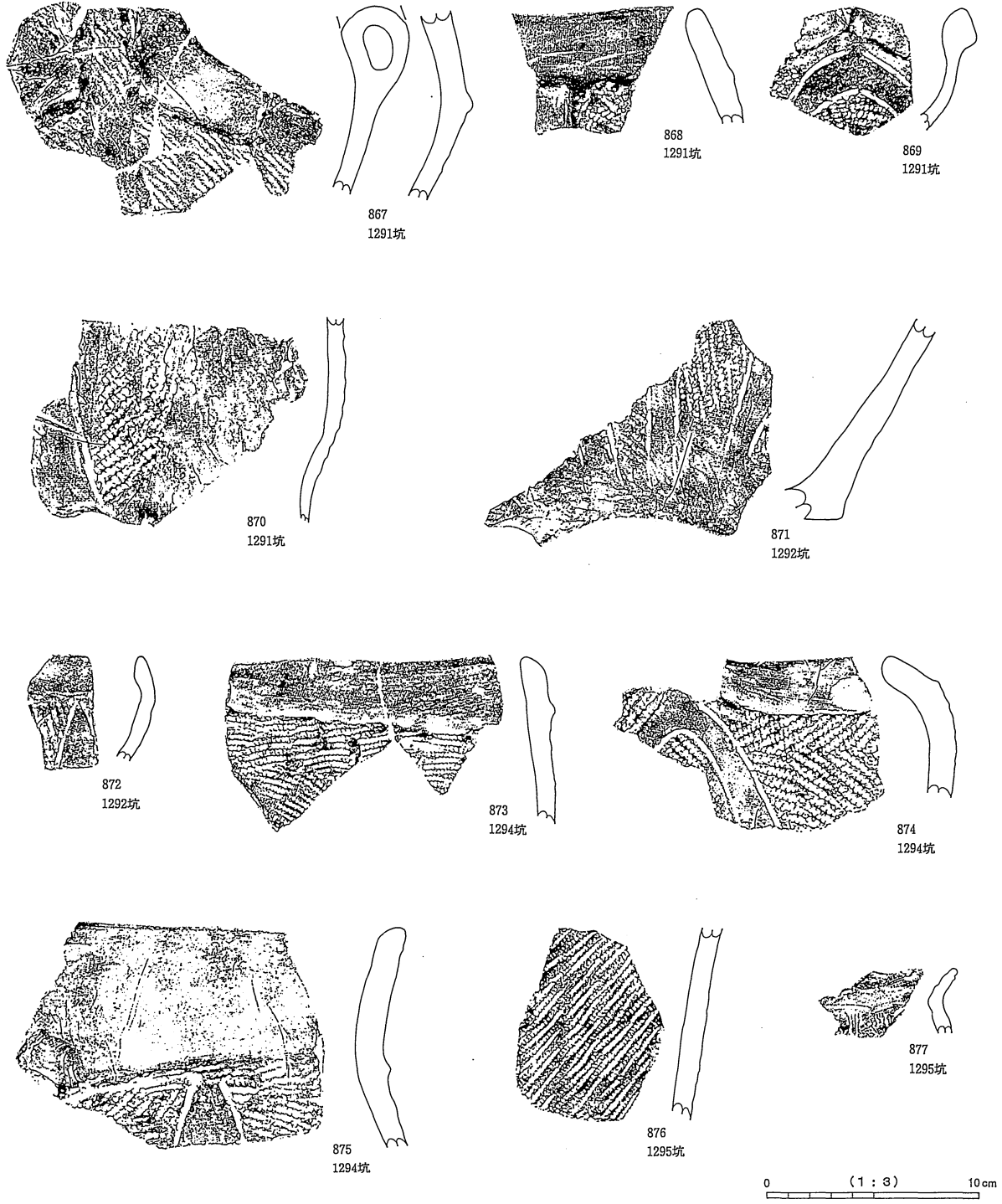

圖版184 土坑出土土器(40) (1:3)

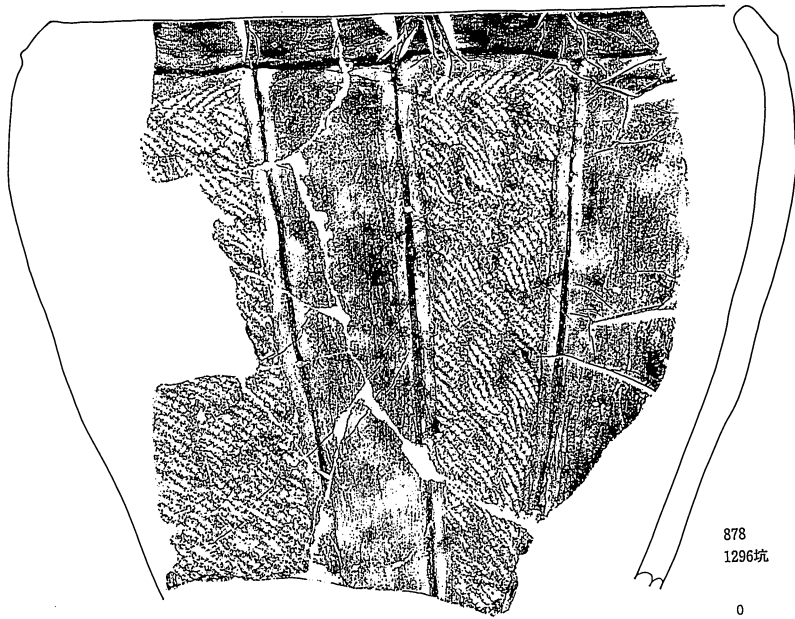

0 (1:4) 10 cm

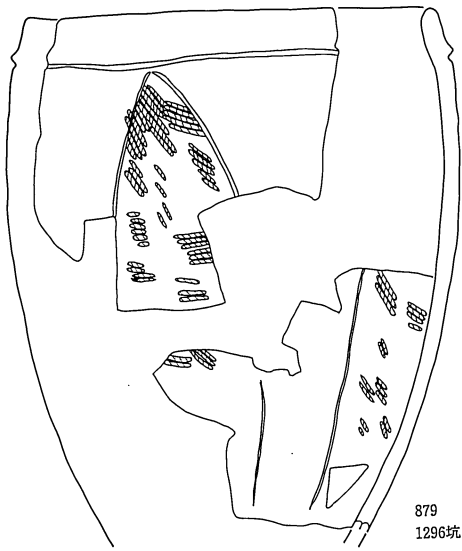

0 (1:6) 15 cm

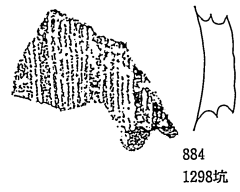
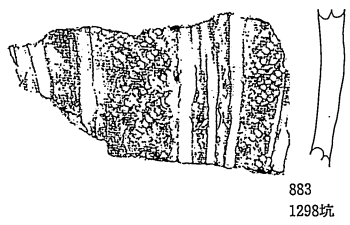
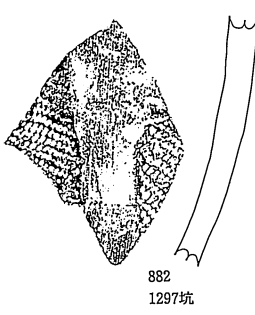
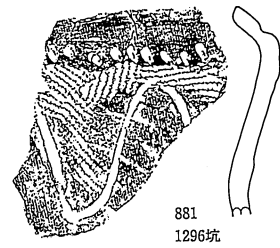
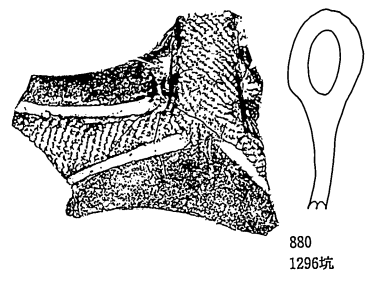

0 (1:3) 10 cm

圖版185 土坑出土土器(1) (878 1:4、879 1:6、他 1:3)

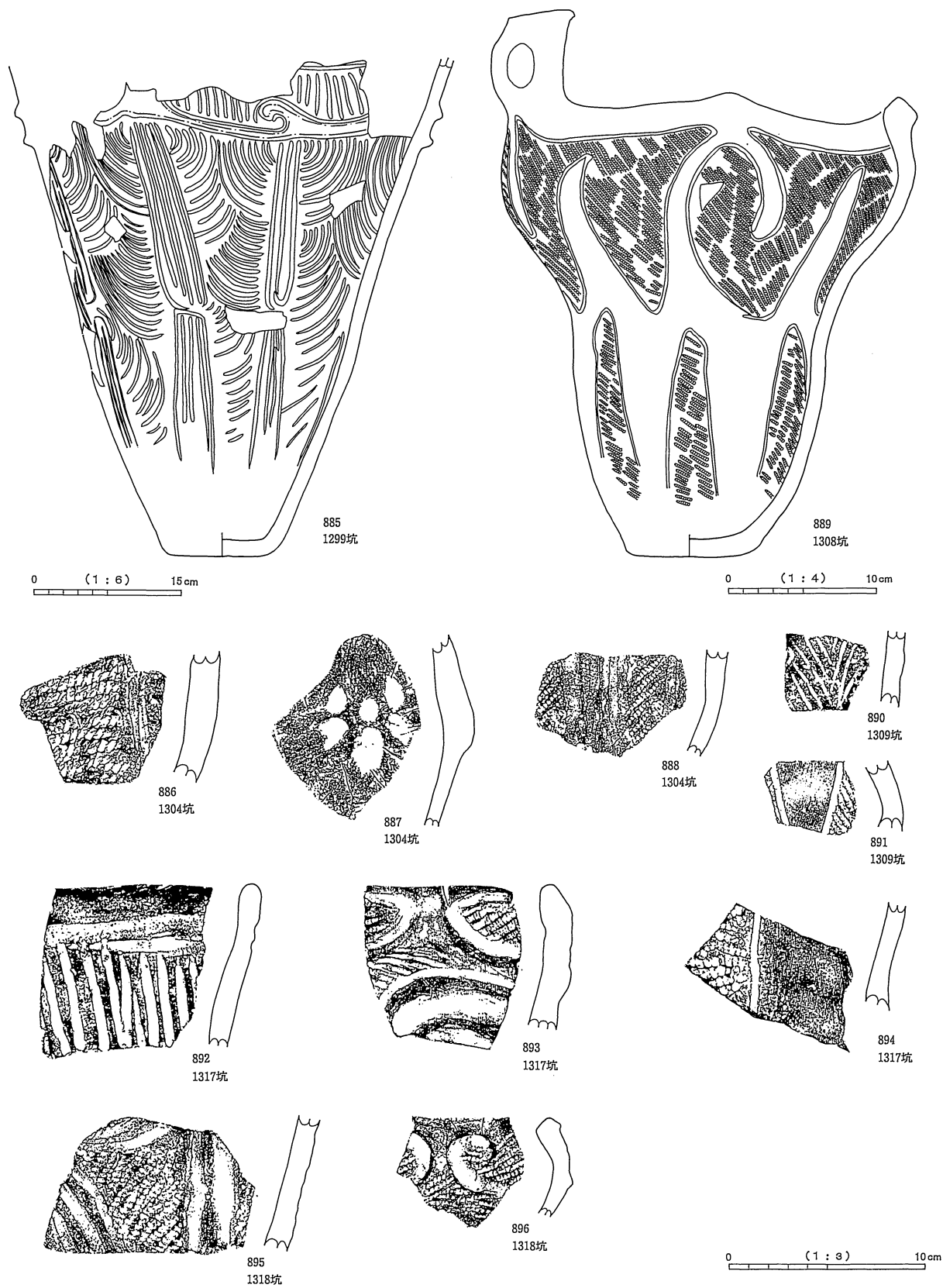

圖版186 土坑出土土器(4) (885 1:6、889 1:4、他 1:3)

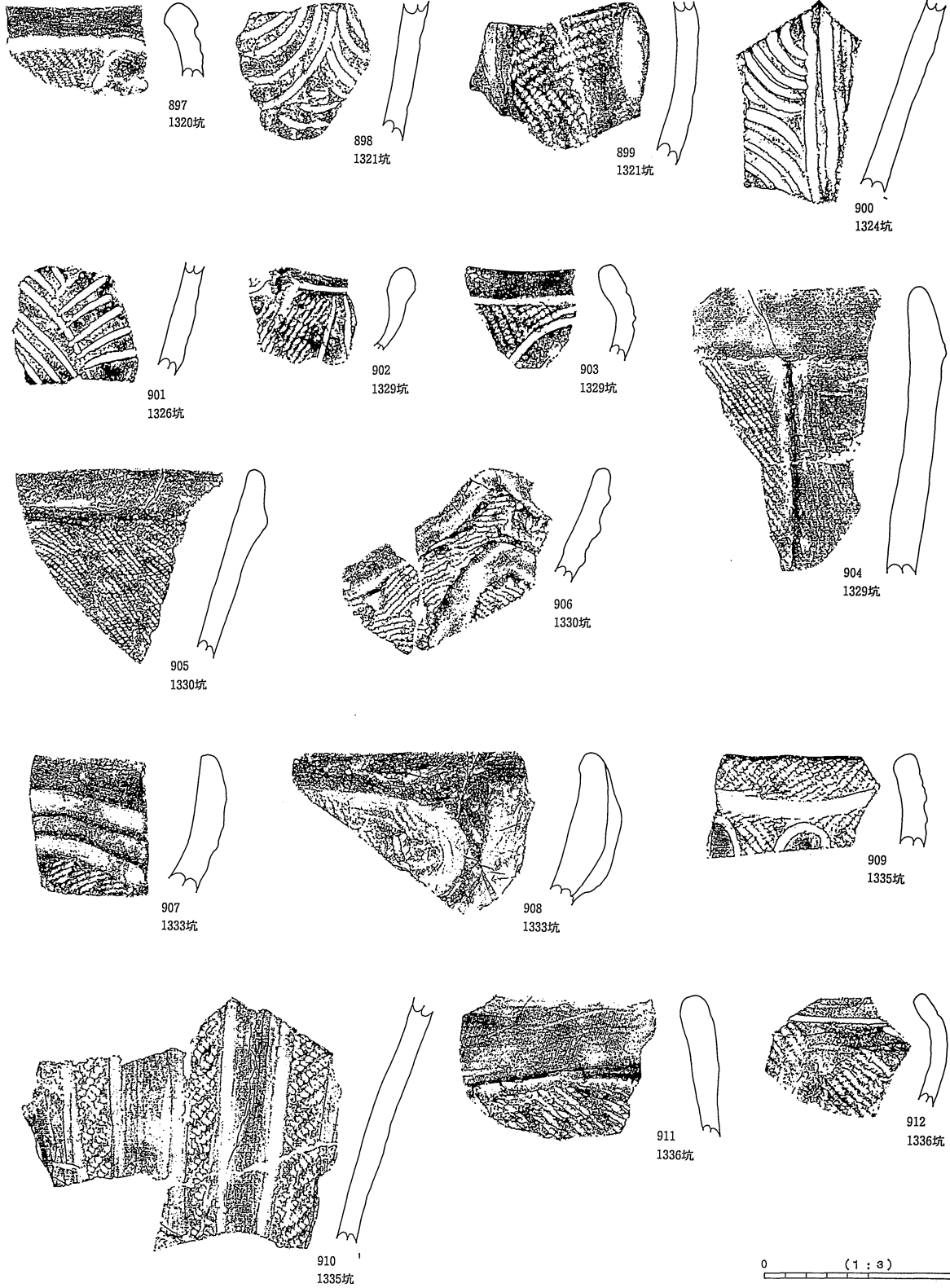

圖版187 土坑出土土器(43) (1:3)

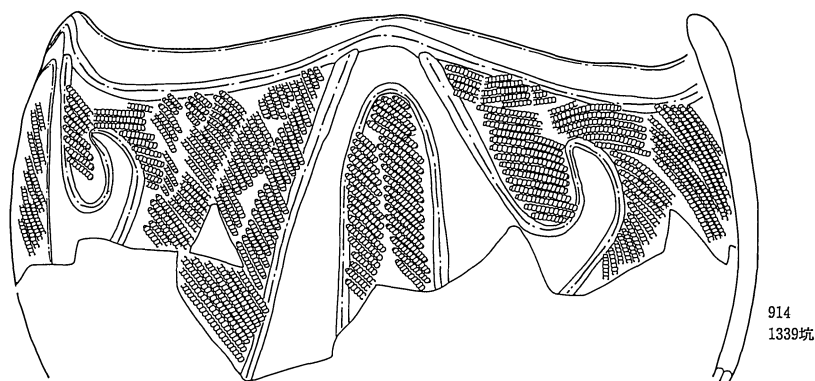
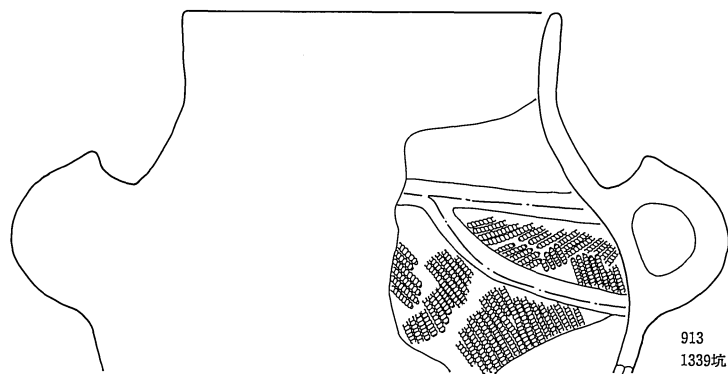

0 (1 : 4) 10 cm

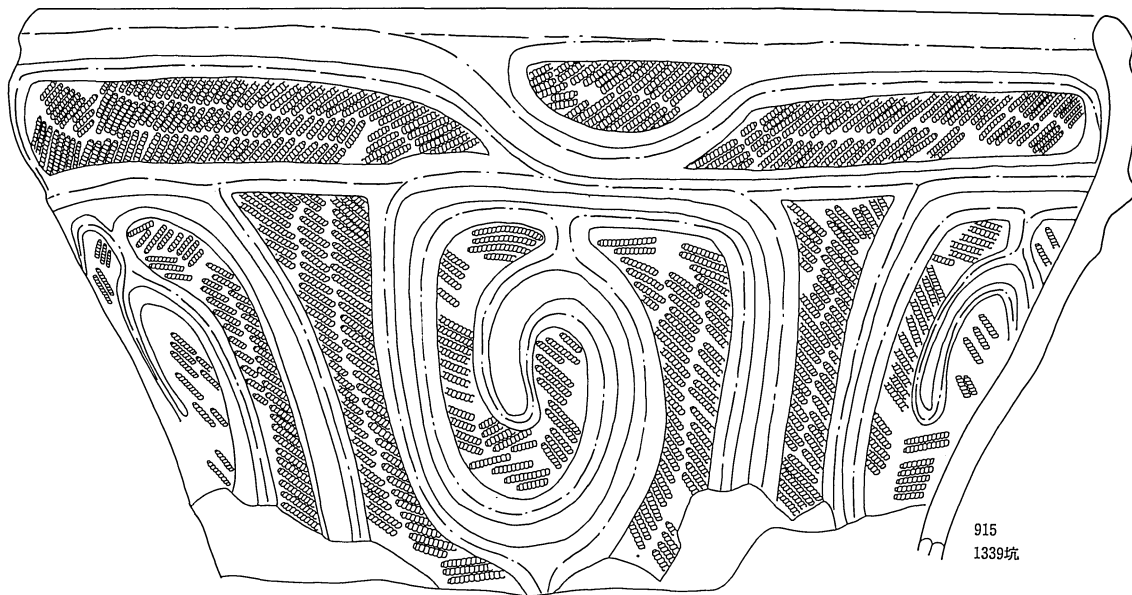

0 (1 : 6) 15 cm

圖版188 土坑出土土器(4) (913·914 1 : 4、915 1 : 6)

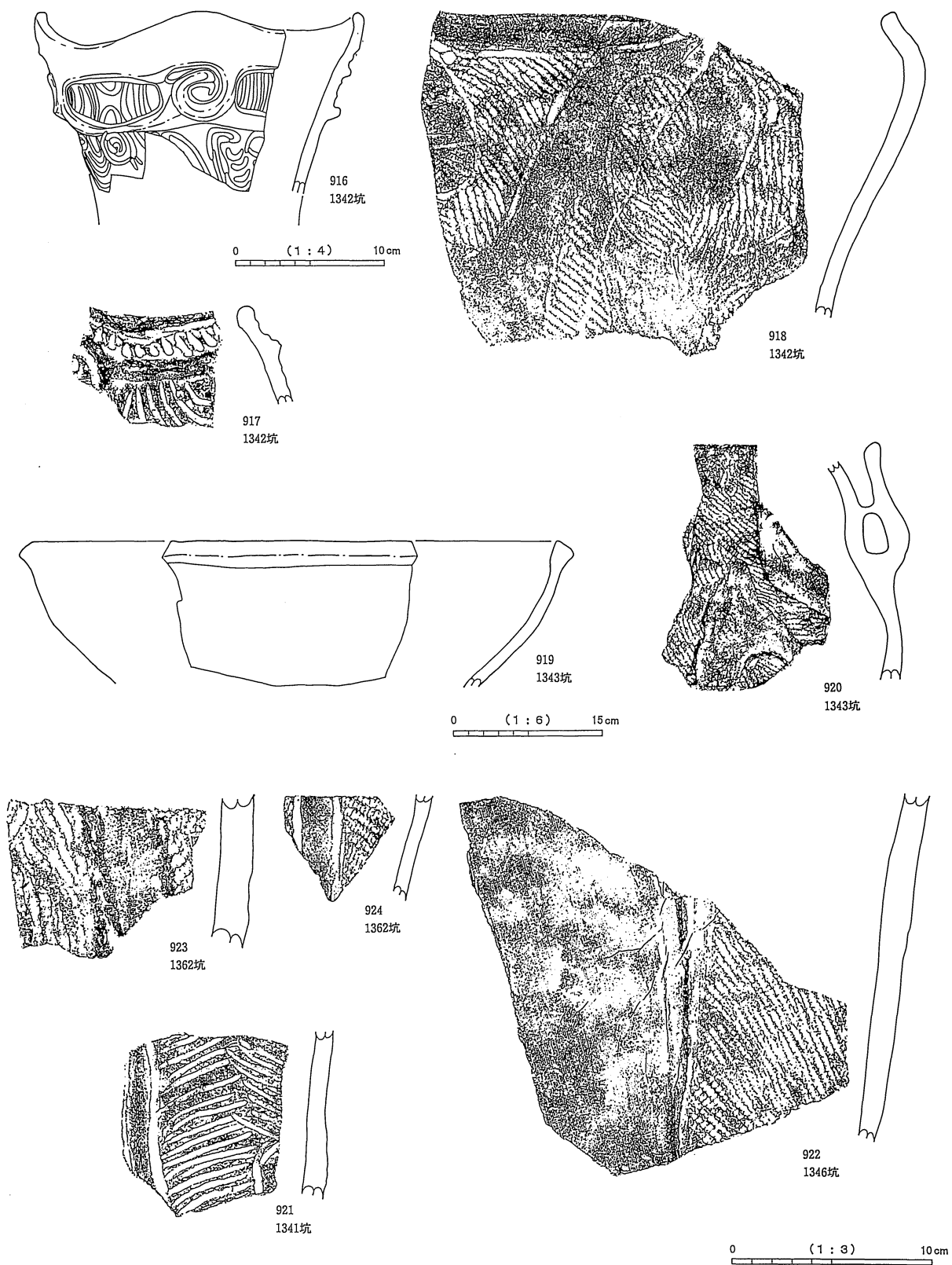

圖版189 土坑出土土器(45) (916 1:4、919 1:6、他 1:3)



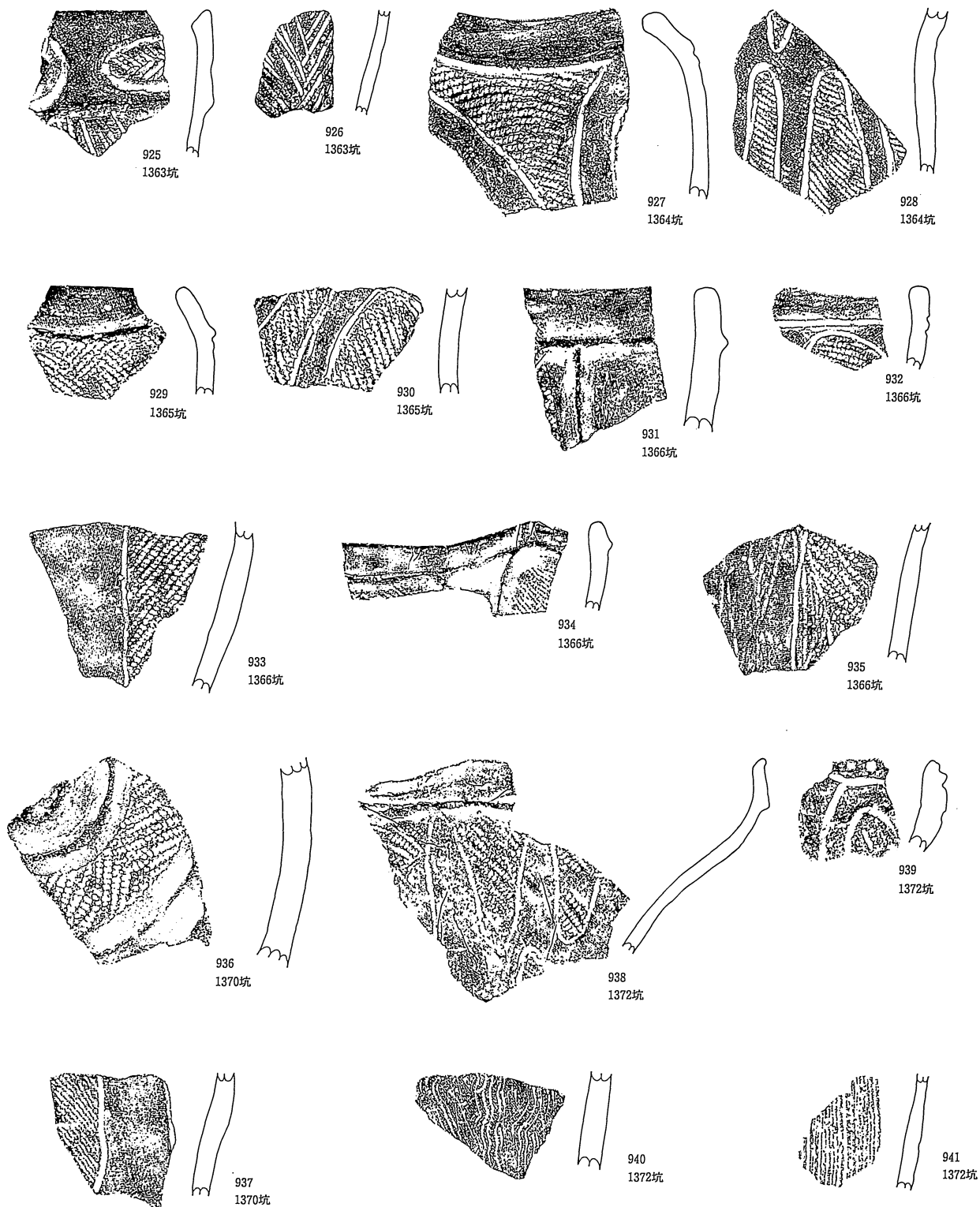

0 (1 : 3) 10 cm



942  
1374坑

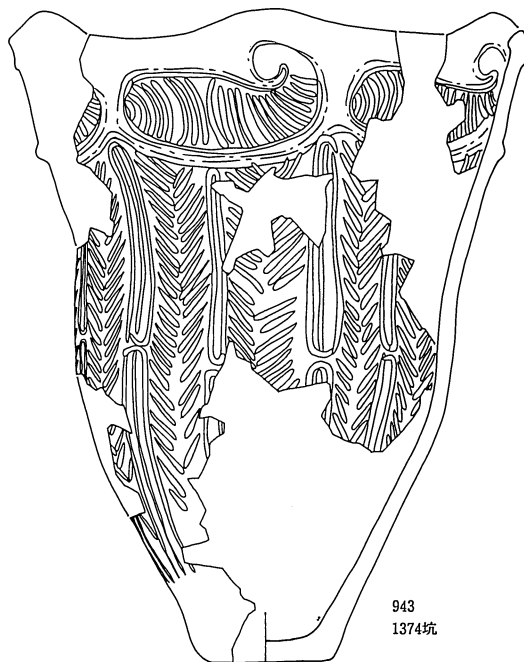

943  
1374坑

0 (1:6) 15cm

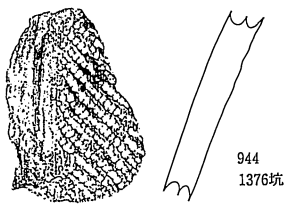

944  
1376坑

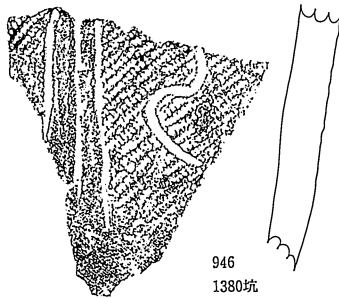

946  
1380坑

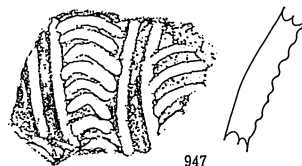

947  
1380坑

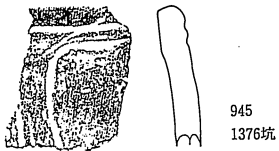

945  
1376坑

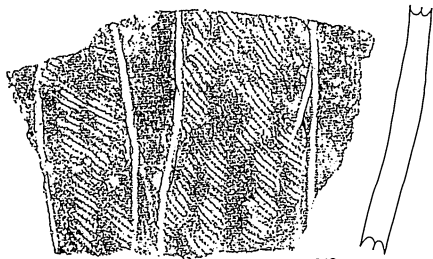

948  
1381坑



949  
1381坑

0 (1:3) 10cm

図版191 土坑出土土器(47) (942・943 1:6、他 1:3)

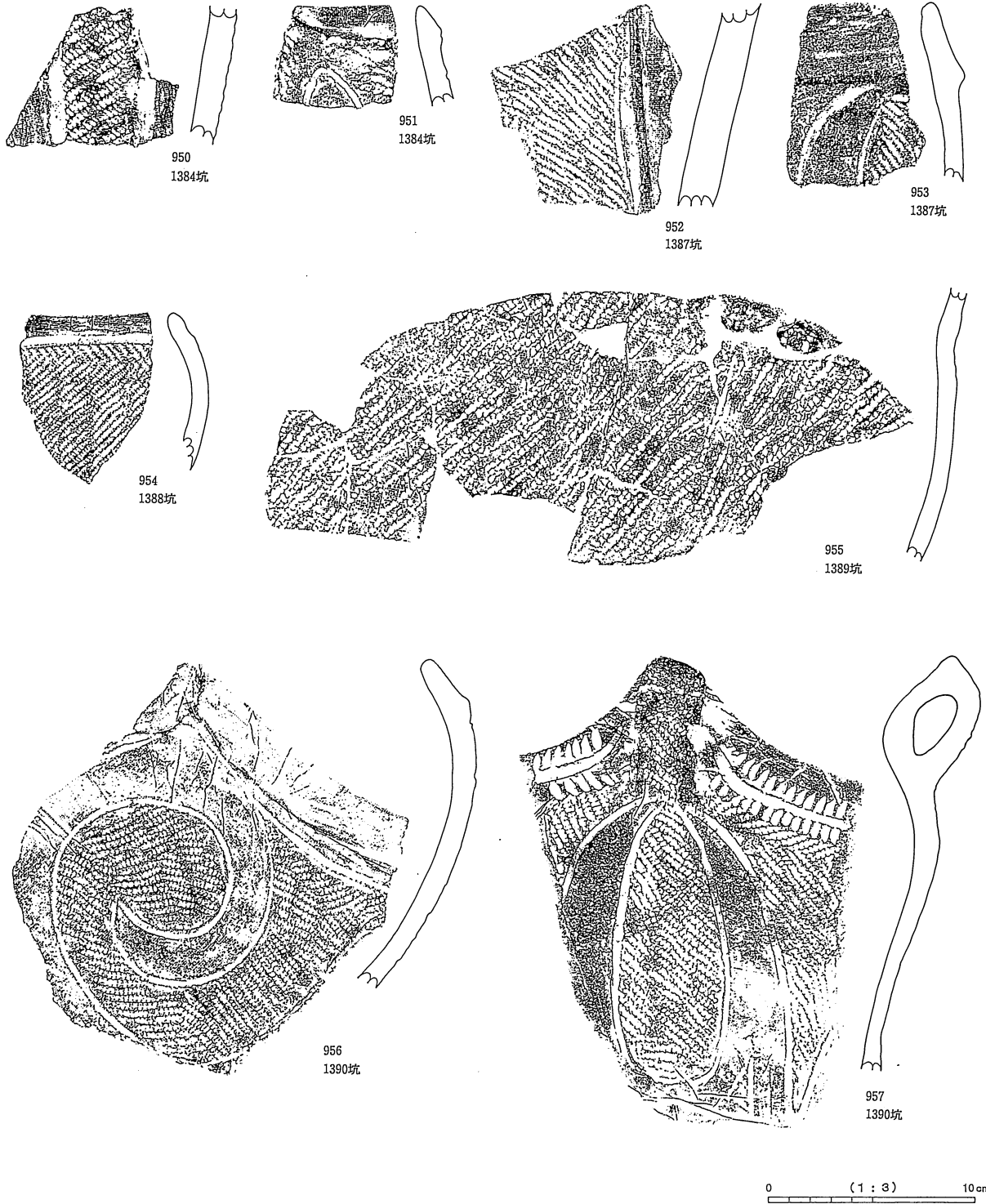

図版192 土坑出土土器(4) (1:3)



958  
1390坑

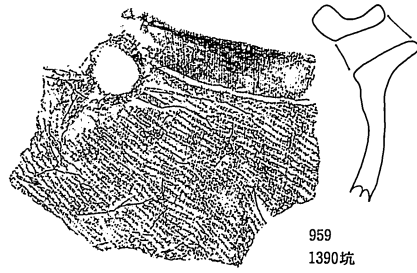

959  
1390坑

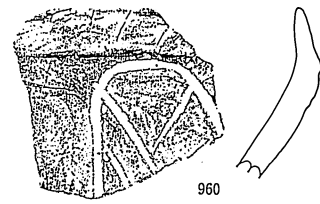

960  
1390坑

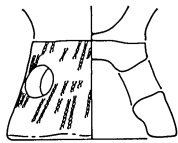

961  
1392坑

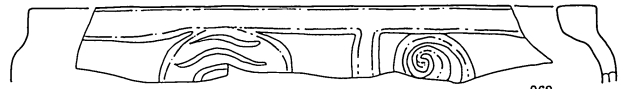

962  
1392坑

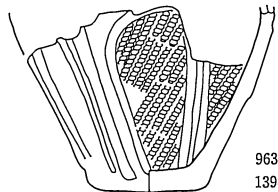

963  
1394坑



967  
集石1

0 (1:4) 10cm

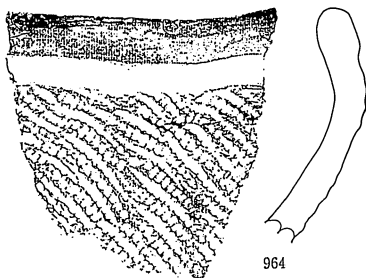

964  
1410坑

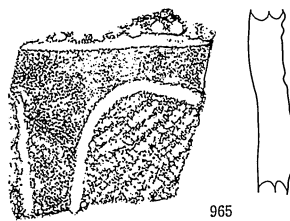

965  
1413坑



966  
1413坑

0 (1:3) 10cm

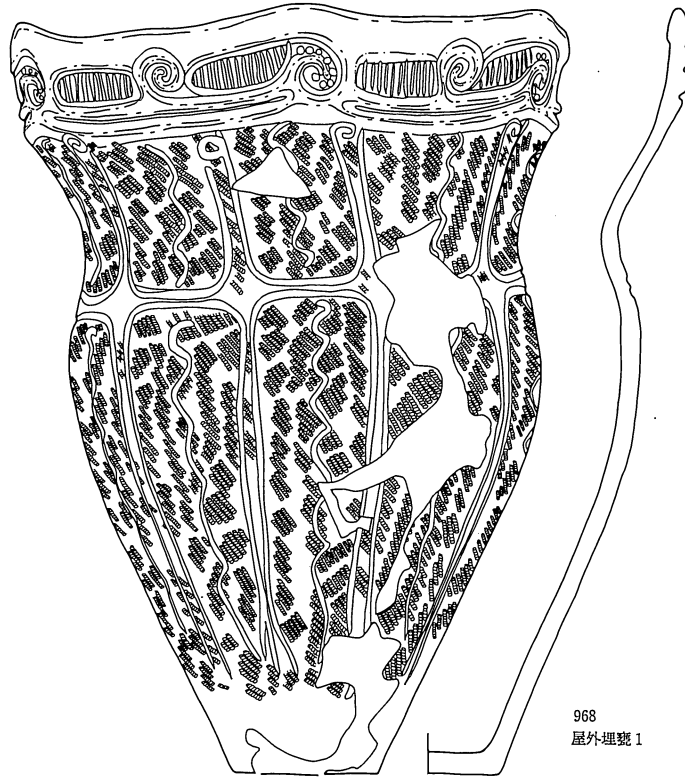

968  
屋外埋甕 1

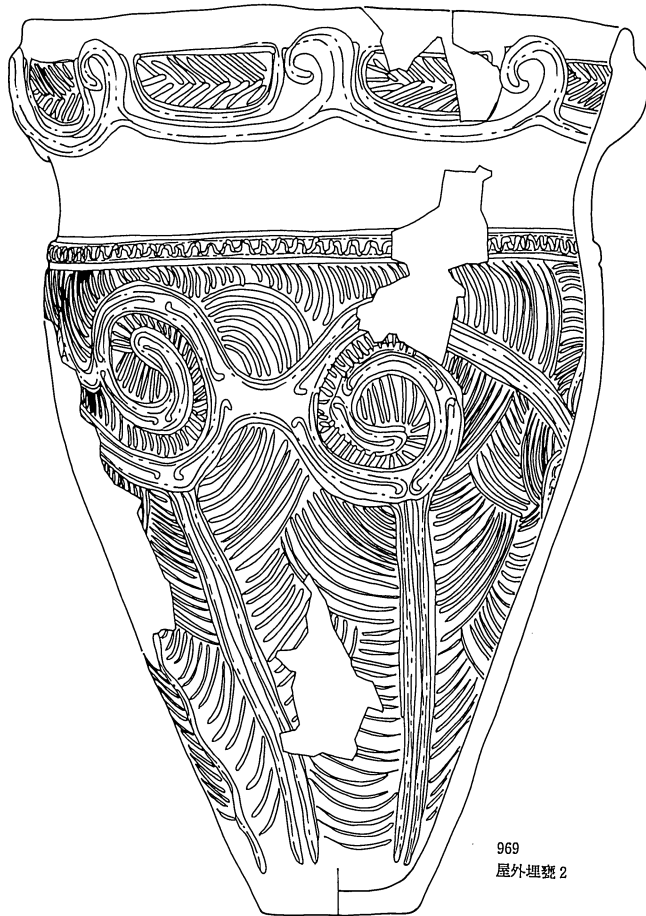

969  
屋外埋甕 2

0 (1 : 6) 15 cm

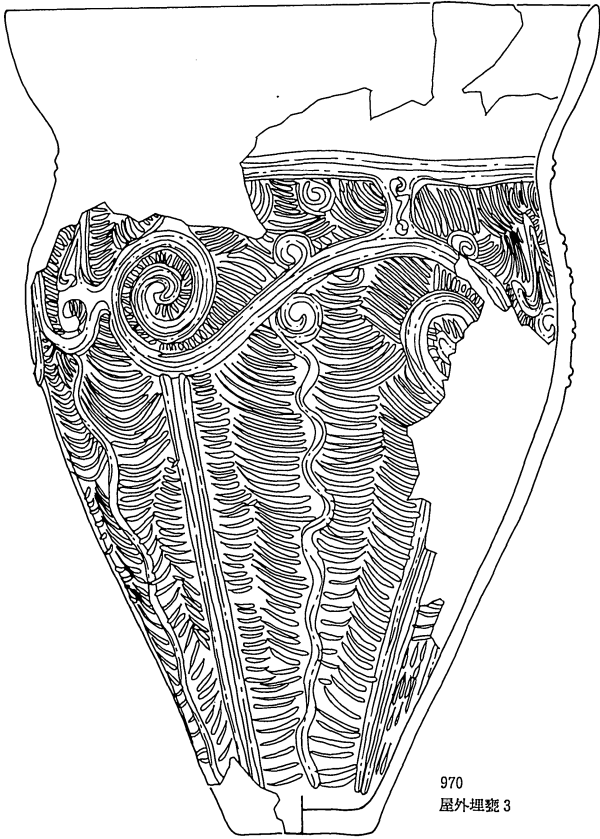

970  
屋外埋甕 3

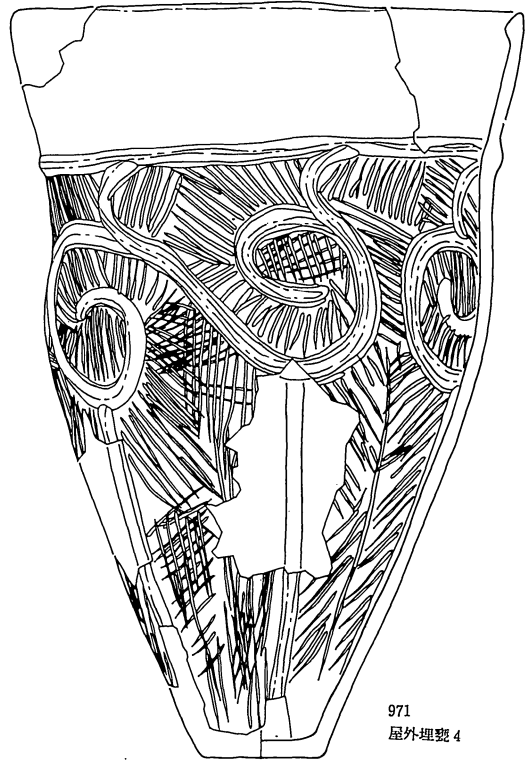

971  
屋外埋甕 4



972  
屋外埋甕 5

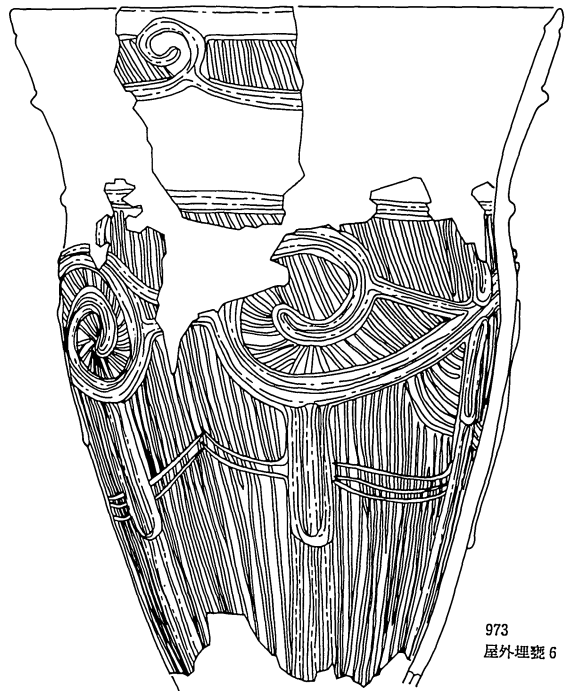

973  
屋外埋甕 6

0 (1 : 6) 15cm

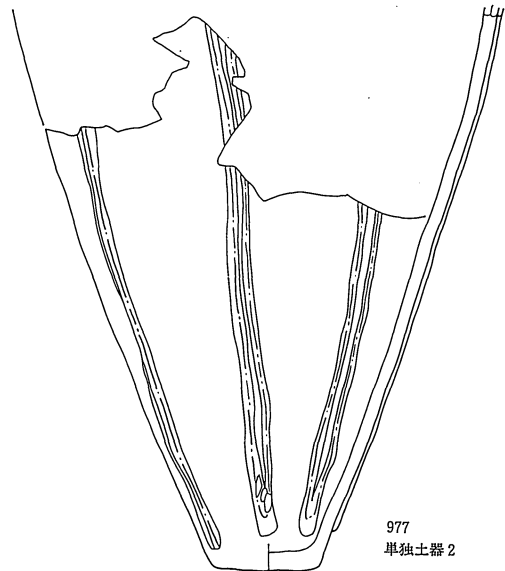
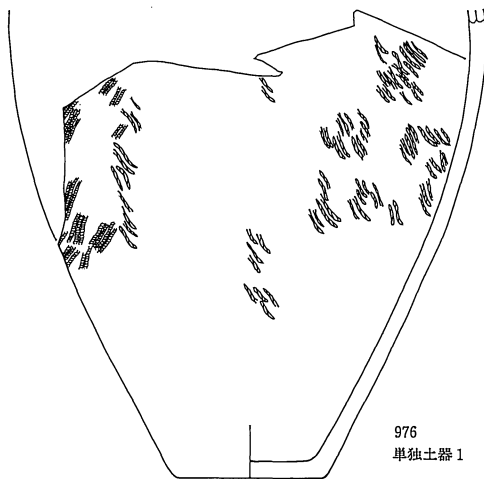
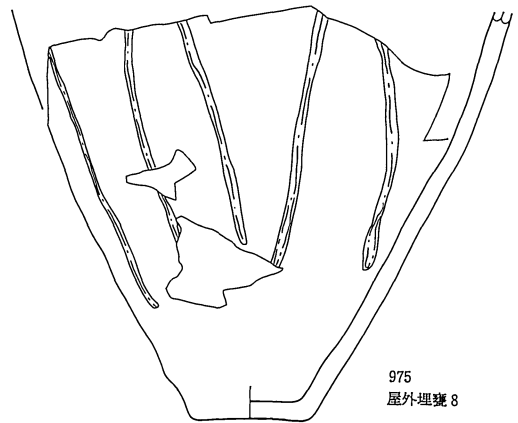
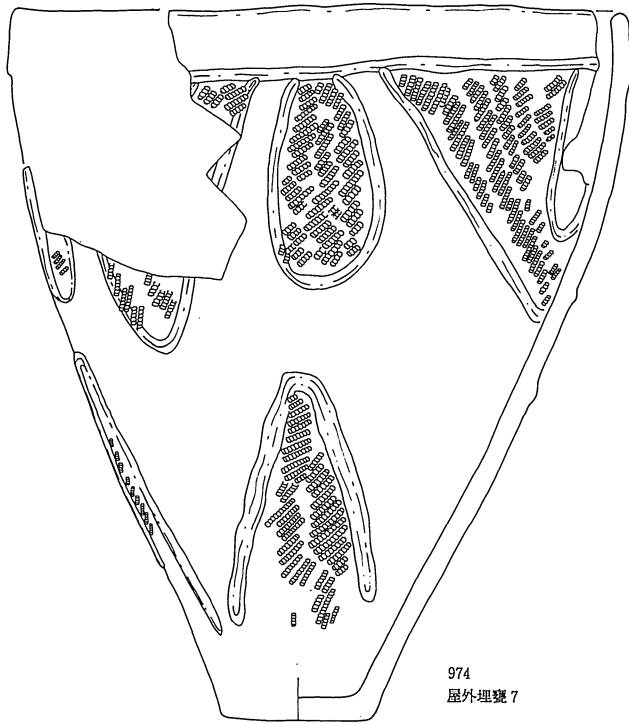

0 (1 : 6) 15 cm

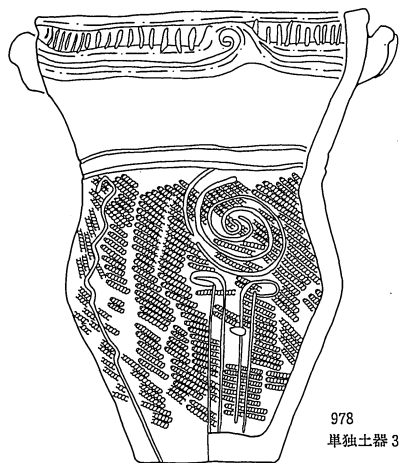

978  
单独土器 3

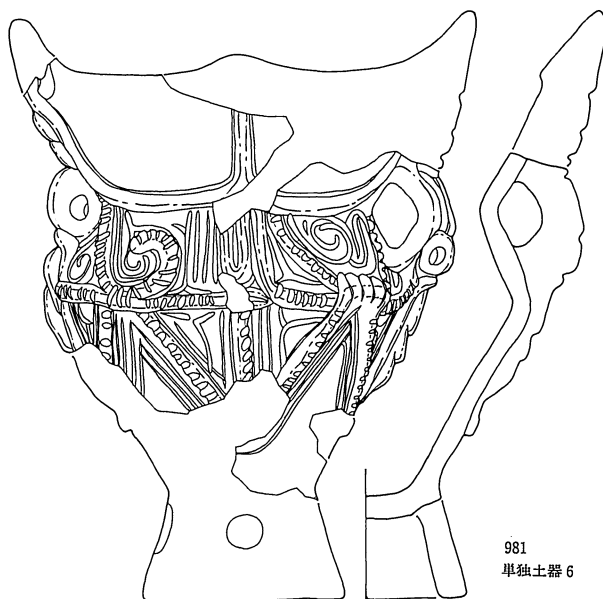

981  
单独土器 6

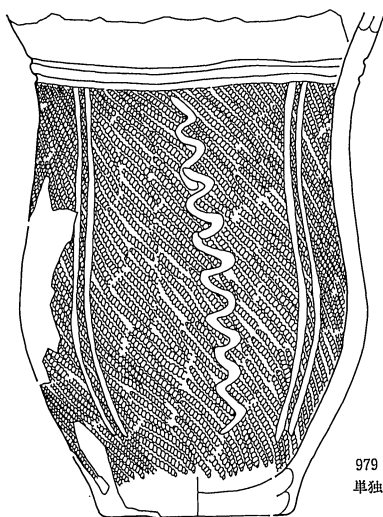

979  
单独土器 4

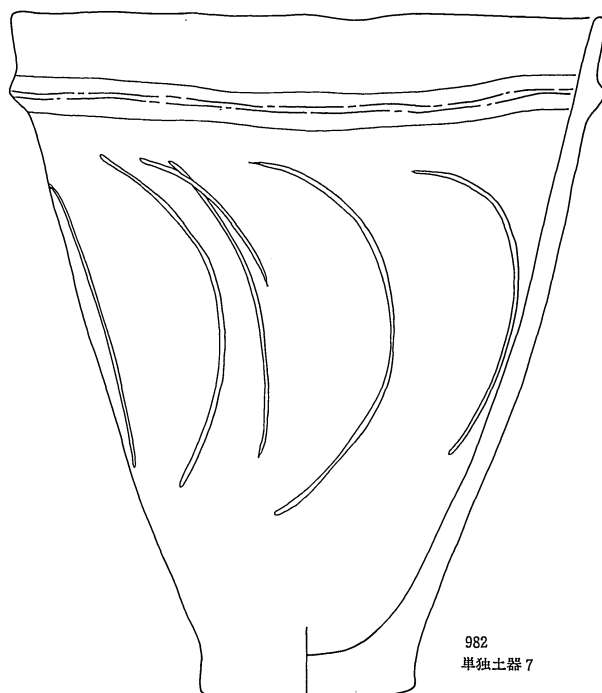

982  
单独土器 7

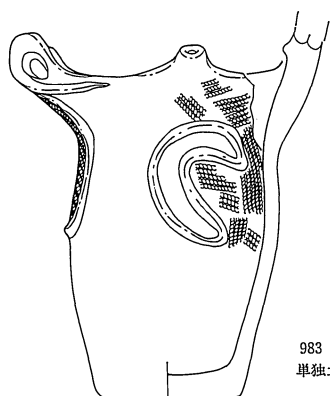

983  
单独土器 8

0 (1:4) 10cm



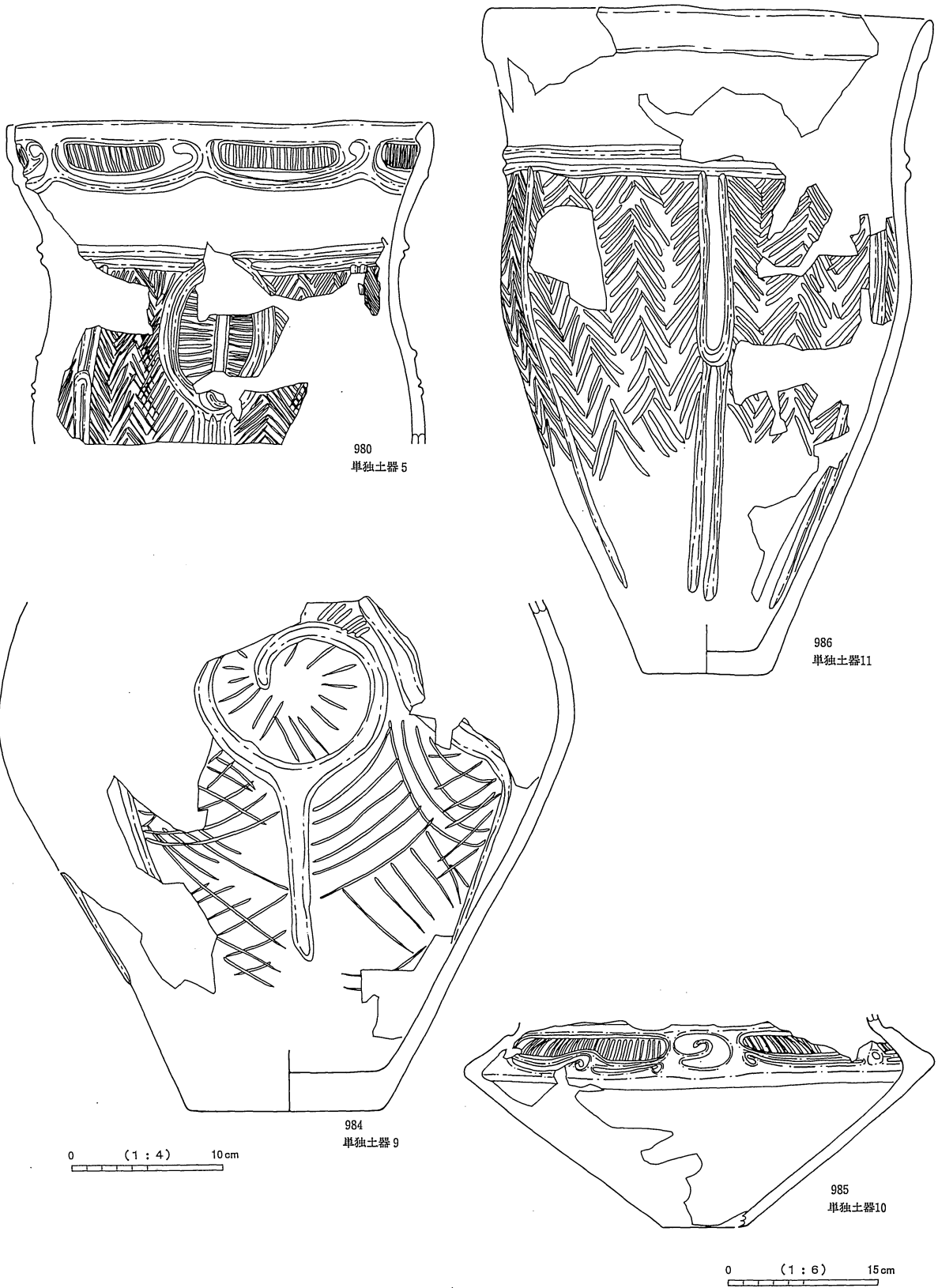

図版198 单独土器 5、9、10、11 (984 1:4、他 1:6)

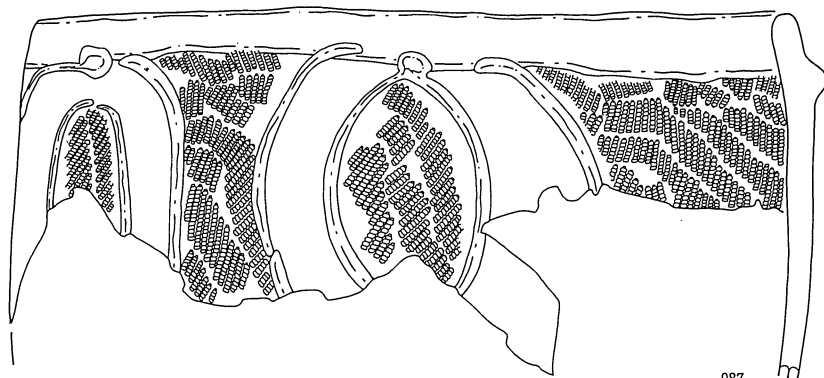

987  
土器集中1

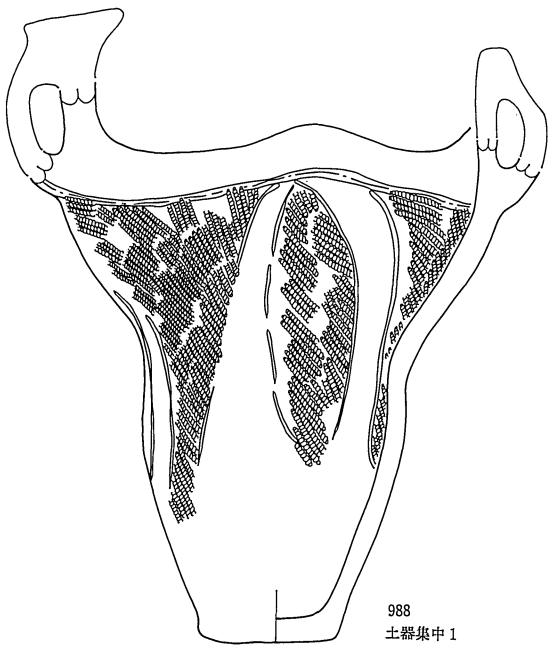

988  
土器集中1

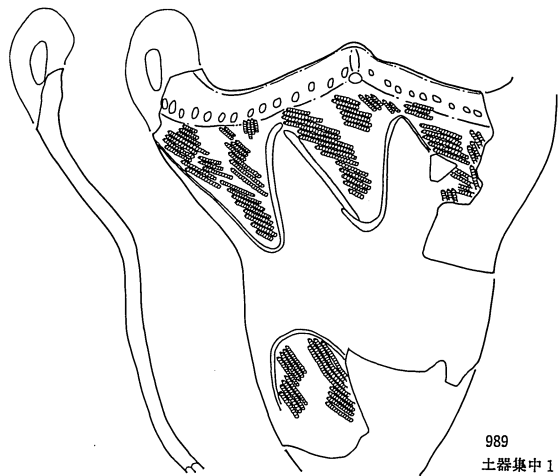

989  
土器集中1

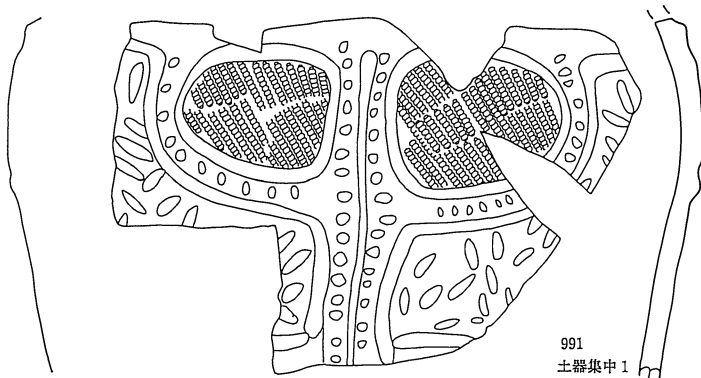

991  
土器集中1

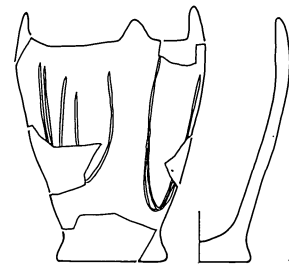

990  
土器集中1

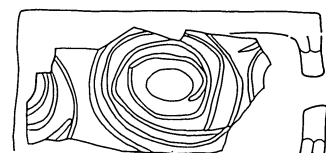

992  
土器集中1

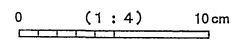

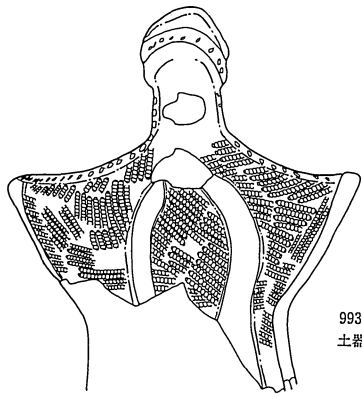
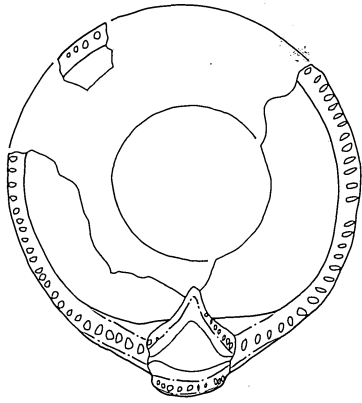

993  
土器集中1



994  
土器集中1

0 (1:6) 15cm

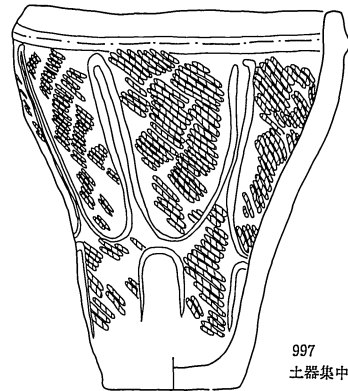

997  
土器集中2

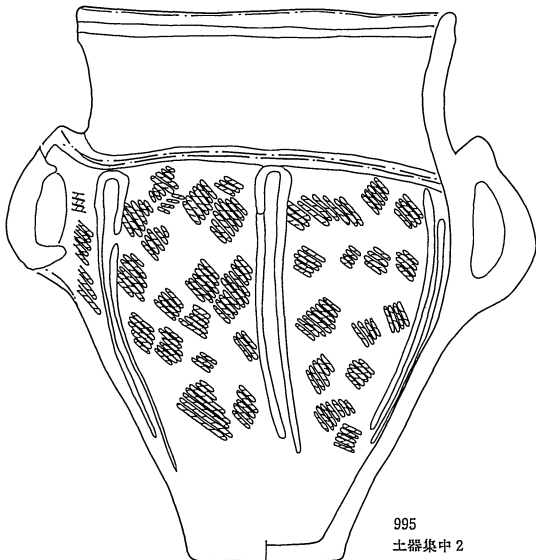

995  
土器集中2

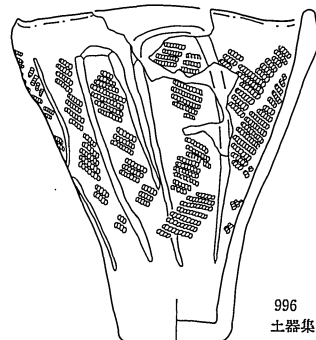

996  
土器集中2

0 (1:4) 10cm

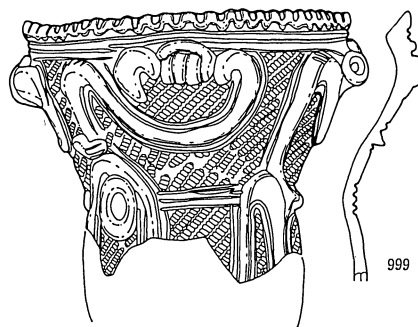
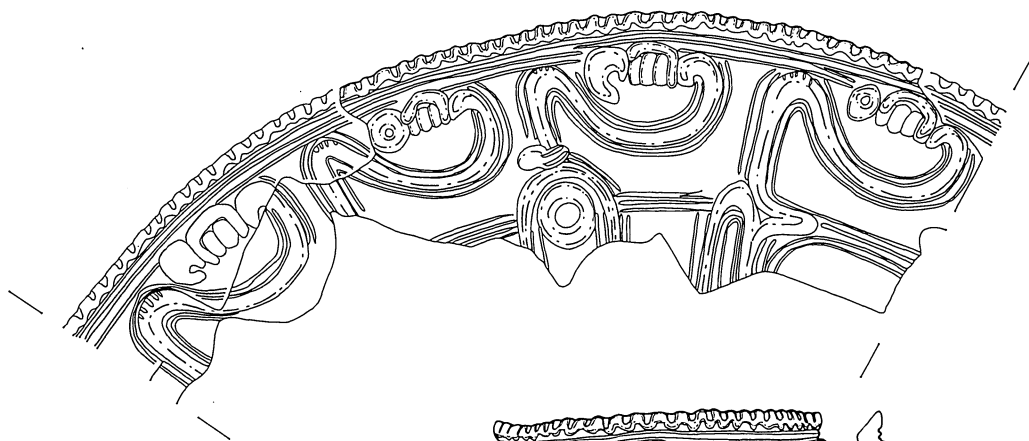
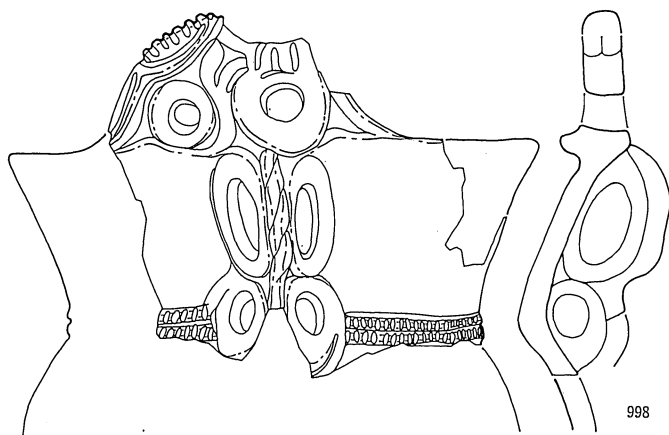
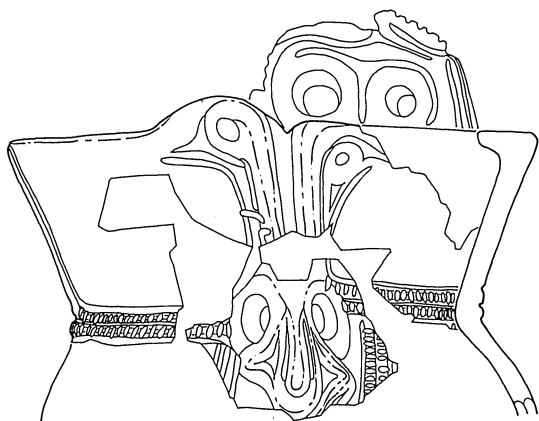

0 (1 : 4) 10 cm

図版201 遺構外出土土器(1) (1 : 4)

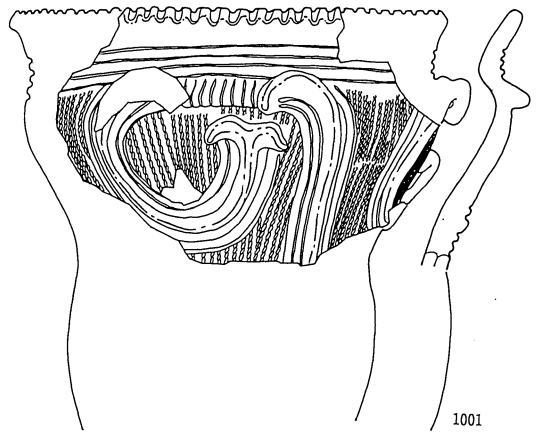
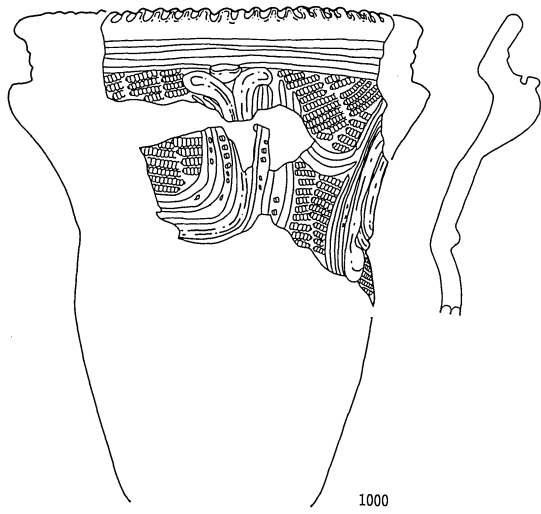

0 (1 : 4) 10 cm

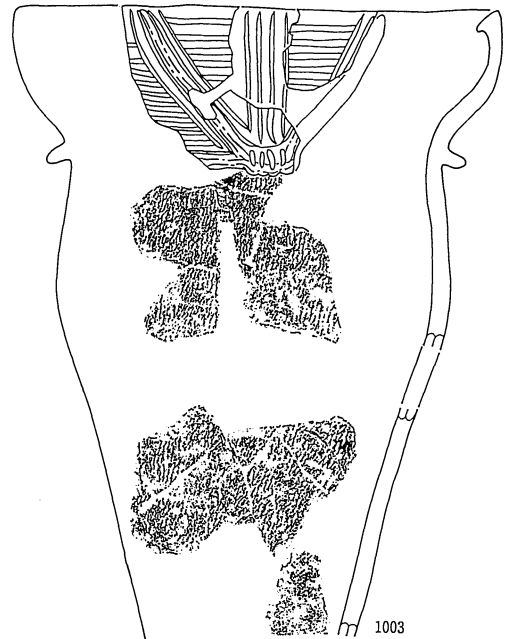

0 (1 : 6) 15 cm

図版202 遺構外出土土器(2) (1000・1001 1 : 4、1002・1003 1 : 6)

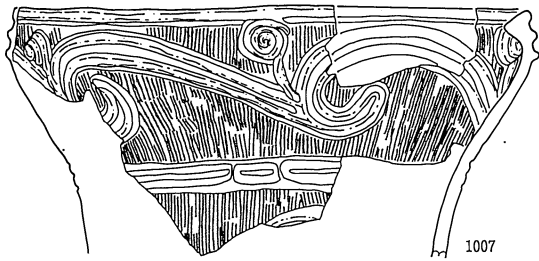
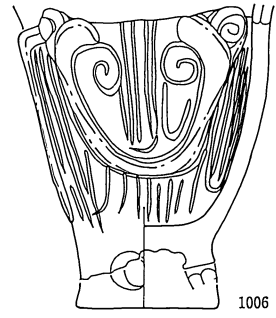
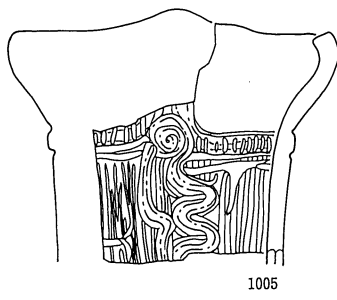
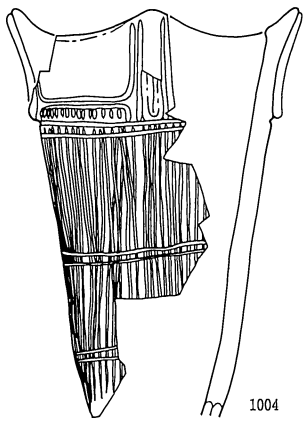

0 (1 : 6) 15cm

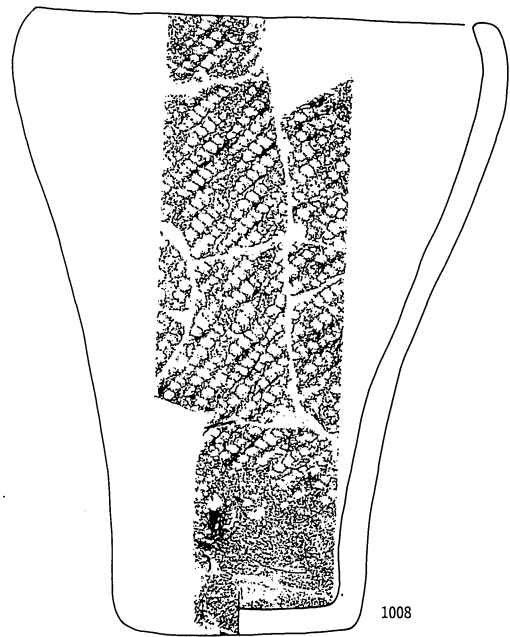

0 (1 : 4) 10cm

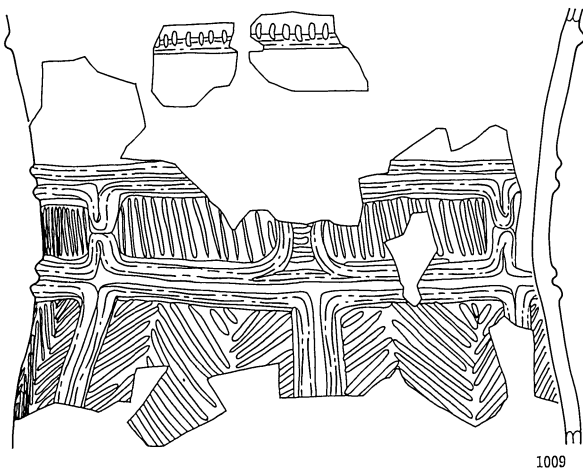

0 (1 : 4) 10cm

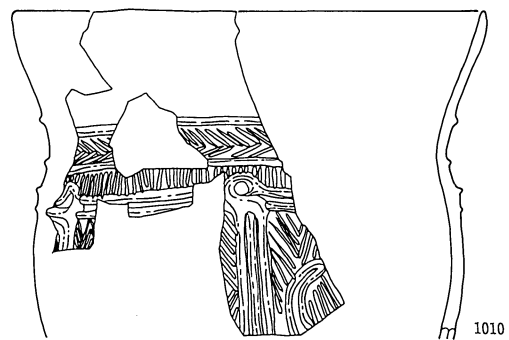

0 (1 : 6) 15cm

図版203 遺構外出土土器(3) (1007・1010、1 : 6、他 1 : 4)

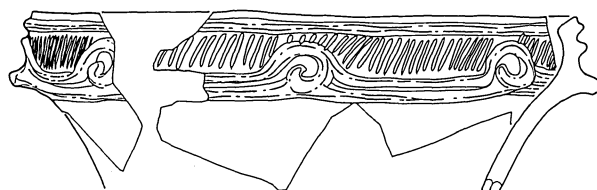
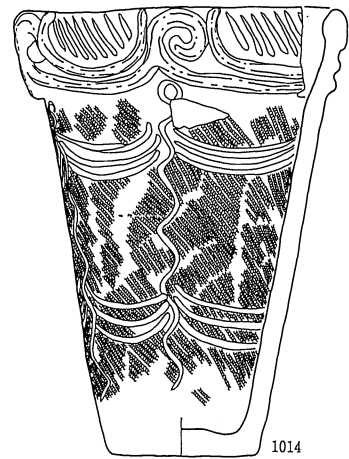
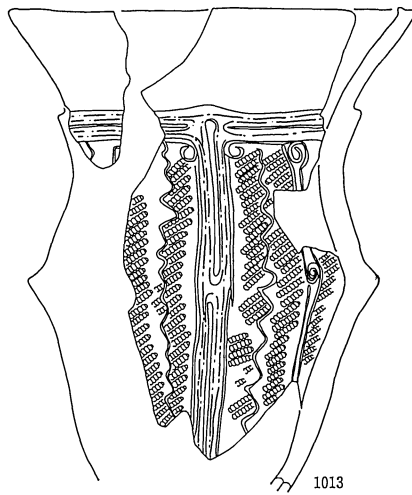
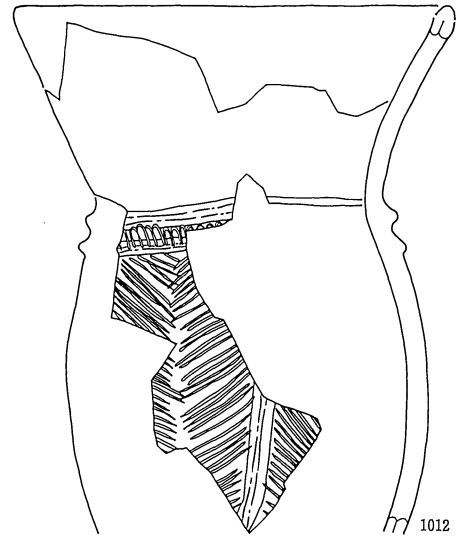
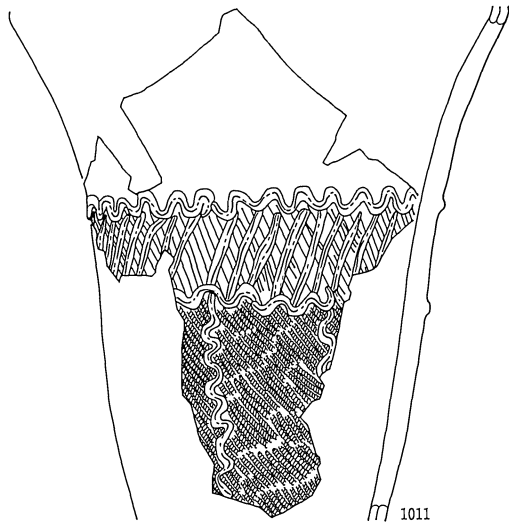

0 (1 : 6) 15 cm

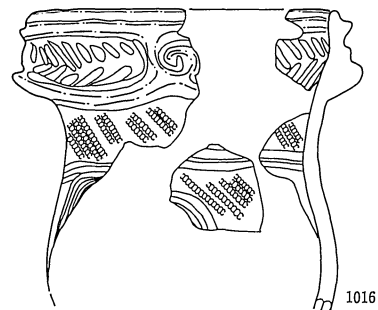

0 (1 : 4) 10 cm

図版204 遺構外出土土器(4) (1015 1 : 6、他 1 : 4)



図版205 遺構外出土土器(5) (1019~1022 1:6、他 1:4)



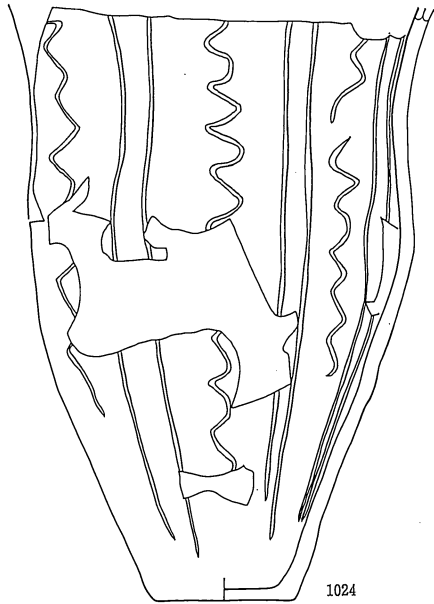

0 (1 : 6) 15 cm

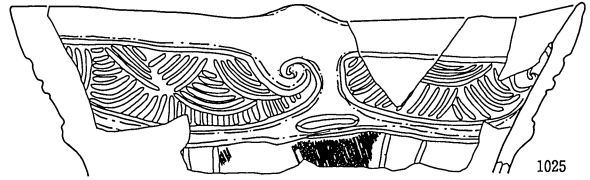

0 (1 : 6) 15 cm

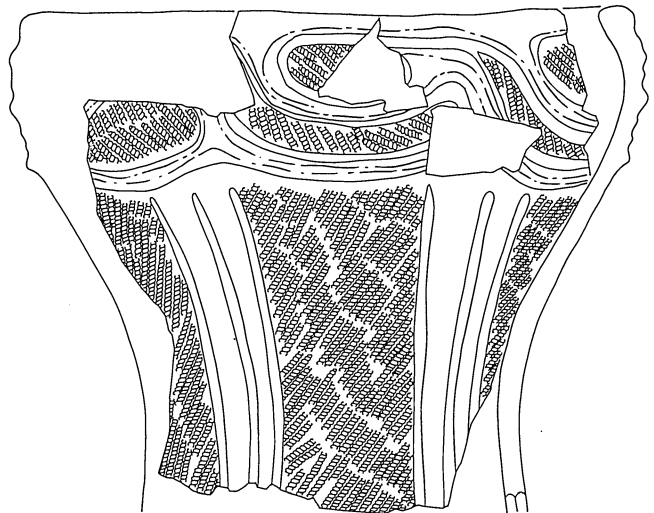
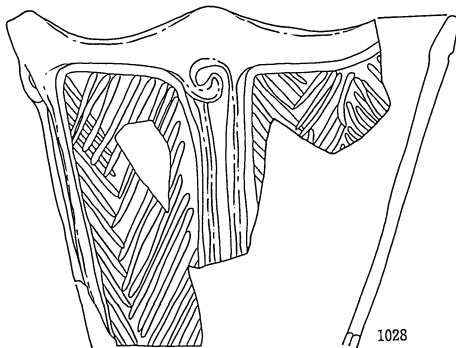
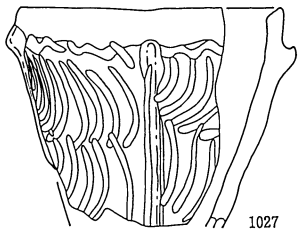
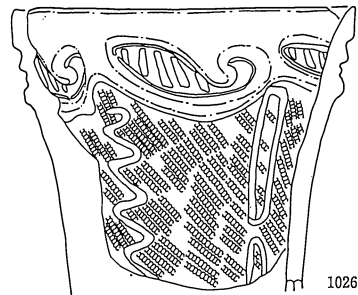

0 (1 : 4) 10 cm

図版206 遺構外出土土器(6) (1024・1025 1 : 6、他 1 : 4)

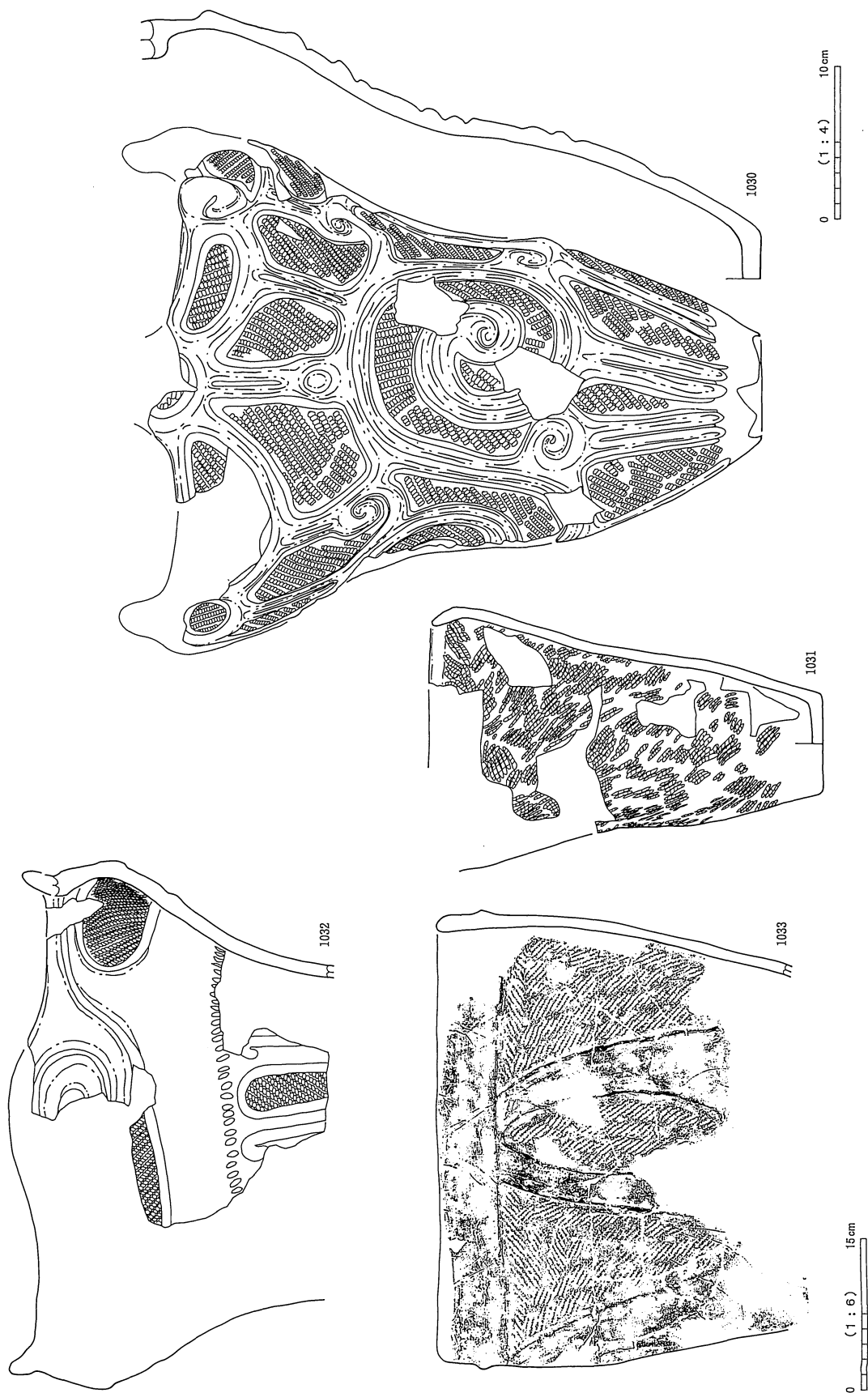

図版207 遺構外出土土器(7) (1030・1031 1:4、他 1:6)

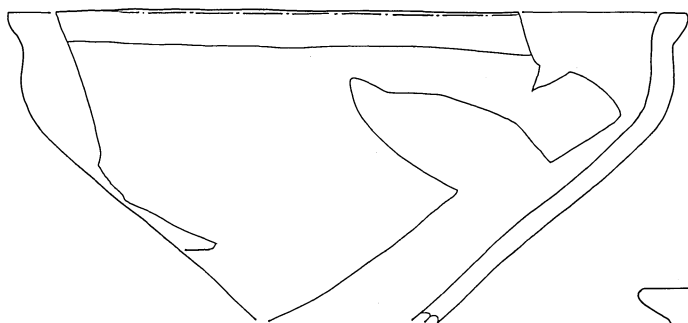

1034

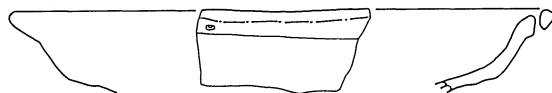

1035

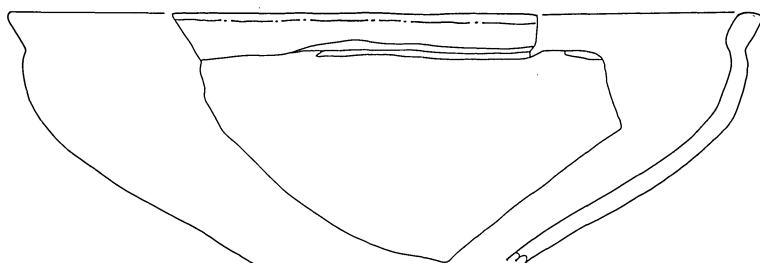

1036

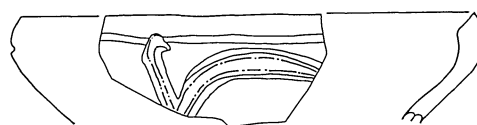

1037

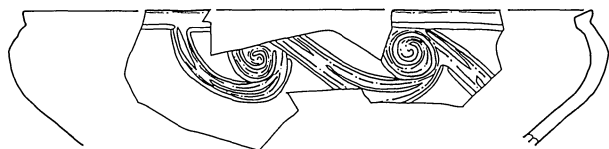

1038

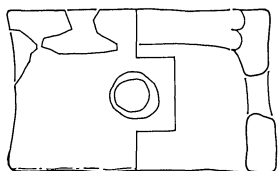

1039

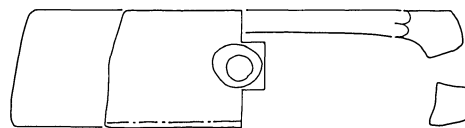

1040

0 (1:4) 10cm

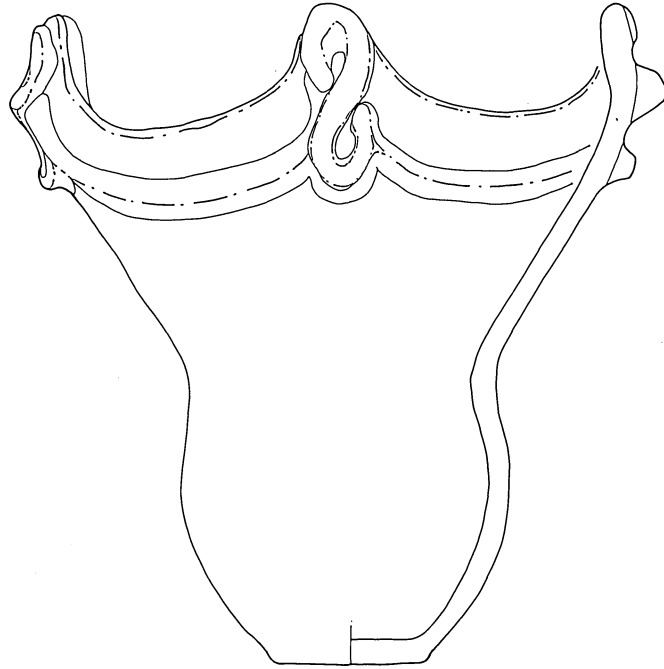

1041

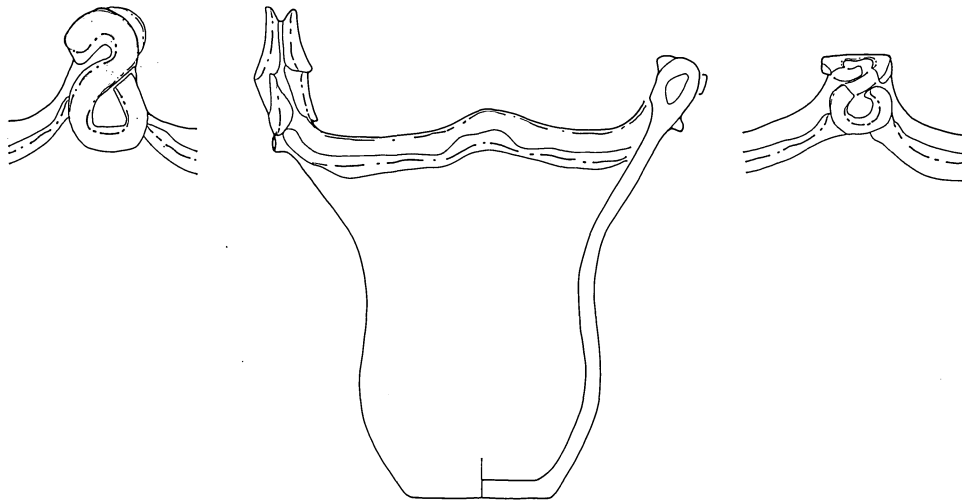

1042

0 (1 : 4) 10cm

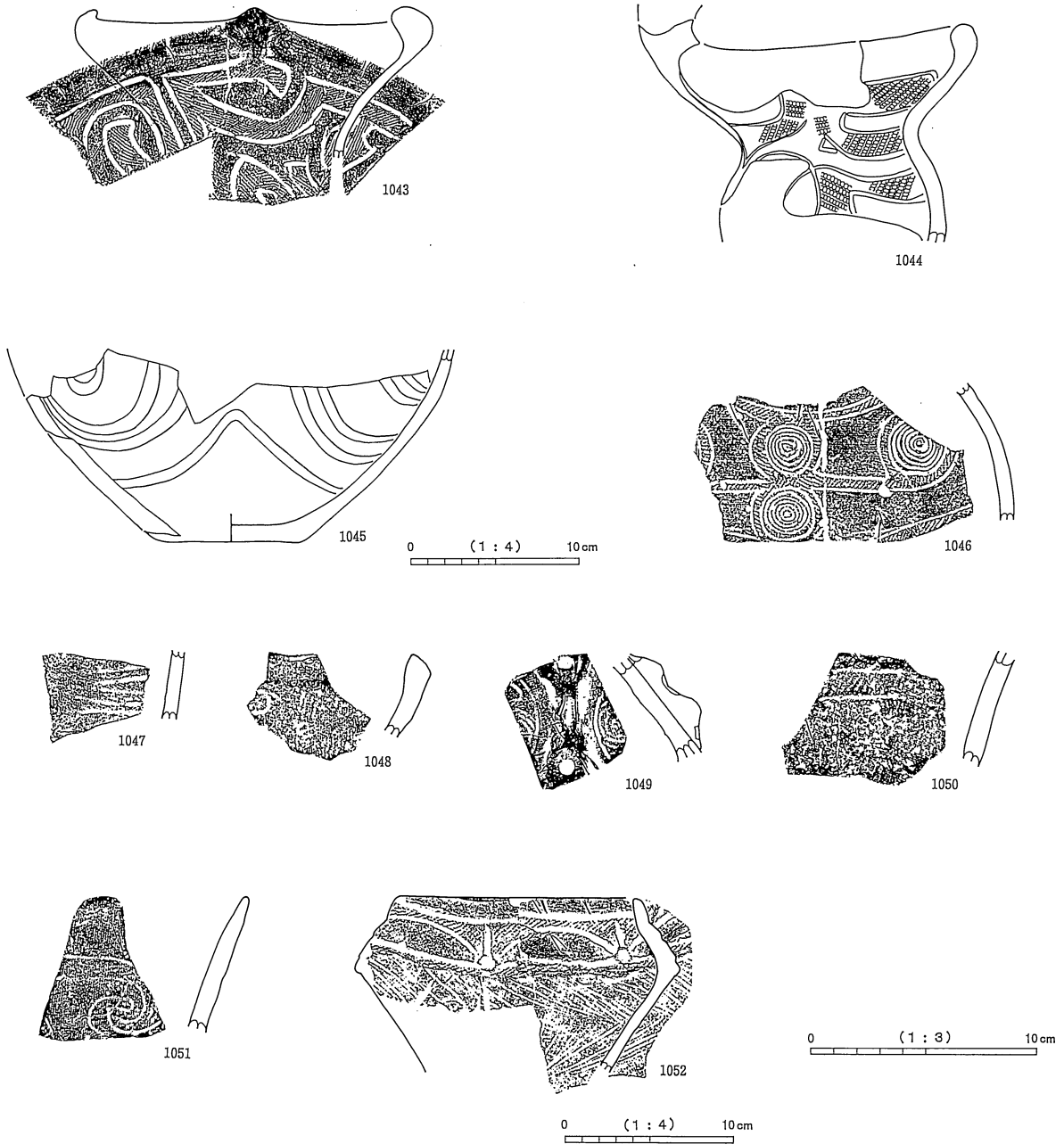

図版210 遺構外出土土器(10) (1043~1045・1052 1:4、他 1:3)

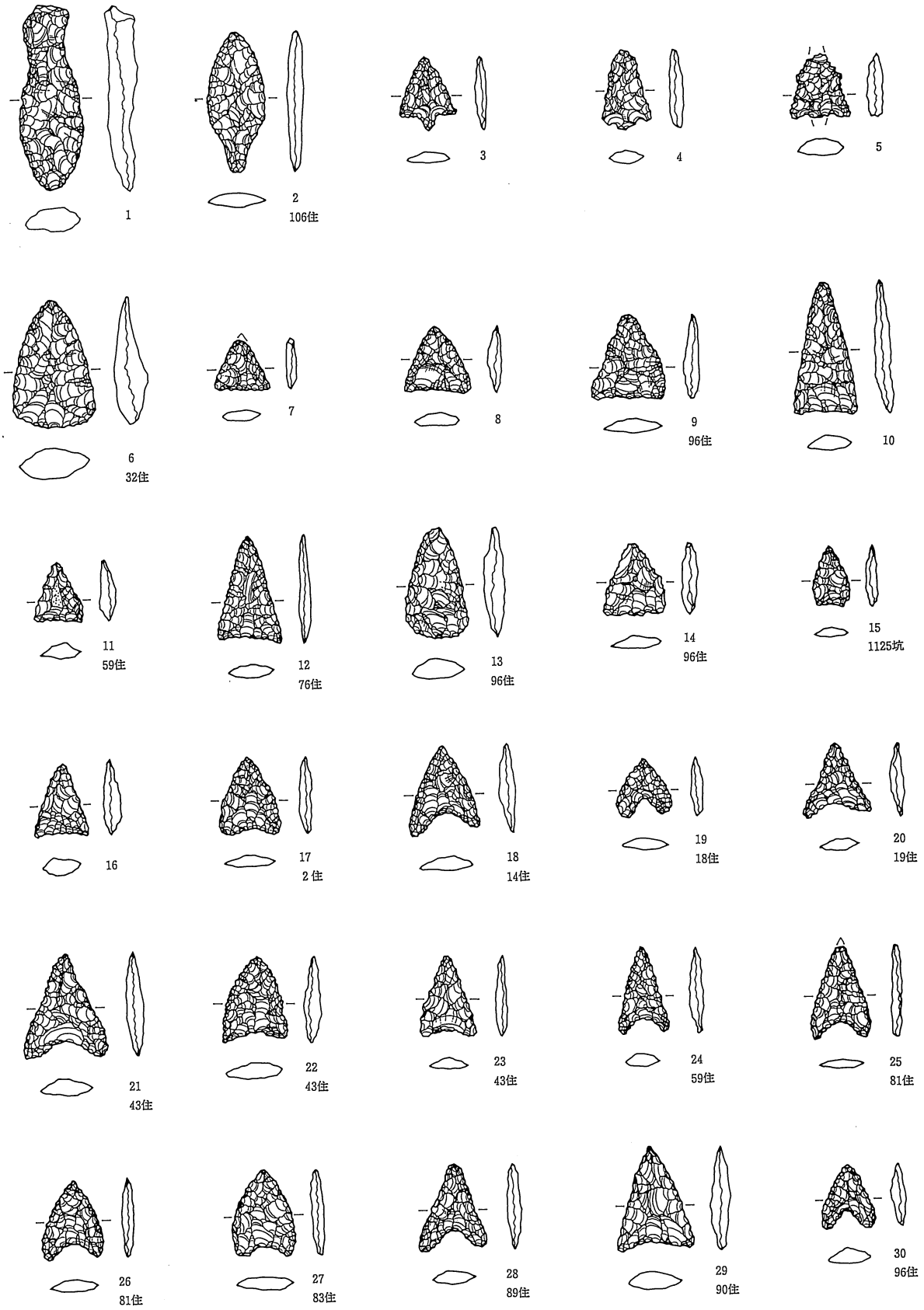

0 5 cm

図版211 縄文時代の石器(1) 2 : 3

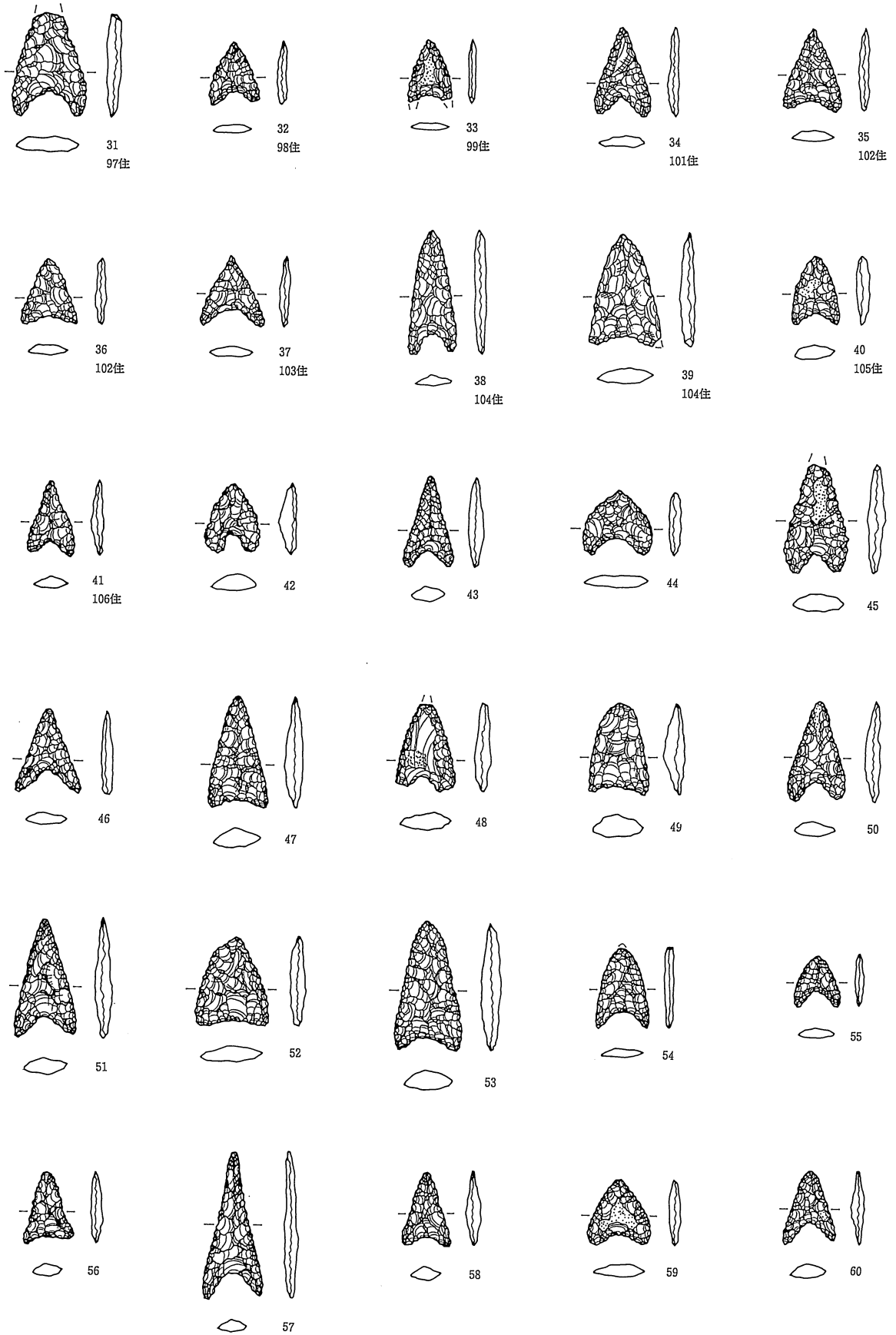

図版212 縄文時代の石器(2) 2 : 3

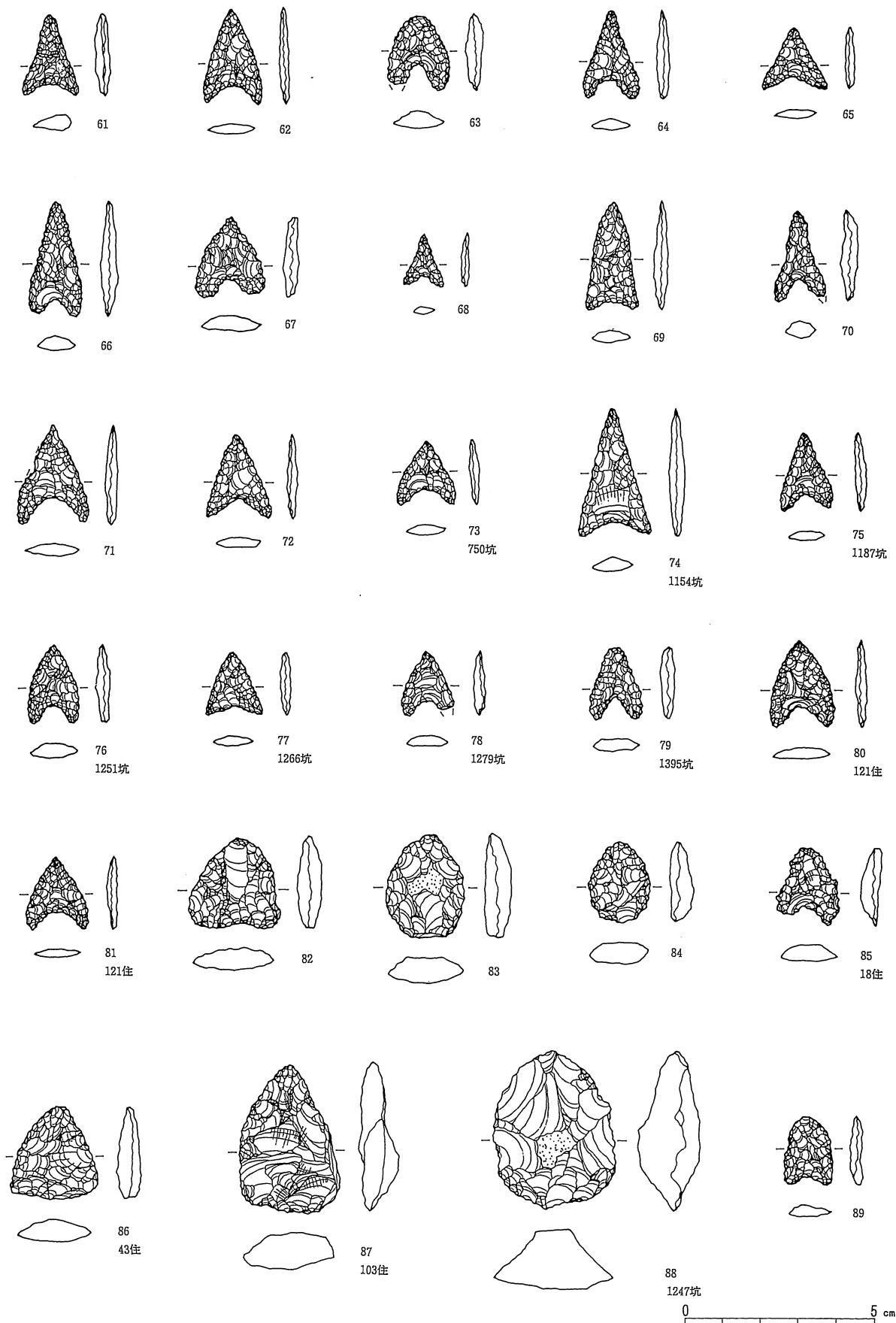

図版213 縄文時代の石器(3) 2 : 3



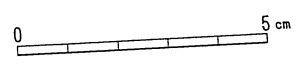
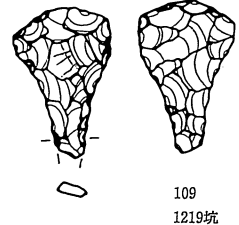
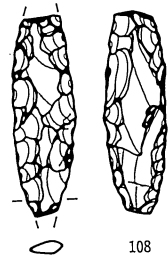
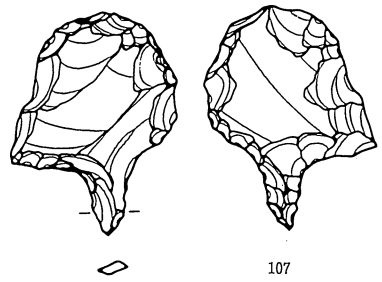
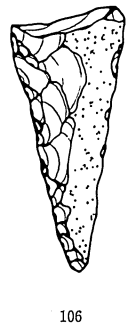
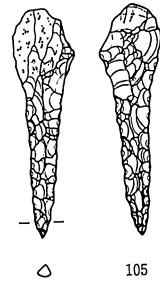
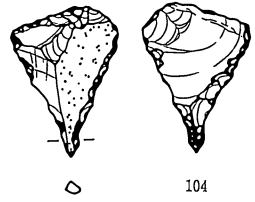
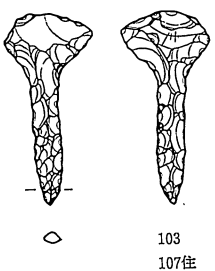
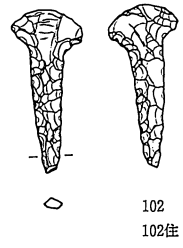
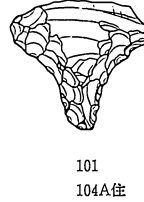
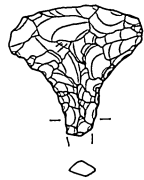
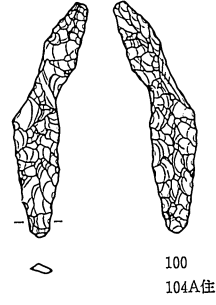
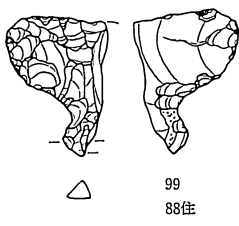
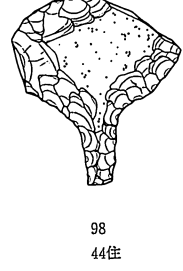
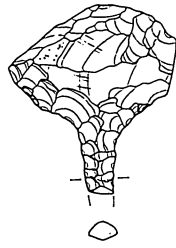
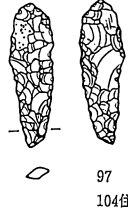
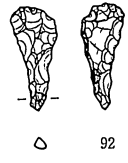
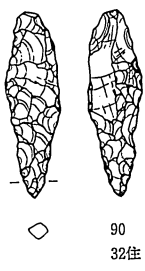

図版214 縄文時代の石器(4) 2 : 3

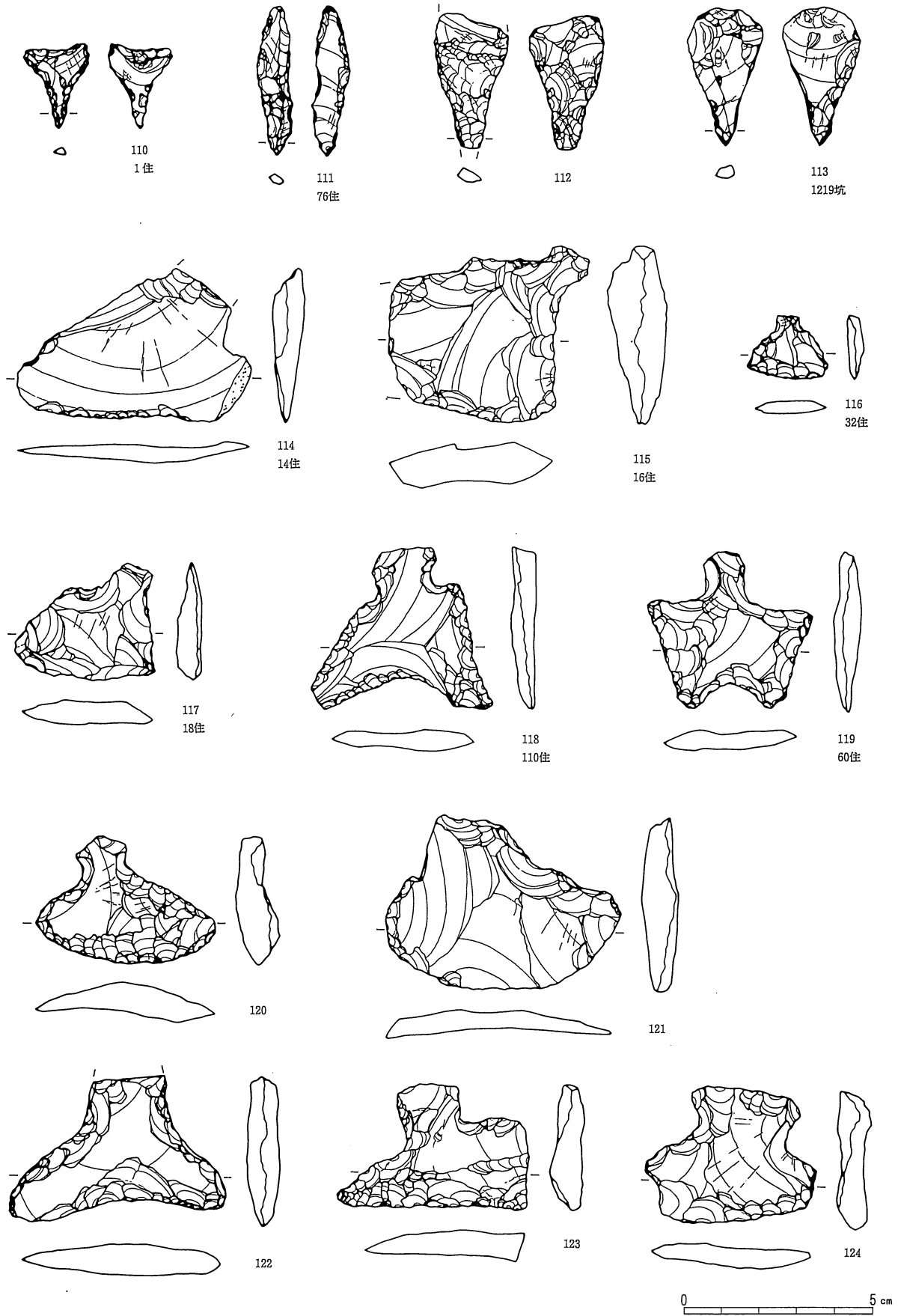

図版215 縄文時代の石器(5) 2 : 3

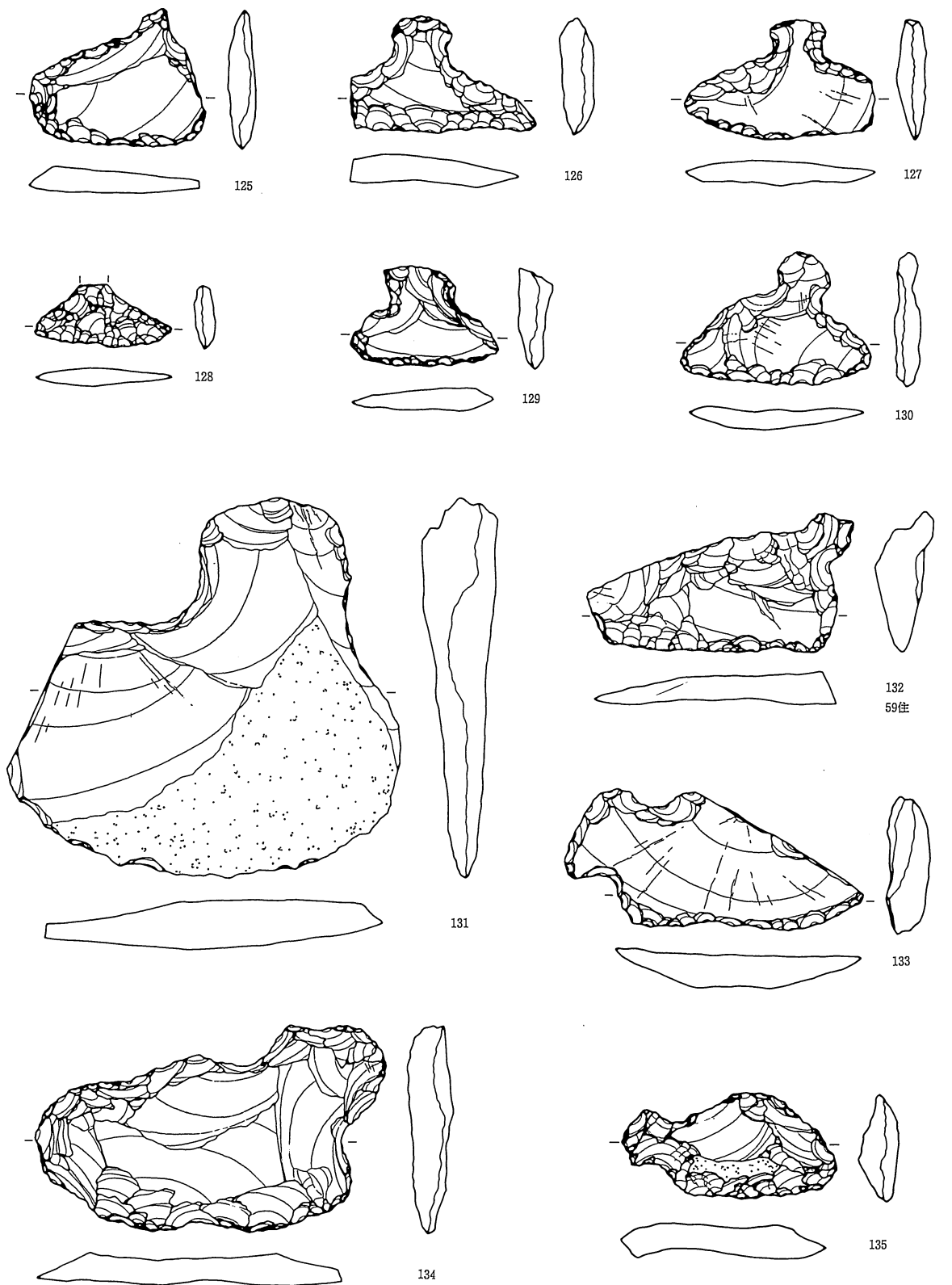

図版216 縄文時代の石器(6) 2 : 3

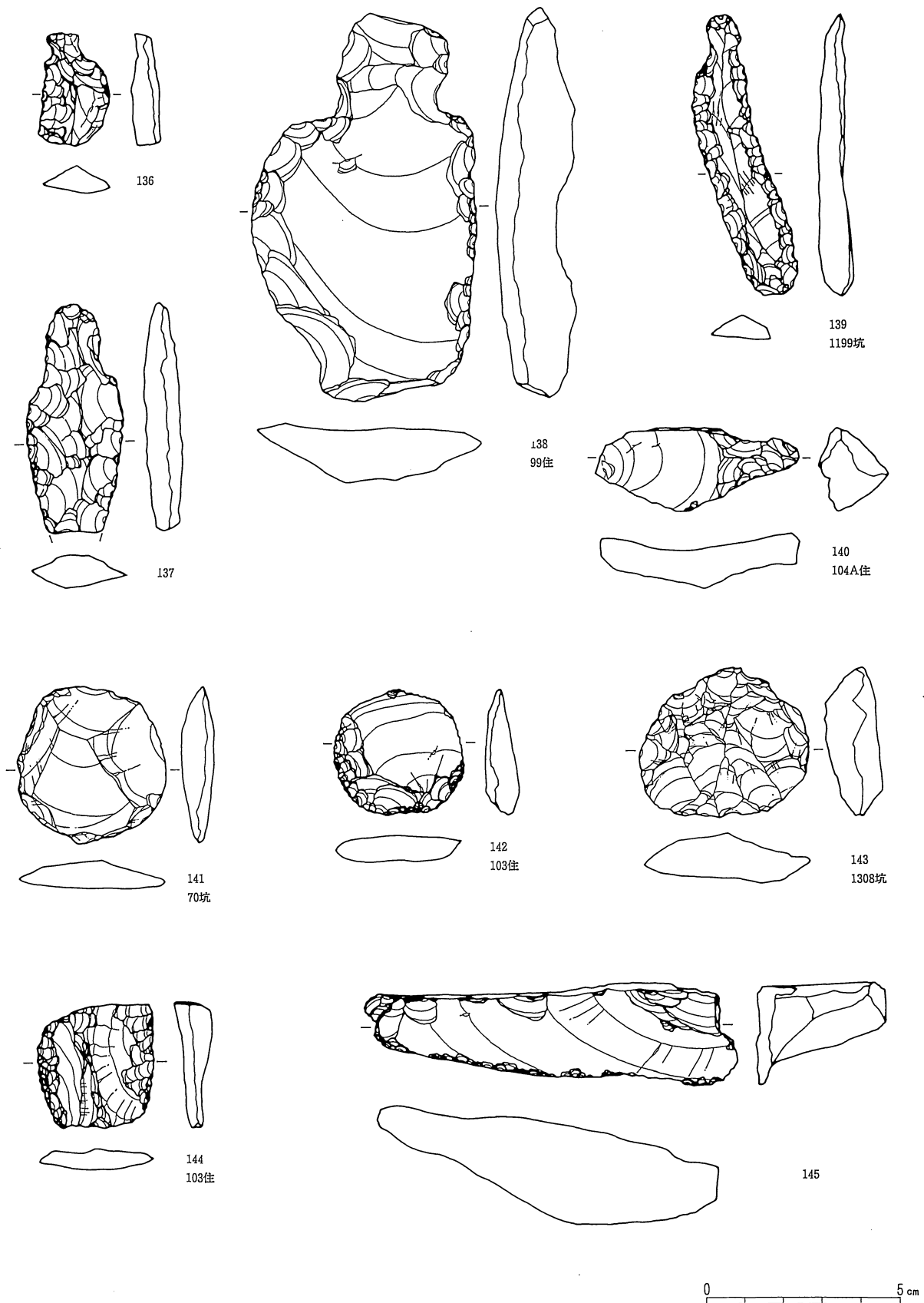

図版217 縄文時代の石器(7) 2 : 3

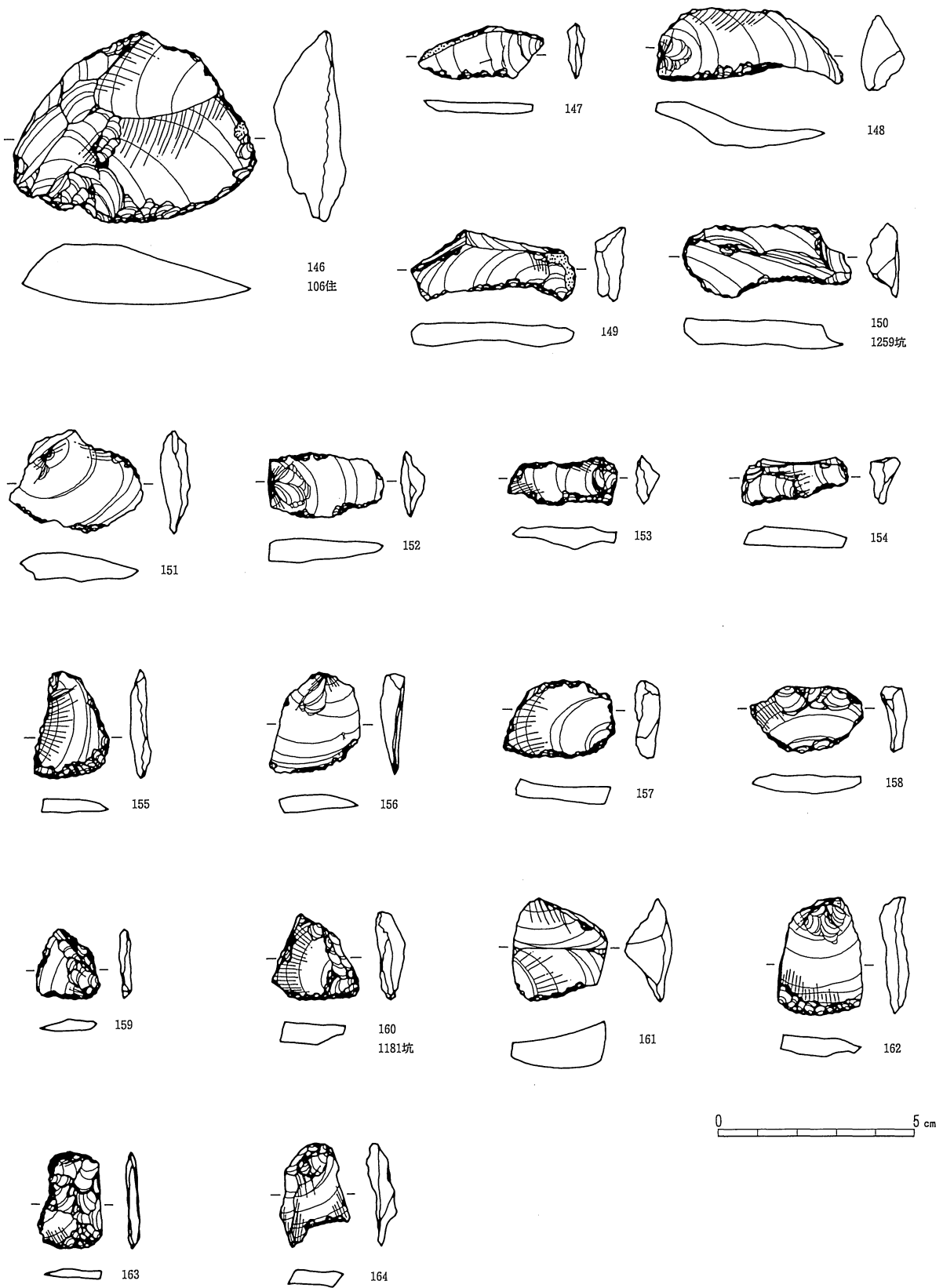

図版218 縄文時代の石器(8) 2 : 3

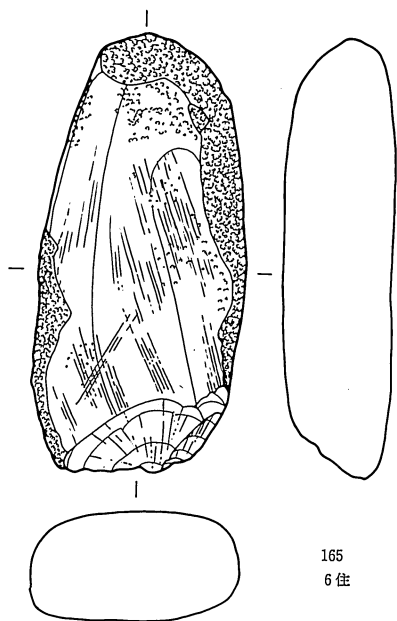

165  
6住

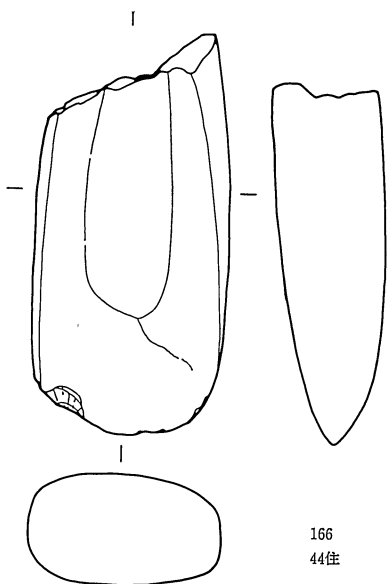

166  
44住

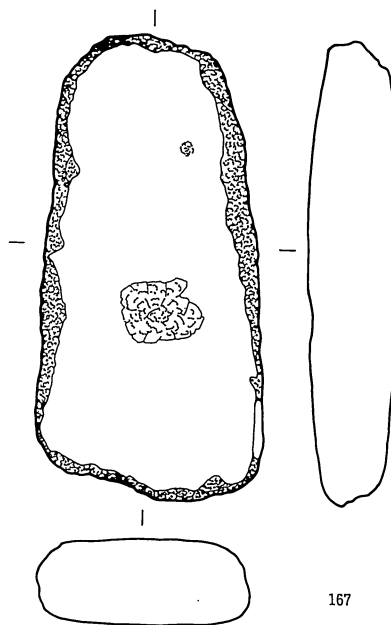

167

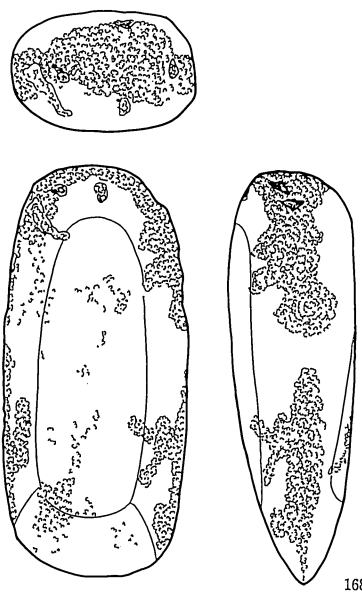

168

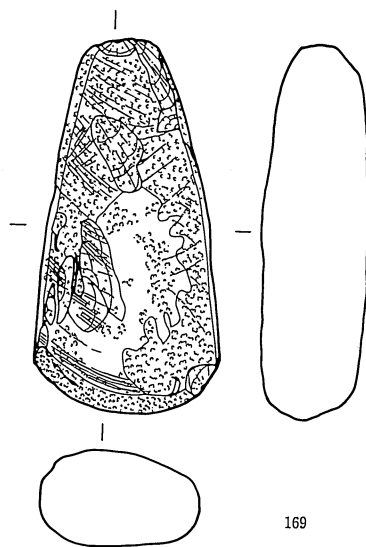

169

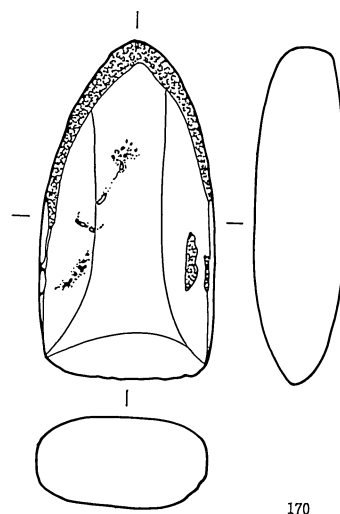

170

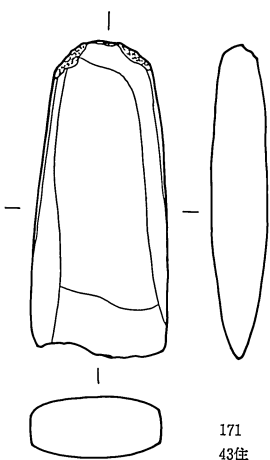

171  
43住

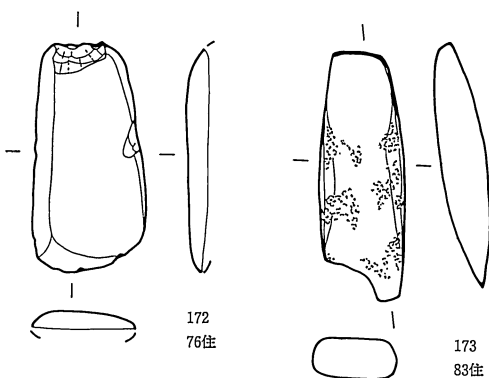

172  
76住

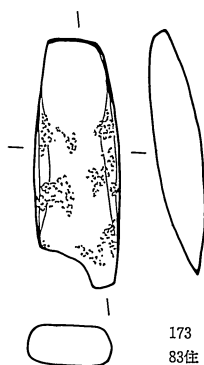

173  
83住

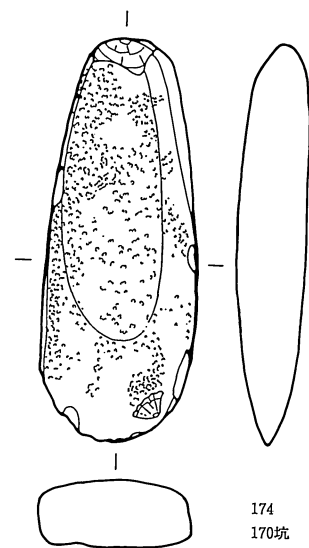

174  
170坑

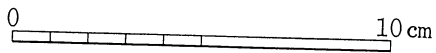

図版219 縄文時代の石器(9) 1 : 2

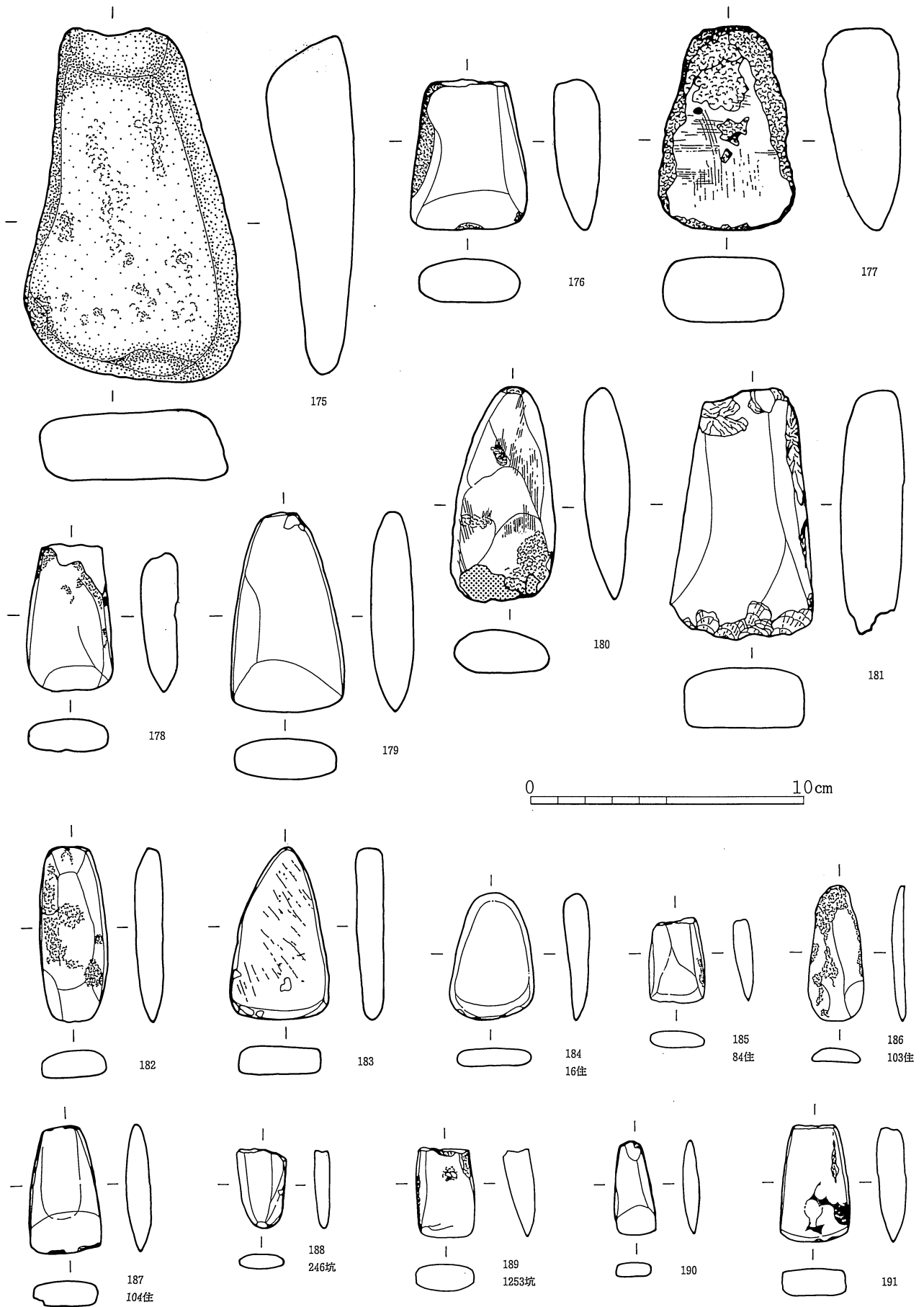

図版220 縄文時代の石器(10) 1 : 2

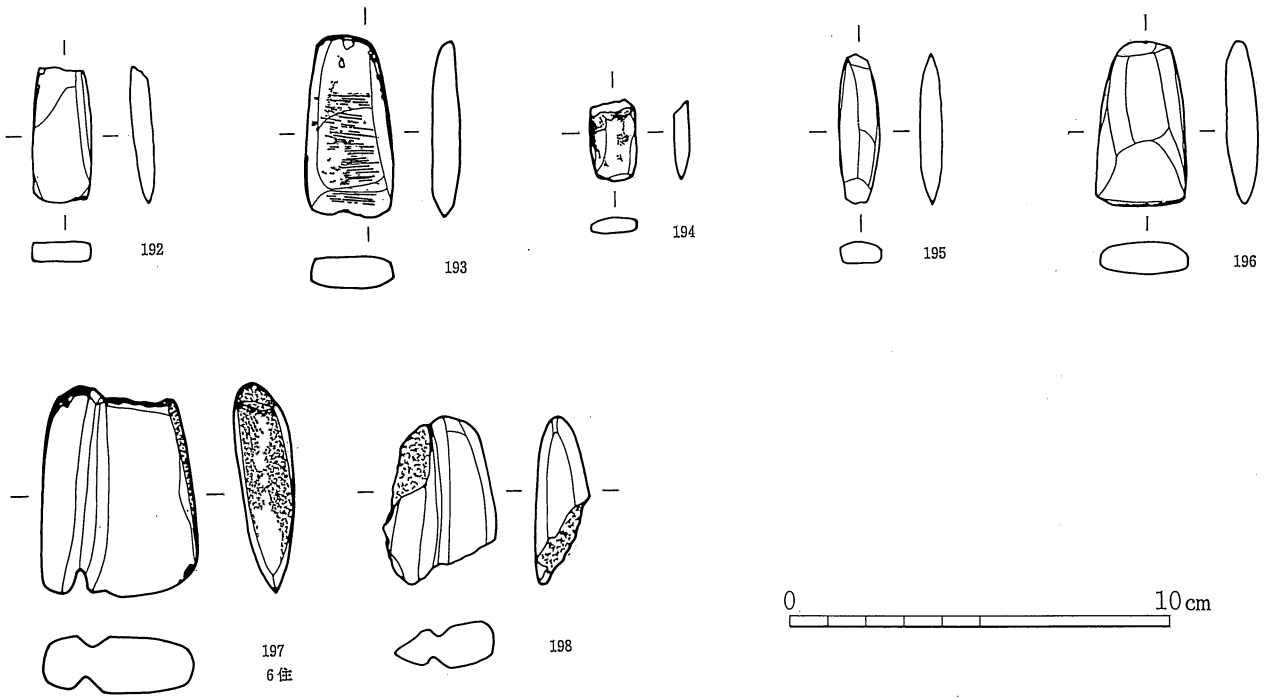

図版221 縄文時代の石器(1) 1 : 2

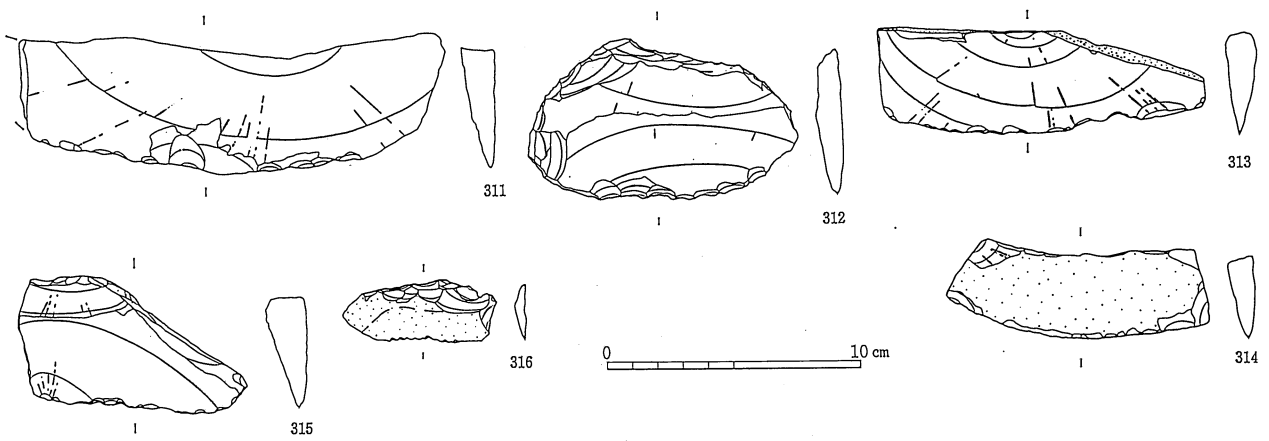

図版229 縄文時代の石器(19) 1 : 3



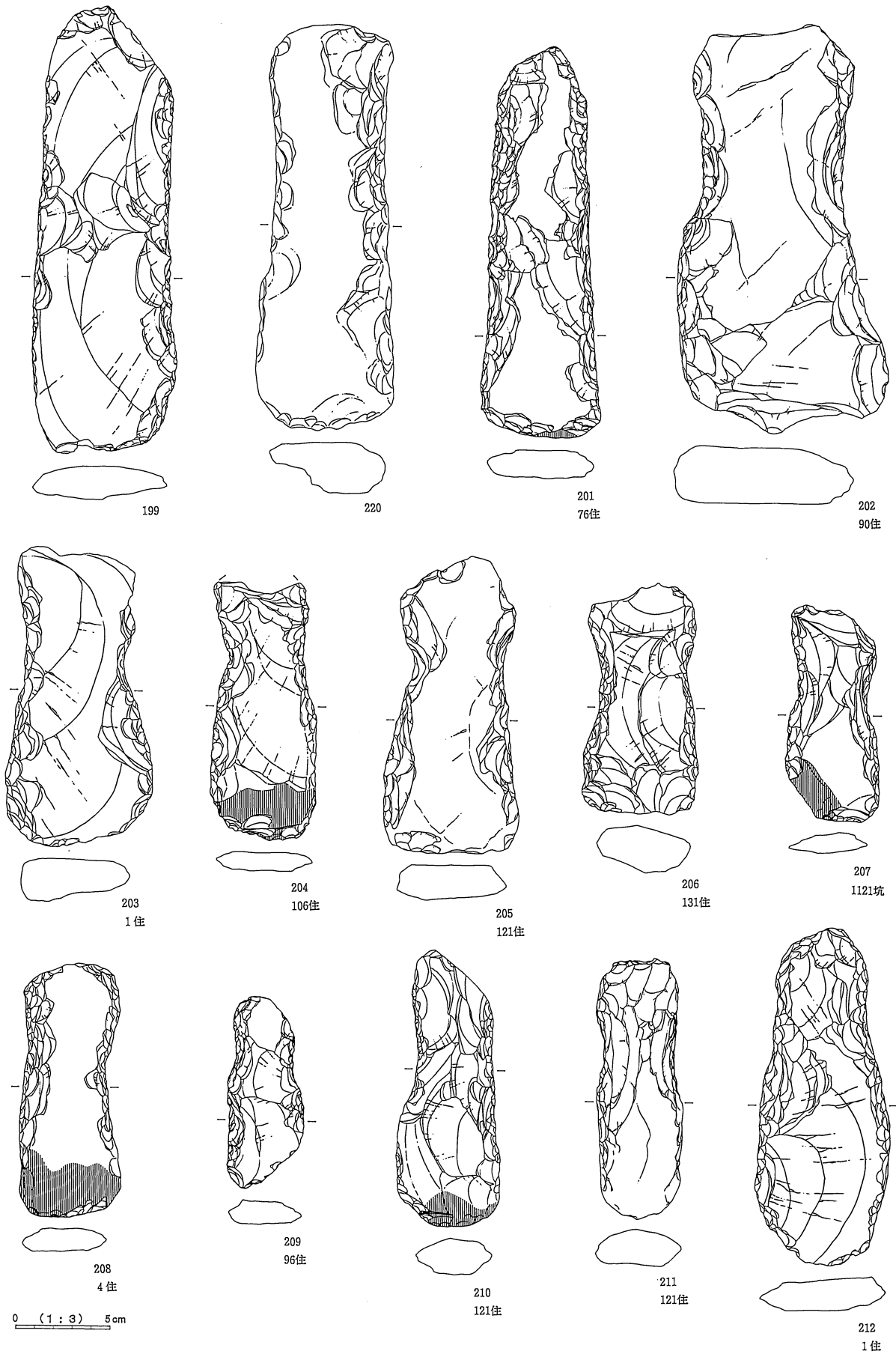

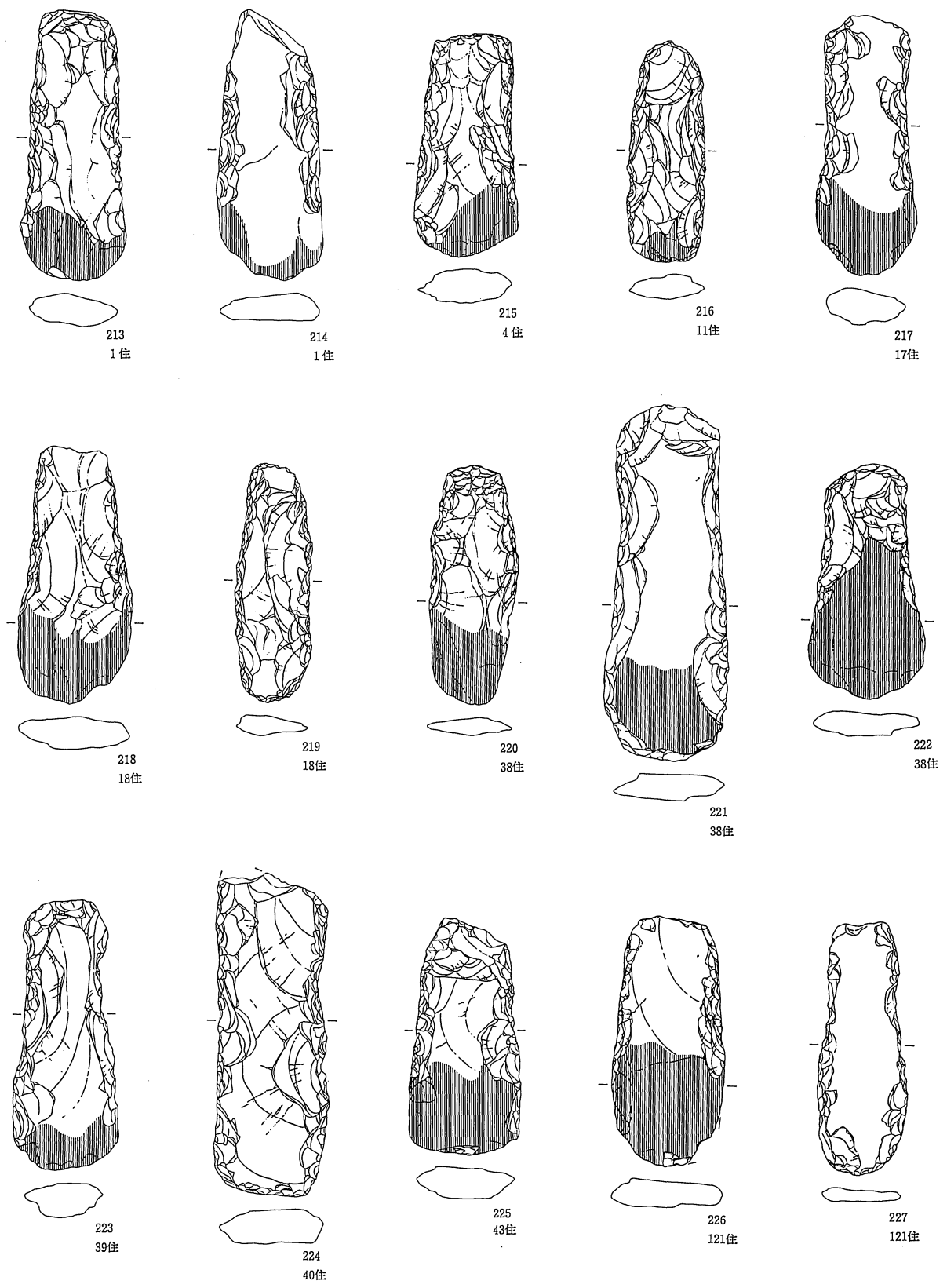

図版223 縄文時代の石器(13) 1 : 3

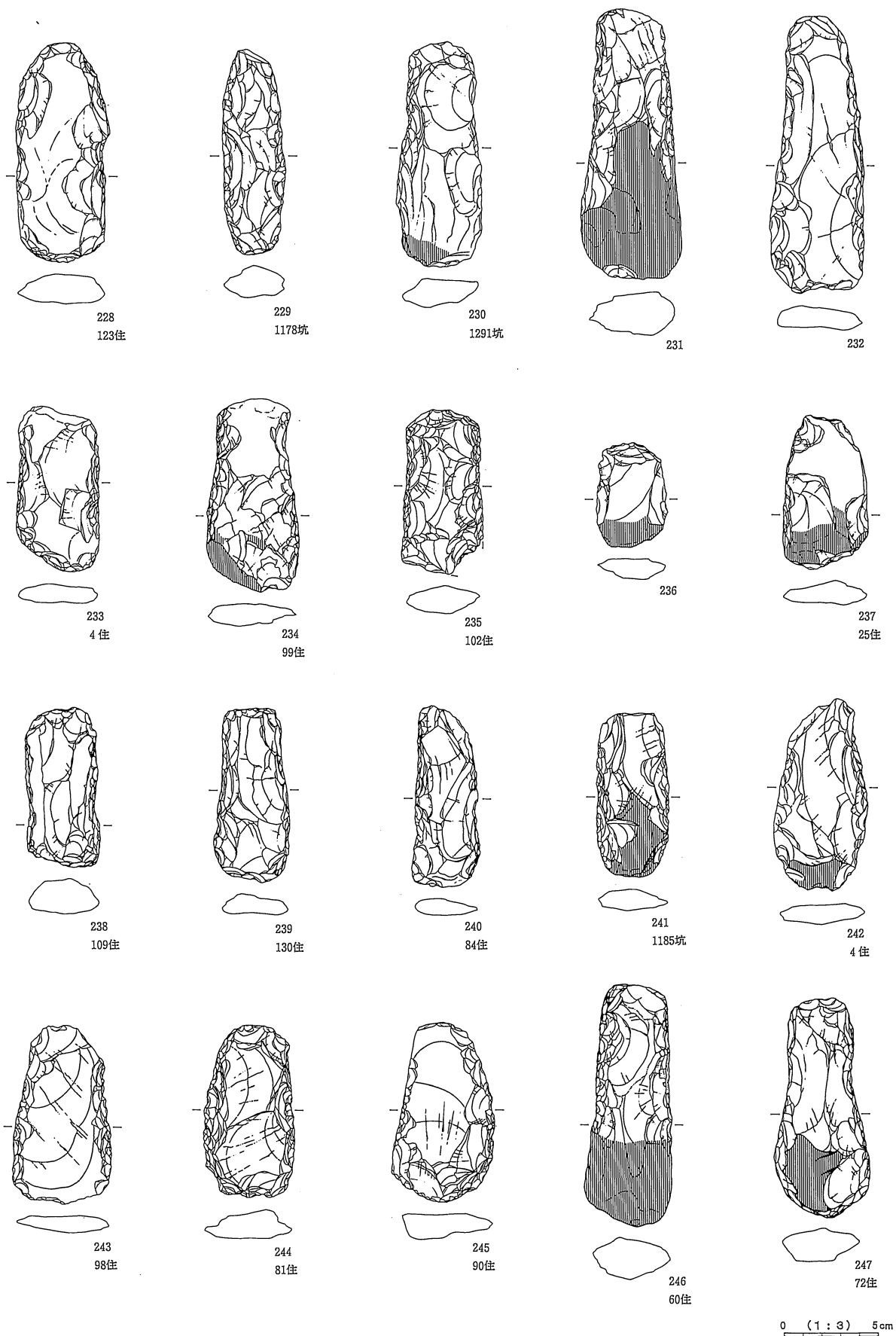

図版224 縄文時代の石器(14) 1:3

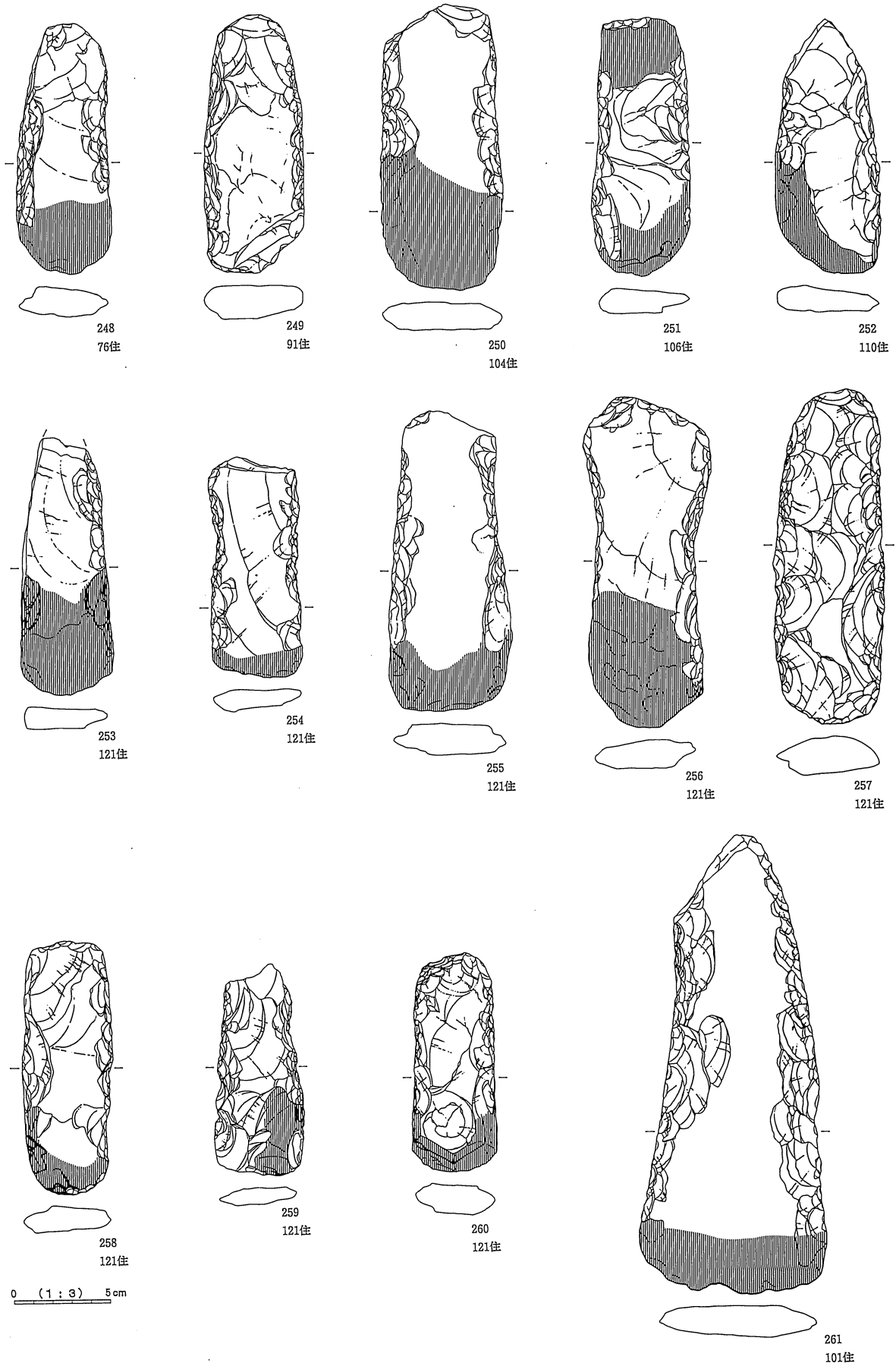

図版225 縄文時代の石器(15) 1:3

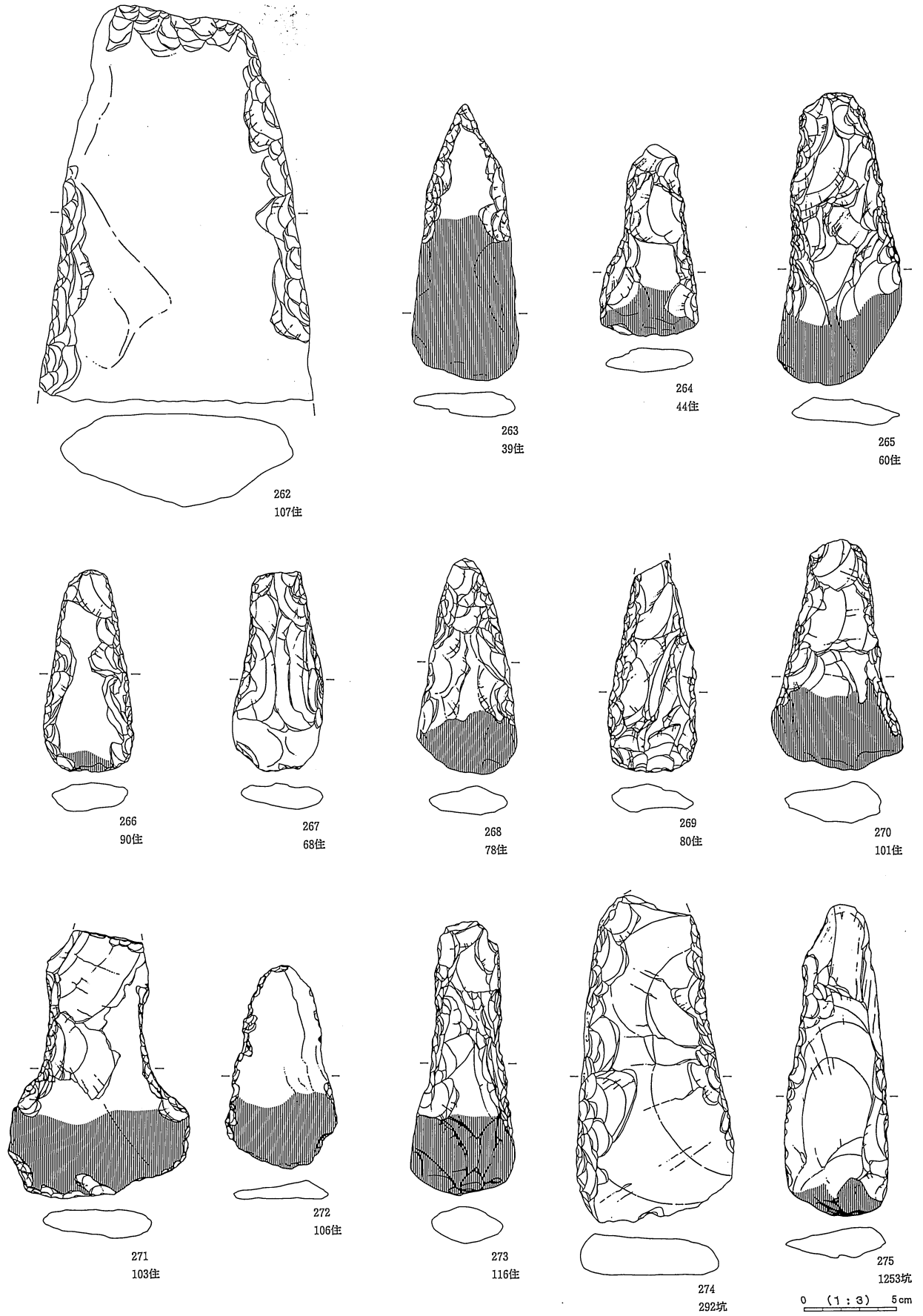

図版226 縄文時代の石器(16) 1 : 3

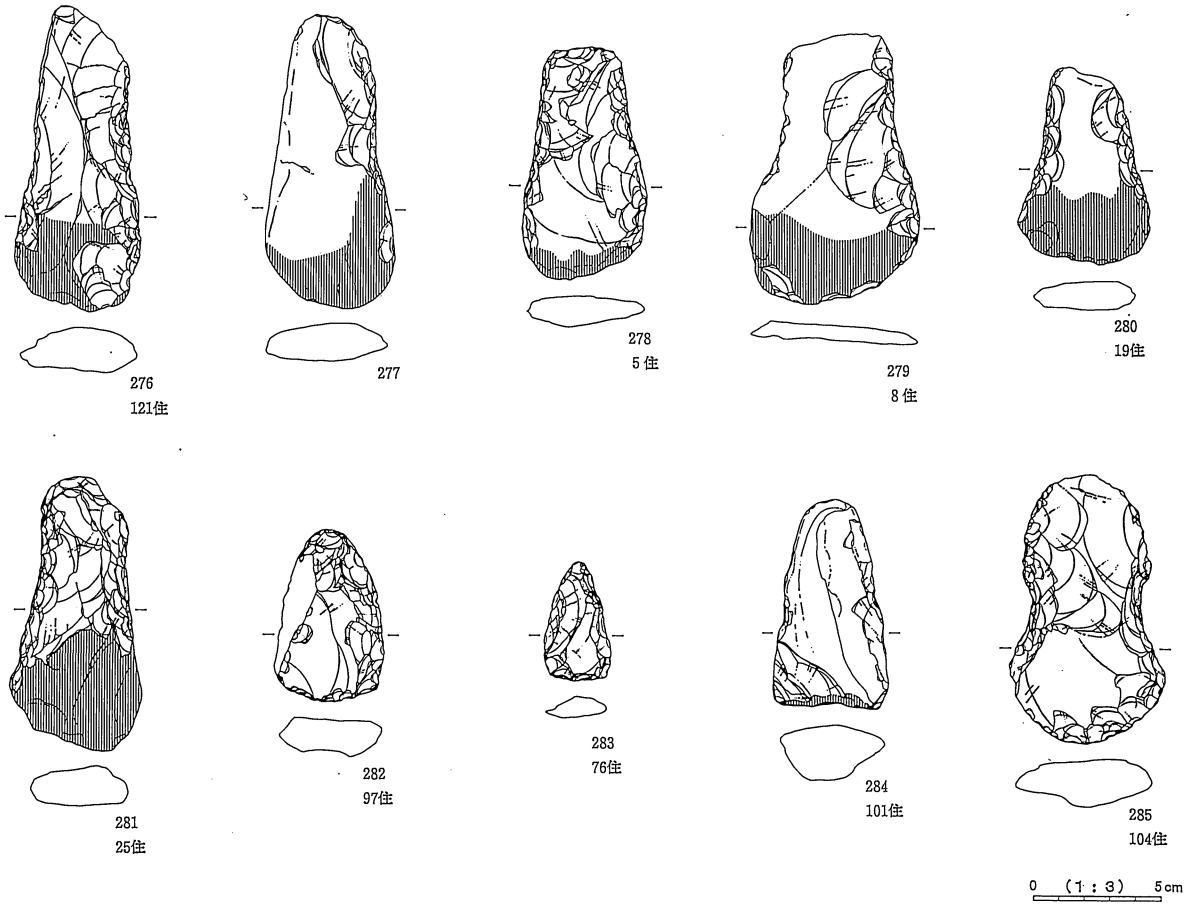

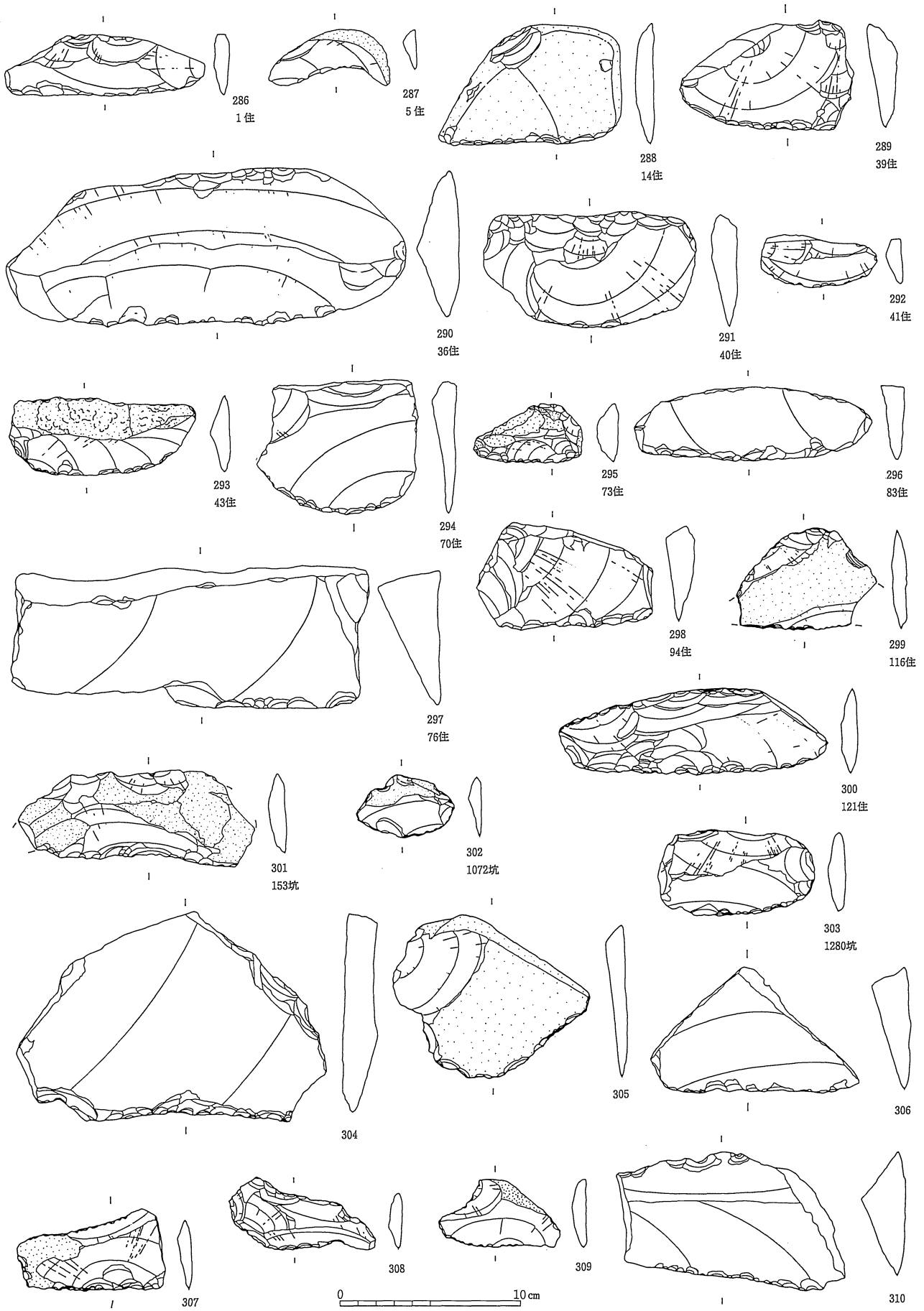

図版228 縄文時代の石器(18) 1 : 3

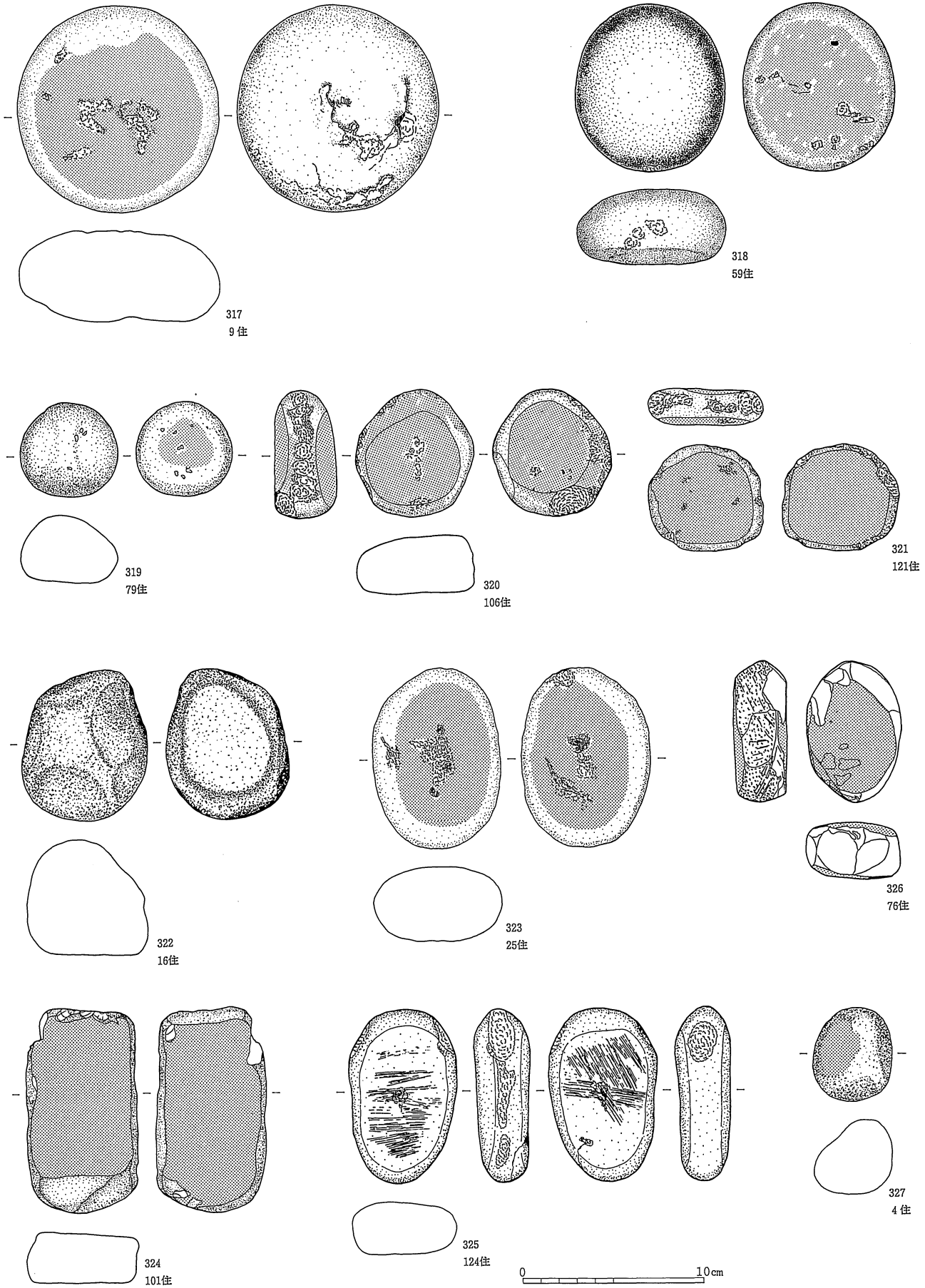

図版230 縄文時代の石器(2) 1 : 3



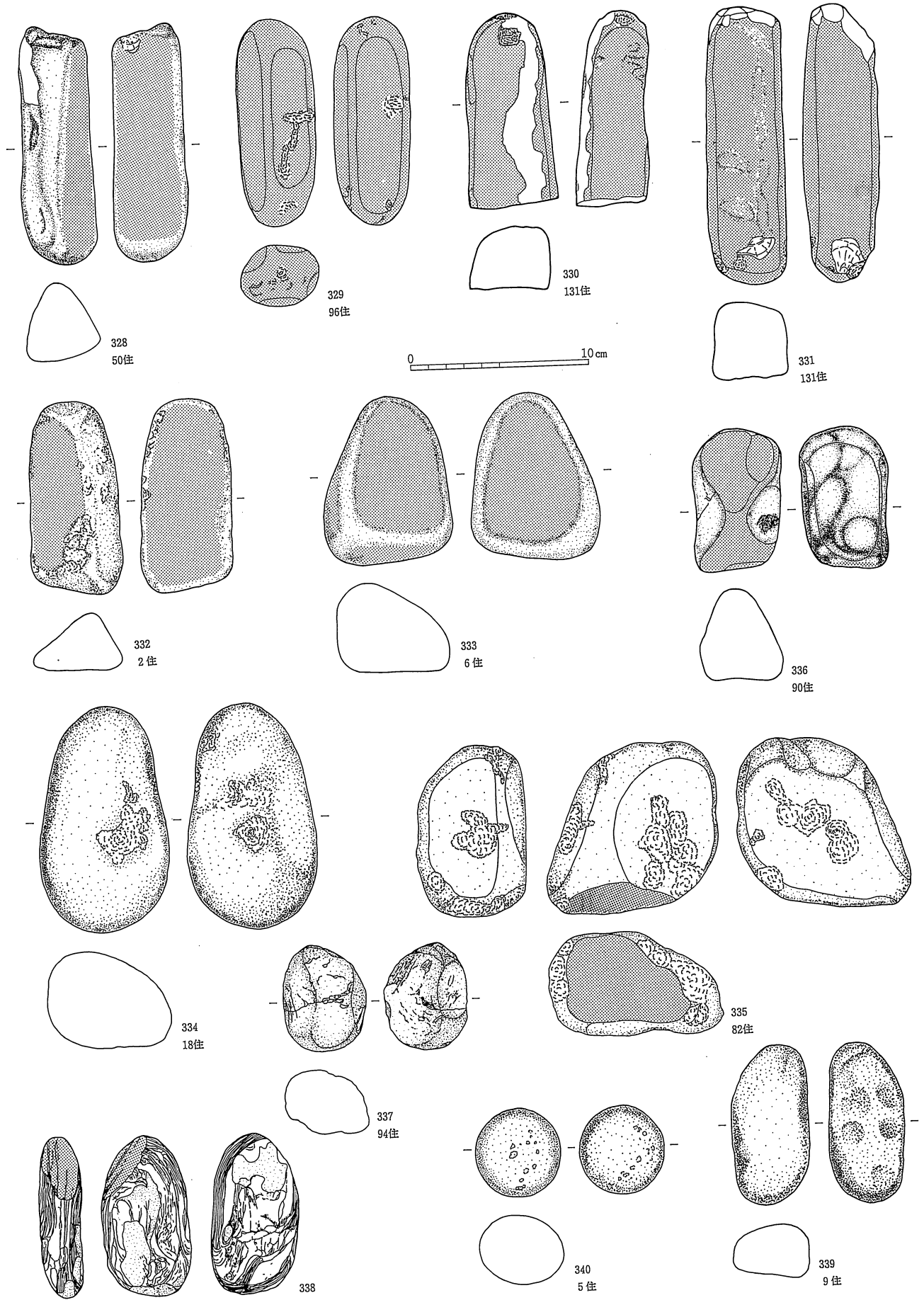

図版231 縄文時代の石器(2) 1 : 3

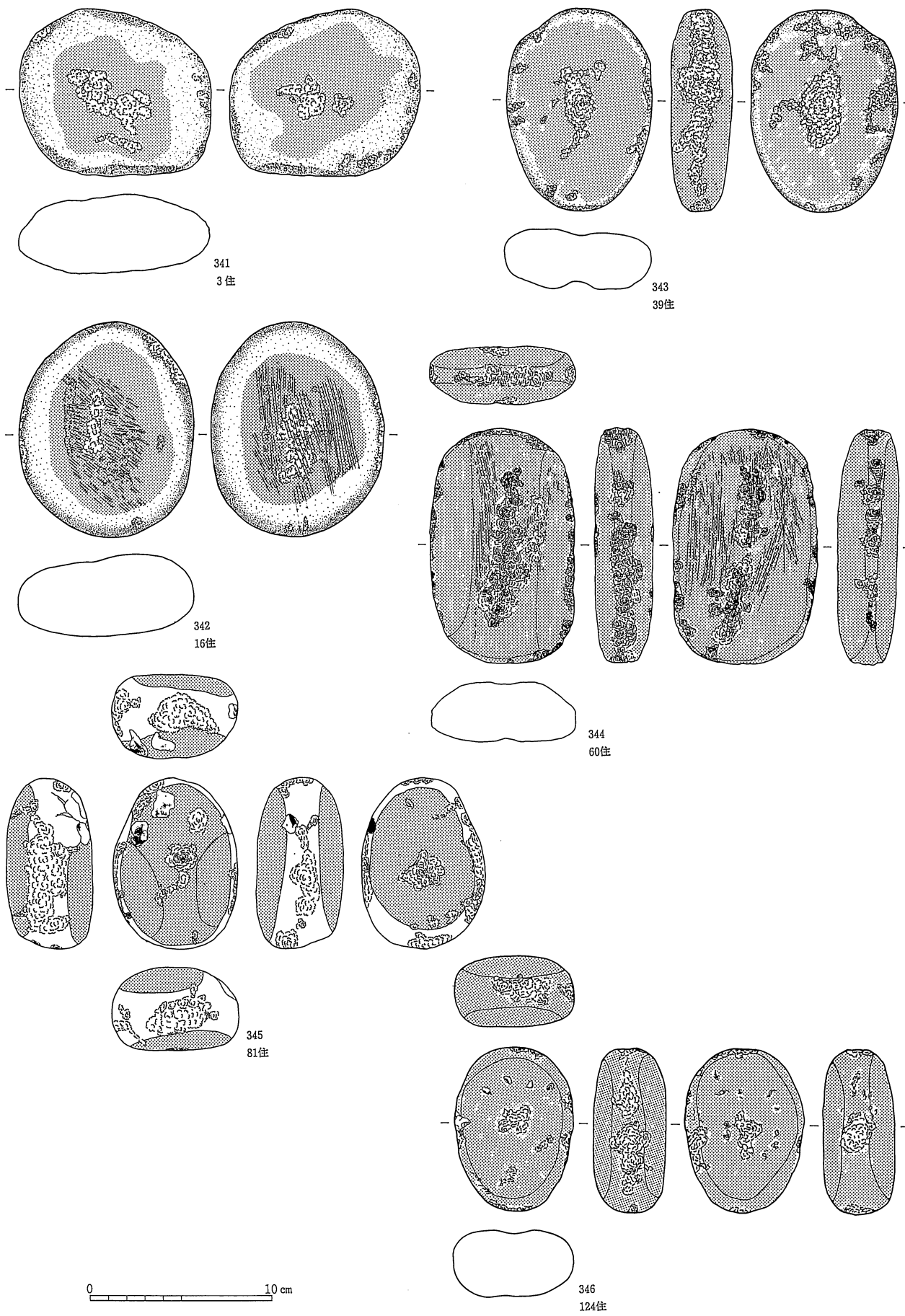

図版232 縄文時代の石器(2) 1 : 3

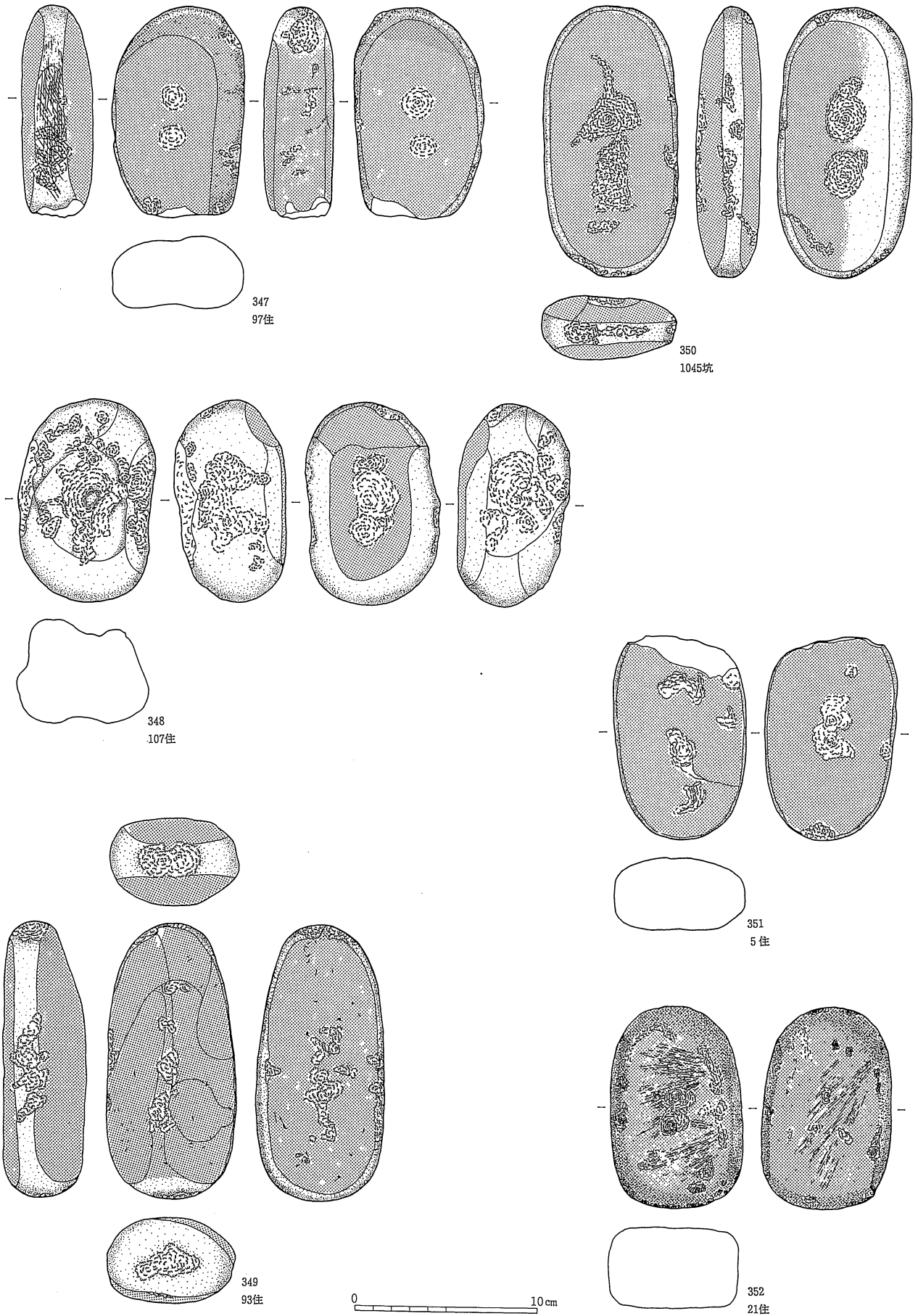

図版233 縄文時代の石器(2) 1 : 3

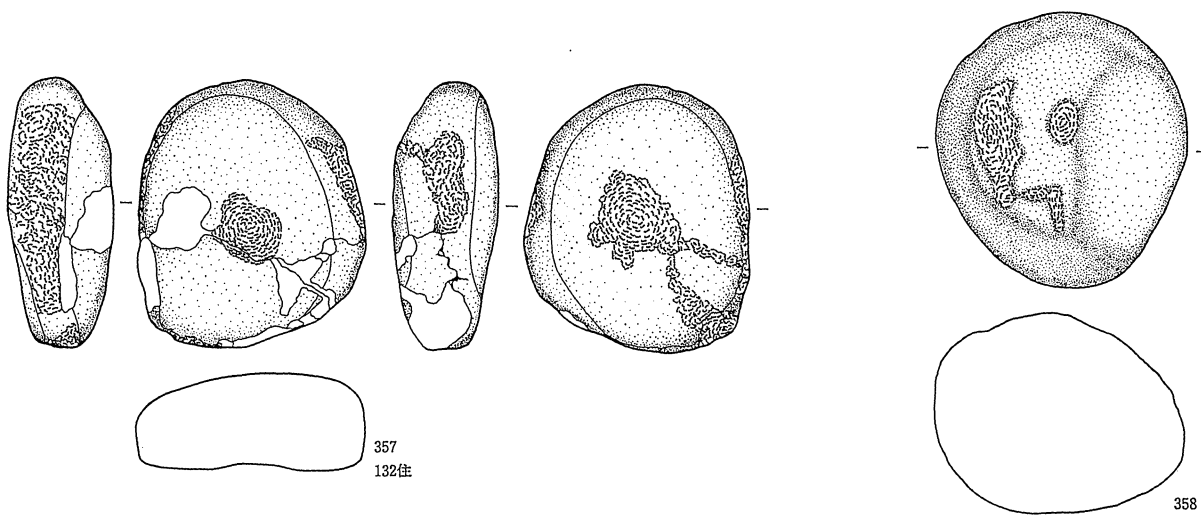
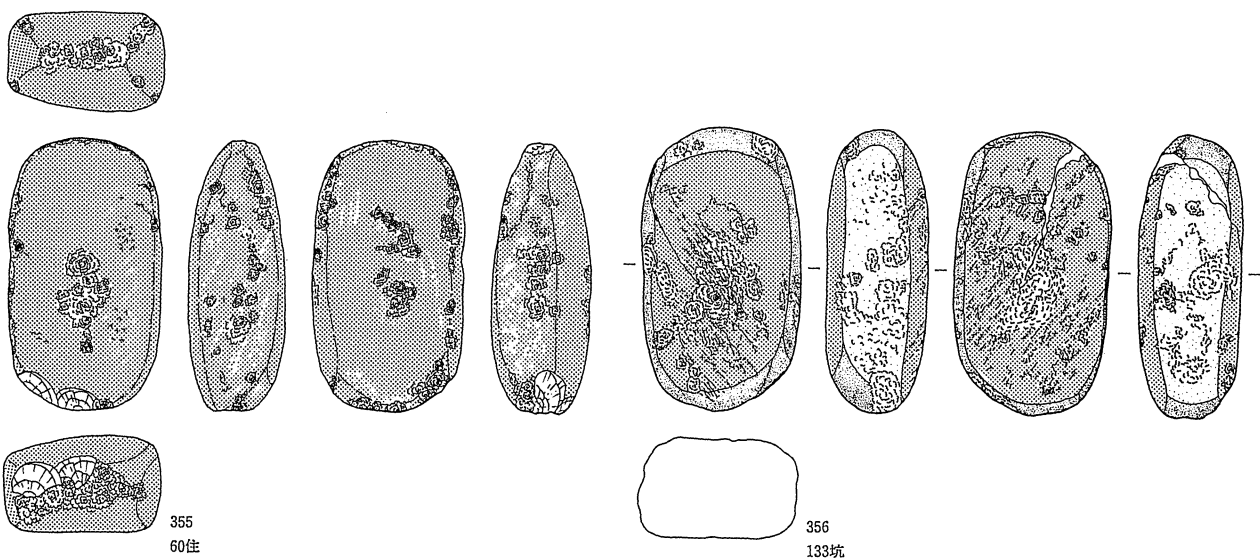
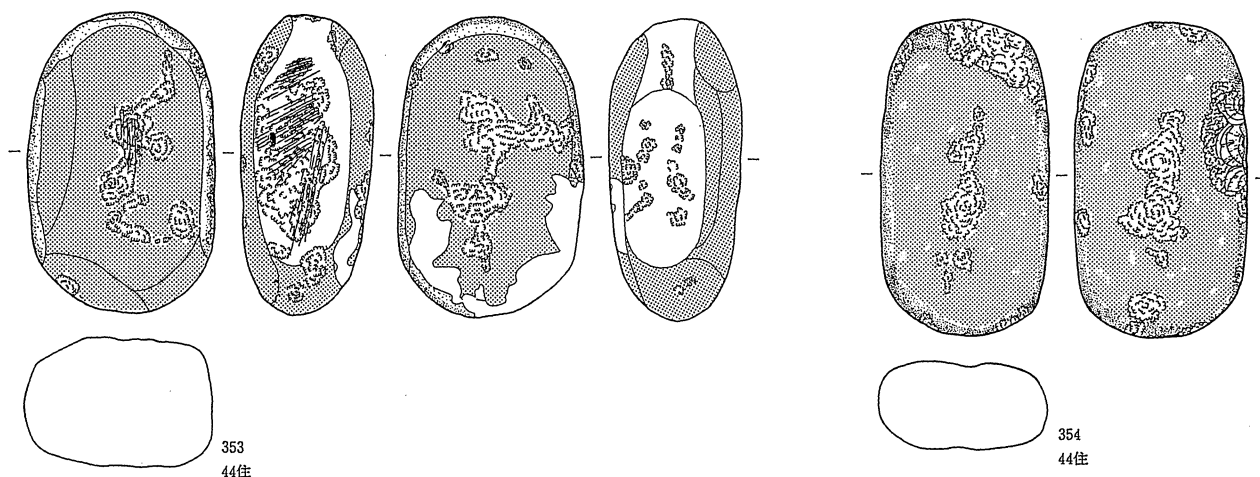

0 10 cm

図版234 縄文時代の石器(4) 1 : 3

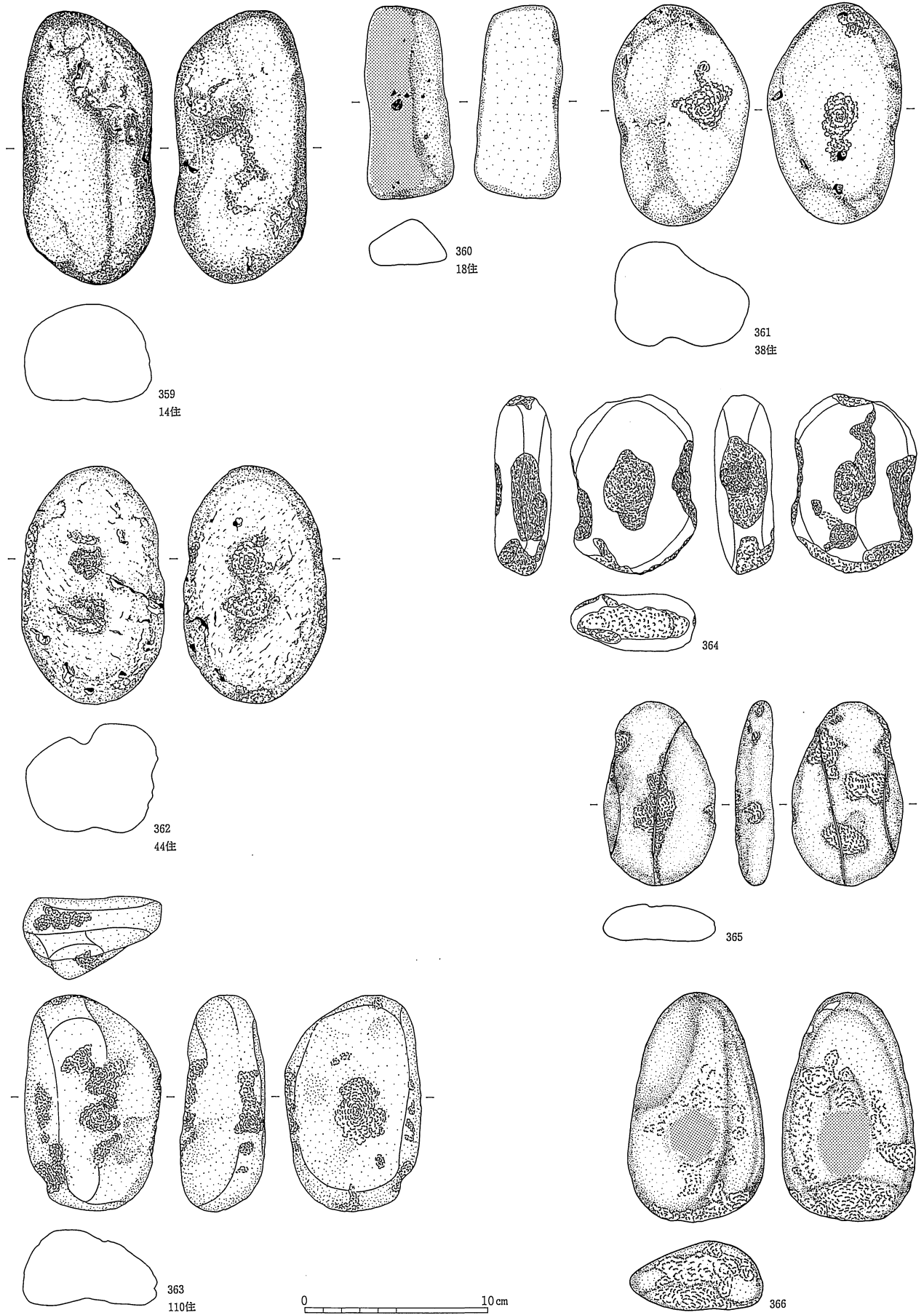

図版235 縄文時代の石器(25) 1 : 3

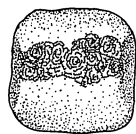
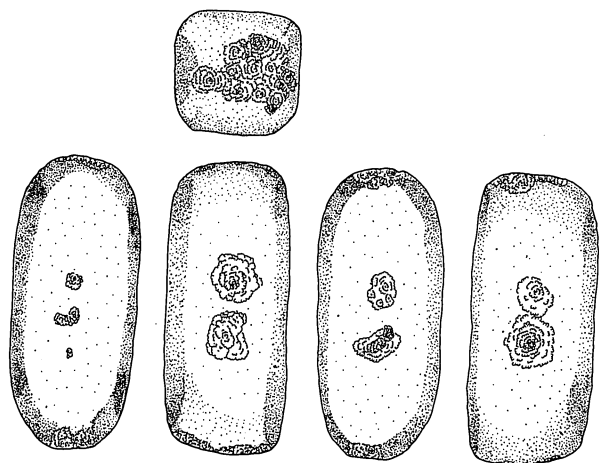

367  
19住

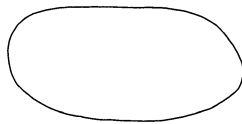
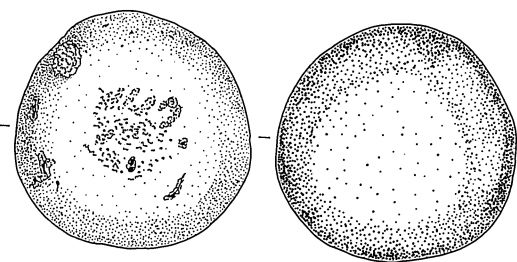

370  
19住

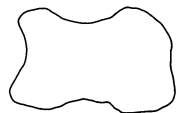
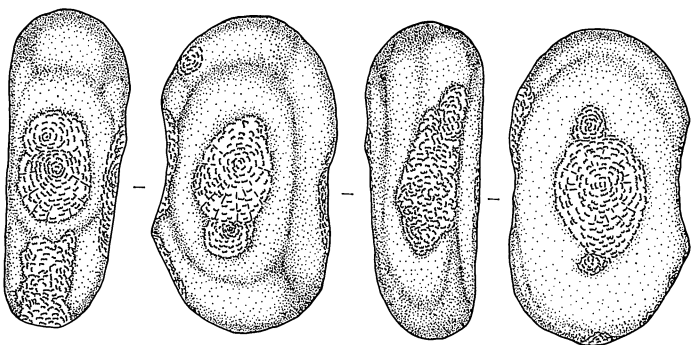

368

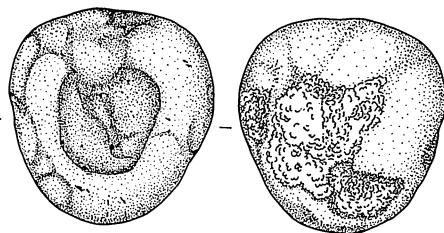

371  
70住

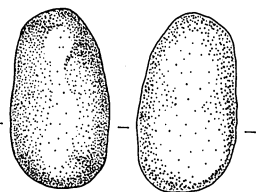

373  
25住

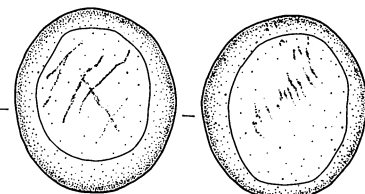

372  
105住

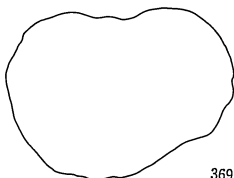
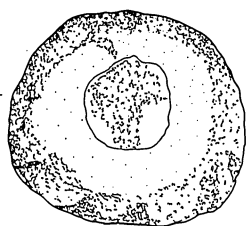

369

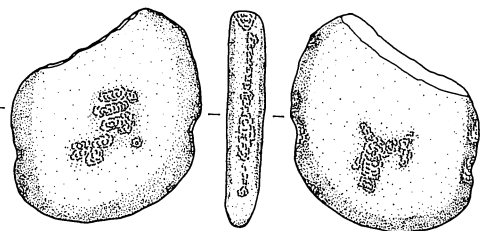

374

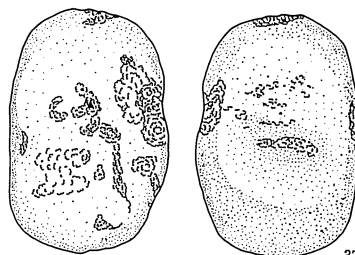
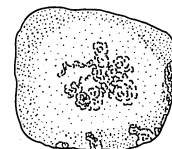

375  
12住

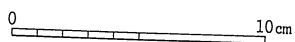

図版236 縄文時代の石器(2) 1 : 3

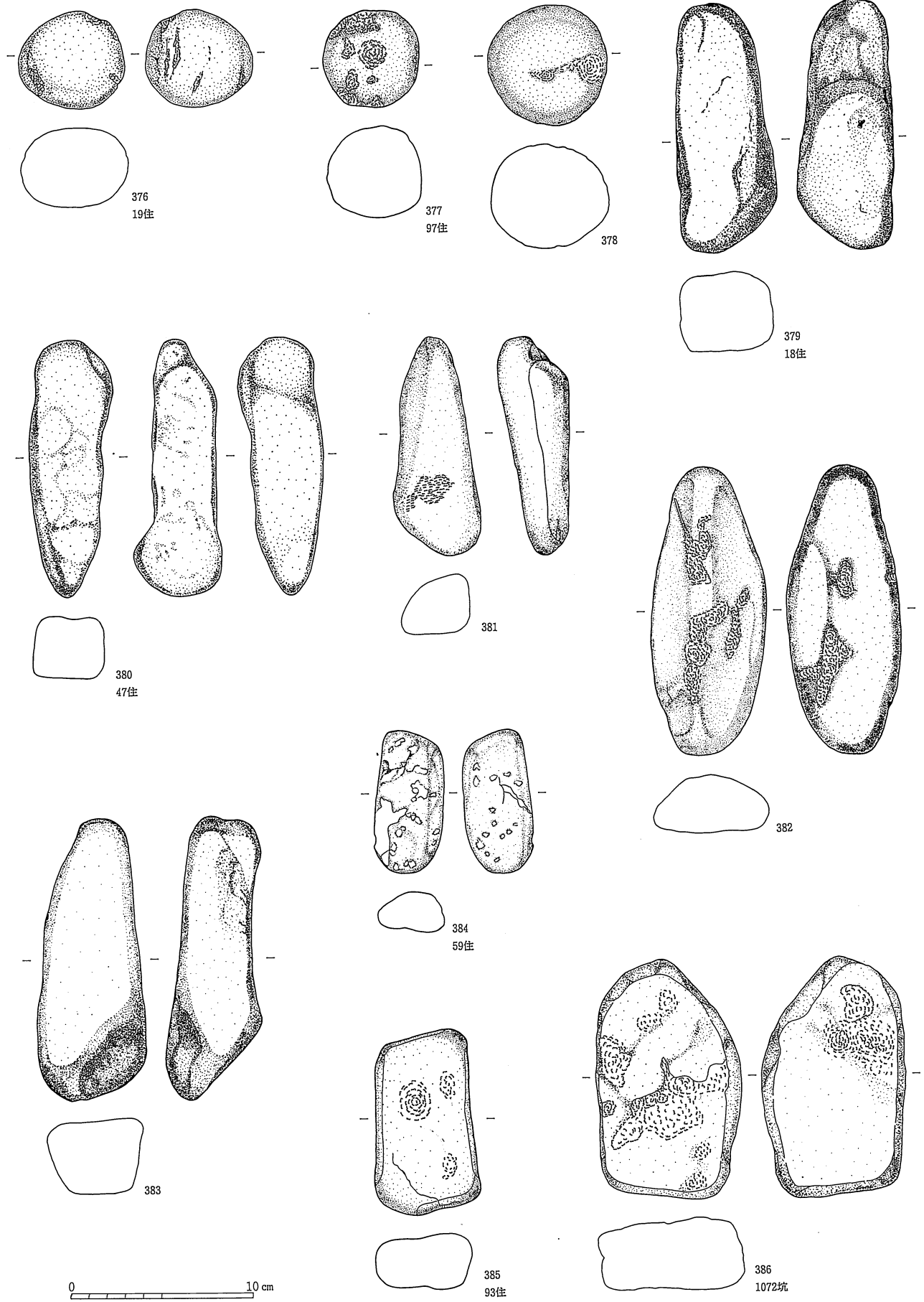



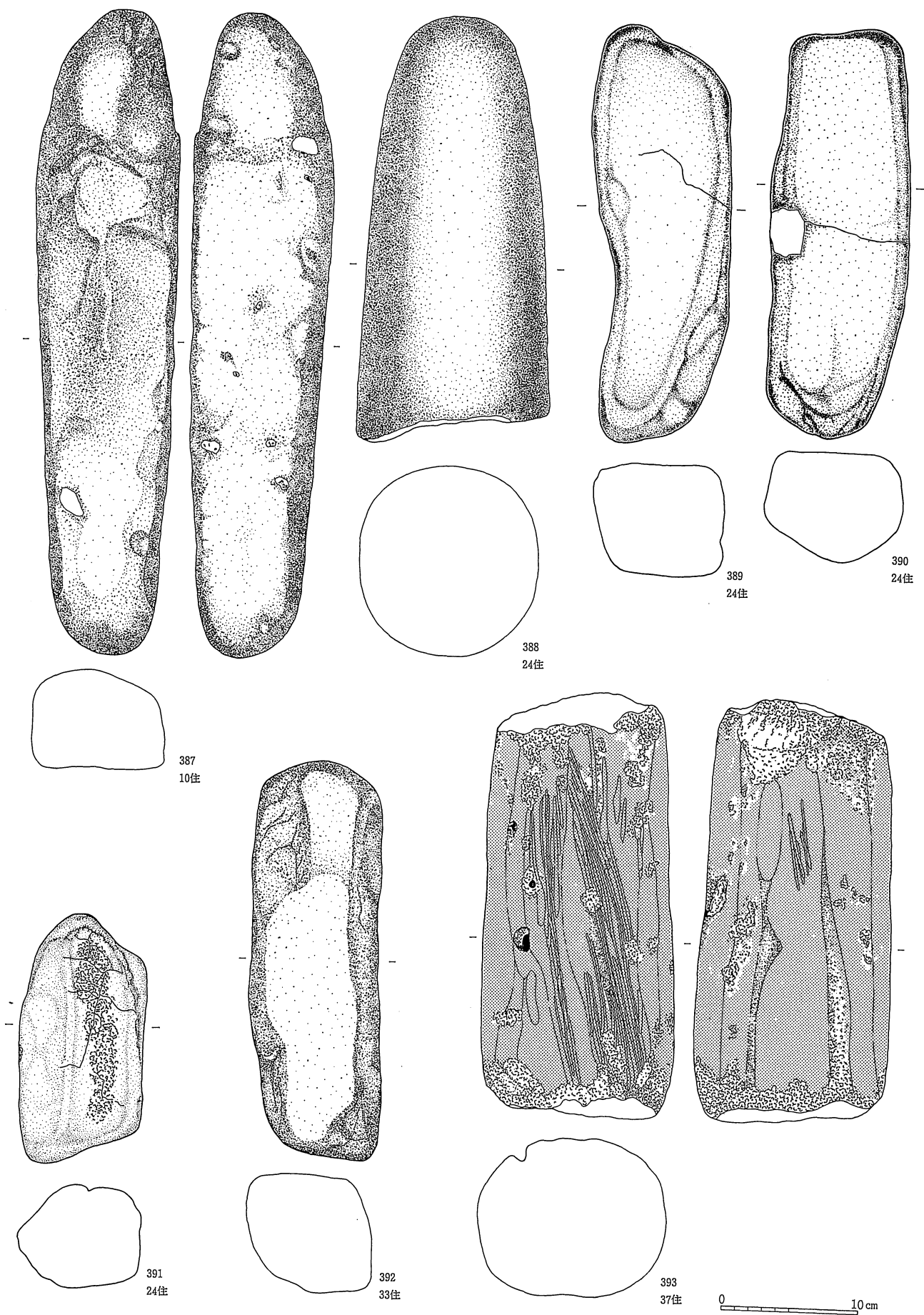

図版238 縄文時代の石器(28) 1 : 4



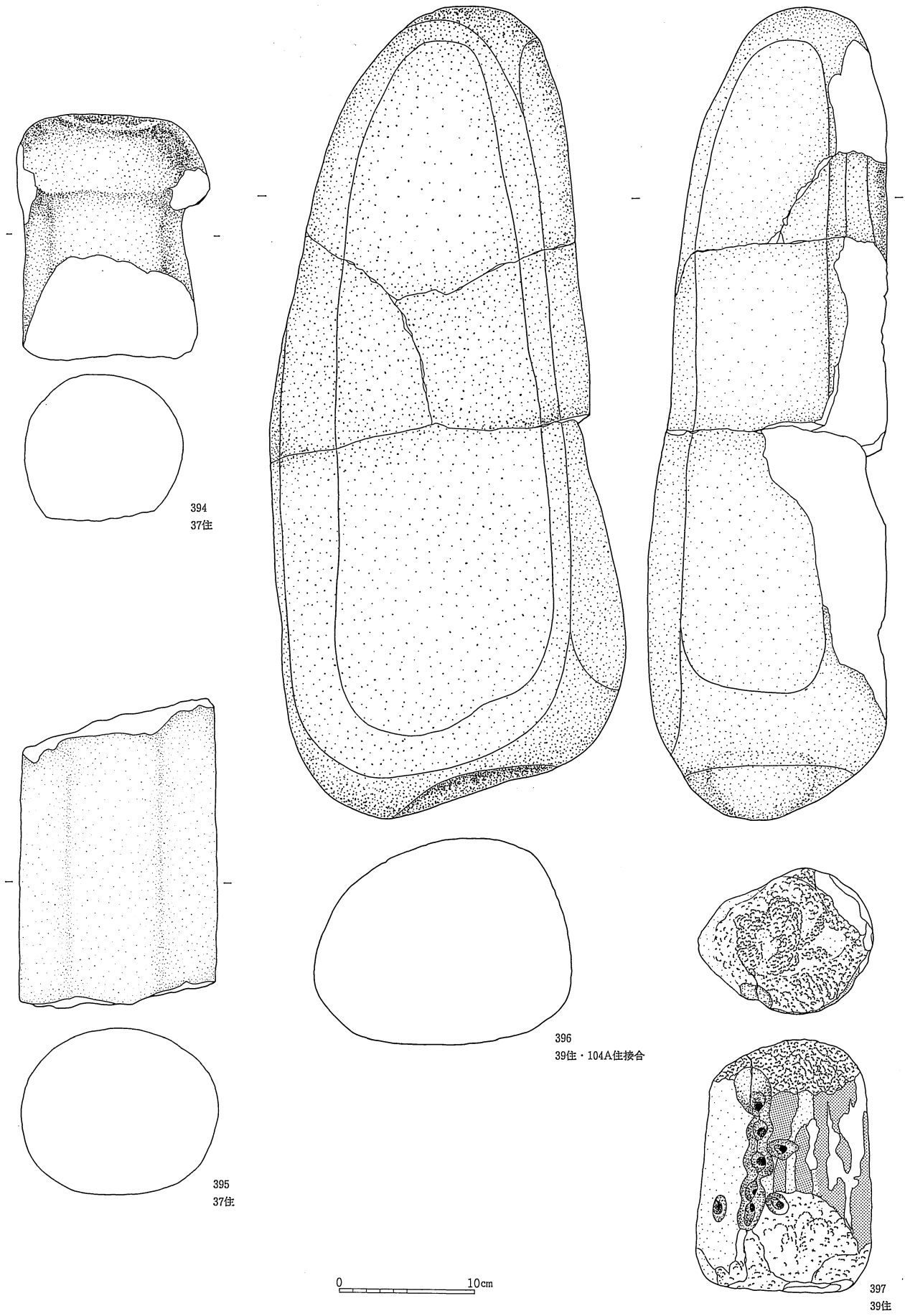

図版239 縄文時代の石器(29) 1 : 4

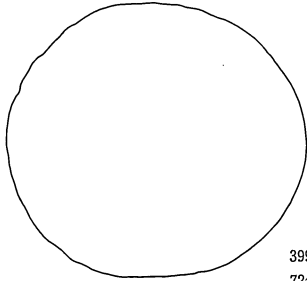
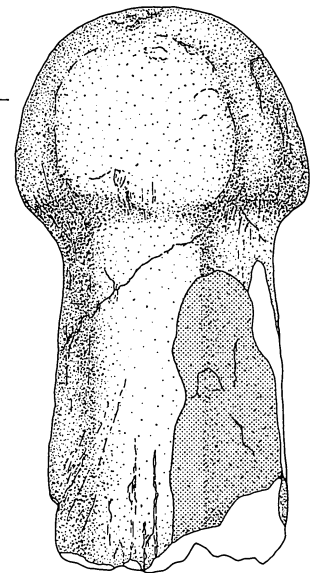
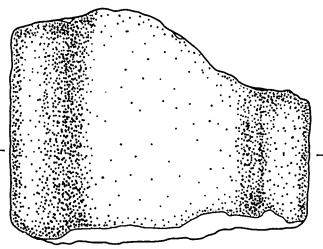
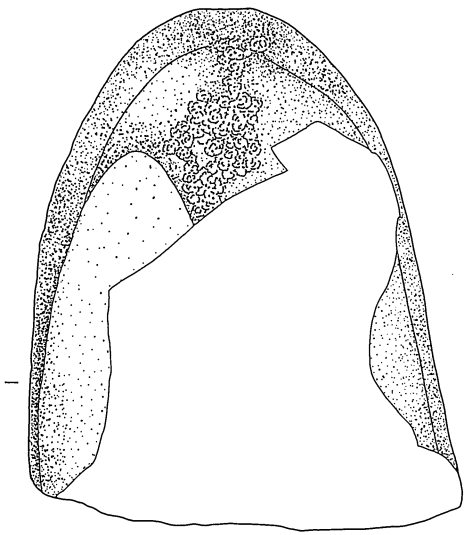

399  
72住

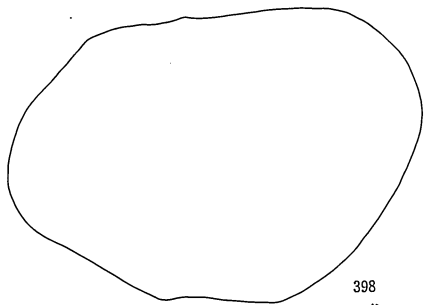

398  
47住

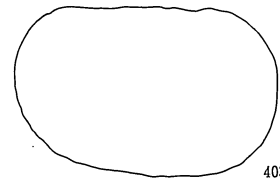
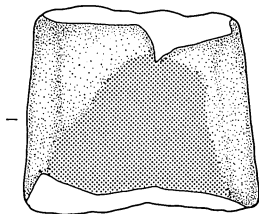

403  
94住

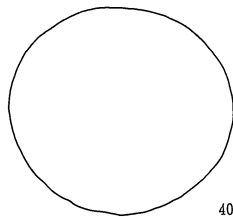

400  
83住

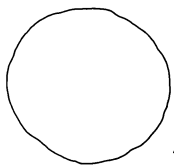
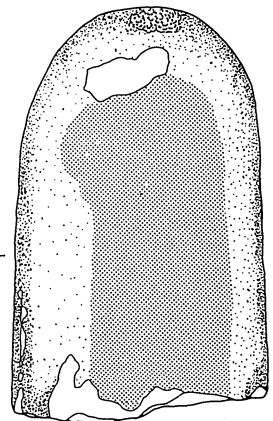
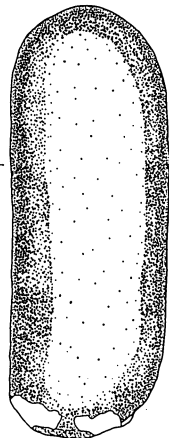
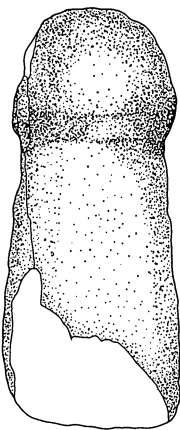
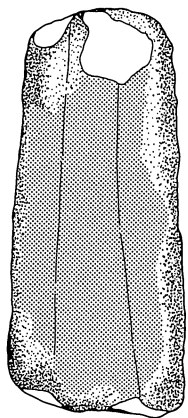
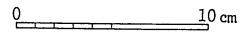

401  
83住

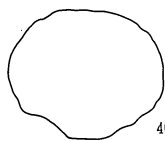

402  
83住

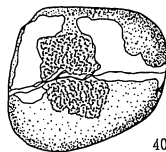

404  
114住

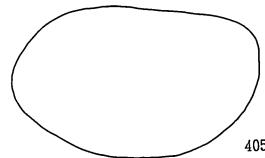

405  
131住

図版240 縄文時代の石器(30) 1 : 4

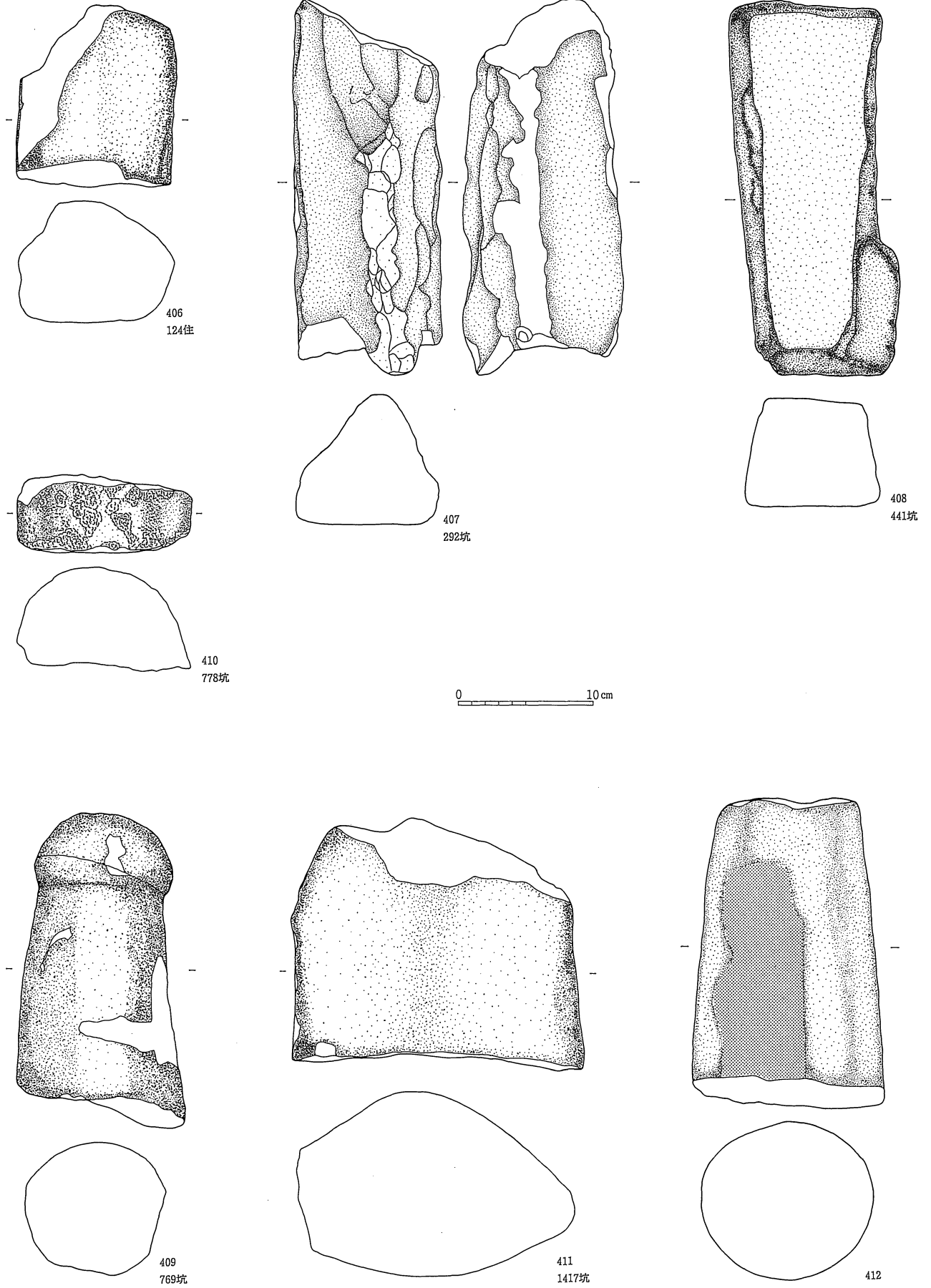

図版241 縄文時代の石器(31) 1 : 4

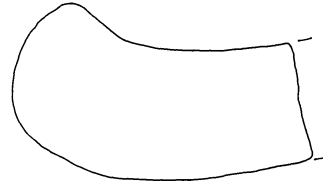
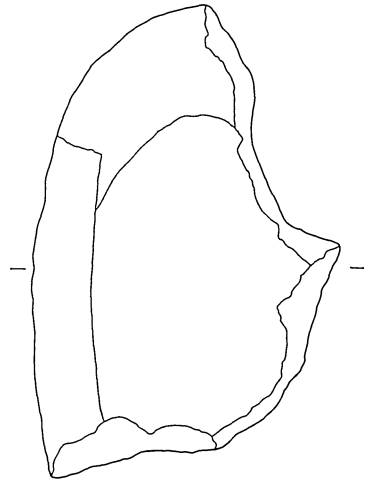
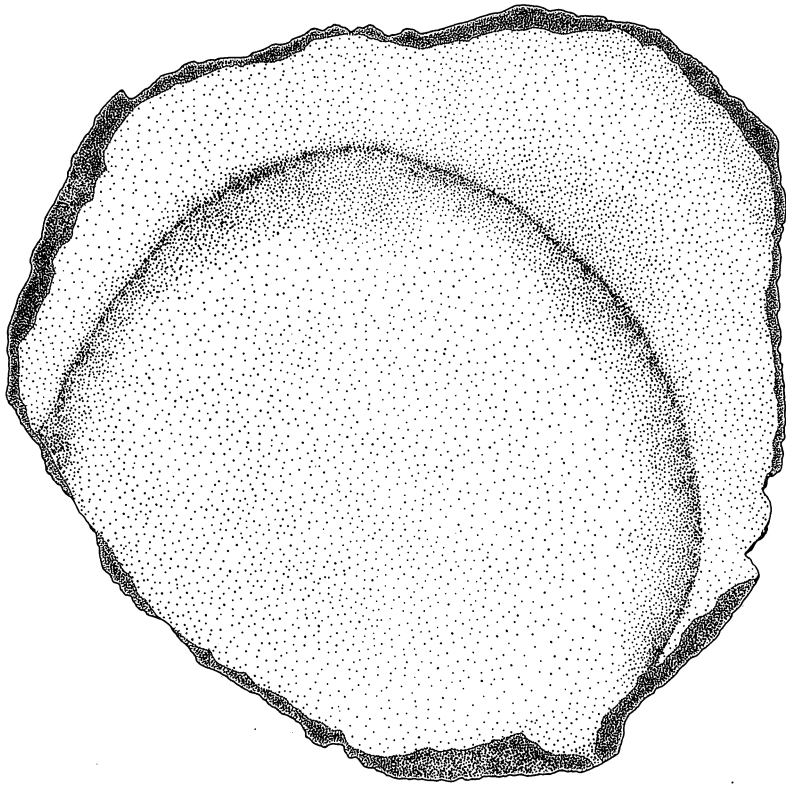

414  
16住

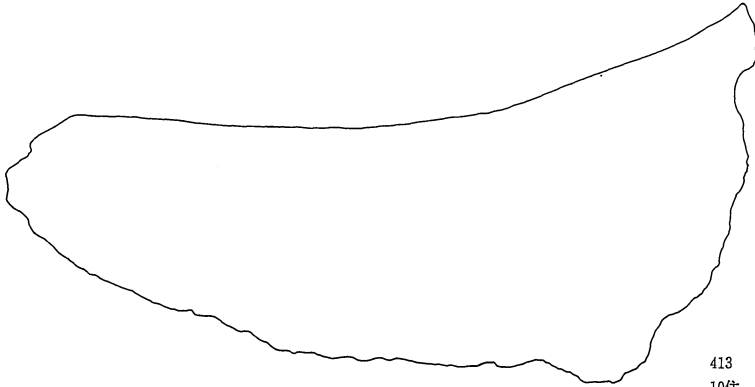

413  
10住

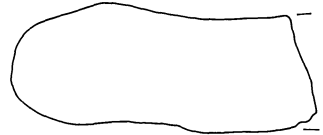
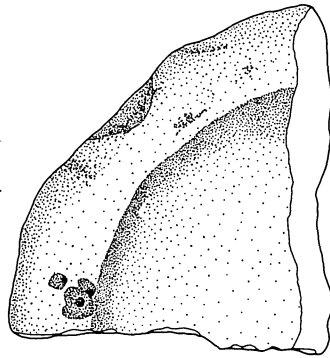

415  
18住

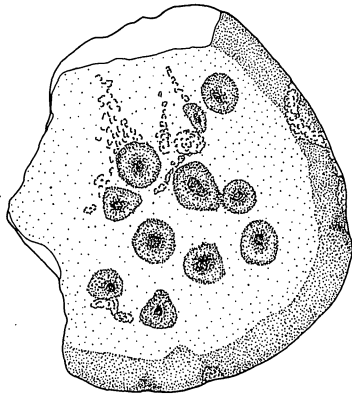
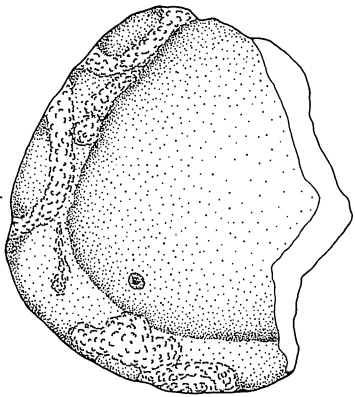

416  
33住

0 10 cm

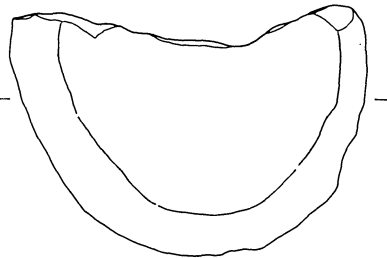

417  
69住

図版242 縄文時代の石器(92) 1 : 4

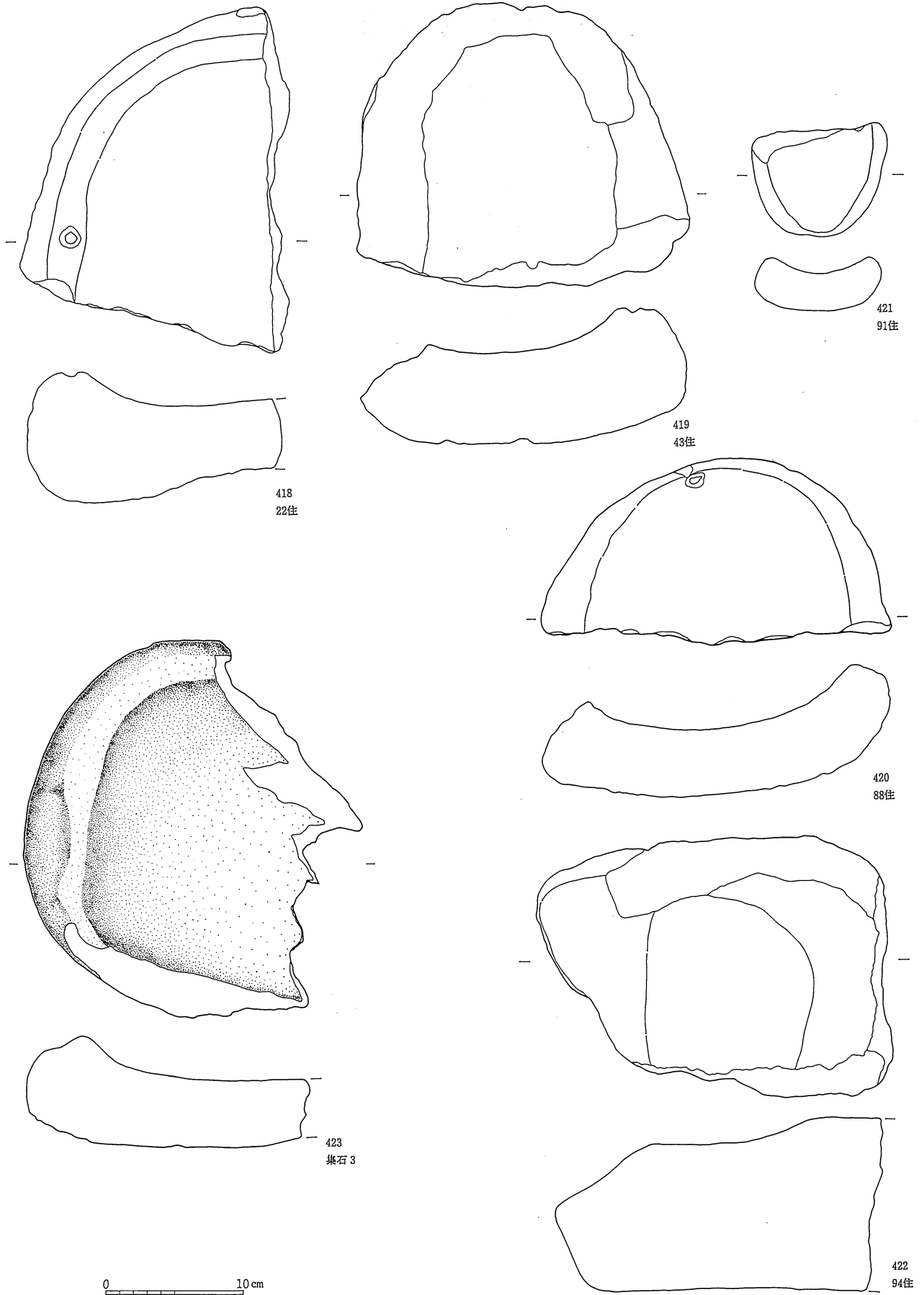

図版243 縄文時代の石器(3) 1 : 4

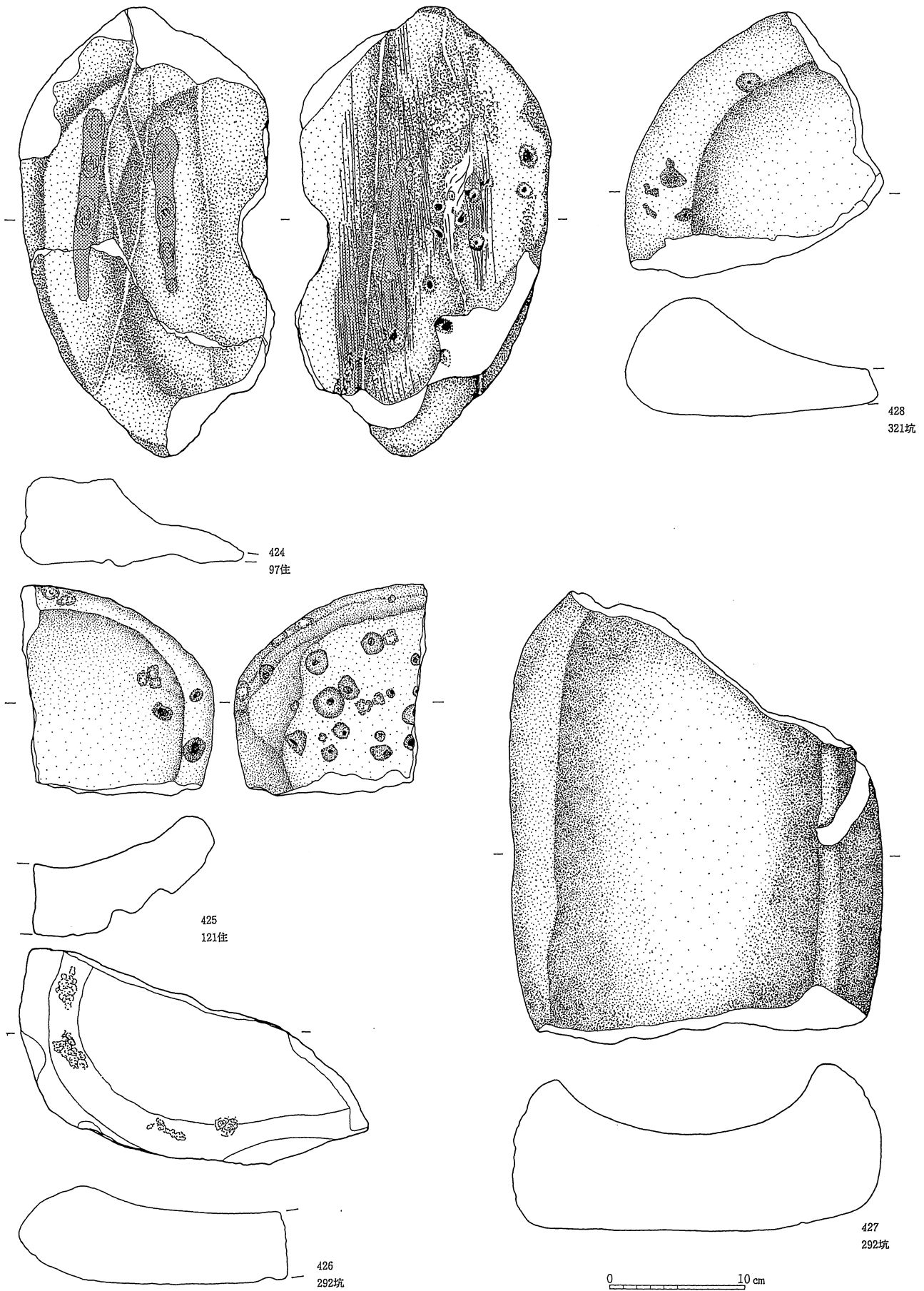

図版244 縄文時代の石器(4) 1 : 4

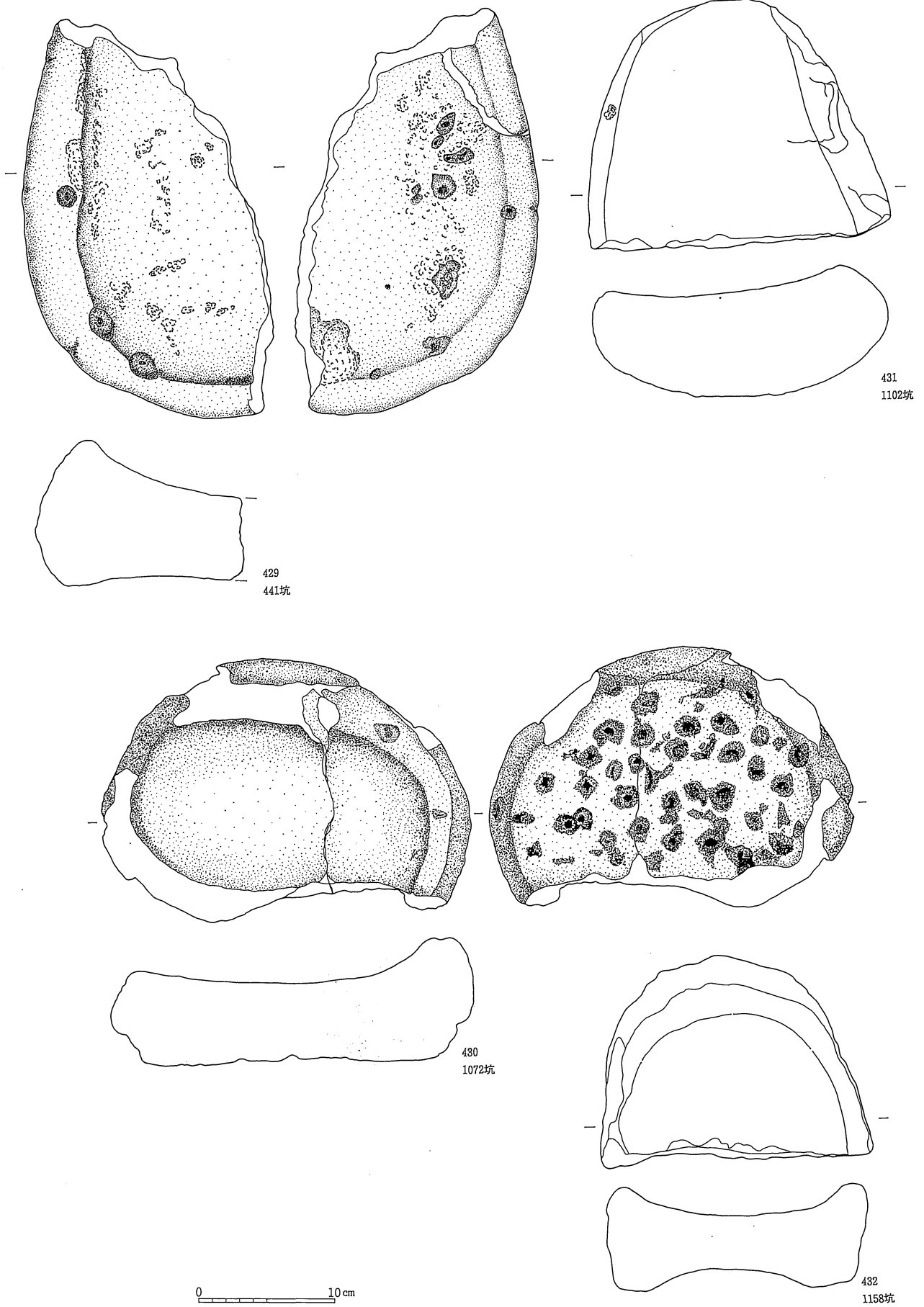

図版245 縄文時代の石器(35) 1 : 4

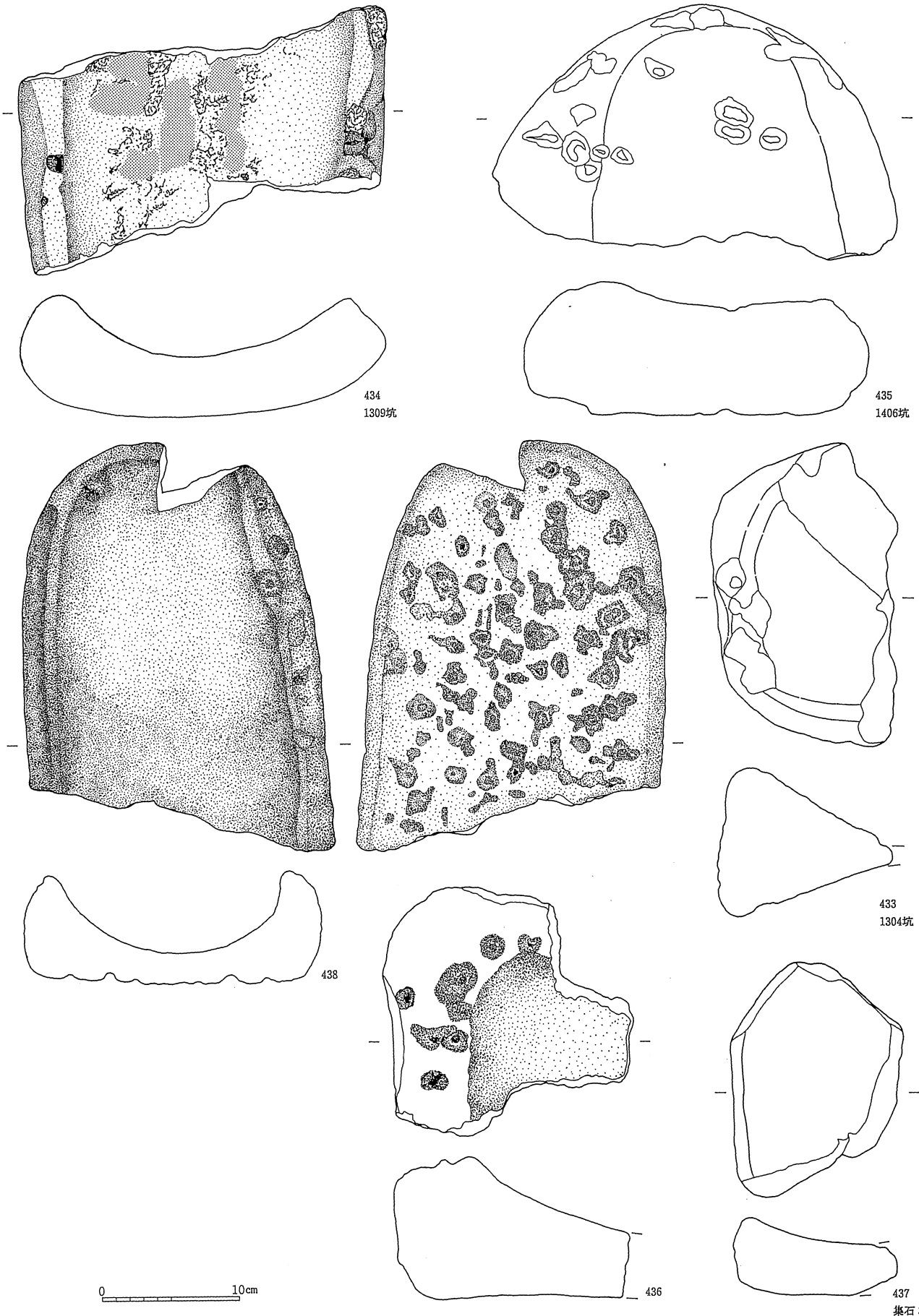

図版246 縄文時代の石器(36) 1 : 4



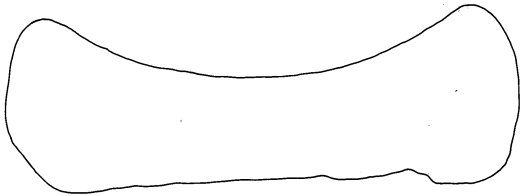
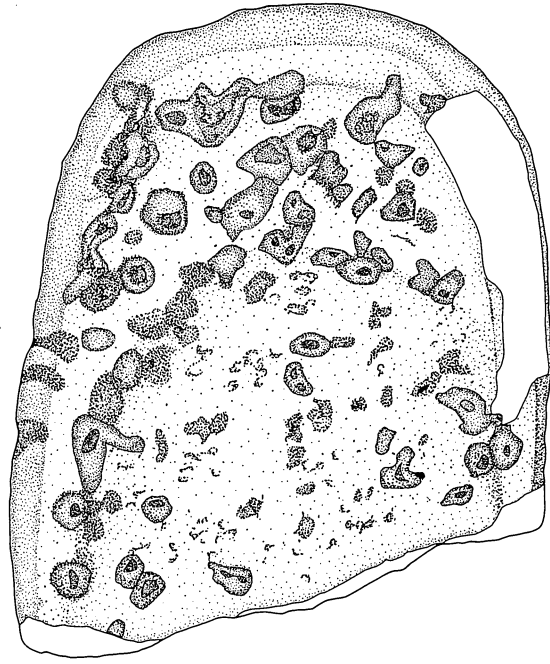
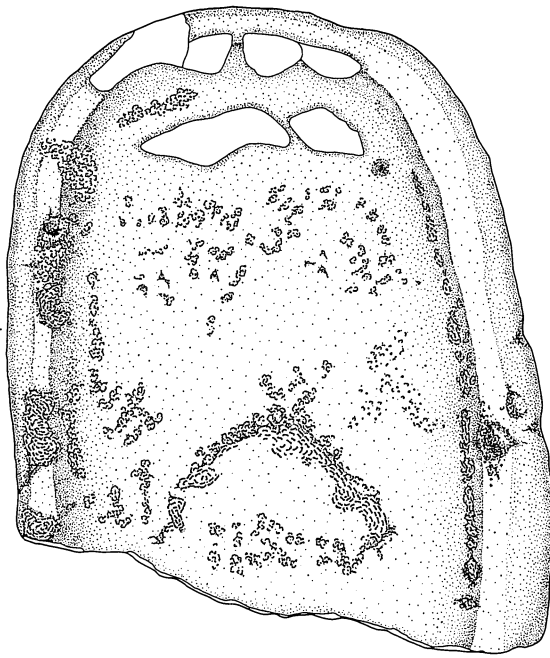

439

0 10 cm

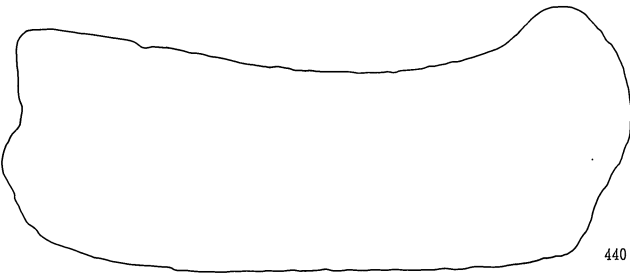
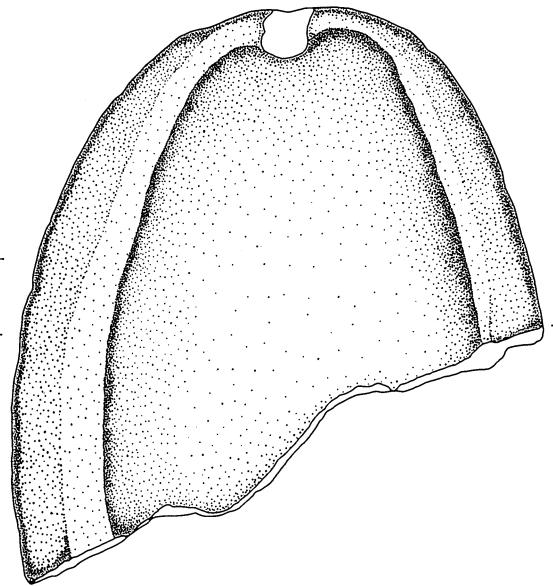
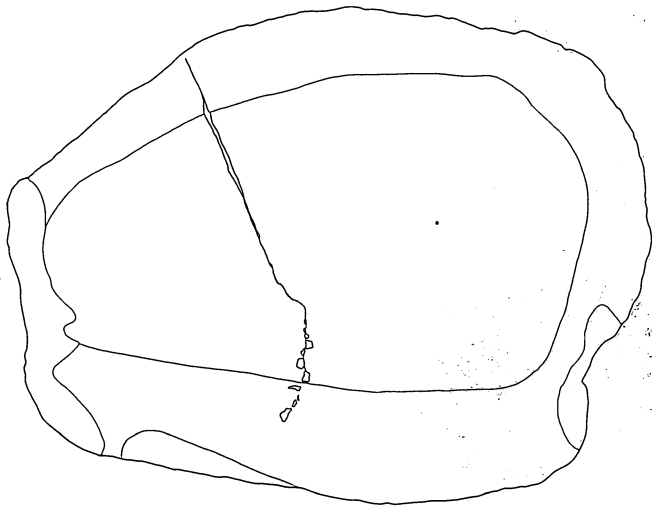

440

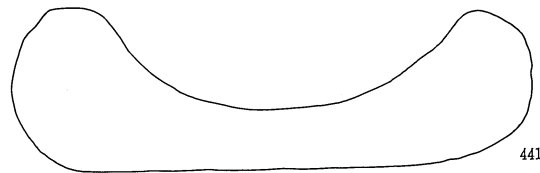

441

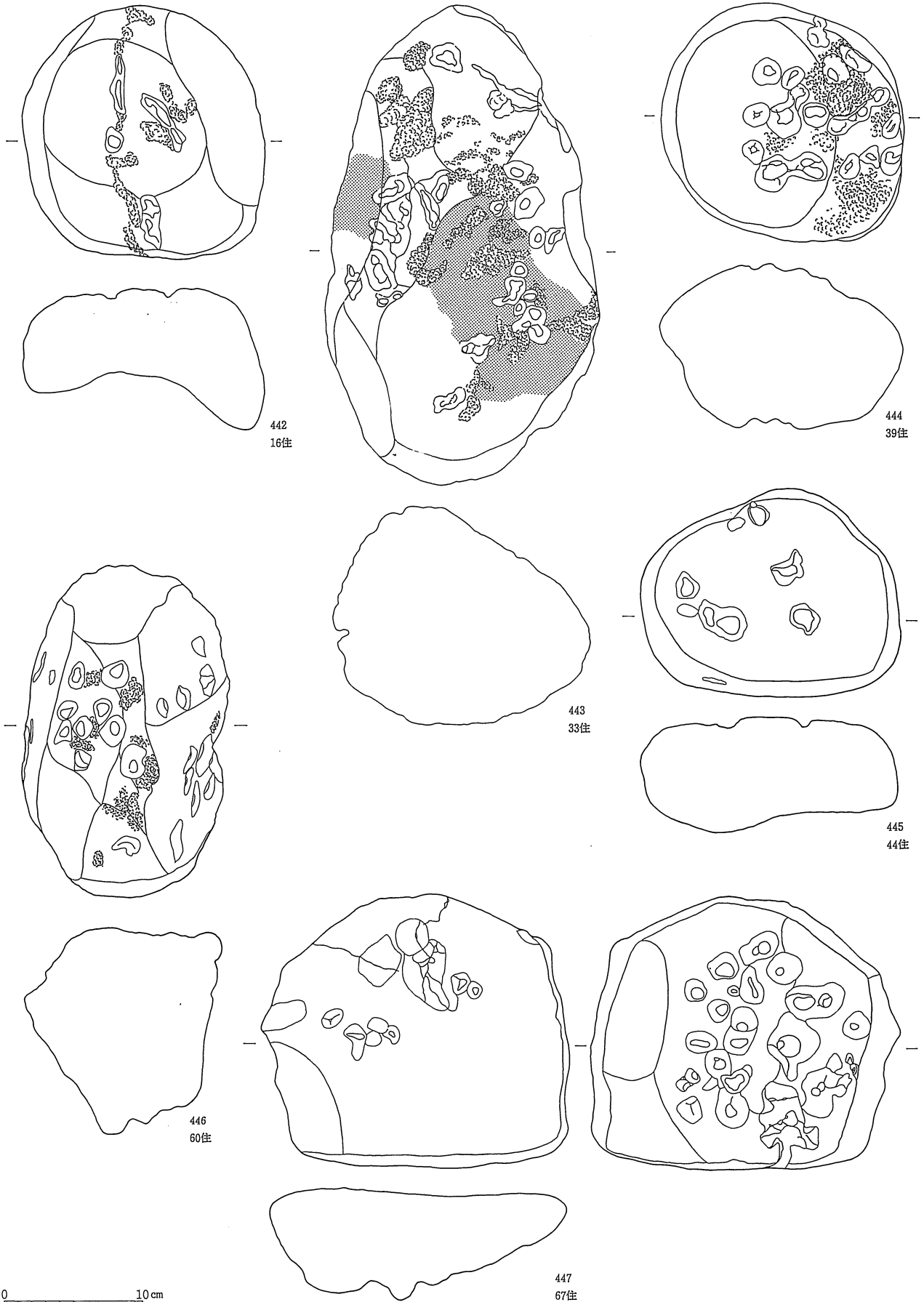

図版248 縄文時代の石器(8) 1 : 4

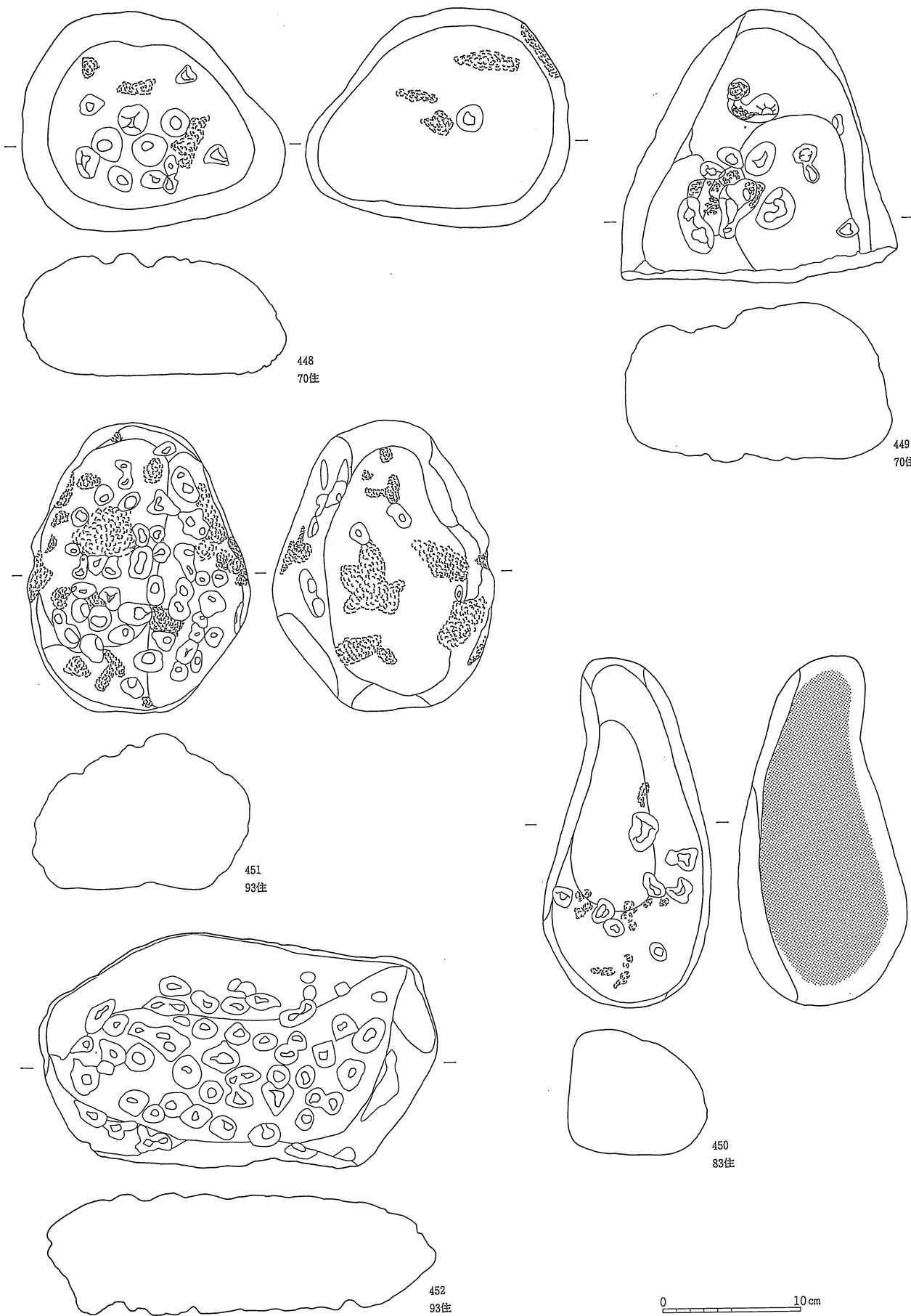

図版249 縄文時代の石器(9) 1 : 4

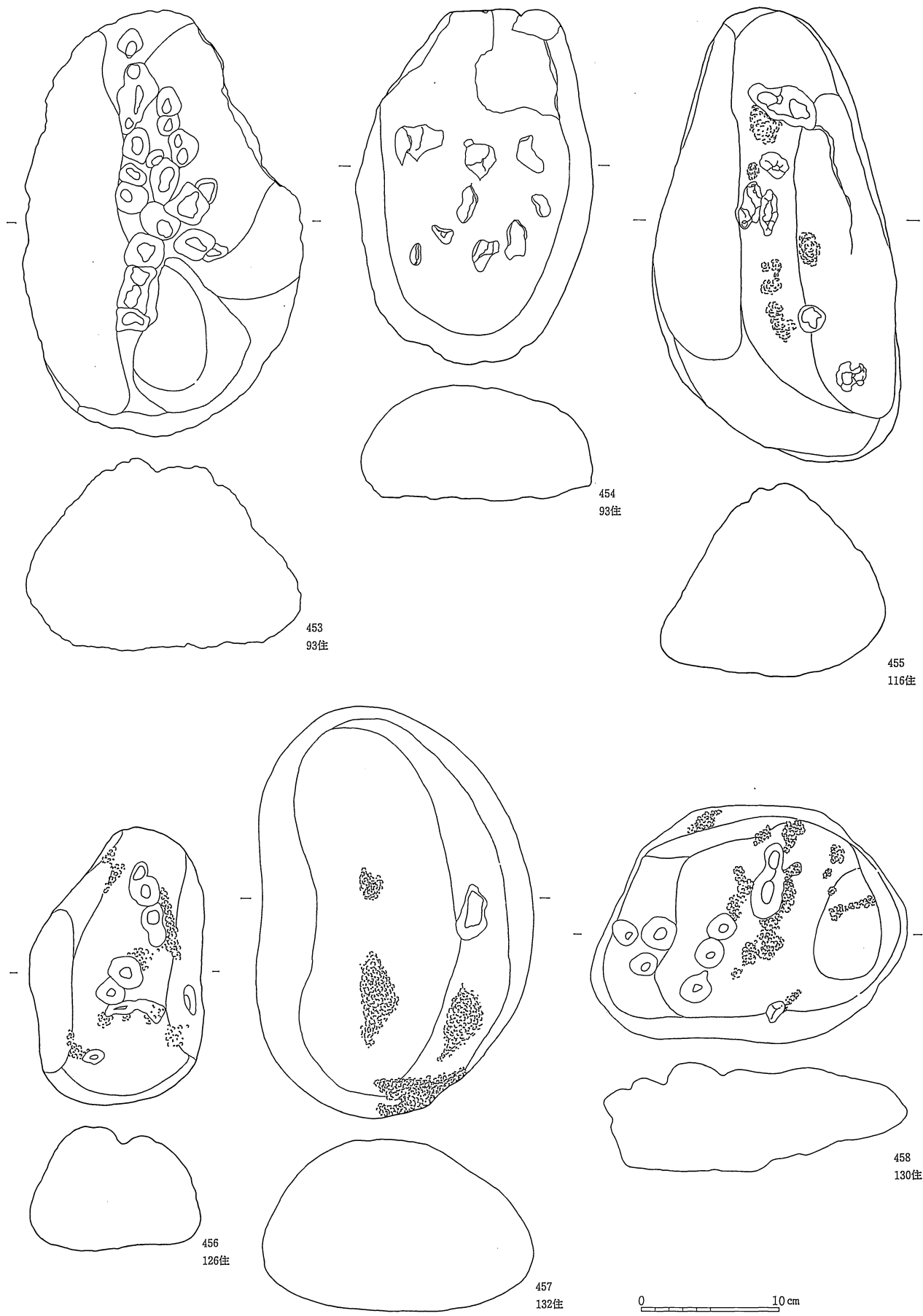

図版250 縄文時代の石器(40) 1 : 4

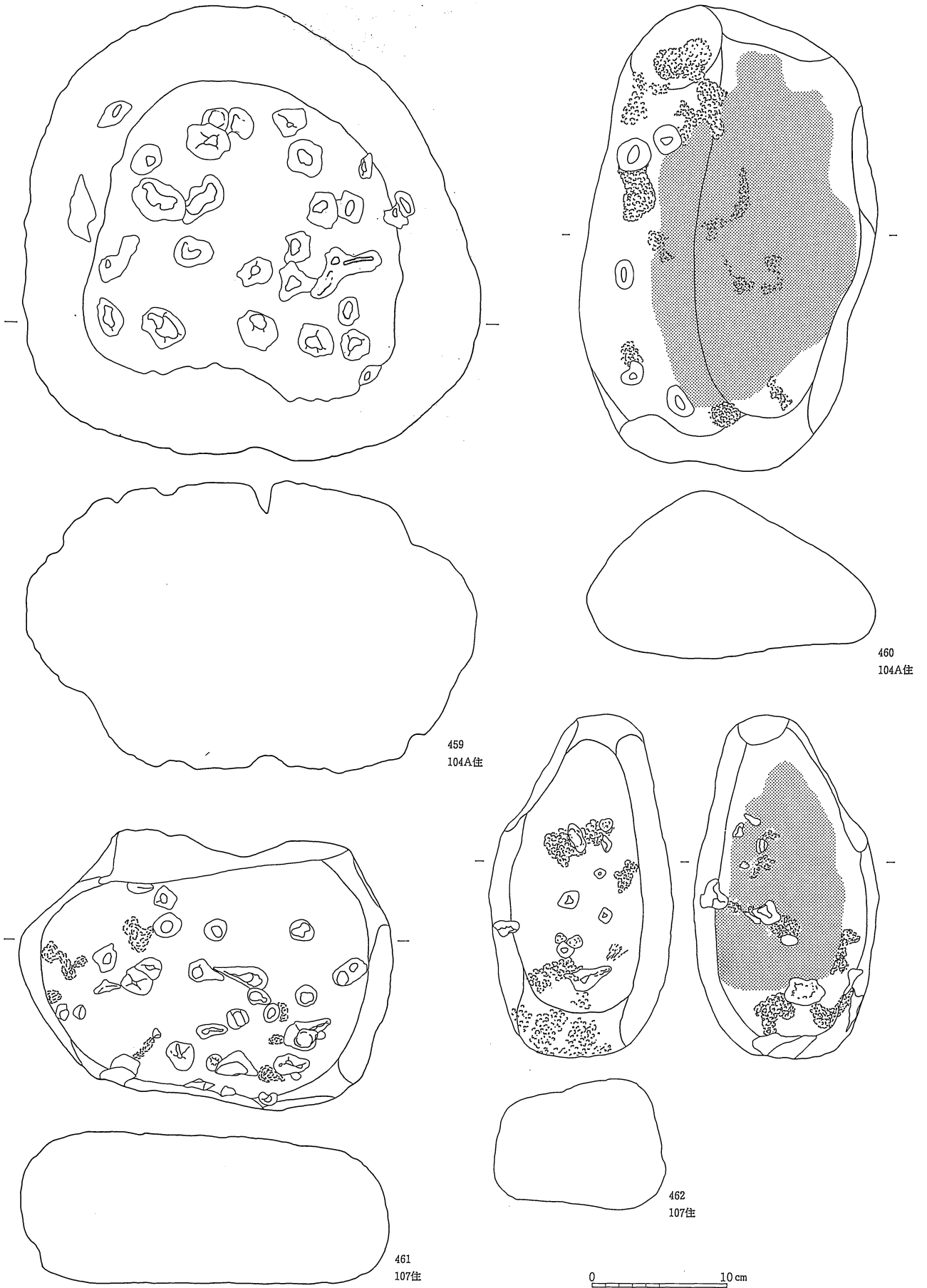

図版251 縄文時代の石器(4) 1 : 4

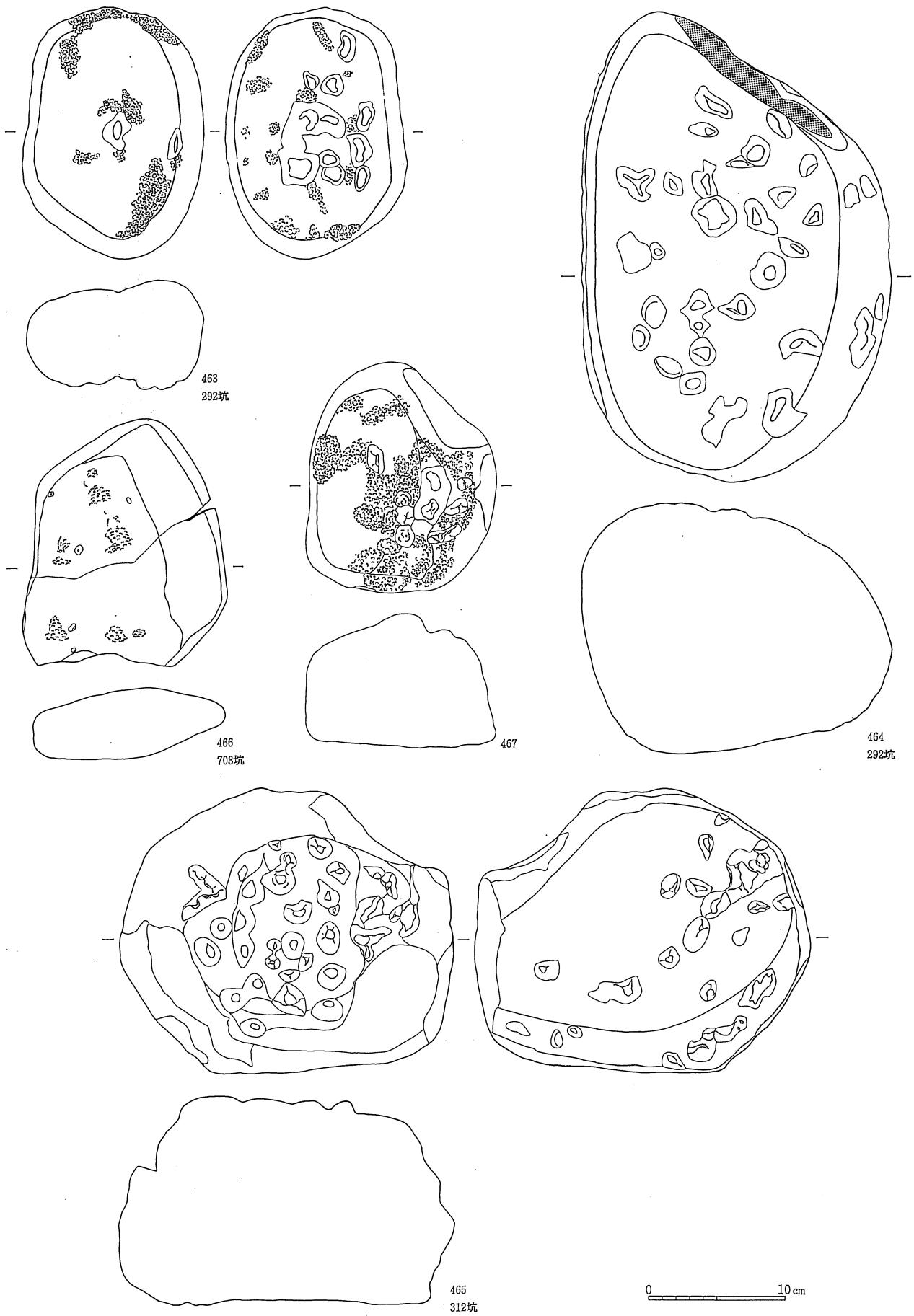

図版252 縄文時代の石器(42) 1 : 4

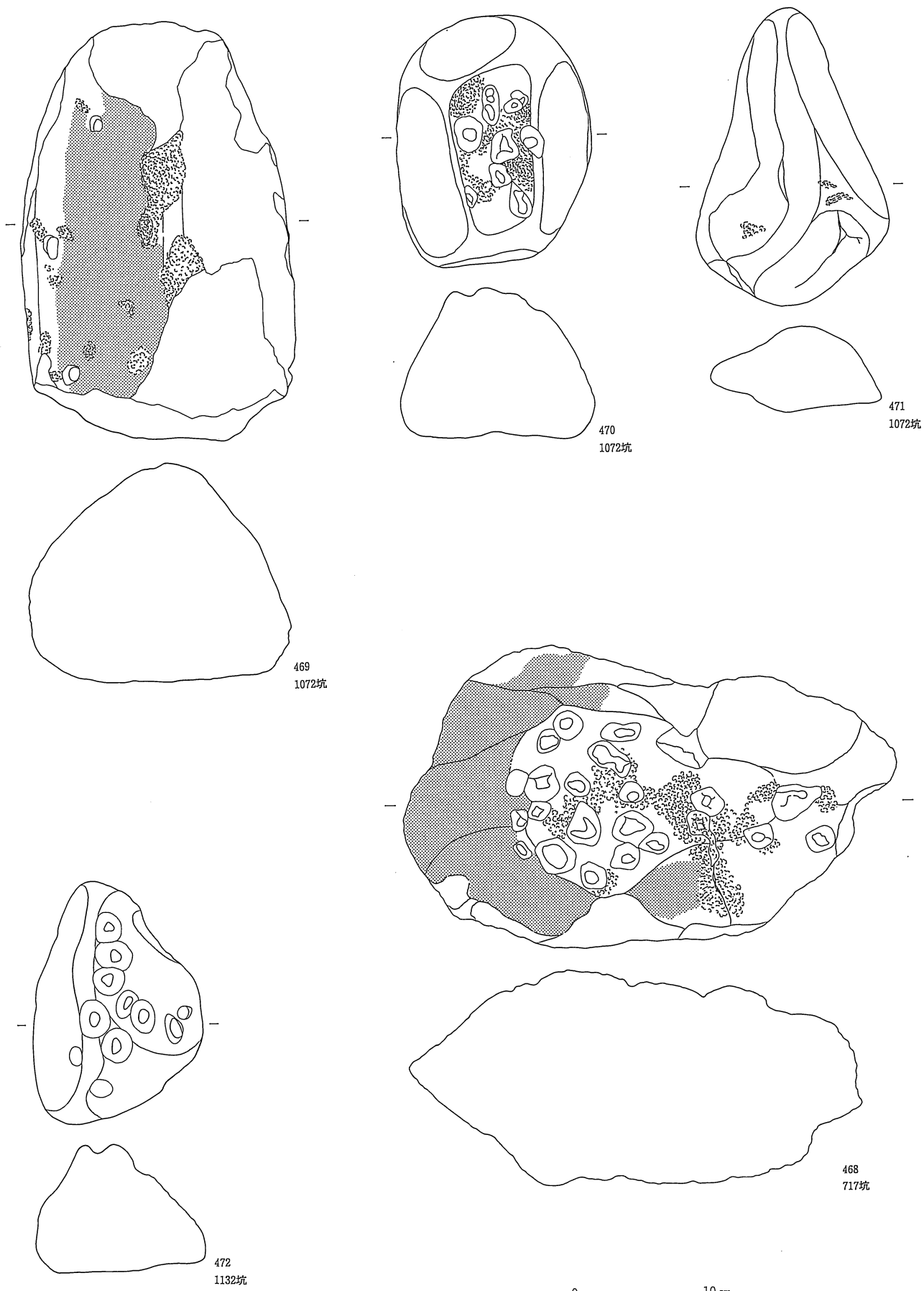

図版253 縄文時代の石器(43) 1 : 4

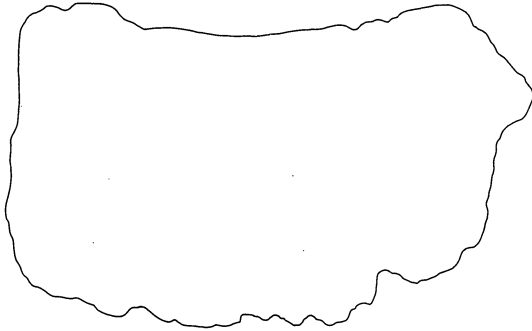
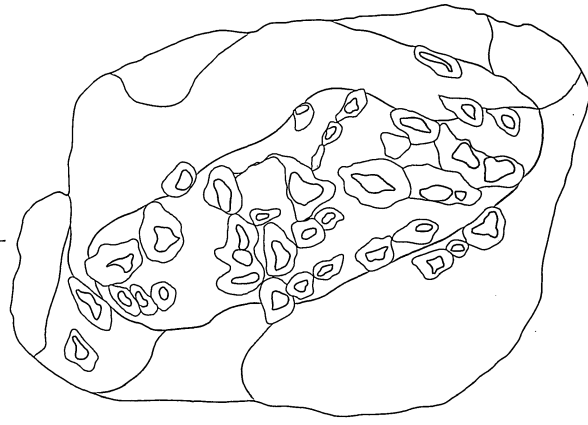
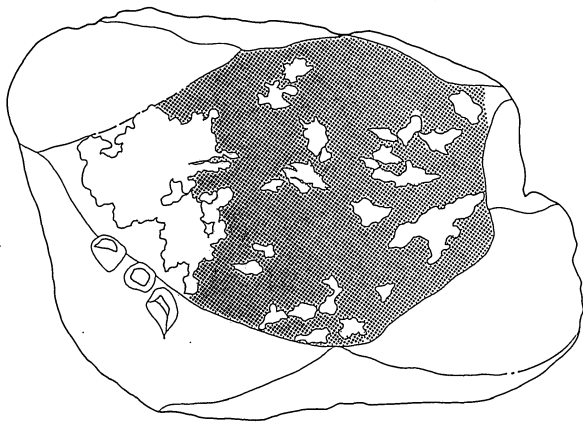

473  
1131坑

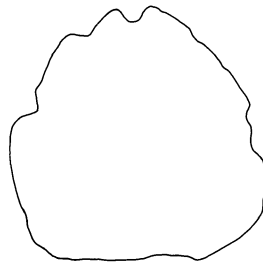
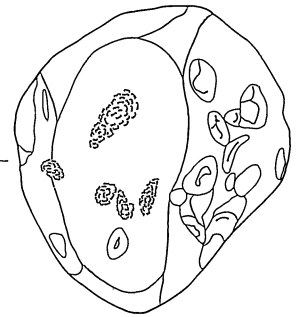
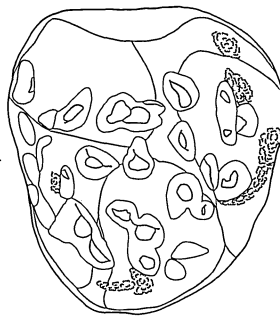

475  
1209坑

0 10cm

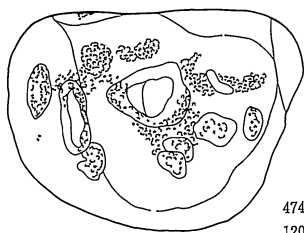
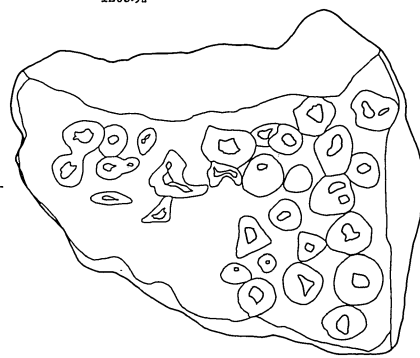
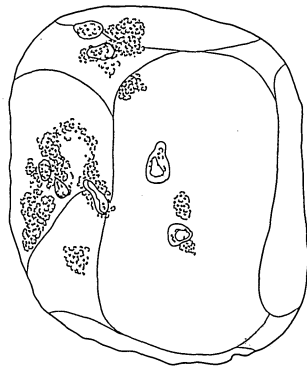
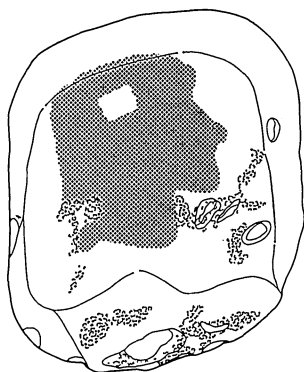

474  
1206坑

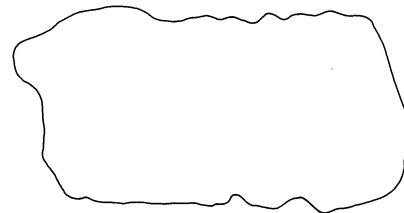

476  
1268坑



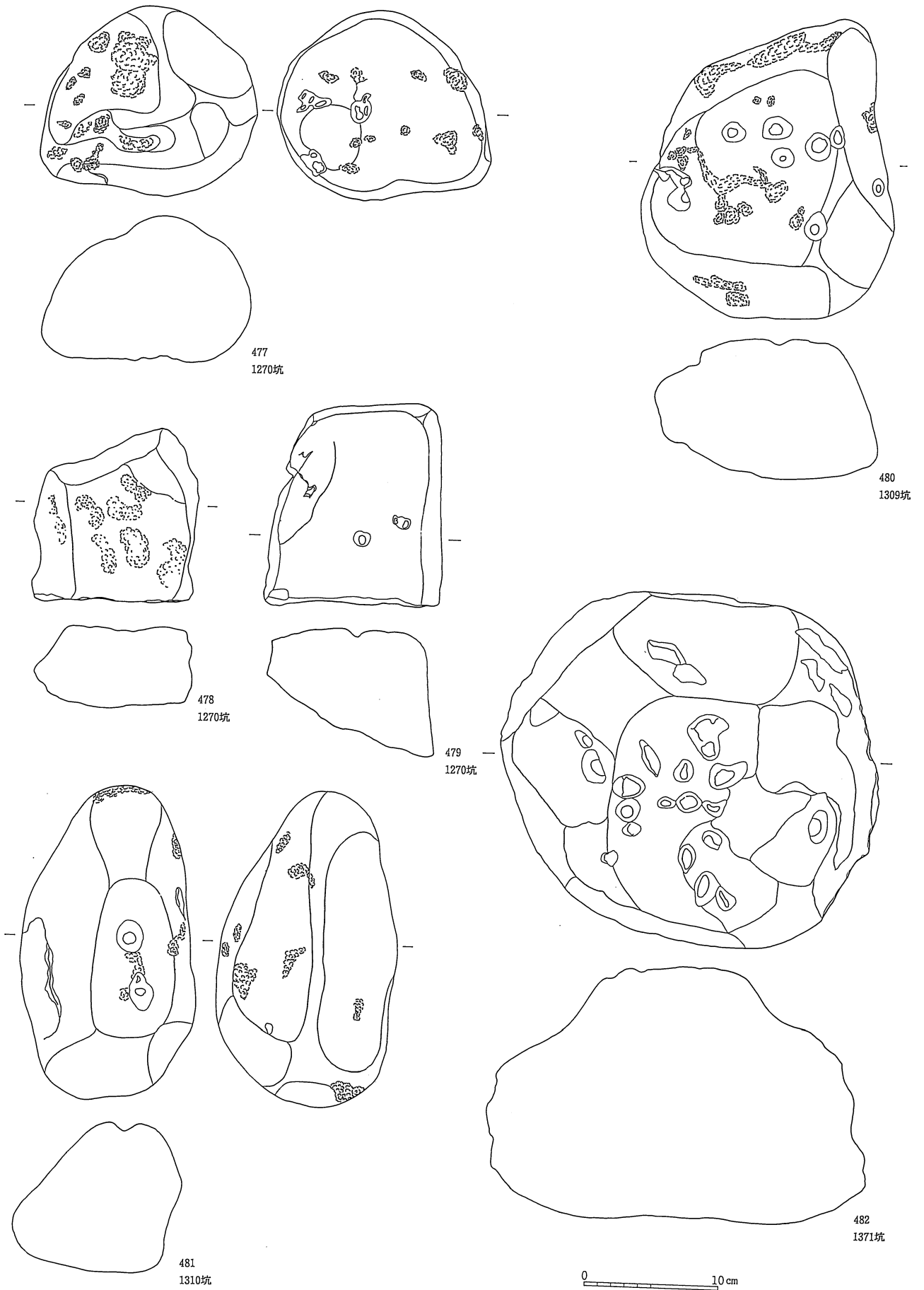

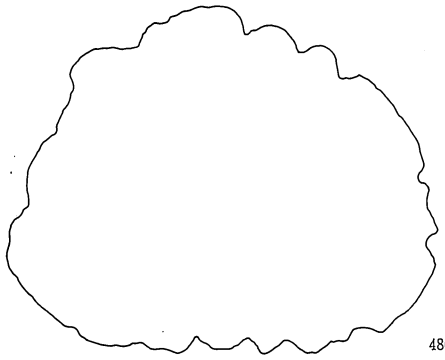
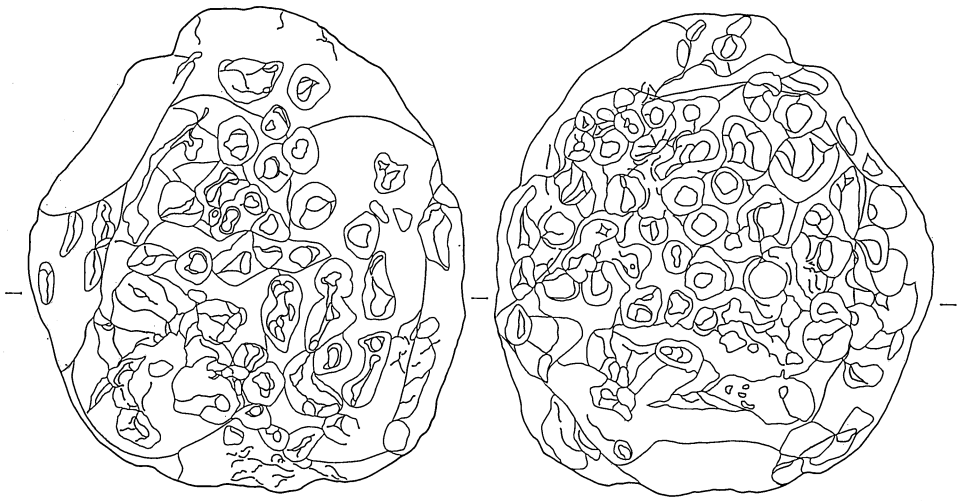

486

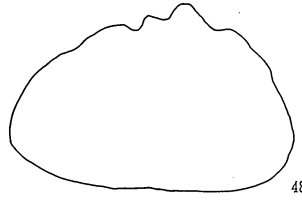
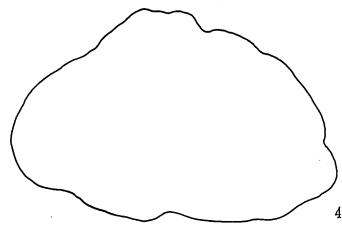
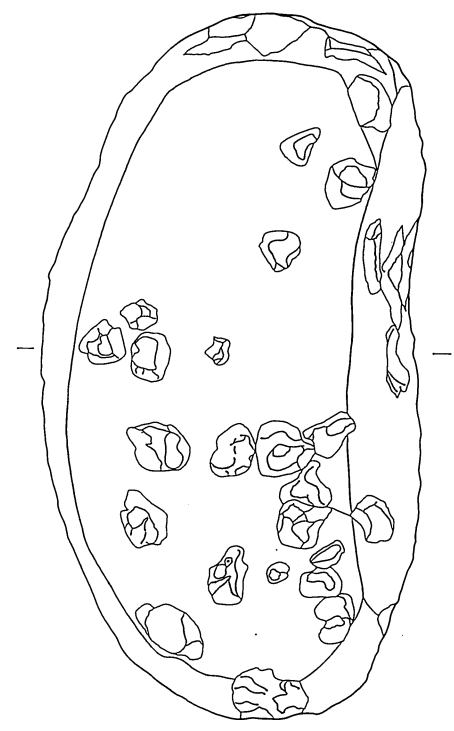
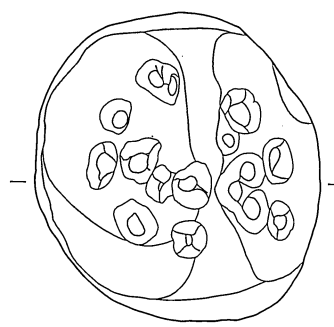
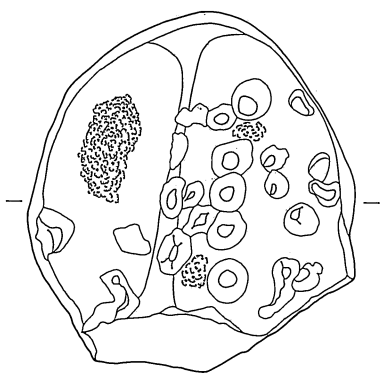

484

483  
1380坑

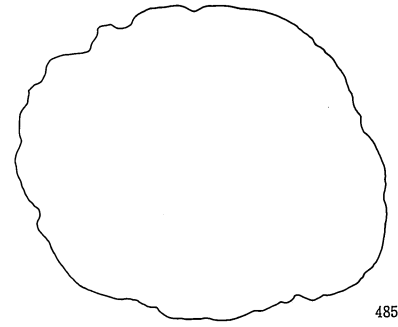

485



図版256 縄文時代の石器(4) 1 : 4

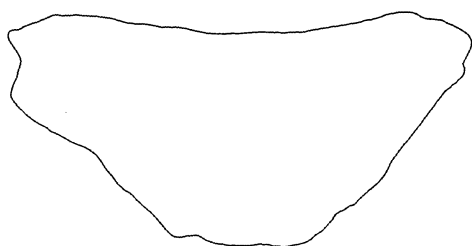
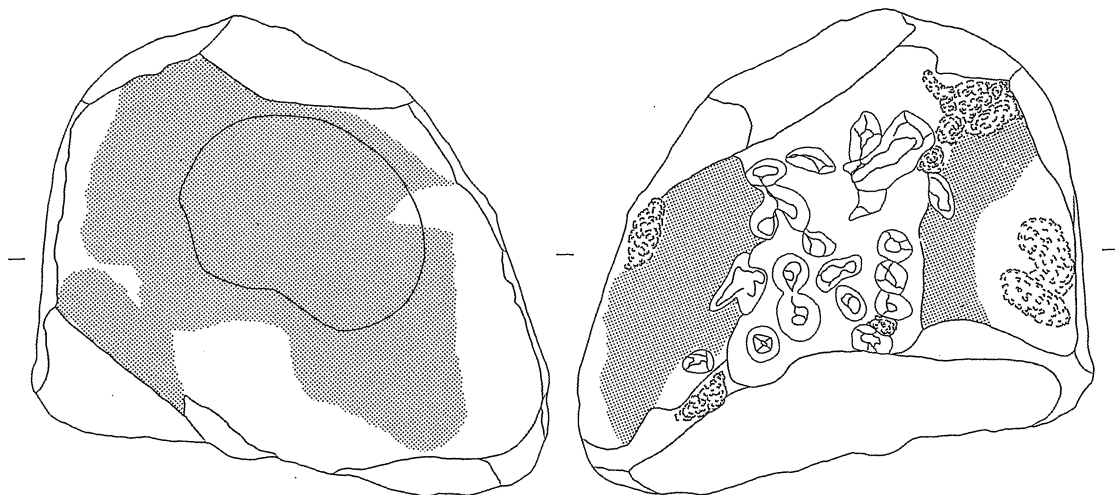

487

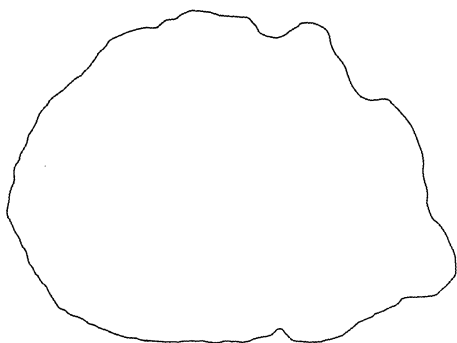
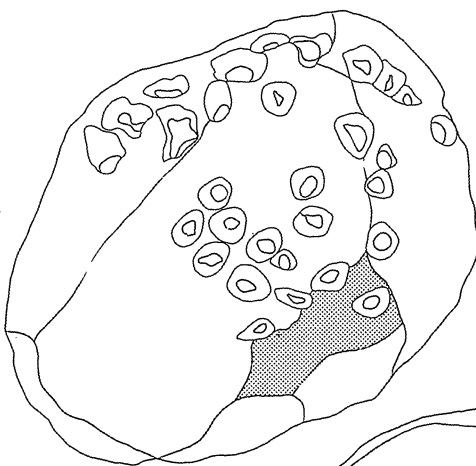
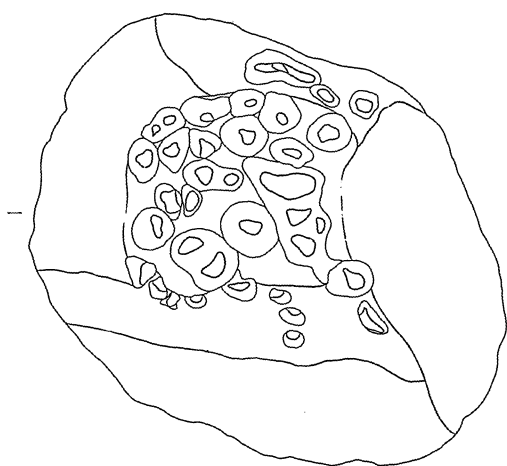

488

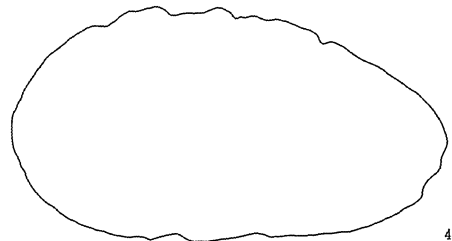
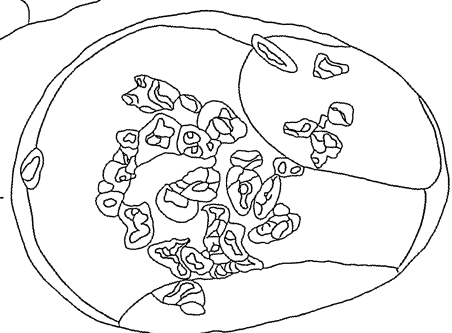

489

0 10 cm

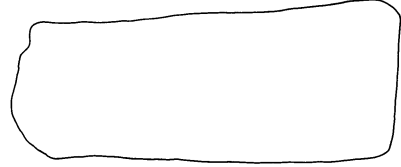
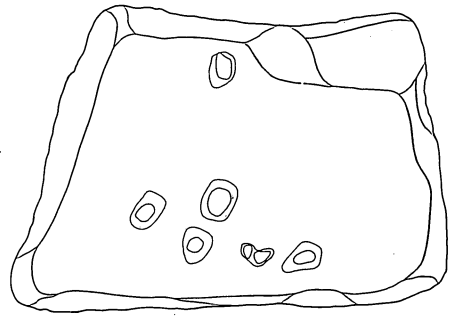
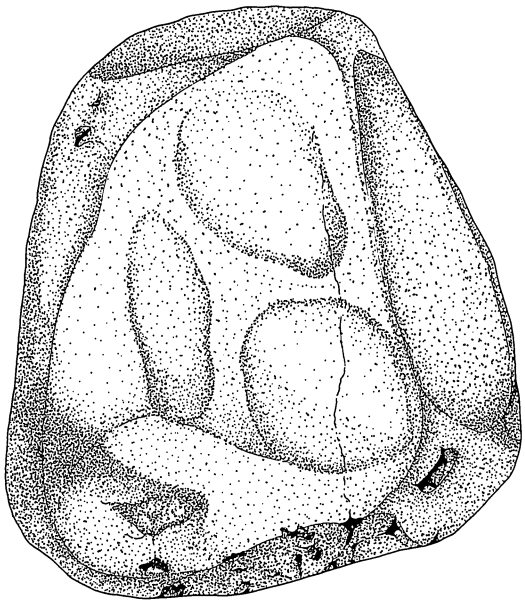

491  
70住

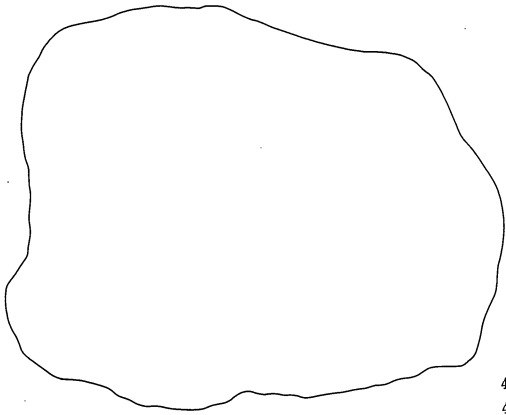

490  
47住

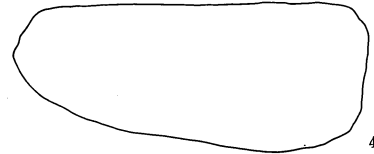
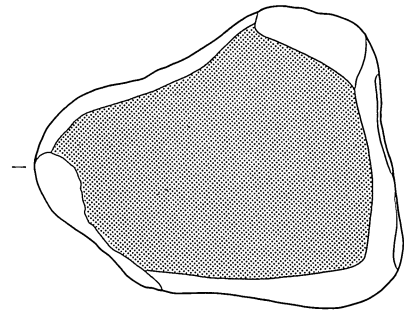

492  
131住

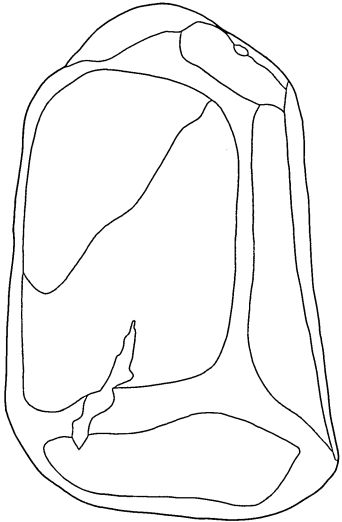

493  
239坑

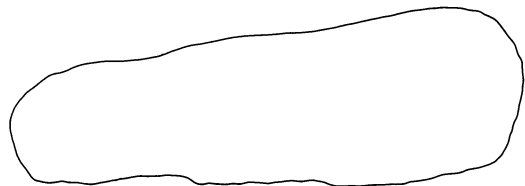
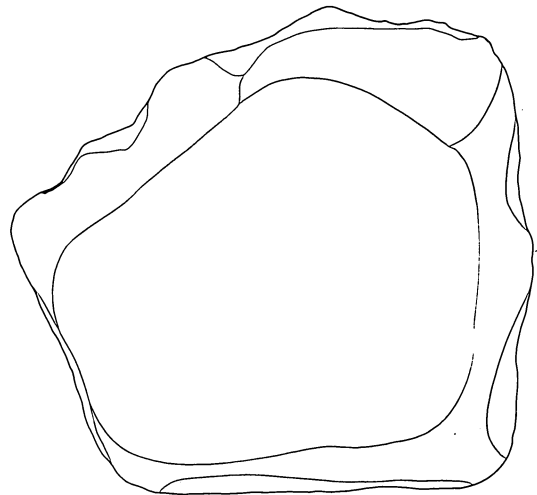

494  
441坑

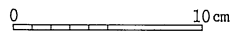

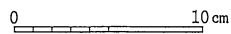
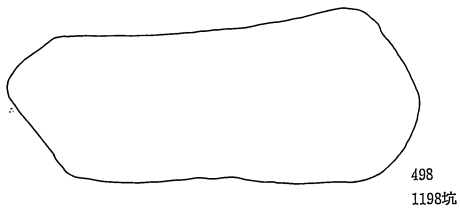
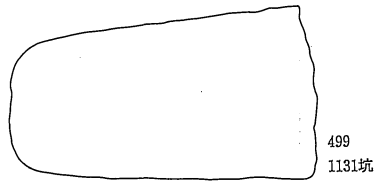
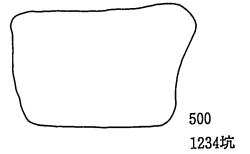
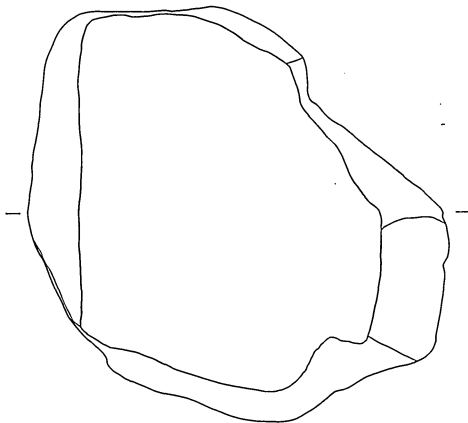
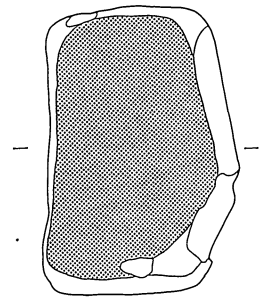
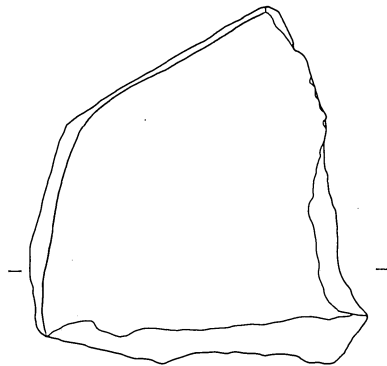
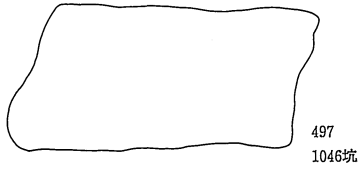
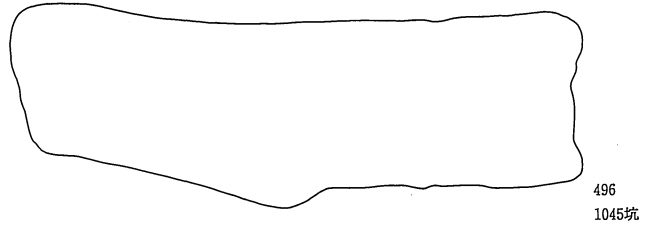
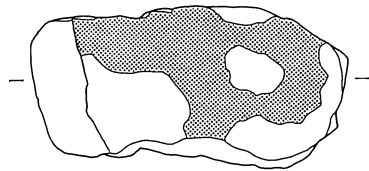
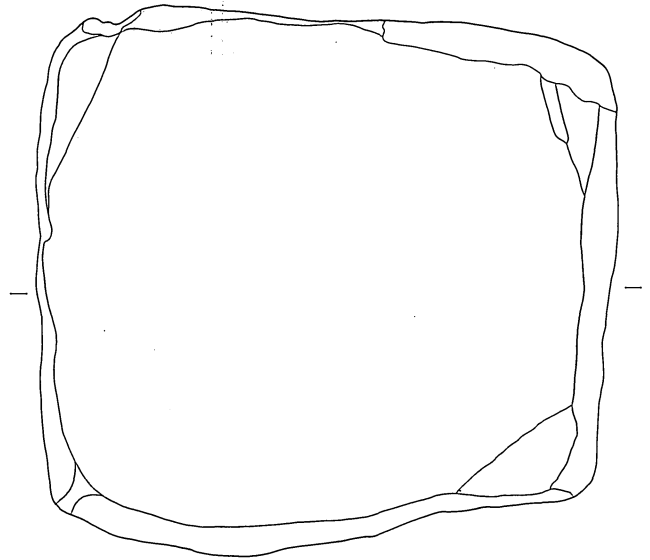
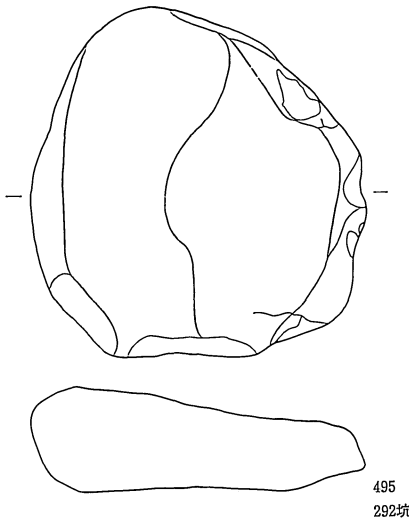

図版259 縄文時代の石器(4) 1 : 4

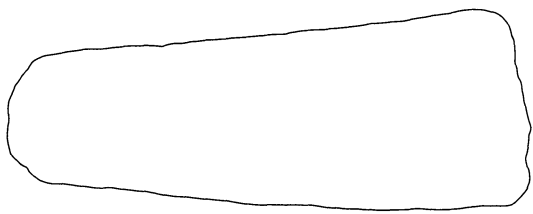
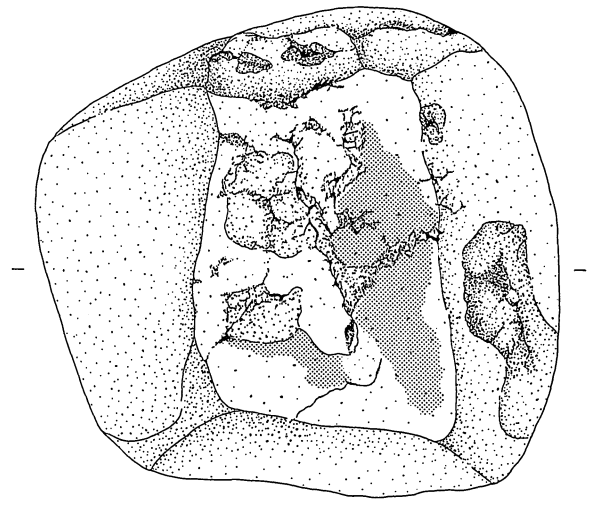
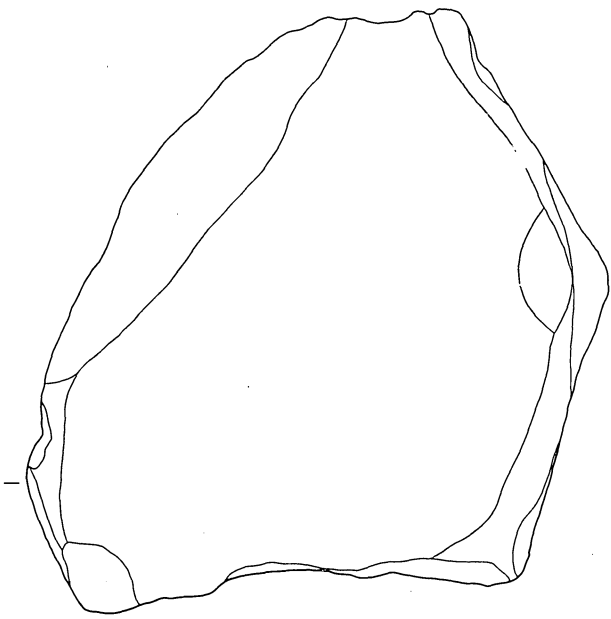

502  
1269坑

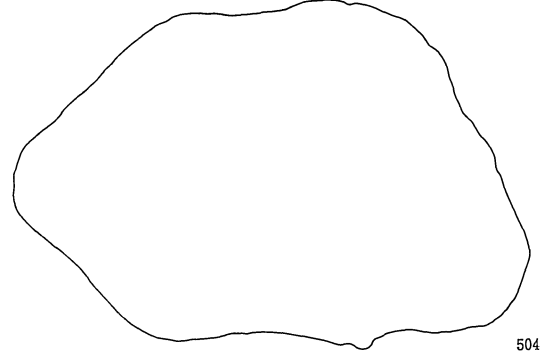

504  
1273坑

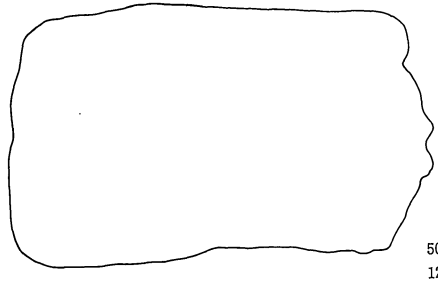
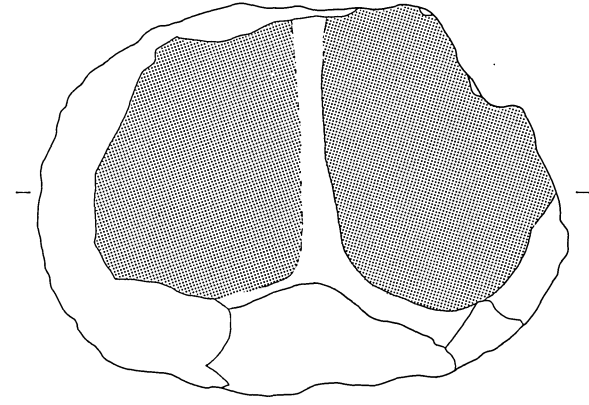
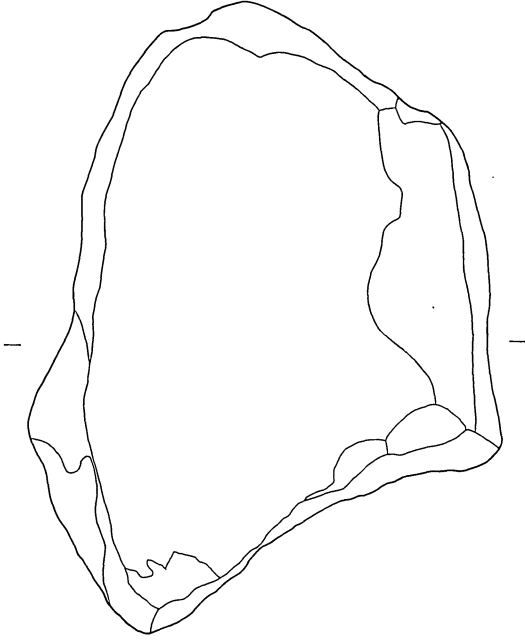

503  
1270坑

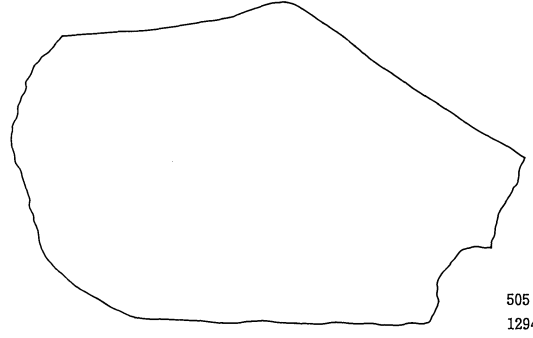

505  
1294坑

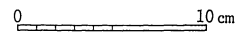

図版260 縄文時代の石器(60) 1 : 4

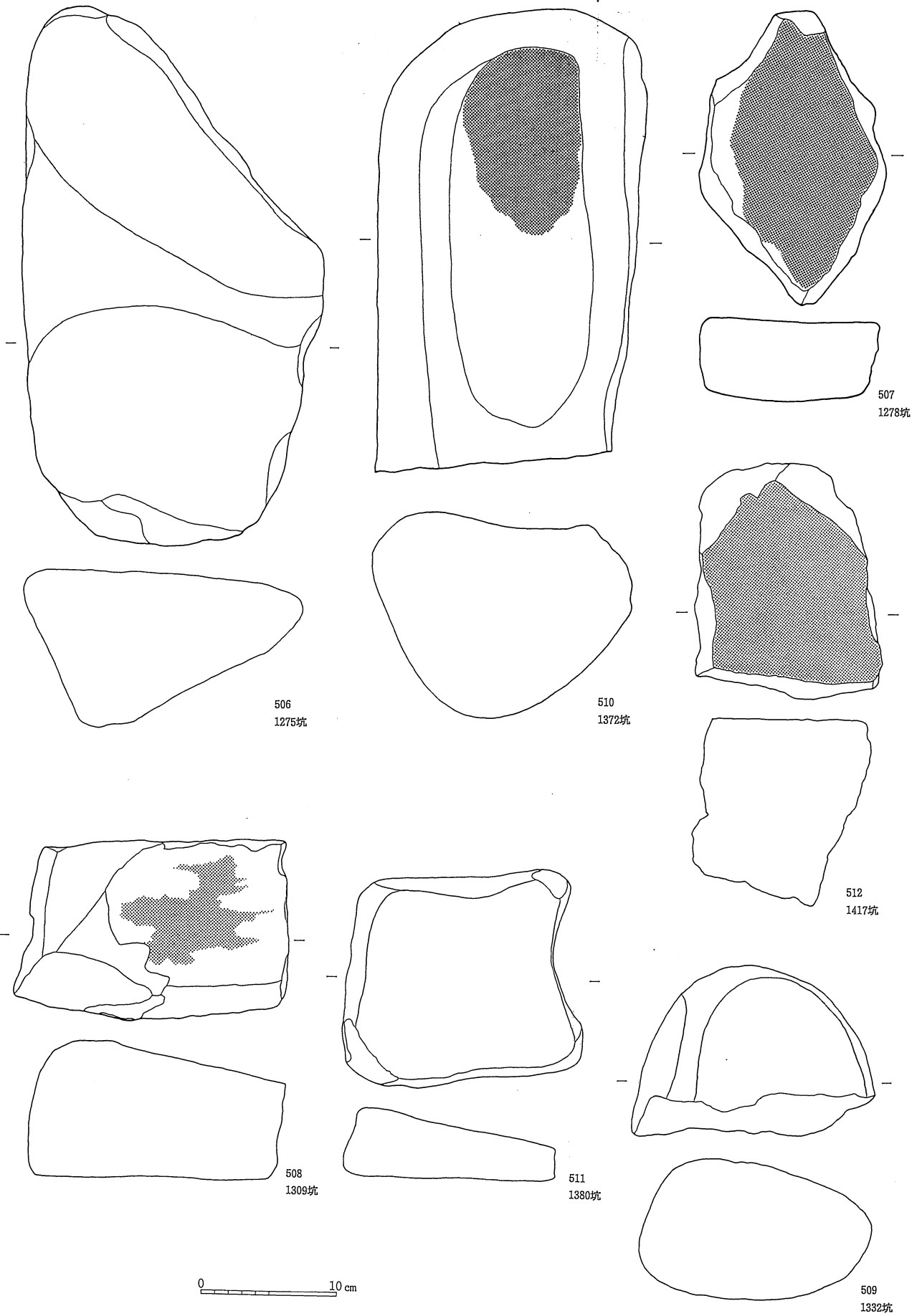

図版261 縄文時代の石器(61) 1 : 4

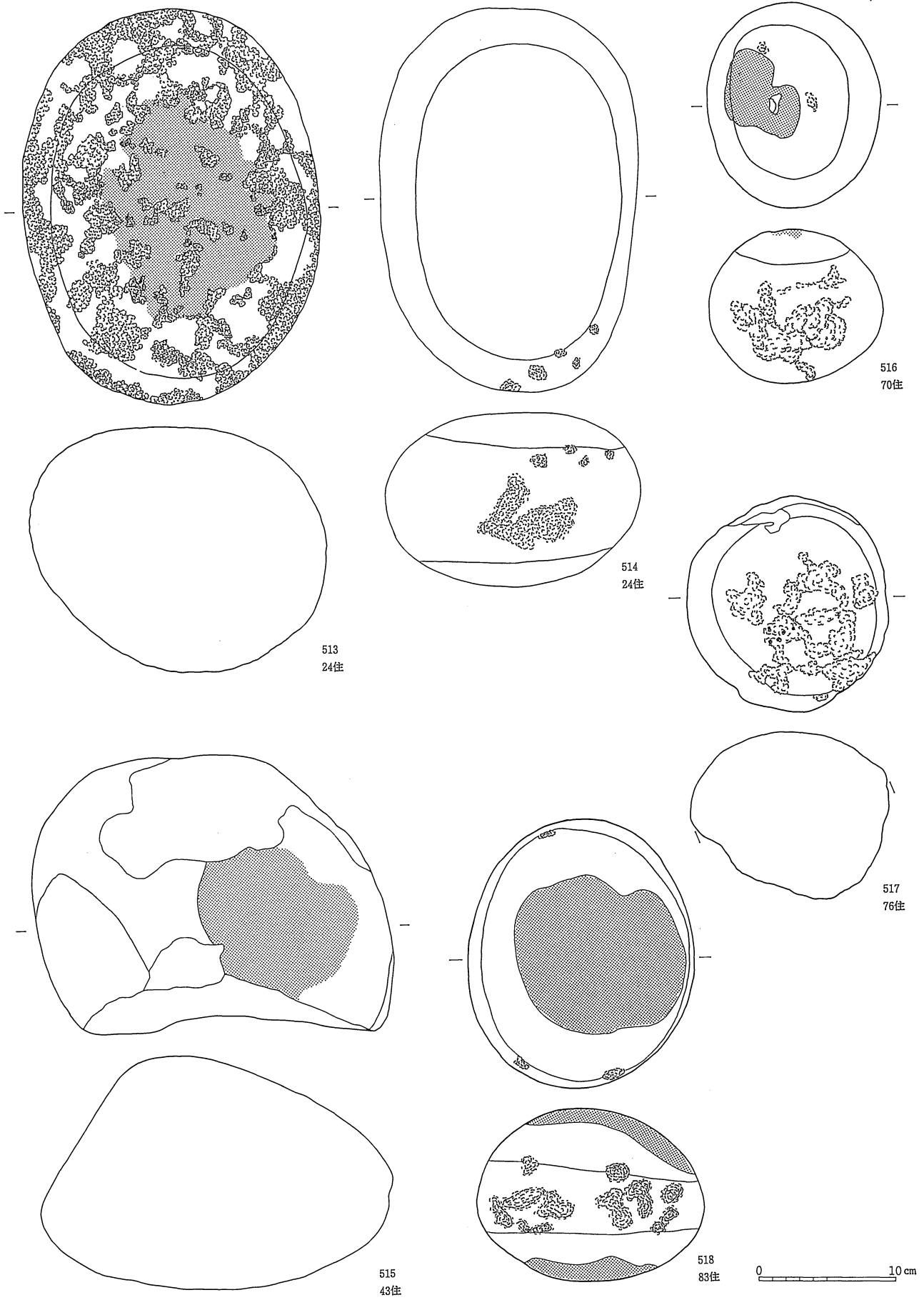

図版262 縄文時代の石器(5) 1 : 4



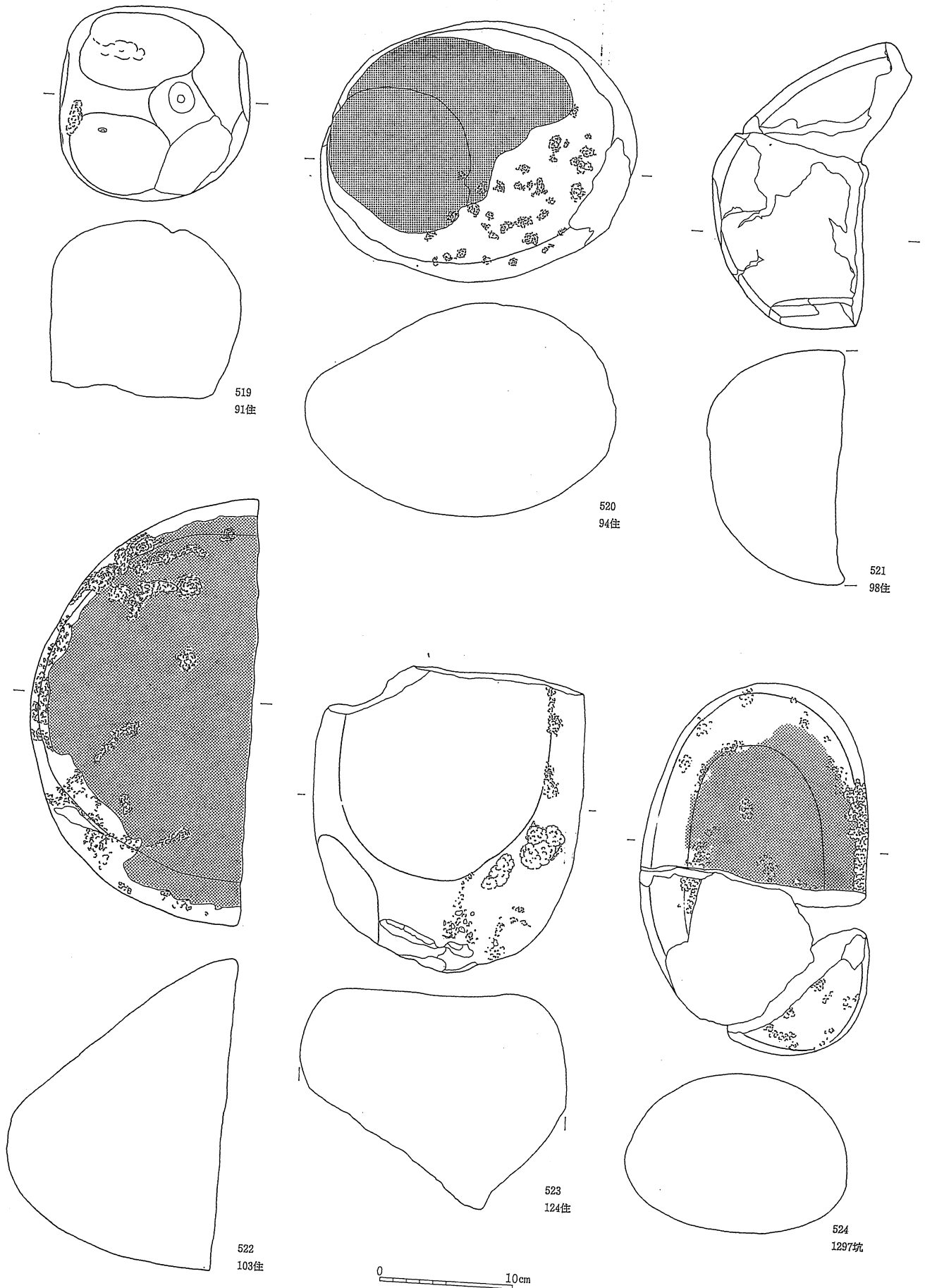

図版263 縄文時代の石器(63) 1 : 4

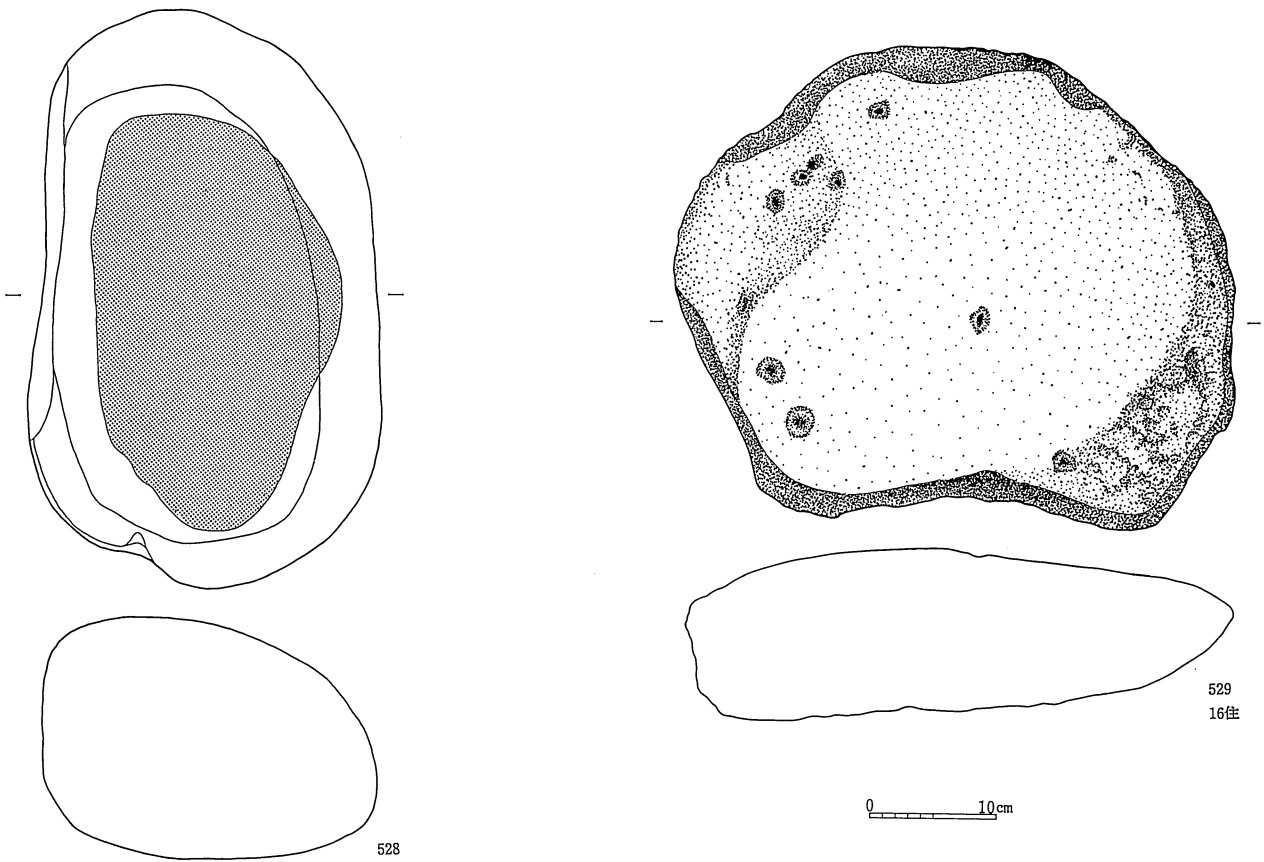
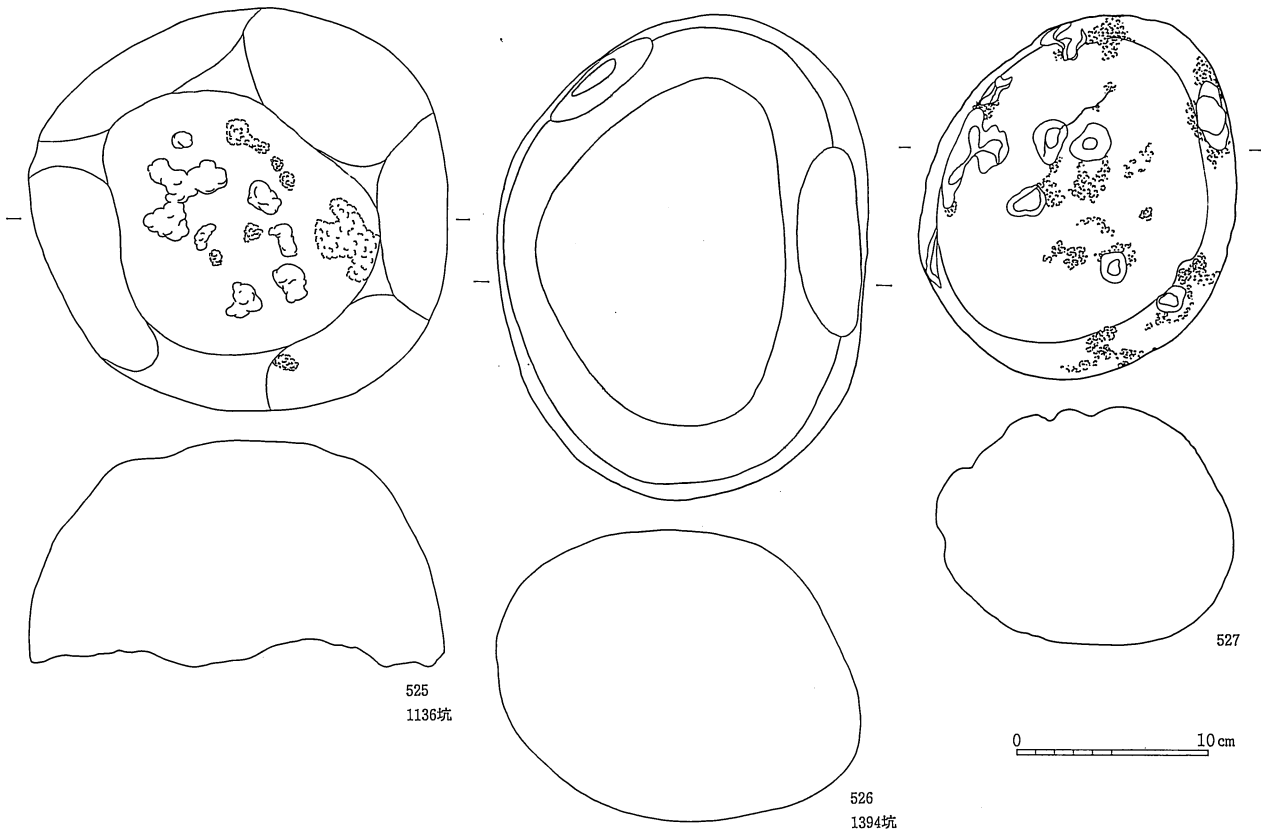

図版264 縄文時代の石器(64) 529・1：6、他・1：4

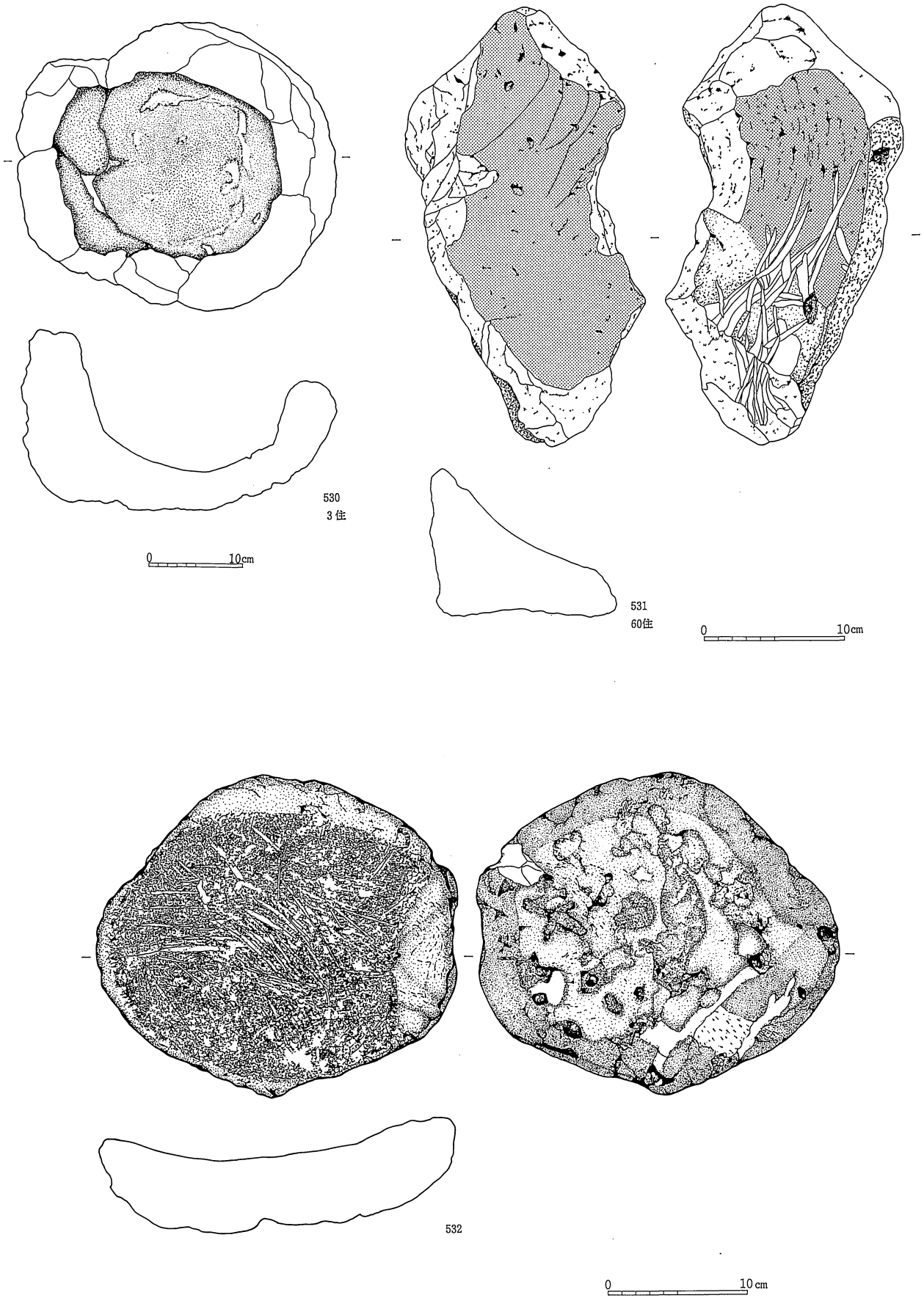

図版265 縄文時代の石器(5) 530・1：6、他・1：4

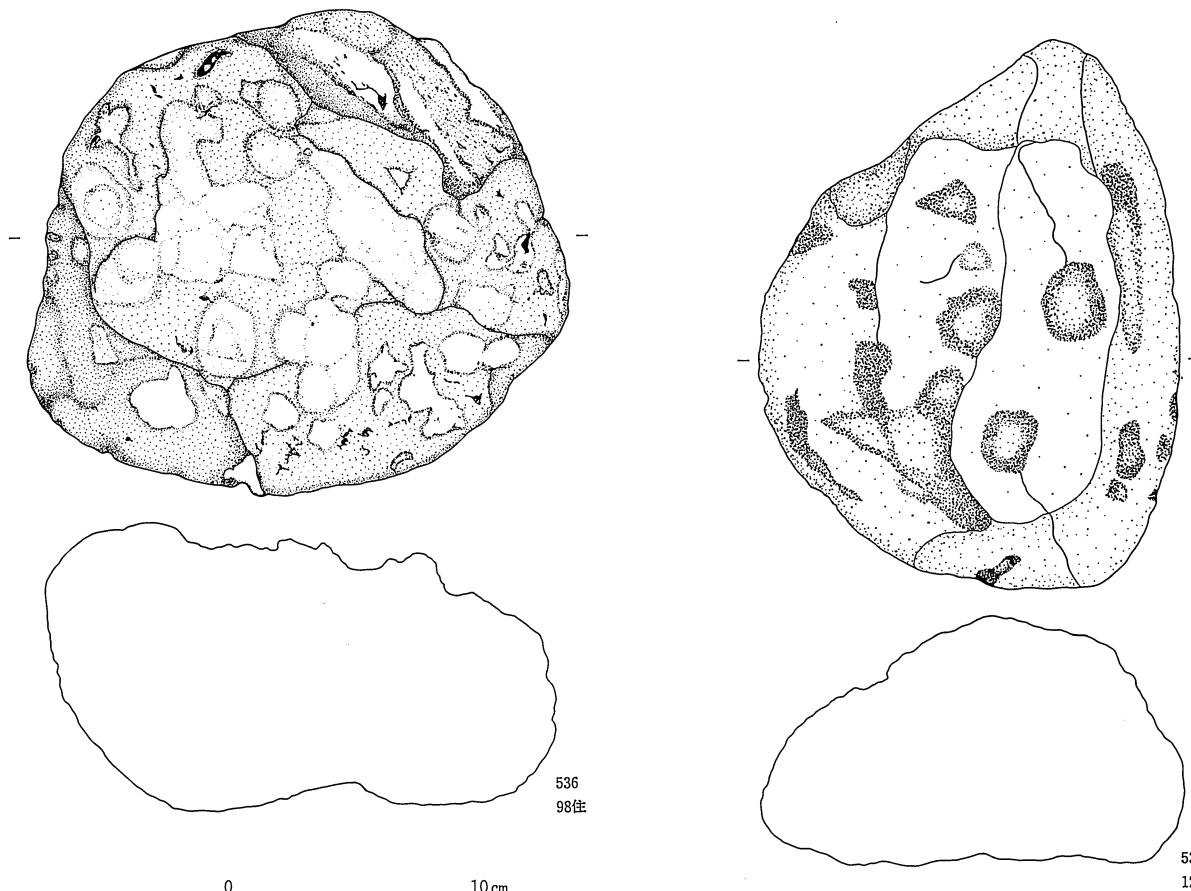
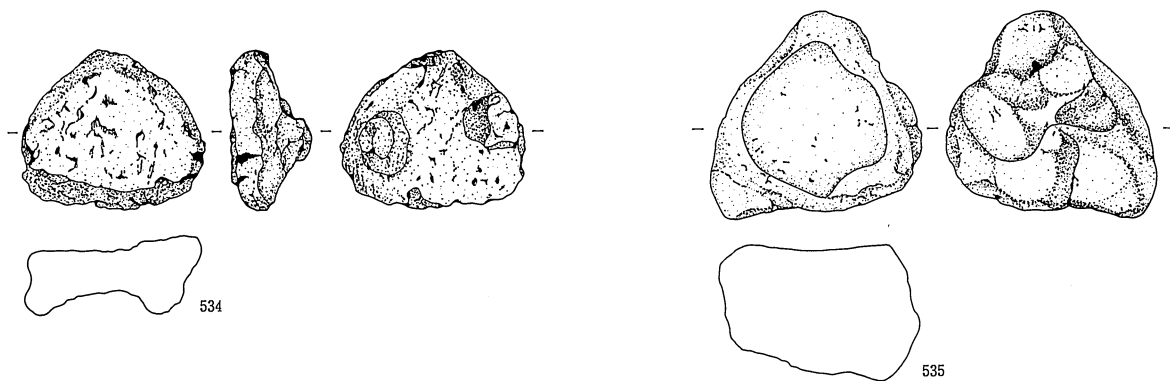
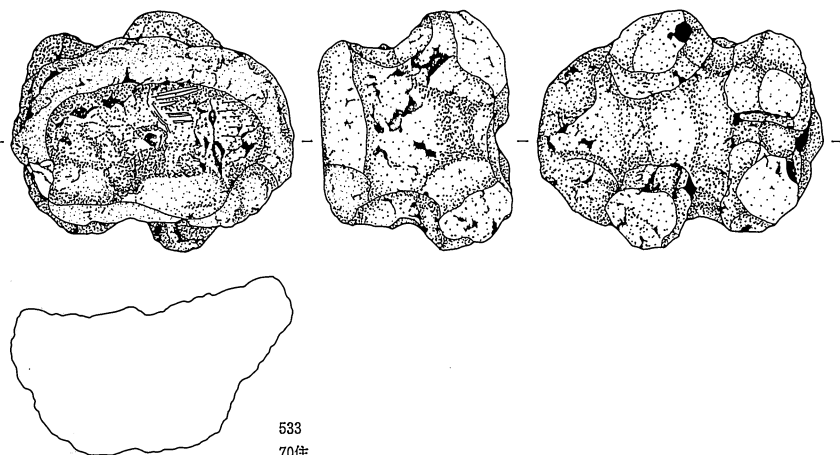

0 10 cm

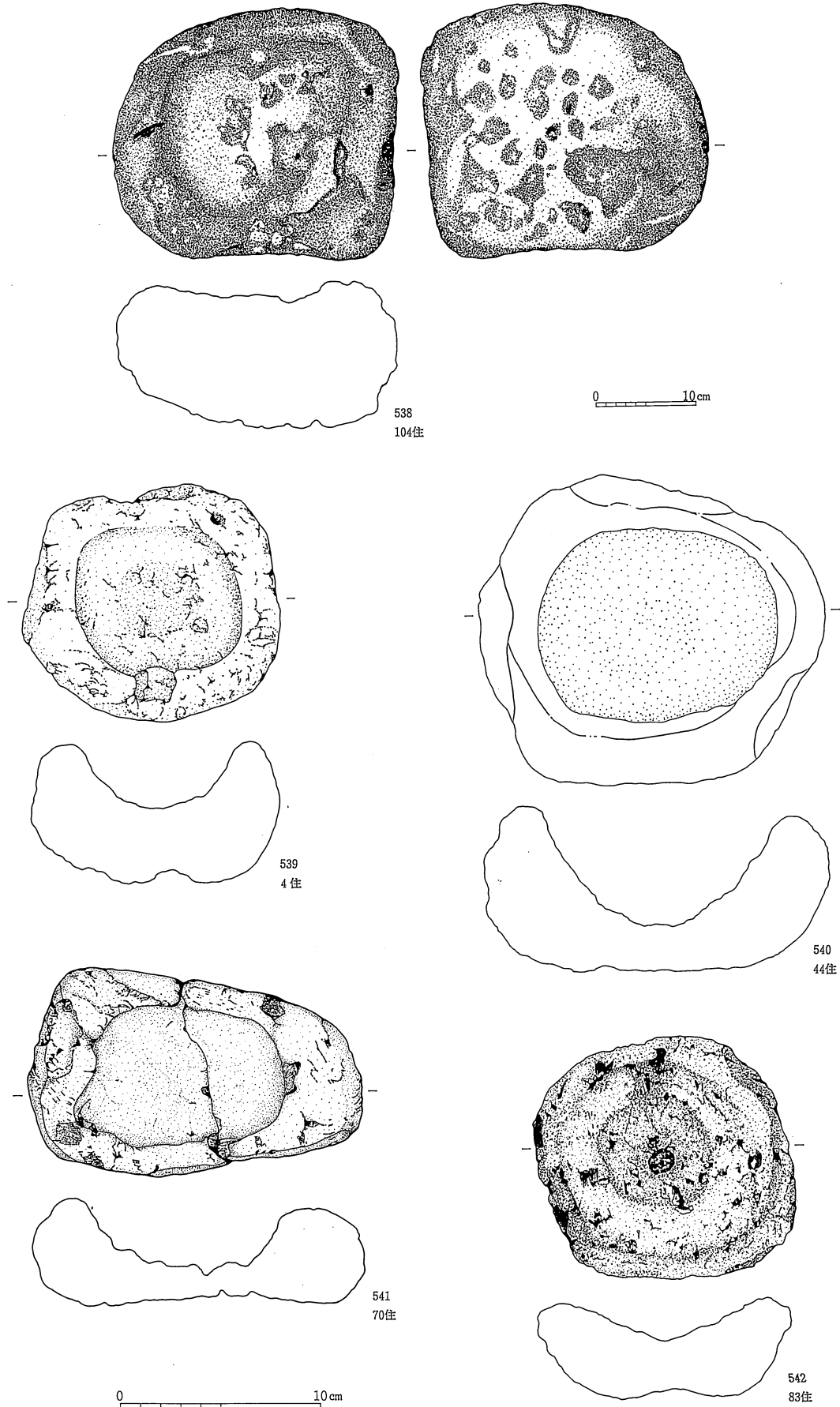

図版267 縄文時代の石器(67) 538・1:6、他・1:3

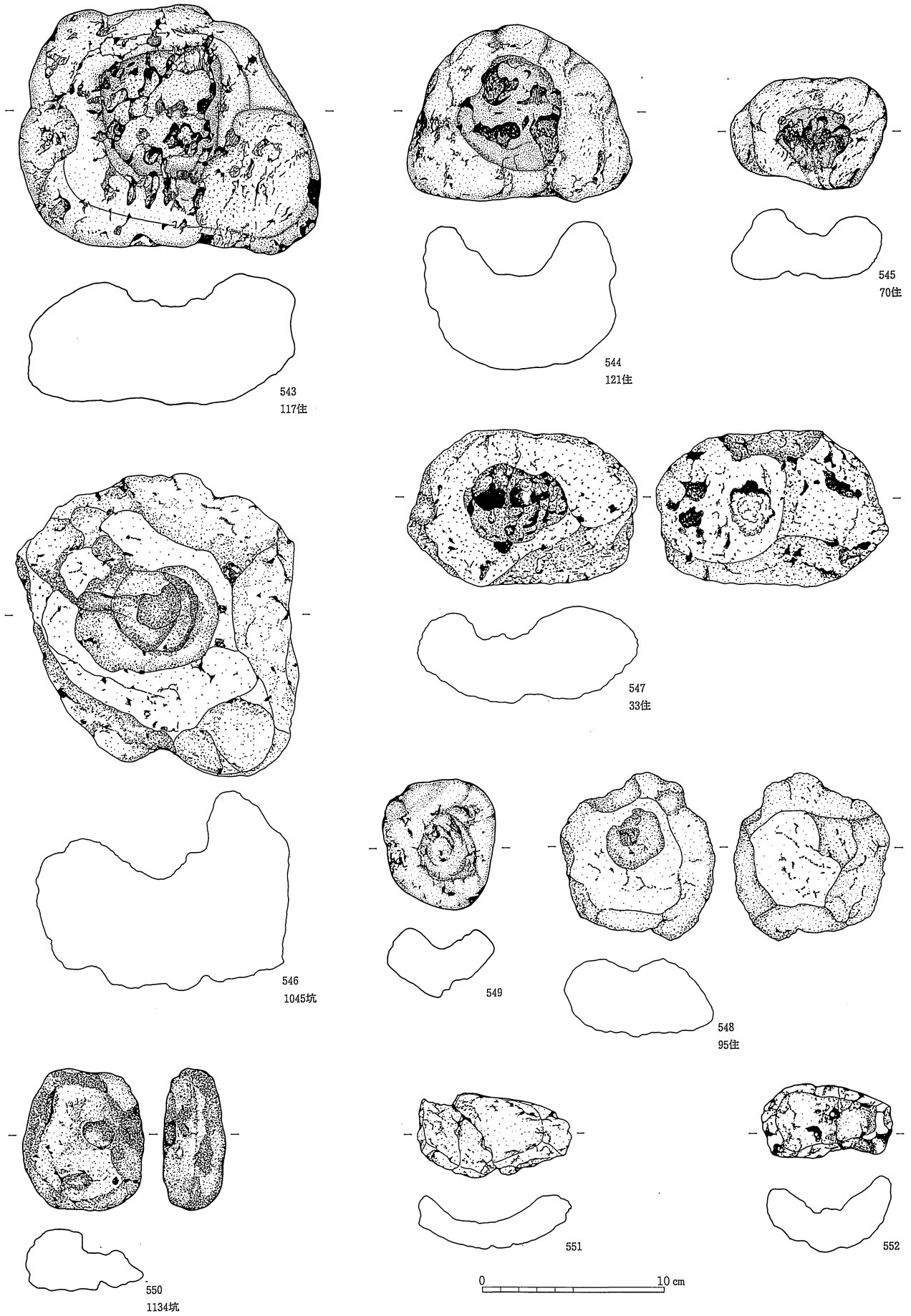

図版268 縄文時代の石器(68) 1 : 3

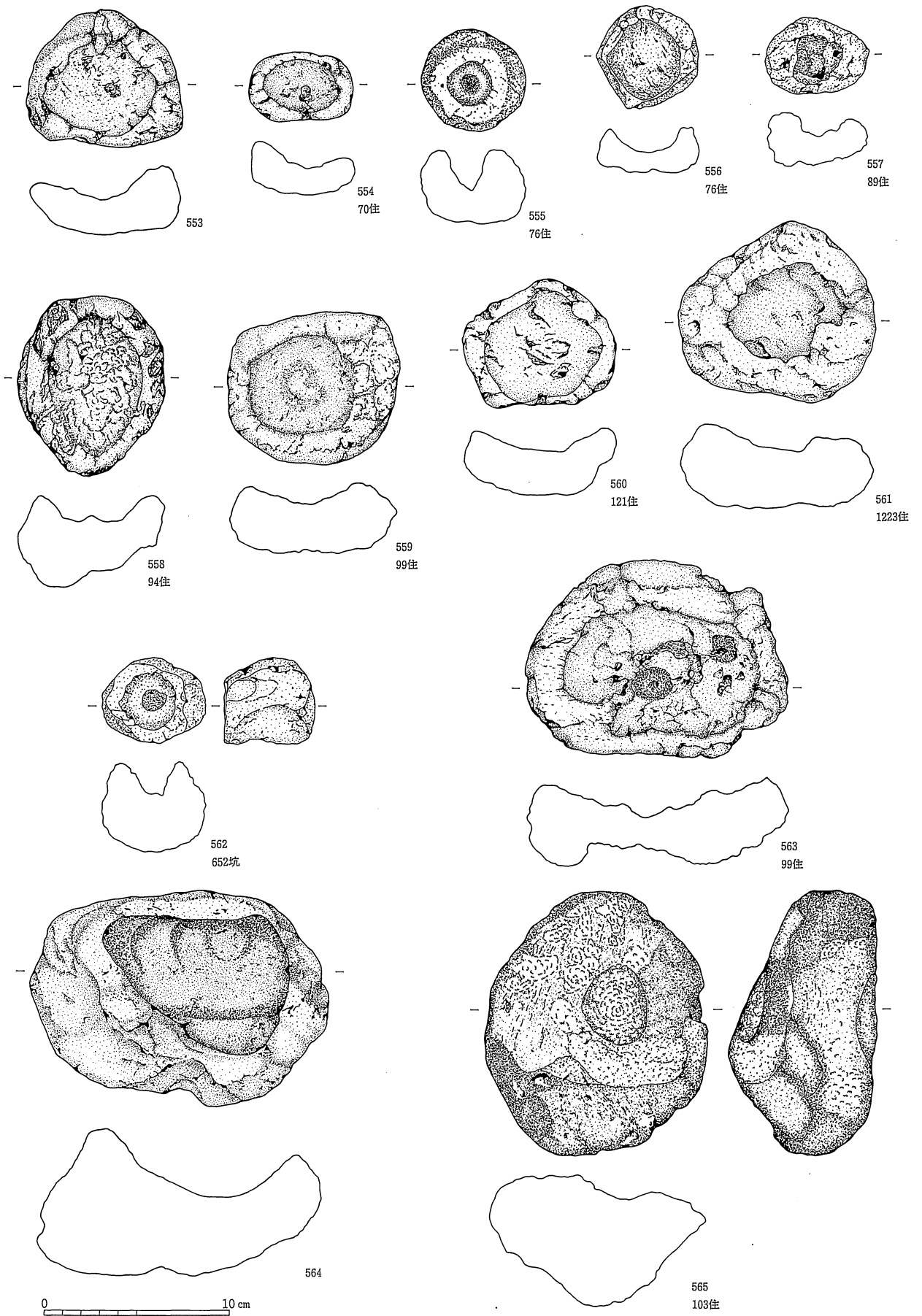

図版269 縄文時代の石器(69) 1 : 3

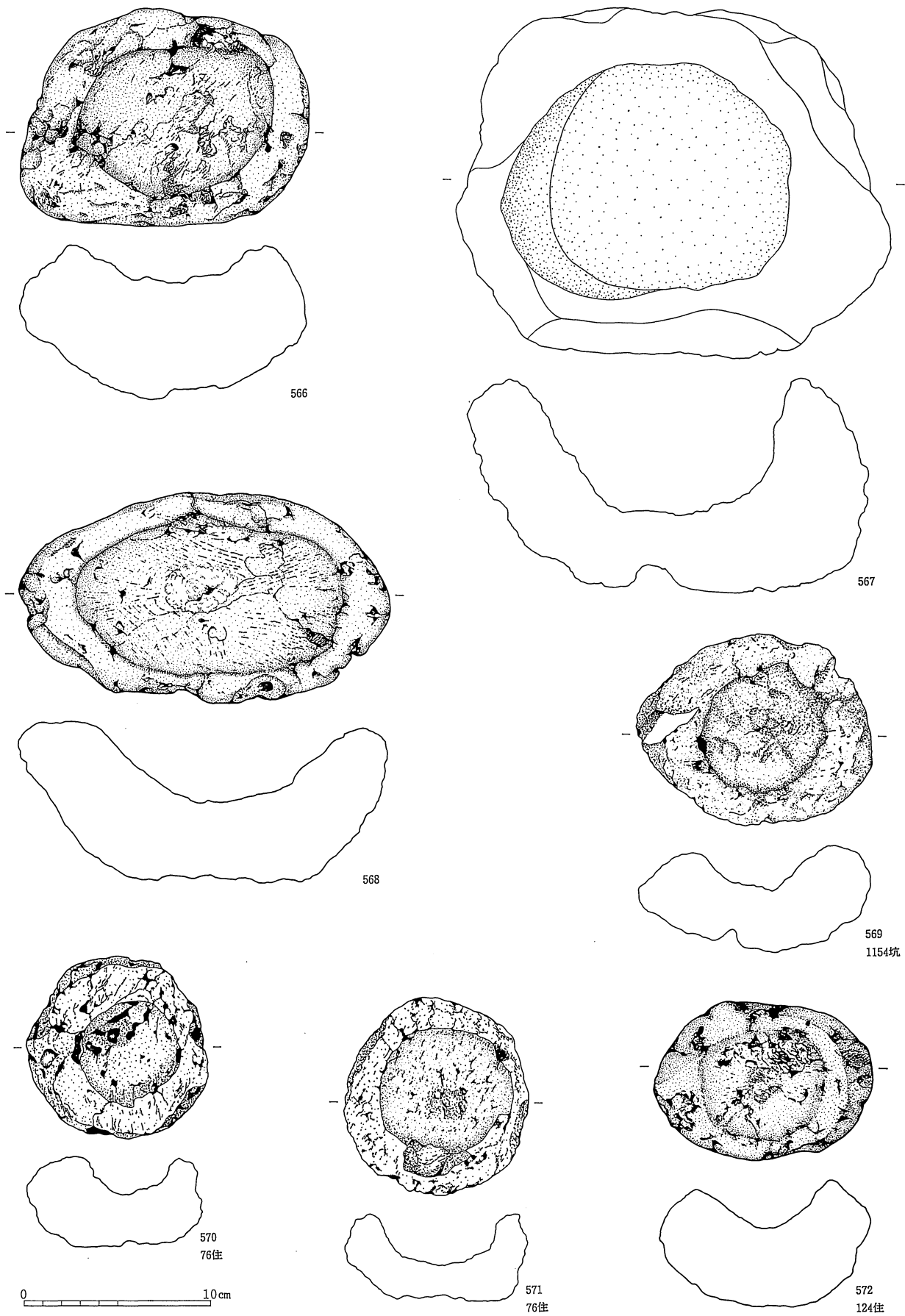

図版270 縄文時代の石器(60) 1 : 3



郷土遺跡

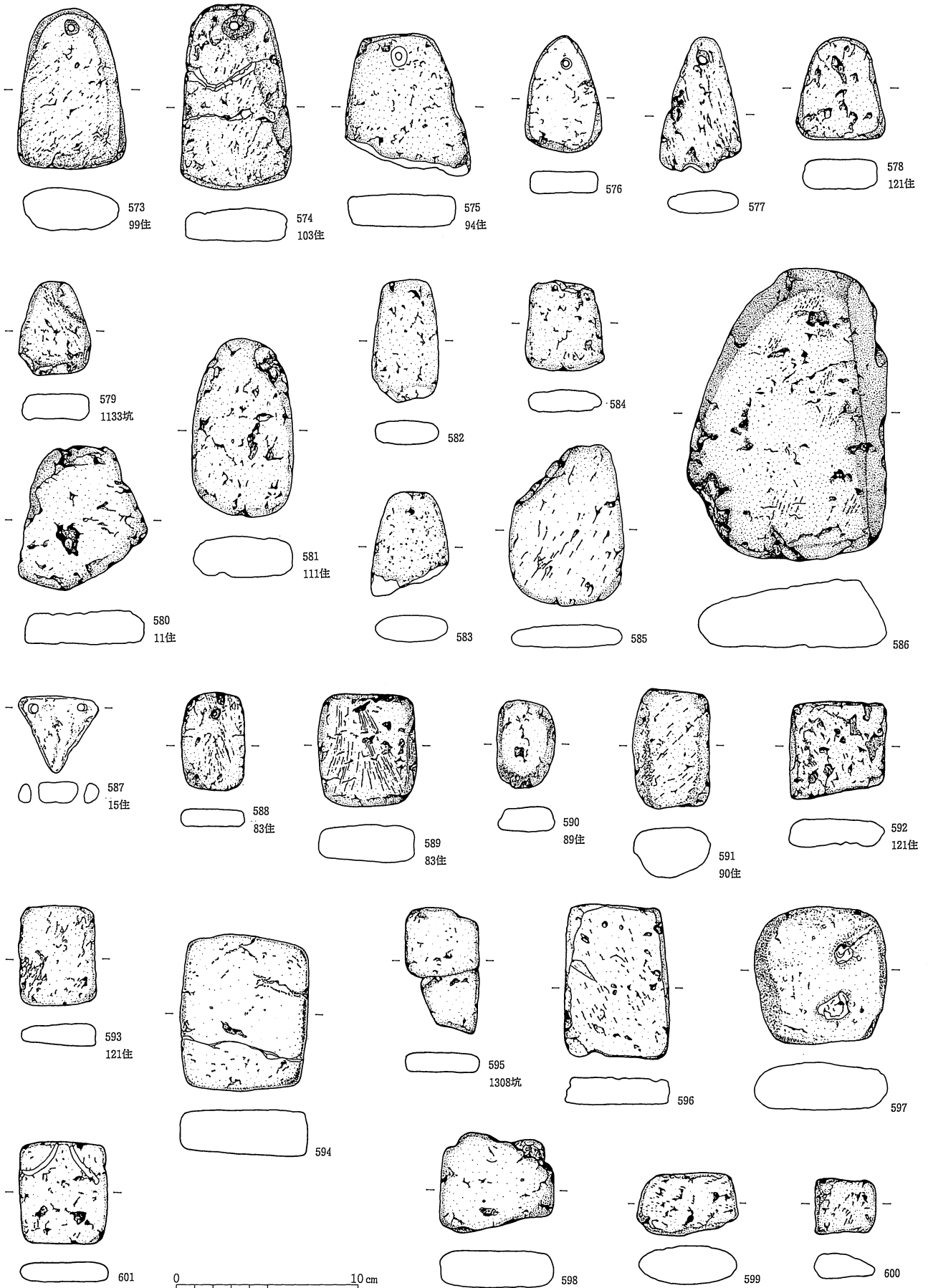

図版271 縄文時代の石器(61) 1 : 3

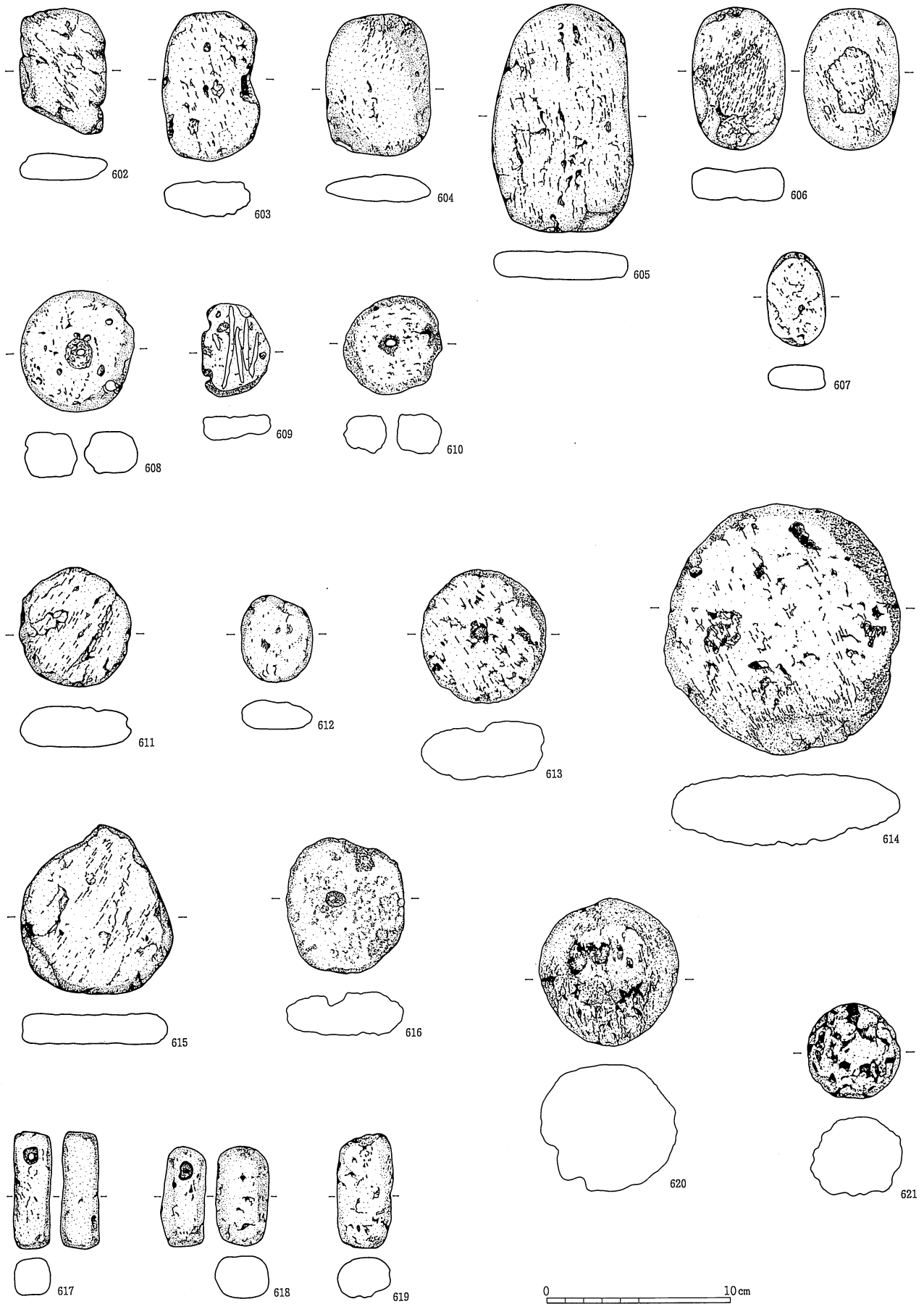

図版272 縄文時代の石器(62) 1 : 3

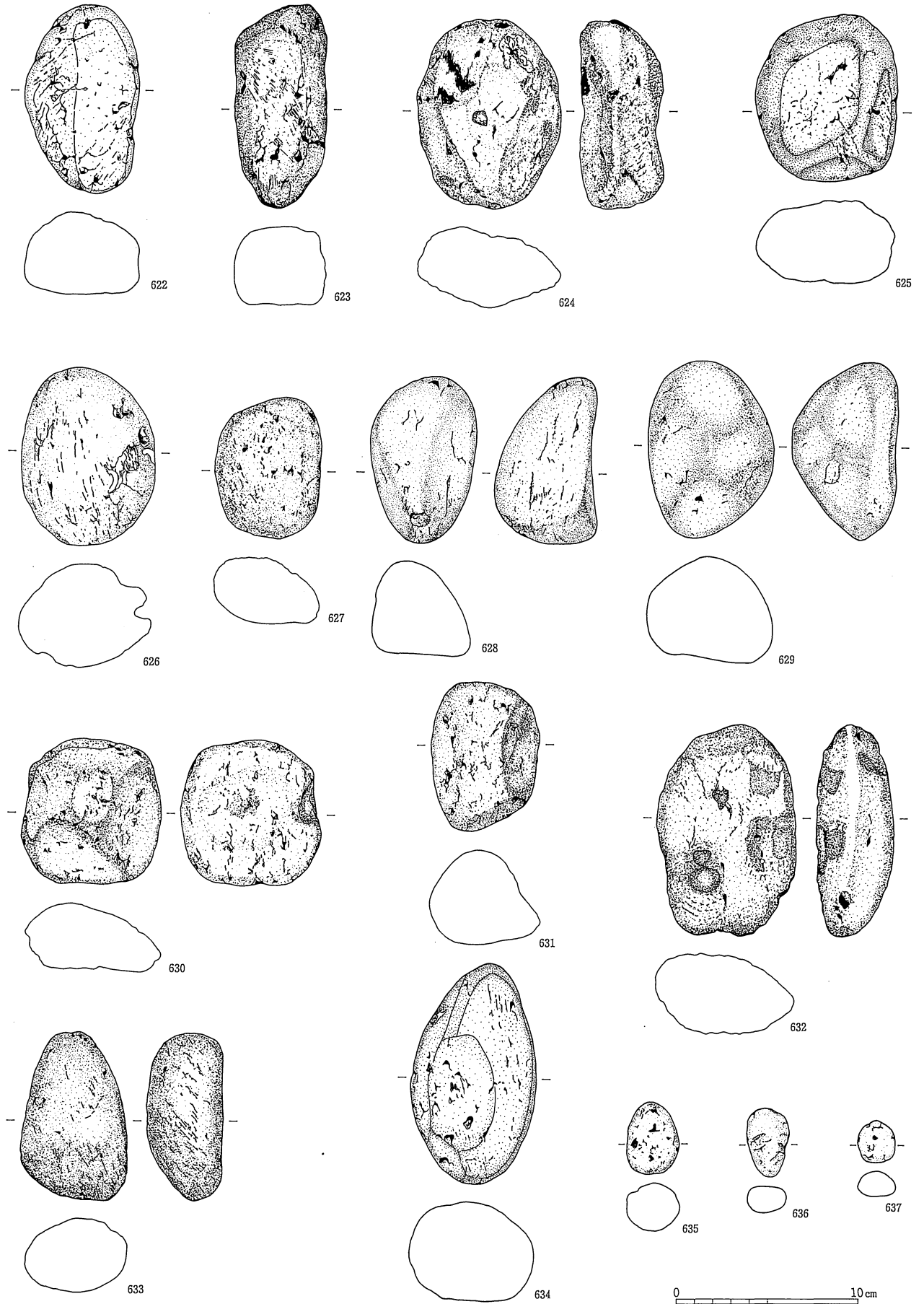

図版273 縄文時代の石器(63) 1 : 3

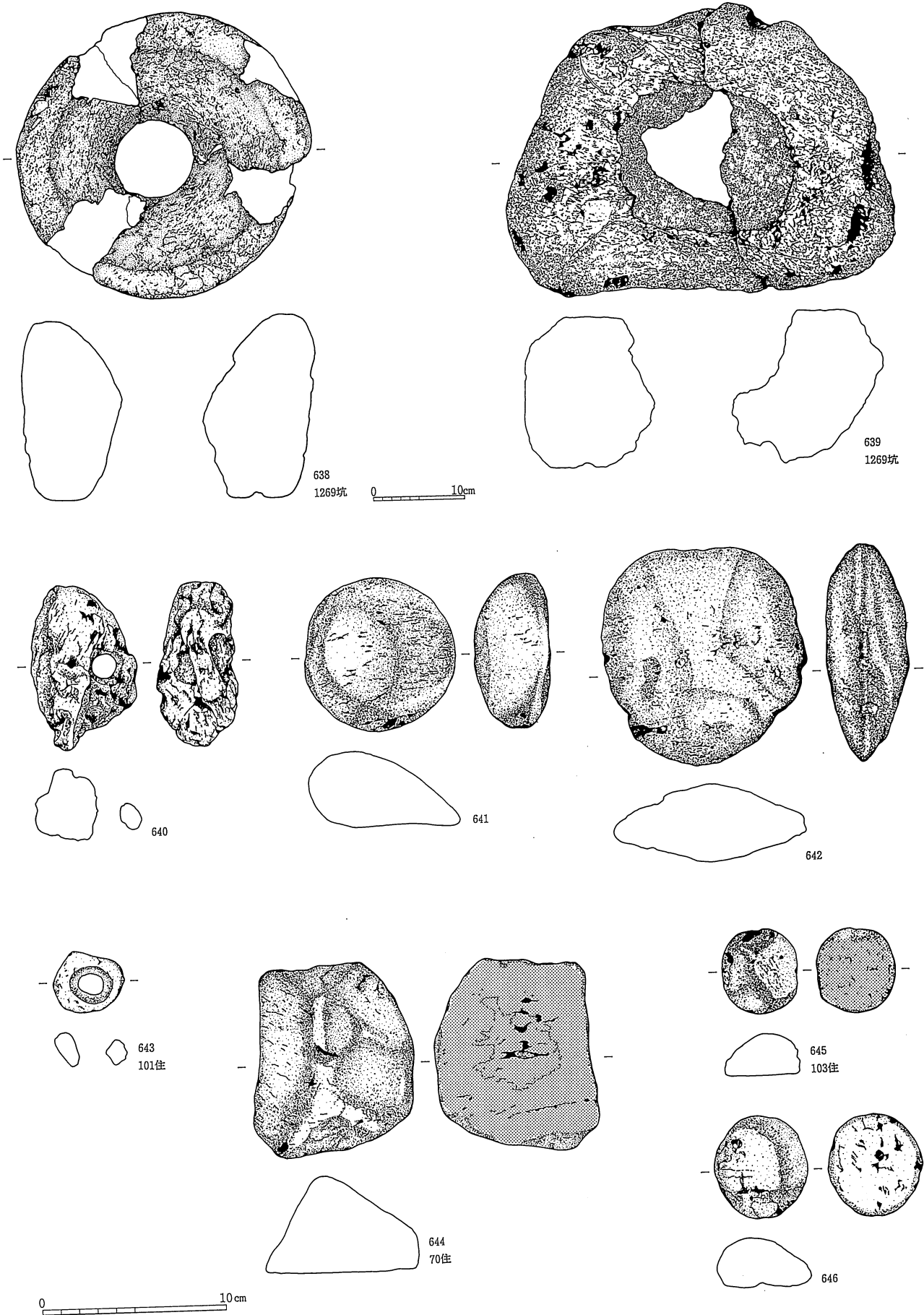

図版274 縄文時代の石器(64) 638・1:6、他・1:3

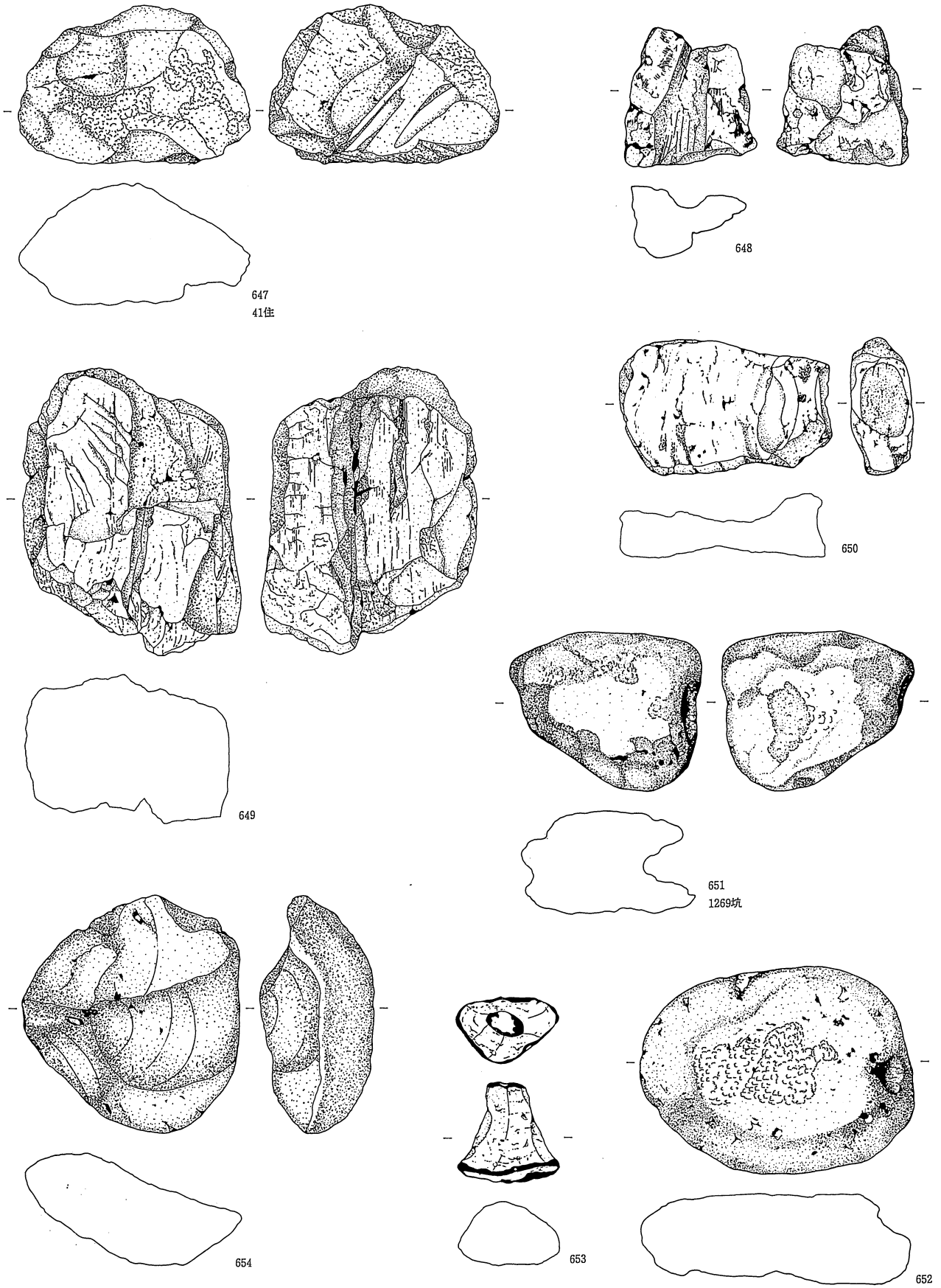

図版275 縄文時代の石器(65) 1 : 3

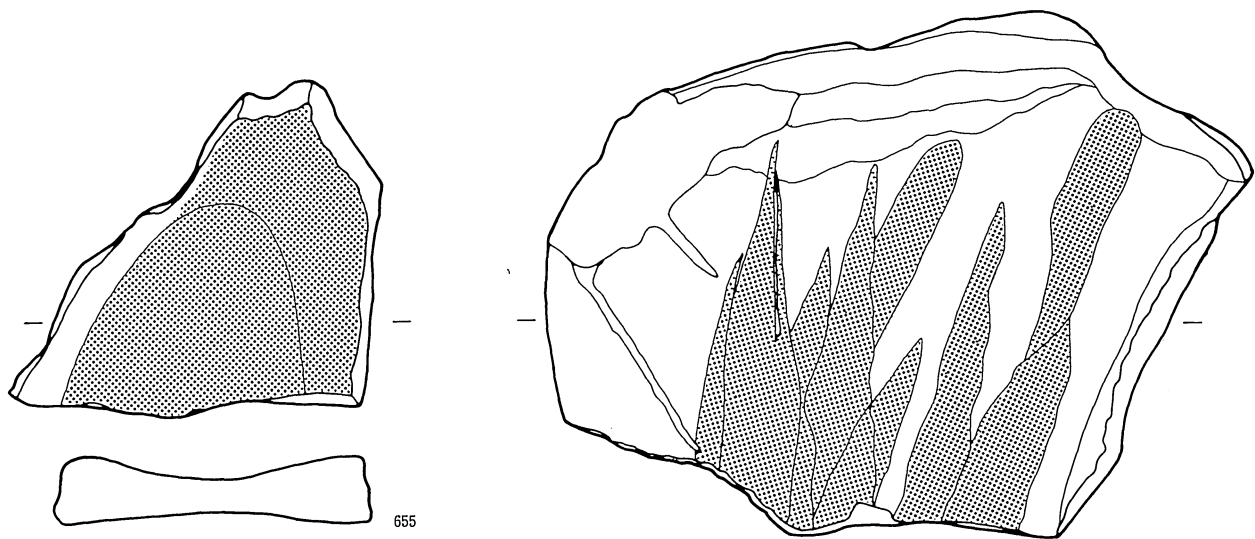

655

656  
16住

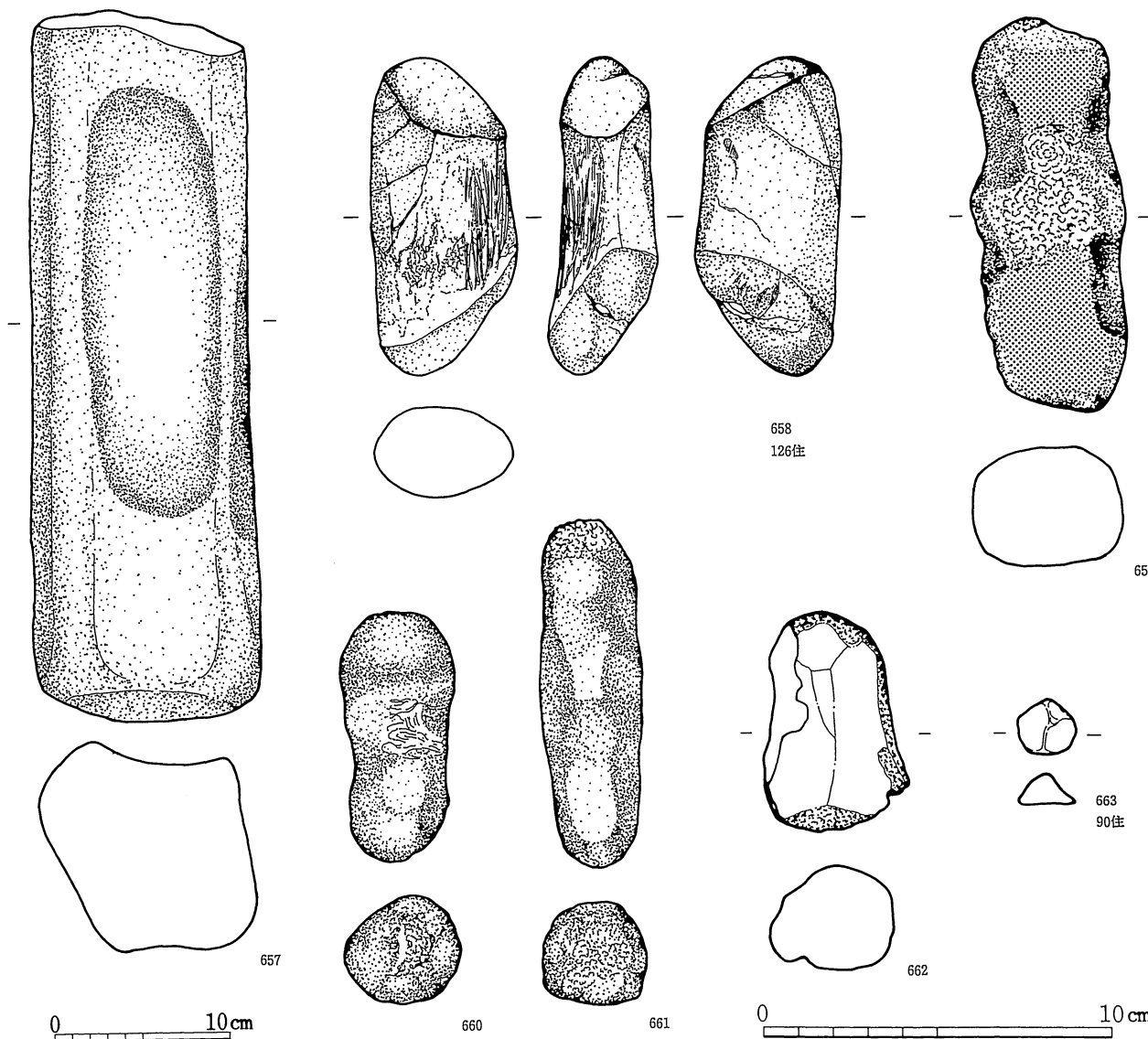

657

658  
126住

659

660

661

662

663  
90住

0 10cm

0 10cm

図版276 縄文時代の石器(60) 3・1:4、他・1:2

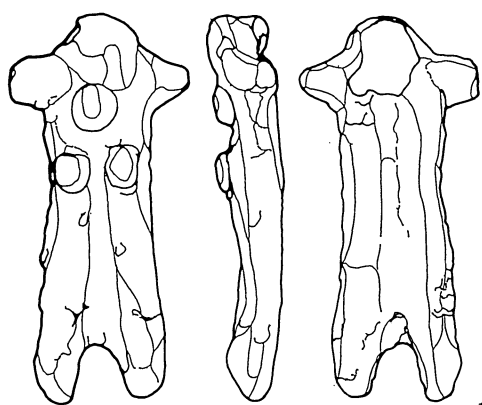

1

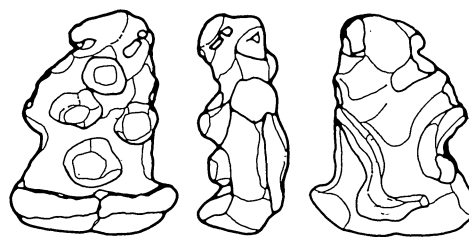

2  
43住

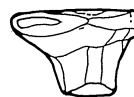
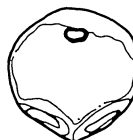
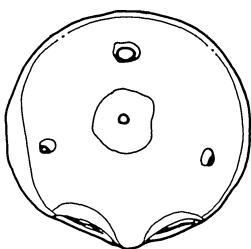
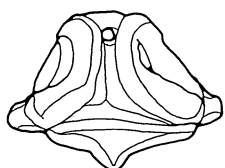

4



3

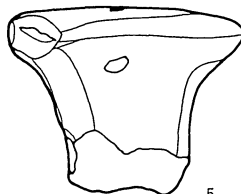
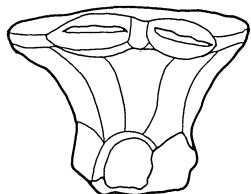

5  
91住

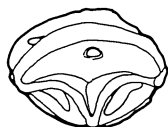

6



7

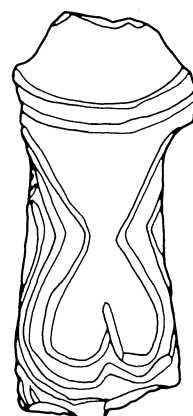
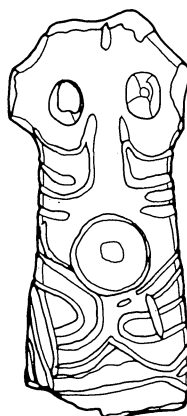

8

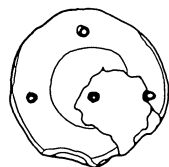
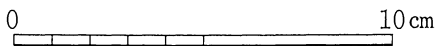

9

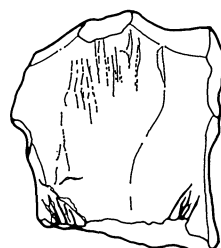
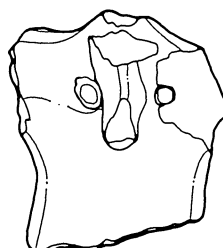

10  
94住

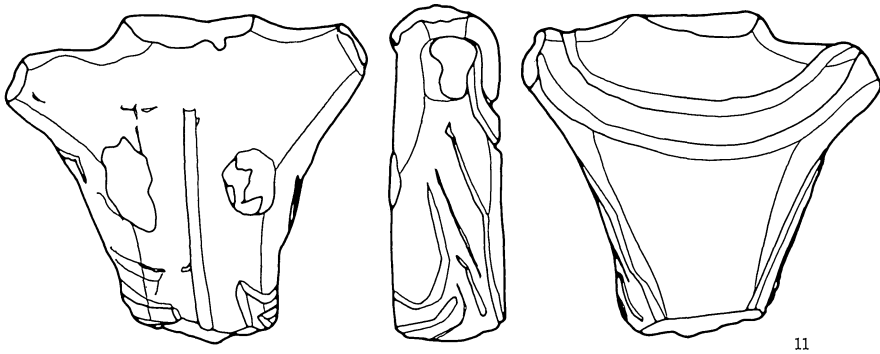

16  
18住

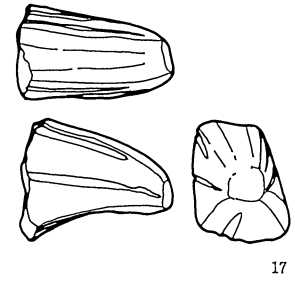

17

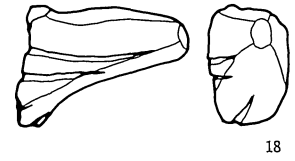
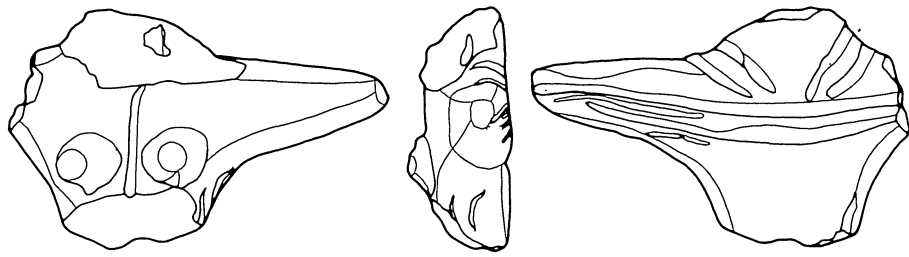

18

12

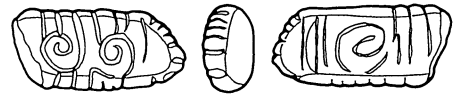
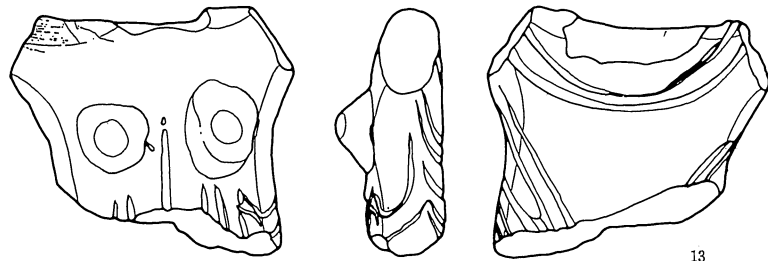

19

13



20

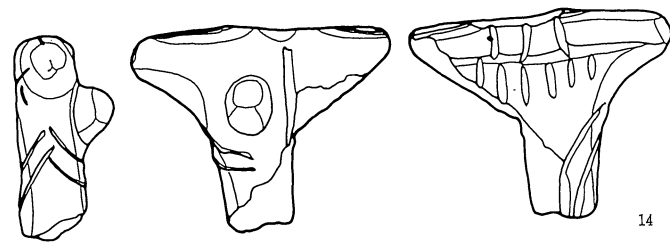

14

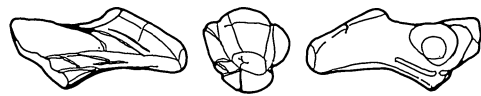

21  
18住

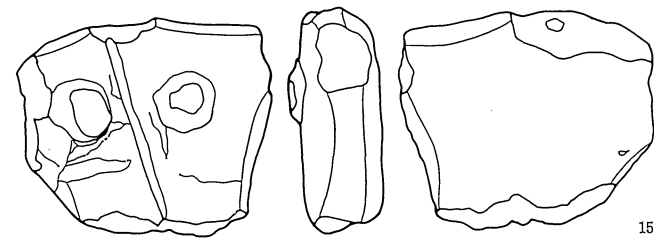

15

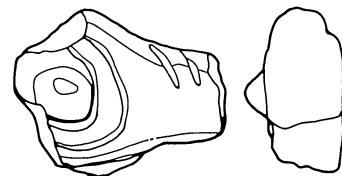

22

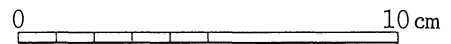

図版278 縄文時代の土製品(2) 1 : 2



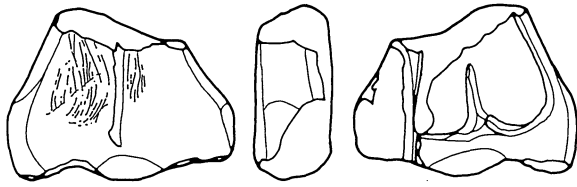

23  
40住



24  
90住

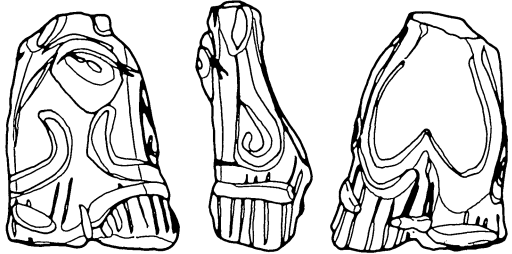

25

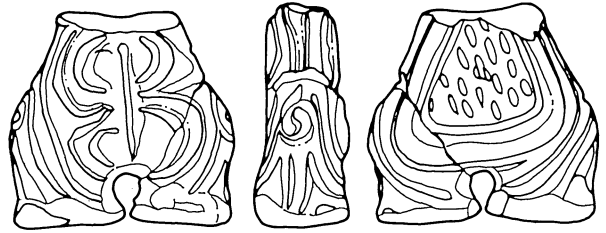

26



27

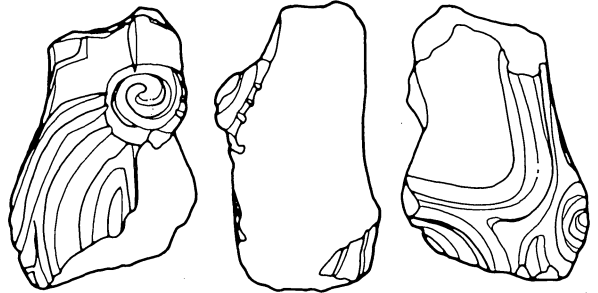

29

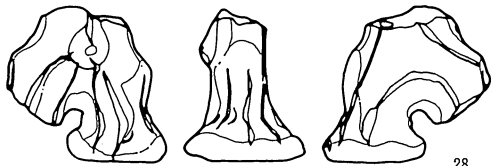

28

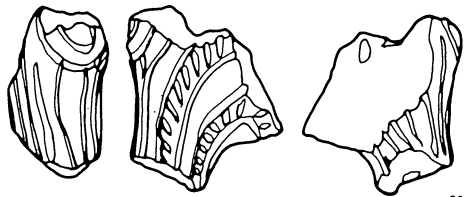

30

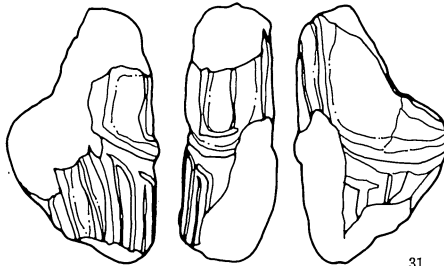

31  
60住

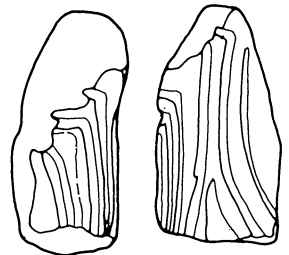

32

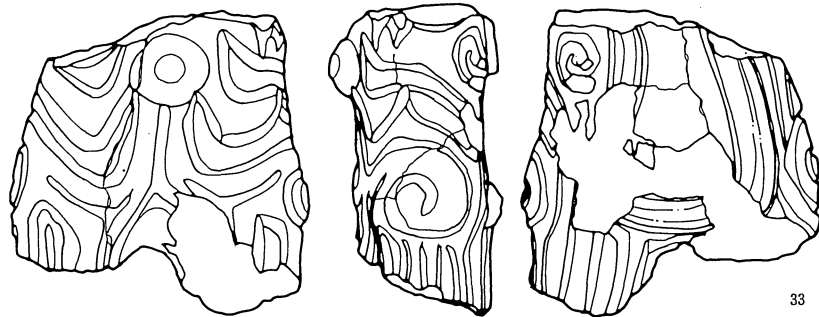

33

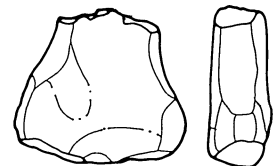

34  
90住

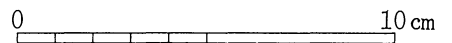



図版280 縄文時代の土製品(4) 1 : 2



図版281 縄文時代の土製品(5) 1 : 2

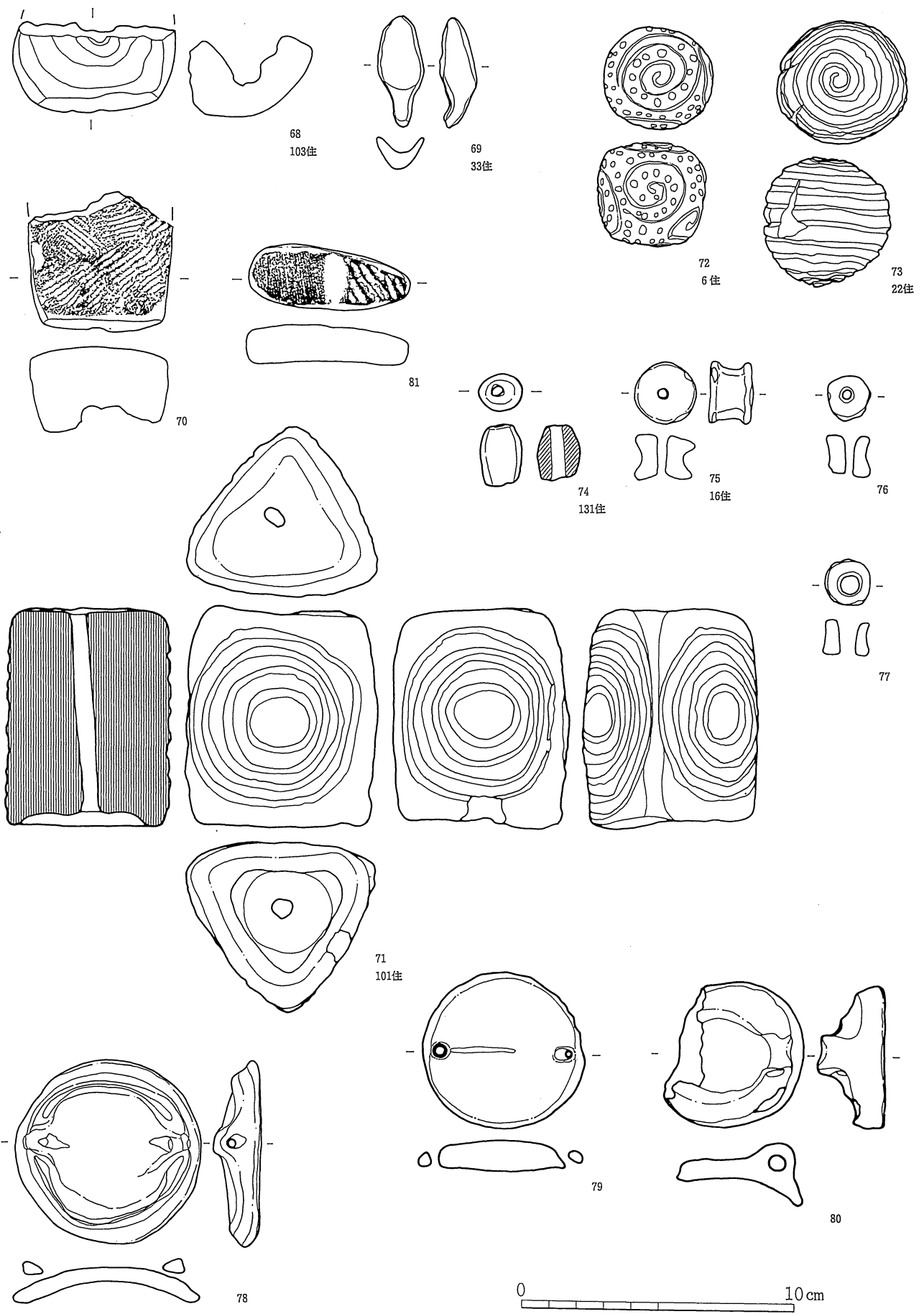

図版282 縄文時代の土製品(6) 1 : 2

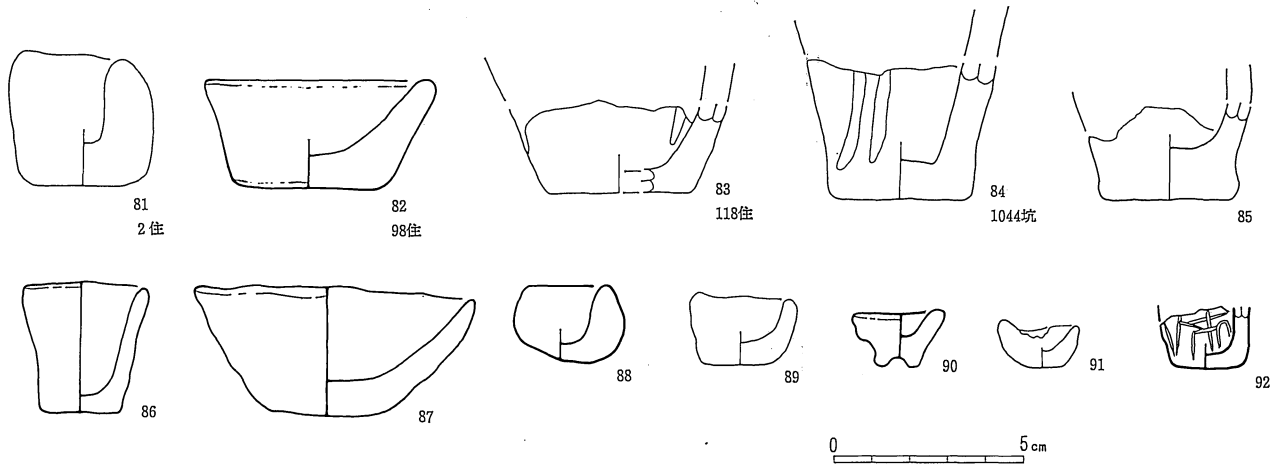

郷土遺跡 石器計測表(1)

番号	重さ(g)	石 材	番号	重さ(g)	石 材	番号	重さ(g)	石 材
1	4.9	黒曜石	46	0.6	黒曜石	91	0.9	黒曜石
2	1.8	チャート	47	1.5	チャート	92	0.7	黒曜石
3	0.5	黒曜石	48	1.1	チャート	93	0.8	黒曜石
4	0.7	黒曜石	49	1.6	玄武岩	94	1.1	チャート
5	0.7	黒曜石	50	1.0	黒曜石	95	0.4	黒曜石
6	4.6	チャート	51	1.2	黒曜石	96	2.2	玄武岩
7	0.4	黒曜石	52	1.5	黒曜石	97	0.9	黒曜石
8	0.7	黒曜石	53	2.3	黒曜石	98	10.5	チャート
9	1.0	チャート	54	0.6	チャート	99	3.1	チャート
10	1.8	安山岩	55	0.2	黒曜石	100	2.4	黒曜石
11	0.7	チャート	56	0.4	黒曜石	101	3.8	チャート
12	0.9	黒曜石	57	1.1	チャート	102	1.2	チャート
13	1.9	黒曜石	58	0.6	チャート	103	2.0	チャート
14	1.9	黒曜石	59	0.7	黒曜石	104	2.7	黒曜石
15	0.4	黒曜石	60	0.4	黒曜石	105	3.0	黒曜石
16	0.8	玄武岩	61	0.8	黒曜石	106	11.7	玄武岩
17	0.8	黒曜石	62	0.7	チャート	107	10.4	玄武岩
18	1.0	黒曜石	63	1.2	玄武岩	108	4.5	玄武岩
19	0.5	黒曜石	64	0.6	黒曜石	109	3.0	玄武岩
20	0.6	黒曜石	65	0.4	黒曜石	110	1.3	黒曜石
21	1.6	黒曜石	66	1.2	黒曜石	111	2.1	黒曜石
22	1.3	黒曜石	67	1.1	黒曜石	112	5.9	黒曜石
23	0.7	玄武岩	68	0.1	黒曜石	113	4.2	黒曜石
24	0.7	チャート	69	1.2	黒曜石	114	14.7	玄武岩
25	0.7	黒曜石	70	0.7	黒曜石	115	35.1	玄武岩
26	0.7	黒曜石	71	1.0	黒曜石	116	1.3	玄武岩
27	1.2	チャート	72	0.5	黒曜石	117	7.3	玄武岩
28	0.9	黒曜石	73	0.4	黒曜石	118	10.1	玄武岩
29	1.7	チャート	74	1.8	安山岩	119	10.4	安山岩
30	0.5	黒曜石	75	0.5	黒曜石	120	10.2	チャート
31	1.8	チャート	76	0.7	黒曜石	121	21.8	安山岩
32	0.3	黒曜石	77	0.5	黒曜石	122	18.7	玄武岩
33	0.3	黒曜石	78	0.5	黒曜石	123	13.5	チャート
34	0.6	黒曜石	79	0.7	黒曜石	124	12.6	玄武岩
35	0.6	黒曜石	80	0.9	黒曜石	125	11.5	安山岩
36	0.5	チャート	81	0.5	黒曜石	126	9.0	玄武岩
37	0.4	黒曜石	82	3.6	黒曜石	127	7.8	安山岩
38	1.0	チャート	83	4.5	たんぱく石	128	2.0	黒曜石
39	1.8	玄武岩	84	2.1	黒曜石	129	5.5	玄武岩
40	0.6	黒曜石	85	1.2	黒曜石	130	7.5	安山岩
41	0.4	黒曜石	86	3.3	チャート	131	123.1	玄武岩
42	0.8	黒曜石	87	7.9	黒曜石	132	23.4	チャート
43	0.8	黒曜石	88	19.3	チャート	133	21.0	玄武岩
44	0.8	黒曜石	89	0.6	黒曜石	134	46.2	玄武岩質安山岩
45	1.8	黒曜石	90	2.4	黒曜石	135	11.2	黒曜石

郷土遺跡 石器計測表(2)

番号	重さ(g)	石 材	番号	重さ(g)	石 材	番号	重さ(g)	石 材
136	4.1	チャート	181	23.5	粘板岩	226	167.5	玄武岩
137	15.1	玄武岩	182	364.3	粘板岩	227	58.8	安山岩
138	98.1	玄武岩	183	282.5	粘板岩	228	140.2	玄武岩
139	10.7	チャート	184	329.1	蛇紋岩	229	123.3	玄武岩
140	12.4	黒曜石	185	313.5	粘板岩	230	103.4	玄武岩
141	10.5	チャート	186	224.9	砂岩	231	187.3	玄武岩
142	10.4	チャート	187	189.8	粘板岩	232	133.8	玄武岩
143	23.7	チャート	188	88.3	粘板岩	233	59.0	角閃輝石安山岩
144	8.5	チャート	189	14.9	粘板岩	234	80.5	玄武岩
145	63.4	黒曜石	190	33.5	粘板岩	235	80.5	玄武岩
146	40.5	黒曜石	191	152.4	粘板岩	236	29.9	玄武岩
147	4.5	黒曜石	192	6.4	粘板岩	237	175.1	玄武岩
148	4.9	黒曜石	193	17.5	粘板岩	238	84.8	玄武岩
149	3.6	黒曜石	194	1.9	チャート	239	62.9	玄武岩
150	1.2	黒曜石	195	4.7	粘板岩	240	46.0	玄武岩
151	4.0	黒曜石	196	15.7	粘板岩	241	53.3	玄武岩
152	2.4	黒曜石	197	60.8	チャート	242	64.0	玄武岩
153	1.2	黒曜石	198	17.2	チャート	243	64.4	安山岩
154	1.8	黒曜石	199	384.1	玄武岩質安山岩	244	83.3	玄武岩
155	2.3	黒曜石	200	614.8	角閃輝石安山岩	245	89.7	玄武岩
156	2.9	黒曜石	201	78.5	角閃輝石安山岩	246	222.2	玄武岩
157	3.0	黒曜石	202	96.9	安山岩	247	121.4	玄武岩
158	2.3	黒曜石	203	36.6	安山岩	248	149.4	安山岩
159	0.8	黒曜石	204	137.0	玄武岩	249	187.8	玄武岩
160	2.6	黒曜石	205	263.2	安山岩	250	282.7	安山岩
161	5.3	黒曜石	206	247.1	玄武岩	251	142.5	玄武岩
162	3.4	黒曜石	207	94.8	玄武岩	252	140.0	玄武岩
163	1.4	黒曜石	208	165.2	安山岩	253	122.2	玄武岩
164	1.6	黒曜石	209	60.1	玄武岩質安山岩	254	93.7	玄武岩
165	439.6	角閃輝石安山岩	210	173.3	玄武岩	255	233.5	安山岩
166	74.4	粘板岩	211	116.1	角閃輝石安山岩	256	267.1	安山岩
167	167.0	粘板岩	212	329.4	安山岩	257	255.7	玄武岩
168	39.1	粘板岩	213	174.3	玄武岩	258	134.1	角閃輝石安山岩
169	71.7	粘板岩	214	155.5	玄武岩	259	66.7	玄武岩
170	76.6	粘板岩	215	154.5	玄武岩	260	122.8	玄武岩
171	205.5	はんれい岩	216	81.3	玄武岩	261	695.3	安山岩
172	33.2	粘板岩	217	148.3	安山岩	262	2199	安山岩
173	39.8	角閃輝石安山岩	218	162.9	玄武岩	263	158.5	安山岩
174	17.7	粘板岩	219	78.3	玄武岩	264	82.5	玄武岩
175	8.0	粘板岩	220	72.9	玄武岩	265	148.5	玄武岩
176	8.2	チャート	221	240.8	玄武岩	266	90.5	玄武岩
177	20.1	粘板岩	222	165.5	角閃輝石安山岩	267	90.9	玄武岩
178	5.7	チャート	223	155.6	玄武岩	268	111.2	玄武岩
179	15.4	粘板岩	224	215.9	玄武岩	269	91.7	玄武岩
180	5.3	粘板岩	225	149.7	玄武岩	270	166.5	玄武岩

郷土遺跡 石器計測表(3)

番号	重さ(g)	石 材	番号	重さ(g)	石 材	番号	重さ(g)	石 材
271	232.1	安山岩	316	7.6	不明	361	583.1	安山岩
272	68.3	玄武岩	317	849.1	安山岩	362	777.0	安山岩
273	171.4	玄武岩	318	450.4	安山岩	363	472.1	安山岩
274	423.8	安山岩	319	142.8	安山岩	364	281.9	角閃輝石安山岩
275	191.3	玄武岩	320	237.2	安山岩	365	160.8	砂岩
276	96.7	玄武岩	321	132.9	安山岩	366	387.5	砂岩
277	116.1	角閃輝石安山岩	322	413.0	安山岩	367	457.1	安山岩
278	76.1	玄武岩	323	433.1	安山岩	368	476.5	角閃輝石安山岩
279	94.5	玄武岩	324	432.3	安山岩	369	638.2	輝石安山岩
280	58.3	玄武岩	325	299.1	安山岩	370	498.2	安山岩
281	132.4	玄武岩	326	234.0	輝緑凝灰岩	371	274.1	安山岩
282	60.4	玄武岩	327	116.3	安山岩	372	152.7	安山岩
283	11.5	玄武岩	328	334.9	安山岩	373	122.1	安山岩
284	94.0	玄武岩	329	275.4	安山岩	374	128.2	安山岩
285	132.2	玄武岩	330	347.5	玄武岩	375	503.9	砂岩
286	38.8	玄武岩	331	545.4	安山岩	376	205.9	安山岩
287	12.9	玄武岩	332	253.4	輝緑岩	377	181.8	安山岩
288	113.8	玄武岩	333	507.9	安山岩	378	281.9	角閃輝石安山岩
289	114.1	玄武岩	334	622.6	安山岩	379	525.3	安山岩
290	498.8	玄武岩	335	594.8	安山岩	380	375.4	安山岩
291	124.7	玄武岩	336	295.5	安山岩	381	240.1	輝石安山岩
292	18.0	玄武岩	337	137.0	チャート	382	416.9	角閃輝石安山岩
293	52.3	玄武岩	338	170.8	結晶片岩	383	648.0	角閃輝石安山岩
294	109.7	玄武岩	339	199.3	安山岩	384	100.0	流紋岩
295	24.4	玄武岩	340	128.0	安山岩	385	330.6	安山岩
296	77.3	玄武岩	341	640.0	安山岩	386	683.3	安山岩
297	659.1	玄武岩	342	687.3	安山岩	387	6400	角閃輝石安山岩
298	98.8	玄武岩	343	448.6	安山岩	388	8200	花崗岩
299	42.1	玄武岩	344	481.6	安山岩	389	4900	角閃輝石安山岩
300	86.5	玄武岩	345	442.0	安山岩	390	4500	輝石安山岩
301	74.4	玄武岩	346	331.6	安山岩	391	2200	角閃輝石安山岩
302	11.7	玄武岩	347	550.8	安山岩	392	4620	不明
303	47.8	玄武岩	348	619.7	安山岩	393	9000	不明
304	444.5	玄武岩	349	695.1	安山岩	394	4000	不明
305	84.3	玄武岩	350	584.3	安山岩	395	6200	不明
306	135.7	玄武岩	351	128.0	安山岩	396	37500	花崗岩
307	30.2	玄武岩	352	619.1	安山岩	397	4100	花崗岩
308	21.5	玄武岩	353	640.8	安山岩	398	1400	花崗岩
309	21.2	玄武岩	354	513.0	安山岩	399	3700	花崗岩
310	270.9	玄武岩	355	394.5	安山岩	400	2350	不明
311	168.3	玄武岩	356	448.0	安山岩	401	1300	不明
312	85.0	デイサイト	357	441.5	安山岩	402	120	不明
313	73.3	玄武岩	358	102.7	角閃輝石安山岩	403	6400	石墨片岩
314	55.9	玄武岩	359	769.4	安山岩	404	2380	不明
315	73.3	玄武岩	360	209.4	安山岩	405	4180	不明



郷土遺跡 石器計測表(4)

番号	重さ(g)	石 材	番号	重さ(g)	石 材	番号	重さ(g)	石 材
406	2400	不明	451	4400	不明	496	17500	輝石安山岩
407	3900	花崗斑岩	452	5000	溶岩	497	2000	輝石安山岩
408	5100	輝石安山岩	453	7000	浮石質安山岩	498	7000	輝石安山岩
409	4000	細粒花崗岩	454	5000	はんれい岩	499	4800	角閃輝石安山岩
410	750	不明	455	8400	角閃輝石安山岩	500	2200	角閃輝石安山岩
411	8000	不明	456	2800	安山岩	501	2400	安山岩
412	5800	不明	457	10600	角閃輝石安山岩	502	16500	輝石安山岩
413	17600	溶岩	458	4000	角閃輝石安山岩	503	16100	輝石安山岩
414	4000	角閃輝石安山岩	459	23600	溶岩	504	17800	輝石安山岩
415	3000	角閃輝石安山岩	460	1200	不明	505	14800	輝石安山岩
416	3200	角閃輝石安山岩	461	9000	角閃輝石安山岩	506	13900	輝石安山岩
417	2000	安山岩	462	4800	角閃輝石安山岩	507	2500	安山岩
418	5400	安山岩	463	2700	角閃輝石安山岩	508	4500	角閃輝石安山岩
419	5400	角閃輝石安山岩	464	16500	角閃輝石安山岩	509	2800	安山岩
420	2600	角閃輝石安山岩	465	9000	溶岩	510	17500	角閃輝石安山岩
421	500	安山岩	466	2000	安山岩	511	2600	角閃輝石安山岩
422	9600	角閃輝石安山岩	467	2600	角閃輝石安山岩	512	4800	輝石安山岩
423	7000	砂岩	468	11000	溶岩	513	18700	花崗岩
424	4100	角閃輝石安山岩	469	14000	角閃輝石安山岩	514	12500	角閃輝石安山岩
425	1800	安山岩	470	3800	輝石安山岩	515	14700	安山岩
426	3600	角閃輝石安山岩	471	3800	角閃輝石安山岩	516	3100	角閃輝石安山岩
427	14300	安山岩	472	2000	角閃輝石安山岩	517	3900	花崗岩
428	3500	角閃輝石安山岩	473	10400	溶岩	518	6100	輝石安山岩
429	7200	安山岩	474	4400	角閃輝石安山岩	519	4100	安山岩
430	5000	安山岩	475	3800	輝石安山岩	520	5900	花崗岩
431	4200	角閃輝石安山岩	476	3800	溶岩	521	5900	花崗岩
432	2900	細粒花崗岩	477	2600	安山岩	522	18700	花崗岩
433	3000	溶岩	478	1400	角閃輝石安山岩	523	9200	花崗岩
434	4000	安山岩	479	2500	角閃輝石安山岩	524	8100	花崗岩
435	4500	溶岩	480	4800	角閃輝石安山岩	525	8200	安山岩
436	4200	角閃輝石安山岩	481	4200	角閃輝石安山岩	526	18700	安山岩
437	1200	砂岩	482	18000	角閃輝石安山岩	527	5500	角閃輝石安山岩
438	5000	角閃輝石安山岩	483	4500	輝石安山岩	528	12500	花崗岩
439	10600	角閃輝石安山岩	484	3000	角閃輝石安山岩	529	28200	安山岩
440	15000	角閃輝石安山岩	485	16000	安山岩	530	5200	軽石
441	7200	角閃輝石安山岩	486	8900	溶岩	531	2200	軽石
442	3900	角閃輝石安山岩	487	7200	溶岩	532	2200	軽石
443	9500	溶岩	488	8000	溶岩	533	275.6	軽石
444	4400	輝緑岩	489	6000	輝石安山岩	534	48.0	軽石
445	2000	溶岩	490	26200	角閃輝石安山岩	535	188.7	軽石
446	5800	角閃輝石安山岩	491	5900	安山岩	536	1800	軽石
447	3800	角閃輝石安山岩	492	3200	不明	537	1400	軽石
448	3800	角閃輝石安山岩	493	7600	角閃輝石安山岩	538	4600	軽石
449	5400	角閃輝石安山岩	494	10300	輝石安山岩	539	388.2	軽石
450	3400	安山岩	495	2800	角閃輝石安山岩	540	734.1	軽石



# 写 真 图 版

遺跡群遠景 (西から)



遺跡群近景 (西から)



三子塚4号墳周溝礫出土状態



左：三子塚4号古墳  
周溝礫出土状態  
右：三子塚4号古墳  
完掘状態

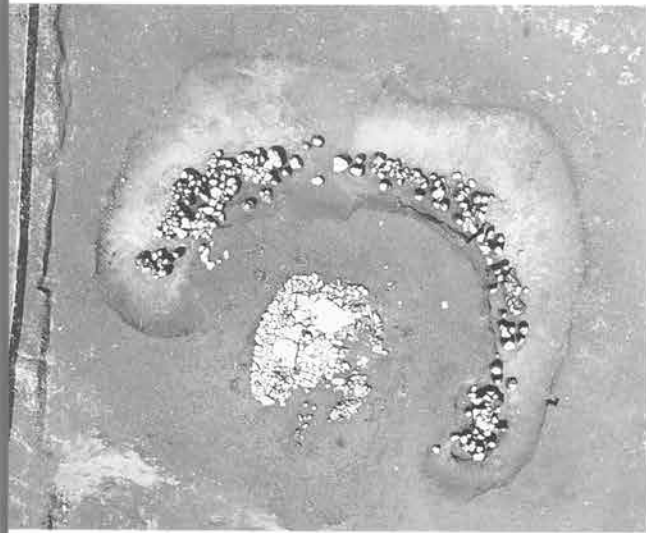

左：三子塚4号古墳  
石室  
右：同上

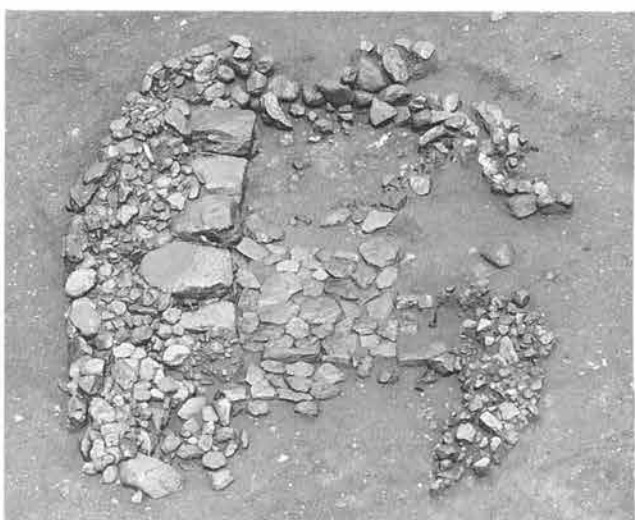



左：三子塚4号古墳  
掘方

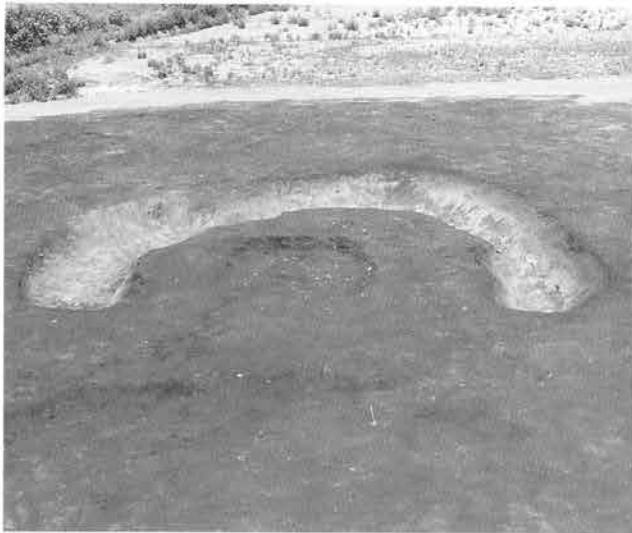

右：三子塚4号古墳  
玄室内人骨出土  
状態



左：三子塚4号古墳  
羨道部遺物出土  
状態



右：三子塚4号古墳  
周溝内遺物出土  
状態



平安時代の集落





左：1号竖穴住居跡  
右：同カマド



左：2号竖穴住居跡  
右：同カマド



左：4号竖穴住居跡  
右：同軽石出土状態



左：4号竖穴住居跡掘方  
右：5号竖穴住居跡



左：6号竖穴住居跡  
掘方  
右：7号竖穴住居跡  
掘方



左：8号竖穴住居跡  
右：同カマド



左：9号竖穴住居跡  
右：同掘方



左：10号竖穴住居跡  
右：同カマド





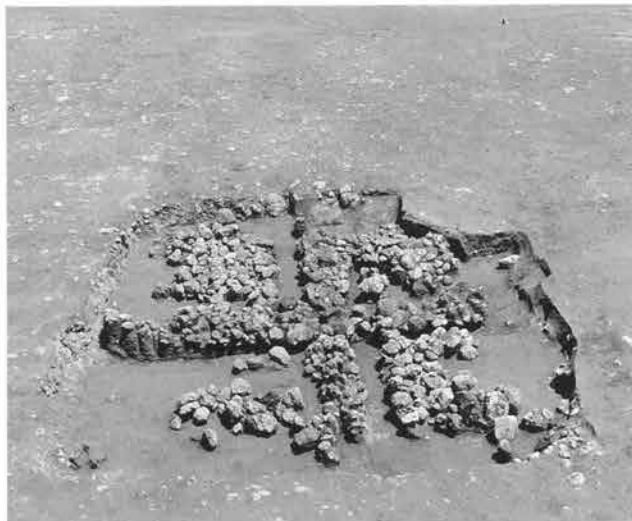

左：12号竖穴住居跡  
右：同軽石出土状態

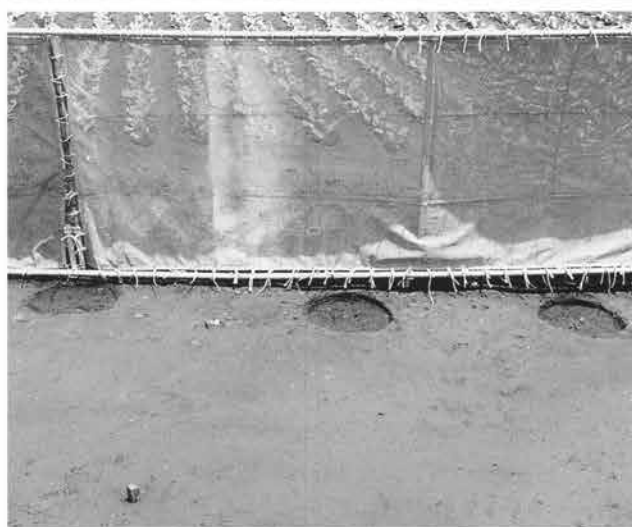

左：13号竖穴住居跡  
右：1号掘立柱建物跡



左：1～5号流路跡  
右：2～5号流路跡



左：畑跡  
右：畑跡の畝間を覆う砂層

縄文時代から古墳時代の土器

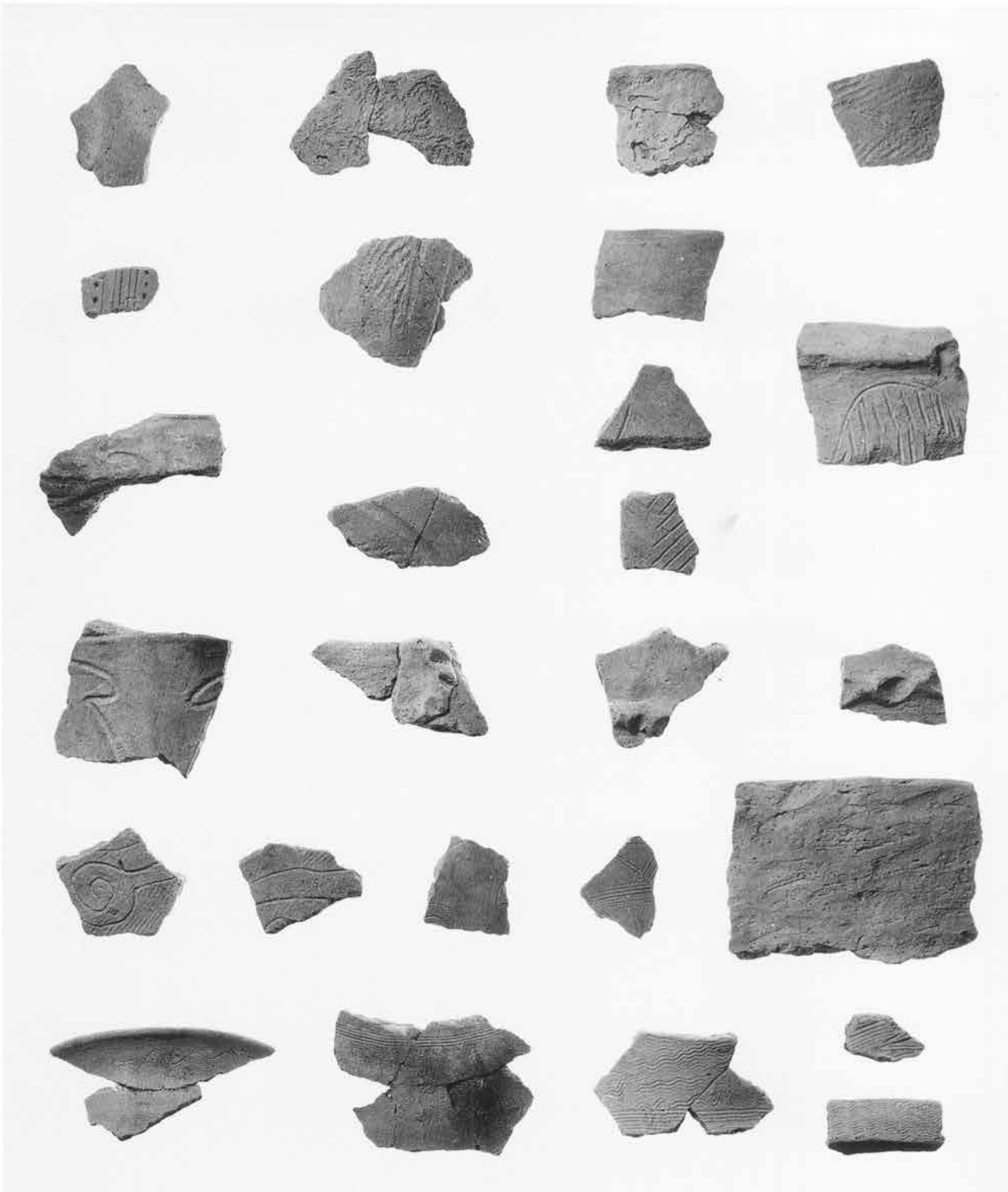

縄文時代の石鏃



縄文時代の打製石斧





1



2



3



5



6



9



12



13



14



15



16



17

左：6号竖穴住居跡  
出土土器  
右：9号竖穴住居跡  
出土土器



1



1

竖穴住居跡出土鉄器

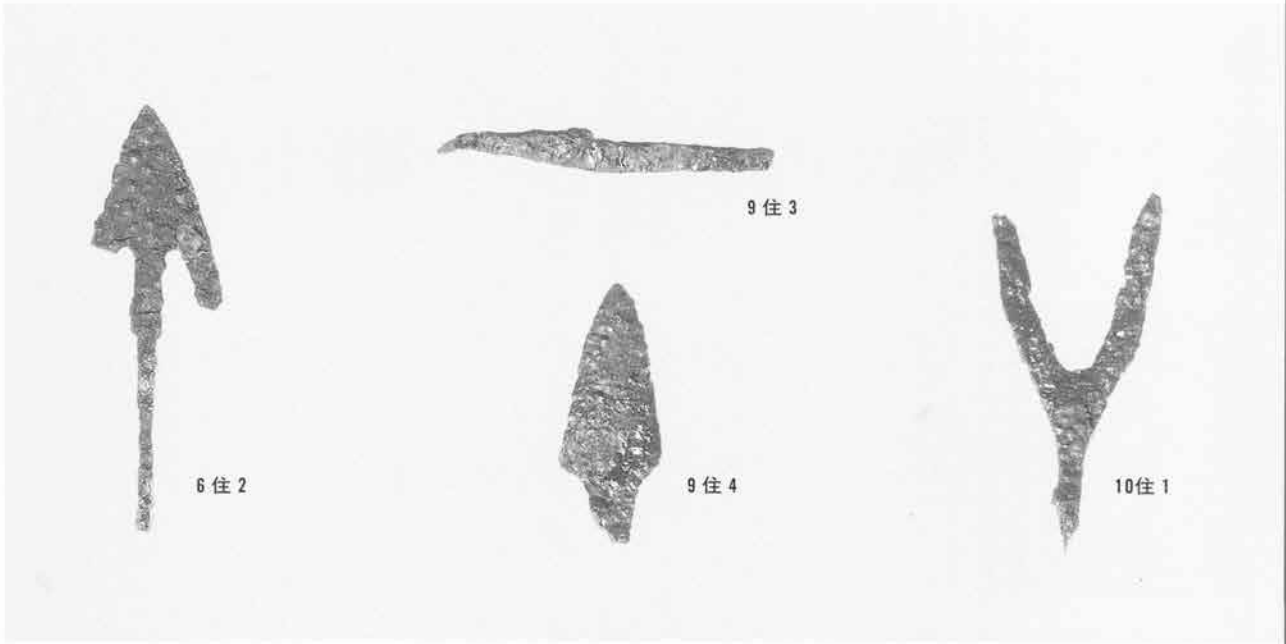

三子塚4号古墳出土  
人骨 (1:1)

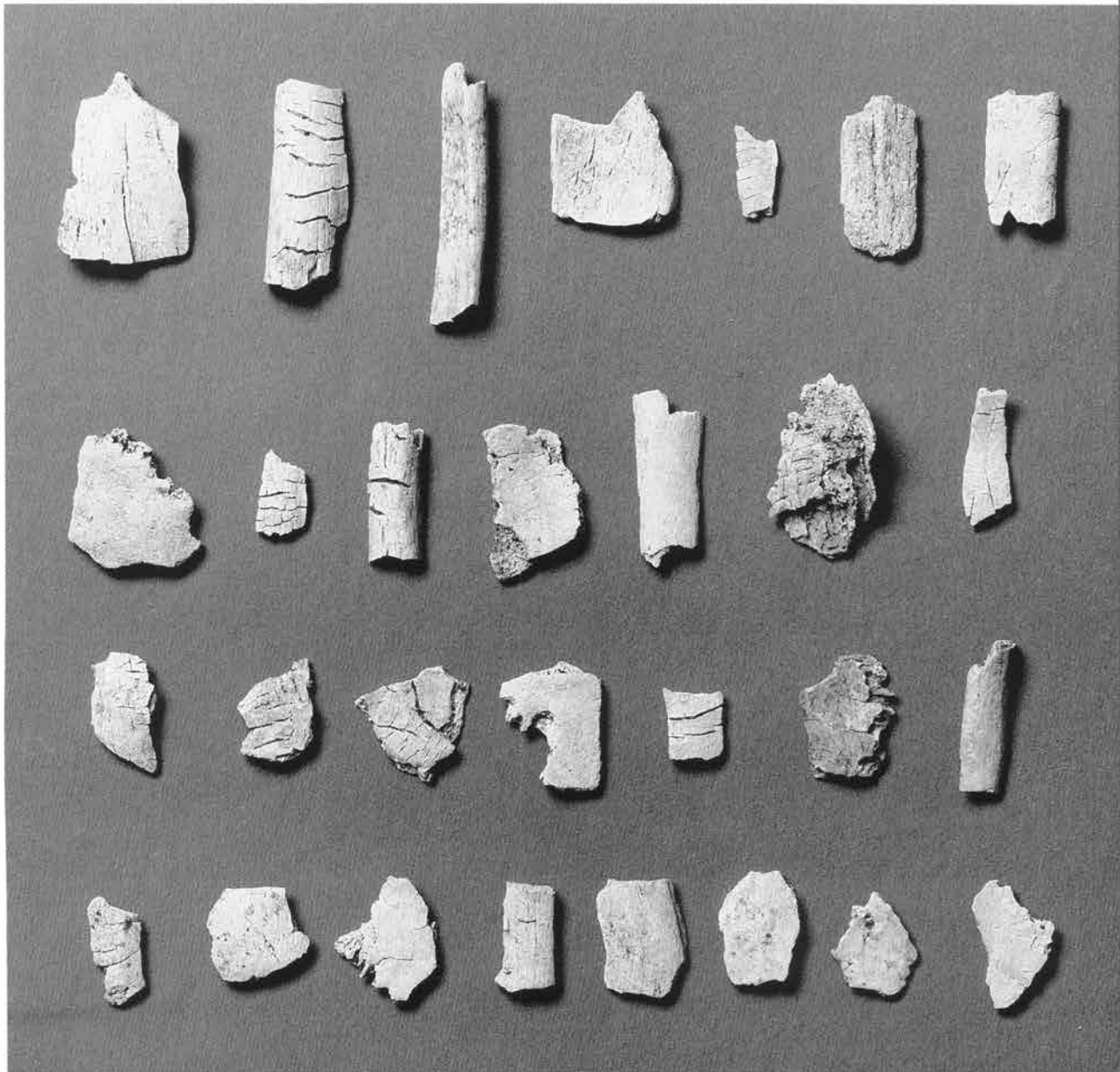



本線部分全景  
(東から)



市道拡幅部分全景



環状集落北端部



1～3号竪穴住居跡  
南側の礫出土状態





4号竖穴住居跡と石列



4号竖穴住居跡と石列

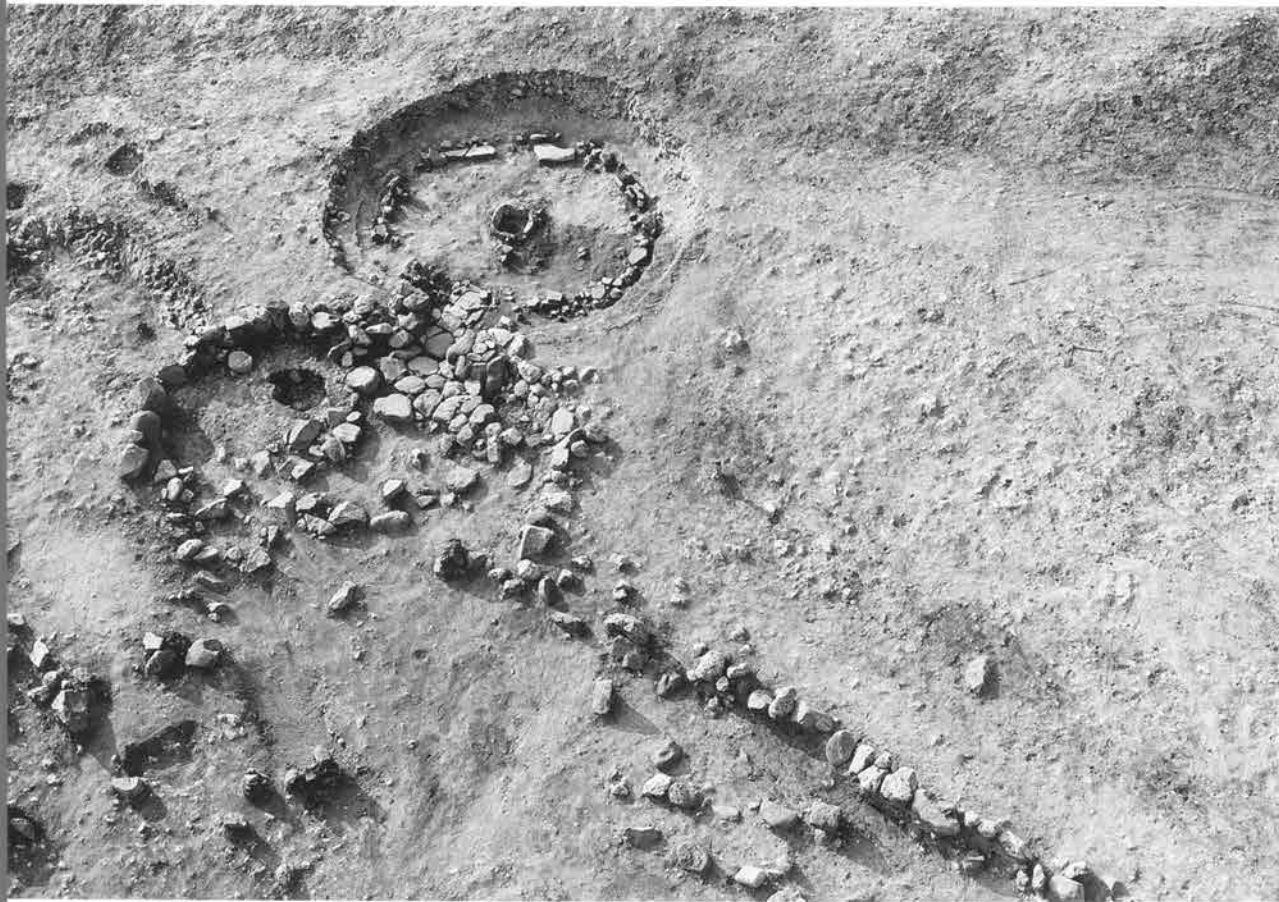

4号竖穴住居跡



4号竖穴住居跡

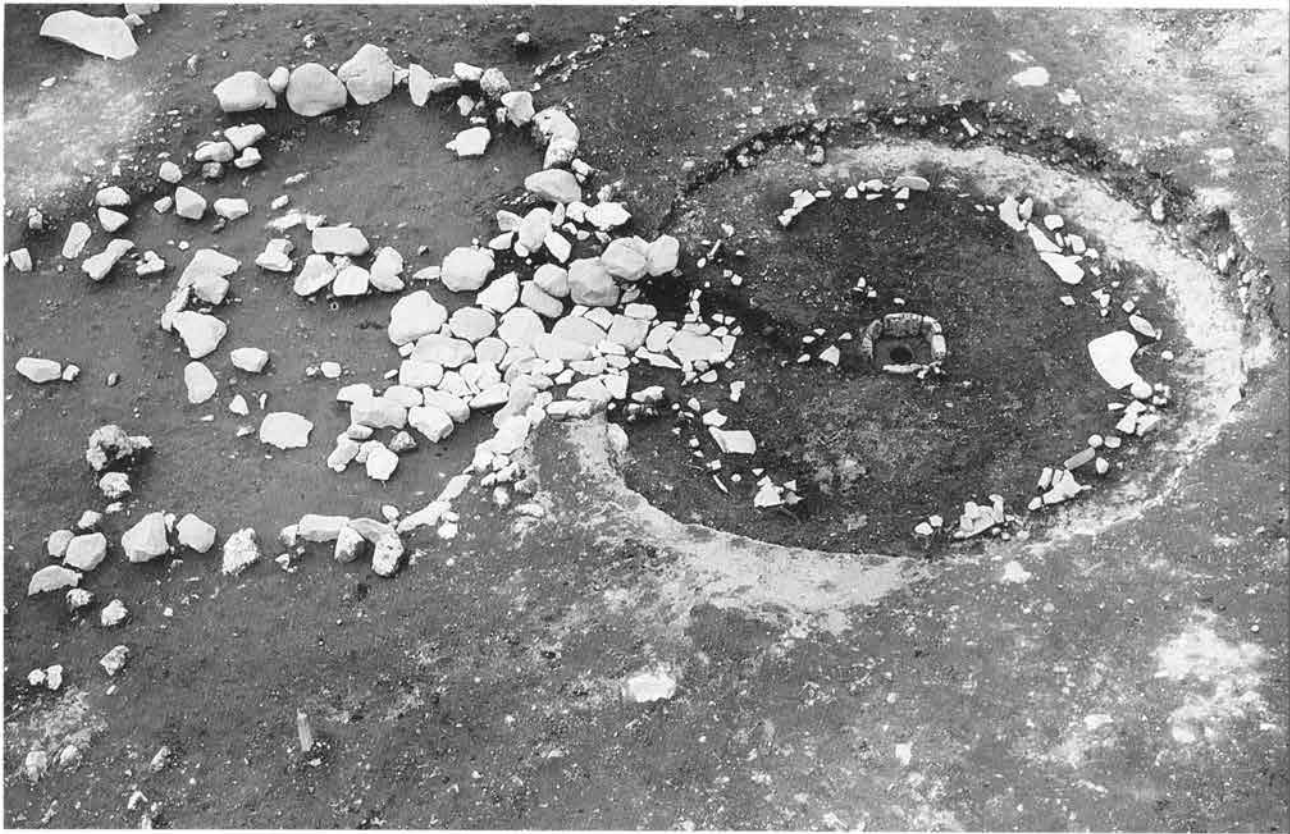

左：4号竖穴住居跡  
主体部  
右：4号竖穴住居跡  
炉

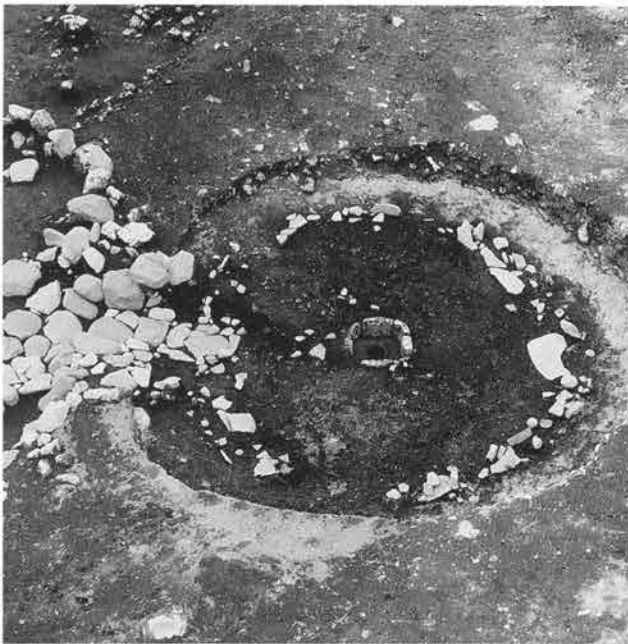

4号竖穴住居跡石棒  
出土状態





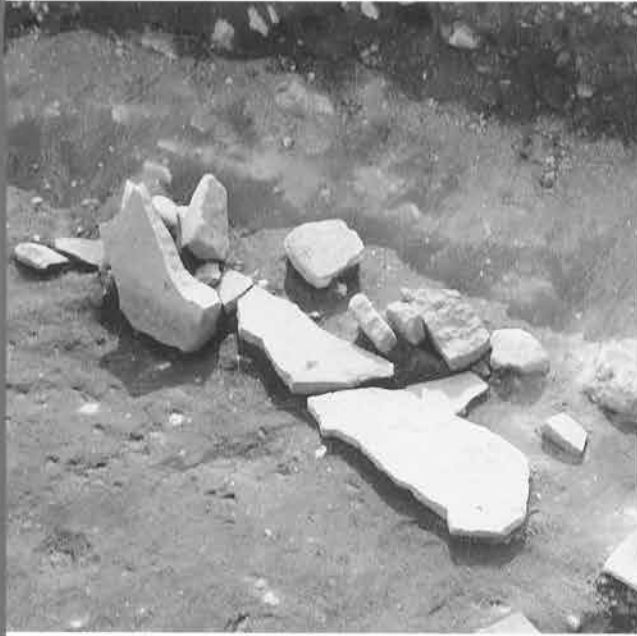

4号竖穴住居跡主体部縁石



左：4号竖穴住居跡主体部内軽石出土状態  
右：4号竖穴住居跡張出部内礫出土状態

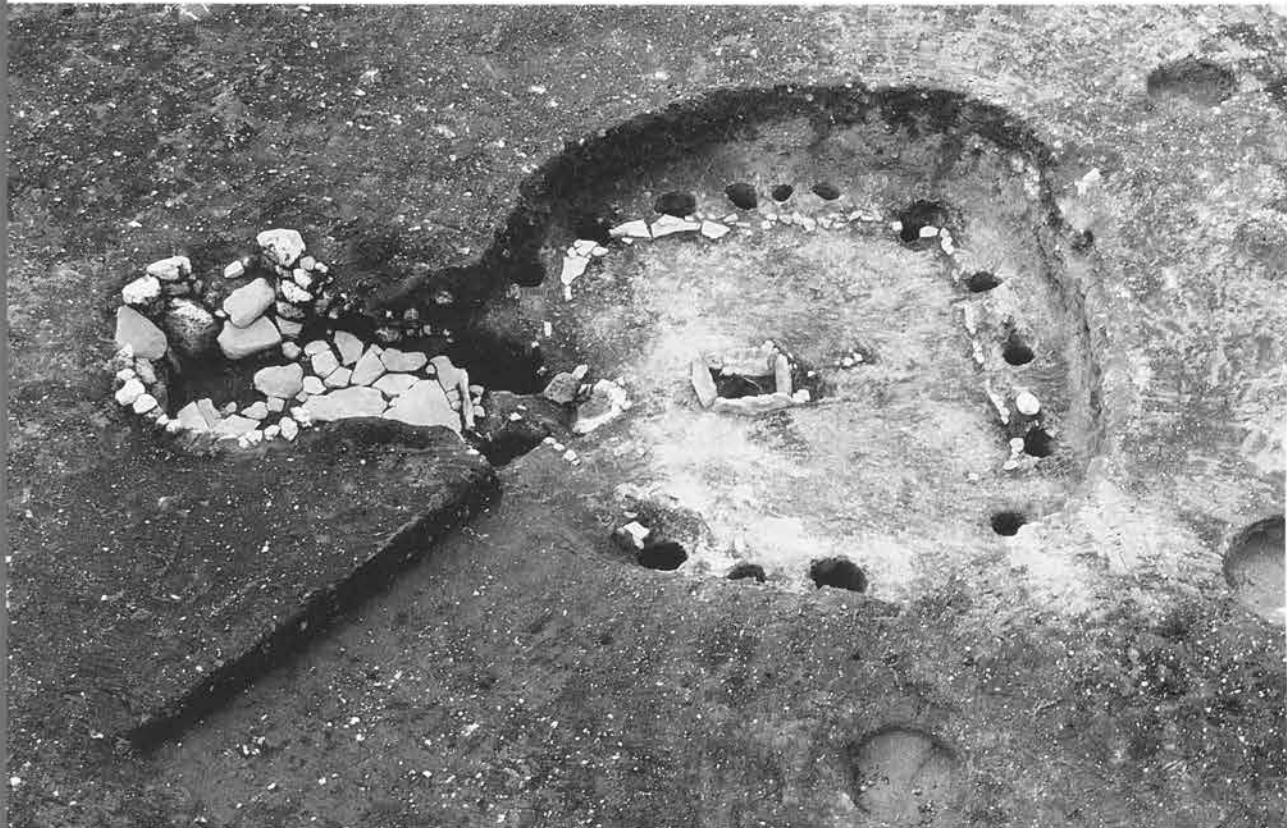

7号竖穴住居跡

7号竪穴住居跡

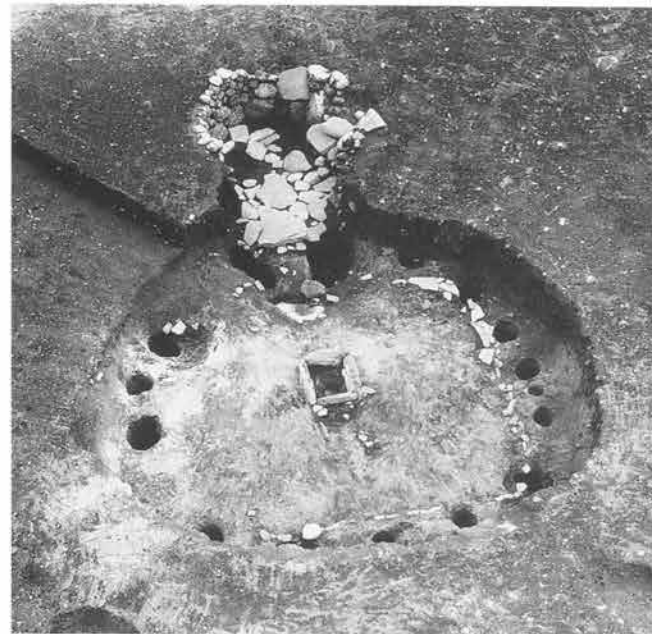
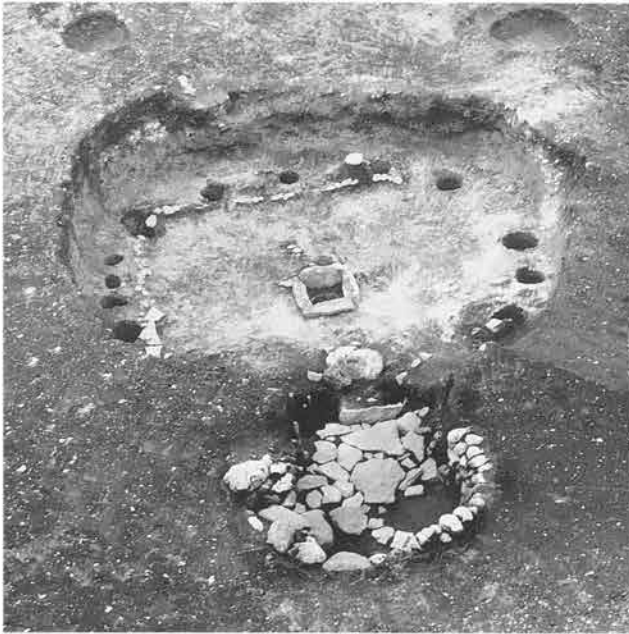

7号竪穴住居跡張出部

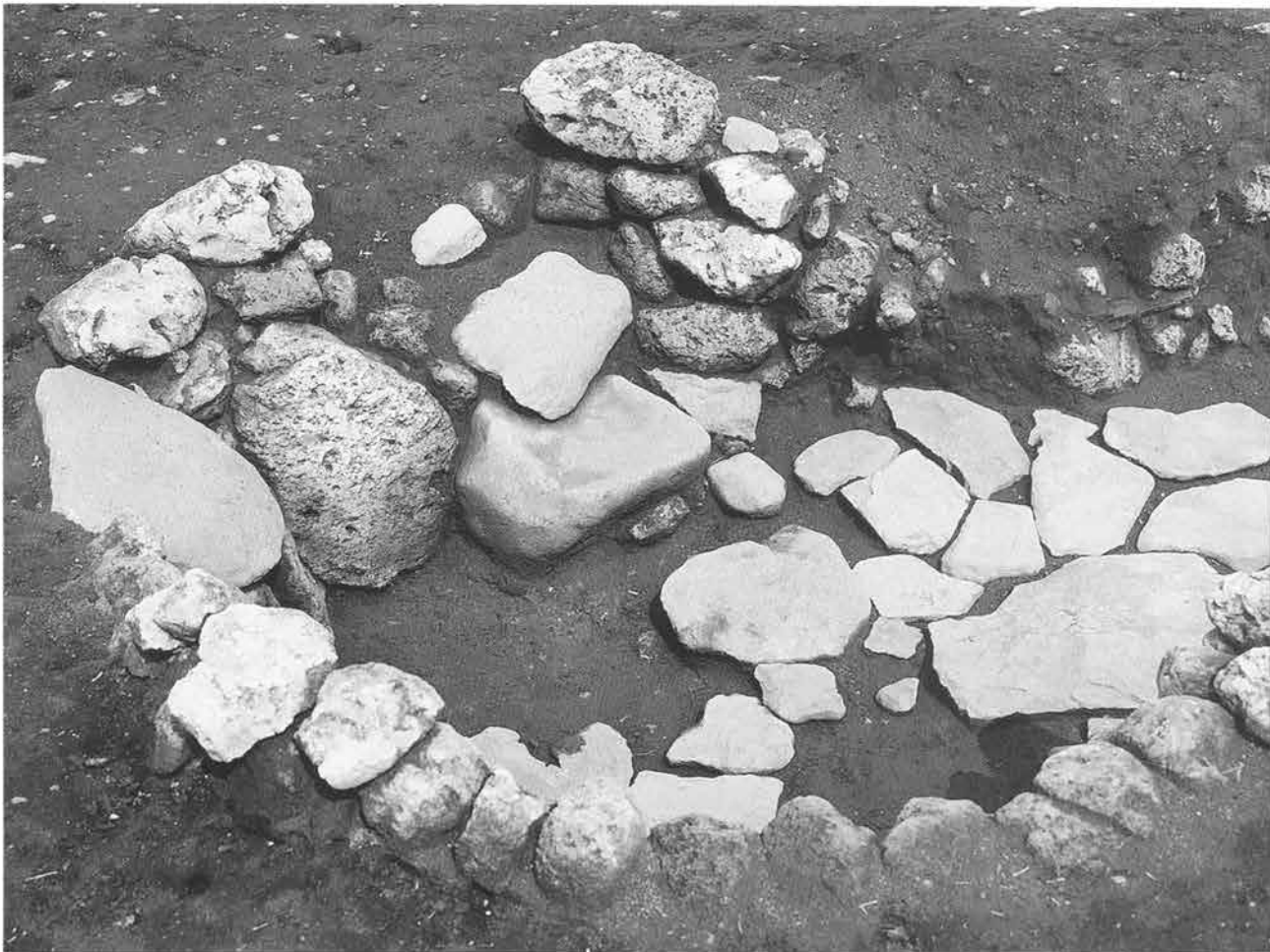





7号竖穴住居跡主体部縁石

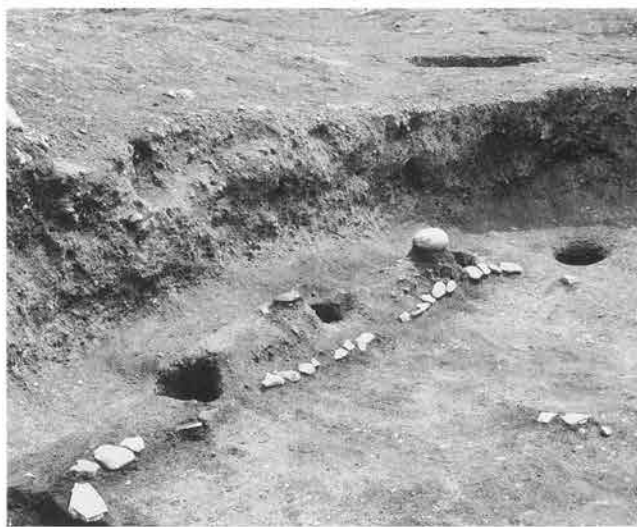

7号竖穴住居跡奥壁周堤部



左：7号竖穴住居跡  
軽石製石鉢出土  
状態

右：7号竖穴住居跡  
張出部掘方

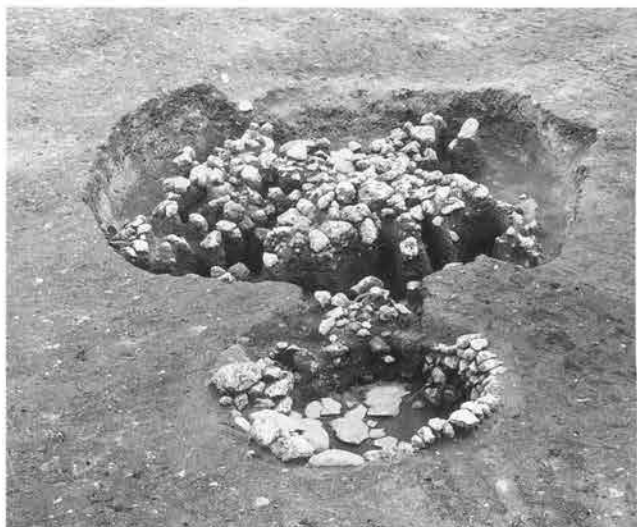
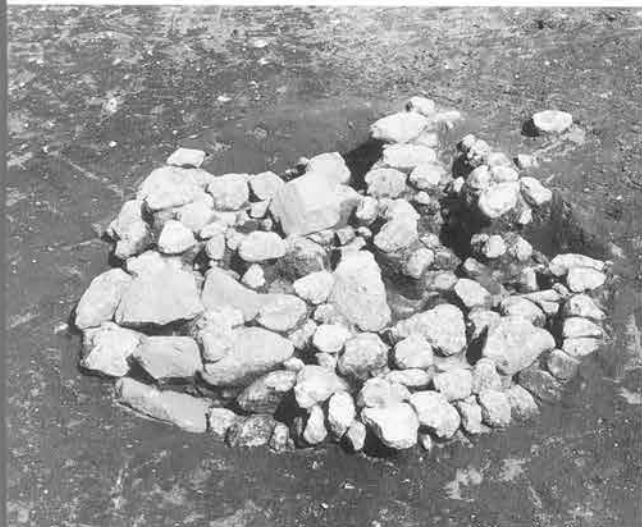

左：7号竖穴住居跡  
張出部内軽石出  
土状態

右：7号竖穴住居跡  
主体部内軽石出  
土状態

11号竖穴住居跡



11号竖穴住居跡炉



左：11号竖穴住居跡埋甕



右：11号竖穴住居跡軽石出土状態







左：12号竖穴住居跡  
遺物出土状態  
右：12号竖穴住居跡  
完掘状態

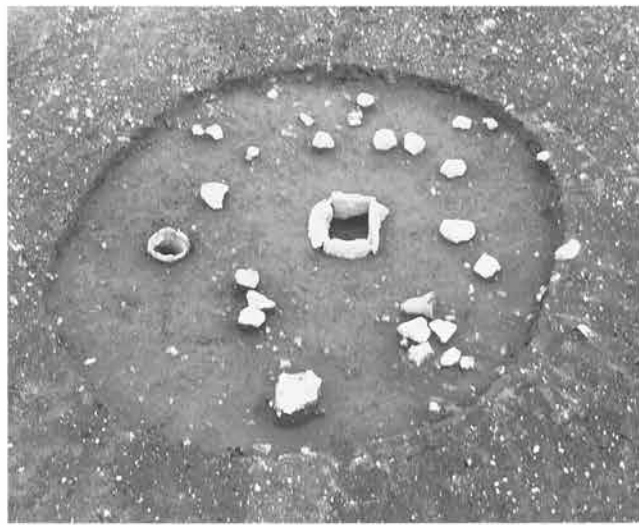
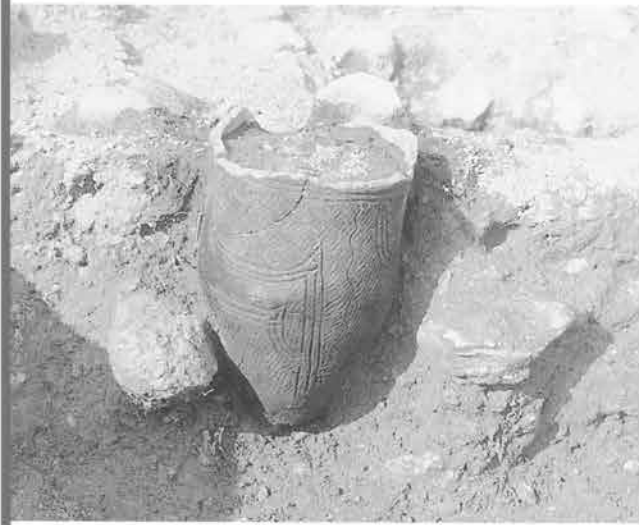

左：12号竖穴住居跡  
埋甕断面  
右：13号竖穴住居跡



左・右上：14号竖穴  
住居跡  
右下：14号竖穴住居  
跡掘方



左：15号竖穴住居跡  
右：17号竖穴住居跡



17号竖穴住居跡

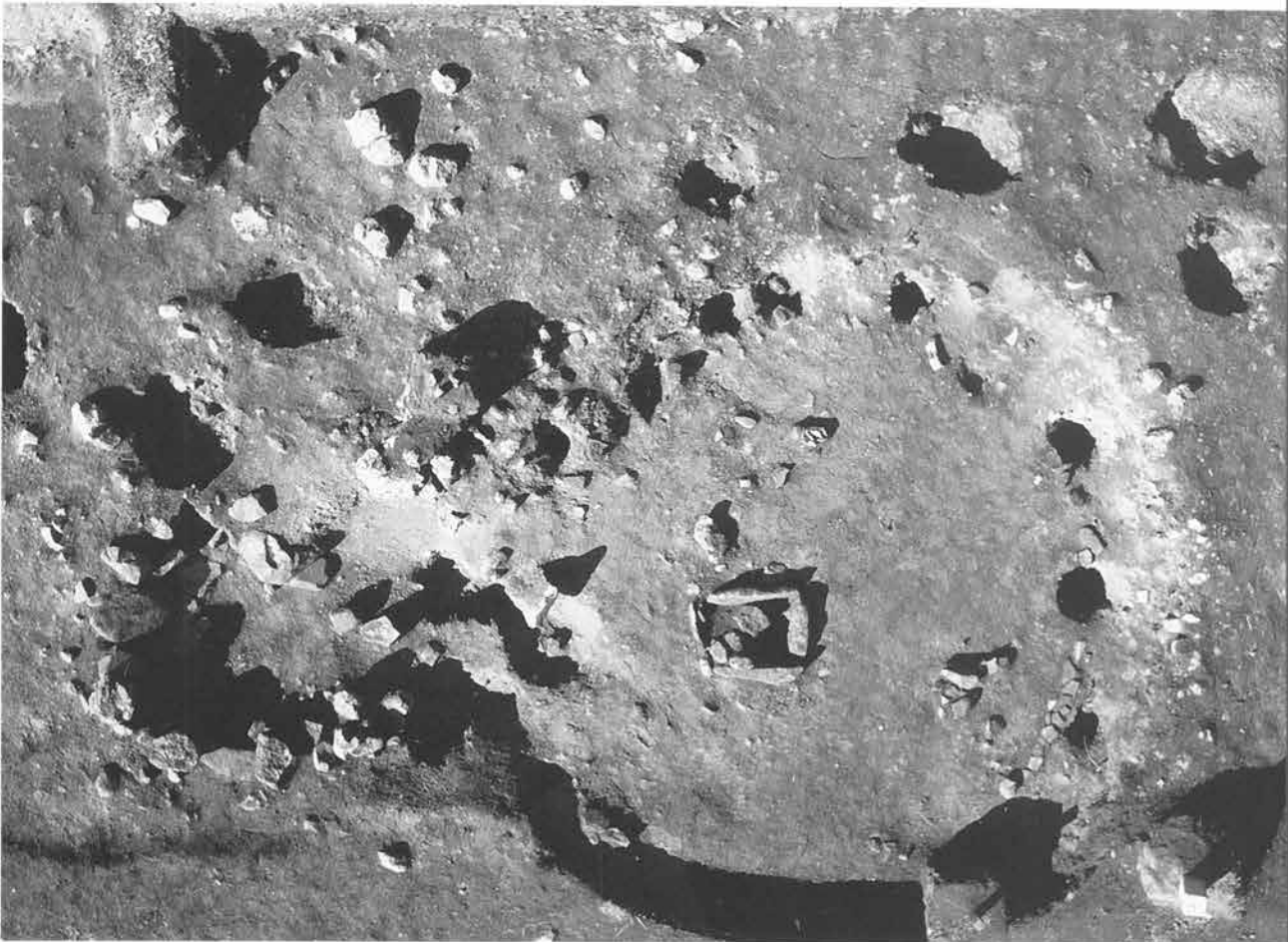

左：17号竖穴住居跡  
張出部出入口部  
右：17号竖穴住居跡  
炉







左・右上：18号竪穴  
住居跡  
右下：18号竪穴住居  
跡張出部石積  
み状態



左・右上：18号竪穴  
住居跡連  
結部  
右下：18号竪穴住居  
跡掘方

左：19・20号竖穴住居跡  
居跡  
右：21号竖穴住居跡



左：22号竖穴住居跡  
右：同炉



左：23号竖穴住居跡  
右：24号竖穴住居跡





遺物溜まり完掘状態



左：遺物溜まり断面  
右：遺物溜まり遺物  
出土状態



左：30号竪穴住居跡  
完掘状態  
右：30号竪穴住居跡  
掘方



左：31号竪穴住居跡  
遺物出土状態  
右：31号竪穴住居跡  
完掘状態

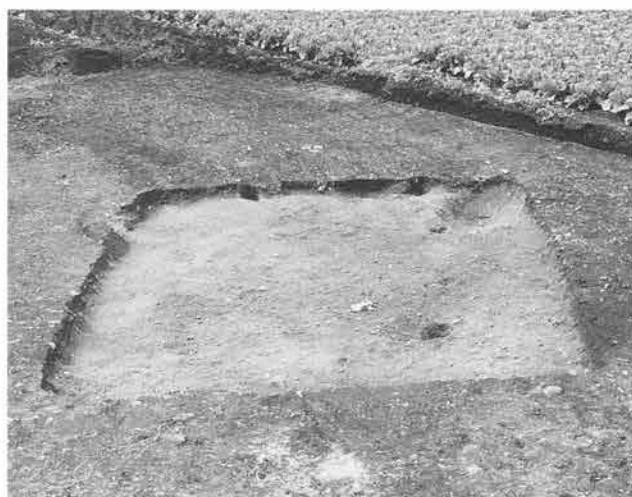

1号竖穴住居跡出土  
土器



左：1号竖穴住居跡  
出土器  
右：4号竖穴住居跡  
出土土器



4号竖穴住居跡出土  
土器



6号竖穴住居跡出土  
土器(1)





2



1



6



2

左：6号竖穴住居跡  
出土土器(2)  
右：7号竖穴住居跡  
出土土器



5

8号竖穴住居跡出土  
土器



1



1

左：9号竖穴住居跡  
出土土器  
右：10号竖穴住居跡  
出土土器

11号竖穴住居跡出土  
土器(1)



3



4





2



6



9



7



10



11



12

11号竖穴住居跡出土  
土器(3)





1



3

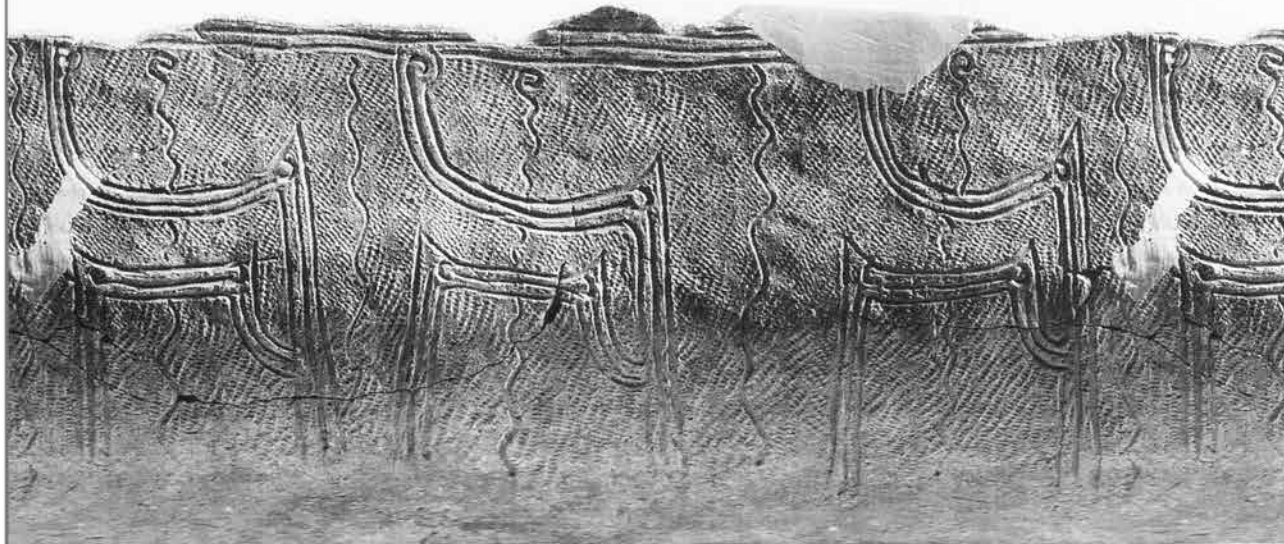

3



2



13号竖穴住居跡出土  
土器



左：13号竖穴住居跡  
出土土器  
右：14号竖穴住居跡  
出土土器



14号竖穴住居跡出土  
土器



左：22号竖穴住居跡  
出土土器  
右：23号竖穴住居跡  
出土土器







1



1

左：8号土坑出土  
土器  
右：23号土坑出土  
土器



1



2



3

遺物溜まり出土土器  
(1)



65



64



66



93



132



92



91



169



193



242

左：石槍  
中：石鏃  
右：石匙

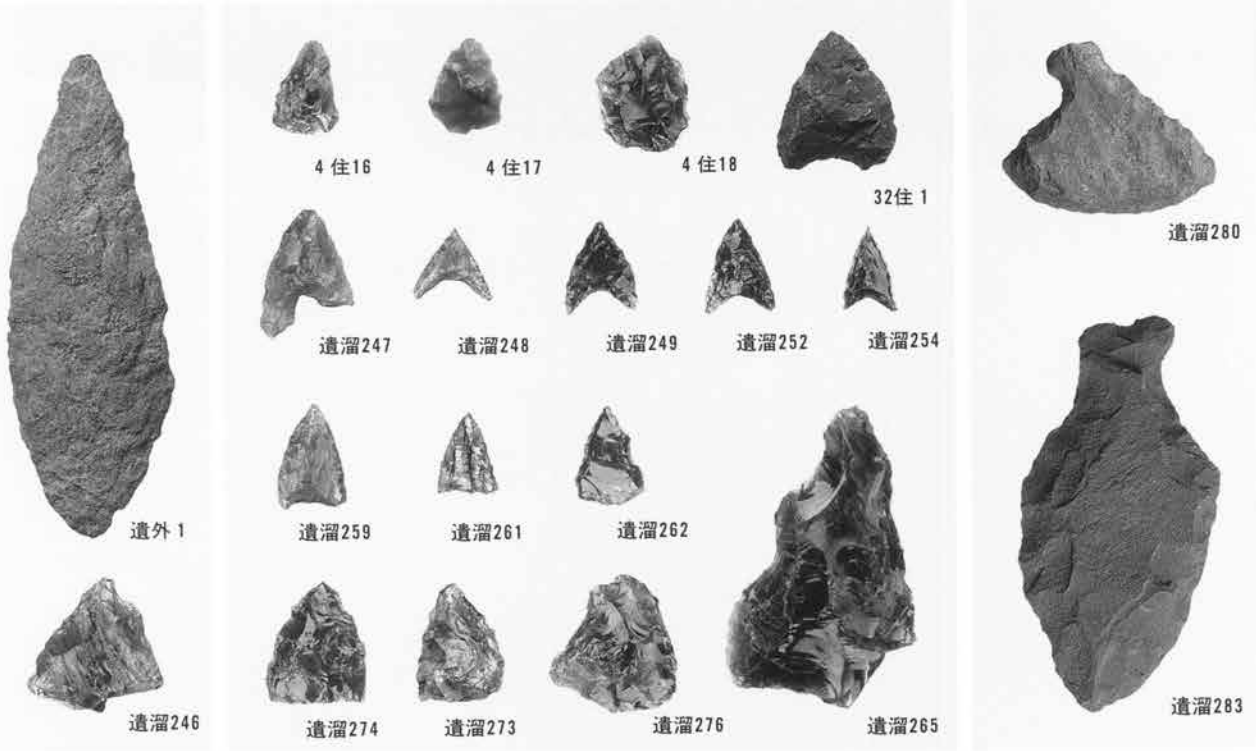

特殊磨石・凹石・磨石・敲石

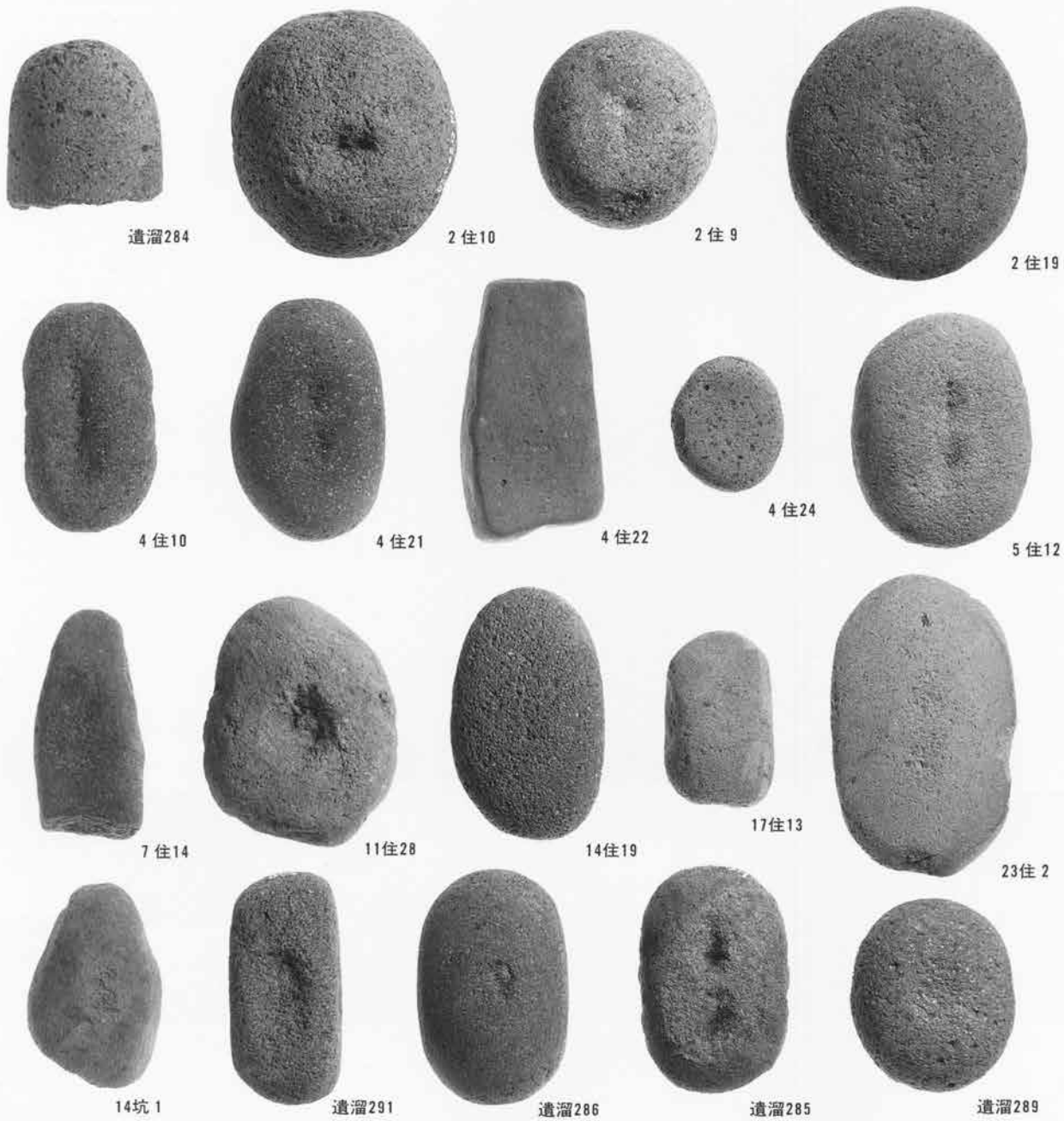

磨製石斧



打製石斧

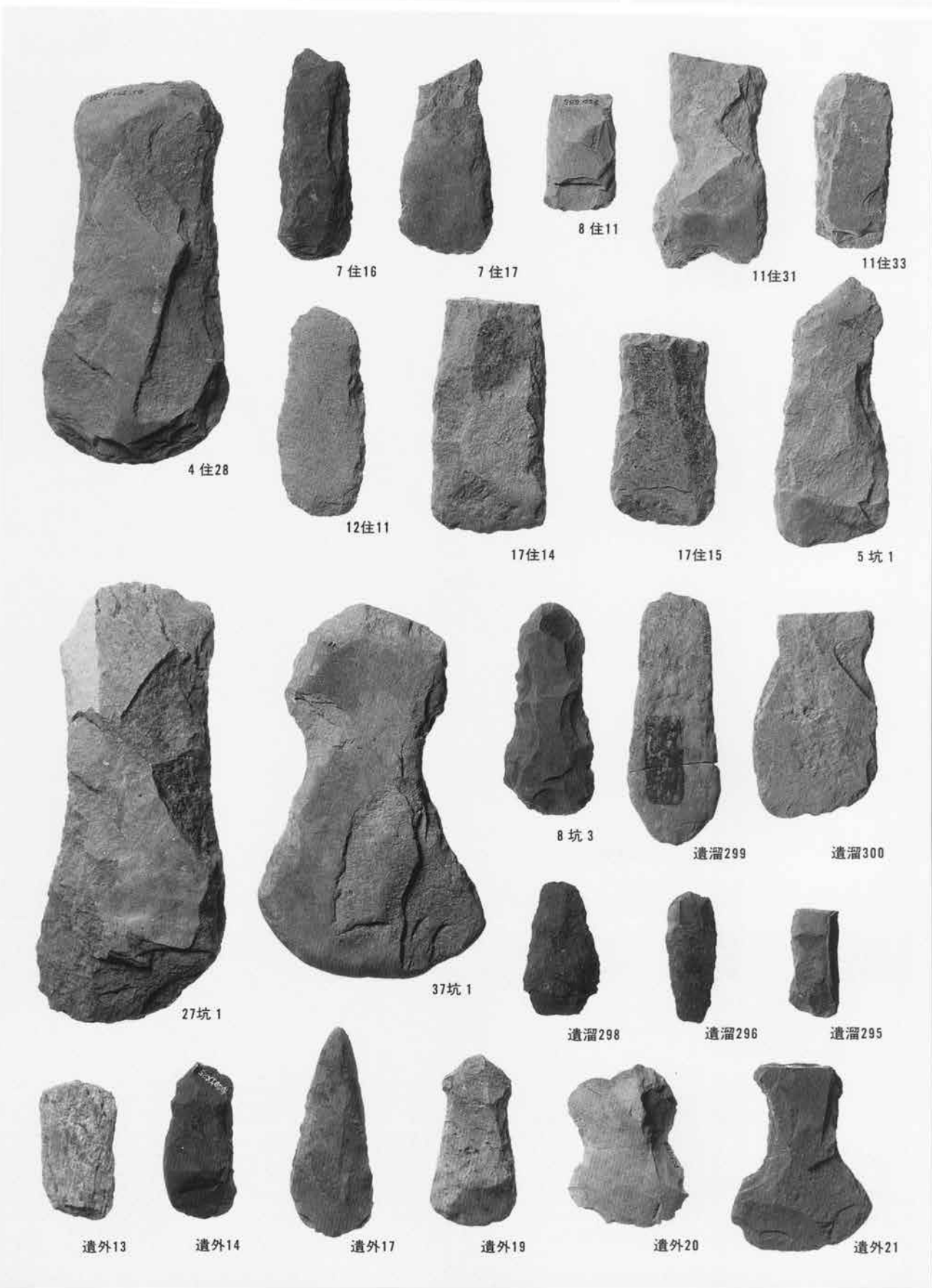

砥石

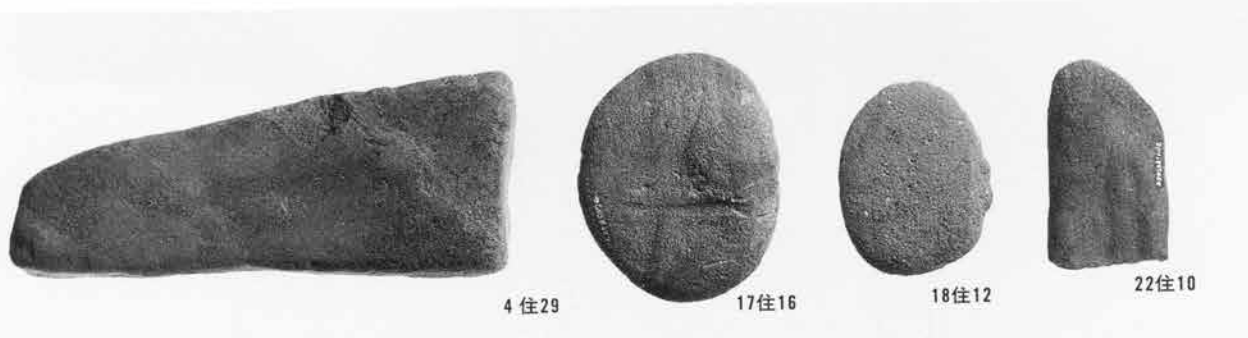

多孔石

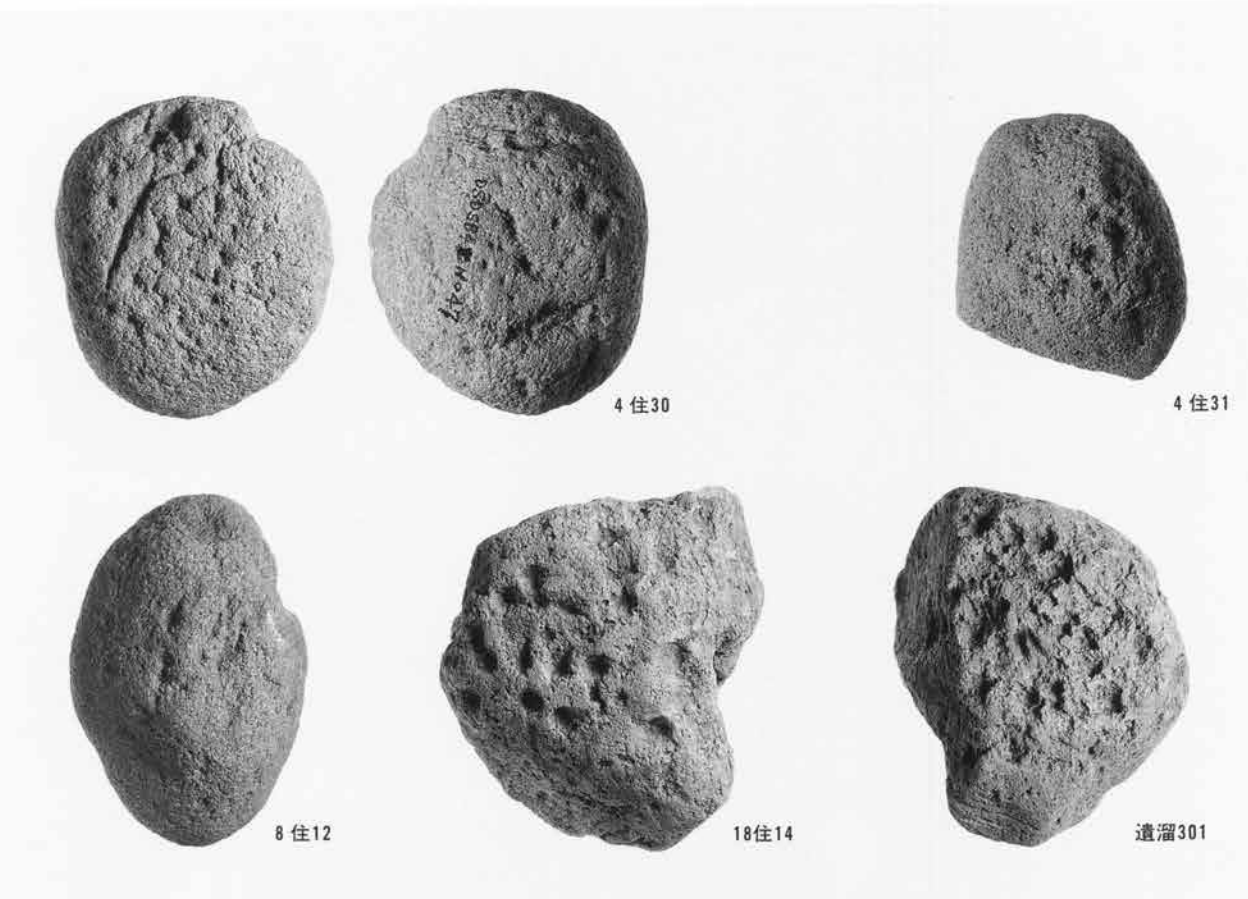

石皿

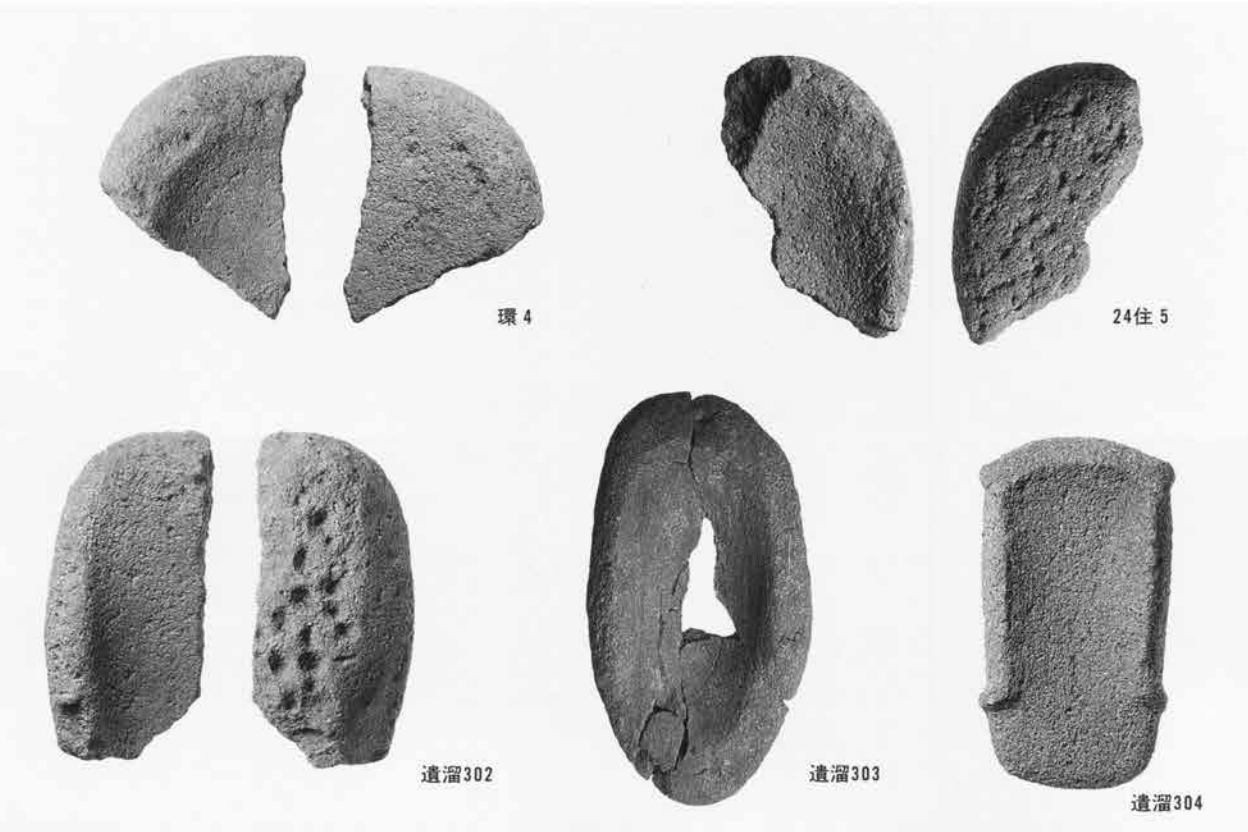



丸石

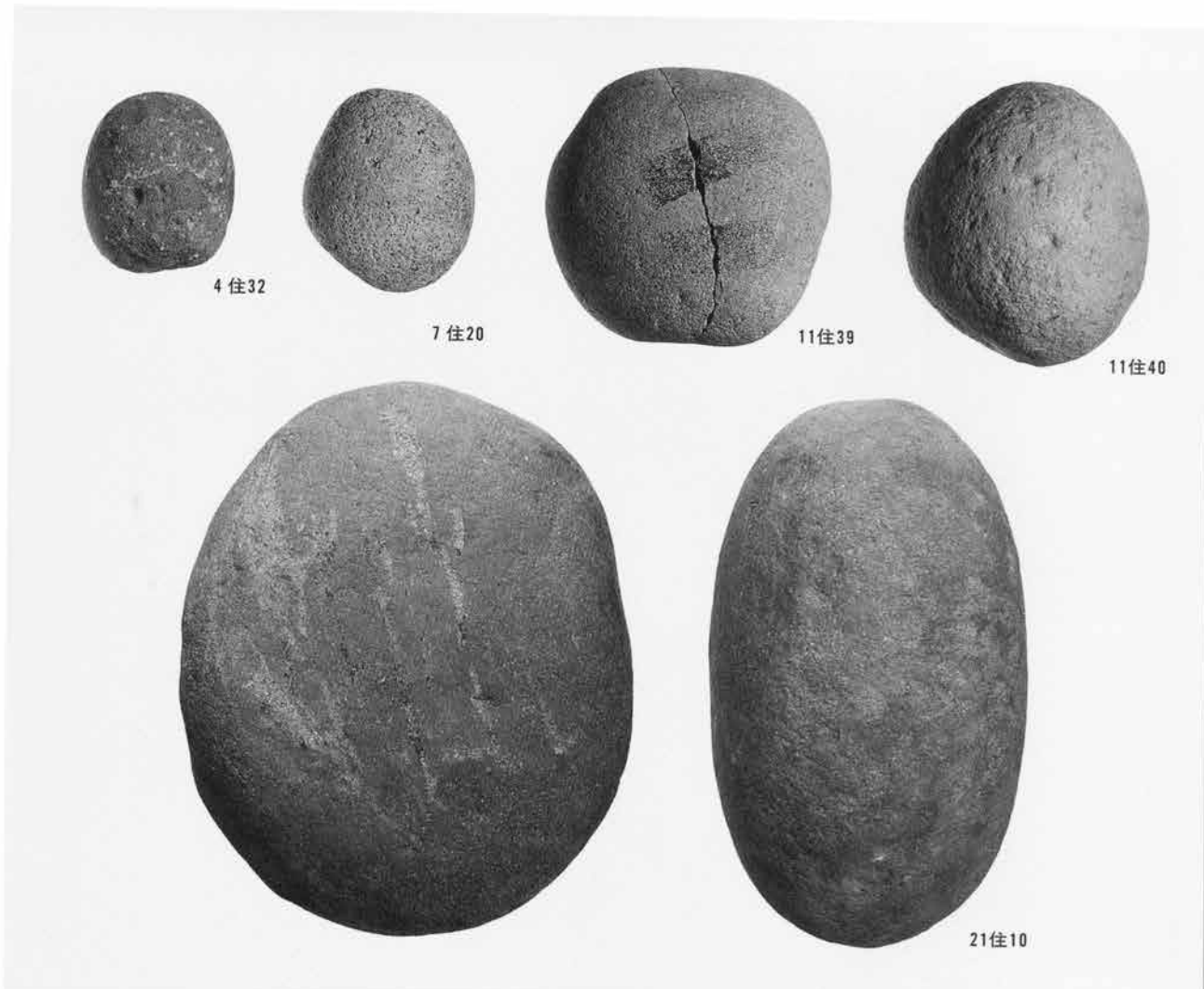

石棒及び類似品

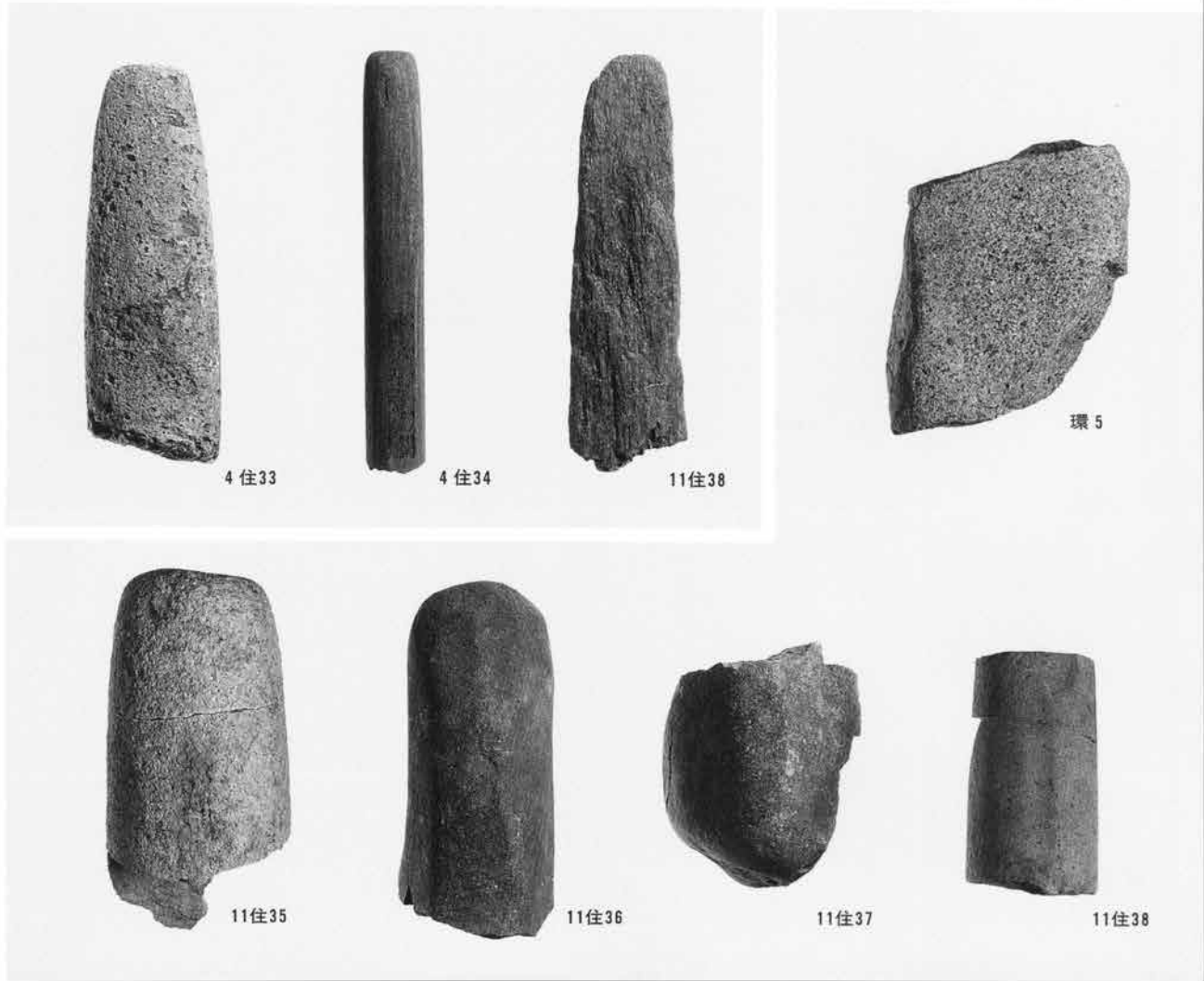



7住22

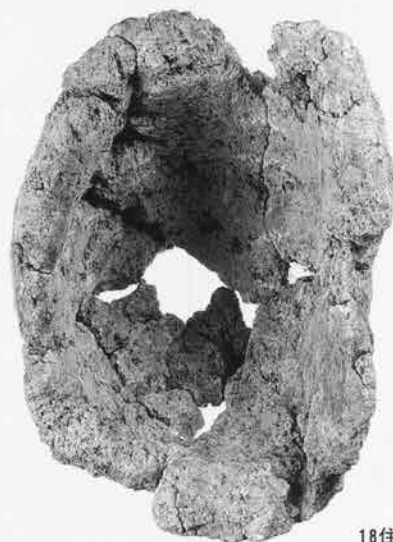

18住13



7住19



11住41



22住13



22住14



22住15



遺溜308

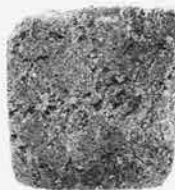

遺溜306



遺溜307



環 3



2住13



4住36



5住14



遺外24



遺外25



11住42

遺跡全景（南から）



遺跡東半部





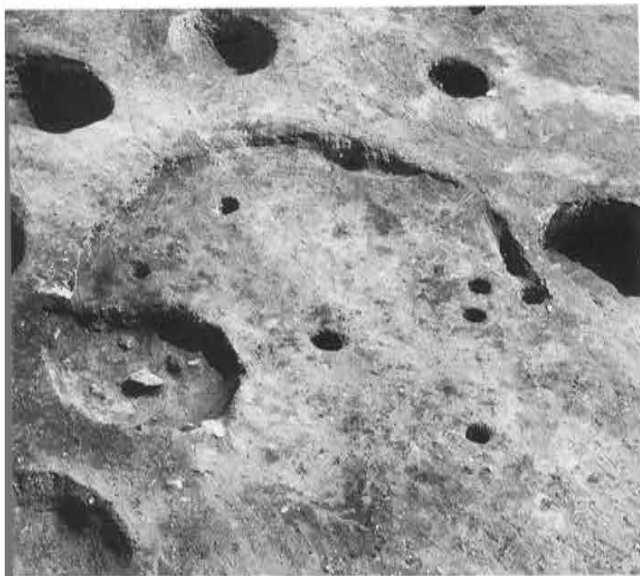

左：2号竪穴住居跡  
右：5号竪穴住居跡

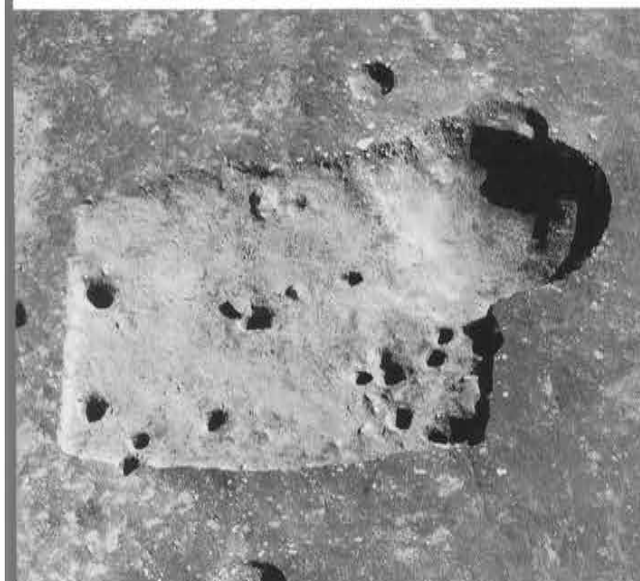

左：10号竪穴住居跡  
右：12号竪穴住居跡

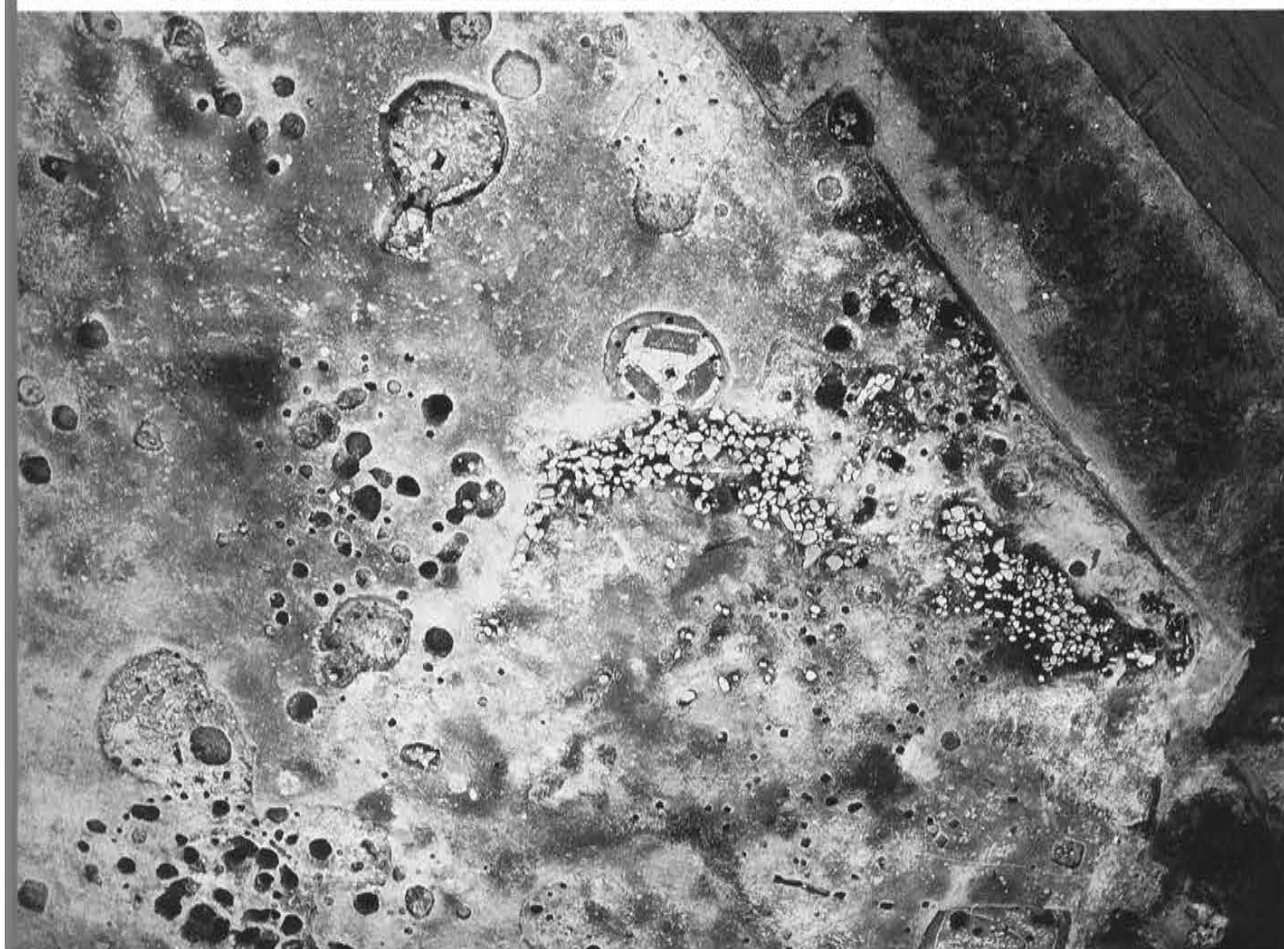

後期前半の環状集落  
北端部







後期前半の環状集落  
の石列根石出土状態



後期前半の環状集落  
の南側を取り巻く土  
坑群

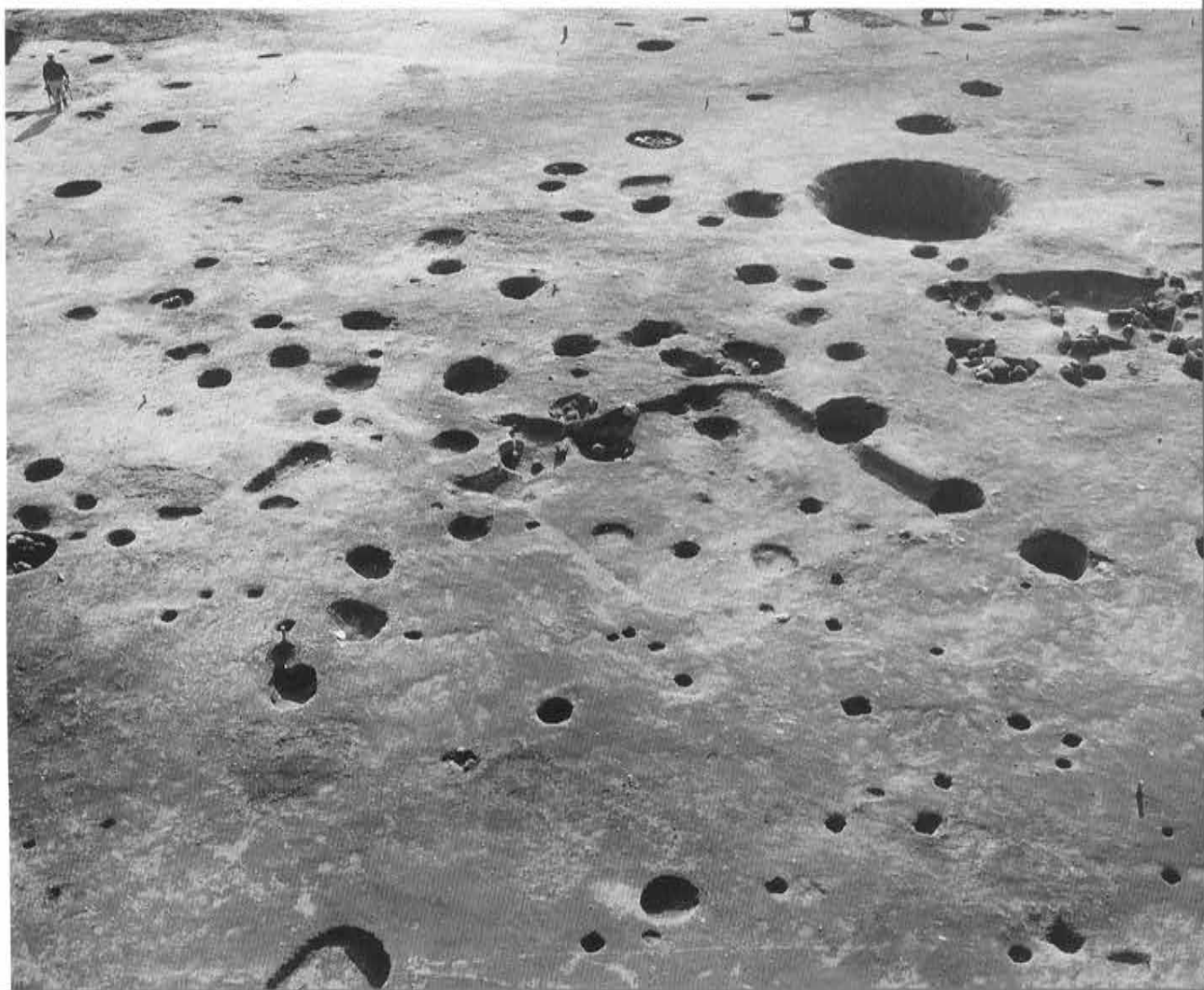



13号竖穴住居跡



13・14号竖穴住居跡

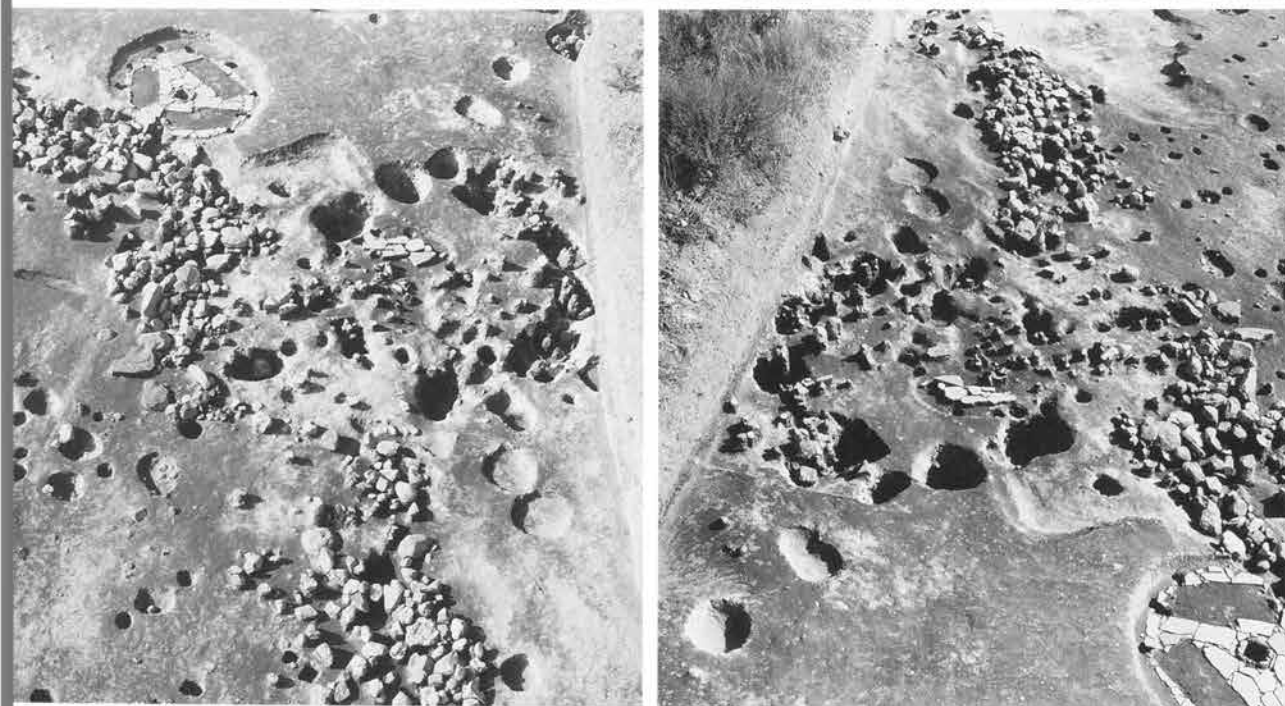

15号竖穴住居跡



15号竖穴住居跡



16号竖穴住居跡





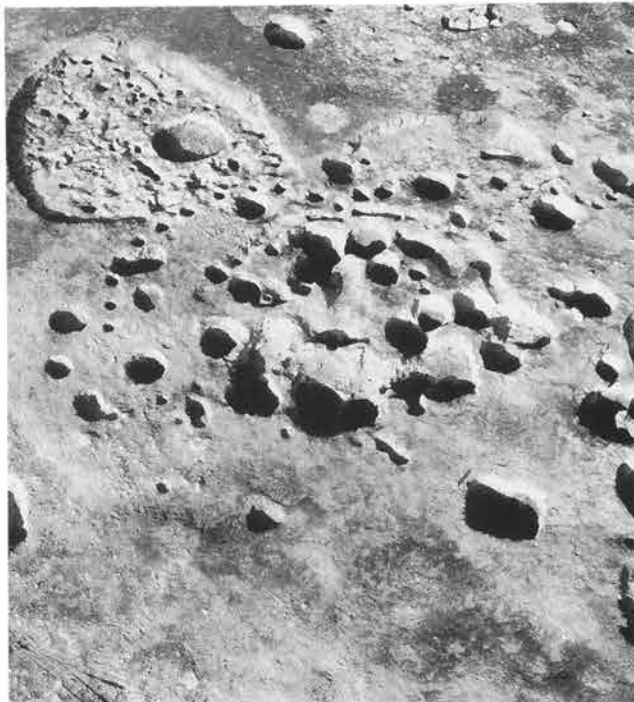
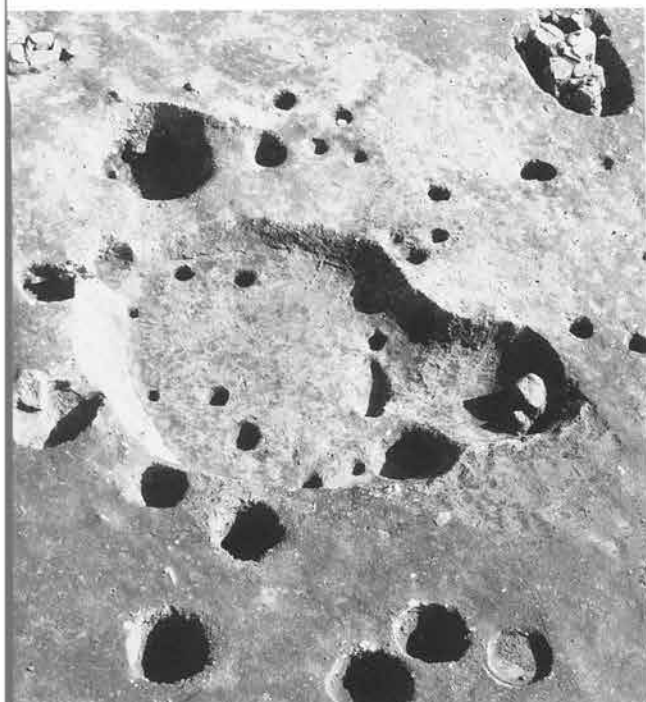

左：18・32号竖穴住居跡  
右：19～22号竖穴住居跡



23～27号竖穴住居跡



左：1号石棺検出状態  
右：1号石棺

石列を伴う28・29号  
竪穴住居跡



左：28号竪穴住居跡  
右：29号竪穴住居跡



左：31号竪穴住居跡  
右：34～36号竪穴住居跡





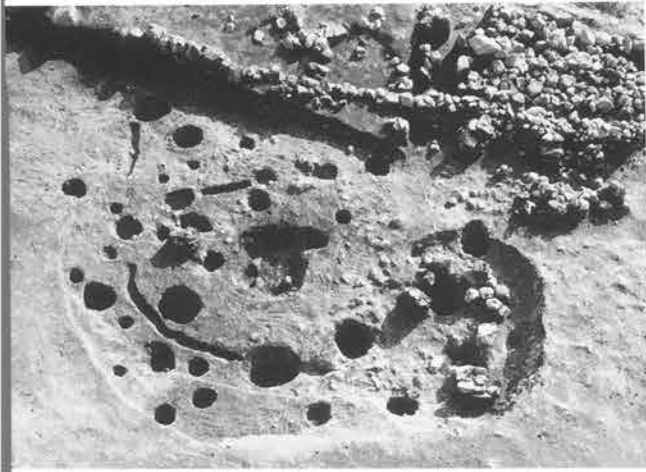

左：37～39号竖穴住居跡  
居跡  
右：40号竖穴住居跡

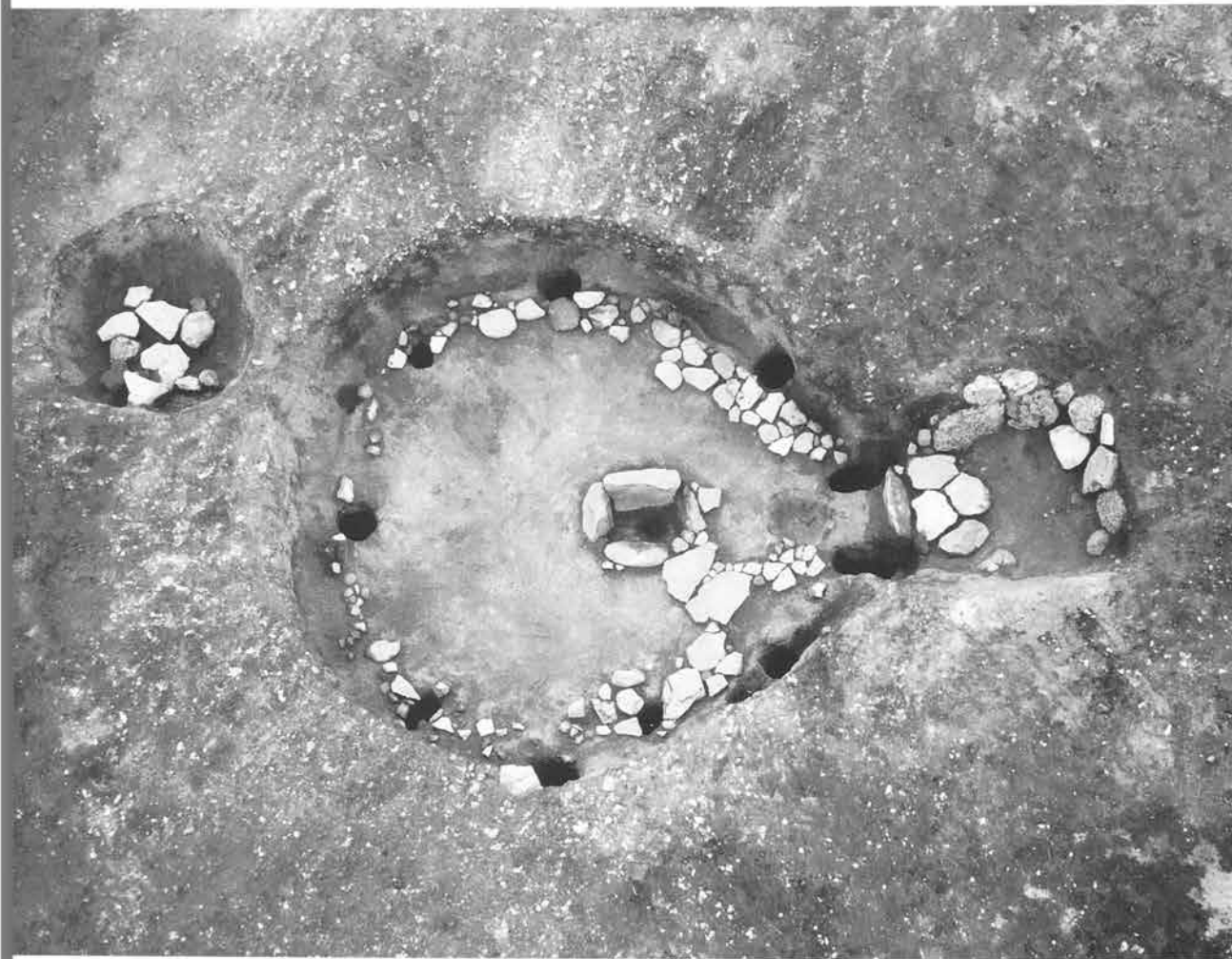

41号竖穴住居跡

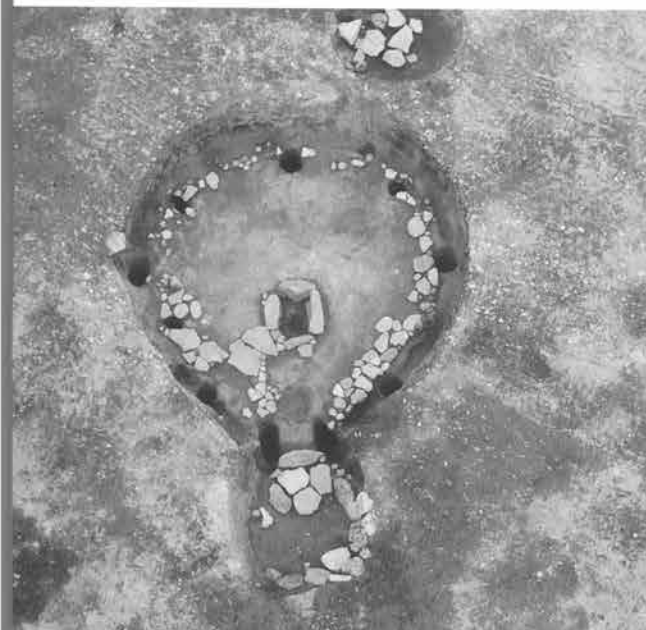

左：41号竖穴住居跡  
右：41号竖穴住居跡  
張出部

左：43号竖穴住居跡  
右：43号竖穴住居跡  
連結部



左：43号竖穴住居跡  
張出部掘方  
右：44号竖穴住居跡

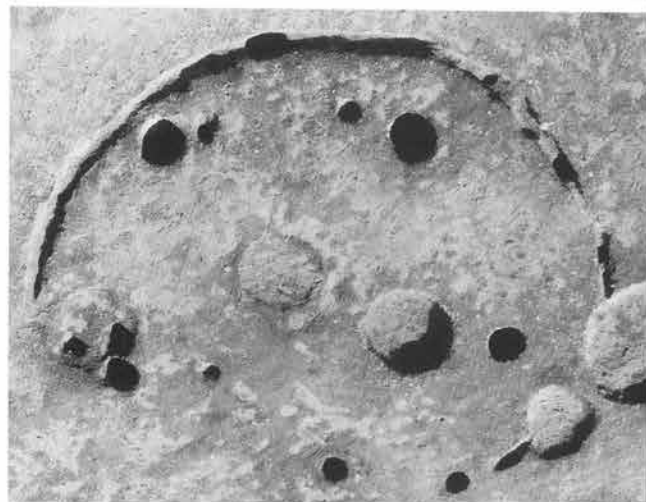

1号平地式住居跡





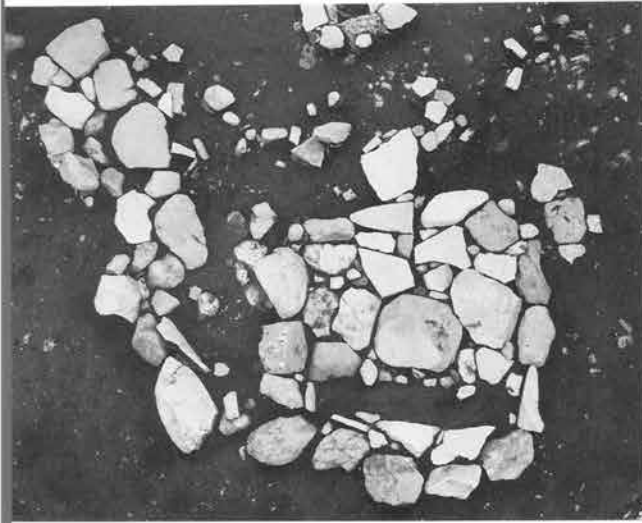

左：1号平地式住居跡張出部  
右：1号平地式住居跡炉

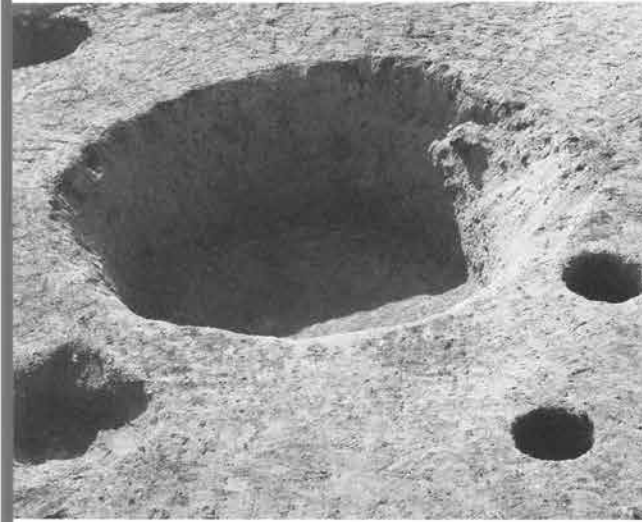

左：7号土坑  
右：7号土坑土層断面



7号土坑遺物出土狀態



左：7号土坑遺物出土狀態  
右：7号土坑獸骨出土狀態

左：9号土坑  
右：10号土坑



左：22号土坑  
右：23号土坑



左：47号土坑  
右：59号土坑

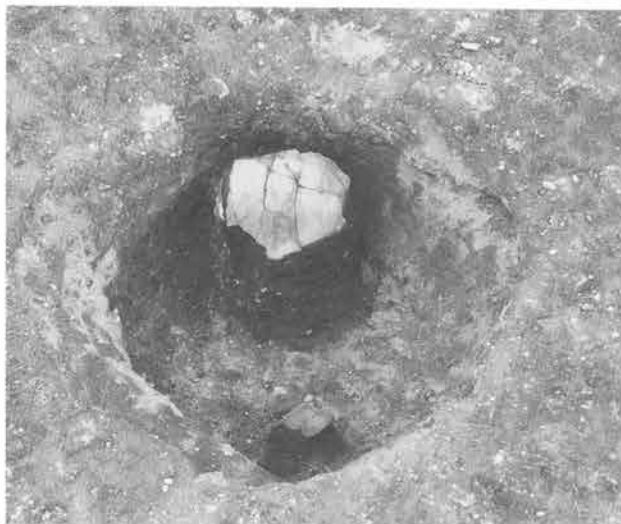

左：61・62号土坑  
右：61号土坑







左：64号土坑  
右：65号土坑



左：71号土坑  
右：74号土坑



左：83号土坑  
右：84号土坑



左：87号土坑  
右：104号土坑

左：107号土坑  
右：117号土坑



左：122号土坑  
右：123号土坑

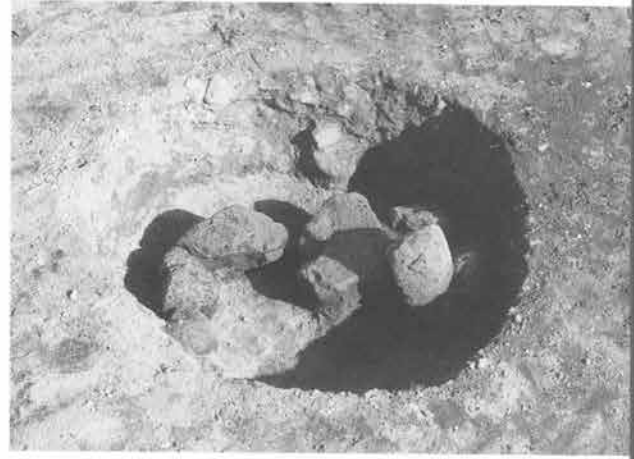

左：48号竖穴住居跡  
右：48号竖穴住居跡  
カマド

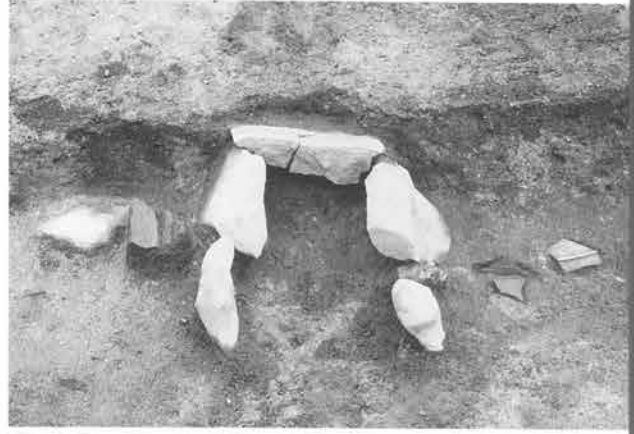

19号竖穴住居跡





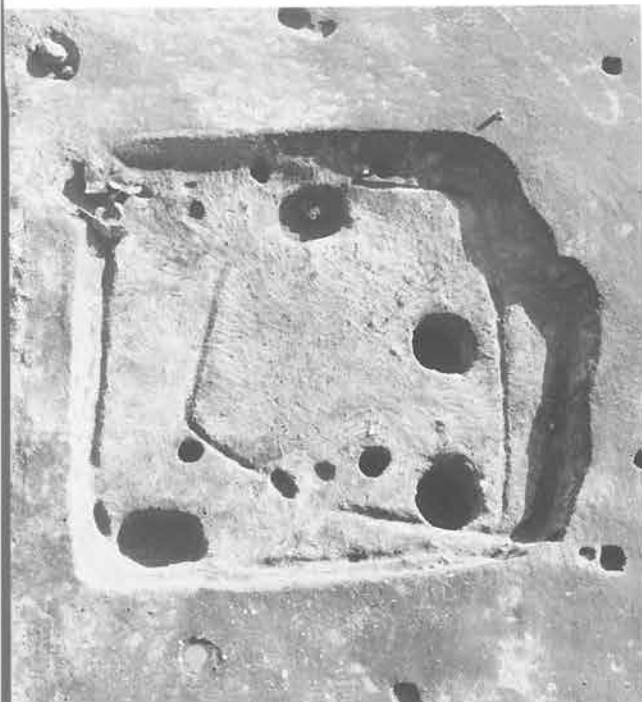

左：47・50号竪穴住居跡  
右：50号竪穴住居跡遺物出土状態



50号竪穴住居跡カマド



左：50号竪穴住居跡カマド検出状態  
右：50号竪穴住居跡内ビット

左：3号竖穴住居跡  
出土土器

右：1号土坑出土土  
器



左：2号土坑出土土  
器

右：13号竖穴住居跡  
出土土器



13号竖穴住居跡出土  
土器





14号竖穴住居跡出土土器



1

16号竖穴住居跡出土土器



3



5

左：19号竖穴住居跡出土土器



1

右：20号竖穴住居跡出土土器



2

21号竖穴住居跡出土土器



1

28号竖穴住居跡出土  
土器



29号竖穴住居跡出土  
土器



左上：34号竖穴住居  
跡出土土器



左下・右：37号竖穴  
住居跡出  
土土器



37号竖穴住居跡出土  
土器 1 展開写真



40号竖穴住居跡出土  
土器



7号土坑出土土器(1)



7号土坑出土土器(2)





1



1

左：22号土坑出土土器  
右：23号土坑出土土器

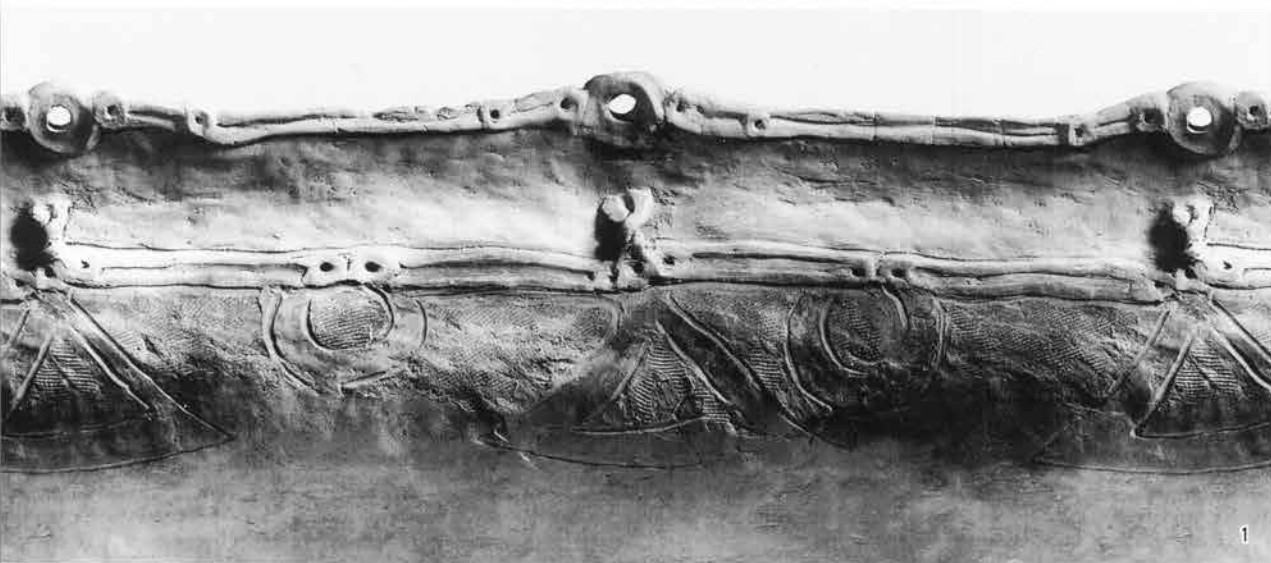

1

23号土坑出土土器1  
展開写真



1

48号土坑出土土器



1



1

左：61号土坑出土土器  
右：69号土坑出土土器



76号土坑出土土器



2

77号土坑出土土器



1



2



5

左：78号土坑出土土器



1

右：84号土坑出土土器



1

左：97号土坑出土土器



1

右：117号土坑出土土器



1

石槍・石鏃・石錐・  
石匙

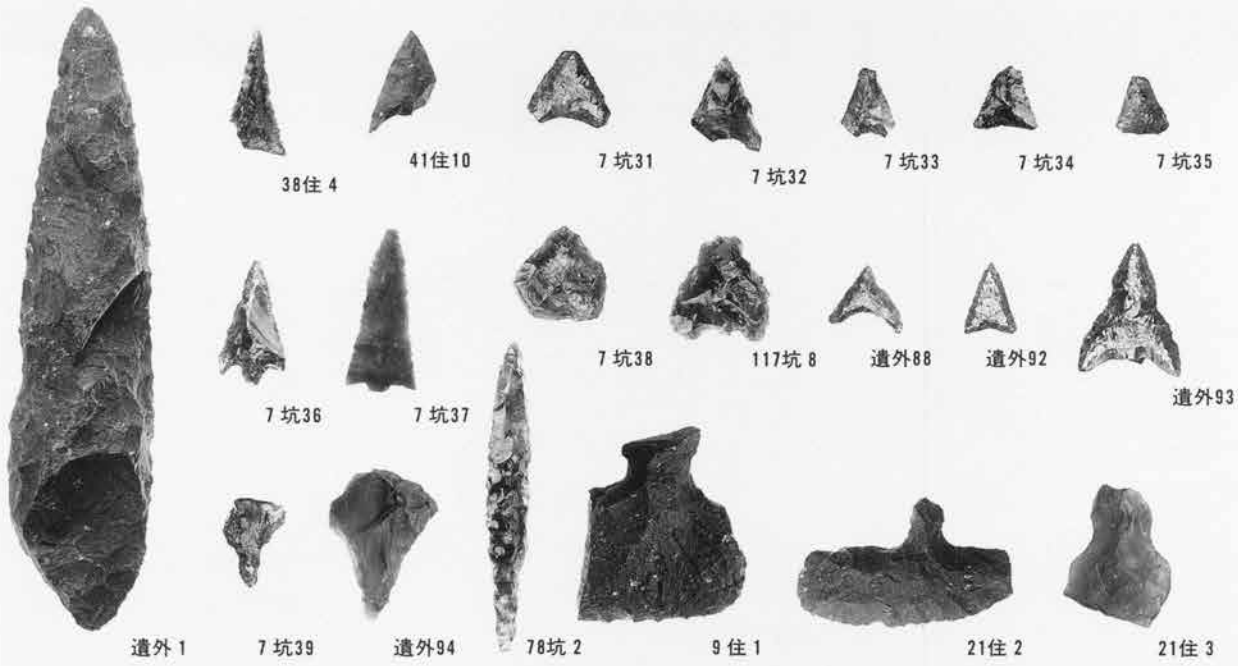

凹石・磨石・敲石

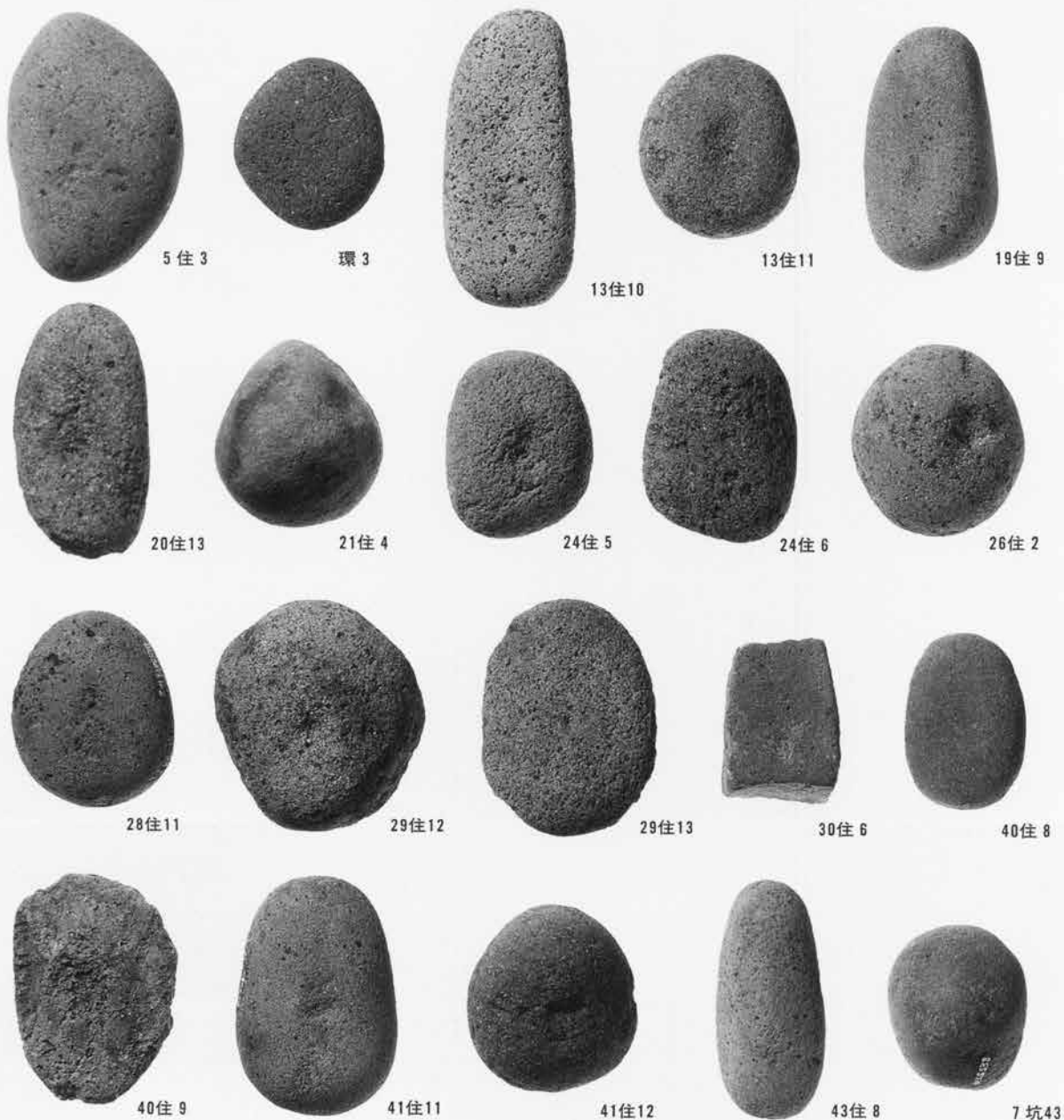

磨製石斧



打製石斧

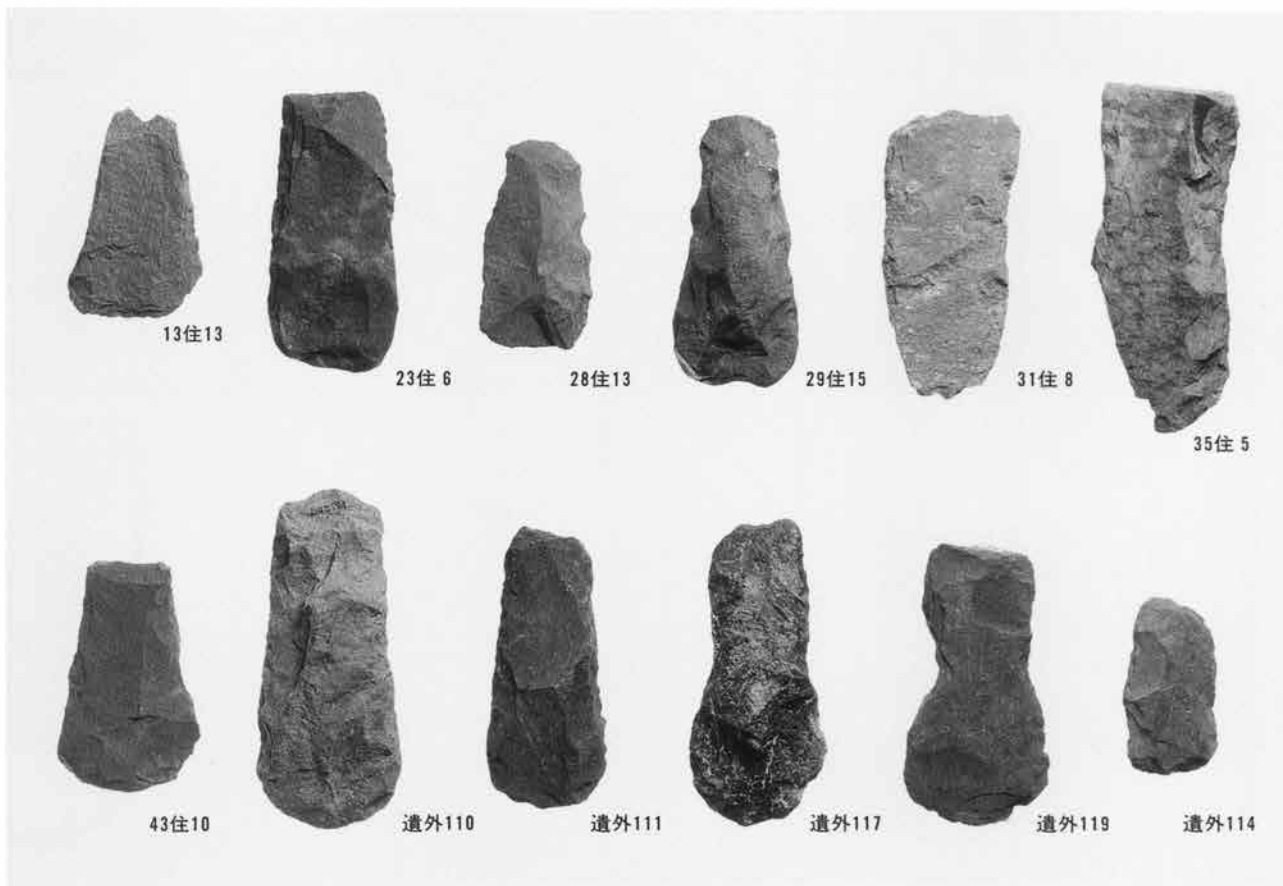

砥石

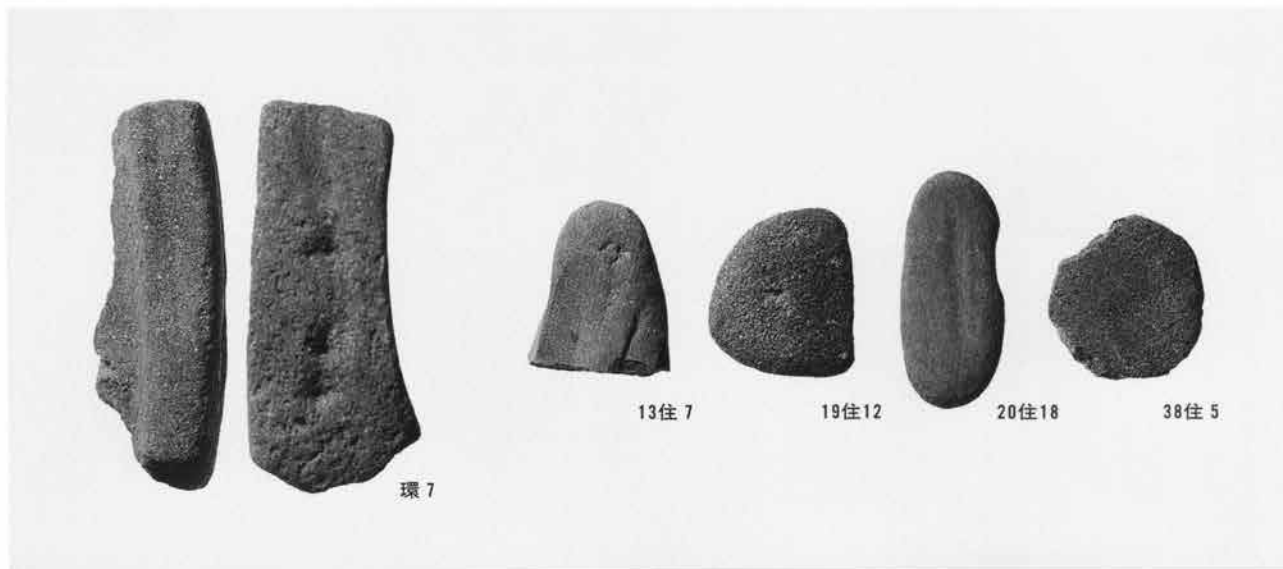





環11



環12



環14



環13



環15



環16



13住22



19住15



20住22



24住7



29住17



62坑1



104坑2



104坑3



104坑4



104坑5



110坑1



116坑1



遺外130



遺外129

石皿

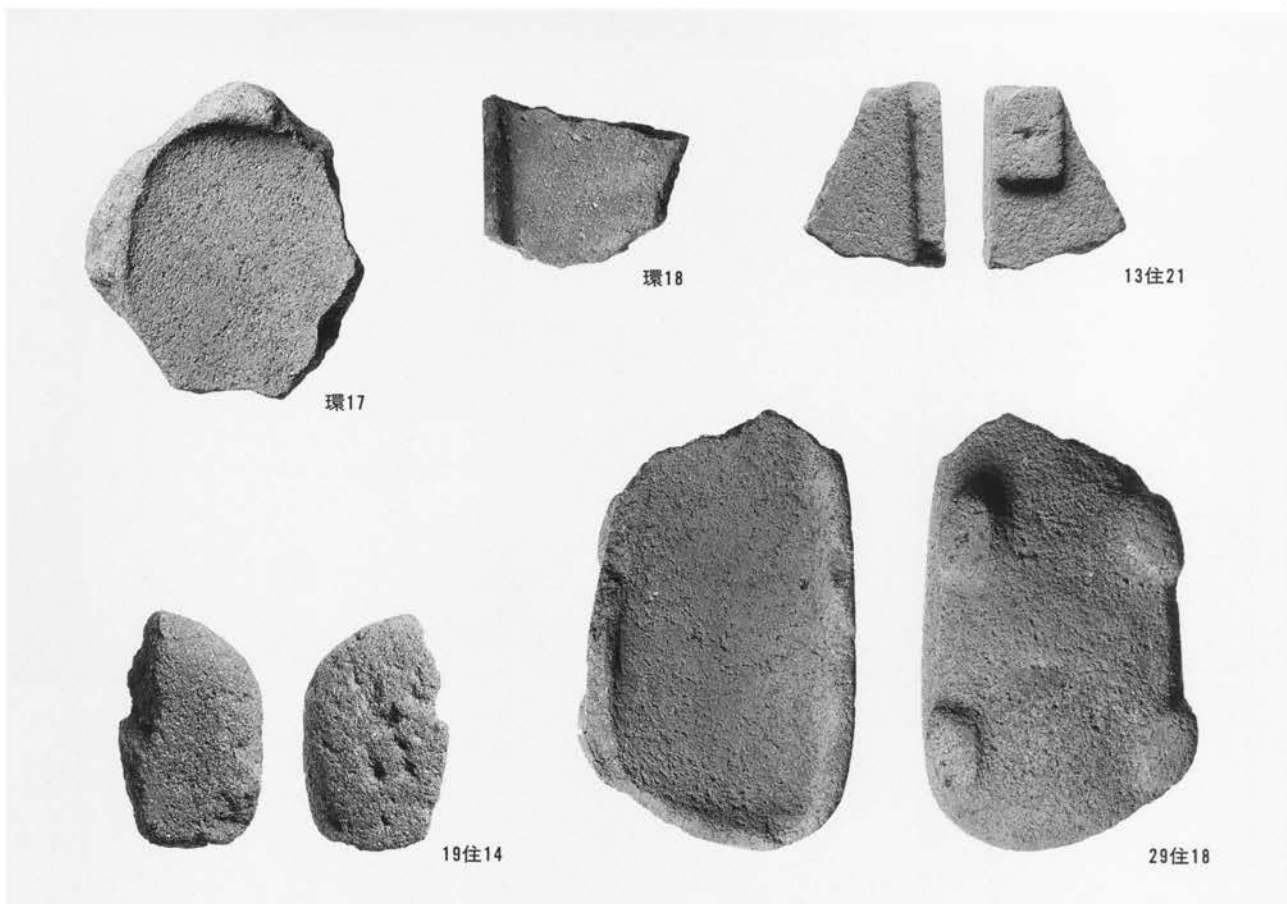

丸石



石棒



石棒



左：石錘  
右：磨石？



輕石製品

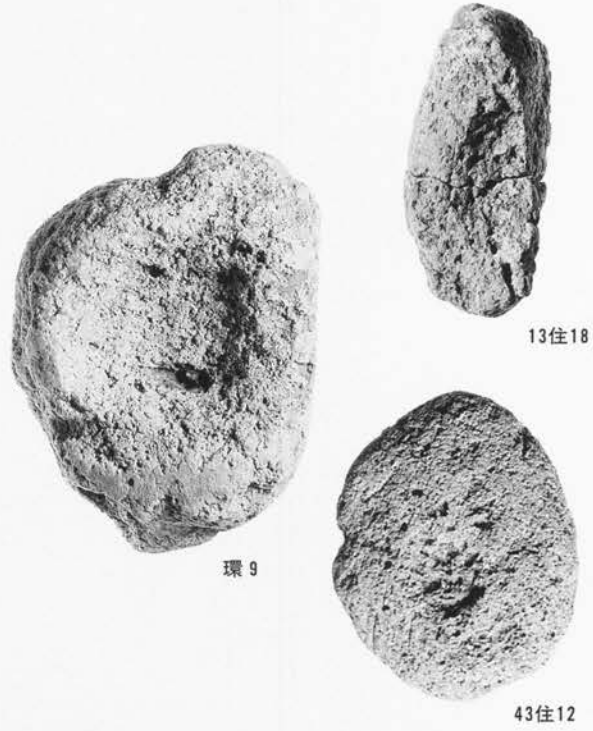
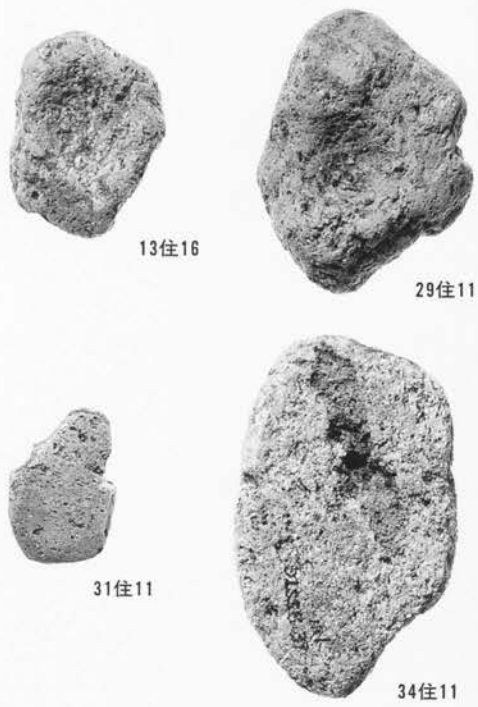

輕石製石鉢



玉類

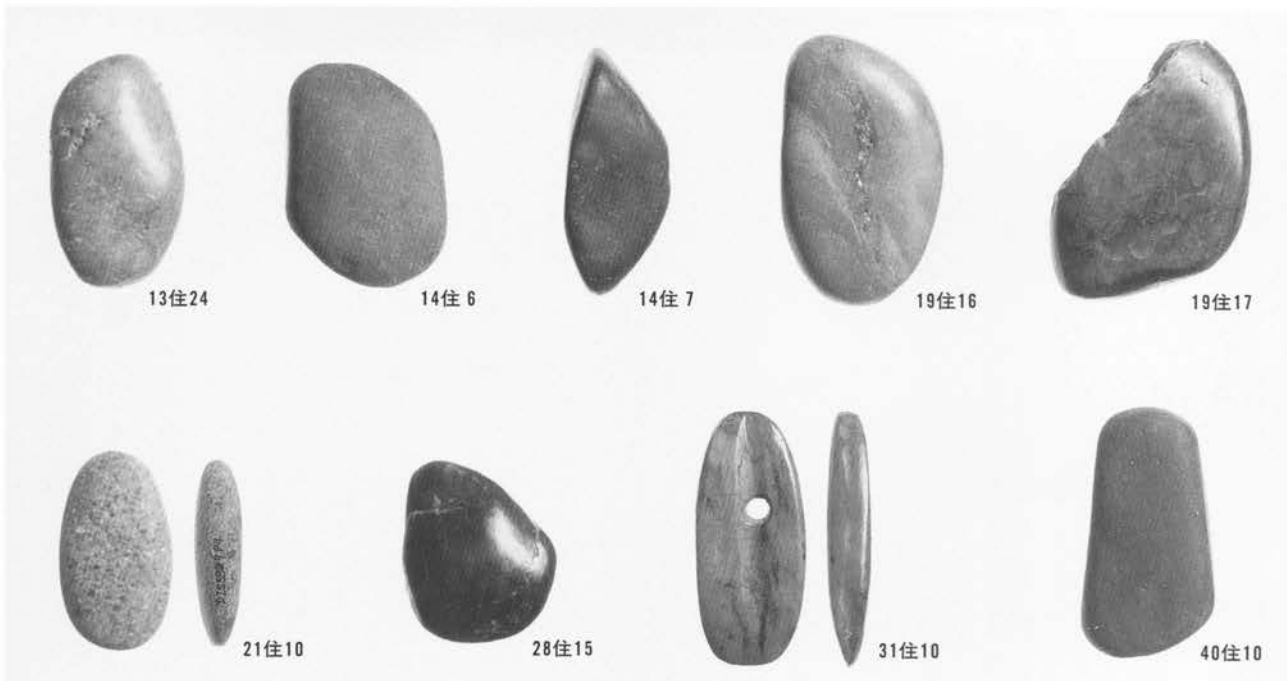

左 : 土偶  
 左中 : 土製蓋  
 右中 : 土製円盤  
 右 : 土製品

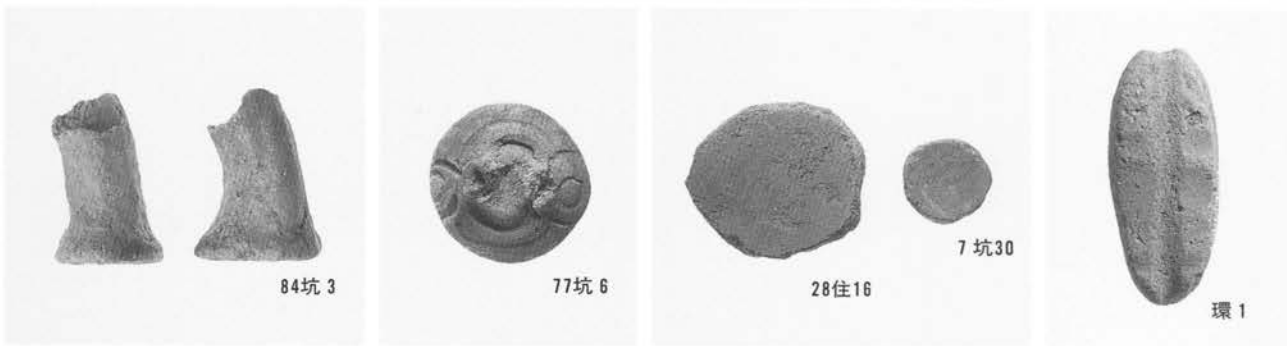

7号土坑出土獣骨  
 (1:3)

1. シカ肩甲骨、2. シカ橈骨、3. シカ下顎左、4. シカ右下顎第三後臼歯、5. シカ頸椎、6. シカ中足骨、7. シカ脛骨、8. シカ肋骨、9. シカ中指骨、10. シカ踵骨、11. シカ末節骨、12. シカ部位不明

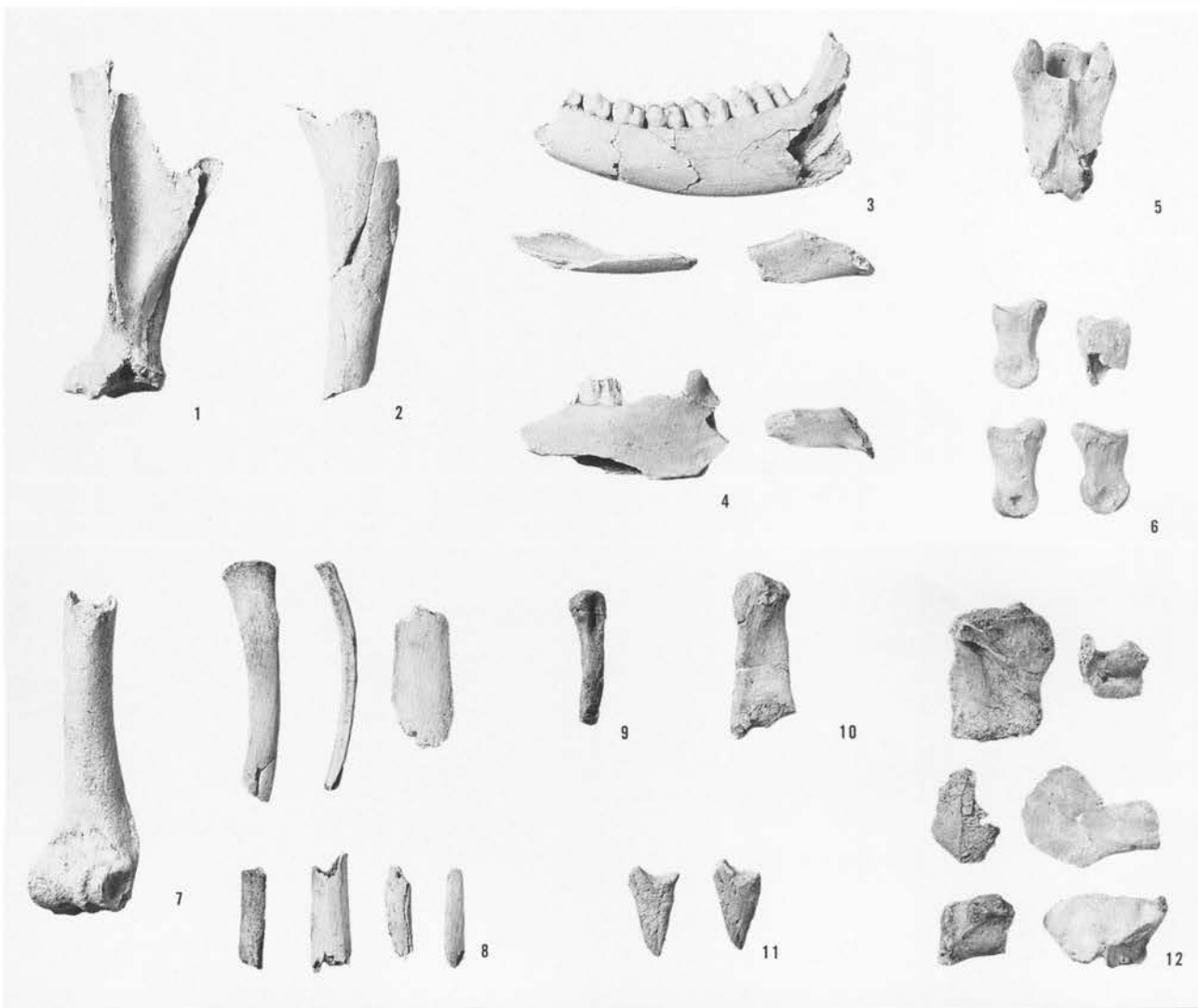



石神遺跡群遠景  
(南から)



調査区全景 (南から)



縄文時代の土坑群

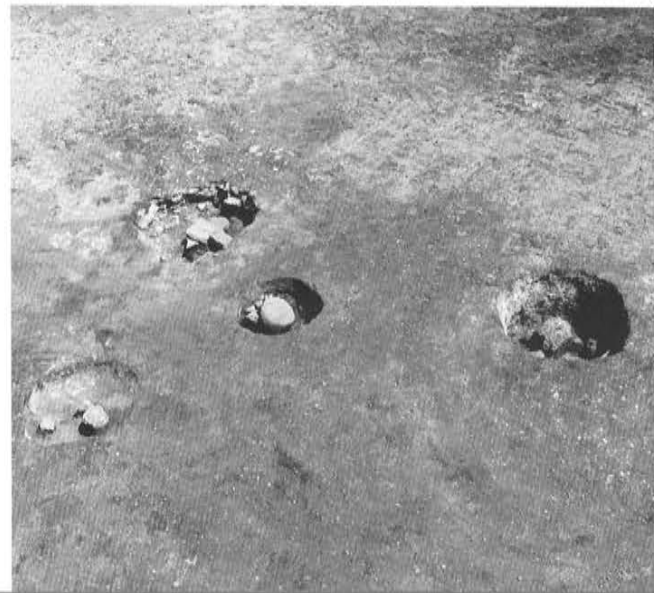



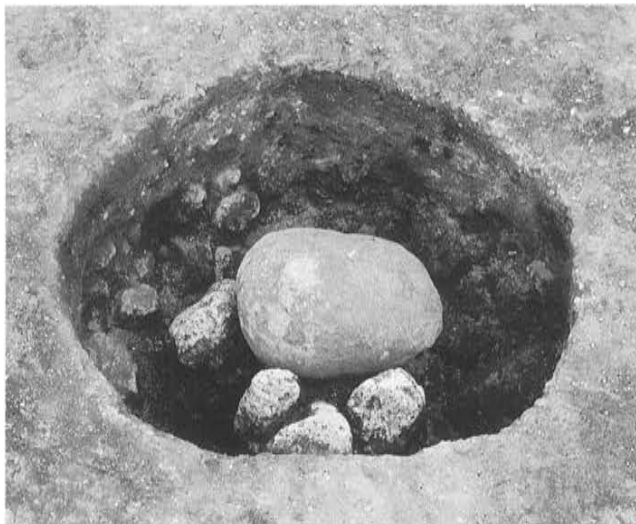

左：9号土坑  
右：10号土坑



左：11号土坑  
右：12号土坑



左：24号土坑  
右：30号土坑



左：32号土坑  
右：43号土坑

左：51号土坑  
右：集石土坑



左：1号竖穴住居跡  
右：2号竖穴住居跡

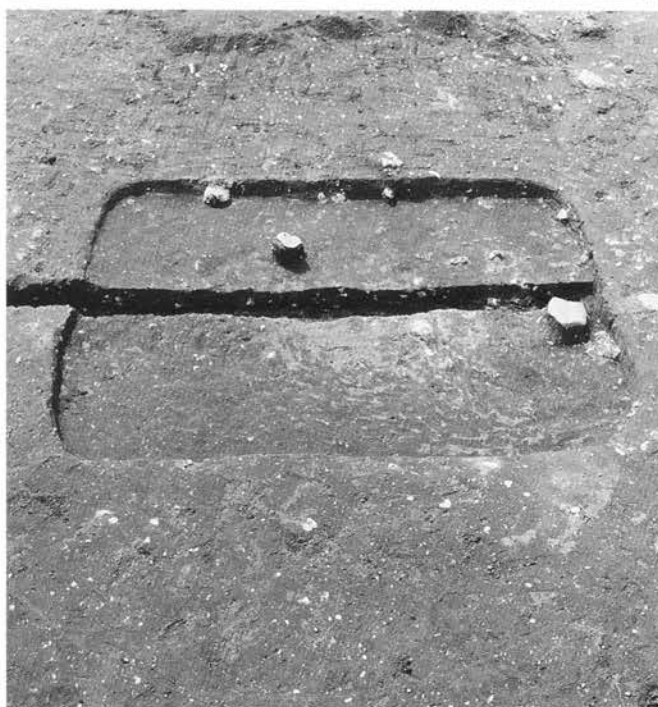

左：3号竖穴住居跡  
右：1号大形土坑







1



1



18

左：51号土坑出土  
土器  
右上：54号土坑出土  
土器  
右下：遺構外出土土  
器



1坑1



2坑1



1坑2



2坑2



9坑1



12坑1



25坑1



41坑1



12坑2



25坑2



41坑2



12坑3



25坑3



41坑3



43坑1

土坑出土土器(1)

土坑出土土器(2)

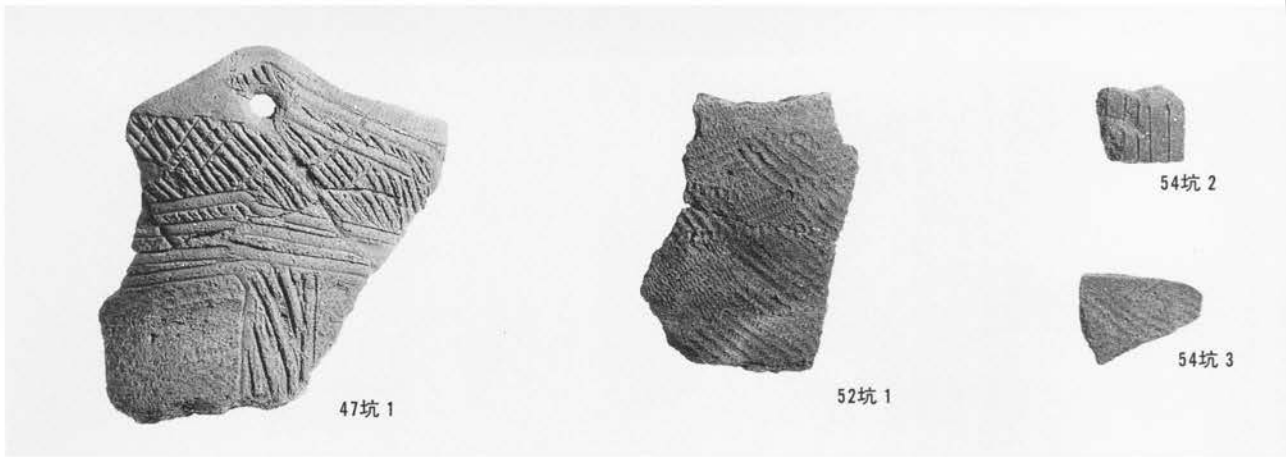

遺構外出土土器

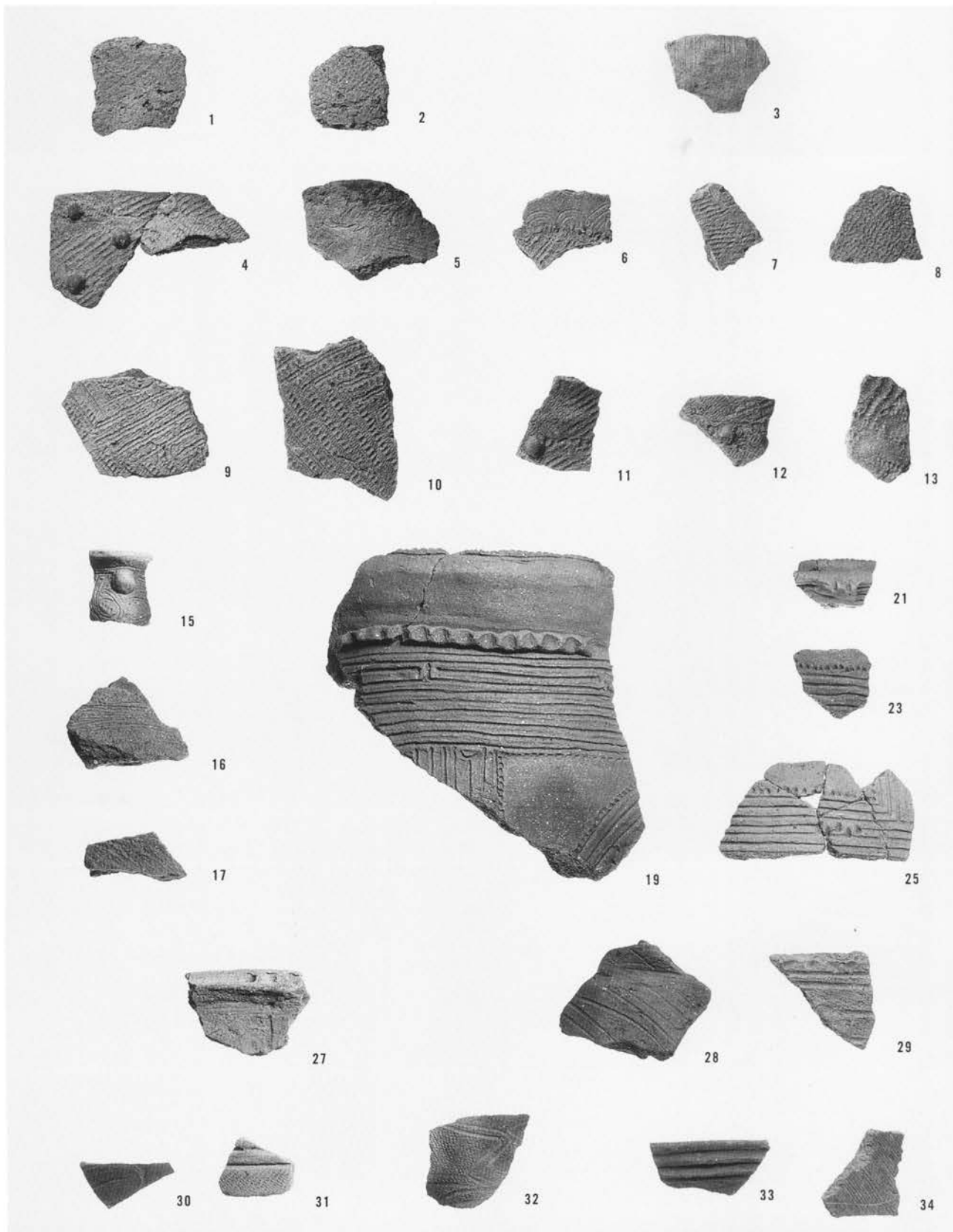

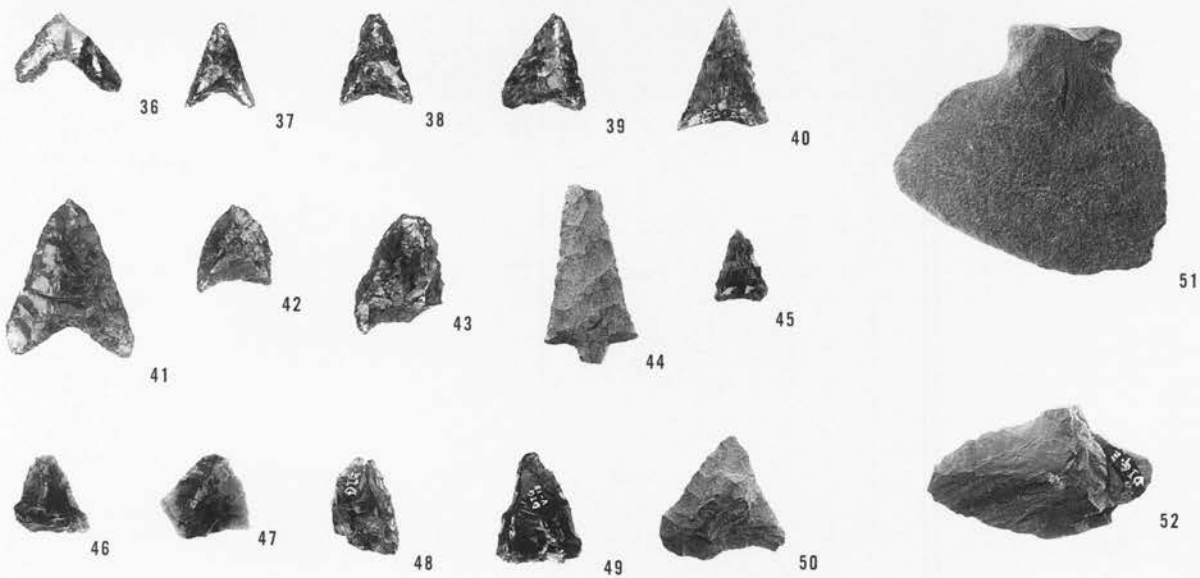

2号竖穴住居跡出土遺物

左：1号竖穴住居跡出土土器  
 中：3号竖穴住居跡出土砥石  
 右：1号大形土坑出土土器

郷土遺跡全景  
(モザイク処理)

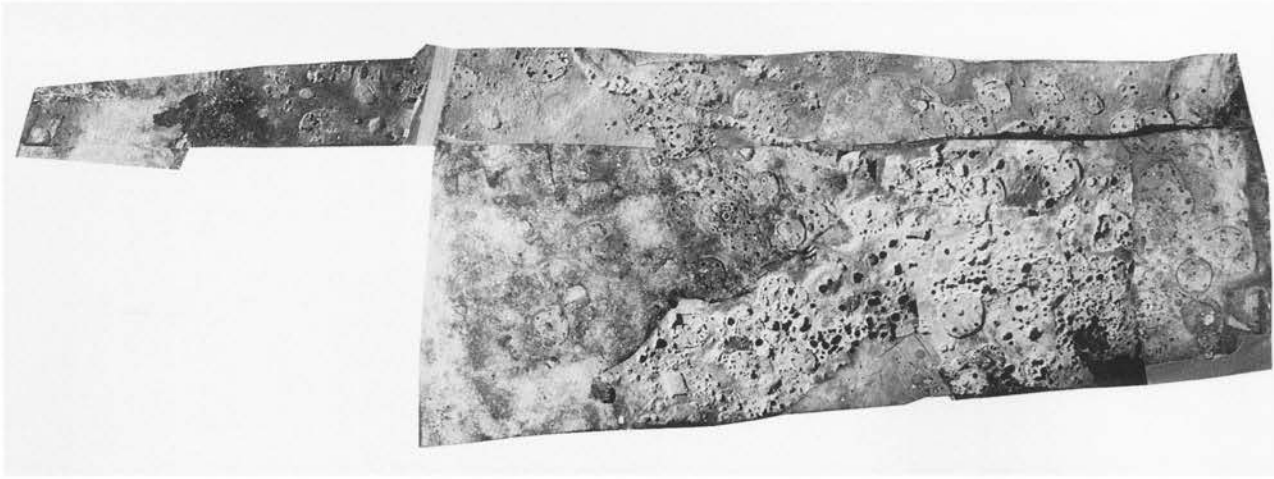

郷土遺跡から南西方向をみる  
(平成5年度)



郷土遺跡から南方向をみる





平成4年度調査地区



左：平成5年度調査地区  
右：平成5年度44号住居付近

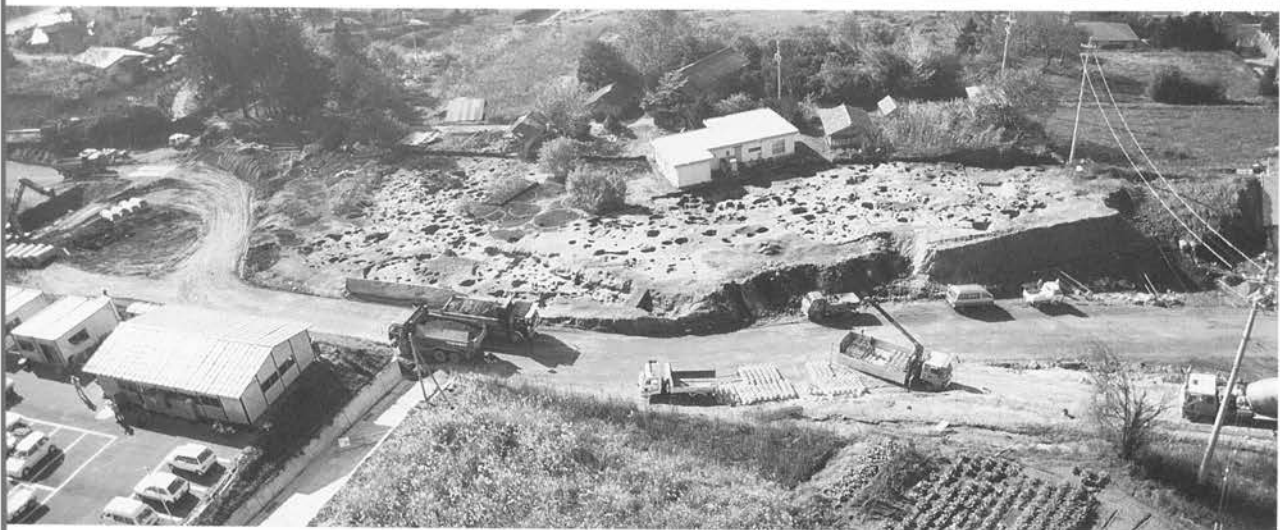

平成6年度調査地区



左：平成6年度調査地区  
右：平成7年度調査地区

平成5年度発掘従事者



平成6年度発掘従事者



整理作業従事者





9号住居



左 : 27号住居  
右上 : 59号住居  
右中 : 61号住居

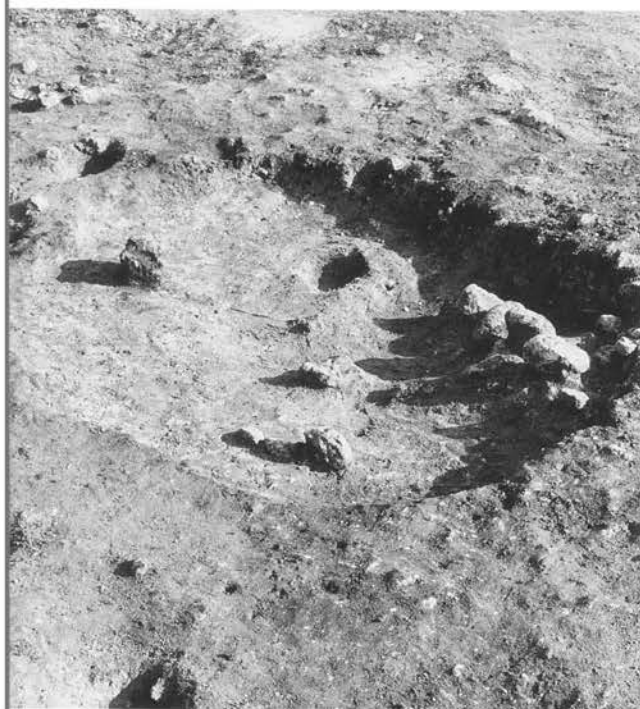

左 : 36号住居  
右下 : 63号住居



左 : 1号住居  
右上 : 1号住居炉



左 : 2号住居  
右上 : 2号住居炉  
右 : 3号住居炉



左 : 3号住居







左：4号住居と17号住居  
右：4号住居炉



5号住居と6号住居



左：6号住居埋甕  
右：8号住居埋甕

10号住居(左)と11号住居(右)



左：10号住居炉  
右：11号住居土器出土状況



12号住居(右中)、15号住居(右下)と20号住居(左上)







左 : 14号住居遺物  
出土状況  
右上 : 14号住居  
右下 : 14号住居の土  
器(44、45他)



左 : 14号住居遺物出  
土状況  
右 : 同上



左 : 14号住居完掘  
右上 : 14号住居炉の  
覆石  
右下 : 14号住居炉体  
土器



左：15号住居炉  
右：16号住居炉

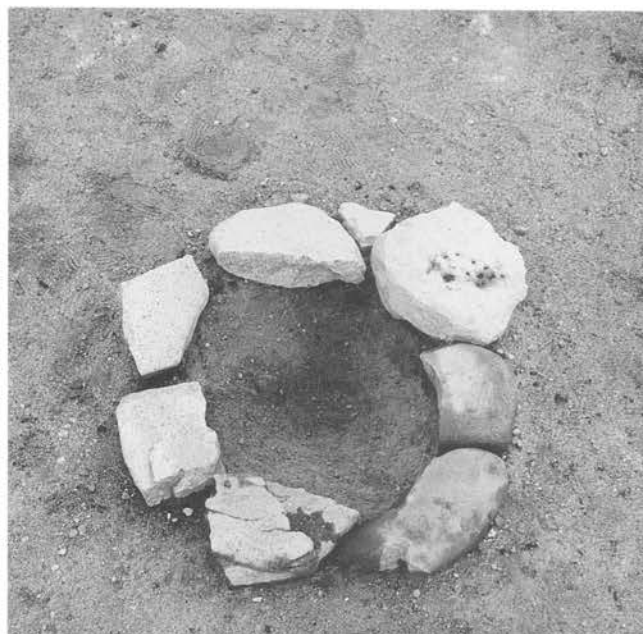
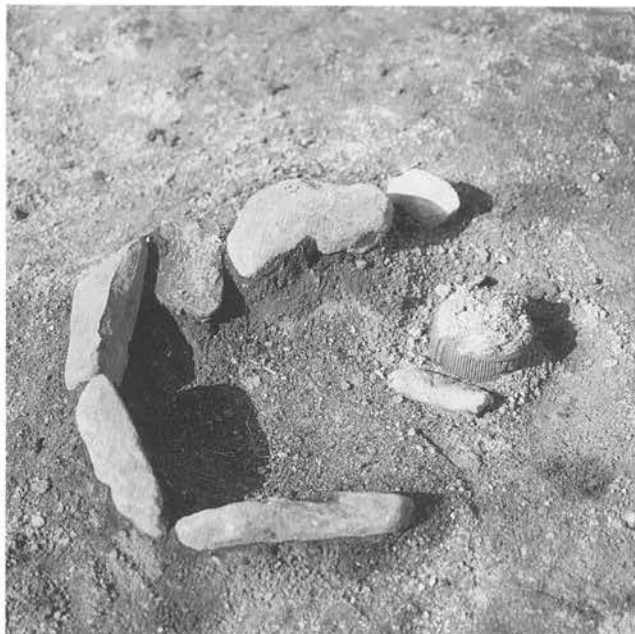

左：16号住居  
右：16号住居の土器  
(70)出土状況



17号住居





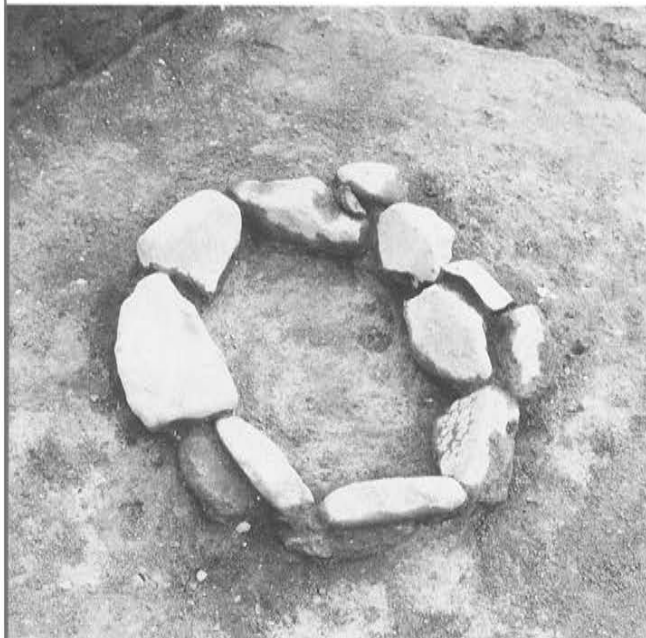

左：18号住居炉  
右：19号住居炉



18号住居(右)、19号住居(中)、21号住居(左)



左：21号住居炉  
右：22号住居

24号住居遺物出土状況



24号住居の遺物  
左：土器109(内)と110(外)  
右：土器109(左)と111(右)



24号住居の状況  
左：平成4年度  
右上：遺物出土状況  
右下：埋壺





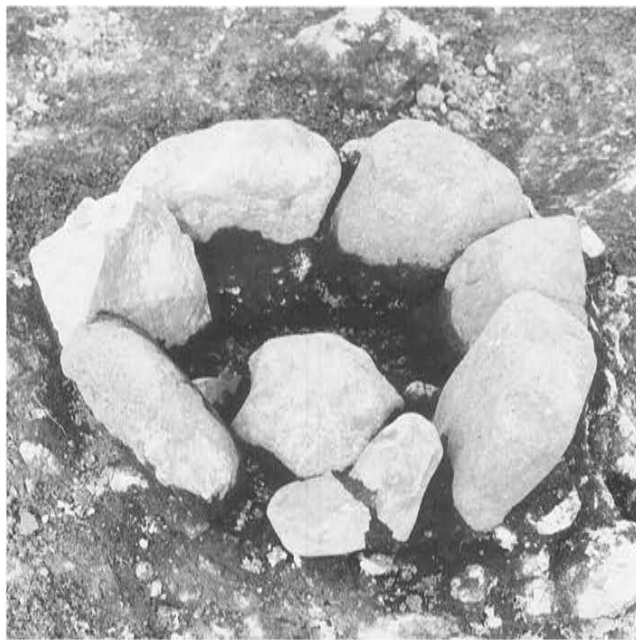

左：25号住居の土器  
集中  
右：25号住居炉



25号住居



左：28号住居  
右：30号住居

左：32号住居  
右：32号住居炉



左：33号住居  
右：33号住居炉

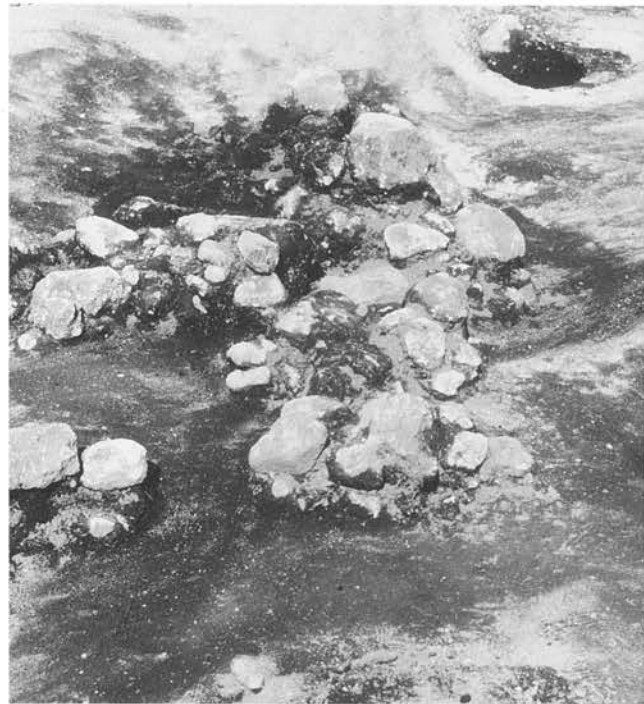

左：33号住居調査中



左：37号住居  
右：37号住居炉







左：38号住居  
右：38号住居炉



39号住居遺物出土状況



左：39号住居埋甕  
右：39号住居

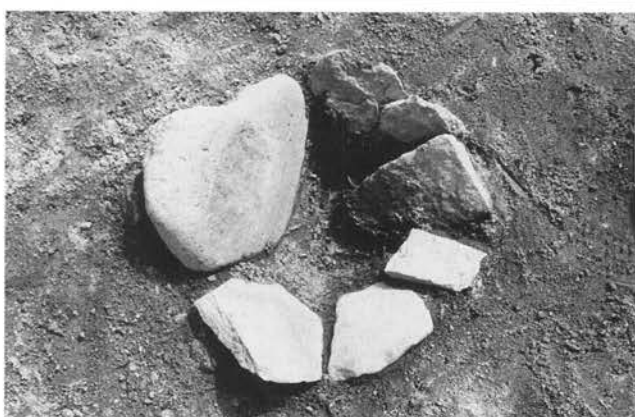

左：40号住居  
右：40号住居炉

左：41号住居(下)と  
49号住居(上)  
右：43号住居

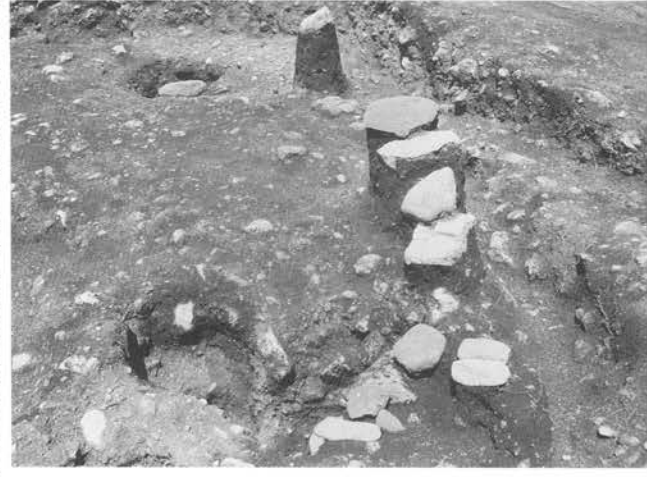

左：41号住居炉  
右上：43号住居炉  
右下：42号住居炉

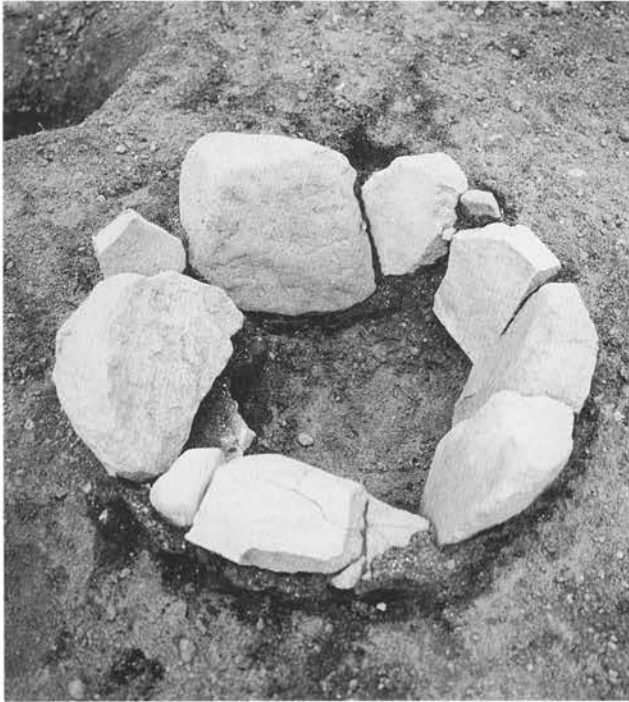

42号住居(左)と43号  
住居(右)

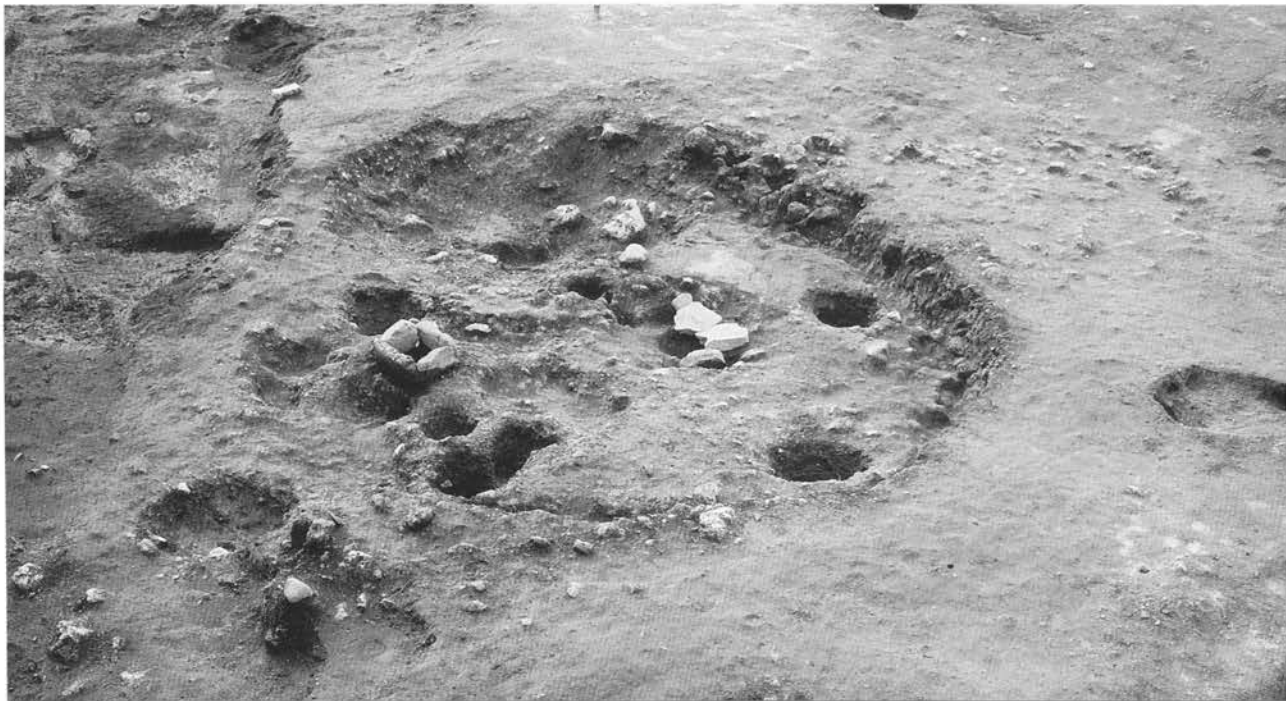



44号住居炉



左：44号住居  
右：44号住居の土器  
181



44号住居の土器180



47号住居(上左)、45  
・46号住居(中右)、  
49号住居(中左)、41  
号住居(下左)、集石  
1・集石2(下右)

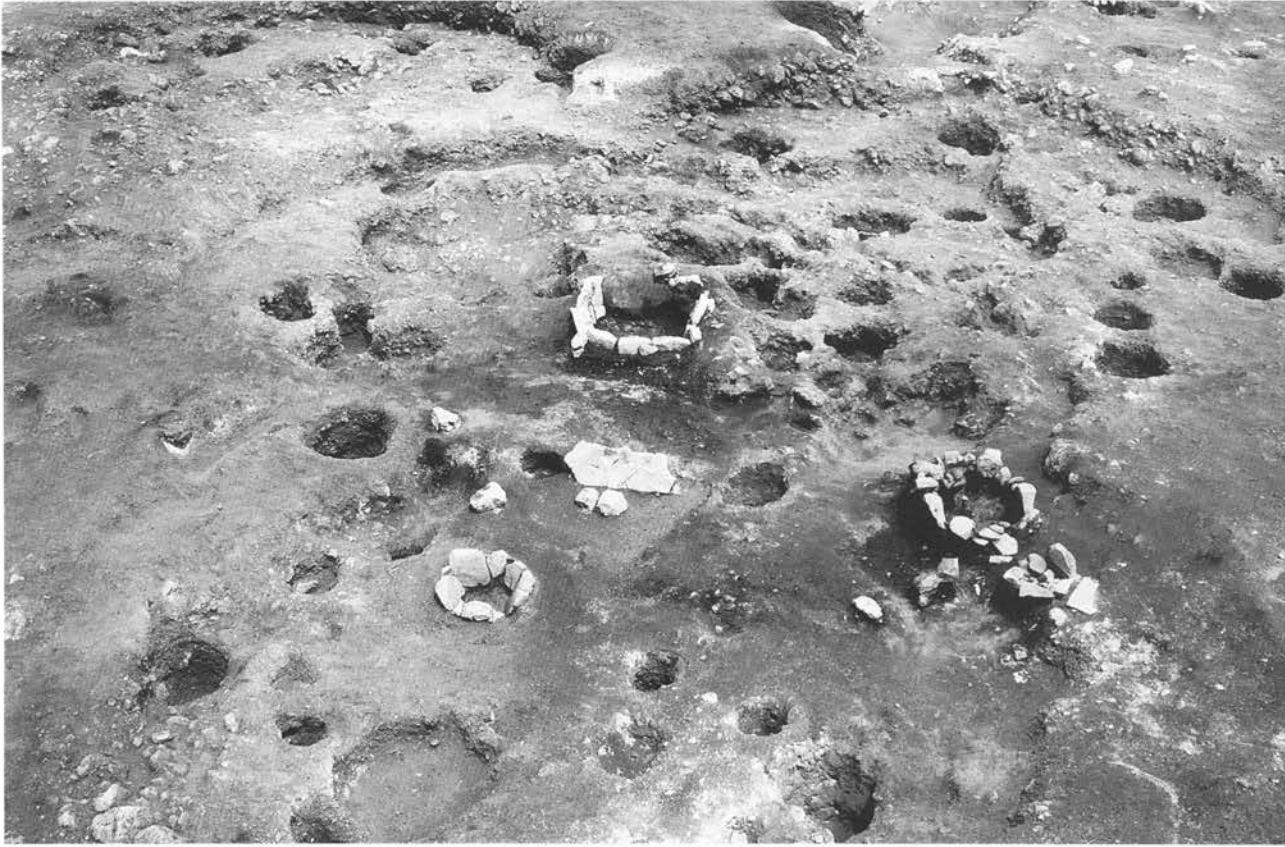

左：45号住居炉  
右：49号住居炉



左：48号住居  
右：49号住居

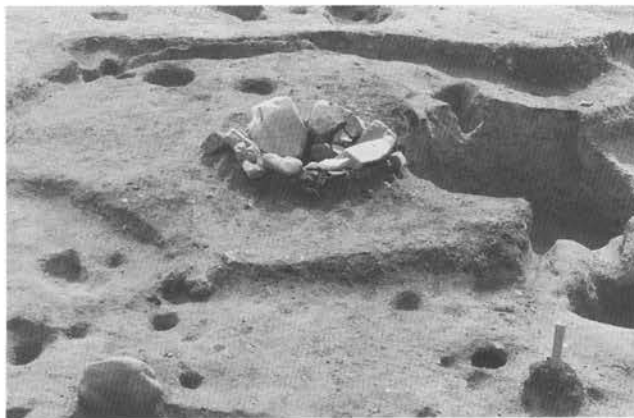

左：48号住居炉  
右：50号住居





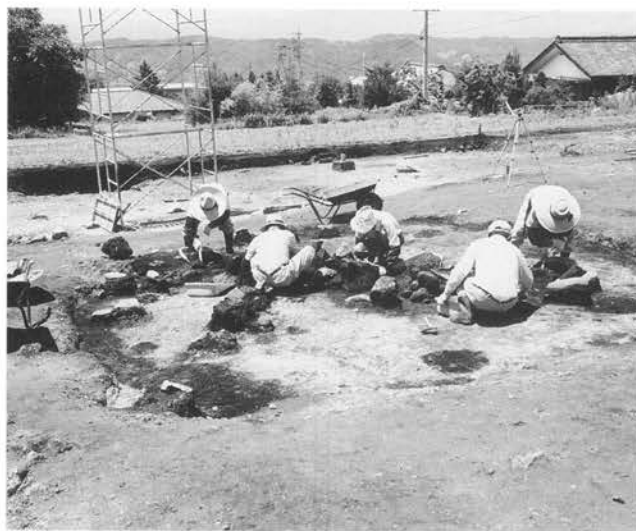

左：60号住居の検出  
右：60号住居の調査



左：60号住居遺物出土状況  
右：60号住居P1

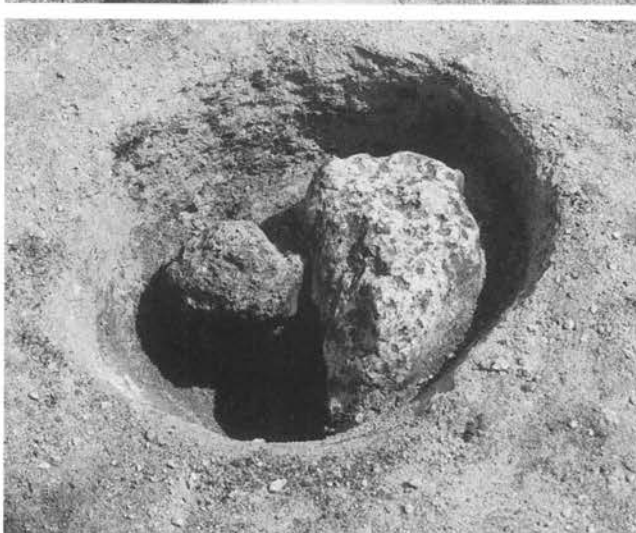

左：60号住居遺物出土状況  
右：60号住居P7



左：60号住居遺物出土状況  
右：60号住居完掘

左：64号住居炉  
右：69号住居



左：70号住居  
右：69号住居炉

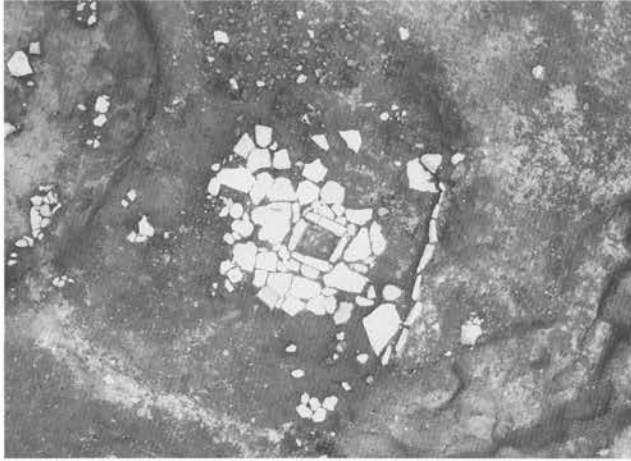

70号住居調査風景



左：70号住居炉  
右：70号住居埋藏







左：71号住居炉  
右：71号住居埋甕

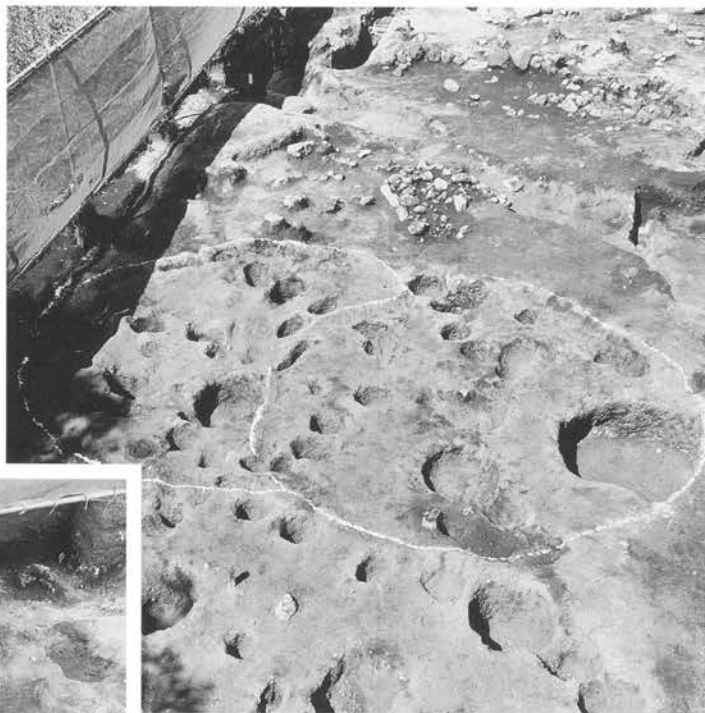

左：72号住居炉  
右：71号住居(右)と  
75号住居(左)



左：72号住居  
右：75号住居埋甕の  
検出



左：72号住居埋甕  
右：75号住居埋甕



左：76号住居(上)、  
77号住居(下右)  
と79号住居(下  
左)  
右：76号住居炉

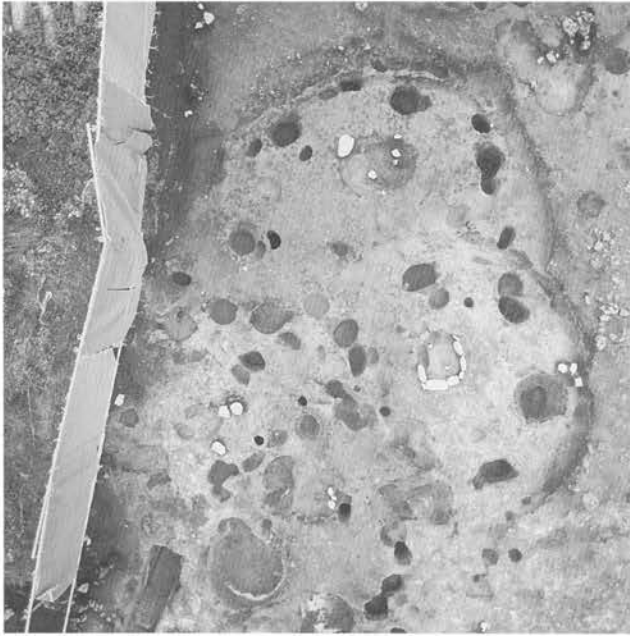

左：76号住居遺物出  
土状況  
右：76号住居の土器  
220と221



77号住居遺物出土状  
況



左：77号住居の土器  
235  
右：77号住居炉





左：80号住居炉  
右：80号住居



左：81号住居軽石出土状況  
右：81号住居埋裏



左：81号住居の調査  
右：81号住居P2



左：81号住居完掘  
右：81号住居炉



83号住居(空撮)

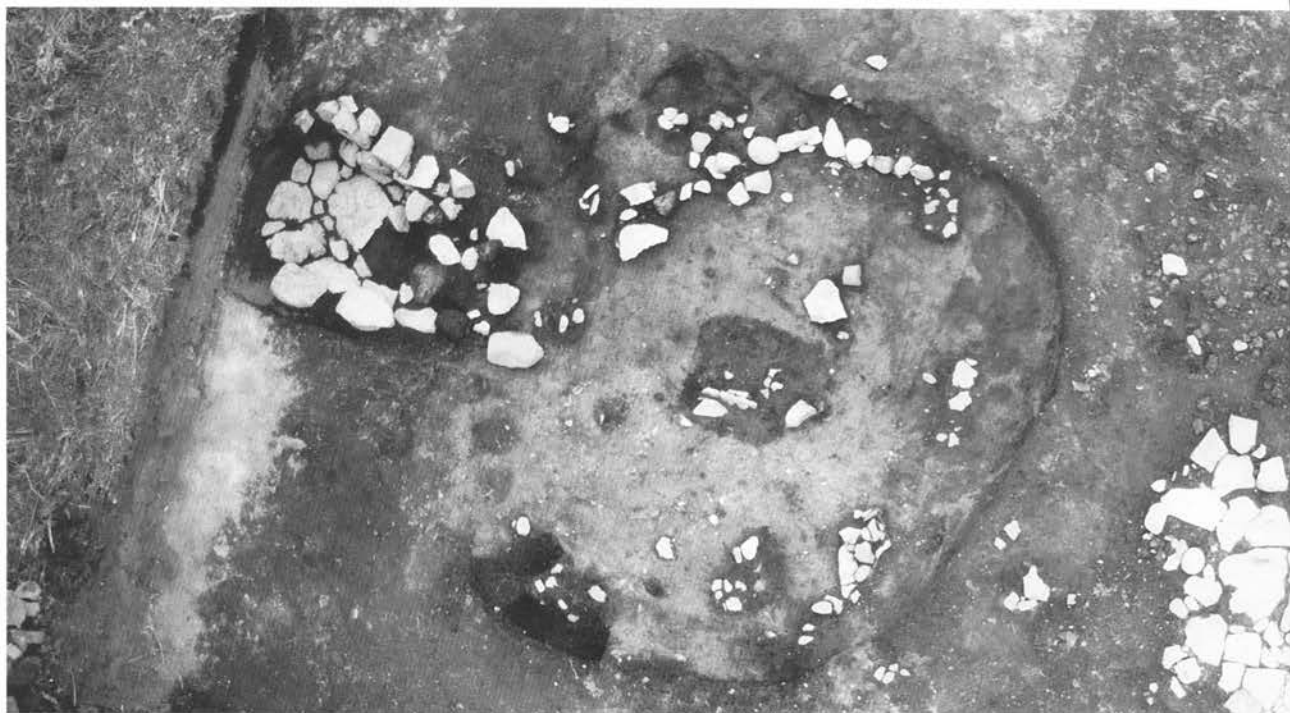

左：83号住居軽石出土状況



右：83号住居石棒(401)出土状況



左：83号住居動物骨出土状況



右：83号住居炉



左：83号住居柄部



右：83号住居





左：78号住居炉  
右：84号住居炉



左：82号住居  
右：82号住居埋甕



84号住居(上)、78号住居(中)、87号住居(下)



左：88号住居P7周辺  
右：88号住居



左：89号住居  
右：89号住居土器集中  
（軽石で被覆）



左：89号住居  
右：89号住居炉



89号住居土器集中



左：90号住居軽石出土状況  
右：90号住居炉



91号住居(上)と92号  
住居(下)の軽石

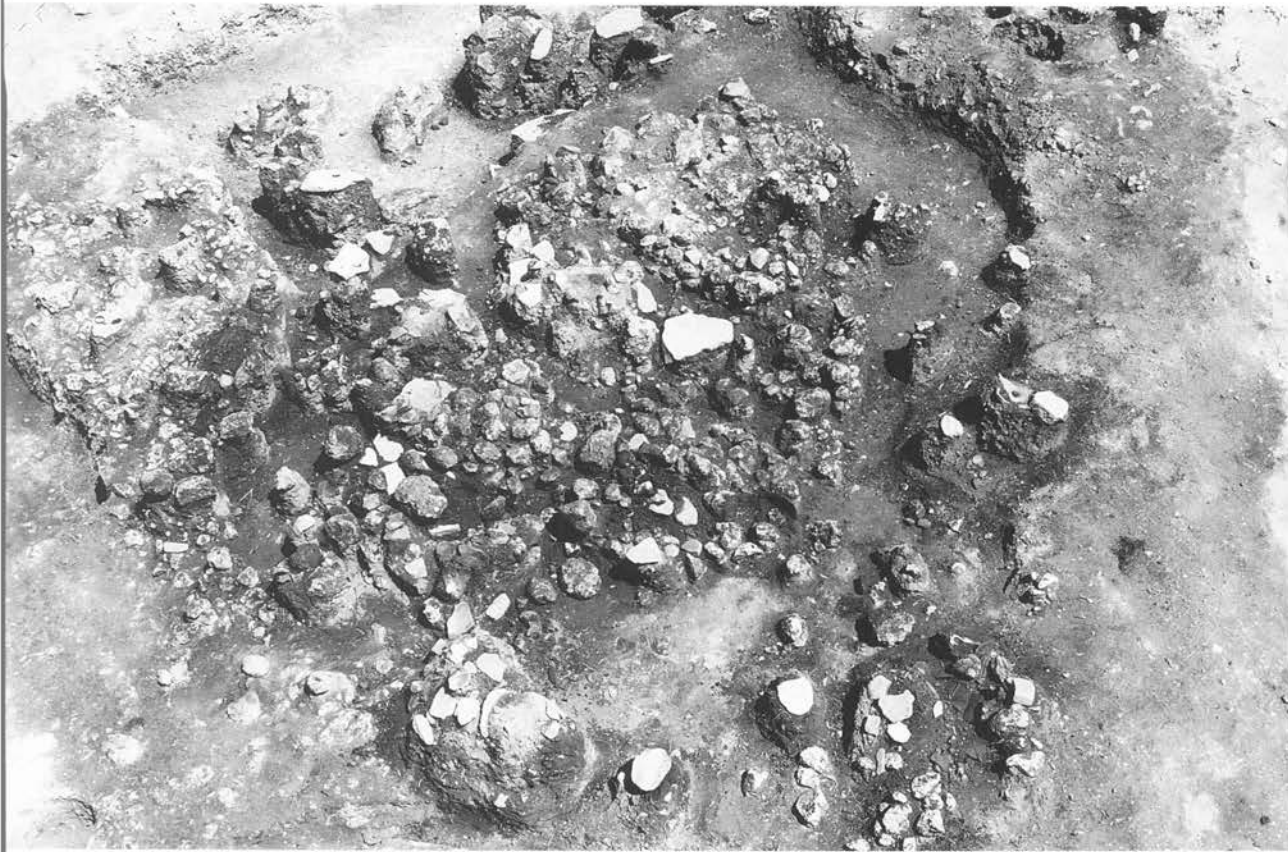

左上：91号住居の土  
器282  
左下：91号住居炉  
右：91号住居



左下：92号住居P5  
右：93号住居





左 : 94号住居石棒  
(403)、石皿  
出土状況  
右上 : 94号住居P6  
右下 : 94号住居(上)、  
95号住居(下)  
遺物出土状況



左 : 94号住居炉



左 : 96号住居  
右 : 97号住居炉(軽  
石で被覆)



左 : 96号住居炉  
右 : 97号住居炉

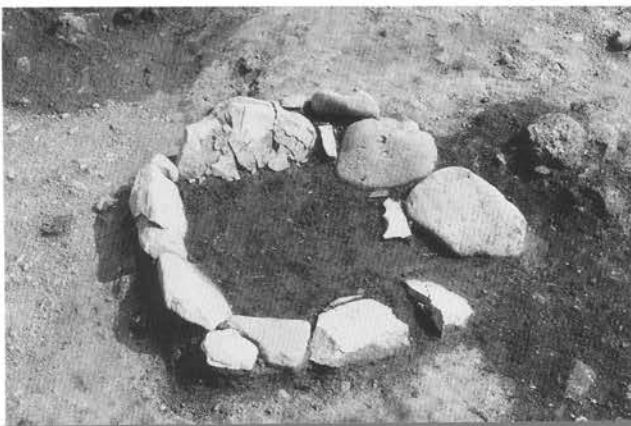





左：98号住居  
右：98号住居炉

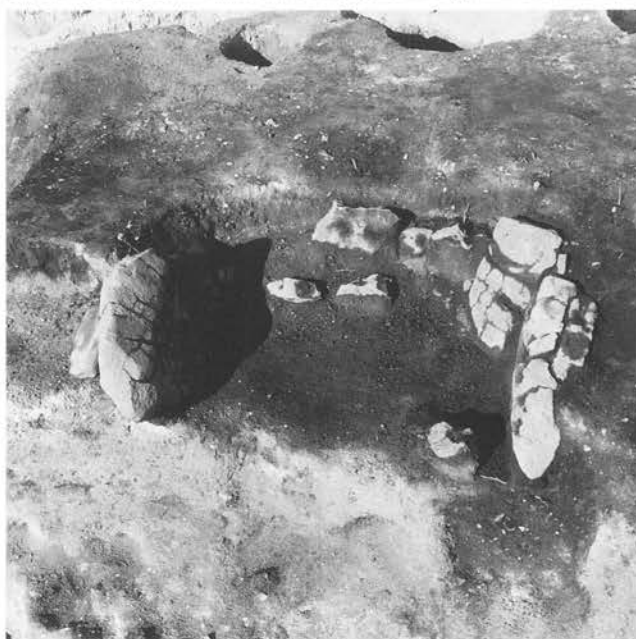

左：99号住居炉  
右：102号住居炉



99号住居(上右)、  
102号住居(上左)、  
104号住居(下左)

101号住居

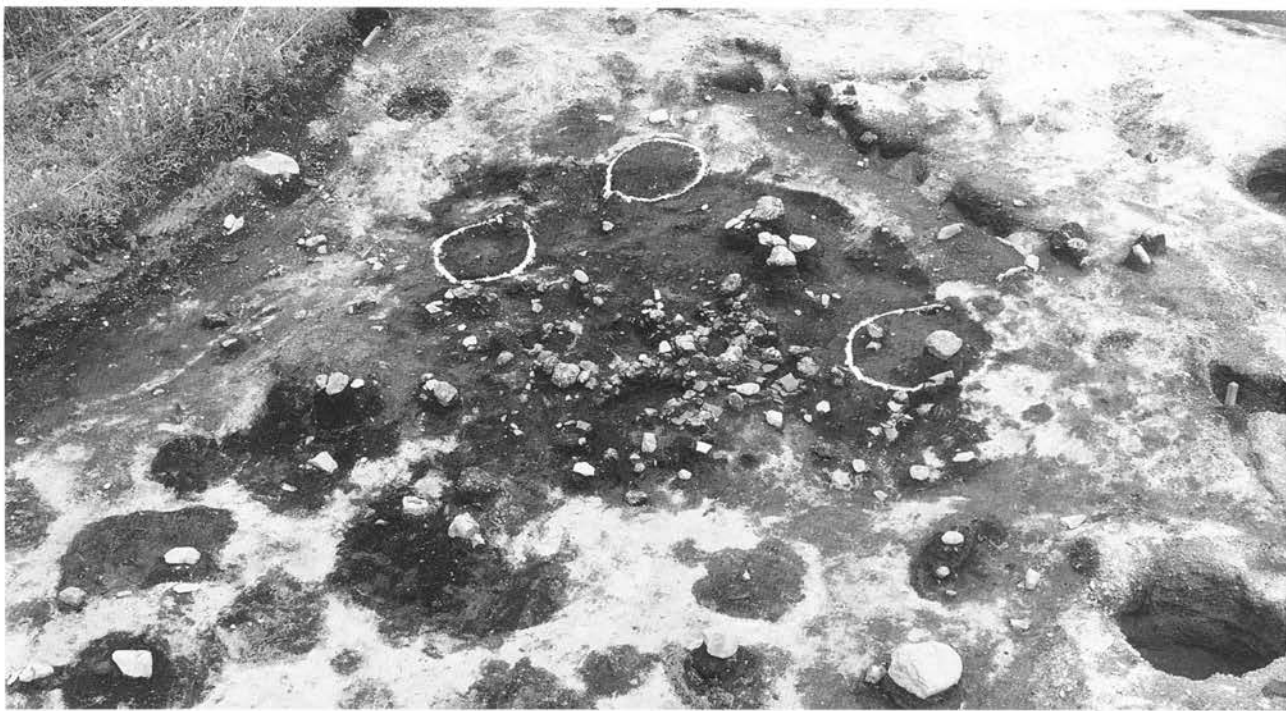

左：101号住居三角  
柱状土製品出土  
状況  
右：101号住居炉



左：103号住居  
右上：103号住居炉  
右下：103号住居磨  
製石斧(186)  
出土状況







左：104A号住居  
右：104B号住居



左：104A号住居  
(上)と104B号  
住居(下)の敷石  
検出  
右：104A号住居と  
104B号住居の  
炉



左：104A号住居の  
土器348出土状  
況  
右：104B号住居P30

左：105号住居炉  
右：107号住居検出



左：106号住居P1検出  
右：107号住居



左：106号住居P1  
右：107号住居



左：106号住居  
右：107号住居炉







左：108号住居 P14  
上面の土器369  
右：108号住居と113  
号住居

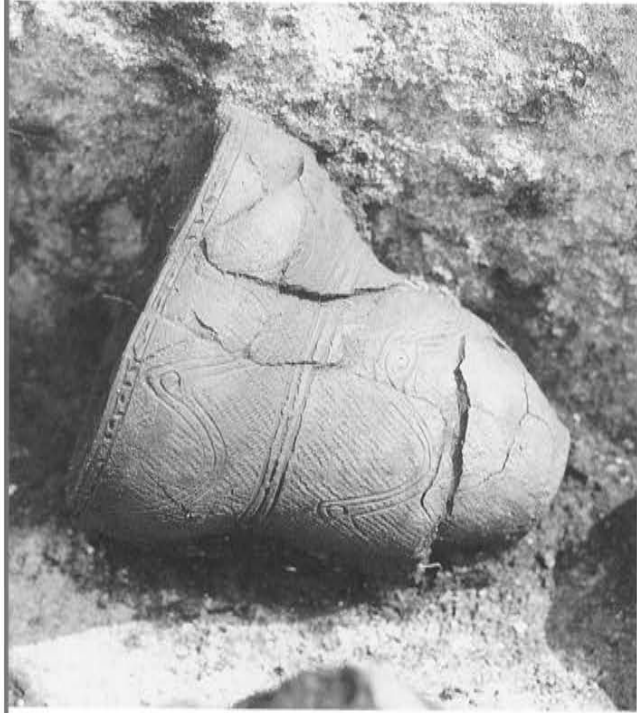

左：110号住居の土  
器373出土状況  
右：109号住居の埋  
甕炉



左：110号住居  
右：109号住居



左：110号住居炉  
右：109号住居の土  
器371出土状況



左：111号住居炉  
右：114号住居P6

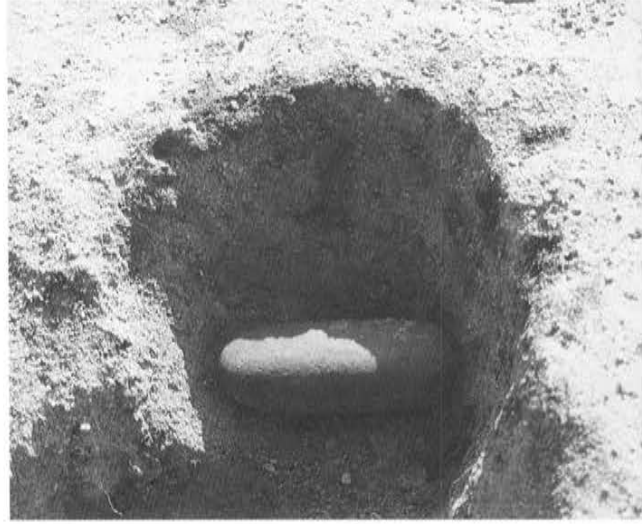
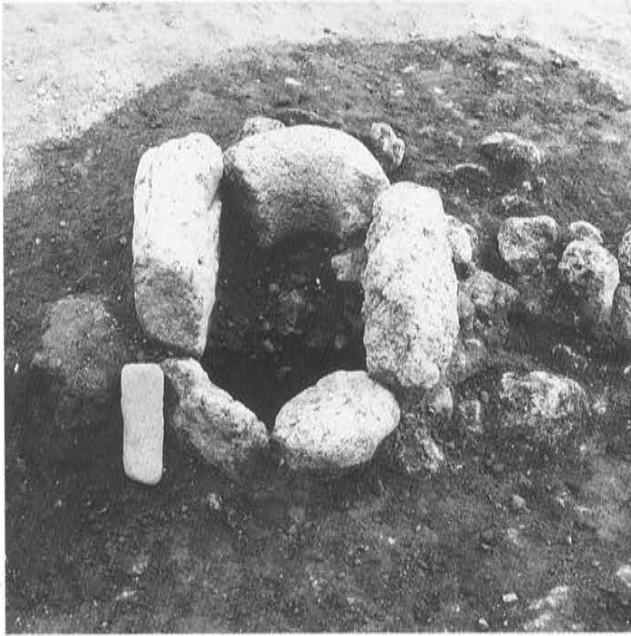

左：112号住居  
右上：114号住居  
右下：116号住居



左：112号住居北側  
敷石  
右：116号住居

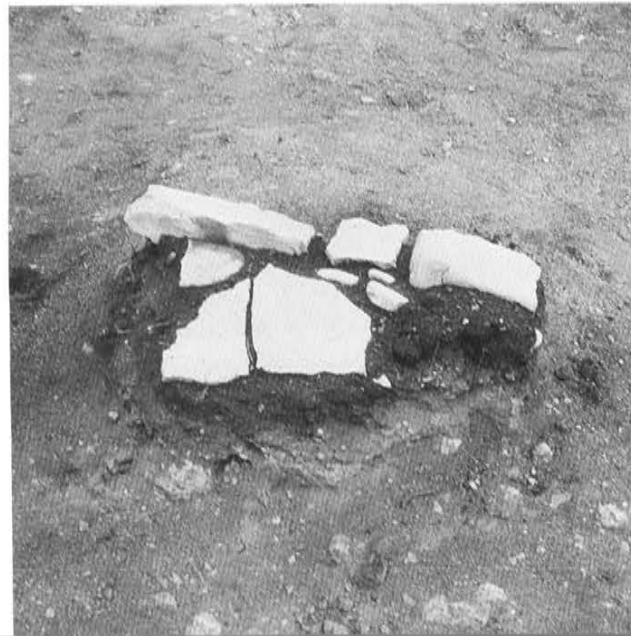





左：118号住居  
右：119号住居

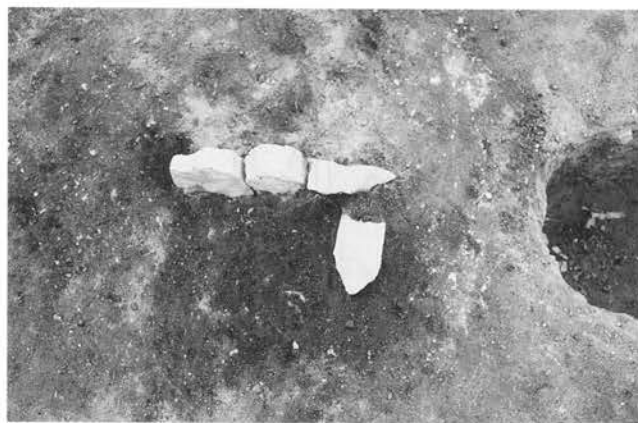

左下：120号住居  
右上：119号住居埋  
甕  
右下：120号住居





左：121号住居  
右：123号住居



左：121号住居埋甕  
右：123号住居土器  
敷炉



左：121号住居炉  
右：124号住居埋甕  
炉



左：124号住居軽石  
製埋甕  
右：124号住居





左：129号住居(上)  
127号住居(中)  
126号住居(下)  
右：126号住居

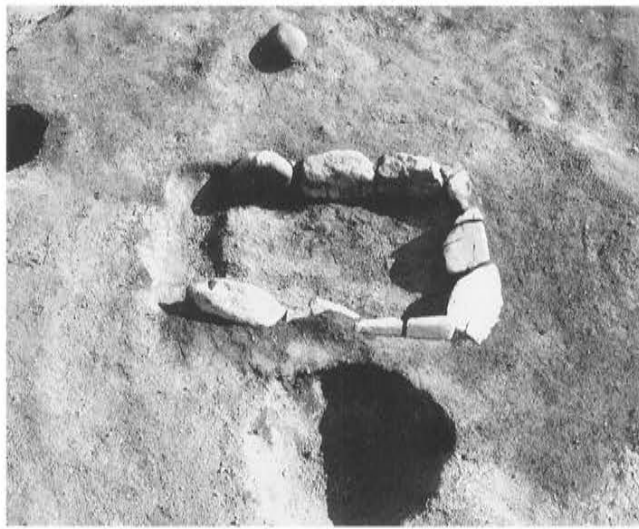

左：126号住居炉  
右：128号住居炉



左：128号住居  
右：130号住居

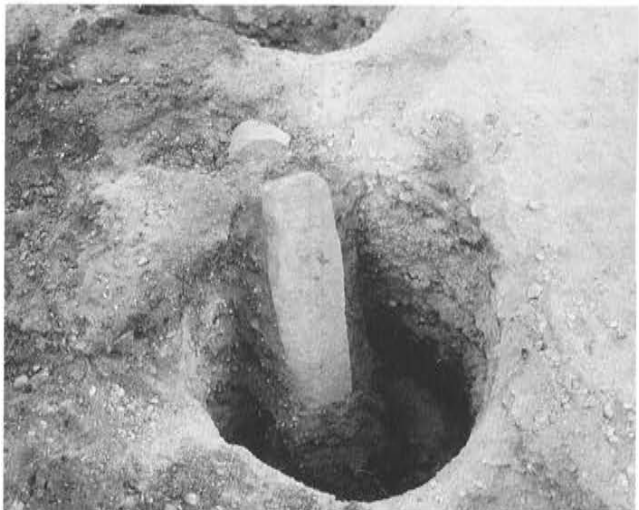

左：131号住居  
右：132号住居P4



左：63号土坑断面  
右：1162号土坑



左：63号土坑  
右上：40号土坑  
右下：50号土坑



左：292号土坑  
右：292号土坑完掘

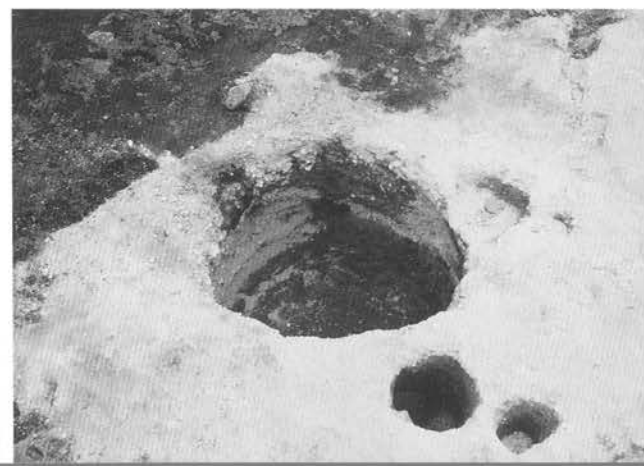
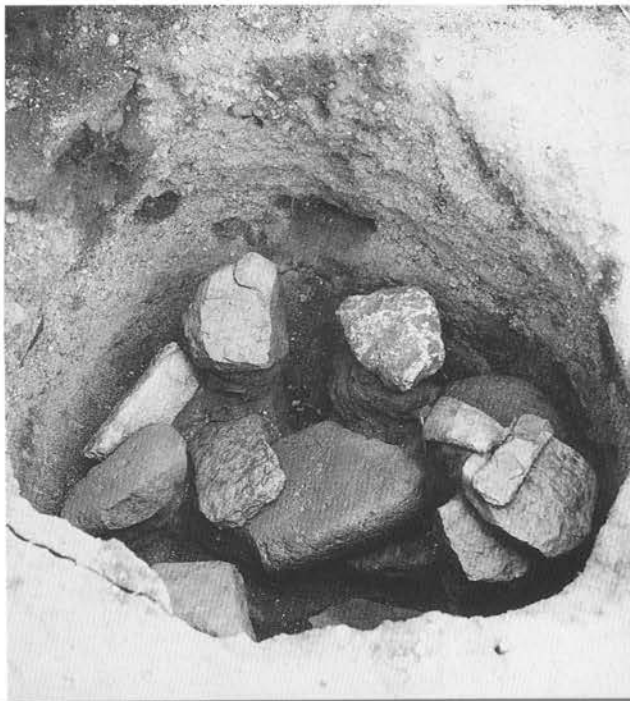

293号土坑



左：321号土坑検出  
右：324号土坑(左)  
355号土坑(右)



左：321号土坑  
右：324号土坑

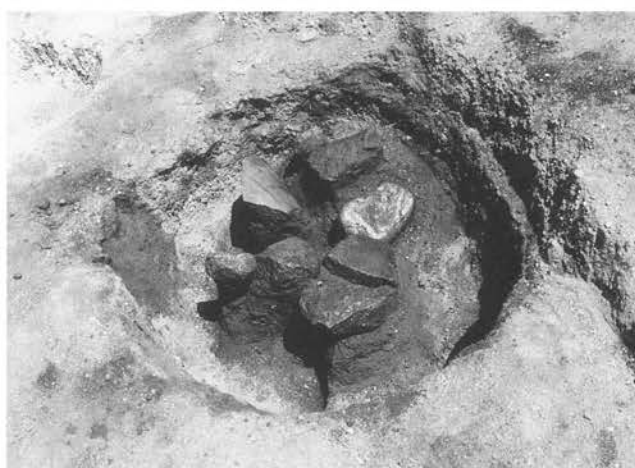

左：441号土坑  
右：571号土坑断面





703号土坑



左：703号土坑  
右：769号土坑検出



左：1042号土坑断面  
右：769号土坑



左：1072号土坑  
右：769号土坑石棒  
(409)





左：1104号土坑土器  
(647)出土狀況  
右：1104号土坑



左：1116号土坑  
右：1117号土坑



左：1120号土坑  
右：1121号土坑



左：1125号土坑  
右：1127号土坑



左：1133号土坑  
右：1133号土坑断面



左：1135号土坑  
(右)と1140号  
土坑(左)  
右上：1134号土坑  
右下：1136号土坑

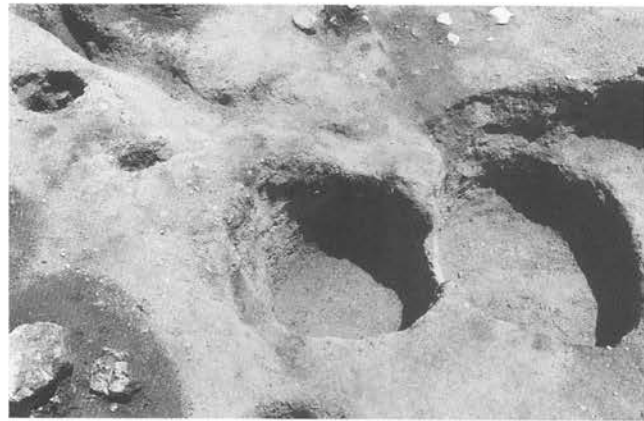
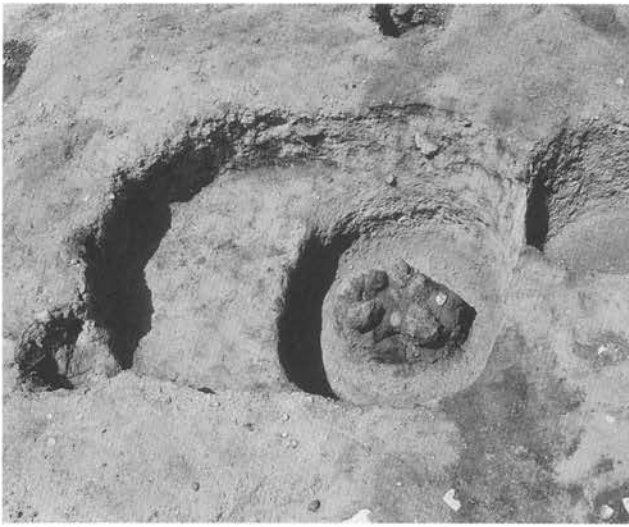

左：1137号土坑  
右：1142号土坑



左：1149号土坑検出  
右：1149号土坑

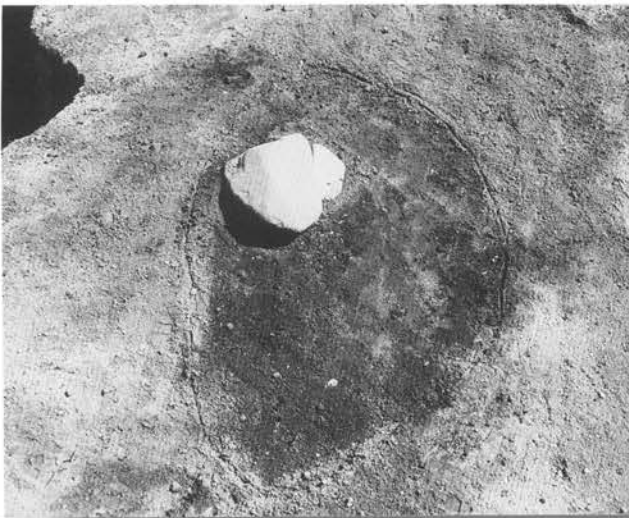





左：1150号土坑  
右：1151号土坑



左：1154号土坑  
右：1158号土坑



左：1170号土坑  
右：1172号土坑(中上)、1173号土坑(中中)、1174号土坑(中下右)、1175号土坑(中下左)



左：1173号土坑  
右：1178号土坑



左：1179号土坑  
右：1181号土坑

左：1192号土坑  
右：1190号土坑

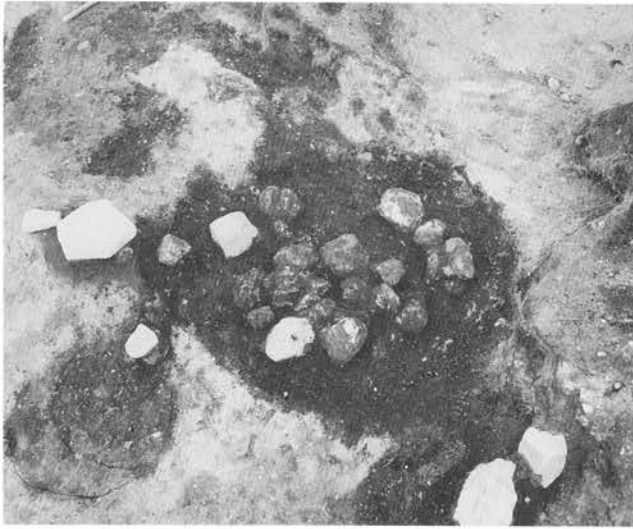

左：1204号土坑  
右：1209号土坑

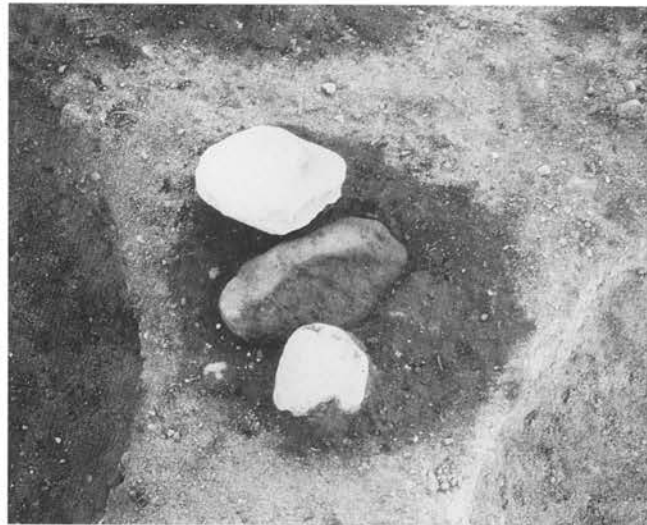

左：1210号土坑  
右：1211号土坑

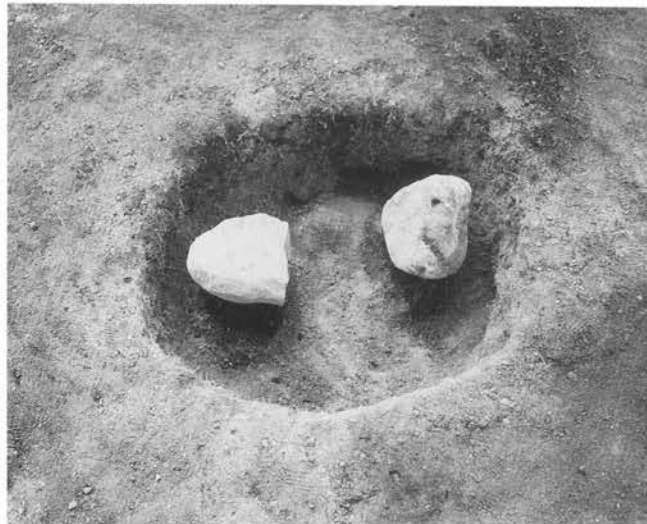

左：1212号土坑  
右：1214号土坑

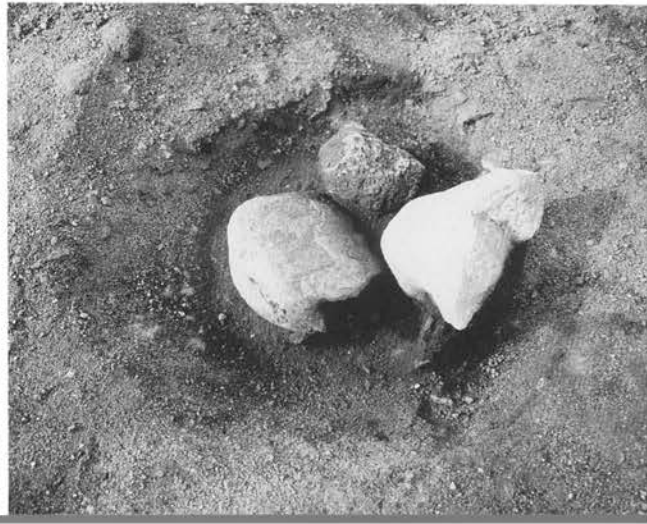





左：1216号土坑  
右：1223号土坑

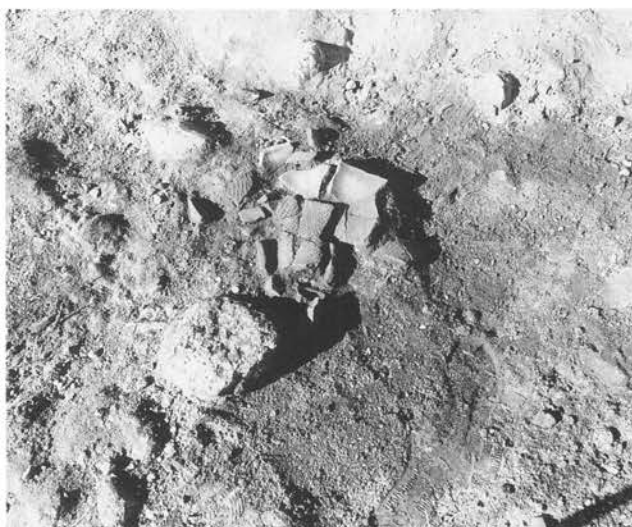

左：1227号土坑  
右：1232号土坑検出

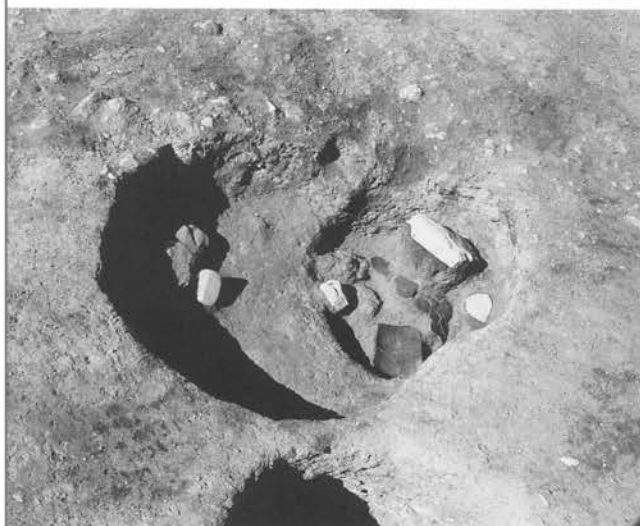

左：1233号土坑(右)  
1234号土坑(左)  
右：1235号土坑



左：1236号土坑  
右：1238号土坑

左：1239号土坑  
右：1244号土坑



左：1247号土坑  
右：1248号土坑



左：1249号土坑

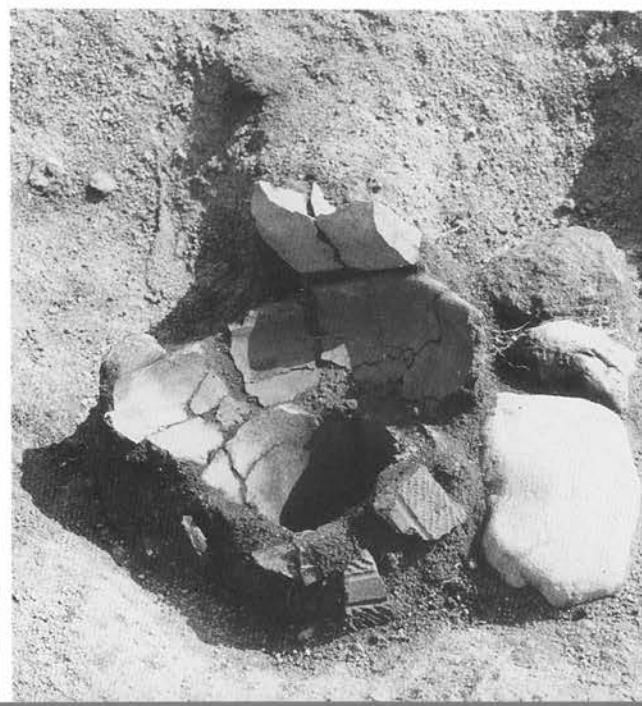

左：1253号土坑  
右：1255号土坑







左：1257号土坑  
右：1258号土坑



左：1260号土坑  
右：1267号土坑

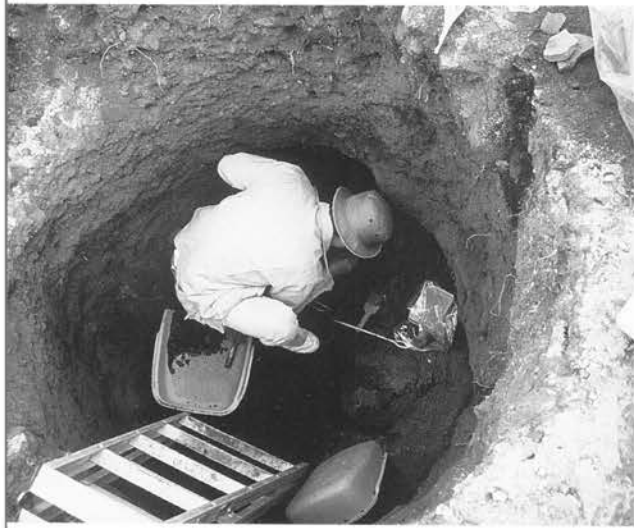

左：1269号土坑調査  
右：1269号土坑

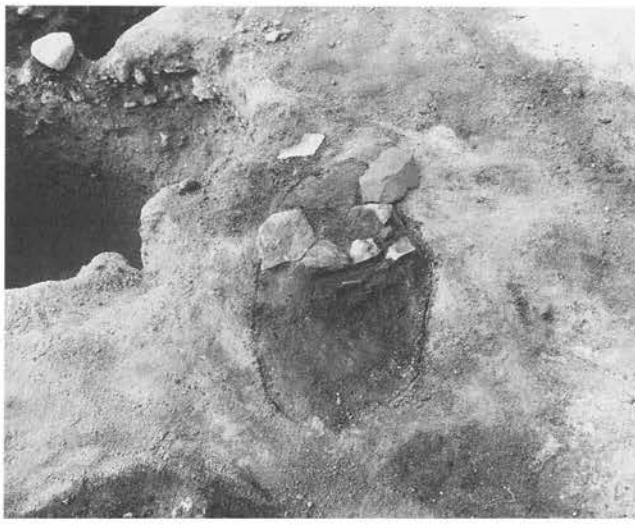

左：1270号土坑  
右：1271号土坑

1276号土坑(上)、  
1274号土坑(中)、  
1275号土坑(下)



左：1276号土坑  
右：1277号土坑



左：1279号土坑  
右：1283号土坑



左：1280号土坑  
右：1290号土坑





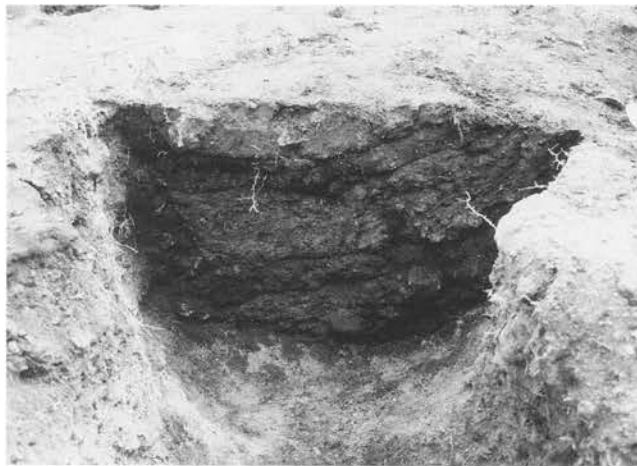
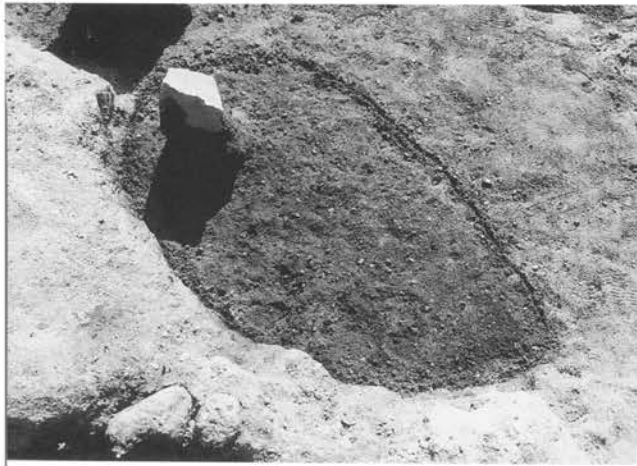

左：1294号土坑検出  
右：1296号土坑断面

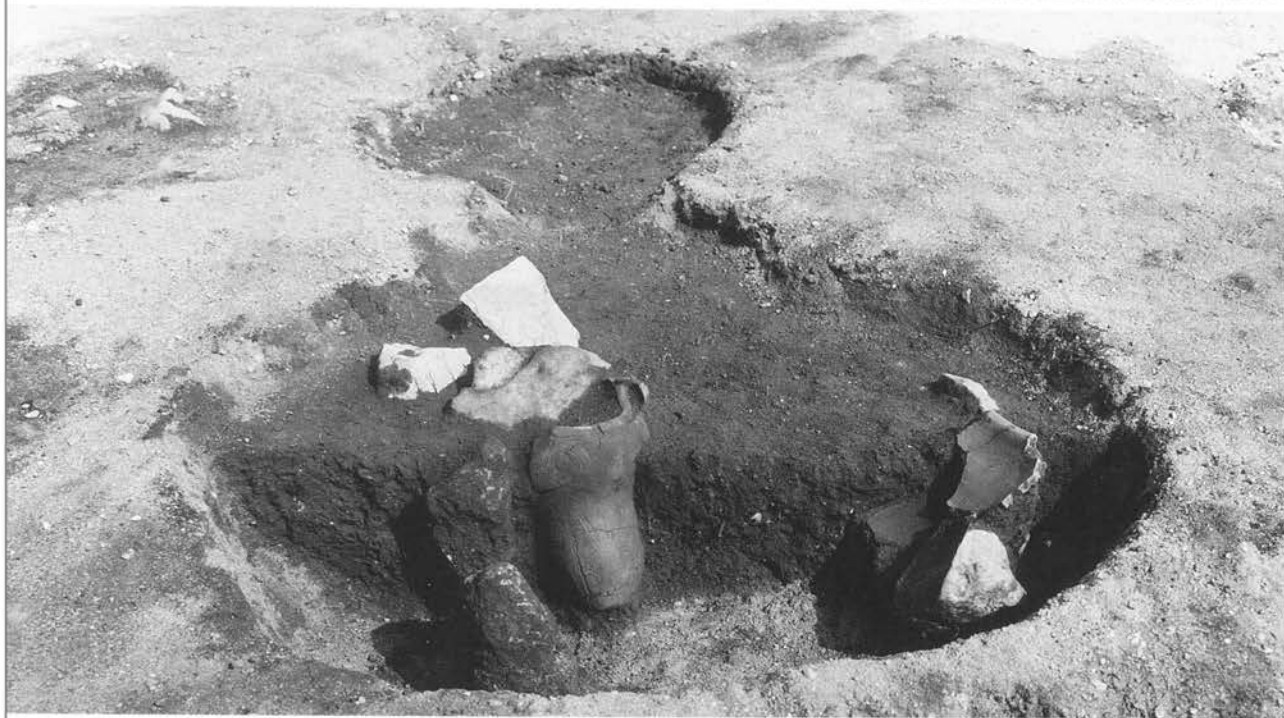

1308号土坑断面



左：1304号土坑  
右：1309号土坑(中)  
1310号土坑(右)  
1313号土坑(右)



左：1314号土坑  
右：1333号土坑検出

1339号土坑と土器集中1の検出



左：1339号土坑  
右：1344号土坑



左：1346号土坑  
右：1362号土坑

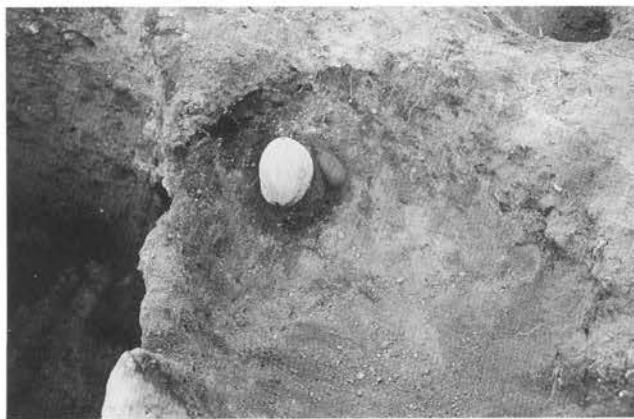

左：1370号土坑検出  
右：1372号土坑

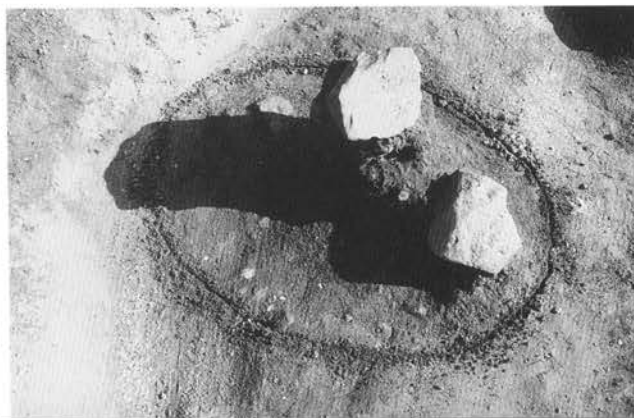





左：1373号土坑検出  
右：1379号土坑検出



左：1374号土坑と土器943  
右：1390号土坑



左上：1389号土坑  
左下：1391号土坑  
右：1392号土坑



左：1394号土坑  
右：1406号土坑

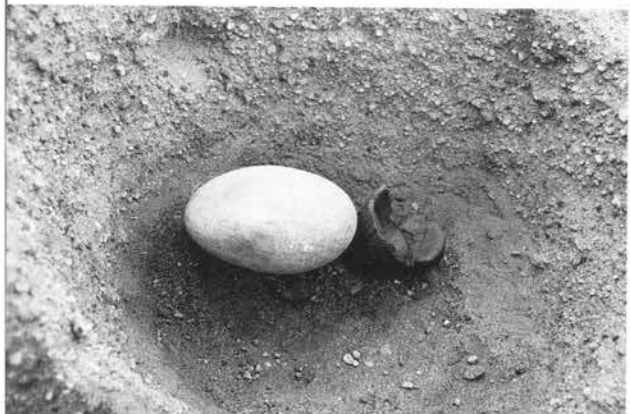

左：集石1(上)と集石2(下)  
右：単独土器5

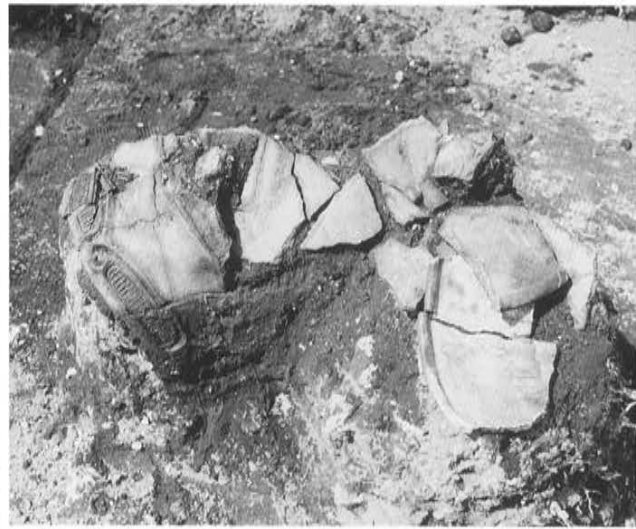

左：集石1  
右：単独土器6



左：土器集中2



左：土器集中2(土器995)  
右：単独土器11



左：土器集中1  
右：0-14グリッド砥石出土状況







左上：郷土2号墳の  
確認  
左下：郷土2号墳人  
骨出土状況  
右：郷土2号墳ト  
レンチ

左：郷土2号墳  
右：郷土2号墳人骨  
出土状況

郷土2号墳石室



左：100号住居竈  
右：1号溝断面図A



左：1号溝(平成4年  
度)  
右：1号溝断面C



1号溝(平成6年度)





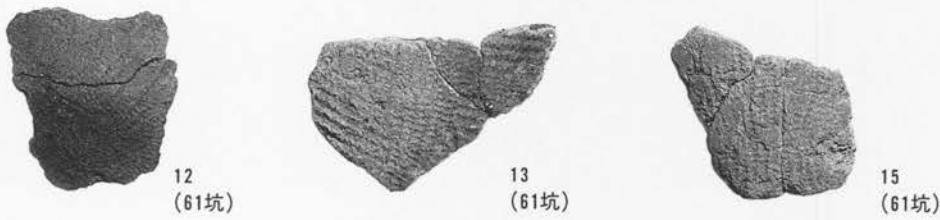
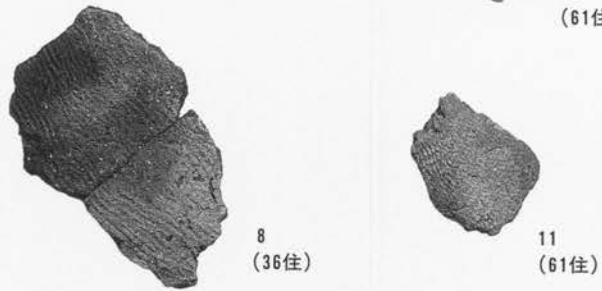
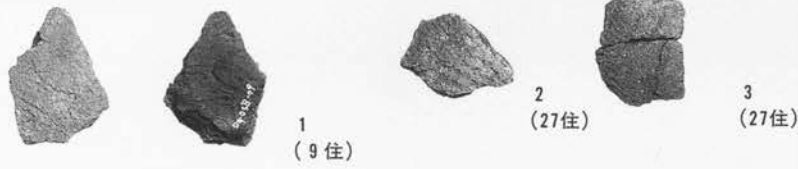

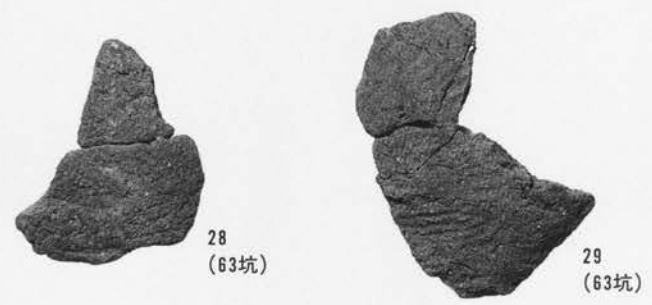
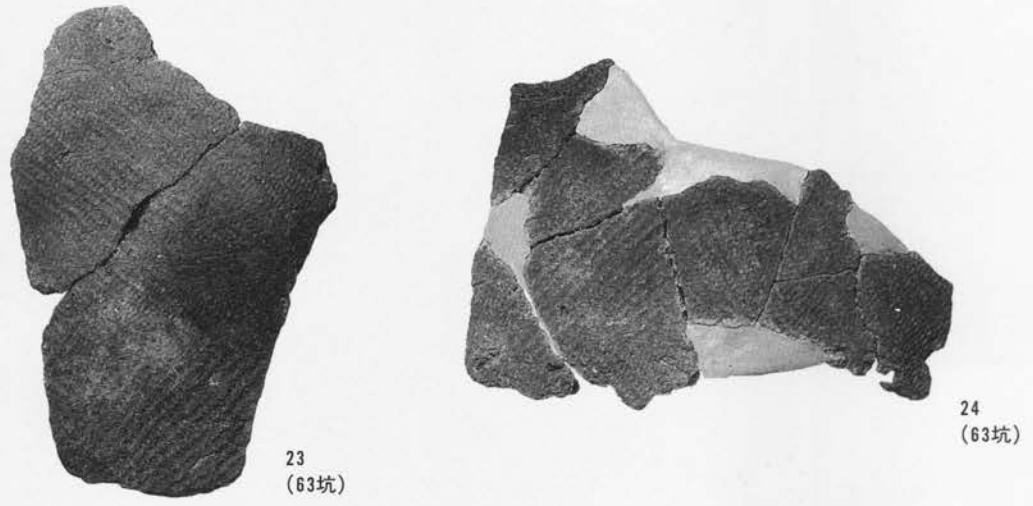
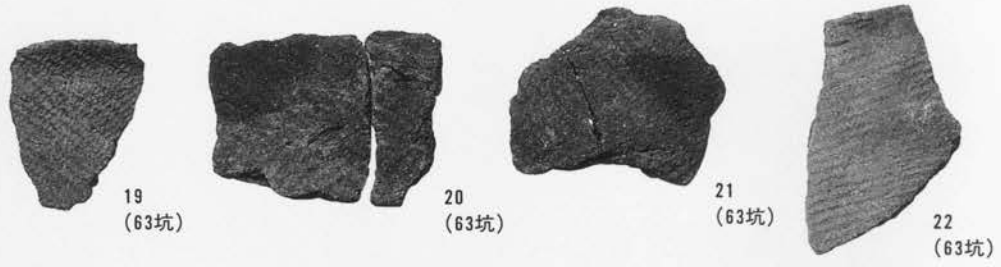

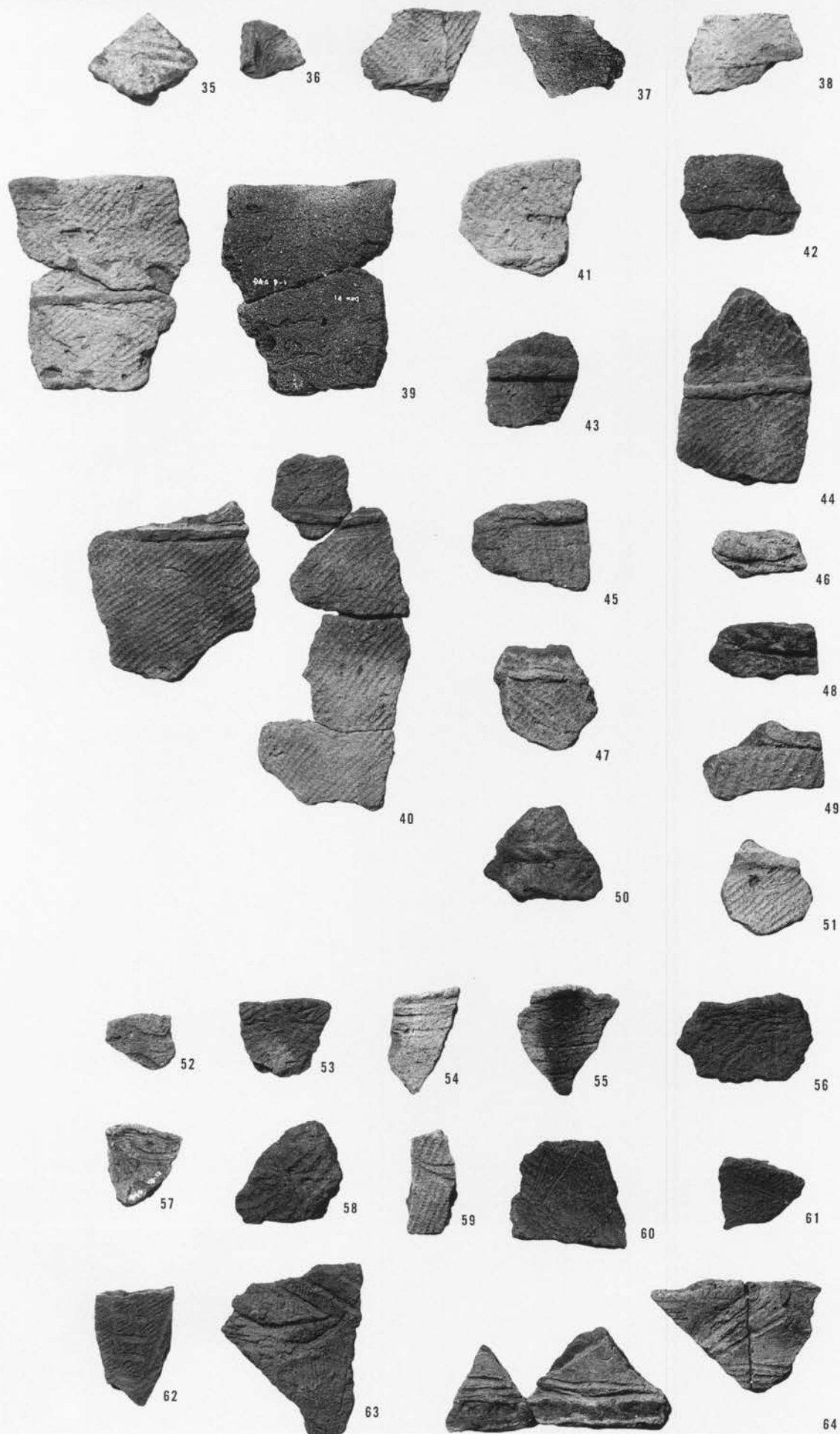

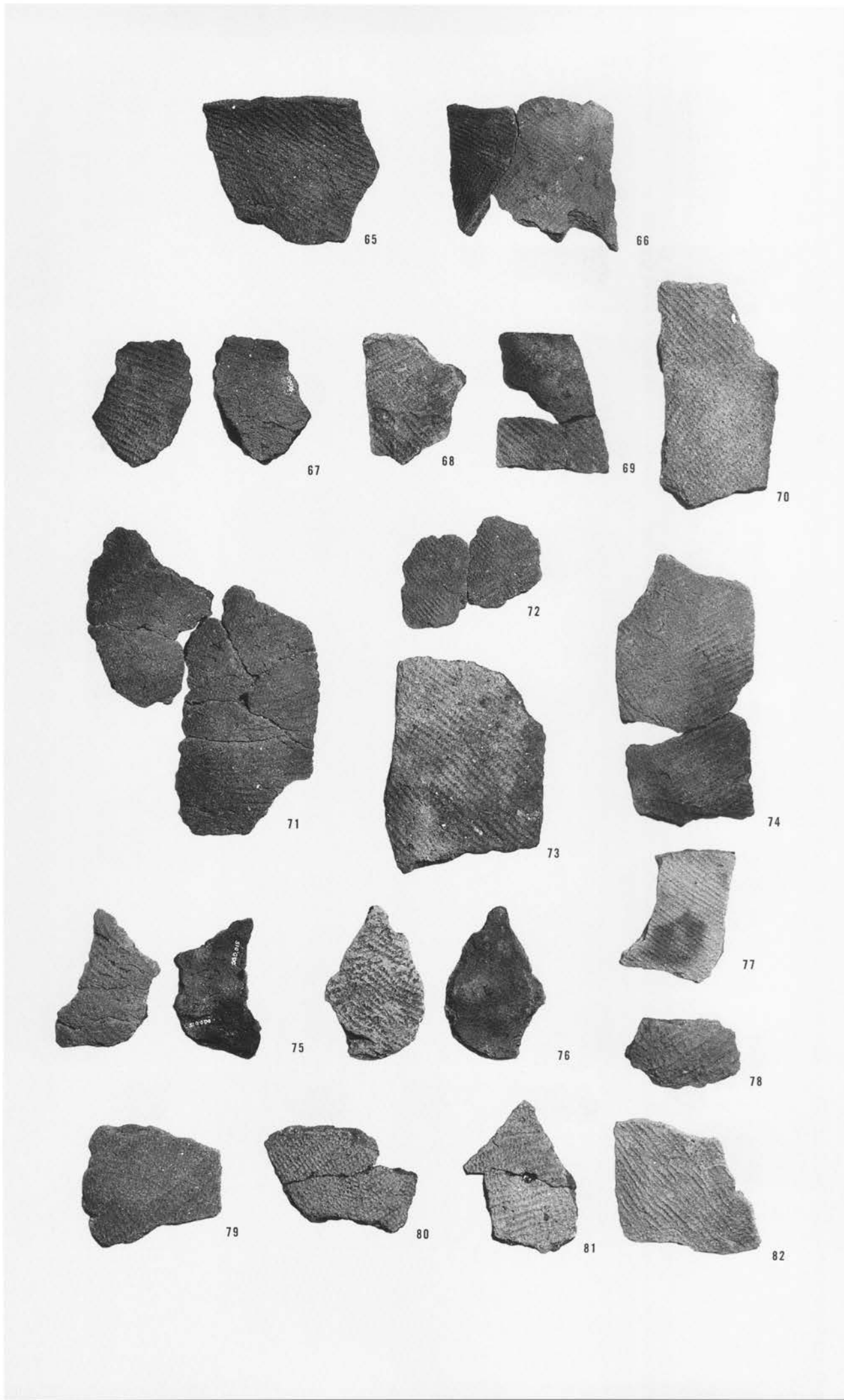

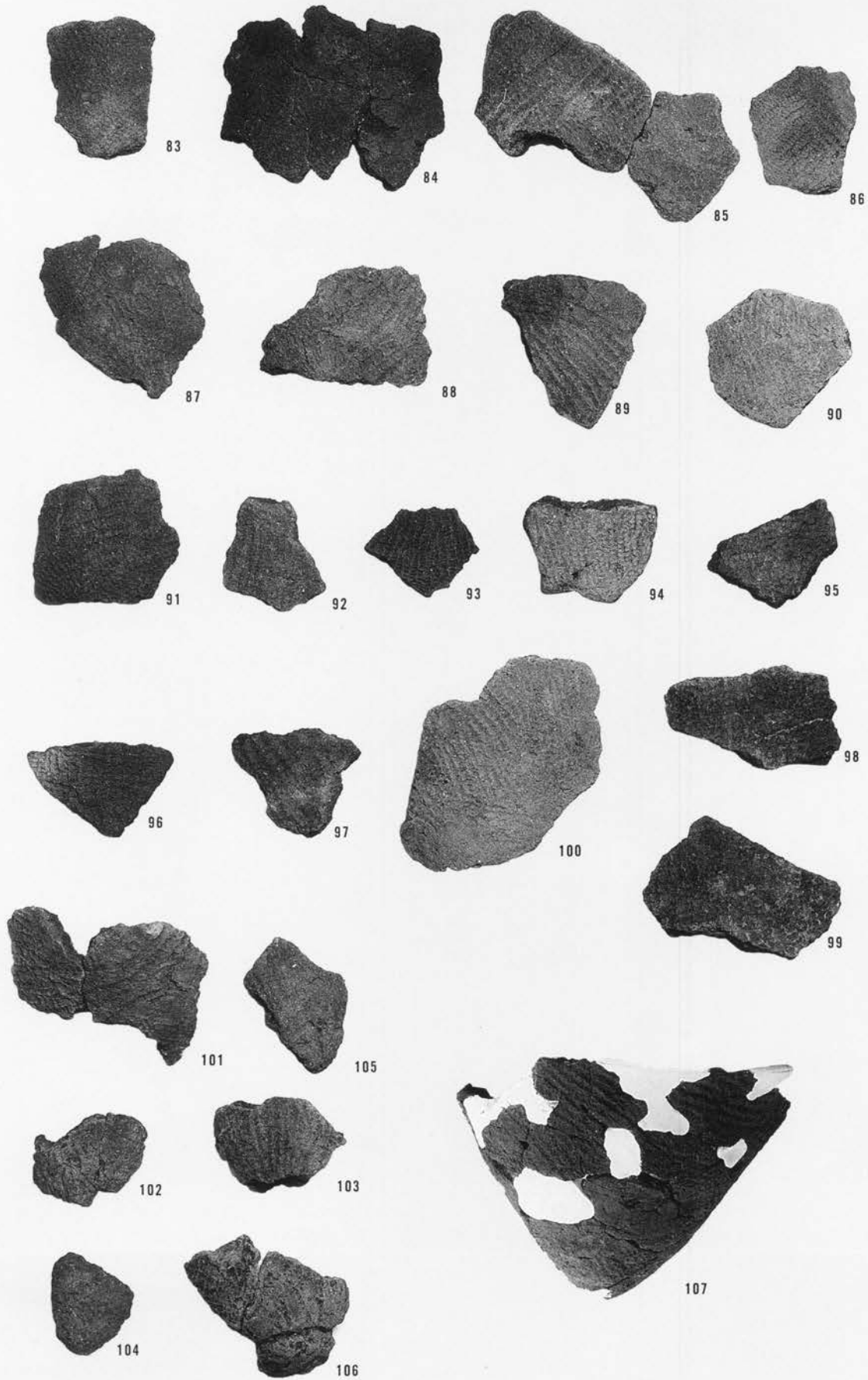

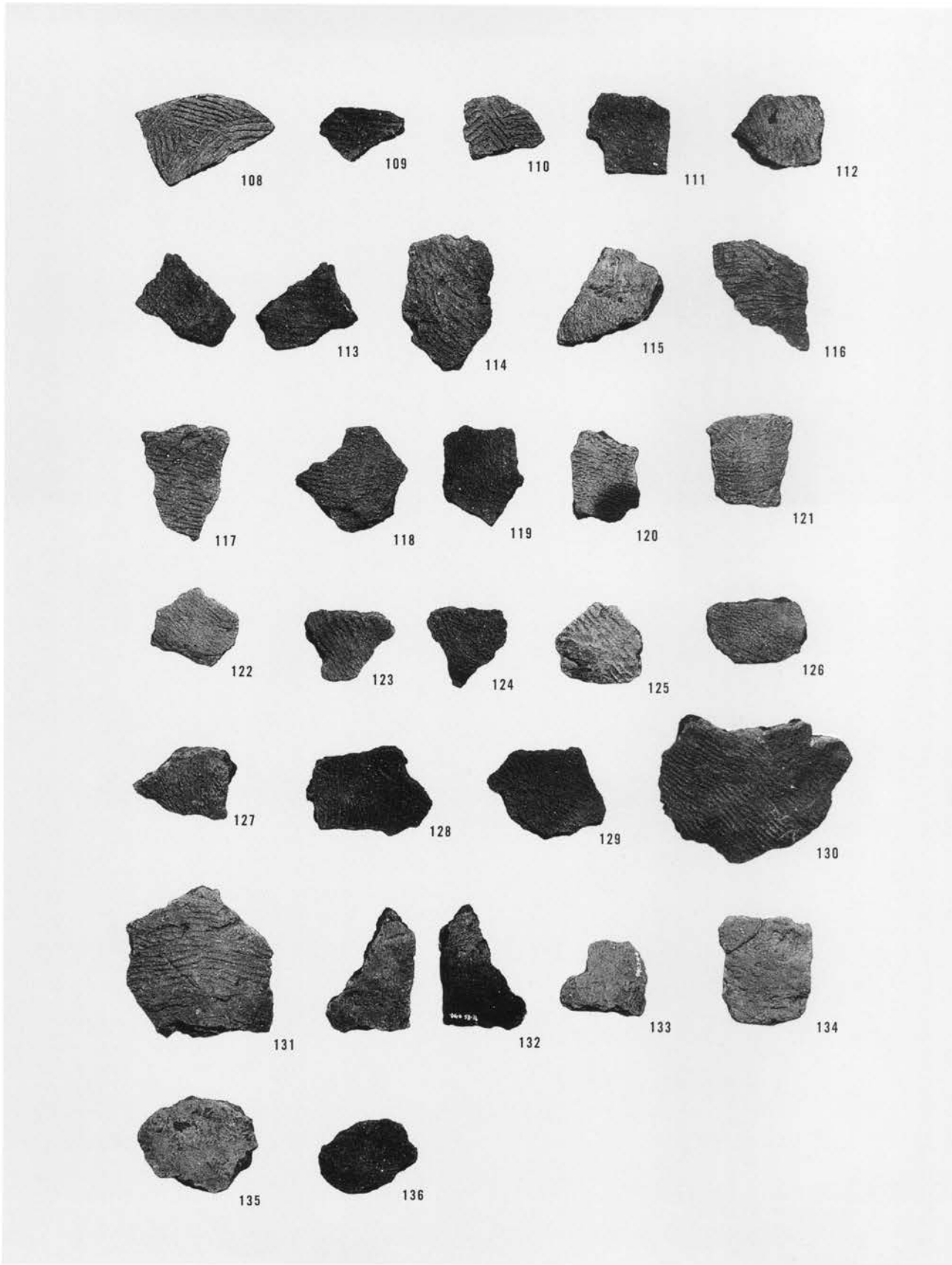



縄文中期の土器

1・2 1:6

他 1:4

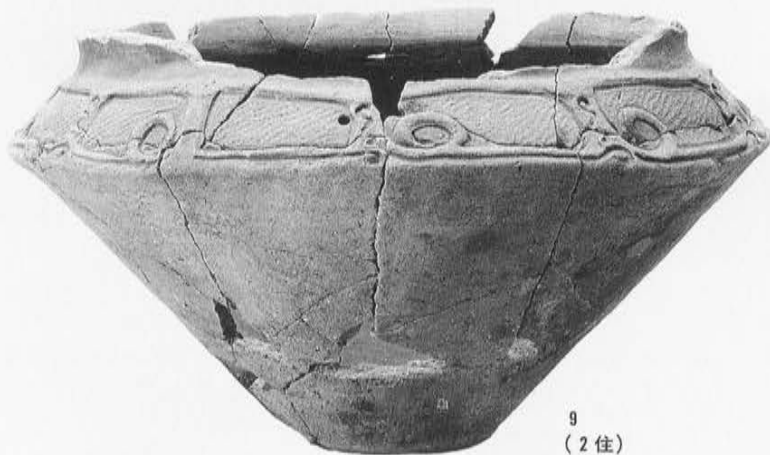

縄文中期の土器  
1 : 4



10  
(2住)



11  
(2住)



14  
(3住)

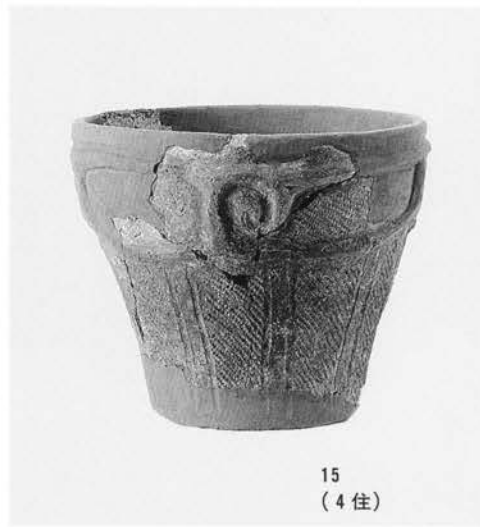

15  
(4住)



24  
(6住)



25  
(6住)



23  
(6住)

縄文中期の土器  
36・37 1:6  
他 1:4



32  
(8住)



35  
(10住)



34  
(10住)



33  
(10住)



36  
(11住)



37  
(11住)

縄文中期の土器  
1 : 4



41  
(12住)



40  
(12住)



38  
(12住)



14住出土土器



縄文中期の土器  
45・49 1 : 6  
他 1 : 4



55  
(14住)



47  
(14住)



45  
(14住)



46  
(14住)



48  
(14住)



49  
(14住)

縄文中期の土器  
1:4

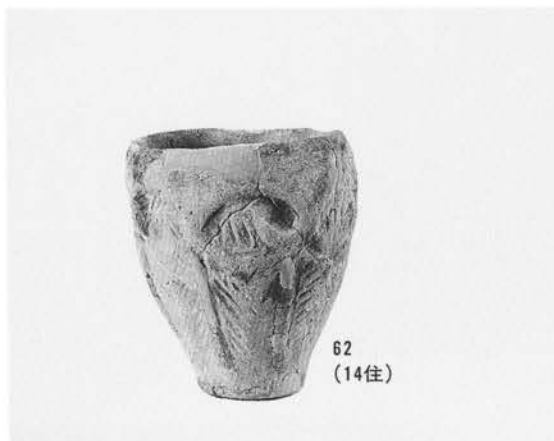





69  
(15住)



68  
(15住)



75  
(16住)



77  
(16住)



70  
(16住)



71  
(16住)



78  
(16住)

縄文中期の土器  
1 : 4





縄文中期の土器  
1 : 4



107  
(24住)



110  
(24住)



106  
(24住)



109  
(24住)



108  
(24住)



111  
(24住)



115  
(24住)





113  
(24住)



117  
(24住)



118  
(24住)



112  
(24住)



119  
(24住)



105  
(24住)

縄文中期の土器

122・123 1:6  
他 1:4



122  
(25住)



123  
(25住)



124  
(24住)



134  
(29住)



135  
(32住)



138  
(32住)



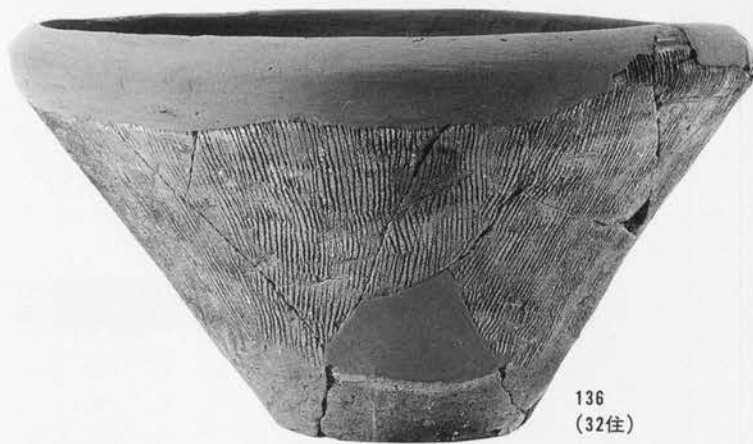

縄文中期の土器

162・163 1 : 4

他 1 : 6



165  
(39住)



163  
(39住)



166  
(39住)



168  
(39住)



167  
(39住)



173  
(41住)



縄文中期の土器

191 1 : 6  
他 1 : 4



186  
(46住)



187  
(46住)



189  
(47住)



188  
(47住)



191  
(47住)

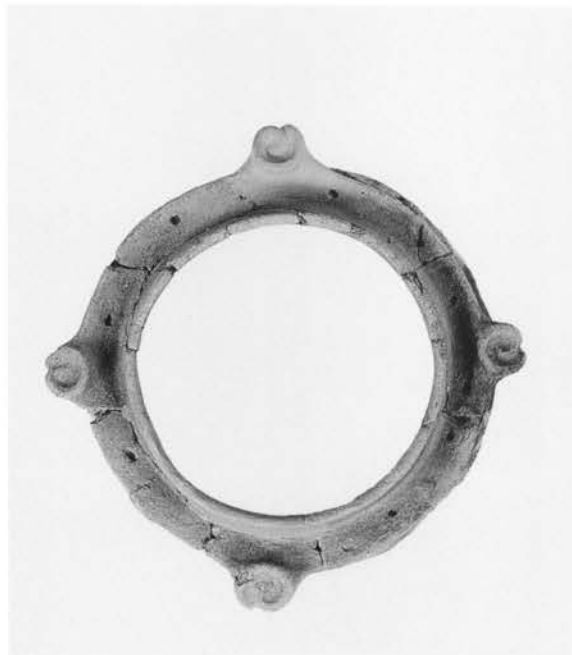

190  
(47住)

縄文中期の土器

193 1 : 6

他 1 : 4



198  
(60住)



195  
(60住)

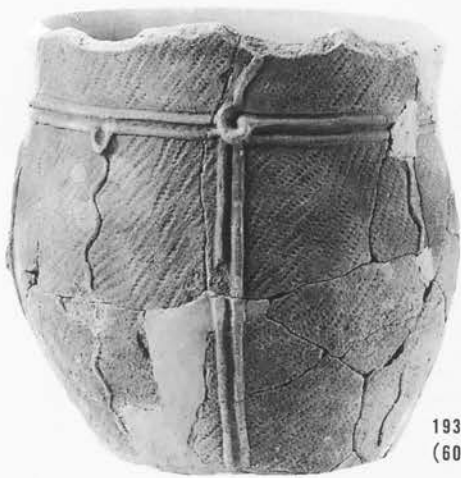

193  
(60住)



197  
(60住)



194  
(60住)



196  
(60住)



縄文中期の土器

1 : 4



201  
(67住)



202  
(69住)



204  
(70住)



205  
(70住)



209  
(71住)



208  
(71住)





212  
(72住)



211  
(72住)



210  
(72住)



213  
(72住)



218  
(75住)



220  
(76住)



225  
(76住)

縄文中期の土器

234 1:6

他 1:4



221  
(76住)



222  
(76住)



234  
(76住)



231  
(76住)



228  
(76住)



227  
(76住)



226  
(76住)



223  
(76住)

縄文中期の土器

241 1 : 6

他 1 : 4



235  
(77住)



237  
(78住)



236  
(78住)



241  
(80住)



244  
(81住)



245  
(81住)



246  
(81住)



243  
(81住)

縄文中期の土器

261 1:6

他 1:4



251  
(83住)



247  
(82住)



252  
(83住)



258  
(85住)



261  
(88住)



1023



縄文中期の土器

265 1 : 6

他 1 : 4



266  
(89住)



268  
(89住)



267  
(89住)



270  
(89住)



271  
(89住)



269  
(89住)



264  
(89住)



265  
(89住)

縄文中期の土器

- 276 1 : 8
- 280 1 : 6
- 他 1 : 4



279  
(90住)

277  
(90住)



276  
(90住)



282  
(91住)



280  
(91住)

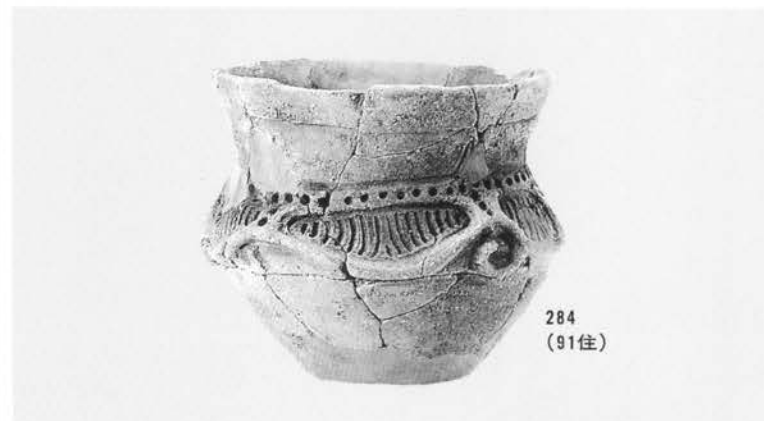

284  
(91住)



285  
(91住)





291



288  
(94住)



307  
(97住)



289  
(94住)



304  
(97住)

縄文中期の土器

348・349 1:6

他 1:4



327  
(101住)

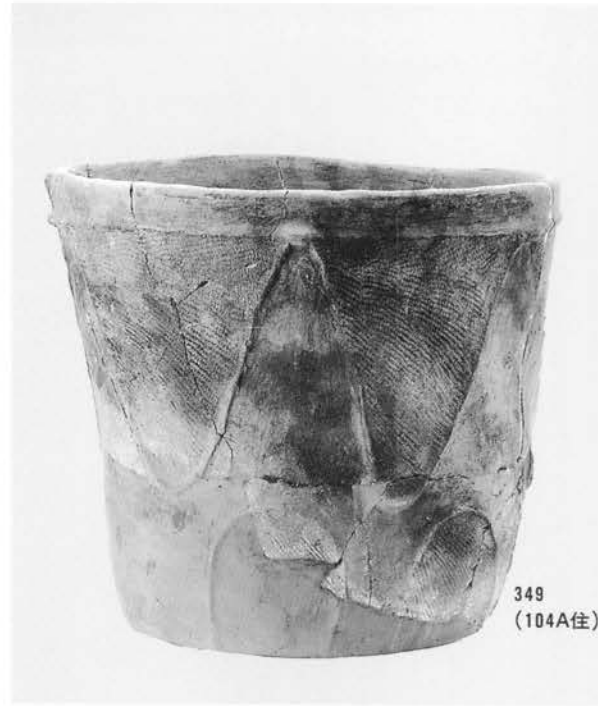

349  
(104A住)



348  
(104A住)



326  
(101住)



357  
(105住)



縄文中期の土器

390 1 : 6

他 1 : 4



373  
(110住)



375  
(112住)



376  
(118住)



377  
(118住)



390  
(121住)

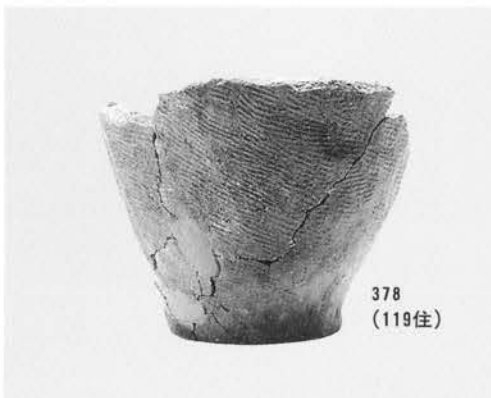

378  
(119住)



392  
(121住)



391  
(121住)



397  
(122住)





399  
(123住)



398  
(123住)



400  
(123住)



401  
(124住)

縄文中期の土器  
1:4



406  
(125住)



410



410  
(126住)

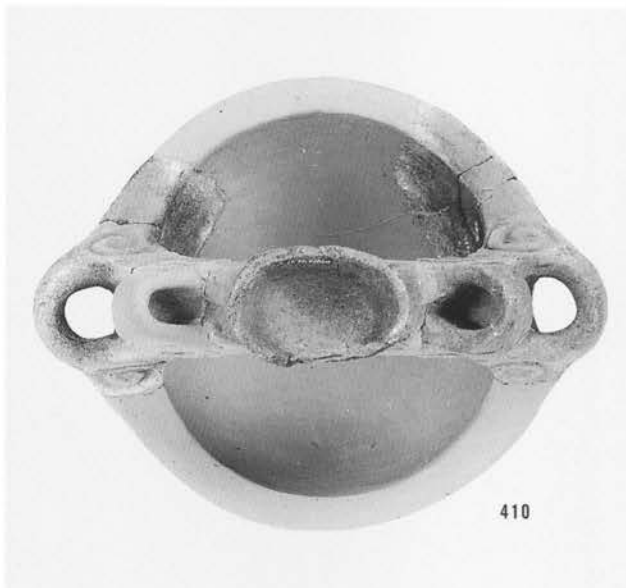

410



407 (126住)



411  
(130住)





421  
(15坑)



422  
(31坑)



423  
(35坑)



424  
(36坑)



460  
(275坑)

縄文中期の土器  
1 : 4



475  
(302坑)



474  
(302坑)



501  
(351坑)



497  
(328坑)



501



540  
(703坑)



501



647  
(1104坑)



648  
(1104坑)



657  
(1108坑)



666  
(1120坑)



670  
(1125坑)



666



676  
(1127坑)

縄文中期の土器

786 1:6

他 1:4

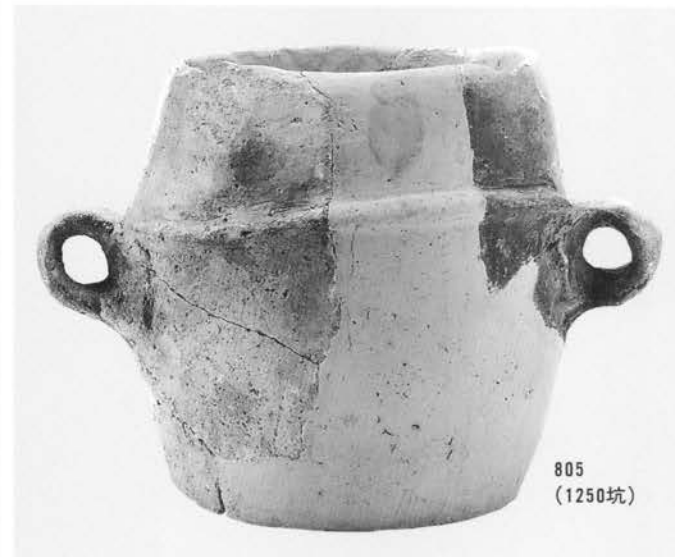
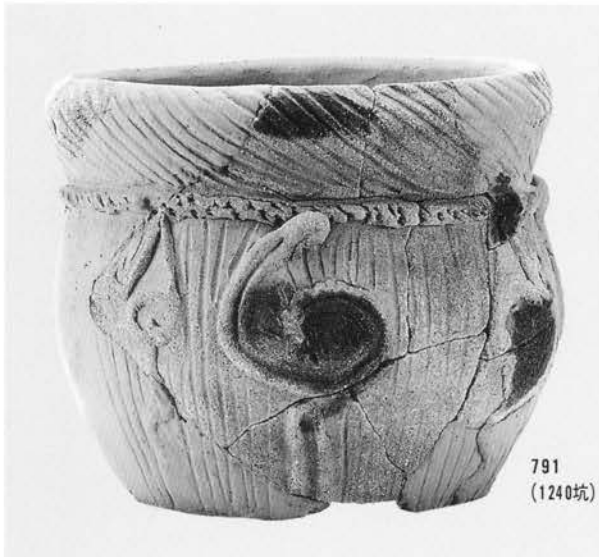



縄文中期の土器

820・833・859

1 : 6

他 1 : 4



833  
(1268坑)



813  
(1255坑)



831  
(1268坑)



820  
(1260坑)



840  
(1278坑)



859  
(1283坑)

縄文中期の土器

885 1:6

他 1:4



885  
(1299坑)



993  
(土器集中1)

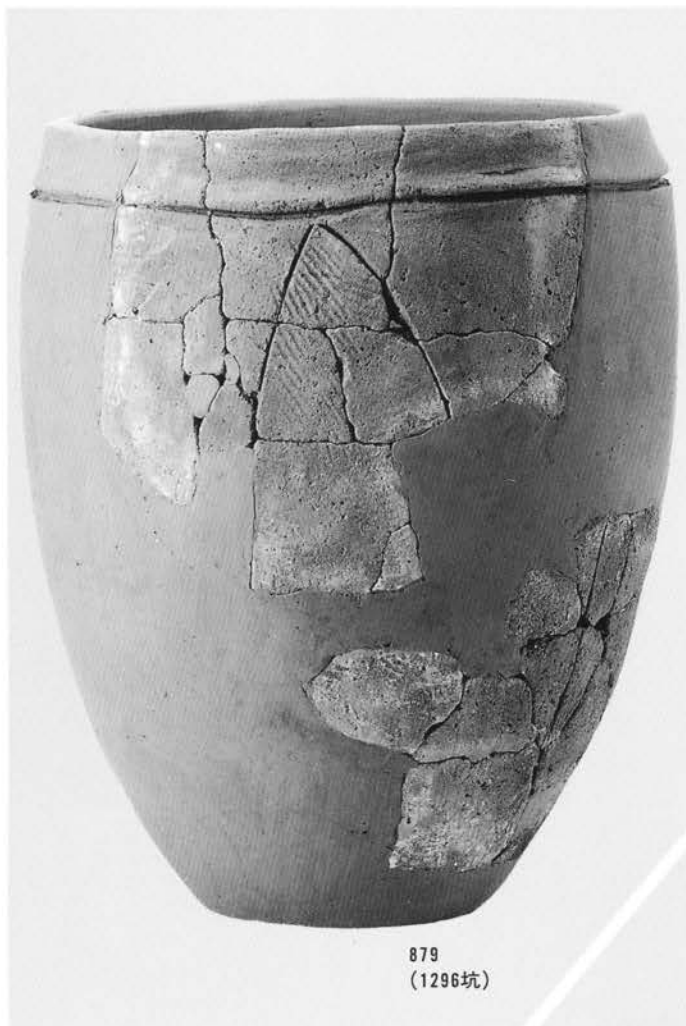

879  
(1296坑)

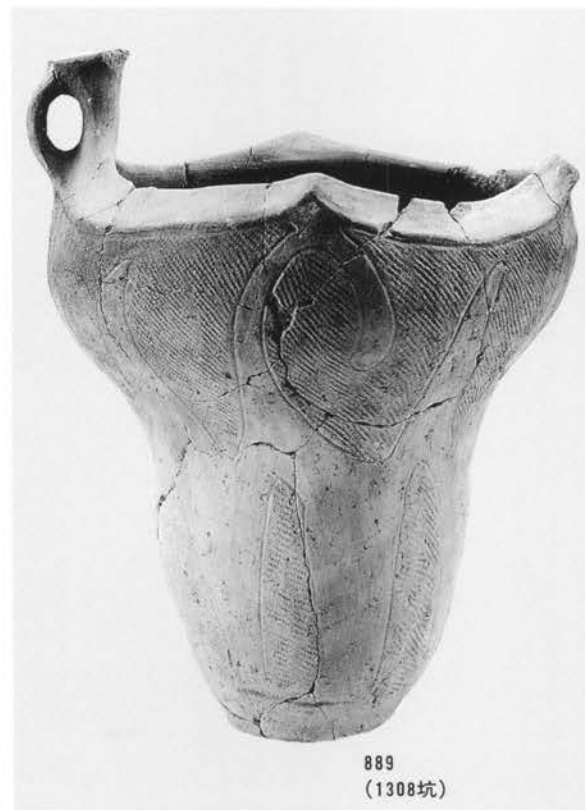

889  
(1308坑)



913  
(1339坑)



縄文中期の土器  
915・943 1:6  
他 1:4



915  
(1339坑)



916  
(1342坑)



914  
(1339坑)



996  
(土器集中2)



997  
(土器集中2)



943  
(1374坑)



995  
(土器集中2)

縄文中期の土器

989 1 : 2

他 1 : 4



991  
(土器集中1)

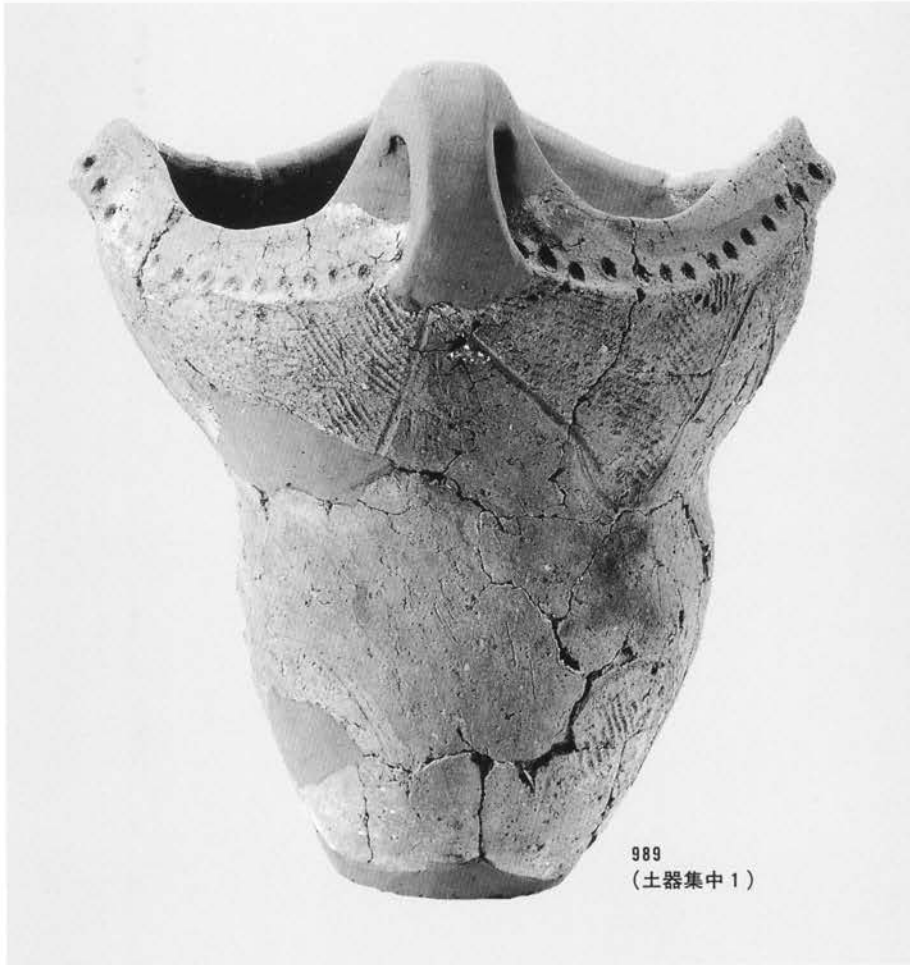

989  
(土器集中1)



990  
(土器集中1)

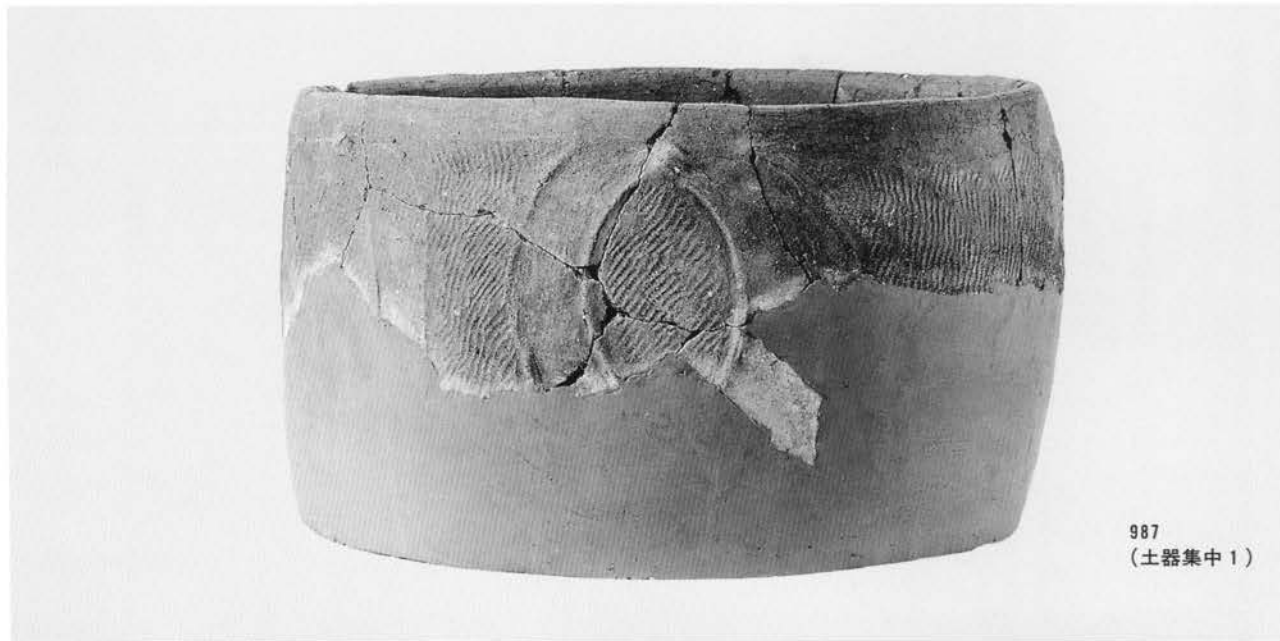

987  
(土器集中1)

縄文中期の土器

977 1:6

他 1:4



994  
(土器集中1)



977  
(単独土器2)



988  
(土器集中1)



978  
(単独土器3)

縄文中期の土器

982	1 : 8
980・984	1 : 6
他	1 : 4



980  
(单独土器 5)



982  
(单独土器 7)



983  
(单独土器 8)



986  
(单独土器 11)



984  
(单独土器 9)

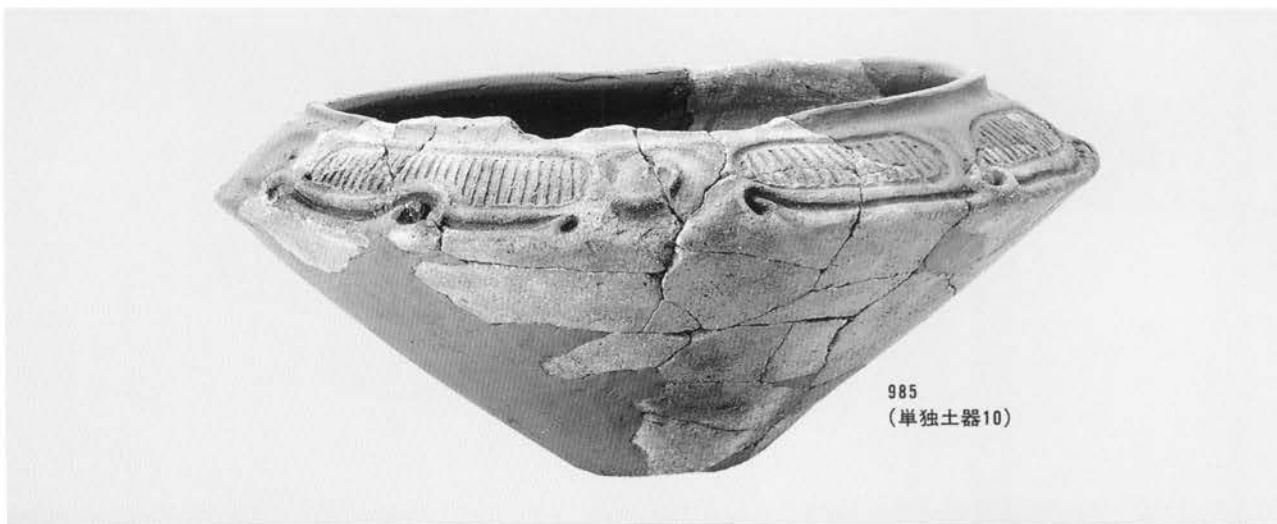

985  
(单独土器 10)



縄文中期の土器

1002 1 : 6

他 1 : 4



1013



1004



1002



1003

縄文中期の土器  
1 : 4

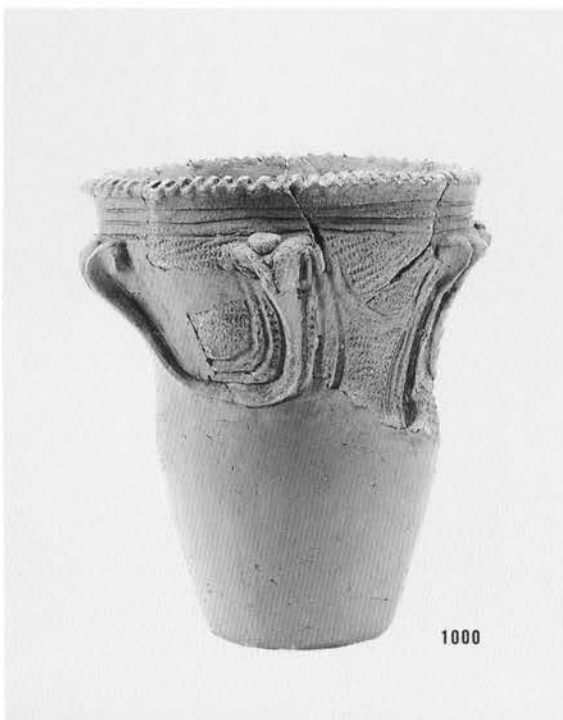





縄文中期の土器  
1 : 4



1031



1044



1039



1028



1033



968  
(屋外埋甕 1)



右：屋外埋甕A群



右：屋外埋甕 2



969  
(屋外埋甕 2)



970  
(屋外埋甕 3)

左：屋外埋甕 3

右：屋外埋甕 5



971  
(屋外埋甕 4)



左：屋外埋甕 4



972  
(屋外埋甕 5)

右：屋外埋甕 6



973  
(屋外埋甕 6)





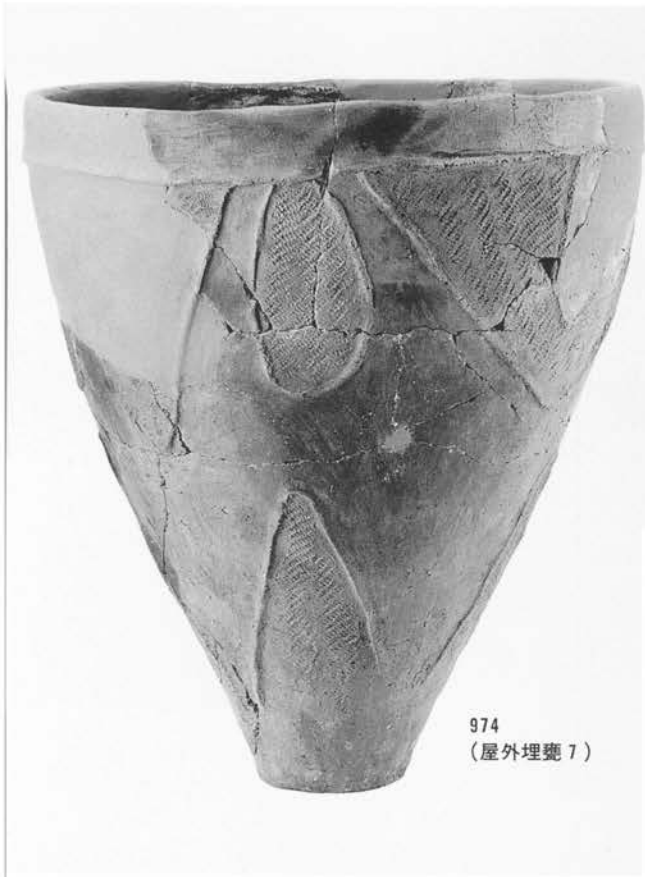

974  
(屋外埋甕7)



右：屋外埋甕7



右：屋外埋甕7



左：屋外埋甕C群  
右：屋外埋甕8



右：屋外埋甕8



975  
(屋外埋甕8)



縄文土器展開写真  
968(屋外埋甕1)

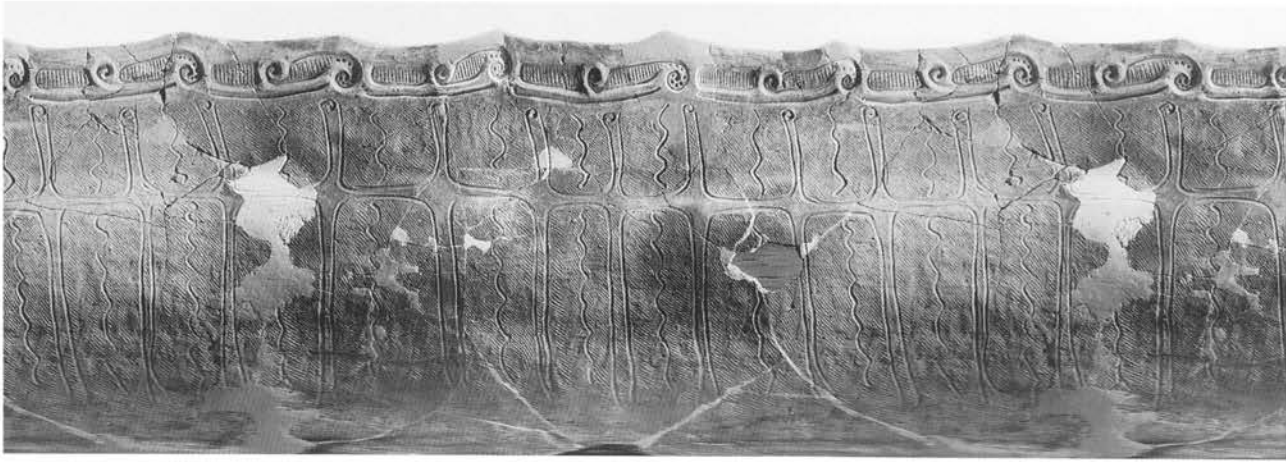

968



969



970

969(屋外埋甕2)



970(屋外埋甕3)







40 (12号住居)



41 (12号住居)



1



40



41

縄文土器展開写真  
44 (14号住居)

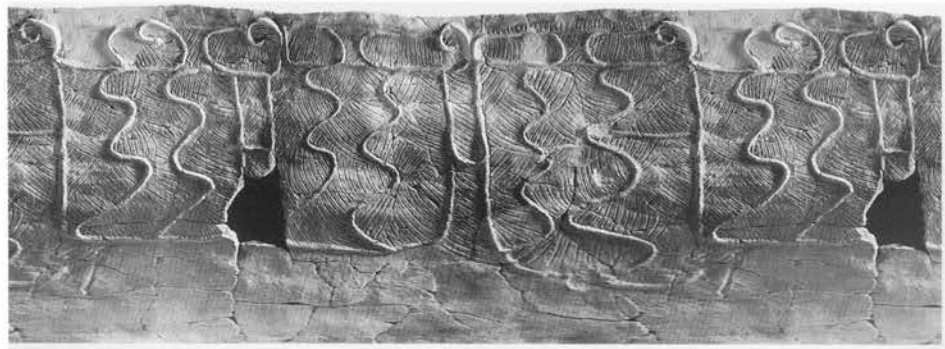

44

46 (14号住居)



46

48 (14号住居)



48

49 (14号住居)



49

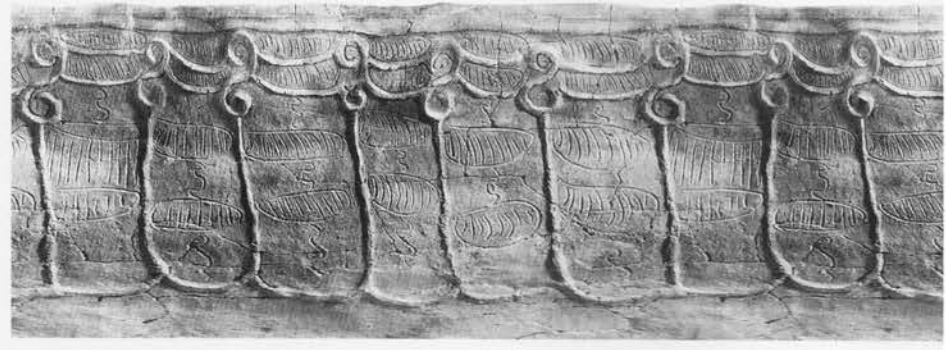

50 (14号住居)



50

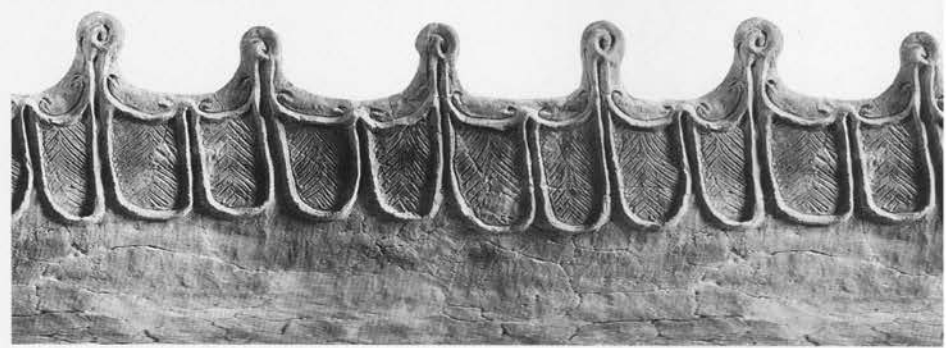

51 (14号住居)



51





縄文土器展開写真  
70 (16号住居)



70

99

96

99 (18号住居)

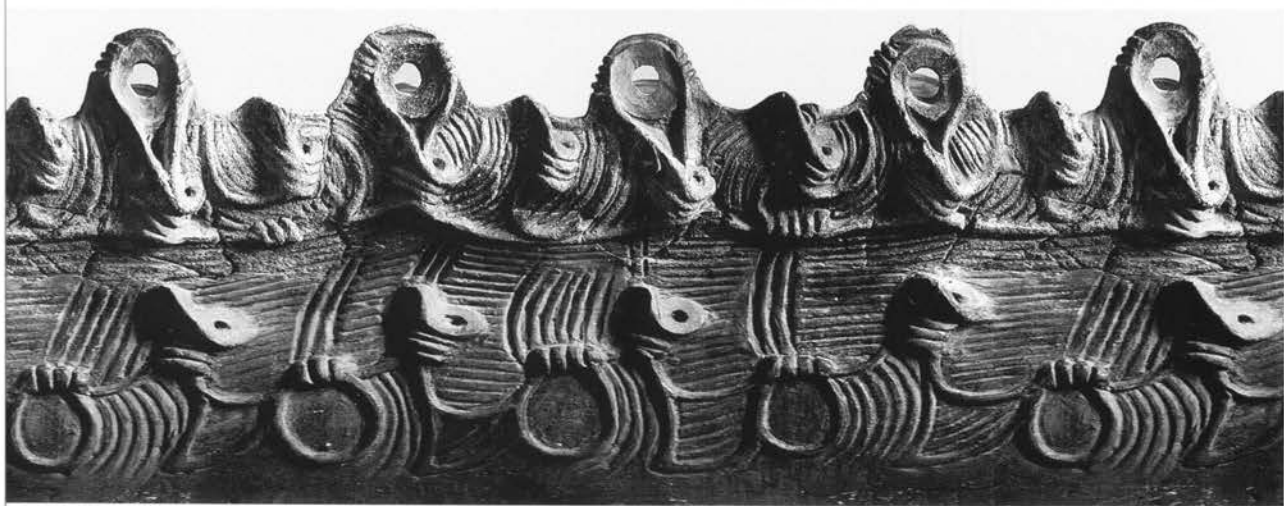

96 (18号住居)

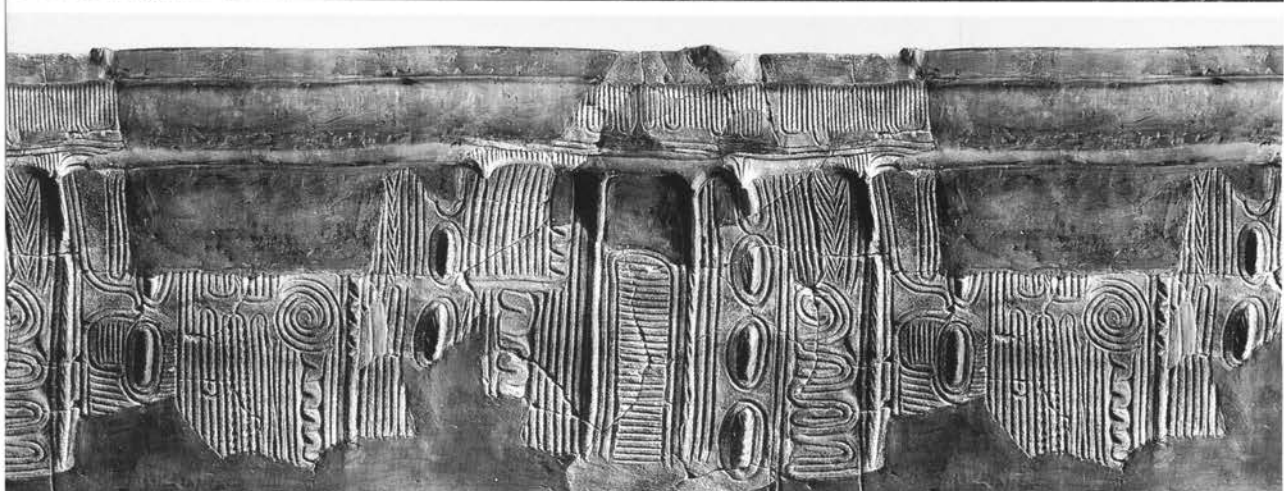

縄文土器展開写真  
112 (24号住居)



107 (24号住居)



106 (24号住居)



110 (24号住居)



109 (24号住居)



111 (24号住居)





縄文土器展開写真  
122 (25号住居)



122

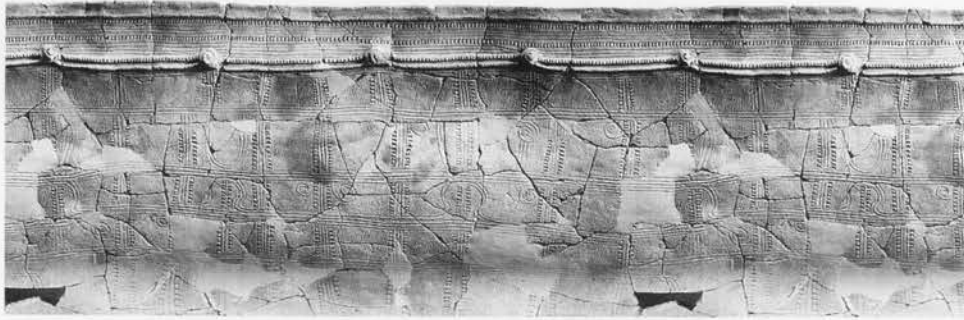

142 (24号土坑)



142



182 (44号住居)



182

180 (44号住居)

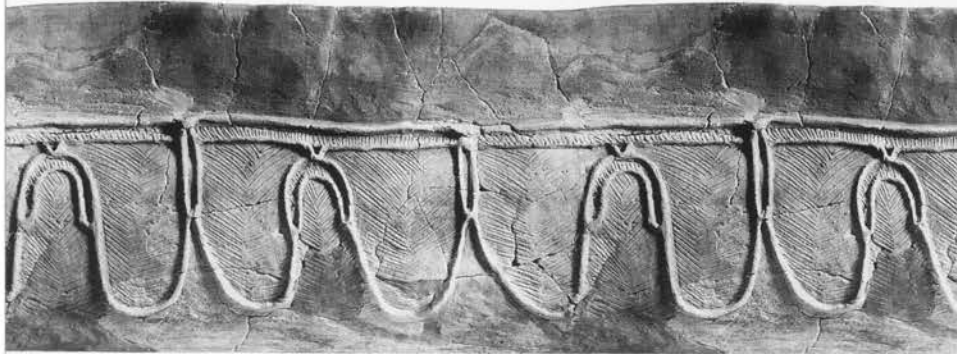

180

178 (44号住居)

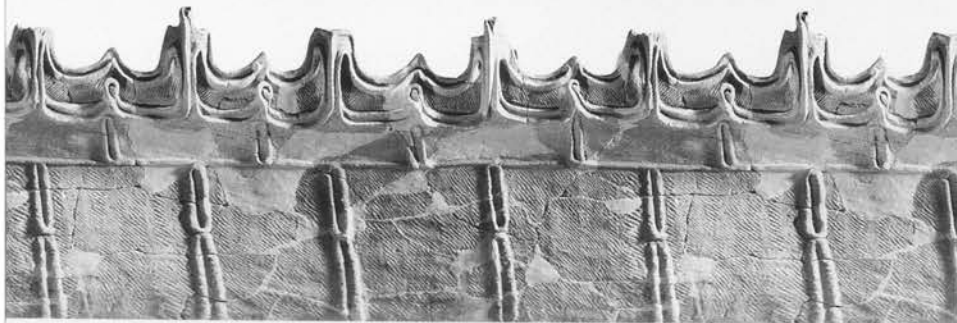

178

181 (44号住居)



181

縄文土器展開写真  
202 (69号住居)



202



220 (76号住居)



220



221 (76号住居)



221

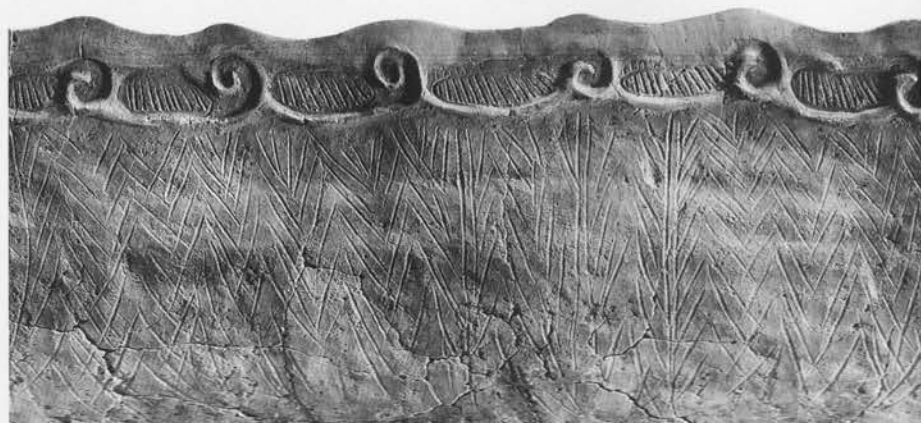

264 (89号住居)



264



373 (110号住居)



373





縄文土器展開写真  
401 (124号住居)



401

407 (126号住居)



407



540



786



915

540 (703号土坑)



786 (1235号土坑)



915 (1339号土坑)



石鏃(1)  
1 : 1

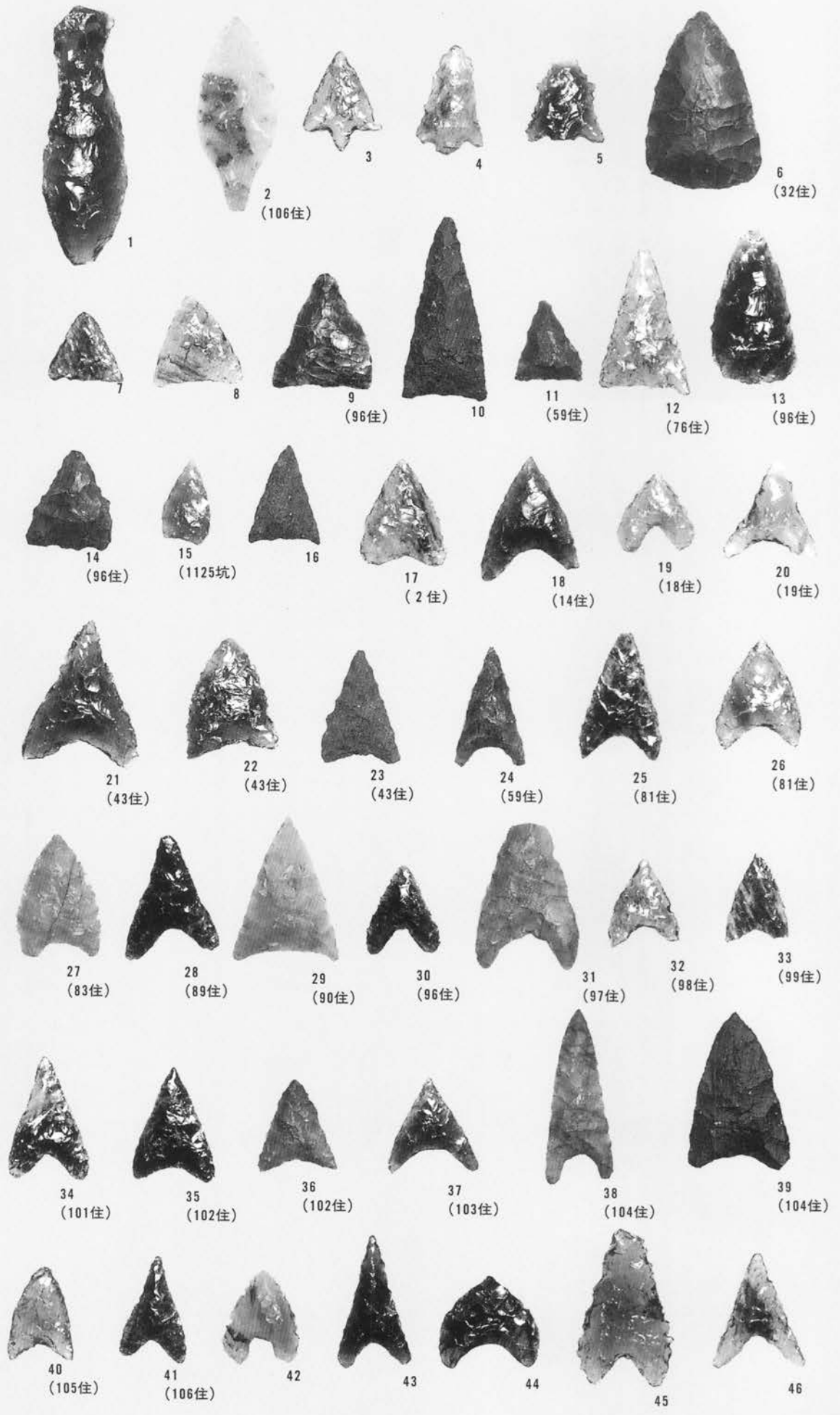

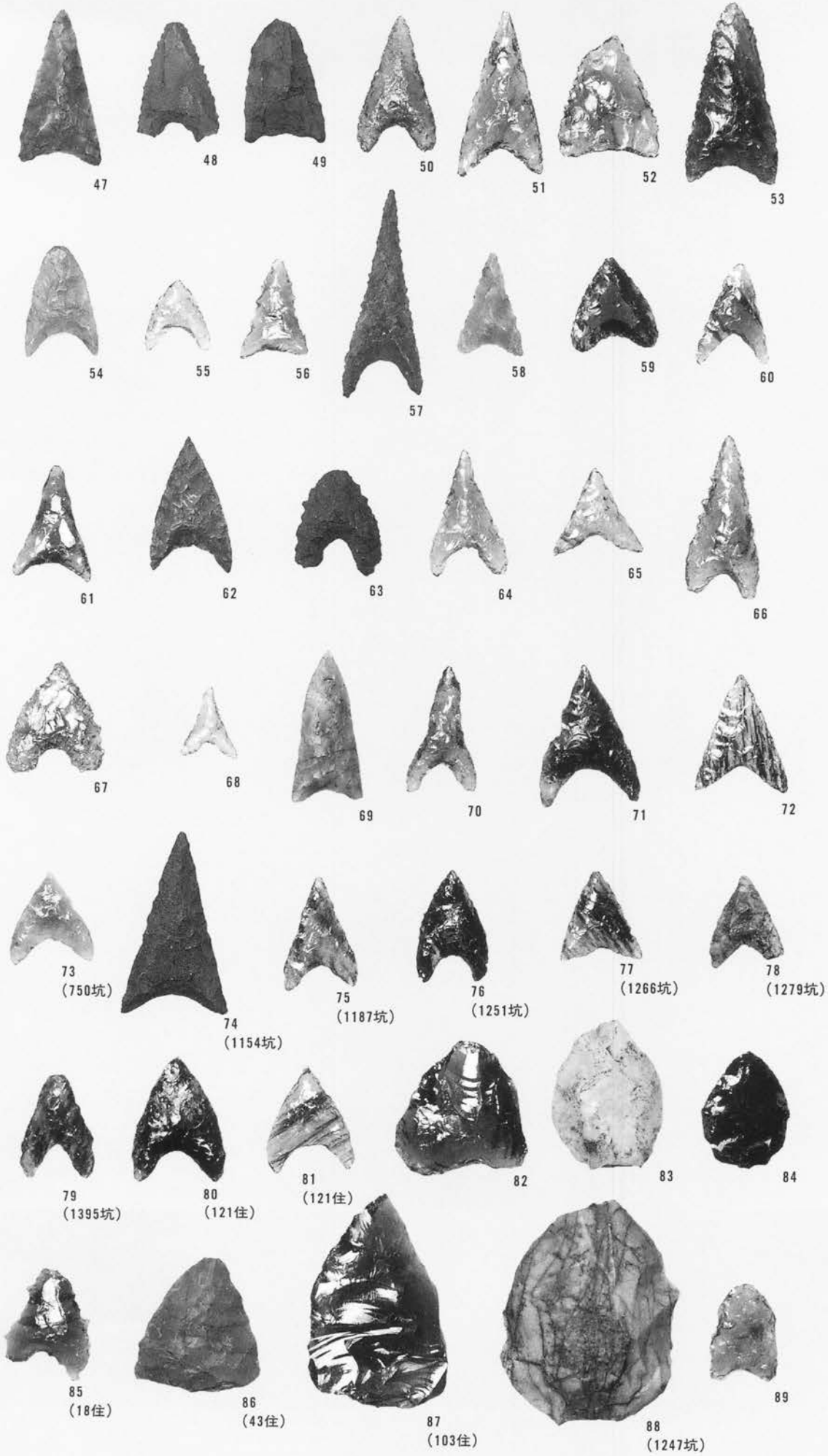

石錘  
1 : 1



90  
(32住)



91



92



93



94



95



96



97  
(104住)



98  
(44住)



99  
(88住)



100  
(104A住)



101  
(104A住)



102  
(102住)



103  
(107住)



104



105



106



107



108



109  
(1219坑)



110  
(1住)



111  
(76住)



112



113  
(1219坑)

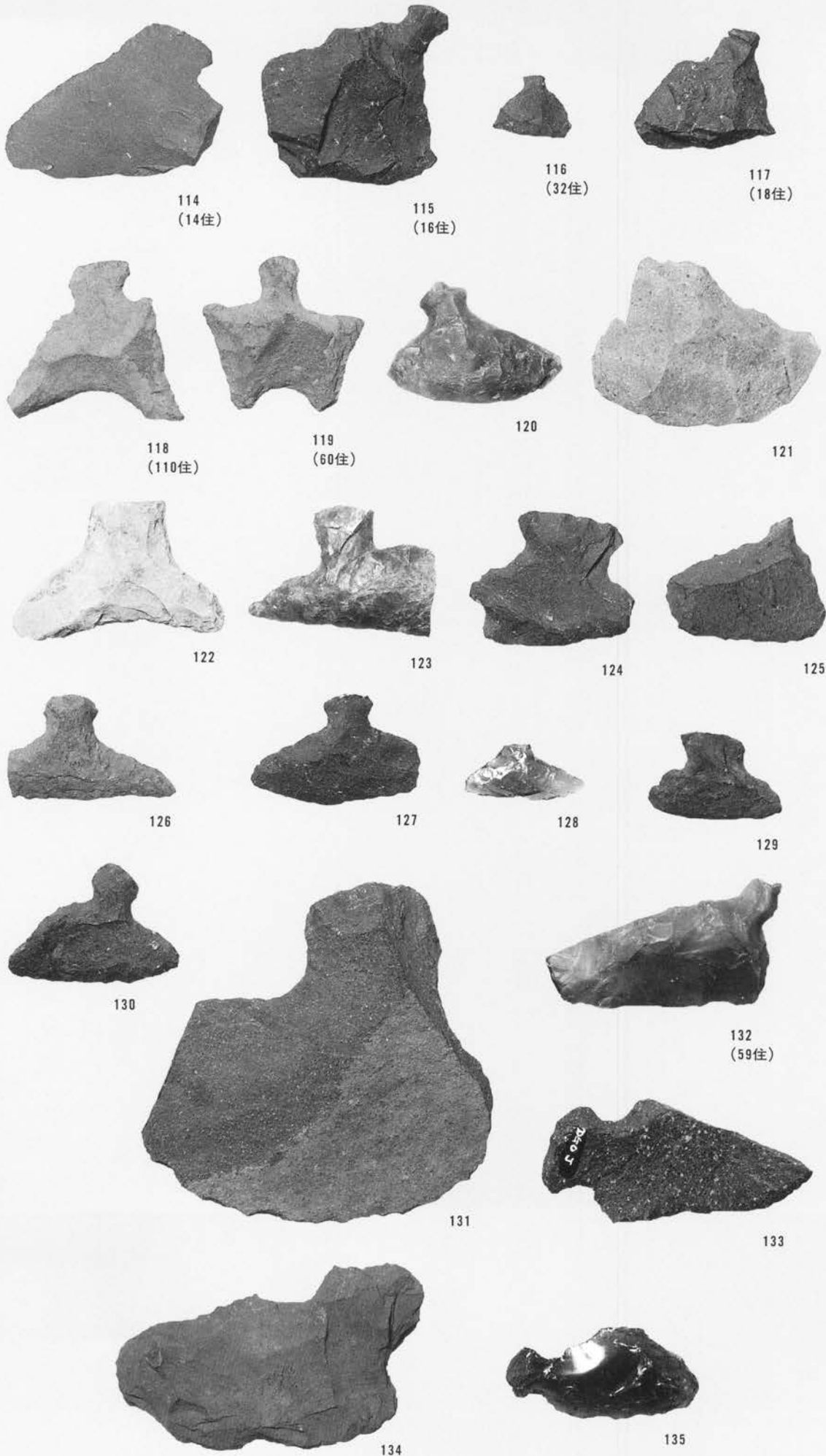



石匙(2)、スクレイパー

2 : 3

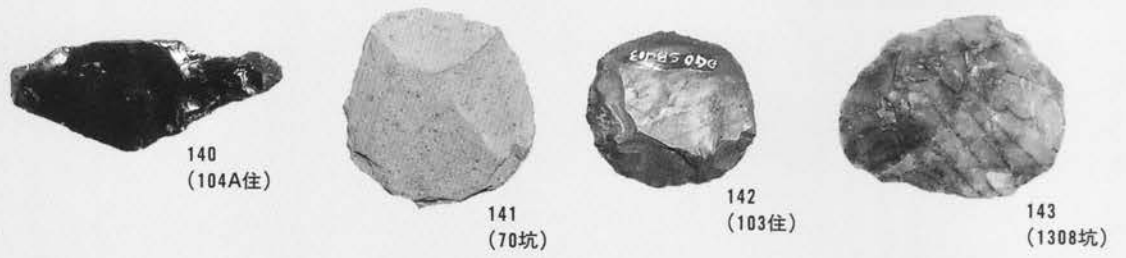

小剝離痕を有する剥片

2 : 3





165  
(6住)



166  
(44住)



167



168



169



170



171  
(43住)



172  
(76住)



174  
(170坑)



175



176



177



180



178



183



173  
(3住)



182



184  
(16住)



179



181



185  
(94住)



186  
(103住)



188  
(246坑)



189  
(1253坑)

磨製石斧 2  
1 : 2

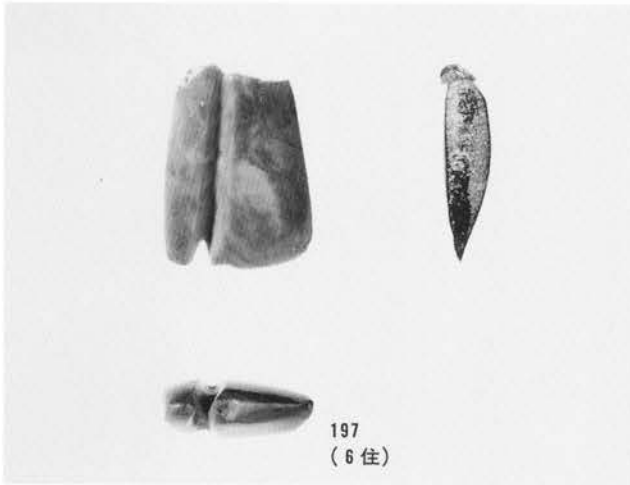
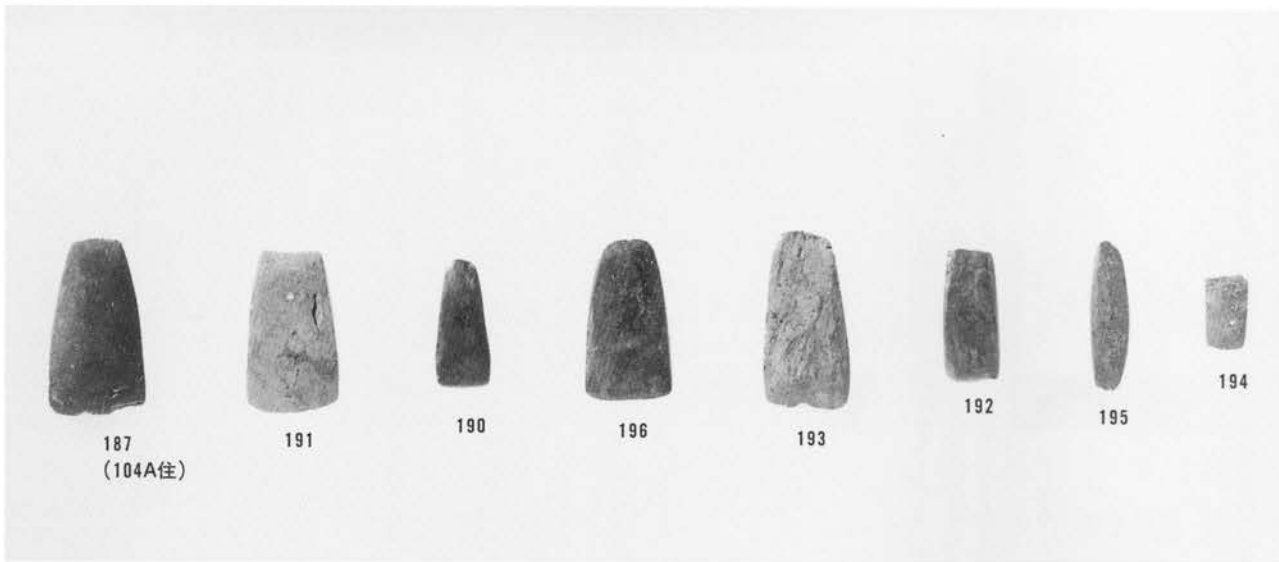

剥片 (107号住居)





199



200



201  
(76住)



202  
(90住)



203  
(1住)



204  
(106住)



205  
(121住)



206  
(131住)



207  
(1121坑)



208  
(4住)



209  
(96住)



210  
(121住)



211  
(121住)



212  
(1住)



213  
(1住)



214  
(1住)



215  
(4住)



216  
(11住)



217  
(17住)



218  
(18住)



219  
(18住)

打製石斧(2)  
1 : 3

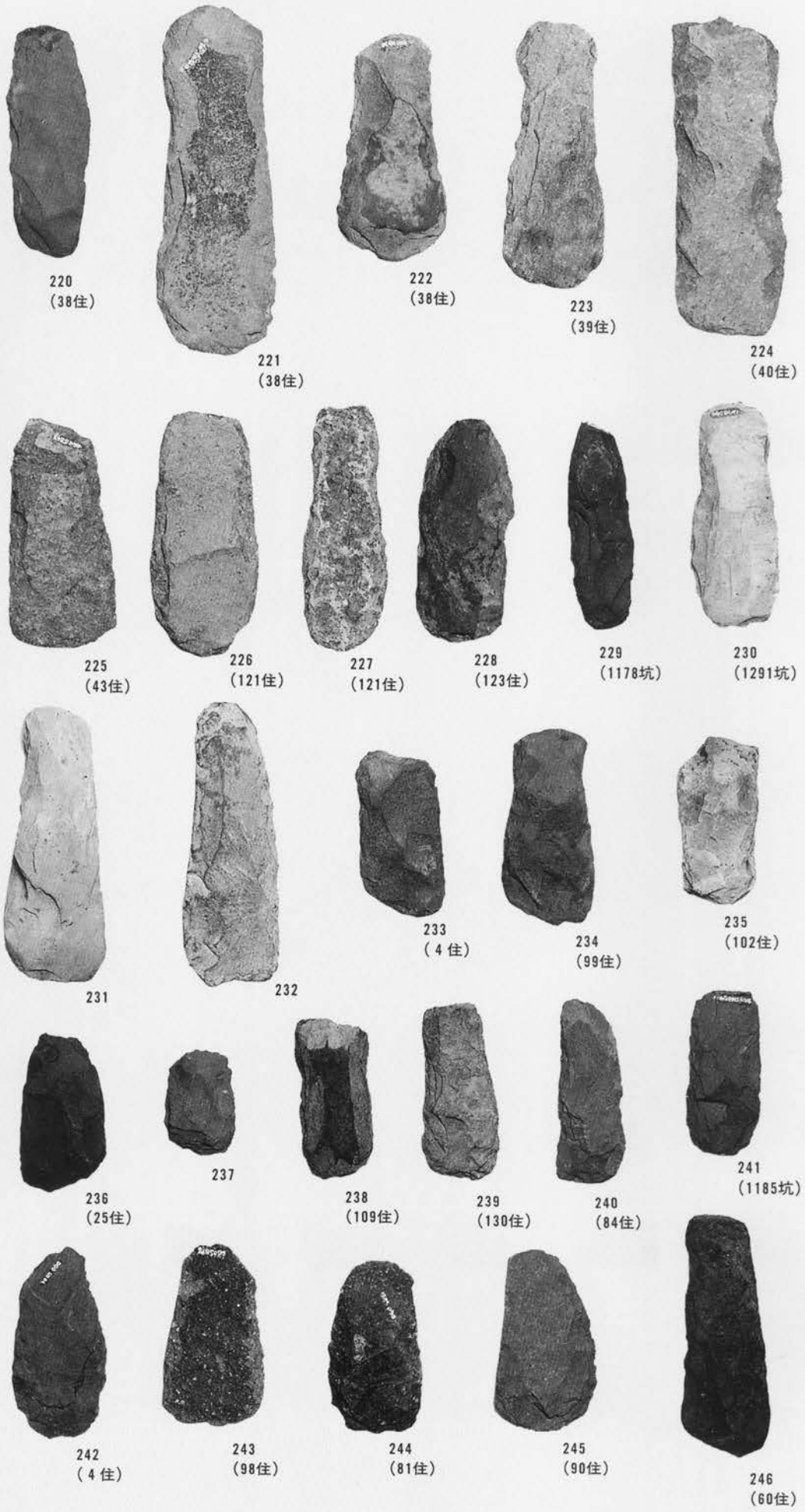



247  
(92住)



248  
(76住)



249  
(91住)



250  
(104住)



251  
(106住)



252  
(110住)



253  
(121住)



254  
(121住)



255  
(121住)



256  
(121住)



257  
(121住)



258  
(121住)



259  
(121住)



260  
(121住)



272  
(106住)



273  
(116住)



274  
(292坑)



275  
(1253坑)



276  
(121住)



277



278  
(5住)



279  
(8住)



打製石斧(4)  
1 : 3

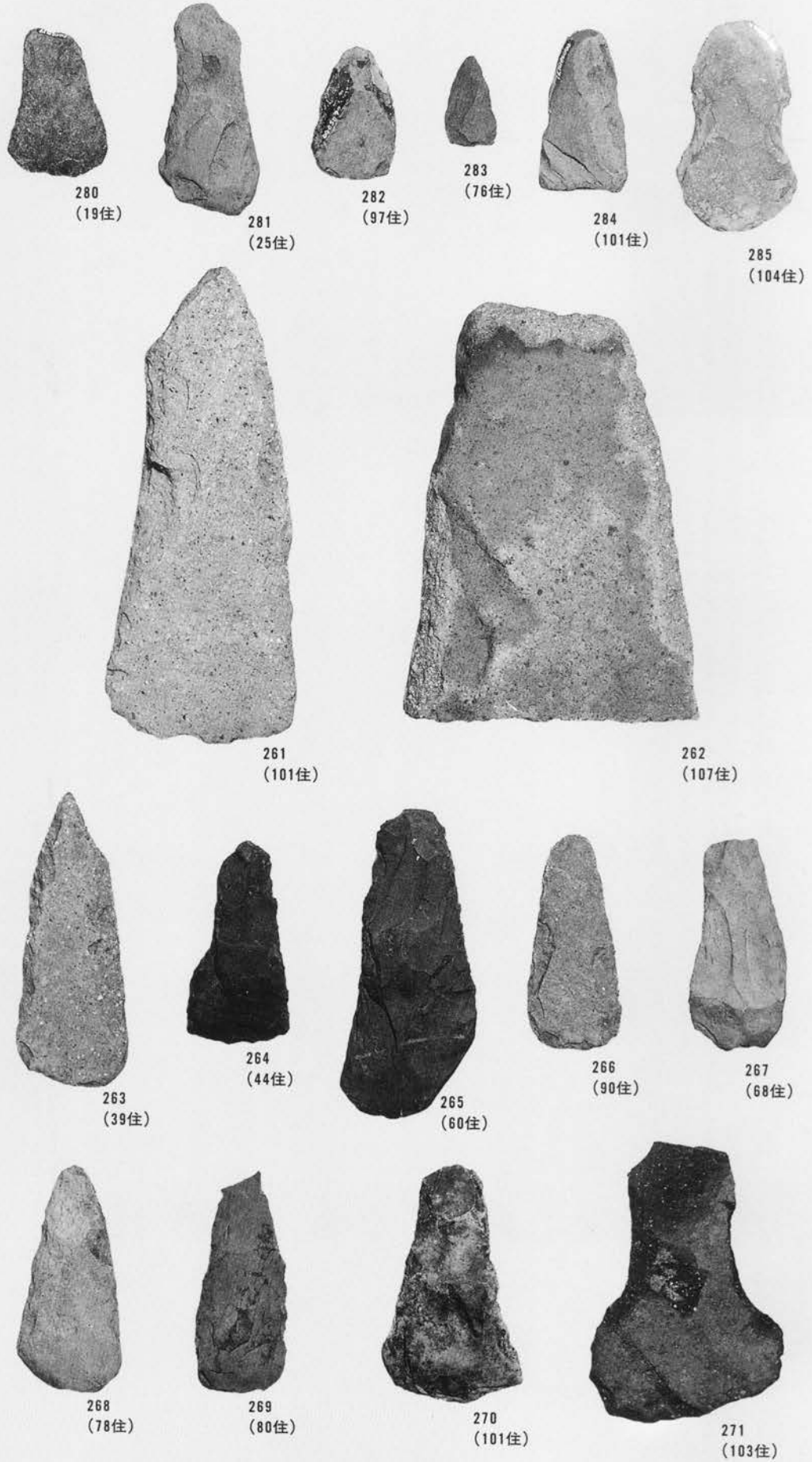





286  
(1住)



287  
(5住)



288  
(14住)



289  
(39住)



290  
(36住)



291  
(40住)



292  
(41住)



293  
(43住)



294  
(70住)



295  
(73住)



296  
(83住)



297  
(76住)



298  
(94住)



299  
(116住)



300  
(121住)

剥片石器 2  
1 : 3



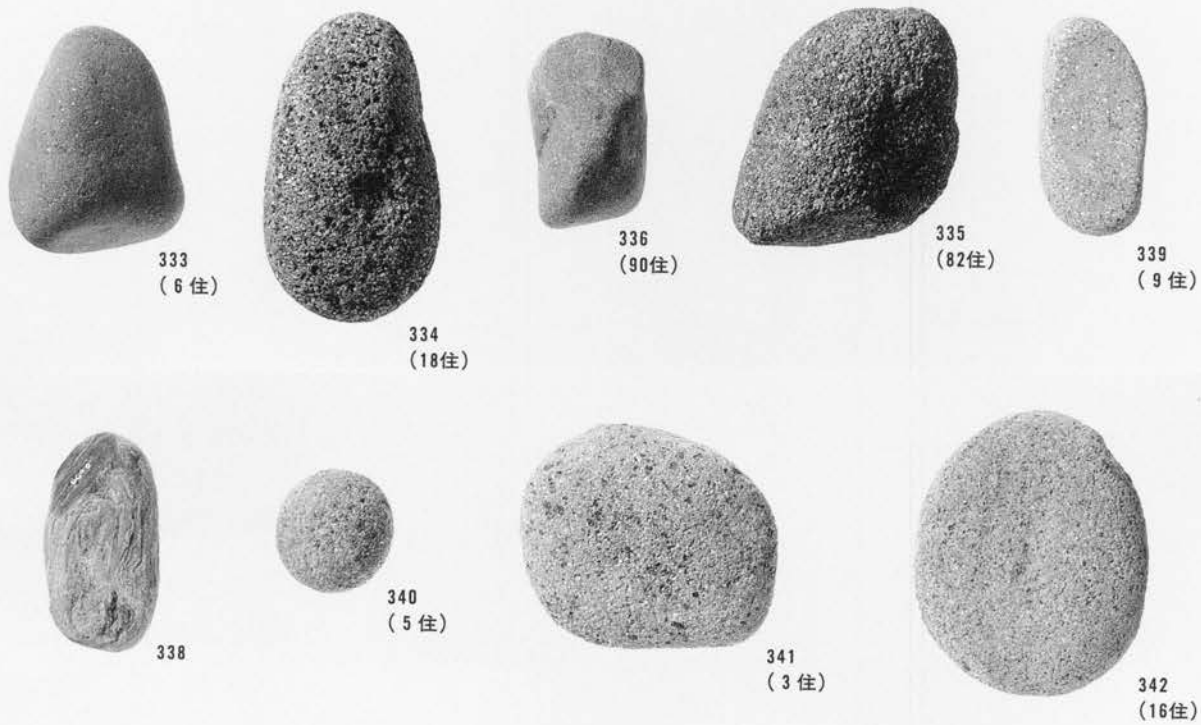
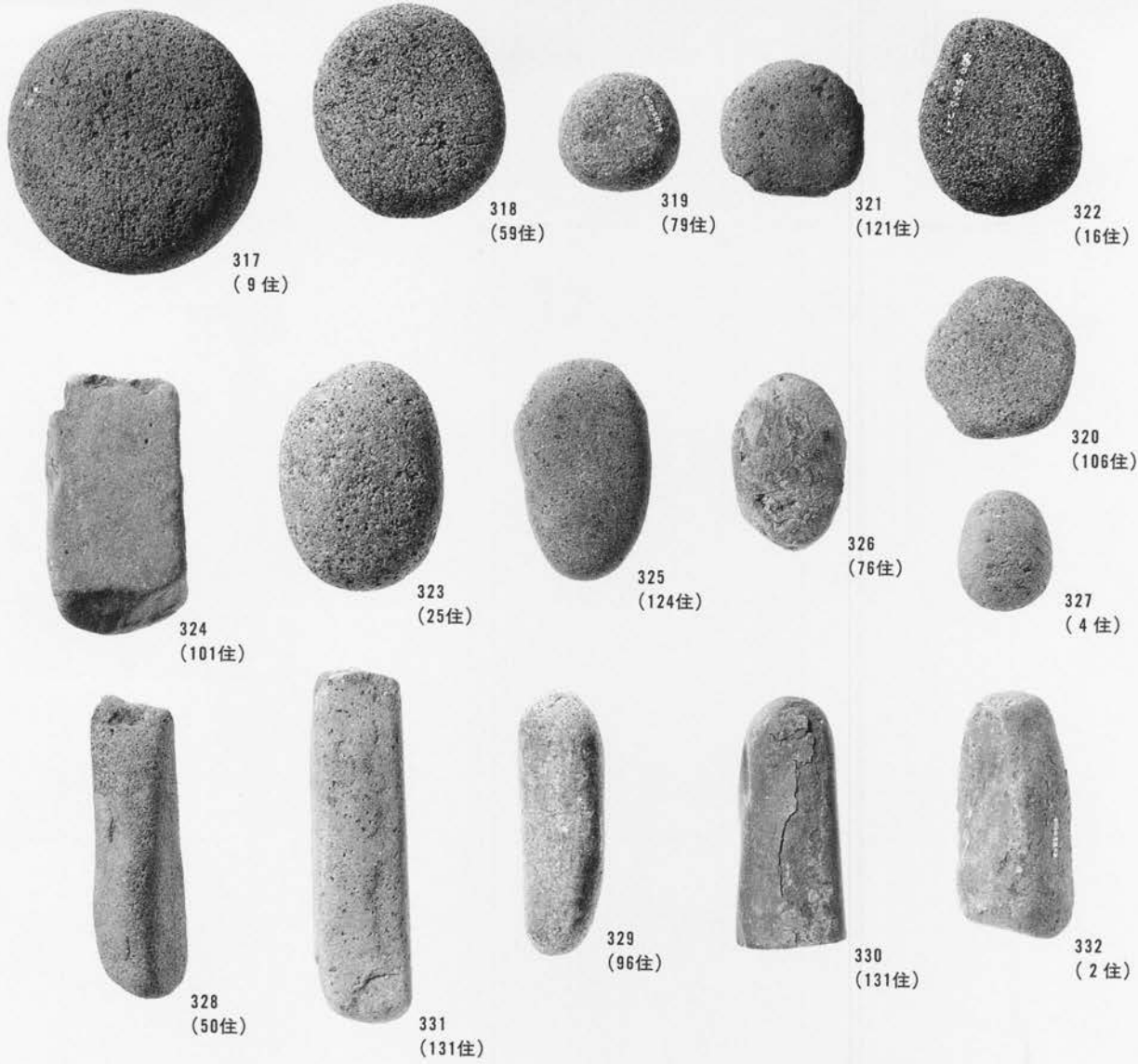

磨石類 2  
1 : 3



344  
(60住)



345  
(81住)



349  
(93住)



347  
(97住)



348  
(107住)



346  
(124住)



350  
(1045坑)



351  
(5住)



352  
(21住)



343  
(39住)



353  
(44住)



354  
(44住)



356  
(133坑)



357  
(132住)



358



360  
(18住)



361  
(38住)



362  
(44住)



363  
(110住)



364



365



366



359  
(14住)



355  
(60住)



367  
(19住)



368



370  
(19住)



371  
(70住)



372  
(105住)



369



374



373  
(25住)



375  
(12住)



376  
(19住)



377  
(97住)



378



379  
(18住)



380  
(47住)



381



382



383



384  
(59住)



385  
(93住)



386  
(1072坑)



石棒類1  
1:4



387  
(10住)



388  
(24住)



391  
(24住)



389  
(24住)



392  
(33住)



393  
(37住)



石棒類 2  
401、402 1 : 3  
他 1 : 4



397  
(39住)



394  
(37住)



396  
(39住)



402  
(83住)



401  
(83住)



403  
(94住)



409  
(769坑)

石皿1  
1:4

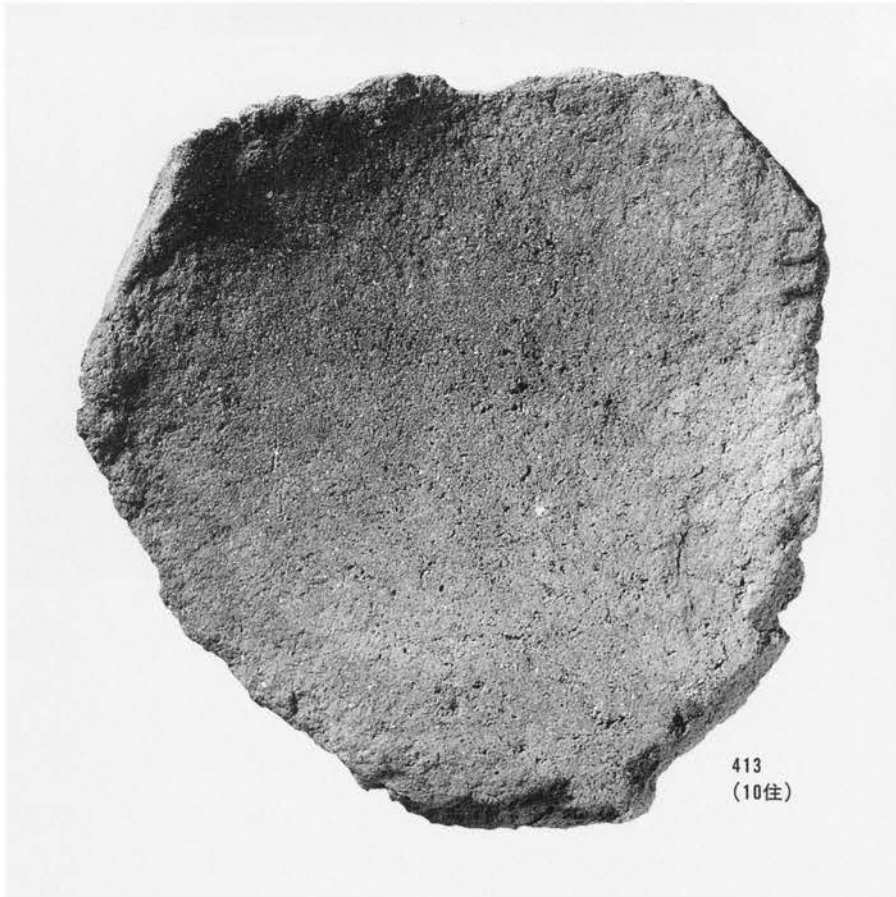

413  
(10住)



433  
(1304坑)



427  
(292坑)



423  
(集石3)



表

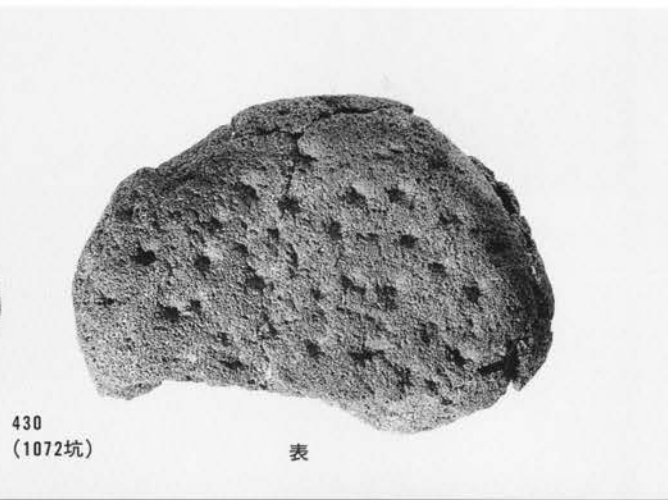

430  
(1072坑)

表



438表



438裏



440



441表

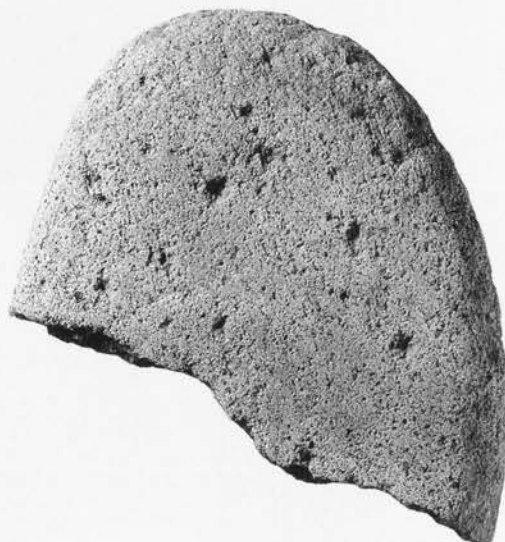

441裏

多孔石 1  
1 : 4



447  
(67住)

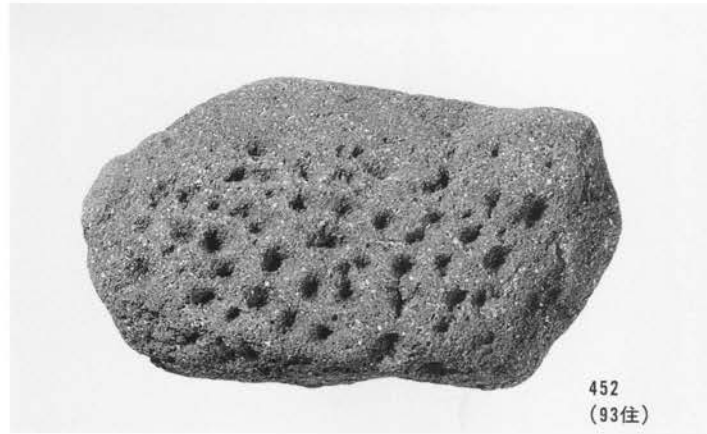

452  
(93住)

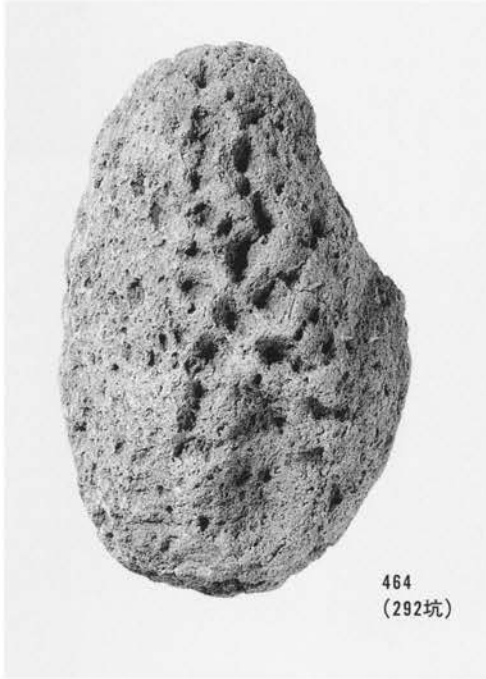

464  
(292坑)



459  
(104 A 住)



465  
(312坑)



468  
(717坑)



473  
(1131坑)



472  
(1132坑)



多孔石 2  
1 : 4



475  
(1209坑)



483  
(1380坑)



484



486



488

台石 1  
1 : 4



490  
(47住)



491  
(70住)



492  
(131住)

台石 2  
1 : 4

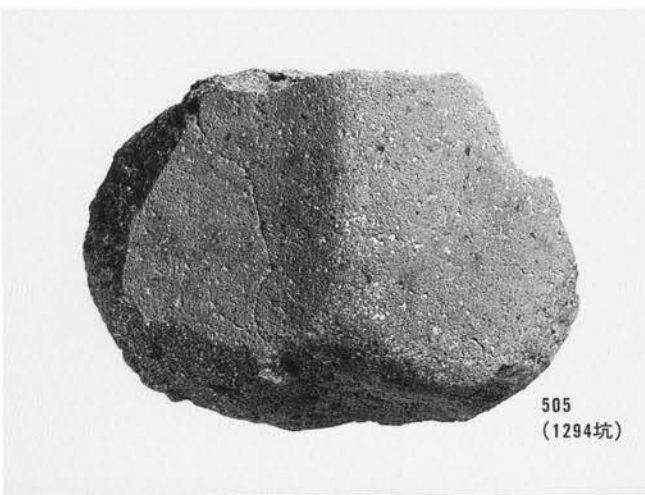
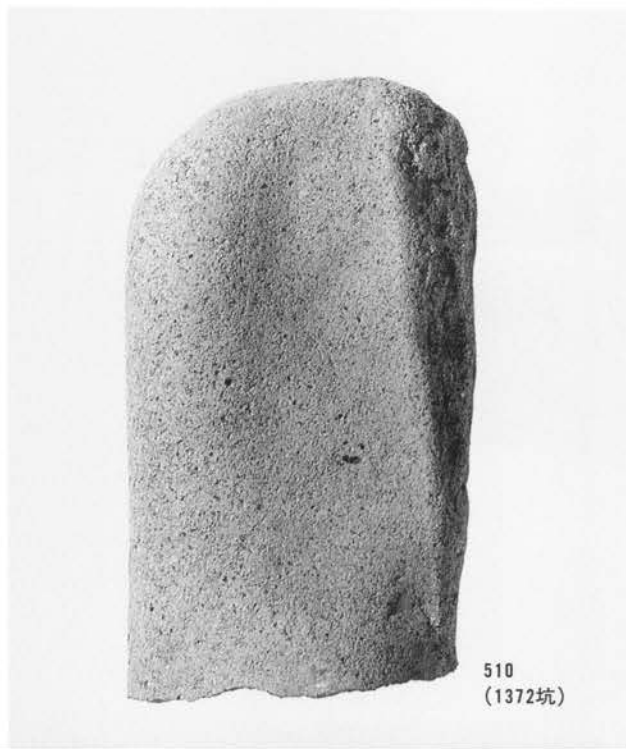



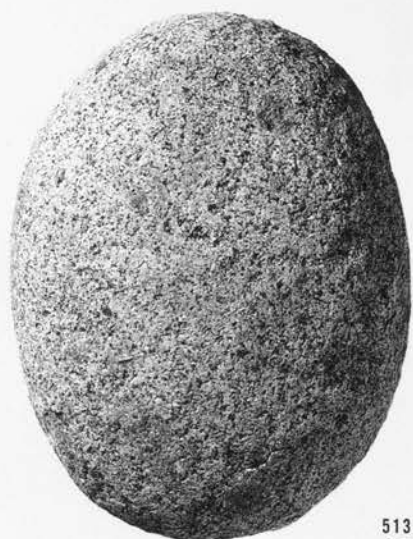

513  
(24住)



514  
(24住)



515  
(43住)



516  
(70住)



517  
(76住)



518  
(83住)



519  
(1291坑)

丸石 2

529 1 : 6  
他 1 : 4



520  
(94住)



525  
(1136坑)



526  
(1394坑)



527



528

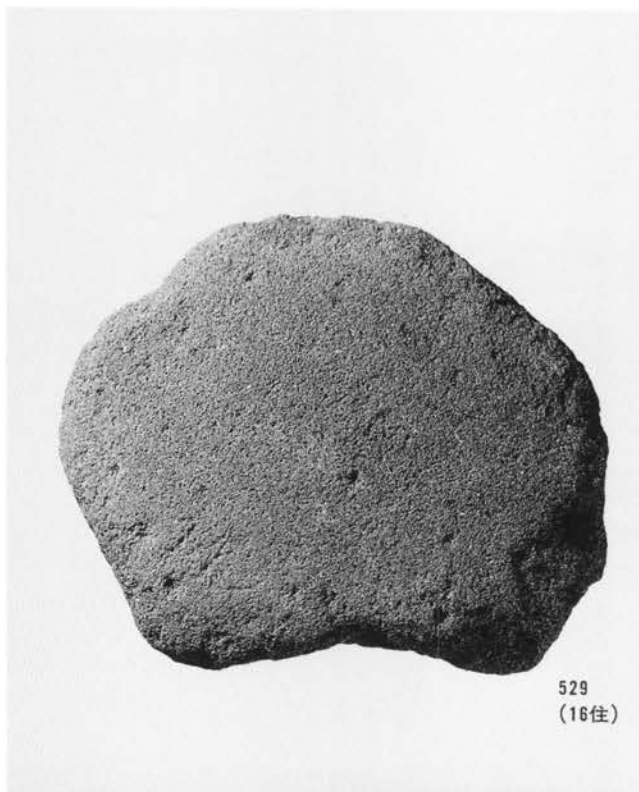

529  
(16住)

軽石製品 1  
530~532 1 : 4  
533、534 1 : 3



530  
(3住)



531  
(60住)



532表



532裏



533表  
(70住)



533立面



533裏



534表



534立面



534裏

軽石製品 2

538 1 : 4

他 1 : 3



535



535



535

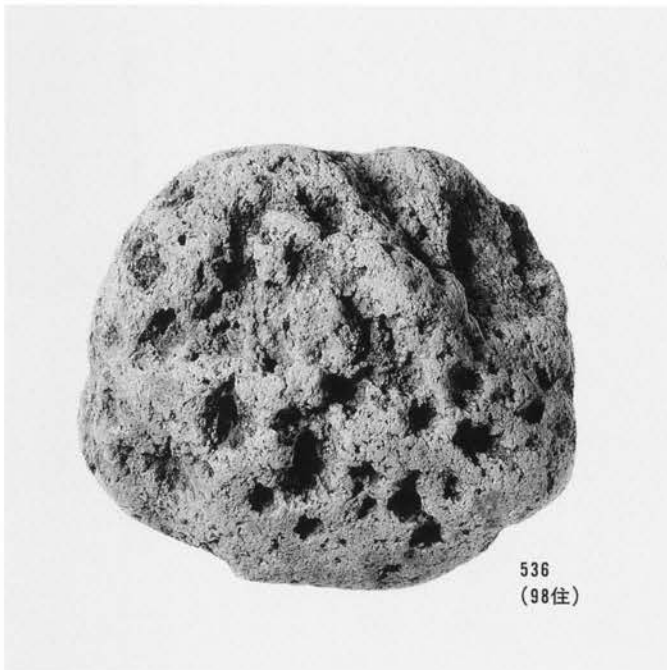

536  
(98住)

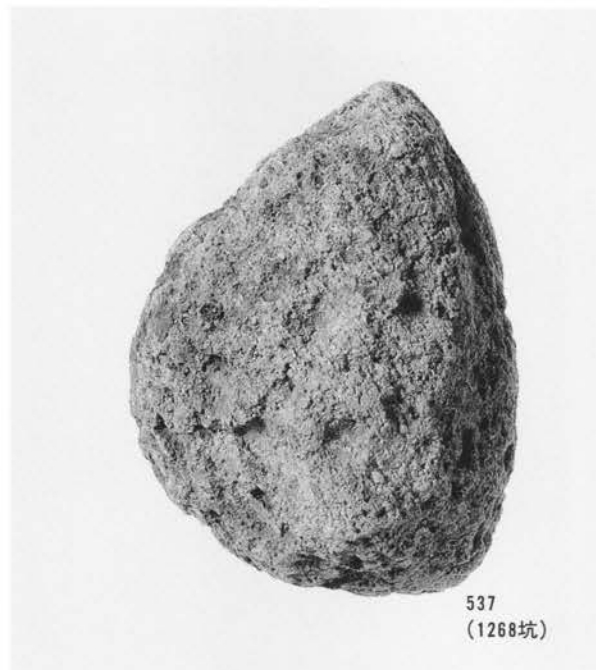

537  
(1268坑)

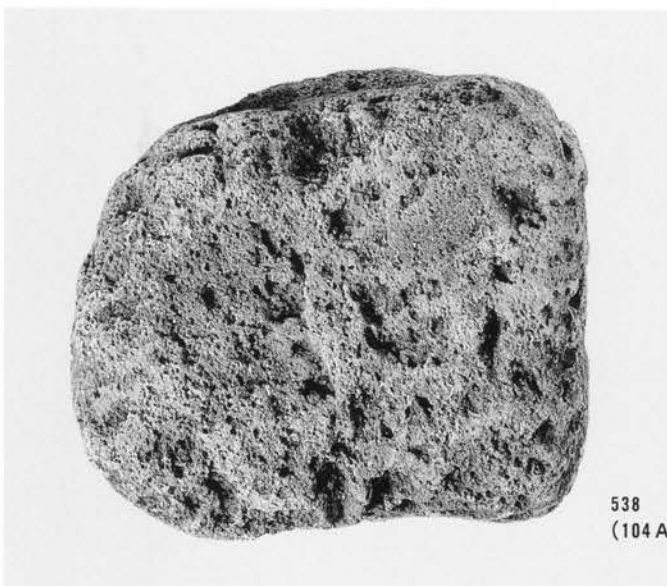

538  
(104 A 住)

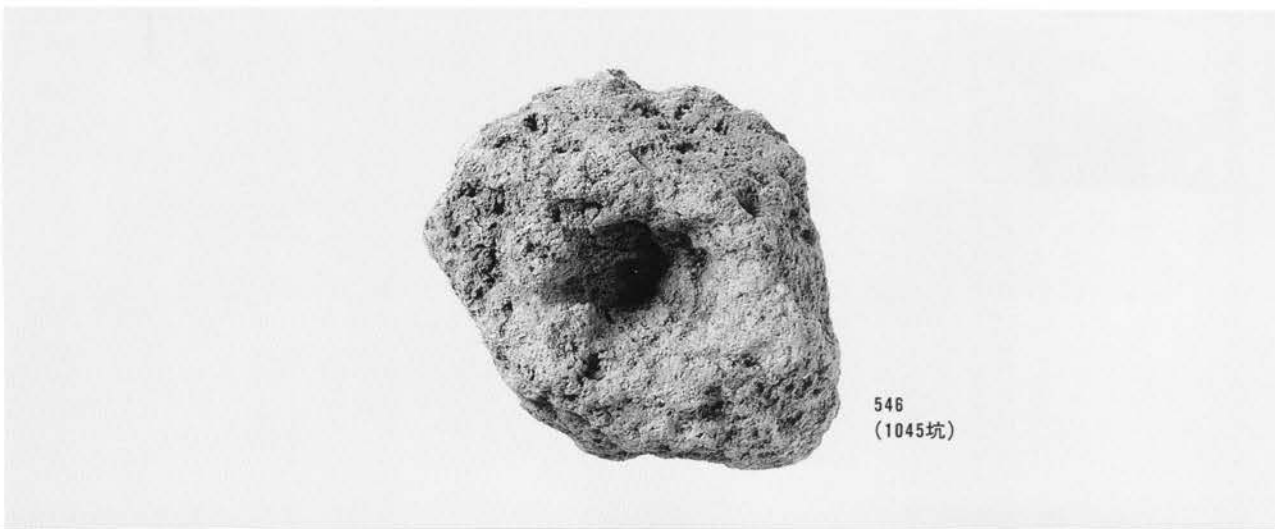
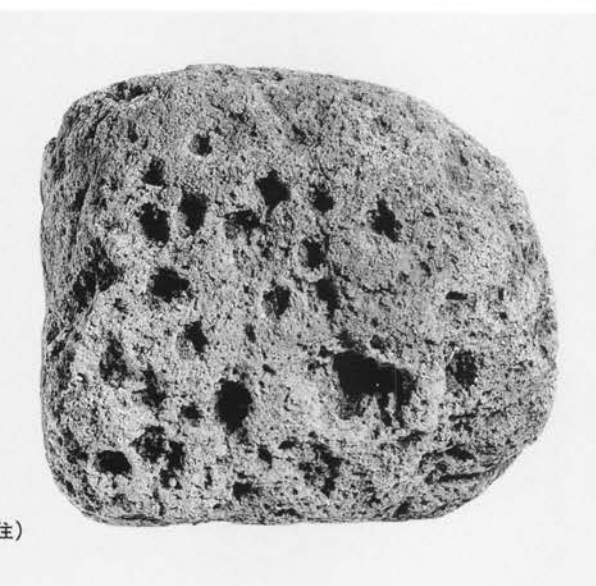

546  
(1045坑)

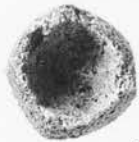

556  
(76住)



557  
(89住)



558  
(94住)



559  
(99住)



560  
(121住)



561  
(1223坑)



562  
(652坑)



563  
(99住)



564  
(4住)



565  
(103住)



543



544  
(121住)



545  
(70住)



547  
(33住)



548  
(95住)



軽石製品 4  
539~542、  
564、567 1 : 3  
他 1 : 4



539  
(4住)



540  
(44住)



541  
(70住)



542  
(83住)



564  
(4住)

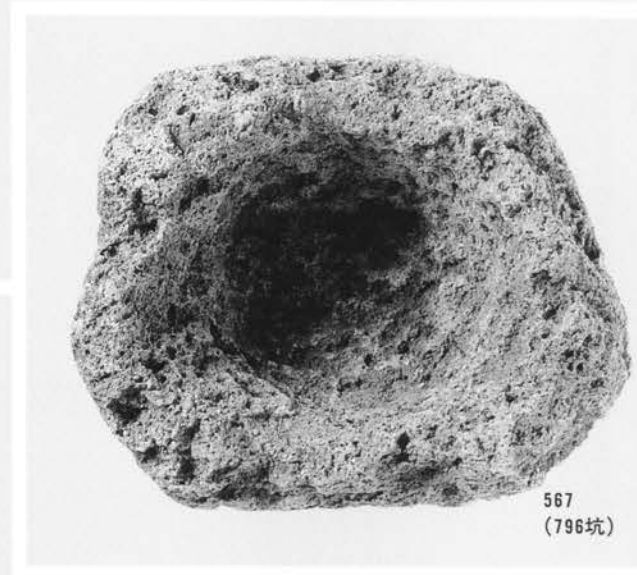

567  
(796坑)



568



569  
(1154坑)



571  
(76住)

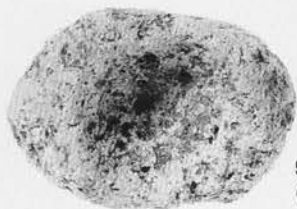

572  
(124住)



554  
(70住)



556  
(76住)





550  
(1134坑)



549



551



552



573  
(99住)



574  
(103住)



575  
(90住)



576



577



578  
(121住)



579  
(1133坑)



581  
(111住)



582



583



586



584



580  
(11住)



588  
(83住)

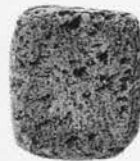

589  
(83住)



585



587  
(15住)



591  
(110住)

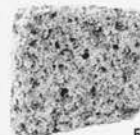

592  
(121住)



593  
(125住)



594  
(1238坑)



595  
(1308坑)



596  
(1390坑)

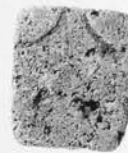

601



599



597



600



598



602  
(43住)



590  
(89住)



603  
(272坑)



604



605

軽石製品 6  
1 : 3

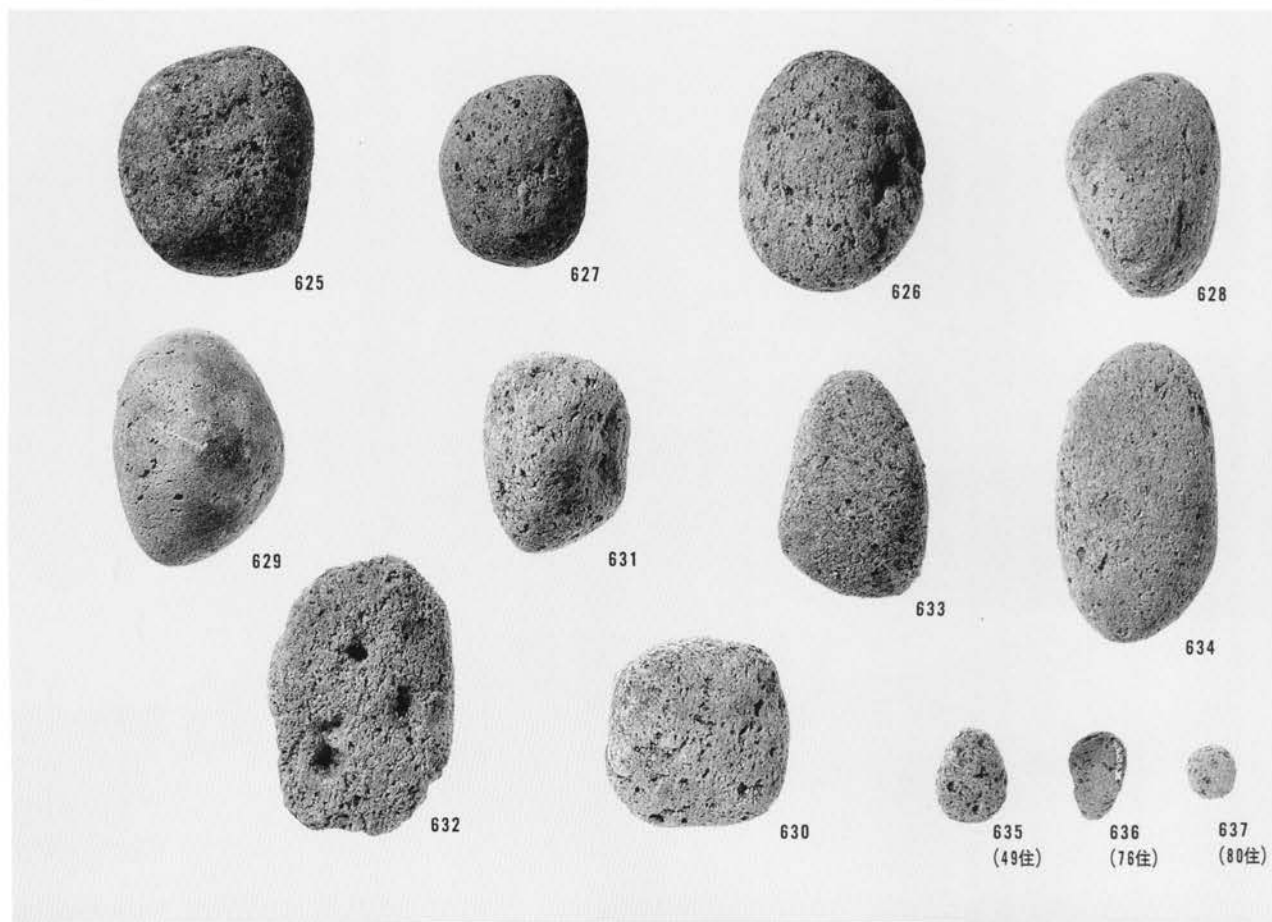
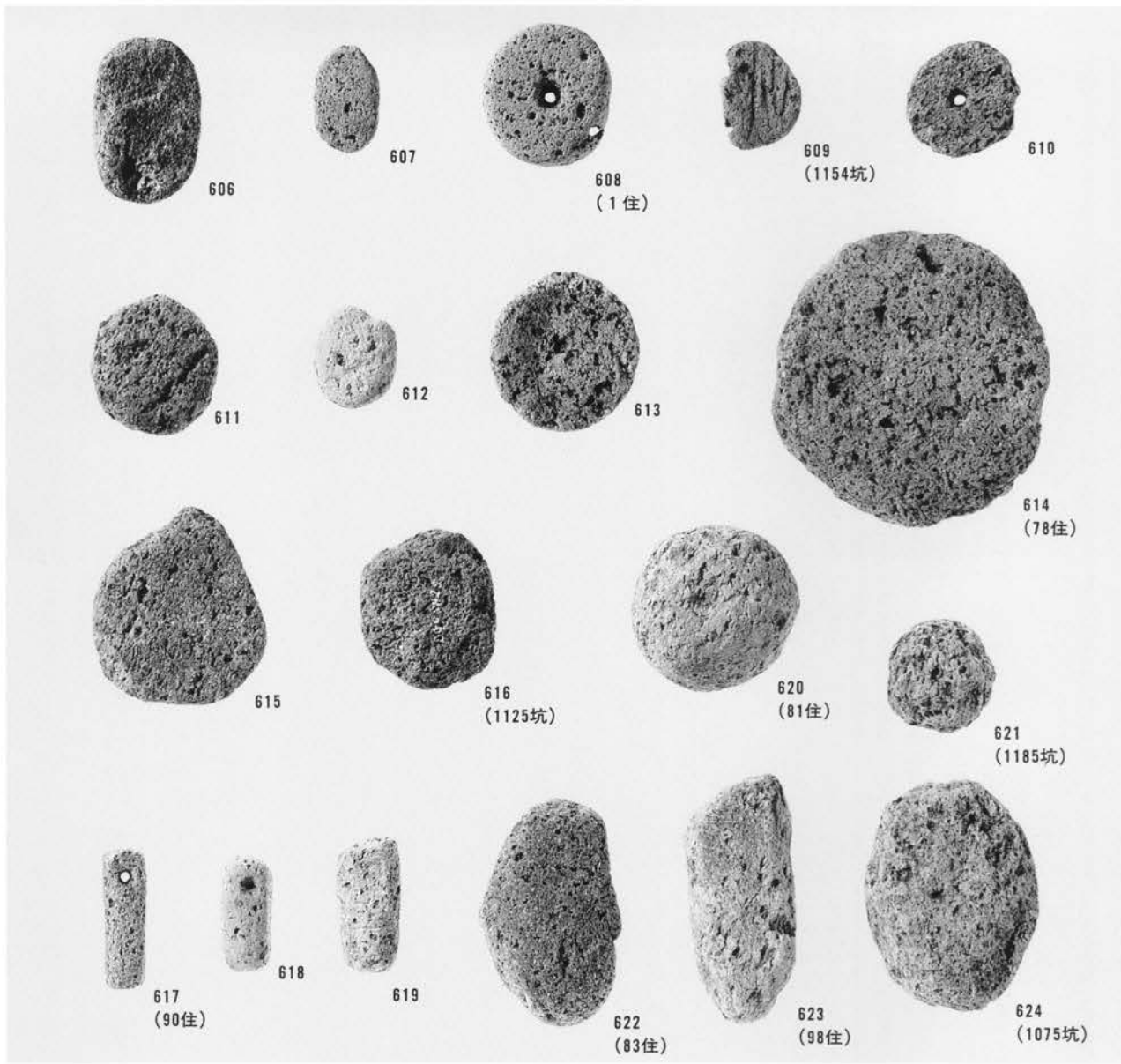

軽石製品 7  
638、639 1 : 4  
640~642 1 : 3



638  
(1269坑)



640



641

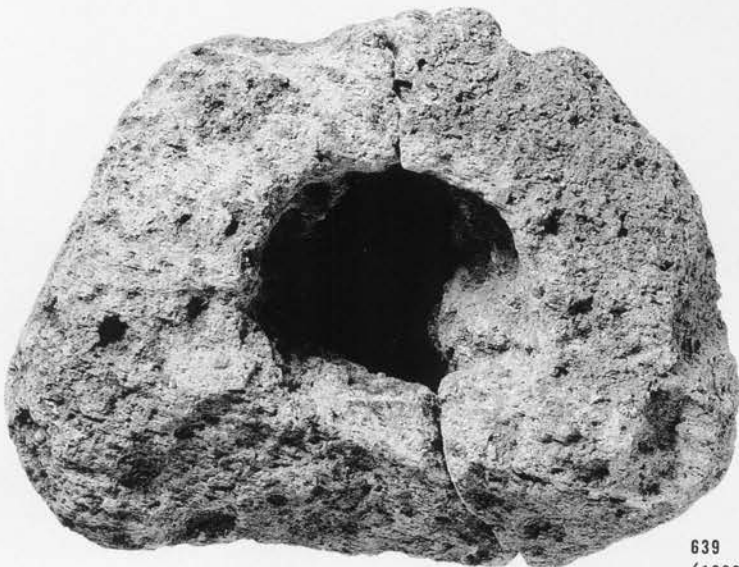

639  
(1269坑)



642

軽石製品 8

653 1 : 2

他 1 : 3



643  
(101住)

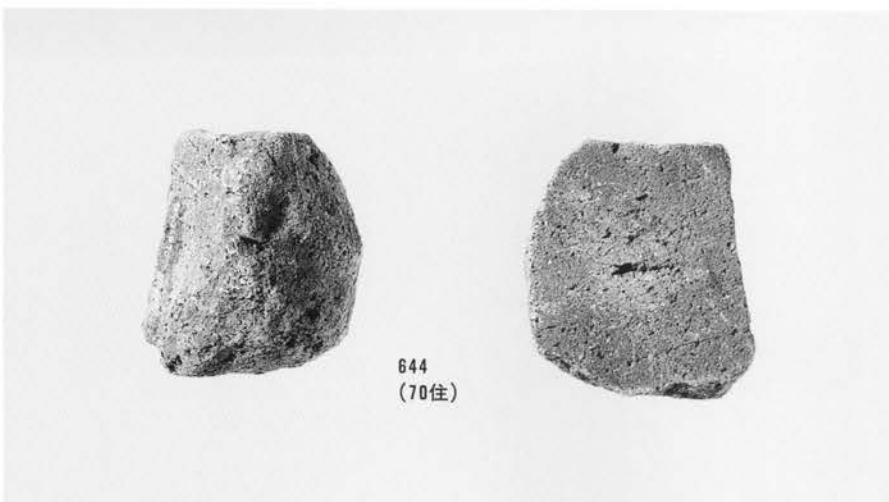

644  
(70住)



647  
(41住)



646



645  
(103住)



648



650



649

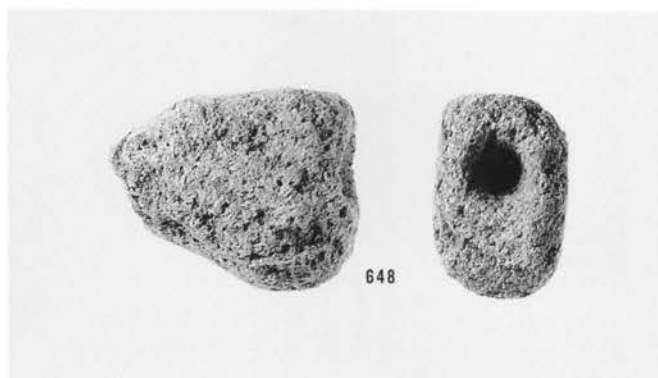

648

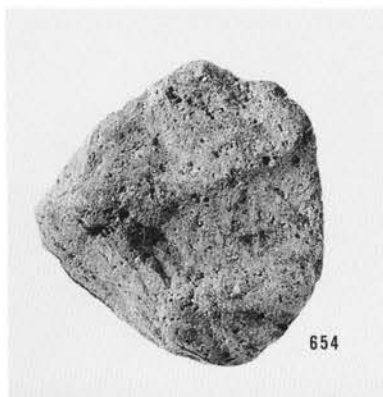

654



653



652  
(123住)



655

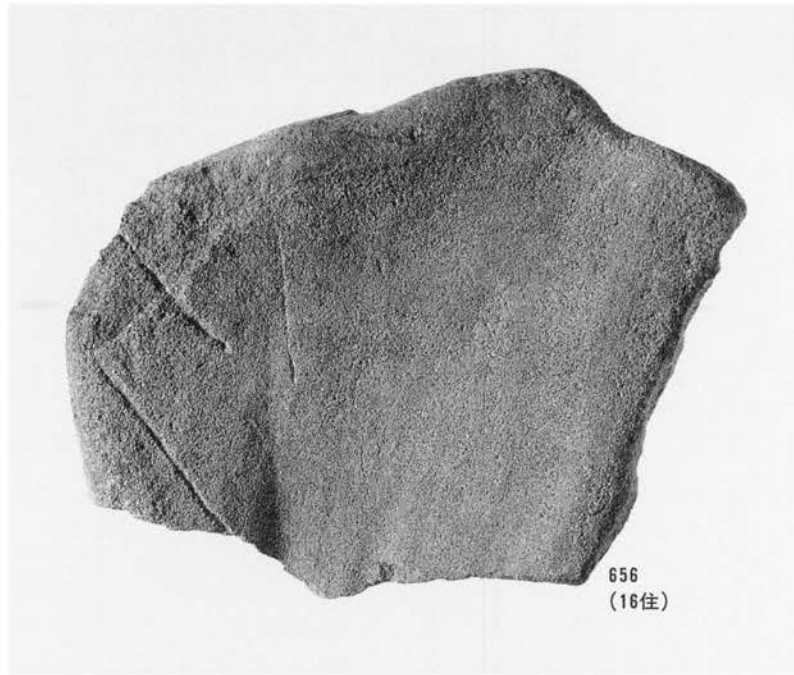

656  
(16住)



657

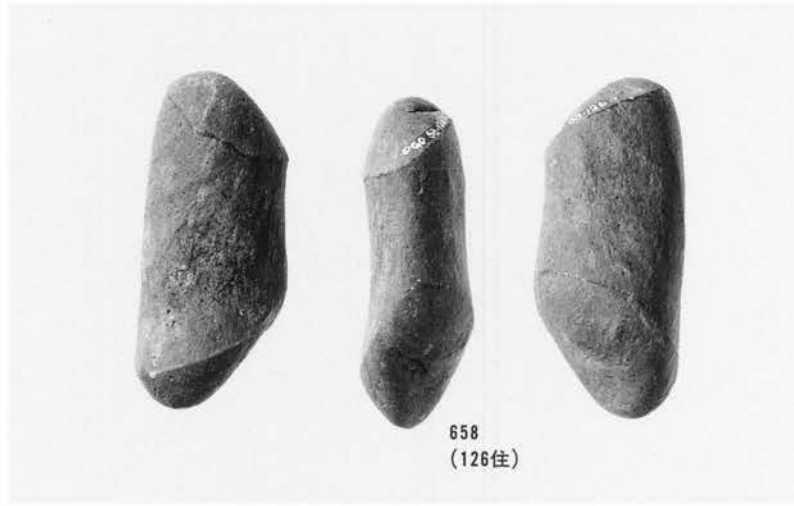

658  
(126住)



662



663  
(90住)



659



660



661

砥石 1

655、656 1 : 2  
657 1 : 4

その他の石器など

658 1 : 2  
他 1 : 3

古代の砥石



1



土偶 1  
1 : 2



1



2  
(43住)



3



5  
(91住)



4



9



6



8  
(脚部1268坑)



10  
(94住)



24  
(90住)





25



26



33



27



11



12



13



14



20

土偶 3  
1 : 2

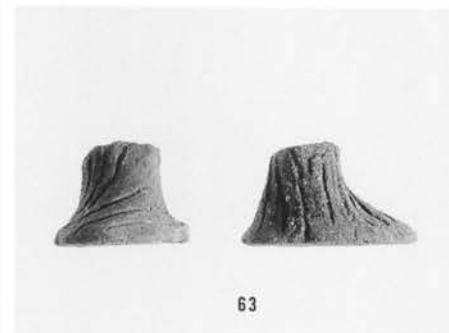
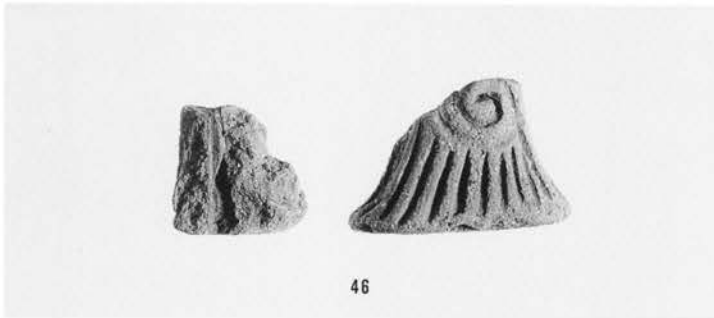

土製品 1  
1 : 2

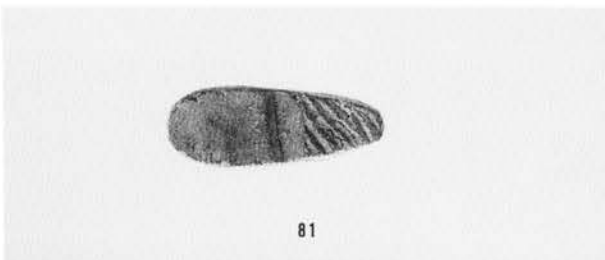
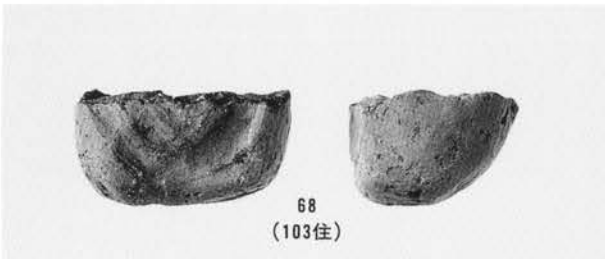

土製品 2  
71~73 1 : 1  
他 1 : 2



71  
(101住)



74  
(131住)



75  
(16住)



72  
(6住)



73  
(22住)



76



77



80



78



79

1125号土坑の鹿角  
1 : 2

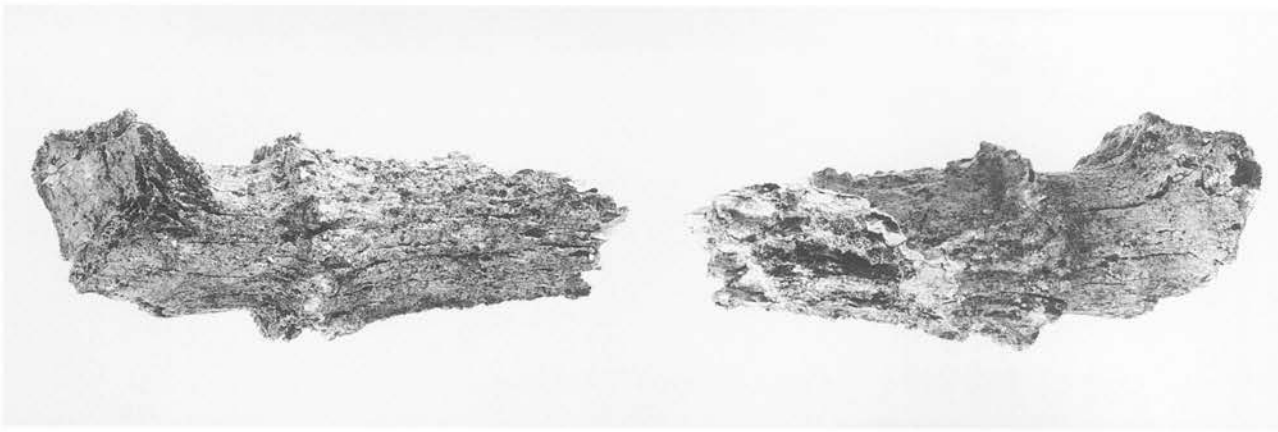

1278号土坑の骨類

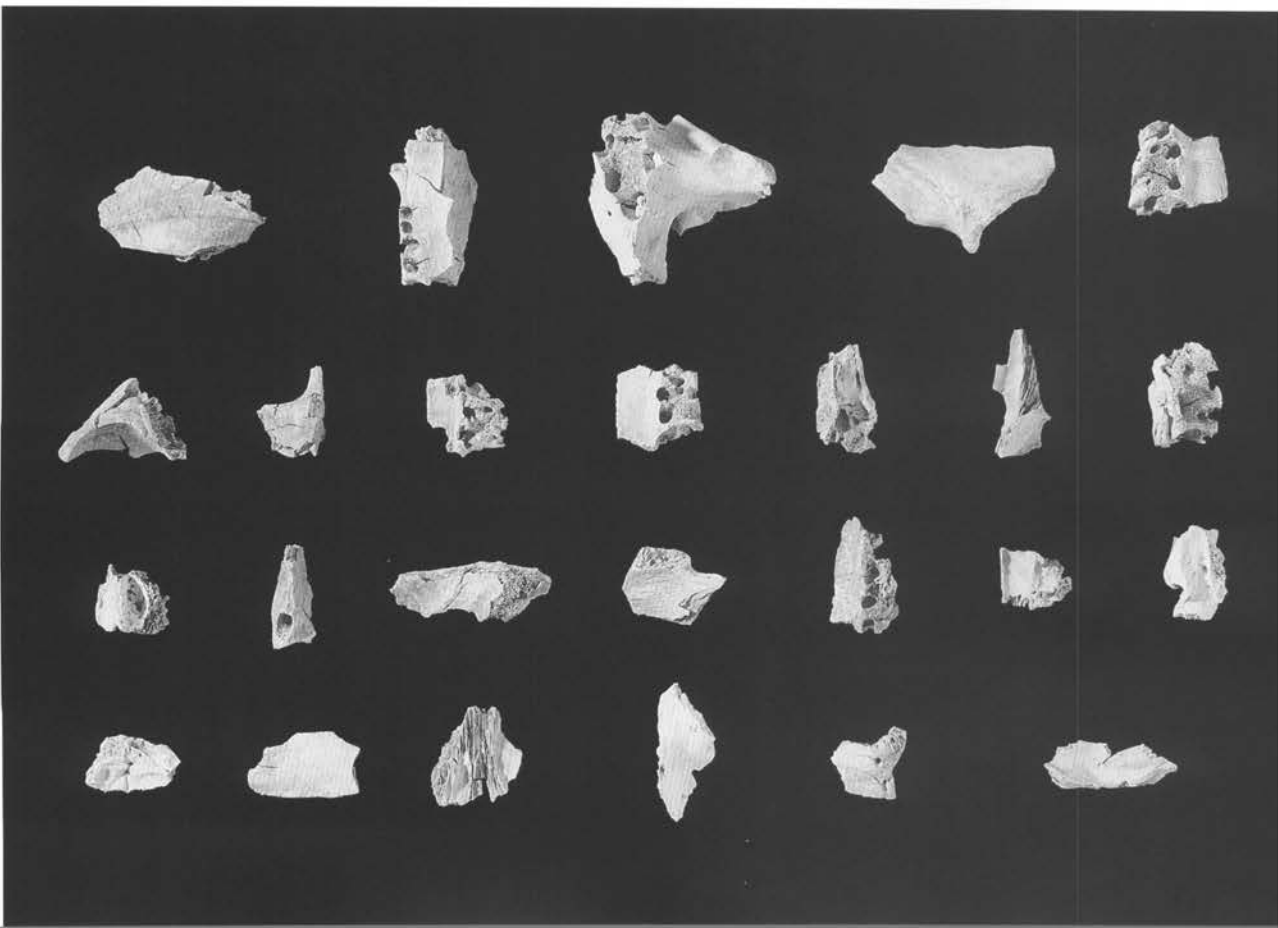
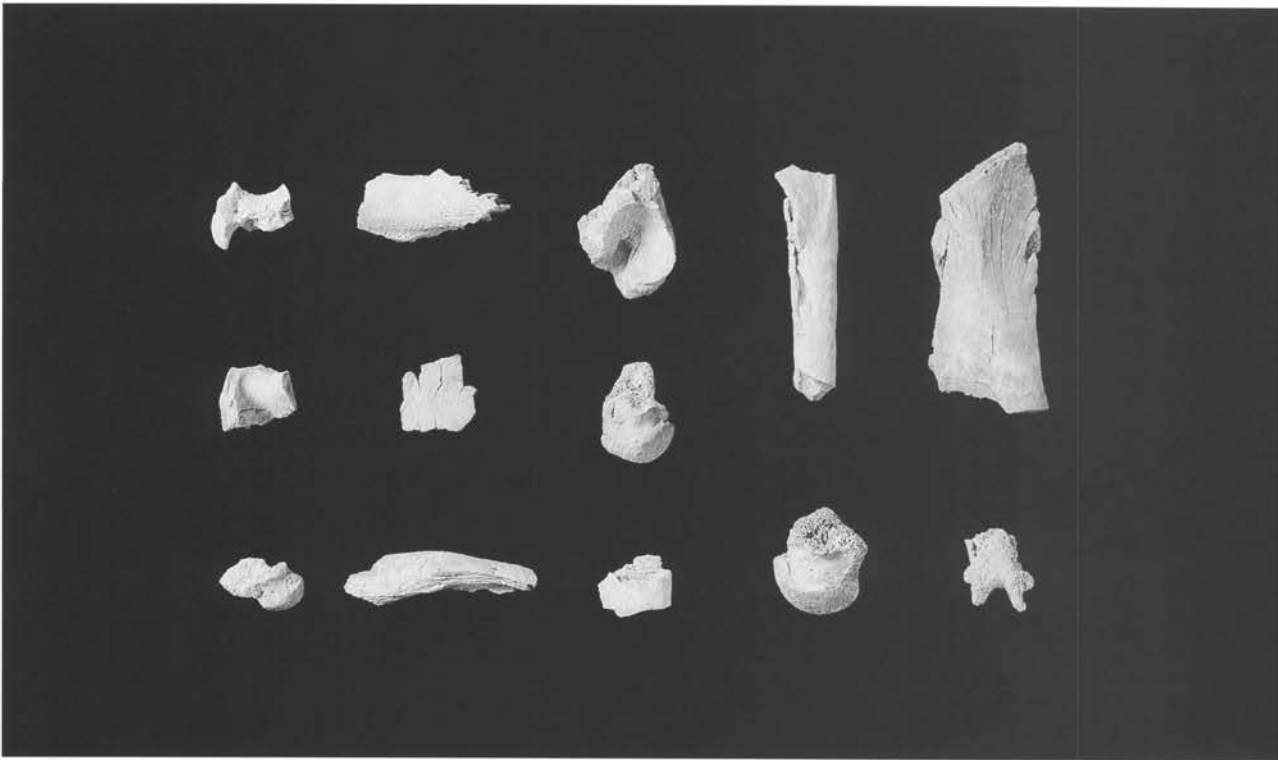



1  
(郷土2号墳)



11



21



4  
(33坑)



3  
(33坑)



10



和同開珎



1  
(1溝)



2  
(1溝)



16



17



遺跡遠景（南から）



遺跡近景（東から）





1号竖穴住居跡

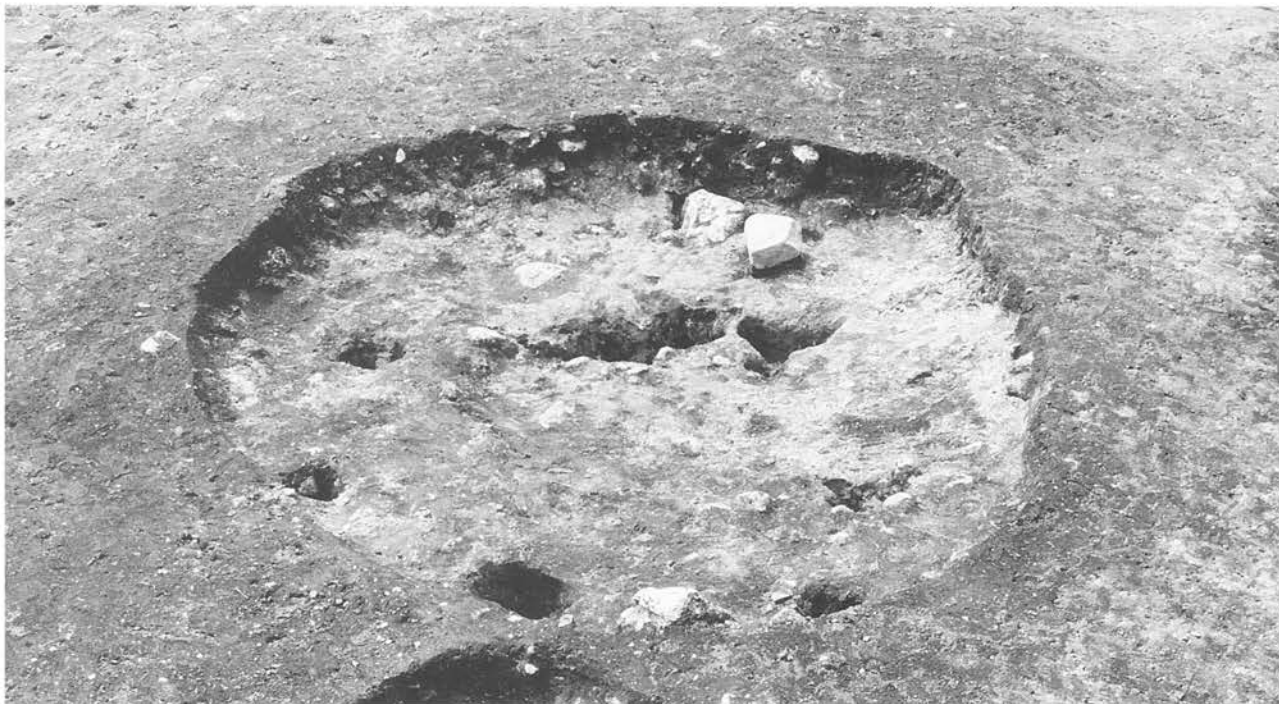

2号竖穴住居跡

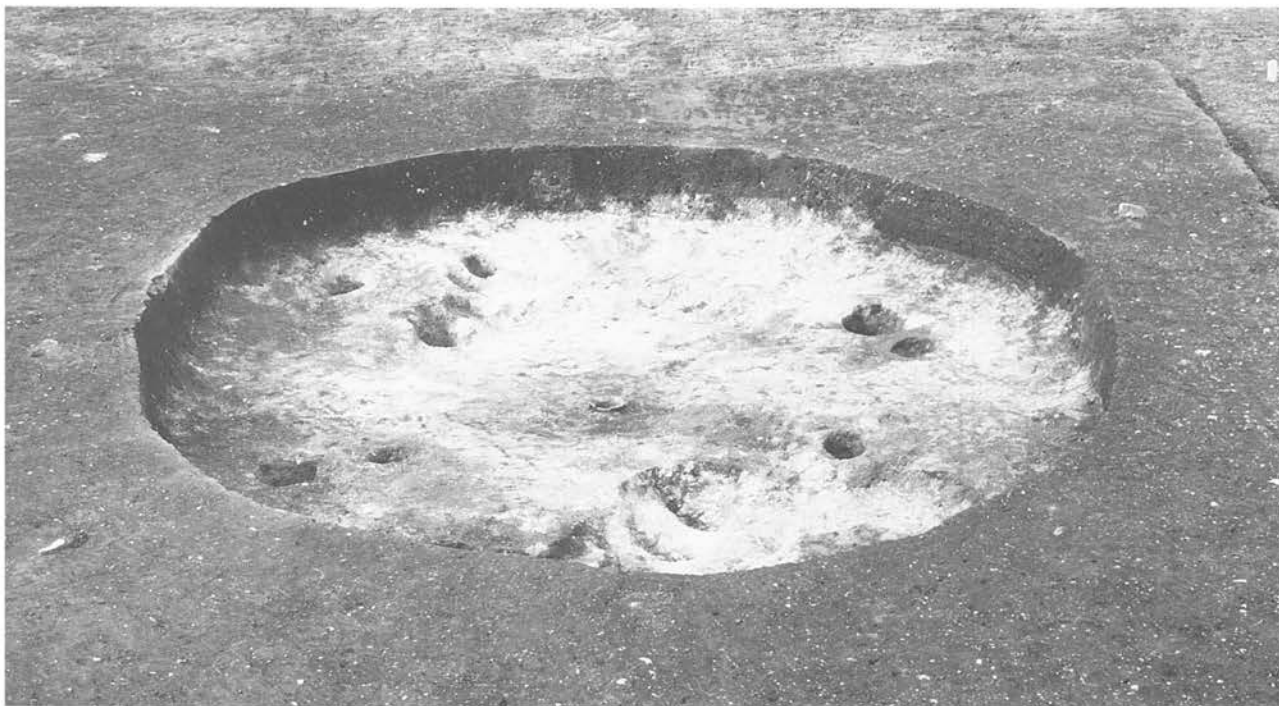

3号竖穴住居跡



土坑群



左：9・10・11・47号  
土坑  
右：29・31・32・35号  
土坑

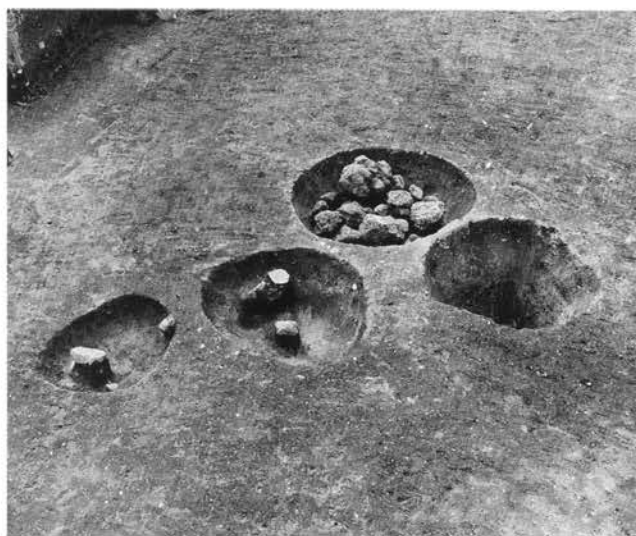

左：35・36号土坑  
右：41号土坑





1号陥し穴



左：2号竪穴住居跡  
出土土器  
右：3号竪穴住居跡  
出土土器



左：31号土坑出土土器  
右：遺構外出土土器



1号竖穴住居跡出土土器

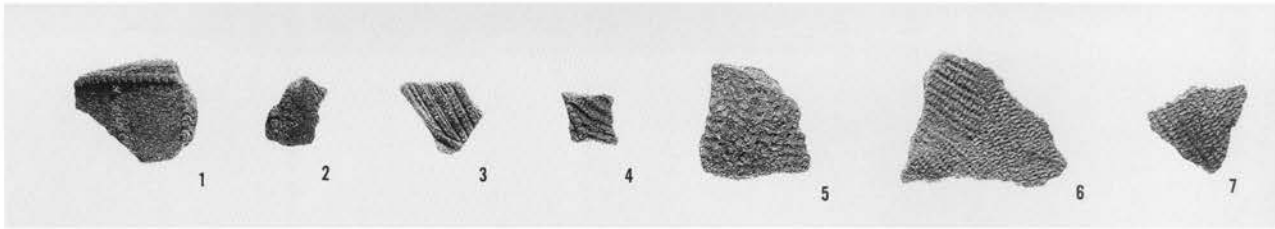

2号竖穴住居跡出土土器

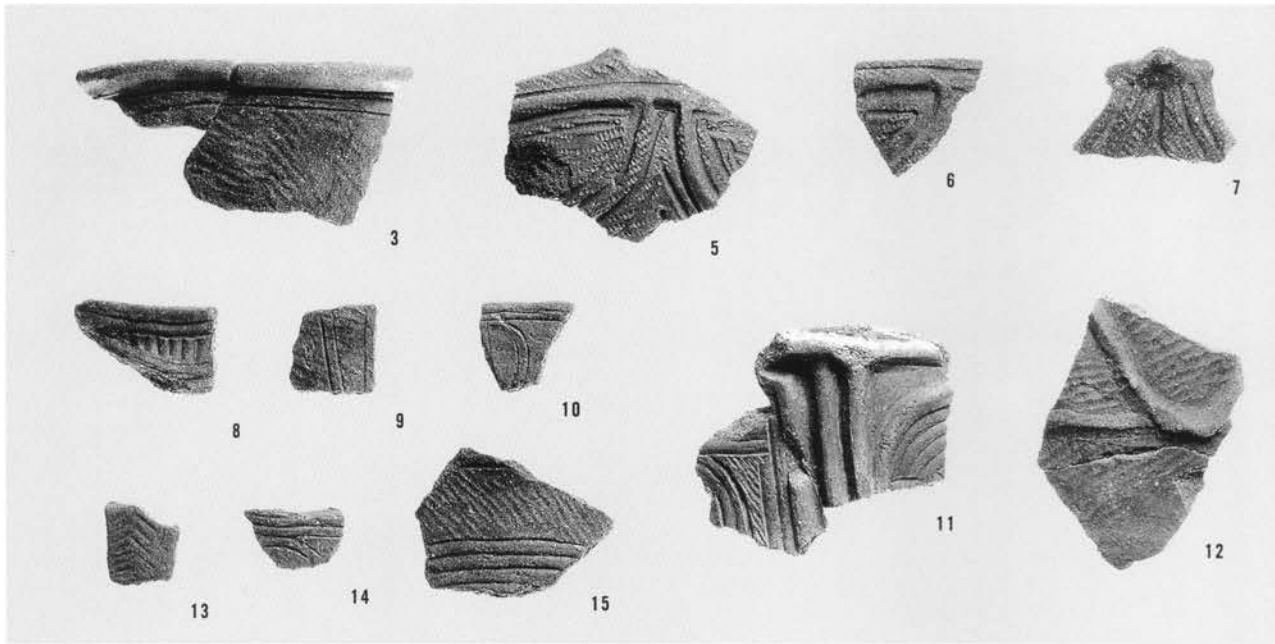

土坑出土土器

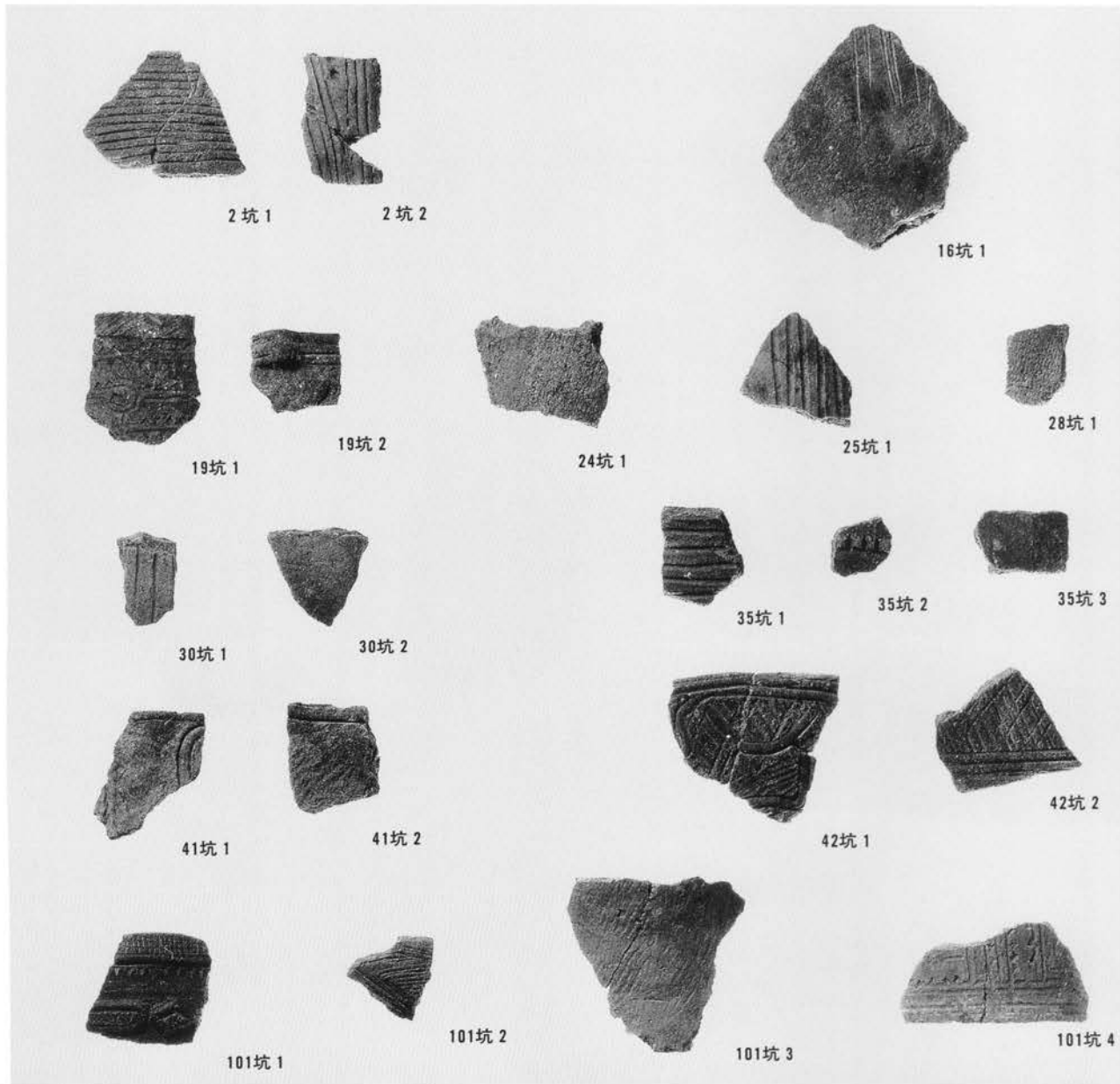

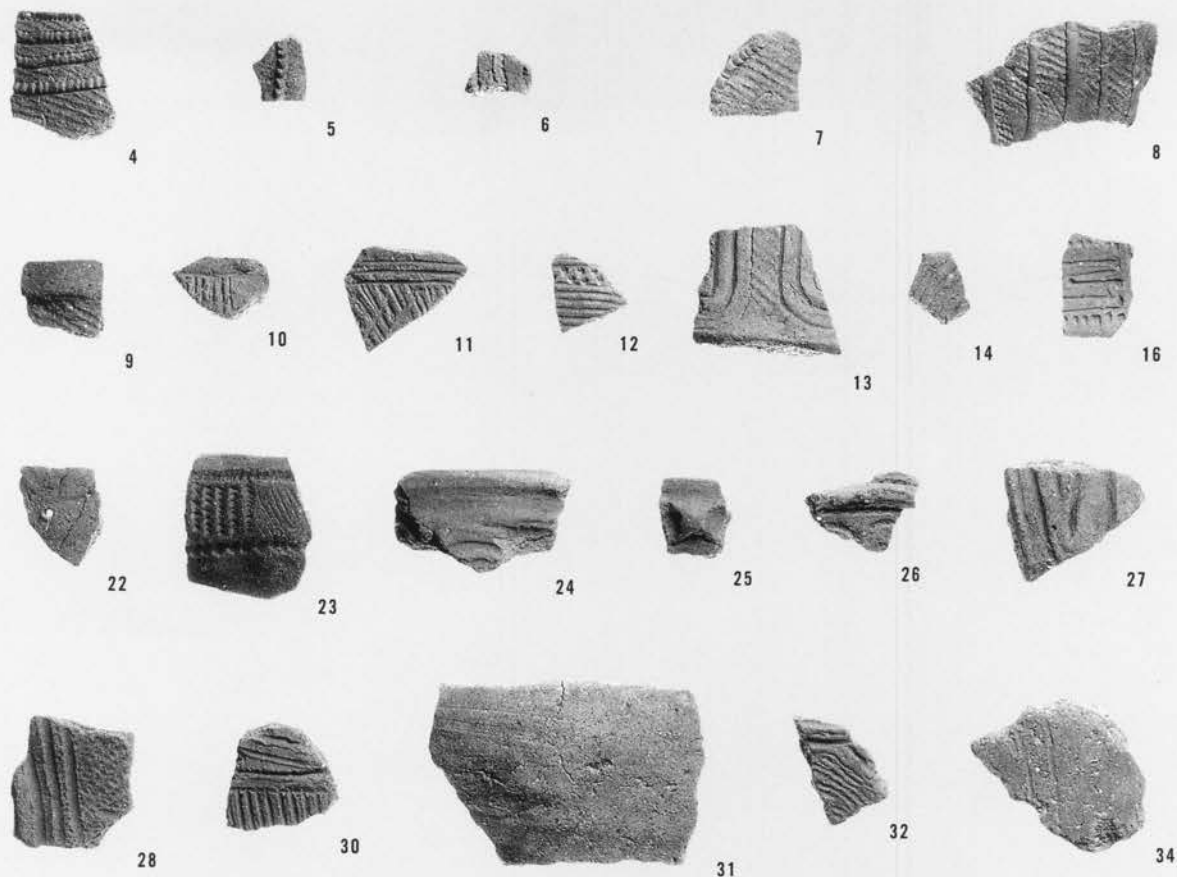



遺跡遠景（南から）



遺跡近景（西から）







左：8・9号土坑  
右：13・14号土坑

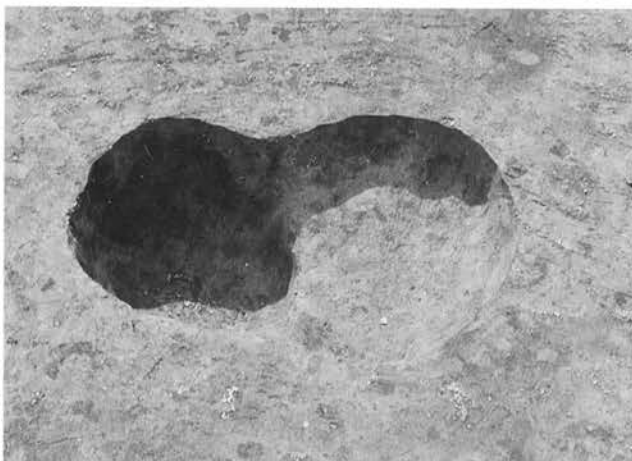

左：15号土坑  
右：18・25号土坑



左：22・40号土坑  
右：28・29・34号  
土坑



左：30号土坑  
右：39号土坑



左：8号土坑出土遺物  
右：遺構外出土土器

1号住居



1号溝の調査



左 1号溝断面  
右 1号溝完掘







左 1号土坑  
右 2号土坑

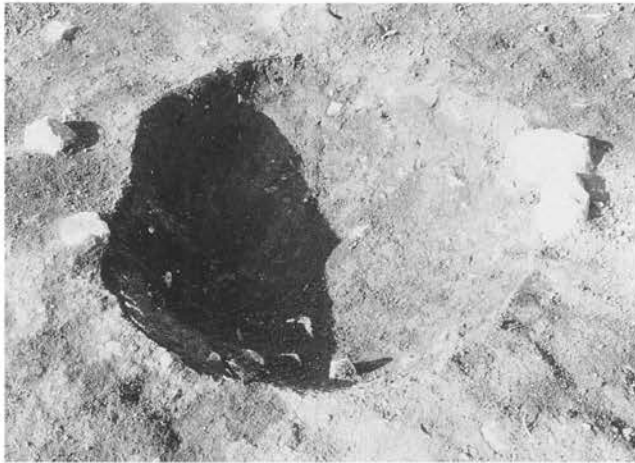

左 1号土坑  
右 3号土坑

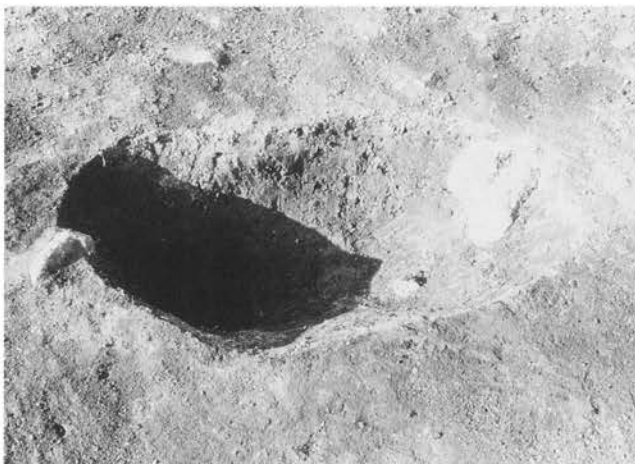

左 1号土坑  
右 4号土坑

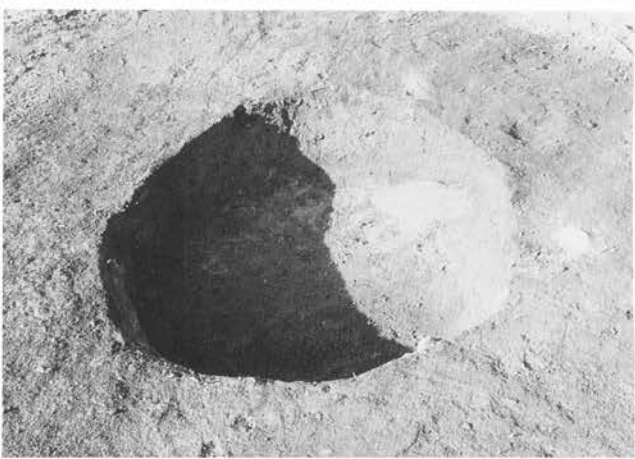

長野県埋蔵文化財センター発掘調査報告書 52

上信越自動車道埋蔵文化財発掘調査報告書 19

—小諸市内3—

三子塚遺跡群 三田原遺跡群 岩下遺跡 石神遺跡群  
郷土遺跡 東丸山遺跡 西丸山遺跡 深沢遺跡群

図 版 編

発 行 平成12年3月30日  
発行者 (財)長野県文化振興事業団長野県埋蔵文化センター  
☎387-0007 更埴市屋代清水260-6 TEL 026-274-3891  
FAX 026-274-3892  
印 刷 第一印刷株式会社