

佐久市

NISHICHIKATSU

西近津遺跡群

中部横断自動車道建設に伴う埋蔵文化財発掘調査報告書2

－佐久市内2－

第3分冊（遺物図版編）

2015.3

国土交通省関東地方整備局
長野県埋蔵文化財センター

凡 例

- 1 遺物番号は、遺物種ごとに登録番号を付してある。本報告の本文・図表・写真では共通して遺物番号を用いている。遺物番号は下記のとおりである。

土器 No.00001 から始まる五桁の通し番号

土製品 No.10001 から始まる五桁の通し番号

石器・石製品 No.20001 から始まる五桁の通し番号

金属製品・鍛冶関連遺物 調査年ごとに登録番号を付けている。表記は左から調査年（西暦年）の下2桁の次に、金属の英訳 Metal の頭文字 M を冠し、通し番号を付す。

（例）06M081 2006年調査の金属製品No.81

骨・骨製品 金属製品同様、調査年ごとに登録番号を付けている。表記は左から調査年（西暦年）の下2桁の次に、骨の英訳 Bone の頭文字 B を冠し、通し番号を付す。

（例）08B14 2008年調査の骨No.14

- 2 本書に掲載した遺物実測図の縮尺は、原則として下記のとおりである。

土器・土器拓影・陶磁器 1：4 縄文土器拓影 1：3

大形土器 1：6 石鏃等小形石器・装身具・原石 2：3

石核・石斧・磨石・敲石など 1：3 台石・石皿など 1：6

金属製品 2：3～1：2 骨製品・骨 1：2

- 3 遺物の器種名については細分せず、過去の埋文センター報告書などを参考にして一般的と思われる名称を用いた。

- 4 遺構記号については第1分冊に詳細を記してあるが、主なものは下記のとおりである。

SB：堅穴住居跡・堅穴状遺構 SK：土坑・井戸跡・土坑墓

ST：掘立柱建物跡 SD：溝跡・自然流路跡

SM：古墳・周溝墓・（土坑墓） SQ：遺物集中

SA：柵列

- 5 実測図中の記号・トーンなどについては、原則として下記のとおりである。これ以外のものについては実測図に例示してある。

 須恵器断面  陶磁器断面  黒色処理  赤彩

- 第1分冊 (本文編)
第2分冊 (遺構図版編)
第3分冊 (遺物図版編)
第4分冊 (写真図版編)

第3分冊 (遺物図版編) 目次

凡例

目次

I	土器・土製品	
	縄文時代の土器・土製品……………	図版 1
	弥生時代中期の土器……………	図版 5
	弥生時代後期の土器・土製品……………	図版 6
	古墳時代～古代の土器……………	図版 58
	中世の陶磁器……………	図版 199
	古墳時代～古代の土製品・瓦……………	図版 200
II	石器・石製品・ガラス製品……………	図版 202
III	金属製品……………	図版 251
IV	鍛冶関連遺物……………	図版 273
V	木製品……………	図版 274
VI	骨角製品・未製品……………	図版 275

縄文時代の遺構

SB7067

SQ4001

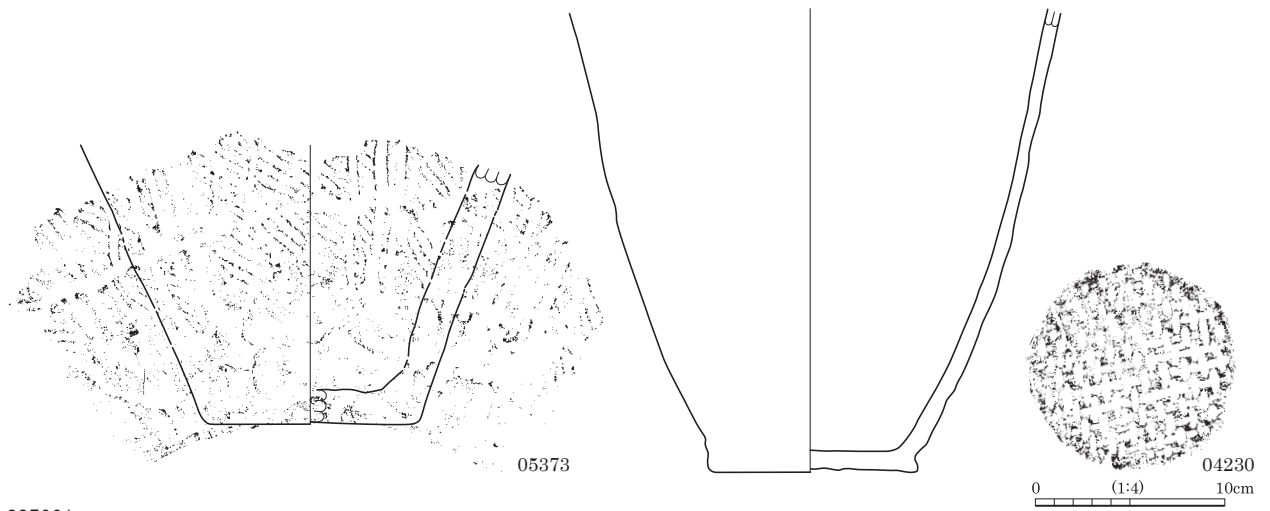

SQ5001

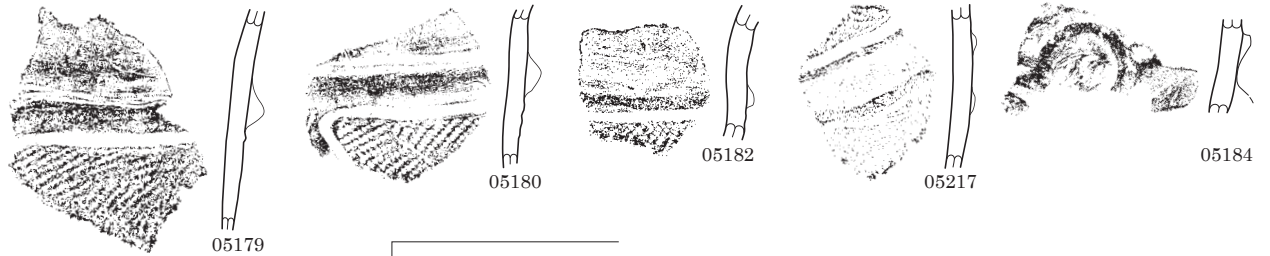

SQ5002



縄文時代以外の遺構、検出面

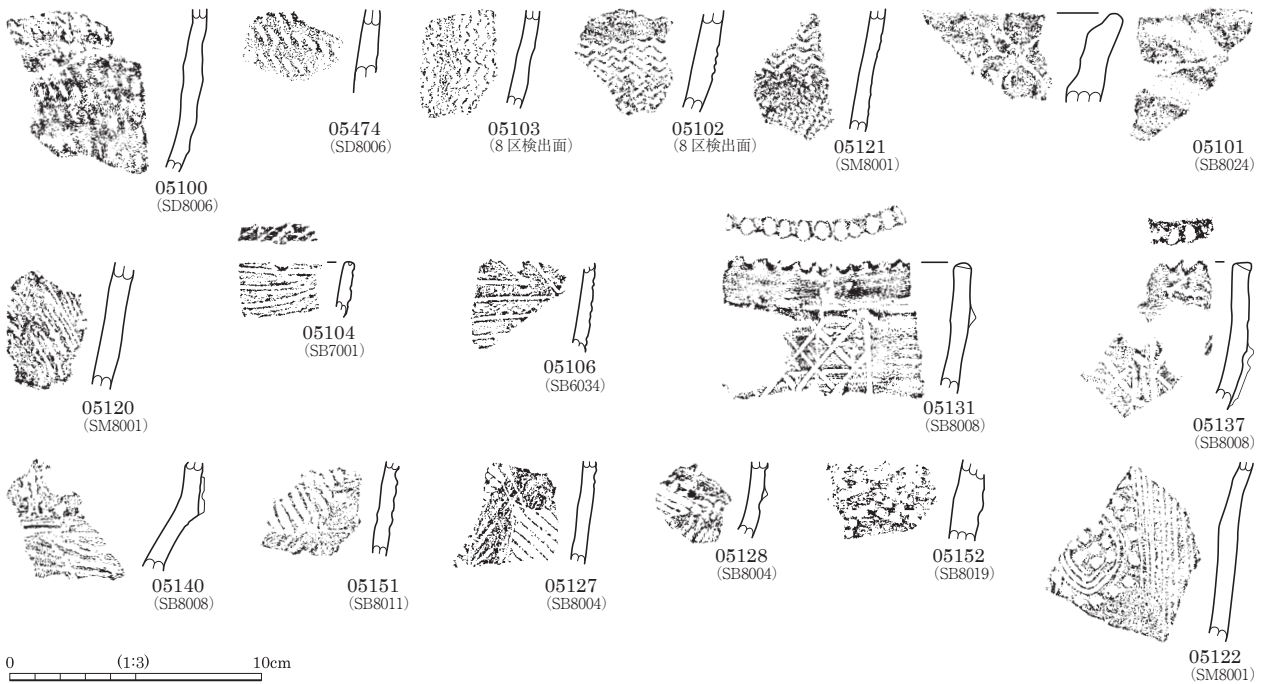

図版2 縄文時代の土器 (2)

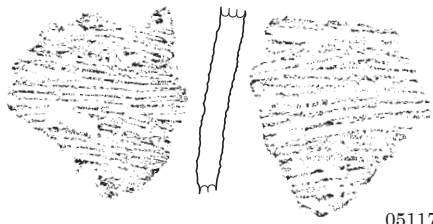

05117
(SM8001)



05123
(SM8003)

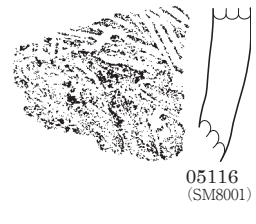

05116
(SM8001)



05108
(SB8040)



05165
(SD8006)



05162
(SB5001)



05163
(SK5113)



05164
(SD6002)



05166
(8区検出面)

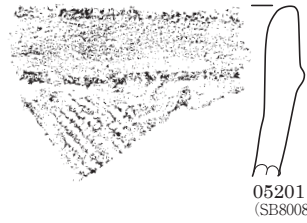

05201
(SB8008)



05193
(SB7042)

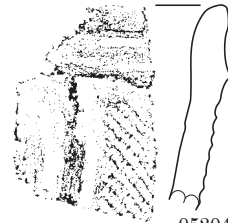

05204
(SB8024)



05194
(SB7045)



05190
(SB7014)



05172
(SD4002)



05174
(SB5015)



05212
(SK6267)

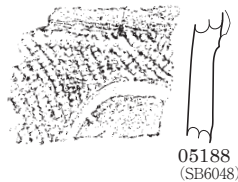

05188
(SB6048)

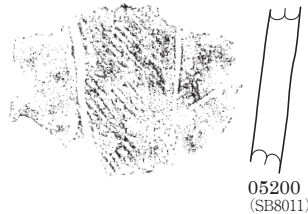

05200
(SB8011)

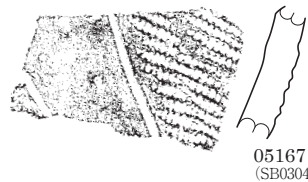

05167
(SB0304)



05176
(SD5006)

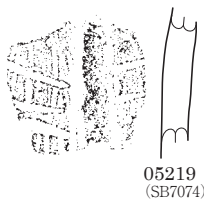

05219
(SB7074)



05224
(SB8024)

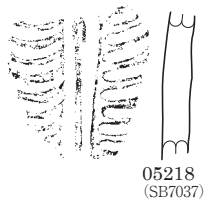

05218
(SB7037)



05225
(SB8024)



05239
(SB0304)



05261
(7区検出面)

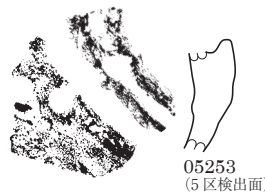

05253
(5区検出面)

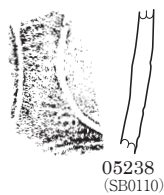

05238
(SB0110)



05255
(SB6050)

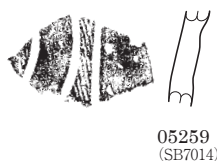

05259
(SB7014)

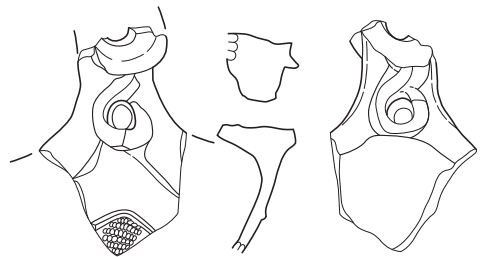

05249
(SB5048)

0 (1:3) 10cm

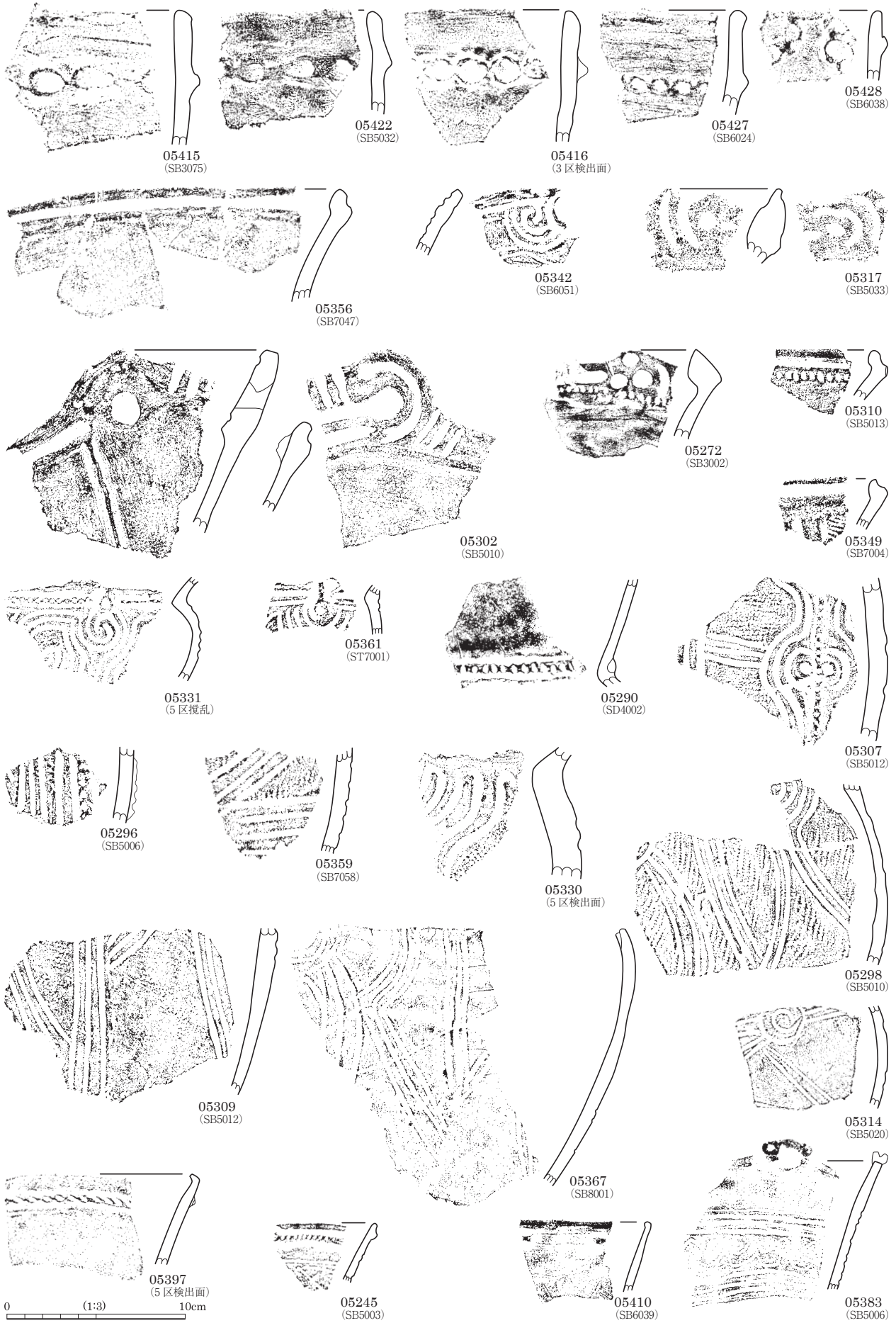

図版 4 縄文時代の土器 (4)・土製品



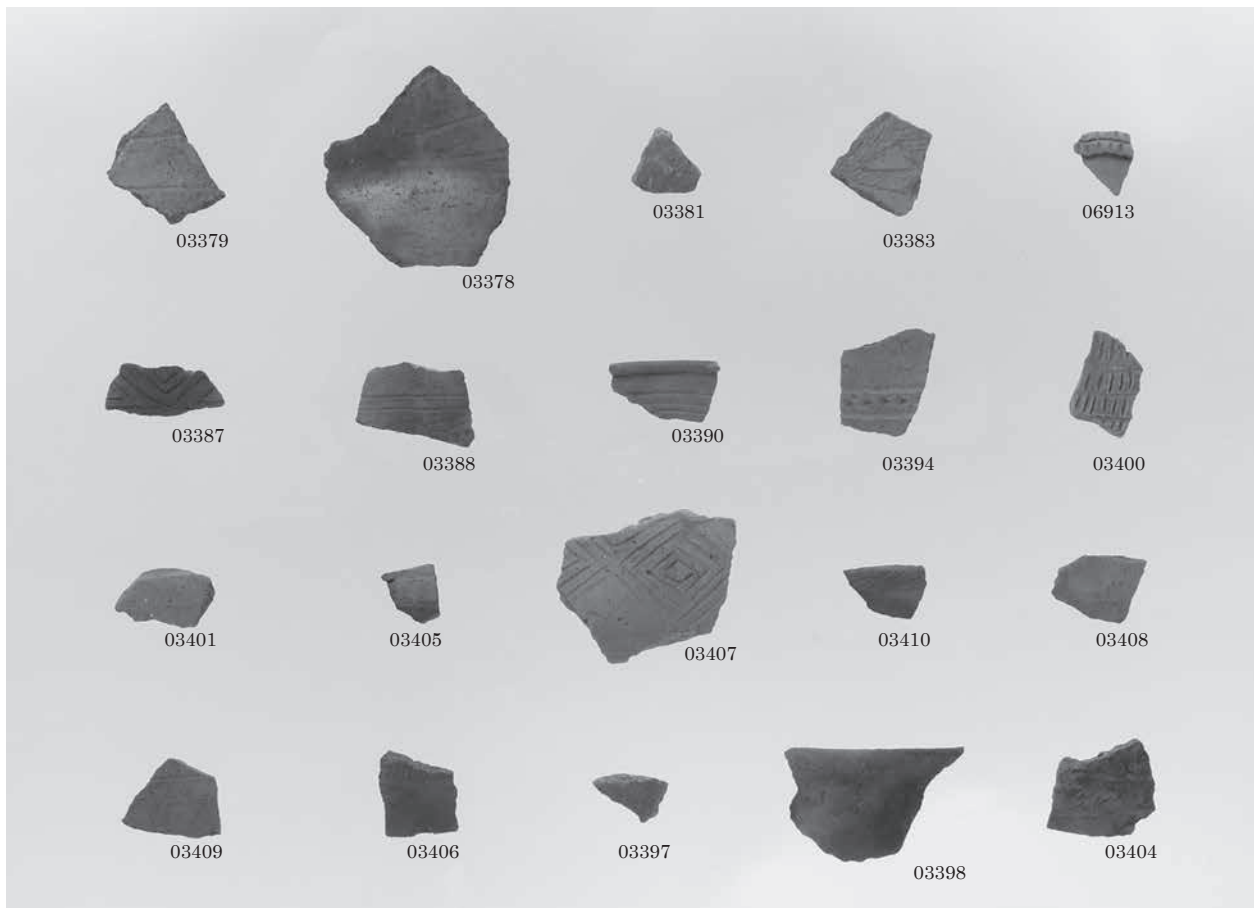
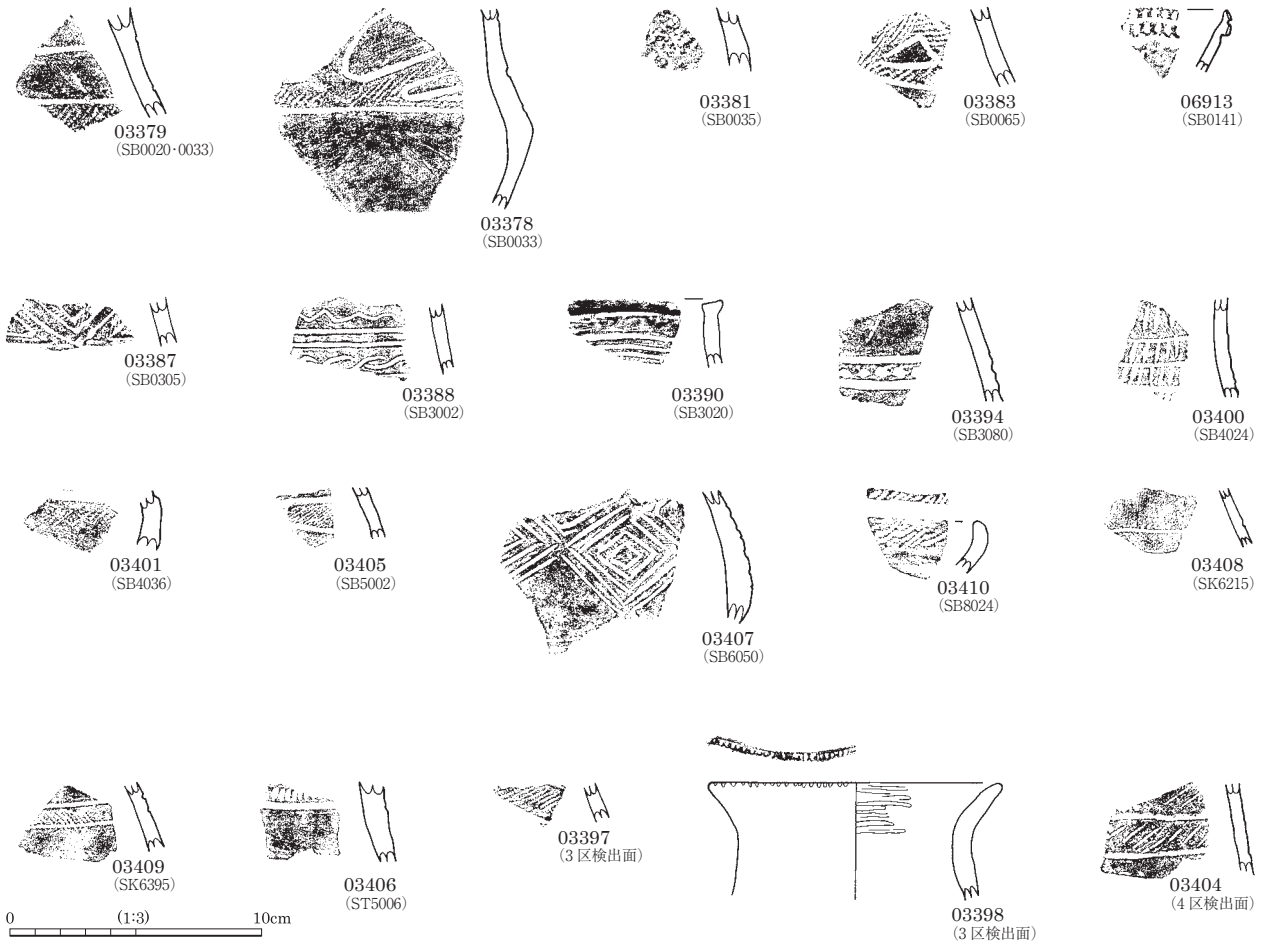

図版 6 弥生時代後期の土器 (1)

SB0002

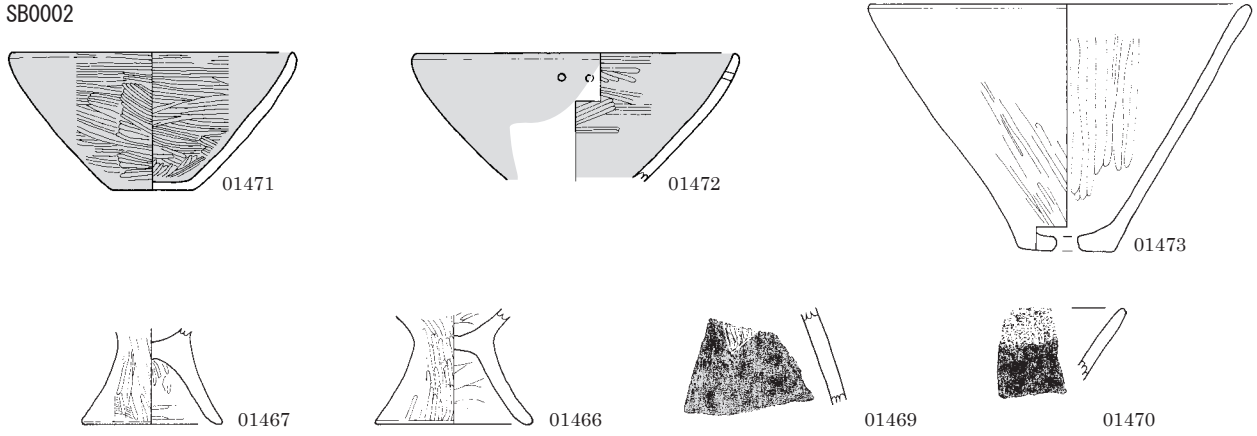

SB0004

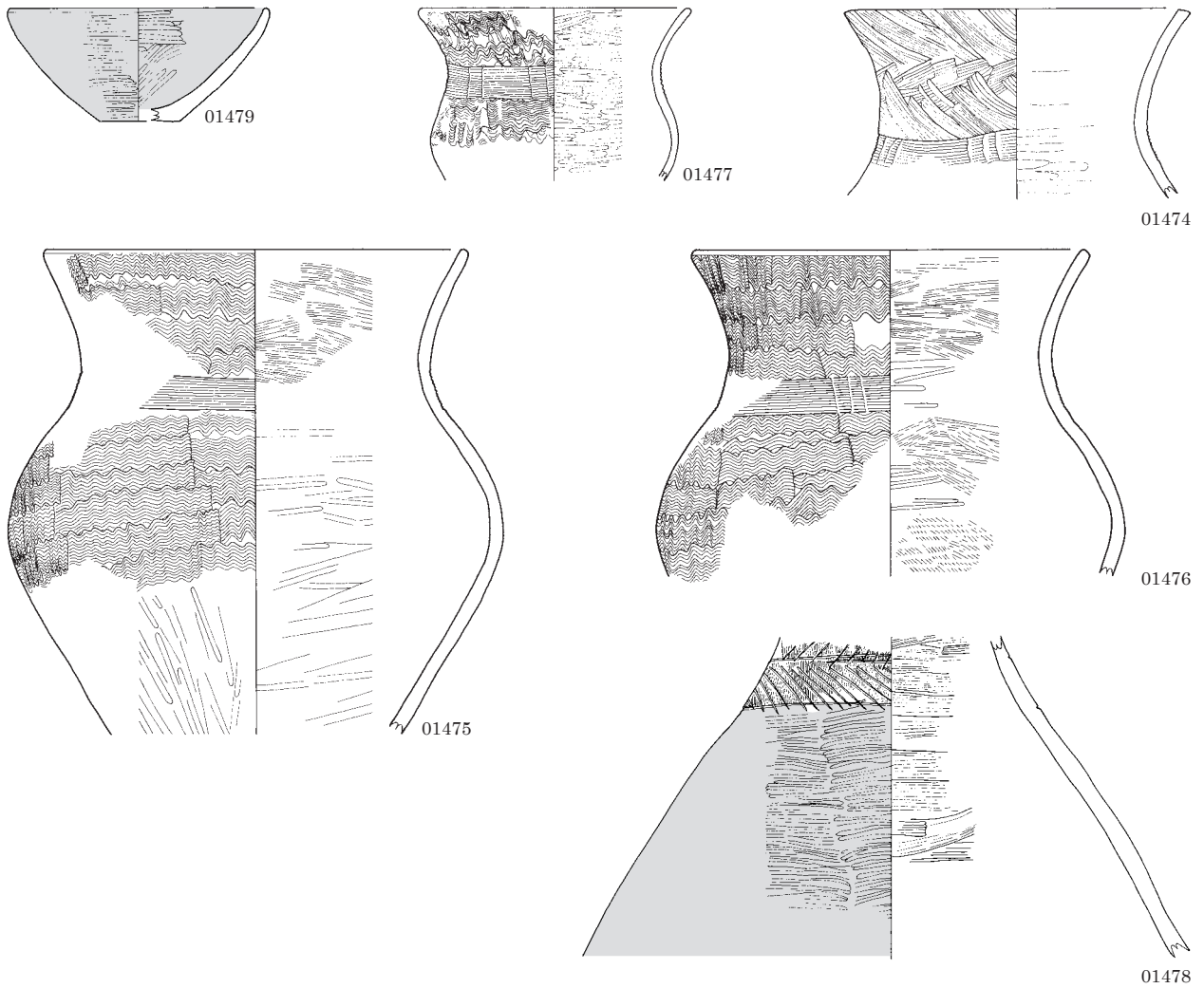

SB0007 (1)

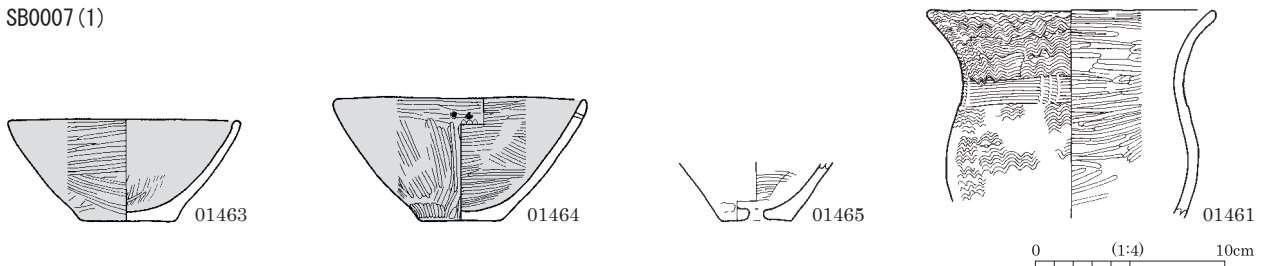

SB0007 (2)

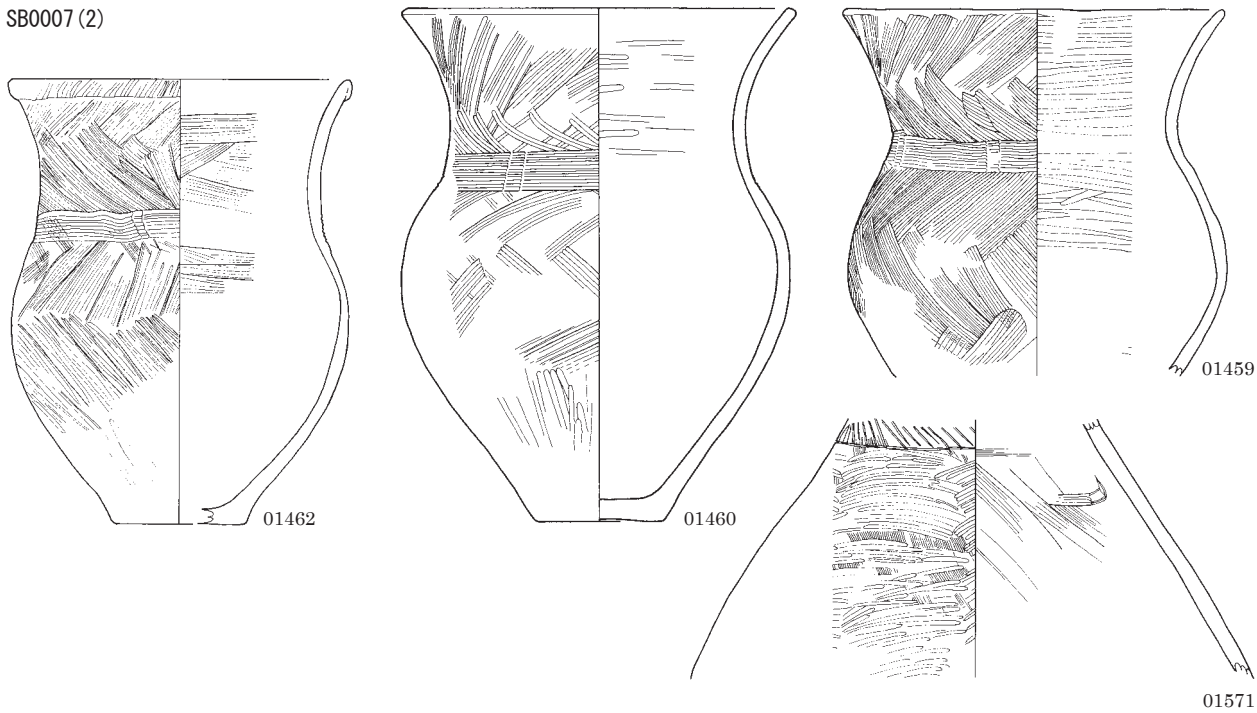

SB0011

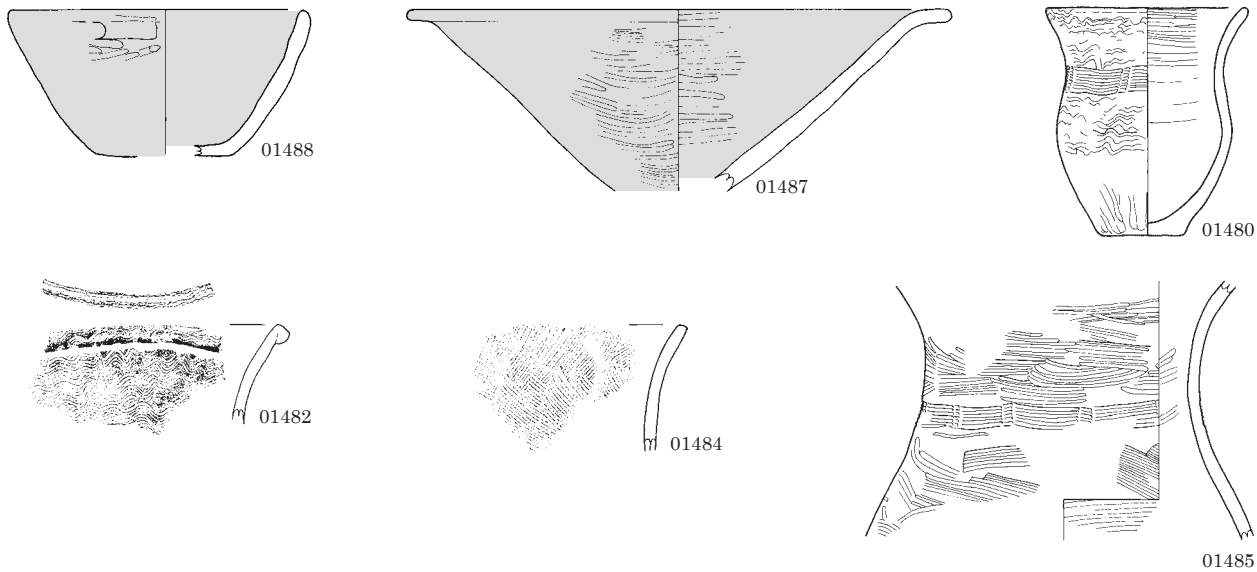

SB0015 (1)

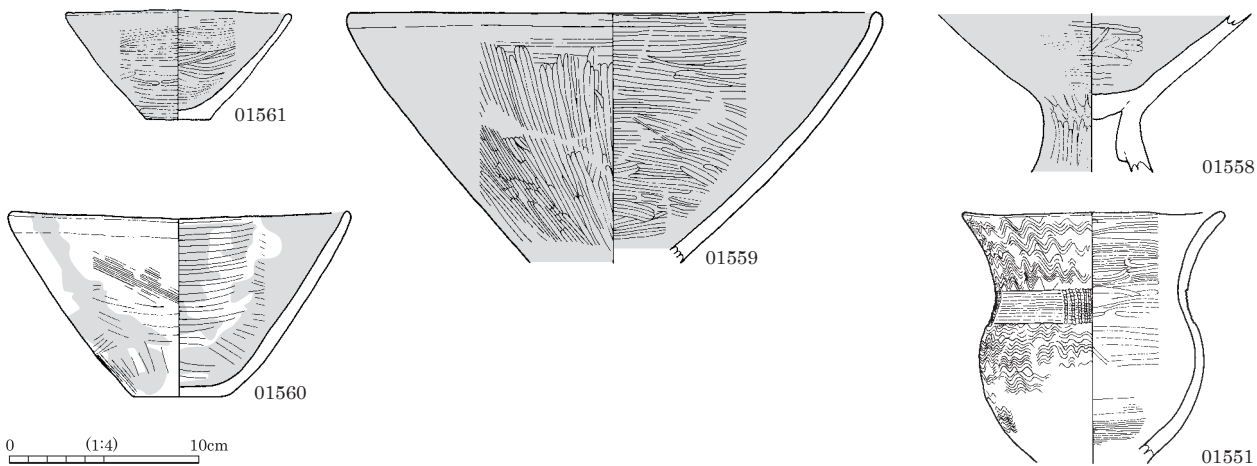

0 (1:4) 10cm

図版 8 弥生時代後期の土器 (3)

SB0015 (2)

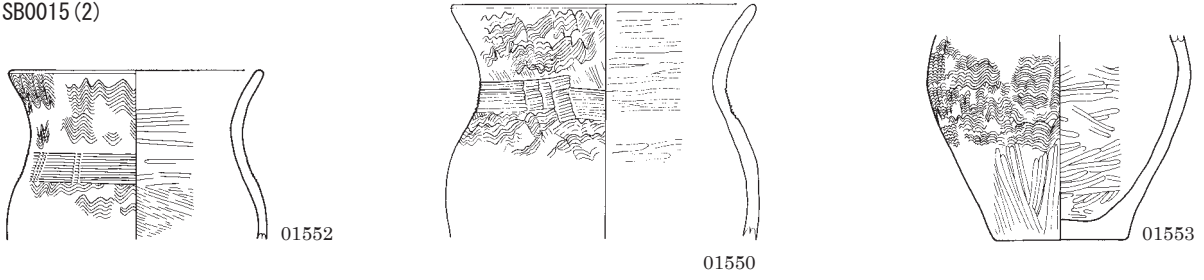

SB0017 (1)

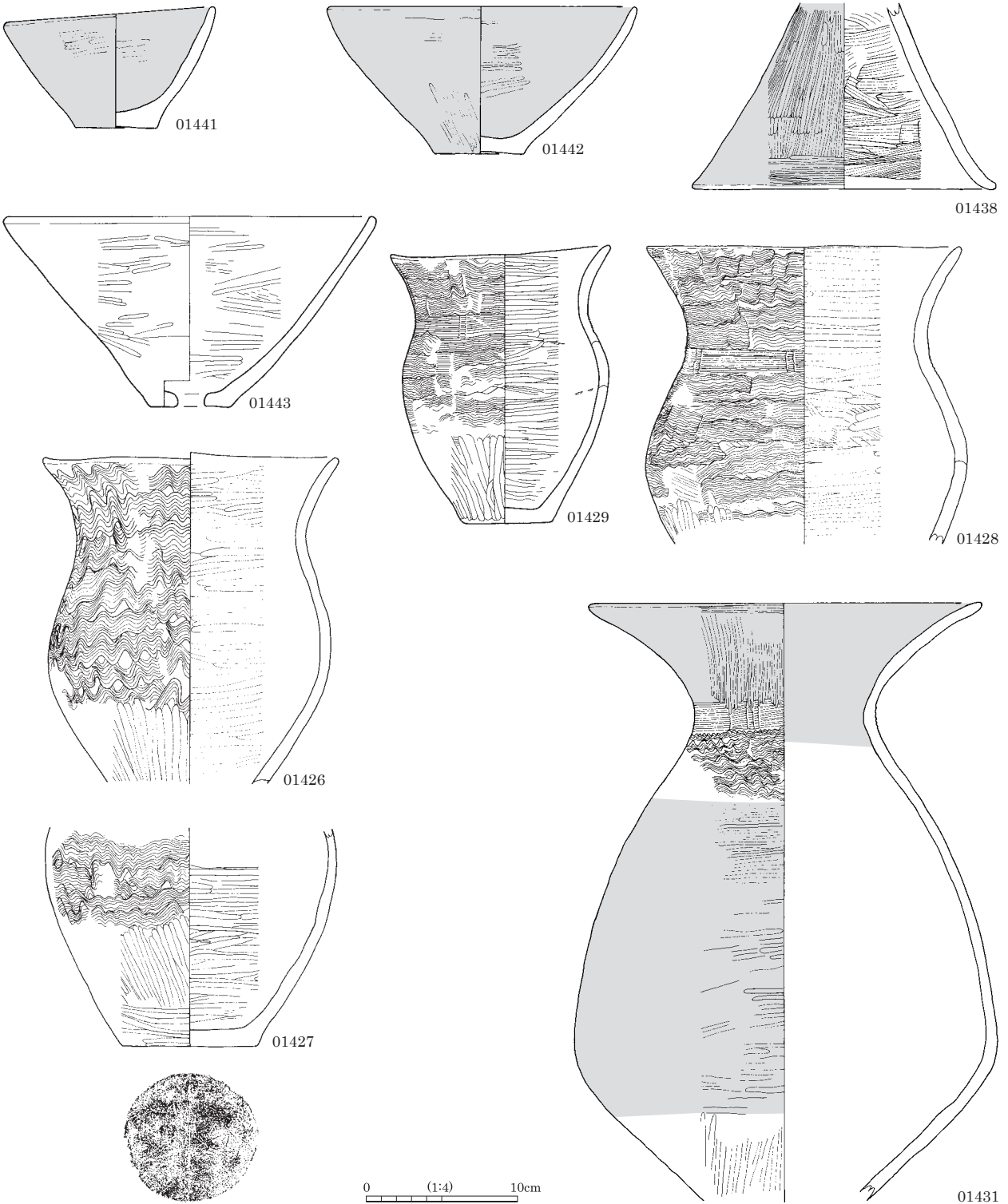

SB0017 (2)

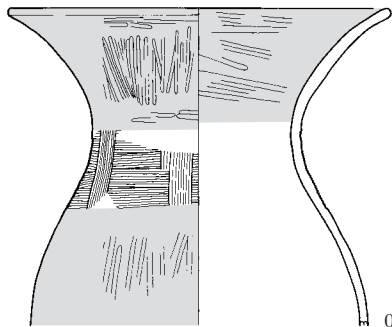

01432

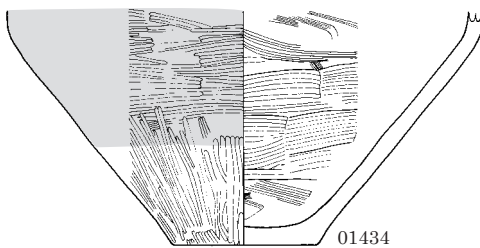

01434



01437

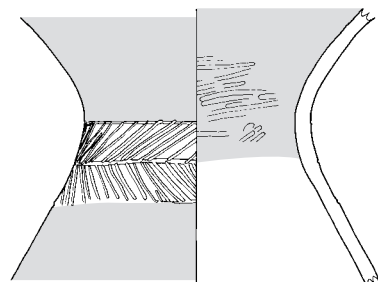

01433

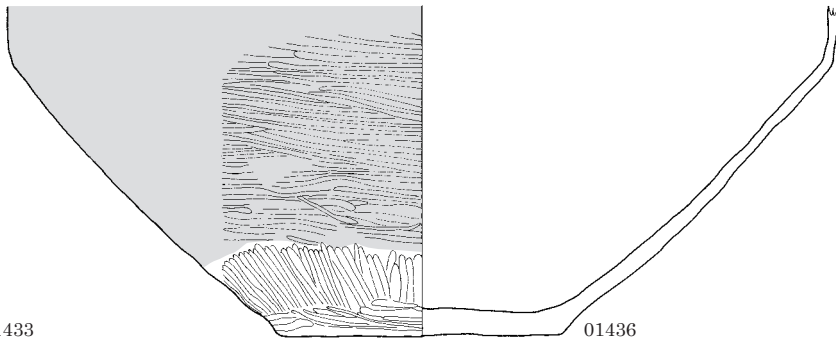

01436

SB0019 (1)

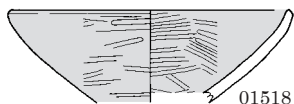

01518



01513



01515



01517

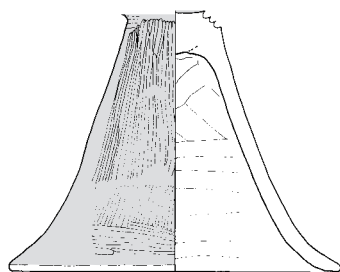

01512



01516

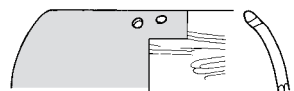

01511

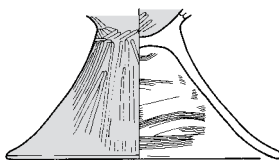

01514

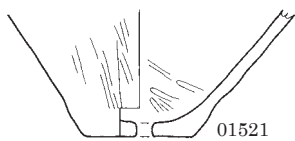

01521

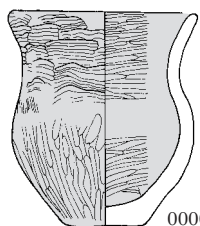

00009

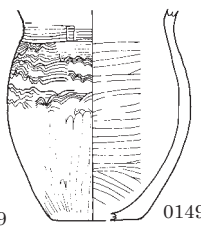

01498

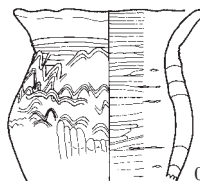

01497

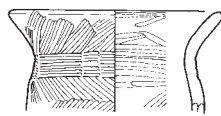

01499

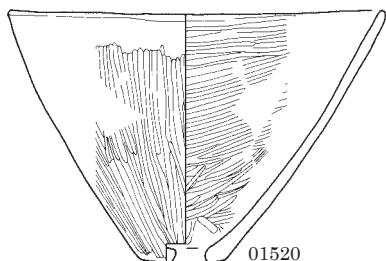

01520



01523

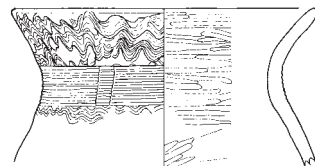

01495



0 1:4 10cm

図版 10 弥生時代後期の土器 (5)

SB0019 (2)

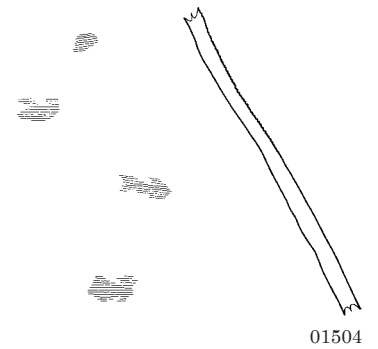
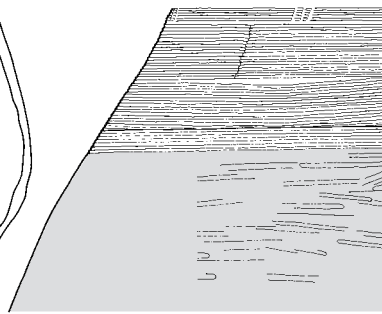
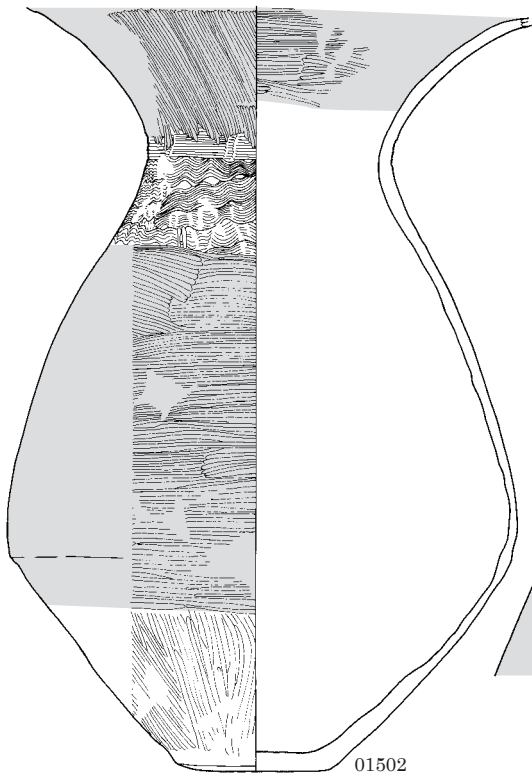
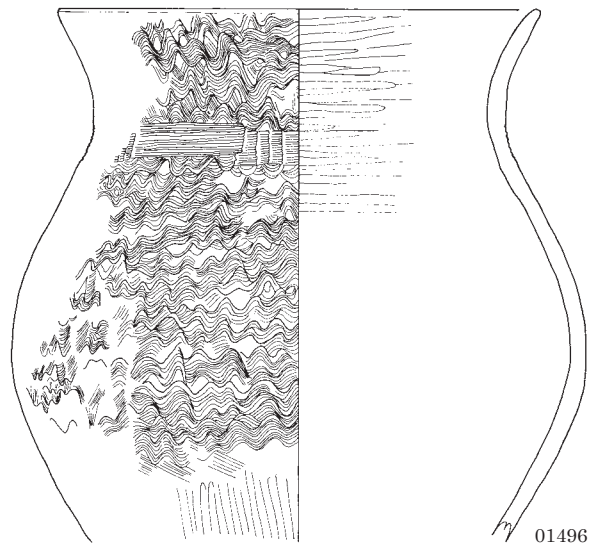
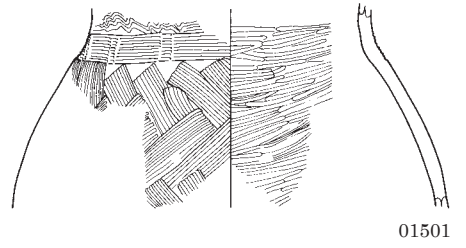
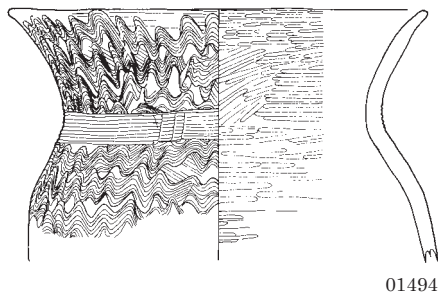
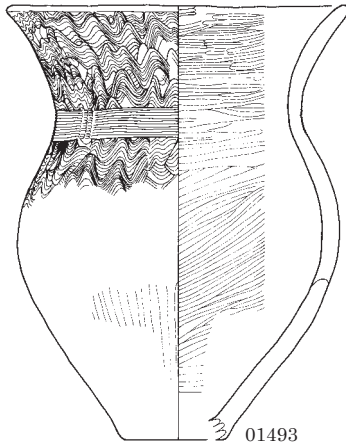
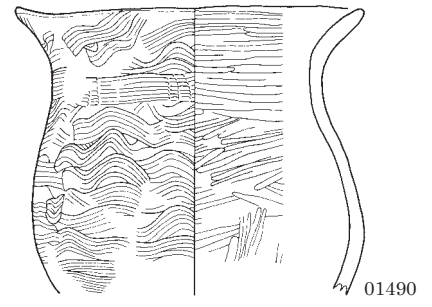
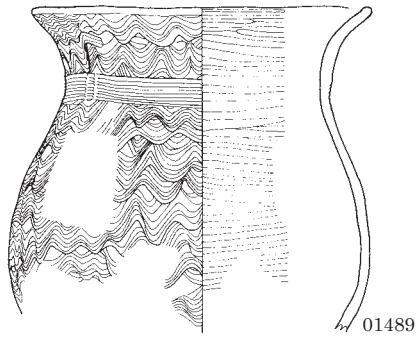
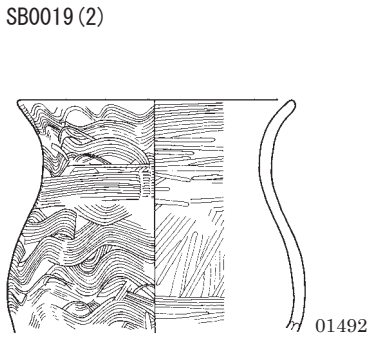

0 1:4 10cm

SB0019 (3)

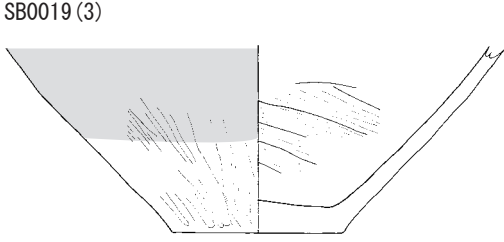

01505

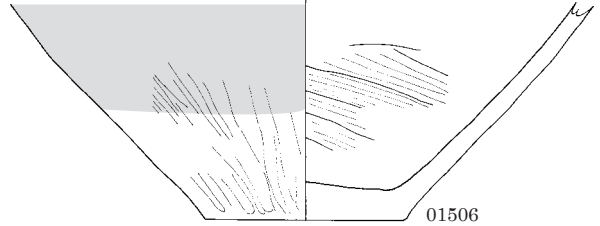

01506

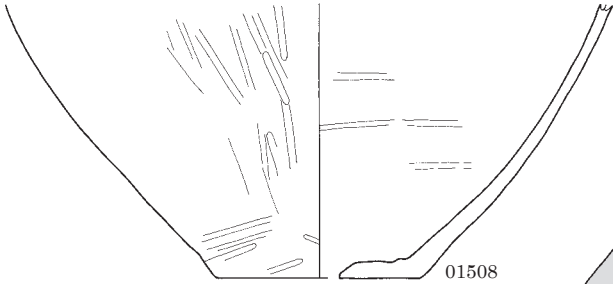

01508

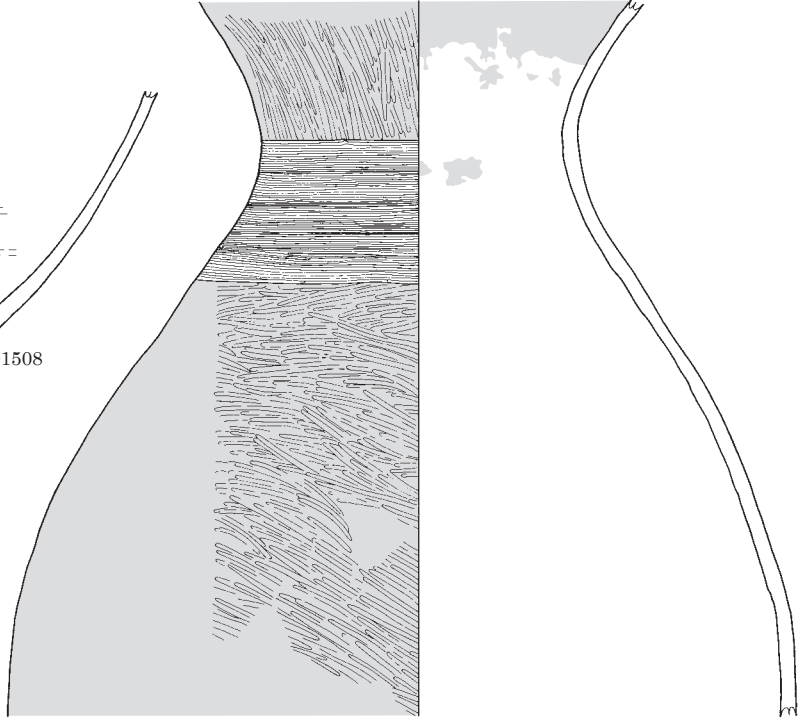
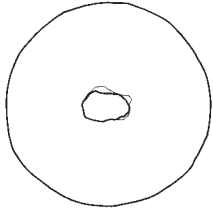

01503

SB0024



01333

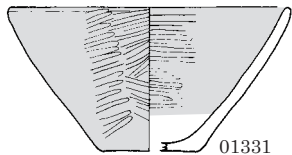

01331

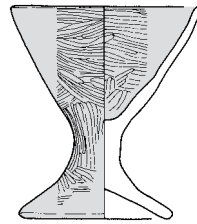

01330

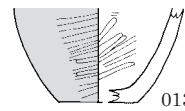

01332

SB0025 (1)



01424



01423

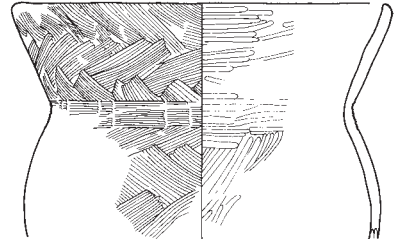

01416

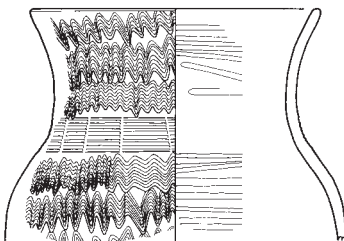

01414

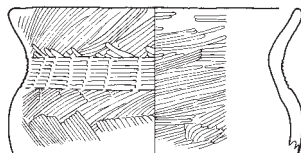

01418

0 (1:4) 10cm

図版 12 弥生時代後期の土器 (7)

SB0025 (2)

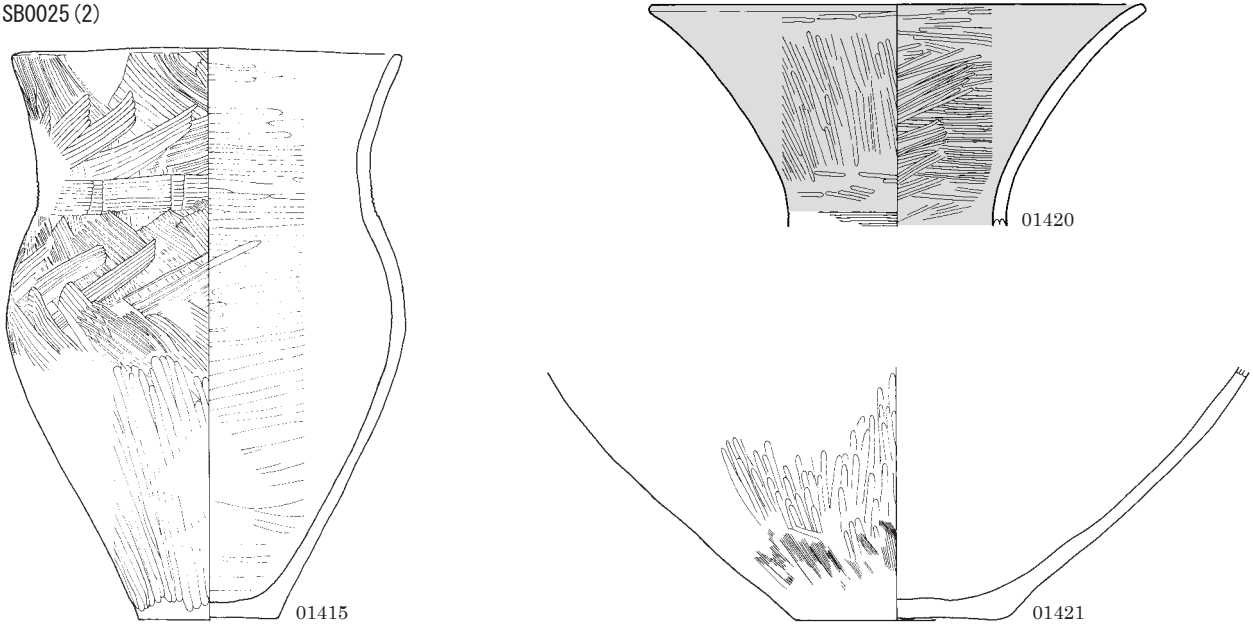

SB0026

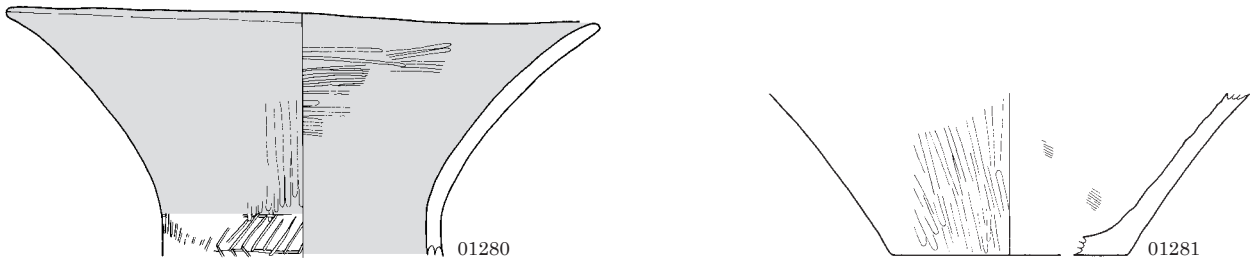

SB0027 (1)

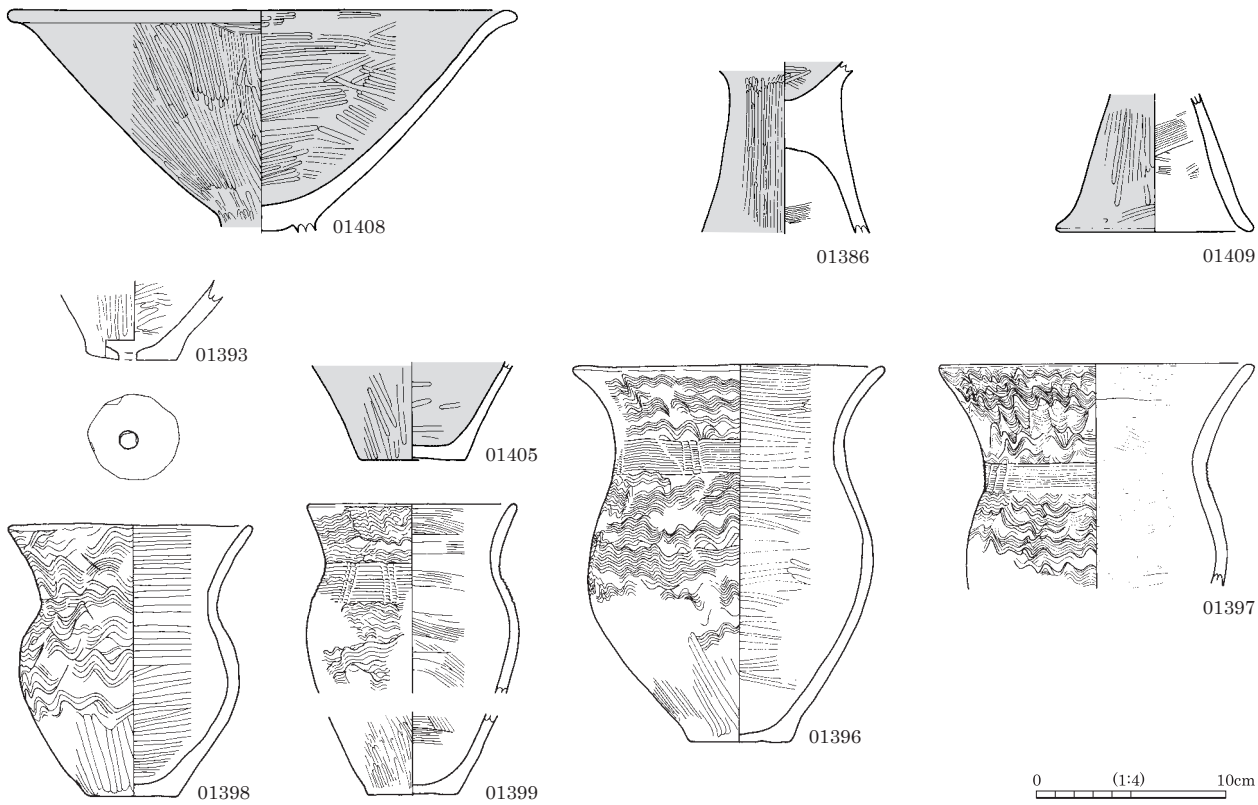

SB0027 (2)

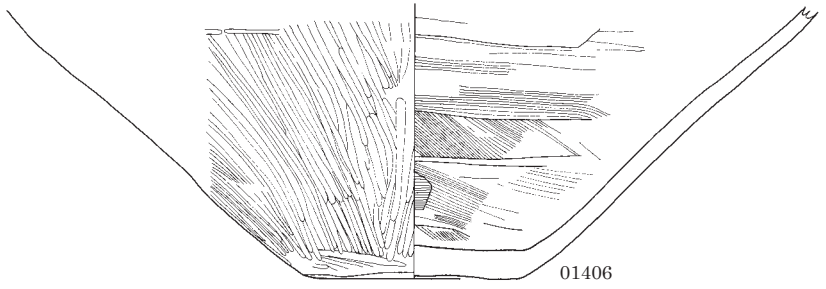
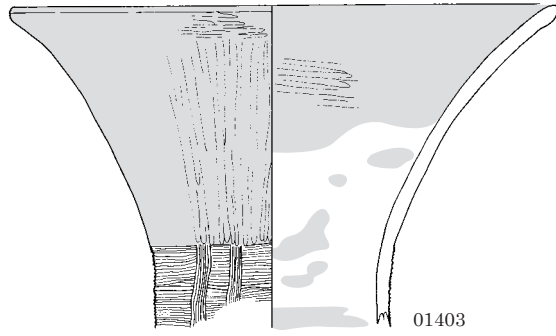
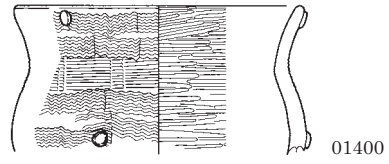
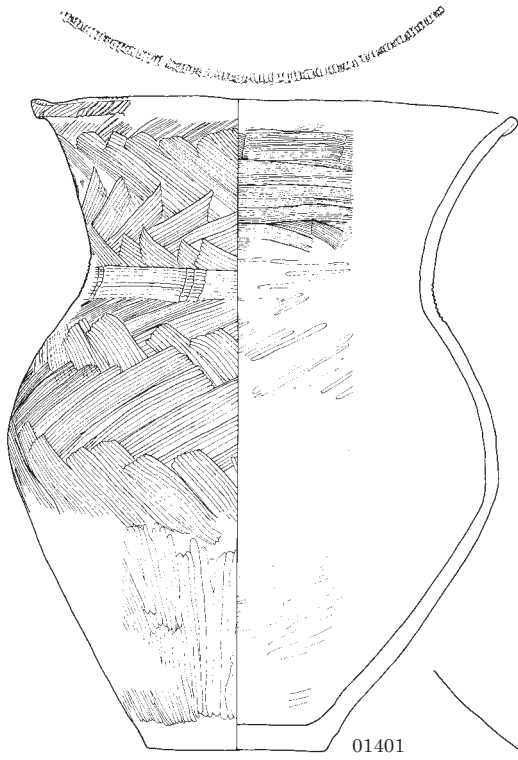

SB0030 (1)

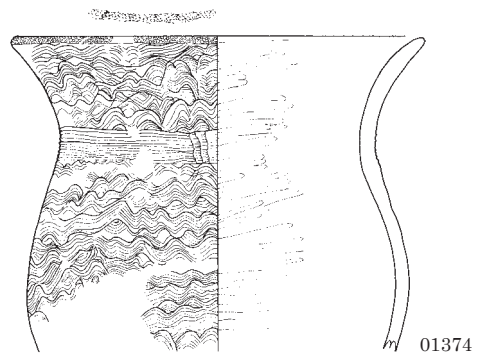
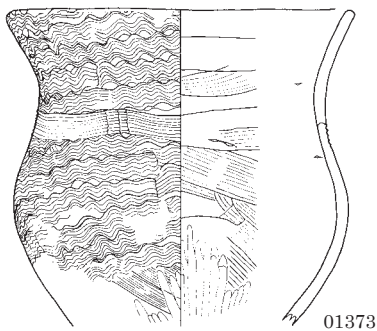
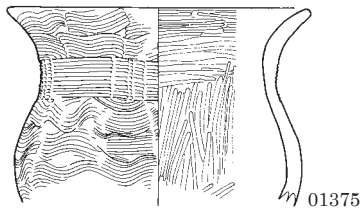
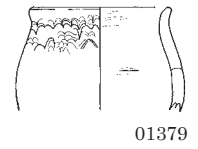
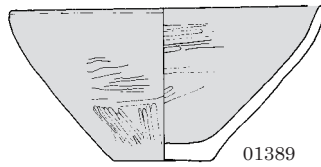
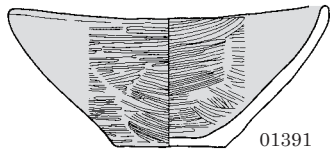
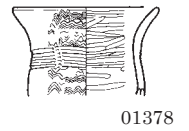
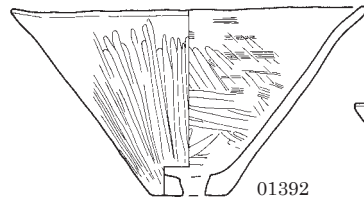
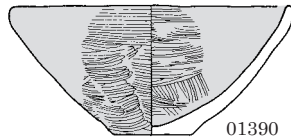
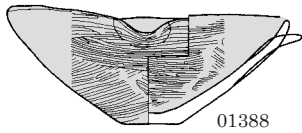

0 (1:4) 10cm

図版 14 弥生時代後期の土器 (9)

SB0030 (2)

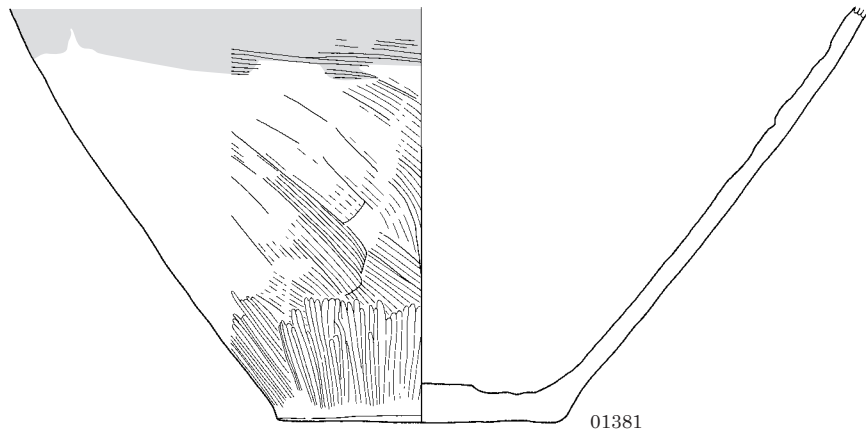
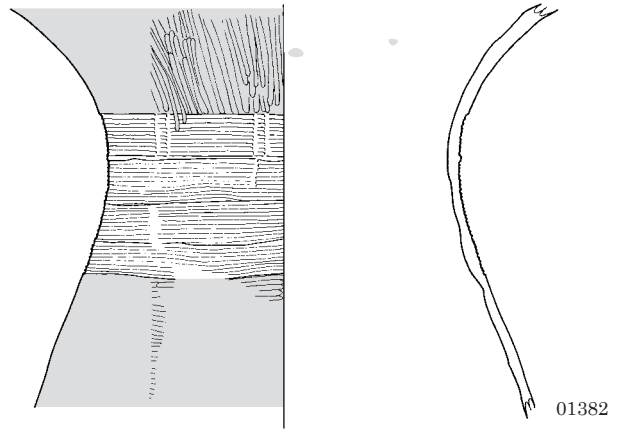
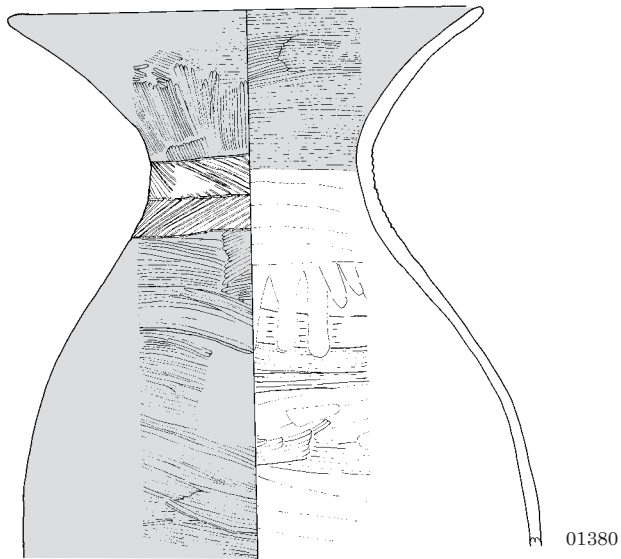
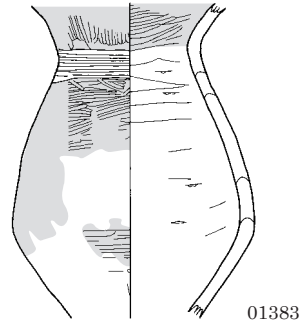
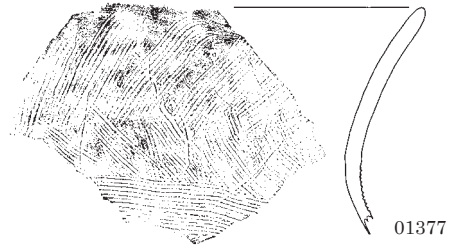
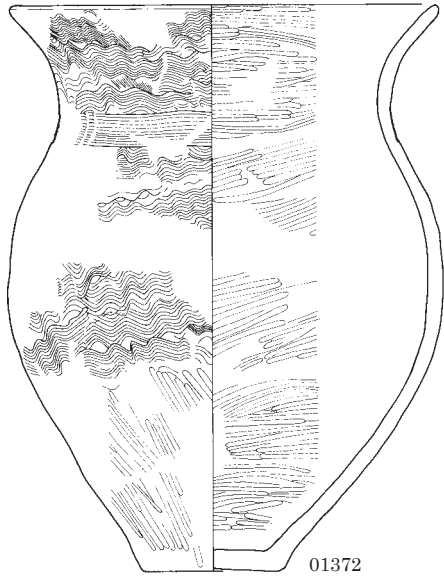

0 1:4 10cm

SB0033

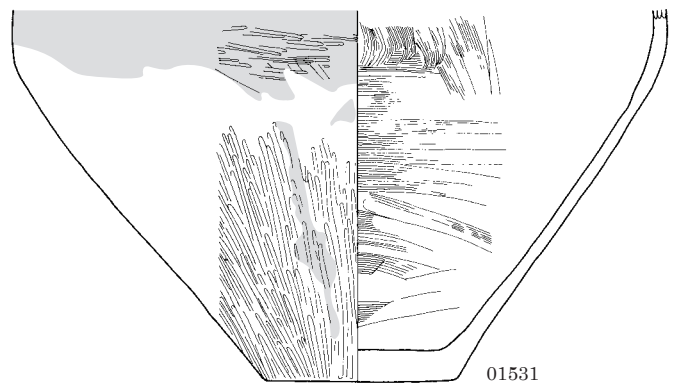
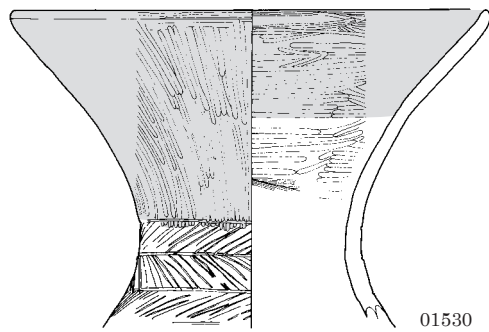
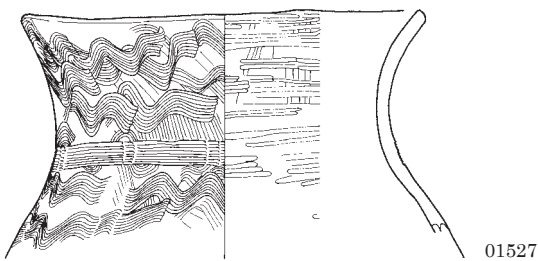
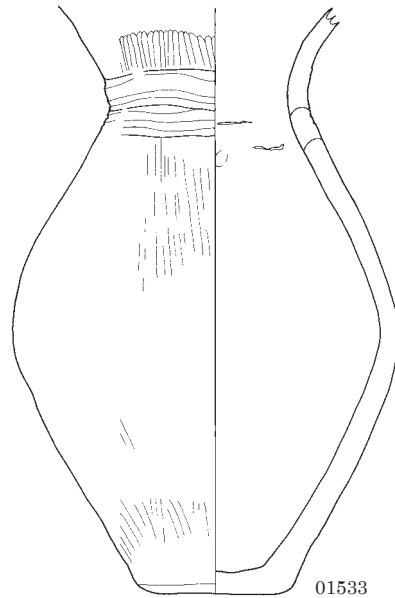
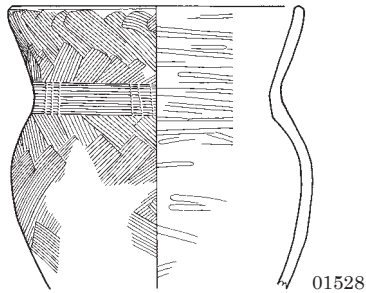
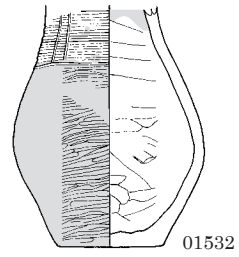
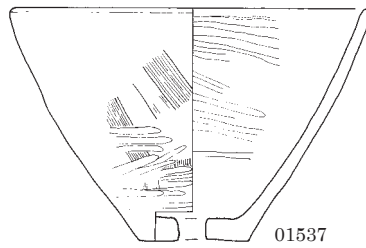
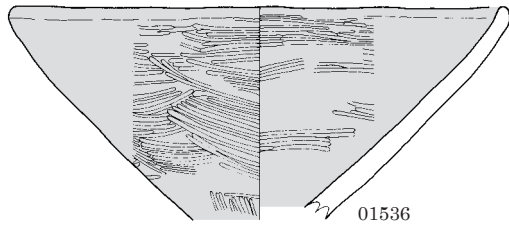

SB0035 (1)

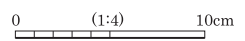
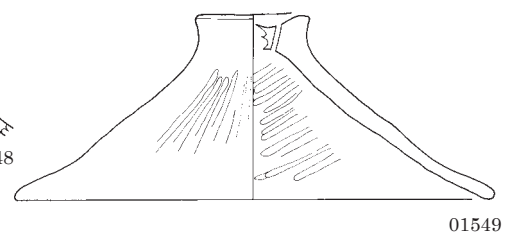
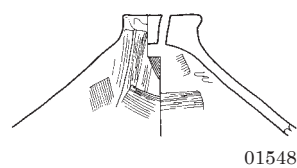
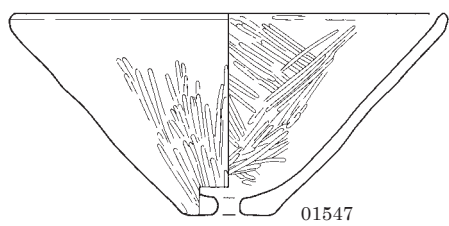
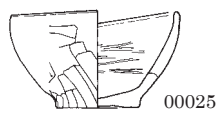

図版 16 弥生時代後期の土器 (11)

SB0035 (2)

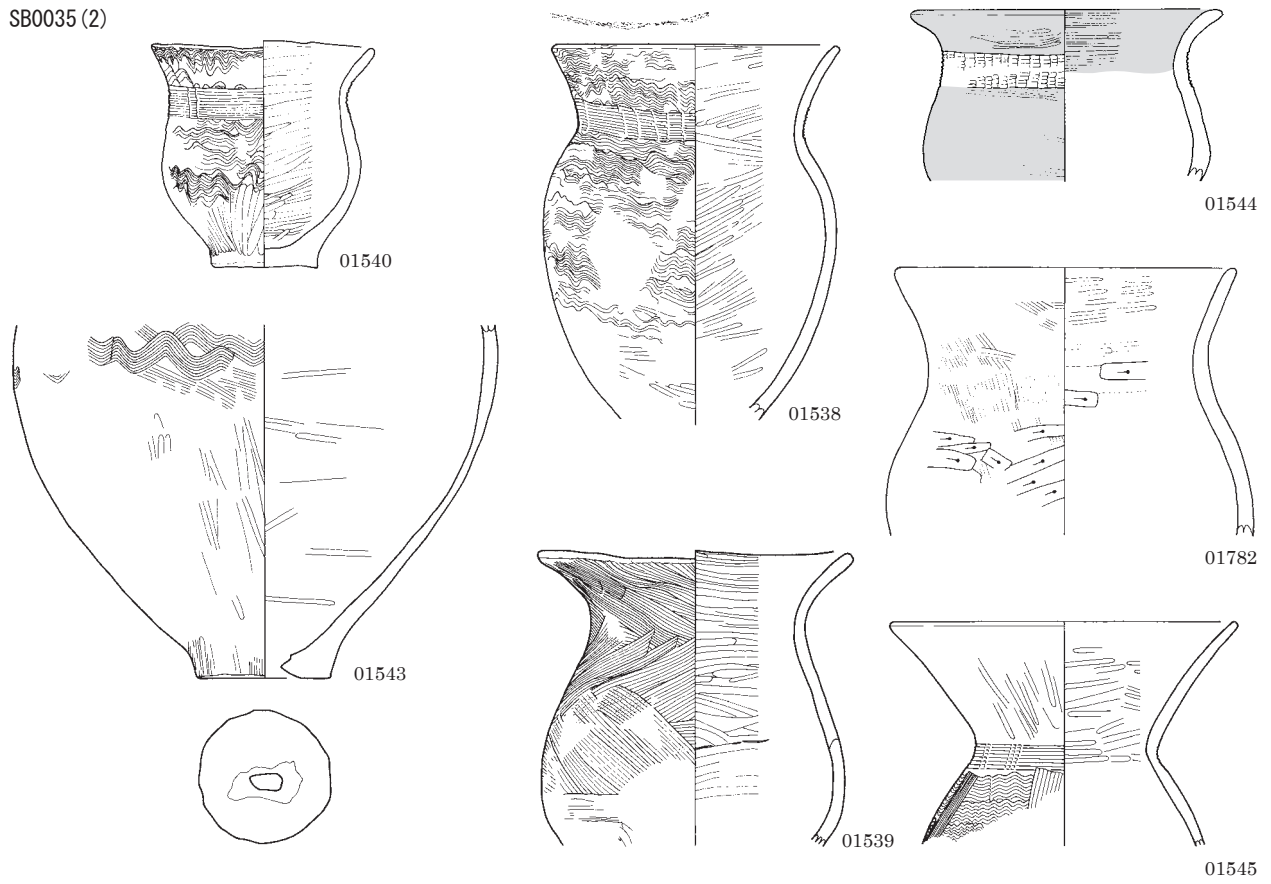

SB0036

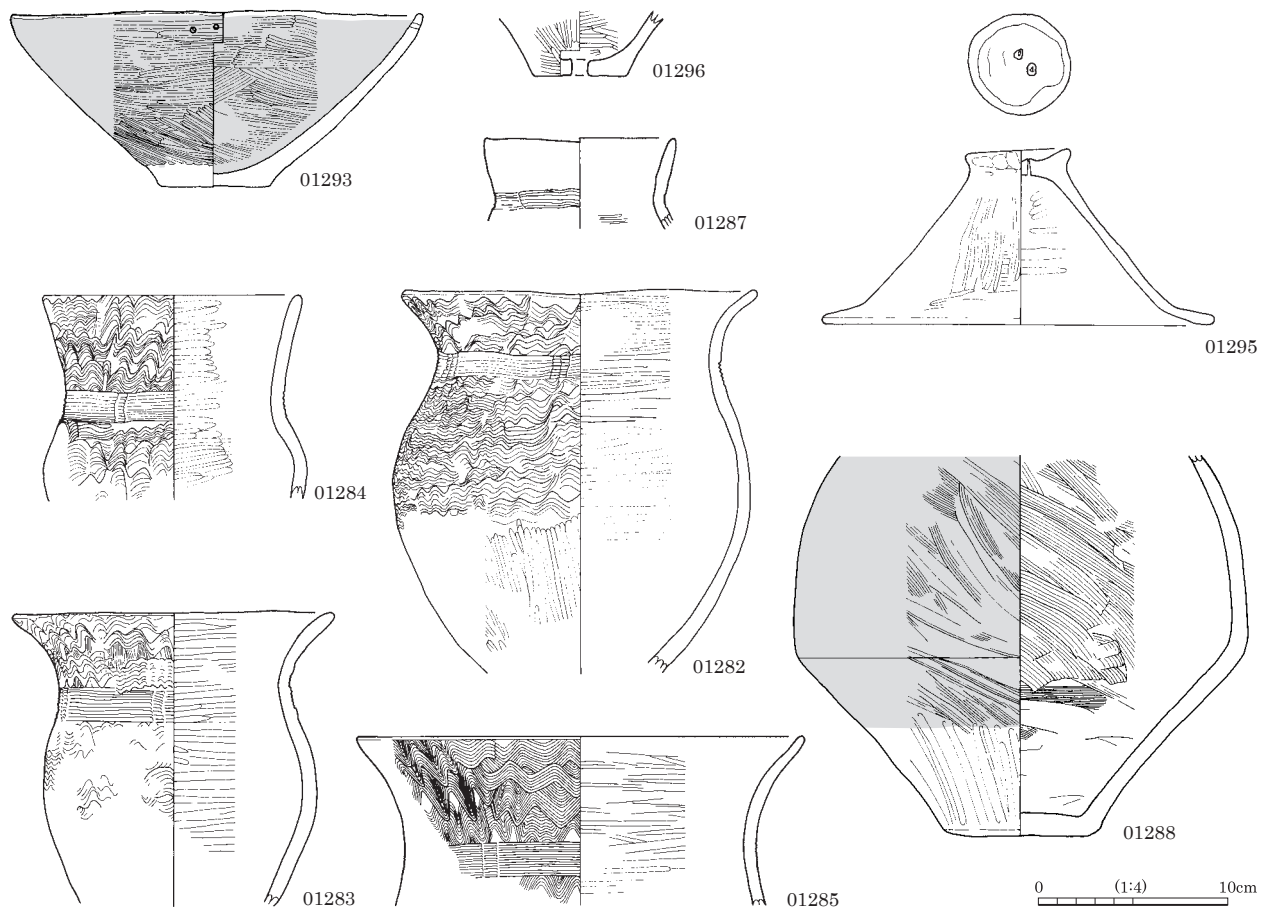

SB0041

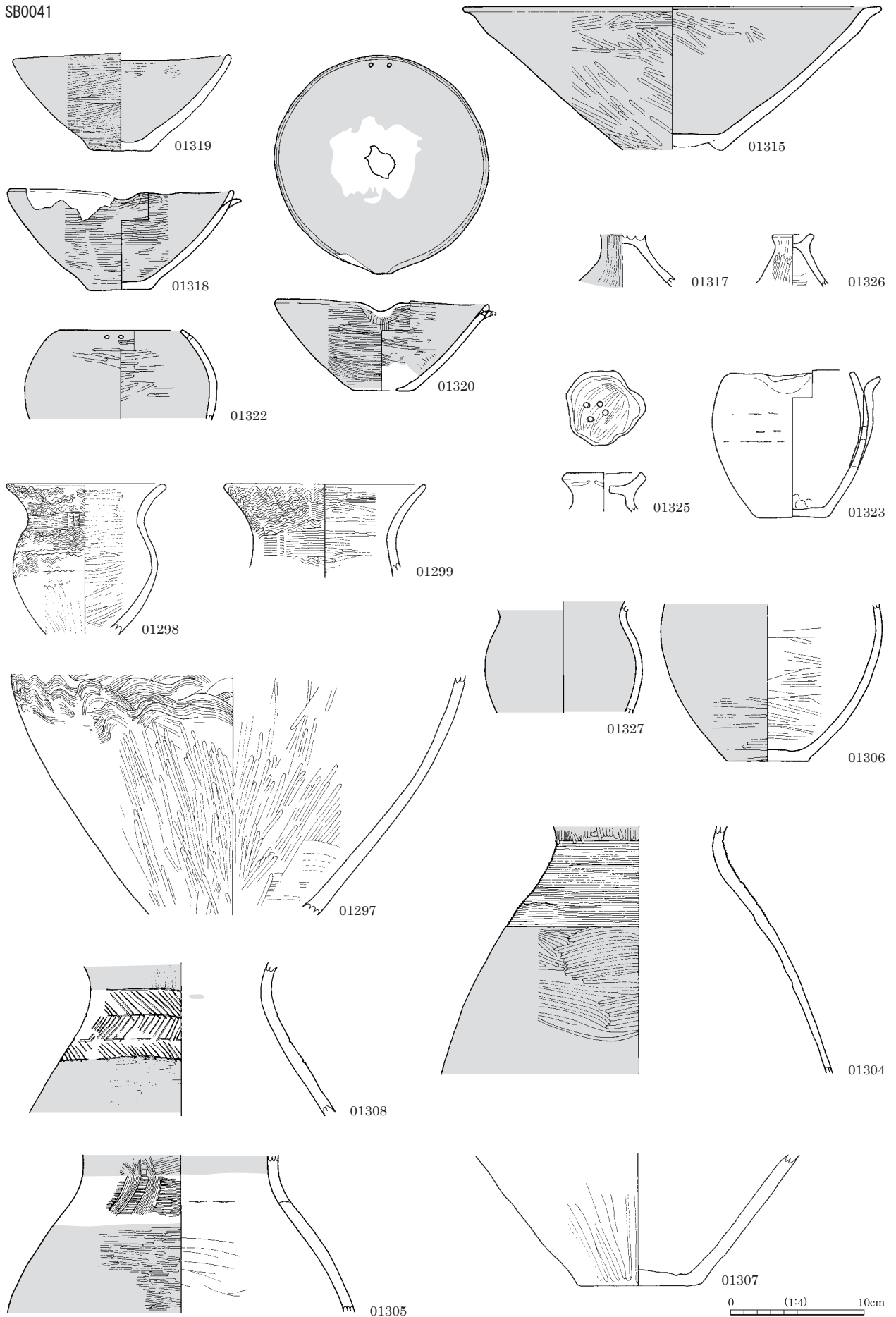

図版 18 弥生時代後期の土器 (13)

SB0047

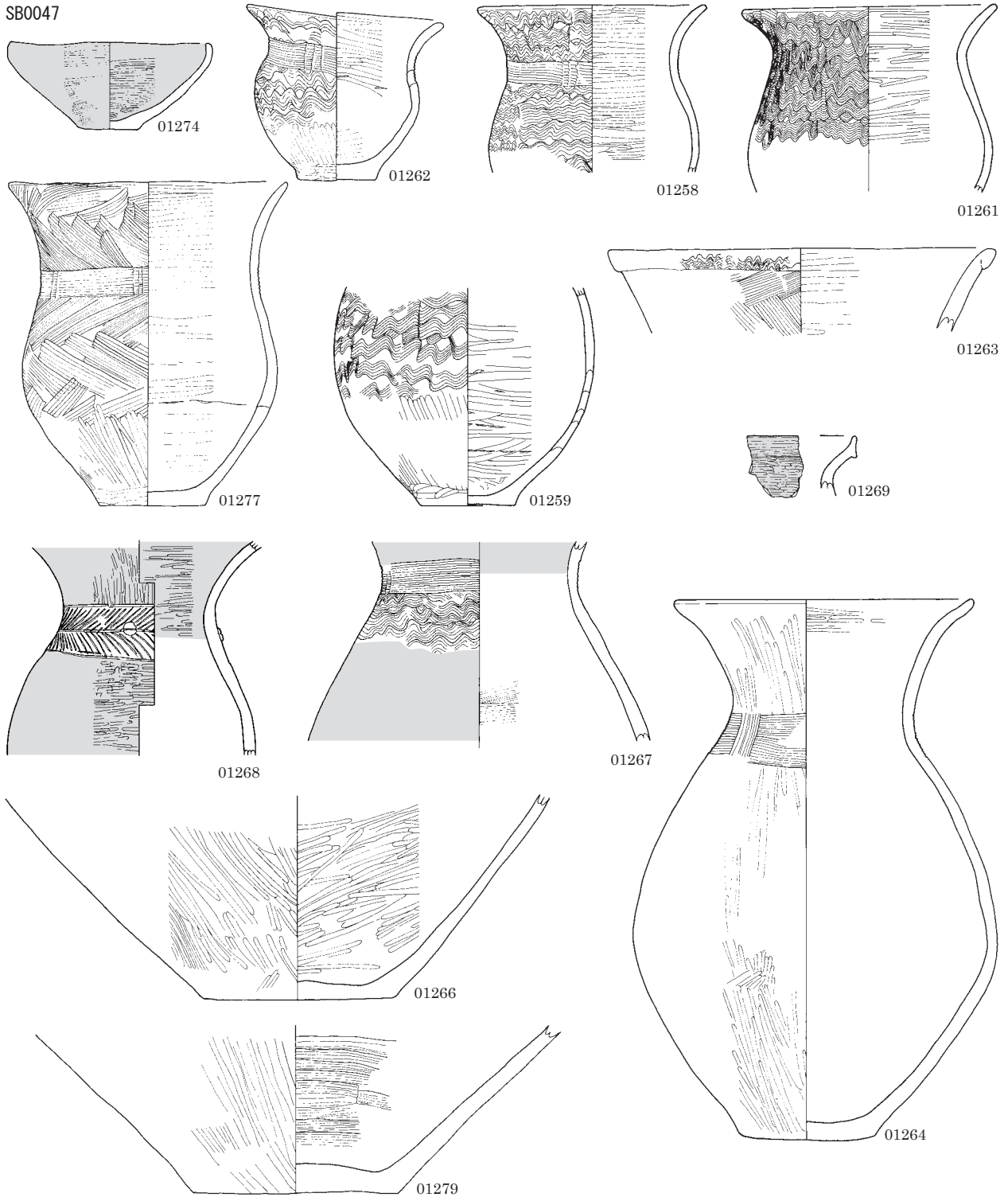

SB0048

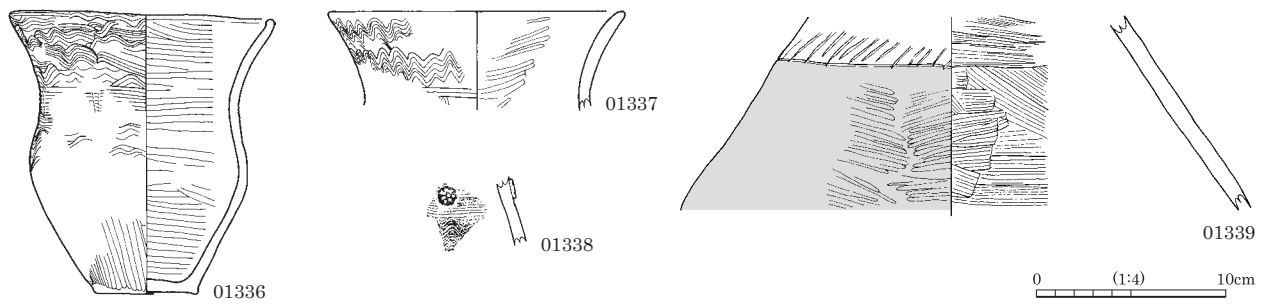

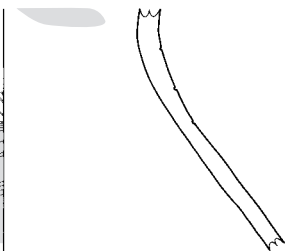
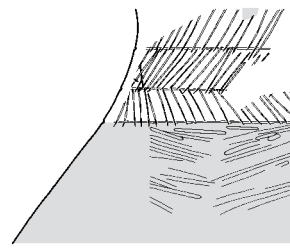
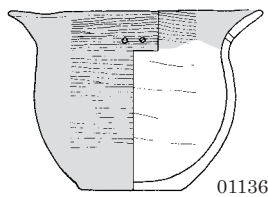
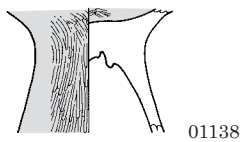
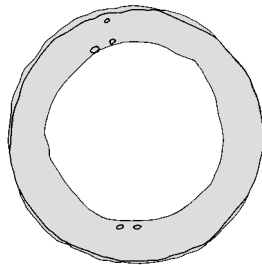
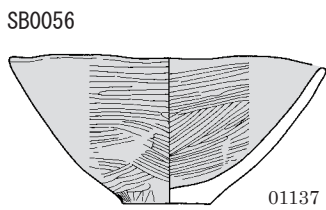
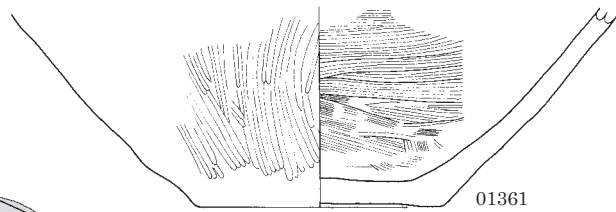
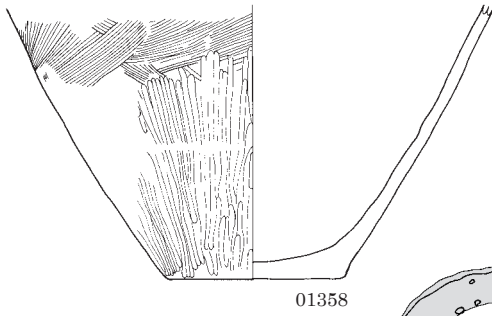
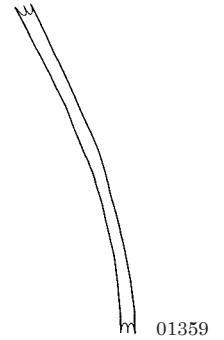
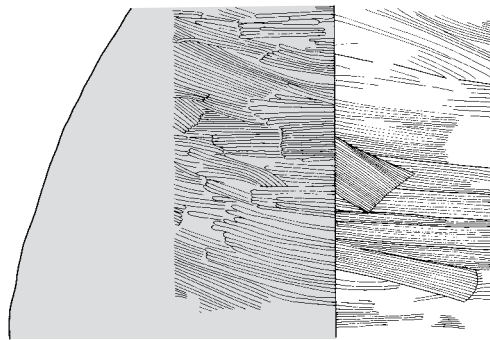
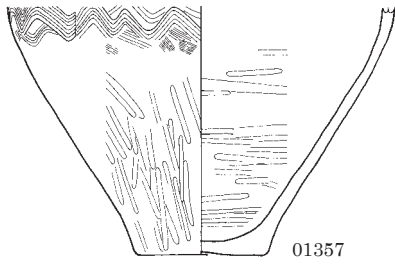
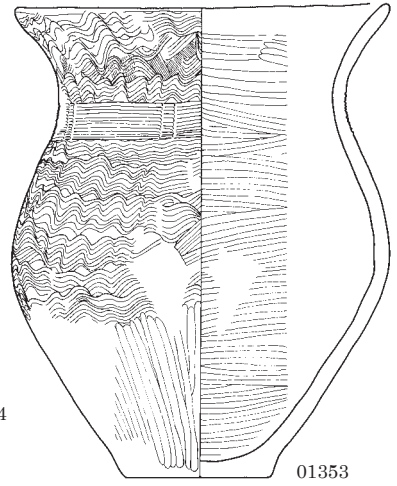
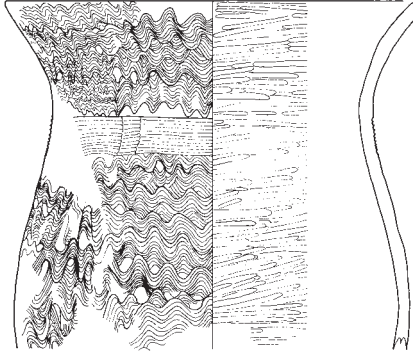
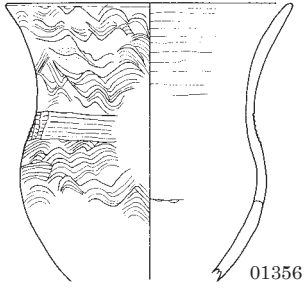
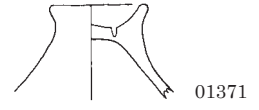
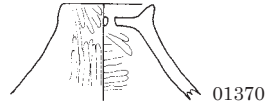
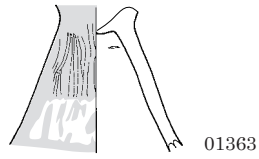
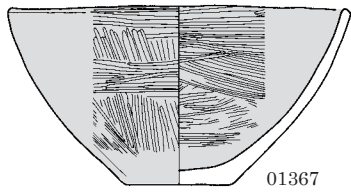
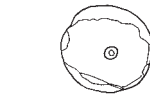
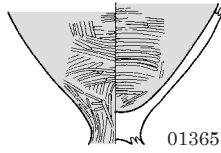

0 1:4 10cm

図版 20 弥生時代後期の土器 (15)

SB0057

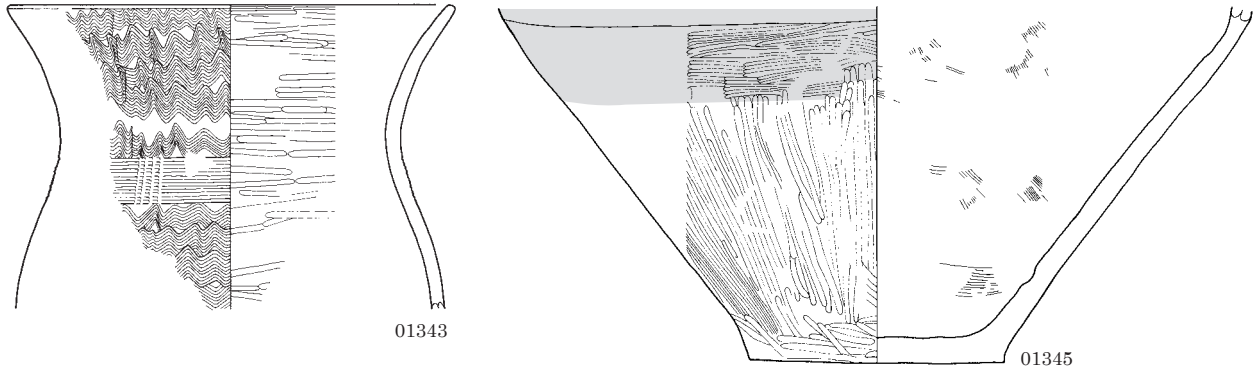
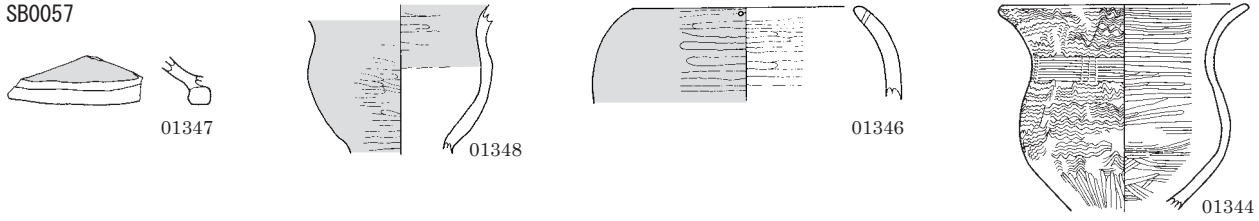

SB0061B

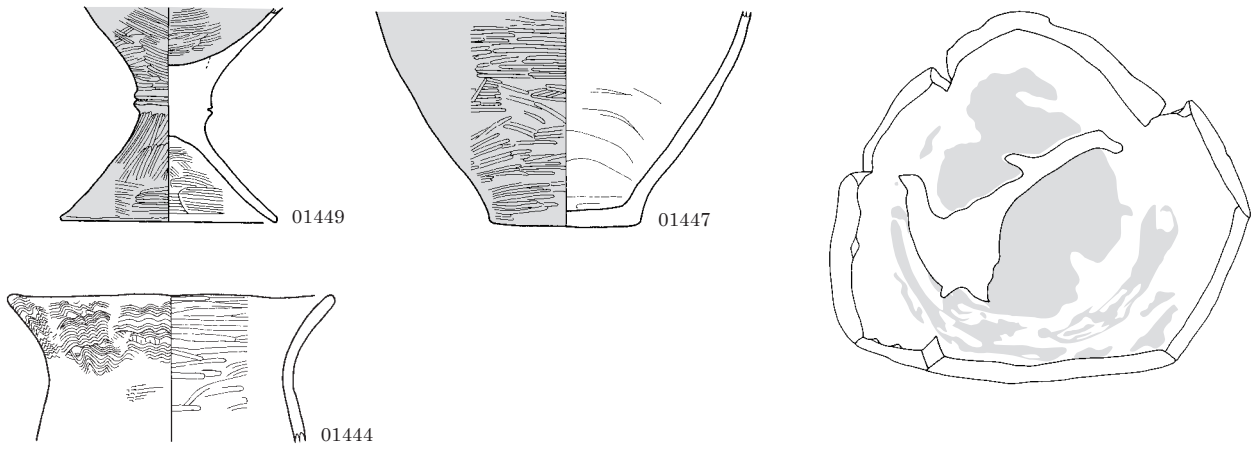

SB0062

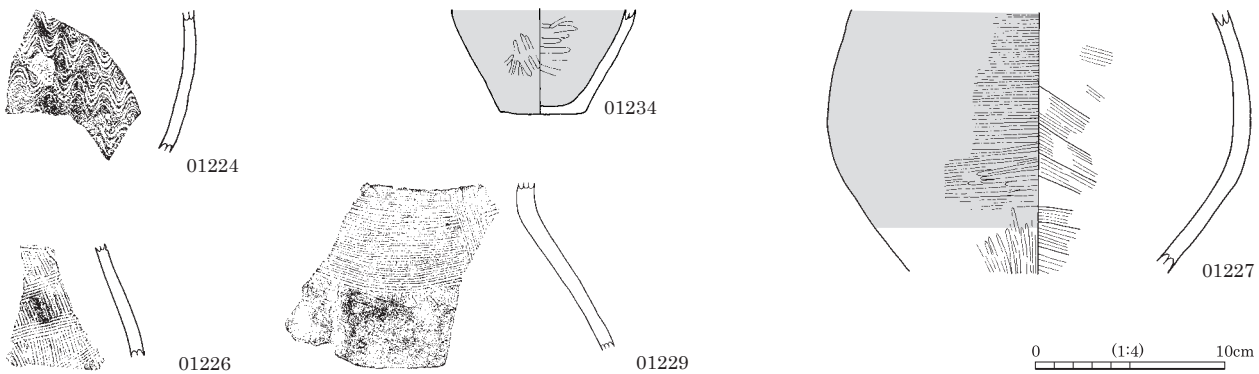
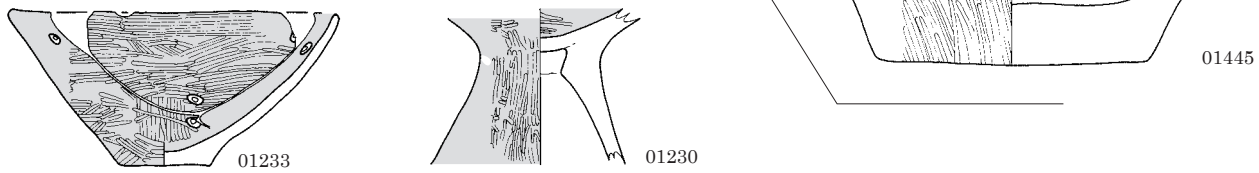

0 (1:4) 10cm

SB0066A

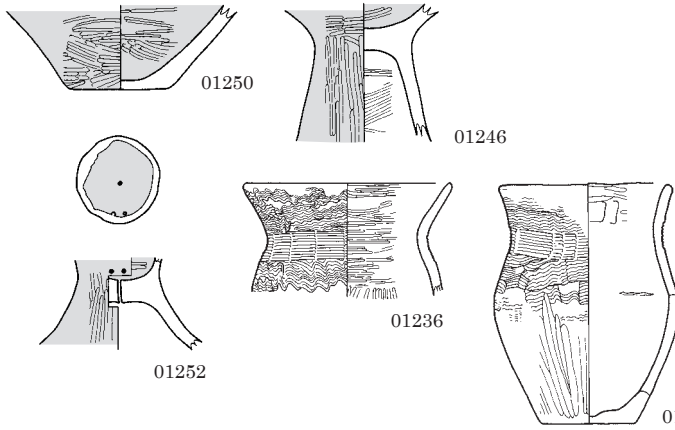

SB0066B

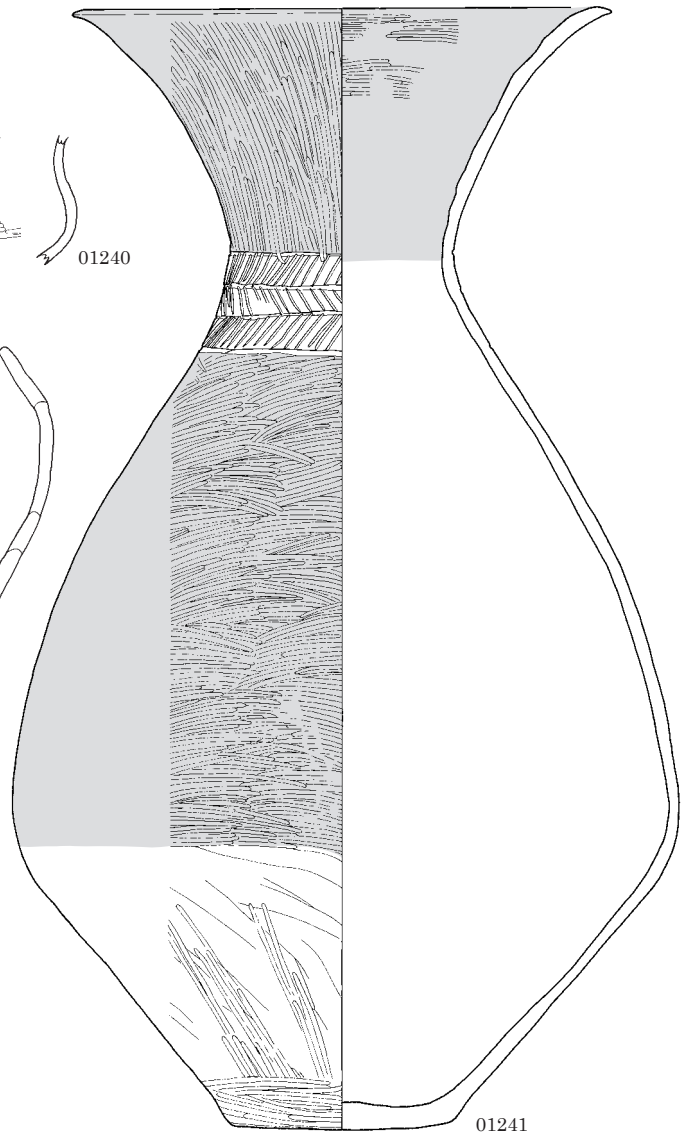
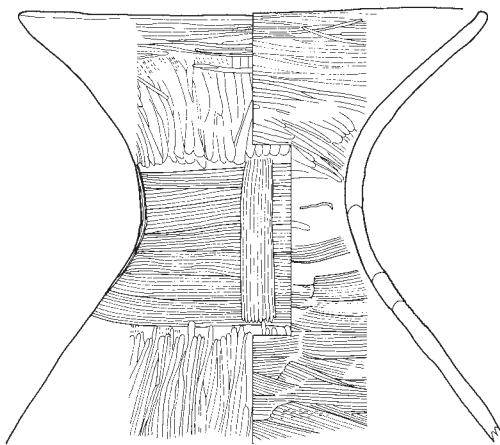
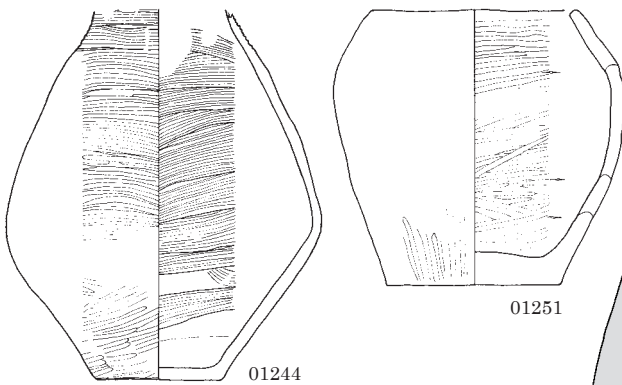
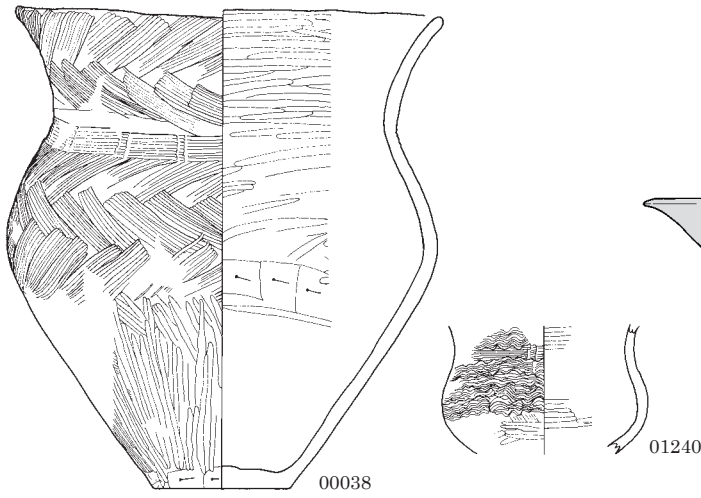
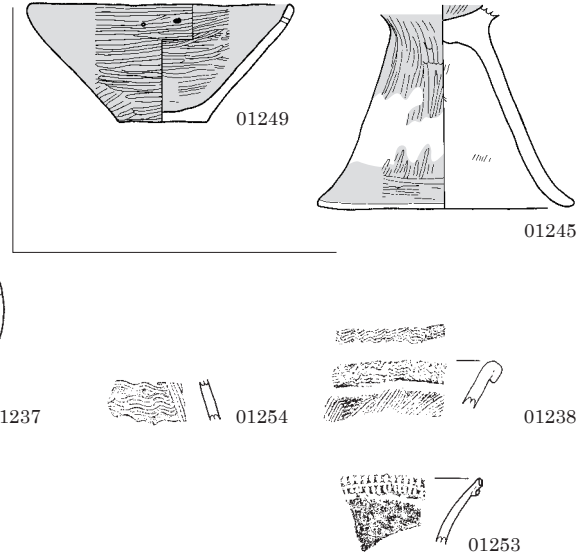

0 (1:4) 10cm

図版 22 弥生時代後期の土器 (17)

SB0067 (1)

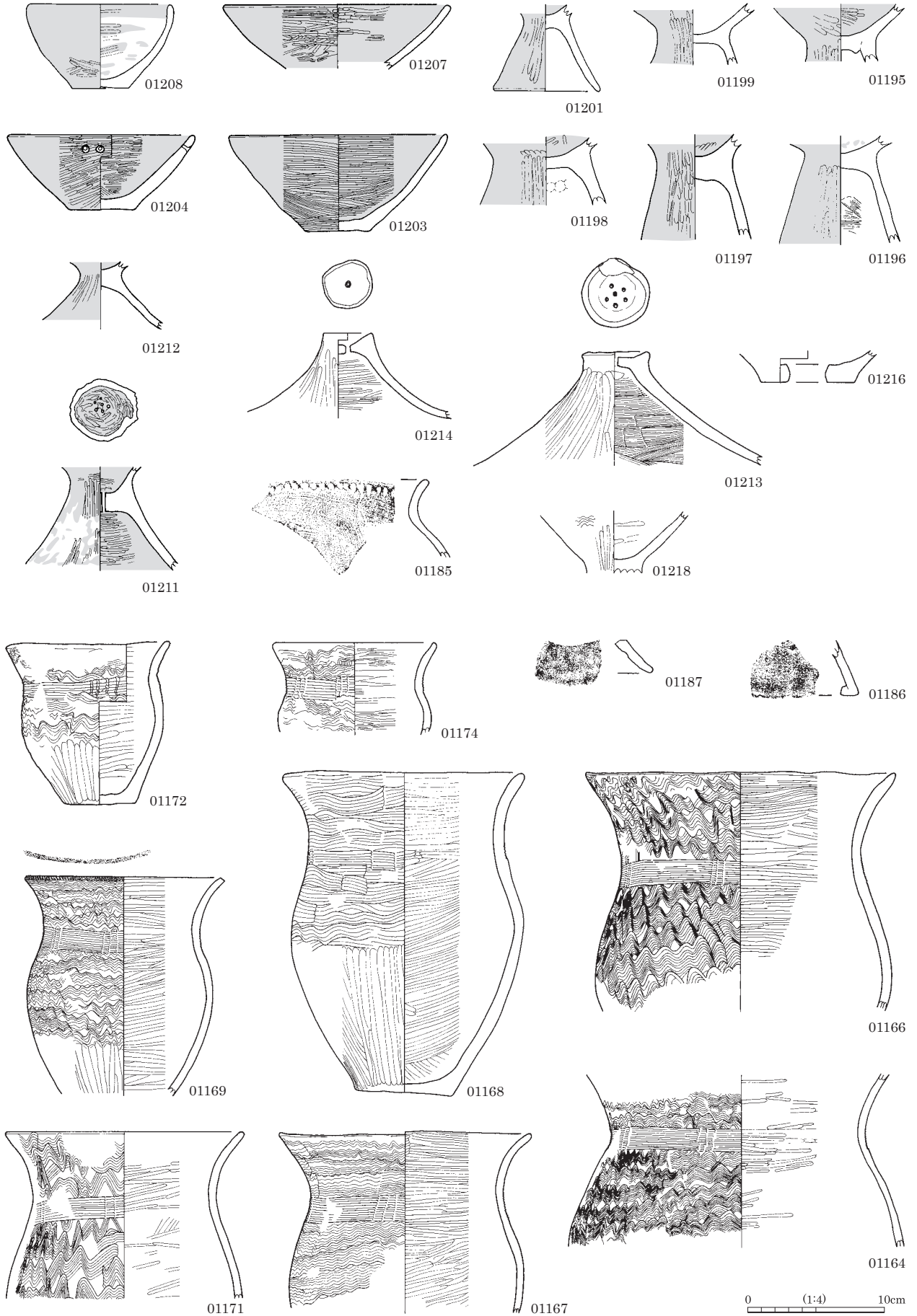

SB0067 (2)

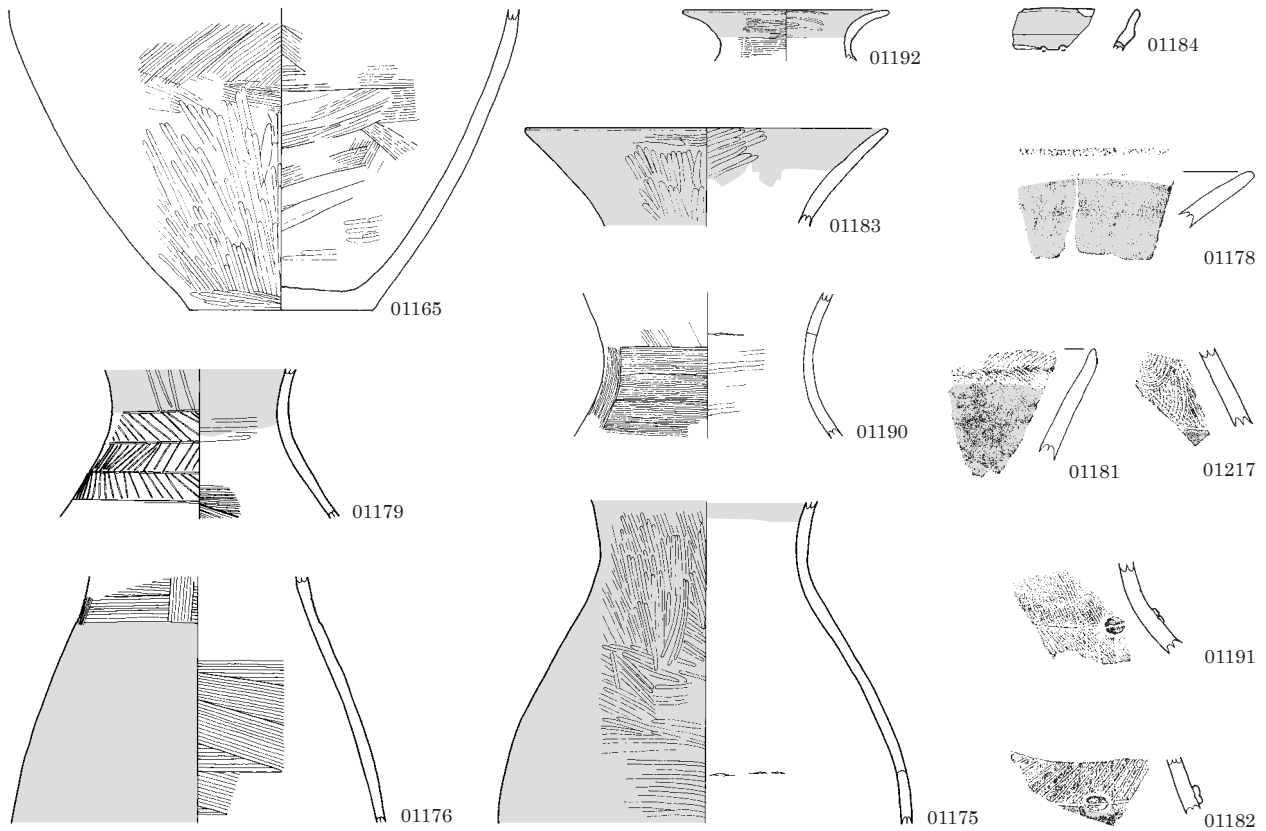
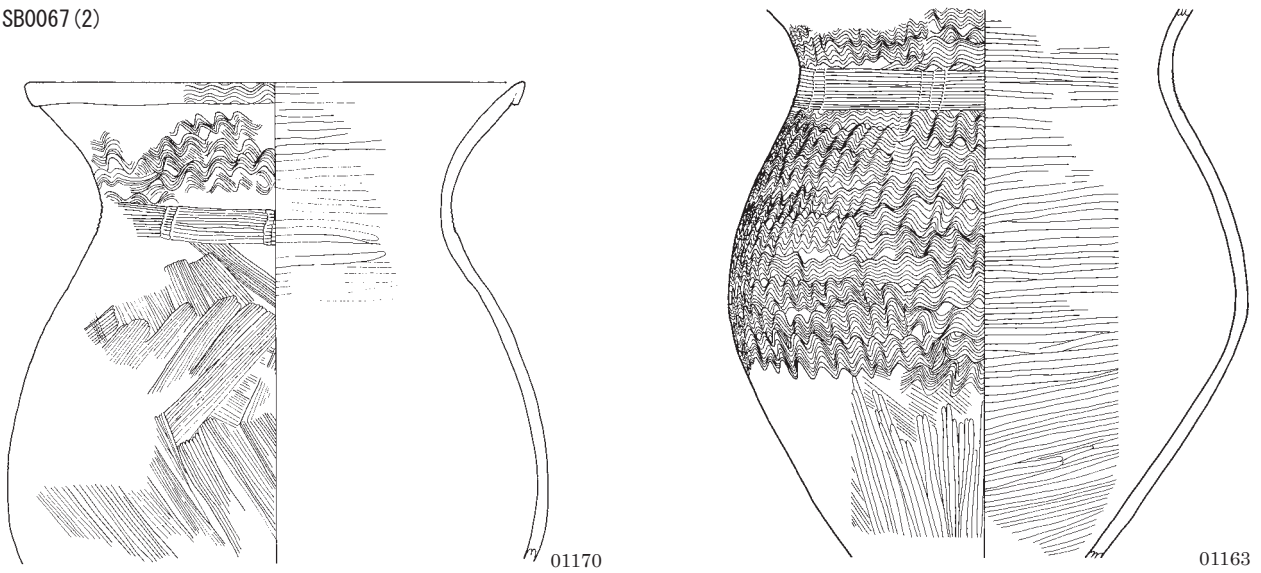

SB0075 (1)

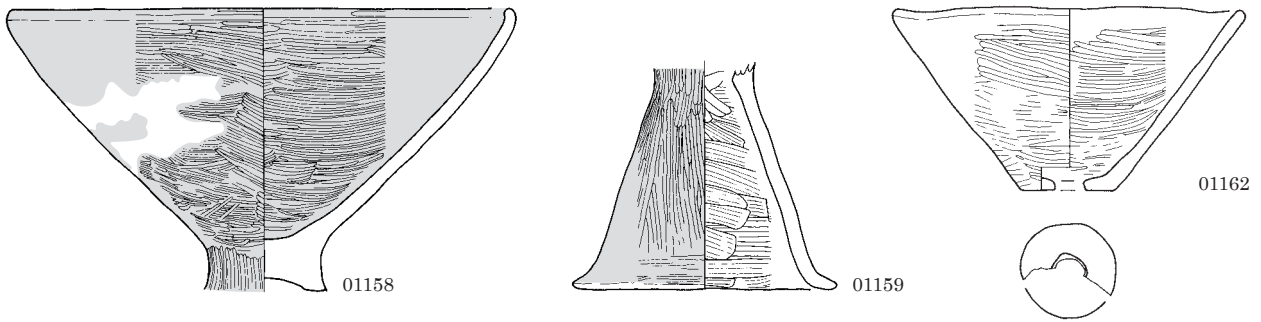

0 10cm (1:4)

図版 24 弥生時代後期の土器 (19)

SB0075 (2)

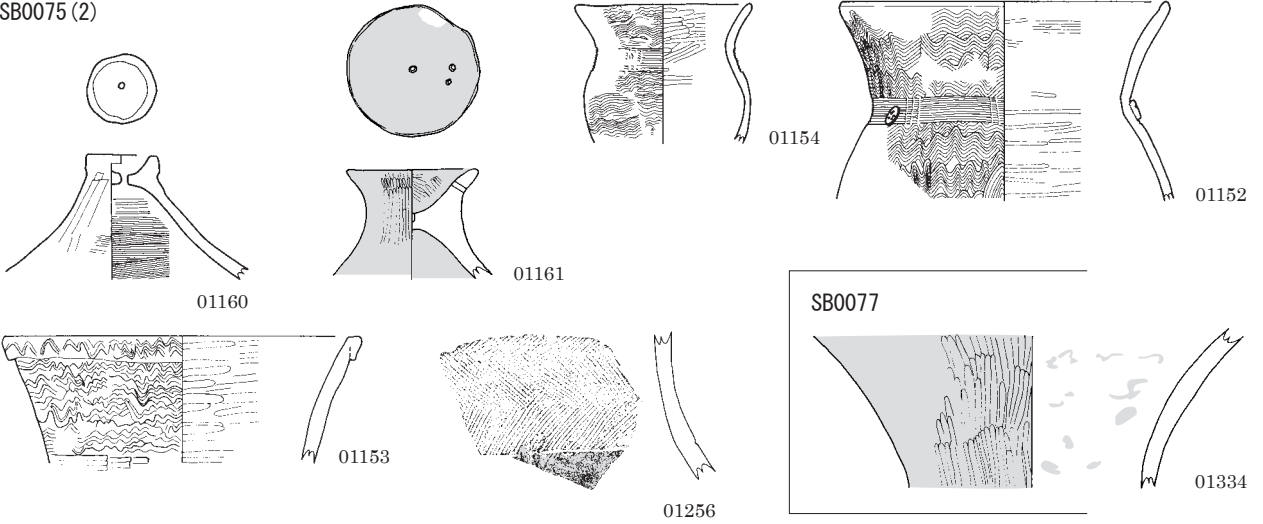

SB0102

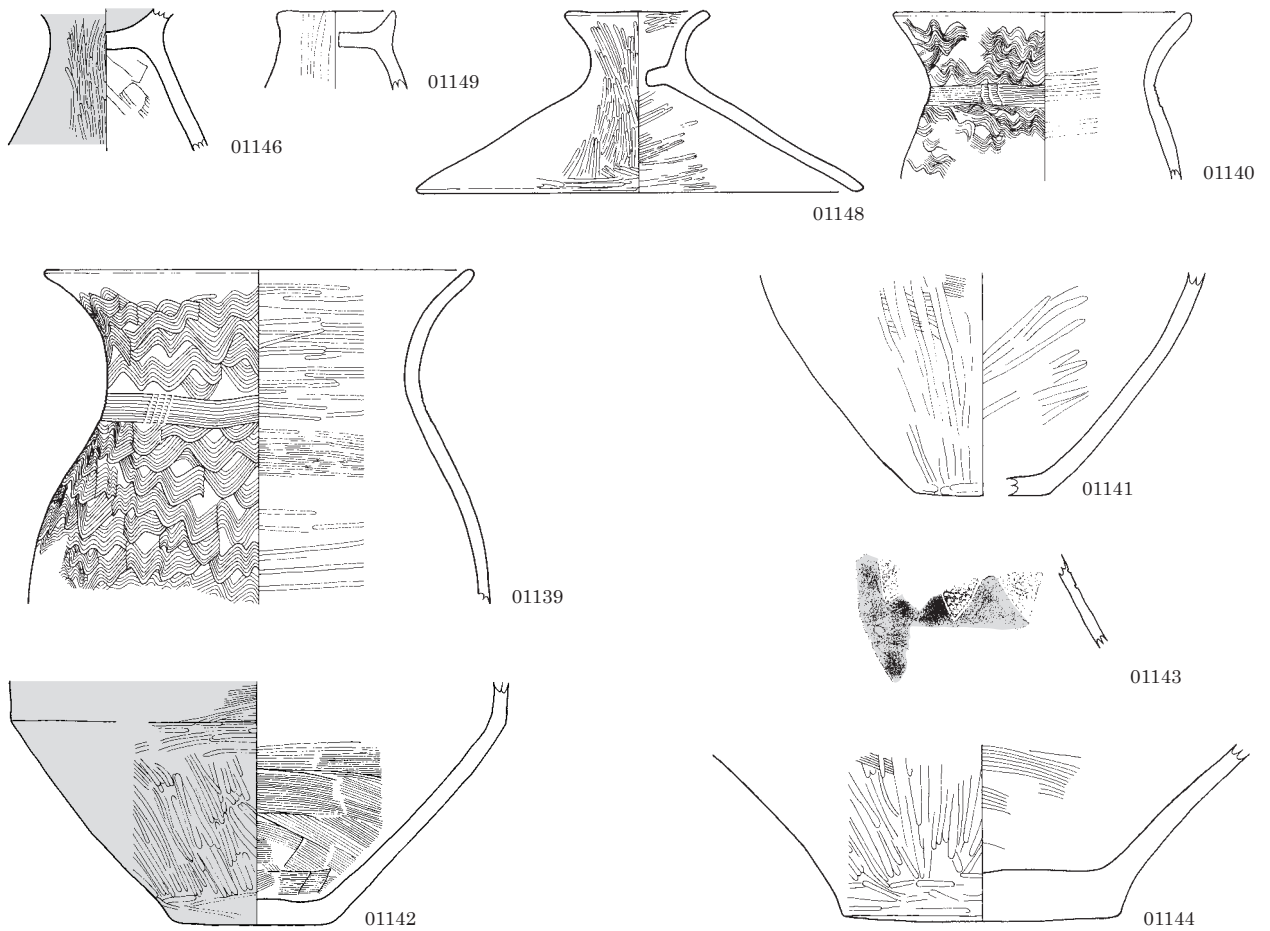

SB0105

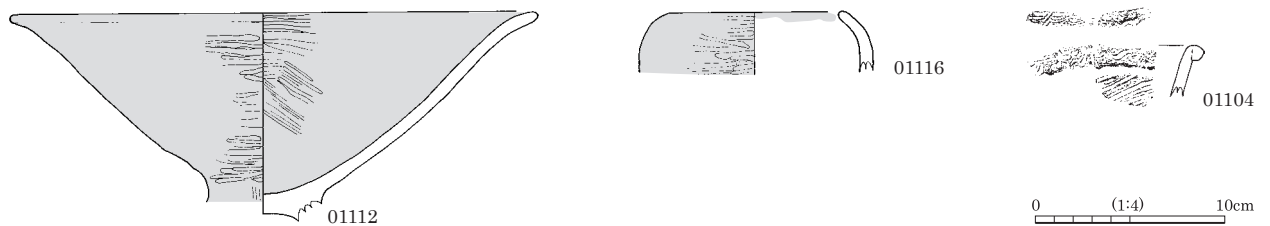

0 (1:4) 10cm

SB0105 南

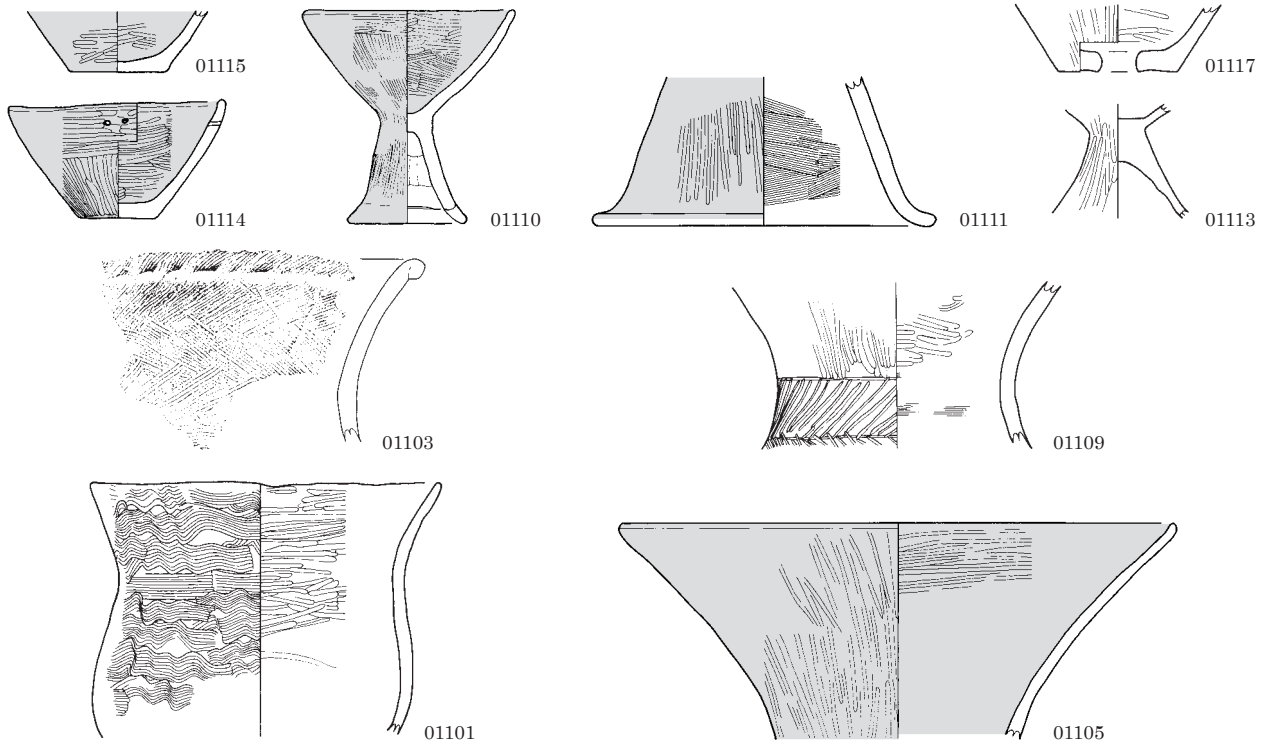

SB0105 北

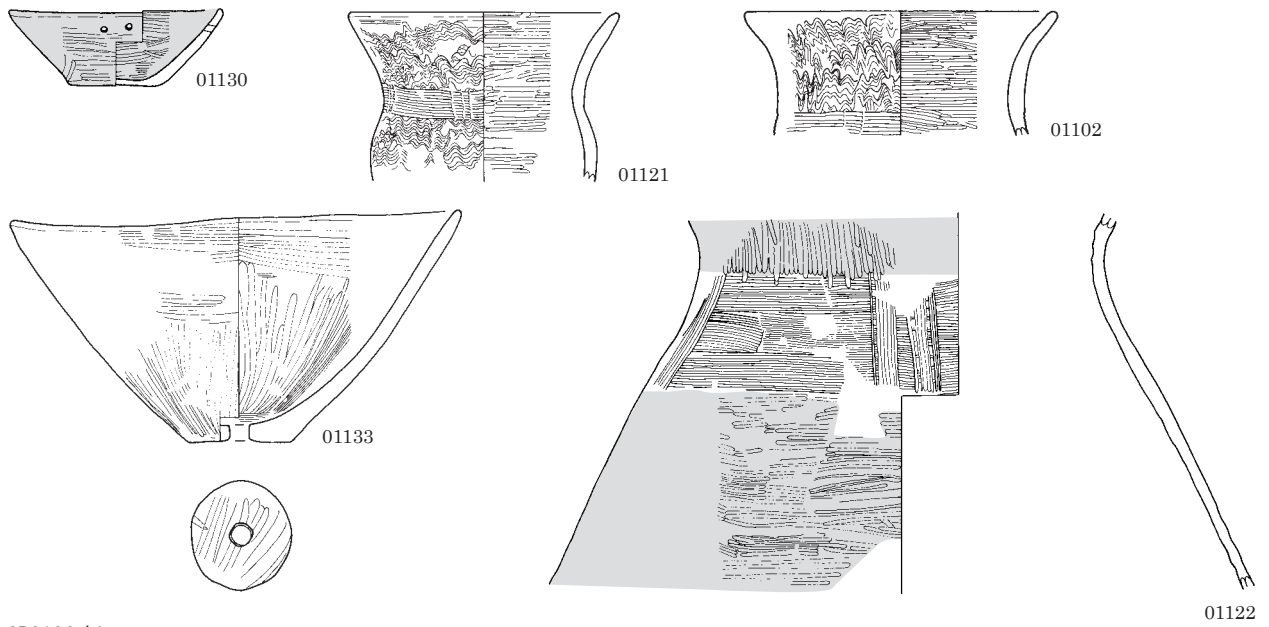

SB0106 新

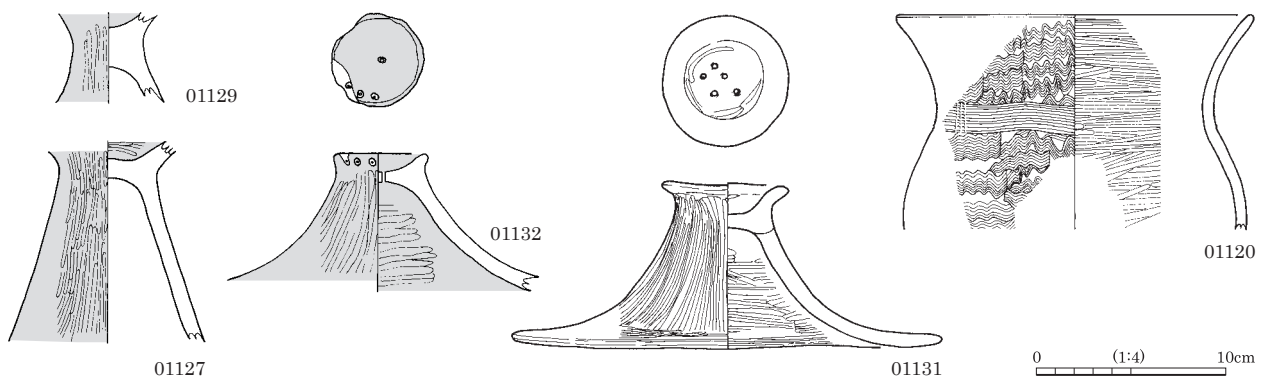

図版 26 弥生時代後期の土器 (21)

SB0110

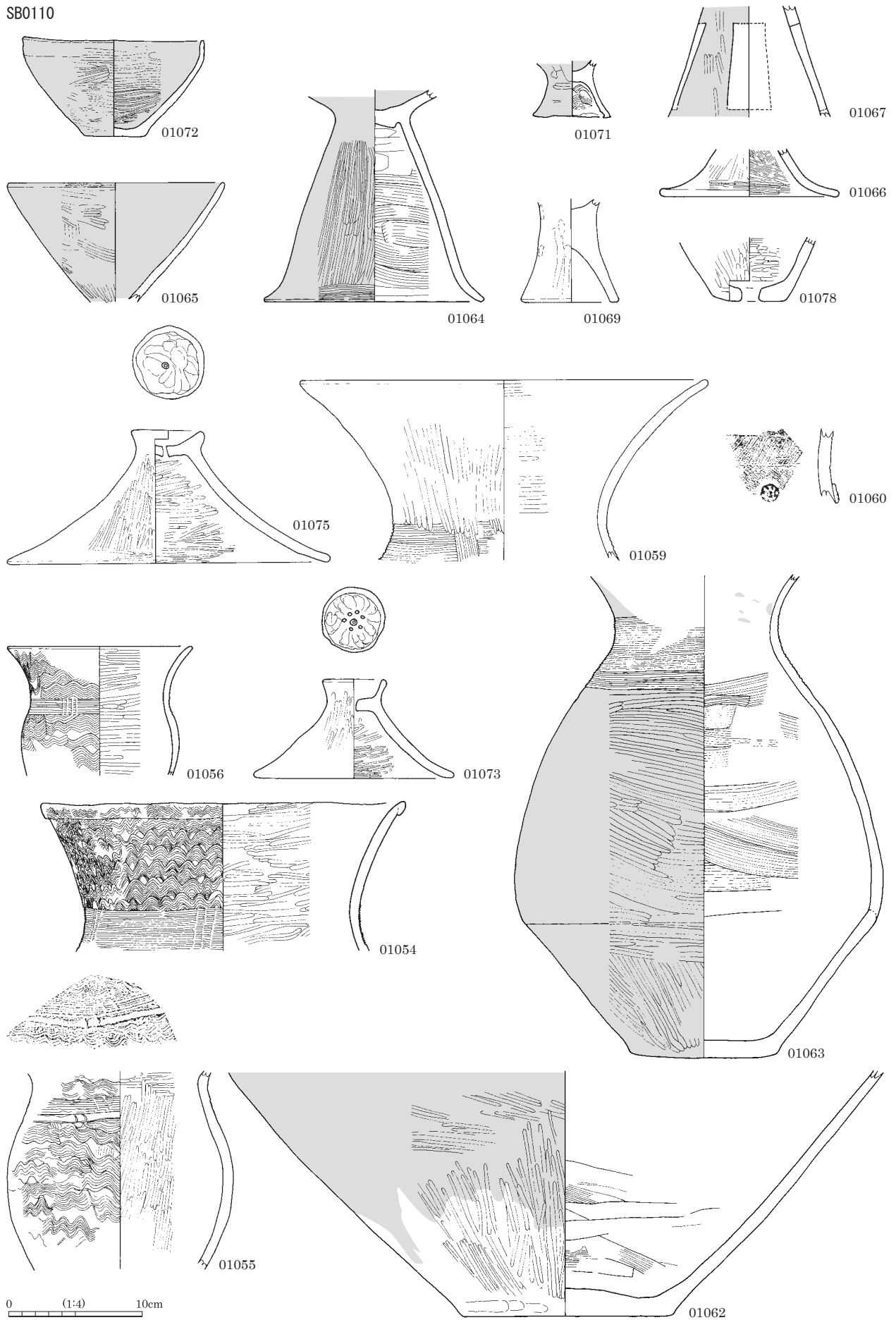

SB0111

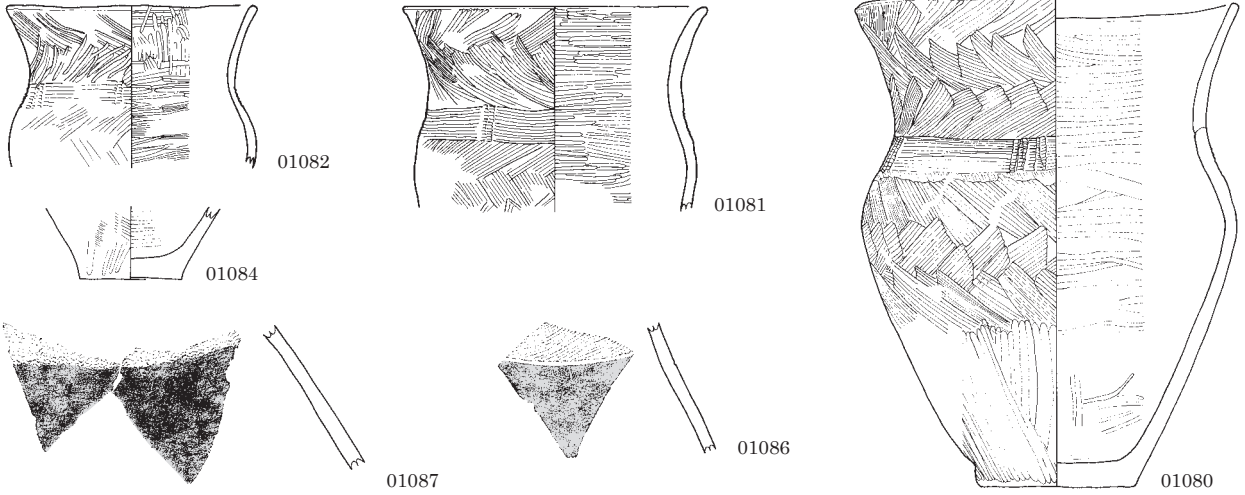

SB0117

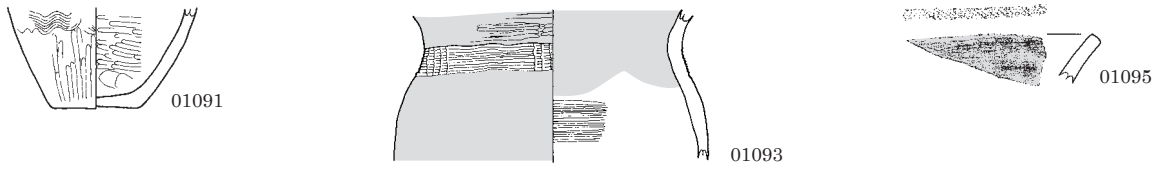

SB0128

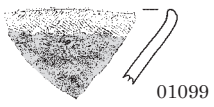

SB0130

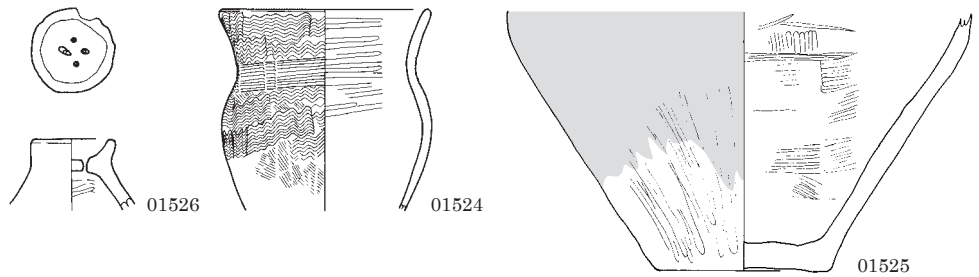

SB0134

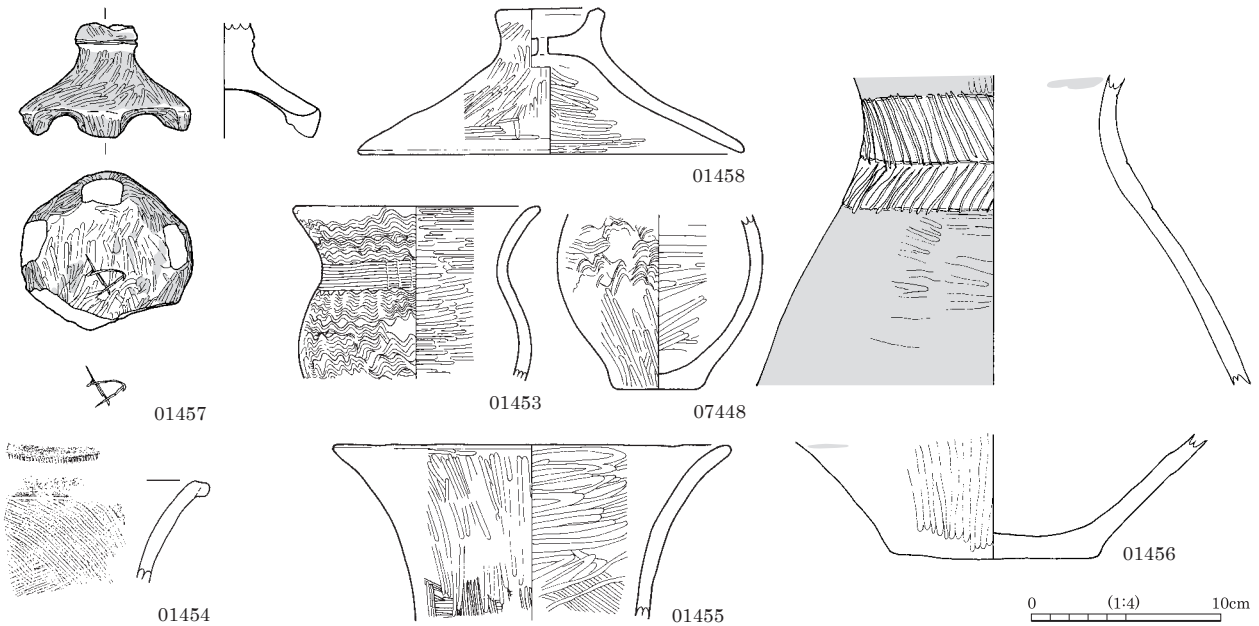

0 (1:4) 10cm

図版 28 弥生時代後期の土器 (23)

SB0149

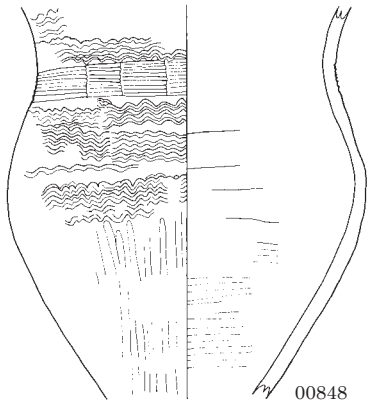

00848

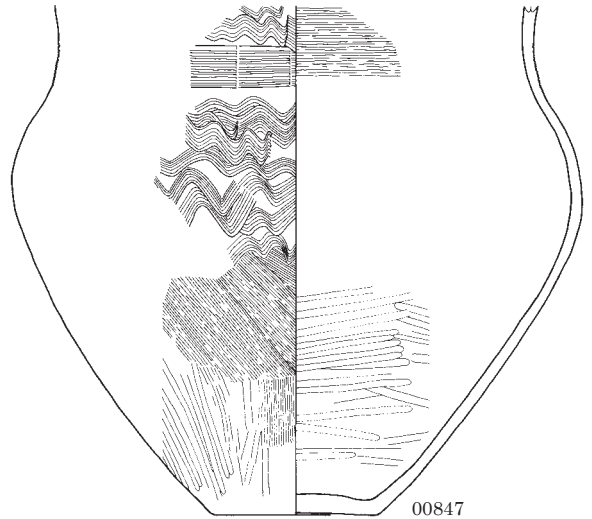

00847

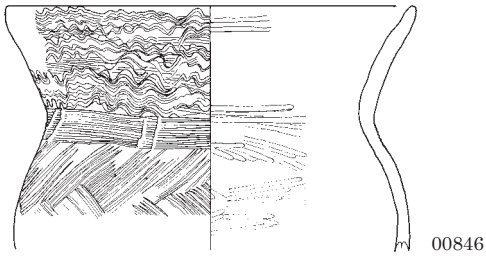

00846

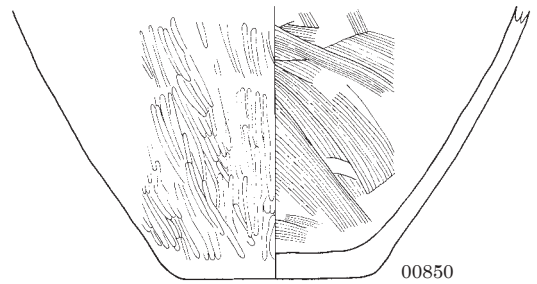

00850

SB0156

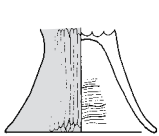

01351



01352

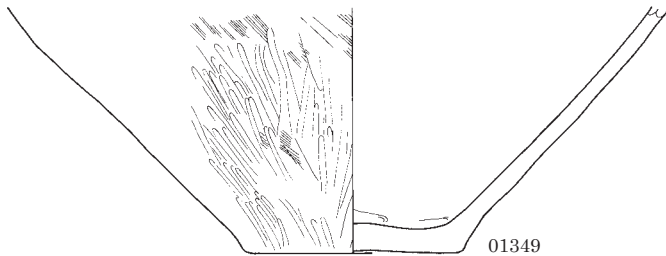

01349

SB0306

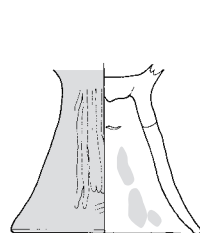

00998

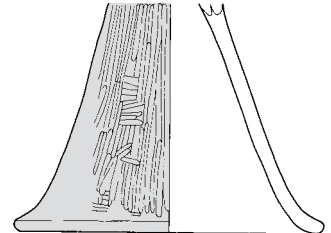

00997

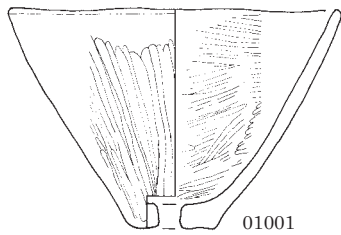

01001

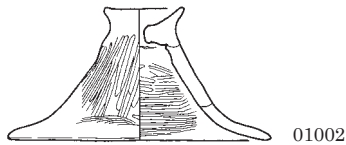

01002

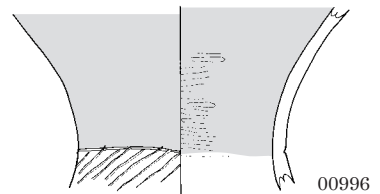

00996

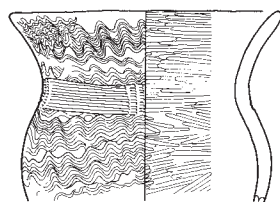

00991

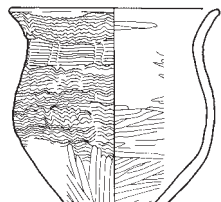

00992

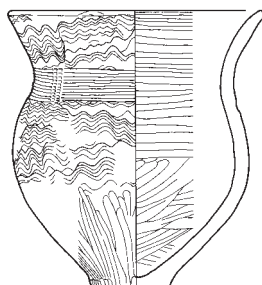

00993

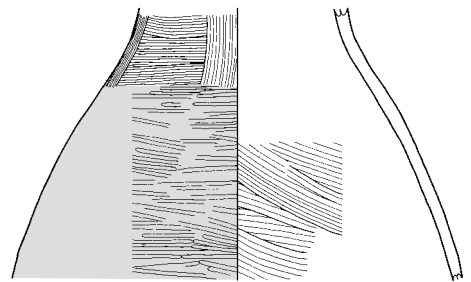

00995

0 1:4 10cm

SB0307

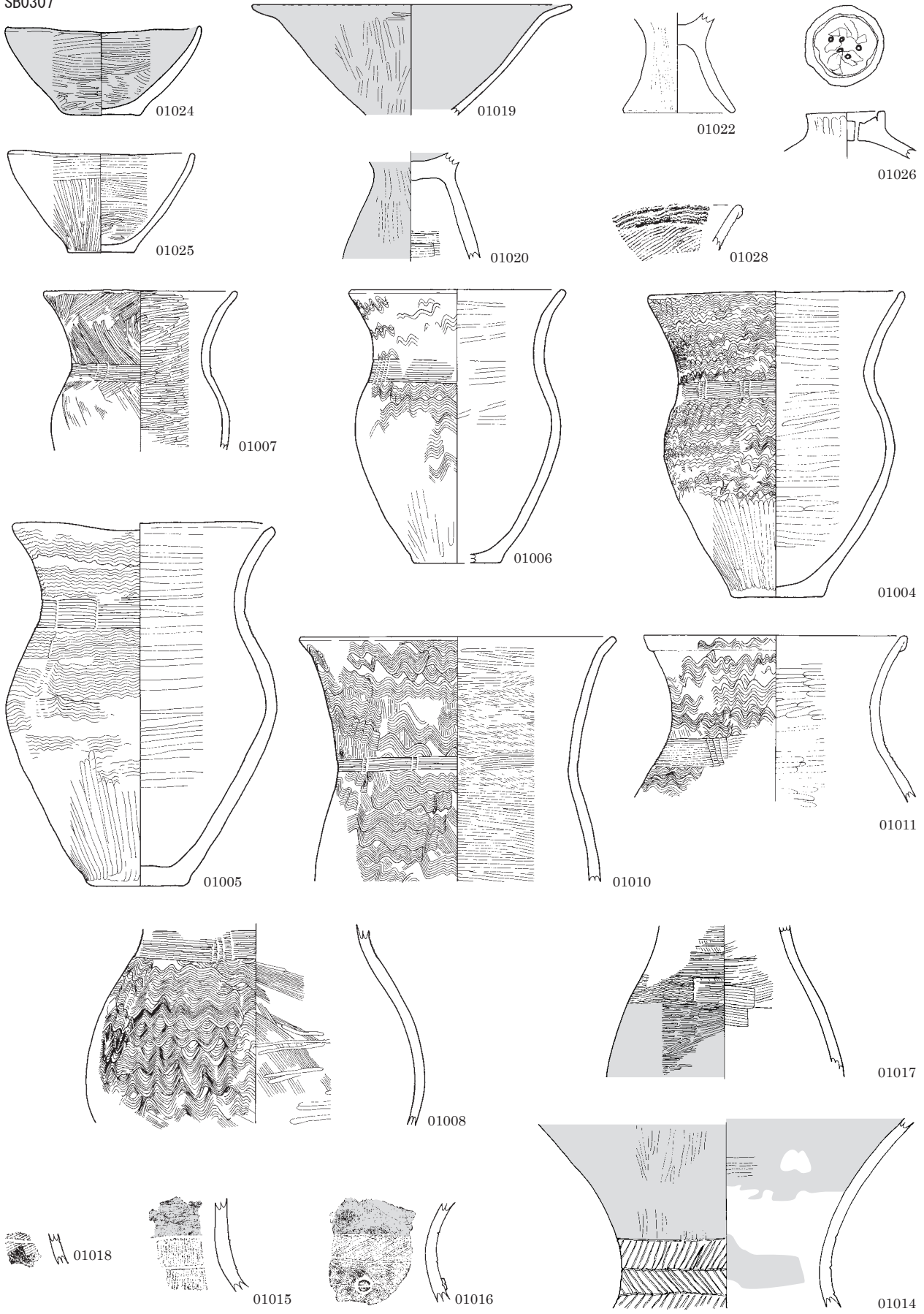

0 1:4 10cm

図版 30 弥生時代後期の土器 (25)

SB0310

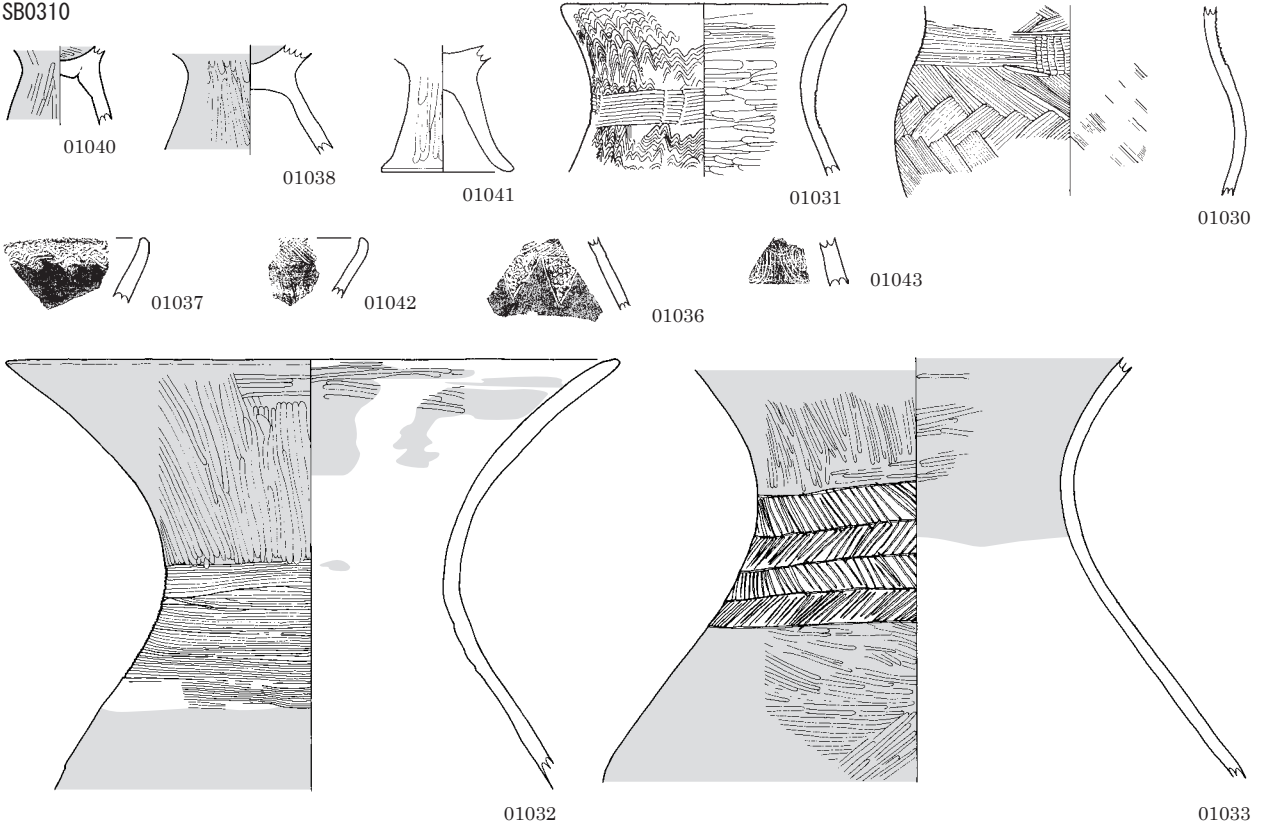

SB0315

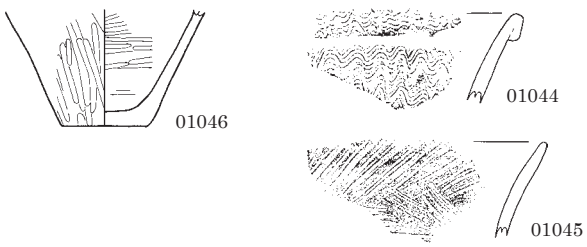

SB0316

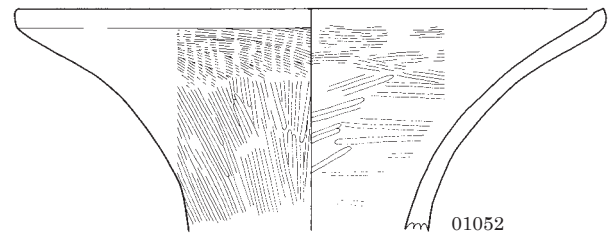

SB3029

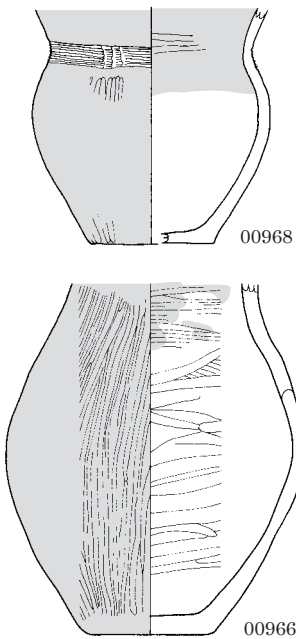

SB3036 (1)

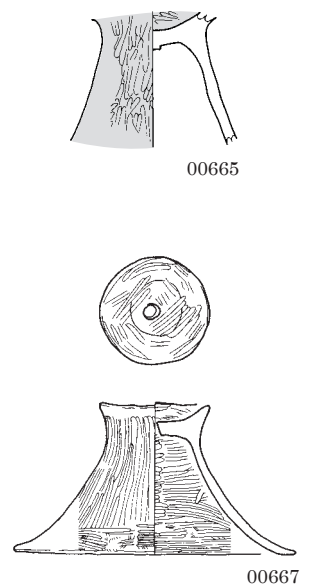
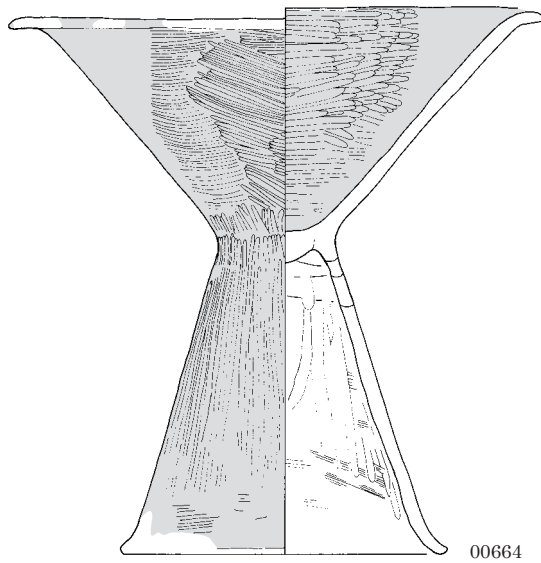

0 1:4 10cm

SB3036 (2)

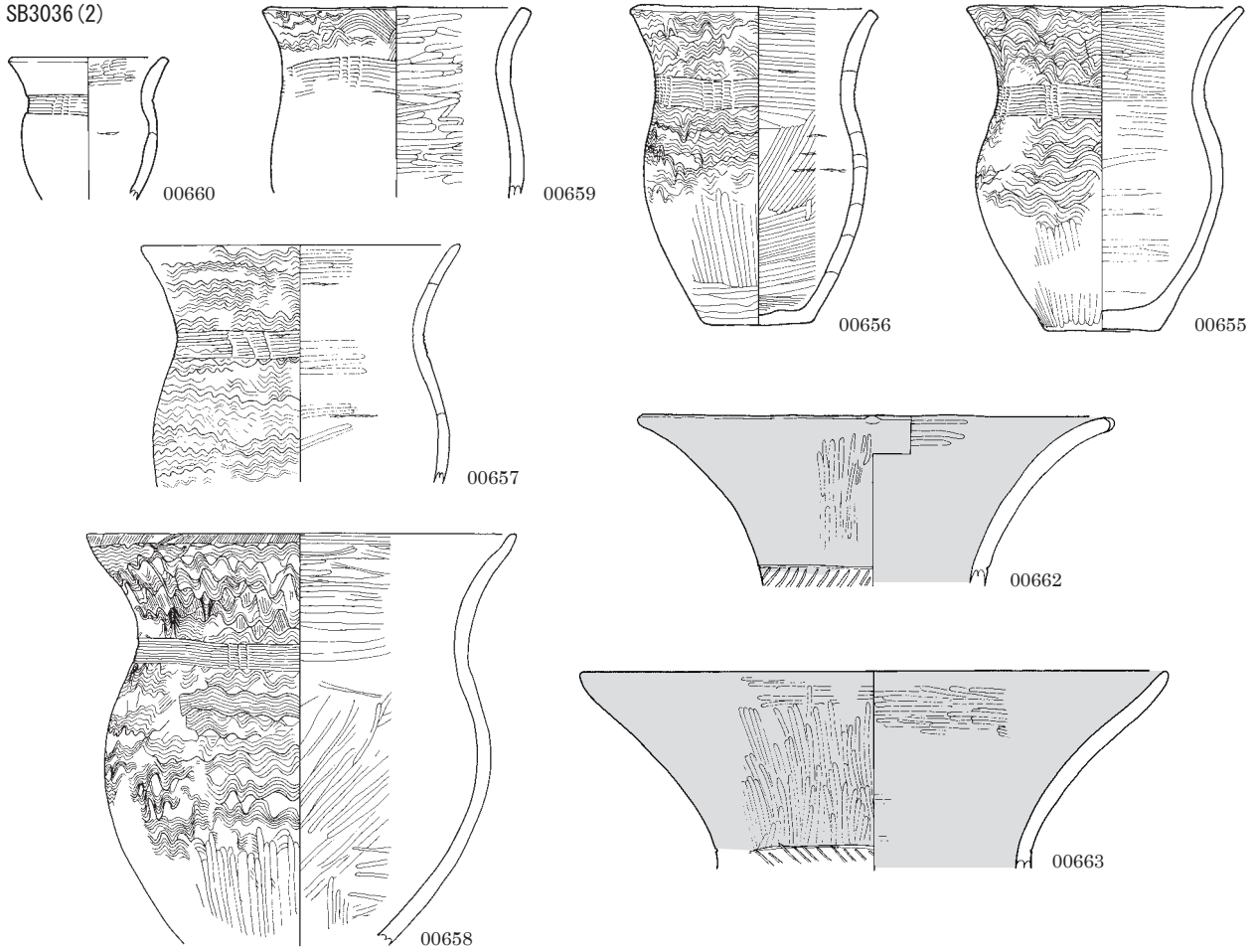

SB3041 (1)

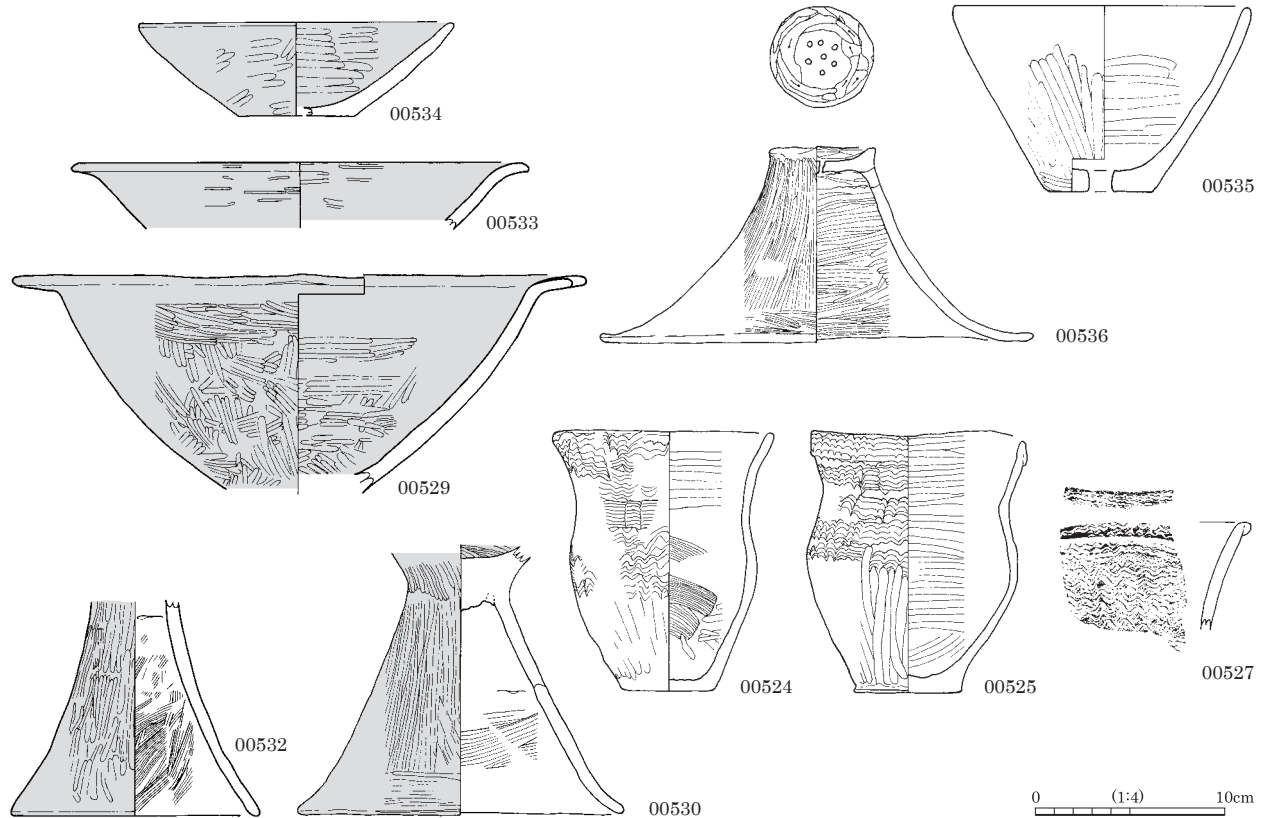

図版 32 弥生時代後期の土器 (27)

SB3041 (2)

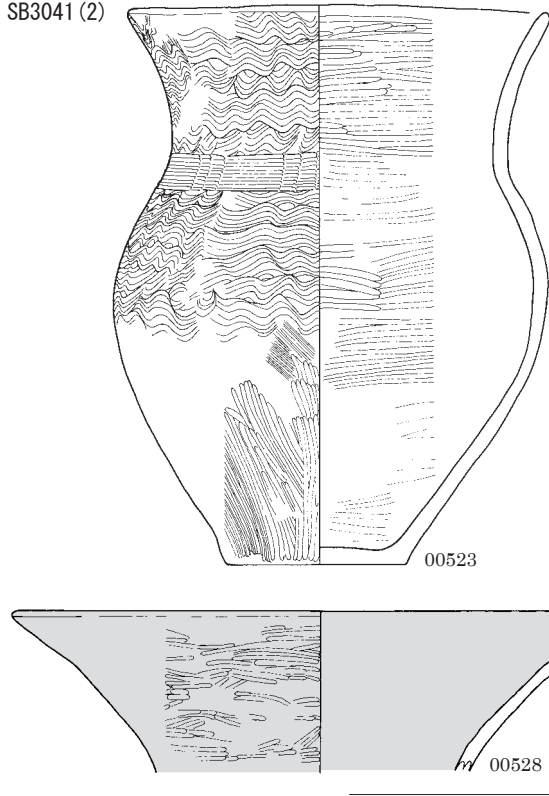

SB3069

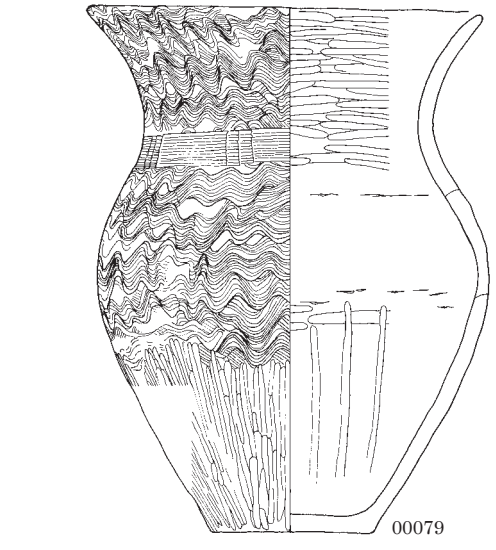
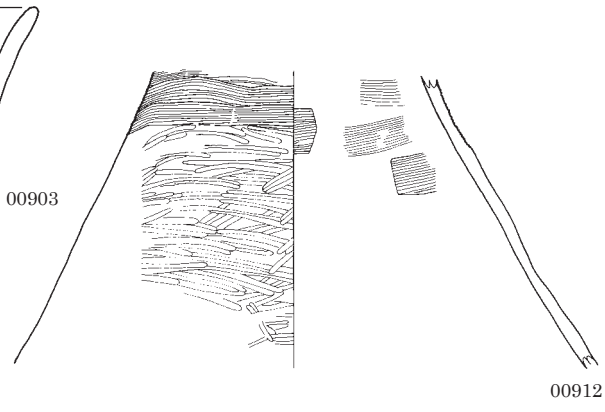
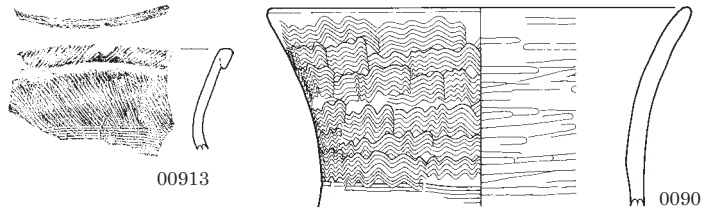
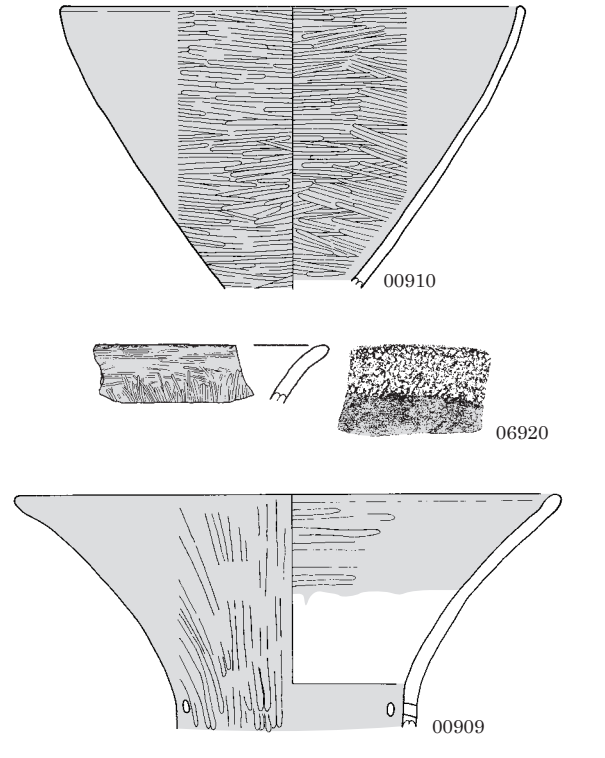

SB3071



図版 34 弥生時代後期の土器 (29)

SB3087

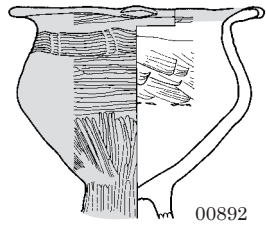

00892

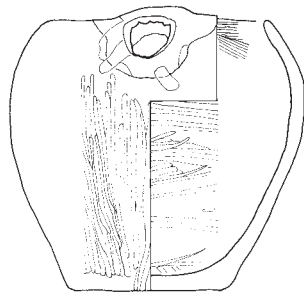

00894

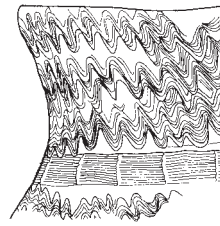
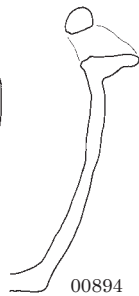

00886

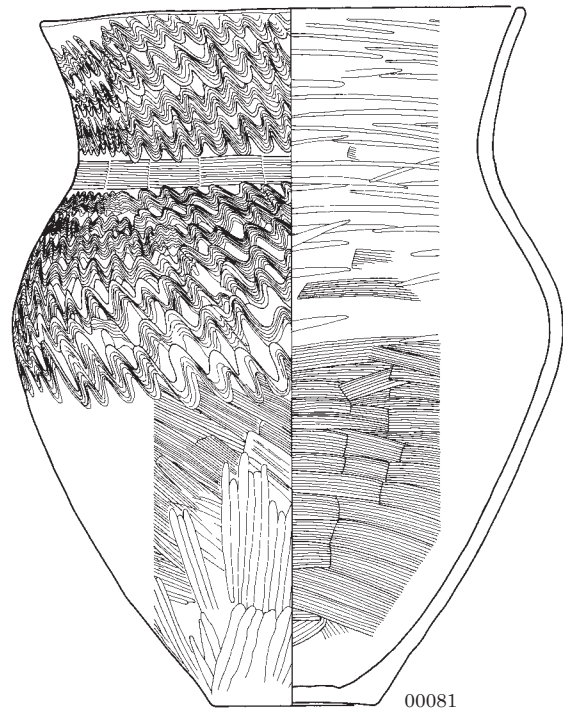
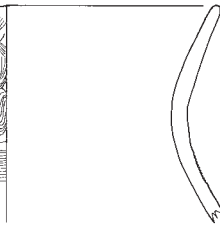

00081

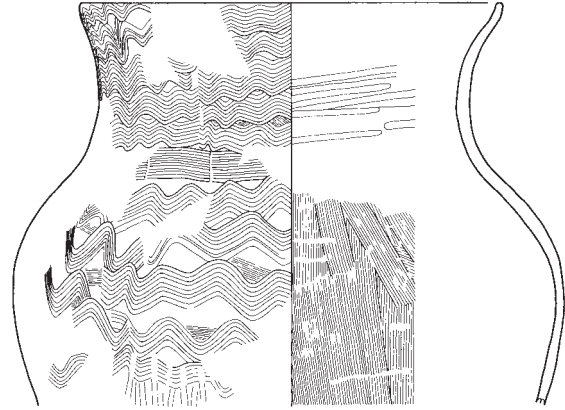

00885

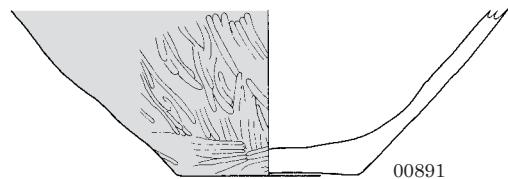

00891

SB3088

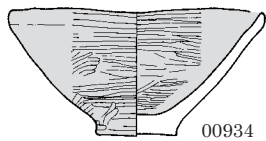

00934

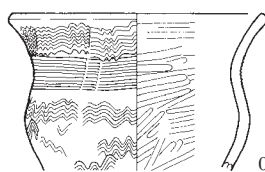

00929

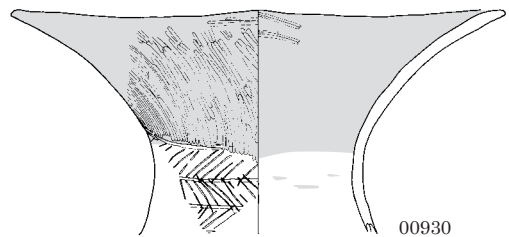

00930

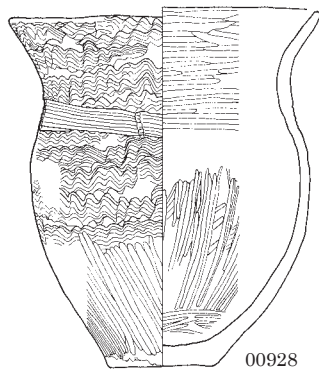

00928

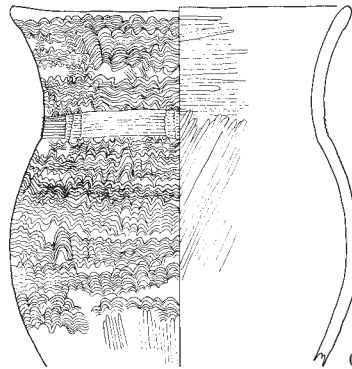

00927

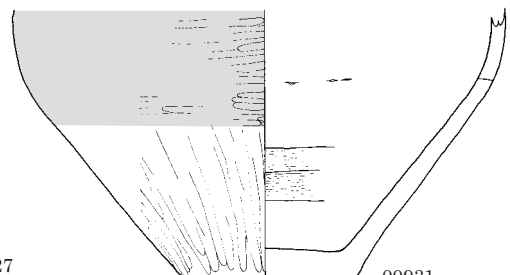

00931

0 (1:4) 10cm

SB3091

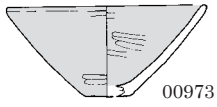

00973

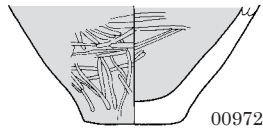

00972

SB3095

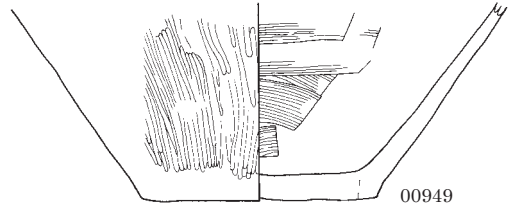

00949

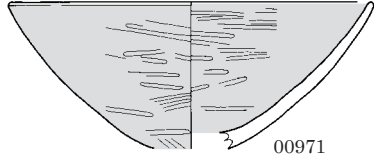

00971

SB3097

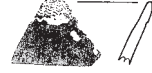

00976

SB3099

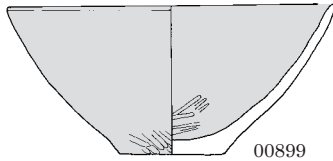

00899

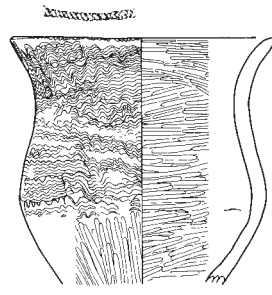

00895

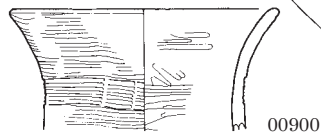

00900

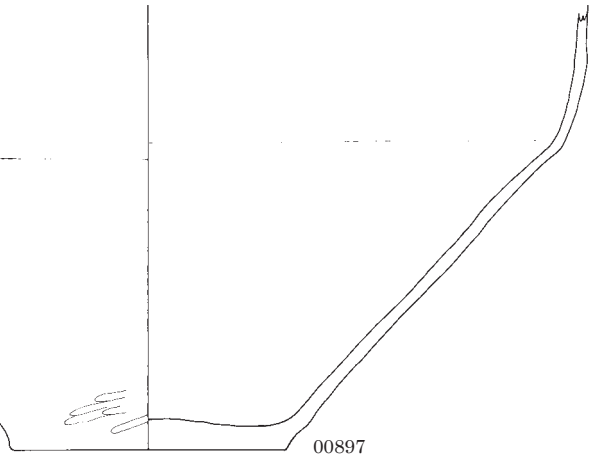

00897

SB4002 (1)

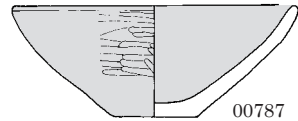

00787

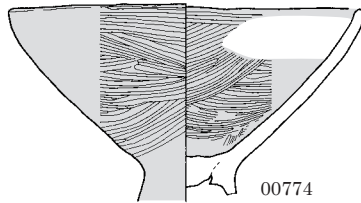

00774

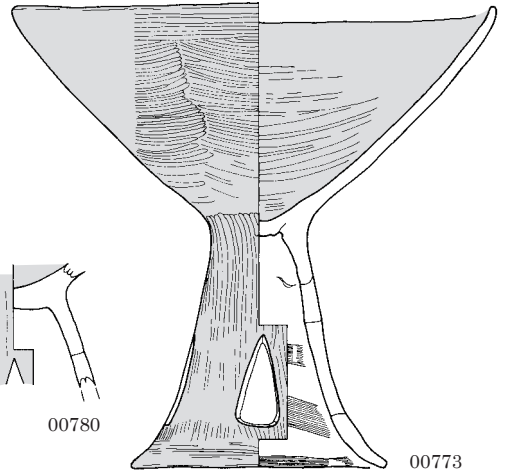

00773

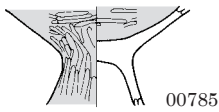

00785

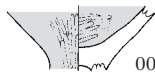

00786

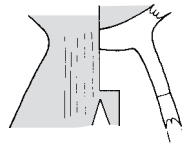

00780

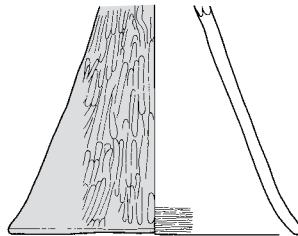

00778

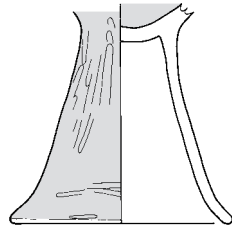

00783

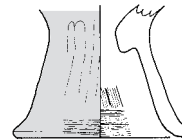

00779

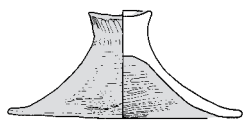

00798

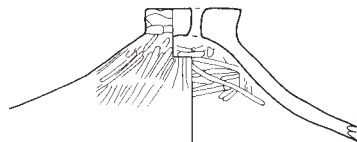

00797

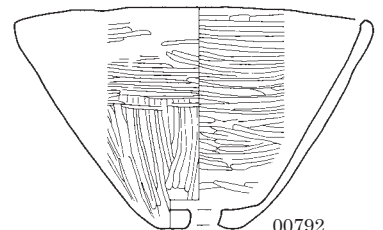

00792

0 (1:4) 10cm

図版 36 弥生時代後期の土器 (31)

SB4002 (2)

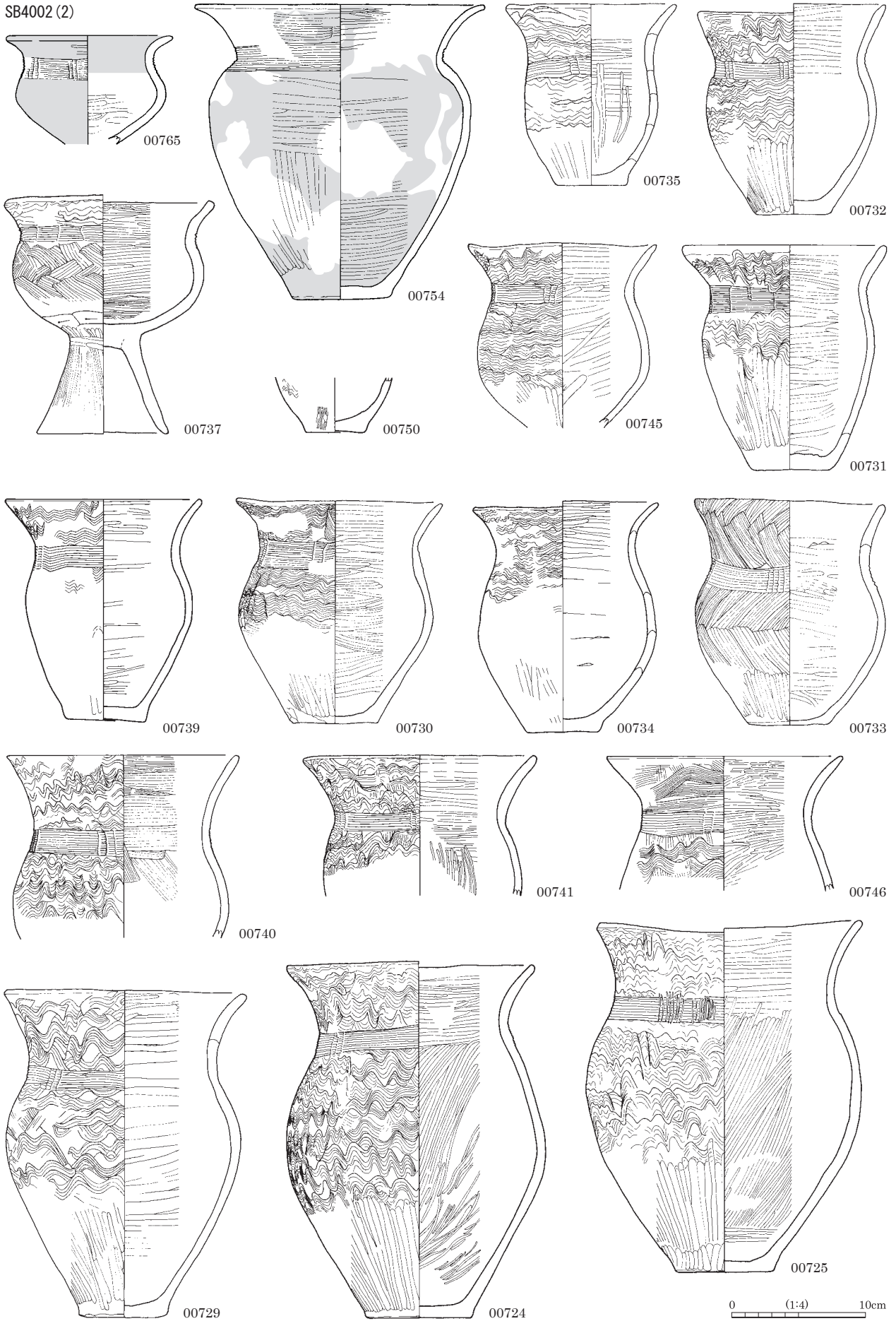

SB4002 (3)

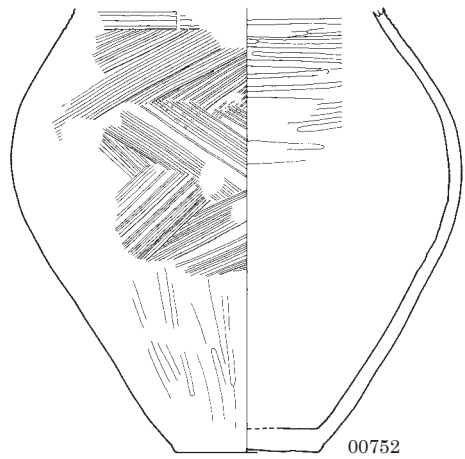
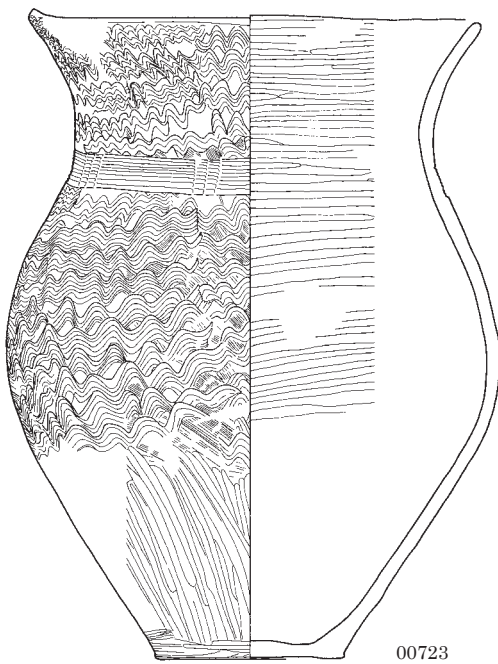
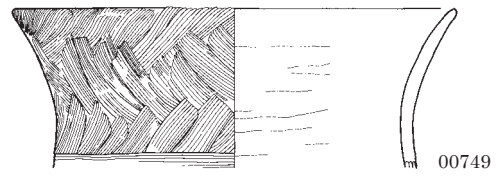
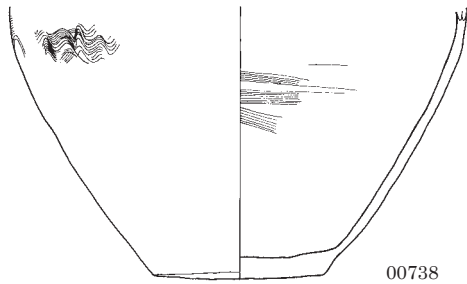
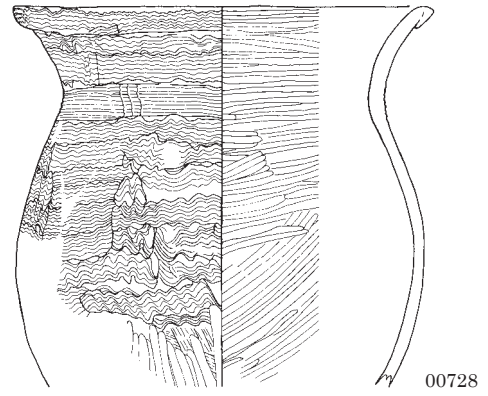
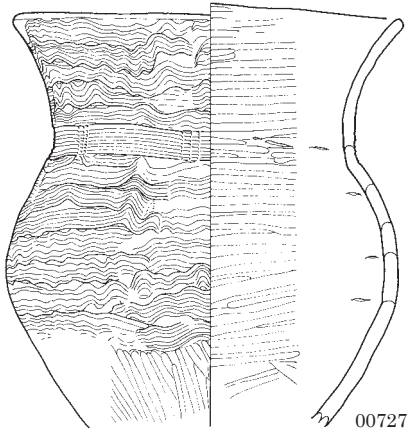
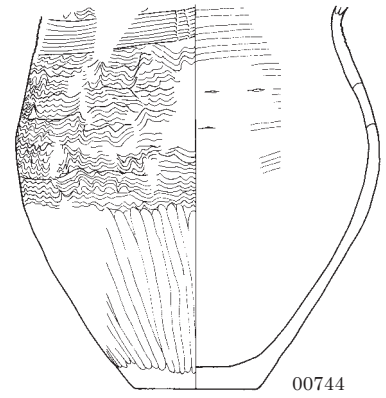
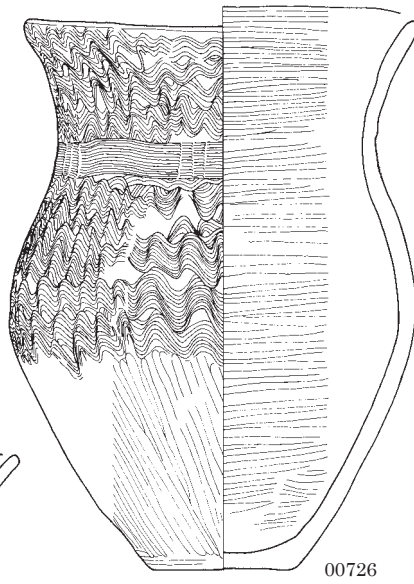
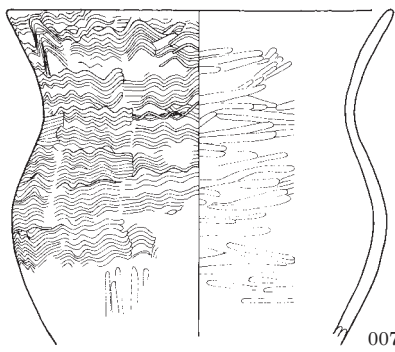

0 (1:4) 10cm

図版 38 弥生時代後期の土器 (33)

SB4002 (4)

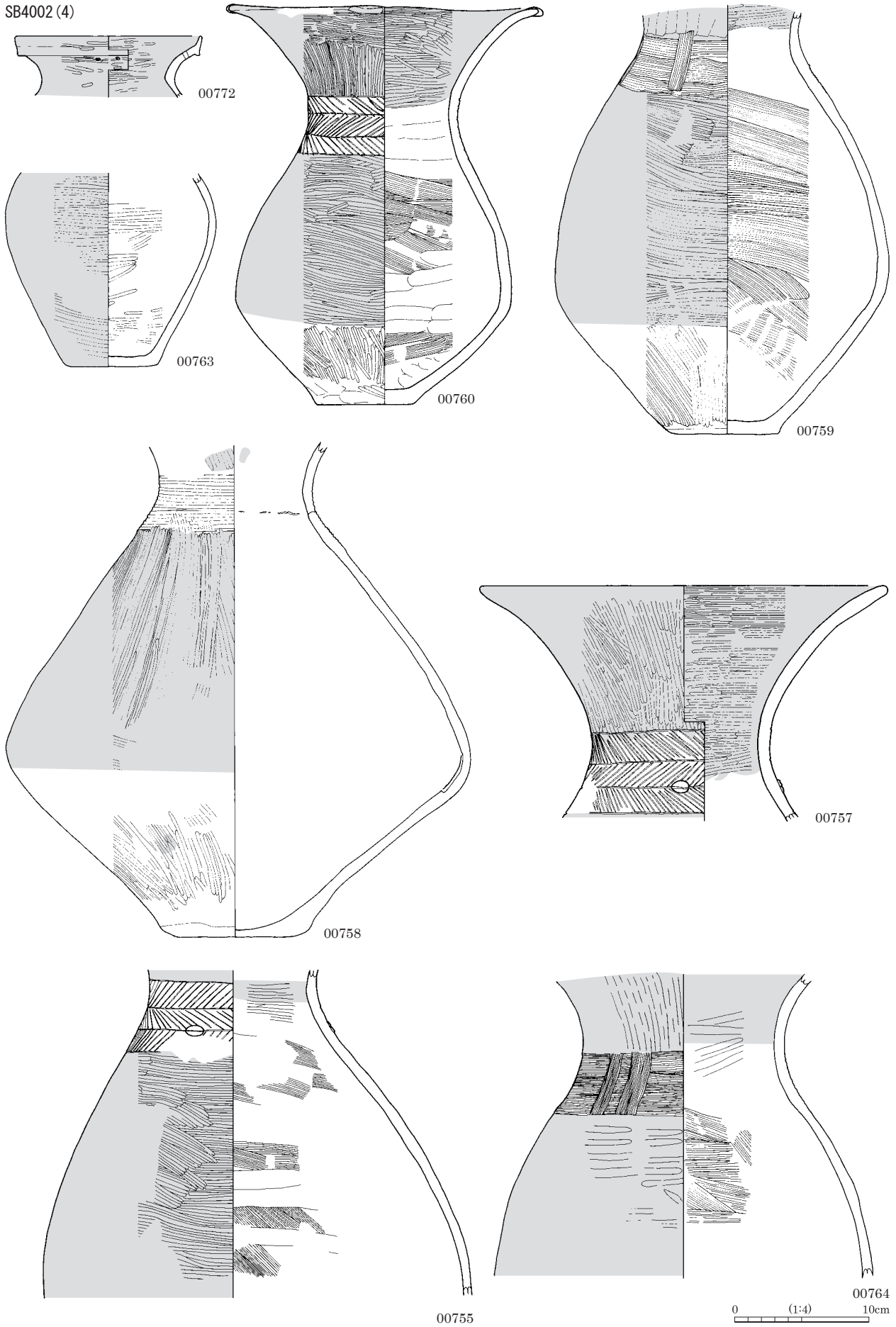

SB4002 (5)

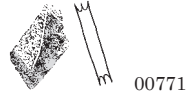
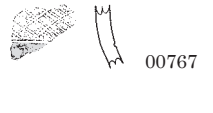
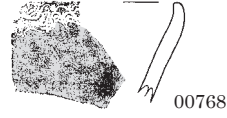
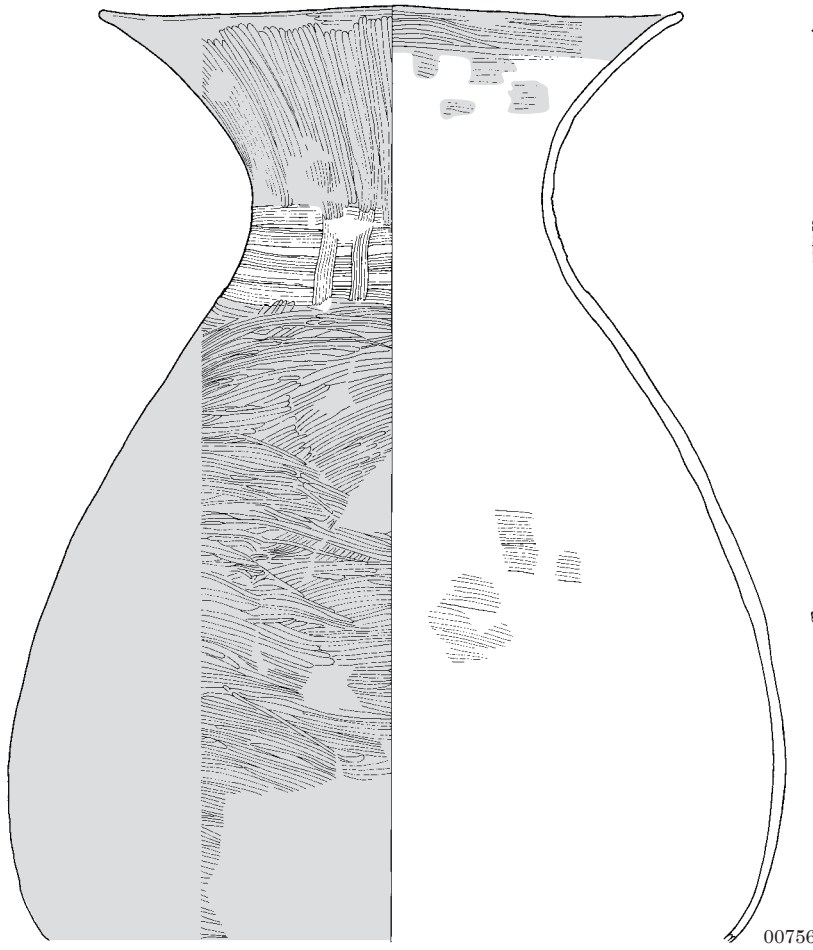

SB4003

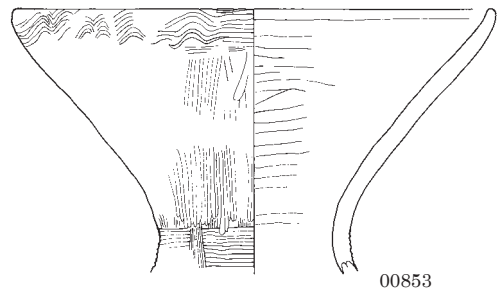
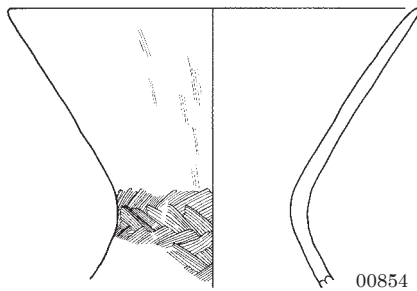

SB4008

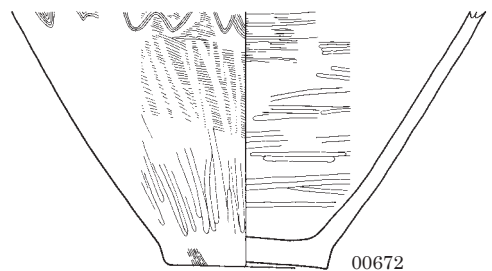
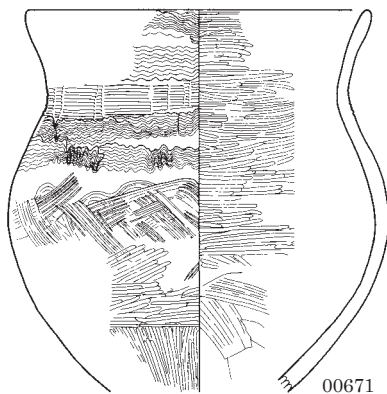
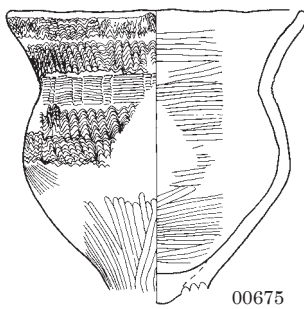

0 (1:4) 10cm

図版 40 弥生時代後期の土器 (35)

SB4016

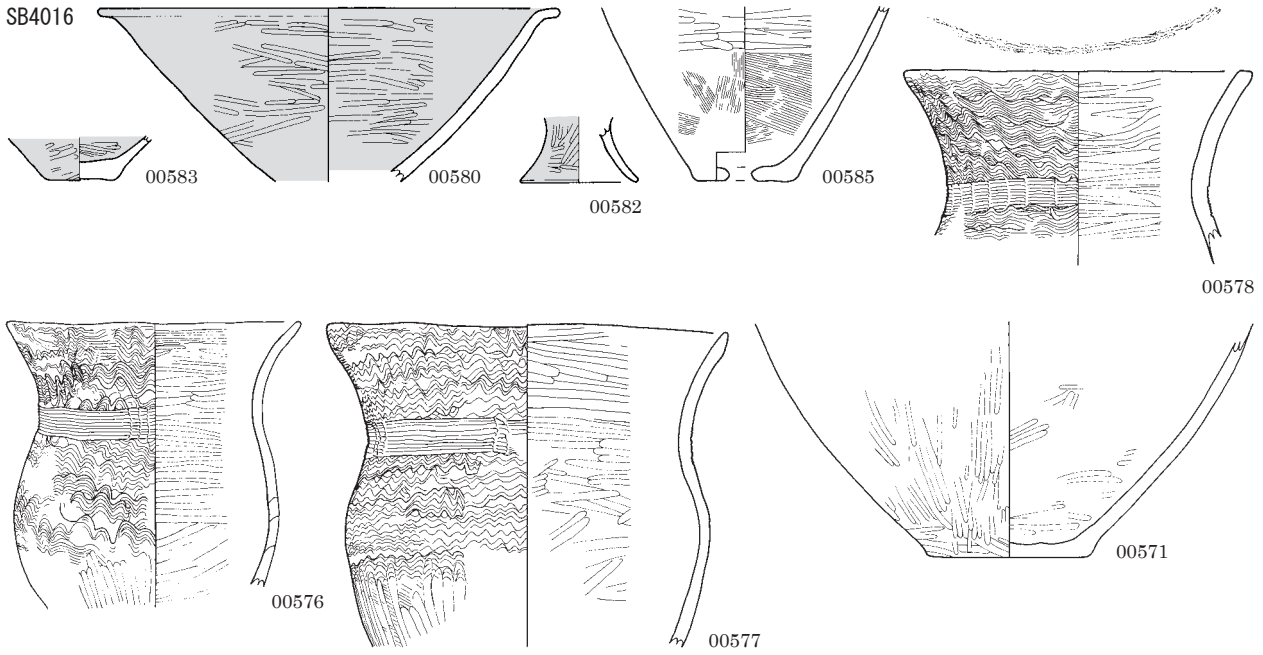

SB4029

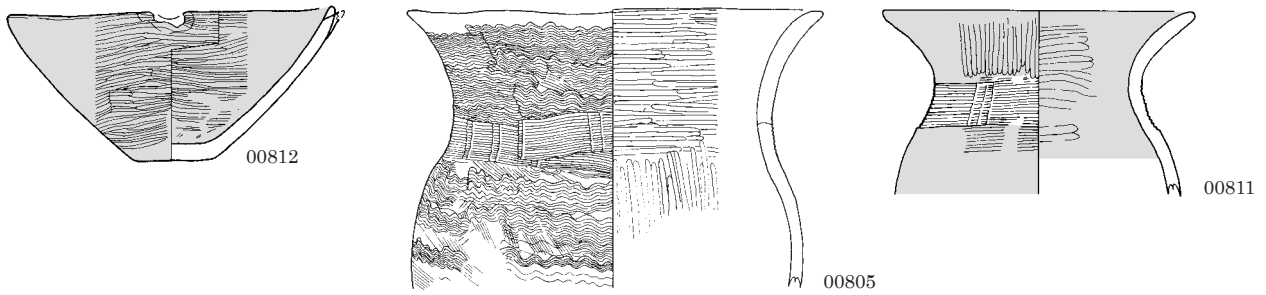

SB4030 (1)

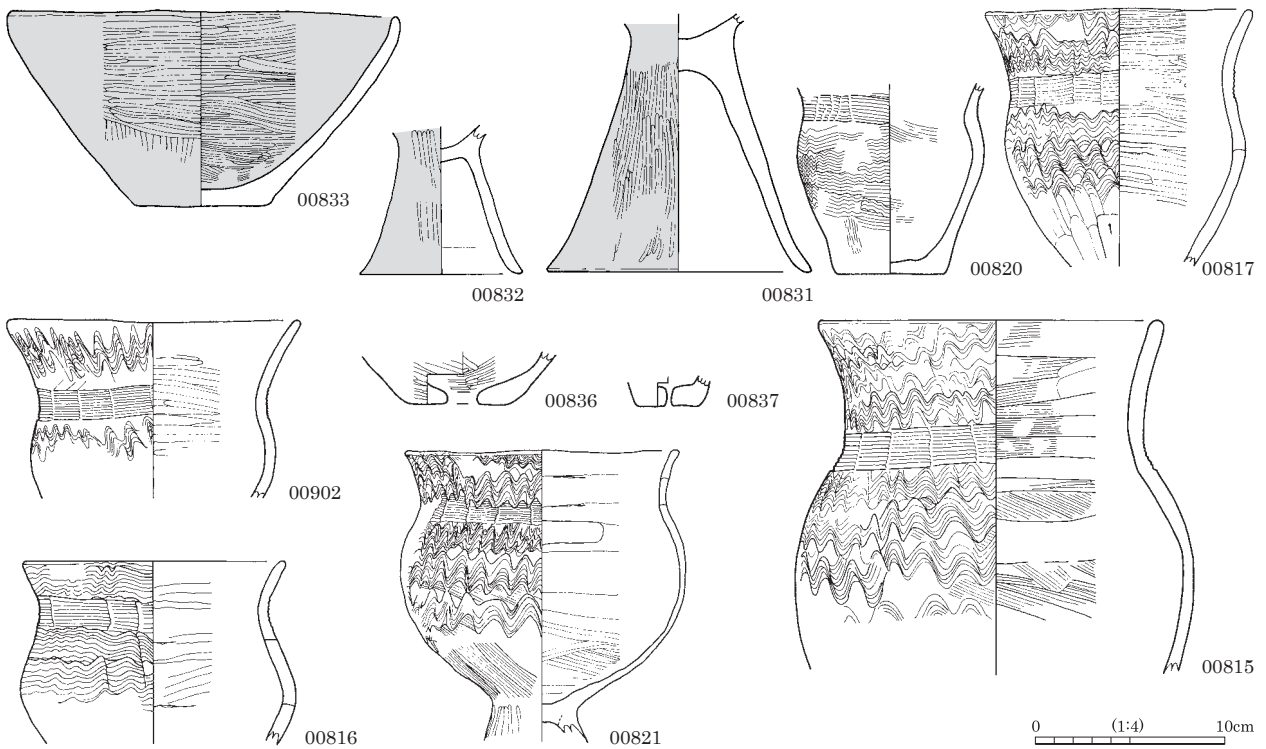

0 (1:4) 10cm

SB4030 (2)

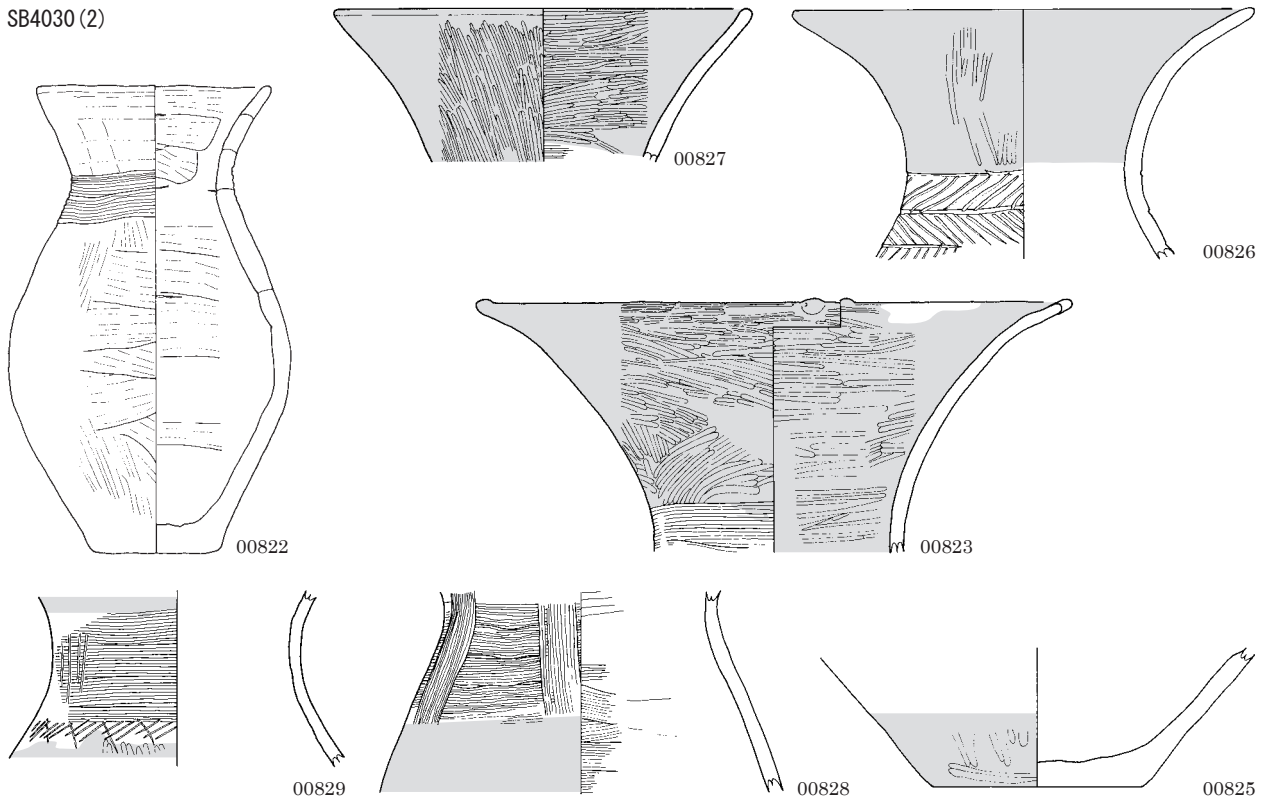

SB4032

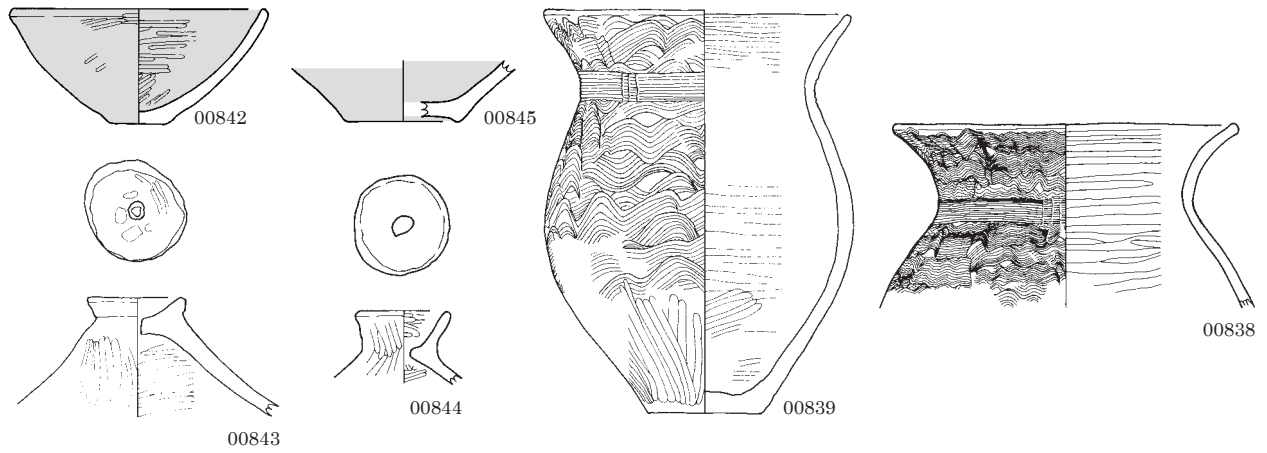

SB4035

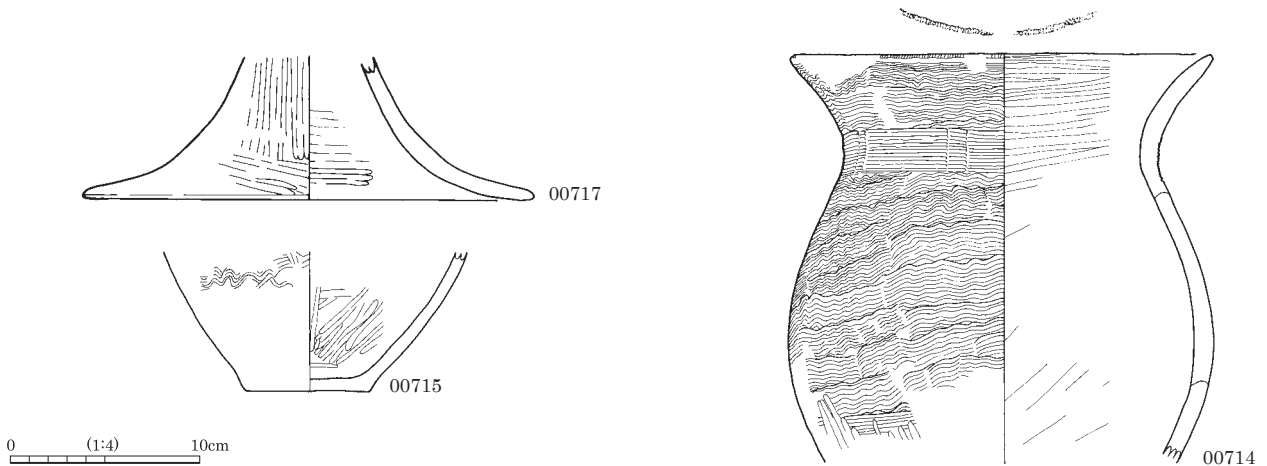

0 (1:4) 10cm

図版 42 弥生時代後期の土器 (37)

SB4038

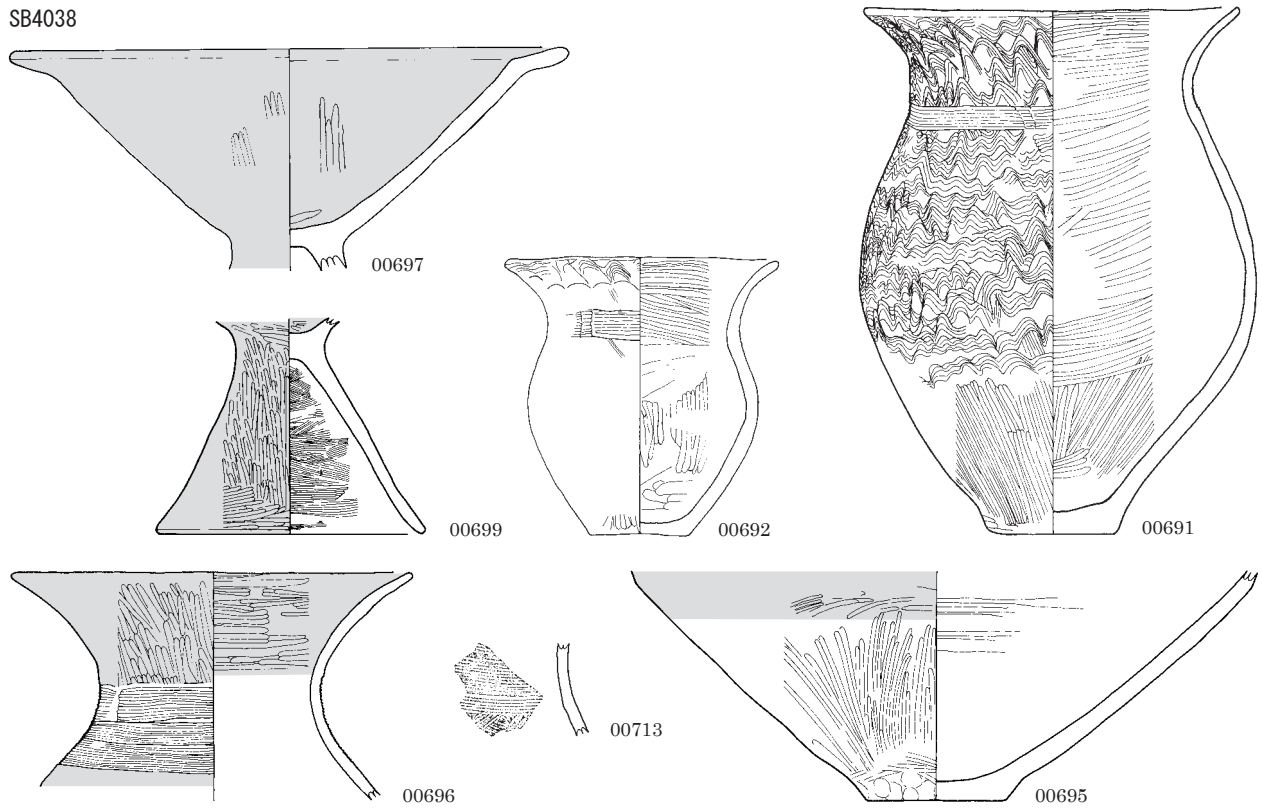

SB4056

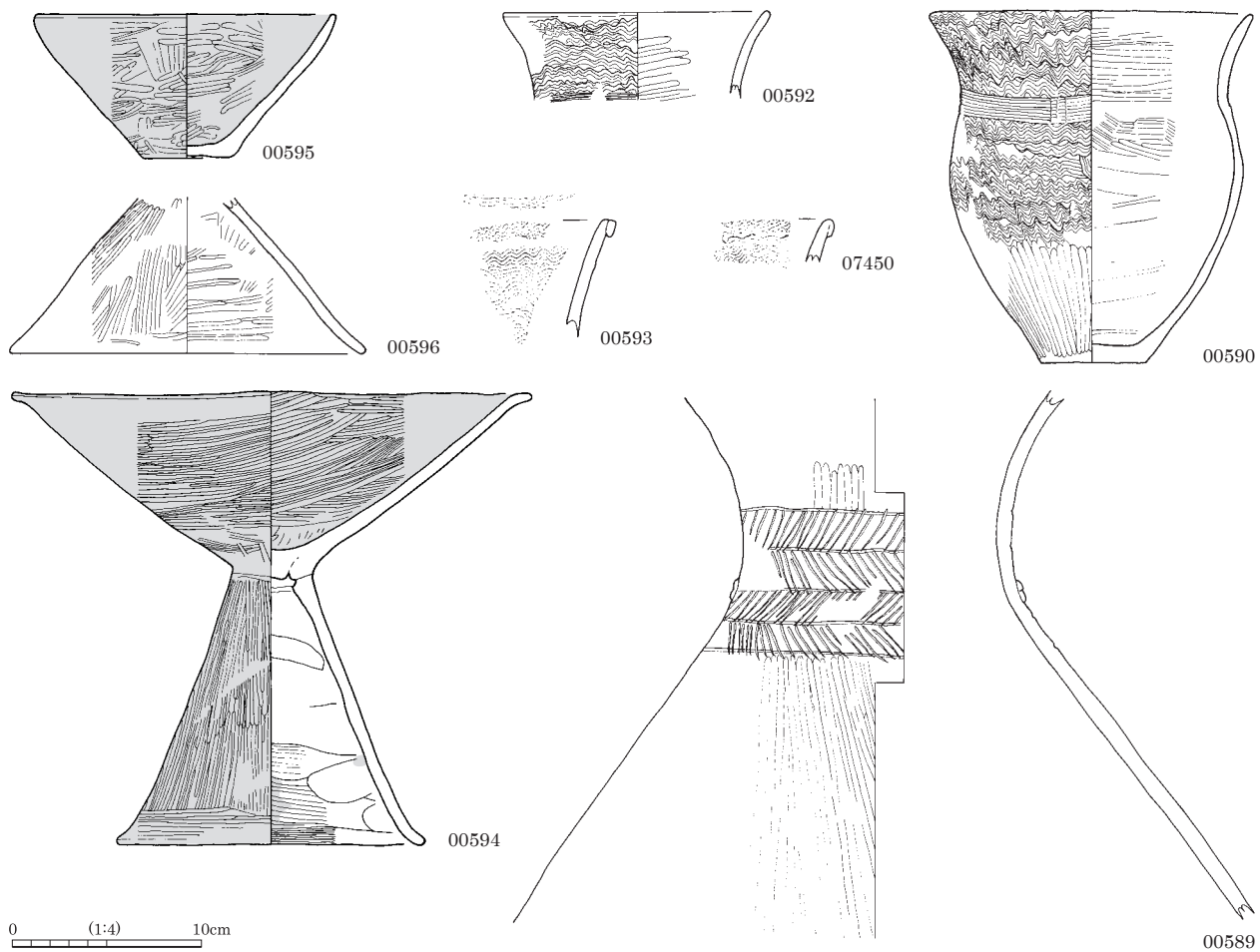

0 (1:4) 10cm

SB4066

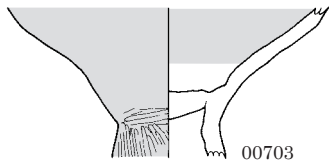

00703

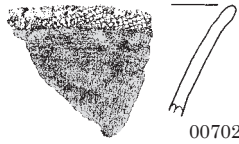

00702

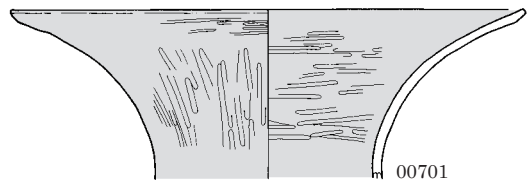

00701

SB4067

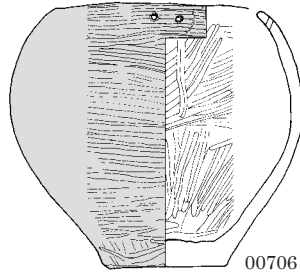
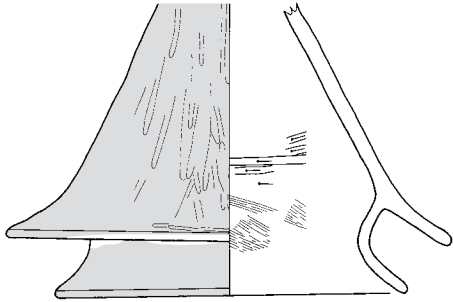

00706

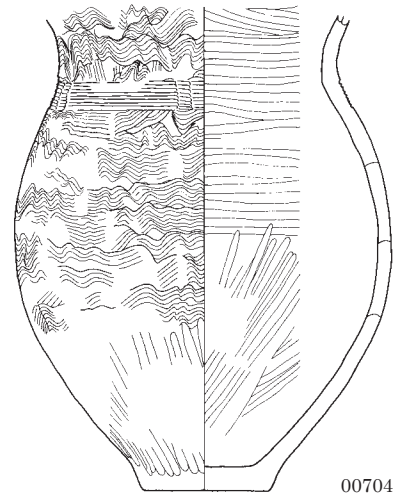

00704

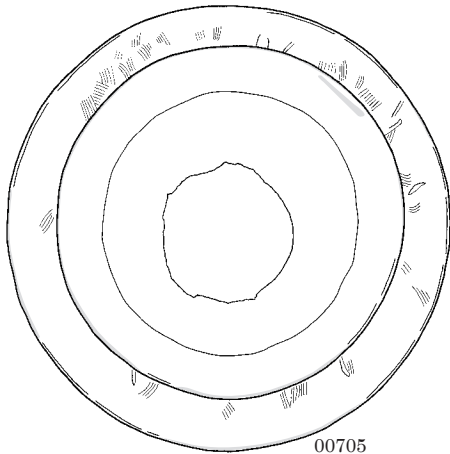

00705

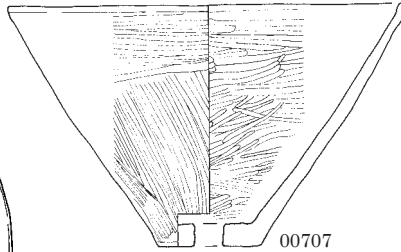

00707



SB4070

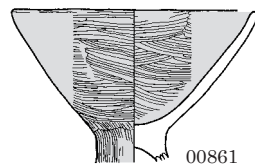

00861

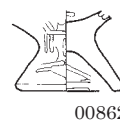

00862



00860

SB5047 (1)

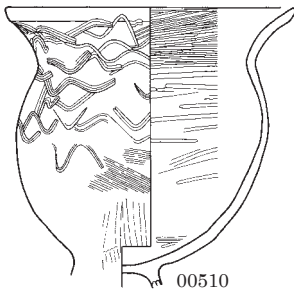

00510

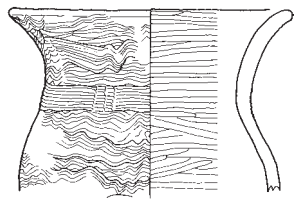

00511

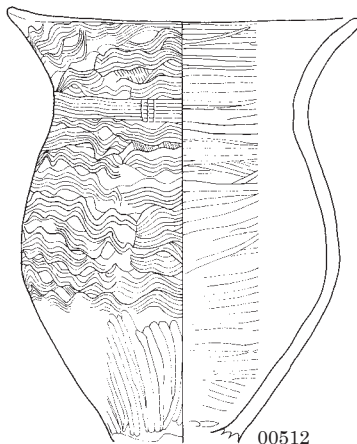

00512

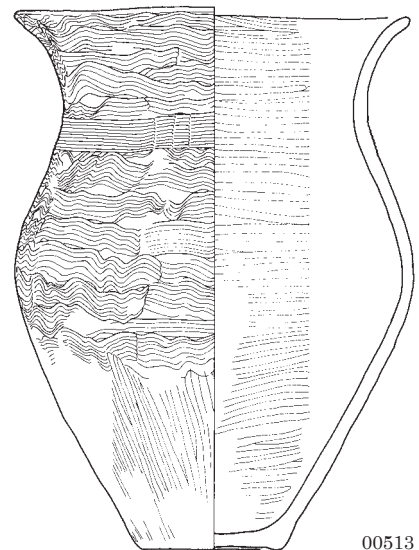

00513

0 (1:4) 10cm

図版 44 弥生時代後期の土器 (39)

SB5047 (2)

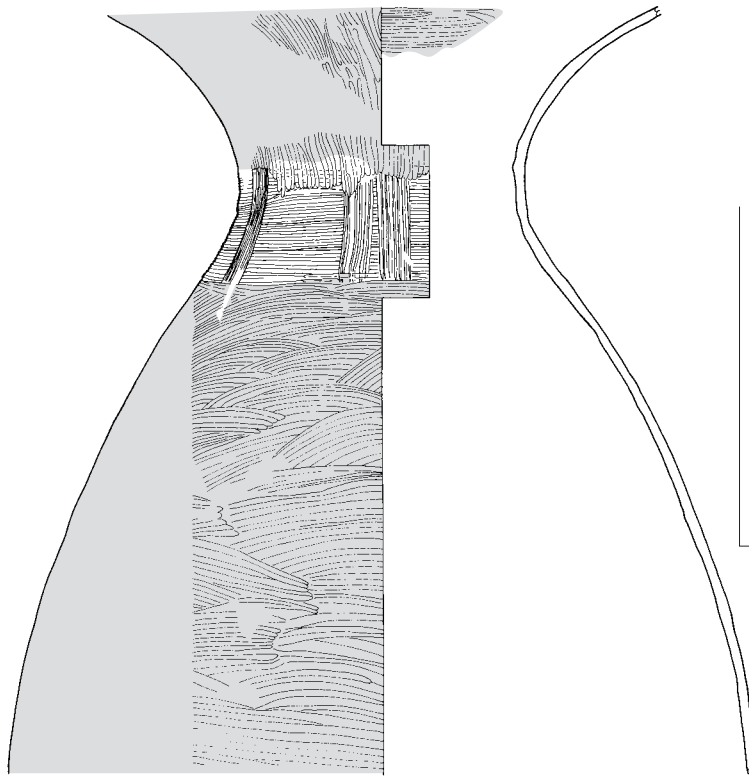

SB6012

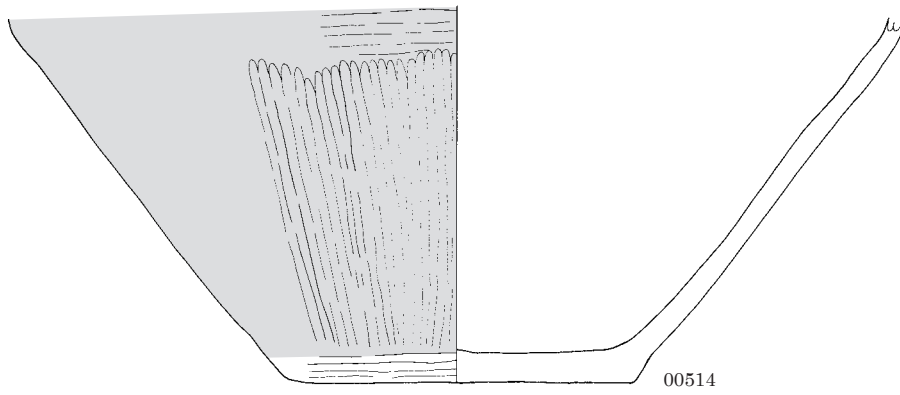
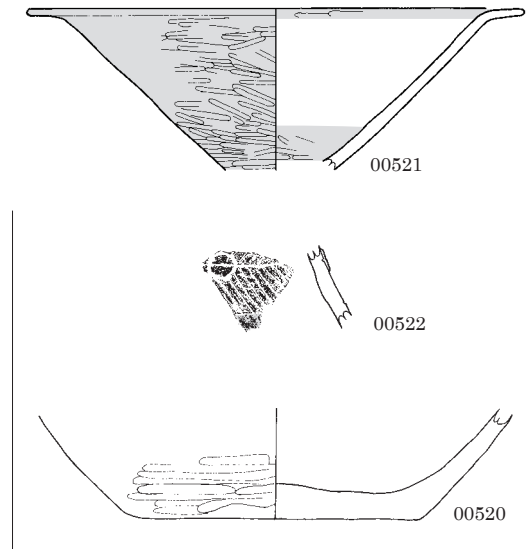

SB6025 (1)

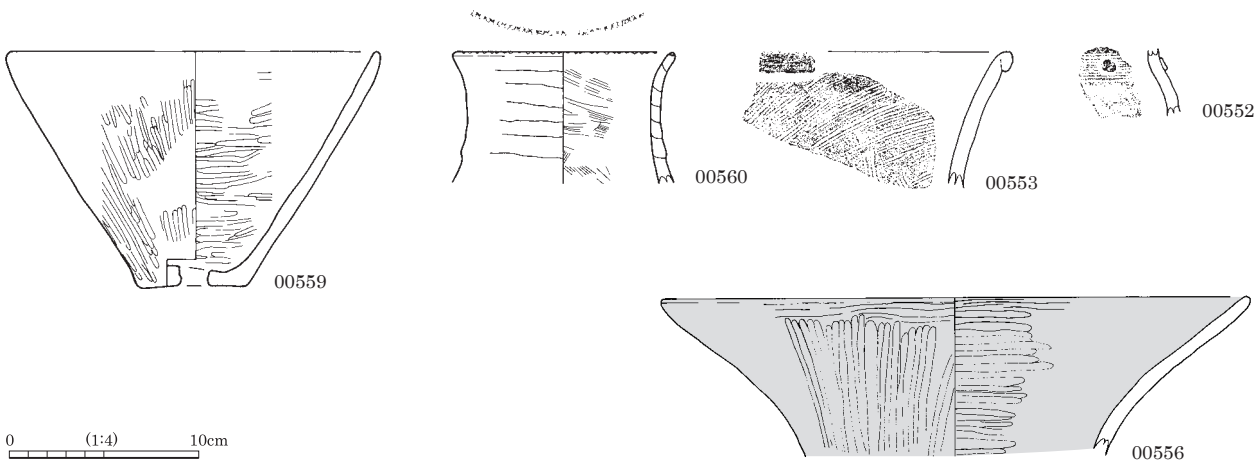

SB6025 (2)

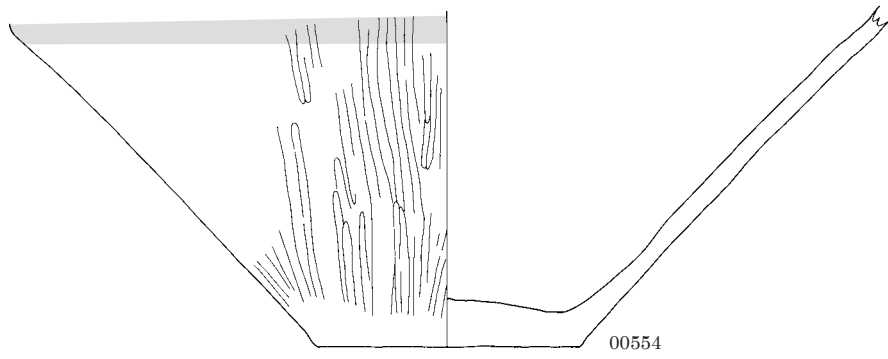

SB6028

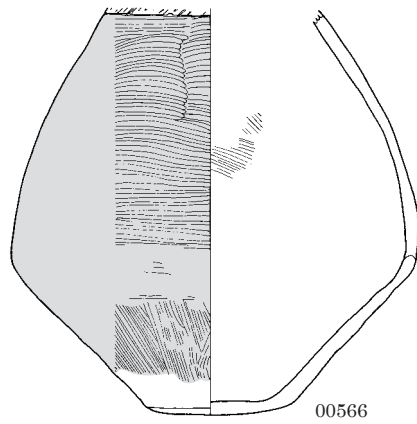
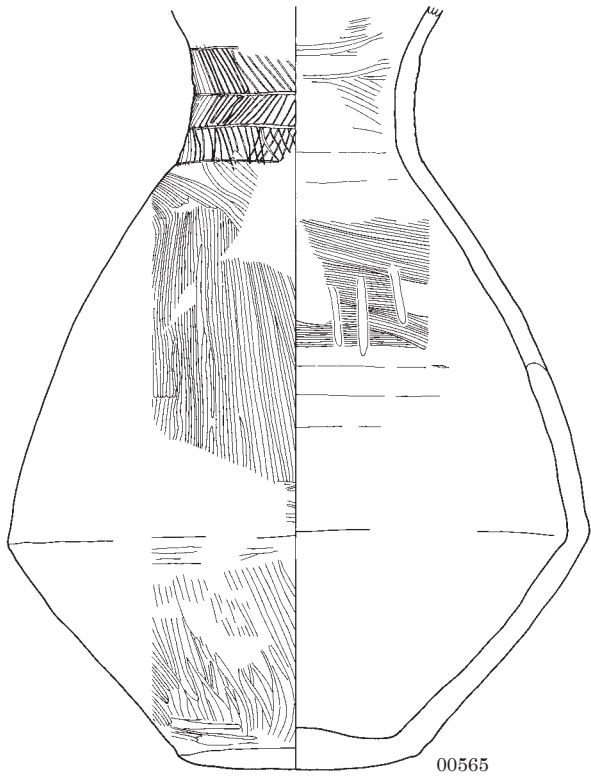
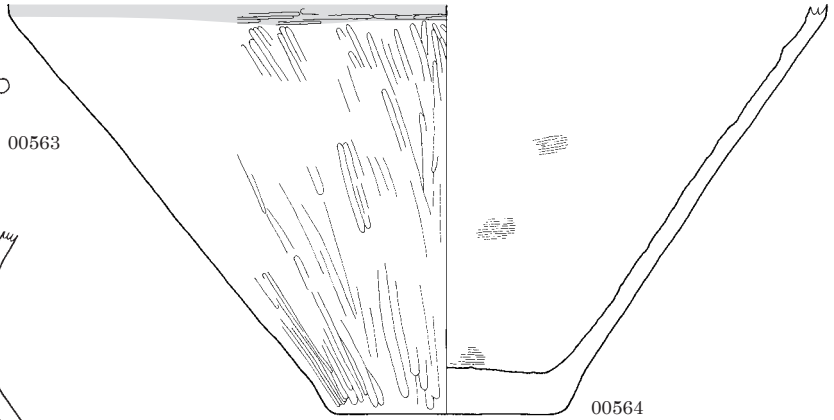
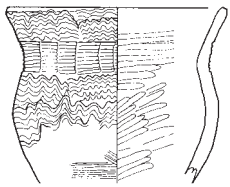

SB6044 (1)

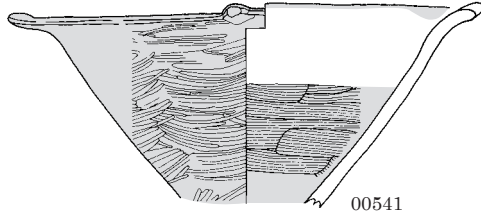
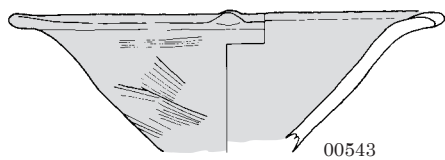

0 (1:4) 10cm

図版 46 弥生時代後期の土器 (41)

SB6044 (2)

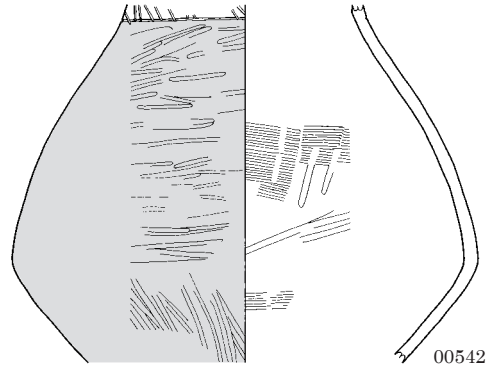
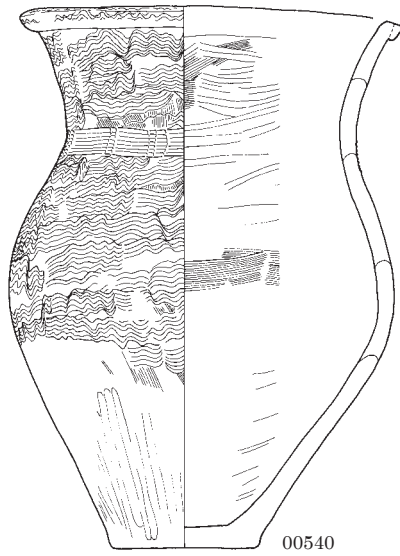
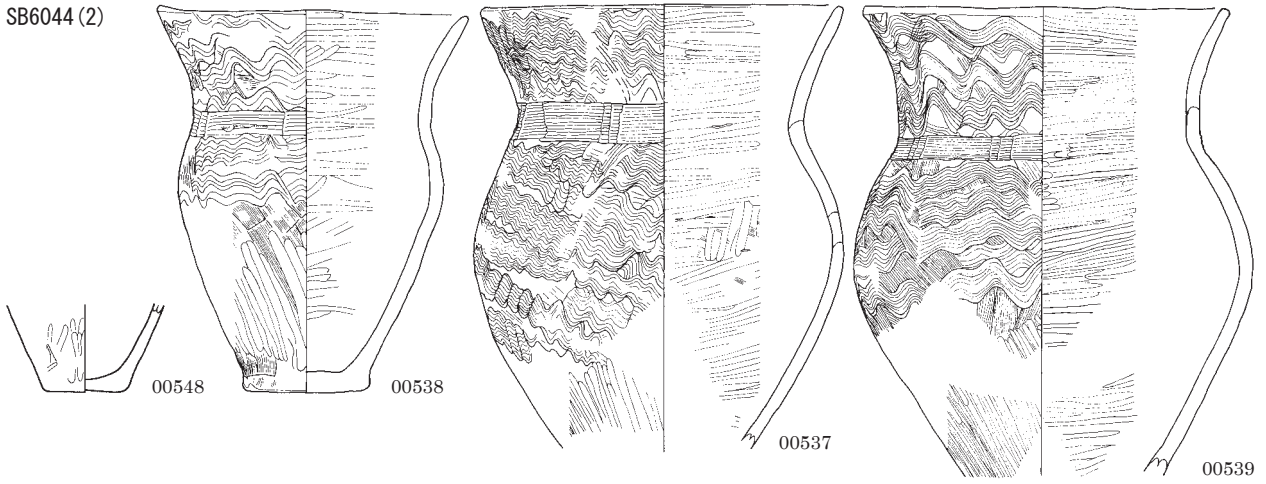

SB6067

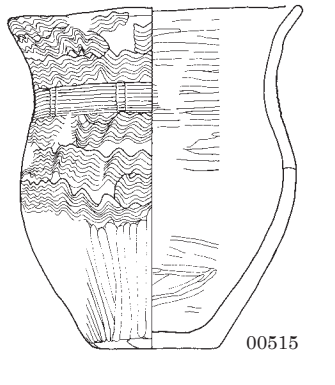

SB7047

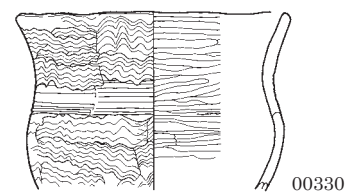
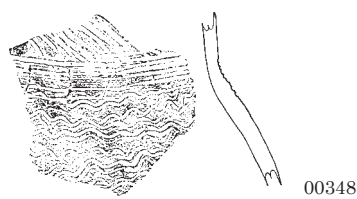
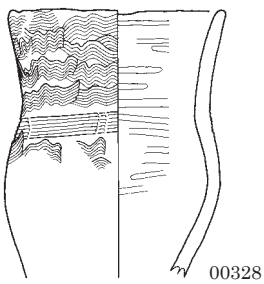
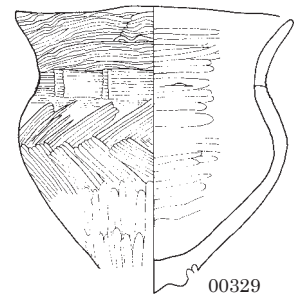
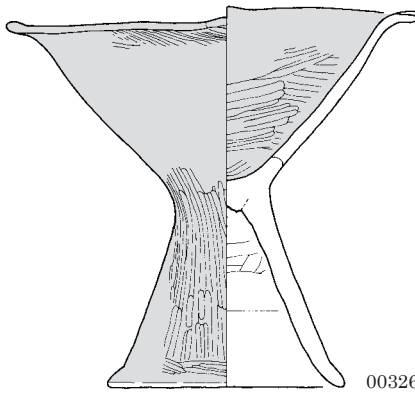

0 (1:4) 10cm

SB8001

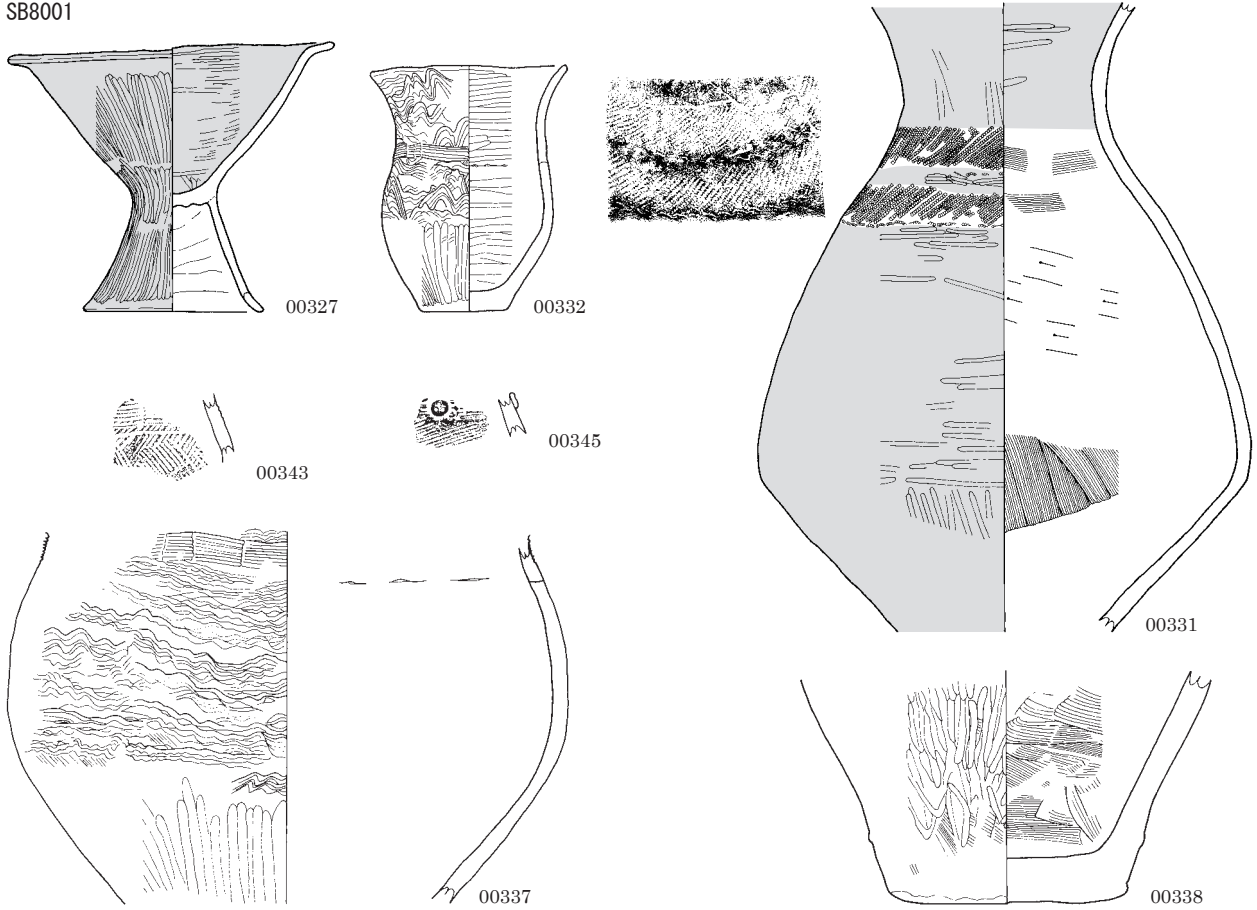

SB8005

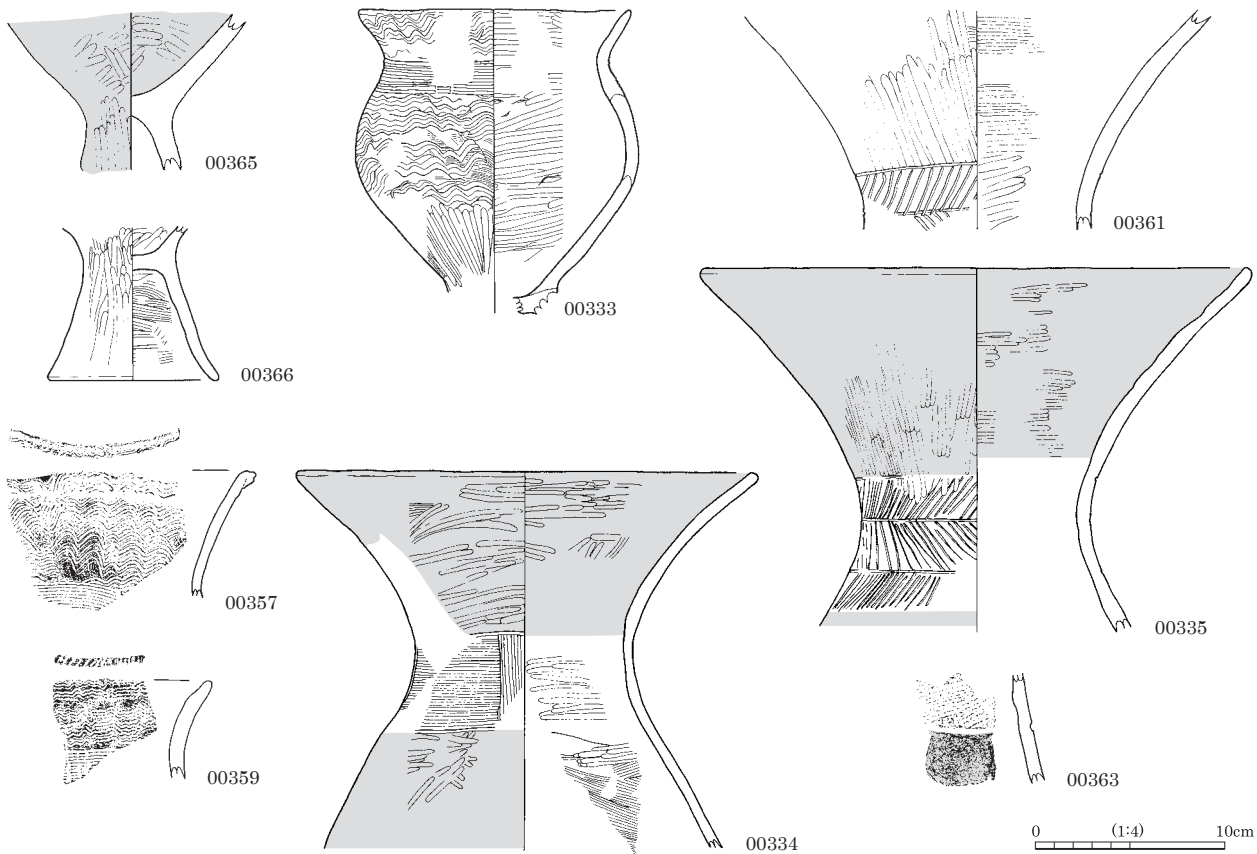

図版 48 弥生時代後期の土器 (43)

SB8006
(SB8027)

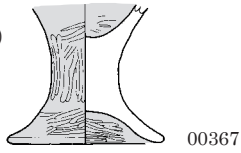

00367



00368



00370

SB8029

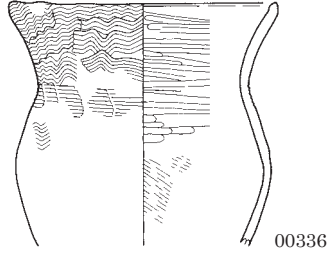

00336

SB8043

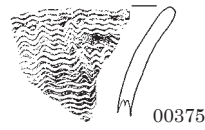

00375



00376

SM3003

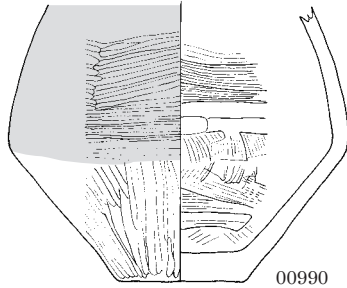

00990

SM4003

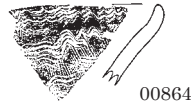

00864

SM4001

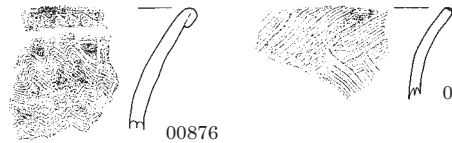

00876



00879

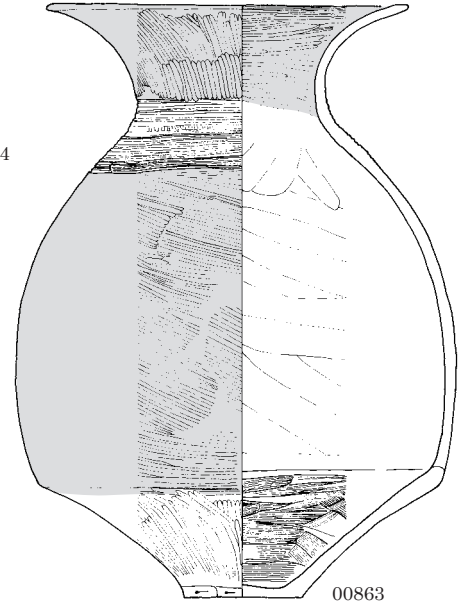

00863

SQ0001

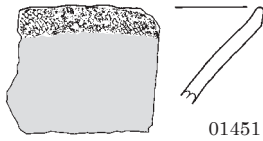

01451

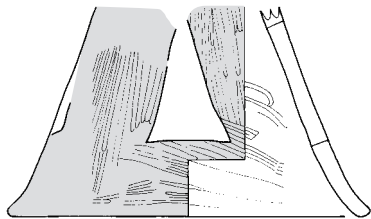

01440

SK0094

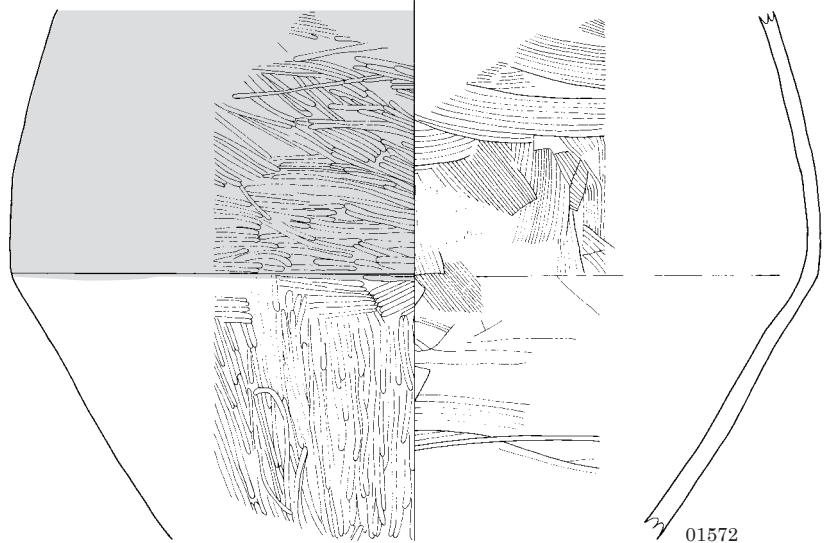

01572

SQ0002

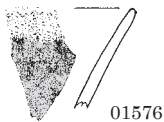

01576

0 1:4 10cm

SK0235



SK0310



SK0315

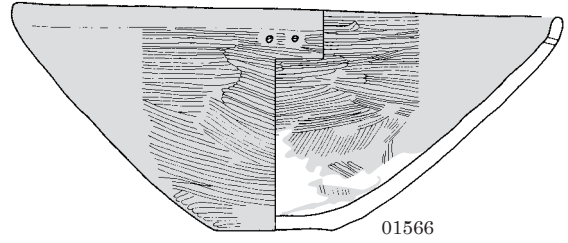

SK3018

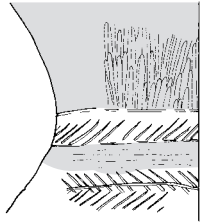

01570

SK3246

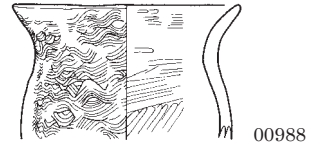
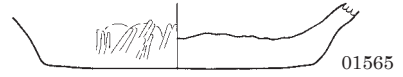

SK3284

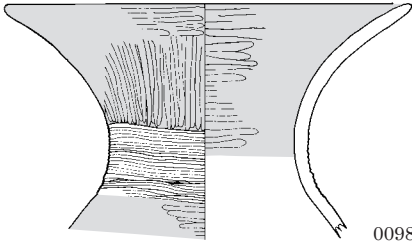

00989

SK4145

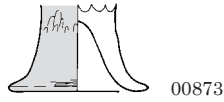

00873

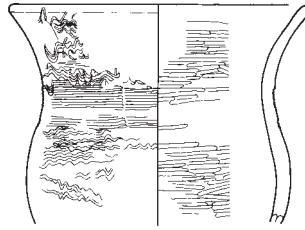

00870

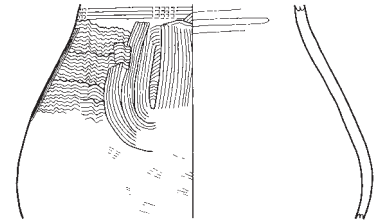

00869

SK4259

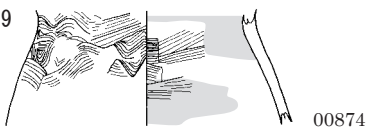

00874

SD3006-4006 (1)
SD3006 出土

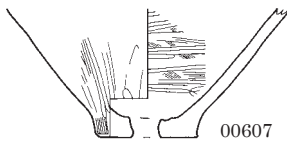

00607

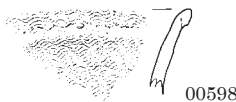

00598

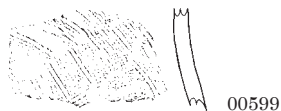

00599

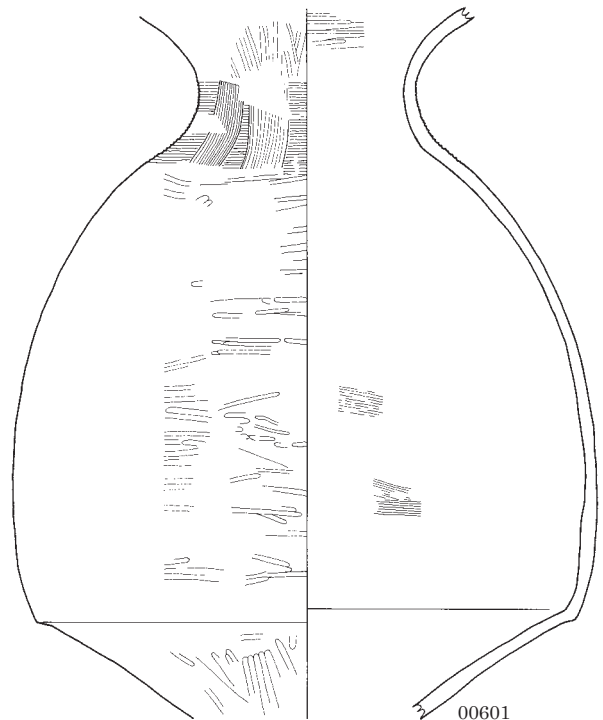

00601

0 (1:4) 10cm

図版 50 弥生時代後期の土器 (45)

SD3006・4006 (2)
SD4006 出土

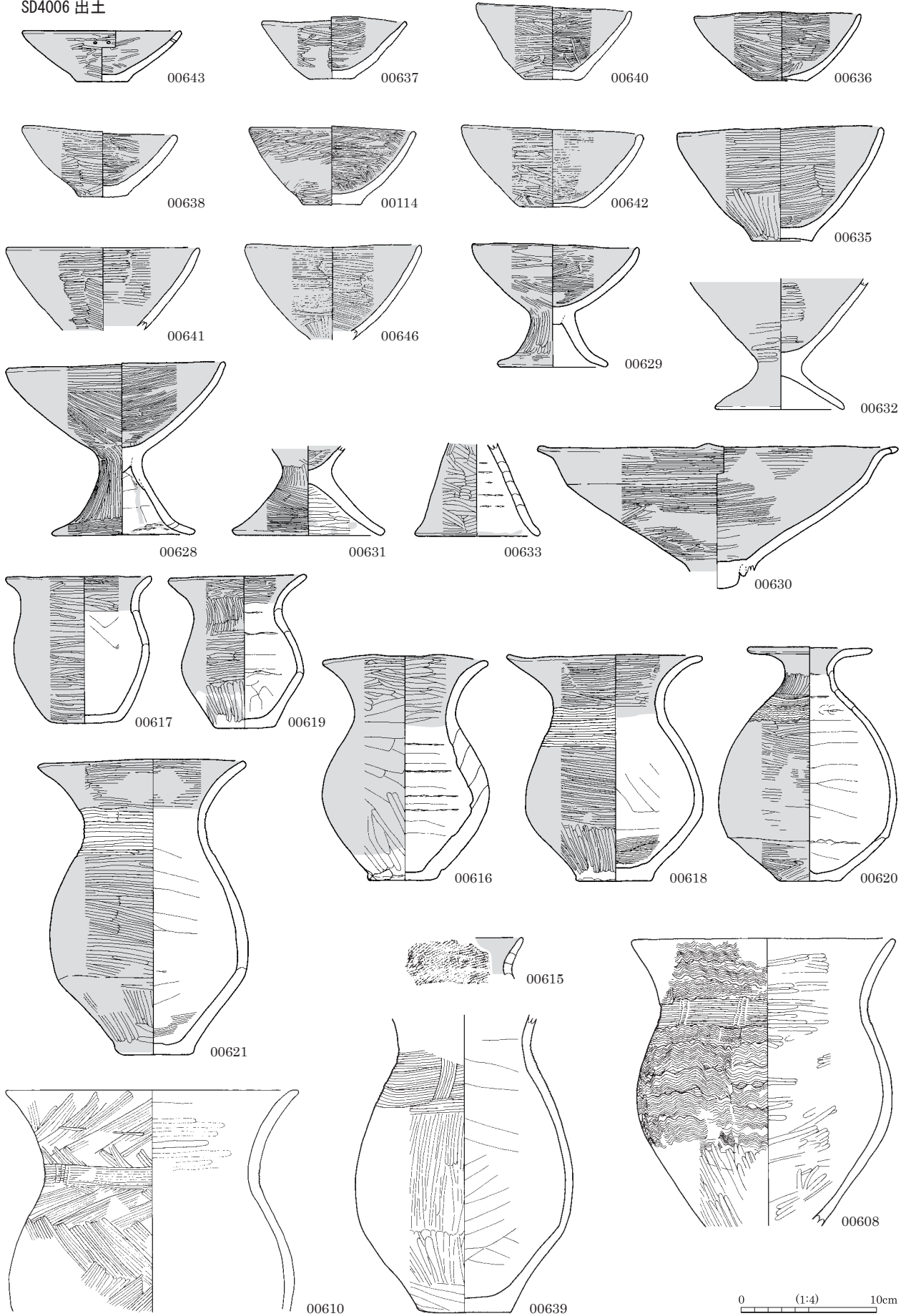

弥生時代遺構外出土

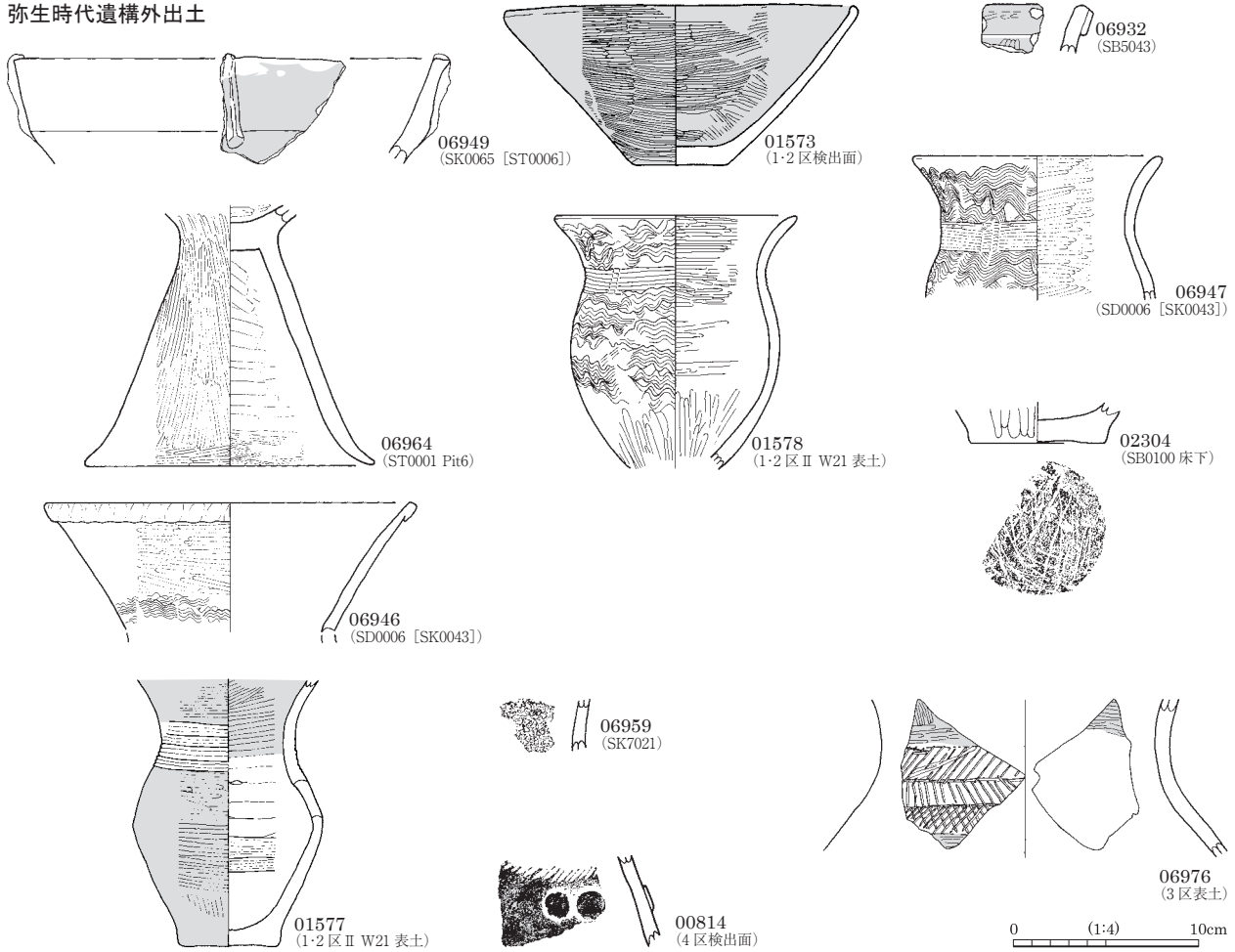

図版 52 弥生時代後期の土器 (47)

ミニチュア土器

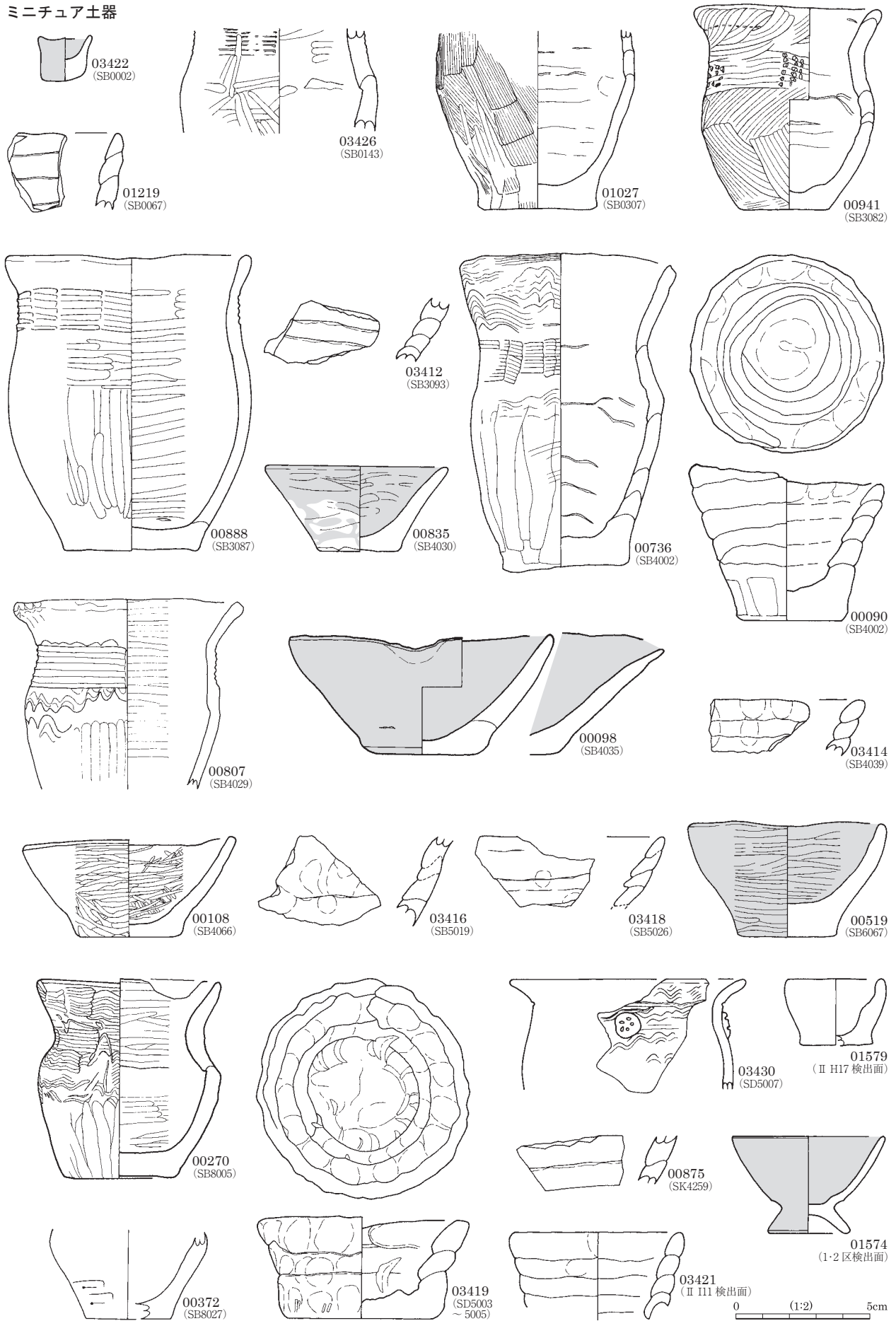

人形土器

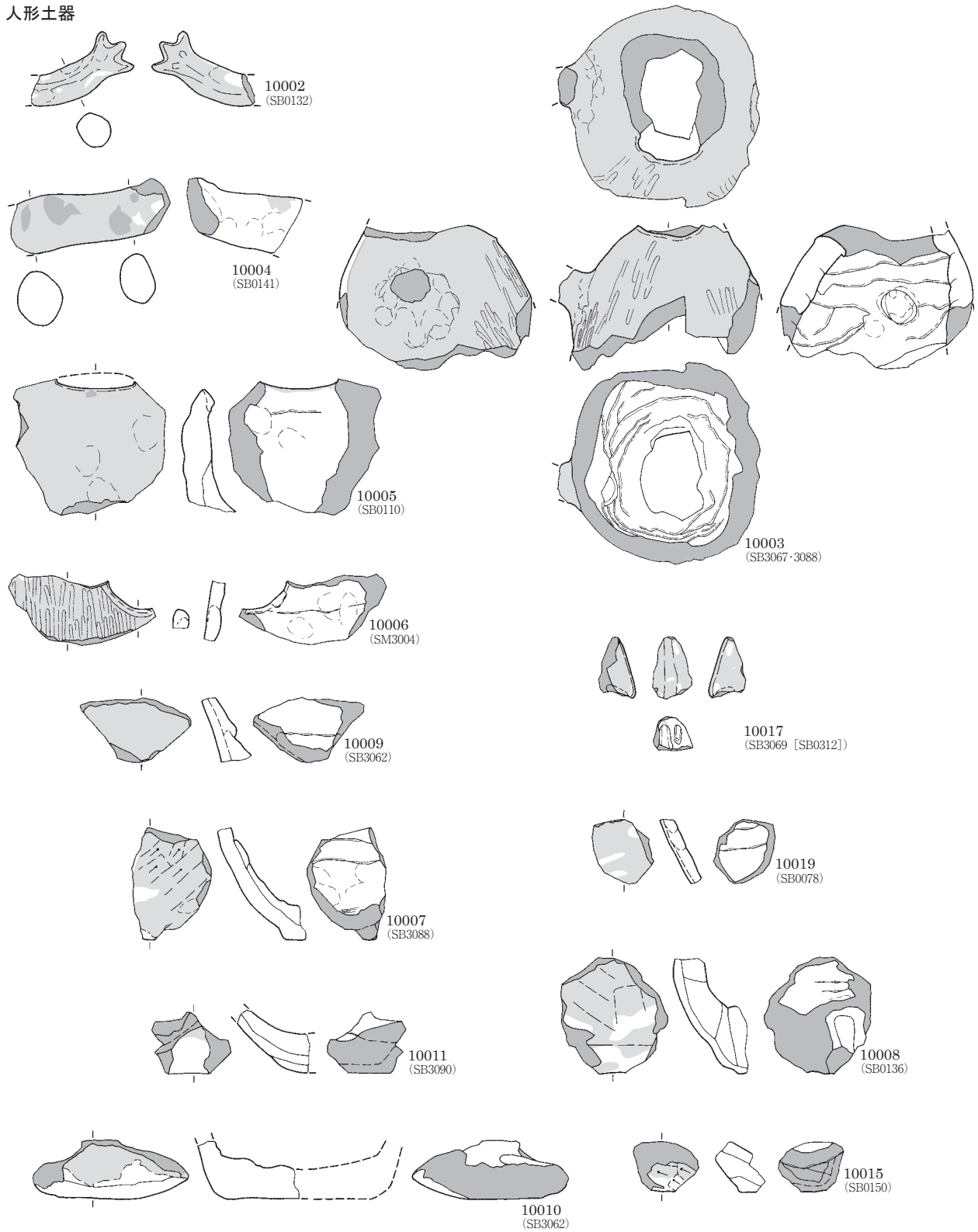

不明土製品

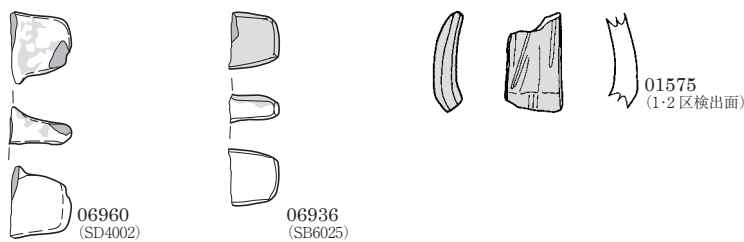

■ 赤彩
■ 欠損面
0 (1:3) 10cm

匙形土製品

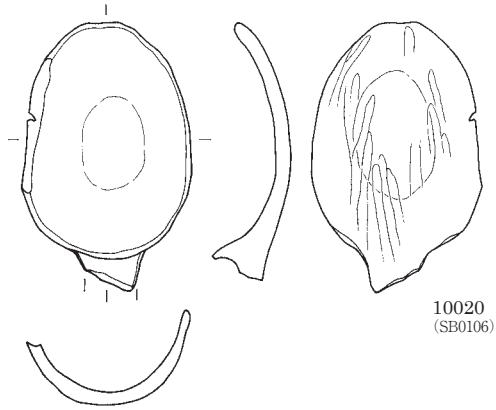

10020
(SB0106)

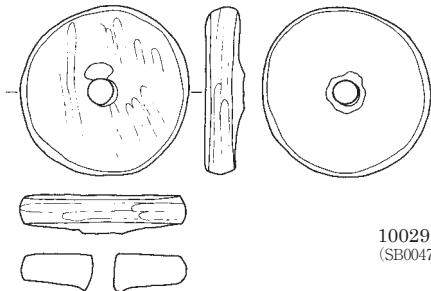

10029
(SB0047)

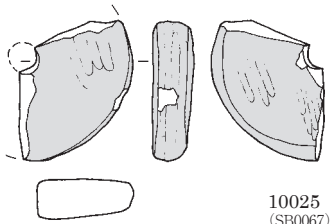

10025
(SB0067)

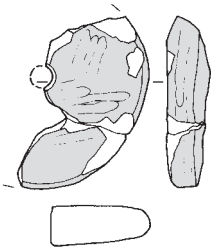

10026
(SB3088)

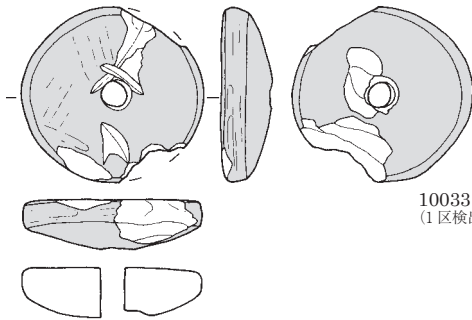

10033
(1区検出面)

土製紡錘車

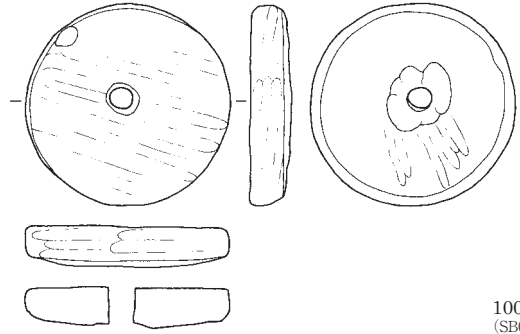

10028
(SB0041)

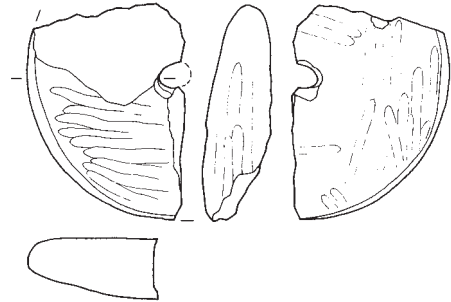

10030
(SB0047)

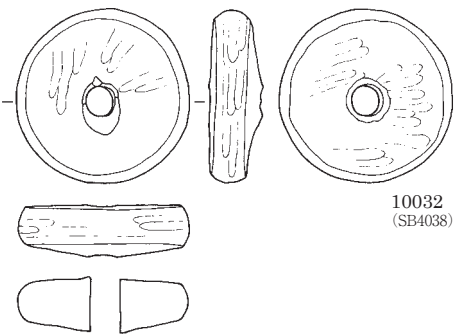

10032
(SB4038)

土製玉類

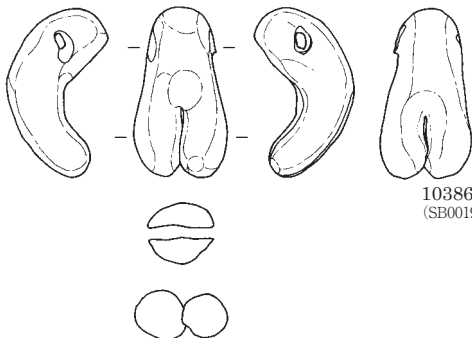

10386
(SB0019)

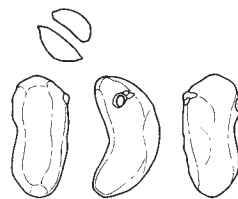

10387
(SB0036 床下 [SB0048])



10388
(SB0110)



10394
(SB3083)

■ 赤色顔料付着

匙形土製品・土製紡錘車
0 (1:2) 5cm

土製玉類
0 (2:3) 5cm

土器片加工板 (1)

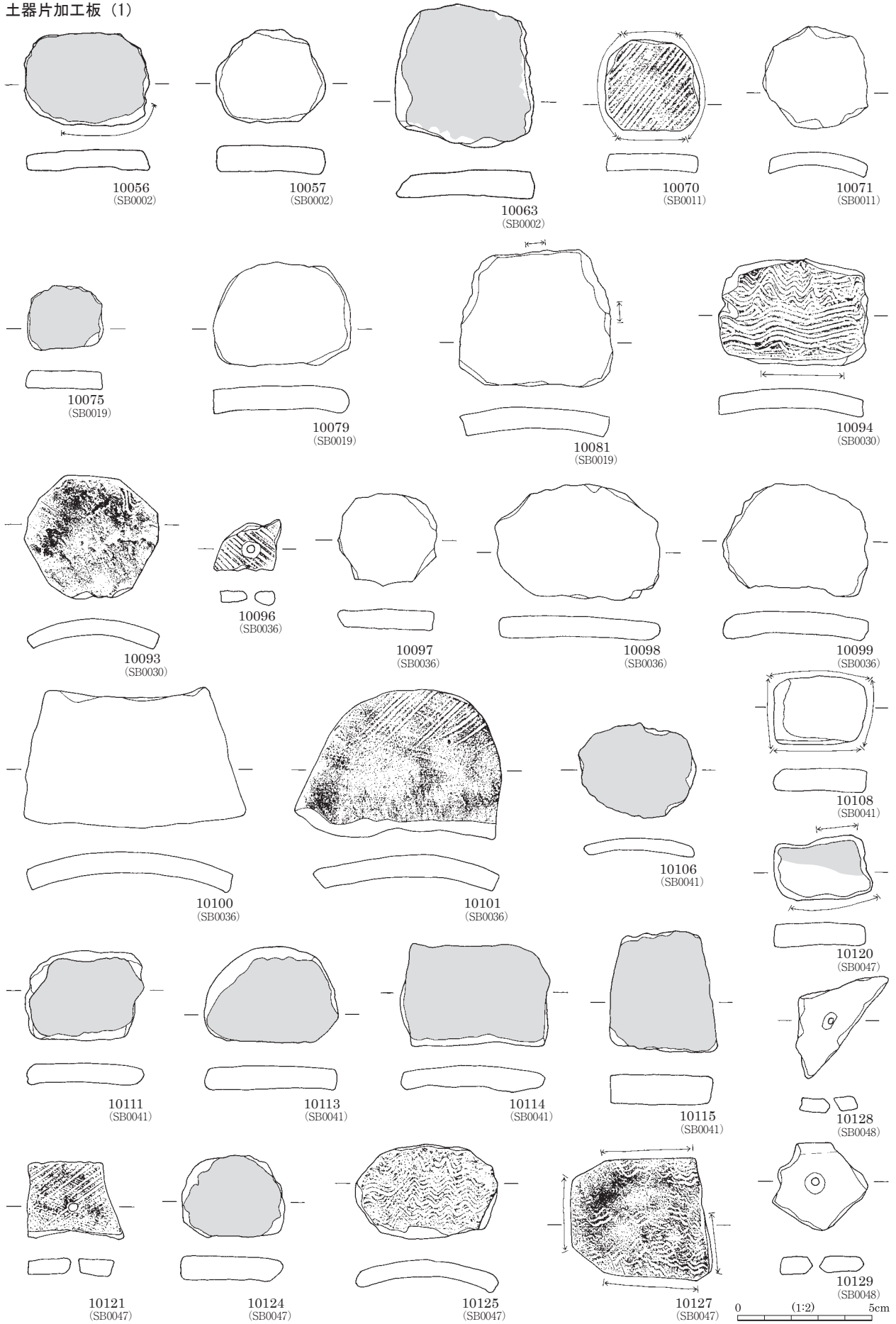

図版 56 弥生時代後期の土製品 (4)

土器片加工板 (2)

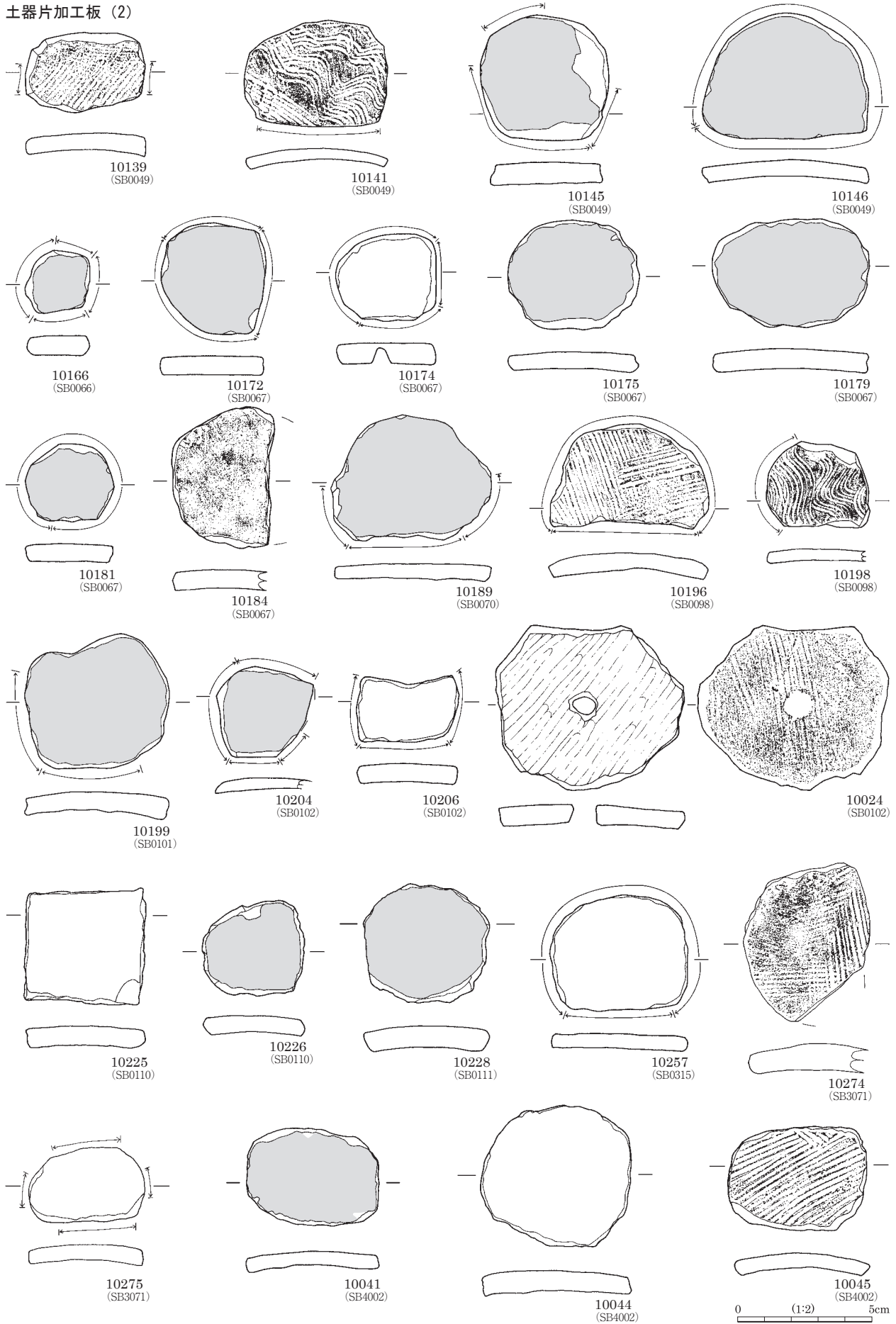

土器片加工板 (3)

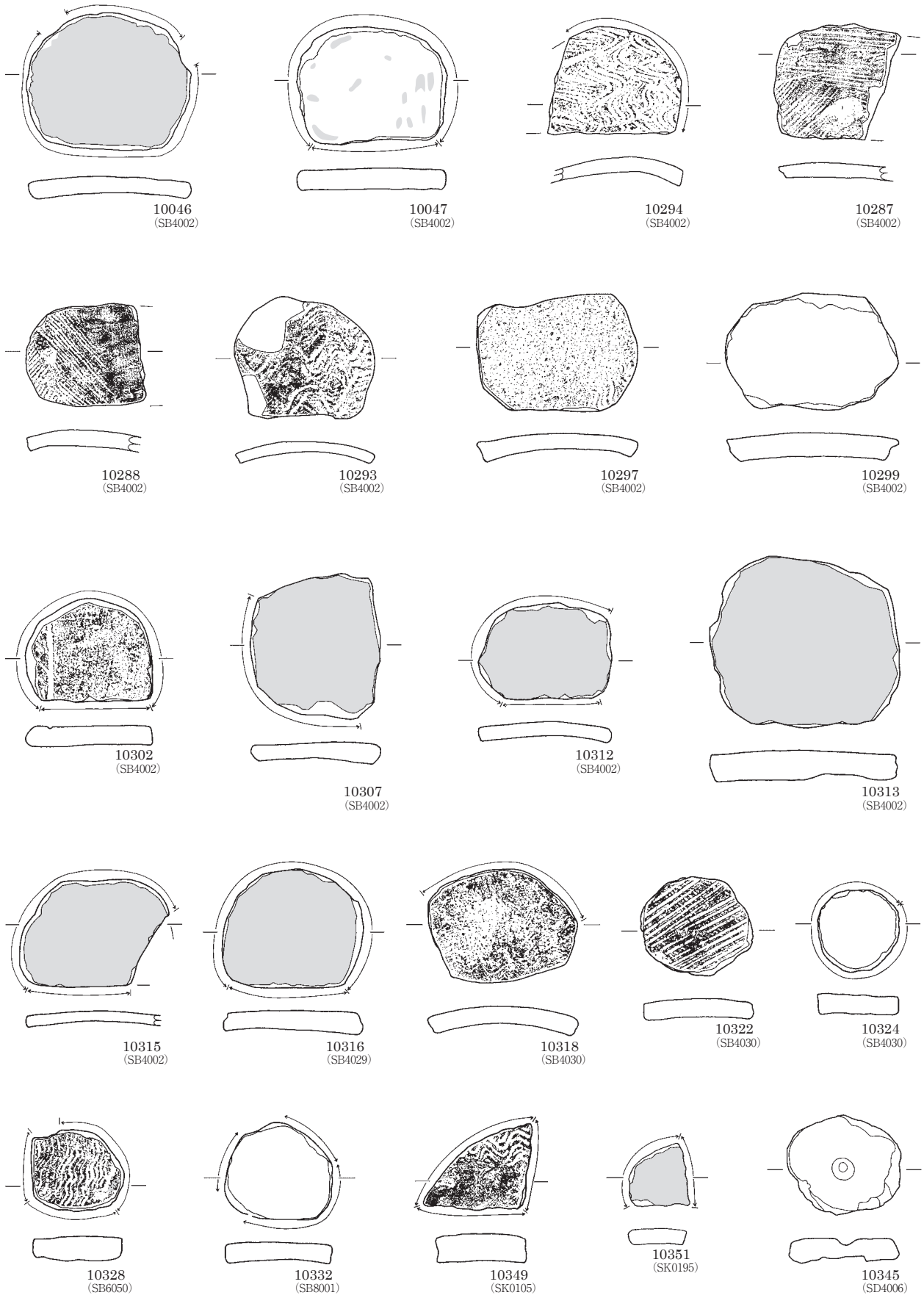

図版 58 古墳時代～古代の土器 (1)

SB0001

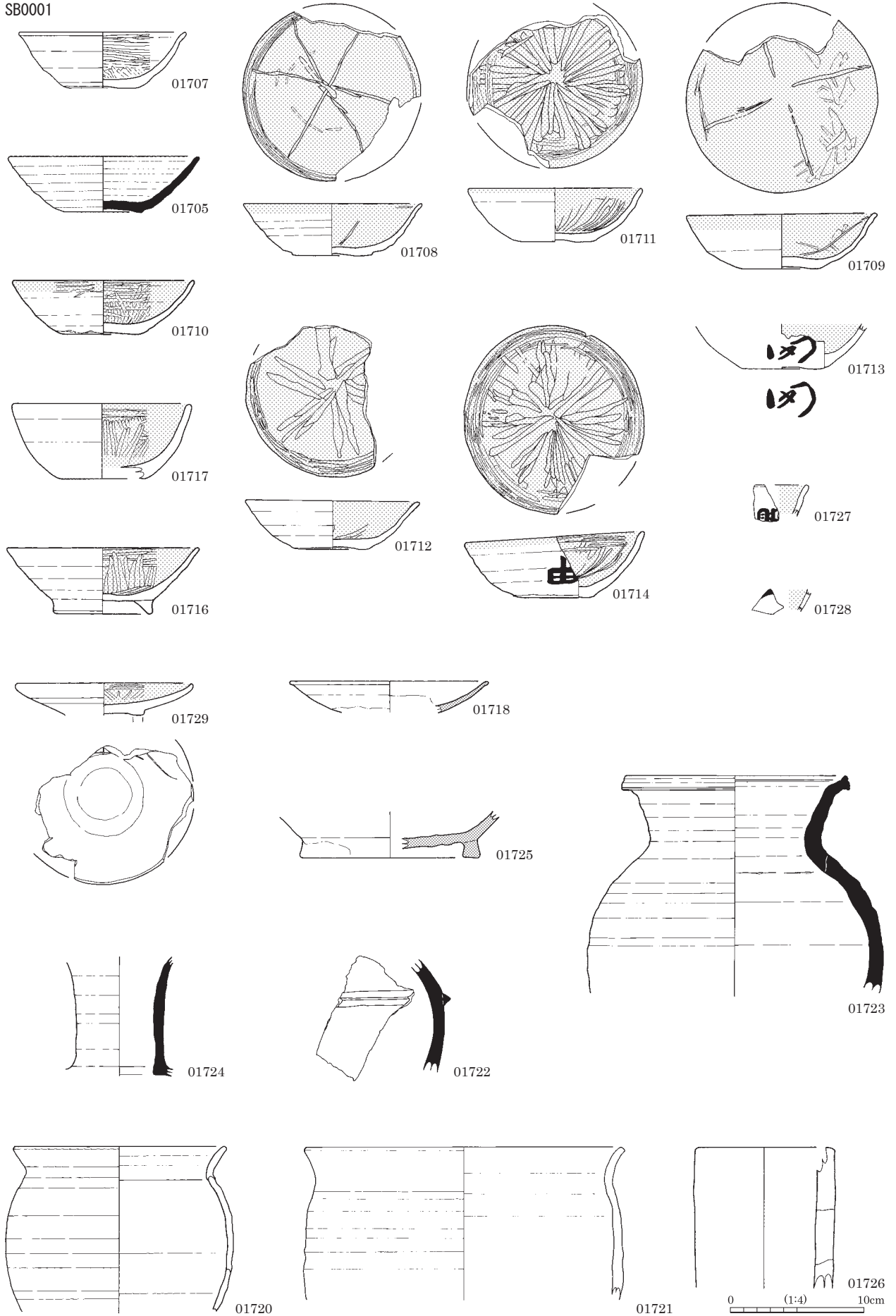

SB0003

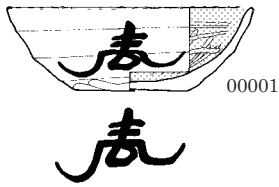

00001

SB0005



01737

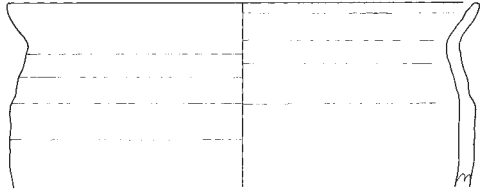

01731



01736

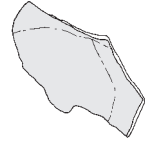

01738

■ 摩耗

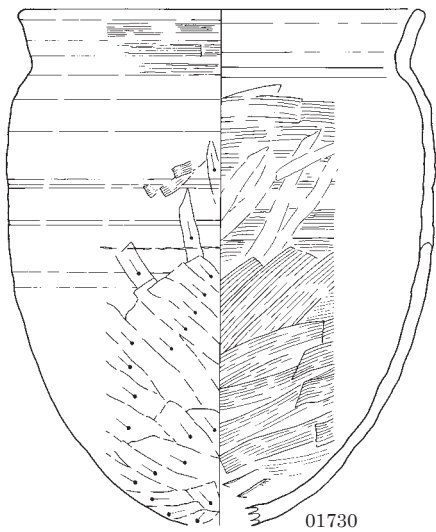

01730

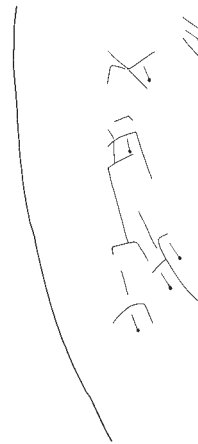

01739



01741

SB0009



01693

SB0010 (1)



01601

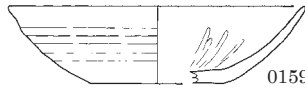

01599

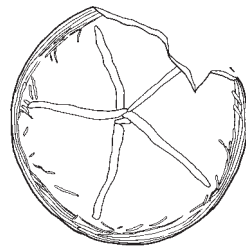

01597

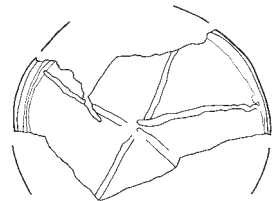

01598

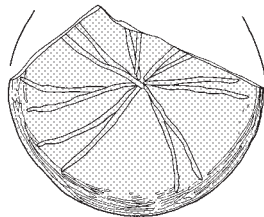

01602

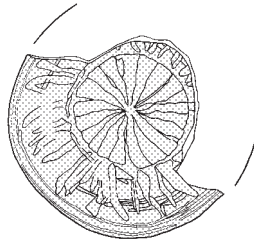

01603

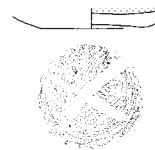

01610



01623

0 (1:4) 10cm

図版 60 古墳時代～古代の土器 (3)

SB0010 (2)

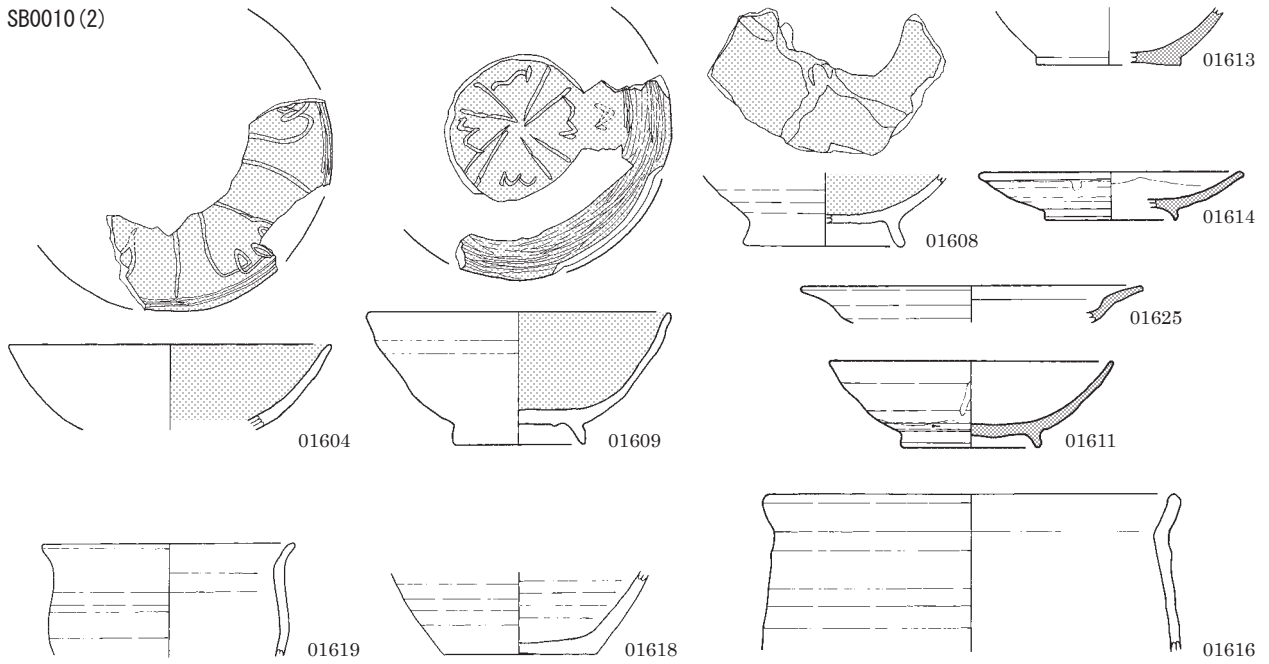

SB0013

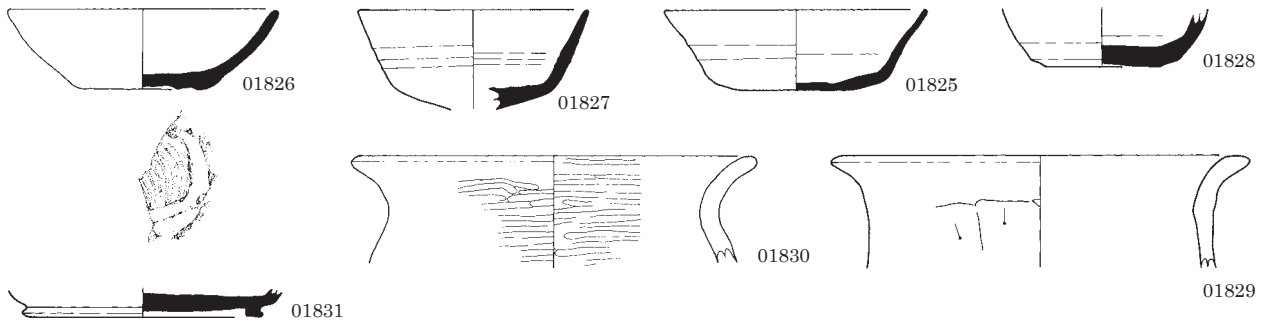

SB0014 (1)

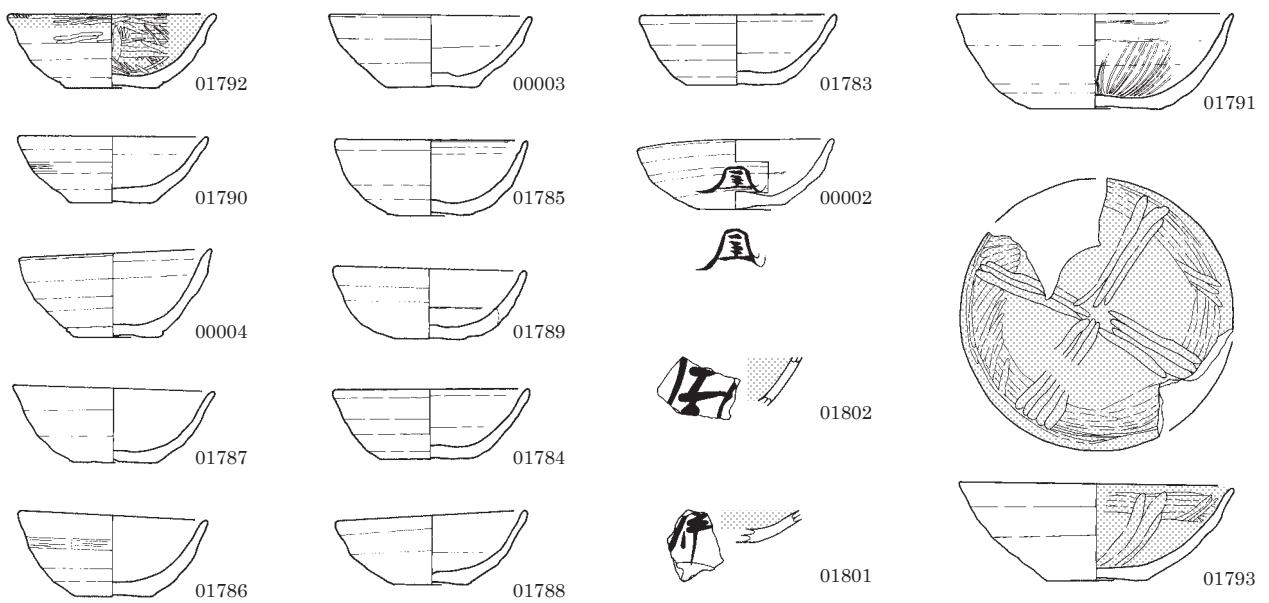

0 (1:4) 10cm

SB0014 (2)

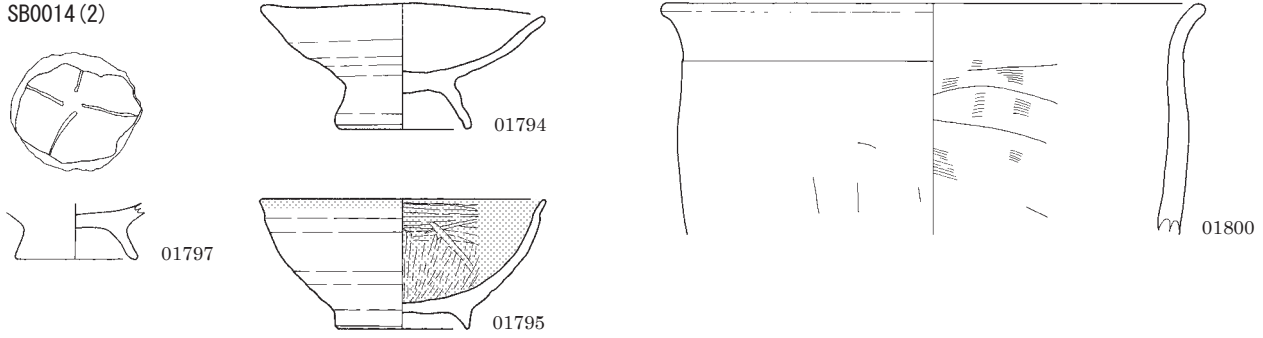

SB0016

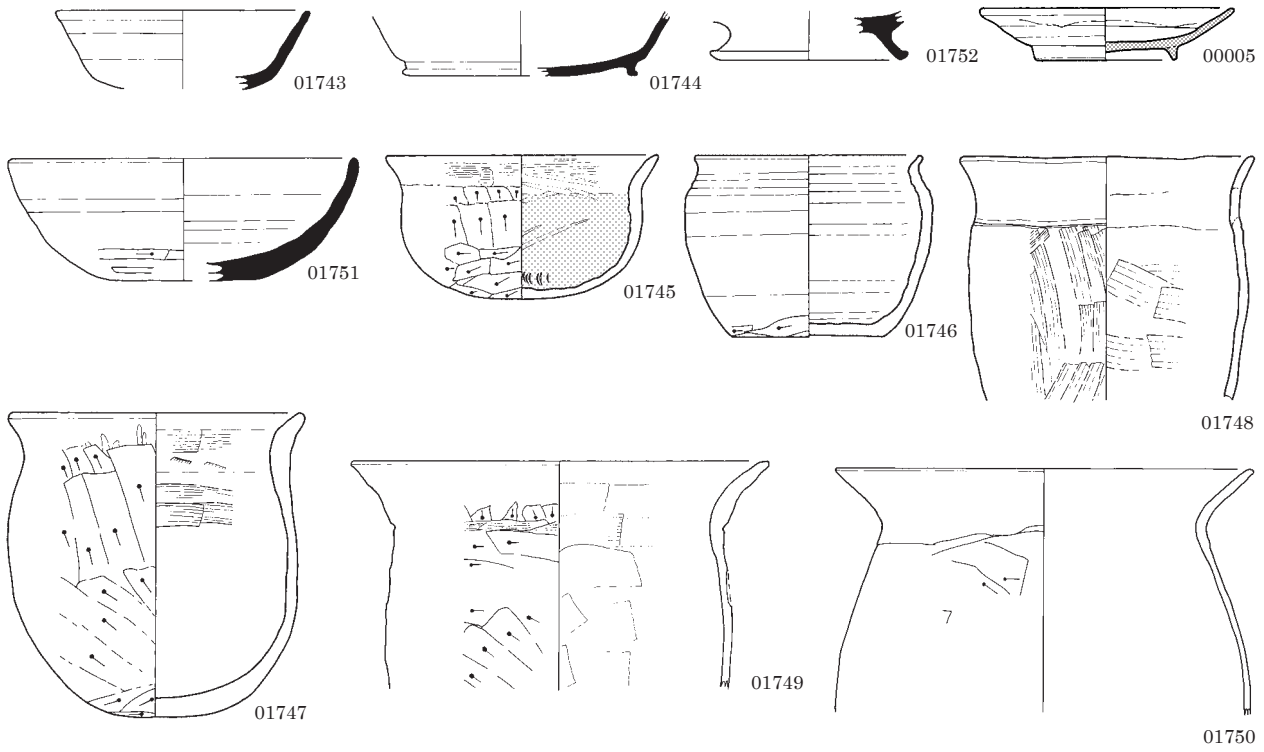

SB0018 (1)

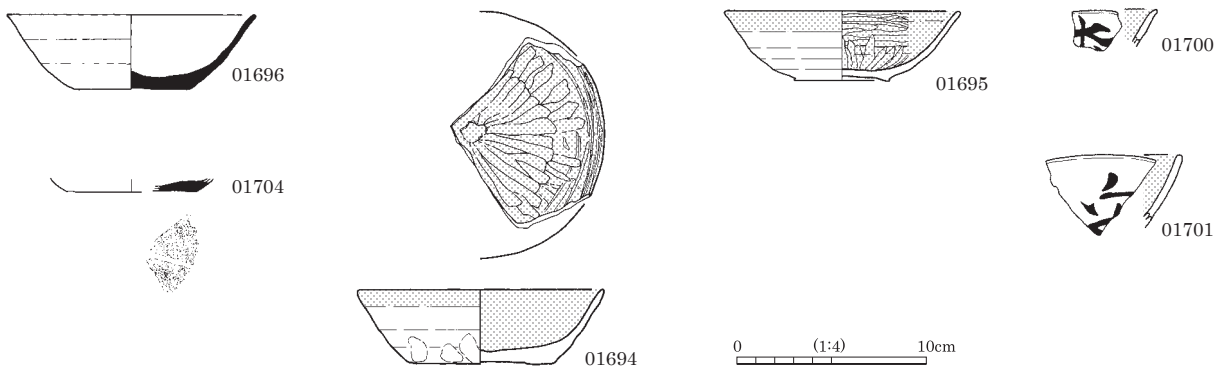

0 (1:4) 10cm

図版 62 古墳時代～古代の土器 (5)

SB0018 (2)

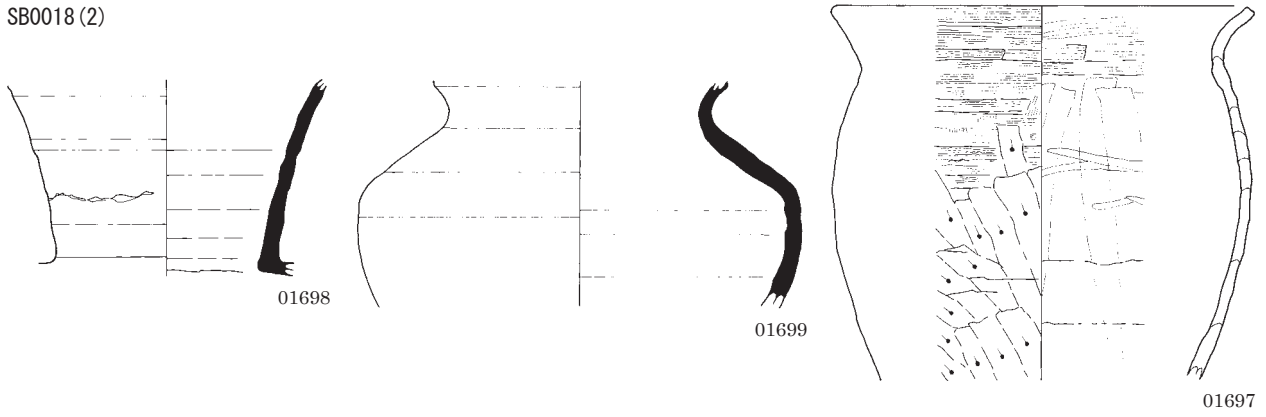

SB0020

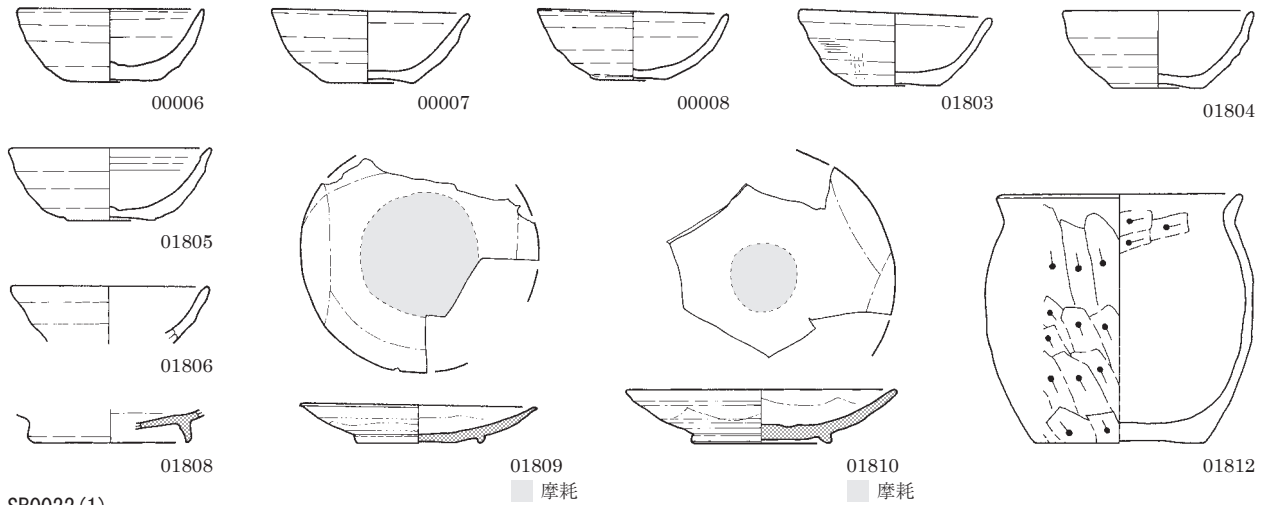

SB0022 (1)

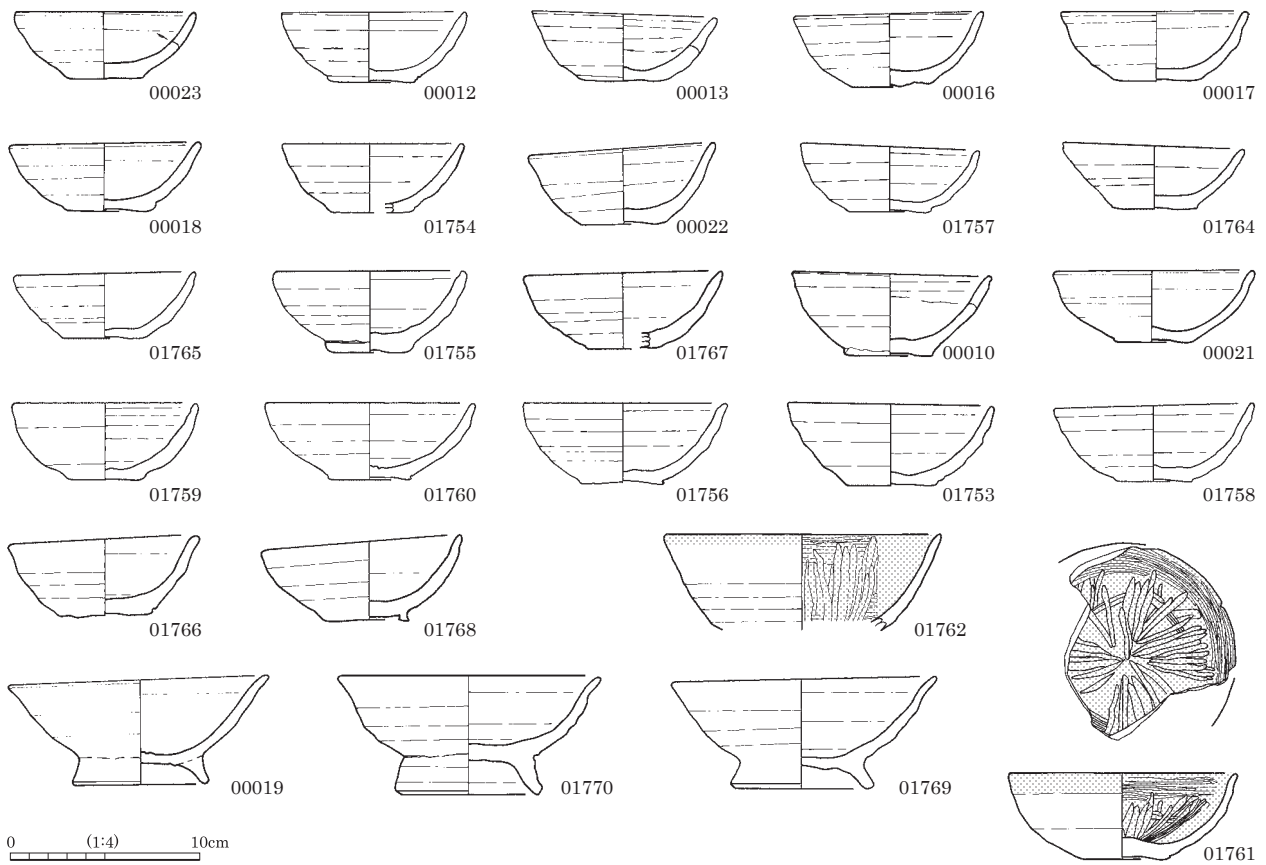

0 (1:4) 10cm

SB0022 (2)

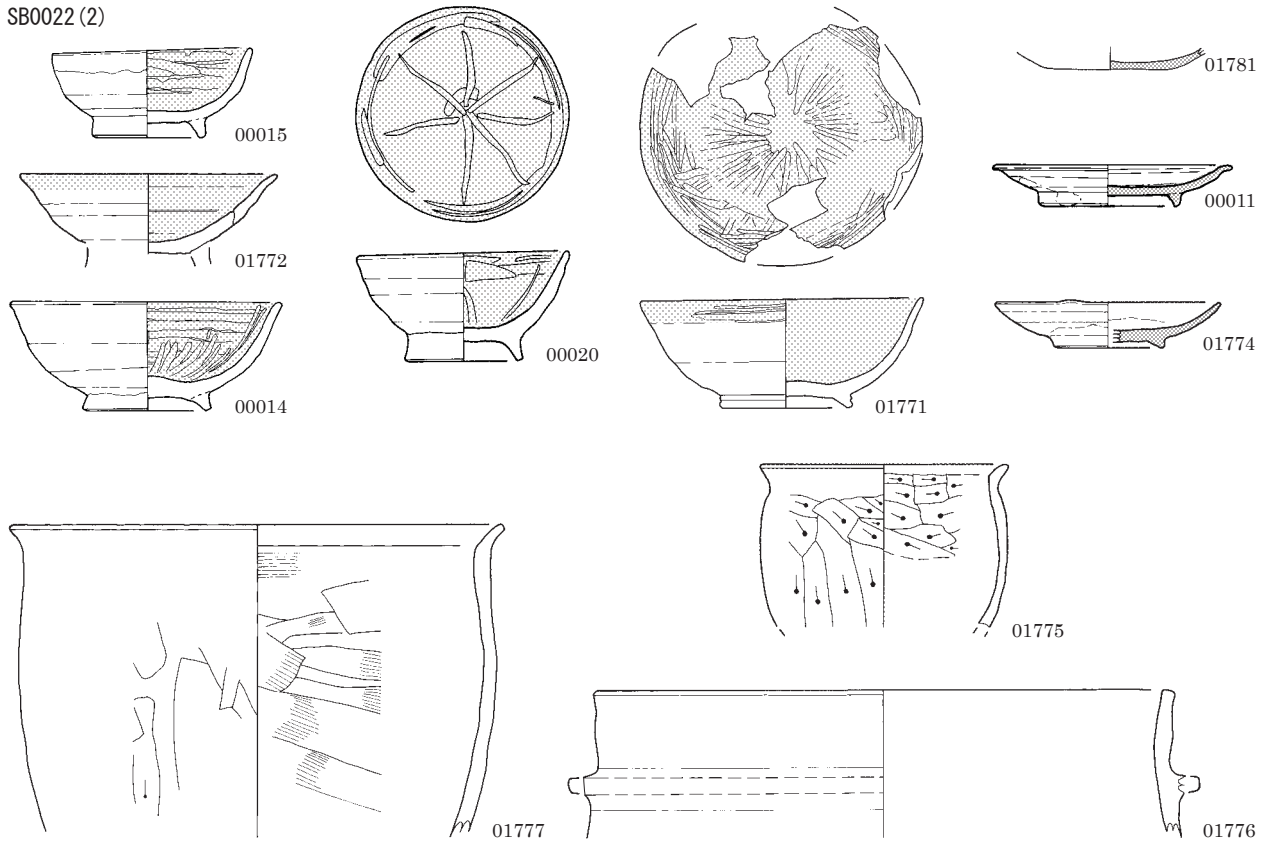

SB0023

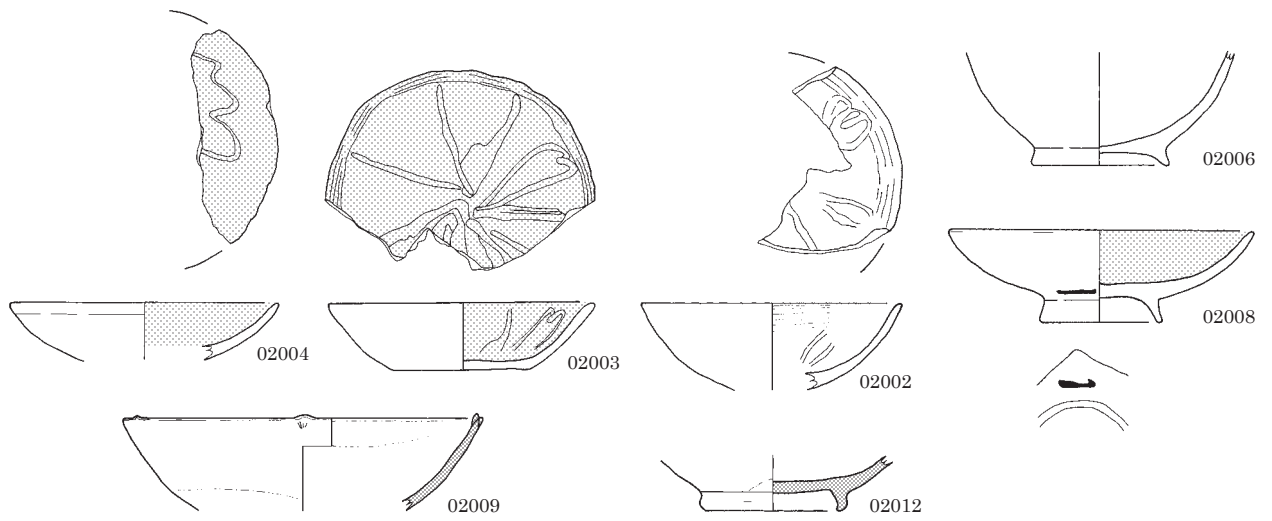

SB0028

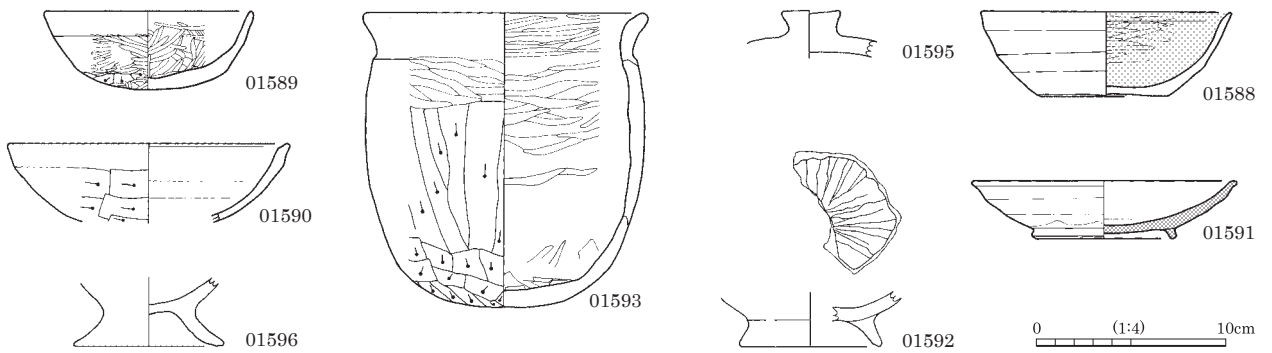

図版 64 古墳時代～古代の土器 (7)

SB0029

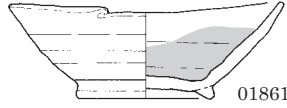
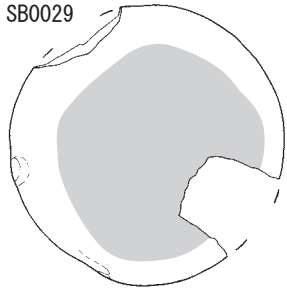

01861
■ 煤付着

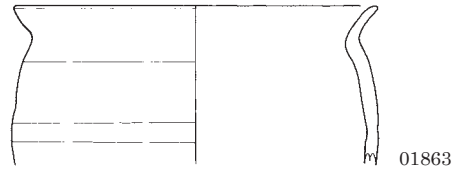
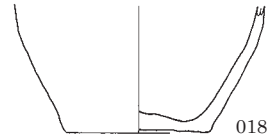
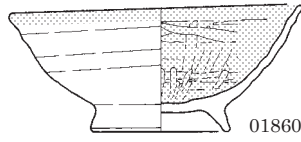
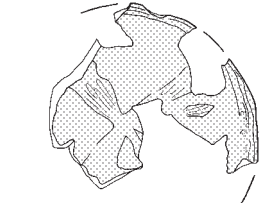

SB0031

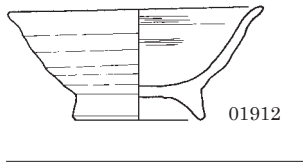

SB0034 (1)

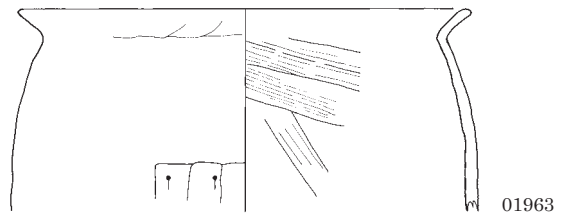
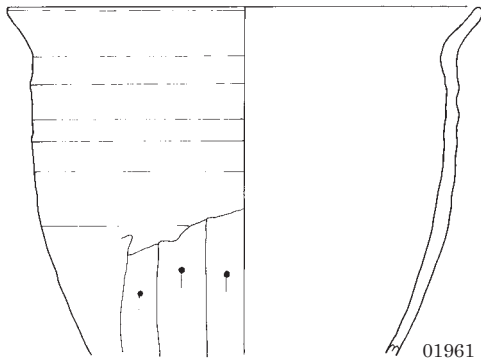
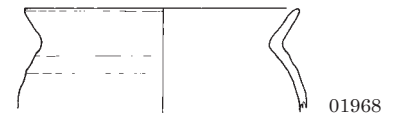
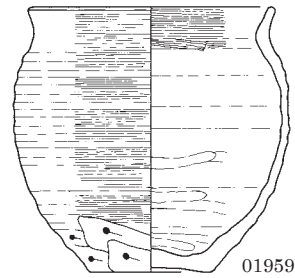
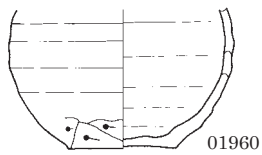
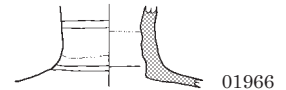
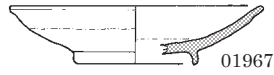
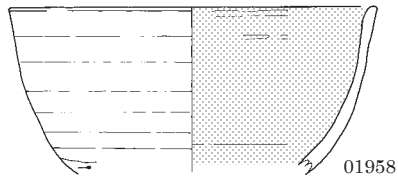
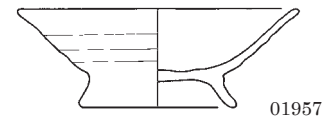
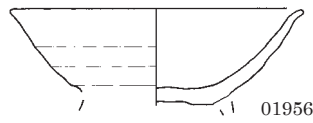
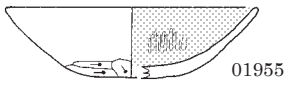
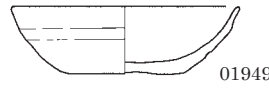
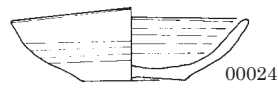

0 (1:4) 10cm

SB0034 (2)

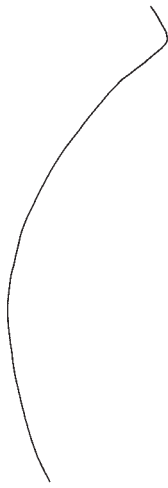

01964

SB0038

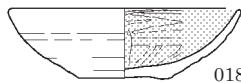

01817

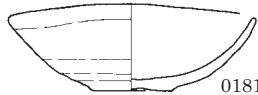
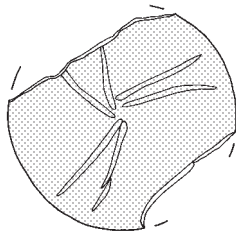

01815

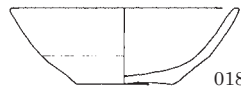
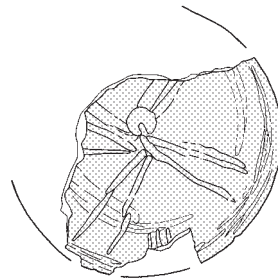

01818

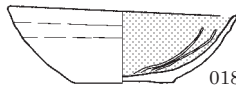

01816

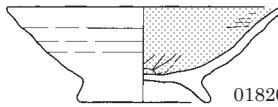

01820

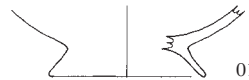
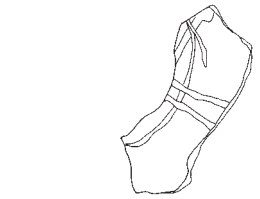

01819



01823

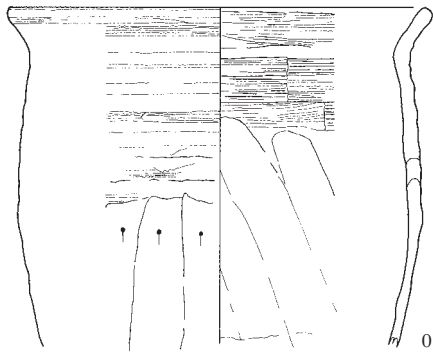

01821

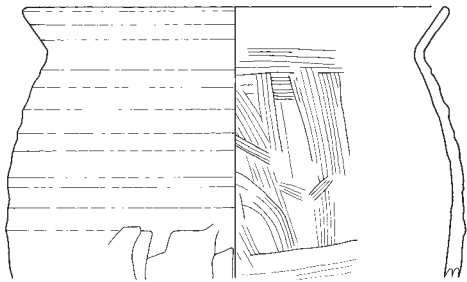

01822

SB0039

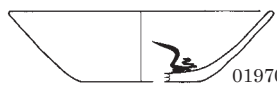

01970

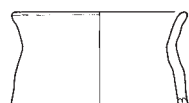

01974

SB0040

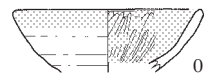

01975

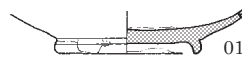

01977

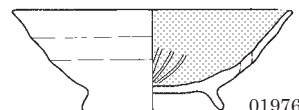
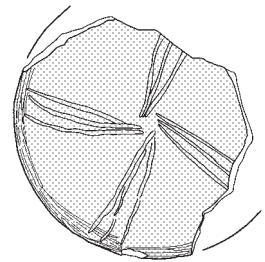

01976

0 (1:4) 10cm

図版 66 古墳時代～古代の土器 (9)

SB0042

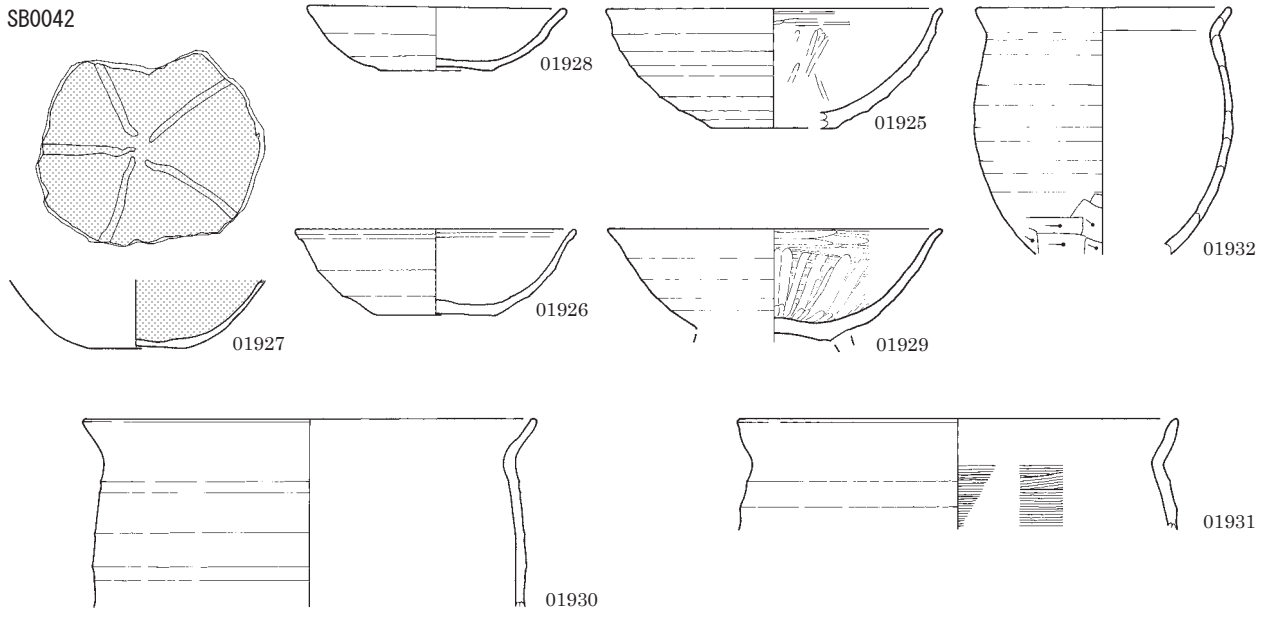

SB0043

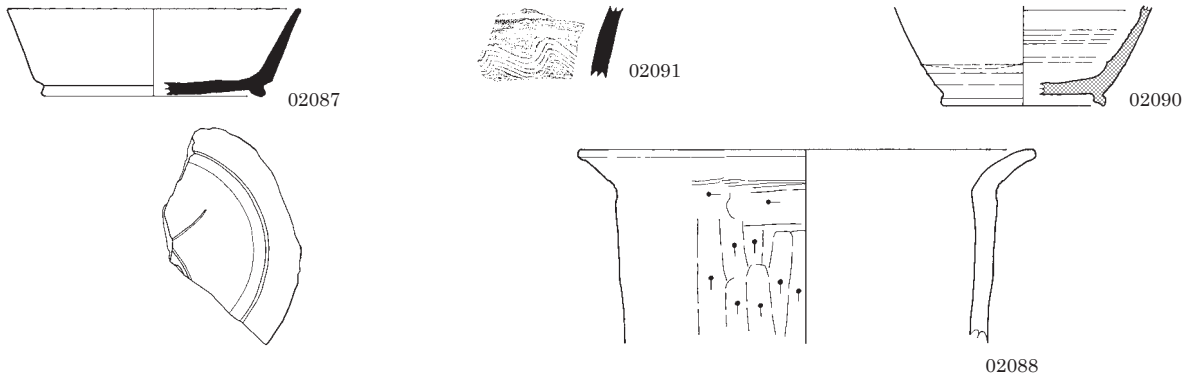

SB0050

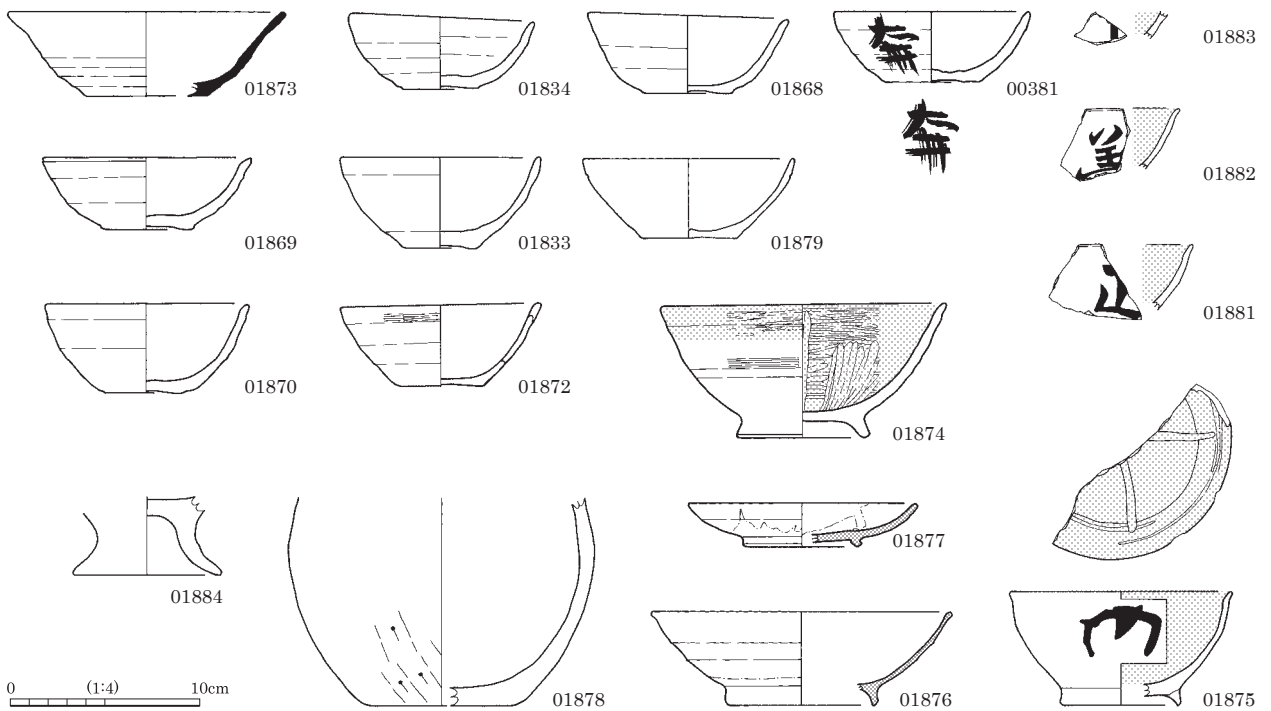

0 (1:4) 10cm

SB0051

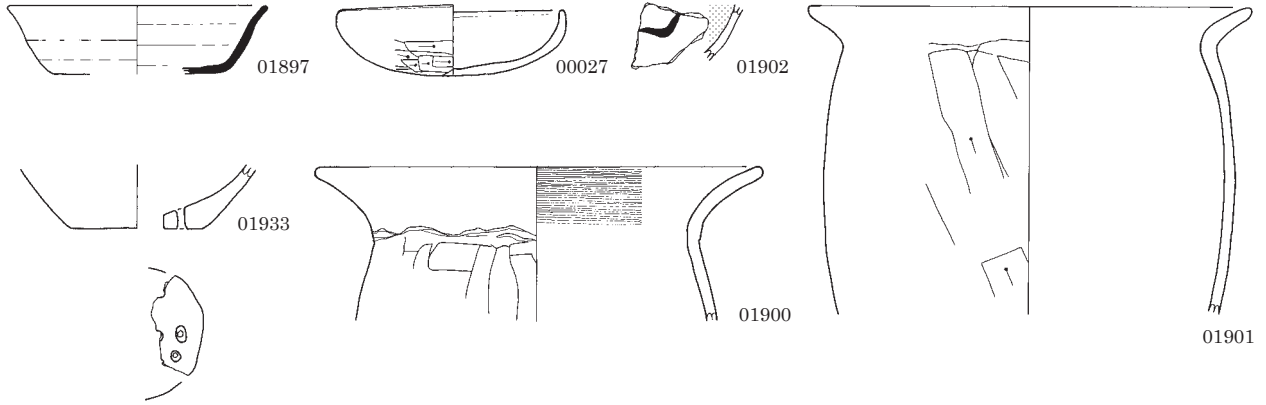

SB0053

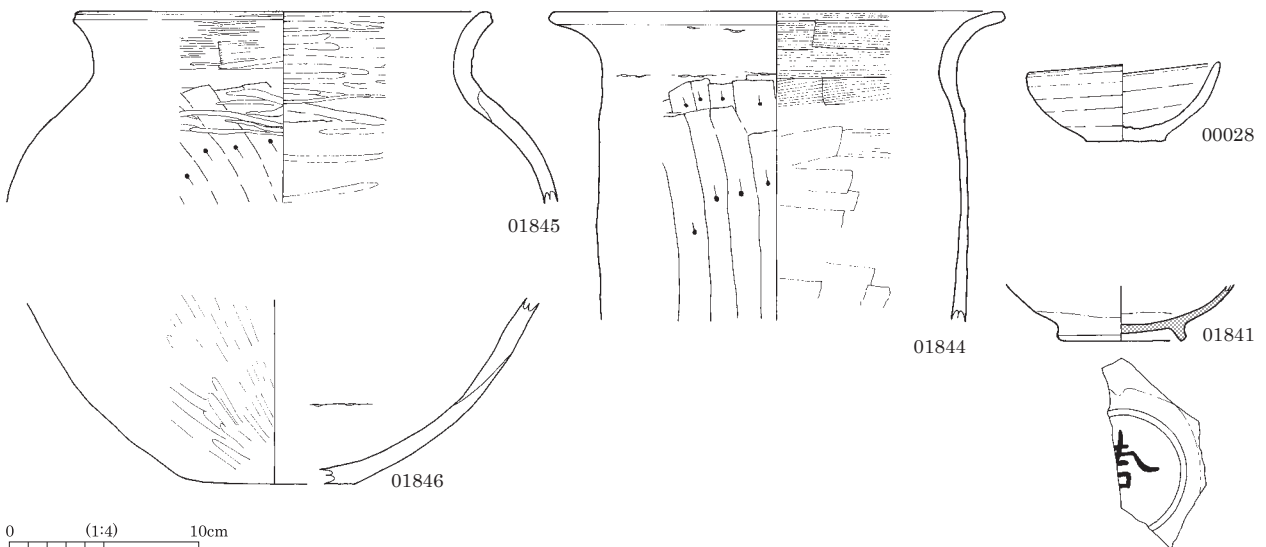
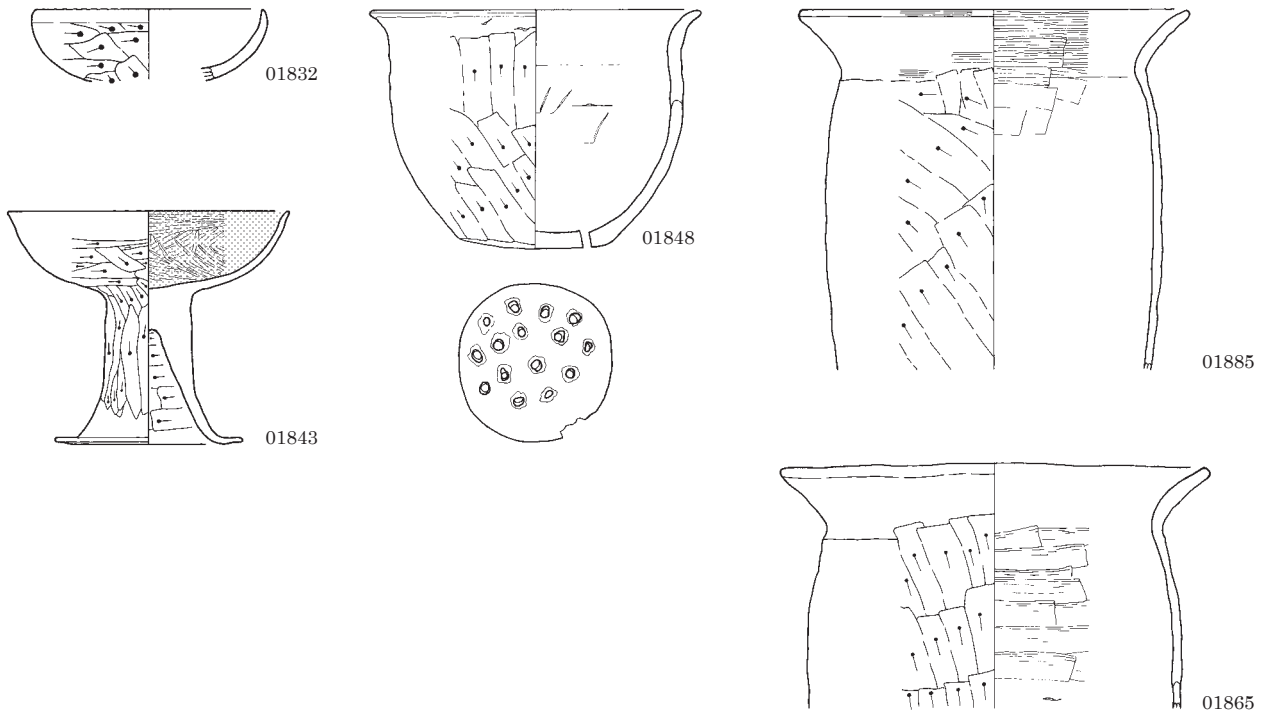

0 (1:4) 10cm

図版 68 古墳時代～古代の土器 (11)

SB0054

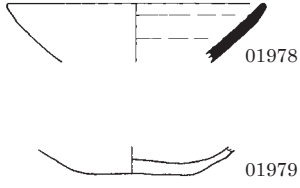

SB0055

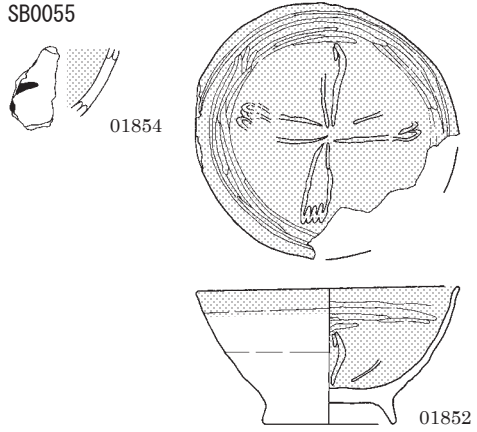

SB0058

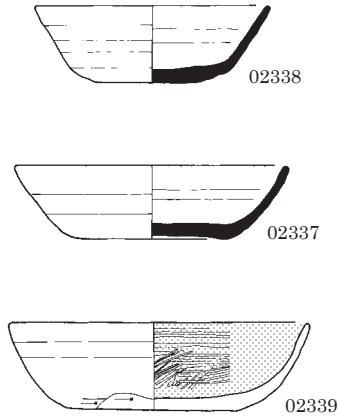

SB0063

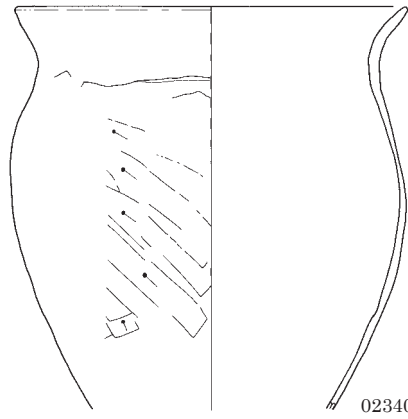
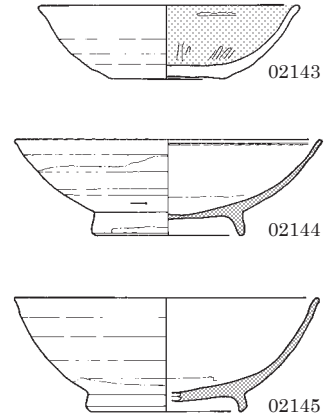

SB0060

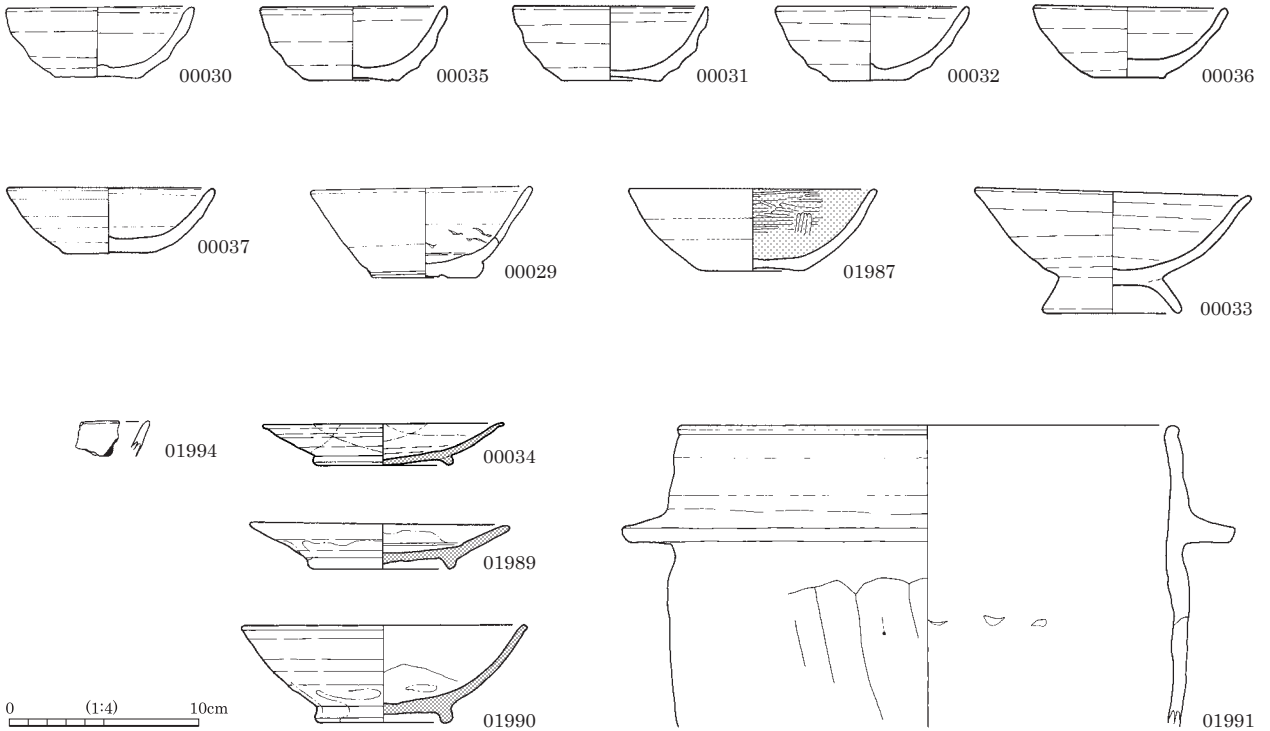

SB0065

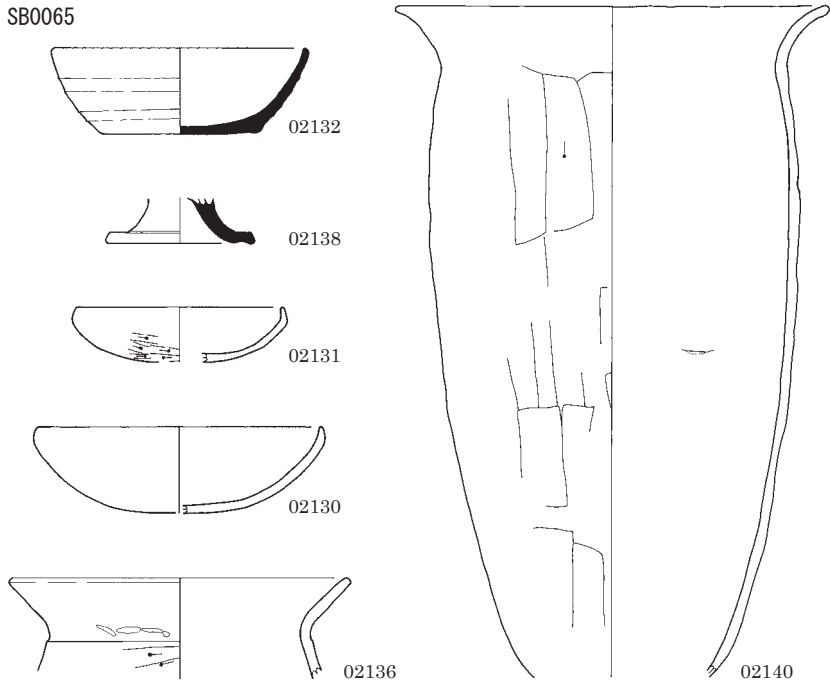

SB0065・66



SB0068

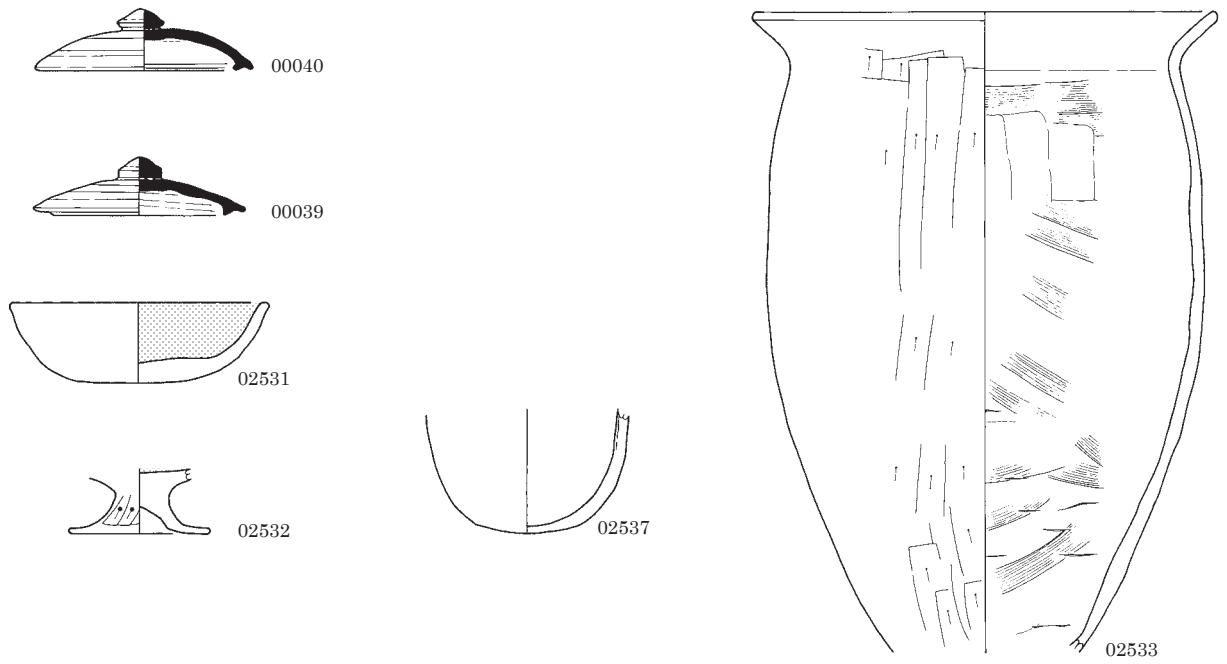

SB0070

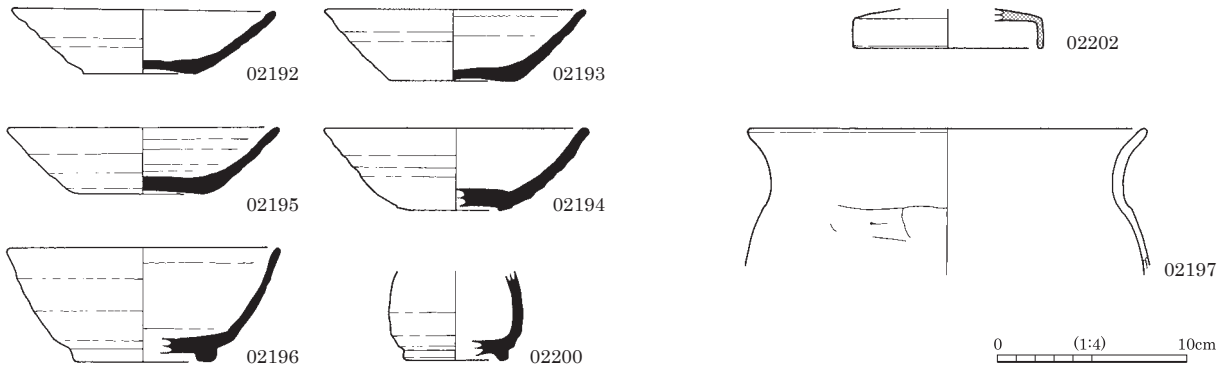

図版 70 古墳時代～古代の土器 (13)

SB0073

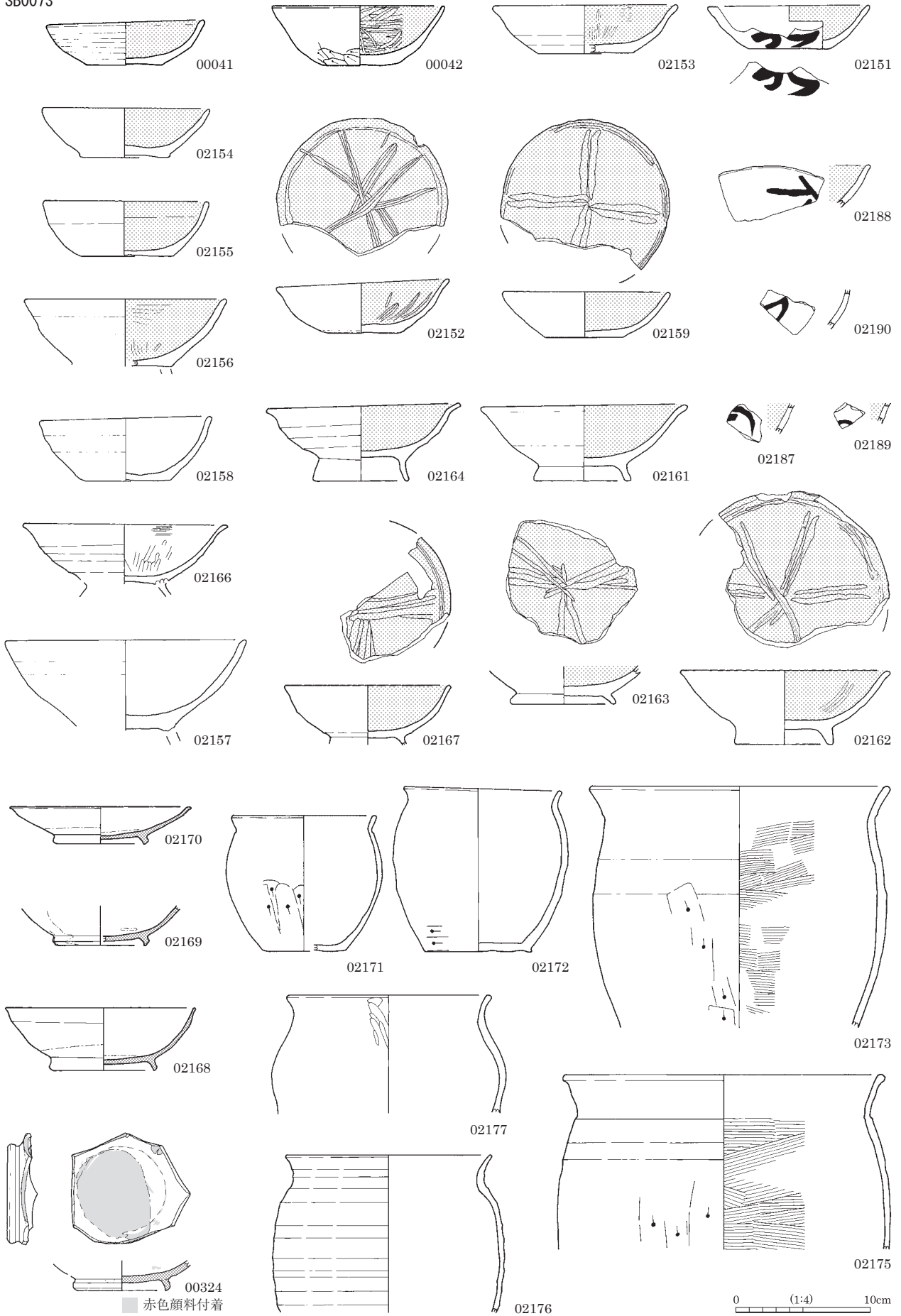

SB0074

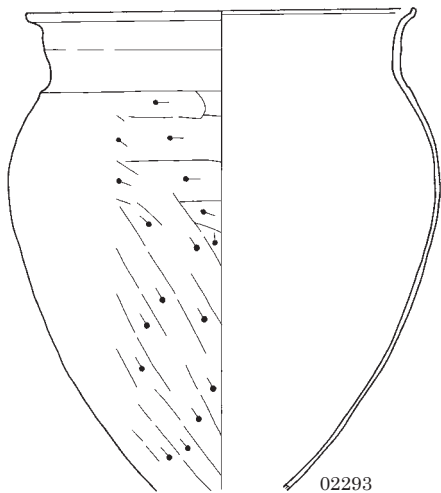
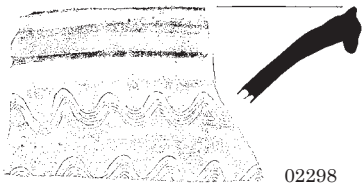
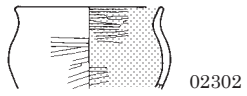
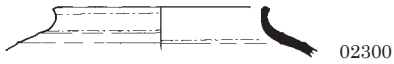
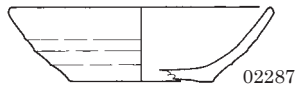
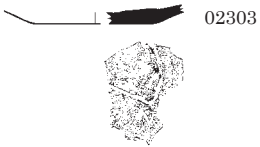
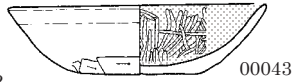

SB0076

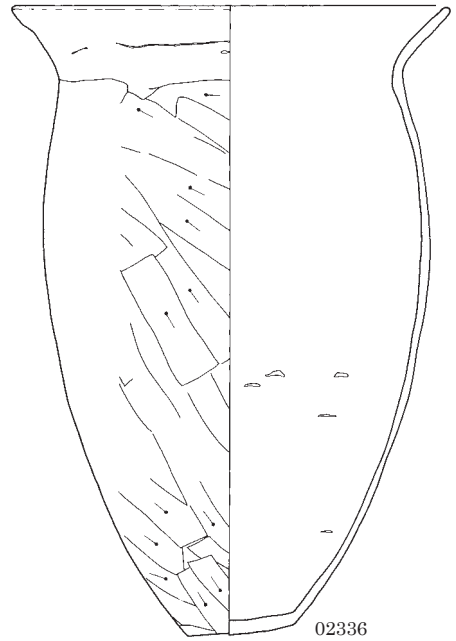
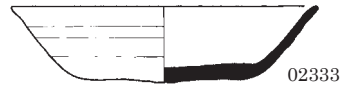
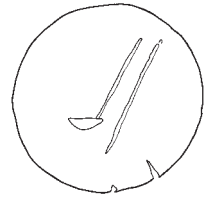
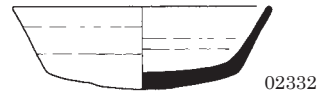

SB0078 (1)

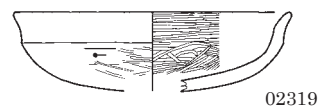
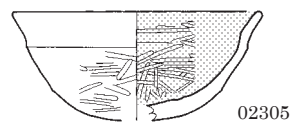
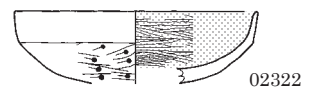

0 1:4 10cm

図版 72 古墳時代～古代の土器 (15)

SB0078 (2)

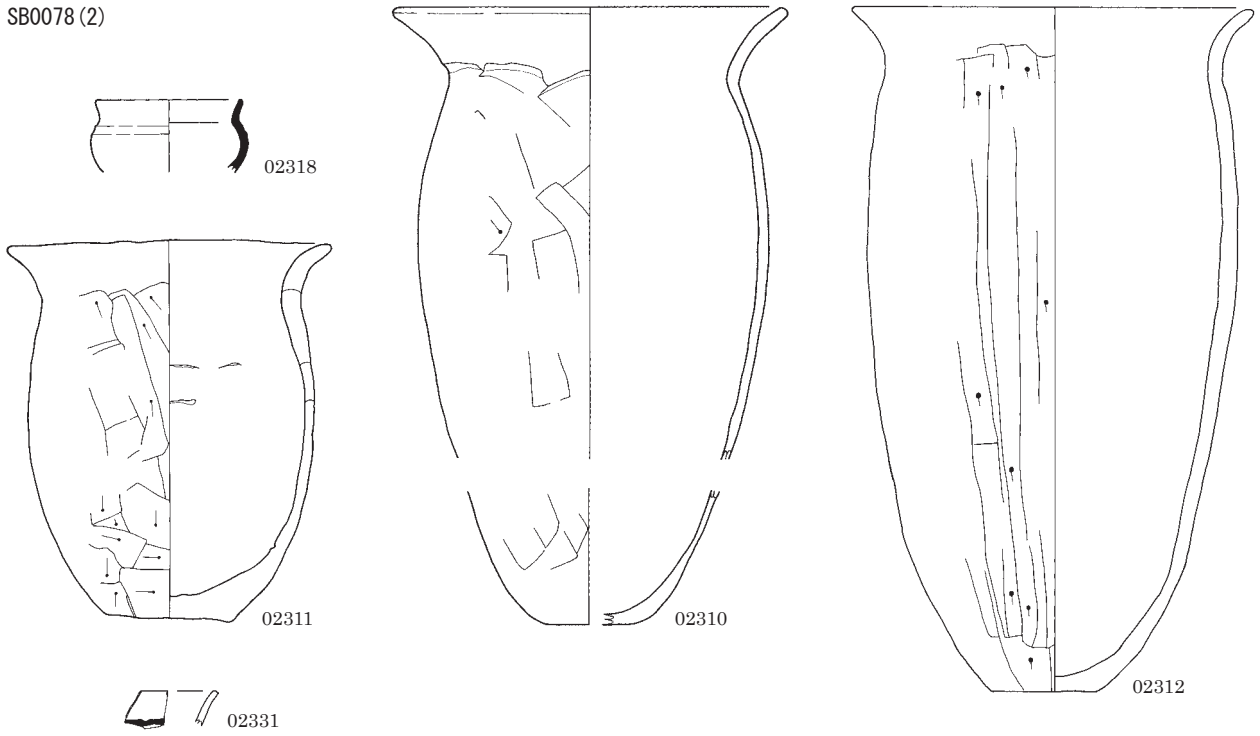

SB0079

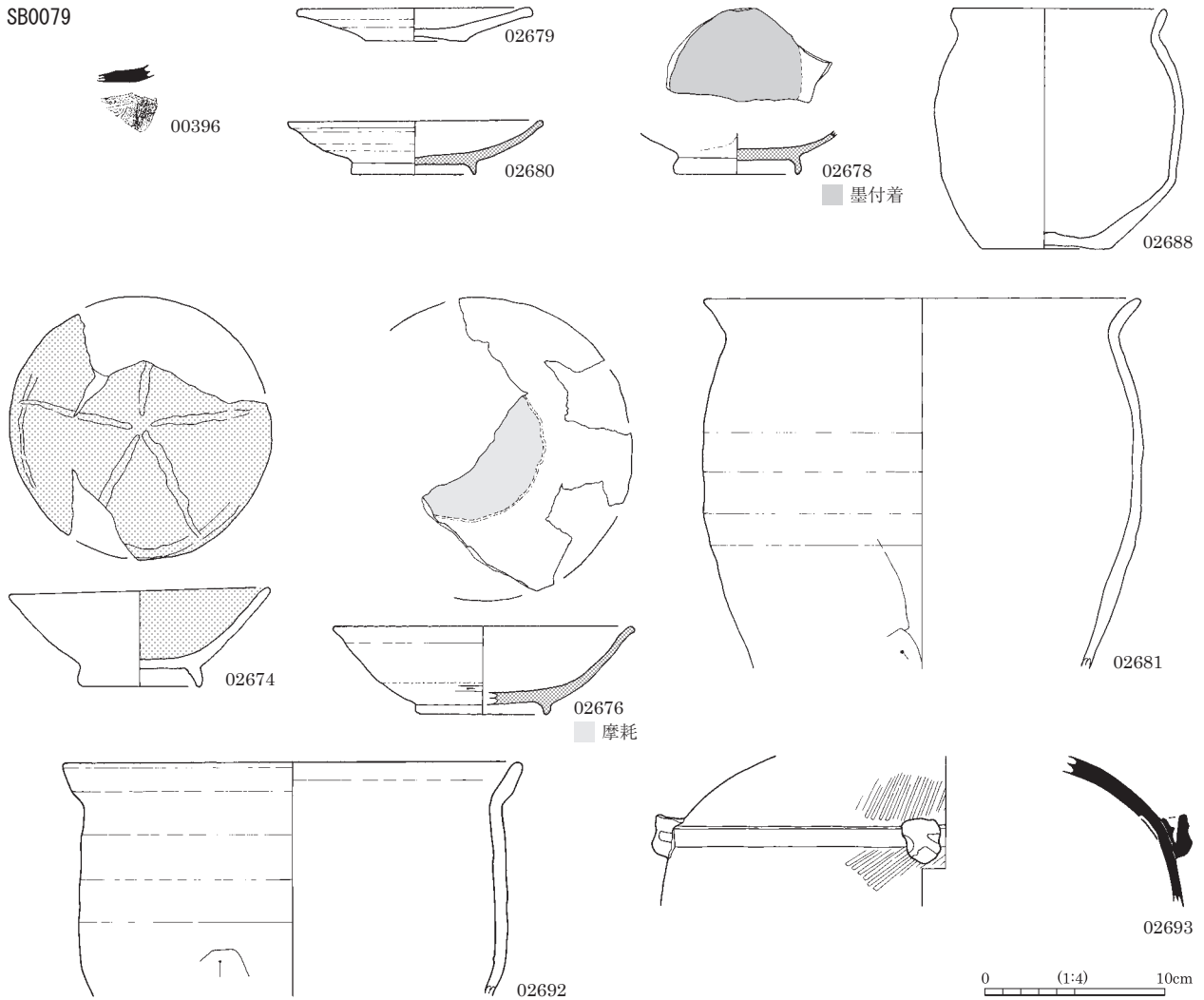

SB0091

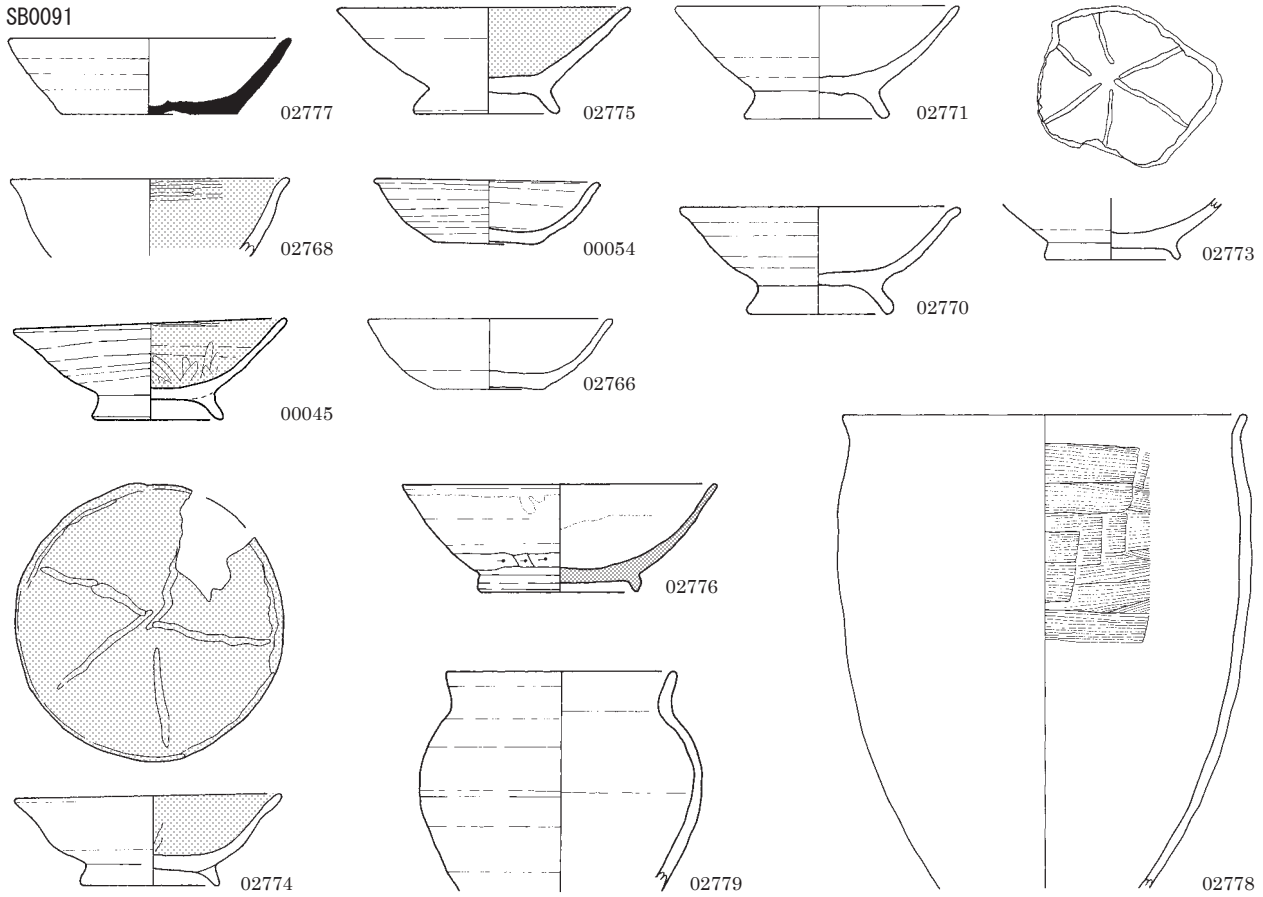

SB0096

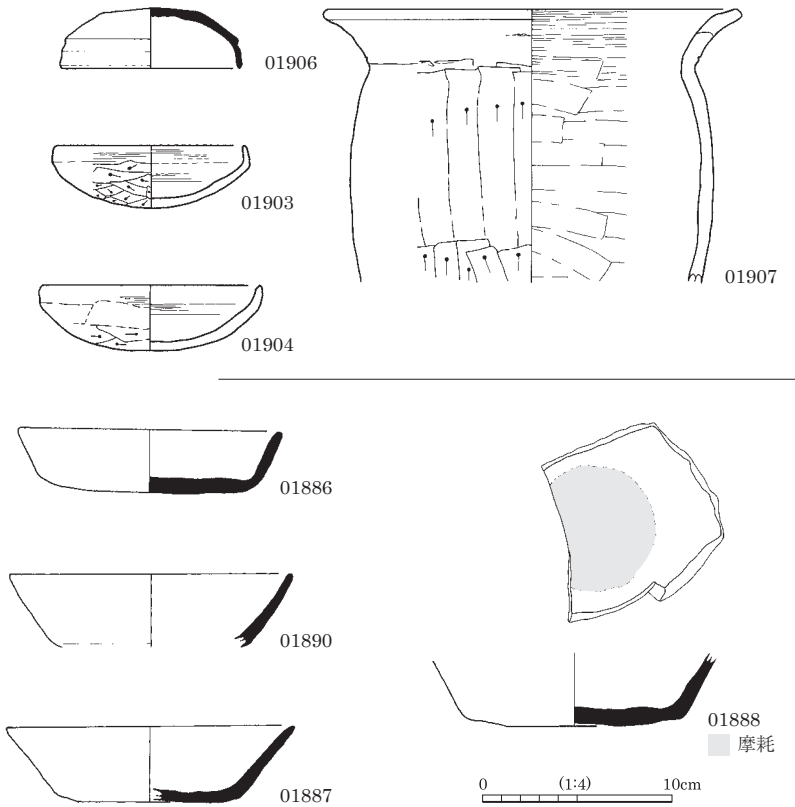

SB0097

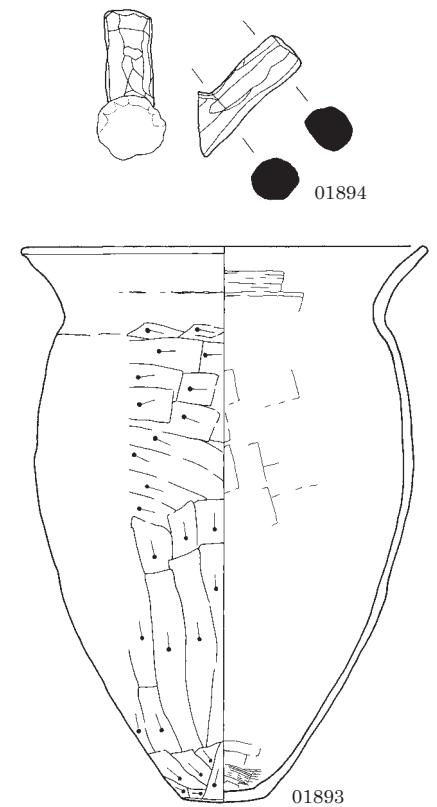

図版 74 古墳時代～古代の土器 (17)

SB0098

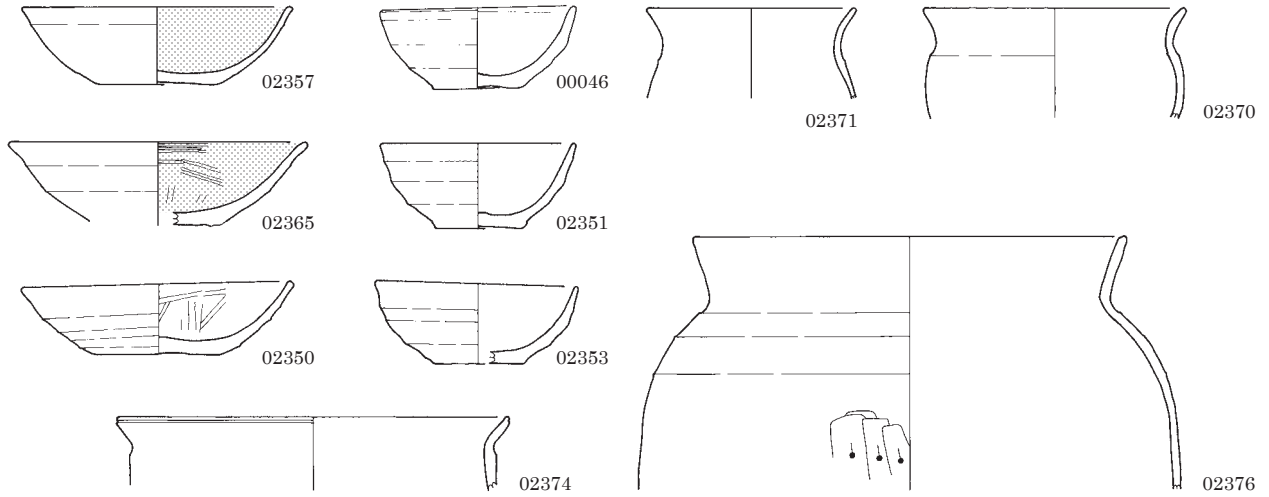

SB0101

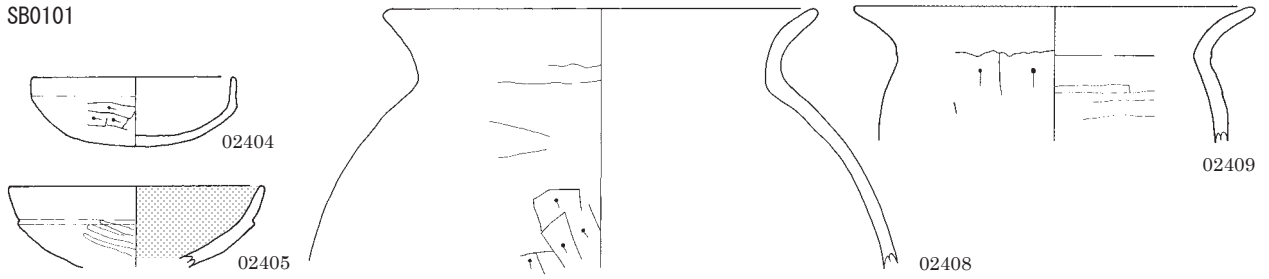

SB0103

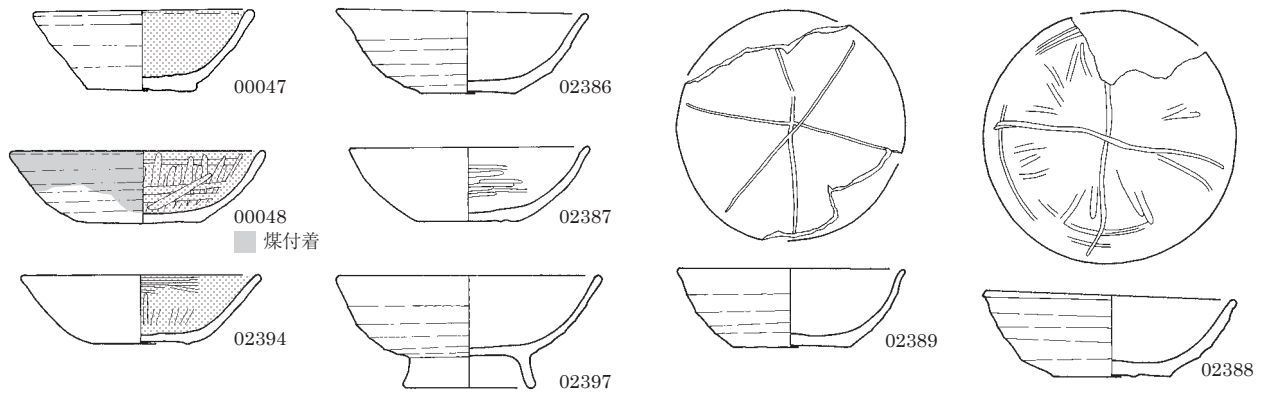

SB0104



SB0107 (1)

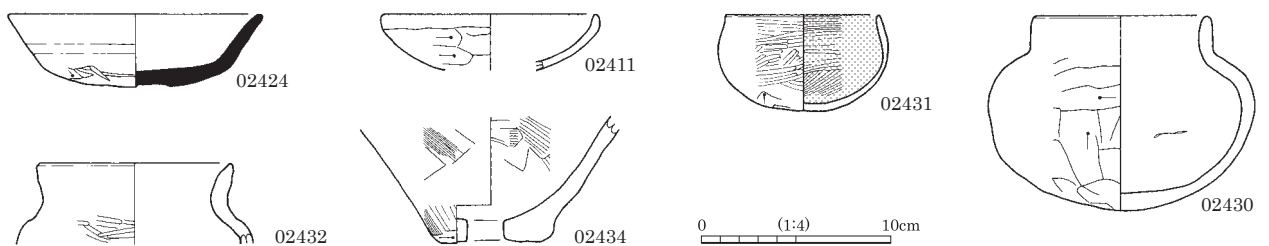

SB0107 (2)

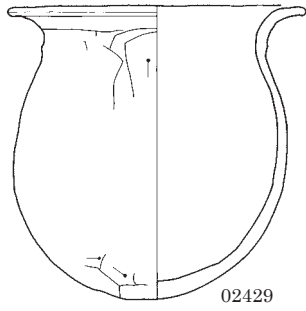

02429

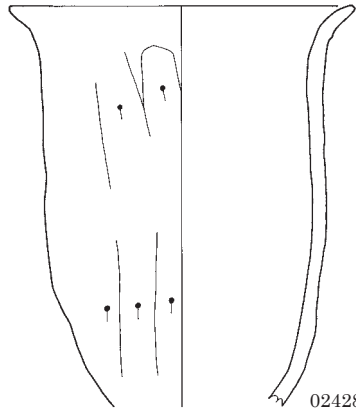

02428

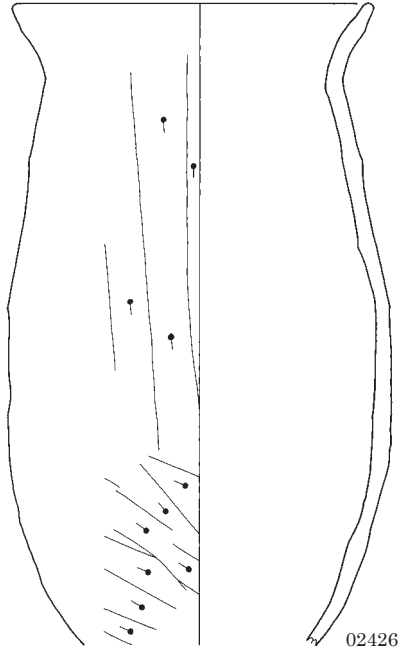

02426

SB0112

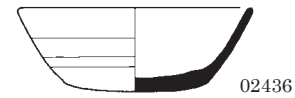

02436

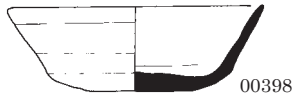

00398

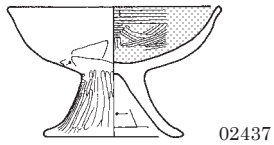

02437



02438

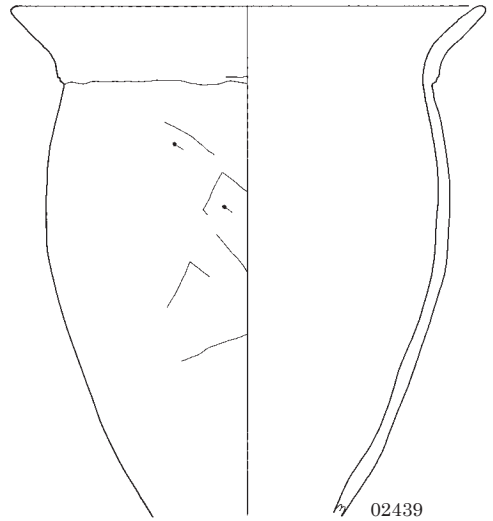

02439

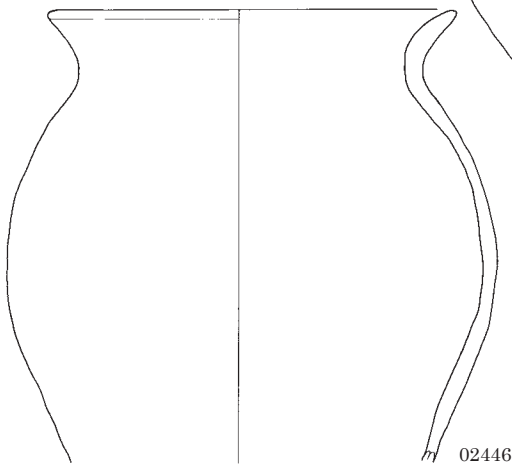

02446

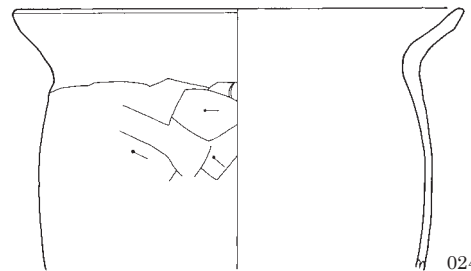

02445

SB0114

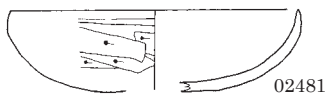

02481

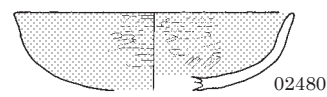

02480

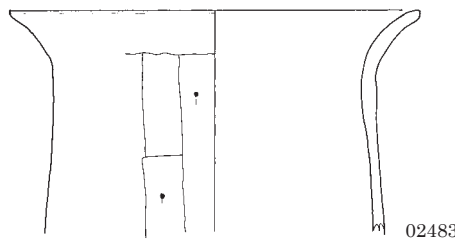

02483

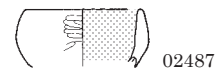

02487

0 10cm (1:4)

図版 76 古墳時代～古代の土器 (19)

SB0115

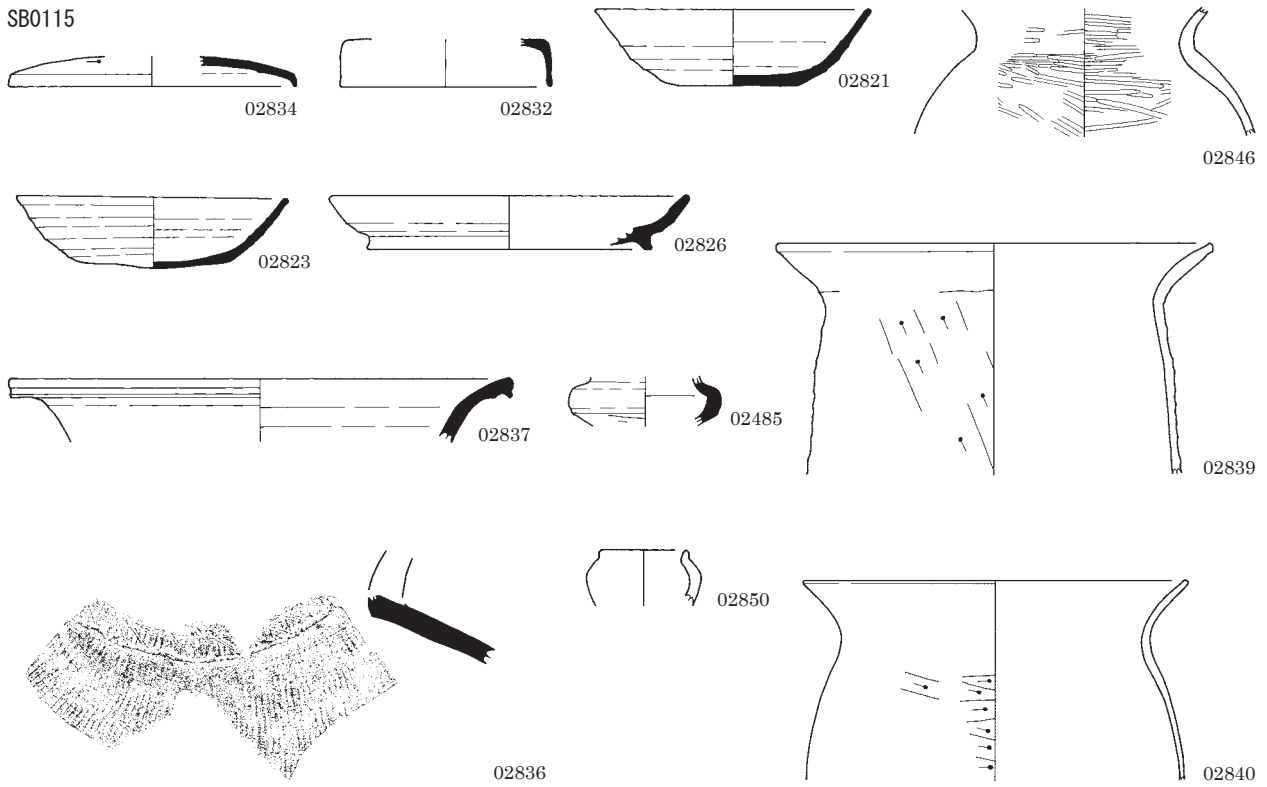

SB0116

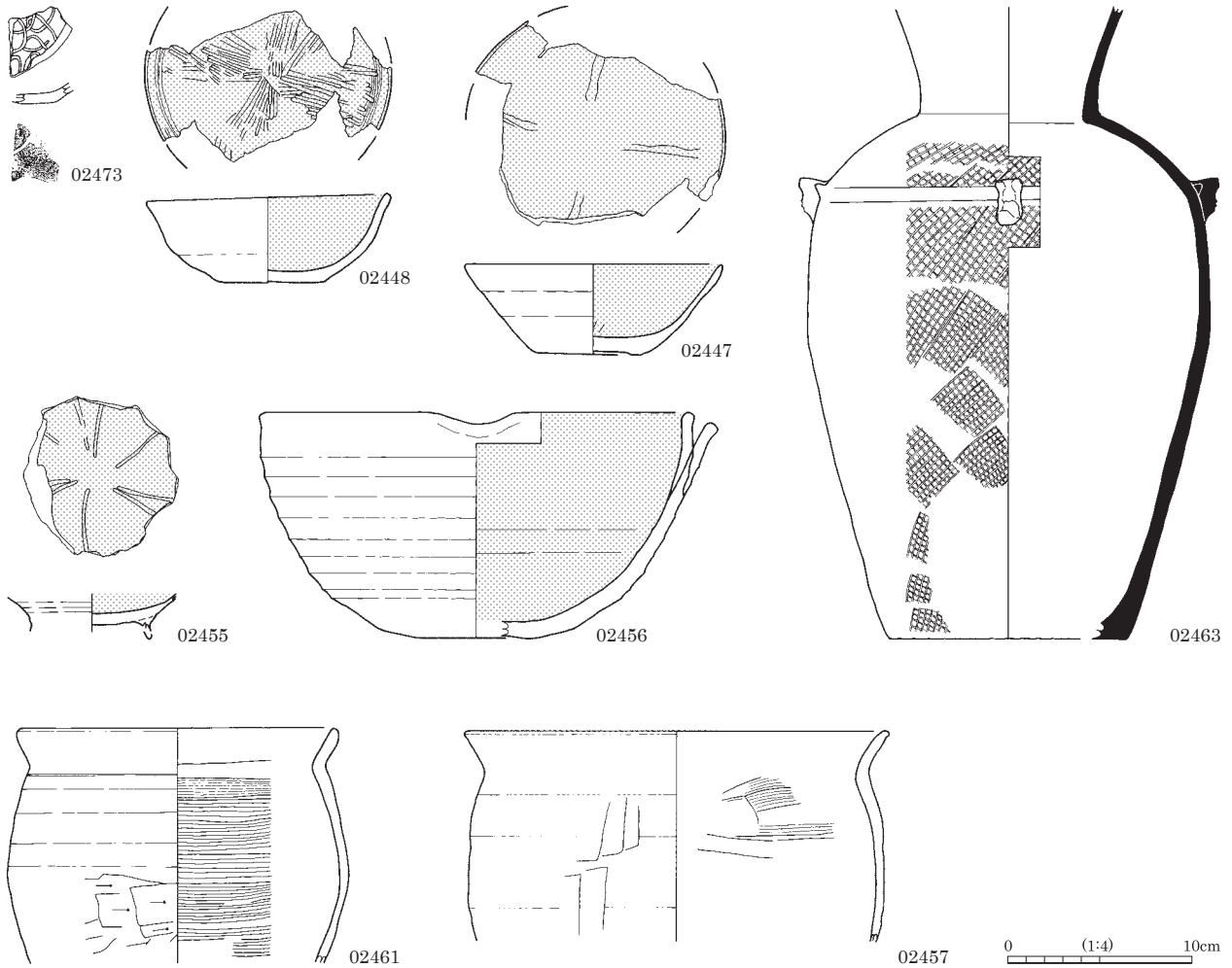

SB0119

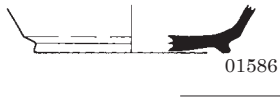

SB0120



SB0121

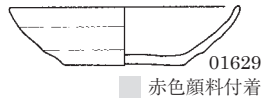
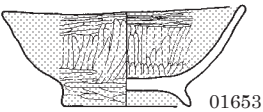
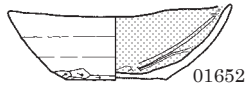
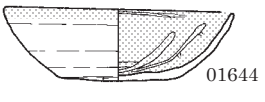
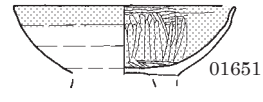
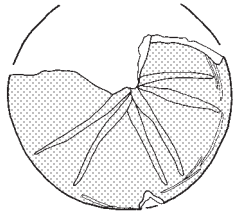
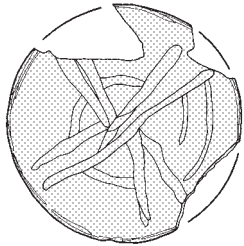
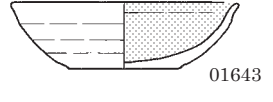
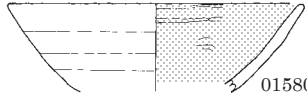
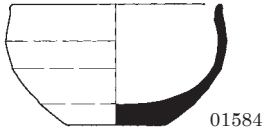
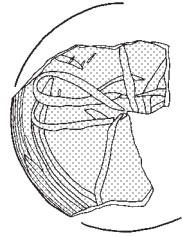
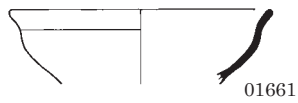
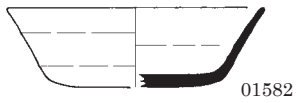
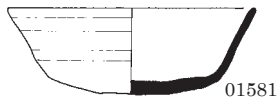
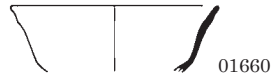

赤色顔料付着

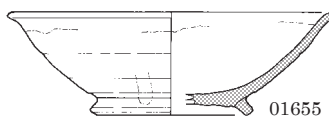
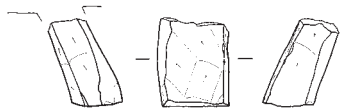
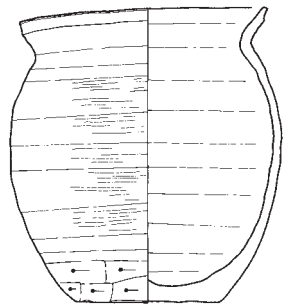
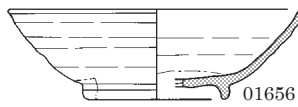
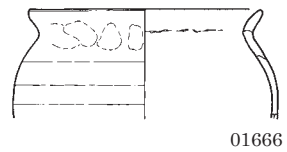
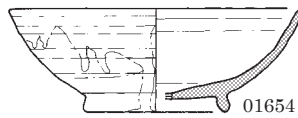
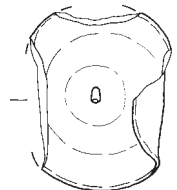
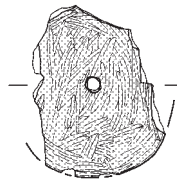
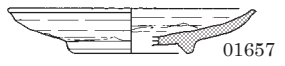
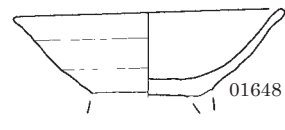
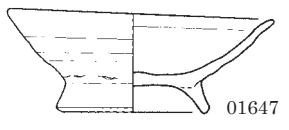
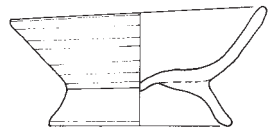
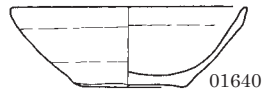
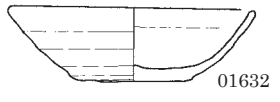
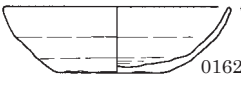
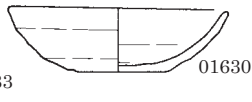
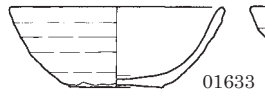
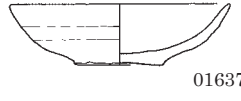
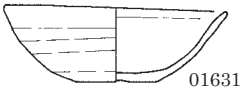
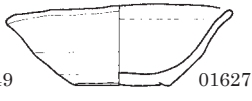
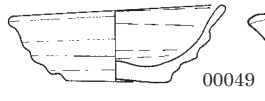

0 10cm (1:4)

図版 78 古墳時代～古代の土器 (21)

SB0125

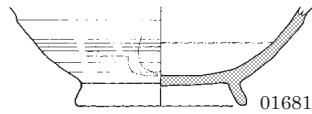
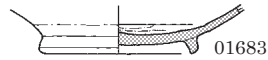
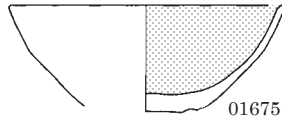
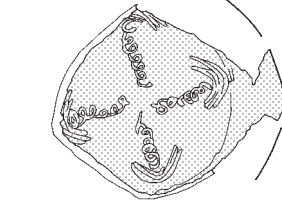
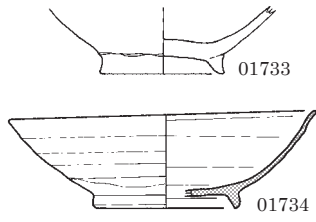
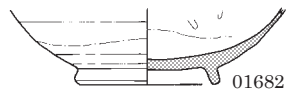
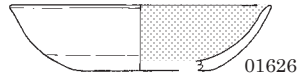
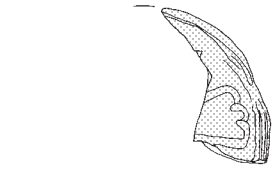
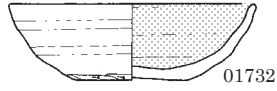
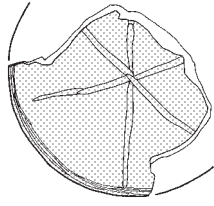

SB0126

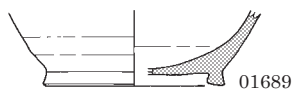
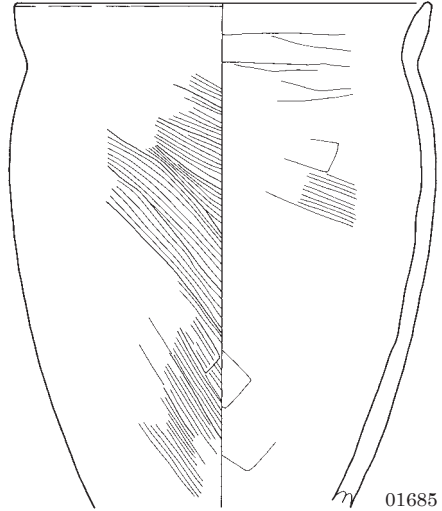
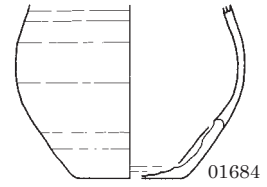
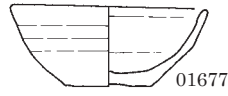
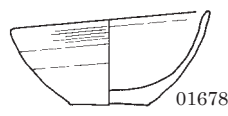

SB0132

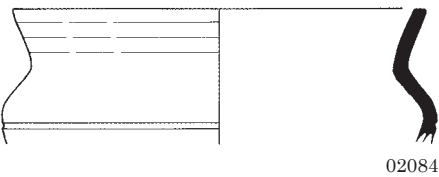
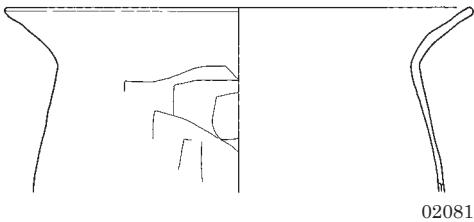
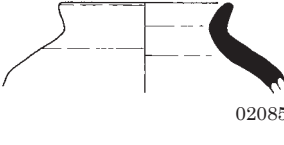
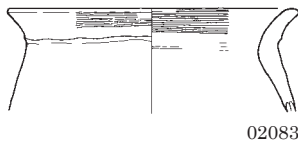

SB0133

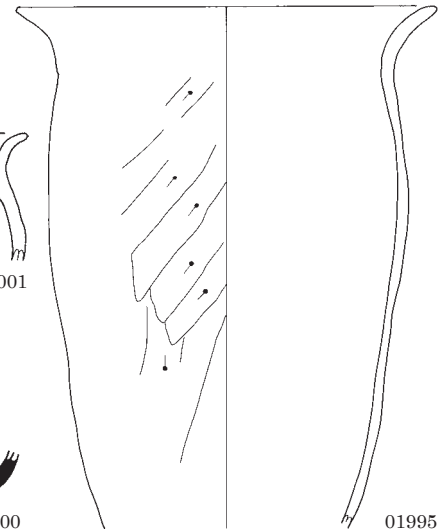
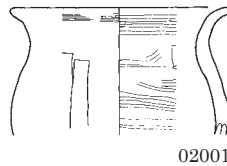
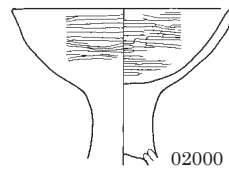

0 (1:4) 10cm

00400

01995

SB0136

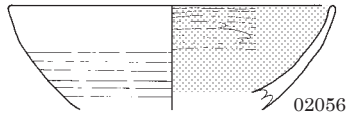

02056

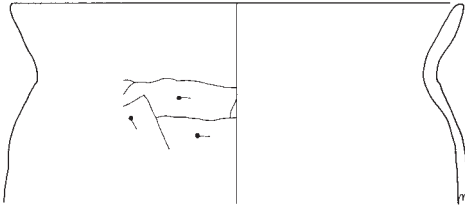

02057

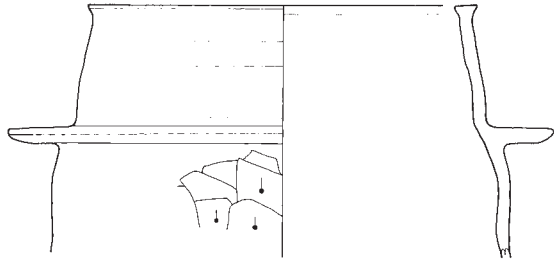

02059



02014
■ 摩耗

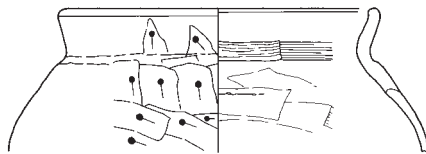

02033

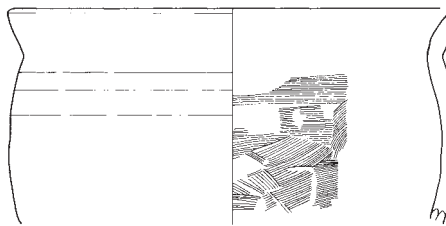

02036

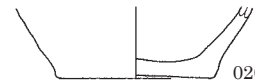

02034

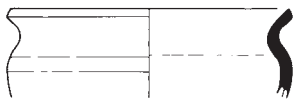

02045

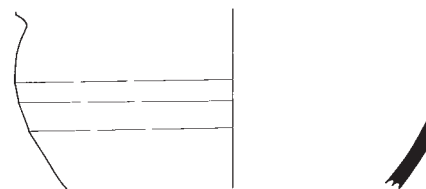

02030



02048

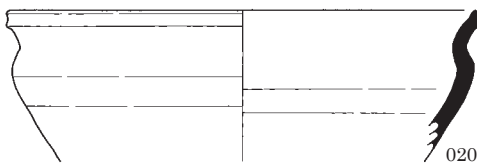

02044

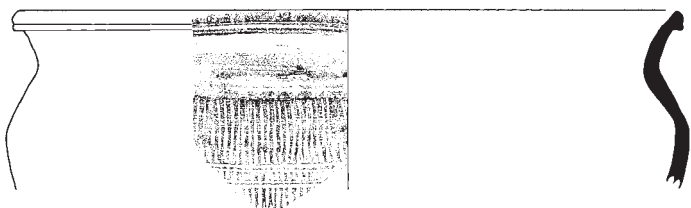

02042

0 (1:4) 10cm

SB0137



02016



02017

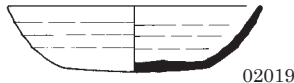

02019



02020



02018



02023



02028

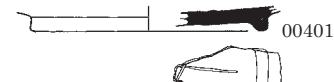

0401

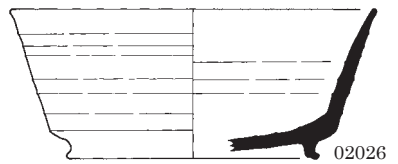

02026

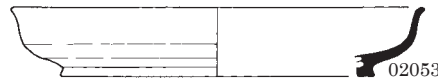

02053

図版 80 古墳時代～古代の土器 (23)

SB0139

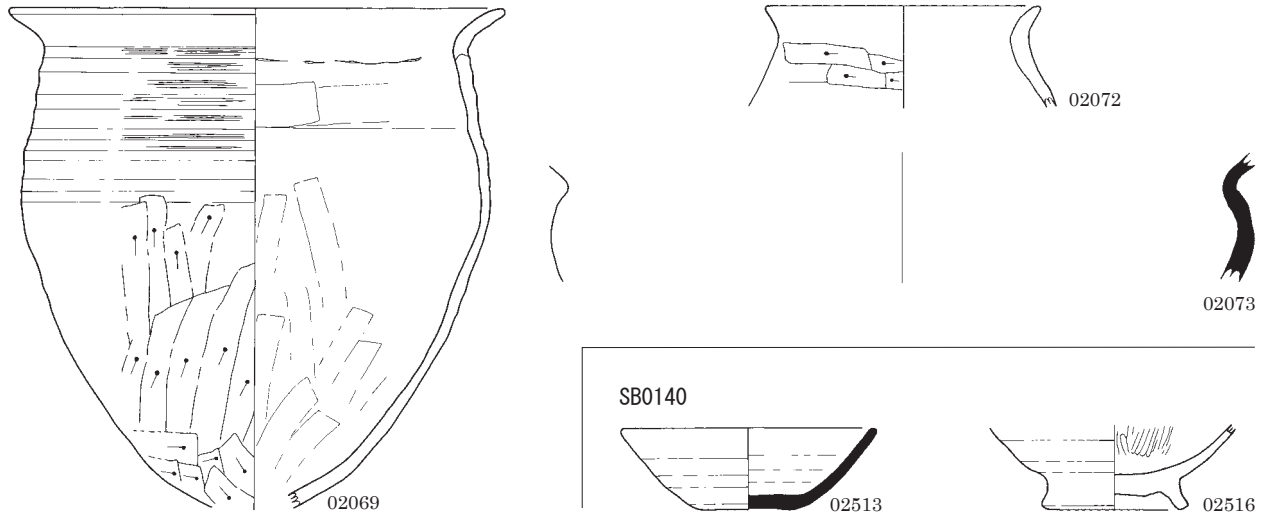
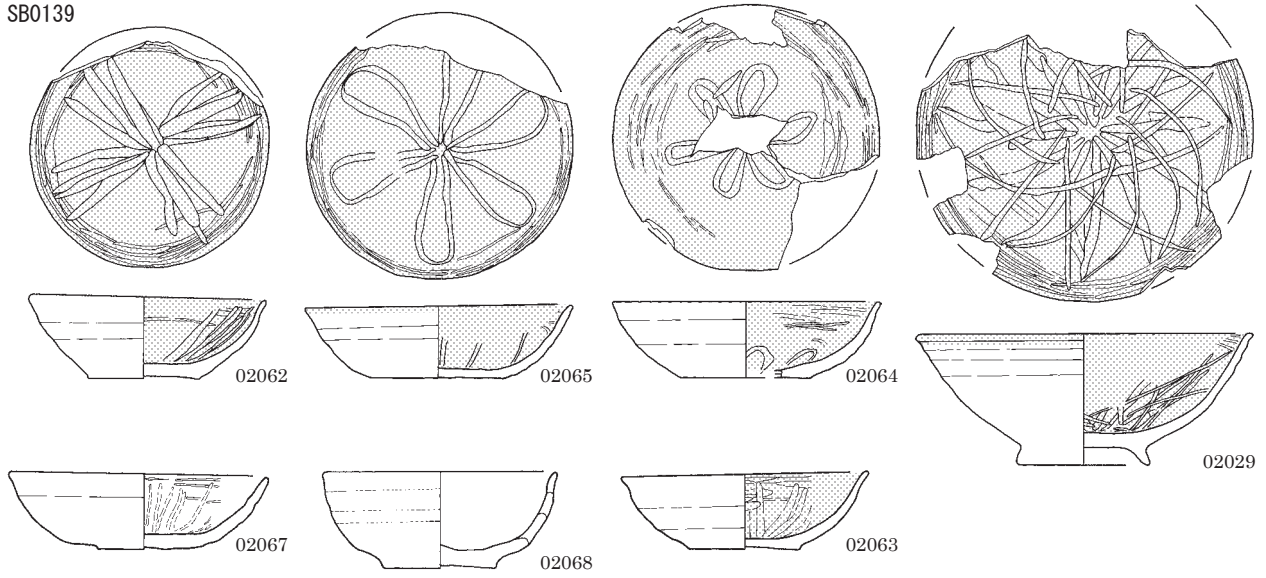

SB0141

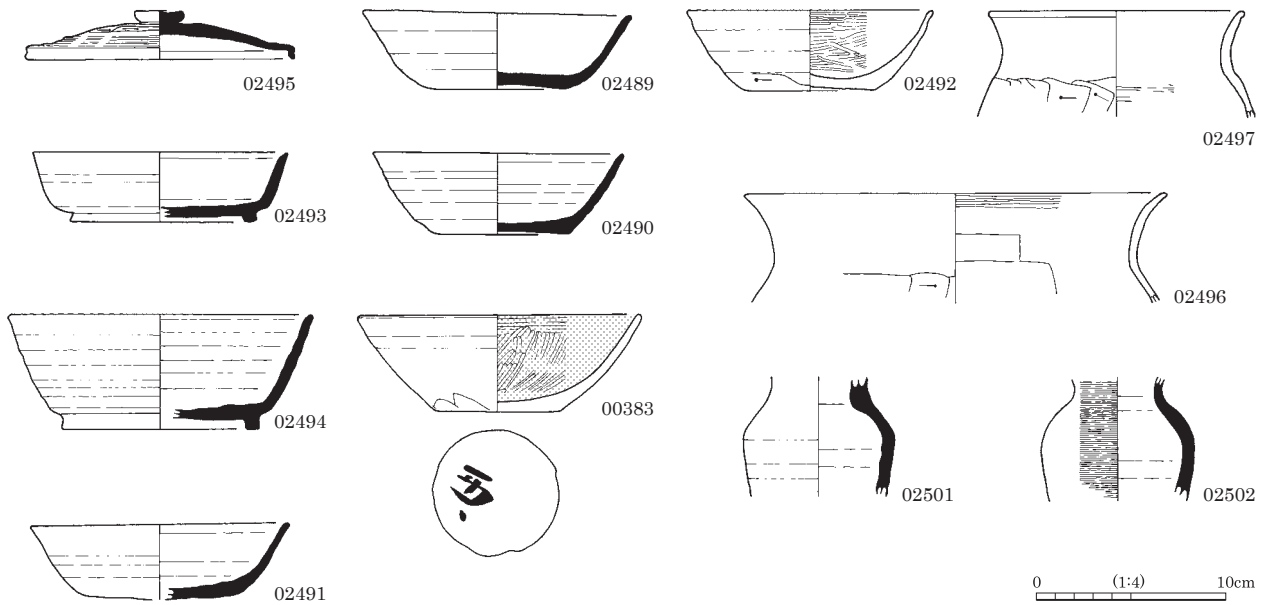

SB0143

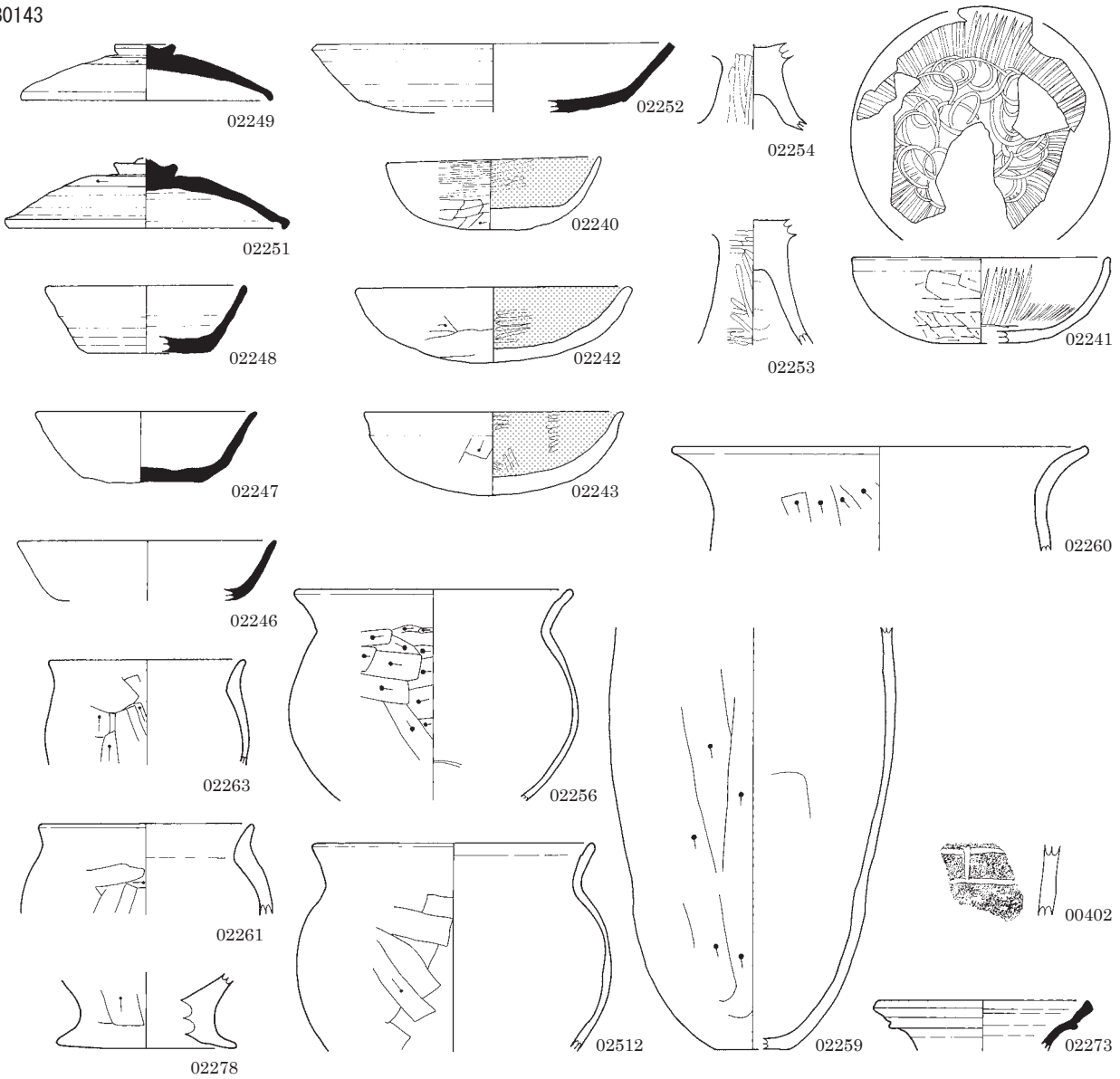

SB0144

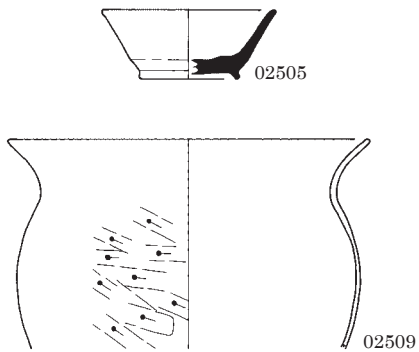

SB0145

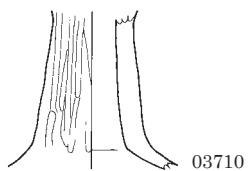

SB0148

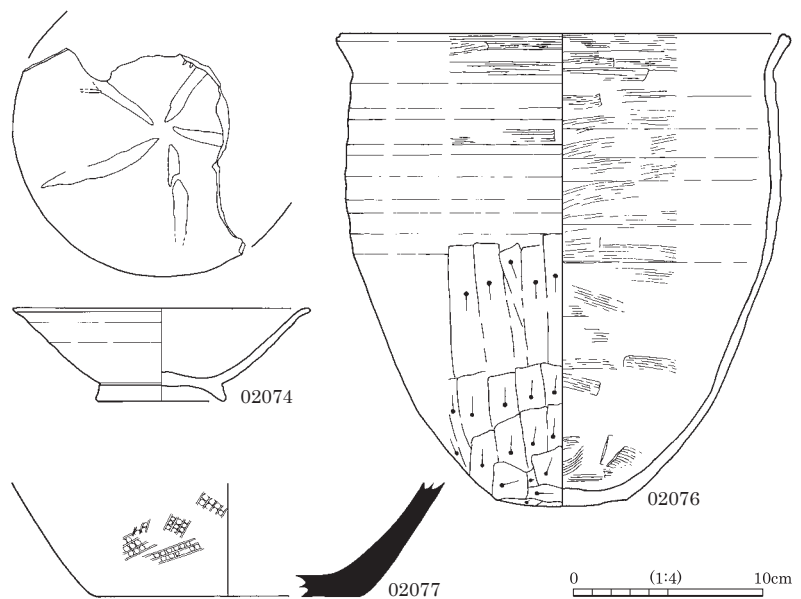

図版 82 古墳時代～古代の土器 (25)

SB0150

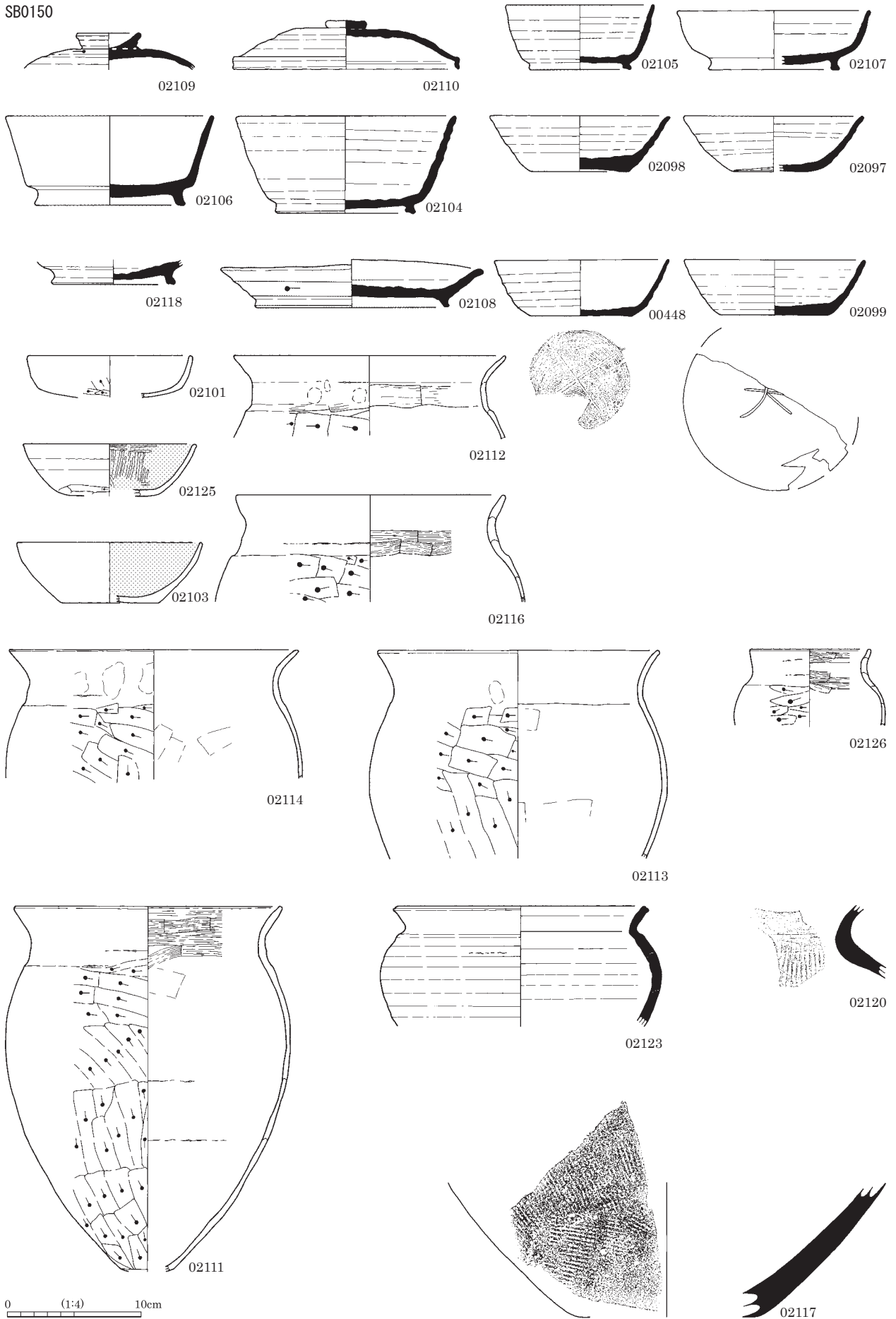

SB0152

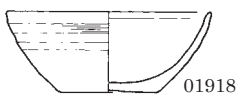
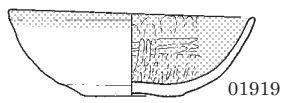
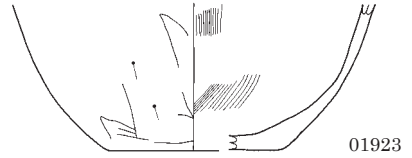
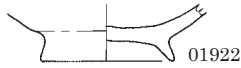
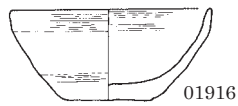
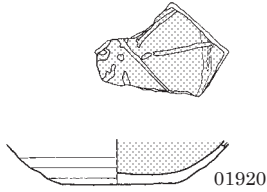
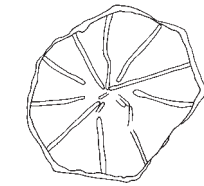
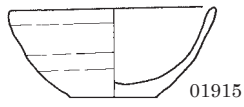
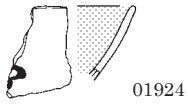
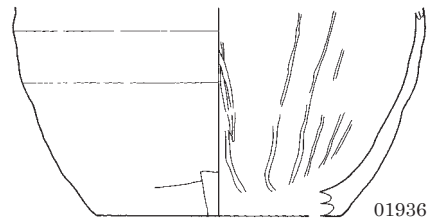
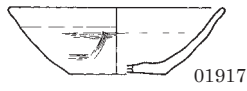
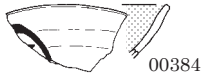

SB0157

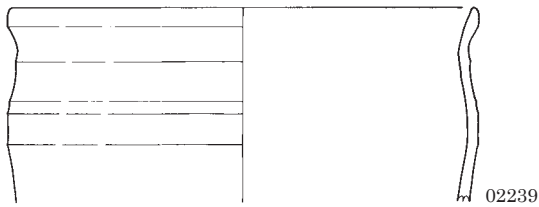

SB0159

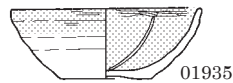
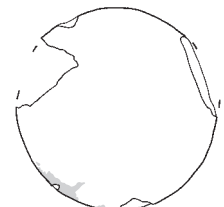
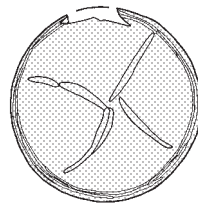

■ 煤附着

SB0161

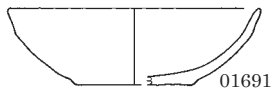

SB0164

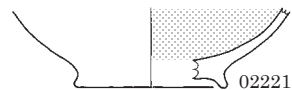
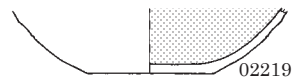
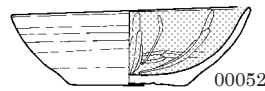
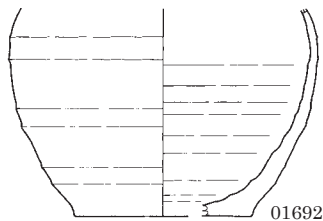
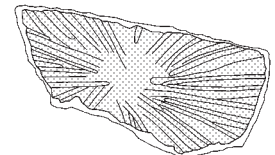
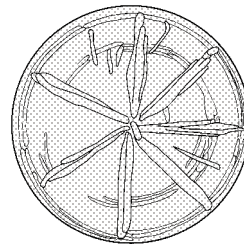

SB0165 (1)

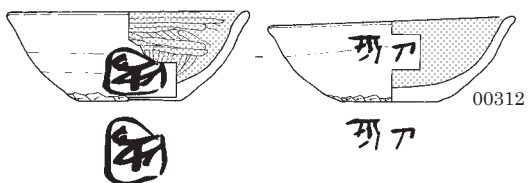
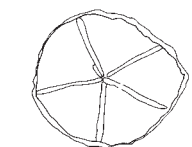
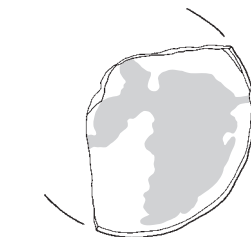

■ 煤附着

0 1:4 10cm

図版 84 古墳時代～古代の土器 (27)

SB0165 (2)

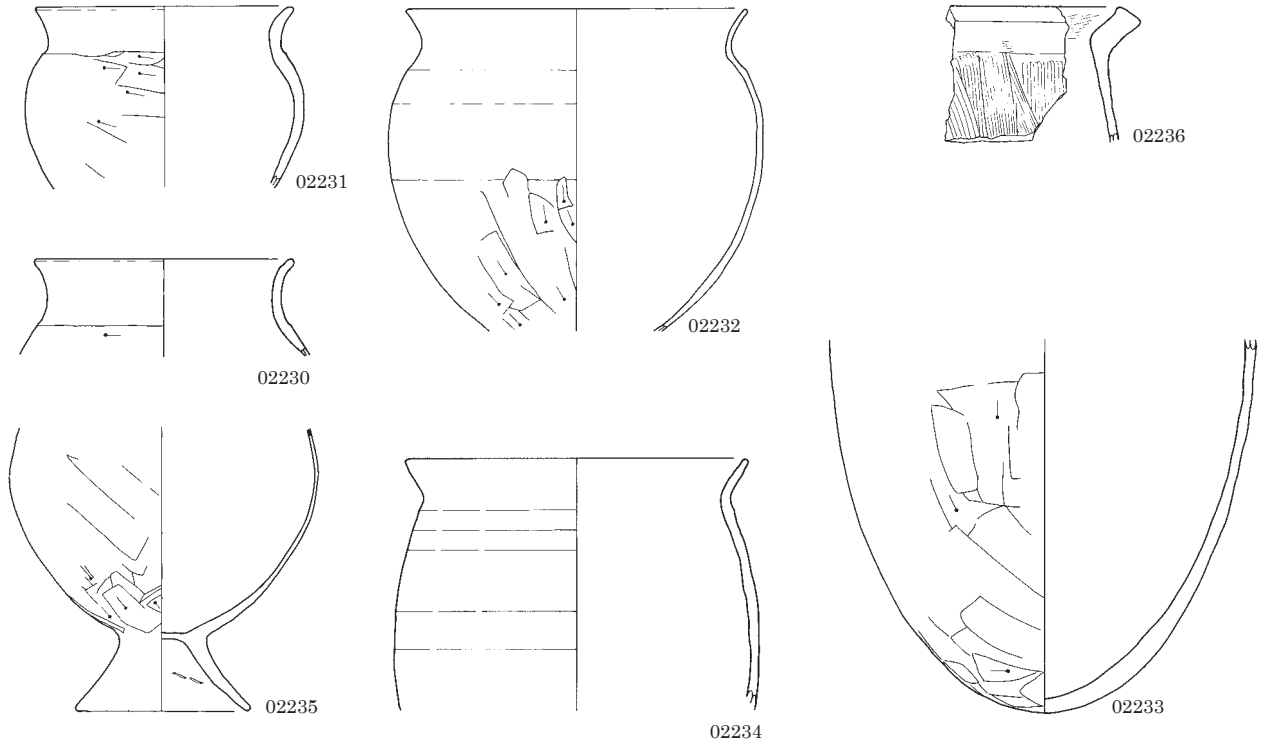

SB0167

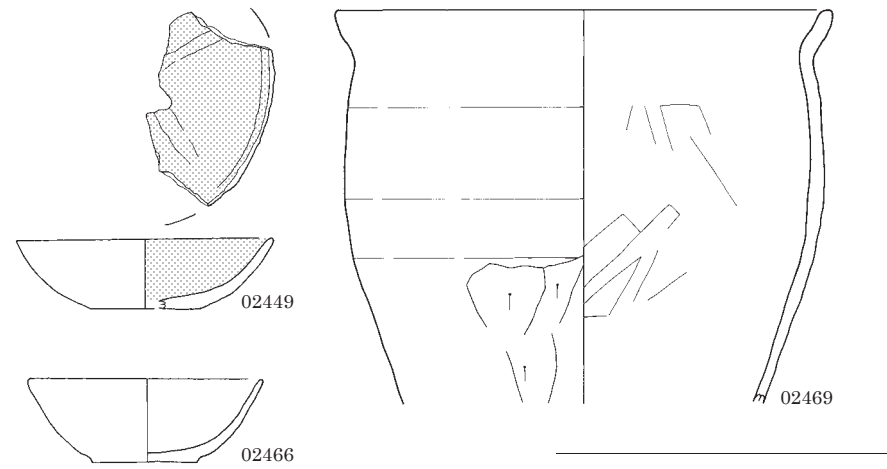

SB0170

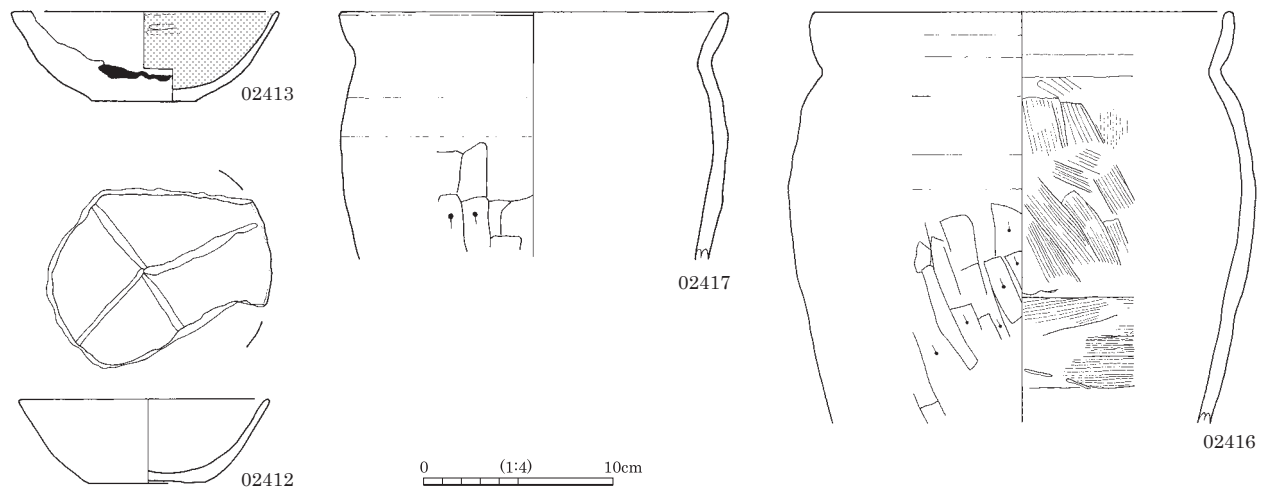
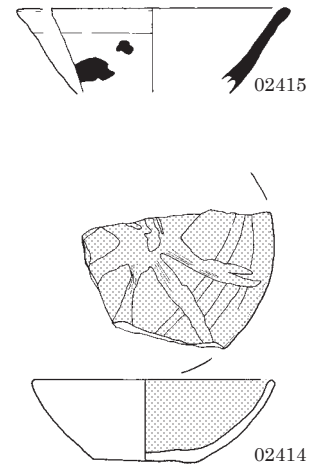

SB0171

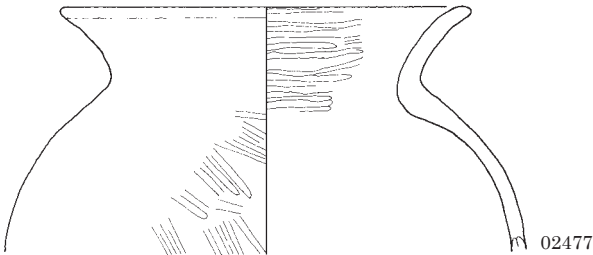
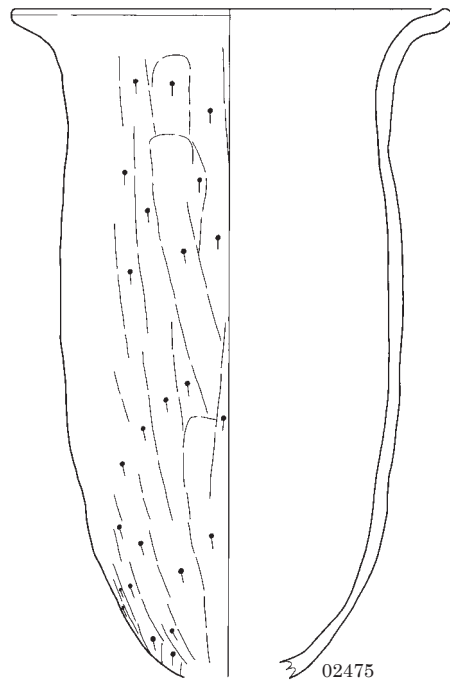
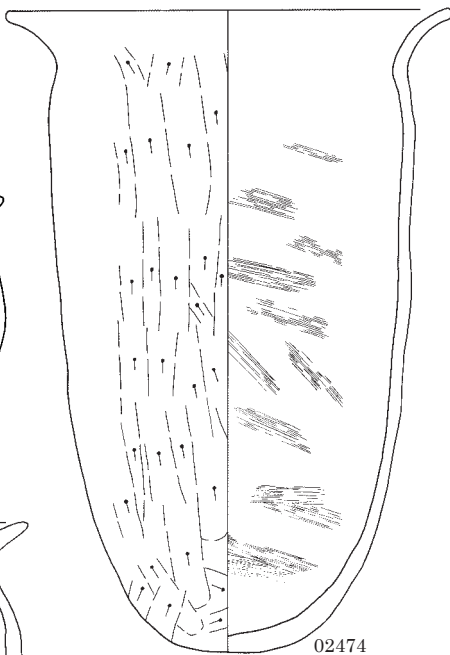
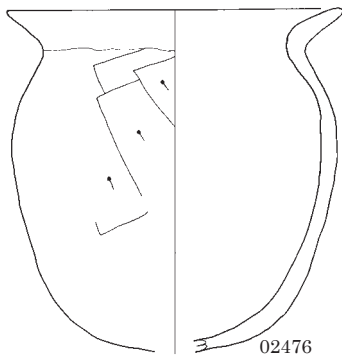
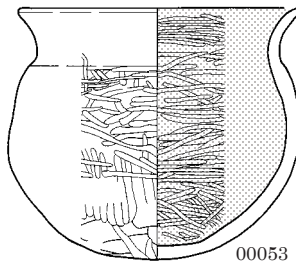
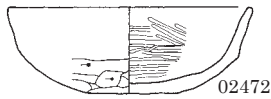

SB0172

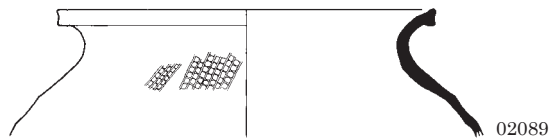
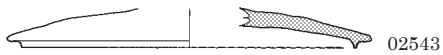

SB0173

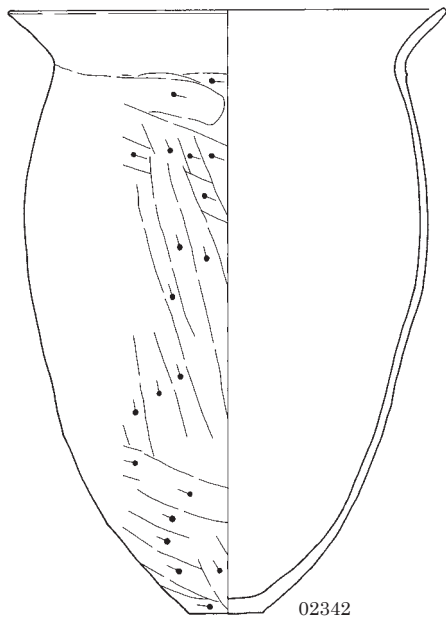
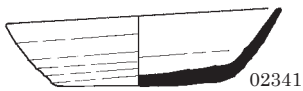

SB0174

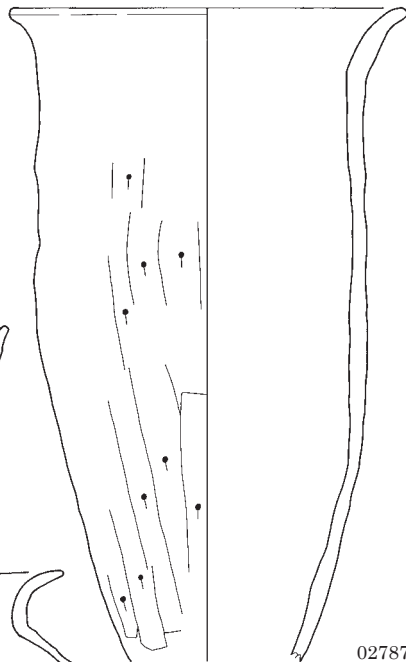
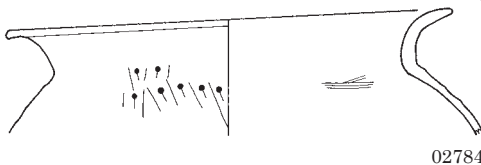
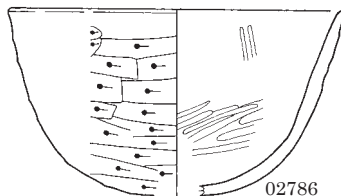
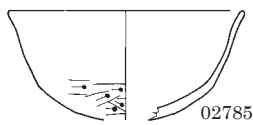

0 1:4 10cm

図版 86 古墳時代～古代の土器 (29)

SB0301

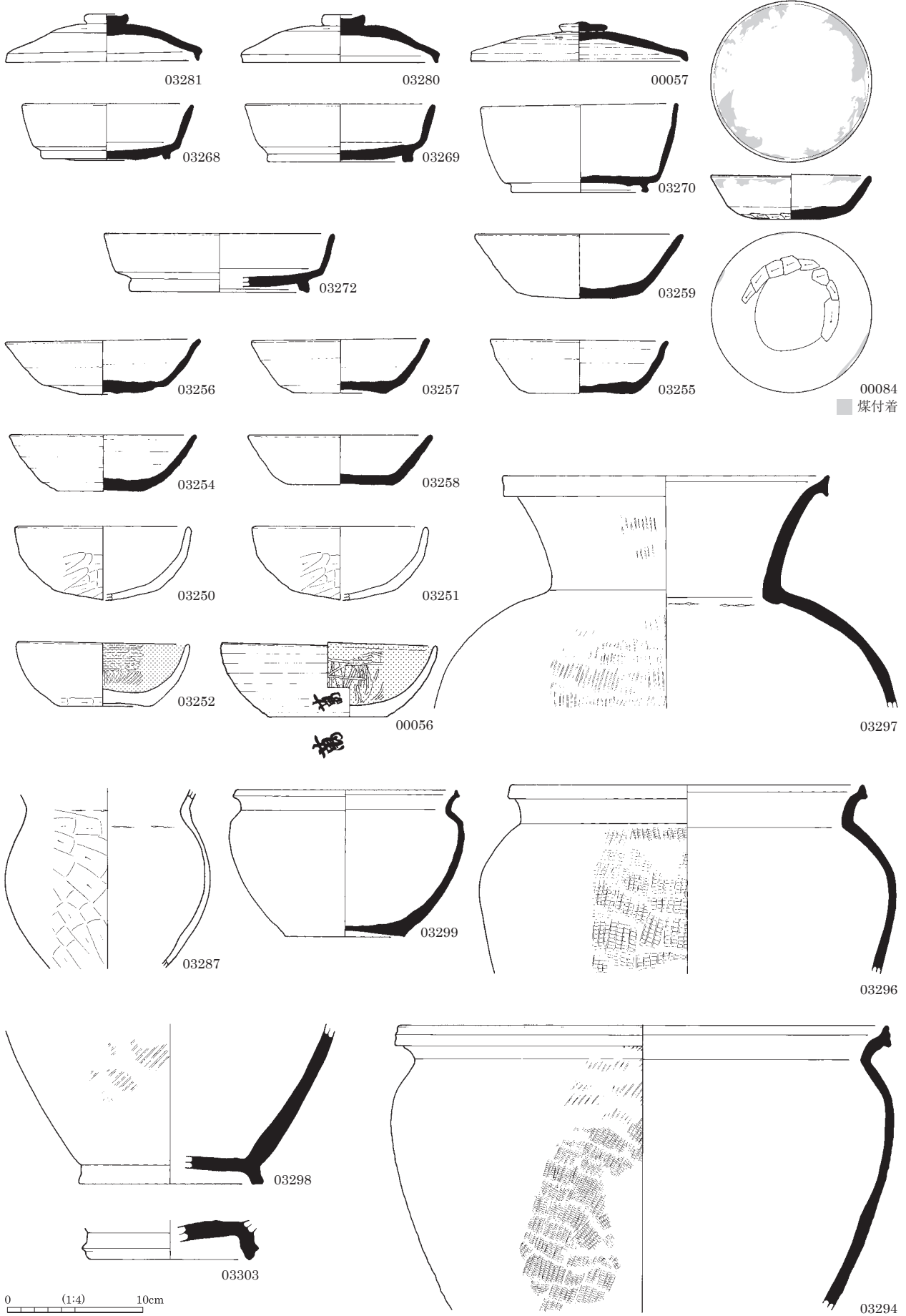

SB0303

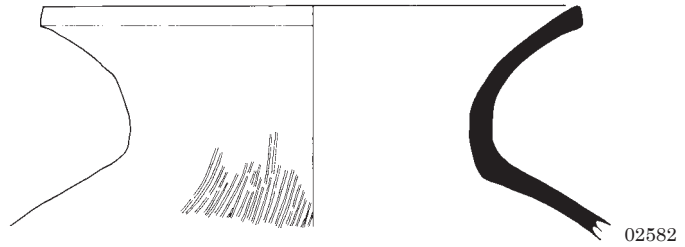

SB0304

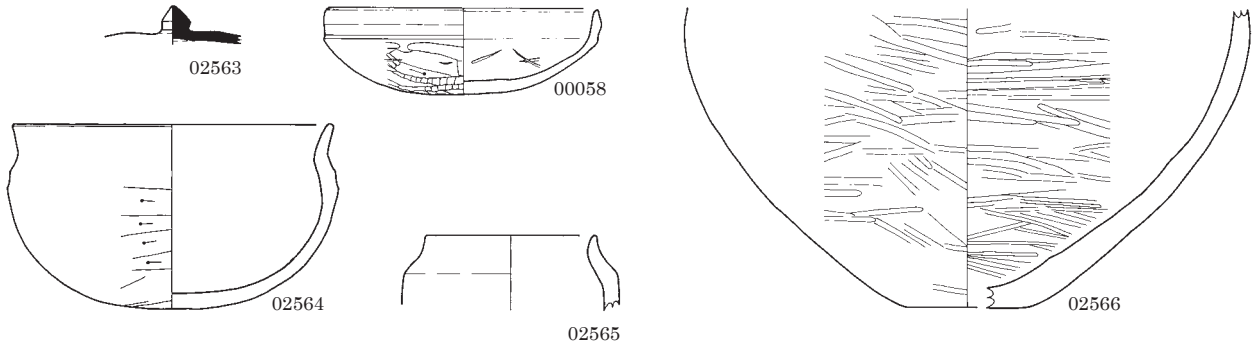

SB0305

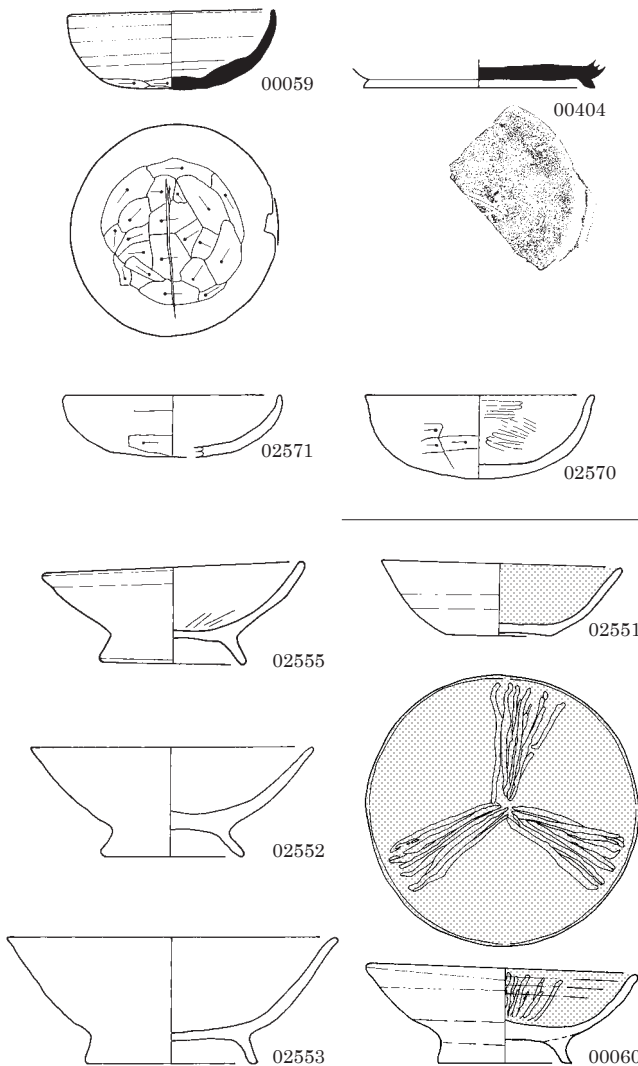

SB0309

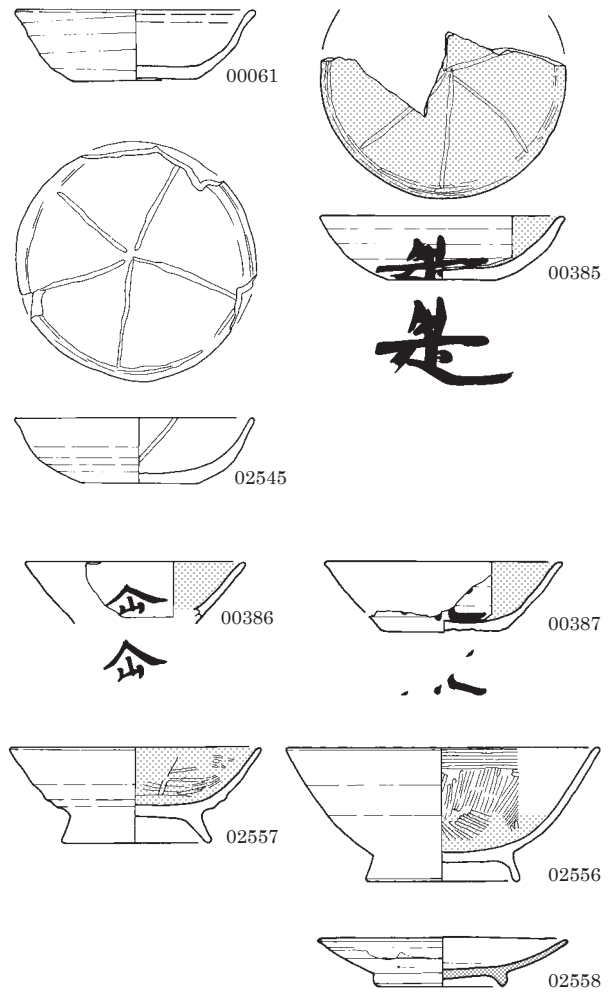

0 (1:4) 10cm

図版 88 古墳時代～古代の土器 (31)

SB0311

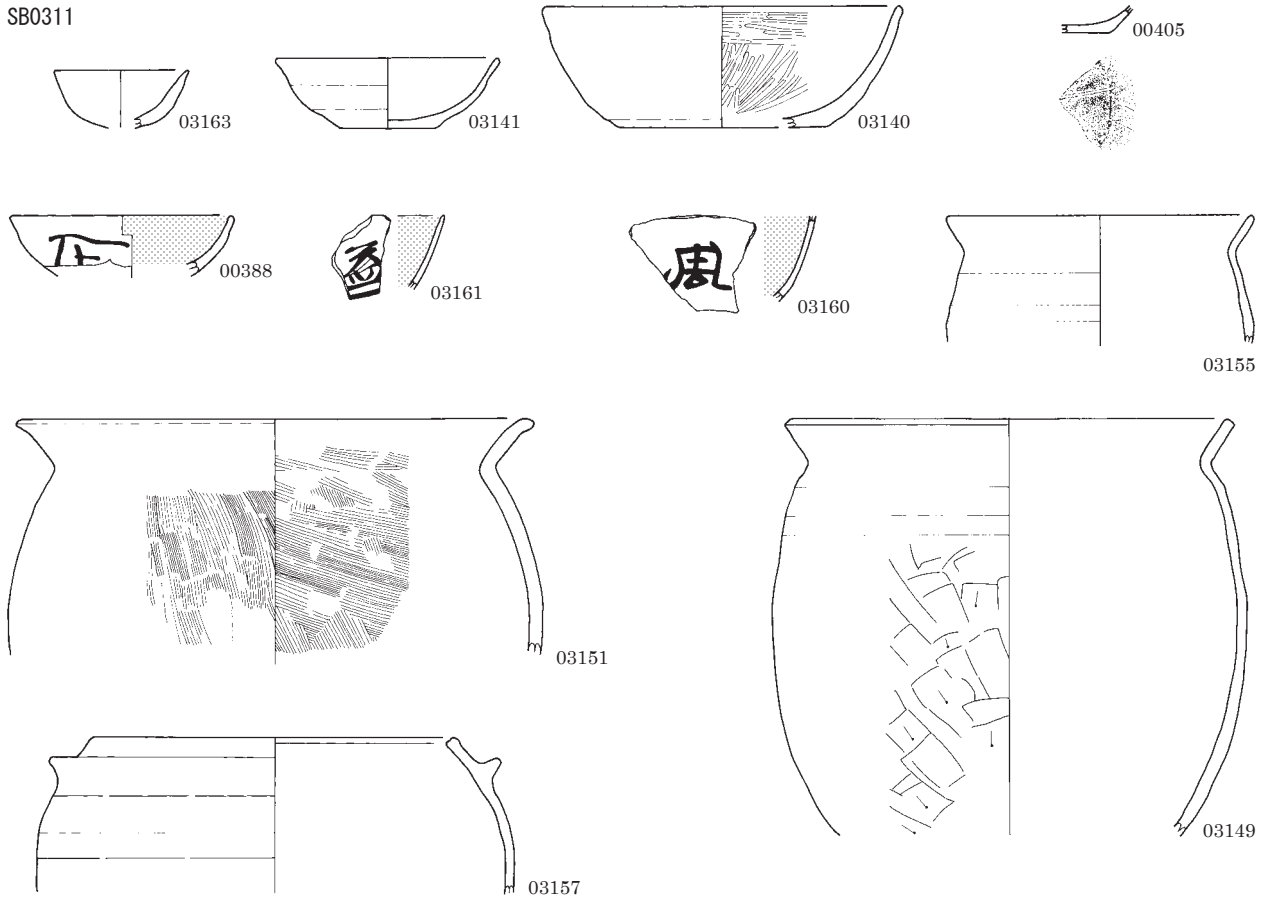

SB0313

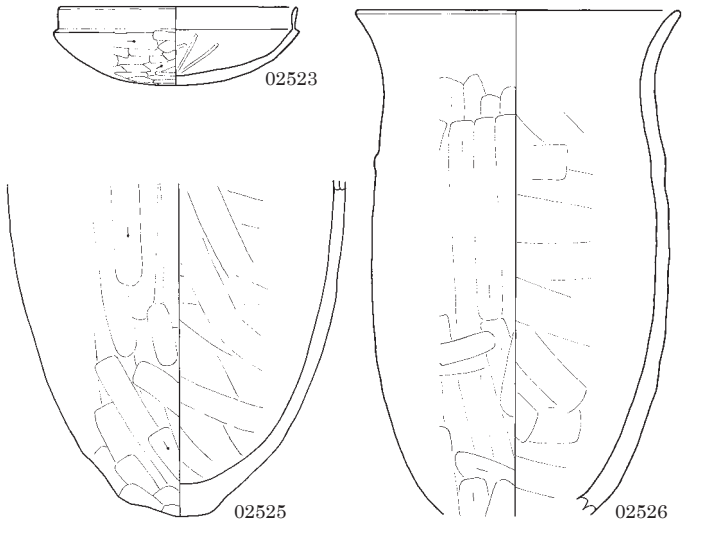

SB3002 (1)

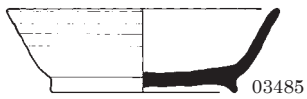
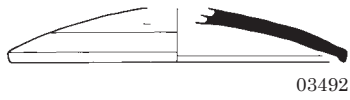
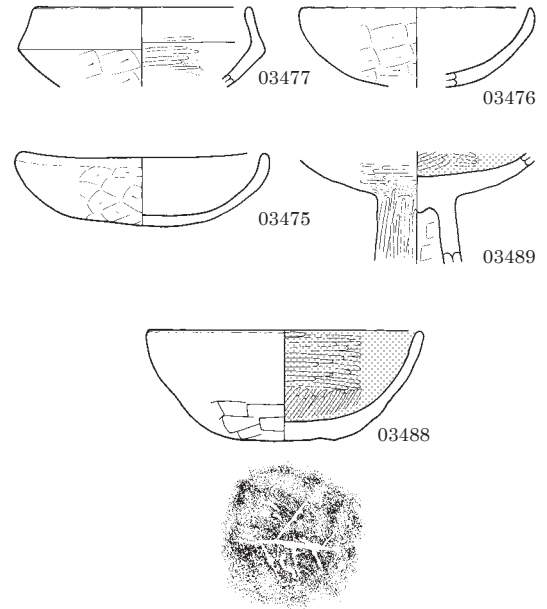

0 1:4 10cm

SB3002 (2)

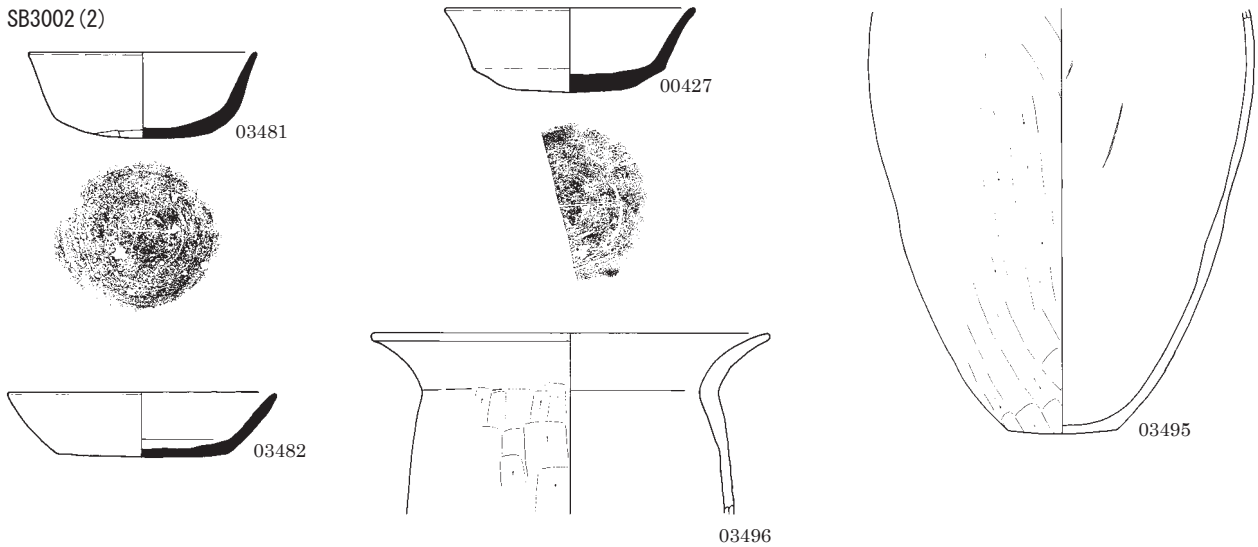

SB3008

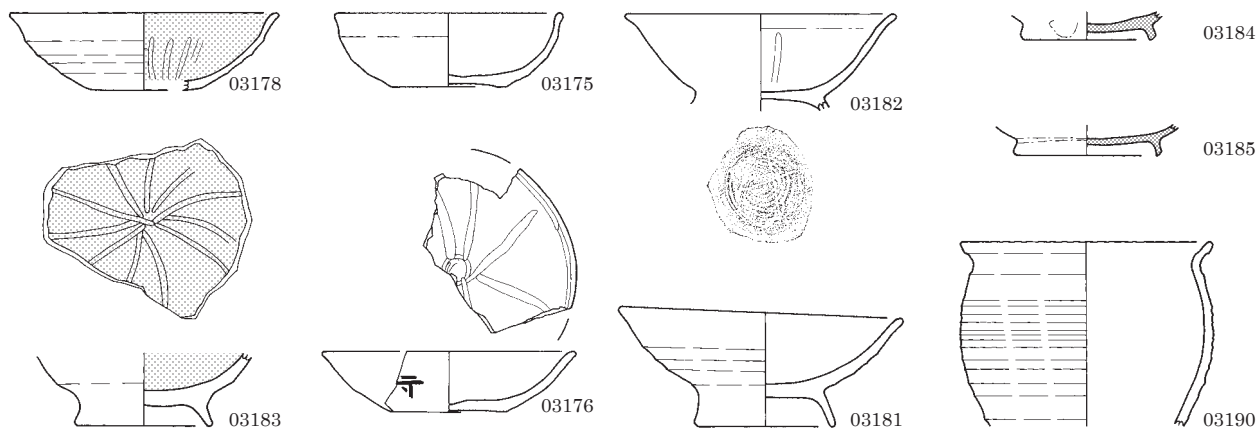

SB3020

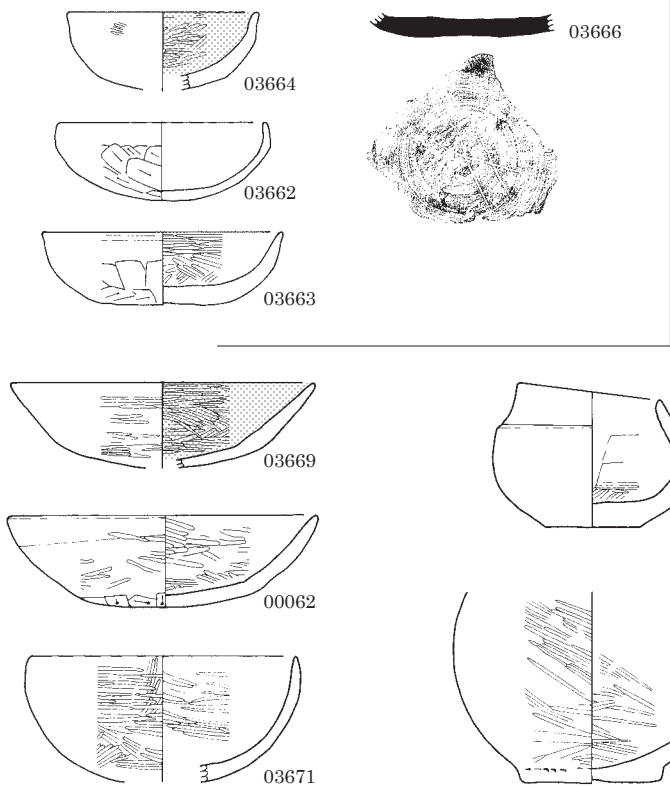

SB3022

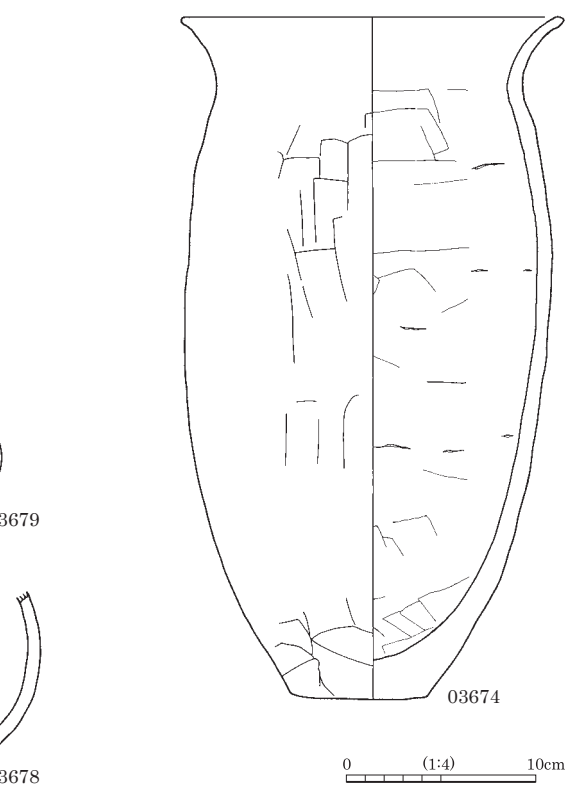

図版 90 古墳時代～古代の土器 (33)

SB3024

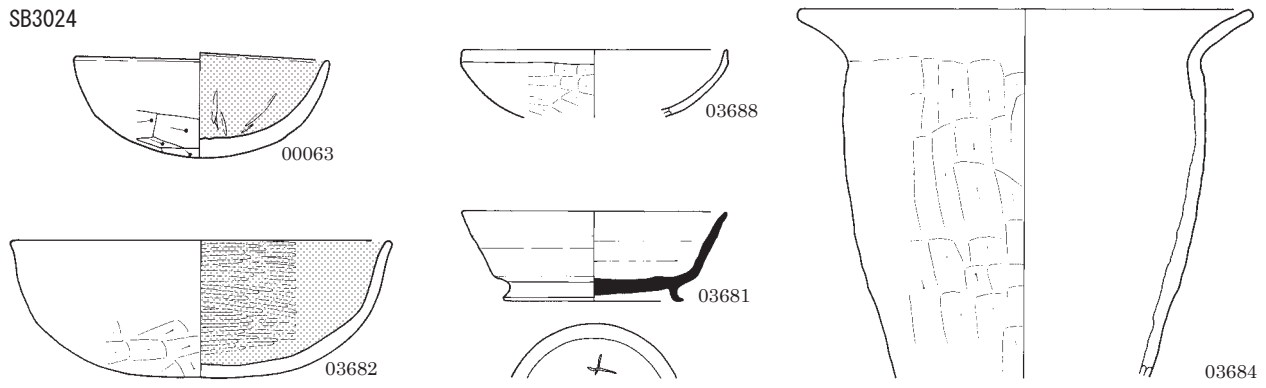

SB3025

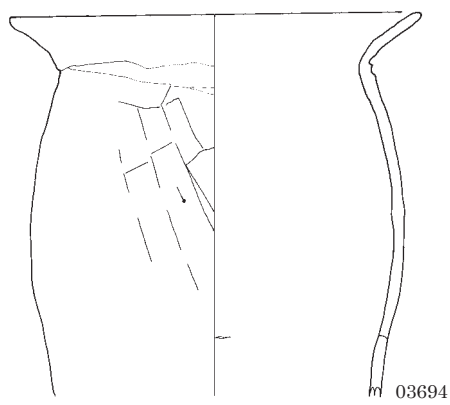
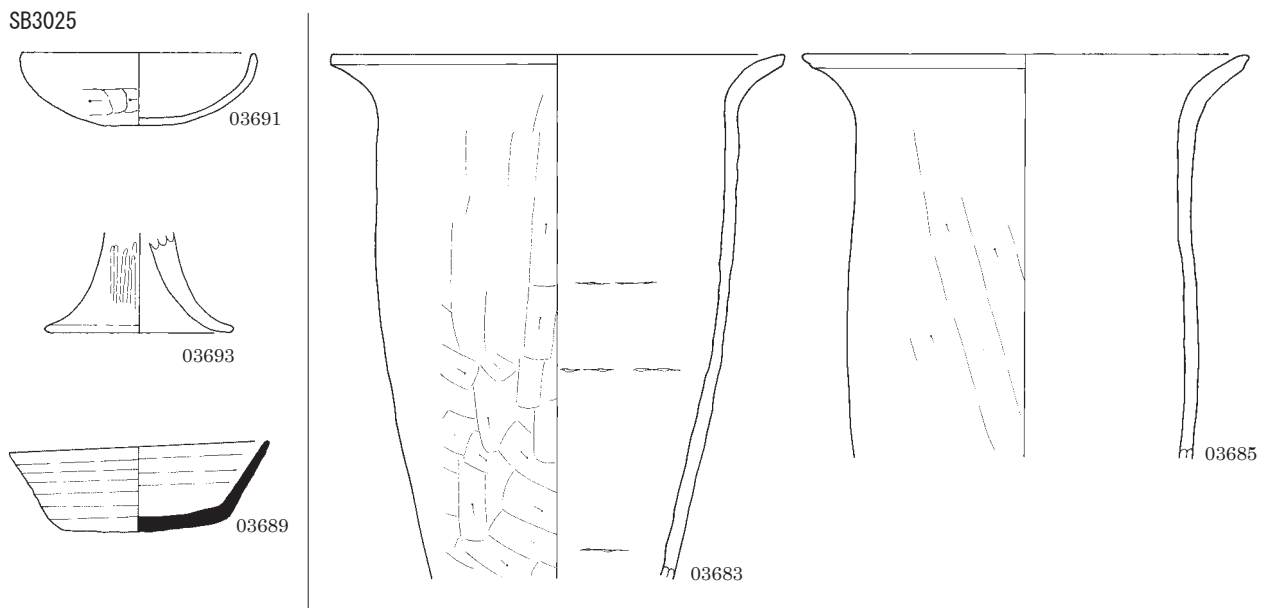

SB3026

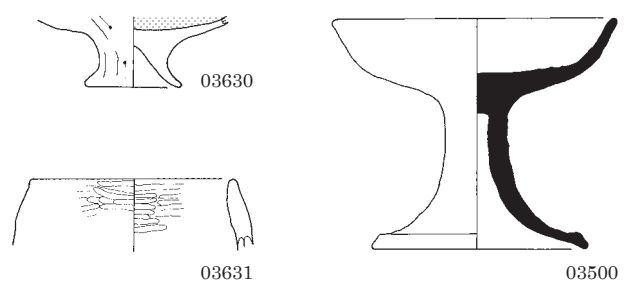

SB3027

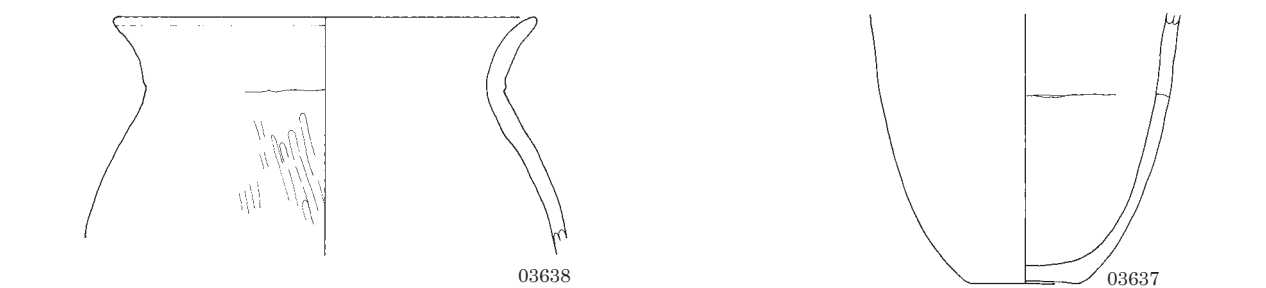

0 (1:4) 10cm

SB3028

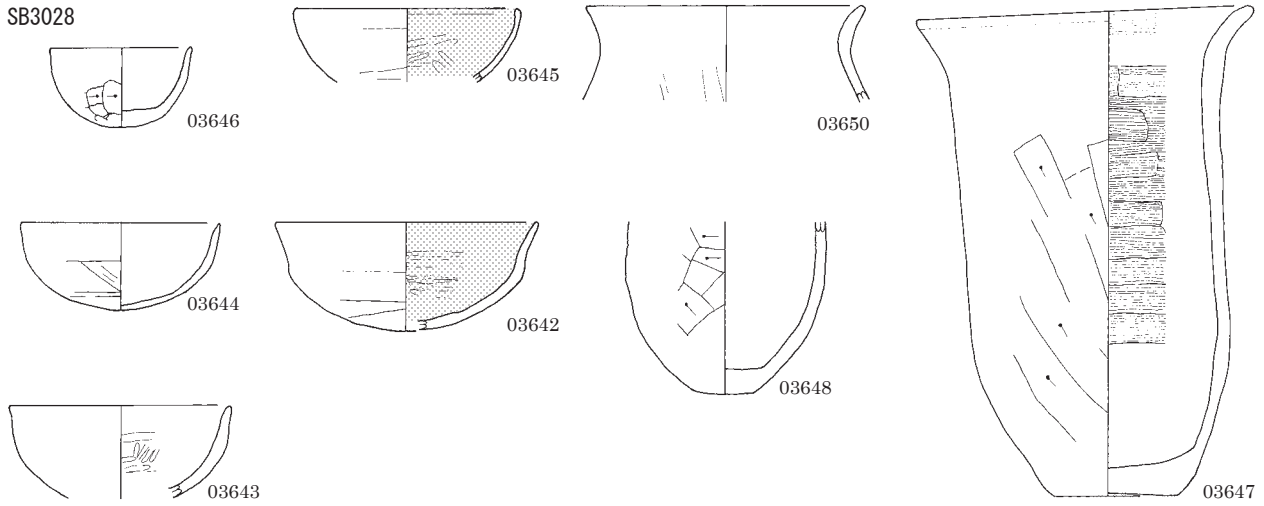

SB3030

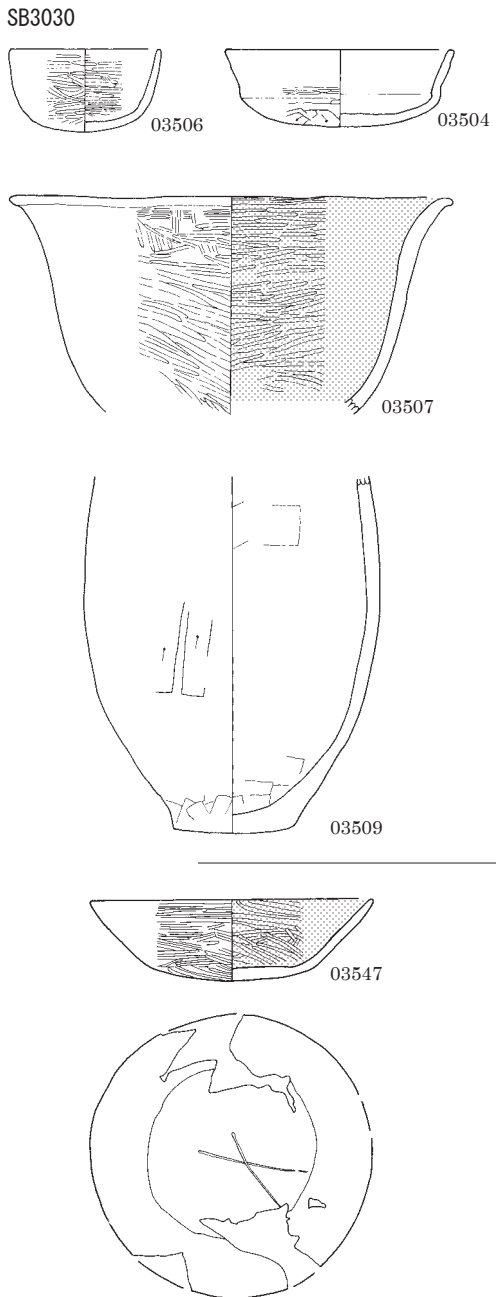

SB3031

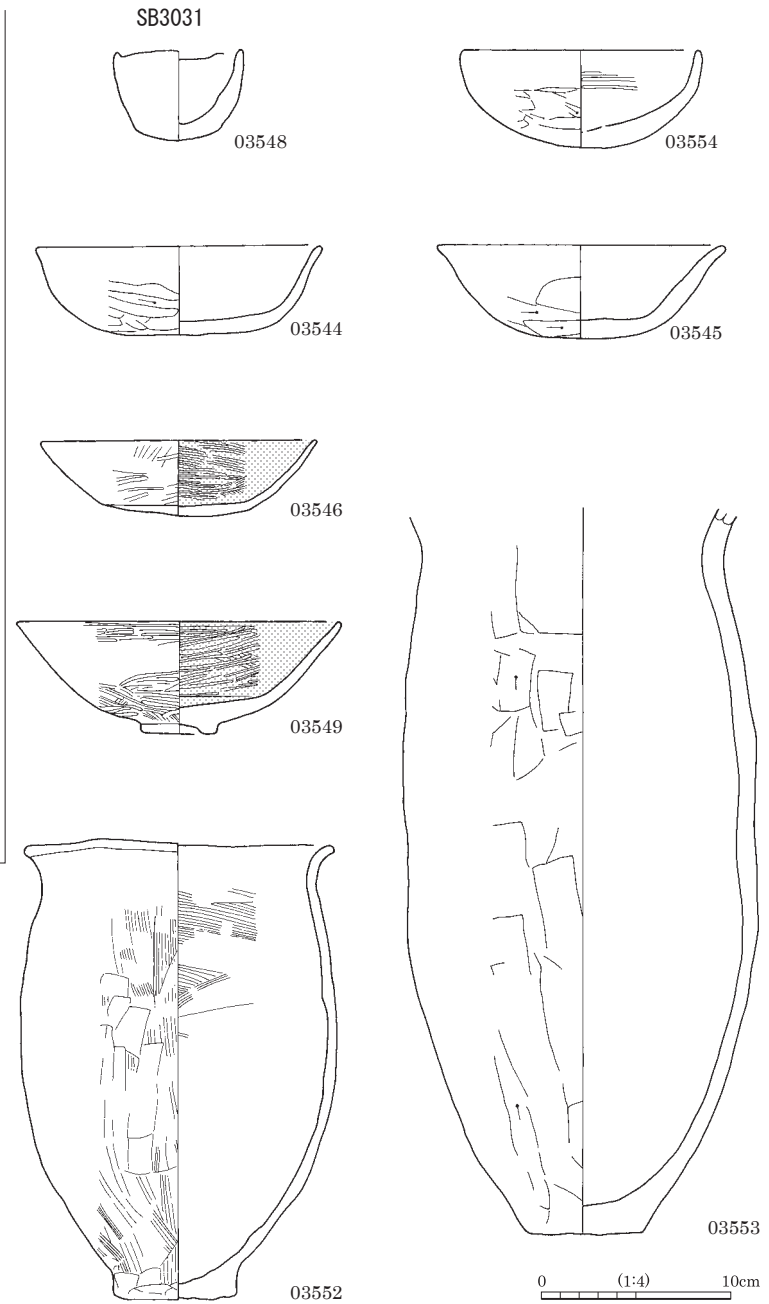

0 1:4 10cm

図版 92 古墳時代～古代の土器 (35)

SB3032

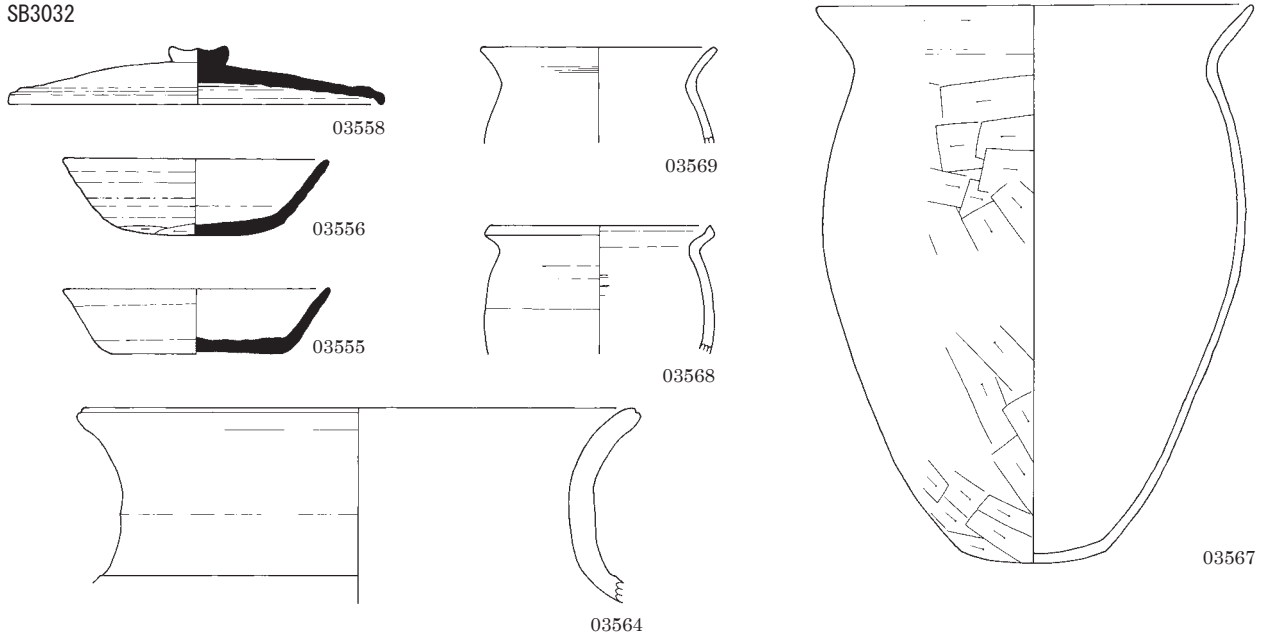

SB3034

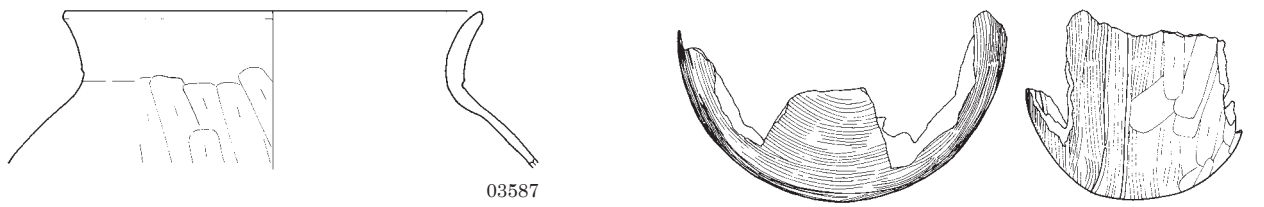

SB3035

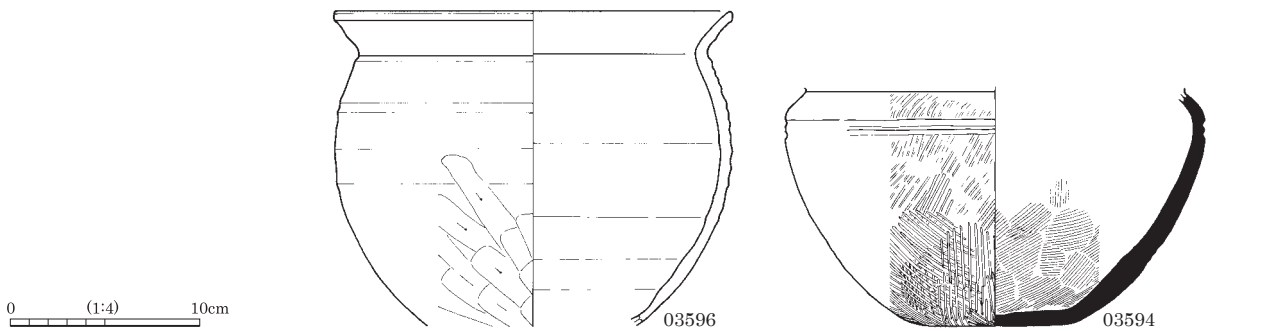
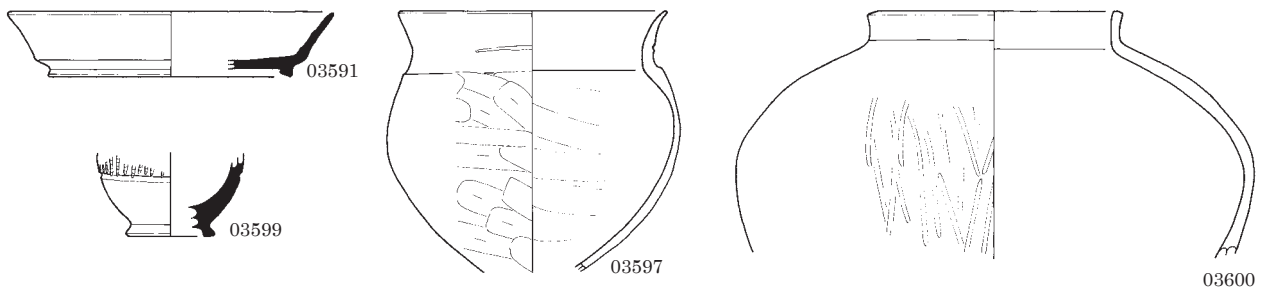

0 (1:4) 10cm

SB3038

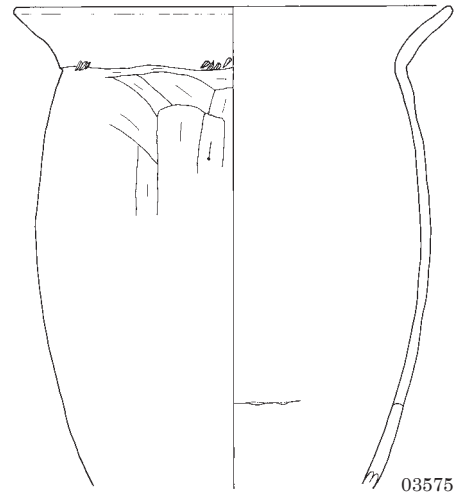
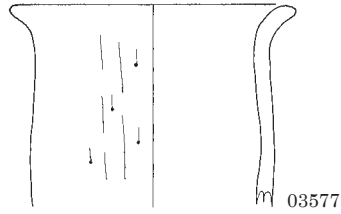
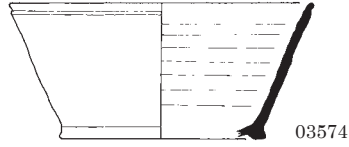
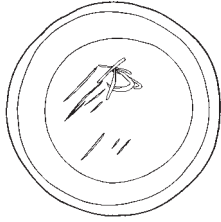
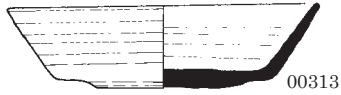

SB3039

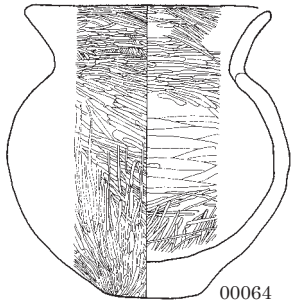
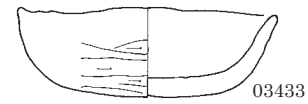
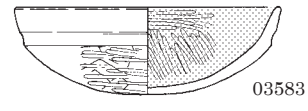

SB3042

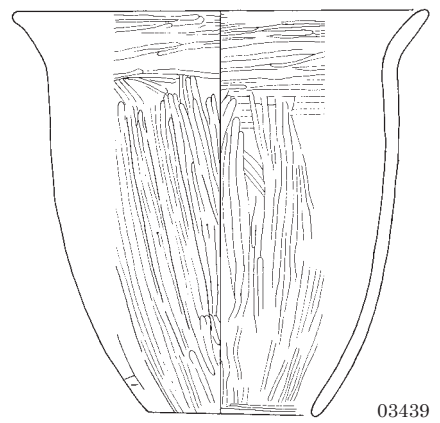
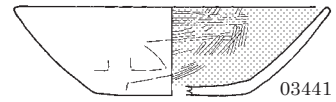
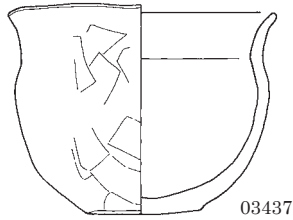
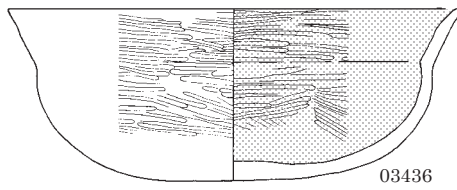
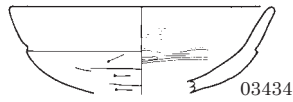

SB3043

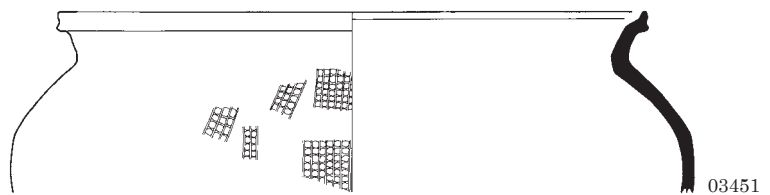
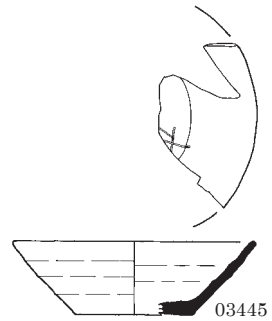
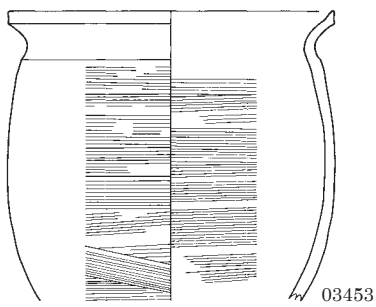
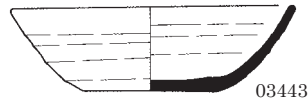
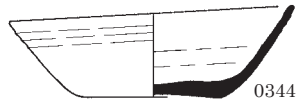

0 (1:4) 10cm

SB3047 (2)

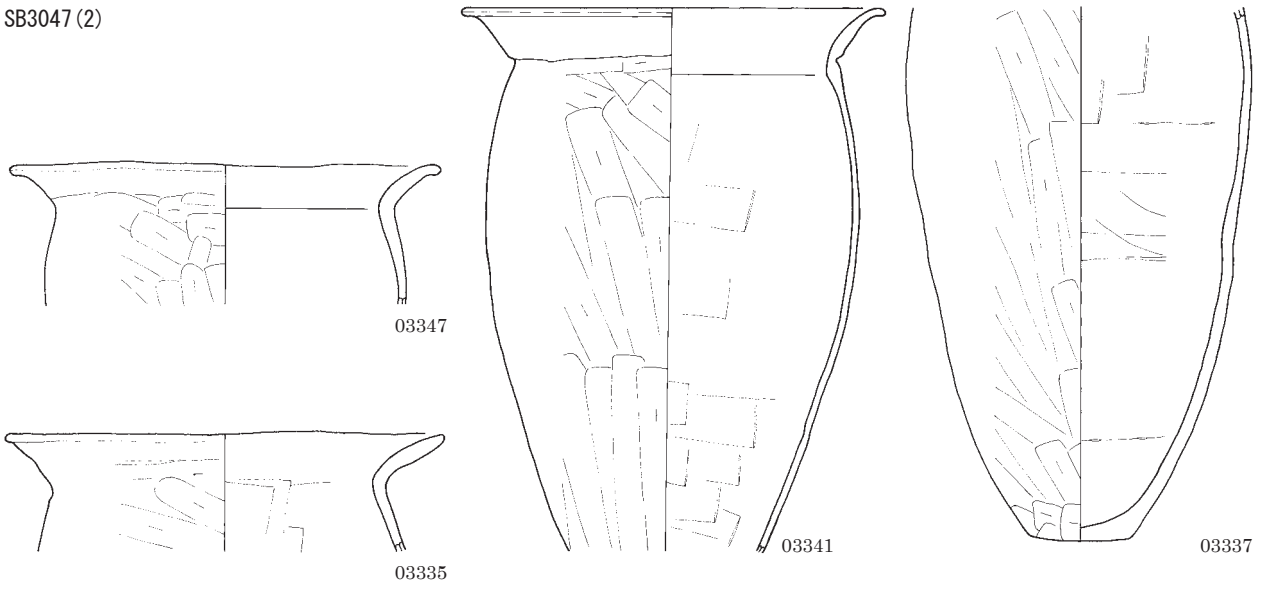

SB3048

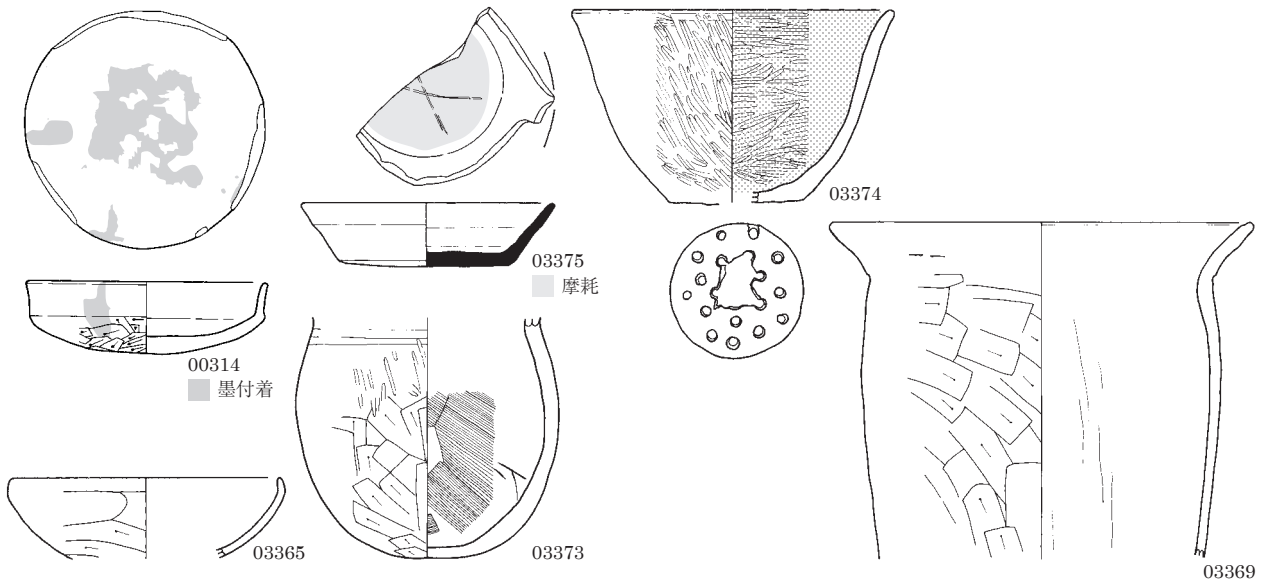

SB3049

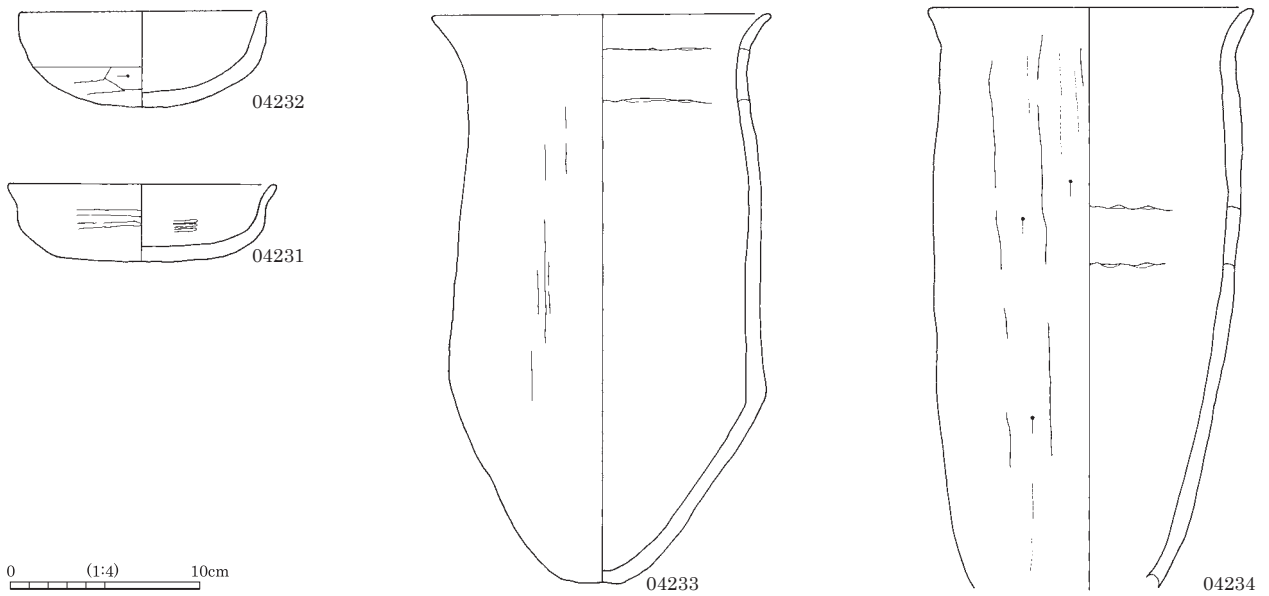

0 (1:4) 10cm

図版 96 古墳時代～古代の土器 (39)

SB3050

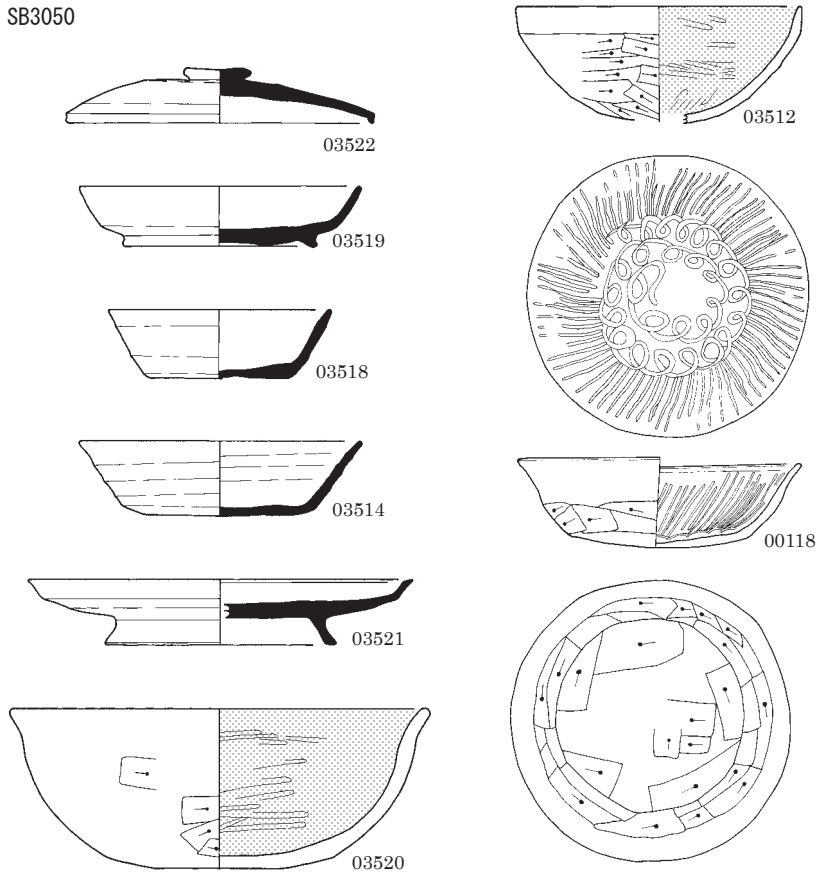

SB3051

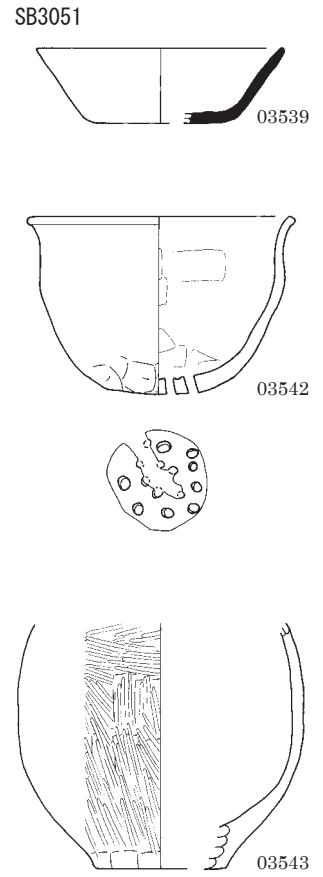

SB3052

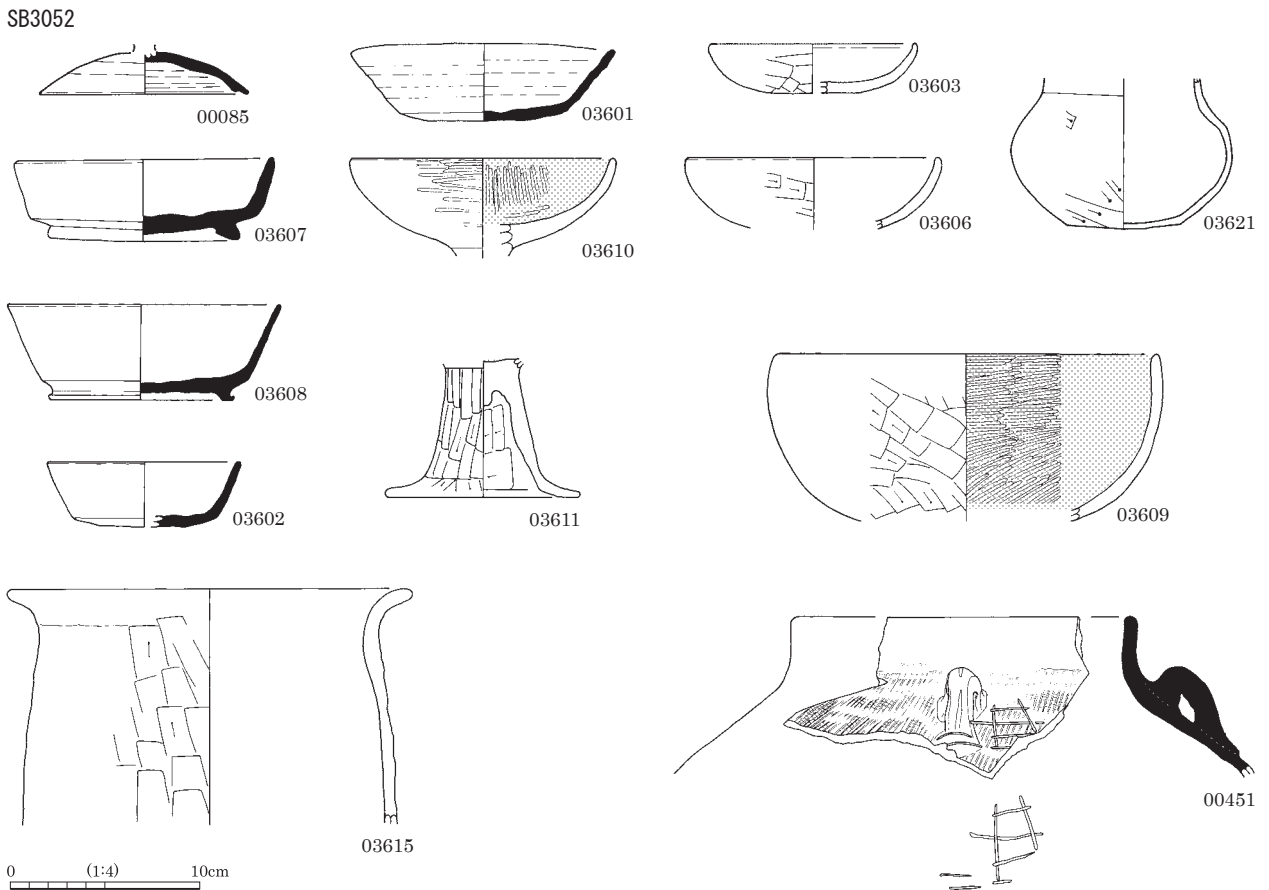

SB3055

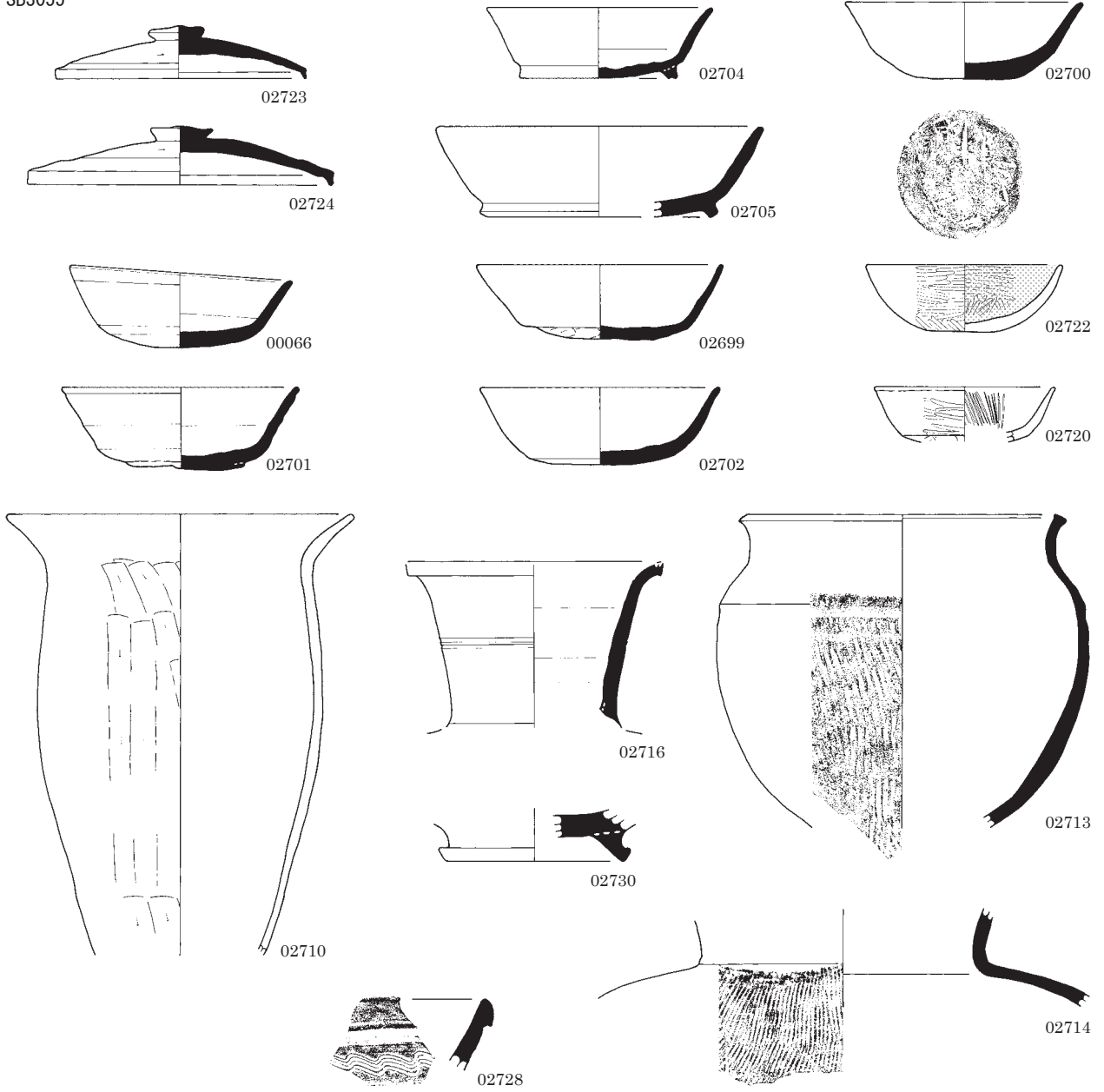

SB3056 (1)

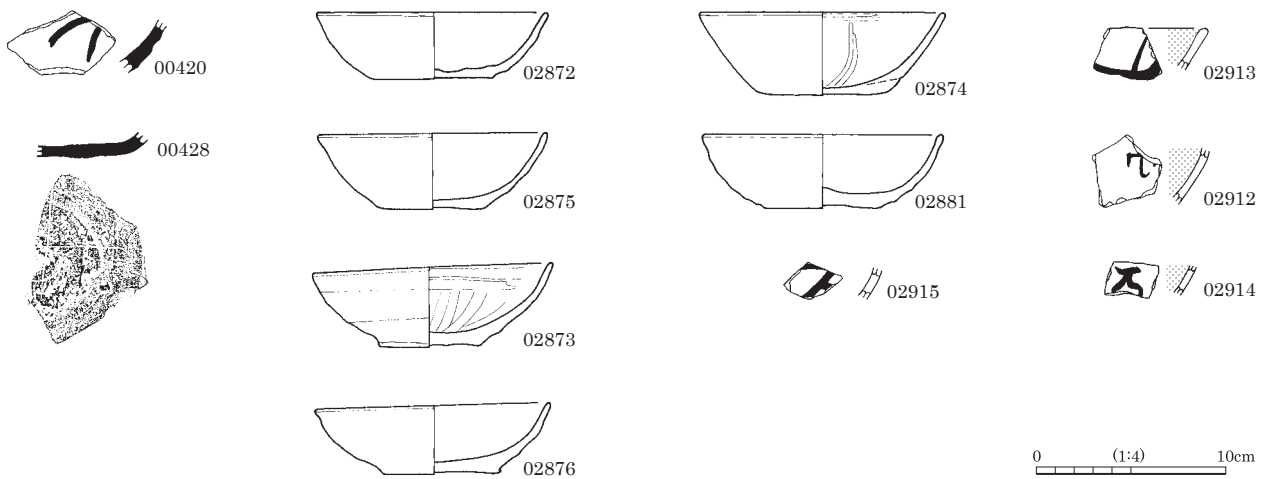

0 (1:4) 10cm

図版 98 古墳時代～古代の土器 (41)

SB3056 (2)

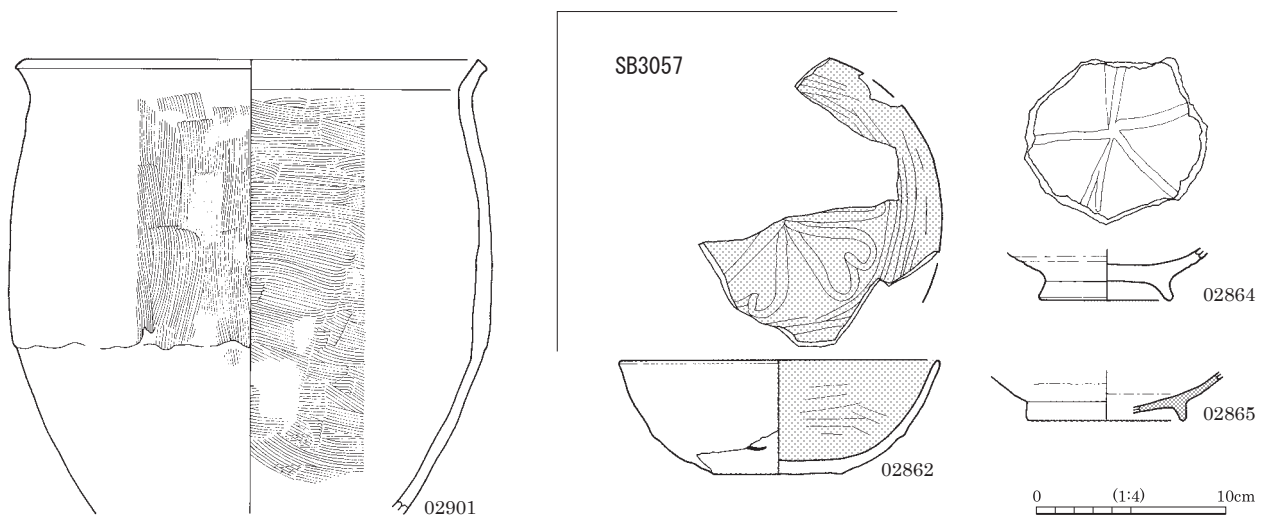
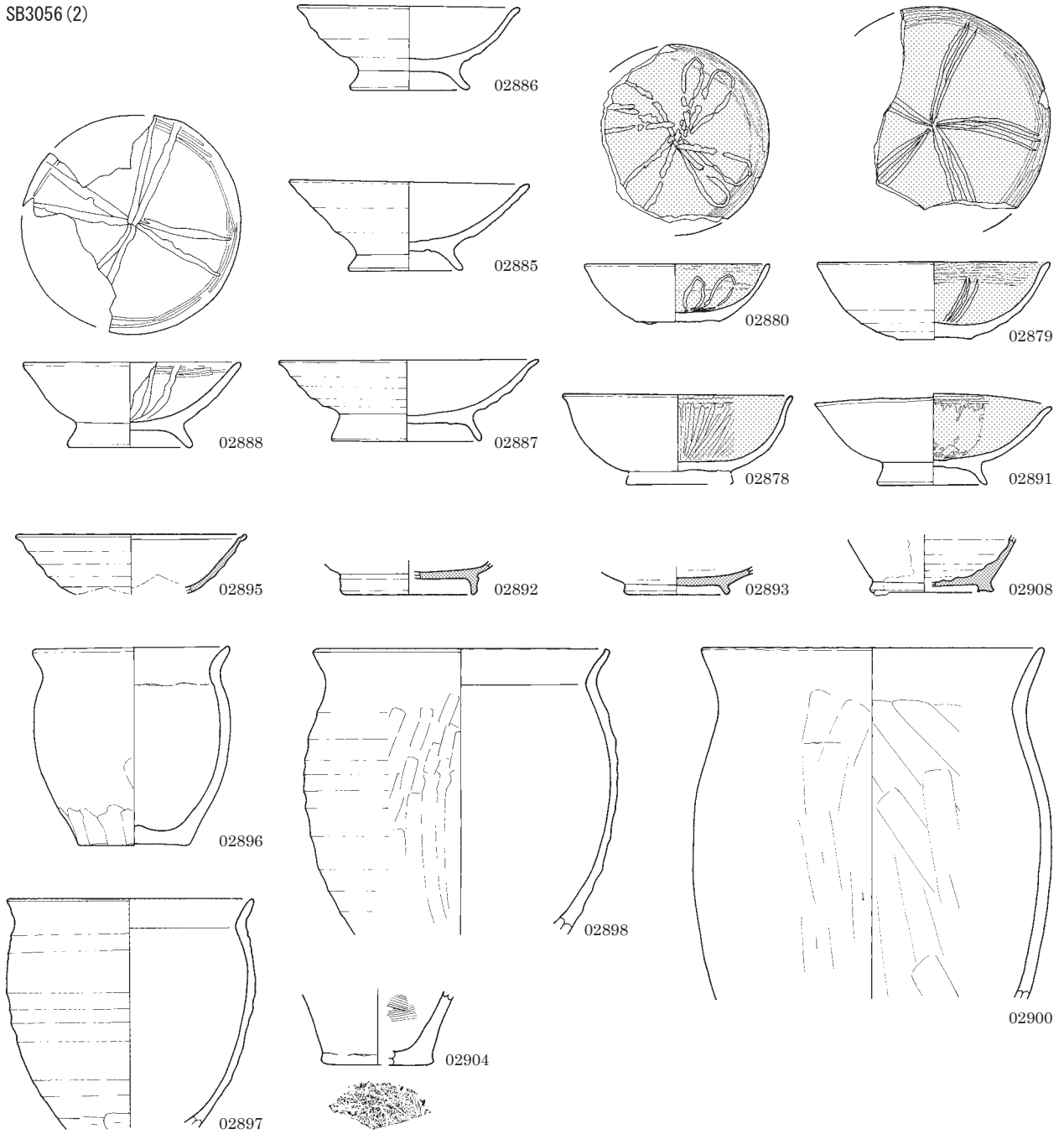

SB3058

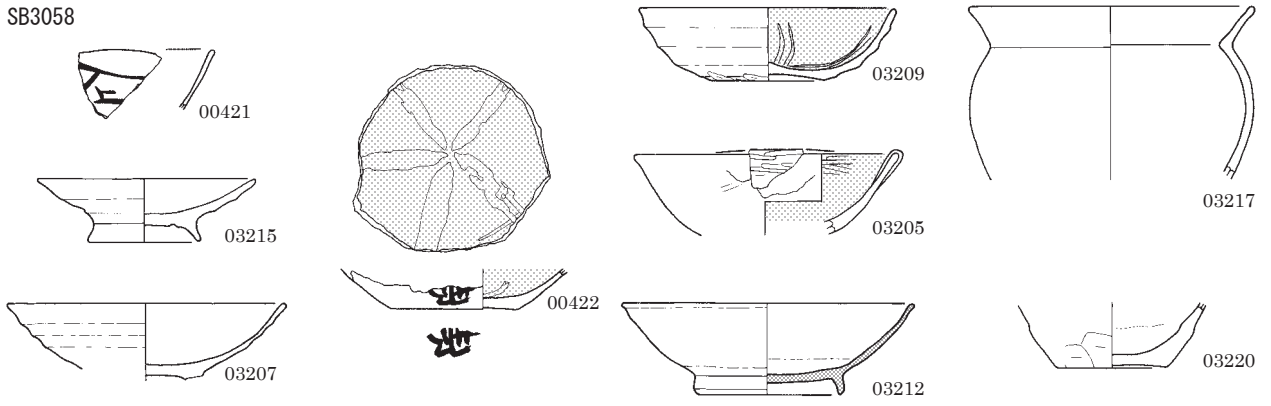

SB3059

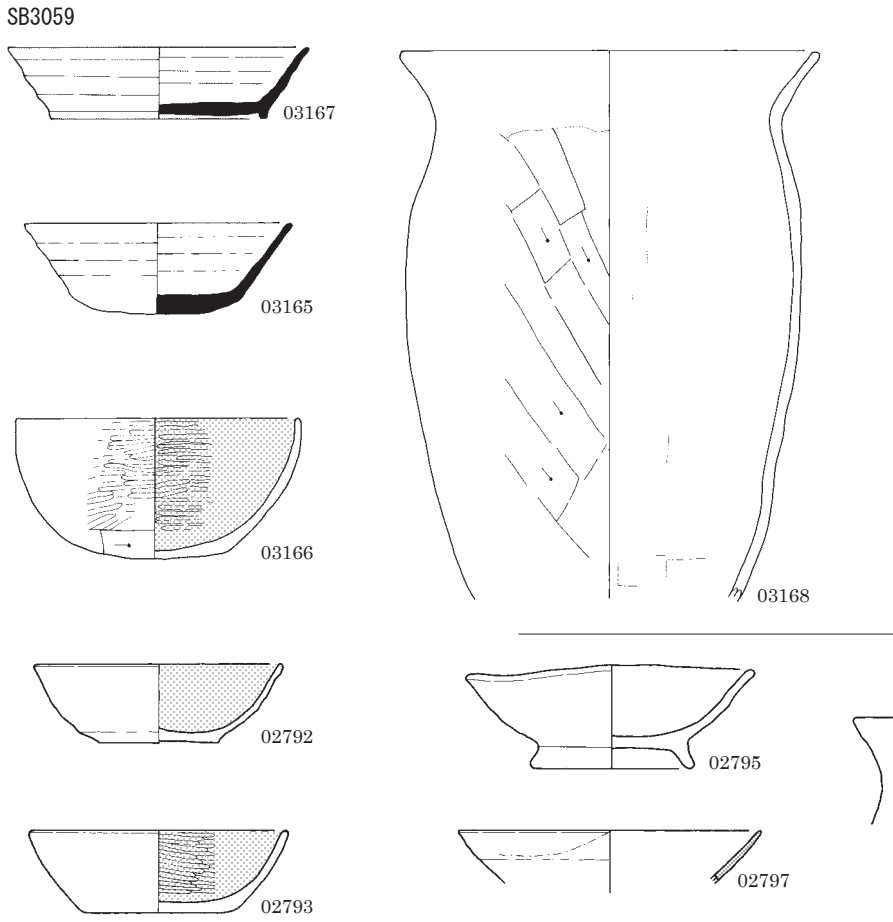

SB3060

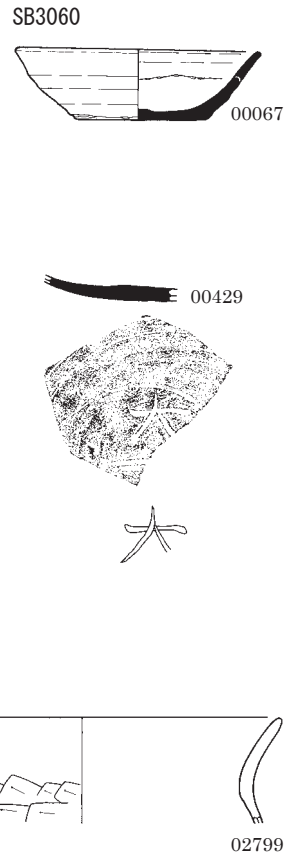

SB3061 (1)

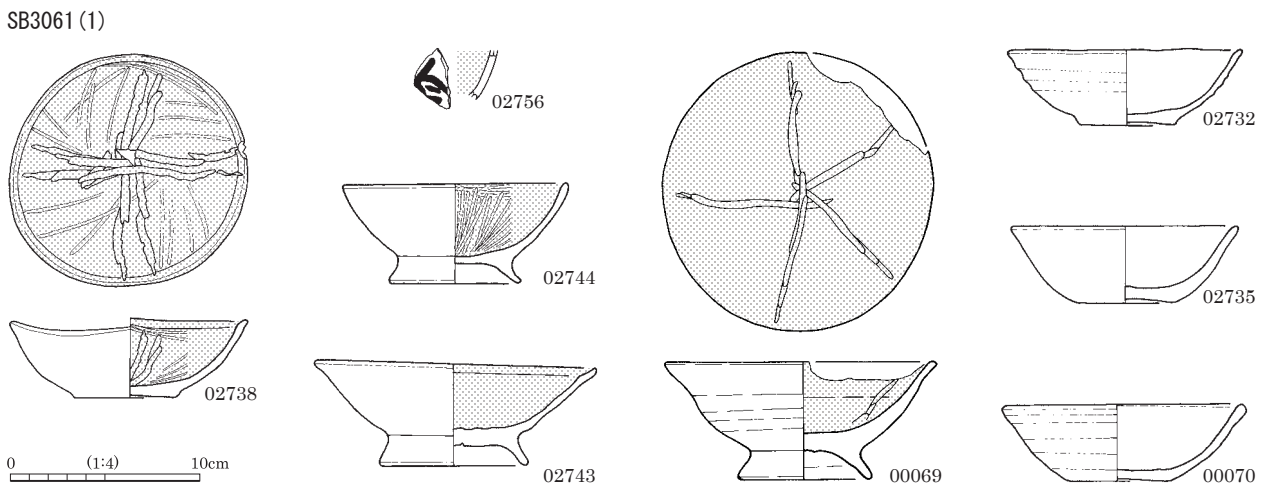

0 (1:4) 10cm

図版 100 古墳時代～古代の土器 (43)

SB3061 (2)

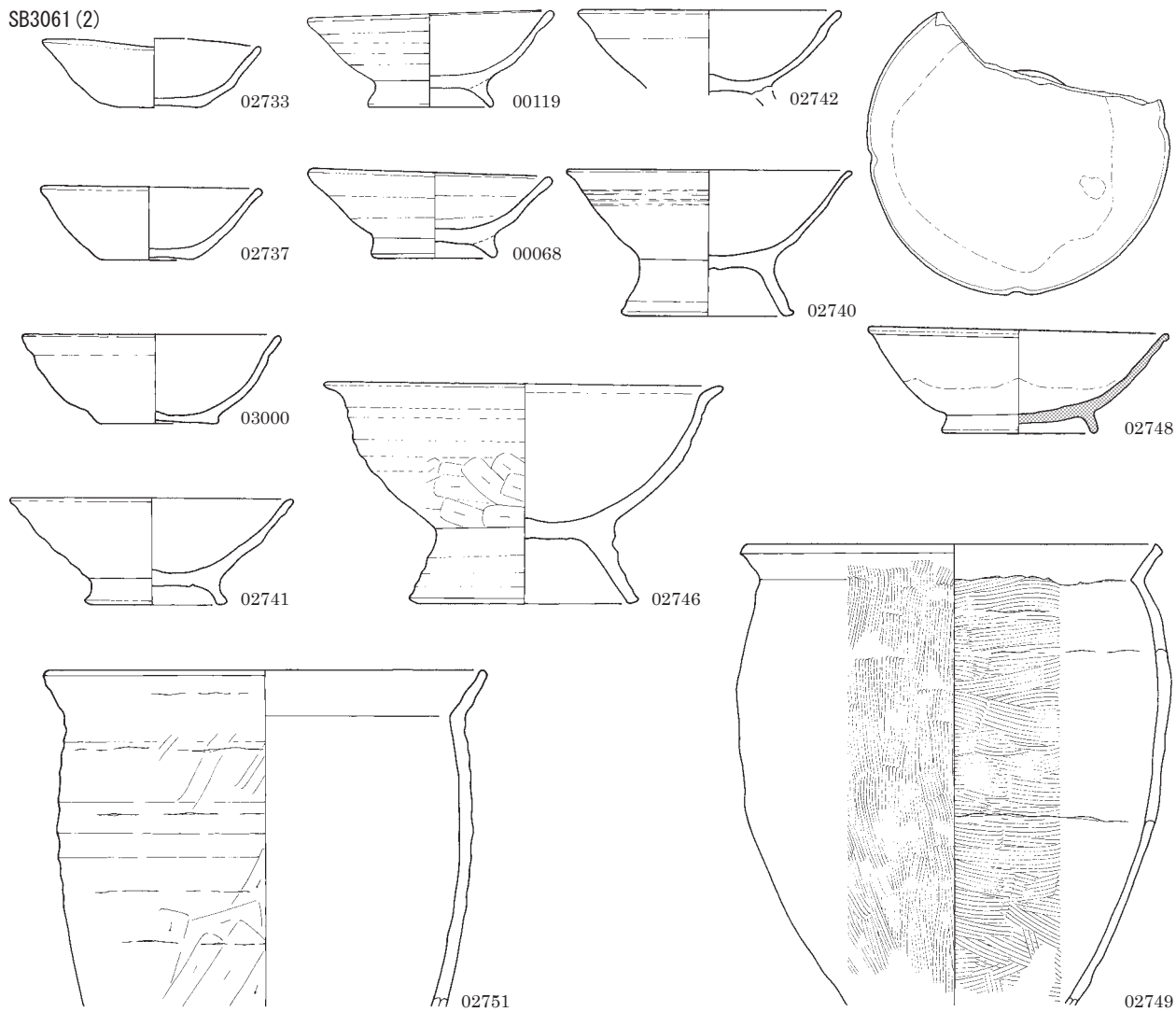

SB3062

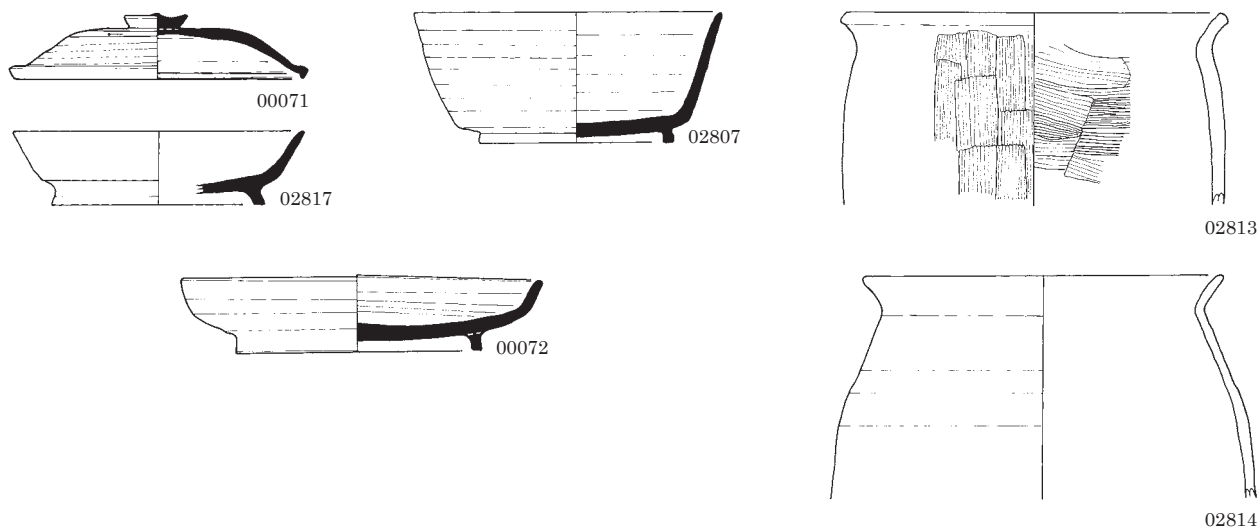

SB3064



0 1:4 10cm

SB3065

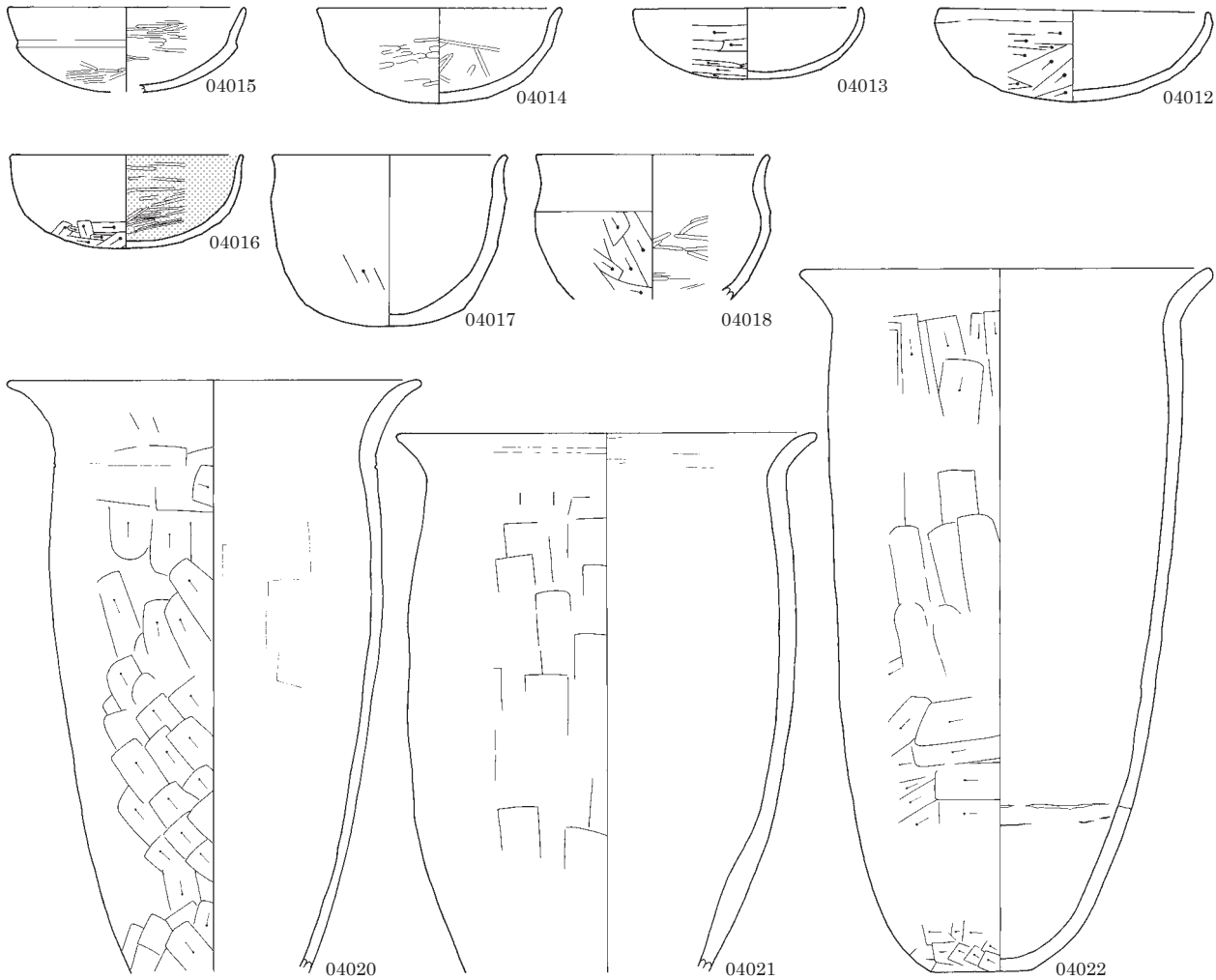

SB3066

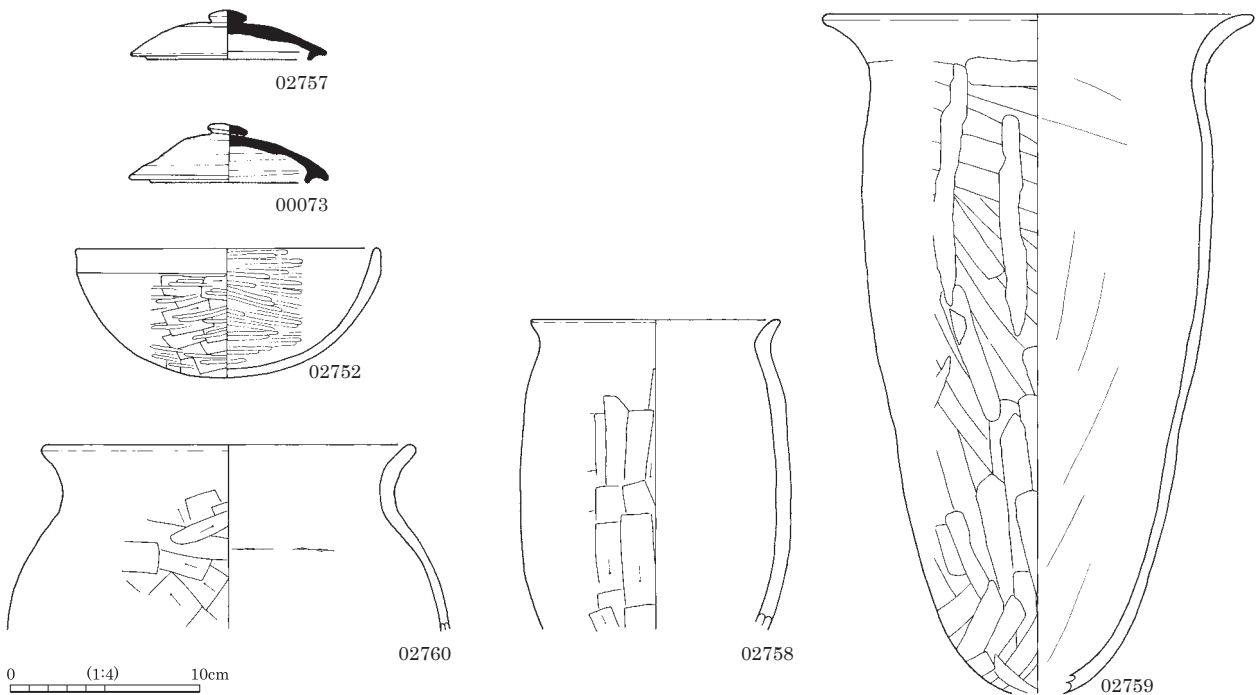

図版 102 古墳時代～古代の土器 (45)

SB3067

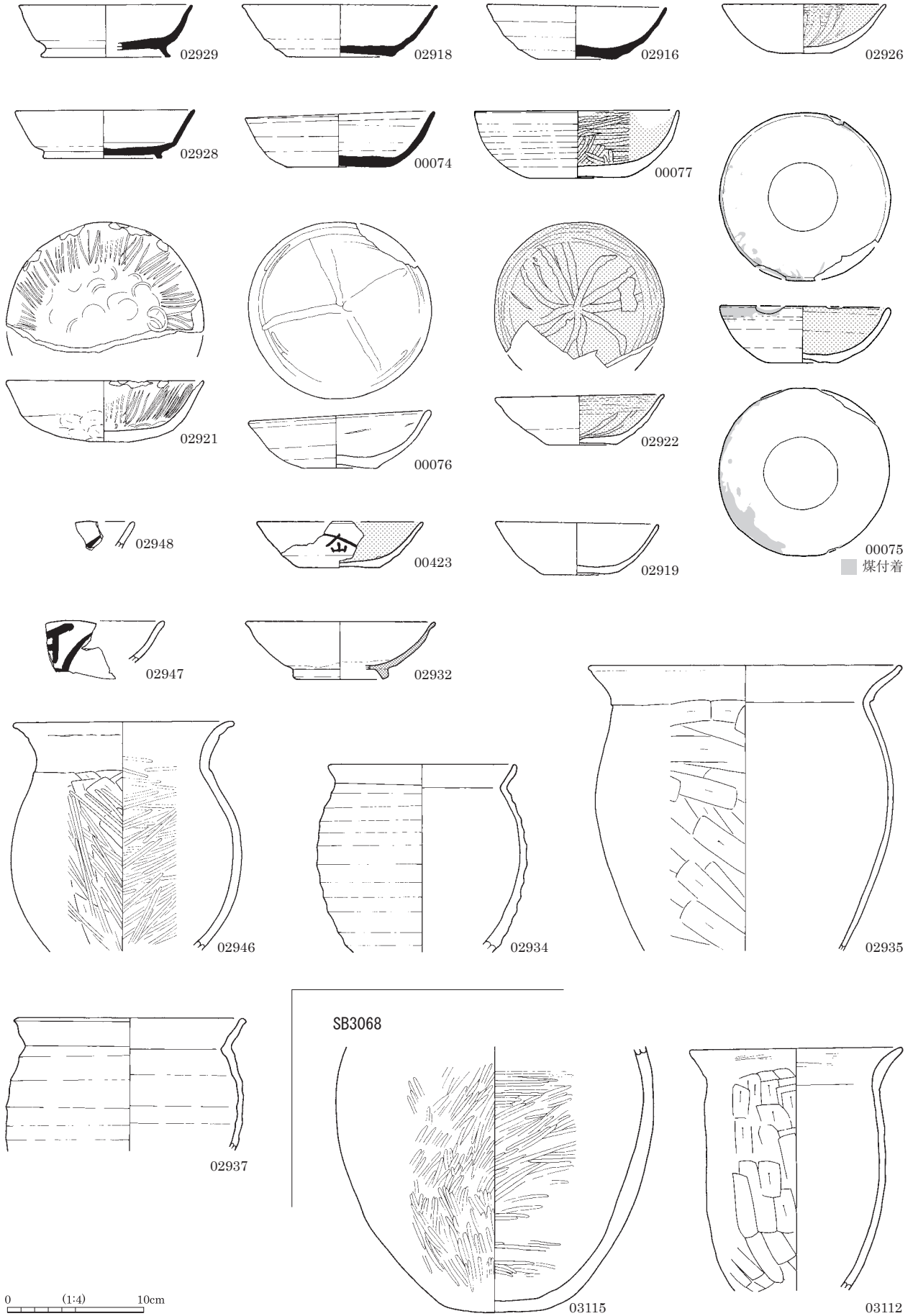

SB3070

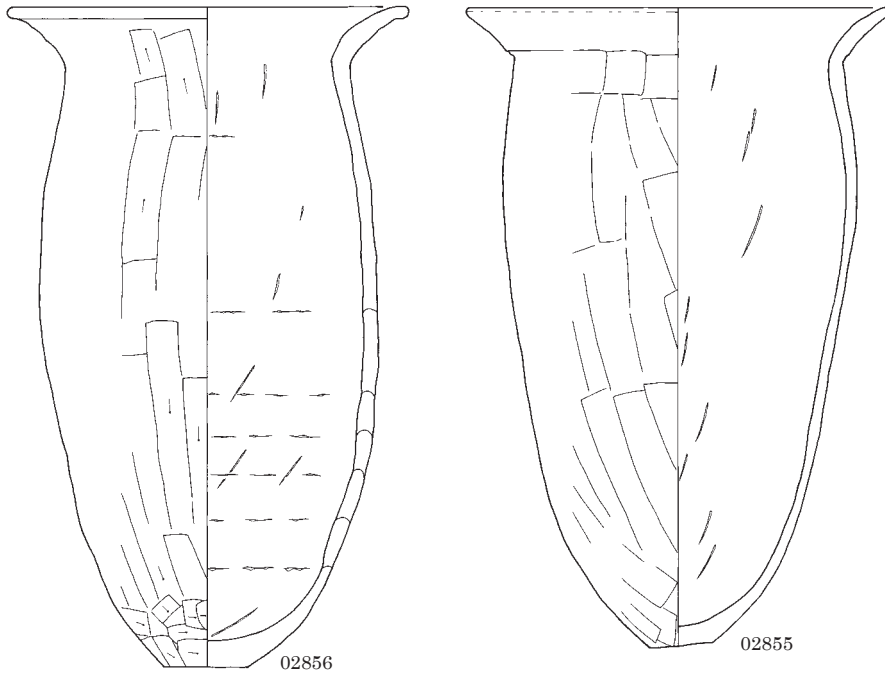
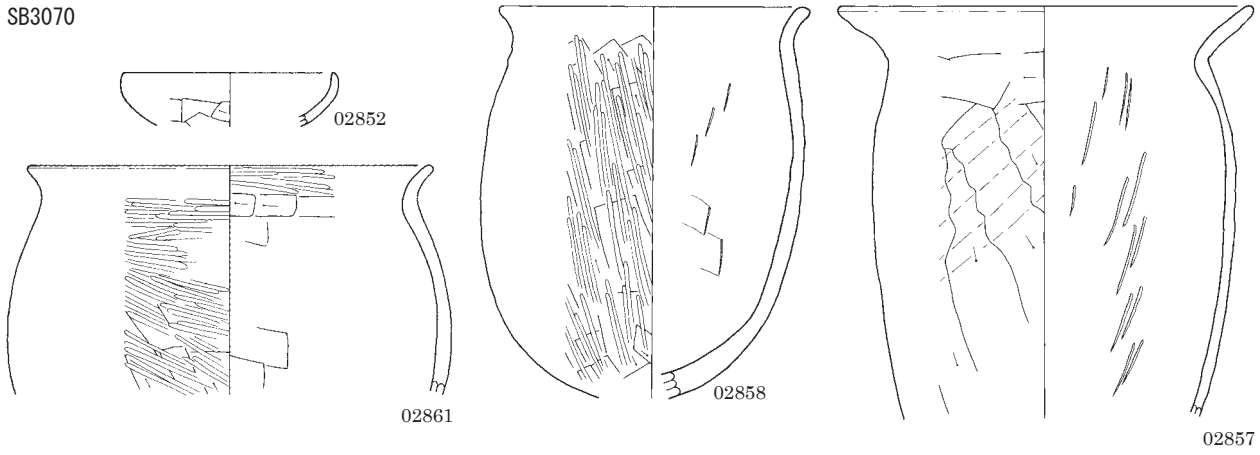

SB3071

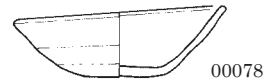

SB3072

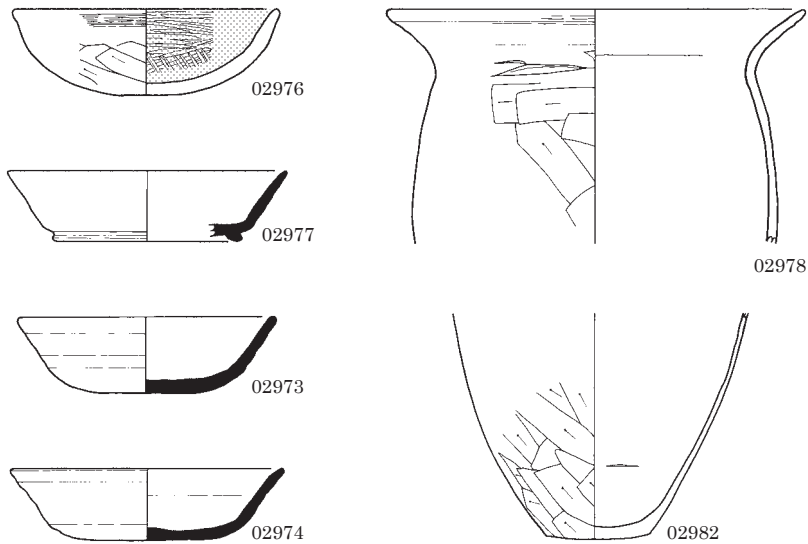

SB3077

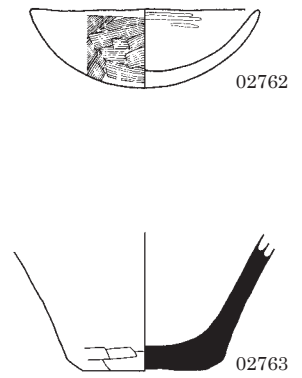

0 (1:4) 10cm

図版 104 古墳時代～古代の土器 (47)

SB3079

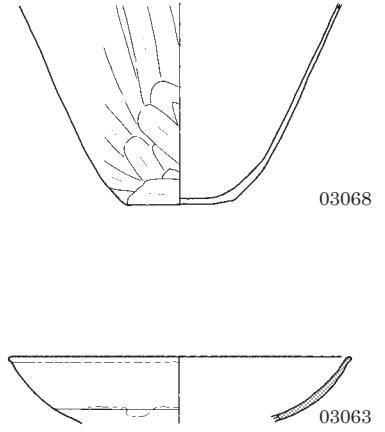
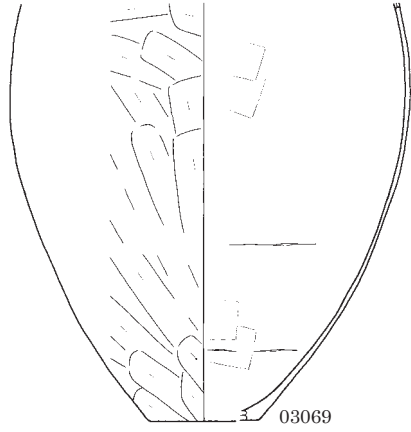
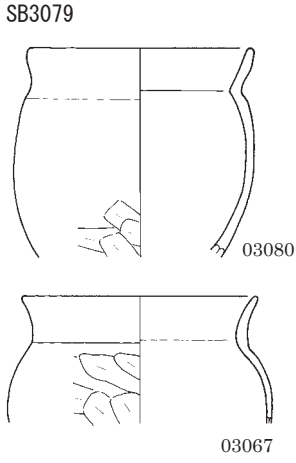

SB3080

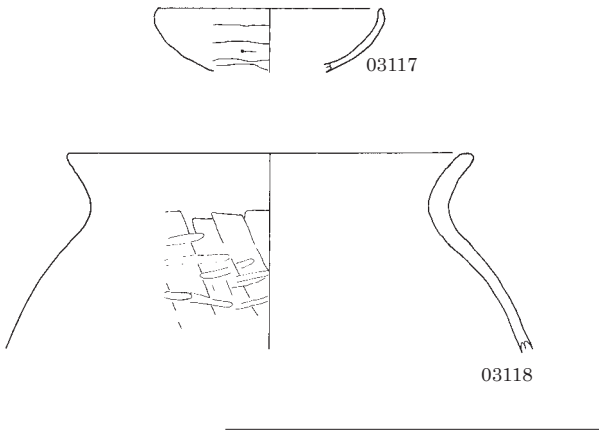

SB3081

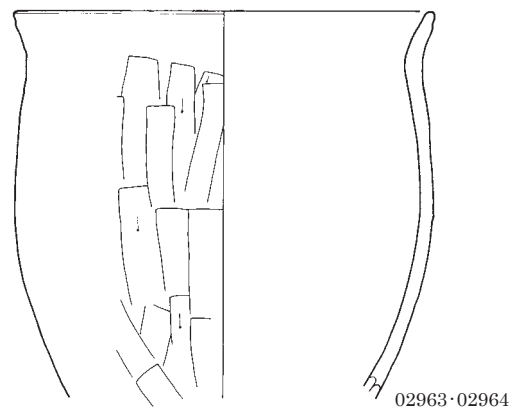
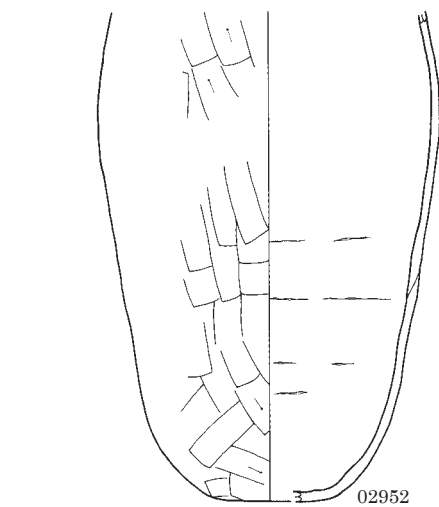
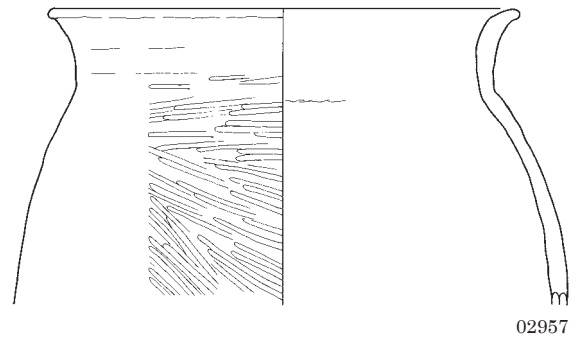
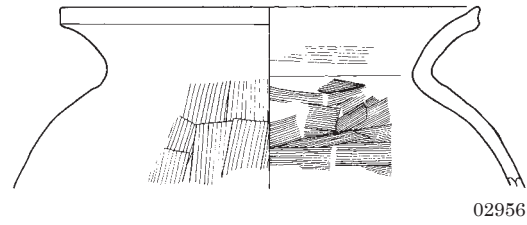
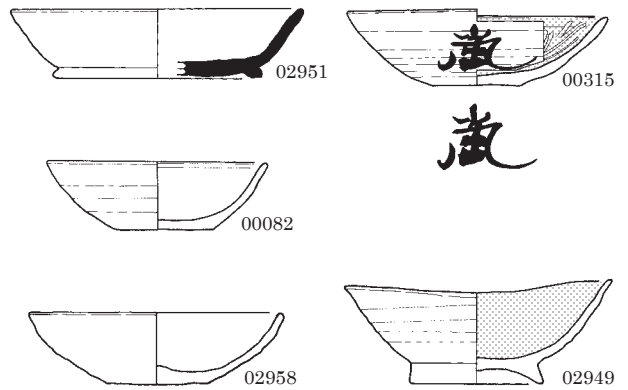

0 (1:4) 10cm

SB3086

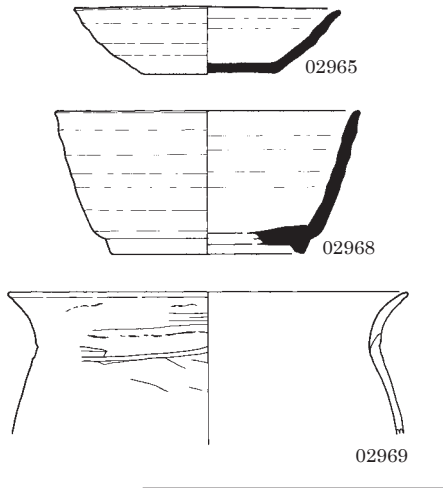

SB3089

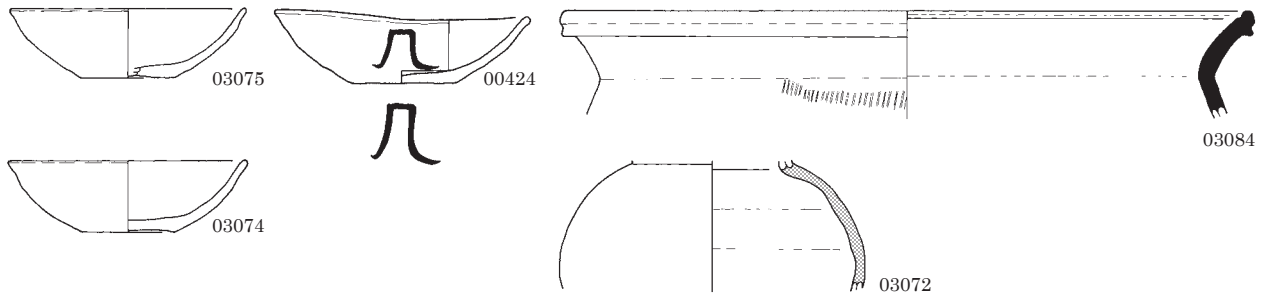
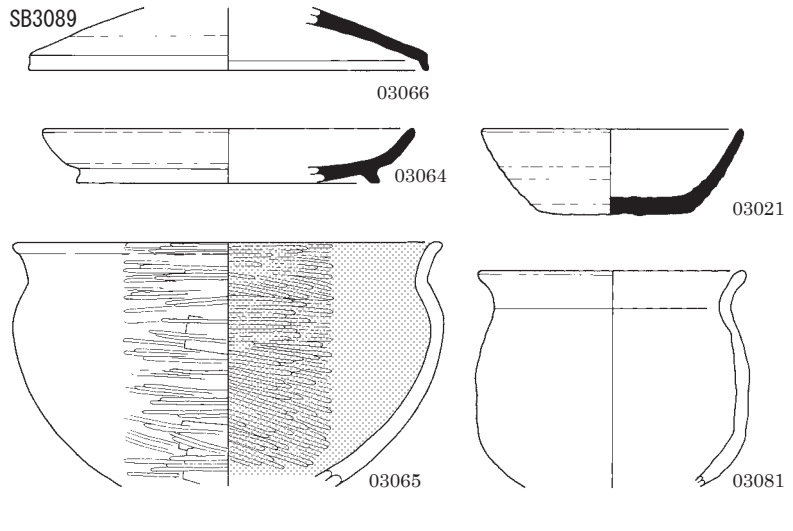

SB3090

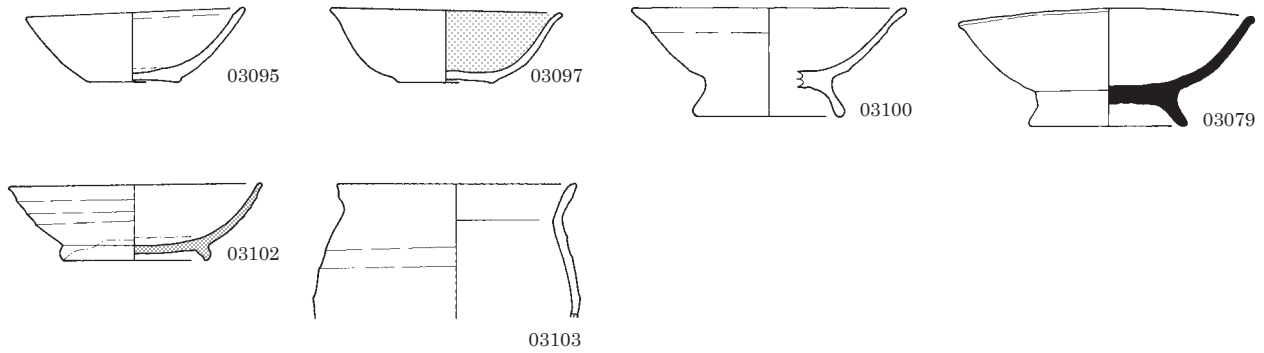

SB3093

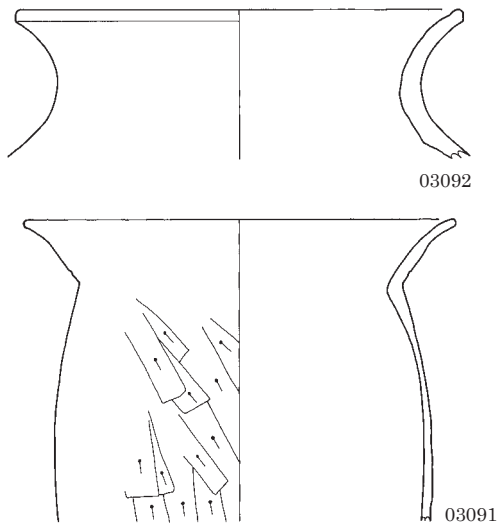

SB3094

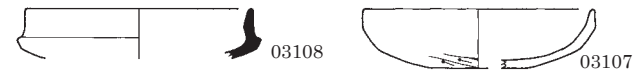

SB3098

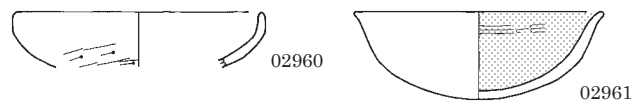

図版 106 古墳時代～古代の土器 (49)

SB4001

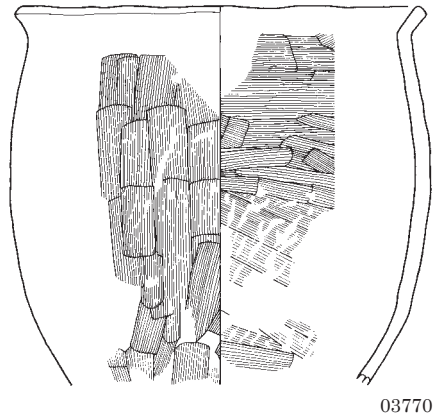
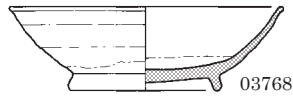
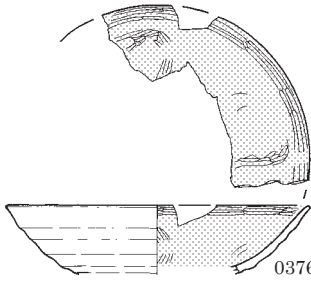
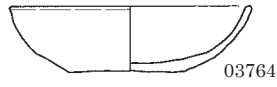
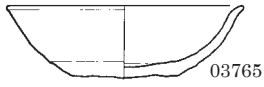

SB4004

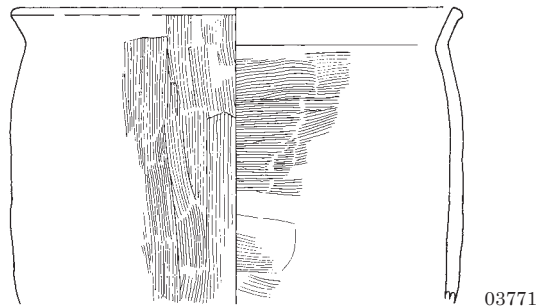
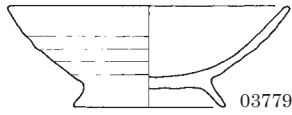
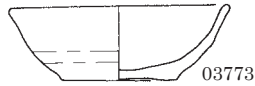
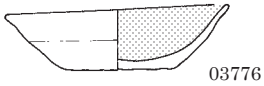
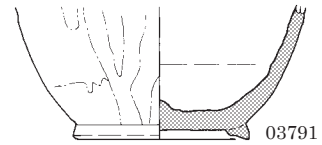
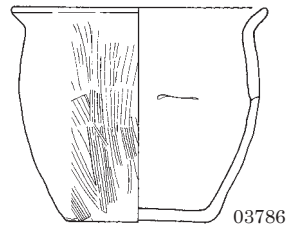
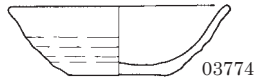
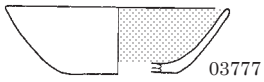

SB4005

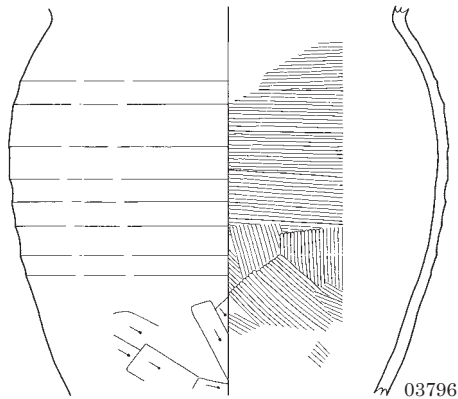
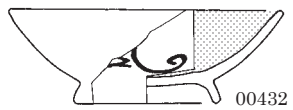
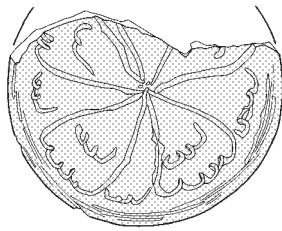

SB4006 (1)

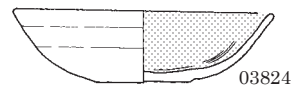
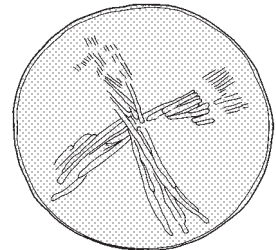
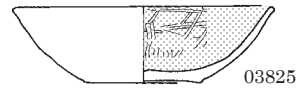
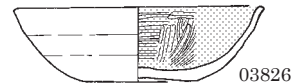

0 (1:4) 10cm

SB4006 (2)

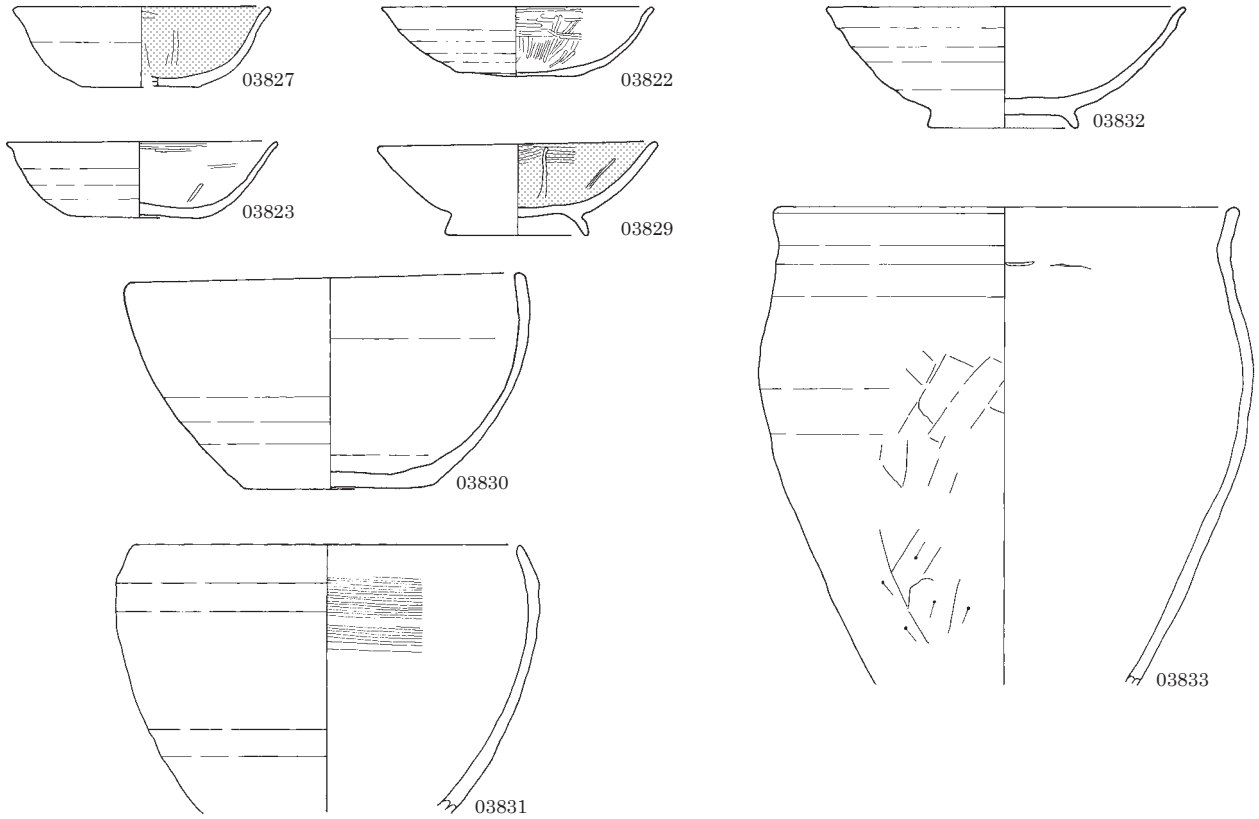

SB4007

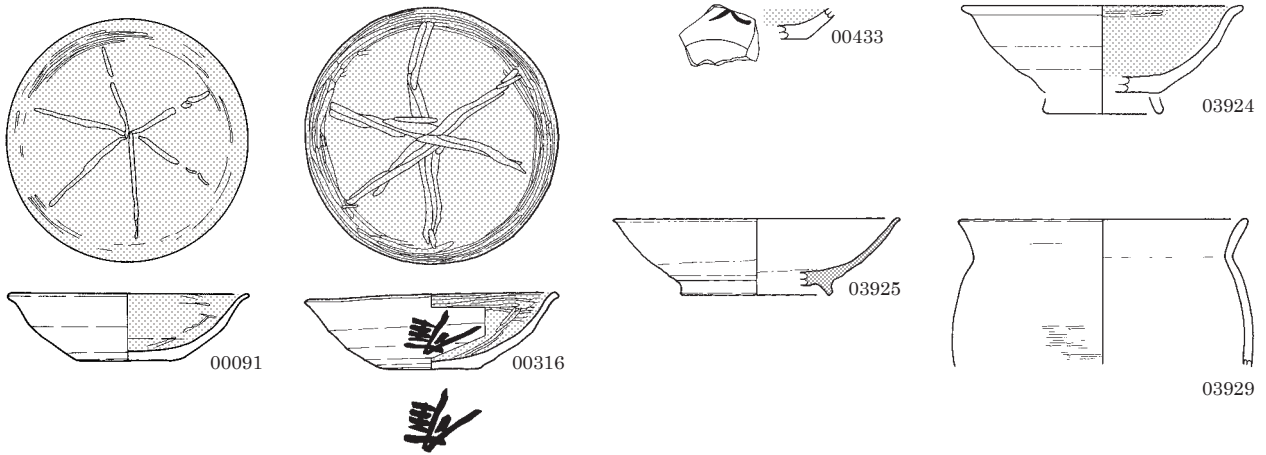

SB4009 (1)

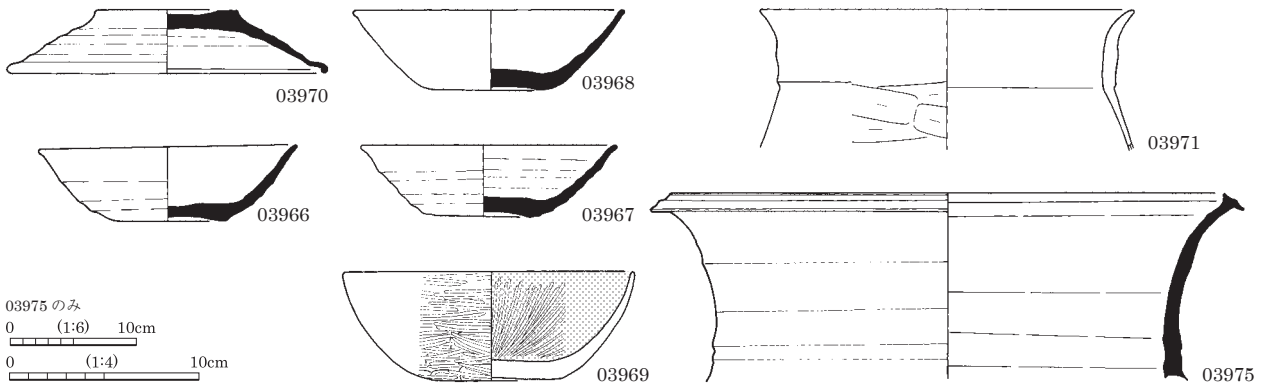

03975 のみ
 0 (1:6) 10cm
 0 (1:4) 10cm

図版 108 古墳時代～古代の土器 (51)

SB4009 (2)

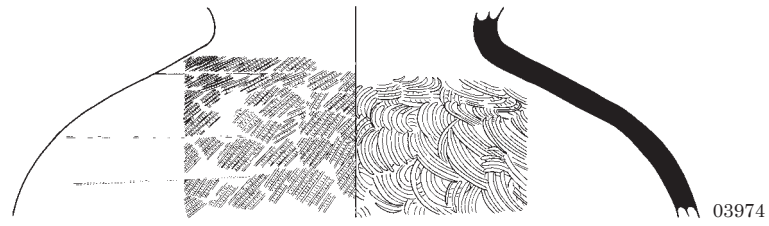

SB4010

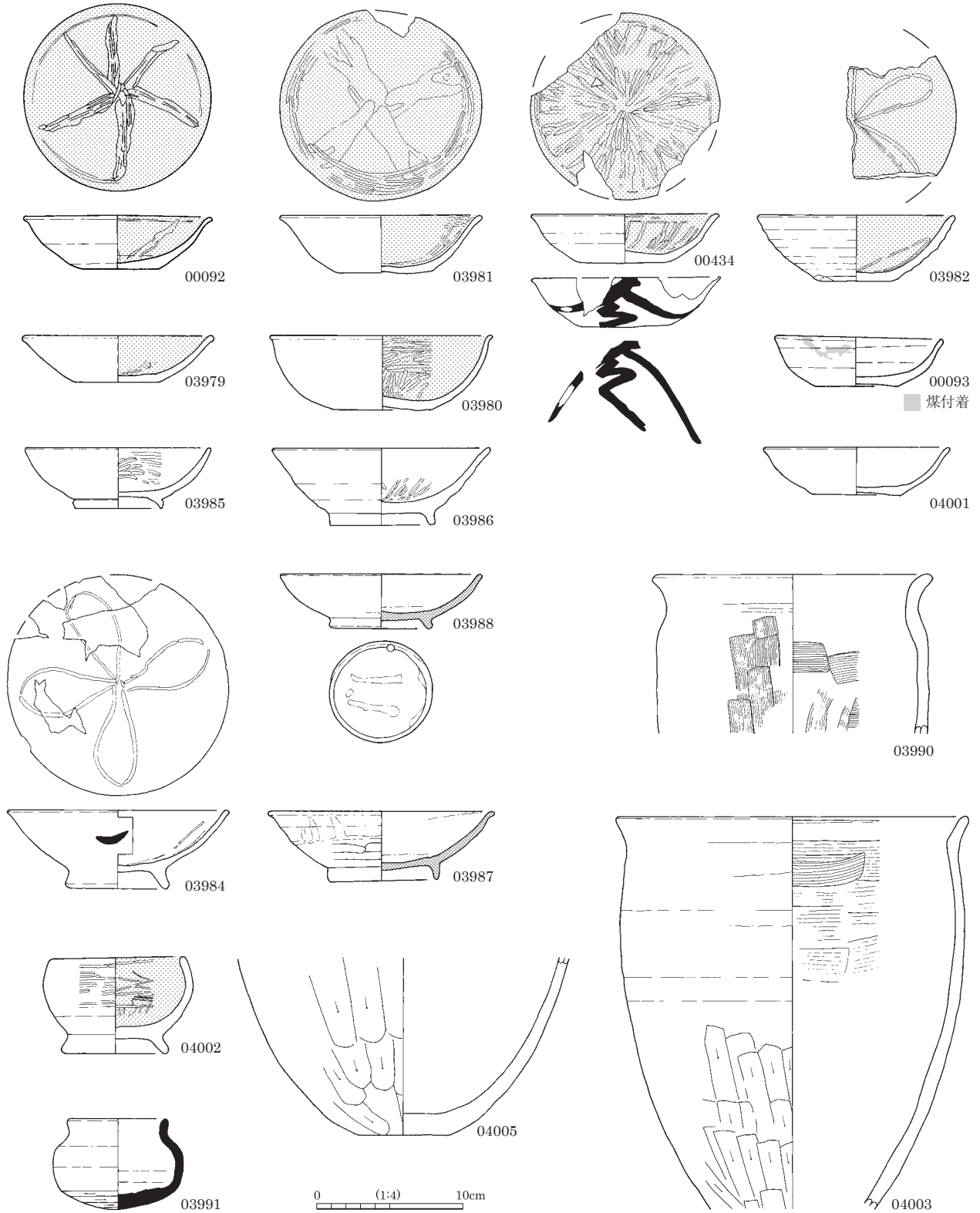

SB4011

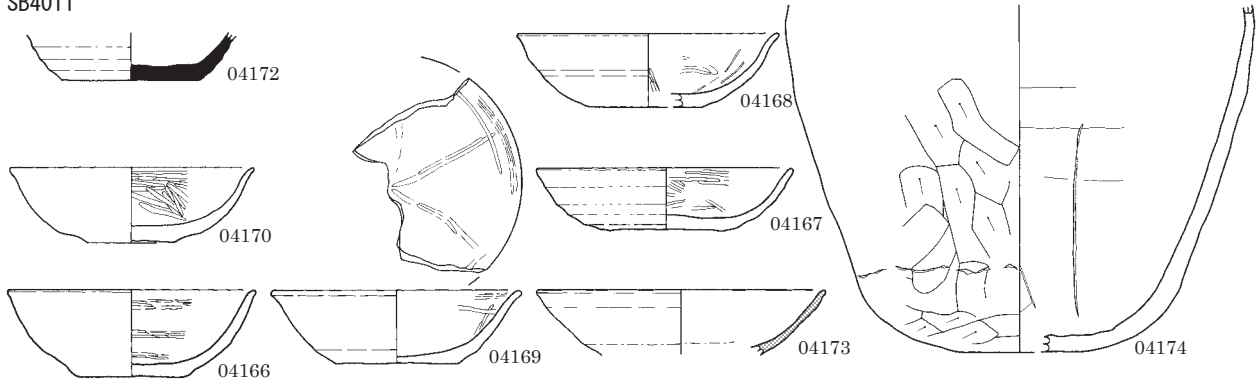

SB4012

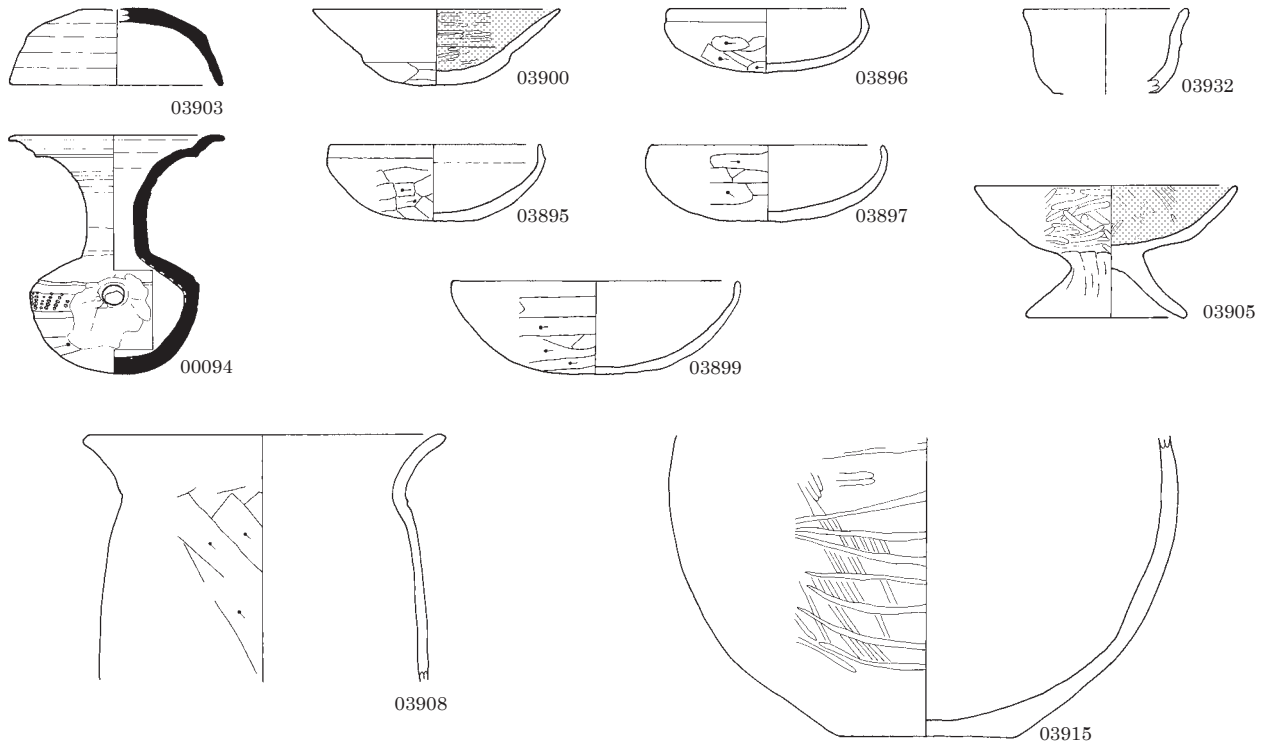

SB4014

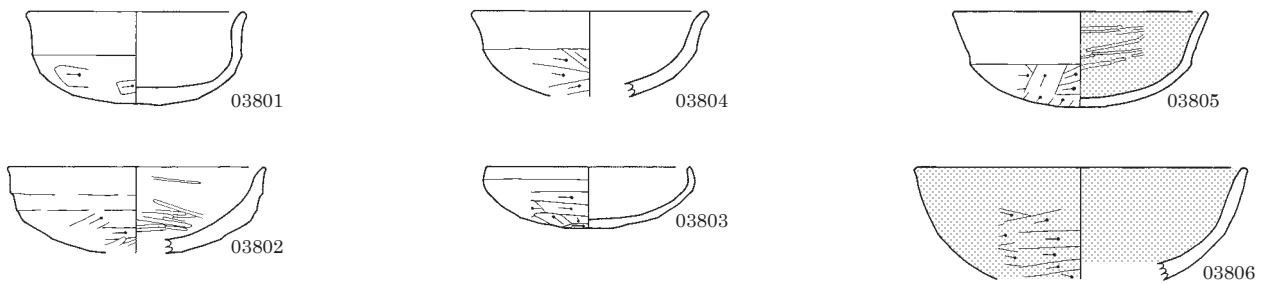

SB4015 (1)

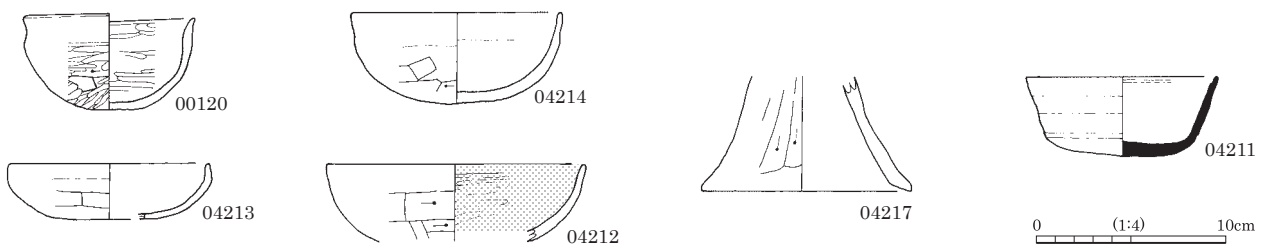

図版 110 古墳時代～古代の土器 (53)

SB4015 (2)

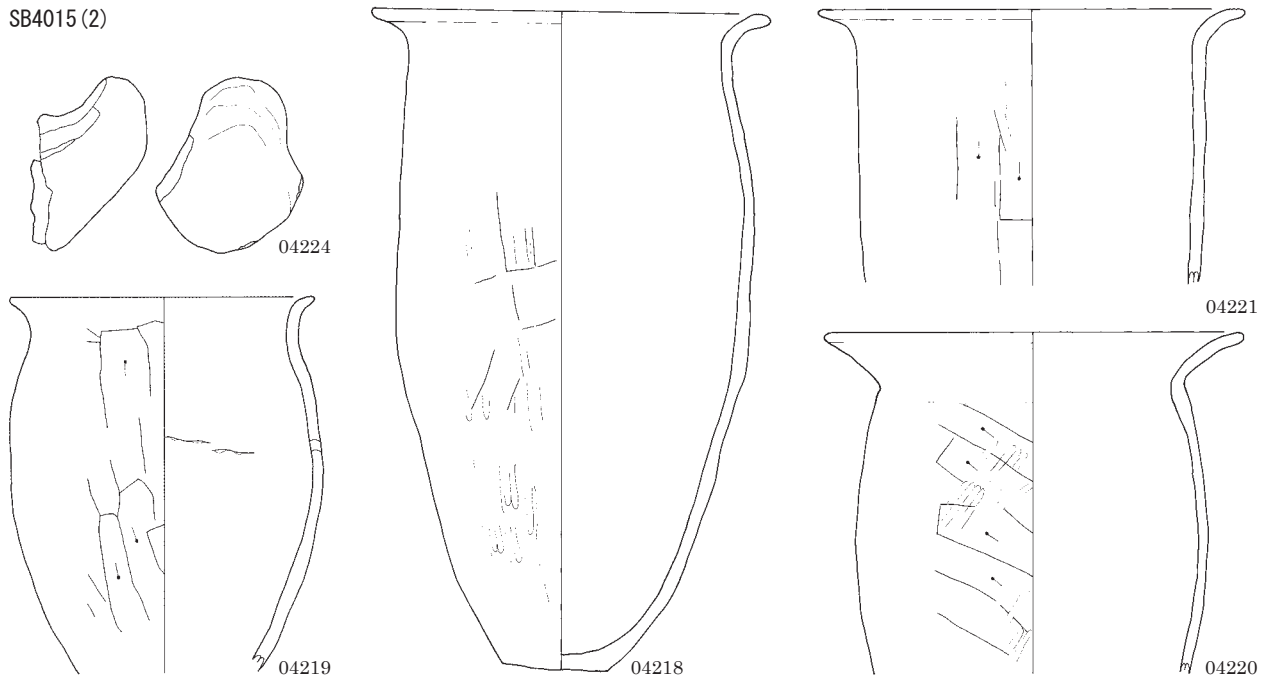

SB4019

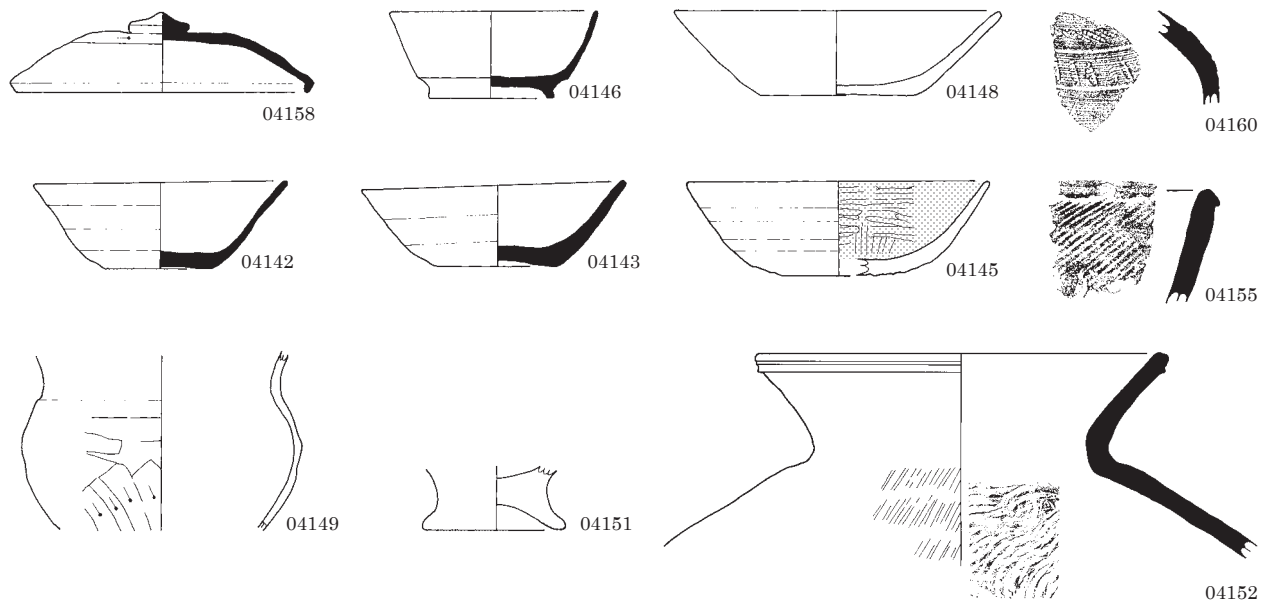

SB4020 (1)

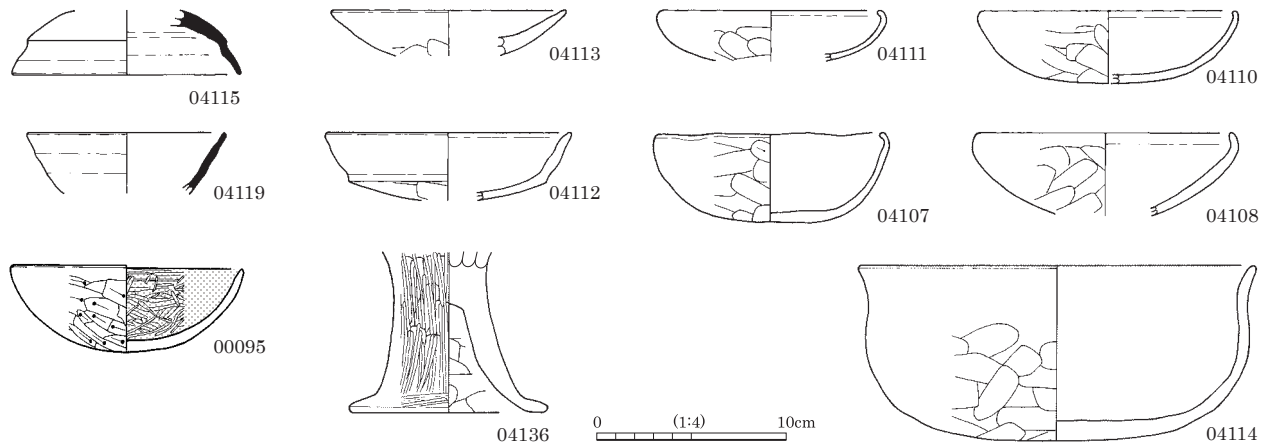

SB4020 (2)

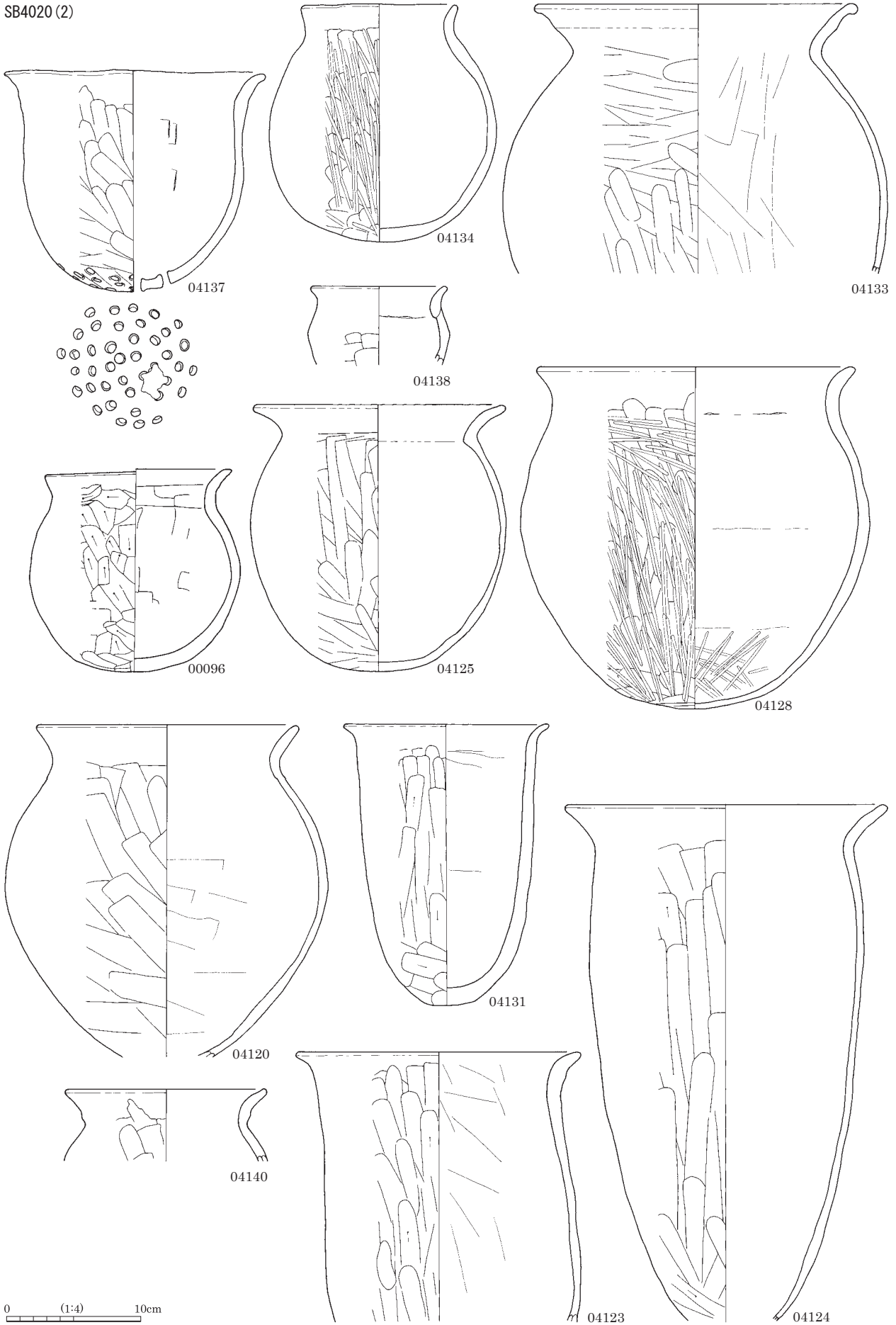

0 (1:4) 10cm

図版 112 古墳時代～古代の土器 (55)

SB4020 (3)

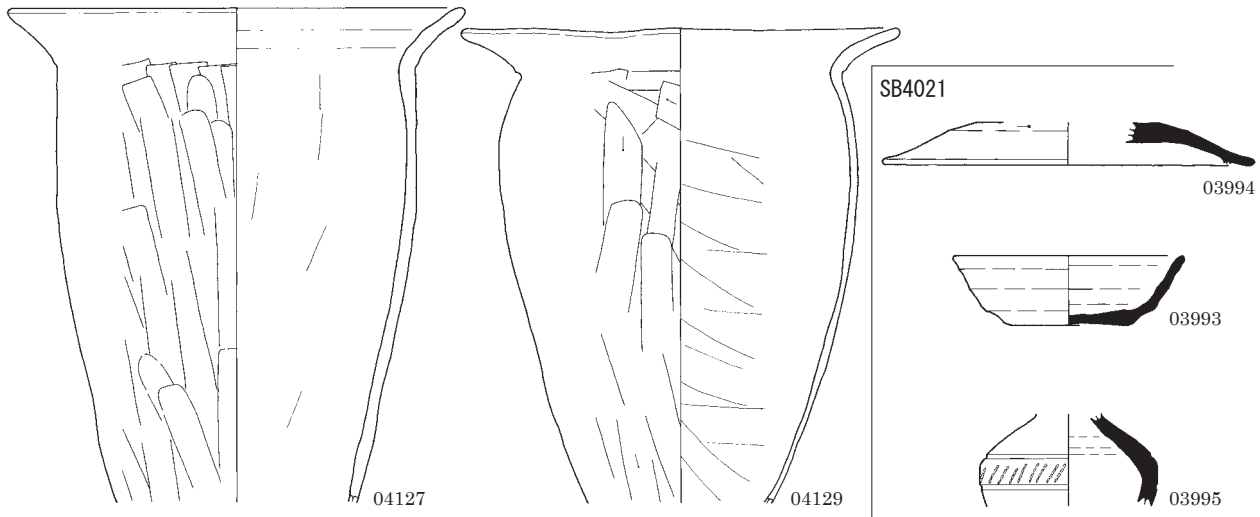
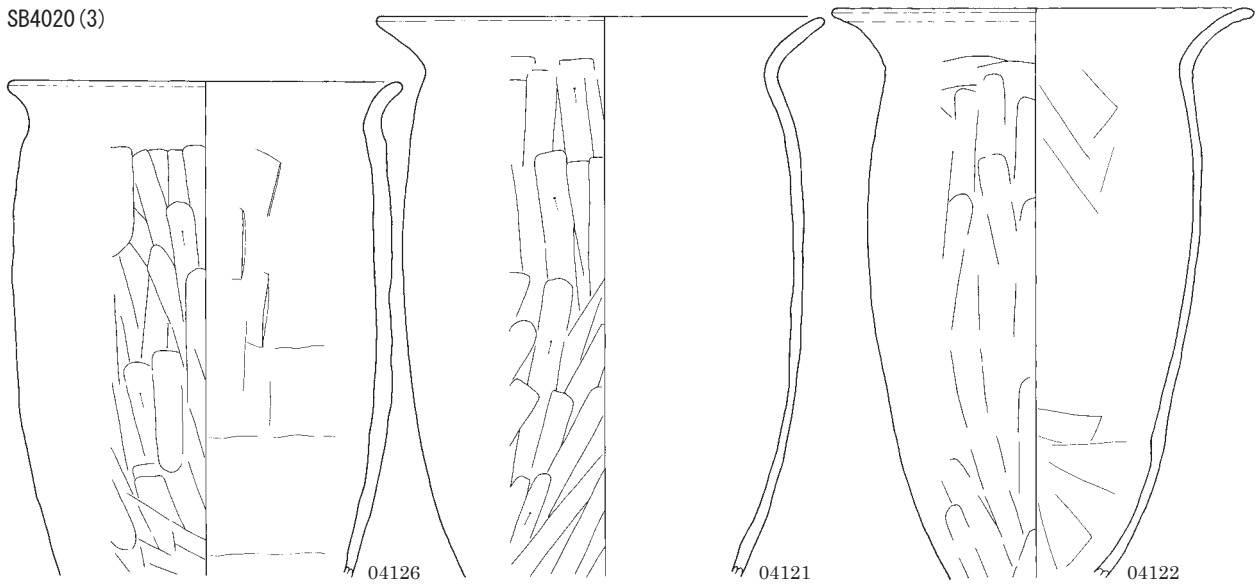

SB4022

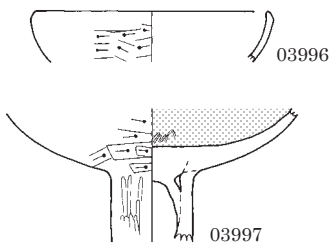

SB4024

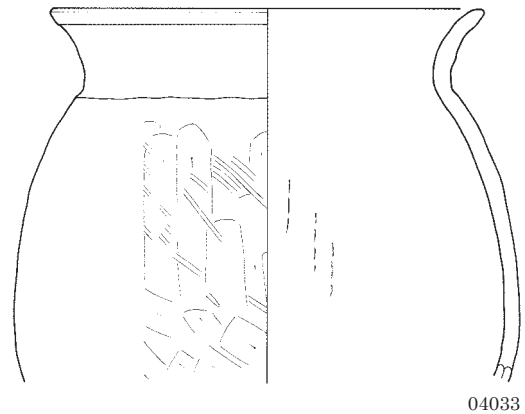
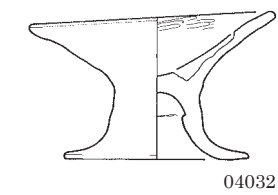
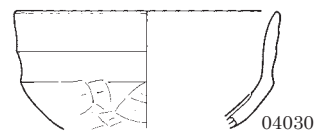
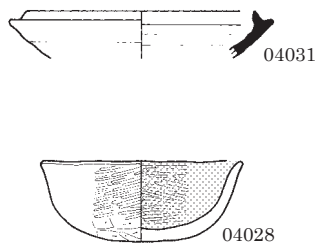

0 (1:4) 10cm

SB4025

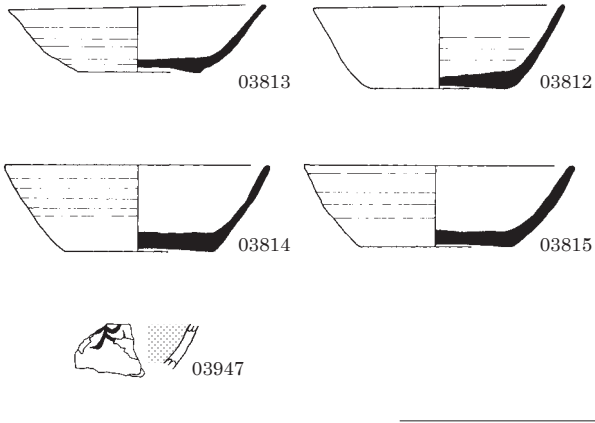

SB4026

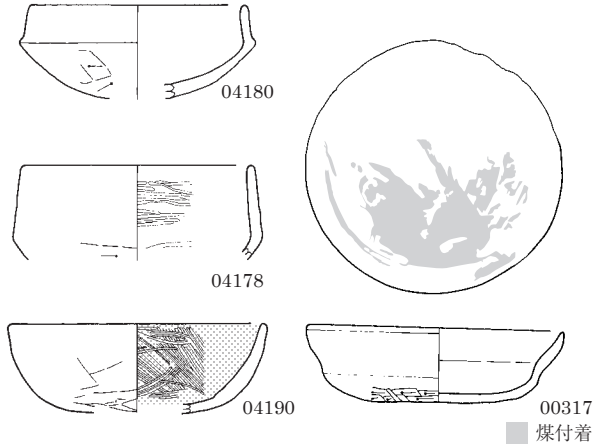

SB4027 (1)

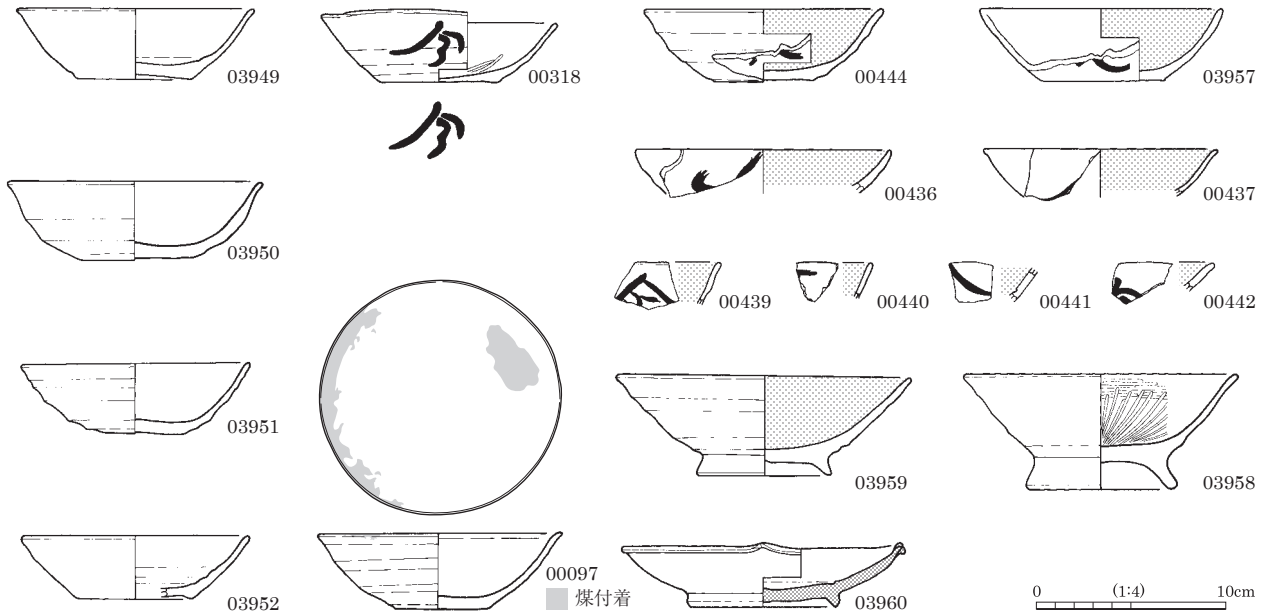

図版 114 古墳時代～古代の土器 (57)

SB4027 (2)



03963

SB4034

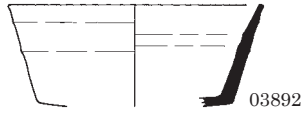

03892

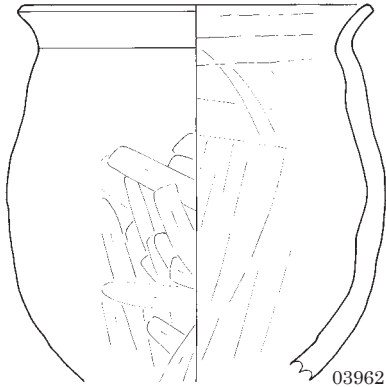

03962

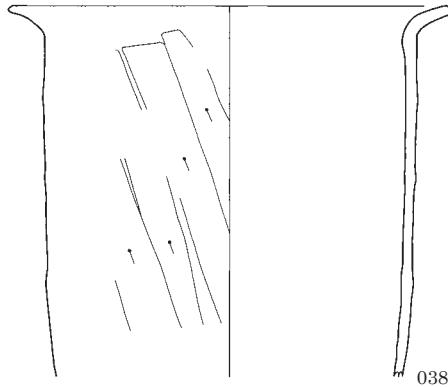

03893

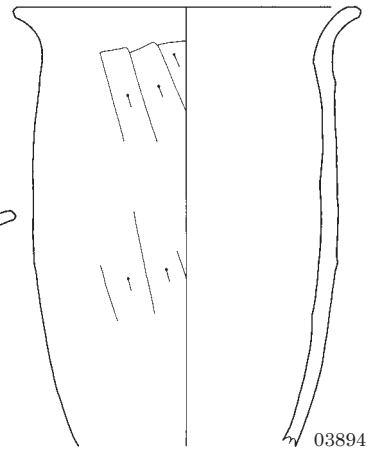

03894

SB4028



00319

SB4036 (1)



00099

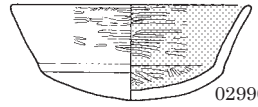

02990

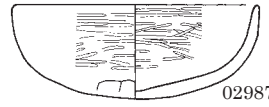

02987

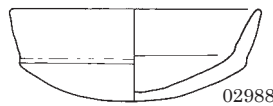
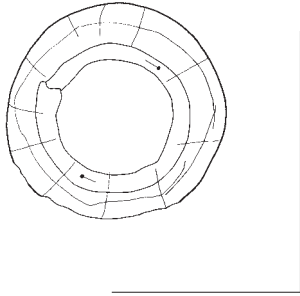

02988



02989

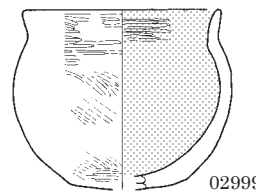

02999

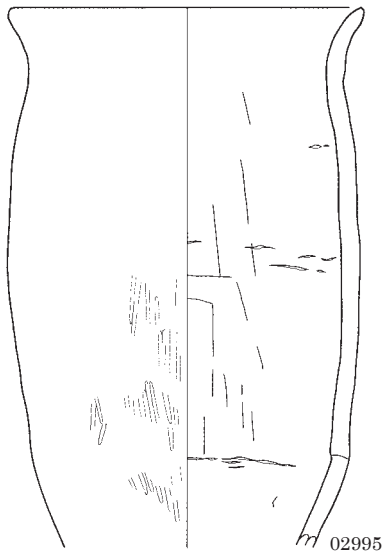

02995

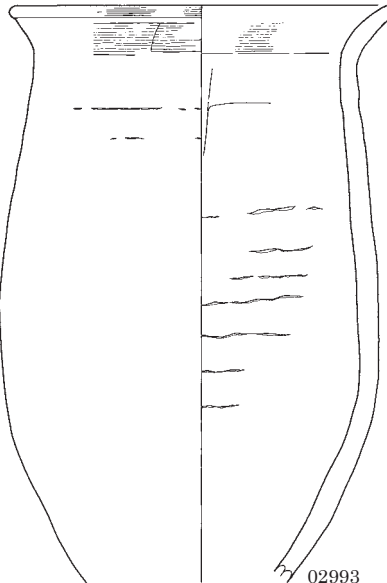

02993

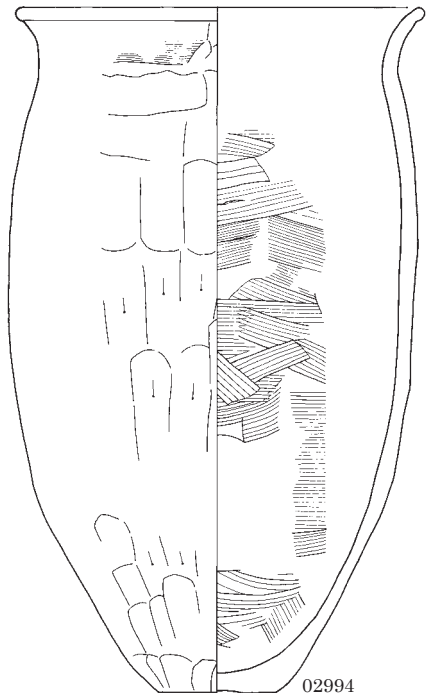

02994

0 (1:4) 10cm

SB4036 (2)

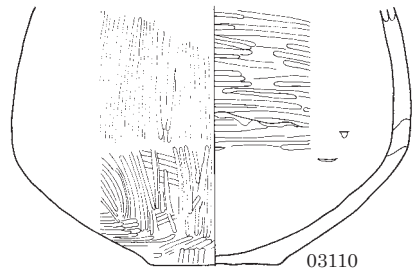
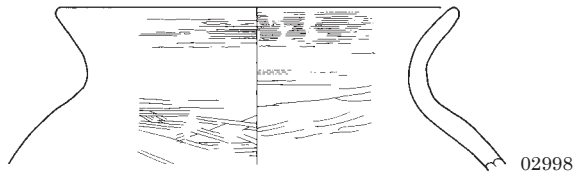

SB4037

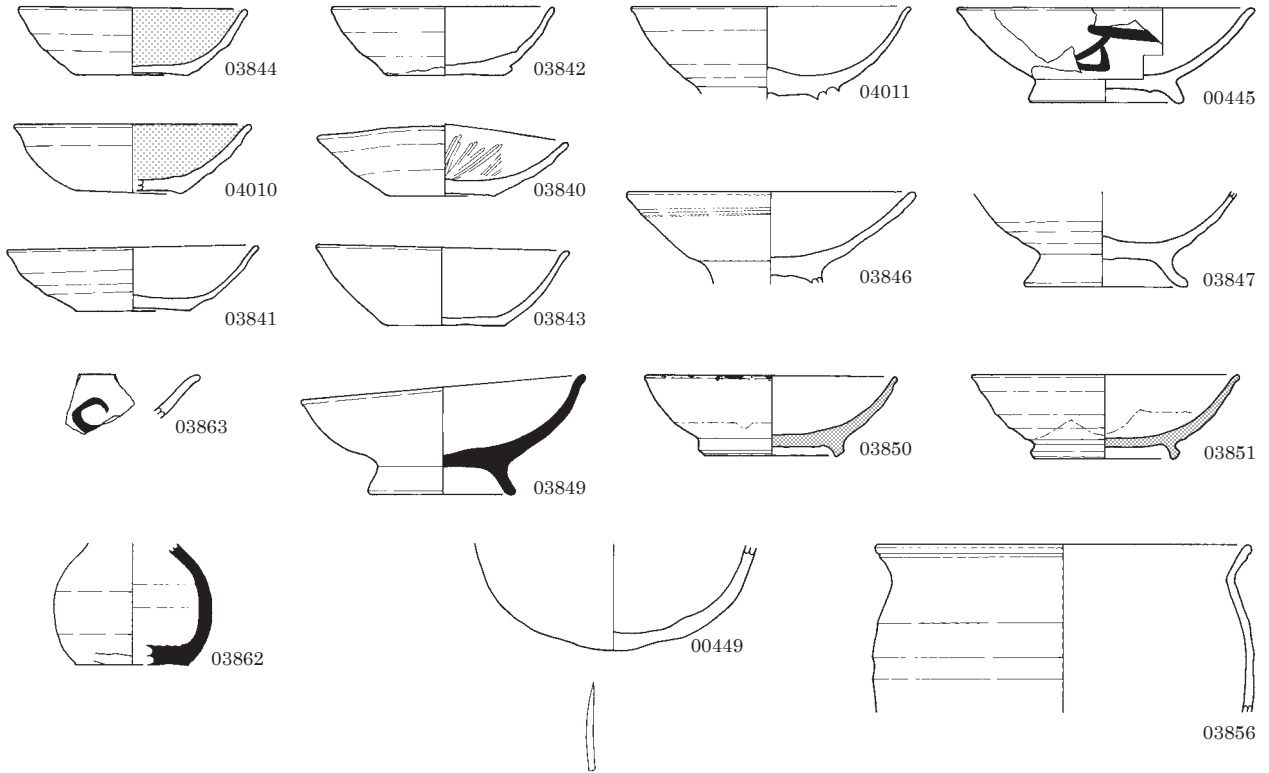

SB4039 (1)

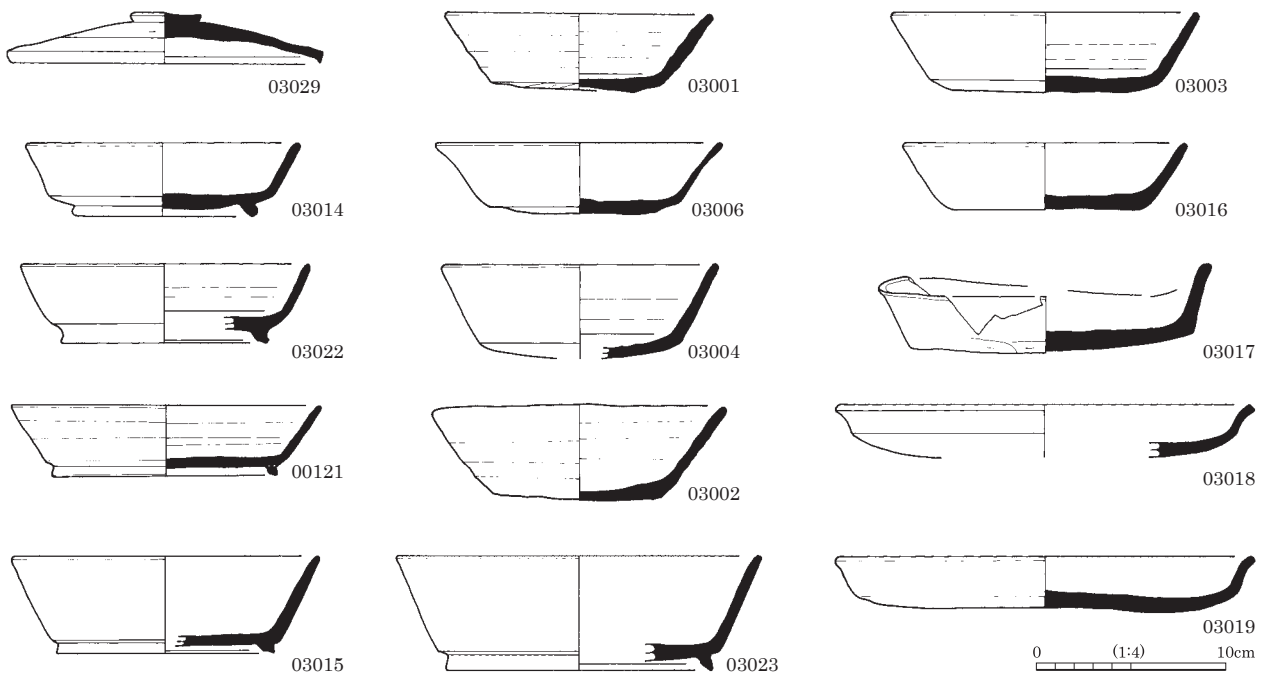

図版 116 古墳時代～古代の土器 (59)

SB4039 (2)

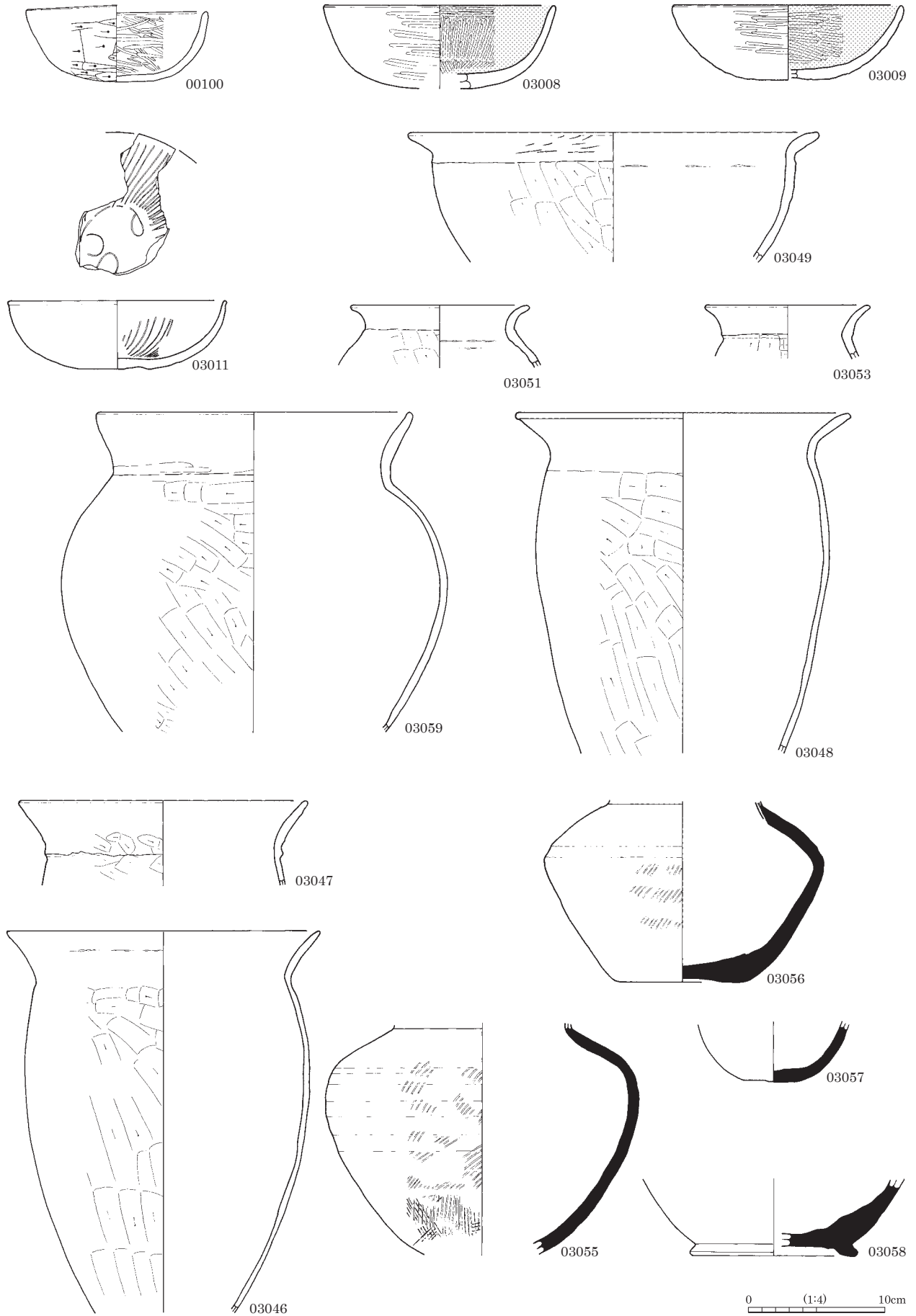

SB4039 (3)

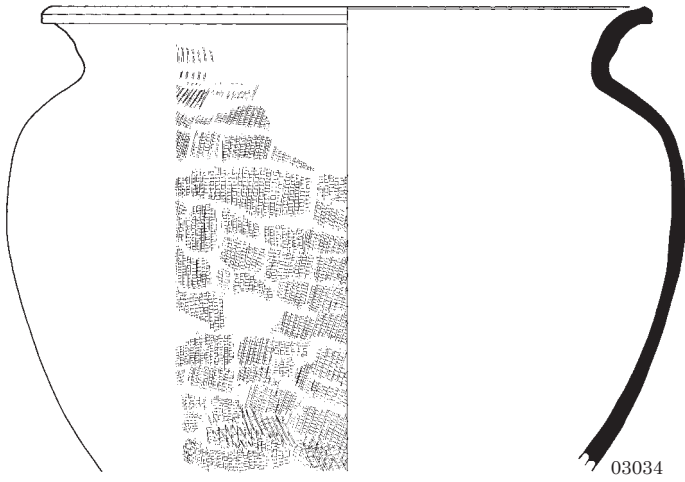
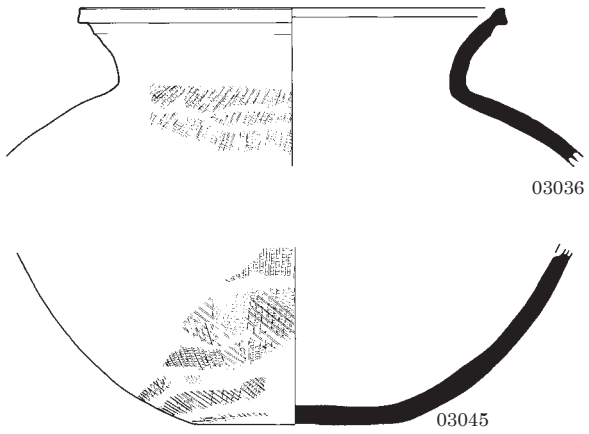

SB4040

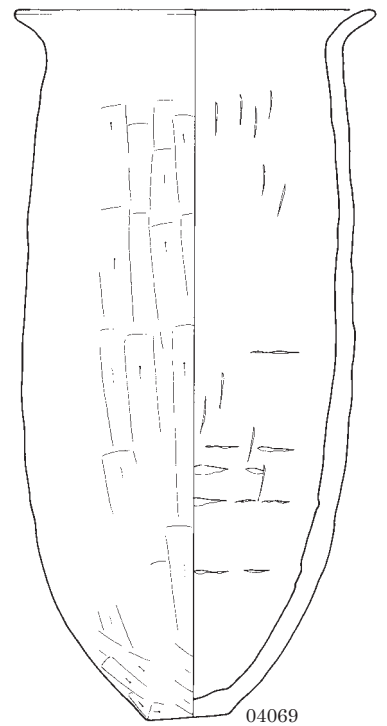
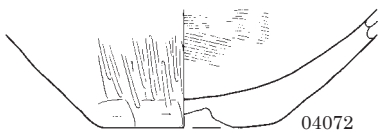
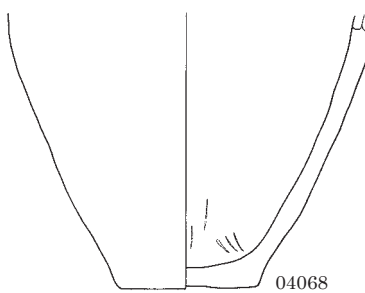
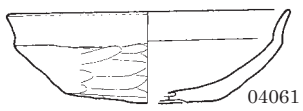
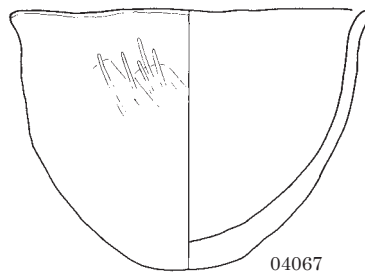
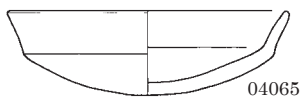
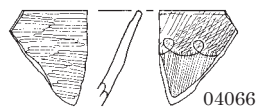

0 1:4 10cm

図版 118 古墳時代～古代の土器 (61)

SB4041

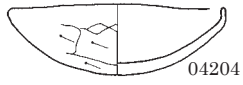

04204

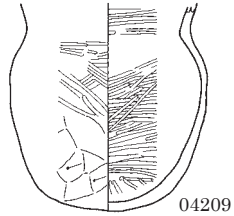

04209

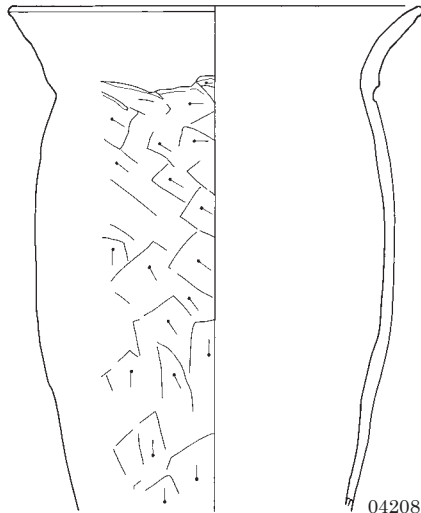

04208

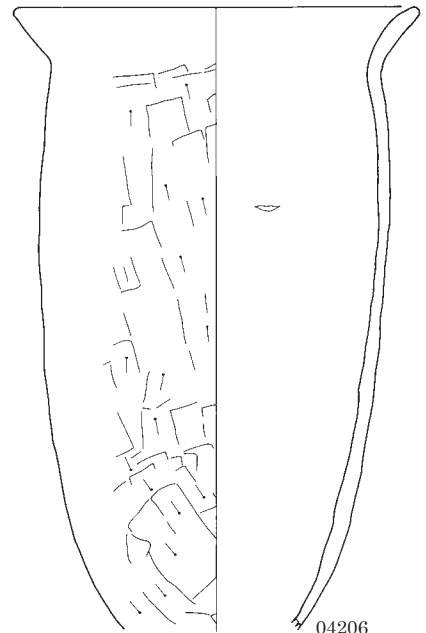

04206

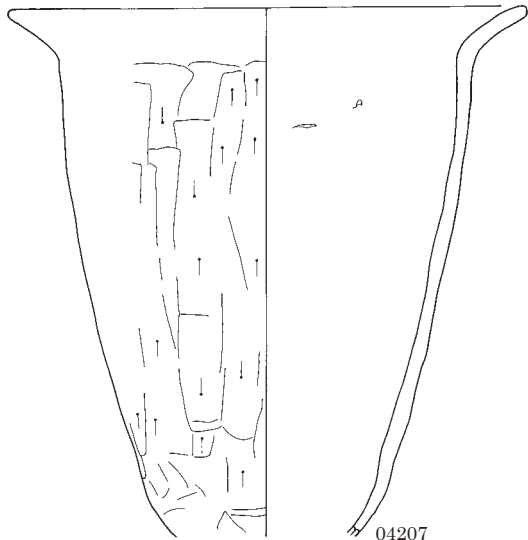

04207

SB4043

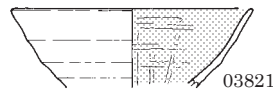

03821

SB4045

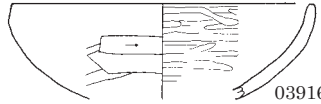

03916

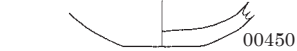

00450

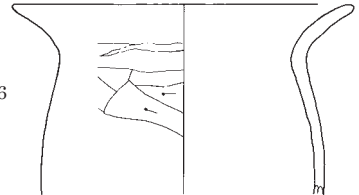

03917

SB4046



04042

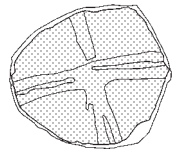

04039

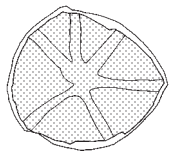

04041

SB4057



03623

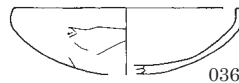

03626

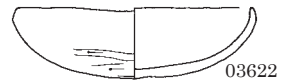

03622

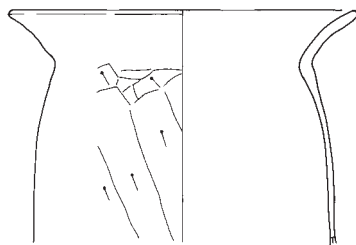

03627

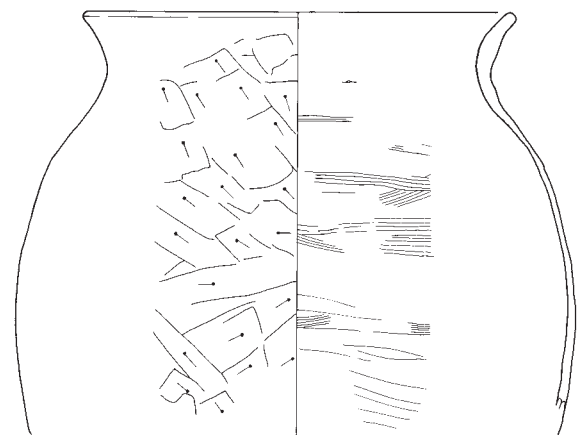

03628

0 (1:4) 10cm

SB4058

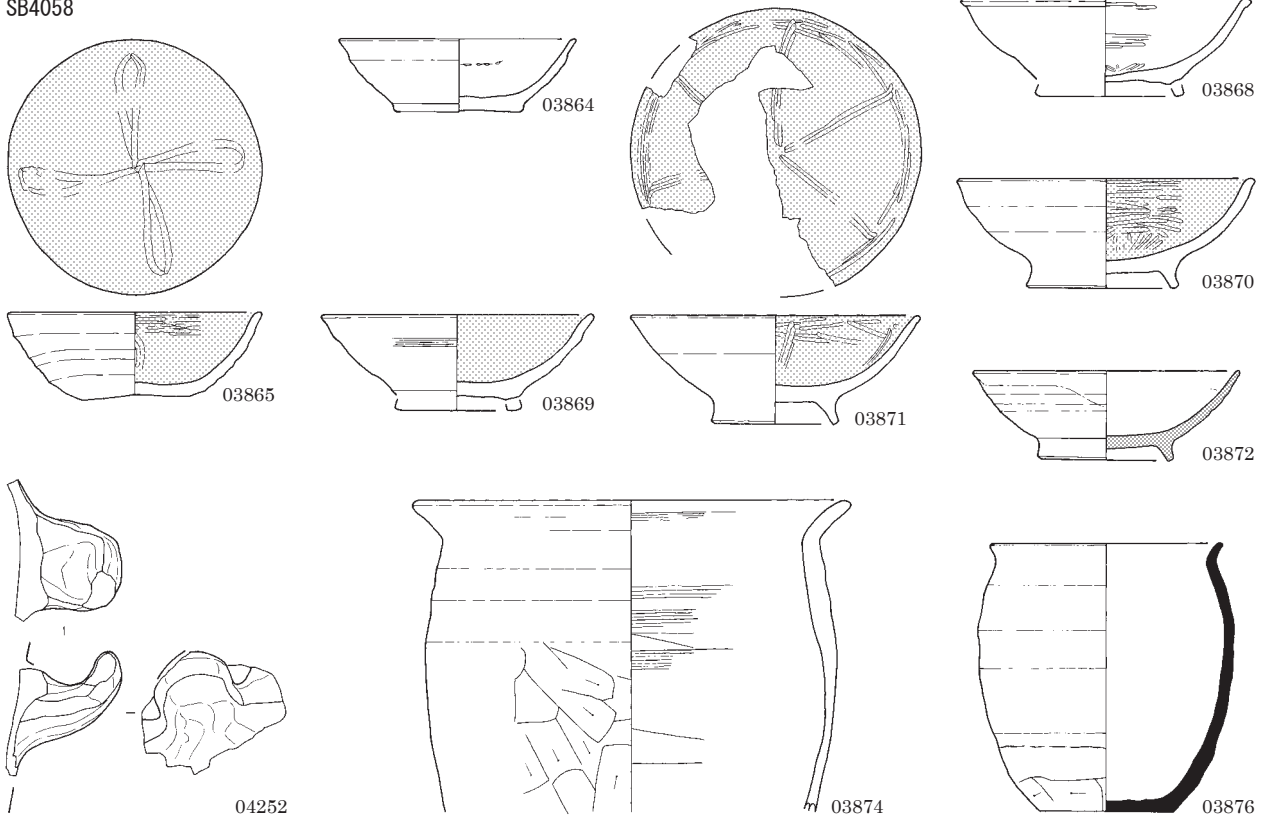

SB4059 (1)

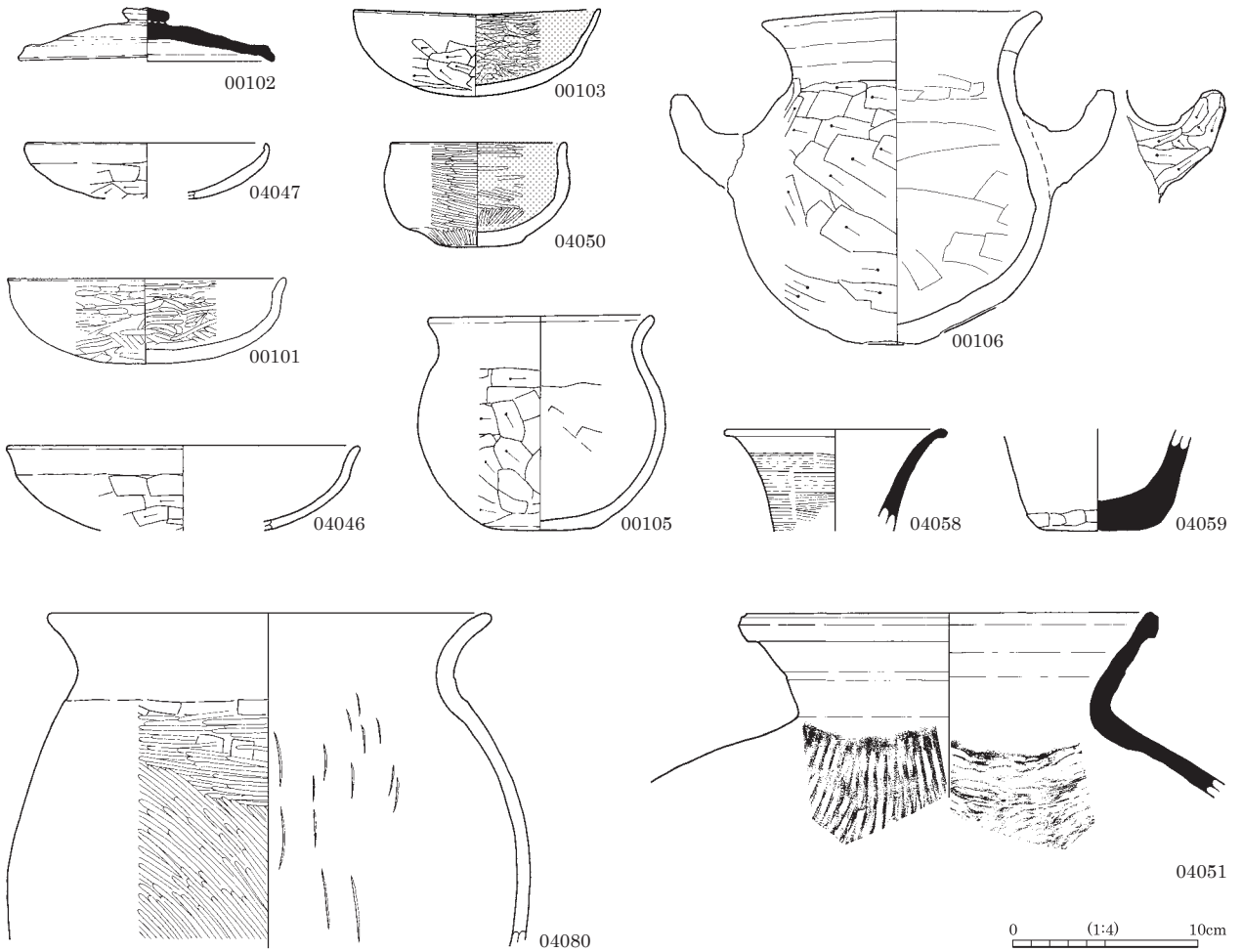

0 1:4 10cm

図版 120 古墳時代～古代の土器 (63)

SB4059 (2)

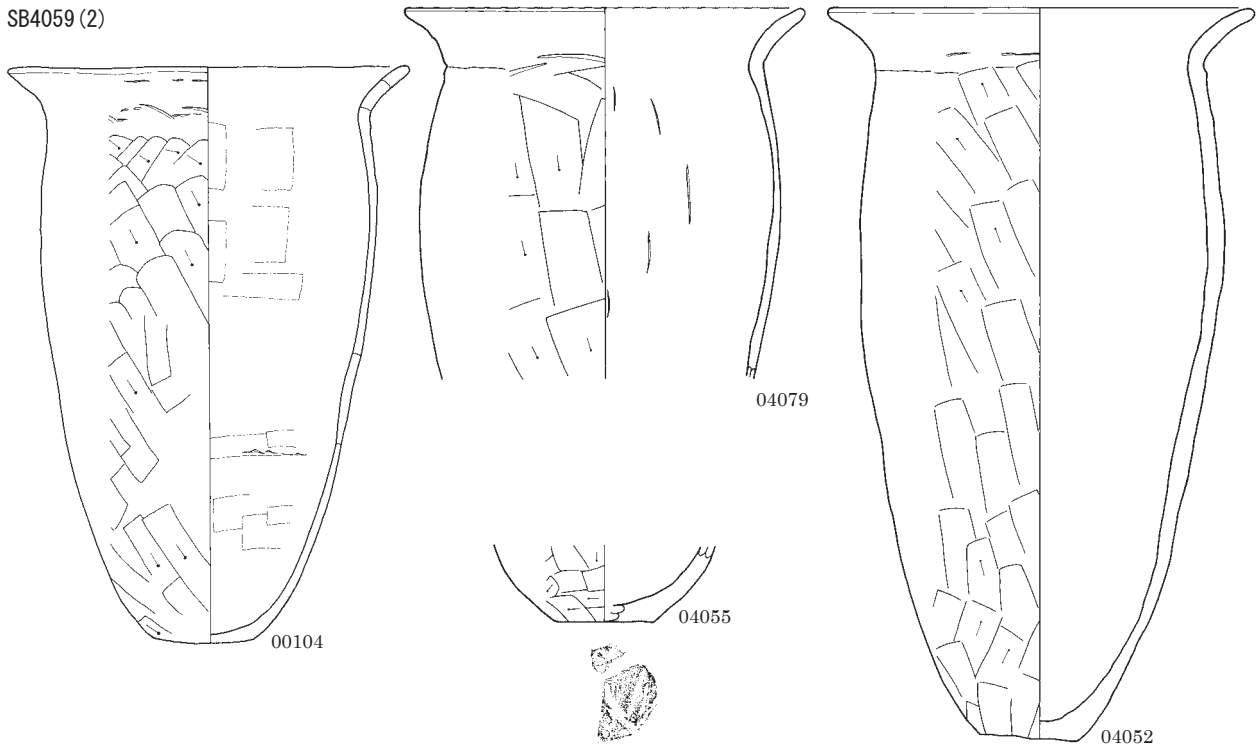

SB4061

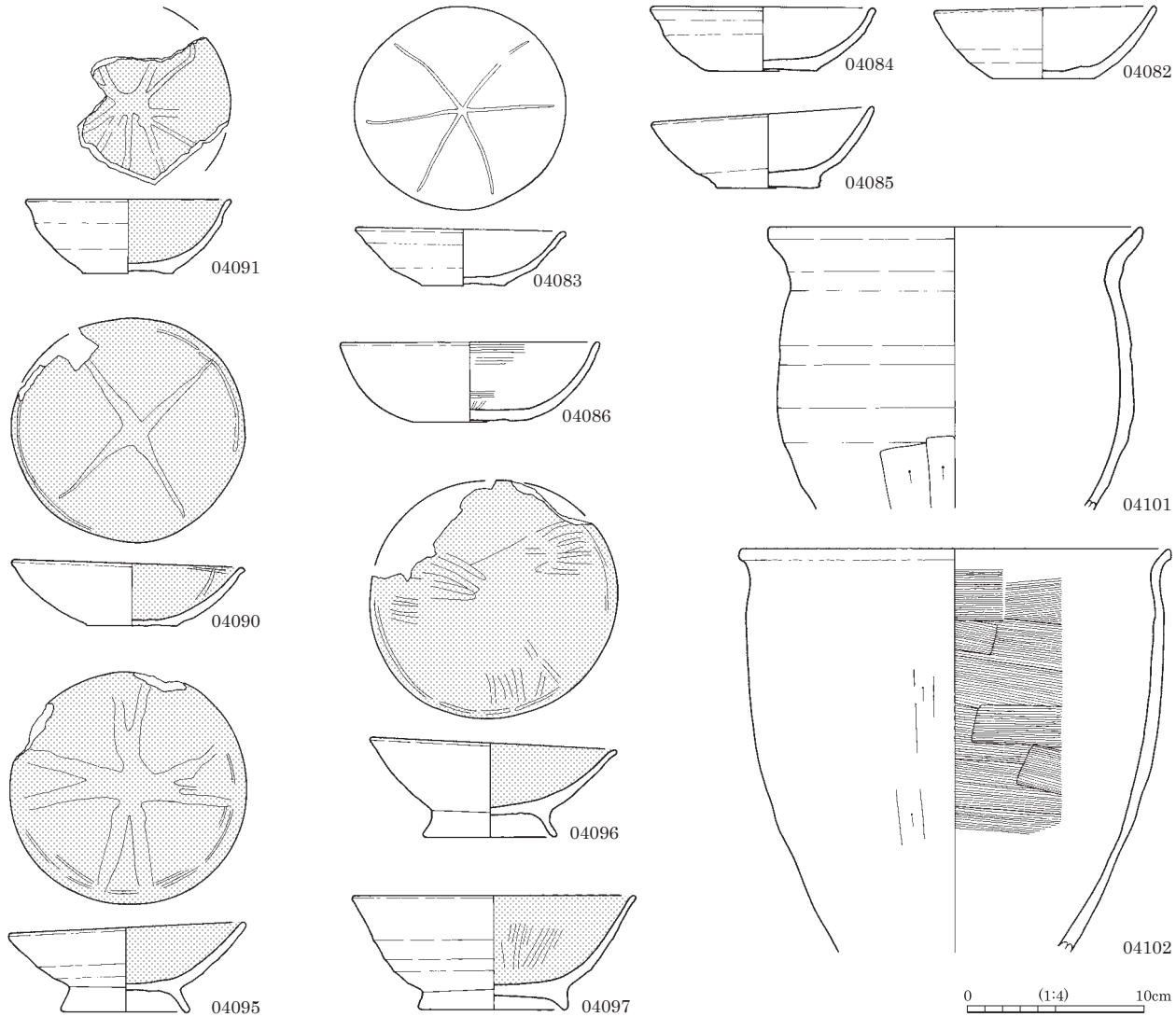

SB4062

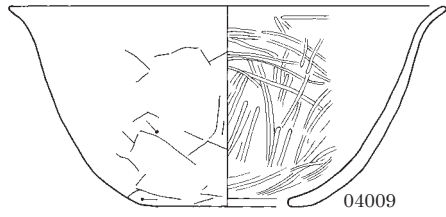

04009

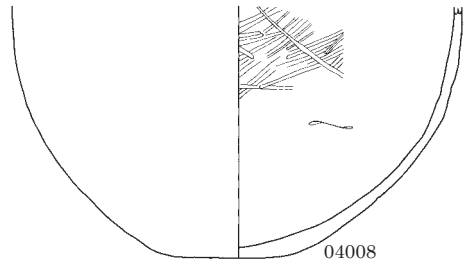

04008

SB4063



03878

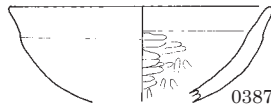

03877

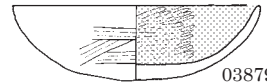

03879

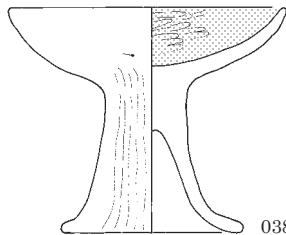

03884

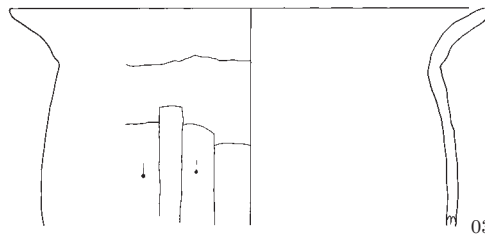

03887

SB4064



03655



03653

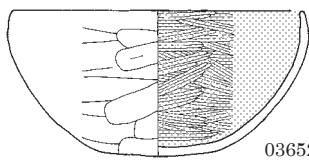

03652

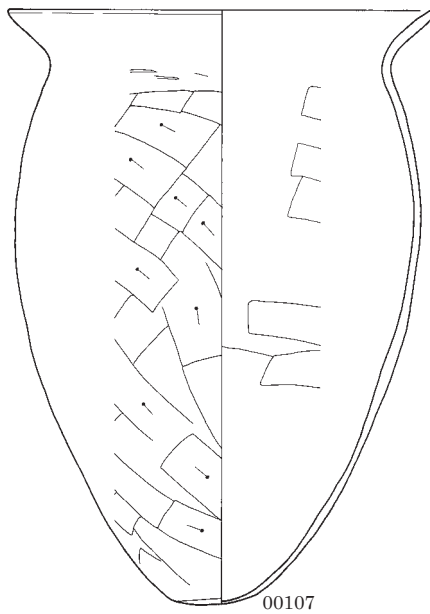

00107

SB4068

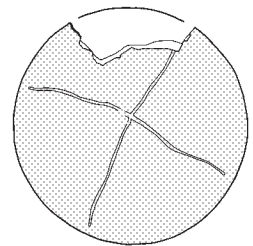

04105

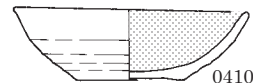

0 (1:4) 10cm

図版 122 古墳時代～古代の土器 (65)

SB5001

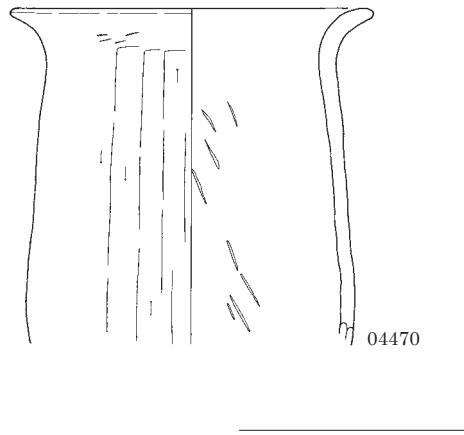

SB5002

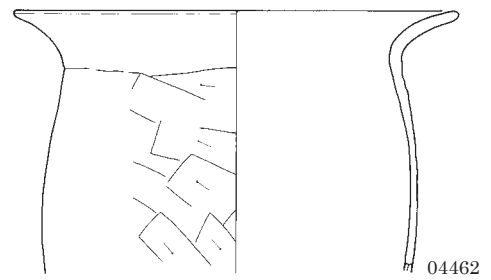
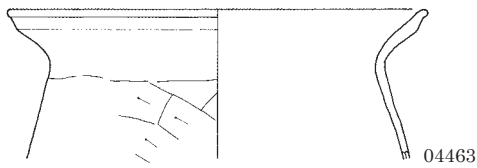
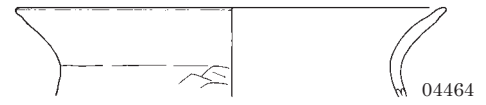
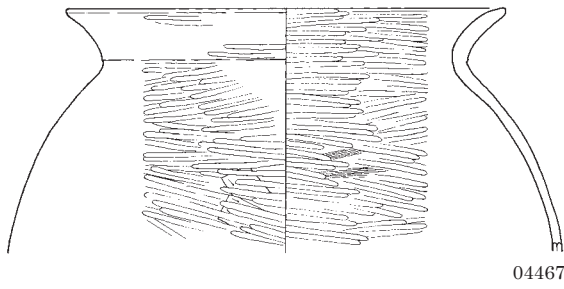
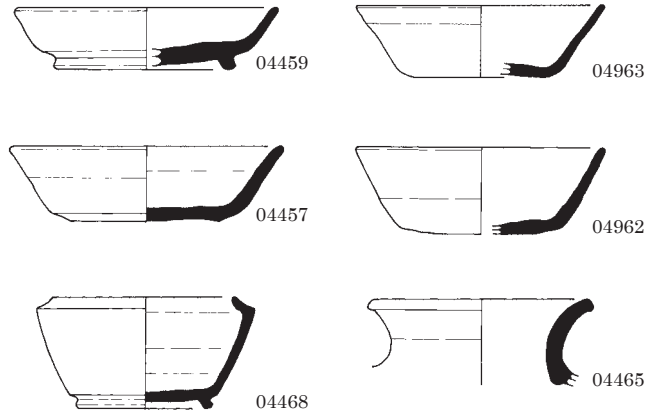

SB5003 (1)

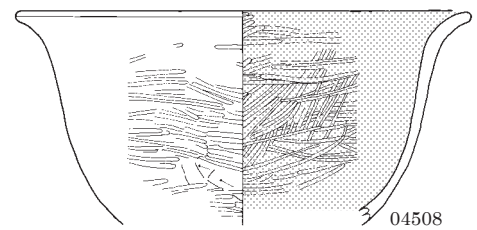
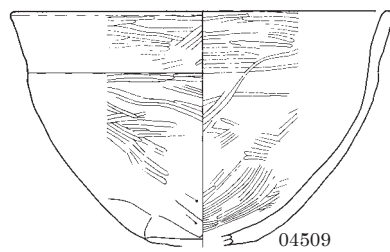
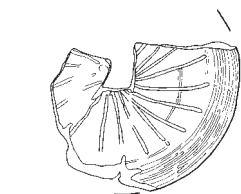
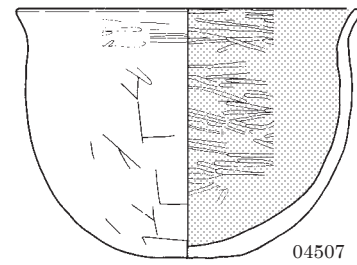
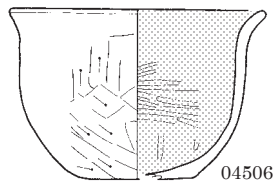
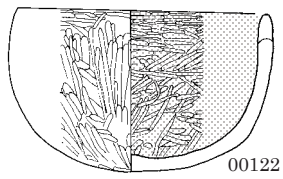
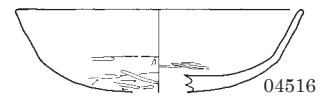
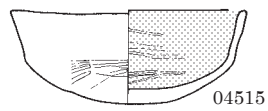
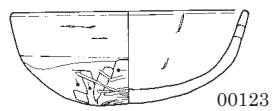

0 (1:4) 10cm

SB5003 (2)

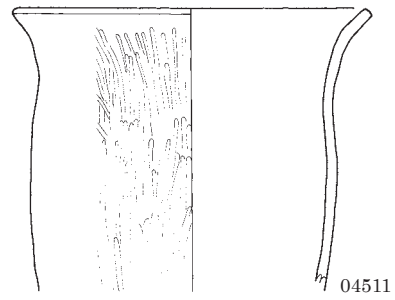
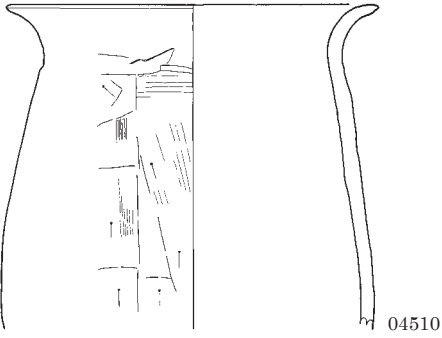
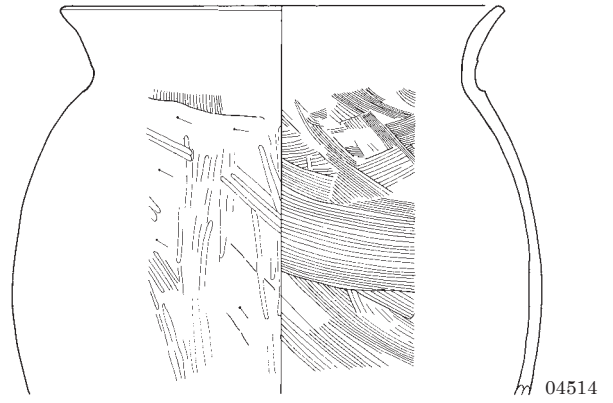
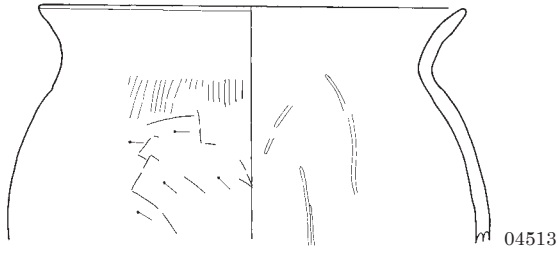

SB5005

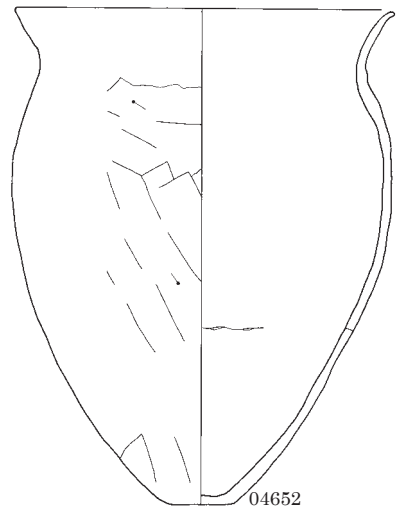
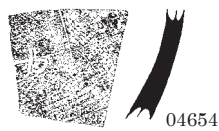
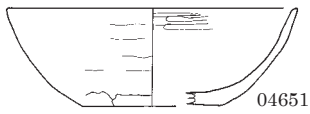
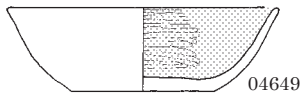
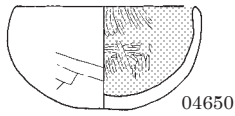

SB5006 (1)

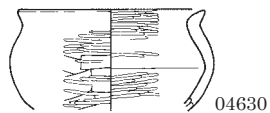
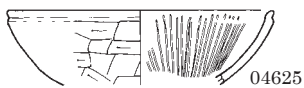
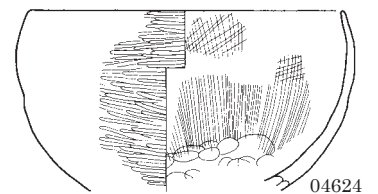
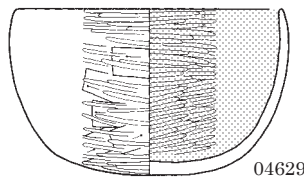
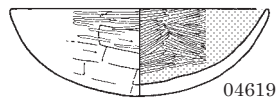
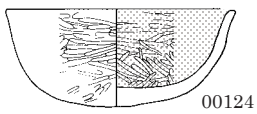
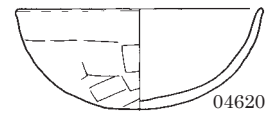
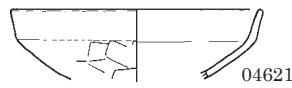
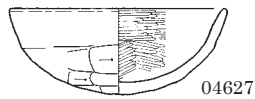
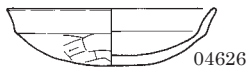

0 (1:4) 10cm

図版 124 古墳時代～古代の土器 (67)

SB5006 (2)

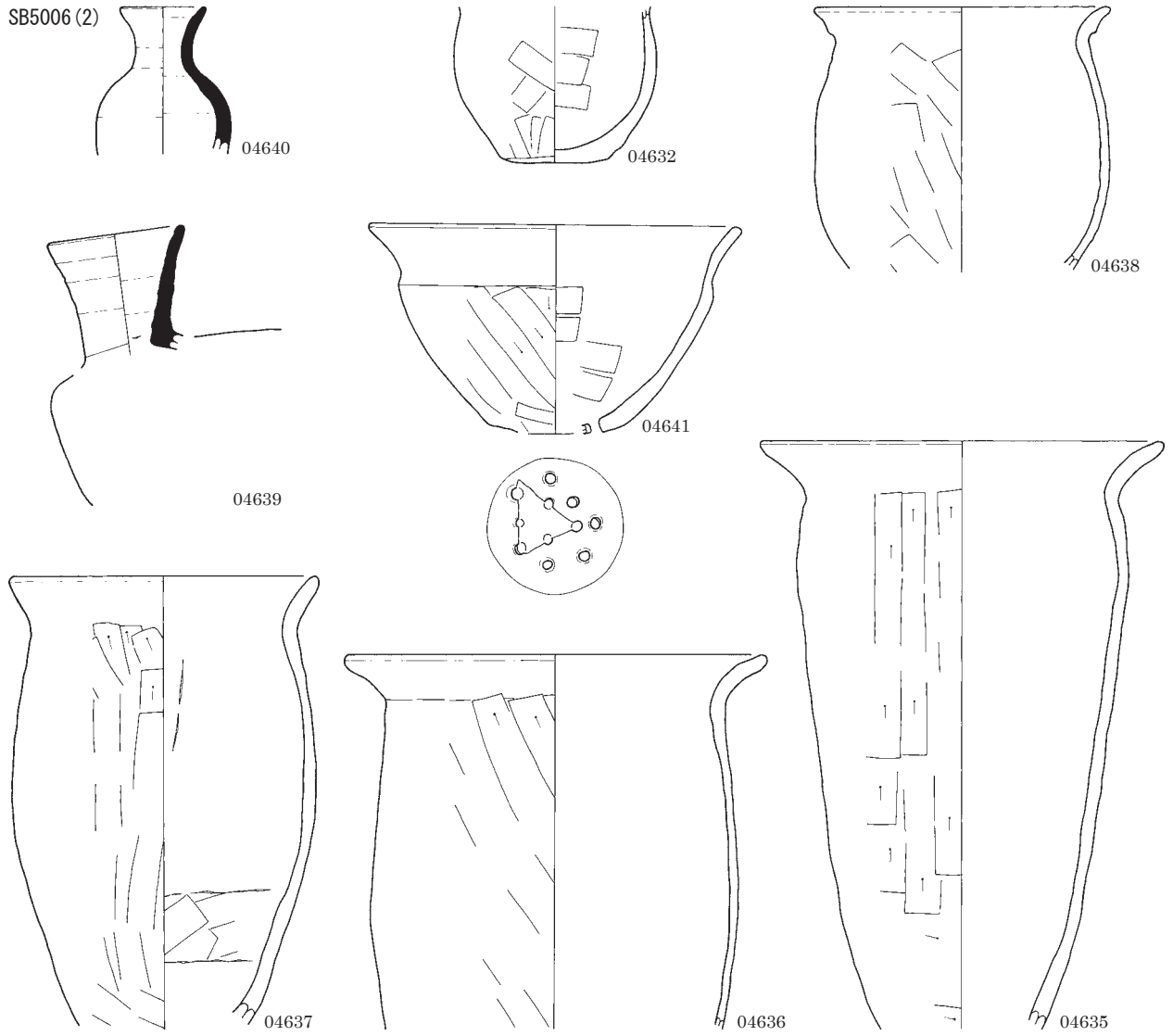

SB5007

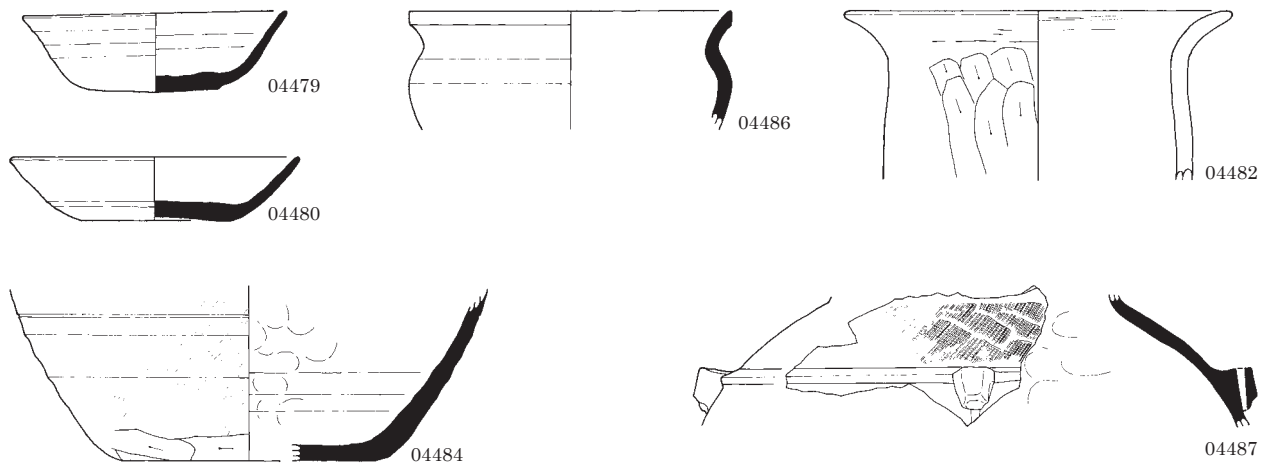

SB5008



0 1:4 10cm

SB5009

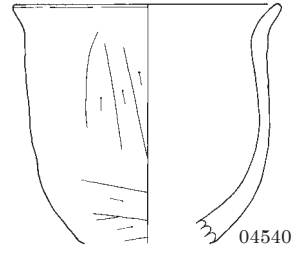
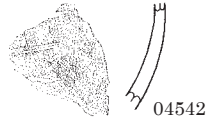

SB5010

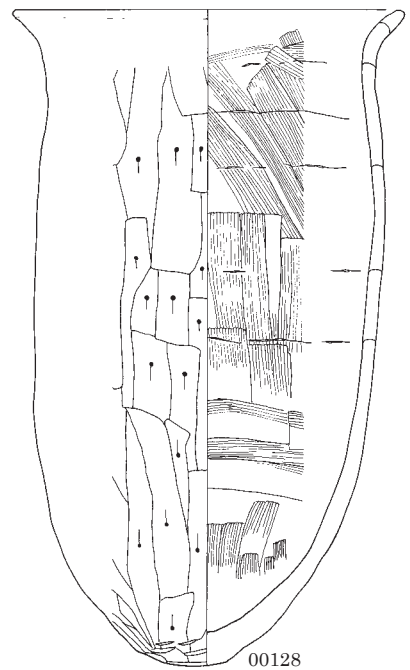
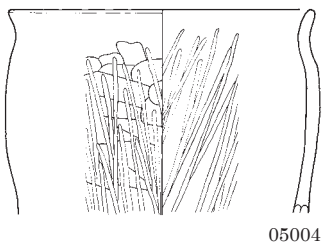
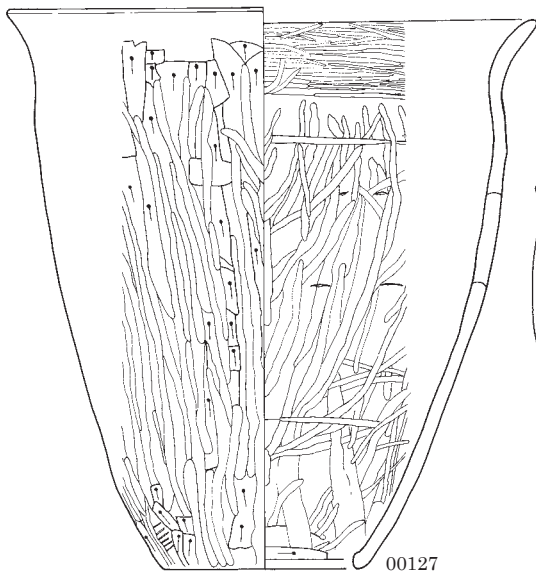
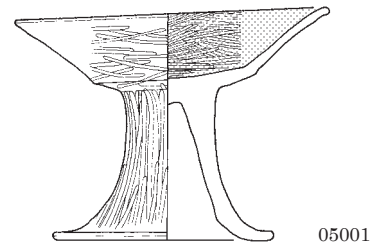
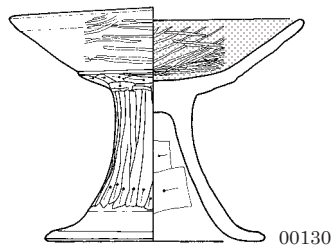
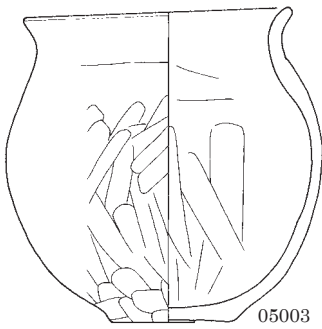
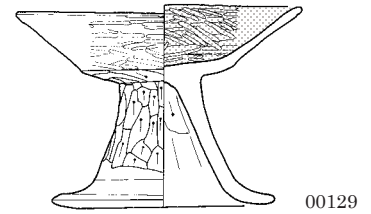
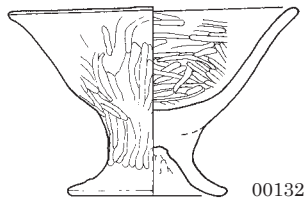
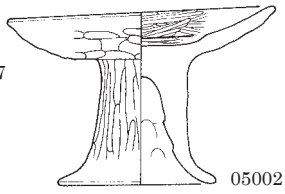
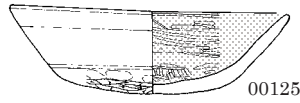
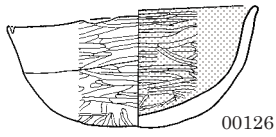
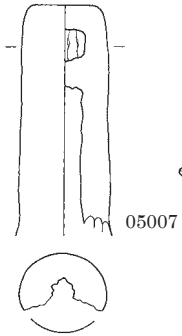
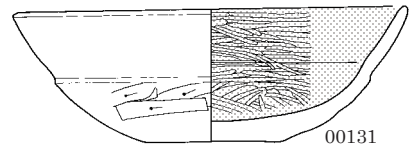
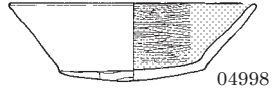
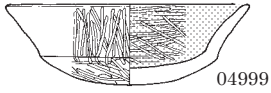

0 (1:4) 10cm

図版 126 古墳時代～古代の土器 (69)

SB5011

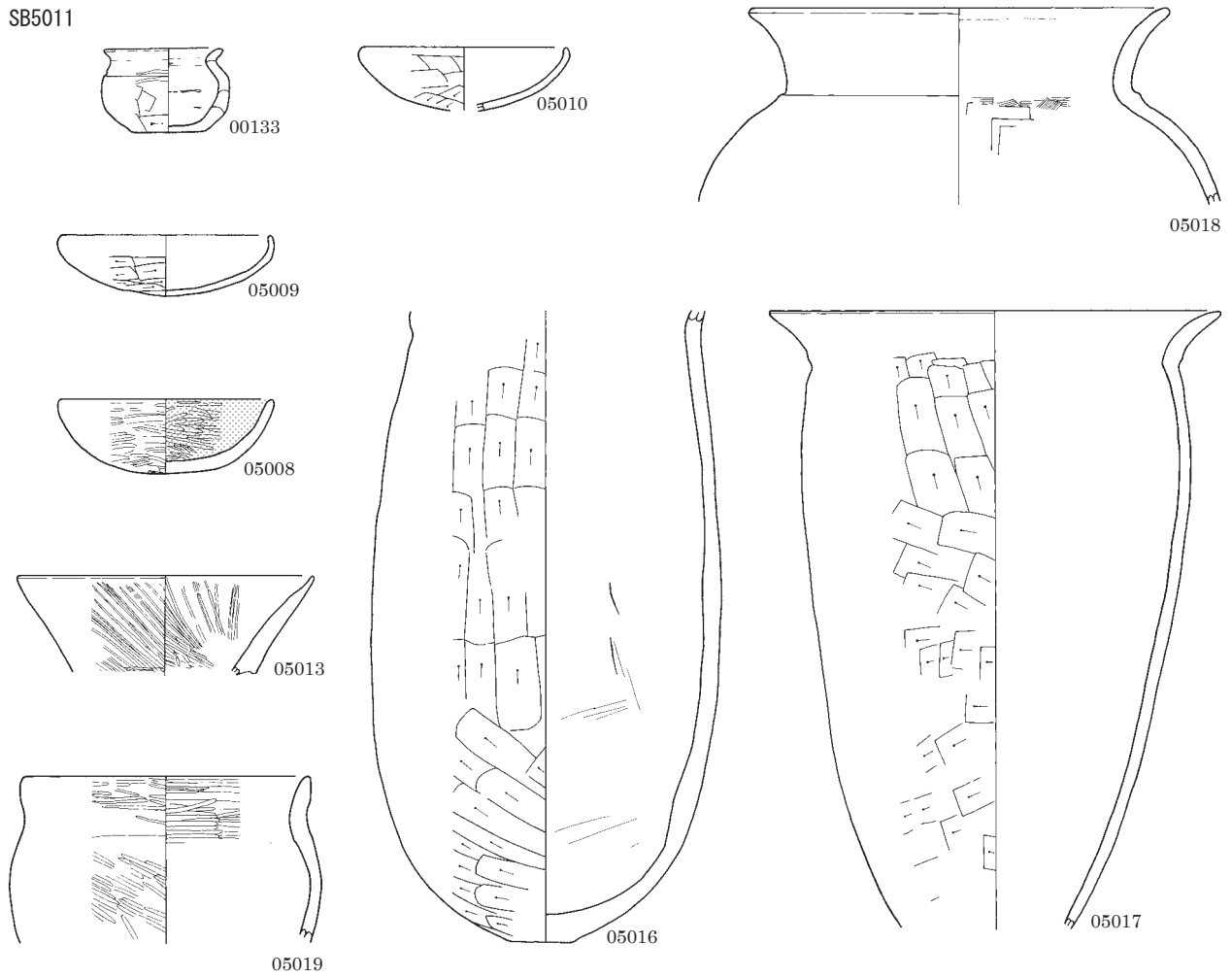

SB5012

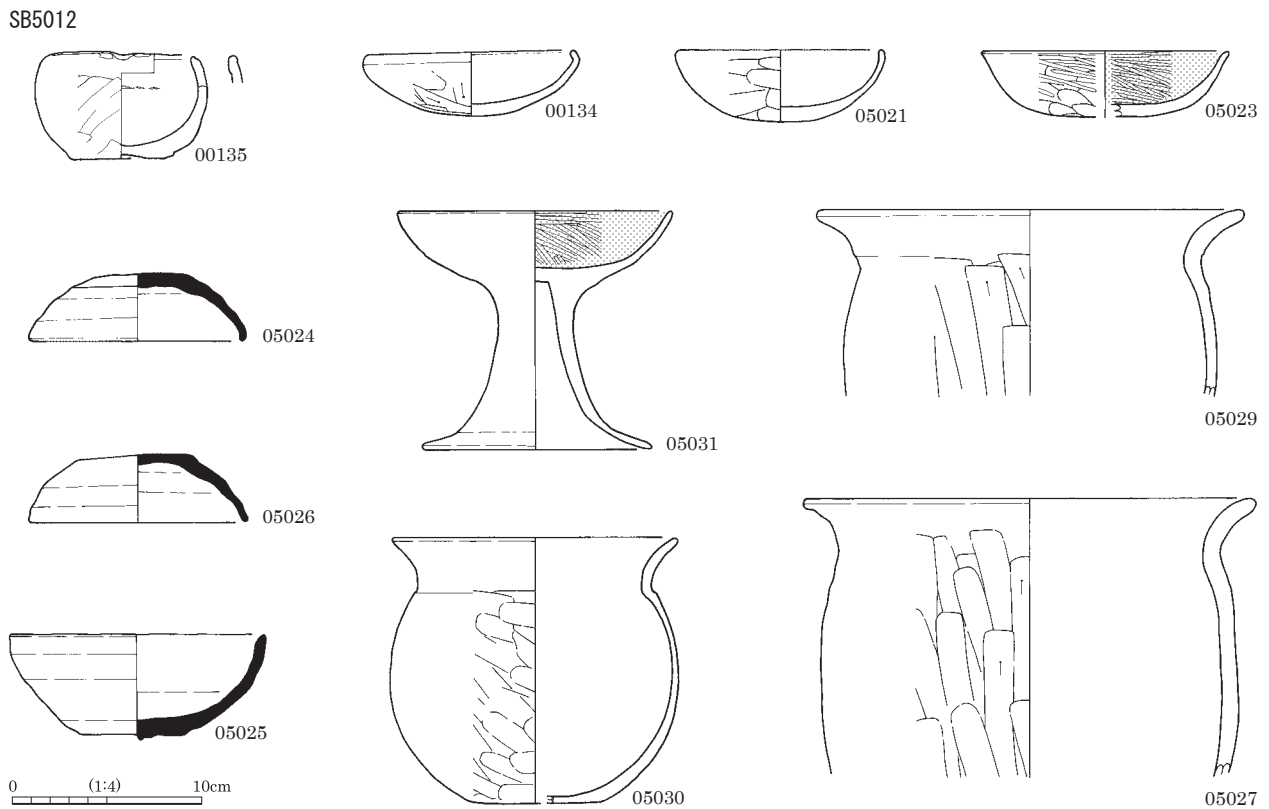

SB5013

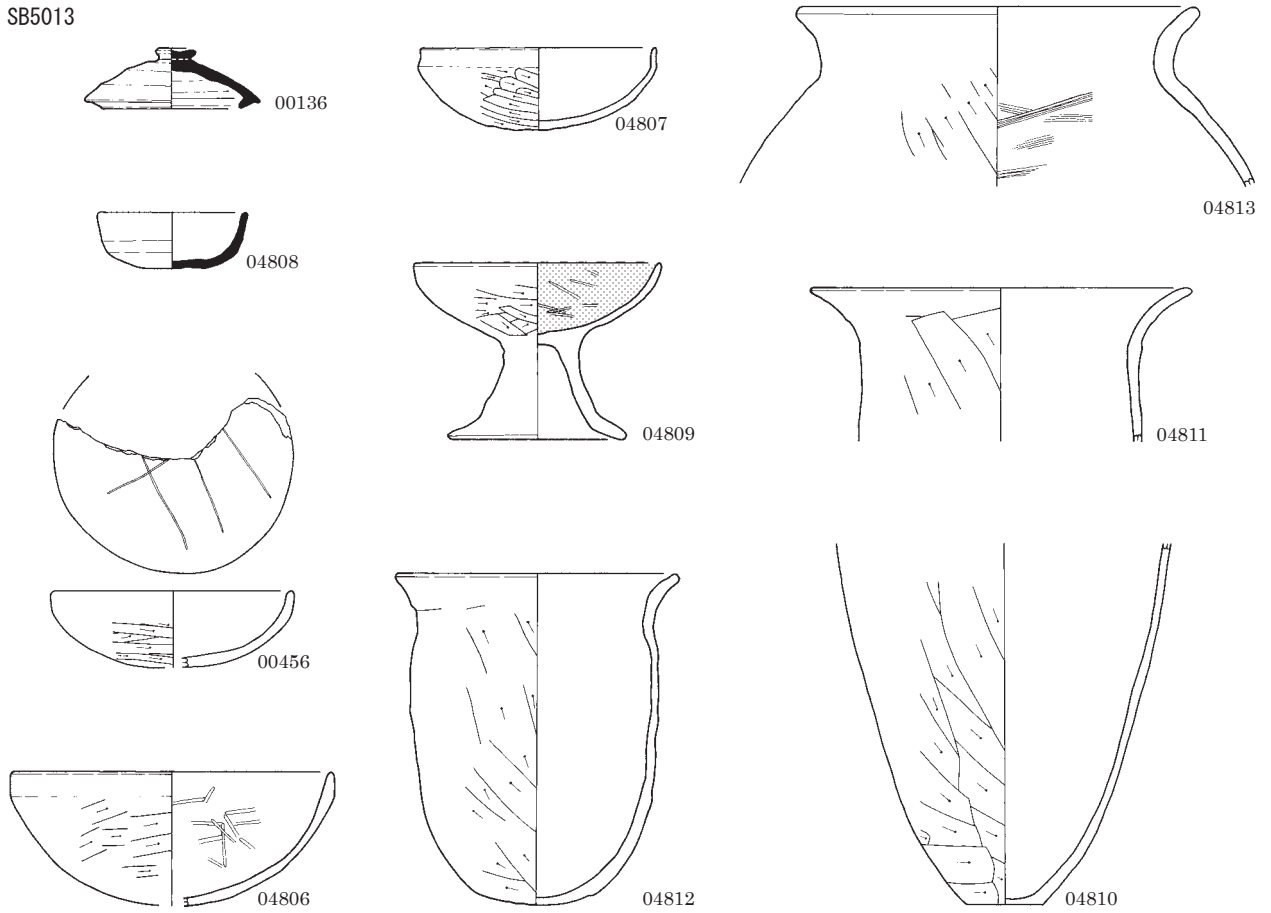

SB5014

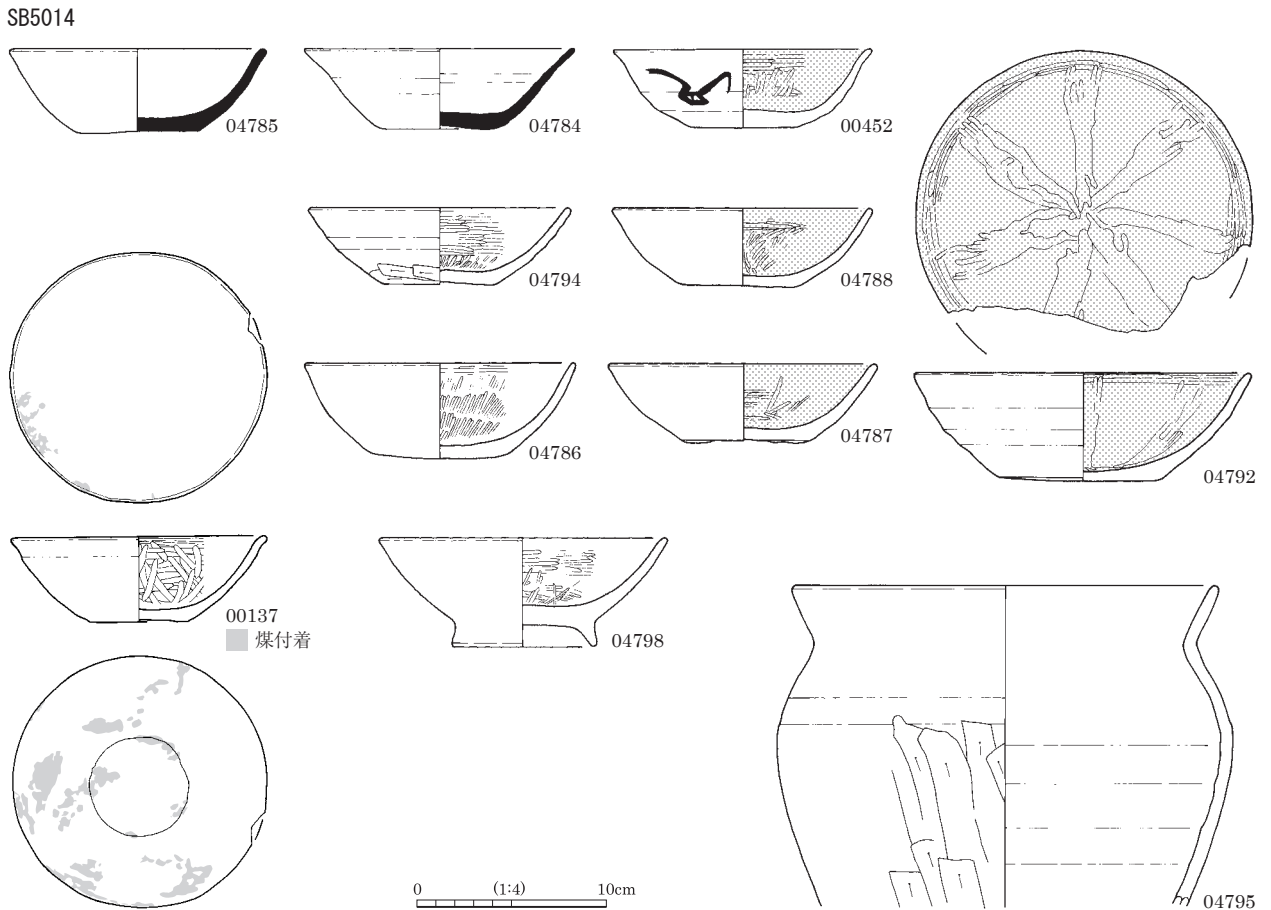

図版 128 古墳時代～古代の土器 (71)

SB5015

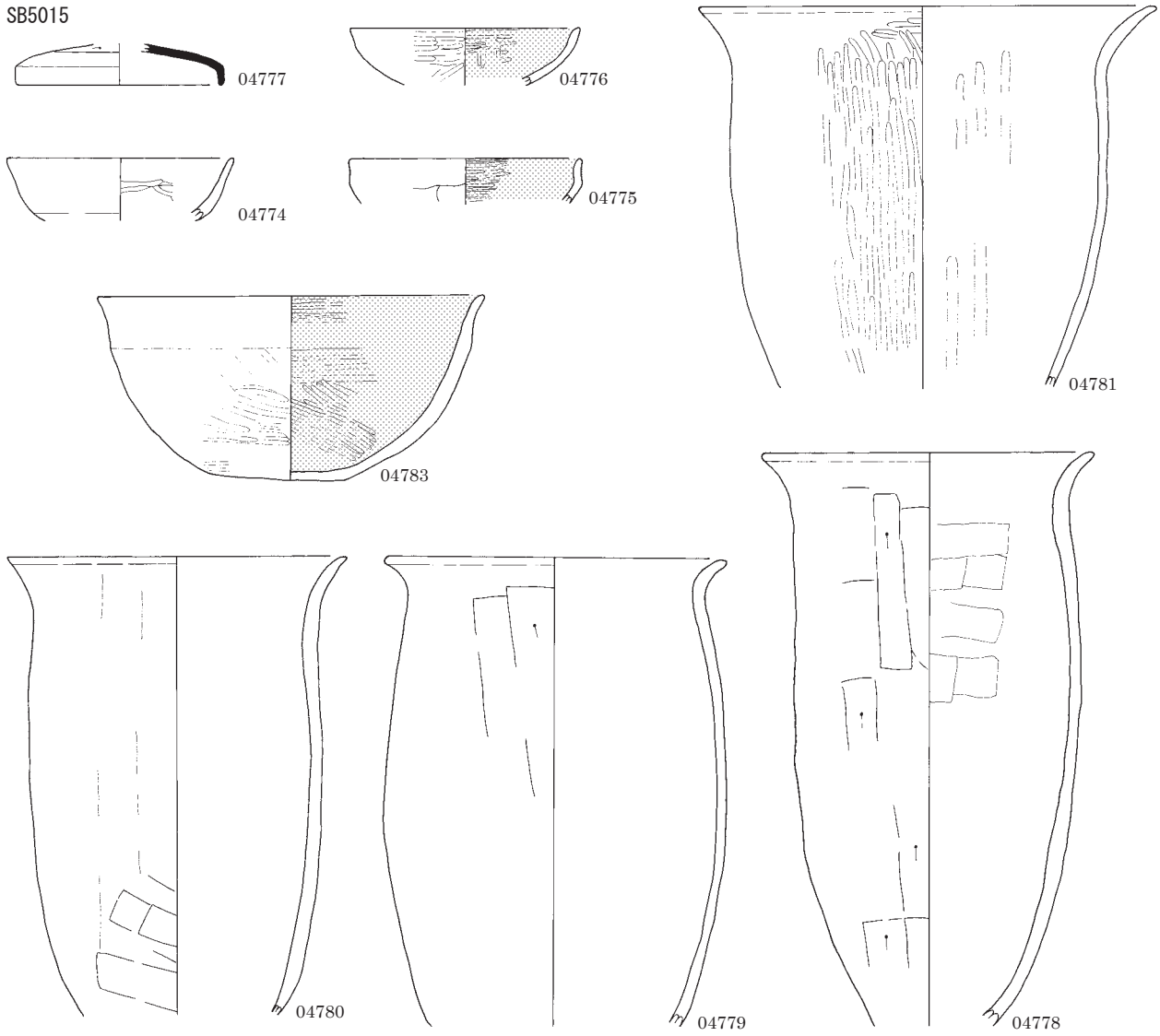

SB5016

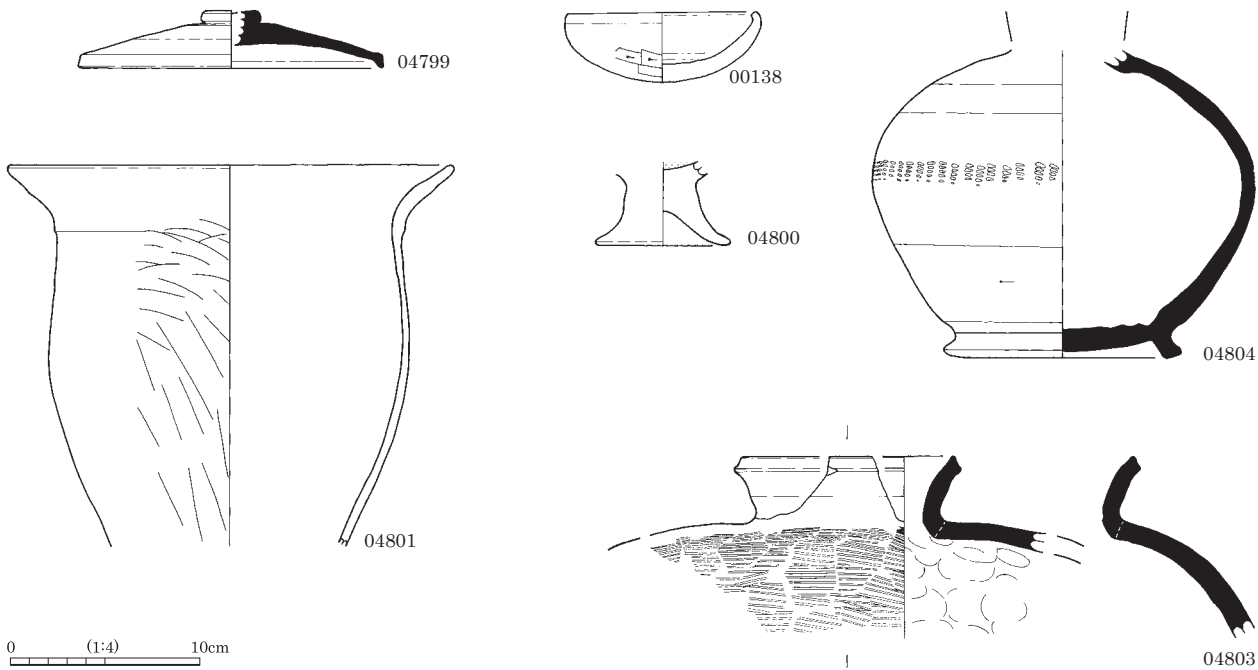

SB5017

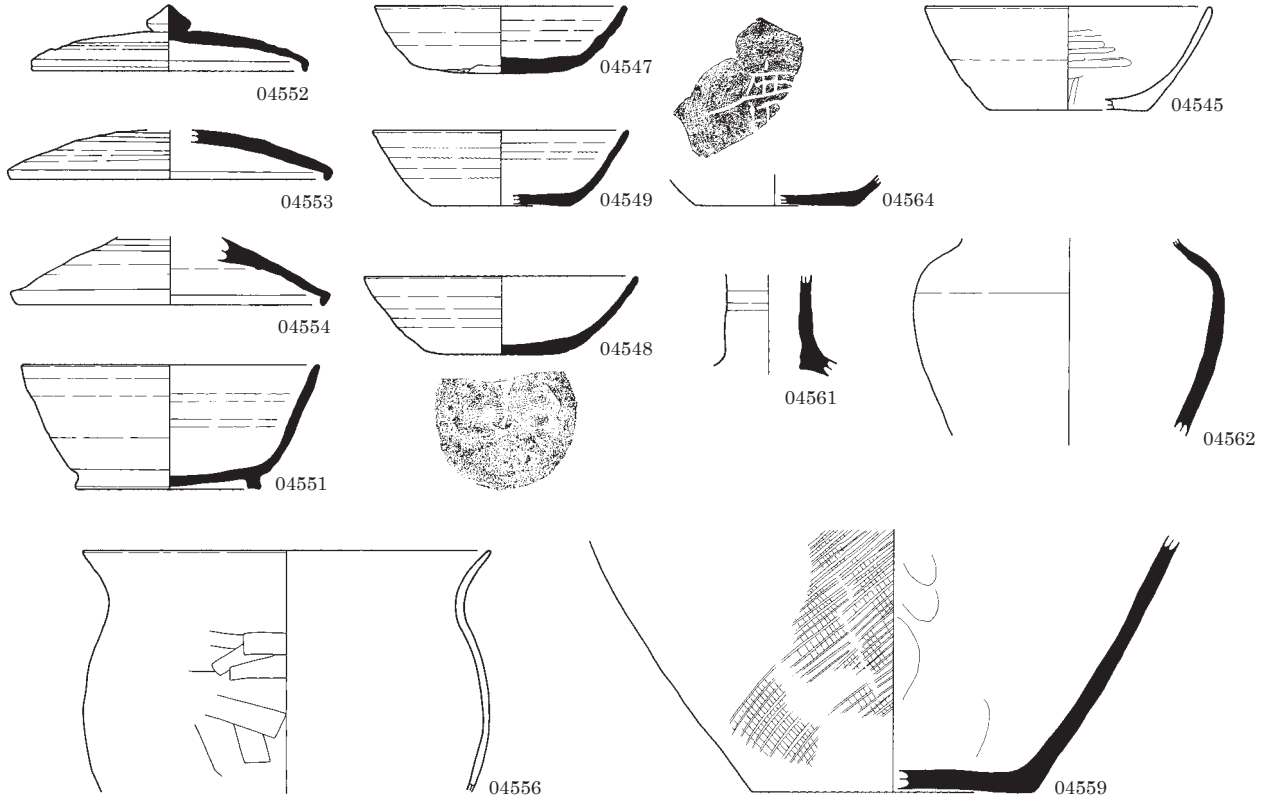

SB5018

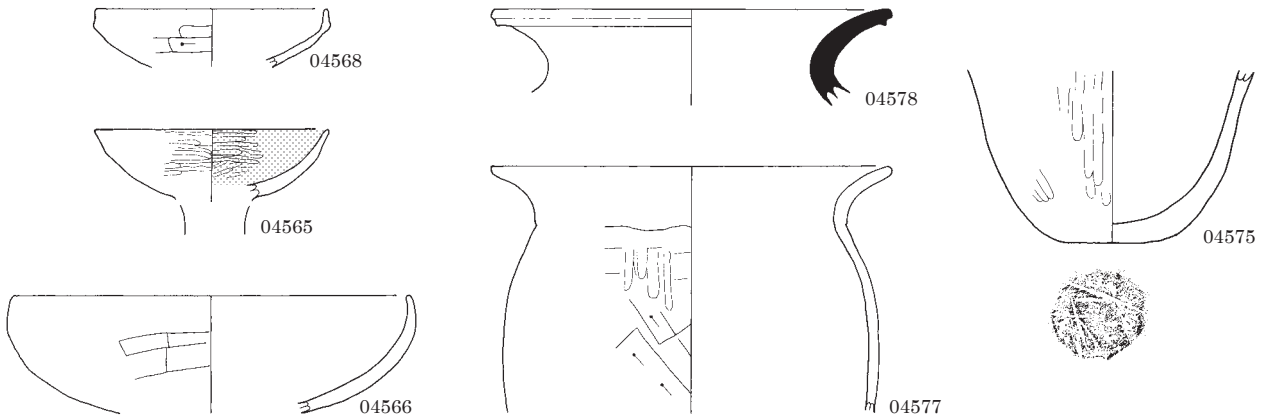

SB5019

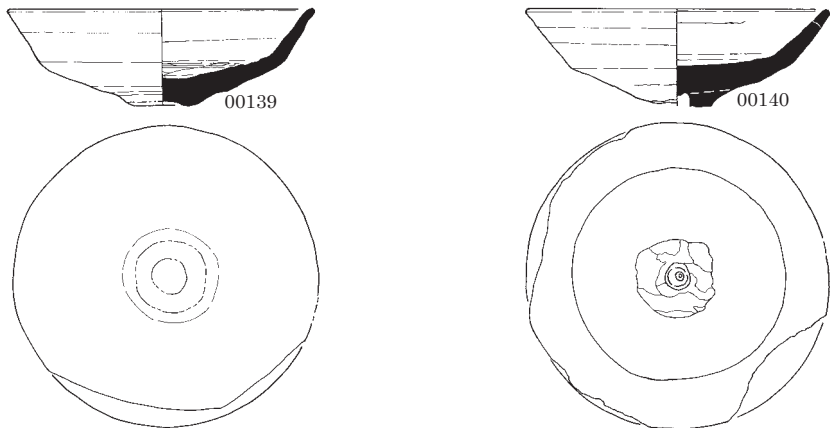

図版 130 古墳時代～古代の土器 (73)

SB5021

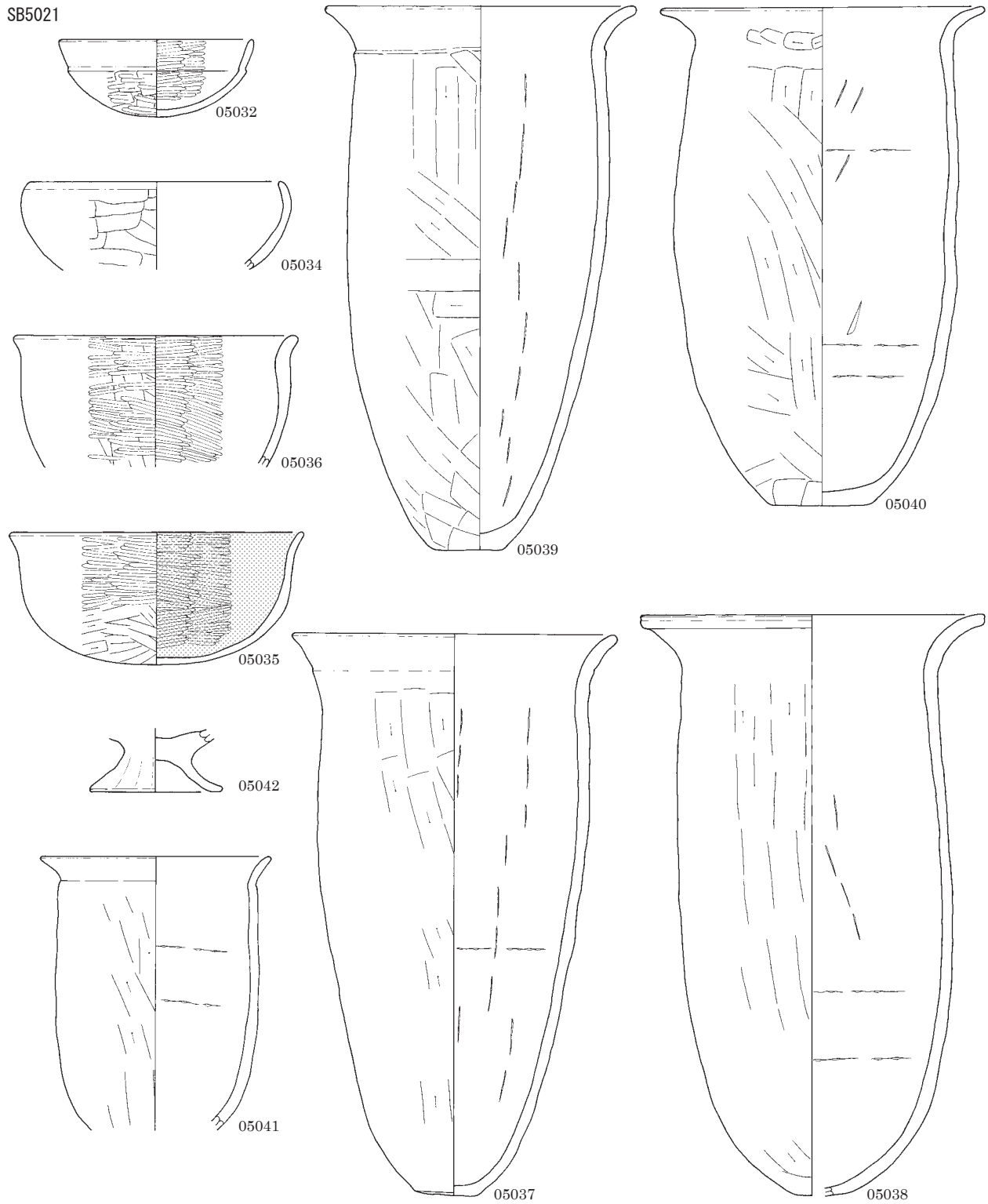

SB5022 (1)

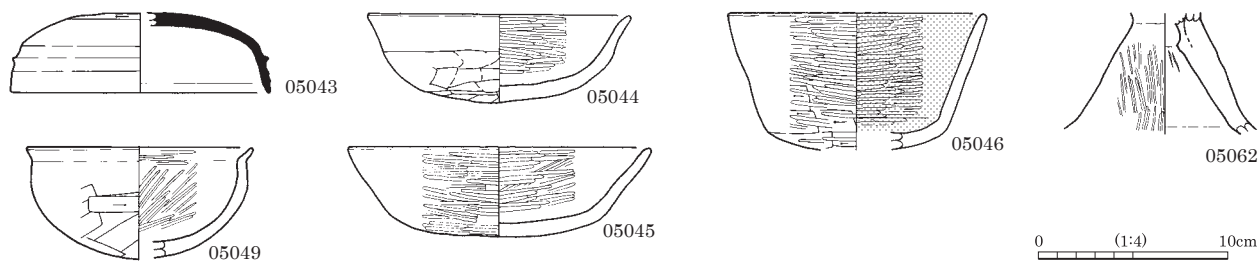

SB5022 (2)

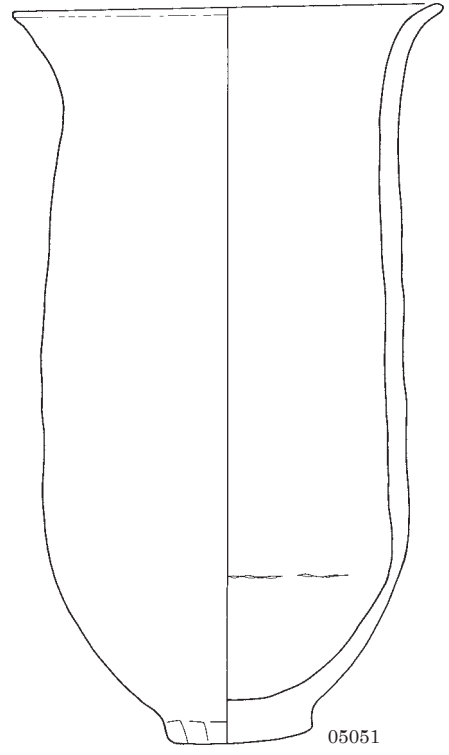
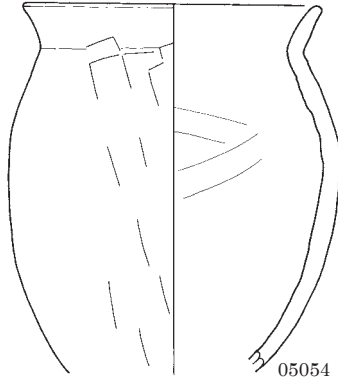
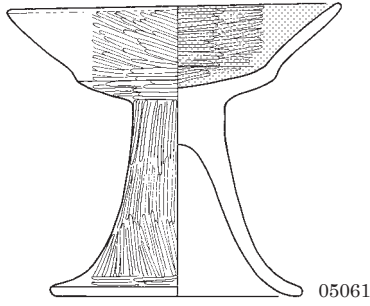
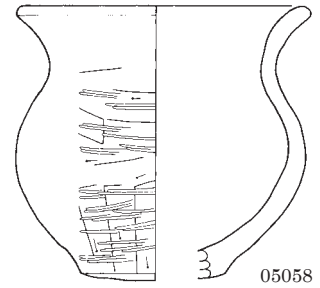
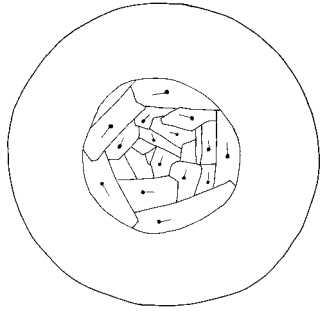
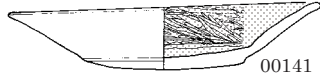

SB5023

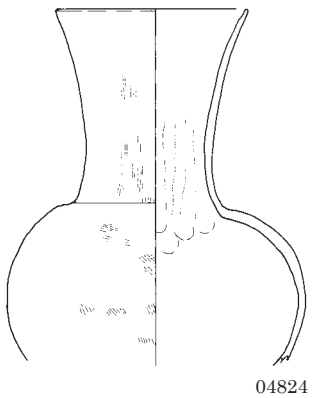
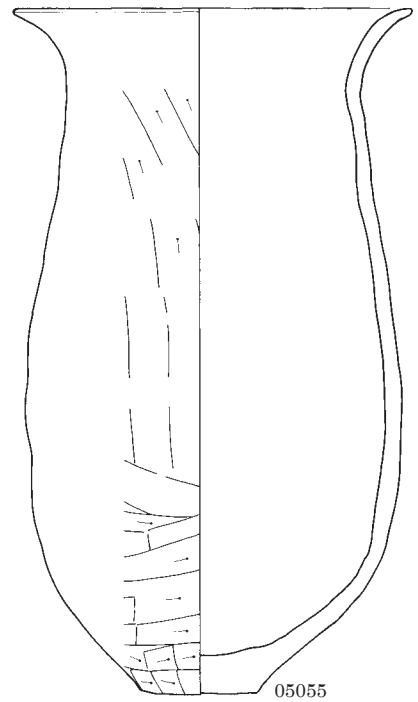
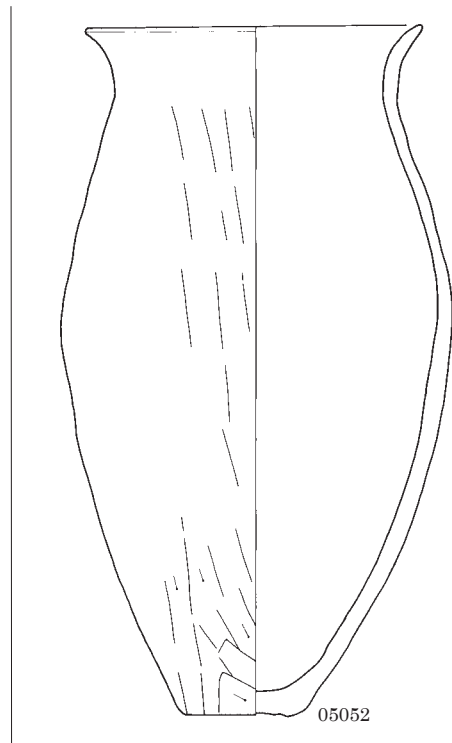
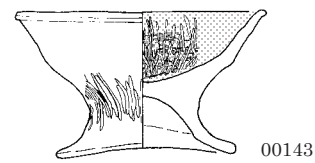
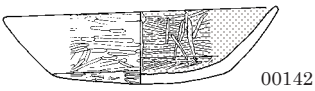
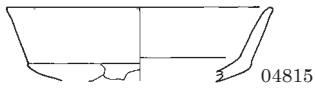

0 1:4 10cm

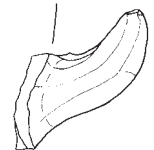
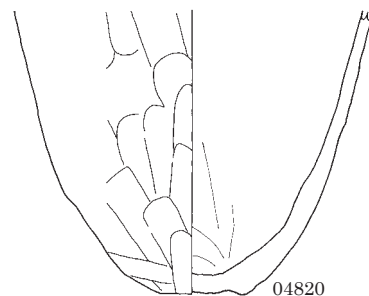
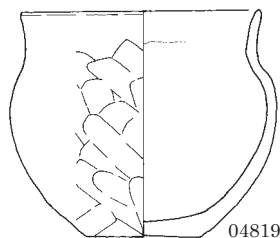

04825

図版 132 古墳時代～古代の土器 (75)

SB5024

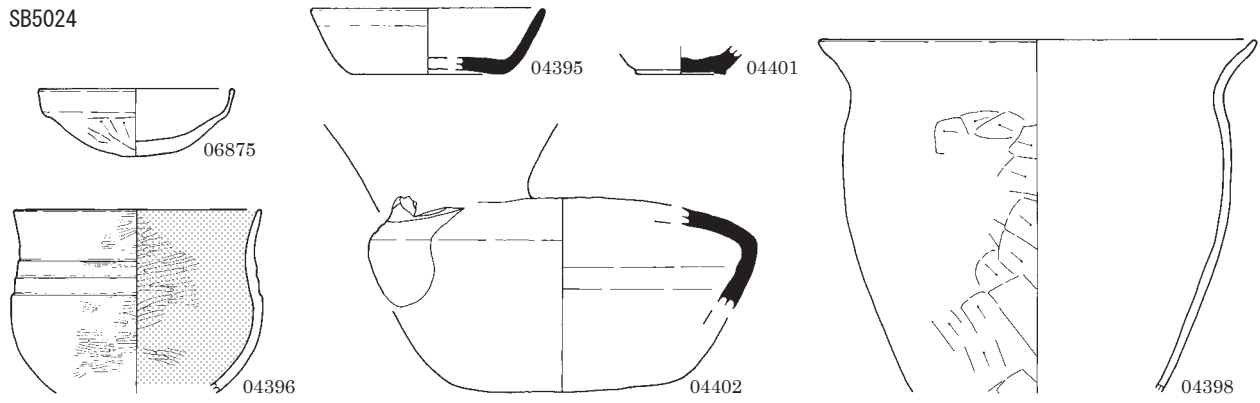

SB5026

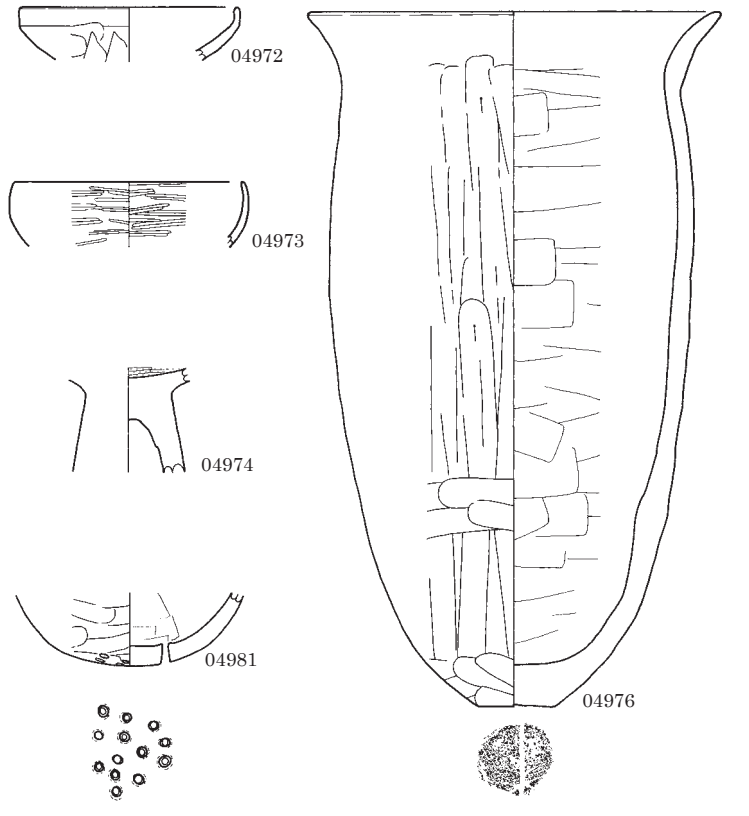

SB5027

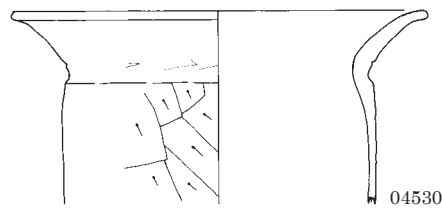
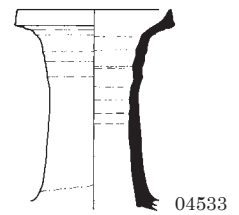
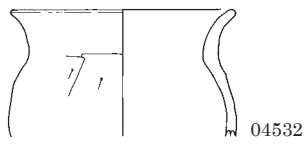
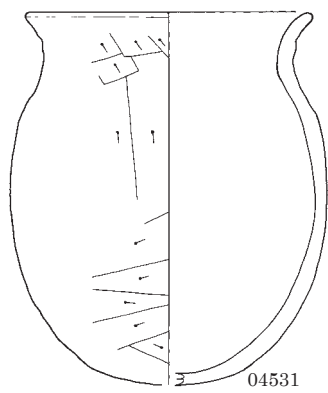
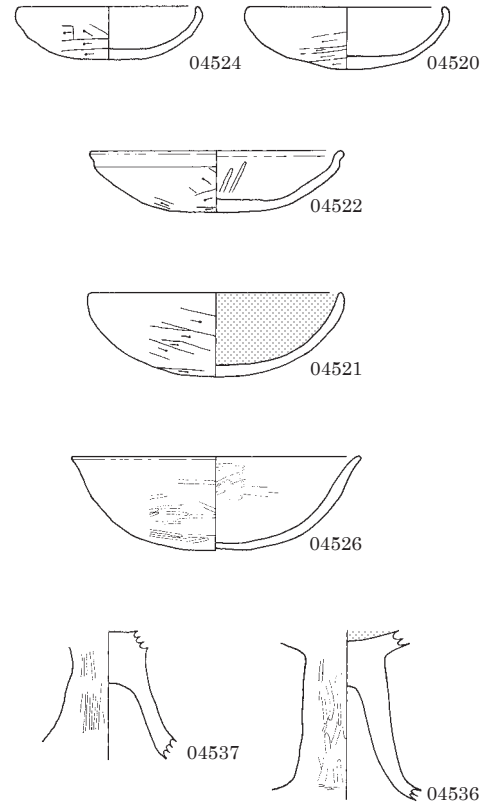

SB5028



0 (1:4) 10cm

SB5029

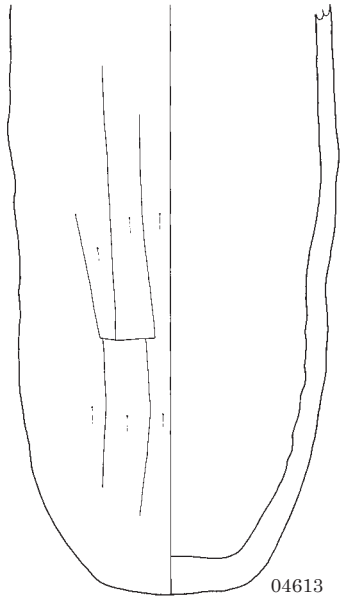
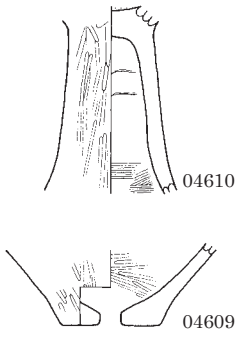

SB5030

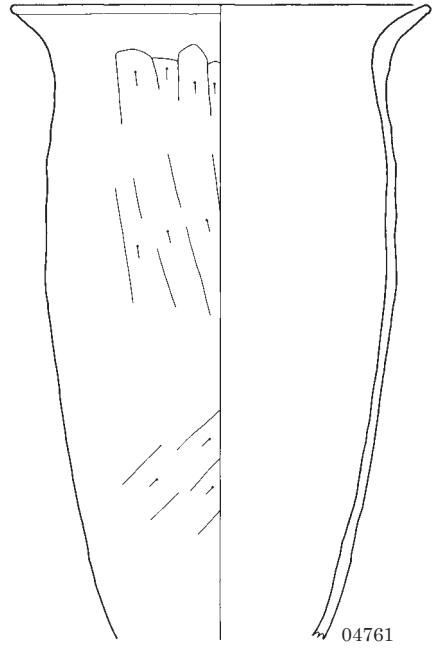
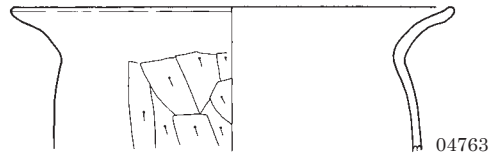
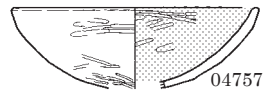
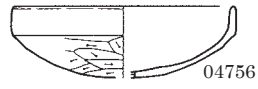
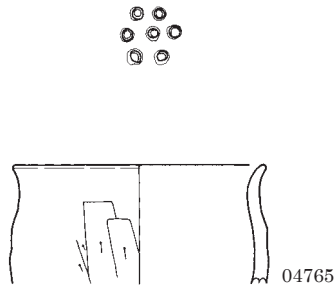
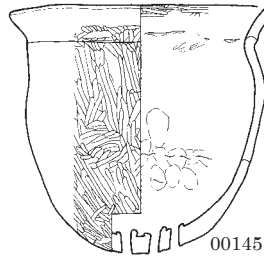
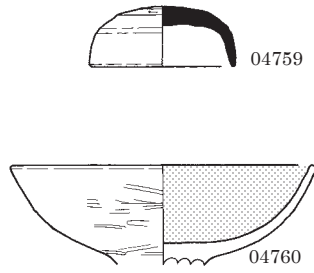

SB5031

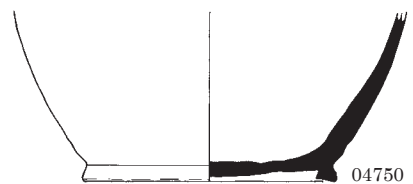
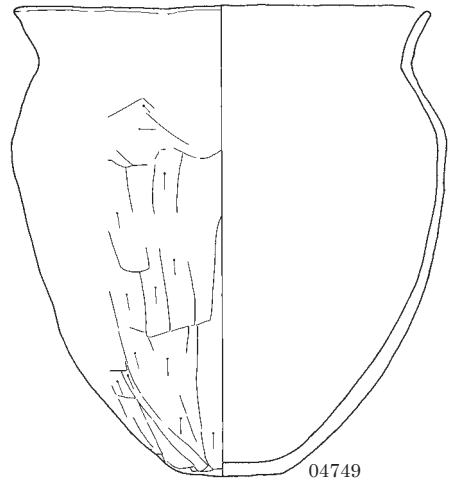
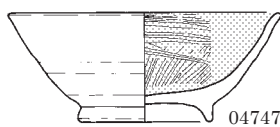
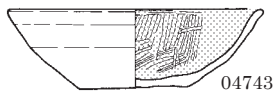
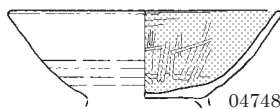
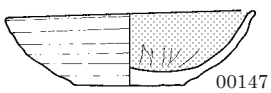
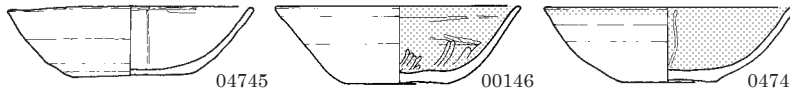
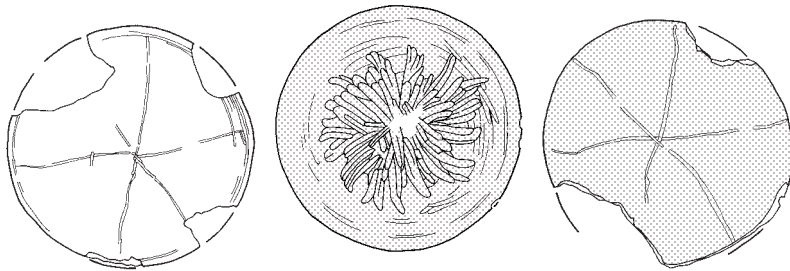

0 (1:4) 10cm

図版 134 古墳時代～古代の土器 (77)

SB5034

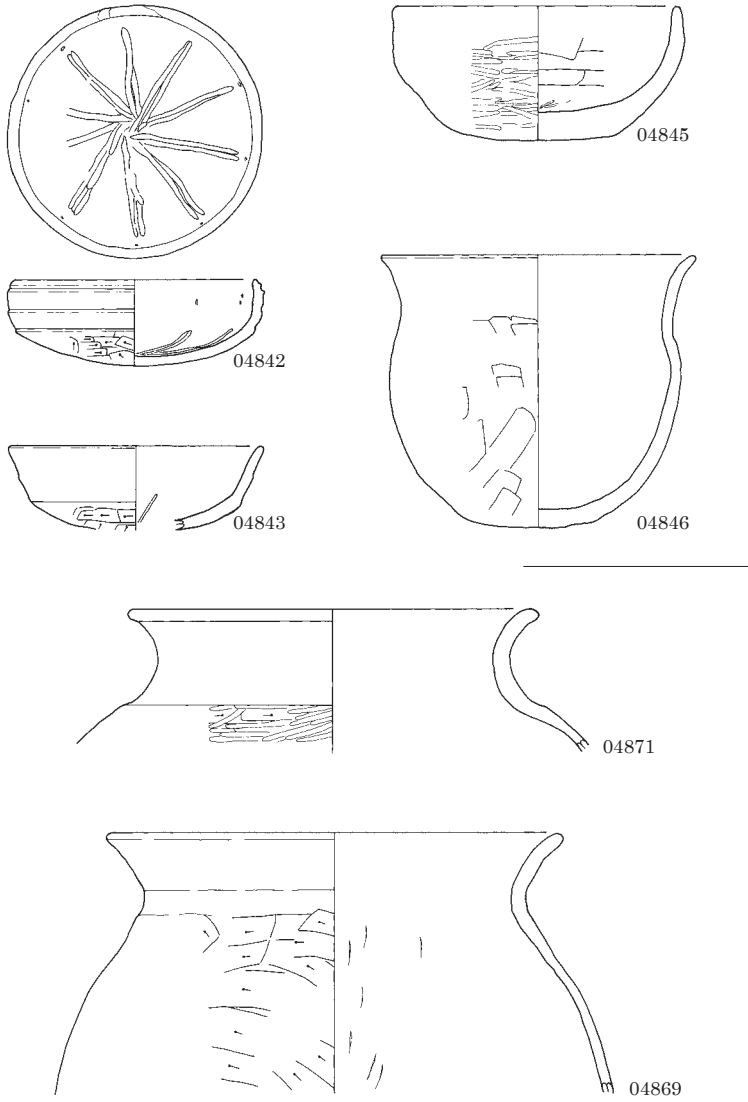

SB5035

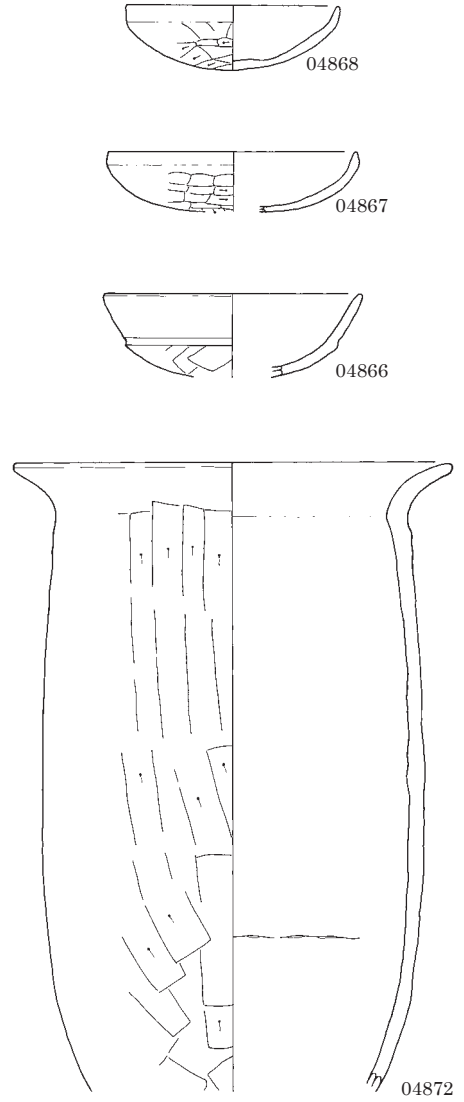

SB5036

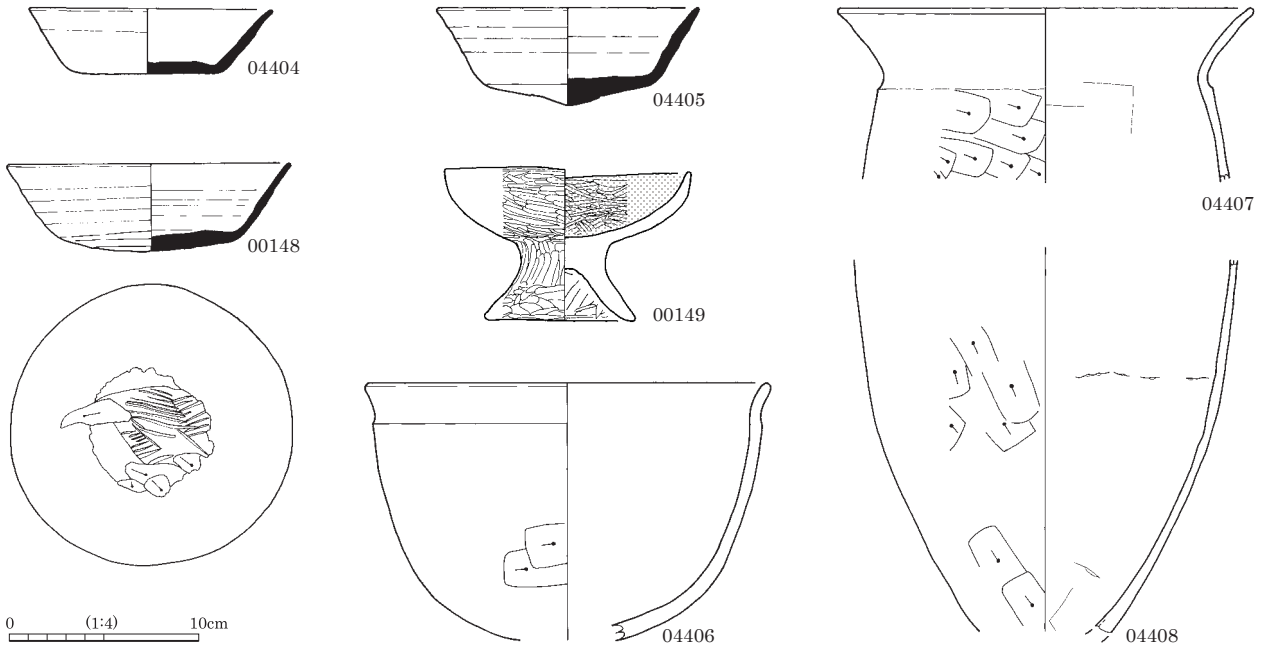

0 (1:4) 10cm

SB5037

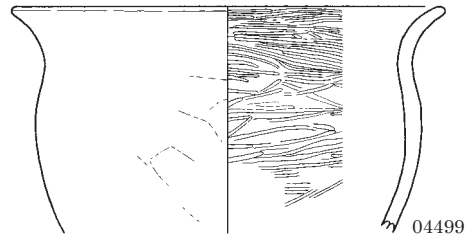
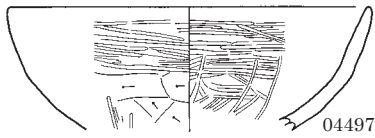

SB5039

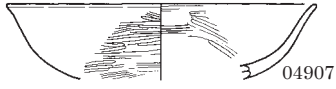

SB5040

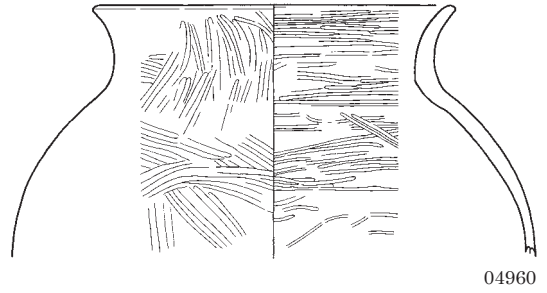
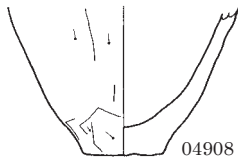

SB5043

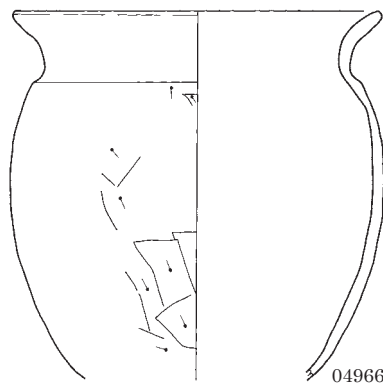
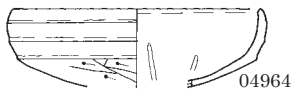

SB5045

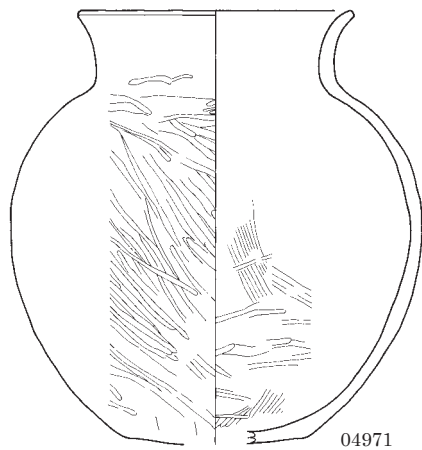
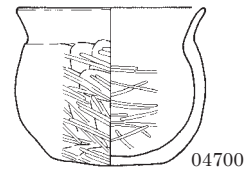
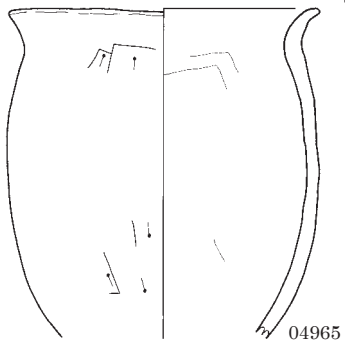
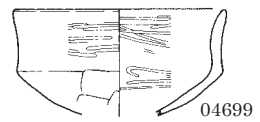

SB5048

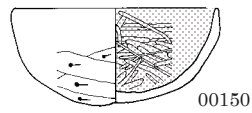
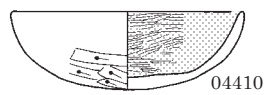

SB5052

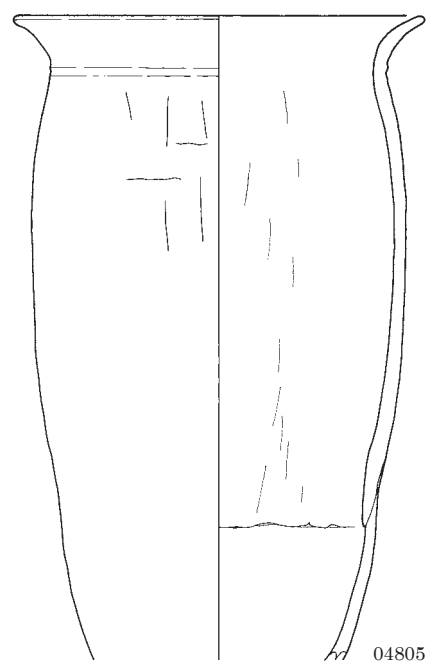

SB5053・5057

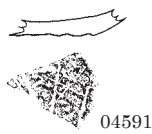

0 1:4 10cm

図版 136 古墳時代～古代の土器 (79)

SB5054

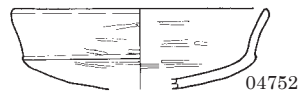

04752

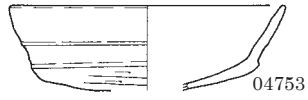

04753

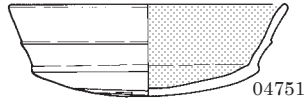

04751

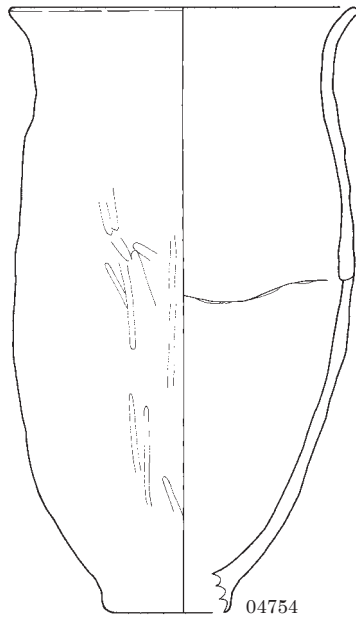

04754

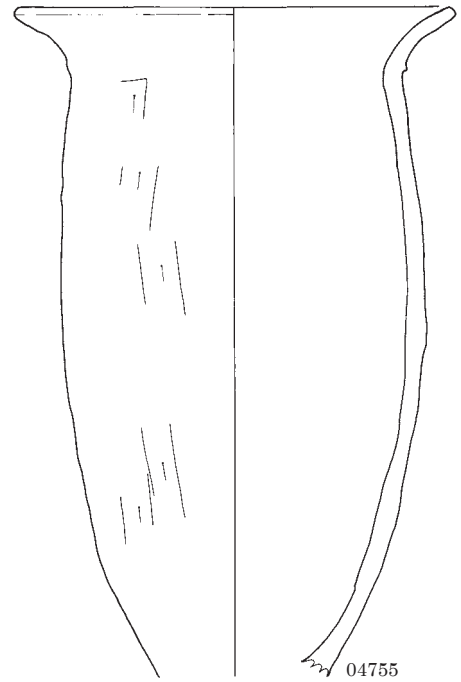

04755

SB5057

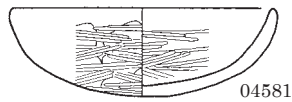

04581

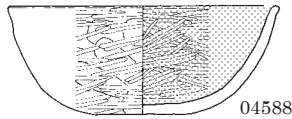

04588

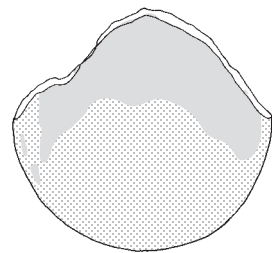

04589

■ 赤色顔料付着

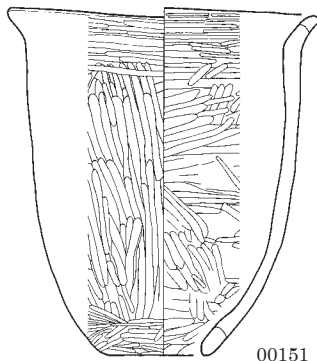

00151

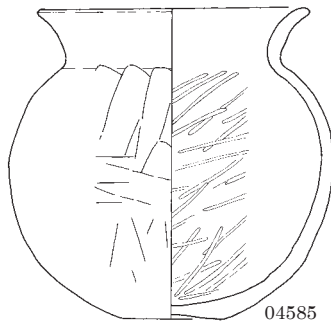

04585

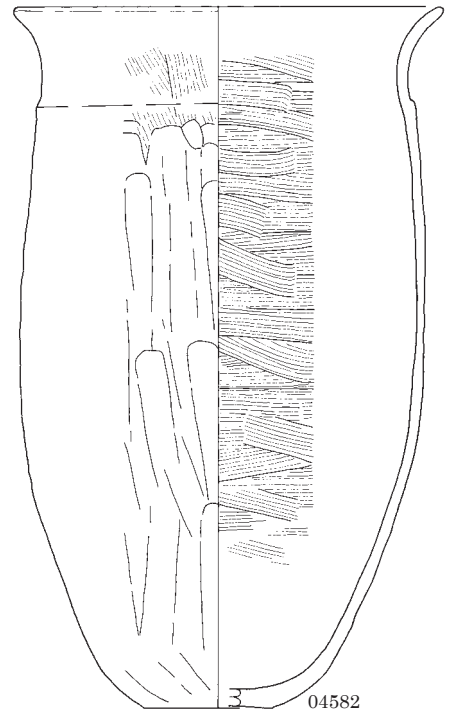

04582

0 10cm (1:4)

SB6001

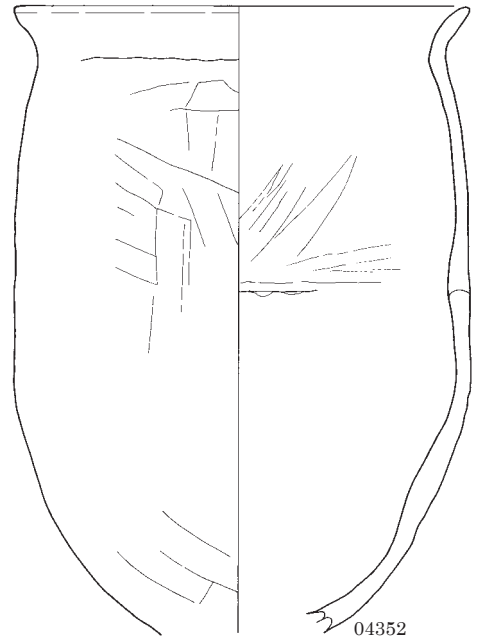
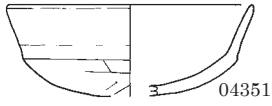

SB6002

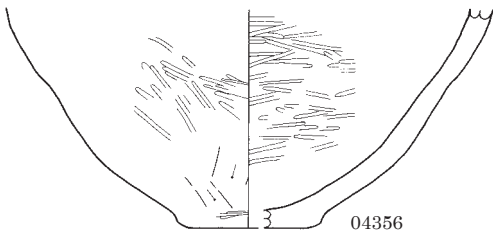

SB6003

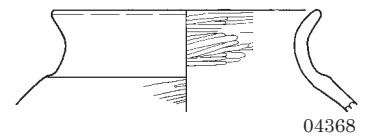
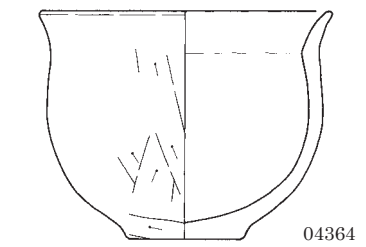
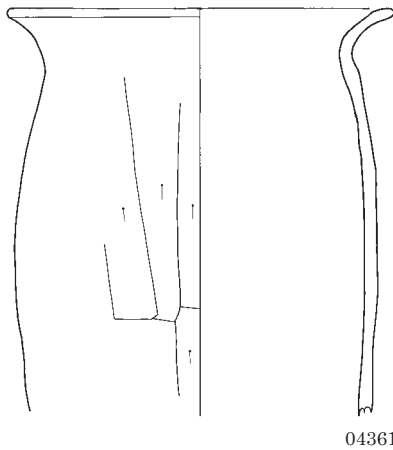
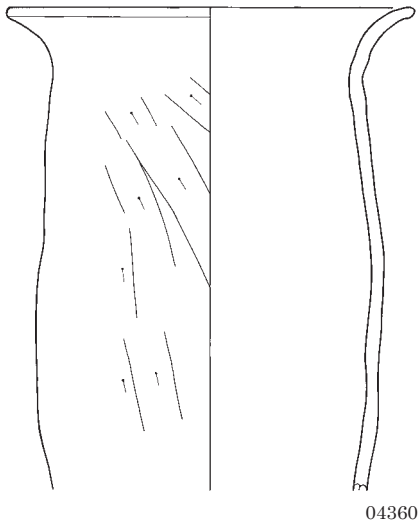
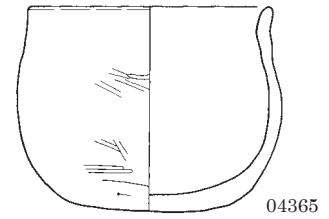
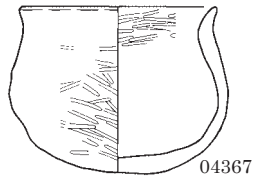
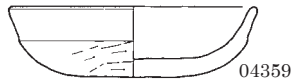
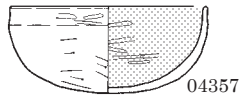

SB6004

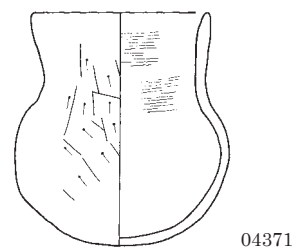
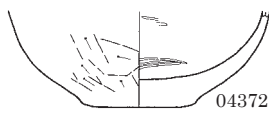
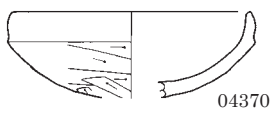

0 (1:4) 10cm

図版 138 古墳時代～古代の土器 (81)

SB6005

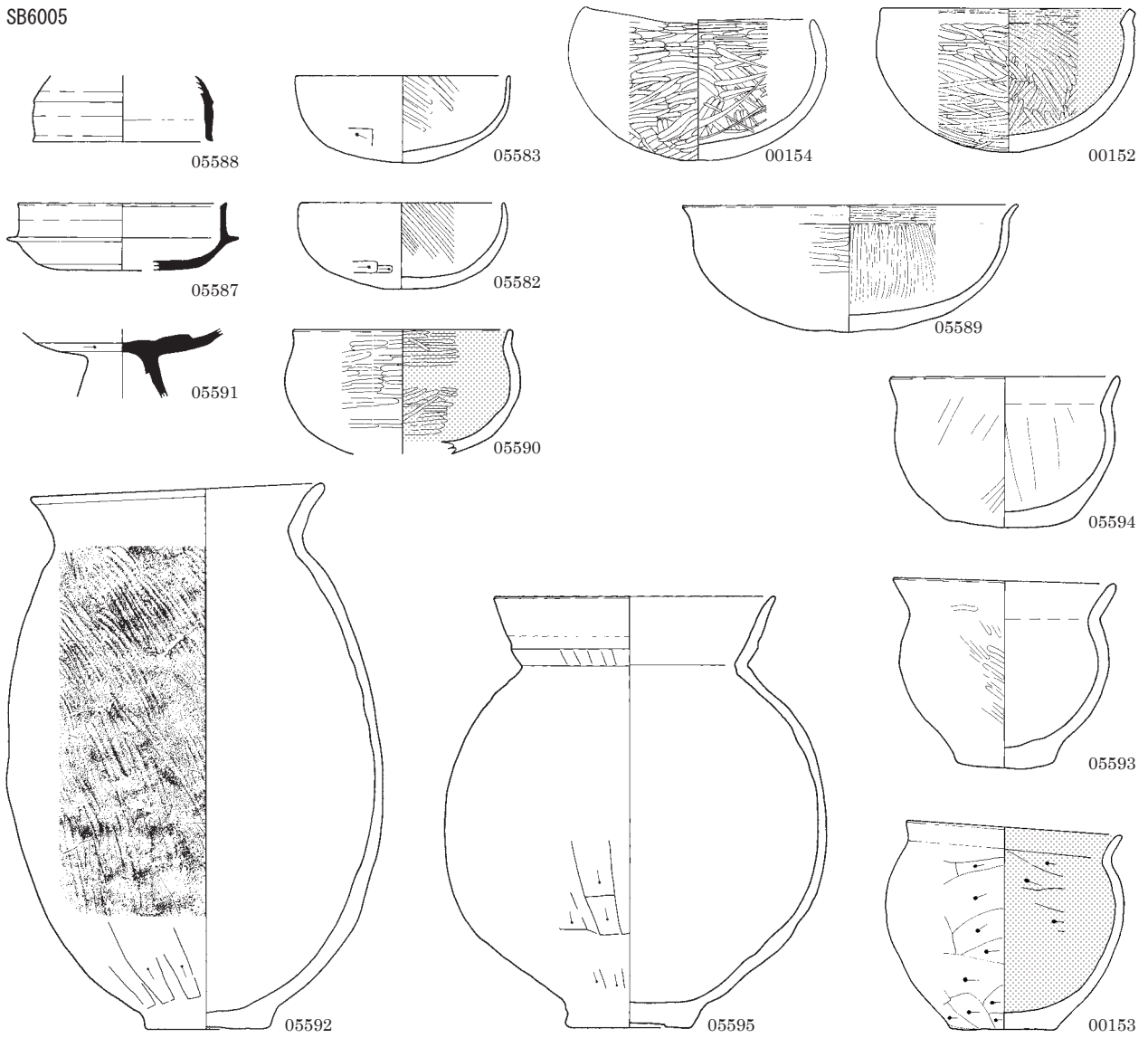

SB6006 (1)

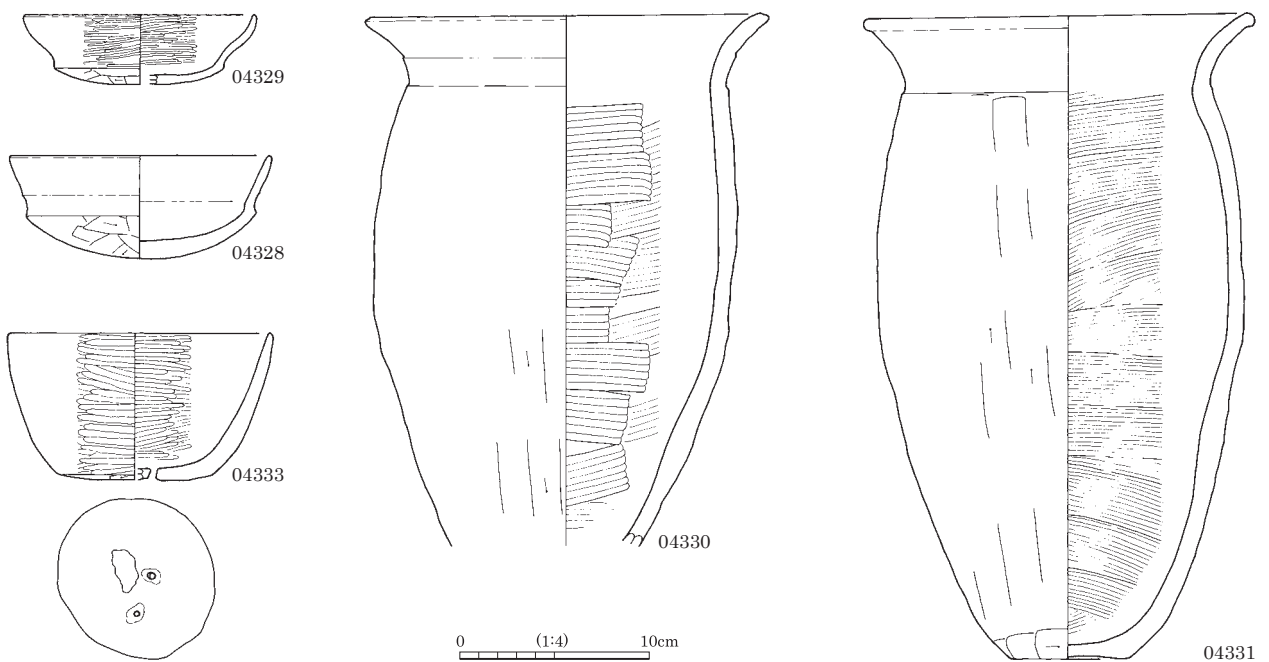

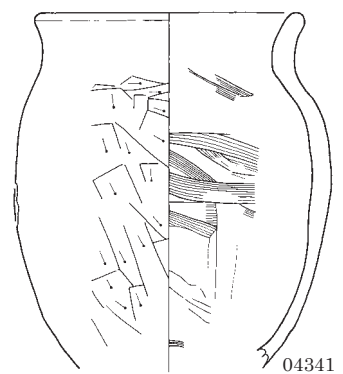
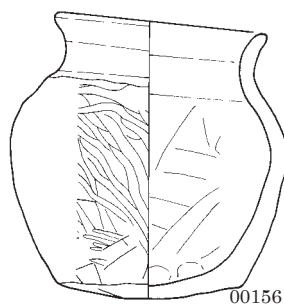
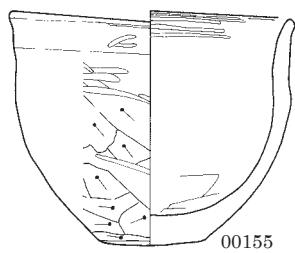
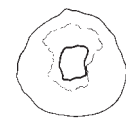
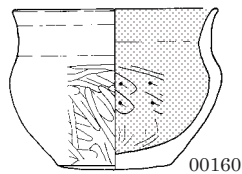
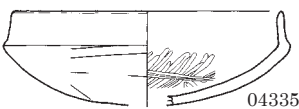
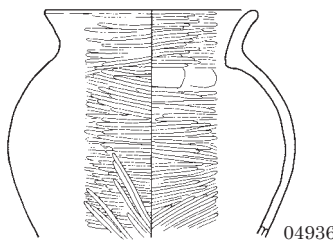
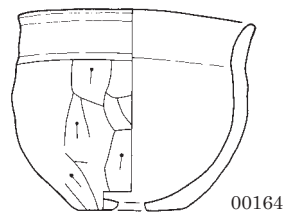
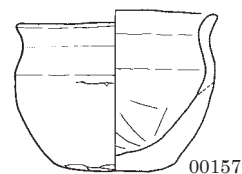
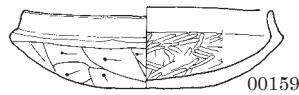
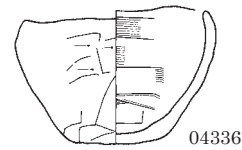
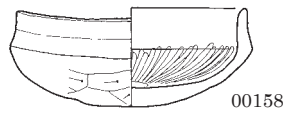
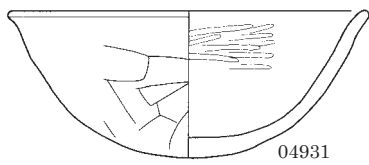
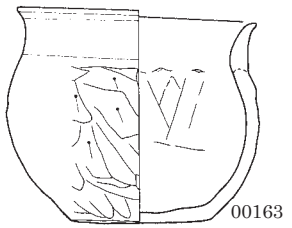
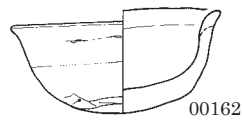
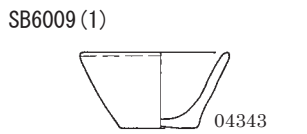
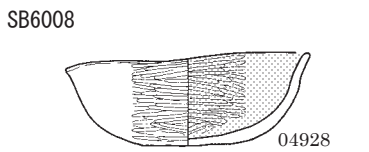
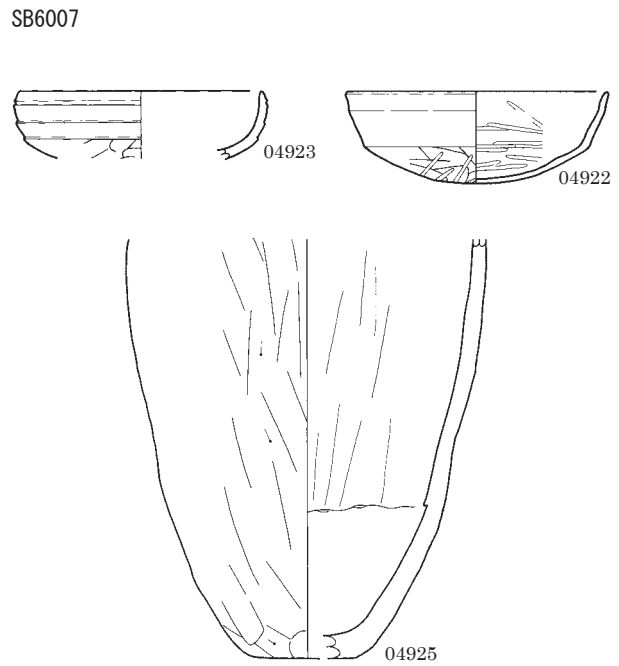
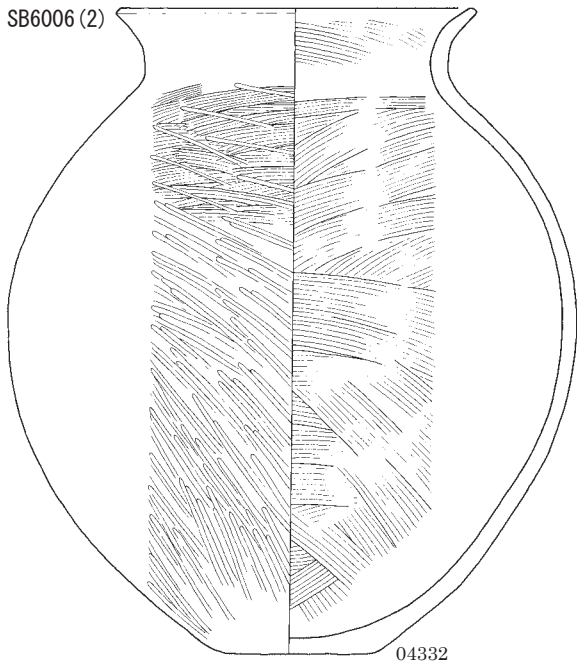

0 (1:4) 10cm

図版 140 古墳時代～古代の土器 (83)

SB6009 (2)

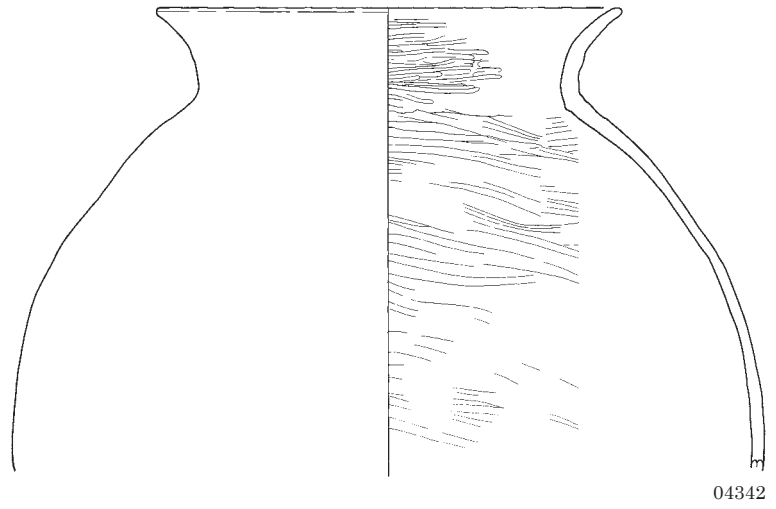
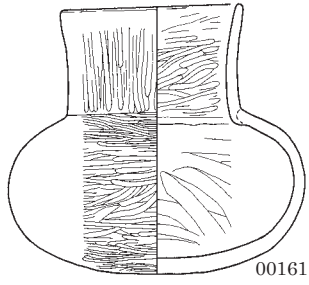
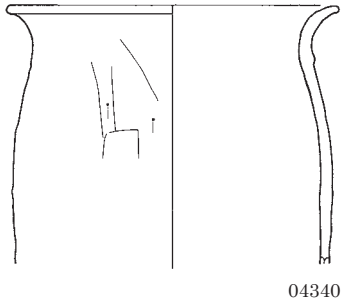

SB6011

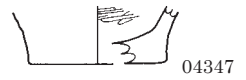

SB6013

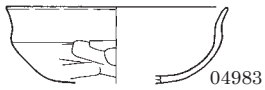
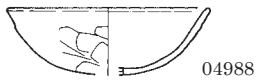

SB6014

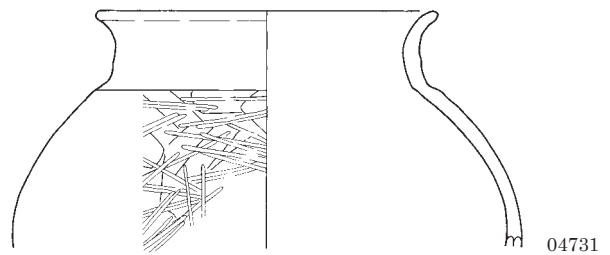
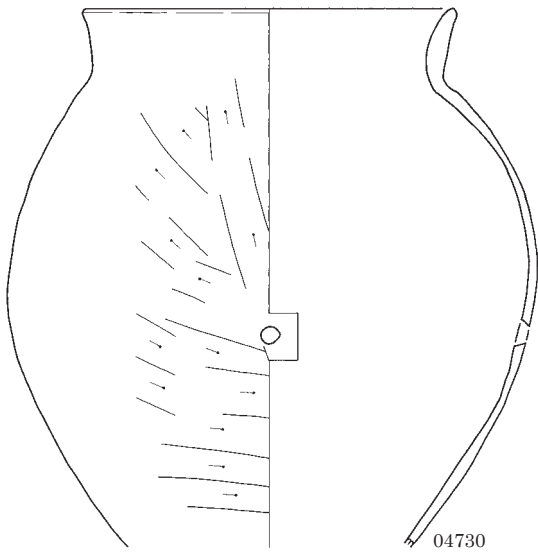
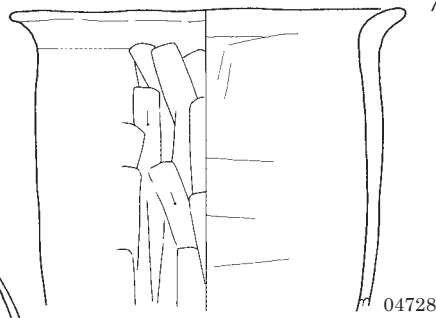
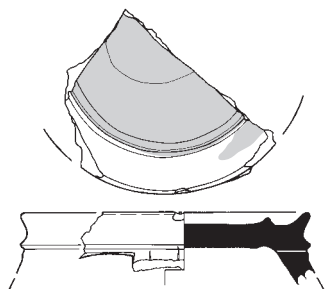
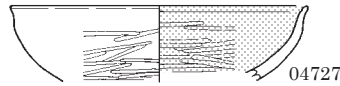
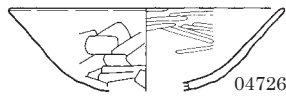

0 1:4 10cm

SB6015

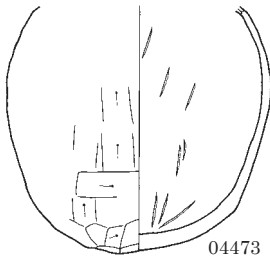
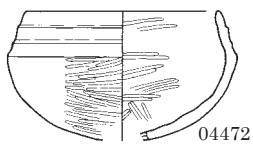
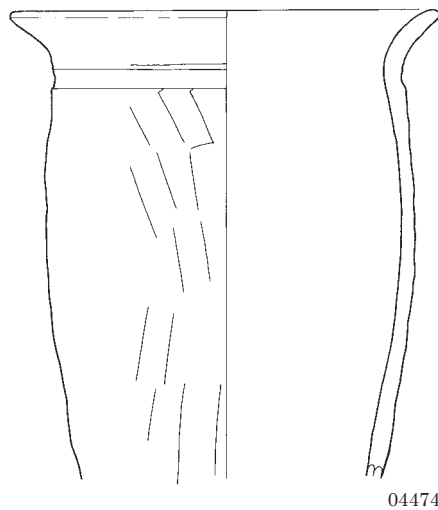
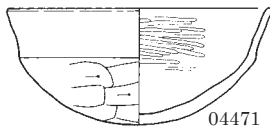
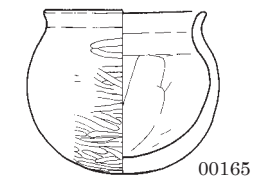

SB6016

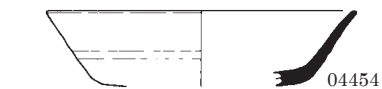

SB6018

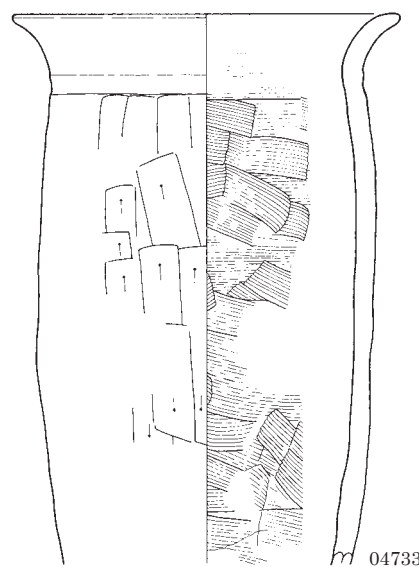
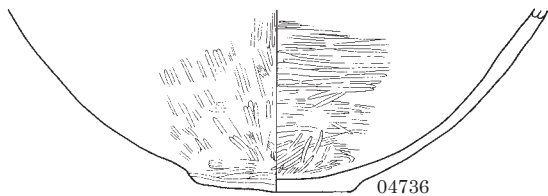
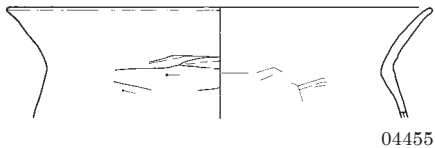
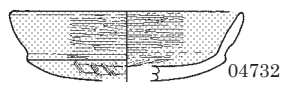

SB6019

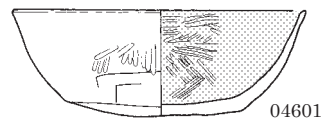
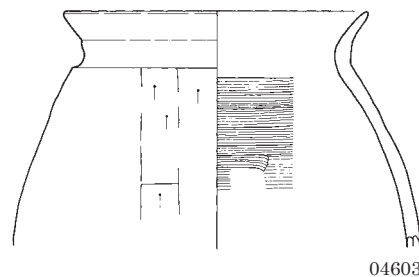
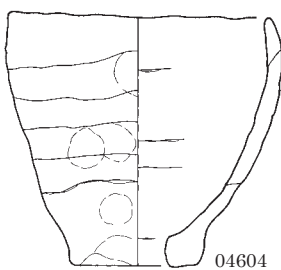
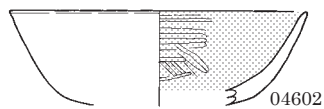

SB6020 (1)

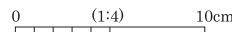
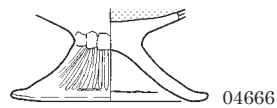
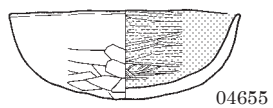
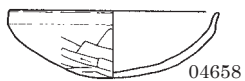
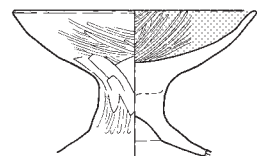
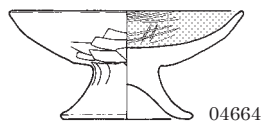
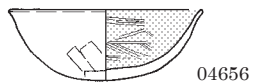

図版 142 古墳時代～古代の土器 (85)

SB6020 (2)

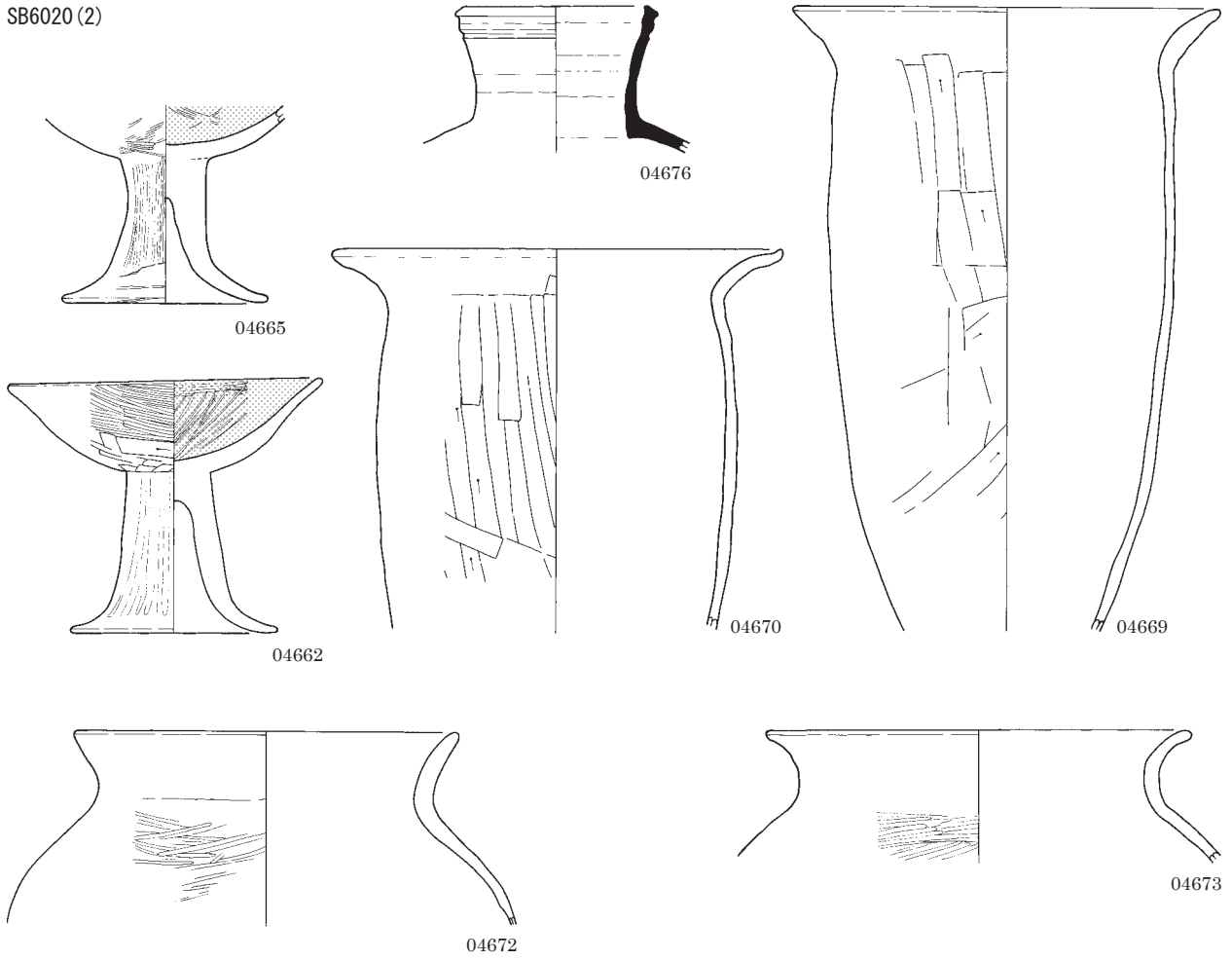

SB6021 (1)

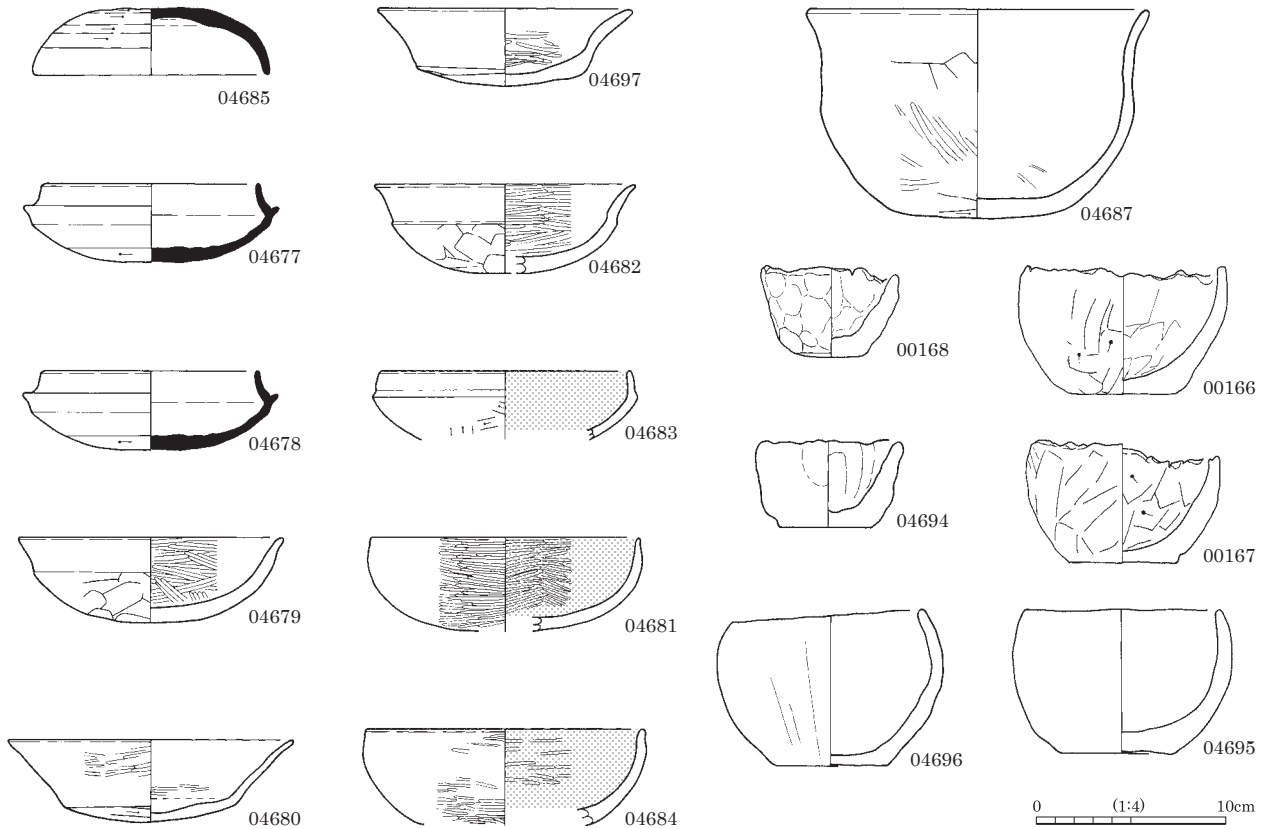

SB6021 (2)

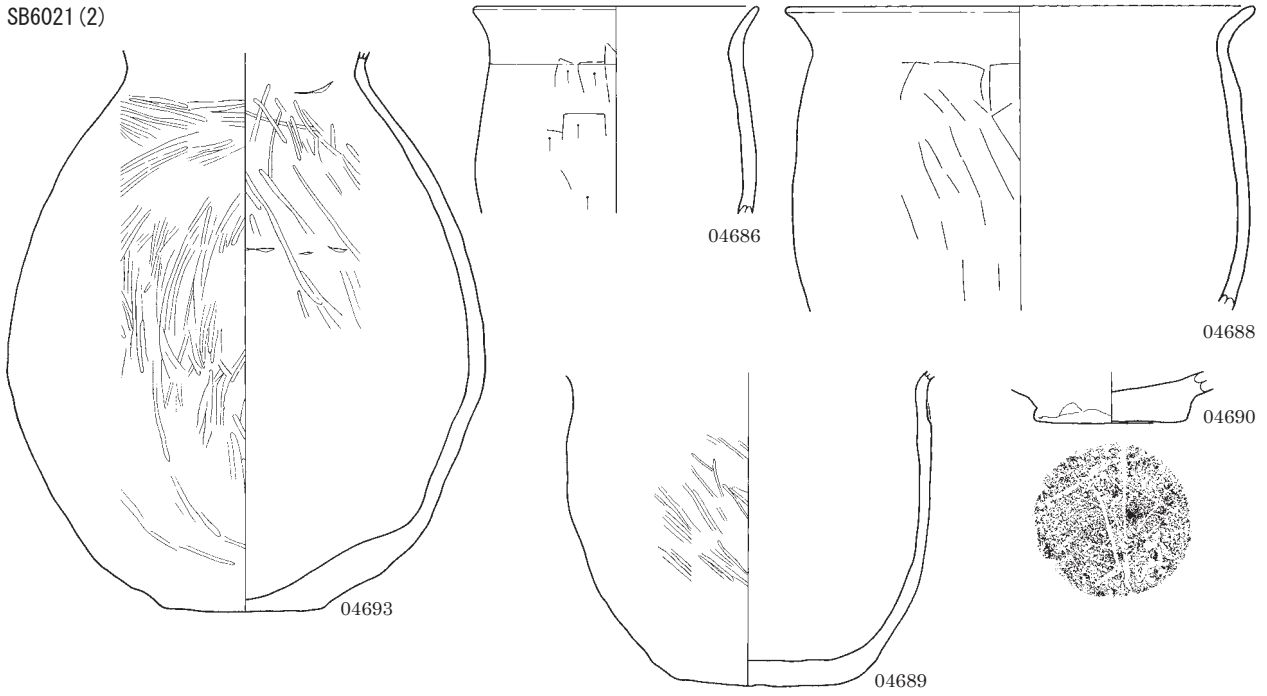

SB6022

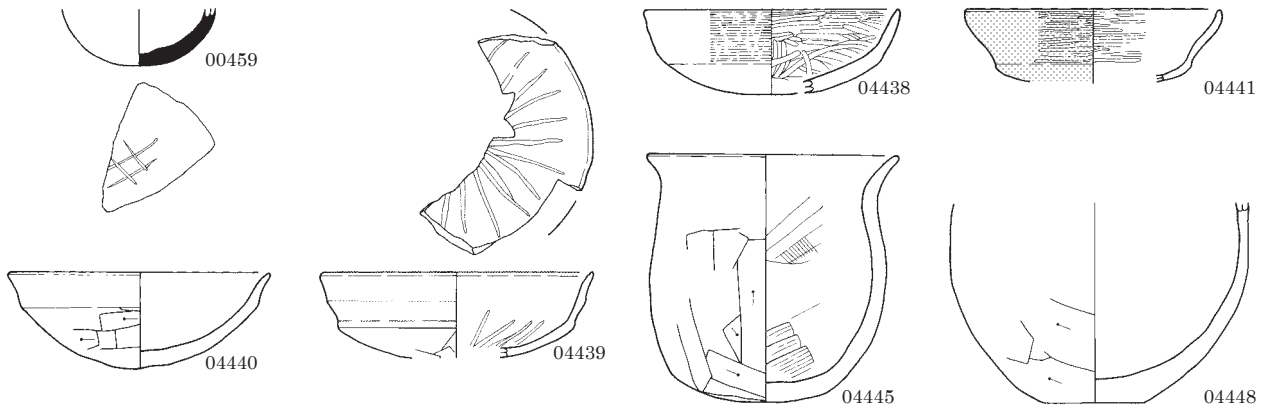

SB6023 (1)

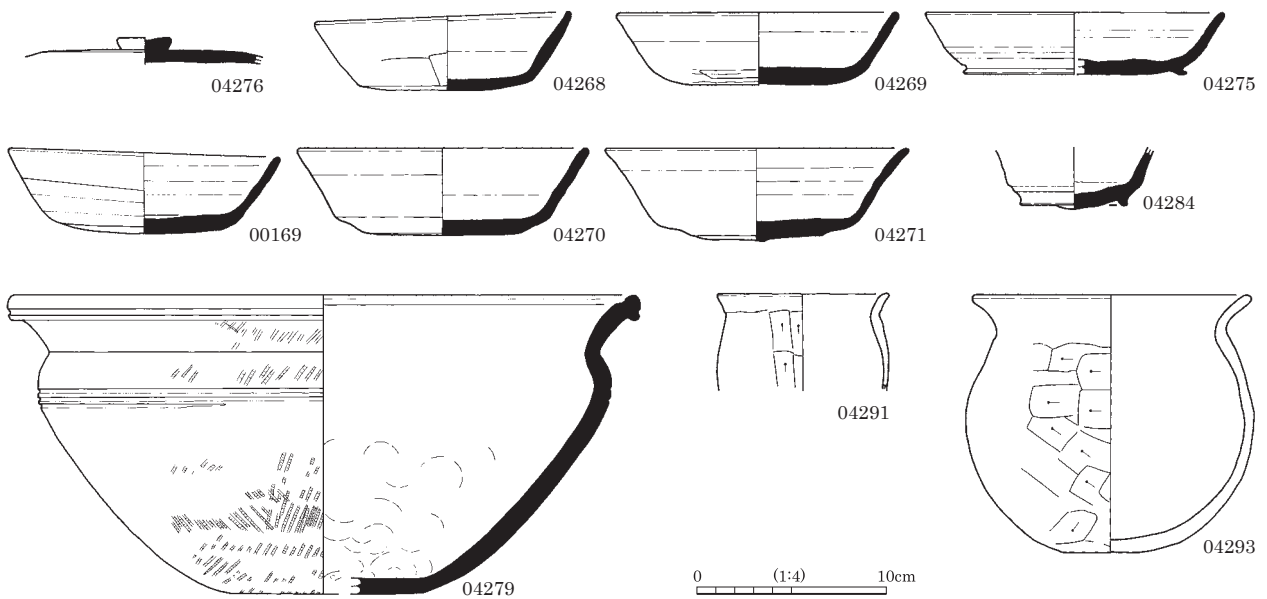

図版 144 古墳時代～古代の土器 (87)

SB6023 (2)

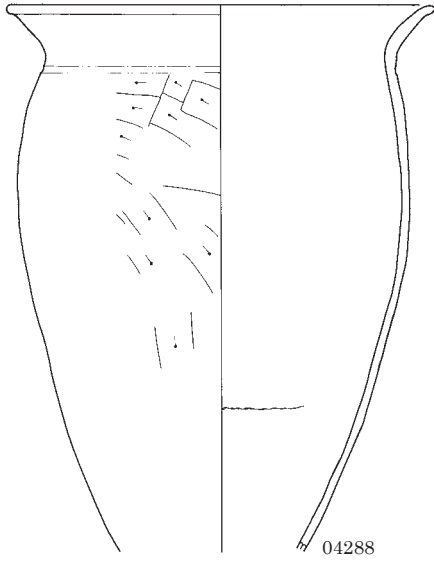

04288

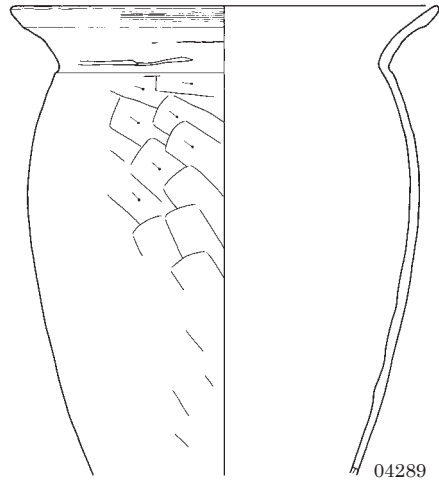

04289

SB6024

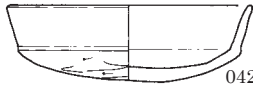

04254

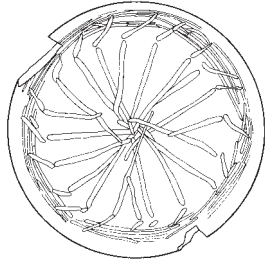

04253

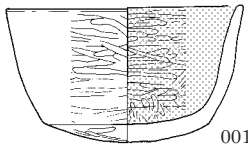

00170

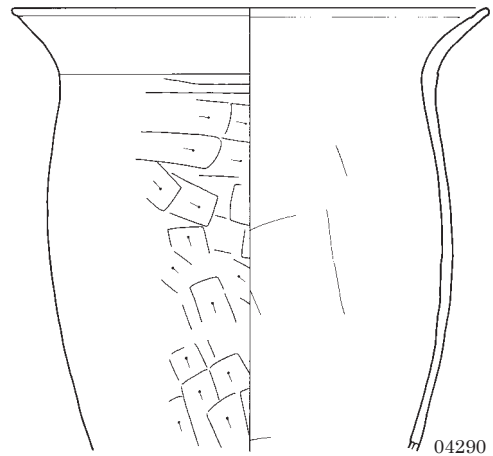
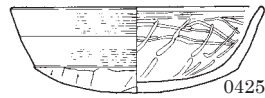

04290

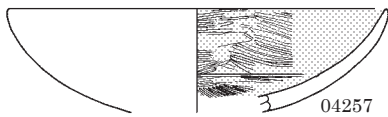

04257

SB6026 (1)

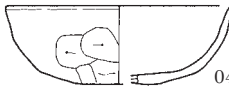

04308

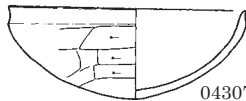

04307

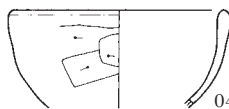

04310

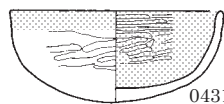

04312

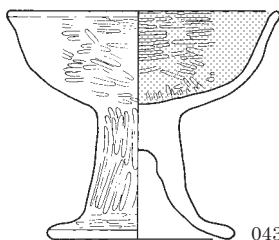

04317

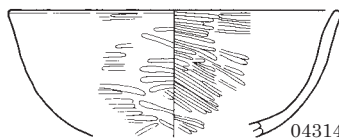

04314

0 (1:4) 10cm

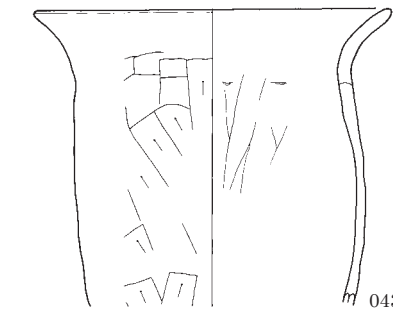

04319

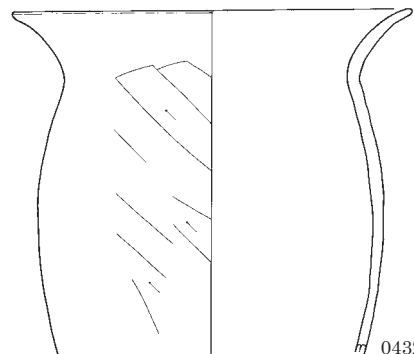

04321

SB6026 (2)

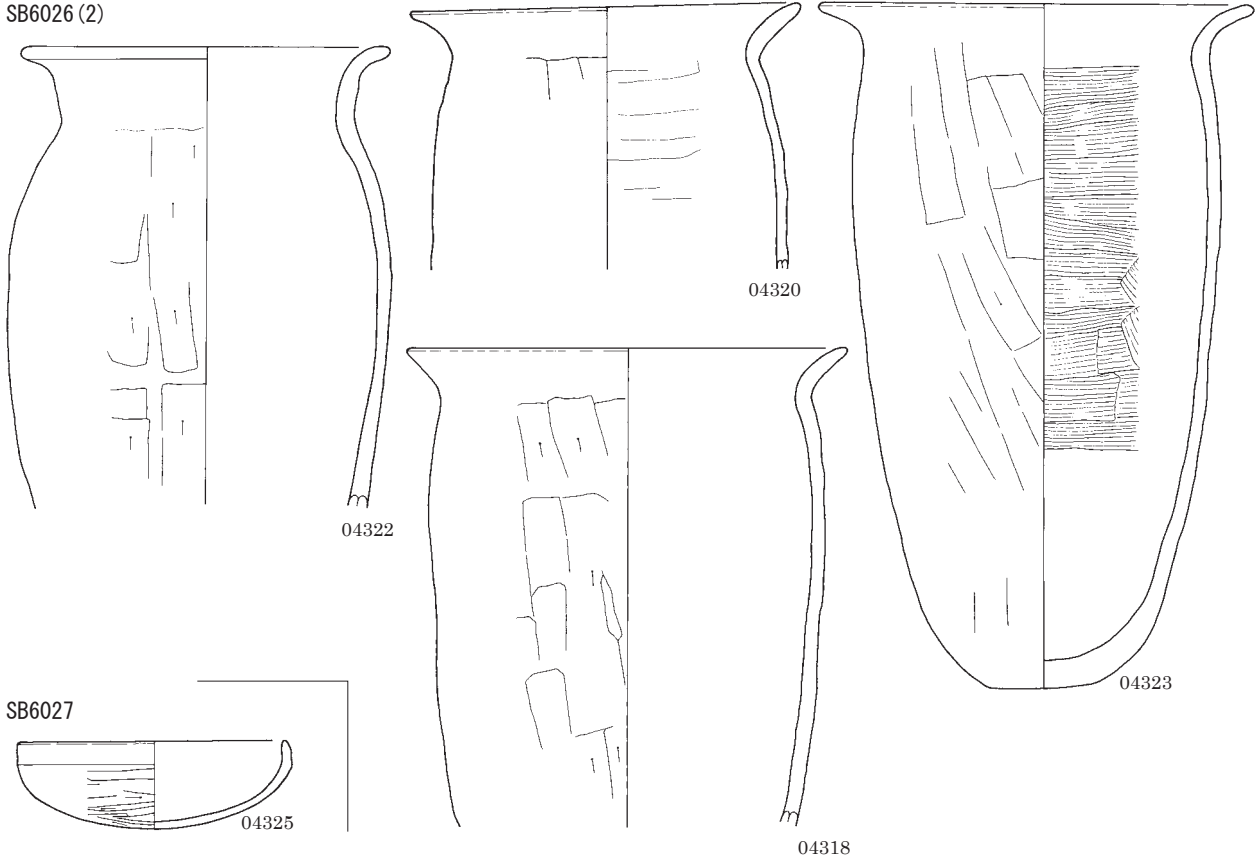

SB6030

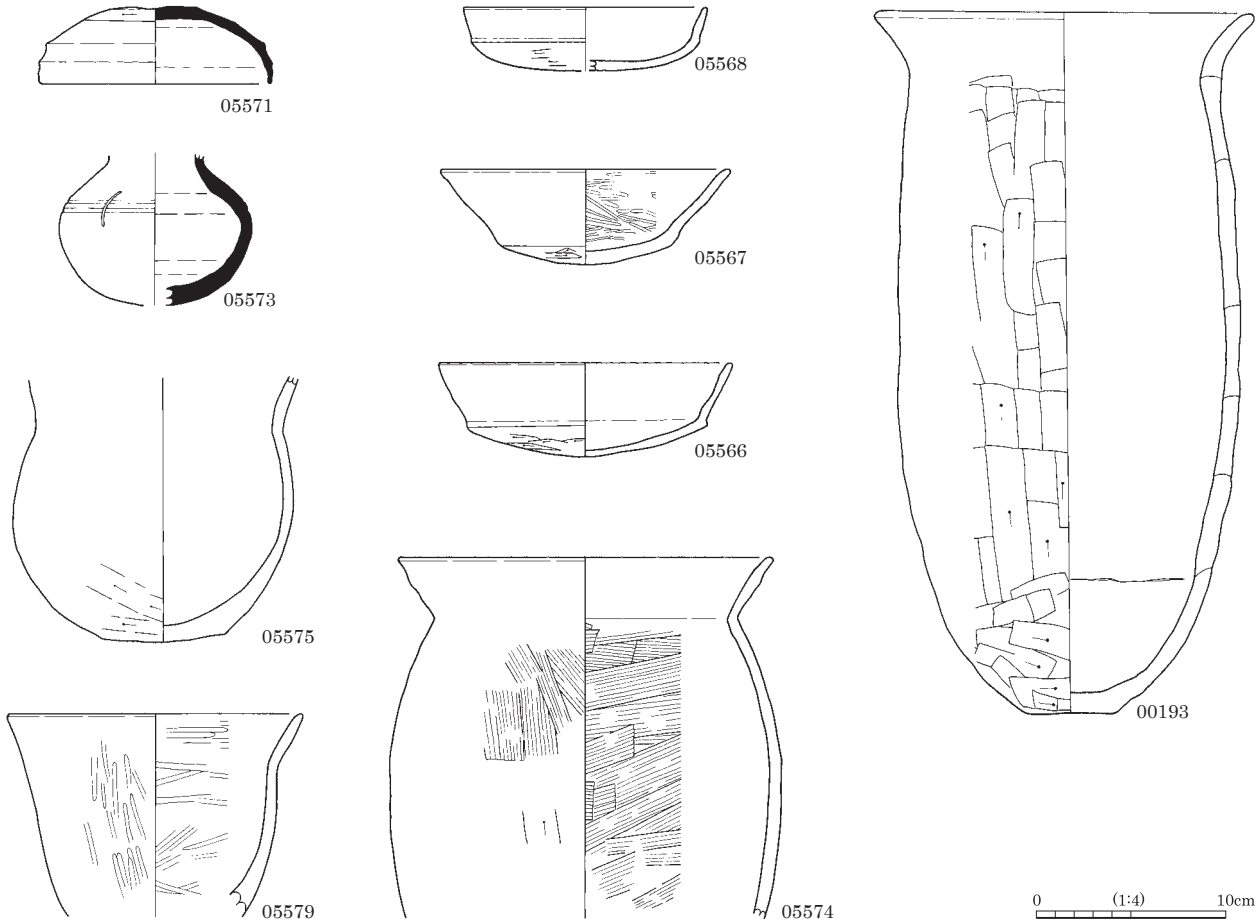

図版 146 古墳時代～古代の土器 (89)

SB6033 (1)

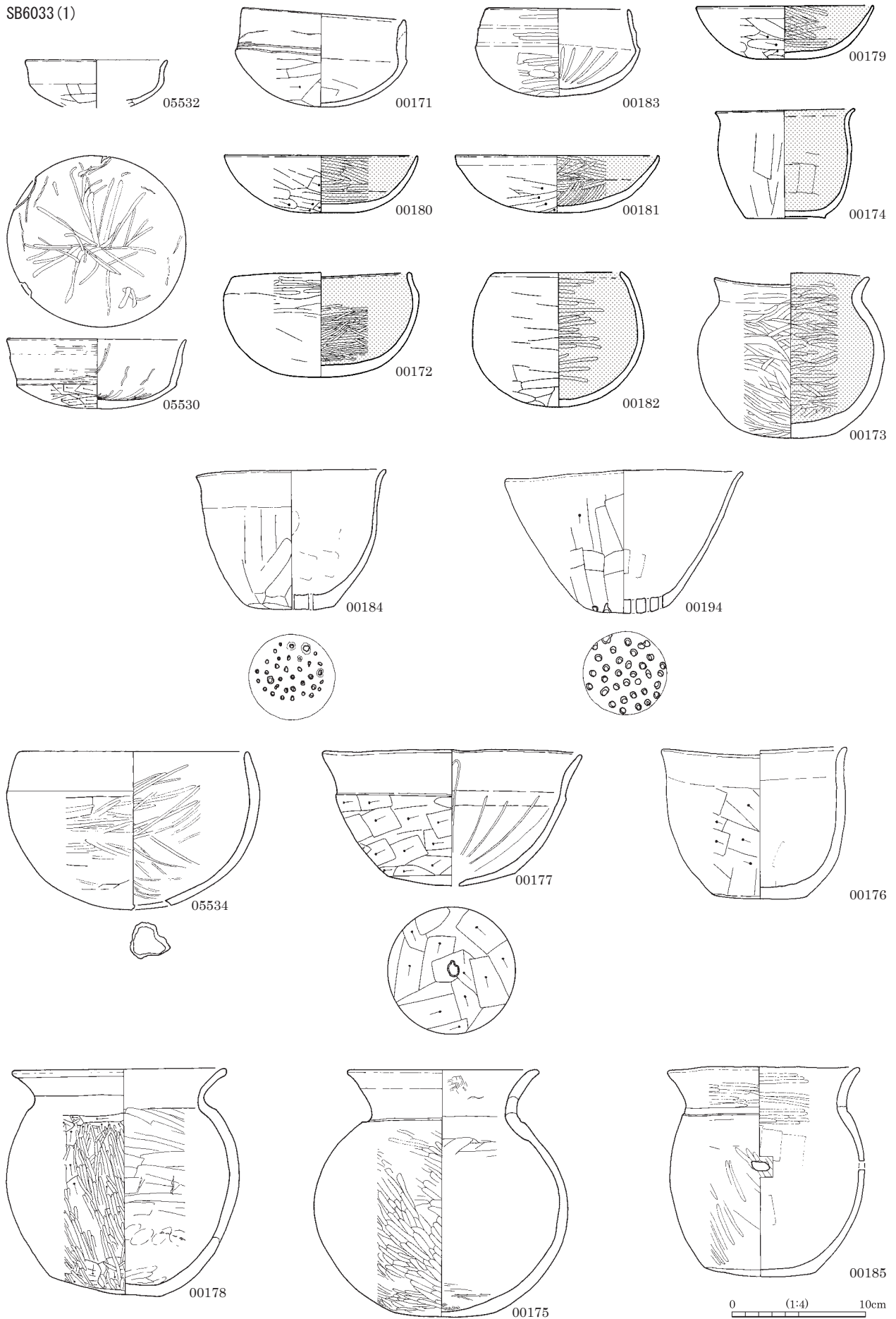

SB6033 (2)

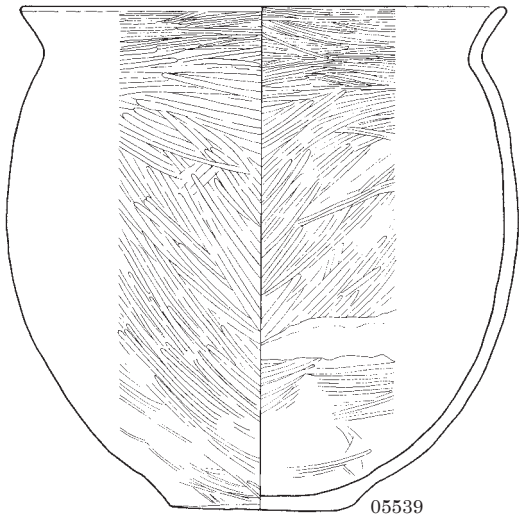

05539

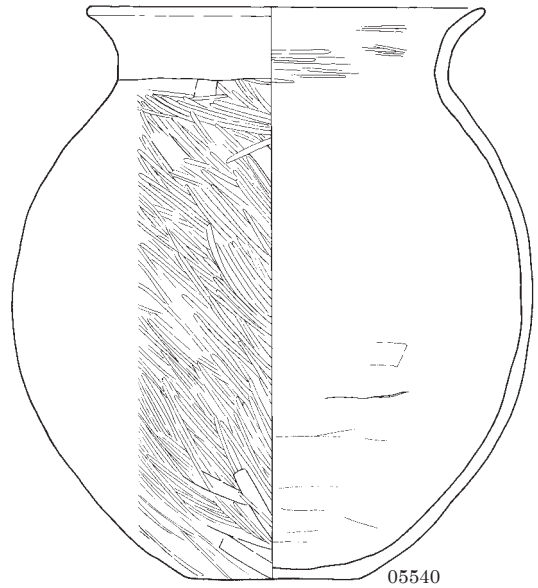

05540

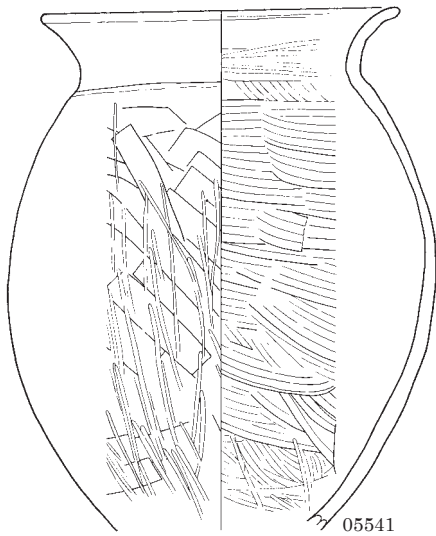

05541

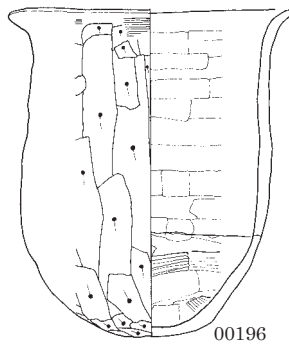

00196

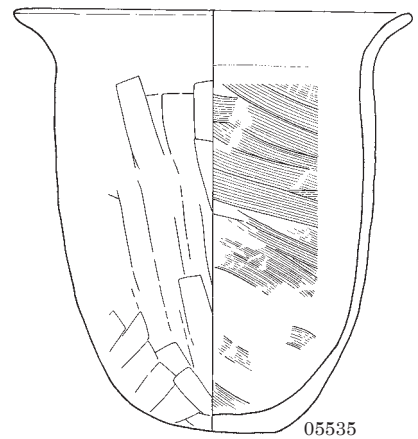

05535

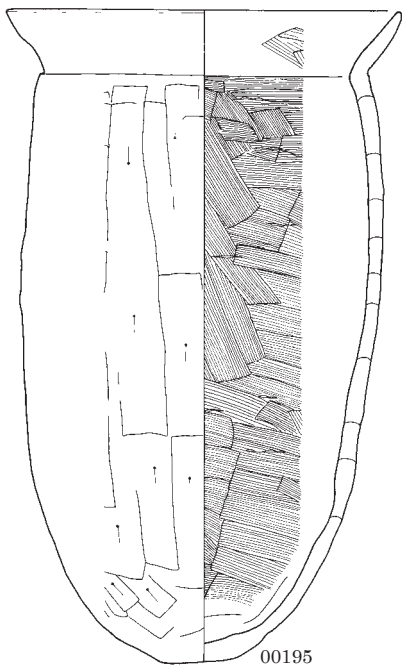

00195

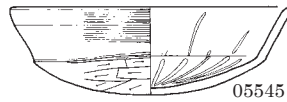
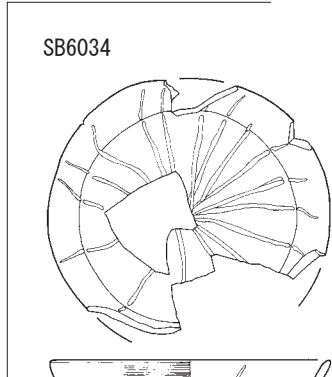

05545

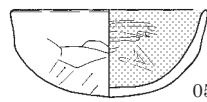

05548

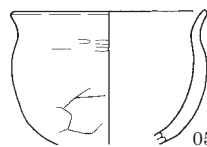

05550

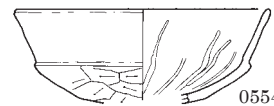

05546

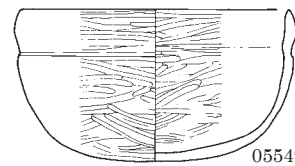

05549

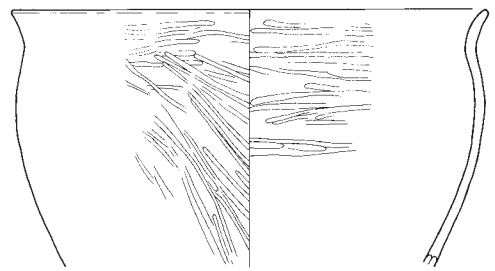

05551

0 (1:4) 10cm

図版 148 古墳時代～古代の土器 (91)

SB6035

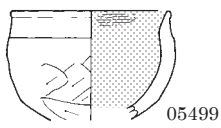
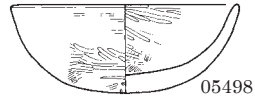
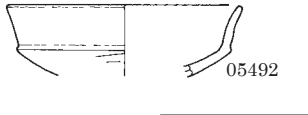

SB6036

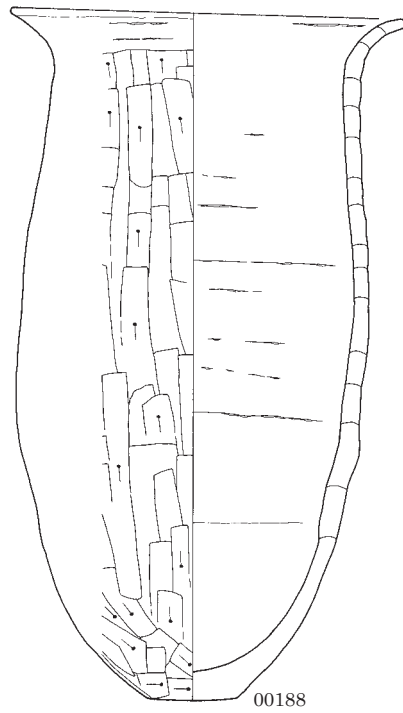

SB6037

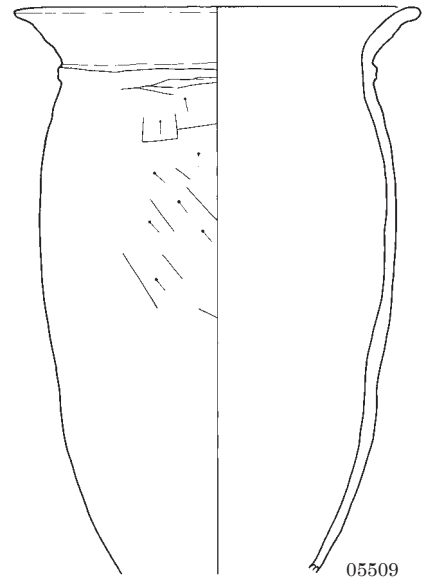
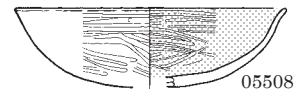

SB6038

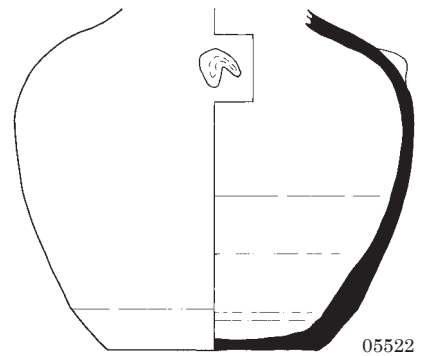
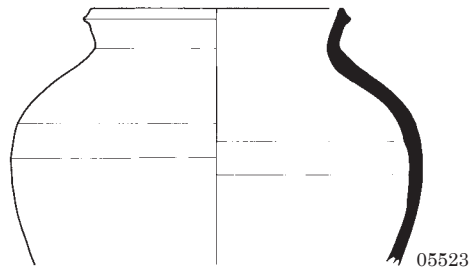
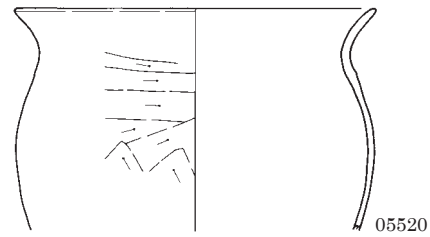
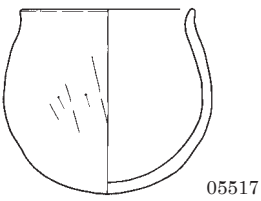
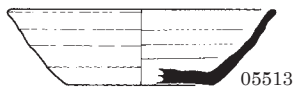
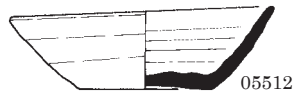

SB6039 (1)

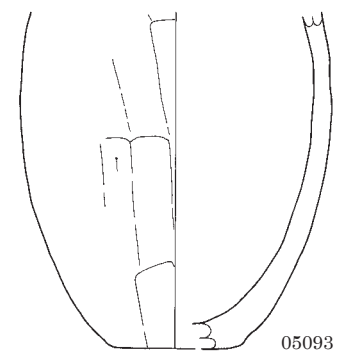
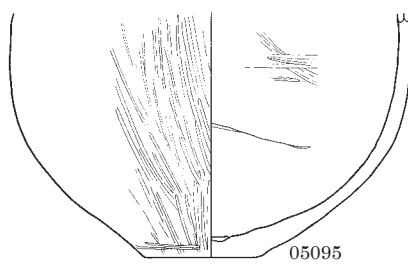
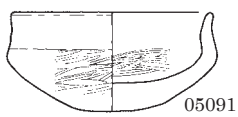

0 (1:4) 10cm

SB6039 (2)

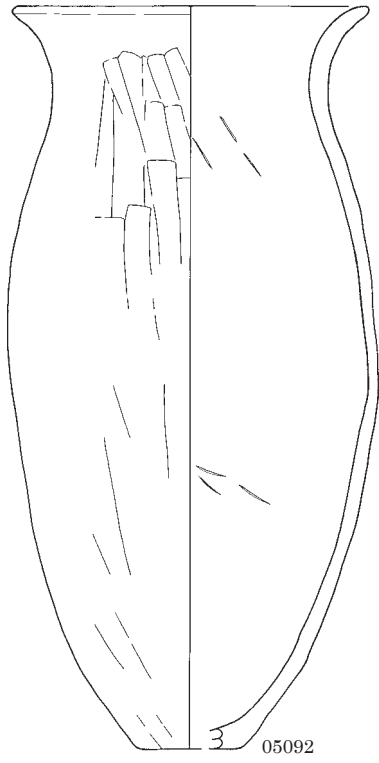

SB6041

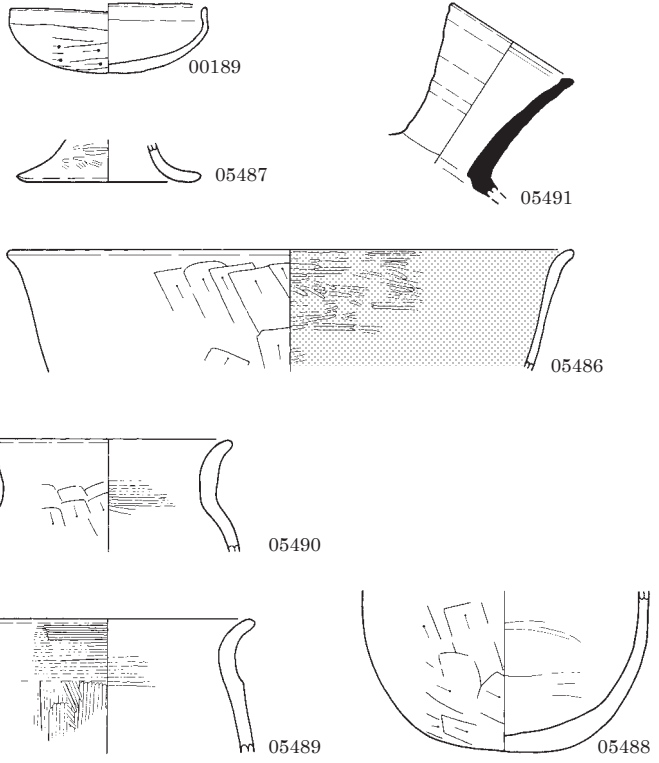

SB6042

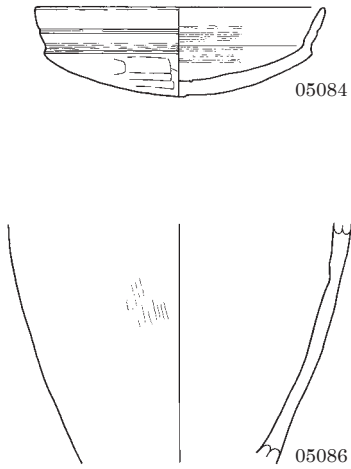

SB6045

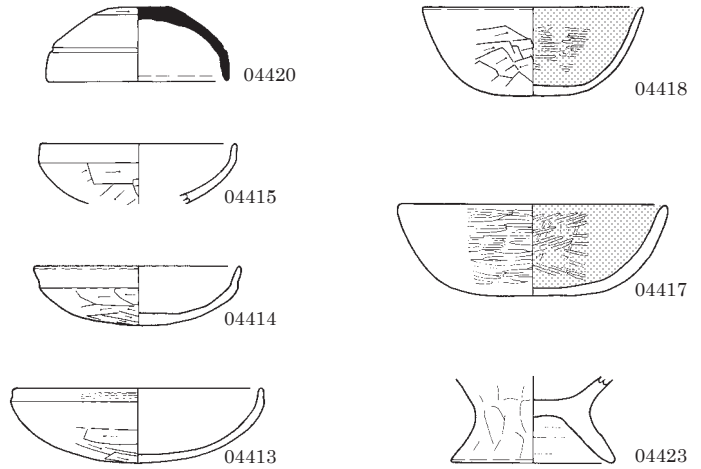

SB6046 (1)

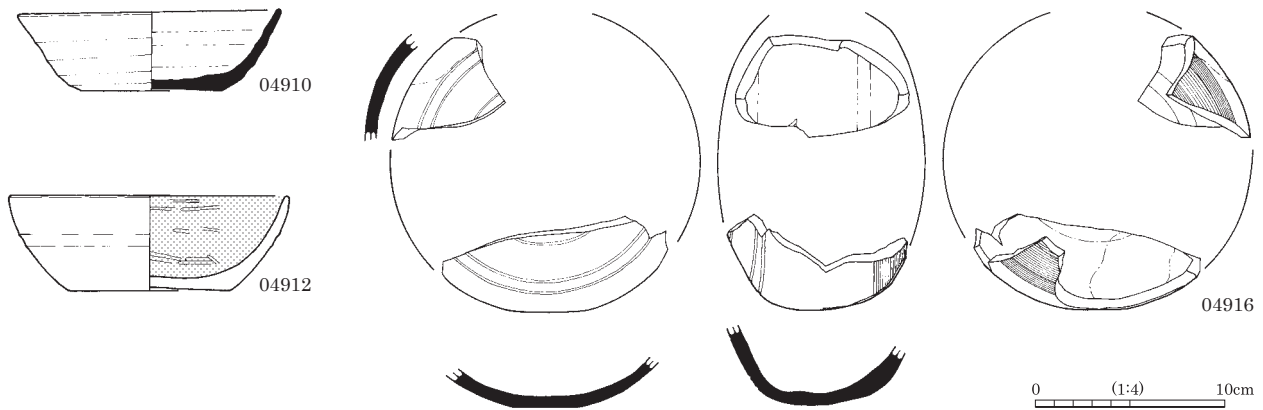

図版 150 古墳時代～古代の土器 (93)

SB6046 (2)

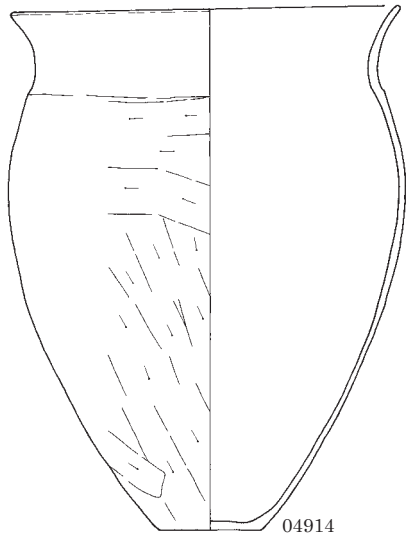
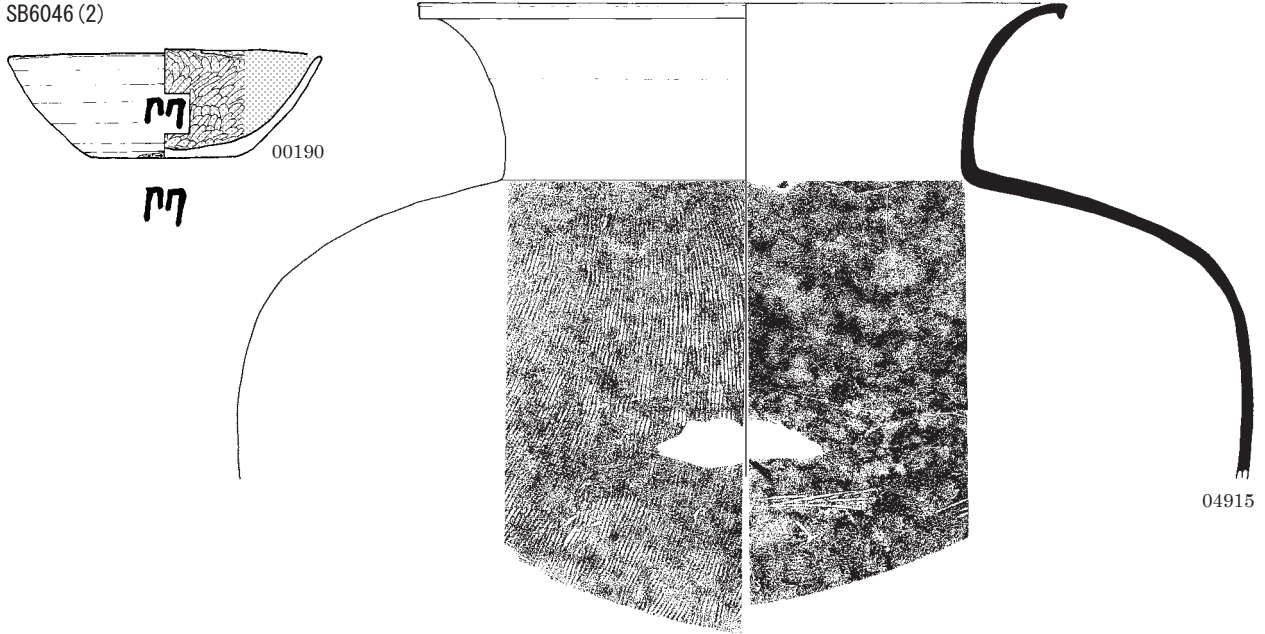

SB6047

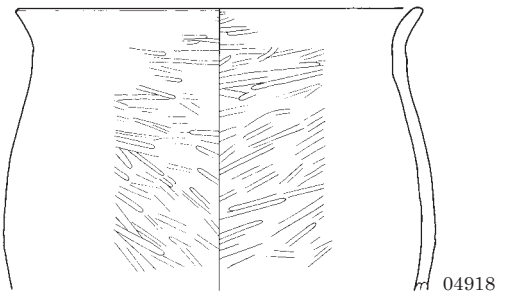
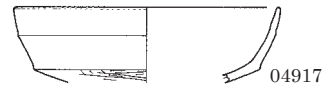

SB6048 (1)

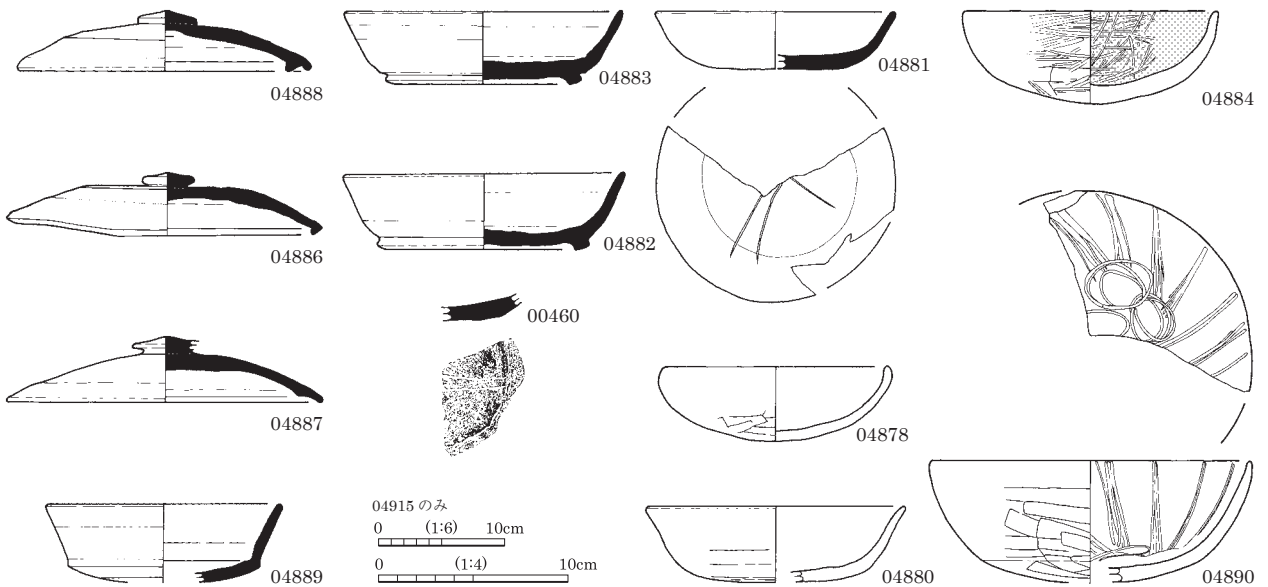

SB6048 (2)

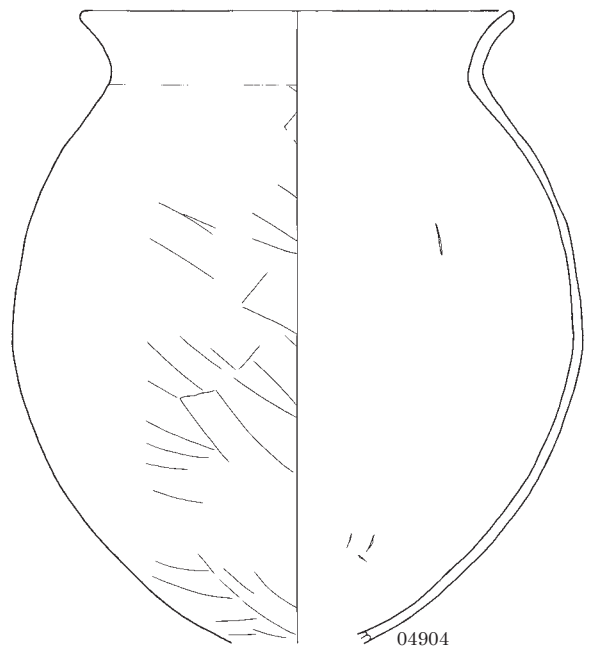
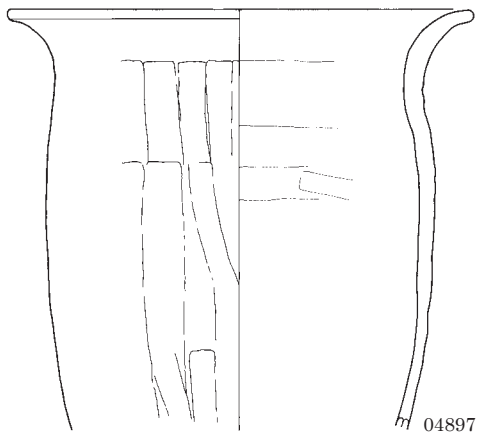
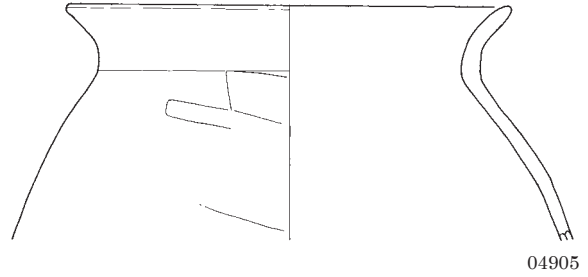
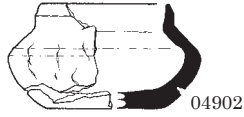
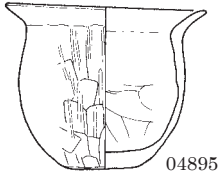
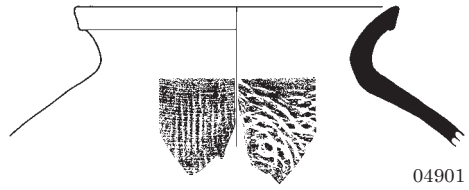
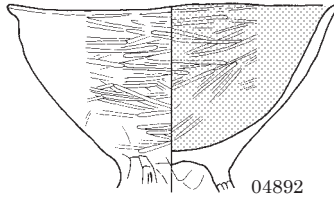
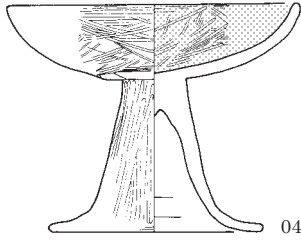

SB6049

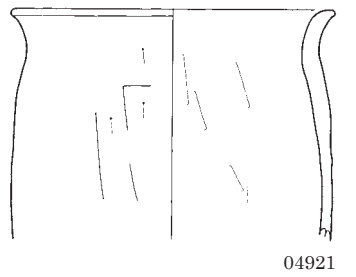
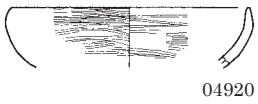

0 1:4 10cm

SB6050 (1)

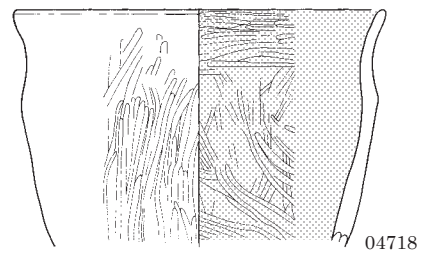
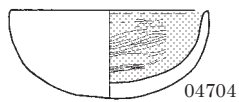
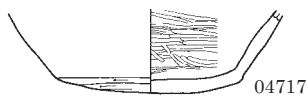
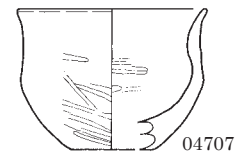
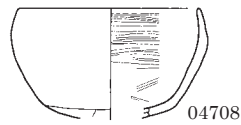

図版 152 古墳時代～古代の土器 (95)

SB6050 (2)

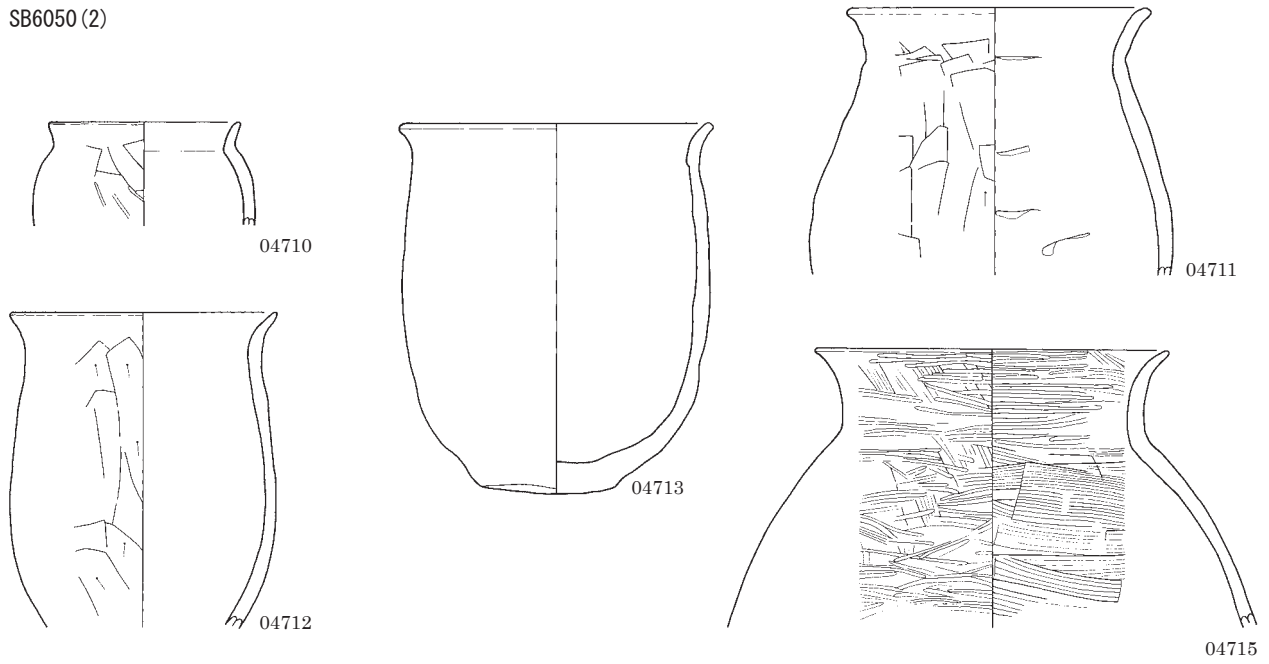

SB6051

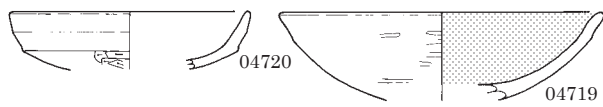

SB6052

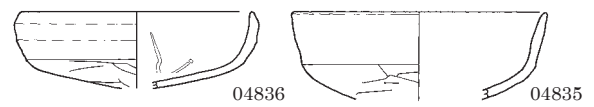

SB6053

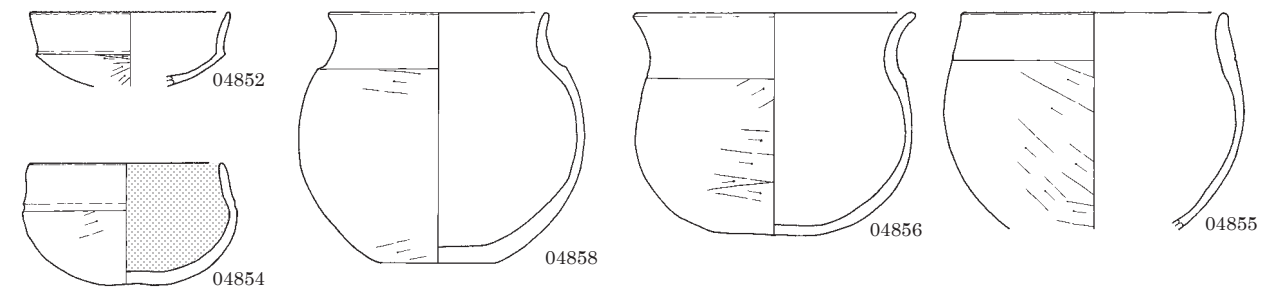

SB6054

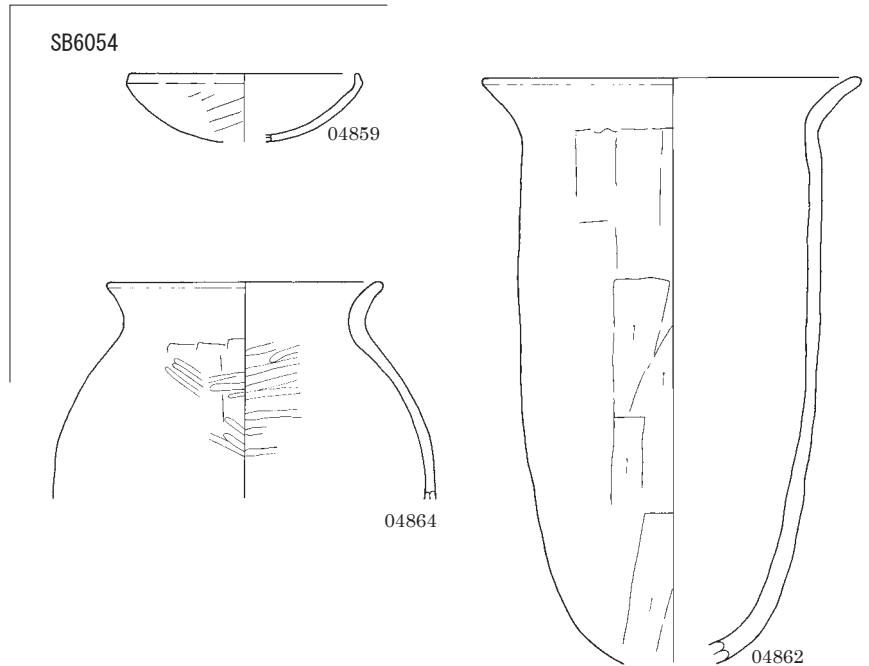

0 (1:4) 10cm

SB6055

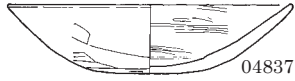

04837

SB6056

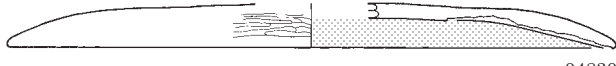

04830

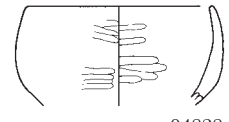

04828

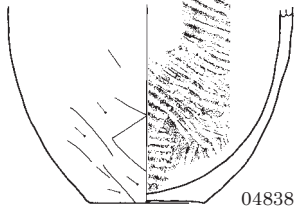

04838

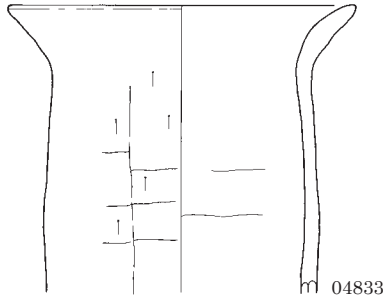

04833

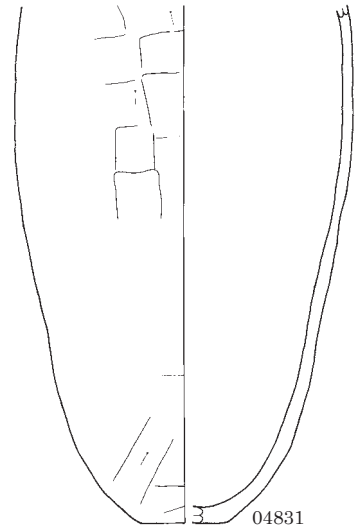

04831

SB6057



05524

SB6058

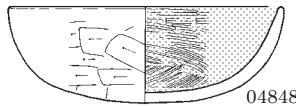

04848

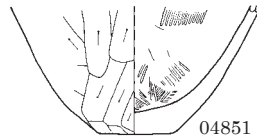

04851

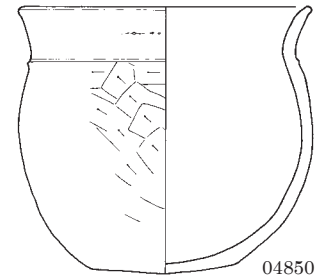

04850

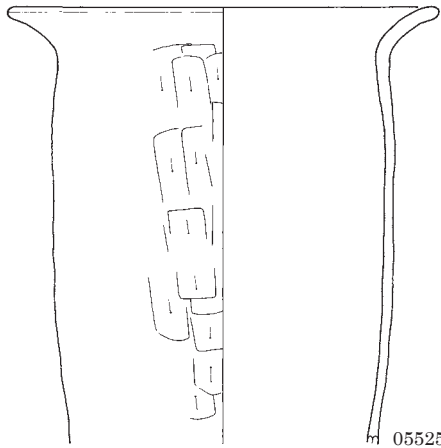

05525

SB6059

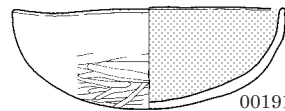

00191

SB6061 (1)

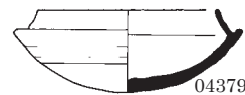

04379

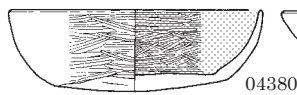

04380

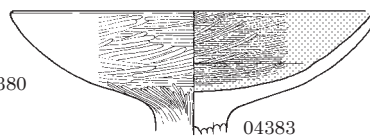

04383

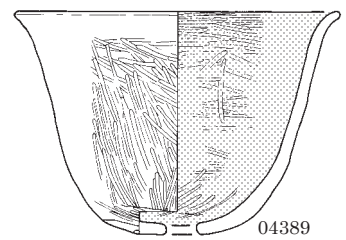

04389

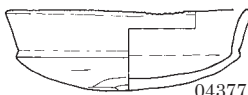

04377



04381

0 10cm (1:4)

図版 154 古墳時代～古代の土器 (97)

SB6061 (2)

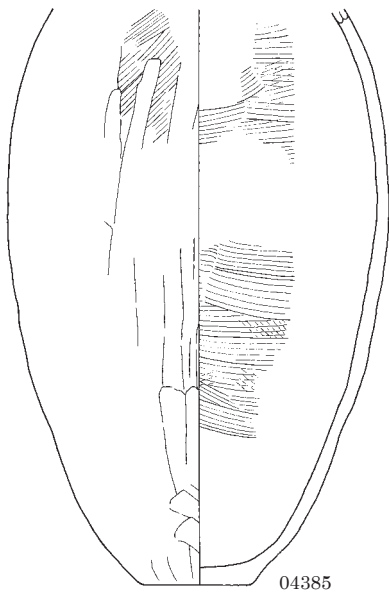
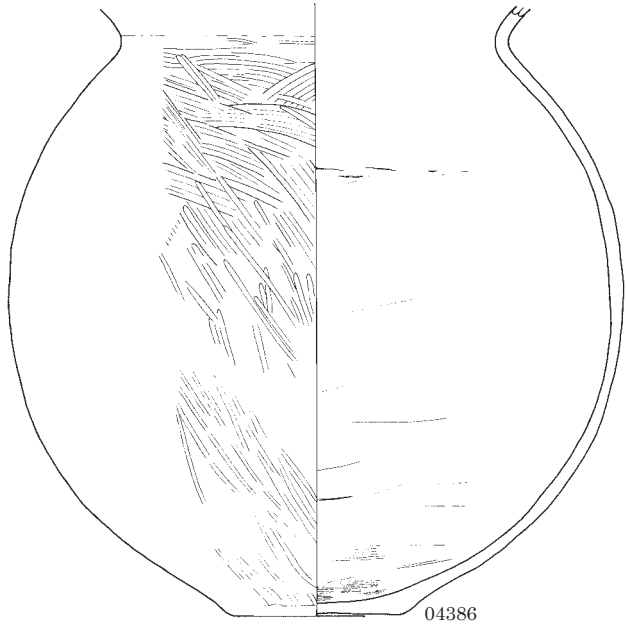
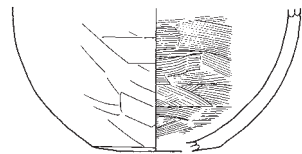
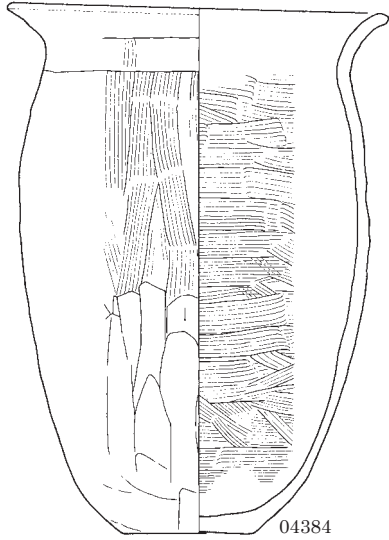

SB6062

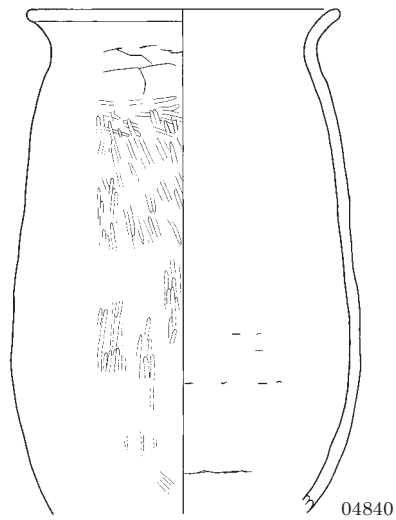
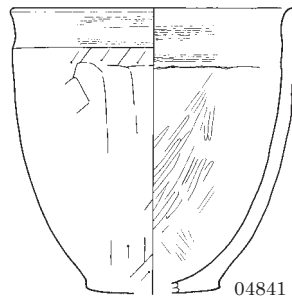

SB6063

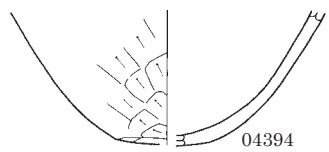
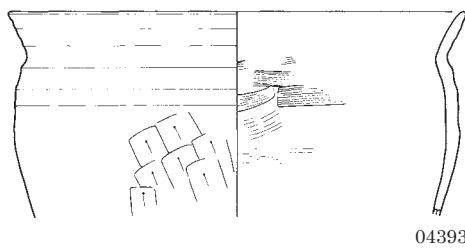
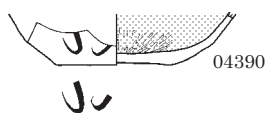
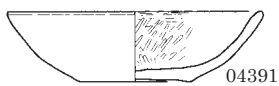

0 1:4 10cm

SB6065

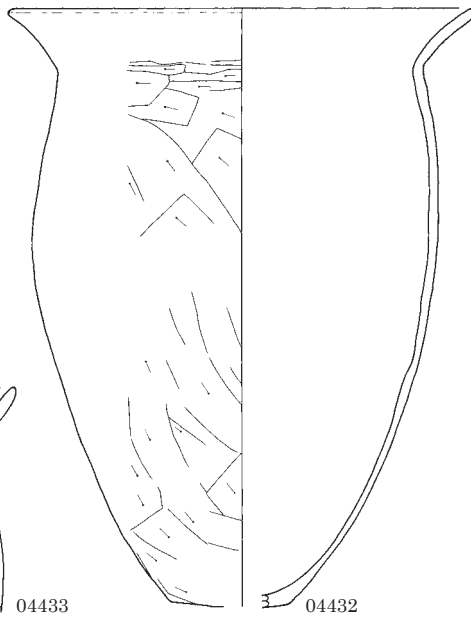
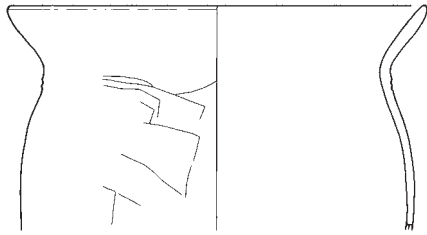
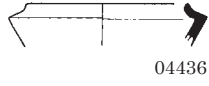

SB6066

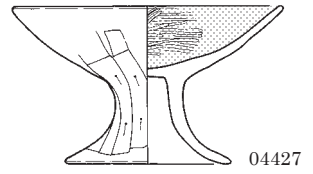
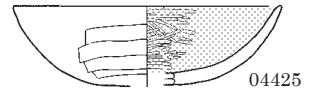

SB6069



SB6070

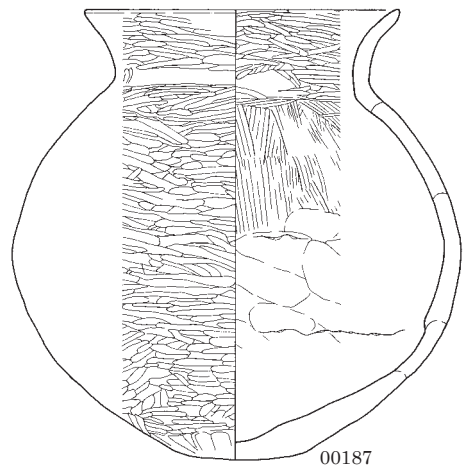
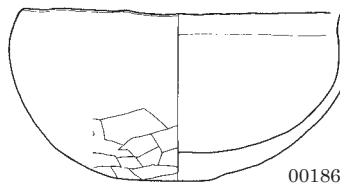
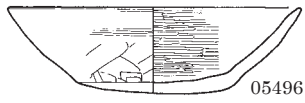
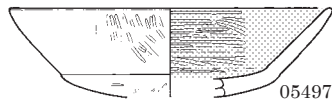
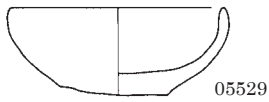

SB6072

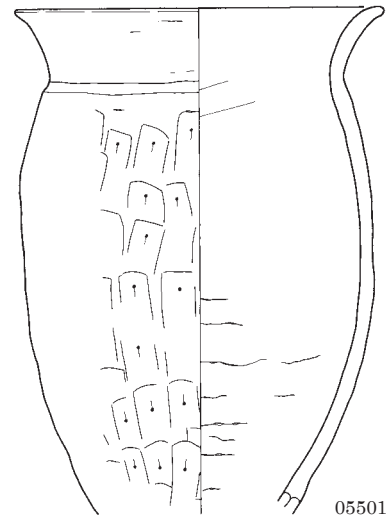
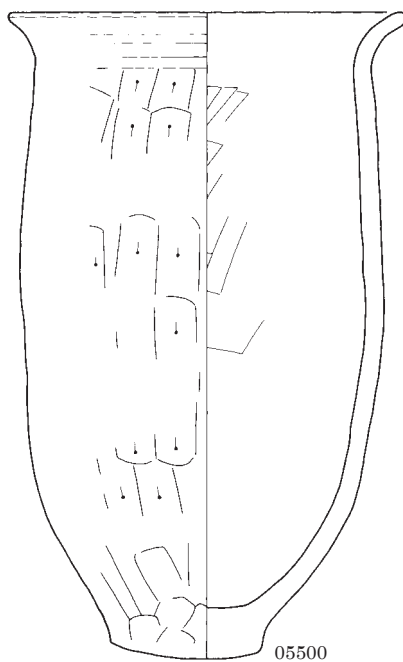
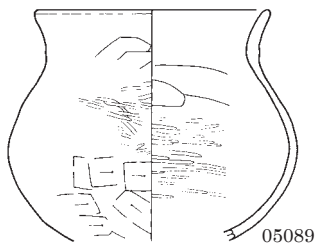

0 1:4 10cm

図版 156 古墳時代～古代の土器 (99)

SB7001

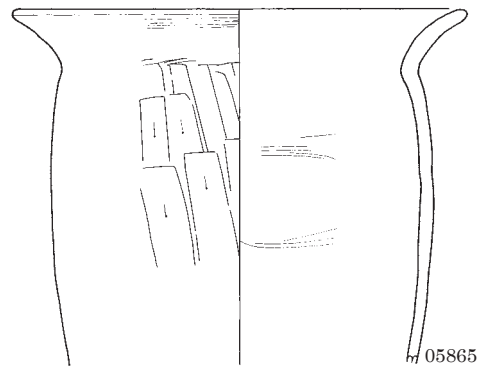
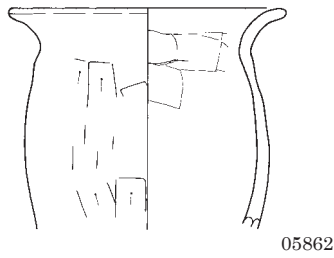
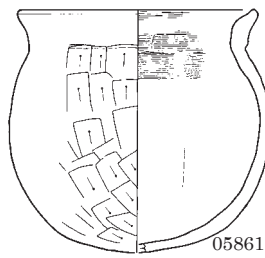
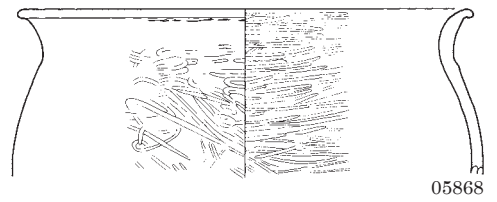
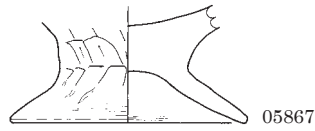
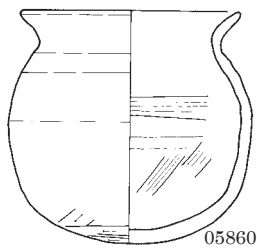
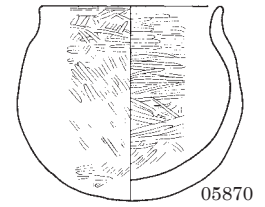
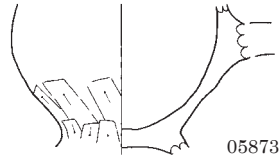
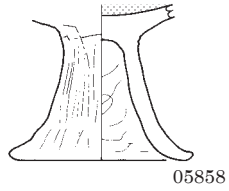
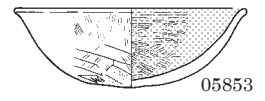
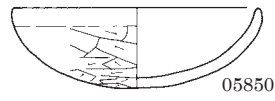
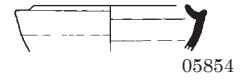
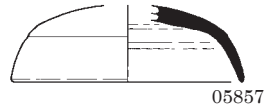
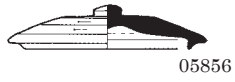
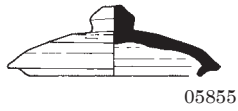

SB7002

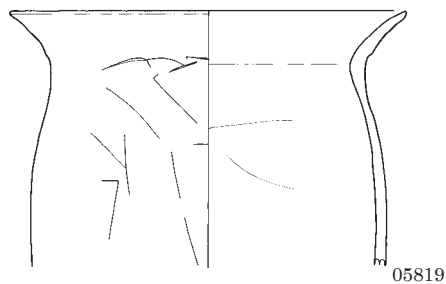
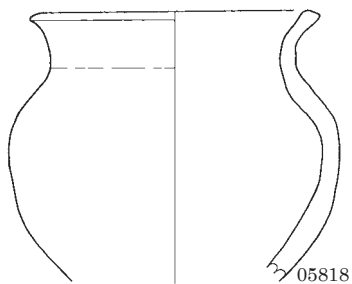
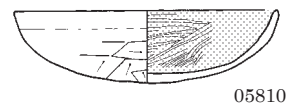
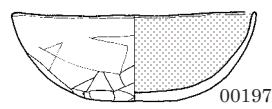
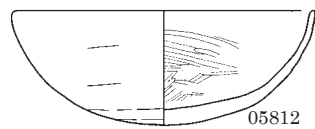
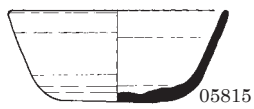
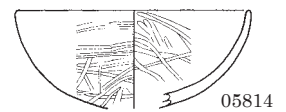
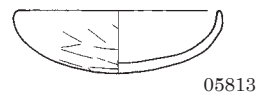
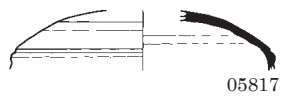
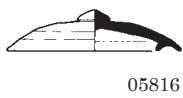

0 (1:4) 10cm

SB7003

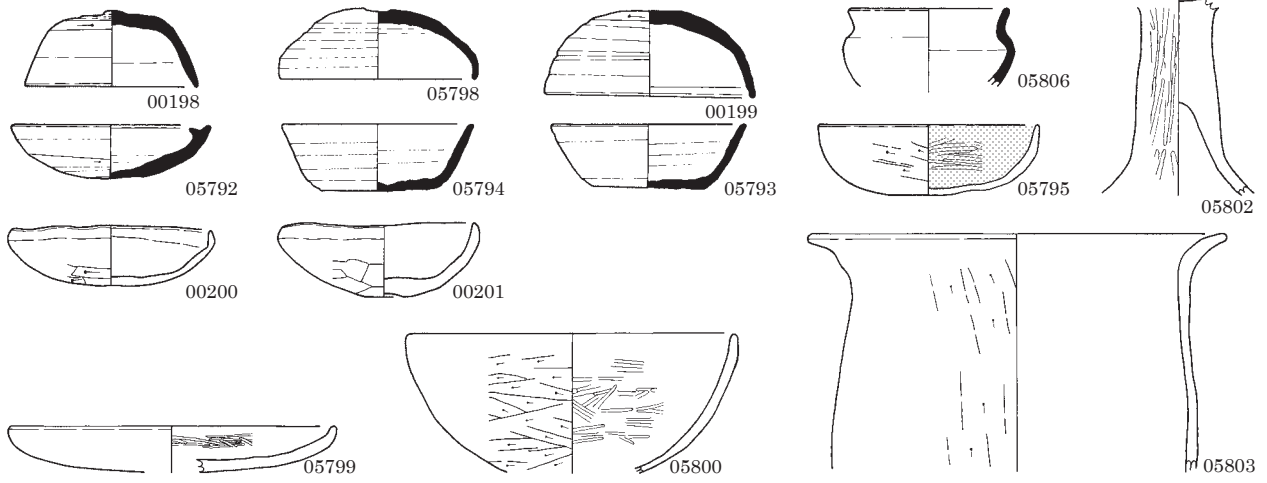

SB7004

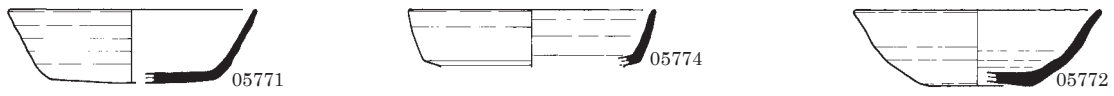

SB7004・7005

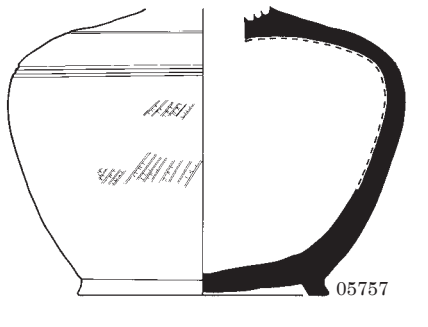

SB7005

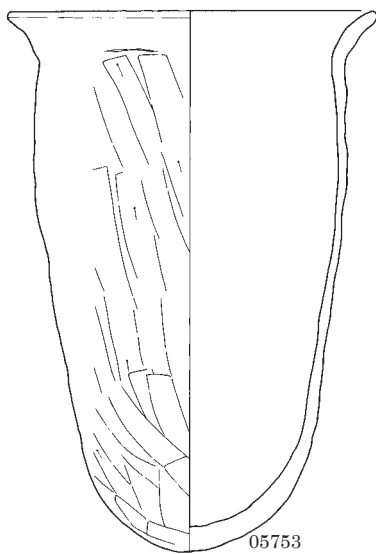
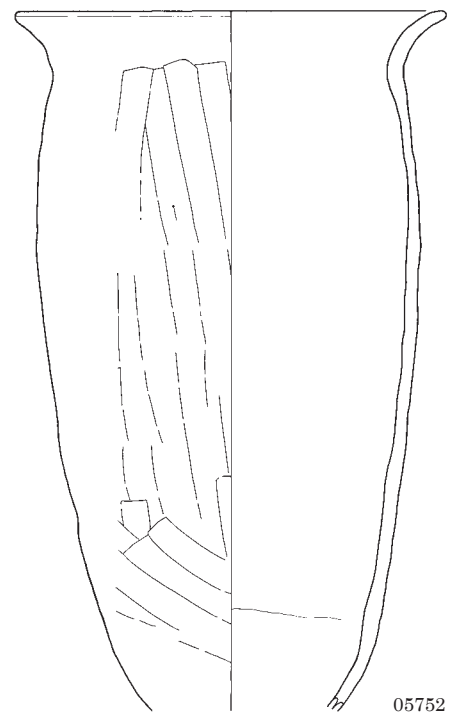
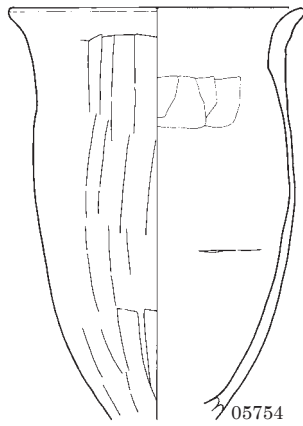
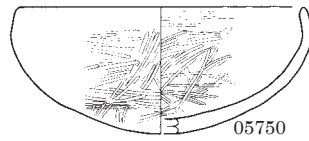

SB7006 (1)

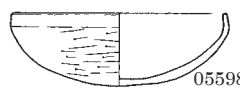
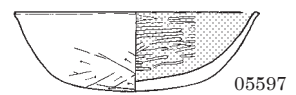
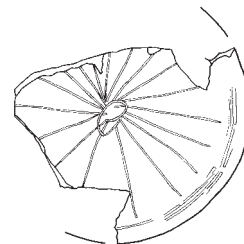

0 (1:4) 10cm

図版 158 古墳時代～古代の土器 (101)

SB7006 (2)

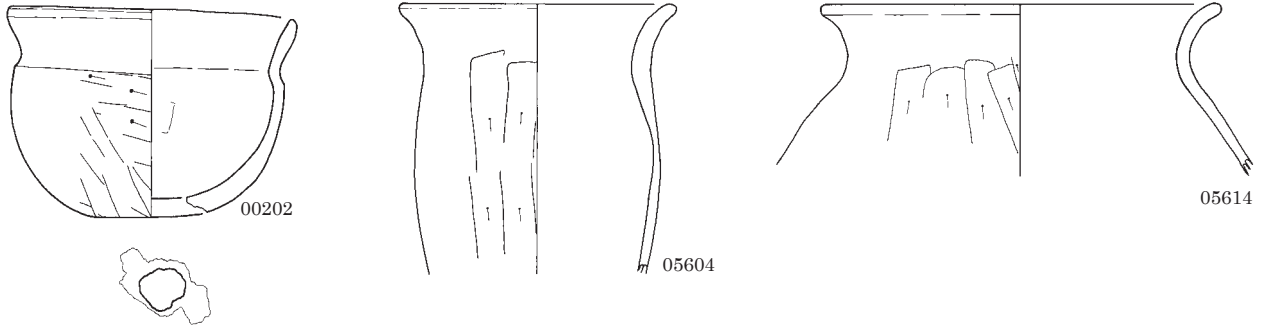

SB7007

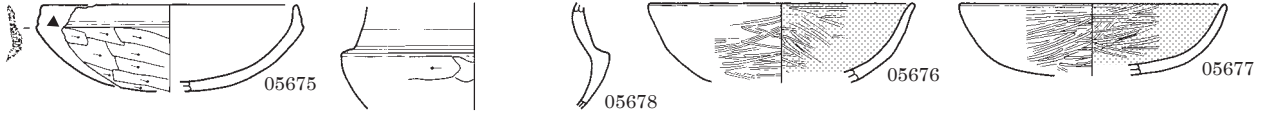

SB7008

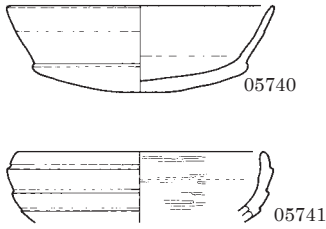

SB7009

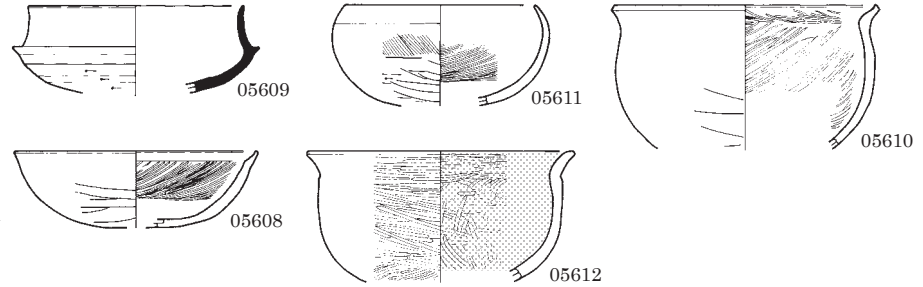

SB7011

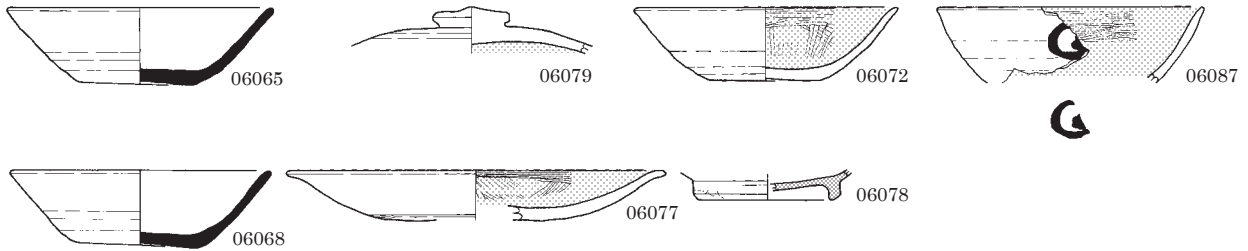

SB7012

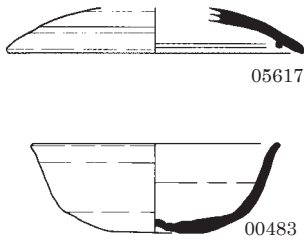

SB7013

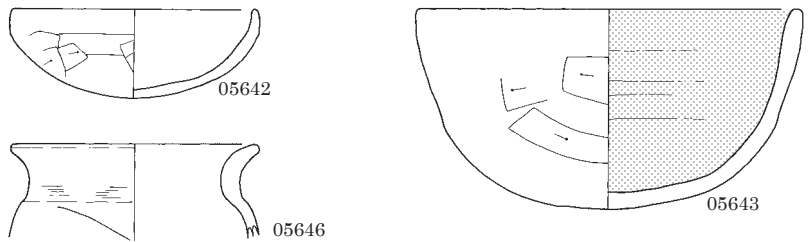

SB7014 (1)

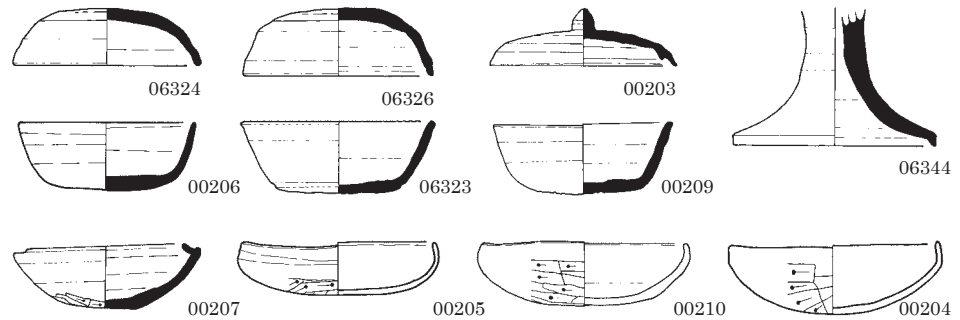

0 (1:4) 10cm

SB7014 (2)

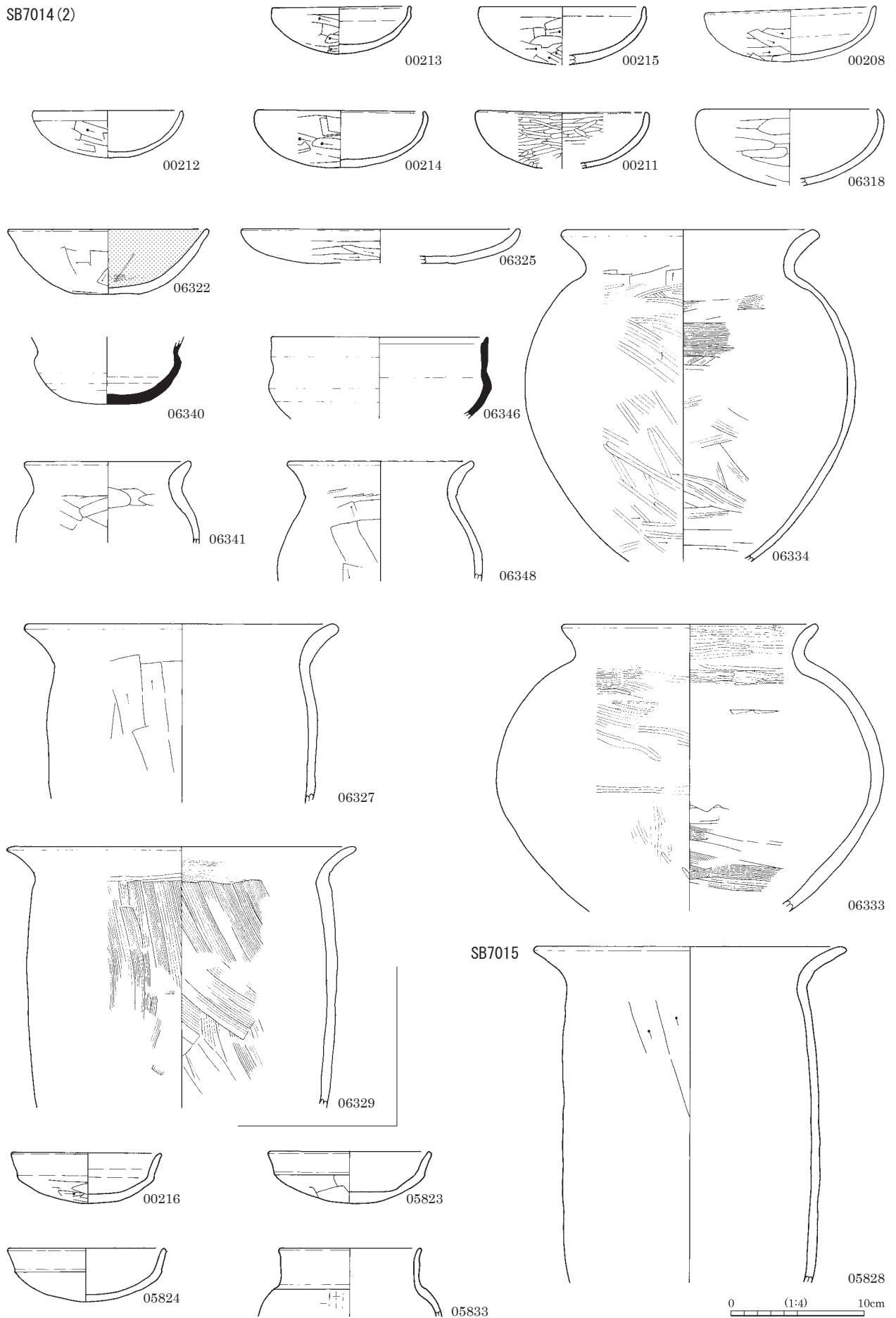

0 1:4 10cm

図版 160 古墳時代～古代の土器 (103)

SB7016

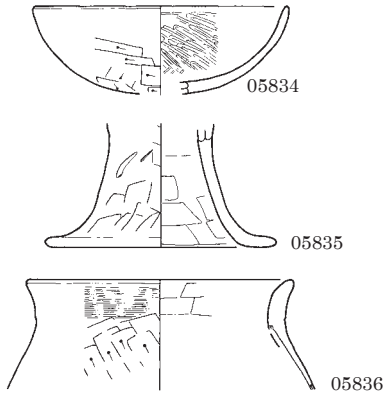

SB7017

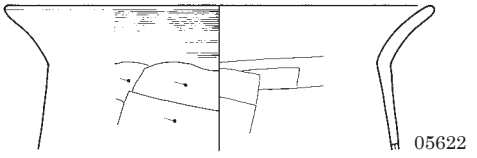
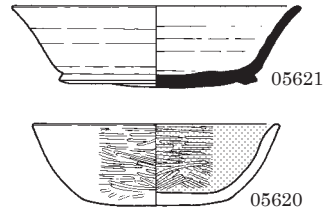
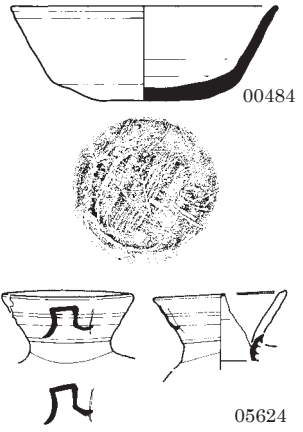

SB7018

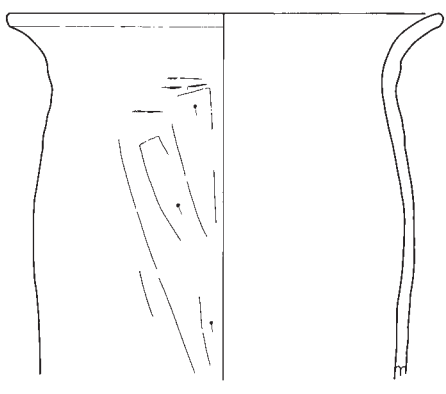
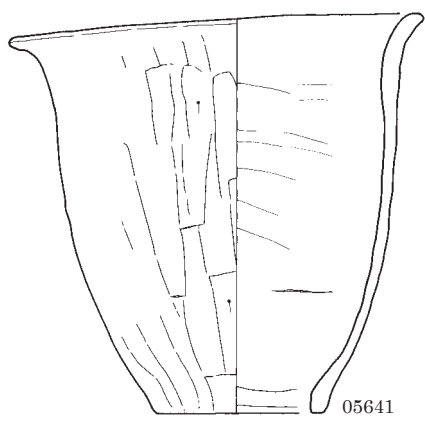
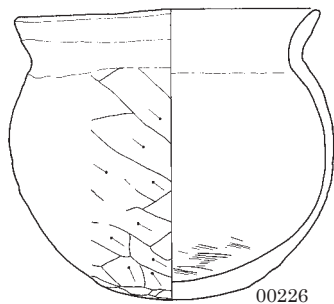
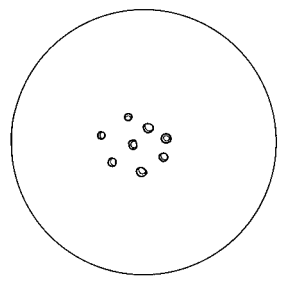
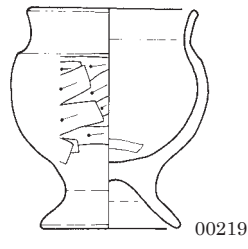
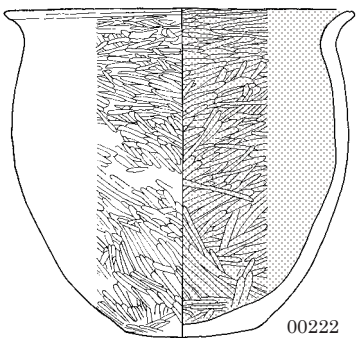
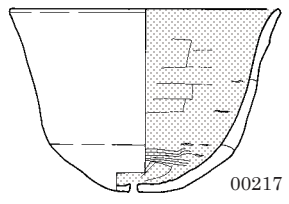
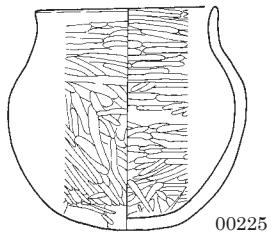
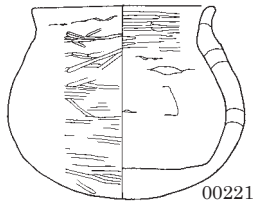
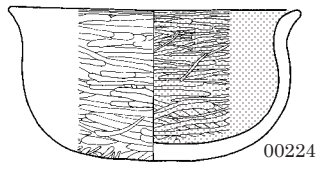
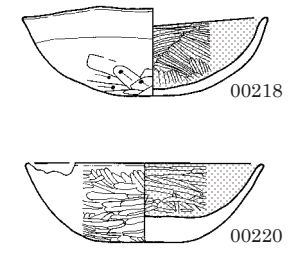

05635 0 (1:4) 10cm

SB7019

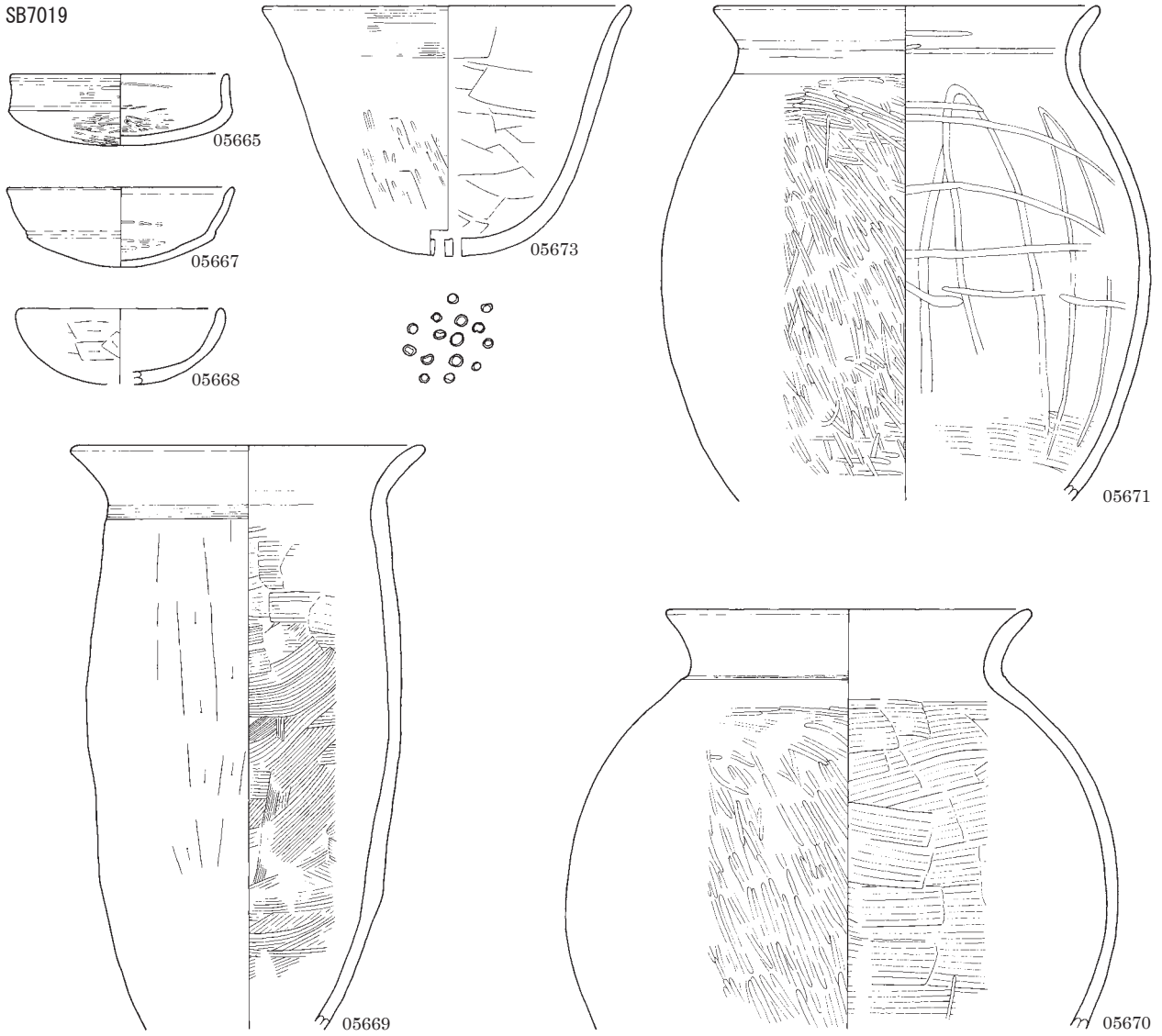

SB7020

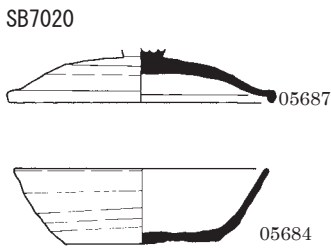

SB7021

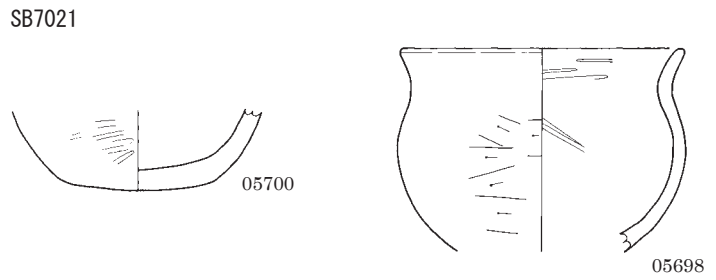

SB7022 (1)

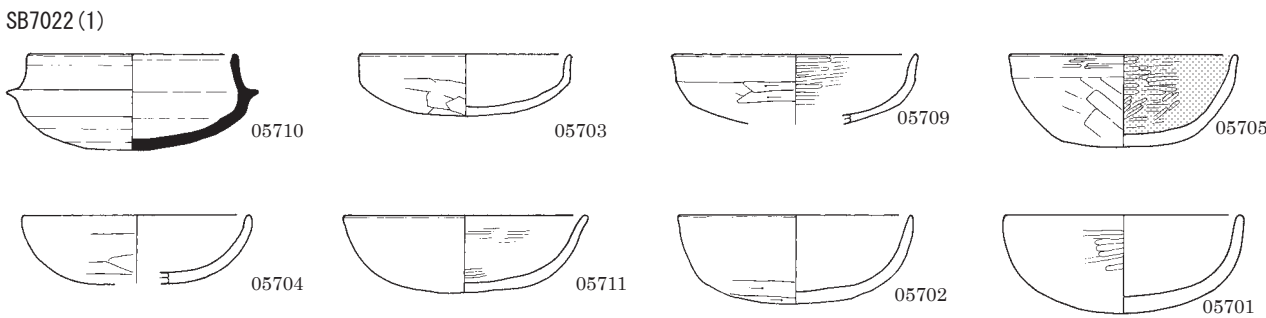

0 (1:4) 10cm

図版 162 古墳時代～古代の土器 (105)

SB7022 (2)

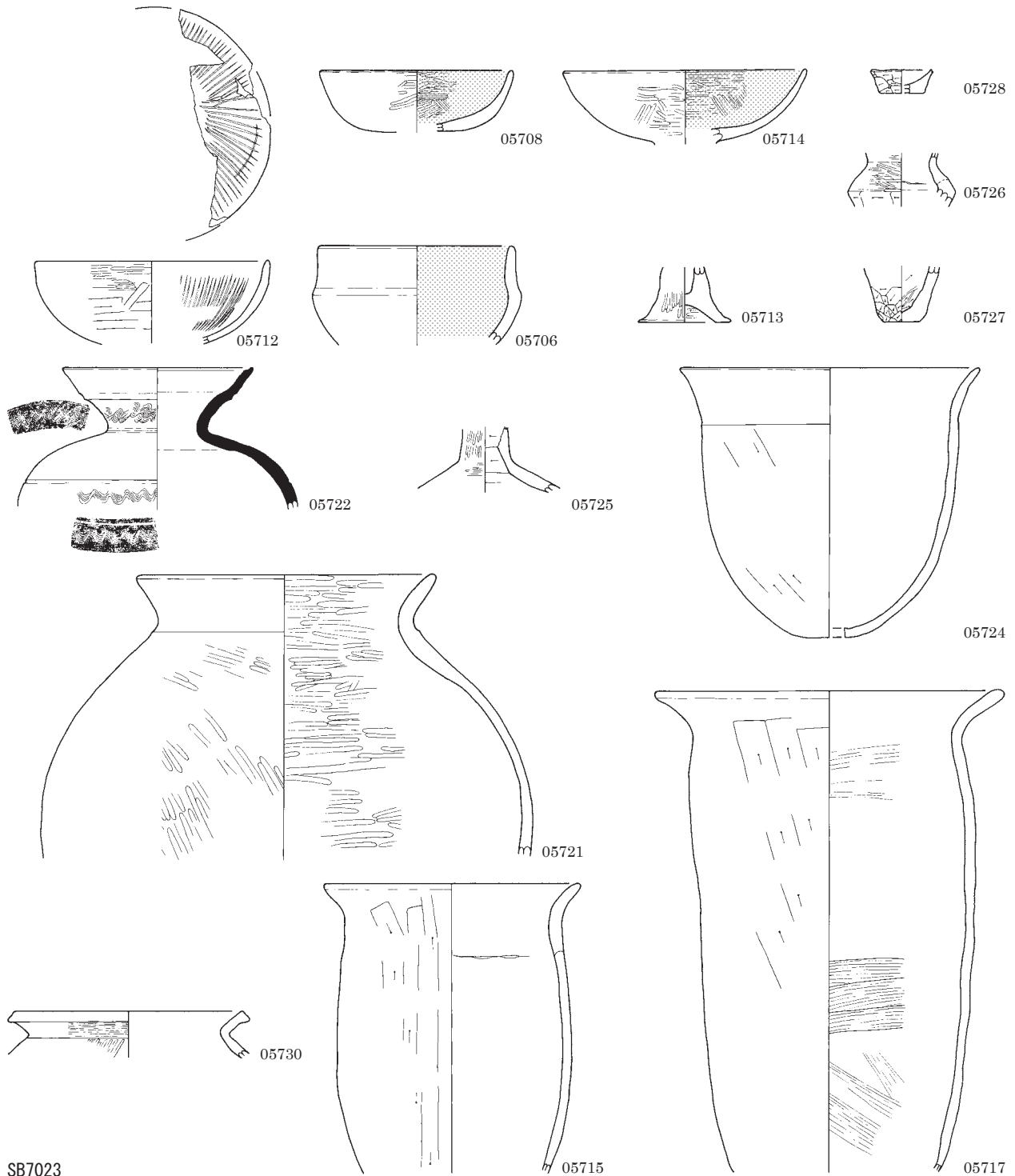

SB7023

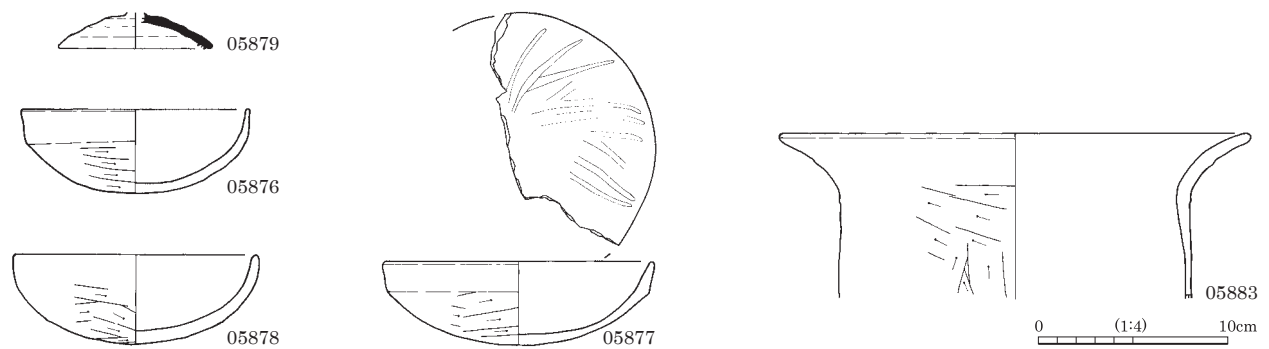

SB7024

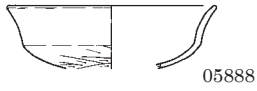

05888

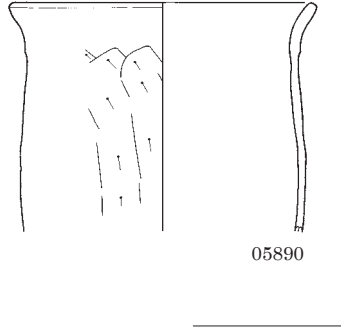

05890



05896

SB7025

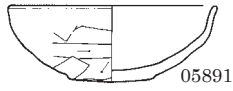

05891

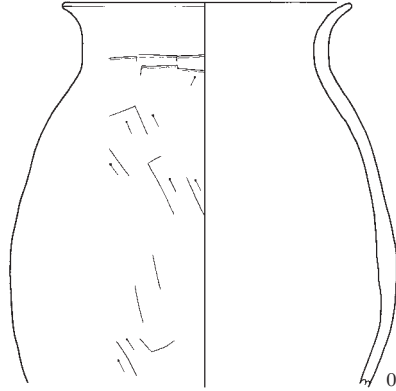

05897

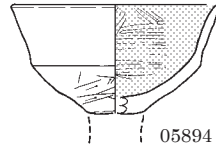

05894

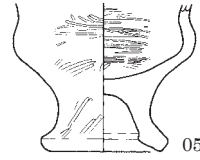

05895

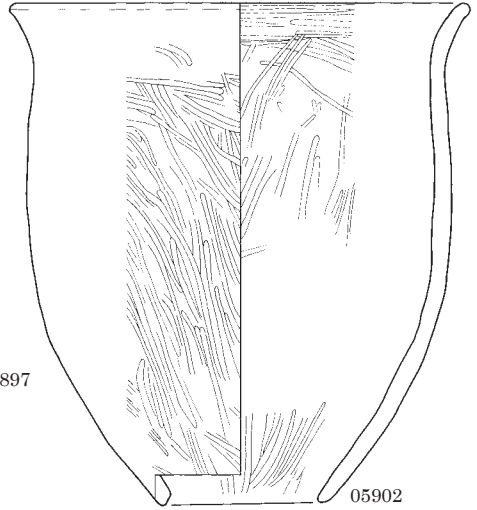

05902

SB7026



05934

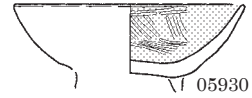

05930

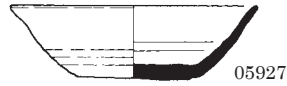

05927

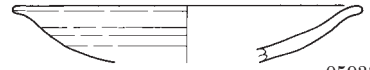

05933



05924

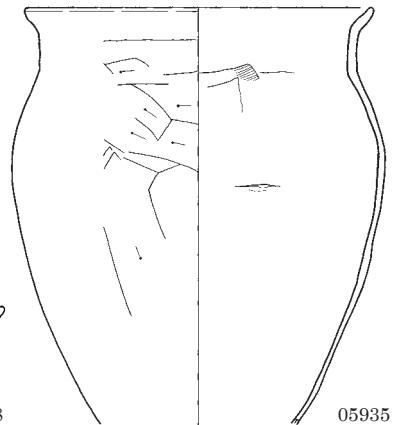

05935

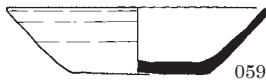

05925



05932



05944

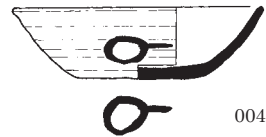

00467

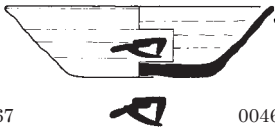

00466

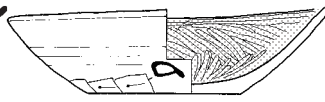

00228

SB7027

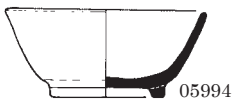

05994

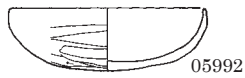

05992

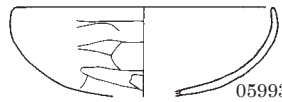

05993

0 1:4 10cm

図版 164 古墳時代～古代の土器 (107)

SB7028

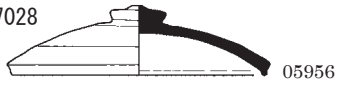

SB7029

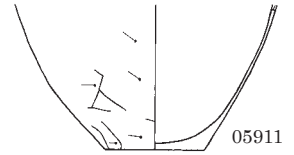
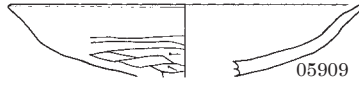
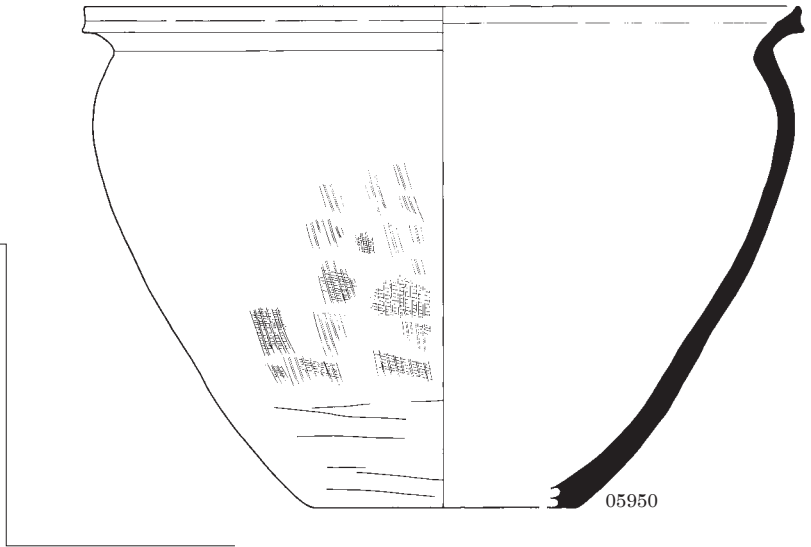
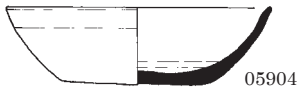

SB7030

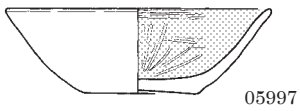
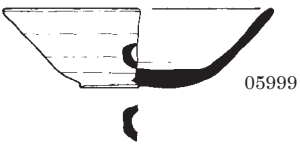
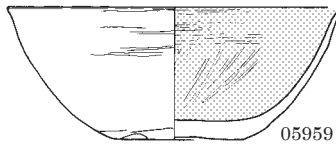

SB7031

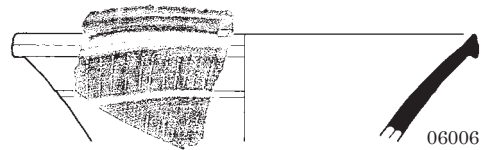
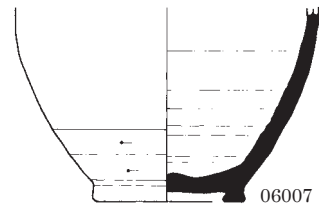
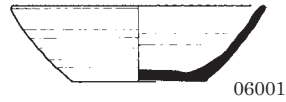
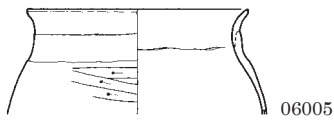
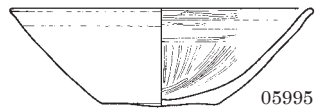
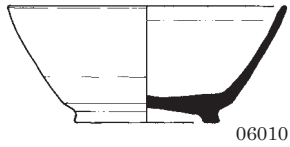

SB7032

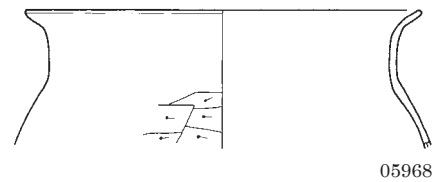
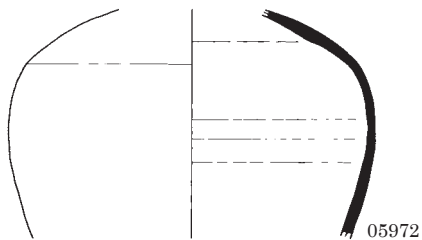
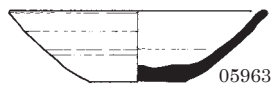

0 (1:4) 10cm

SB7033

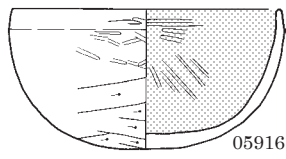

05916

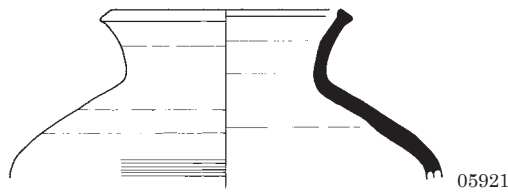

05921

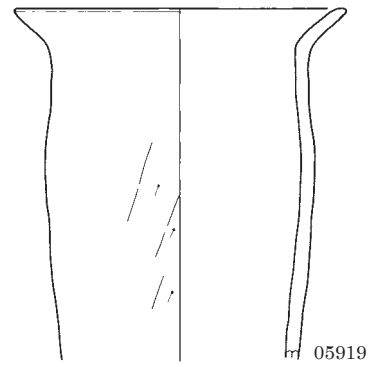

05919

SB7034

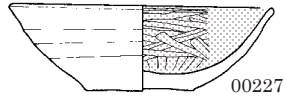

00227

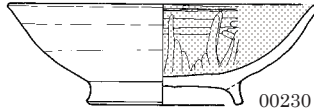

00230

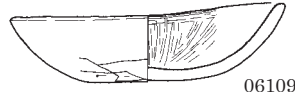

06109



06111

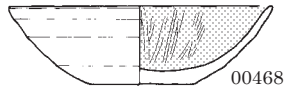

00468

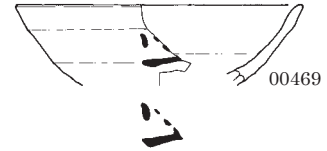
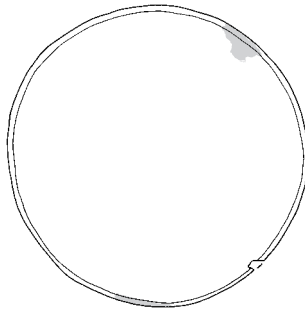

00469

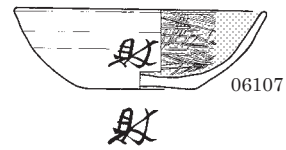

06107

射

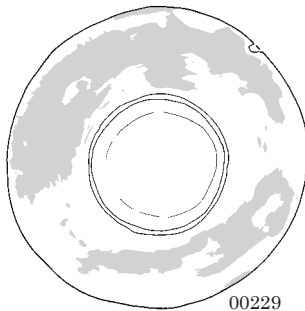
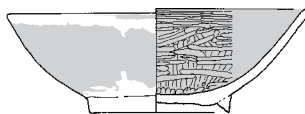

00229

■ 煤附着

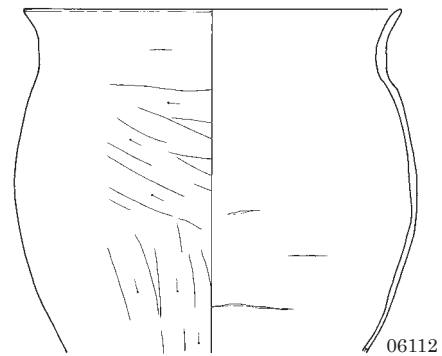

06112

SB7035 (1)



06136

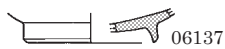

06137

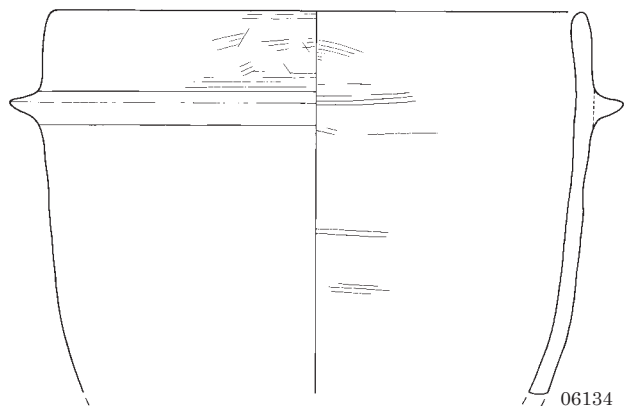

06134

0 (1:4) 10cm

図版 166 古墳時代～古代の土器 (109)

SB7035 (2)

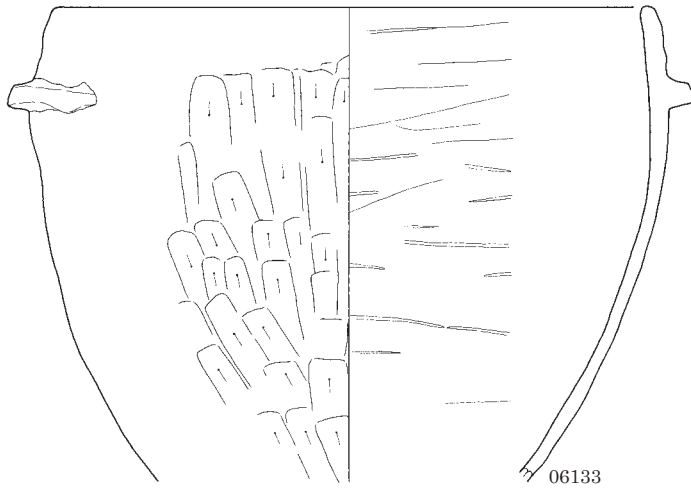

06133

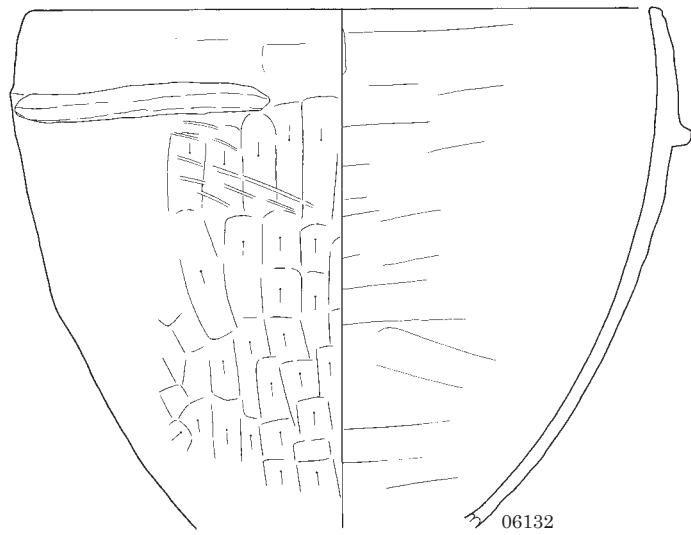

06132

SB7036 (1)

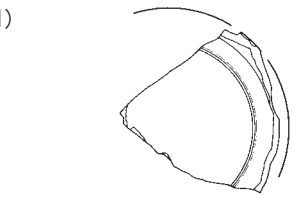

00506

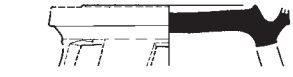

06044



00232

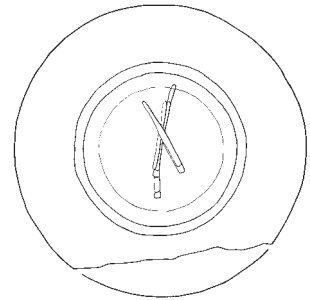

06036



06026



00233

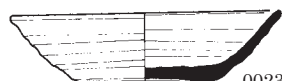

00231



00486



06033

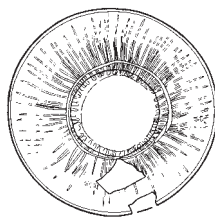

06032



06035

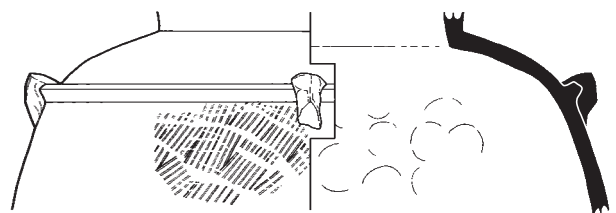

06042

0 1:4 10cm

SB7036 (2)

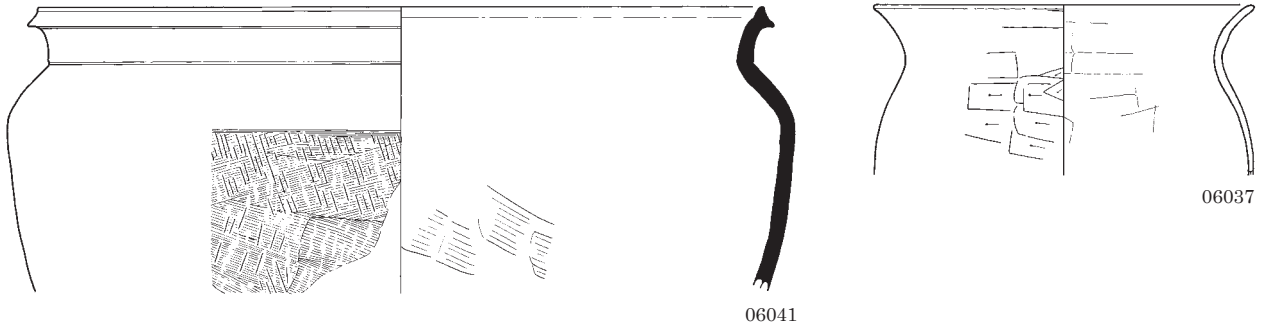

06037

06041

SB7037

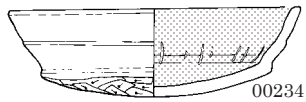

00234



06089

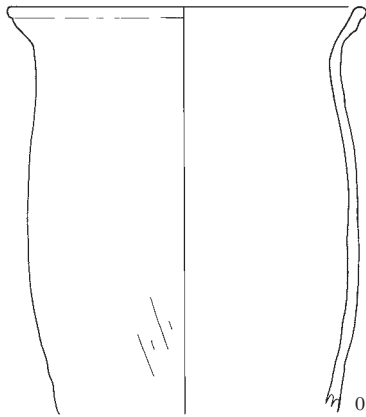

06092

SB7039



06014



06013



06011

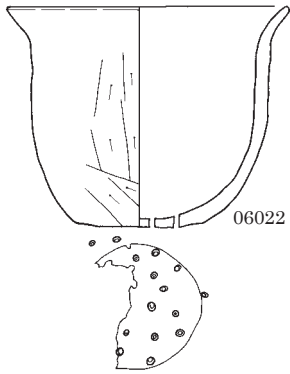

06022

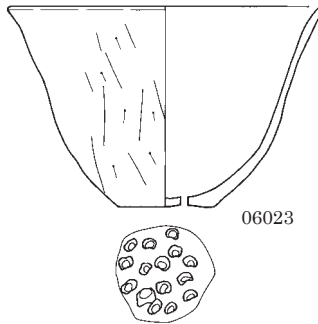

06023

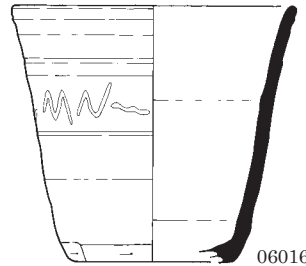

06016



06047

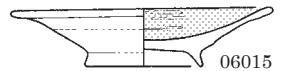

06015

SB7040

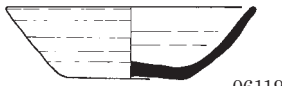

06119

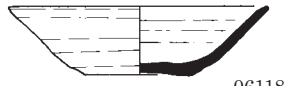

06118

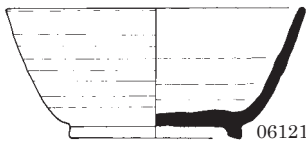

06121

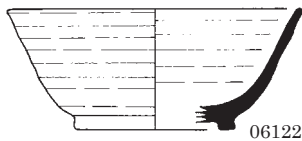

06122

SB7041 (1)



06146

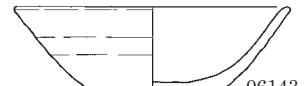

06143



06148



06144



06123

0 1:4 10cm

図版 168 古墳時代～古代の土器 (111)

SB7041 (2)

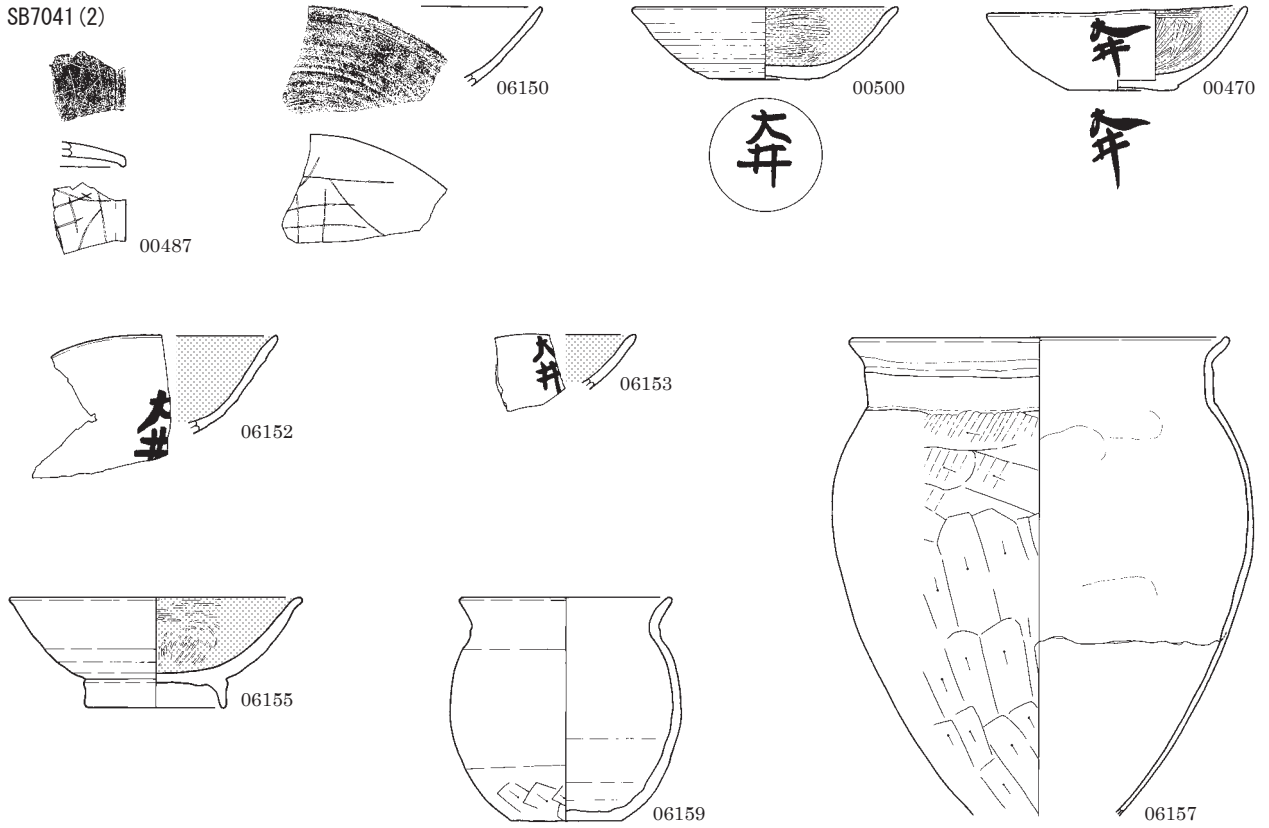

SB7042 (1)

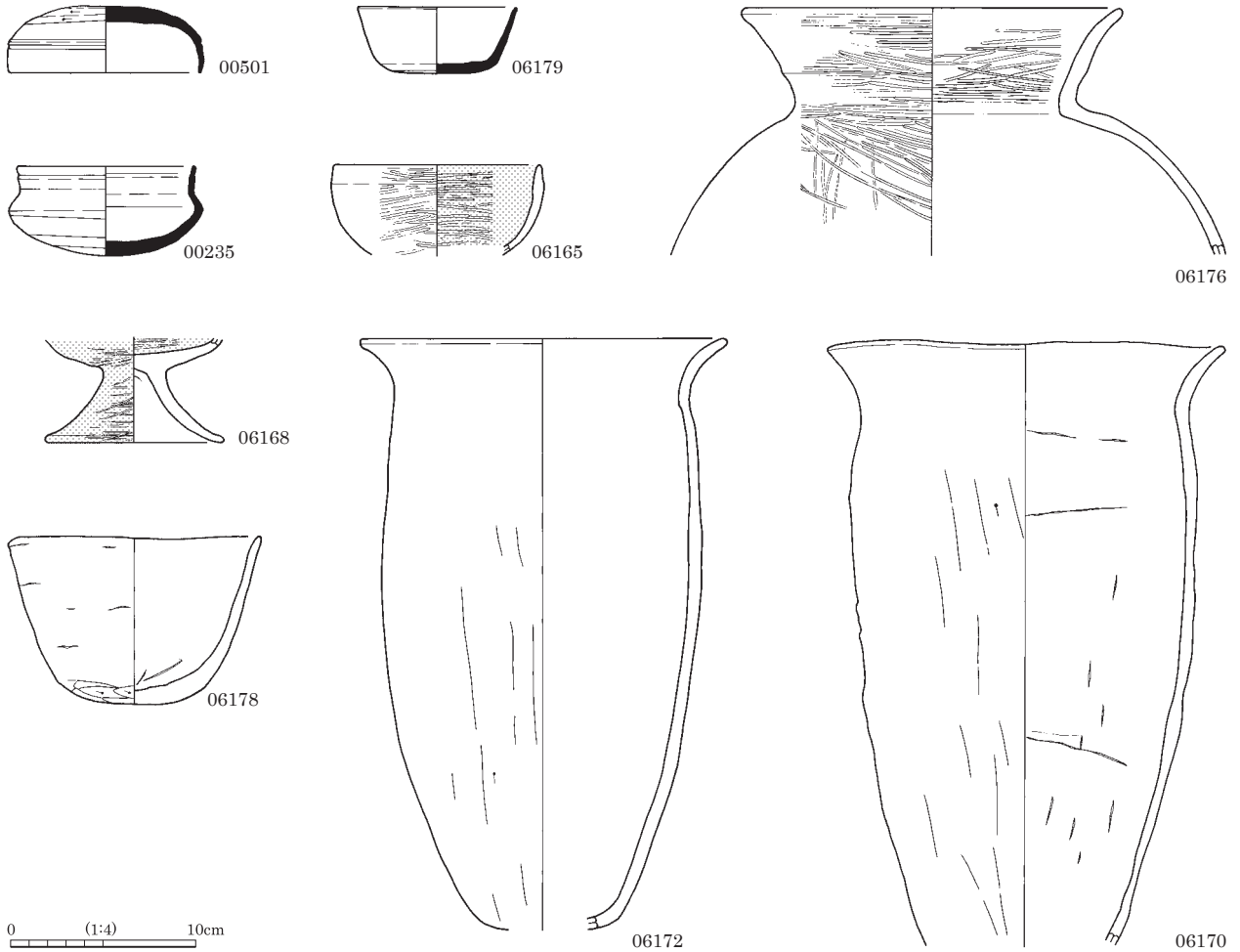

SB7042 (2)

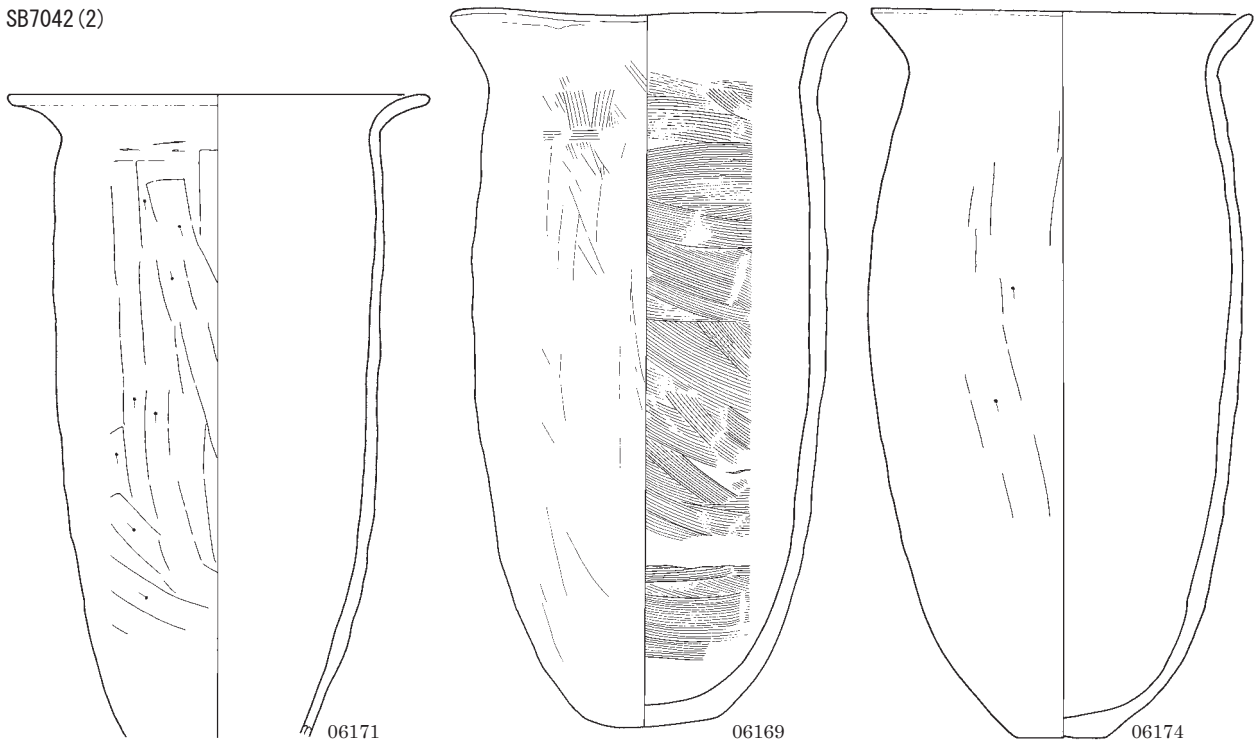

SB7043 (1)

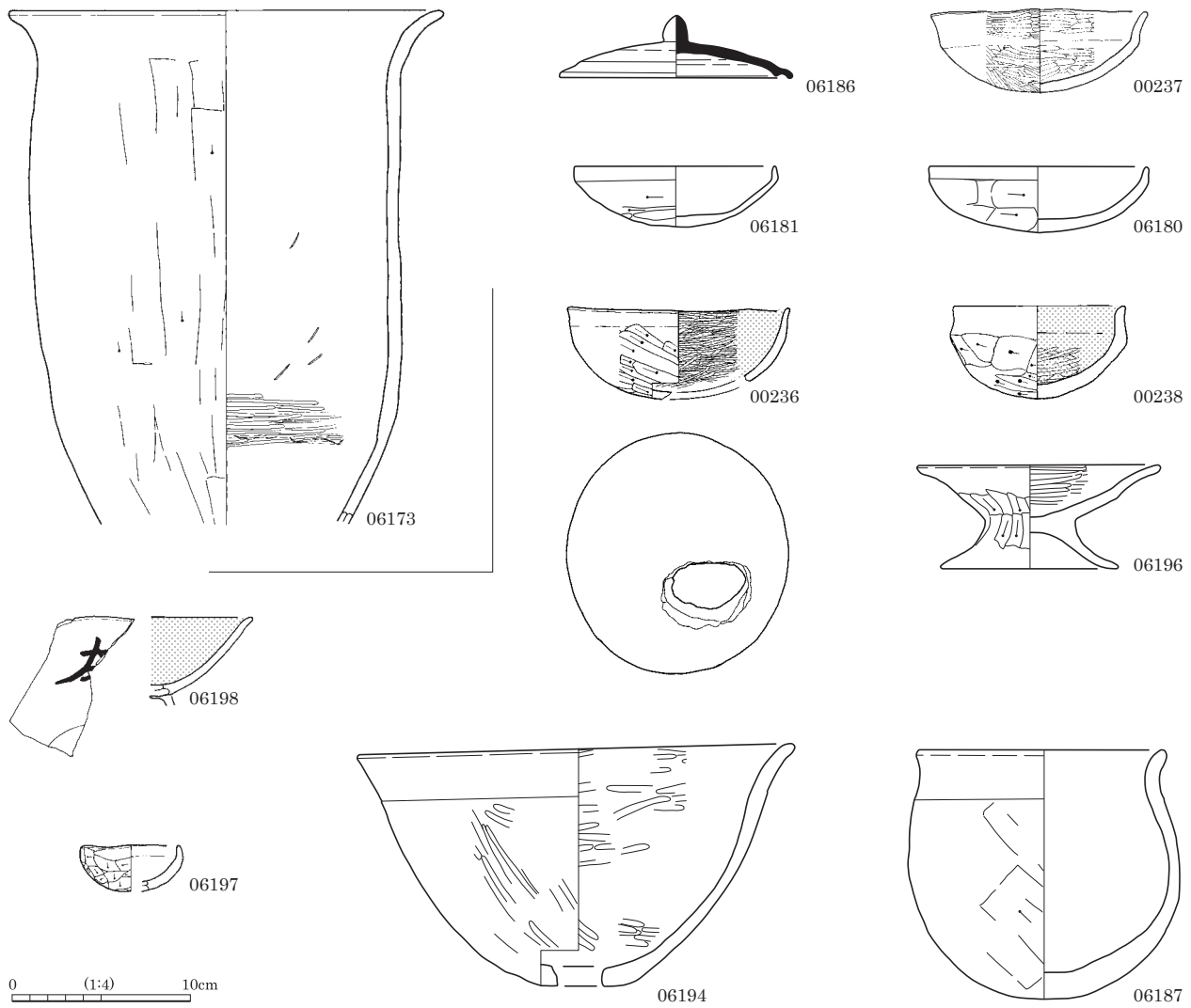

図版 170 古墳時代～古代の土器 (113)

SB7043 (2)

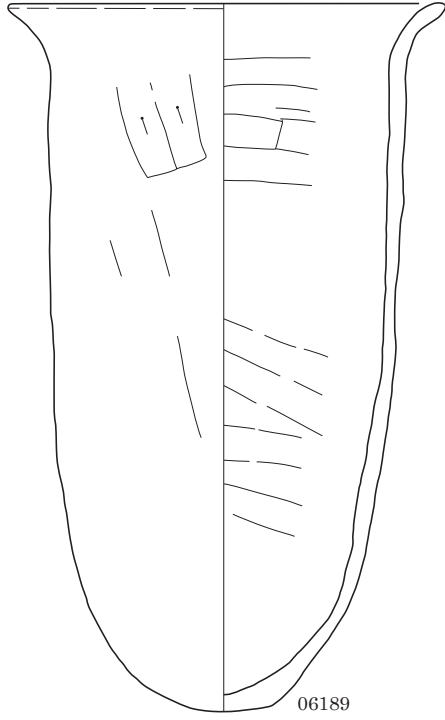
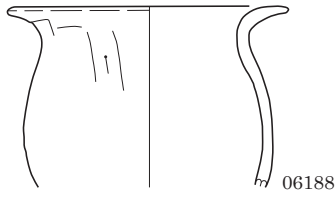

SB7044

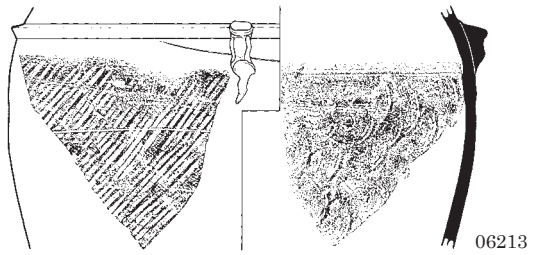
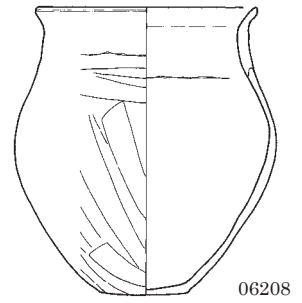
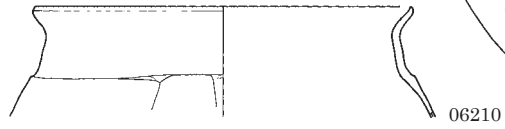
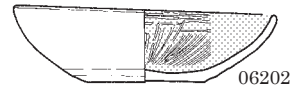
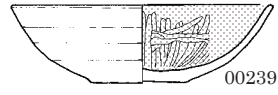

SB7045

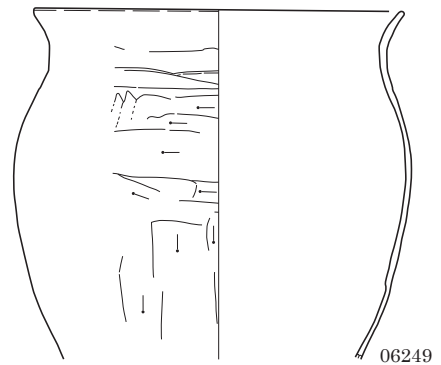
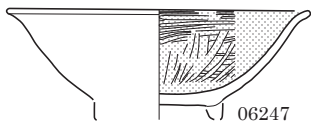
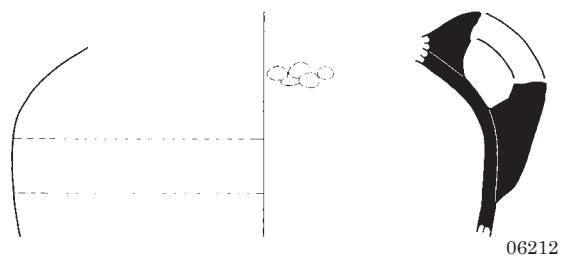
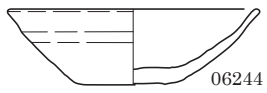
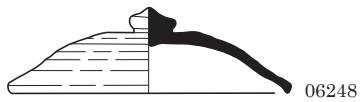

0 (1:4) 10cm

SB7046

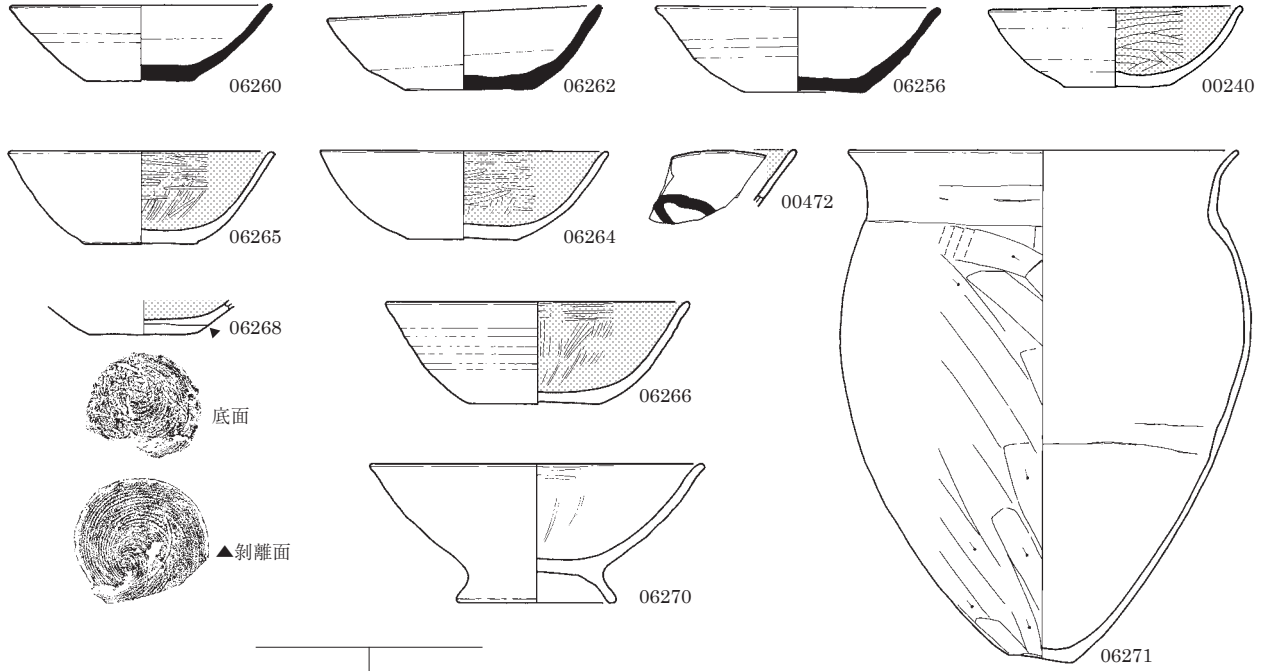

SB7048

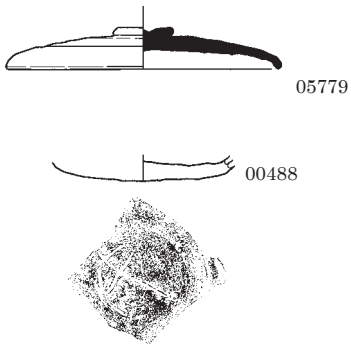

SB7050

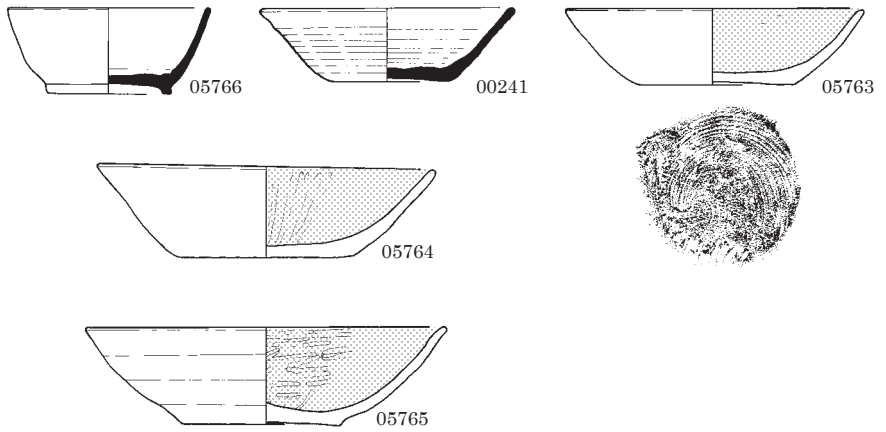

SB7049

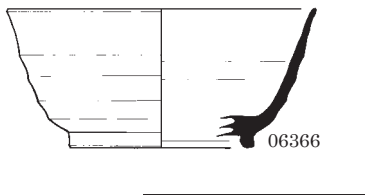

SB7052

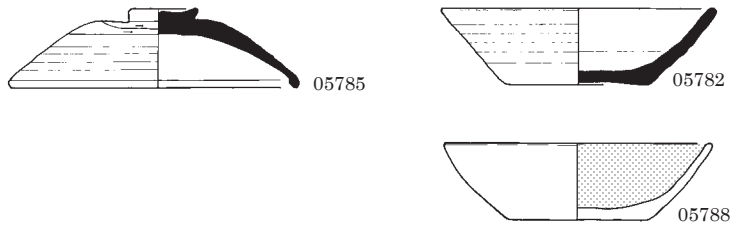

SB7055 (1)

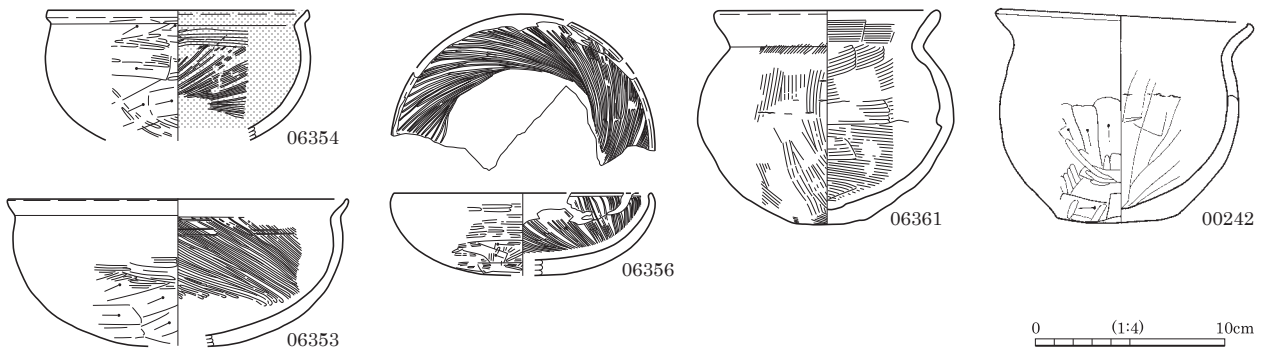

図版 172 古墳時代～古代の土器 (115)

SB7055 (2)

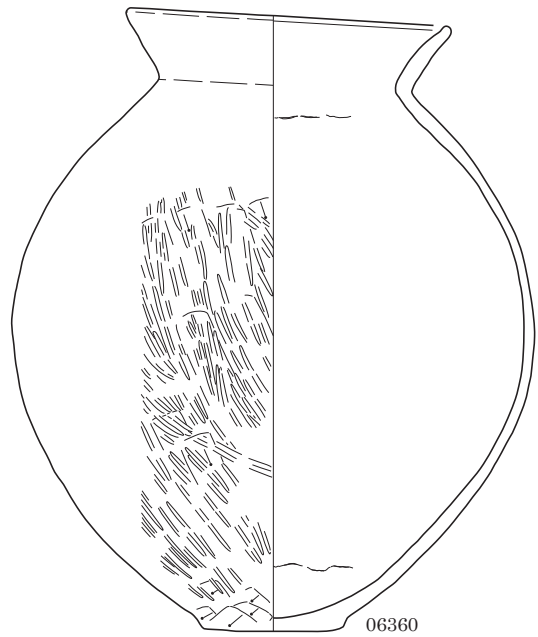
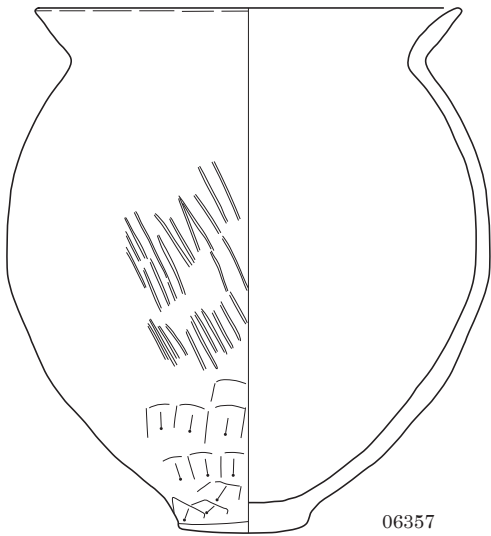
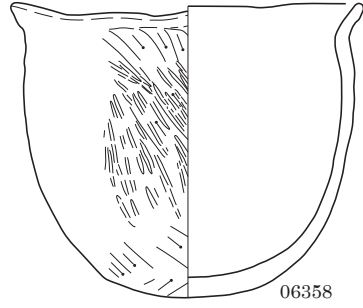
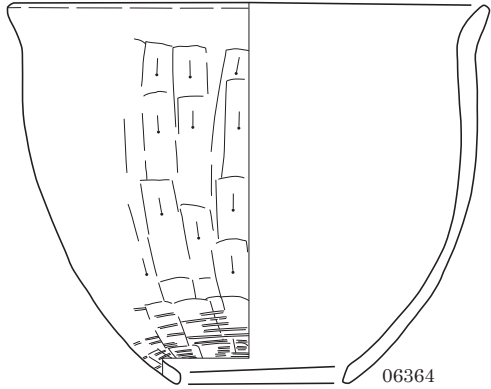

SB7057

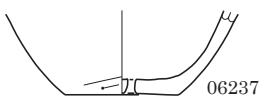
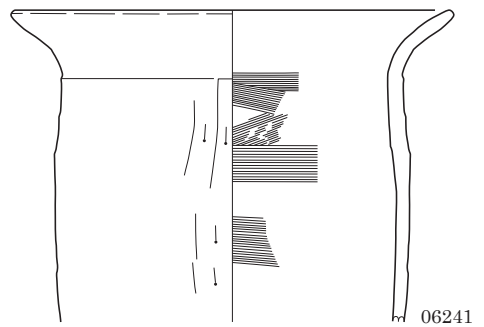
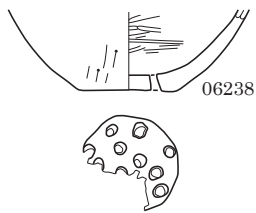
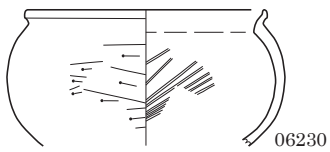

0 (1:4) 10cm

SB7058

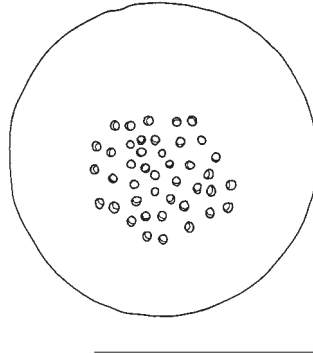
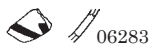
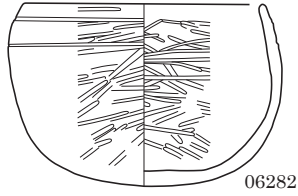
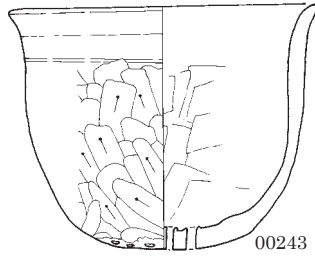

SB7060

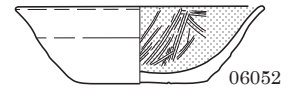
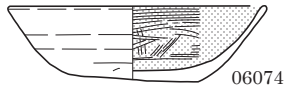
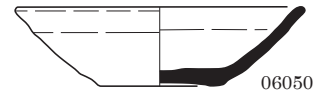
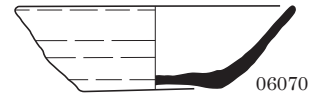
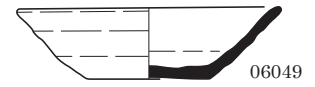

SB7061

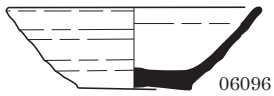

SB7063

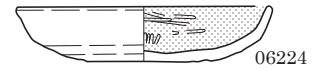
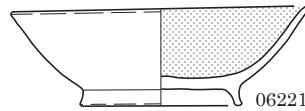
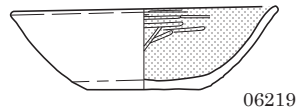
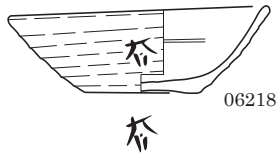

茶

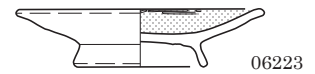

SB7065

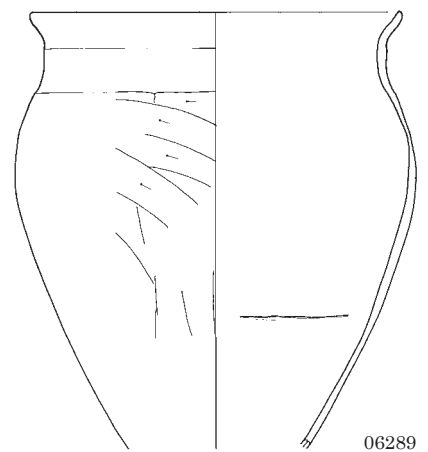
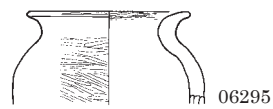
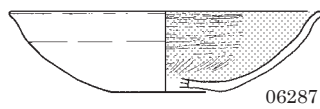
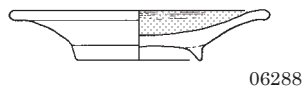

0 (1:4) 10cm

図版 174 古墳時代～古代の土器 (117)

SB7068



00473



00489

SB7069

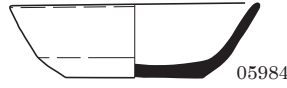

05984



00244

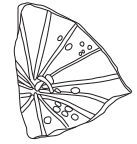

05985

SB7070



06374



06375

SB7071

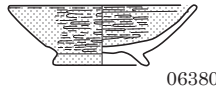

06380

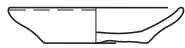

06389

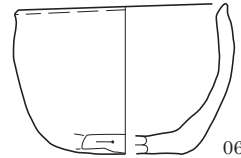

06382

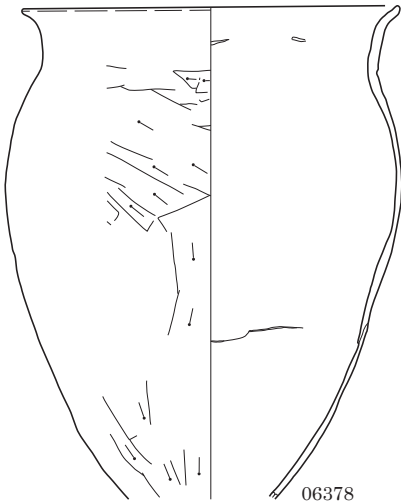

06378

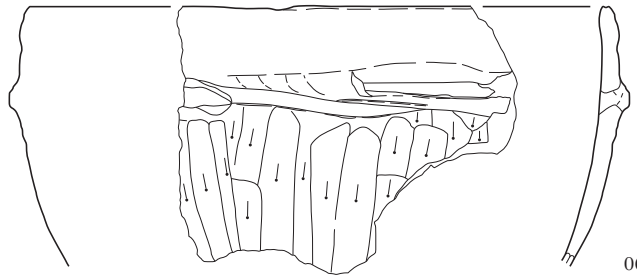

06387

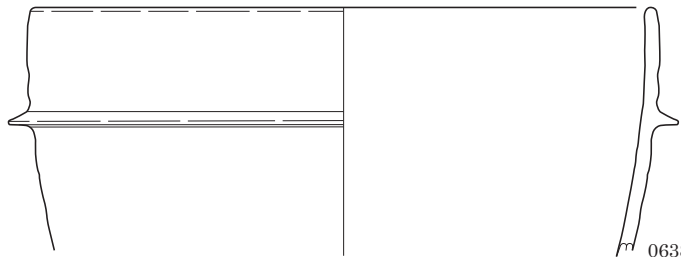

06388

SB7072

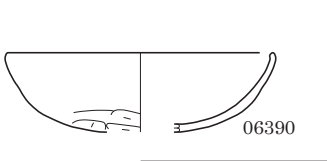

06390

SB7073

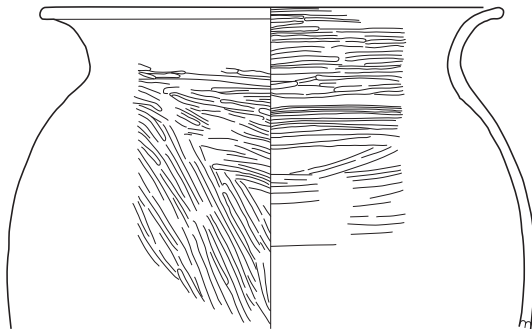

06393

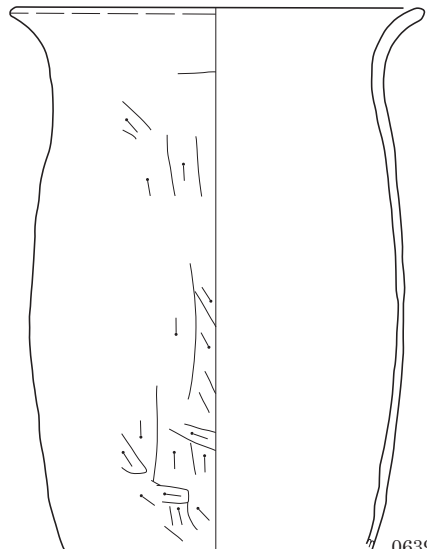

06392

0 (1:4) 10cm

SB8003

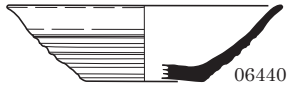

06440

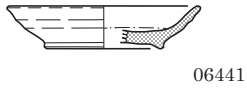

06441



06448

SB8004



06444



06455



06454

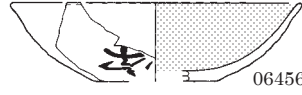

06456



06457



06459

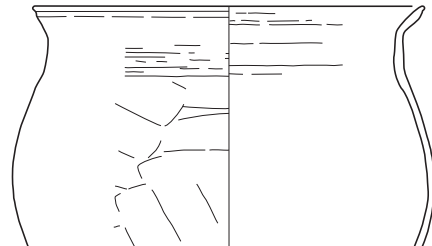

06450

SB8006

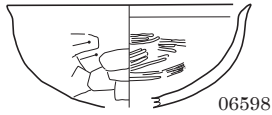

06598

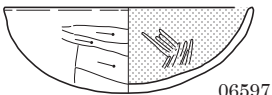

06597

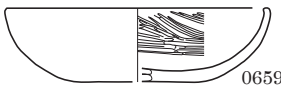

06599

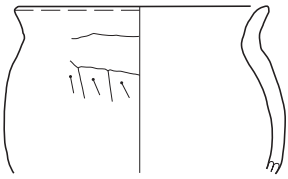

06600

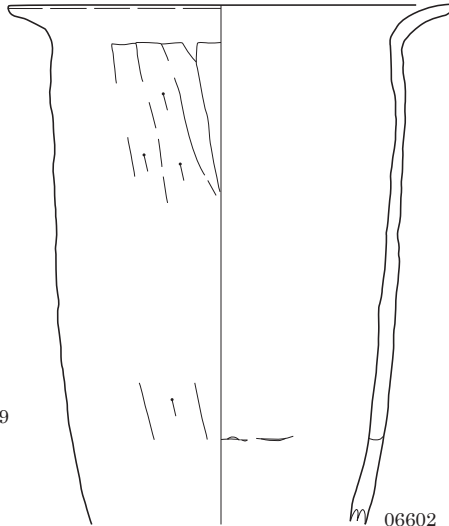

06602

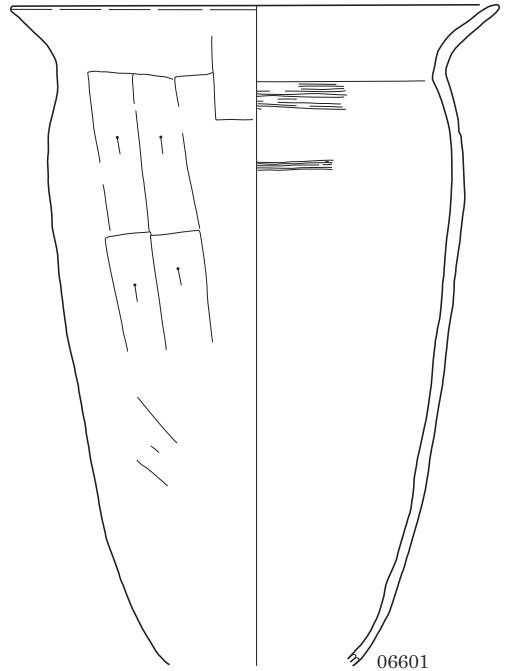

06601

SB8007



06616

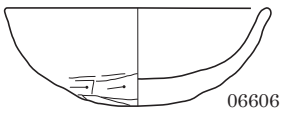

06606

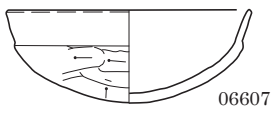

06607

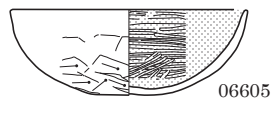

06605

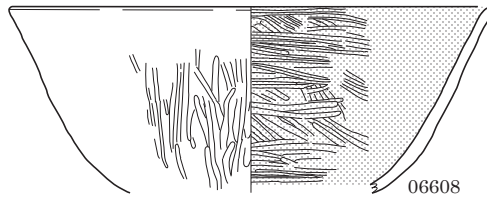

06608

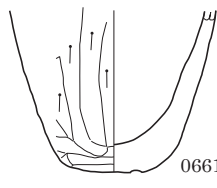

06610

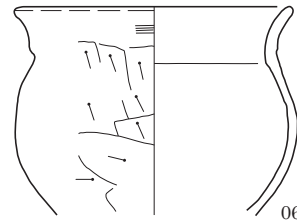

06611

0 (1:4) 10cm

図版 176 古墳時代～古代の土器 (119)

SB8008

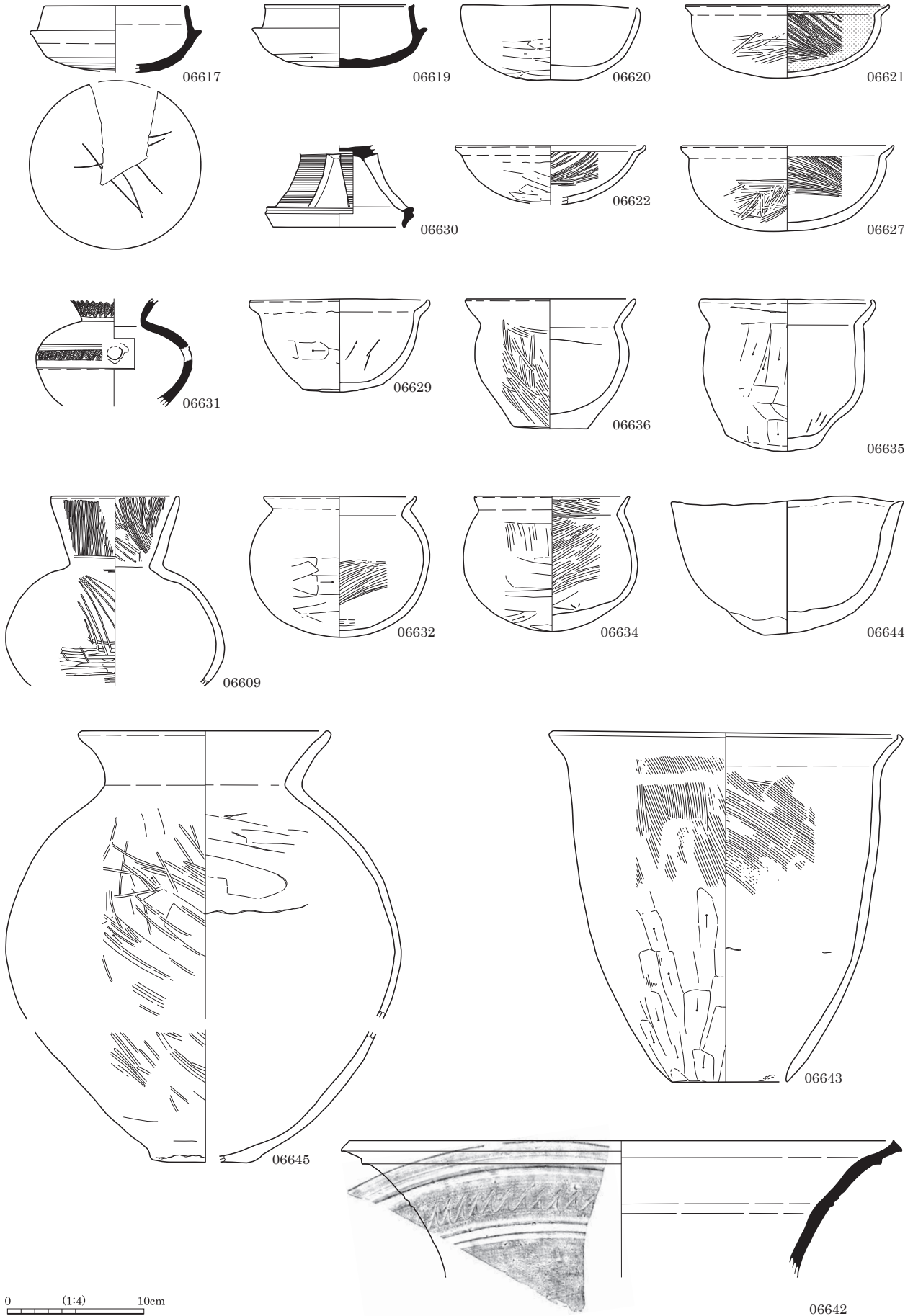

SB8009

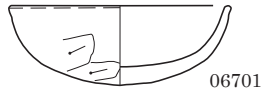

06701

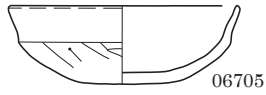

06705

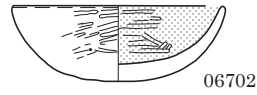

06702

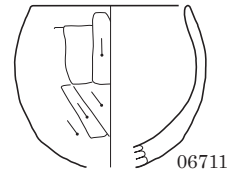

06711

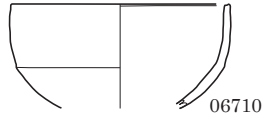

06710



06706

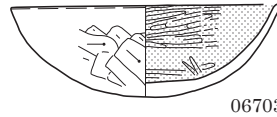

06703

SB8010



06714



06713

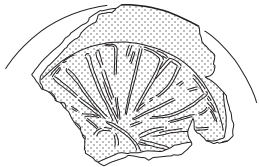

06413

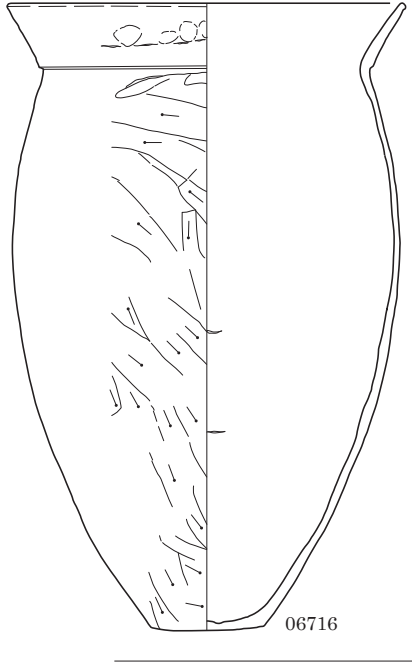

06716

SB8011



06418



06419

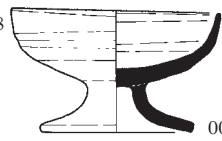

00271

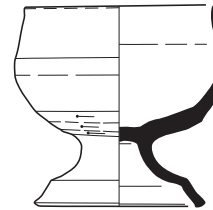

06420



06410



06411



06409

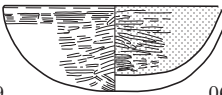

06408

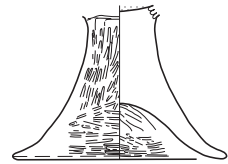

06421

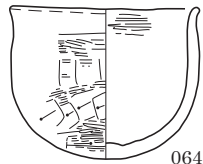

06429

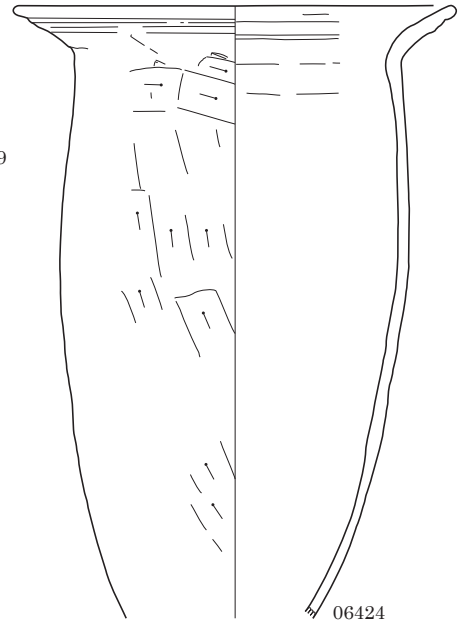

06424

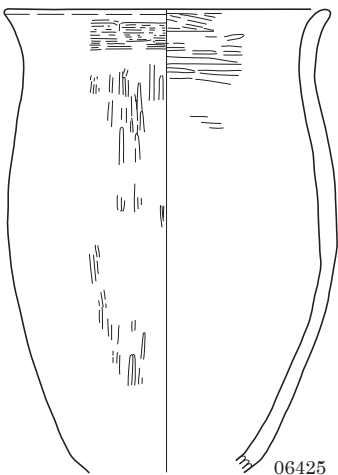

06425

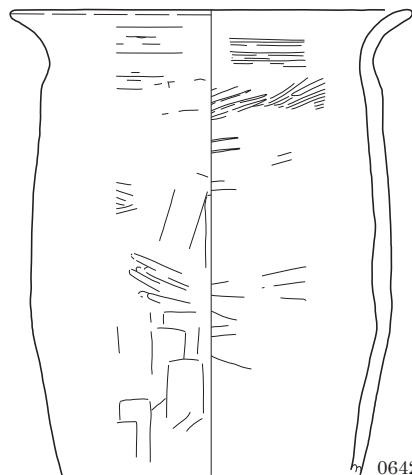

06426

0 (1:4) 10cm

図版 178 古墳時代～古代の土器 (121)

SB8012

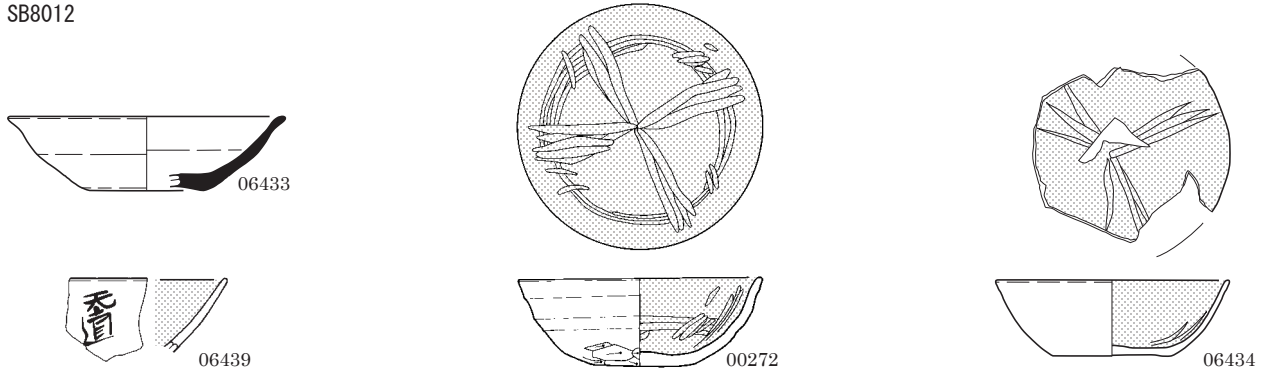

SB8013

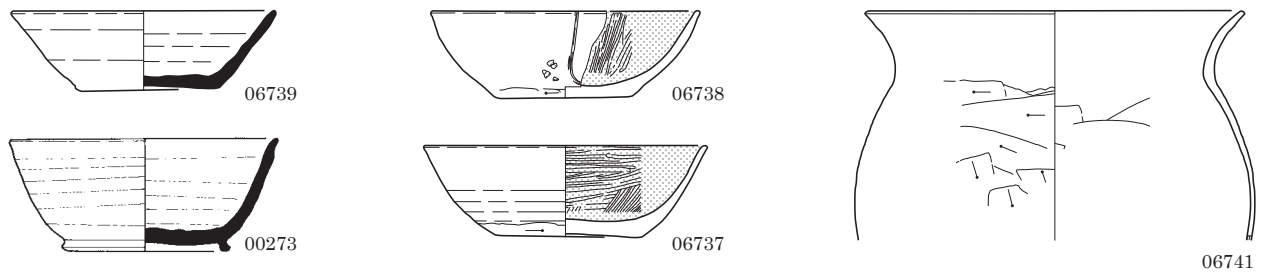

SB8014

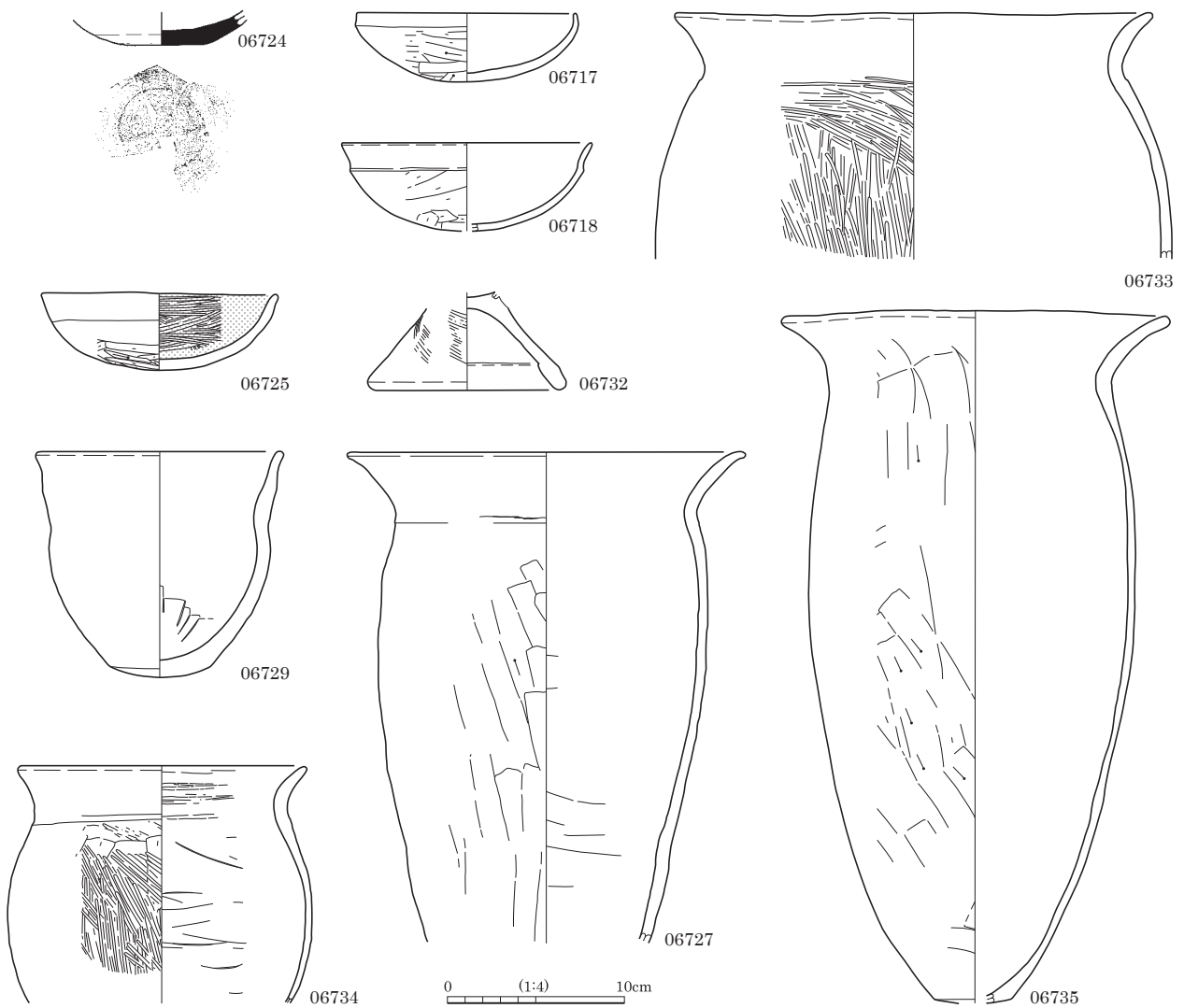

SB8015

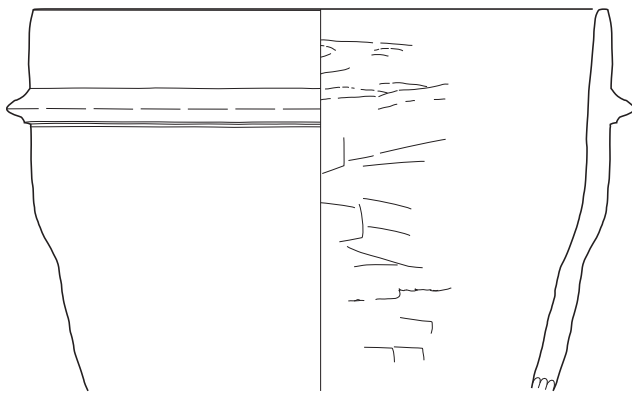

06744

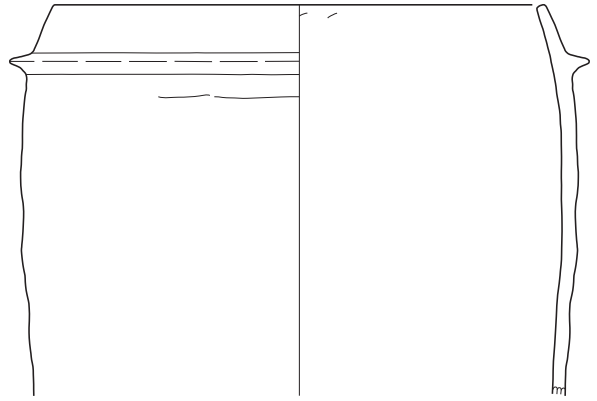

06745

SB8016

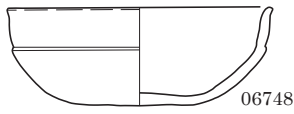

06748

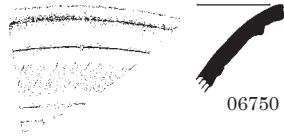

06750

SB8017



06751

SB8018

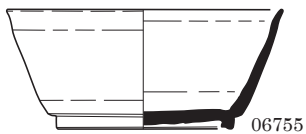

06755

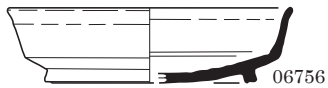

06756

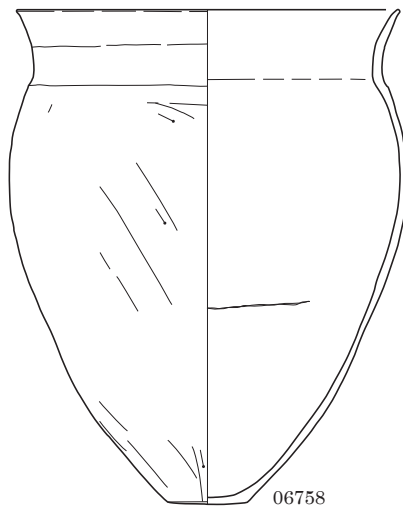
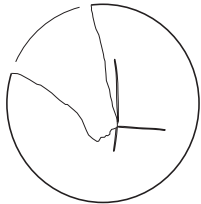

06758

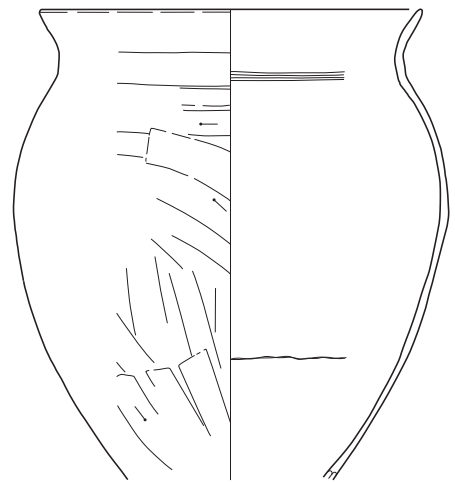

06757

SB8019

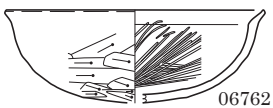

06762

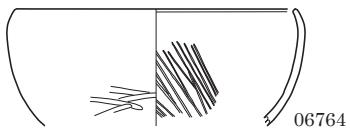

06764

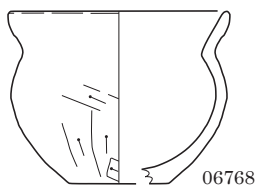

06768

SB8021

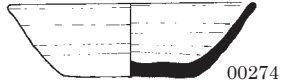

00274



06770

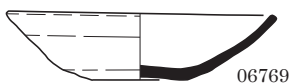

06769

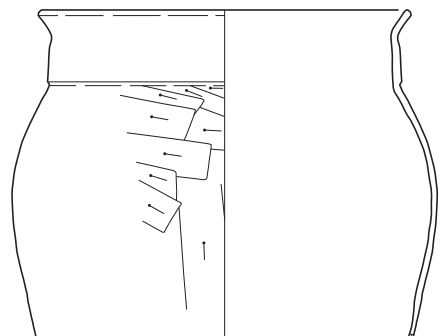

06772

0 1:4 10cm

図版 180 古墳時代～古代の土器 (123)

SB8022

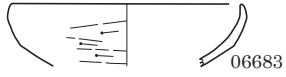

06683

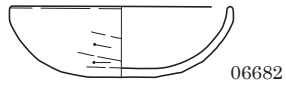

06682

SB8023

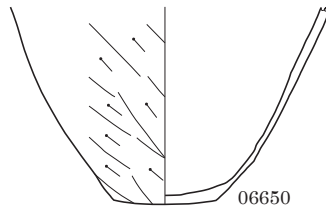

06650

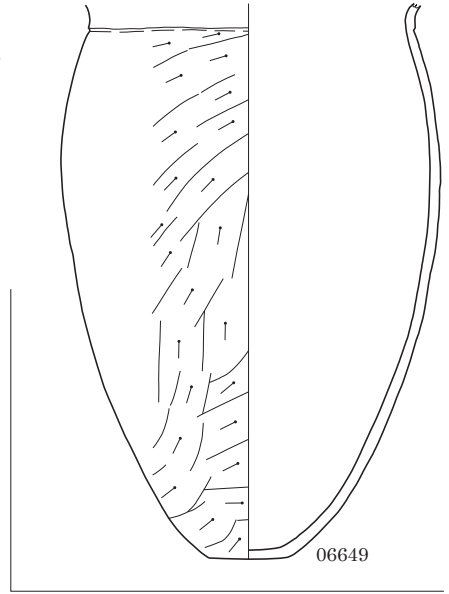

06649

SB8024 (1)

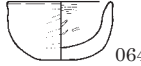

06485



06484



06464

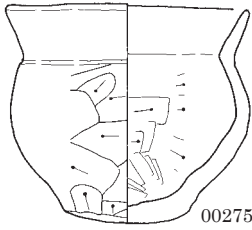

00275

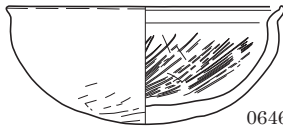

06461

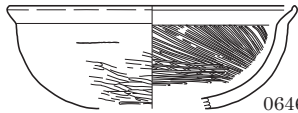

06463

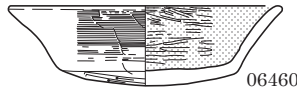

06460

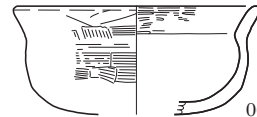

06466

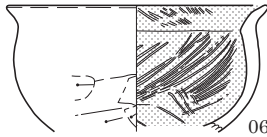

06462

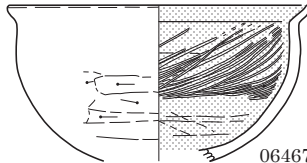

06467

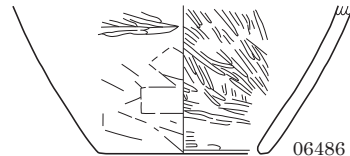

06486

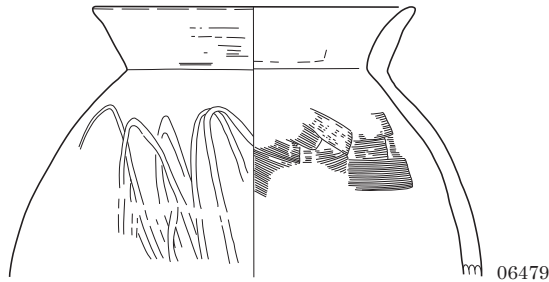

06479

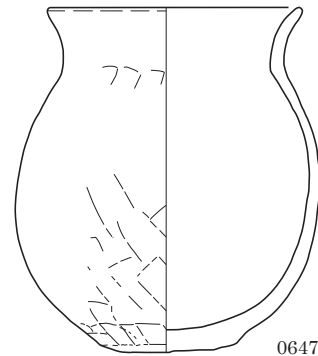

06474

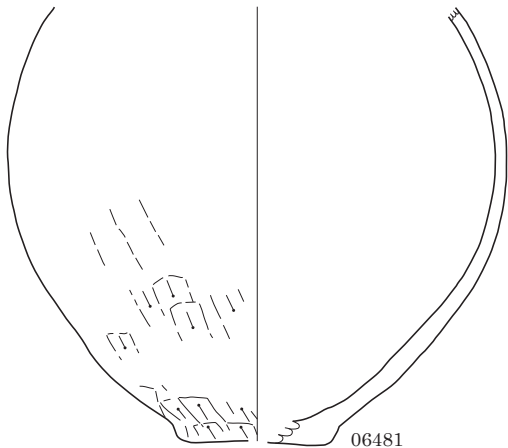

06481

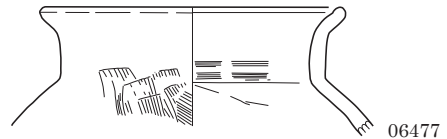

06477

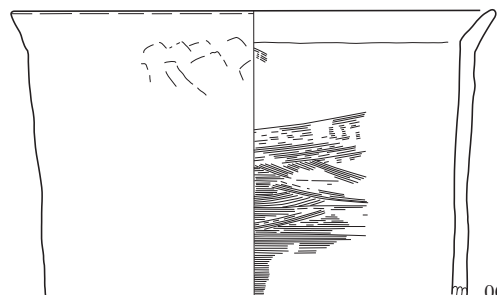

06469

0 (1:4) 10cm

SB8024 (2)

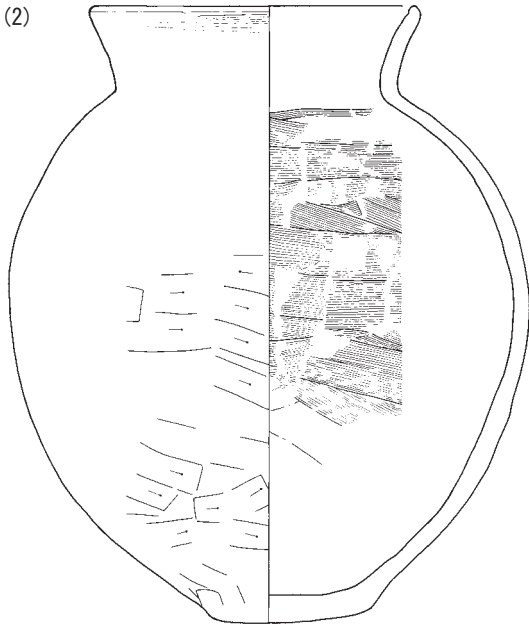

06472

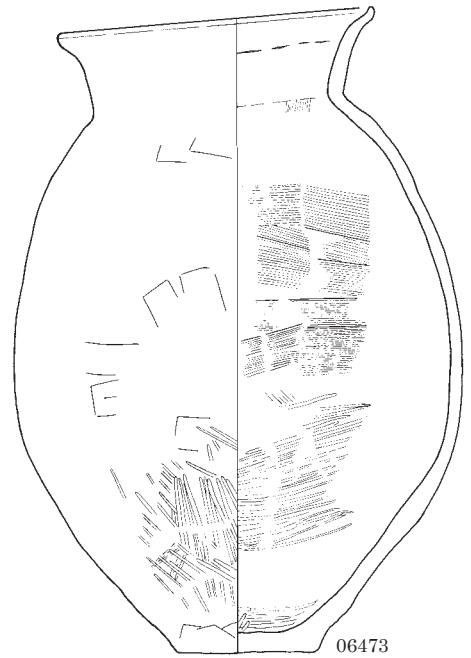

06473

SB8025 (1)

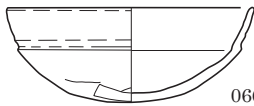

06688

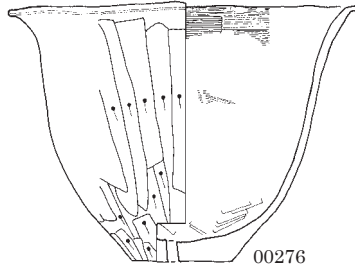

00276

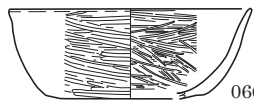

06689

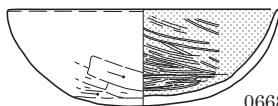
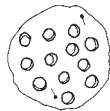

06687

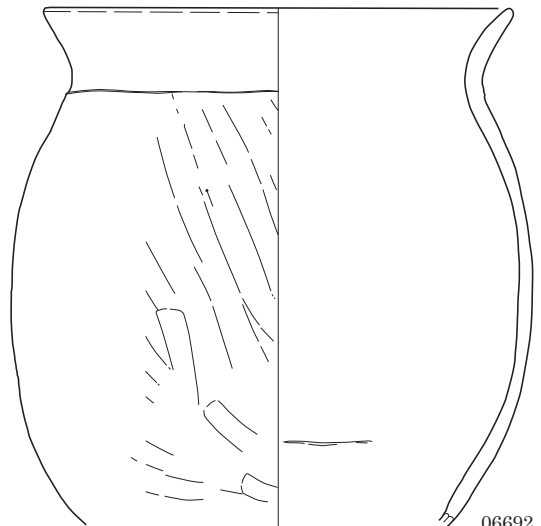

06692

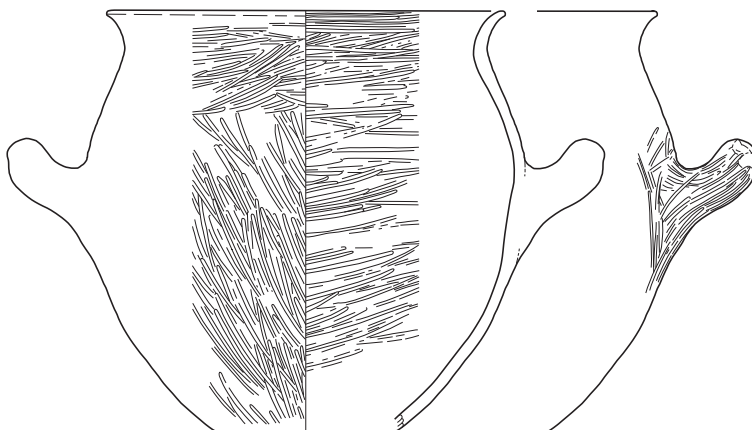

06693

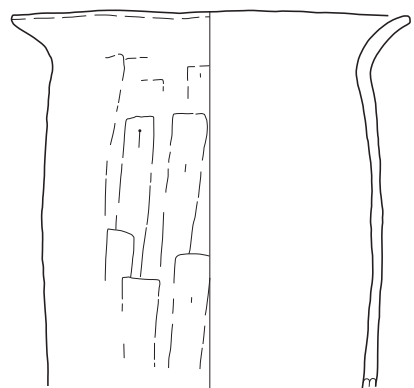

06695

0 1:4 10cm

図版 182 古墳時代～古代の土器 (125)

SB8025 (2)

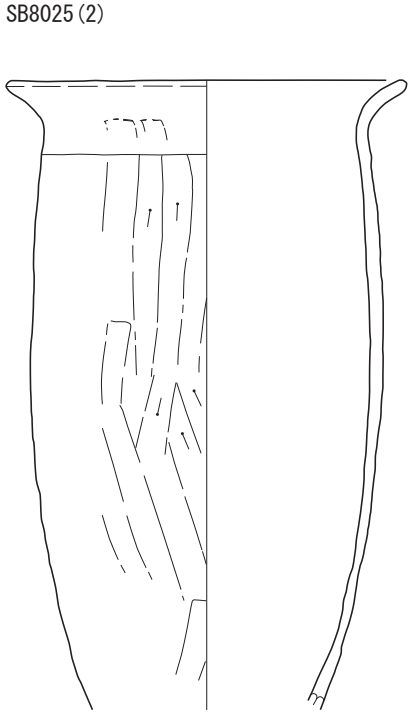

06697

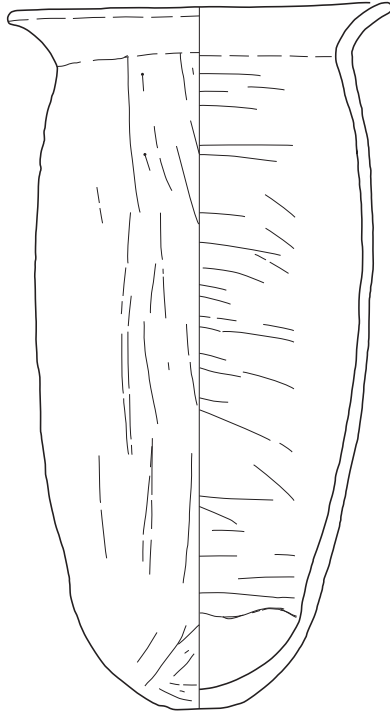

06694

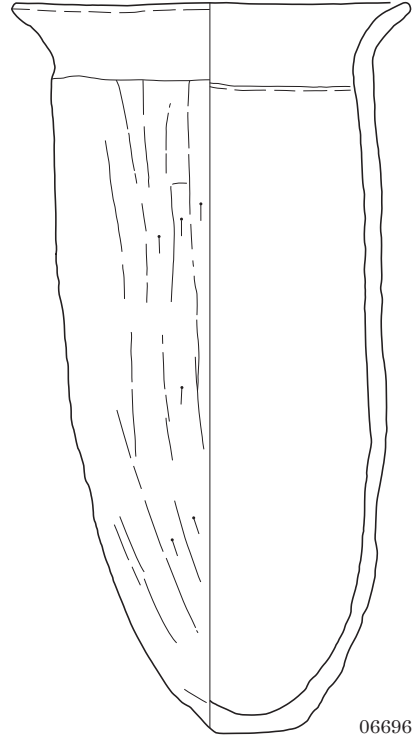

06696

SB8026

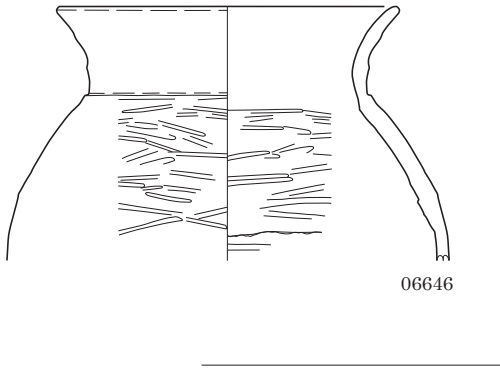

06646

SB8028

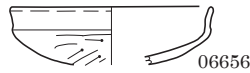

06656

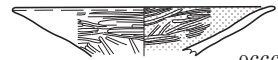

06668

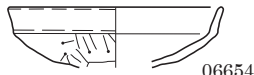

06654



06658

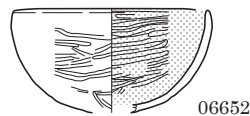

06652

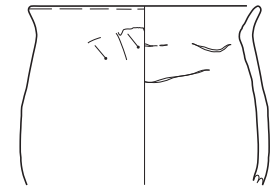

06661



06664

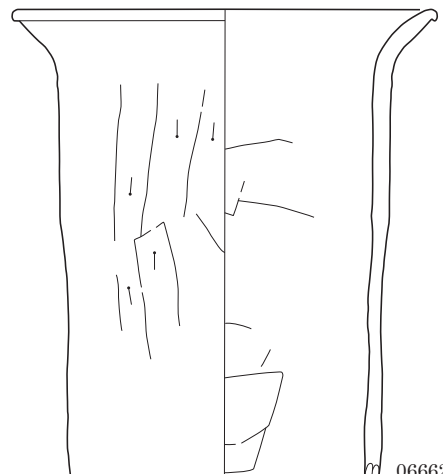

06662

0 (1:4) 10cm

SB8030

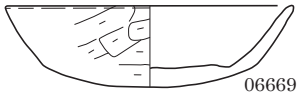

06669

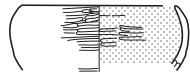

06671

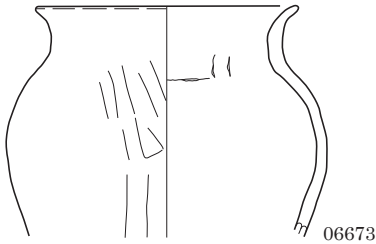

06673

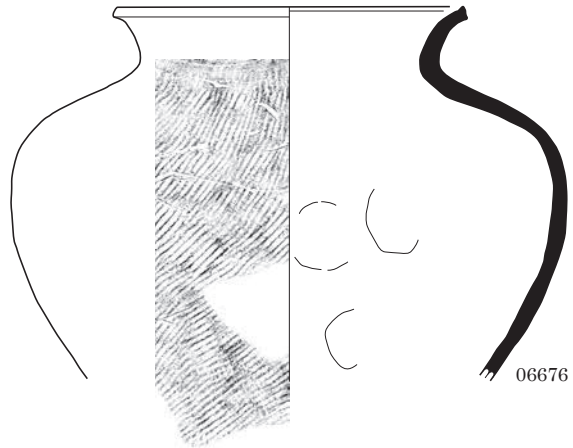

06676

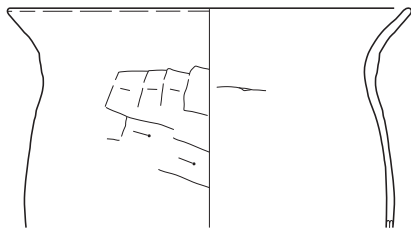

06672

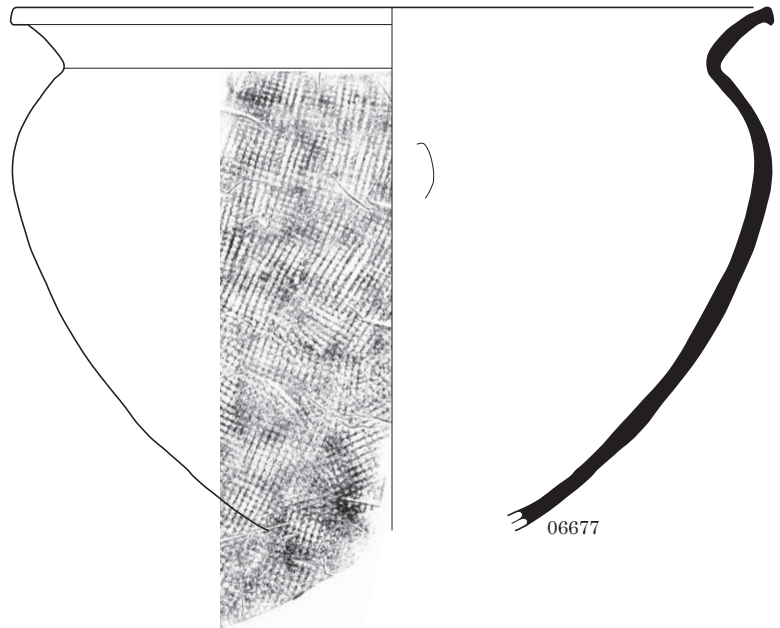

06677

SB8031

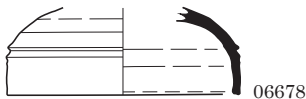

06678

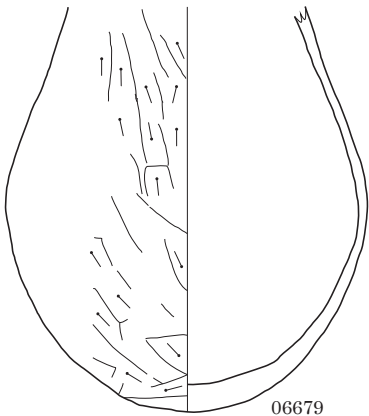

06679

SB8039

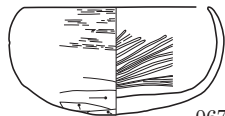

06779

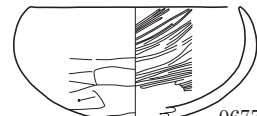

06778

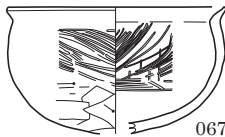

06780

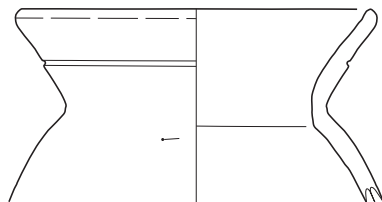

06782

SB8036

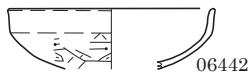

06442

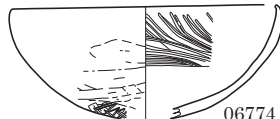

06774

SB8038

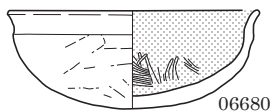

06680

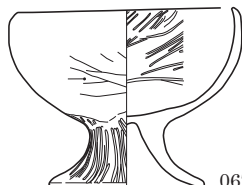

06781



06784

0 (1:4) 10cm

図版 184 古墳時代～古代の土器 (127)

SB8040

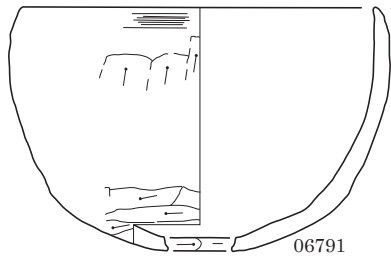
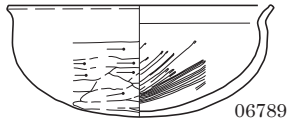
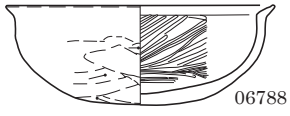
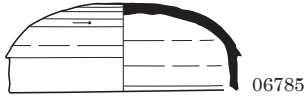

SB8041

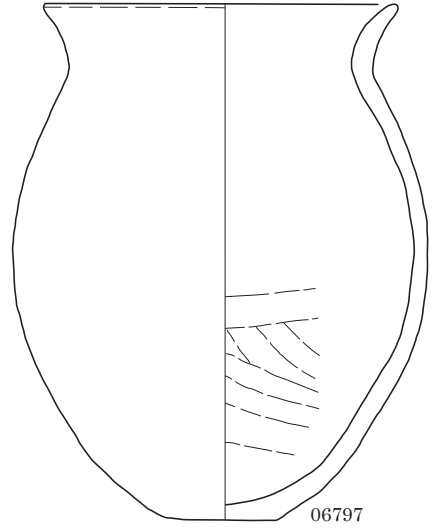
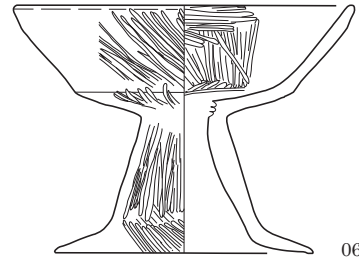
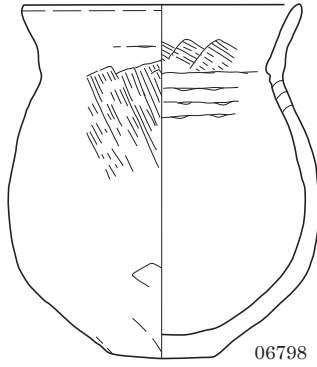
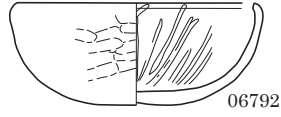
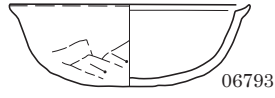

SB8042a

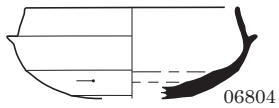

SB8042b

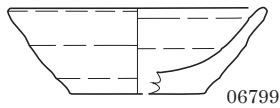

SB8042c

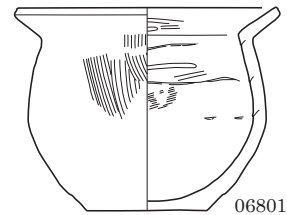
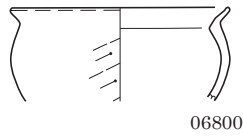

SB8044a (1)

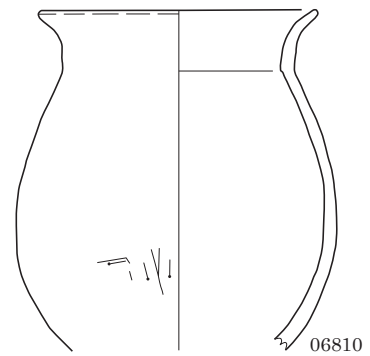
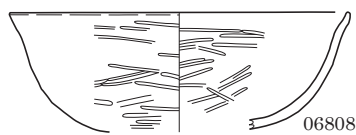
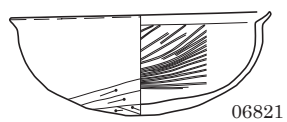
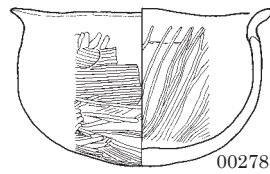
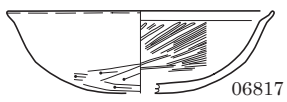
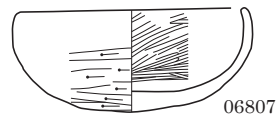
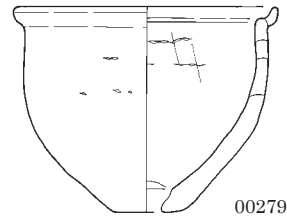
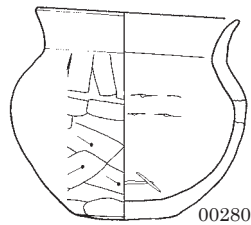
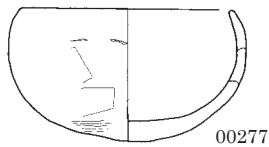
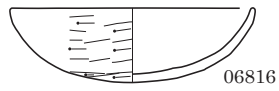

0 1:4 10cm

SB8044a (2)

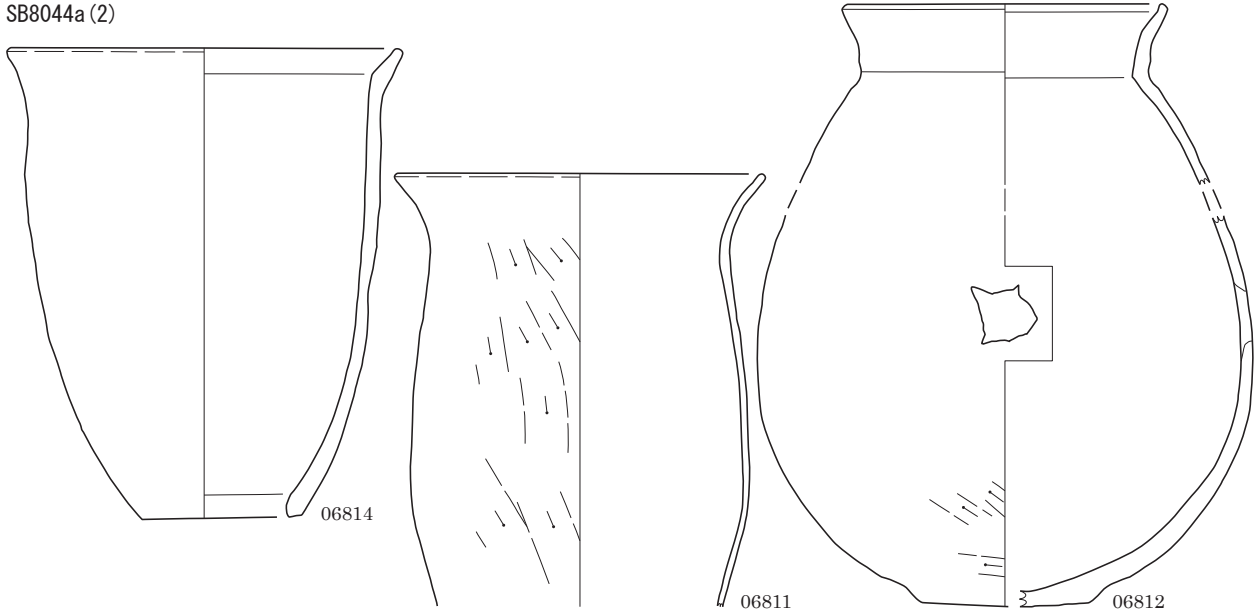

SB8044b

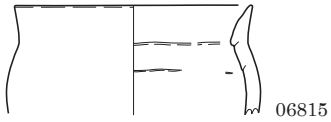

SB8045

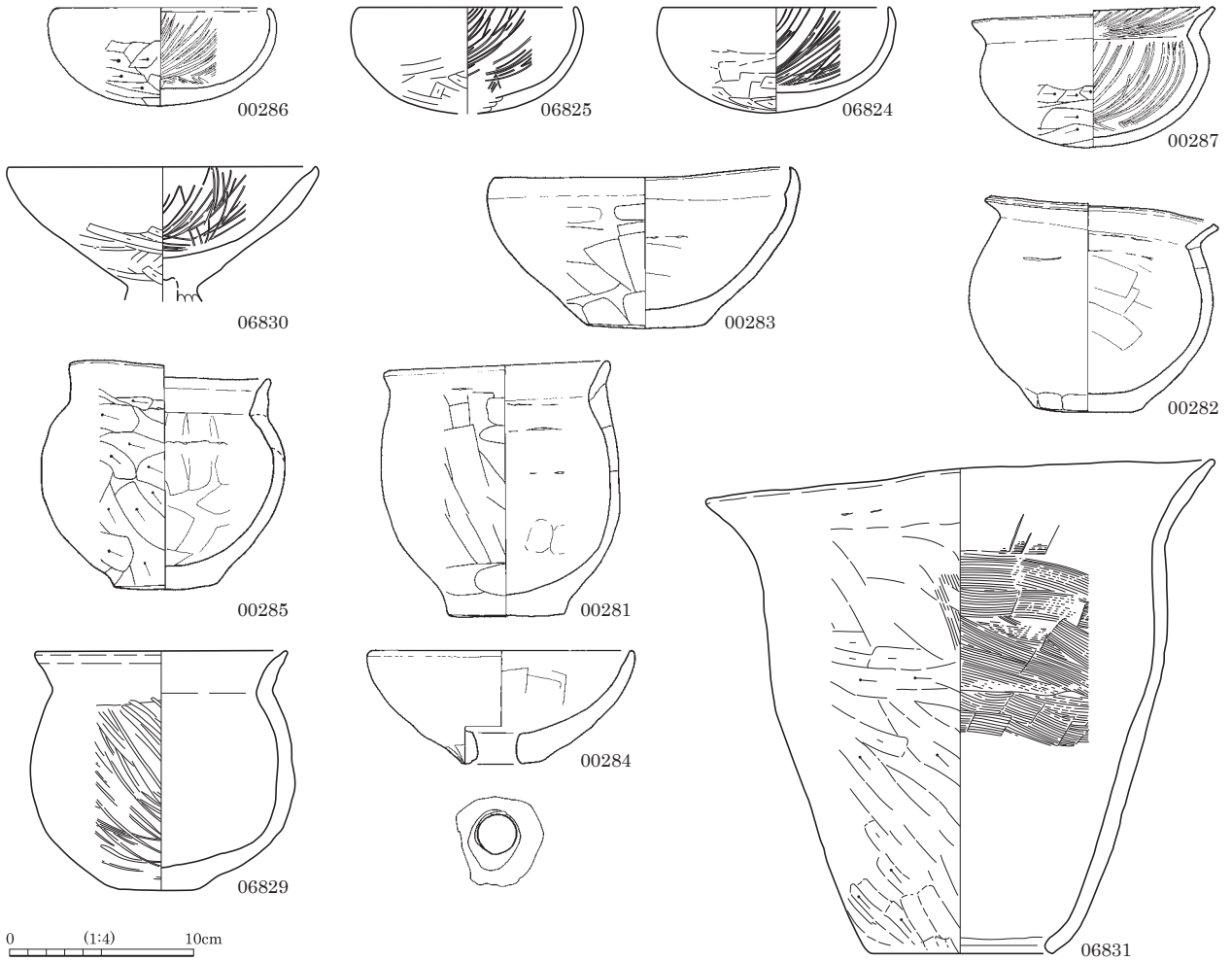

図版 186 古墳時代～古代の土器 (129)

ST0002

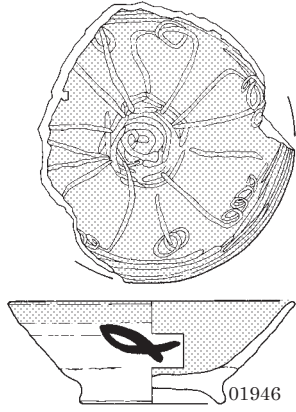

ST0005

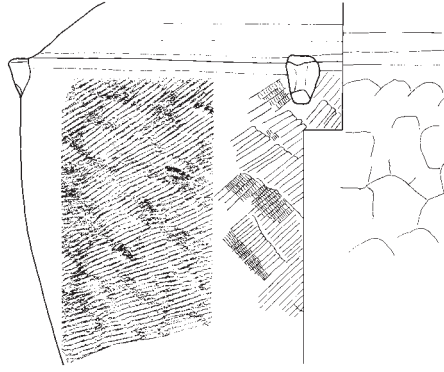

ST0007

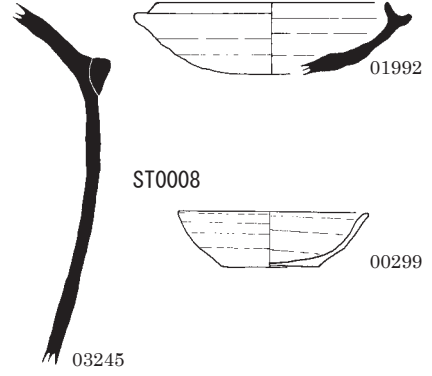

ST0008

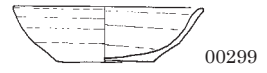

ST0306

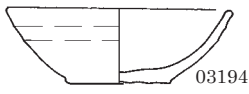

ST4002

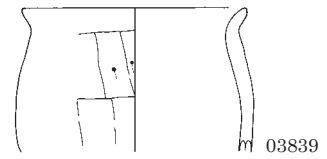
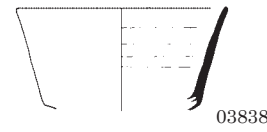
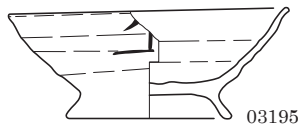

ST4004

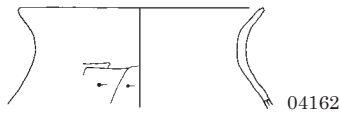

ST4009

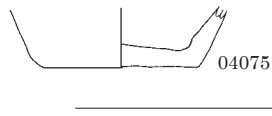

ST5006

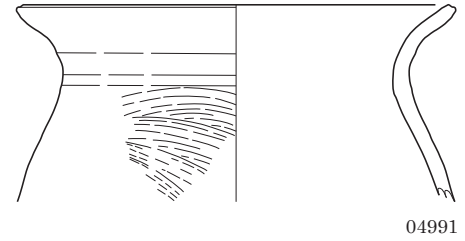
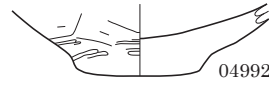
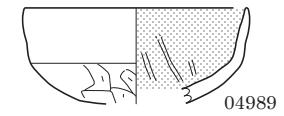
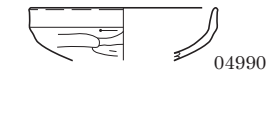

ST5007

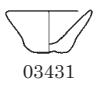

ST6009

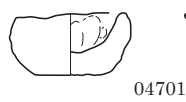

ST6014

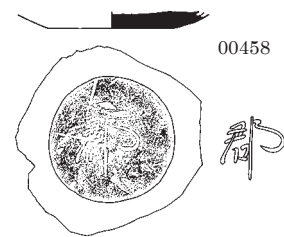
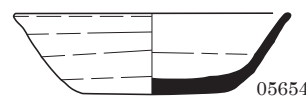
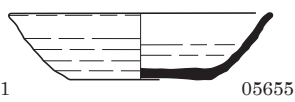

ST6028

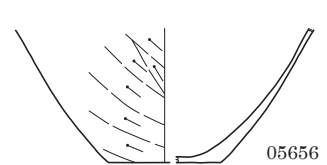
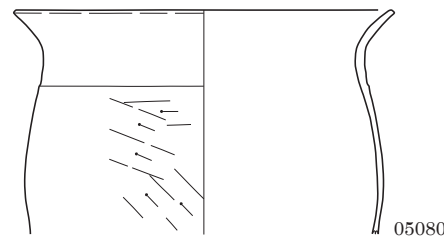
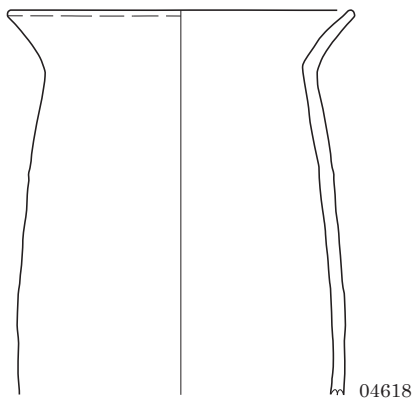

ST6015

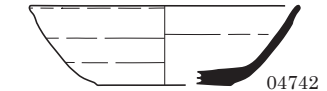

0 (1:4) 10cm

ST6022

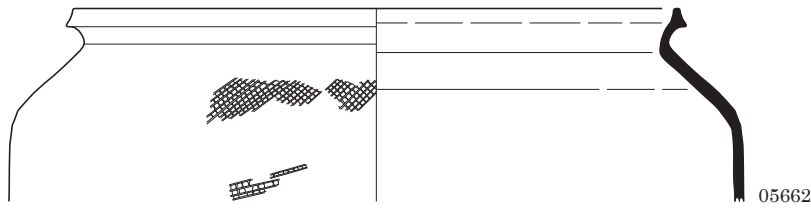

ST6035



05660

05662

ST7034

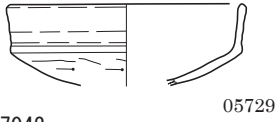

05729

ST7035



05737

05738

ST7039

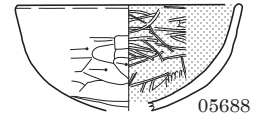

05688

ST7042

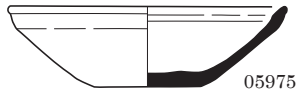

05975



05976

05991

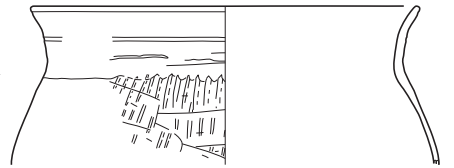

05970

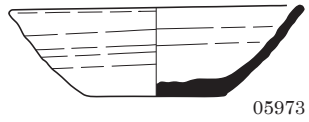

05973

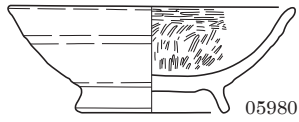

05980

SK0001

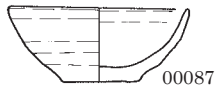

00087



02592

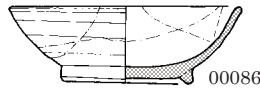

00086



02593

SK0031



00407

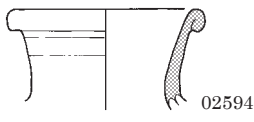

02594

SK0034

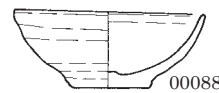

00088

SK0037

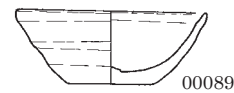

00089



02596

SK0049

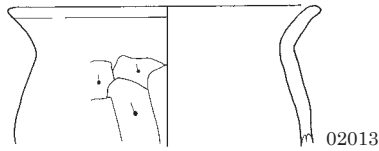

02013

SK0053

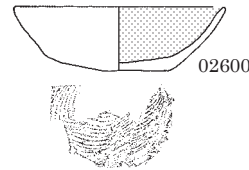

02600

SK0054



00408

SK0057

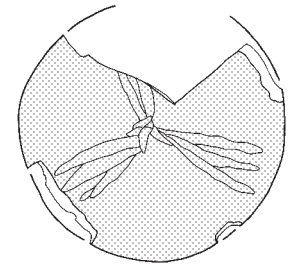

SK0071



01942

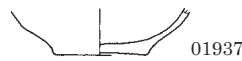

01937

SK0070



02597



01938

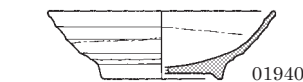

01940

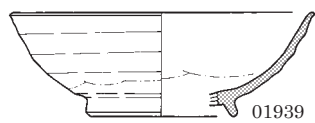

01939

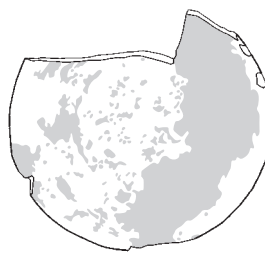

00323

■ 黑色付着物

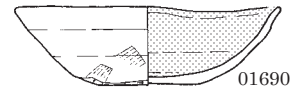

01690

SK0080

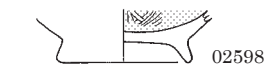

02598

SK0081

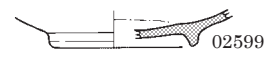

02599

0 1:4 10cm

図版 188 古墳時代～古代の土器 (131)

SK0082



01982

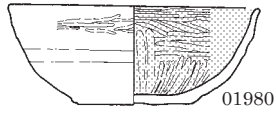

01980

SK0083



01983

SK0091



01945

SK0120

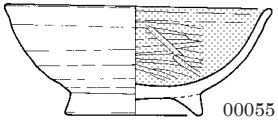

00055

SK0126

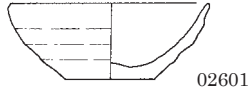

02601

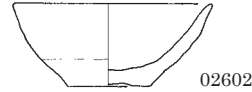

02602

SK0140



SK0147



02603

SK0194



00389

SK0196

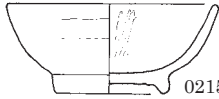

02150



02149

SK0191



02605

SK0200



02607

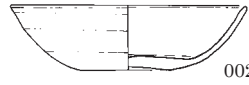

00298

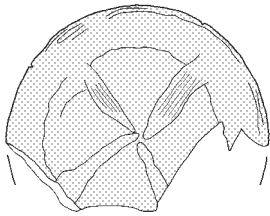

02612



02610

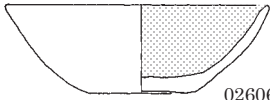

02606

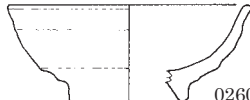

02609

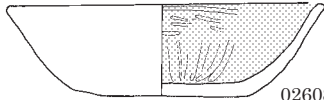

02608



02613

SK0214



00409

SK0235

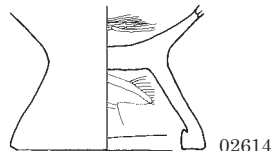

02614

SK0241

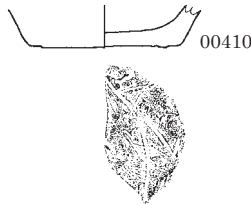

00410

SK0277



00117

SK0275

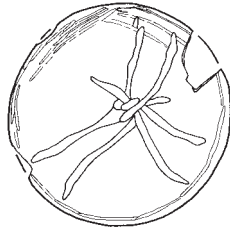
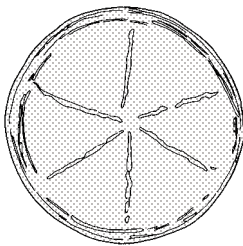

SK0290



00026

SK0291



01993



00116

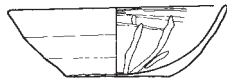

01587

0 (1:4) 10cm

SK0325



02216

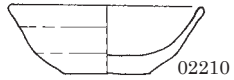

02210

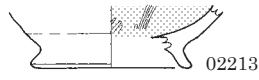

02213



02217



02212

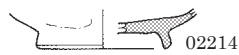

02214



02215

SK0331

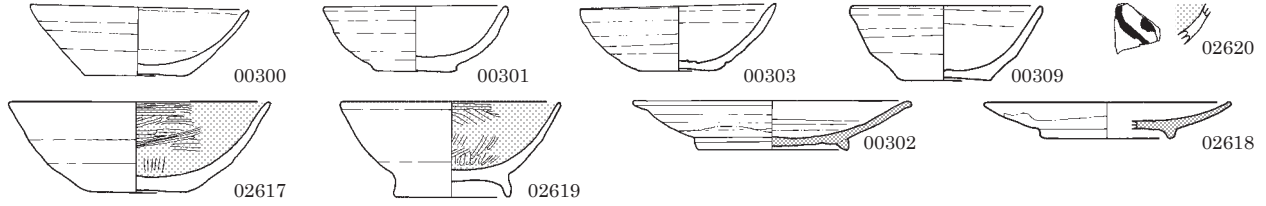

SK0347

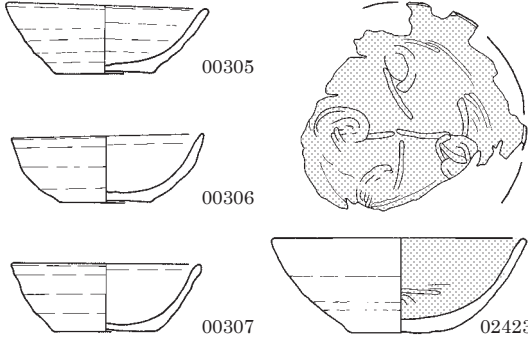

SK0349

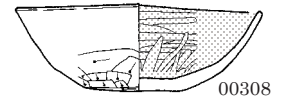

SK0363

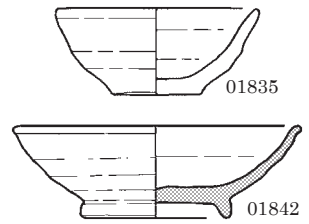

SK0350



SK3006



SK3007

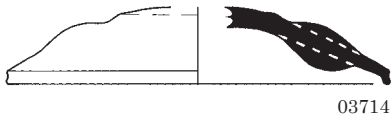

SK3016

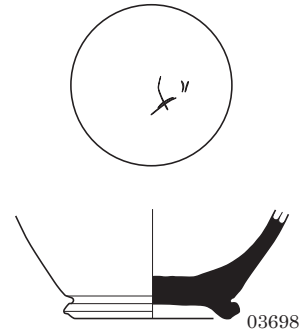
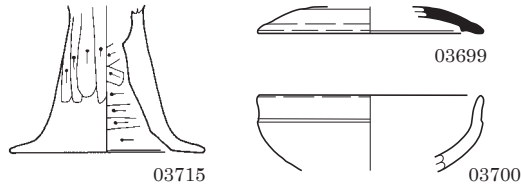

SK3029

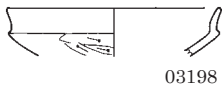

SK3080

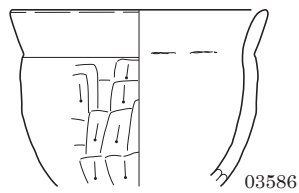
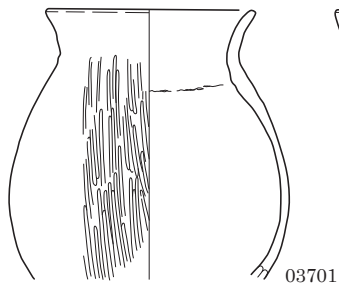

SK3100

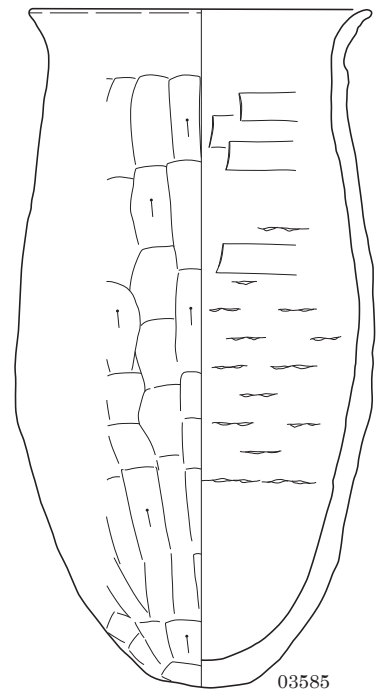
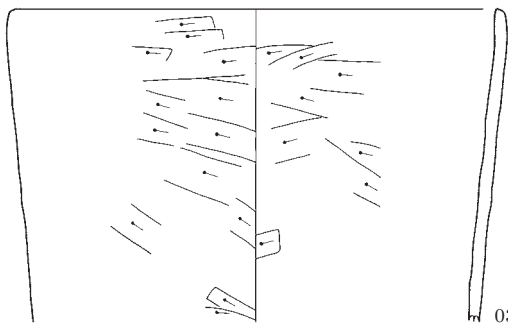

0 (1:4) 10cm

図版 190 古墳時代～古代の土器 (133)

SK3180

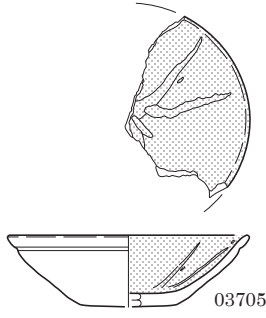

SK3220

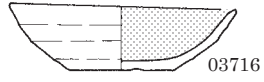

03716

SK3279

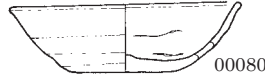

00080



00083

SK4051

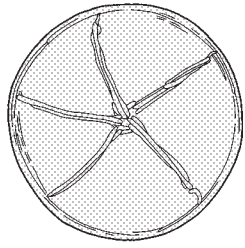

冪



00109



冪



00320

正

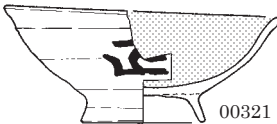

00321

正

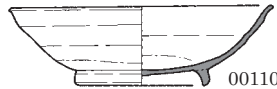

00110



周

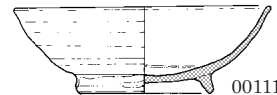

00111

SK4094



03937

SK4144

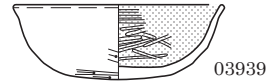

03939

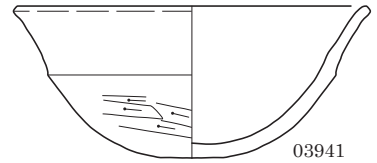

03941

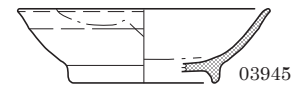

03945

SK4151

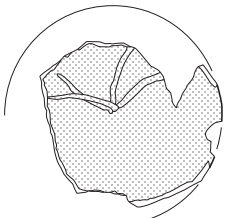

03933

SK4246

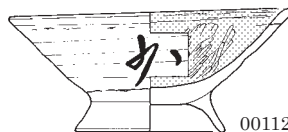
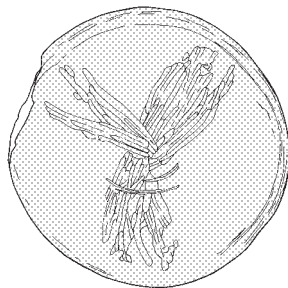

00112

冪

SK4270

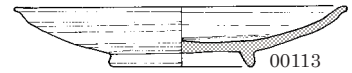

00113

SK4266

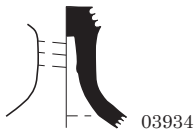

03934

0 (1:4) 10cm

SK5002

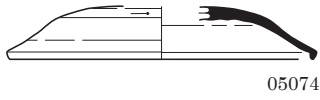

05074

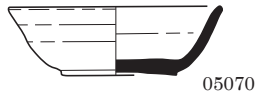

05070

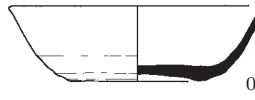

04502

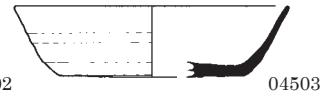

04503

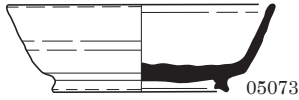

05073

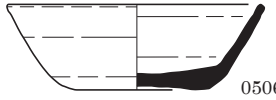

05066

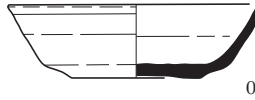

05067

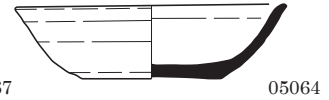

05064

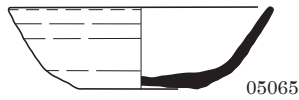

05065

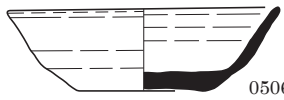

05068

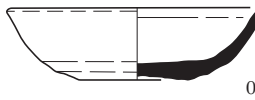

05069

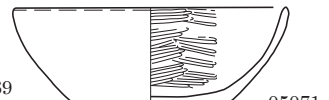

05071

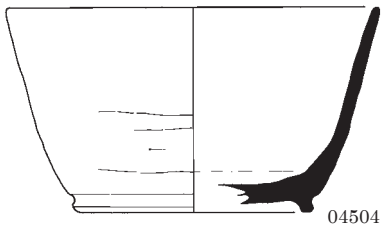

04504

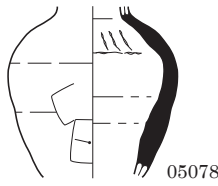

05078

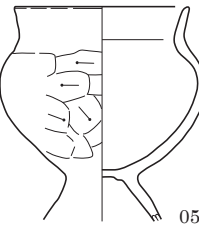

05075

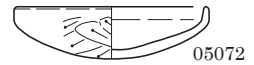

05072

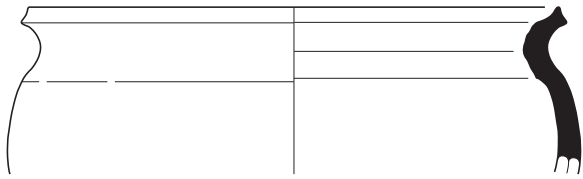

05077

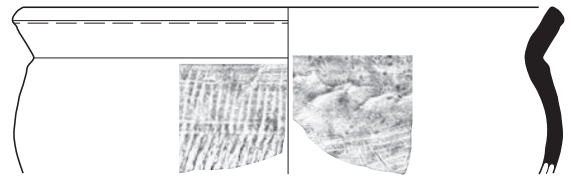

05076

SK5075

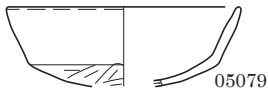

05079

SK5143

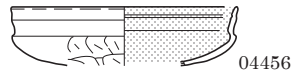

04456

SK5168

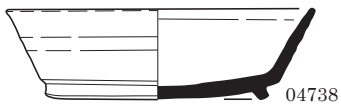

04738

SK5298



00453

SK6062



04940

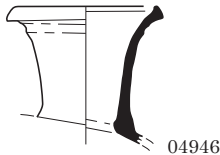

04946

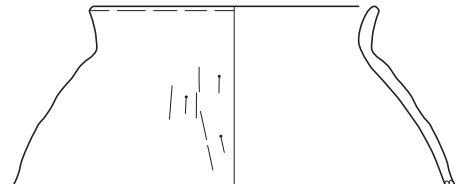

04949

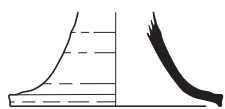

04948

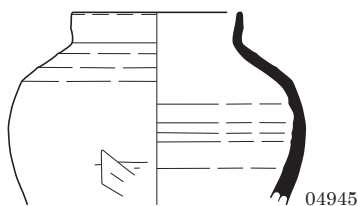

04945

0 (1:4) 10cm

図版 192 古墳時代～古代の土器 (135)

SK6063

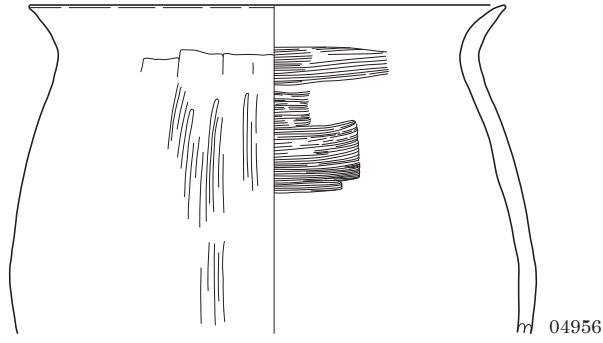
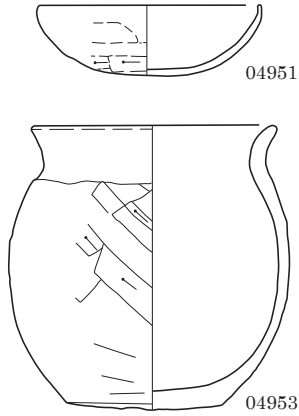

SK6183

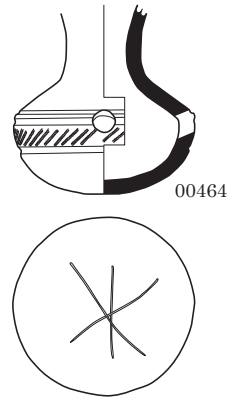

SK6182



SK6221

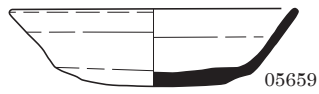

SK6246



SK6439

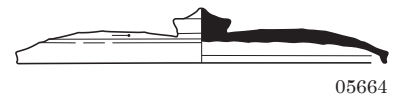

SK7021

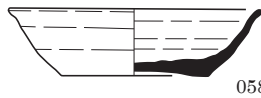
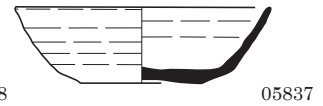
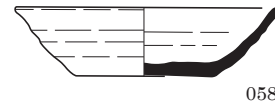
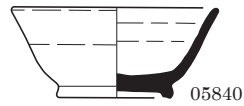

SK7023

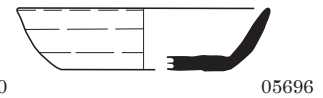
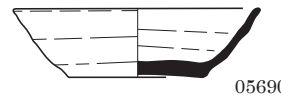
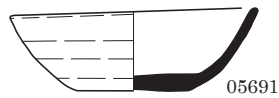

大井



SK7061

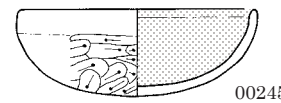

SK7126

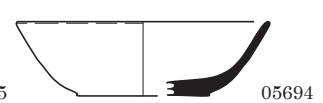

SK7210

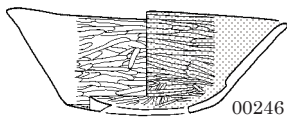

SK7211

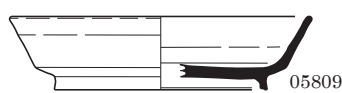

SK7243



SK7335



SK7697



SK7720

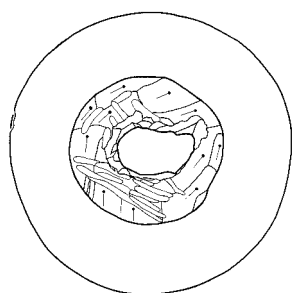
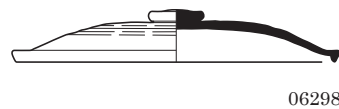

0 (1:4) 10cm

SK7782

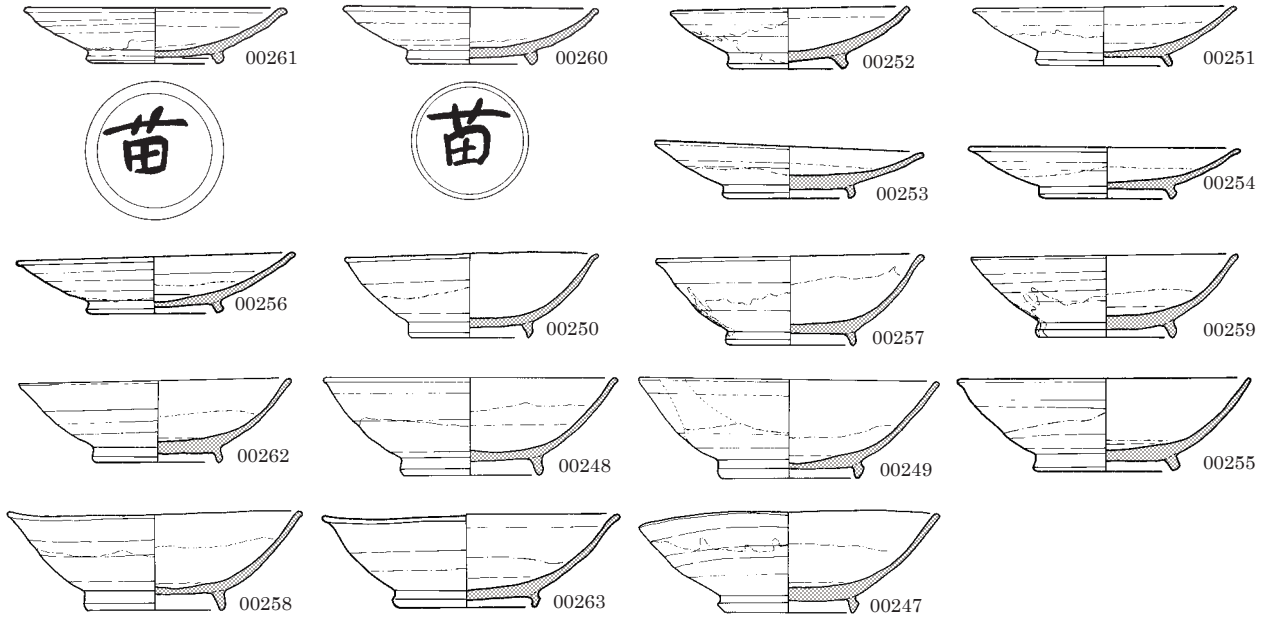

SK7847



SK7905

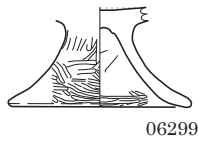

SK7925



SK8107

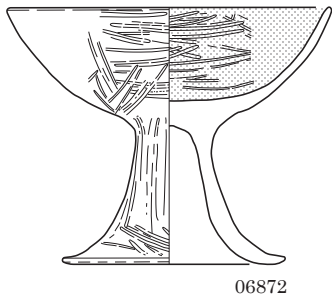

SK8149

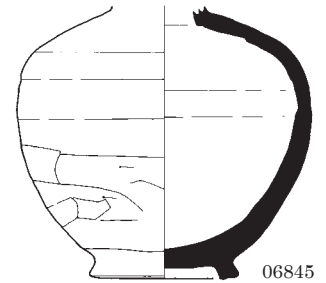
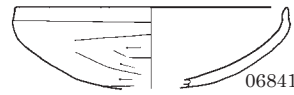
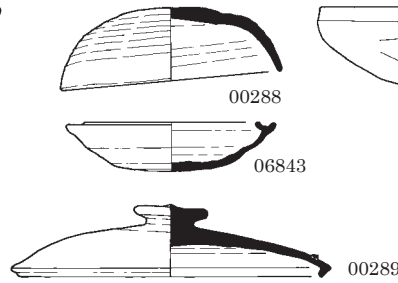

SK8204

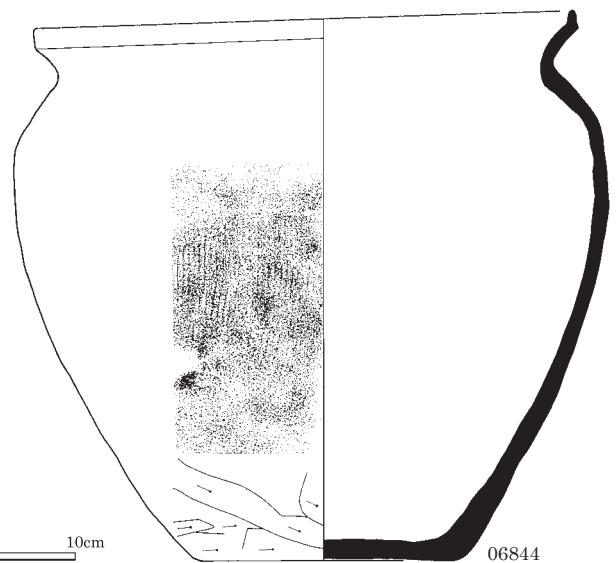
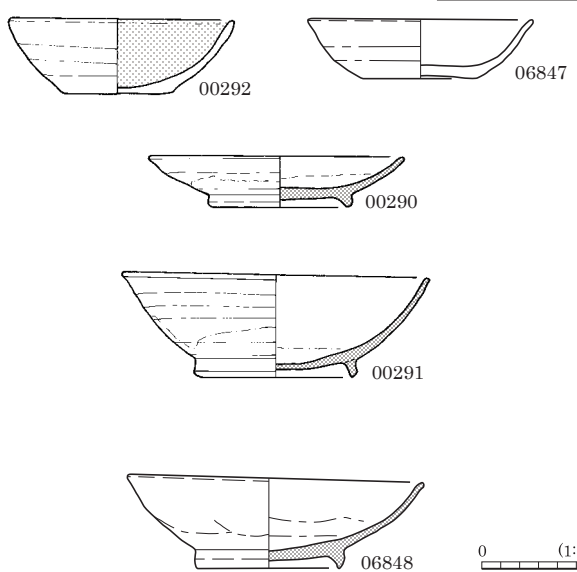

0 1:4 10cm

図版 194 古墳時代～古代の土器 (137)

SK8210

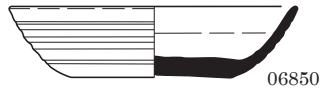

SM8001

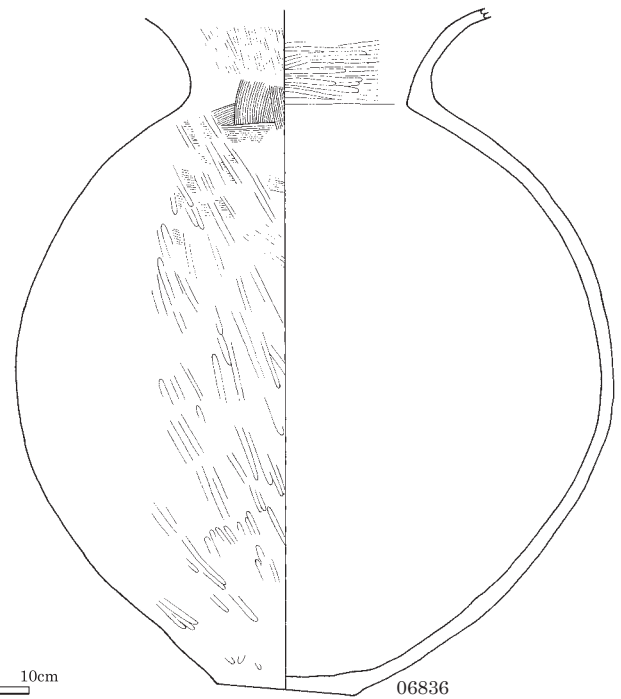
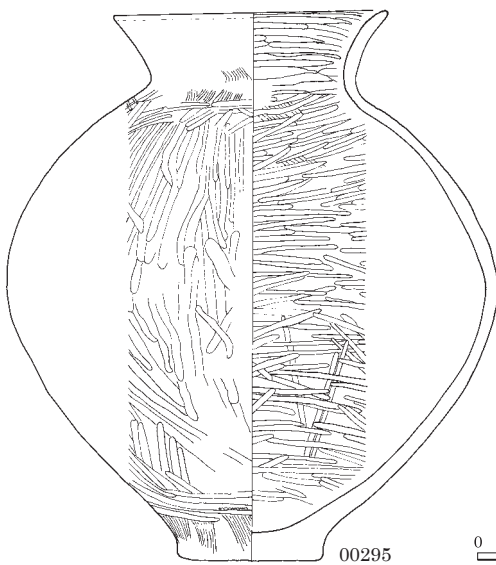
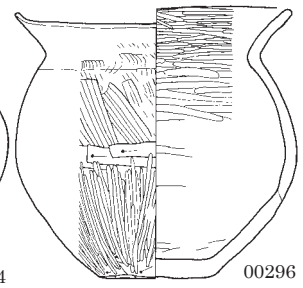
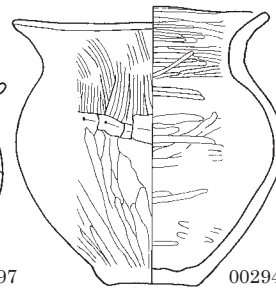
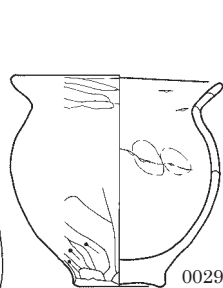
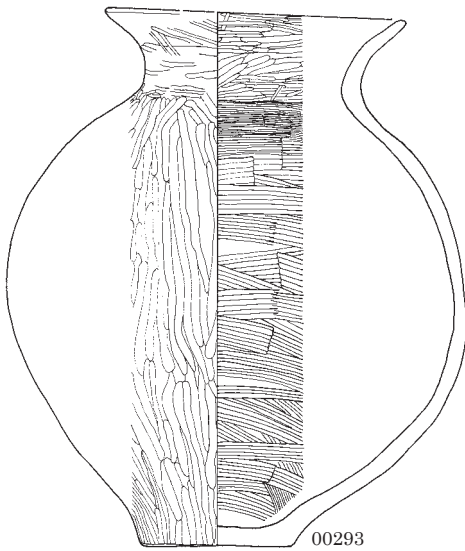
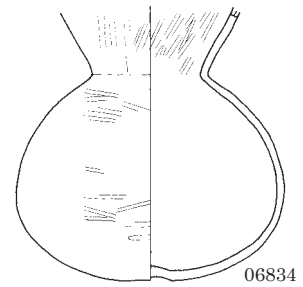
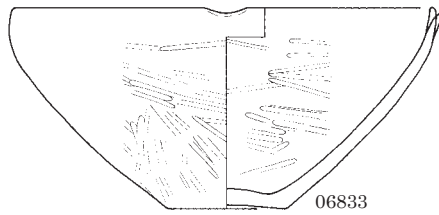
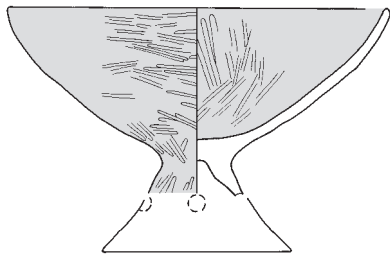
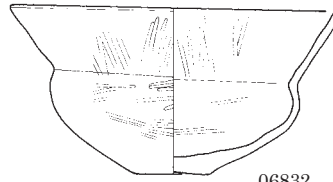
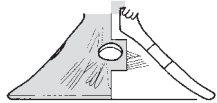

0 (1:4) 10cm

SD0002

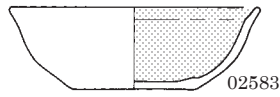
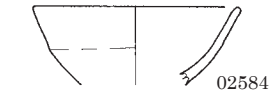
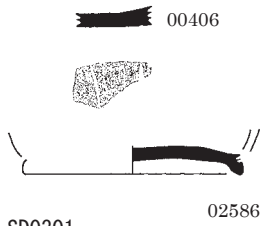

SD0004

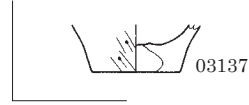
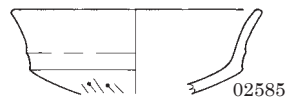
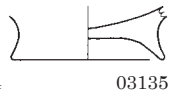
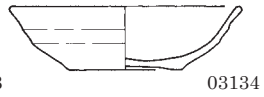

SD0301

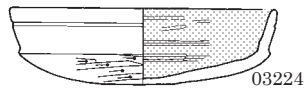
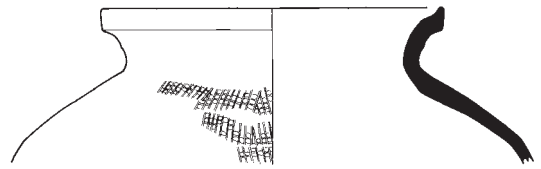
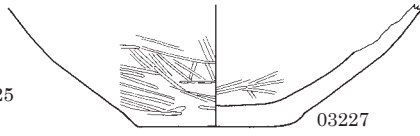
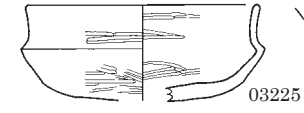

SD3001

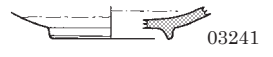
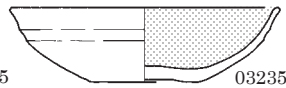
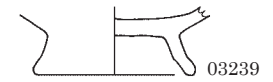
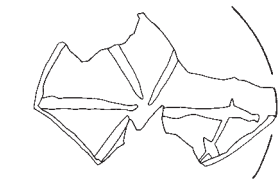
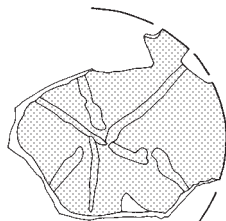
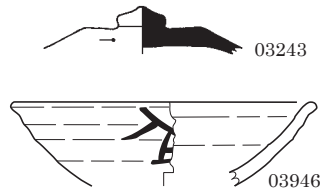

SD3003

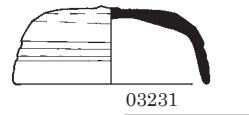

SD3004



SD4002

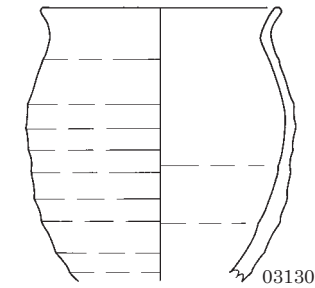

SD3005

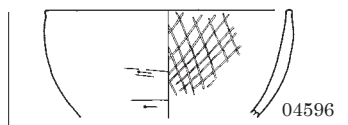
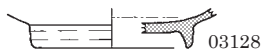
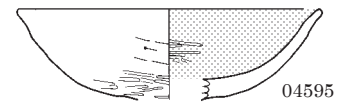
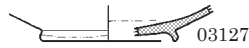

SD3006

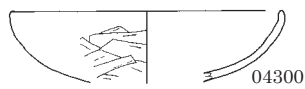
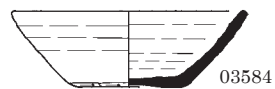

SD4005

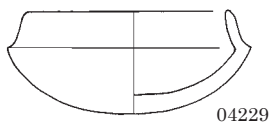

SD5001

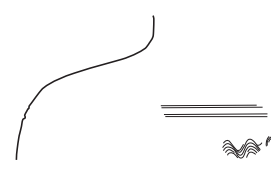
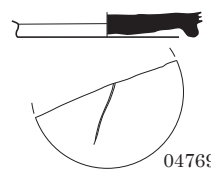
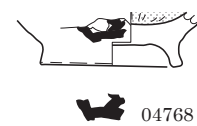

SD5003

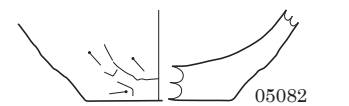
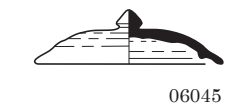

0 (1:4) 10cm

図版 196 古墳時代～古代の土器 (139)

SD5003・5004

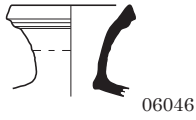

SD5003 ~ 5005

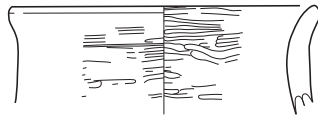

SD5007

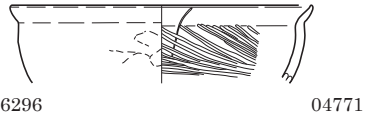

SD6001



SD6002

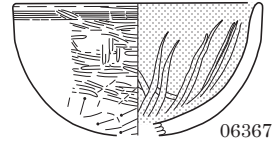
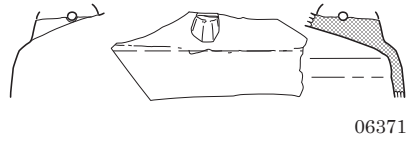
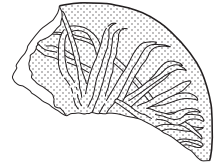
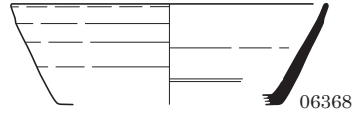
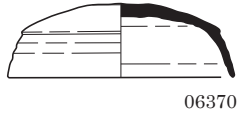

SD7002

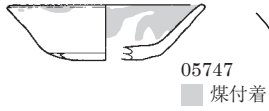

SD8002

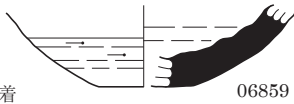

SD8003

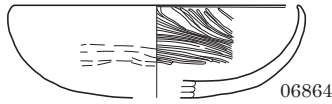

SD8006 A層

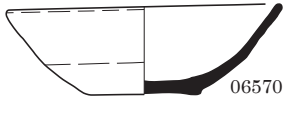

SD8006 B層

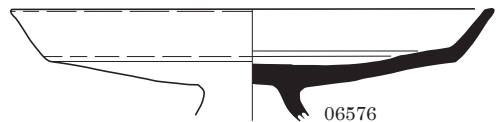
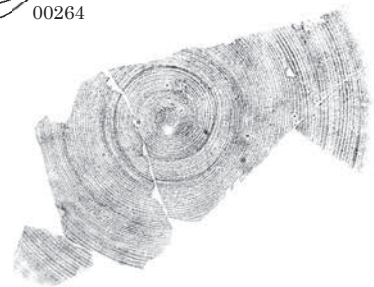
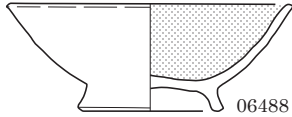
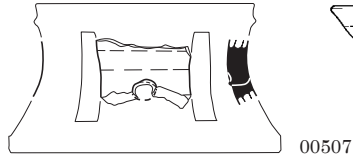

0 (1:4) 10cm

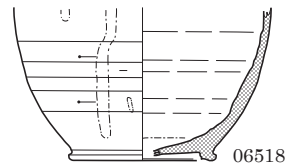
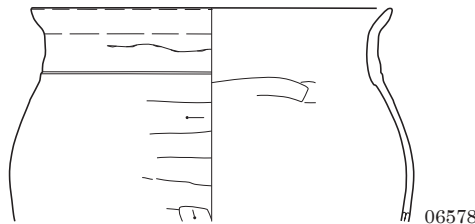
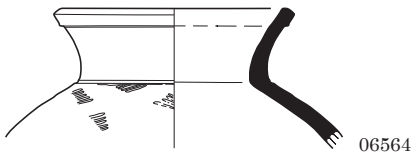

SD8006 C層

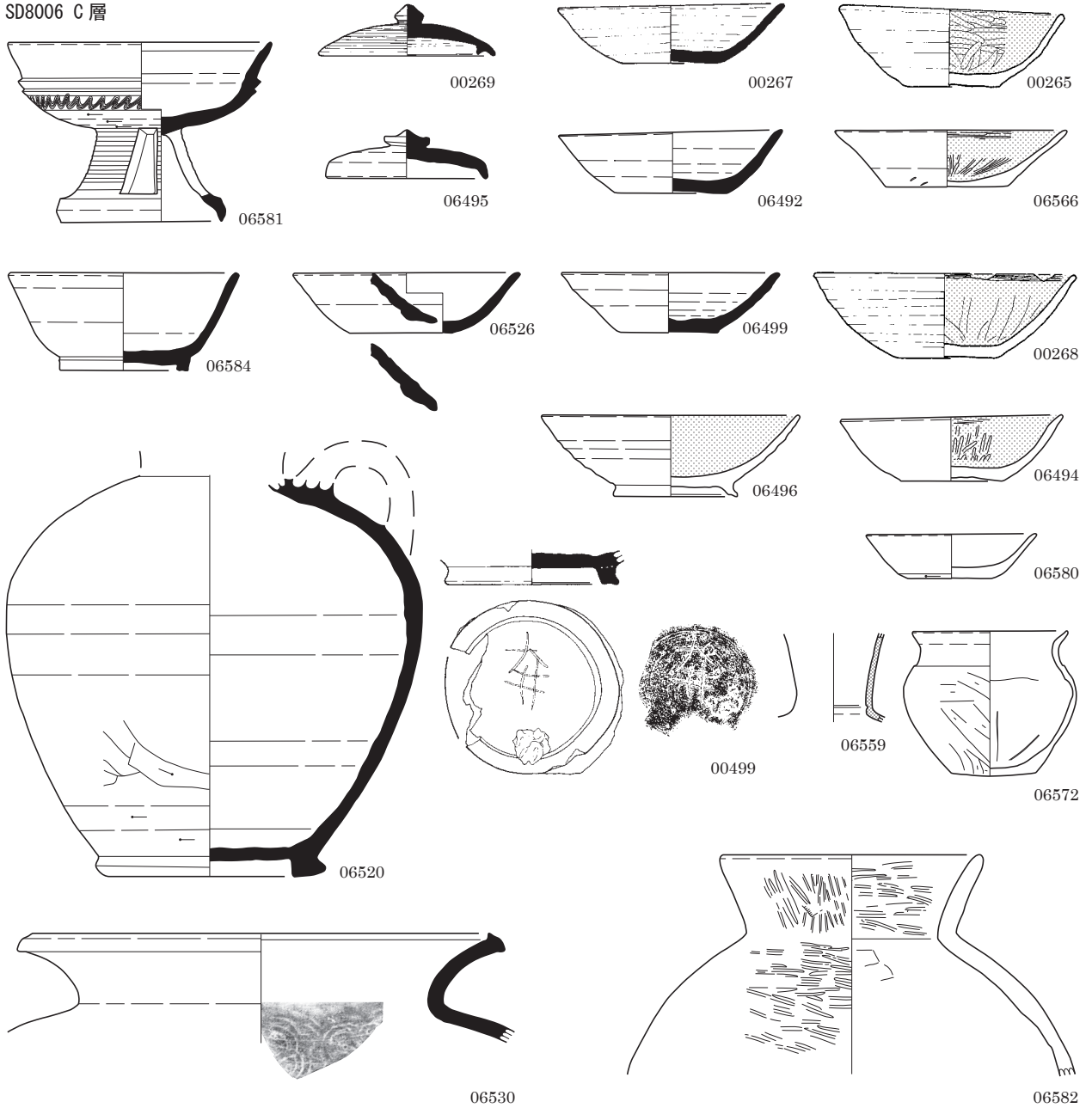

SD8006 I X10 敷石部

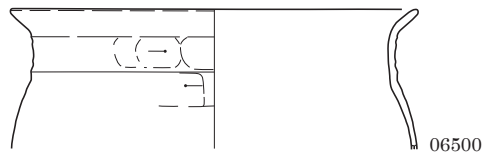
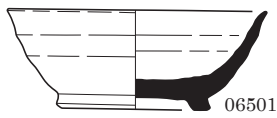

SD8006 層位不明

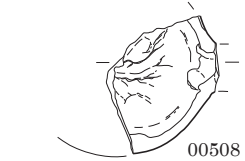
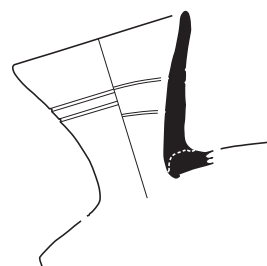
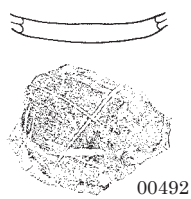
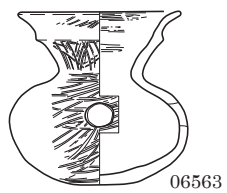
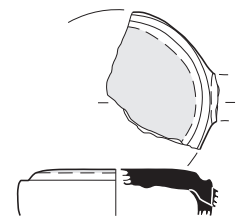

0 10cm (1:4)

図版 198 古墳時代～古代の土器 (141)

1・2区 検出面

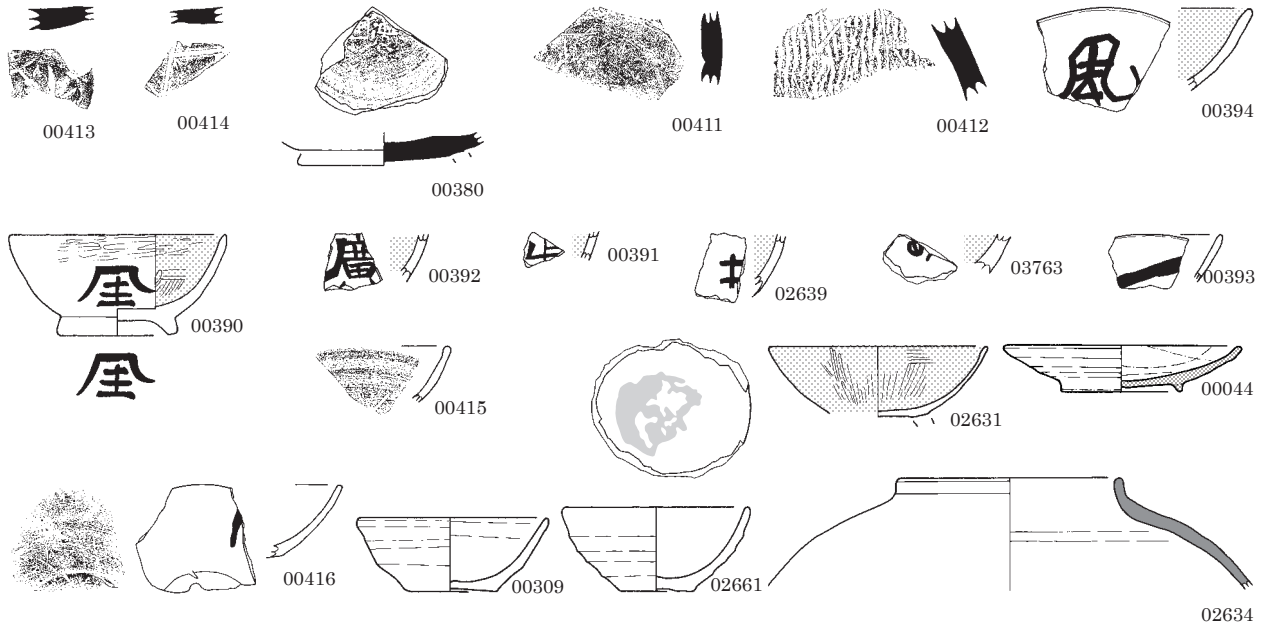

表土

攪乱ほか

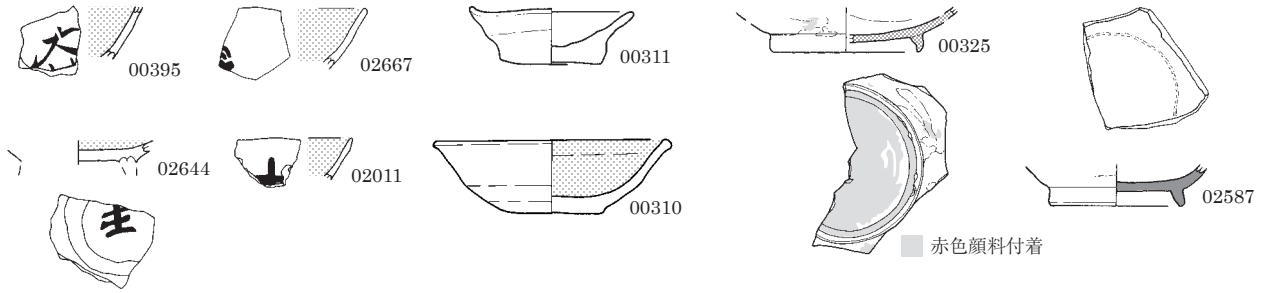

3区

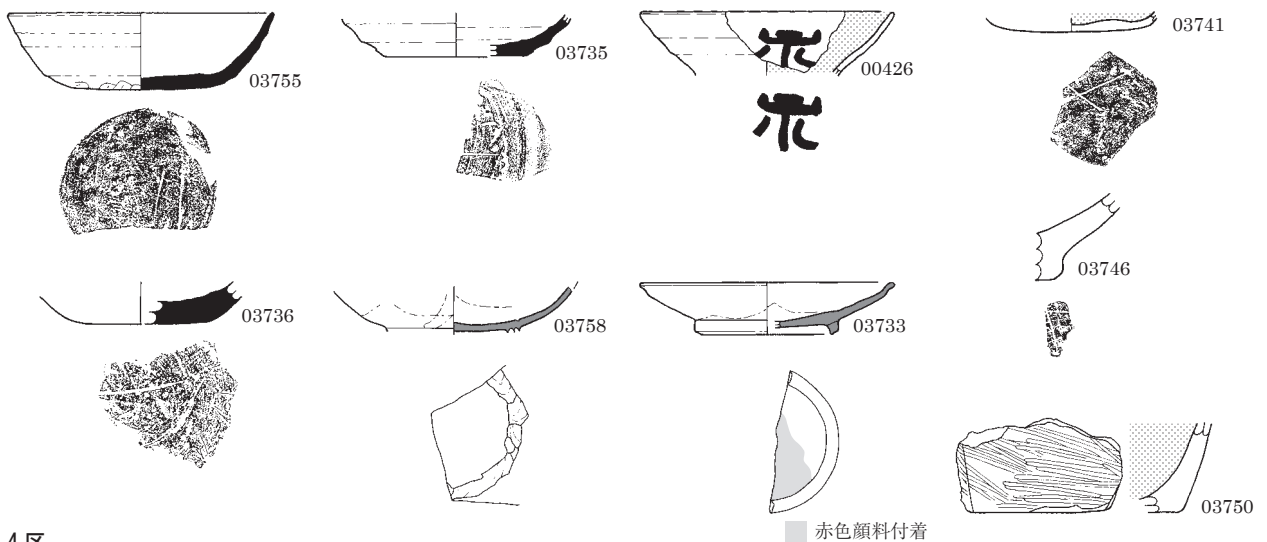

4区



5区

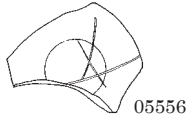
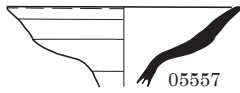

6区

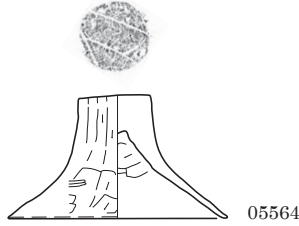

7区 I X13

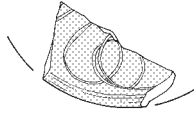
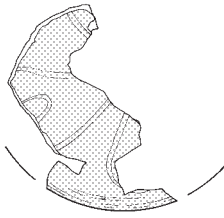

I Y02



I Y08



I Y06



I Y17

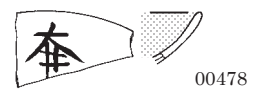

表土



検出面



地点不明

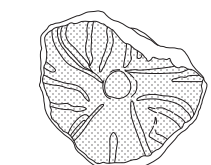

攪乱

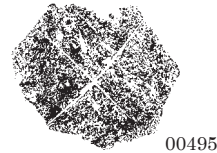

8区

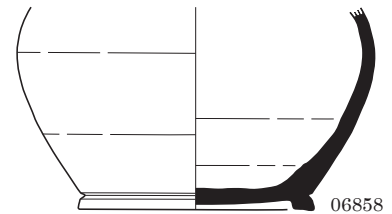
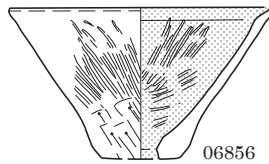
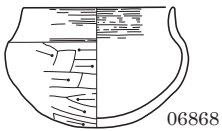

中世陶磁器

SB0006

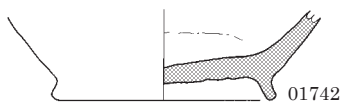

SK0181

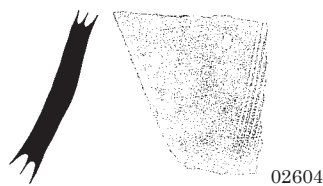

0 (1:4) 10cm

図版 200 古墳時代～古代の土製品 (1)

土製玉類ほか

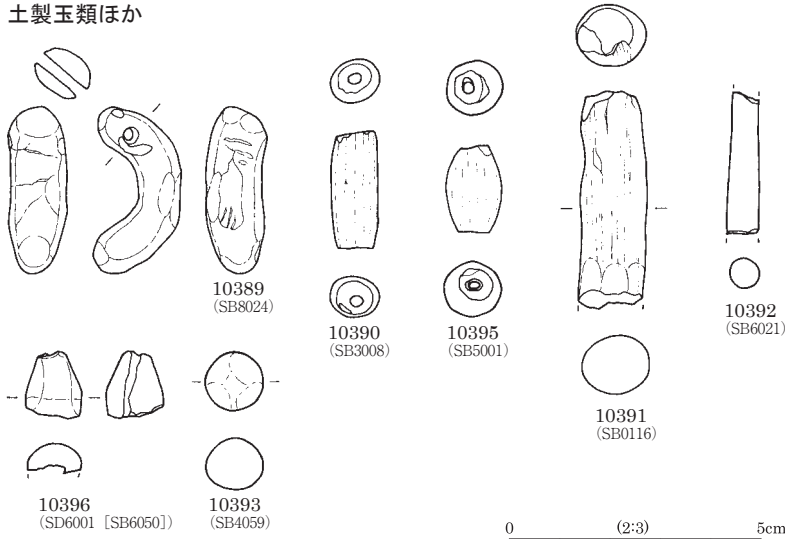

土製紡錘車

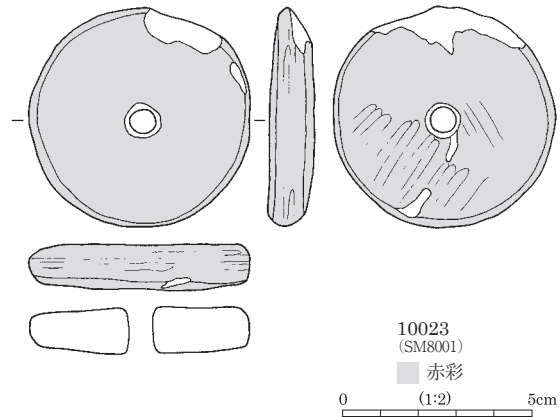
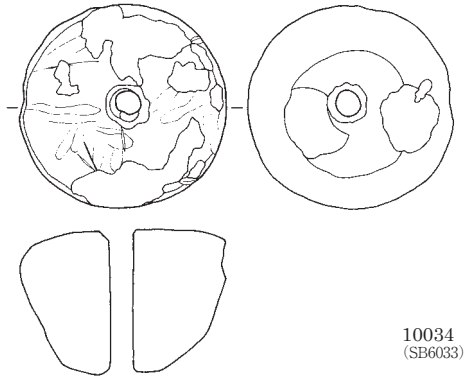
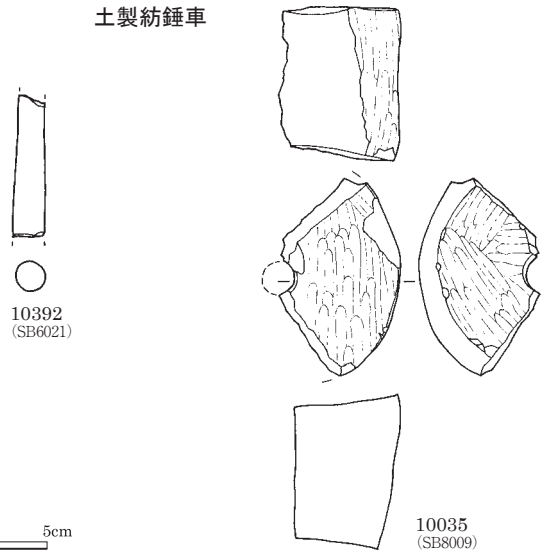

円筒形土製品

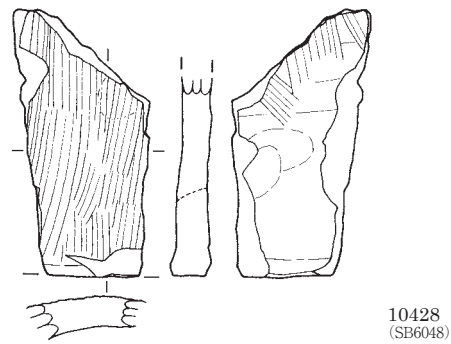

盤状土製品

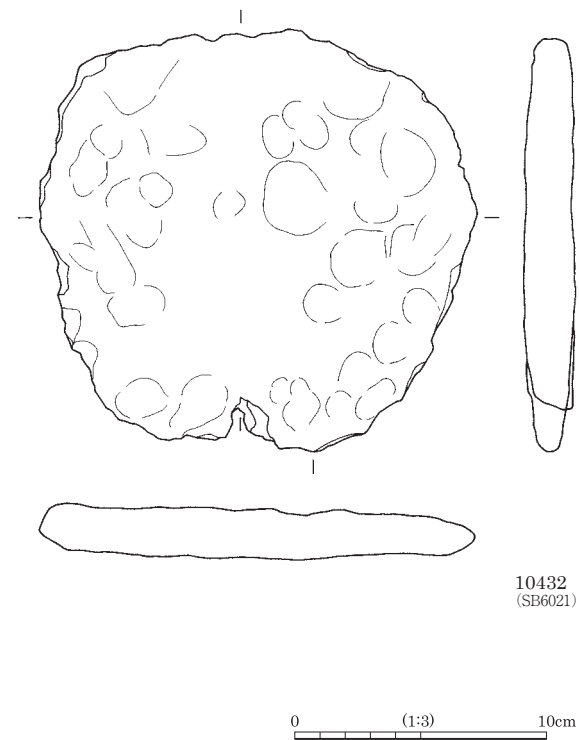

鉄斧形土製品

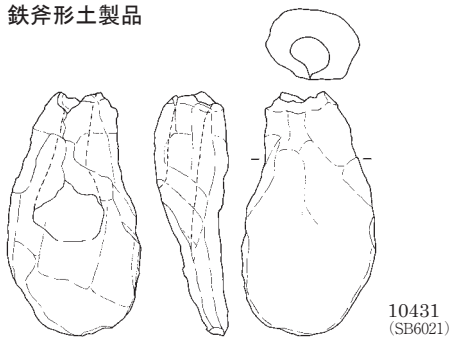

轆羽口

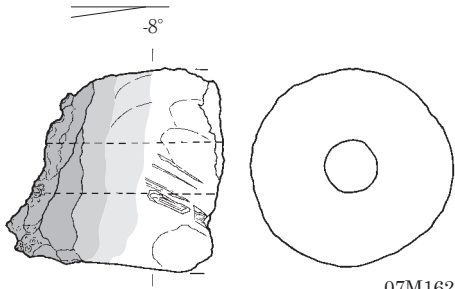

07M162
(SB4037)

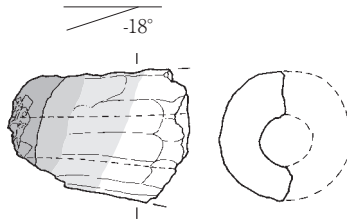

07M386
(SB3047)

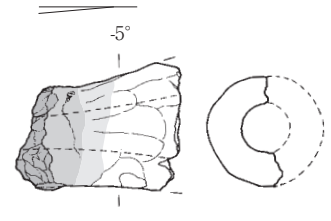

07M392
(SK3007)

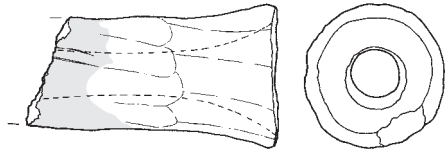

07M529
(SB5006)

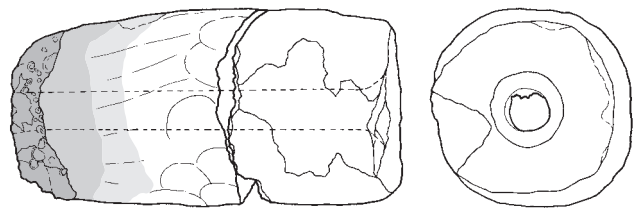

08M187
(SB8015)

■ 滓化範囲 ■ 溶解範囲 ■ 被熱変色範囲

0 (1:3) 10cm

瓦



07045
(SD4002)

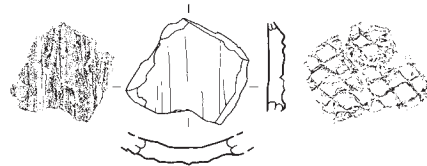

07044
(1区表土)

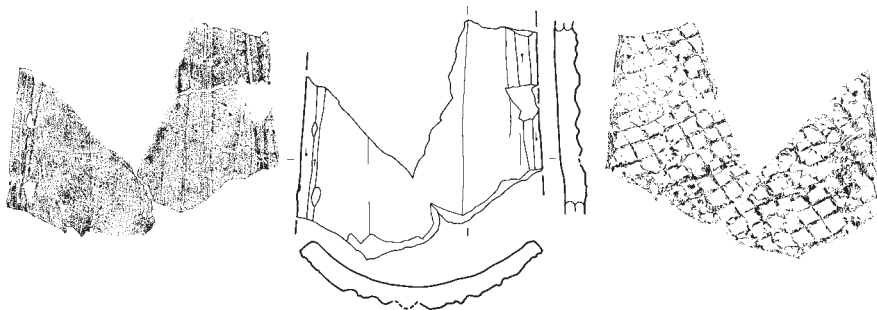

06583
(SD8006)

0 (1:6) 10cm

図版 202 石器・石製品 (1) - 縄文時代 -

原石



22528
(SD4002 石積み)

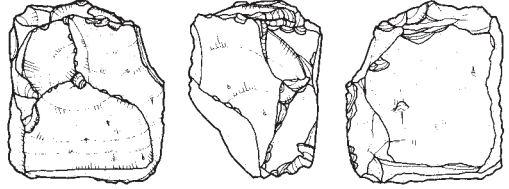
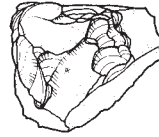

22557
(SB7039)

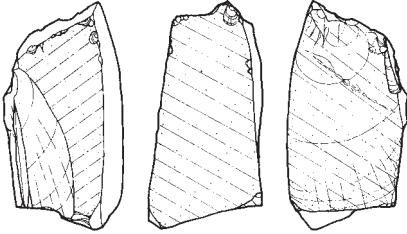

22662
(SM8001)

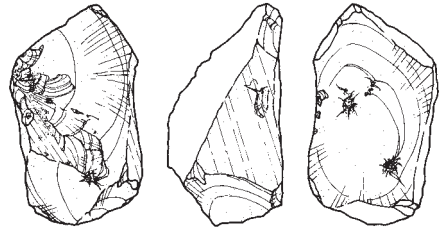
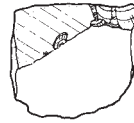

22634
(8区検出面)

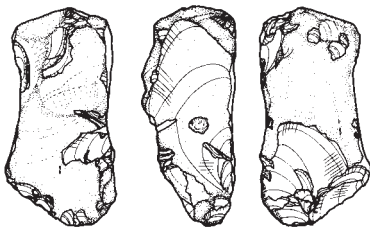
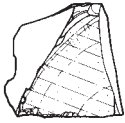

22611
(SD8006 I X18 B層)

石核

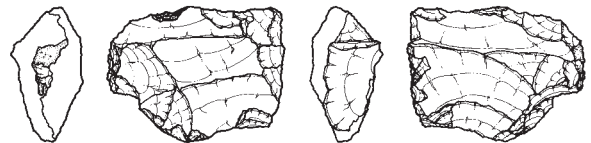

22467
(SM8001)



0 (2:3) 5cm

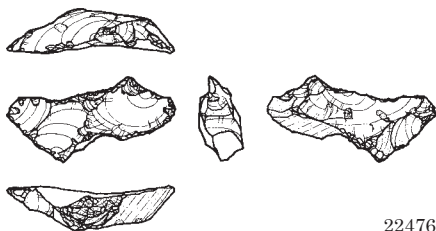

22476
(SB0075 Pit10)



22484
(SB7041 床下)



22581
(SB8007)

0 (1:3) 10cm

楔形石器

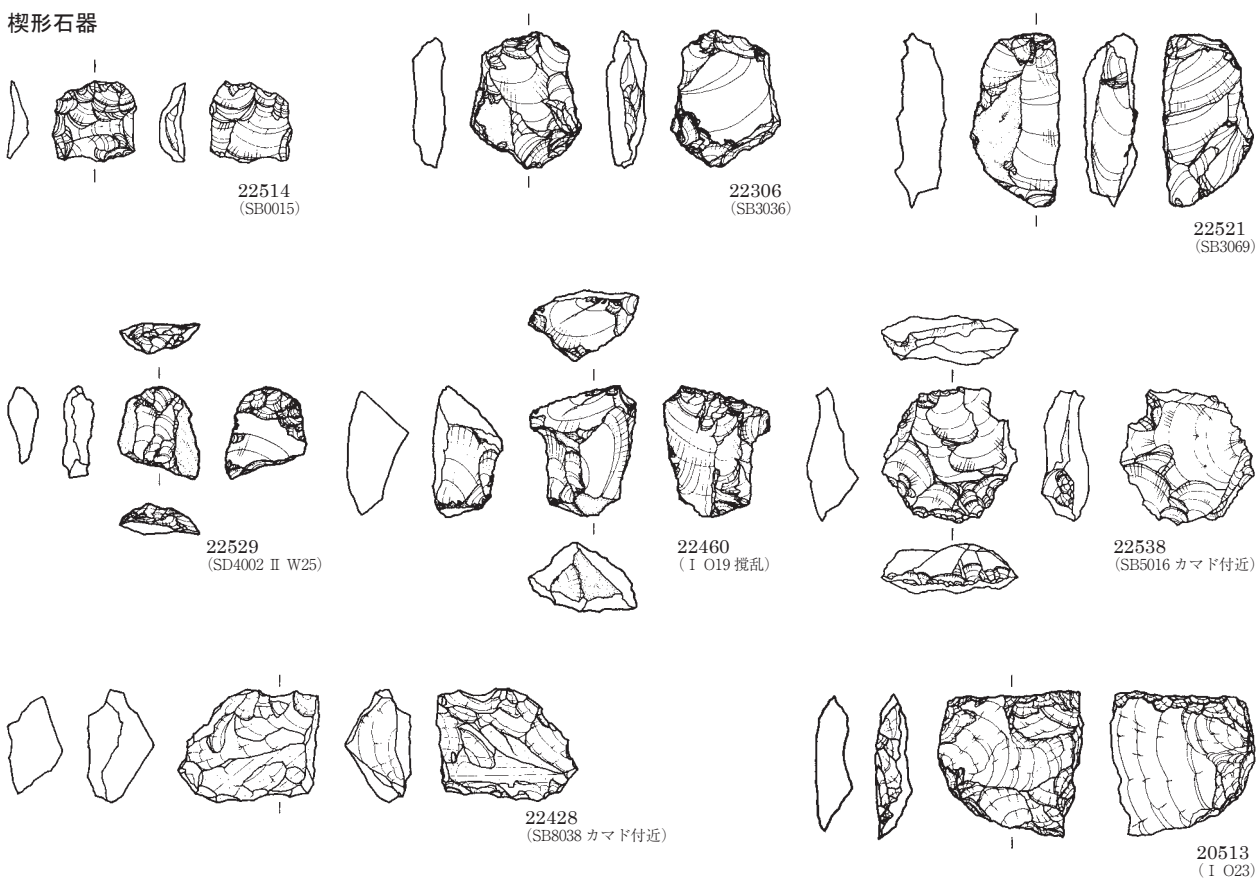

打製石鏃

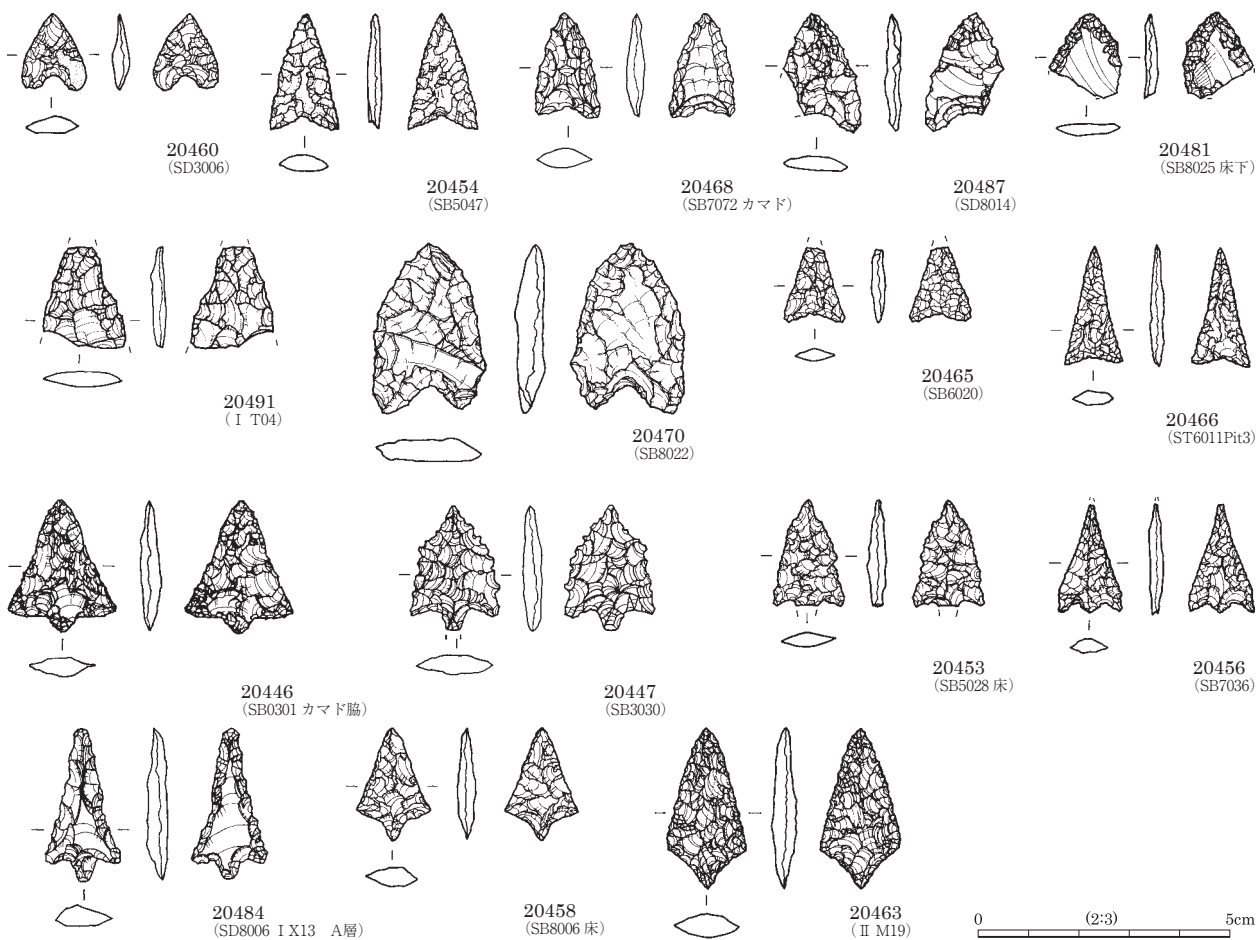

0 (2:3) 5cm

図版 204 石器・石製品 (3) - 縄文時代 -

石匙

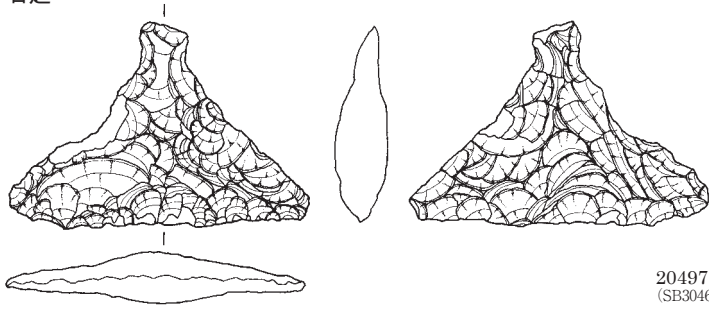

20497
(SB3046)

20492
(SB7011)

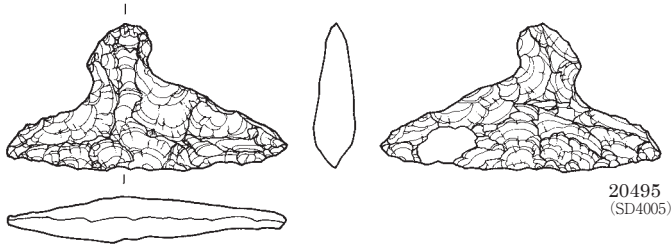

20495
(SD4005)

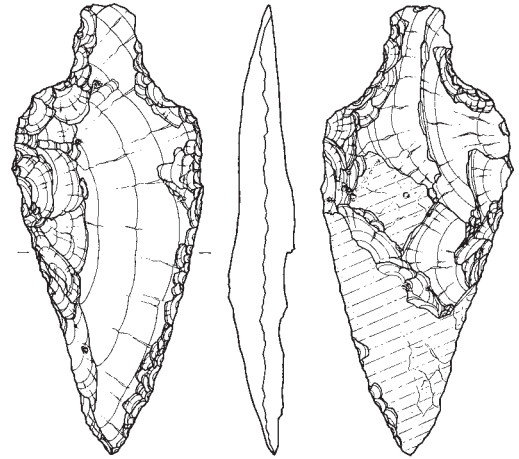

20498
(SB7015)

小形刃器

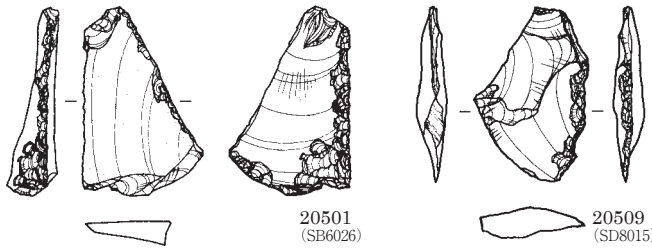

20501
(SB6026)

20509
(SD8015)

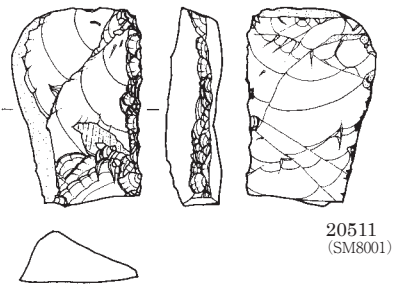

20511
(SM8001)

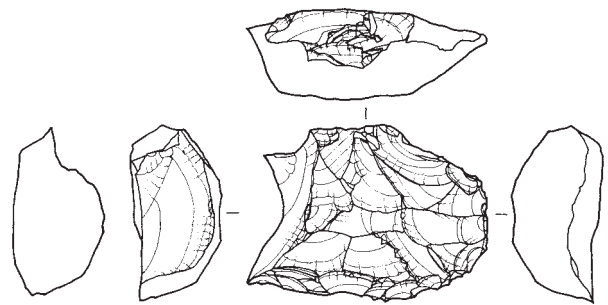

22448
(SD8013)

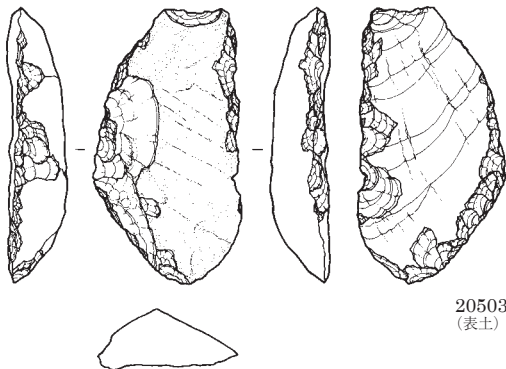

20503
(表土)

0 (2:3) 5cm

打製石斧 (1)

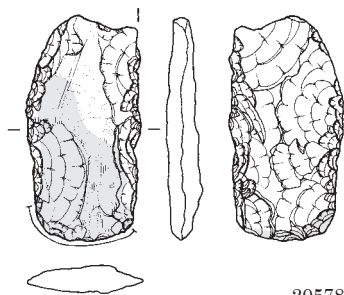

20578
(SB5026 上撓乱)

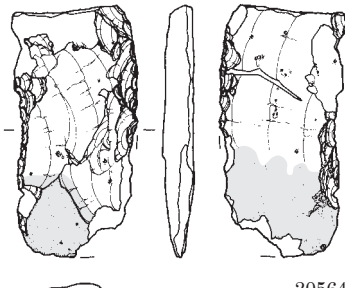

20564
(SB3067)

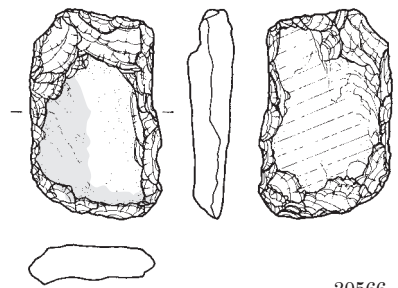

20566
(検出面)

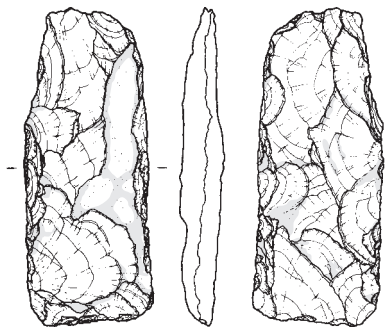

20542
(SB0067)

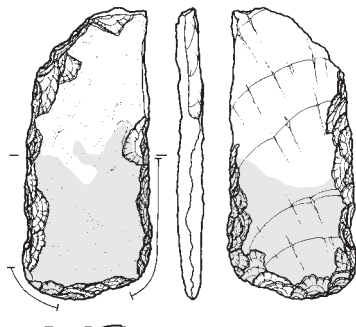

20587
(SB6058)

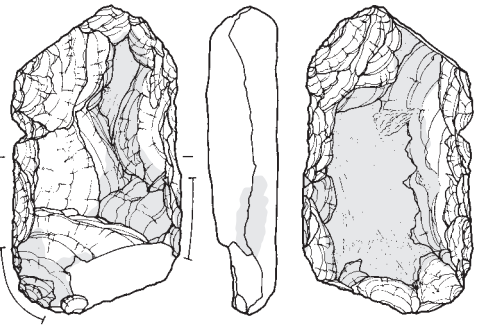

20595
(SB7004)

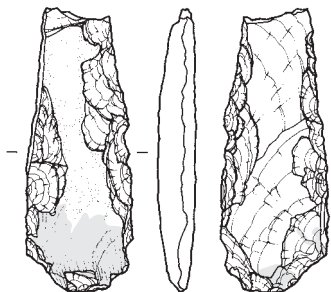

20557
(SB0030)

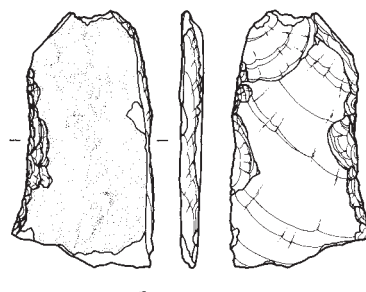

20544
(SB0068)

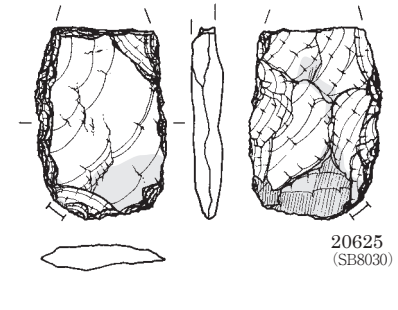

20625
(SB8030)

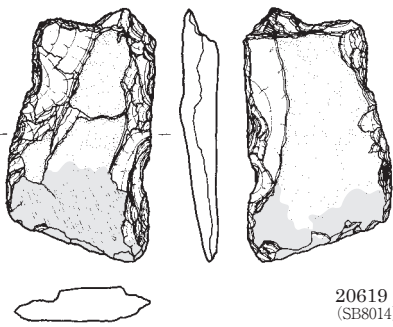

20619
(SB8014)

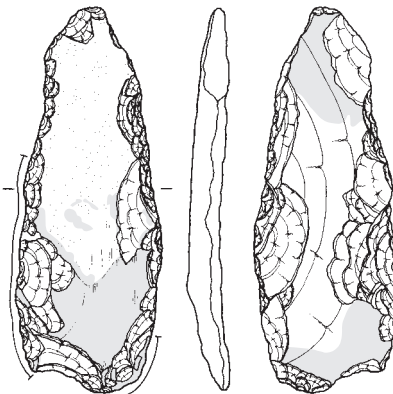

20534
(SB0068)

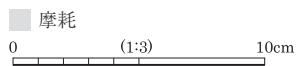

打製石斧 (2)

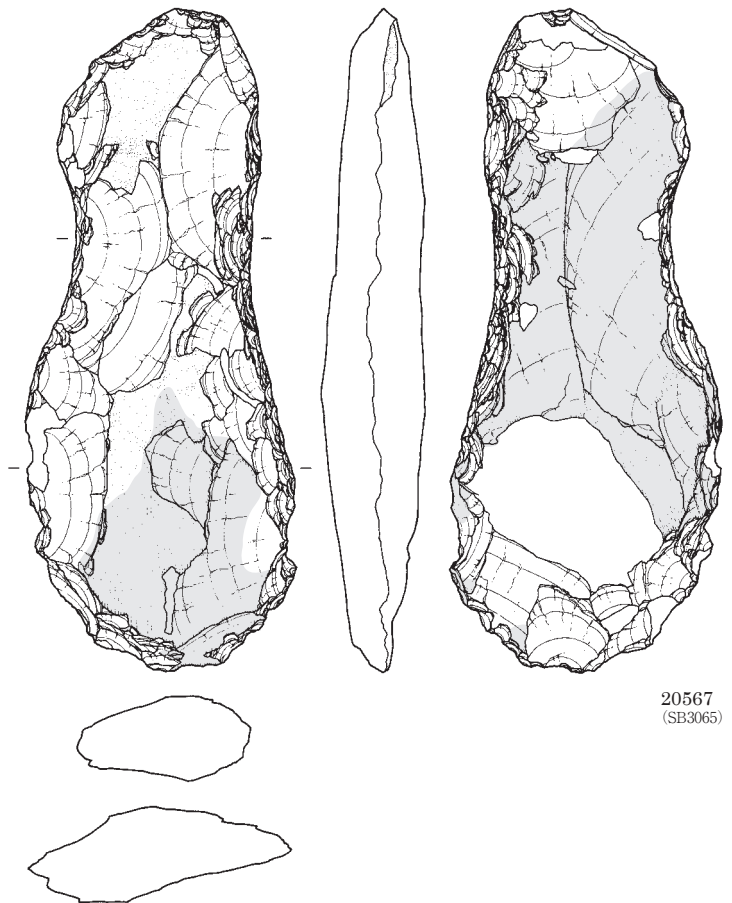
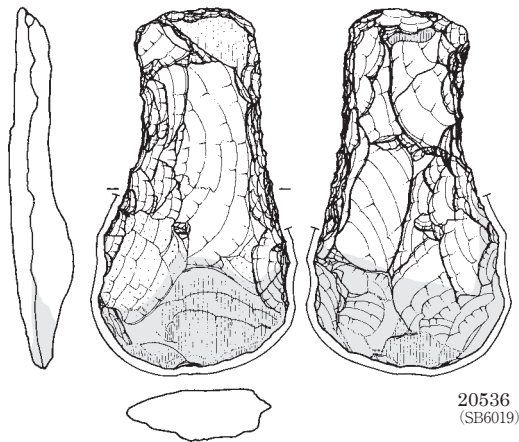
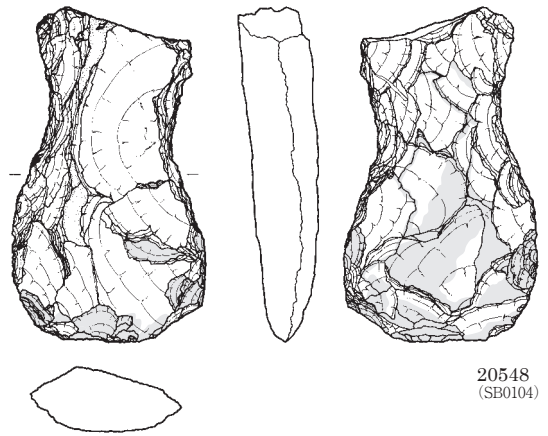
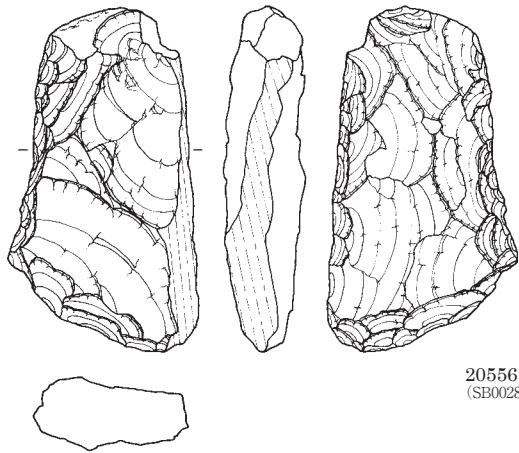

磨製石鏃

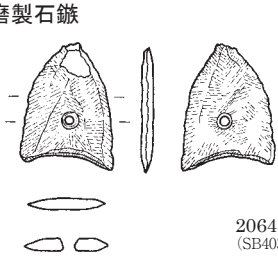

20646
(SB4038)

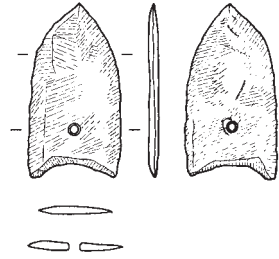

20641
(SB0035)

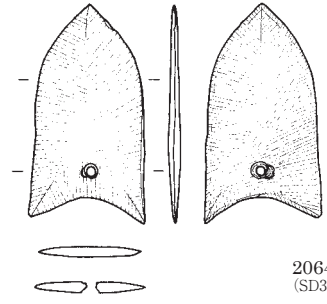

20645
(SD3006)

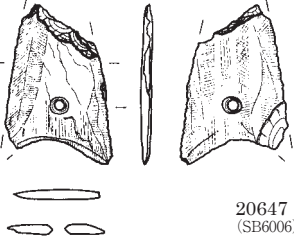

20647
(SB6006)

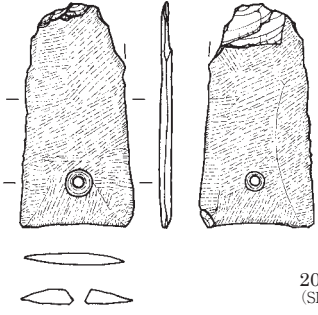

20642
(SB0075)

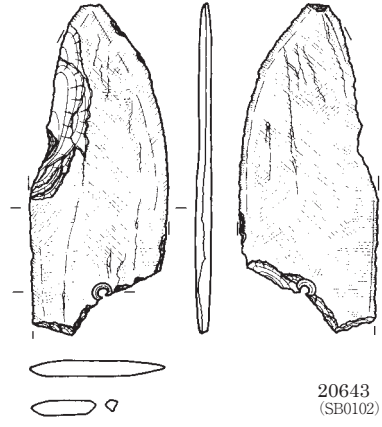

20643
(SB0102)

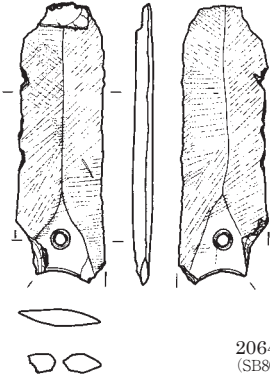

20648
(SB8029)

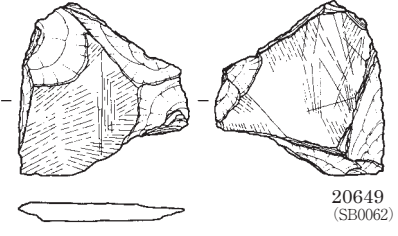

20649
(SB0062)

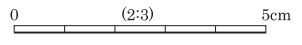

磨製石斧 (1)

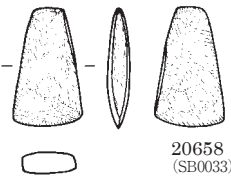

20658
(SB0033)

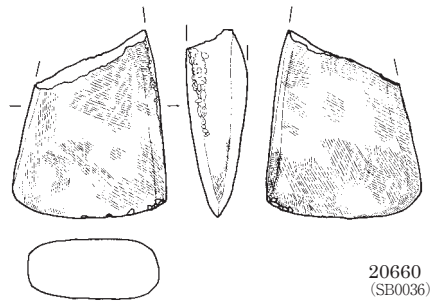

20660
(SB0036)

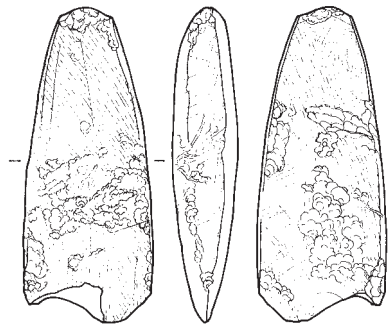

20653
(SB0065)

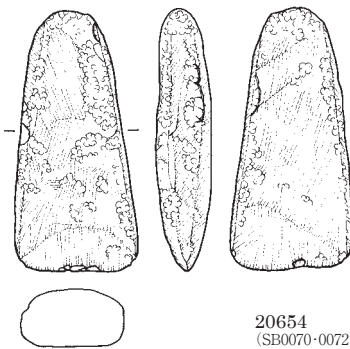

20654
(SB0070-0072)

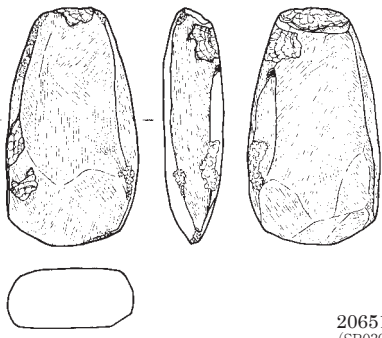

20651
(SB0304)

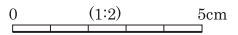

磨製石斧 (2)

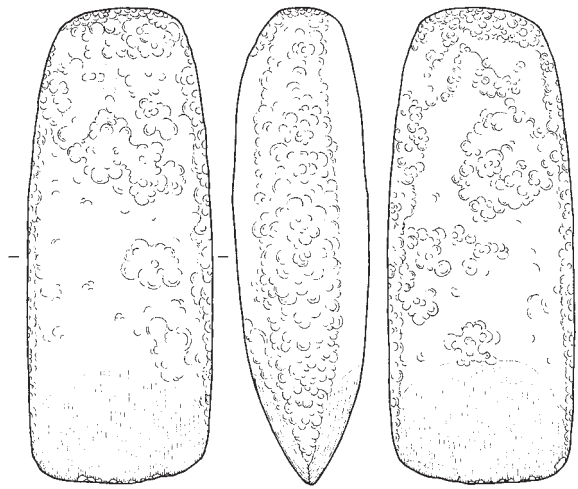

20659
(SB0033)

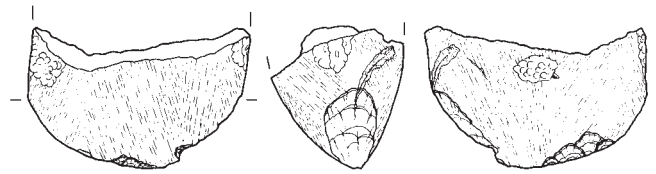
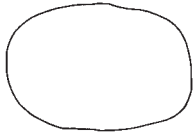

20663
(SB3090)

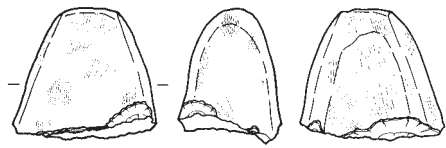
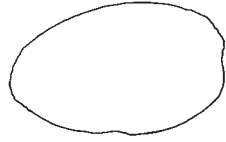

20667
(SK8210)

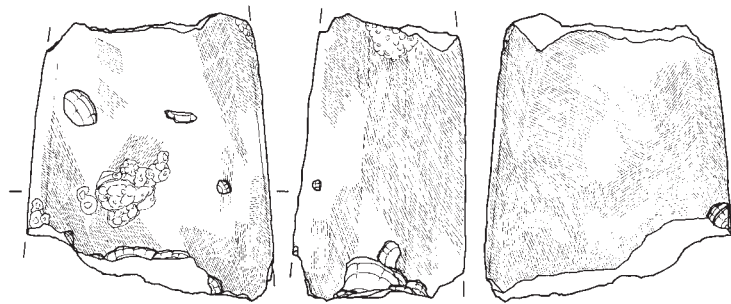
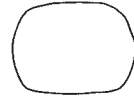

20662
(SB3069)

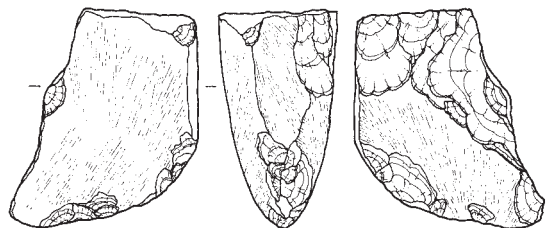
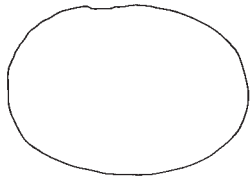

20664
(SB7071)

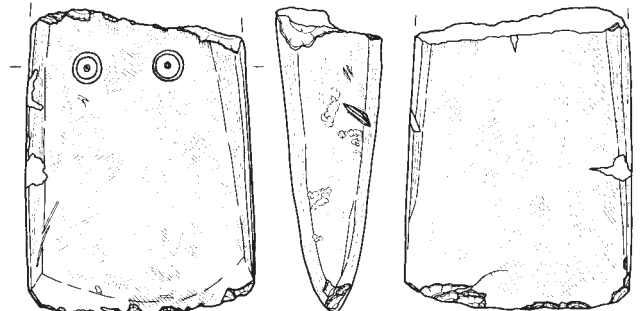

20652
(II E16)



磨製石斧 (3)

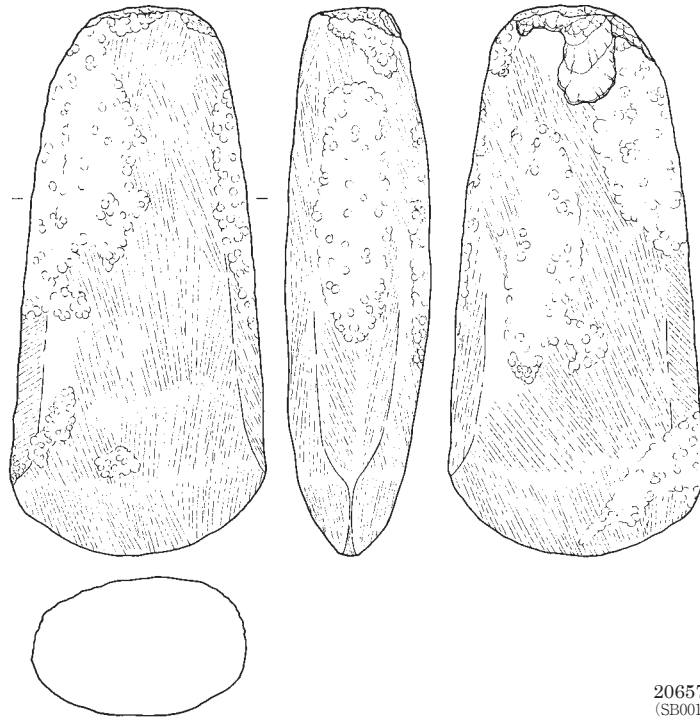

20657
(SB0011)

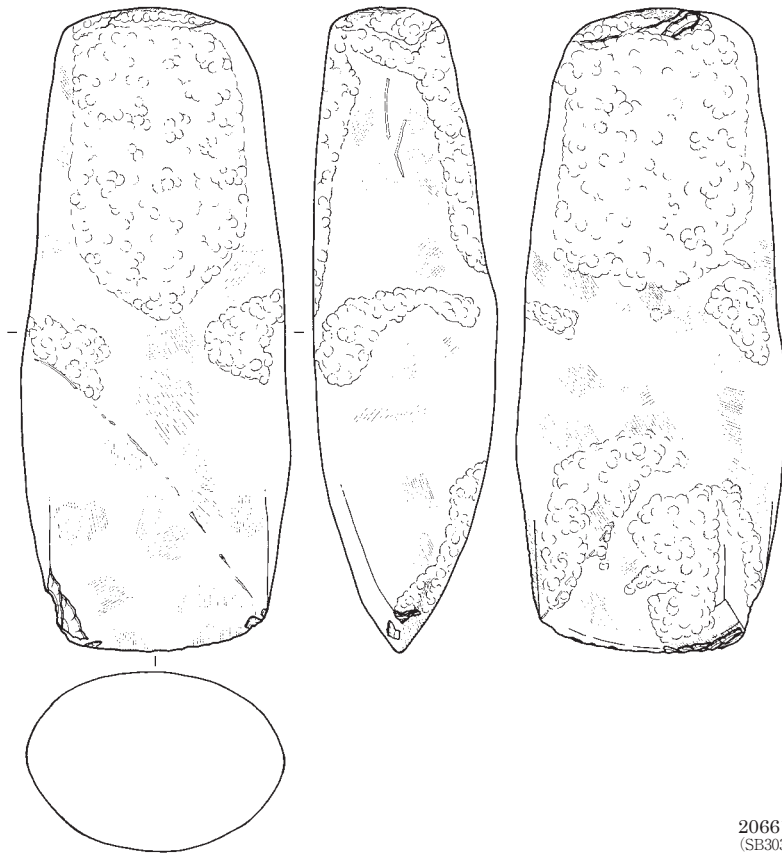

20661
(SB3038)

0 (1:2) 5cm

図版 210 石器・石製品 (9) - 弥生時代 -

みがき石

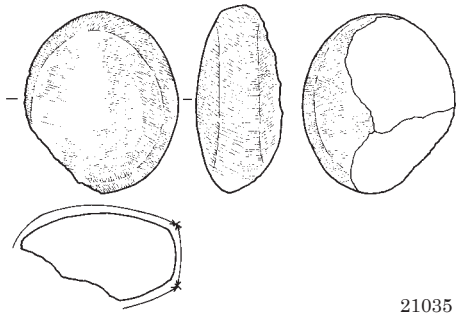

21035
(SB0011)

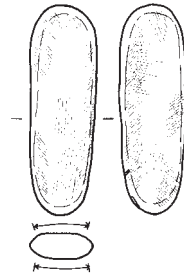

21044
(SB0027)

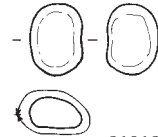

21013
(SB0035)

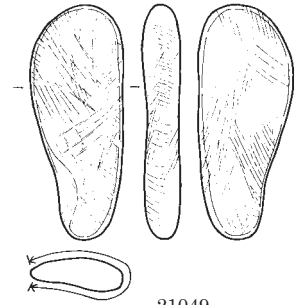

21049
(SB0036-0046-0048)

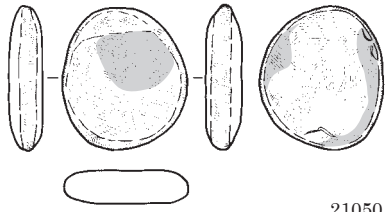

21050
(SB0037)
■ 赤色顔料付着

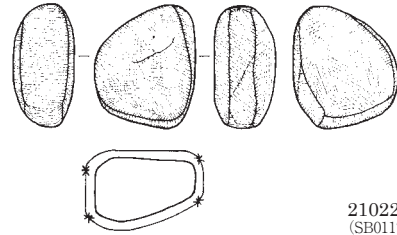

21022
(SB0117)

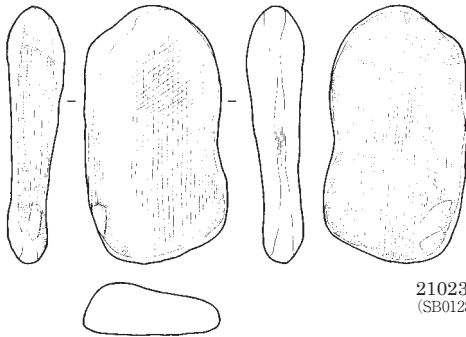

21023
(SB0128)

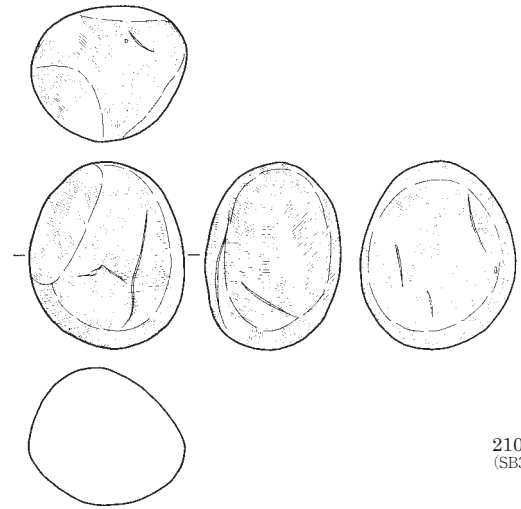

21059
(SB3052)

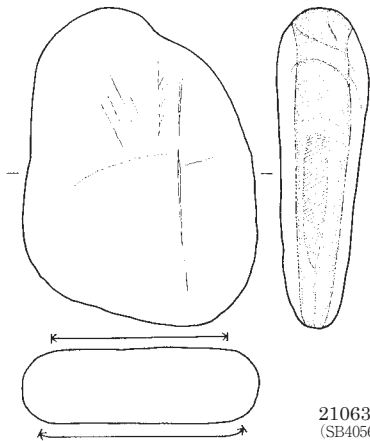

21063
(SB4056)

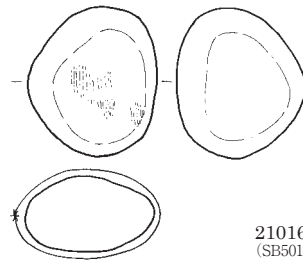

21016
(SB5011)

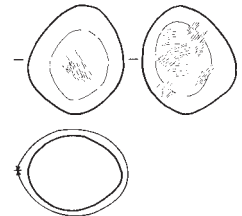

21017
(SB5024)

0 (1:2) 5cm

石製玉類

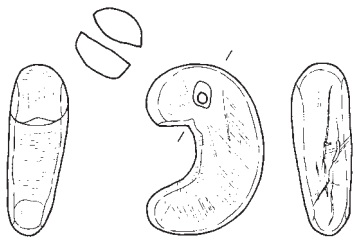

20040
(SB4002)

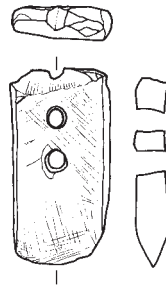

20058
(SB4030)

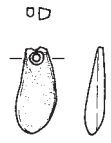

20051
(SD4002 II W25)

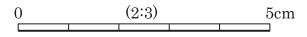

管玉



20031
(SB0004)



20032
(SB0019)



20033
(SB0136)



20034
(SB3051)



20035
(SB8010)



20036
(SB8024 床)



20037
(SB8044b 床)



20038
(SB4028)



20039
(検出面)

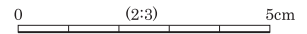

不明石製品

丸玉



20043
(SB0036)



20049
(SB8011)



20052
(SK7324)



20050
(ST5006Pit10)



20048
(SB7068 掘方)



20057
(I Y11)



20044
(SB0119
床F Pit7)



20046
(SB5030)



20053
(SB7015)



20047
(SB7037)



20055
(SB8028)

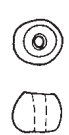

20056
(SK7512)



20045
(SB5008)



20054
(SB7022)

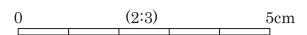

ガラス小玉



20059
(SB0067 床)



20060
(SB3060)



20061
(SB7042)



20062
(SB8019)



20063
(SM4002)



20064
(SM4002)



20065
(SM4002)



20066
(SM4002)

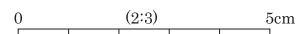

図版 212 石器・石製品 (11) - 古墳時代~古代 -

滑石製模造品 (1)

SB3022



20310
(床)

SB3042



20311
(カマド)

SB4026



20312



20313

SB4040



20314



20315

SB5007・5008

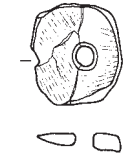

20408

SB5011

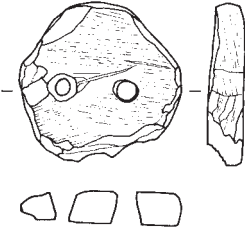

20417

SB5012



20318

SB5022



20319



20320
(床)



20321
(床)



20322
(床)

SB5030



20323

SB5034



20324

SB5054



20325

SB6020



20326
(カマド)

SB6021



20327



20329



20330



20333



20334

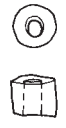

20335



20336



20337



20338



20339



20340



20341



20342

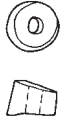

20343



20344



20345



20346



20347



20348

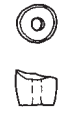

20349



20350

SB6022



20351
(周溝)



20352
(床)

SB6024



20353



20354



20355



20356



20357



20358



20359

0 (2:3) 5cm

滑石製模造品 (2)

SB6033

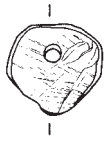

20409
(床下)



20410
(床下)

SB6040



20360
(掘方)

SB6048

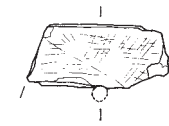

22872
(床下)

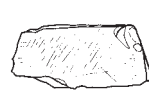

20361



20362

SB6050



20363



20364



20365



20366



20367



20368



20369



20370



20371



20372



20373



20374



20375



20376



20377



20378



20379



20380



20381



20382



20383



20384



20385



20386



20387



20388



20389



20390



20391



20392

SB6054



20390

SB6061



20391

SB7005

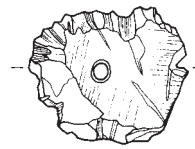

20411

SB7006



20393

SB7008



20394

SB7019



20395



20396



20397

SB7022



20412

SB7025



20398

SB7037



20399



20400

図版 214 石器・石製品 (13) - 古墳時代~古代 -

滑石製模造品 (3)

SB7037



20401



20402
(床)

SB7041



20407
(SB7041 掘方北西隅 Pit)

SB8007



20403
(床)

SB8016



20068



20069



20070



20071



20072



20073



20074



20075
(床)



20076



20077



20080



20081

SB8019



20083

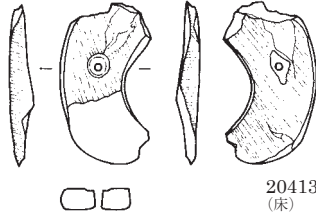

20413
(床)



20084



20085



20086



20089



20090



20091



20092



20094



20095



20096



20098



20102



20103



20104



20105



20106



20107



20108



20109



20110



20111



20112



20113



20115



20116



20117



20118



20119



20120



20121



20123



20124



20125



20126



20129



20132



20133

0 (2:3) 5cm

滑石製模造品 (4)

SB8019

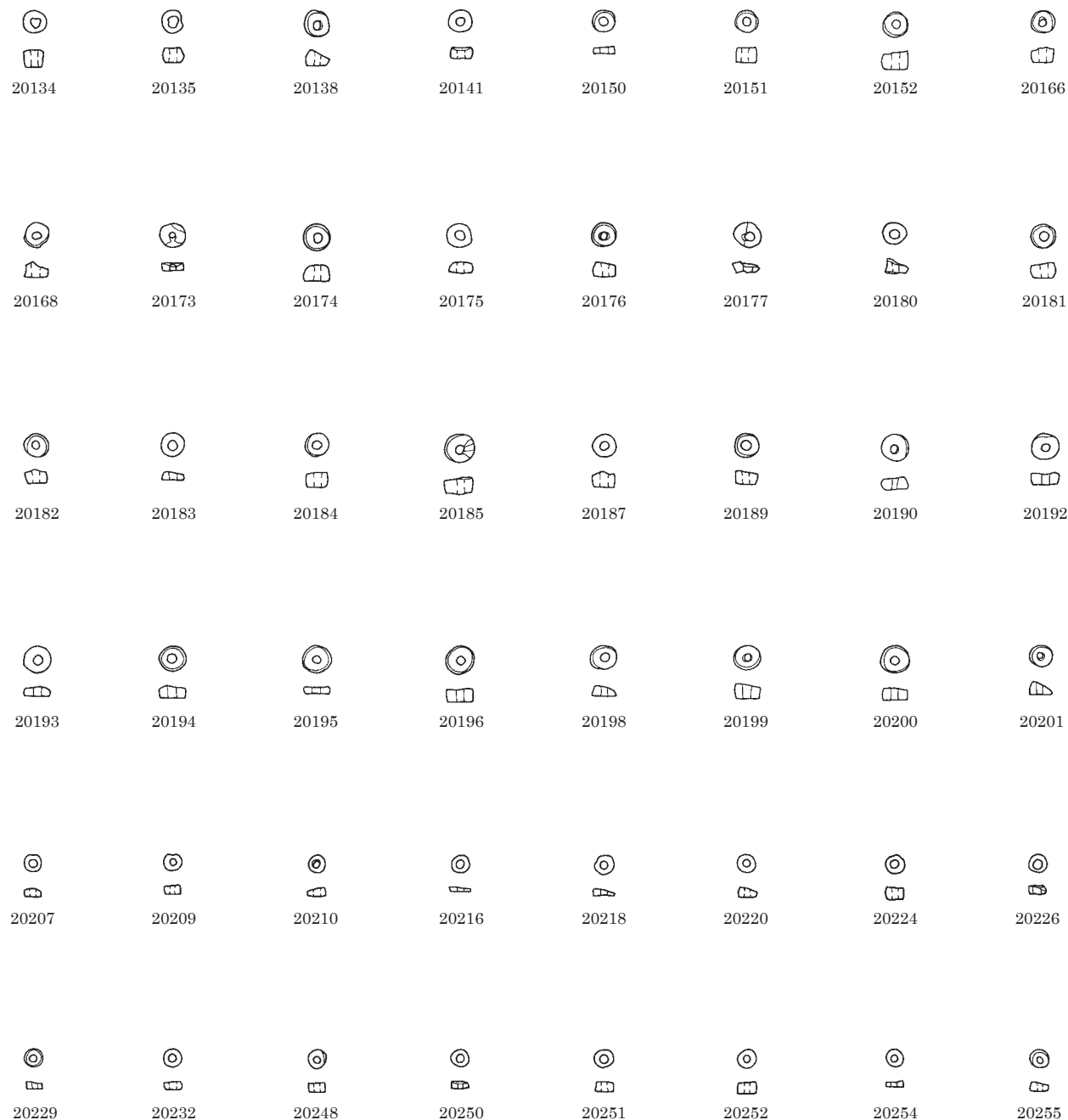

SB8024

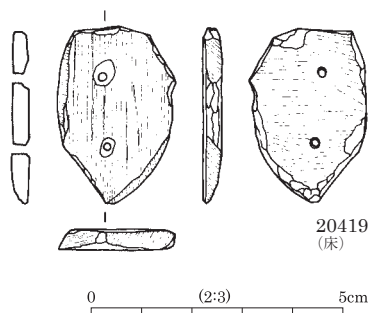

図版 216 石器・石製品 (15) - 古墳時代~古代 -

滑石製模造品 (5)

SB8024



20264

SB8029



20405

SB8040

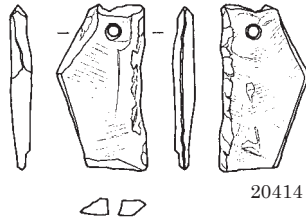

20414

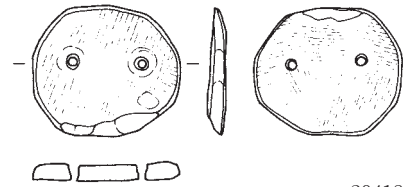

20418



20266



20267



20268



20269



20270



20271



20273



20275



20277



20278



20281



20283



20284



20287



20288



20289



20290



20292



20293



20294



20295



20296



20297

SB8044

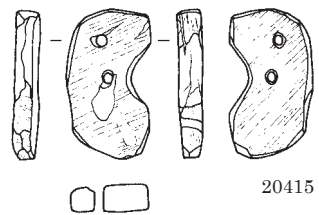

20415

SD0002

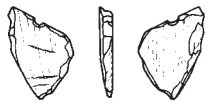

20427

SD4005



20316

SD8005



20300



20301



20302



20303



20304



20305



20306



20307



20308

SD8013

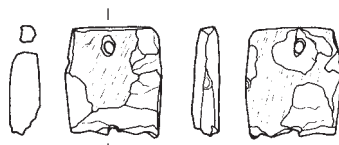

20426

SD8014



20406

ST7010



20309
(Pit7)

0 (2:3) 5cm

石製紡錘車 (1)

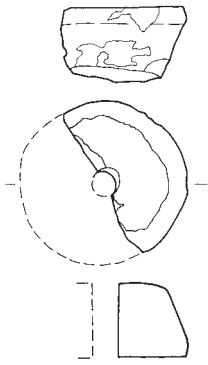

20005
(SB3020)

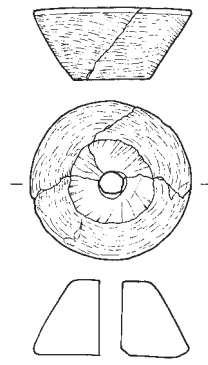

20006
(SB3022)

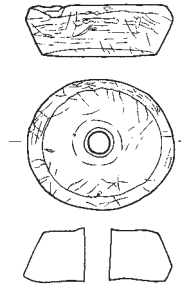

20007
(SB3024)

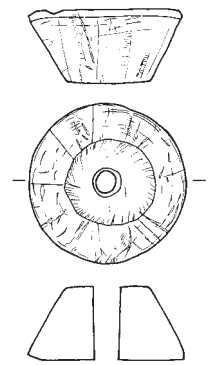

20008
(SB3030)

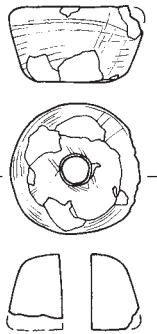

20009
(SB4015)

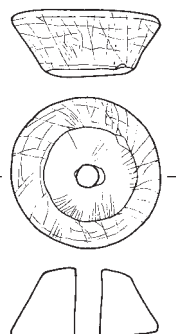

20010
(SB4015)

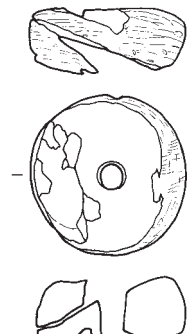

20011
(SB4045)

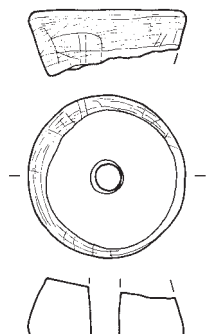

20012
(SB4063)

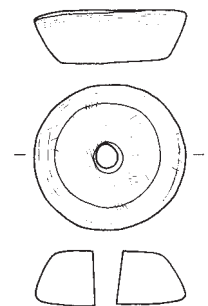

20013
(SB4063)

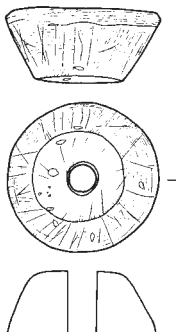

20015
(SB5009)

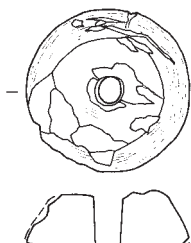

20016
(SB5011)

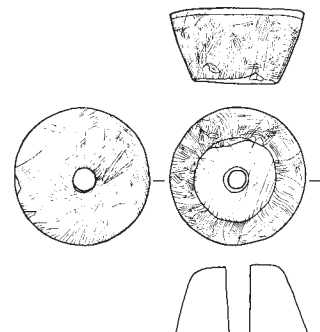

20017
(SB5050)

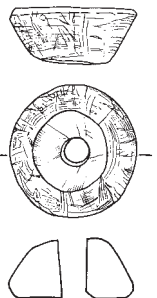

20018
(SB6015 カマド)

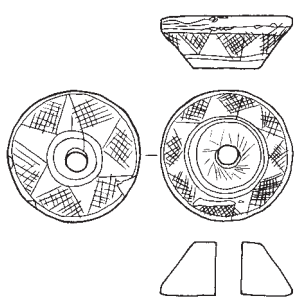

20019
(SB6021)

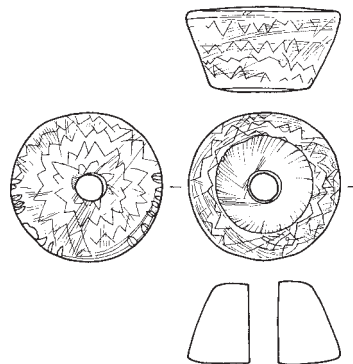

20020
(SB6021)

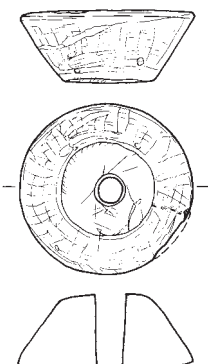

20028
(SB7009)

石製紡錘車 (2)

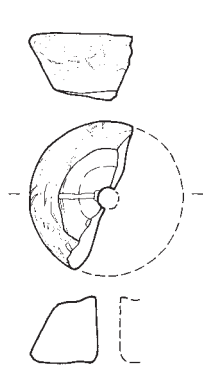

20022
(SB7022)

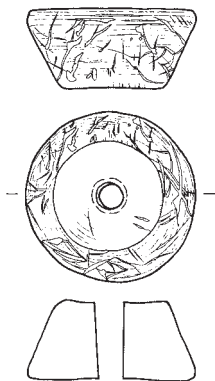

20025
(SB7023)

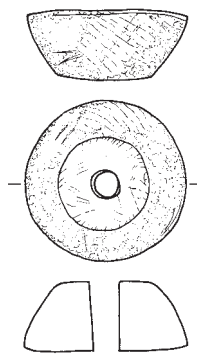

20026
(SB7023)

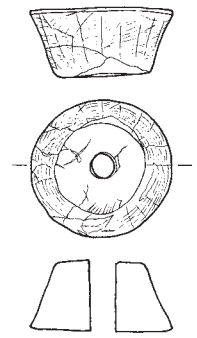

20027
(SB7048)

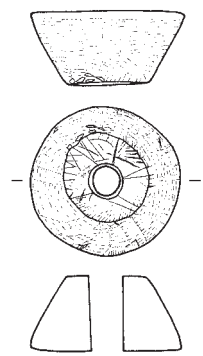

20023
(SB7025)

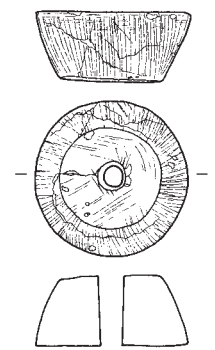

20024
(SK8025)

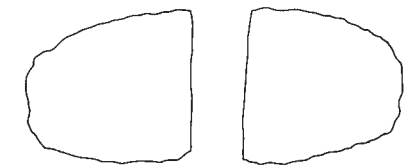
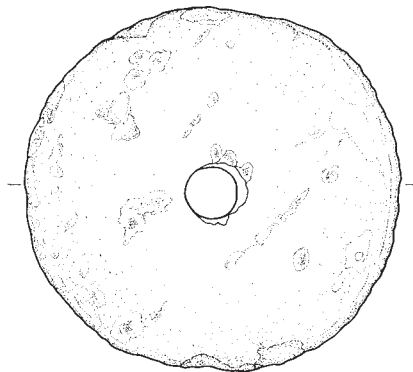

20029
(SB8010)

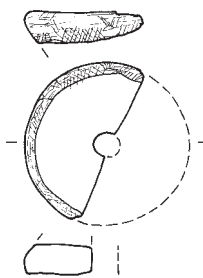

20021
(ST6009Pit8)

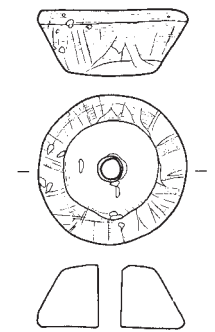

20014
(SD4002)

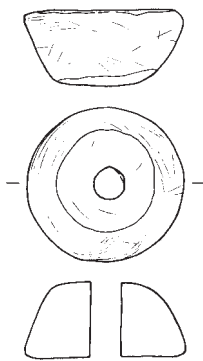

22859
(SD5002)

石製腰帶飾具

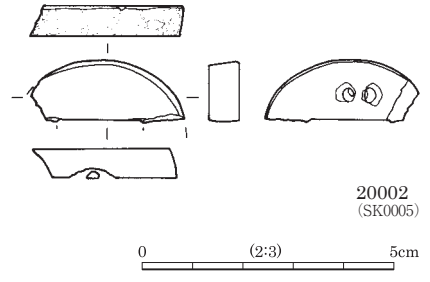
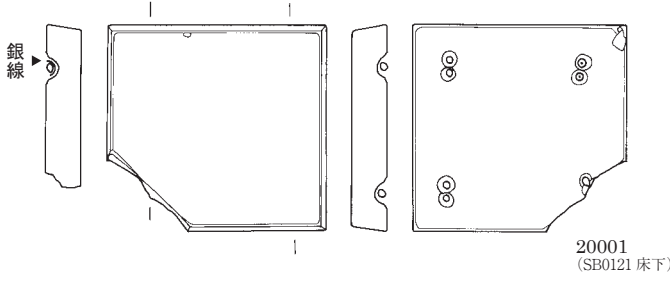

温石

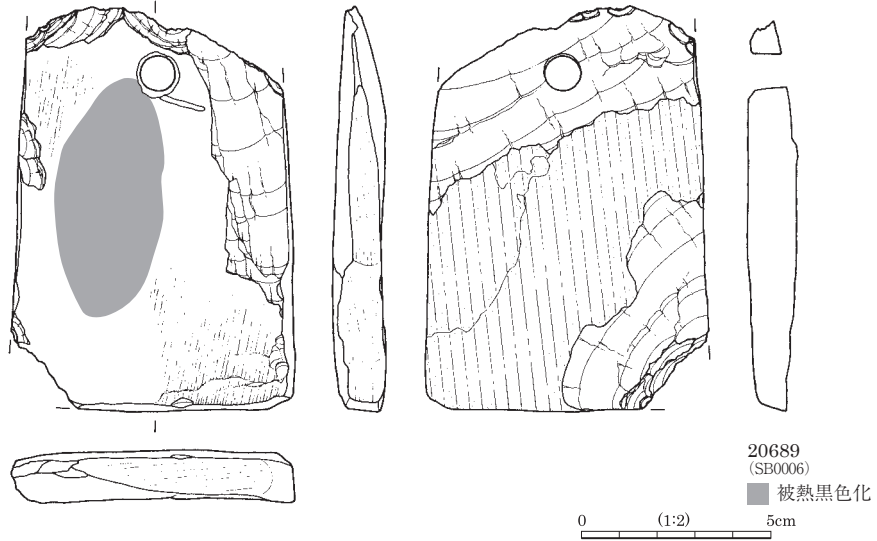

硯

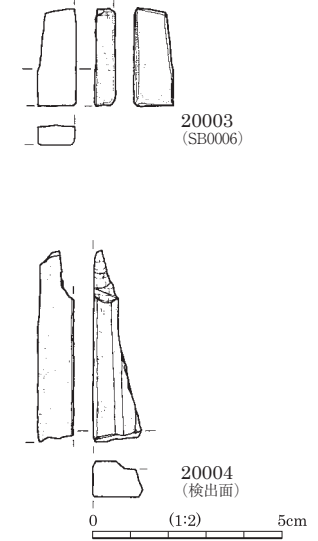

軽石製品 (1)

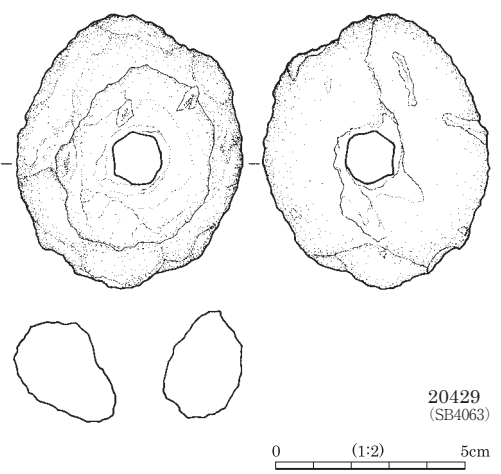
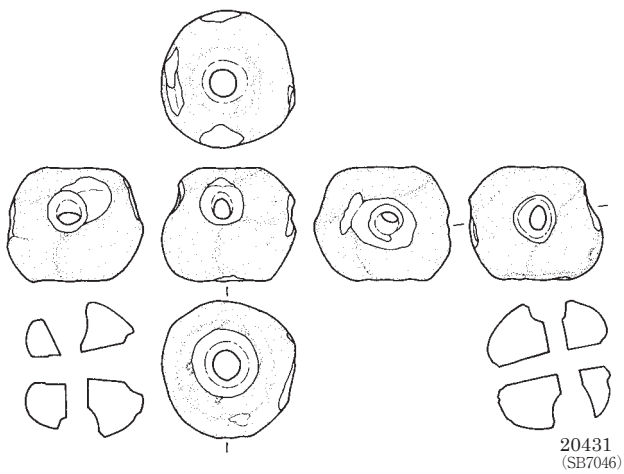
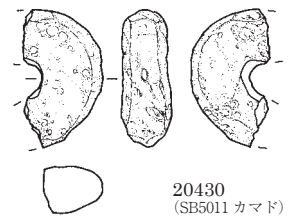
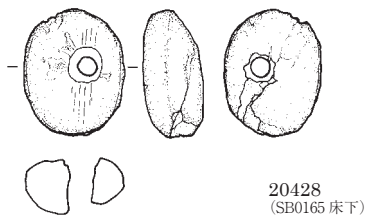
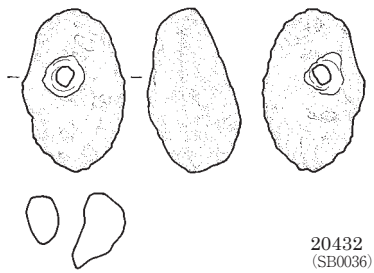

図版 220 石器・石製品 (19) - 弥生時代～中世 -

軽石製品 (2)



20436
(SB0050)

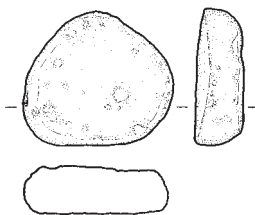

20435
(SB0301 カマド)

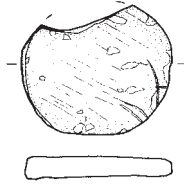

20433
(SB6014)

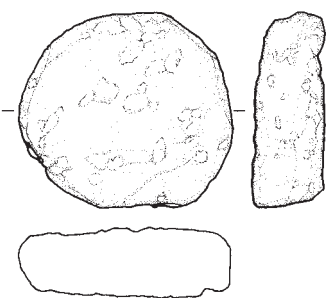

20442
(SB5012)

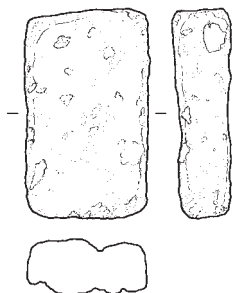

20434
(SB0115)



20438
(SB3067)

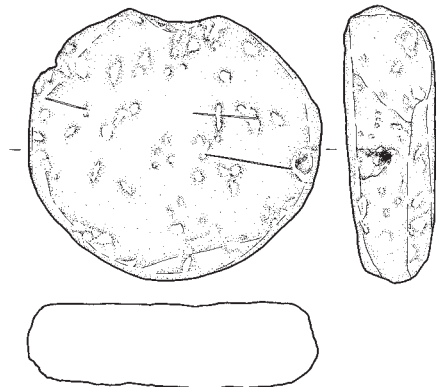

20441
(攪乱)

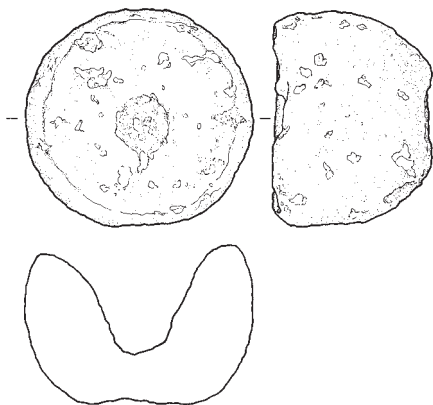

20443
(SB7017)

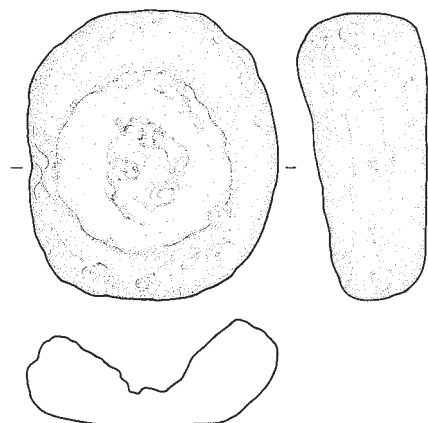

20440
(攪乱)

0 (1:2) 5cm

小形砥石 (1)

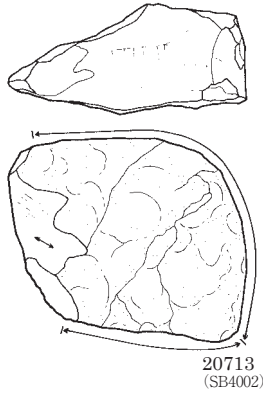
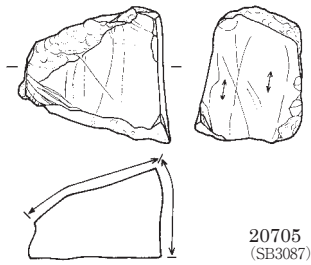
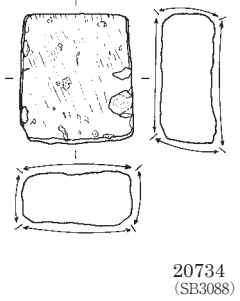
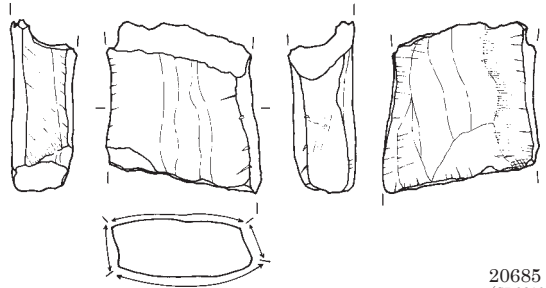
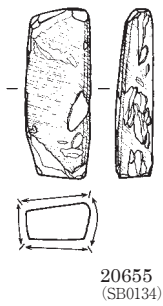
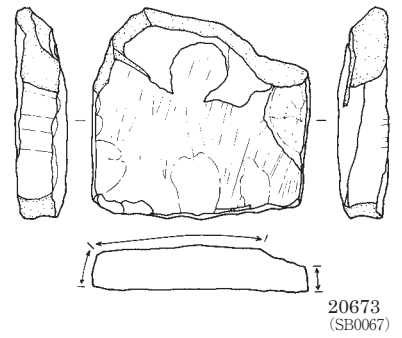
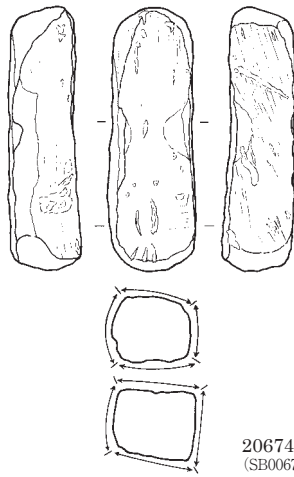
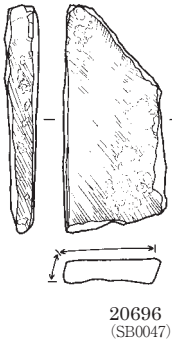
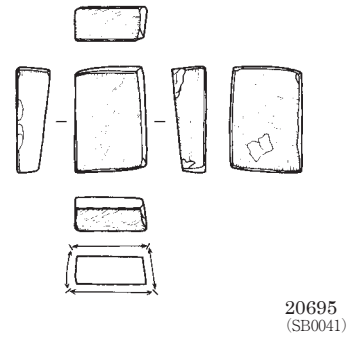
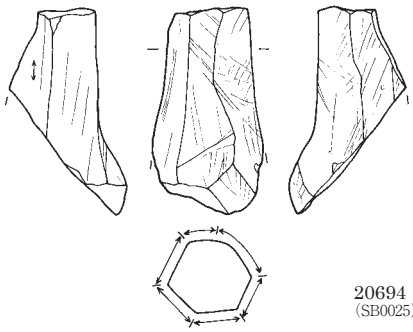
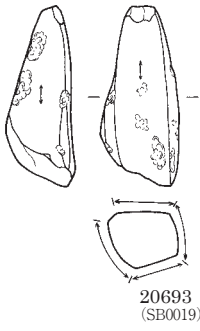

小形砥石 (2)

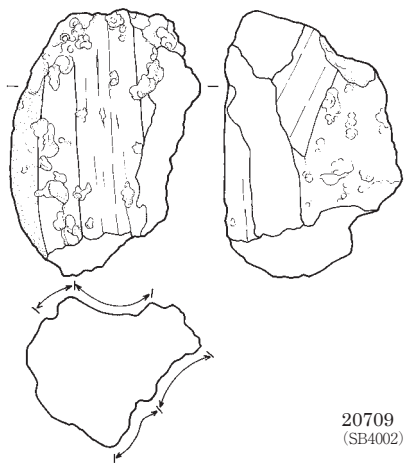

20709
(SB4002)

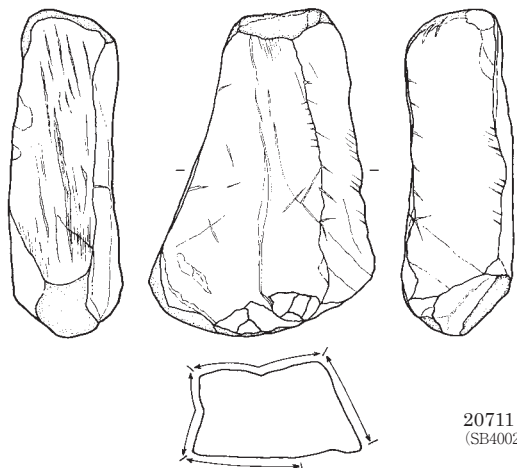

20711
(SB4002)

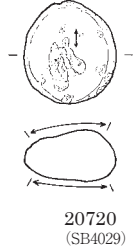

20720
(SB4029)

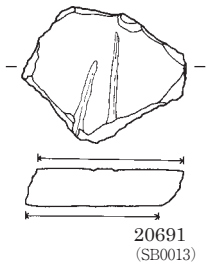

20691
(SB0013)

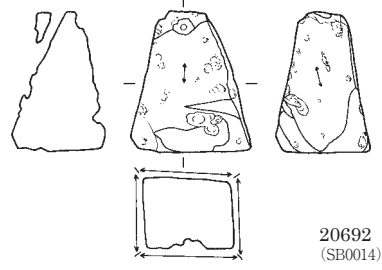

20692
(SB0014)

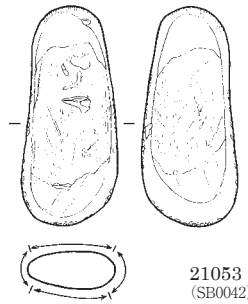

21053
(SB0042)

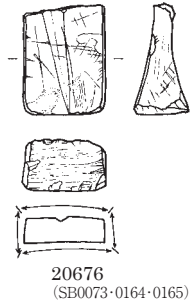

20676
(SB0073-0164-0165)

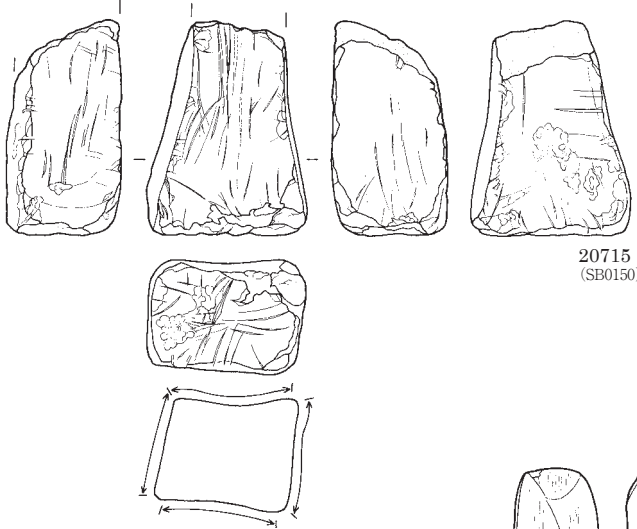

20715
(SB0150)

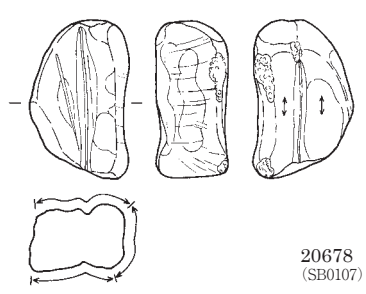

20678
(SB0107)

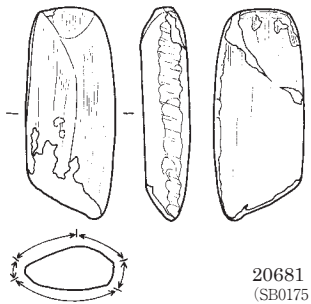

20681
(SB0175 床～床下)

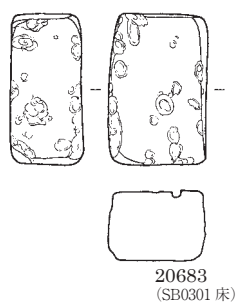

20683
(SB0301 床)

0 (1:3) 10cm

小形砥石 (3)

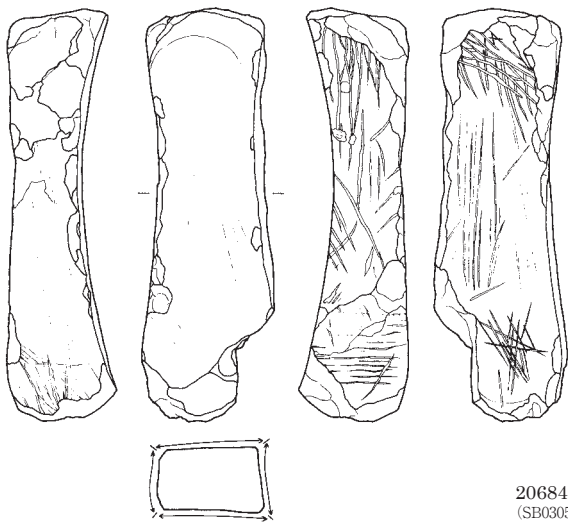

20684
(SB3035)

20699
(SB3038)

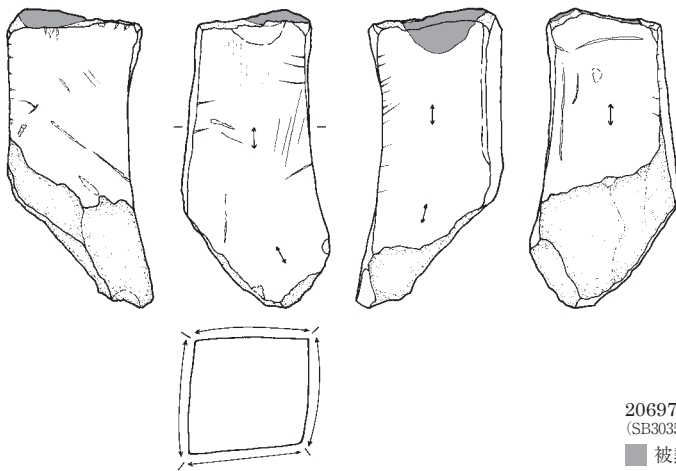

20697
(SB3035)

■ 被熱黒色化

20698
(SB3035)

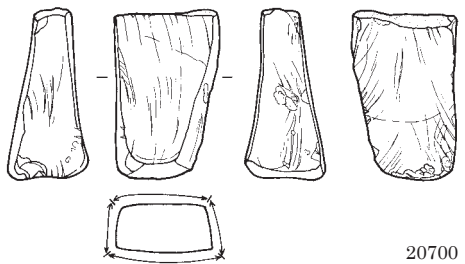

20700
(SB3045)

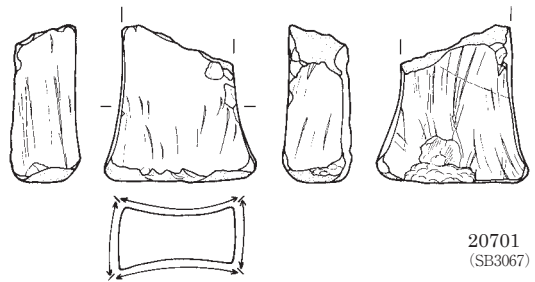

20701
(SB3067)

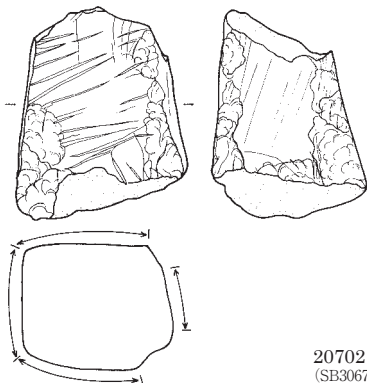

20702
(SB3067)

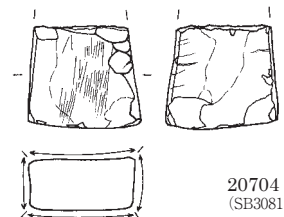

20704
(SB3081)

0 (1:3) 10cm

小形砥石 (4)



小形砥石 (5)



小形砥石 (6)

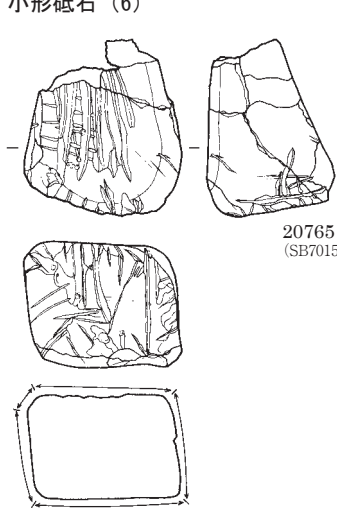

20765
(SB7015)

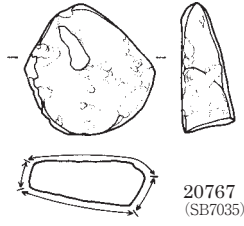

20767
(SB7035)

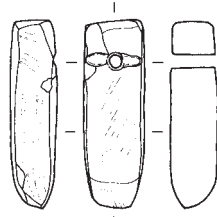

20669
(SB7039)

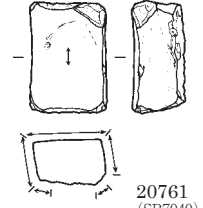

20761
(SB7040)

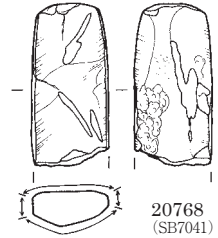

20768
(SB7041)

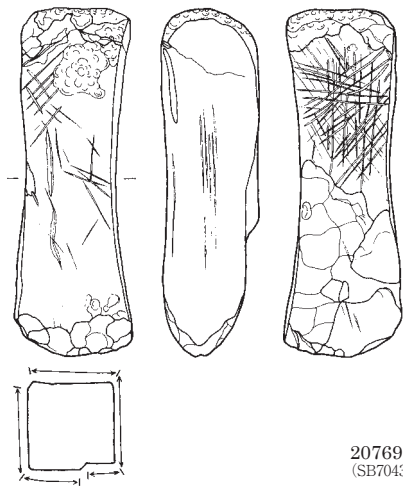

20769
(SB7043)

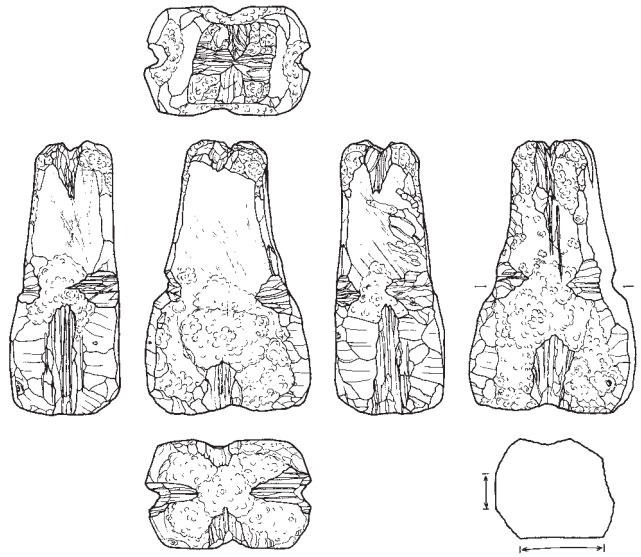

20770
(SB7046)

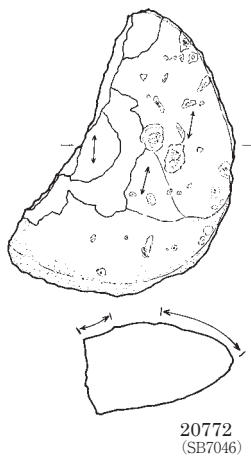

20772
(SB7046)

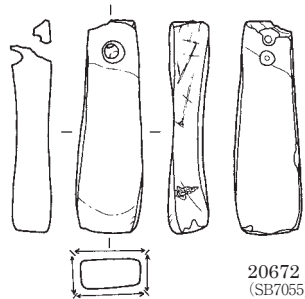

20672
(SB7055)

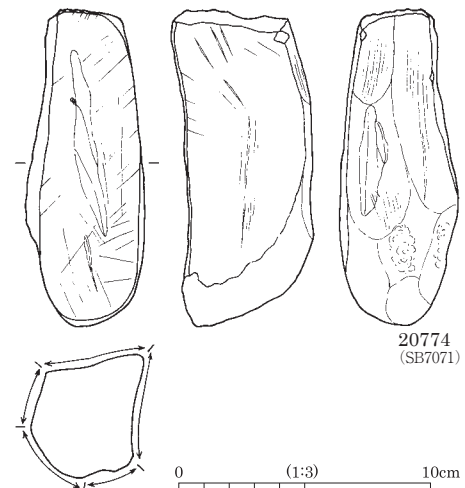

20774
(SB7071)

0 (1:3) 10cm

小形砥石 (7)

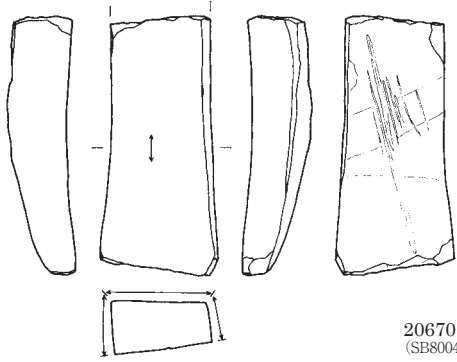

20670
(SB8004)

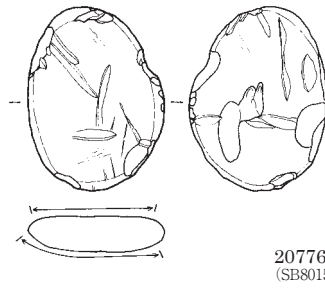

20776
(SB8015)

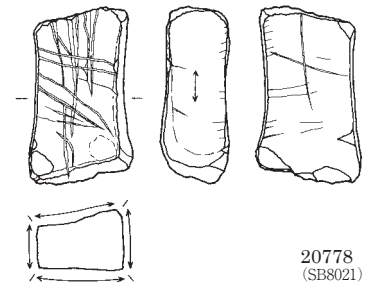

20778
(SB8021)

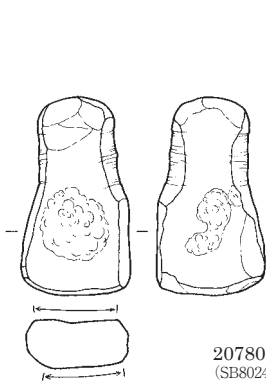

20780
(SB8024)

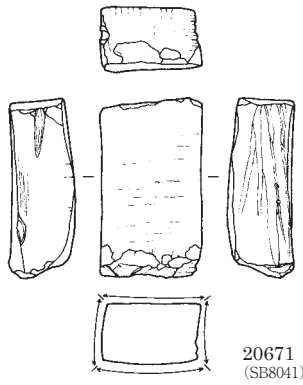

20671
(SB8041)

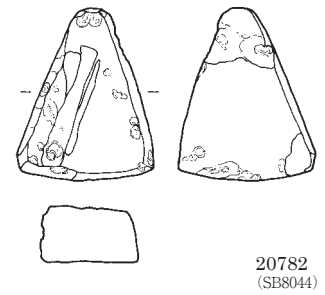

20782
(SB8044)

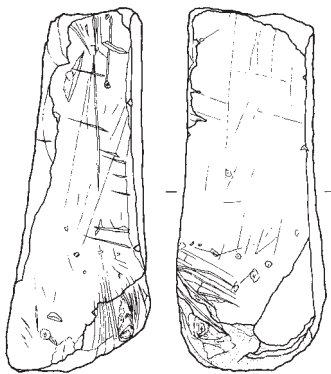

20779
(SB8028)

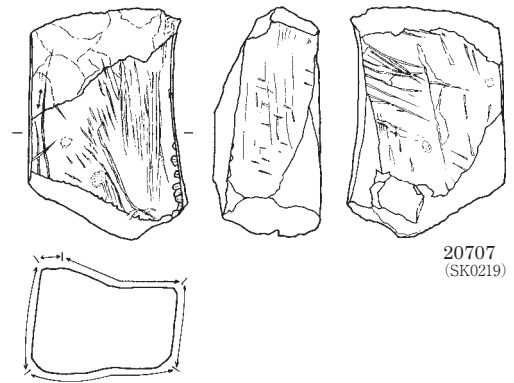

20707
(SK0219)

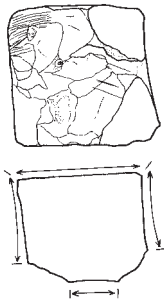

20779
(SB8028)

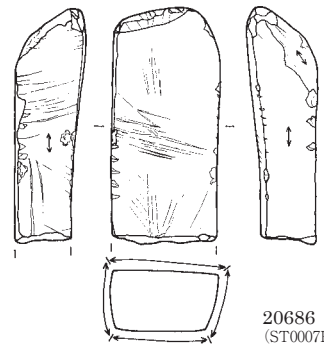

20686
(ST0007Pit4)

0 (1:3) 10cm

小形砥石 (8)

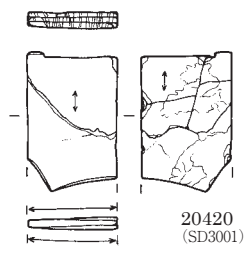

20420
(SD3001)

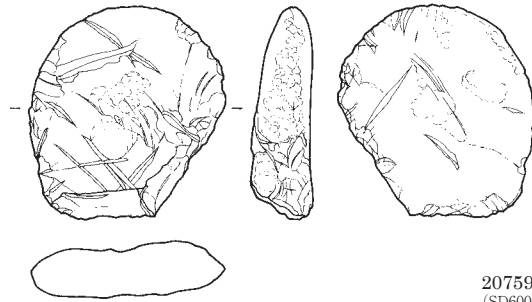

20759
(SD6002 II D18)

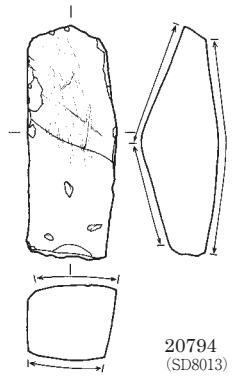

20794
(SD8013)

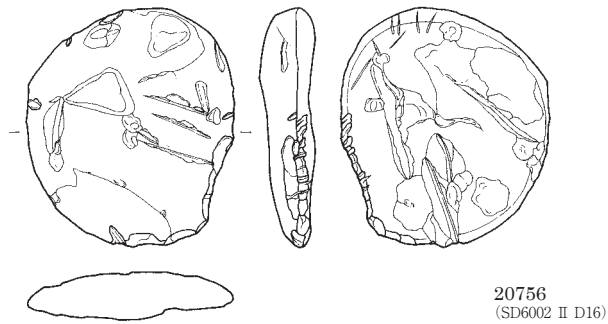

20756
(SD6002 II D16)

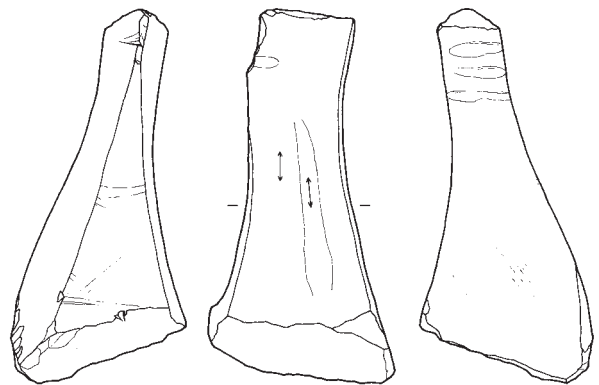

20726
(SB0108)

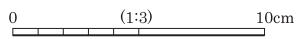

大形砥石 (1)

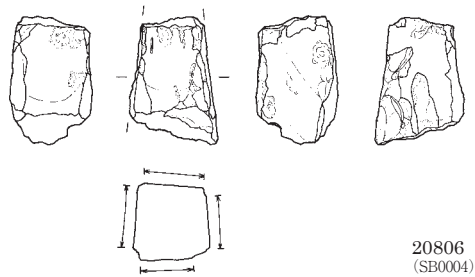

20806
(SB0004)

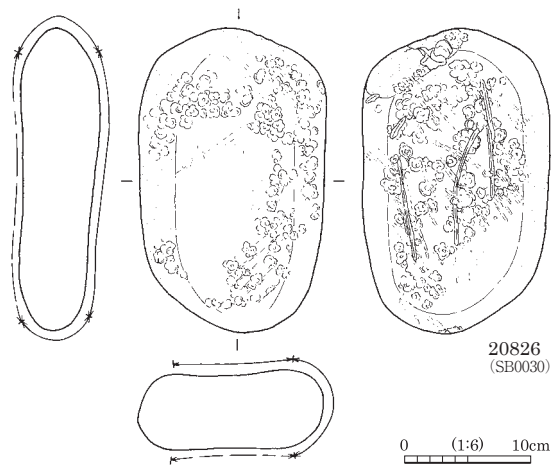

20826
(SB0030)

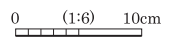

大形砥石 (2)



20802
(SB0066)

20809
(SB0077)

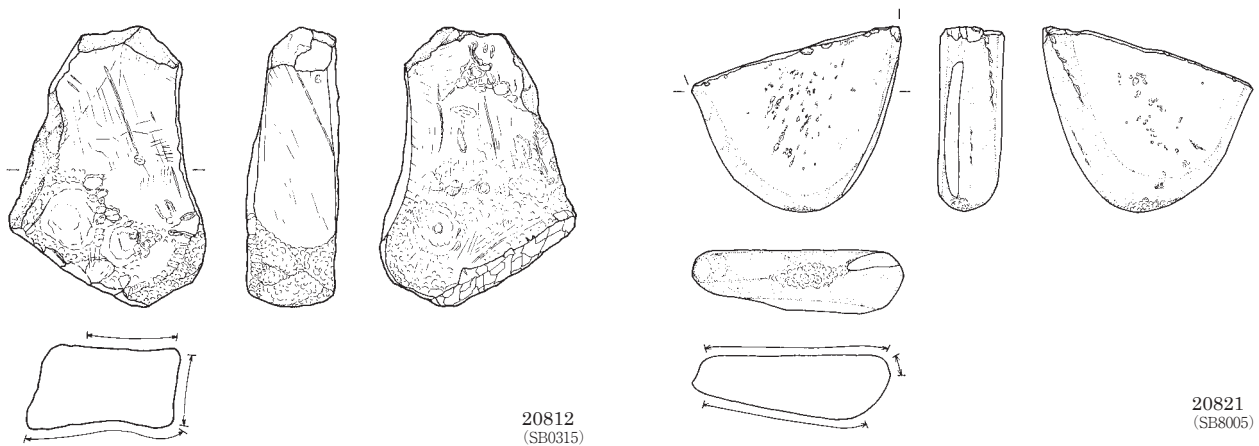

20812
(SB0315)

20821
(SB8005)

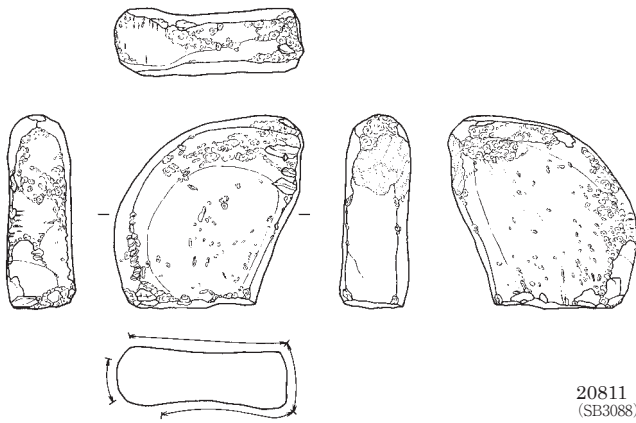

20811
(SB3088)

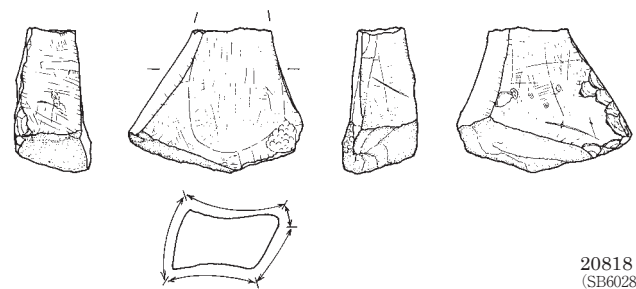

20818
(SB6028)

大形砥石 (3)



20827
(SB4002)

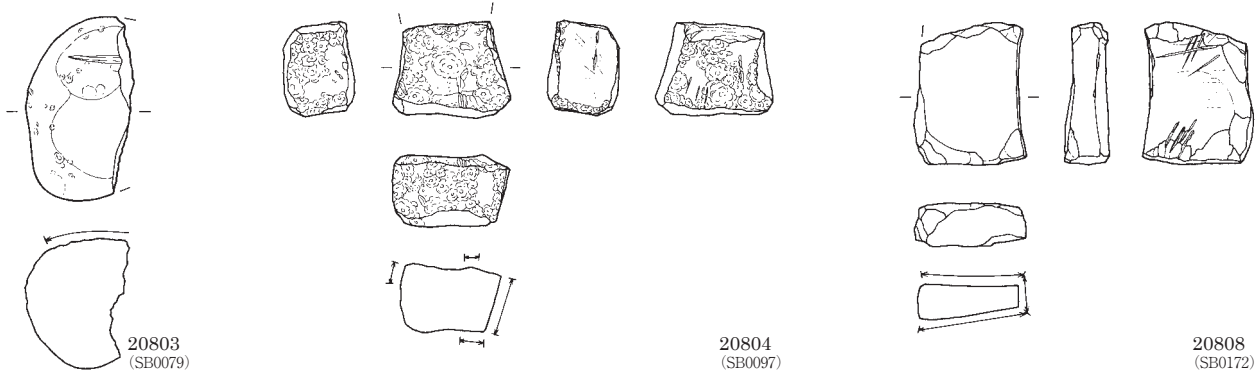

20803
(SB0079)

20804
(SB0097)

20808
(SB0172)

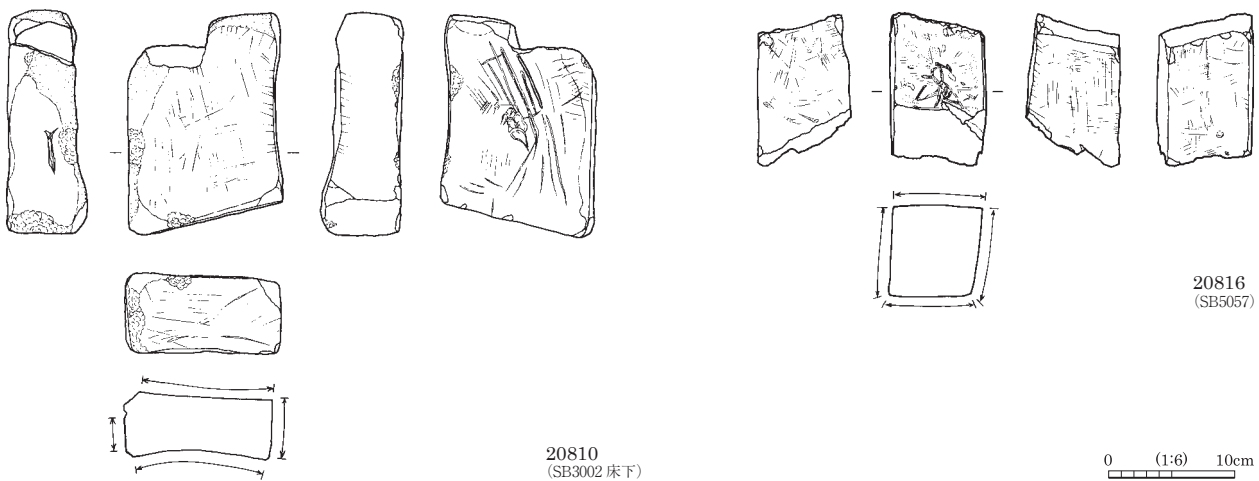

20810
(SB3002 床下)

20816
(SB5057)

大形砥石 (4)

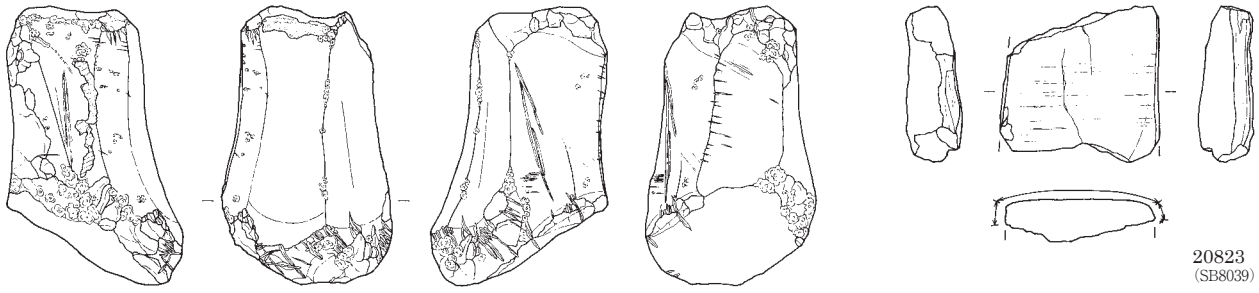

20815
(SB5031)

20823
(SB8039)

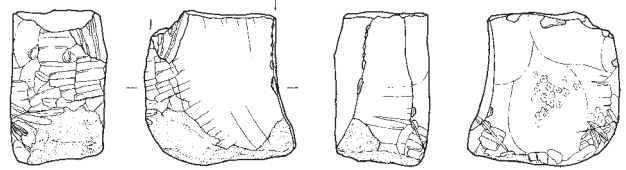
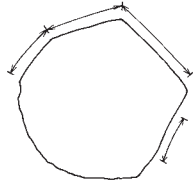

20819
(SB7001)

20820
(SB7046)

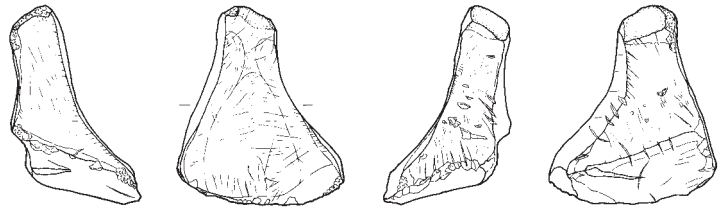
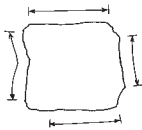
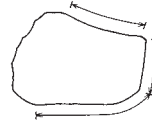
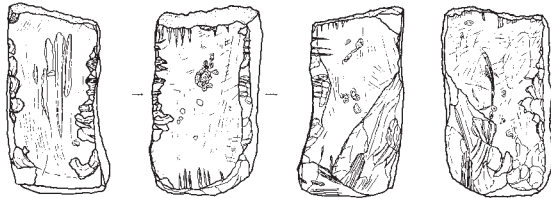

20822
(SB8024)

20813
(SD4006)

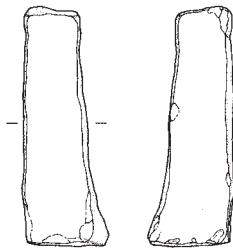

20824
(SB8041)

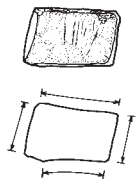
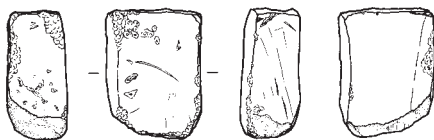
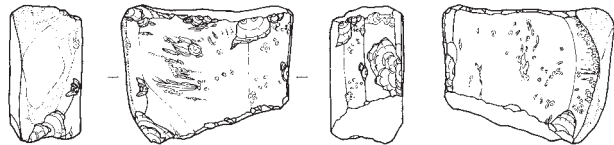

20805
(SK0034)

20825
(SD8006 I X13 B層)

0 (1:6) 10cm

大形刃器

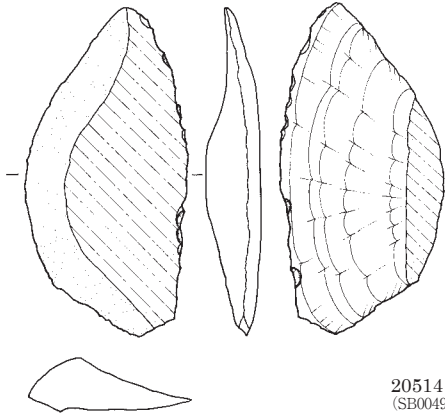

20514
(SB0049)

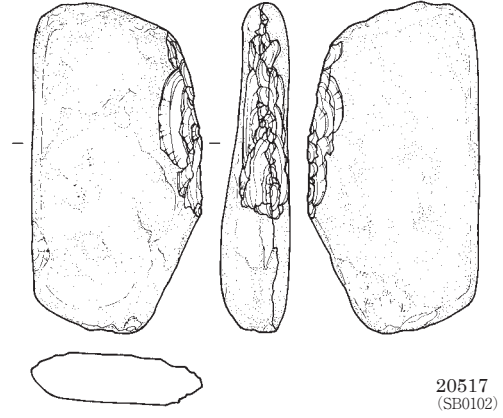

20517
(SB0102)

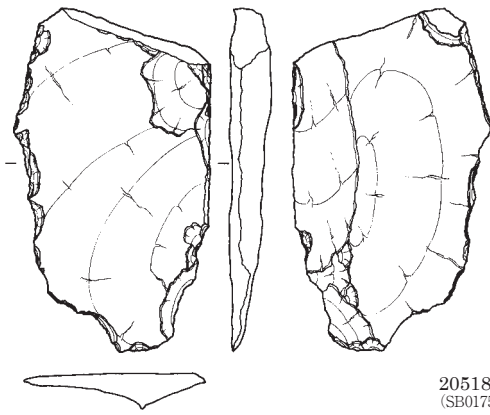

20518
(SB0175 床下)

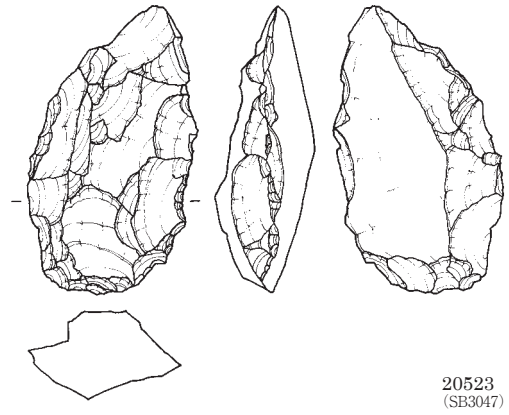

20523
(SB3047)

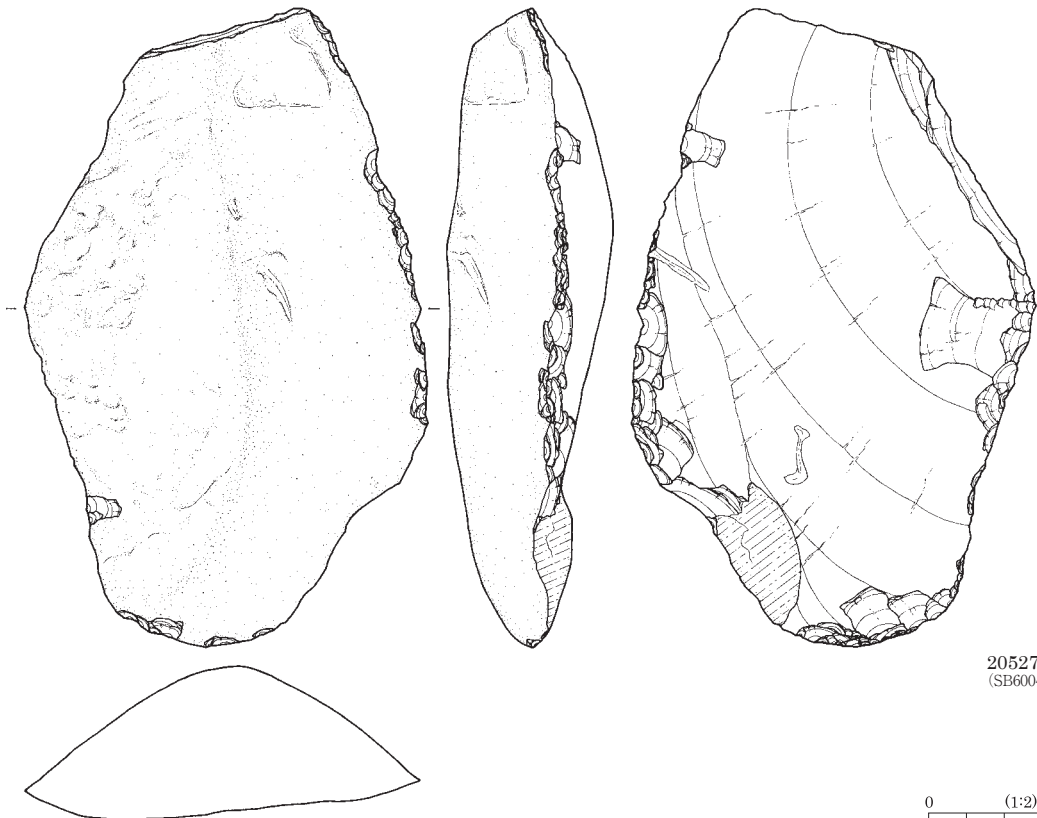

20527
(SB6004)

磨石 (1)

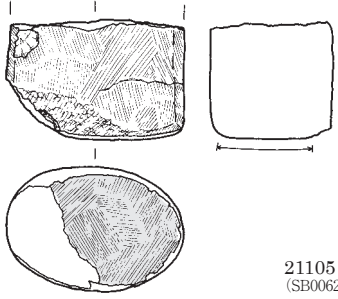

21105
(SB0062)

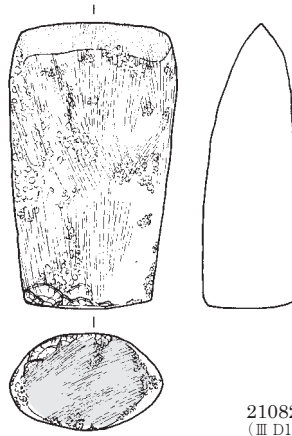

21082
(Ⅲ D16 検出面)

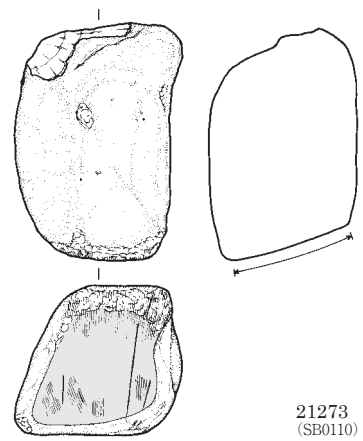

21273
(SB0110)

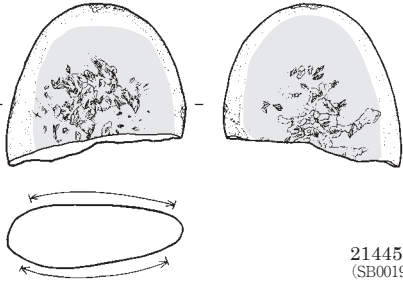

21445
(SB0019)

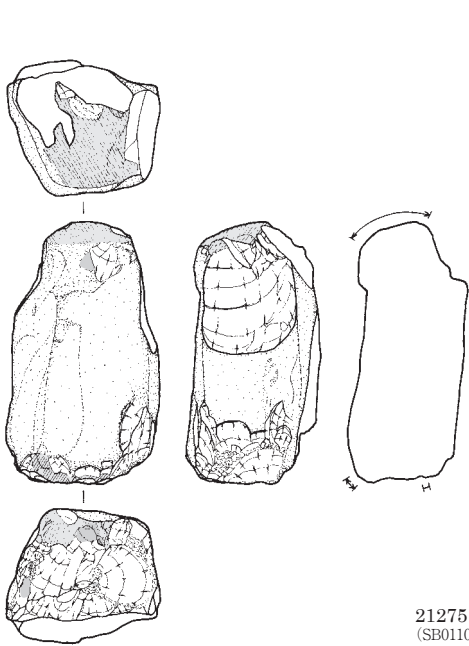

21275
(SB0110)

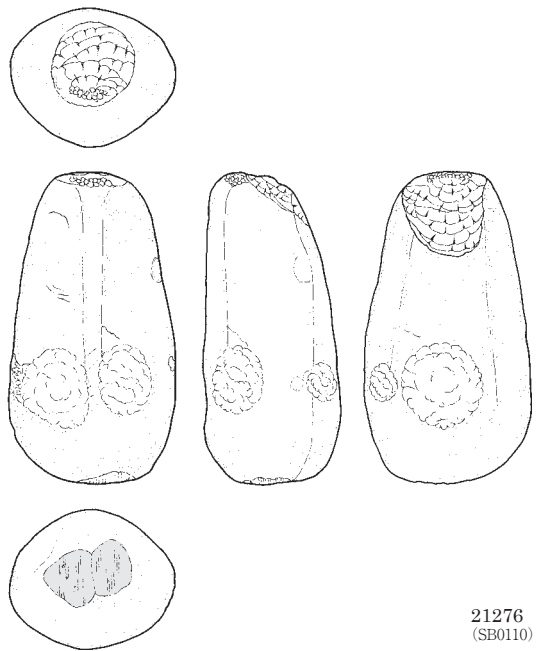

21276
(SB0110)

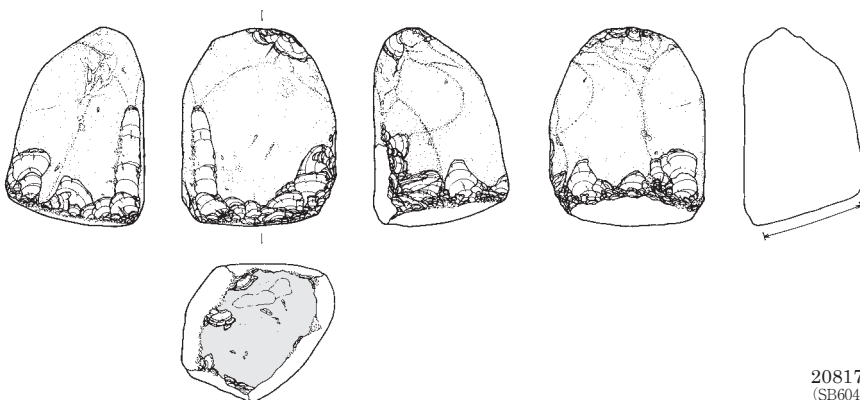

20817
(SB6047)

■ 摩耗
■ 赤色顔料付着

0 (1:3) 10cm

磨石 (2)

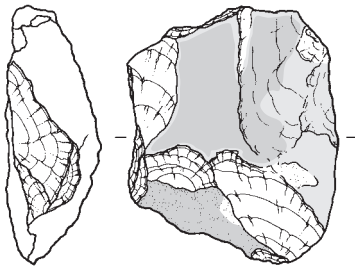

21084
(SB0006)

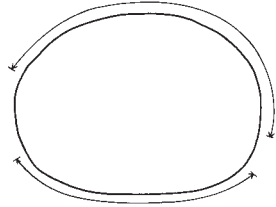
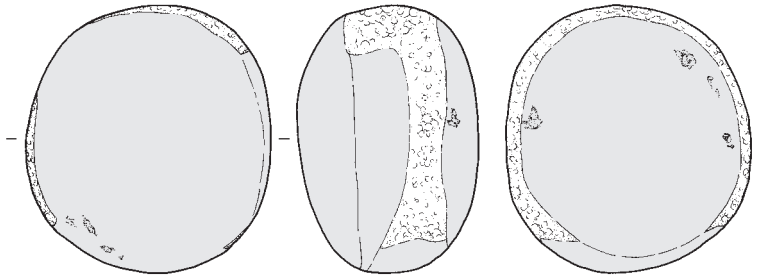

21127
(SB6021)

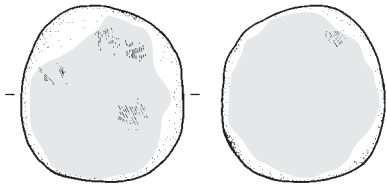

21111
(SB4064)

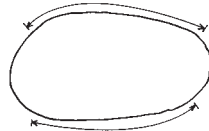
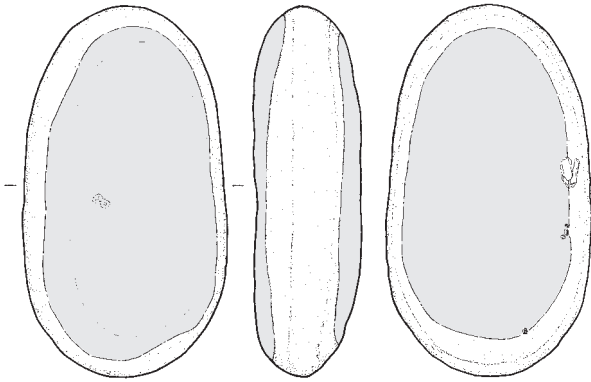

21151
(SB8011)

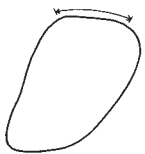
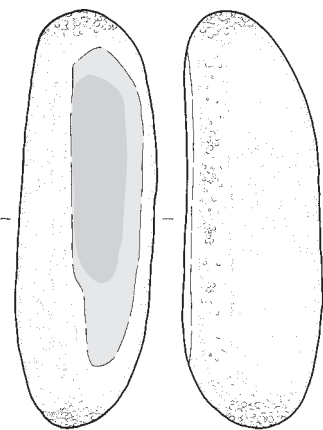
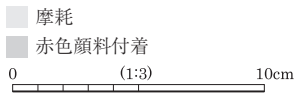

21159
(SB8043)

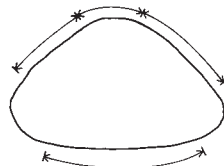
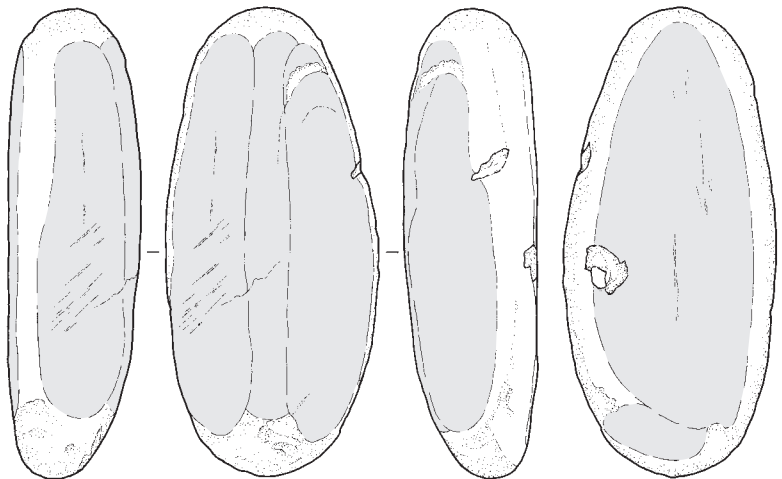

21156
(SB8039)

磨石 (3)

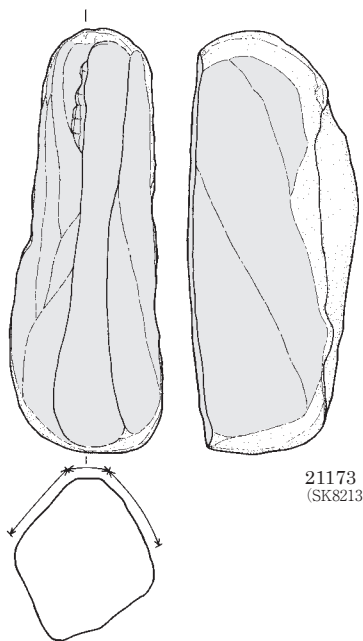

21173
(SK8213)

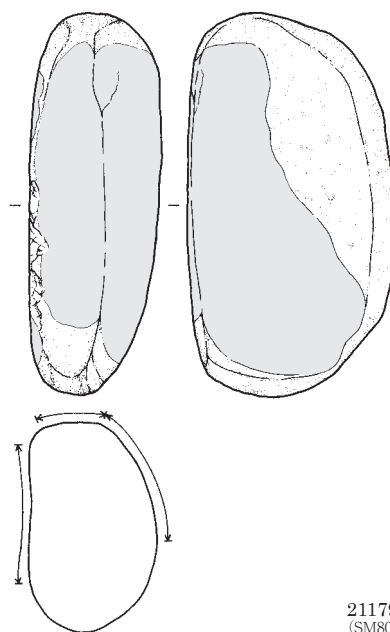

21179
(SM8001)

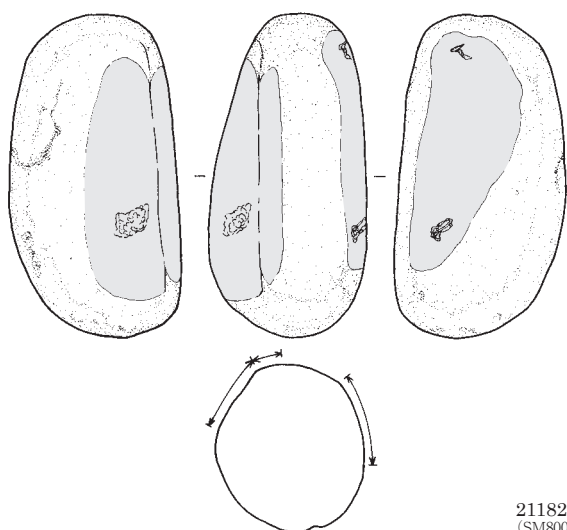

21182
(SM8001)

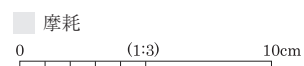

敲石 (1)

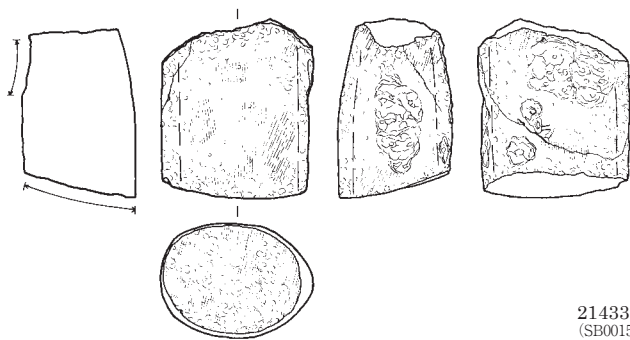

21433
(SB0015Pit2)

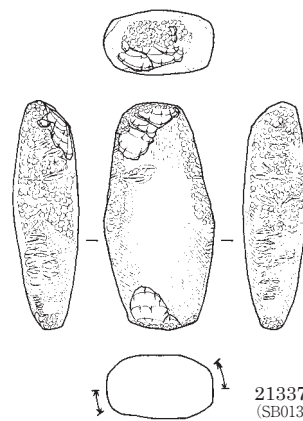

21337
(SB0137 床下)

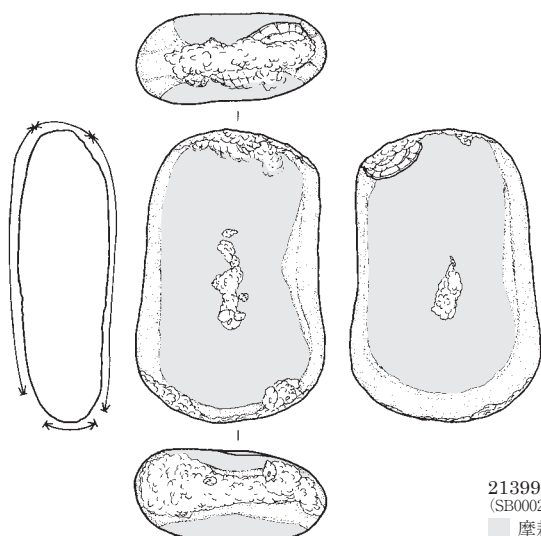

21399
(SB0002 床)
■ 摩耗

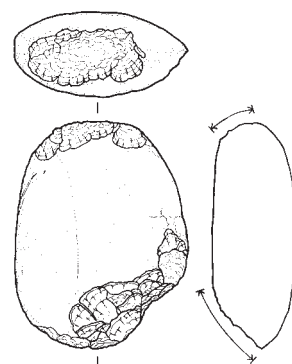

21402
(SB0004Pit1)

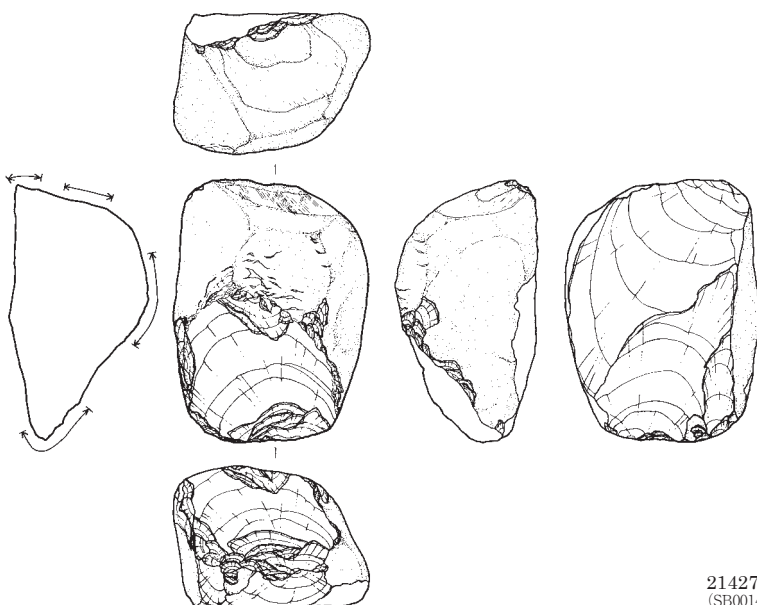

21427
(SB0014)

0 (1:3) 10cm

敲石 (2)

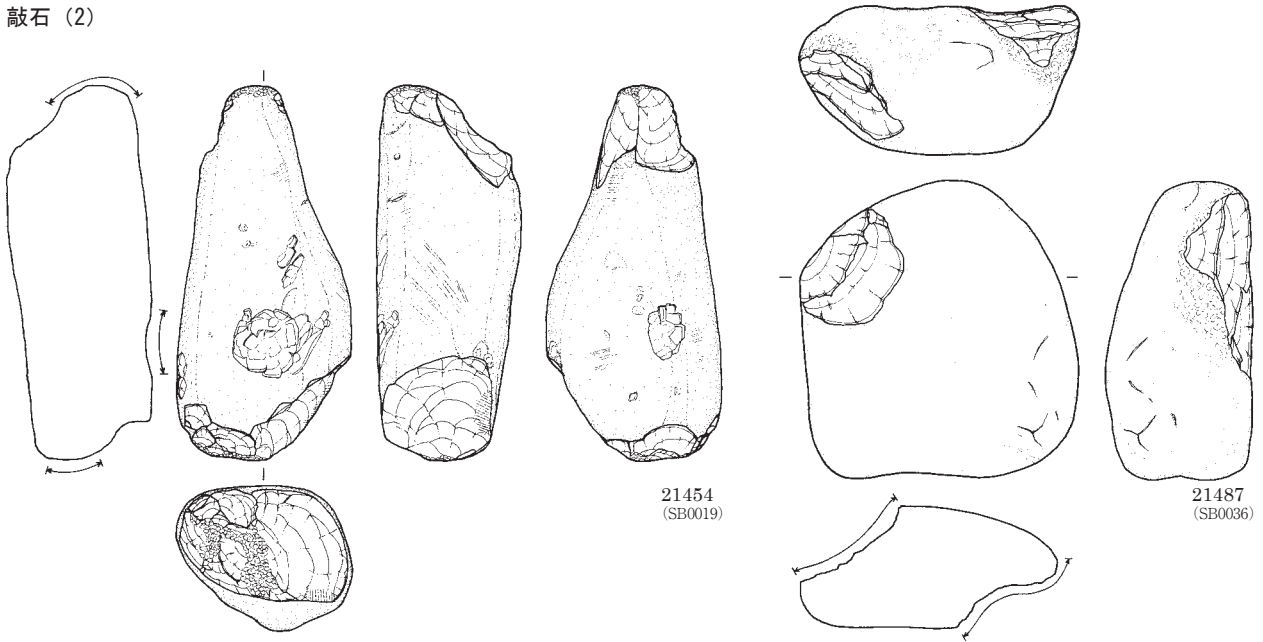

21454
(SB0019)

21487
(SB0036)

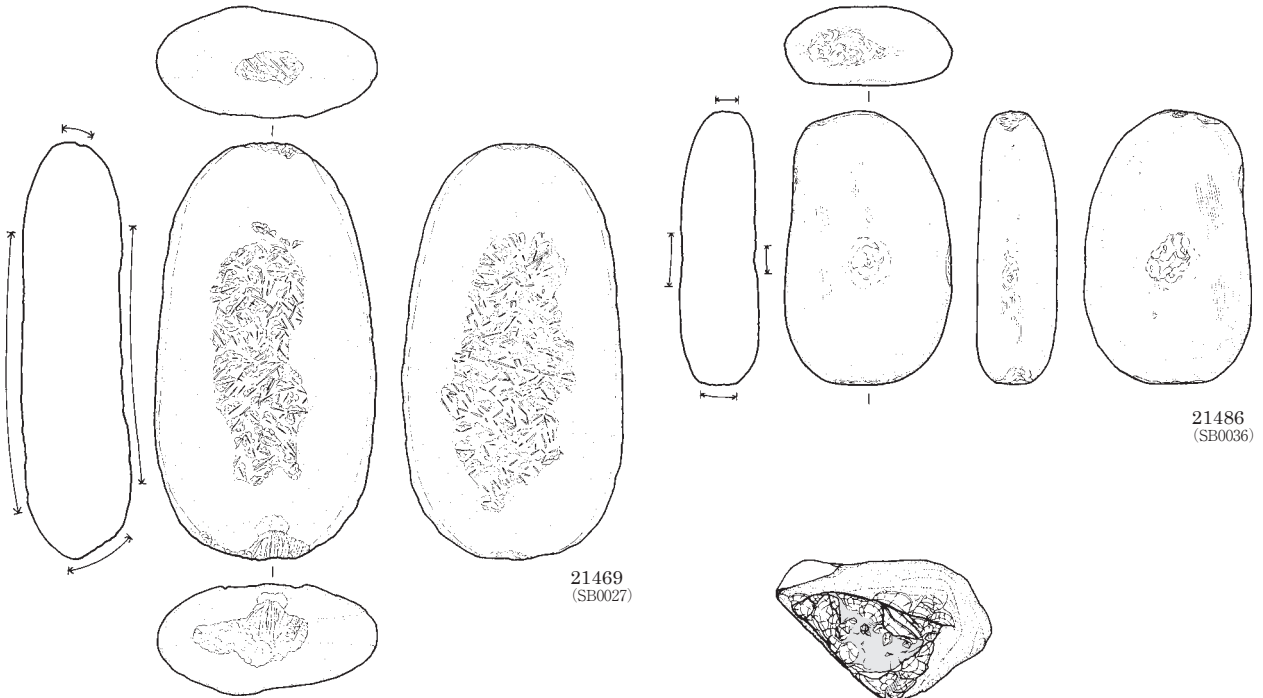

21469
(SB0027)

21486
(SB0036)

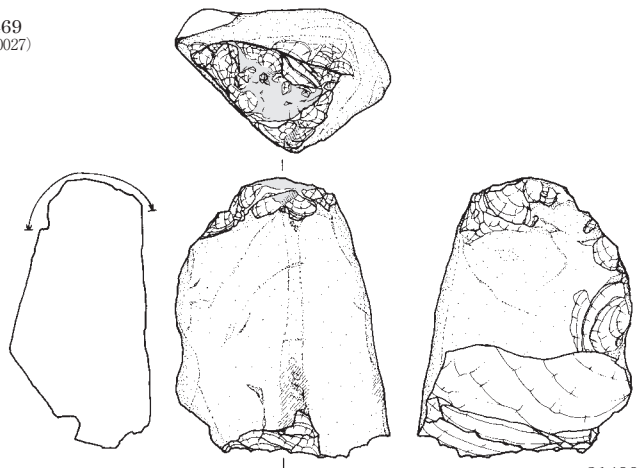

21490
(SB0036)

■ 摩耗

0 (1:3) 10cm

敲石 (3)

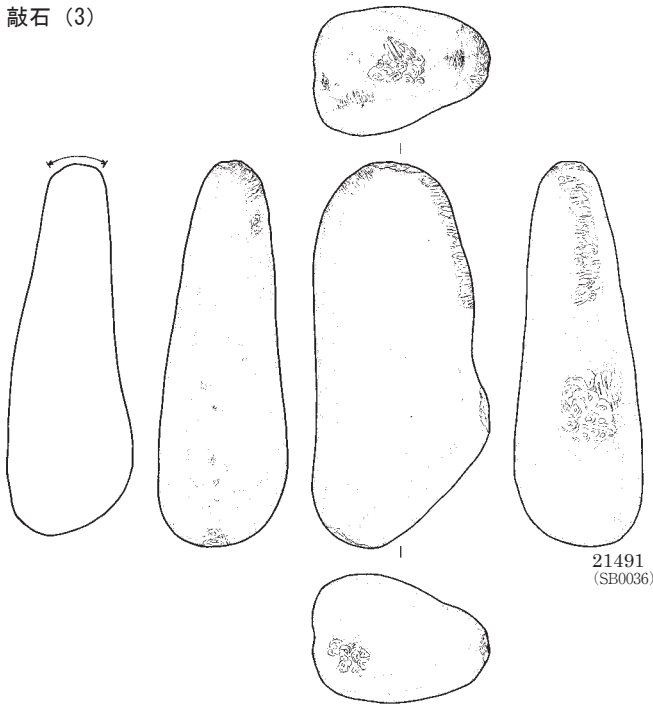

21491
(SB0036)

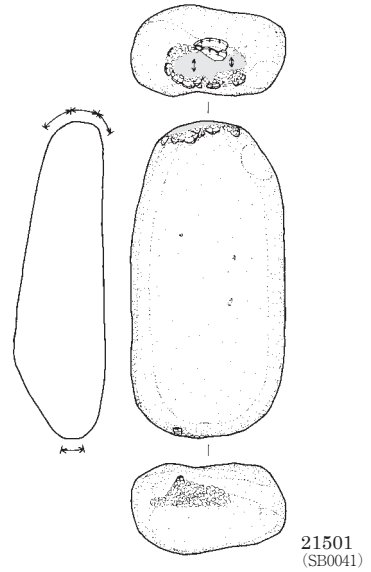

21501
(SB0041)

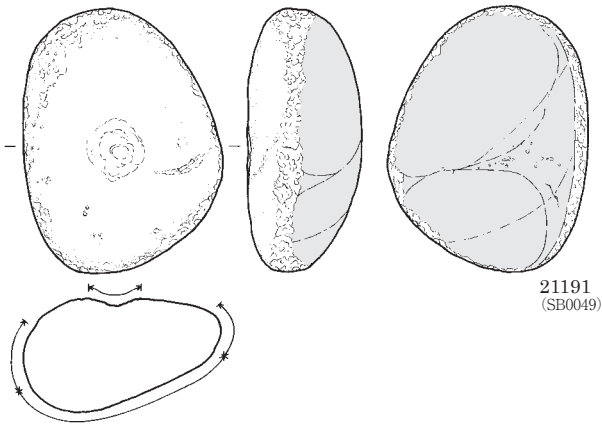

21191
(SB0049)

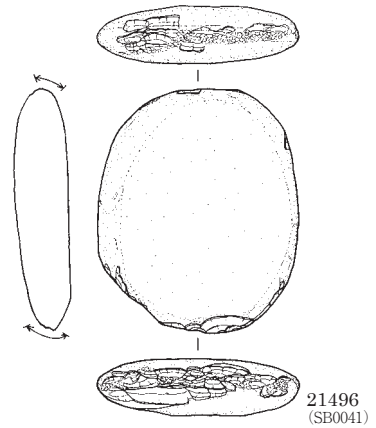

21496
(SB0041)

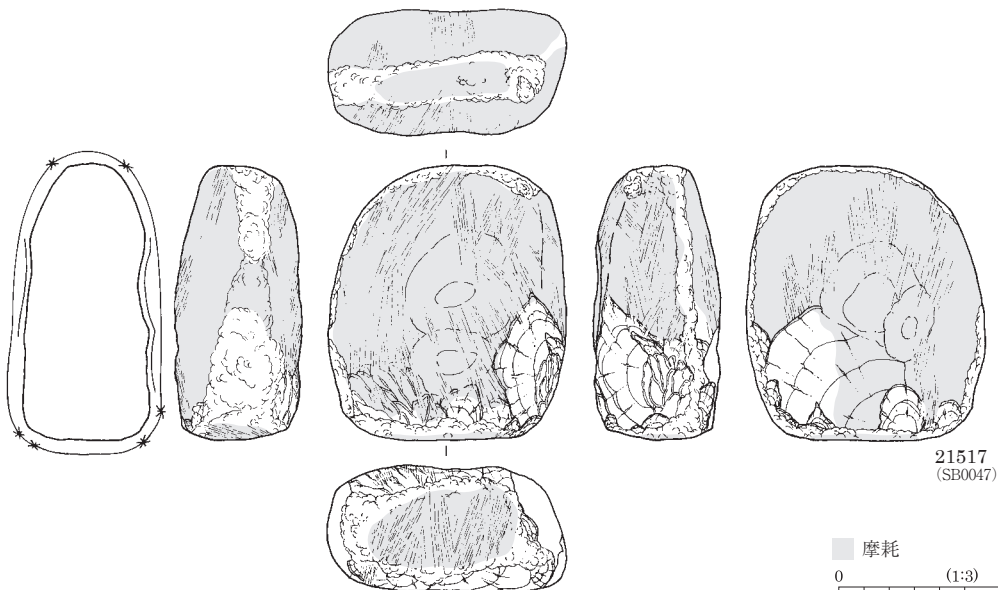

21517
(SB0047)

■ 摩耗
0 (1:3) 10cm

敲石 (4)

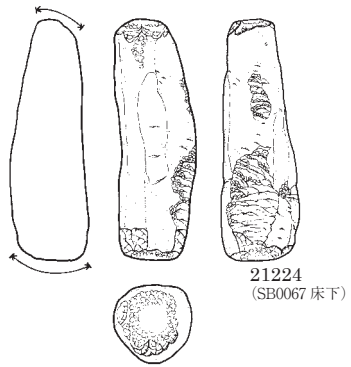

21224
(SB0067 床下)

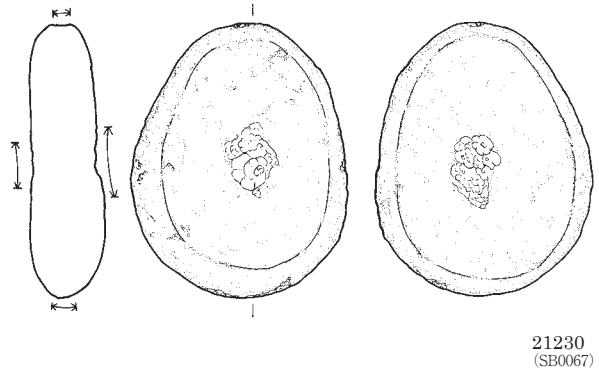

21230
(SB0067)

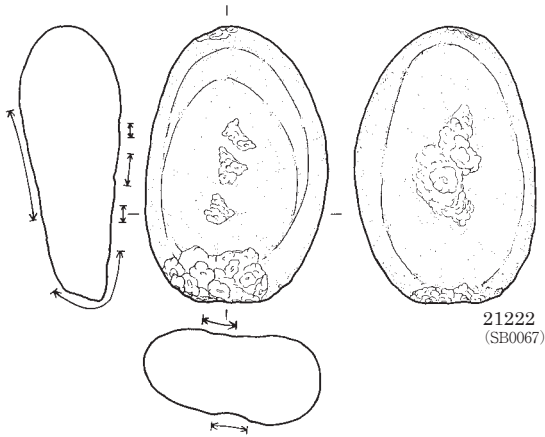

21222
(SB0067)

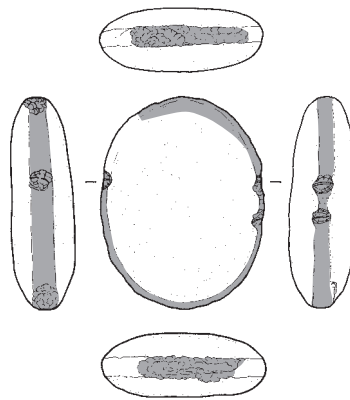

21254
(SB0075)

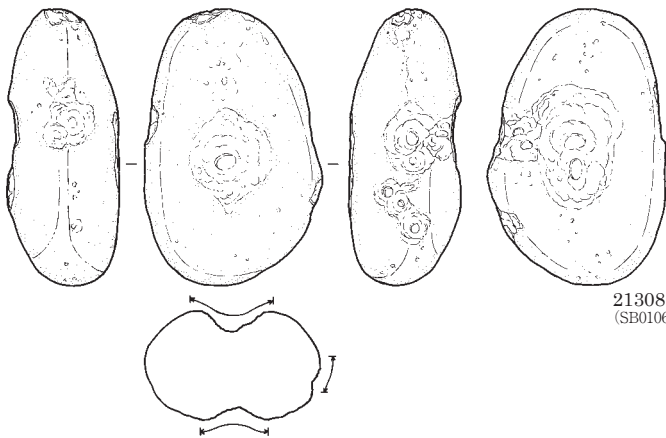

21308
(SB0106)

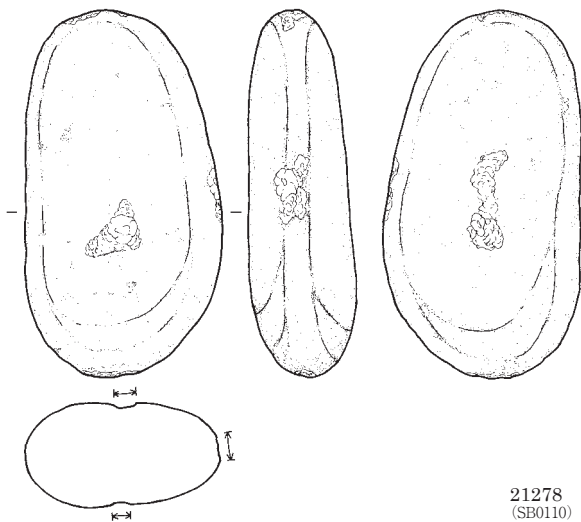

21278
(SB0110)

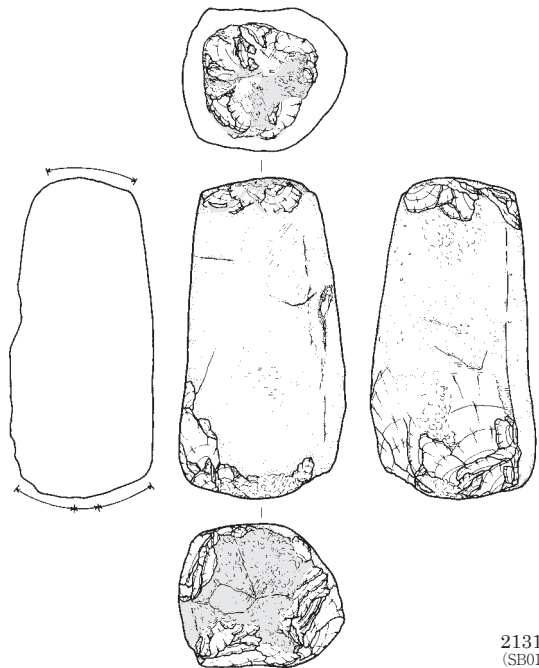

21317
(SB0117)

■ 摩耗

■ 赤色顔料付着

0 (1:3) 10cm

敲石 (5)

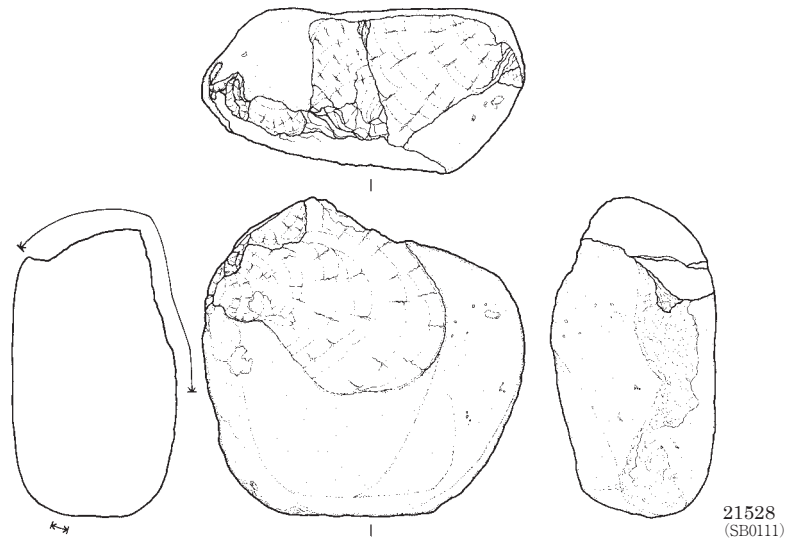

21528
(SB0111)

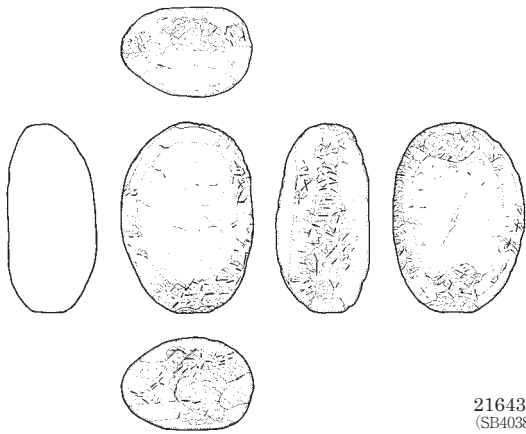

21643
(SB4038)

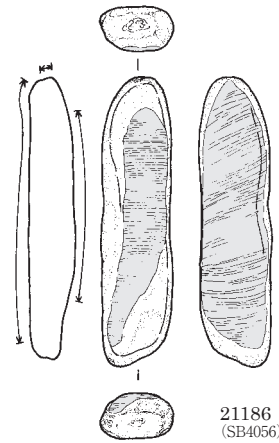

21186
(SB4056)

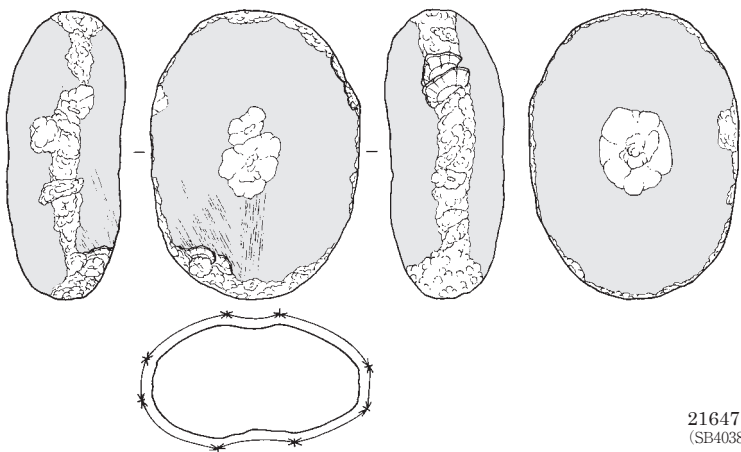

21647
(SB4038)

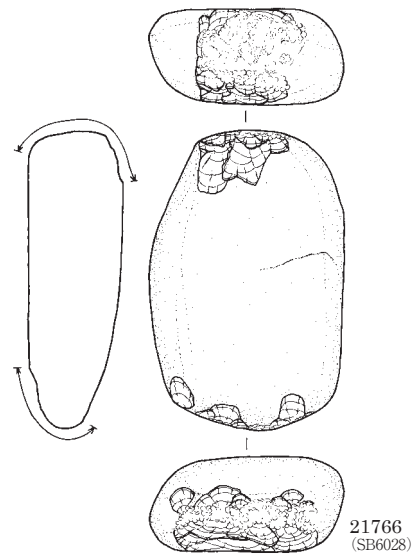

21766
(SB6028)

■ 摩耗
0 (1:3) 10cm

敲石 (6)

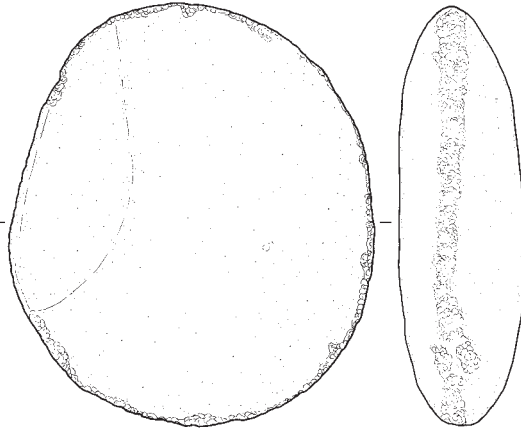

21281
(SB0052)

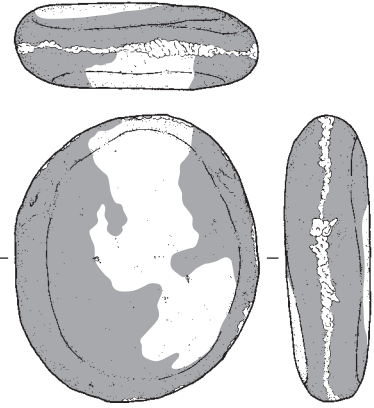

21248
(SB0073)

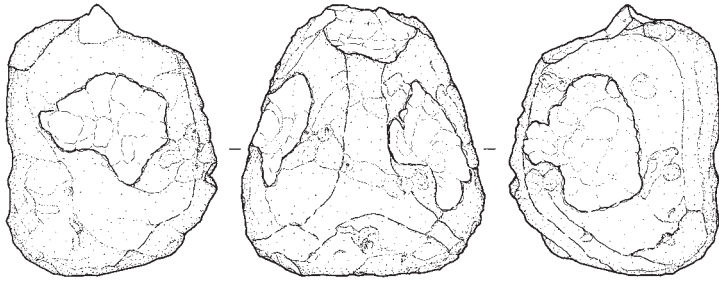

21246
(SB0073)

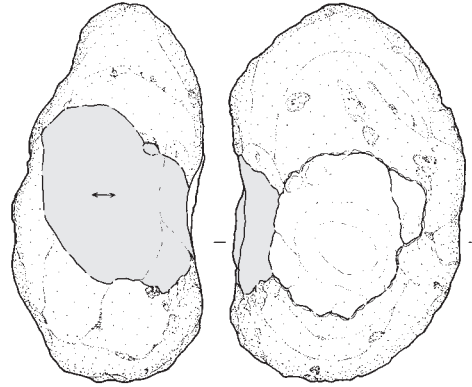

21289
(SB0074)



21290
(SB0074)

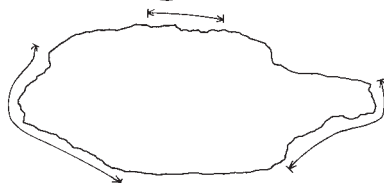

■ 摩耗
■ 被熱黒色化

0 (1:3) 10cm

敲石 (7)

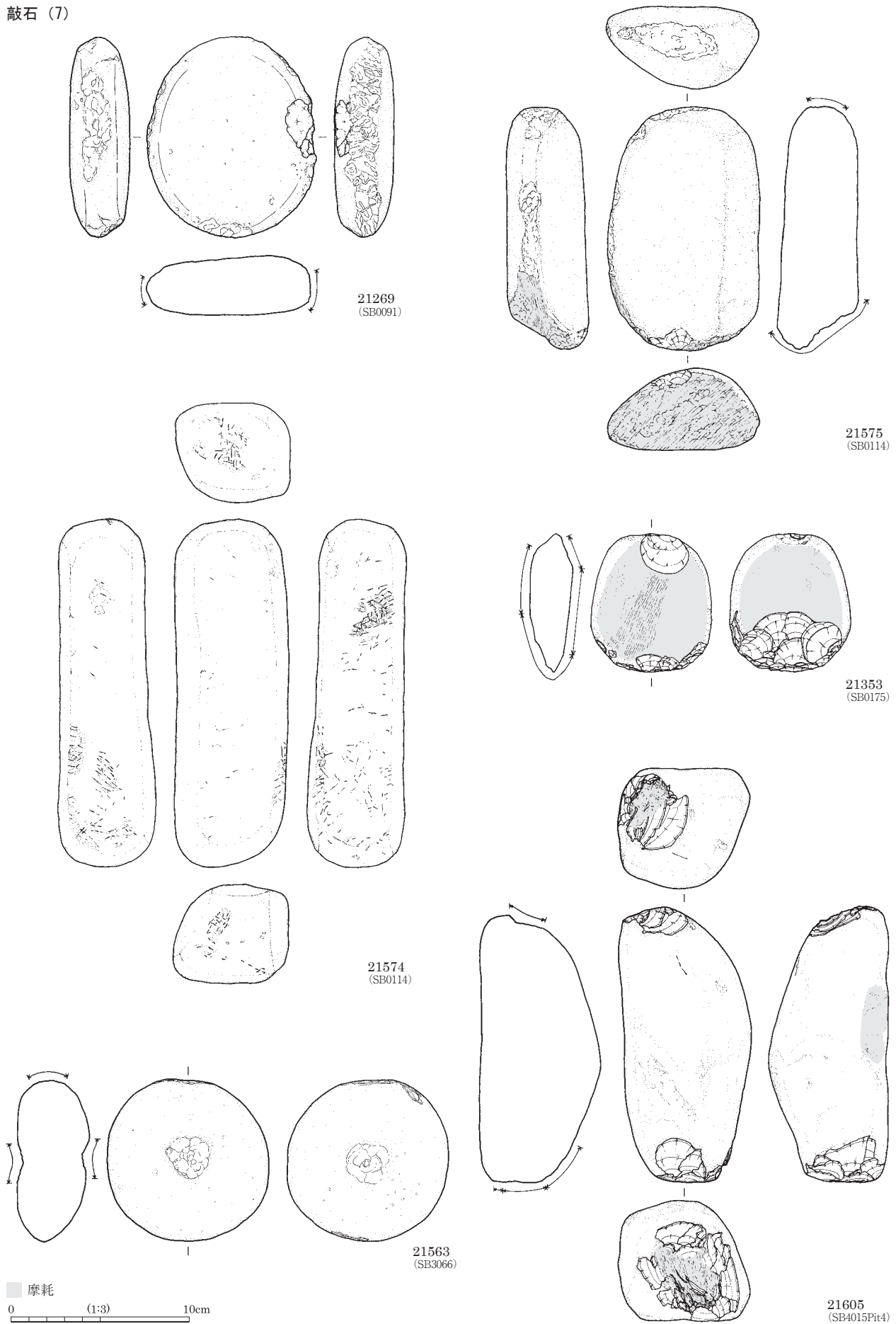

敲石 (8)

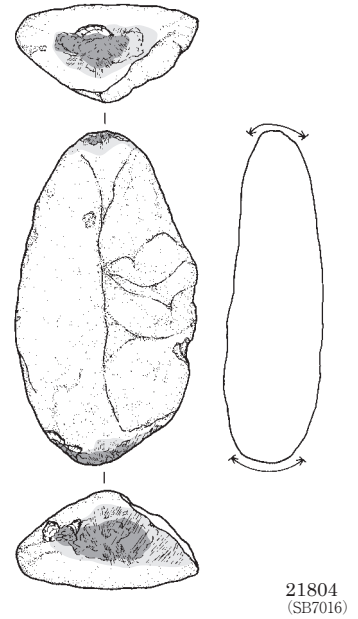
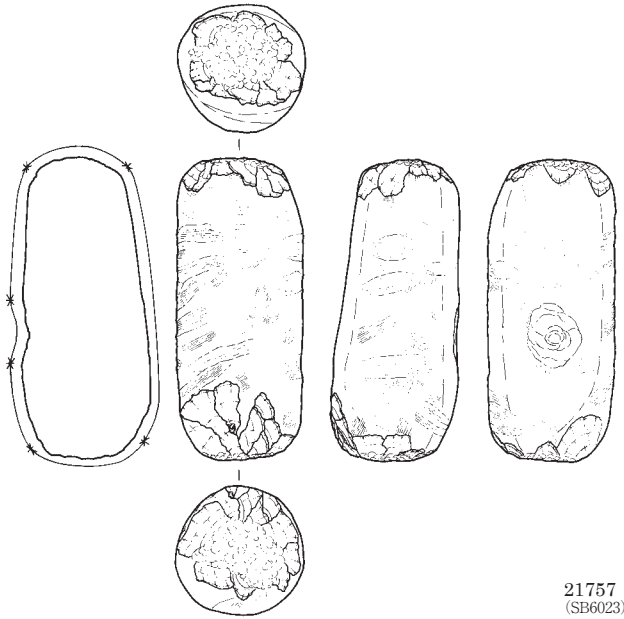
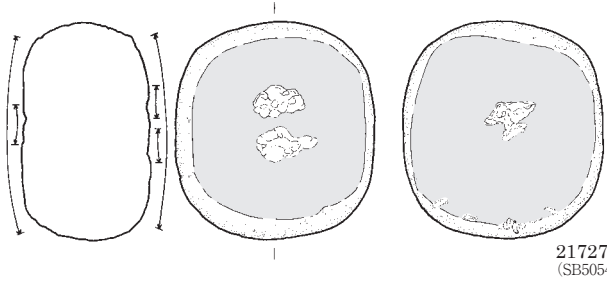

■ 摩耗
■ 赤色顔料付着
0 (1:3) 10cm

図版 244 石器・石製品 (43) - 弥生時代～中世 -

台石 (1)

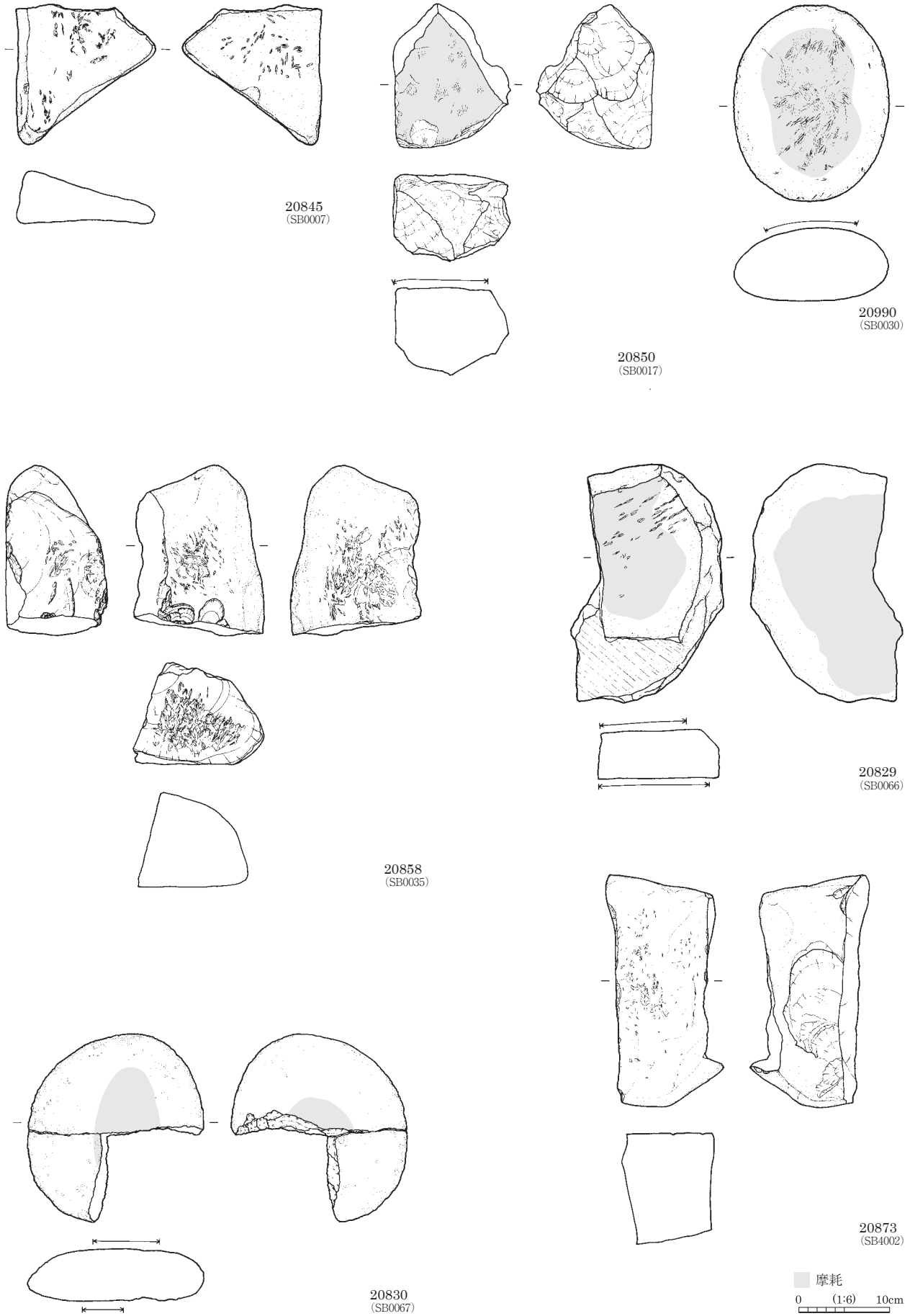

台石 (2)

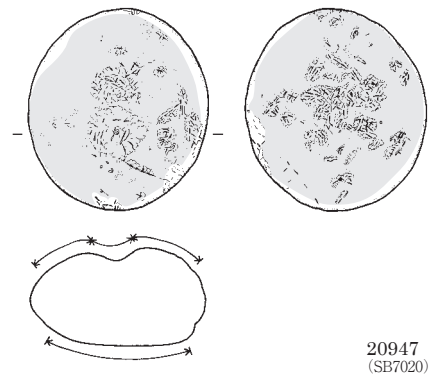
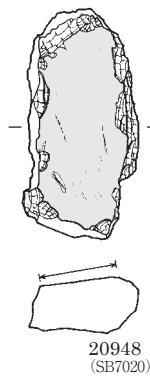
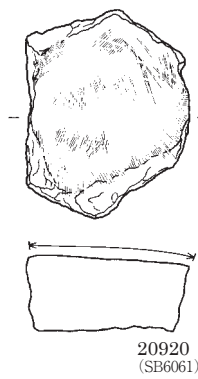
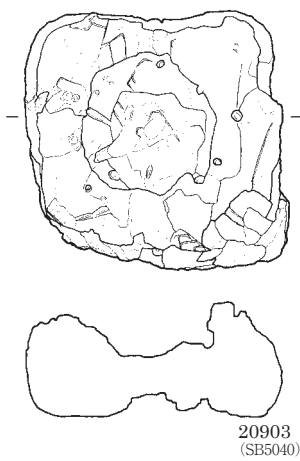
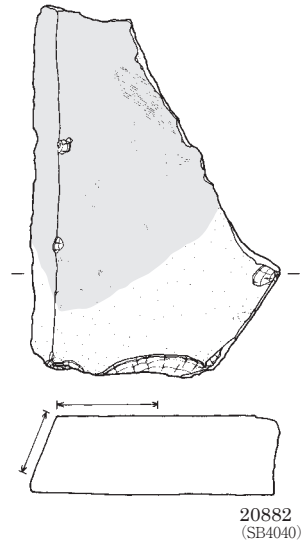
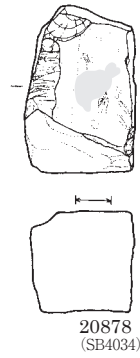
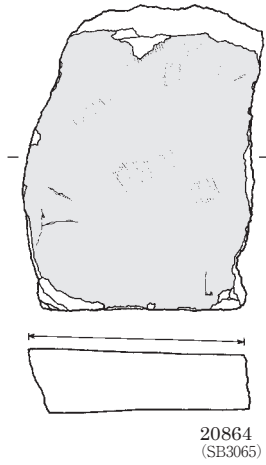
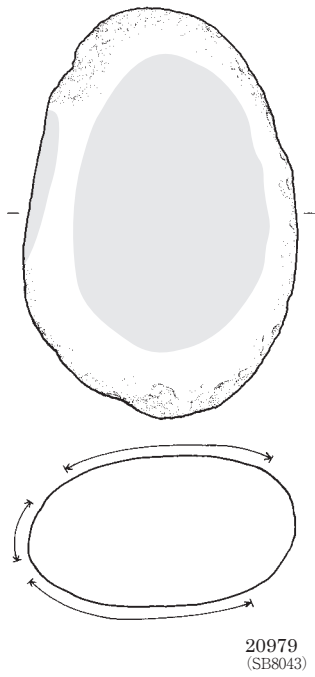
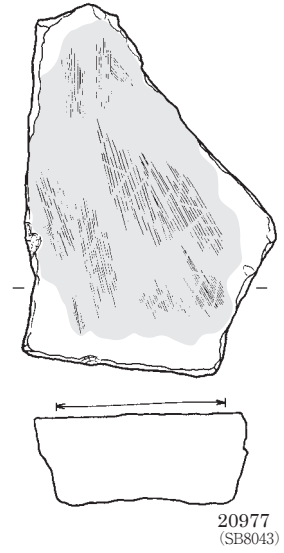
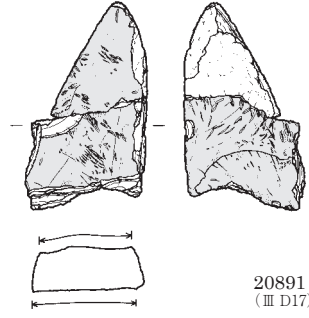
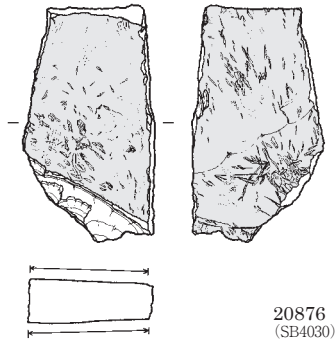

■ 摩耗
0 (1:6) 10cm

図版 246 石器・石製品 (45) - 弥生時代～中世 -

台石 (3)

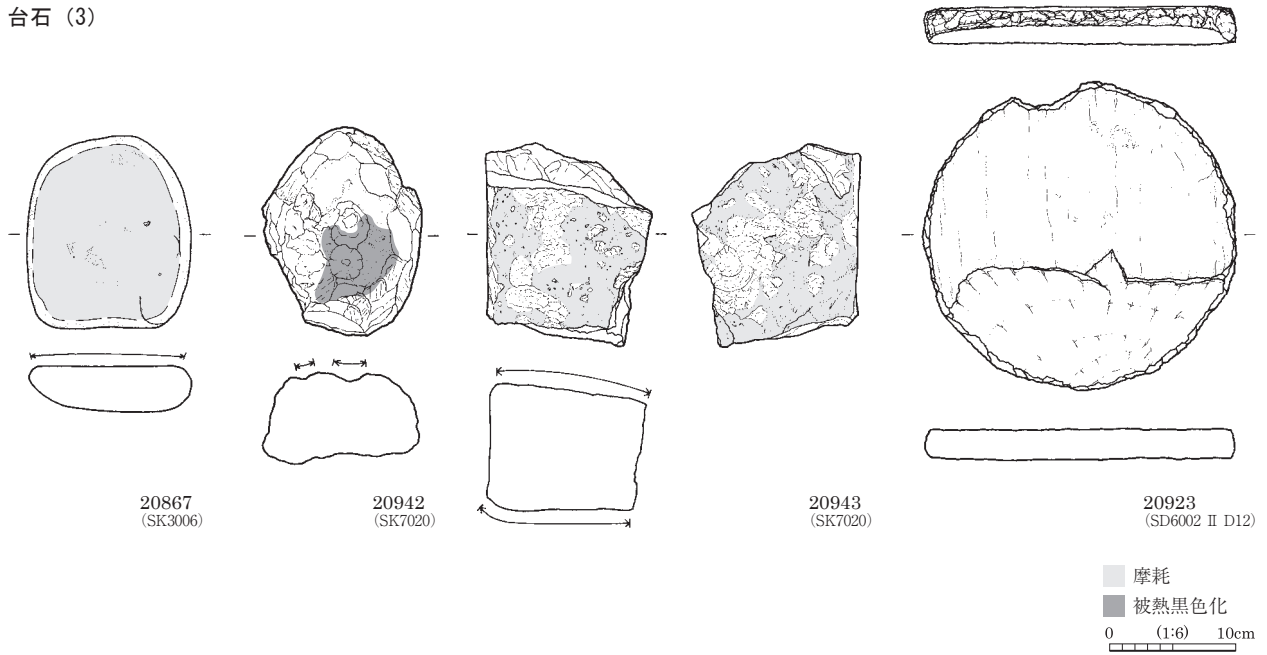

石皿 (1)

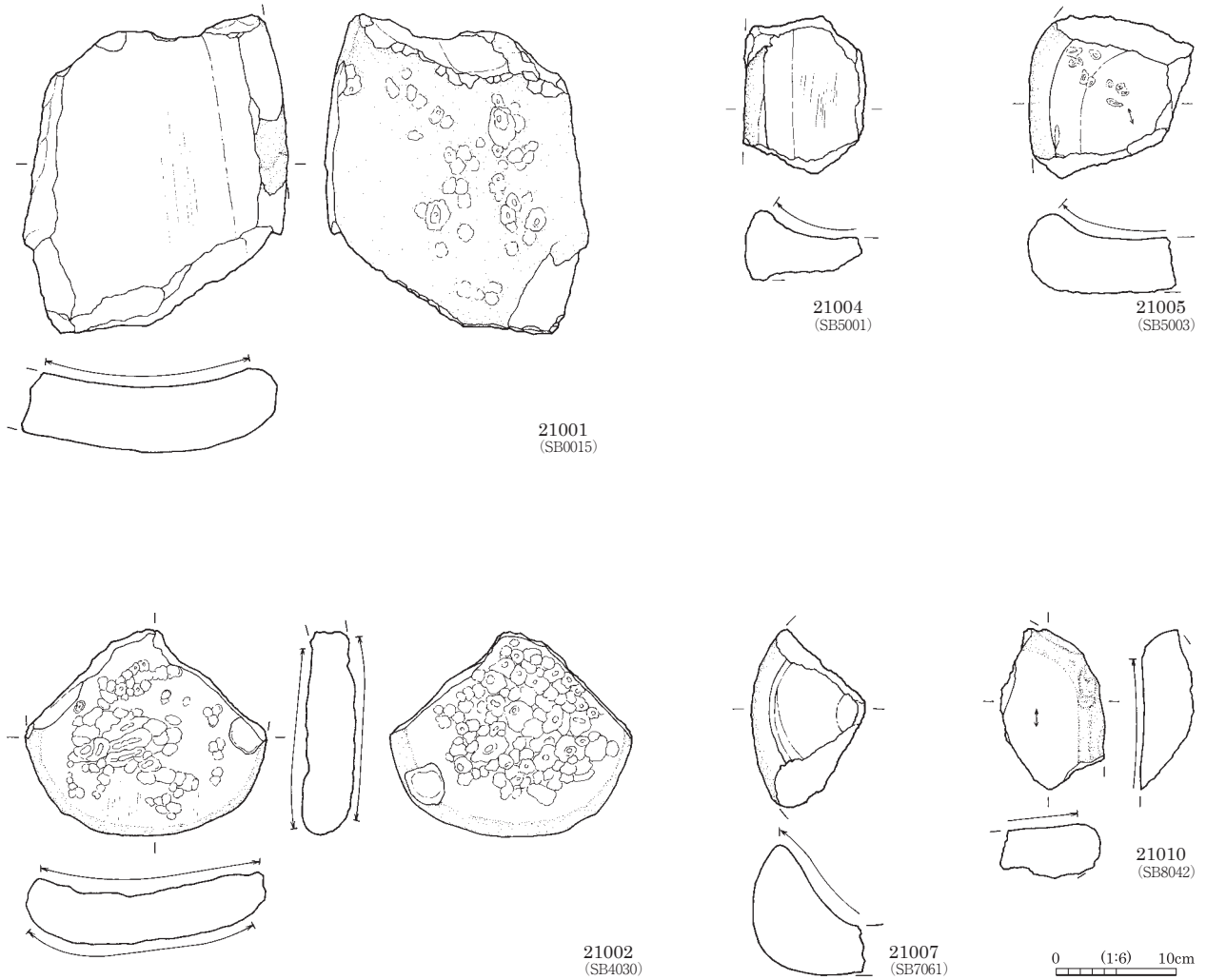

石皿 (2)

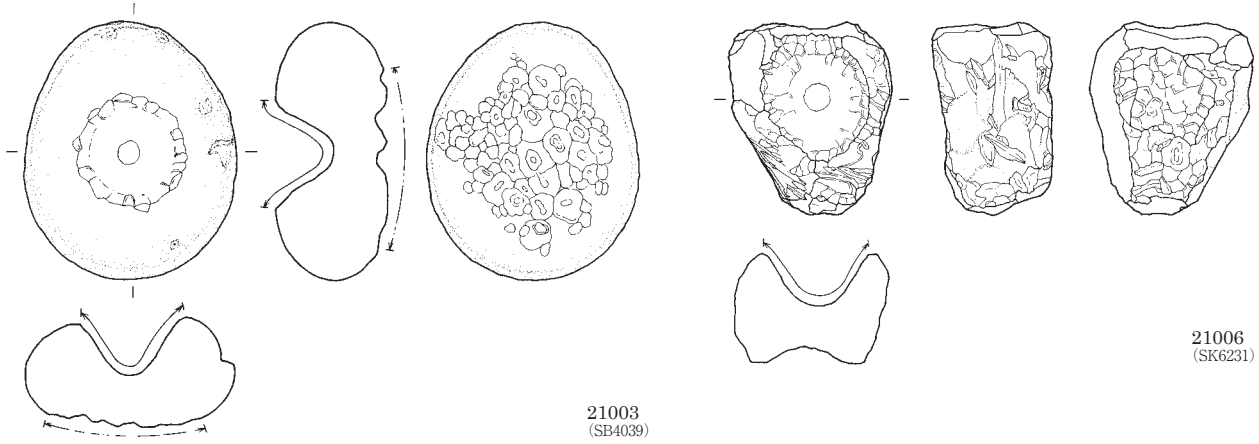

21003
(SB4039)

21006
(SK6231)

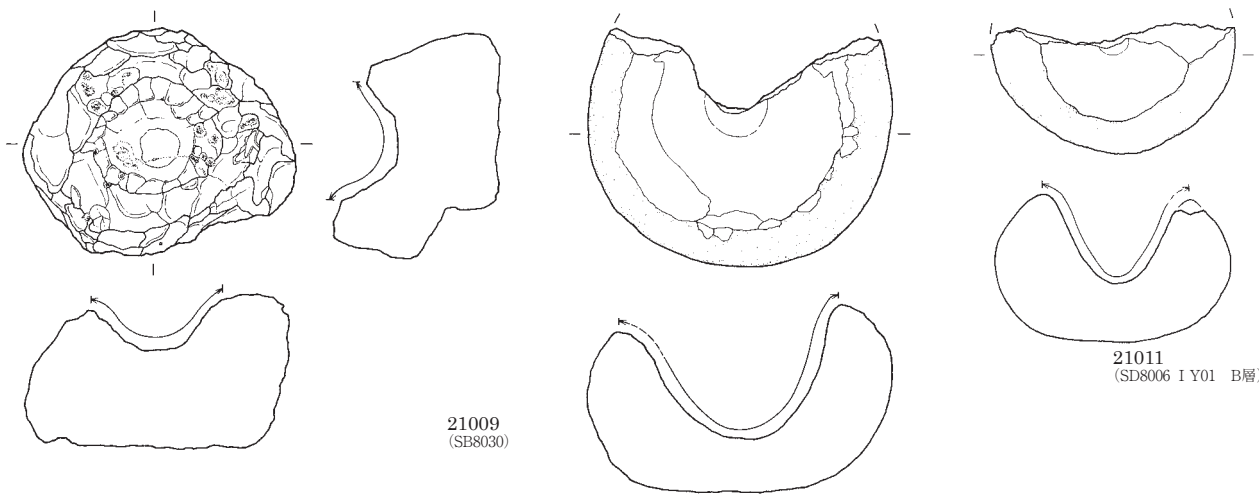

21009
(SB8030)

21011
(SD8006 I Y01 B層)

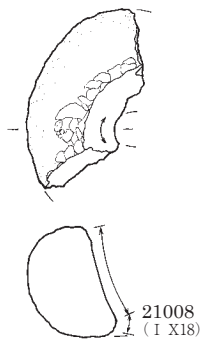

21008
(I X18)

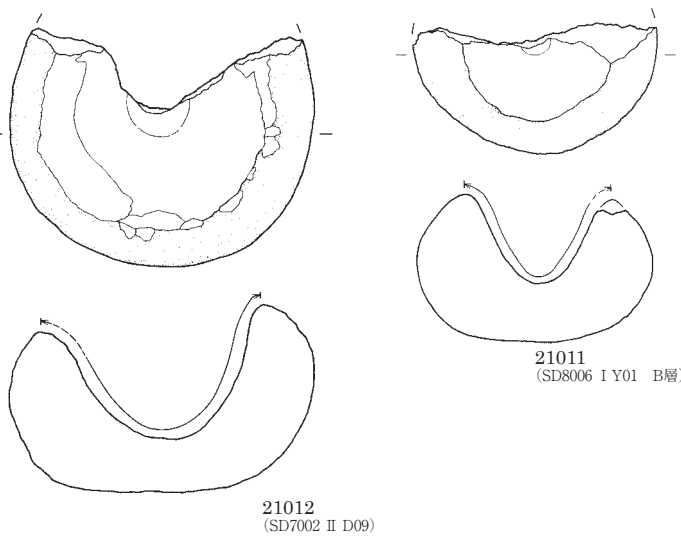

21012
(SD7002 II D09)

0 (1:6) 10cm

石錘

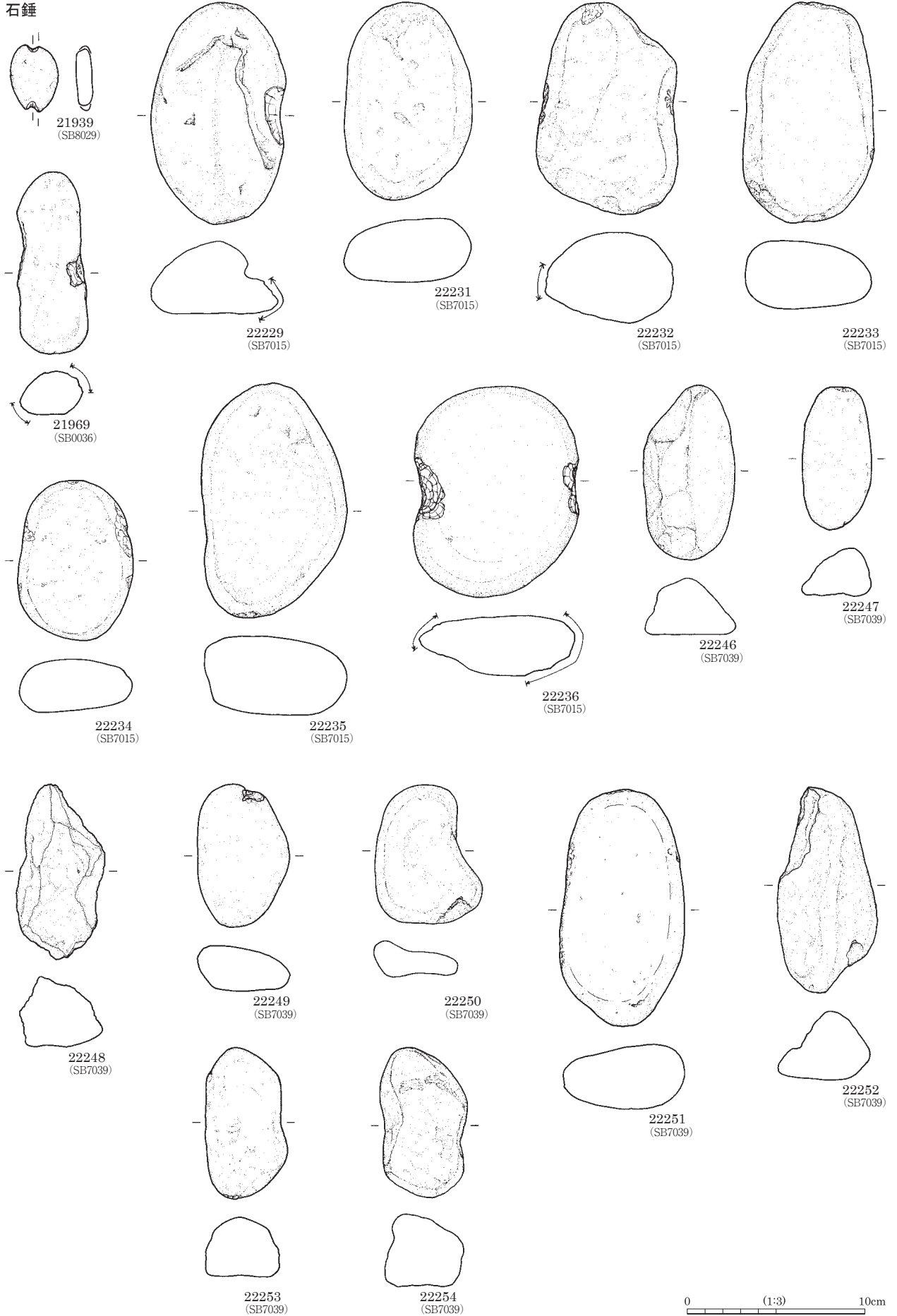

カマド材 (1)
支脚石

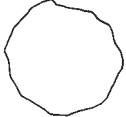
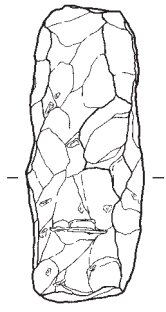

22745
(SB4047)



22752
(SB5007)

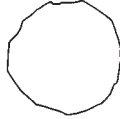

22754
(SB5017)



22760
(SB5057)

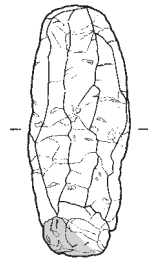

22761
(SB5054)



22785
(SB6006)



22786
(SB6014)



22789
(SB6023)

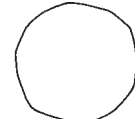

22790
(SB6024)

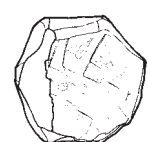
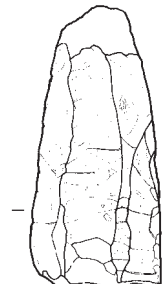

22794
(SB6046)

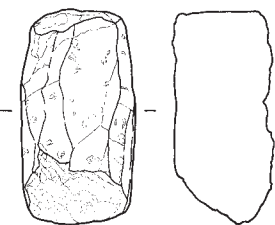

22823
(SB7044)



22824
(SB7046)



22828
(SB7070)

■ 粘土付着範囲
■ 被熱変色範囲

0 (1:6) 10cm



図版 250 石器・石製品 (49) - 古墳時代~古代 -

カマド材 (2)
袖石

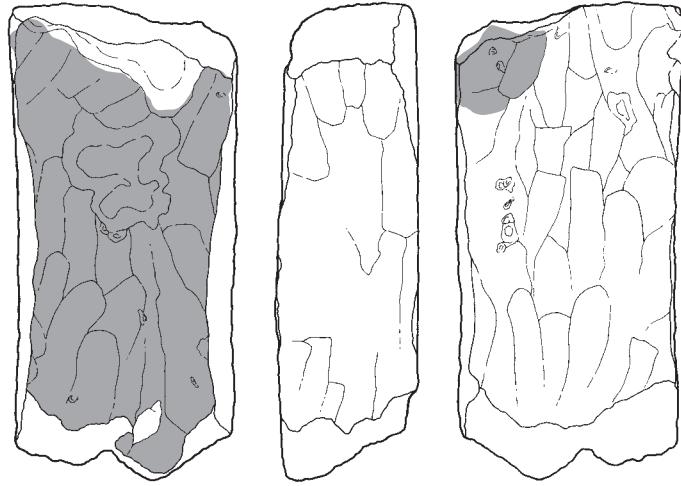

22804
(SB5017)

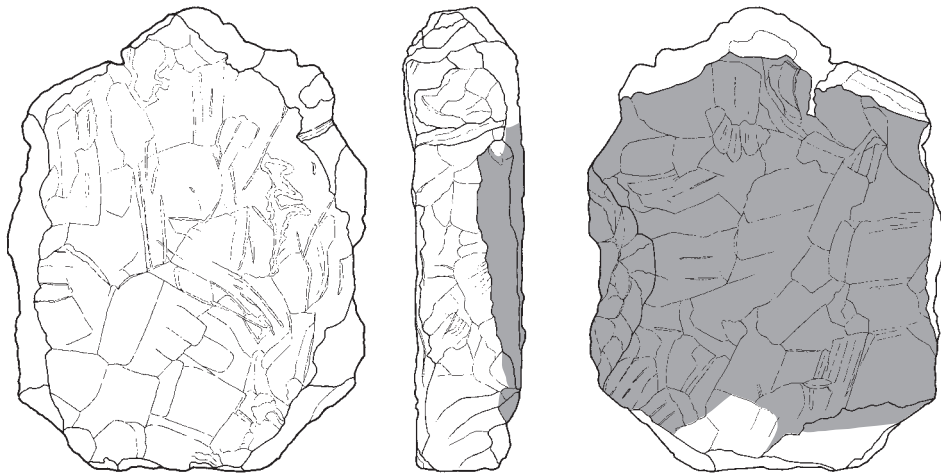

22795
(SB6046)

■ 被熱変色範囲
0 (1:6) 10cm

銅釧

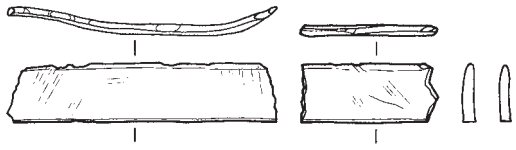

06M013
(SB0015)

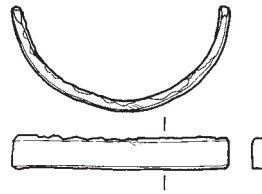

06M015
(SB0015)

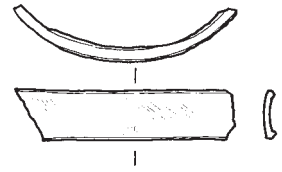

06M064
(SB0067・64下)

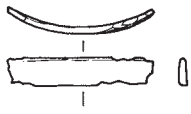

06M031
(SB0027)

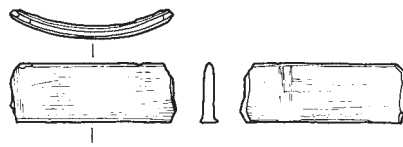

06M099
(SB0151)

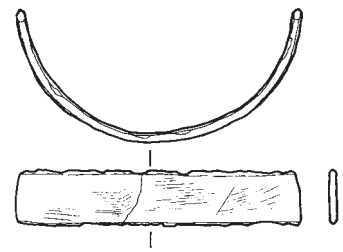

06M100
(SB0156)



06M135
(SB0067)

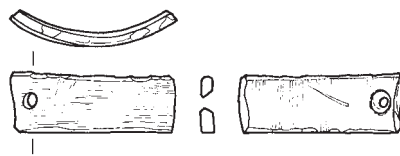

06M186
(SB0027)



07M056
(SB3049)

銅鏃

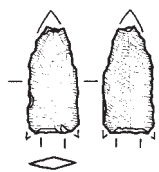

06M117
(SK0019)

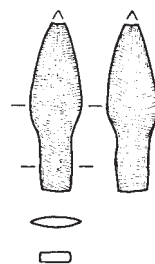

07M297
(SB4016)

0 (2:3) 5cm

図版 252 金属製品 (2) - 古墳時代～古代・中近世の青銅製品 -

耳環

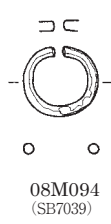
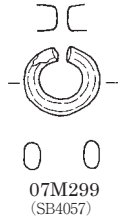
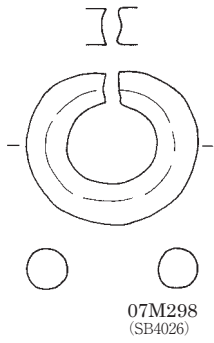

馬具 (帯先金具)

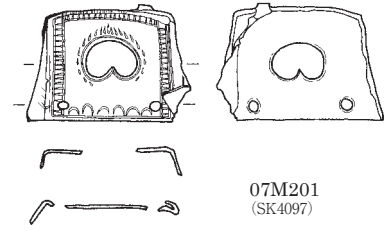

帯金具



腰帶飾具

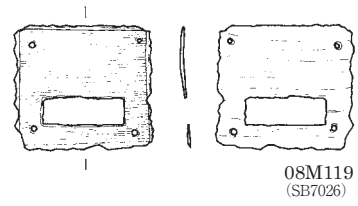

0 2:3 5cm

銅印

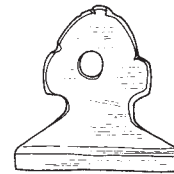
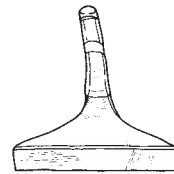
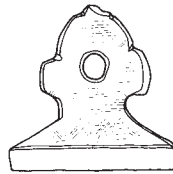
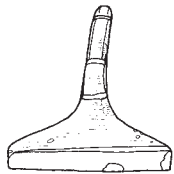
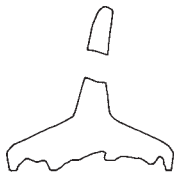
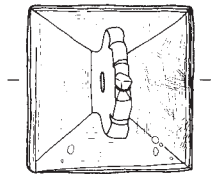

赤色顔料付着

07M376
(SB4001)

0 2:3 5cm

鎖

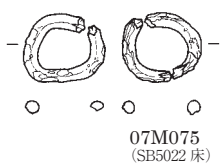

0 1:2 5cm

銅製管状品

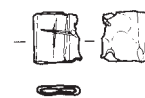

06M193
(SB0131)

銅製円板

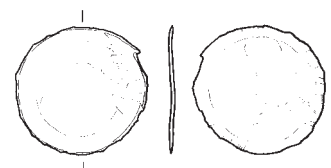

06M091
(SB0136)

銭貨



06M132 開元通寶
(SB0006)



06M133 天聖元寶
(SB0006)



06M014
(SB0015)



06M140 太平通寶
(SB0131)



07M377 寬永通寶
(SB3086)



07M300 寬永通寶
(SB4039)



08M120 寬永通寶
(SB7055)



07M305 隆平永寶
(SK8210)



07M307 永樂通寶
(SK8218)



07M306 元祐通寶
(SK8218)



07M290 治平通寶
(SK8218)



07M291-1 天聖元寶
(SK8218)



07M291-2 皇宋通寶
(SK8218)

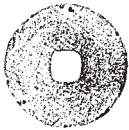

07M292 至道元寶
(SK8218)



07M267 至道元寶
(SD4002)



08M022 神功開寶
(SD8006 I Y01)

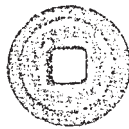

06M134 聖宋元寶
(1区攪乱)



07M200 寬永通寶?
(III D09 攪乱)

鉄鏃 (1)

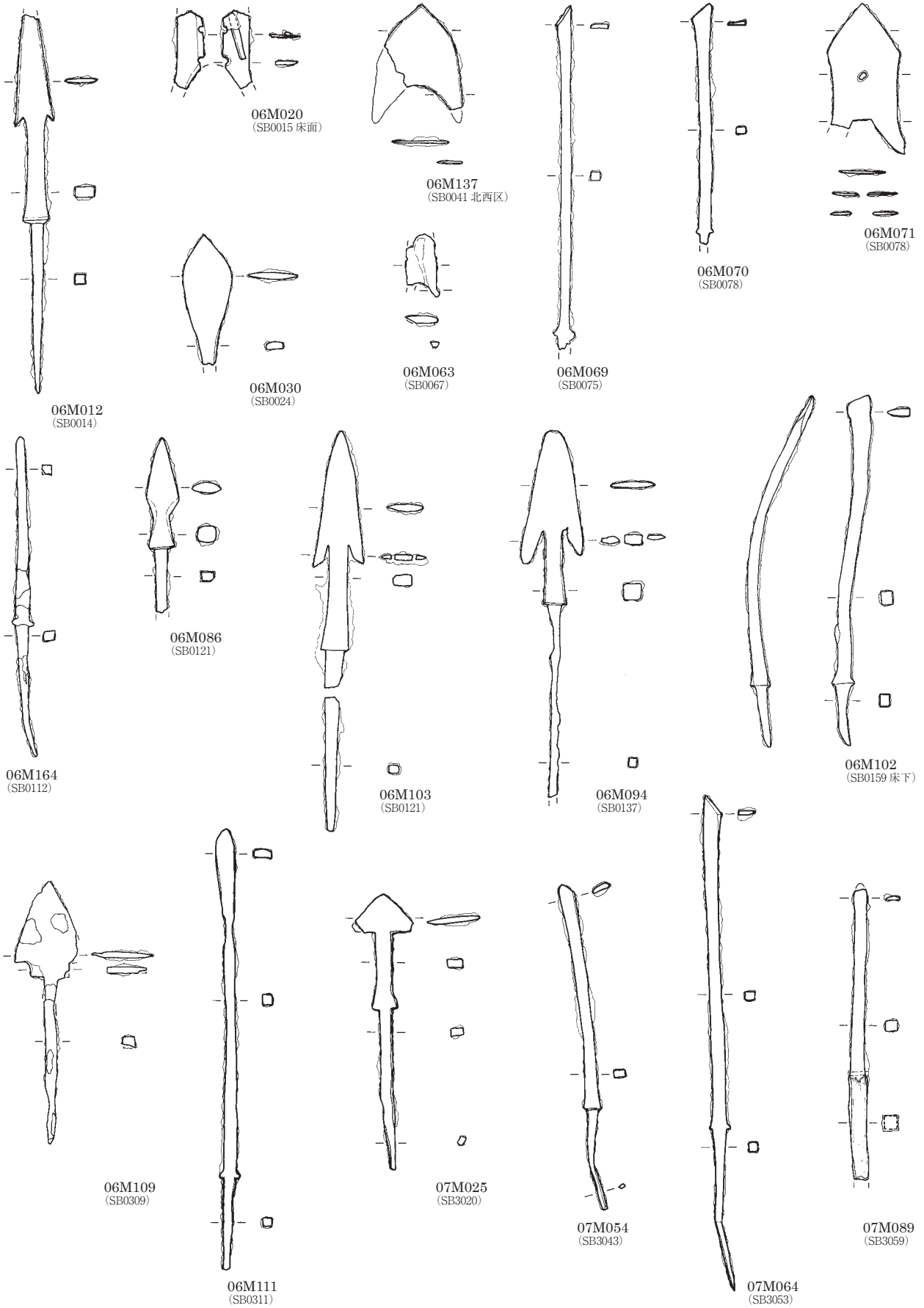

0 (1:2) 5cm

鉄鏃 (2)

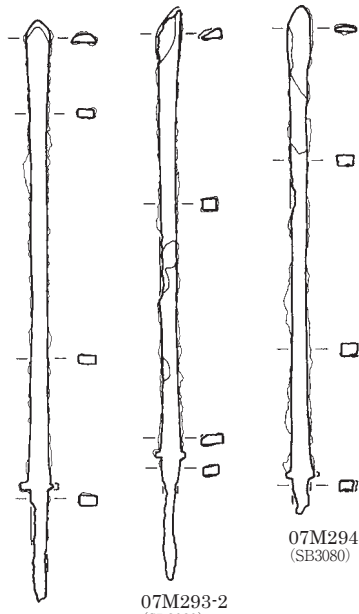
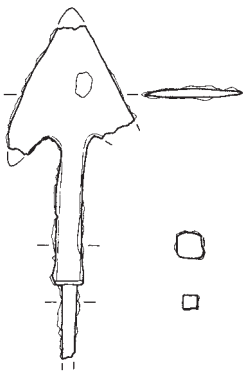
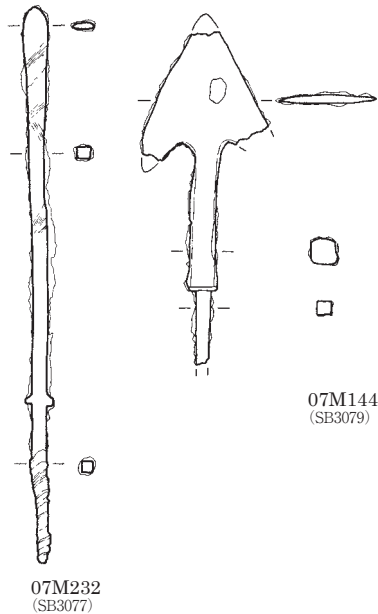

07M293-2
(SB3080)

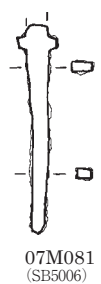
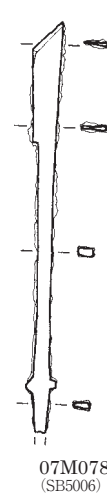
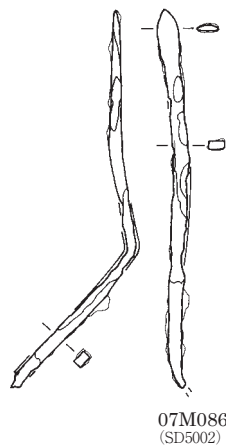
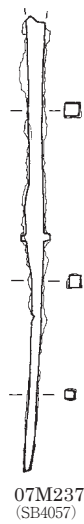
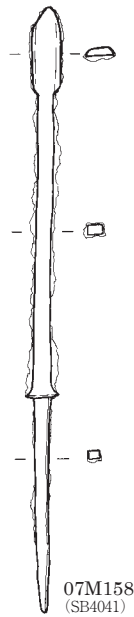
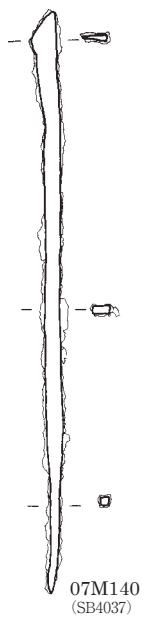
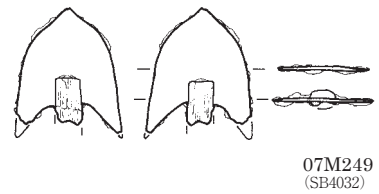
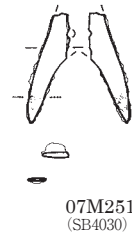
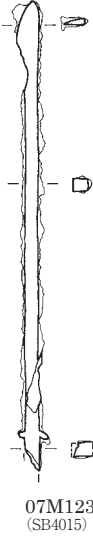
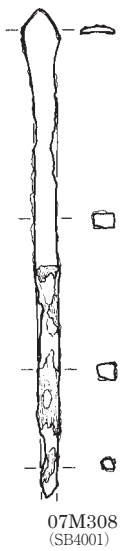
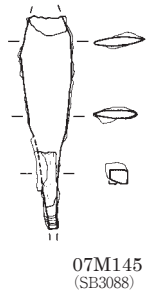
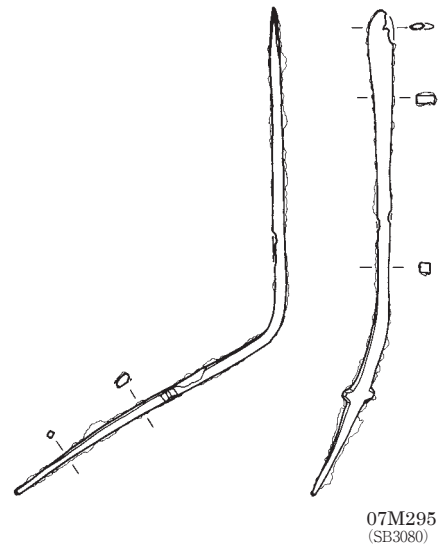

0 (1:2) 5cm

図版 256 金属製品 (6) - 弥生時代～中近世の鉄製品 -

鉄鏃 (3)

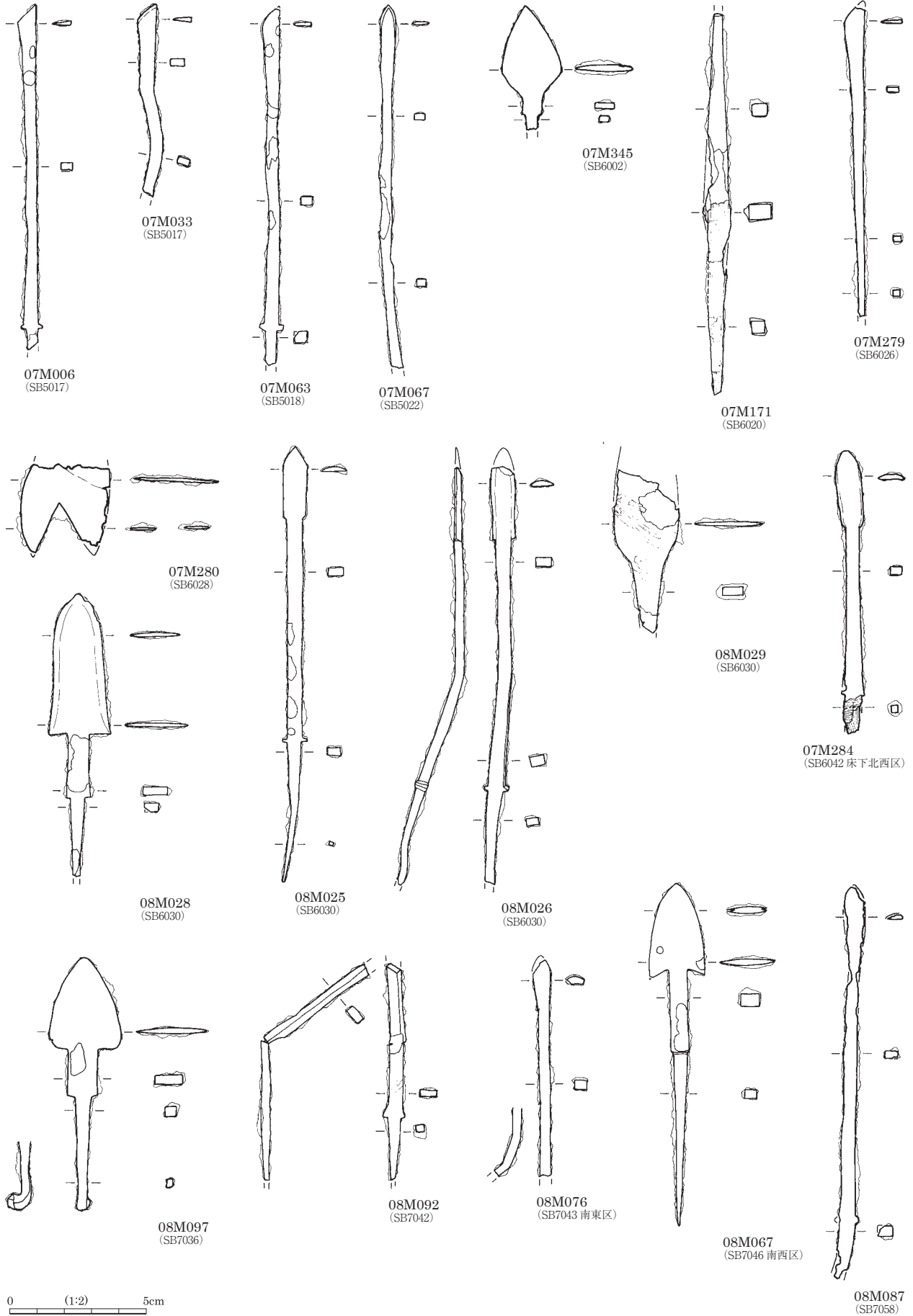

鉄鏃 (4)



08M098
(SB7065)

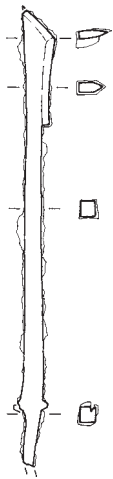

08M107
(SB7072)

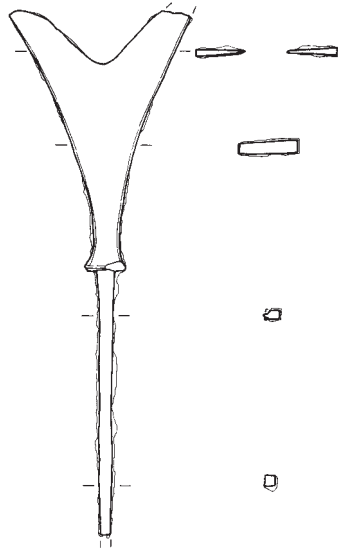

07M095
(SB8004)

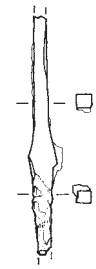

07M168
(SB8004 カマド)

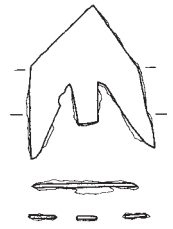

07M092
(SB8011)

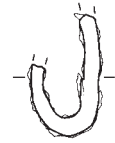

07M321
(SB8004)

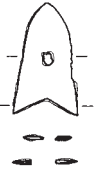

07M113
(SB8043)

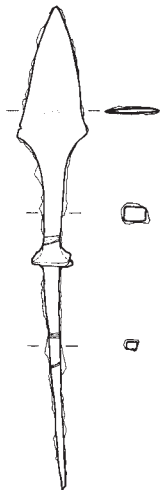

07M091
(SB8015)



07M100
(SB8016)

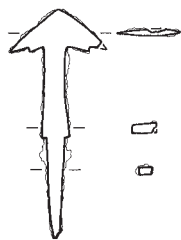

07M282
(ST6028Pit3)



08M111
(ST7012Pit1)



07M213
(SM4001)

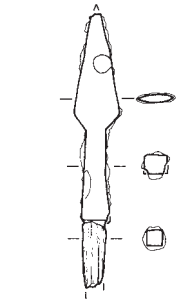

07M239
(SK3279)

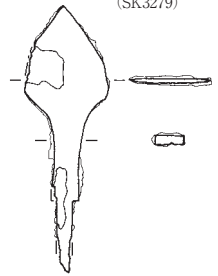

07M214
(SK4005)



07M045
(SK5027)



07M044
(SK5120)

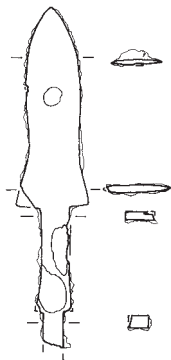

08M075
(SK7293)

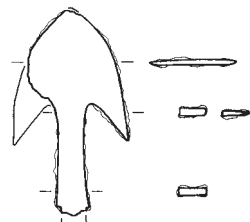

08M059
(SK7322)

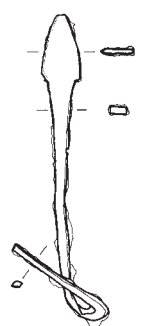

07M104
(SD4002)

0 (1:2) 5cm

図版 258 金属製品 (8) - 弥生時代～中近世の鉄製品 -

鉄鏃 (5)

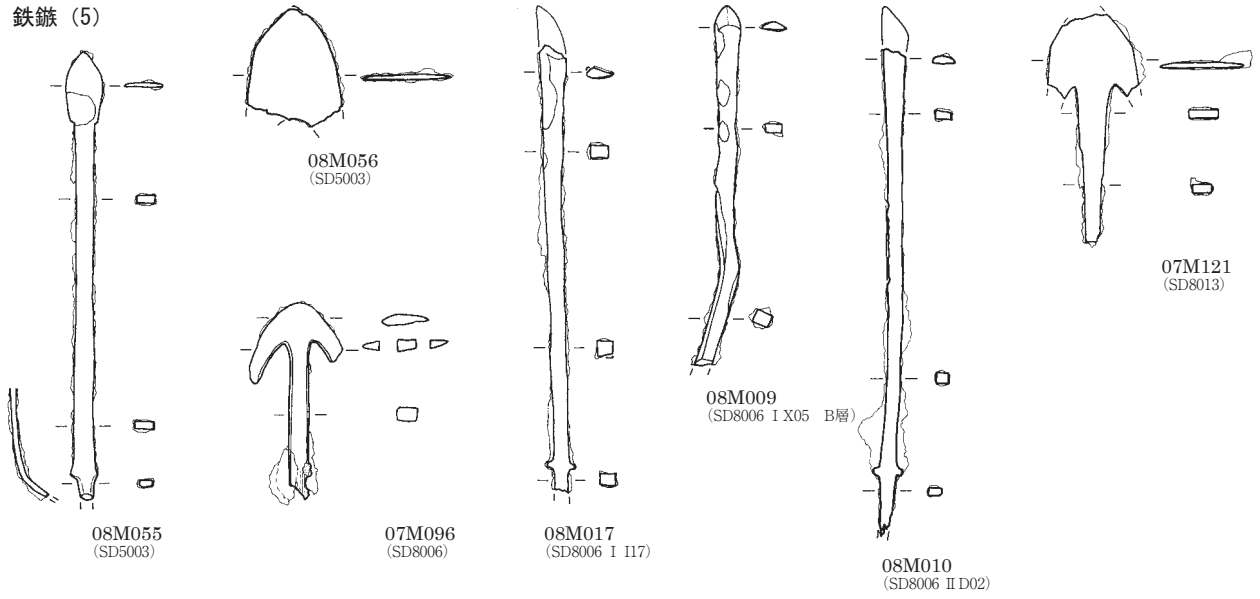

鉄剣

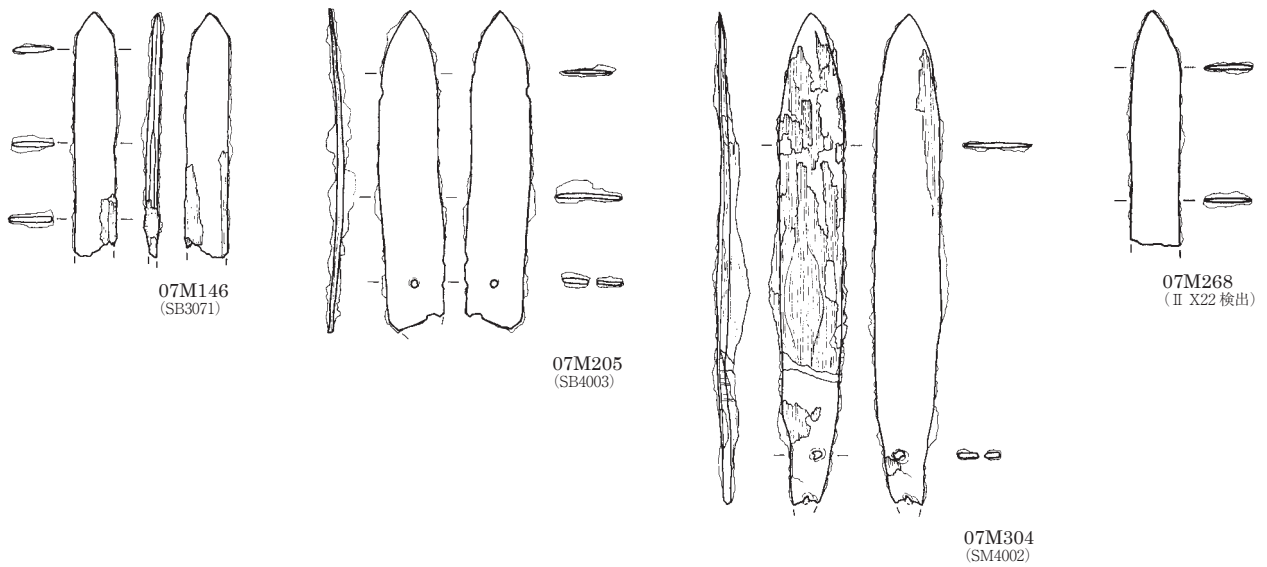

刀子 (1)

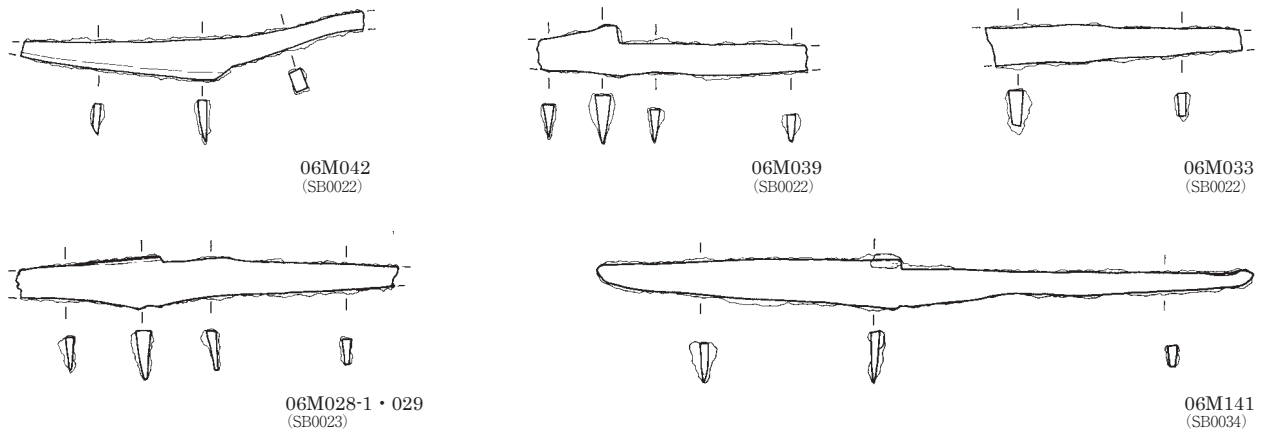

0 (1:2) 5cm

刀子 (2)

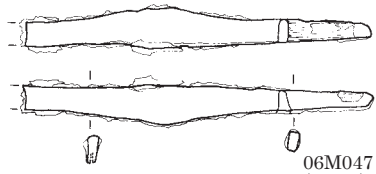

06M047
(SB0038)



06M155
(SB0047)

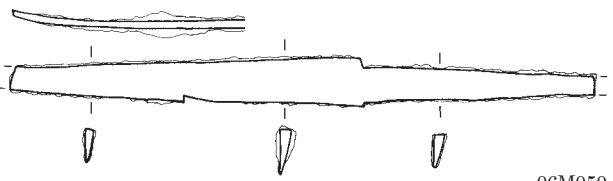

06M050
(SB0047)

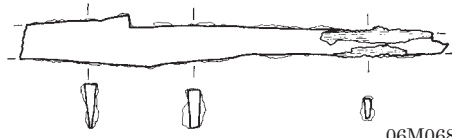

06M068
(SB0073)



06M067
(SB0073)

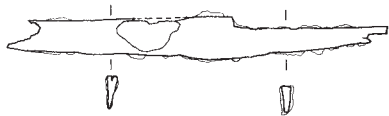

06M078
(SB0098)

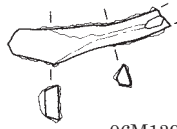

06M139
(SB0110)



06M084
(SB0115)

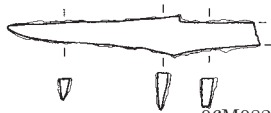

06M082
(SB0115)

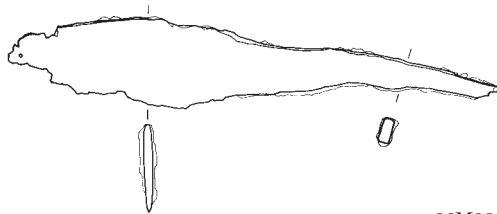

06M088
(SB0125)

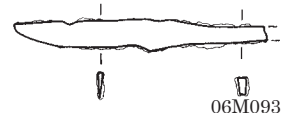

06M093
(SB0137)



06M092
(SB0137)

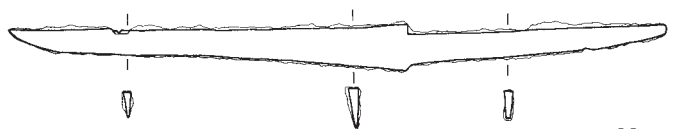

06M105
(SB0301)



06M108
(SB0301)



06M107
(SB0301)

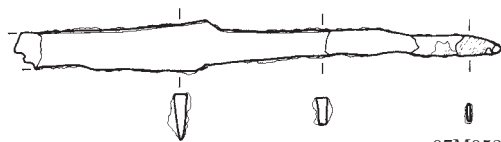

07M053
(SB3045)

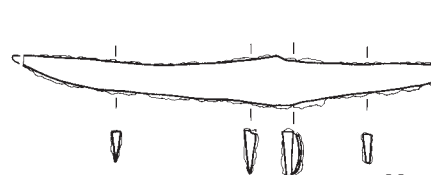

07M193
(SB3052 床下)

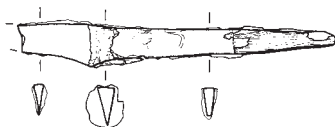

07M065
(SB3052)

0 (1:2) 5cm

図版 260 金属製品 (10) - 弥生時代～中近世の鉄製品 -

刀子 (3)

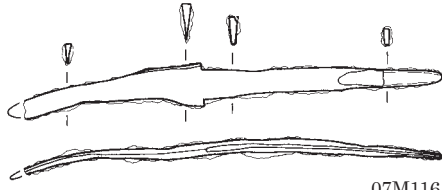

07M116
(SB3055)

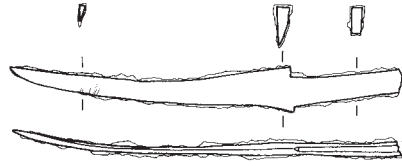

07M220
(SB3055)

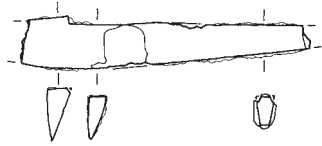

07M314
(SB3055)

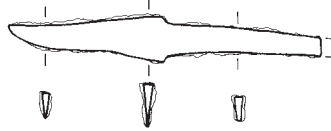

07M225
(SB3056)

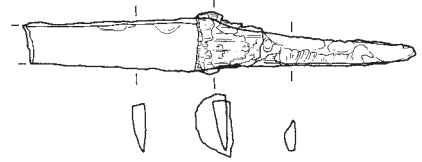

07M090
(SB3065)

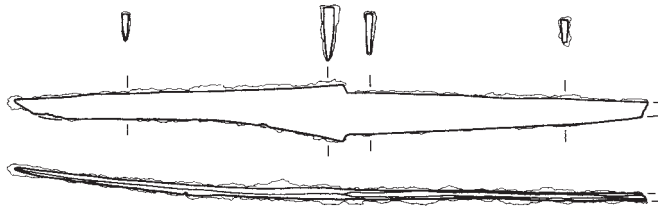

07M224
(SB3056)



07M235
(SB3081)

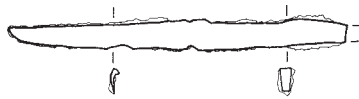

07M105
(SD4002)



07M204
(SB4002)

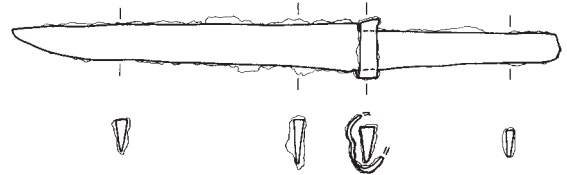

07M296
(SB4012)

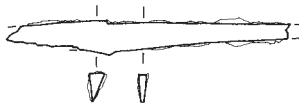

07M276
(SB4020)

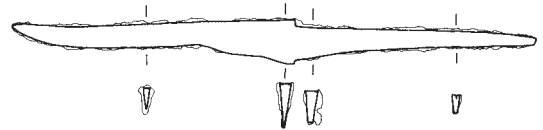

07M274
(SB4039)

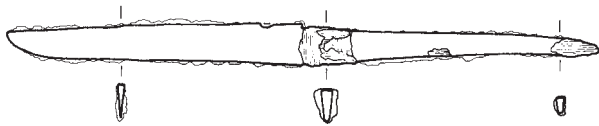

07M210
(SB4043)

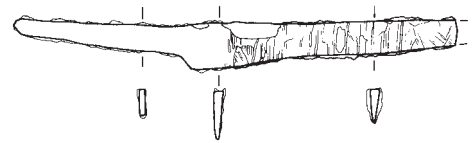

07M255
(SB4045)



07M034
(SB5005)

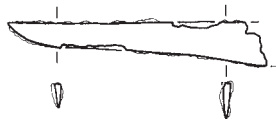

07M076
(SB5005)

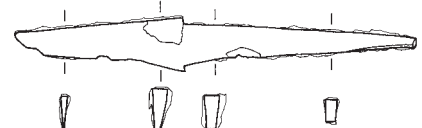

07M077
(SB5005)



07M021
(SB5011)

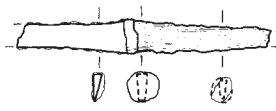

07M029-030
(SB5012)

0 (1:2) 5cm

刀子 (4)

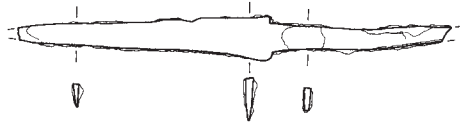

07M035
(SB5014)

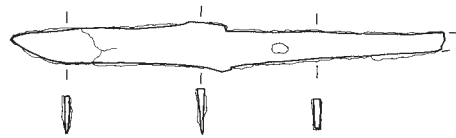

07M074
(SB5018)

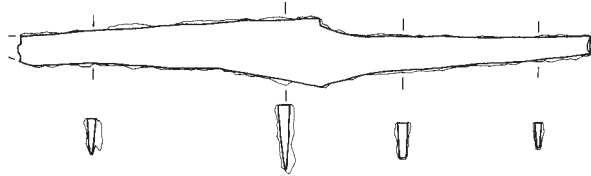

07M062
(SB5017)

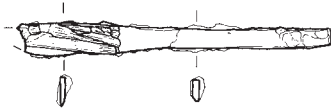

07M150-1
(SB6023)

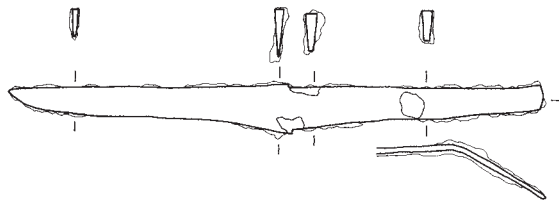

07M278
(SB6026)



07M246
(SB6048 床下)



08M044
(SB7011)

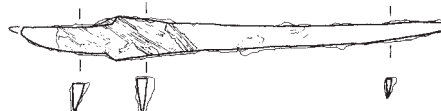

08M045
(SB7011)

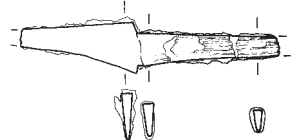

08M049
(SB7011)

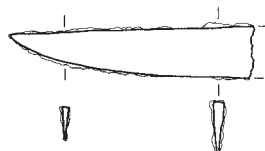

08M109
(SB7014 北西部中層)



08M127
(SB7029 カマド)

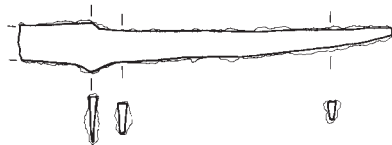

08M060
(SB7032)



08M066
(SB7046 南西区)



08M037
(SB7036)

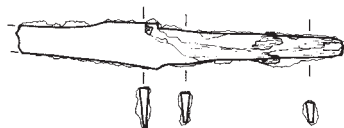

08M082
(SB7040)

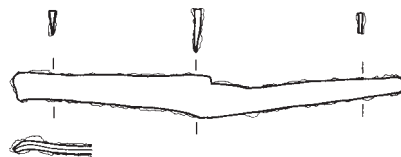

08M089
(SB7042)

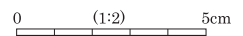

08M080
(SB7046)

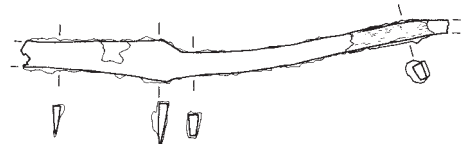

08M106
(SB7070)

図版 262 金属製品 (12) - 弥生時代~中近世の鉄製品 -

刀子 (5)

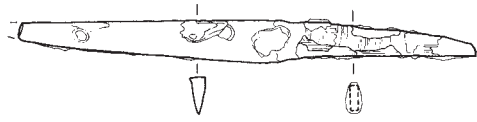

07M107
(SB8003)

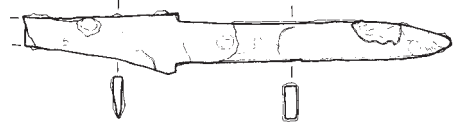

07M088
(SB8006)

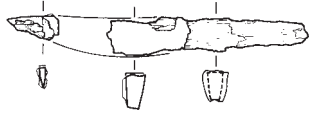

07M289
(SB8022)

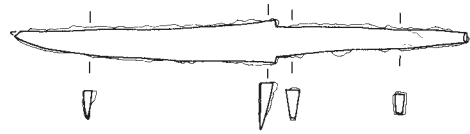

08M101
(SK7904)

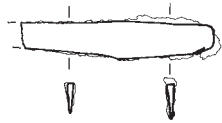

08M016
(SD8006 I T17 C層)

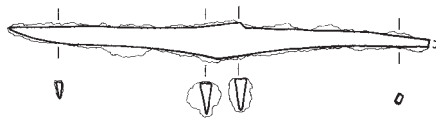

08M035
(SD8006 I Y01 C層)

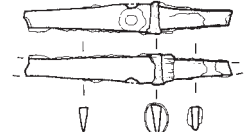

07M060
(3区南側検出面)

剃刀

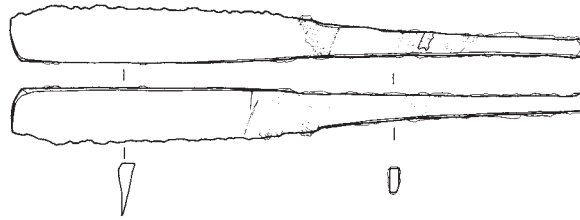

07M059
(SD3001)

金具 (責金具か)

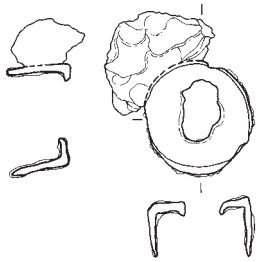

06M076-1
(SB0097)

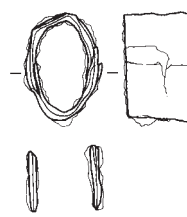

07M195
(SB5035 床面)



08M014
(SD8006 I T22 B層)

鉄釧

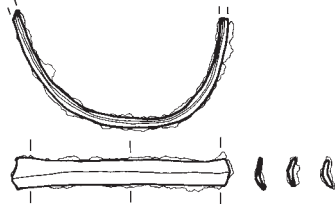

07M250
(SB4032)

鉄鐸



07M169
(SB6021)

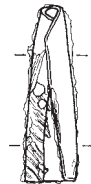

08M027
(SB6030)

鉄鐸舌



07M170
(SB6021)

0 (1:2) 5cm

弓金具

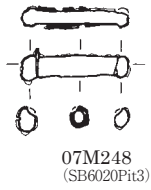

07M248
(SB6020Pit3)

経軸端金具か

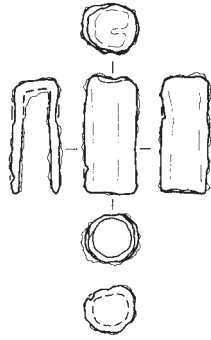

06M057
(SB0051)

蛇尾

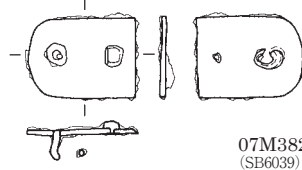

07M382
(SB6039)

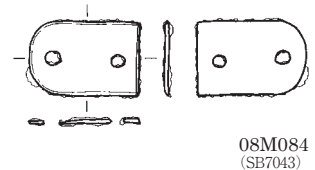

08M084
(SB7043)

鉄製金具など

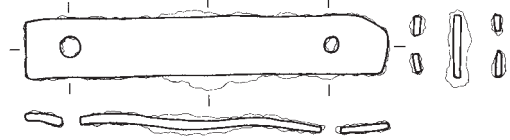

06M090
(SB0136Pit1)

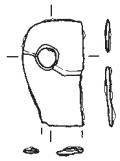

07M117
(SB3055)

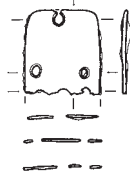

07M137
(SB5024)

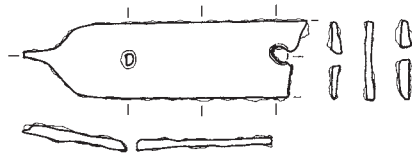

07M016
(SB5011 床)

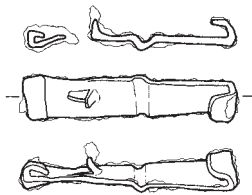

07M131
(SD4006)



08M083
(SB7063)

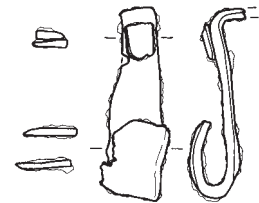

07M266
(SD4002 II W25)

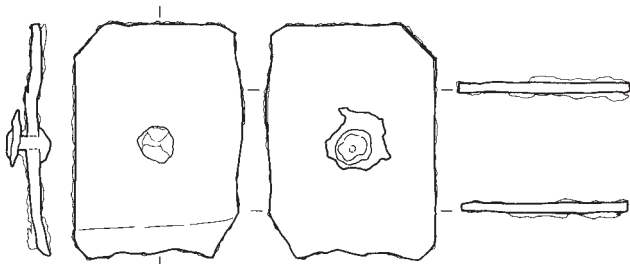

06M150
(SB0025 検出面)

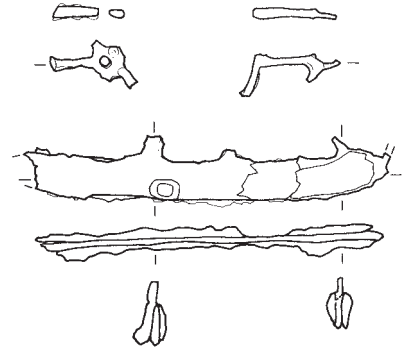

06M049
(SB0047)

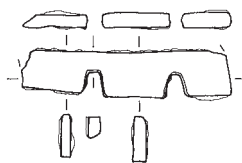

08M112
(SB7014 カマド)

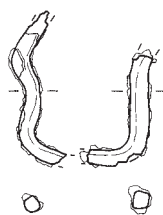

07M209
(SB4025)

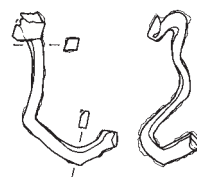

07M110・139
(SD4007)

0 1(1:2) 5cm

図版 264 金属製品 (14) - 古墳時代~中近世の鉄製品 -

馬具など

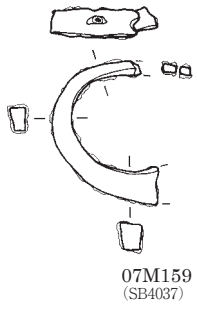

07M159
(SB4037)

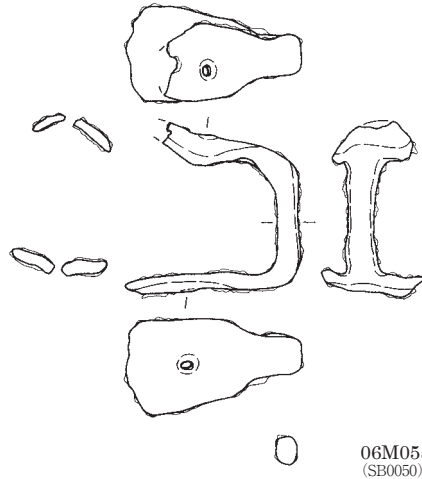

06M055
(SB0050)

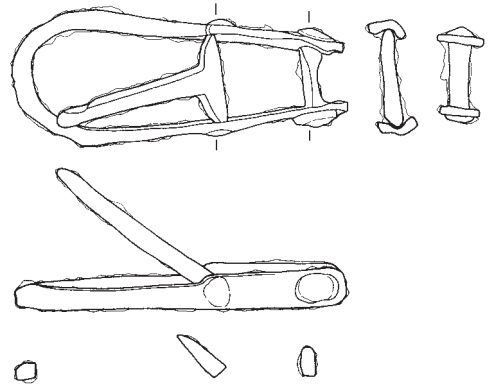

07M019
(SB3020)

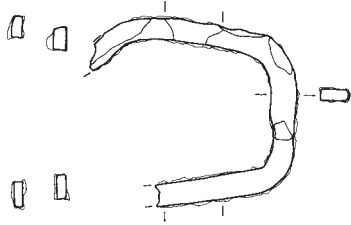

07M156
(SB0150)

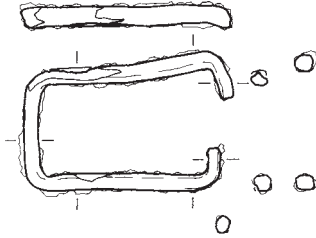

08M091
(SB7042)

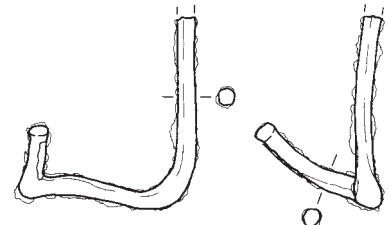

07M166
(SM8001)

不明板状製品

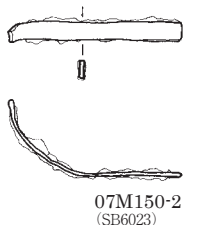

07M150-2
(SB6023)

鑷子



08M116
(SK7020)

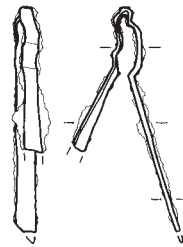

07M194
(SB4039)



07M050
(SB5006)

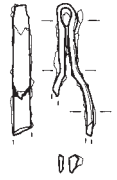

07M051
(SB5006)

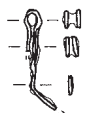

08M051
(SB7001)

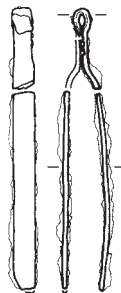

08M041
(SB7013)

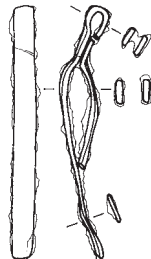

08M126
(SB7017)

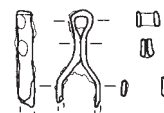

08M020
(SD8006)

0 (1:2) 5cm

鋏

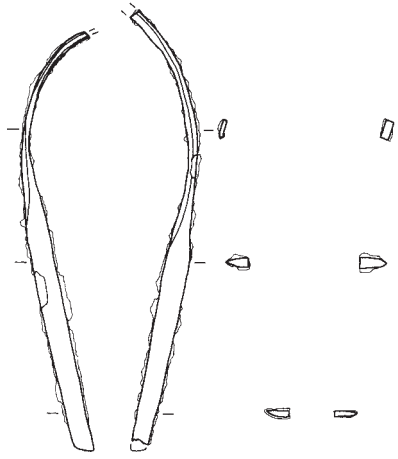

07M256·257
(SB4039)

針



08M072
(SB7041)

紡錘車

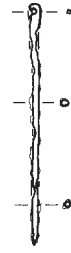

07M341
(SD8004)

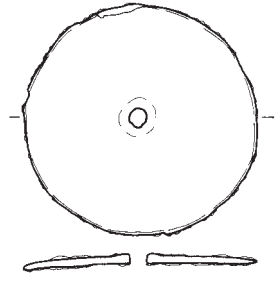

07M141
(SB3079)

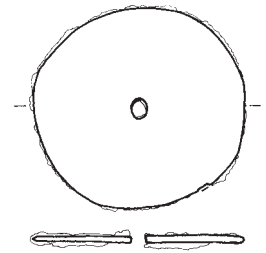

07M142
(SB3079)

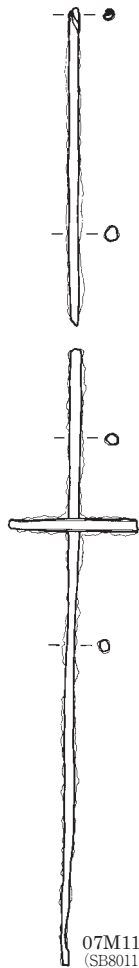
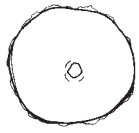

07M119
(SB8011)

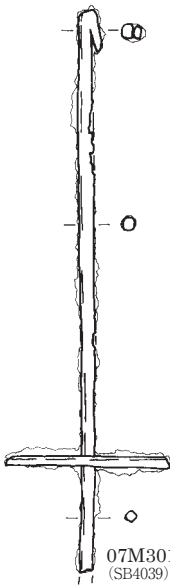
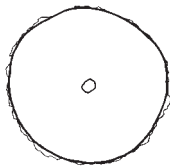

07M301
(SB4039)

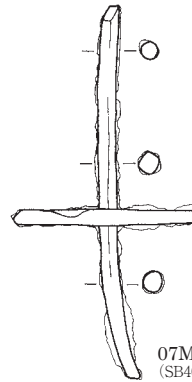
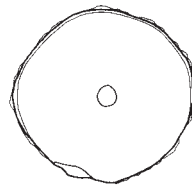

07M157
(SB4064)



07M149
(SB6023)

0 (1:2) 5cm

焼印

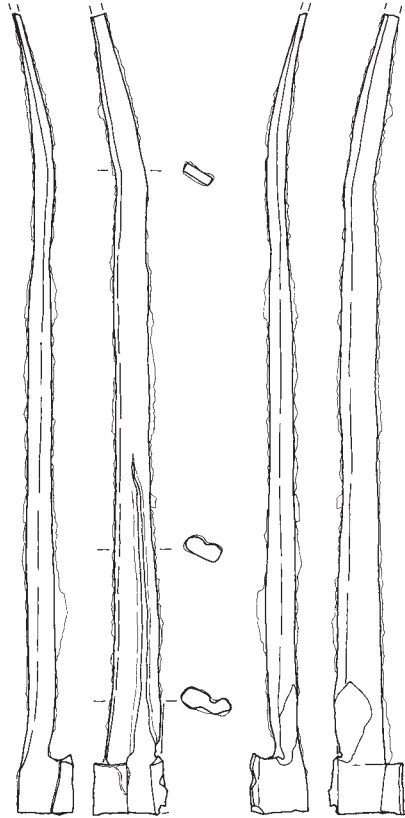

07M218
(SB4025)

鉄鉗

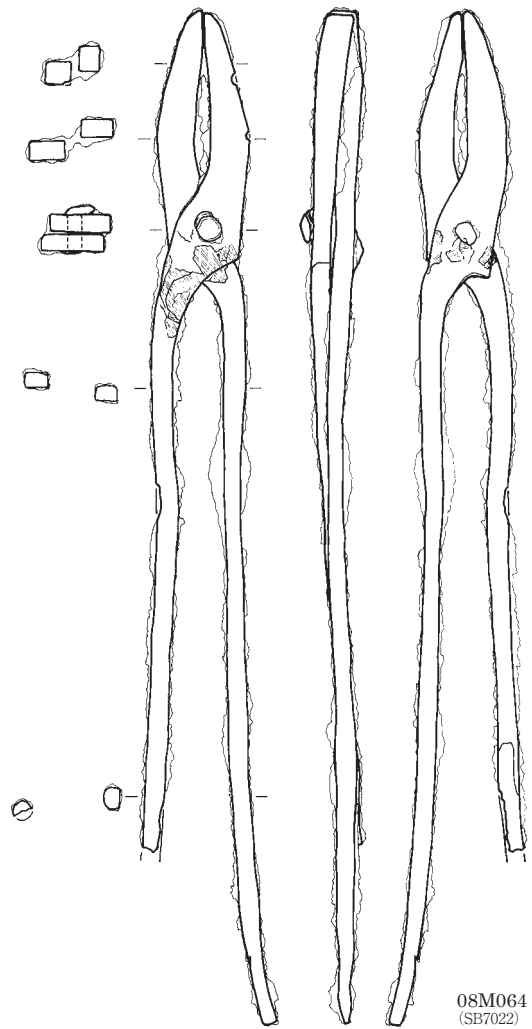

08M064
(SB7022)

槍鉋

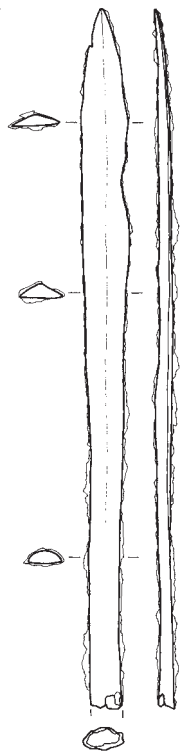

06M025
(SB0020)

鑿

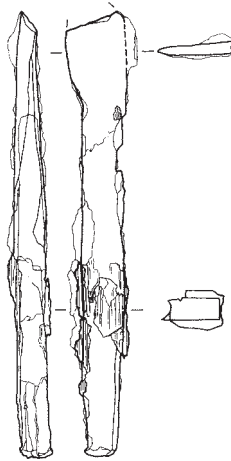

07M198
(SM4006)

鋸

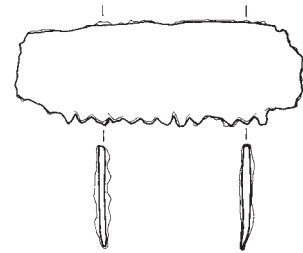

06M076-2
(SB0097)

楔

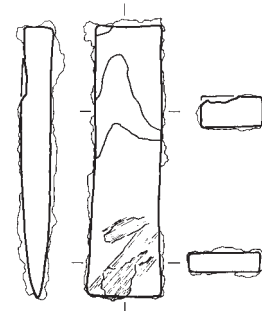

07M261
(SB4027)

0 1:2 5cm

工具など

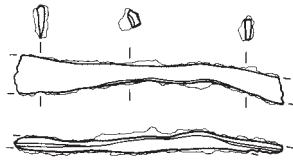

06M016
(SB0015)

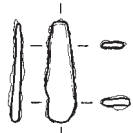

06M009-2
(SB0011)

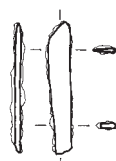

06M018
(SB0015)

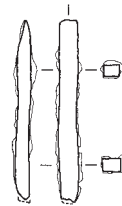

06M138
(SB0106)

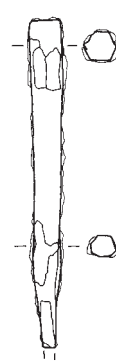

07M207
(SB4004)

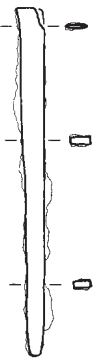

08M019
(SD8006 I X18)

鉄斧

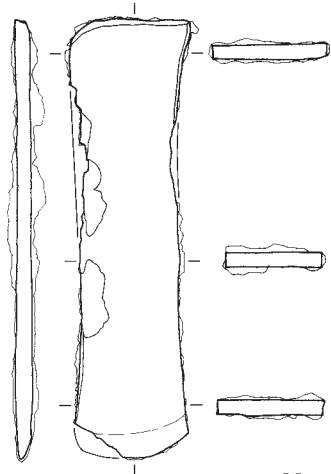

06M129
(1区)



07M196
(SB4045 床下)

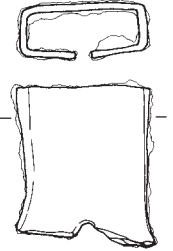
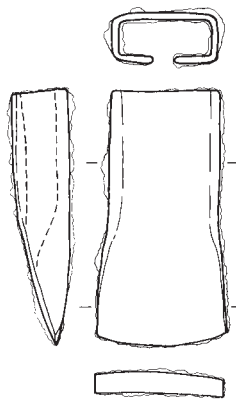

07M072
(SB5035 床直上)

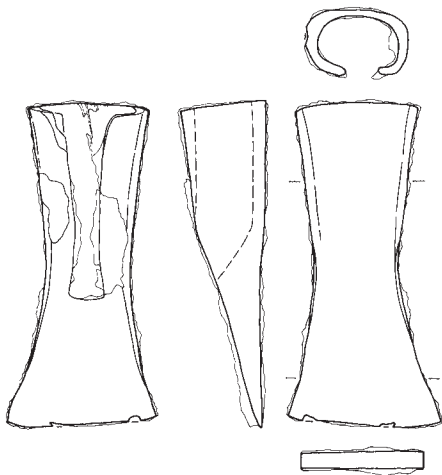

08M128
(SB7035)

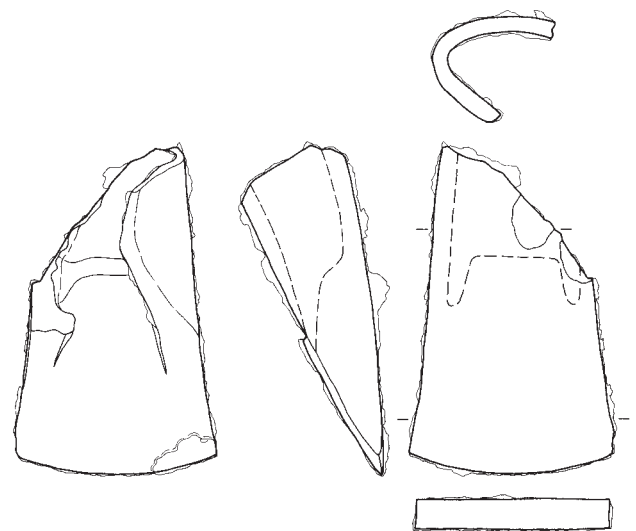

07M042
(ST5002Pit12)

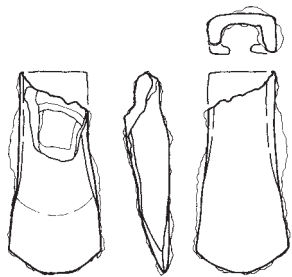

06M183
(SD0004)

0 (1:2) 5cm

図版 268 金属製品 (18) - 古墳時代~中近世の鉄製品 -

苧引具

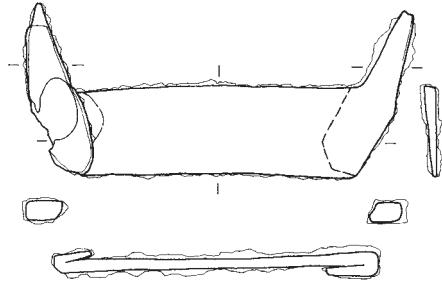

06M041
(SB0022)

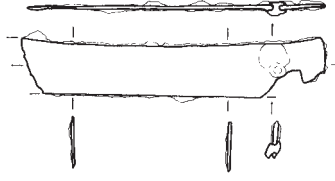

07M129
(SB4015)

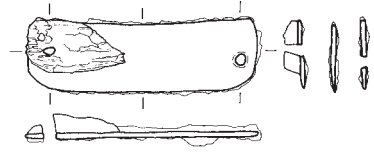

08M030
(SB6030)

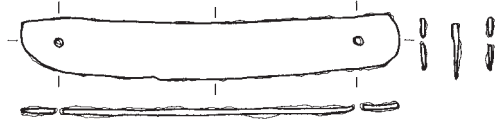

07M040
(SB5008)



07M285
(SB6059)

鎌 (1)

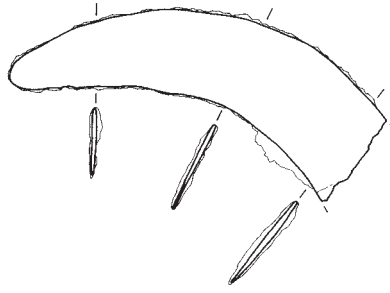

06M037
(SB0022)

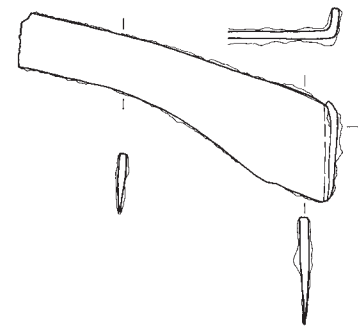

06M060
(SB0065 床直上)

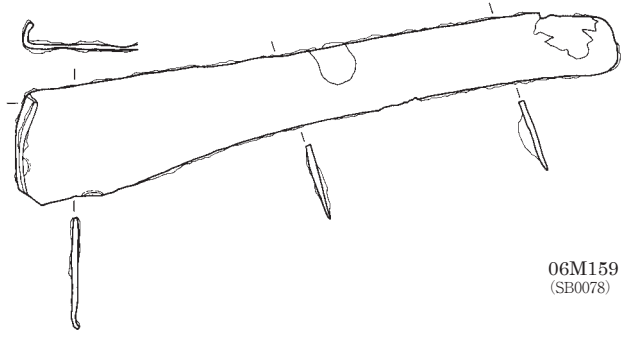

06M159
(SB0078)

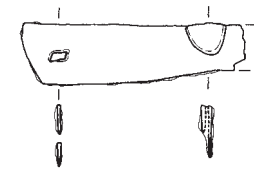

06M073
(SB0079)

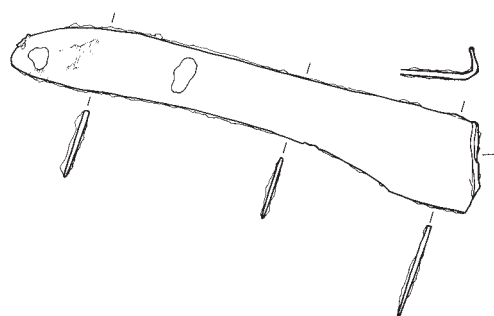

07M047
(SB5006)

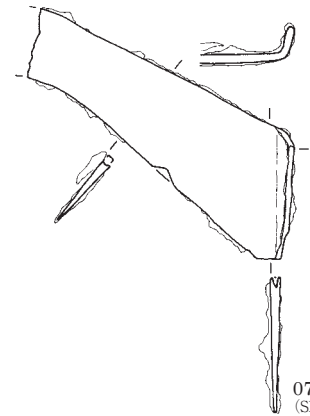

07M233
(SB3077)

0 (1:2) 5cm

鎌 (2)

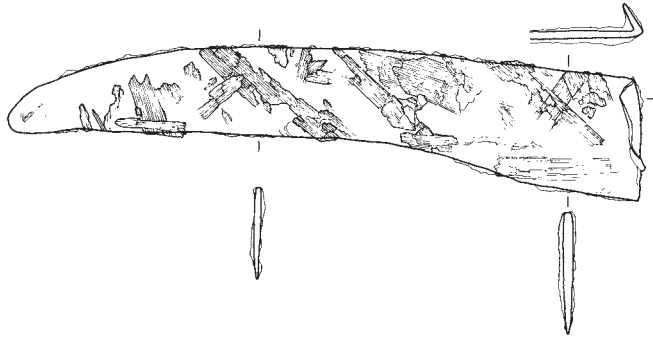

07M009
(SB5013)

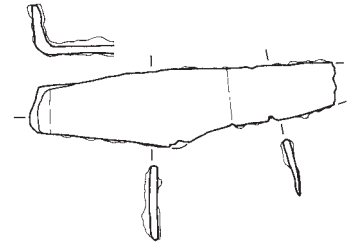

07M005
(SB5017)

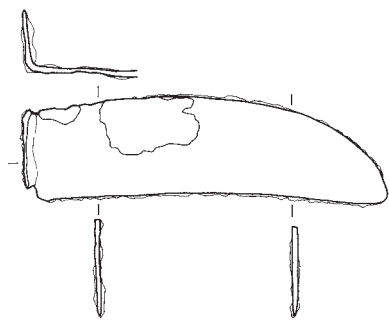

07M046
(SB5027)

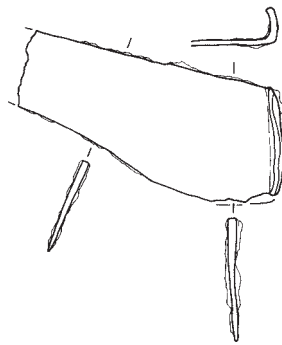

07M120
(SB6011)

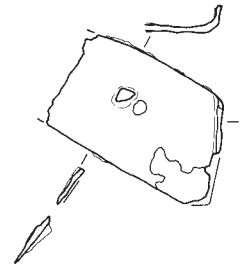

07M288
(SB6063)

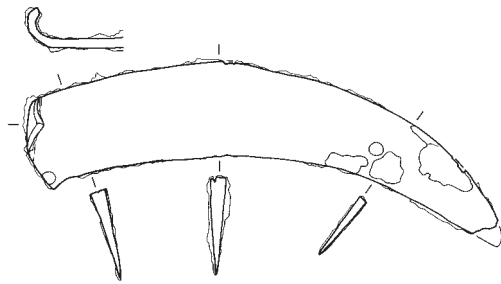

08M065
(SB7036)

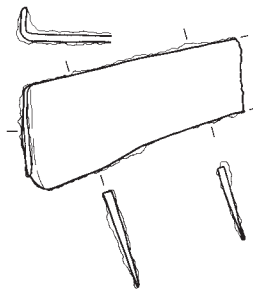

08M113
(SB7040)

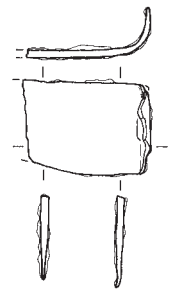

08M103
(SB7057)

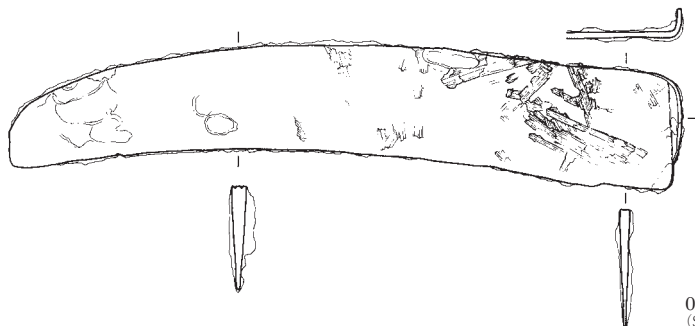

07M087
(SB8006 床直上)

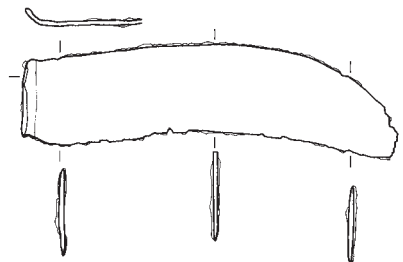

07M018
(SK3060)

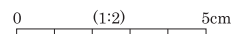

鎌 (3)

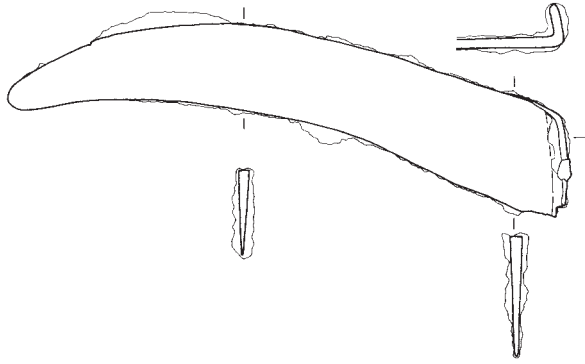

07M133
(SK8149)

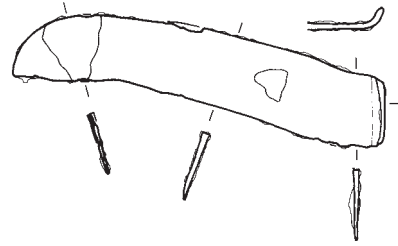

07M242
(SD3001)

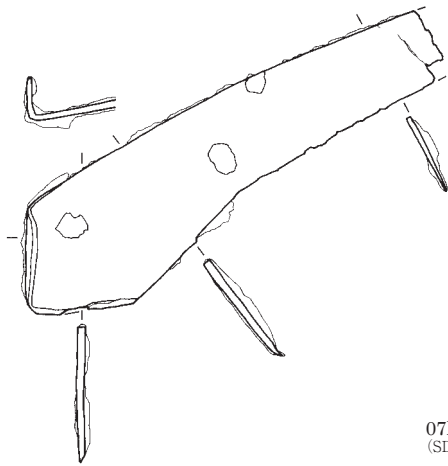

07M324
(SD8003)

鍬・鋤先

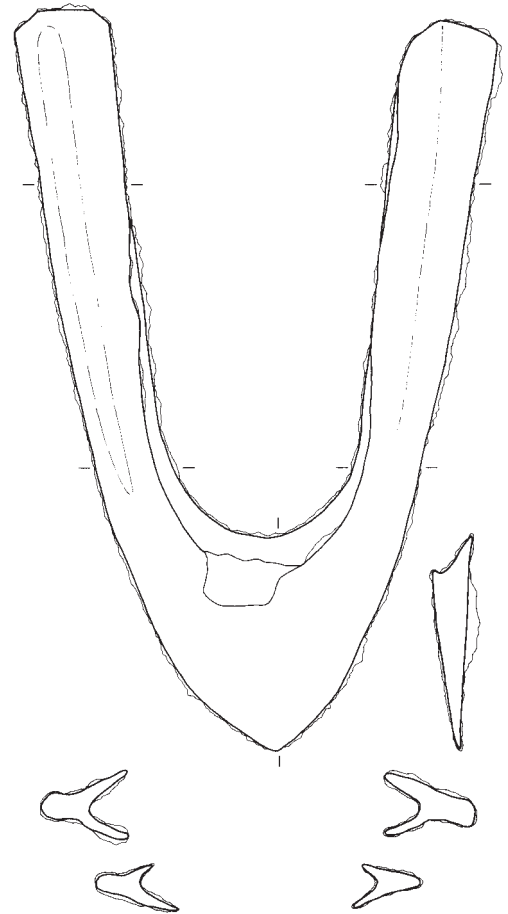

06M056
(SB0050)

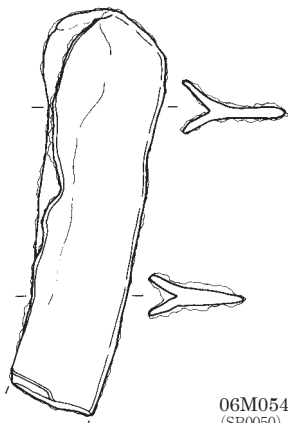

06M054
(SB0050)

0 1:2 5cm

棒状品

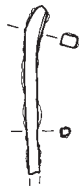

07M254
(SB4030)

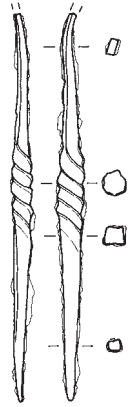

08M096
(SB7036)

T字形製品

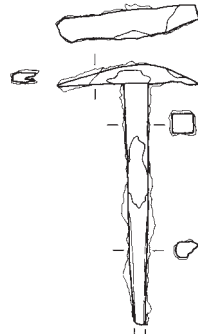

06M101
(SB0159)

鋸

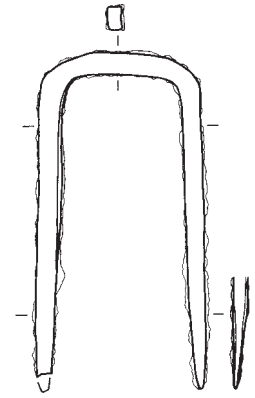

07M015
(SB5007)

釘

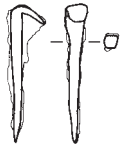

06M001
(SB0001)

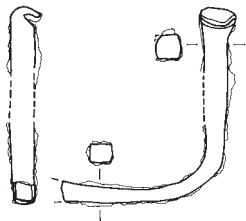

06M002-038
(SB0006-0022)

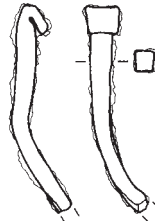

06M042-4
(SB0022)

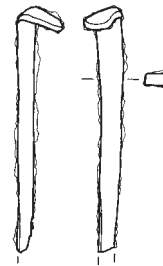

06M044
(SB0034)



06M173
(SB0131)

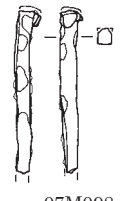

07M098
(SB4015)



07M160
(SB4037)

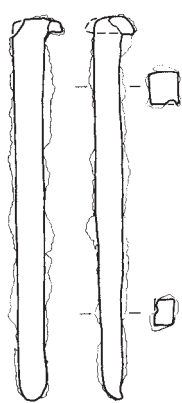

07M212
(SB4063)

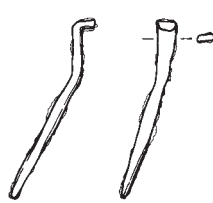

07M013
(SB5017)



08M061
(SB7032)

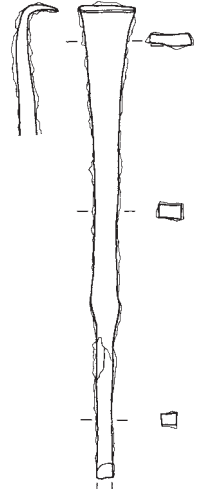

08M071
(SB7045 北東区)

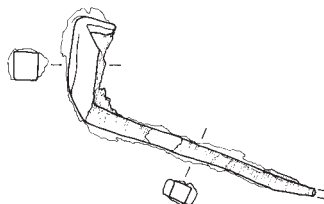

07M215
(SK4051 中層)

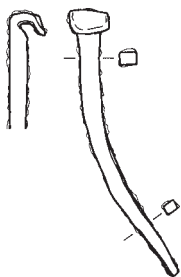

08M062
(SB7045)

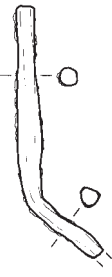

06M116
(SK0008)

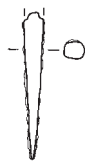

07M216
(SK4051 中層)



07M217
(SK4051 床面上)

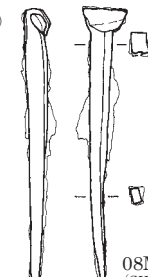

08M052
(SK7020 II D19・20)

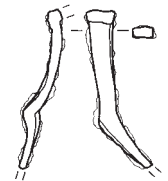

08M018
(SD8006 I X05)

0 (1:2) 5cm

図版 272 金属製品 (22) - 弥生時代～中近世の鉄製品 -

長方形板状鉄製品

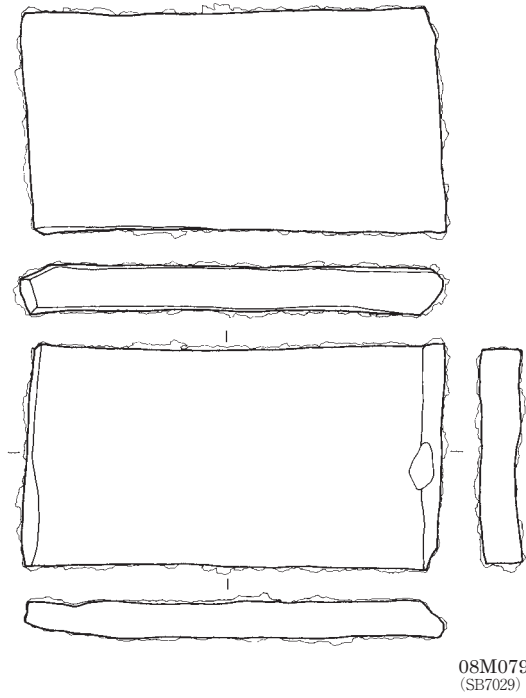

鉄製容器

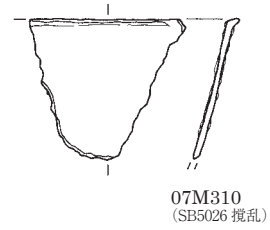

集合鉄片

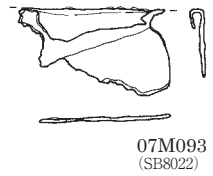

鉄片

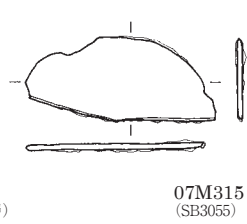
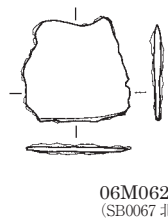
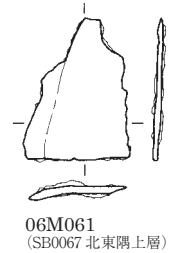
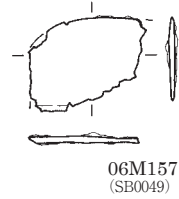
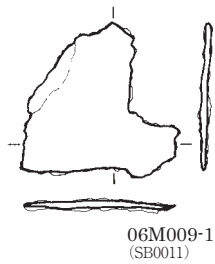

0 (1:2) 5cm

鉄器片

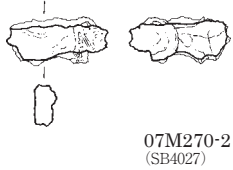

07M270-2
(SB4027)



07M532
(SB4037 床面)

鉄塊系遺物

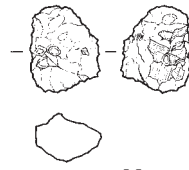

07M252-1
(SB4037 炉1)



07M326
(SB4037 床面)

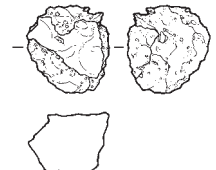

07M355
(SB4037 南東隅床面)

鉄滓(1)

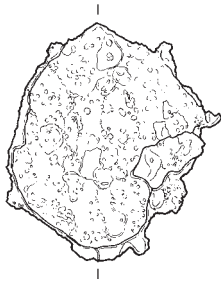

06M048
(SB0047)



06M158-1
(SB0070)



06M162
(SB0091)

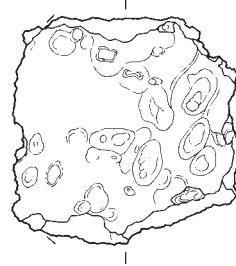

07M378
(SB3046)



07M188
(SB4037)



07M372-1
(SB4024)



07M270-1
(SB4027)

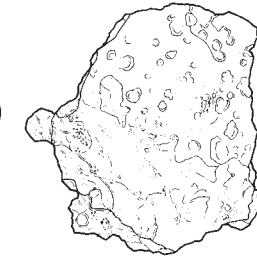

07M186-1
(SB4037)

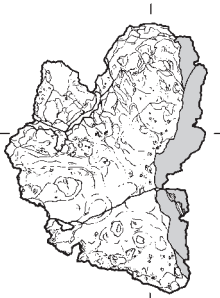
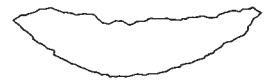
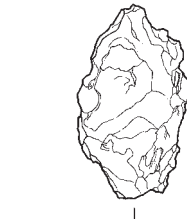

■ 溶解範囲

0 (1:3) 10cm

図版 274 鍛冶関連遺物 (2)・木製品

鉄滓 (2)

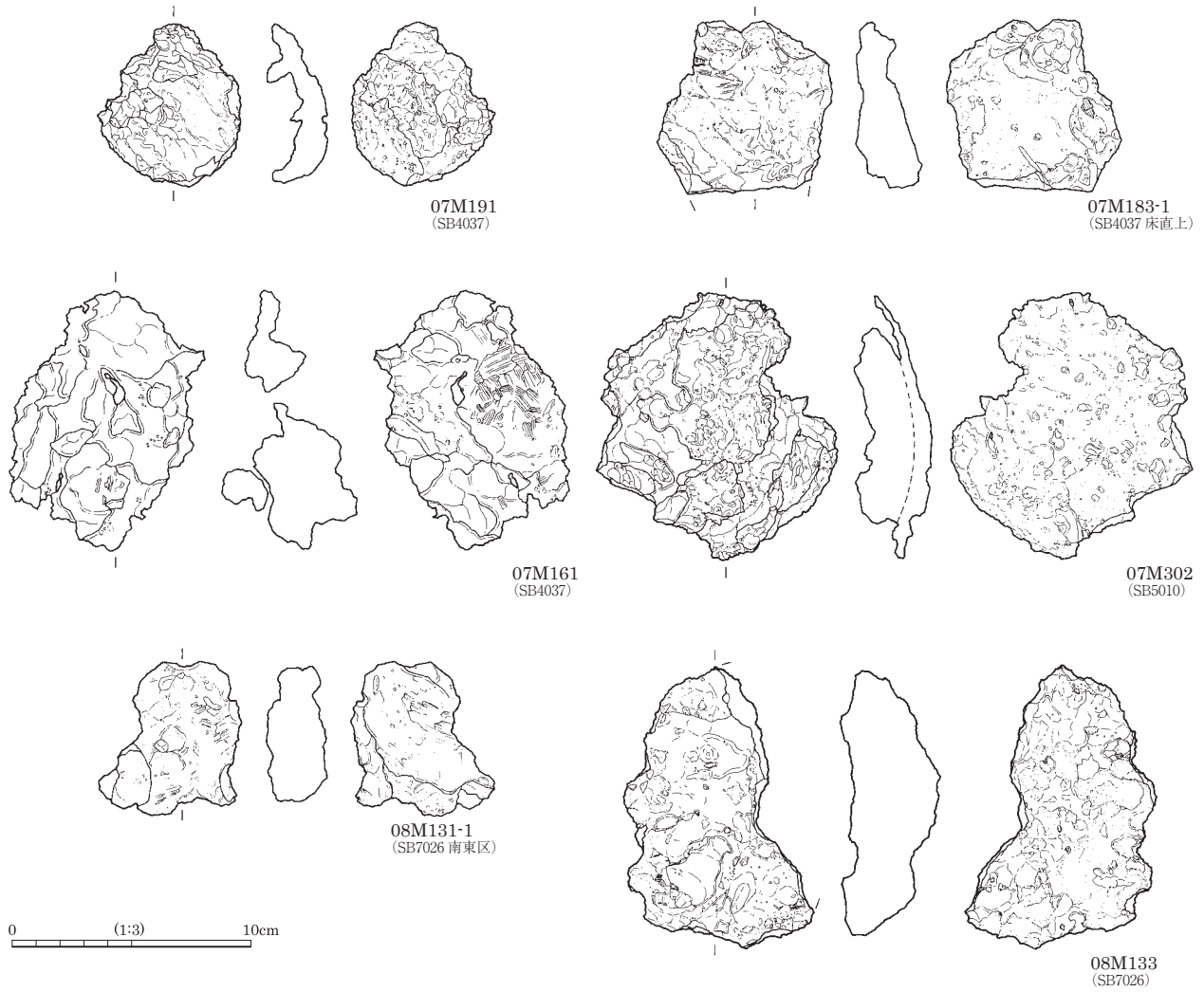

木製品

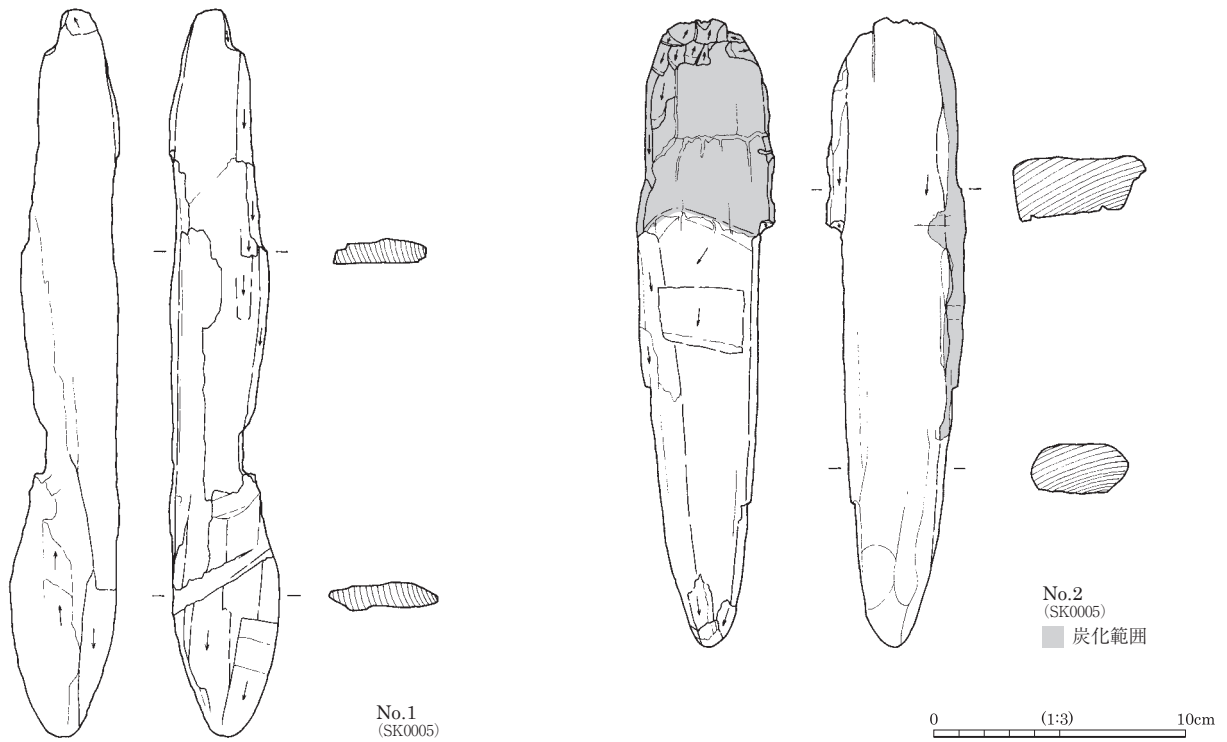

SB0036 出土

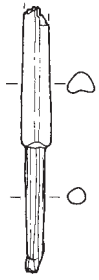

06B120-3
(種不明、中手骨または中足骨か)



06B121
(シカ、中足骨)



06B85-1-2
(シカ、角)

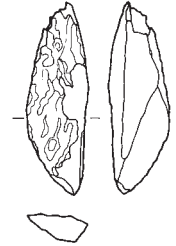

06B120-1-4
(シカ、角)

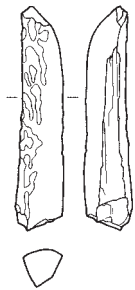

06B120-1-2
(シカ、角)



06B120-1-1
(シカ、角)

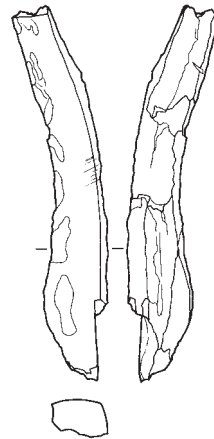

06B120-1-3
(シカ、角)

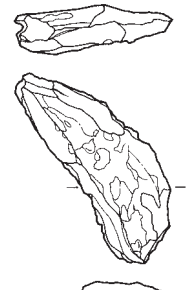

06B120-1-5
(シカ、角)

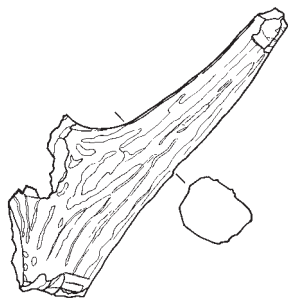

06B85-1-1
(シカ、角)

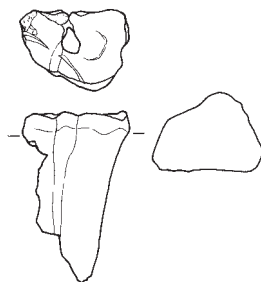

06B85-1-3
(シカ、中手骨近位端)

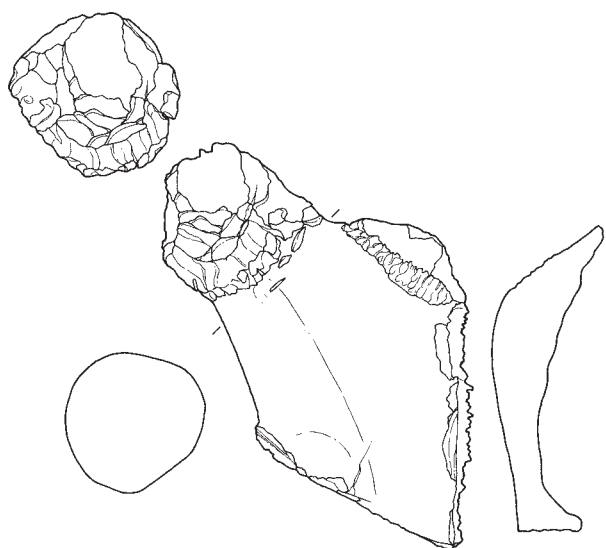

06B81-1
(シカ、角)

0 (1:2) 5cm

平成 27 (2015) 年 3 月 27 日 発行

長野県埋蔵文化財センター発掘調査報告書 104

西近津遺跡群

中部横断自動車道建設に伴う埋蔵文化財発掘調査報告書 2

－ 佐久市内 2 －

第 3 分冊 (遺物図版編)

発行者 国土交通省 関東地方整備局
(一財) 長野県文化振興事業団
長野県埋蔵文化財センター
〒 388-8007 長野県長野市篠ノ井布施高田 963-4
Tel 026-293-5926 Fax 026-293-8157
E-Mail info@naganomaibun.or.jp

印刷者 信毎書籍印刷株式会社
〒 381-0037 長野県長野市西和田 1-30-3
Tel 026-243-2105 Fax 026-243-3494