

図面102

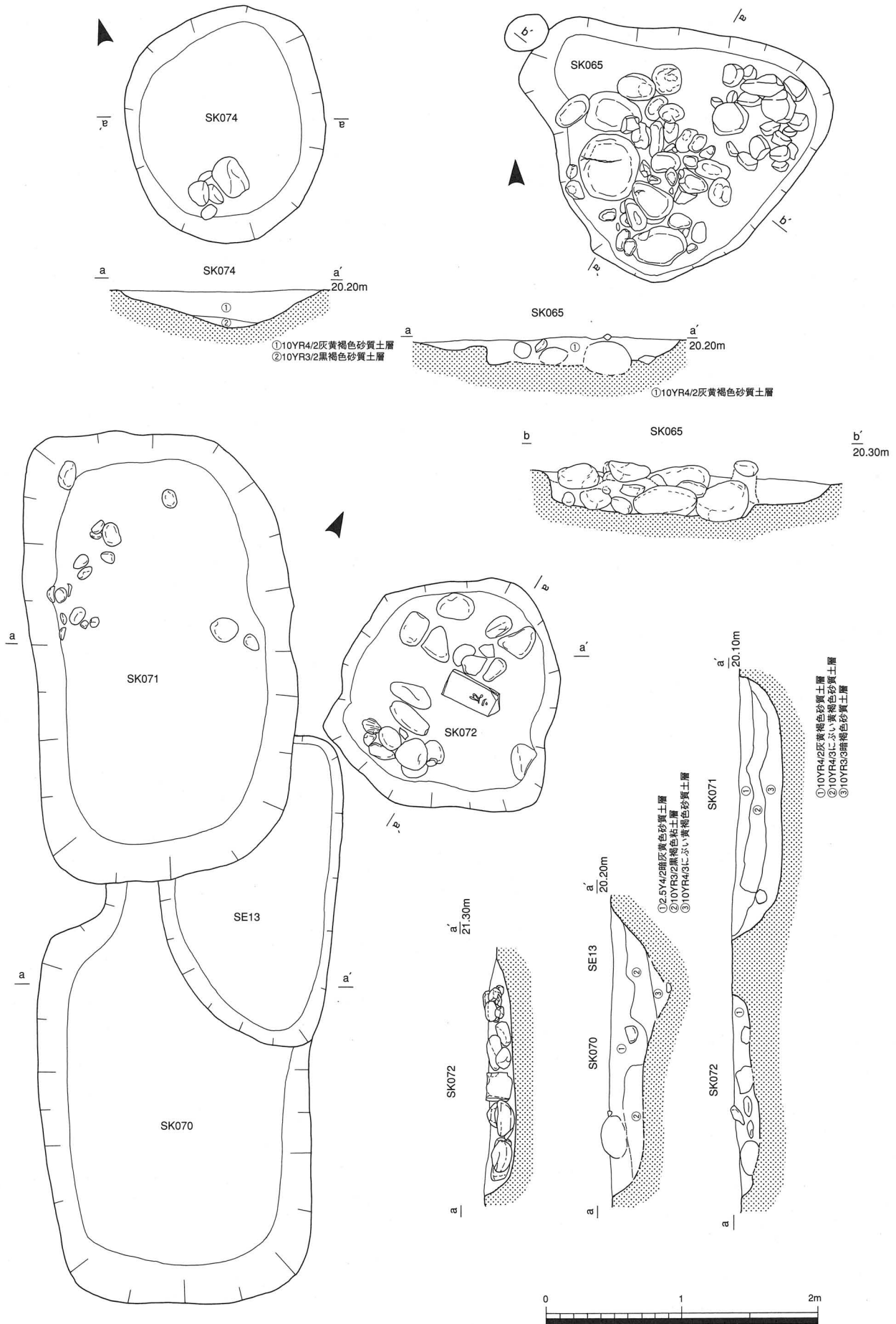

A地区土坑実測図(9)

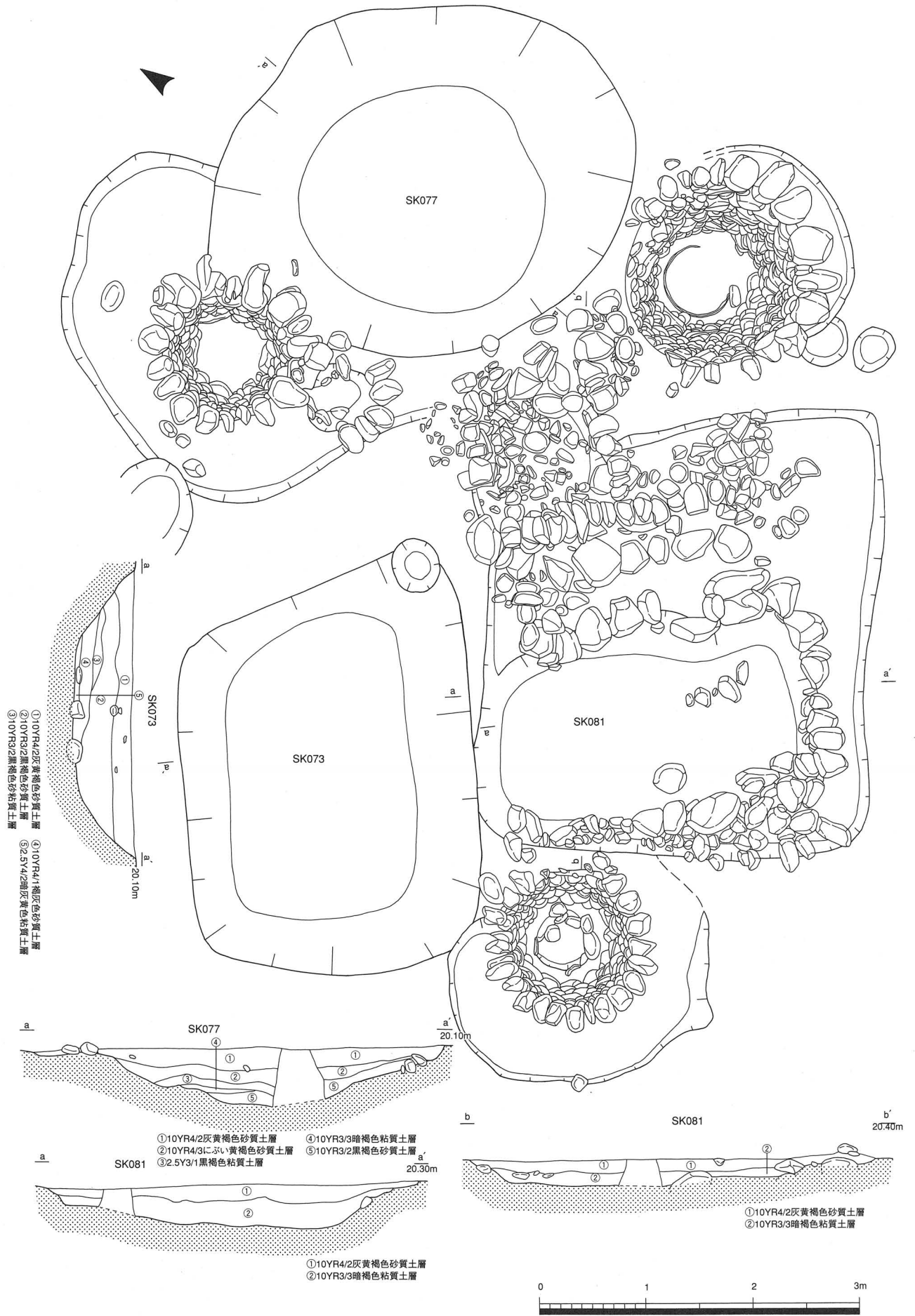

A地区土坑実測図(10)

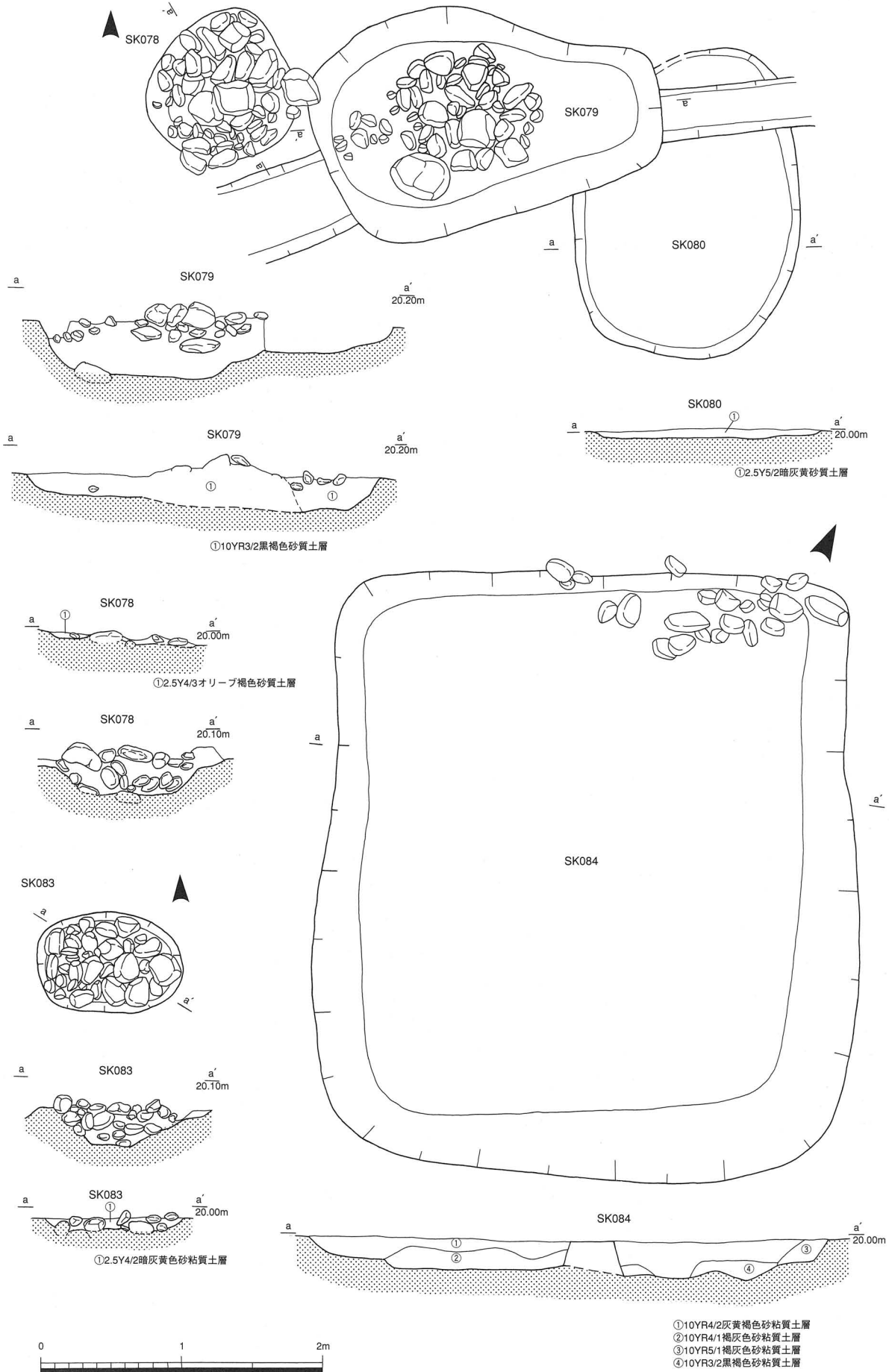

A地区土坑実測図(11)

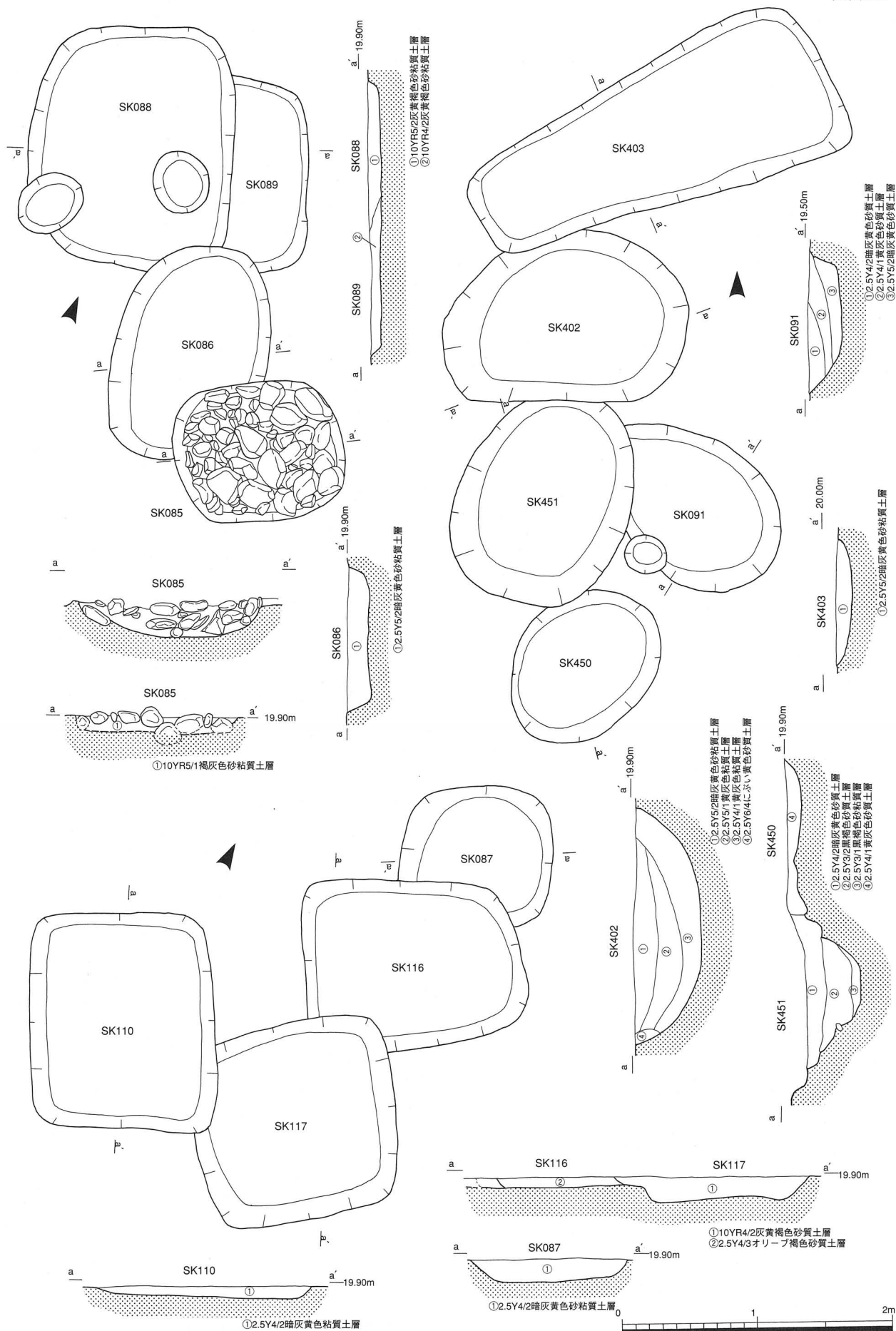

A地区土坑実測図 (12)



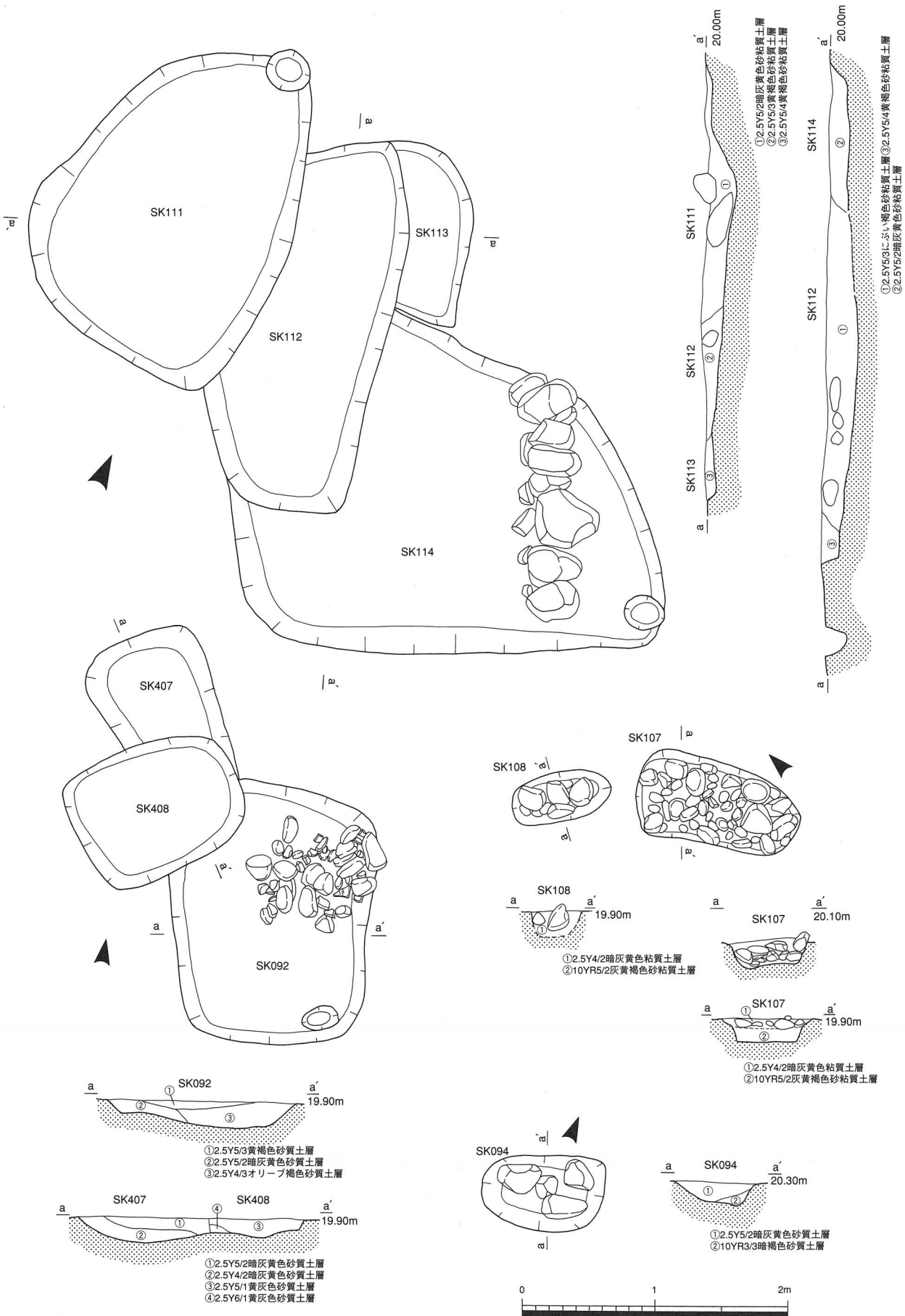

A地区土坑実測図 (13)

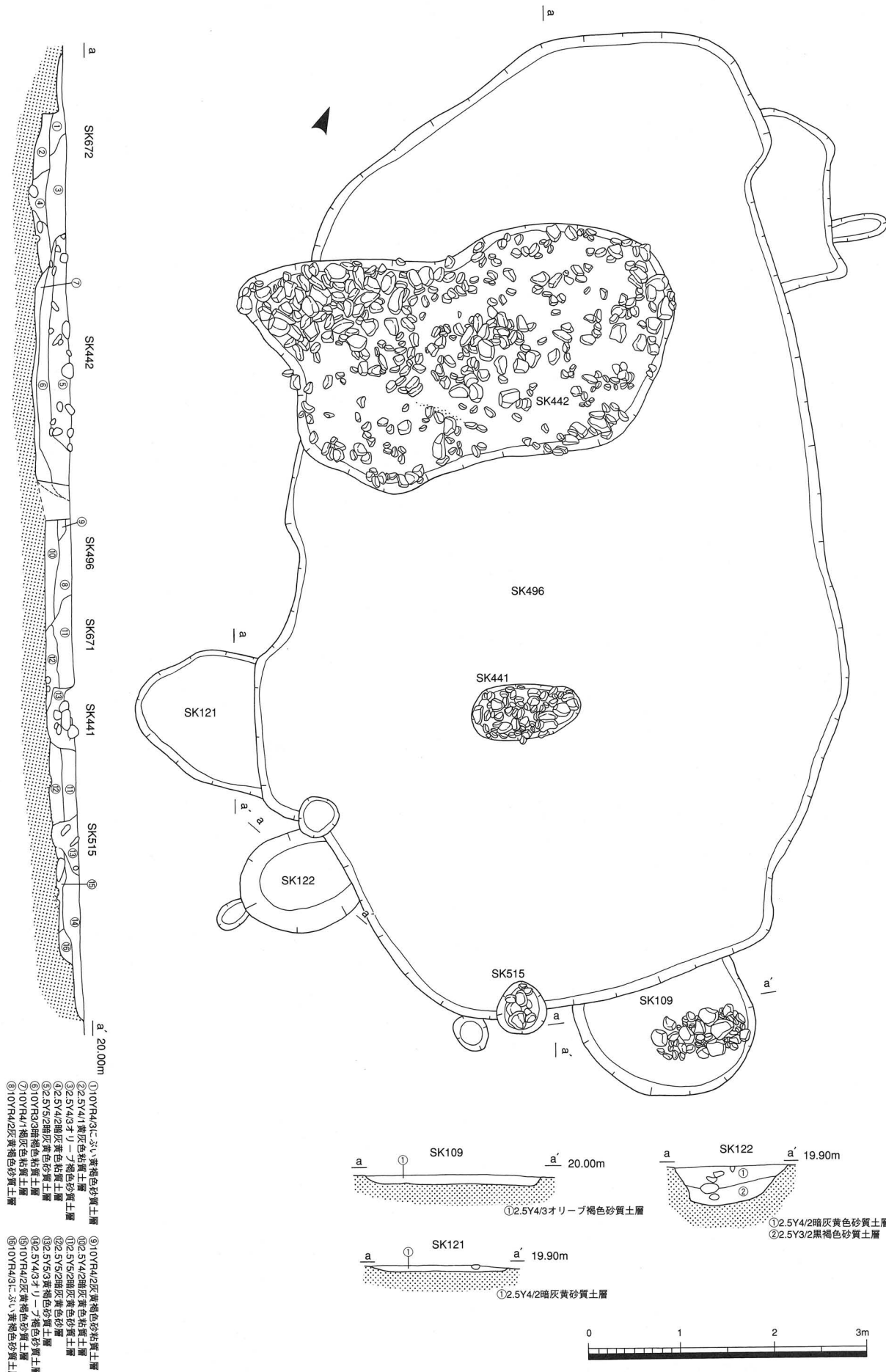

A地区土坑実測図 (14)

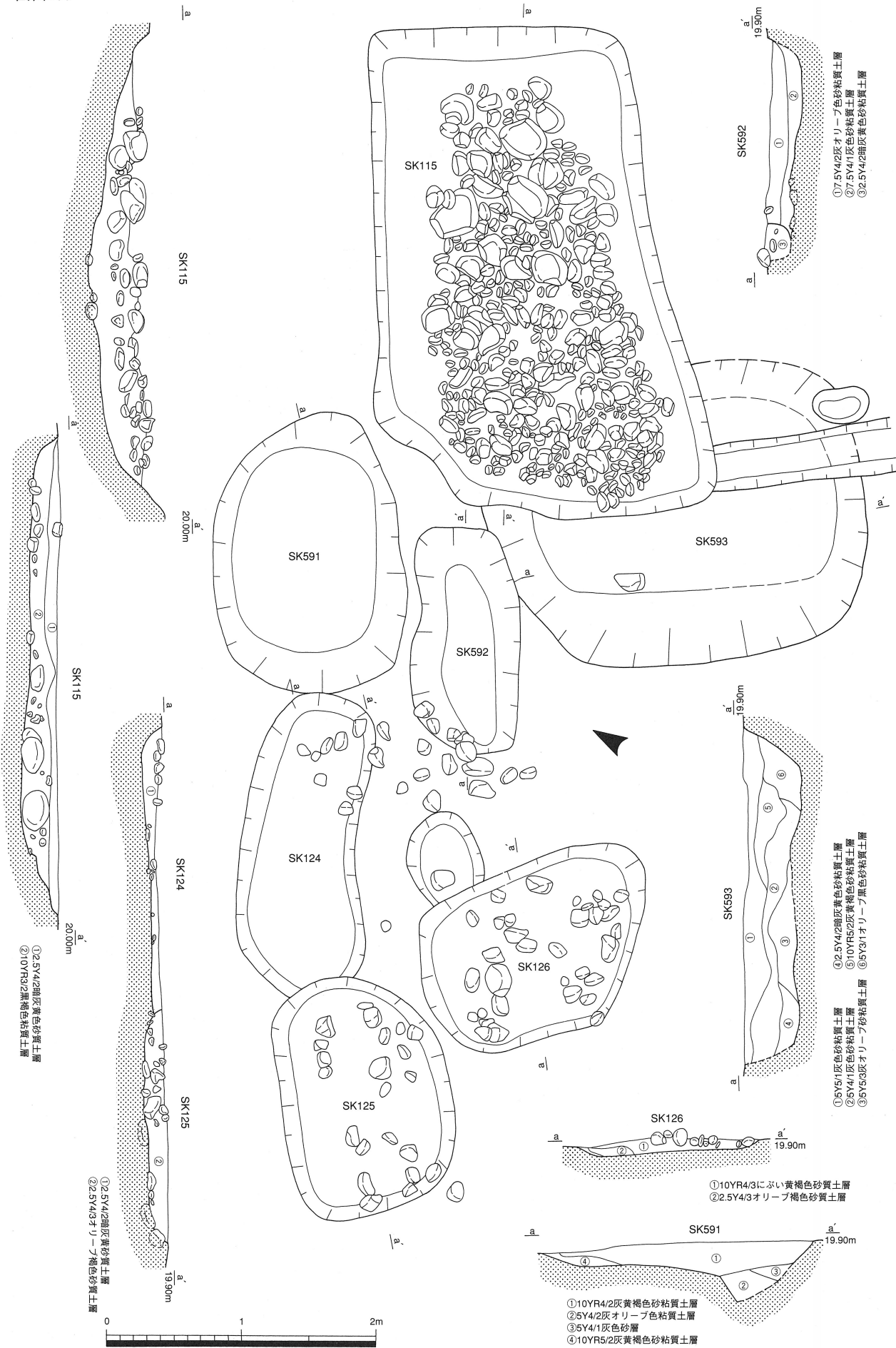

- ① 07 5Y4/2 灰オリブ色砂粘質土層
- ② 07 5Y4/1 灰色砂粘質土層
- ③ 2.5Y4/2 暗灰黄色砂粘質土層

- ① 5Y6/1 灰色砂粘質土層
- ② 5Y4/1 灰色砂粘質土層
- ③ 6Y5/3 灰オリブ砂粘質土層
- ④ 2.5Y4/2 暗灰黄色砂粘質土層
- ⑤ 10YR5/2 灰黄褐色砂粘質土層
- ⑥ 6Y3/1 灰オリブ黑色砂粘質土層

- ① 10YR4/3 にぶい黄褐色砂質土層
- ② 2.5Y4/3 オリーブ褐色砂質土層

- ① 10YR4/2 灰黄褐色砂粘質土層
- ② 5Y4/2 灰オリブ色粘質土層
- ③ 5Y4/1 灰色砂層
- ④ 10YR5/2 灰黄褐色砂粘質土層

A地区土坑実測図(15)

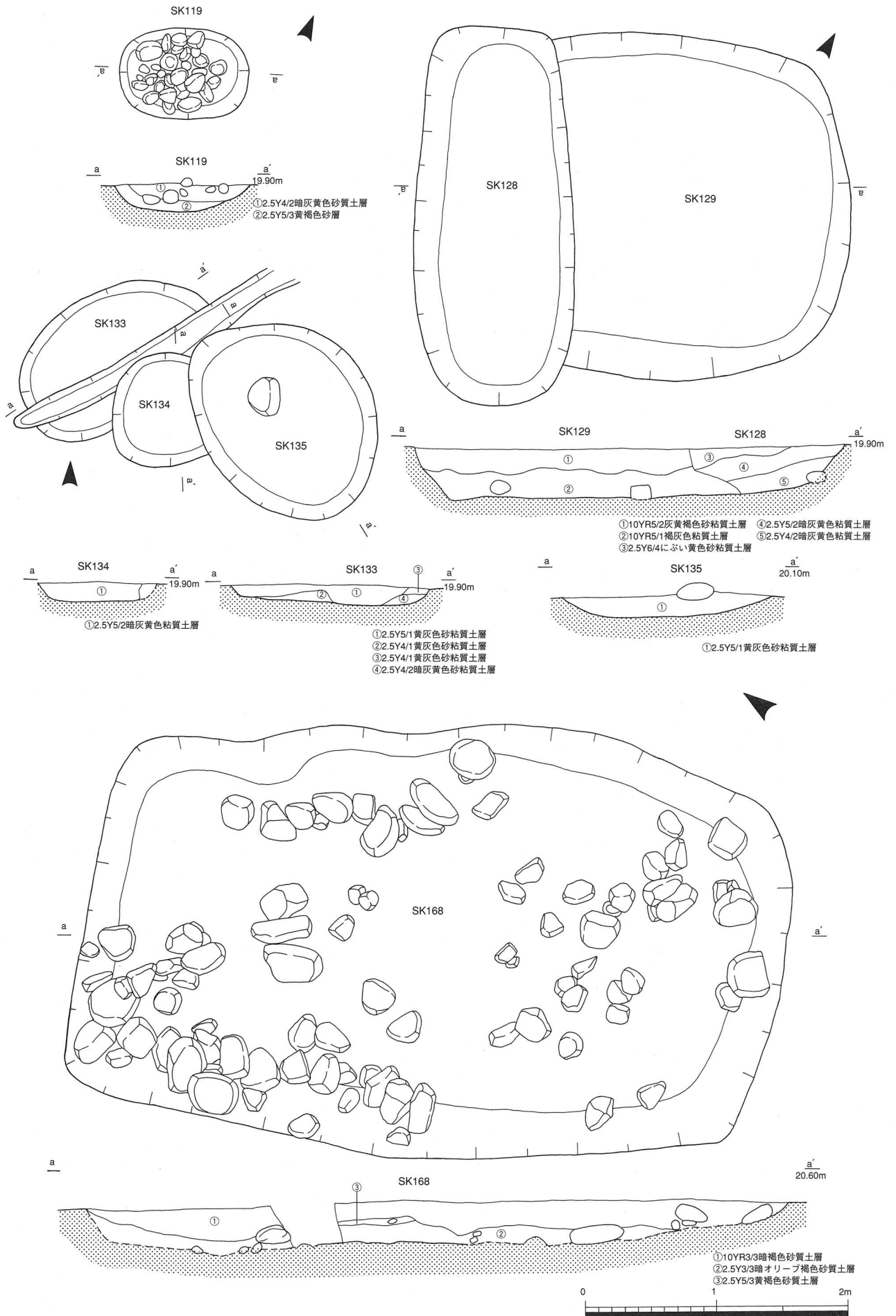

A地区土坑実測図 (16)

図面110

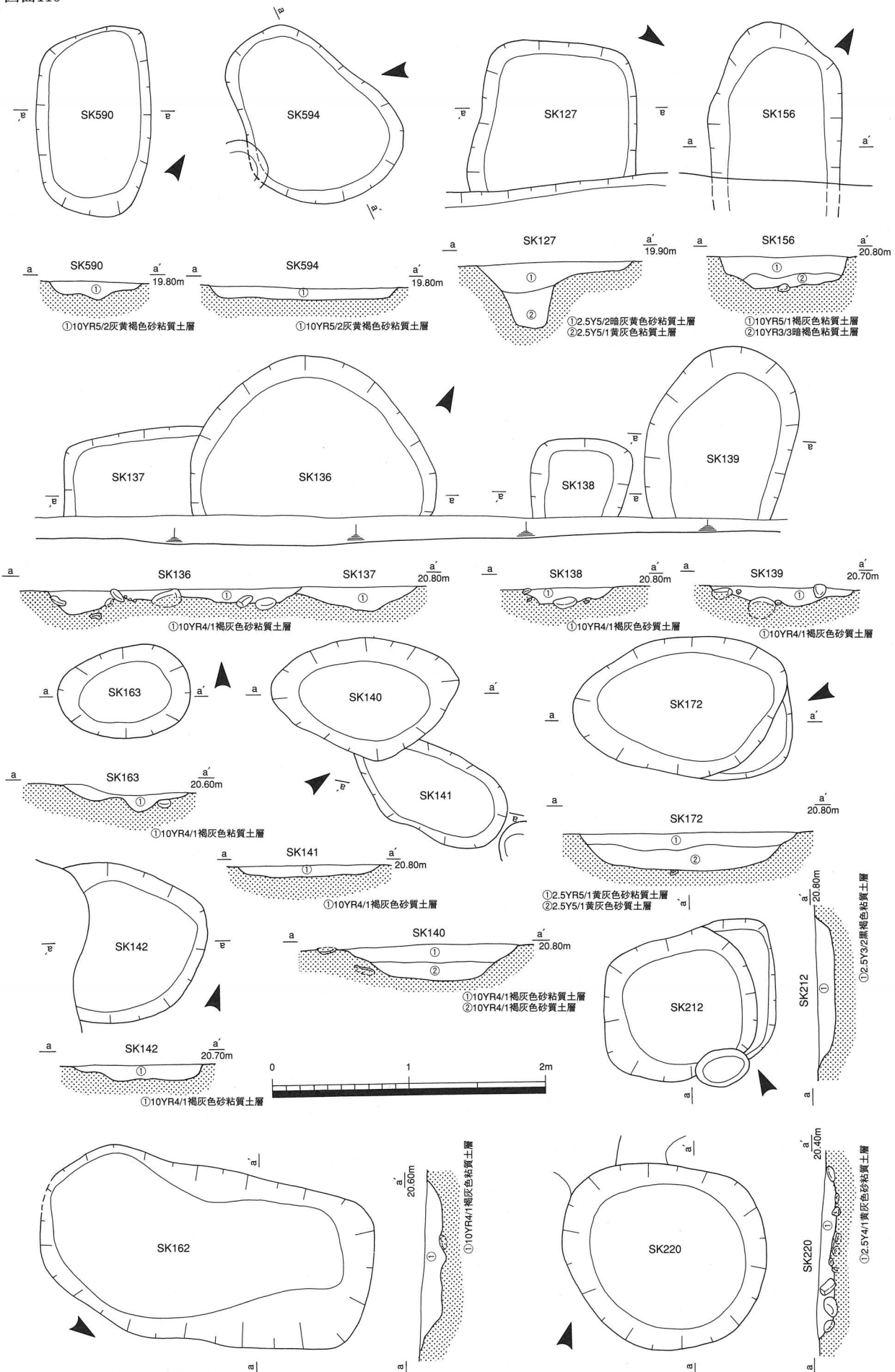

A地区土坑実測図(17)

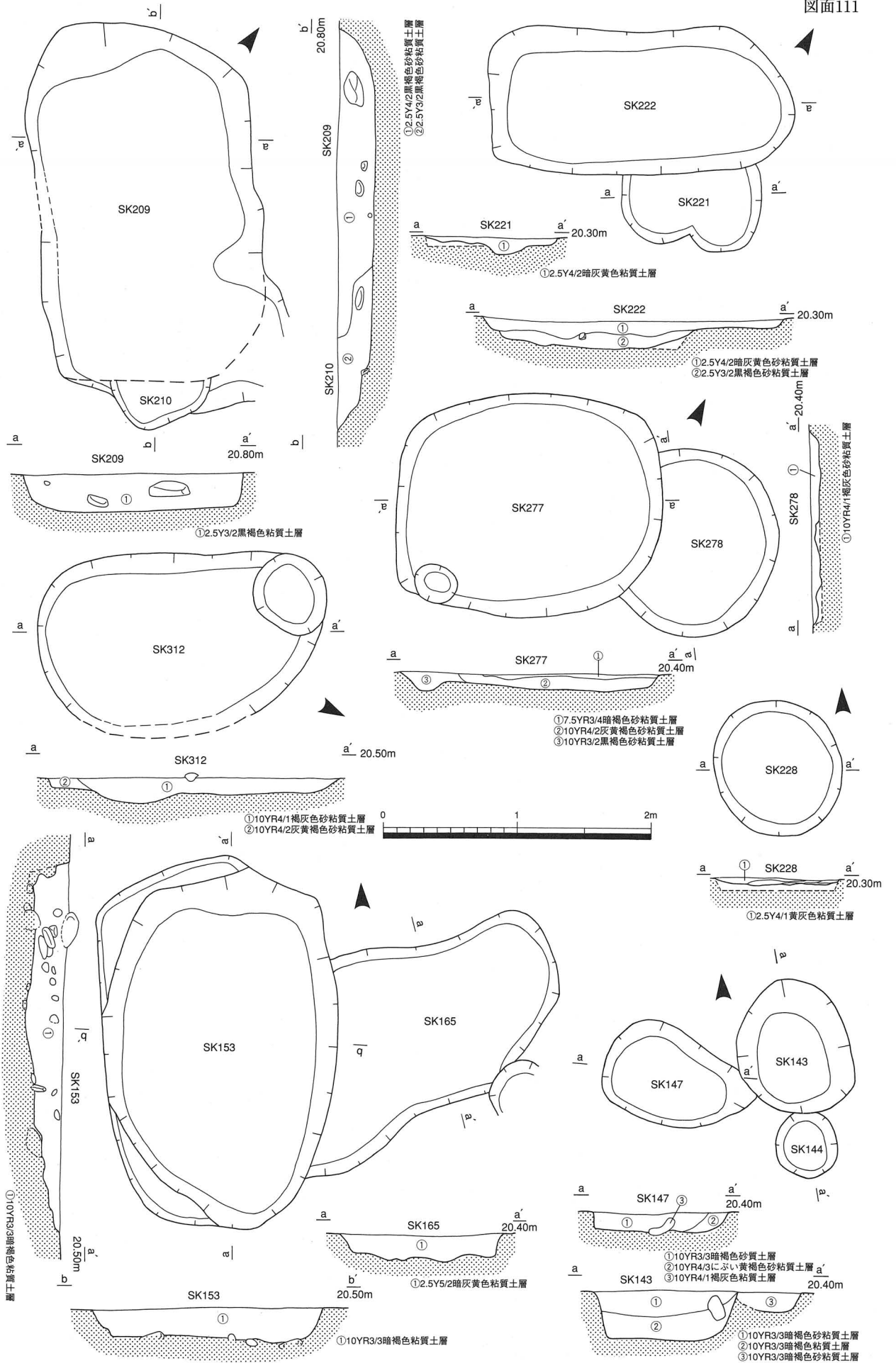

A地区土坑実測図(18)

図面112

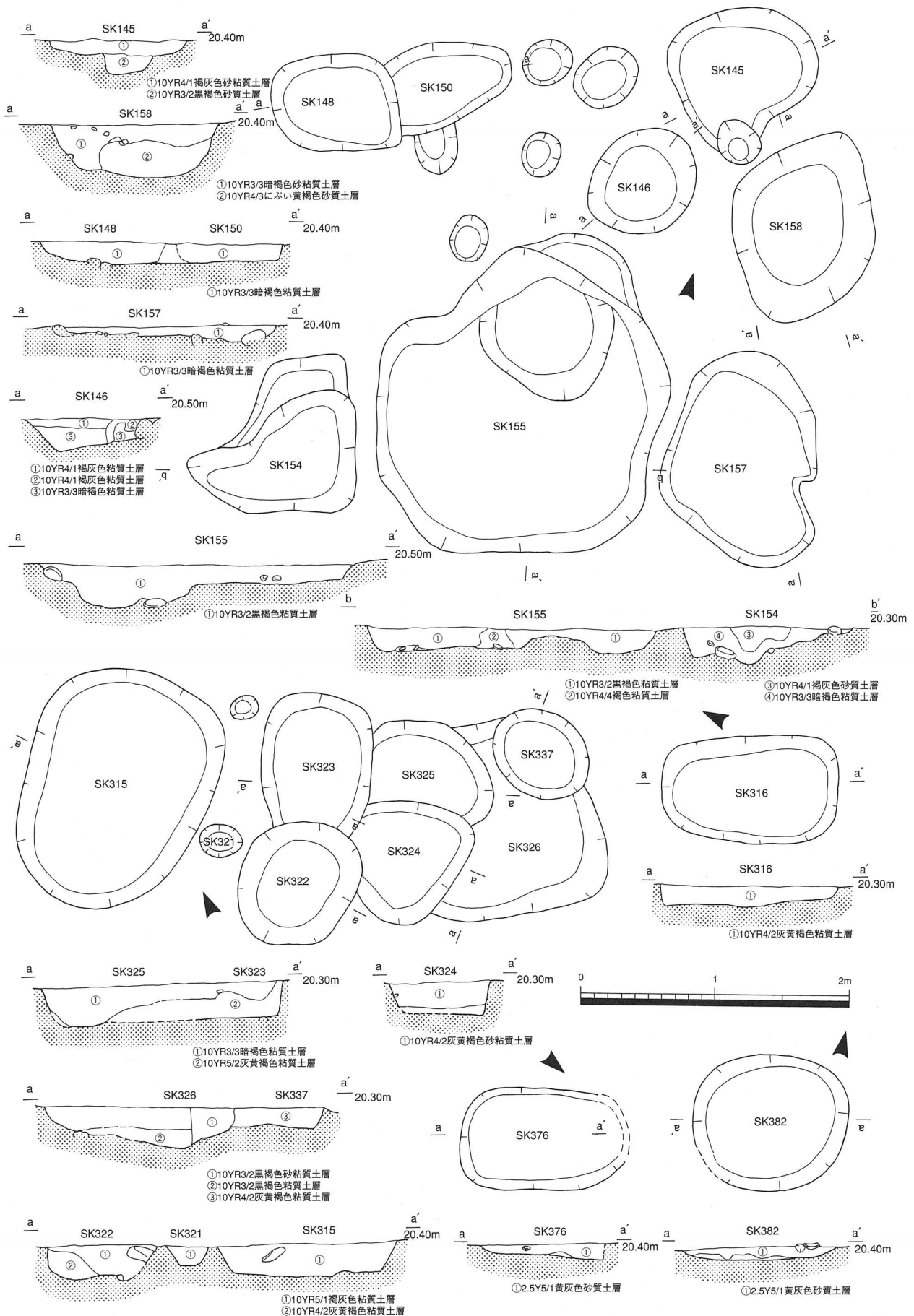

A地区土坑実測図(19)

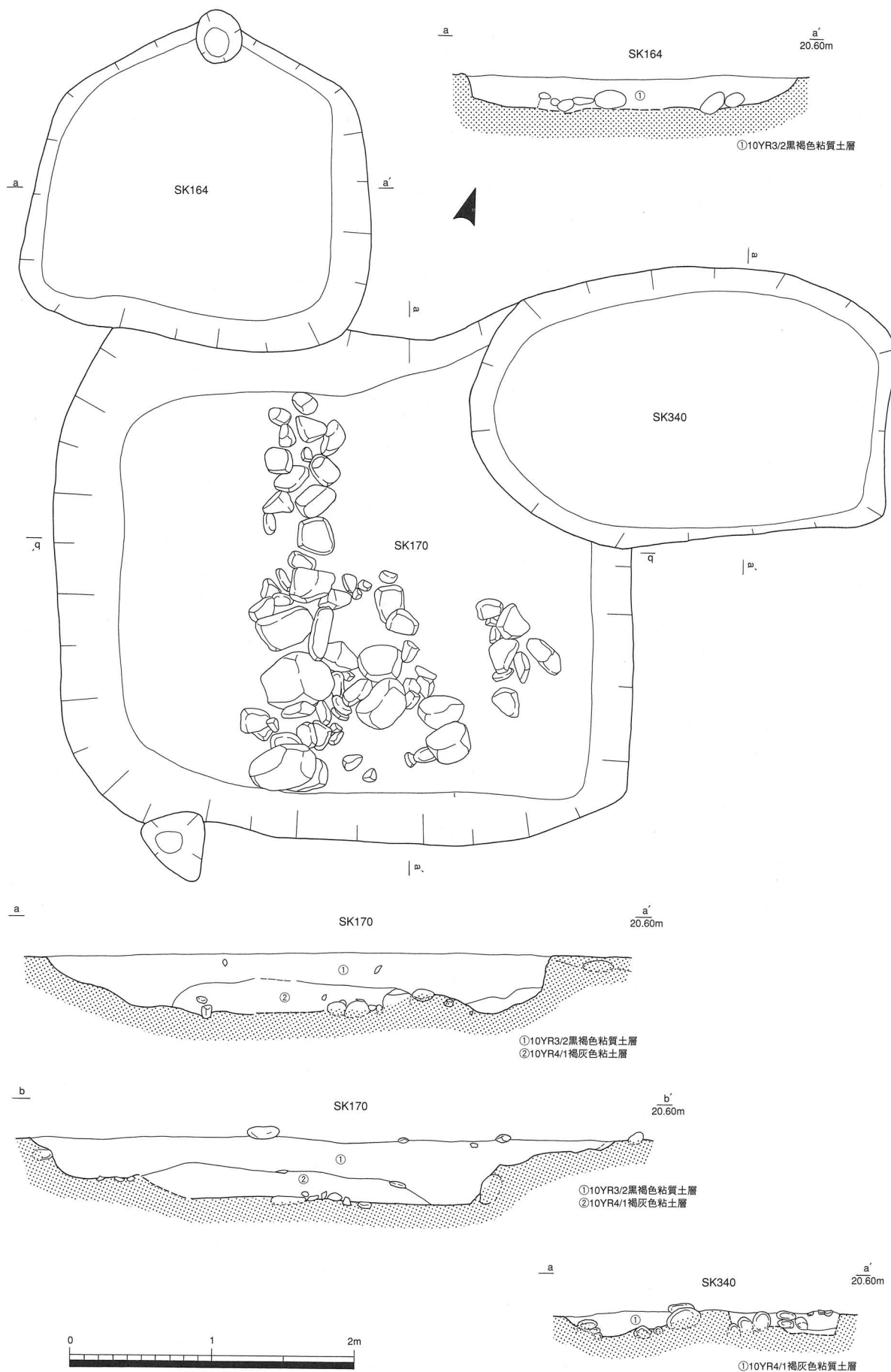

A地区土坑実測図 (20)



図面114

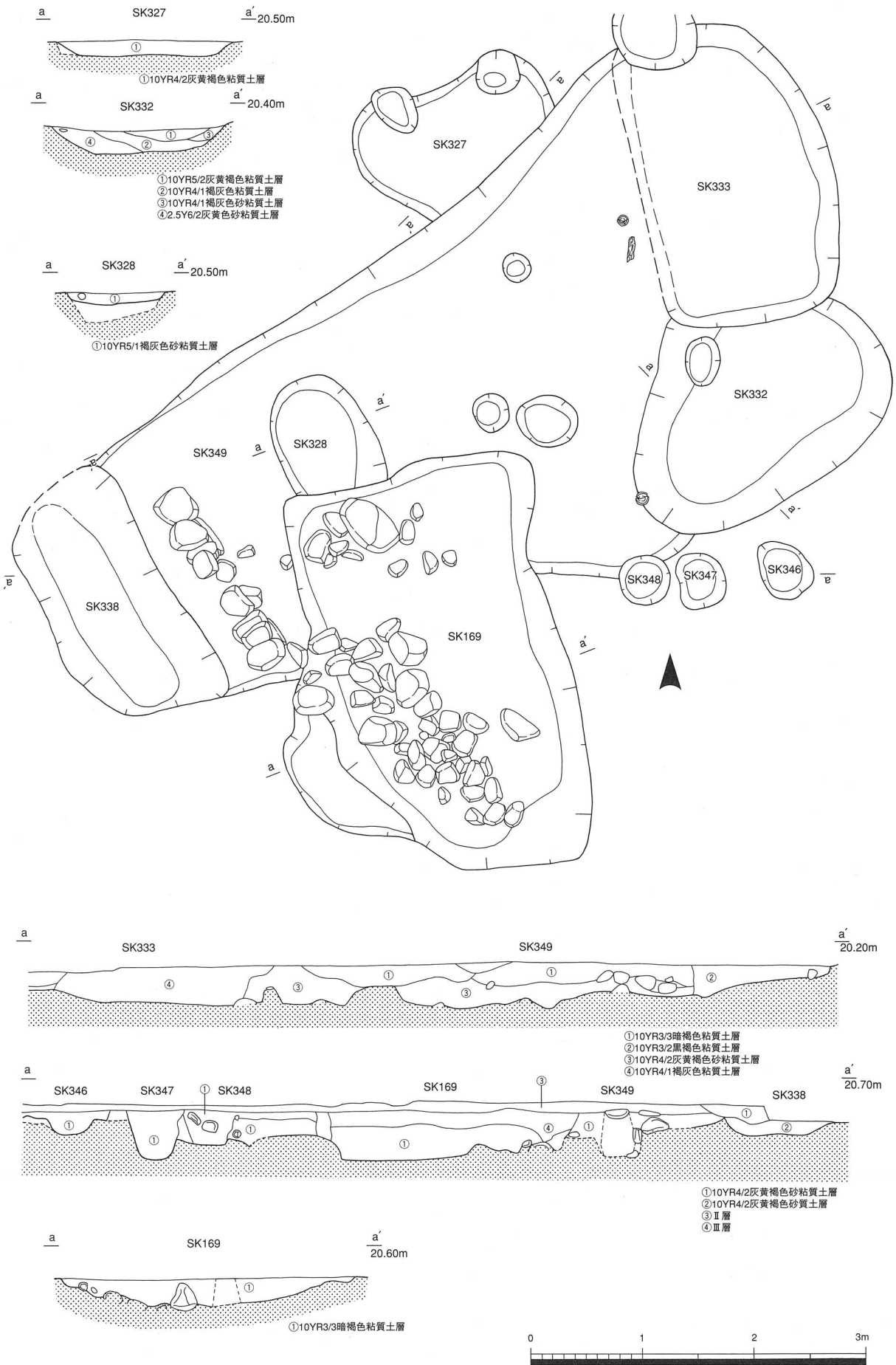

A地区土坑実測図(21)

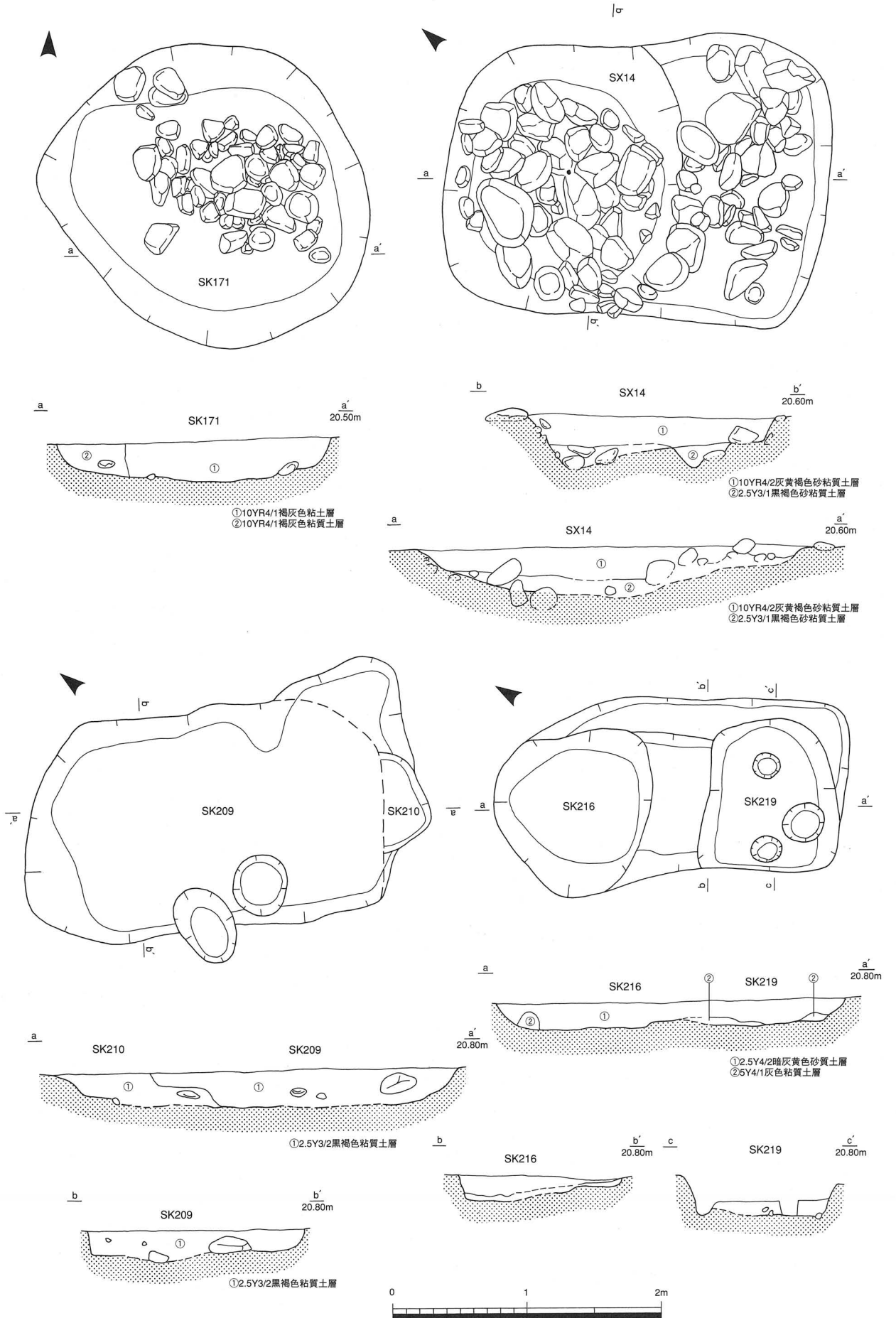

A地区土坑実測図(22)

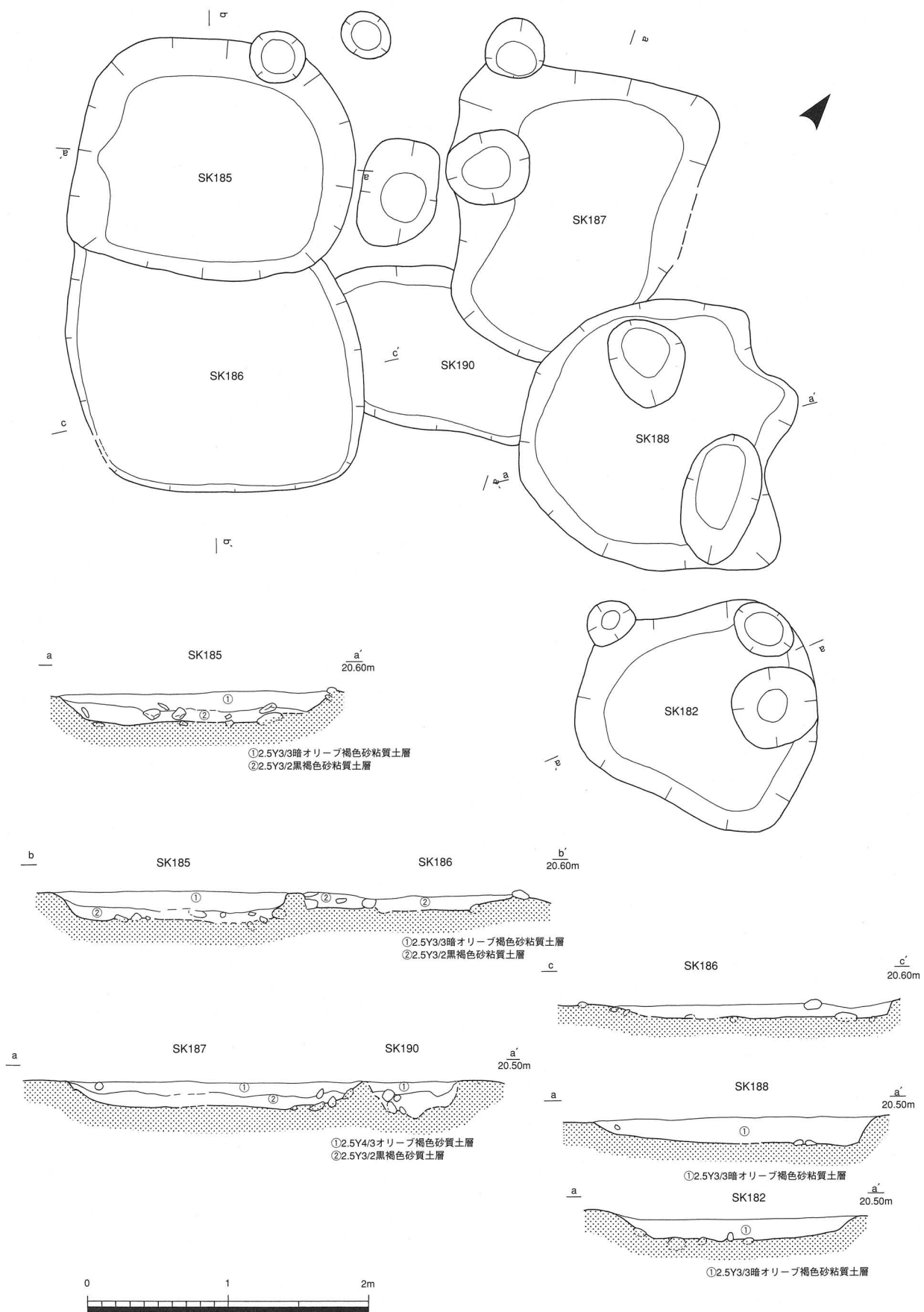

A地区土坑実測図 (23)

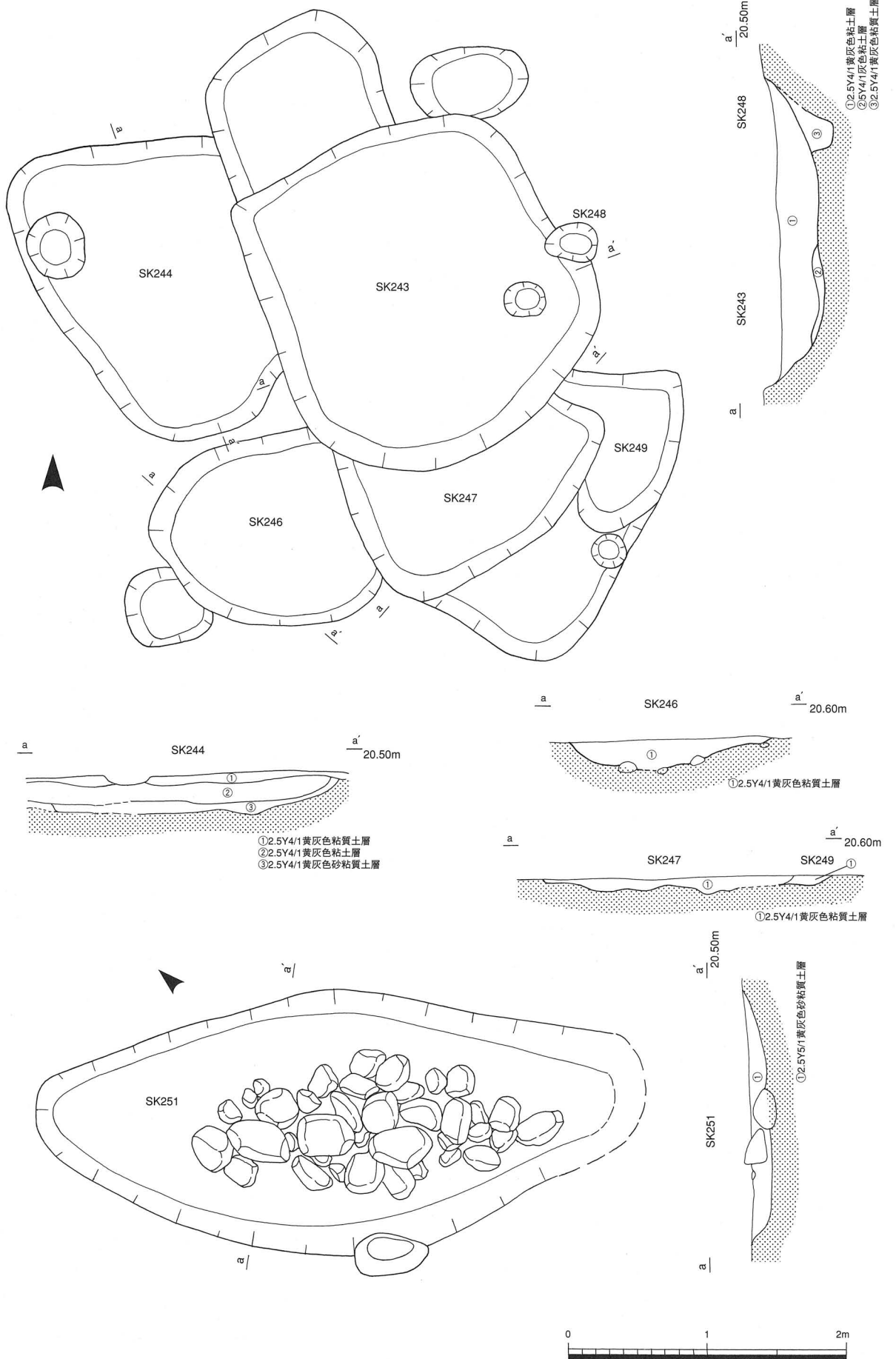

A地区土坑实测图(24)

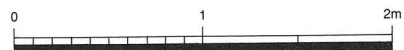
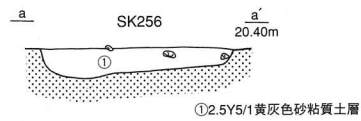
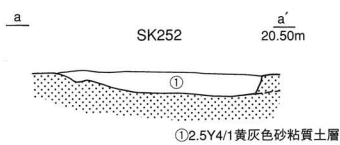
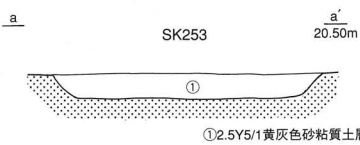
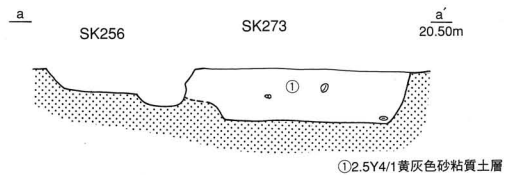
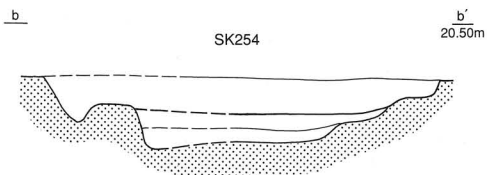
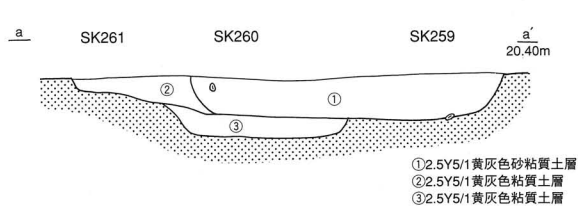
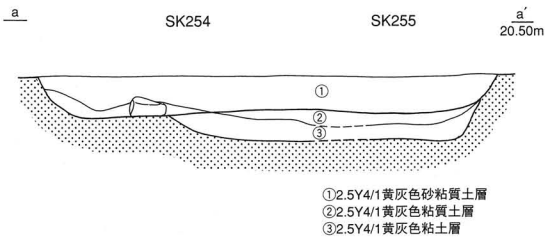
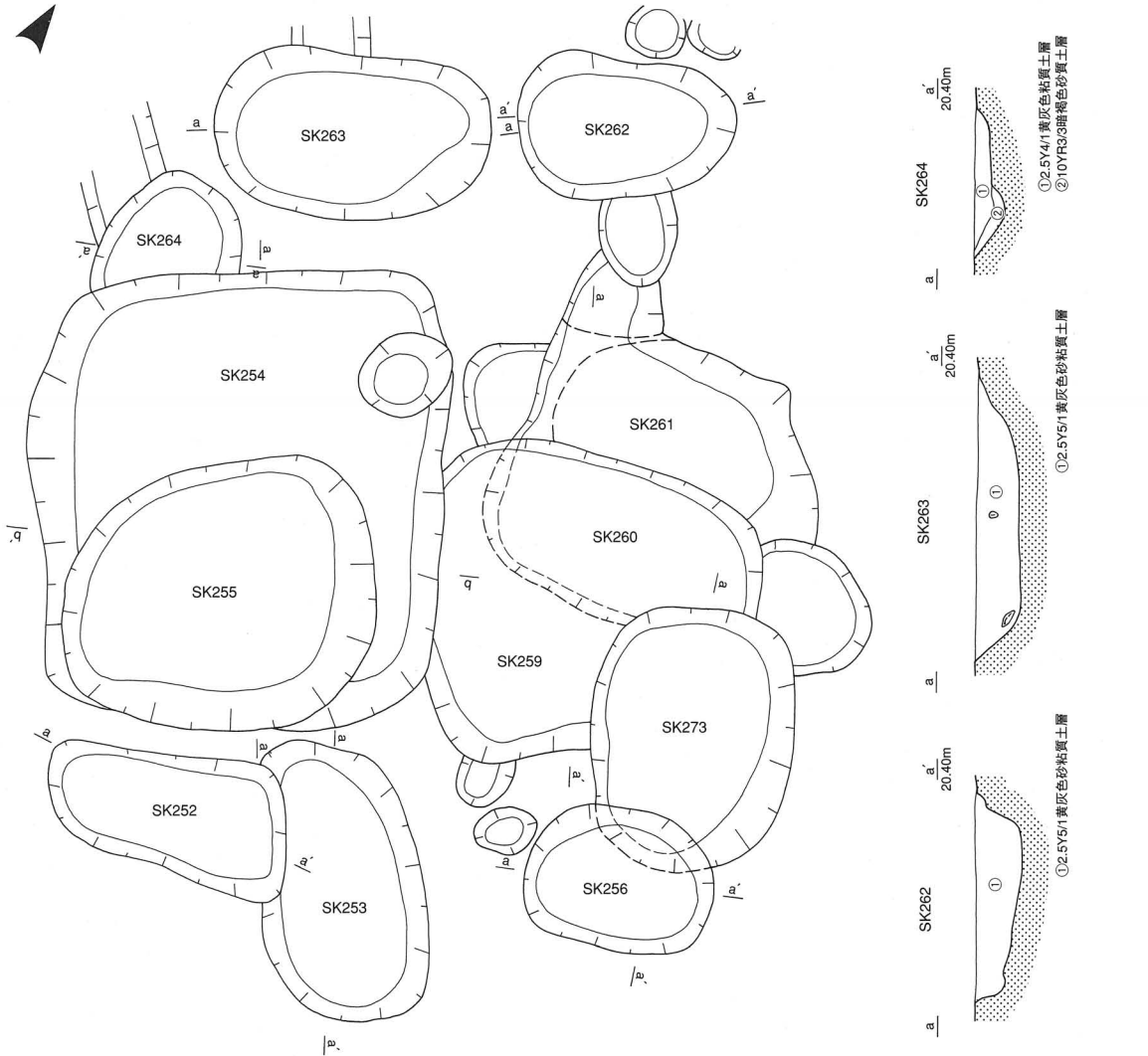

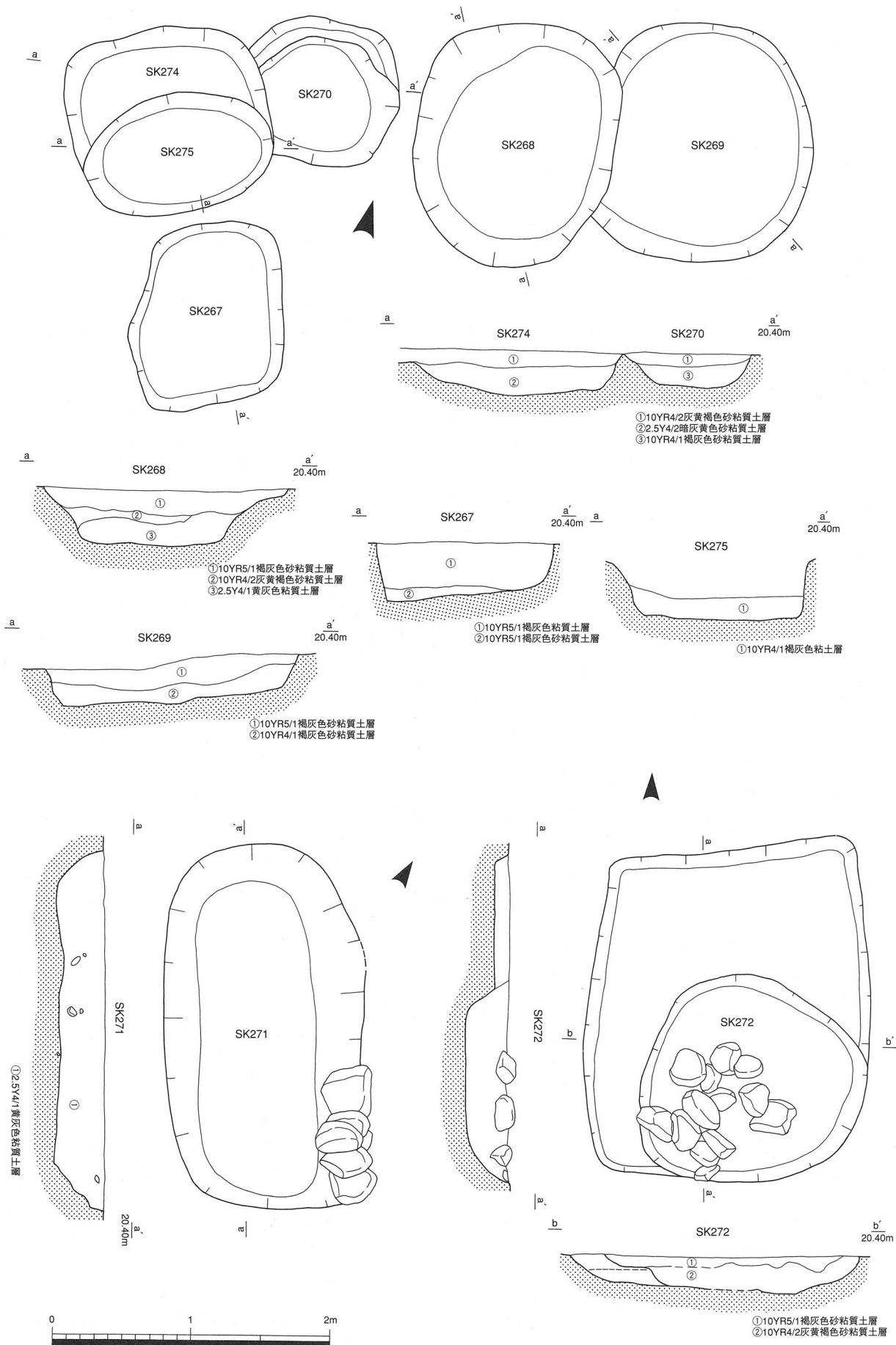

A地区土坑实测图(26)

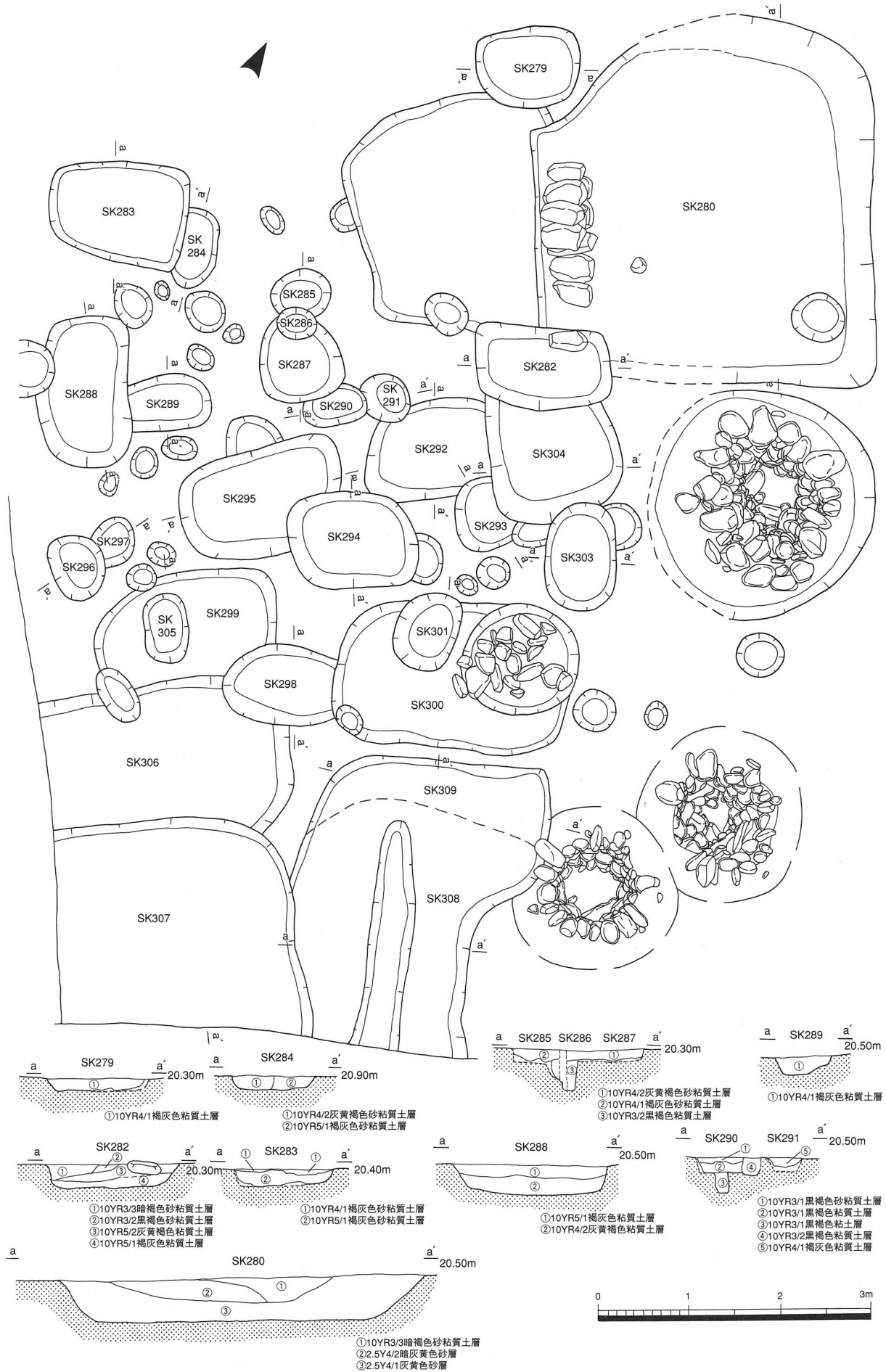

A地区土坑実測図(27)

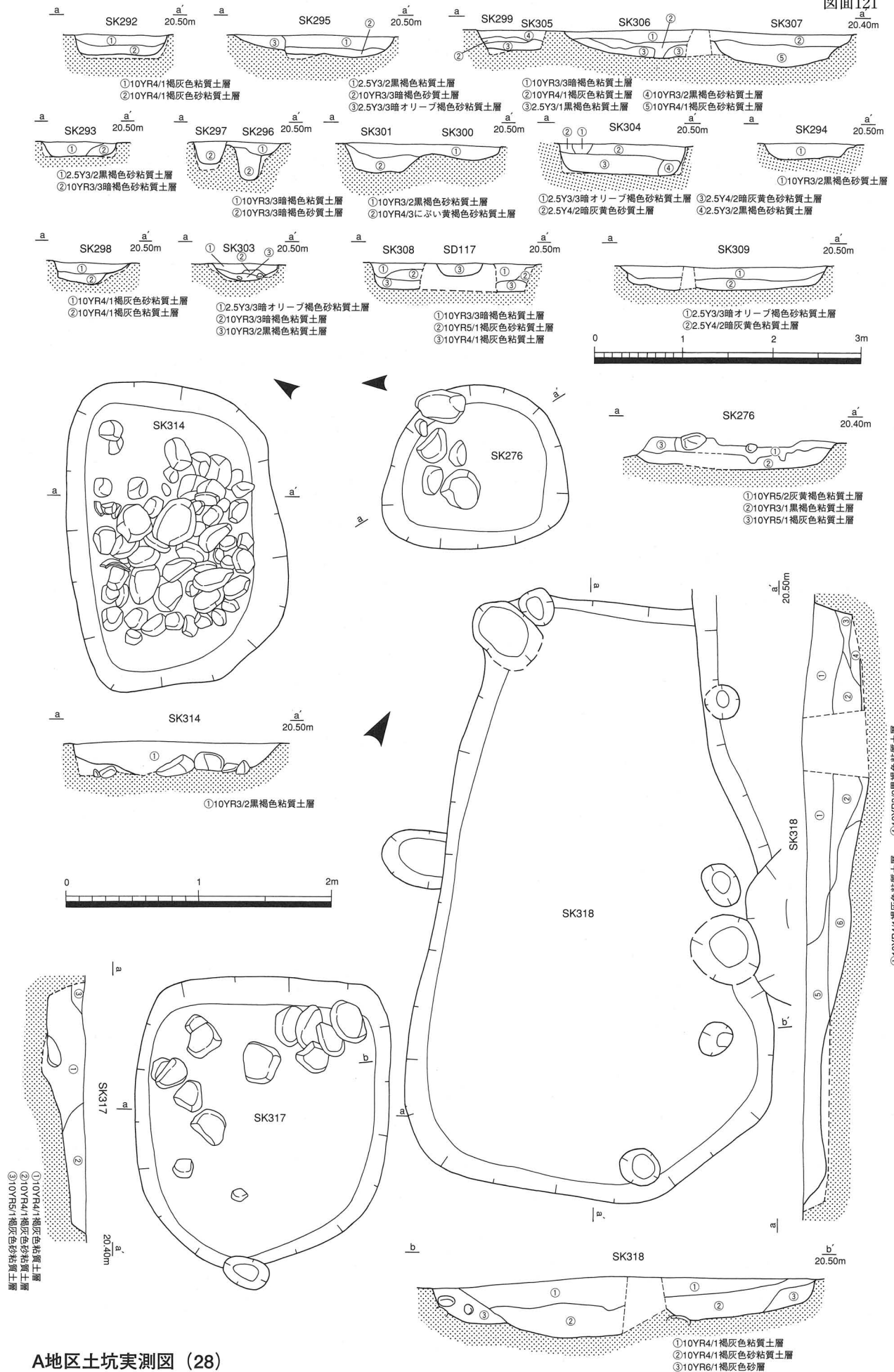

A地区土坑実測図 (28)



图面122

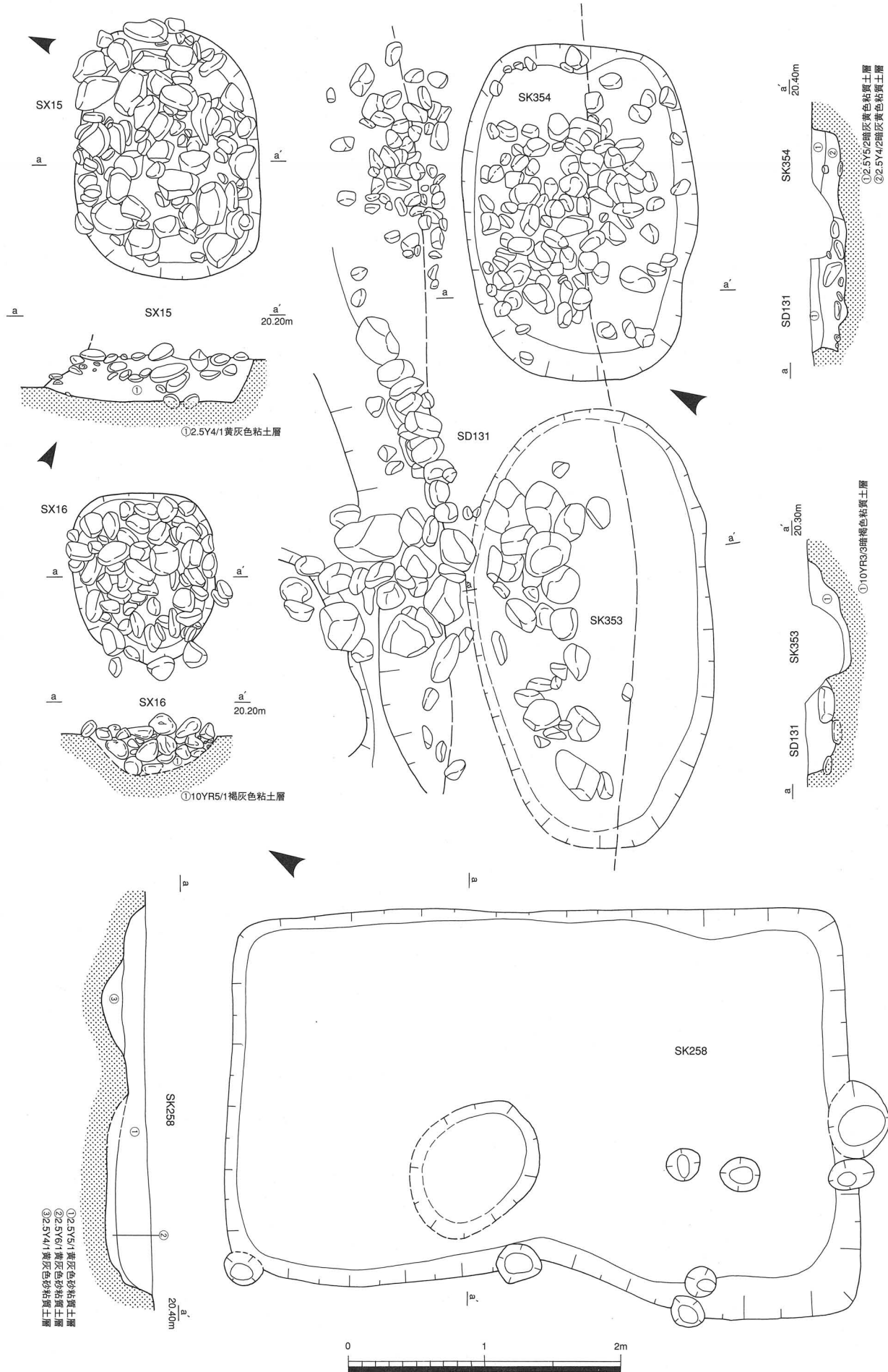

A地区土坑实测图(29)

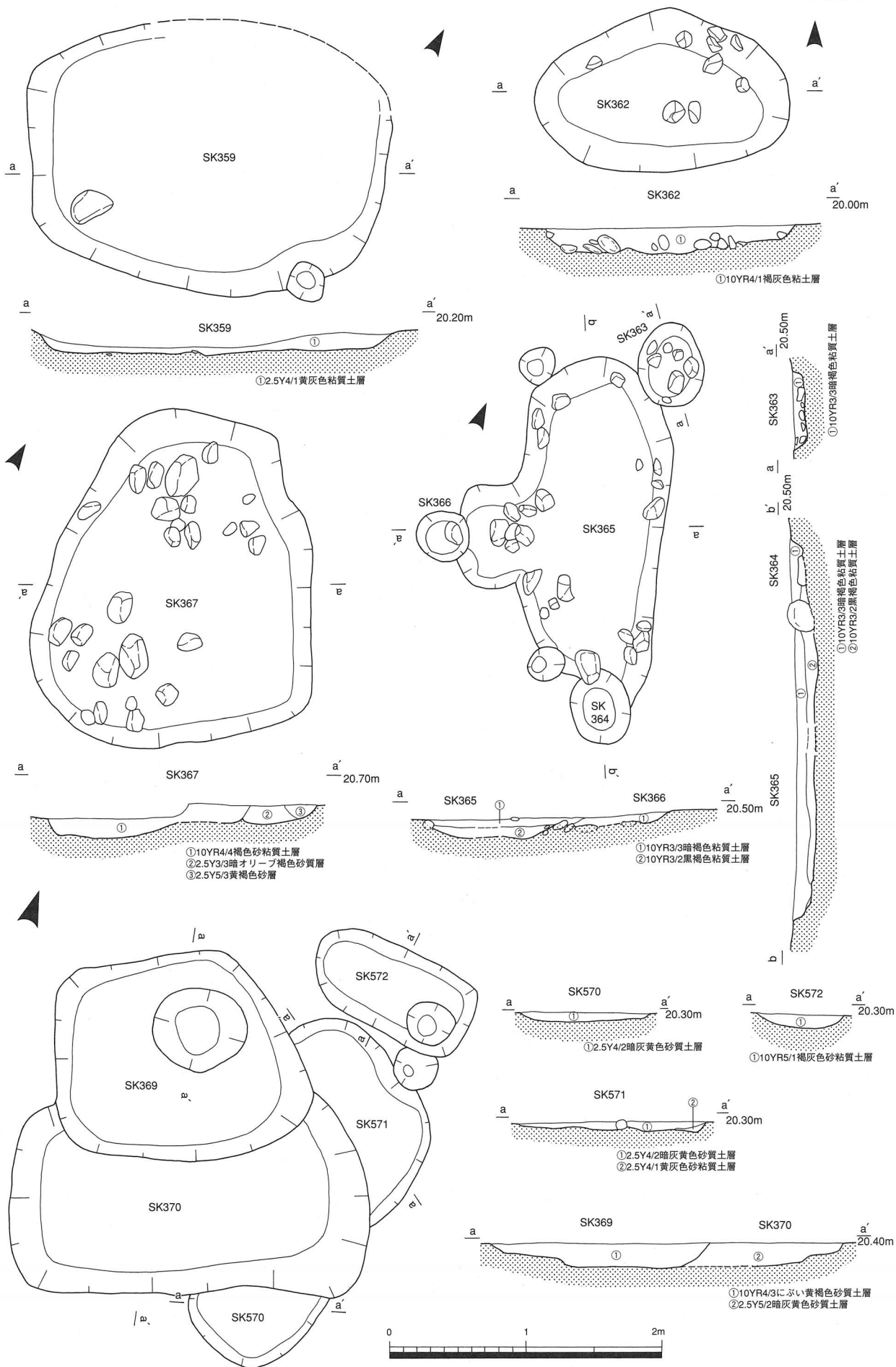

A地区土坑実測図 (30)



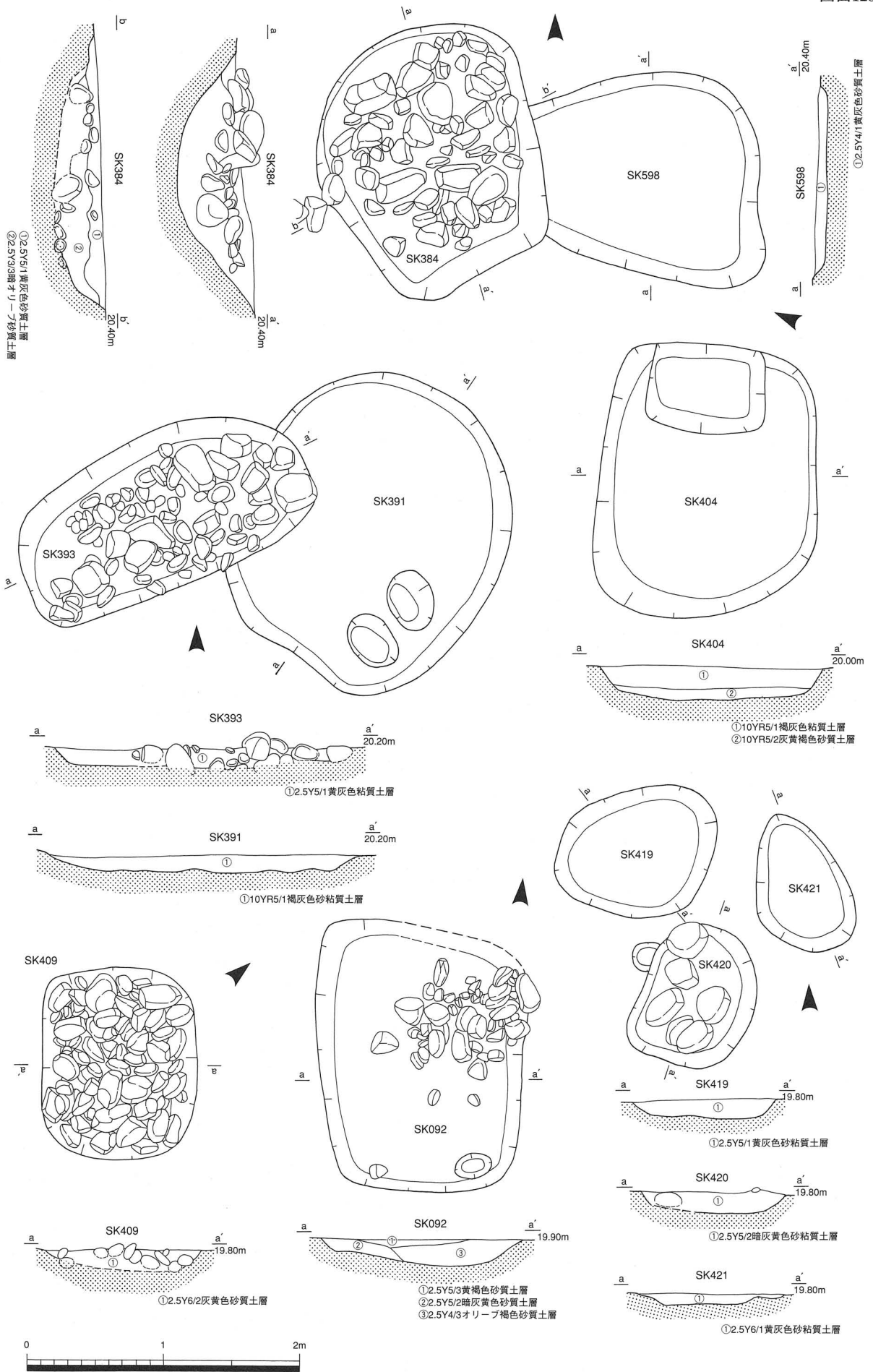

A地区土坑実測図(32)

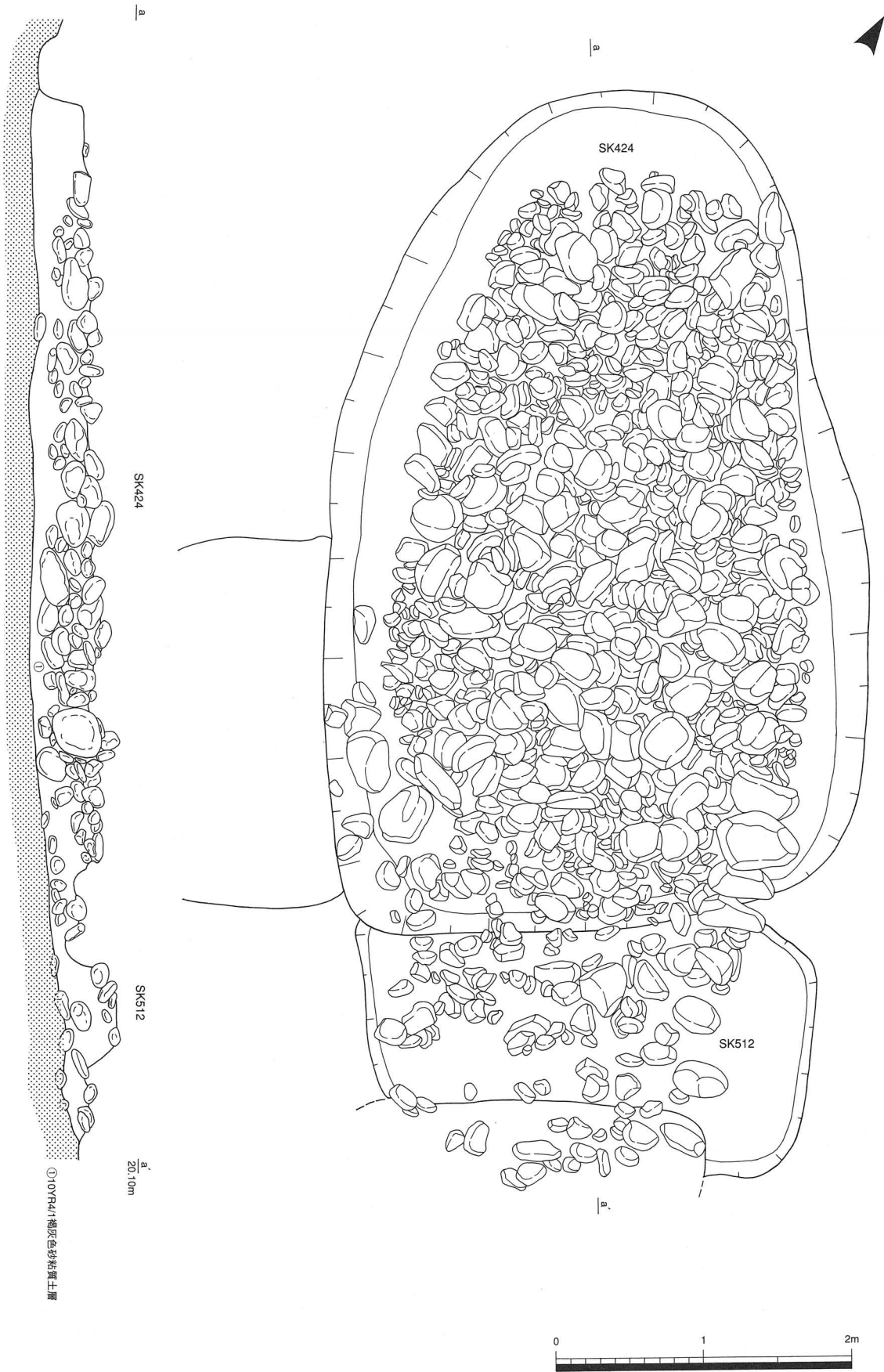

A地区土坑実測図 (33)

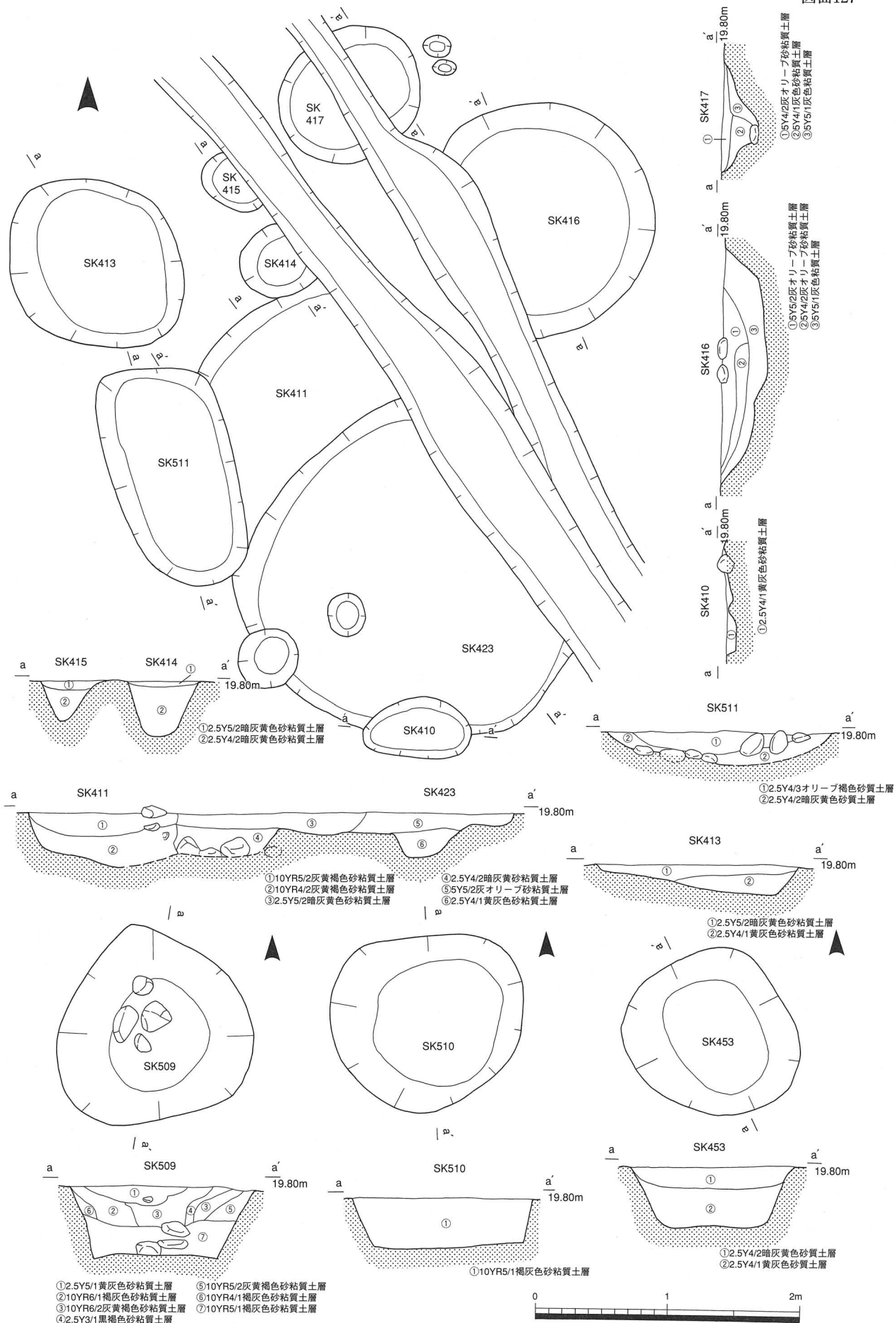

A地区土坑実測図 (34)

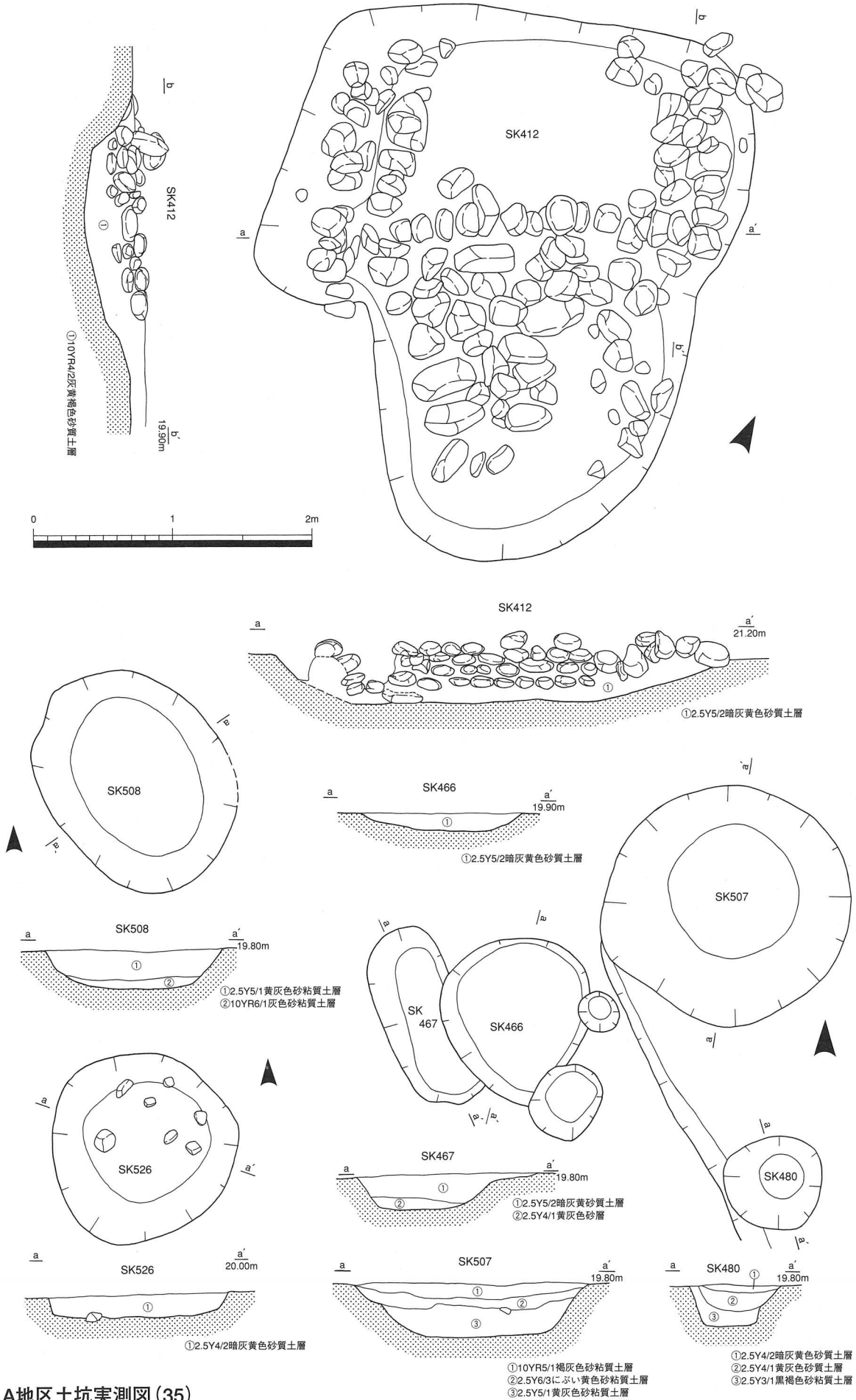

A地区土坑実測図 (35)



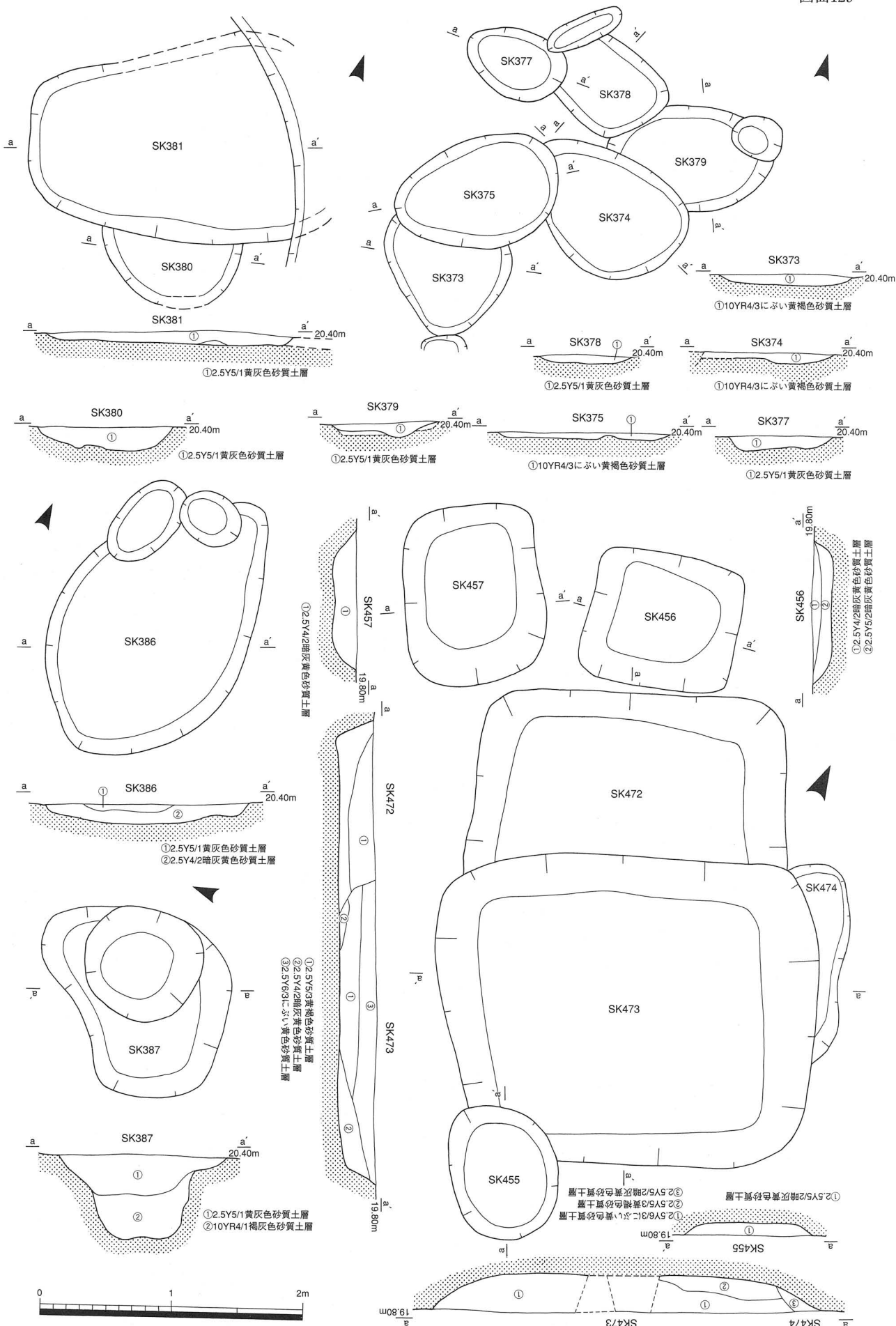

A地区土坑実測図(36)



图面130

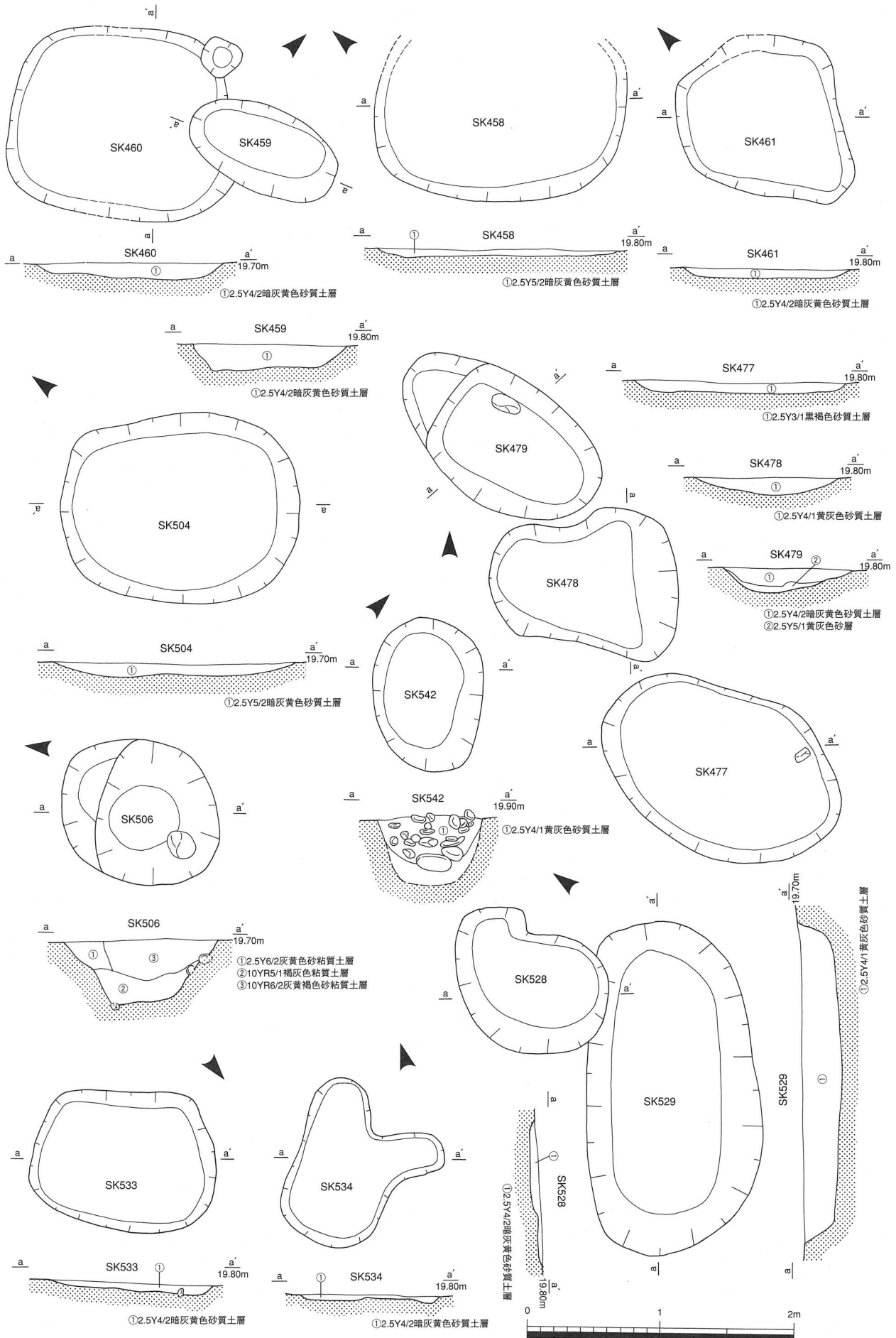

A地区土坑実測図(37)

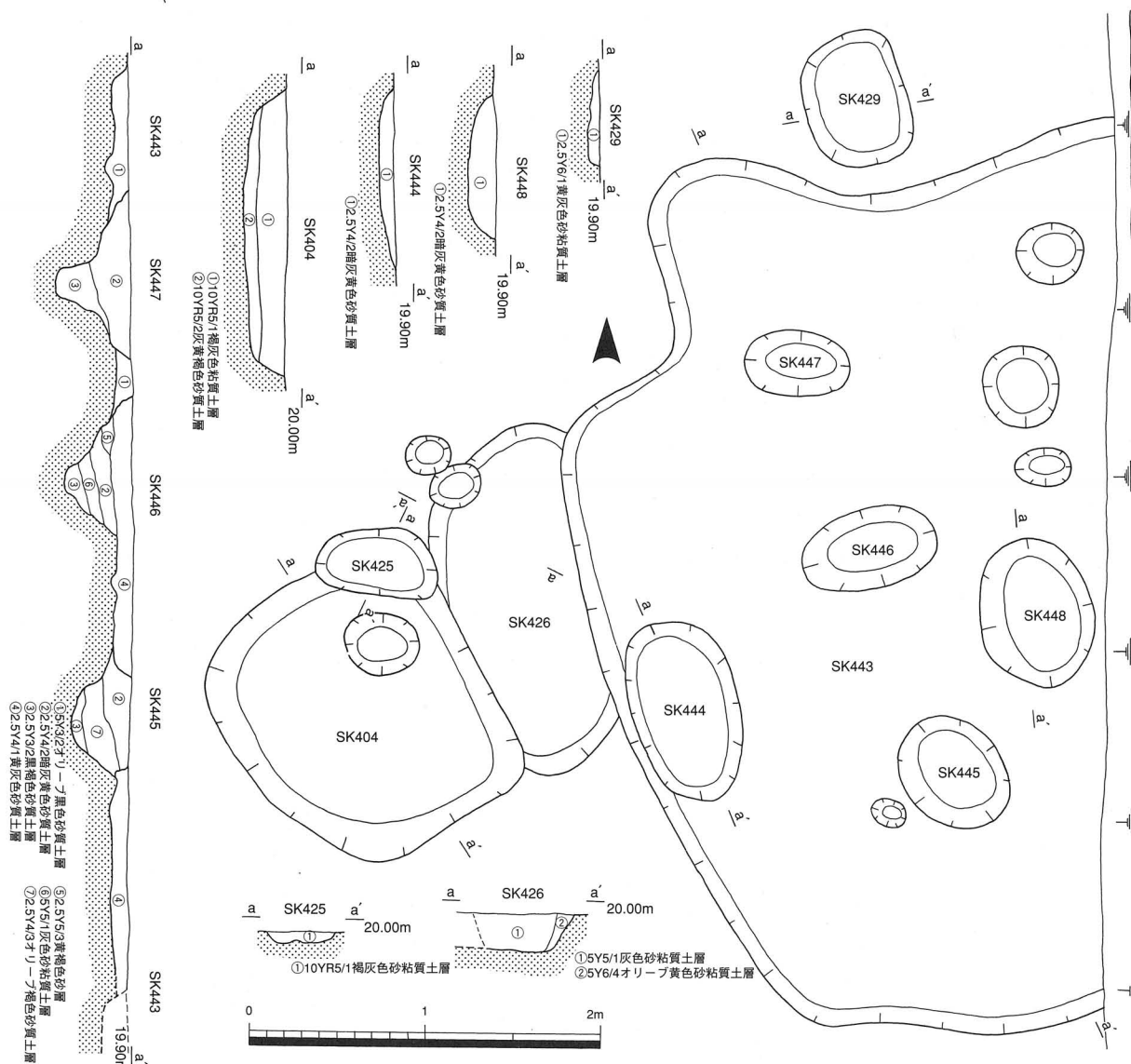
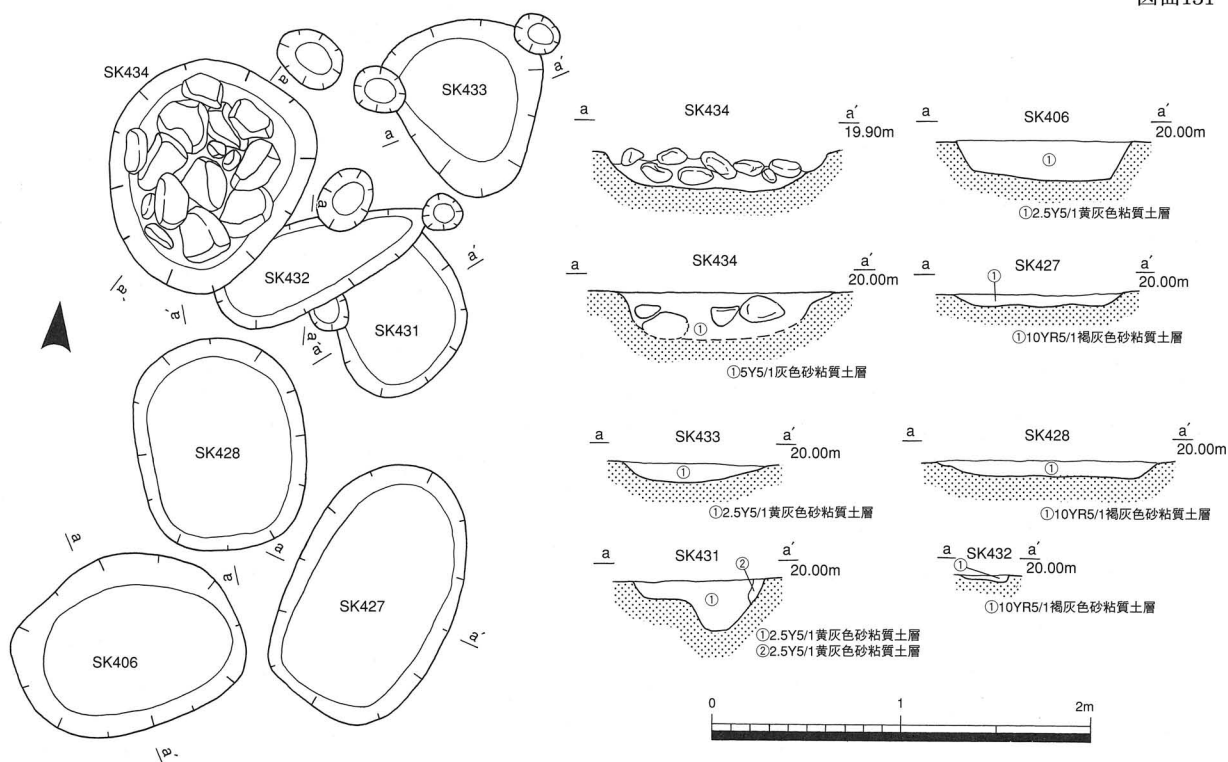

A地区土坑実測図(38)



A地区土坑実測図(39)

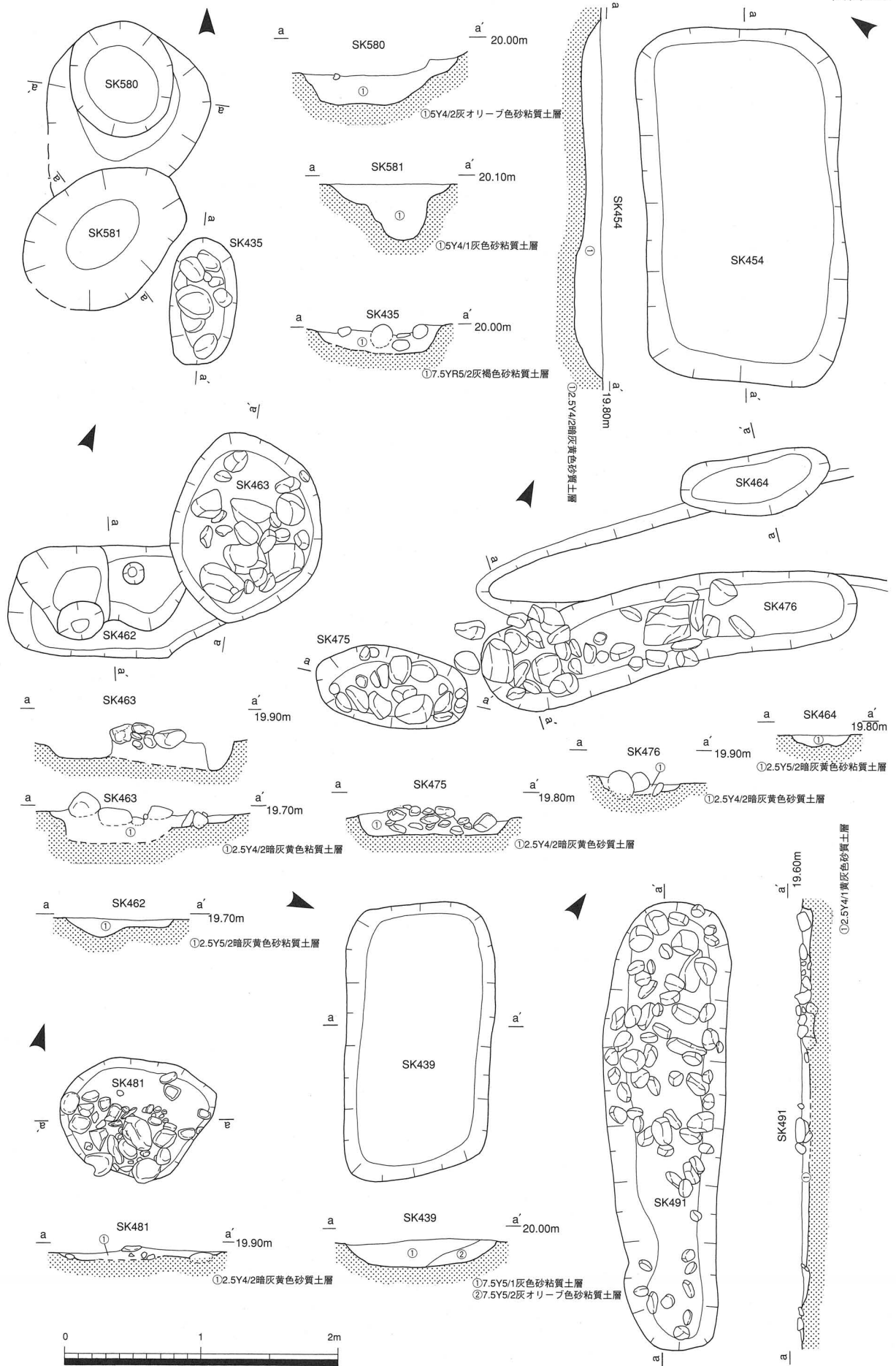

A地区土坑実測図 (40)

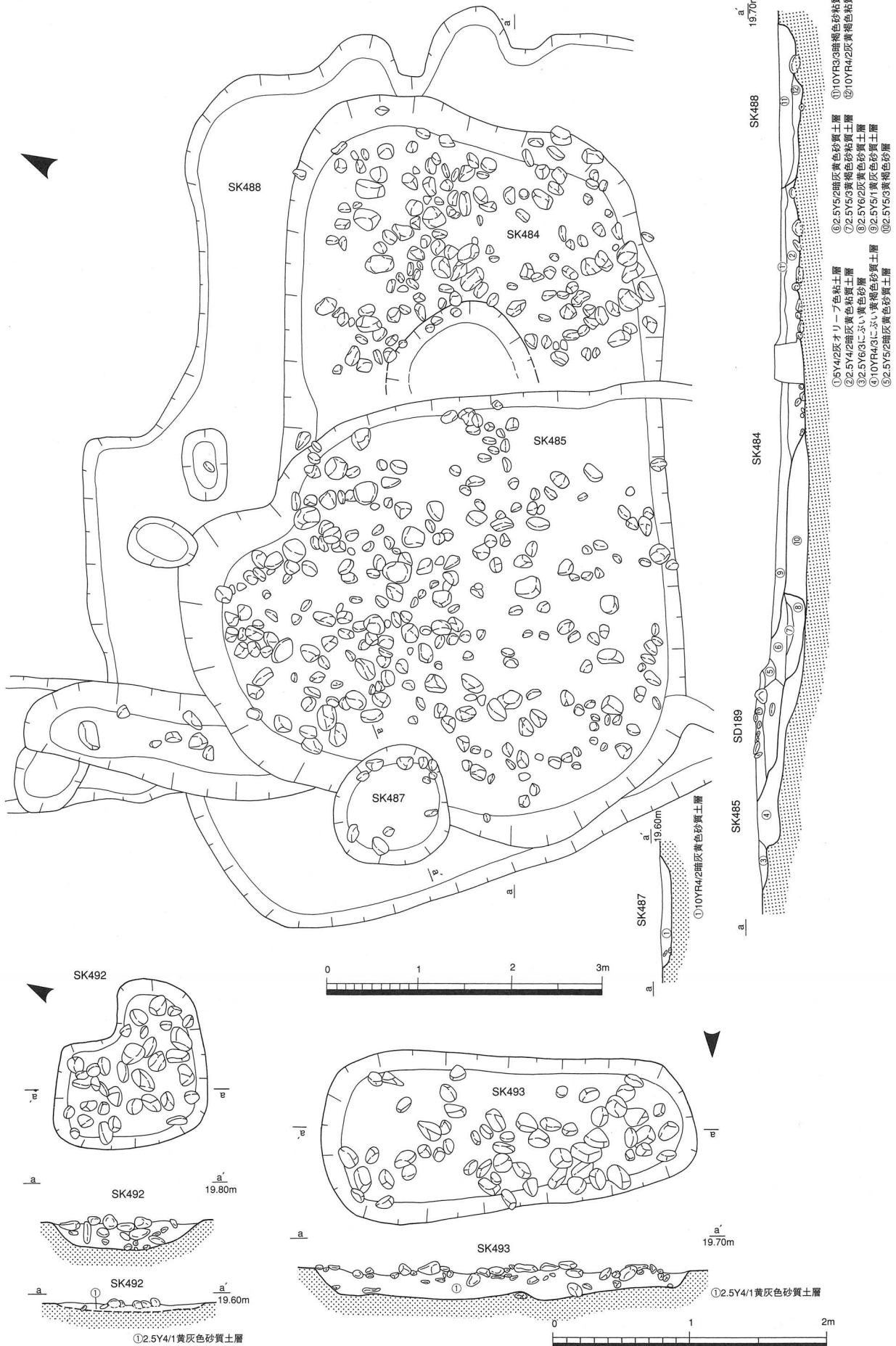

A地区土坑実測図(41)

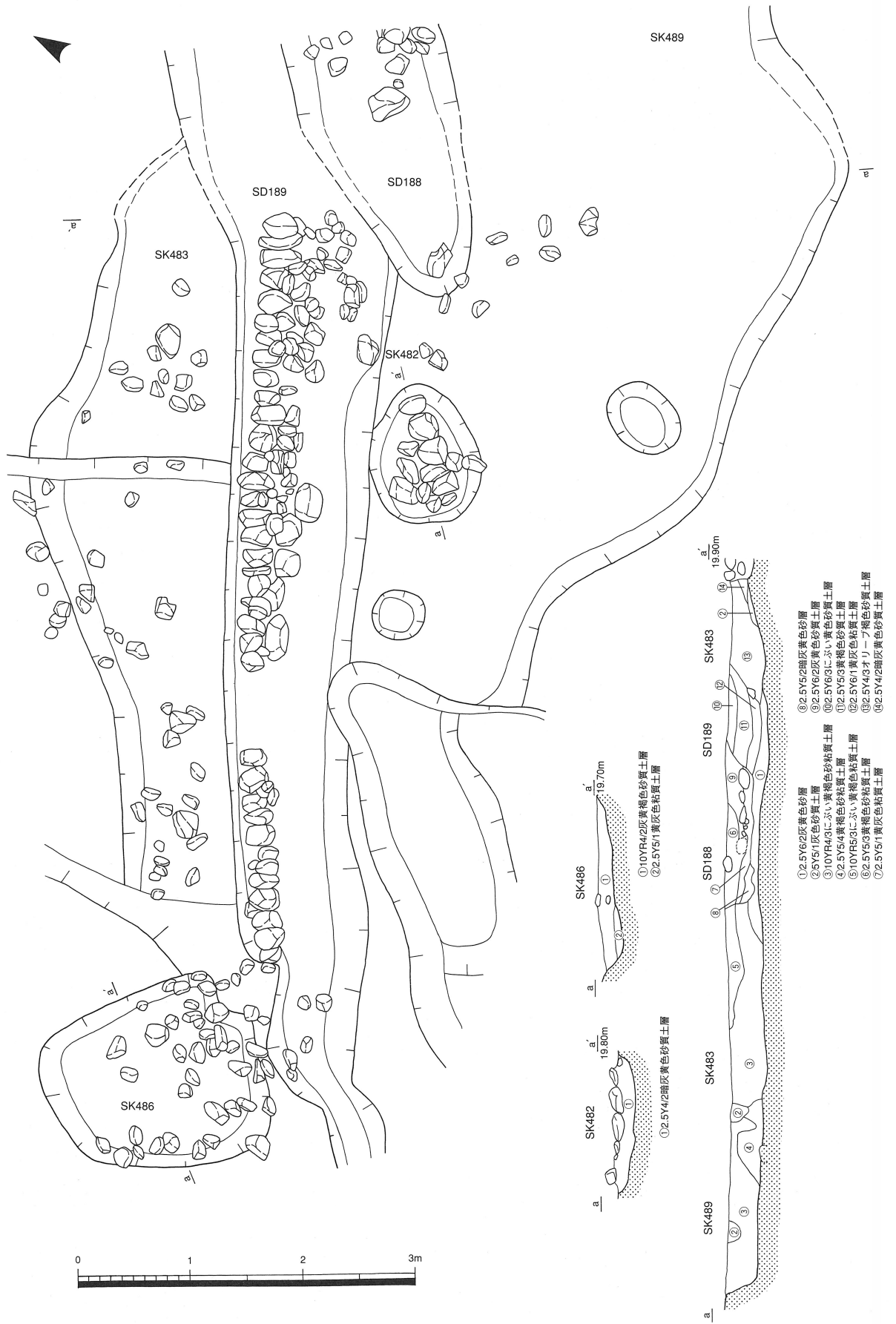

A地区土坑実測図 (42)

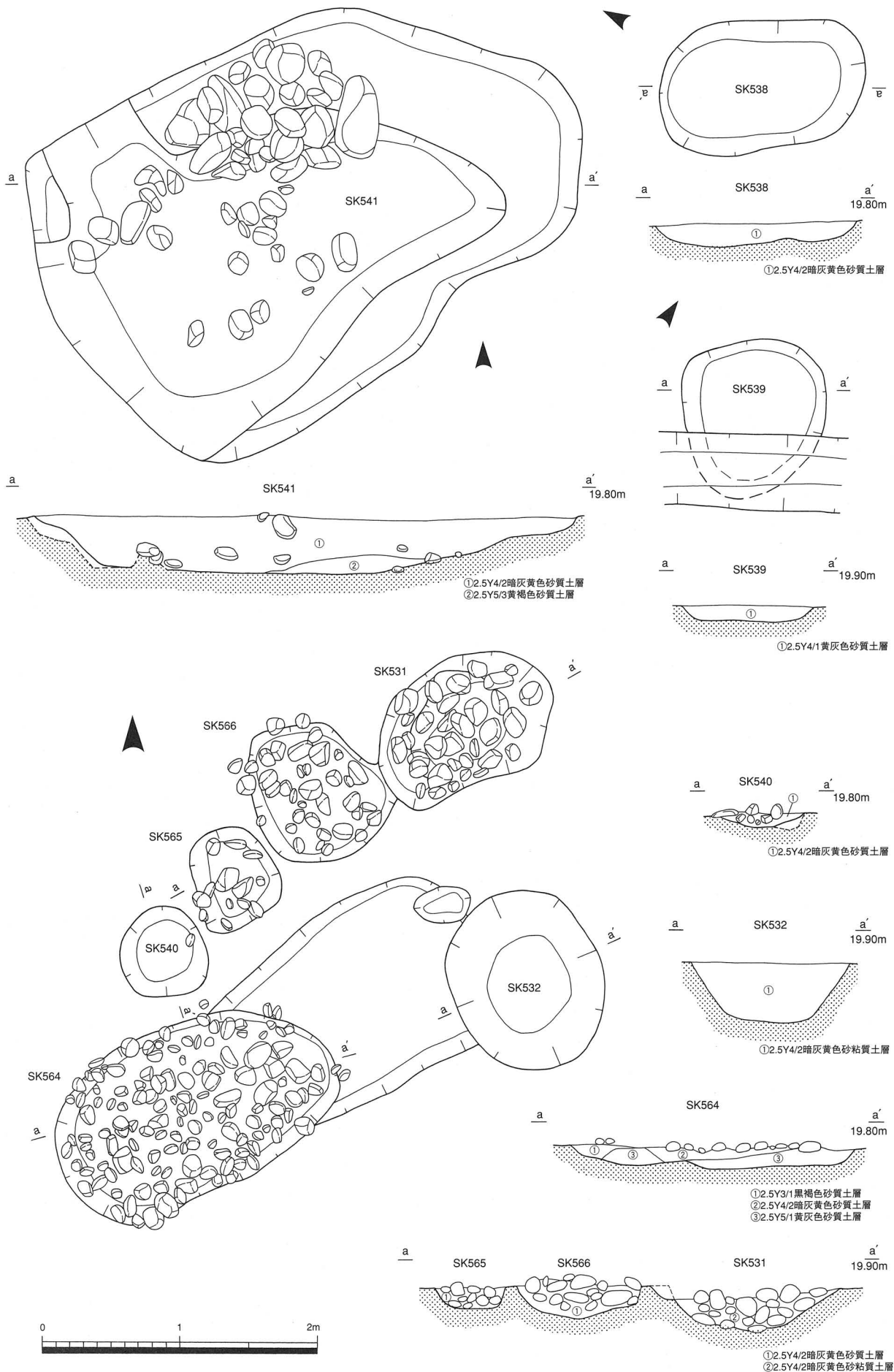

A地区土坑実測図(43)

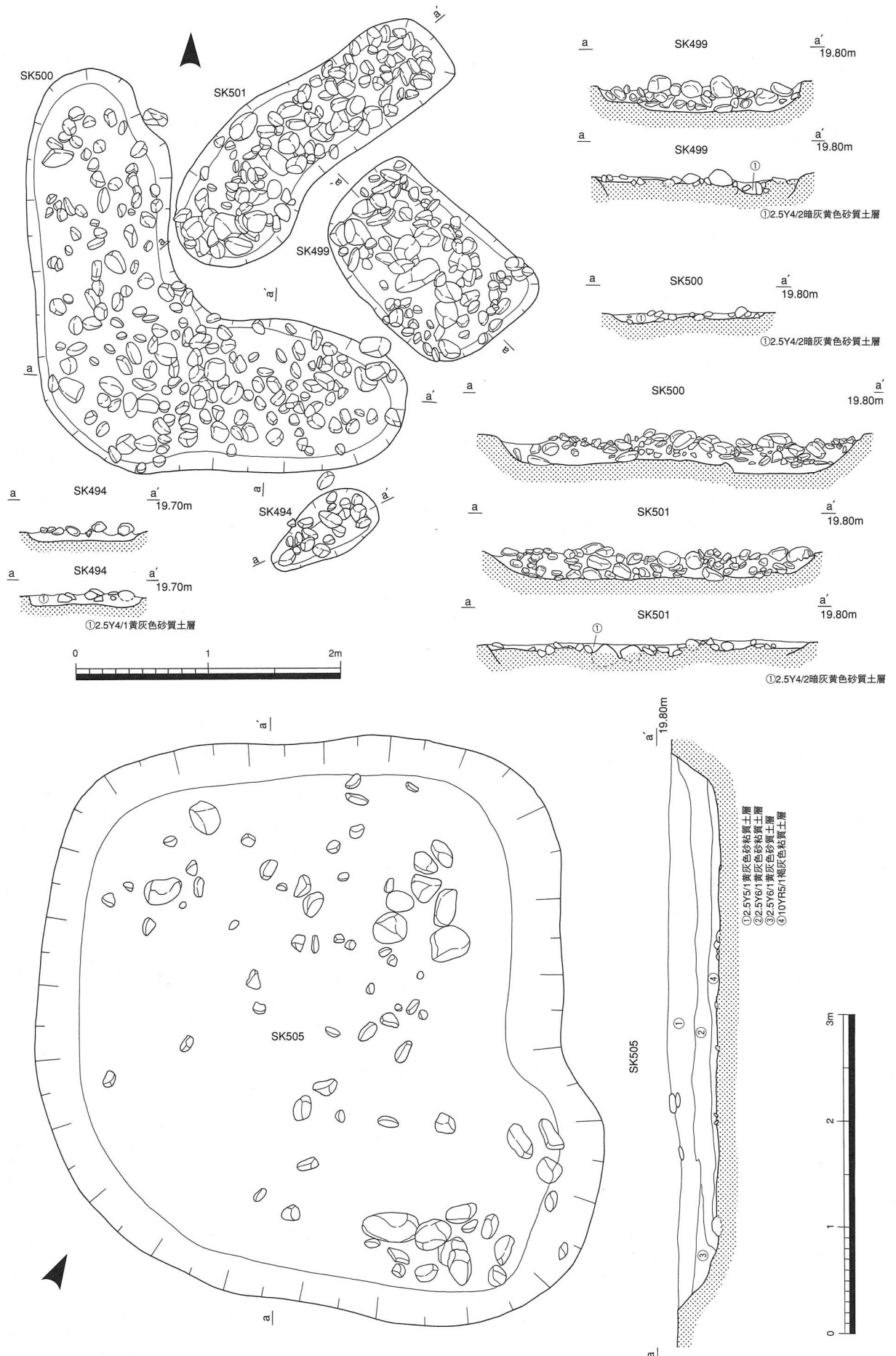

A地区土坑实测图(44)



図面138

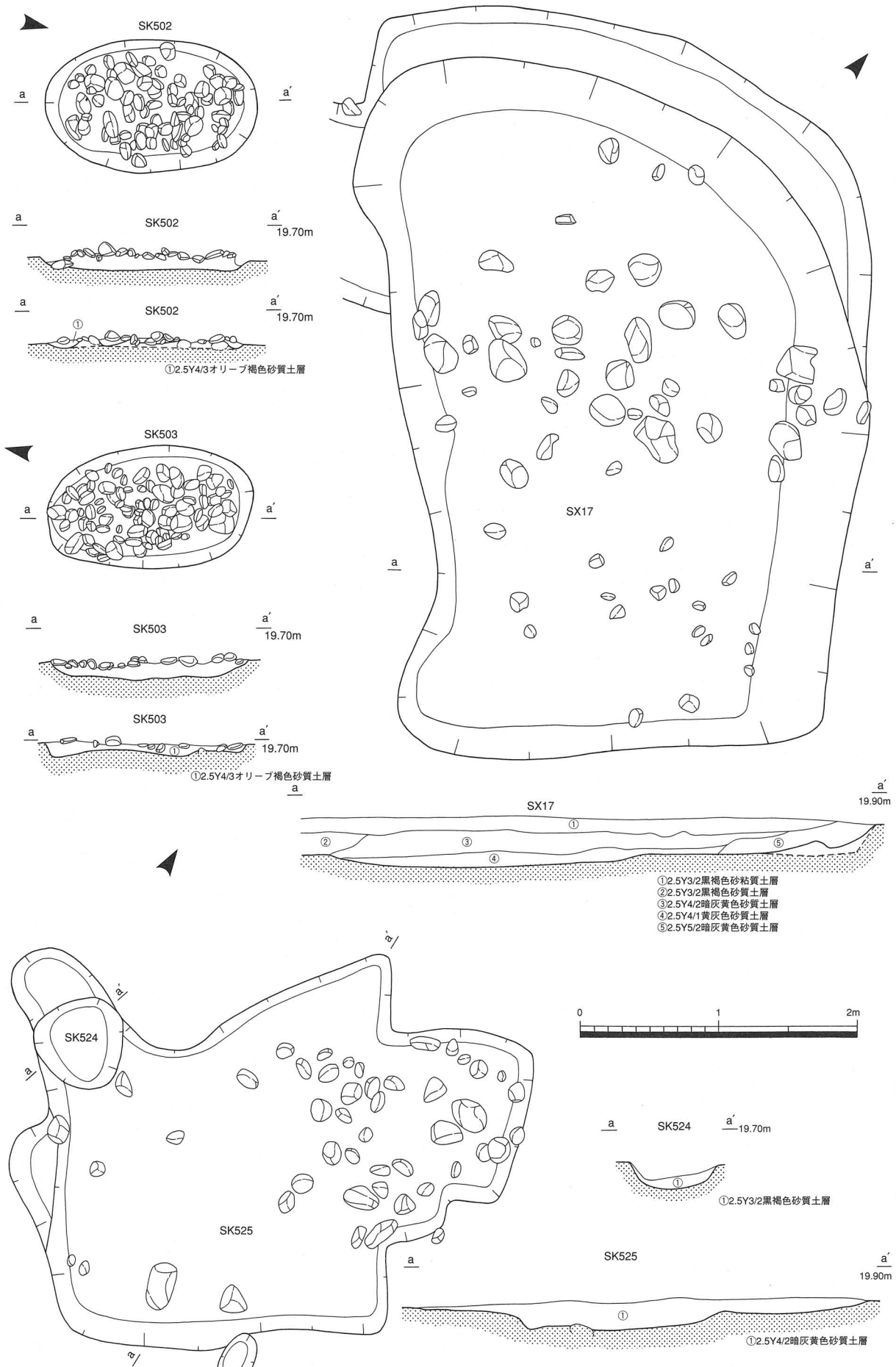

A地区土坑実測図(45)

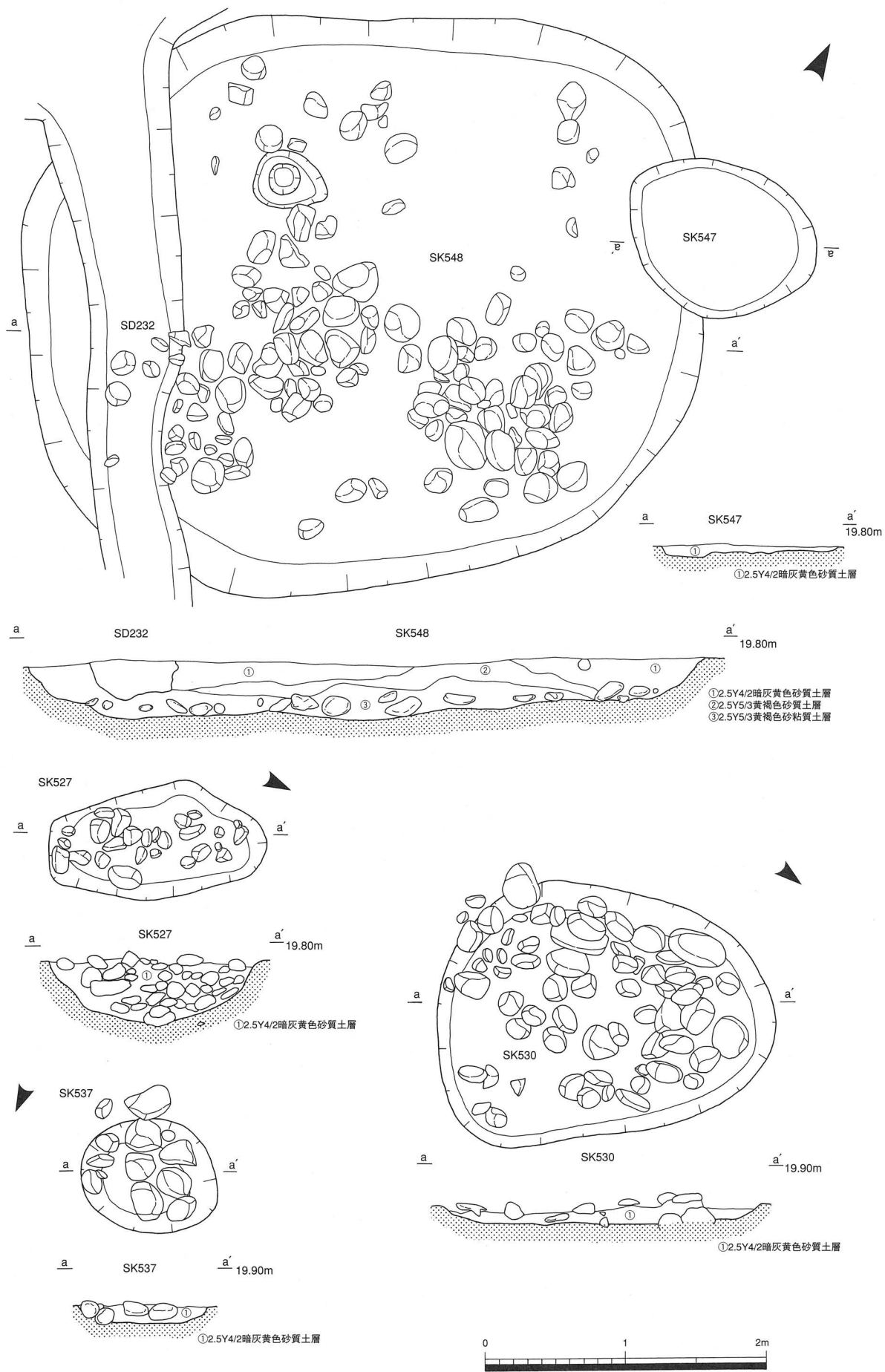

A地区土坑实测图 (46)

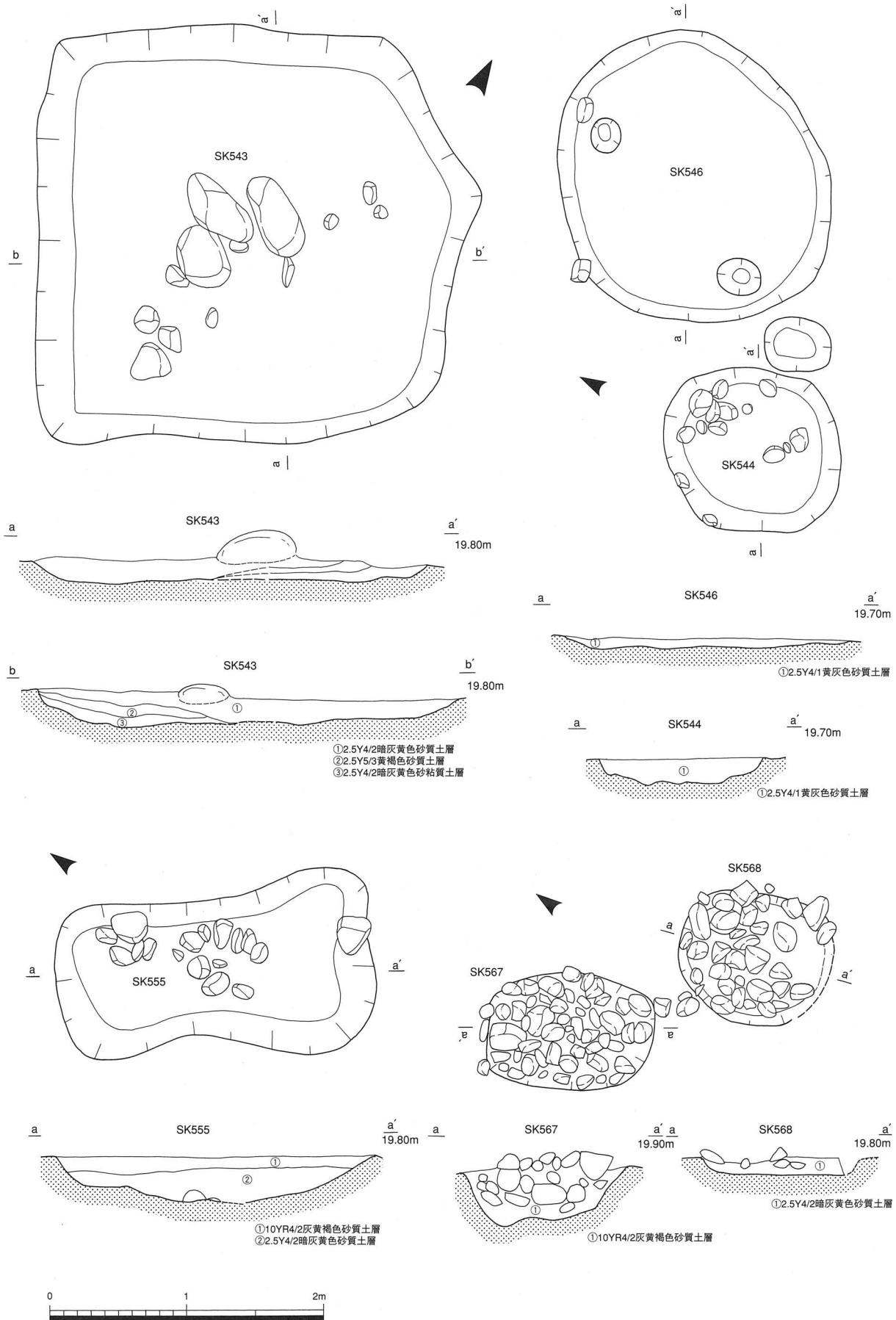

A地区土坑実測図(47)

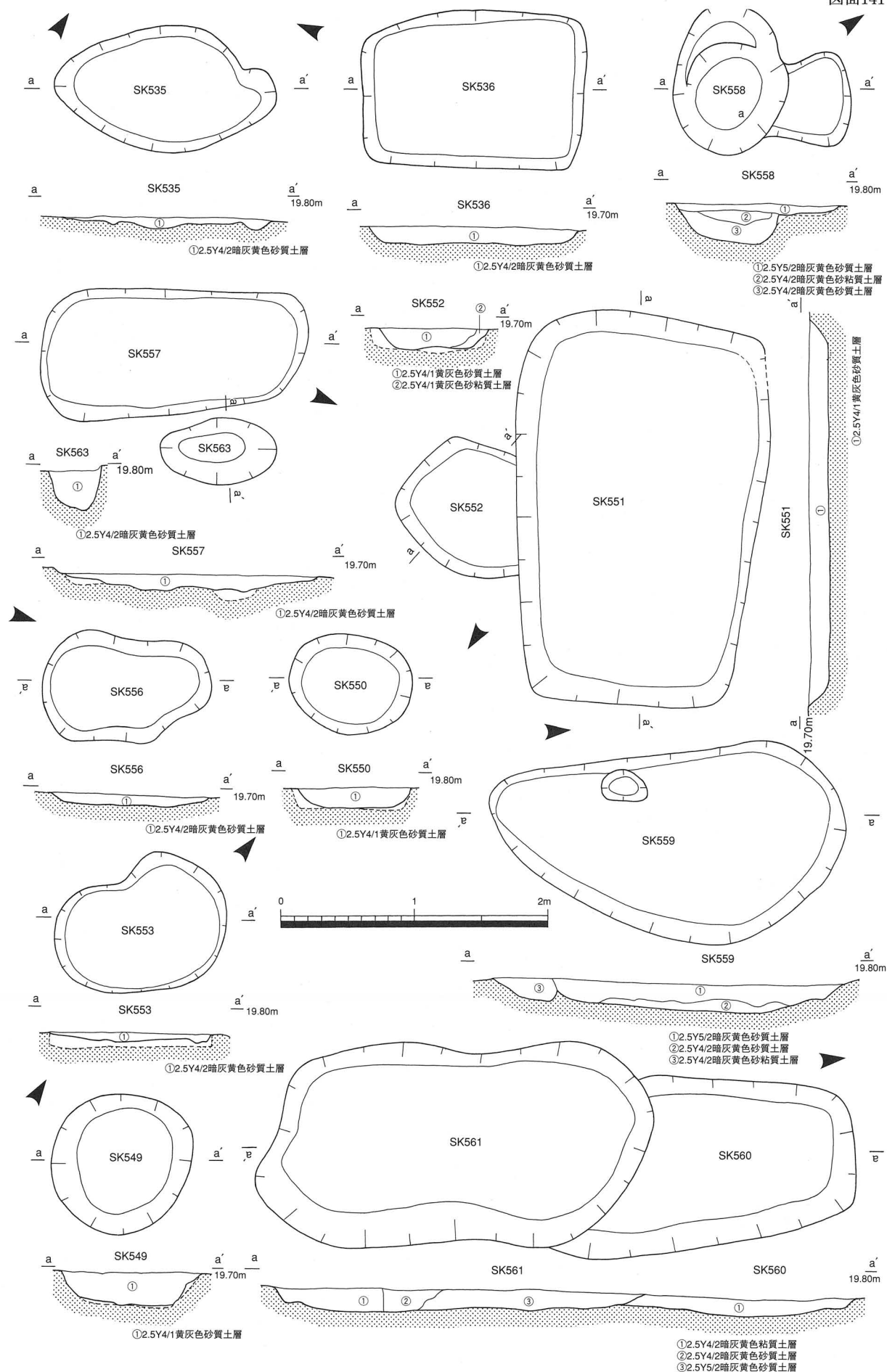

A地区土坑实测图(48)

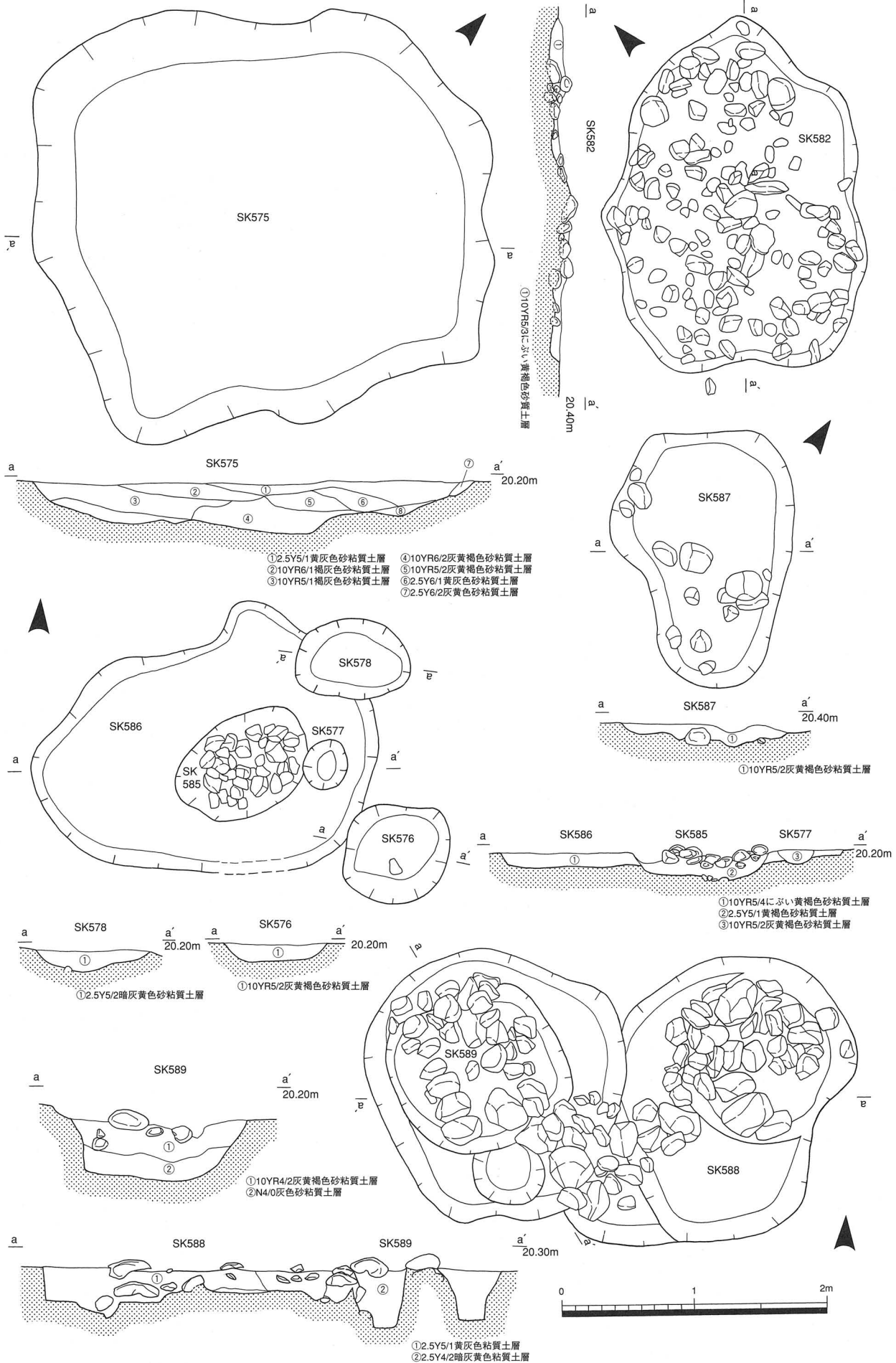

A地区土坑実測図 (49)

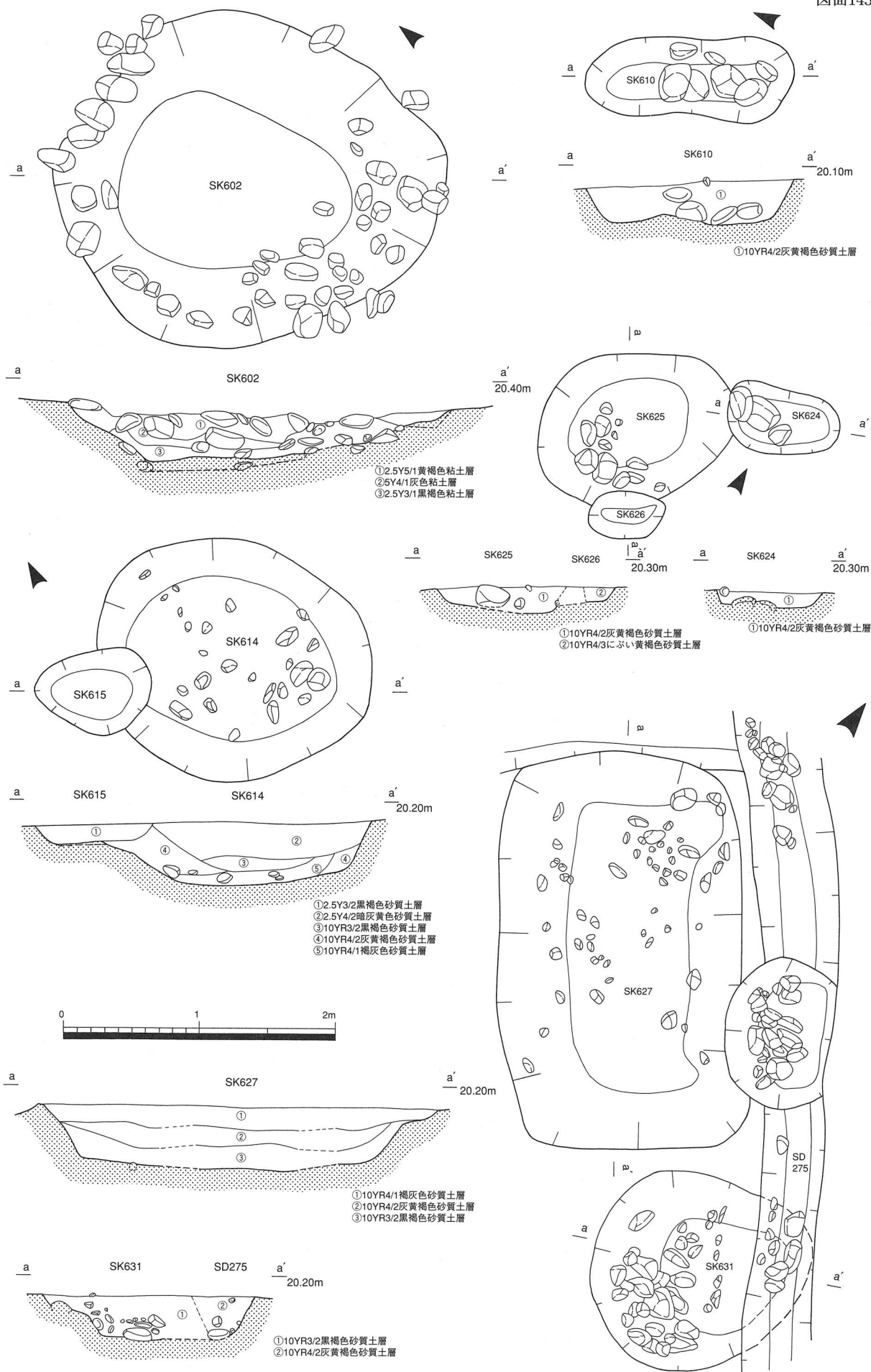

A地区土坑実測図(50)

図面144

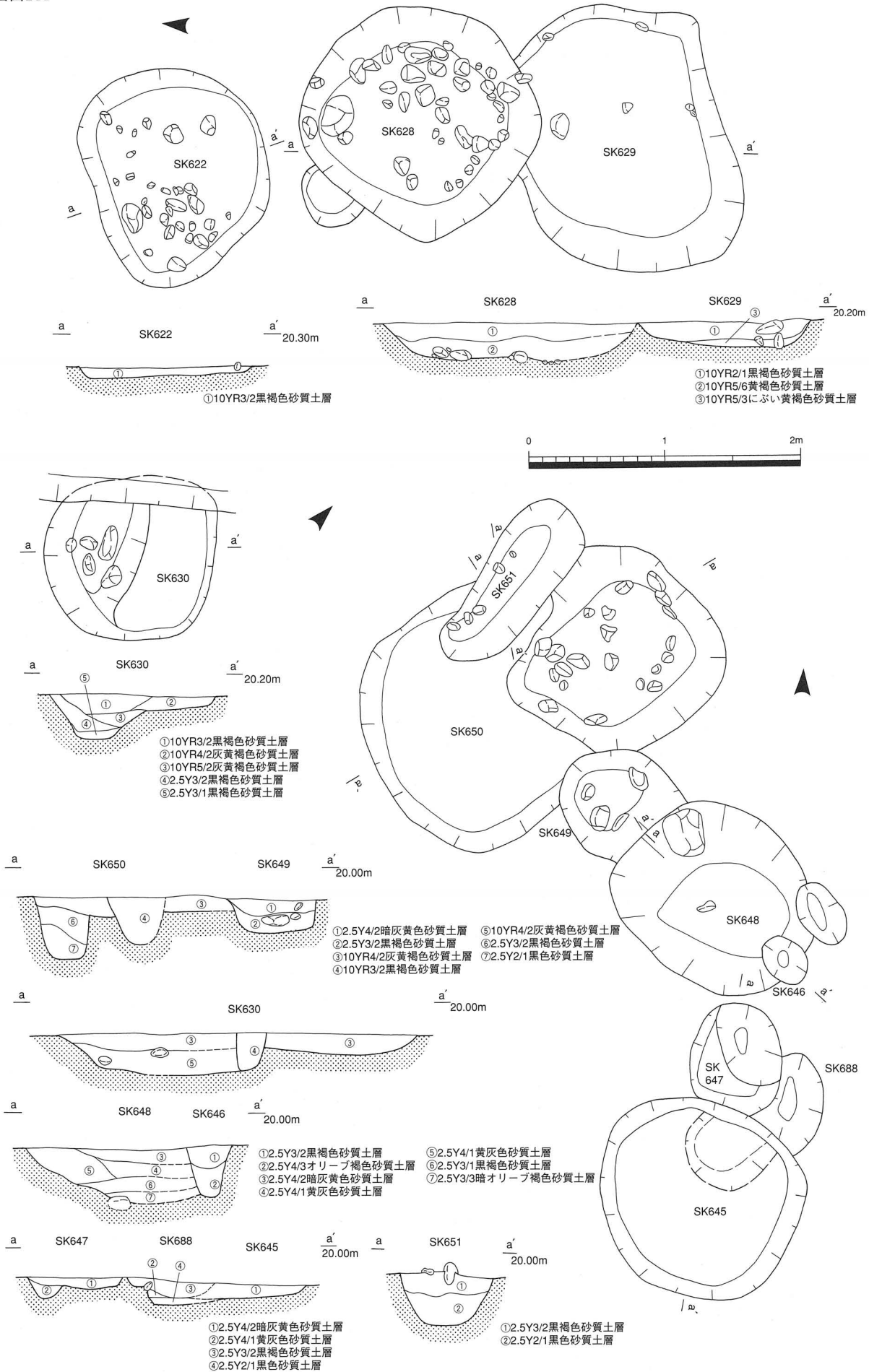

A地区土坑実測図 (51)

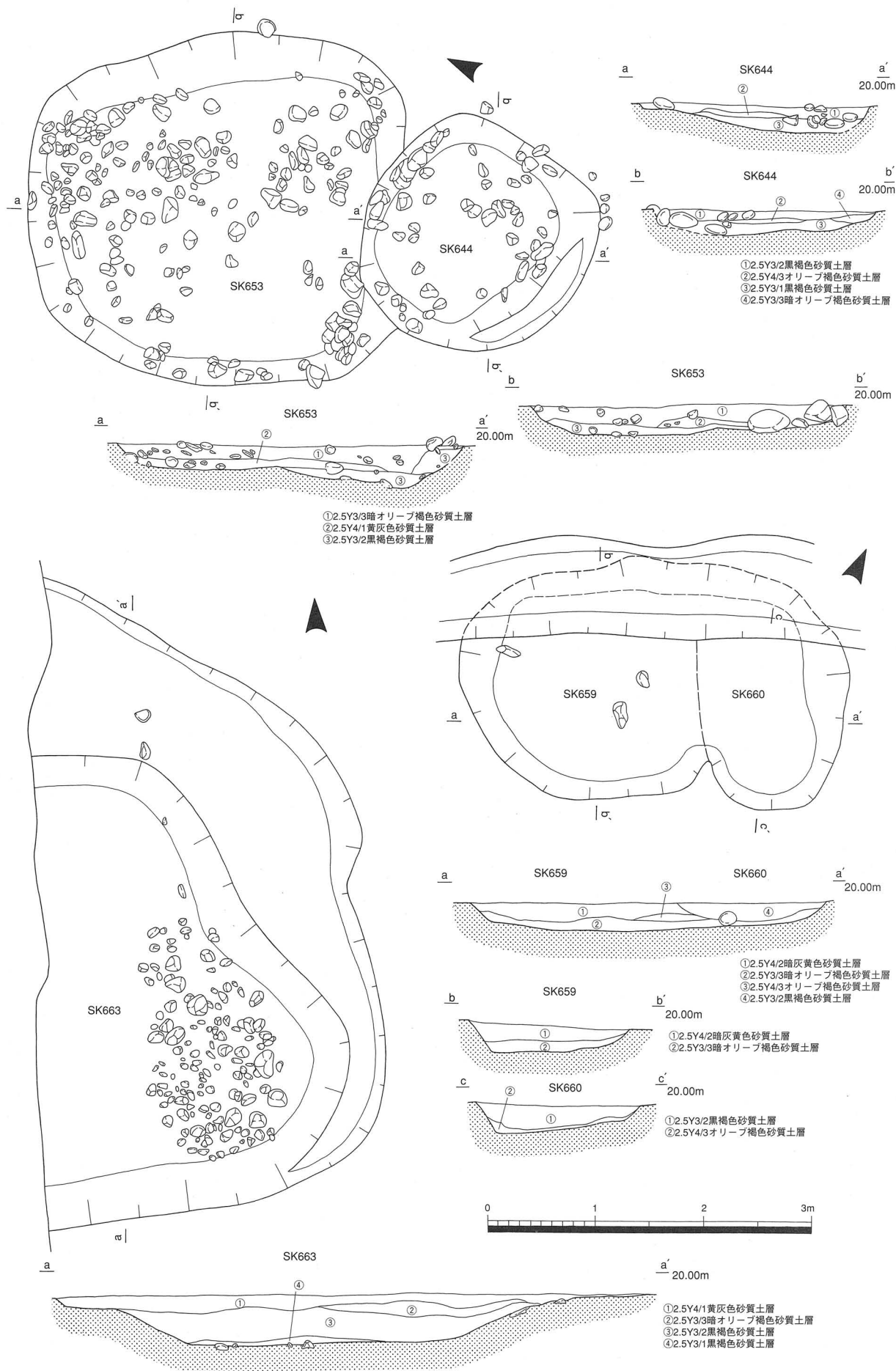

A地区土坑実測図(52)



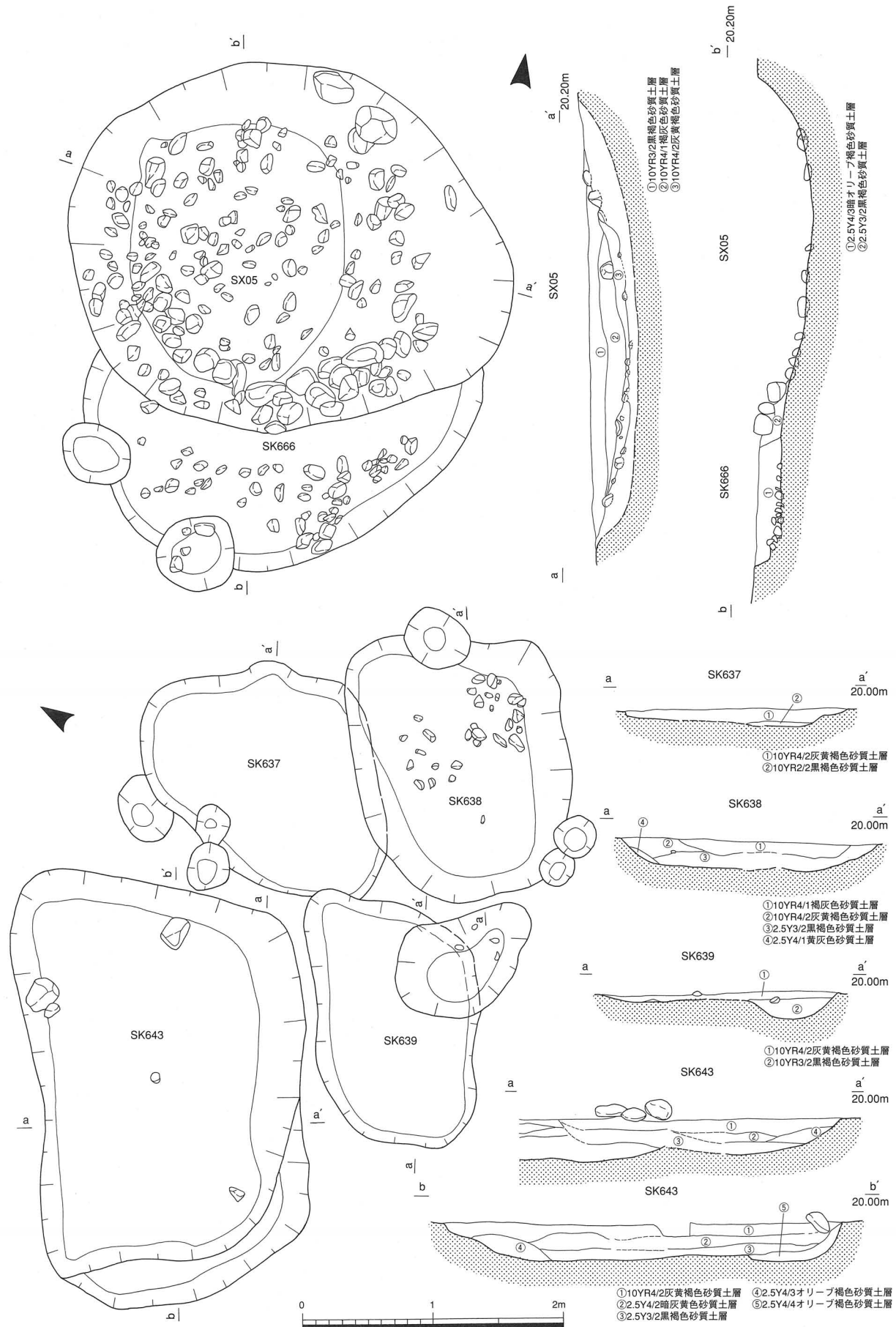

A地区土坑実測図(53)

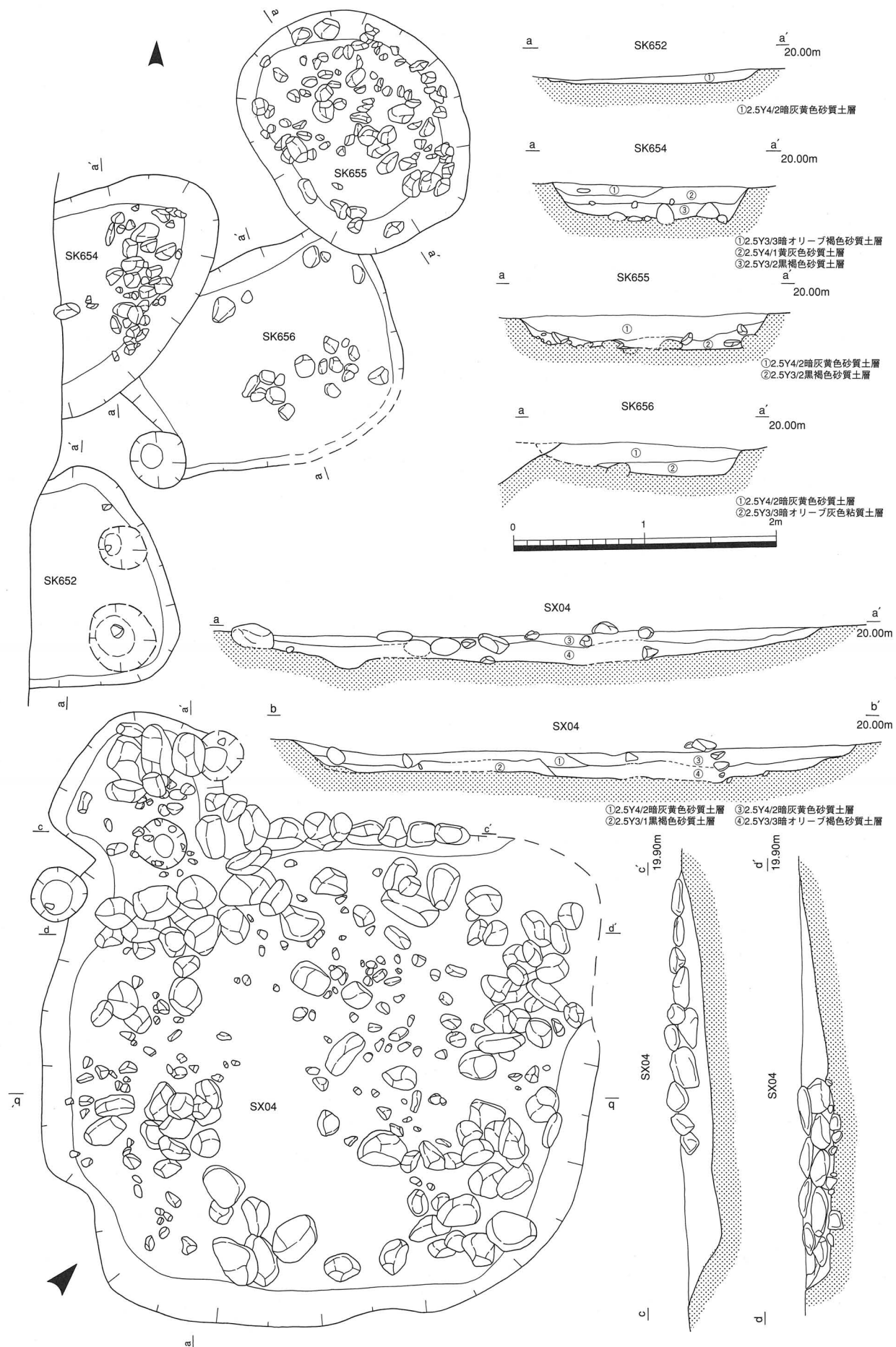

A地区土坑実測図(54)

図面148

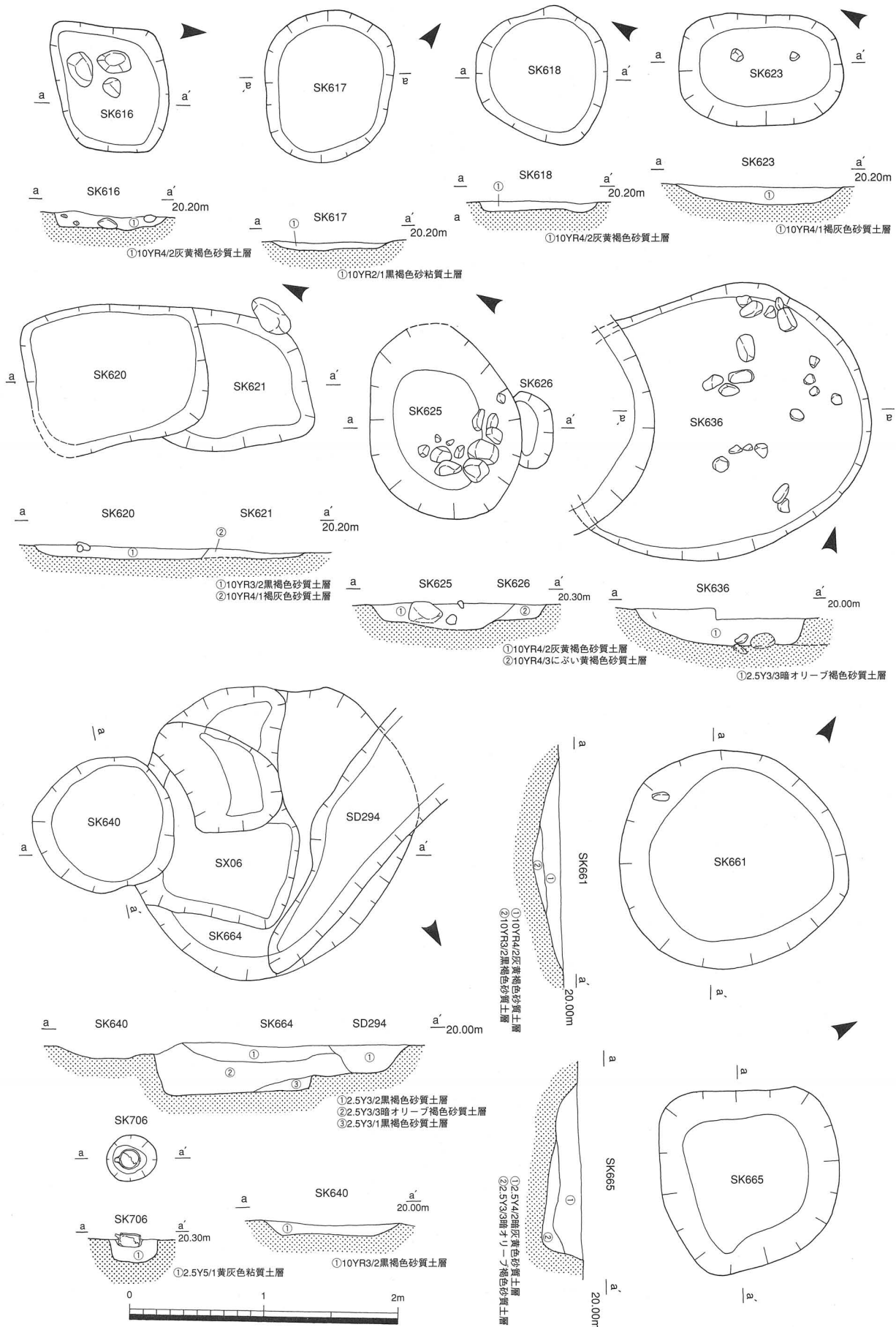

A地区土坑実測図 (55)

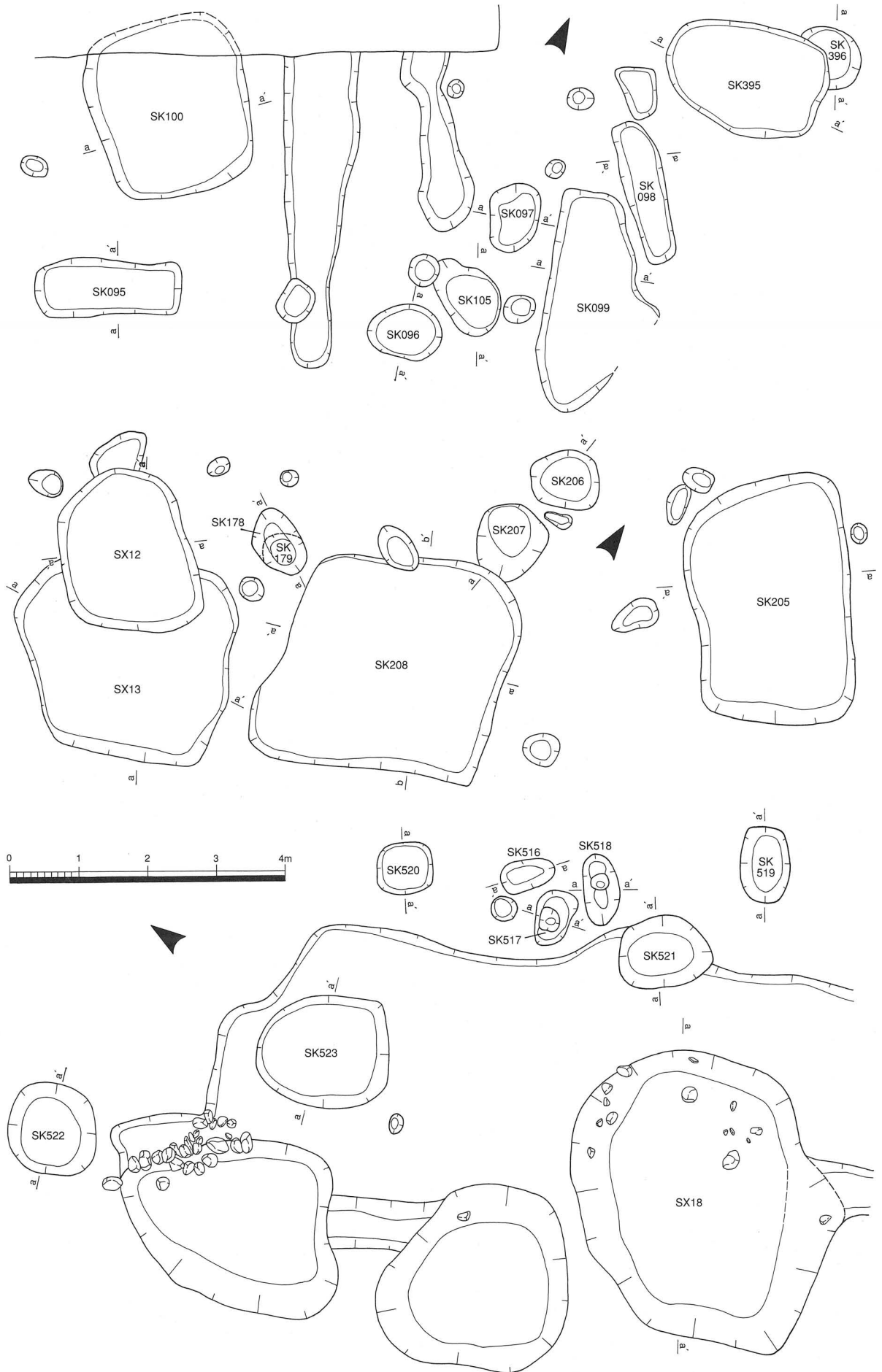

A地区土坑实测图(56)

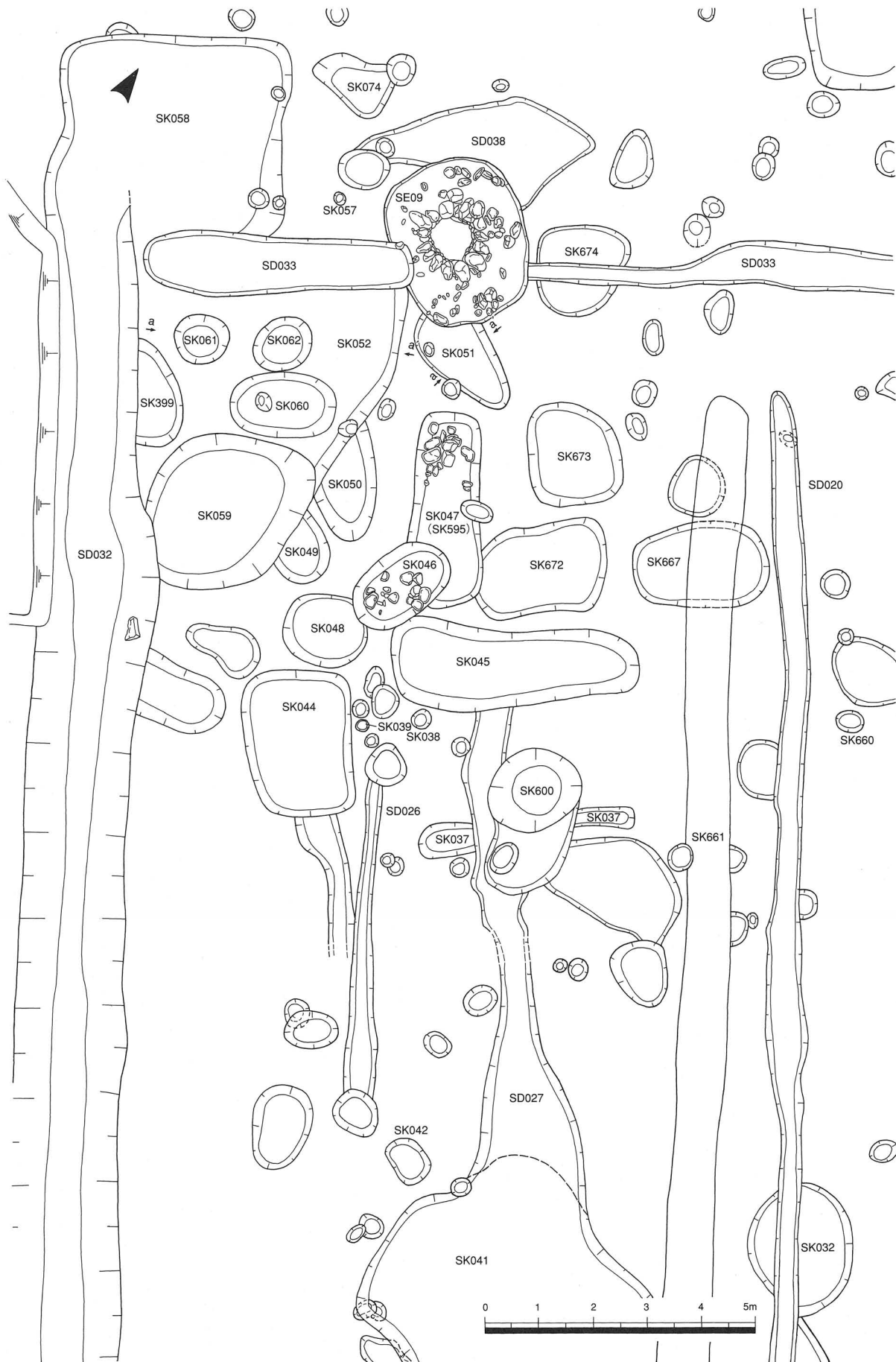

A地区土坑群実測図(1)

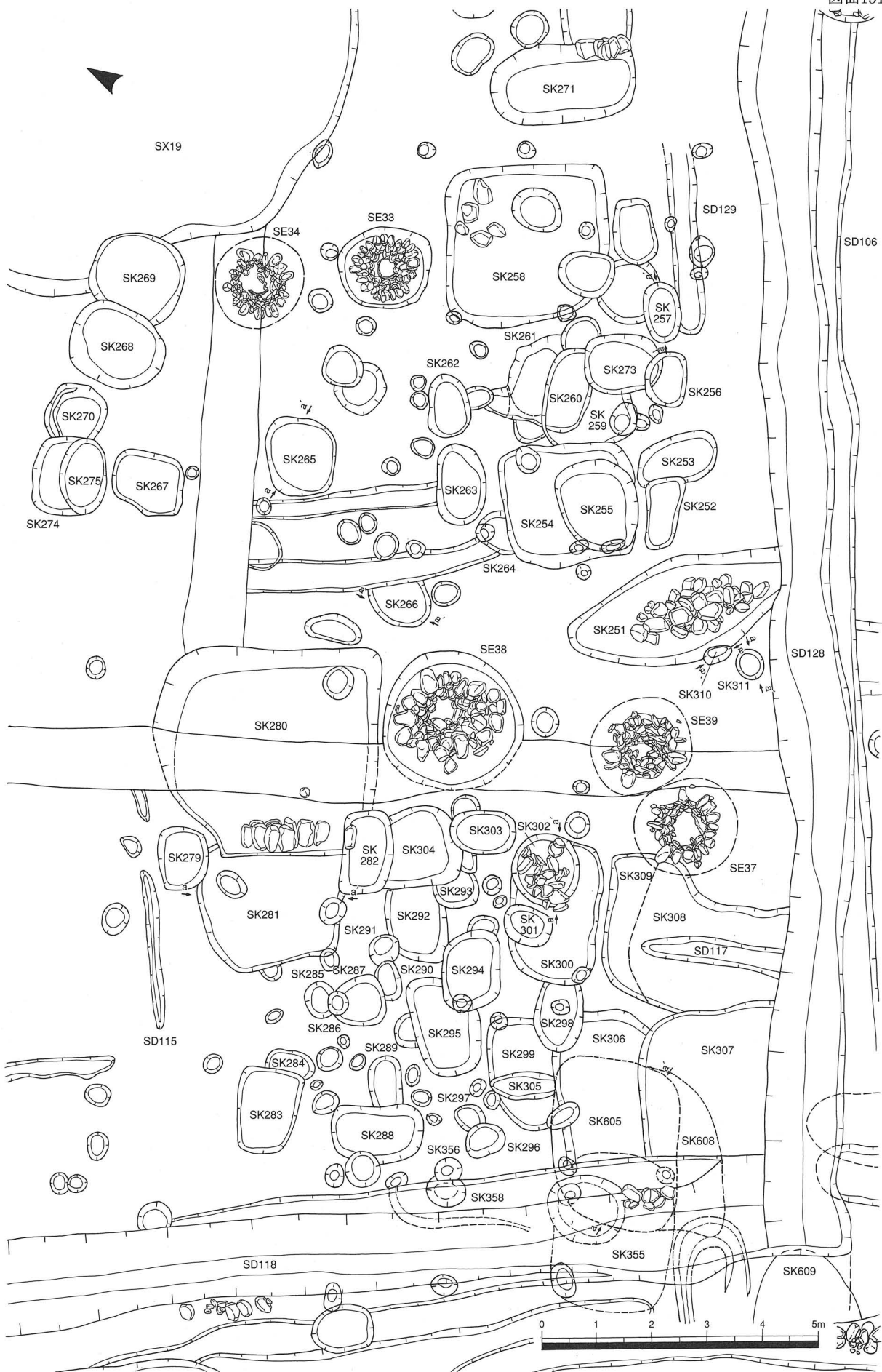

A地区土坑群实测图(2)

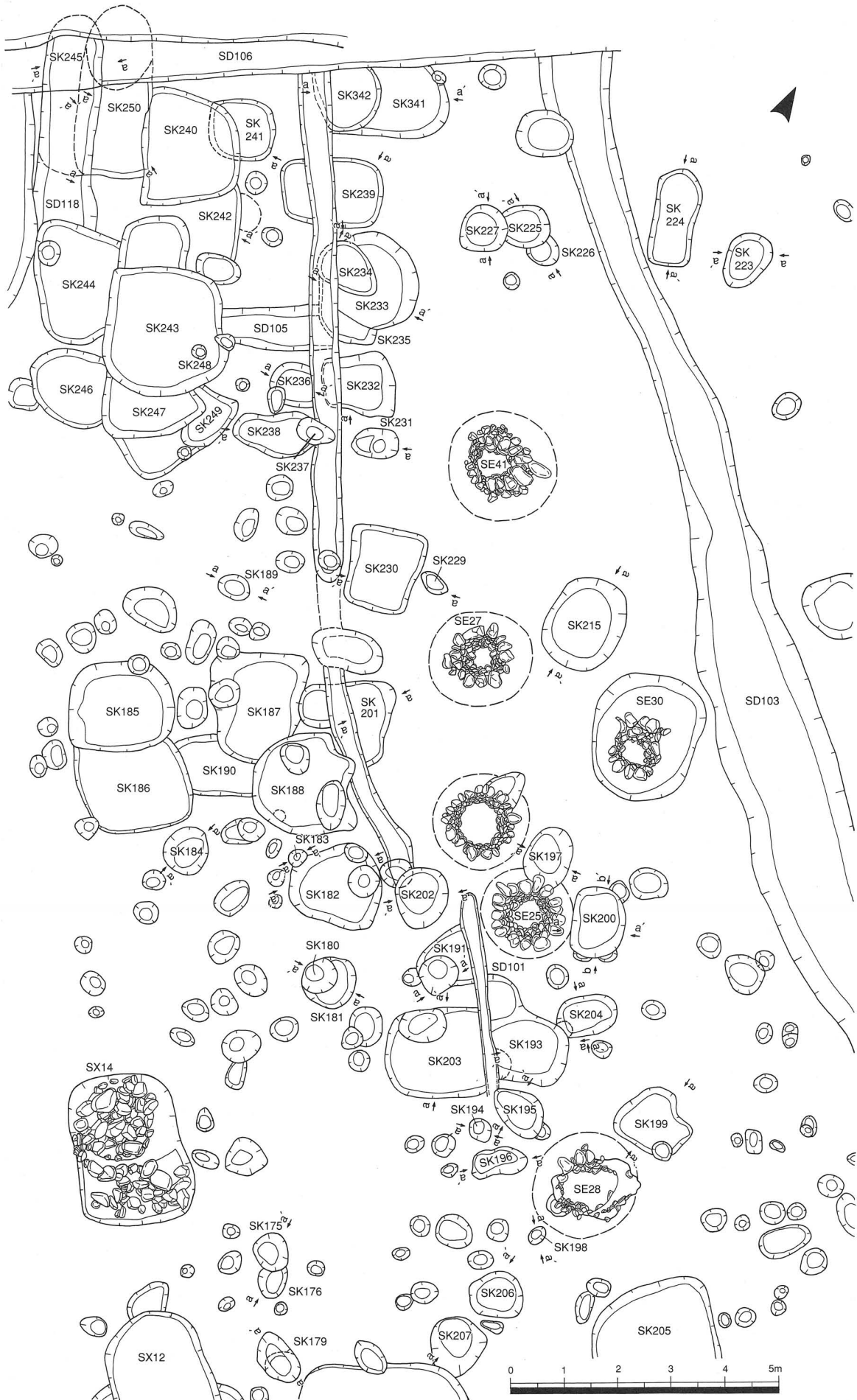

A地区土坑群実測図(3)







図面154

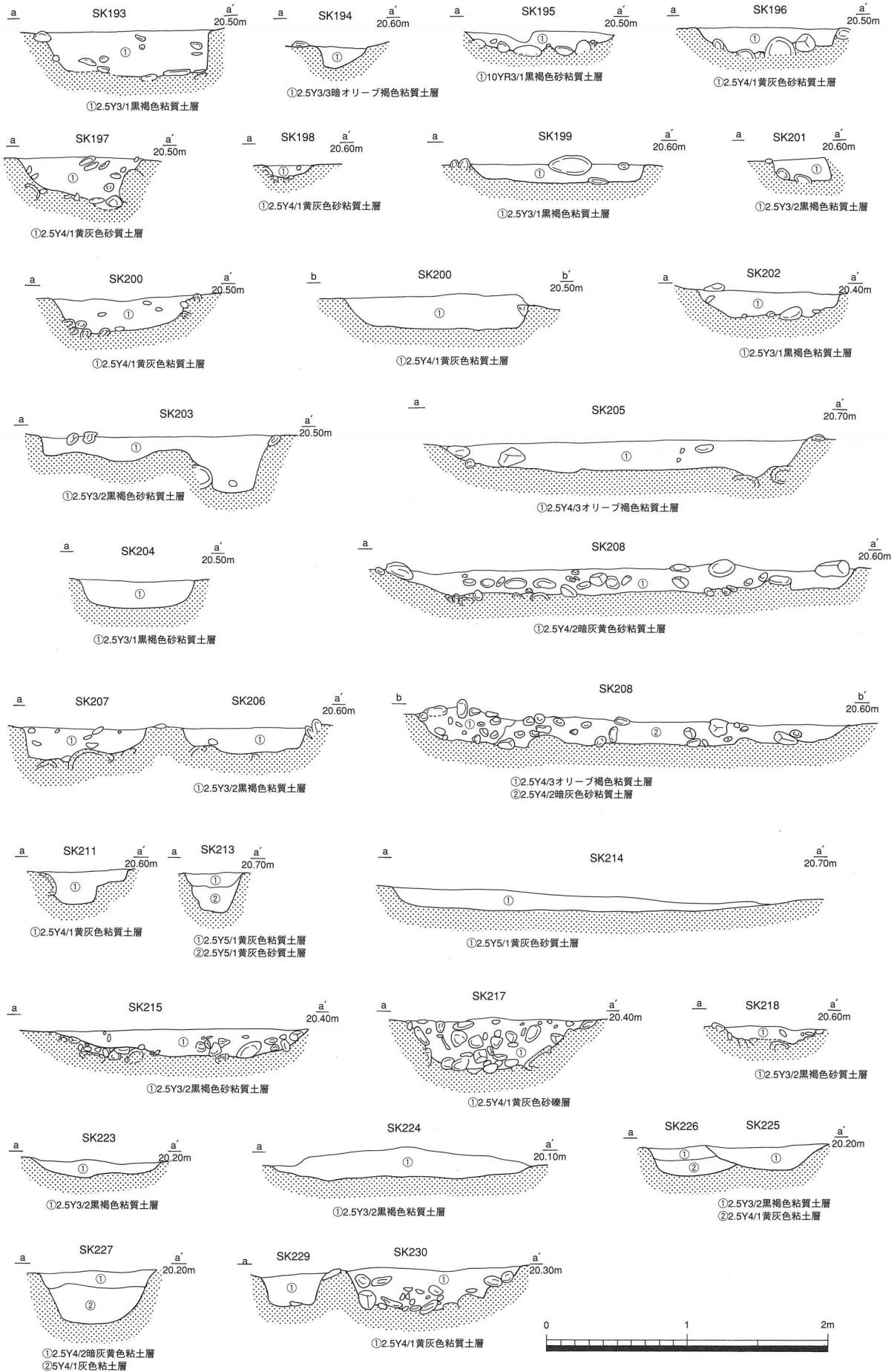

A地区溝・土坑断面図(2)



図面156

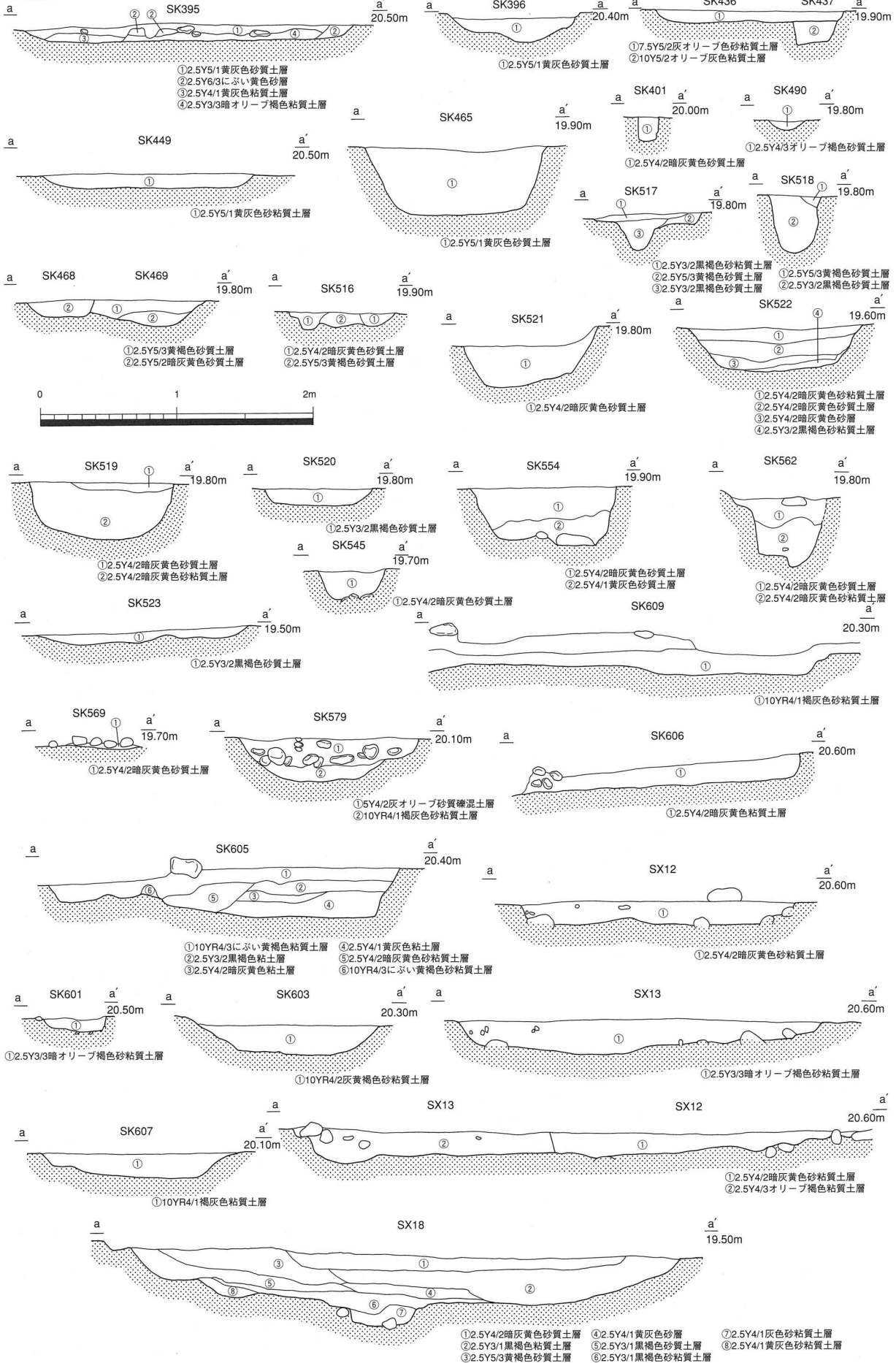

A地区溝・土坑断面図(4)



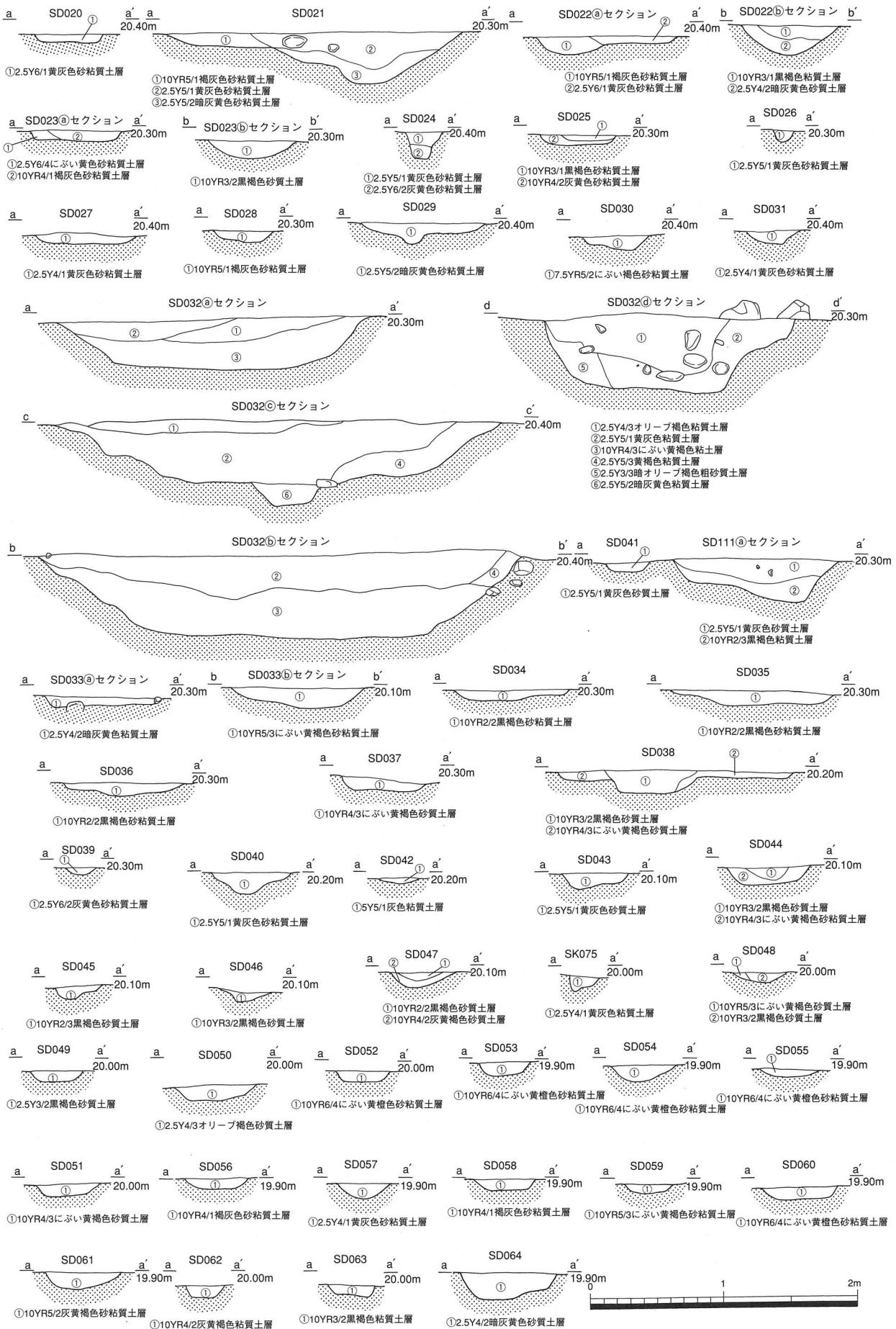

A地区溝・土坑断面図(6)

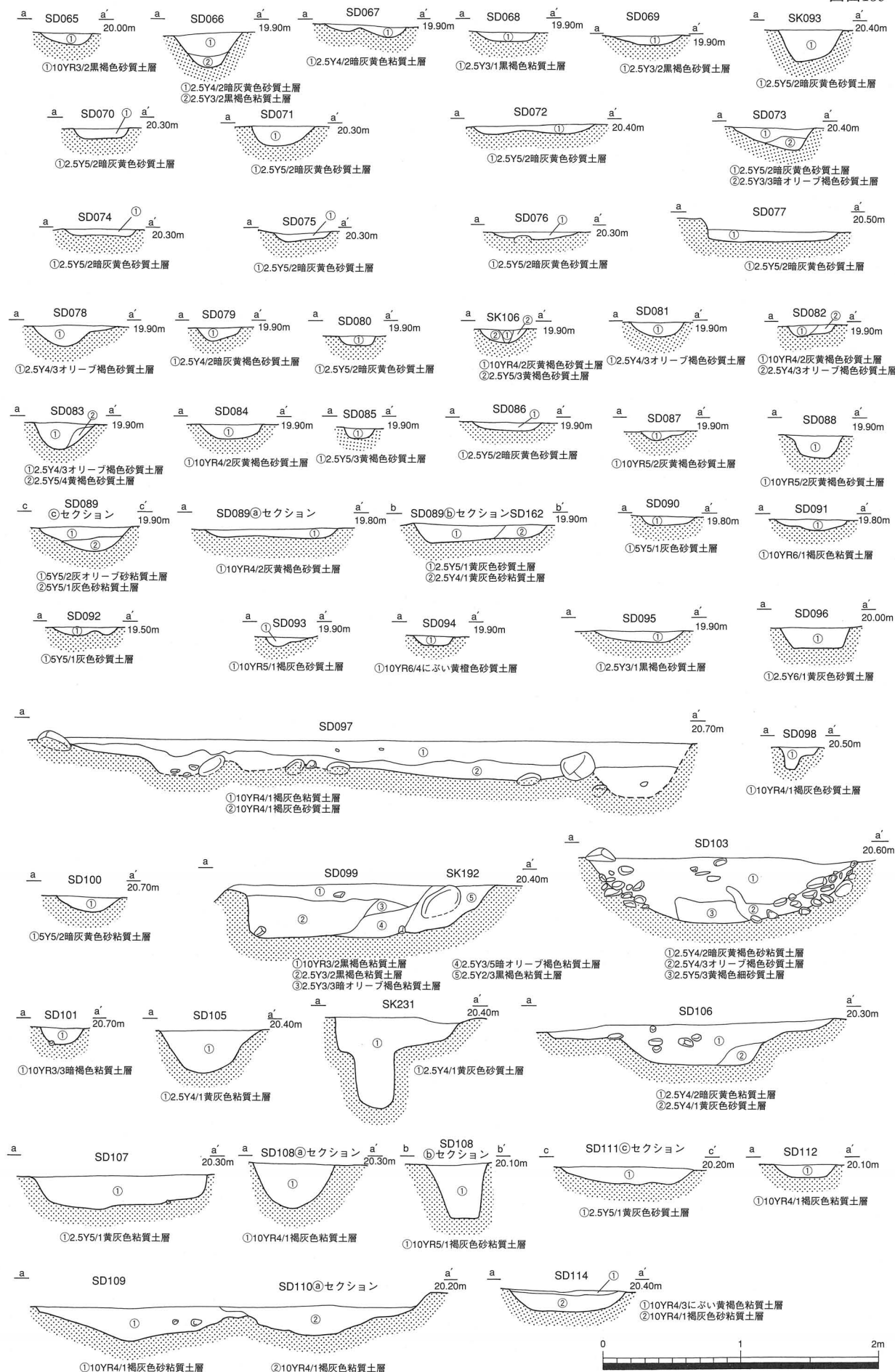

A地区溝・土坑断面図(7)



図面160

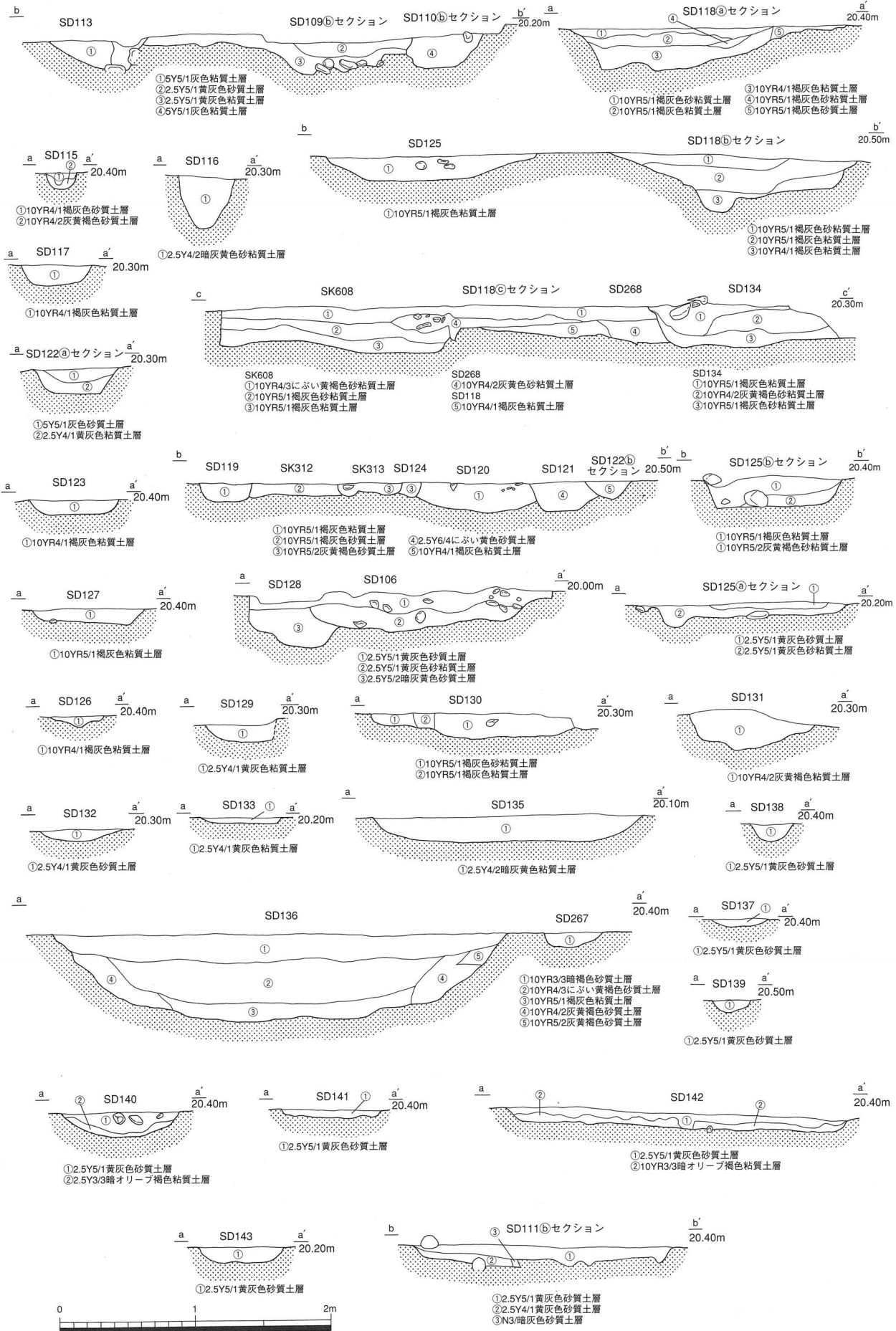

A地区溝・土坑断面図(8)

