

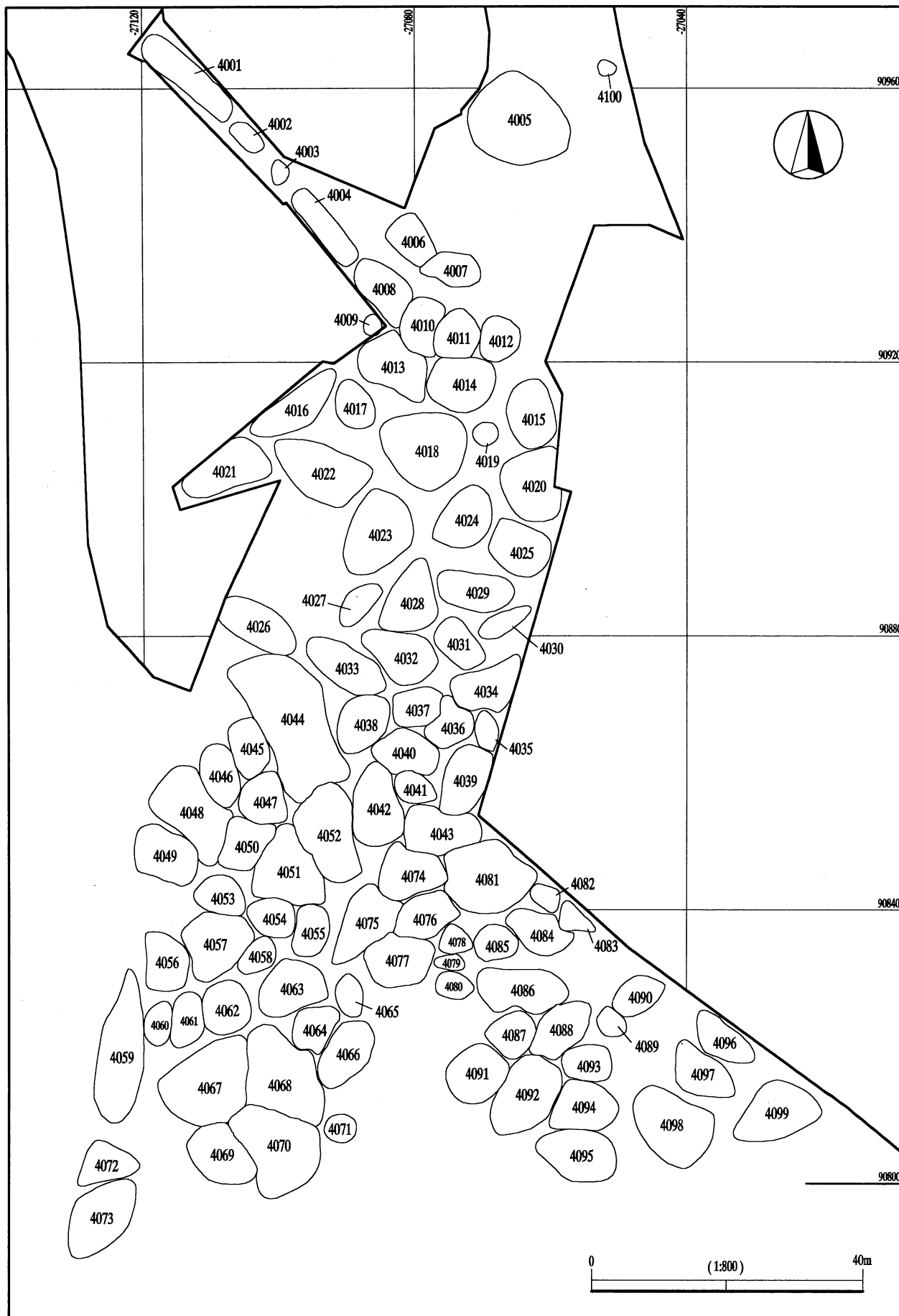

第4地点 BL石器全点 (BL範囲入り) (貫ノ木遺跡)

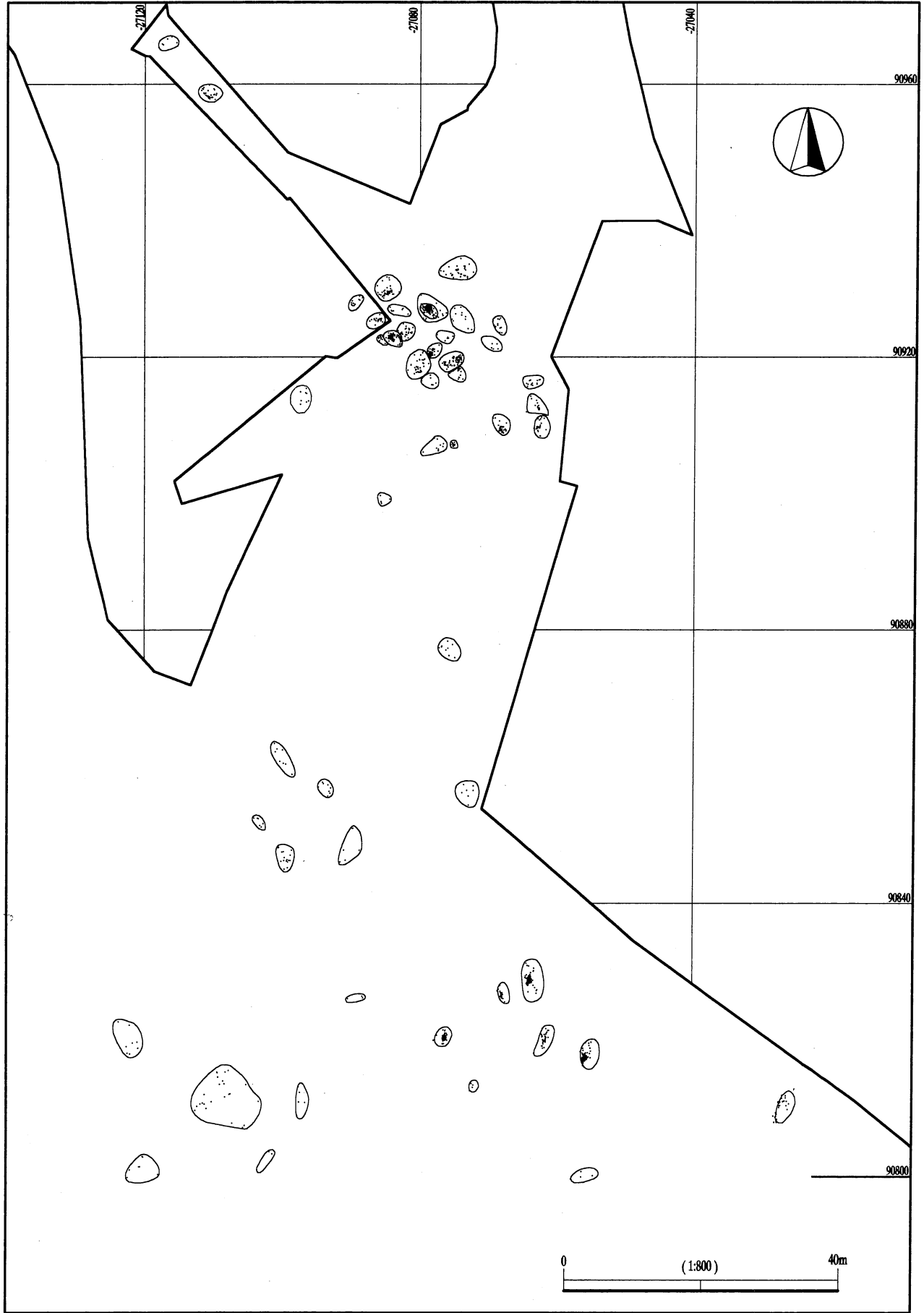

第4地点 ブロック配置図 (貫ノ木遺跡)



第4地点 礫分布図 (貫ノ木遺跡)

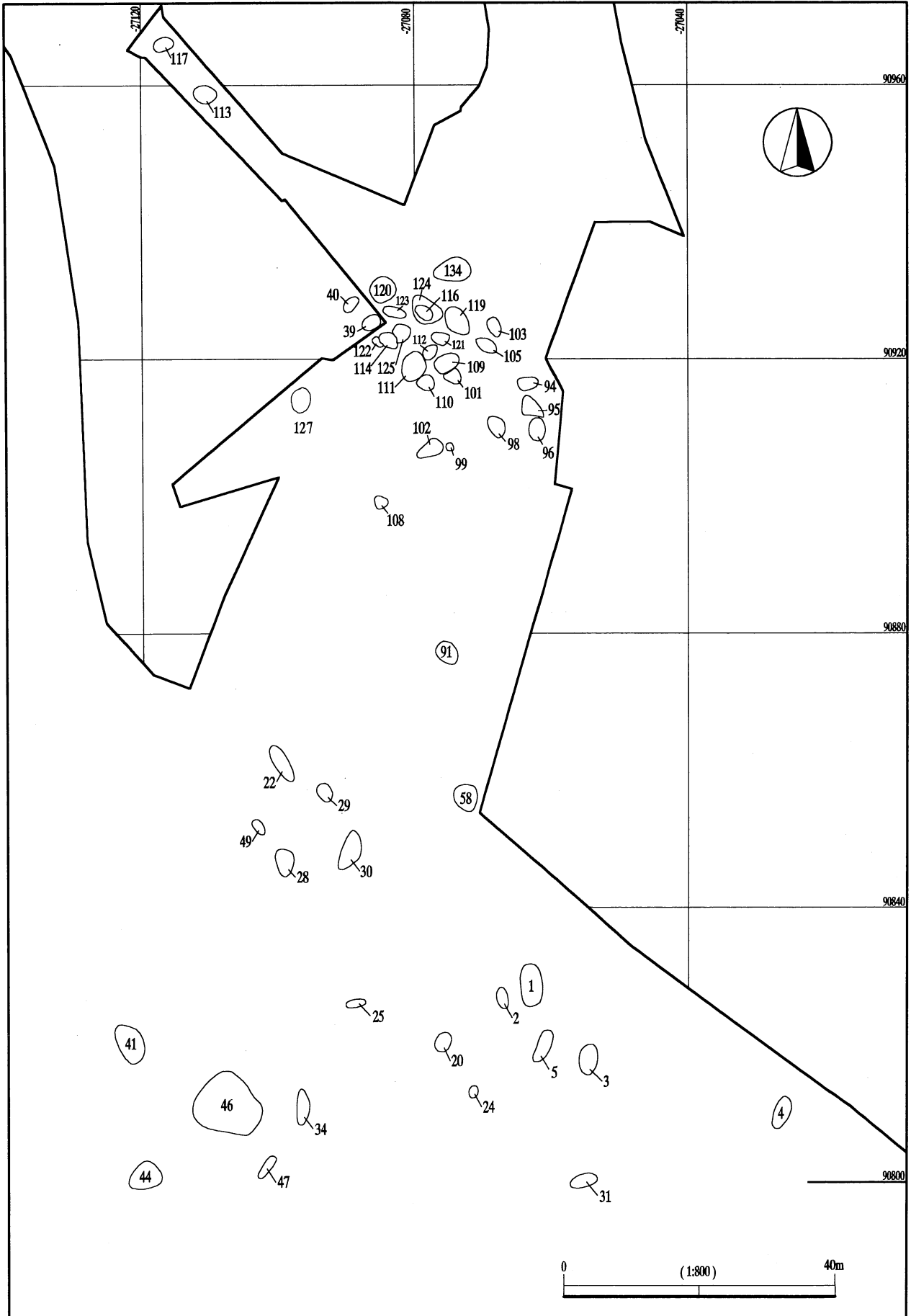

第4地点 礫群配置図 (貫ノ木遺跡)

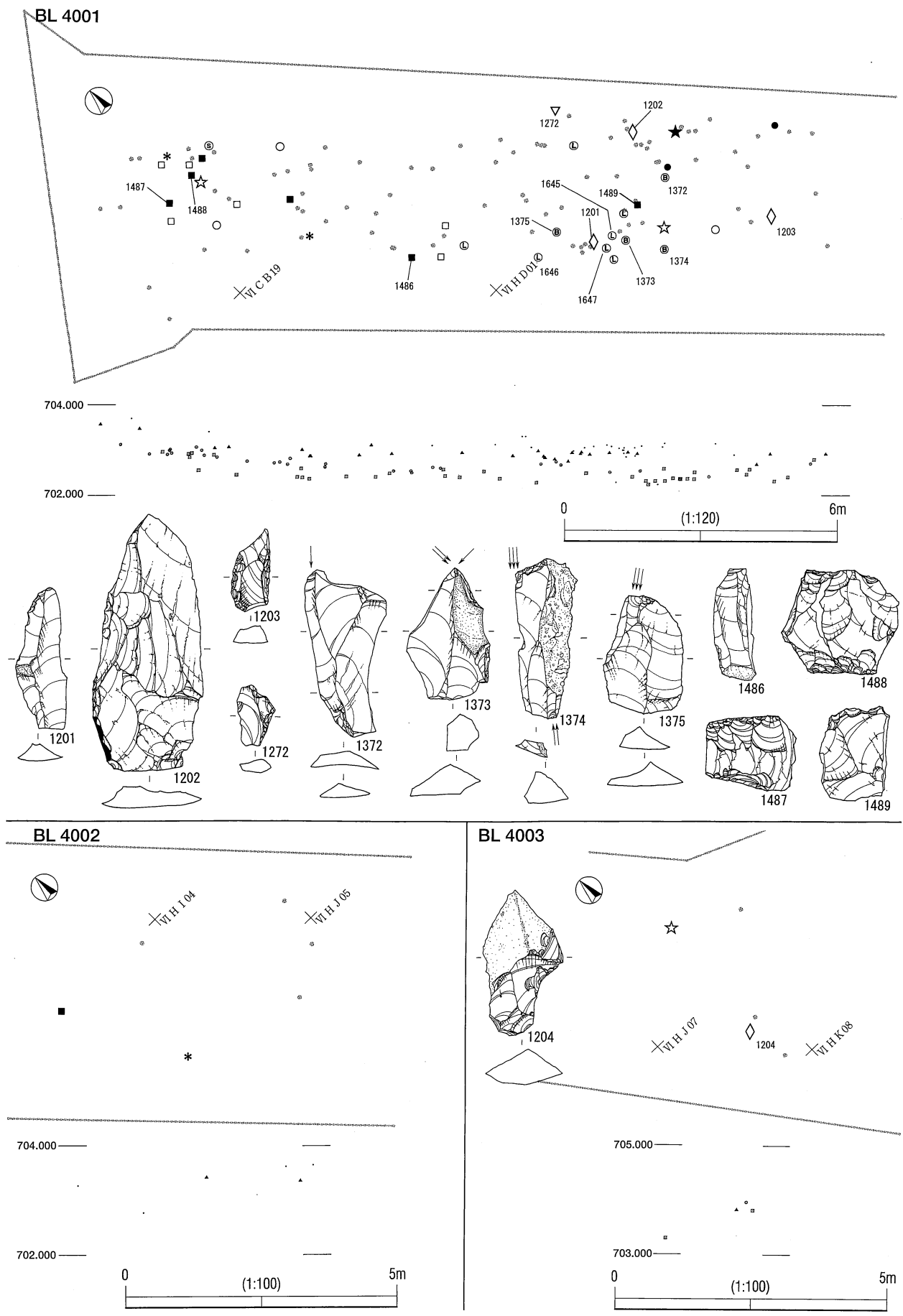

第4地点 BL4001・4002・4003 遺物分布図 (貫ノ木遺跡)

BL 4004

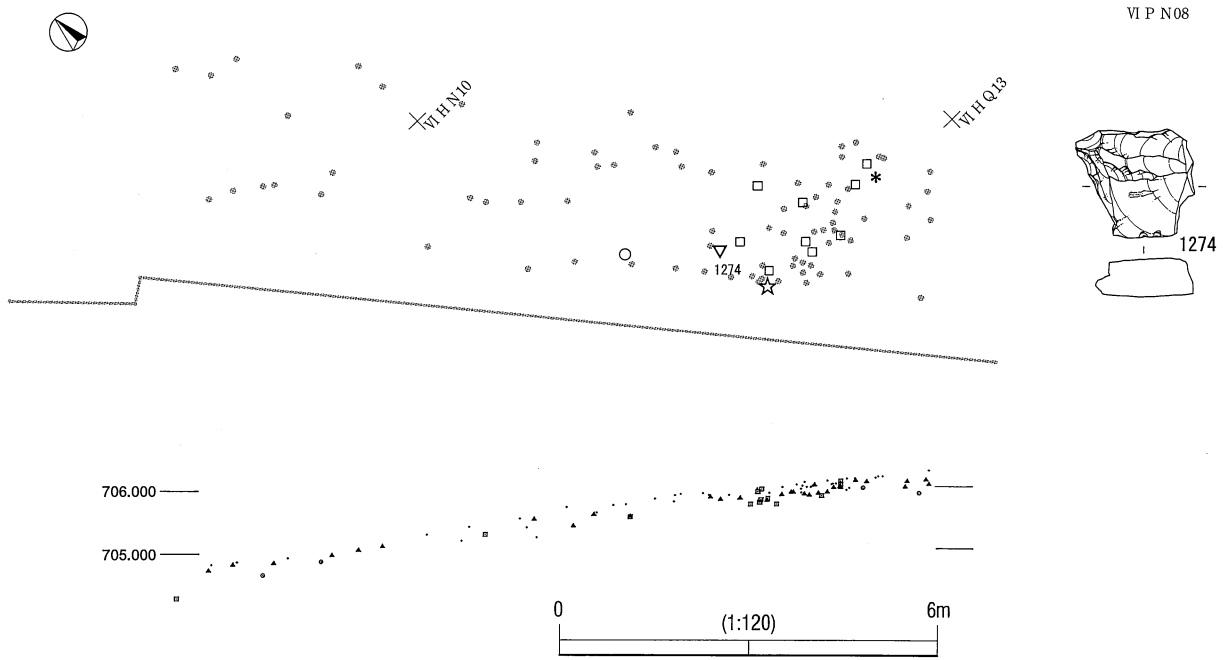

BL 4005

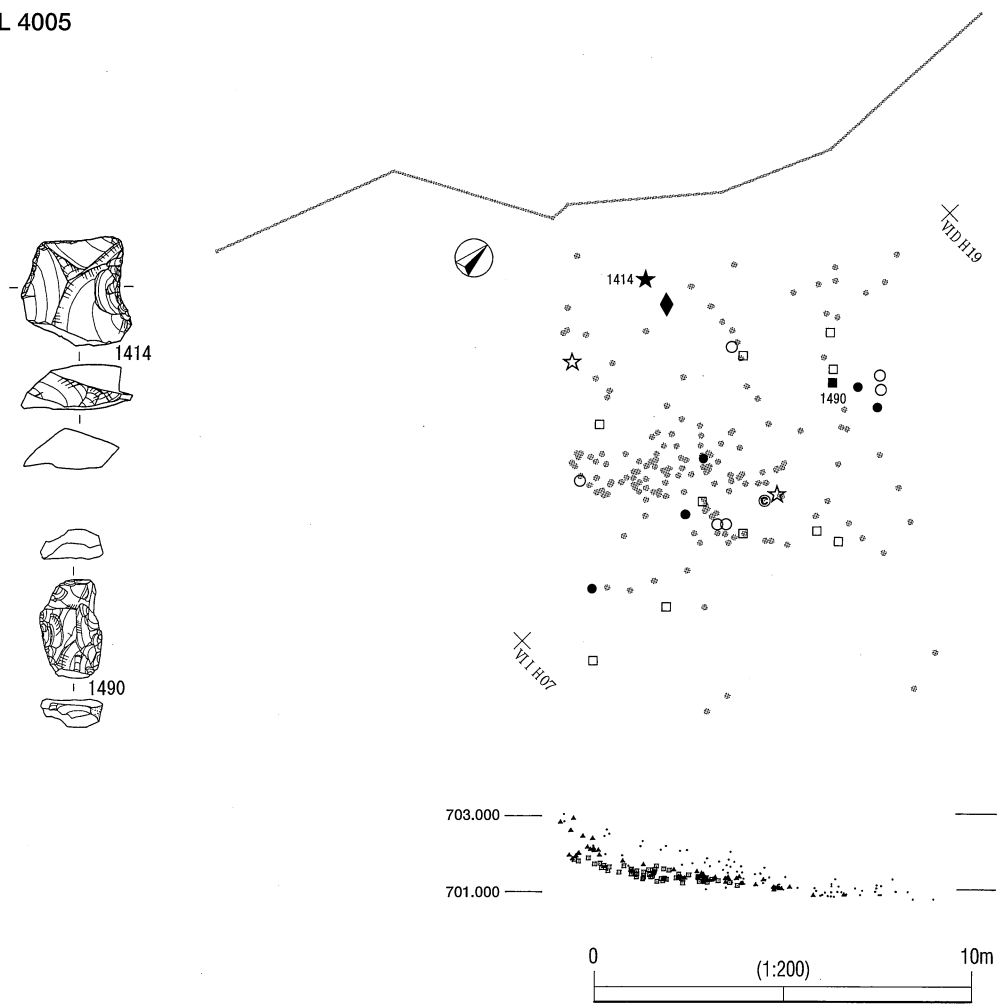

第4地点 BL4004・4005 遺物分布図 (貫ノ木遺跡)

BL 4006

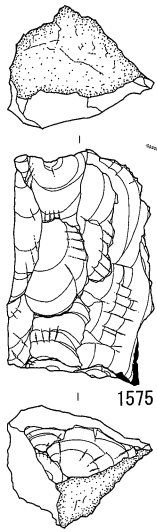

VI I B 10

707.000
706.000

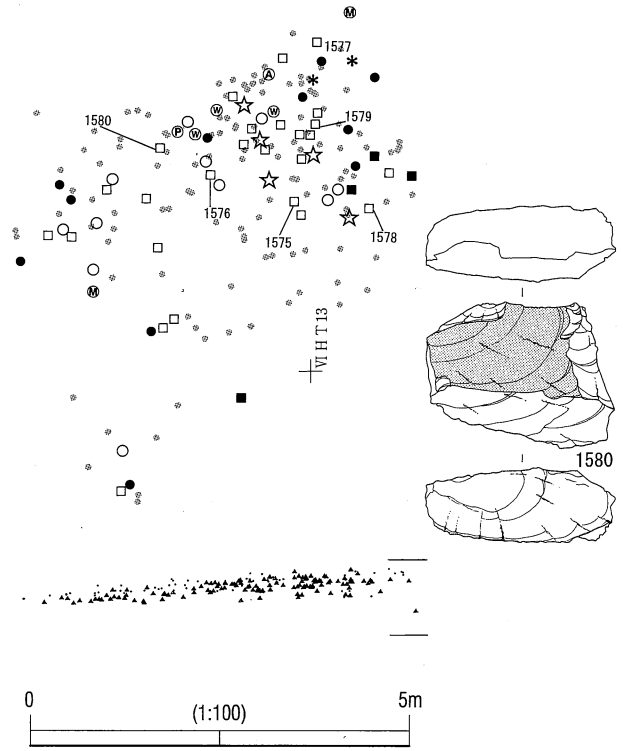

BL 4007

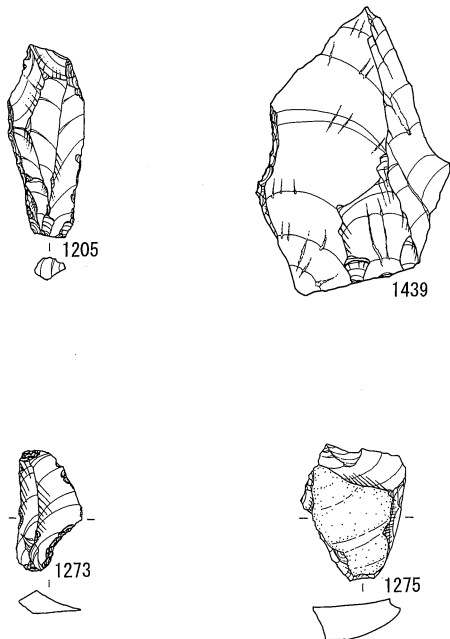

VI I E 13

707.000
706.000

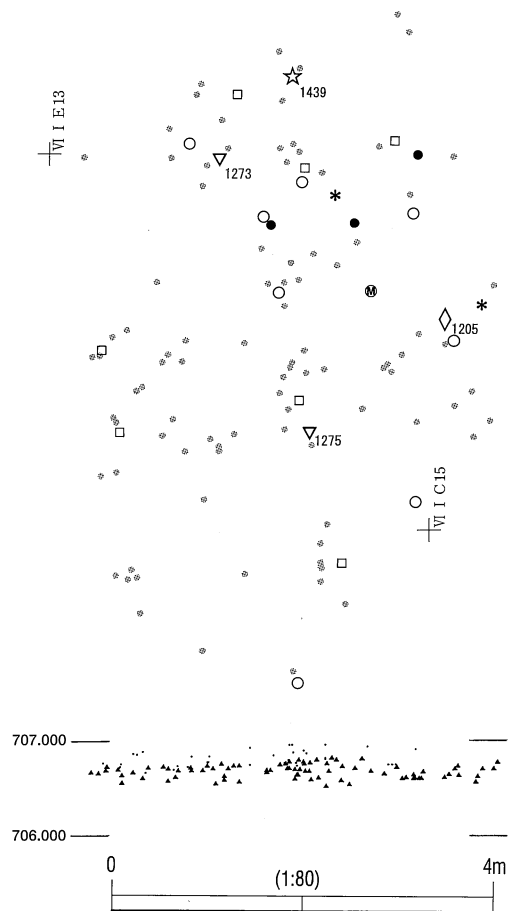

第4地点 BL4006・4007 遺物分布図 (貫ノ木遺跡)

BL 4008

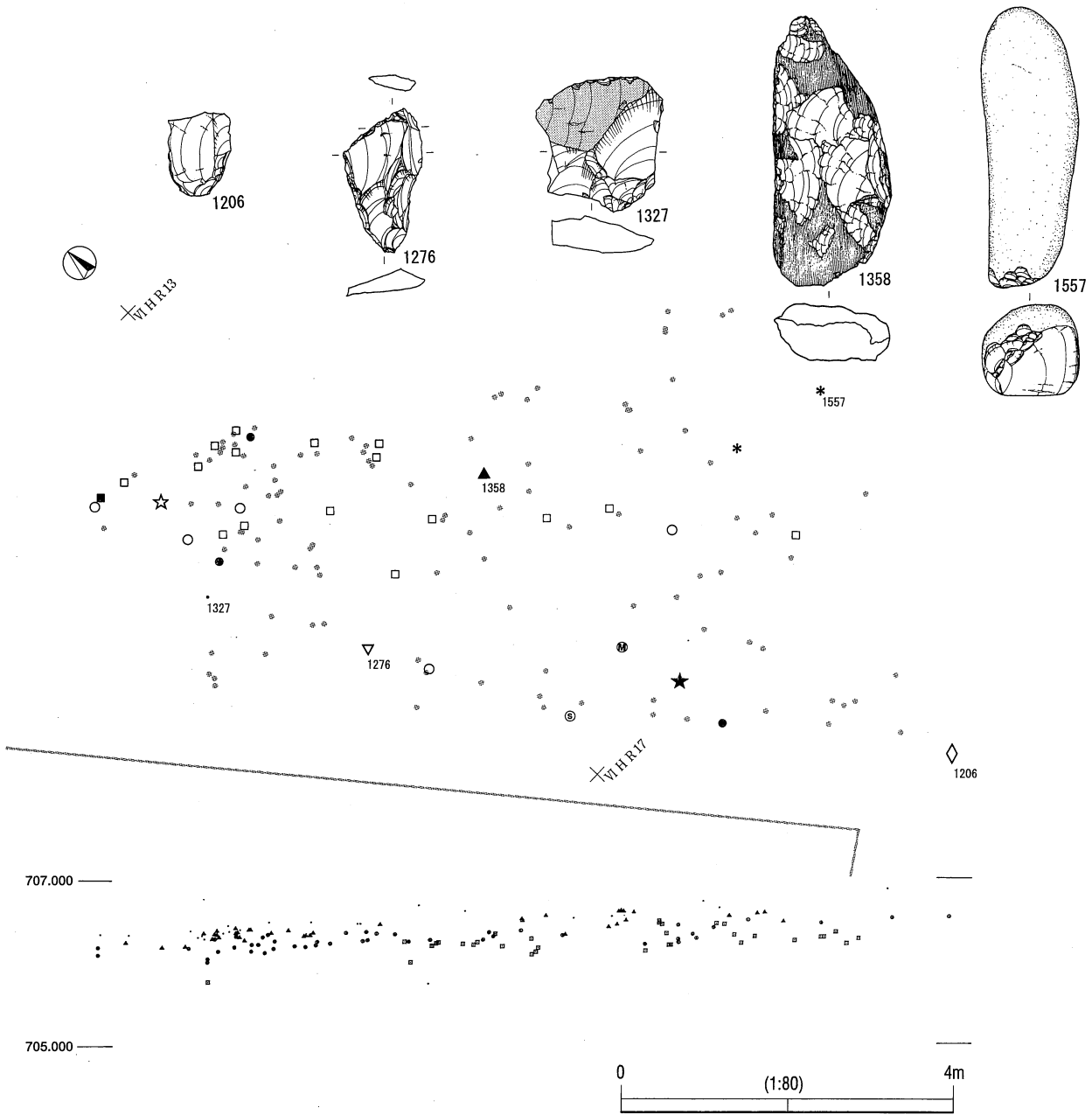

BL 4009

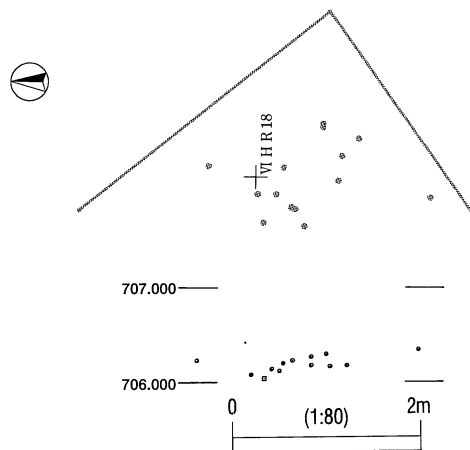

第4地点 BL4008・4009 遺物分布図 (貫ノ木遺跡)

BL 4010

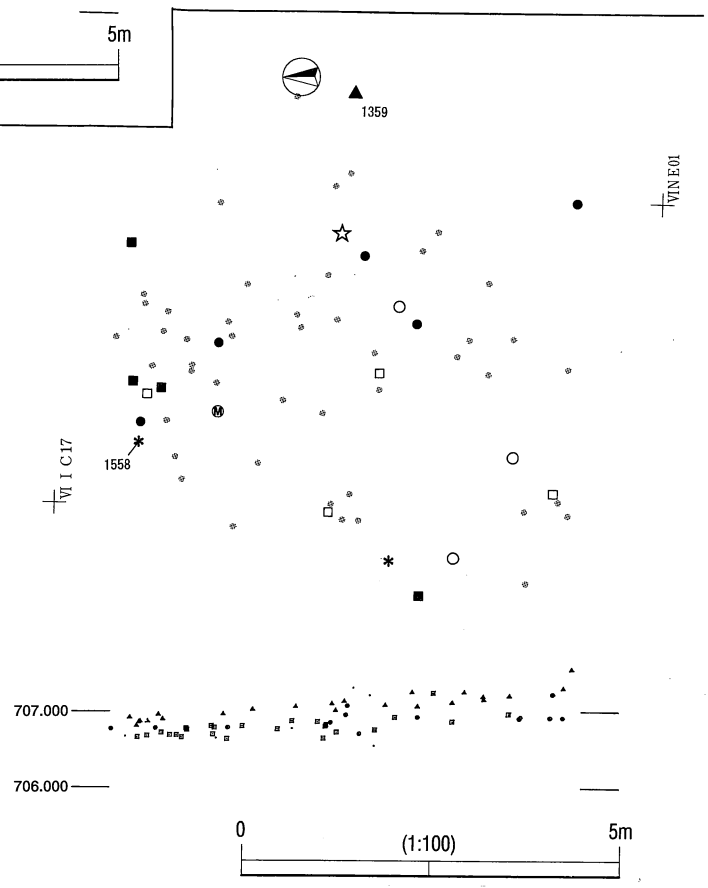
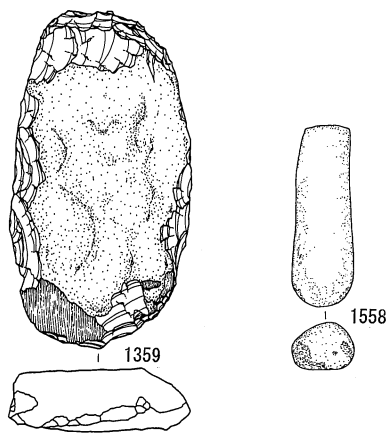
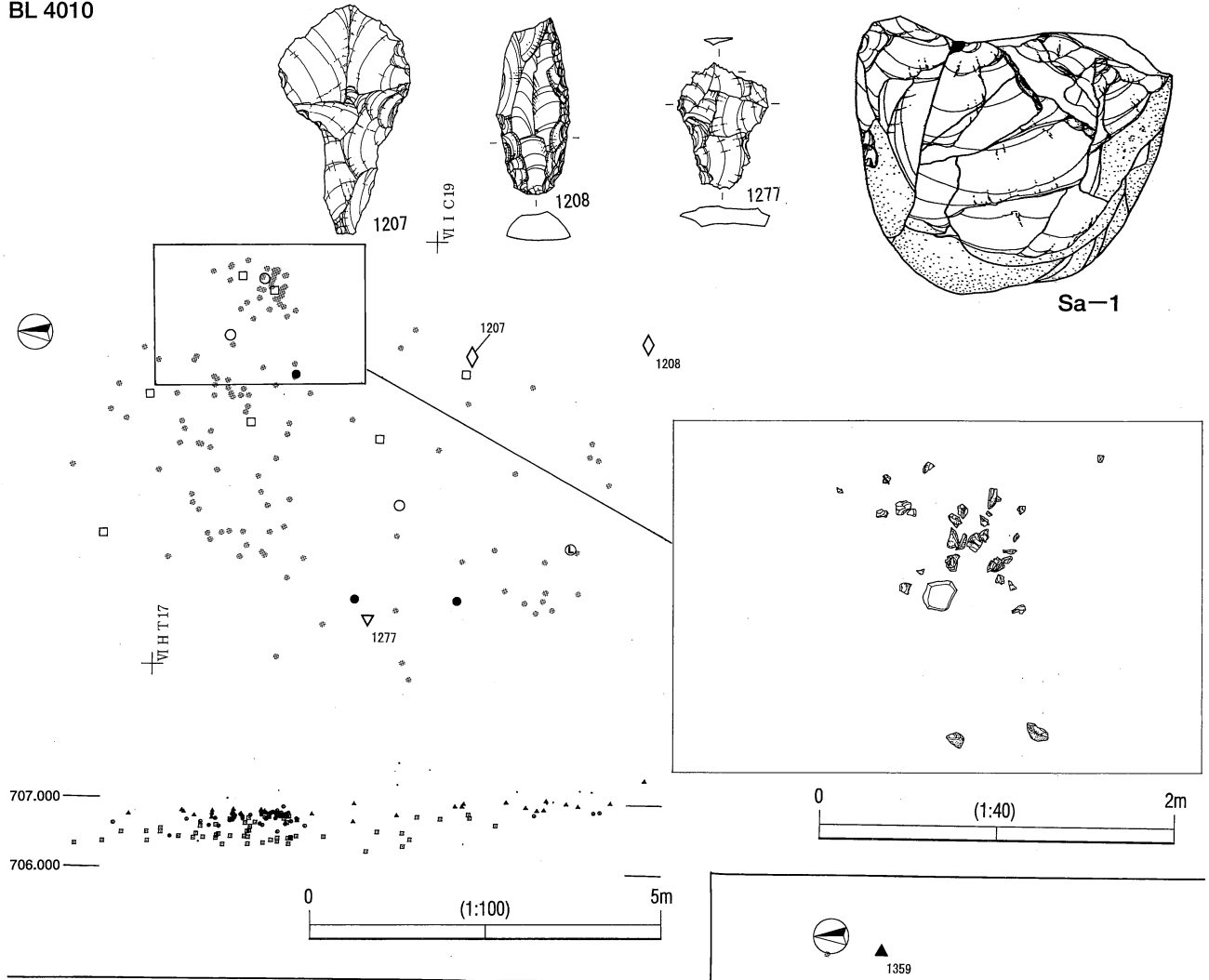

第4地点 BL4010・4011 遺物分布図 (貫ノ木遺跡)

BL 4012

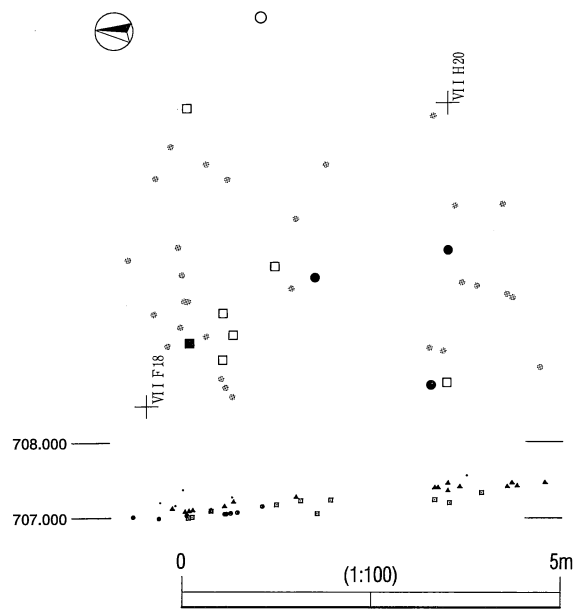

BL 4013

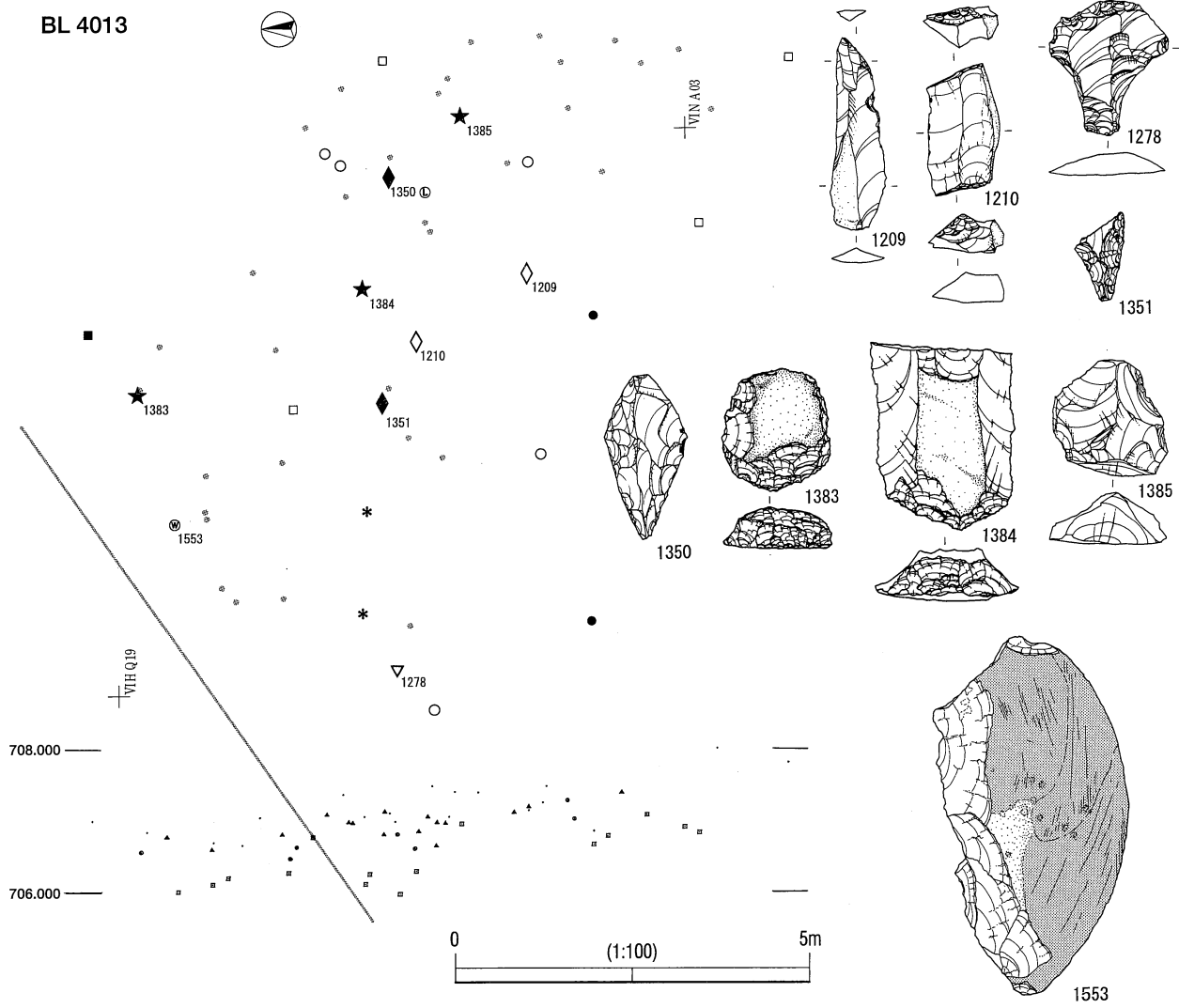

第4地点 BL4012・4013 遺物分布図 (貫ノ木遺跡)

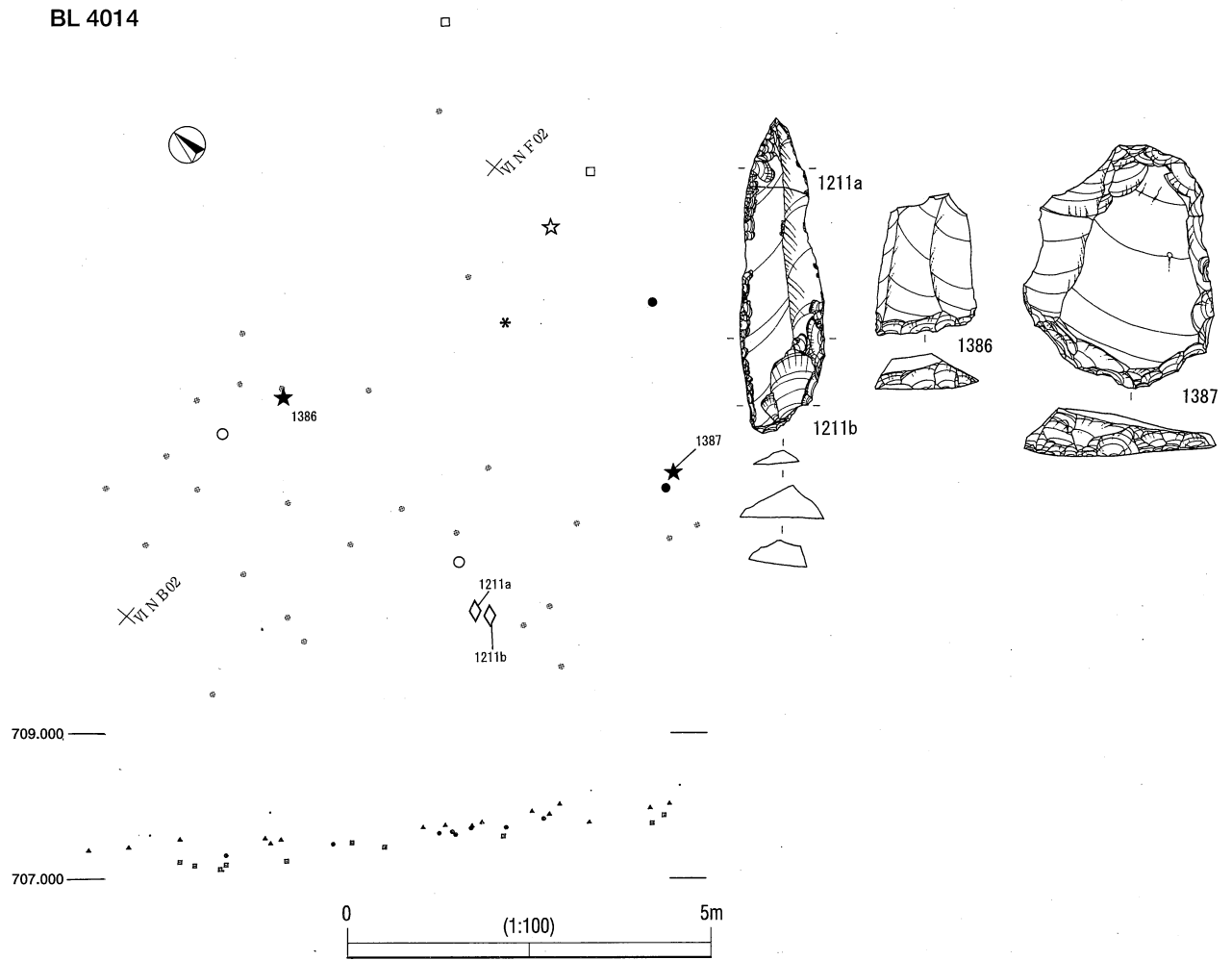

BL 4015

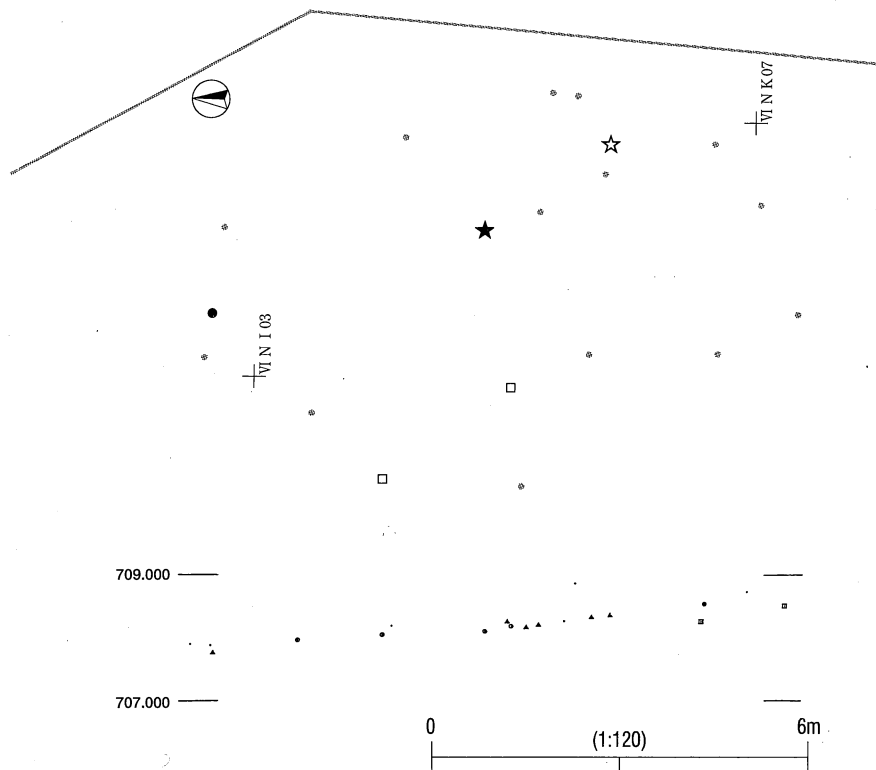

第 4 地点 BL4014・4015 遺物分布図 (貫ノ木遺跡)

BL 4016

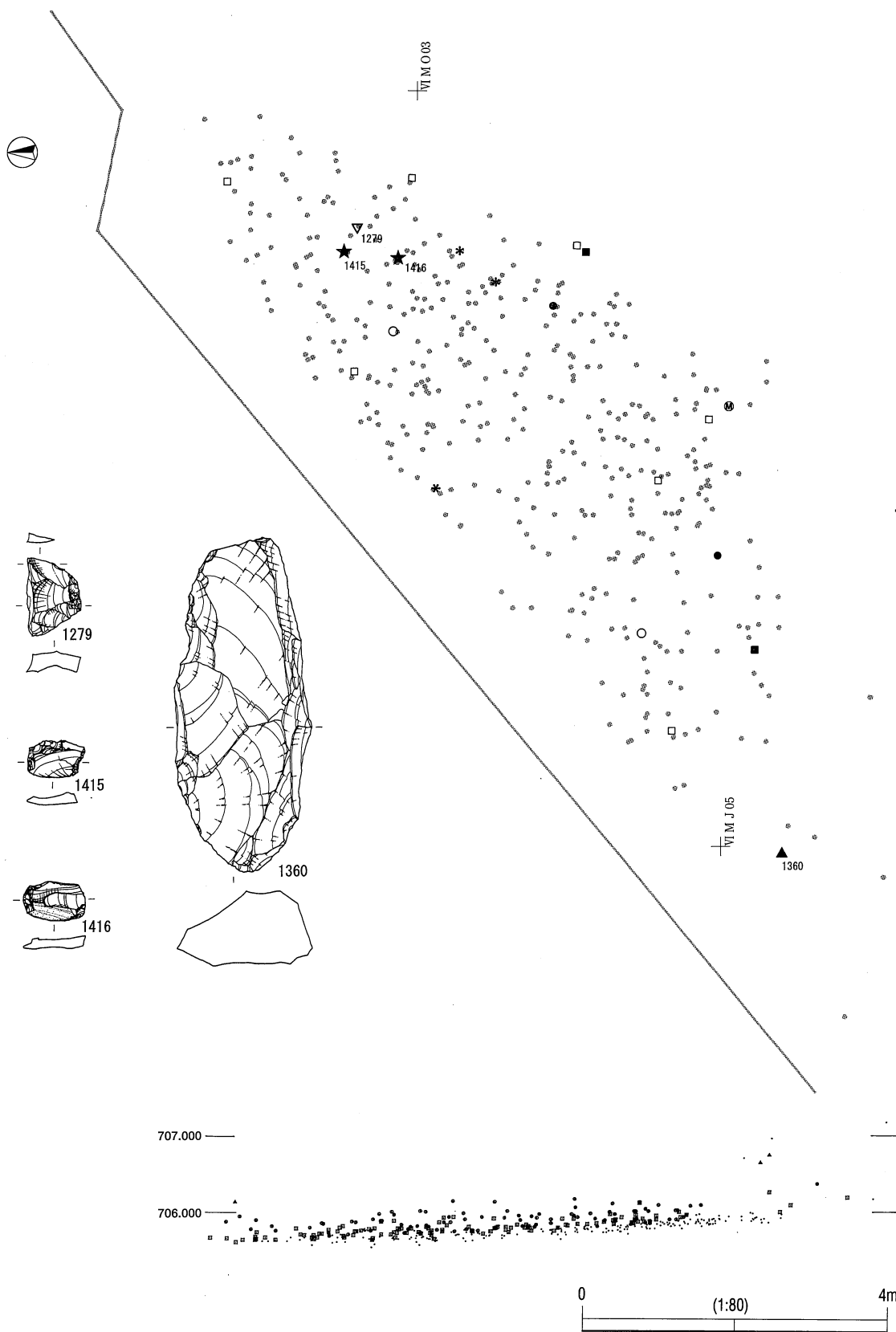

第4地点 BL4016 遺物分布図 (貫ノ木遺跡)

BL 4018

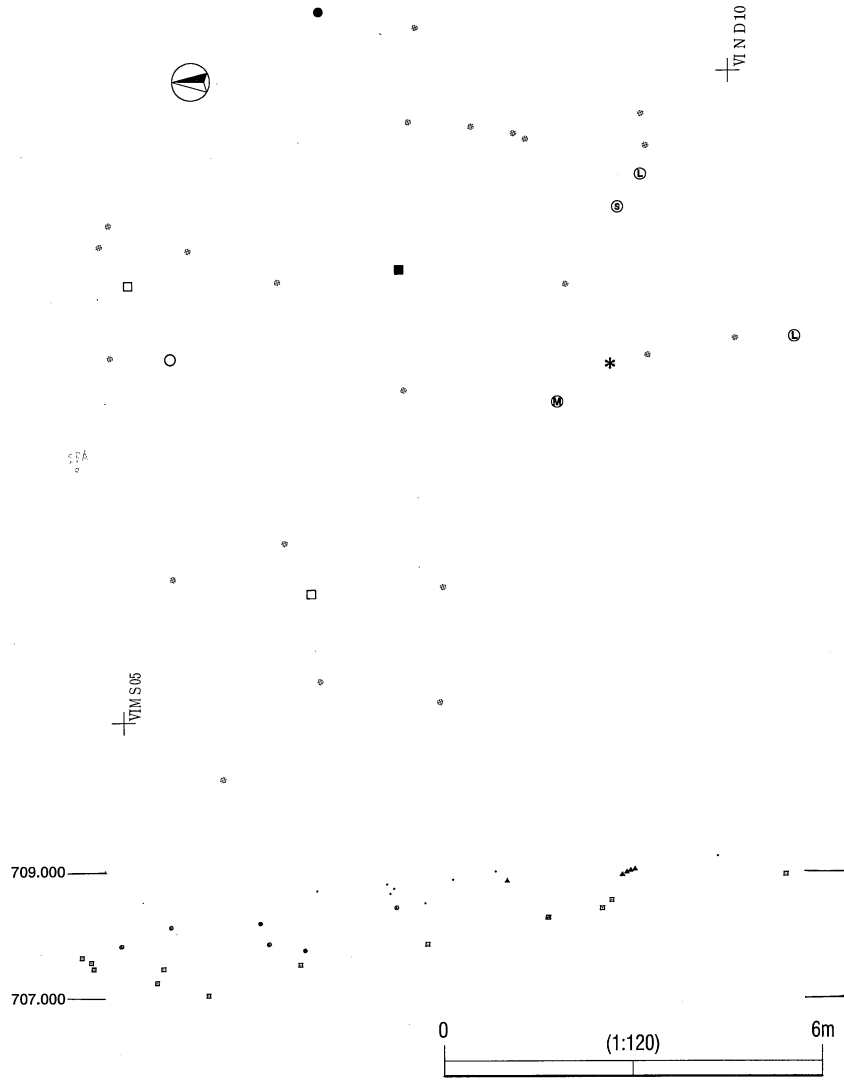

BL 4017

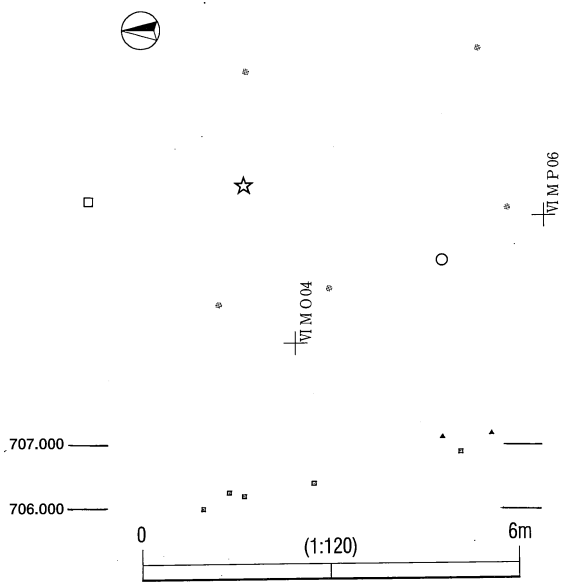

BL 4019

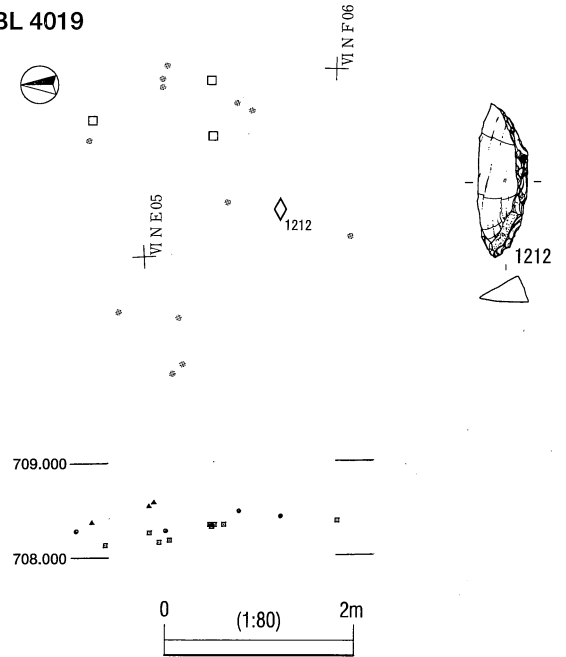

第 4 地点 BL4017・4018・4019 遺物分布図 (貫ノ木遺跡)

BL 4020

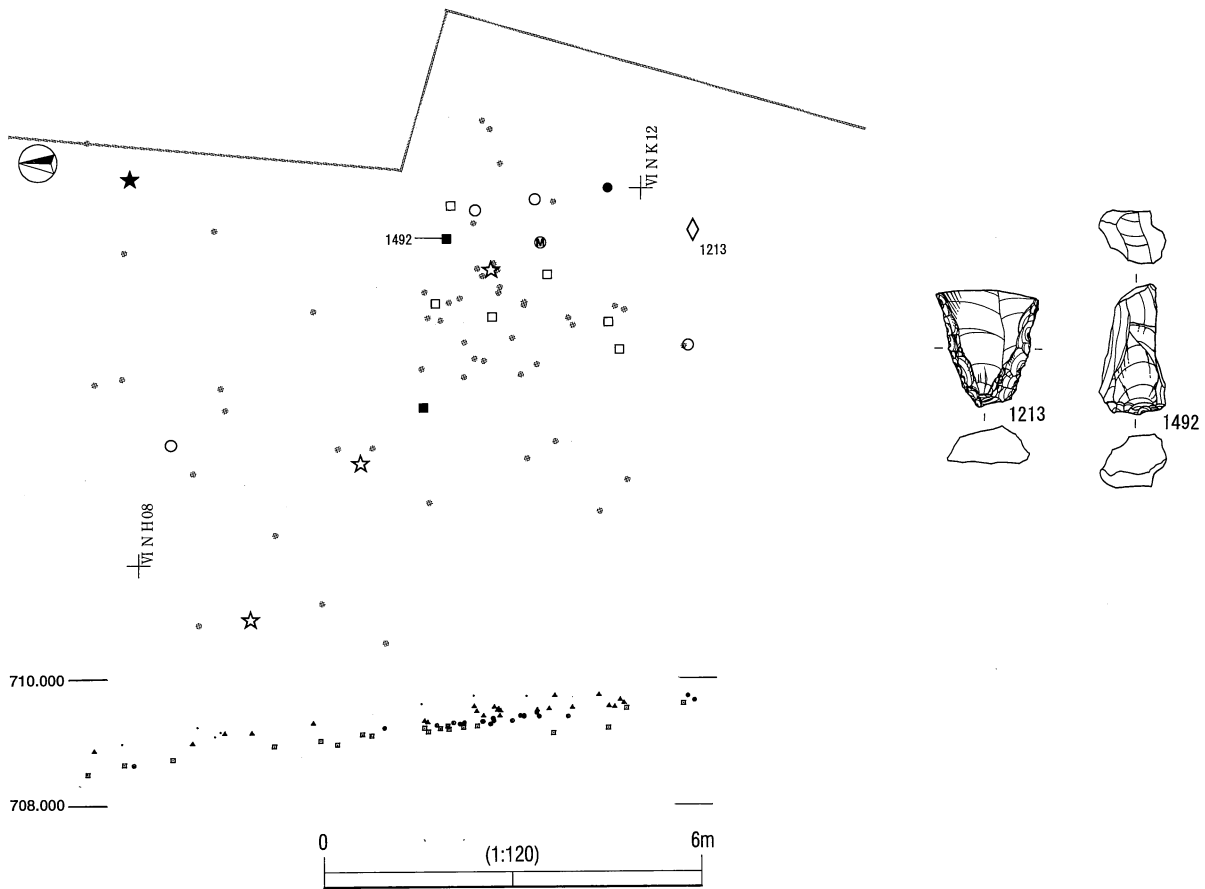

BL 4021

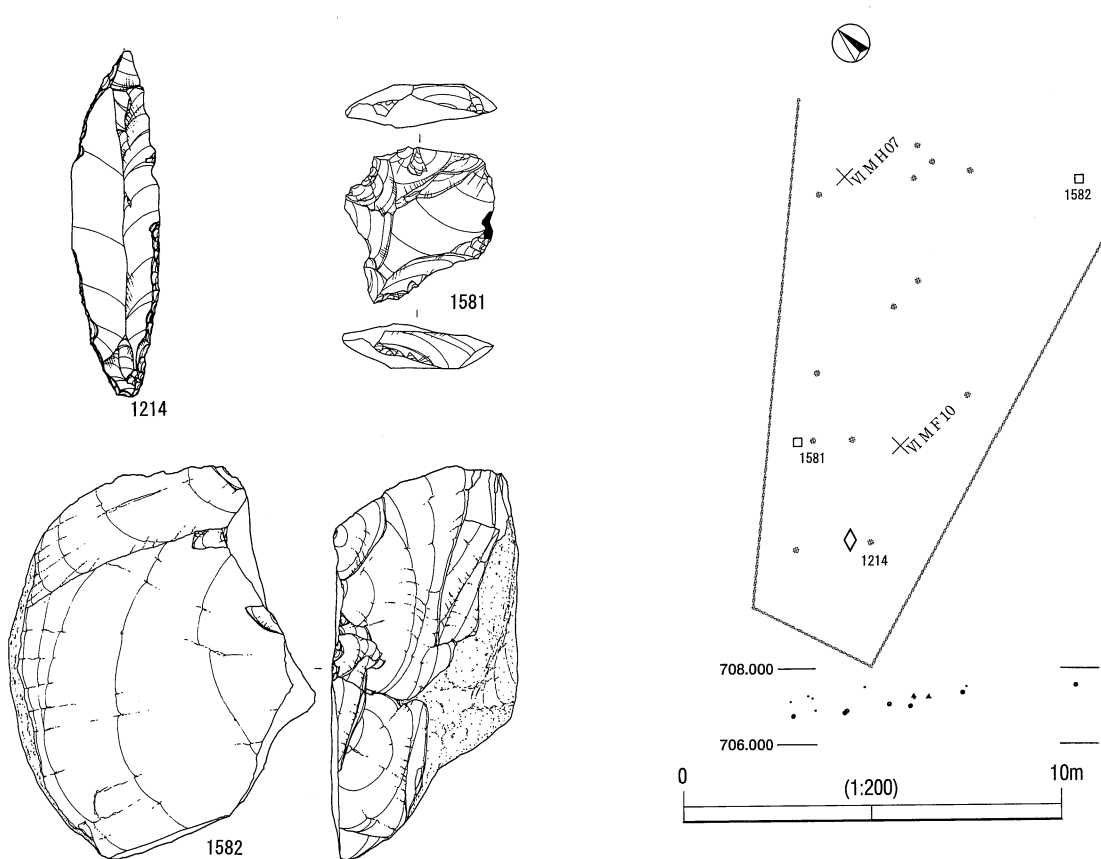

第4地点 BL4020・4021 遺物分布図 (貫ノ木遺跡)

BL 4022

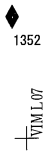
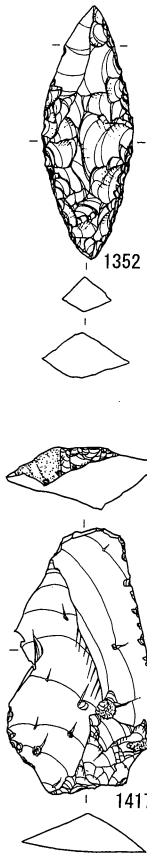

709.000

707.000

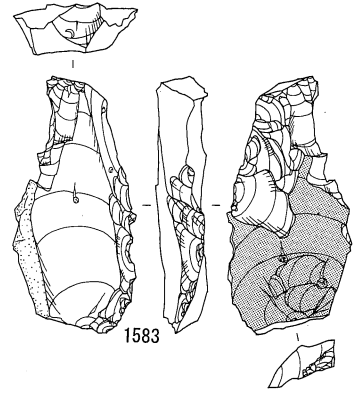
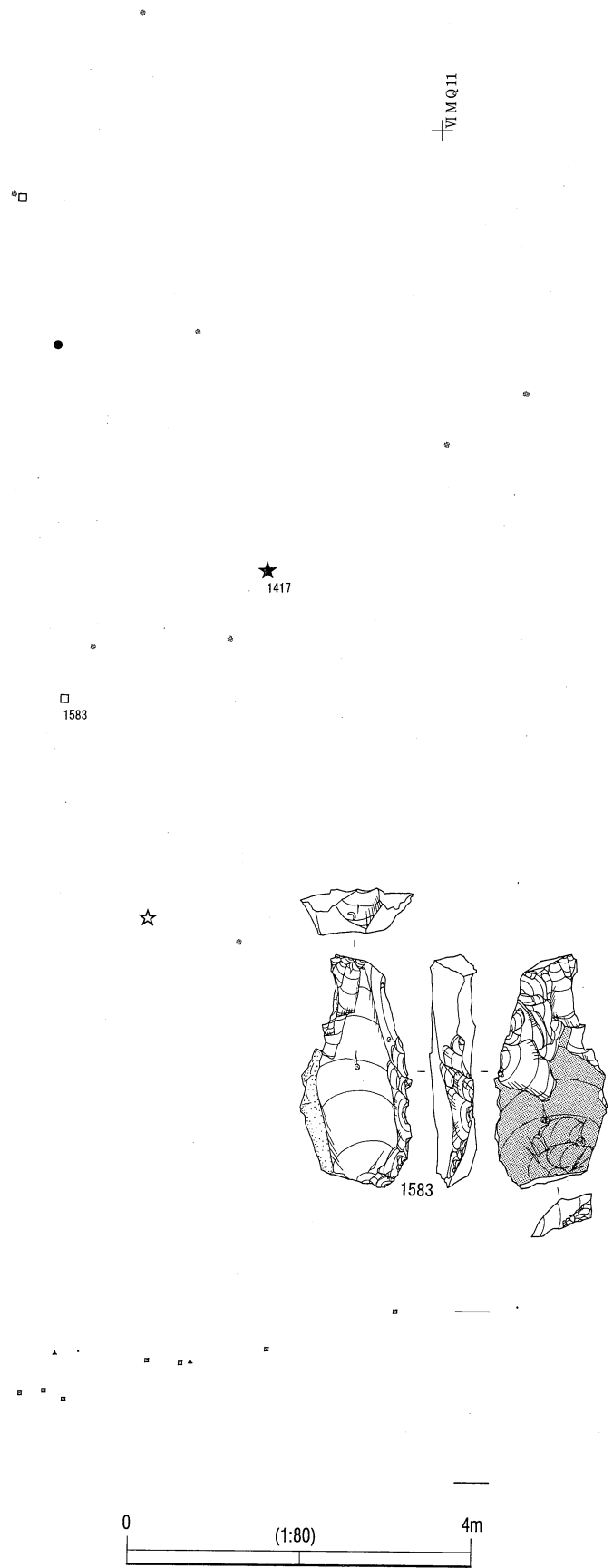

第 4 地点 BL4022 遺物分布図 (貫ノ木遺跡)

BL 4023

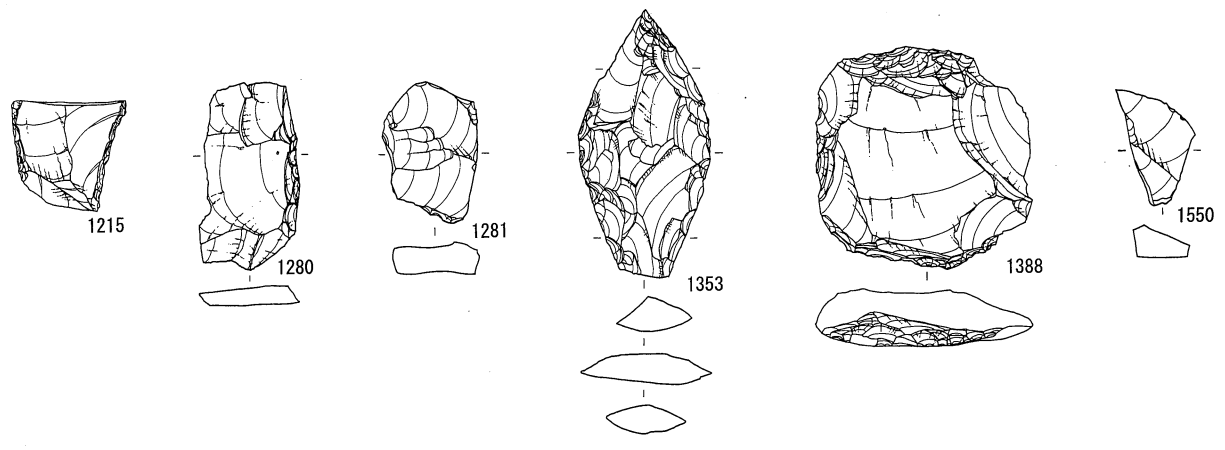
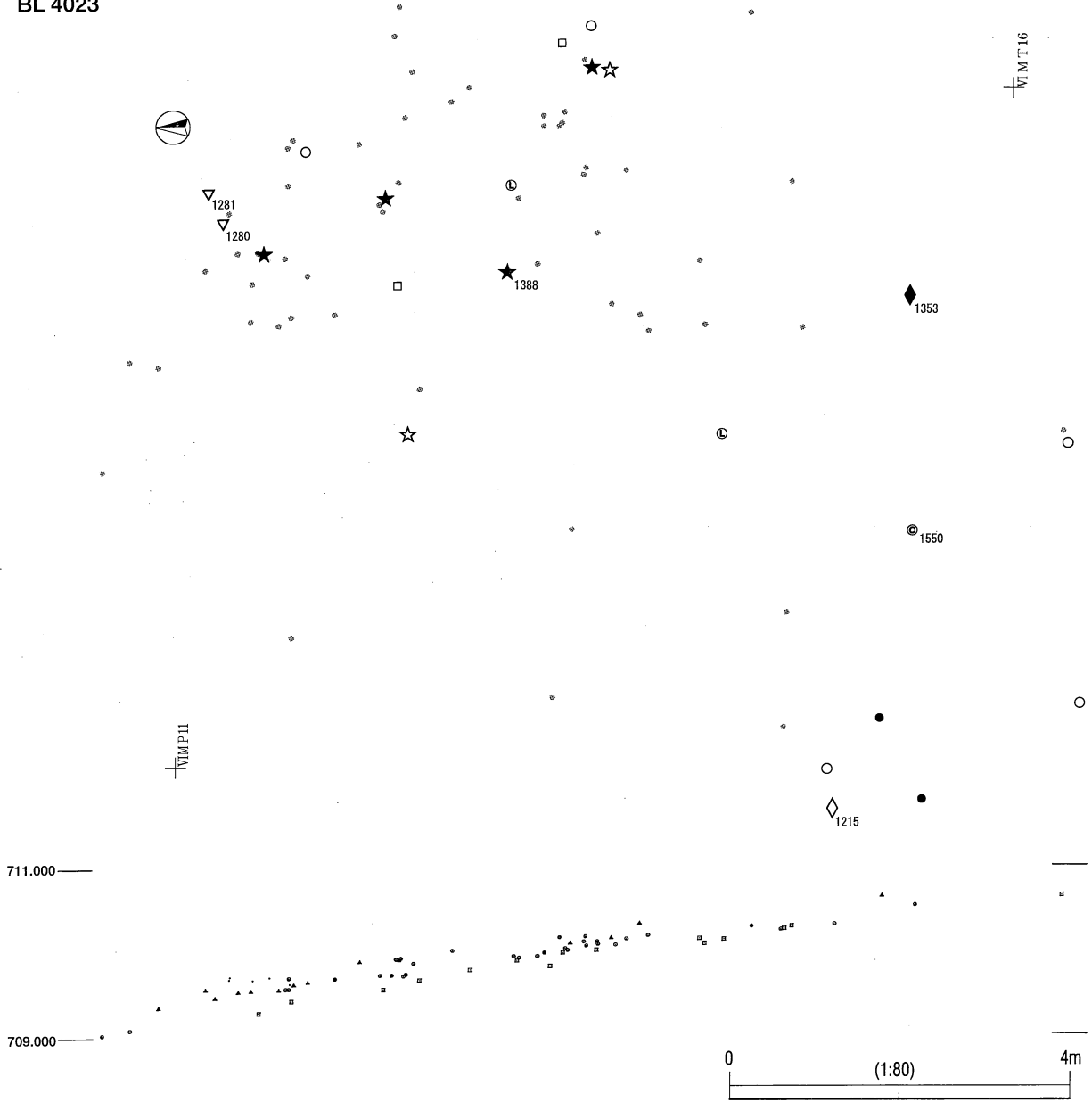

第4地点 BL4023 遺物分布図 (貫ノ木遺跡)

BL 4024

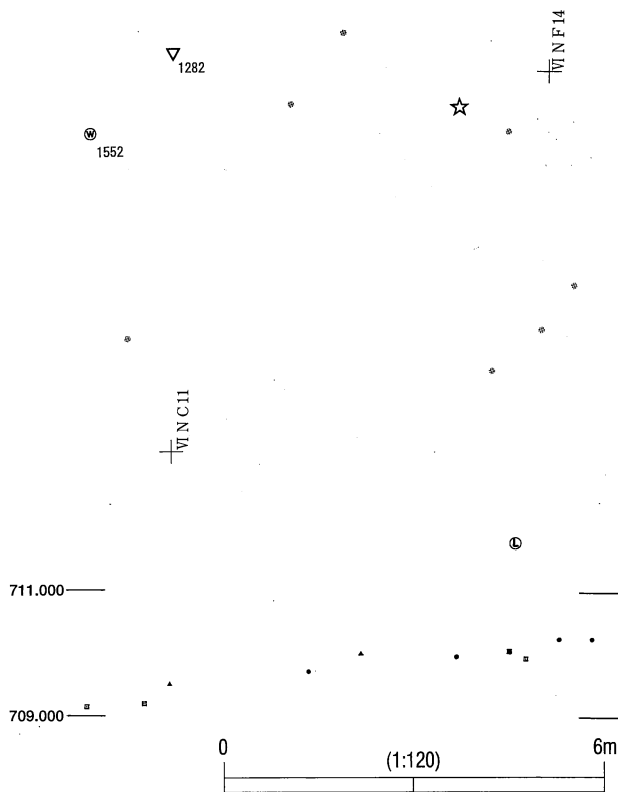
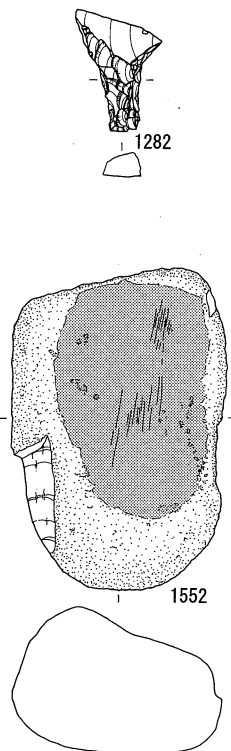

BL 4025

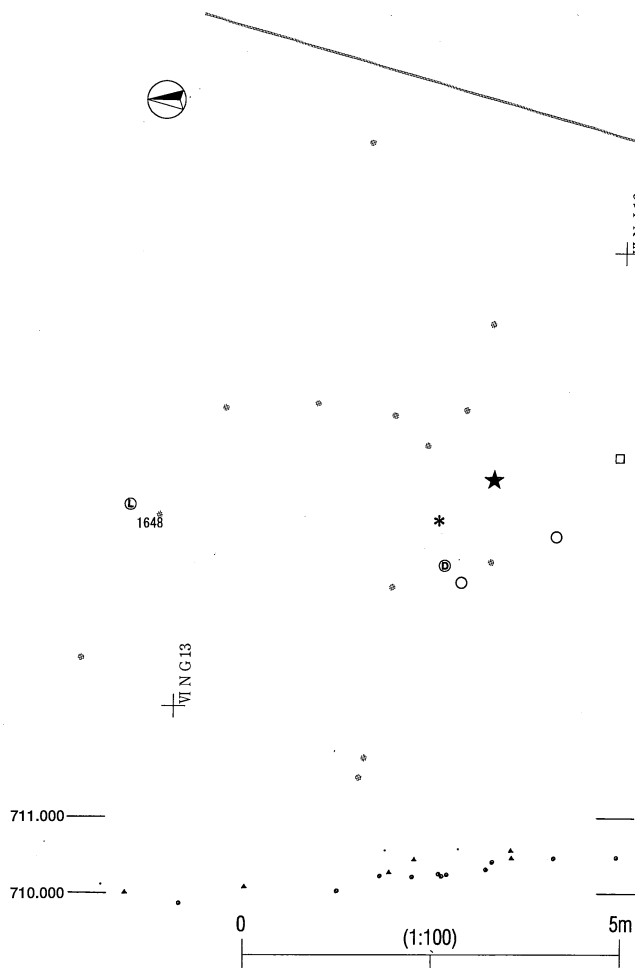

第4地点 BL4024・4025 遺物分布図 (貫ノ木遺跡)

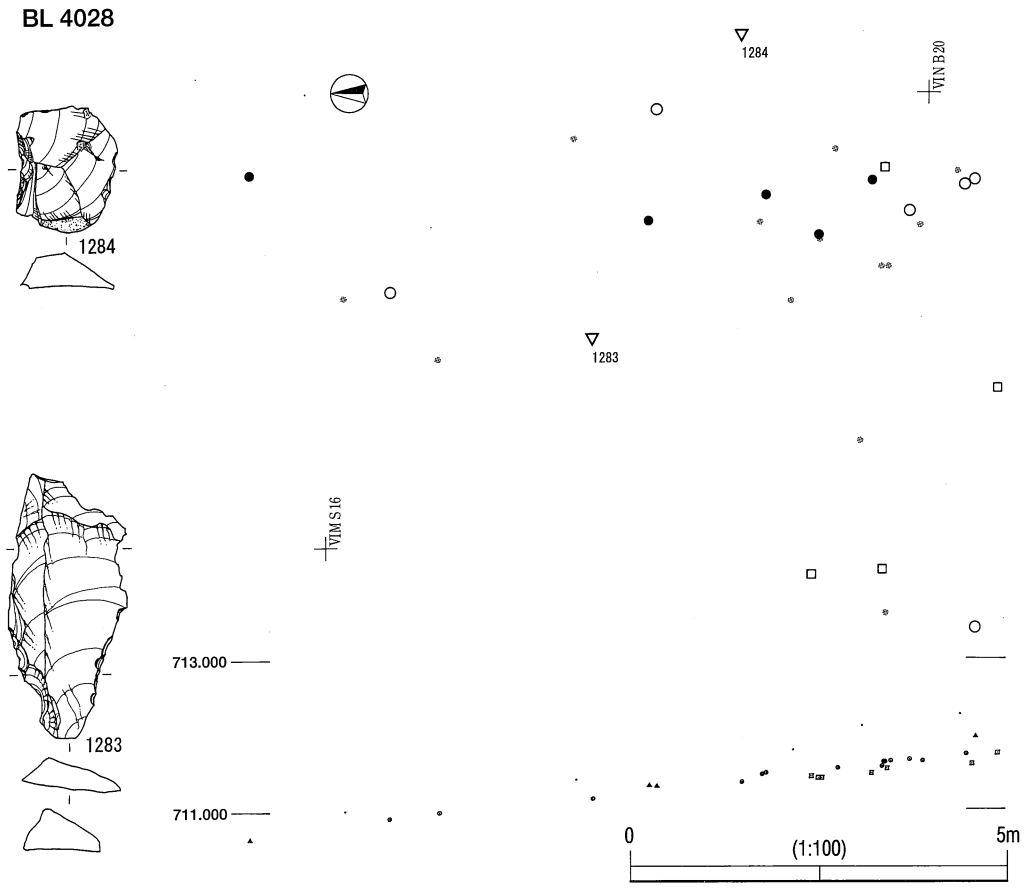
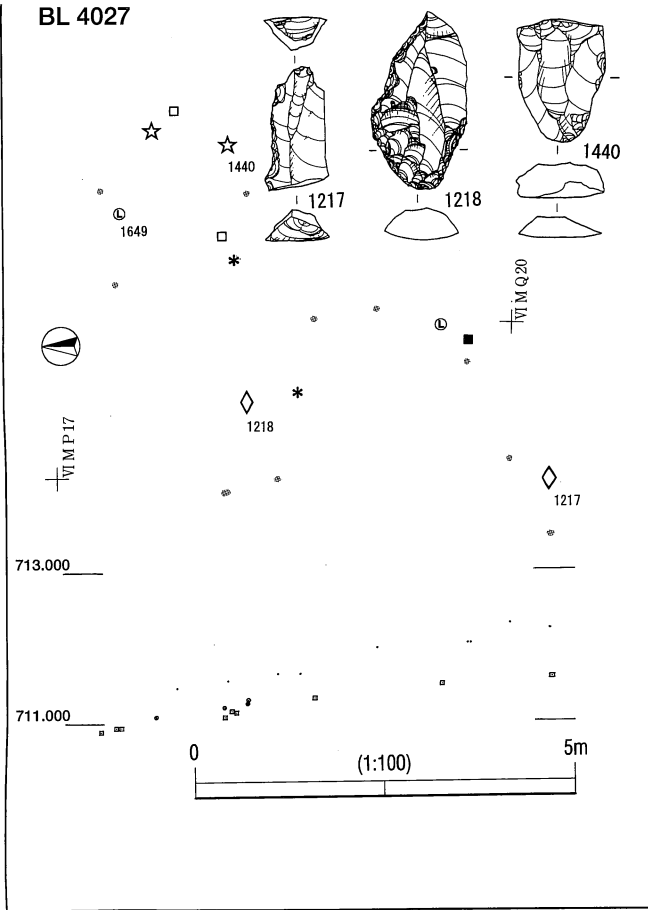
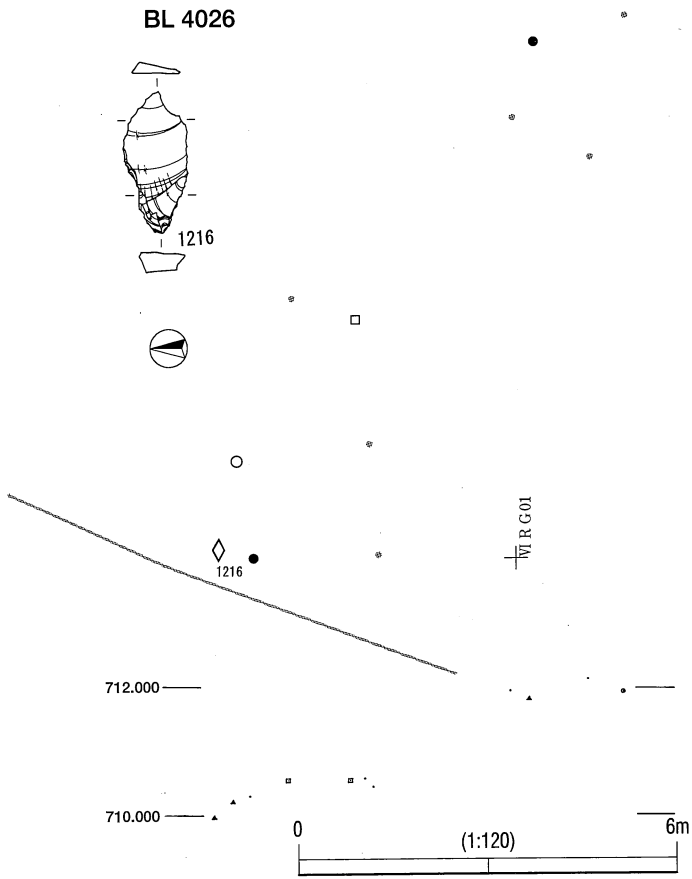

第4地点 BL4026・4027・4028 遺物分布図 (貫ノ木遺跡)

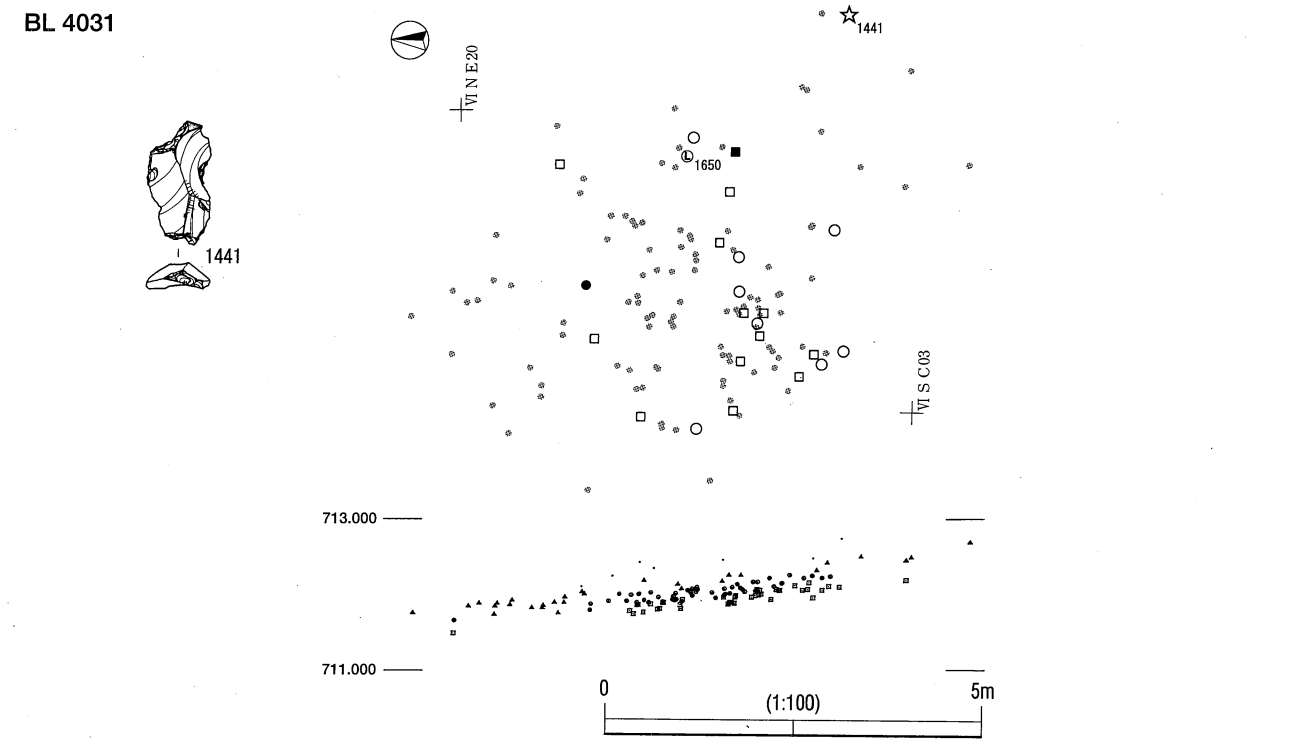
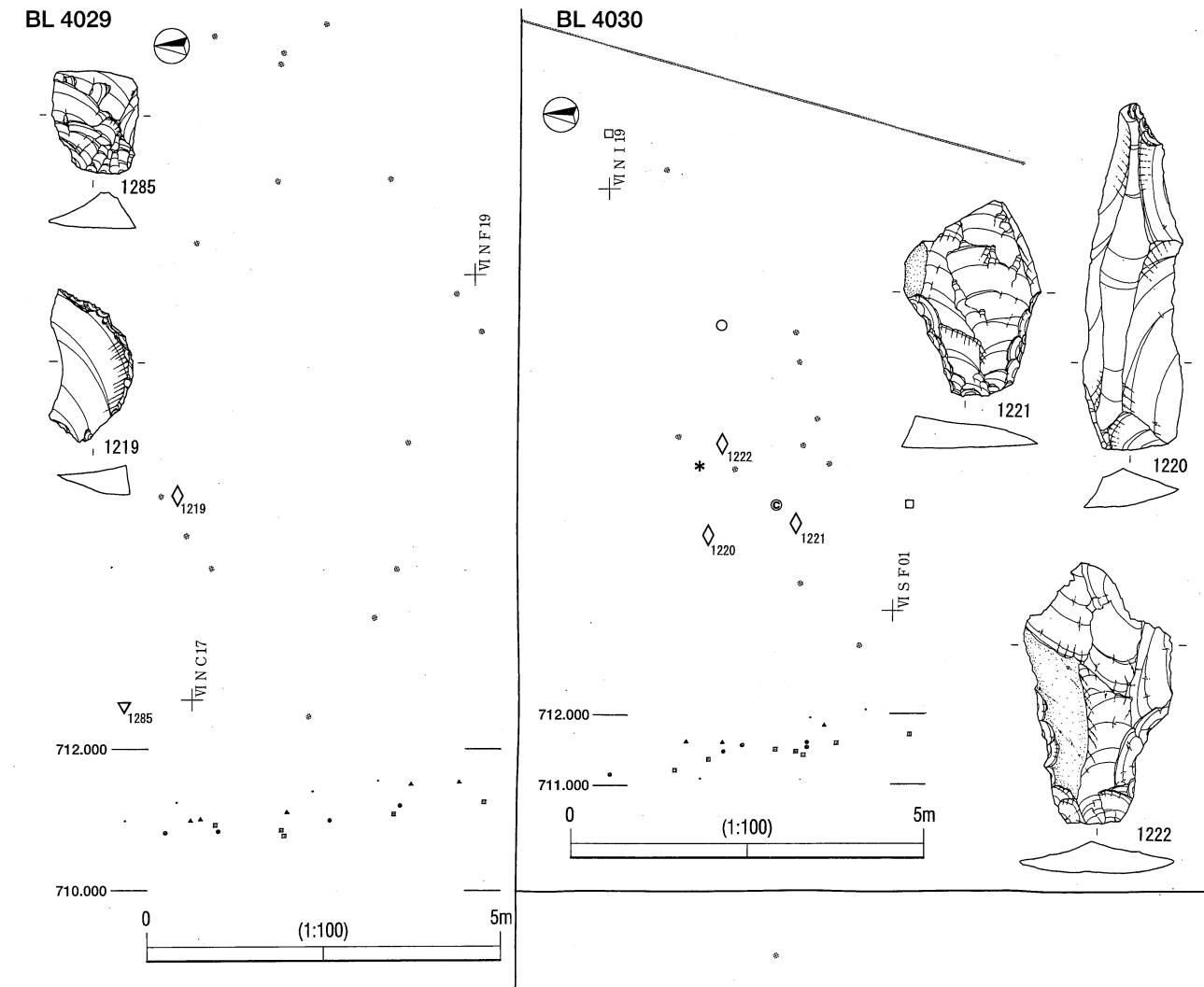

第4地点 BL4029・4030・4031 遺物分布図 (貫ノ木遺跡)

BL 4032

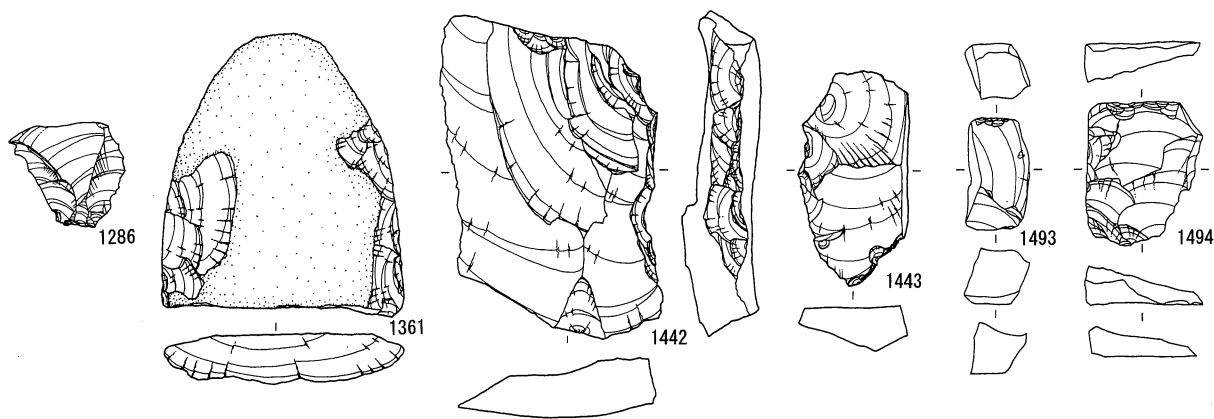
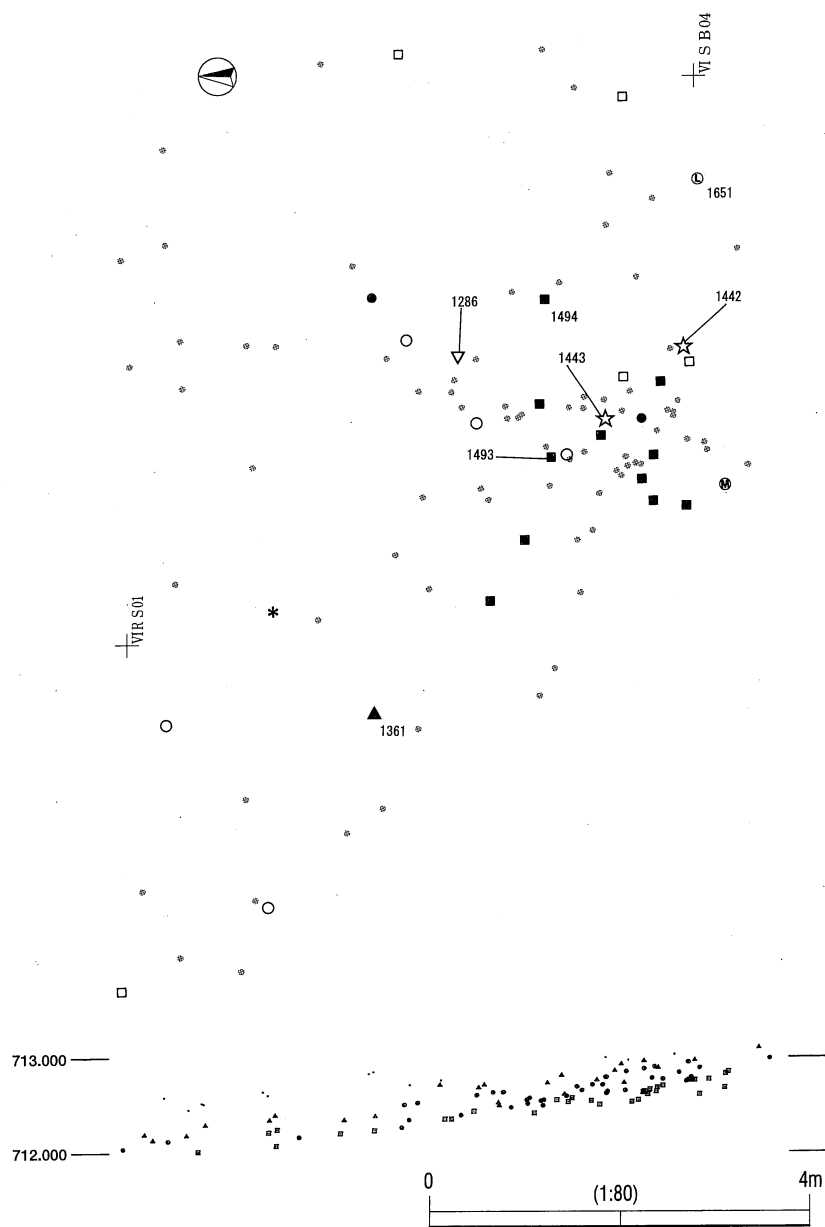

第4地点 BL4032 遺物分布図 (貫ノ木遺跡)

BL 4033

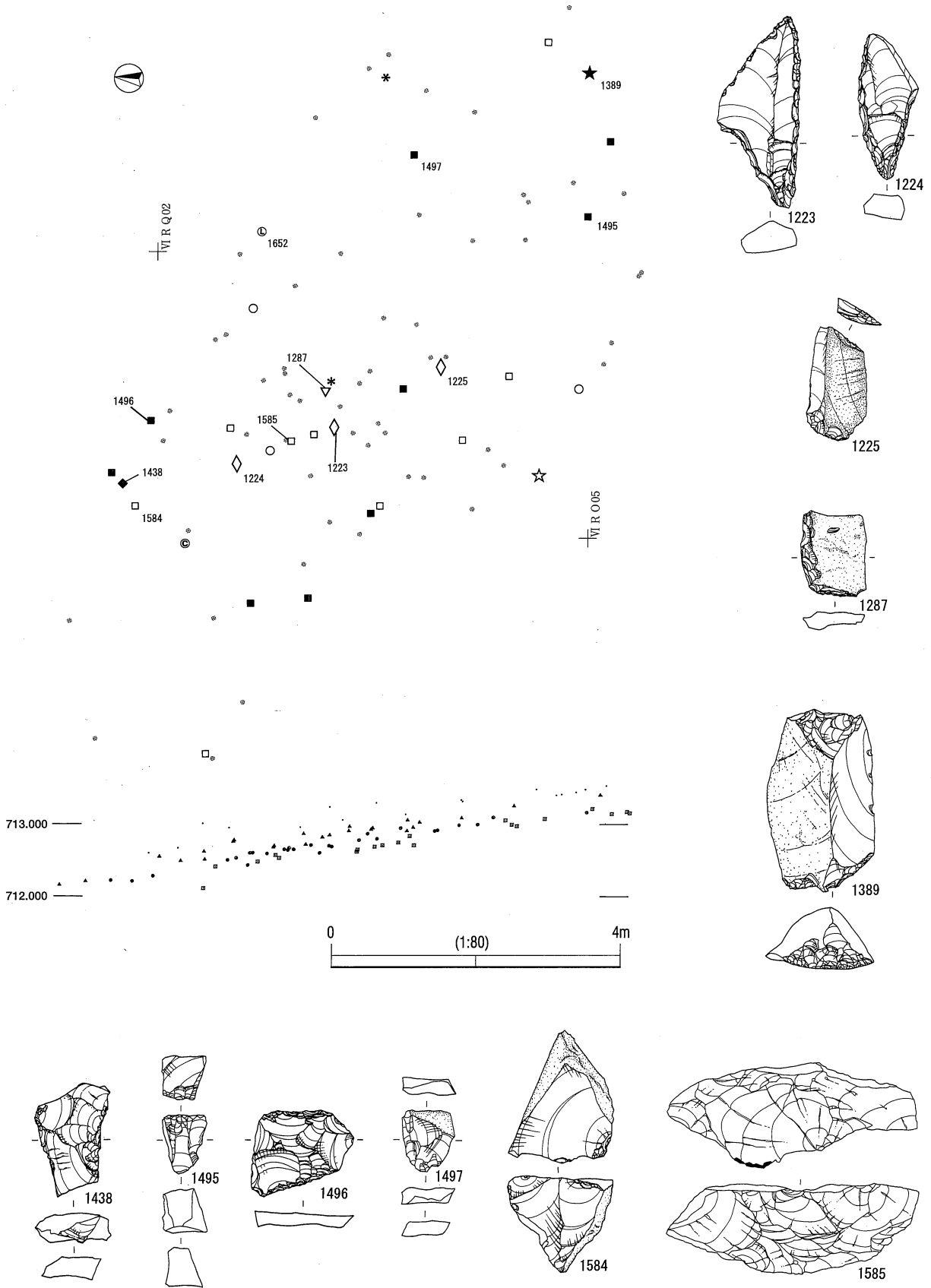

第4地点 BL4033 遺物分布図 (貫ノ木遺跡)

BL 4034

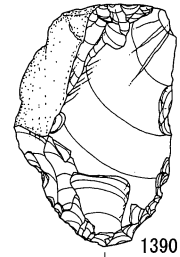
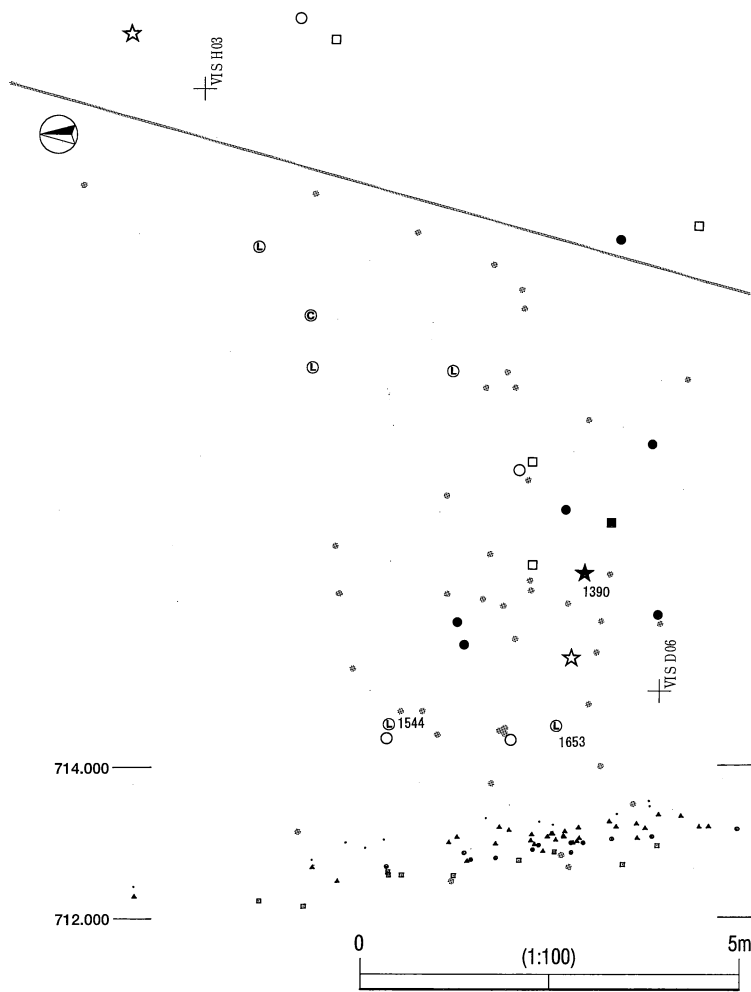

1390

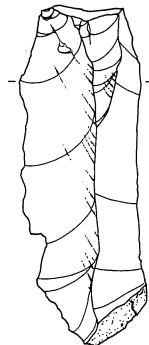

1544

BL 4035

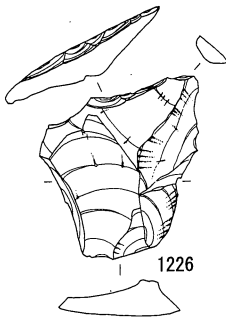

1226

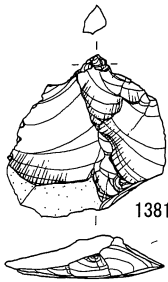

1381

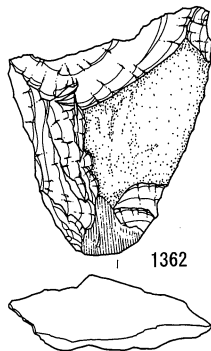

1362



1498

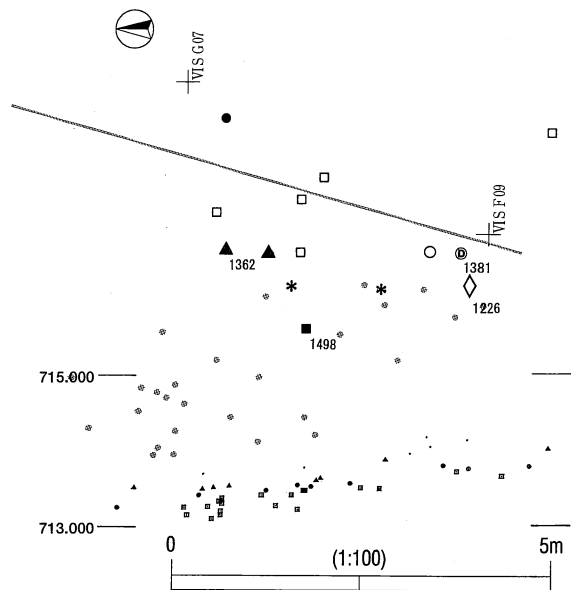

第4地点 BL4034・4035 遺物分布図 (貫ノ木遺跡)

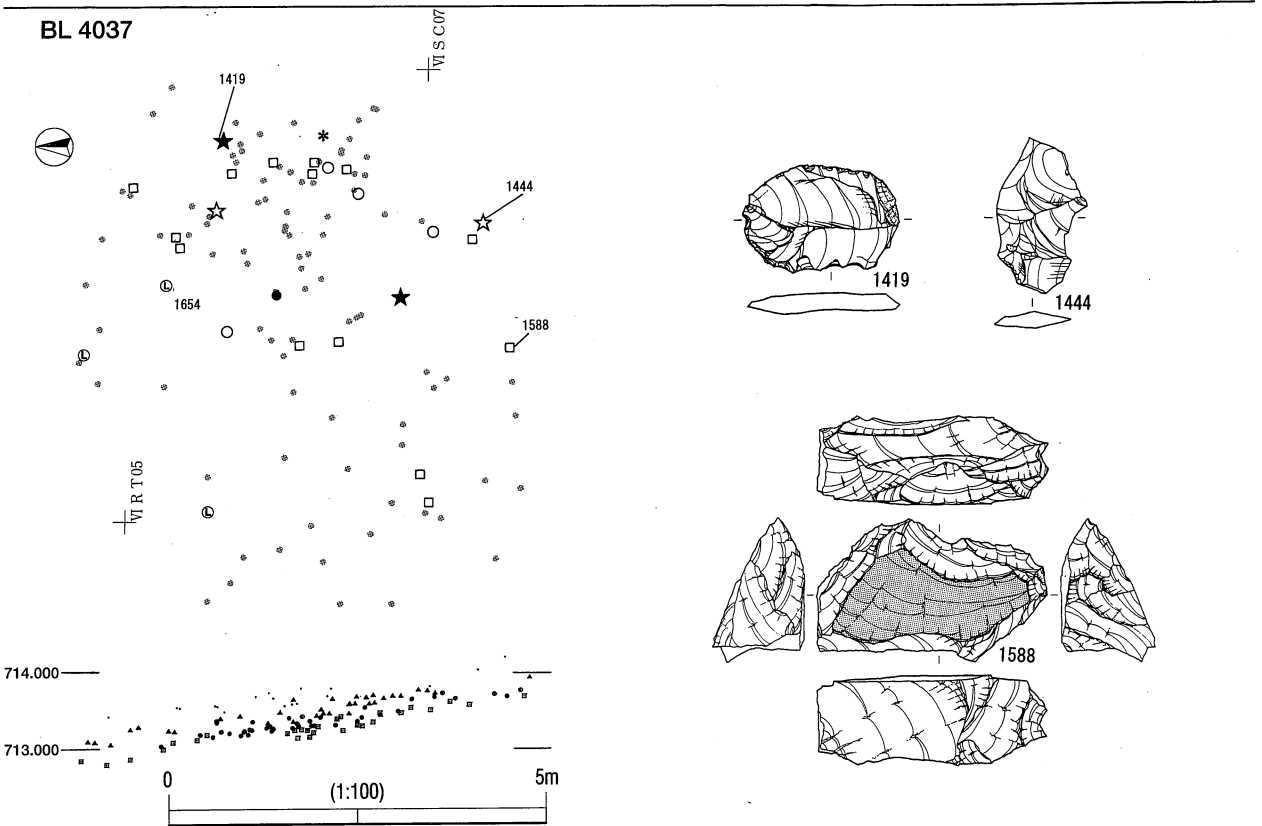
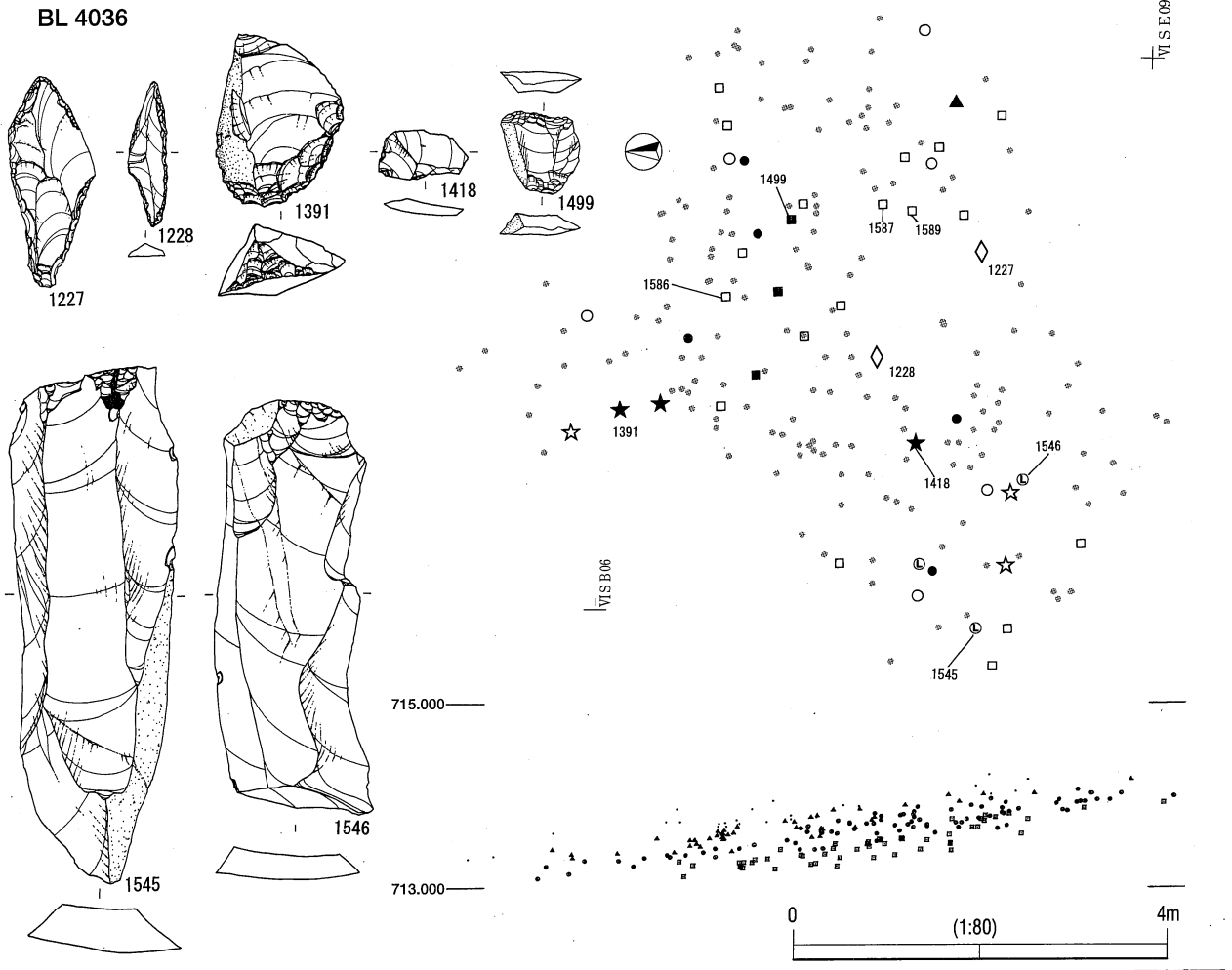

第4地点 BL4036・4037 遺物分布図 (貫ノ木遺跡)

BL 4038

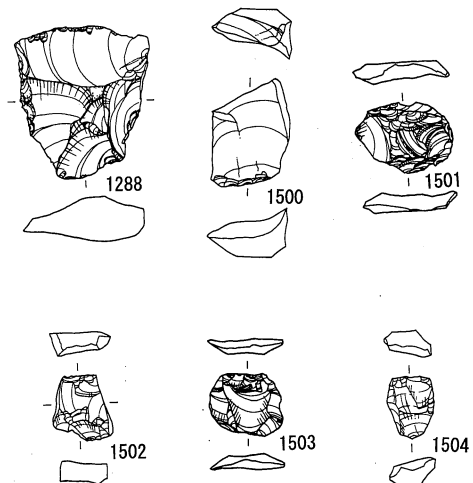
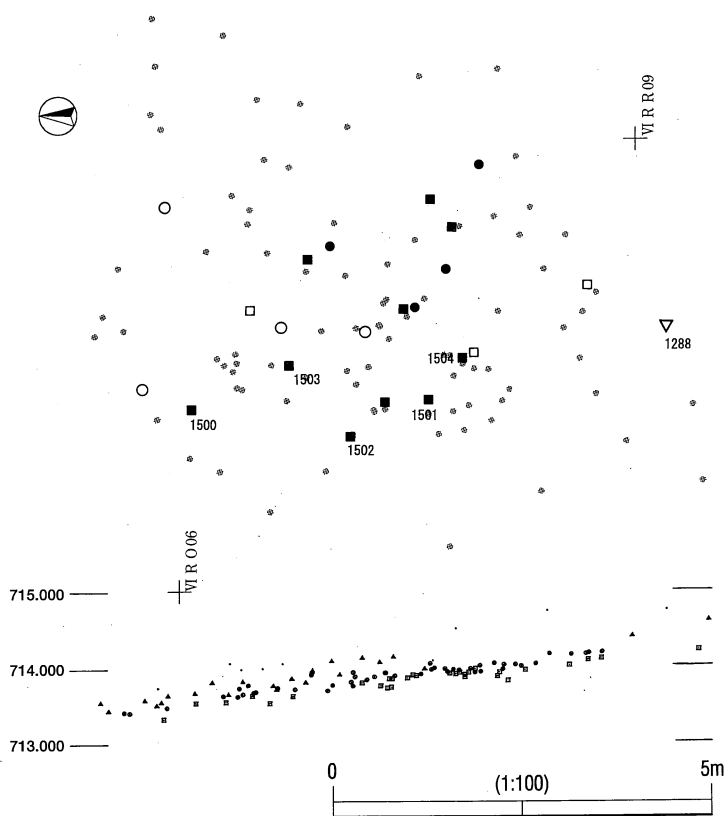

BL 4039

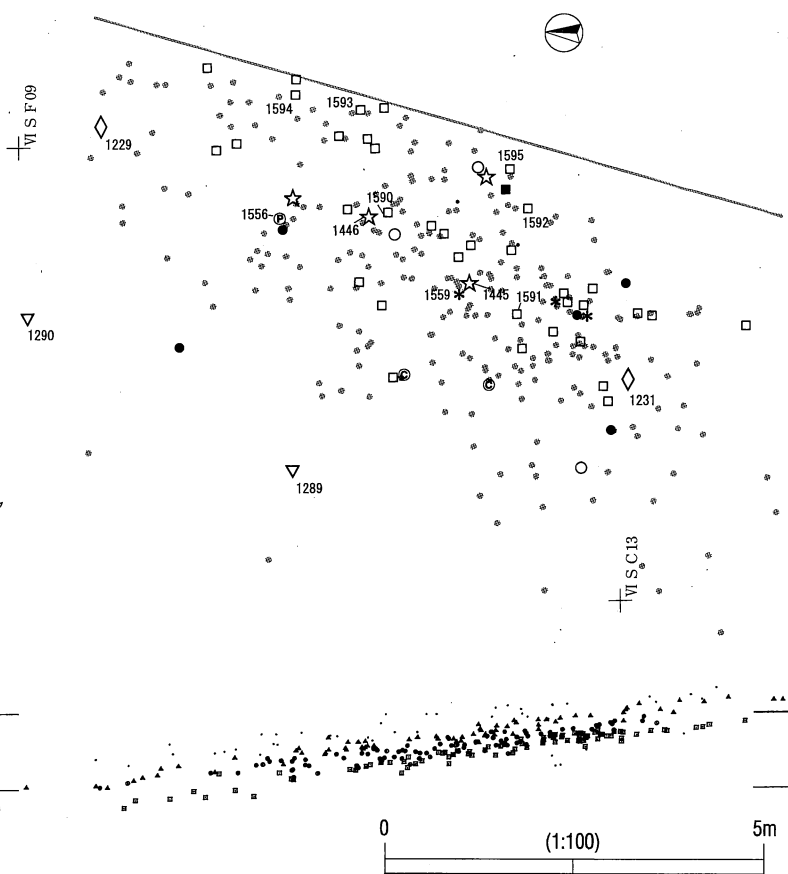
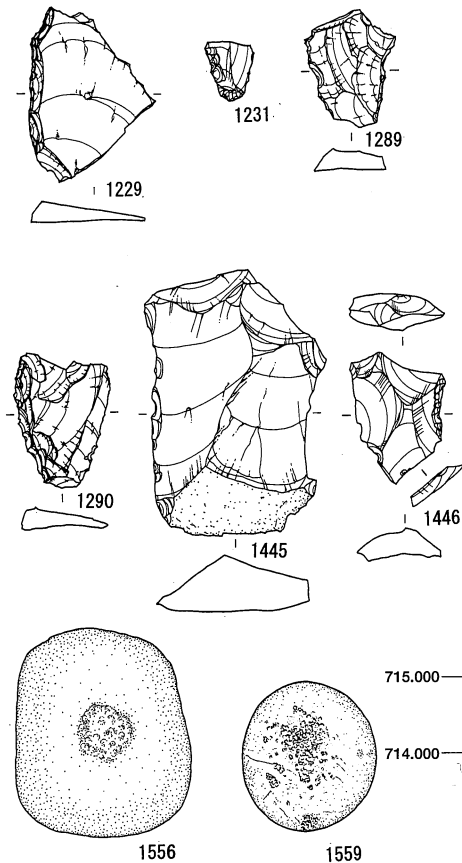

第4地点 BL4038・4039 遺物分布図 (貫ノ木遺跡)

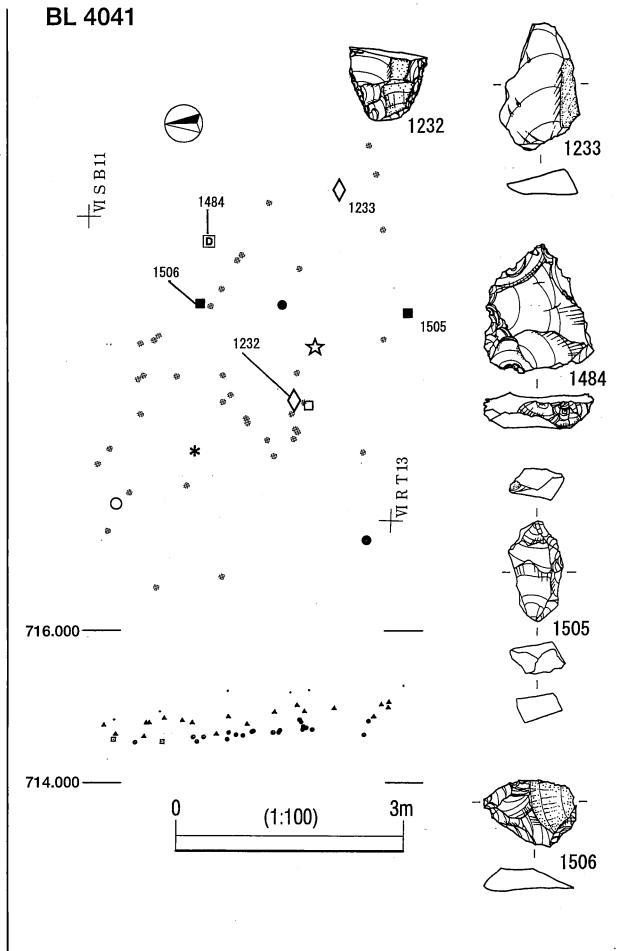
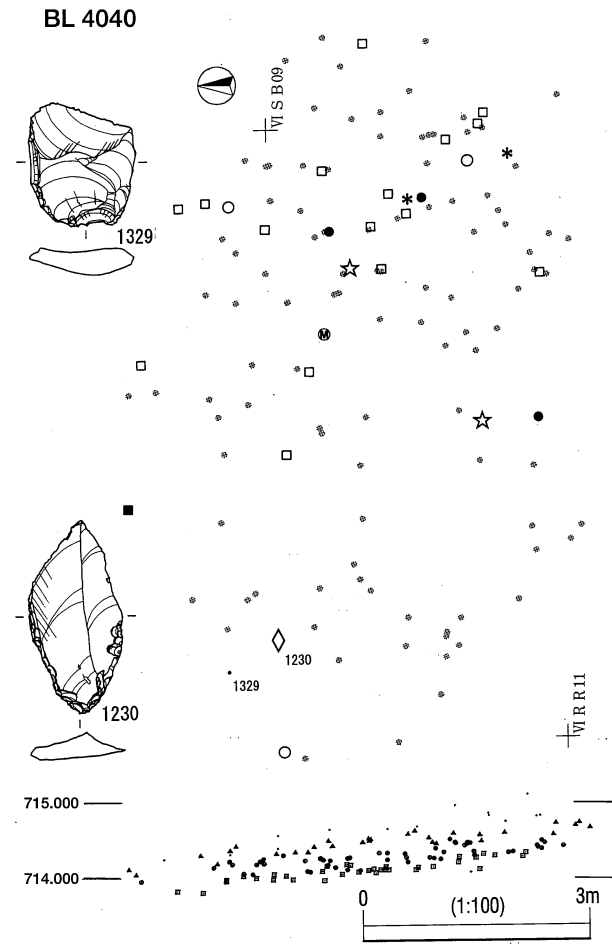

第4地点 BL4040・4041・4042 遺物分布図 (貫ノ木遺跡)



第4地点 BL4043・4045 遺物分布図 (貫ノ木遺跡)

BL 4044

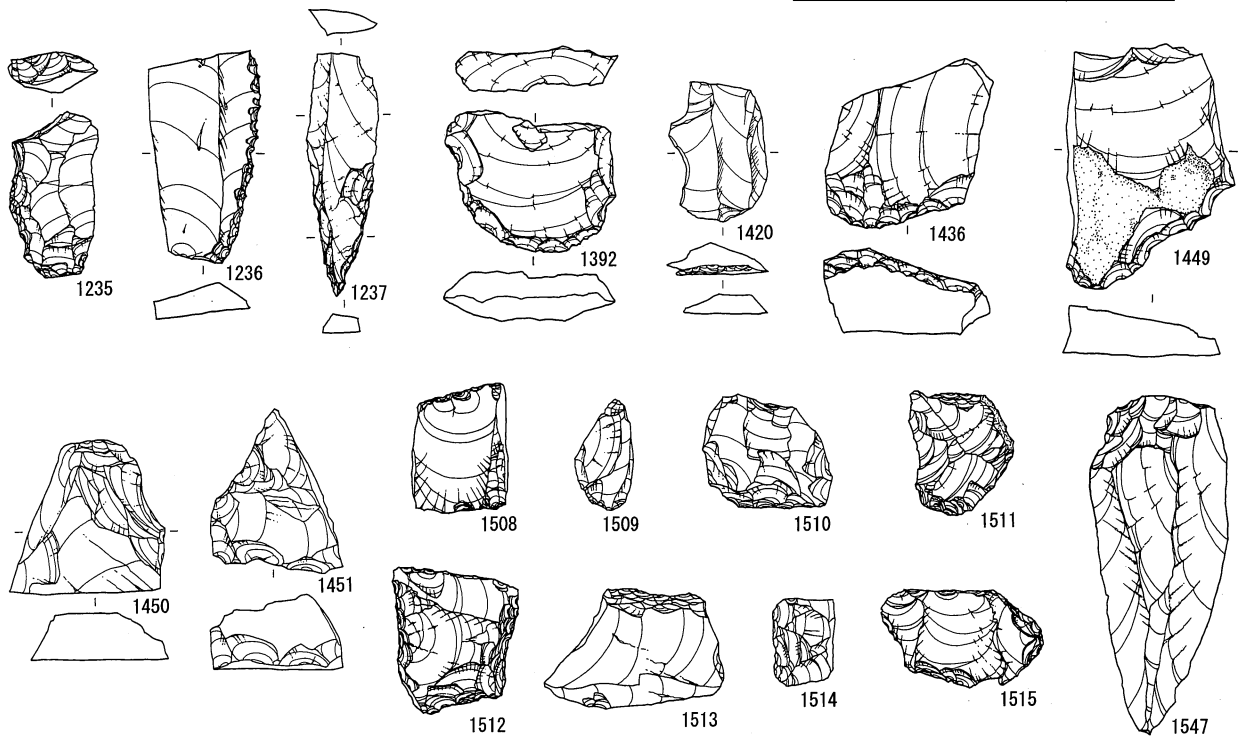
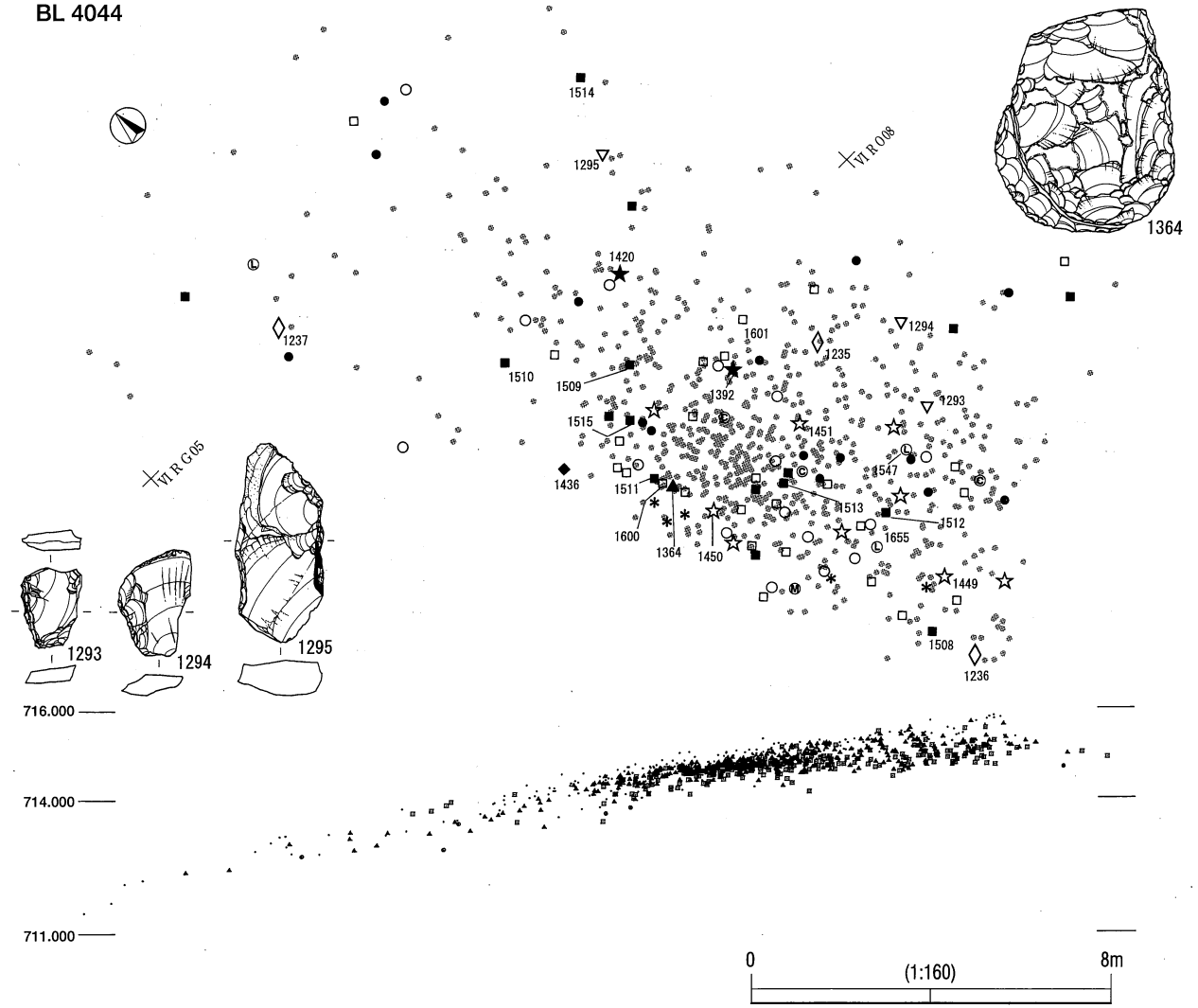

第4地点 BL4044 遺物分布図 (貫ノ木遺跡)

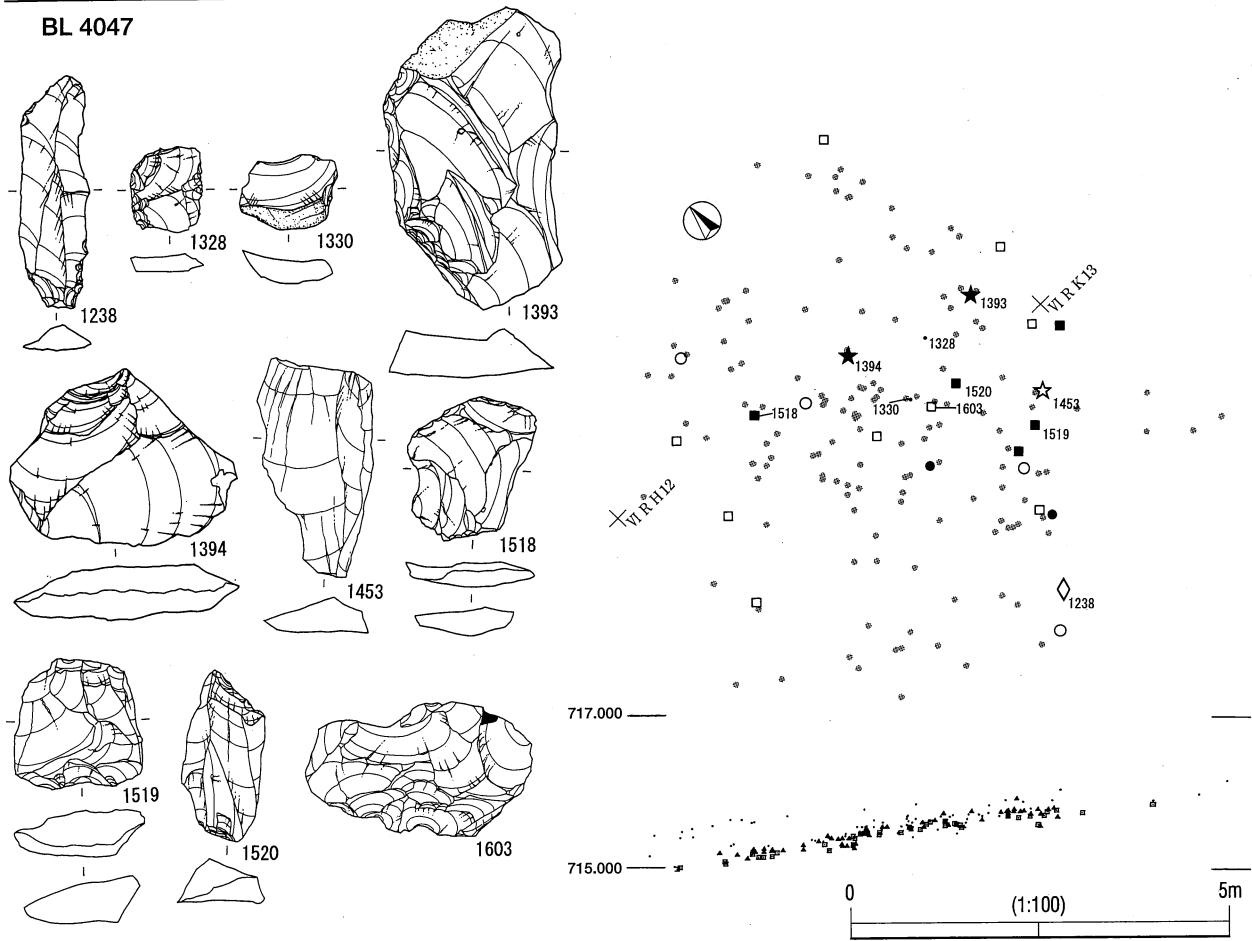
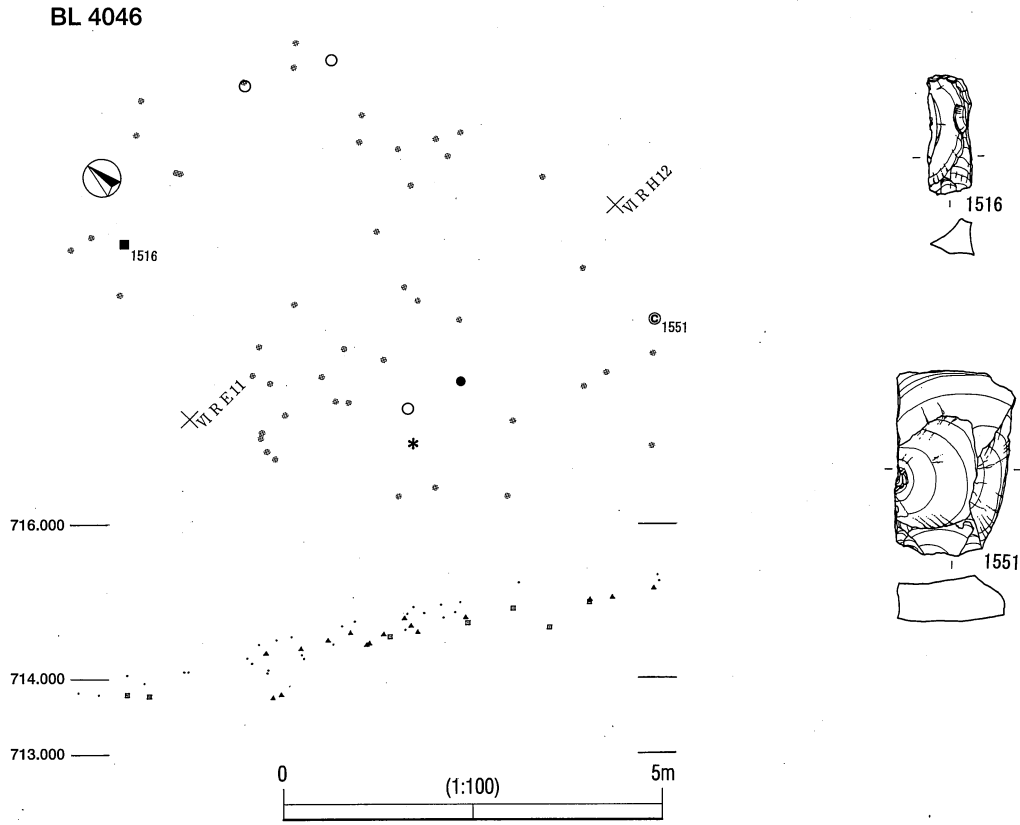

第4地点 BL4046・4047 遺物分布図 (貫ノ木遺跡)

BL 4048

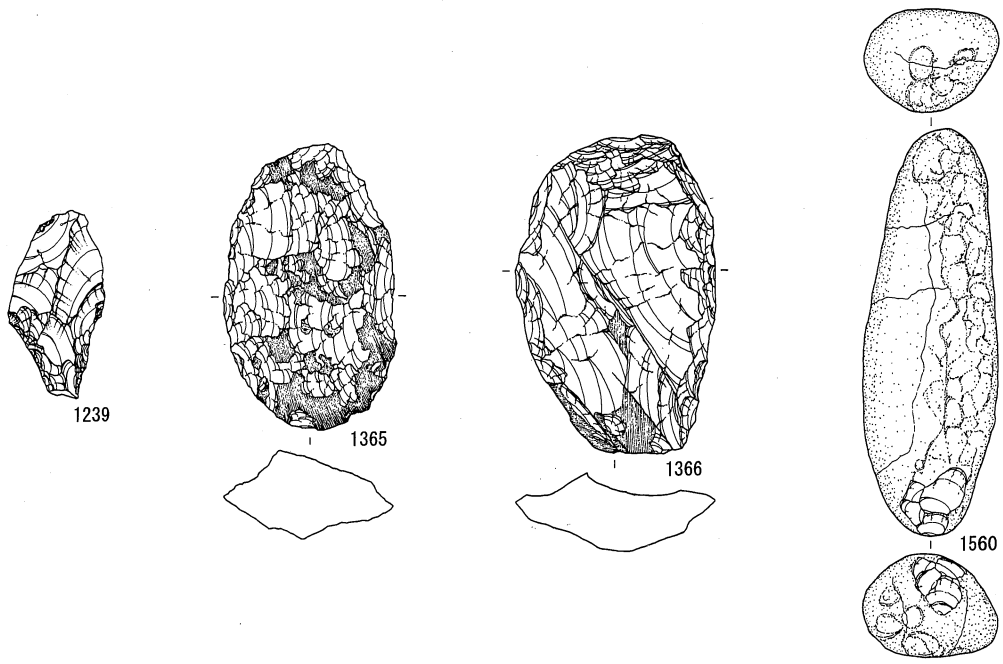
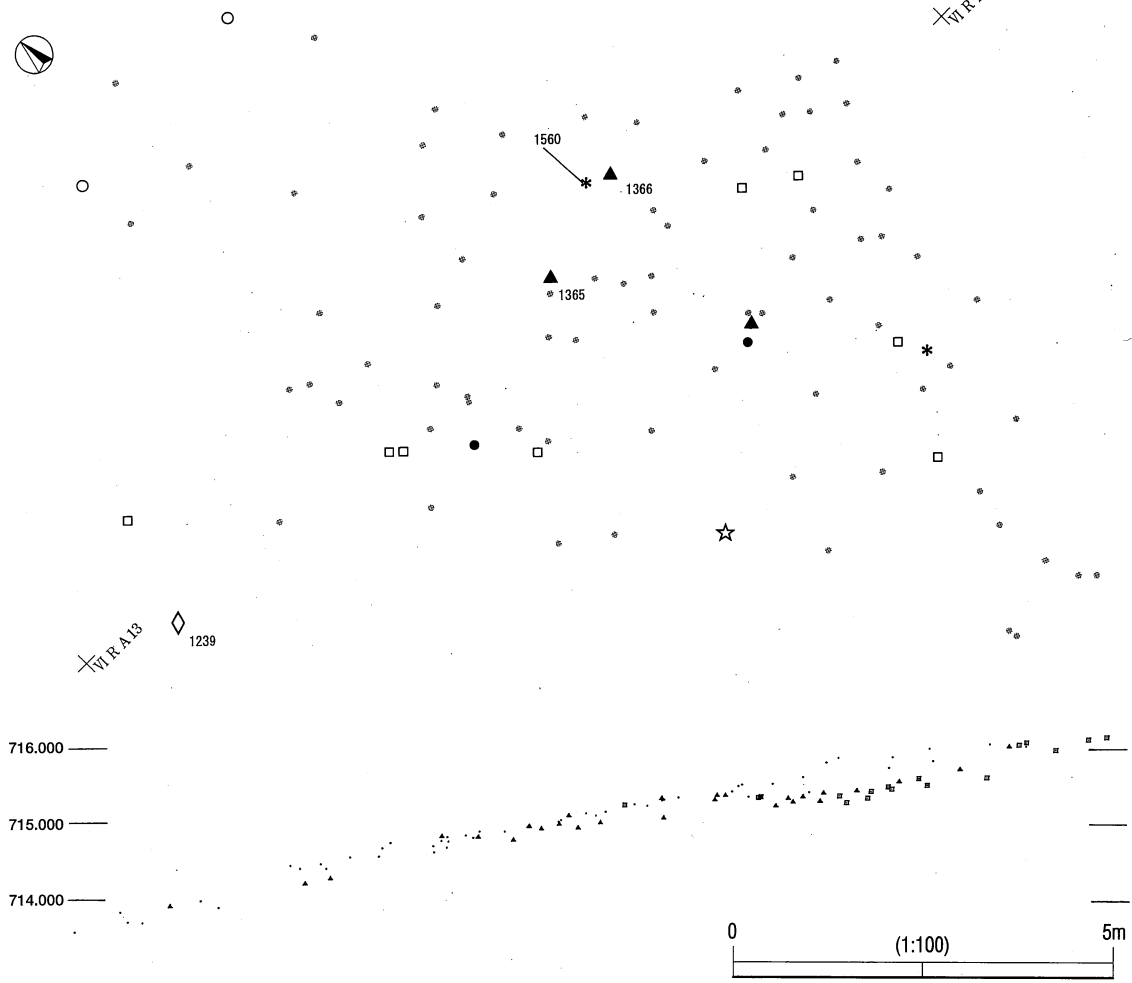

第 4 地点 BL4048 遺物分布図 (貫ノ木遺跡)

BL 4049

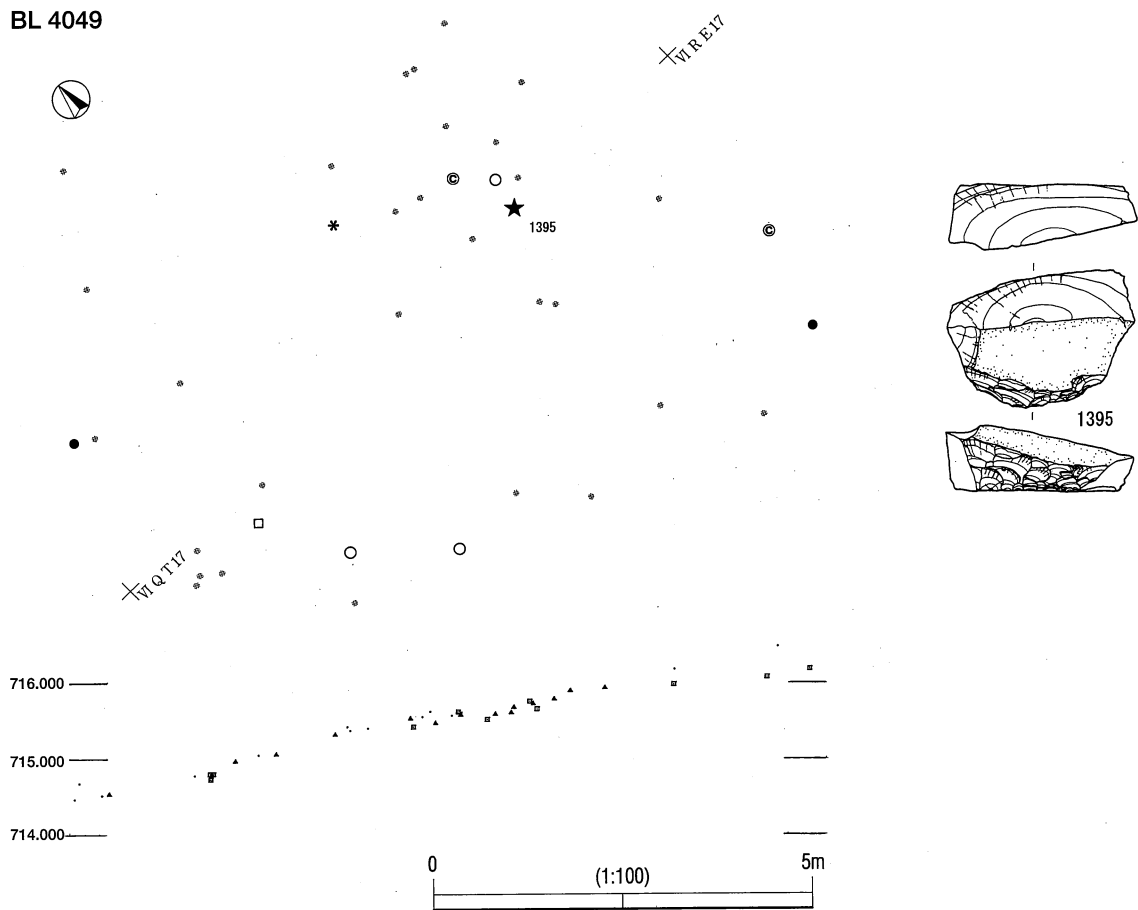

BL 4050

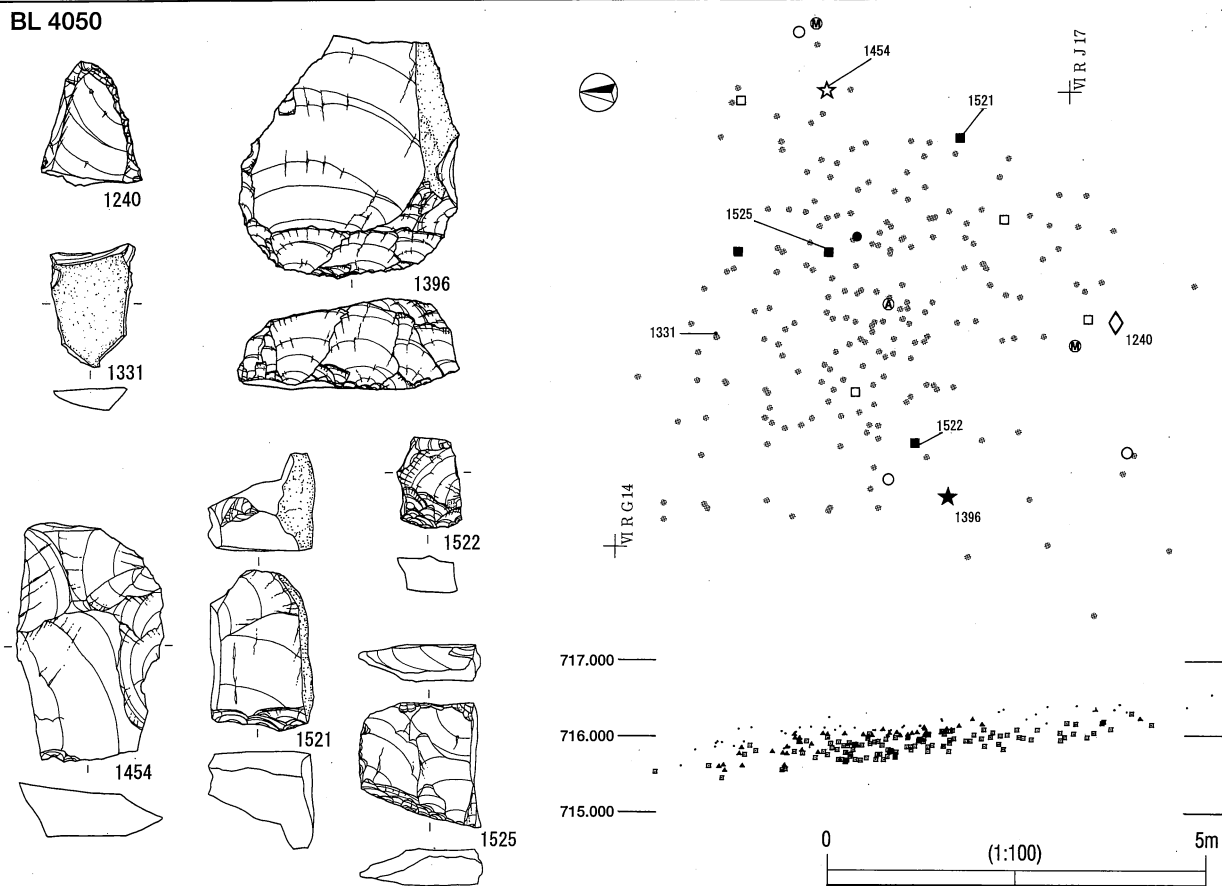

第4地点 BL4049・4050 遺物分布図 (貫ノ木遺跡)

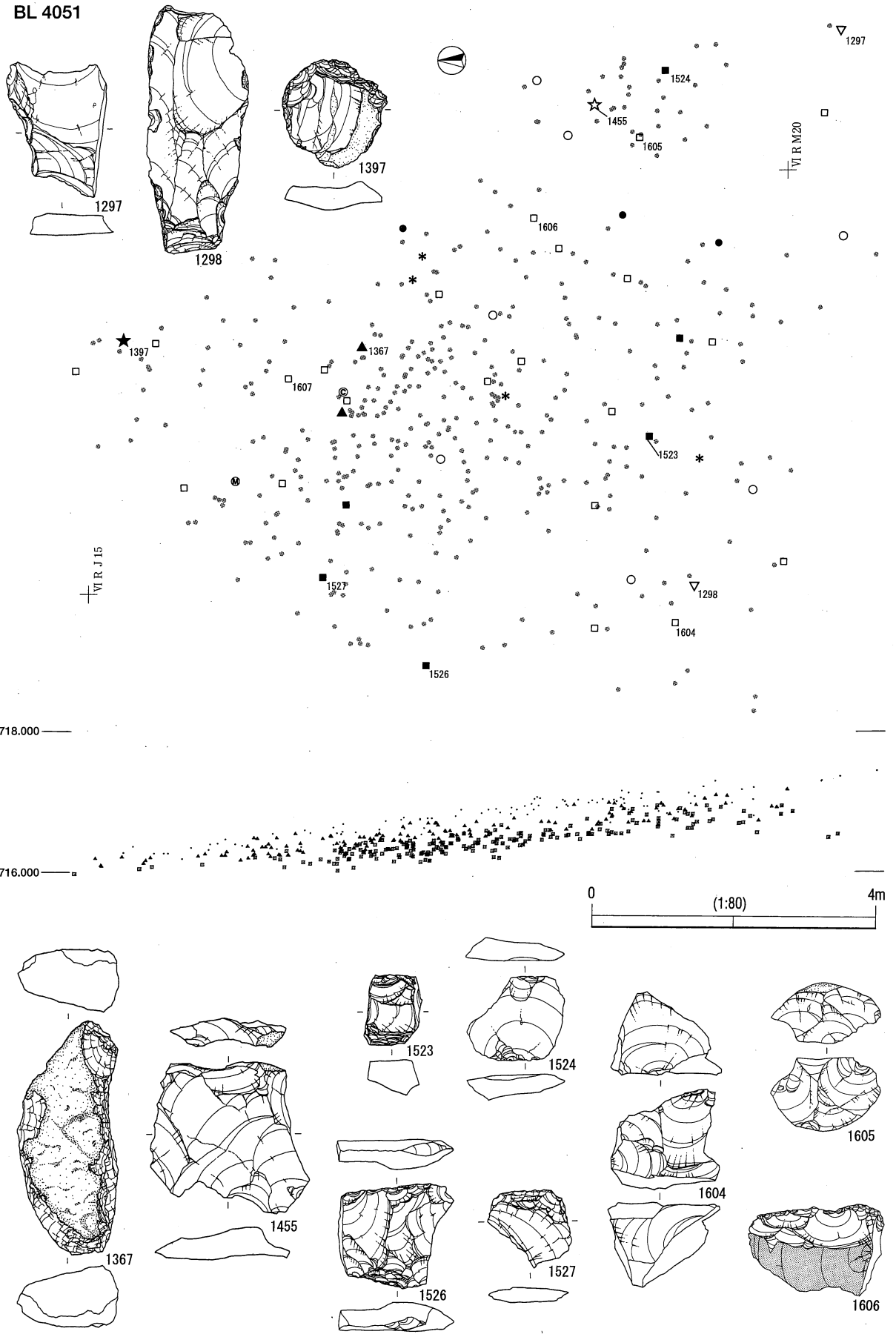

第4地点 BL4051 遺物分布図 (貫ノ木遺跡)

BL 4052

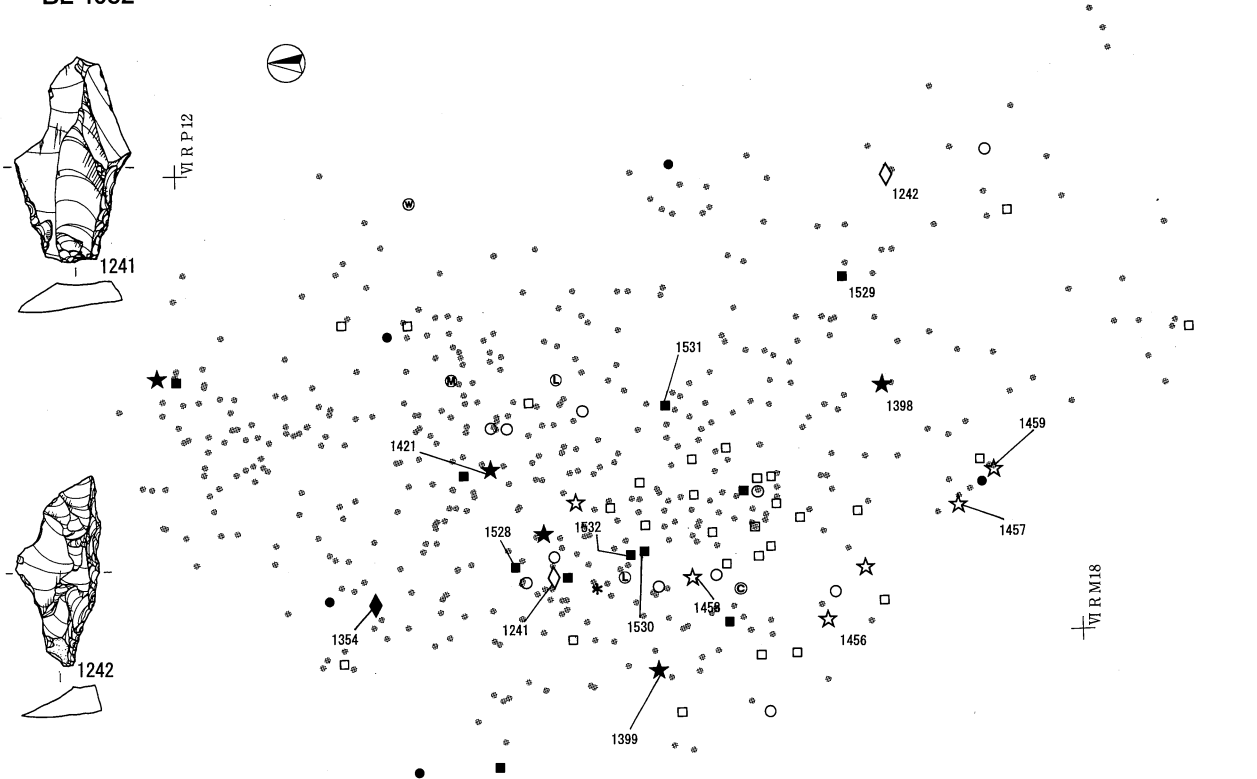

717.000

715.000

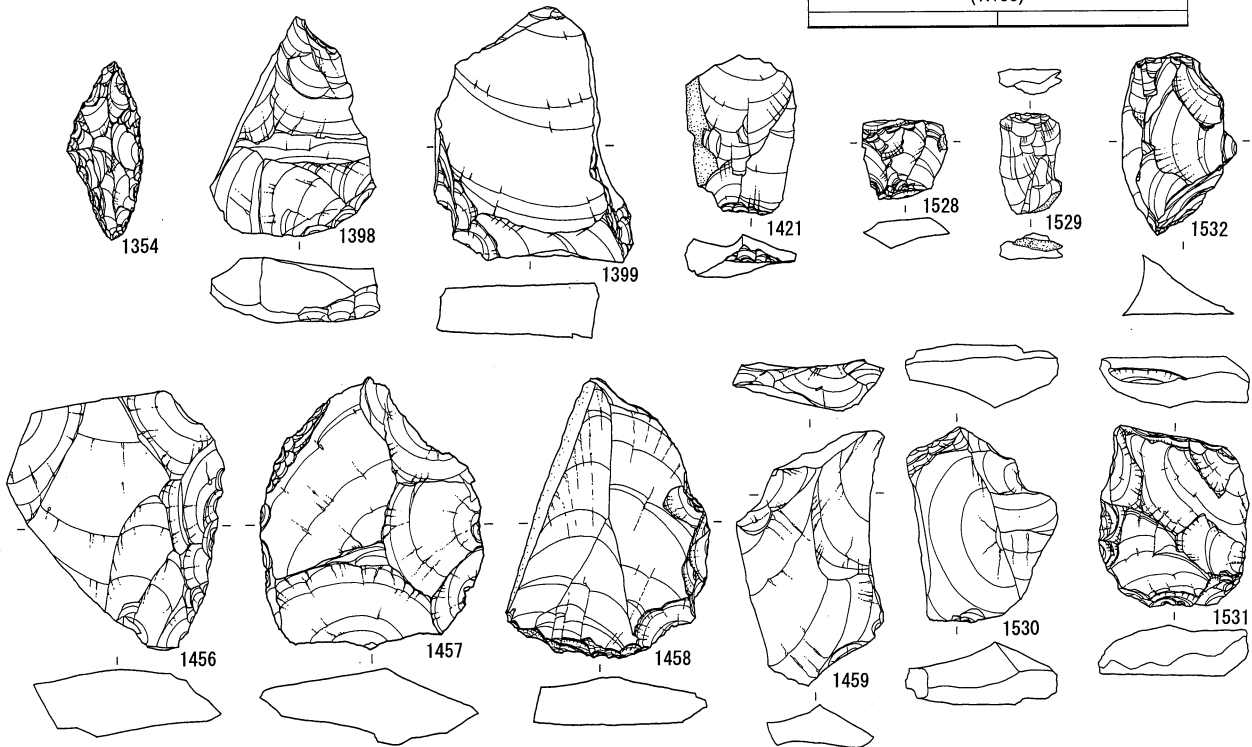
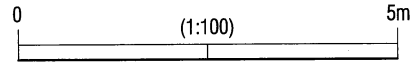

第4地点 BL4052 遺物分布図 (貫ノ木遺跡)

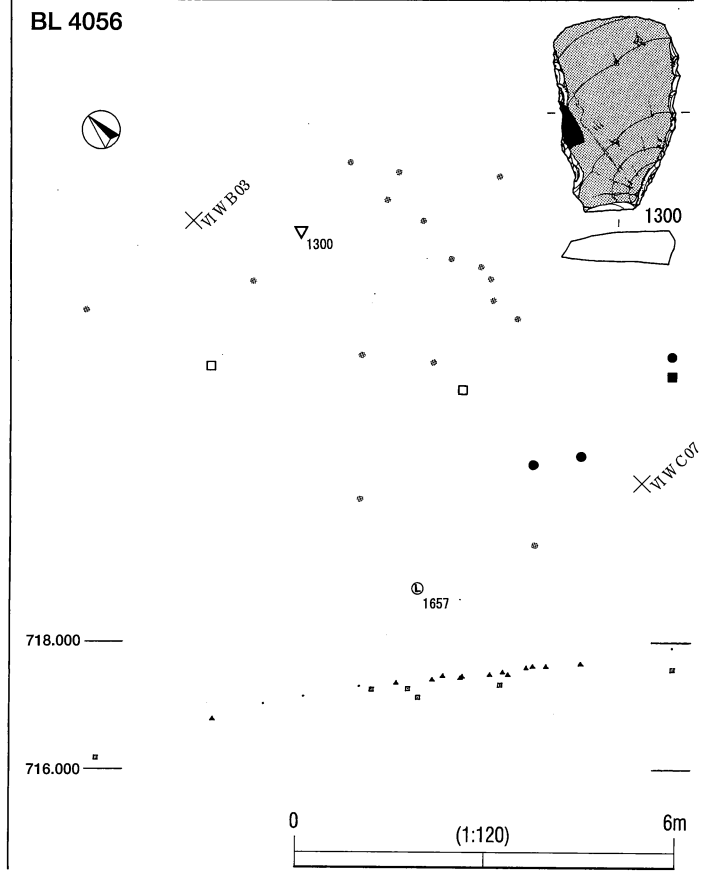
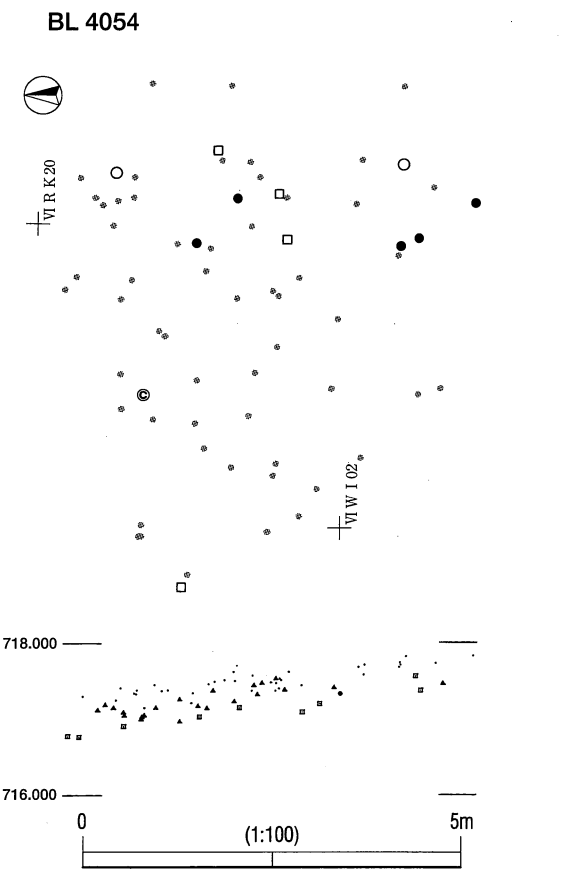
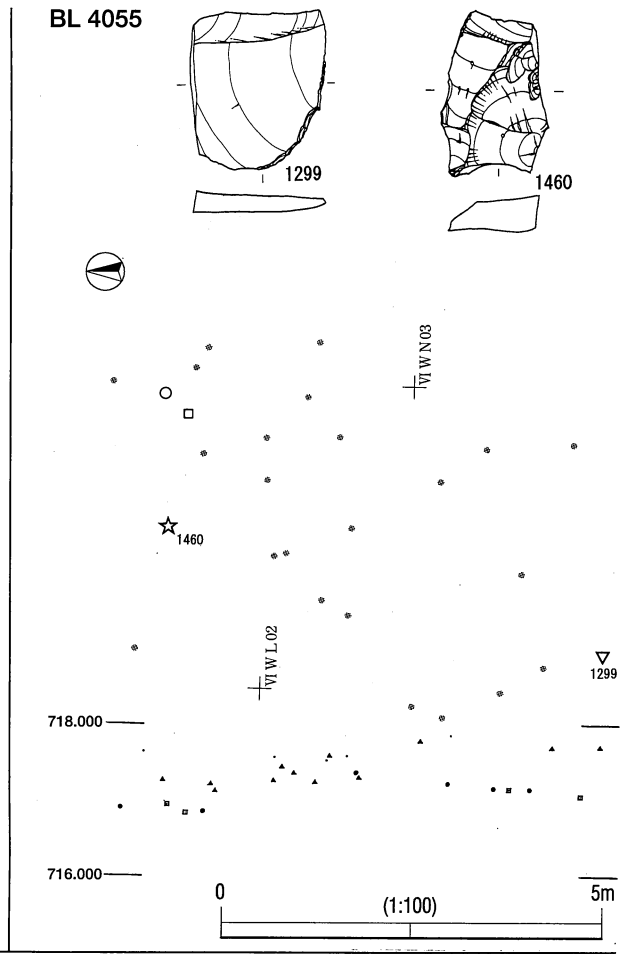
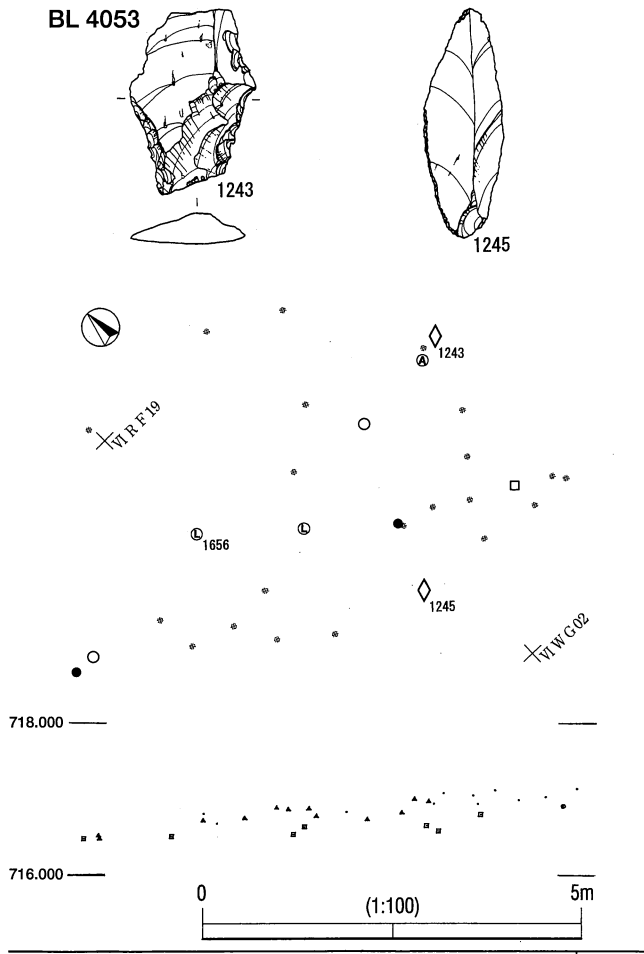

第4地点 BL4053・4054・4055・4056 遺物分布図 (貫ノ木遺跡)

BL 4057



第4地点 BL4057 遺物分布図 (貫ノ木遺跡)

BL 4058

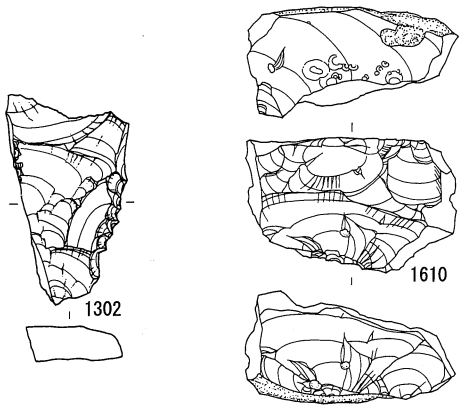
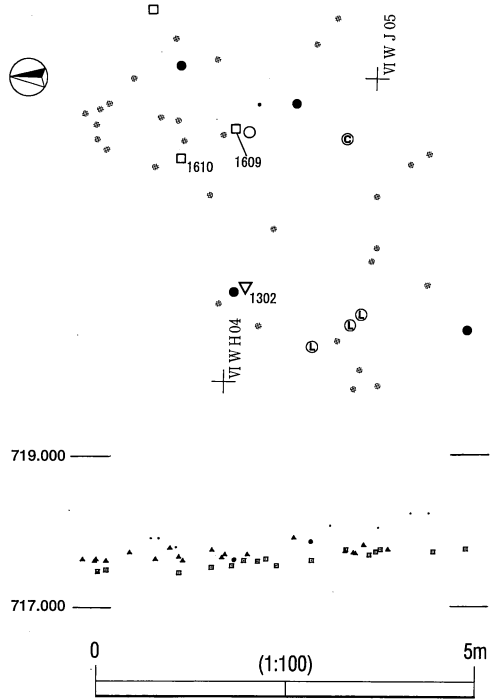

BL 4059

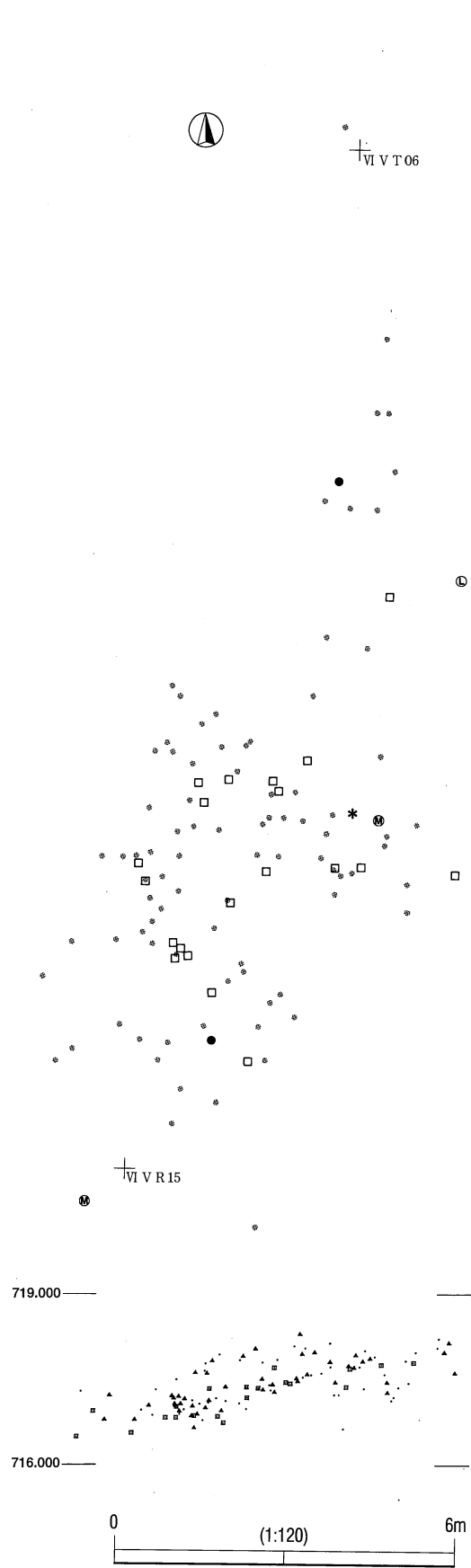

第4地点 BL4058・4059 遺物分布図 (貫ノ木遺跡)

BL 4060

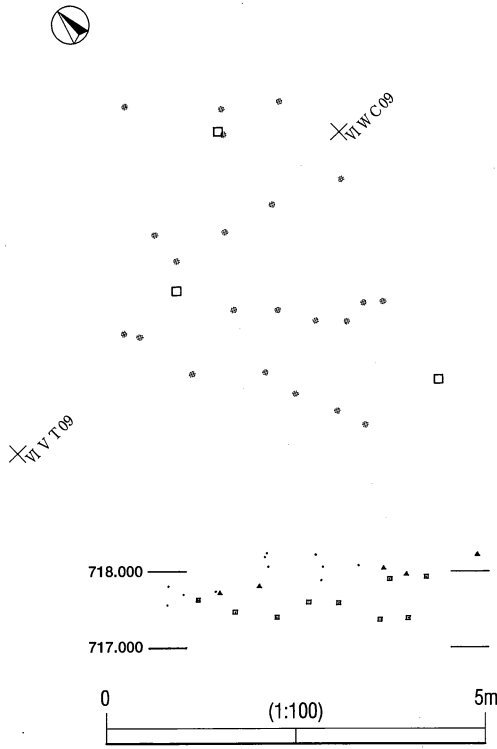

BL 4061

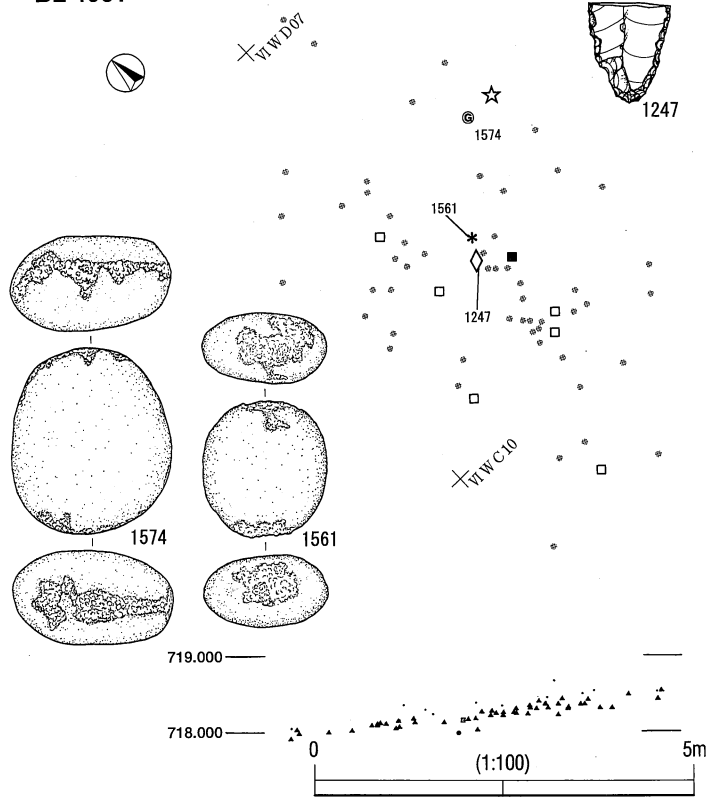

BL 4062

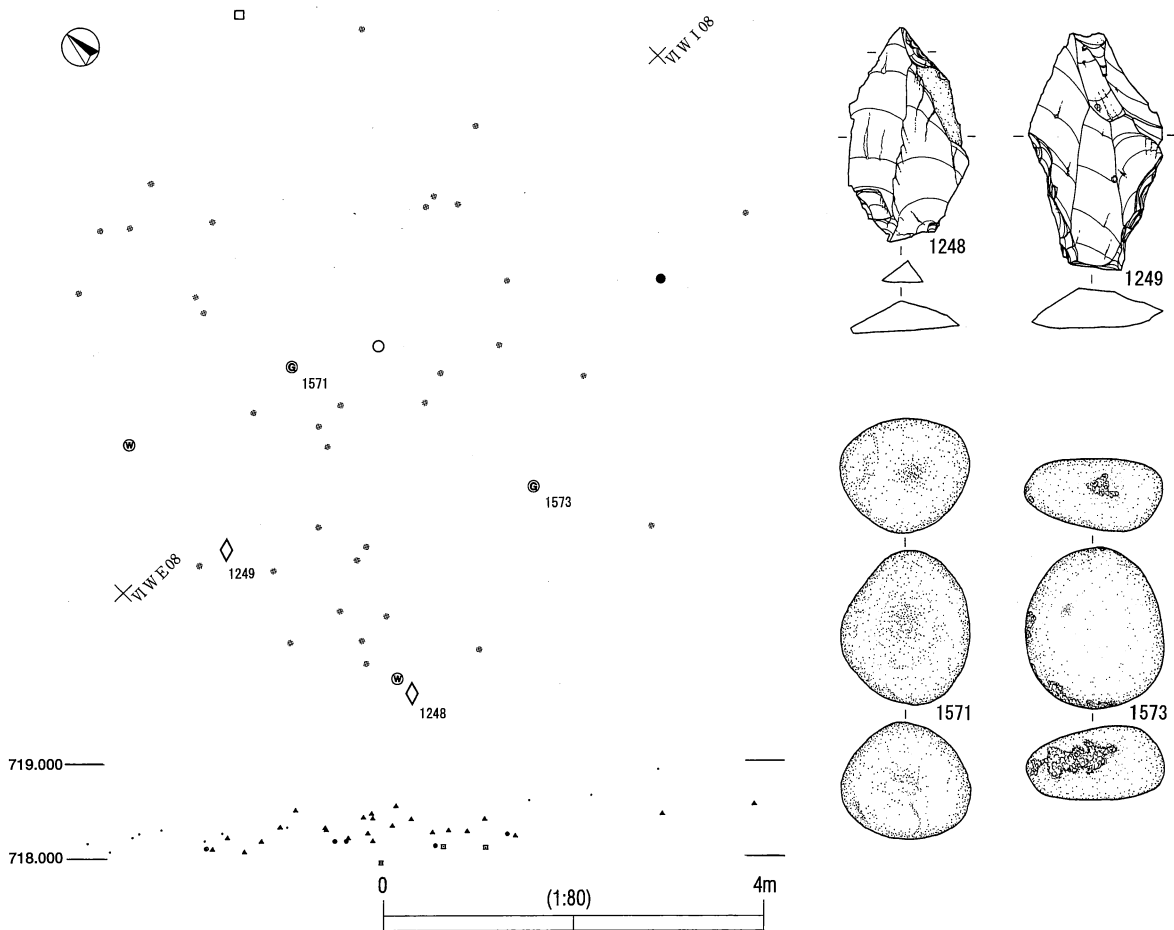

第4地点 BL4060・4061・4062 遺物分布図 (貫ノ木遺跡)

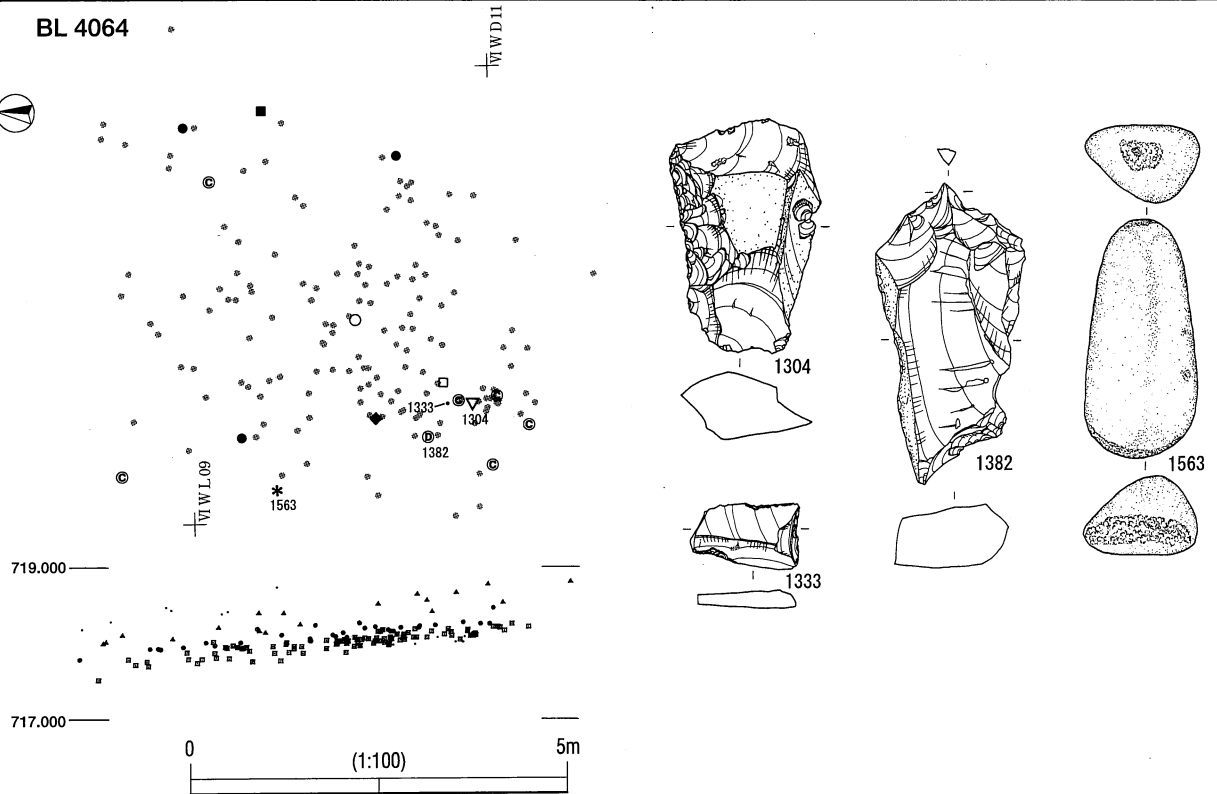
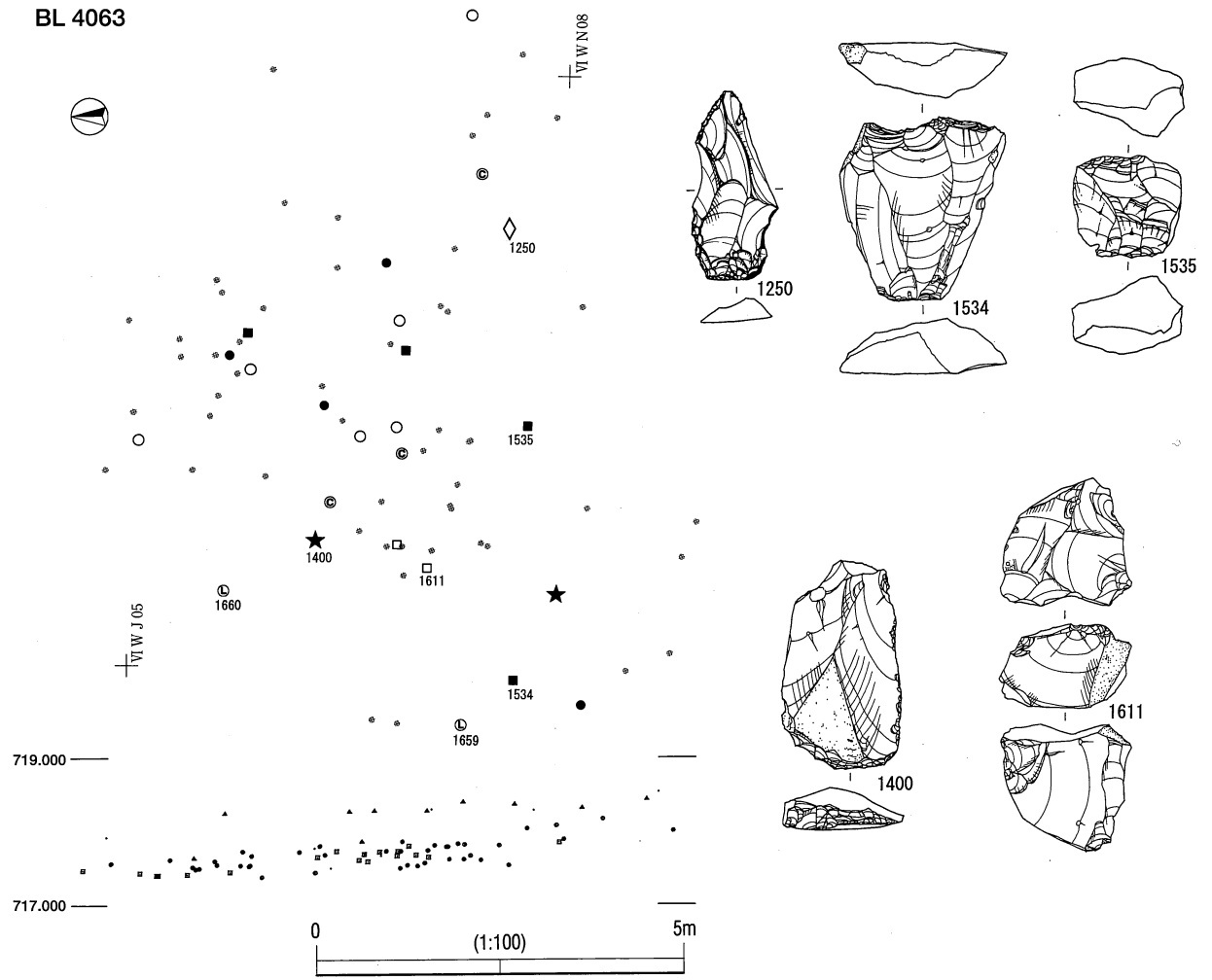

第4地点 BL4063・4064 遺物分布図 (貫ノ木遺跡)

BL 4065

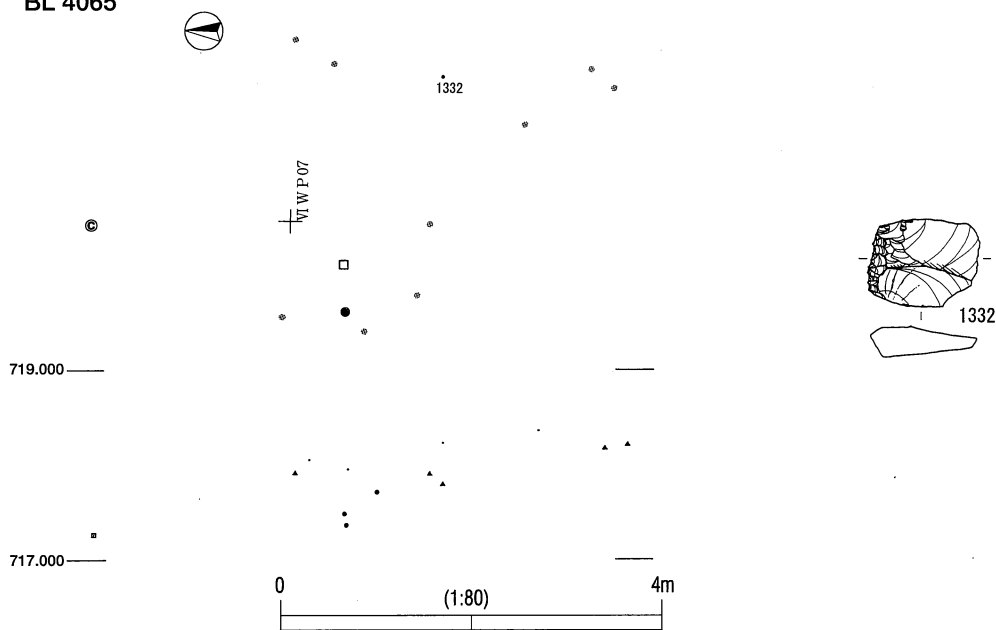

BL 4066

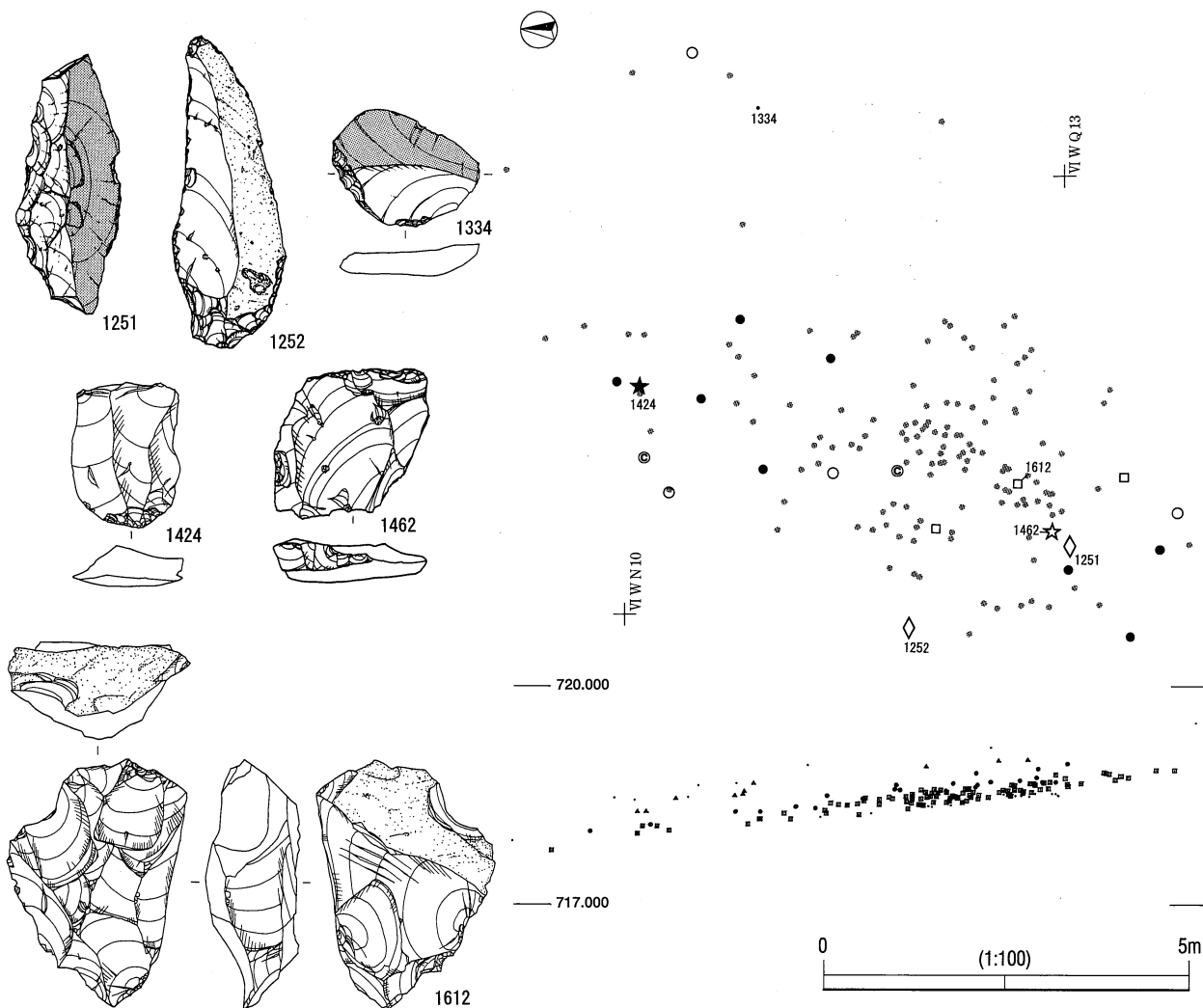

第4地点 BL4065・4066 遺物分布図 (貫ノ木遺跡)

BL 4067

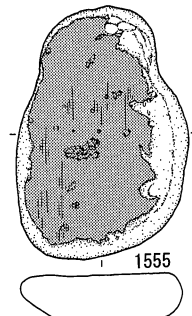
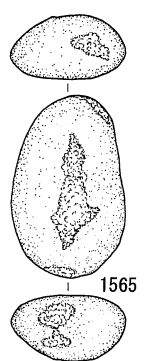
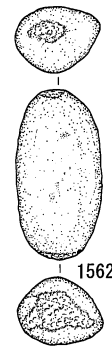
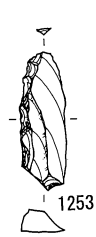
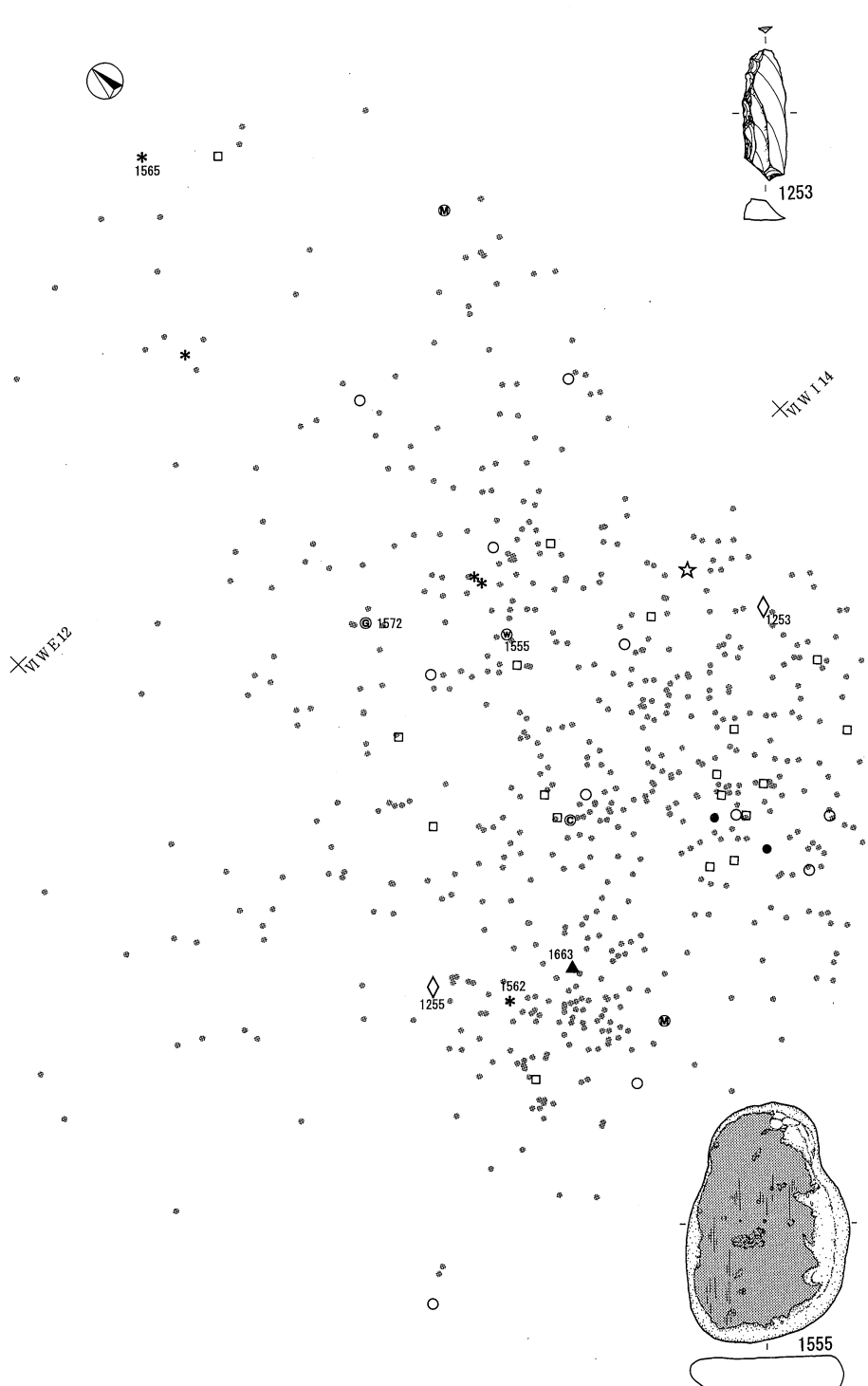
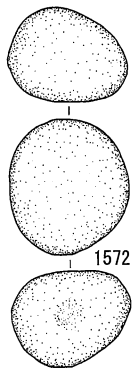

720.000

718.000

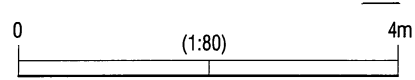

第4地点 BL4067 遺物分布図 (貫ノ木遺跡)

BL 4068

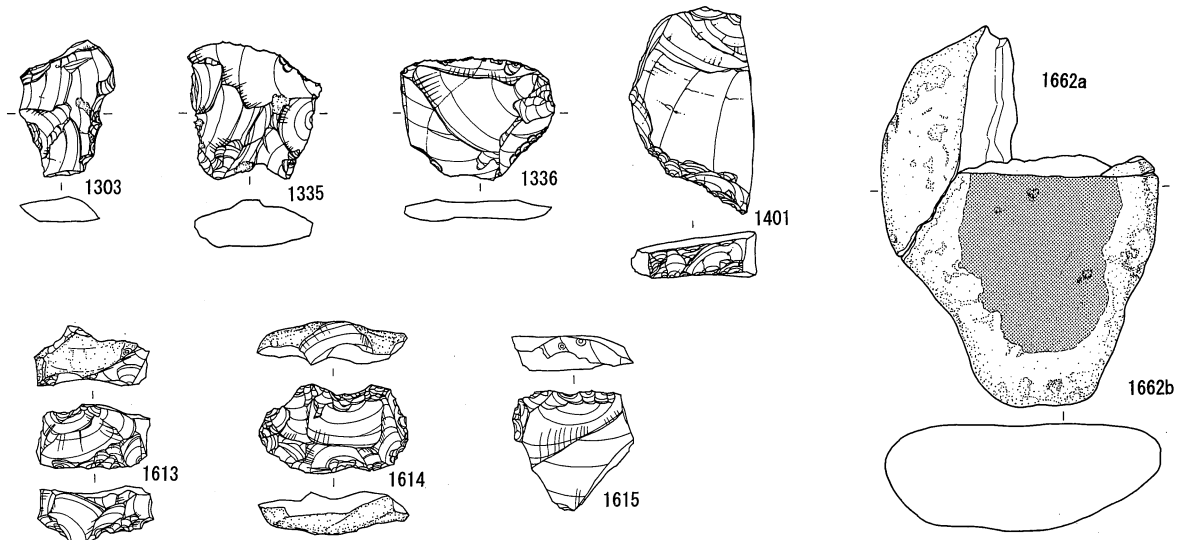
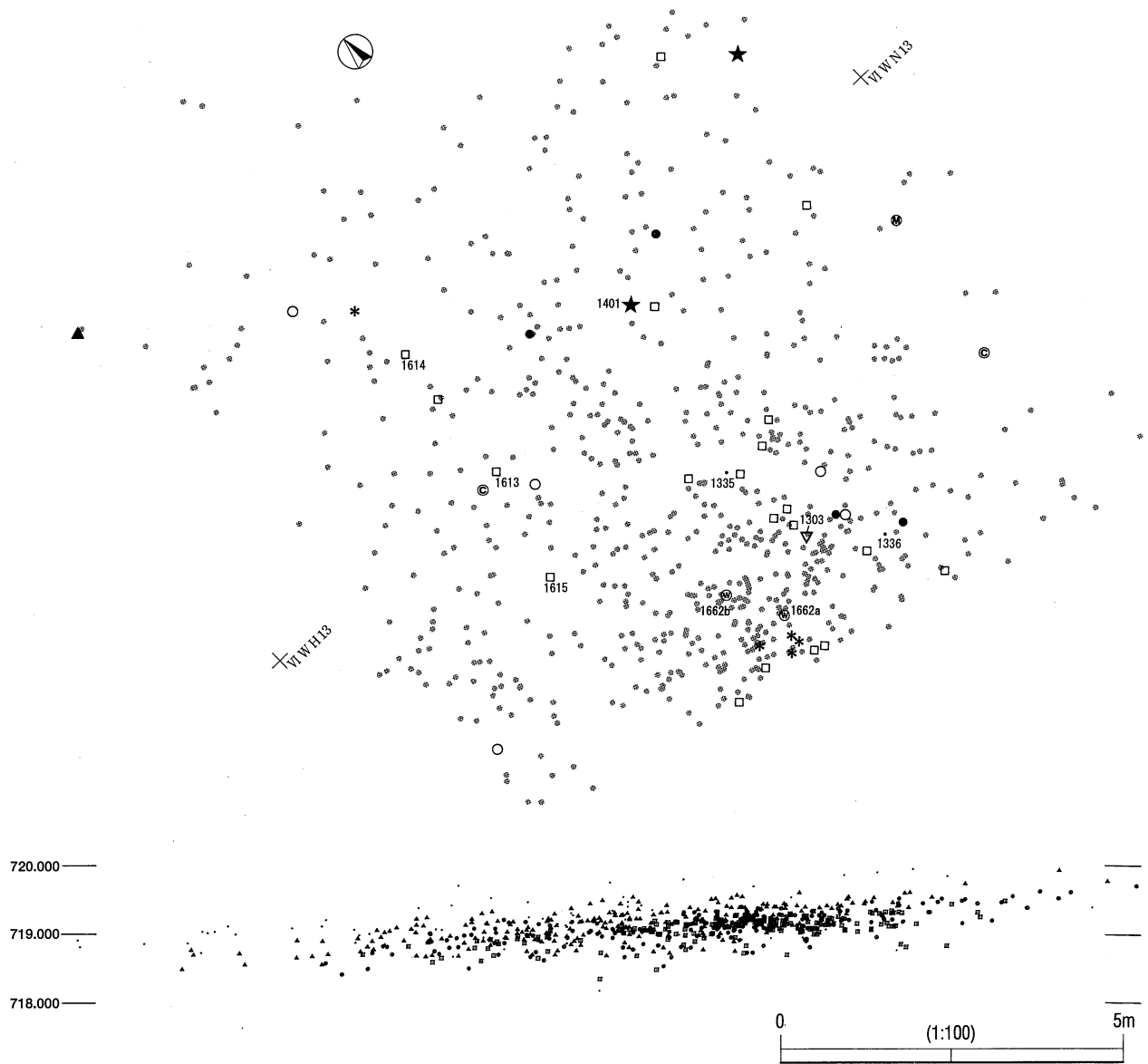

第4地点 BL4068 遺物分布図 (貫ノ木遺跡)

BL 4069

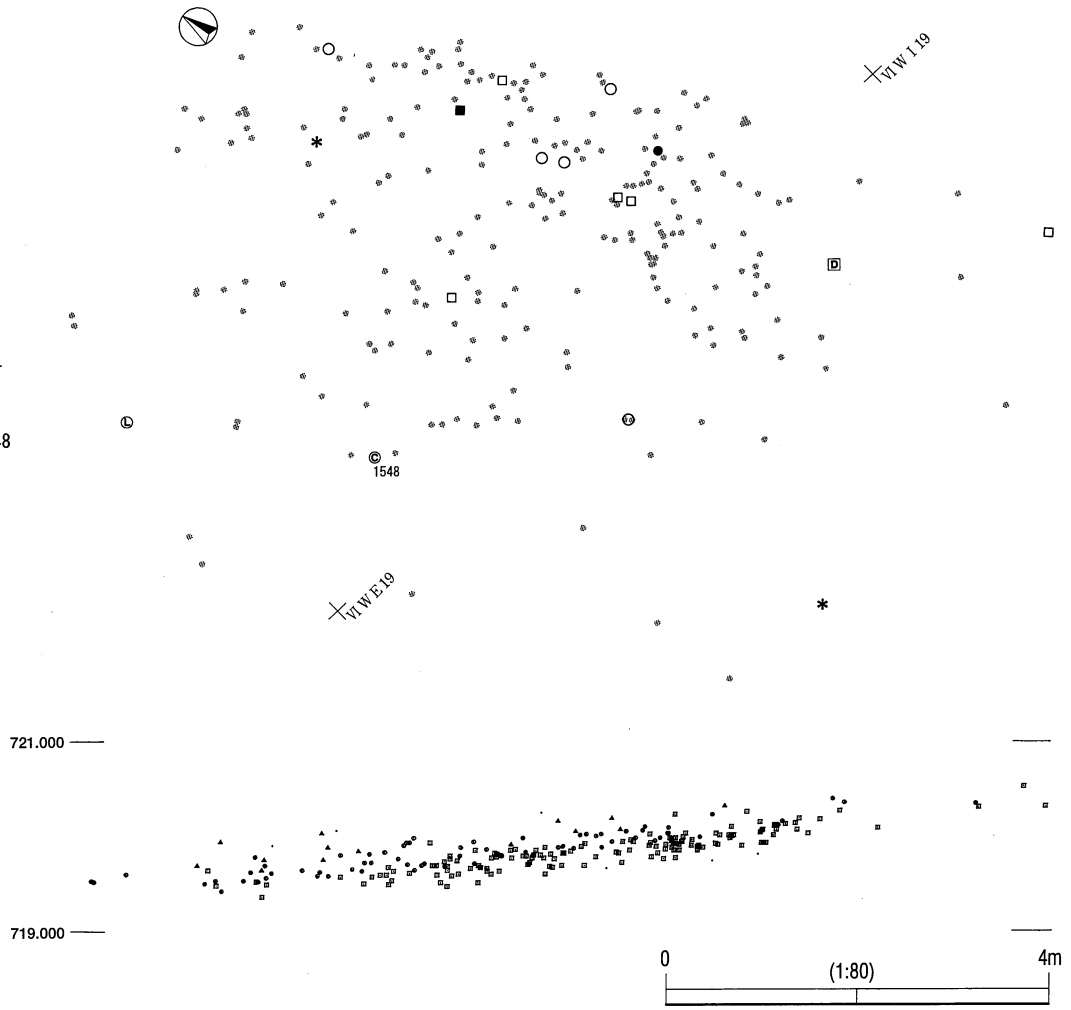
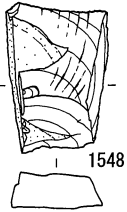

BL 4071

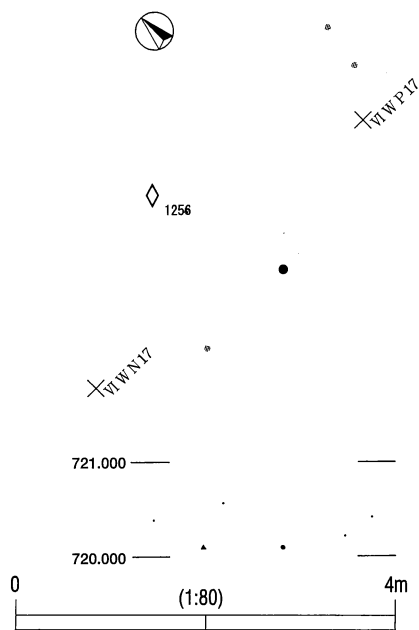

第4地点 BL4069・4071 遺物分布図 (貫ノ木遺跡)

BL 4070

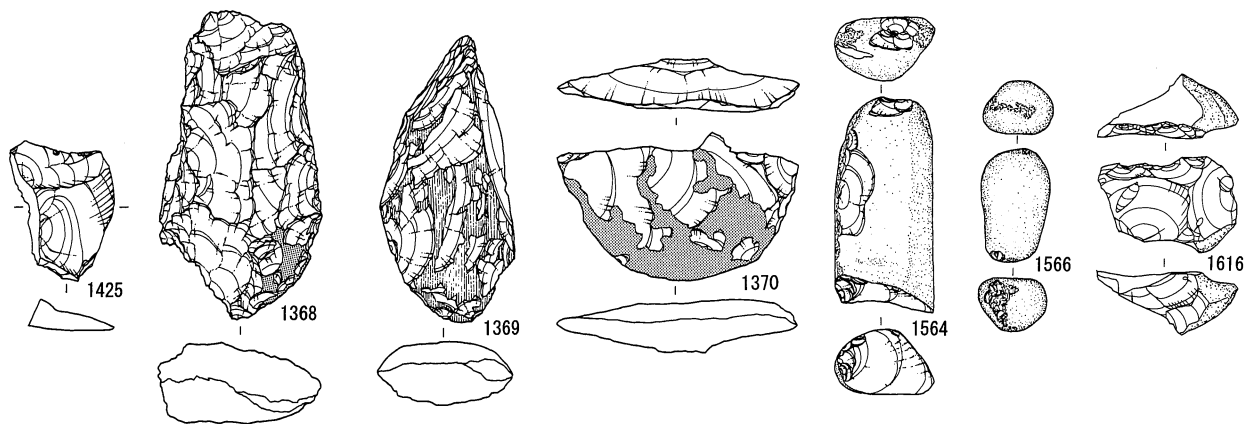
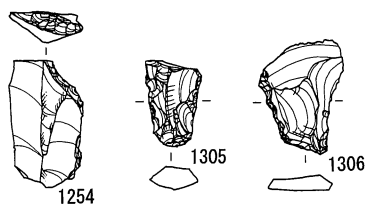
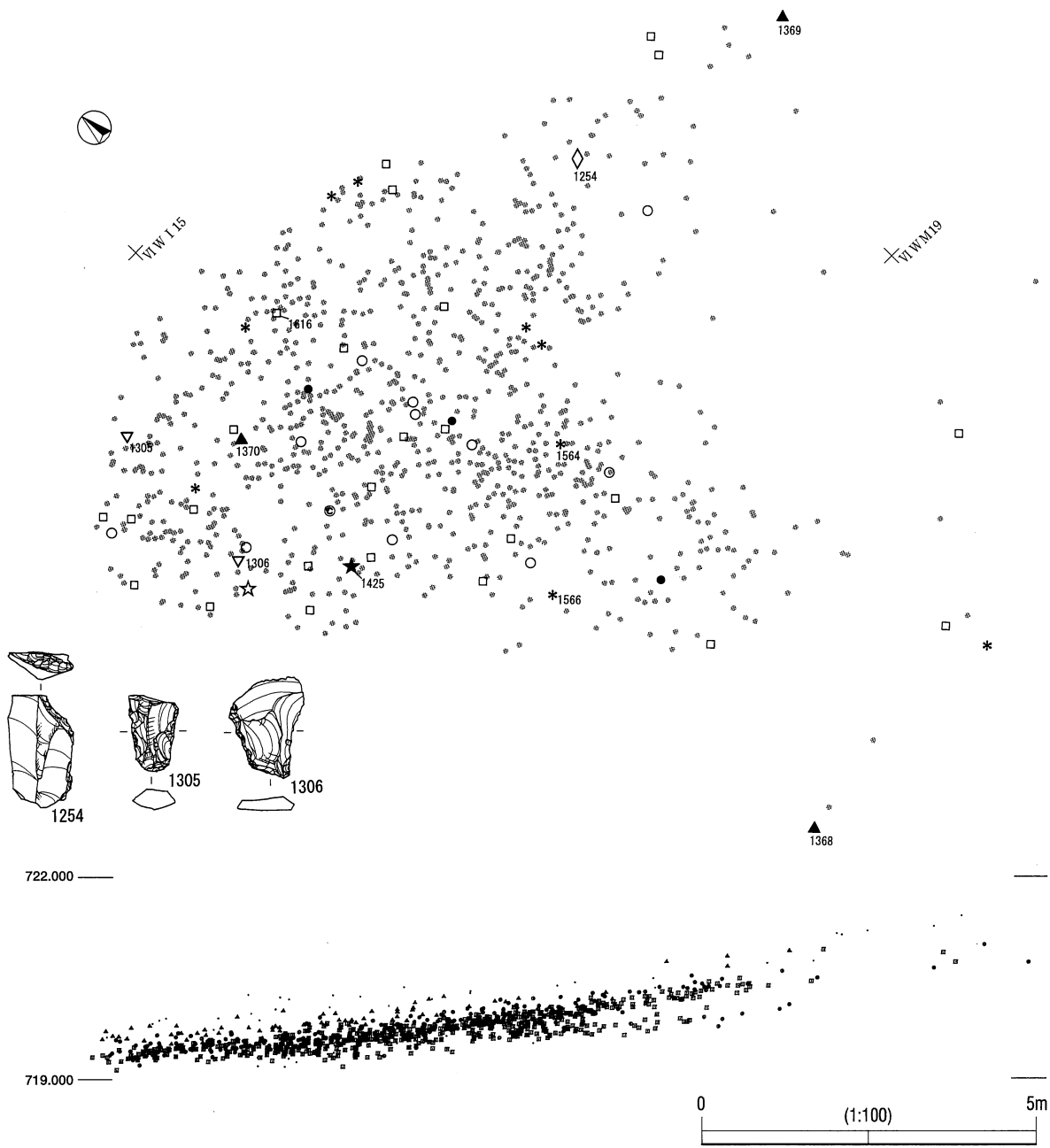

第4地点 BL4070 遺物分布図 (貫ノ木遺跡)

BL 4072

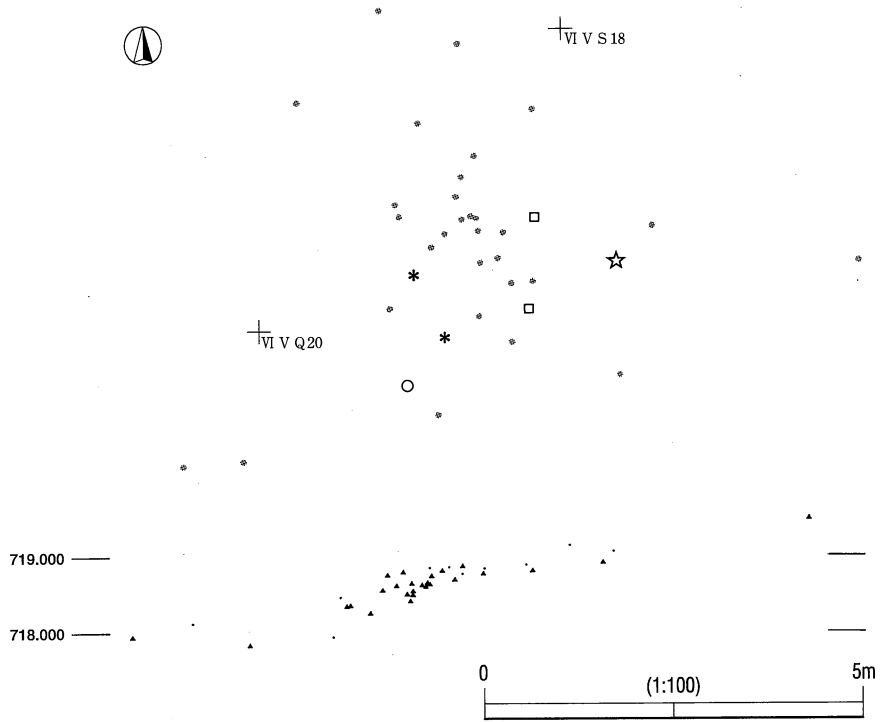

BL 4073

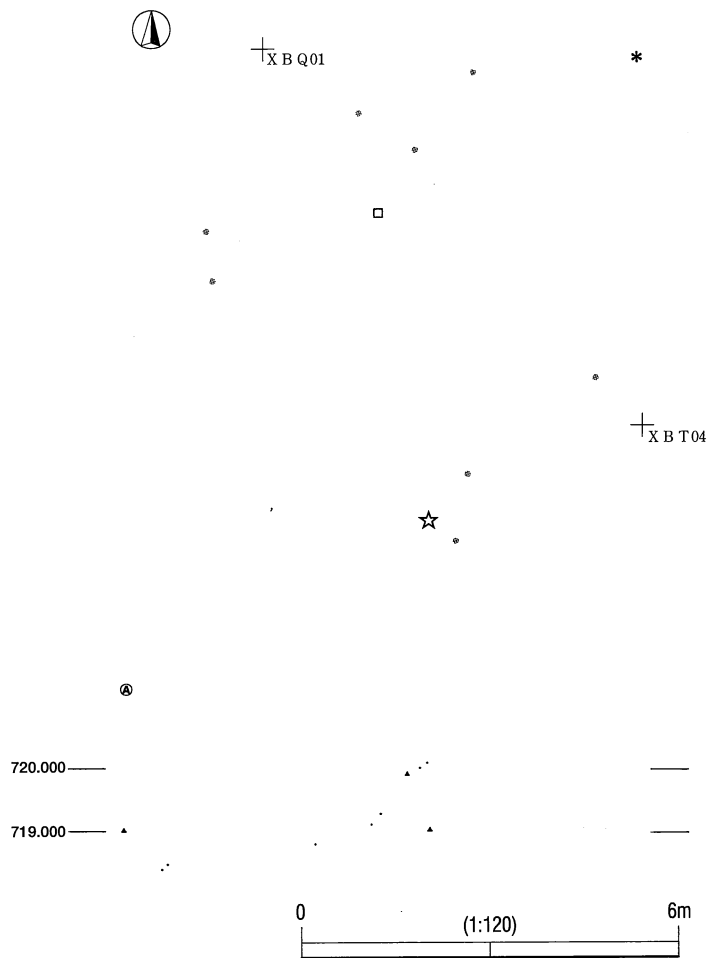

第4地点 BL4072・4073 遺物分布図 (貫ノ木遺跡)

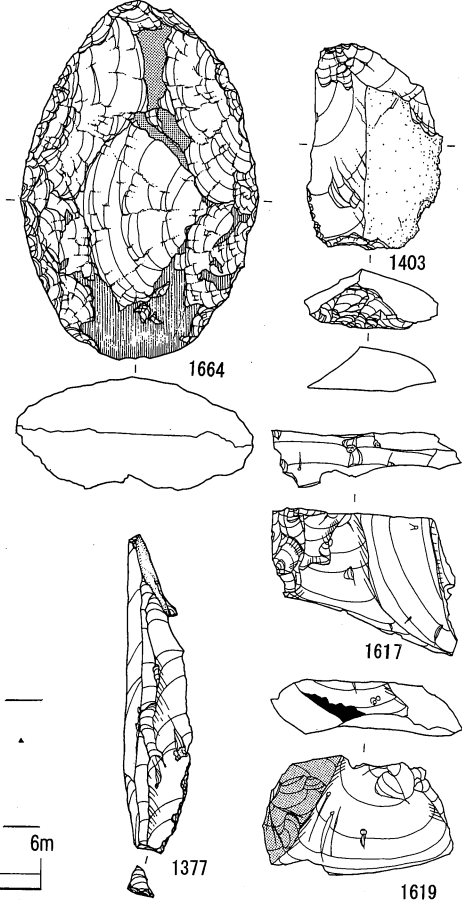
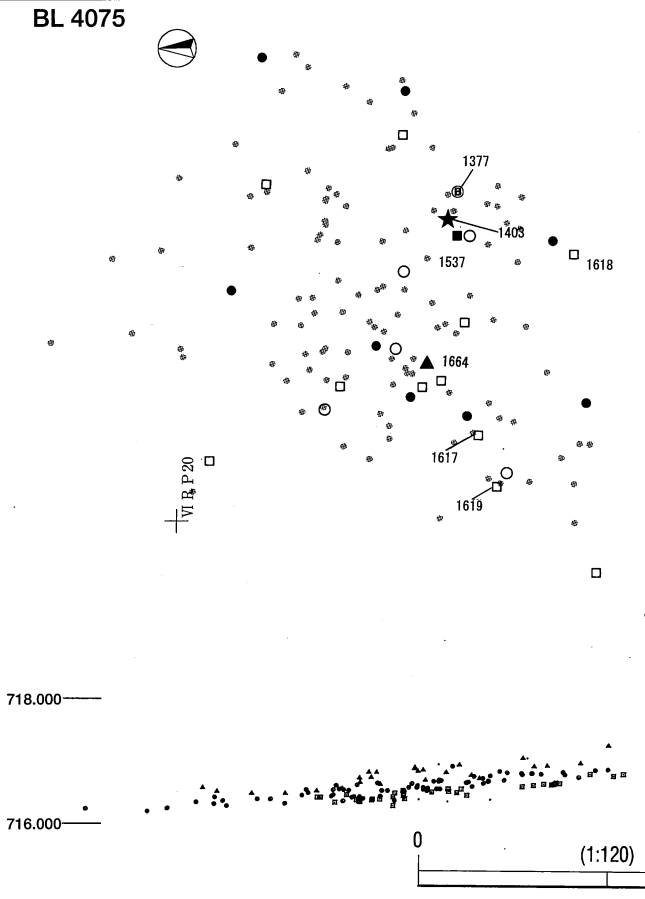
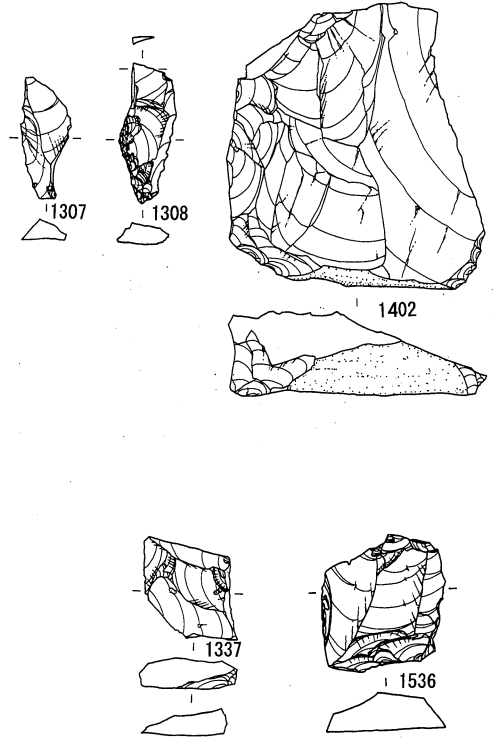
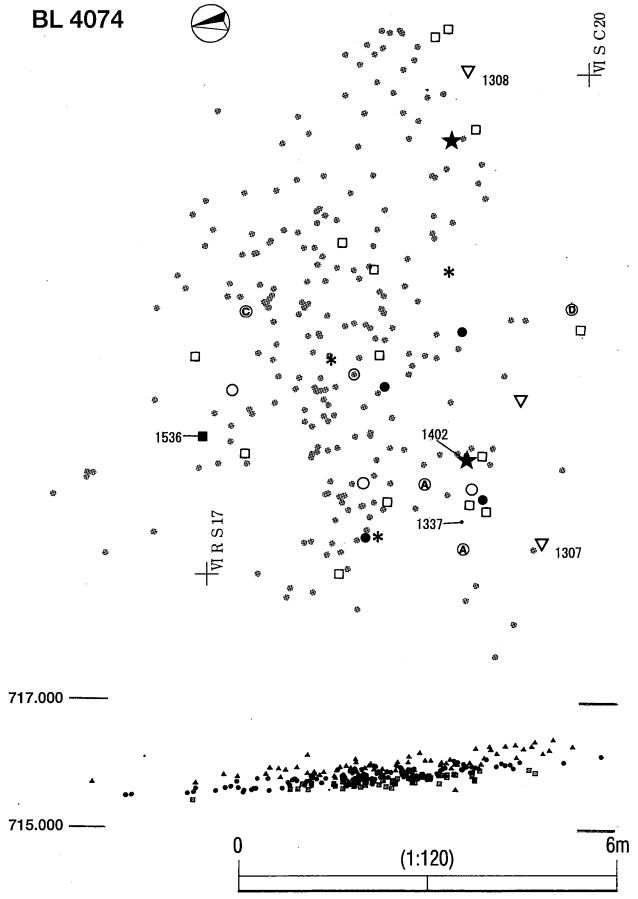

第4地点 BL4074・4075 遺物分布図 (貫ノ木遺跡)

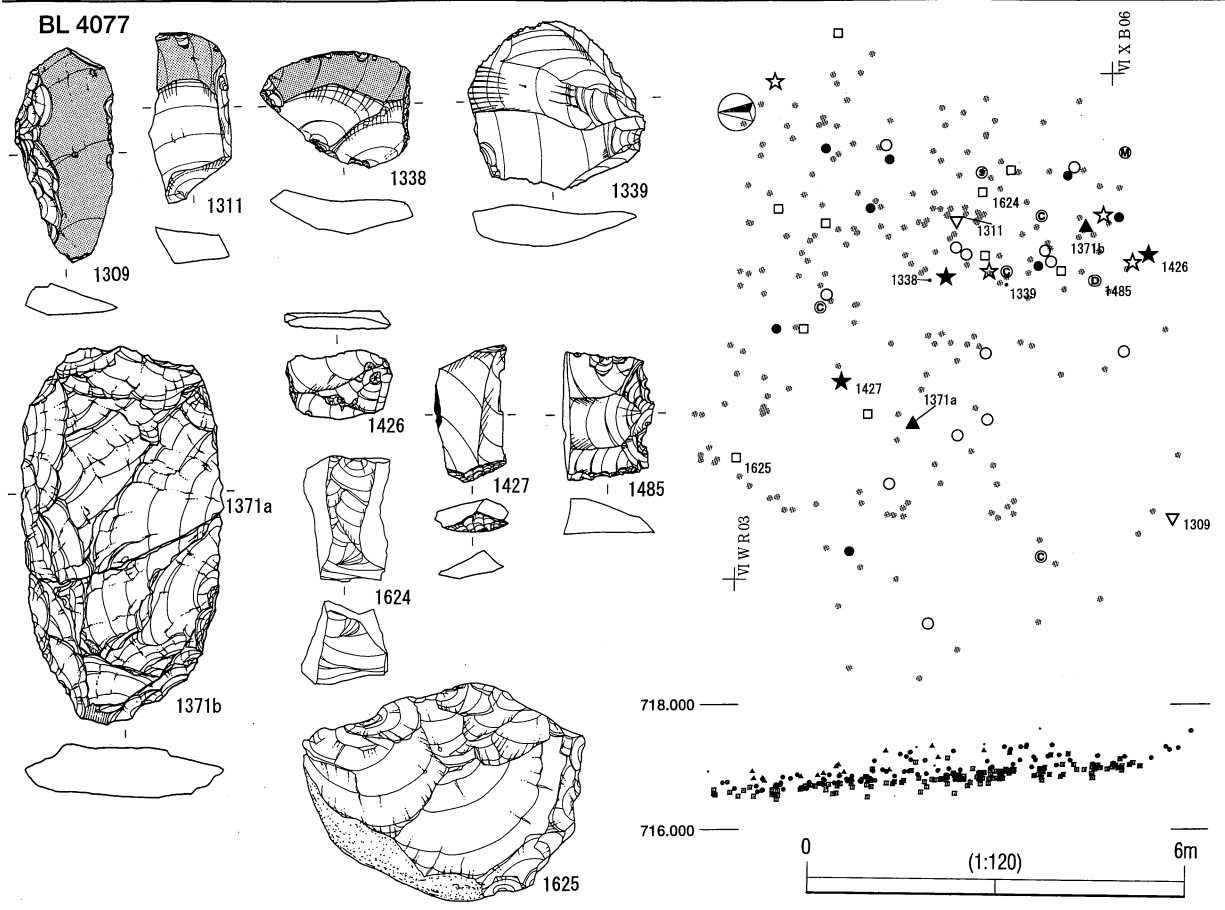
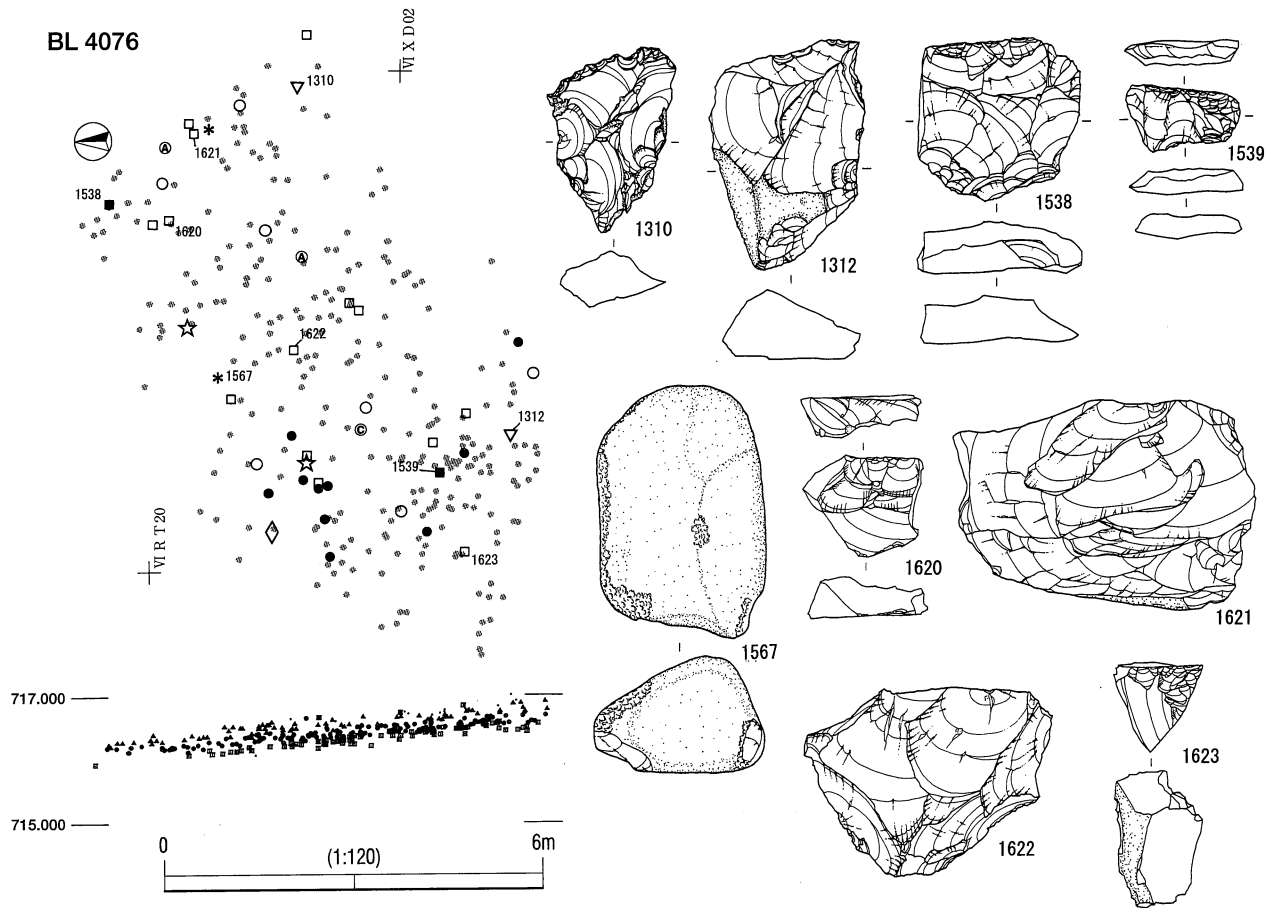

第4地点 BL4076・4077 遺物分布図 (貫ノ木遺跡)

BL 4078

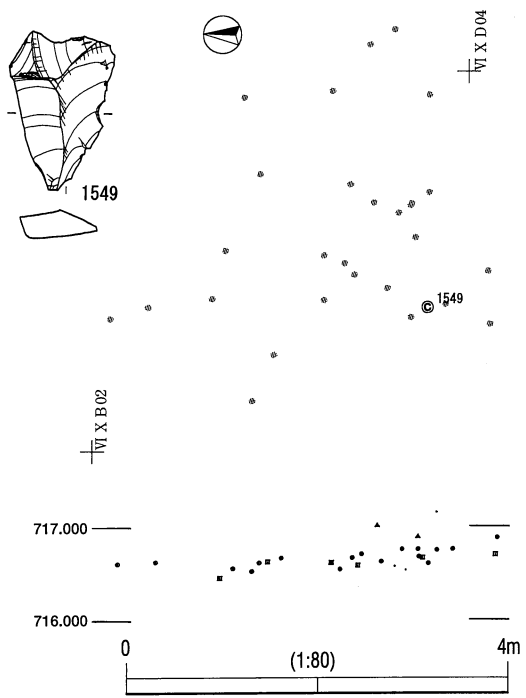

BL 4079

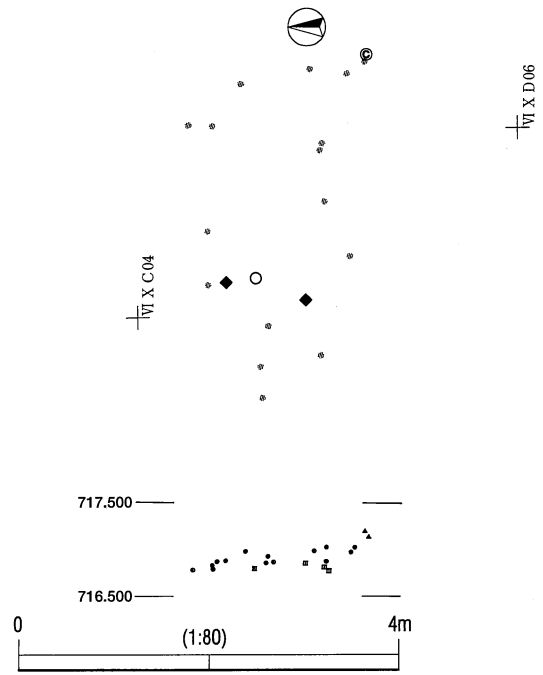

BL 4080

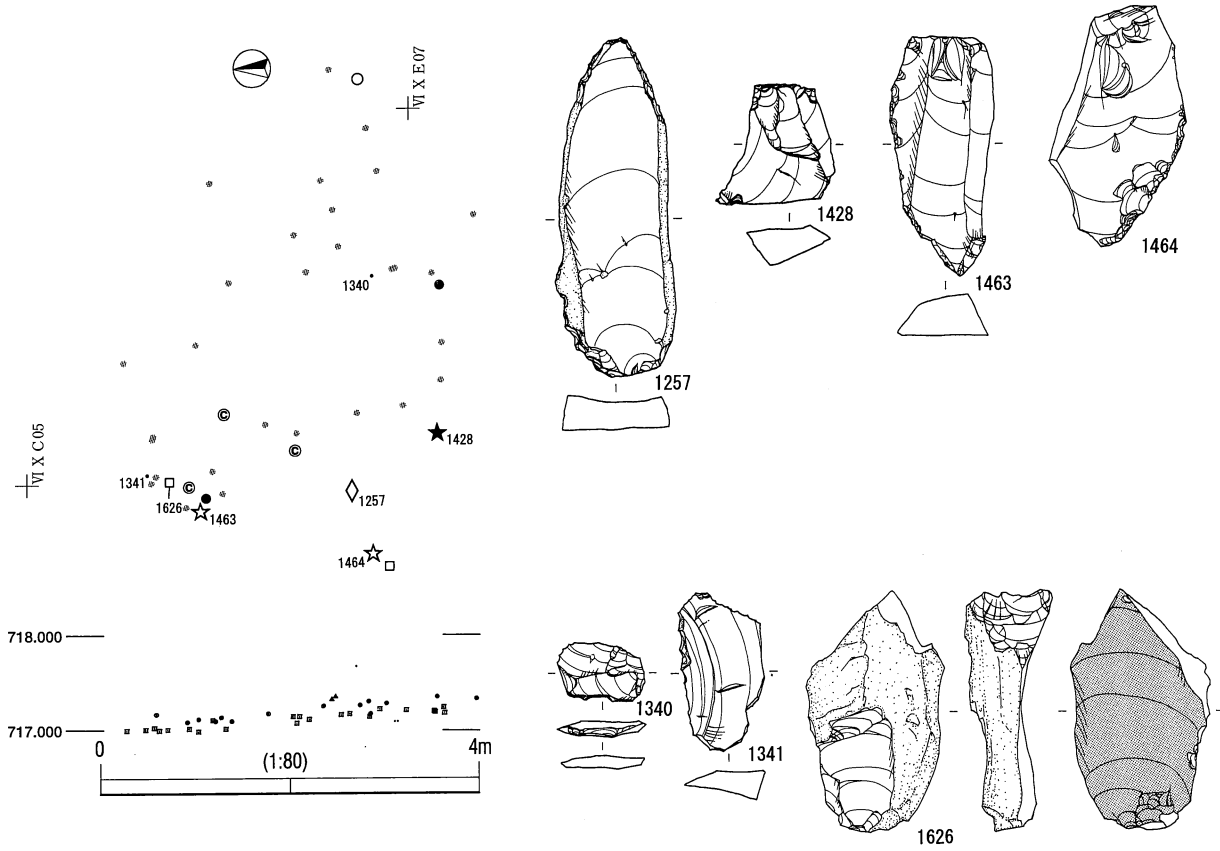

第4地点 BL4078・4079・4080 遺物分布図 (貫ノ木遺跡)



第4地点 BL4081 遺物分布図 (貫ノ木遺跡)

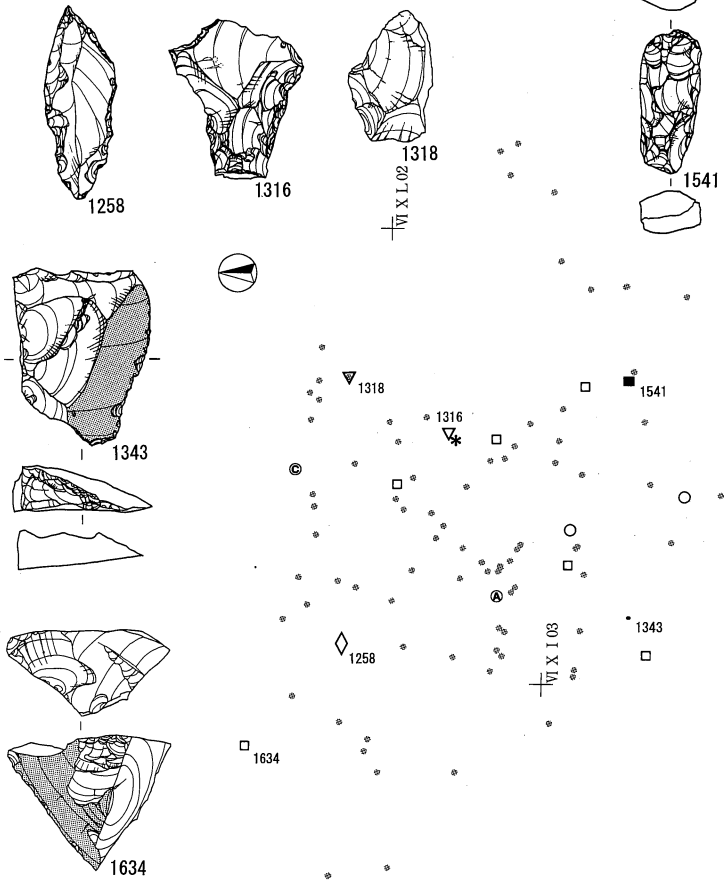
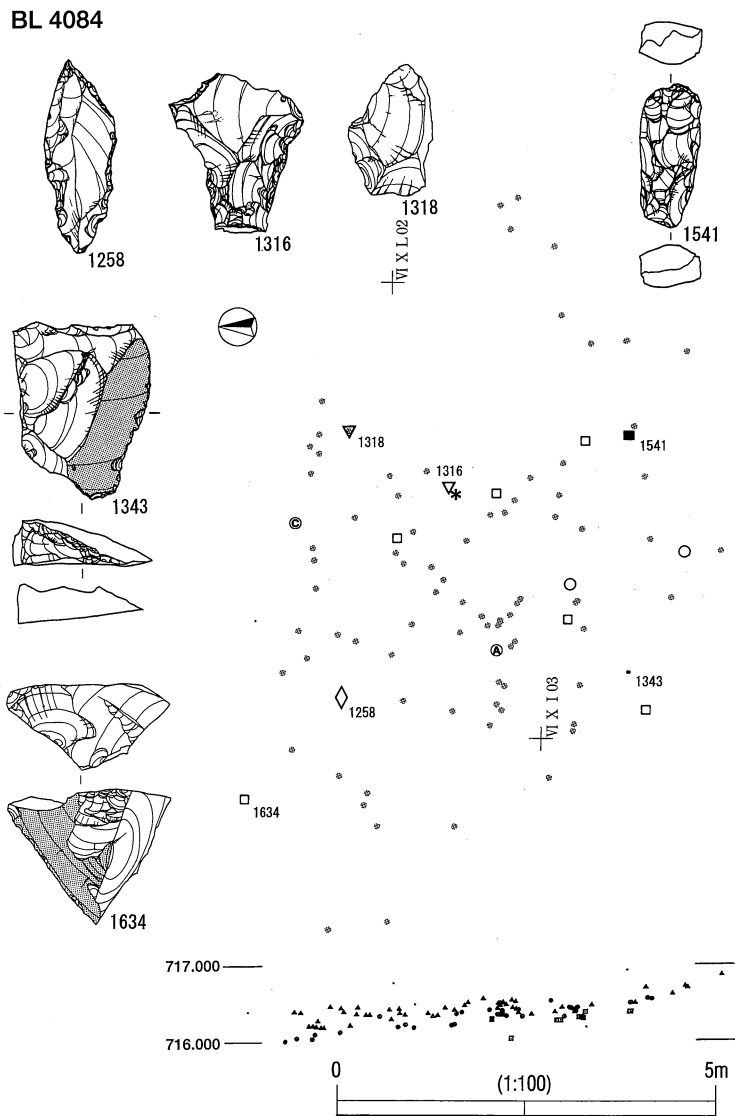
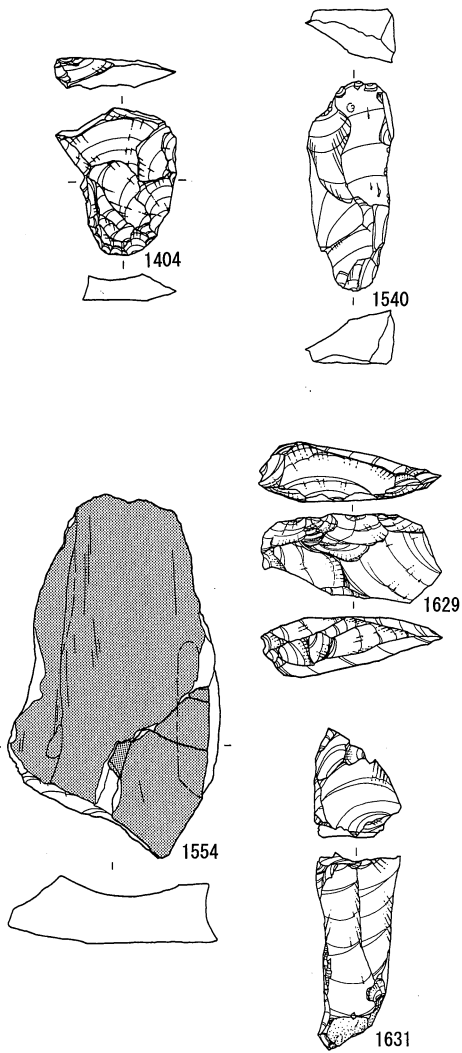
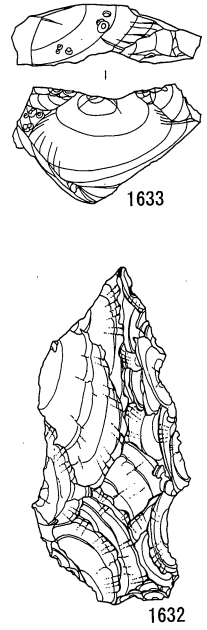
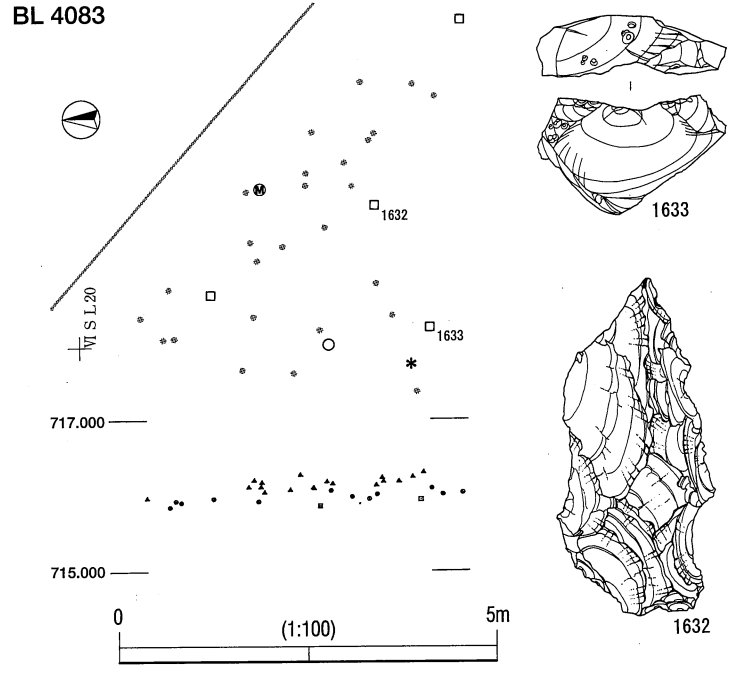
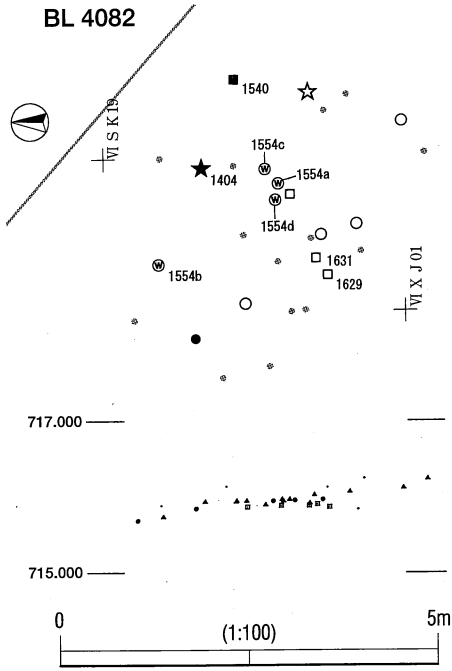

第4地点 BL4082・4083・4084 遺物分布図 (貫ノ木遺跡)

BL 4085

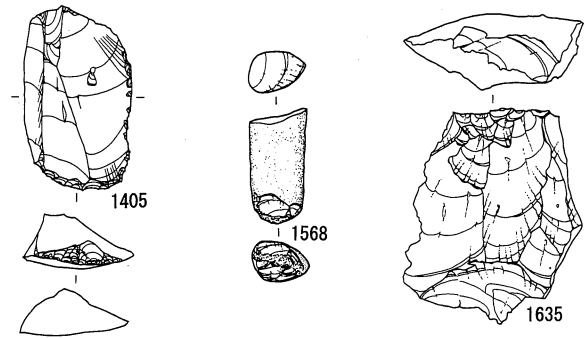
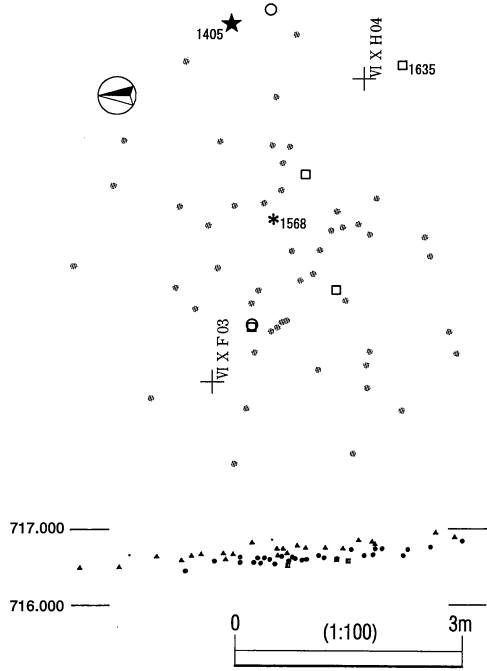

BL 4086

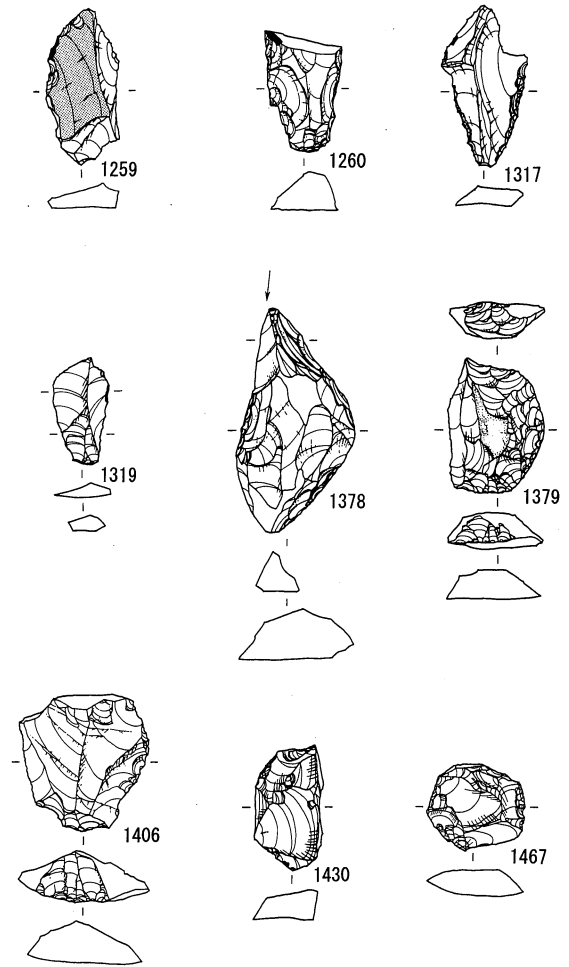
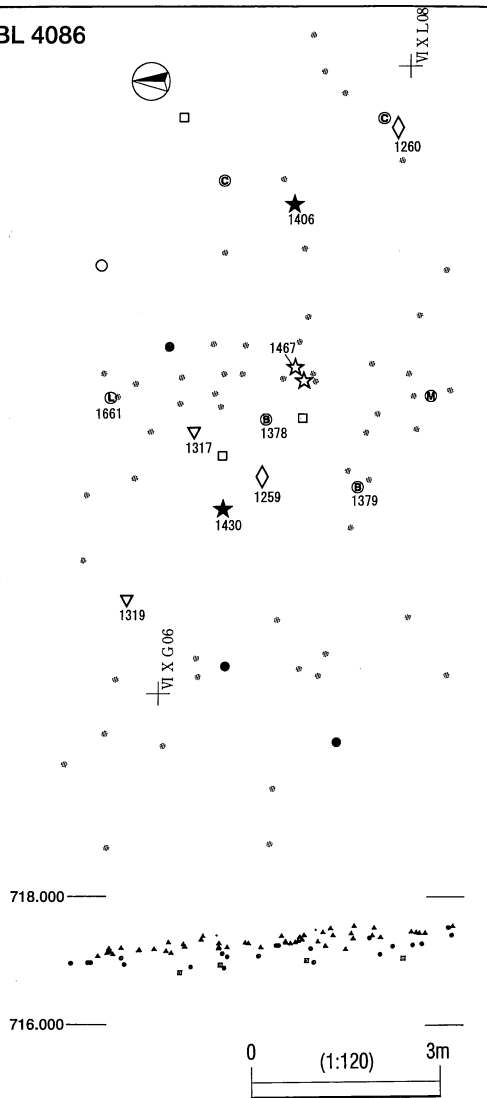

第4地点 BL4085・4086 遺物分布図 (貫ノ木遺跡)

BL 4087

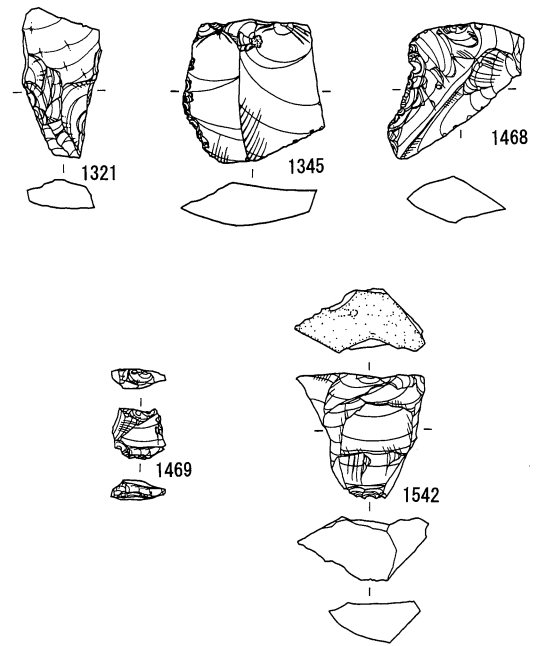
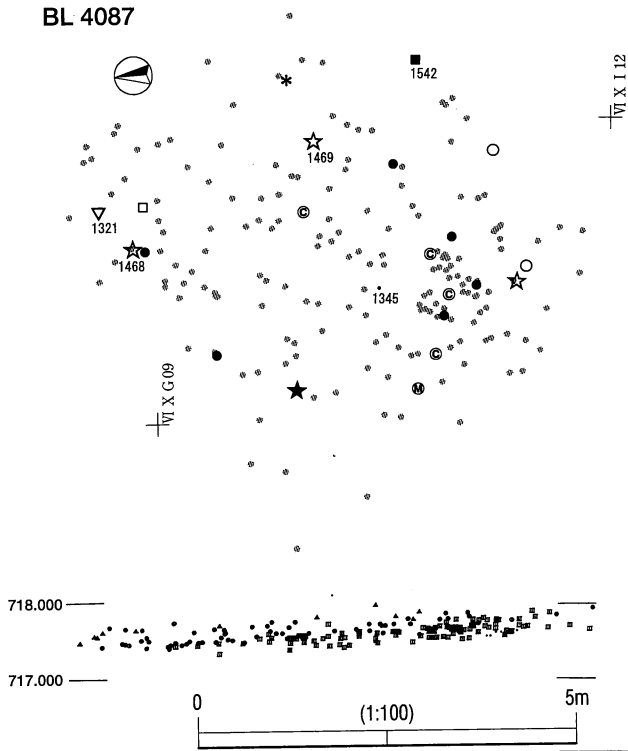

BL 4088

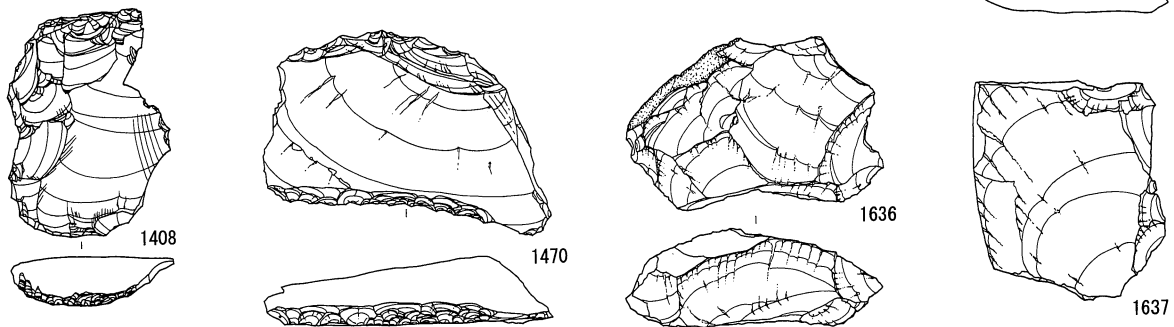
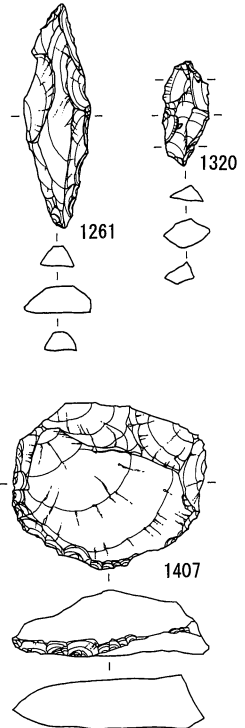
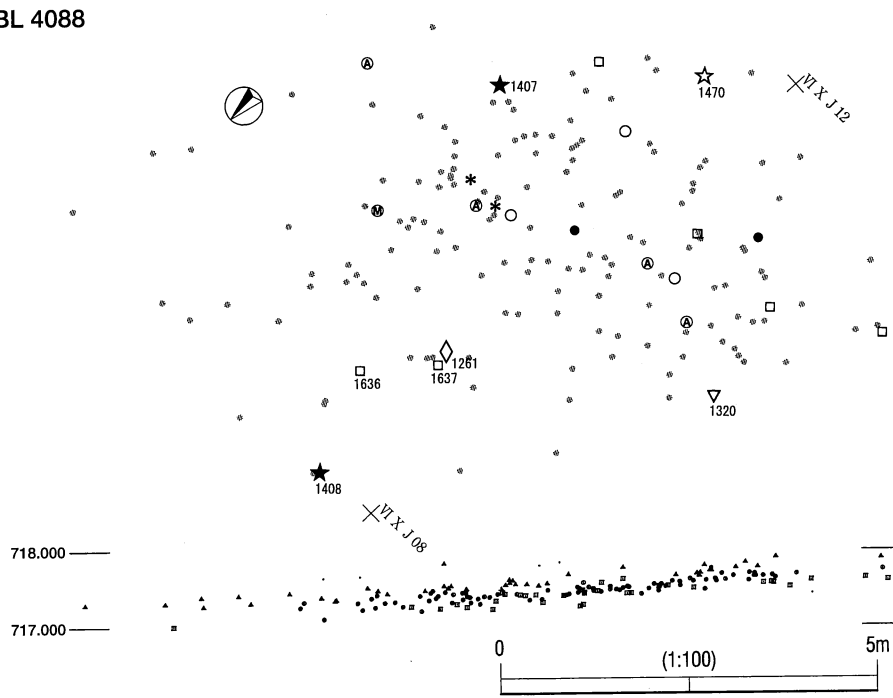

第4地点 BL4087・4088 遺物分布図 (貫ノ木遺跡)

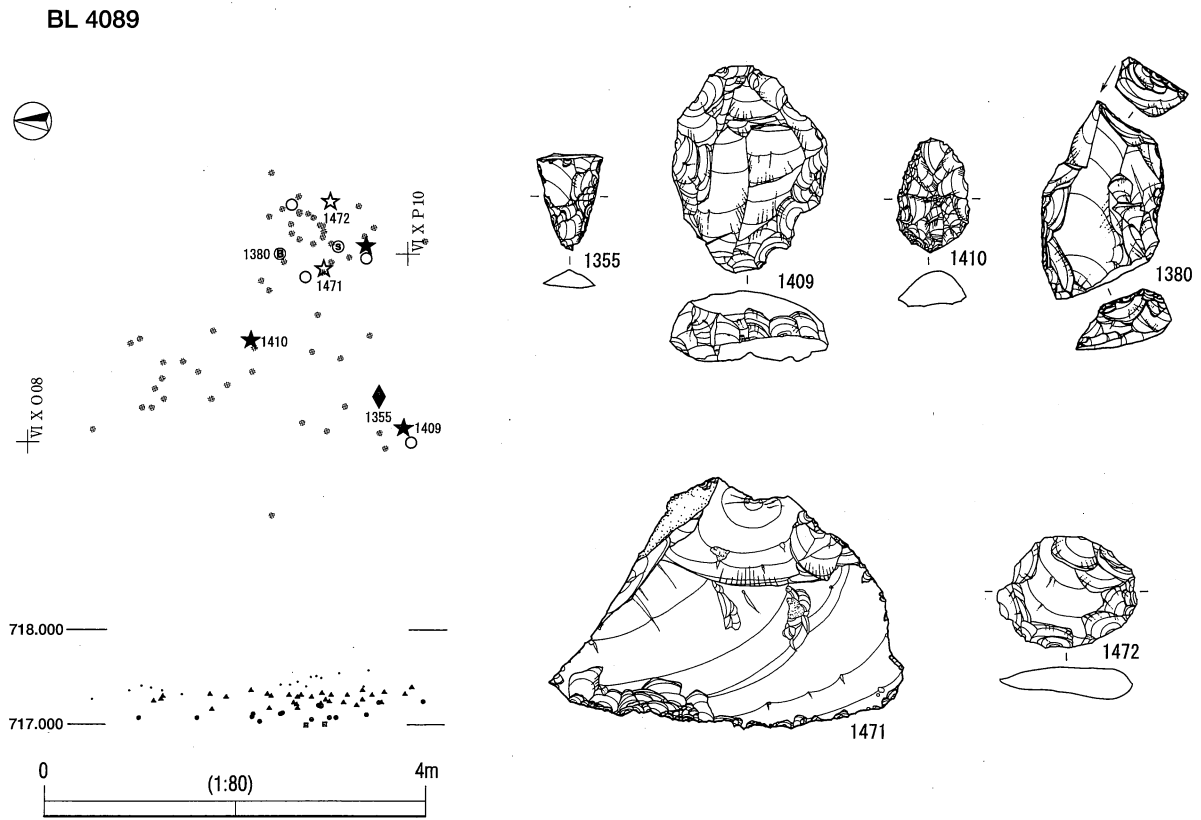

BL 4090

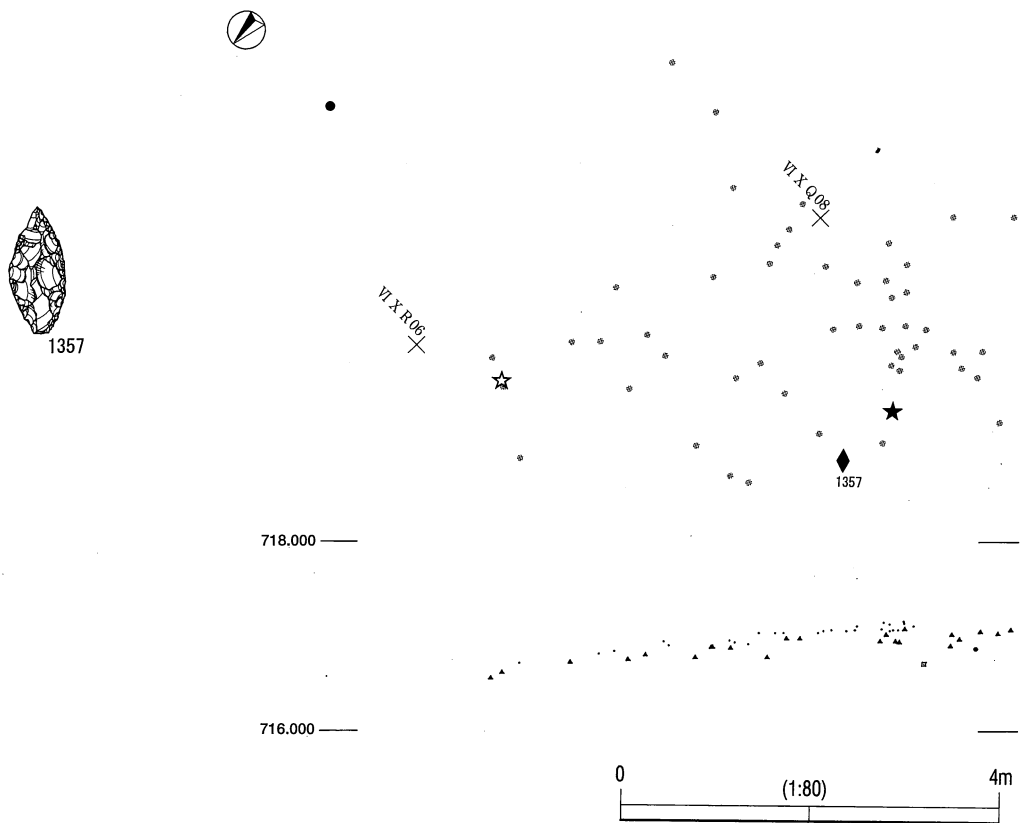

第4地点 BL4089・4090 遺物分布図 (貫ノ木遺跡)

BL 4091

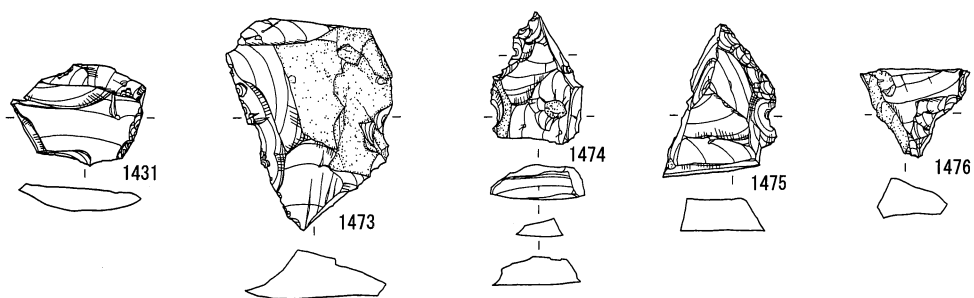
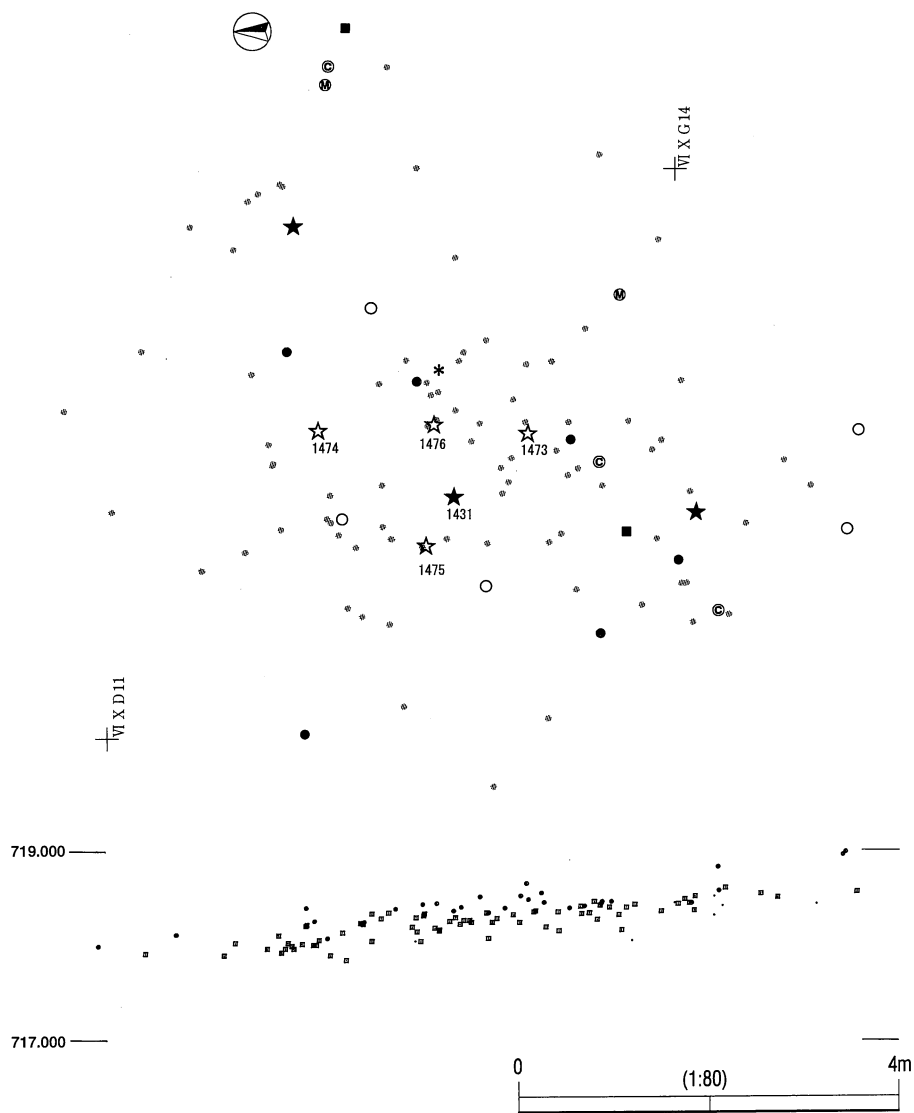

第4地点 BL4091 遺物分布図 (貫ノ木遺跡)

BL 4092

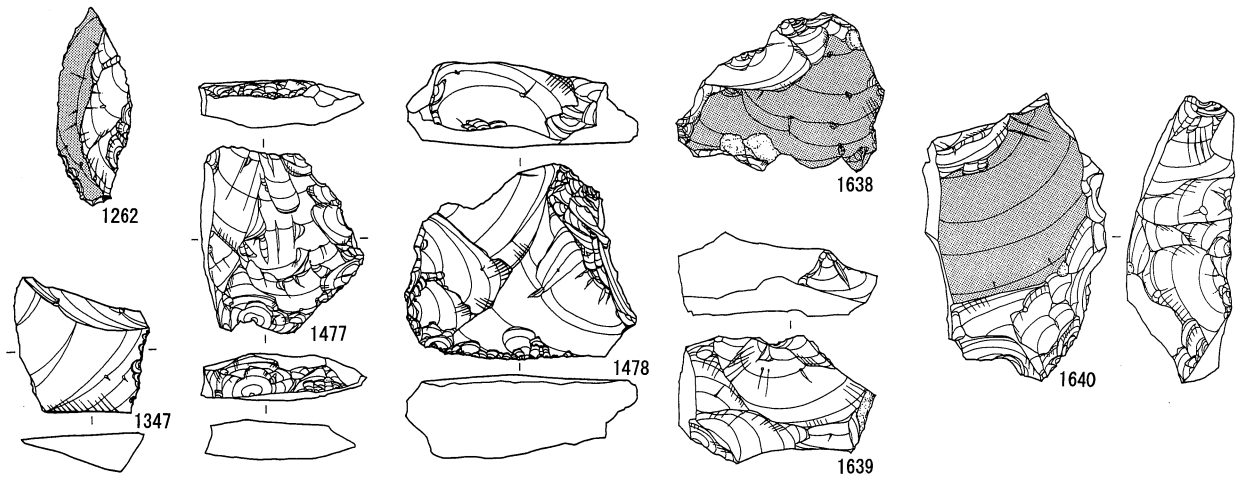
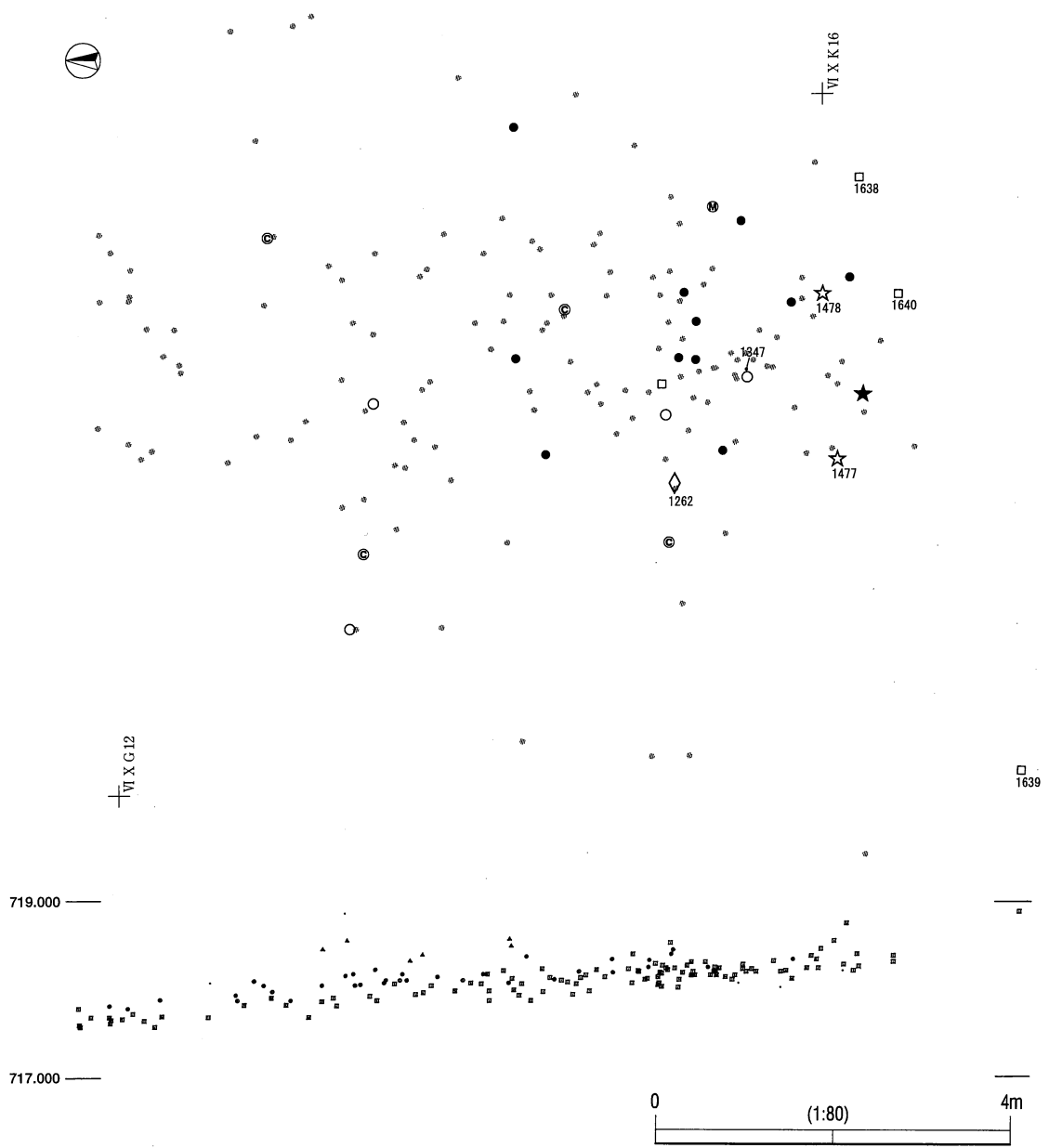

第4地点 BL4092 遺物分布図 (貫ノ木遺跡)

BL 4093

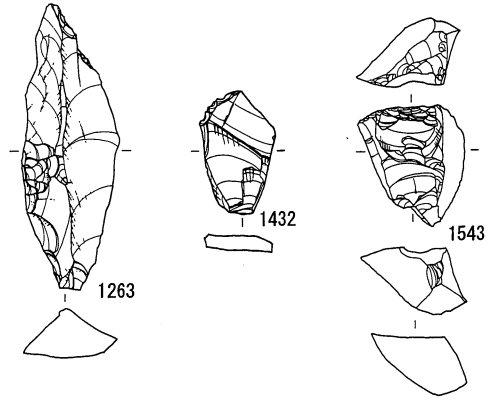
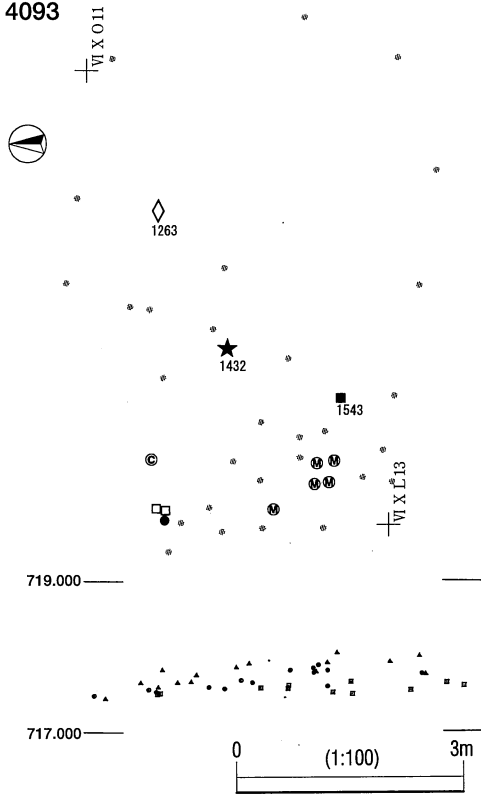

BL 4094

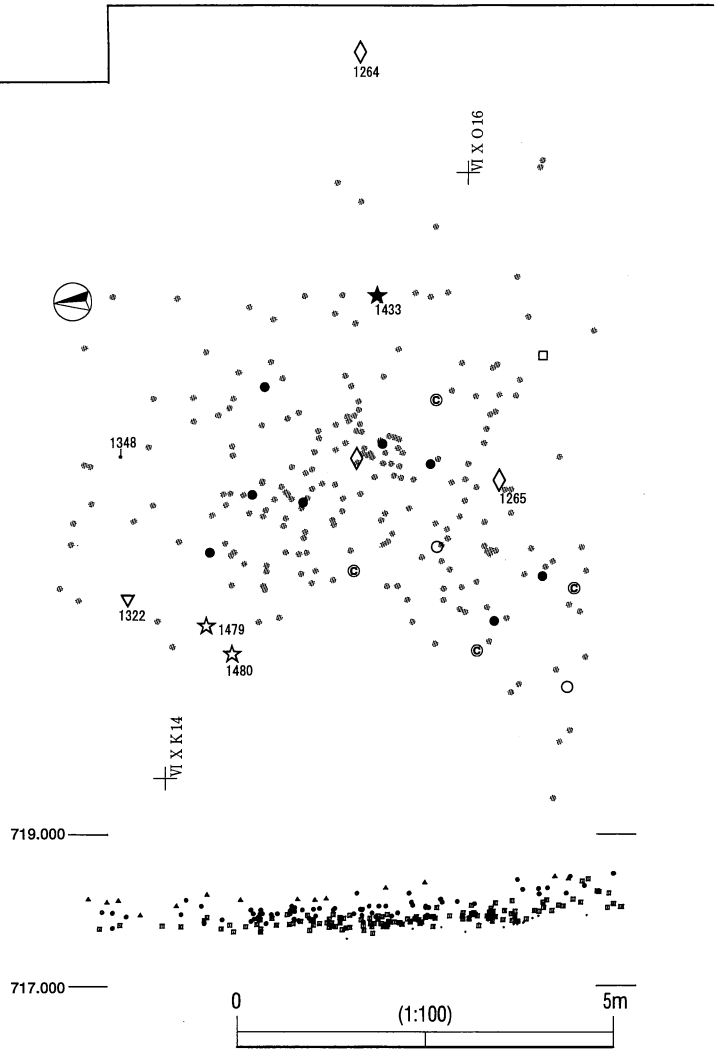
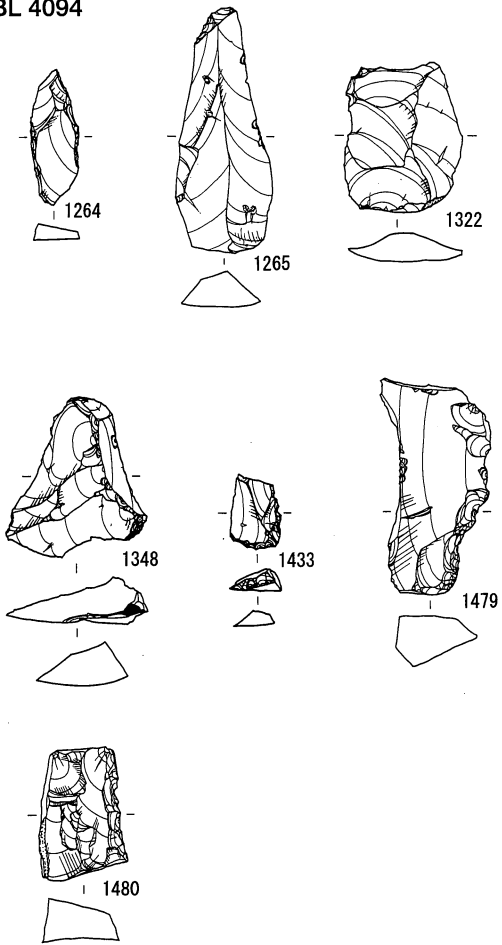

第4地点 BL4093・4094 遺物分布図 (貫ノ木遺跡)

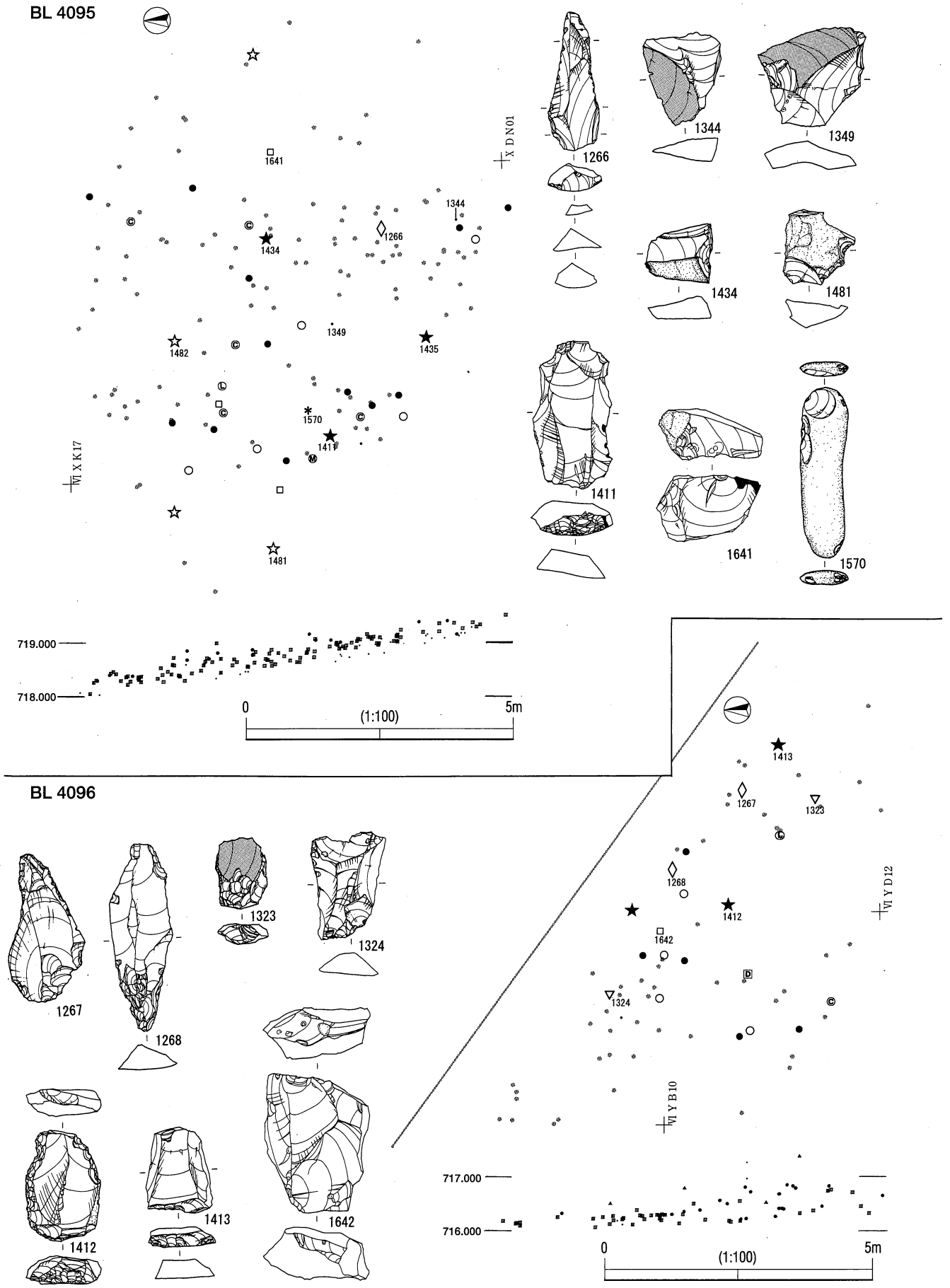

第4地点 BL4095・4096 遺物分布図 (貫ノ木遺跡)

BL 4097

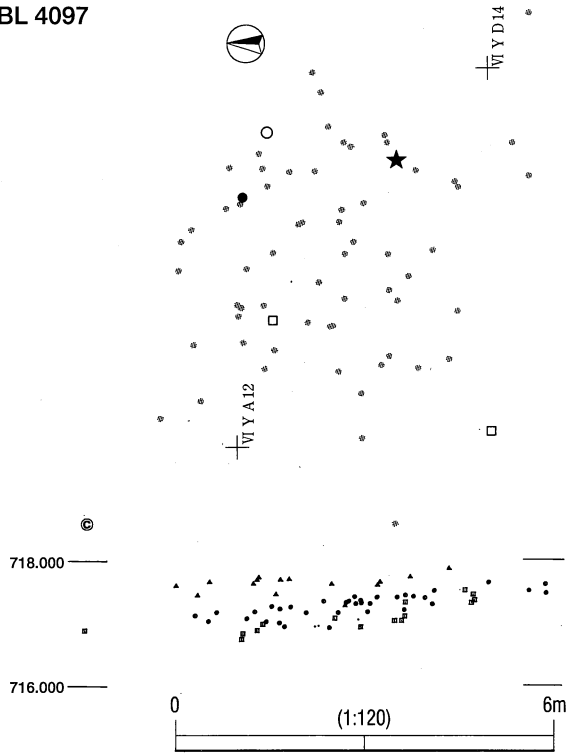

BL 4100

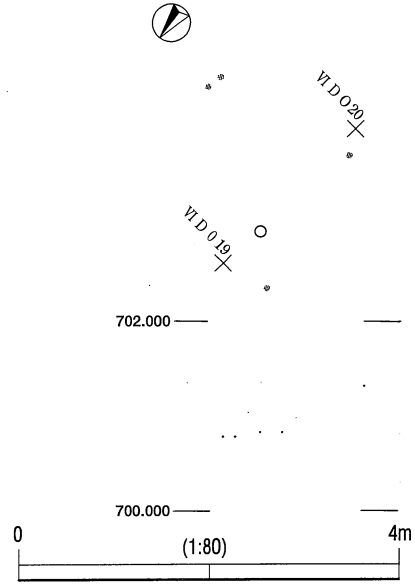

BL 4098

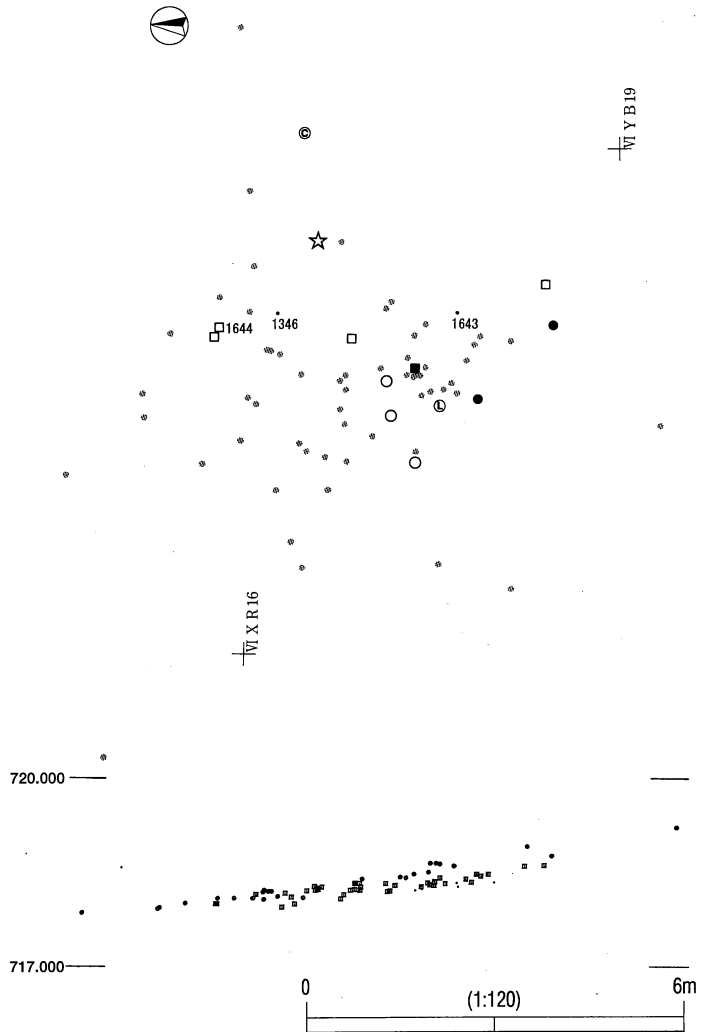
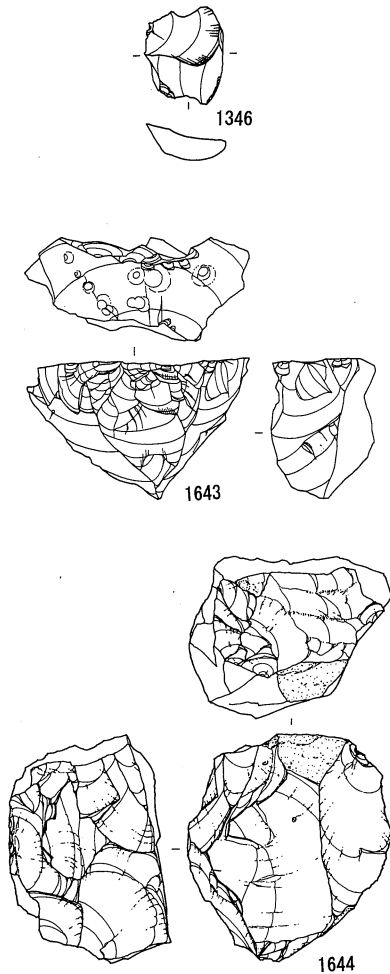

第4地点 BL4097・4098・4100 遺物分布図 (貫ノ木遺跡)

BL 4099

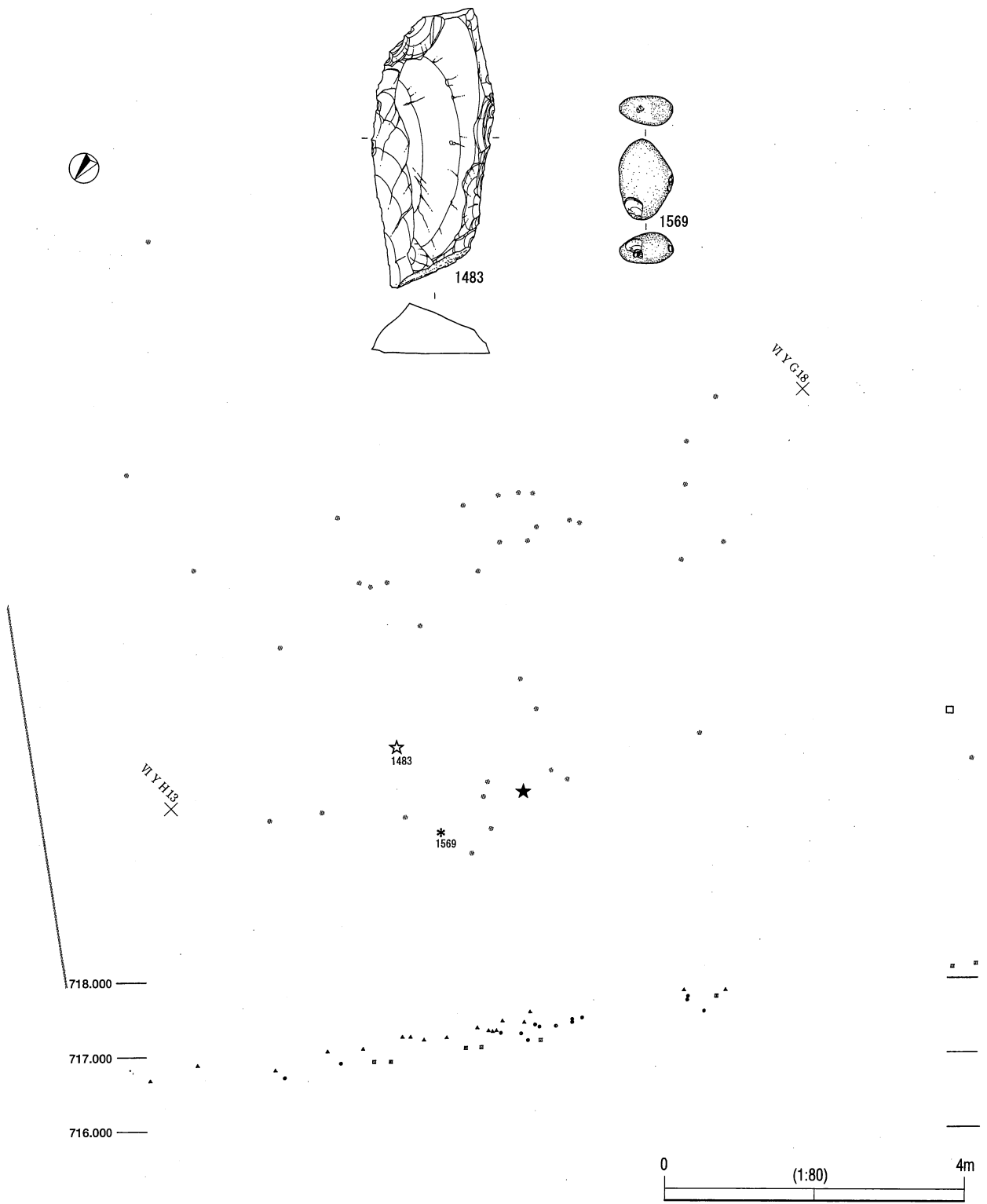

第4地点 BL4099 遺物分布図 (貫ノ木遺跡)

SH 1

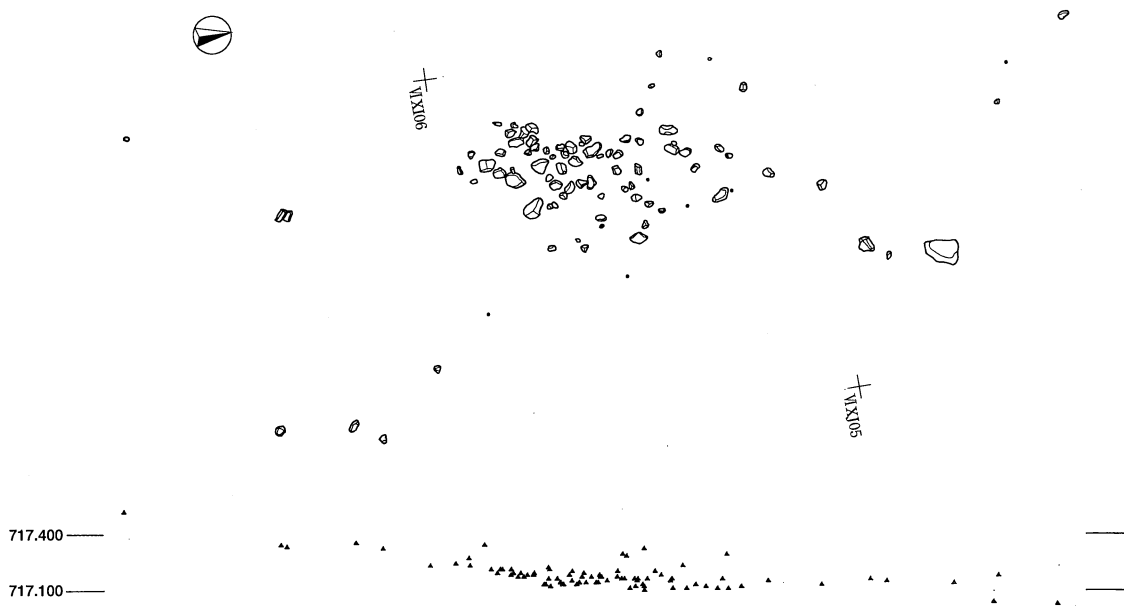

SH 30

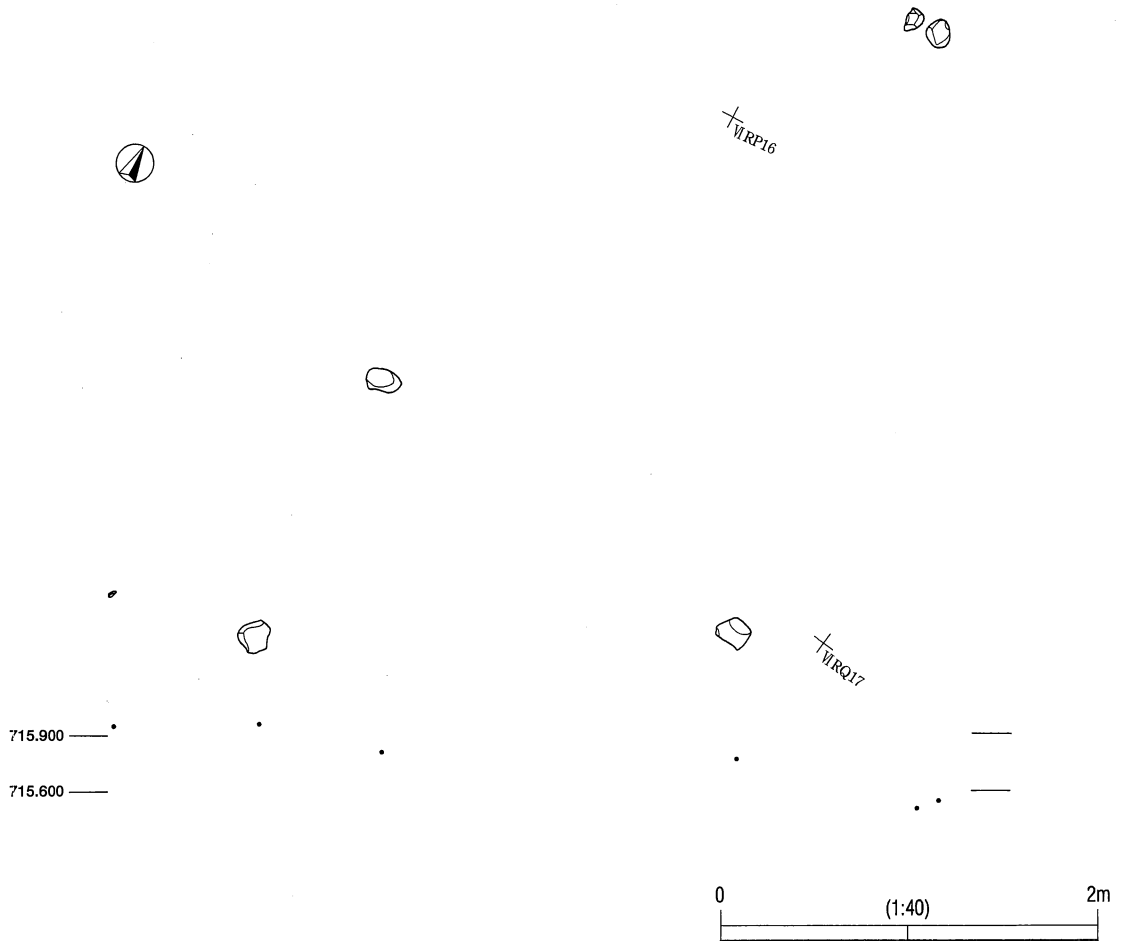

第4地点 SH 1・30 遺物分布図 (貫ノ木遺跡)

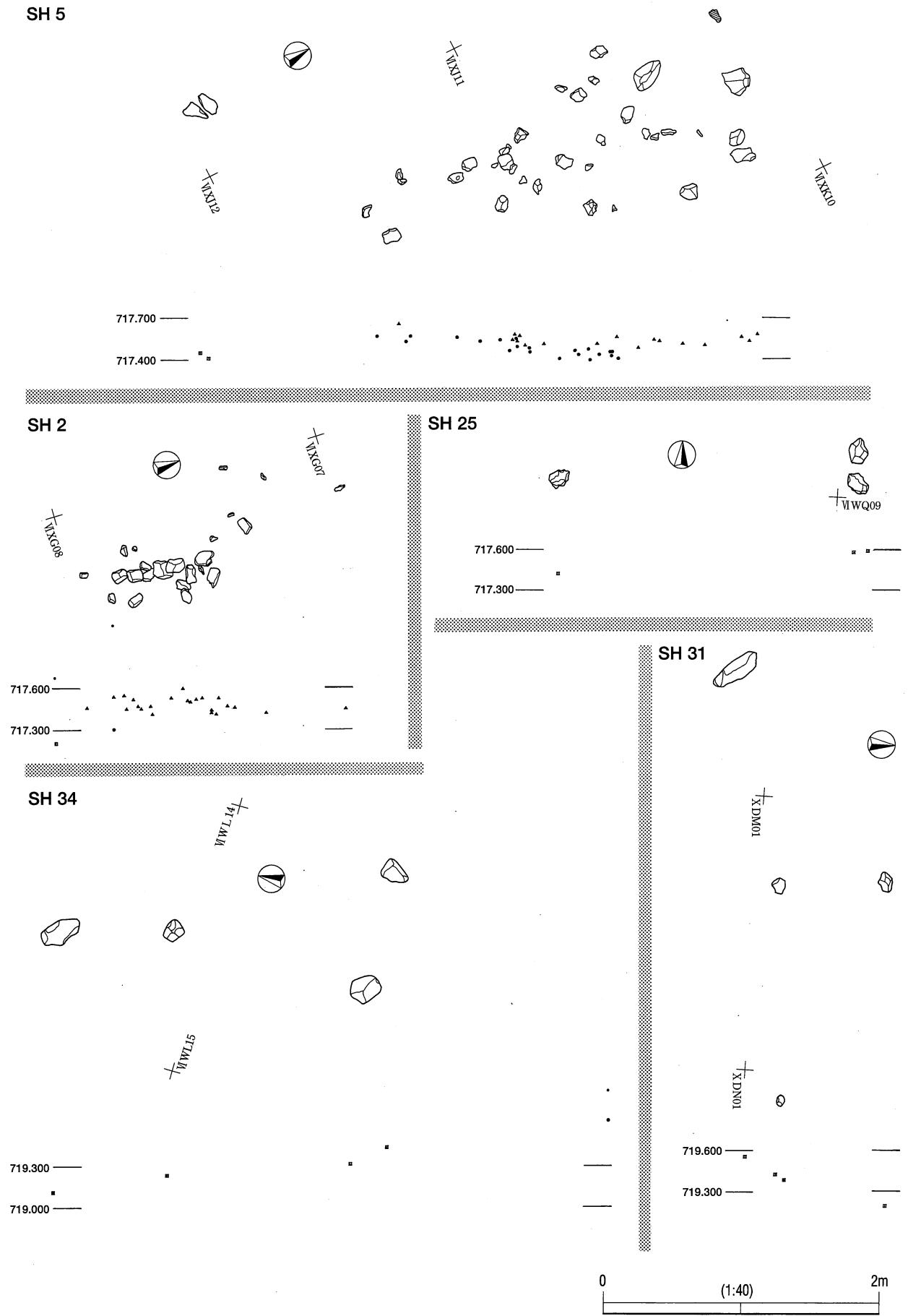

第4地点 SH 2・5・25・31・34 遺物分布図 (貫ノ木遺跡)

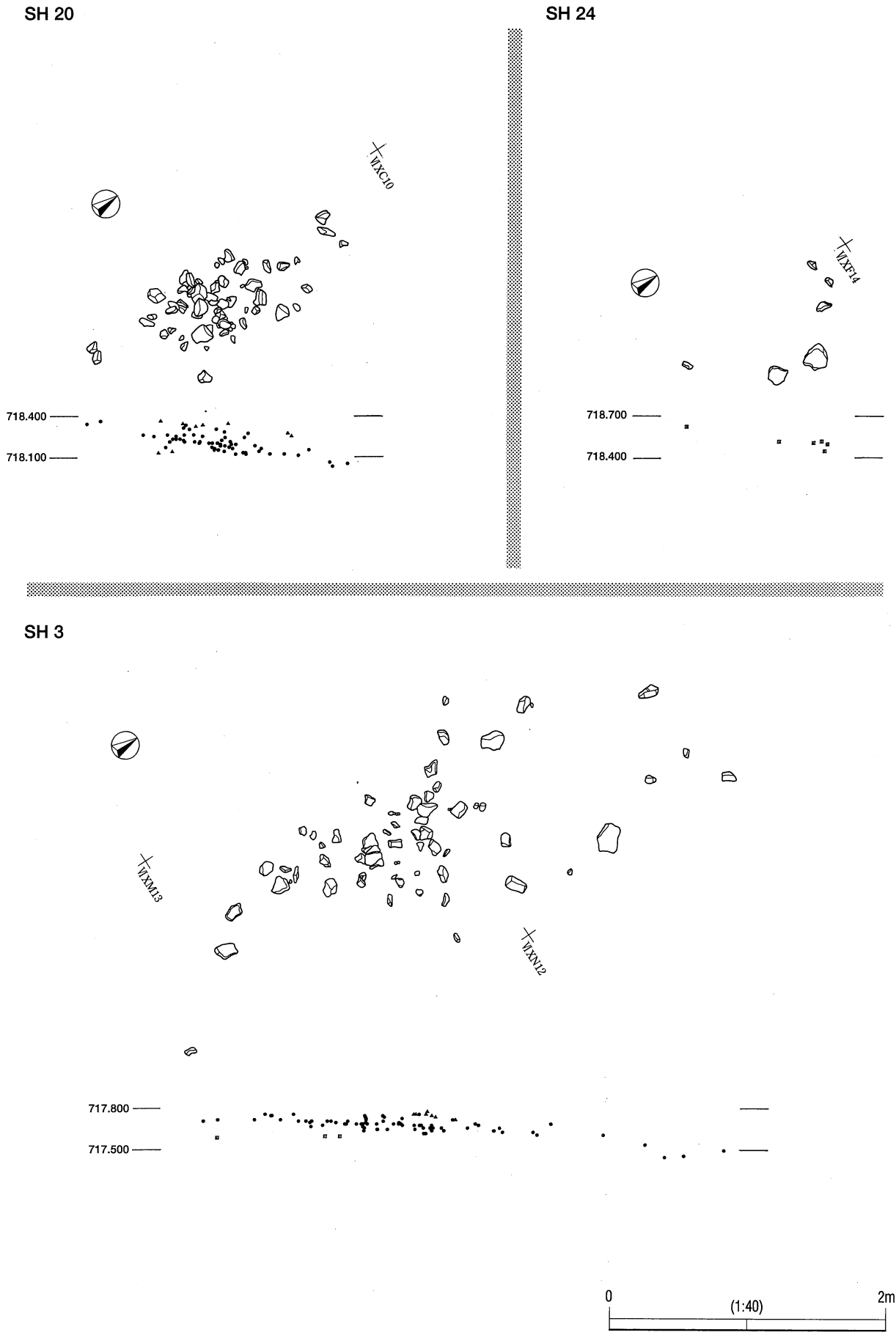

第4地点 SH 3・20・24 遺物分布図 (貫ノ木遺跡)

SH 47

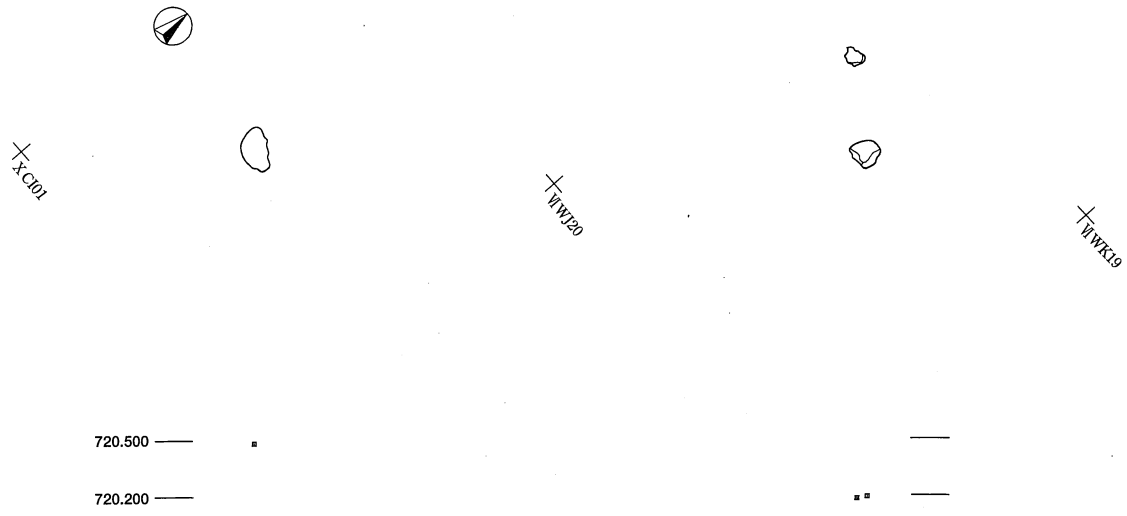

SH 4

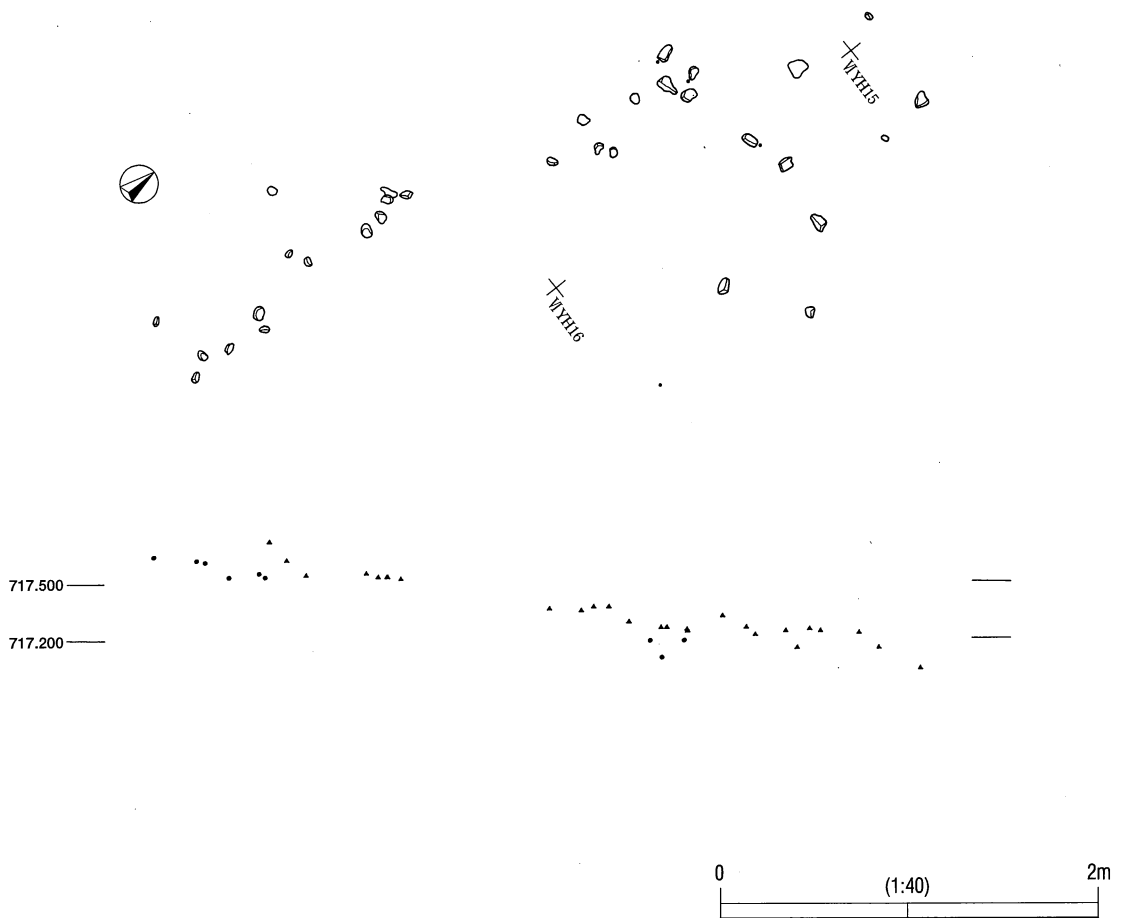

第 4 地点 SH 4・47 遺物分布図 (貫ノ木遺跡)

SH 41



SH 44

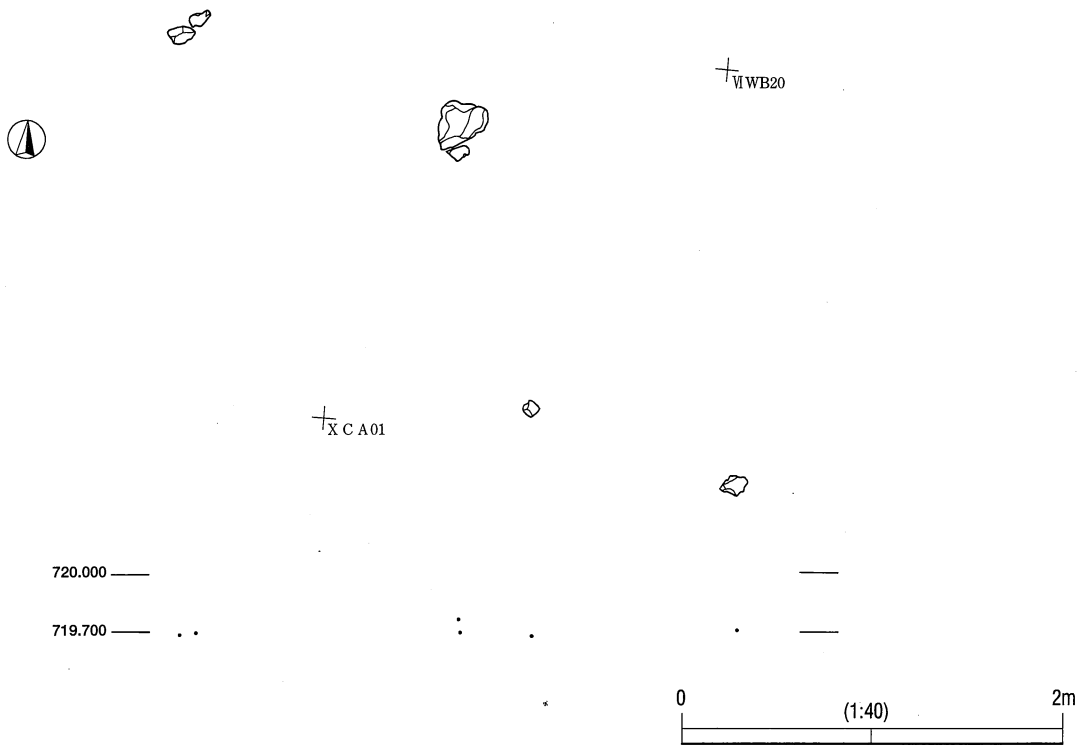

第4地点 SH 41・44 遺物分布図 (貫ノ木遺跡)

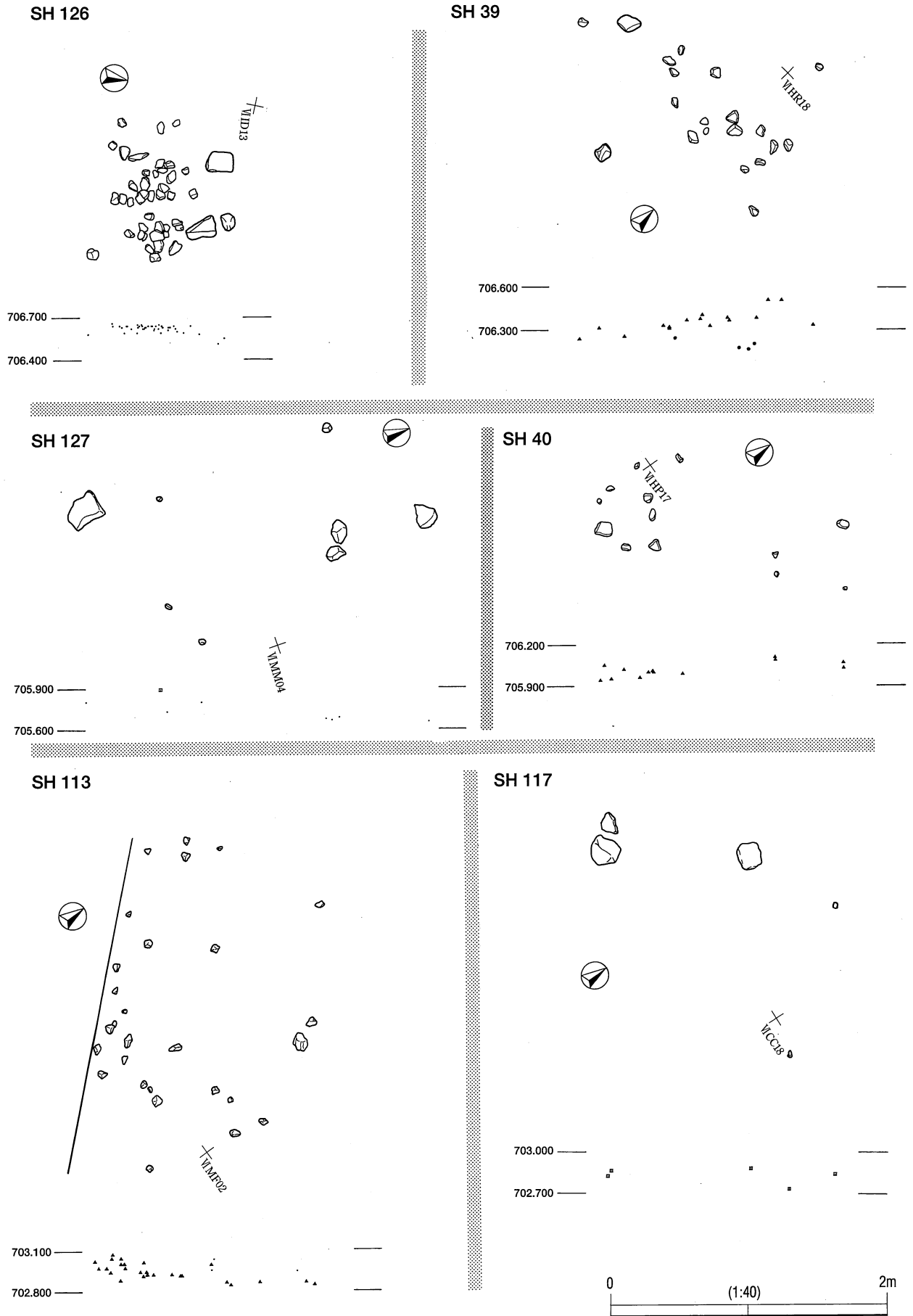

第4地点 SH 39・40・113・117・126・127 遺物分布図 (貫ノ木遺跡)

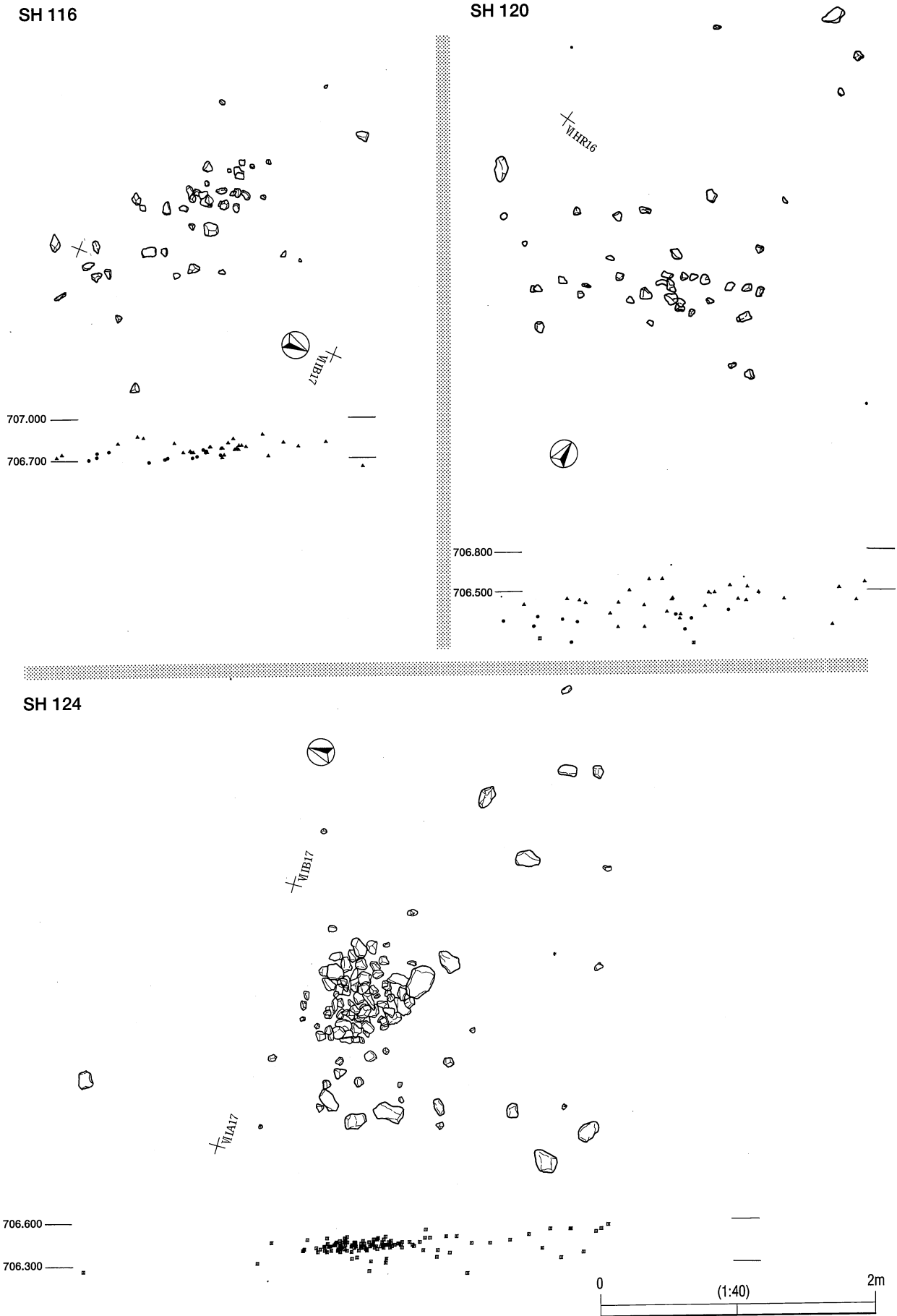

第4地点 SH 116・120・124 遺物分布図 (貫ノ木遺跡)

SH 114

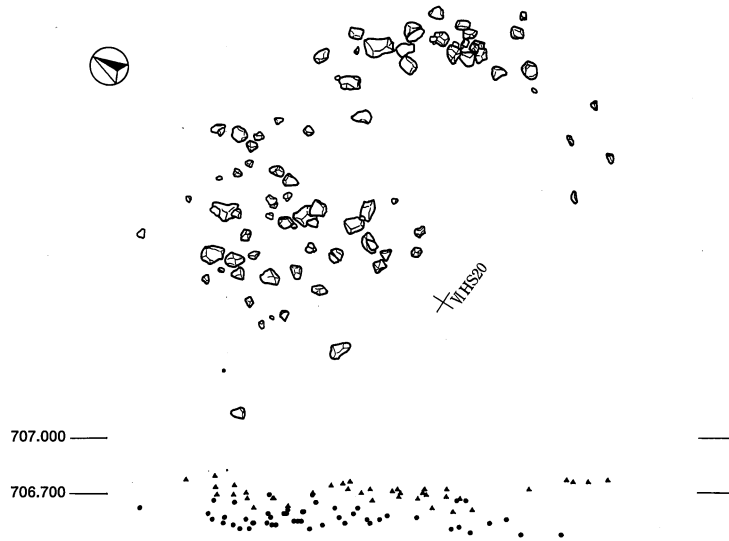

SH 123

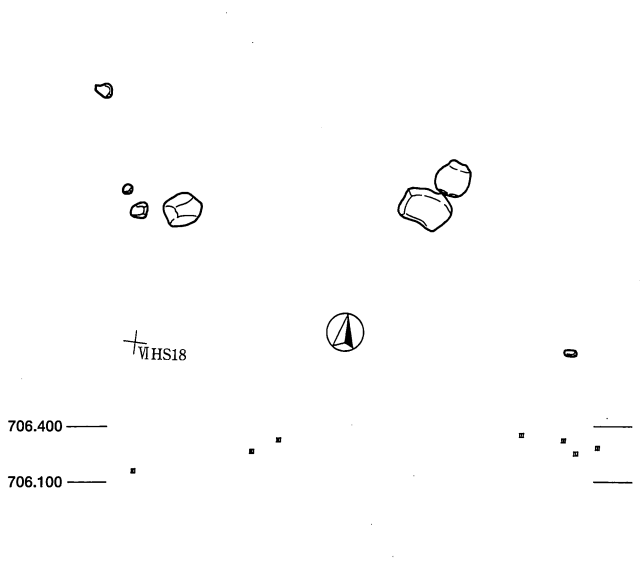

SH 125

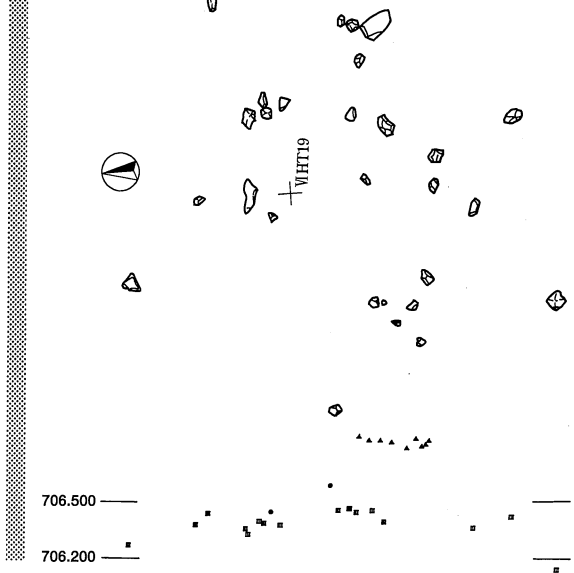

SH 109

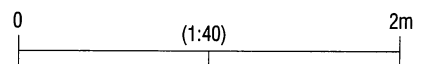
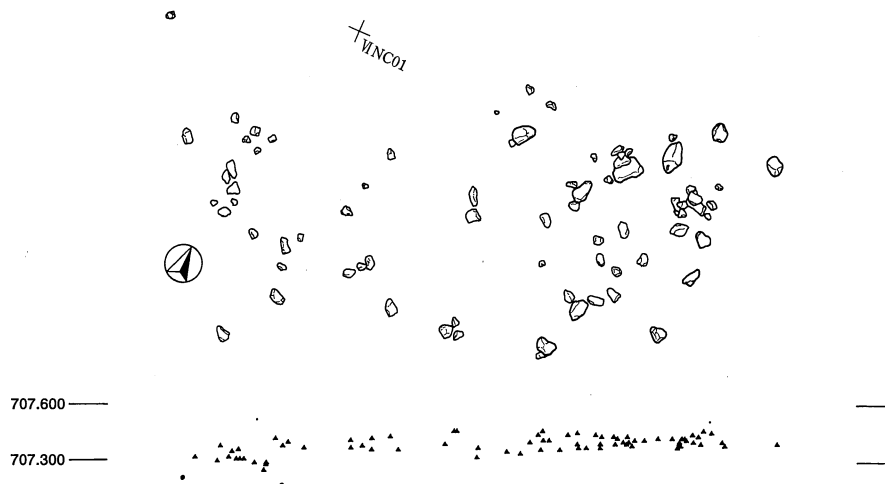

第4地点 SH 109・114・123・125 遺物分布図 (貫ノ木遺跡)

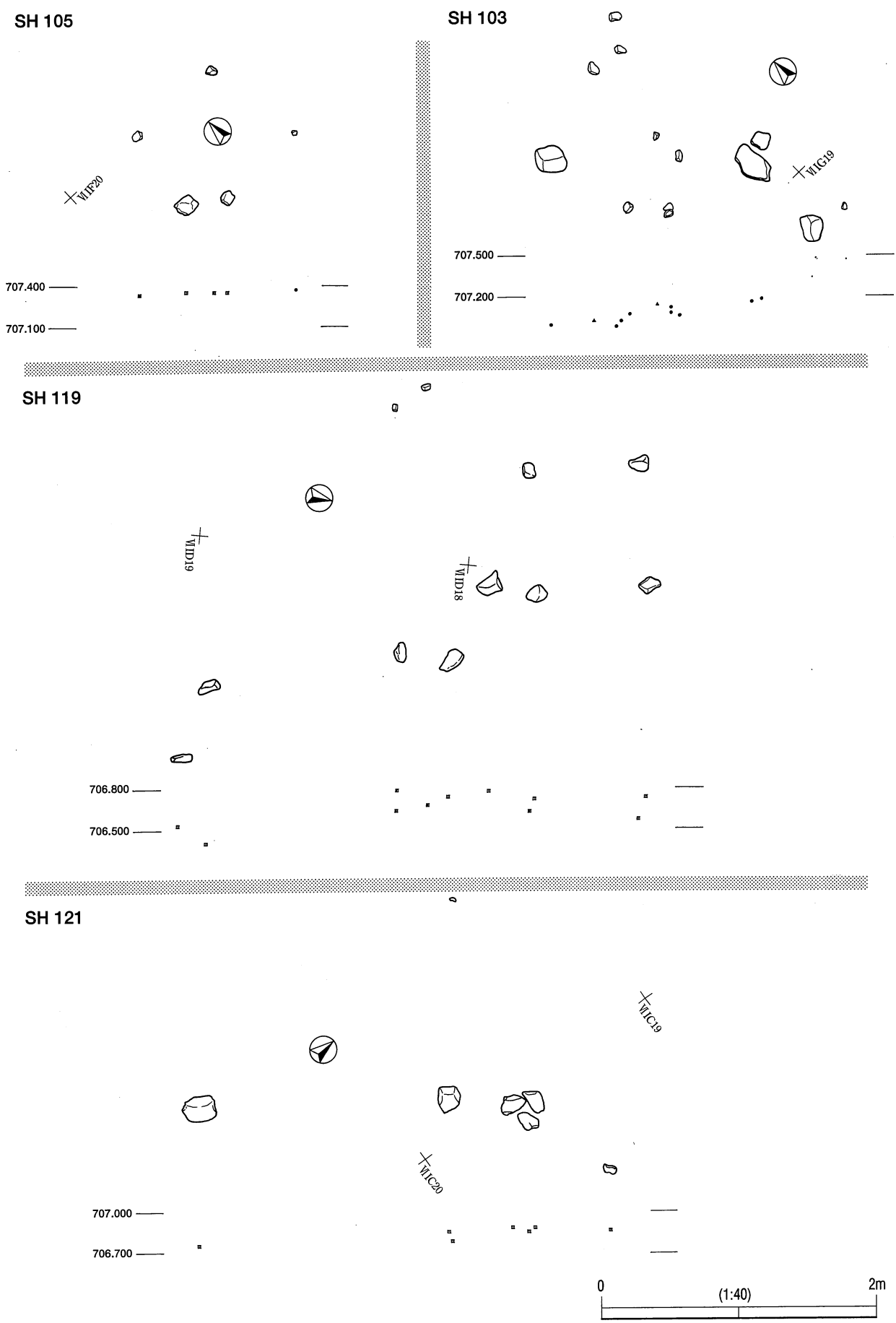

第4地点 SH 103・105・119・121 遺物分布図 (貫ノ木遺跡)

SH 101

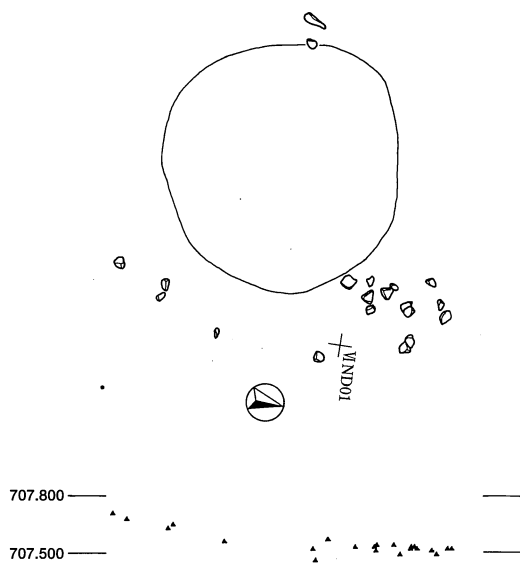

SH 111

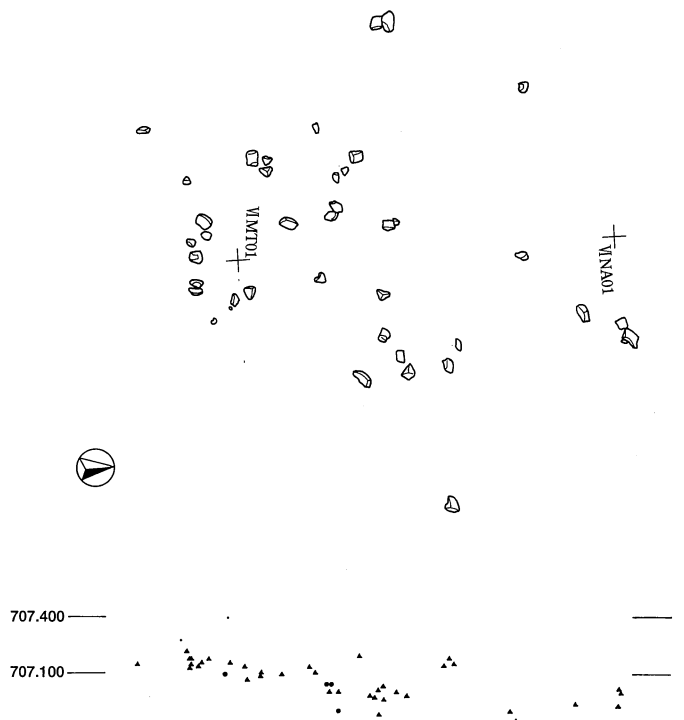

SH 112

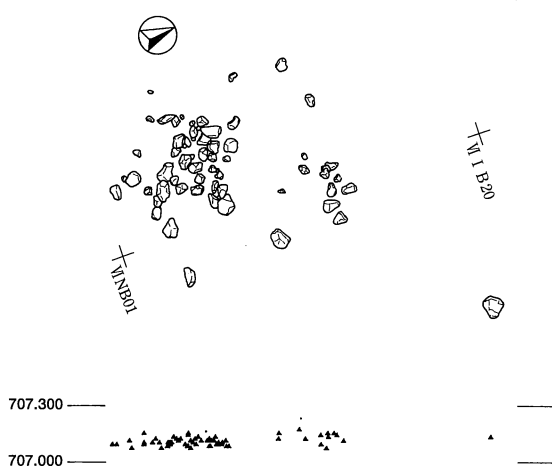

SH 110

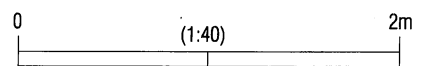
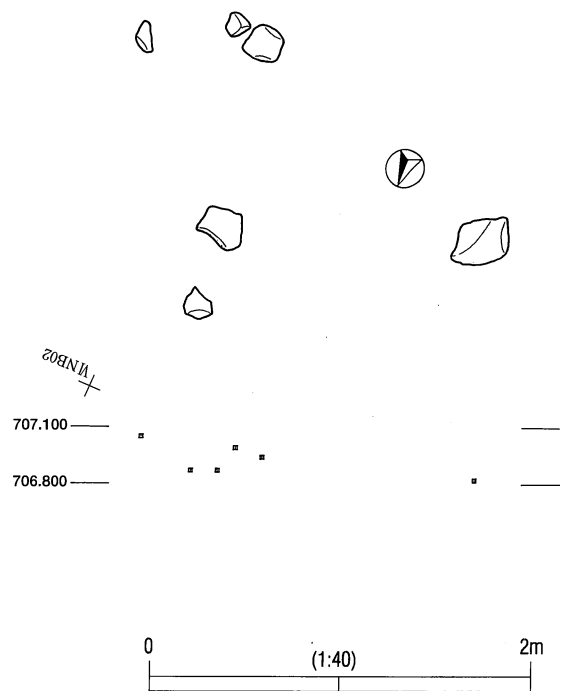

第 4 地点 SH 101・110・111・112 遺物分布図 (貫ノ木遺跡)

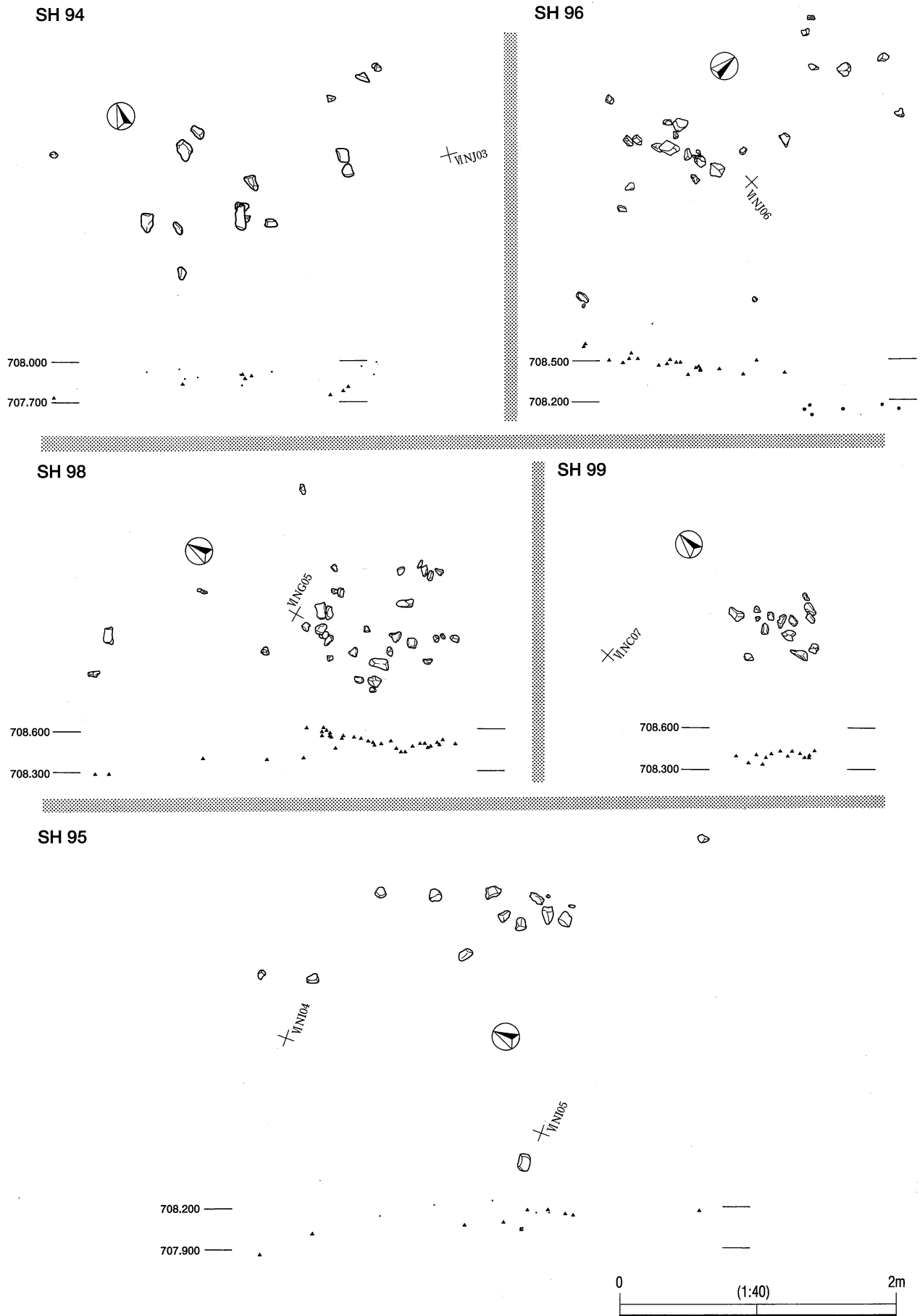

第4地点 SH 94・95・96・98・99 遺物分布図 (貫ノ木遺跡)

SH 122

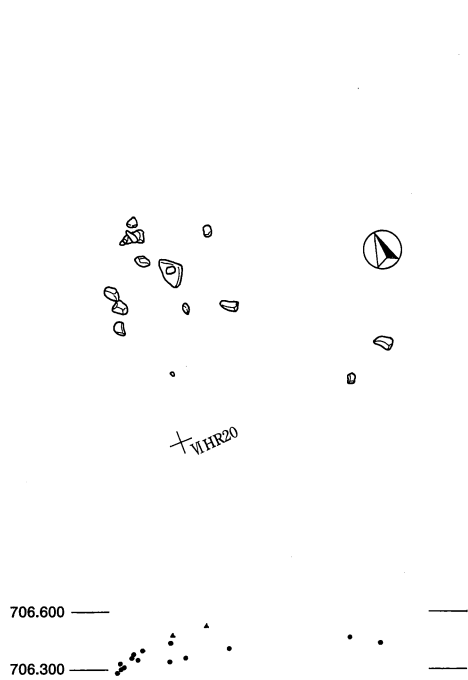

SH 108

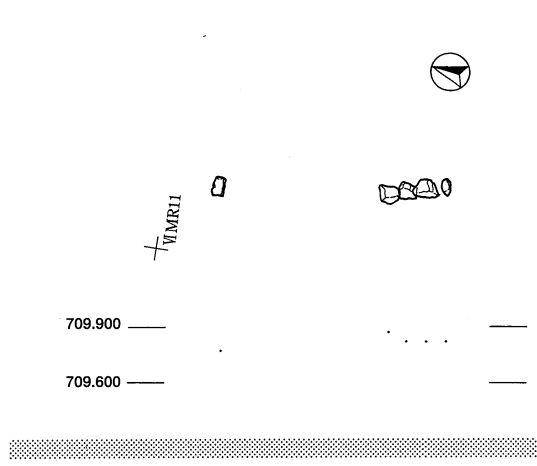

SH 102

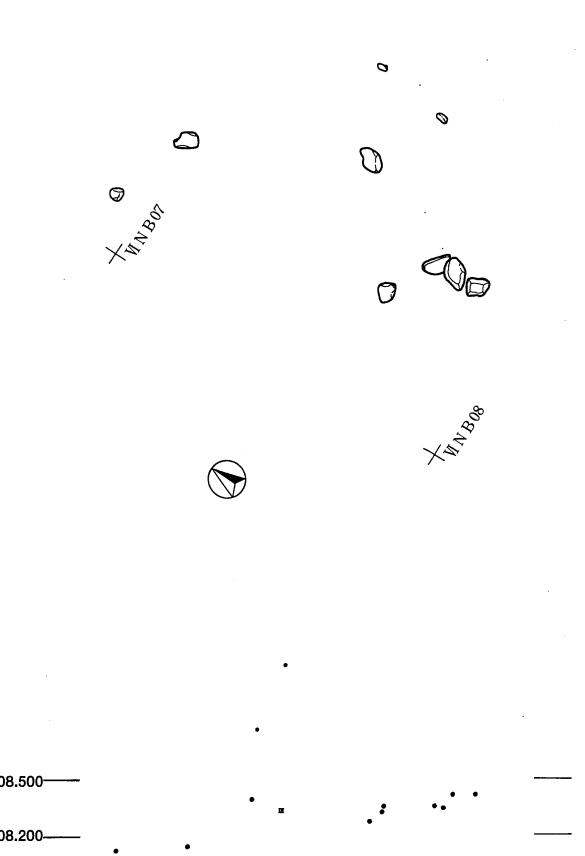

SH 91

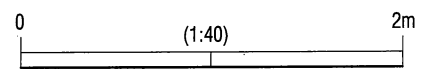
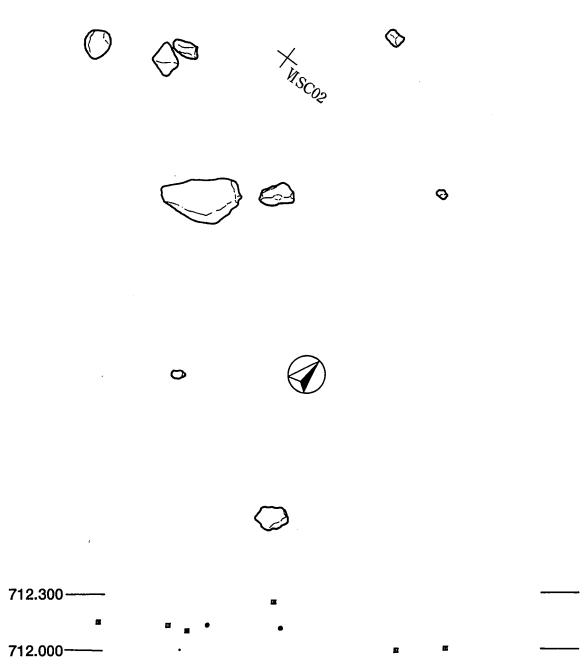

第4地点 SH 91・102・108・122 遺物分布図 (貫ノ木遺跡)

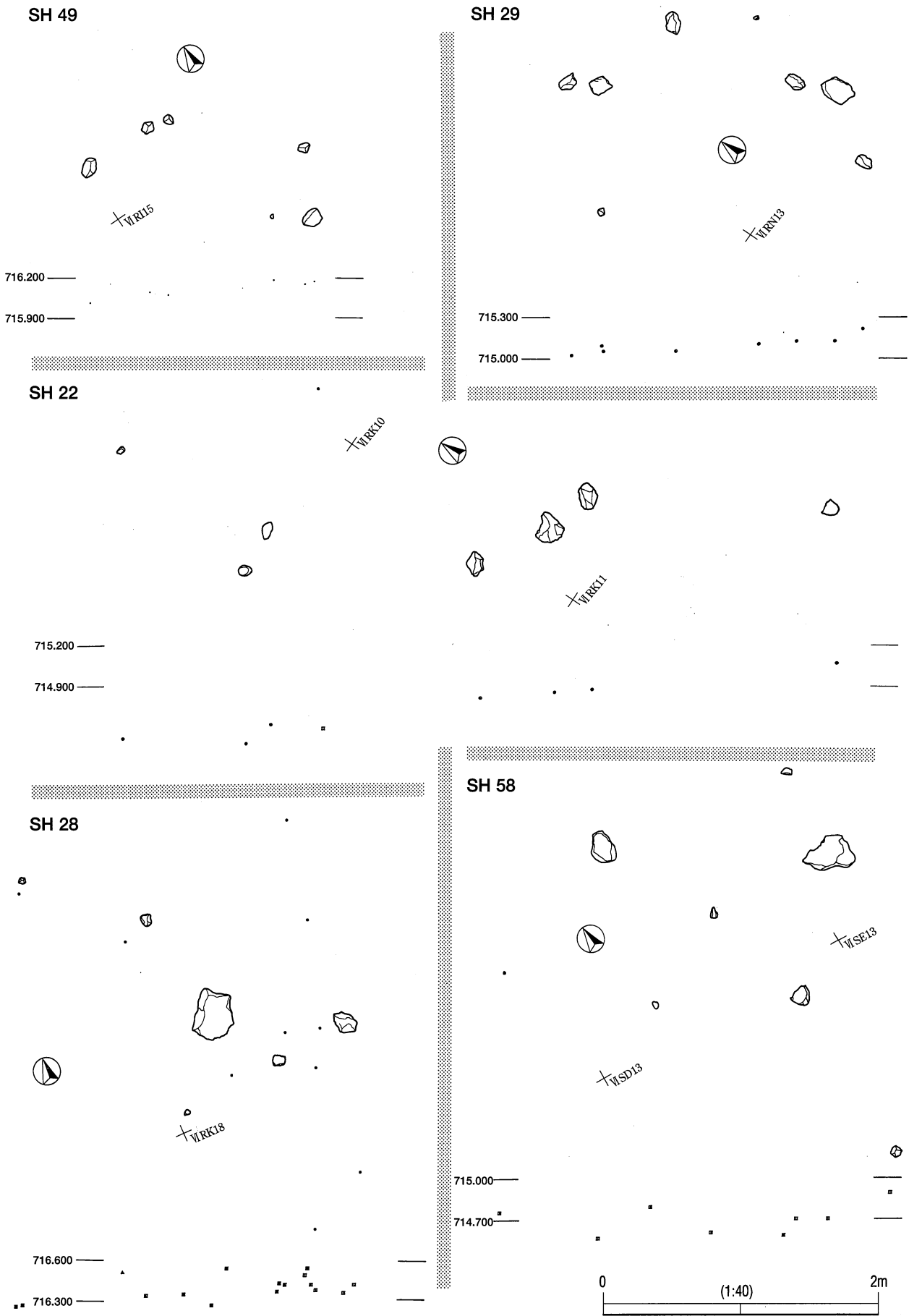

第4地点 SH 22・28・29・49・58 遺物分布図 (貫ノ木遺跡)

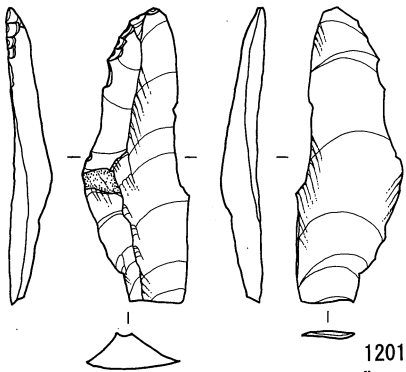

1201
Kn SS
BL4001 3.6g
III VI-H 63

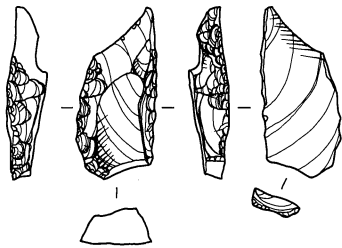

1203
Kn Ob SWHD
BL4001 2.43g
IV VI-H 77

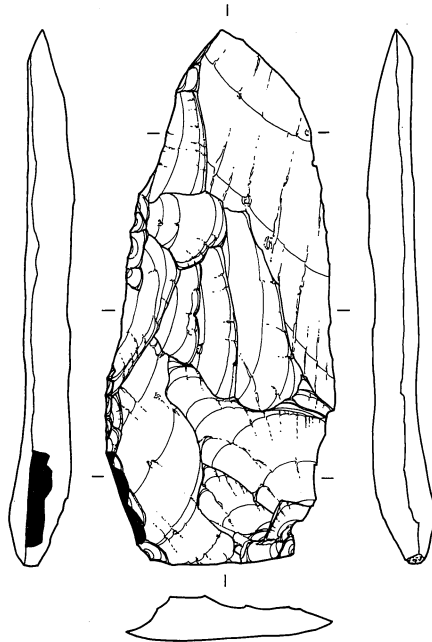

1202
Kn An
BL4001 40.66g
V b VI-C 104

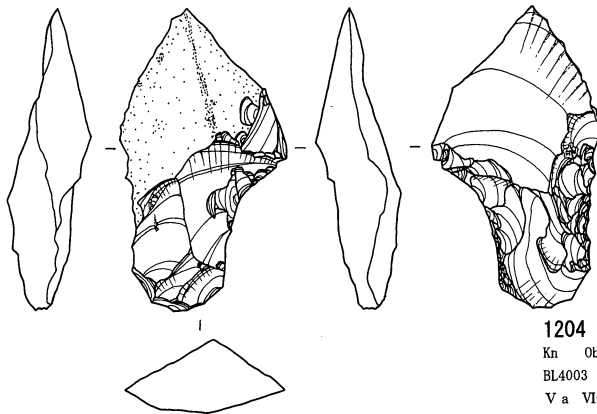

1204
Kn Ob WDTY
BL4003 11.61g
V a VI-H 573

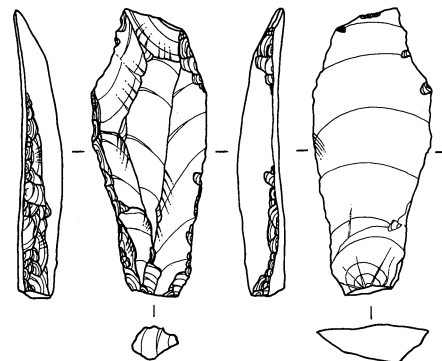

1205
Kn TS
BL4007 6.67g
IV VI-I 546

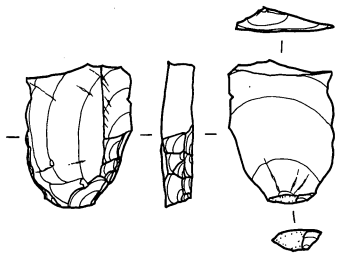

1206
Kn An
BL4008 2.6g
V a VI-H 280

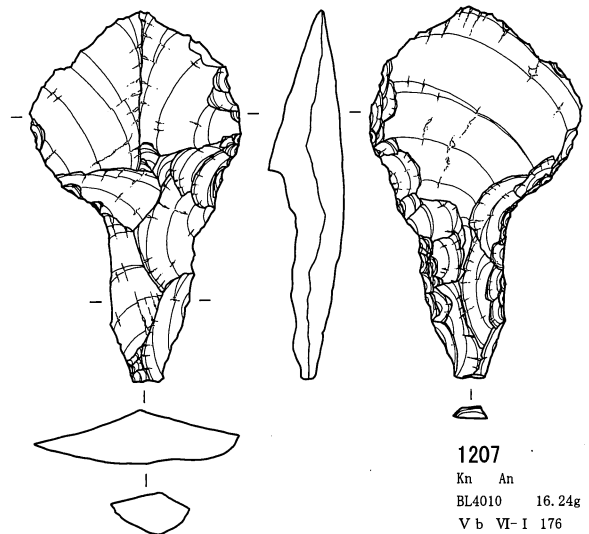

1207
Kn An
BL4010 16.24g
V b VI-I 176

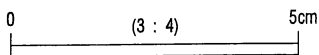

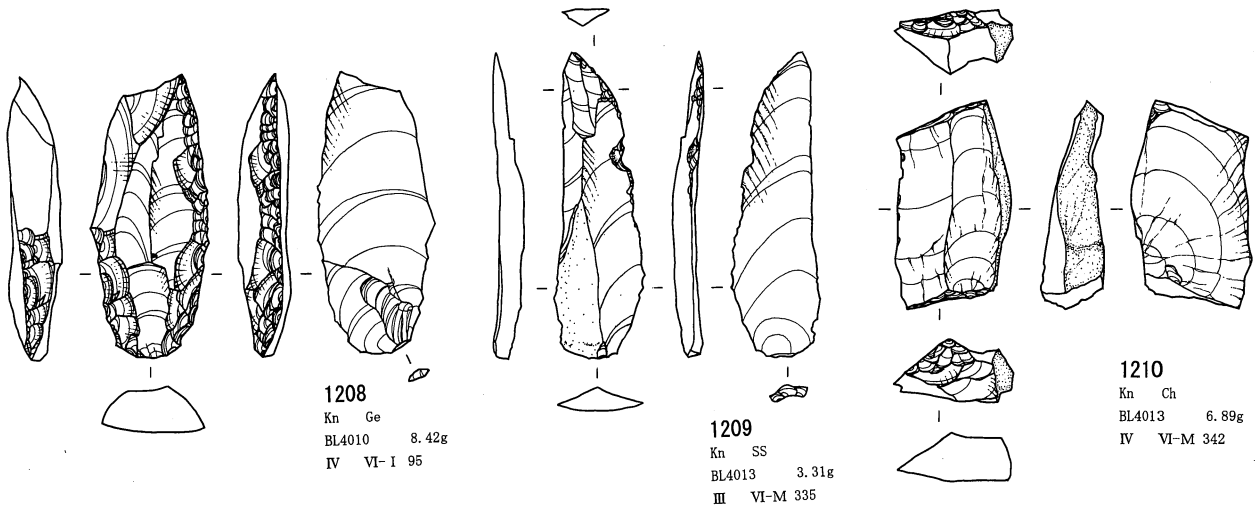

1208
Kn Ge
BL4010 8.42g
IV VI-I 95

1209
Kn SS
BL4013 3.31g
III VI-M 335

1210
Kn Ch
BL4013 6.89g
IV VI-M 342

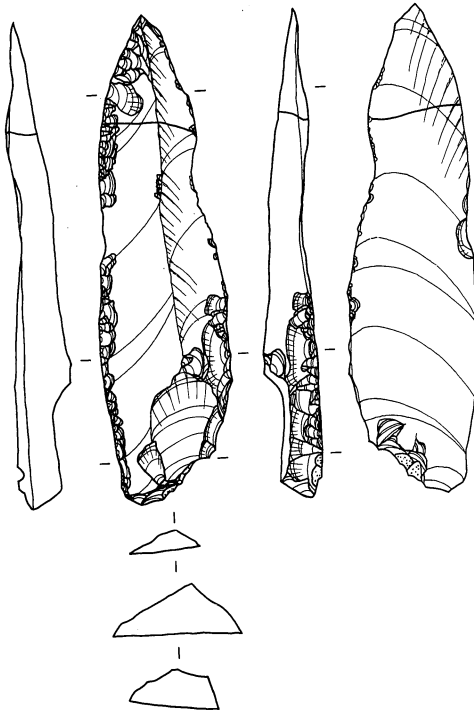

1211a
Kn破 Ob WDTN
BL4014 1.01g
IV VI-N 305

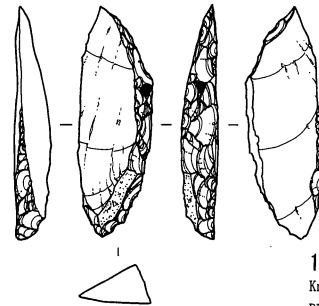

1212
Kn An
BL4019 2.93g
V a VI-N 242

1211b
Kn Ob
BL4014 12.19g
IV VI-N 306

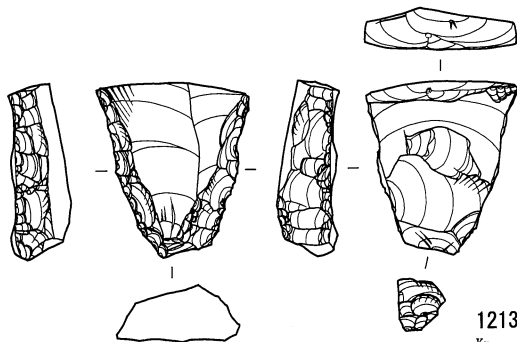

1213
Kn Ob WDTN
BL4020 7.18g
V a VI-N 133

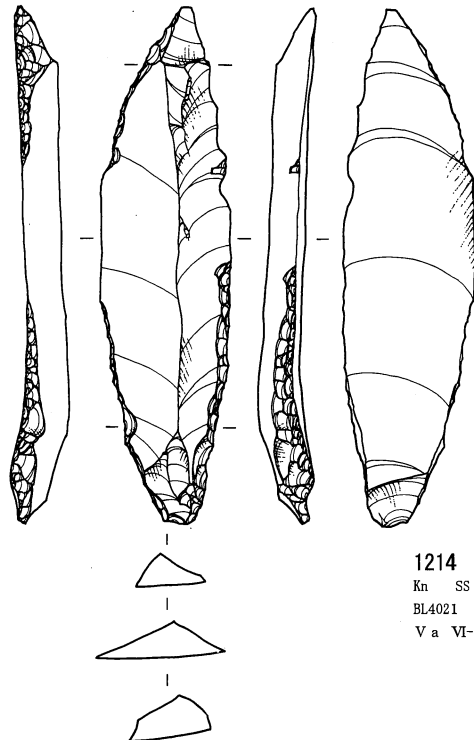

1214
Kn SS
BL4021 14.89g
V a VI-M 765

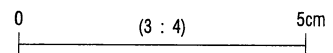

第4地点 石器実測図2 (ナイフ形石器2) (貫ノ木遺跡)

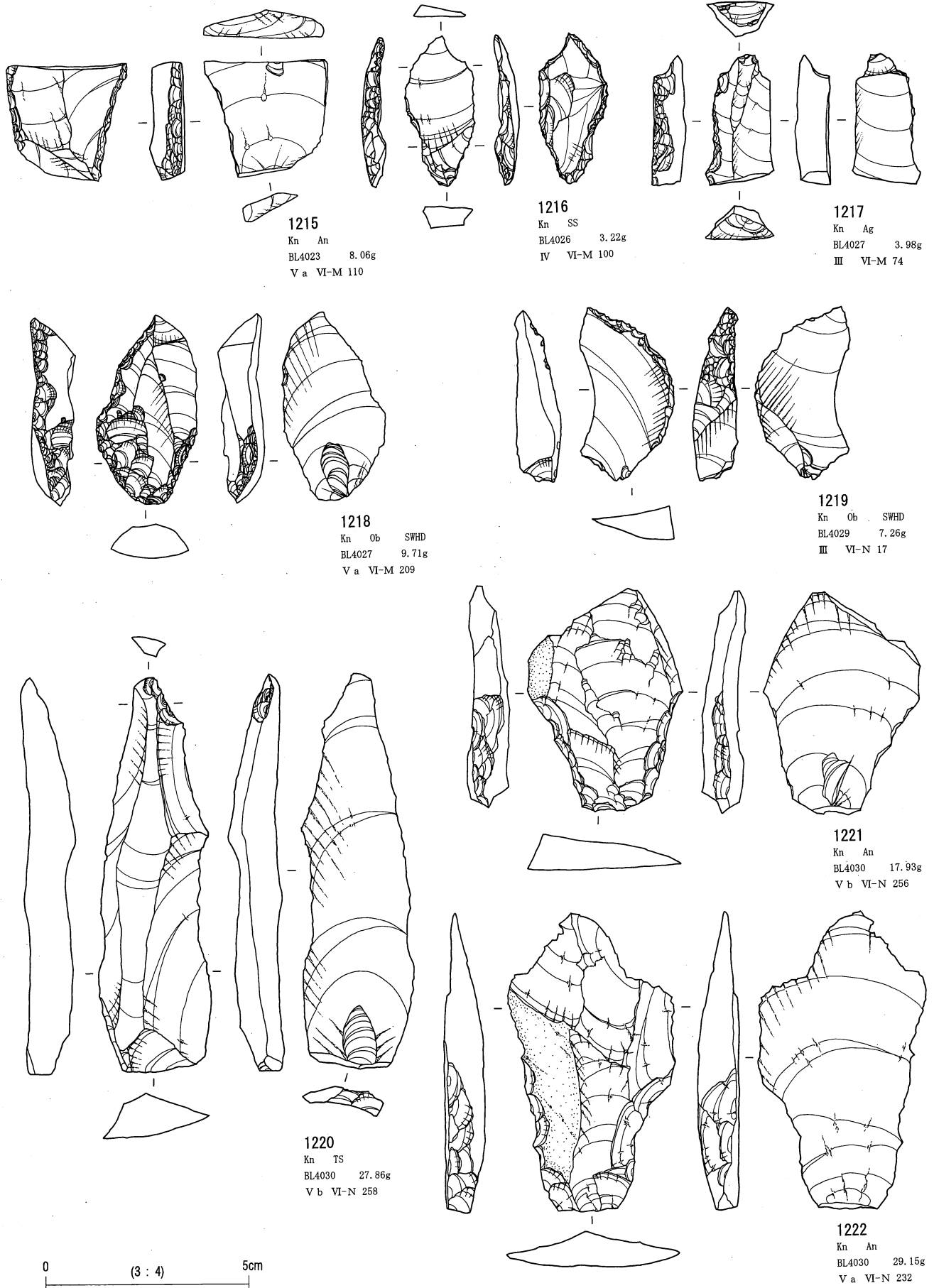

第4地点 石器実測図3 (ナイフ形石器3) (貫ノ木遺跡)

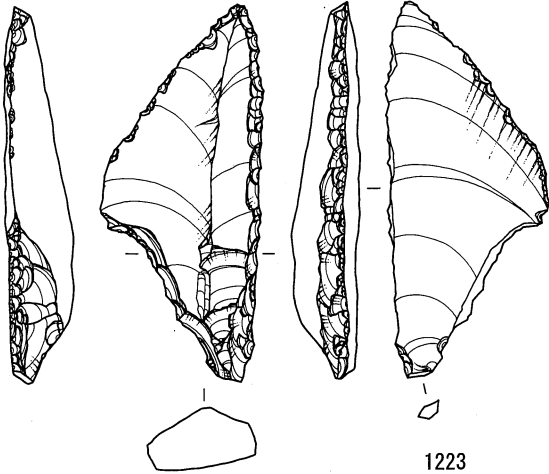

1223
Kn Ag
BL4033 14.28g
V a VI-R 3658

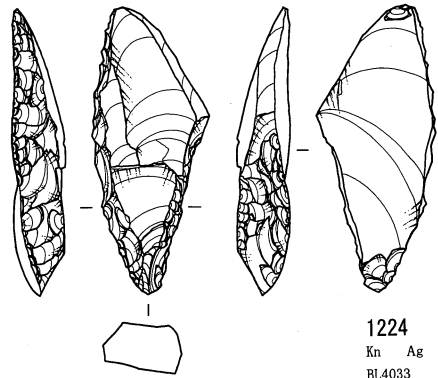

1224
Kn Ag
BL4033 8.13g
IV VI-R 3579

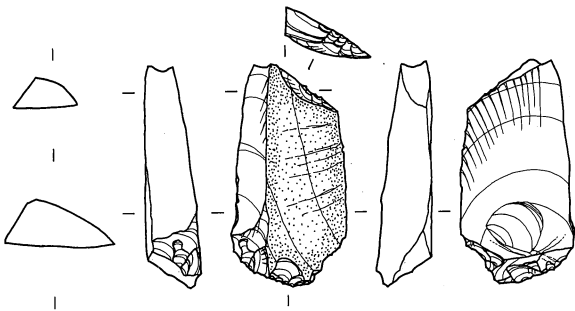

1225
Kn Ob SWHD
BL4033 6.53g
V a VI-R 3655

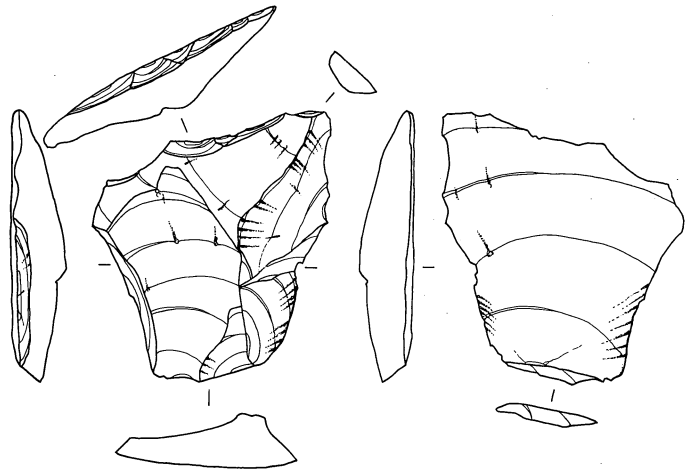

1226
Kn An
BL4035 14.07g
III VI-S 1185

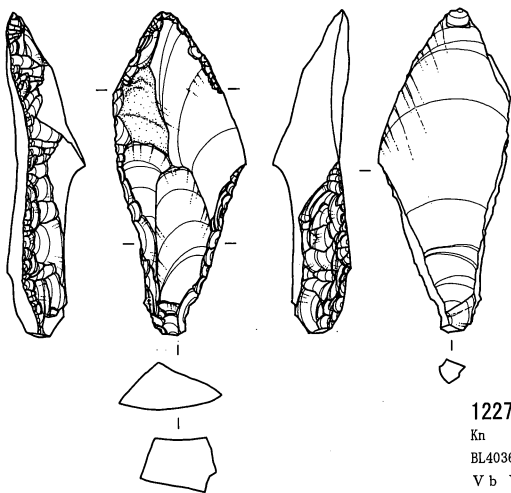

1227
Kn TS
BL4036 10.8g
V b VI-S 1409

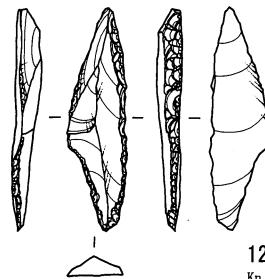

1228
Kn SS
BL4036 1.32g
V a VI-S 1369

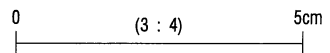

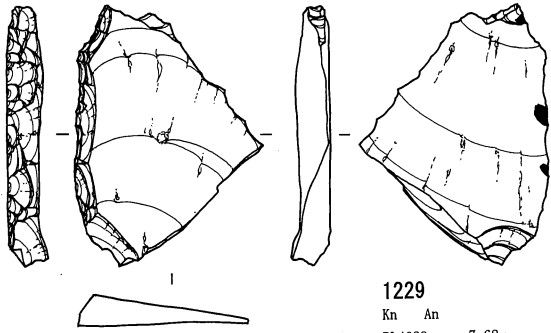

1229
Kn An
BL4039 7.68g
V a VI-S 1175

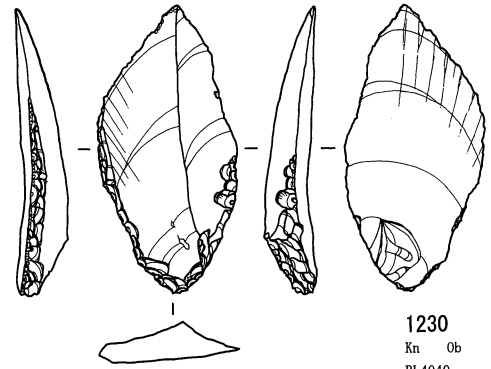

1230
Kn Ob SWHD
BL4040 6.12g
III VI-R 3242

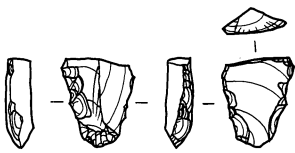

1231
Kn Ob SWHD
BL4039 0.79g
IV VI-S 878

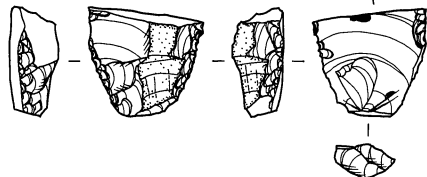

1232
Kn Ob WDTY
BL4041 2.85g
III VI-R 243

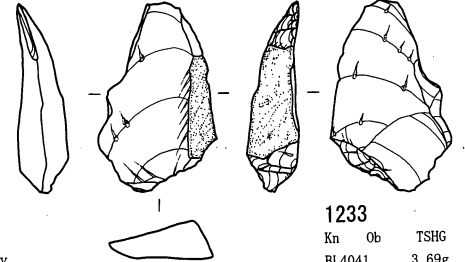

1233
Kn Ob TSHG
BL4041 3.69g
IV VI-S 870

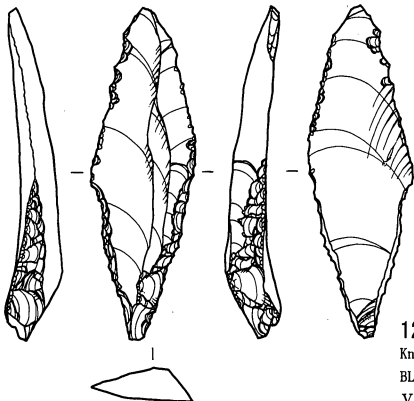

1234
Kn Ob WDTY
BL4042 5.54g
V a VI-R 563

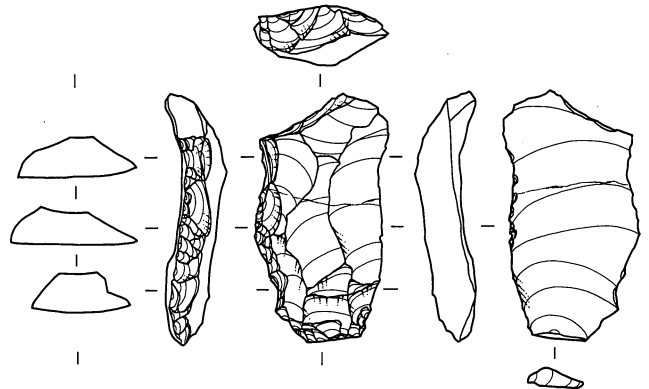

1235
Kn Ch
BL4044 9.22g
III VI-R 681

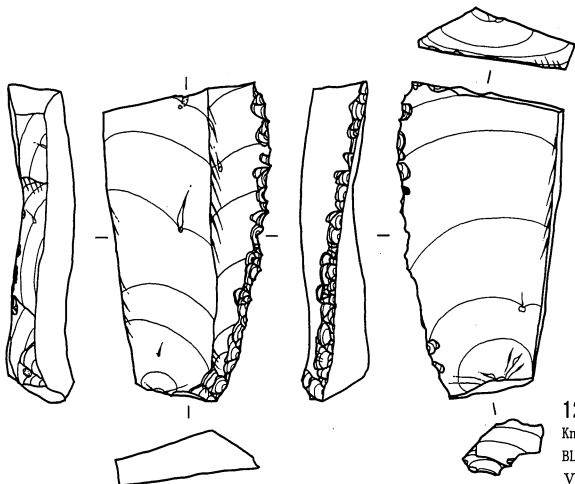

1236
Kn Ob WDTY
BL4044 15.61g
V a VI-R 3086

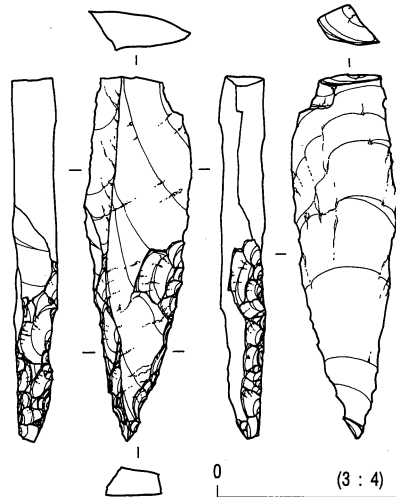

1237
Kn An
BL4044 9.53g
III VI-R 3331

0 (3 : 4) 5cm

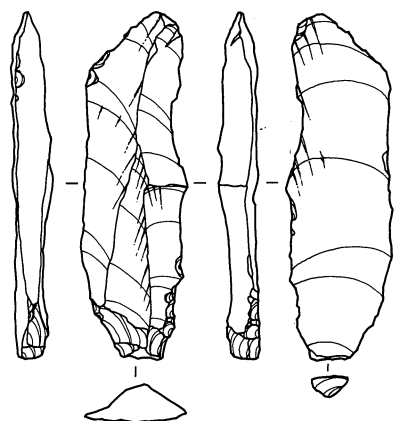

1238
Kn TS
BL4047 7.01g
III VI-R 745

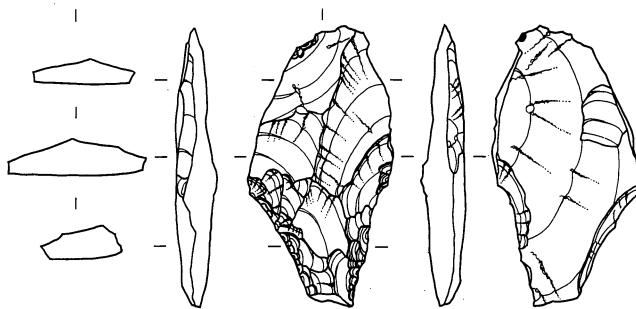

1239
Kn An
BL4048 8.37g
IV VI-R 2804

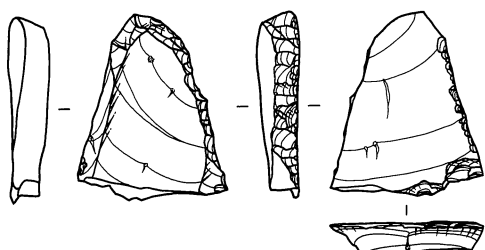

1240
Kn Ob TSTY
BL4050 4.71g
III VI-R 2736

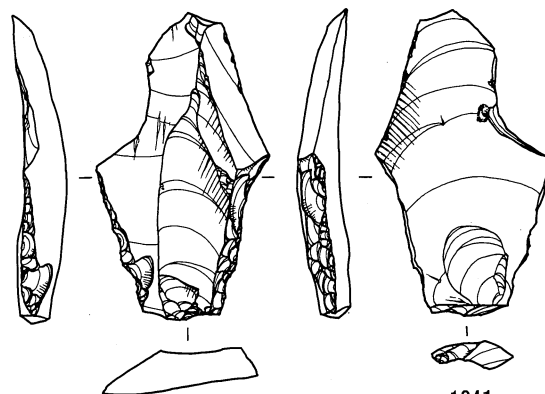

1241
Kn Ob WDTY
BL4052 9.22g
IV F VI-R 763

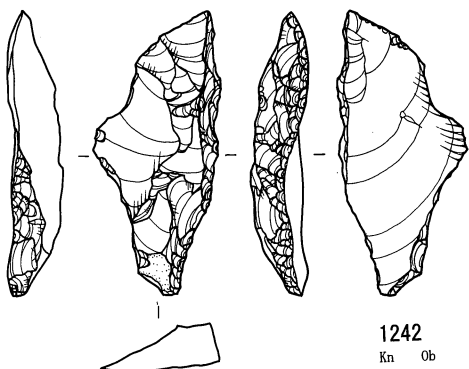

1242
Kn Ob WDTY
BL4052 6.77g
V VI-R 2515

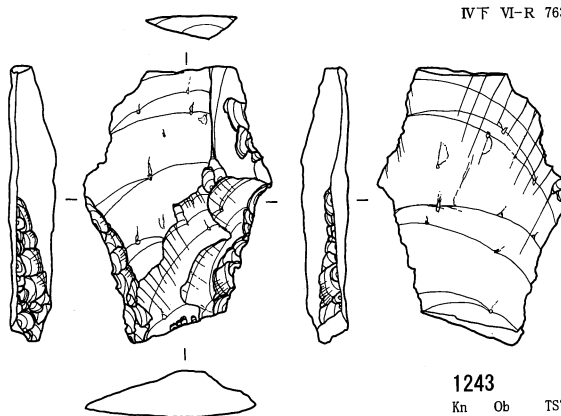

1243
Kn Ob TSTY
BL4053 10.66g
V VI-R 3050

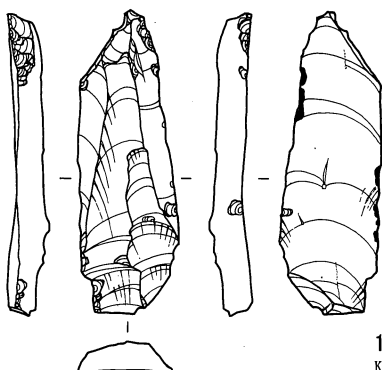

1244
Kn Ob WDTK
BL4057 4.9g
IV VI-W 1015

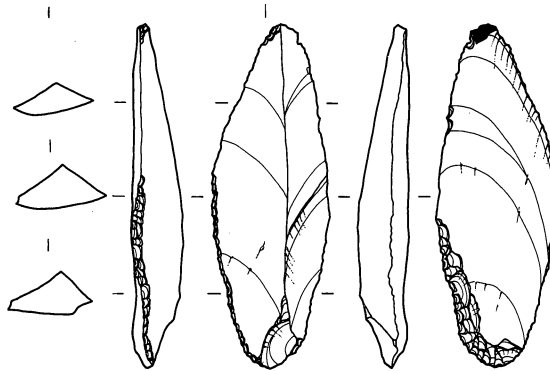

1245
Kn SS
BL4053 7.56g
IV VI-W 2403

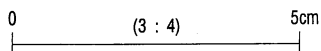

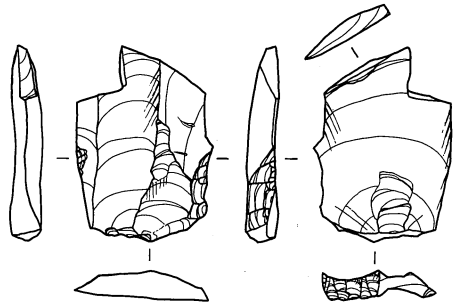

1246
Kn Ob WDTY
BL4057 4.14g
V VI-W 2963

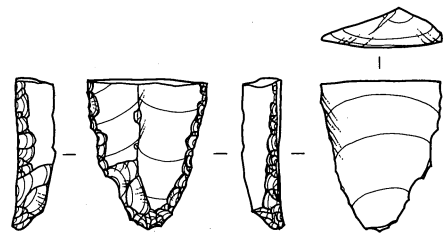

1247
Kn Ag
BL4061 3.4g
IV上 VI-W 1314

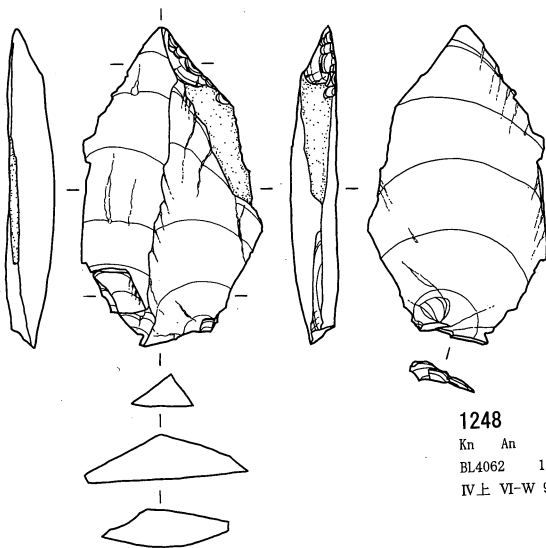

1248
Kn An
BL4062 11.56g
IV上 VI-W 941

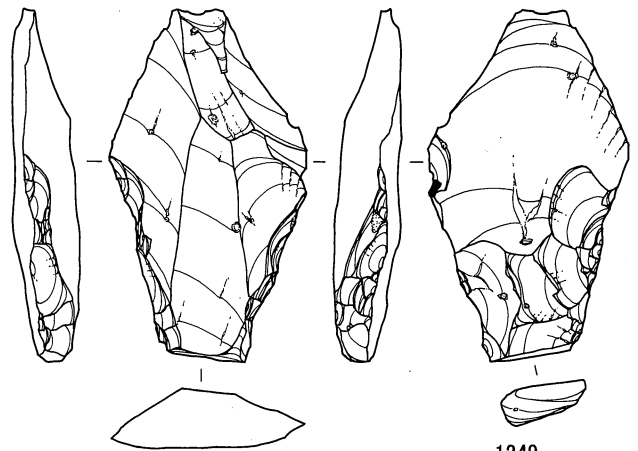

1249
Kn An
BL4062 22.57g
IV上 VI-W 949

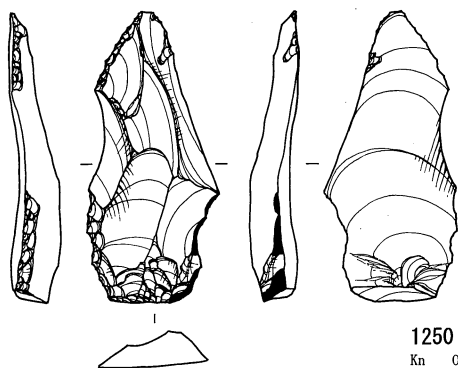

1250
Kn Ob WDTY
BL4063 6.97g
V a VI-W 1927

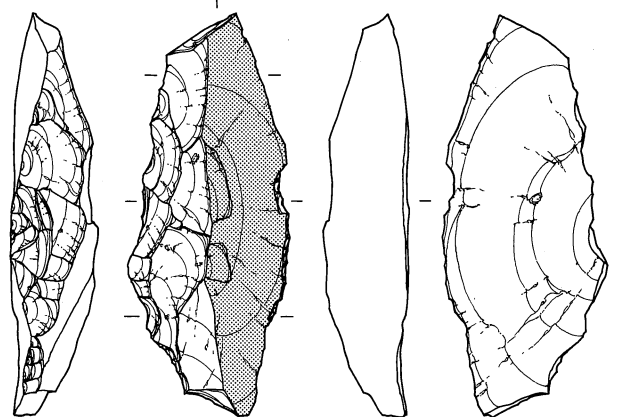

1251
Kn An
BL4066 23.05g
V a VI-W 1448

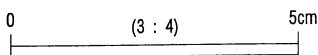

第4地点 石器実測図7 (ナイフ形石器7) (貫ノ木遺跡)

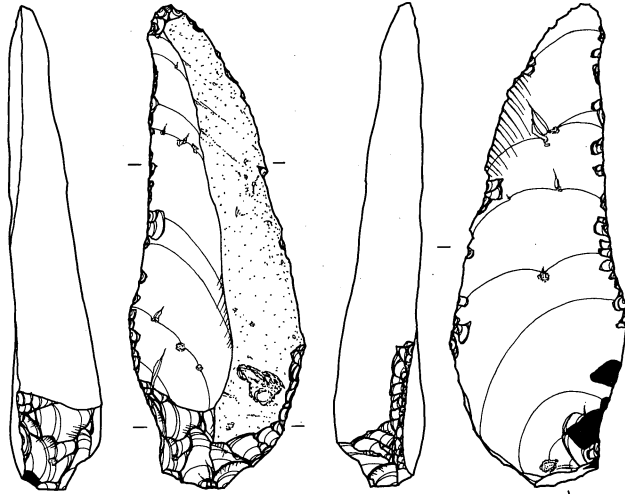

1252
Kn Ob WDTY
BL4066 24.83g
V b VI-W 1853

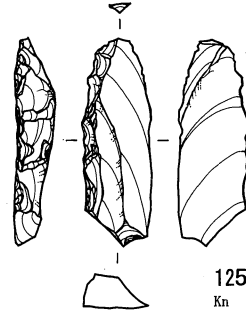

1253
Kn Ag
BL4067 2.92g
III VI-W 2484

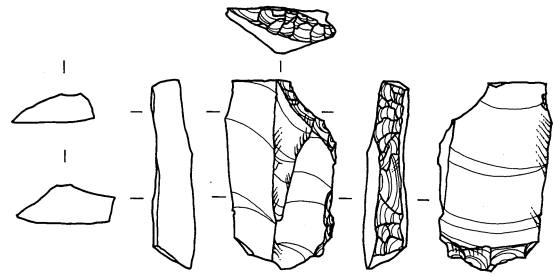

1254
Kn GT
BL4070 4.98g
III VI-W 4474

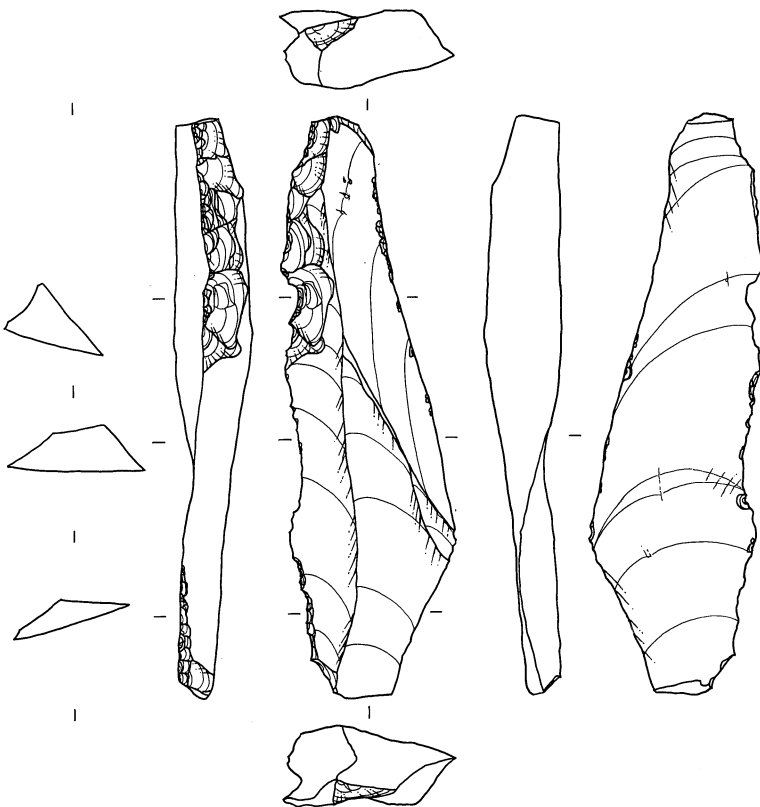

1255
Kn SS
BL4067 21.68g
V a VI-W 3183

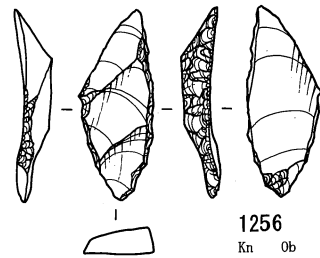

1256
Kn Ob SWHD
BL4071 1.54g
II VI-W 1209

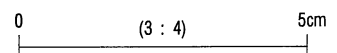

第4地点 石器実測図8 (ナイフ形石器8) (貫ノ木遺跡)

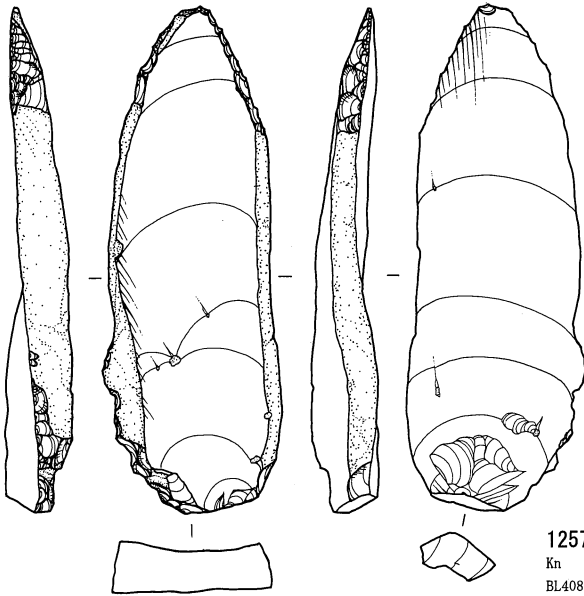

1257
Kn Ob WDTY
BL4080 25.51g
Vb VI-X 827

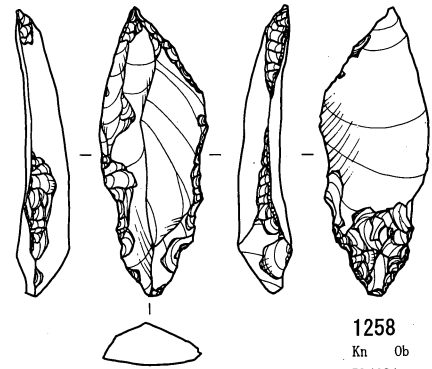

1258
Kn Ob WDTY
BL4084 5.53g
IV上 VI-X 101

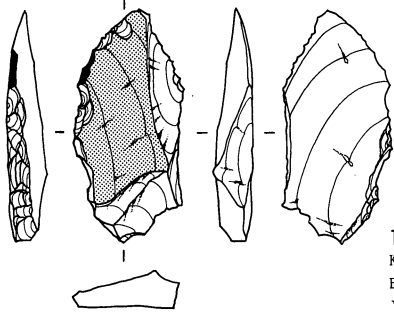

1259
Kn An
BL4086 4.93g
Va VI-X 740

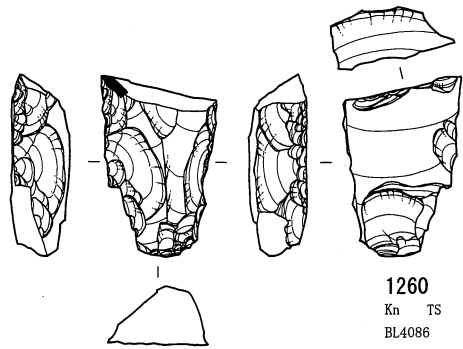

1260
Kn TS
BL4086 6.27g
Va VI-X 378

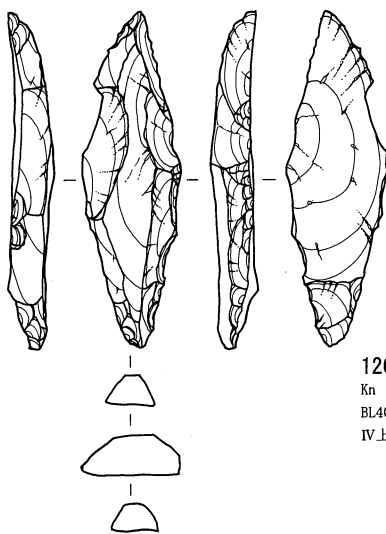

1261
Kn An
BL4088 6.93g
IV上 VI-X 230

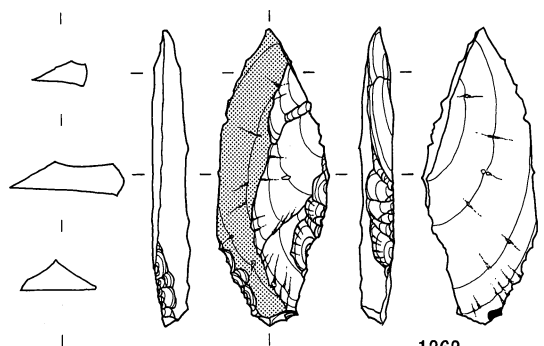

1262
Kn An
BL4092 5g
Va VI-X 2178

0 (3 : 4) 5cm

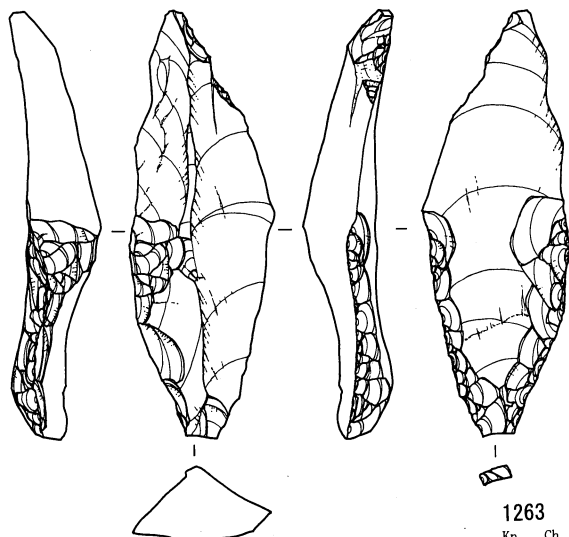

1263
Kn Ch
BL4093 17.8g
Va VI-X 543

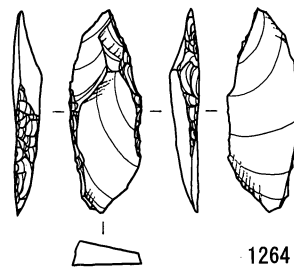

1264
Kn An
BL4094 1.74g
Va VI-X 560

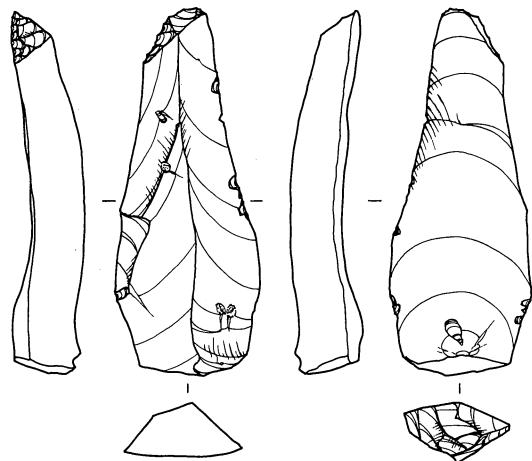

1265
Kn Ob WDTY
BL4094 12.79g
Vb VI-X 2123

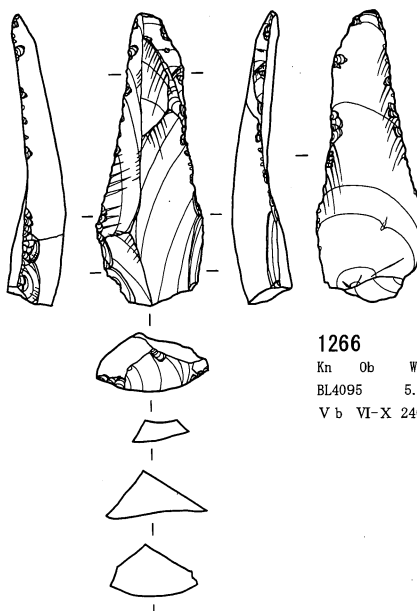

1266
Kn Ob WDTY
BL4095 5.19g
Vb VI-X 2404

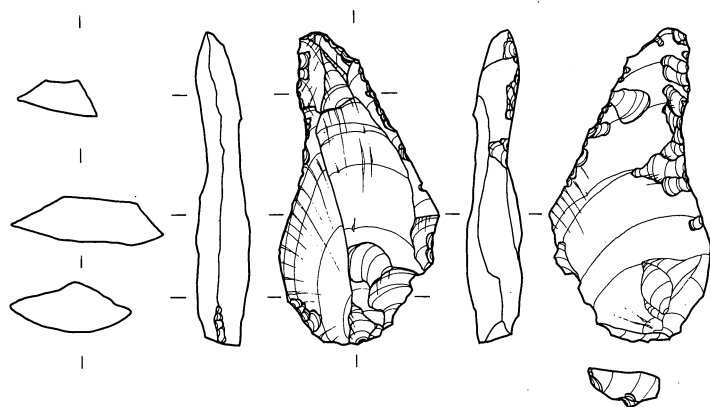

1267
Kn Ob WDTY
BL4096 9.57g
Va VI-Y 42

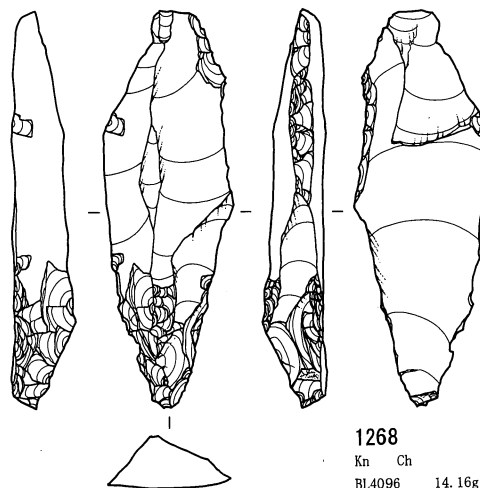

1268
Kn Ch
BL4096 14.16g
Va VI-Y 45

0 (3 : 4) 5cm

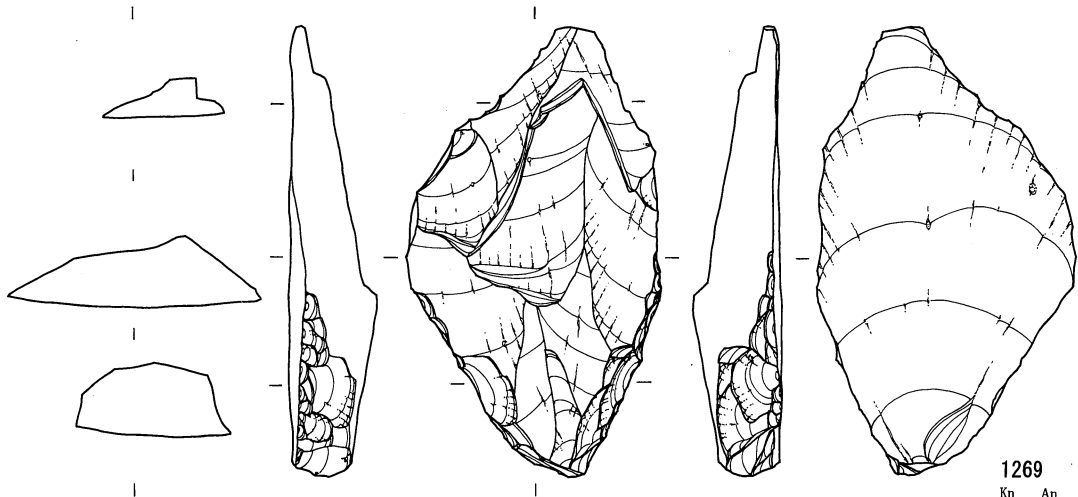

1269
Kn An
外 38.32g
III X-B 33

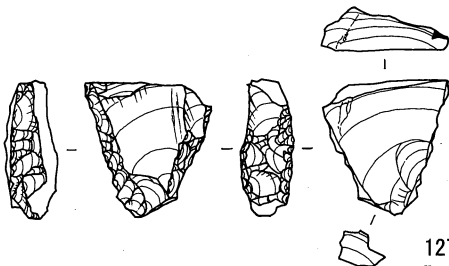

1270
Kn Ob WDTY
外 3.98g
V a VI-R 2338

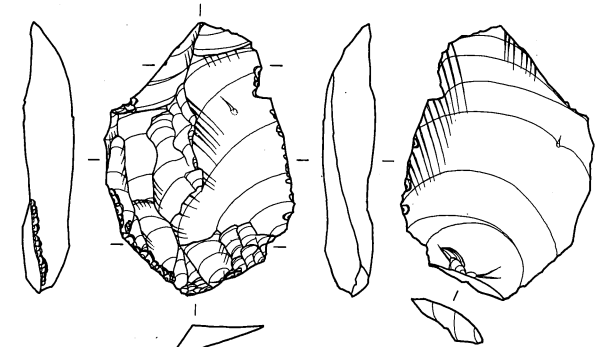

1271
Kn Ob WDTY
外 10.16g
V VI-W 4279

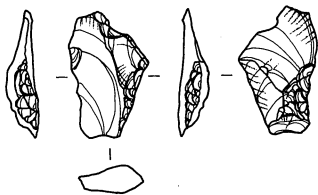

1272
Tr Ch
BL4001 1.09g
IV VI-C 103

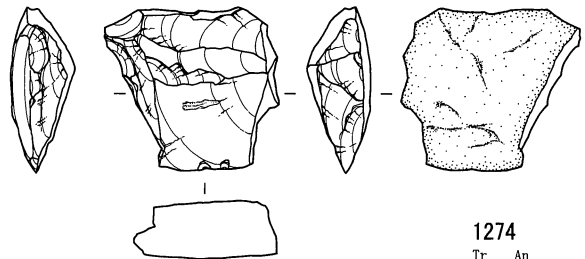

1274
Tr An
BL4004 10.68g
IV VI-H 409

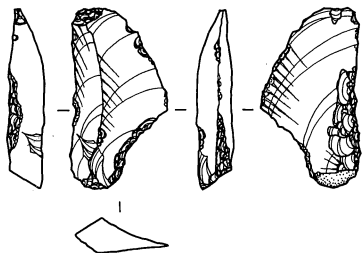

1273
Tr Ob WDTY
BL4007 2.68g
IV VI-I 621

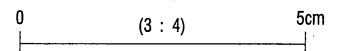

第4地点 石器実測図 11 (ナイフ形石器 11・台形石器 1) (貫ノ木遺跡)

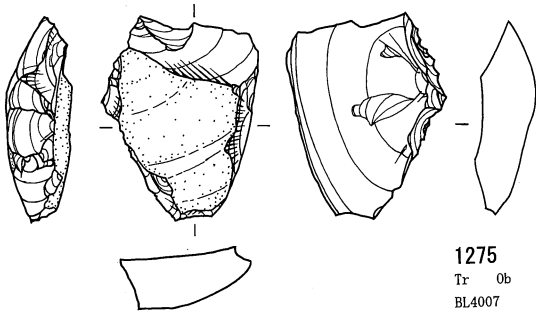

1275
Tr Ob WDTY
BL4007 8.8g
IV VI-I 558

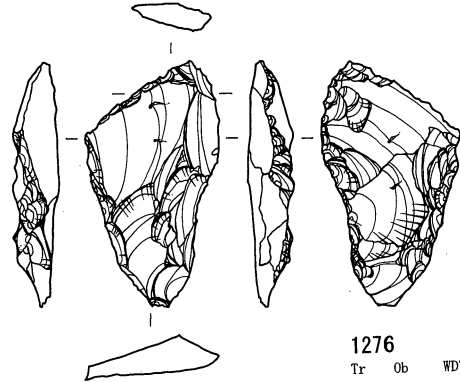

1276
Tr Ob WDTY
BL4008 5.62g
V a VI-H 243

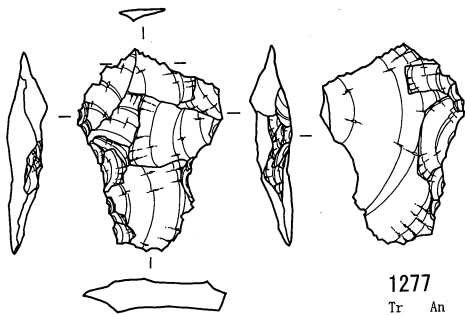

1277
Tr An
BL4010 5.32g
V b VI-H 437

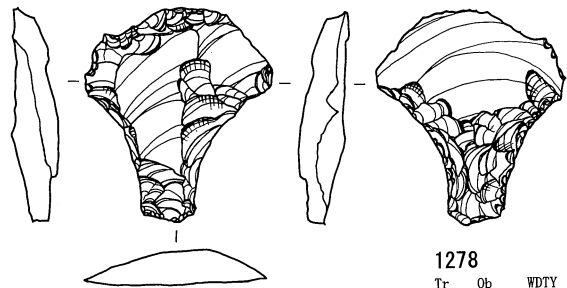

1278
Tr Ob WDTY
BL4013 6.5g
V b VI-H 284

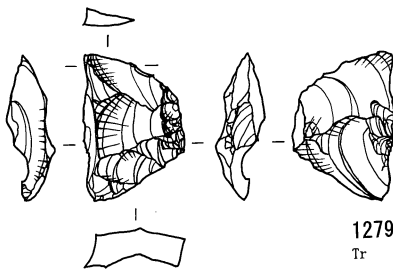

1279
Tr Ob WDTY
BL4016 2.82g
V b VI-M 575

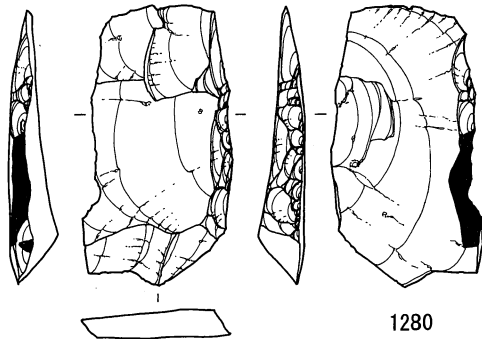

1280
Tr An
BL4023 9.07g
III VI-M 89

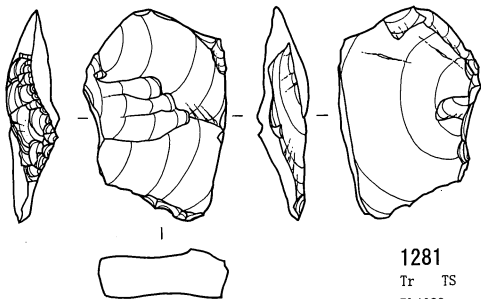

1281
Tr TS
BL4023 7.26g
IV VI-M 228

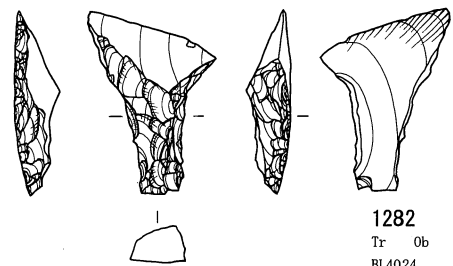

1282
Tr Ob SWHD
BL4024 2.73g
IV VI-N 98

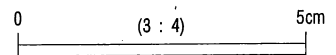

第4地点 石器実測図12(台形石器2)(貫ノ木遺跡)

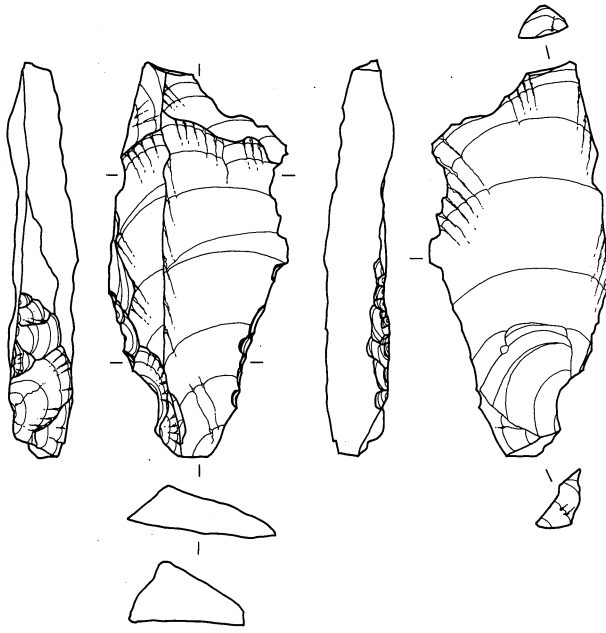

1283
Tr An
BL4028 19.58g
V a VI-M 106

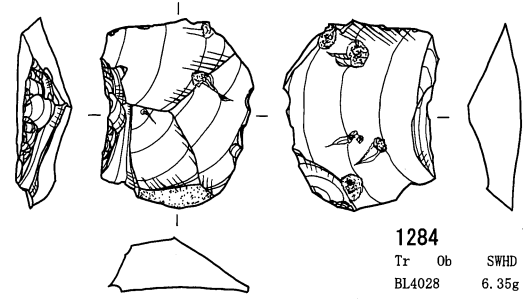

1284
Tr Ob SWHD
BL4028 6.35g
V a VI-N 163

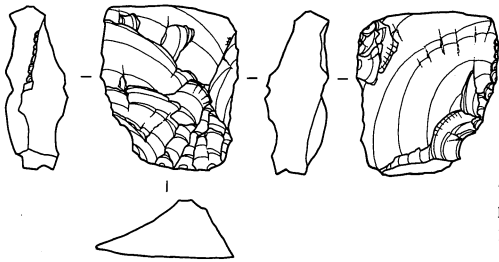

1285
Tr Ag
BL4029 7.29g
III VI-N 16

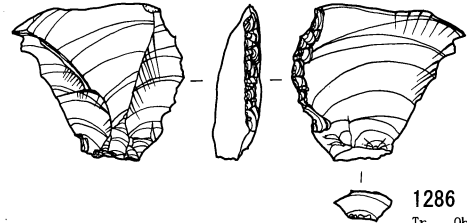

1286
Tr Ob SWHD
BL4032 4.25g
V a VI-R 3762

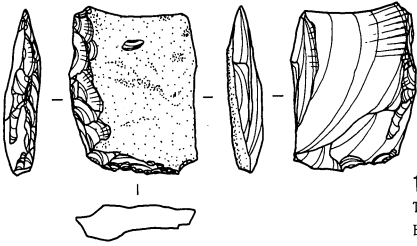

1287
Tr Ob SWHD
BL4033 4.13g
IV VI-R 3589

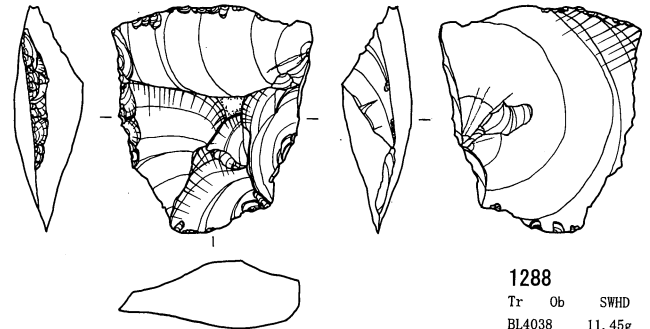

1288
Tr Ob SWHD
BL4038 11.45g
III VI-R 1846

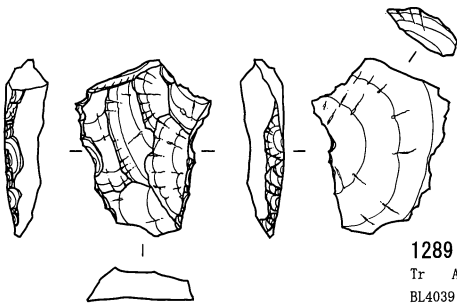

1289
Tr An
BL4039 4.21g
V b VI-S 1535

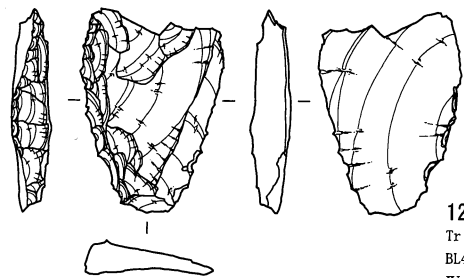

1290
Tr An
BL4039 5.21g
IV VI-S 1221

0 (3 : 4) 5cm

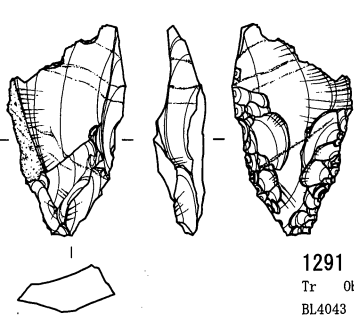

1291
Tr Ob SWHD
BL4043 4.02g
V a VI-R 276

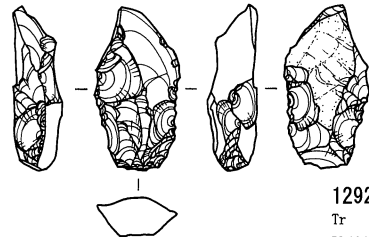

1292
Tr Ob WDTM
BL4043 2.74g
V b VI-S 816

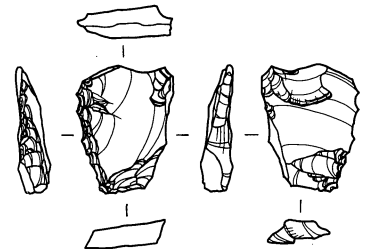

1293
Tr Ob SWHD
BL4044 1.72g
V VI-R 2562

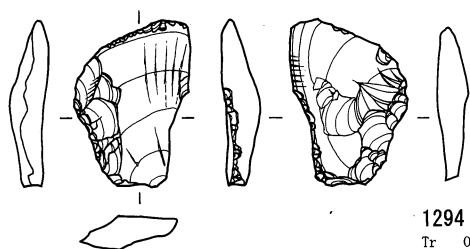

1294
Tr Ob 不可
BL4044 2.81g
V VI-R 2582

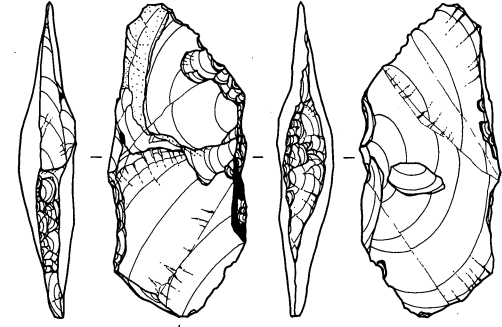

1295
Tr TS
BL4044 10.57g
V b VI-R 3518

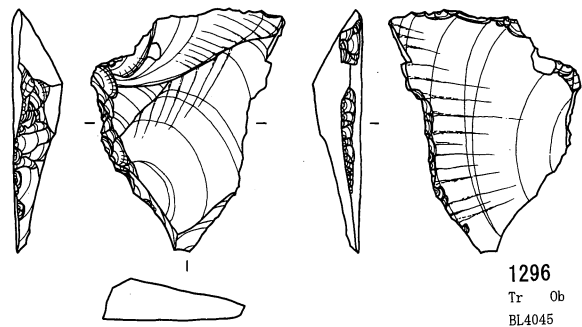

1296
Tr Ob WDTY
BL4045 7.57g
III VI-R 1113

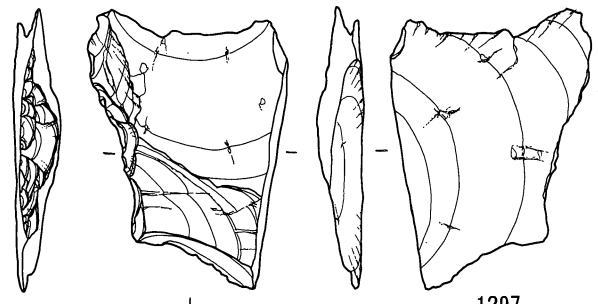

1297
Tr An
BL4051 10.95g
V b VI-R 3060

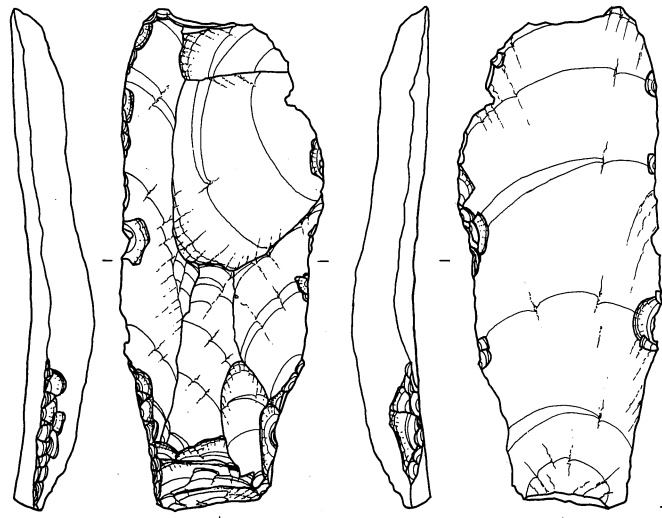

1298
Tr An
BL4051 31.47g
V VI-R 3047

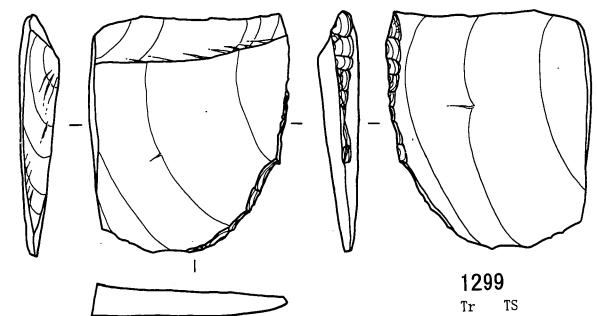

1299
Tr TS
BL4055 10.15g
IV下 VI-W 447

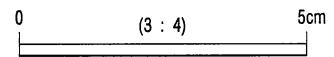

第4地点 石器実測図14 (台形石器4) (貫ノ木遺跡)

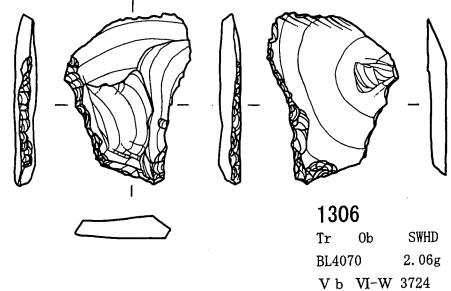
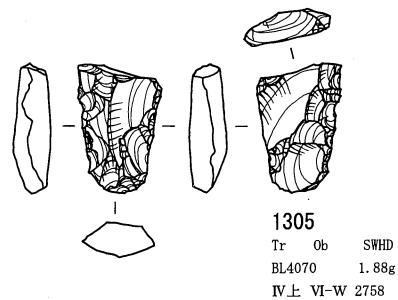
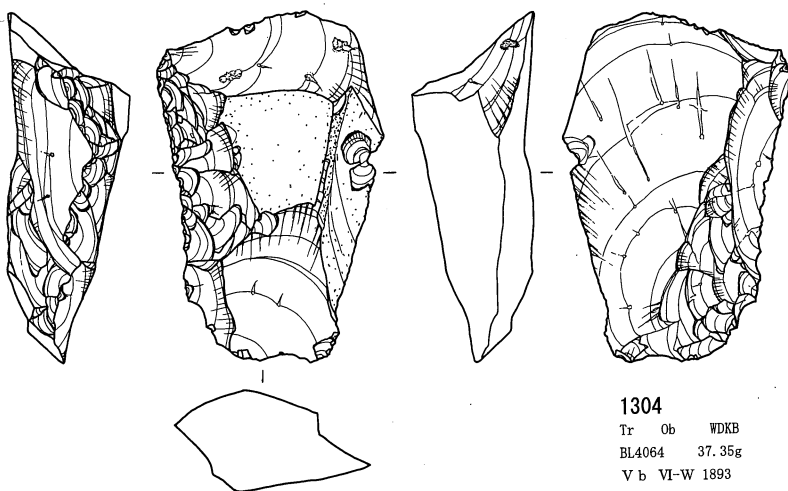
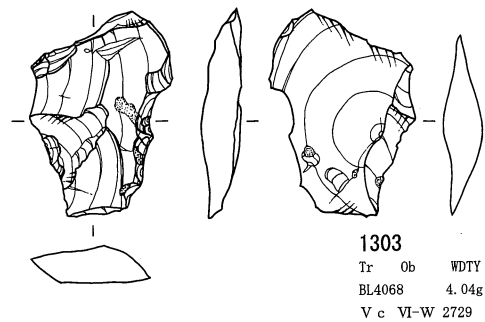
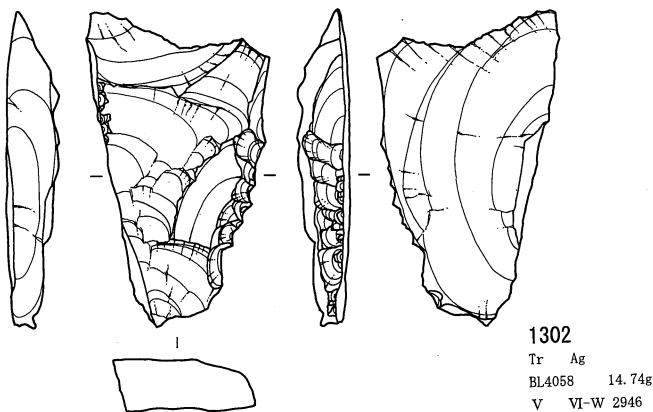
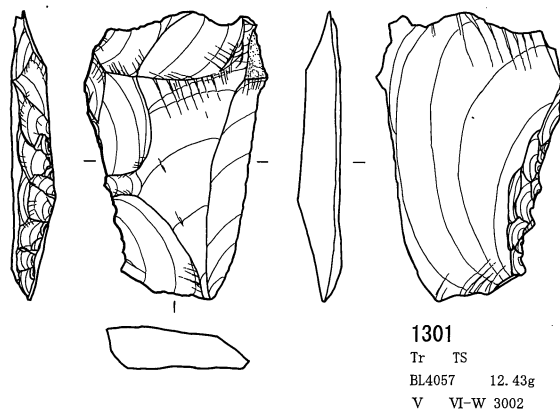
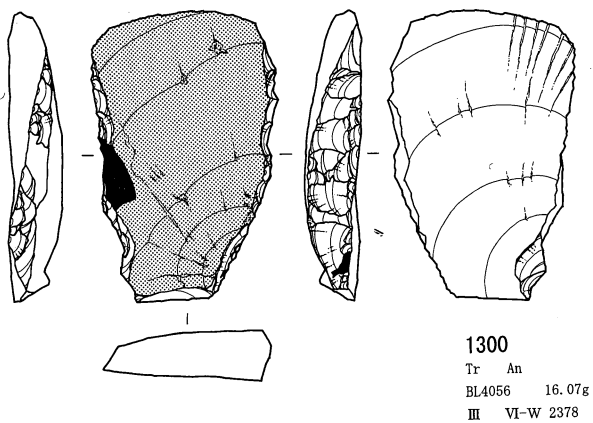

0 (3 : 4) 5cm

第4地点 石器実測図15 (台形石器5) (貫ノ木遺跡)

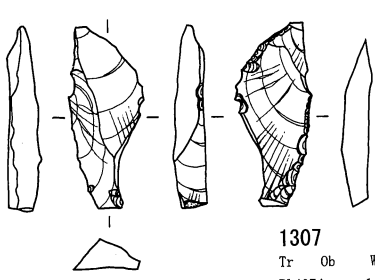

1307
Tr Ob WDTY
BL4074 1.57g
V b VI-R 122

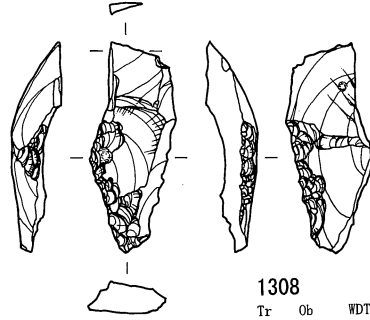

1308
Tr Ob WDTN
BL4074 3.21g
IV F VI-S 176

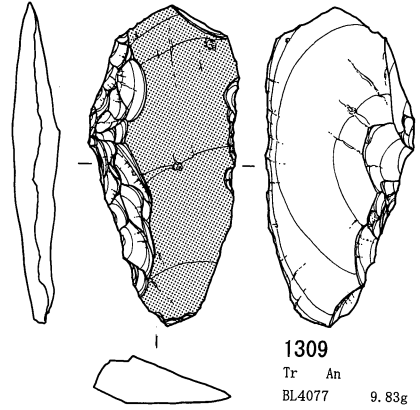

1309
Tr An
BL4077 9.83g
V a VI-W 960

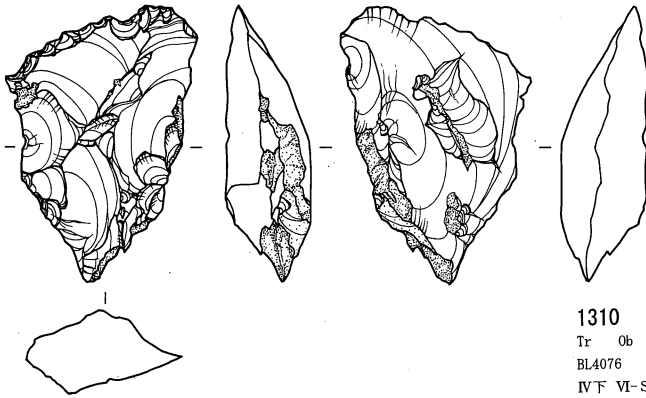

1310
Tr Ob WDTY
BL4076 15.56g
IV F VI-S 161

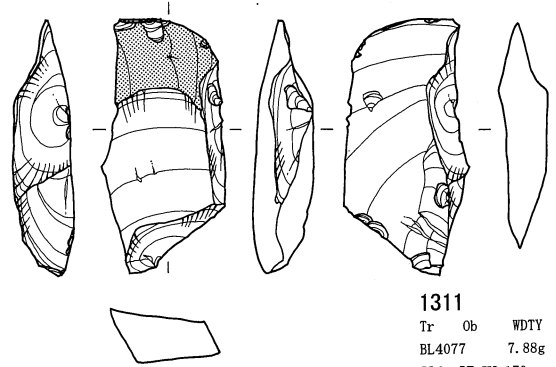

1311
Tr Ob WDTY
BL4077 7.88g
V b VI-W 170

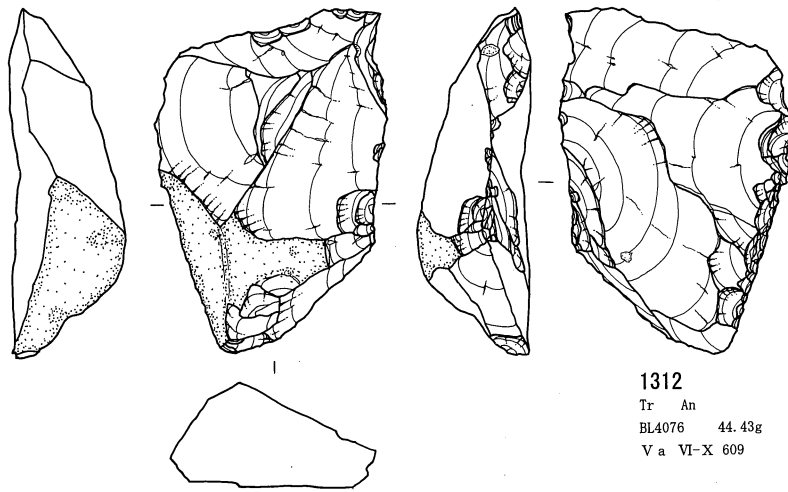

1312
Tr An
BL4076 44.43g
V a VI-X 609

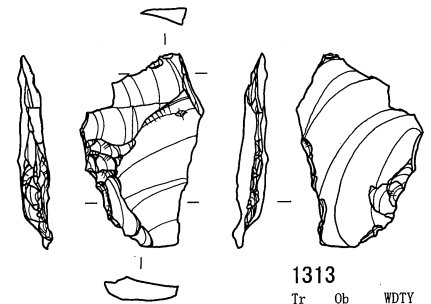

1313
Tr Ob WDTY
BL4081 2.93g
IV F VI-S 668

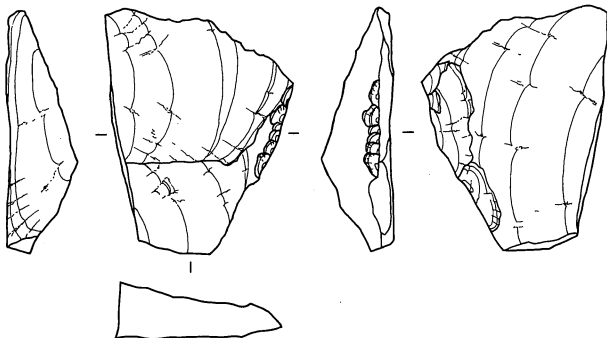

1314
Tr An
BL4081 13.57g
V a VI-S 368

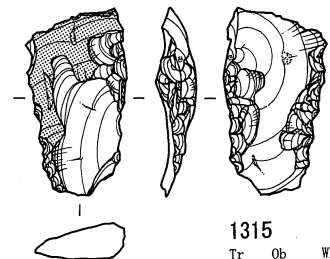

1315
Tr Ob WDTM
BL4081 2.68g
V b VI-S 643

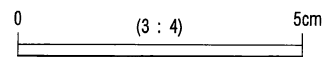

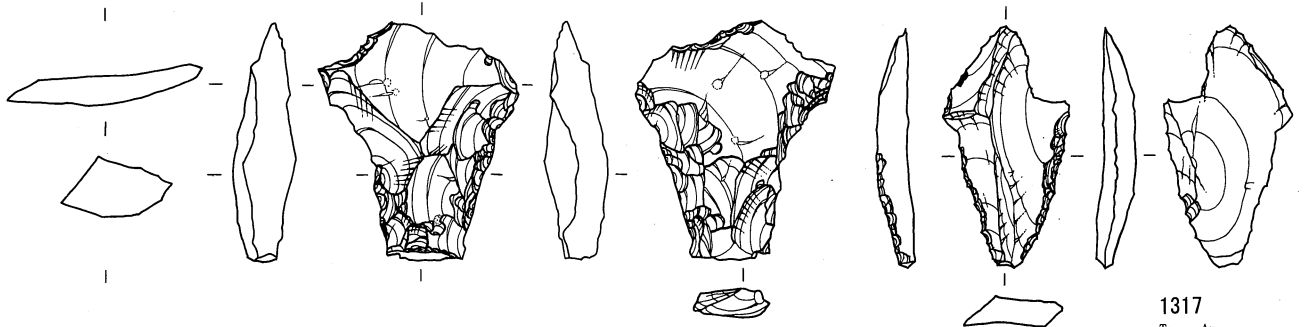

1316
Tr Ob WDTM
BL4084 8.66g
V a VI-X 735

1317
Tr An
BL4086 3.47g
V a VI-X 742

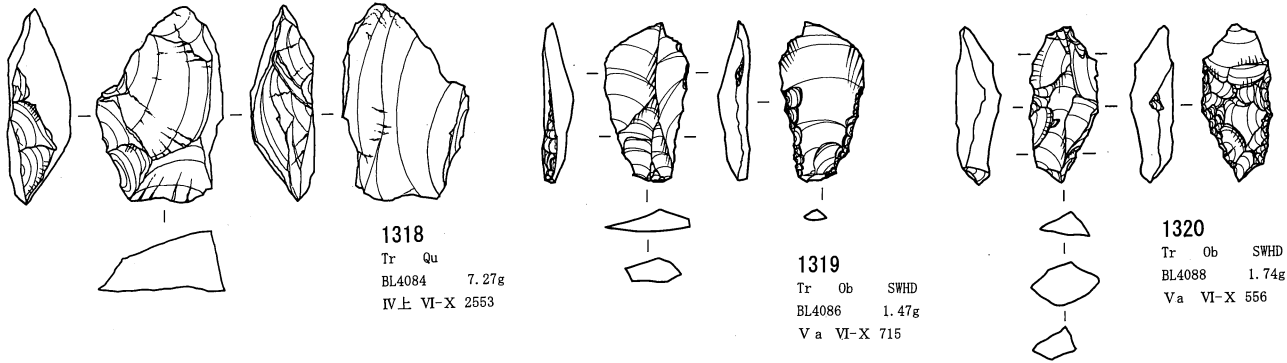

1318
Tr Qu
BL4084 7.27g
IV上 VI-X 2553

1319
Tr Ob SWHD
BL4086 1.47g
V a VI-X 715

1320
Tr Ob SWHD
BL4088 1.74g
V a VI-X 556

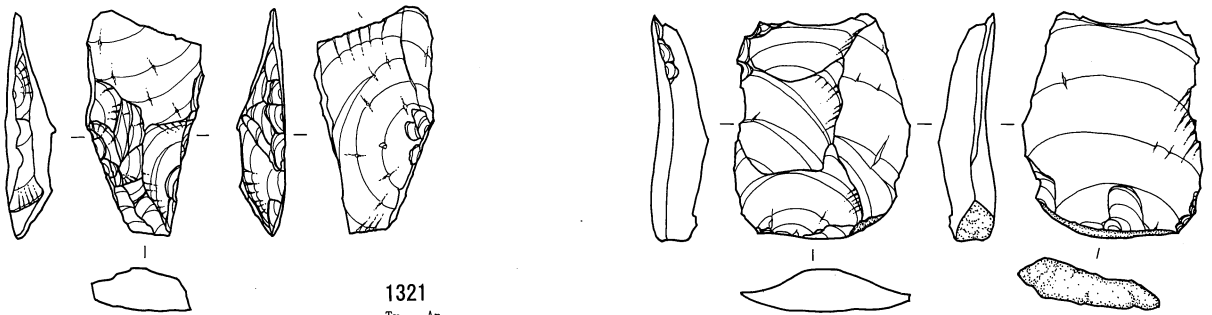

1321
Tr An
BL4087 5.83g
V a VI-X 745

1322
Tr Ch
BL4094 11.5g
V a VI-X 1515

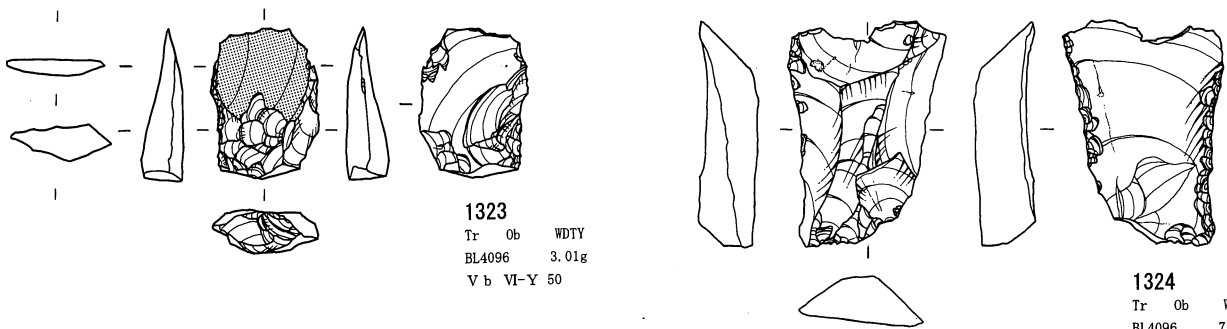

1323
Tr Ob WDTY
BL4096 3.01g
V b VI-Y 50

1324
Tr Ob WDKB
BL4096 7.97g
IV下 VI-Y 17

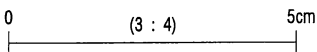

第4地点 石器実測図 17 (台形石器 7) (貫ノ木遺跡)

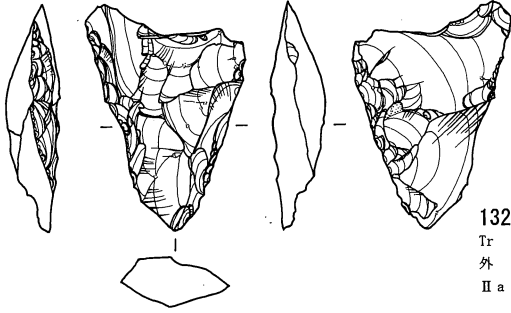

1325
Tr Ob TSTY
外 6.45g
II a VI-D 114

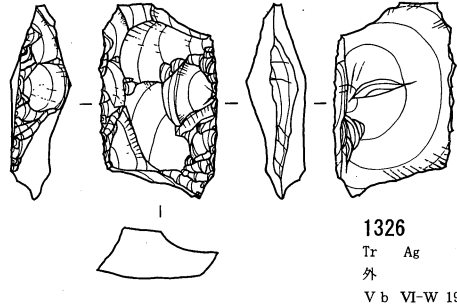

1326
Tr Ag
外 6.8g
V b VI-W 1908

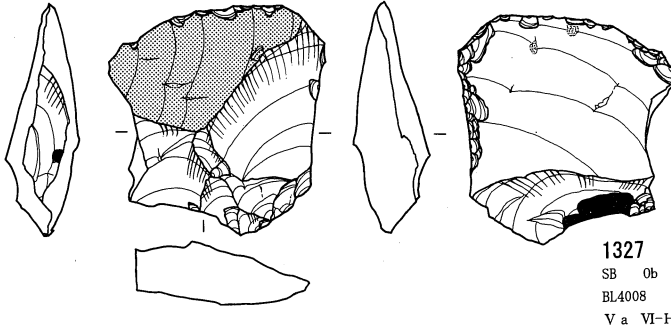

1327
SB Ob WDKB
BL4008 14.07g
V a VI-H 228

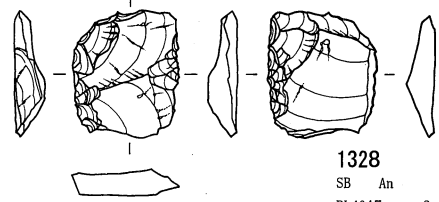

1328
SB An
BL4047 2.13g
IV VI-R 1459

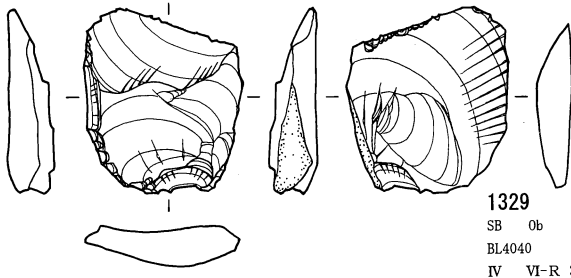

1329
SB Ob SWHD
BL4040 5.29g
IV VI-R 3268

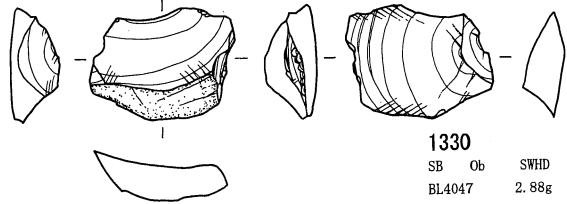

1330
SB Ob SWHD
BL4047 2.88g
V VI-R 2236

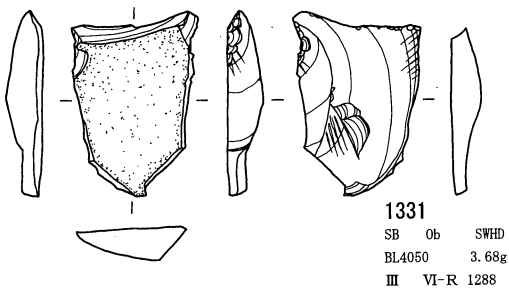

1331
SB Ob SWHD
BL4050 3.68g
III VI-R 1288

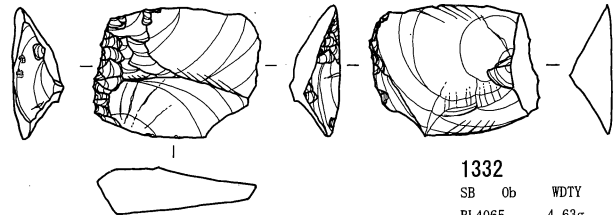

1332
SB Ob WDTY
BL4065 4.63g
IV下 VI-W 320

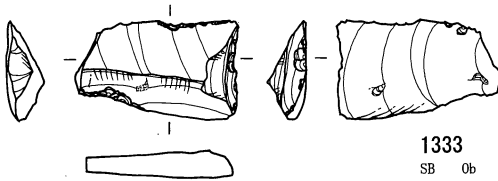

1333
SB Ob WDKB
BL4064 2.61g
V b VI-W 1863

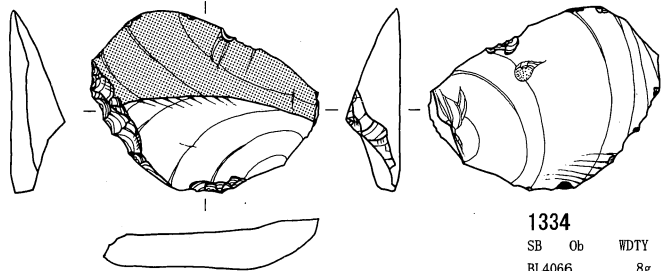

1334
SB Ob WDTY
BL4066 8g
IV上 VI-W 373

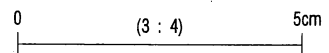

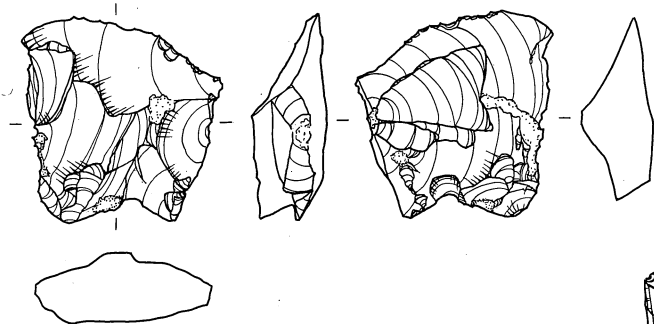

1335
SB Ob WDTY
BL4068 11.72g
V a VI-W 2127

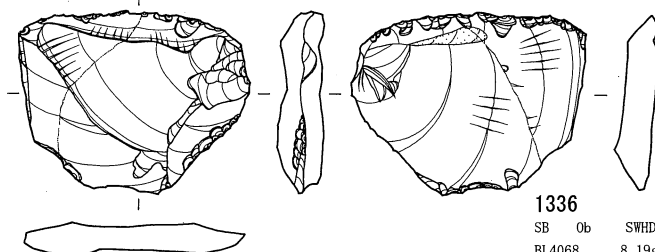

1336
SB Ob SWHD
BL4068 8.19g
V b VI-W 2239

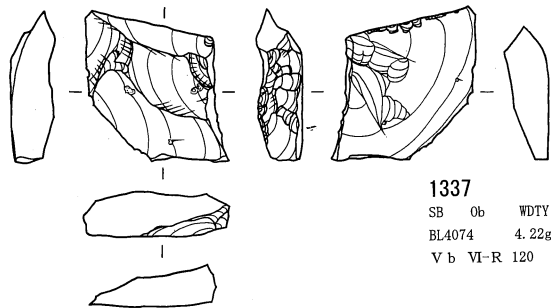

1337
SB Ob WDTY
BL4074 4.22g
V b VI-R 120

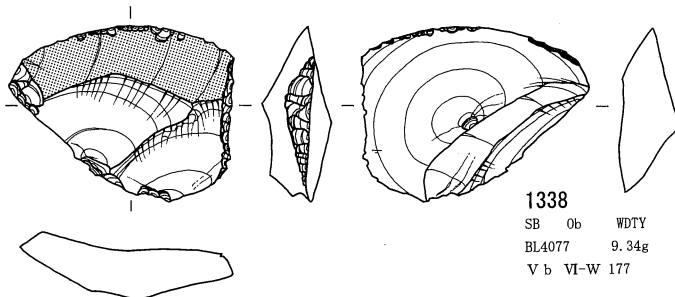

1338
SB Ob WDTY
BL4077 9.34g
V b VI-W 177

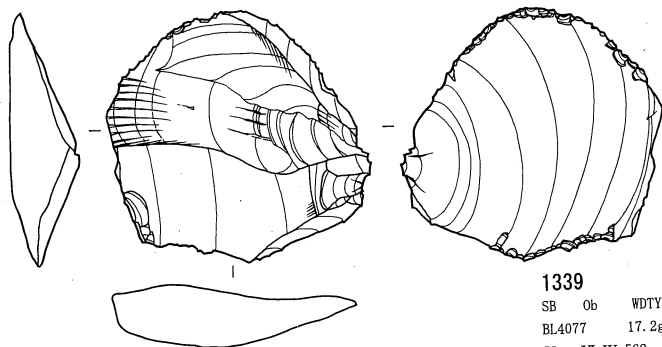

1339
SB Ob WDTY
BL4077 17.2g
V c VI-W 562

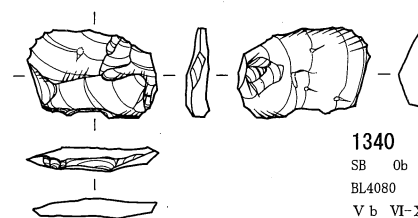

1340
SB Ob WDTY
BL4080 1.17g
V b VI-X 820

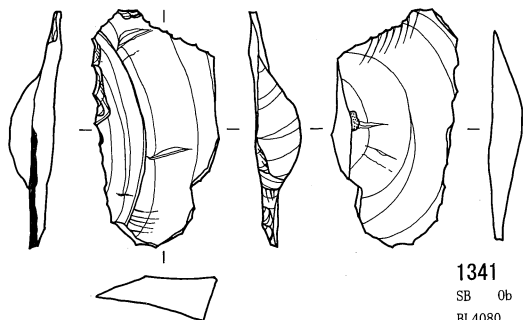

1341
SB Ob WDKB
BL4080 4.33g
V b VI-X 837

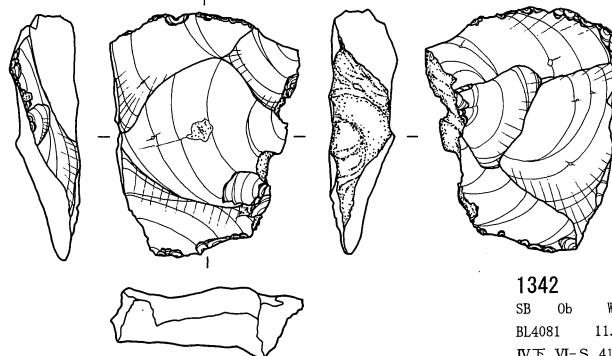

1342
SB Ob WDTY
BL4081 11.38g
IV F VI-S 41

0 (3 : 4) 5cm

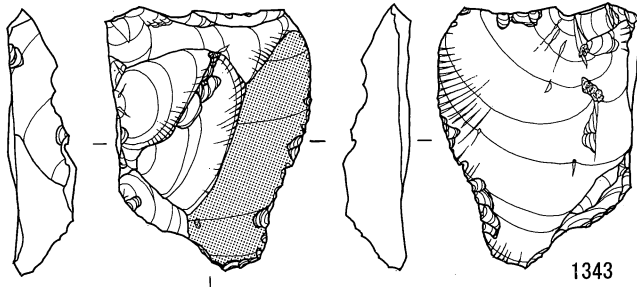

1343
SB Ob WDTY
BL4084 14.88g
V a VI-X 720

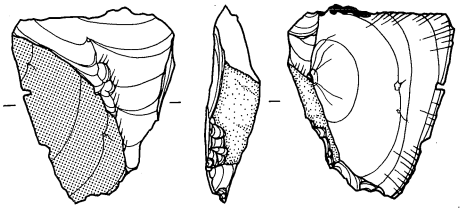

1344
SB Ob WDTY
BL4095 5.36g
V b VI-X 2515

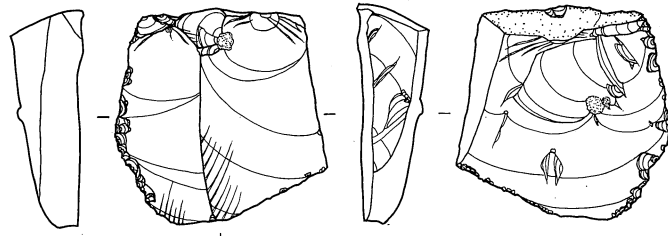
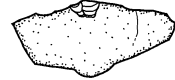
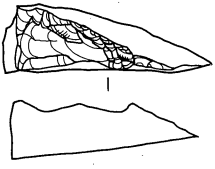

1345
SB Ob WDTY
BL4087 15.63g
V a VI-X 771

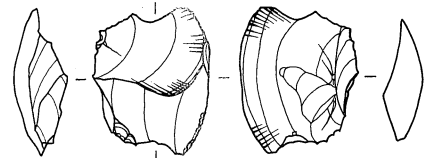

1346
SB Ob WDTY
BL4098 3.19g
V a VI-X 1482

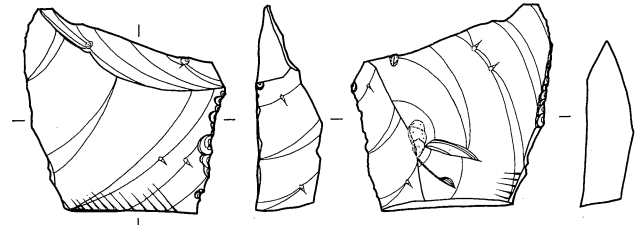

1347
SB Ob WDTY
BL4092 8.91g
V b VI-X 2329

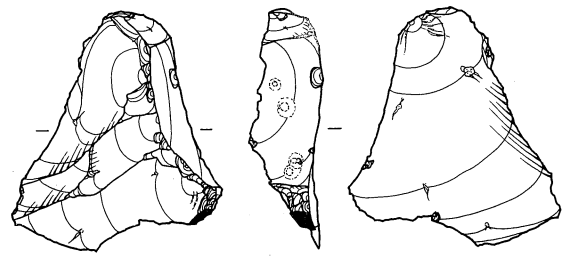

1348
SB Ob WDTY
BL4094 8.84g
IV下 VI-X 2555

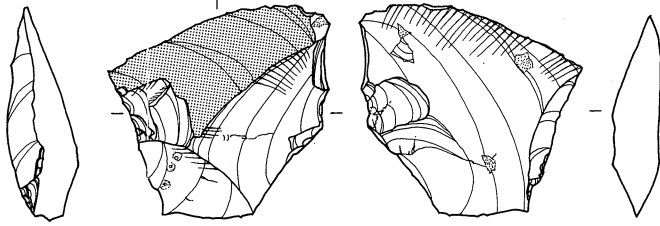
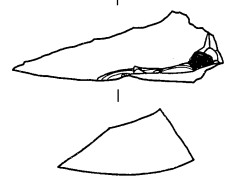
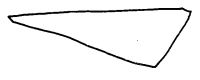

1349
SB Ob WDTY
BL4095 11.28g
V a VI-X 2367

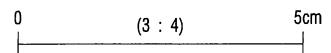
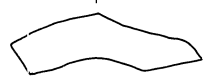

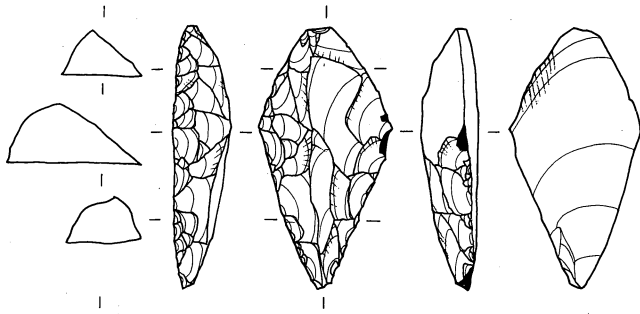

1350
Po TS
BL4013 6g
III SH111 41

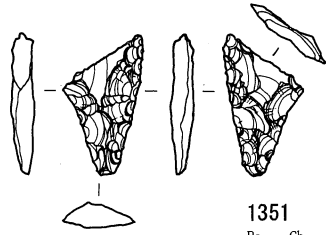

1351
Po Ch
BL4013 1.07g
IV VI-H 58

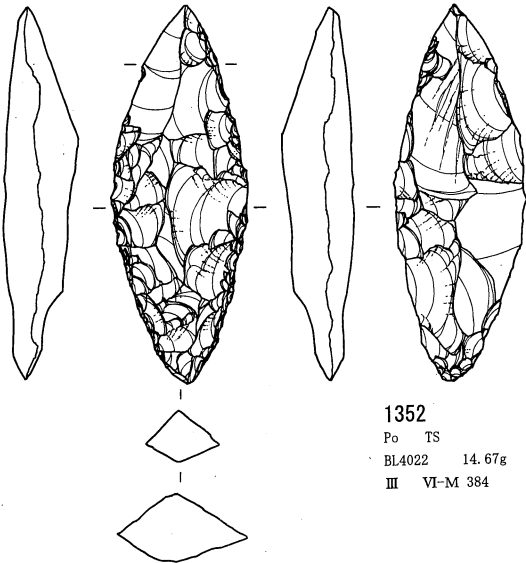

1352
Po TS
BL4022 14.67g
III VI-M 384

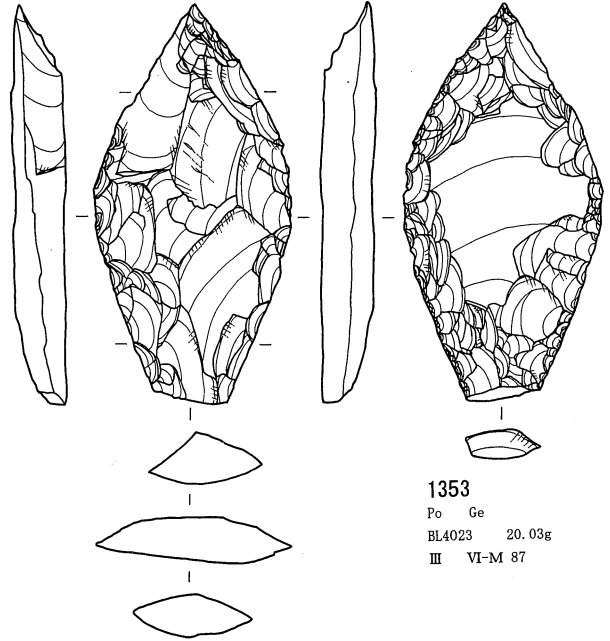

1353
Po Ge
BL4023 20.03g
III VI-M 87

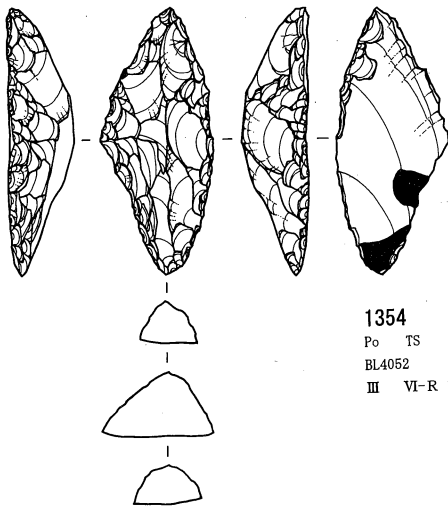

1354
Po TS
BL4052 7.53g
III VI-R 746

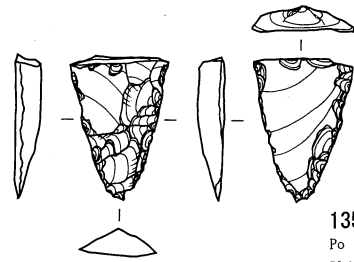

1355
Po Ob SWHD
BL4089 1.46g
IVF VI-X 410

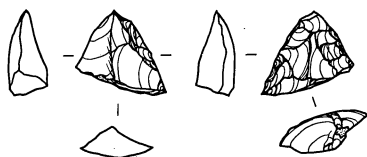

1356
Po Ob WDTY
BL4081 0.88g
IV上 VI-S 65

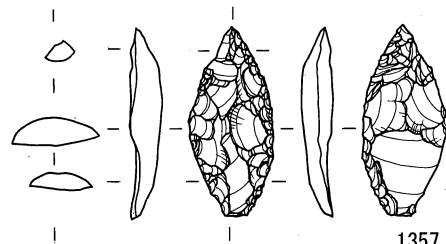

1357
Po Ob WDTY
BL4090 1.96g
III VI-X 30

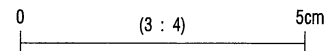

第4地点 石器実測図 21 (槍先形尖頭器) (貫ノ木遺跡)

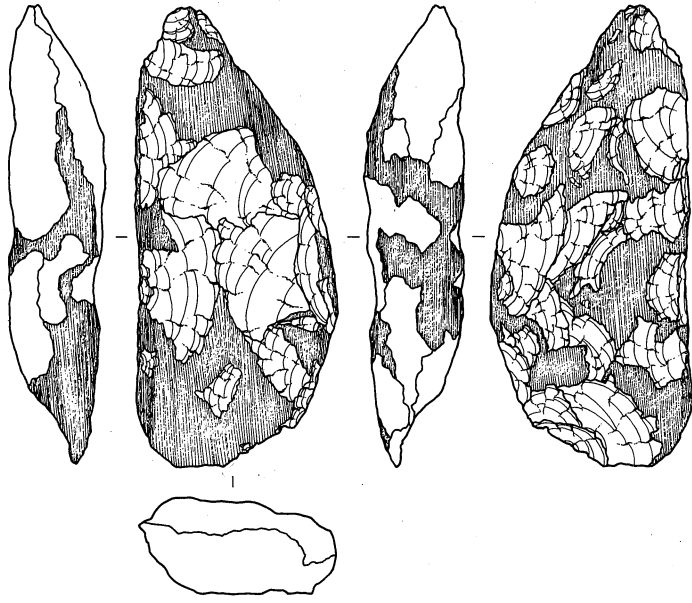

1358
 Ax Se
 BL4008 63.51g
 Va VI-H 266

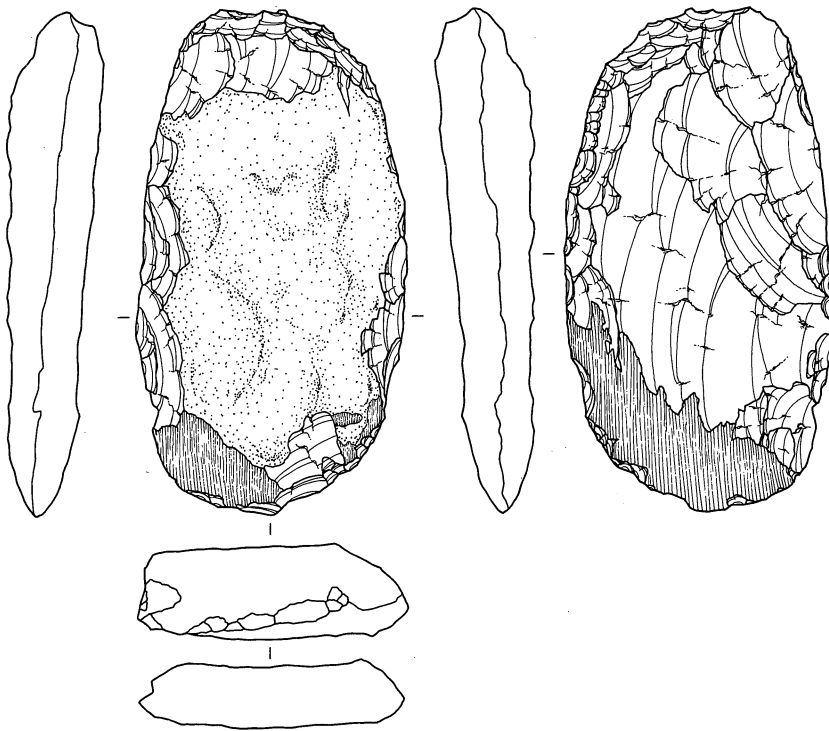

1359
 Ax Se
 BL4011 83.75g
 Va VI-I 31

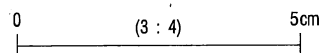

第4地点 石器実測図 22 (斧形石器 1) (貫ノ木遺跡)

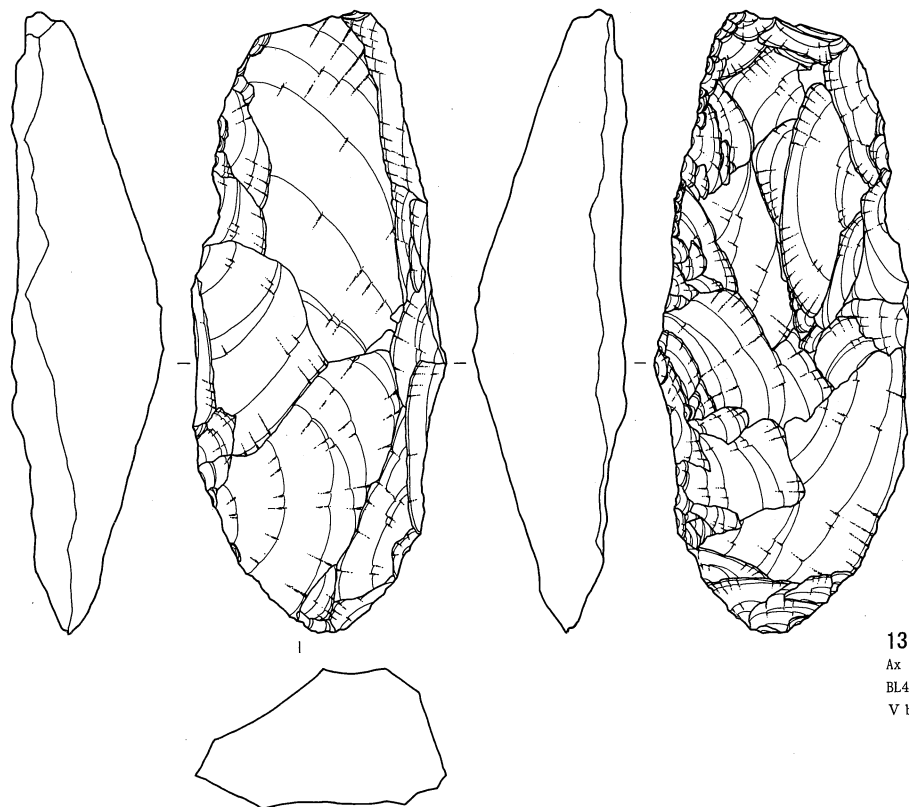

1360

Ax Sa
BL4016 125.49g
V b VI-M 550

0 (3 : 4) 5cm

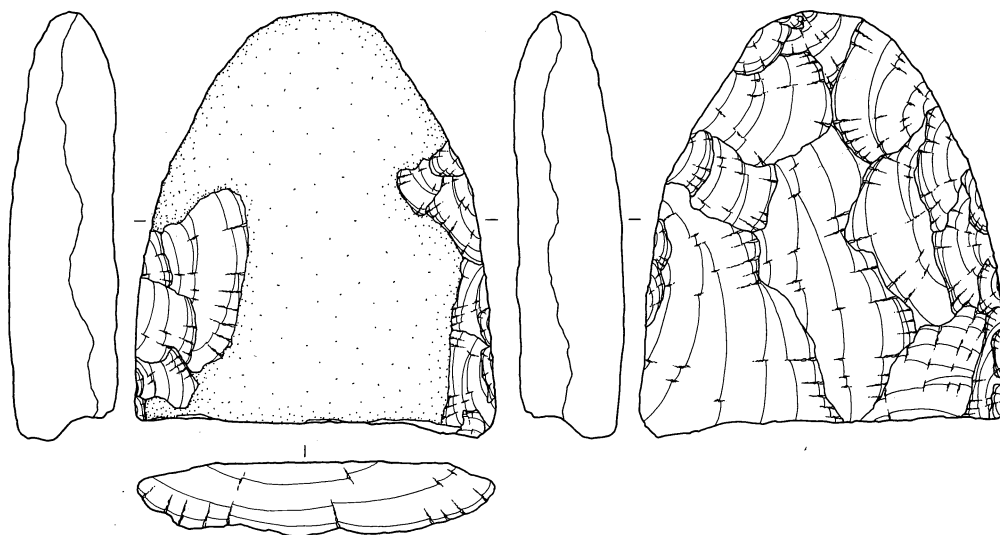

1361

Ax An
BL4032 390g
V b VI-R 3736

0 (1 : 2) 5cm

第4地点 石器実測図 23 (斧形石器 2) (貫ノ木遺跡)

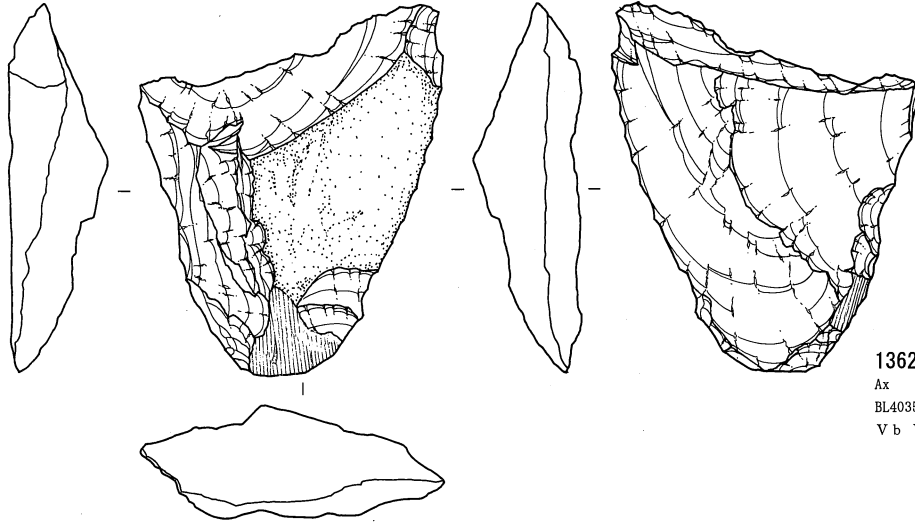

1362
 Ax GT
 BL4035 51.3g
 V b VI-S 1770

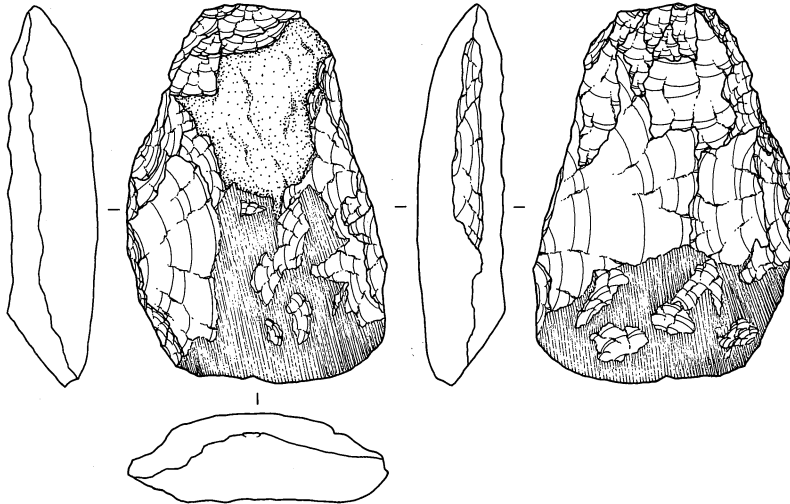

1363
 Ax Se
 BL4043 56.54g
 V b VI-R 2654

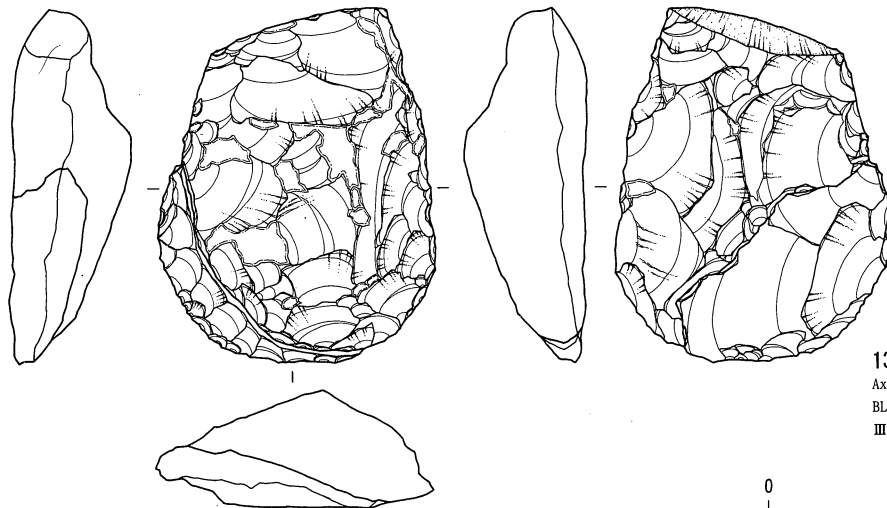

1364
 Ax TS
 BL4044 65.62g
 III VI-R 499

0 (3 : 4) 5cm

第4地点 石器実測図 24 (斧形石器 3) (貫ノ木遺跡)

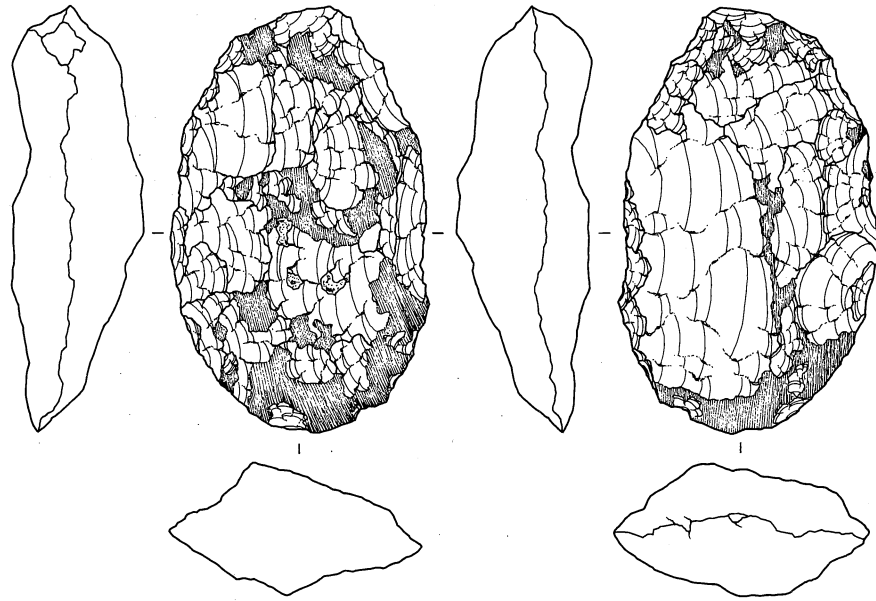

1365
 Ax Se
 BL4048 80.43g
 IV VI-R 2809

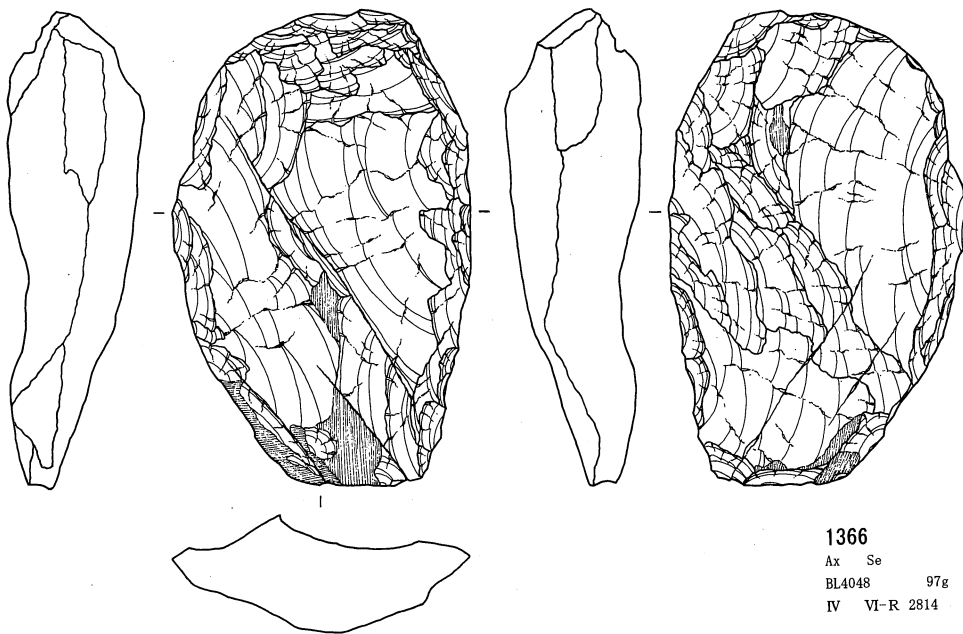

1366
 Ax Se
 BL4048 97g
 IV VI-R 2814

0 (3 : 4) 5cm

第4地点 石器実測図 25 (斧形石器 4) (貫ノ木遺跡)

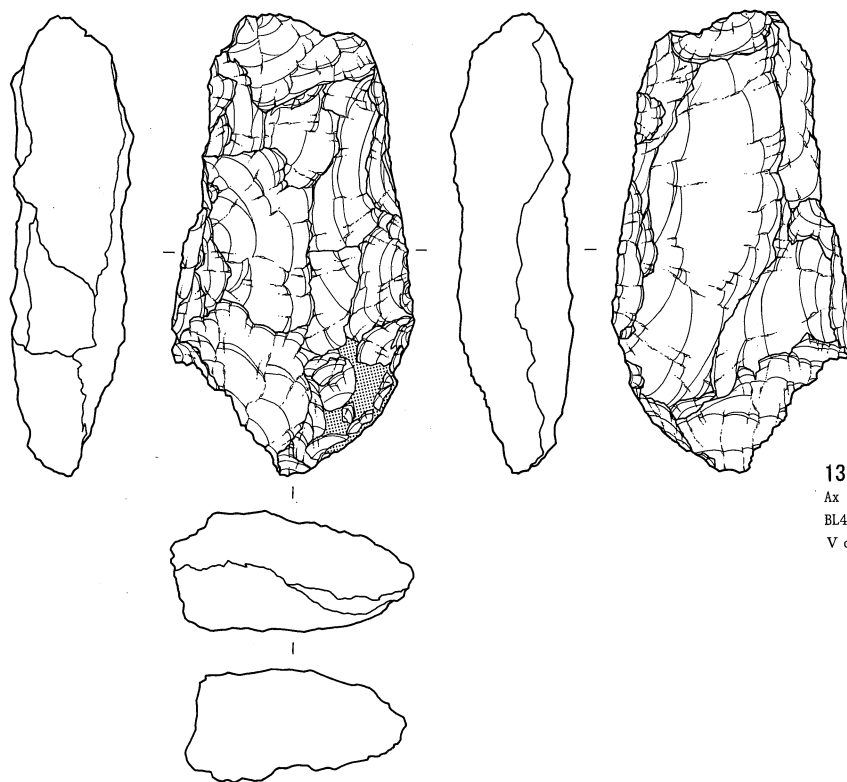
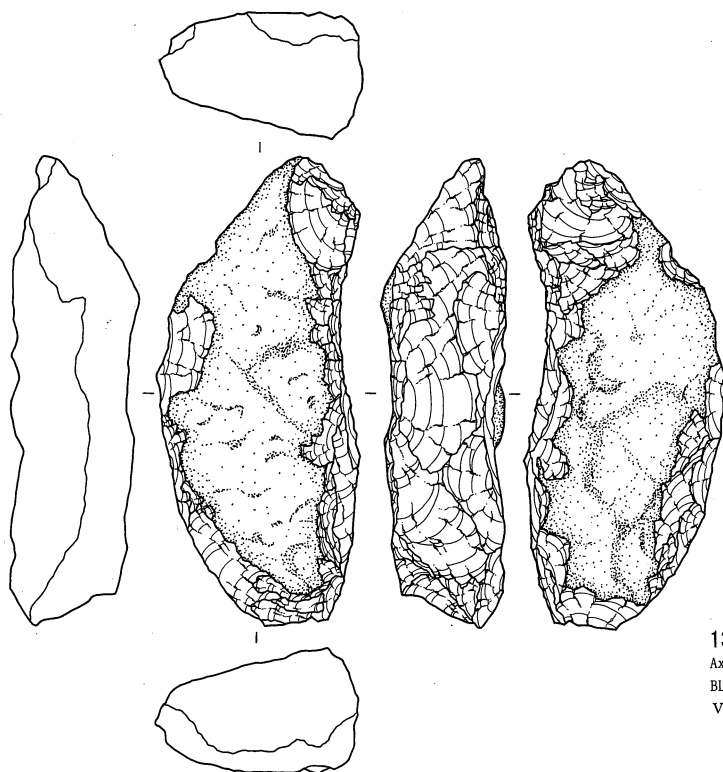

0 (1:2) 5cm

第4地点 石器実測図 26 (斧形石器 5) (貫ノ木遺跡)

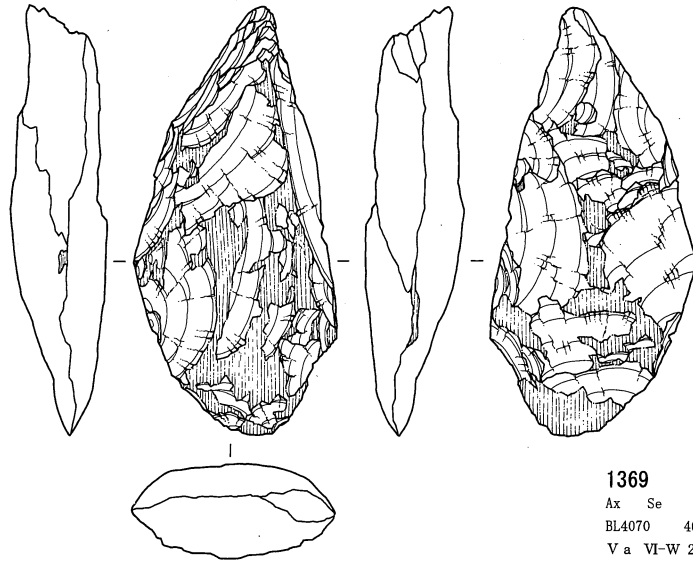

1369
Ax Se
BL4070 46.82g
V a VI-W 2056

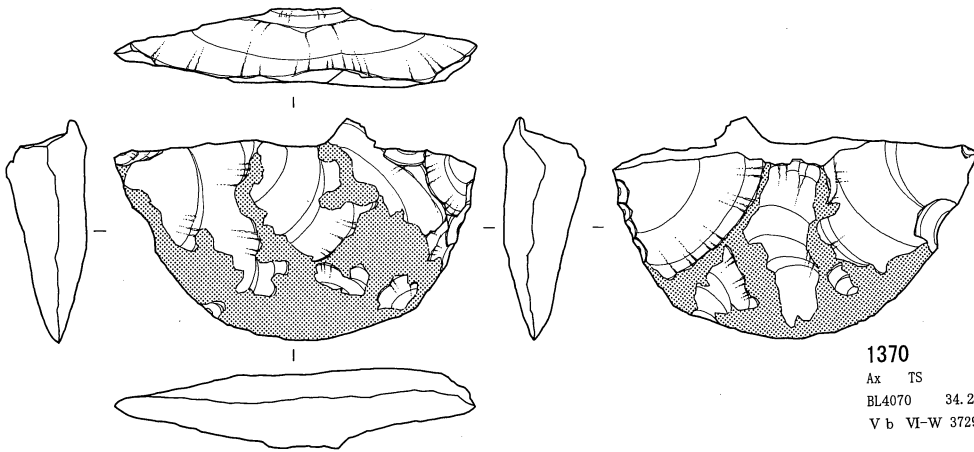

1370
Ax TS
BL4070 34.29g
V b VI-W 3729

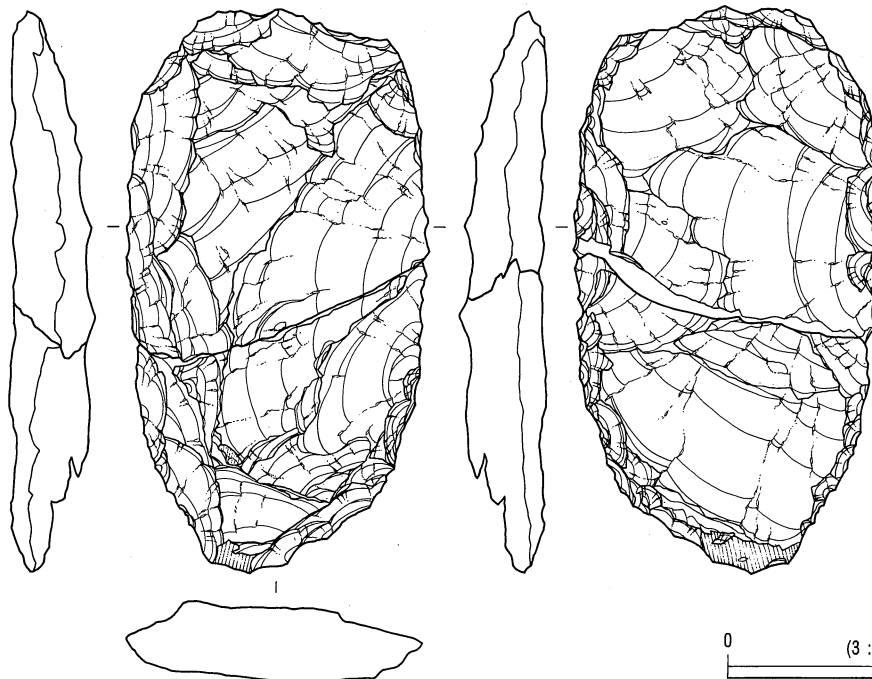

1371a
Ax Se
BL4077 50.78g
V a VI-W 477

1371b
Ax破 Se
BL4077 34.03g
V b VI-W 631

0 (3 : 4) 5cm

第4地点 石器実測図 27 (斧形石器 6) (貫ノ木遺跡)

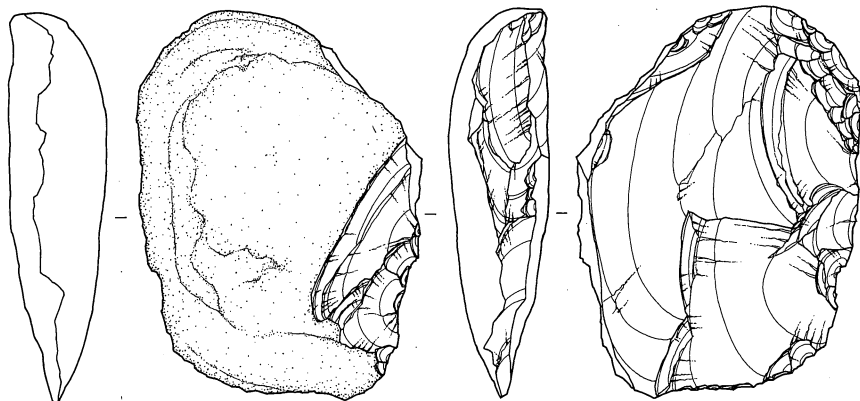

1663
Ax GT
BL4067 69.05g
V b VI-W 3874

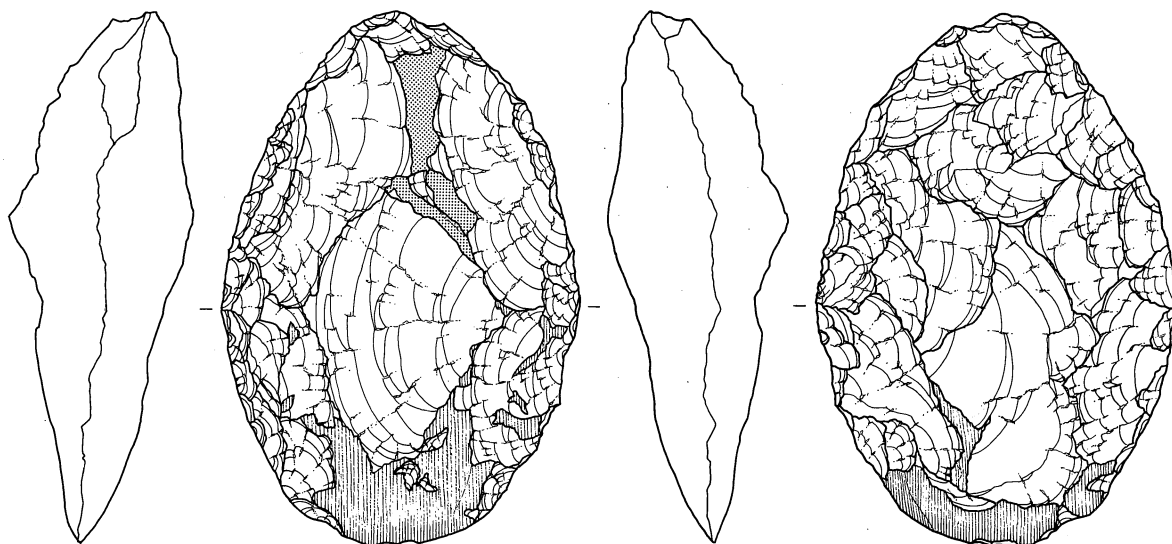

1664
Ax Se
BL4075 179.77g
V c VI-W 278

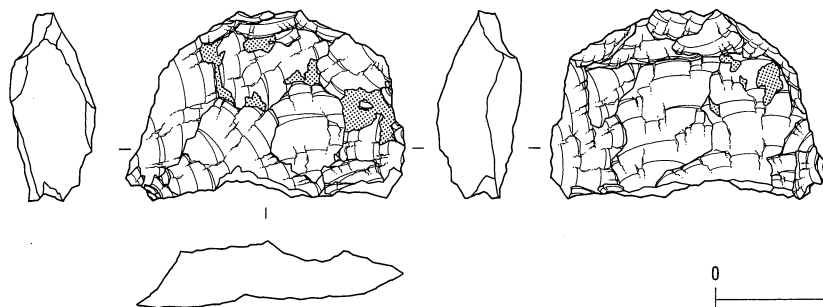

1665
Ax Se
BL4081 26.26g
V a VI-S 694

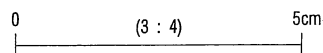

第4地点 石器実測図28 (斧形石器7) (貫ノ木遺跡)

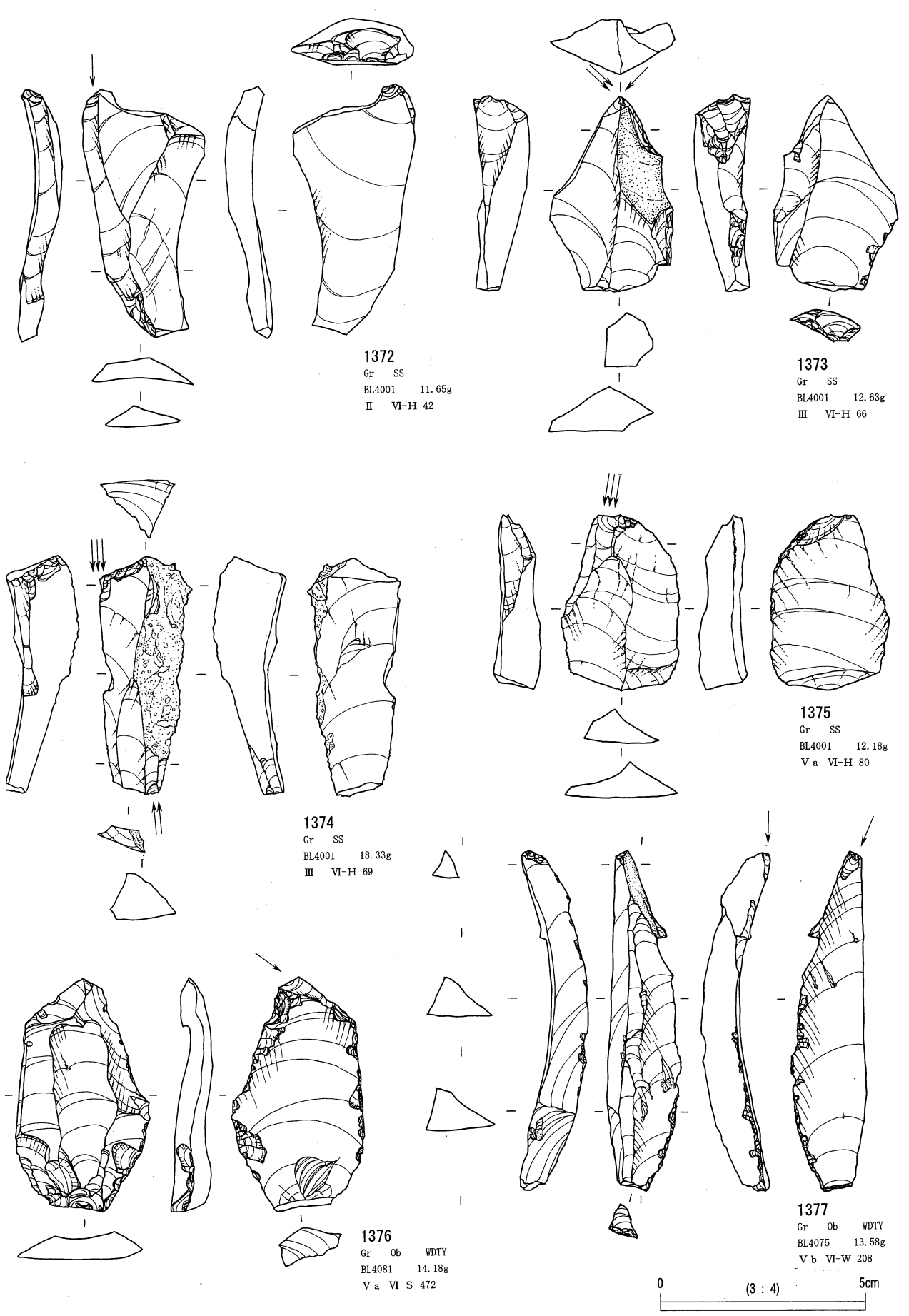

第4地点 石器実測図 29 (彫器 1) (貫ノ木遺跡)

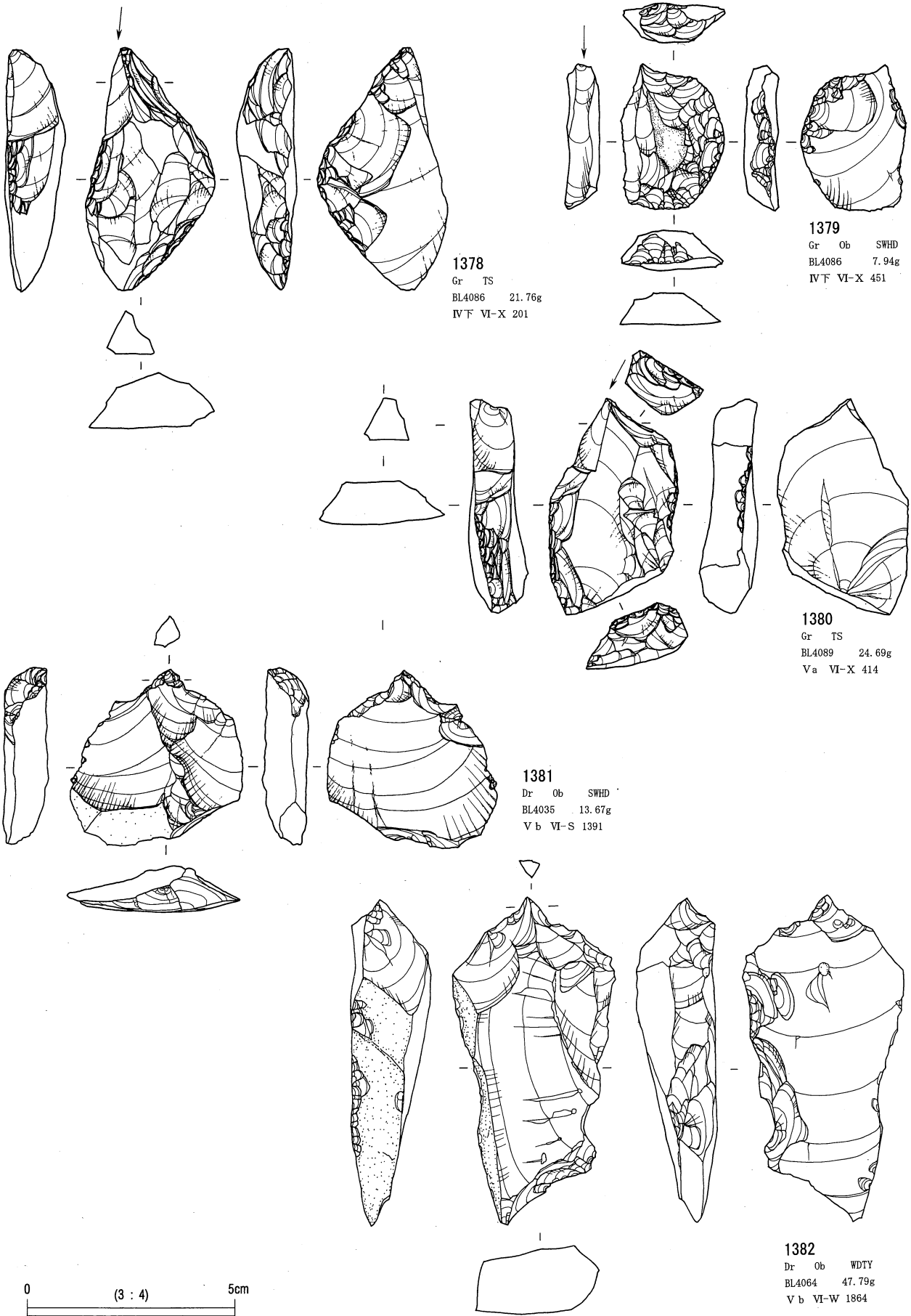

第4地点 石器実測図 30 (彫器 2・揉錐器) (貫ノ木遺跡)

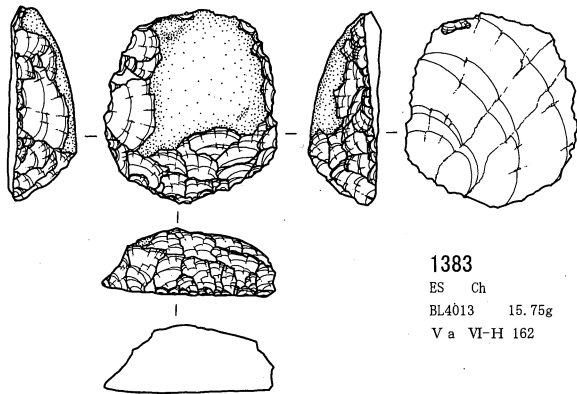

1383
ES Ch
BL4013 15.75g
V a VI-H 162

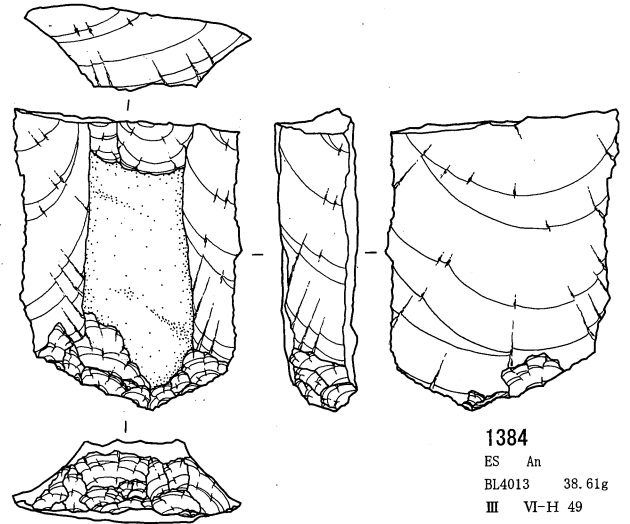

1384
ES An
BL4013 38.61g
III VI-H 49

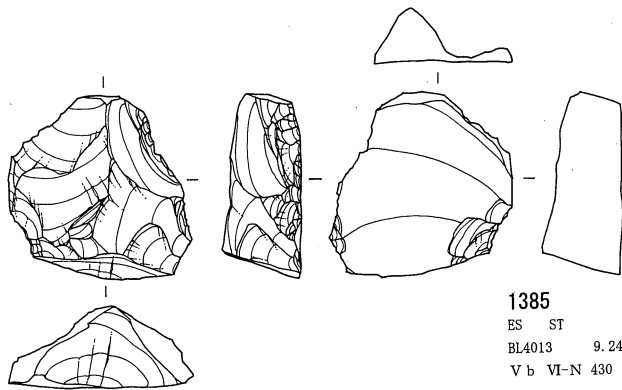

1385
ES ST
BL4013 9.24g
V b VI-N 430

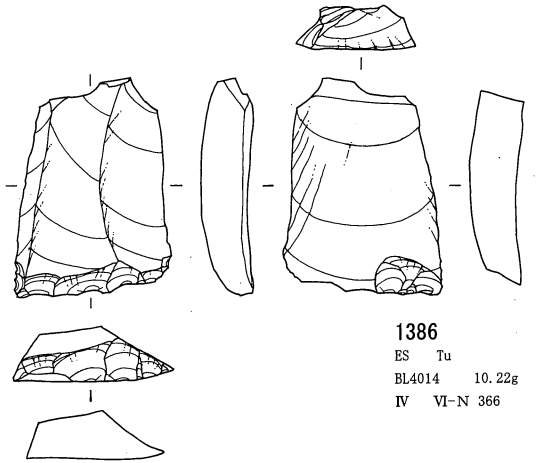

1386
ES Tu
BL4014 10.22g
IV VI-N 366

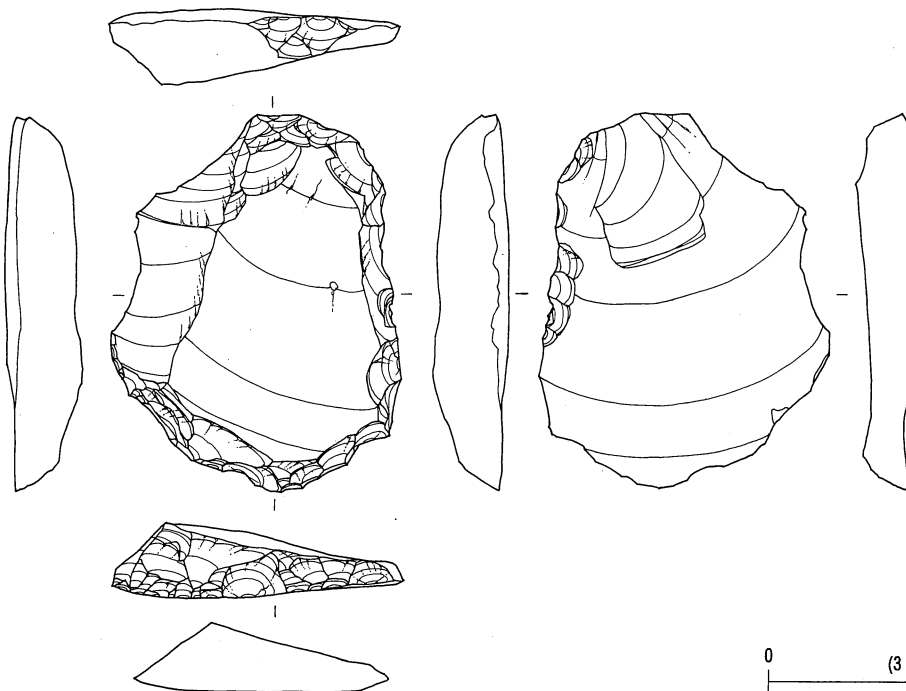

1387
ES An
BL4014 42.33g
IV VI-N 109

0 (3 : 4) 5cm

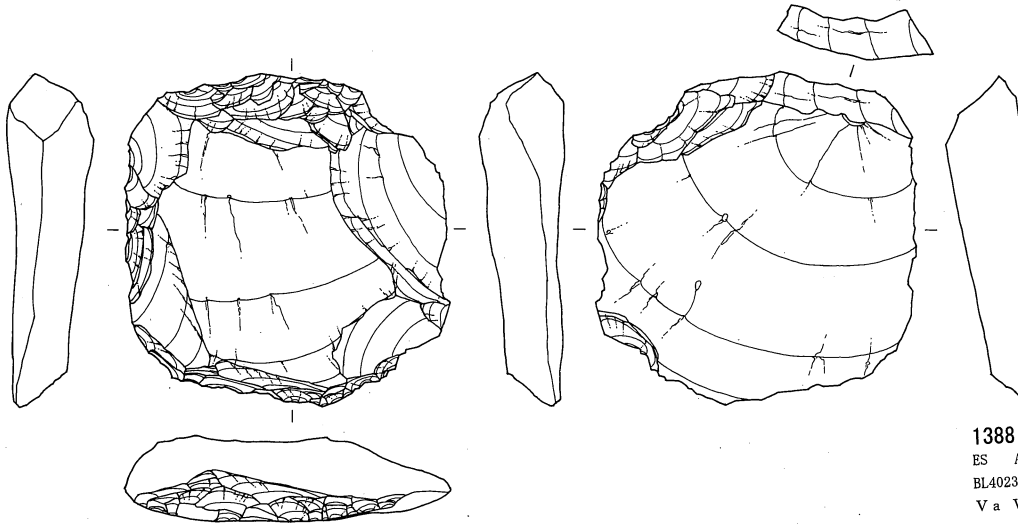

1388
 ES An
 BL4023 48.46g
 V a VI-M 236

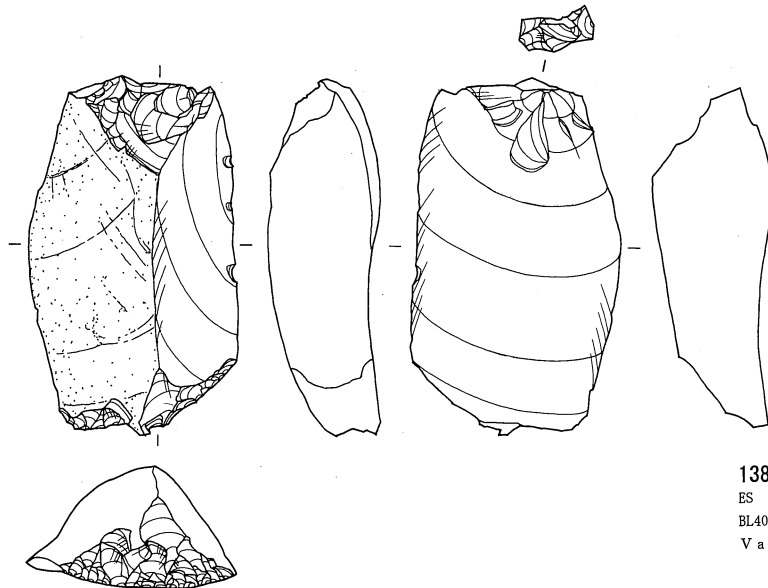

1389
 ES Ob SWHD
 BL4033 38.08g
 V a VI-R 3651

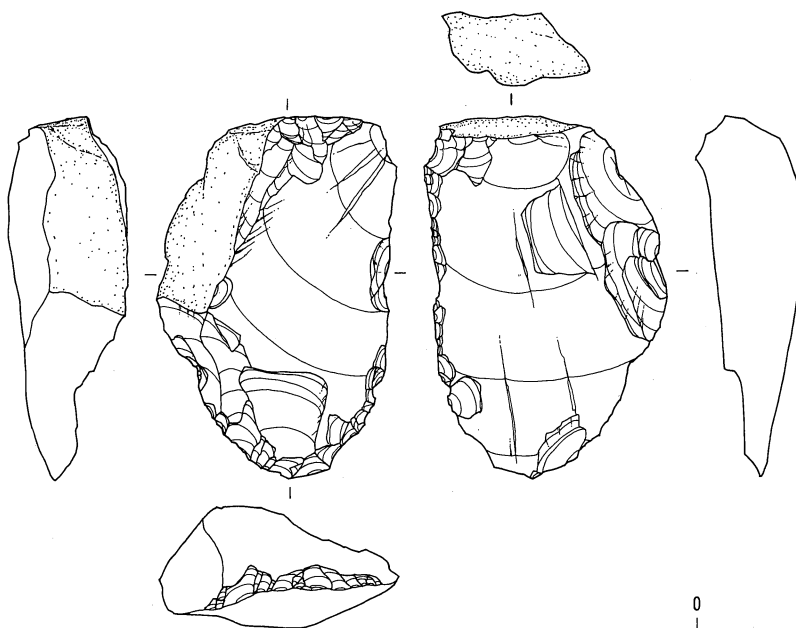

1390
 ES TS
 BL4034 45.41g
 V a VI-S 1863

0 (3 : 4) 5cm

第4地点 石器実測図 32 (搔器 2) (貫ノ木遺跡)

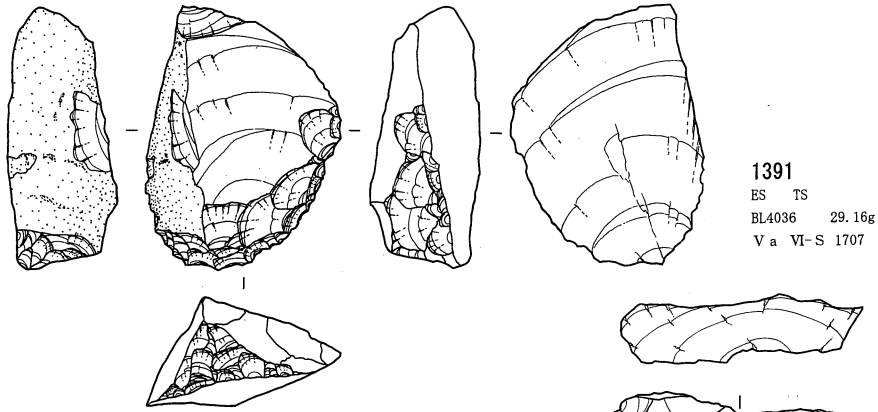

1391
ES TS
BL4036 29.16g
V a VI-S 1707

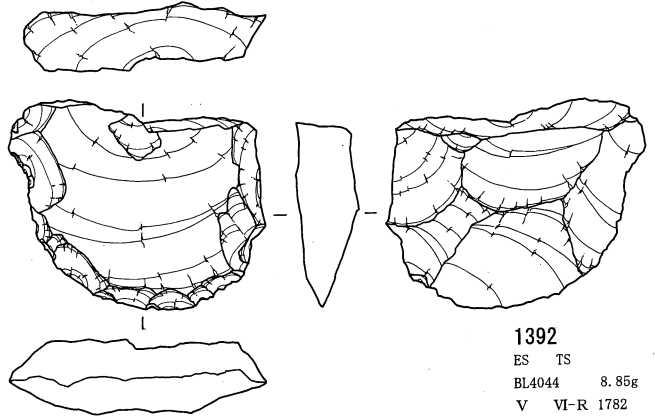

1392
ES TS
BL4044 8.85g
V VI-R 1782

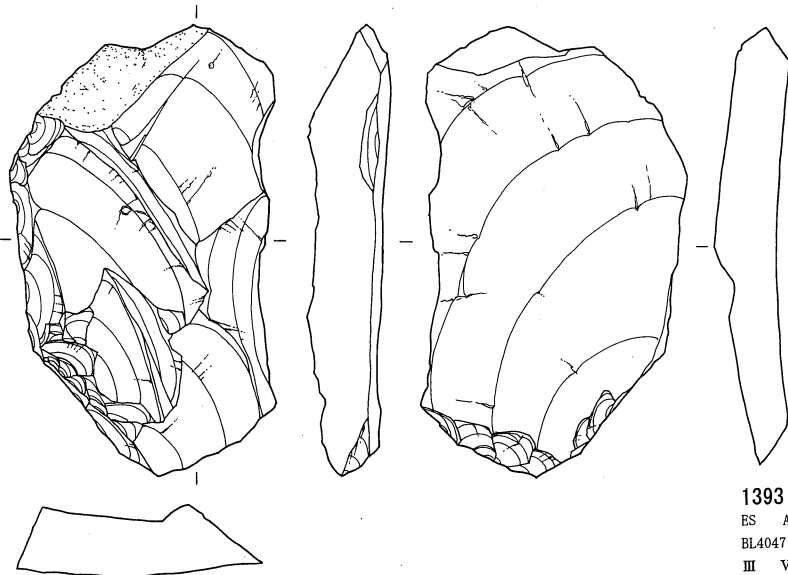

1393
ES An
BL4047 53.19g
III VI-R 901

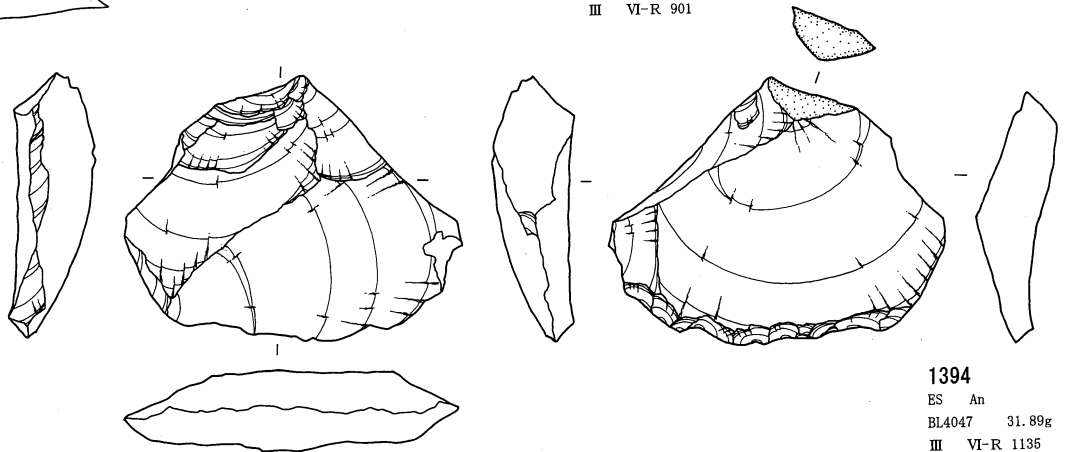

1394
ES An
BL4047 31.89g
III VI-R 1135

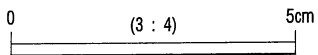

第4地点 石器実測図 33 (搔器 3) (貫ノ木遺跡)

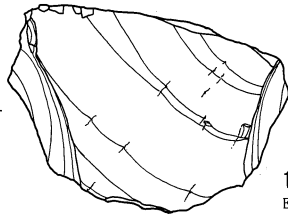
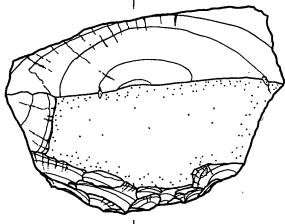

1395

ES An
BL4049 28.53g
IV VI-R 2929

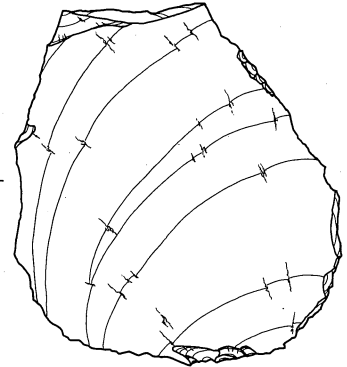
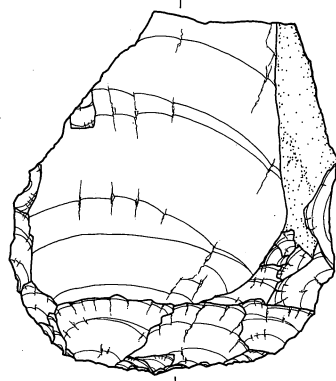

1396

ES An
BL4050 87.36g
V VI-R 2087

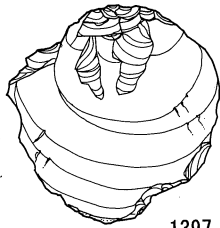
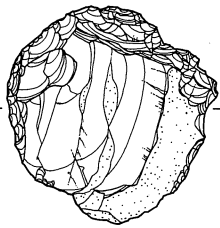
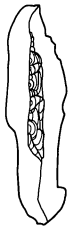
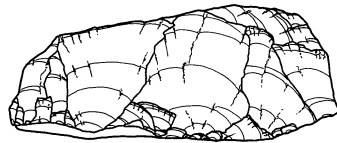

1397

ES Ch
BL4051 12.59g
III VI-R 462

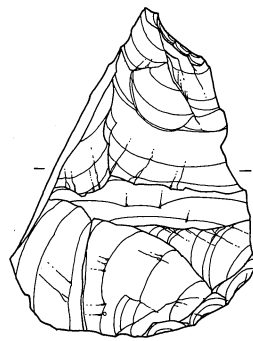

1398

ES An
BL4052 33.36g
III VI-R 160

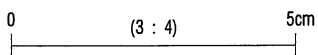
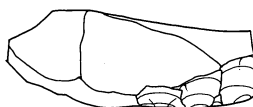

第4地点 石器実測図 34 (搔器 4) (貫ノ木遺跡)

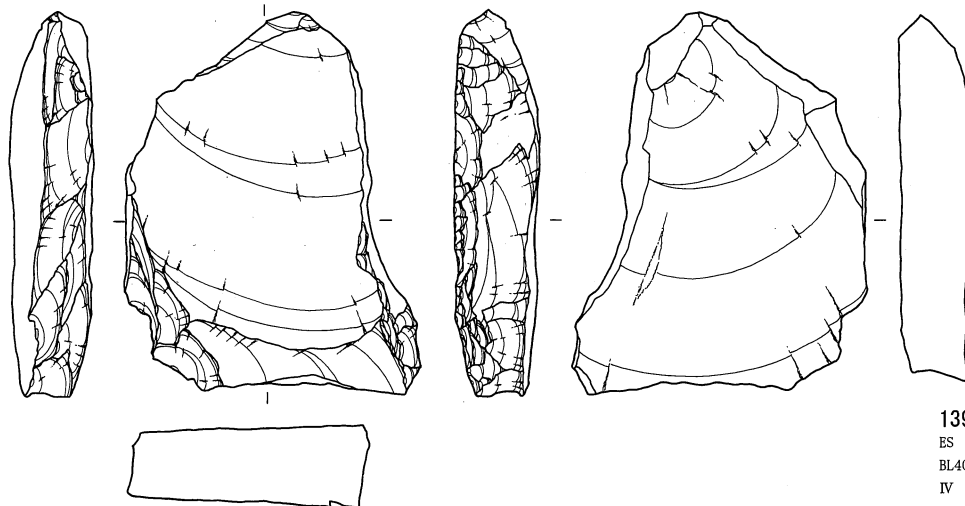

1399
 ES An
 BL4052 59.22g
 IV VI-R 2225

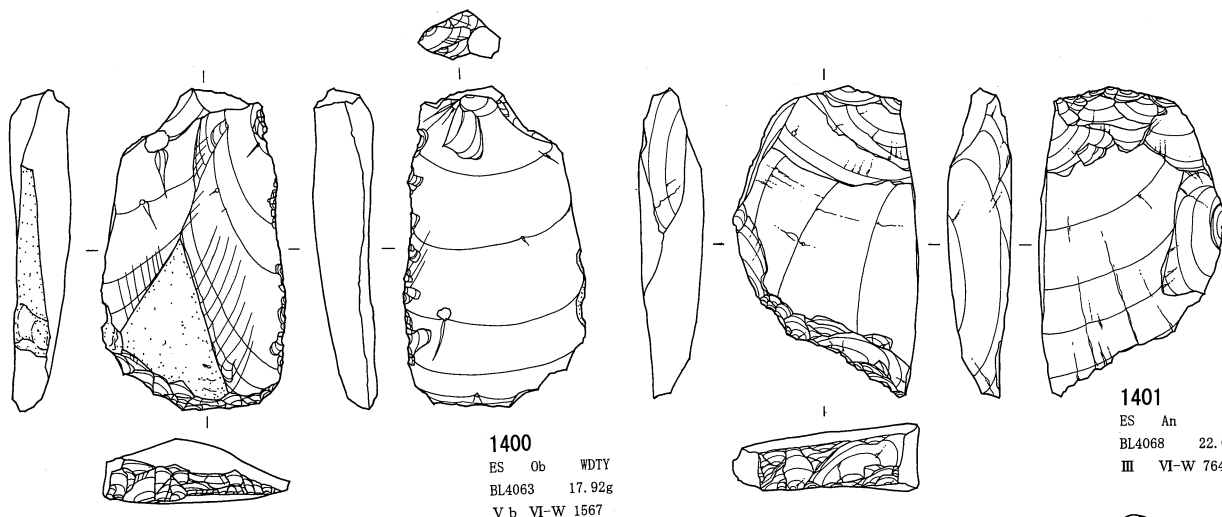

1400
 ES Ob WDTY
 BL4063 17.92g
 V b VI-W 1567

1401
 ES An
 BL4068 22.01g
 III VI-W 764

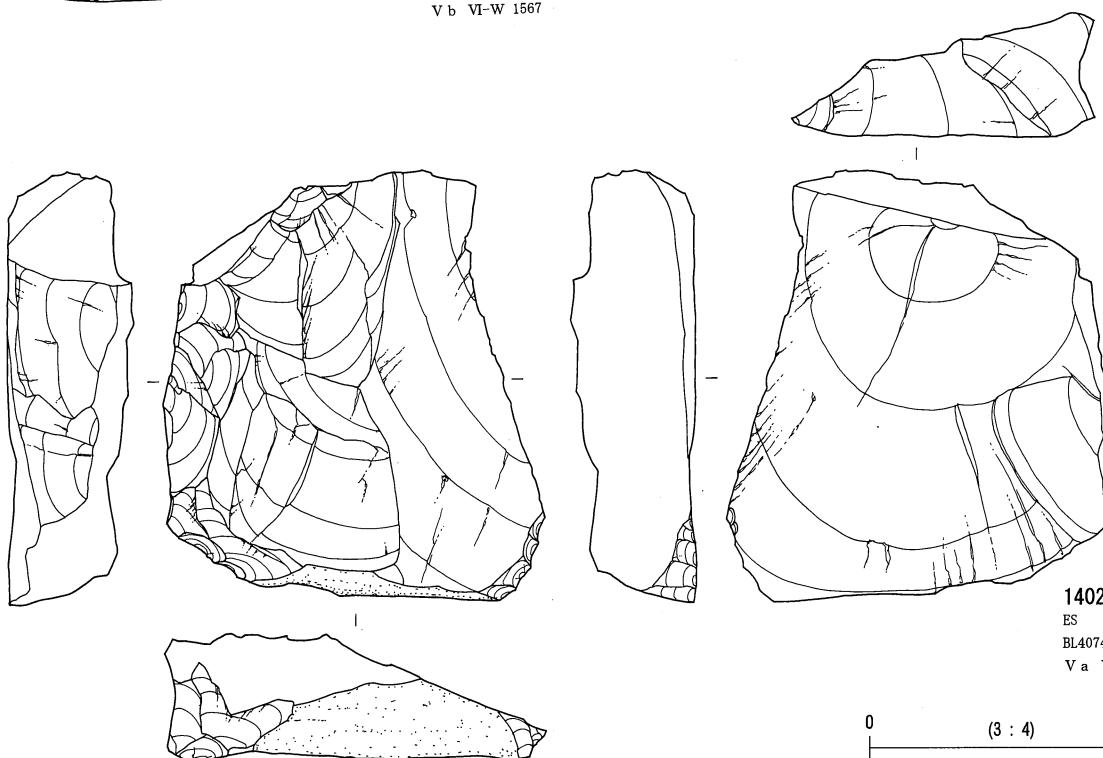

1402
 ES An
 BL4074 110.34g
 V a VI-R 79

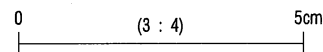

第4地点 石器実測図 35 (搔器 5) (貫ノ木遺跡)

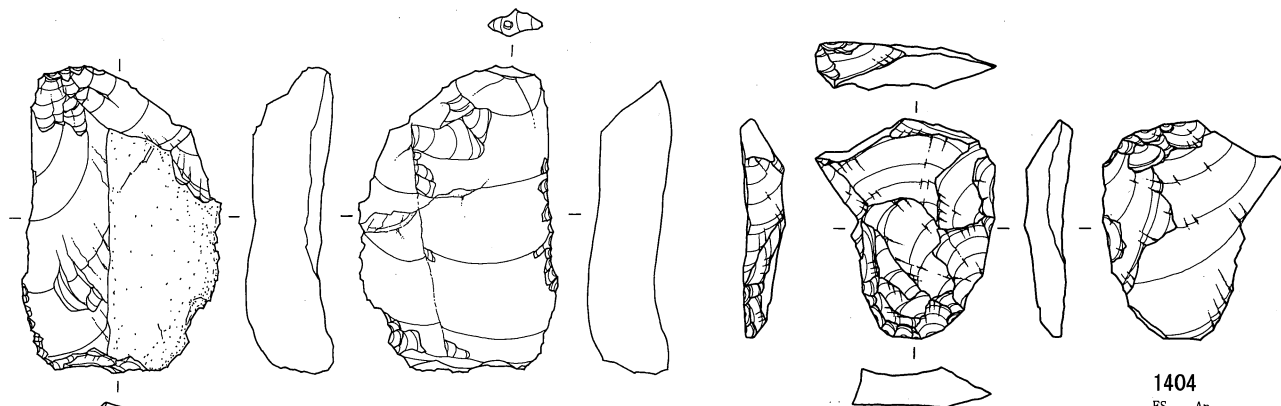

1403
ES Ch
BL4075 25.46g
V a VI-W 59

1404
ES An
BL4082 7.69g
IV下 VI-S 657

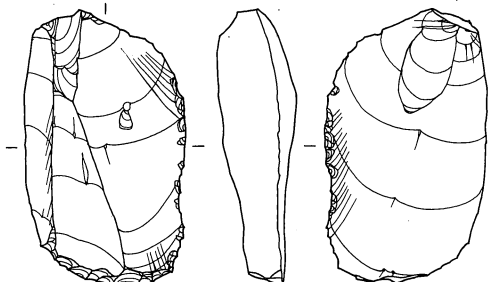
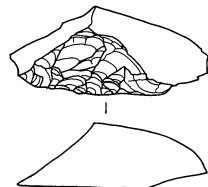

1405
ES Ob WDTY
BL4085 15.53g
IV上 VI-X 140

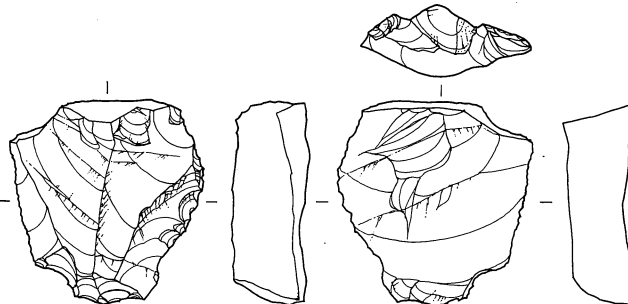

1406
ES Ch
BL4086 16.87g
IV上 VI-X 225

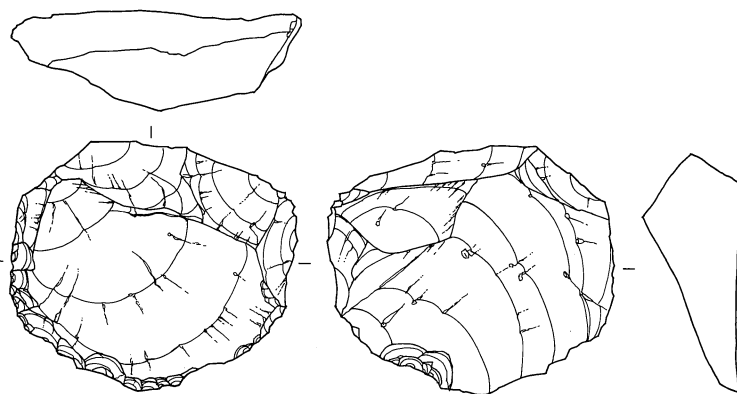
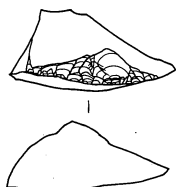

1407
ES An
BL4088 30.53g
V b VI-X 1622

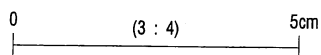

第4地点 石器実測図 36 (搔器 6) (貫ノ木遺跡)

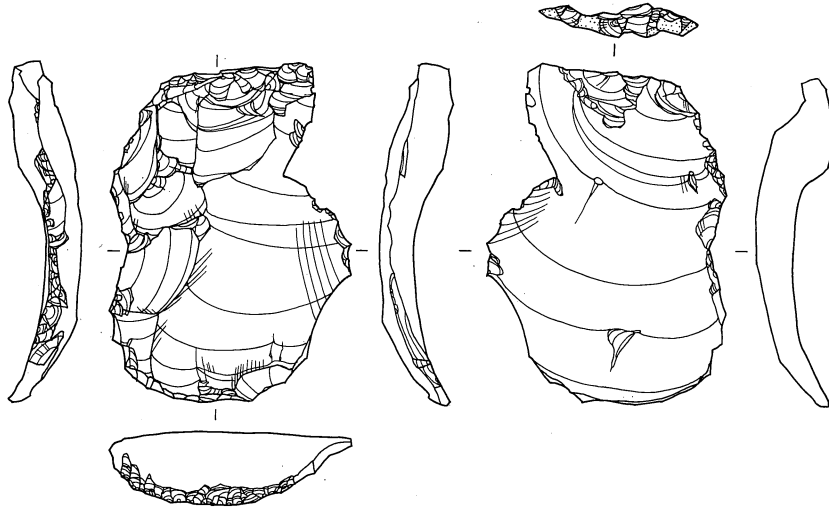

1408
 ES Ob WDTY
 BL4088 16.25g
 Va VI-X 2552

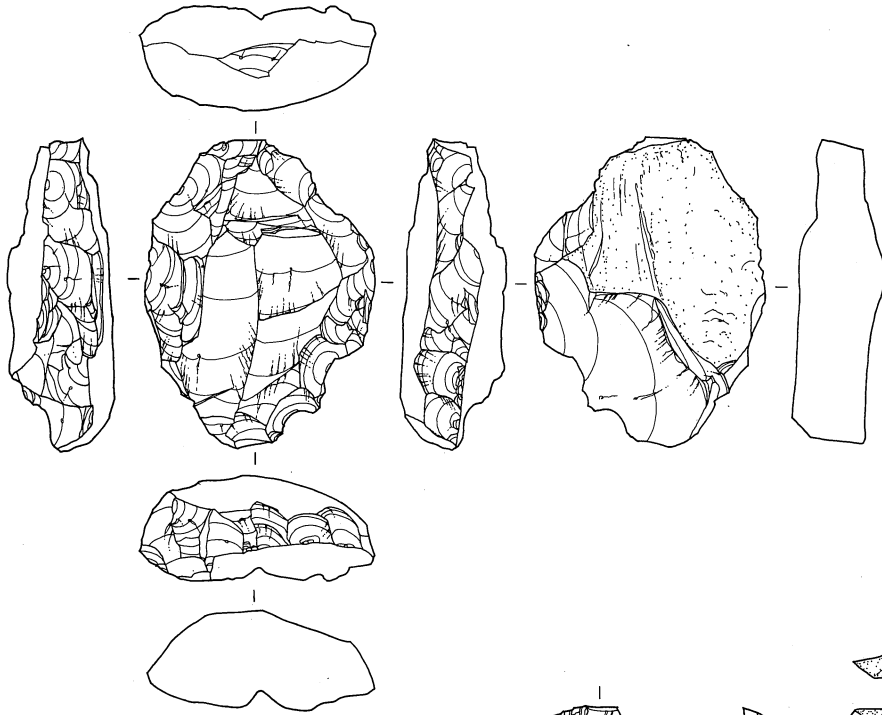

1409
 ES An
 BL4089 37.88g
 IV下 VI-X 409

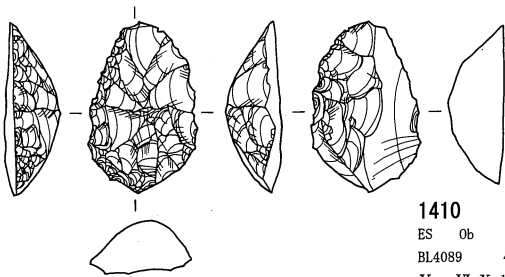

1410
 ES Ob WDTY
 BL4089 4.43g
 Va VI-X 1541

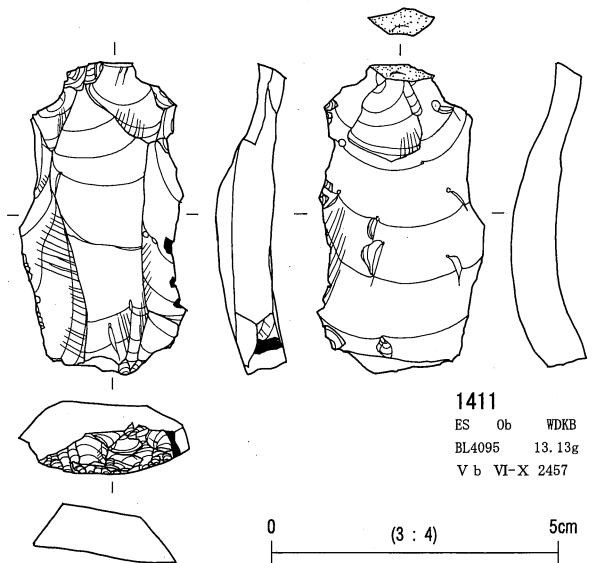

1411
 ES Ob WDKB
 BL4095 13.13g
 Vb VI-X 2457

0 (3:4) 5cm

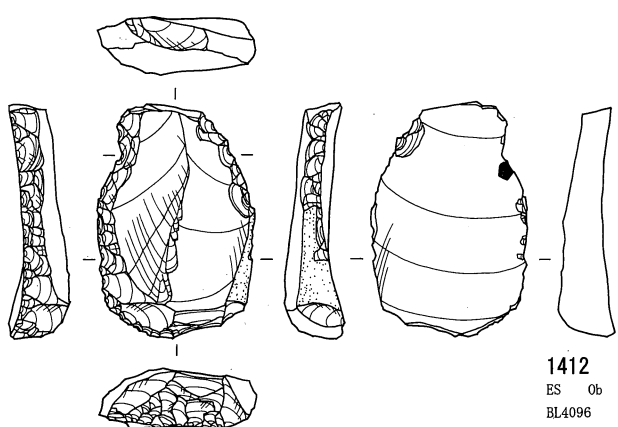

1412
ES Ob SWHD
BL4096 9.74g
Va VI-Y 46

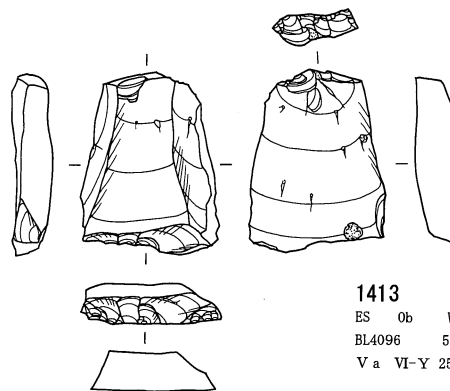

1413
ES Ob WDTY
BL4096 5.43g
Va VI-Y 259

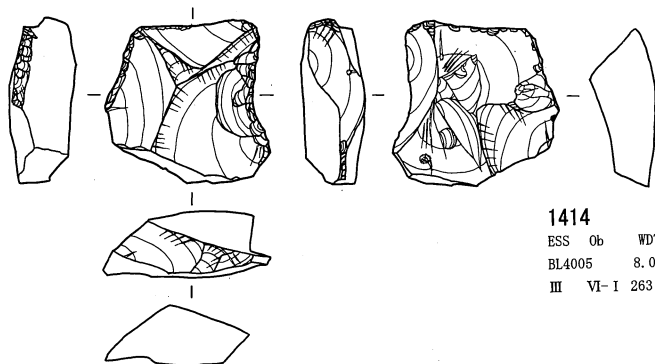

1414
ESS Ob WDTN
BL4005 8.04g
III VI-I 263



1415
ESS Ob WDTY
BL4016 0.88g
Vb VI-M 577

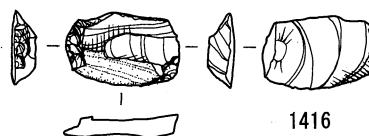

1416
ESS Ob WDTY
BL4016 1.06g
Vb VI-M 573

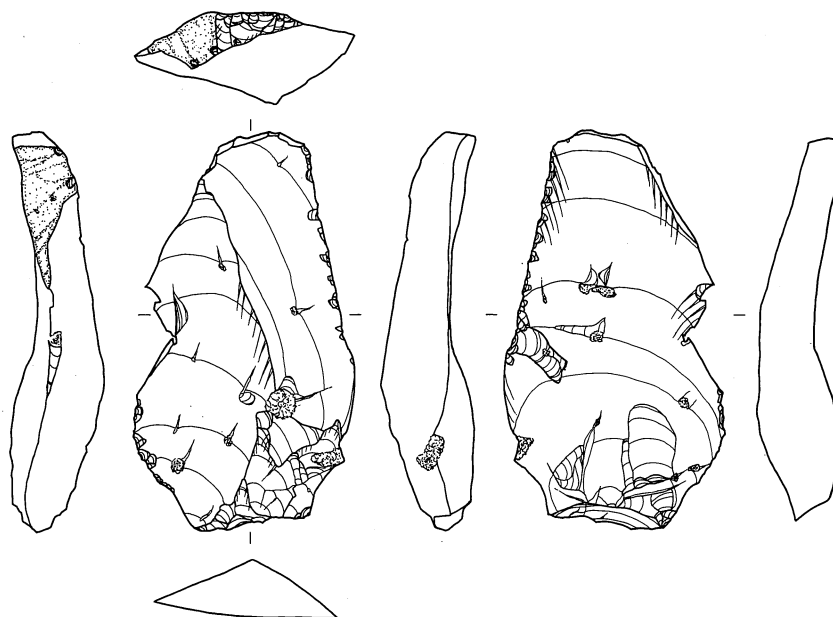

1417
ESS Ob WDKB
BL4022 28.77g
Vb VI-M 286

0 (3 : 4) 5cm

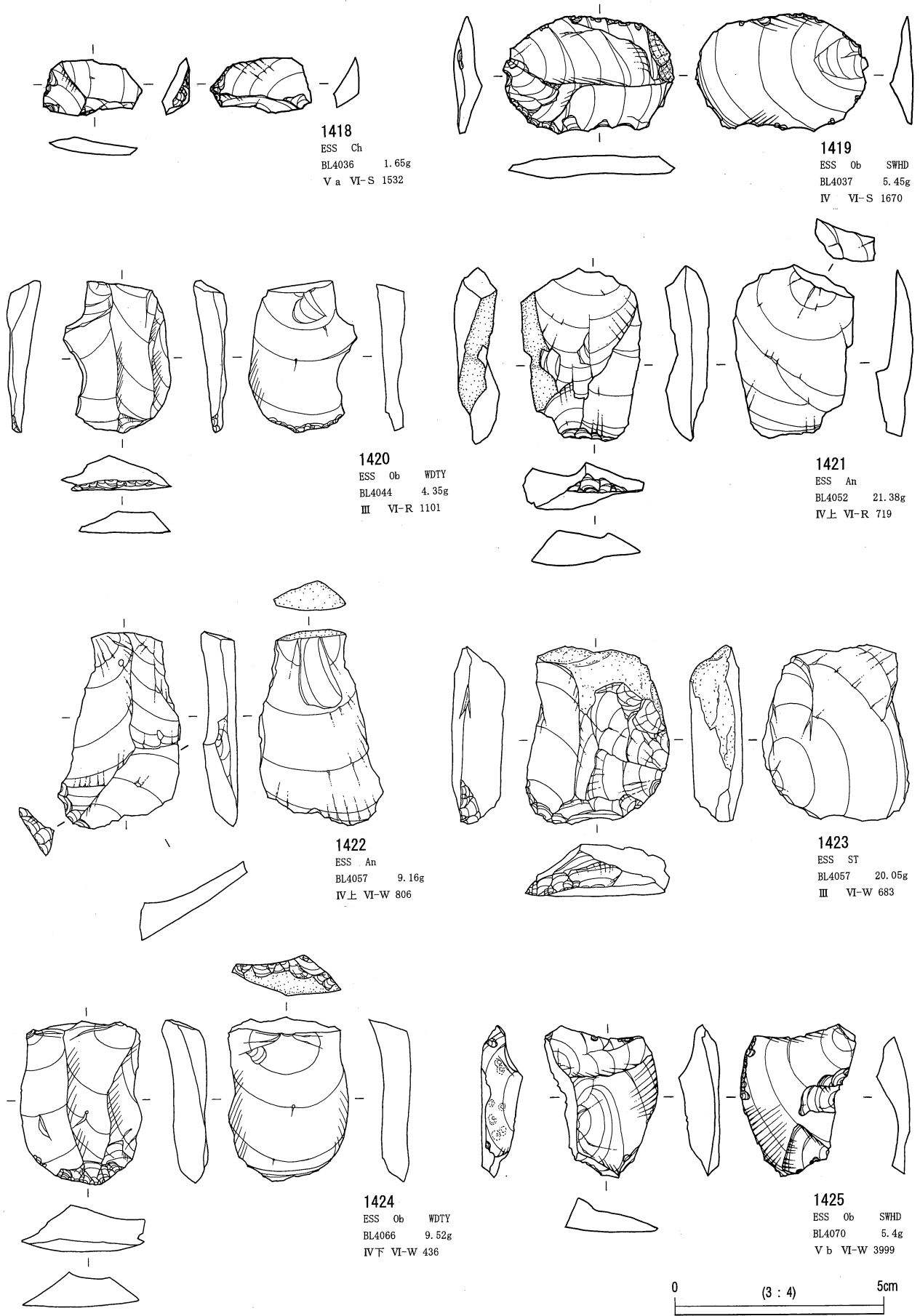

第4地点 石器実測図 39 (搔器状石器 2) (貫ノ木遺跡)

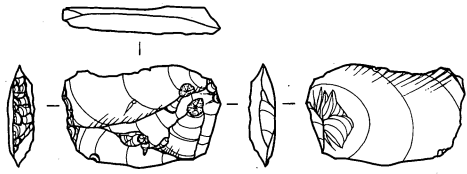

1426
ESS Ob WDTY
BL4077 2.37g
V b VI-W 693

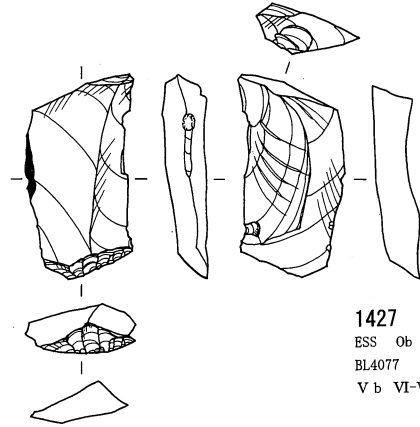

1427
ESS Ob WDTY
BL4077 4.28g
V b VI-W 183

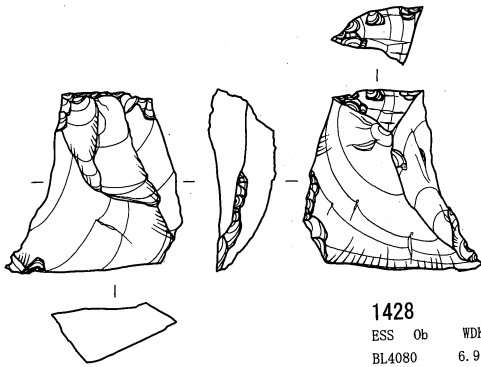

1428
ESS Ob WDKB
BL4080 6.95g
V b VI-X 1940

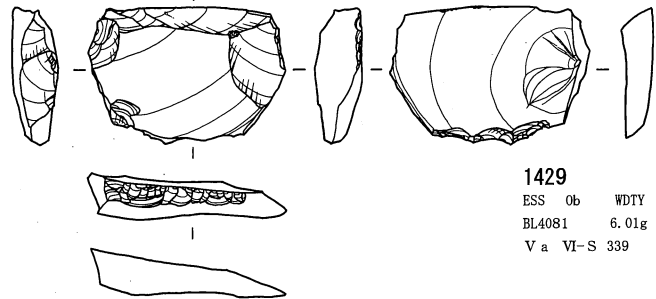

1429
ESS Ob WDTY
BL4081 6.01g
V a VI-S 339

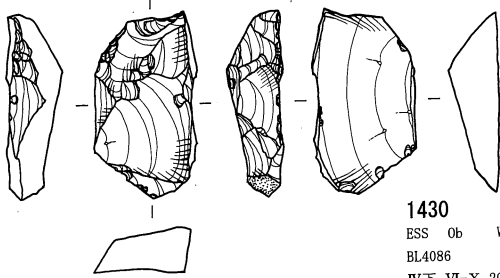

1430
ESS Ob WDTY
BL4086 5g
IV下 VI-X 200

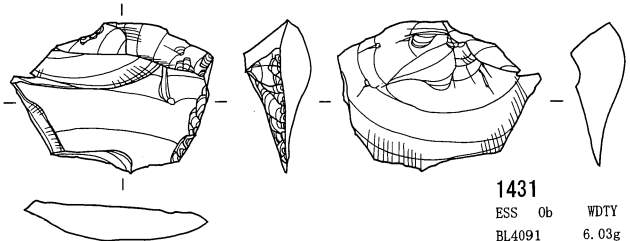

1431
ESS Ob WDTY
BL4091 6.03g
V a VI-X 2191

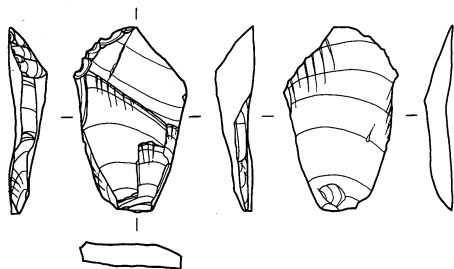

1432
ESS Ob WDTY
BL4093 2.61g
V a VI-X 1194

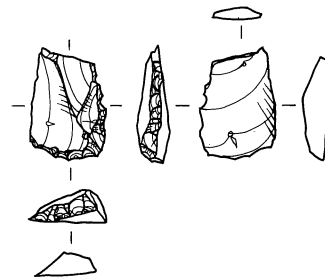

1433
ESS Ob WDTY
BL4094 1.07g
V b VI-X 1783

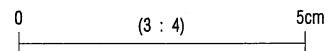

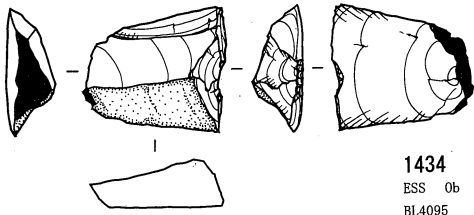

1434
 ESS Ob WDTY
 BL4095 4.27g
 V b VI-X 2392

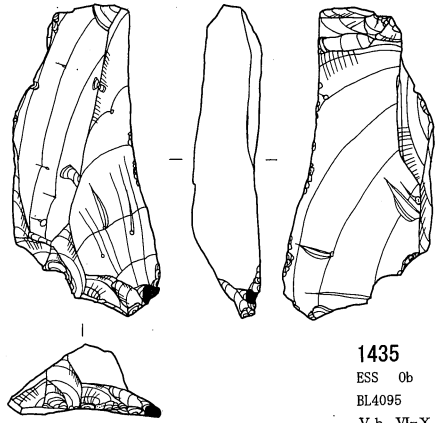

1435
 ESS Ob WDTY
 BL4095 10.85g
 V b VI-X 2509

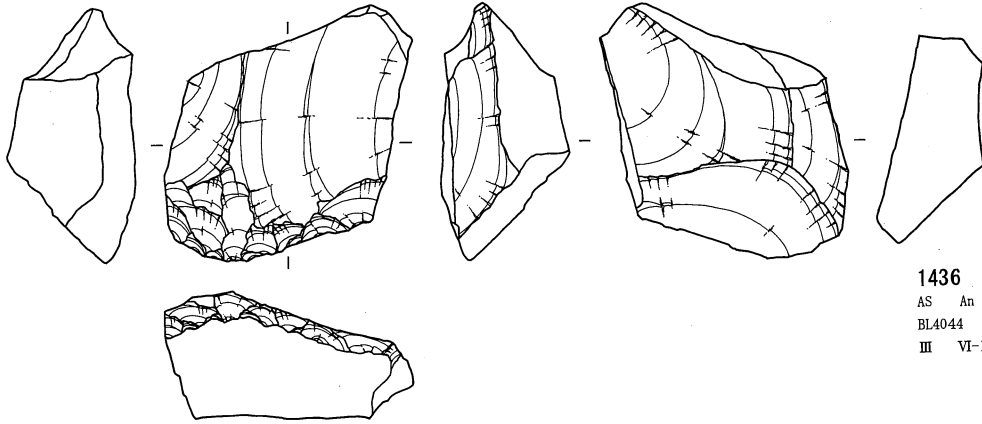

1436
 AS An
 BL4044 34.93g
 III VI-R 505

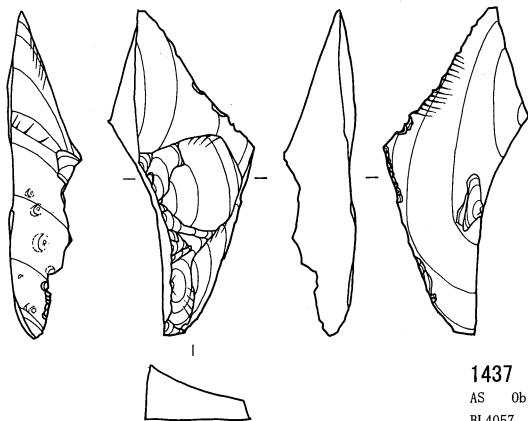

1437
 AS Ob WDTY
 BL4057 8.41g
 V VI-W 2985

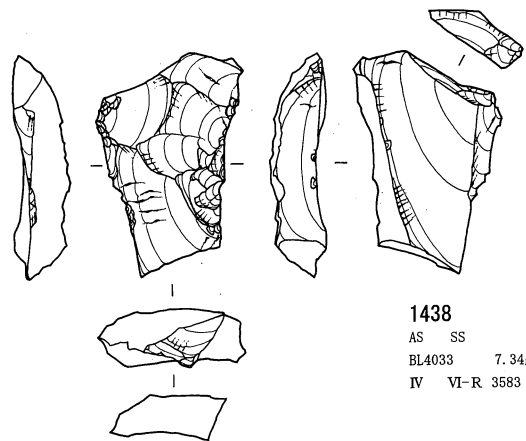

1438
 AS SS
 BL4033 7.34g
 IV VI-R 3583

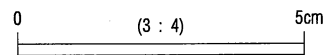

第4地点 石器実測図 41 (搔器状石器4・厚刃削器) (貫ノ木遺跡)

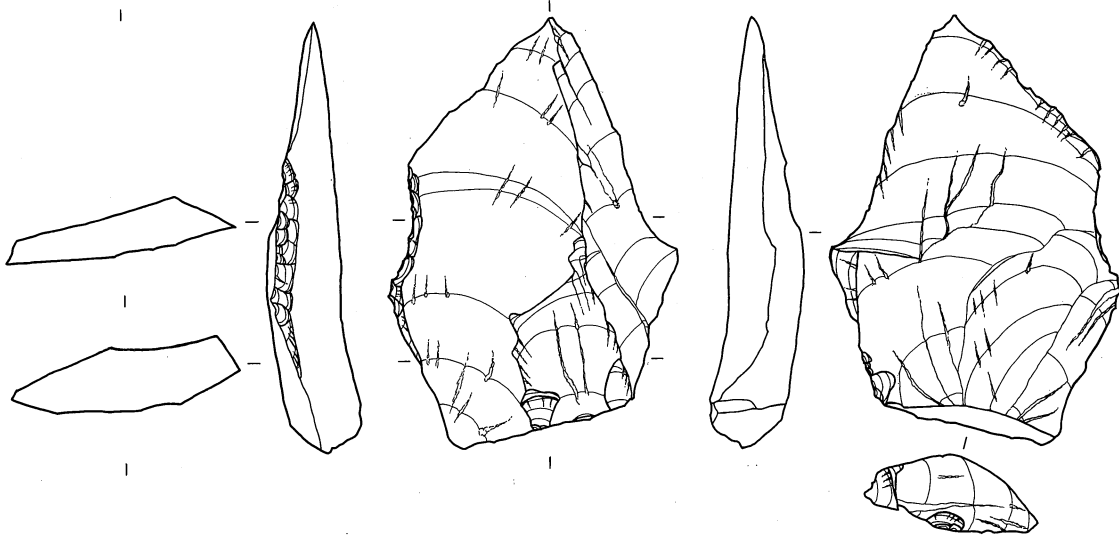

1439
 Sc An
 BL4007 36.46g
 IV VI-I 628

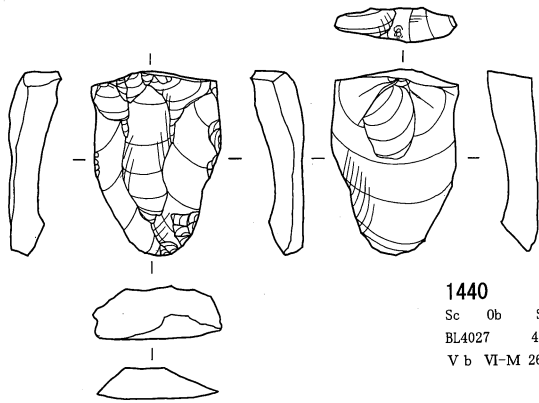

1440
 Sc Ob SWHD
 BL4027 4.76g
 V b VI-M 264

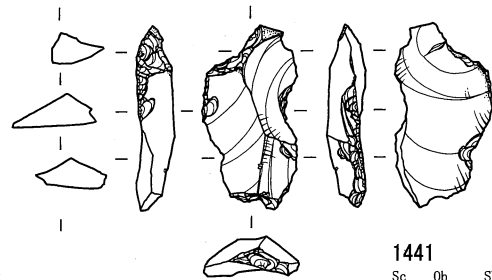

1441
 Sc Ob SWHD
 BL4031 3.01g
 III VI-S 1523

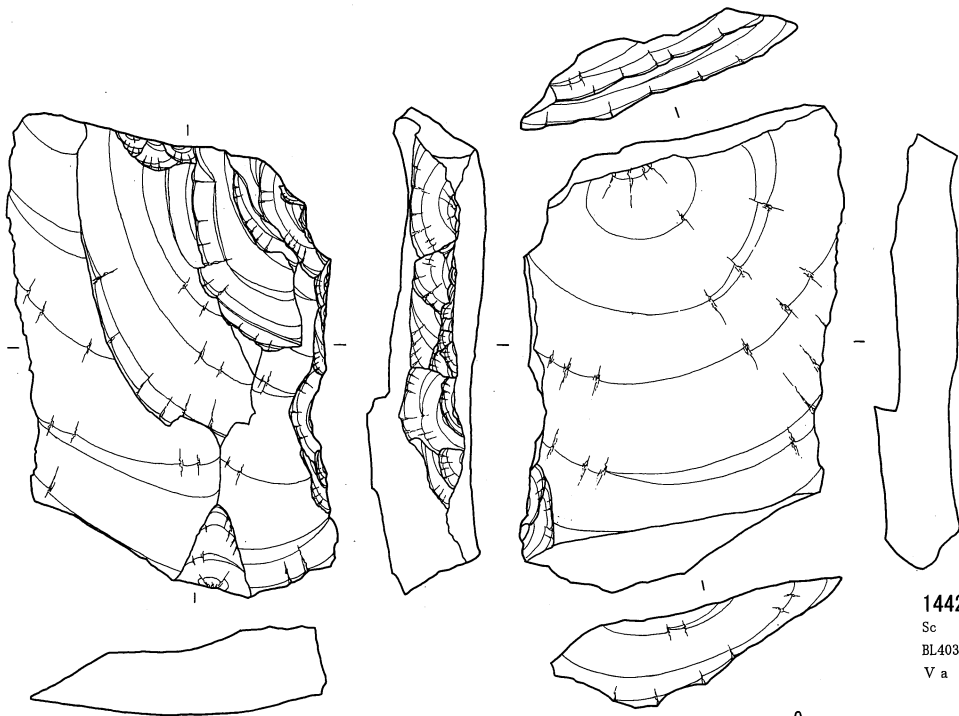

1442
 Sc An
 BL4032 86.47g
 V a VI-R 3763

0 (3:4) 5cm

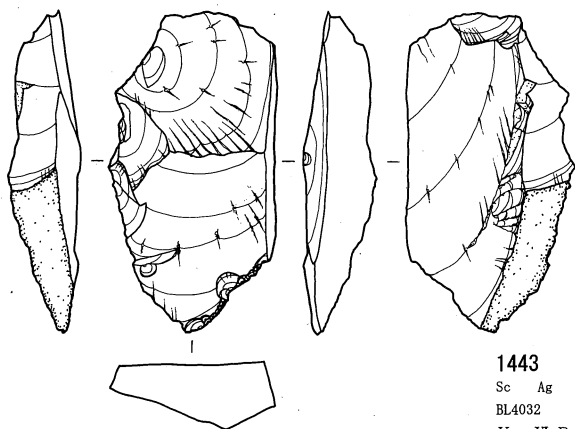

1443
 Sc Ag
 BL4032 15.44g
 V a VI-R 3702

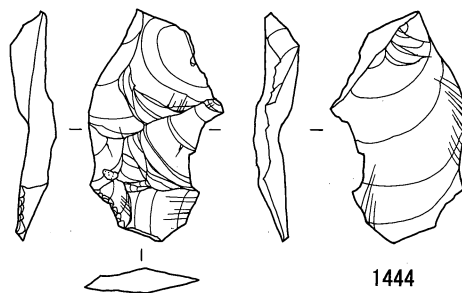

1444
 Sc Ob WDTY
 BL4037 3.74g
 III VI-S 1193

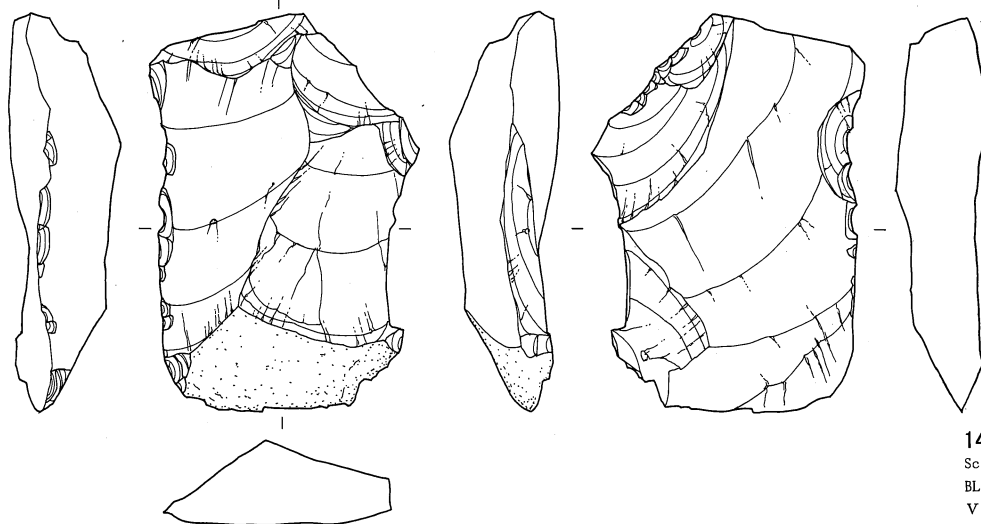

1445
 Sc An
 BL4039 51.12g
 V a VI-S 1263

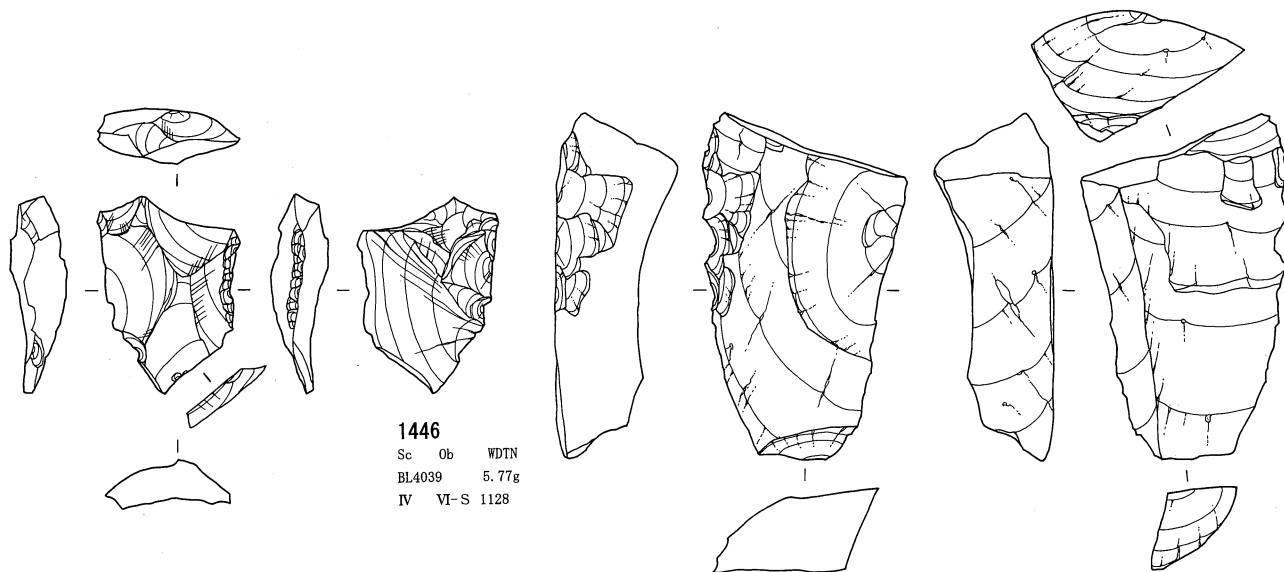

1446
 Sc Ob WDTN
 BL4039 5.77g
 IV VI-S 1128

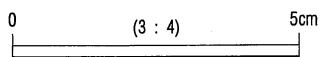

1447
 Sc An
 BL4042 38.53g
 V b VI-R 2663

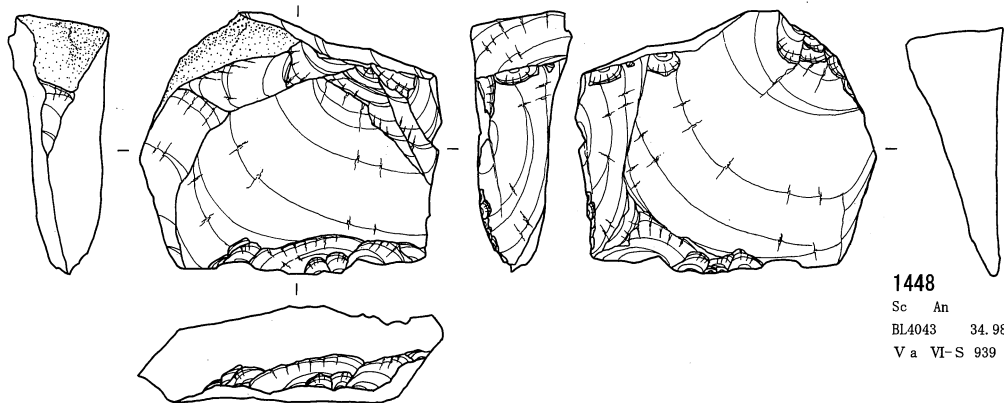

1448
 Sc An
 BL4043 34.98g
 V a VI-S 939

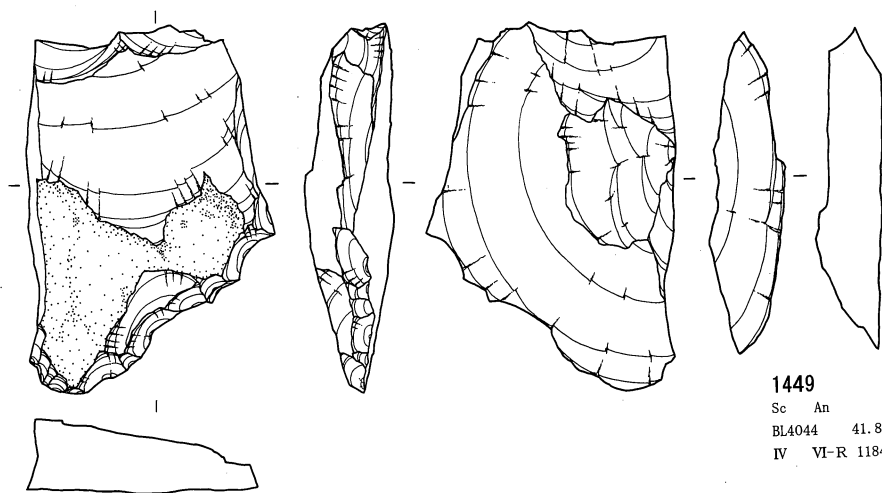

1449
 Sc An
 BL4044 41.87g
 IV VI-R 1184

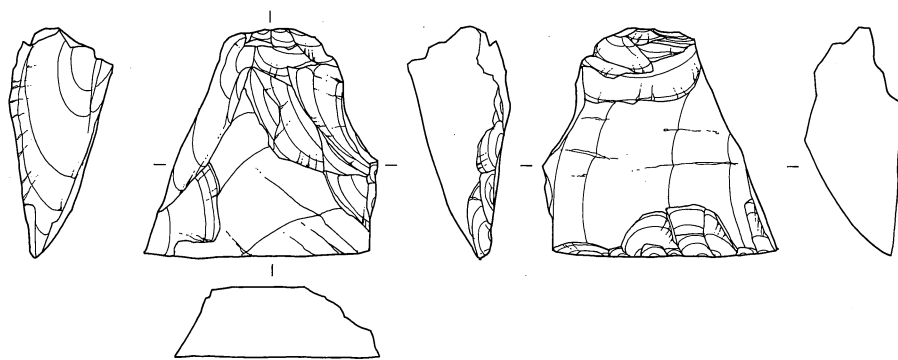

1450
 Sc An
 BL4044 25.25g
 V VI-R 1817

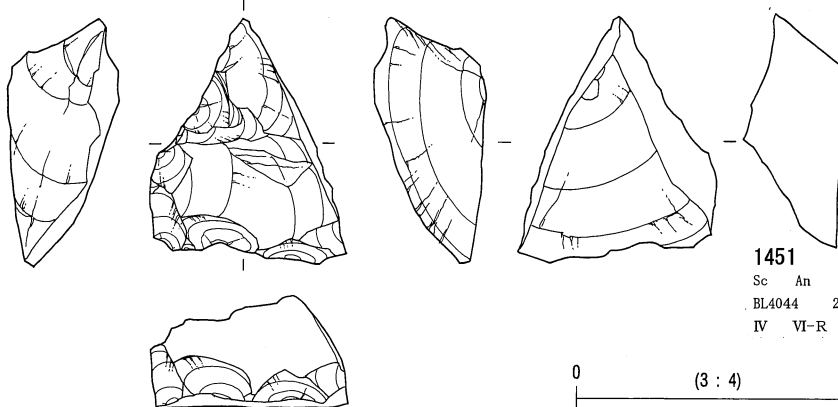

1451
 Sc An
 BL4044 23.11g
 IV VI-R 1599

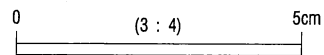

第4地点 石器実測図 44 (削器 3) (貫ノ木遺跡)

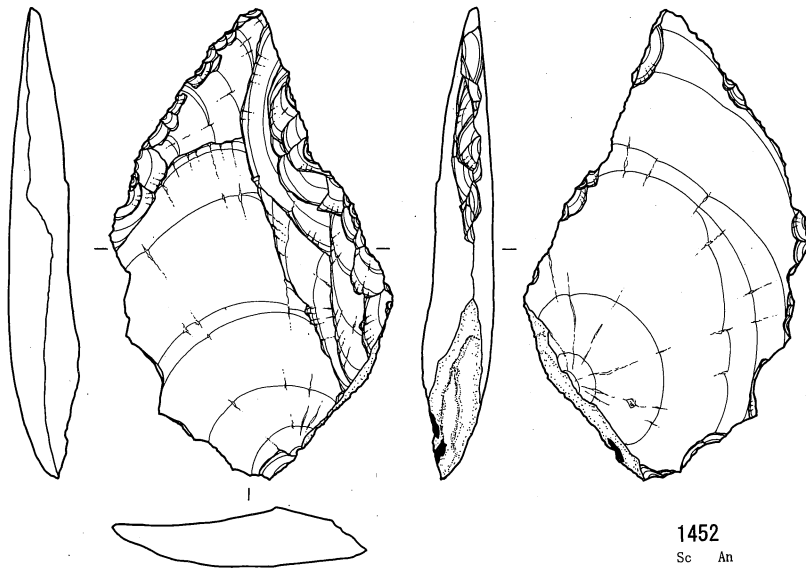

1452
 Sc An
 BL4045 36.29g
 IV VI-R 1027

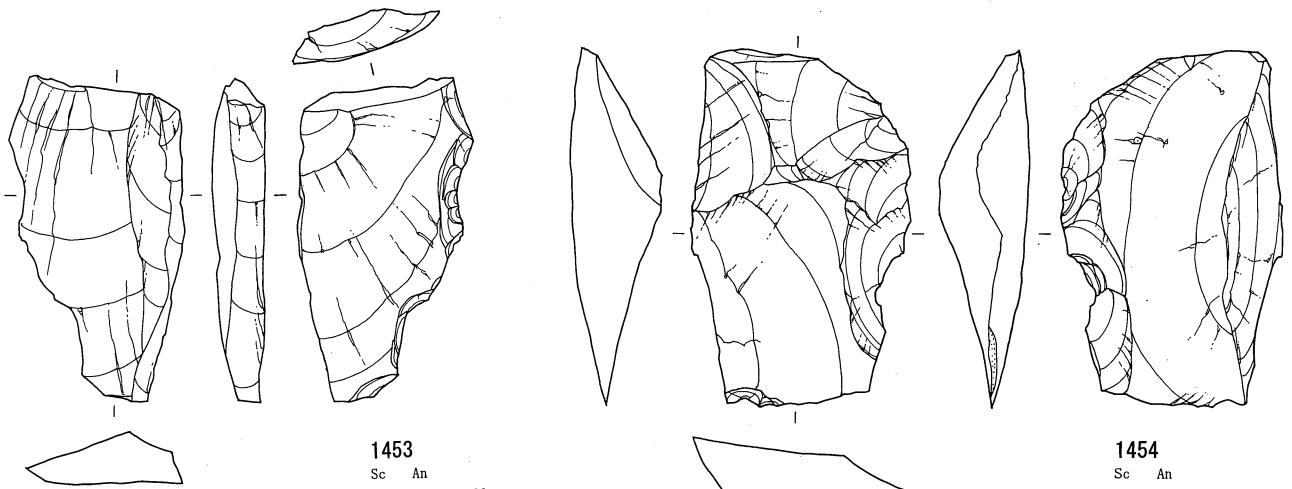

1453
 Sc An
 BL4047 15.66g
 IV VI-R 2956

1454
 Sc An
 BL4050 33.06g
 V VI-R 3110

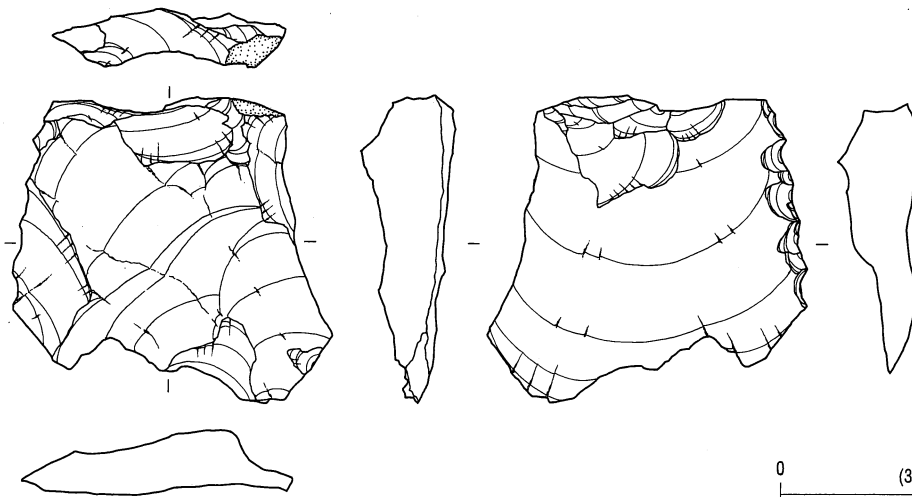

1455
 Sc Ch
 BL4051 37.81g
 III VI-R 3165

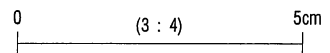

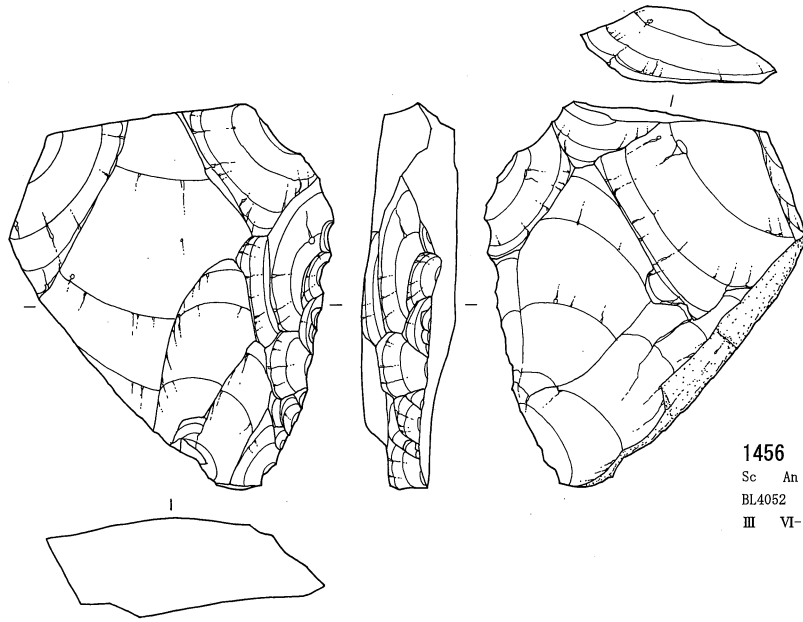

1456
 Sc An
 BL4052 65.39g
 III VI-R 313

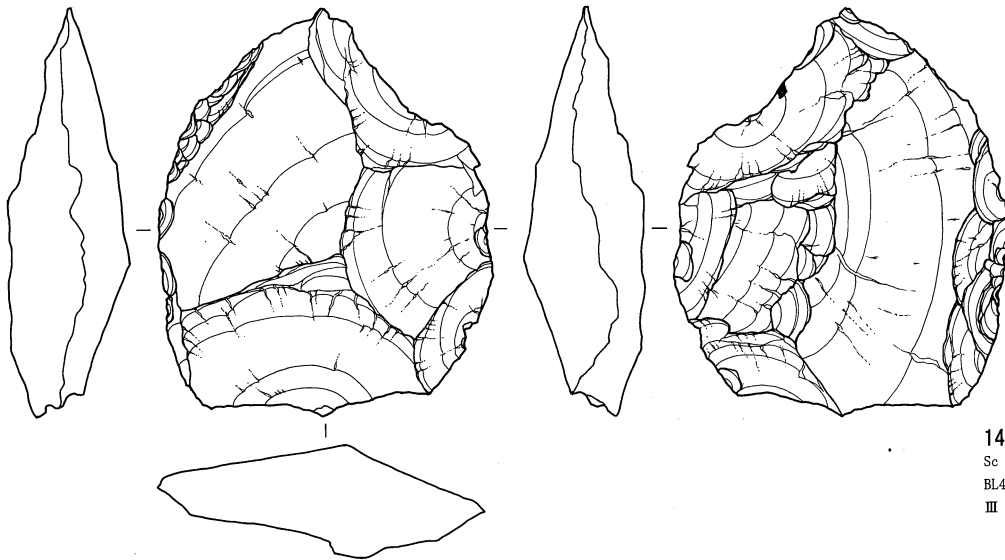

1457
 Sc An
 BL4052 67.88g
 III VI-R 582

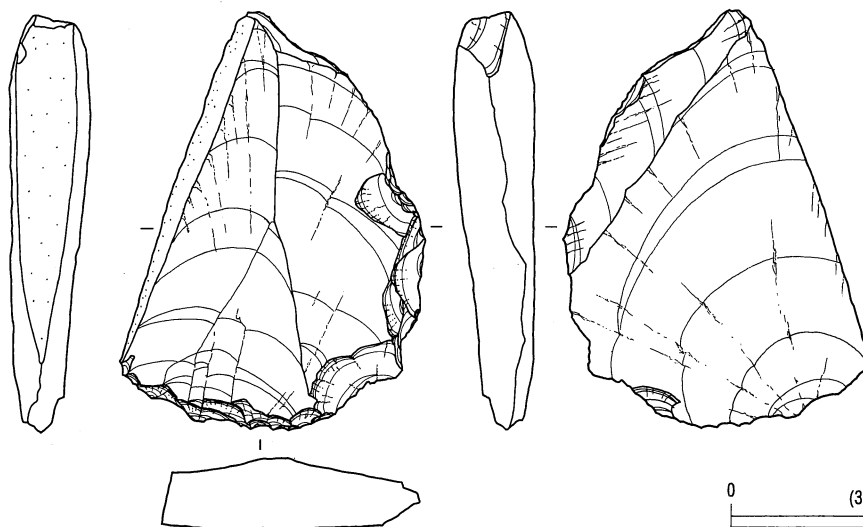

1458
 Sc TS
 BL4052 50.82g
 III VI-R 930

0 (3 : 4) 5cm

第4地点 石器実測図46 (削器5) (貫ノ木遺跡)

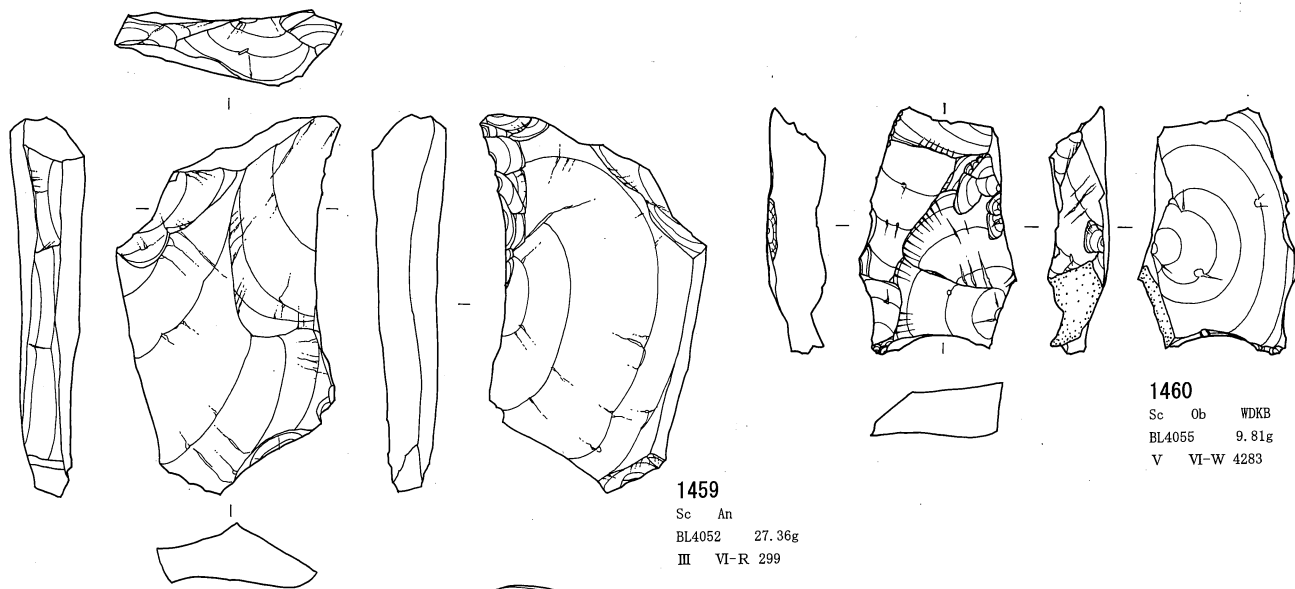

1460
Sc Ob WDKB
BL4056 9.81g
V VI-W 4283

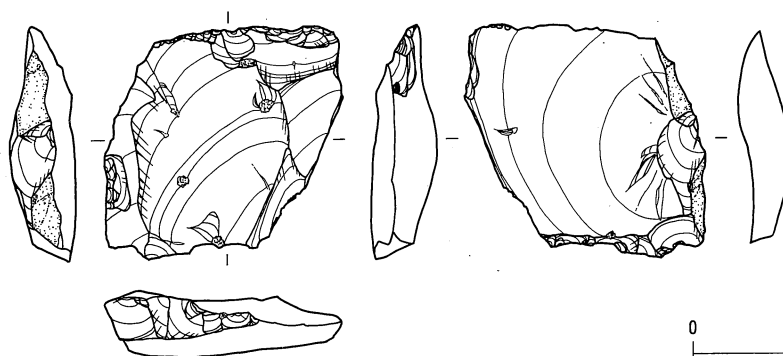
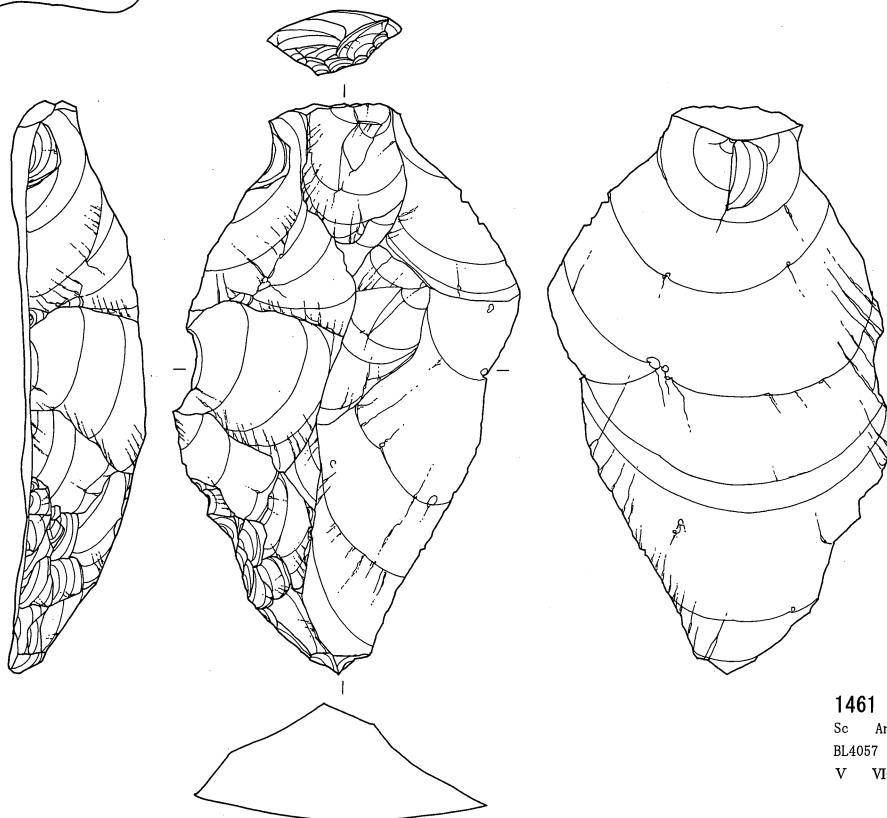

0 (3 : 4) 5cm

第4地点 石器実測図 47 (削器 6) (貫ノ木遺跡)

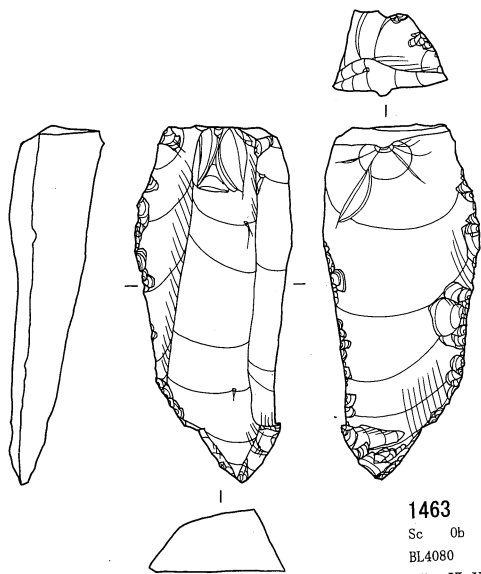

1463
 Sc Ob WDTY
 BL4080 20.59g
 Vb VI-X 832

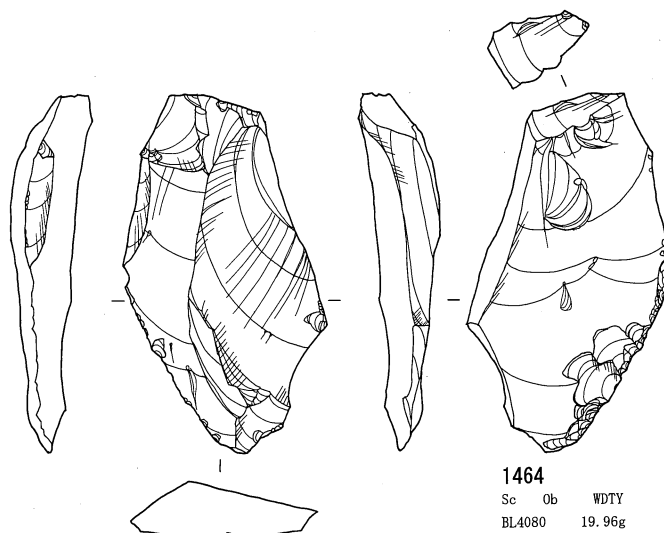

1464
 Sc Ob WDTY
 BL4080 19.96g
 Va VI-X 1938

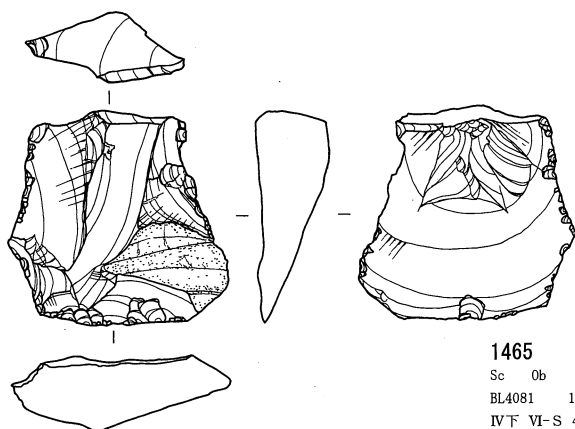

1465
 Sc Ob SWHD
 BL4081 13.73g
 IV下 VI-S 49

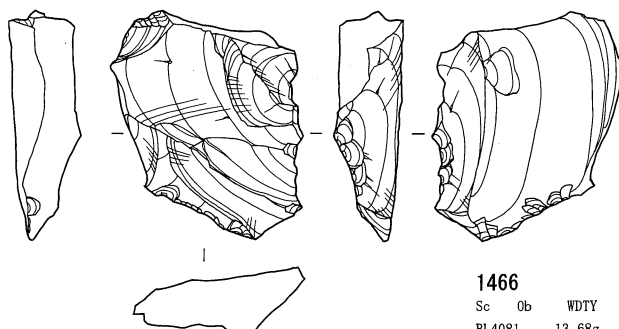

1466
 Sc Ob WDTY
 BL4081 13.68g
 Vb VI-S 503

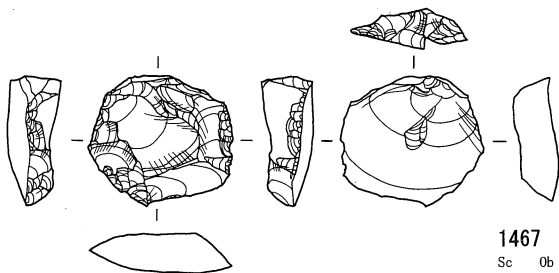

1467
 Sc Ob SWHD
 BL4086 4.69g
 IV上 VI-X 159

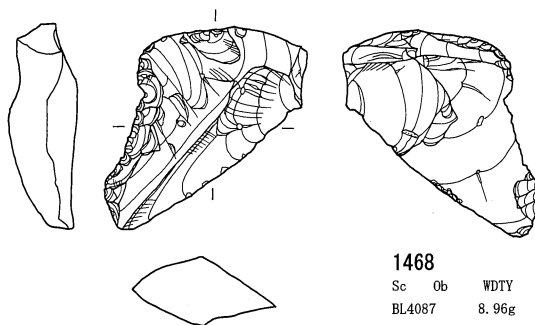

1468
 Sc Ob WDTY
 BL4087 8.96g
 Va VI-X 753

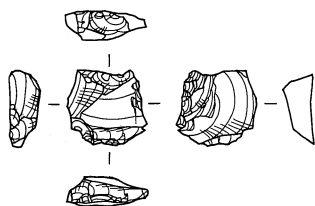

1469
 Sc Ob WDTY
 BL4087 0.92g
 IV上 VI-X 518

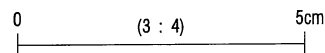

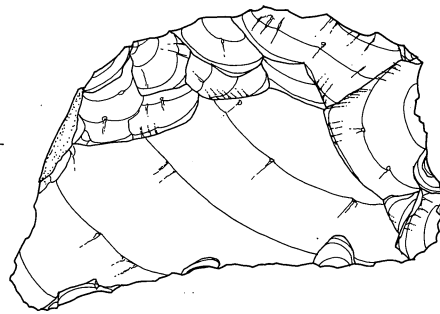
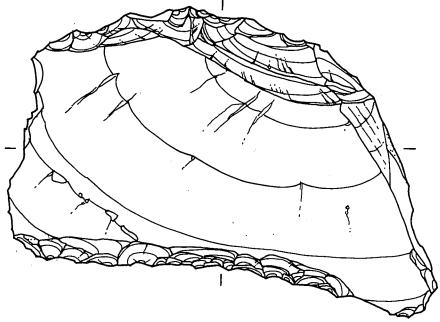
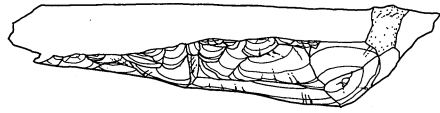

1470
Sc An
BL4088 52.34g
V a VI-X 1168

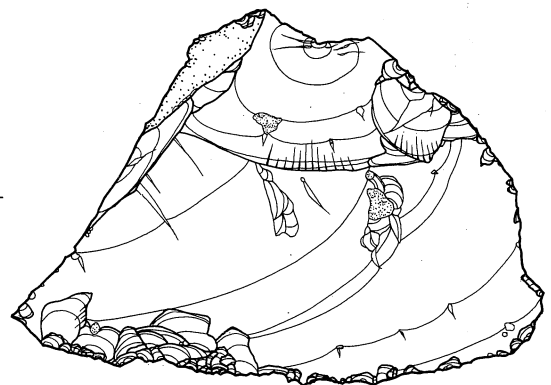
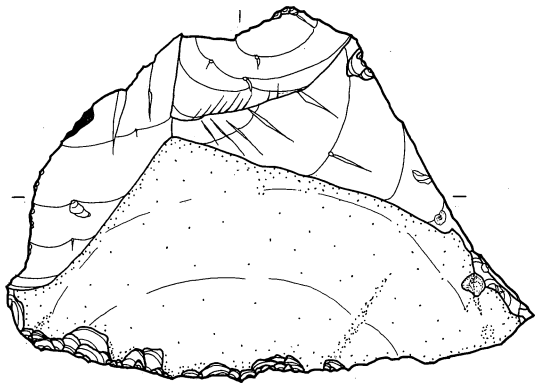
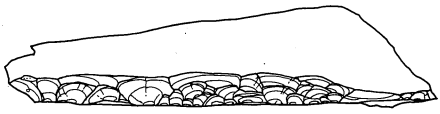

1471
Sc Ob WDTY
BL4089 97.93g
V b VI-X 1629

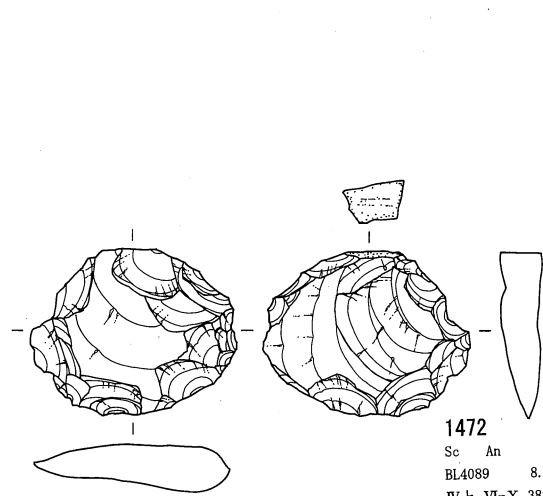

1472
Sc An
BL4089 8.24g
IV上 VI-X 382

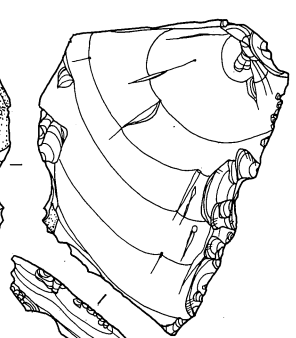
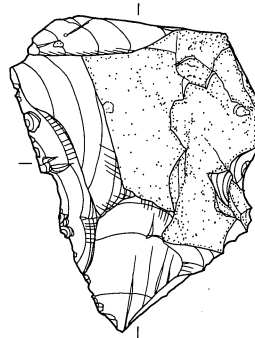

1473
Sc Ob WDTY
BL4091 28.56g
V a VI-X 2185

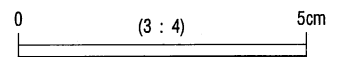

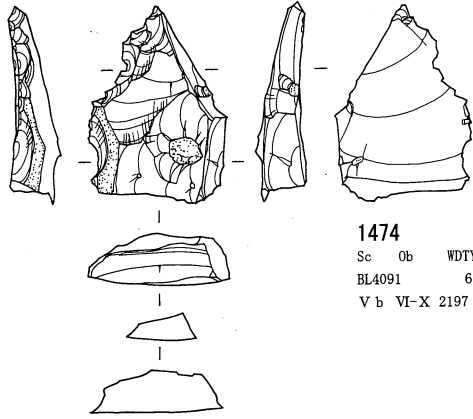

1474
 Sc Ob WDTY
 BL4091 6g
 V b VI-X 2197

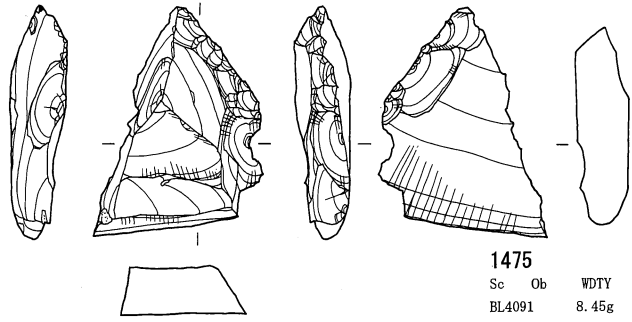

1475
 Sc Ob WDTY
 BL4091 8.45g
 V b VI-X 2334

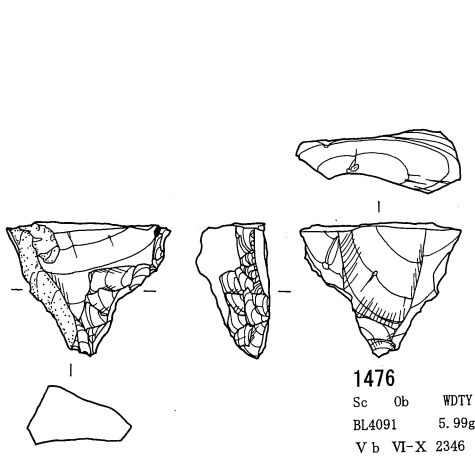

1476
 Sc Ob WDTY
 BL4091 5.99g
 V b VI-X 2346

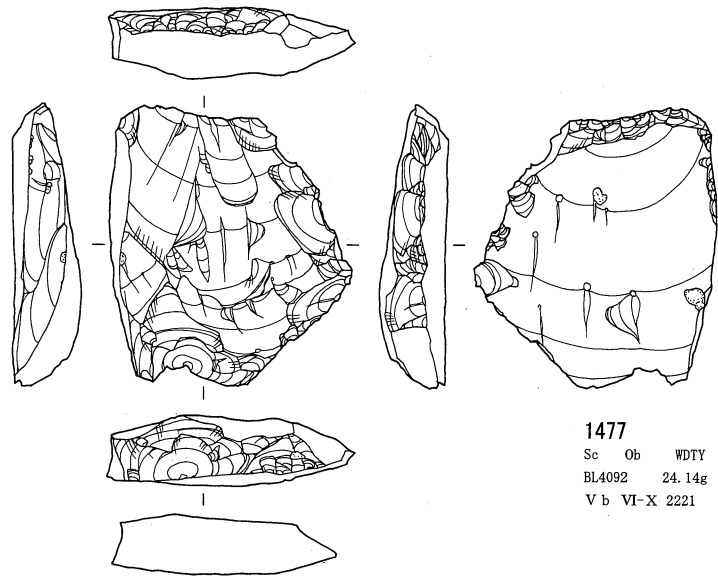

1477
 Sc Ob WDTY
 BL4092 24.14g
 V b VI-X 2221

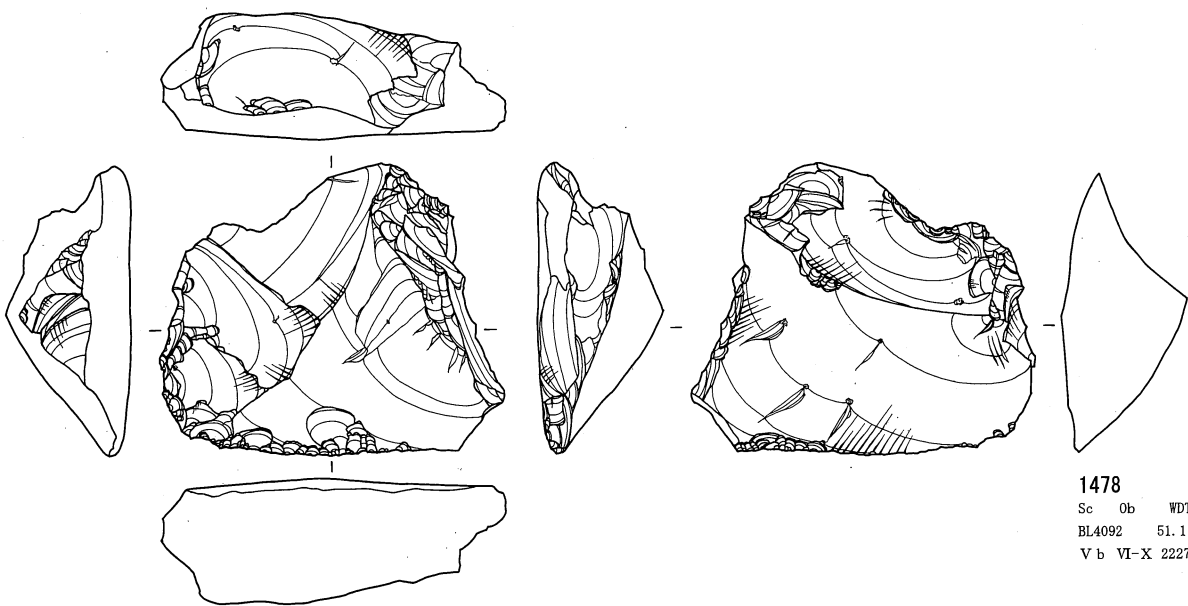

1478
 Sc Ob WDTY
 BL4092 51.11g
 V b VI-X 2227

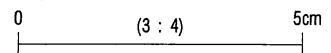

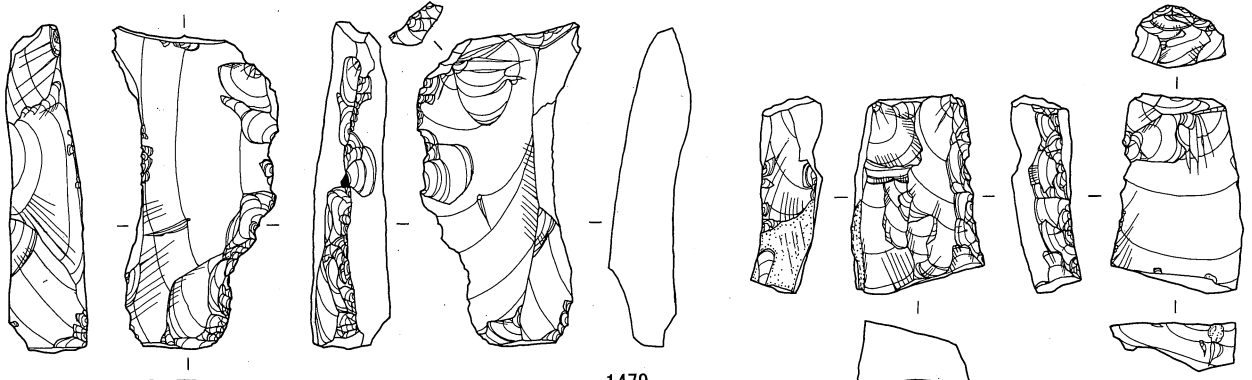

1479
Sc Ob WDTY
BL4094 18.04g
V b VI-X 1638

1480
Sc Ob WDTY
BL4094 10.7g
V b VI-X 1639

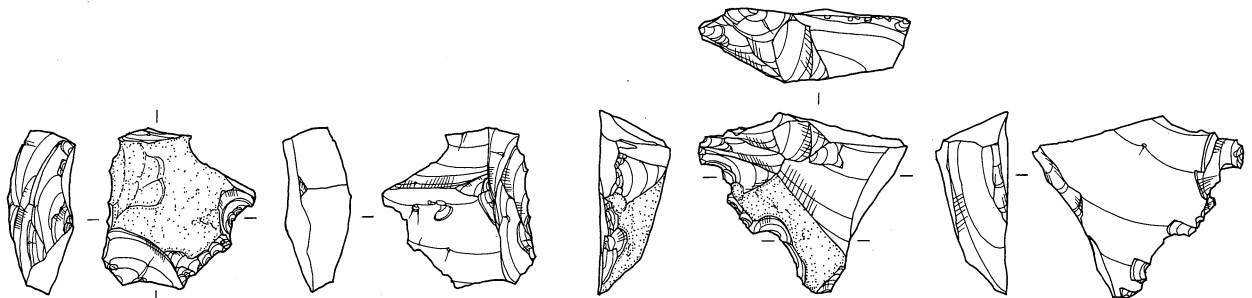

1481
Sc Ob WDTY
BL4095 6.09g
V b VI-X 2453

1482
Sc Ob WDTY
BL4095 9.02g
V b VI-X 2142

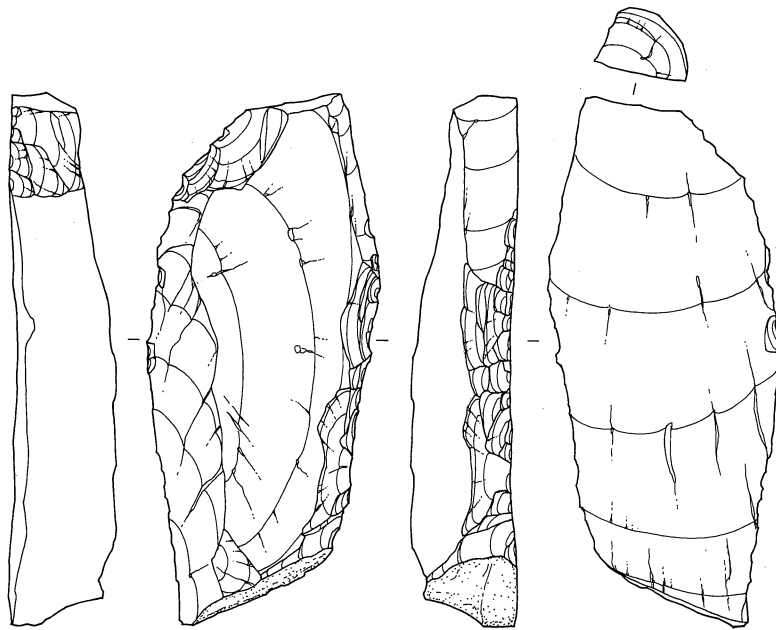

1483
Sc An
BL4099 74.53g
IV上 VI-Y 69

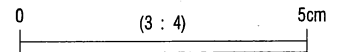

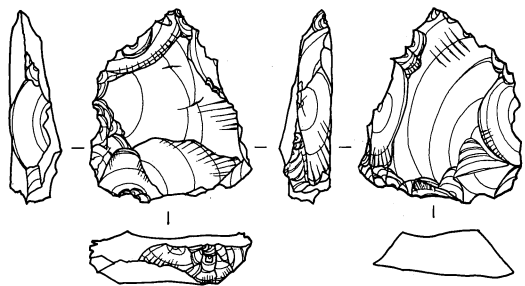

1484
DS Ob SWHD
BL4041 6.81g
V a VI-S 770

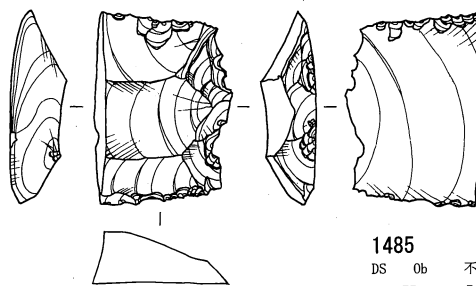

1485
DS Ob 不可
BL4077 7.6g
V b VI-W 582

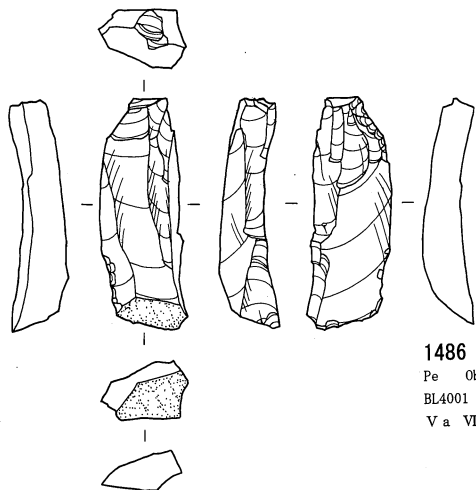

1486
Pe Ob WDTY
BL4001 4.44g
V a VI-C 69

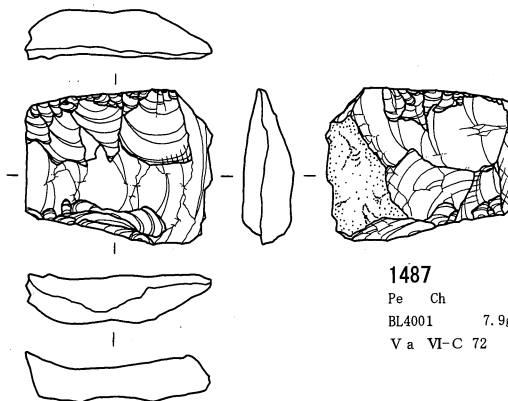

1487
Pe Ch
BL4001 7.9g
V a VI-C 72

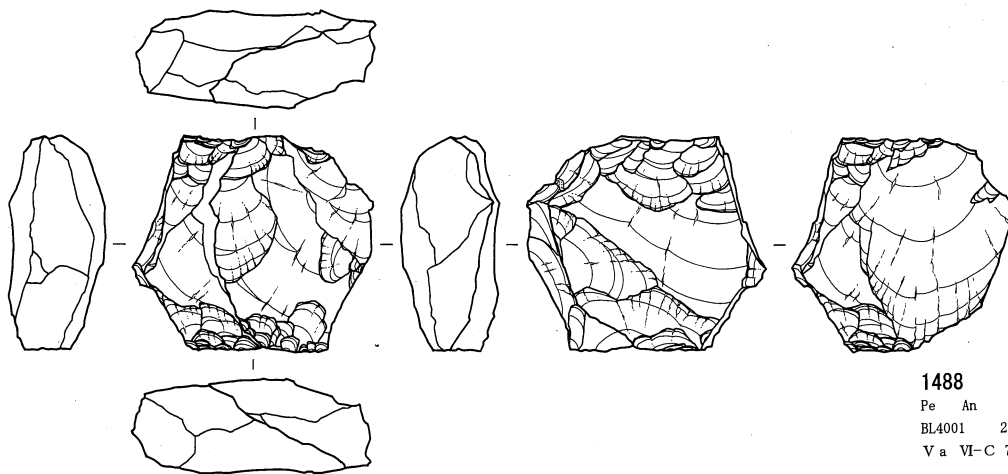

1488
Pe An
BL4001 21.75g
V a VI-C 71

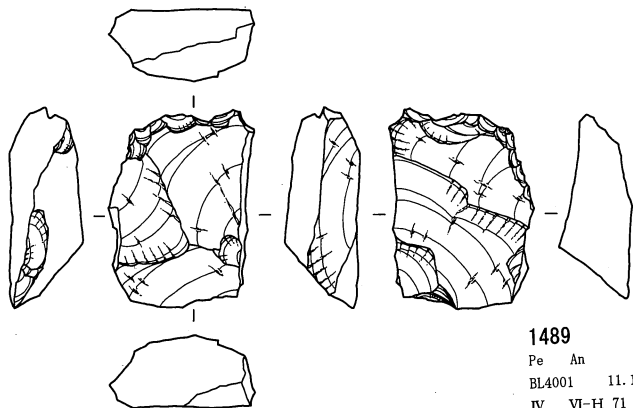

1489
Pe An
BL4001 11.14g
IV VI-H 71

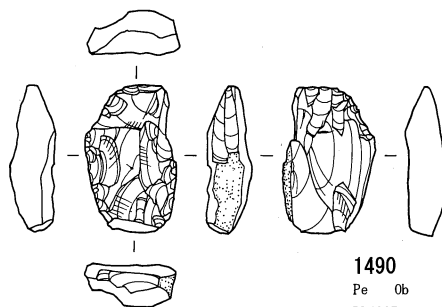

1490
Pe Ob WDTY
BL4005 2.82g
II VI-I 304

0 (3 : 4) 5cm

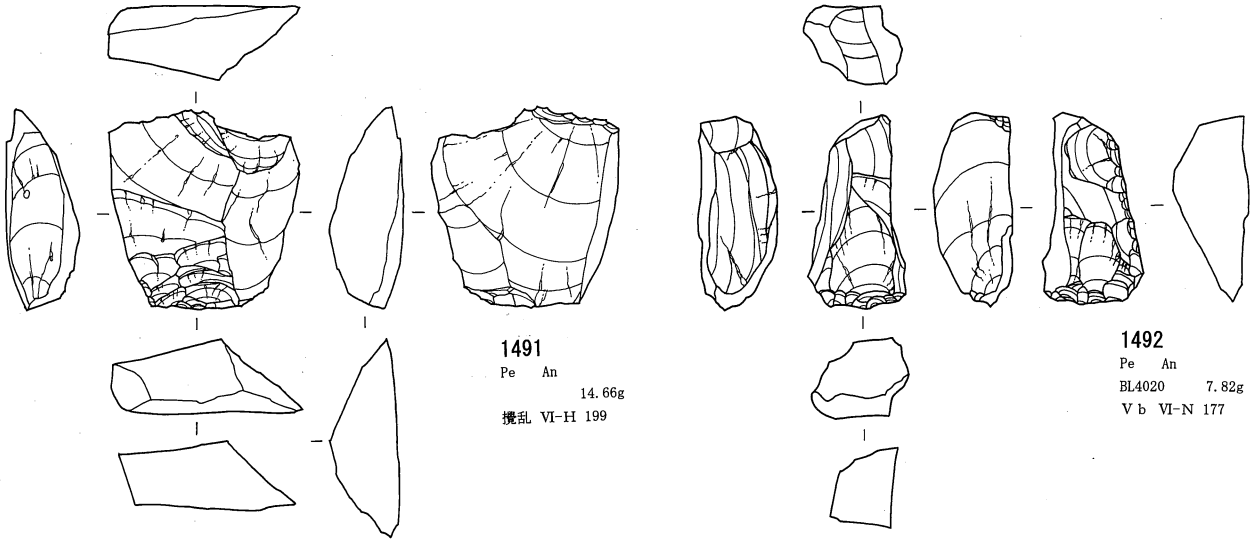

1491
Pe An
14.66g
攪乱 VI-H 199

1492
Pe An
BL4020 7.82g
V b VI-N 177

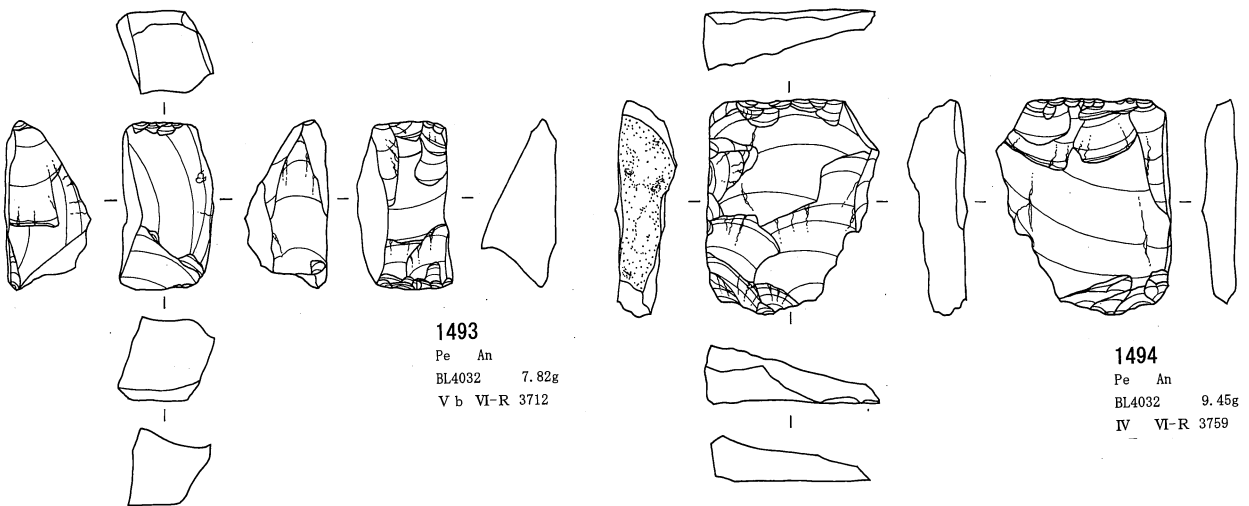

1493
Pe An
BL4032 7.82g
V b VI-R 3712

1494
Pe An
BL4032 9.45g
IV VI-R 3759

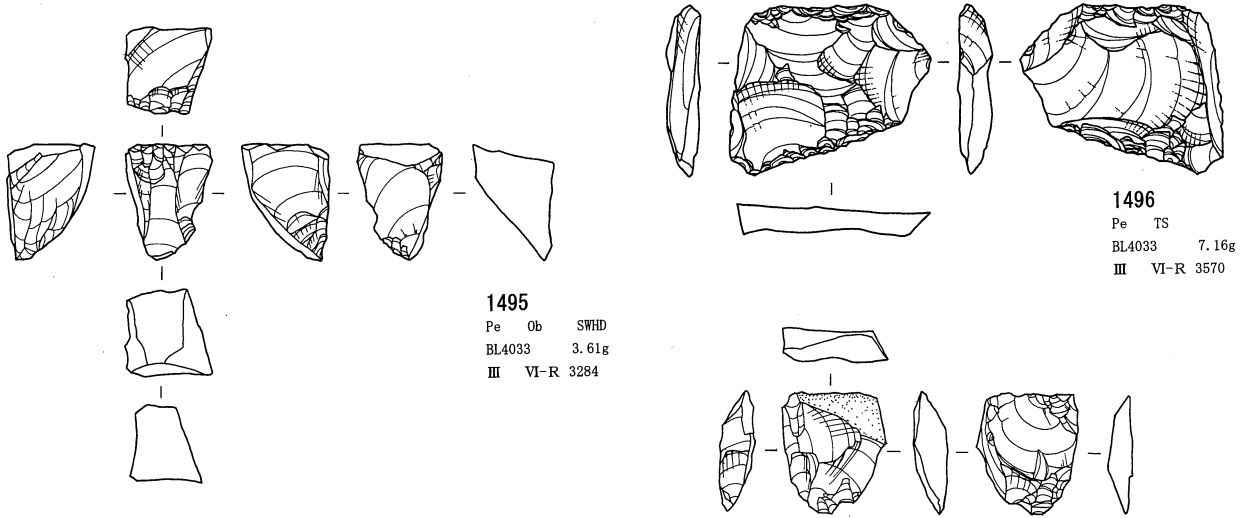

1495
Pe Ob SWHD
BL4033 3.61g
III VI-R 3284

1496
Pe TS
BL4033 7.16g
III VI-R 3570

0 (3 : 4) 5cm

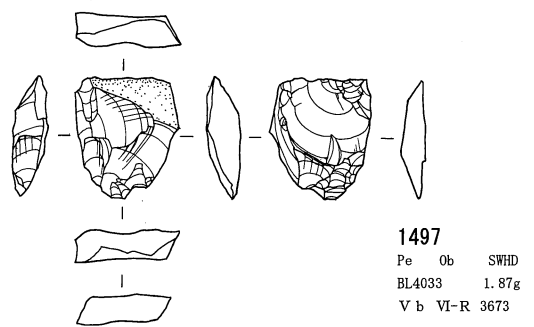

1497
Pe Ob SWHD
BL4033 1.87g
V b VI-R 3673

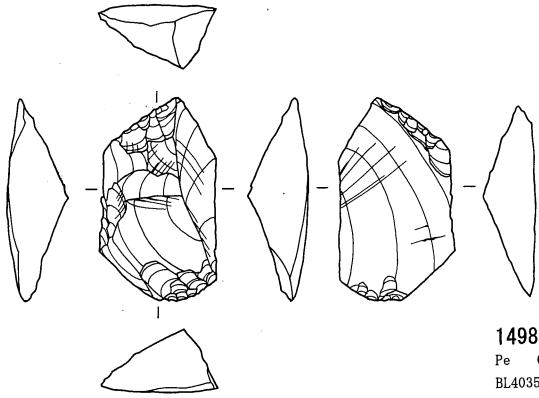

1498
Pe Ob SWHD
BL4035 5.61g
V b VI-S 1774

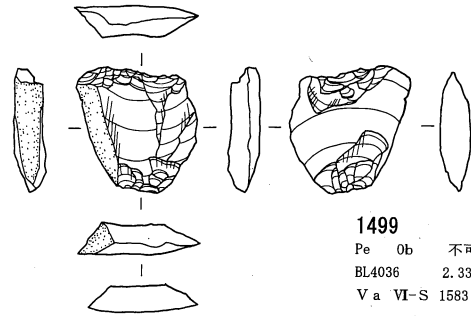

1499
Pe Ob 不可
BL4036 2.33g
V a VI-S 1583

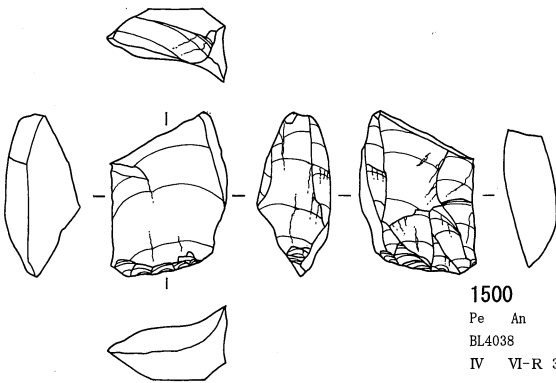

1500
Pe An
BL4038 5.99g
IV VI-R 3311

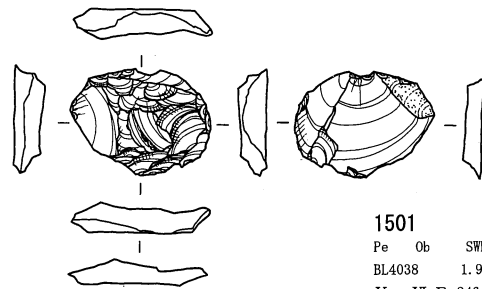

1501
Pe Ob SWHD
BL4038 1.91g
V a VI-R 3464

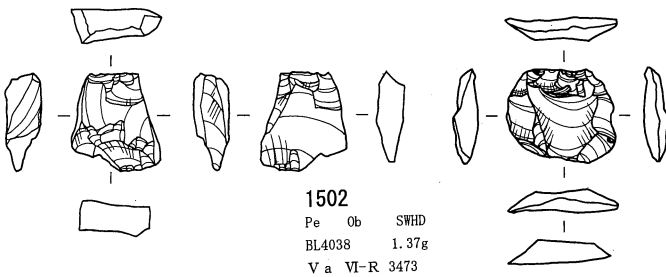

1502
Pe Ob SWHD
BL4038 1.37g
V a VI-R 3473

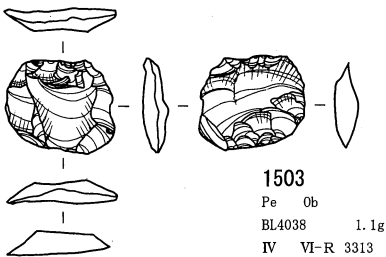

1503
Pe Ob
BL4038 1.1g
IV VI-R 3313

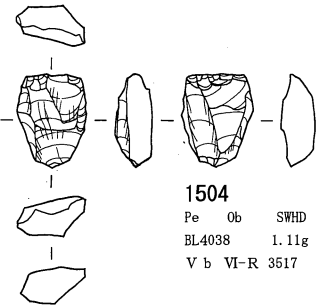

1504
Pe Ob SWHD
BL4038 1.11g
V b VI-R 3517

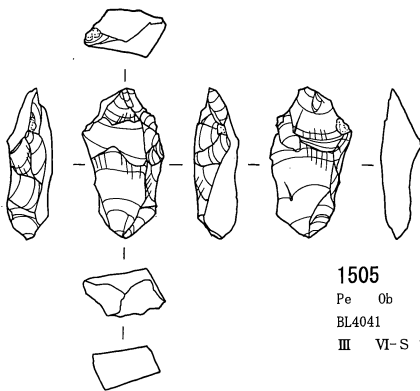

1505
Pe Ob WDTY
BL4041 2.26g
III VI-S 723

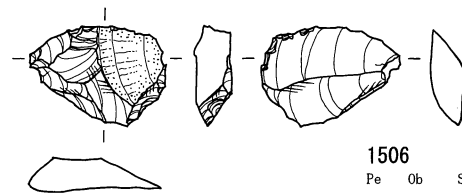

1506
Pe Ob SWHD
BL4041 1.9g
V a VI-S 814

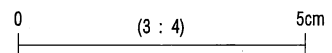

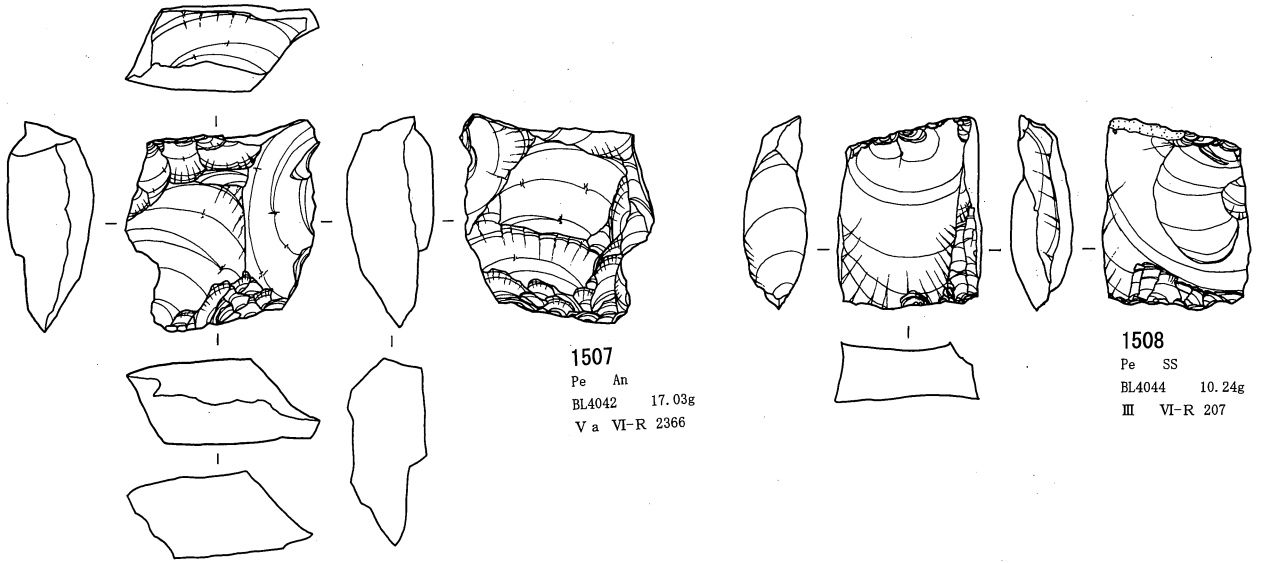

1507
Pe An
BL4042 17.03g
V a VI-R 2366

1508
Pe SS
BL4044 10.24g
III VI-R 207

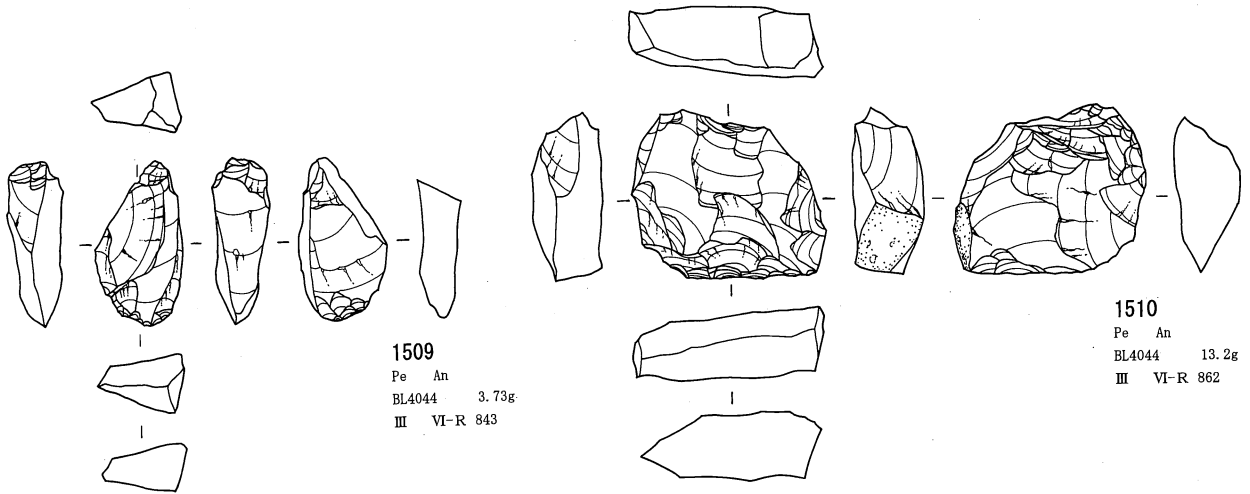

1509
Pe An
BL4044 3.73g
III VI-R 843

1510
Pe An
BL4044 13.2g
III VI-R 862

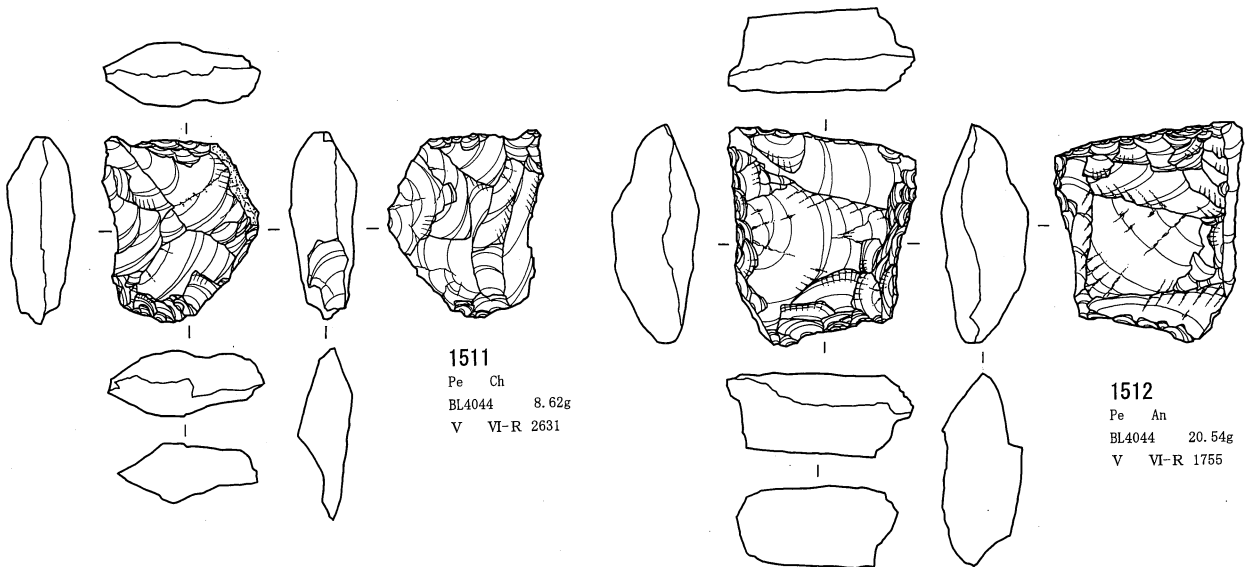

1511
Pe Ch
BL4044 8.62g
V VI-R 2631

1512
Pe An
BL4044 20.54g
V VI-R 1755

0 (3 : 4) 5cm

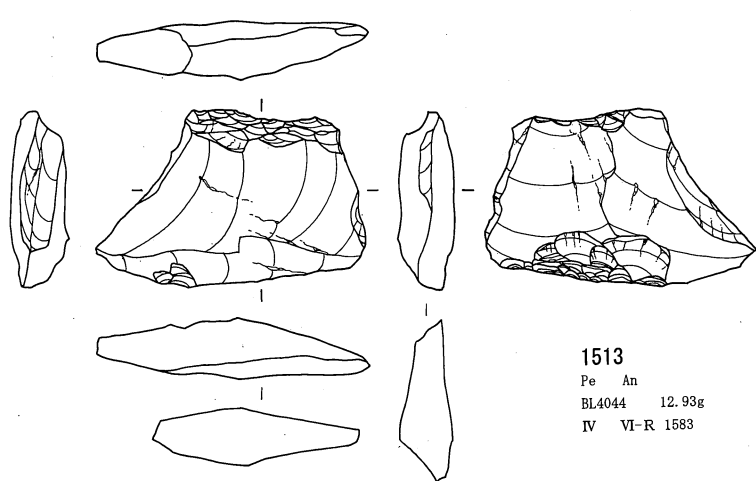

1513
Pe An
BL4044 12.93g
IV VI-R 1583

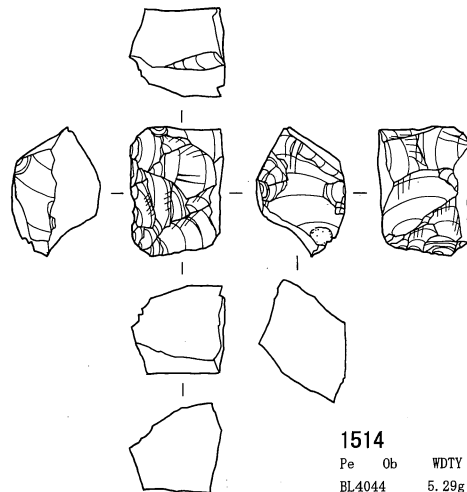

1514
Pe Ob WDTY
BL4044 5.29g
III VI-R 3288

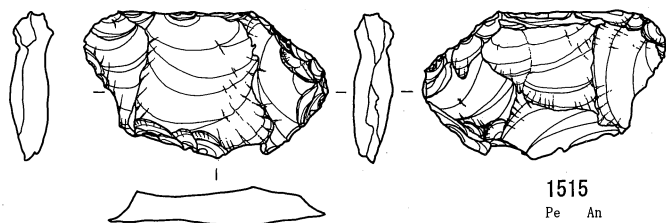

1515
Pe An
BL4044 6.74g
IV VI-R 1519

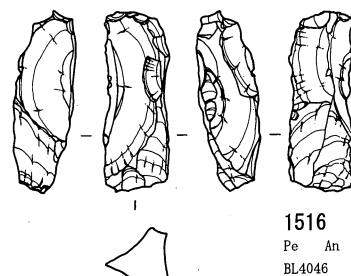

1516
Pe An
BL4046 4.7g
V VI-R 3078

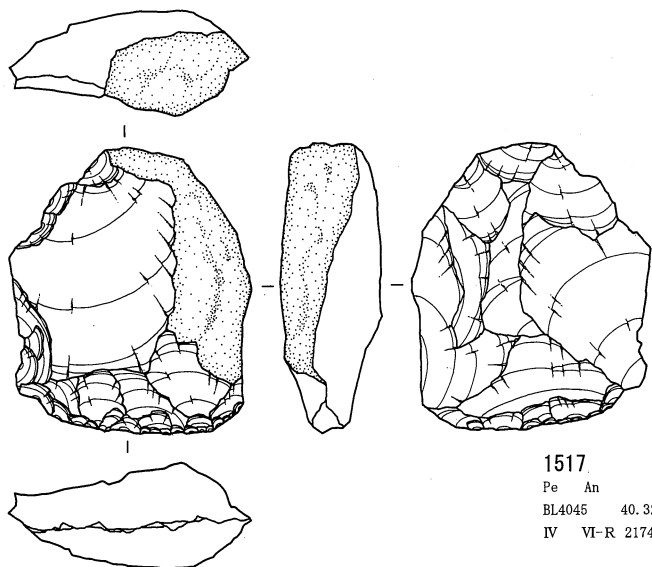

1517
Pe An
BL4045 40.32g
IV VI-R 2174

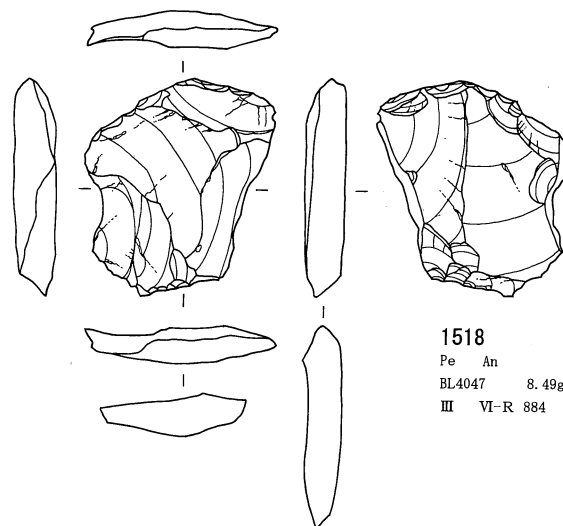

1518
Pe An
BL4047 8.49g
III VI-R 884

0 (3 : 4) 5cm

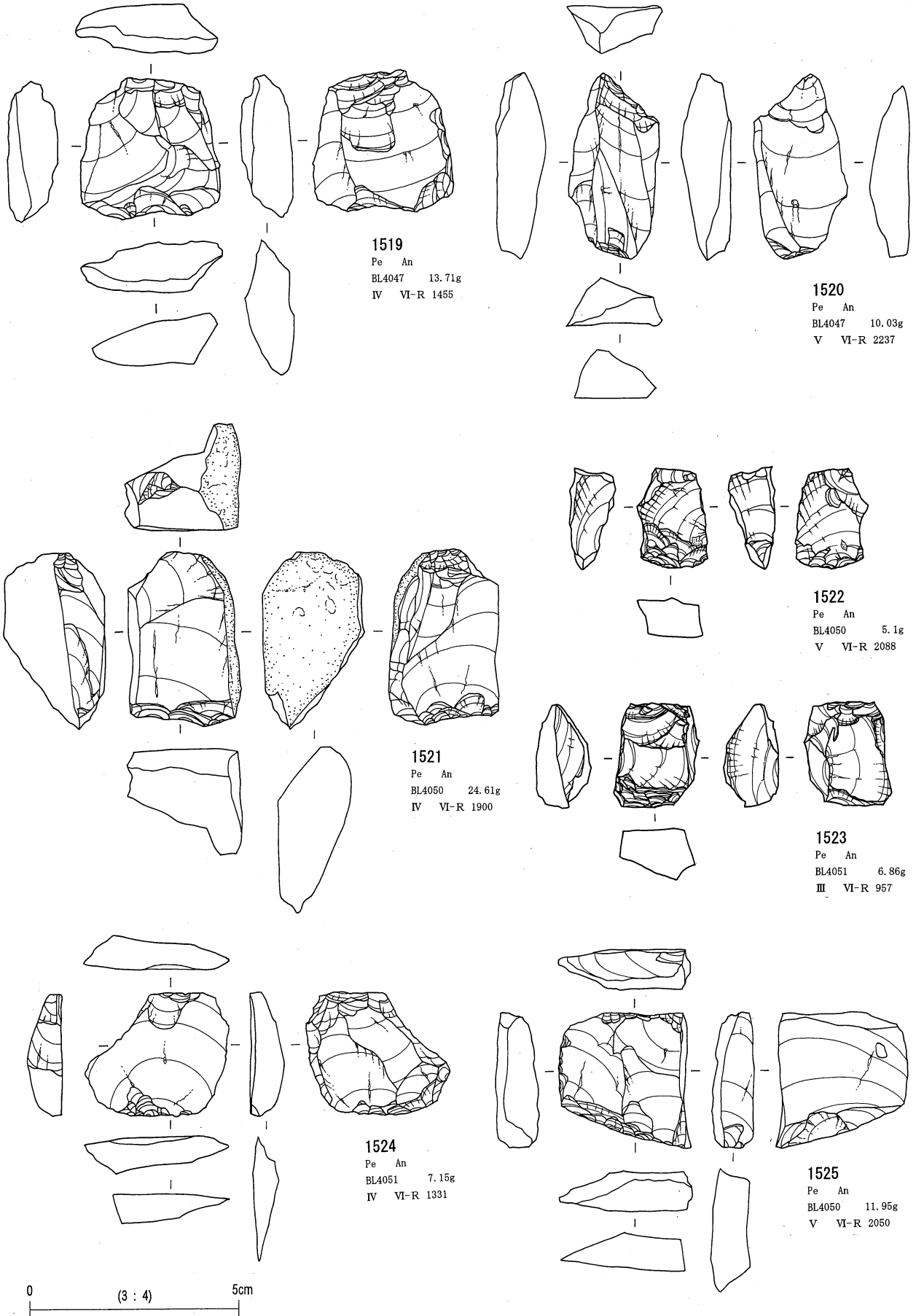

第4地点 石器実測図 57 (楔形石器 6) (貫ノ木遺跡)

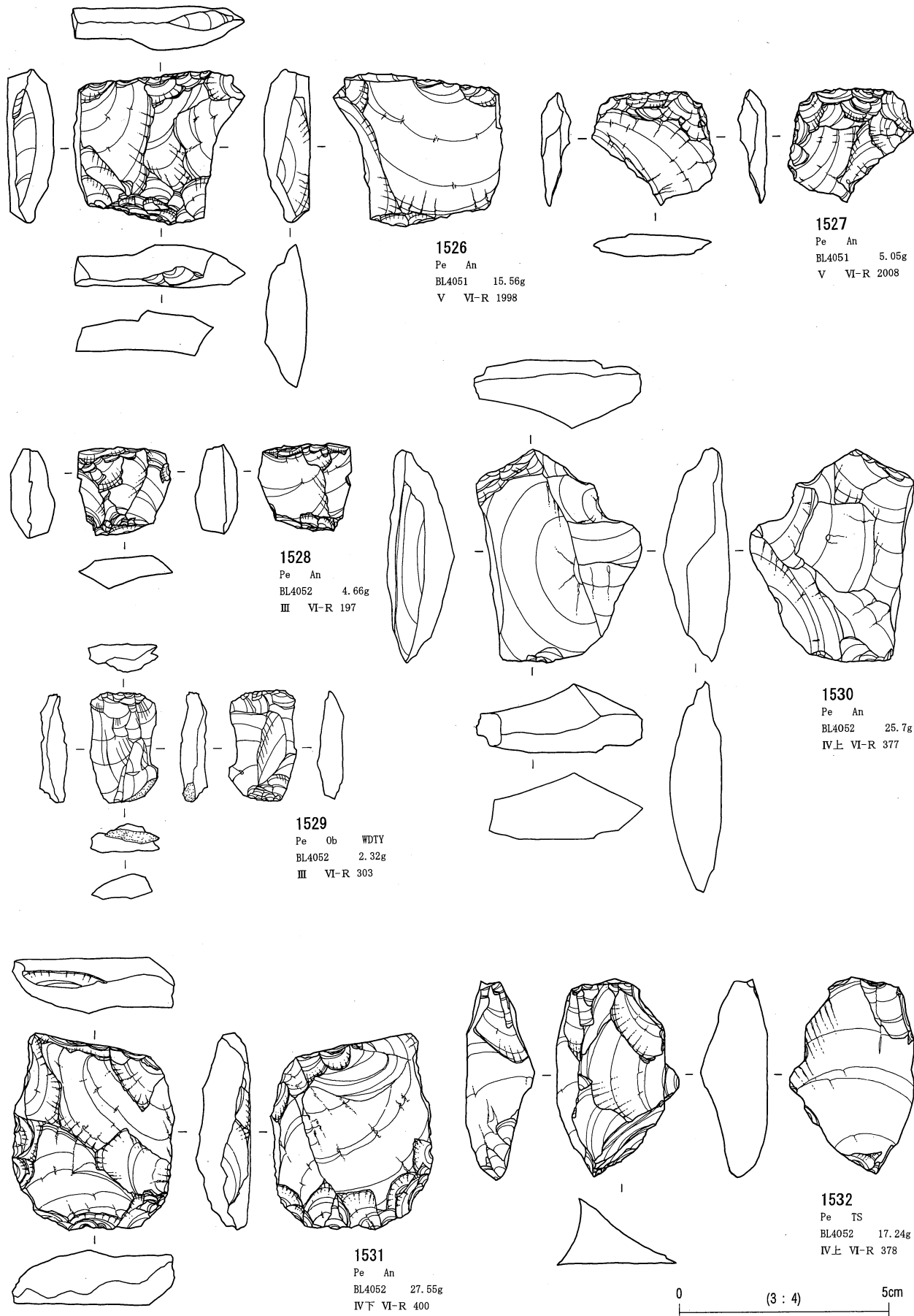

第4地点 石器実測図 58 (楔形石器 7) (貫ノ木遺跡)

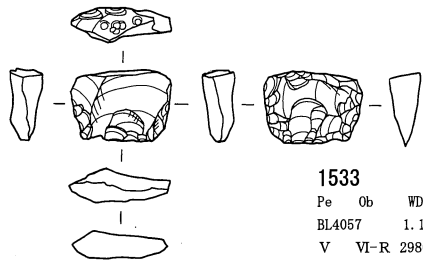

1533
Pe Ob WDTK
BL4057 1.13g
V VI-R 2980

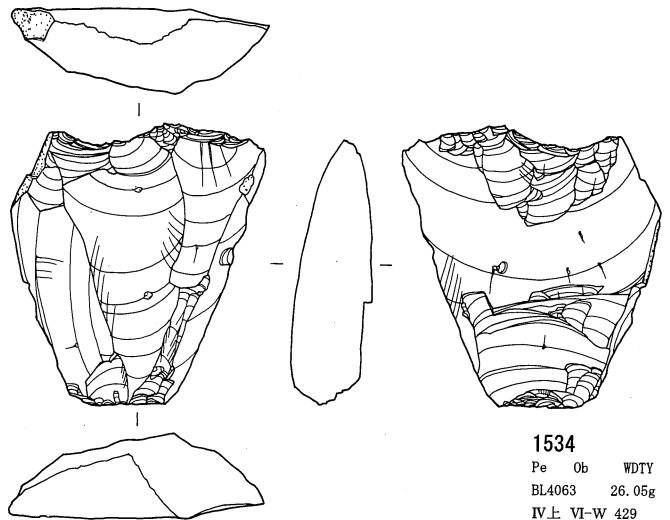

1534
Pe Ob WDTY
BL4063 26.05g
IV上 VI-W 429

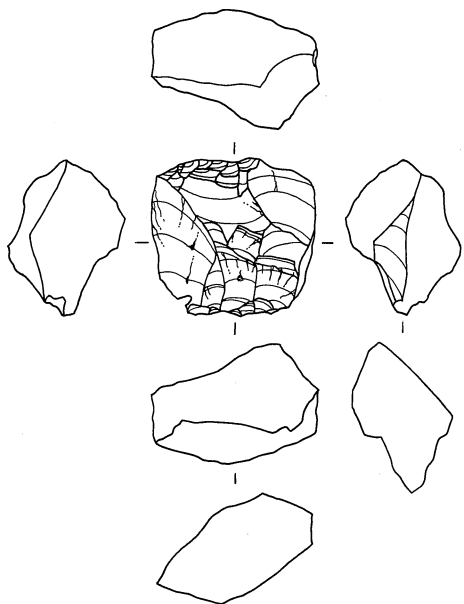

1535
Pe An
BL4063 12.84g
V a VI-W 1103

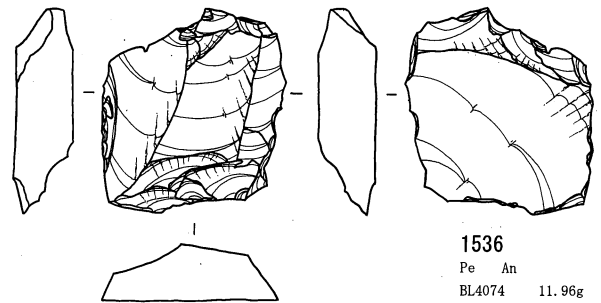

1536
Pe An
BL4074 11.96g
IV F VI-R 559

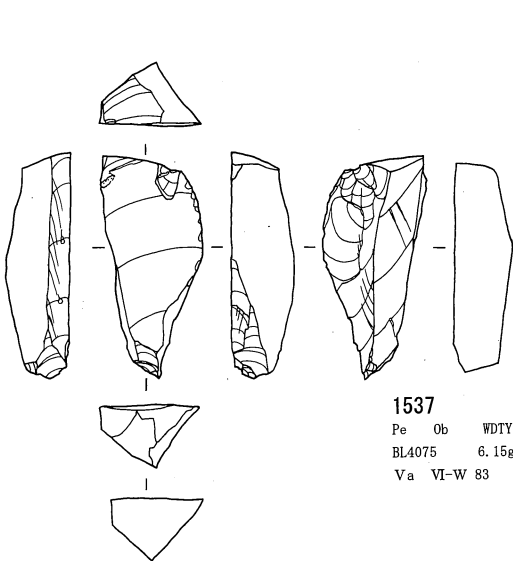

1537
Pe Ob WDTY
BL4075 6.15g
V a VI-W 83

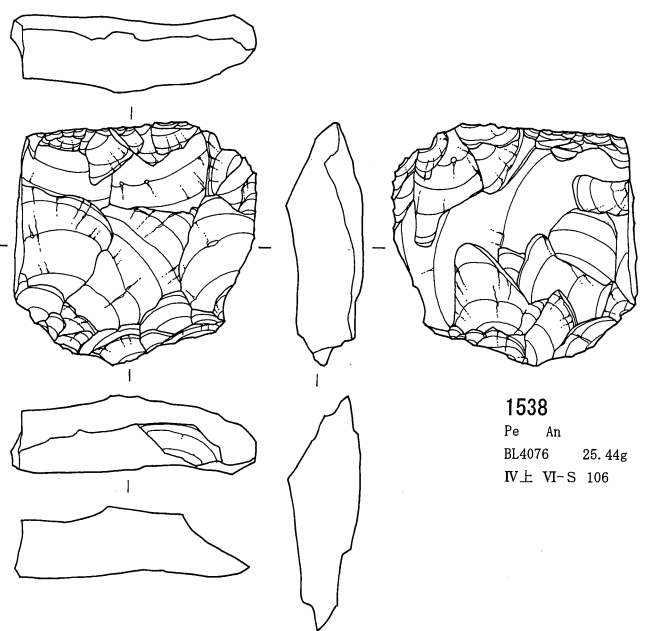

1538
Pe An
BL4076 25.44g
IV上 VI-S 106

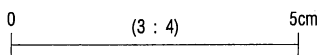

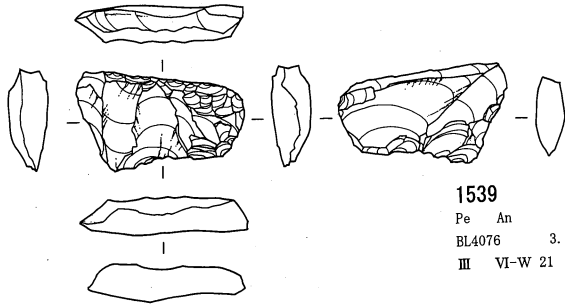

1539
Pe An
BL4076 3.5g
III VI-W 21

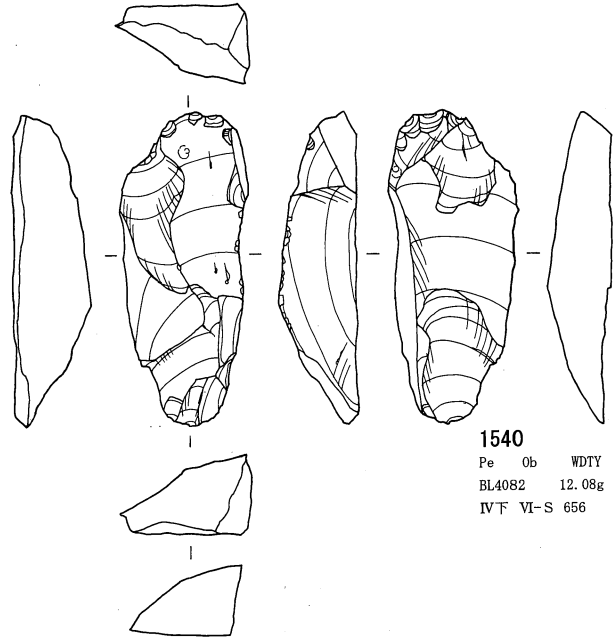

1540
Pe Ob WDTY
BL4082 12.08g
IV下 VI-S 656

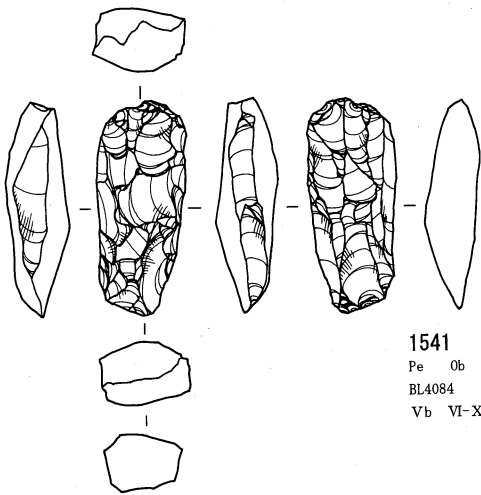

1541
Pe Ob SWHD
BL4084 5.79g
Vb VI-X 803

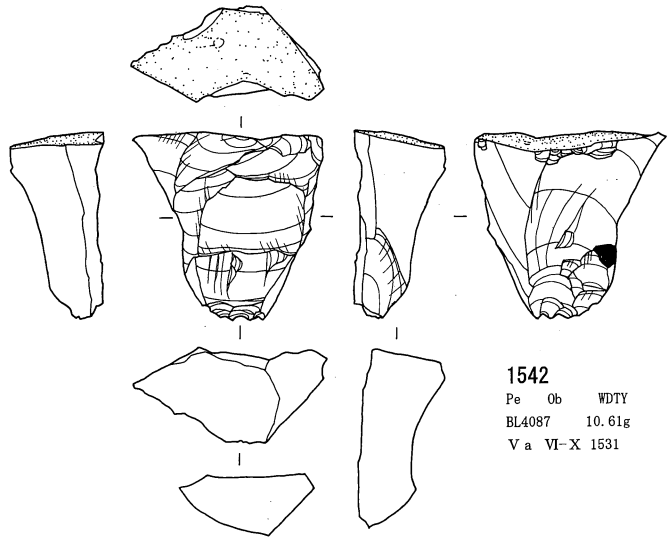

1542
Pe Ob WDTY
BL4087 10.61g
Va VI-X 1531

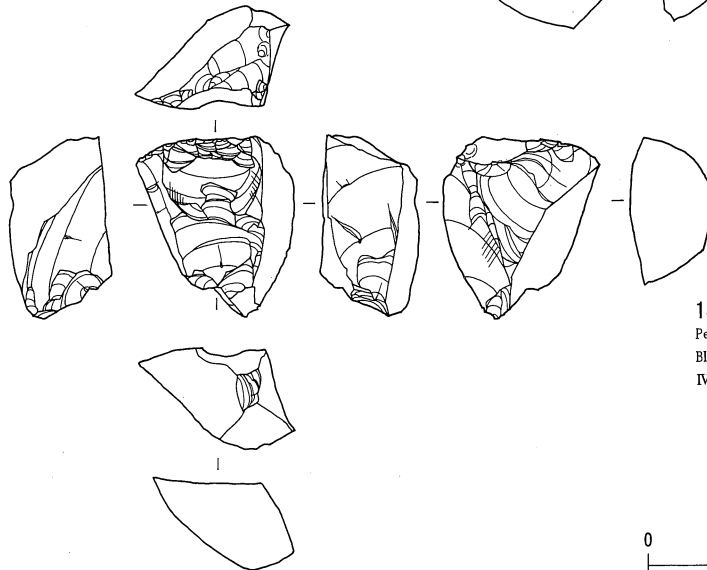

1543
Pe Ob WDTY
BL4093 11.05g
IV上 VI-X 501

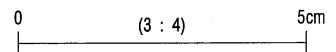

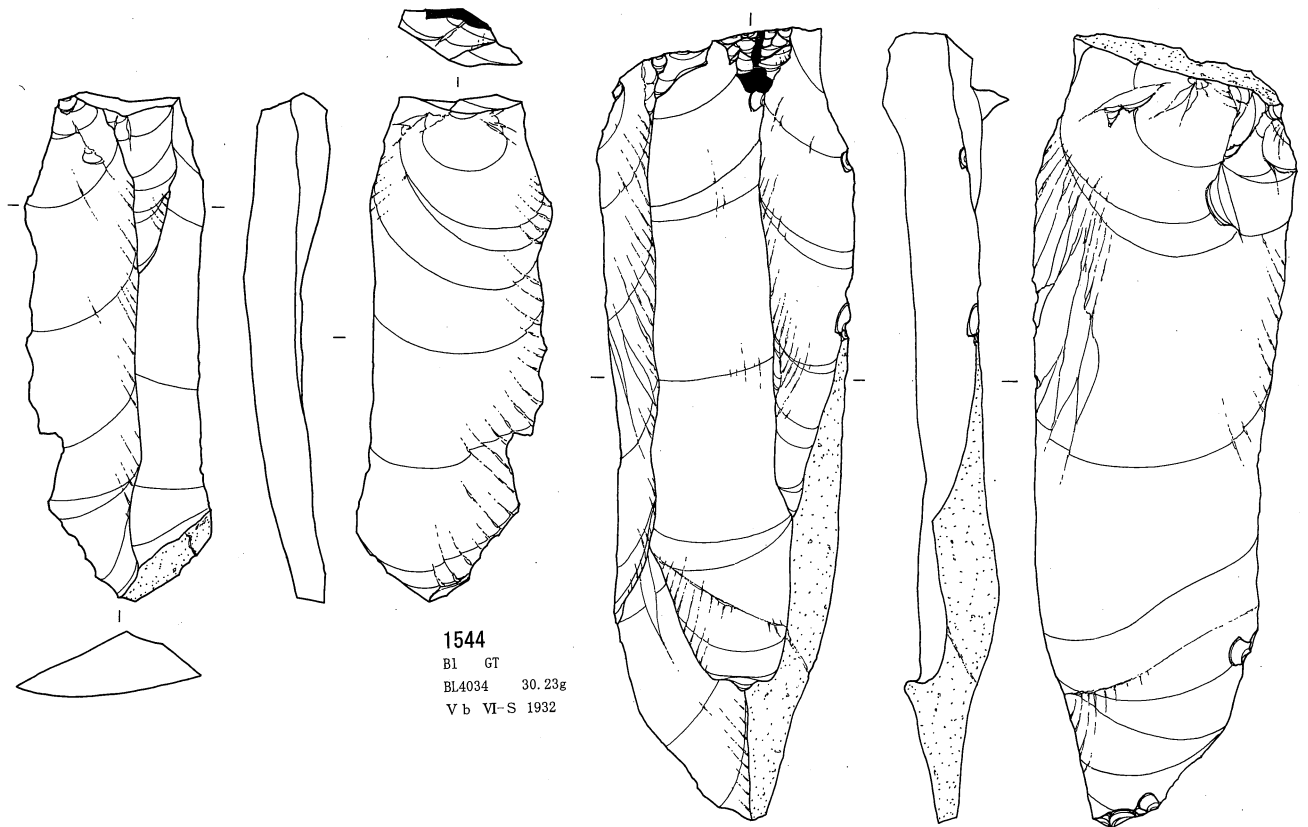

1544
 B1 GT
 BL4034 30.23g
 V b VI-S 1932

1545
 B1 TS
 BL4036 101.55g
 V b VI-S 1436

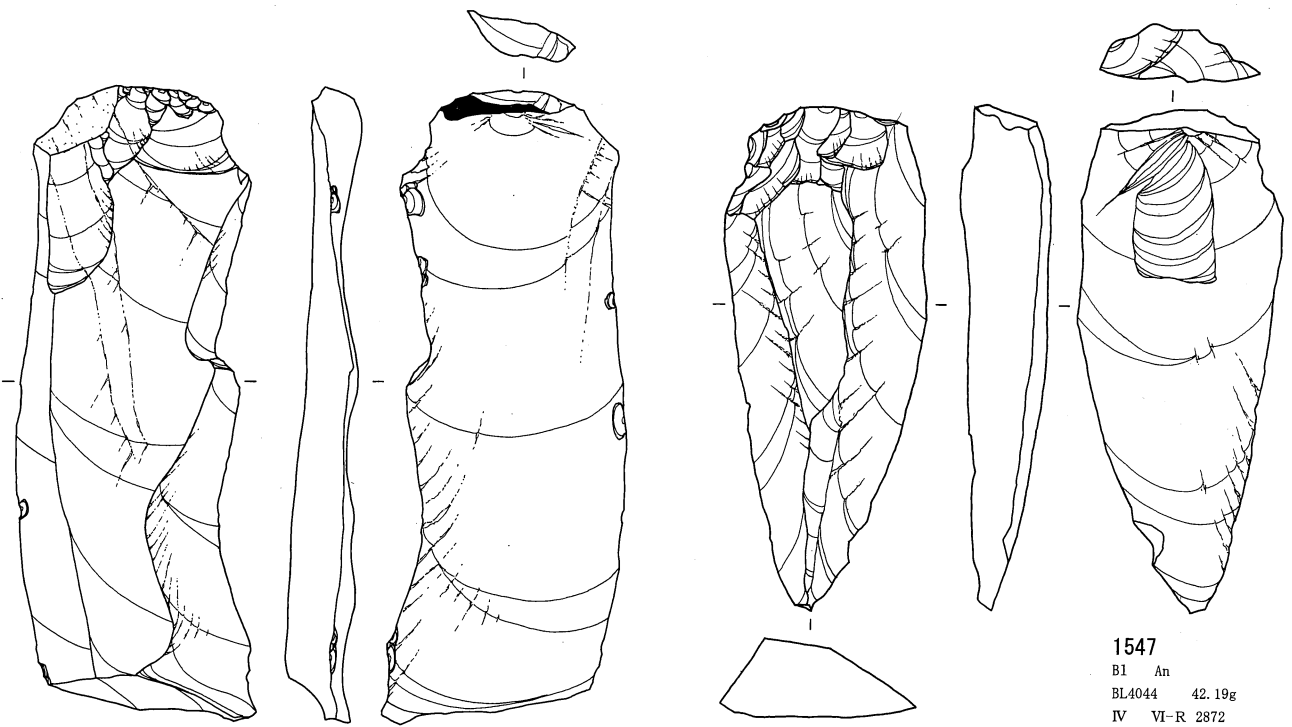

1546
 B1 Sh
 BL4036 56.97g
 V a VI-S 1331

1547
 B1 An
 BL4044 42.19g
 IV VI-R 2872

0 (3 : 4) 5cm

第4地点 石器実測図 61 (石刃) (貫ノ木遺跡)

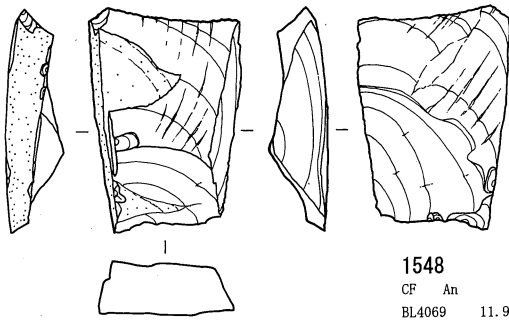

1548
CF An
BL4069 11.97g
V a VI-W 4255

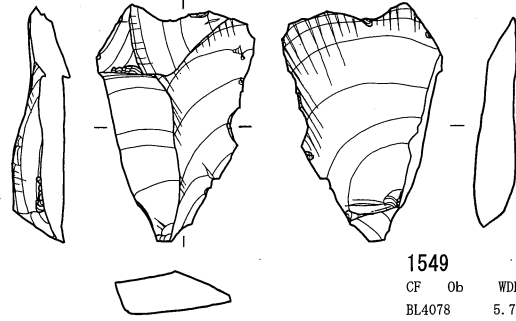

1549
CF Ob WDKB
BL4078 5.72g
V a VI-X 660

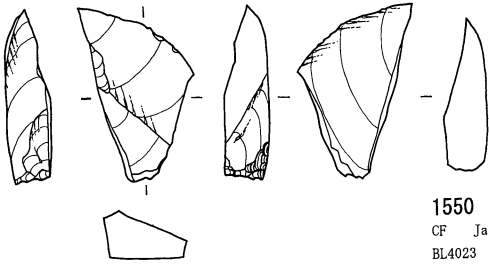

1550
CF Ja
BL4023 3.74g
V a VI-M 251

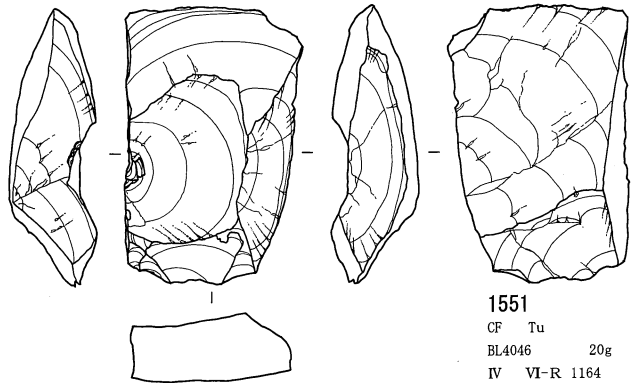

1551
CF Tu
BL4046 20g
IV VI-R 1164

0 (3 : 4) 5cm

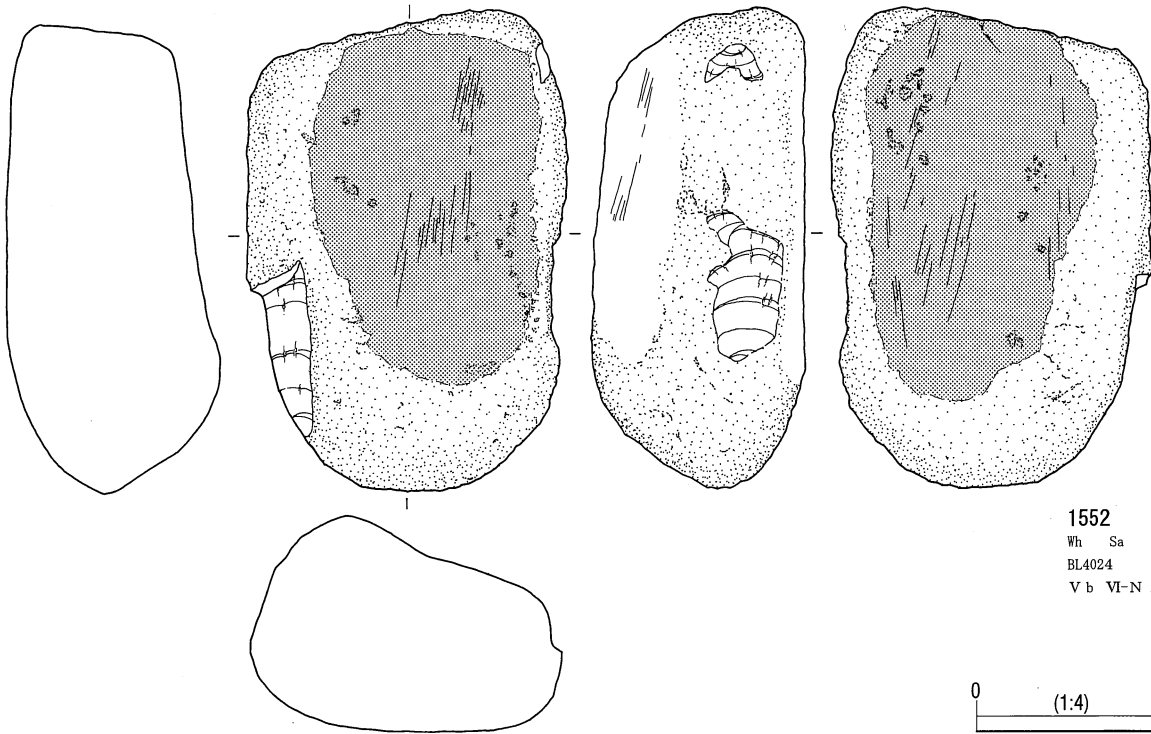

1552
Wh Sa
BL4024 2800g
V b VI-N 267

0 (1:4) 10cm

第4地点 石器実測図 62 (折断剥片・砥石1) (貫ノ木遺跡)

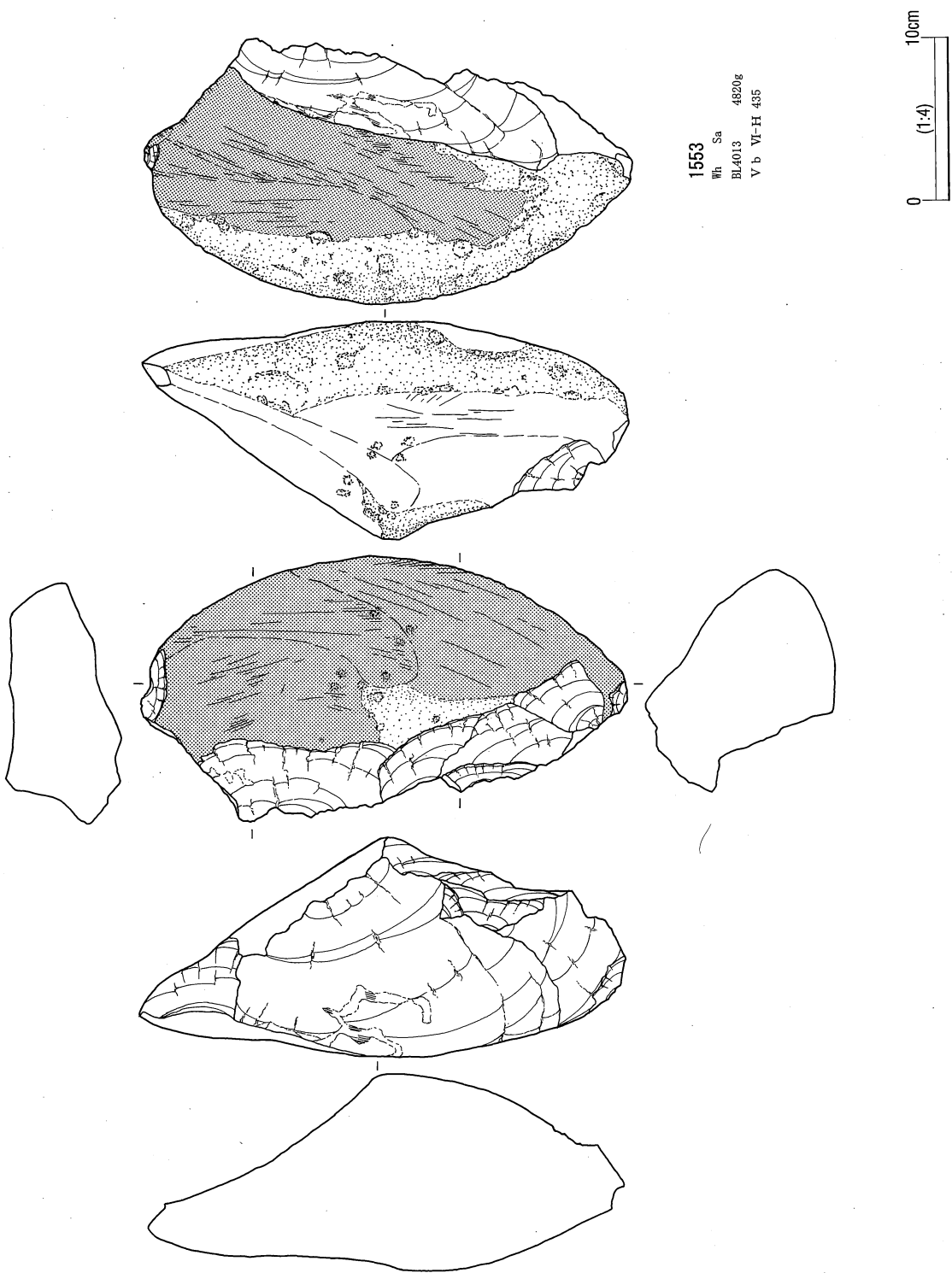

第4地点 石器実測図 63 (砥石 2) (貫ノ木遺跡)

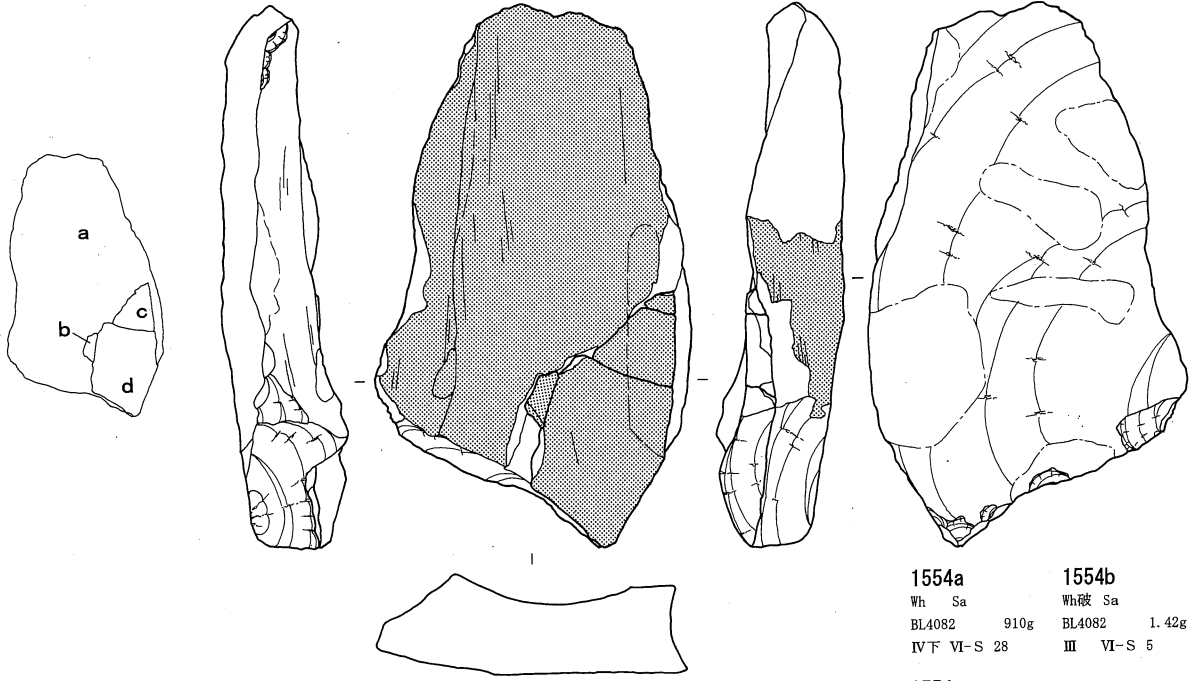

1554a	Wh Sa		1554b	Wh破 Sa
BL4082	910g		BL4082	1.42g
IV下 VI-S 28			III VI-S 5	
1554c	Wh破 Sa		1554d	Wh破 Sa
BL4082	12.56g		BL4082	53.49g
IV下 VI-S 30			IV下 VI-S 29	

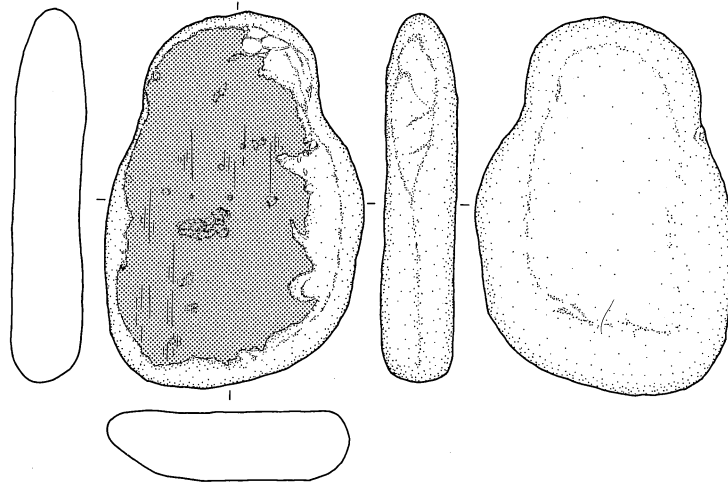

1555
Wh Sa
BL4067 1495g
V a VI-W 2850

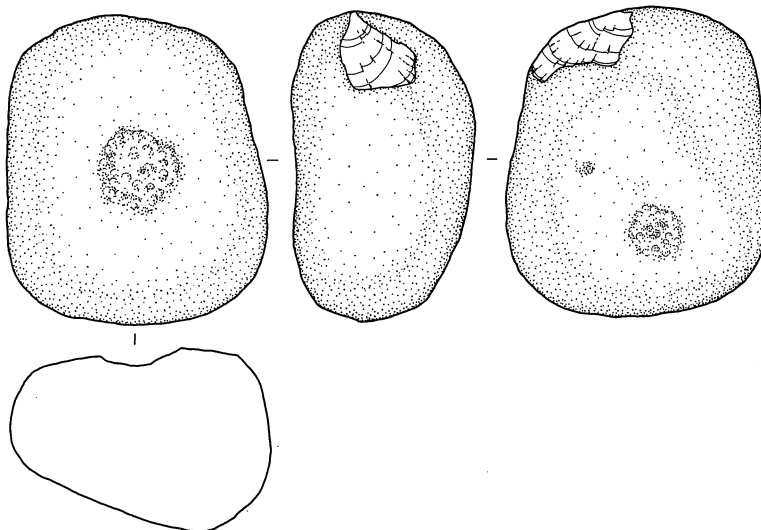

1556
Ps 安山岩
BL4039 1470g
V b VI-S 1289

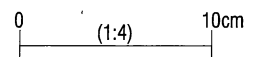

第4地点 石器実測図 64 (砥石3・凹石) (貫ノ木遺跡)

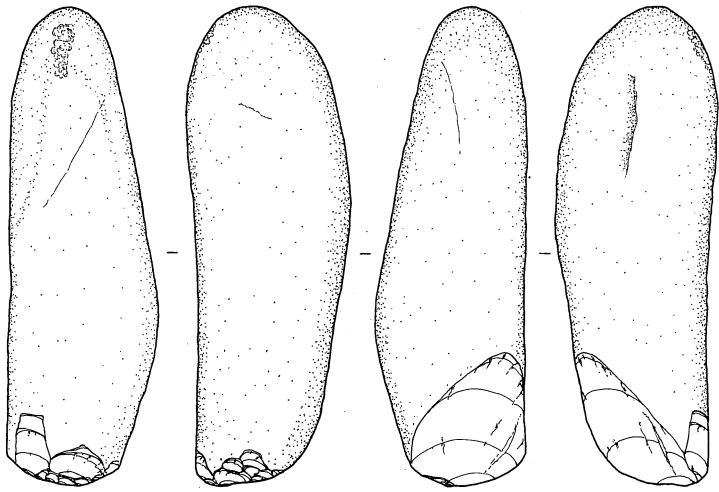

1557
Ha Sa
BL4008 1050g
Va VI-H 137

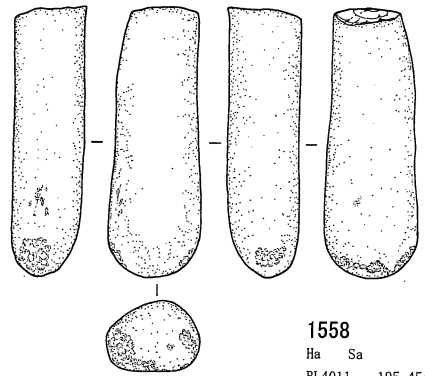

1558
Ha Sa
BL4011 195.45g
Vb SH115 46

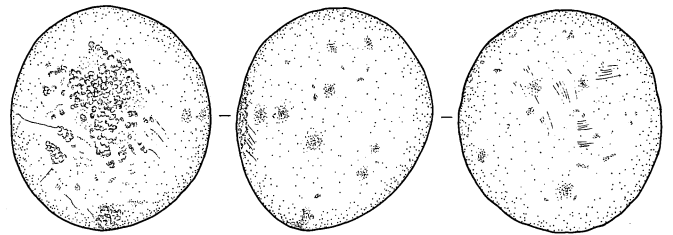
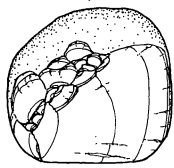

1559
Ha Tu
BL4039 860g
Va VI-S 1262

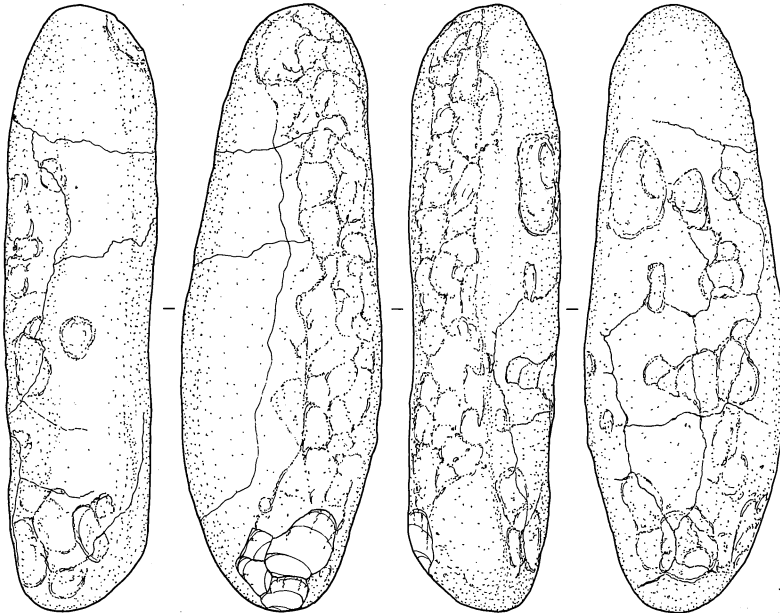
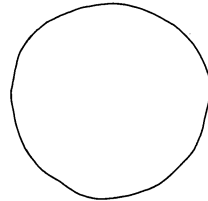
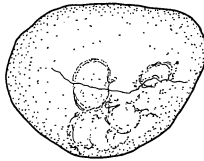

1560
Ha 安山岩
BL4048 1645g
IV VI-R 2813

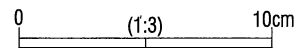
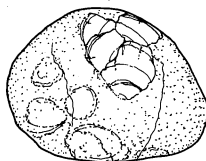

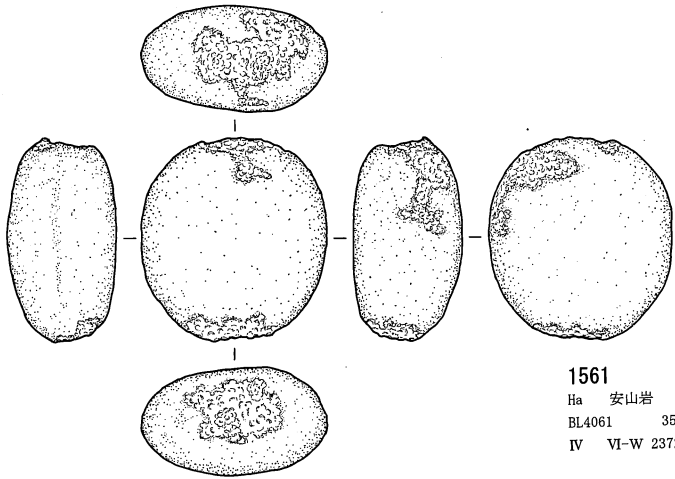

1561
Ha 安山岩
BL4061 350g
IV VI-W 2372

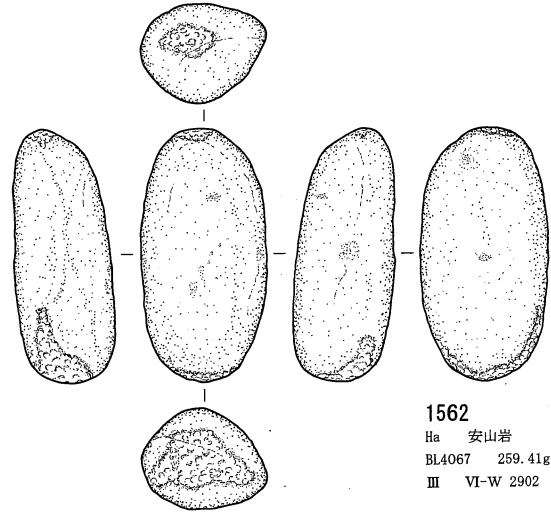

1562
Ha 安山岩
BL4067 259.41g
III VI-W 2902

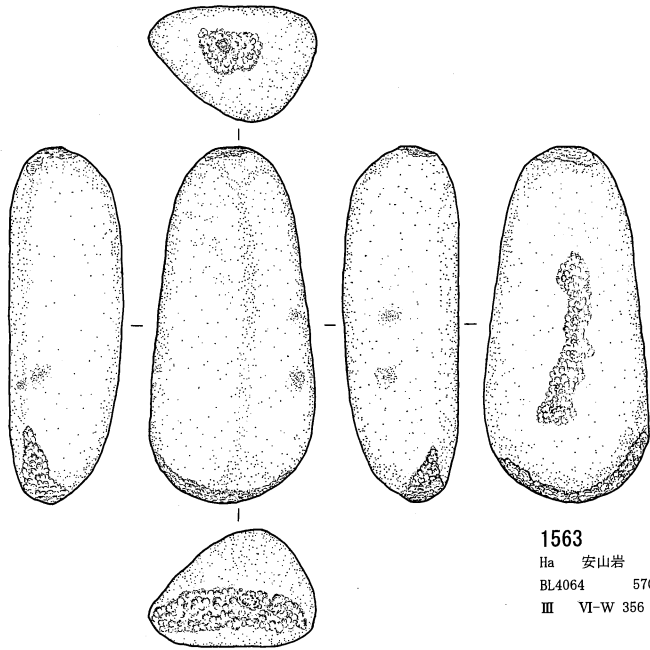

1563
Ha 安山岩
BL4064 570g
III VI-W 356

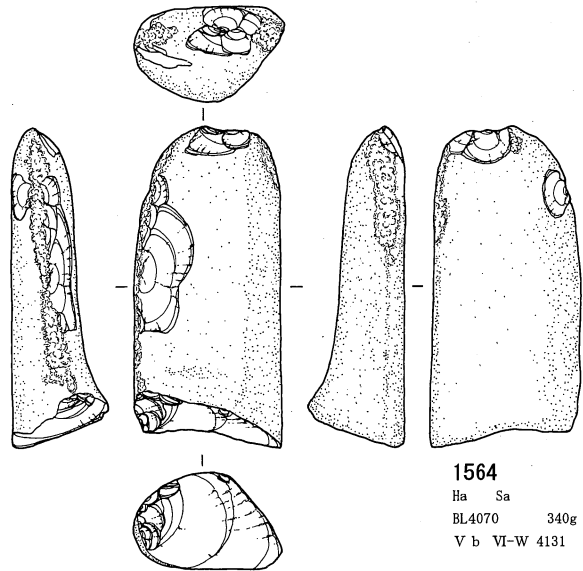

1564
Ha Sa
BL4070 340g
V b VI-W 4131

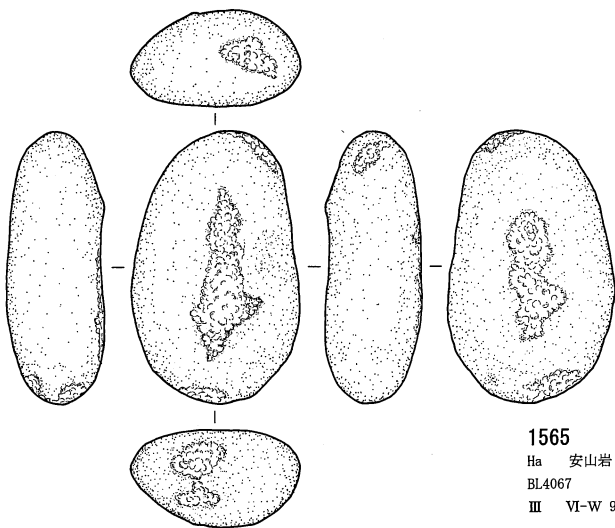

1565
Ha 安山岩
BL4067 370g
III VI-W 912

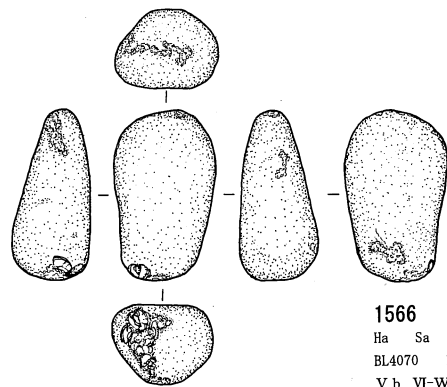

1566
Ha Sa
BL4070 120.53g
V b VI-W 4158

0 (1:3) 10cm

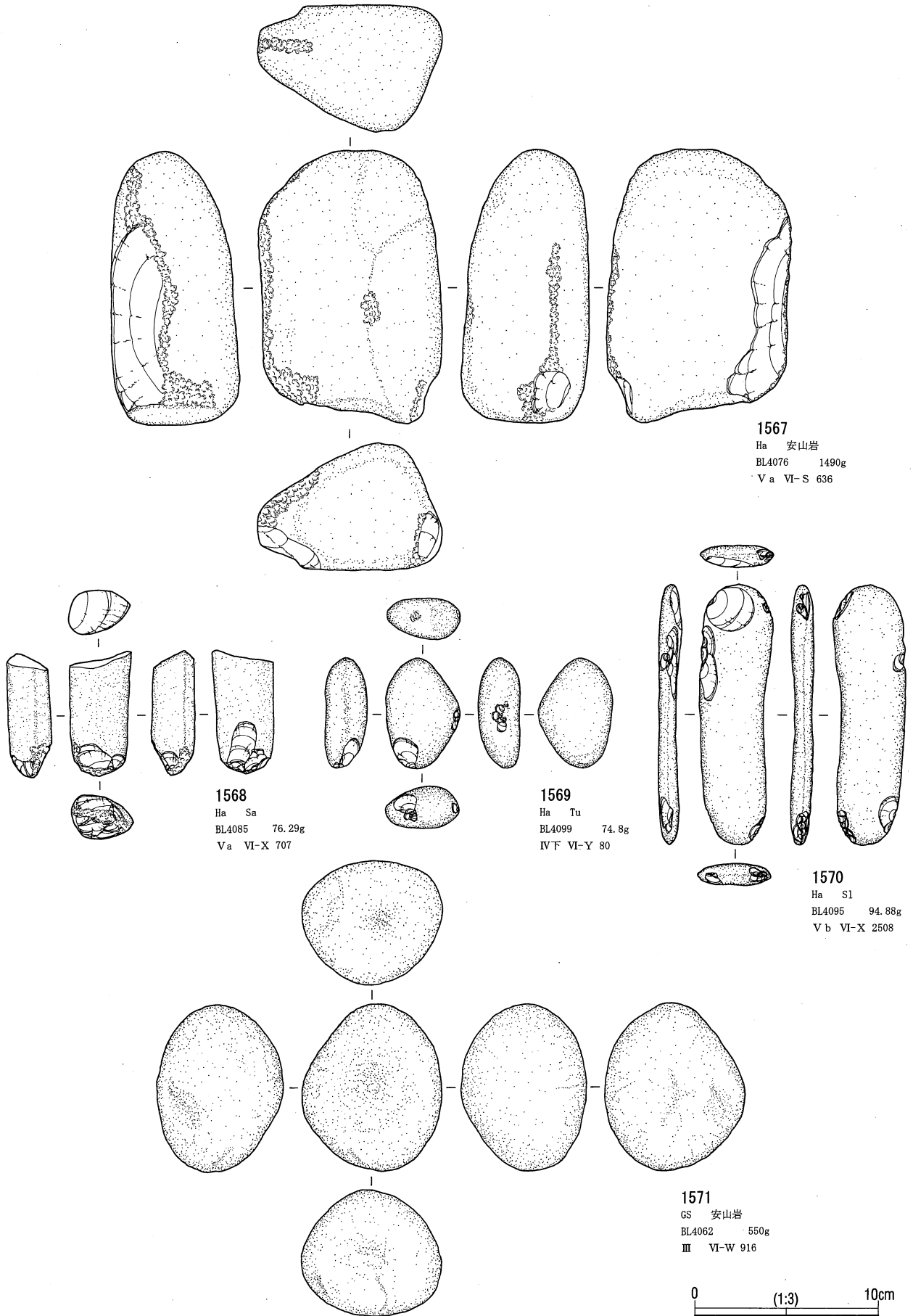

第4地点 石器実測図 67 (敲石3・磨石1) (貫ノ木遺跡)

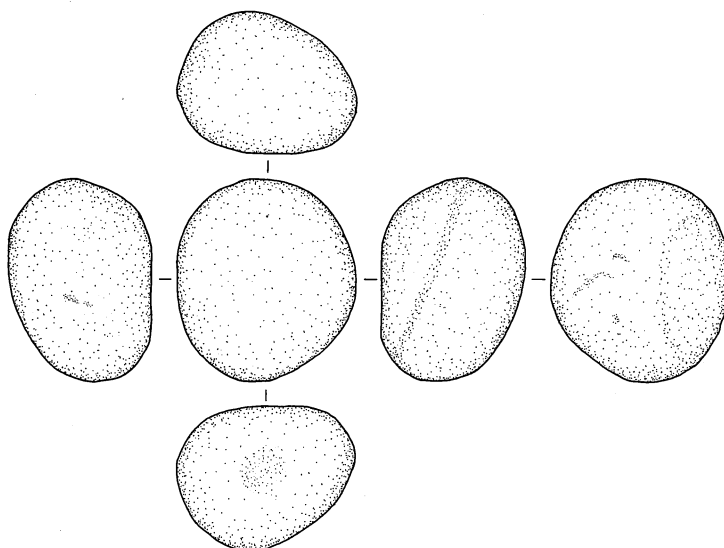

1572

GS 安山岩
BL4067 430g
III VI-W 2506

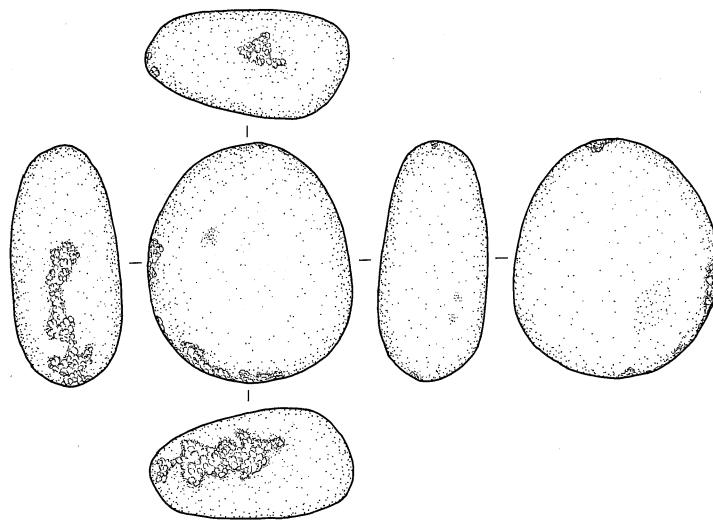

1573

GS 安山岩
BL4062 450g
III VI-W 771

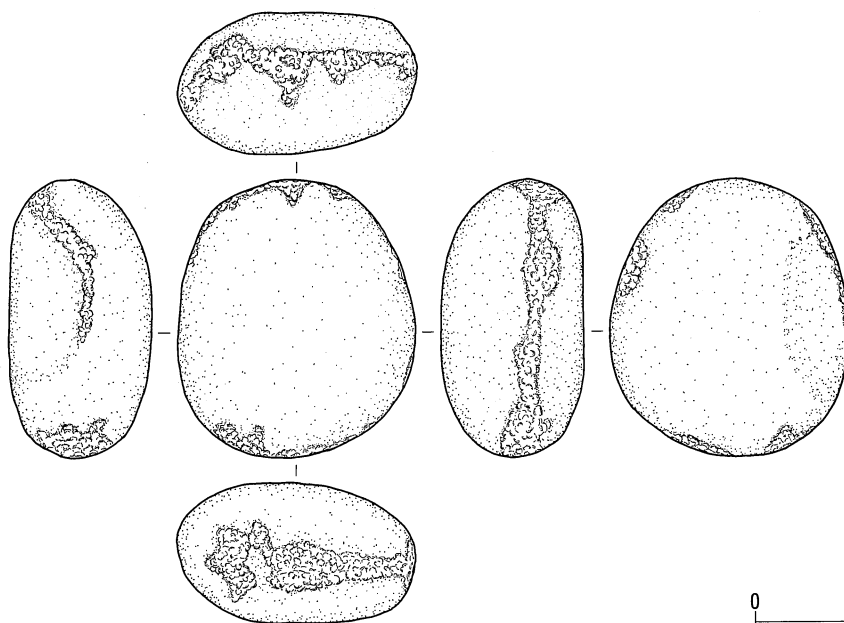

1574

GS 安山岩
BL4061 840g
III VI-W 772

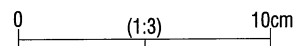

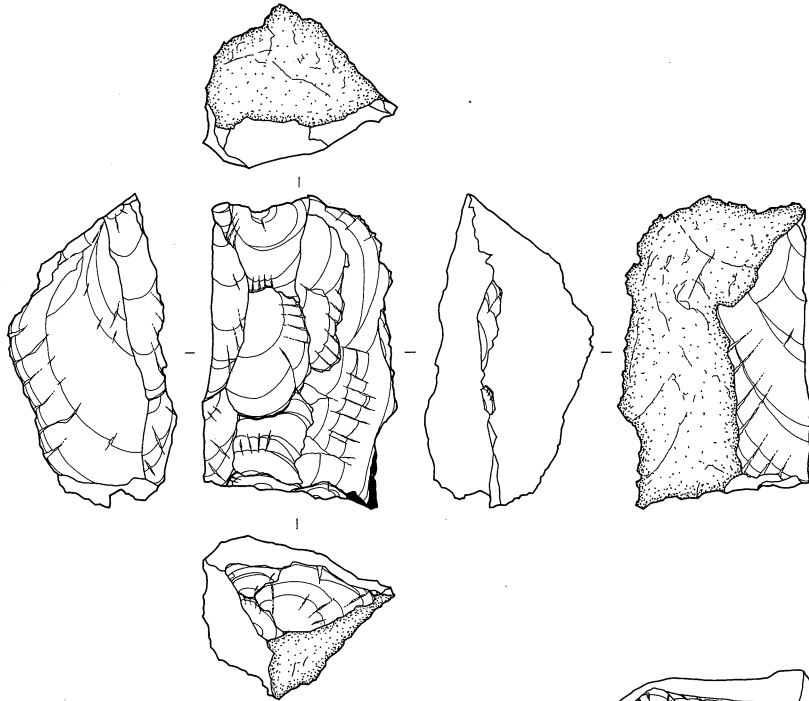

1575
Co An
BL4006 78.58g
IV VI-I 489

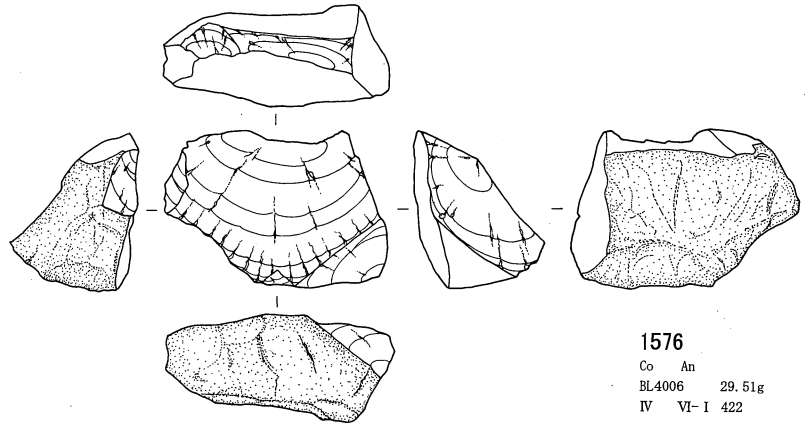

1576
Co An
BL4006 29.51g
IV VI-I 422

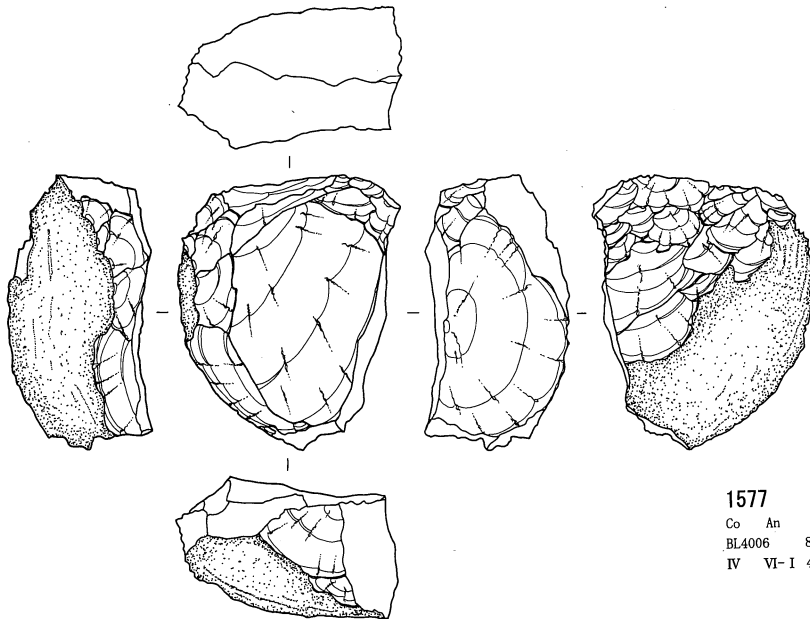

1577
Co An
BL4006 82.44g
IV VI-I 479

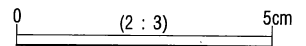

第4地点 石器実測図 69 (石核 1) (貫ノ木遺跡)

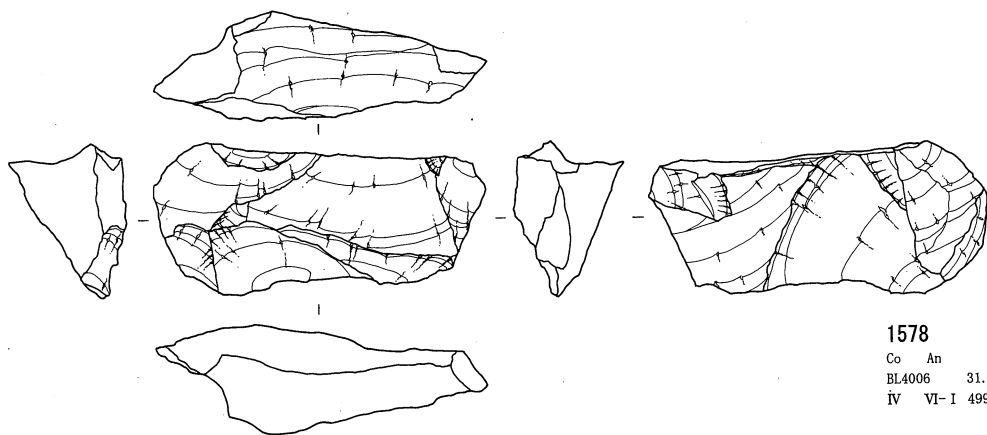

1578
Co An
BL4006 31.06g
IV VI-I 499

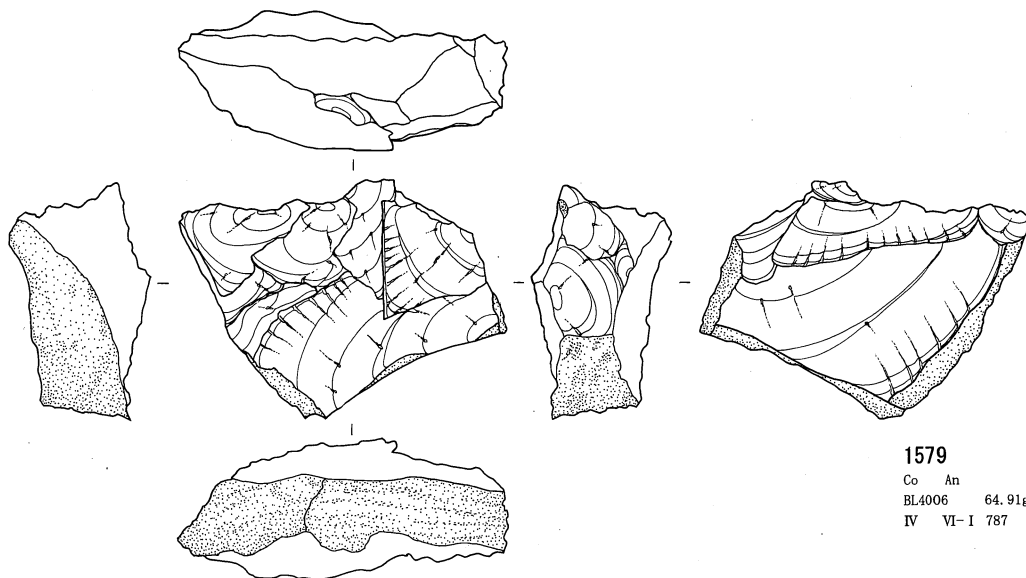

1579
Co An
BL4006 64.91g
IV VI-I 787

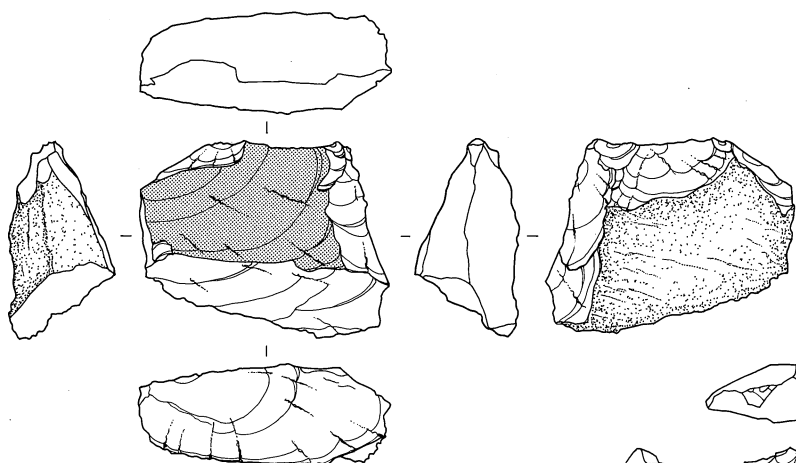

1580
Co An
BL4006 35.88g
III VI-I 510

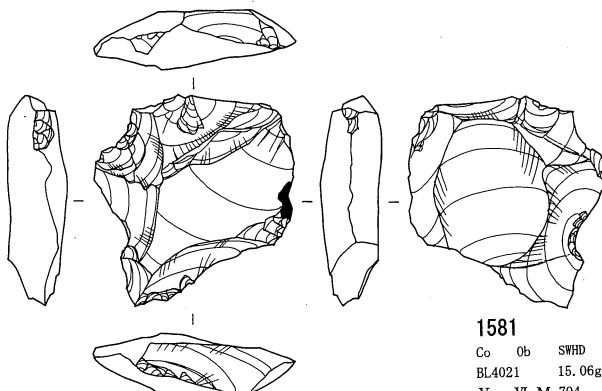

1581
Co Ob SWHD
BL4021 15.06g
V a VI-M 794

0 (2:3) 5cm

第4地点 石器実測図70(石核2)(貫ノ木遺跡)

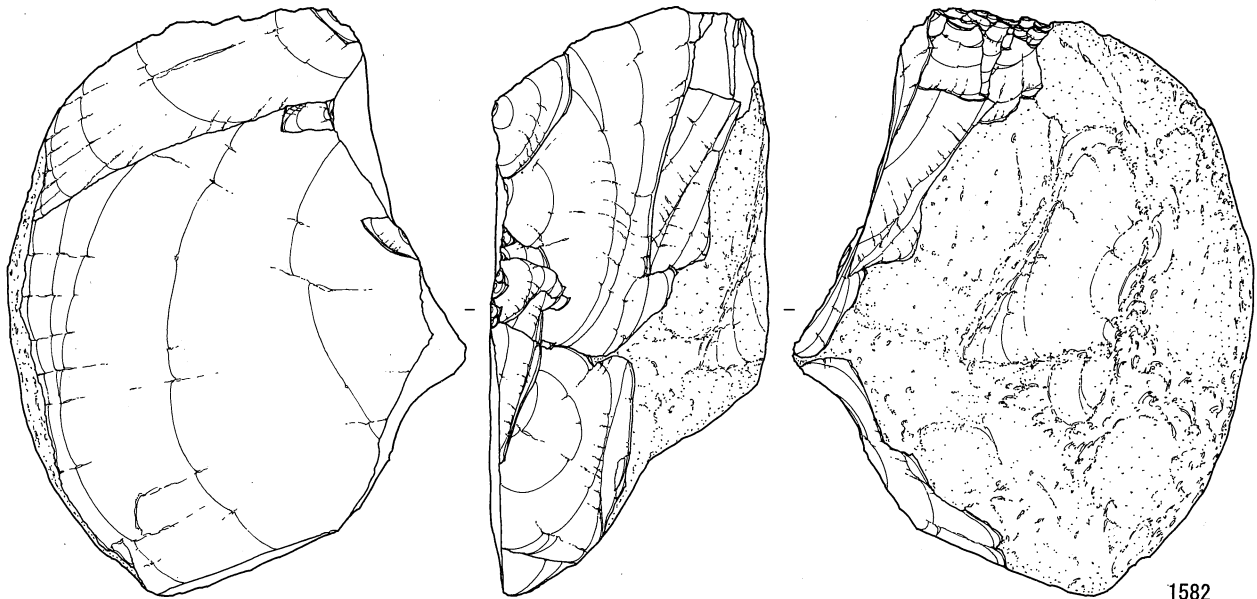

0 (1:3) 10cm

1582
Co An
BL4021 5000g
V a VI-M 413

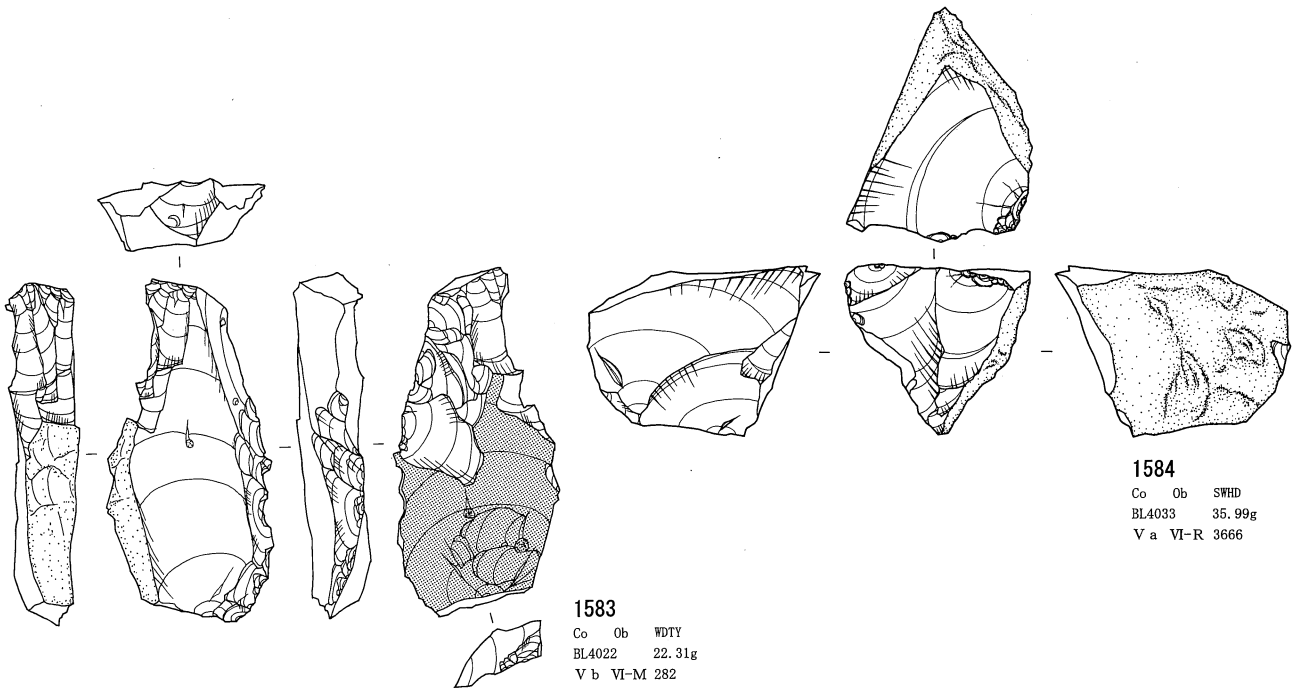

1583
Co Ob WDTY
BL4022 22.31g
V b VI-M 282

1584
Co Ob SWHD
BL4033 35.99g
V a VI-R 3666

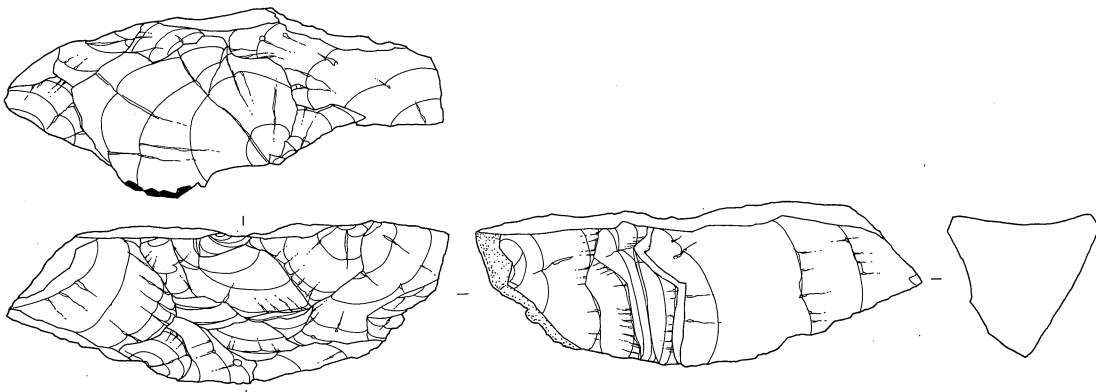

1585
Co An
BL4033 80.22g
V a VI-R 3660

0 (2:3) 5cm

第4地点 石器実測図71 (石核3) (貫ノ木遺跡)

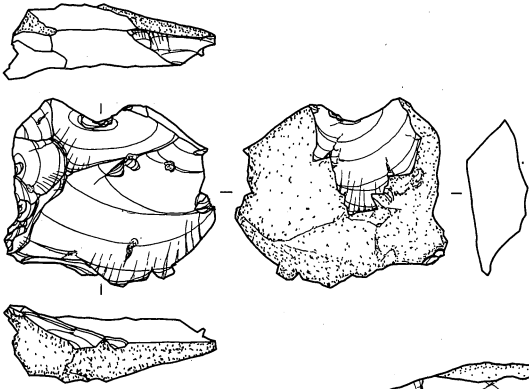

1586
Co Ob SWHD
BL4036 33.58g
IV VI-S 1577

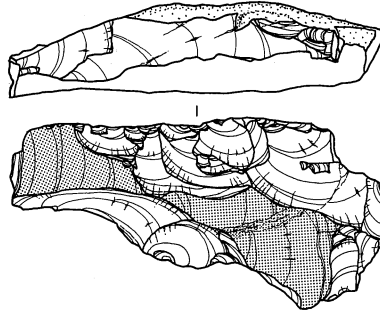

1587
Co Ag
BL4036 95.8g
V b VI-S 1399

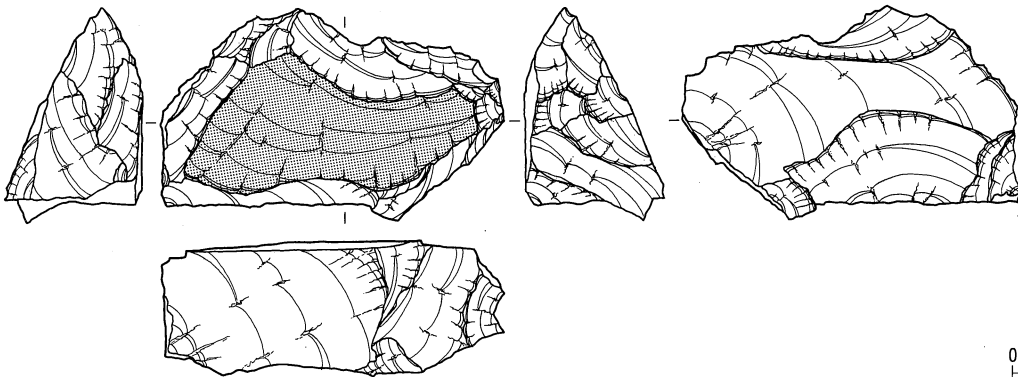
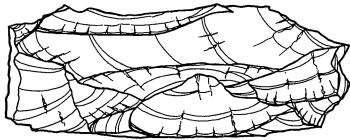

1588
Co An
BL4037 192.06g
V a VI-S 1318

0 (1 : 2) 5cm

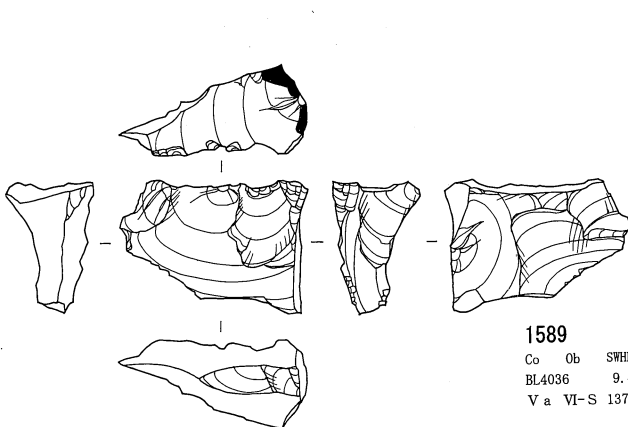

1589
Co Ob SWHD
BL4036 9.45g
V a VI-S 1379

0 (2 : 3) 5cm

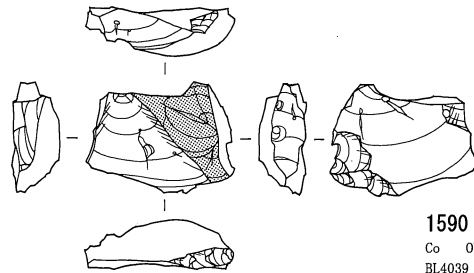

1590
Co Ob WDKB
BL4039 4.51g
III VI-S 1093

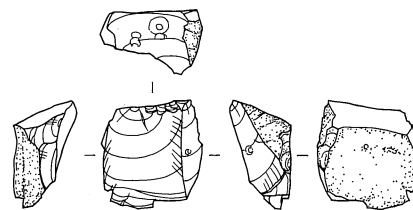

1591
Co Ob WDTY
BL4039 3.8g
IV VI-S 889

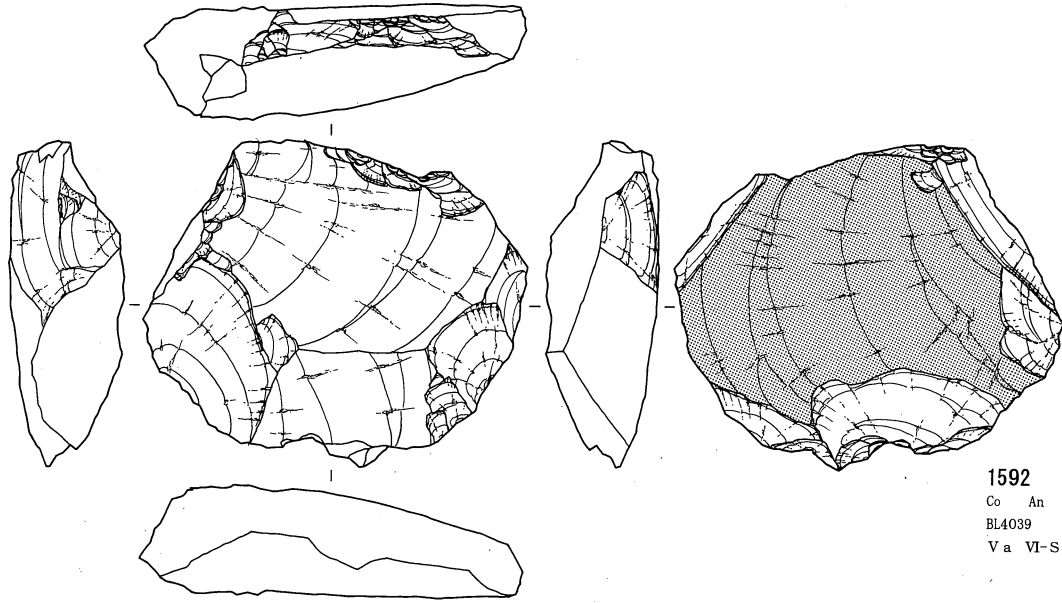

1592
 Co An
 BL4039 240g
 Va VI-S 1256

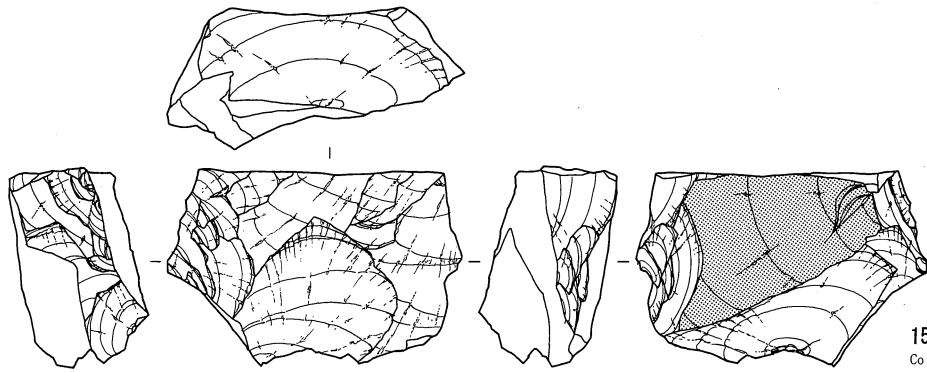

1593
 Co An
 BL4039 124.94g
 Va VI-S 1249

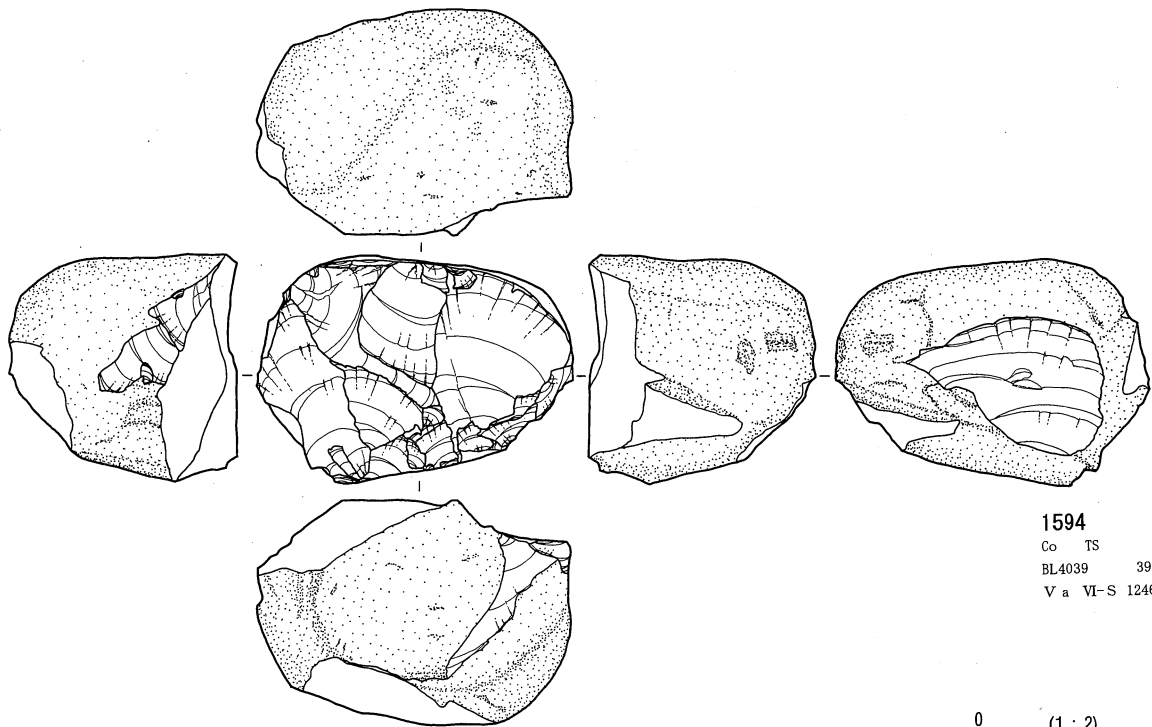

1594
 Co TS
 BL4039 390g
 Va VI-S 1246

0 (1:2) 5cm

第4地点 石器実測図 73 (石核 5) (貫ノ木遺跡)

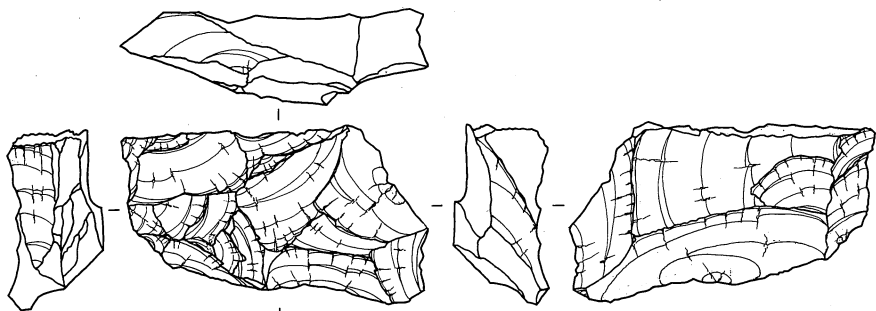

1595
Co An
BL4039 71.63g
V a VI-S 1469

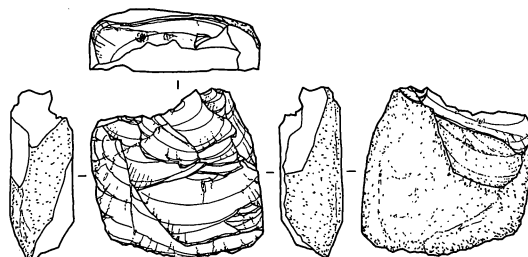
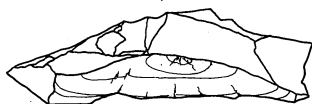

1596
Co Ch
BL4042 36.12g
V a VI-R 2385

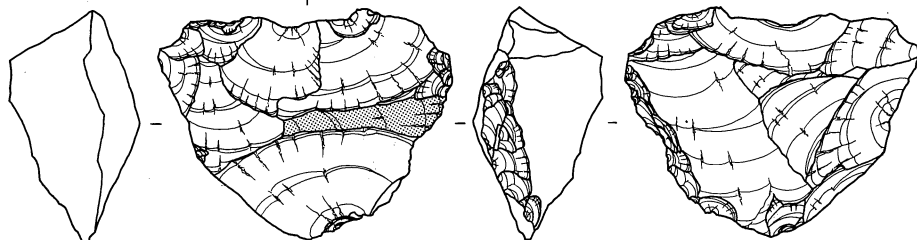
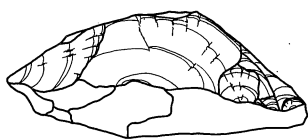

1597
Co An
BL4042 114.23g
V a VI-R 2435

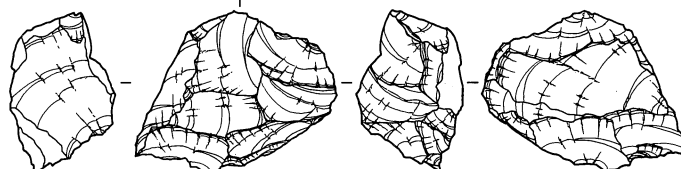
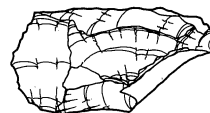

1598
Co An
BL4043 58.07g
V a VI-S 772

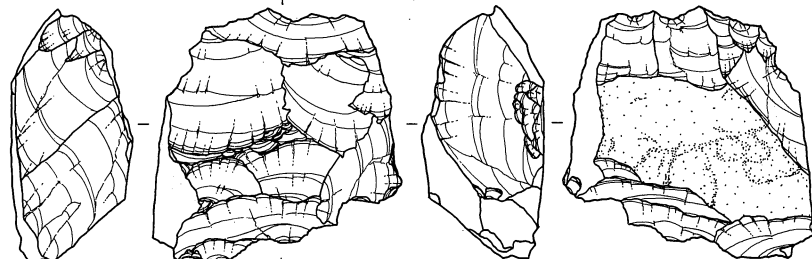
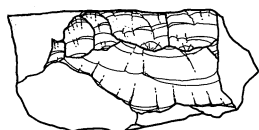

1599
Co Tu
BL4043 146.88g
V b VI-S 1001



0 (1:2) 5cm

第4地点 石器実測図 74 (石核6) (貫ノ木遺跡)

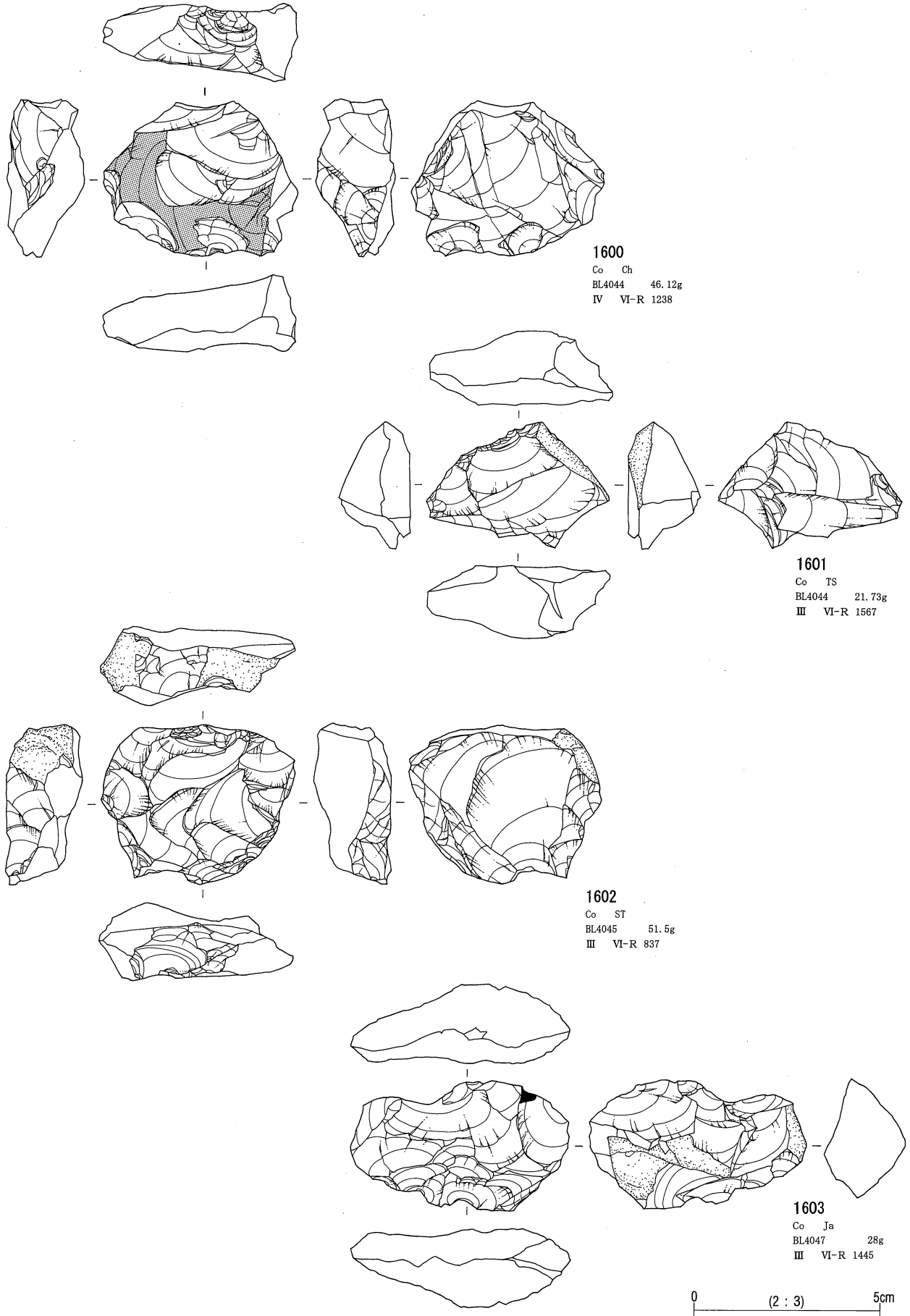

第4地点 石器実測図 75 (石核 7) (貫ノ木遺跡)

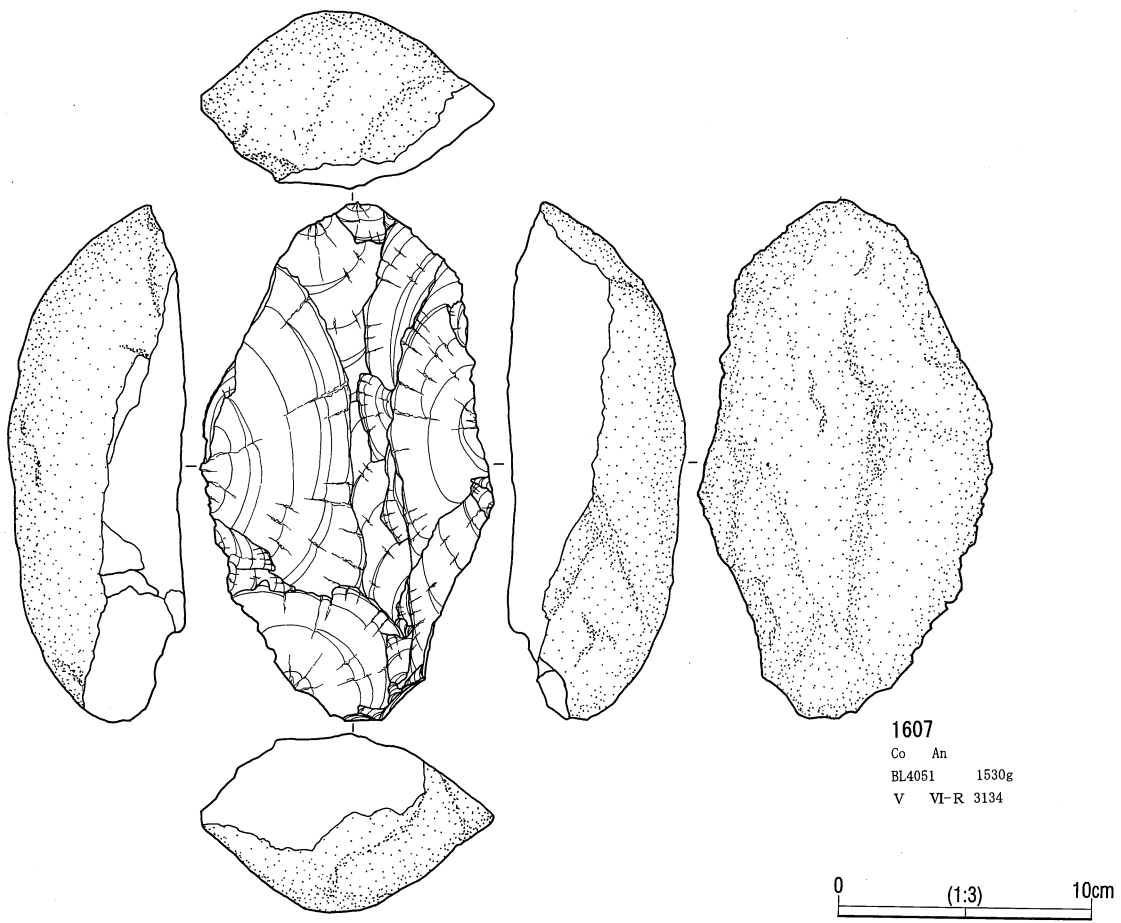
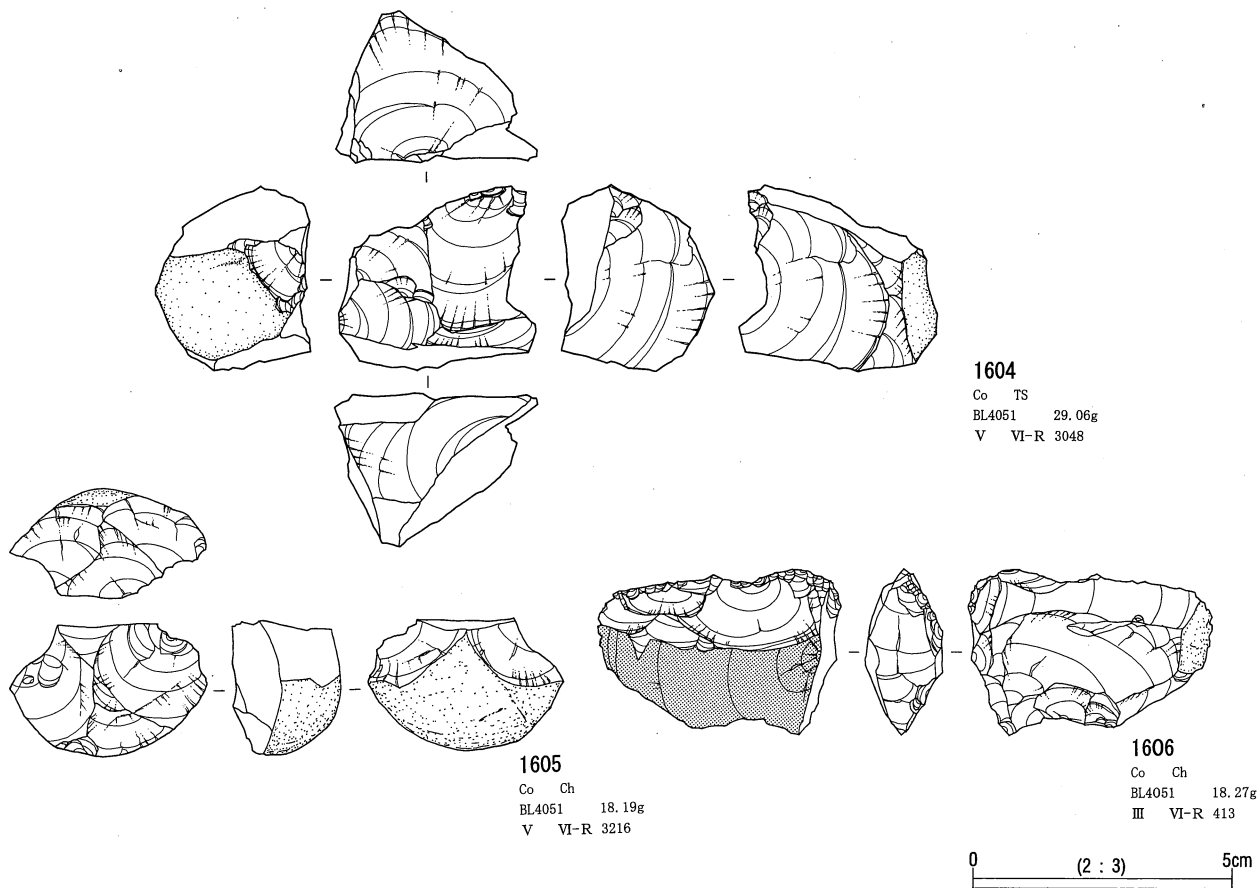

第4地点 石器実測図76 (石核8) (貫ノ木遺跡)

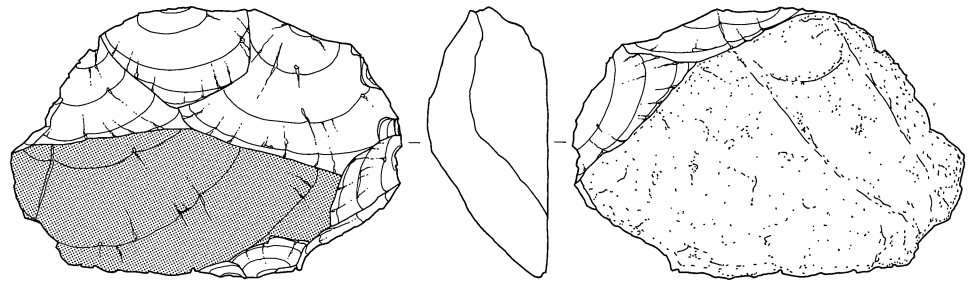

1608
 Co An
 BL4057 90.96g
 V a VI-W 1113

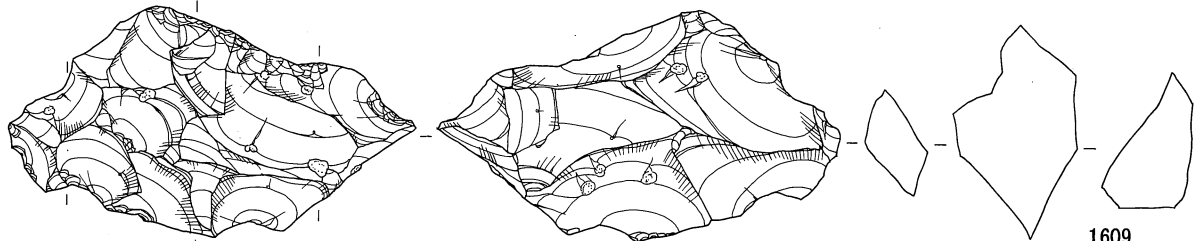
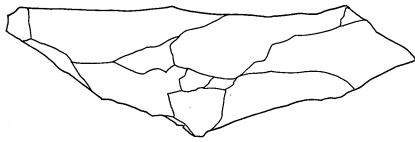

1609
 Co Ob WDTY
 BL4058 54.92g
 V a VI-W 1106

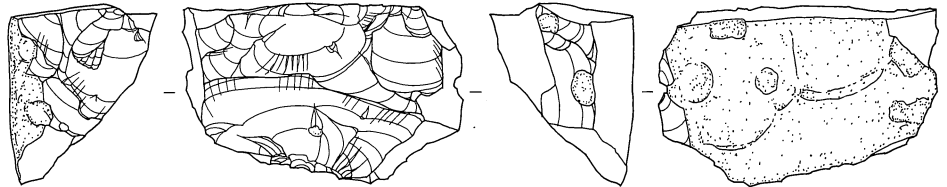
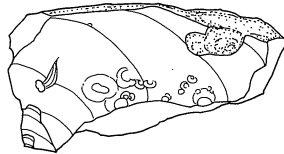
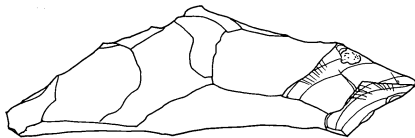

1610
 Co Ob WDTY
 BL4058 49.46g
 V VI-W 3009

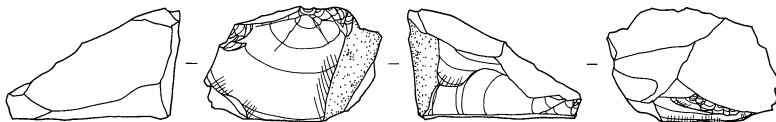
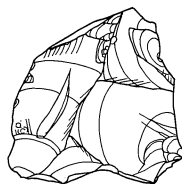
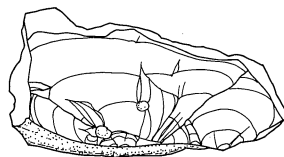

1611
 Co Ob WDTY
 BL4063 19.65g
 V a VI-W 1920

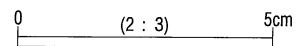
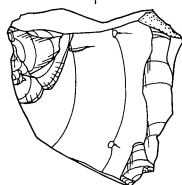

第4地点 石器実測図 77 (石核 9) (貫ノ木遺跡)

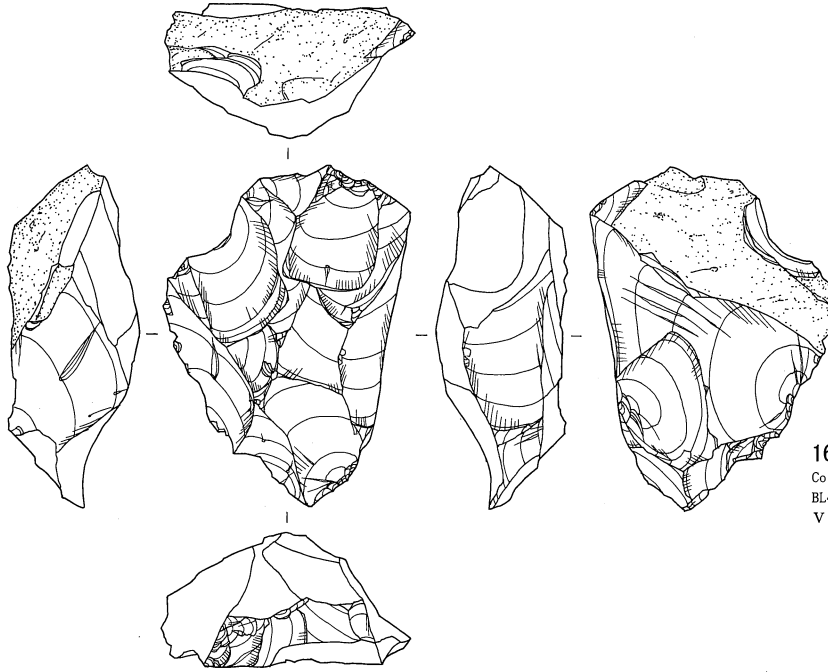

1612
Co Ob WDTY
BL4066 57.41g
V b VI-W 1451

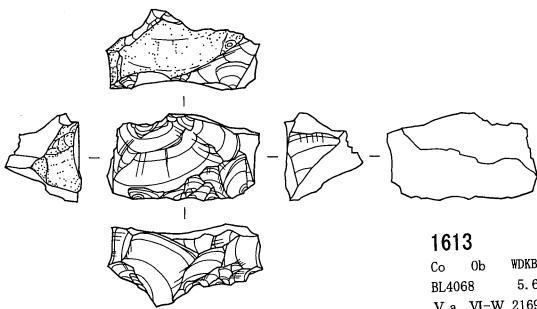

1613
Co Ob WDKB
BL4068 5.67g
V a VI-W 2169

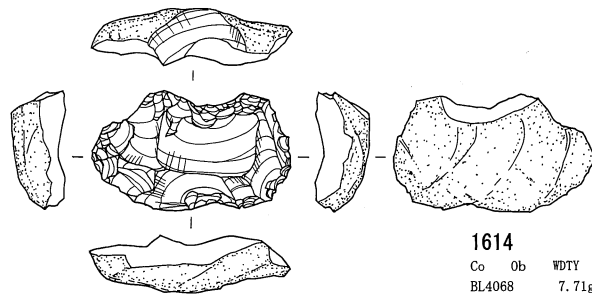

1614
Co Ob WDTY
BL4068 7.71g
IV上 VI-W 935

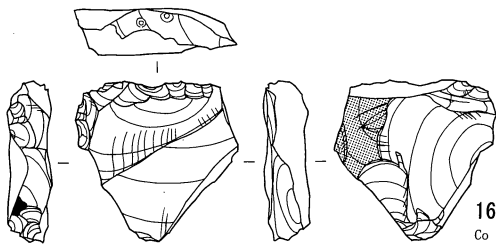

1615
Co Ob SWHD
BL4068 7.23g
V b VI-W 2321

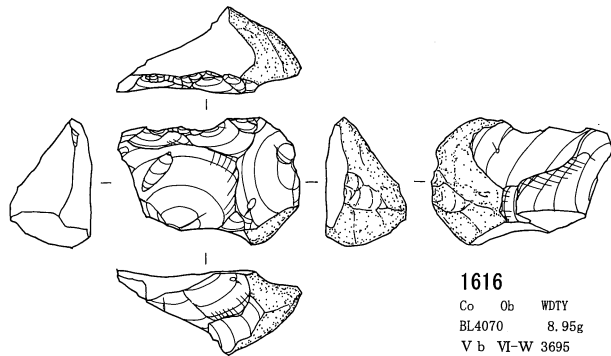

1616
Co Ob WDTY
BL4070 8.95g
V b VI-W 3695

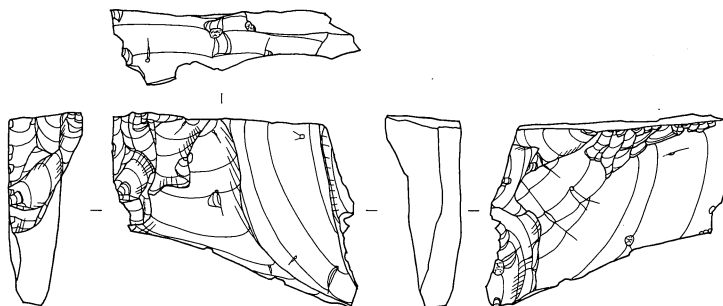

1617
Co Ob WDTY
BL4075 17.28g
IV下 VI-W 466

0 (2 : 3) 5cm

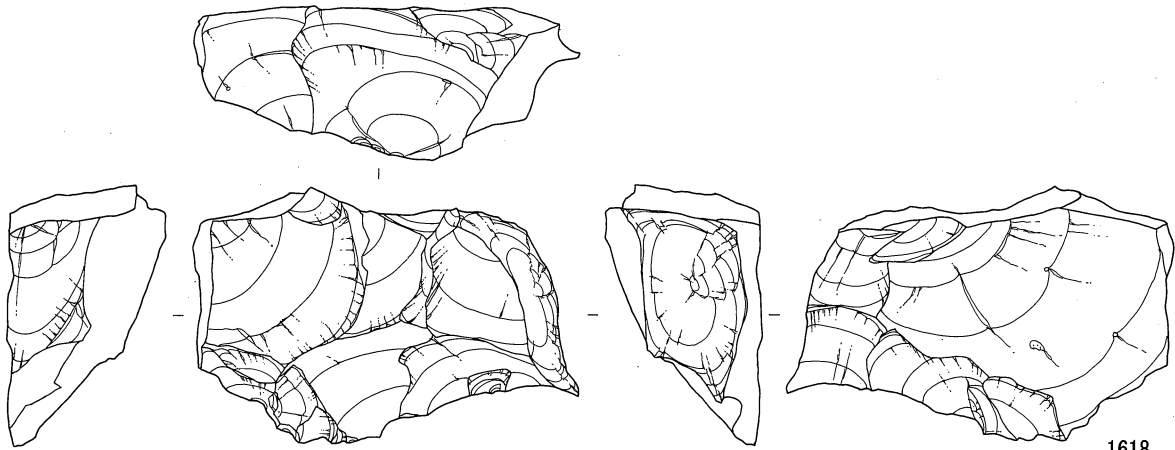

1618
Co An
BL4075 136.64g
V a VI-W 596

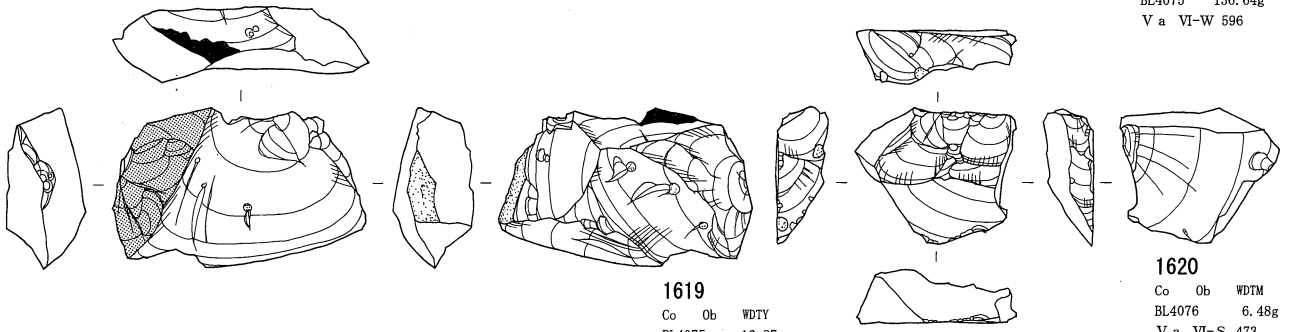

1619
Co Ob WDTY
BL4075 16.27g
V a VI-W 609

1620
Co Ob WDTM
BL4076 6.48g
V a VI-S 473

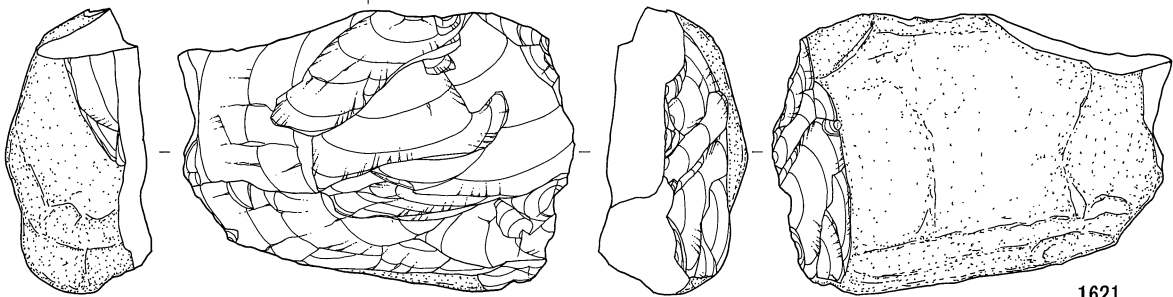
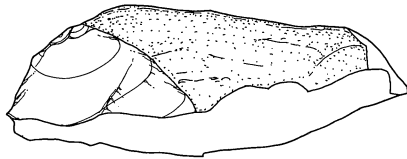

1621
Co Ch
BL4076 127.51g
V a VI-S 607

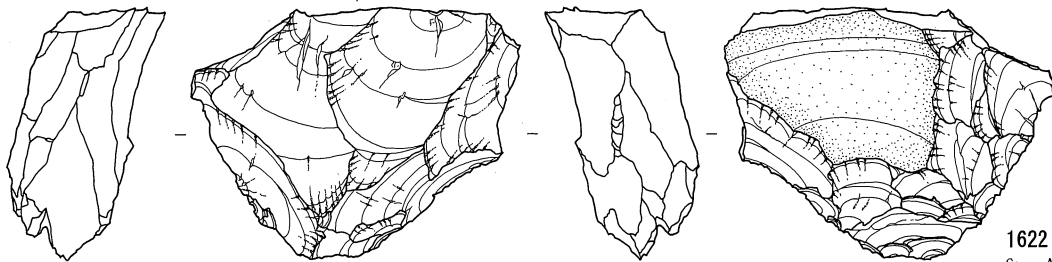
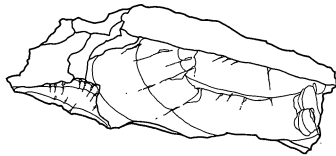

1622
Co An
BL4076 70.07g
V a VI-X 487

0 (2:3) 5cm

第4地点 石器実測図 79 (石核 11) (貫ノ木遺跡)

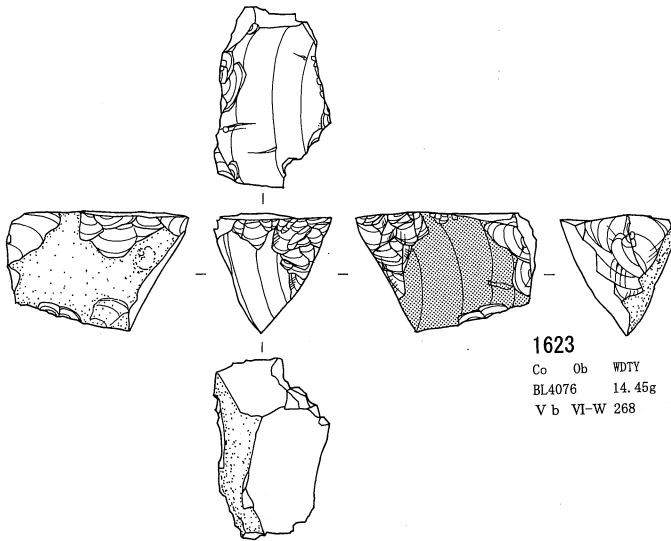

1623
Co Ob WDTY
BL4076 14.45g
V b VI-W 268

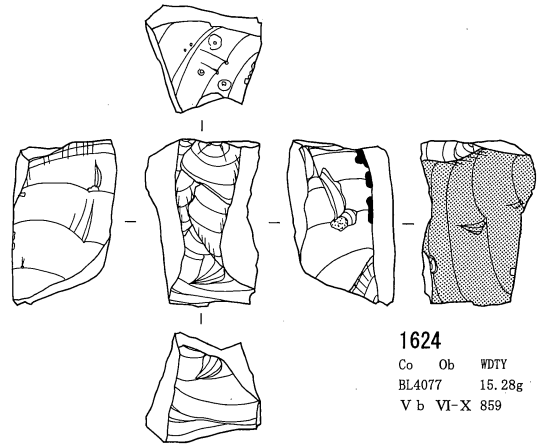

1624
Co Ob WDTY
BL4077 15.28g
V b VI-X 859

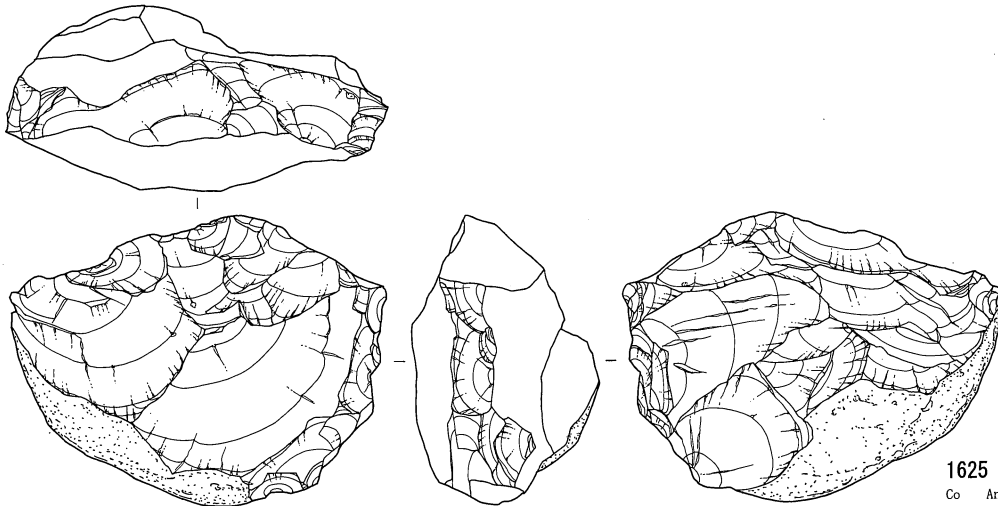

1625
Co An
BL4077 142.59g
V a VI-W 101

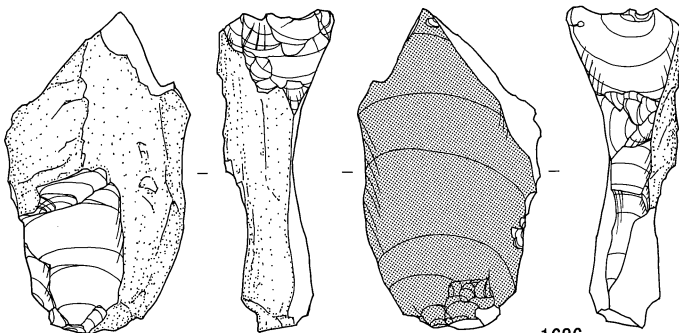

1626
Co Ob WDKB
BL4080 32.5g
V b VI-X 834

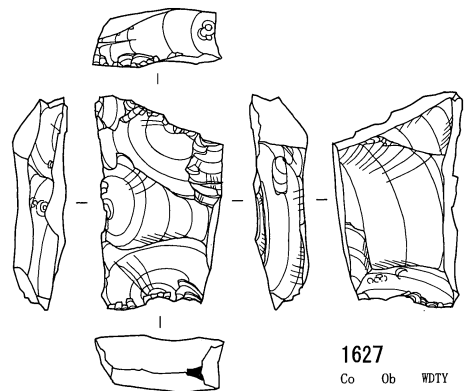

1627
Co Ob WDTY
BL4081 10.64g
IV F VI-S 34

0 (2 : 3) 5cm

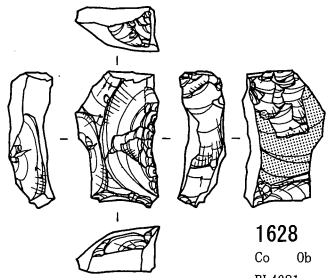

1628
Co Ob WDTM
BL4081 7.4g
V a VI-S 385

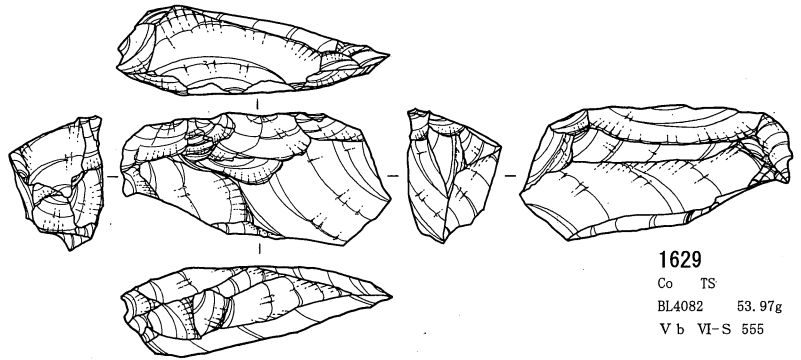

1629
Co TS
BL4082 53.97g
V b VI-S 555

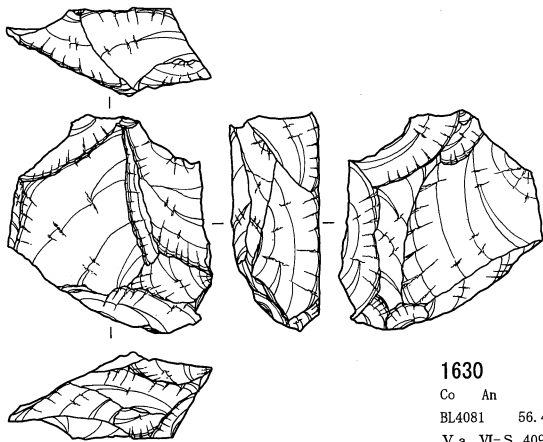

1630
Co An
BL4081 56.48g
V a VI-S 409

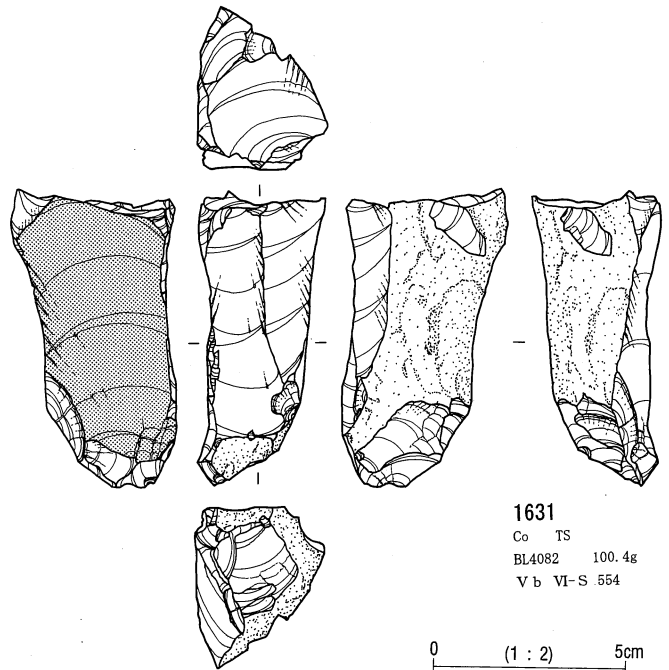

1631
Co TS
BL4082 100.4g
V b VI-S 554

0 (1 : 2) 5cm

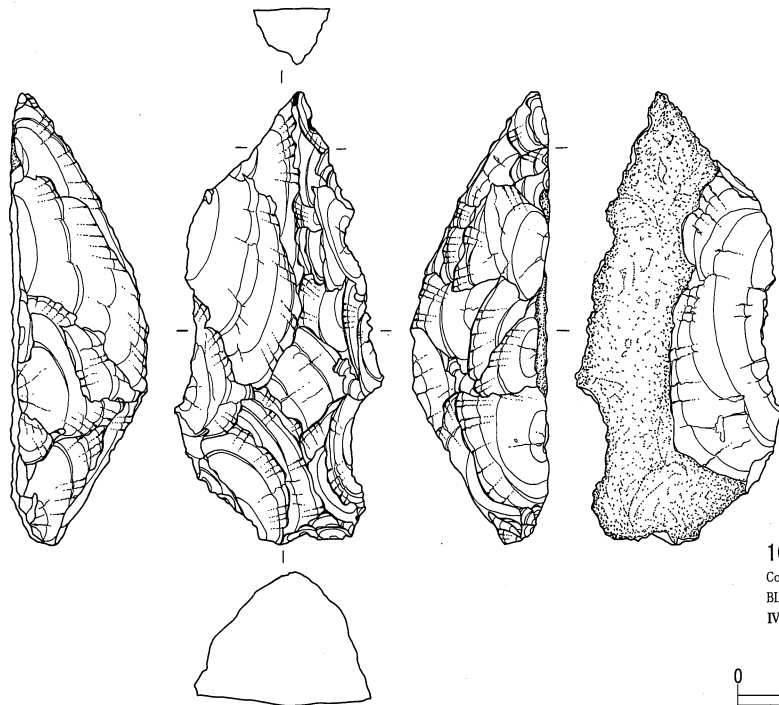

1632
Co An
BL4083 73.26g
IV下 VI-X 119

0 (2 : 3) 5cm

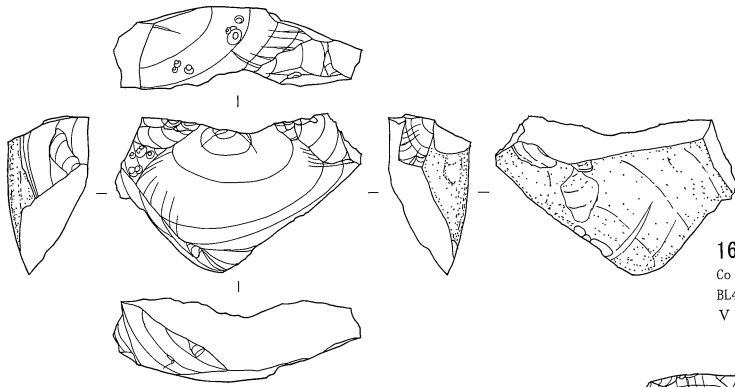

1633
Co Ob WDTY
BL4083 16.98g
V a VI-X 734

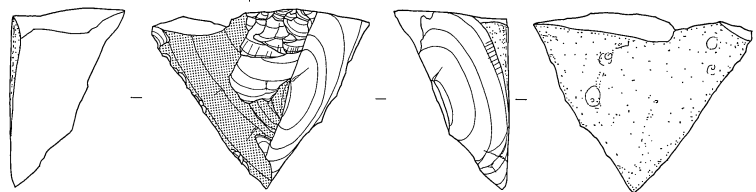

1634
Co Ob WDTY
BL4084 16.63g
III VI-X 105

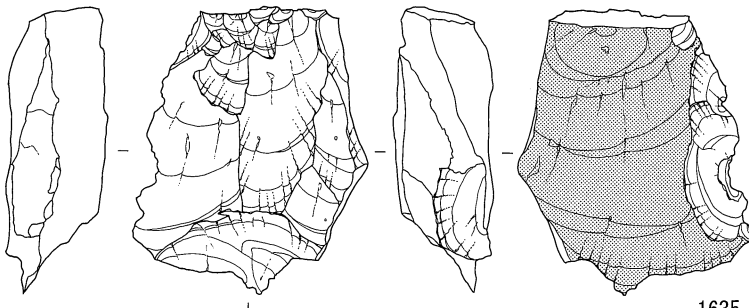

1635
Co An
BL4085 50.15g
V a VI-X 718

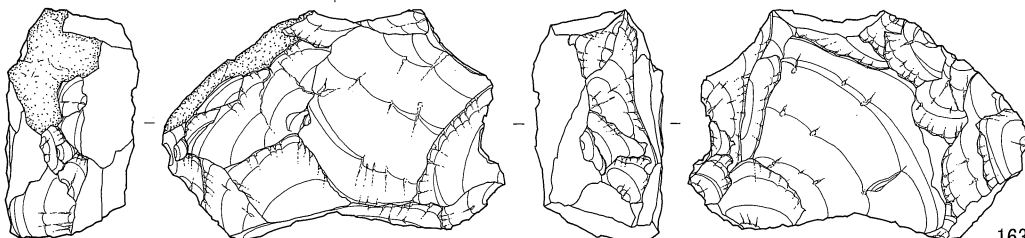
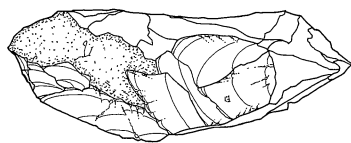

1636
Co An
BL4088 91.08g
V a VI-X 1191

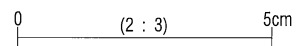
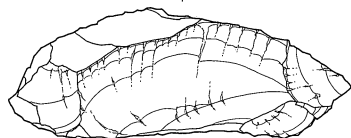

第4地点 石器実測図 82 (石核 14) (貫ノ木遺跡)

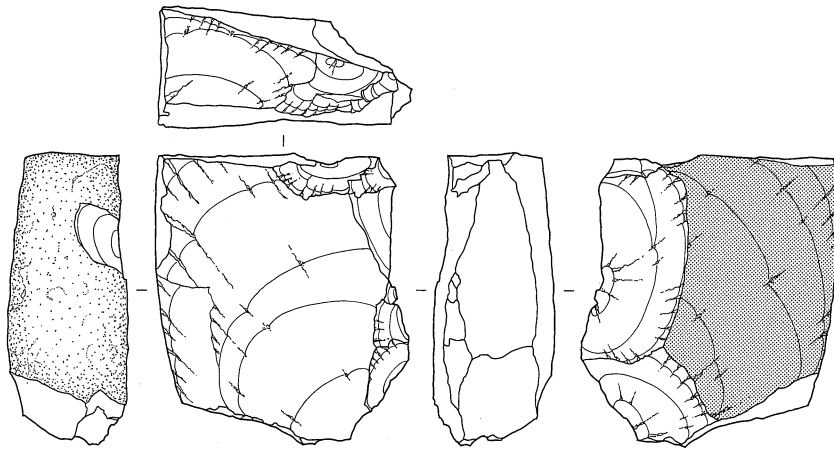

1637

Co An
BL4088 90.92g
V b VI-X 1595

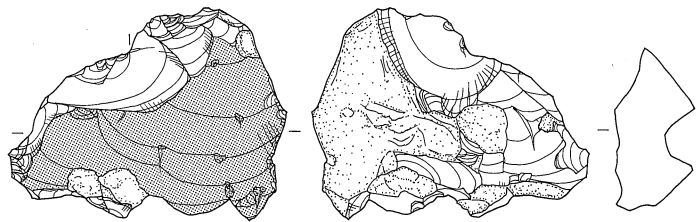
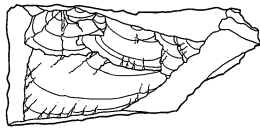

1638

Co Ob WDTY
BL4092 25.01g
V b VI-X 2289

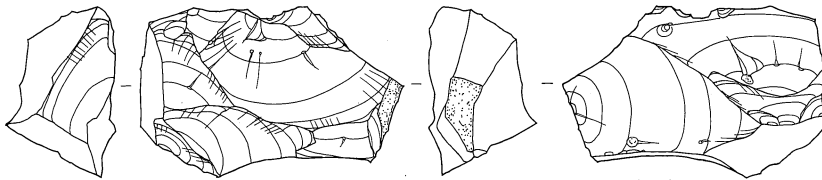
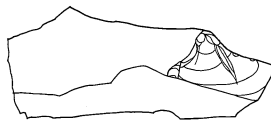

1639

Co Ob WDTY
BL4092 24.9g
V b VI-X 2450

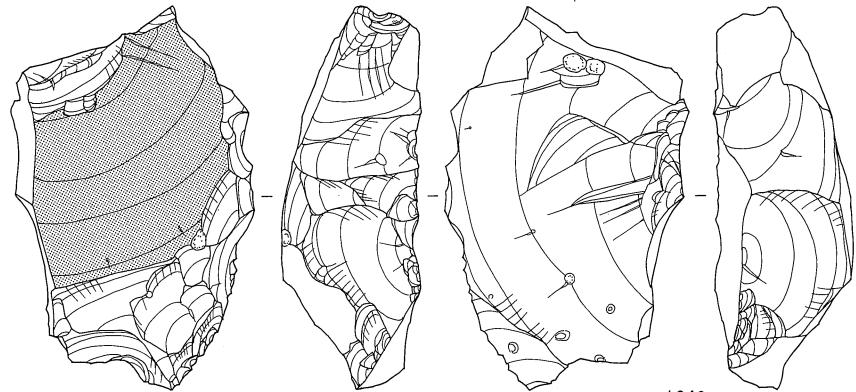
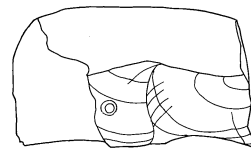
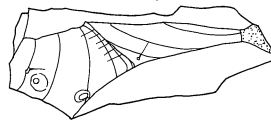

1640

Co Ob WDTY
BL4092 94.59g
V b VI-X 2290

0 (2 : 3) 5cm

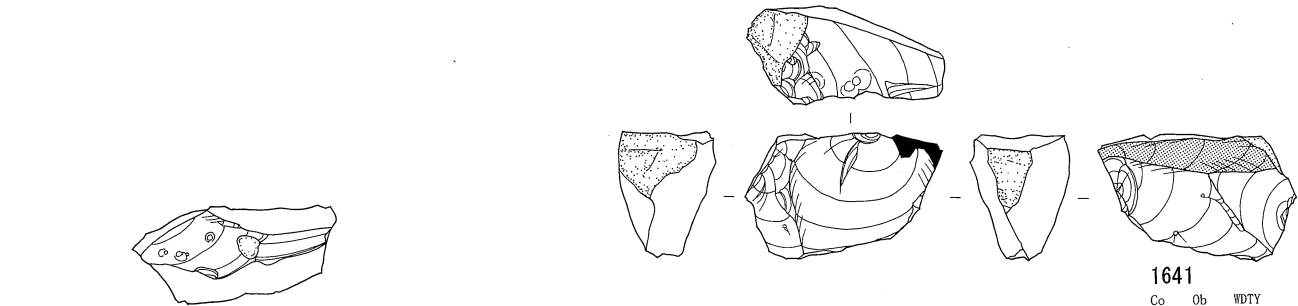

1641
 Co Ob WDTY
 BL4095 14.75g
 V b VI-X 2413

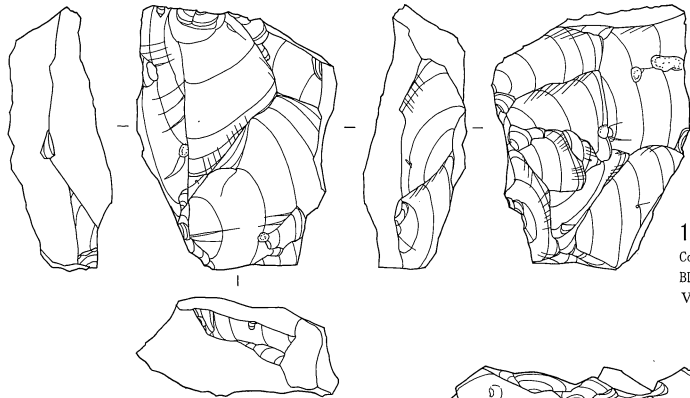

1642
 Co Ob WDTY
 BL4096 32.69g
 V b VI-Y 291

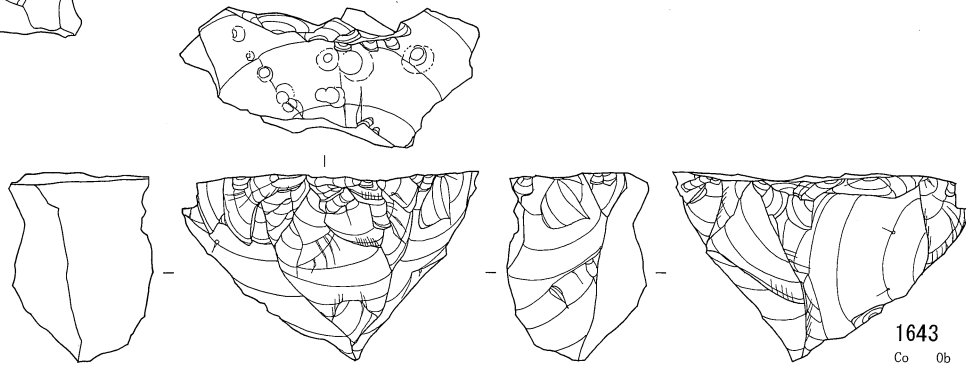

1643
 Co Ob WDTY
 BL4098 40.68g
 V b VI-X 1299

0 (2:3) 5cm

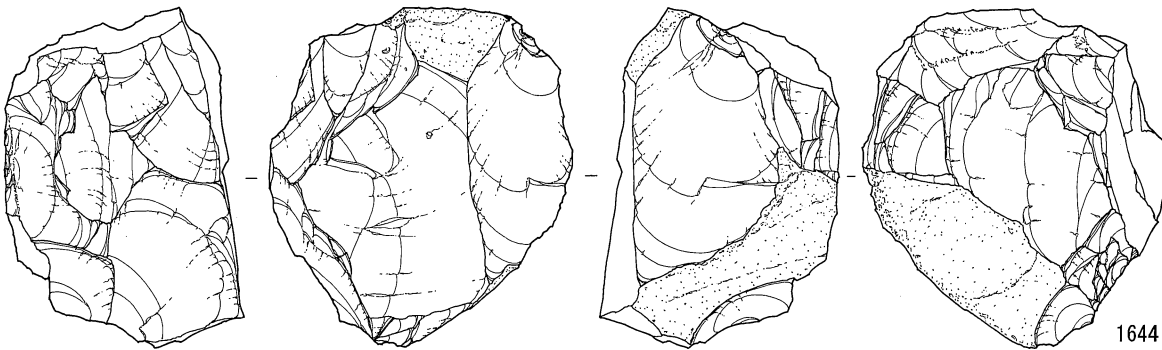
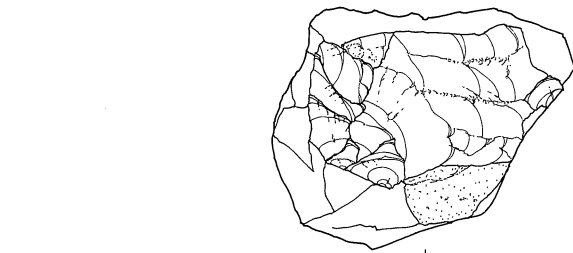

1644
 Co An
 BL4098 1640g
 V b VI-X 1309

0 (1:3) 10cm

第4地点 石器実測図 84 (石核 16) (貫ノ木遺跡)

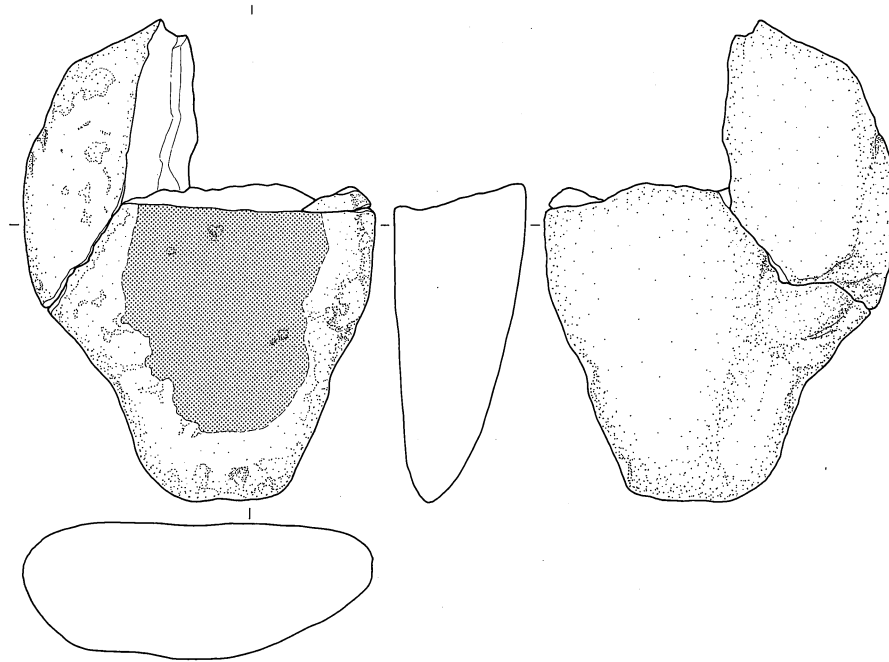

1662a
Wh 安山岩
BL4068 1040g
Va SH33 5

1662b
Wh破 安山岩
BL4068 2320g
Va SH33 12



スクリーン・トーンは黒色の付着物範囲を示す

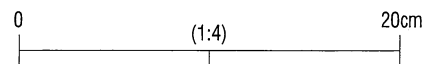

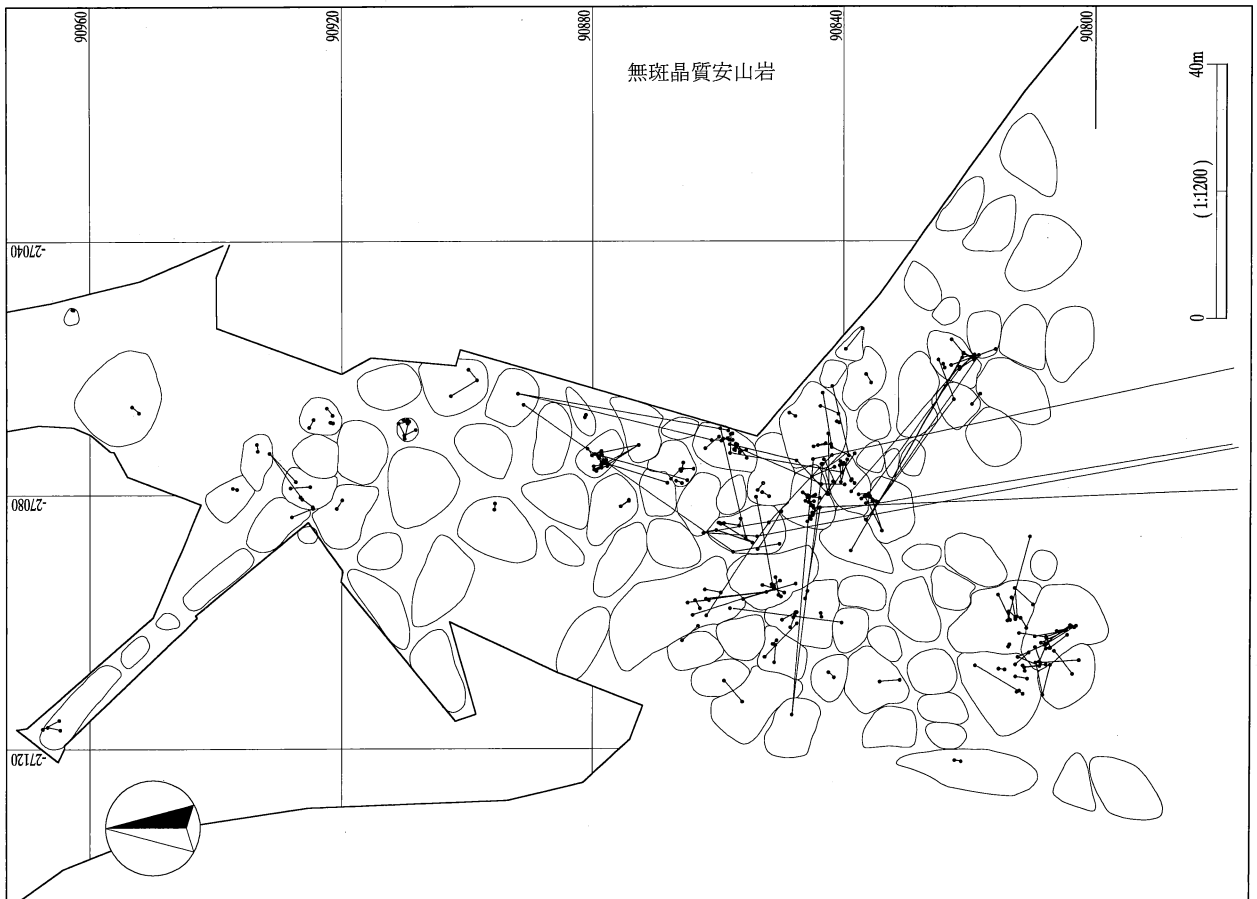
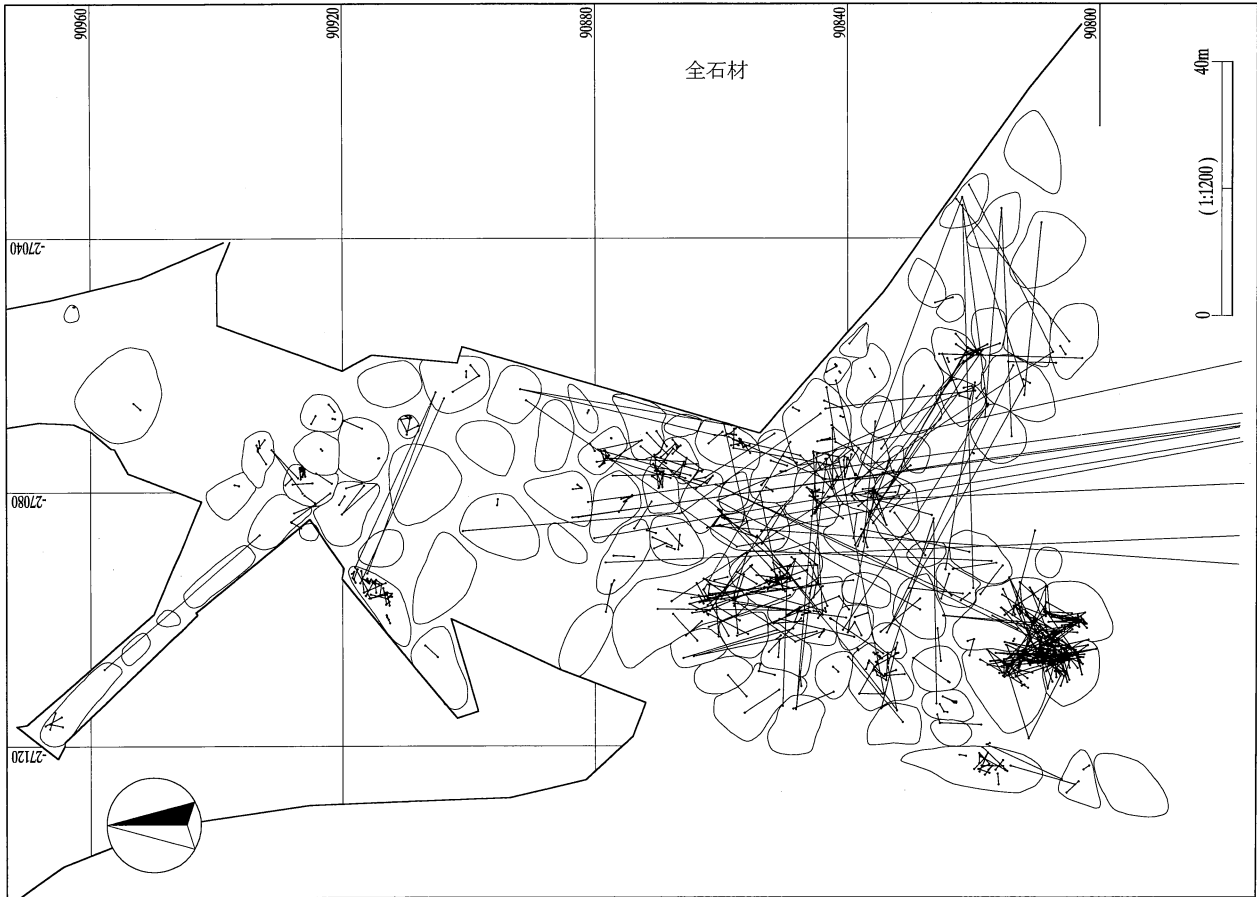

第 4 地点 接合資料分布図 1 (貫ノ木遺跡)

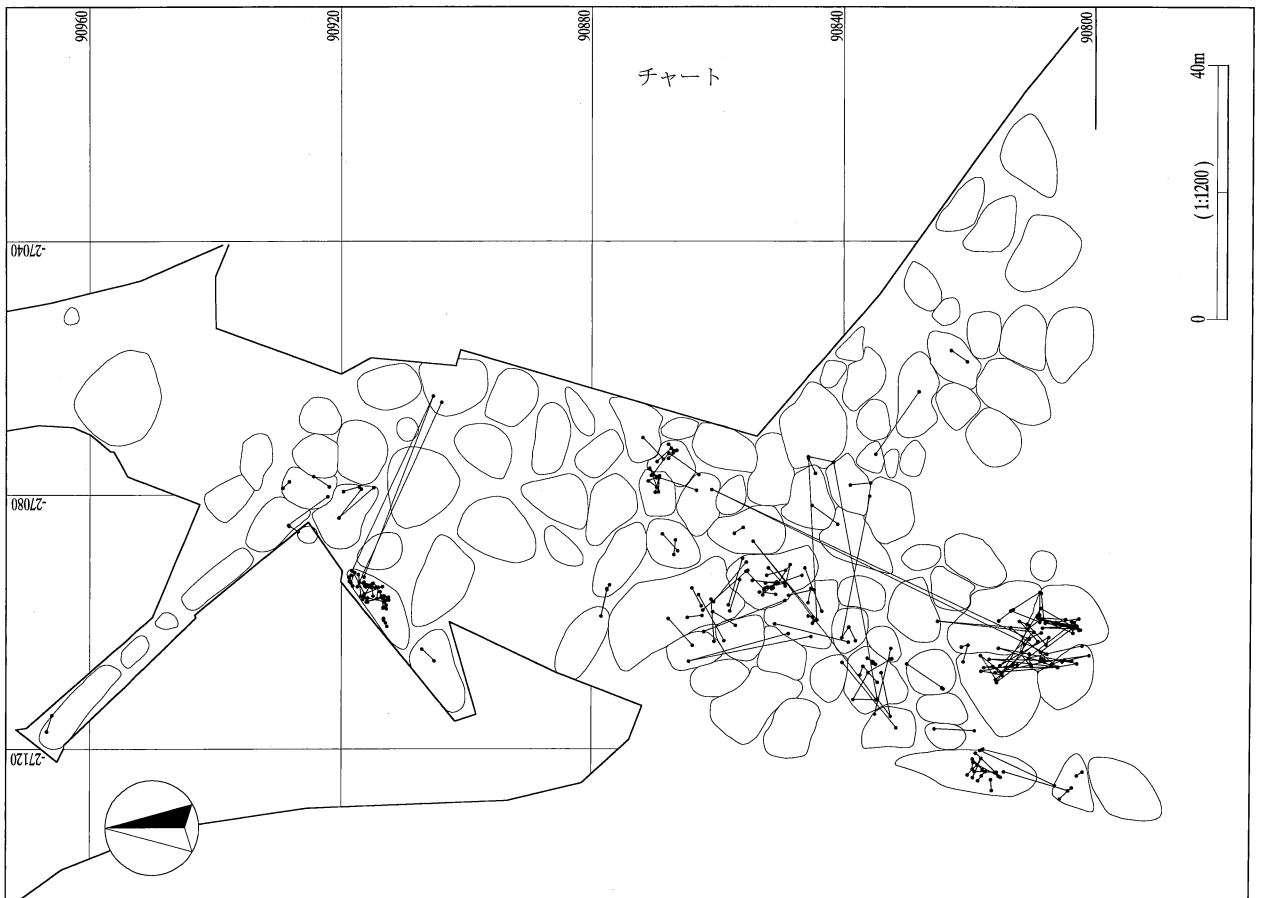
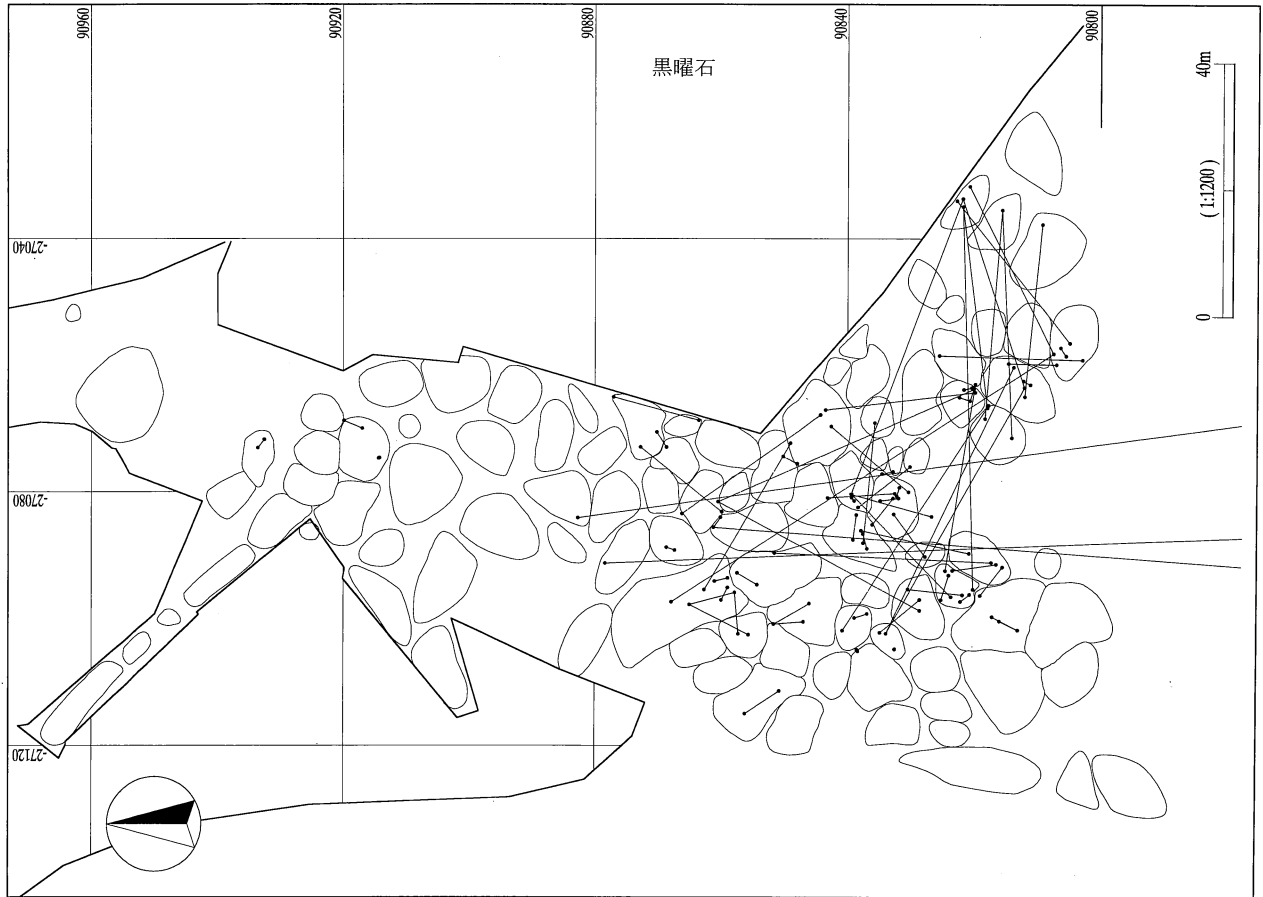

第4地点 接合資料分布図2 (貫ノ木遺跡)

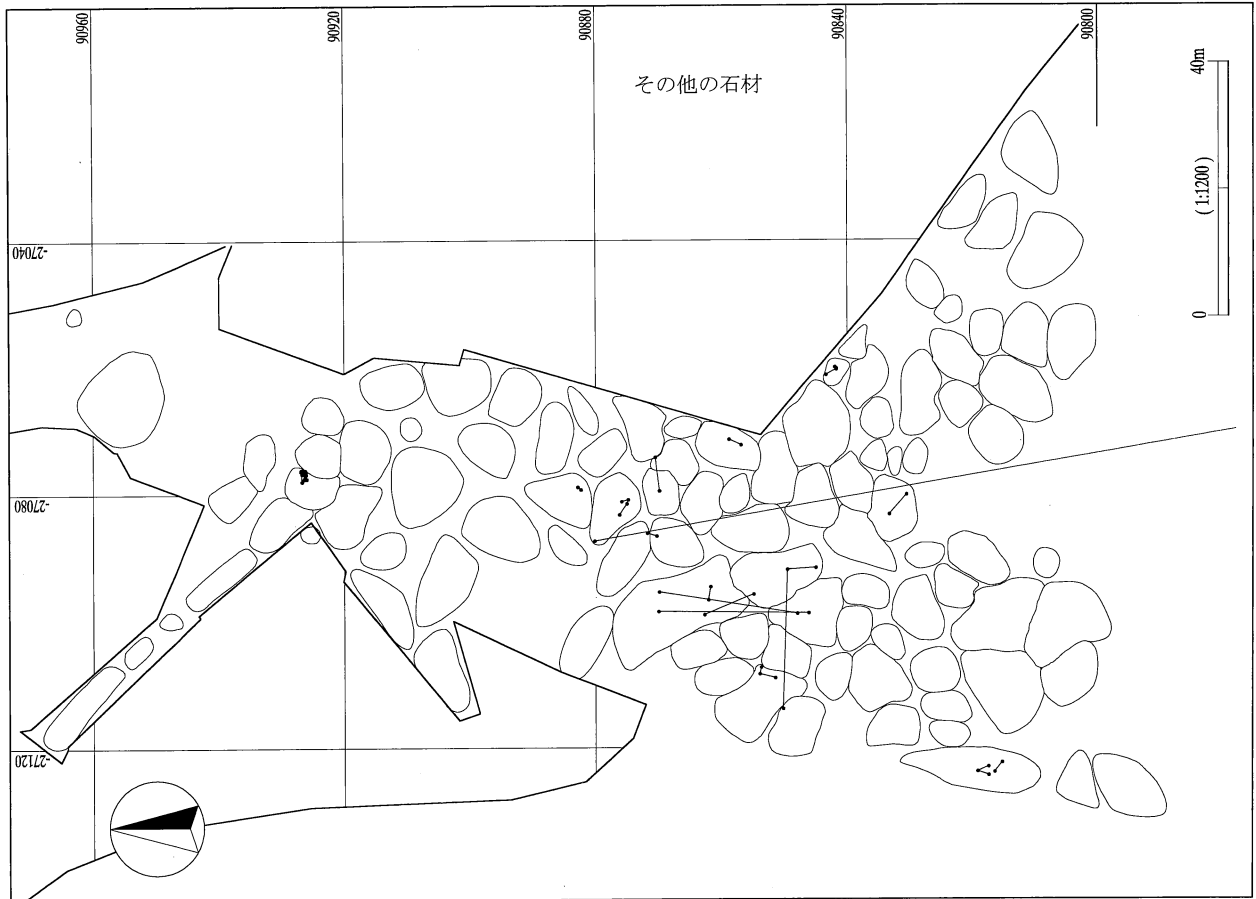
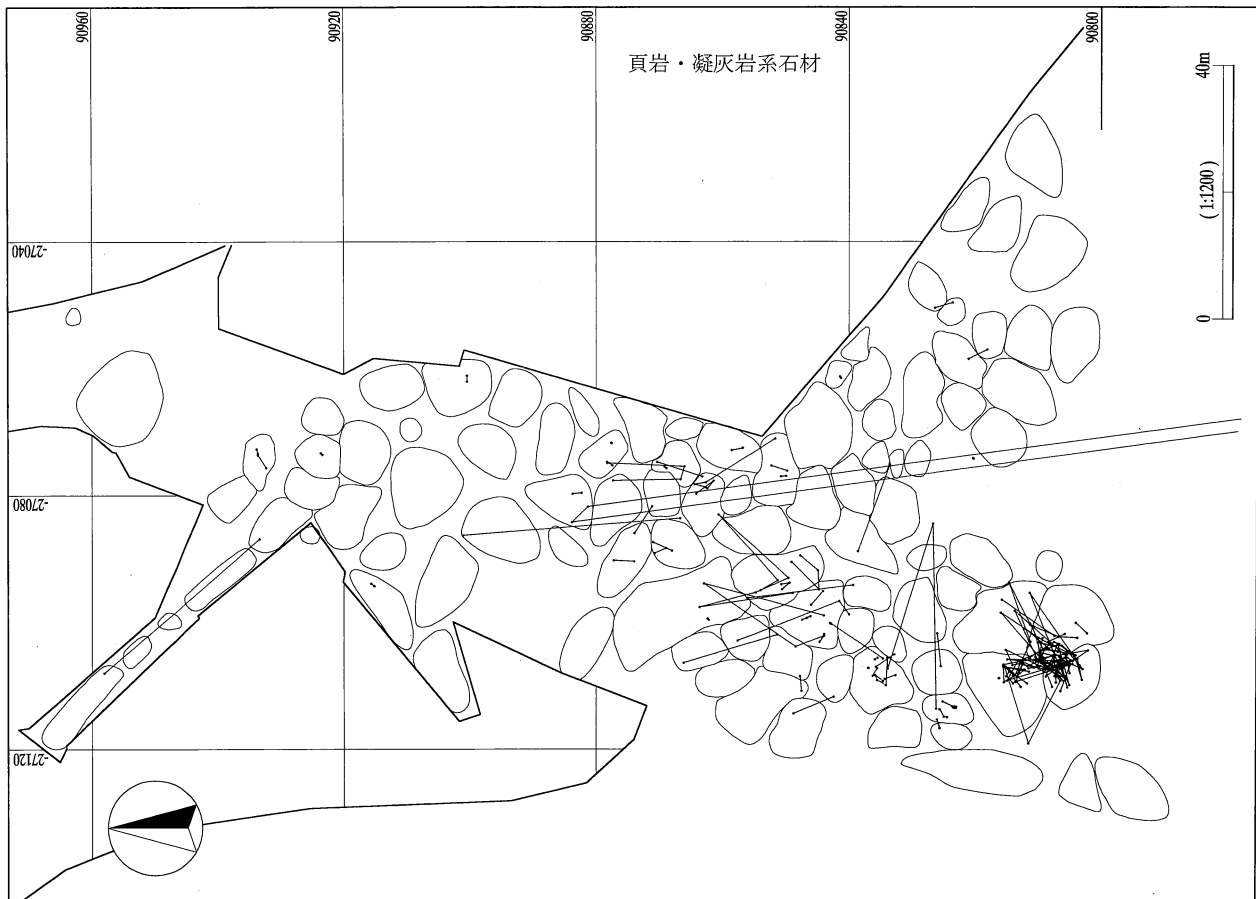

第4地点 接合資料分布図3 (貫ノ木遺跡)

An-10

剥離順序	遺物番号	ブロック	出土層位	器種	重量g	打面	作業面
1	VI-R2883	4042	V b	Fl	32.3	正面	上
2	X-I 128	2016	IV	Fl	31.4	正面	左
3	X-I 135	2016	IV	Fl	12	左	正面
4	X-I 134	2016	IV	Fl	3.29	左	正面
5	X-I 132	2016	IV	Fl	27.6	右	正面
6	X-I 130	2016	IV	Fl	7.49	右	正面
7	VI-R1850	4040	IV	Fl	4.68	左	正面
8	VI-R2408	4042	V a	Fl	25	正面	右
9	VI-R2448	4042	V a	Fl	33.1	正面	下
10	VI-R2398	4042	V a	Fl	3.86	右	正面
11	VI-R1063	4042	III	Fl	12.9	右	正面
12	VI-R2396	4042	V a	Co	274		

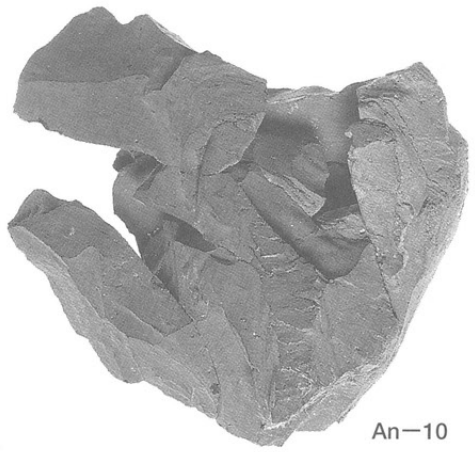
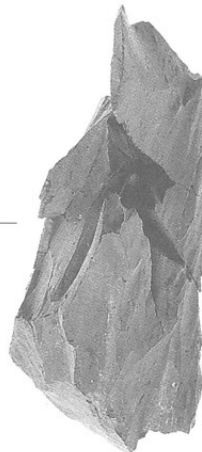

An-10

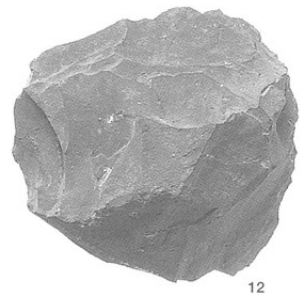
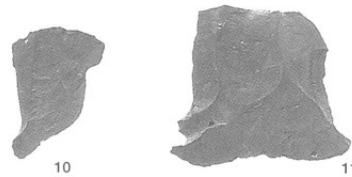
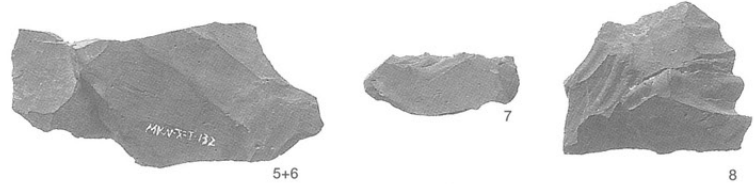
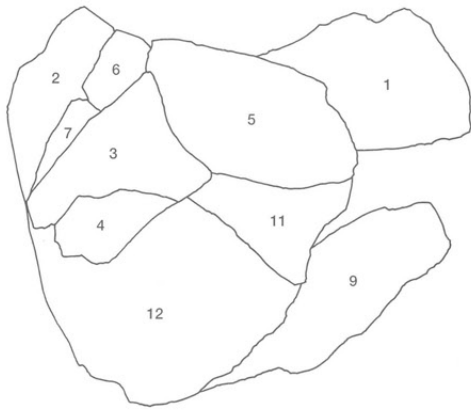

An-10 集合写真



第4地点 接合資料1 (An-10) (貫ノ木遺跡)

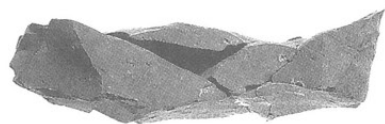

An-22

剥離順序	遺物番号	ブロック	出土層位	器種	重量g	打面	作業面
1	VI-R2645	4074	V b	FI	55.4	上	正面
2	VI-R79	4074	V a	ES	110	上	正面
3	VI-R81	4074	V a	FI	49.6	上	正面
4	X-N2953	2040	V a	FI	54	上	正面



An-22

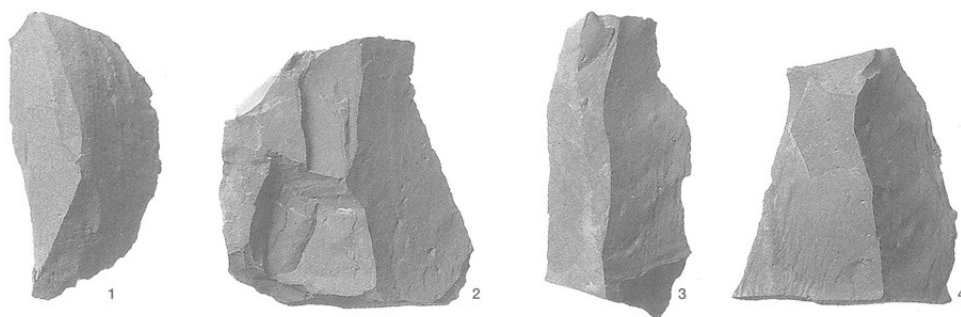
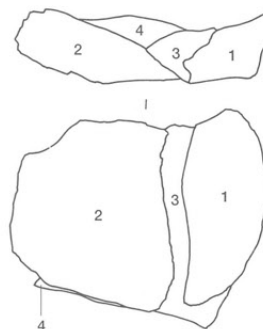

An-22 集合写真

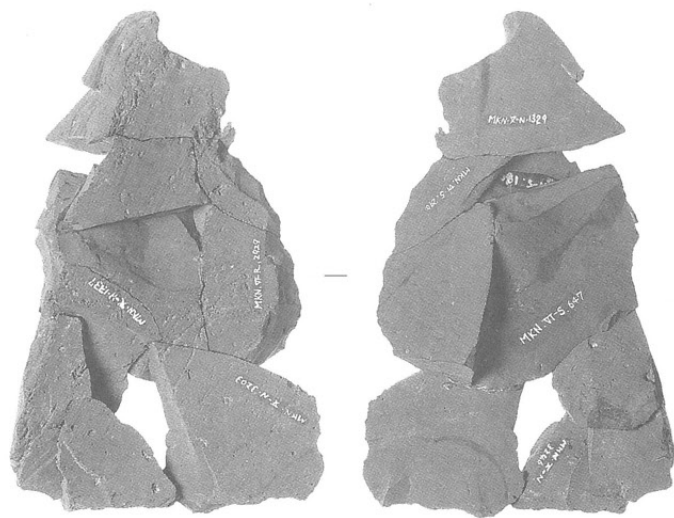

An-112

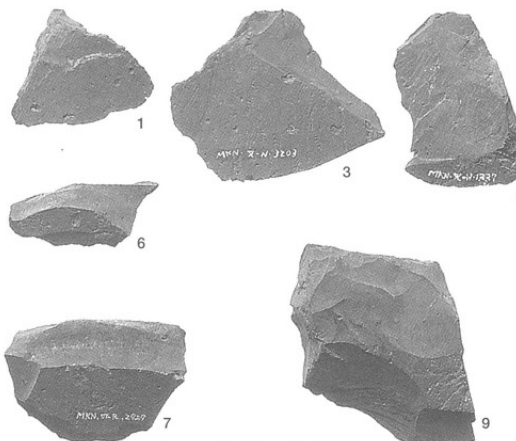

An-112 集合写真

An-112

剥離順序	遺物番号	ブロック	出土層位	器種	重量g	打面	作業面
1	X-N3246	2100	V a	FI	6.53	左	正面
2	X-N1324	2100	IV	FI	16.7	左	正面
3	X-N3203	2100	V b	FI	12	下	正面
4	X-N1337	2100	IV	FI	9.94	左	正面
5	X-N1329	2100	IV	FI	24.9		
6	VI-S290	4081	V a	ES破	5.5	正面	右
7	VI-R2929	4049	IV	ES	28.5	正面	右
8	VI-S180	4081	IV下	FI	9.16	右	正面
9	VI-S647	4081	V b	Sc	40.9	上	正面

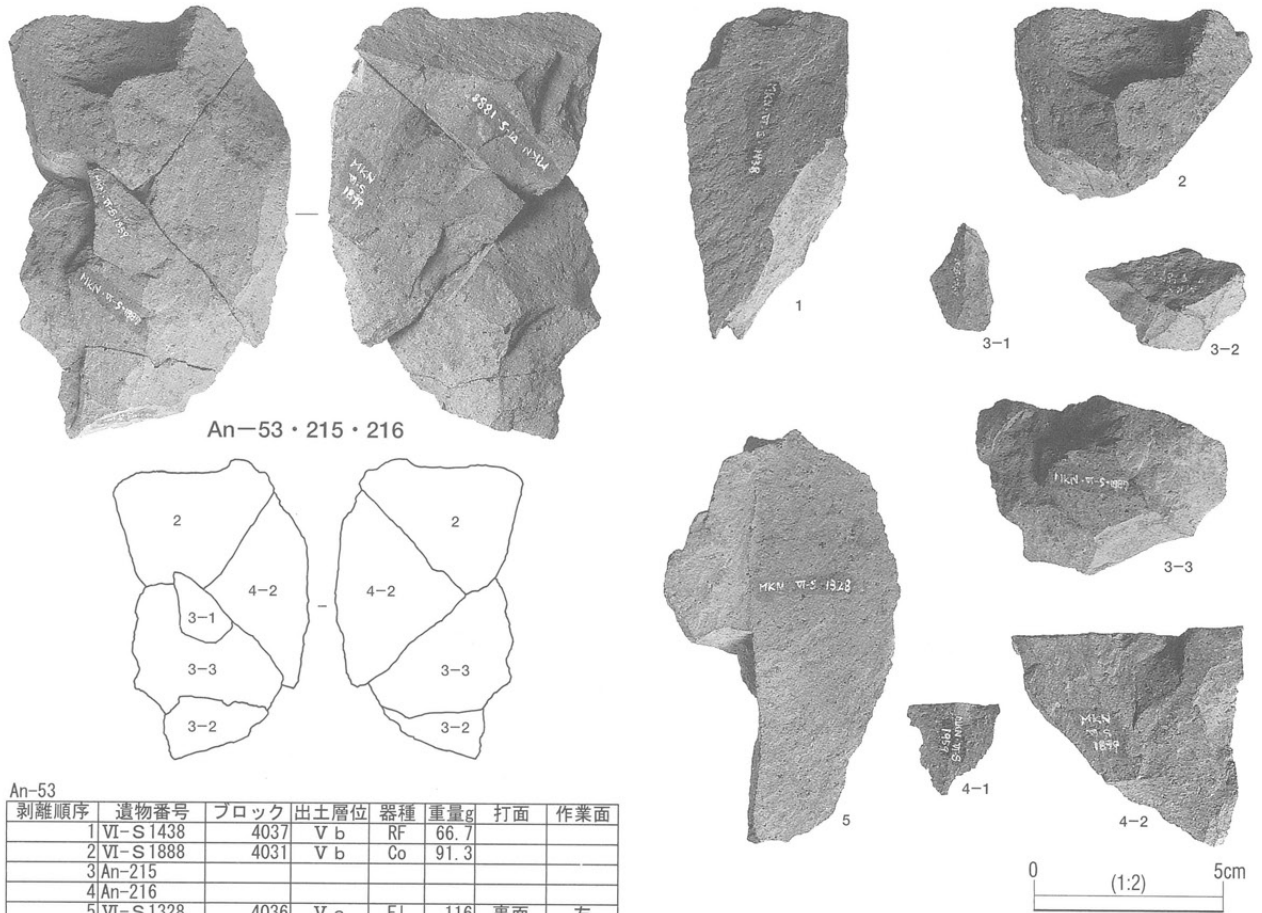

An-53

剥離順序	遺物番号	ブロック	出土層位	器種	重量g	打面	作業面
1	VI-S1438	4037	V b	RF	66.7		
2	VI-S1888	4031	V b	Co	91.3		
3	An-215						
4	An-216						
5	VI-S1328	4036	V a	FI	116	裏面	左

An-53 · 215 · 216 集合写真

An-215

剥離順序	遺物番号	ブロック	出土層位	器種	重量g	打面	作業面
3-1	VI-S1859	4034	V a	FI	5.42	上	正面
3-2	VI-S1876	4031	V b	Co	14	裏面	下
3-3	VI-S1887	4031	V b	Co	62.9		

An-216

剥離順序	遺物番号	ブロック	出土層位	器種	重量g	打面	作業面
4-1	VI-S1959	4031	V b	FI	2.63	上	裏面
4-2	VI-S1899	4031	V b	Co	78.6		

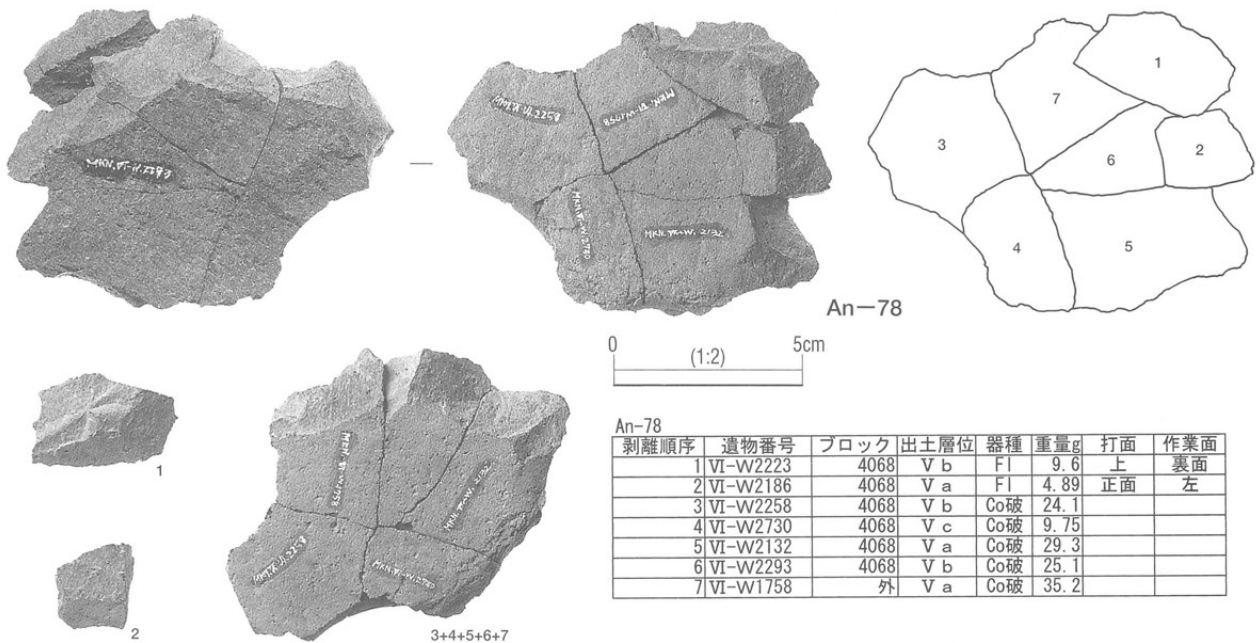

An-78 集合写真

An-78

剥離順序	遺物番号	ブロック	出土層位	器種	重量g	打面	作業面
1	VI-W2223	4068	V b	FI	9.6	上	裏面
2	VI-W2186	4068	V a	FI	4.89	正面	左
3	VI-W2258	4068	V b	Co破	24.1		
4	VI-W2730	4068	V c	Co破	9.75		
5	VI-W2132	4068	V a	Co破	29.3		
6	VI-W2293	4068	V b	Co破	25.1		
7	VI-W1758	外	V a	Co破	35.2		



An-54

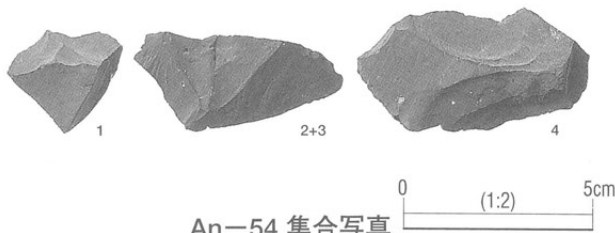

An-54 集合写真

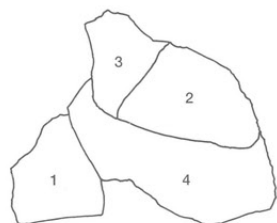

An-54

剥離順序	遺物番号	ブロック	出土層位	器種	重量g	打面	作業面
1	VI-S 239	4076	V a	Fl	7.24		
2	VI-S 219	4076	IV下	RF	6.8	裏面	上
3	VI-S 885	4039	IV	Fl	2.54	裏面	上
4	VI-S 1301	4039	V b	Sc	26.5		

An-89

剥離順序	遺物番号	ブロック	出土層位	器種	重量g	打面	作業面
1	VI-S 1629	4031	V a	Fl	21.5	裏面	下
2	VI-S 1827	4031	V a	Fl	22.1	正面	左
3	VI-S 1829	4031	V a	Fl	14.1	正面	左
4	VI-S 1893	4031	V b	Fl	14.3	正面	左
5	VI-S 1637	4031	IV	Fl	13.3	上	右
6	VI-S 1842	4031	V a	Fl	12.2	右	正面
7	VI-S 1761	4031	V a	Fl	21.1	正面	裏面
8	VI-S 1874	4031	V b	Fl	27.7	裏面	上
9	VI-S 1892	4031	V b	Co	131		

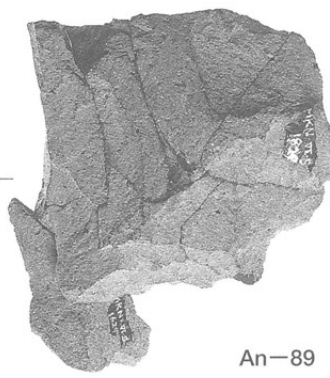

An-89

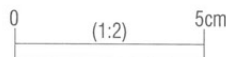
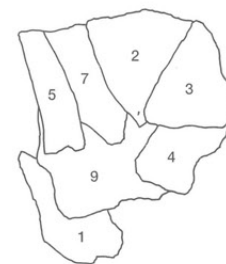

An-89 集合写真

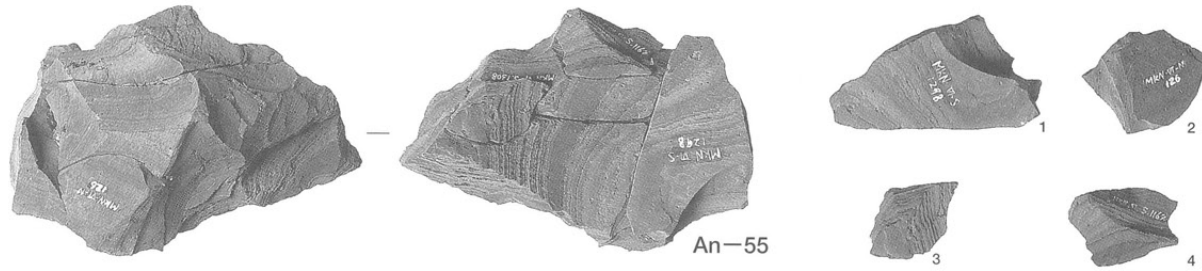

An-55

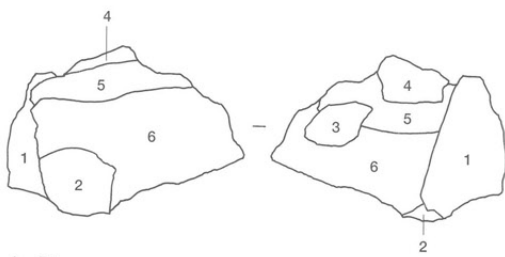

0 (1:2) 5cm



An-55 集合写真

An-55

剥離順序	遺物番号	ブロック	出土層位	器種	重量g	打面	作業面
1	VI-S 1298	4039	V b	Fl	18.1	正面	左
2	VI-N 126	4025	V a	Fl	7.6	左	正面
3	VI-S 1169	4039	V a	Fl	3.12	正面	上
4	VI-S 1162	4039	V a	Fl	3.45	正面	上
5	VI-S 1308	4039	V b	Fl	21.5	正面	上
6	VI-S 1469	4039	V a	Co	71.6		

An-103

剥離順序	遺物番号	ブロック	出土層位	器種	重量g	打面	作業面
1	VI-W 168	4076	V a	Fl	58	正面	上
2	VI-X 610	4076	V a	Fl	41	正面	上
3	VI-X 1524	4088	V a	Fl	4.15	正面	上
4	VI-X 1625	4088	V b	Fl	96.7	正面	上
5	VI-X 1620	4088	V b	Fl	22	正面	上
6	VI-W 612	4075	V a	Fl	21.5	正面	上
7	VI-X 1184	4088	V a	Fl	38		
8	VI-X 1627	4093	V b	Co	78.4		
9	VI-X 1523	4088	V a	Fl	47	右	正面
10	VI-X 1626	4093	V b	Co	191		

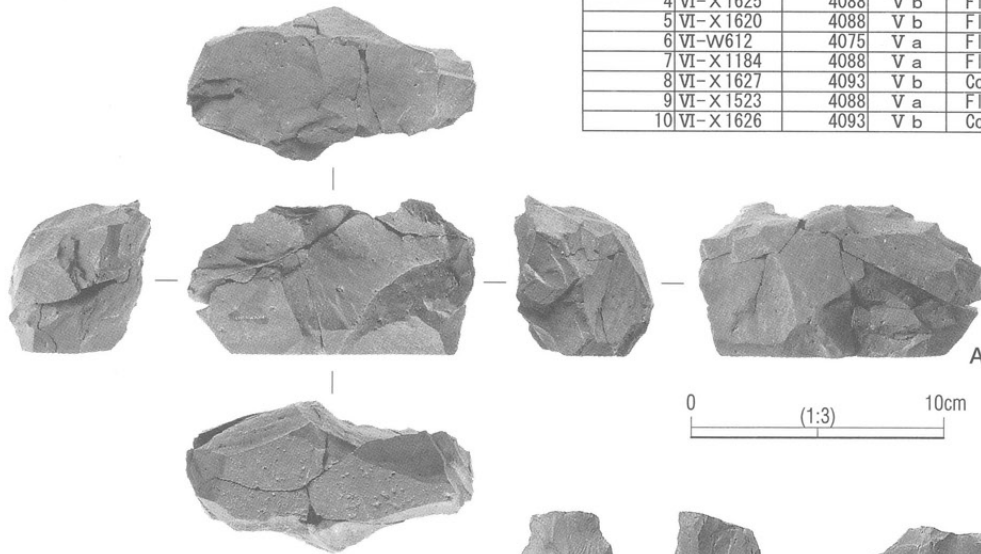

An-103

0 (1:3) 10cm

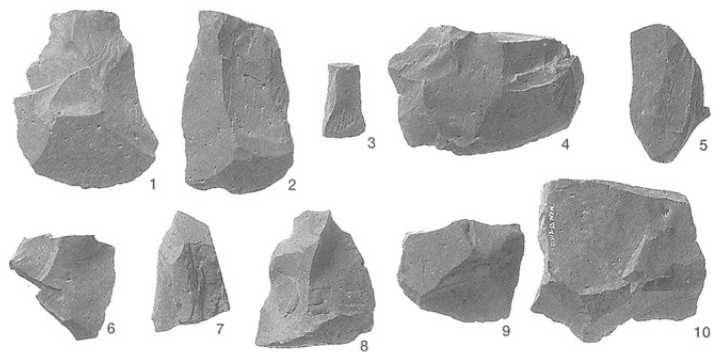
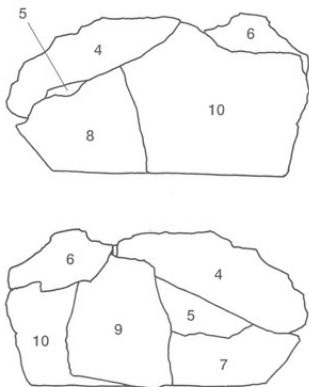

An-103 集合写真

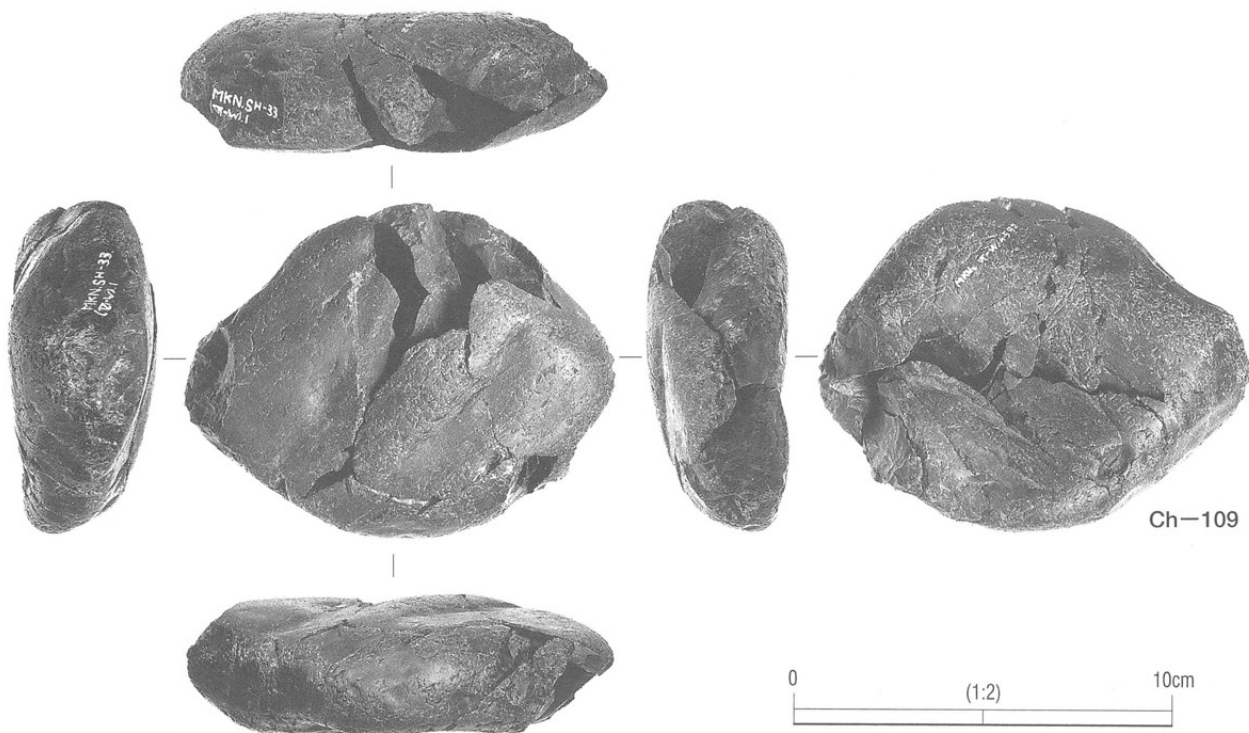

Ch-109

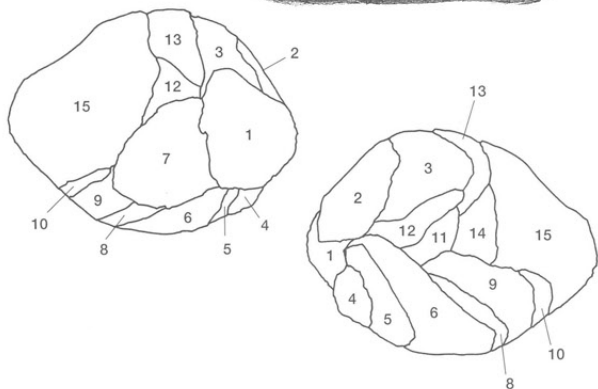

Ch-109

剥離順序	遺物番号	ブロック	出土層位	器種	重量g	打面	作業面
1	VI-W2060	4070	V a	Fl	19.8	左	正面
2	VI-W4397	4070	V b	Fl	12.3	正面	左
3	VI-W4532	4070	V b	Fl	25.6	正面	左
4	VI-W4346	4070	V b	Fl	4.23	正面	左
5	VI-W1257	4068	IV上	Fl	6.5	正面	左
6	VI-W2061	4070	V a	Fl	46.9	正面	左
7	VI-W4530	4070	V b	Fl	17.1	左	正面
8	VI-W4452	4070	V b	Fl	12.1	正面	左
9	VI-W4550	4070	V b	Fl	30.8	正面	左
10	VI-W1916	4063	V a	Fl	7.41	正面	左
11	VI-W3216	4070	V b	Fl	7.78	正面	左
12	VI-W3840	4067	V b	Fl	12.7	正面	左
13	VI-W3555	4070	V b	Fl	22	正面	左
14	VI-W3640	4070	V b	Fl	27.2	正面	左
15	SH331	4070	V a	Co	157		

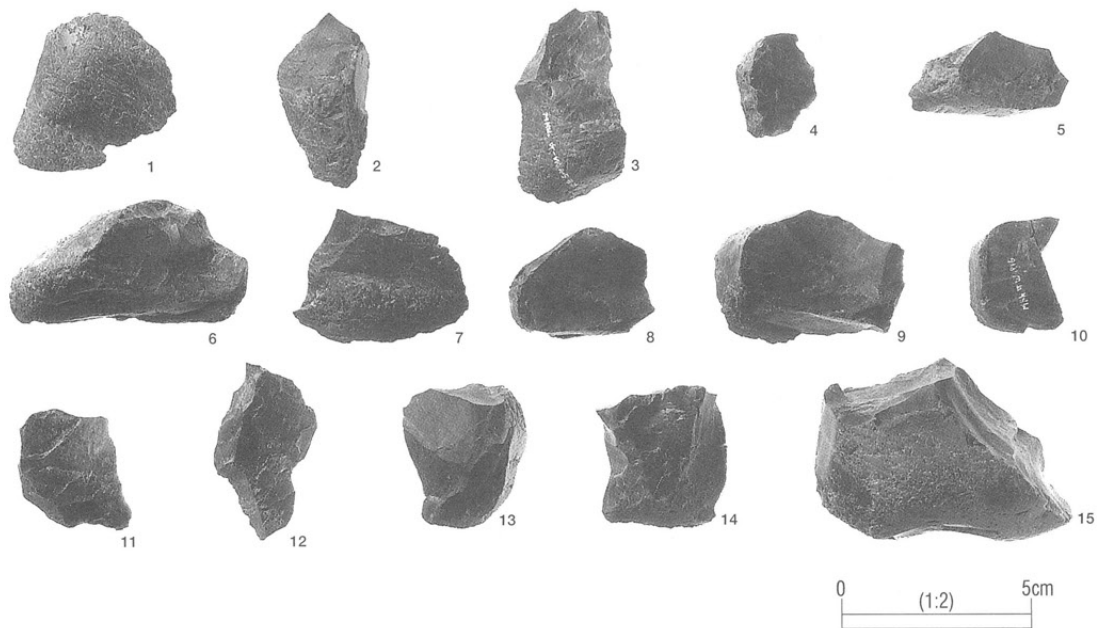

Ch-109 集合写真

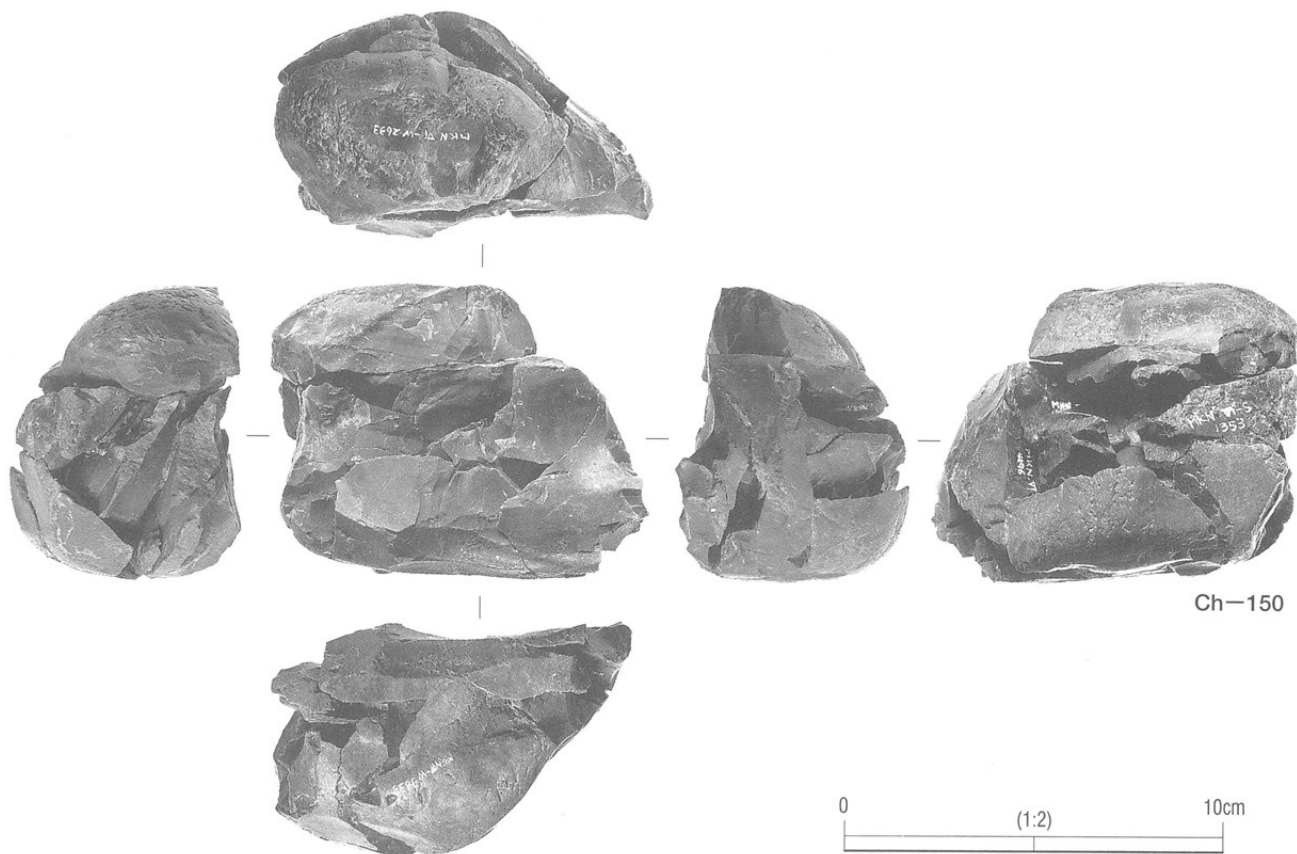

Ch-150

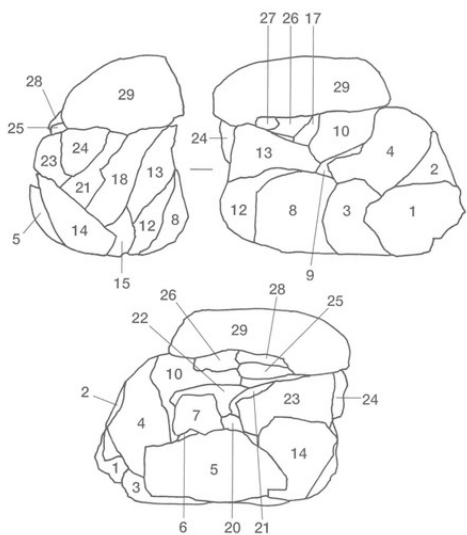

Ch-150

剥離順序	遺物番号	ブロック	出土層位	器種	重量g	打面	作業面
1	VI-W2826	4070	V a	FI	9.79	右	正面
2	VI-W4536	4070	V b	FI	4.78	右	正面
3	VI-W4178	4070	V b	FI	18.3	右	正面
4	VI-W4196	4070	V b	FI	43.7	右	正面
5	VI-W3833	4070	V a	FI	35.6	正面	右
6	VI-W2571	4070	IV上	FI	11.8	正面	右
7	VI-W4082	4070	V b	FI	5.6	正面	右
8	VI-W3310	4070	V a	UF	24.7	右	正面
9	VI-W4181	4070	V b	FI	4.86	右	正面
10	VI-W3826	4070	V a	FI	19.5	上	正面
11	VI-W3070	4070	V a	FI	2.33	正面	下
12	VI-W3486	4070	V b	FI	9.53	左	正面
13	VI-W3307	4070	V a	FI	25.6	右	正面
14	VI-W2531	4070	IV上	FI	15.2	正面	下
15	VI-W4187	4070	V b	FI	1.97	下	正面
16	VI-W3205	4070	V b	FI	5.53	下	正面
17	VI-W4183	4070	V b	FI	13.9	下	正面
18	VI-W2627	4067	V a	FI	25.7	下	正面
19	VI-W2212	4070	V b	FI	9.19	下	正面
20	VI-W4189	4070	V b	FI	5.99	下	正面
21	VI-W3969	4070	V b	FI	10.5	下	正面
22	VI-W3254	4070	V b	FI	4.27	右	正面
23	VI-S1353	4040	V a	FI	19.2	裏面	下
24	VI-W2576	4070	IV下	FI	4.31	裏面	下
25	VI-W4472	4067	V b	FI	3.74	裏面	下
26	VI-W3933	4067	V b	FI	19.7	裏面	下
27	VI-W4056	4067	V b	FI	1.36		
28	VI-W1692	4067	IV下	FI	2.13		
29	VI-W2633	4067	V a	FI	99.7		
30	VI-W3115	4070	V a	FI	1.87		
31	VI-W1333	4068	IV下	FI	2.44		
32	VI-W4648	4070	V b	Co	99.2		

第4地点 接合資料7 (Ch-150) (貫ノ木遺跡)

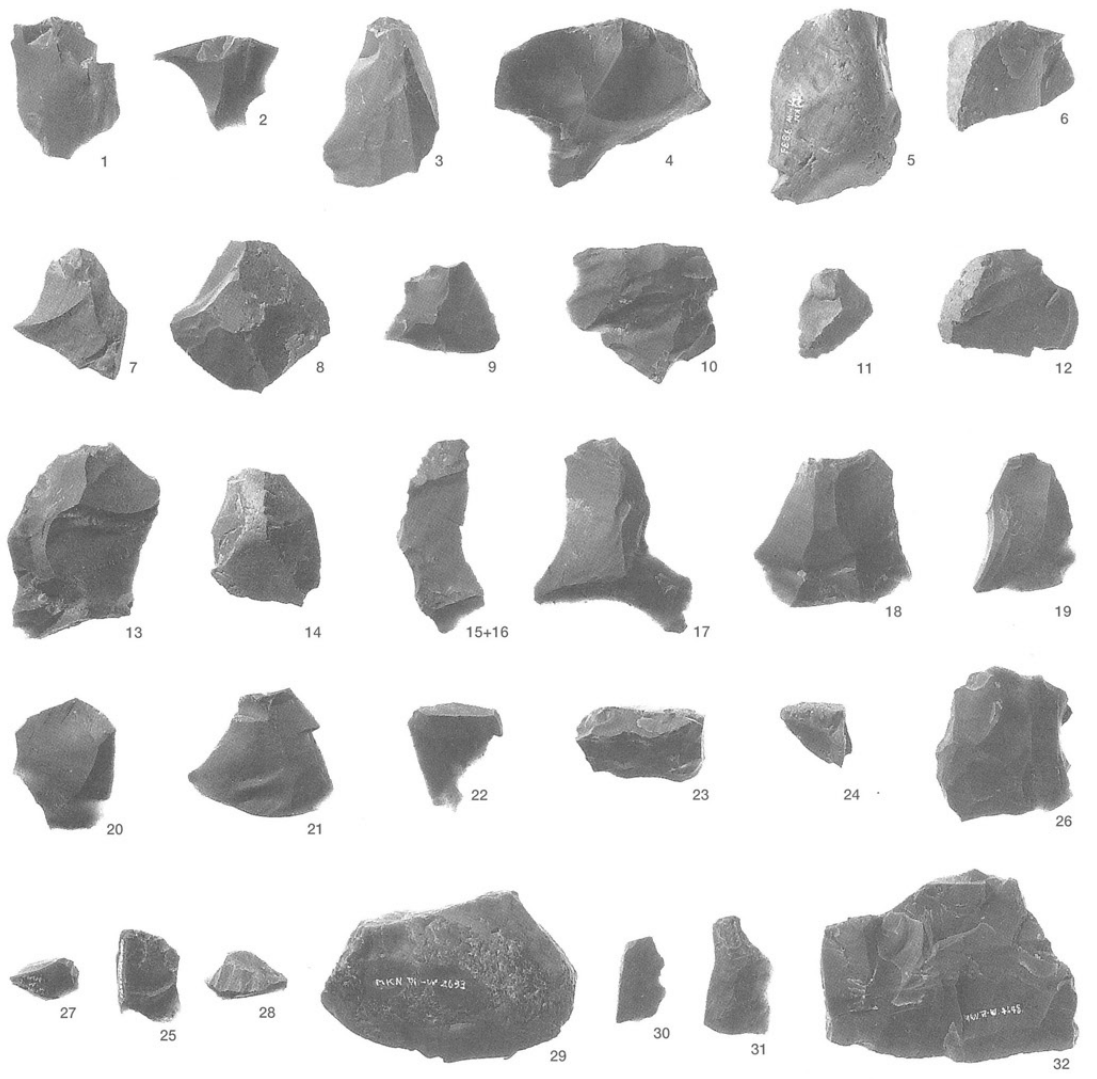

Ch-150 集合写真

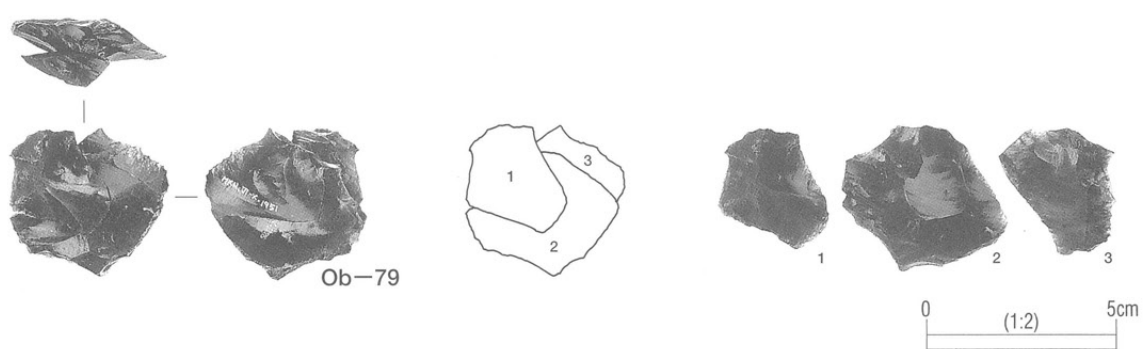

Ob-79

Ob-79 集合写真

Ob-79

剥離順序	遺物番号	ブロック	出土層位	器種	重量g	打面	作業面
1	VI-X2441	4091	V b	ESS	4.03	上	正面
2	VI-Y276	4097	V b	ES	9.88	上	正面
3	VI-X1951	4091	V b	ESS	3.19	上	正面

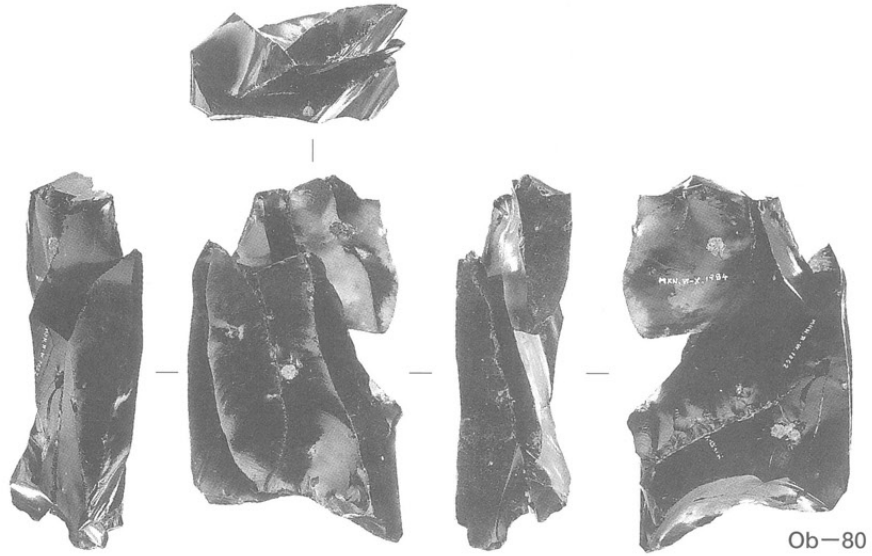

Ob-80

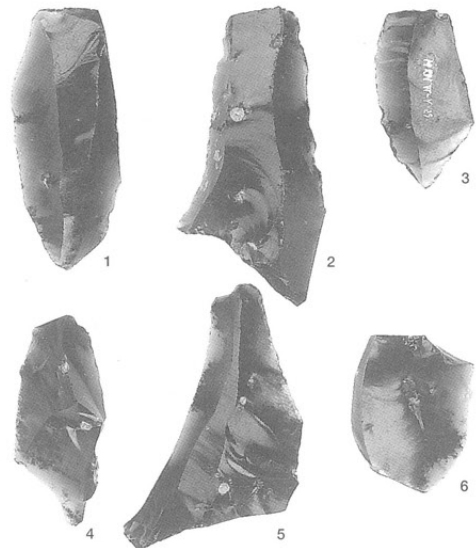
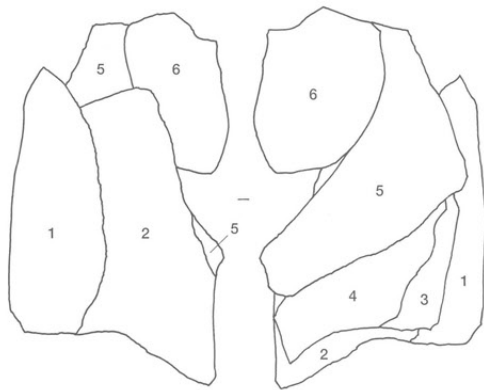

Ob-80 集合写真

Ob-80

剥離順序	遺物番号	ブロック	出土層位	器種	重量g	打面	作業面
1	VI-W958	外	V a	UF	30.8	下	正面
2	VI-W190	4076	V b	UF	38.6	上	正面
3	VI-Y290	4096	V b	RF	10.4	下	正面
4	VI-X2315	4092	V b	RF	17.3	右	正面
5	VI-W1062	4058	IV	RF	28.9	右	正面
6	VI-X1984	4092	V a	UF	15.6	上	正面

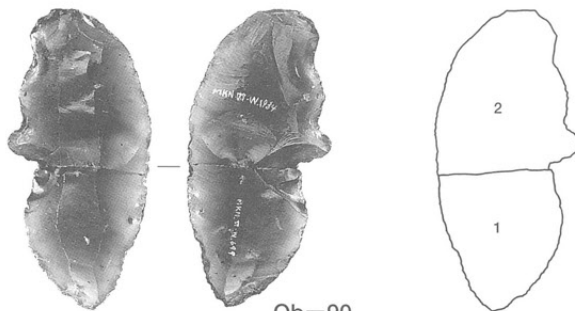

Ob-90

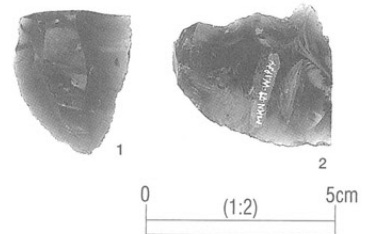

Ob-90 集合写真

Ob-90

剥離順序	遺物番号	ブロック	出土層位	器種	重量g	打面	作業面
1	VI-W699	4077	V b	RF	12.7		
2	VI-W1934	4065	V a	Co	21.4		

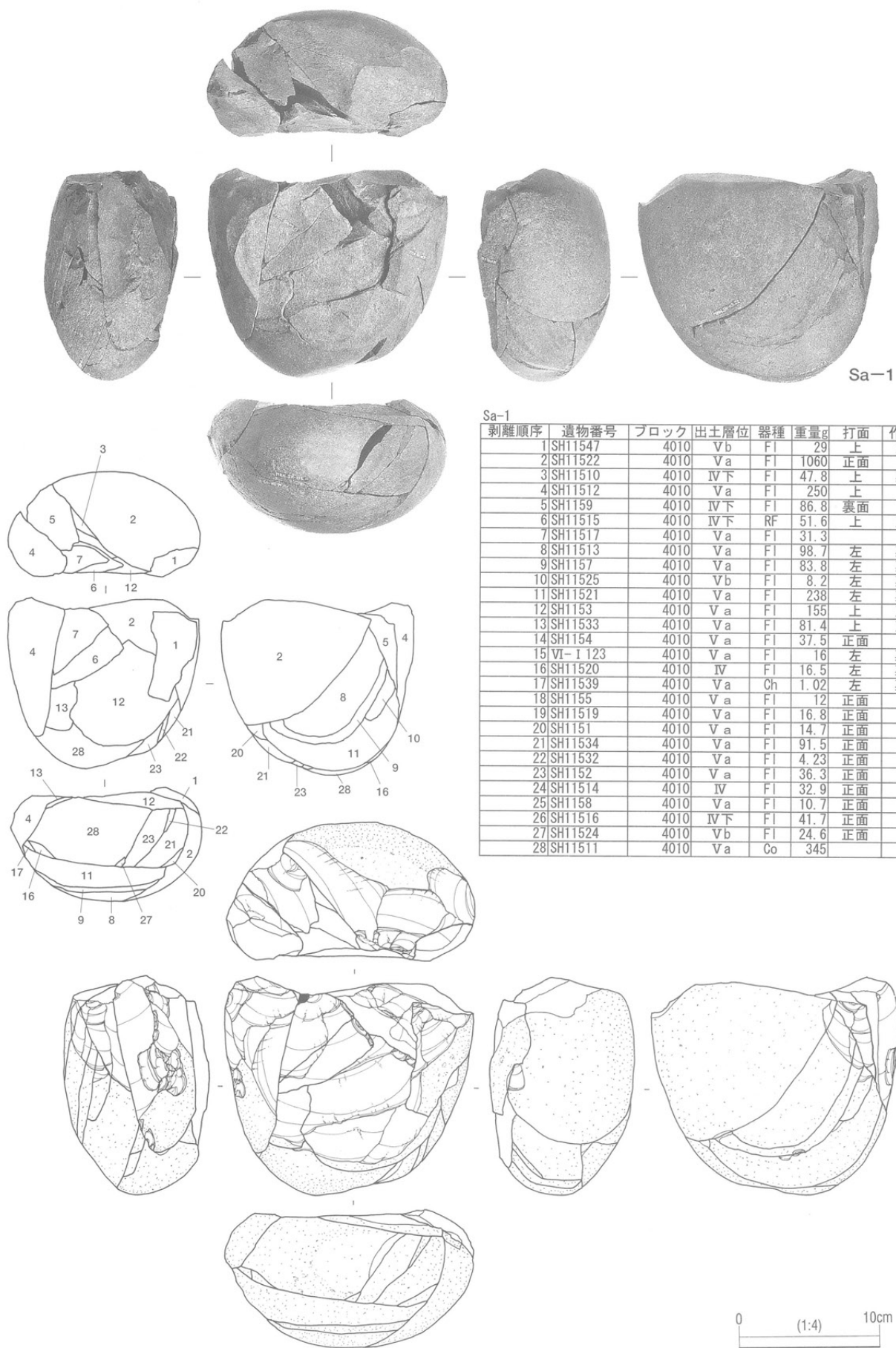

Sa-1

Sa-1

剥離順序	遺物番号	ブロック	出土層位	器種	重量g	打面	作業面
1	SH11547	4010	Vb	Fl	29	上	正面
2	SH11522	4010	Va	Fl	1060	正面	上
3	SH11510	4010	IV下	Fl	47.8	上	裏面
4	SH11512	4010	Va	Fl	250	上	左
5	SH1159	4010	IV下	Fl	86.8	裏面	左
6	SH11515	4010	IV下	RF	51.6	上	正面
7	SH11517	4010	Va	Fl	31.3		
8	SH11513	4010	Va	Fl	98.7	左	裏面
9	SH1157	4010	Va	Fl	83.8	左	裏面
10	SH11525	4010	Vb	Fl	8.2	左	裏面
11	SH11521	4010	Va	Fl	238	左	裏面
12	SH1153	4010	Va	Fl	155	上	正面
13	SH11533	4010	Va	Fl	81.4	上	正面
14	SH1154	4010	Va	Fl	37.5	正面	上
15	VI-1123	4010	Va	Fl	16	左	裏面
16	SH11520	4010	IV	Fl	16.5	左	裏面
17	SH11539	4010	Va	Ch	1.02	左	裏面
18	SH1155	4010	Va	Fl	12	正面	上
19	SH11519	4010	Va	Fl	16.8	正面	上
20	SH1151	4010	Va	Fl	14.7	正面	上
21	SH11534	4010	Va	Fl	91.5	正面	上
22	SH11532	4010	Va	Fl	4.23	正面	上
23	SH1152	4010	Va	Fl	36.3	正面	上
24	SH11514	4010	IV	Fl	32.9	正面	上
25	SH1158	4010	Va	Fl	10.7	正面	上
26	SH11516	4010	IV下	Fl	41.7	正面	上
27	SH11524	4010	Vb	Fl	24.6	正面	上
28	SH11511	4010	Va	Co	345		

第4地点 接合資料10 (Sa-1) (貫ノ木遺跡)

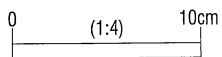
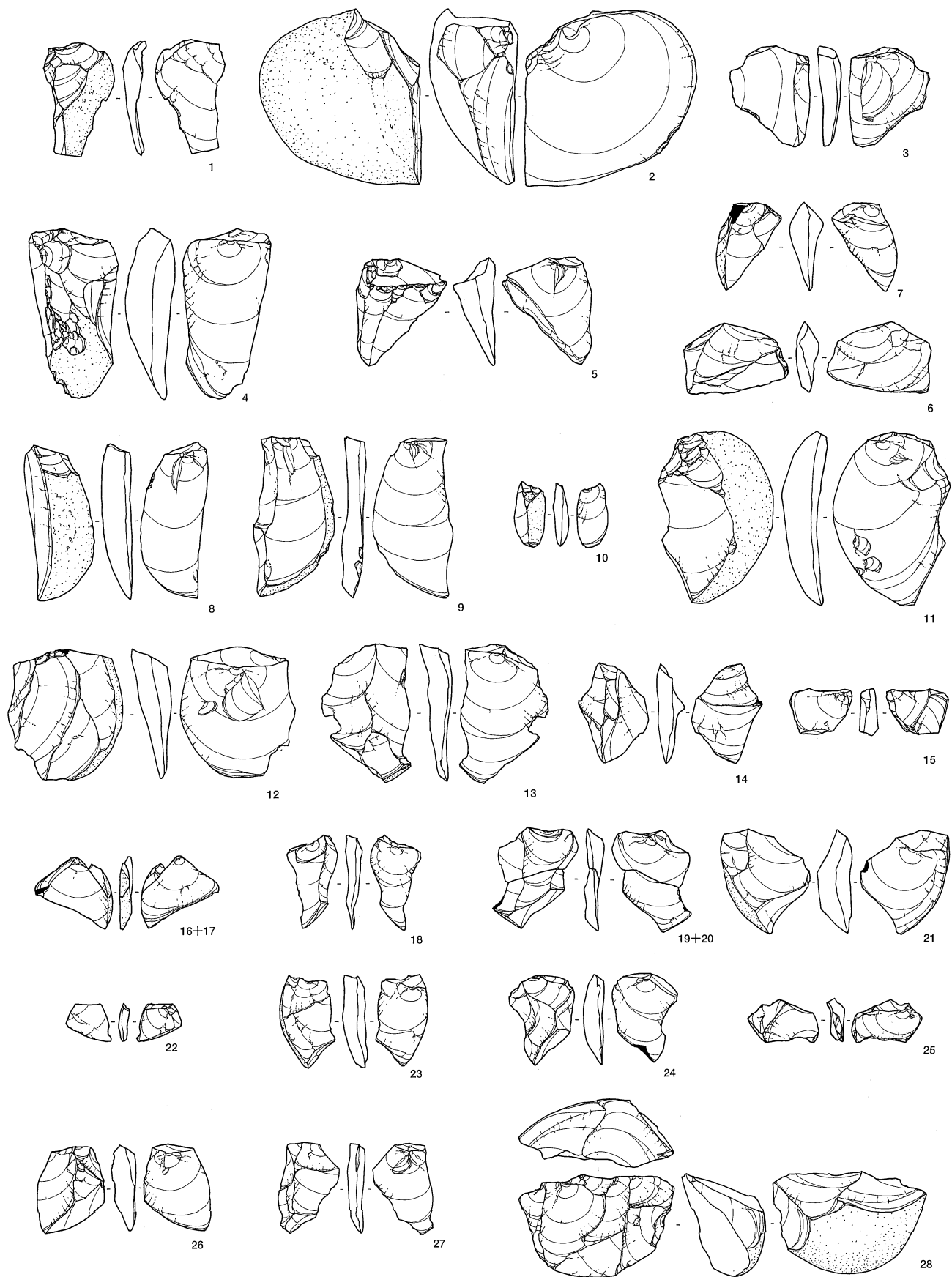

第4地点 接合資料11 (Sa-1) (貫ノ木遺跡)

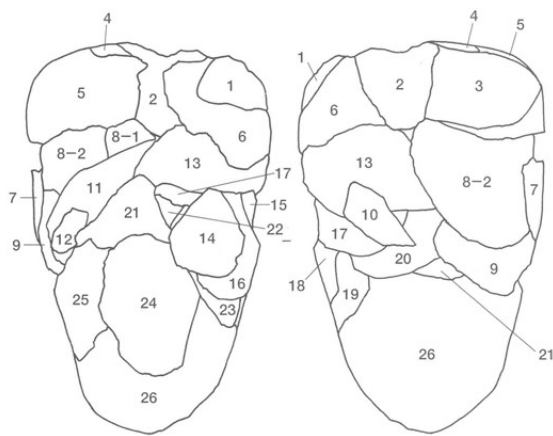

SS-12

剥離順序	遺物番号	ブロック	出土層位	器種	重量g	打面	作業面
1	VI-W3189	4069	V a	FI	3.78	右	裏面
2	VI-W4222	4069	V b	FI	15.2	正面	上
3	VI-W4214	4069	V b	FI	30.9	正面	上
4	VI-W3567	4070	V b	FI	1.55	正面	上
5	VI-W4599	4069	V b	FI	44.4	正面	上
6	VI-W3987	4070	V b	FI	18.7	上	正面
7	VI-W3233	4070	V b	FI	3.74	上	裏面
8	SS-54					左	裏面
9	VI-W3142	4070	V a	FI	14.3	左	裏面
10	VI-W4247	4069	V b	FI	4.02	上	裏面
11	VI-W2833	4070	V a	FI	21.7	正面	上
12	VI-W3711	4070	V b	FI	1.22	正面	上
13	VI-W3246	4067	V b	FI	36.1	正面	上
14	VI-W2589	4067	IV下	FI	6.85	上	正面
15	VI-W4003	4070	V b	FI	1	上	正面
16	VI-W3649	4070	V b	FI	17	上	正面
17	VI-W4000	4070	V b	FI	24.8	右	裏面
18	VI-W2795	4070	IV下	FI	6.08	上	右
19	VI-W2337	4068	V b	FI	9.79	上	右
20	VI-W3131	4070	V a	FI	11.7	右	裏面
21	VI-W3813	4067	V a	FI	24.2	正面	裏面
22	VI-W2565	4067	IV上	FI	4.43	上	正面
23	VI-W3470	4067	V a	FI	11.4	上	正面
24	VI-W2849	4067	V a	Co	37.4	上	正面
25	VI-W4473	4067	V b	FI	36.9	正面	左
26	VI-W2611	4067	IV下	Co	350		

SS-54

剥離順序	遺物番号	ブロック	出土層位	器種	重量g	打面	作業面
8-1	VI-W3411	4070	V a	FI	1.22	上	正面
8-2	VI-W4241	4069	V b	Co	47.7		

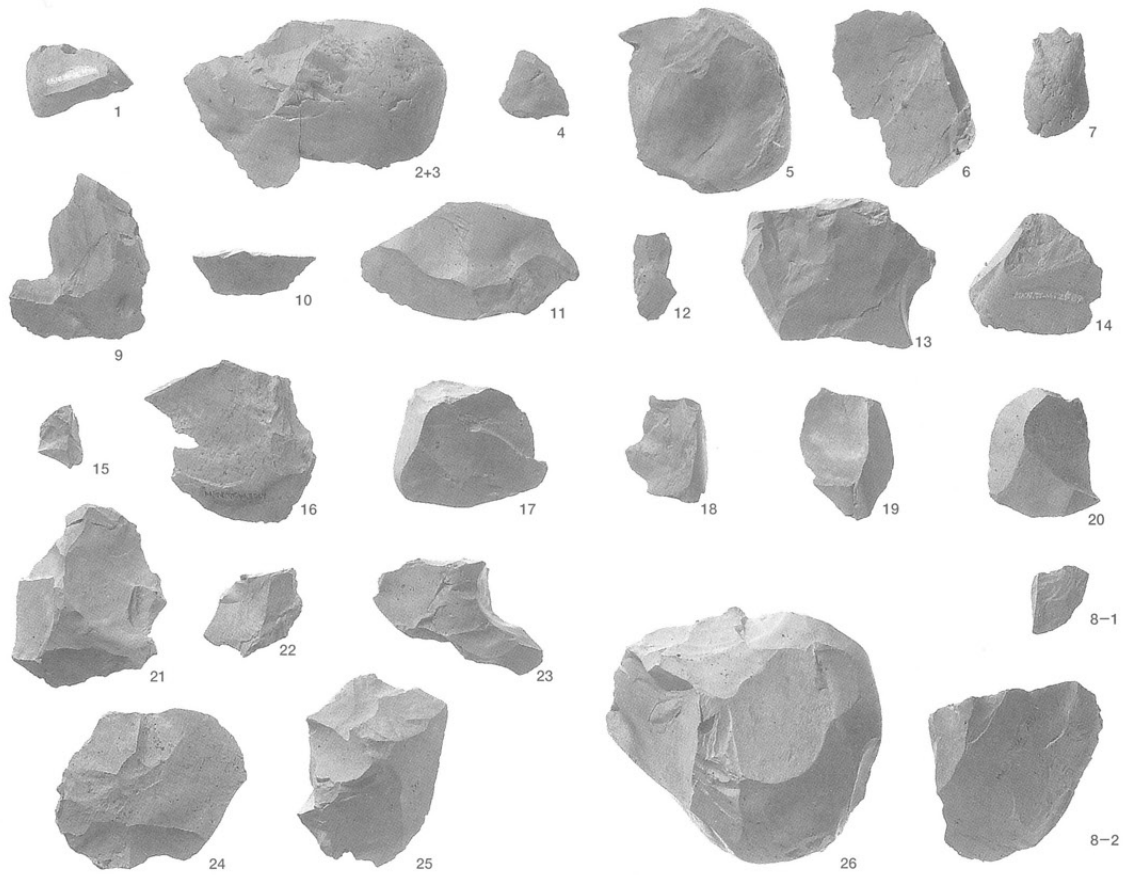

SS-12・54 集合写真

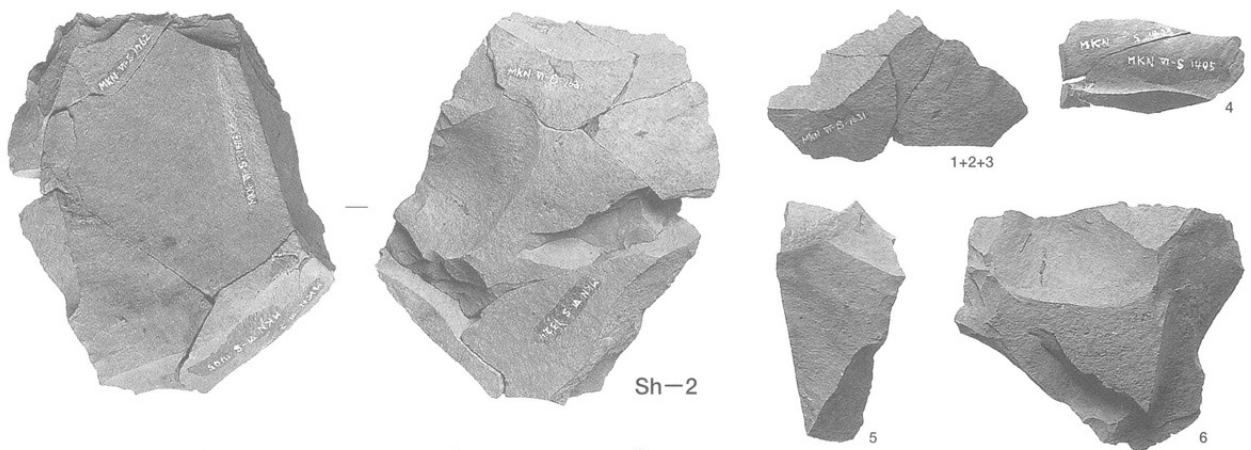

Sh-2

Sh-2 集合写真

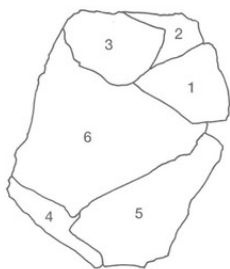

剥離順序	遺物番号	ブロック	出土層位	器種	重量g	打面	作業面
1	VI-S1639	4031	IV	RF	13.3	左	裏面
2	VI-S1762	4031	V a	RF	9.66	左	裏面
3	VI-S1631	4031	V a	FI	7.12	左	裏面
4	VI-S1405	4036	V b	FI	10.8	裏面	下
5	VI-S1324	4036	V a	UF	36.3		
6	VI-S1873	4032	V a	Co	92.8		

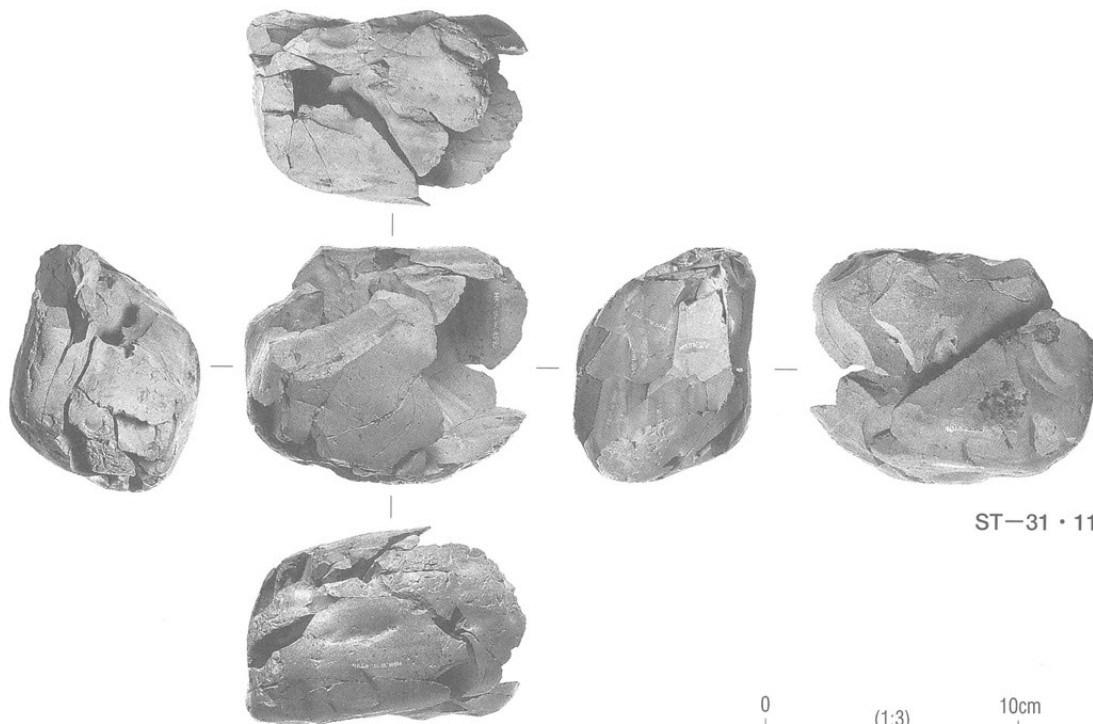

ST-31・113・114

0 (1:3) 10cm

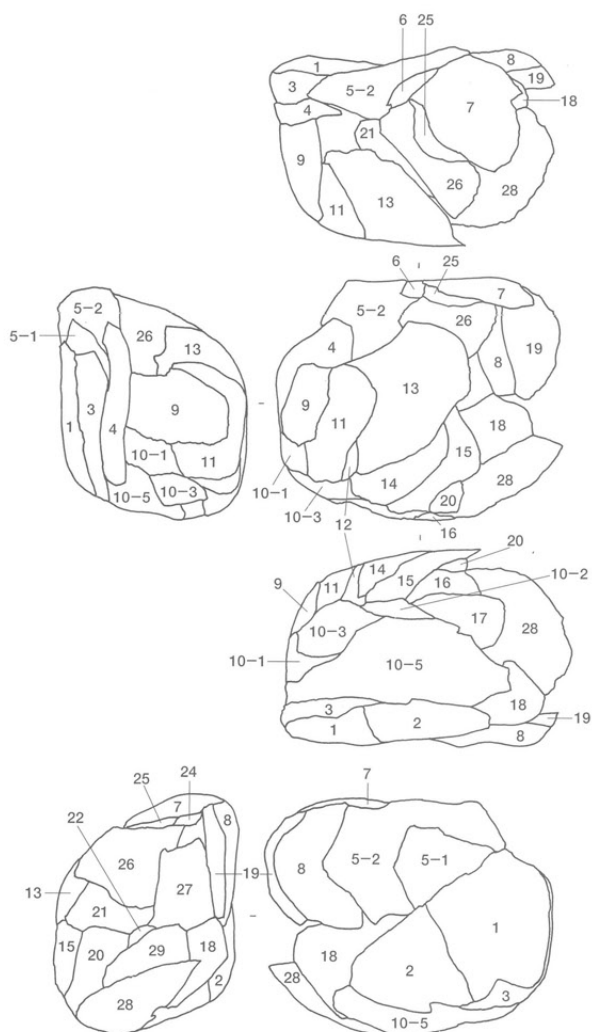

ST-31

剥離順序	遺物番号	ブロック	出土層位	器種	重量g	打面	作業面
1	VI-W3972	4070	V b	FI	26.6	左	裏面
2	VI-W3971	4070	V b	FI	14.1	左	裏面
3	VI-W4352	4069	V b	FI	31.4	左	裏面
4	VI-W3590	4070	V b	FI	9.99	左	裏面
5	ST-113					上	裏面
6	VI-W3225	4070	V b	FI	1.23	上	裏面
7	VI-W2197	4068	V a	FI	11.5	裏面	上
8	VI-W4254	4069	V a	FI	16.9	上	裏面
9	VI-W3781		IV	FI	14.8	裏面	左
10	ST-114					左	下
11	VI-W4203	4069	V b	FI	21.8	裏面	左
12	VI-W4388	4069	V a	FI	3.42	裏面	左
13	VI-W2621	4067	IV下	Co	59.9	裏面	左
14	VI-W3157	4067	V a	FI	10.6	左	正面
15	VI-W3754	4067	V b	FI	24.2	左	裏面
16	VI-W3956	4069	V b	FI	3.21	左	正面
17	VI-W4240	4069	V b	FI	9.33	左	裏面
18	VI-W2332	4068	V b	FI	55.4	左	裏面
19	VI-W2592	4067	IV下	FI	5.68	上	裏面
20	VI-W3425	4067	V a	FI	14.6	裏面	左
21	VI-W3438	4067	V a	FI	9.79	裏面	左
22	VI-W3158	4067	V a	FI	1.65	左	裏面
23	VI-W3304	4067	IV下	FI	3.9	左	裏面
24	VI-W4595	4069	V b	FI	1.49	裏面	上
25	VI-W3201	4069	V a	FI	1.9	裏面	上
26	VI-W3765	4067	V b	FI	20.4	裏面	上
27	VI-W3252	4067	V b	FI	11.3	上	裏面
28	VI-W4514	4067	V a	FI	34	左	下
29	VI-W3182	4067	V a	FI	17.1	左	裏面

ST-113

剥離順序	遺物番号	ブロック	出土層位	器種	重量g	打面	作業面
5-1	VI-W3191	4070	V a	FI	10.4	正面	裏面
5-2	VI-W2759	4067	IV上	Co	48.6		

ST-114

剥離順序	遺物番号	ブロック	出土層位	器種	重量g	打面	作業面
10-1	VI-W3467	4067	V a	FI	12	裏面	上
10-2	VI-W2815	4067	IV下	FI	4.47	下	上
10-3	VI-W4062	4067	V b	FI	11.9	下	上
10-4	VI-W3838	4067	IV上	FI	6.1	裏面	正面
10-5	VI-W3774	4067	V b	Co	63.2		

第4地点 接合資料14 (ST-31・113・114) (貫ノ木遺跡)

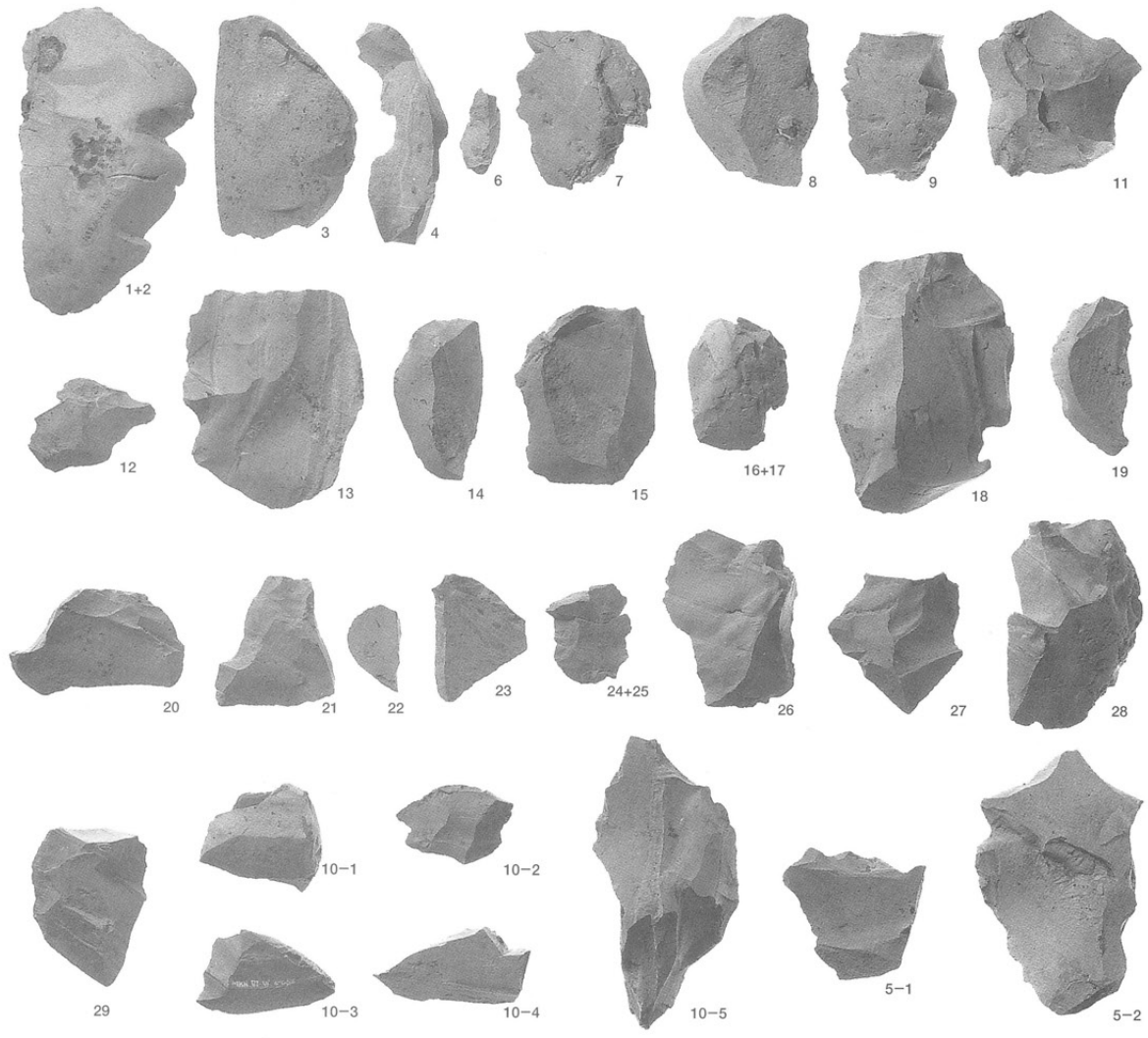

ST-31・113・114 集合写真



Ag-3



Ag-3 集合写真

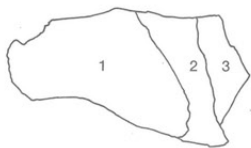

Ag-3							
剥離順序	遺物番号	ブロック	出土層位	器種	重量g	打面	作業面
1	VI-R2743	4049	III	F1	25.9	上	正面
2	VI-R2517	4052	V	F1	14.4	上	正面
3	VI-R158	4052	III	F1	6.37	上	正面

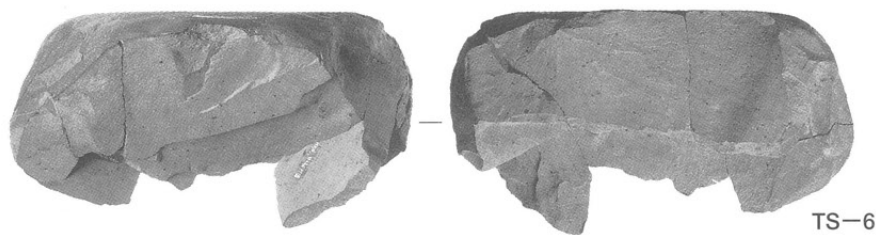

TS-6

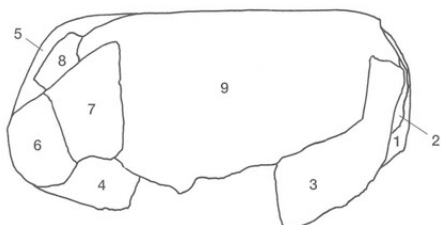

TS-6

剥離順序	遺物番号	ブロック	出土層位	器種	重量g	打面	作業面
1	VI-W1320	4061	IV上	Fl	113	正面	下
2	VI-W950	4061	IV上	Fl	11.6	左	裏面
3	VI-W1318	4061	IV上	Fl	116	正面	下
4	VI-W2698	4061	IV	Fl	76.7	正面	下
5	VI-W1316	4061	IV上	Fl	290	正面	下
6	VI-W1317	4061	IV上	Fl	34.9	裏面	左
7	VI-W2699	4061	IV	Fl	31	裏面	下
8	VI-W1319	4061	IV上	Fl	12.9	裏面	下
9	VI-W1315	4061	IV上	Co	1530		

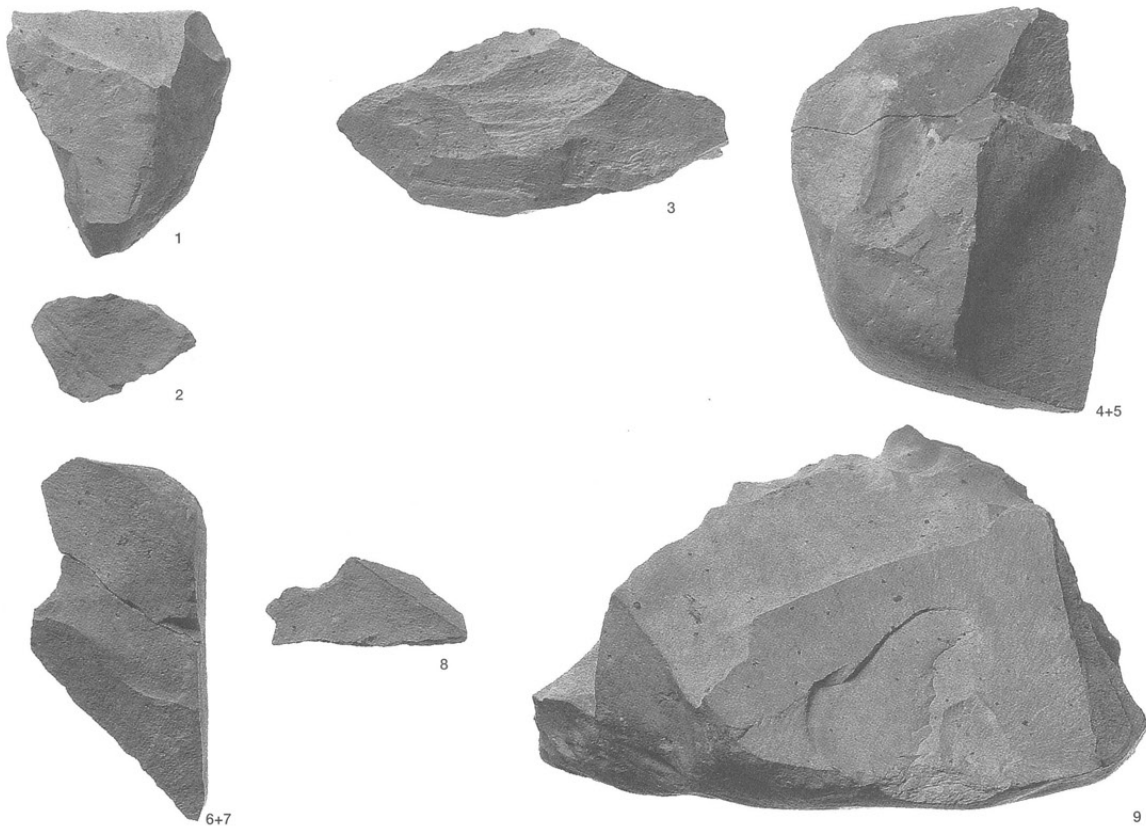
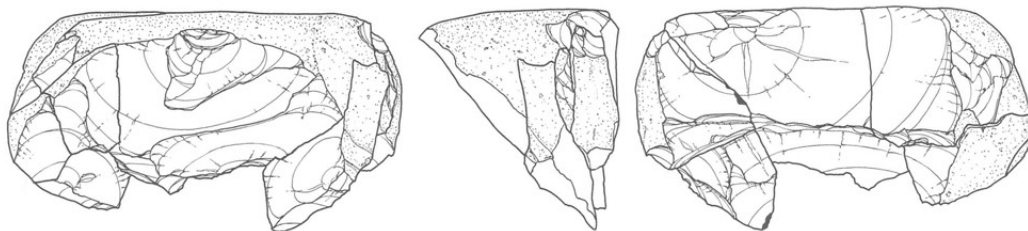

TS-6 集合写真



TS-11

剥離順序	遺物番号	ブロック	出土層位	器種	重量g	打面	作業面
1	VI-R999	4051	IV下	FI	9.55	右	上
2	VI-R1657	4044	IV	FI	49.4		
3	VI-R2022	4050	V	FI	10.3		
4	VI-R3048	4051	V	FI	29.1		
5	VI-R2983	4051	V	FI	51.2		
6	VI-R2762	4051	IV	FI	120		

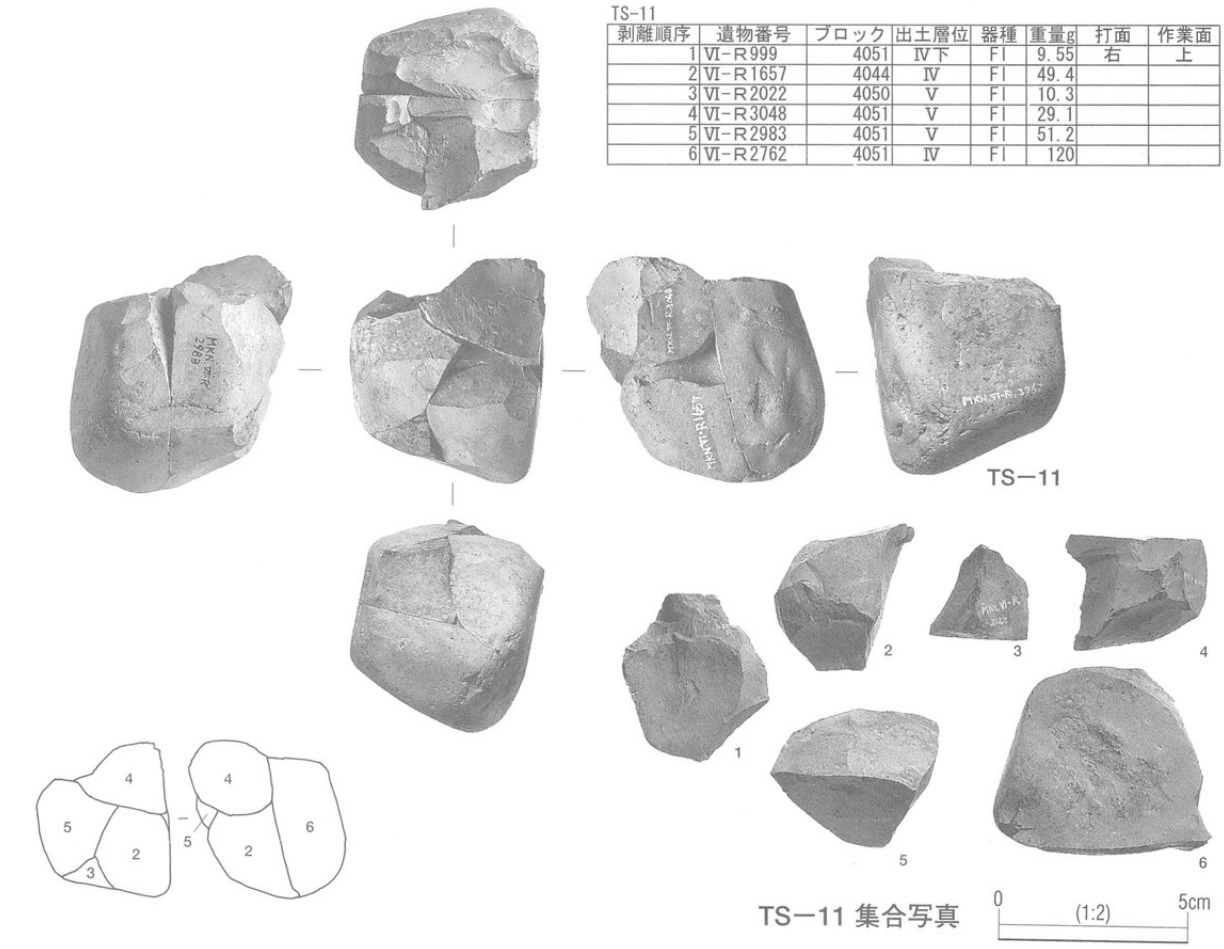

TS-11 集合写真

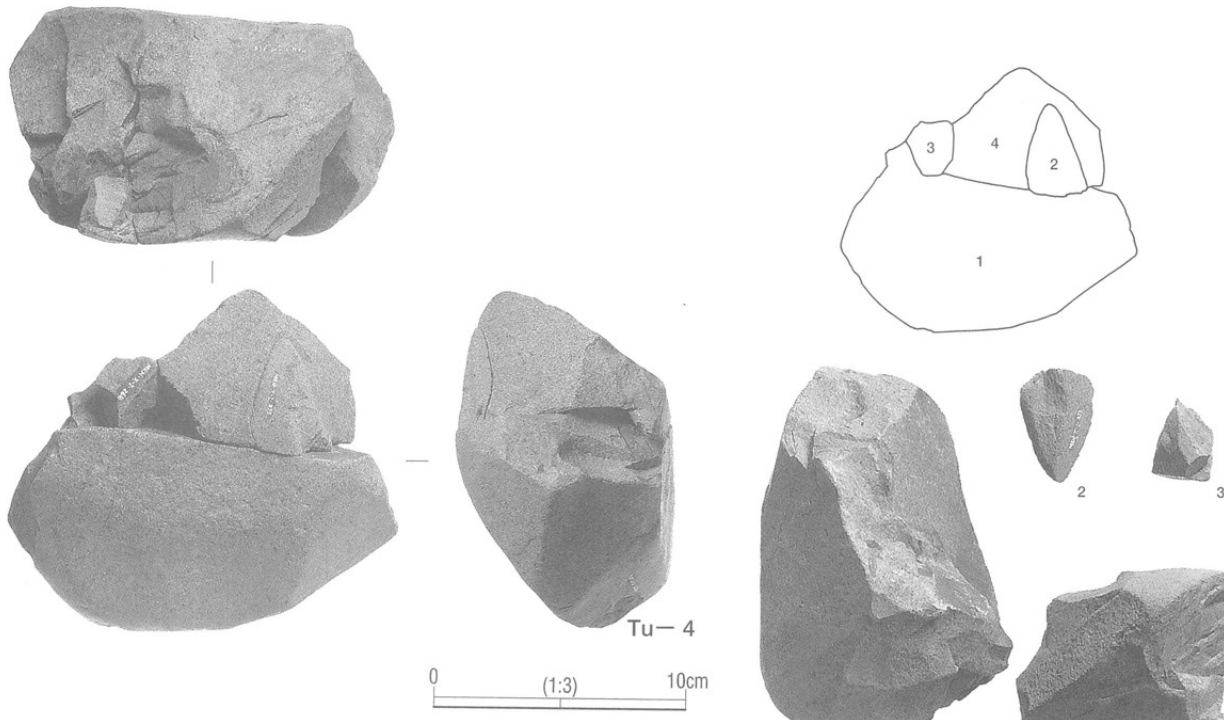

Tu-4

Tu-4

剥離順序	遺物番号	ブロック	出土層位	器種	重量g	打面	作業面
1	VI-M256	4028	Vb	Co	1630		
2	X-I 273	2007	IV	FI	10.3	下	正面
3	X-I 268	2007	III	FI	19.3		
4	VI-M258	4028	Vb	Co	470		

Tu-4 集合写真

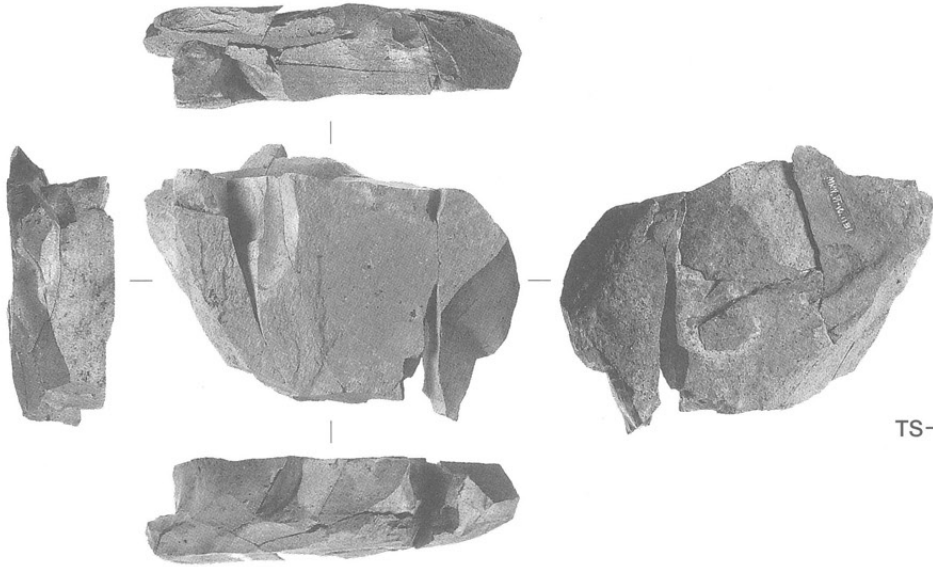

TS-32

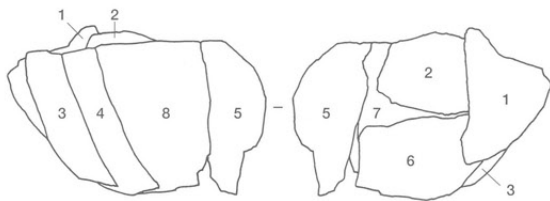
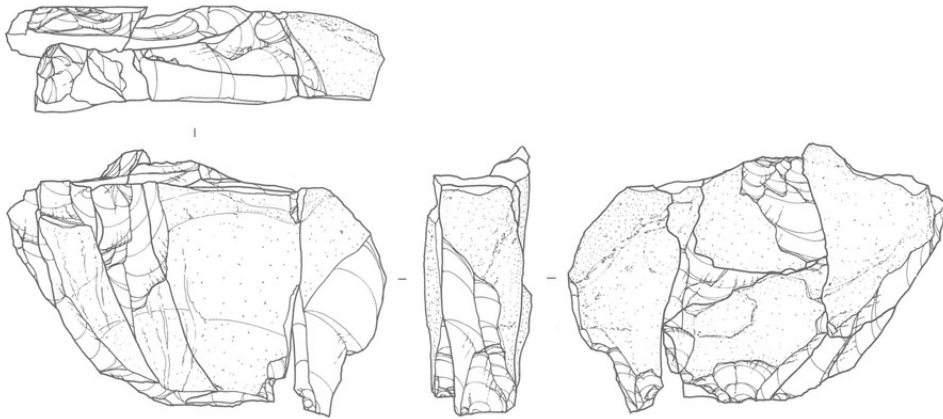

TS-32

剥離順序	遺物番号	ブロック	出土層位	器種	重量g	打面	作業面
1	VI-W1131	4061	IV	Fl	20.9	上	裏面
2	VI-W315	外	II	Fl	11.5	上	裏面
3	VI-W1033	4057	IV	Fl	20.1	上	左
4	VI-W2950	4057	V	Fl	21.7	上	左
5	VI-W1992	4057	V	Fl	36.8	下	右
6	VI-W997	4057	IV	Fl	14.1	下	裏面
7	VI-W1010	4057	IV	Fl	19	下	裏面
8	VI-W2969	4057	V	Co	68.5		

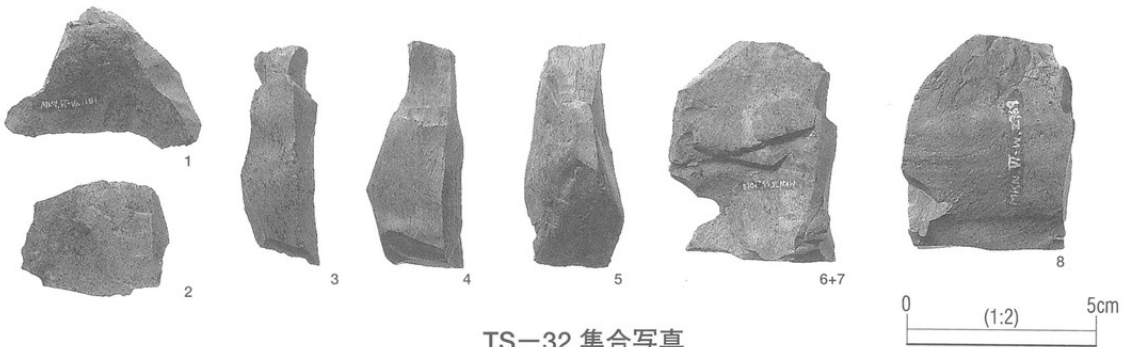

TS-32 集合写真

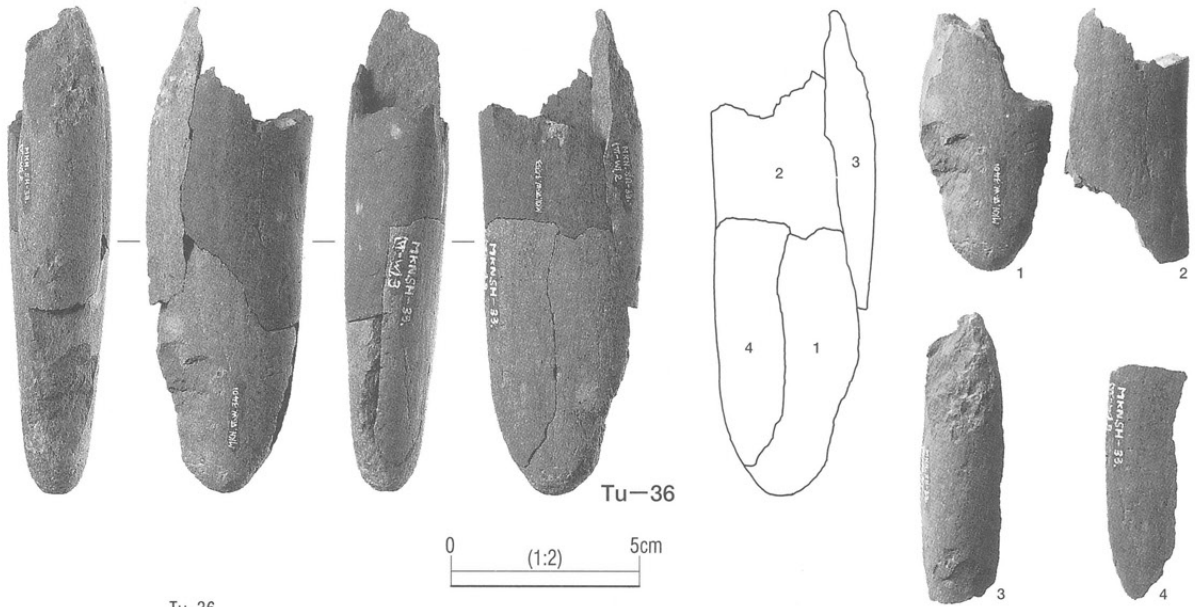

Tu-36

剥離順序	遺物番号	ブロック	出土層位	器種	重量g	打面	作業面
1	VI-W3401	4070	V a	Ha	71.3		
2	VI-W4553	4070	V b	Ha	69.6		
3	SH332	4068	V a	Ha	27.6		
4	SH333	4068	V a	Ha	17.4		

Tu-36 集合写真

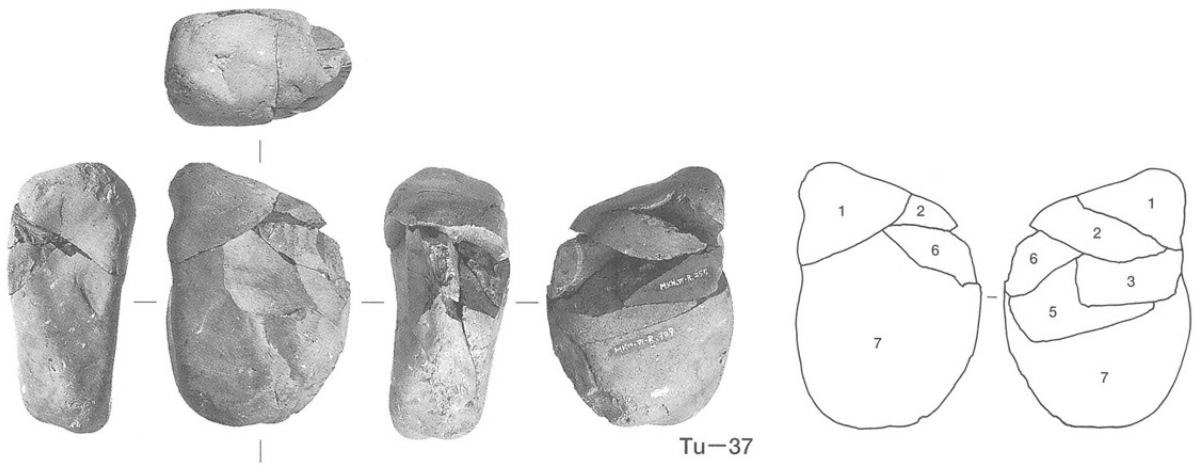

Tu-37

剥離順序	遺物番号	ブロック	出土層位	器種	重量g	打面	作業面
1	VI-R200	4052	Ⅲ	Fl	25.3	裏面	上
2	VI-R173	4052	Ⅲ	Fl	13.3	正面	上
3	VI-R255	4040	Ⅲ	Fl	4.86	正面	上
4	VI-R347	4052	Ⅳ上	Fl	4	上	正面
5	VI-R204	4052	Ⅲ	Fl	6.1	正面	上
6	VI-R1797	4044	V	Fl	9.28	正面	上
7	VI-R309	4052	Ⅲ	Co	104		

Tu-37 集合写真

西岡 A 遺跡



BL石器全点 (BL範囲入り) (西岡A遺跡)

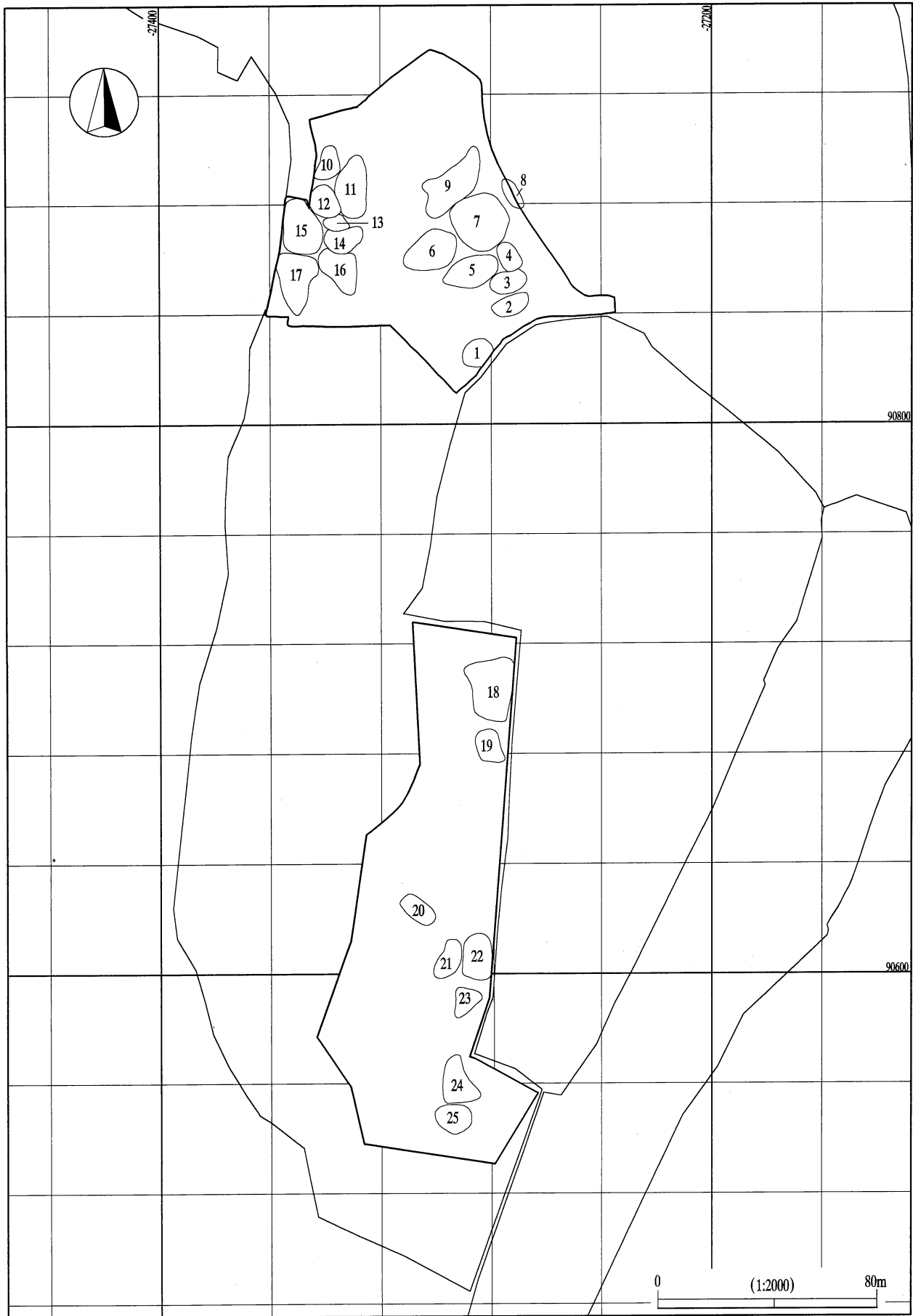

ブロック配置図 (西岡 A 遺跡)

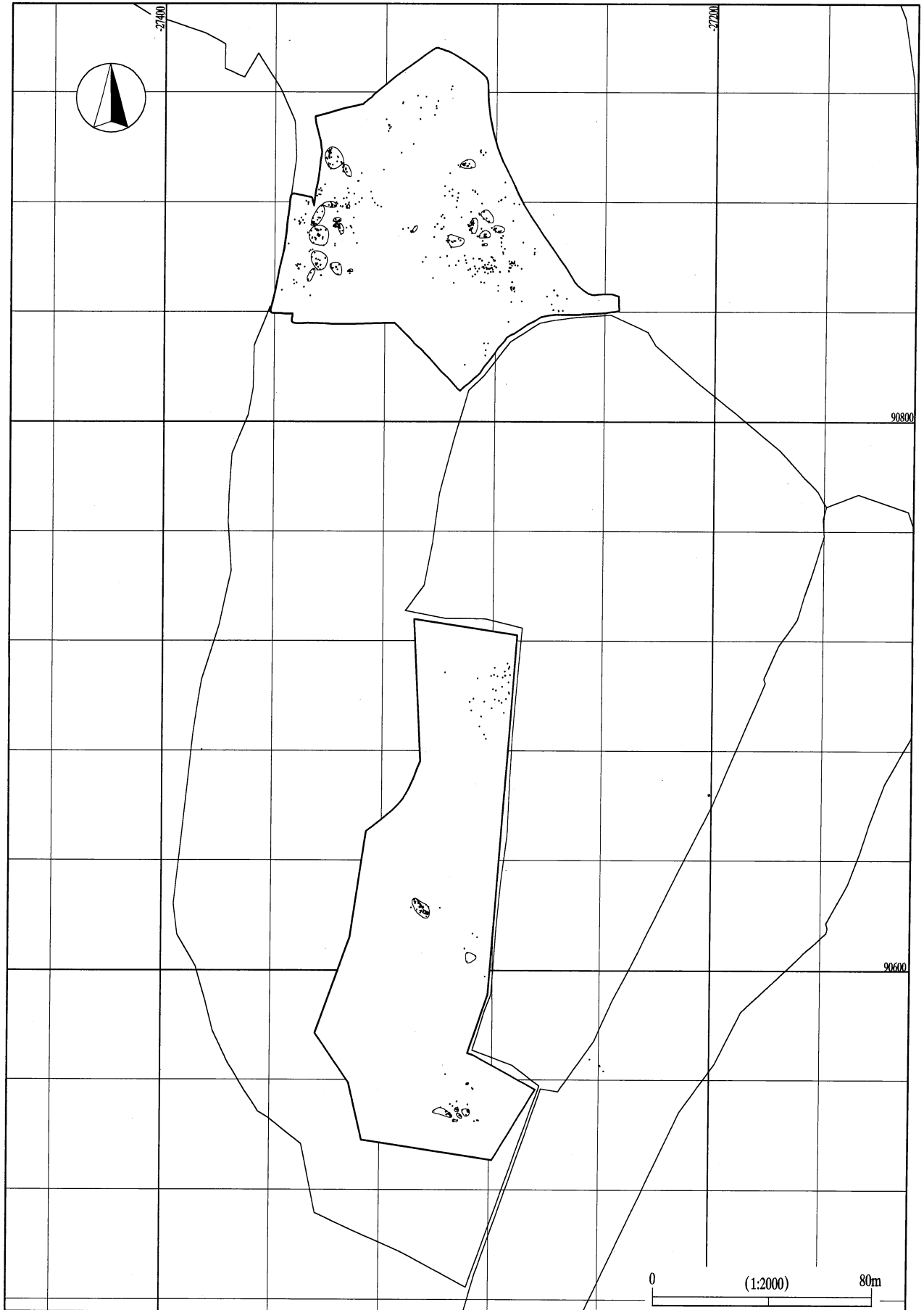

礫群（礫群範囲入り）（西岡 A 遺跡）



礫群配置図 (西岡 A 遺跡)

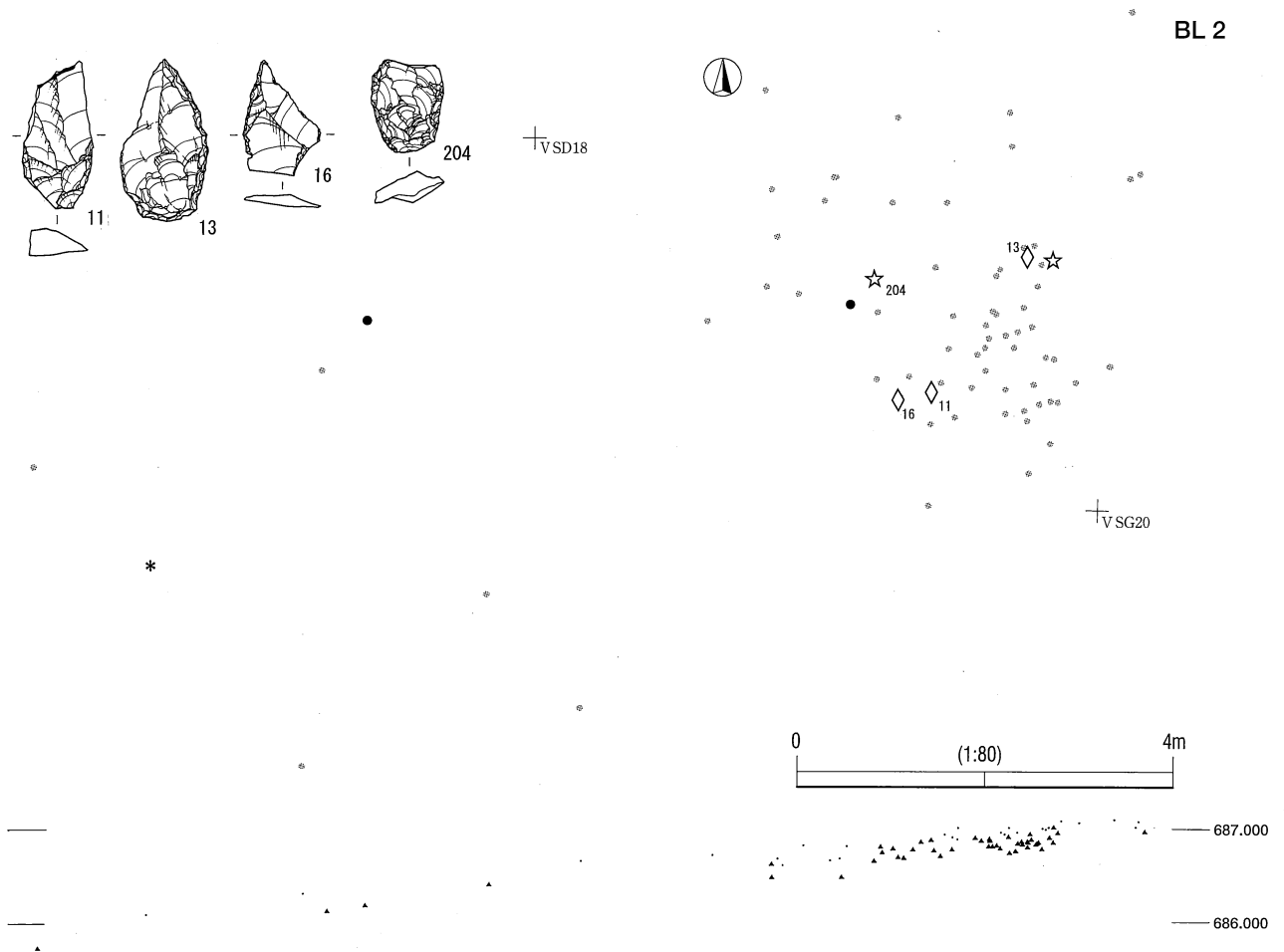
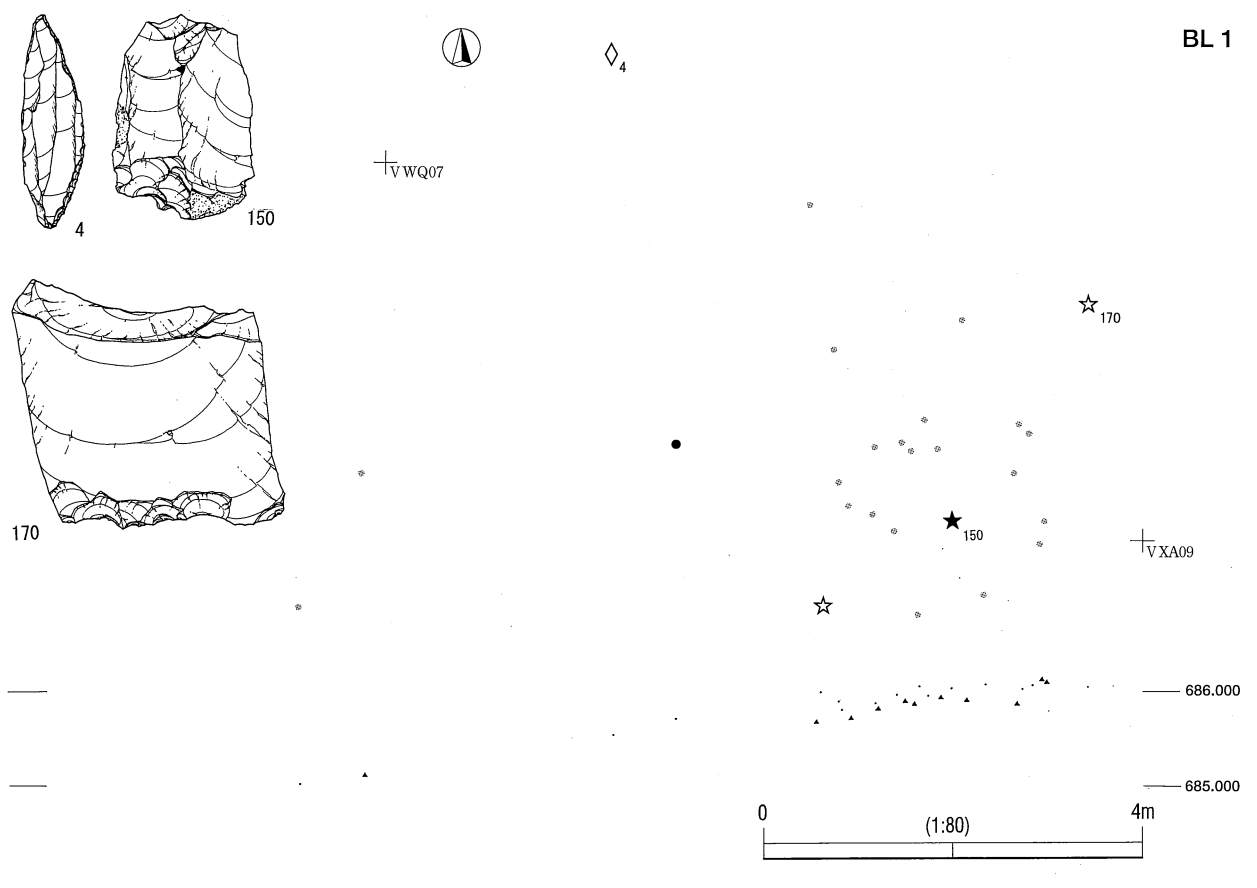

BL 1・2 遺物分布図 (西岡A遺跡)

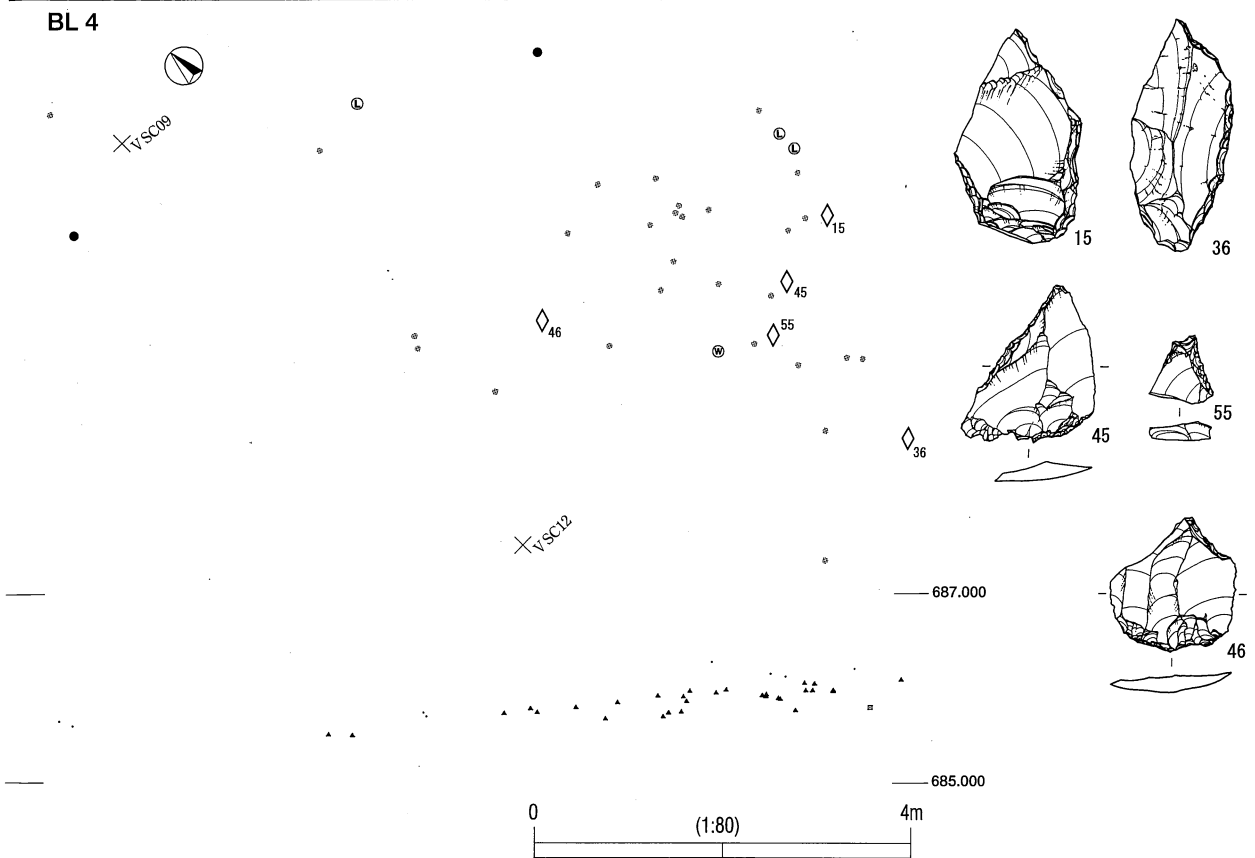
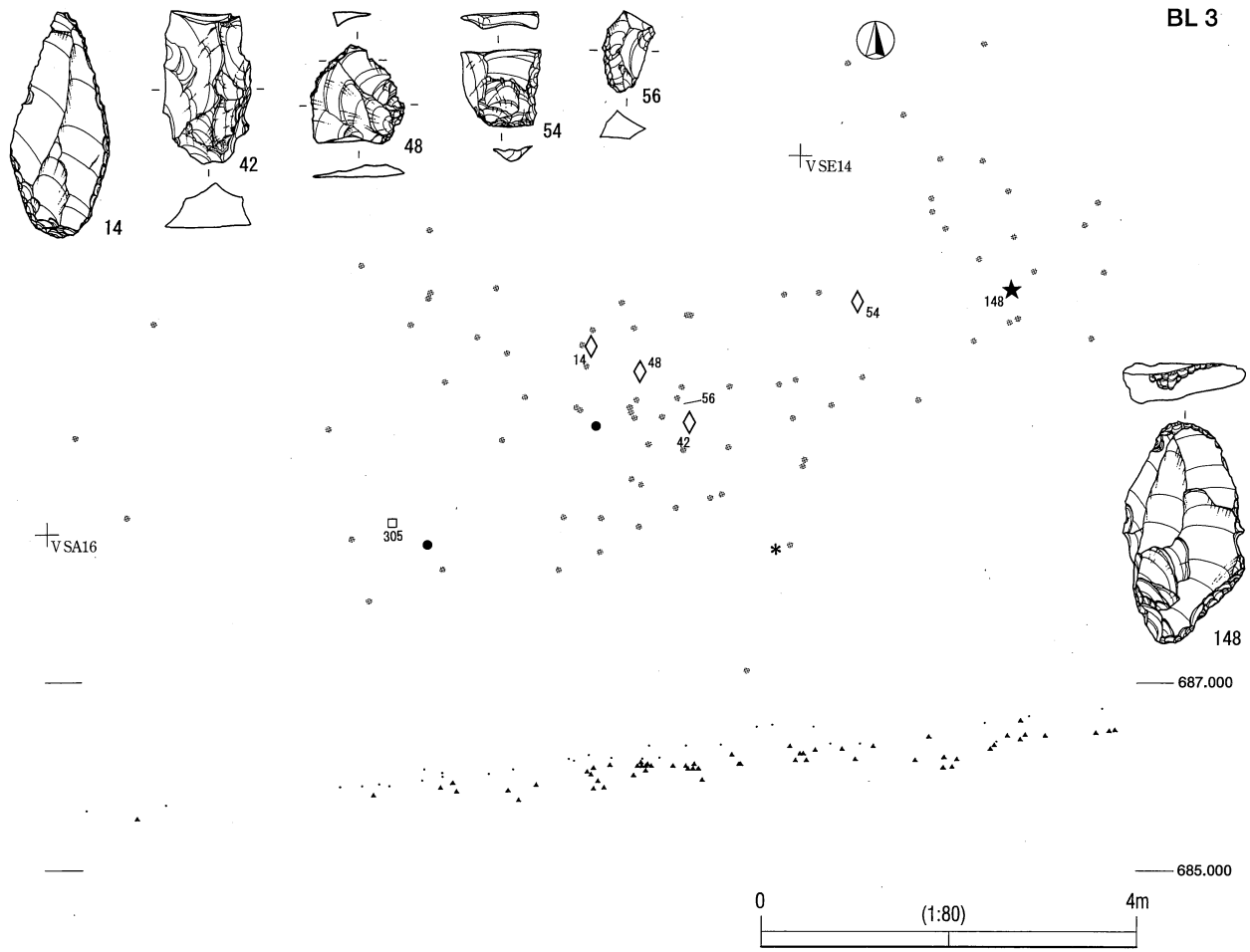

BL 3・4 遺物分布図 (西岡 A 遺跡)

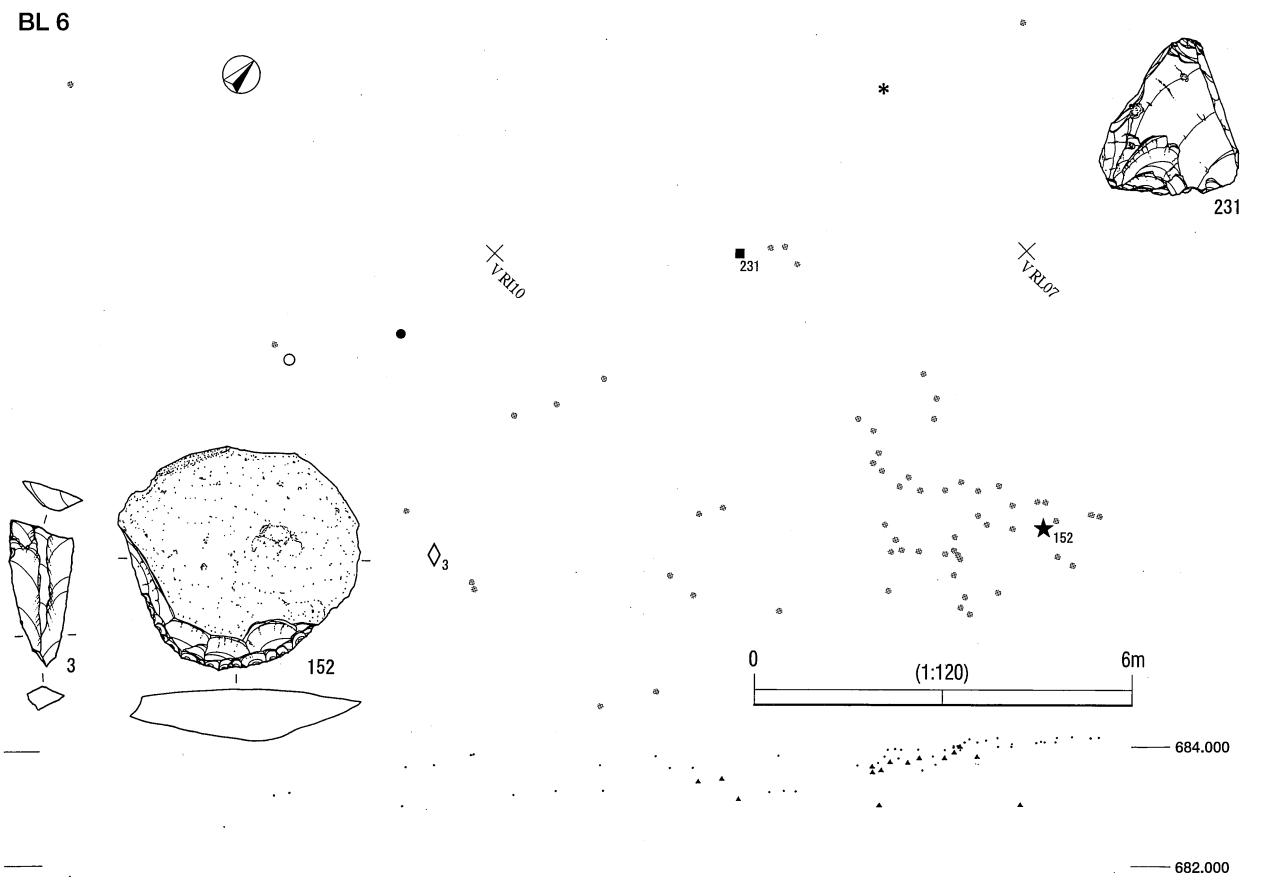
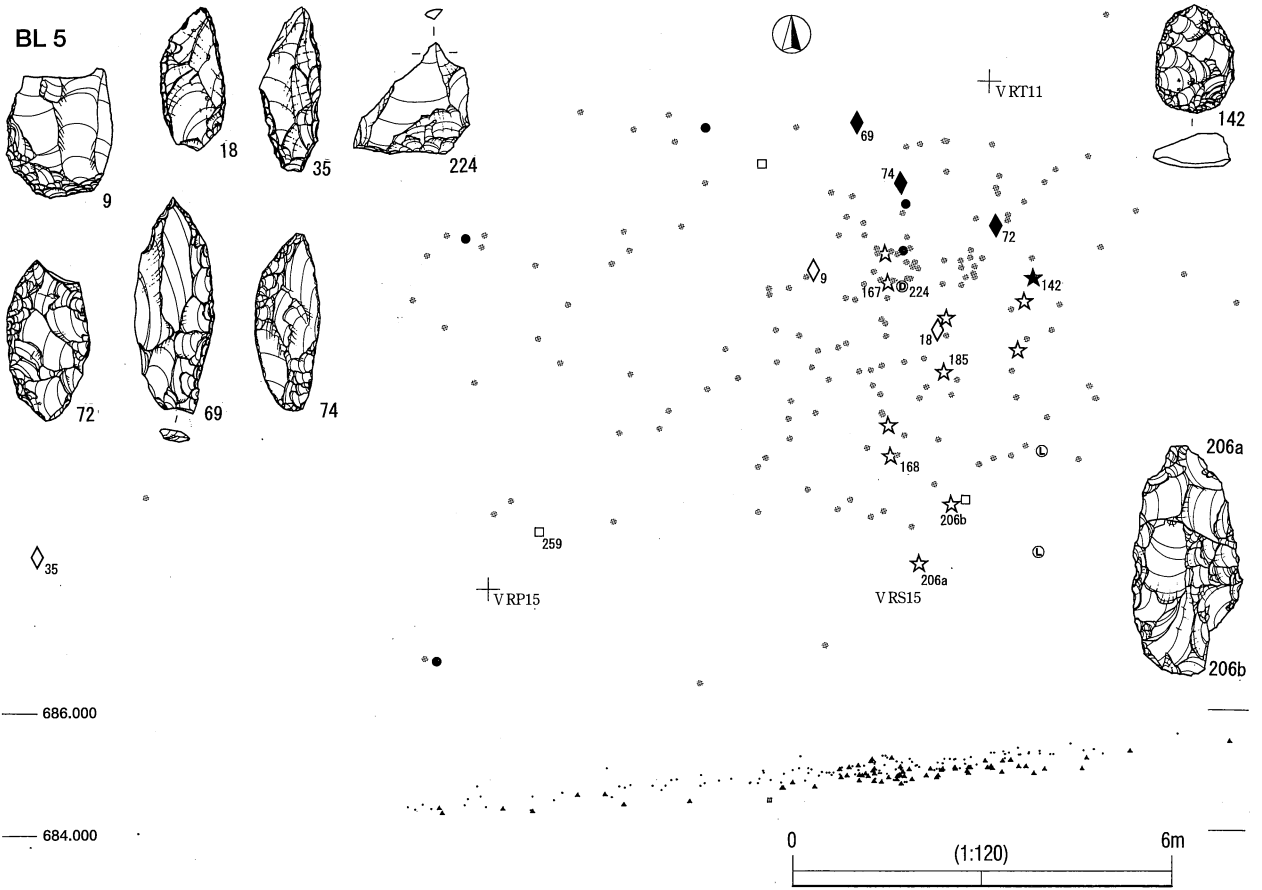

BL 5・6 遺物分布図 (西岡 A 遺跡)

BL 7

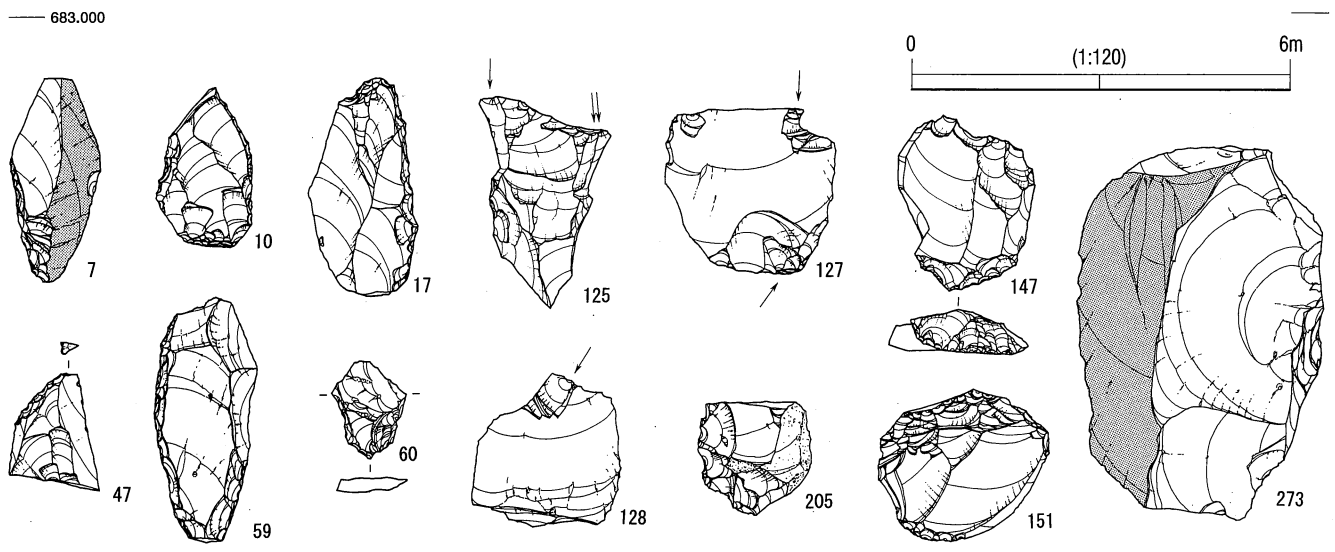

BL 7 遺物分布図 (西岡 A 遺跡)

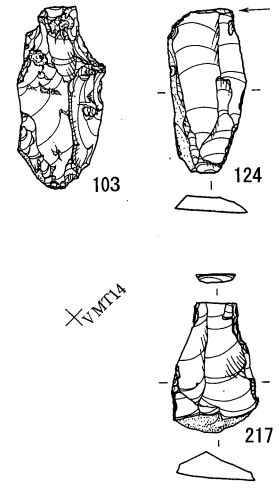
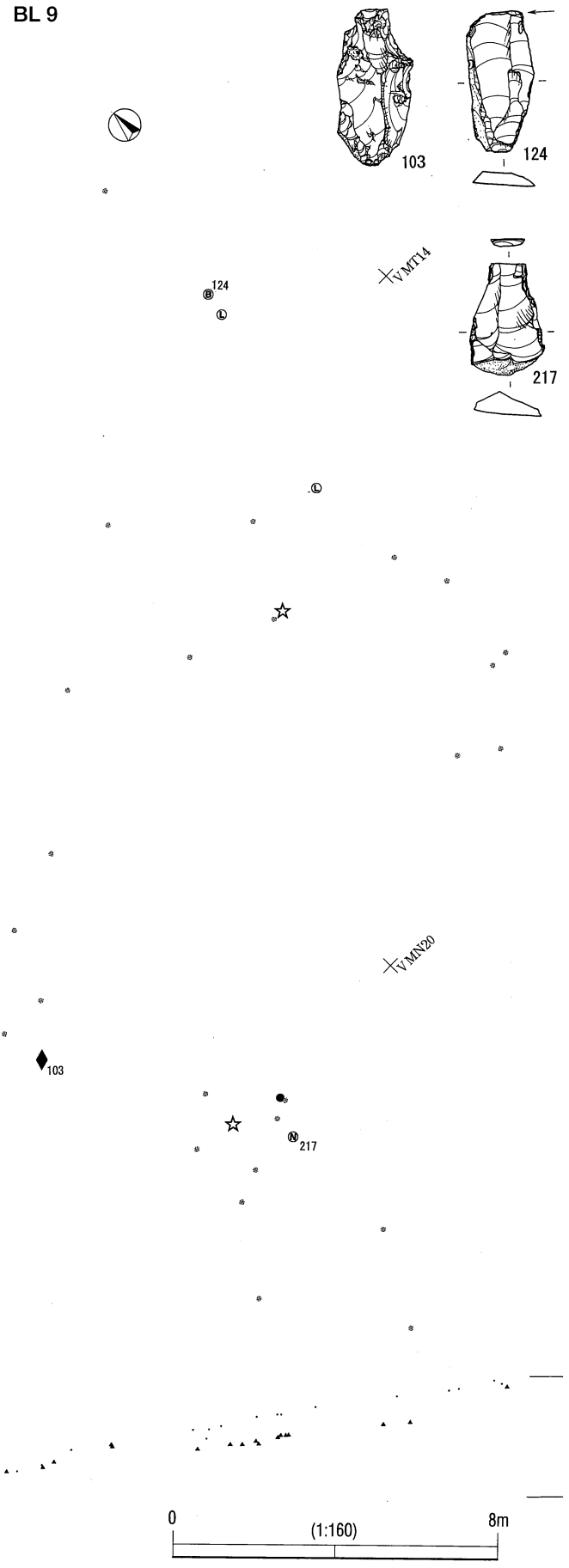
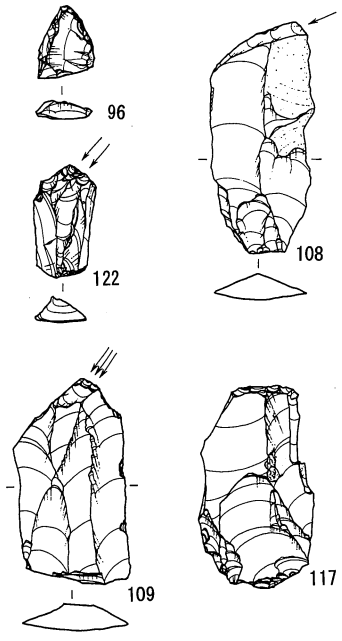
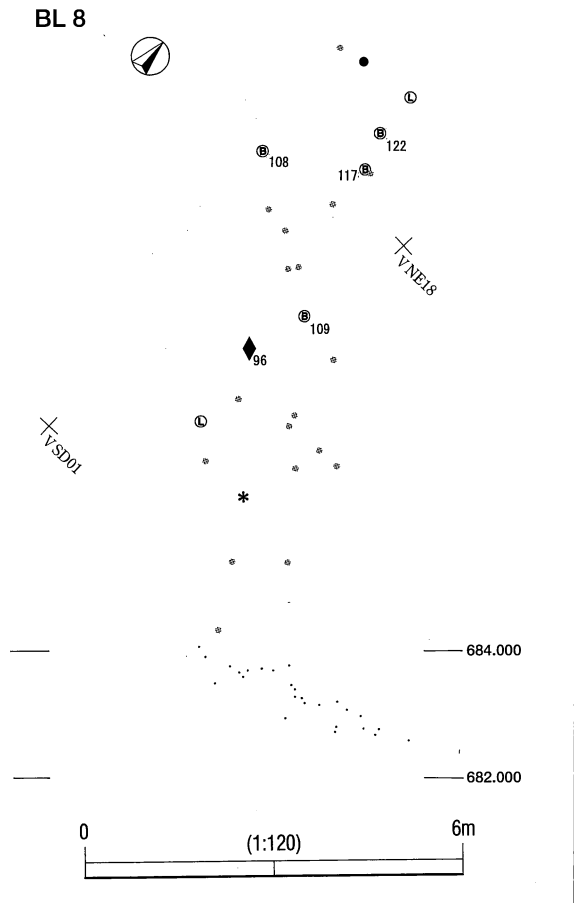

BL 8・9 遺物分布図 (西岡 A 遺跡)

BL 10

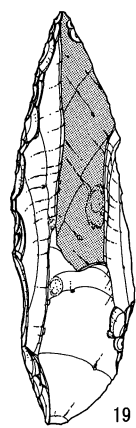
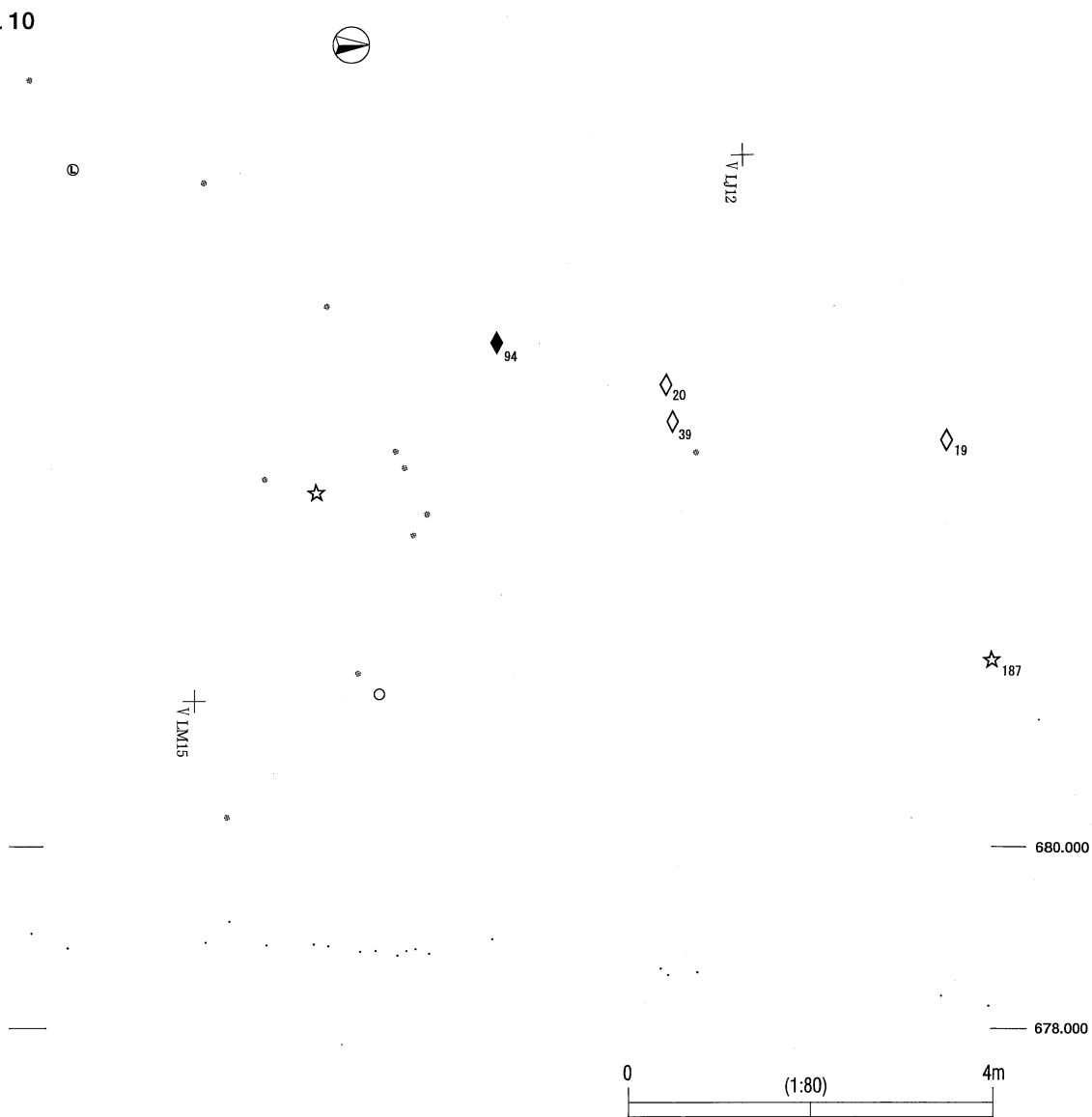

19

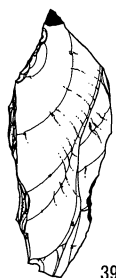

39

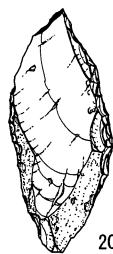

20



94



187



BL 10 遺物分布図 (西岡 A 遺跡)

BL 11

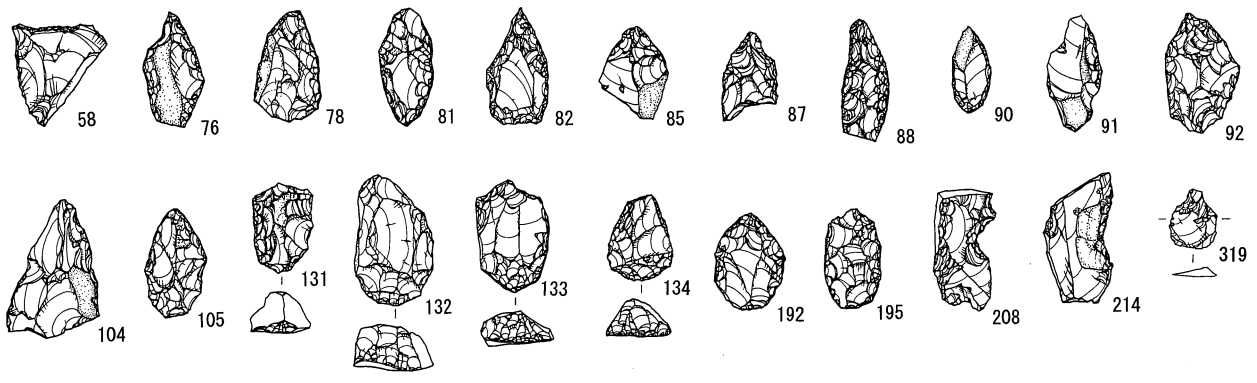
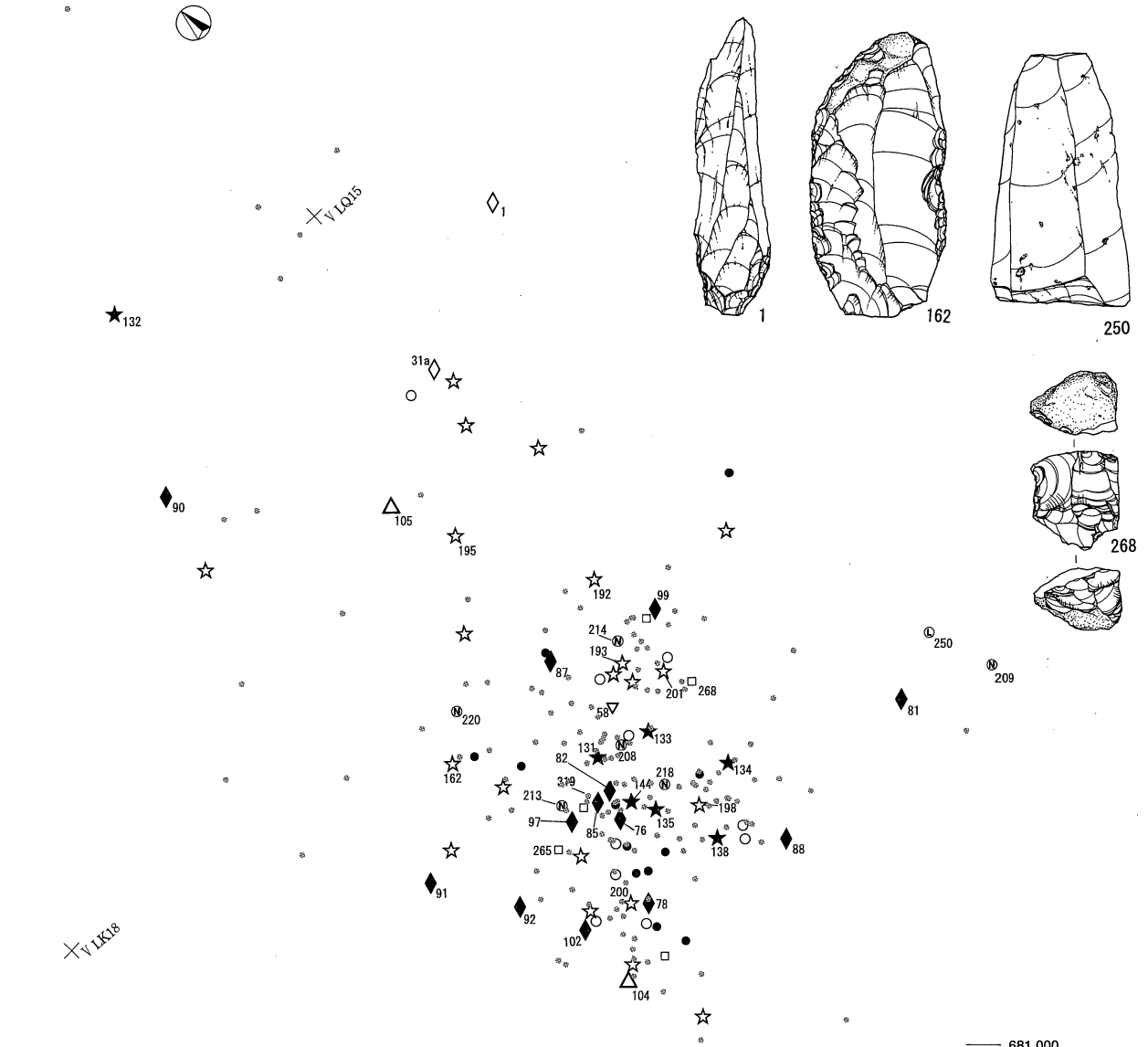

BL 11 遺物分布図 (西岡 A 遺跡)

BL 12

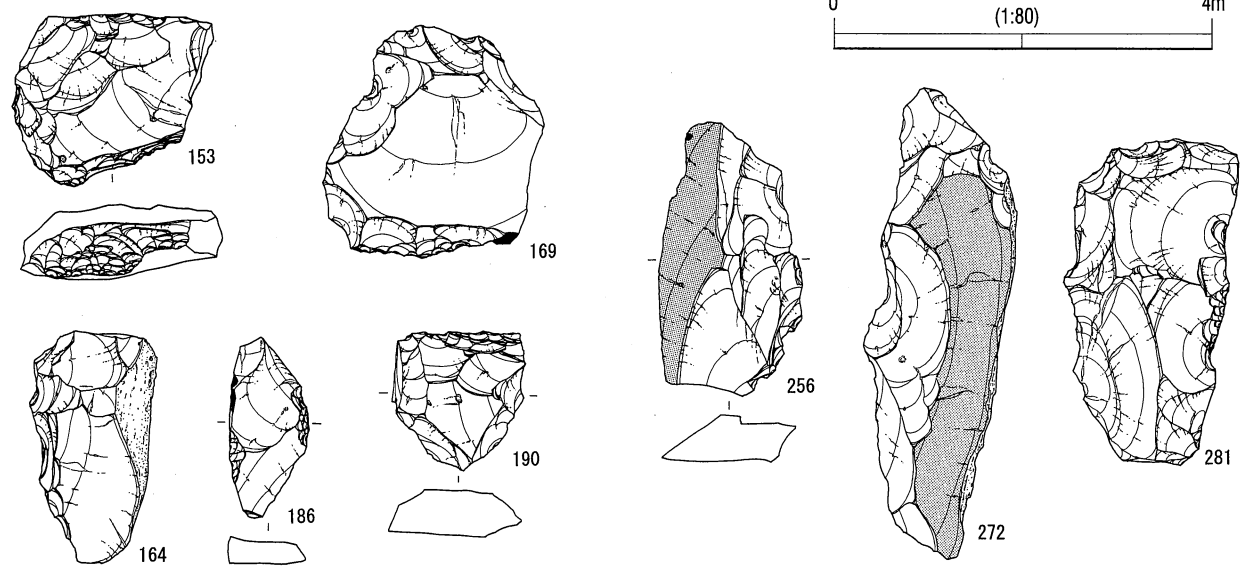

BL 12 遺物分布図 (西岡 A 遺跡)

BL 13



†V QK04

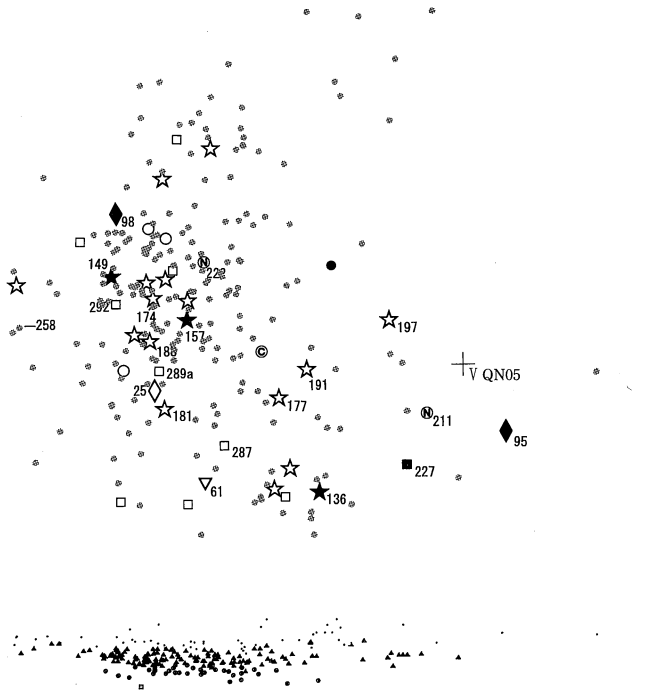

681.000

679.000

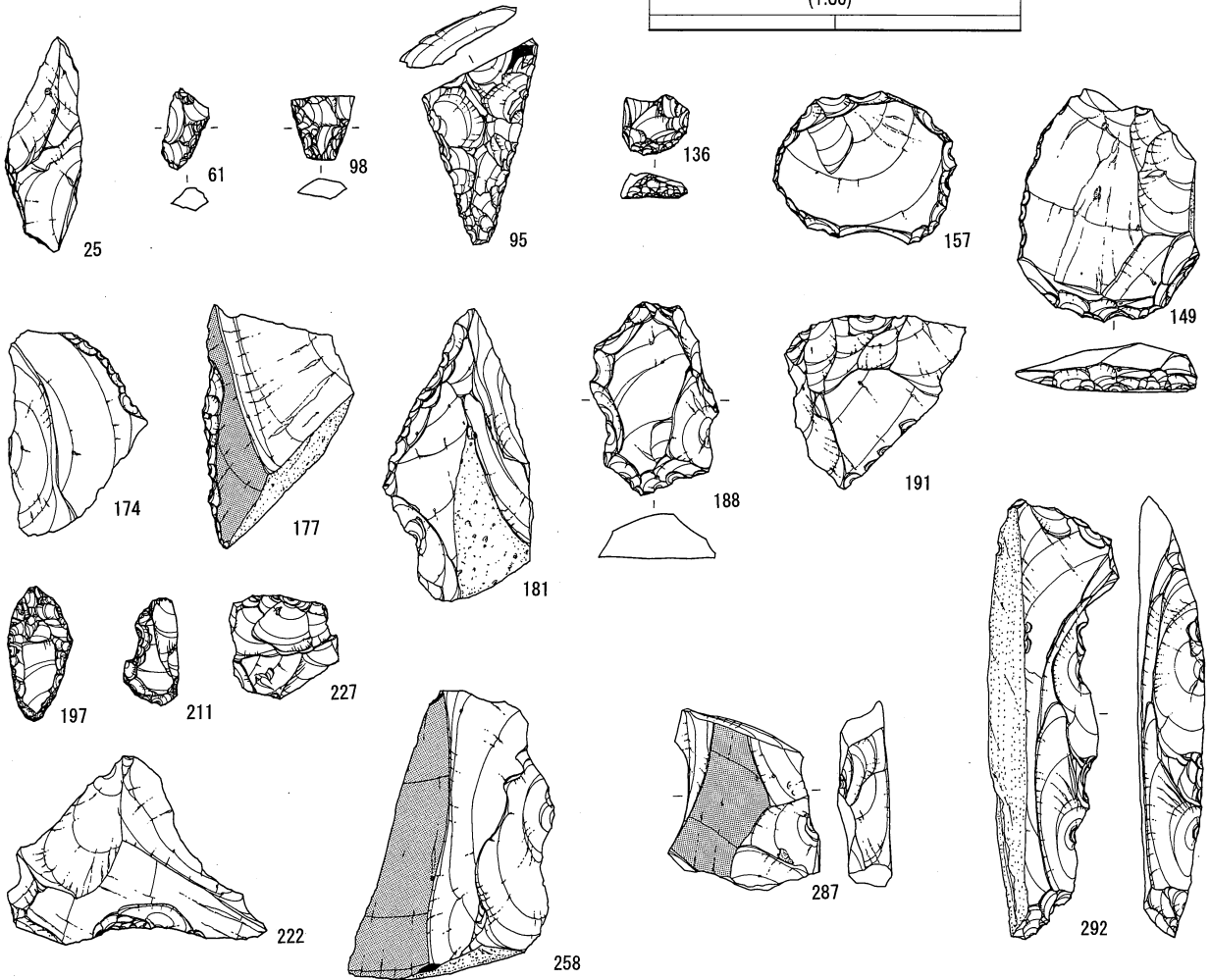
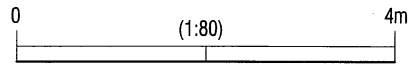

BL 13 遺物分布図 (西岡A遺跡)

BL 14

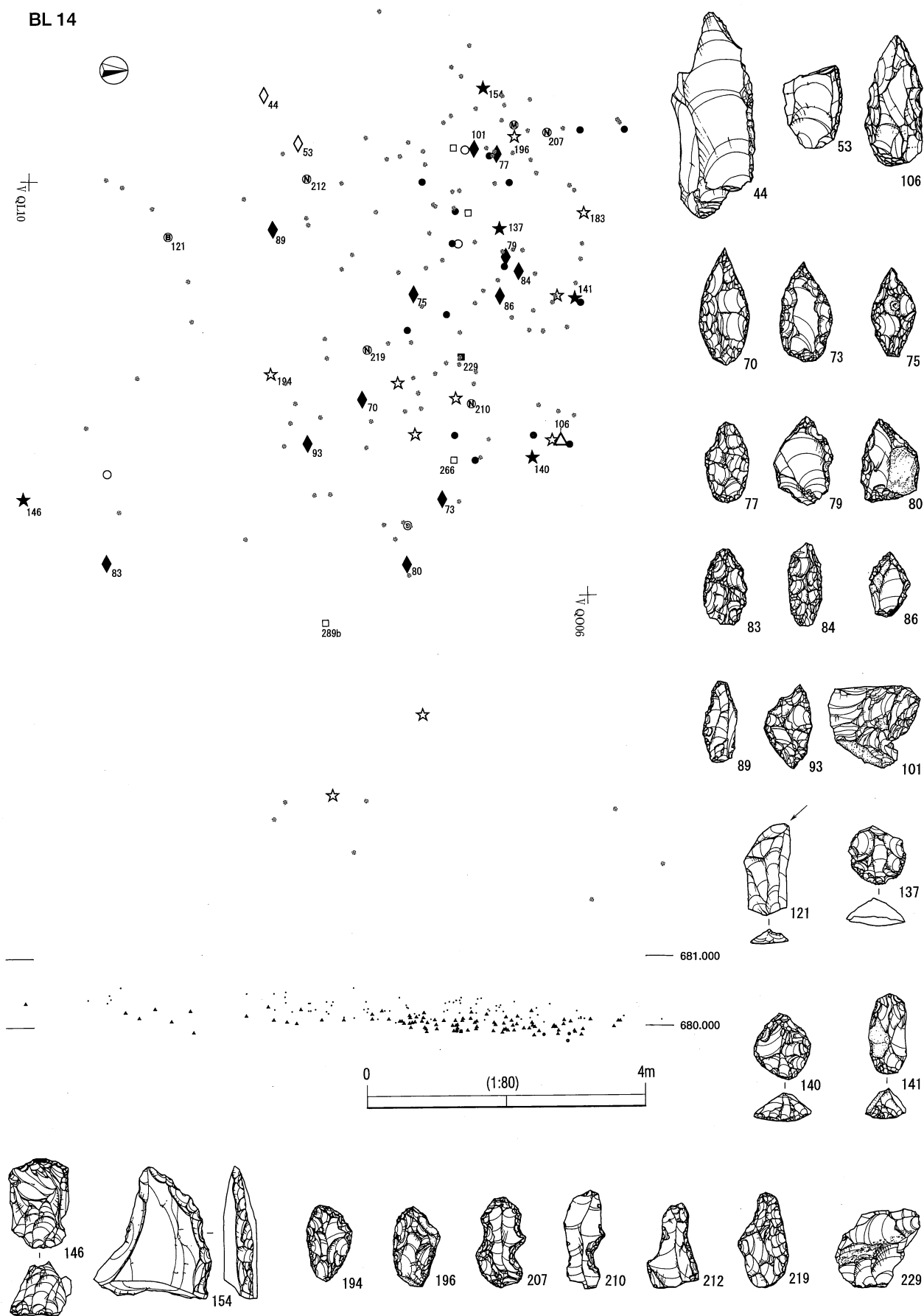

BL 14 遺物分布図 (西岡 A 遺跡)

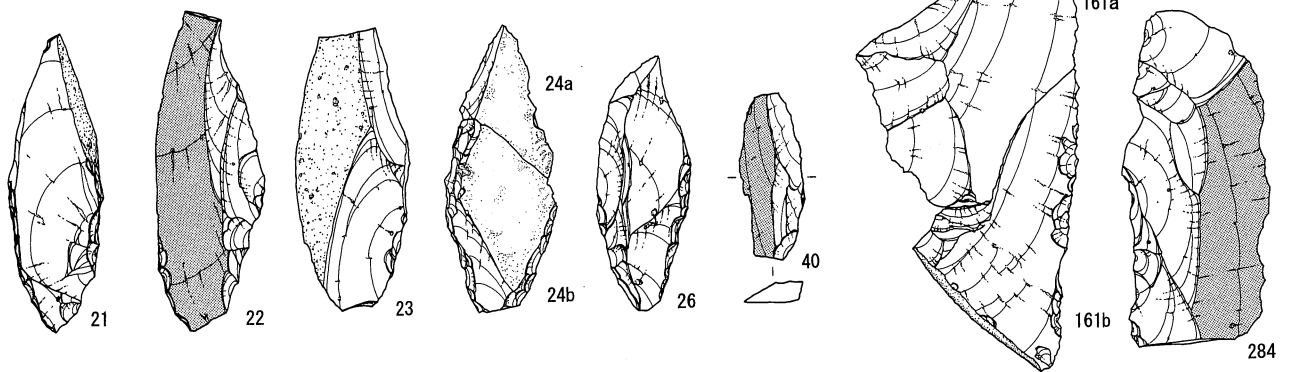
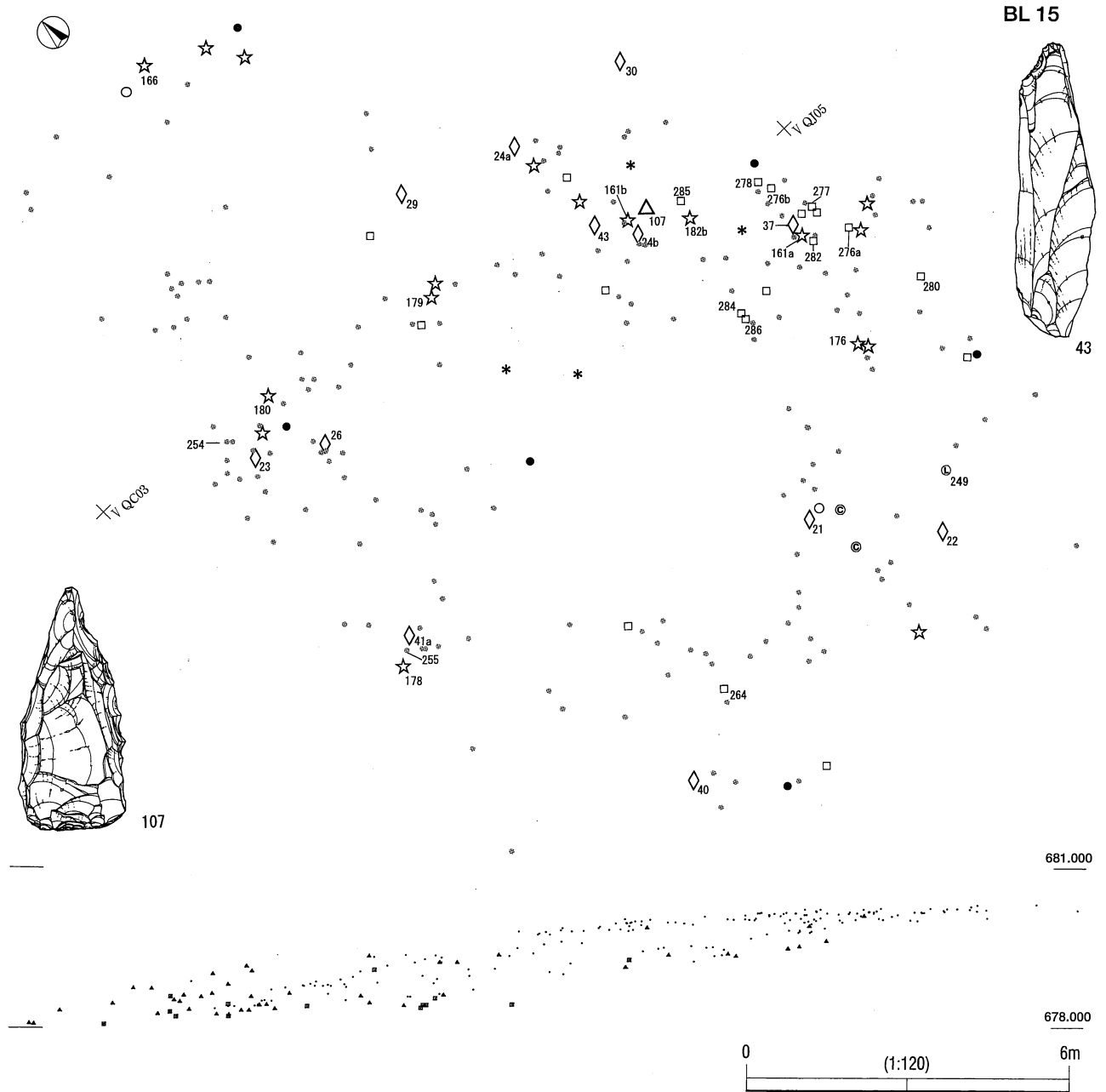

BL 15 遺物分布図 (西岡A遺跡)

BL 16

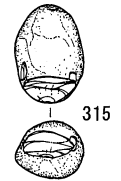
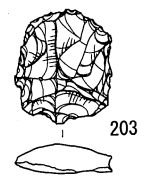
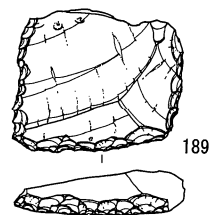
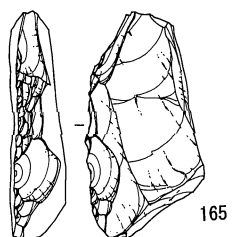
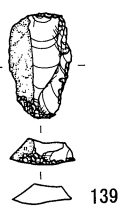
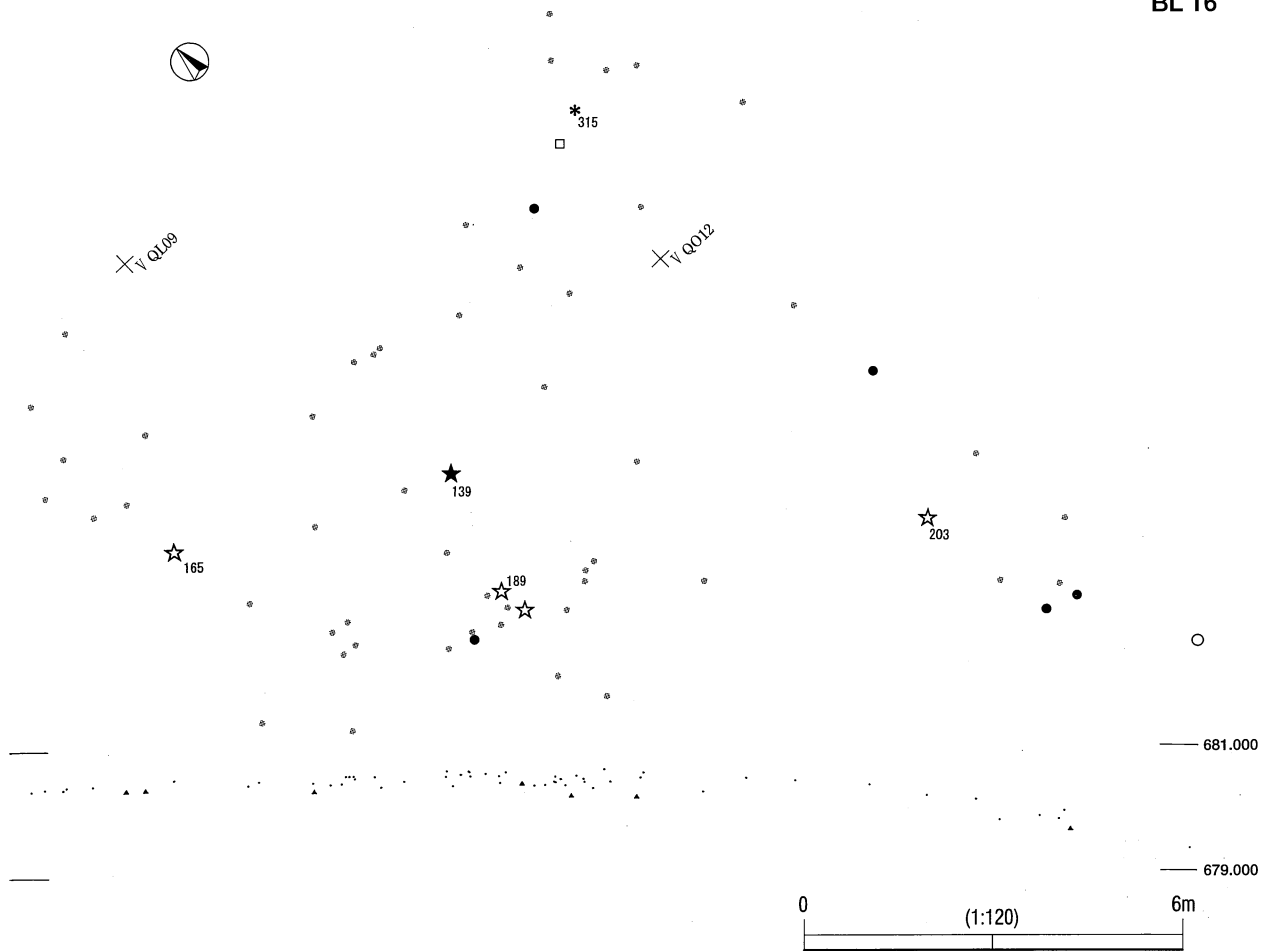

BL 16 遺物分布図 (西岡 A 遺跡)

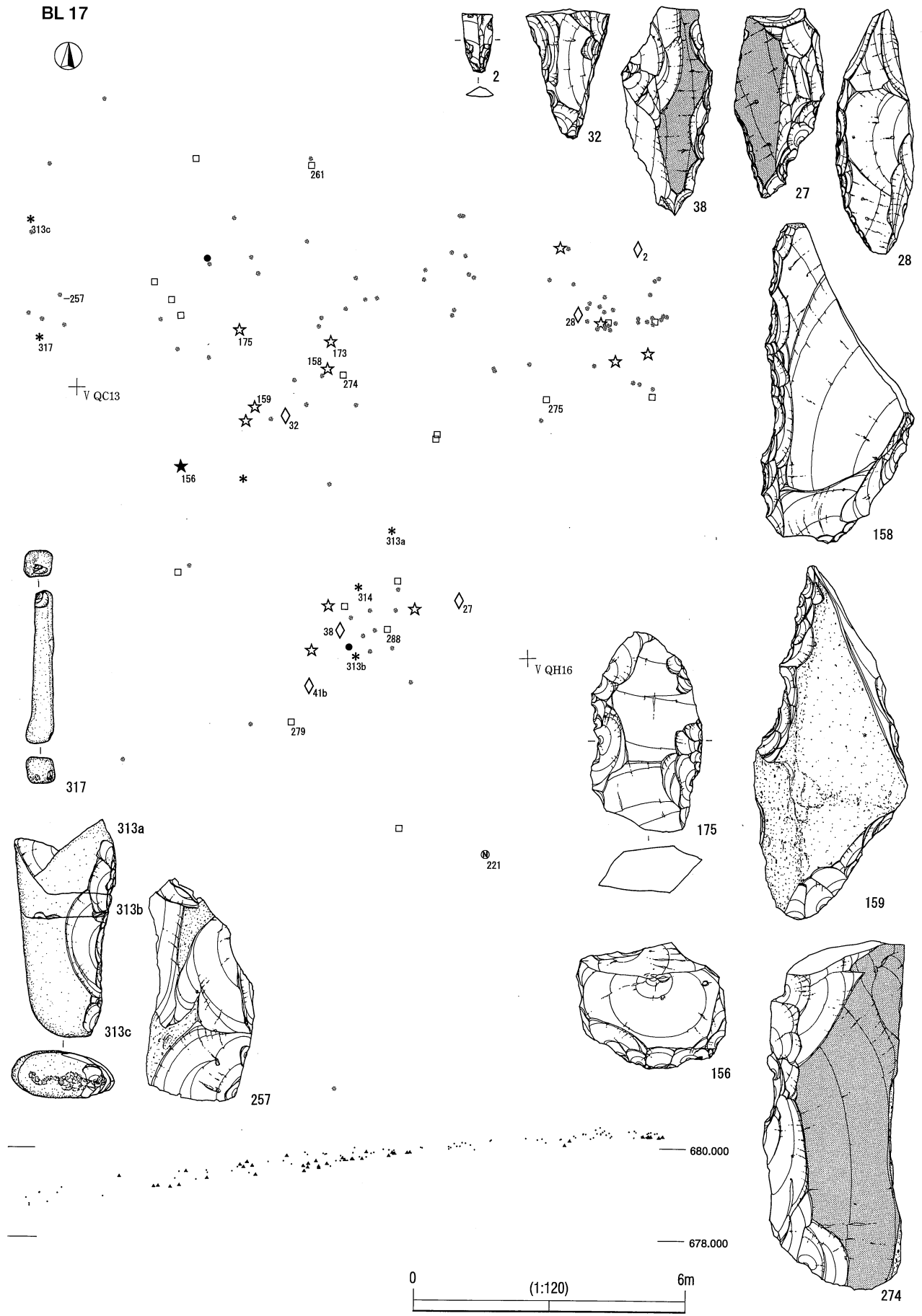

BL 17 遺物分布図 (西岡 A 遺跡)

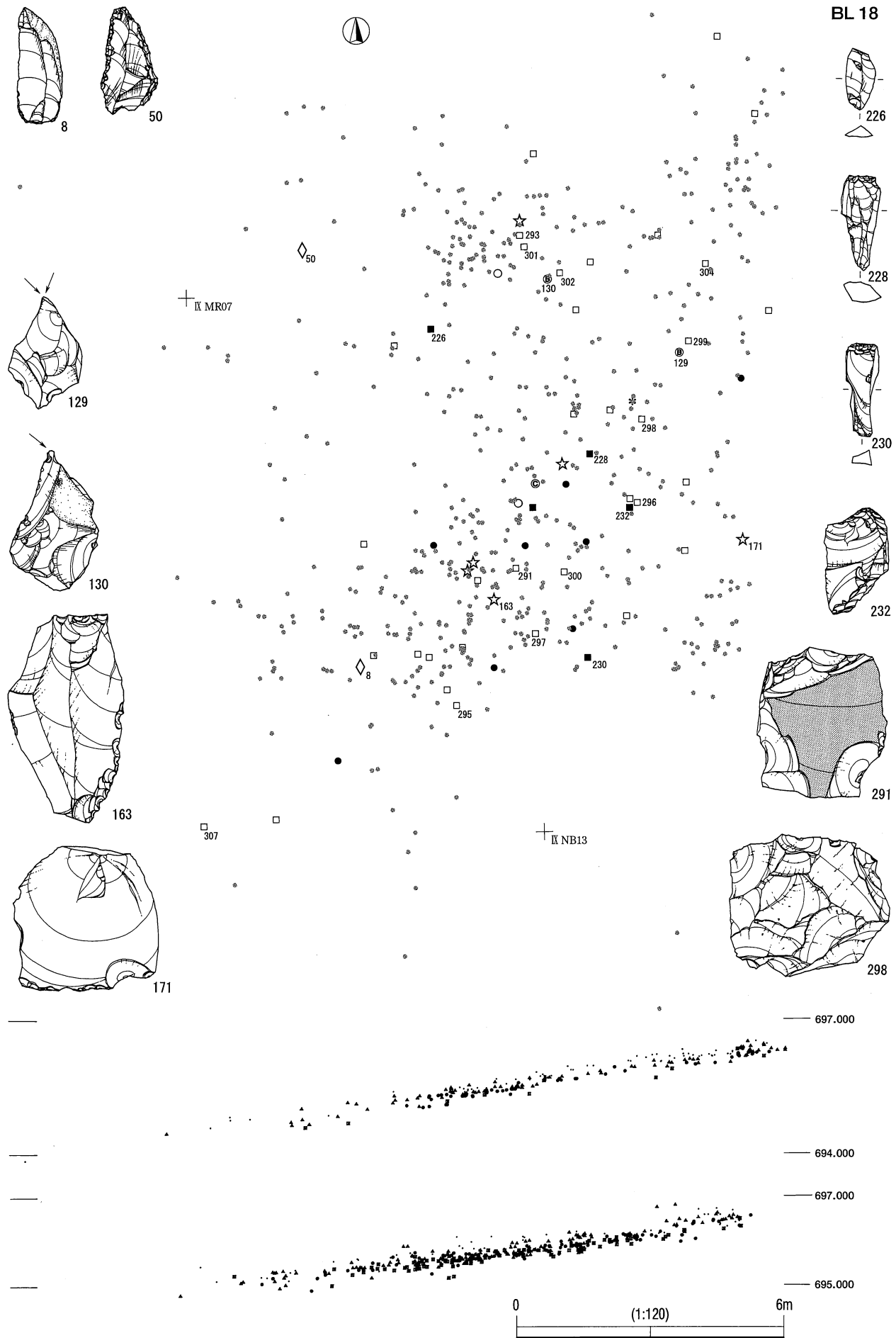

BL 18 遺物分布図 (西岡A遺跡)

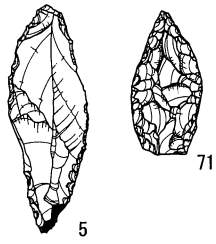

BL 19

✕ IK-MQ17

◆ 71

✕ IK-NC20

◇ 5

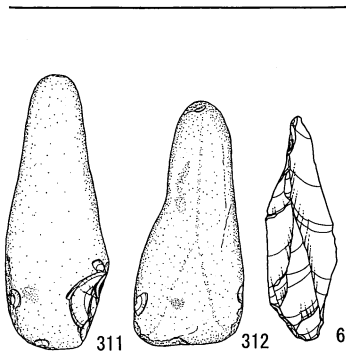
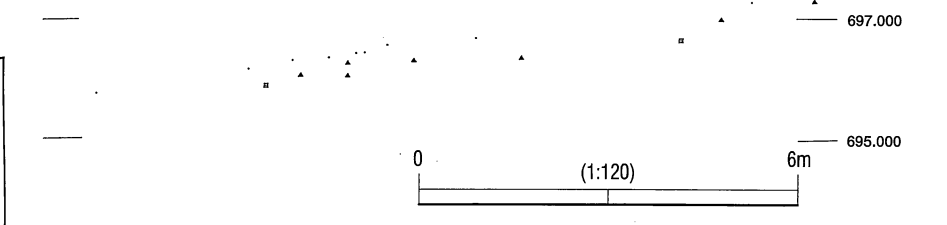

BL 20



✕ IK-W100

✕ IK-W108

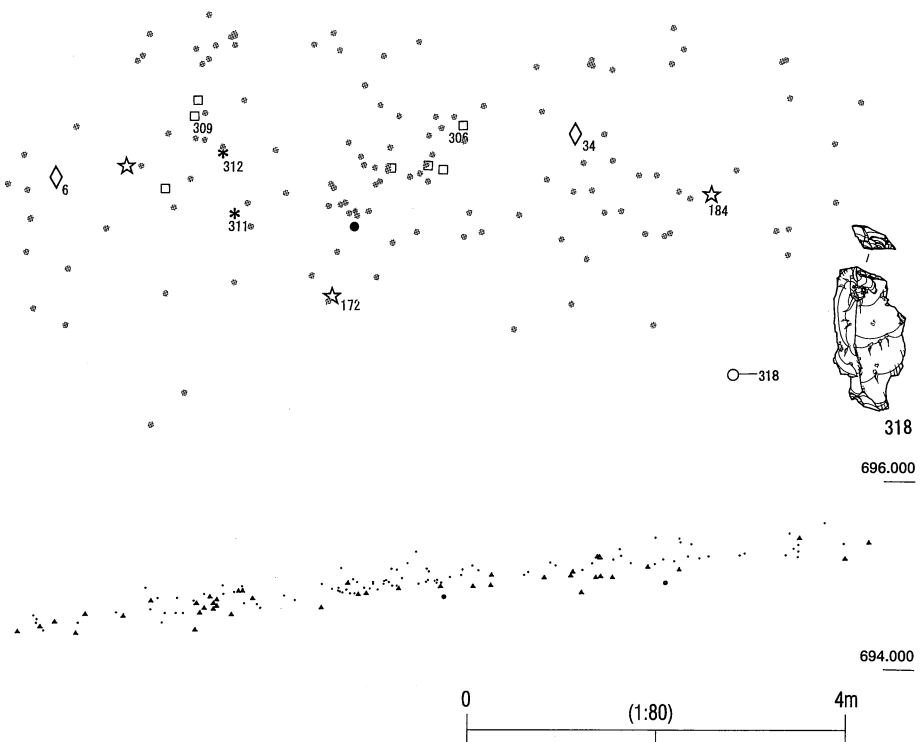

BL 19・20 遺物分布図 (西岡 A 遺跡)

BL 21



BL 21 遺物分布図 (西岡A遺跡)

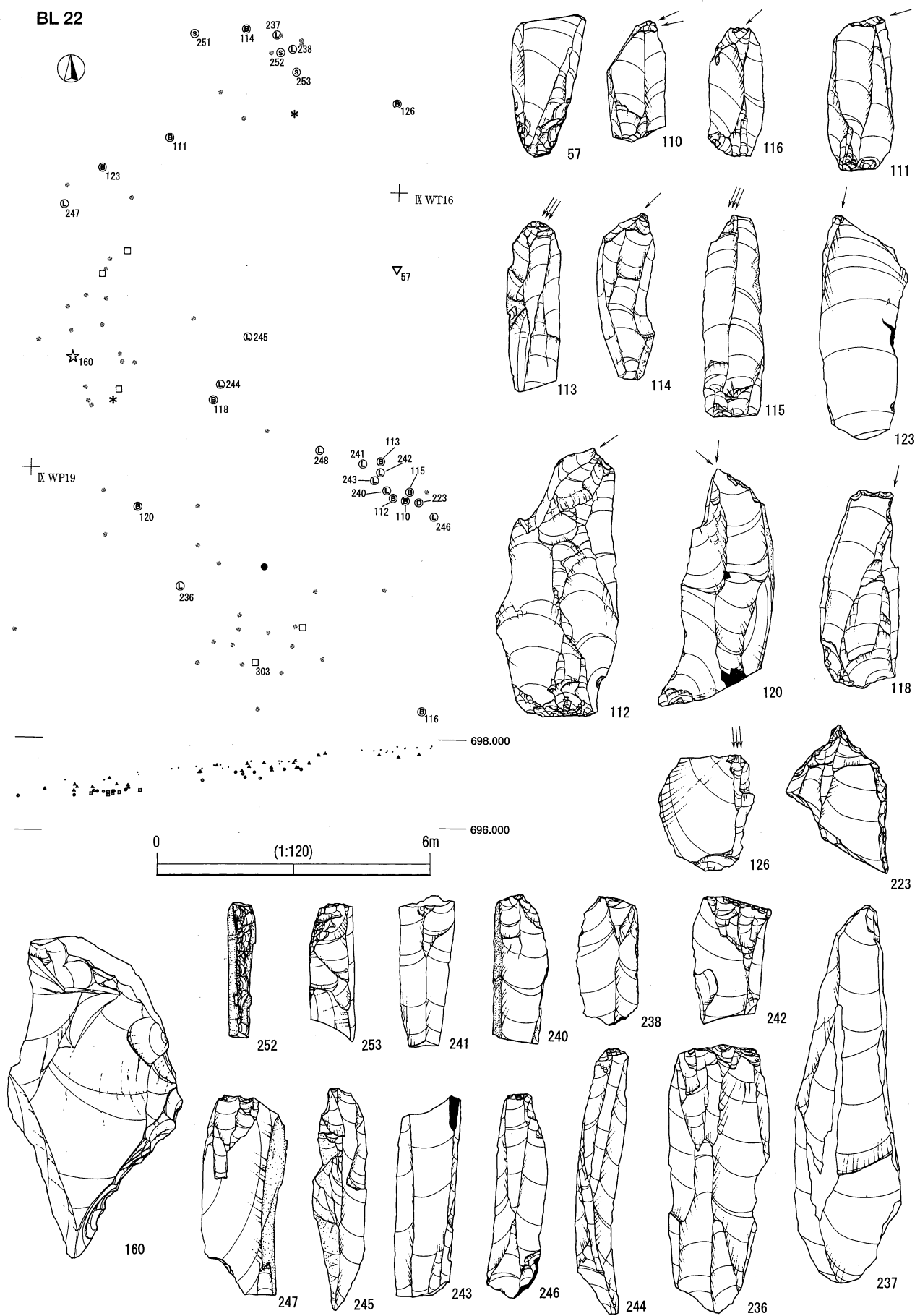

BL 22 遺物分布図 (西岡 A 遺跡)

BL 23

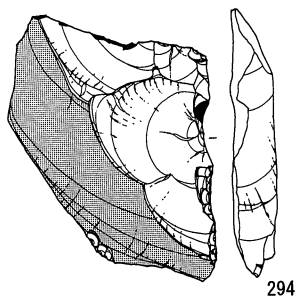

294



294

XIV CO05

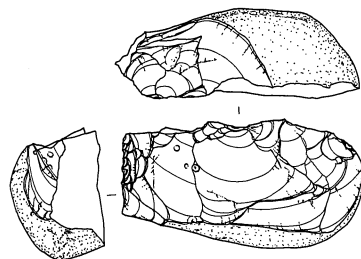
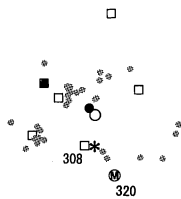

308

XIV CS07

*

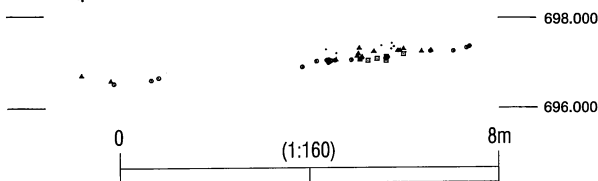

BL 24



XIV CP18



100



66

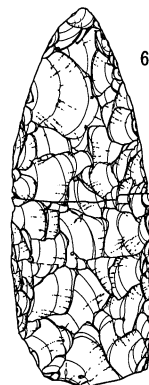

63a



64



65

100

119

65

64

66

XIV HR04



119



310

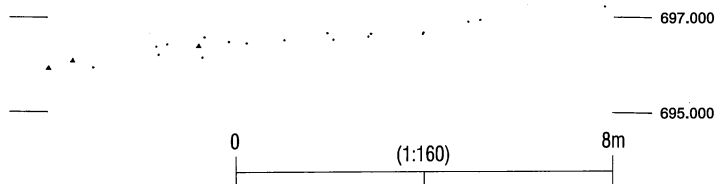

BL 23・24 遺物分布図 (西岡 A 遺跡)

BL 25

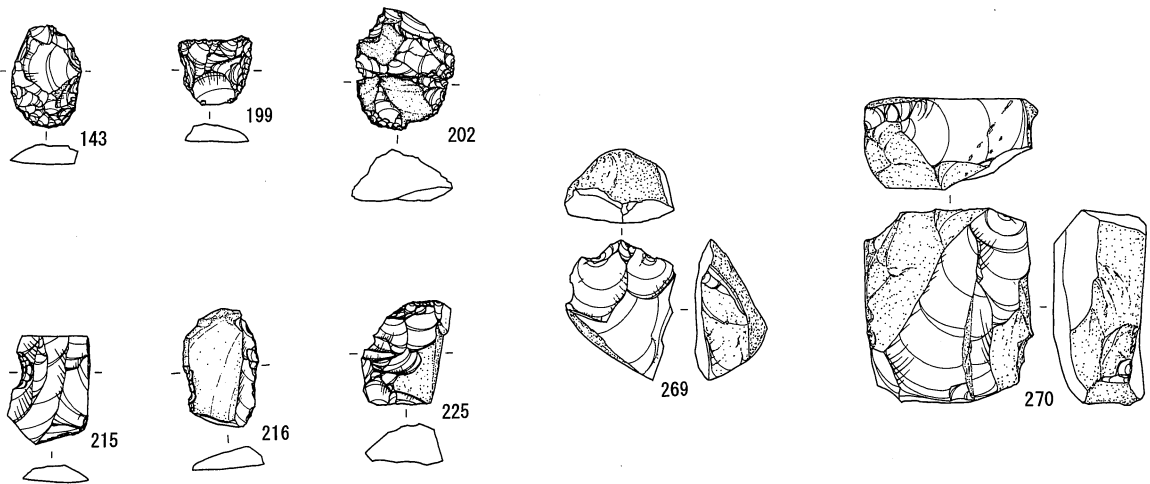
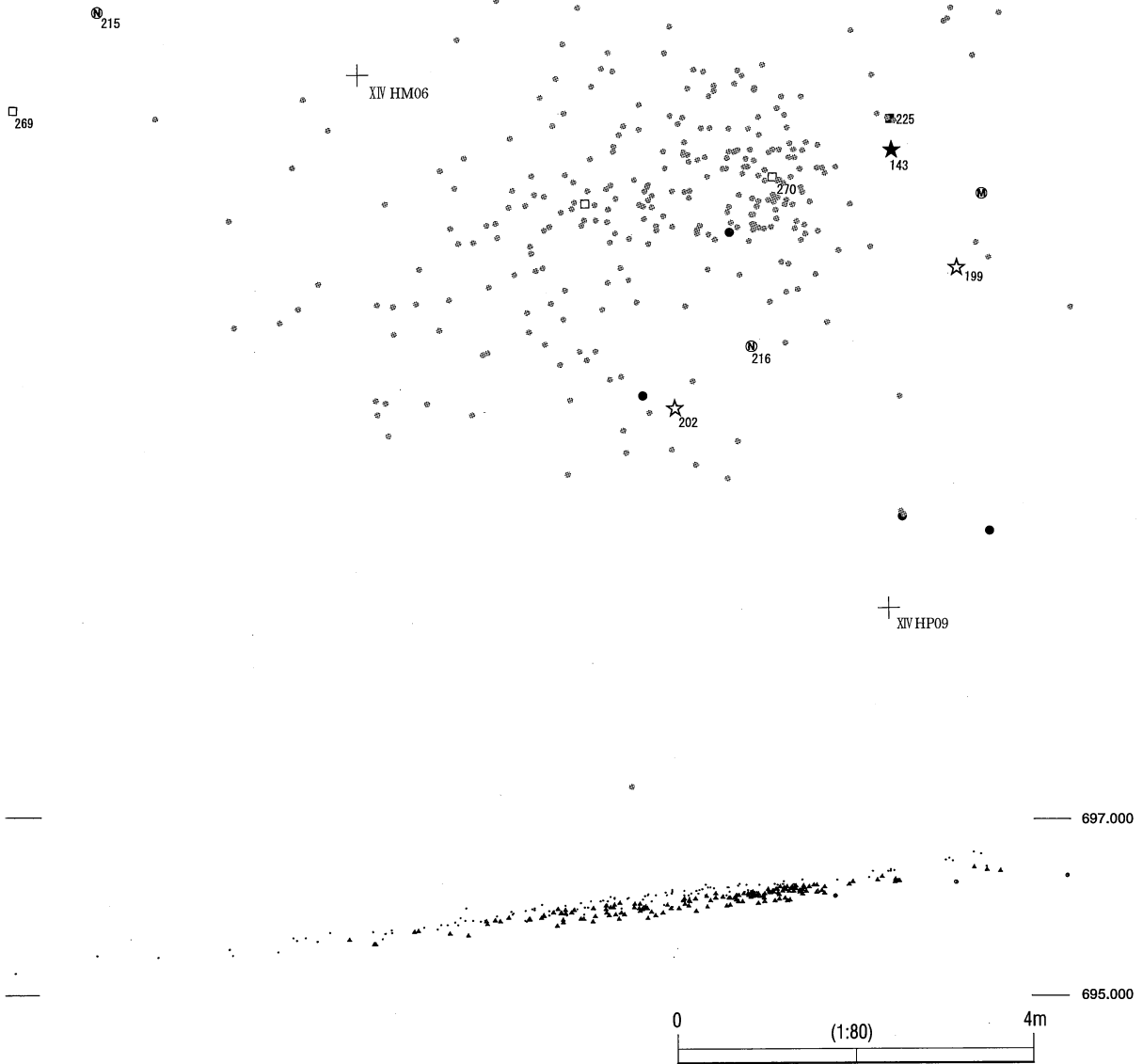

BL 25 遺物分布図 (西岡 A 遺跡)

SH 1

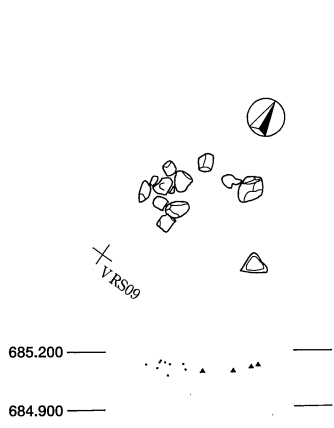

SH 3

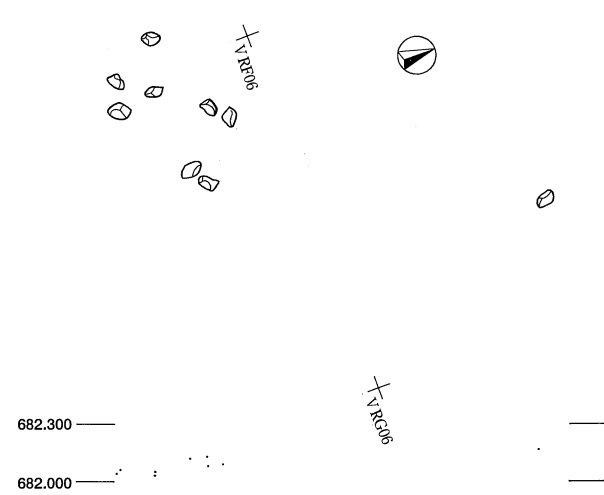

SH 2

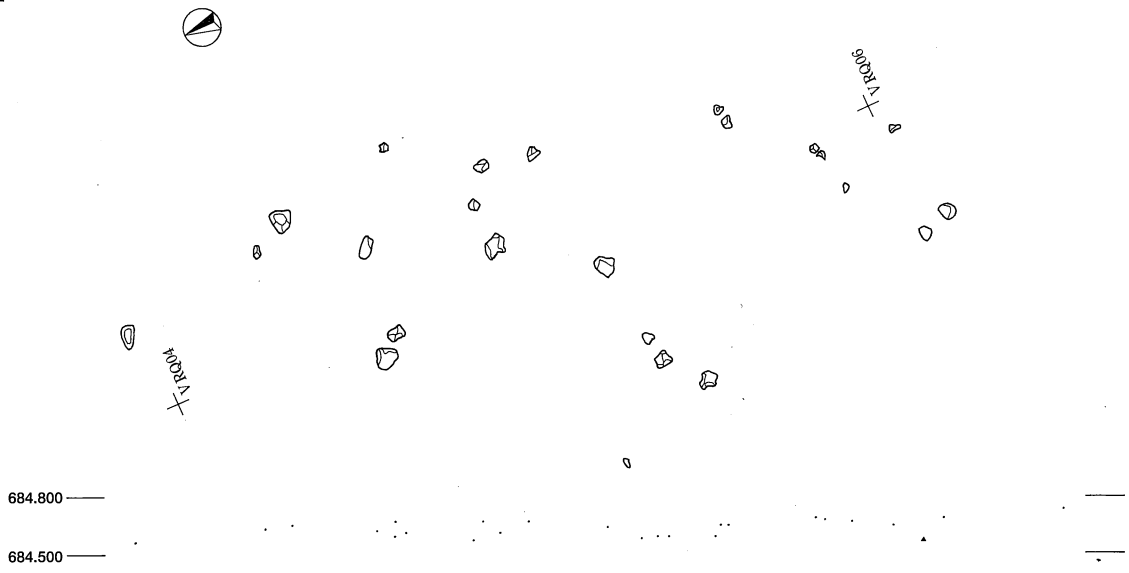

SH 4

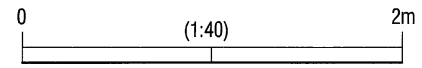
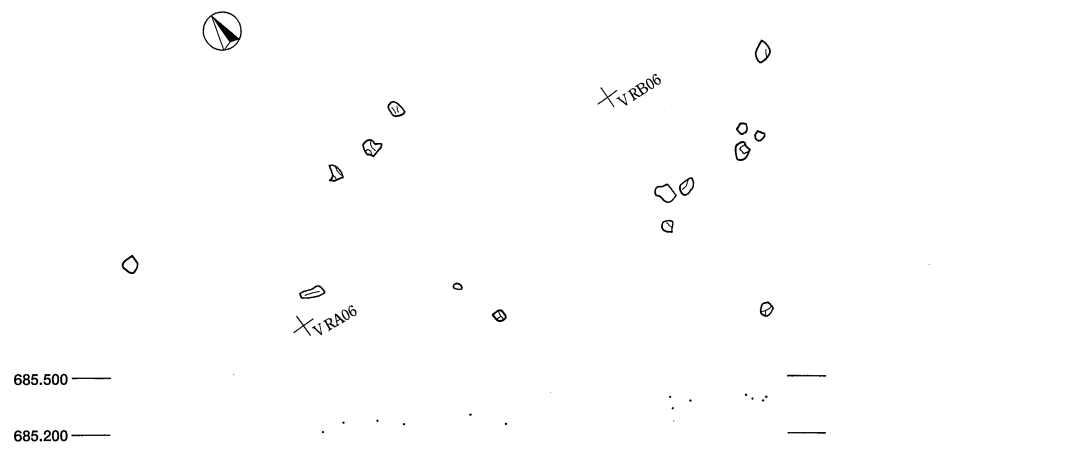

SH 1・2・3・4 遺物分布図 (西岡 A 遺跡)

SH 5

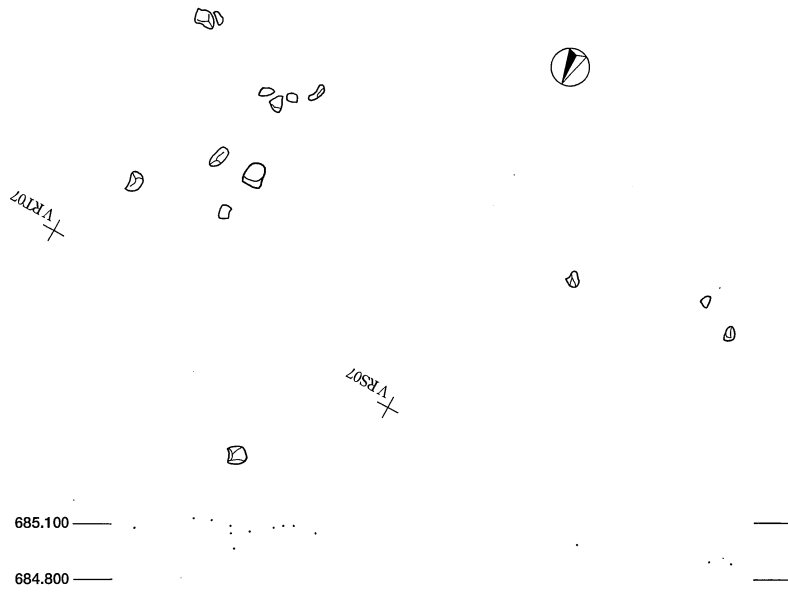

SH 6

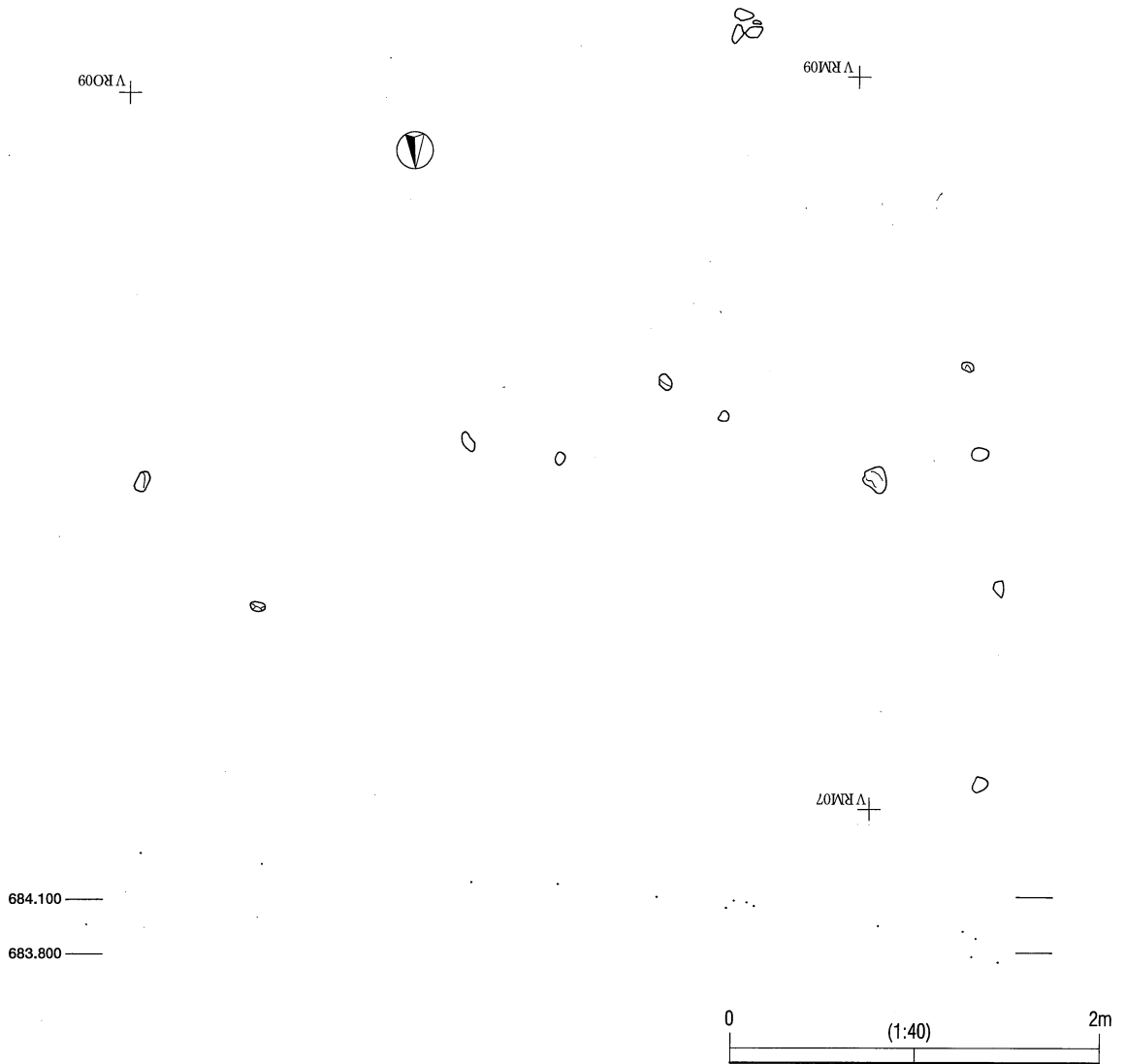

SH 5・6 遺物分布図 (西岡 A 遺跡)

SH 7

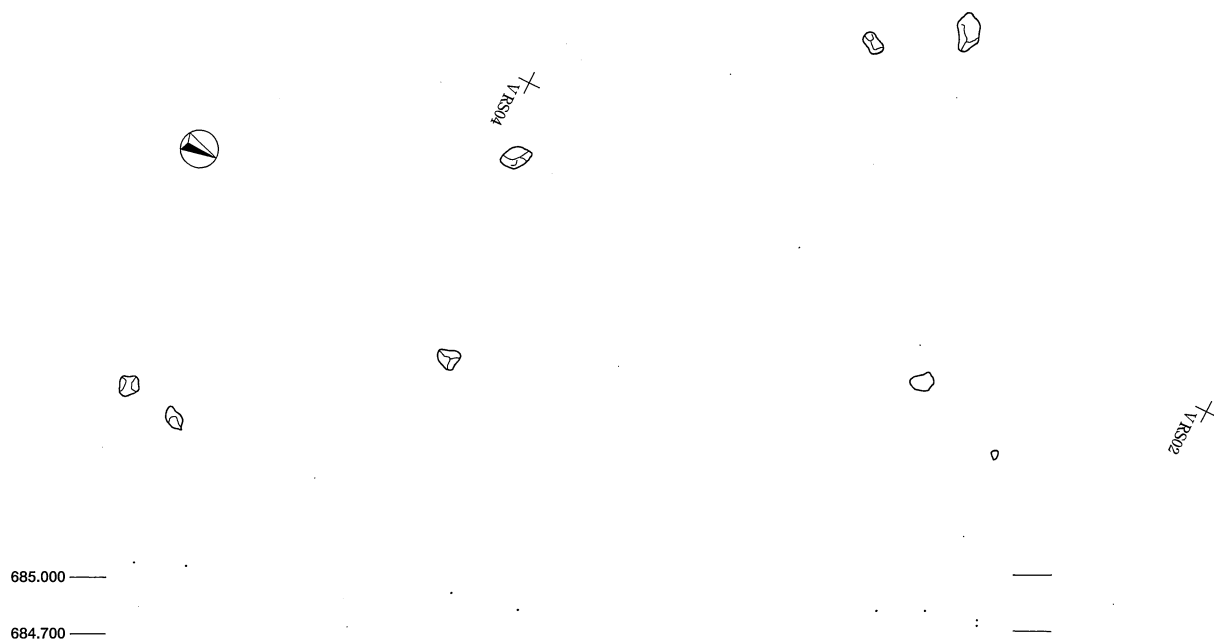

SH 8

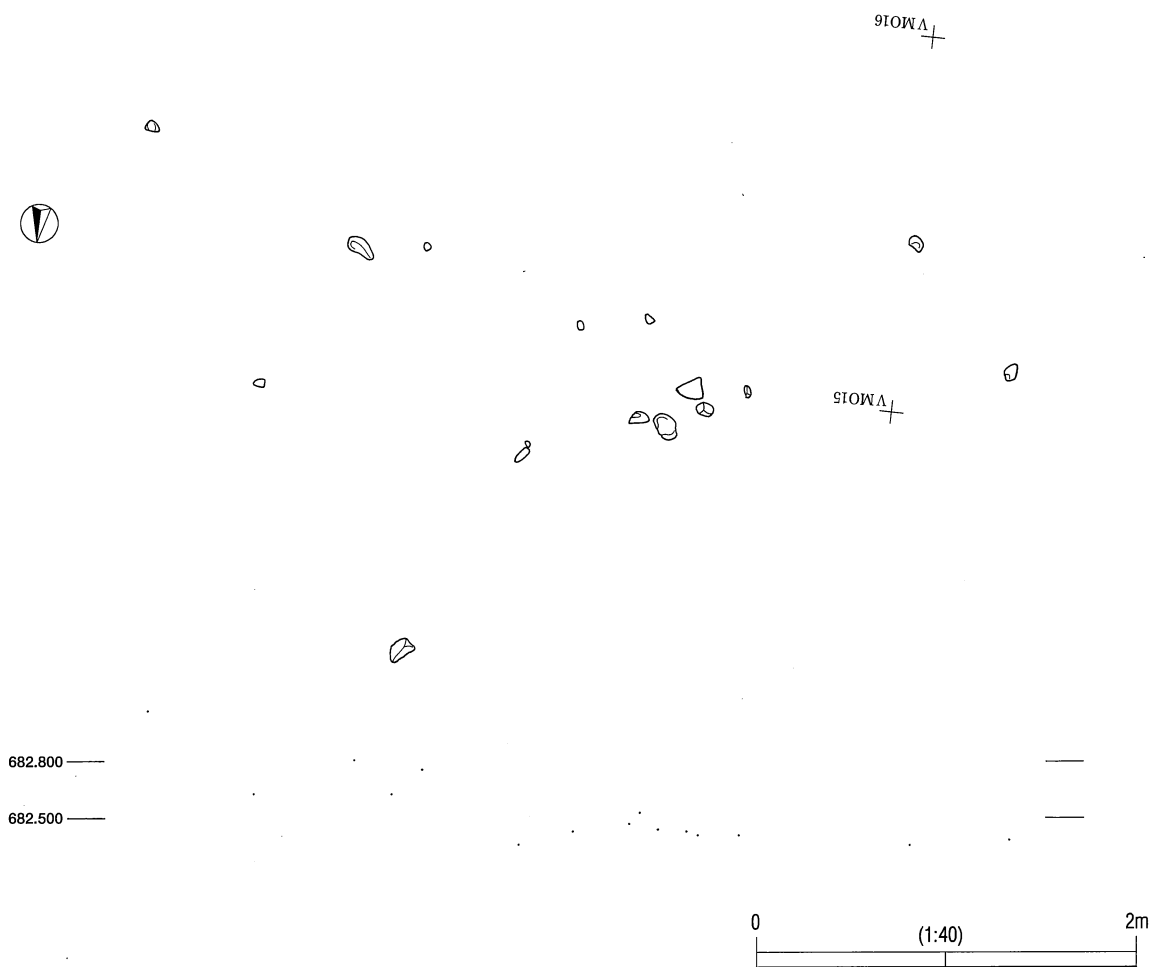

SH 7・8 遺物分布図 (西岡 A 遺跡)

SH 9

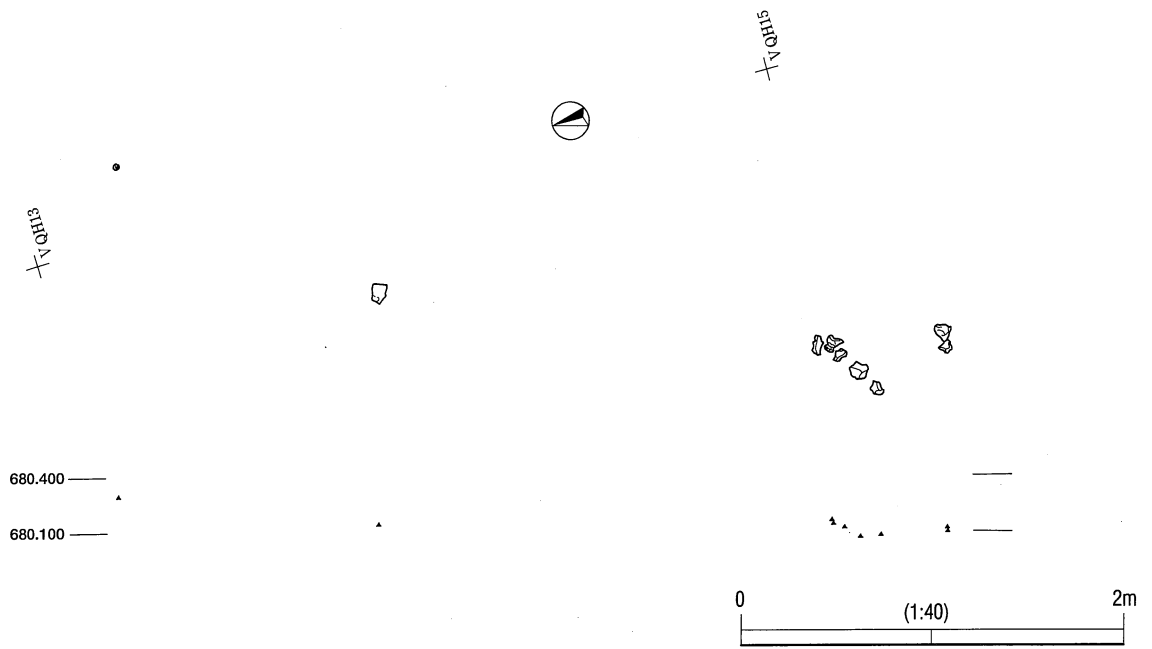

SH 10

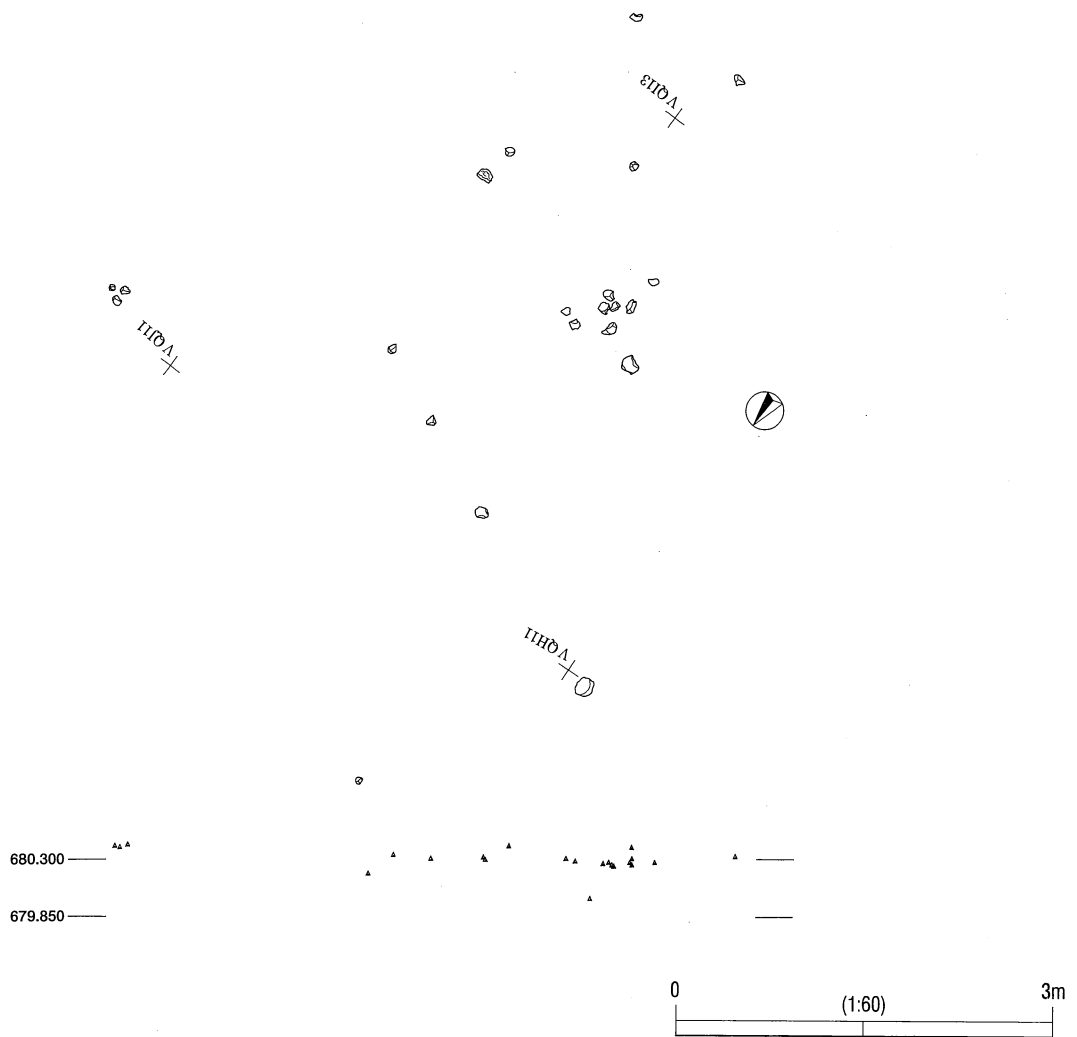

SH 9・10 遺物分布図 (西岡 A 遺跡)

SH 11



SH 12



SH 11・12 遺物分布図 (西岡 A 遺跡)

SH 13

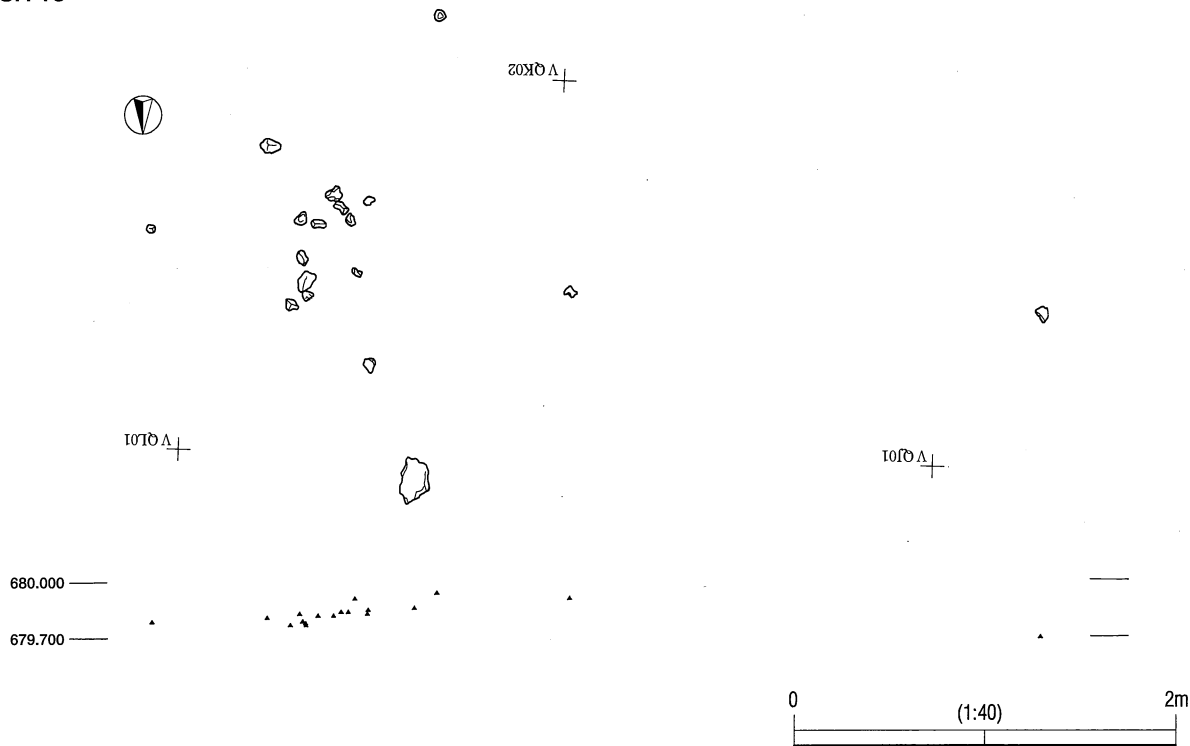

SH 14

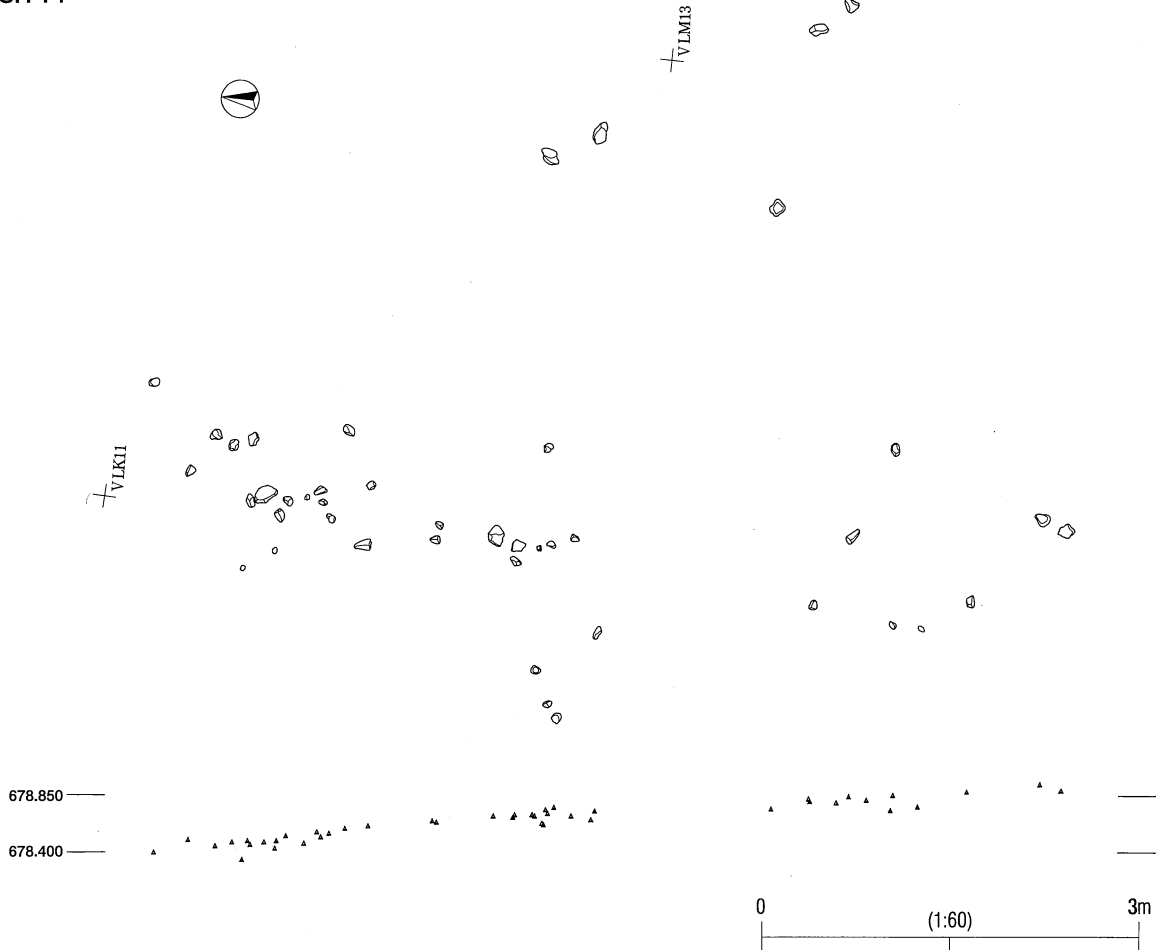

SH 13・14 遺物分布図 (西岡 A 遺跡)

SH 21

SH 22

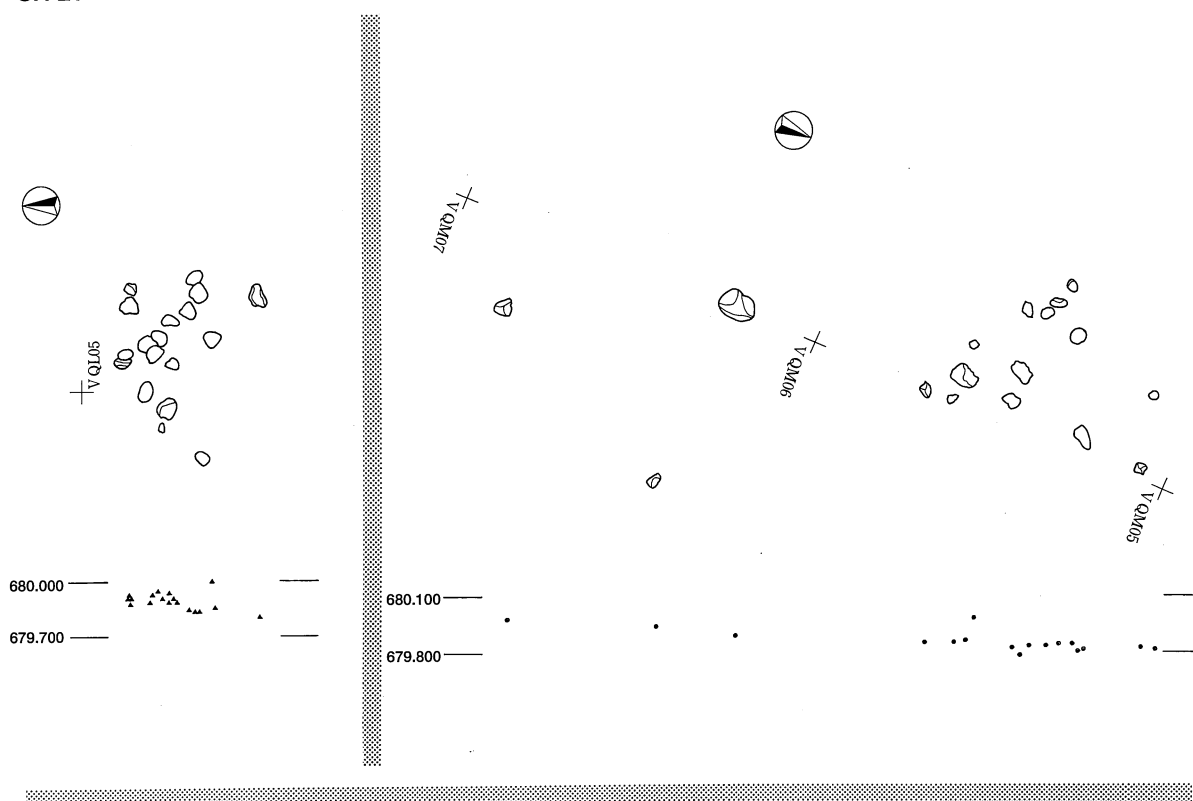

SH 23

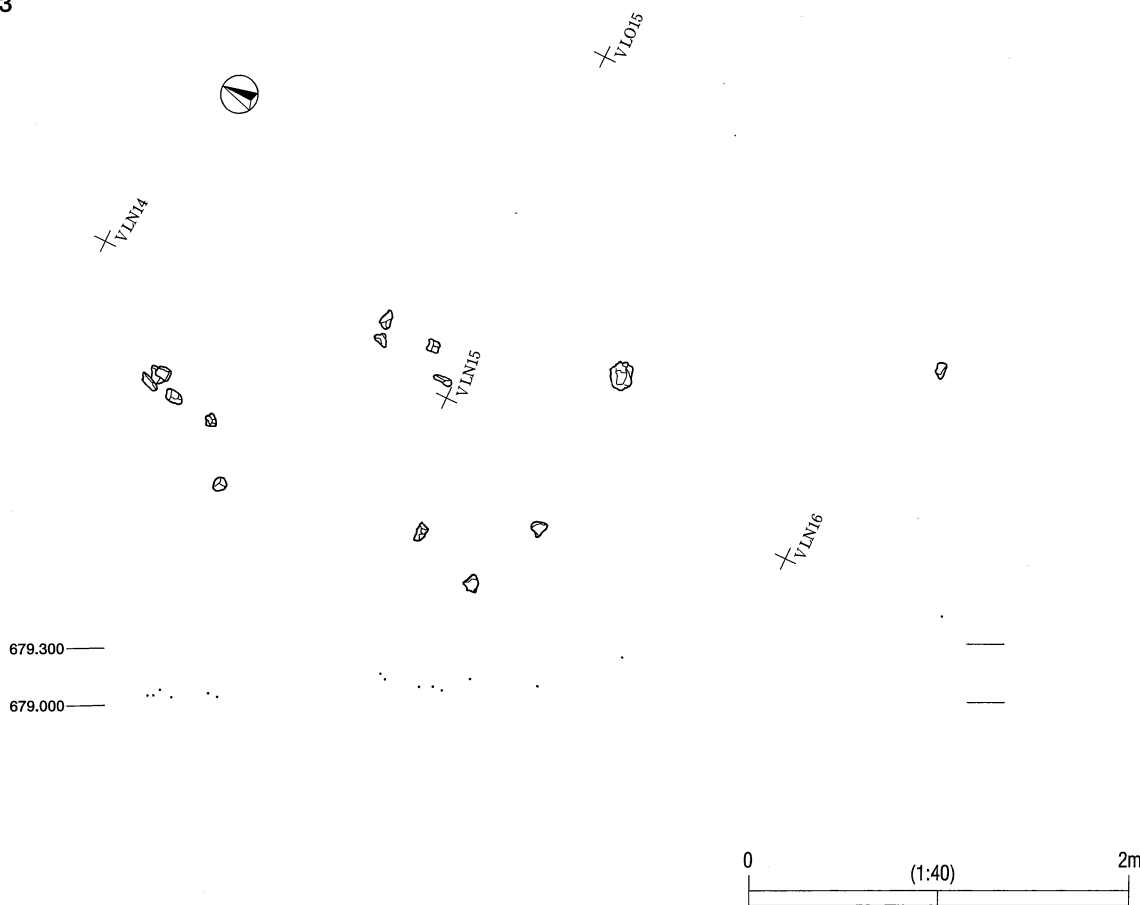

SH 21・22・23 遺物分布図 (西岡 A 遺跡)

SH 24

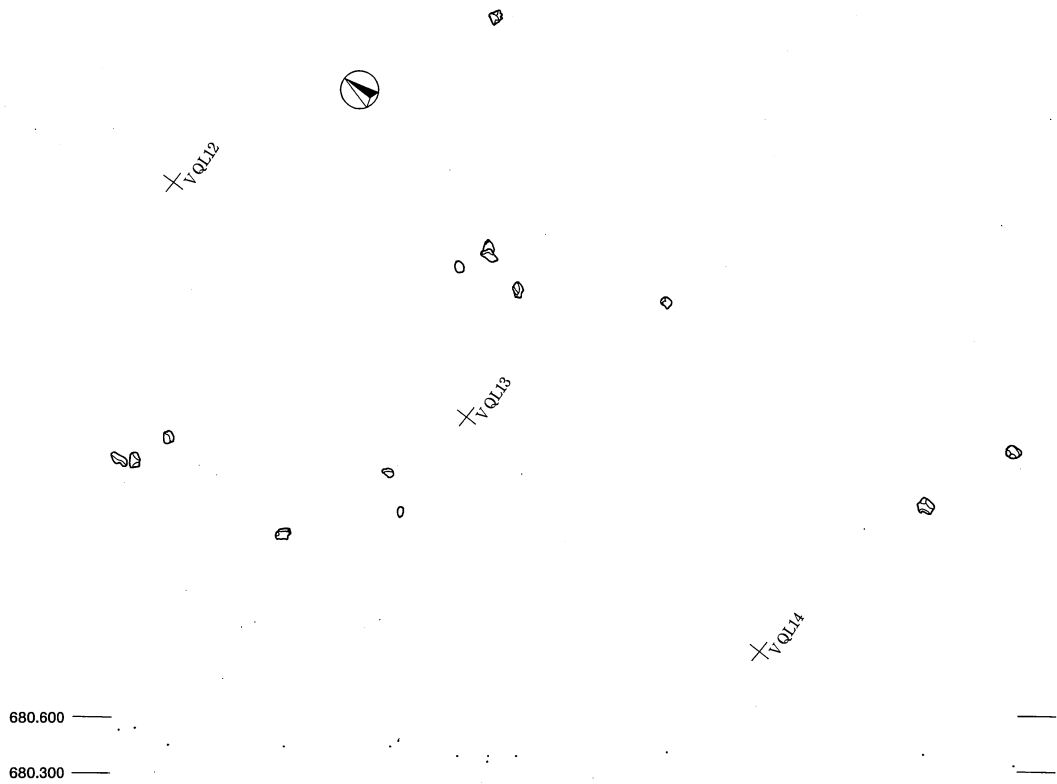

SH 25

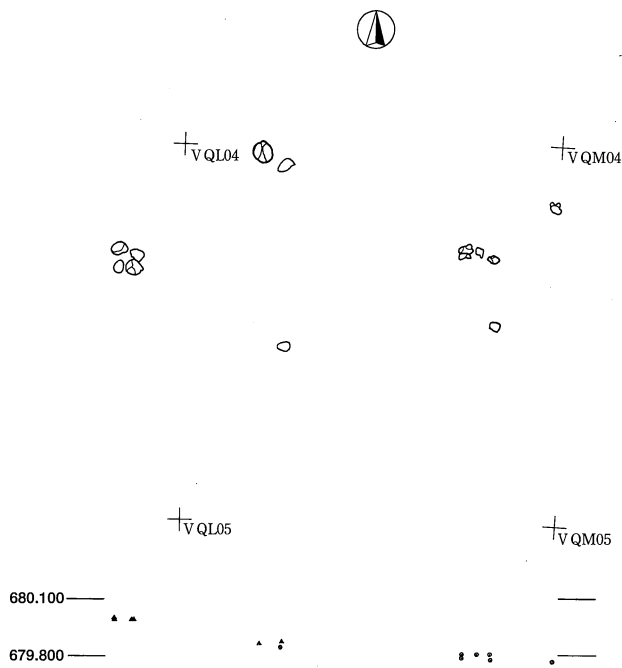

SH 26

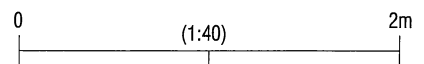
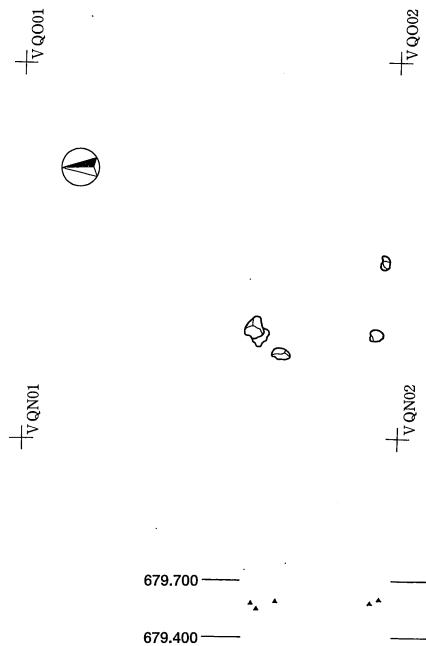

SH 24・25・26 遺物分布図 (西岡 A 遺跡)

SH 27

SH 28

+VQN13

+VQ013

+VLM1A

+VQN14

+VQ014

+VLM1A

680.100

679.100

679.800

678.800

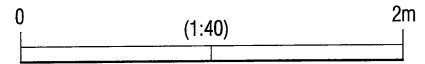

SH 31

+IYWH08

+IYWH10

+IYWH09

+IYWH11

695.050

694.600

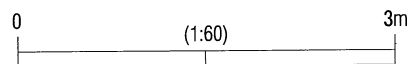

SH 27・28・31 遺物分布図 (西岡 A 遺跡)

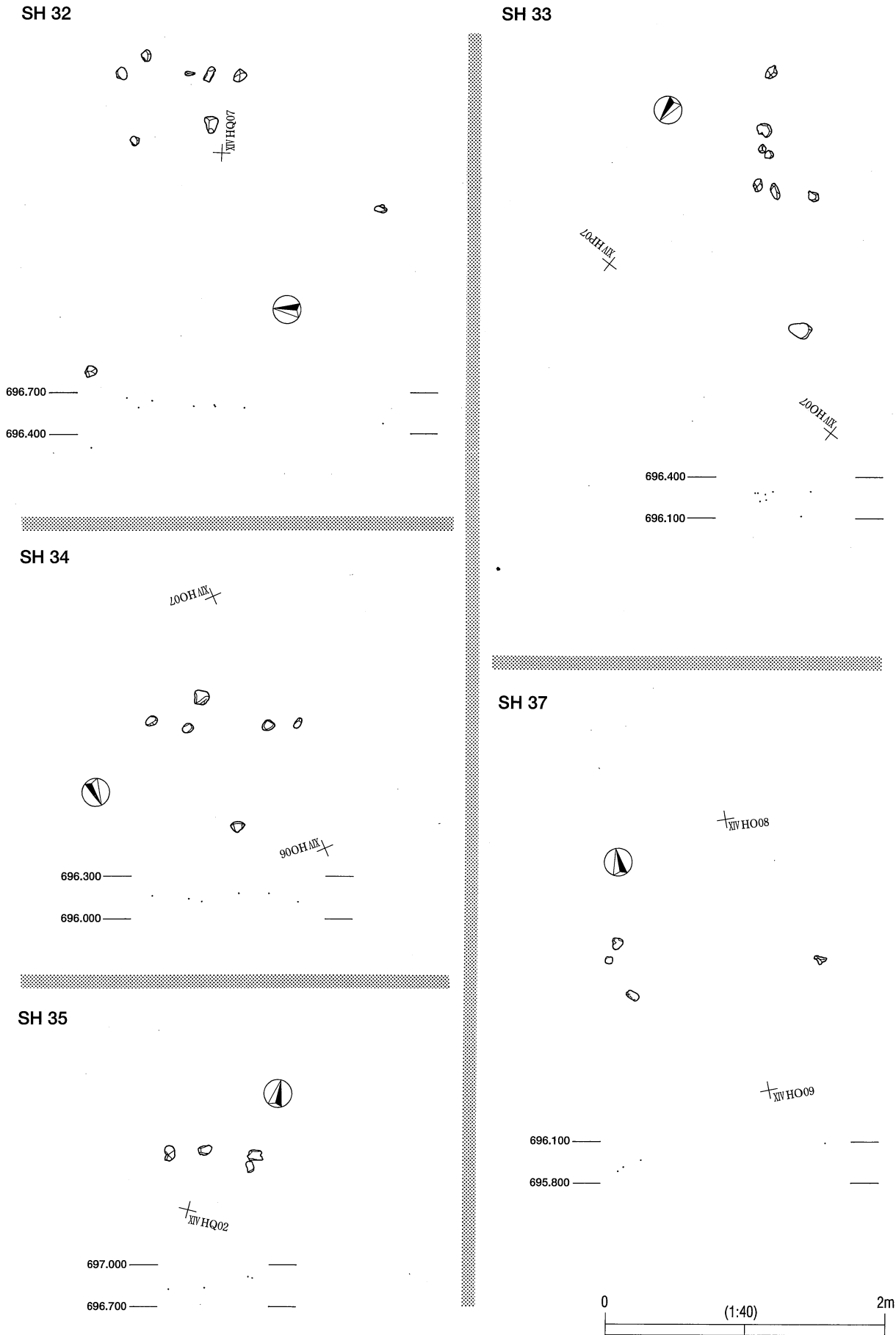

SH 32・33・34・35・37 遺物分布図 (西岡 A 遺跡)

SH 36

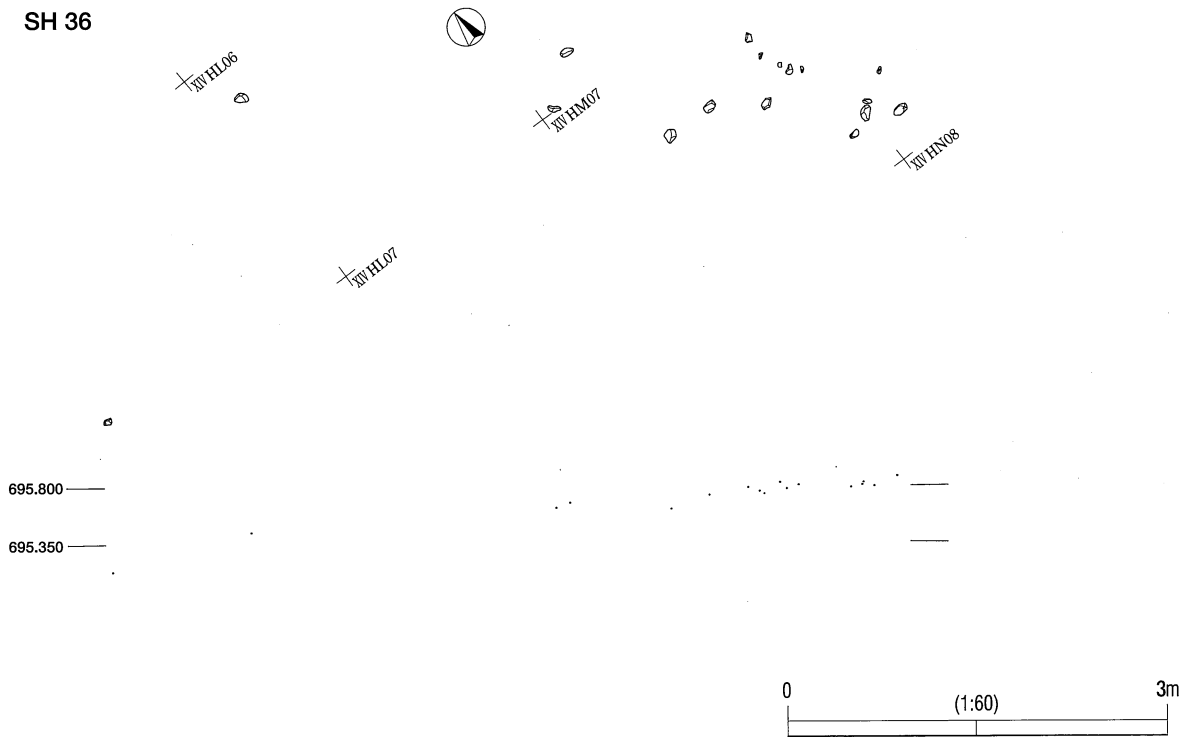

SH 38

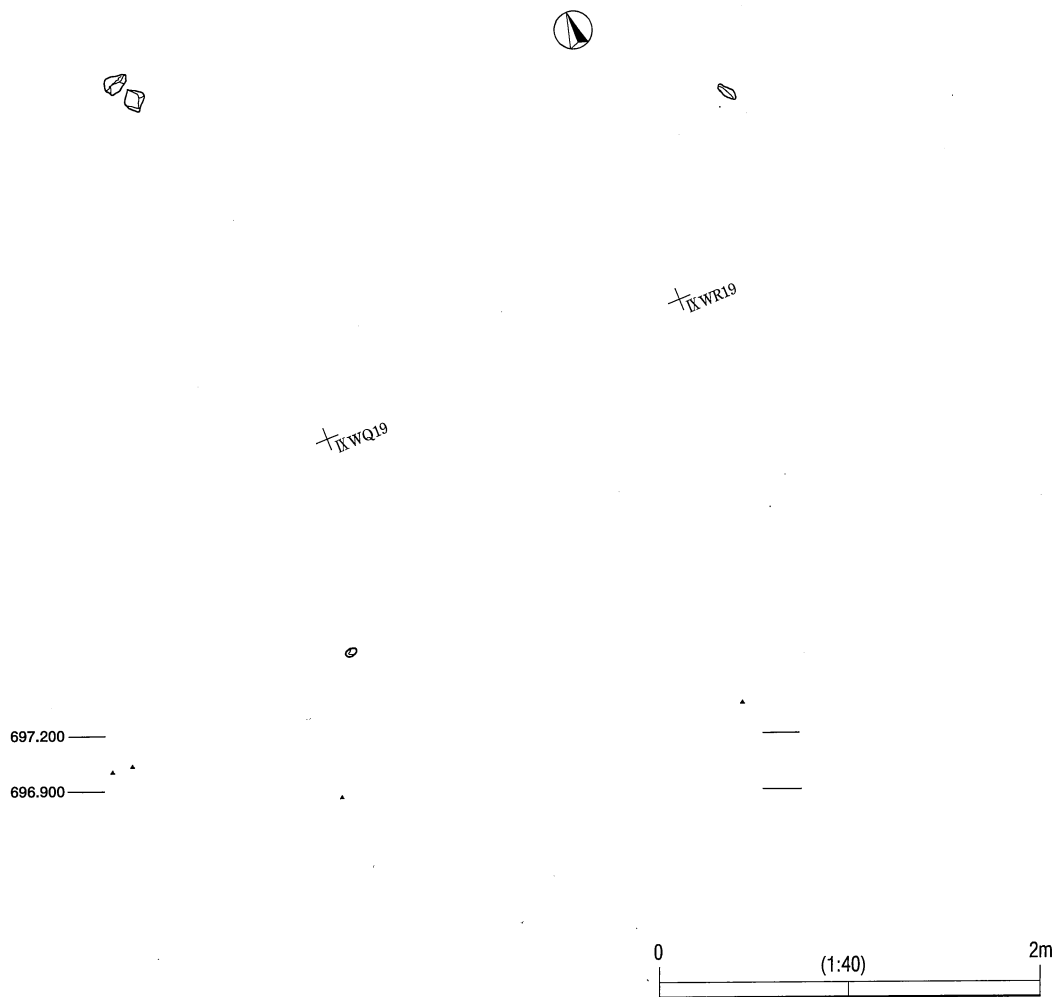

SH 36・38 遺物分布図 (西岡 A 遺跡)

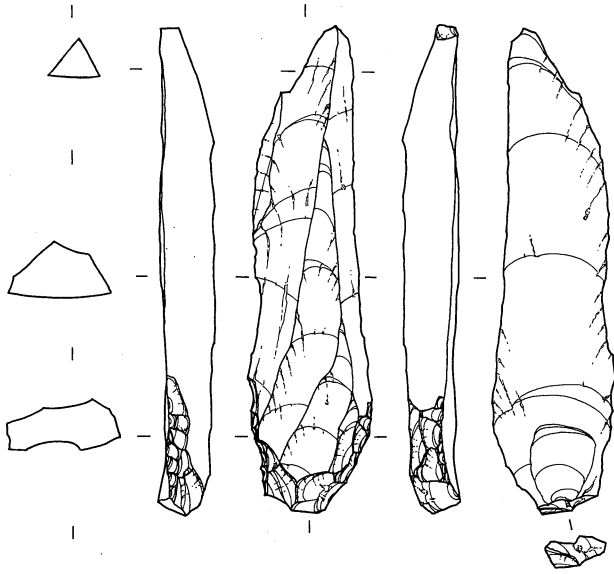

1
Kn An
BL11 16.84g
Va V-L 235

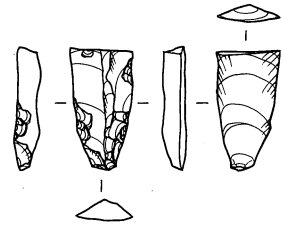

2
Kn Ob SWHD
BL17 0.75g
III V-Q 277

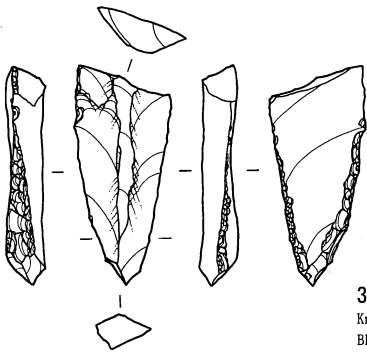

3
Kn SS
BL6 3.93g
III V-R 483

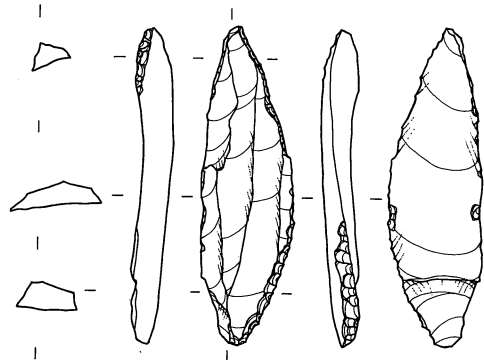

4
Kn SS
BL1 4.13g
III V-W 6

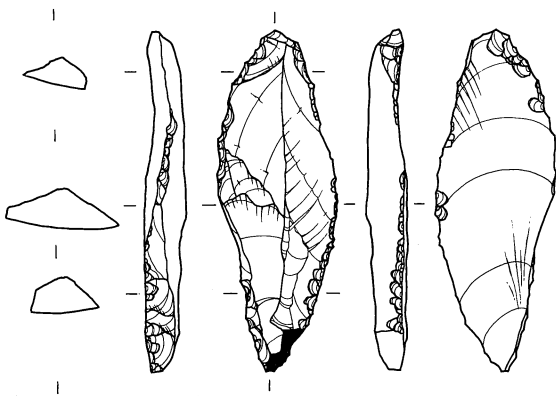

5
Kn Ob TSTY
BL19 6.5g
III IX-N 184

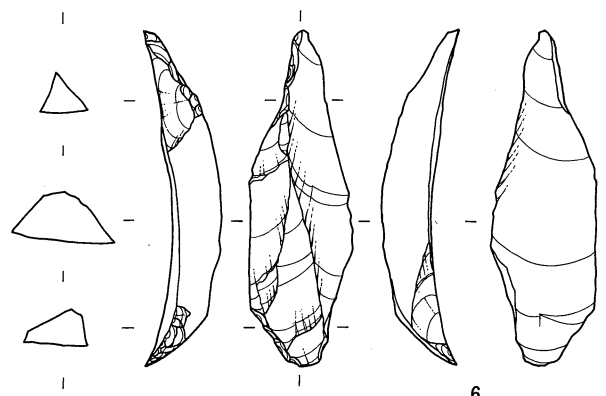

6
Kn GT
BL20 8.27g
IV上 IX-W 233

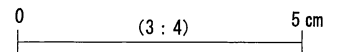

石器実測図 1 (ナイフ形石器 1) (西岡 A 遺跡)

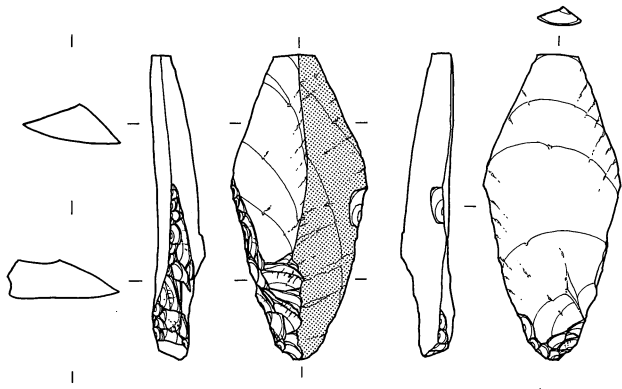

7
Kn An
BL7 8.11g
III V-S 7

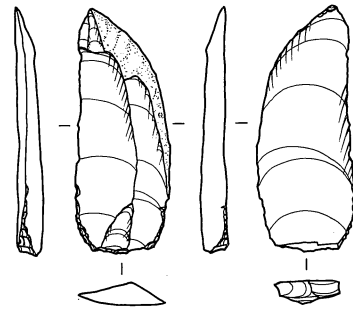

8
Kn Ob SWHD
BL18 2.65g
III IX-M 33

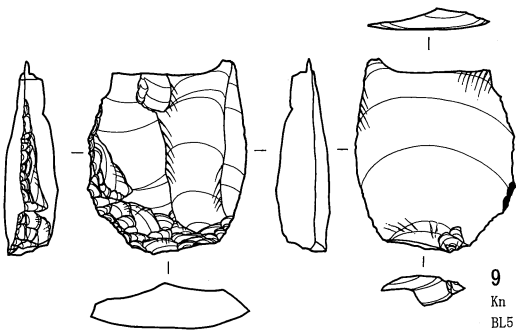

9
Kn Ob SWHD
BL5 6.63g
III V-R 442

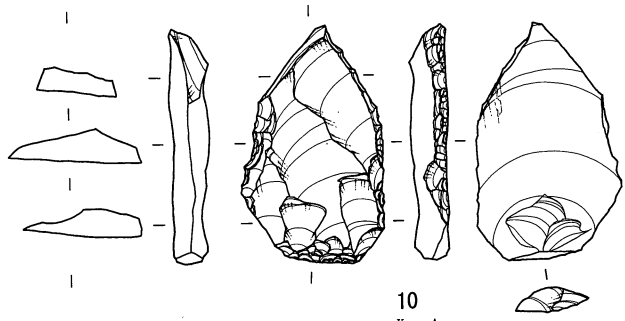

10
Kn Ag
BL7 5.82g
III V-R 42

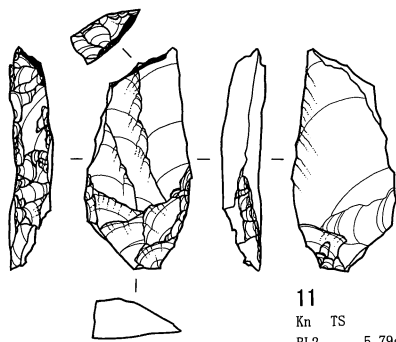

11
Kn TS
BL2 5.79g
IV V-S 138

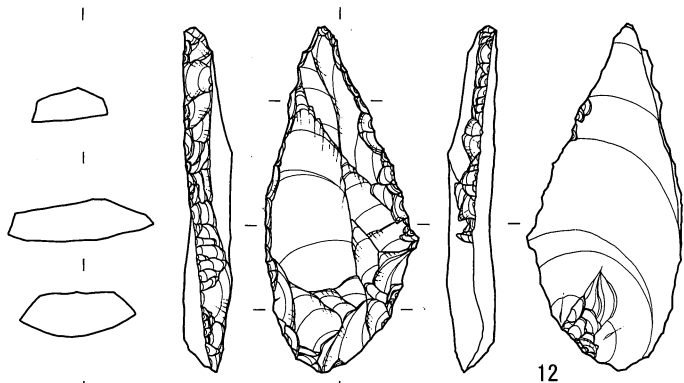

12
Kn SS
BL12 12.12g
III V-Q 408

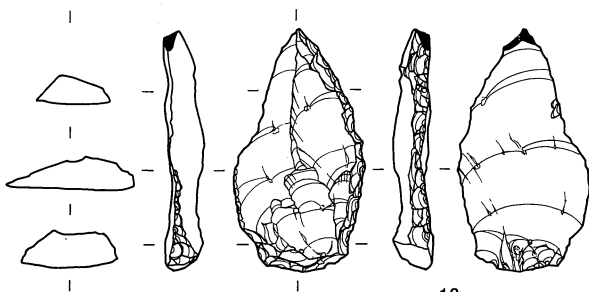

13
Kn Ob TSTY
BL2 5.24g
IV V-S 167

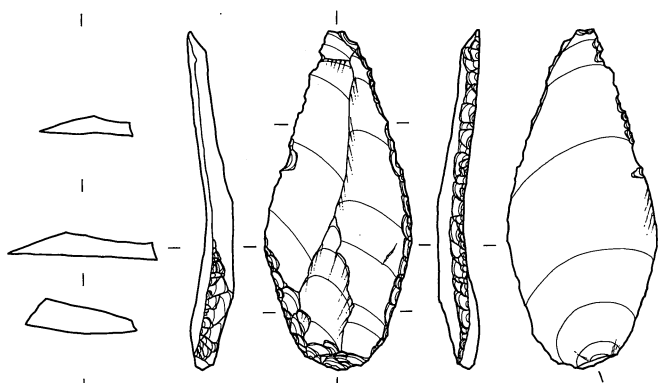

14
Kn Sh
BL3 7.43g
III V-S 101

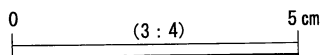

石器実測図 2 (ナイフ形石器 2) (西岡 A 遺跡)

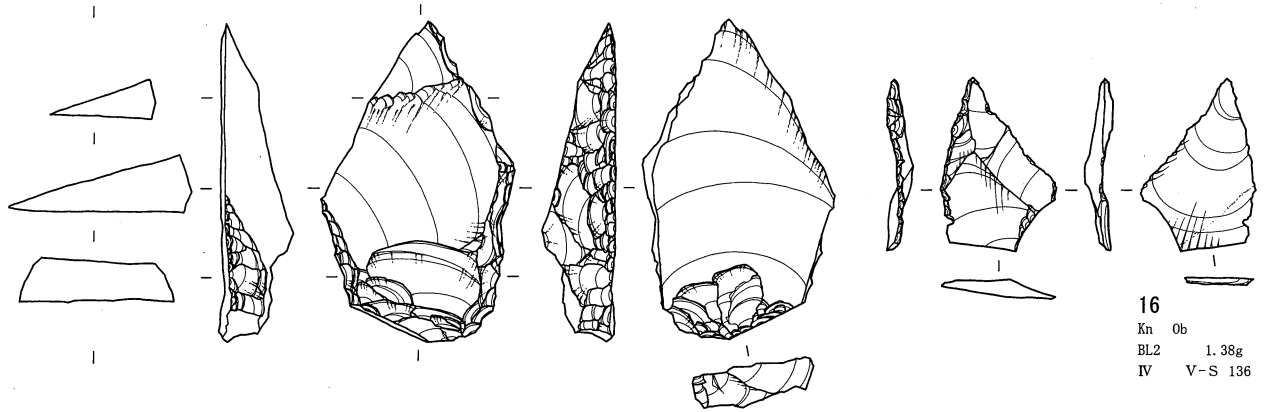

15
Kn Sh
BL4 15.94g
IV V-S 42

16
Kn Ob
BL2 1.38g
IV V-S 136

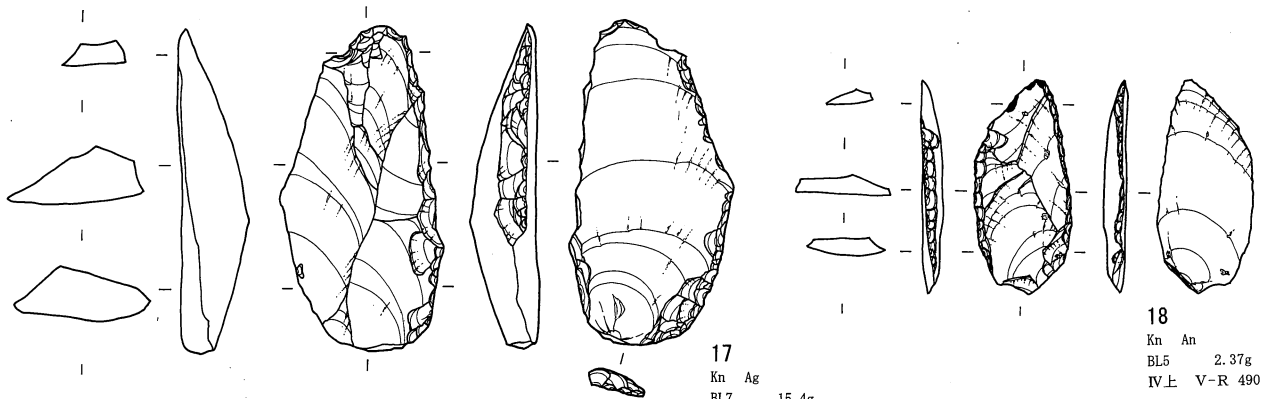

17
Kn Ag
BL7 15.4g
IV V-R 65

18
Kn An
BL5 2.37g
IV上 V-R 490

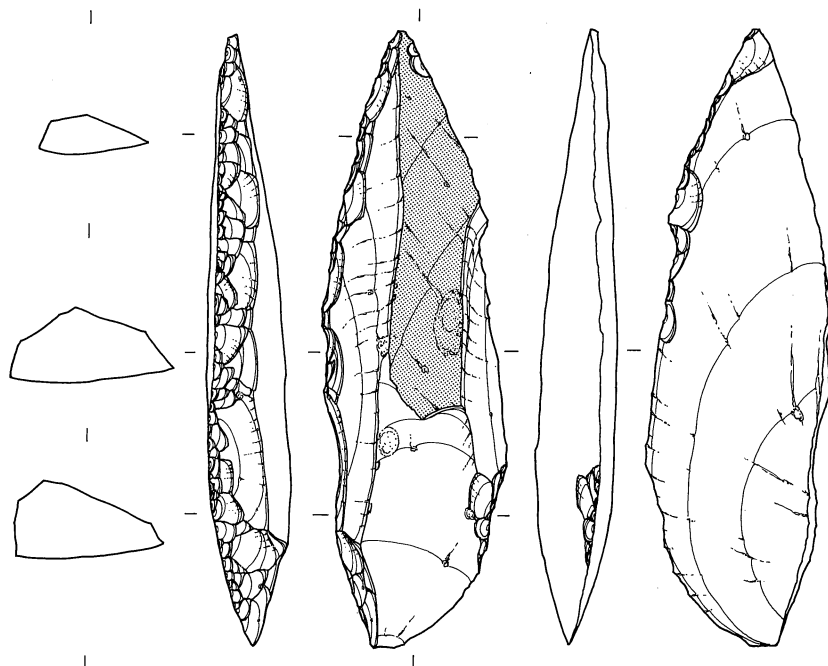

19
Kn An
BL10 45.85g
II V-L 47

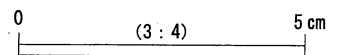

石器実測図 3 (ナイフ形石器 3) (西岡 A 遺跡)

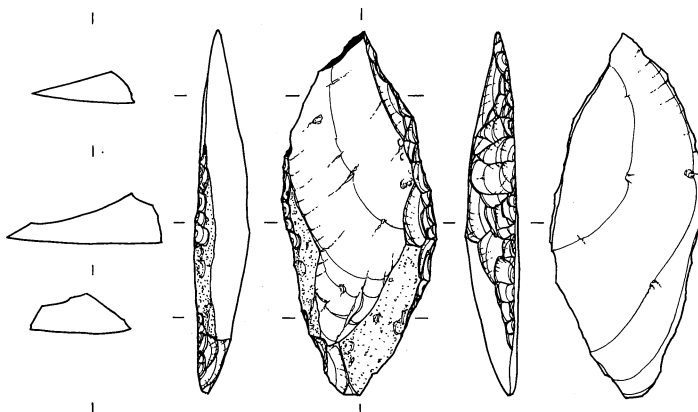

20
Kn An
BL10 11.71g
III V-L 44



21
Kn An
BL15 15.09g
III V-Q 308

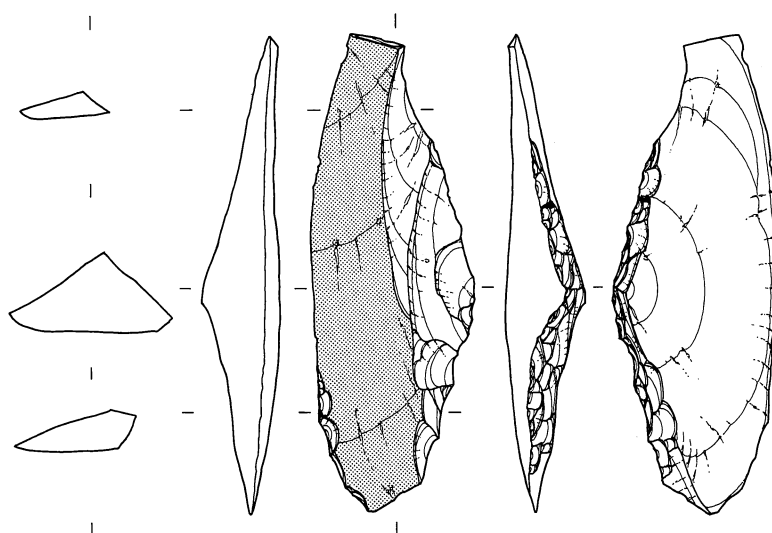

22
Kn An
BL15 22.63g
III V-Q 299

0 (3 : 4) 5 cm

石器実測図 4 (ナイフ形石器 4) (西岡 A 遺跡)

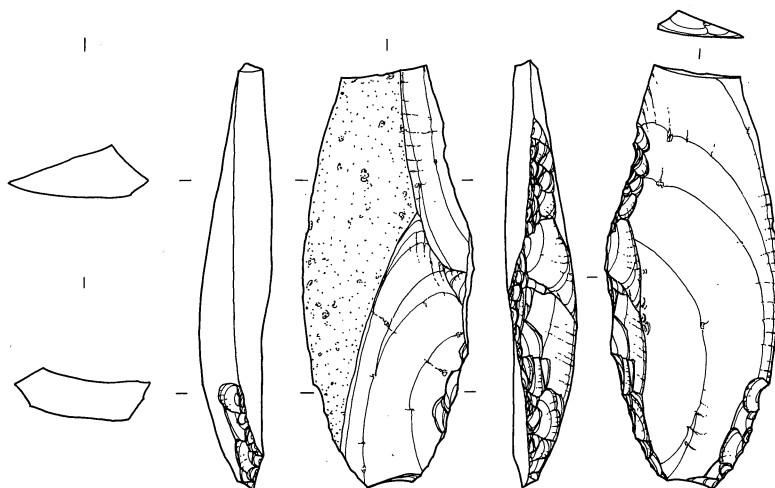

23
 Kn An
 BL15 25.14g
 III V-Q 13

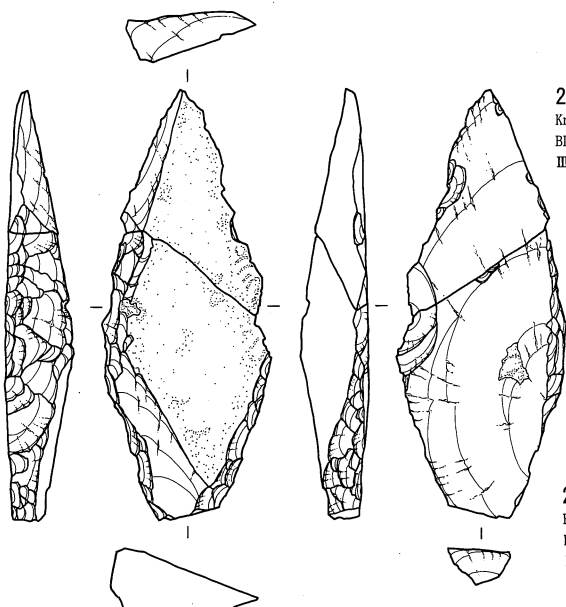

24a
 Kn 破
 BL15 4.46g
 III V-Q 406



24b
 Kn An
 BL15 17.84g
 III V-Q 384

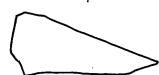

25
 Kn An
 BL13 8.22g
 IV上 V-Q 684

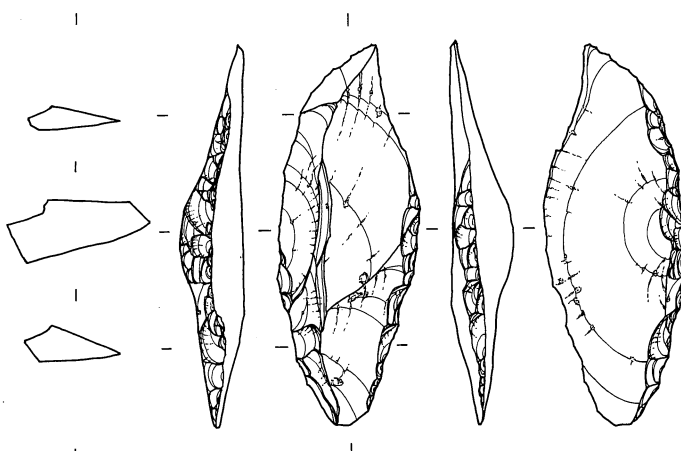

26
 Kn An
 BL15 11.05g
 III V-Q 174

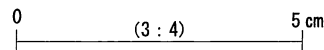

石器実測図 5 (ナイフ形石器 5) (西岡 A 遺跡)

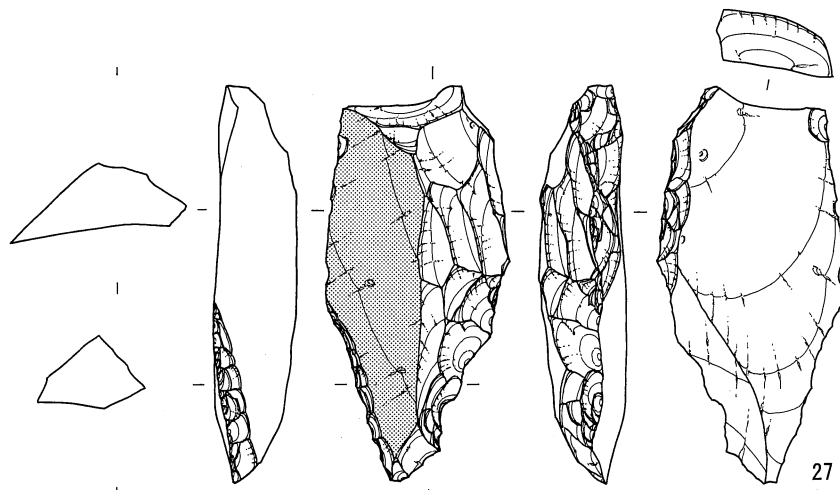

27
Kn An
BL17 29.19g
III V-Q 231

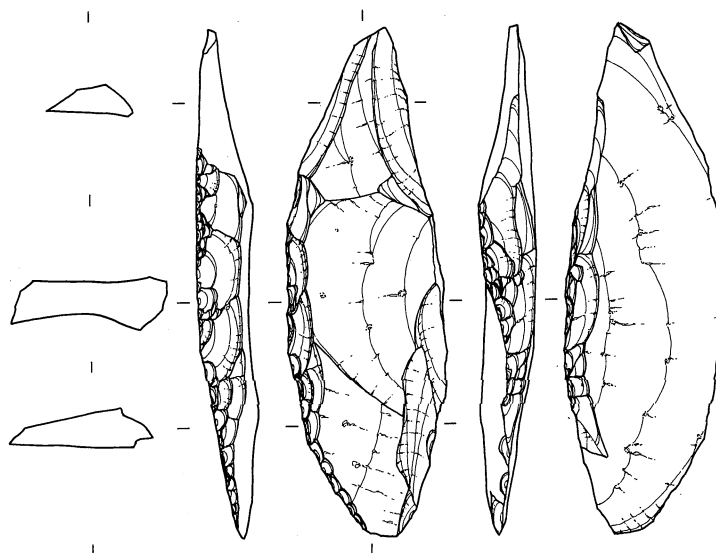

28
Kn An
BL17 23.03g
III V-Q 256

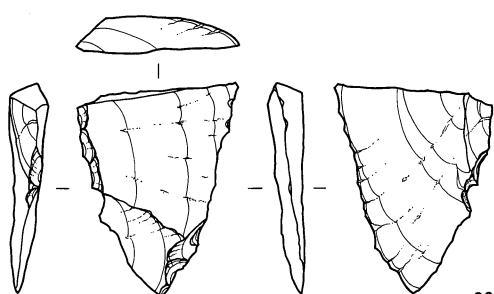

29
Kn An
BL15 5.61g
III V-Q 38

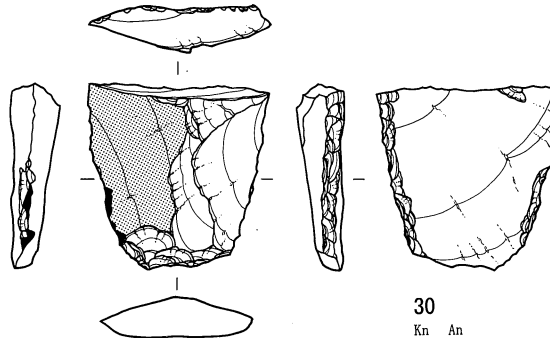

30
Kn An
BL15 10.23g
III V-Q 403

0 (3 : 4) 5 cm

石器実測図 6 (ナイフ形石器 6) (西岡 A 遺跡)

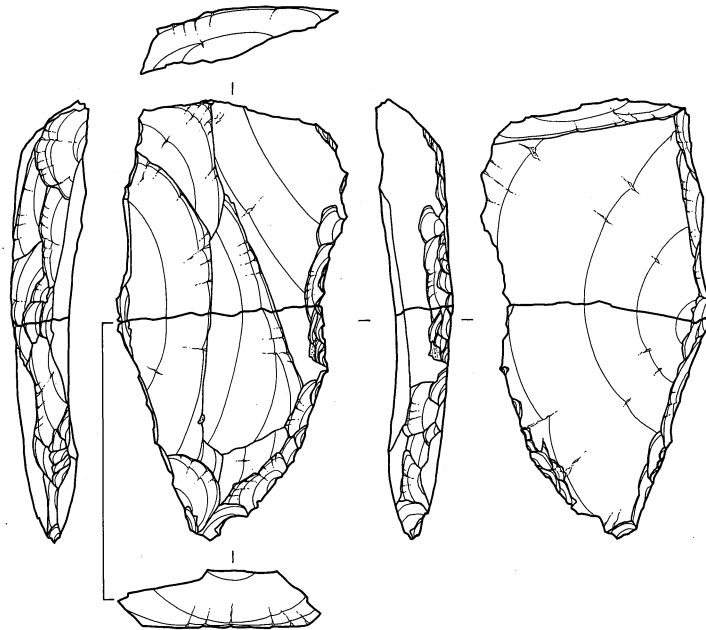

31a
 Kn 破
 BL11 24.26g
 V a V-L 234

31b
 Kn An
 BL12 15.84g
 III V-Q 415

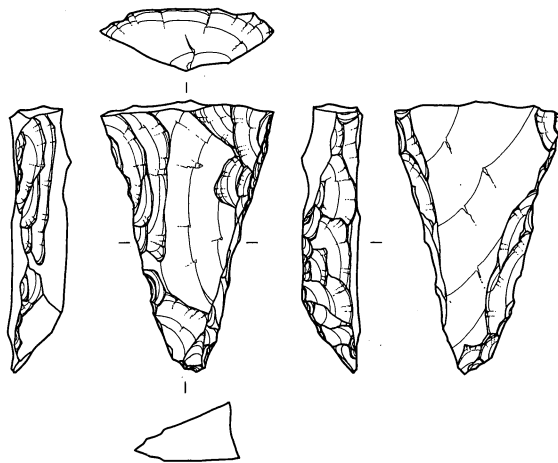

32
 Kn An
 BL17 12.7g
 III V-Q 120

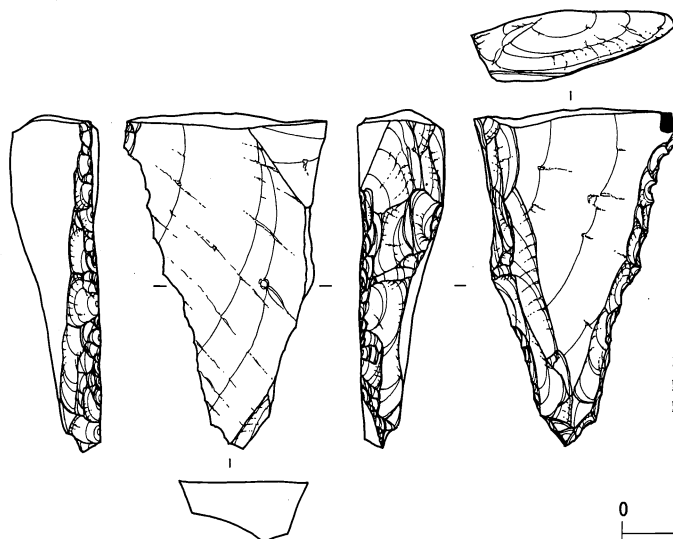

33
 Kn An
 BL12 23.37g
 III V-Q 407

0 (3 : 4) 5 cm

石器実測図 7 (ナイフ形石器 7) (西岡 A 遺跡)

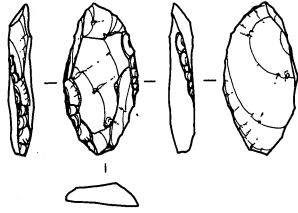

34
Kn An
BL20 1.41g
IV上 IX-W 247

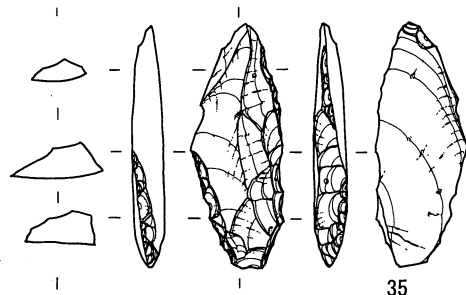

35
Kn An
BL5 3.57g
III V-R 286

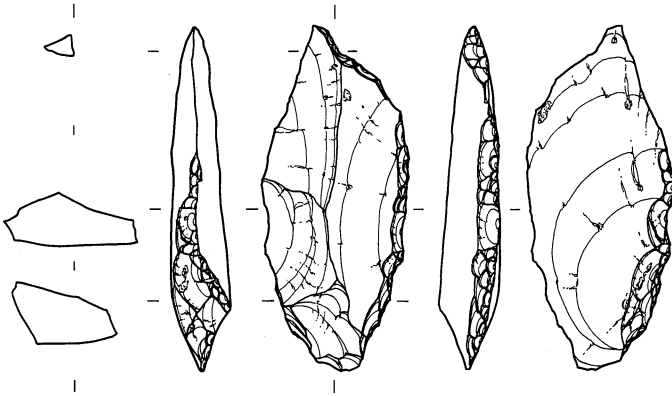

36
Kn An
BL4 12.6g
IV V-S 246

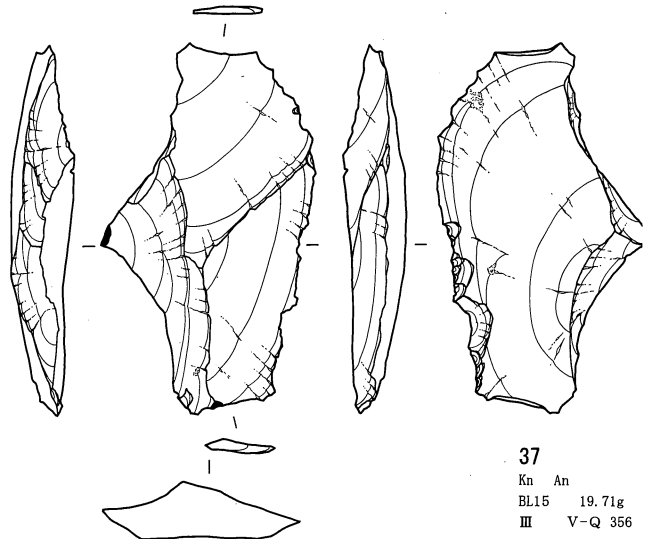

37
Kn An
BL15 19.71g
III V-Q 356

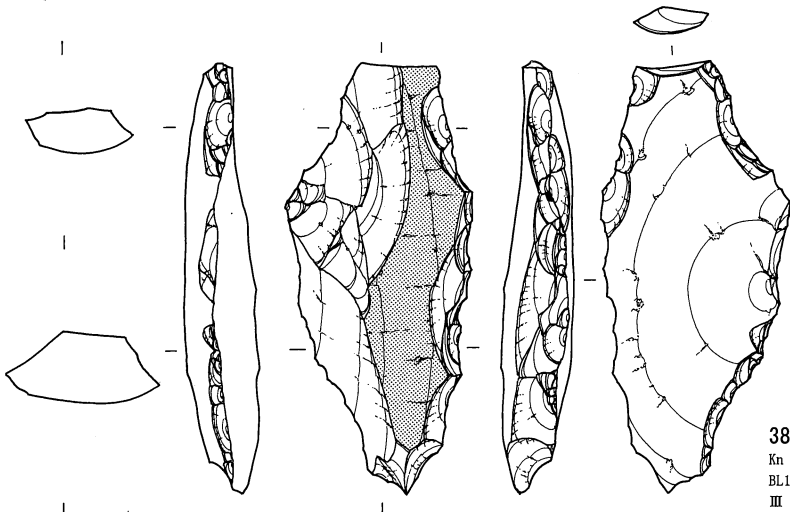

38
Kn An
BL17 27.55g
III V-Q 226

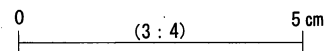

石器実測図 8 (ナイフ形石器 8) (西岡 A 遺跡)

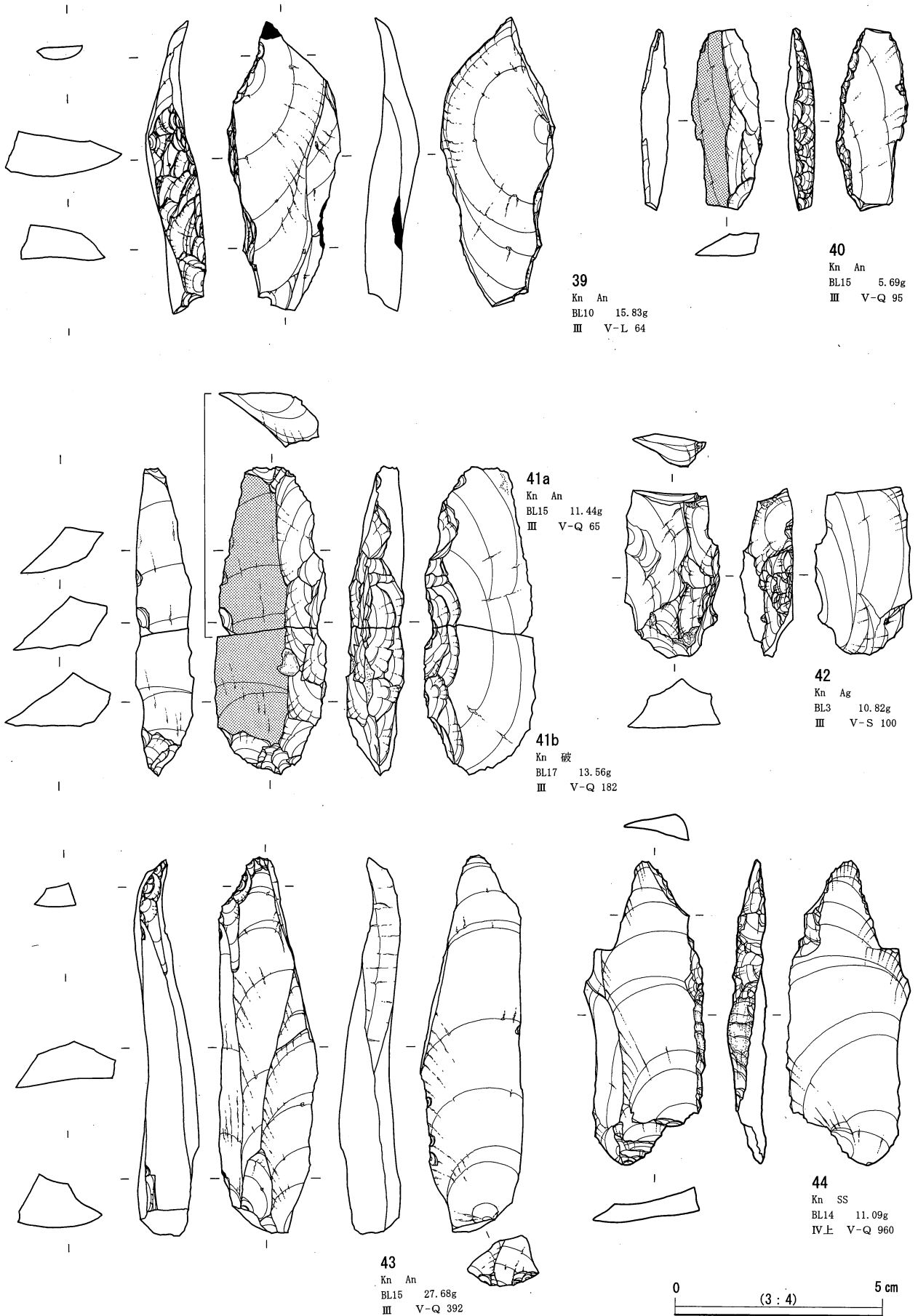

石器実測図 9 (ナイフ形石器 9) (西岡 A 遺跡)

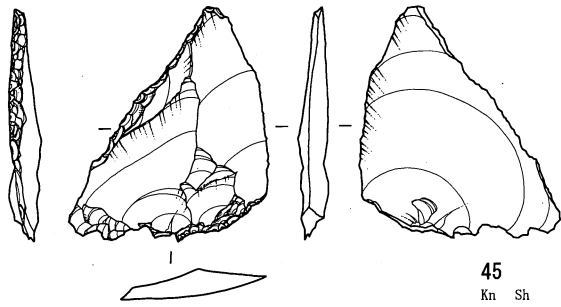

45
Kn Sh
BL4 4.79g
IV下 V-S 50

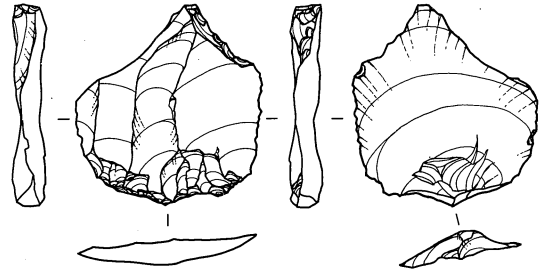

46
Kn Sh
BL4 5.47g
IV V-S 34

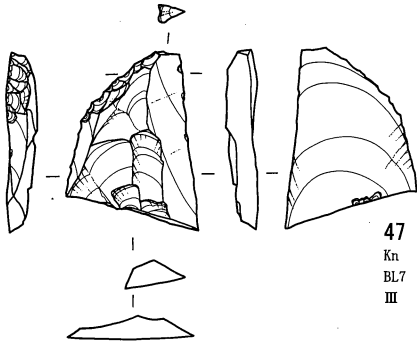

47
Kn SS
BL7 3.52g
III V-M 3

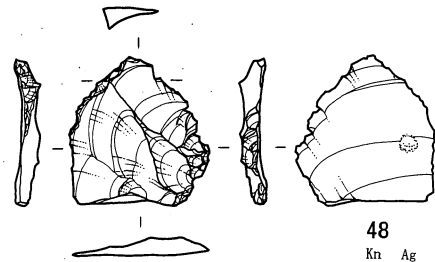

48
Kn Ag
BL3 1.83g
IV V-S 214

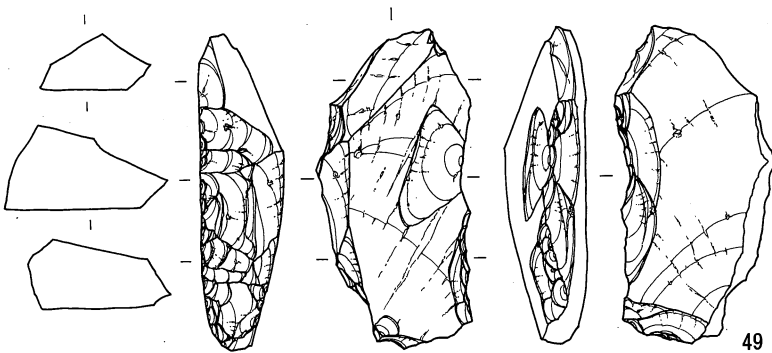

49
Kn An
BL12 21.23g
III V-L 20

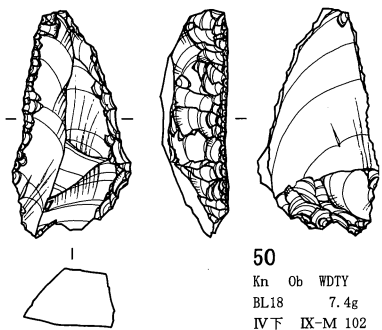

50
Kn Ob WDTY
BL18 7.4g
IV下 IX-M 102

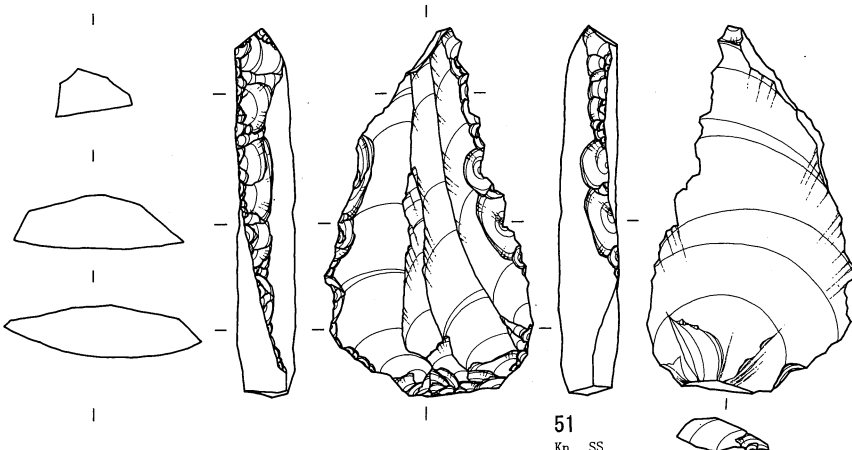

51
Kn SS
BL12 22.74g
III V-Q 436

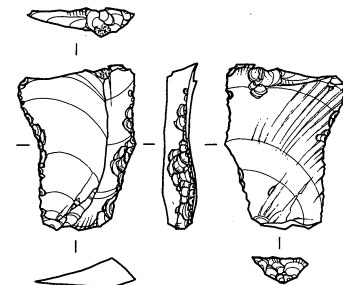

52
Kn Ob
外 2.6g
III V-W 37

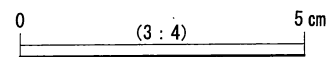

石器実測図 10 (ナイフ形石器 10) (西岡 A 遺跡)

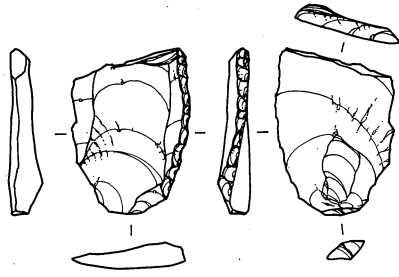

53
Kn An
BL14 2.22g
IV上 V-Q 661

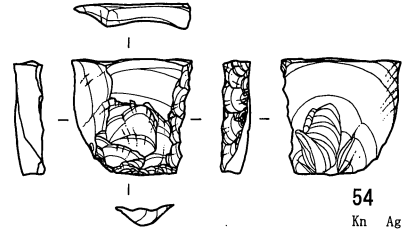

54
Kn Ag
BL3 2.63g
IV V-S 231

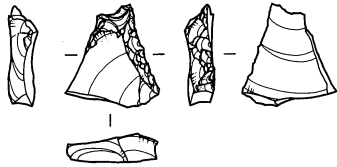

55
Kn Sh
BL4 1.4g
IV下 V-S 52

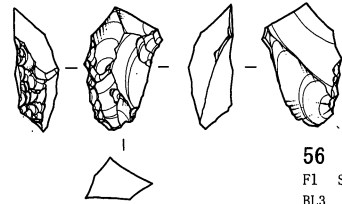

56
Fl Sh
BL3 1.54g
IV V-S 208

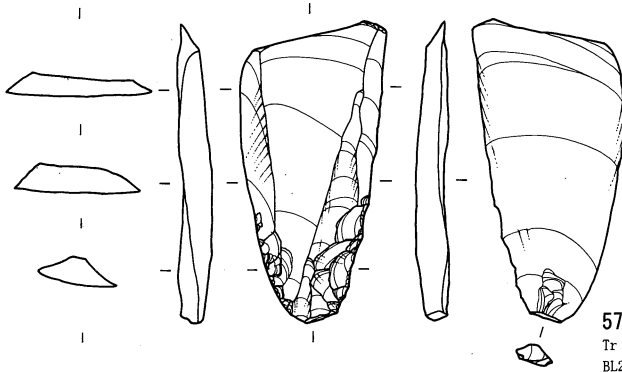

57
Tr SS
BL22 7.63g
IV下 IX-W 158

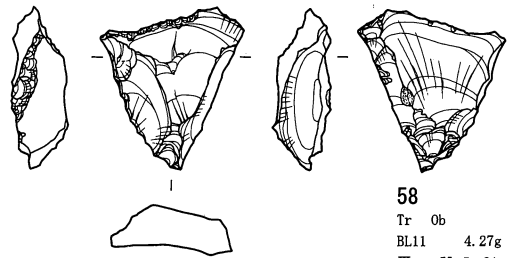

58
Tr Ob
BL11 4.27g
III V-L 91

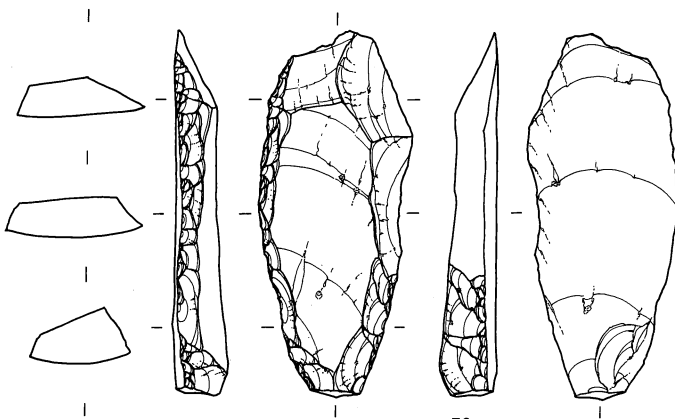

59
Tr An
BL7 14.62g
III V-S 11

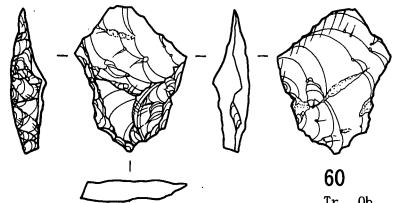

60
Tr Ob
BL7 2.04g
III V-S 5

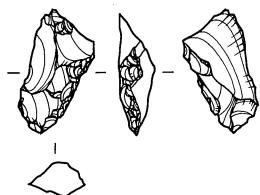

61
Tr Ob
BL13 0.93g
IV下 V-Q 746

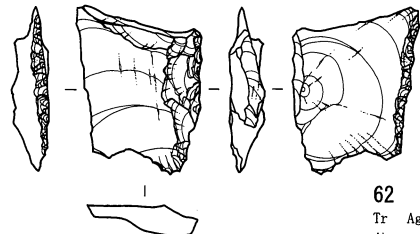

62
Tr Ag
外 3.36g
III V-R 495

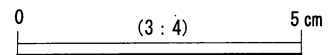

石器実測図 11 (ナイフ形石器 11・台形石器) (西岡A遺跡)

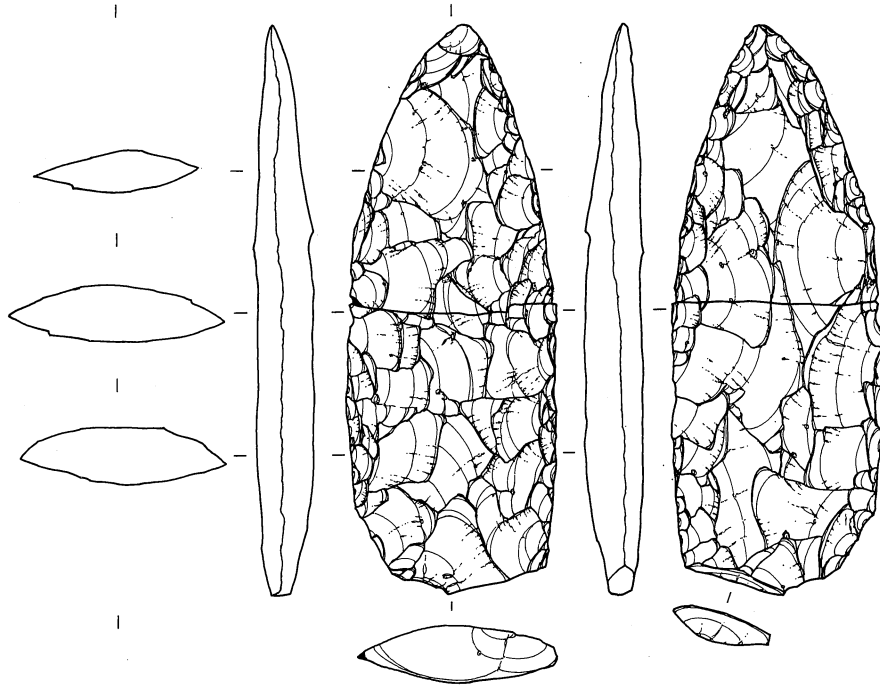

63a
Po An
BL24 16.6g
IVF XIV-C 9

63b
Po 破
BL24 26.85g
III XIV-H 109

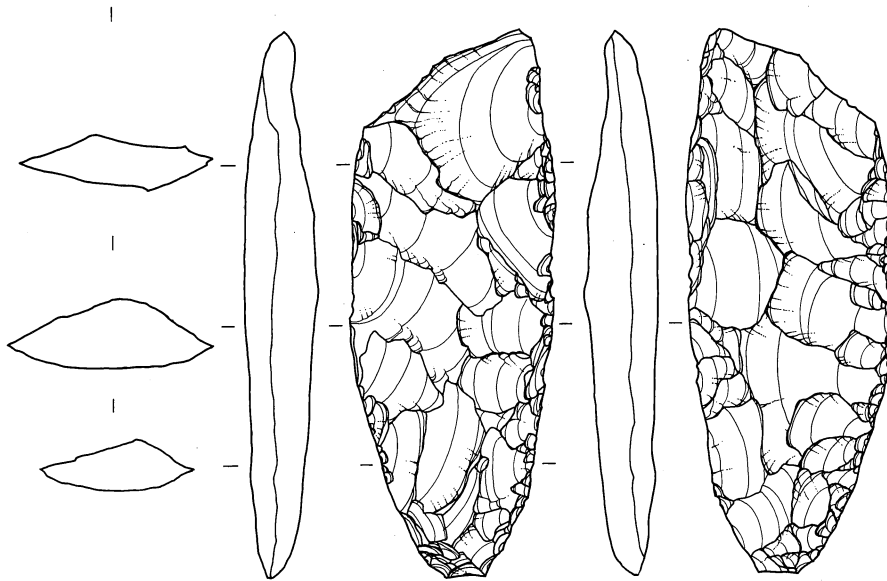

64
Po TS
BL24 36.91g
III XIV-H 118

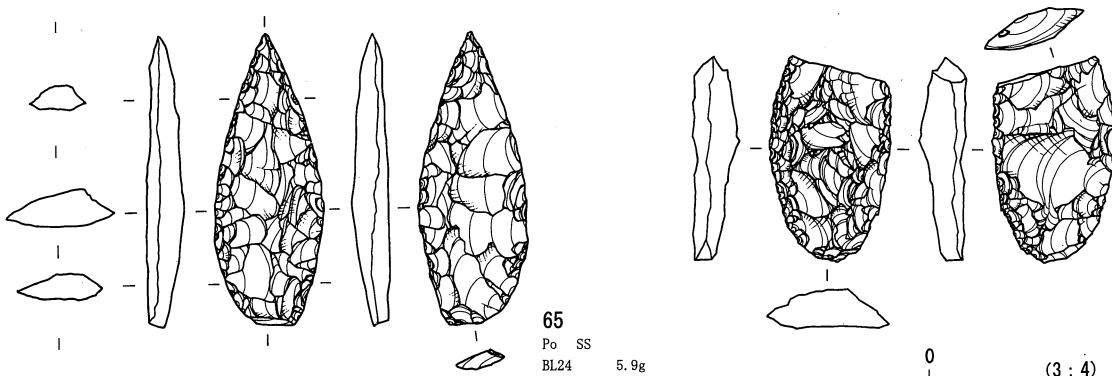

65
Po SS
BL24 5.9g
III XIV-H 117

66
Po Ob WDTY
BL24 5.19g
III XIV-H 127

0 (3 : 4) 5 cm

石器実測図 12 (槍先形尖頭器 1) (西岡 A 遺跡)

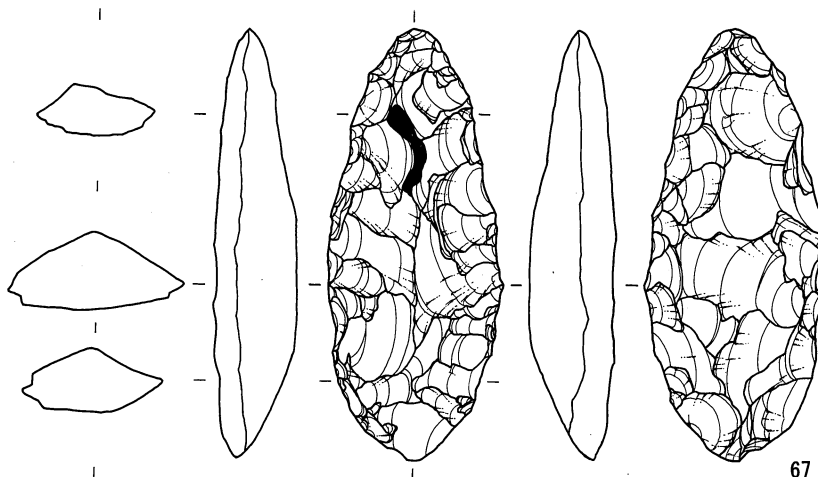

67
Po TS
外 31.96g
III V-W 4

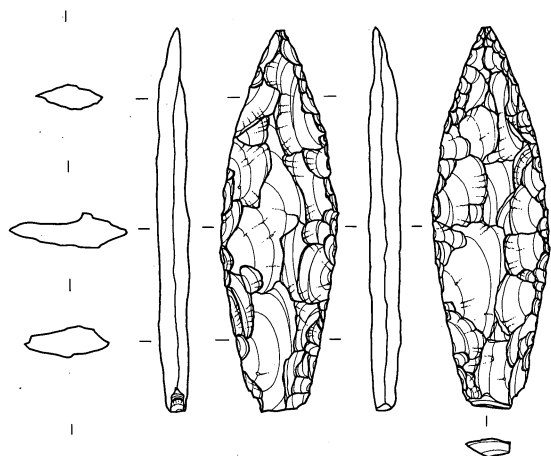

68
Po An
BL21 7.59g
III IX-W 98

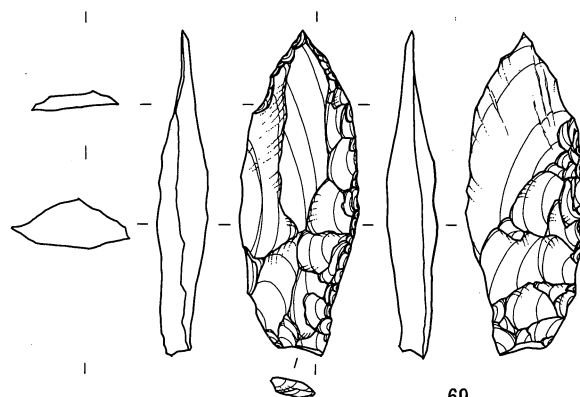

69
Po ST
BL5 7.88g
III V-R 241

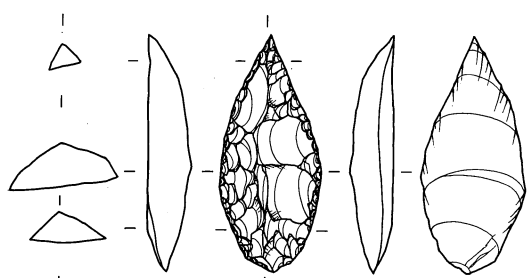

70
Po Ob WDTY
BL14 3.84g
III V-Q 607

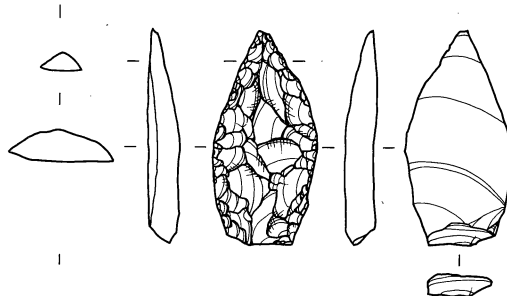

71
Po Ob WDTY
BL19 3.55g
III IX-M 1

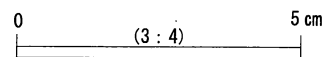

石器実測図 13 (槍先形尖頭器 2) (西岡 A 遺跡)

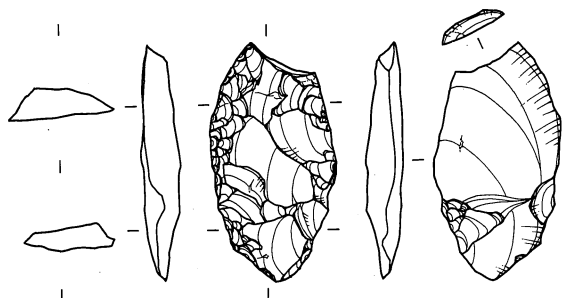

72
Po Ob WDTM
BL5 5.32g
IV上 V-R 230

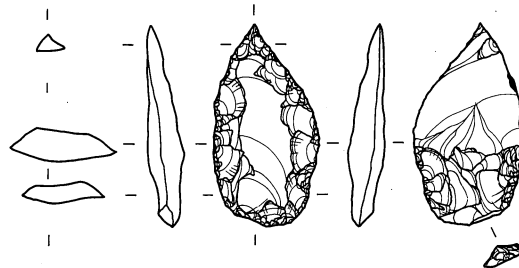

73
Po Ob WDTY
BL14 3.2g
IV上 V-Q 739

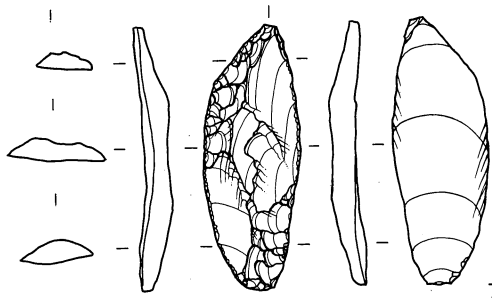

74
Po Ob SWHD
BL5 3.19g
III V-R 240

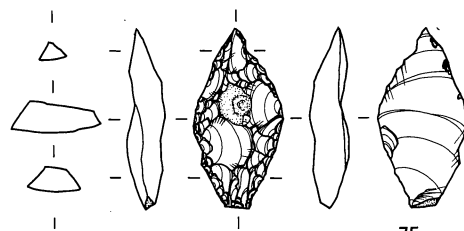

75
Po Ob WDTY
BL14 2.33g
IV上 V-Q 654

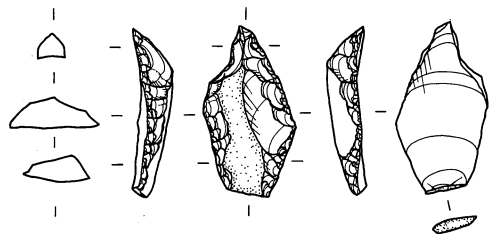

76
Po Ob WDTY
BL11 2.25g
IV上 V-L 159

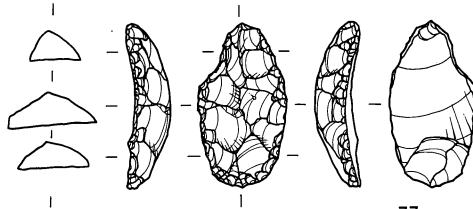

77
Po Ob WDTY
BL14 2.69g
IV上 V-Q 962

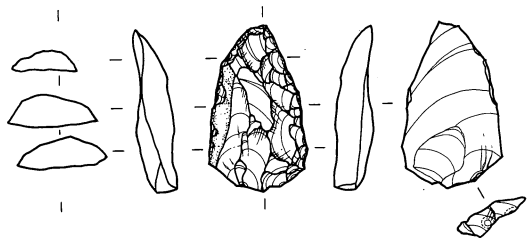

78
Po Ob WDTY
BL11 3.1g
V a V-Q 1100

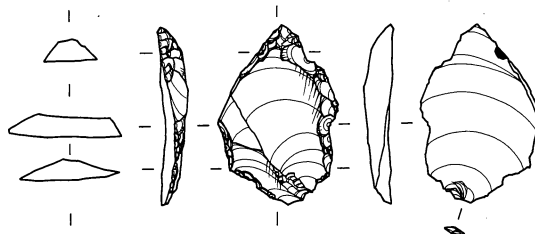

79
Po Ob SWHD
BL14 2.34g
IV上 V-Q 669

0 (3:4) 5 cm

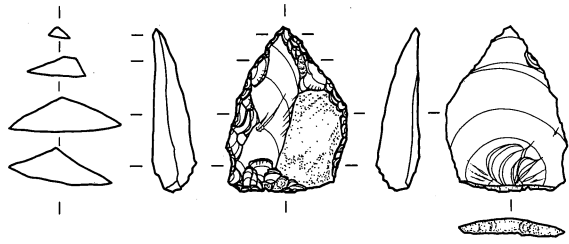

80
Po Ob WDTY
BL14 3.07g
III V-Q 619

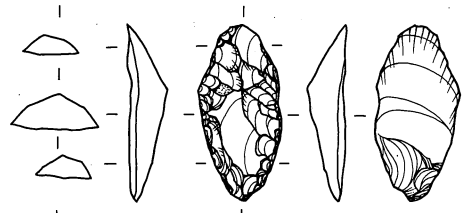

81
Po Ob WDTY
BL11 2.06g
III V-Q 751

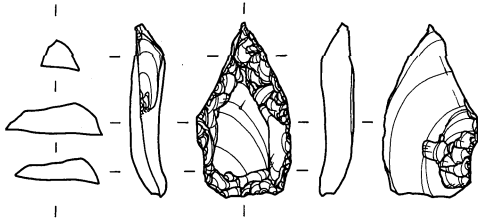

82
Po Ob WDTY
BL11 2.44g
IV上 V-L 164

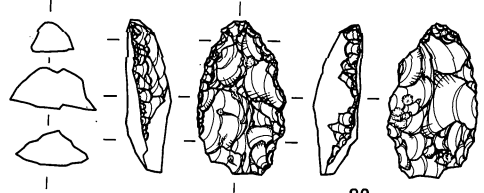

83
Po Ob WDTY
BL14 2.55g
III V-Q 622

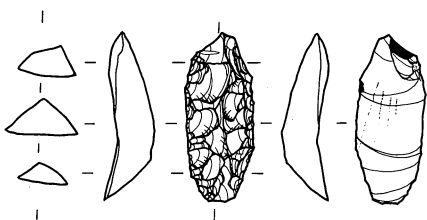

84
Po Ob WDTY
BL14 2g
III V-Q 569

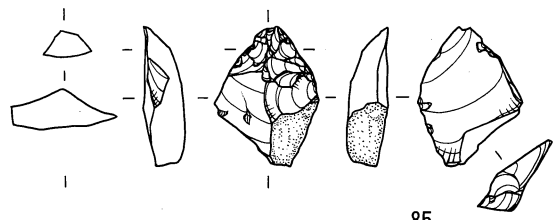

85
Po Ob WDTY
BL11 2.34g
IV下 V-L 229

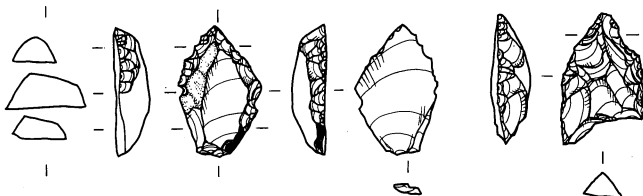

86
Po Ob WDTY
BL14 1.62g
III V-Q 571

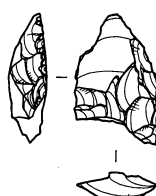

87
Po Ob WDTY
BL11 1.8g
III V-L 93

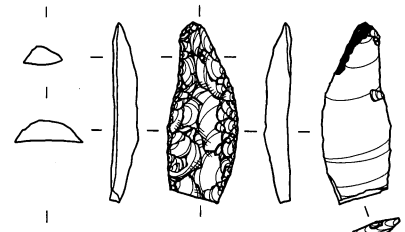

88
Po Ob WDTY
BL11 1.42g
IV上 V-Q 999

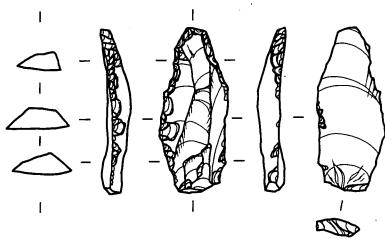

89
Po Ob WDTY
BL14 1.31g
III V-Q 599

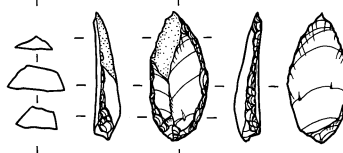

90
Po Ob WDTY
BL11 0.77g
III V-L 74

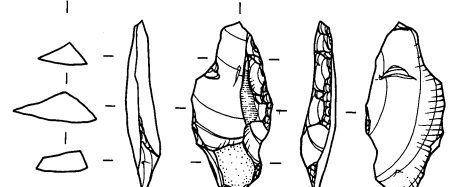

91
Po Ob WDTY
BL11 1.63g
III V-L 77

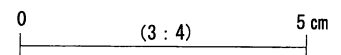

石器実測図 15 (槍先形尖頭器 4) (西岡A遺跡)

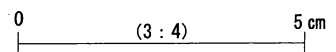
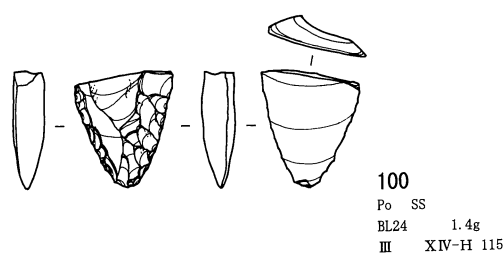
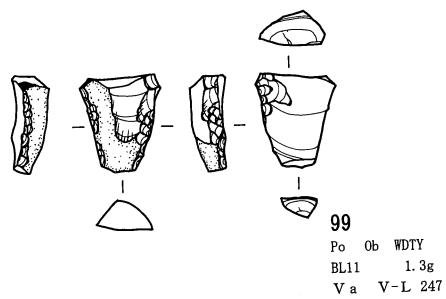
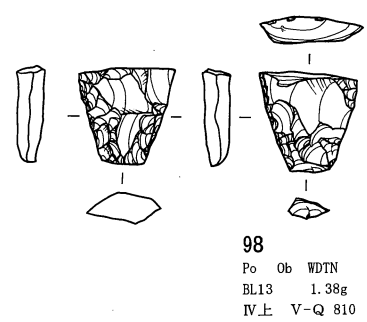
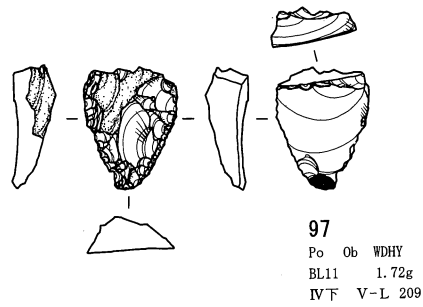
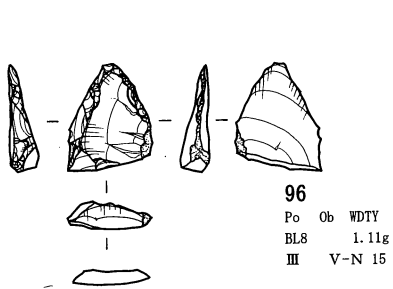
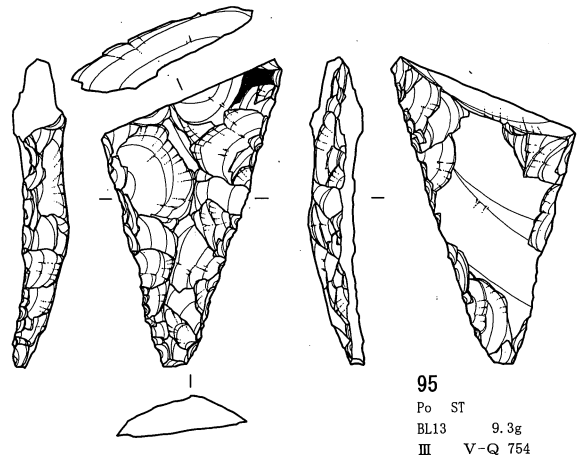
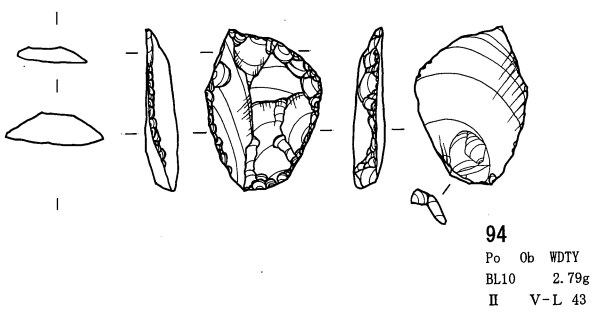
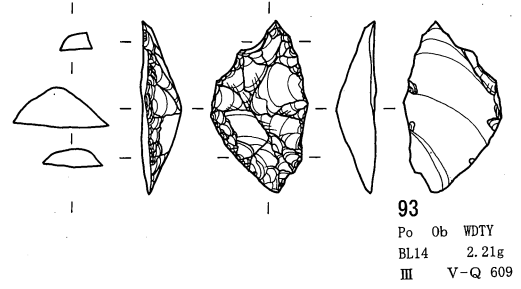
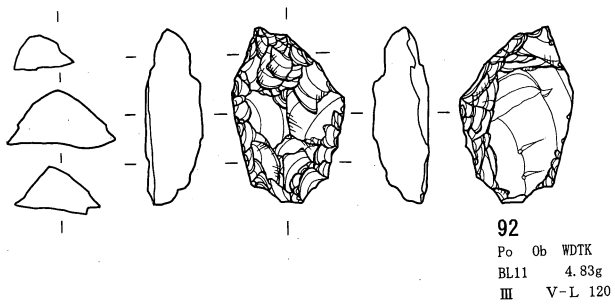

石器実測図 16 (槍先形尖頭器 5) (西岡 A 遺跡)

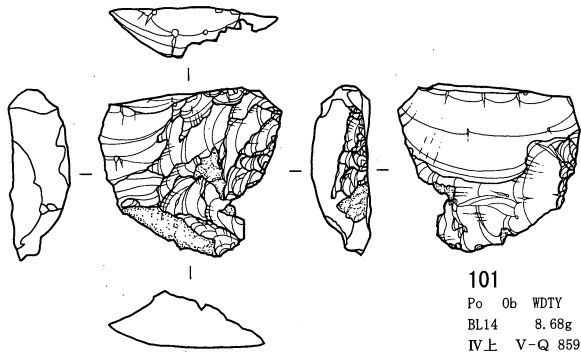

101
Po Ob WDTY
BL14 8.68g
IV上 V-Q 859

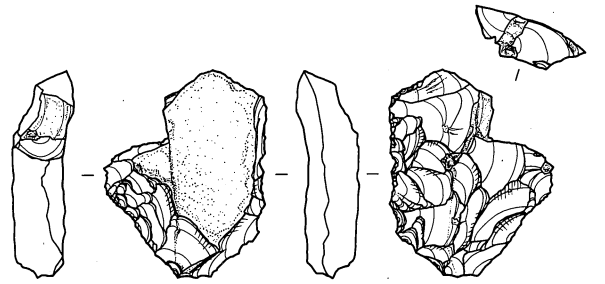

102
Po Ob WDTY
BL11 7.97g
IV下 V-Q 1023

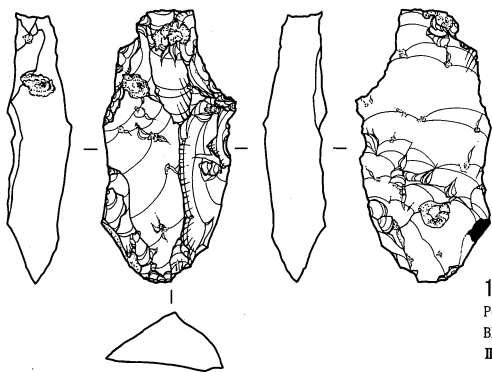

103
Po Ob WDKB
BL9 9.63g
III V-M 72

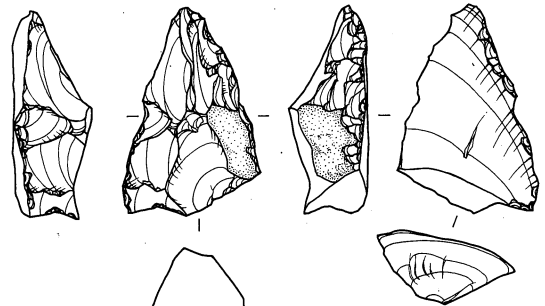

104
Bo Ob
BL11 7.57g
IV上 V-Q 985

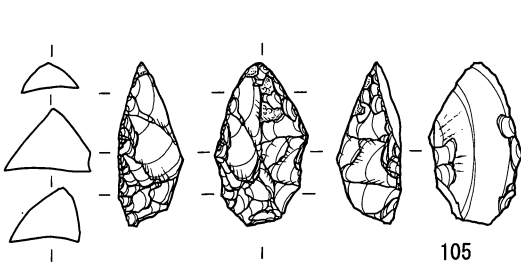

105
Bo Ob WDHY
BL11 3.45g
III V-L 136

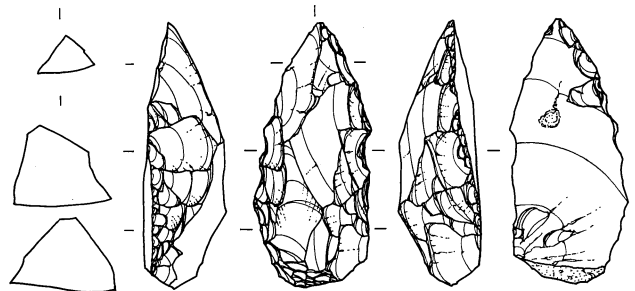

106
Bo Ag
BL14 11.64g
IV下 V-Q 705

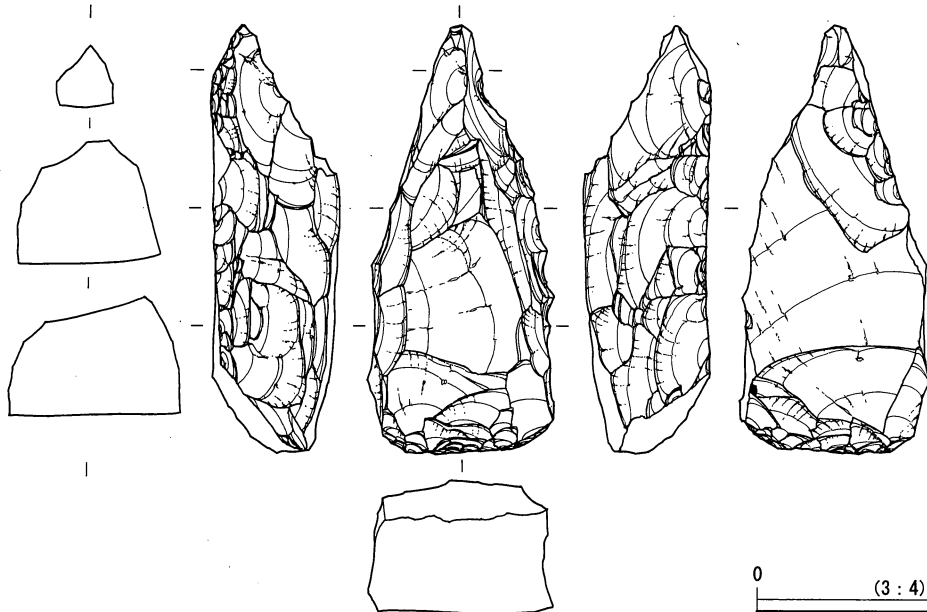

107
Bo An
BL15 64.89g
III V-Q 387

0 (3 : 4) 5 cm

石器実測図 17 (槍先形尖頭器 6・角錐状石器) (西岡 A 遺跡)

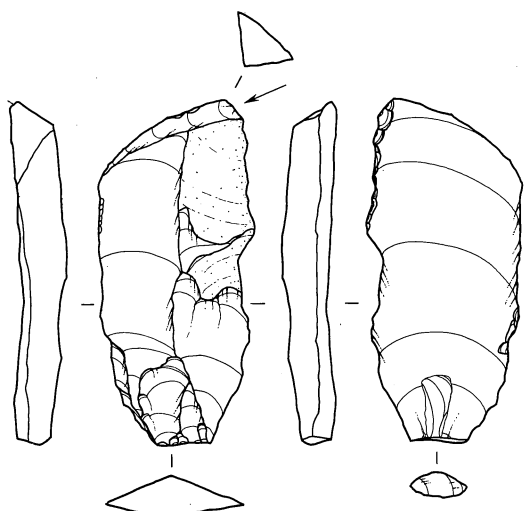

108
Gr ST
BL8 11.65g
III V-N 20

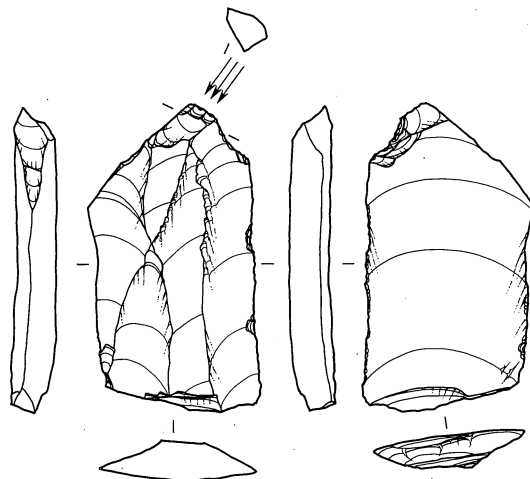

109
Gr SS
BL8 13.06g
III V-N 35

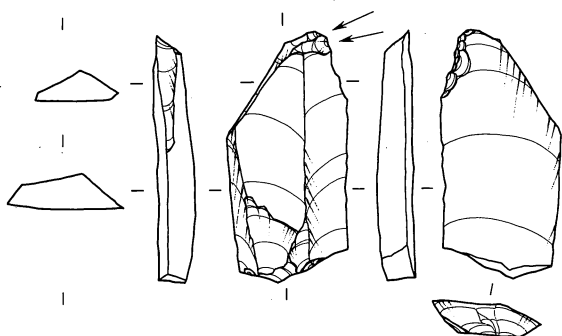

110
Gr ST
BL22 6.23g
III IX-W 136

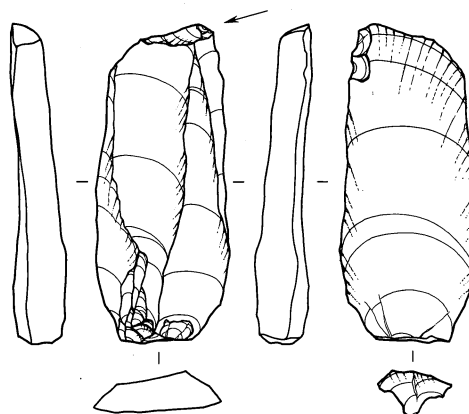

111
Gr ST
BL22 10.94g
III IX-W 90

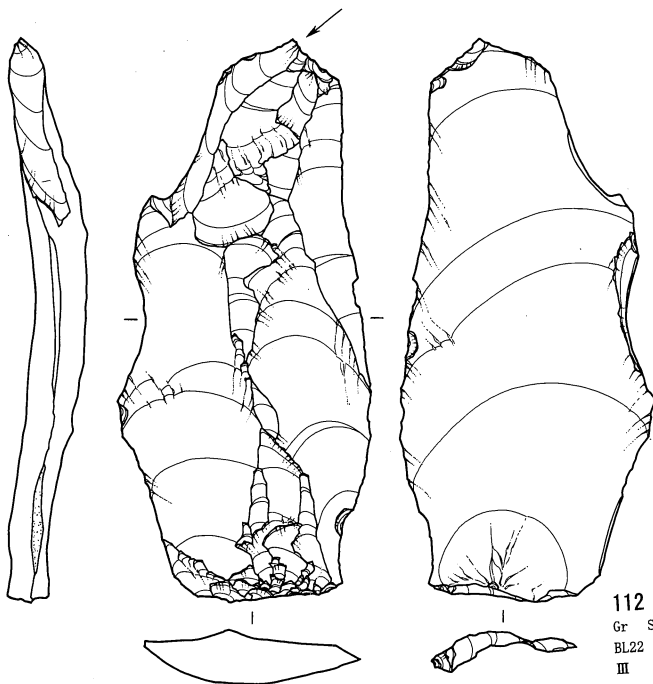

112
Gr ST
BL22 40.51g
III IX-W 137

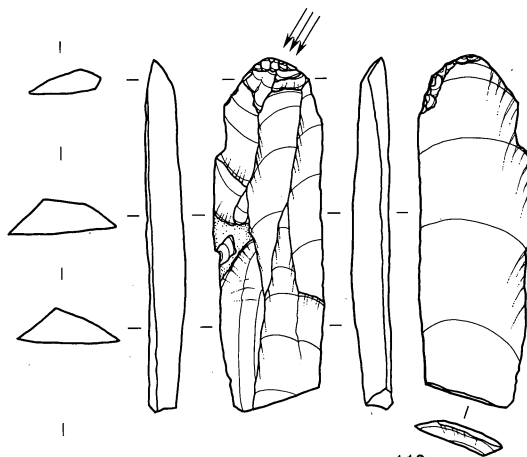

113
Gr ST
BL22 8.99g
III IX-W 141

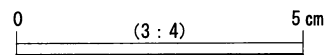

石器実測図 18 (彫器 1) (西岡 A 遺跡)

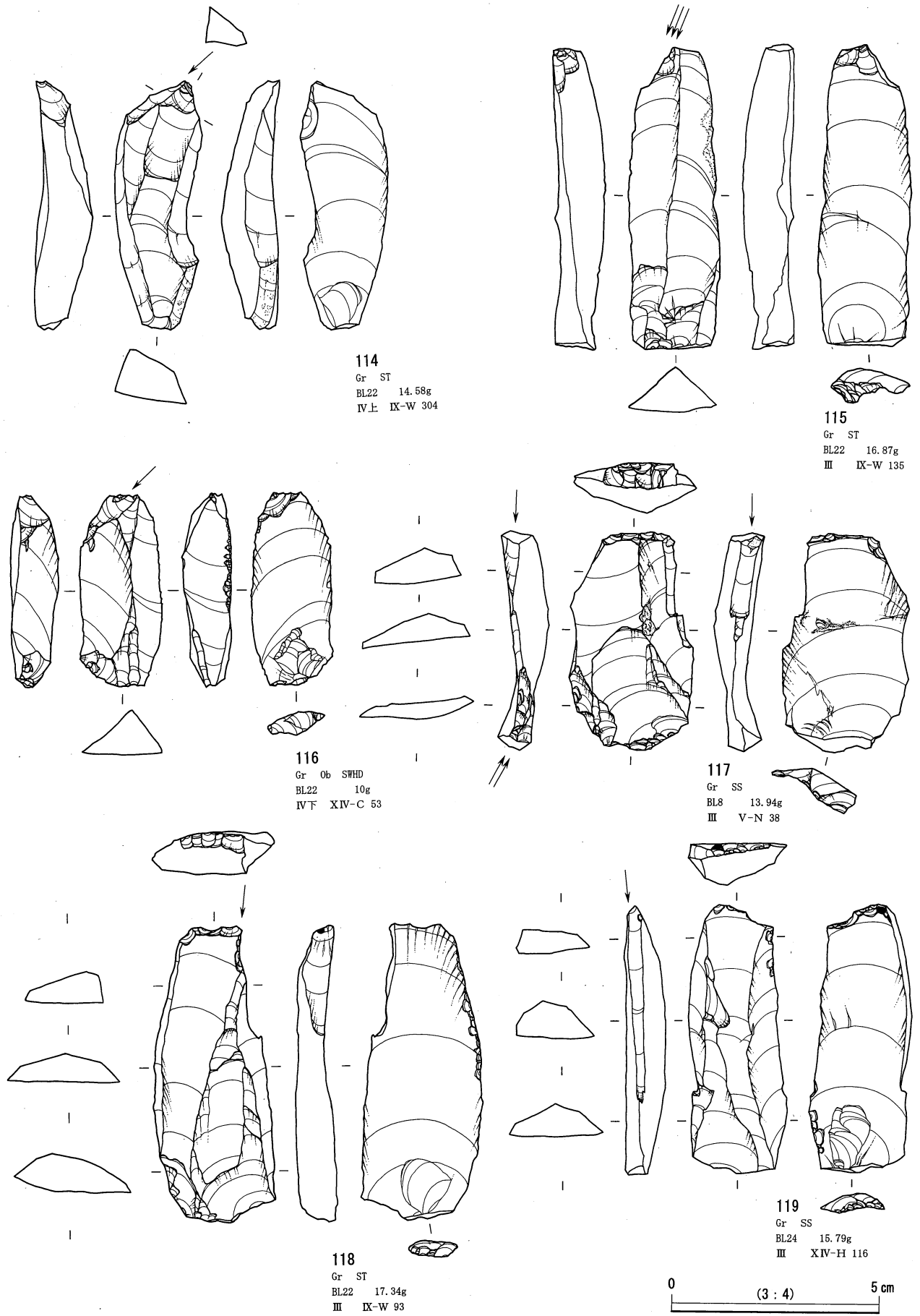

石器実測図 19 (彫器 2) (西岡A遺跡)

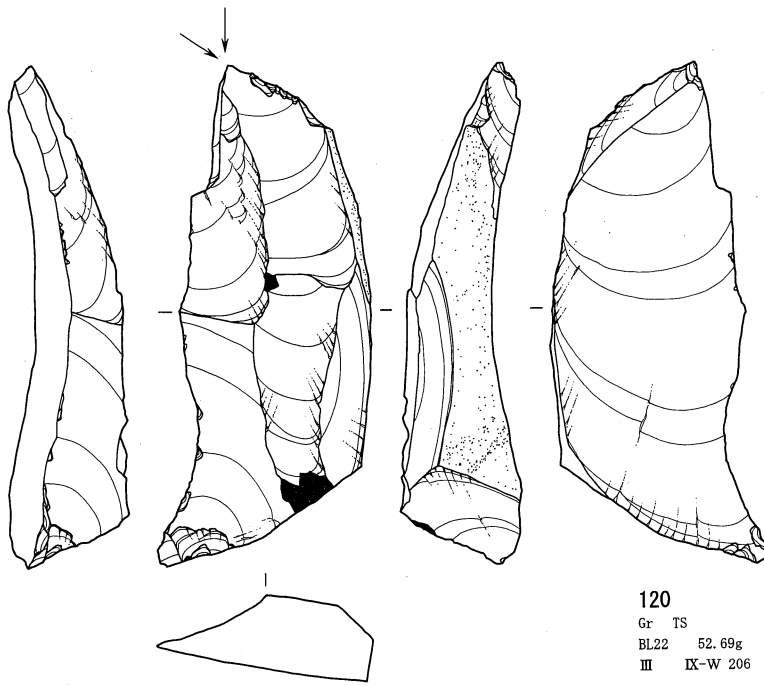

120
Gr TS
BL22 52.69g
III IX-W 206

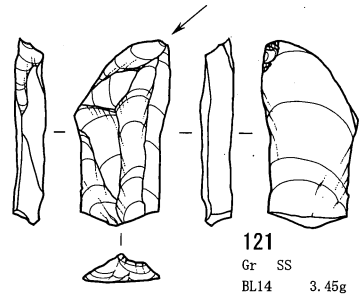

121
Gr SS
BL14 3.45g
IV上 V-Q 1111

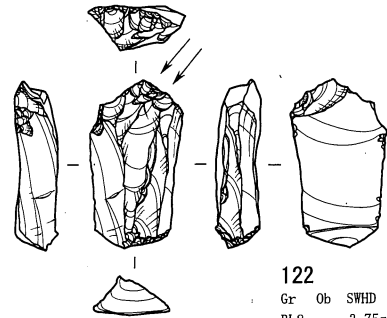

122
Gr Ob SWHD
BL8 3.75g
III V-N 39

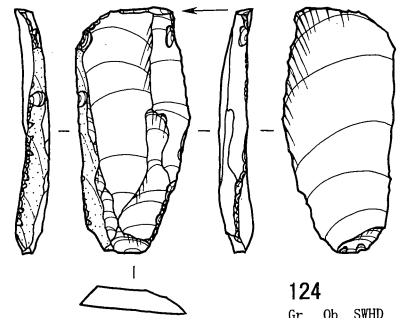

124
Gr Ob SWHD
BL9 4.35g
III V-M 29

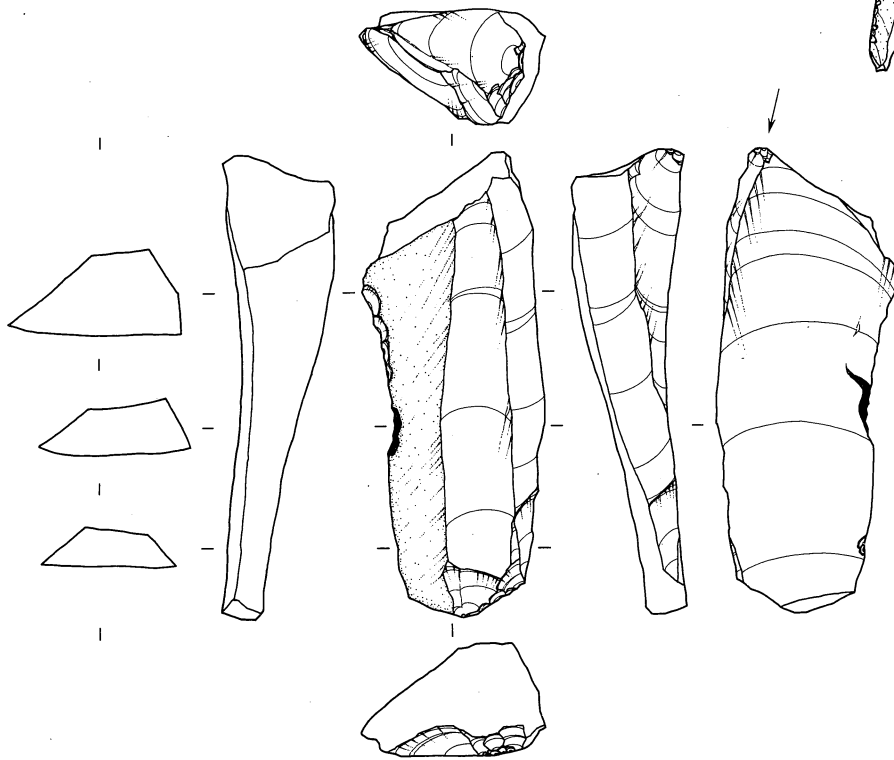

123
Gr ST
BL22 39.4g
III IX-W 147

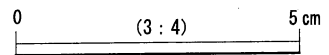

石器実測図 20 (彫器 3) (西岡 A 遺跡)

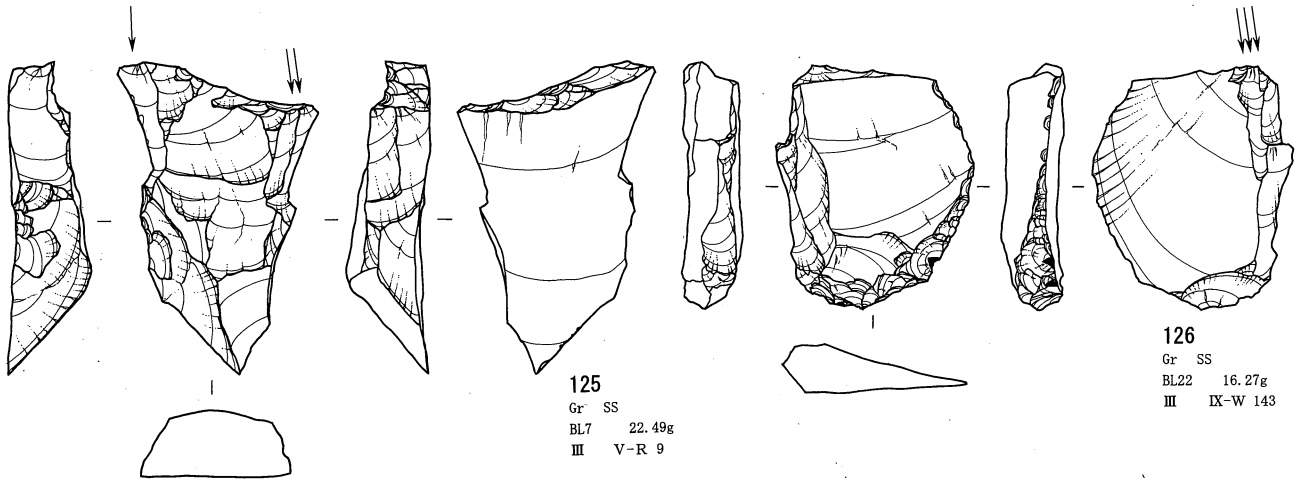

125
Gr SS
BL7 22.49g
III V-R 9

126
Gr SS
BL22 16.27g
III IX-W 143

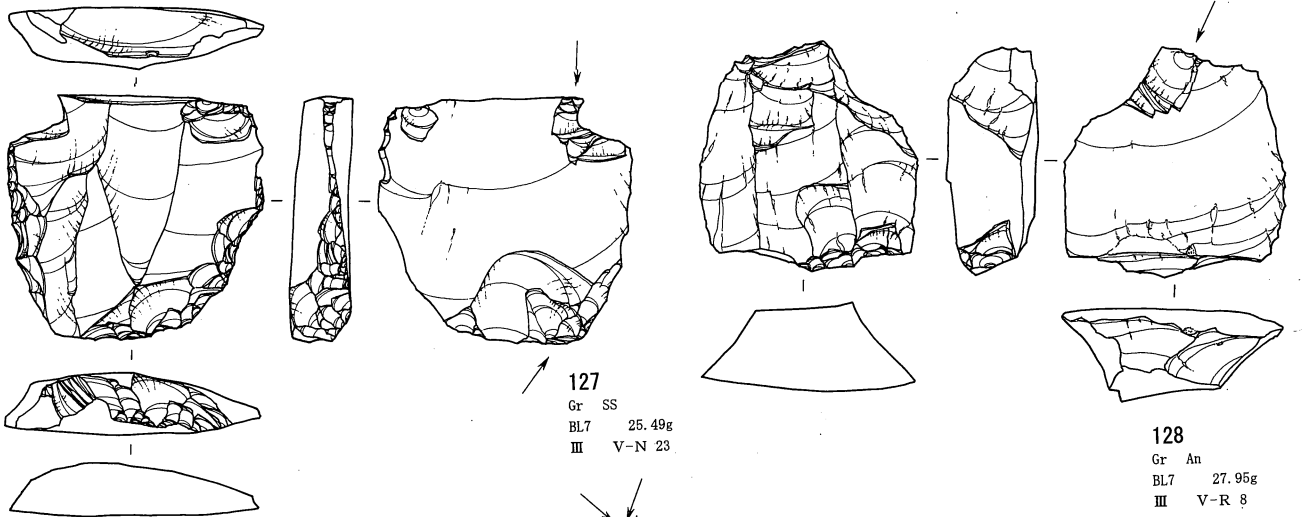

127
Gr SS
BL7 25.49g
III V-N 23

128
Gr An
BL7 27.95g
III V-R 8

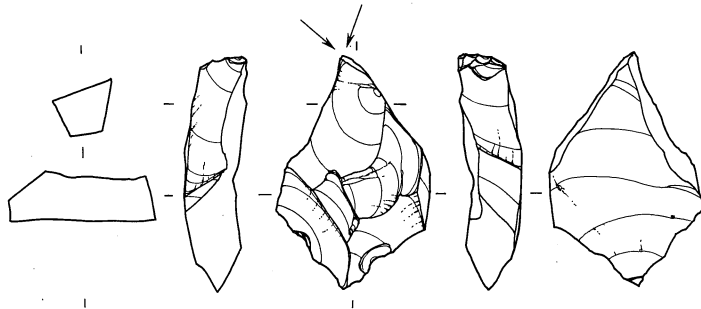

129
Gr Ch
BL18 8.03g
III IX-N 85

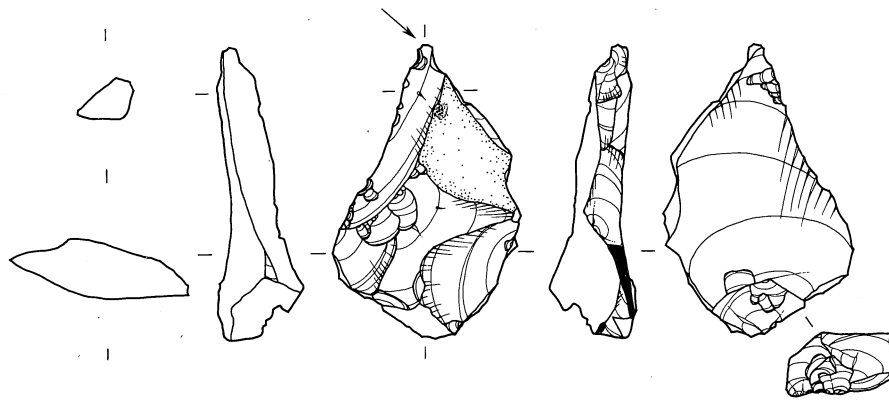

130
Gr Ob WDTY
BL18 12.56g
IV下 IX-N 43

0 (3:4) 5 cm

石器実測図 21 (彫器 4) (西岡 A 遺跡)

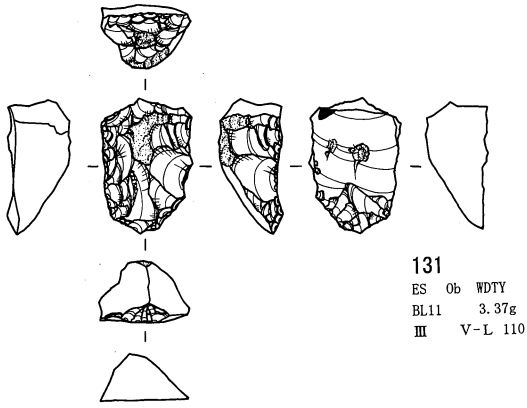

131
ES Ob WDTY
BL11 3.37g
III V-L 110

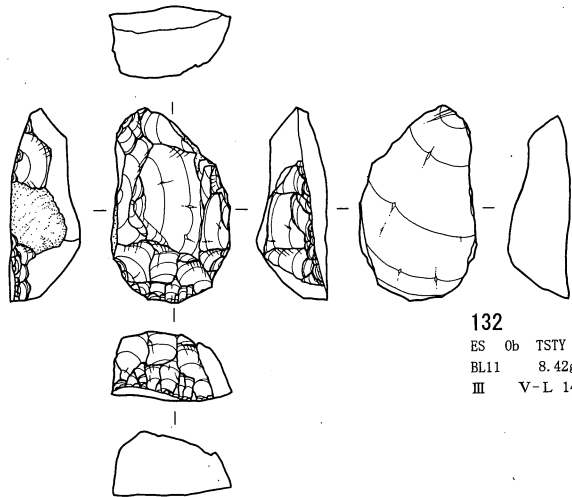

132
ES Ob TSTY
BL11 8.42g
III V-L 140

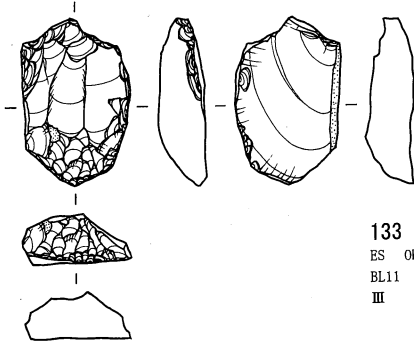

133
ES Ob WDTY
BL11 4.9g
III V-L 148

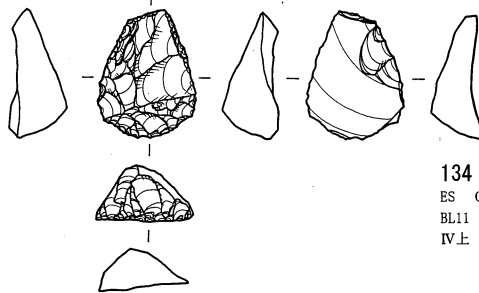

134
ES Ob SWHD
BL11 2.46g
IV上 V-L 171

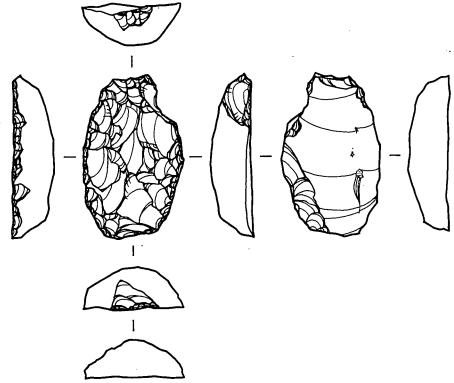

135
ES Ob TSTY
BL11 3.52g
IV下 V-L 204

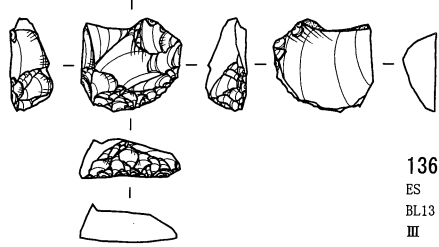

136
ES Ob WDTY
BL13 1.95g
III V-Q 560

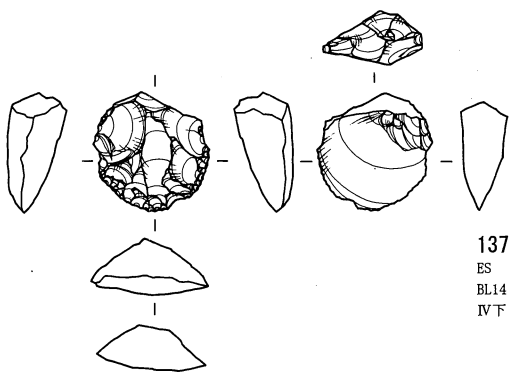

137
ES Ob WDTY
BL14 3.18g
IV下 V-Q 698

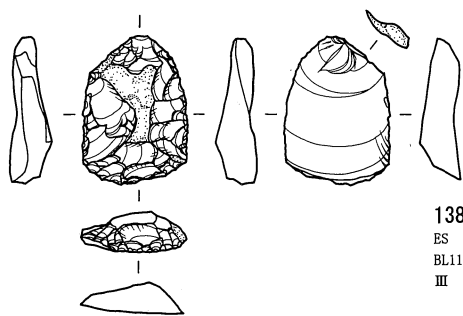

138
ES Ob WDTY
BL11 2.78g
III V-Q 729

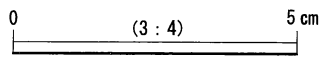

石器実測図 22 (搔器 1) (西岡 A 遺跡)

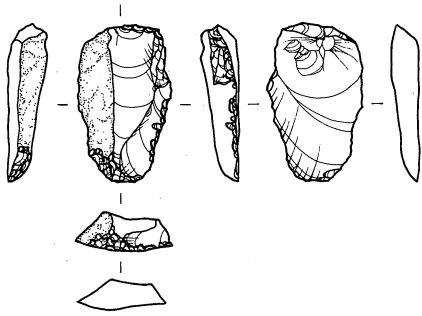

139
ES Ob WDTY
BL16 2.69g
III V-Q 904

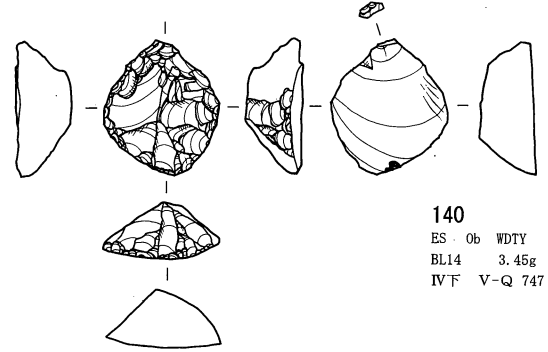

140
ES Ob WDTY
BL14 3.45g
IV下 V-Q 747

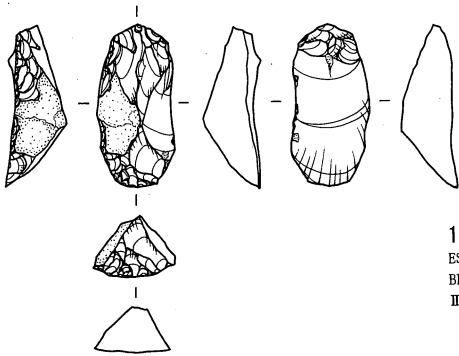

141
ES Ob WDTY
BL14 2.97g
III V-Q 763

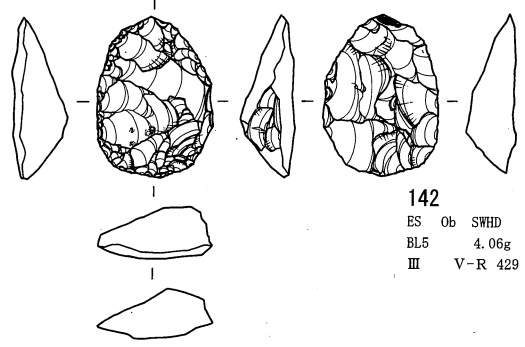

142
ES Ob SWHD
BL5 4.06g
III V-R 429

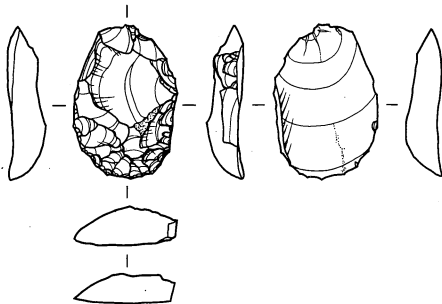

143
ES Ob SWHD
BL25 2.74g
III XIV-H 101

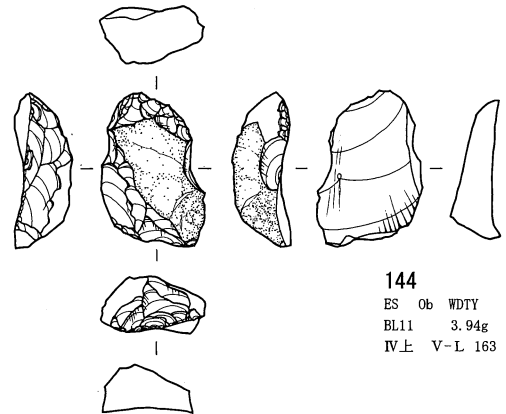

144
ES Ob WDTY
BL11 3.94g
IV上 V-L 163

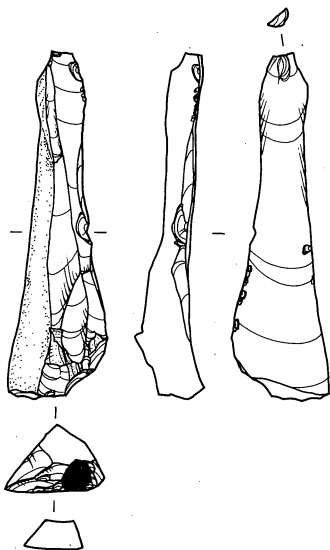

145
ES Ob SWHD
BL21 6g
III IX-W 96

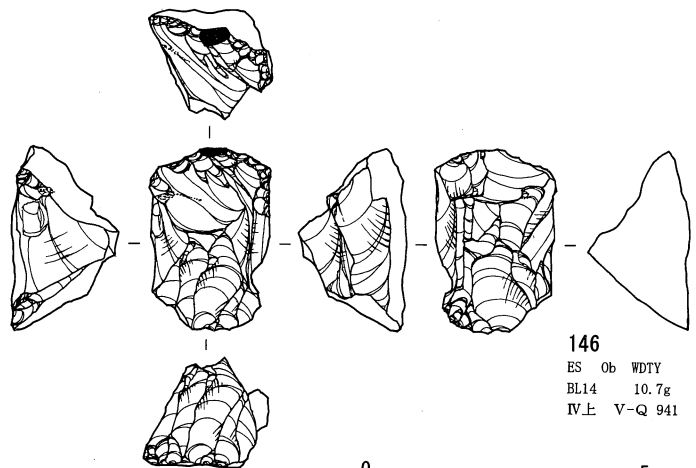

146
ES Ob WDTY
BL14 10.7g
IV上 V-Q 941

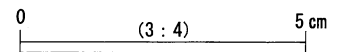

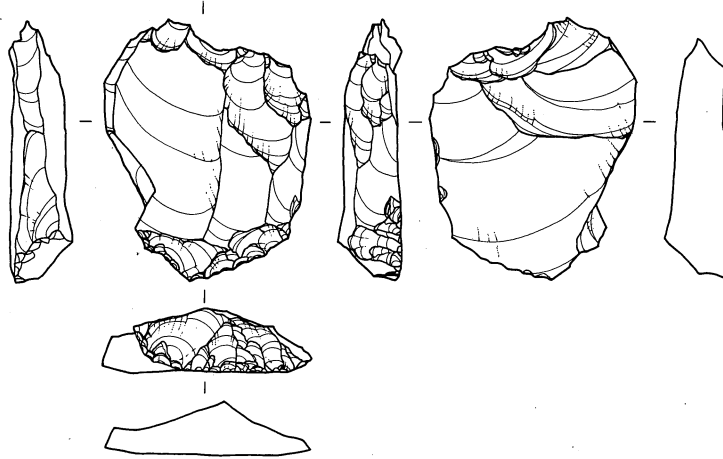

147
 ES SS
 BL7 18.87g
 III V-R 3

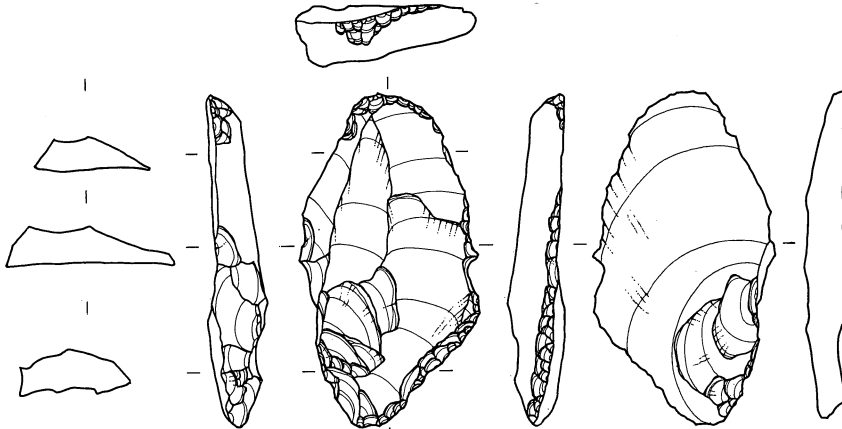

148
 ES Ag
 BL3 14.28g
 IV V-S 234

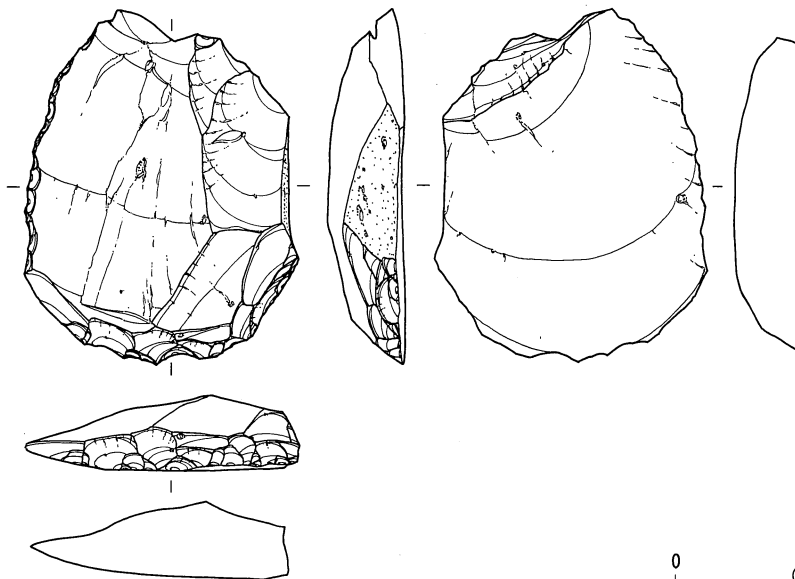

149
 ES An
 BL13 39.04g
 IV F V-Q 1013

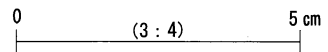

石器実測図 24 (搔器 3) (西岡 A 遺跡)

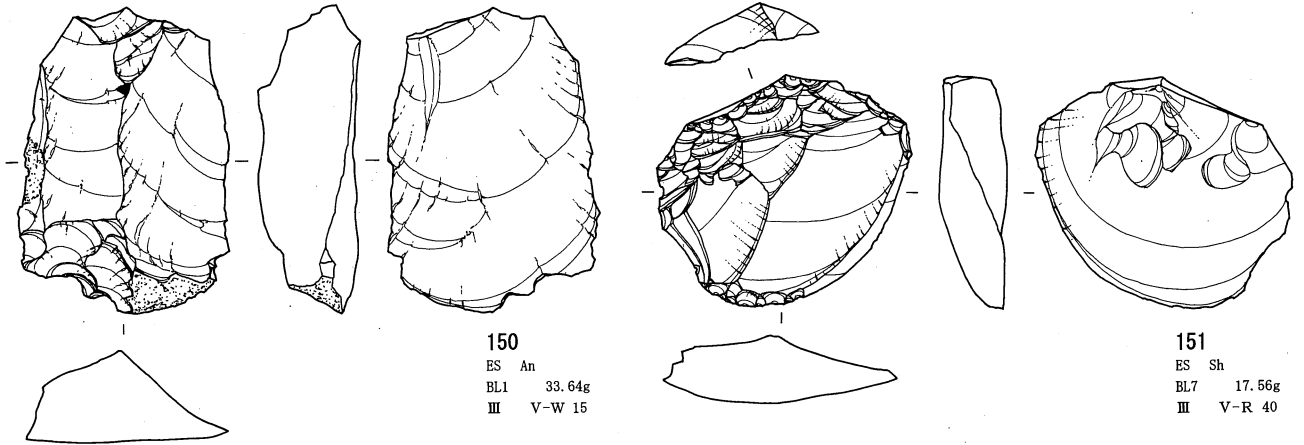

150
ES An
BL1 33.64g
III V-W 15

151
ES Sh
BL7 17.56g
III V-R 40

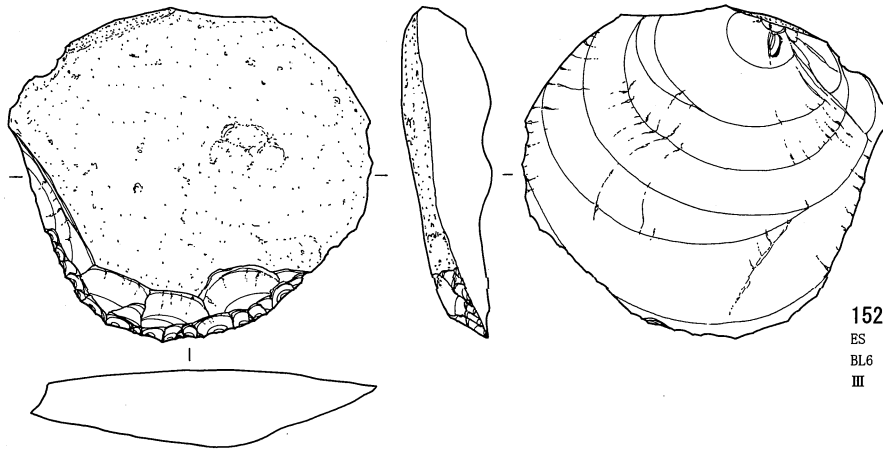

152
ES SS
BL6 53.28g
III V-R 49

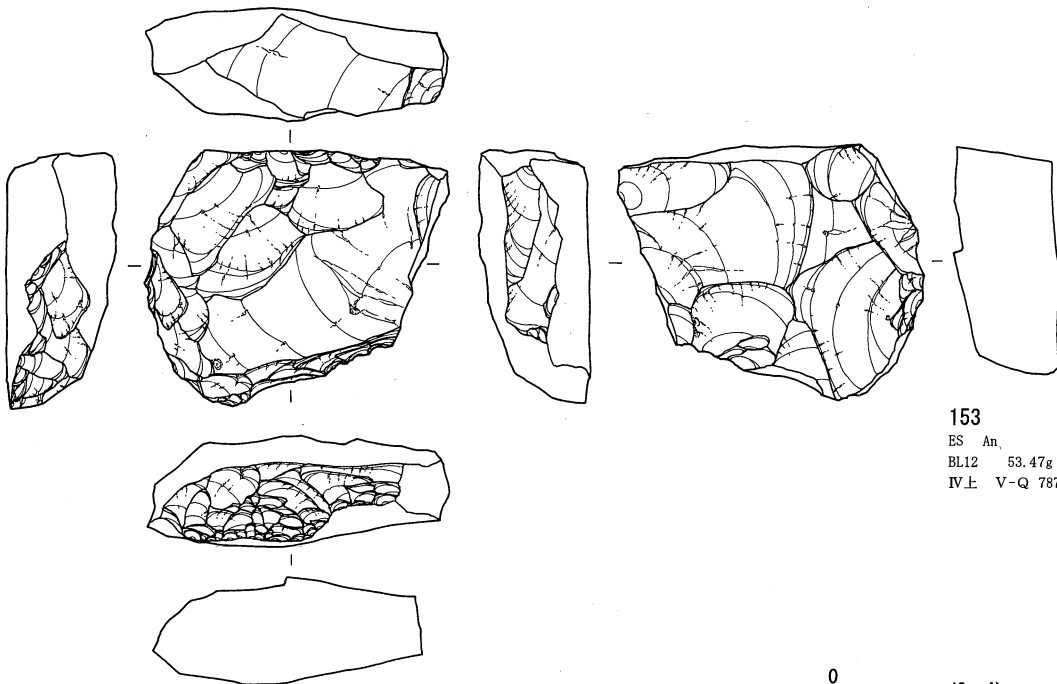

153
ES An
BL12 53.47g
IV上 V-Q 787

0 (3:4) 5 cm

石器実測図 25 (搔器 4) (西岡 A 遺跡)

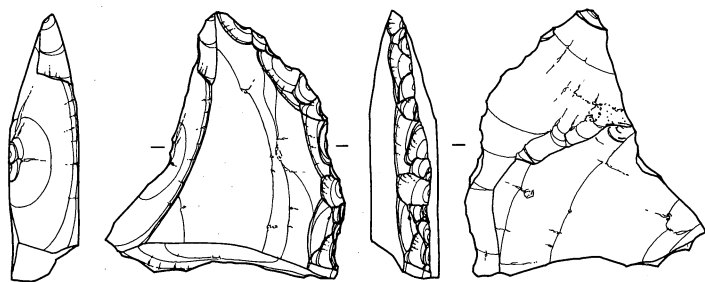

154
 ES An
 BL14 20.66g
 IV上 V-Q 968

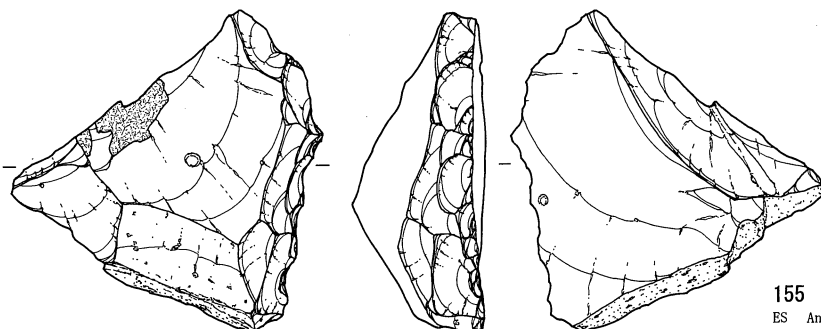
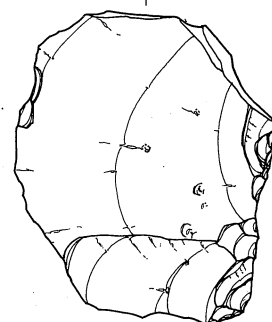
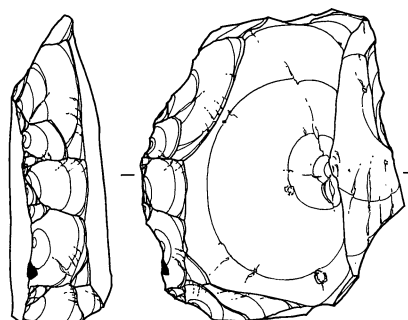
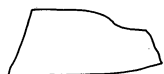

155
 ES An
 BL21 45.83g
 V a XIV-C 56



156
 ES An
 BL17 49.48g
 III V-Q 123

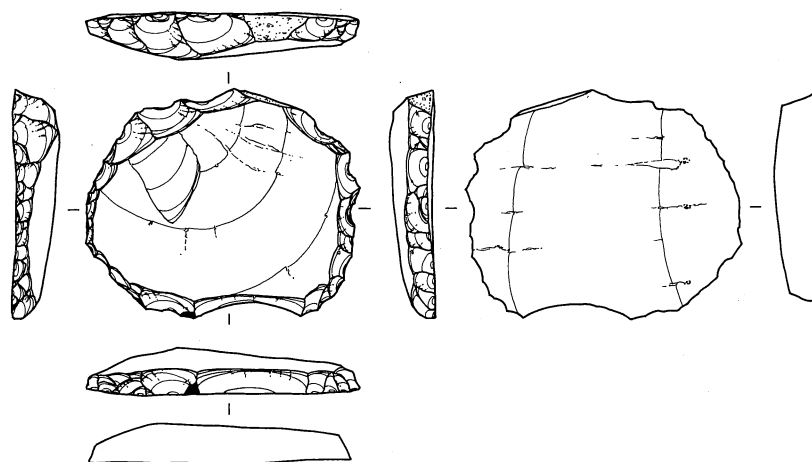

157
 ES An
 BL13 18.4g
 V a V-Q 1076

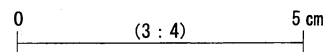

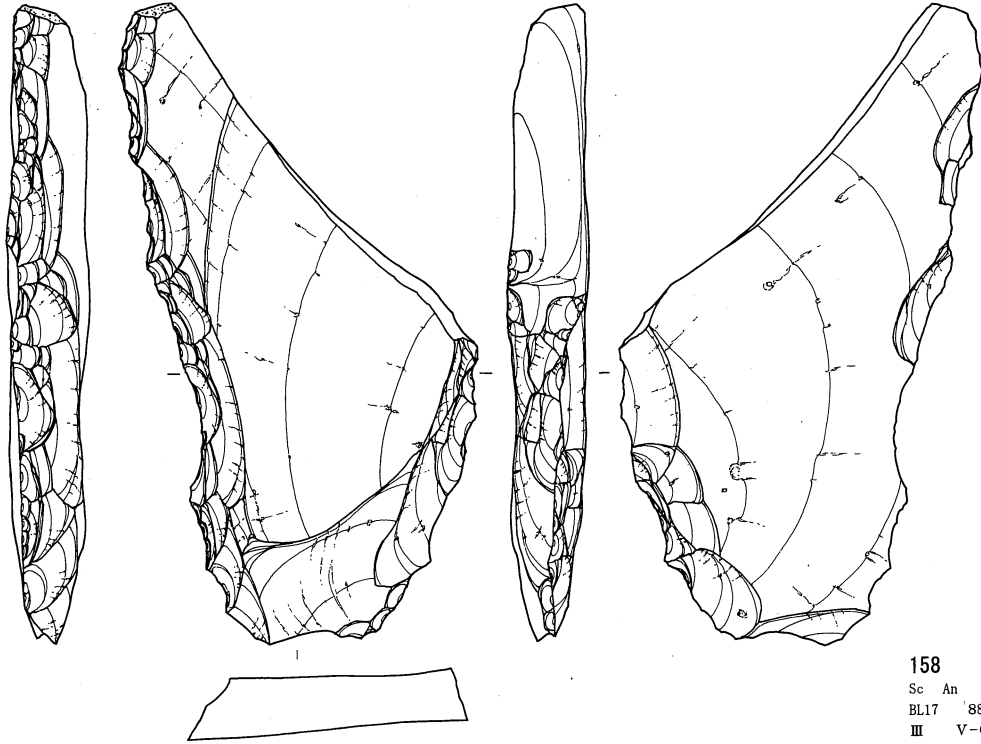

158
 Sc An
 BL17 '88.31g
 III V-Q 118

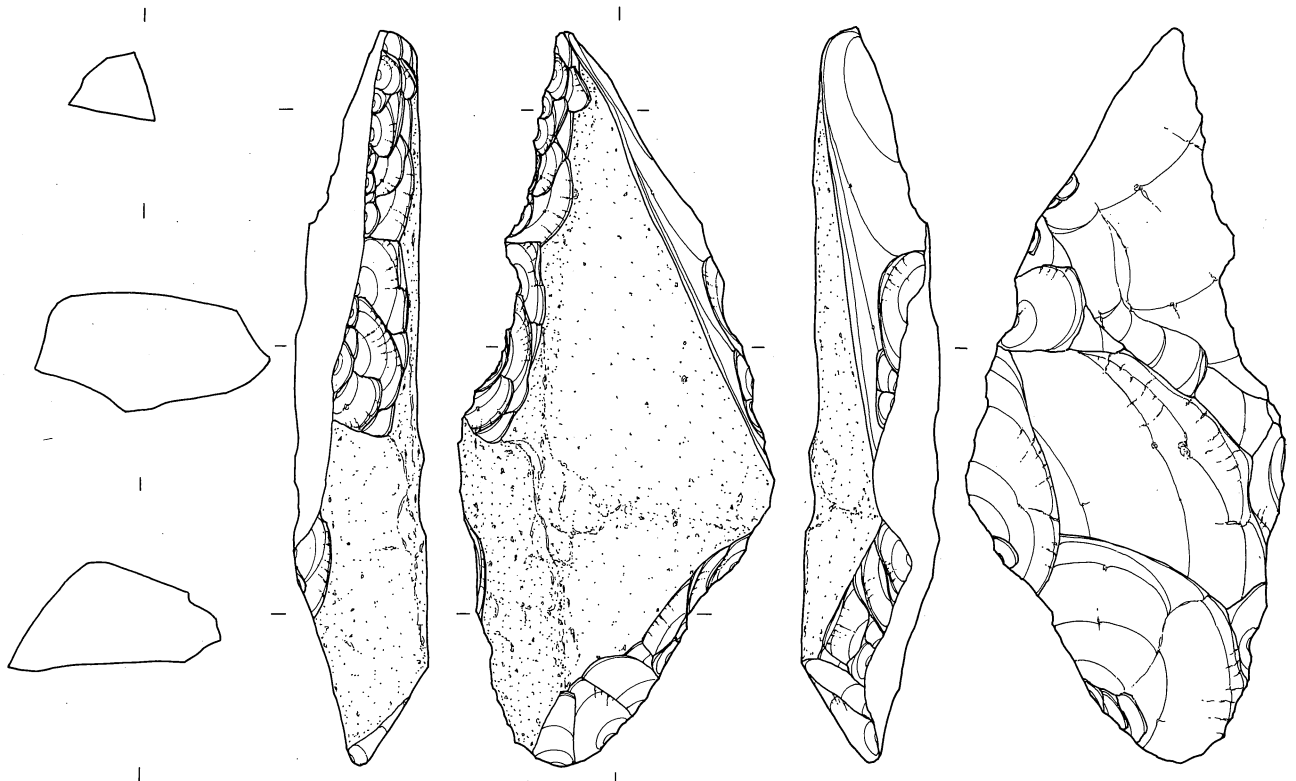

159
 Sc An
 BL17 128.56g
 IV V-Q 145

0 (3 : 4) 5 cm

石器実測図 27 (削器 1) (西岡 A 遺跡)

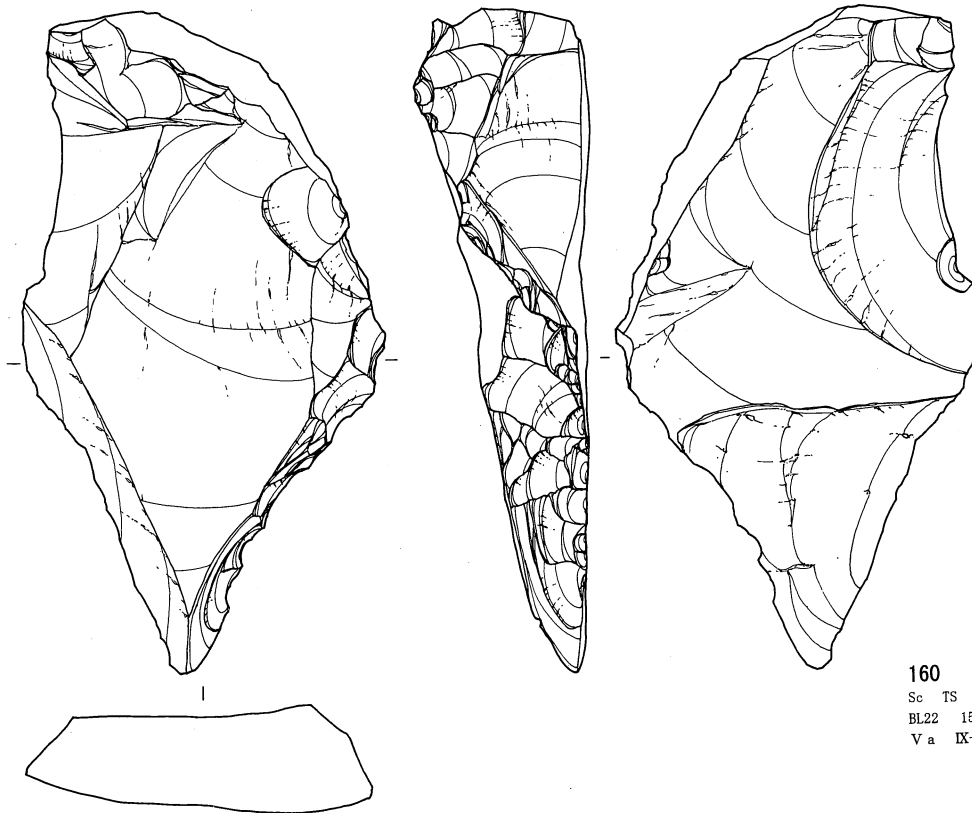

160
 Sc TS
 BL22 151.98g
 V a IX-W 284

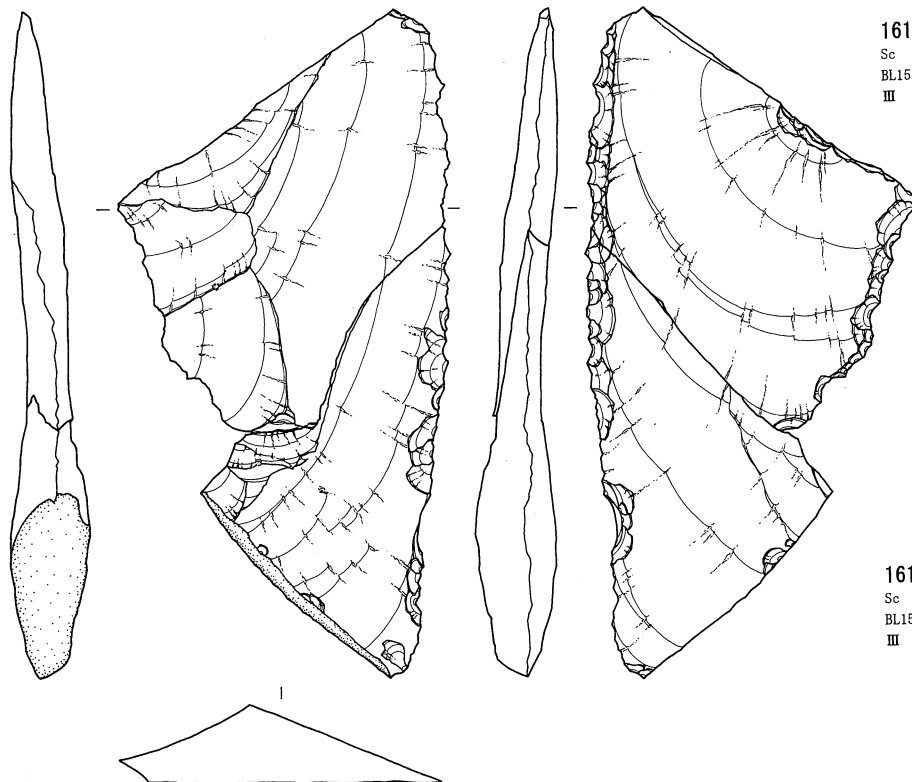

161a
 Sc An
 BL15 37.38g
 III V-Q 353

161b
 Sc An
 BL15 28.3g
 III V-Q 385

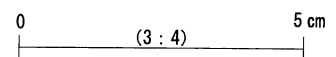

石器実測図 28 (削器 2) (西岡 A 遺跡)

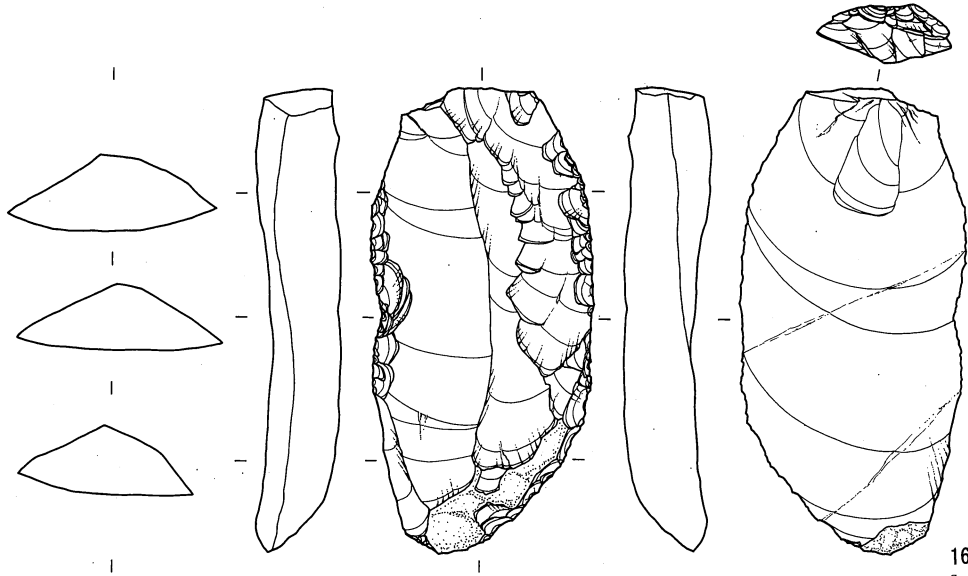

162
 Sc SS
 BL11 48.17g
 IVF V-L 213

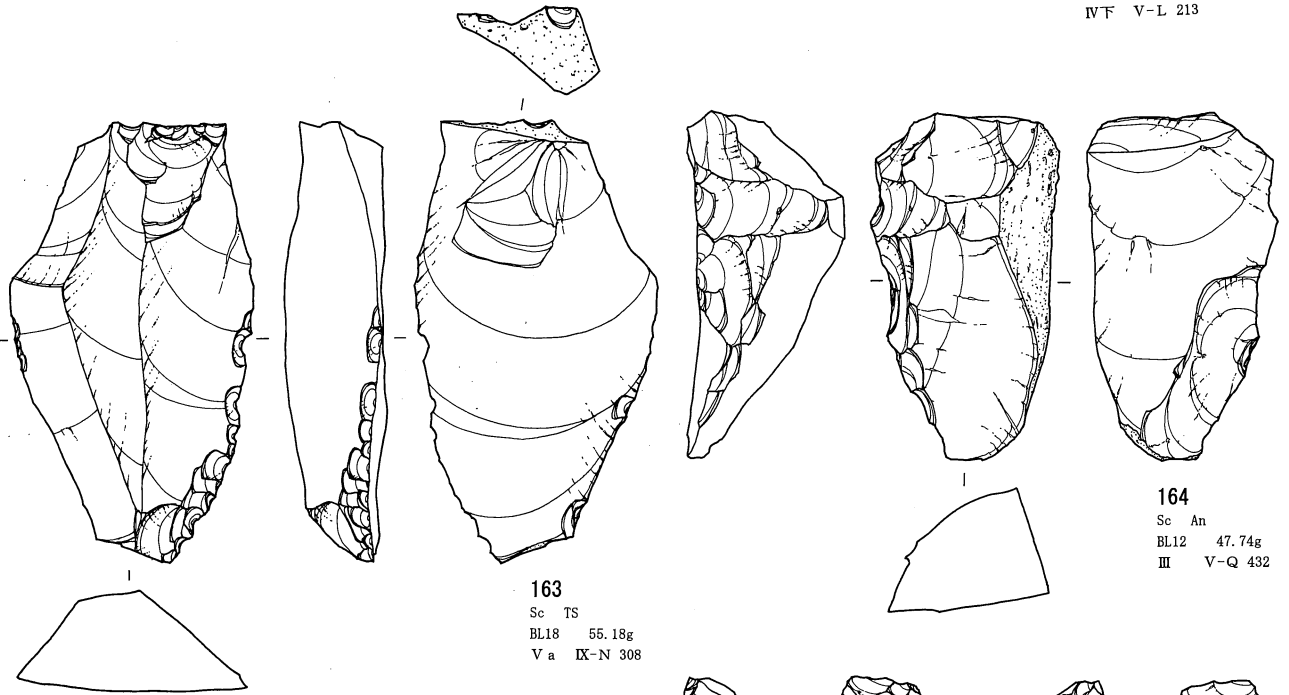

163
 Sc TS
 BL18 55.18g
 Va IX-N 308

164
 Sc An
 BL12 47.74g
 III V-Q 432

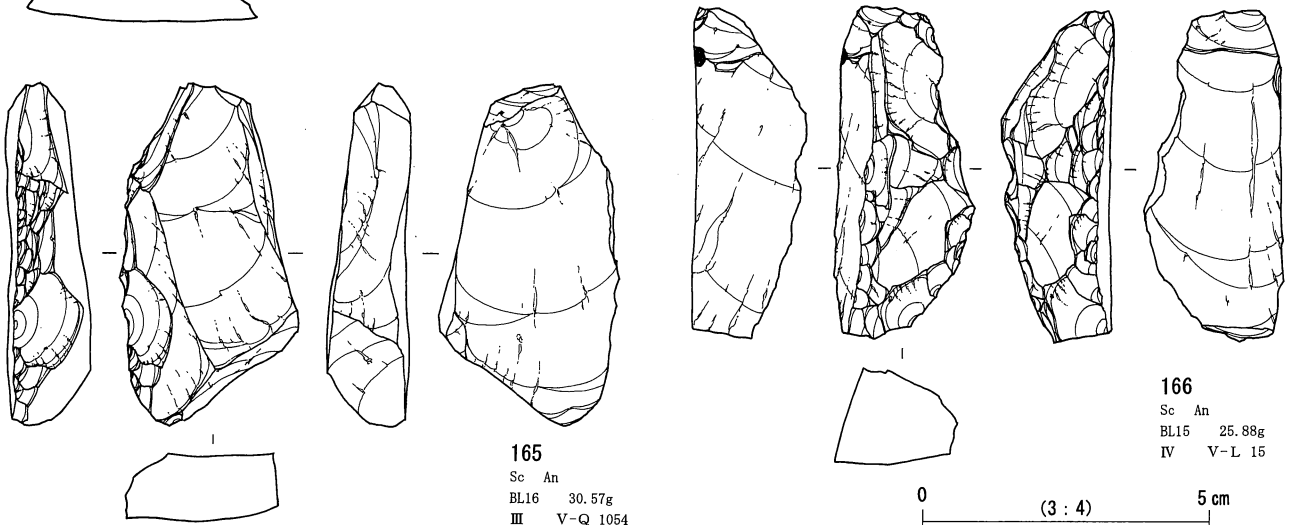

165
 Sc An
 BL16 30.57g
 III V-Q 1054

166
 Sc An
 BL15 25.88g
 IV V-L 15

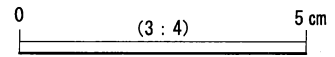

石器実測図 29 (削器 3) (西岡A遺跡)

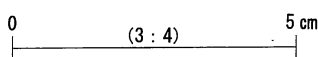
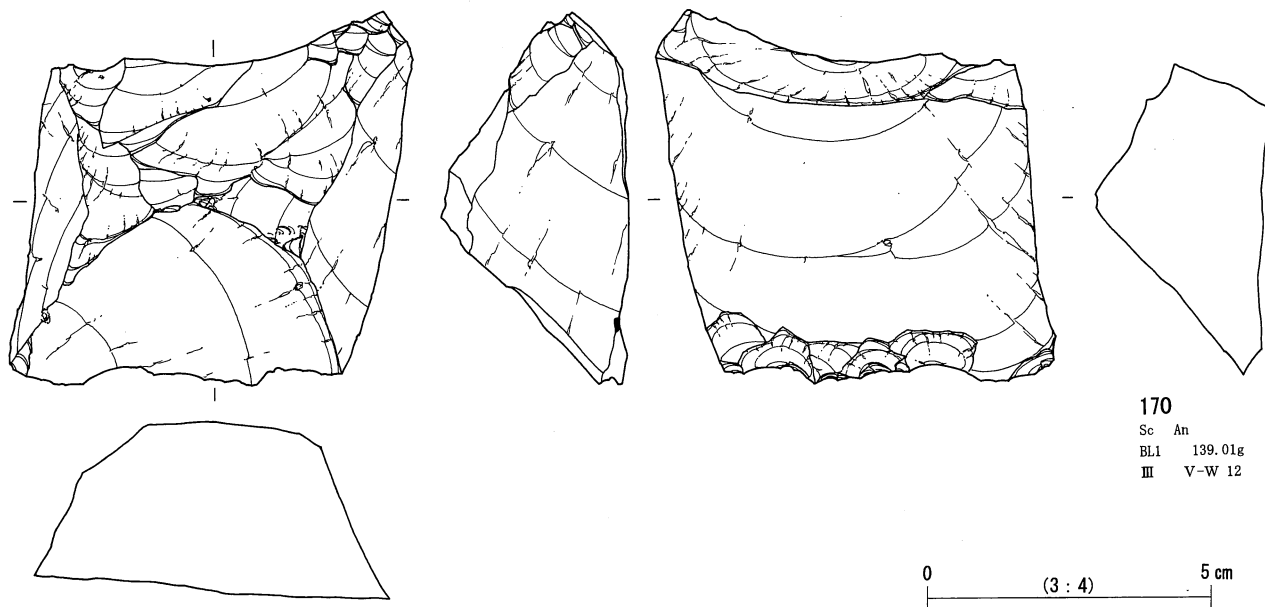
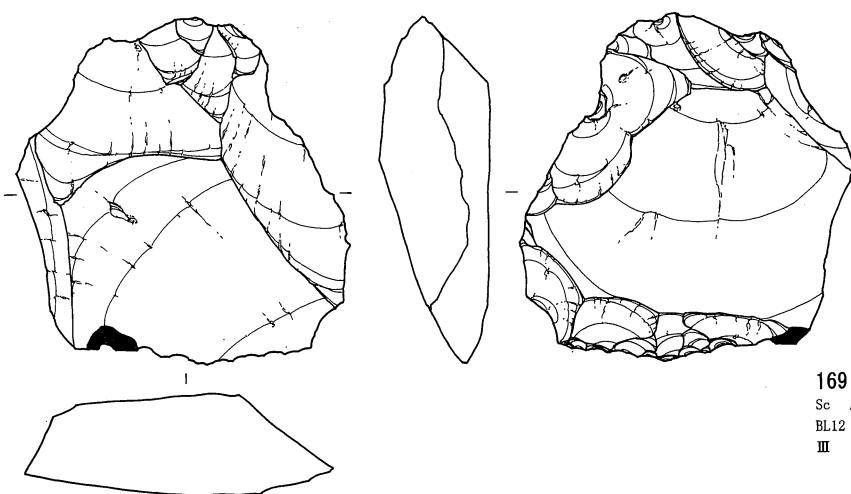
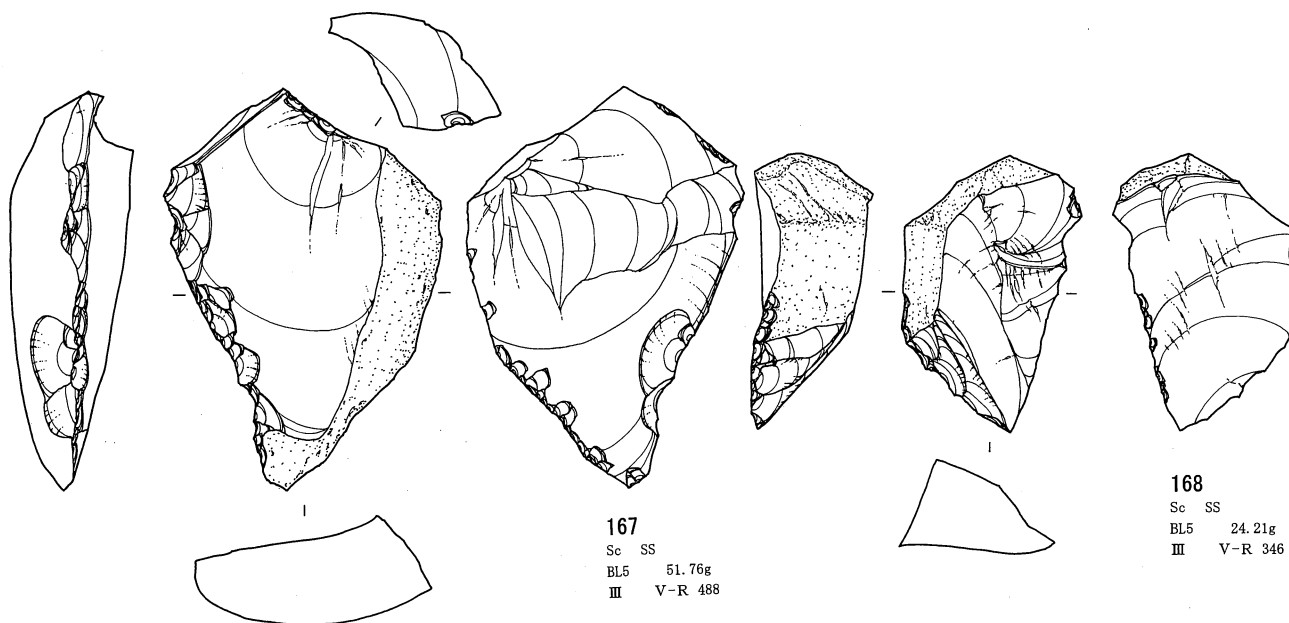

石器実測図 30 (削器 4) (西岡 A 遺跡)

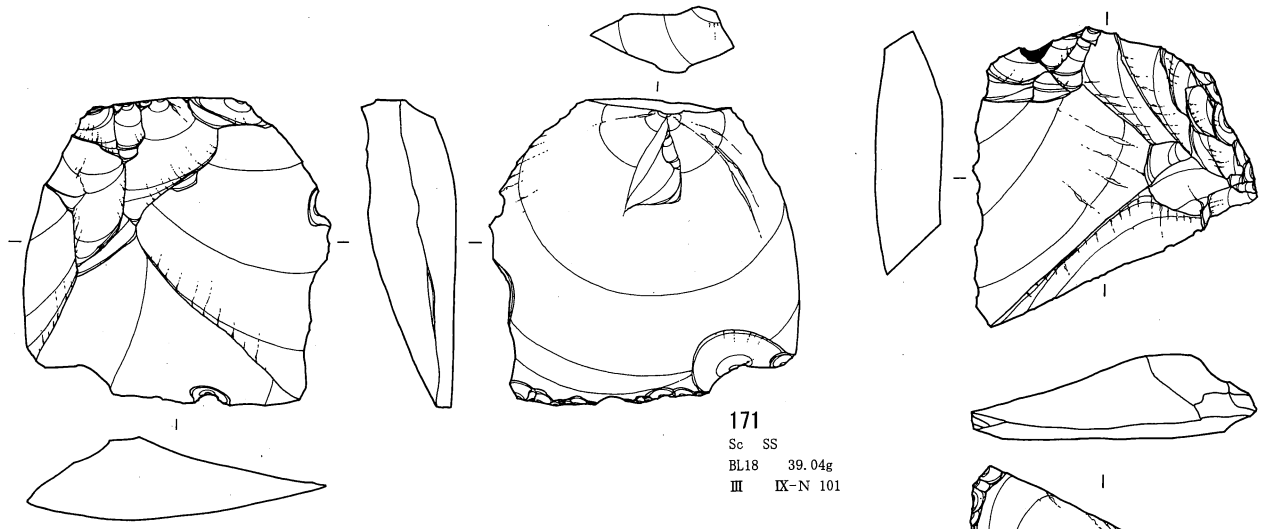

171
 Sc SS
 BL18 39.04g
 III IX-N 101

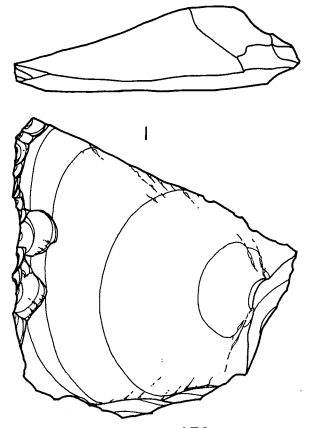

173
 Sc Sa
 BL17 30.15g
 IV V-Q 146

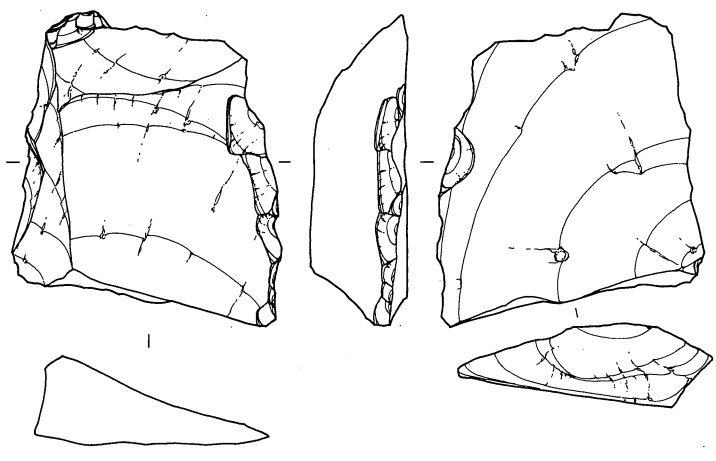

172
 Sc An
 BL20 37.35g
 III IX-W 20

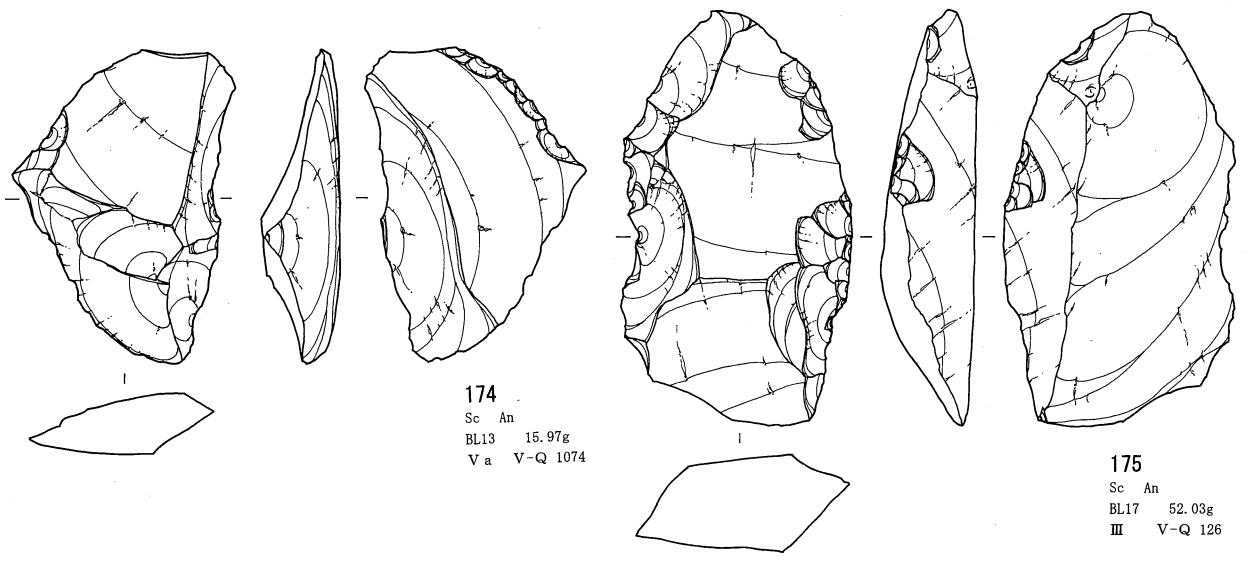

174
 Sc An
 BL13 15.97g
 V a V-Q 1074

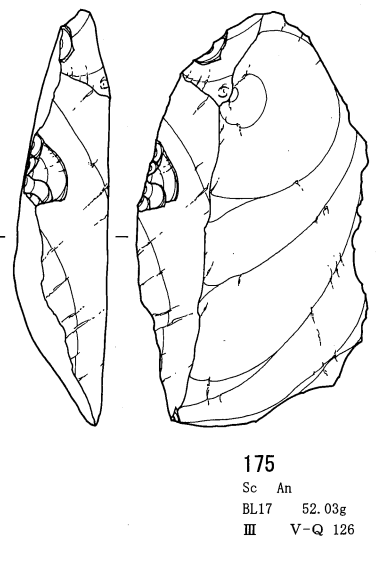

175
 Sc An
 BL17 52.03g
 III V-Q 126

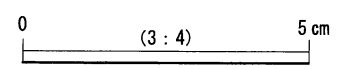

石器実測図 31 (削器 5) (西岡A遺跡)

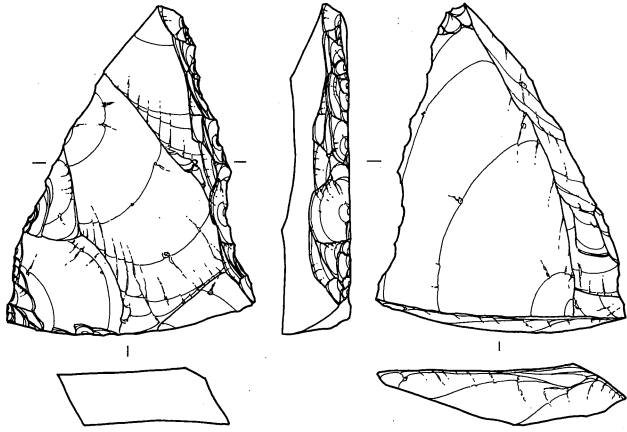

176
Sc An
BL15 24.85g
IV V-Q 465

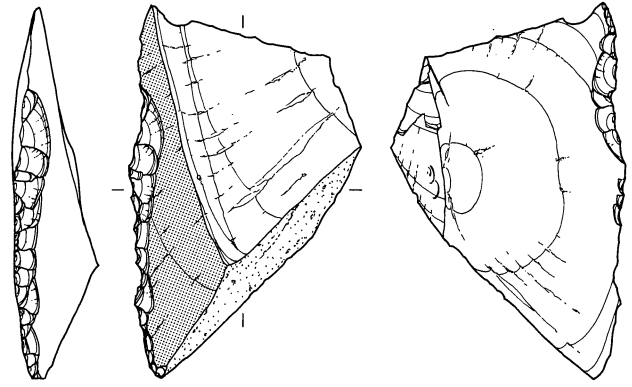

177
Sc An
BL13 24.95g
Va V-Q 1095

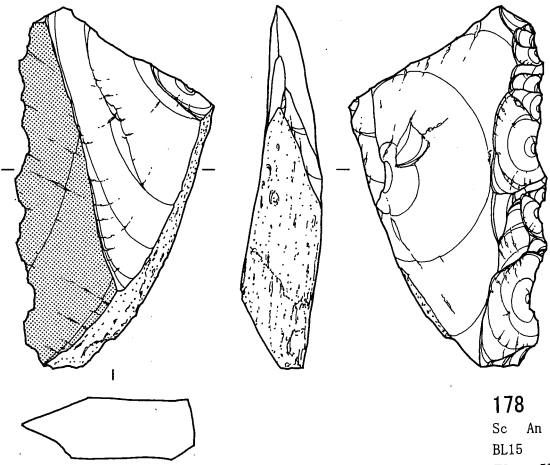

178
Sc An
BL15 26.7g
IV V-Q 177

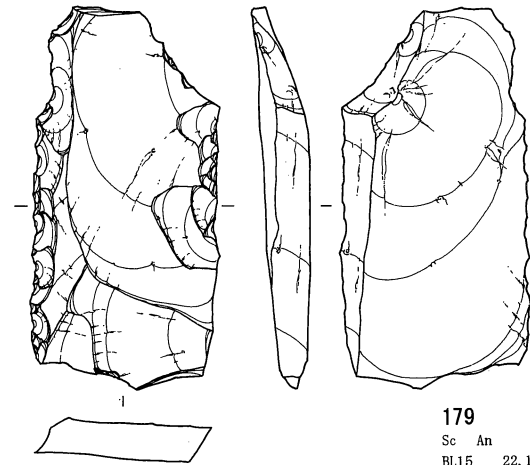

179
Sc An
BL15 22.12g
III V-Q 37

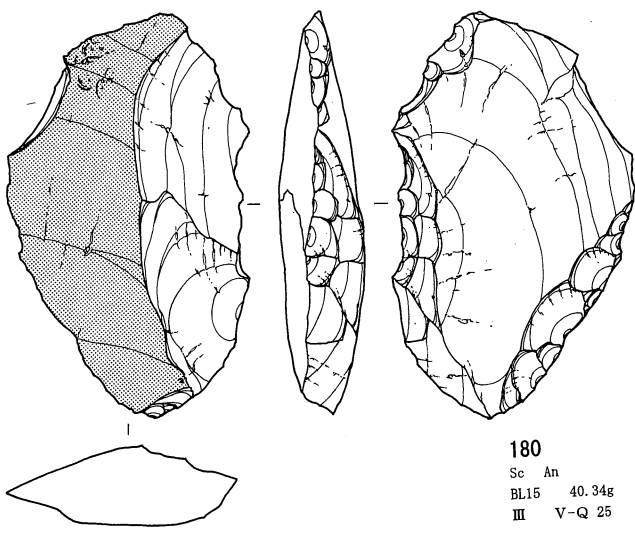

180
Sc An
BL15 40.34g
III V-Q 25

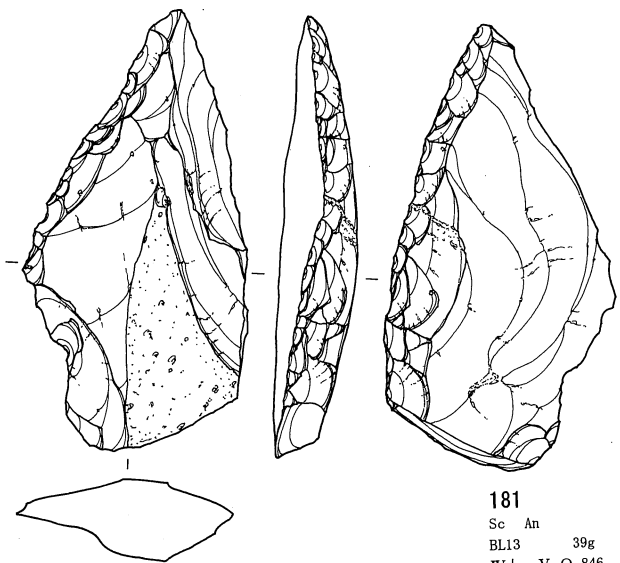

181
Sc An
BL13 39g
IV上 V-Q 846

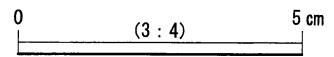

石器実測図 32 (削器 6) (西岡A遺跡)

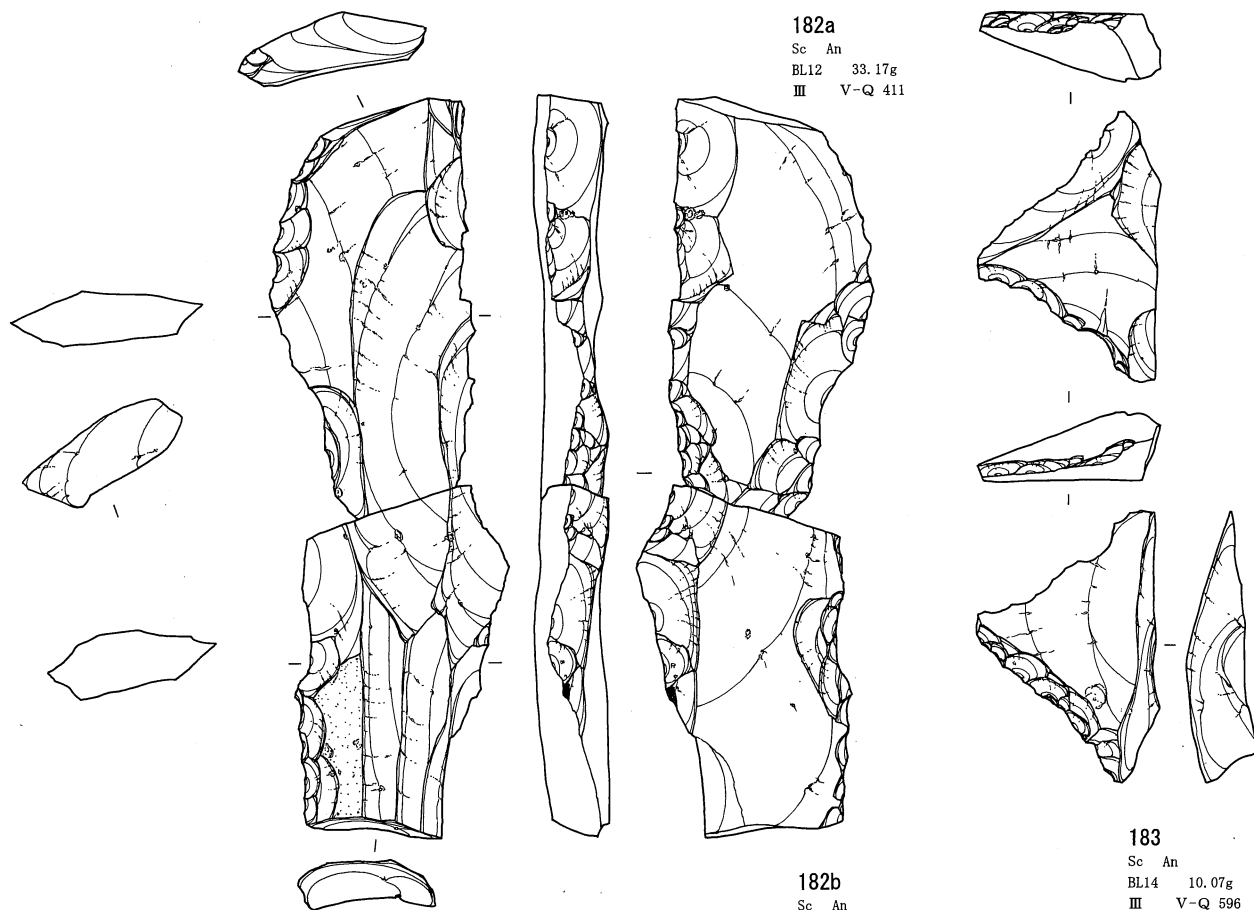

182a
 Sc An
 BL12 33.17g
 III V-Q 411

182b
 Sc An
 BL15 31.32g
 III V-Q 389

183
 Sc An
 BL14 10.07g
 III V-Q 596

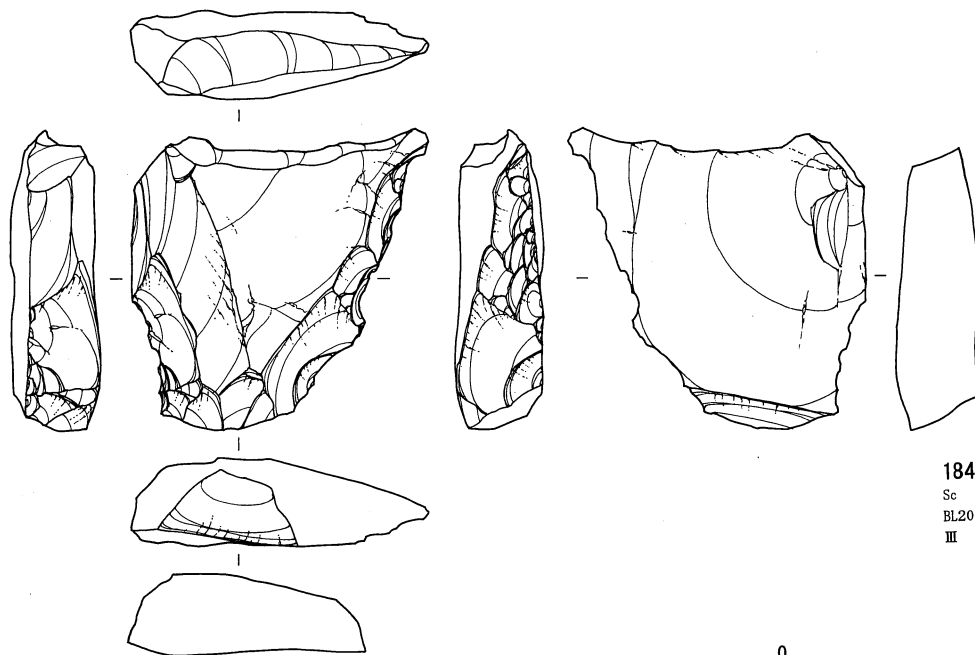

184
 Sc GT
 BL20 45.02g
 III IX-W 75

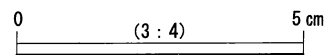

石器実測図 33 (削器 7) (西岡 A 遺跡)

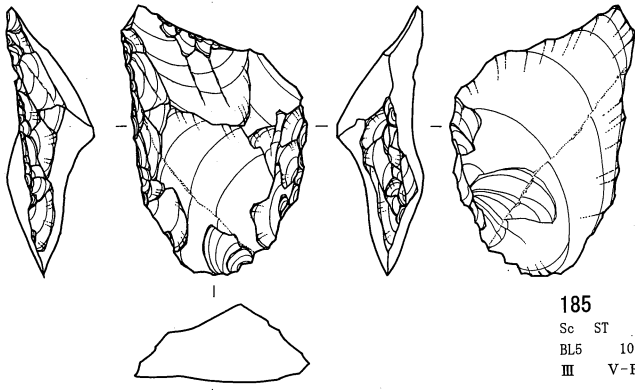

185
Sc ST
BL5 10.69g
III V-R 360

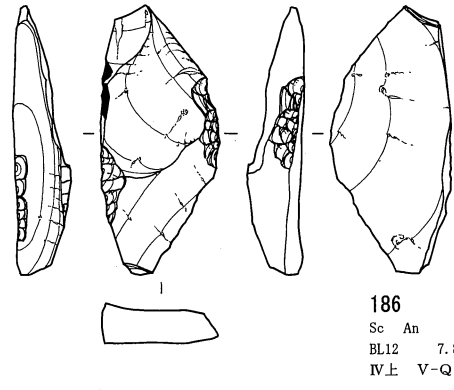

186
Sc An
BL12 7.85g
IV上 V-Q 686

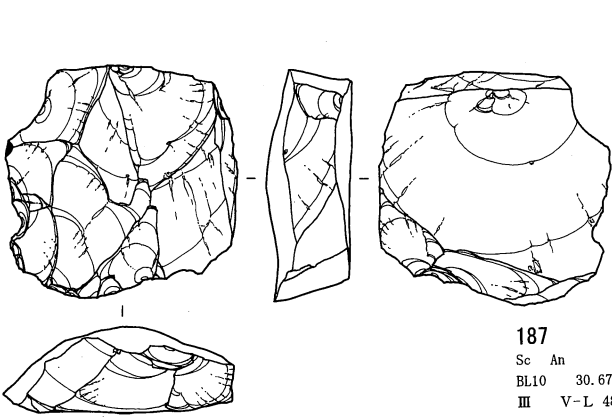

187
Sc An
BL10 30.67g
III V-L 48

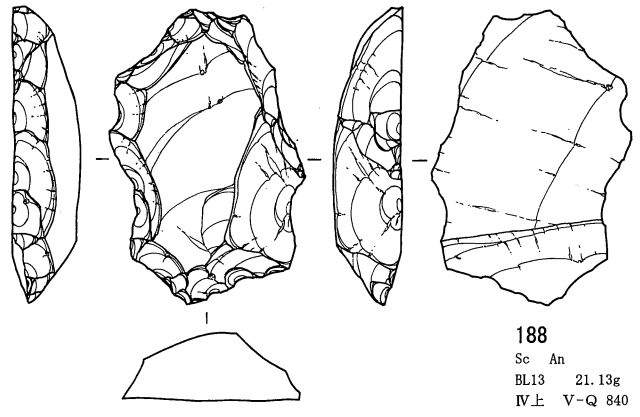

188
Sc An
BL13 21.13g
IV上 V-Q 840

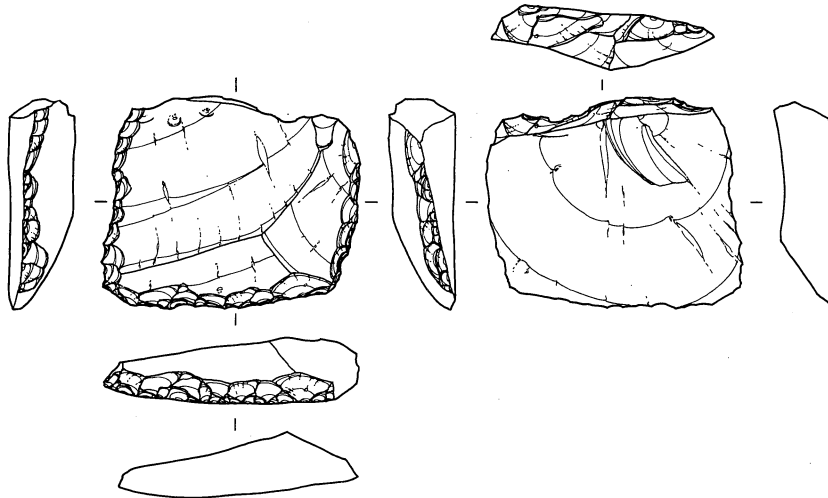

189
Sc An
BL16 20.01g
III V-Q 912

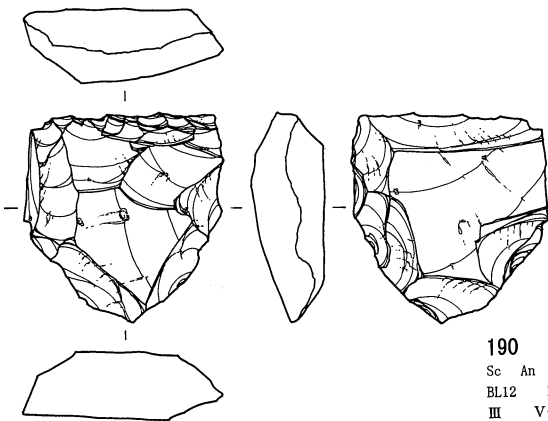

190
Sc An
BL12 18.97g
III V-Q 419

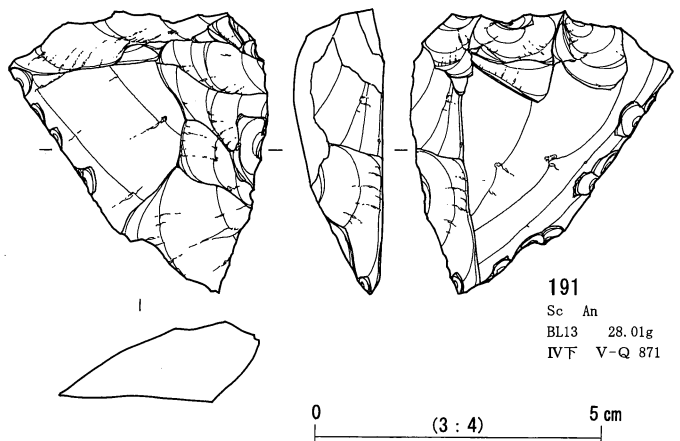

191
Sc An
BL13 28.01g
IVF V-Q 871

0 (3 : 4) 5 cm

石器実測図 34 (削器 8) (西岡 A 遺跡)

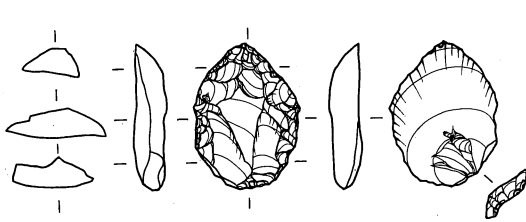

192
Sc Ob WDTY
BL11 2.35g
III V-L 131

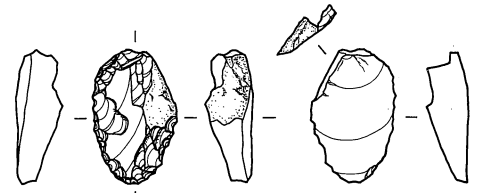

193
Sc Ob WDTY
BL11 2.18g
IV上 V-L 188

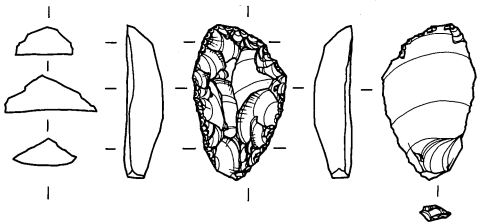

194
Sc Ob WDTY
BL14 2.35g
IV下 V-Q 717

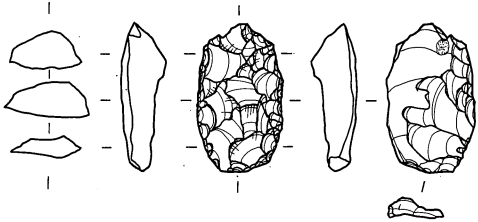

195
Sc Ob TSTY
BL11 2.67g
III V-L 134

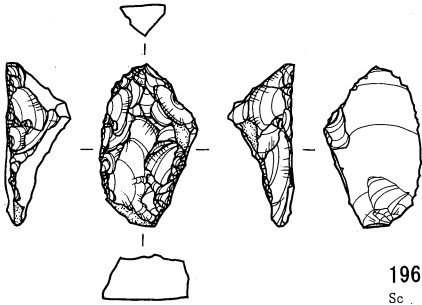

196
Sc Ob
BL14 4.19g
IV下 V-Q 1041

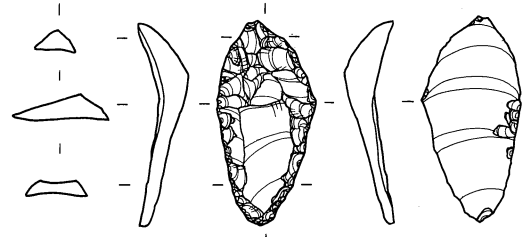

197
Sc Ob WDTY
BL13 2.15g
IV上 V-Q 852

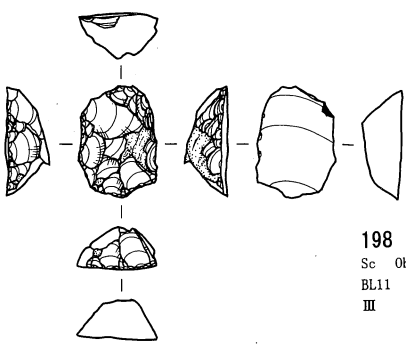

198
Sc Ob WDTY
BL11 1.8g
III V-L 107

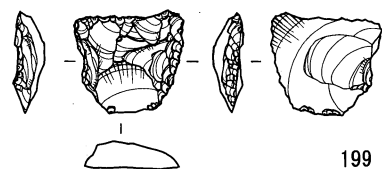

199
Sc Ob SWHD
BL25 1.36g
V a XIV-H 166

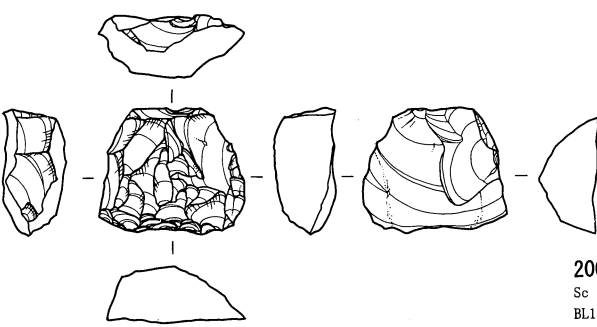

200
Sc Ob WDTY
BL11 5.23g
IV上 V-Q 995

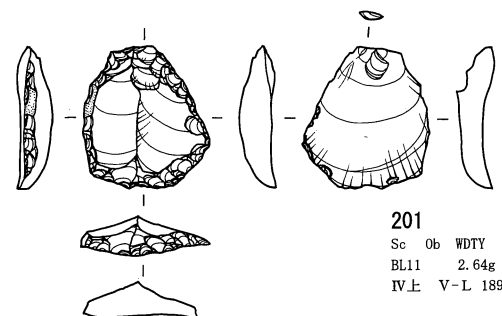

201
Sc Ob WDTY
BL11 2.64g
IV上 V-L 189

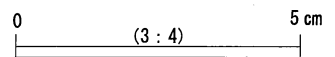

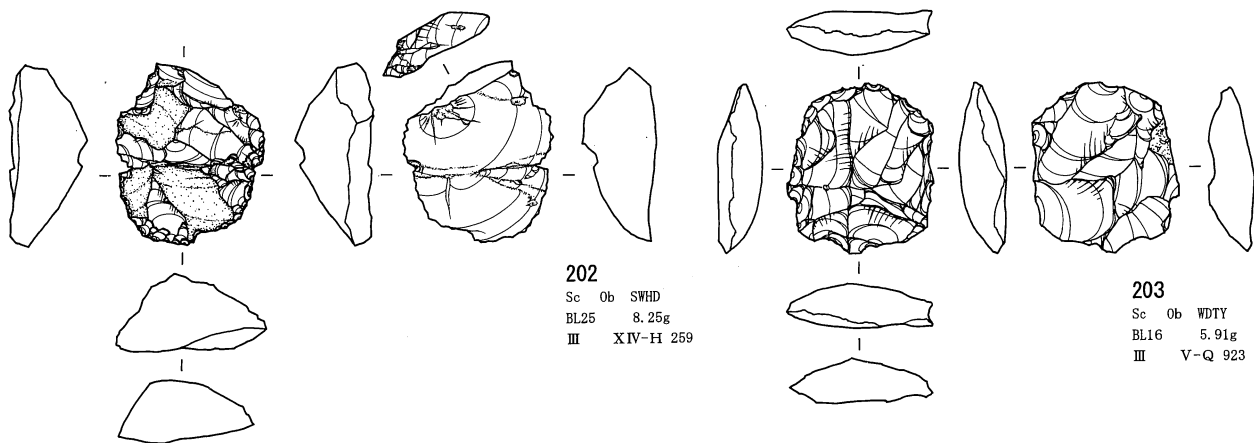

202
Sc Ob SWHD
BL25 8.25g
III XIV-H 259

203
Sc Ob WDTY
BL16 5.91g
III V-Q 923

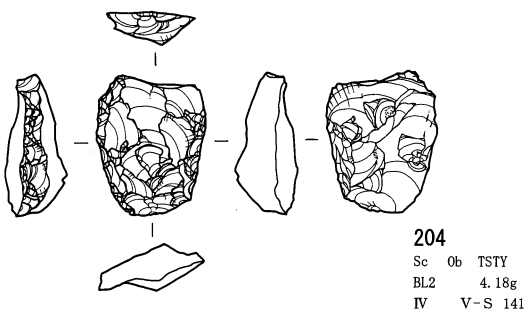

204
Sc Ob TSTY
BL2 4.18g
IV V-S 141

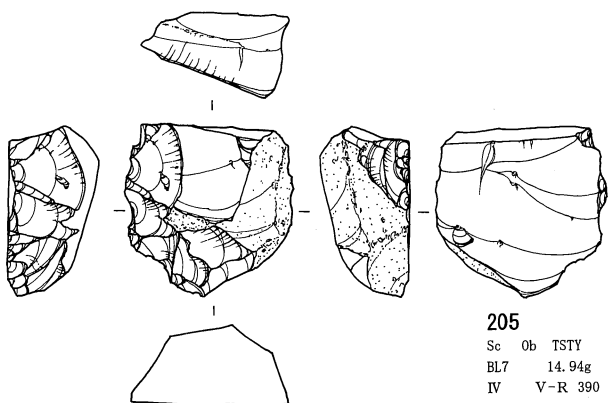

205
Sc Ob TSTY
BL7 14.94g
IV V-R 390

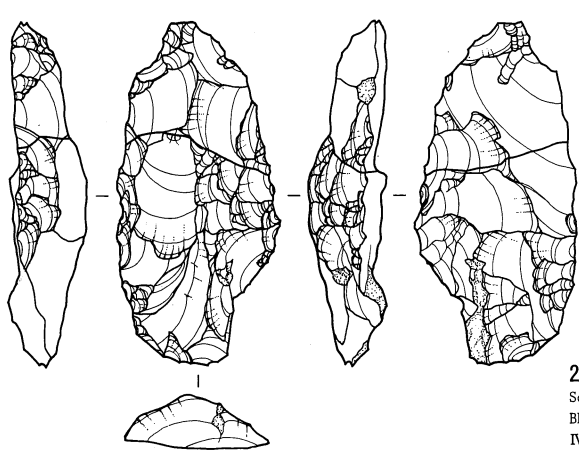

206a
Sc Ag
BL5 5.47g
III V-R 356

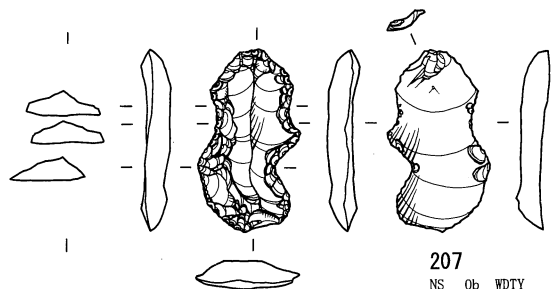

207
NS Ob WDTY
BL14 2.02g
III V-Q 951

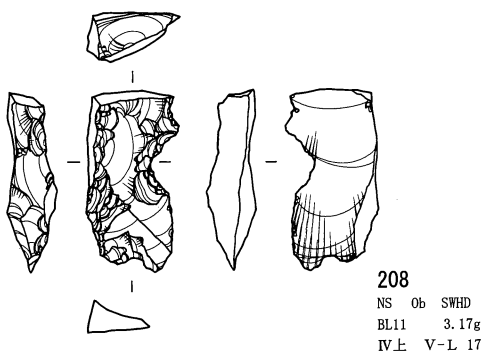

208
NS Ob SWHD
BL11 3.17g
IV上 V-L 177

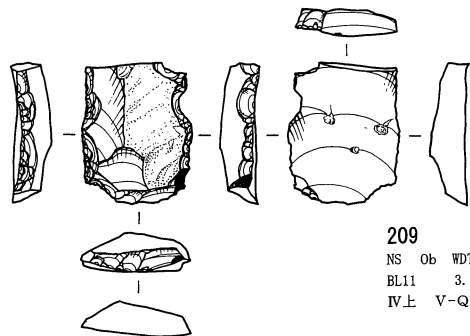

209
NS Ob WDTY
BL11 3.15g
IV上 V-Q 1003

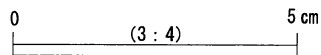

石器実測図 36 (削器 10・抉入削器 1) (西岡 A 遺跡)

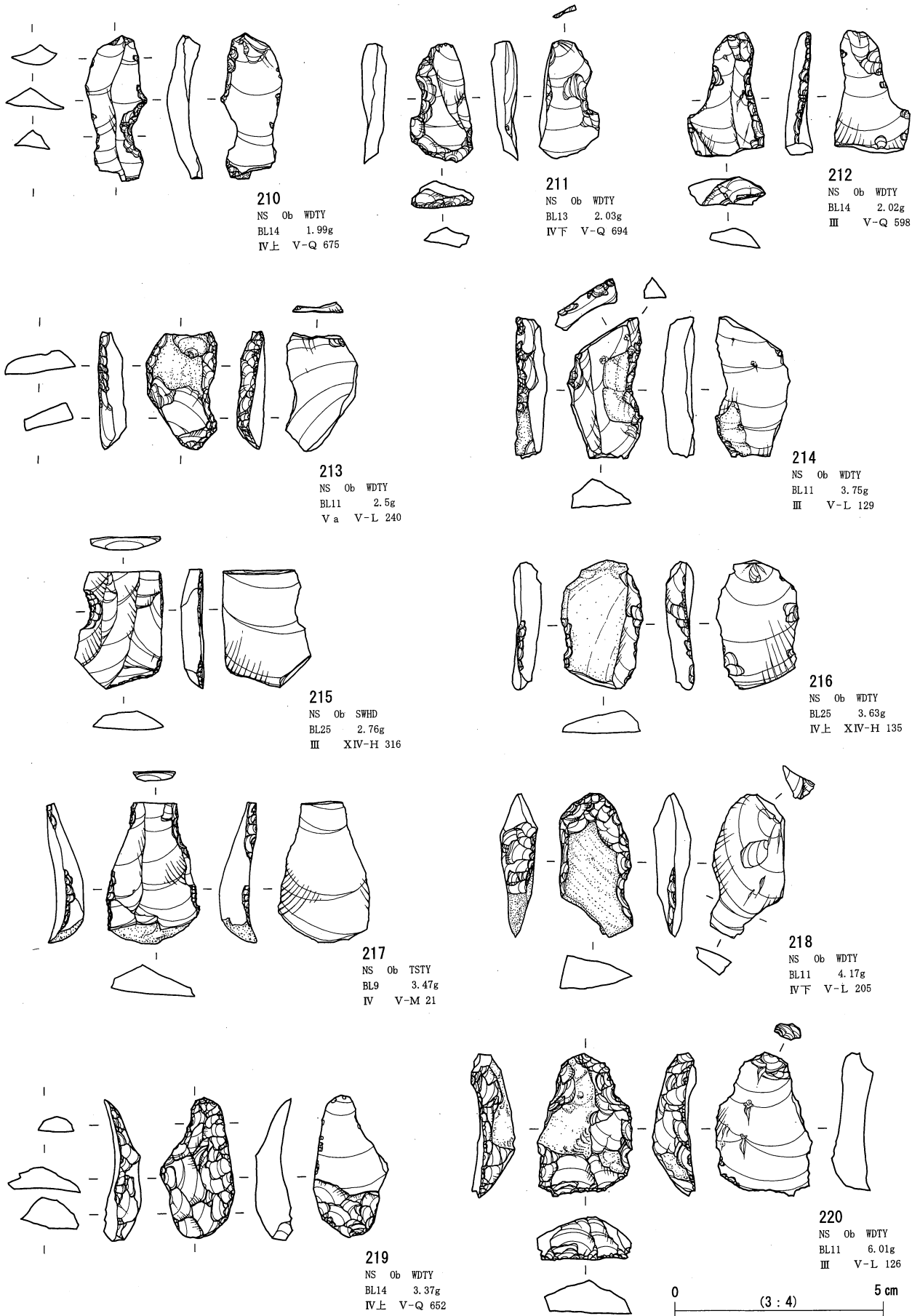

石器実測図 37 (挟入削器 2) (西岡 A 遺跡)

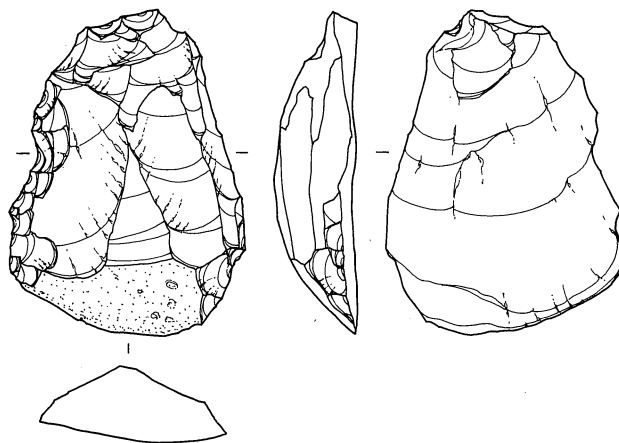

221
NS Tu
BL17 29.22g
III V-Q 219

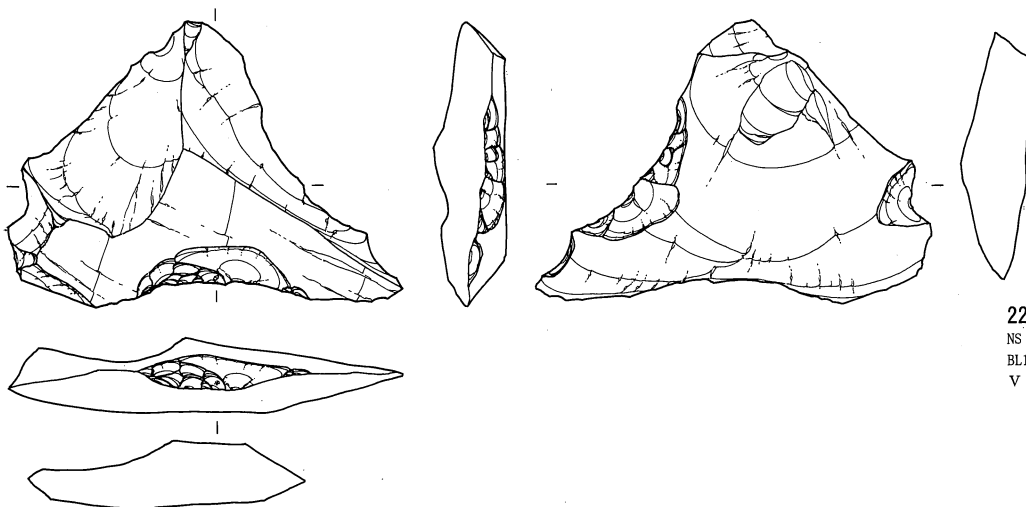

222
NS An
BL13 26.73g
V a V-Q 1086

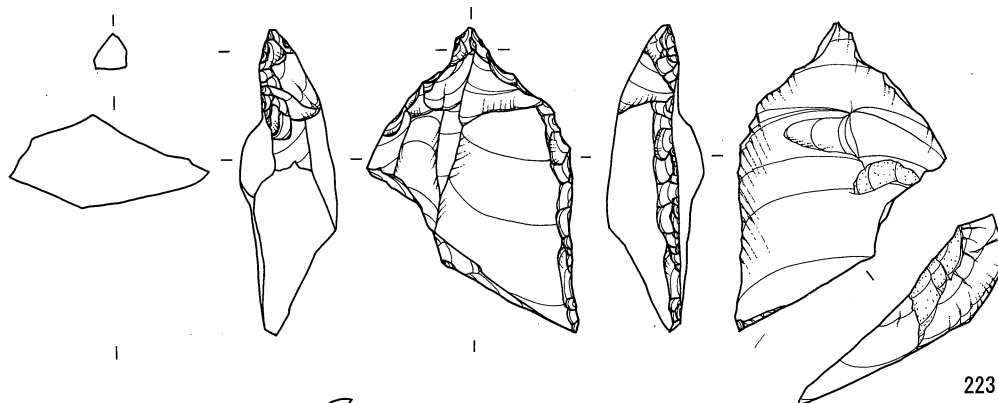

223
Dr ST
BL22 19.64g
III IX-W 133

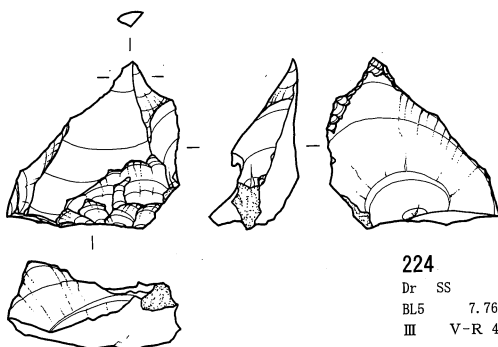

224
Dr SS
BL5 7.76g
III V-R 466

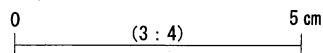

石器実測図 38 (挟入削器 3・揉錐器) (西岡 A 遺跡)

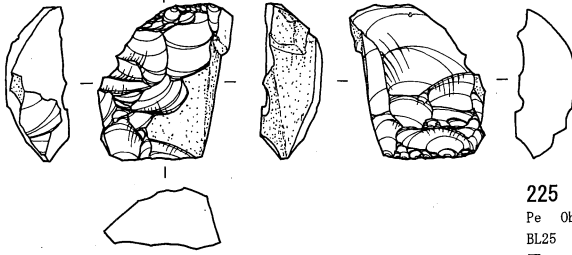

225
Pe Ob WDTY
BL25 6.7g
III XIV-H 98

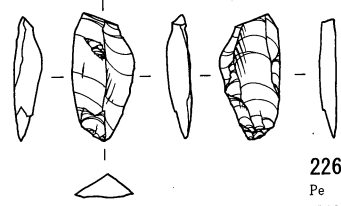

226
Pe Ob WDHY
BL18 0.93g
Va IX-M 77

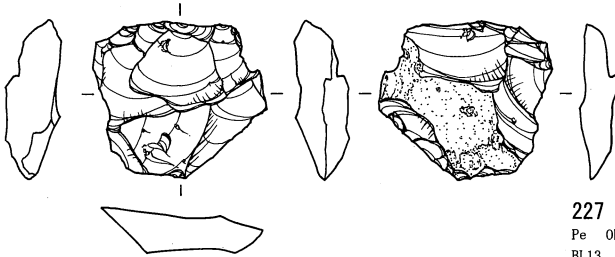

227
Pe Ob WDTY
BL13 6.7g
IV下 V-Q 695

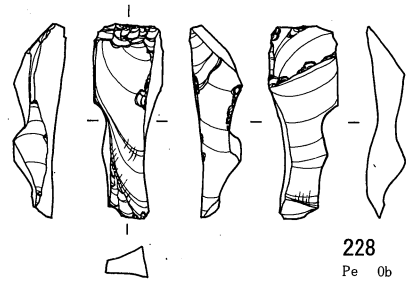

228
Pe Ob WDHY
BL18 2.5g
Va IX-N 271

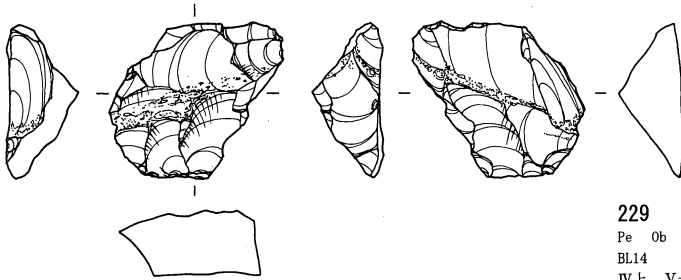

229
Pe Ob SWHD
BL14 7.42g
IV上 V-Q 672

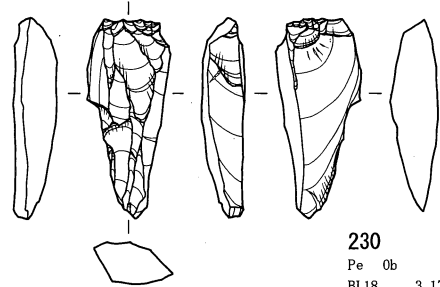

230
Pe Ob
BL18 3.17g
IV下 IX-N 335

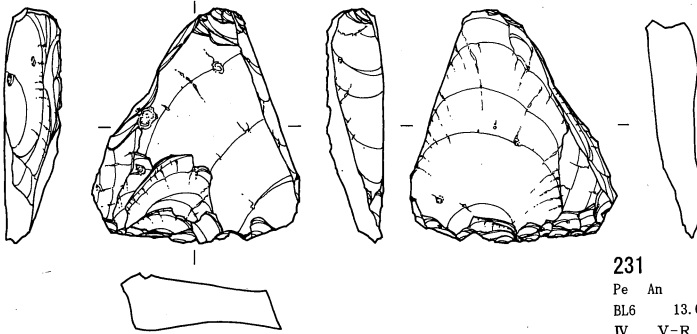

231
Pe An
BL6 13.66g
IV V-R 92

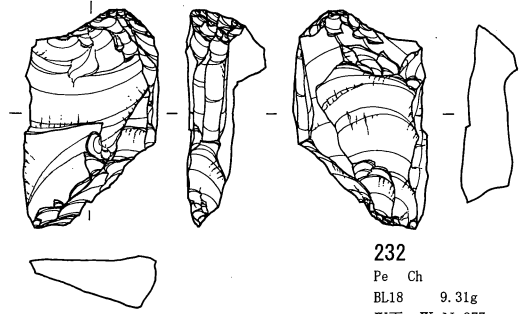

232
Pe Ch
BL18 9.31g
IV下 IX-N 277

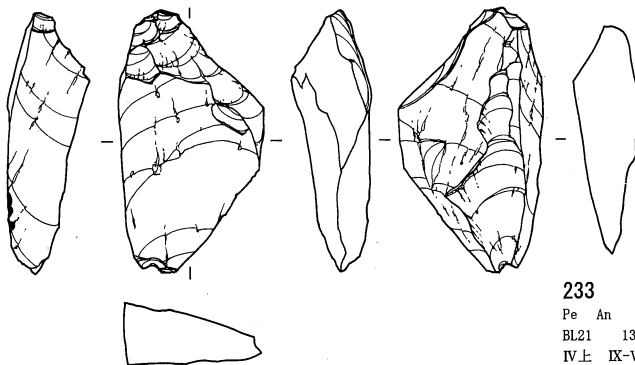

233
Pe An
BL21 13.74g
IV上 IX-W 110

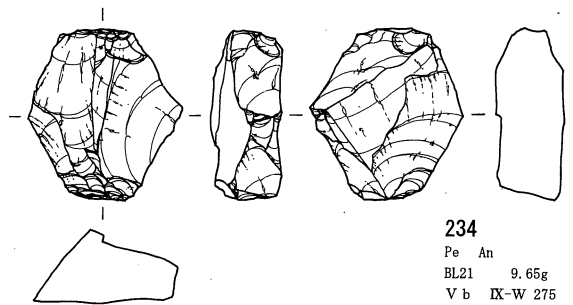

234
Pe An
BL21 9.65g
Vb IX-W 275

0 (3:4) 5 cm

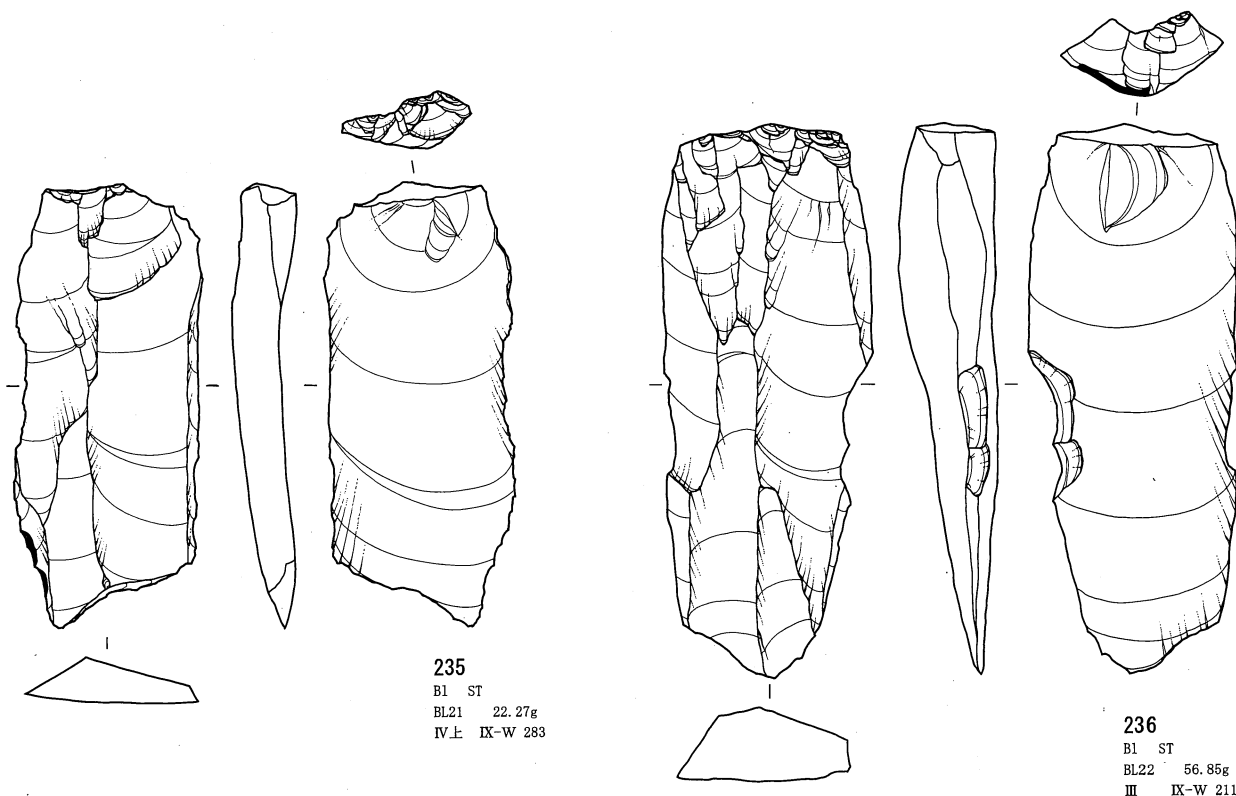

235
 B1 ST
 BL21 22.27g
 IV上 IX-W 283

236
 B1 ST
 BL22 56.85g
 III IX-W 211

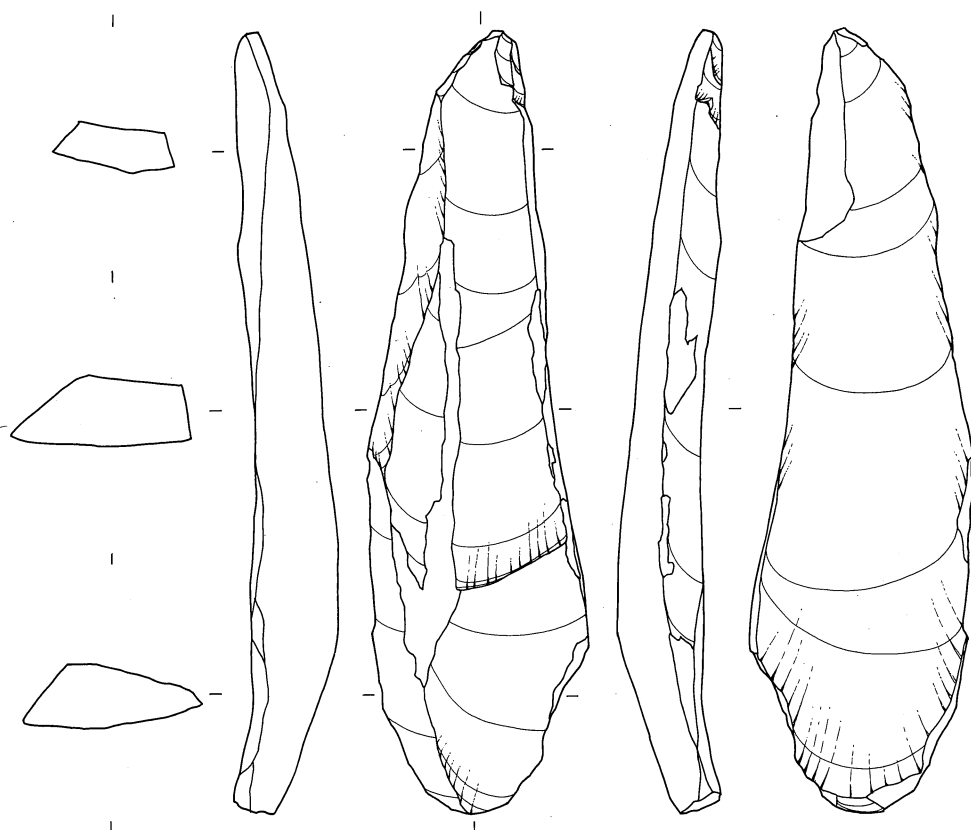

237
 B1 ST
 BL22 69.79g
 III IX-W 298

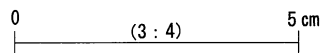

石器実測図 40 (石刃 1) (西岡 A 遺跡)

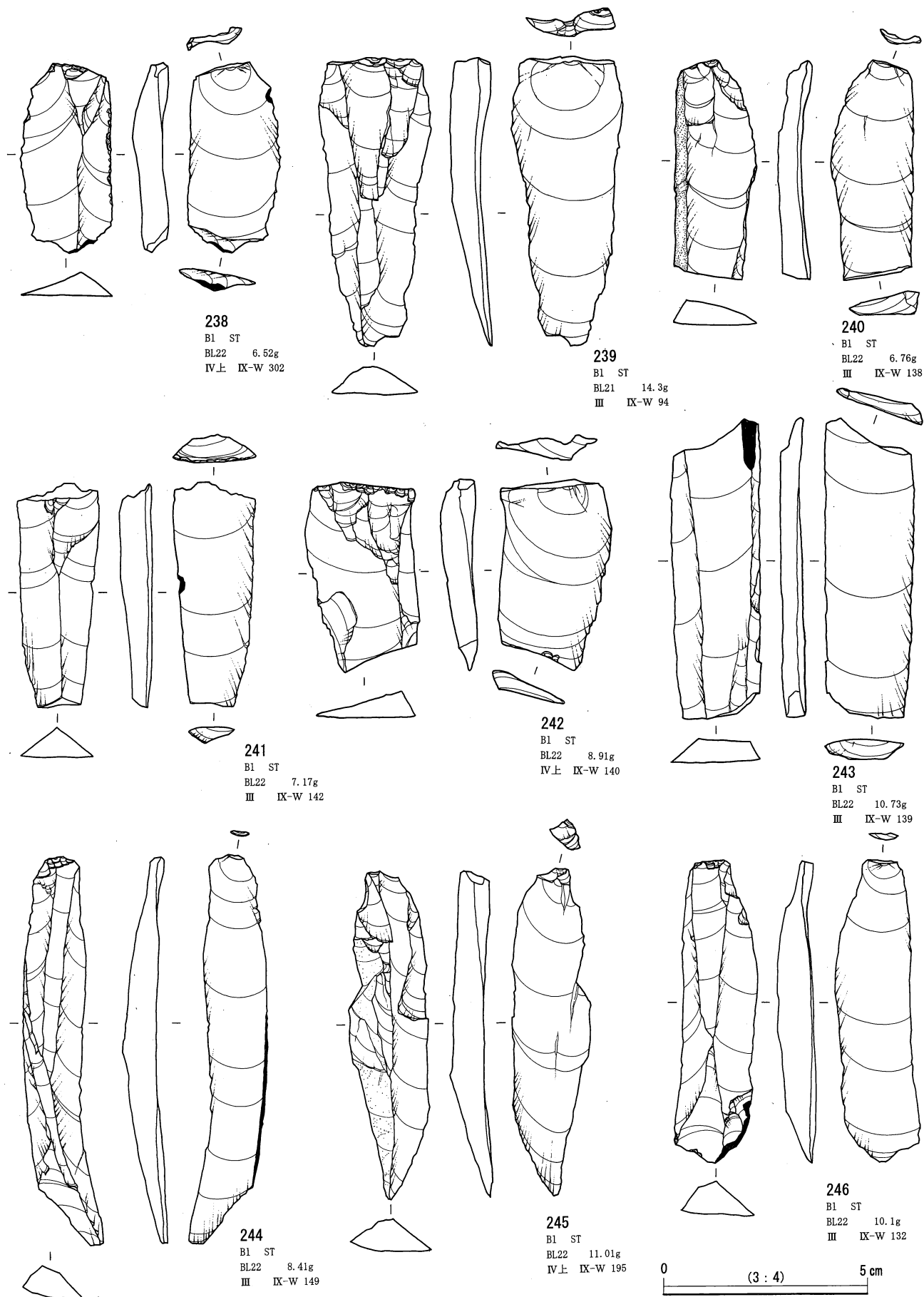

石器実測図 41 (石刃 2) (西岡A遺跡)

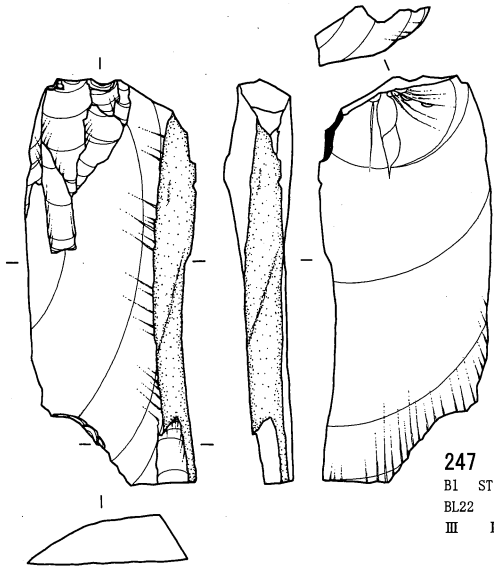

247
B1 ST
BL22 21.22g
III IX-W 194

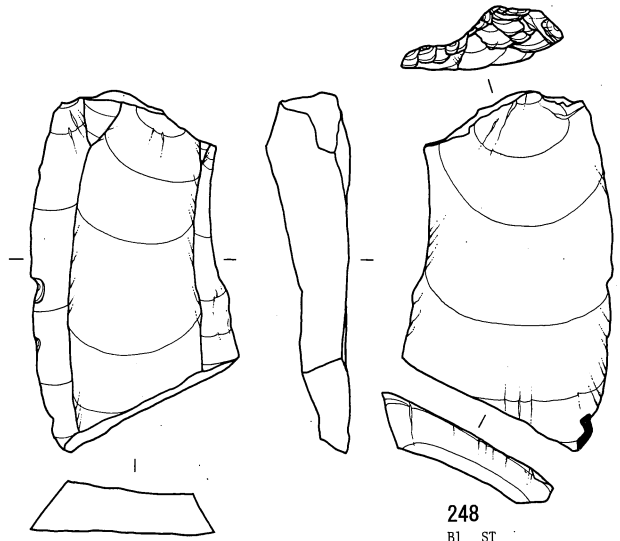

248
B1 ST
BL22 25.02g
III IX-W 150

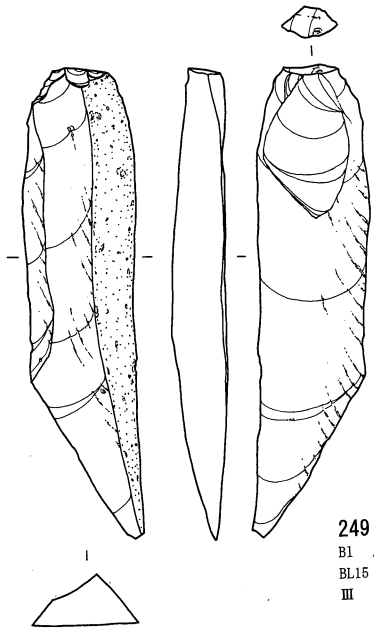

249
B1 An
BL15 15.57g
III V-Q 298

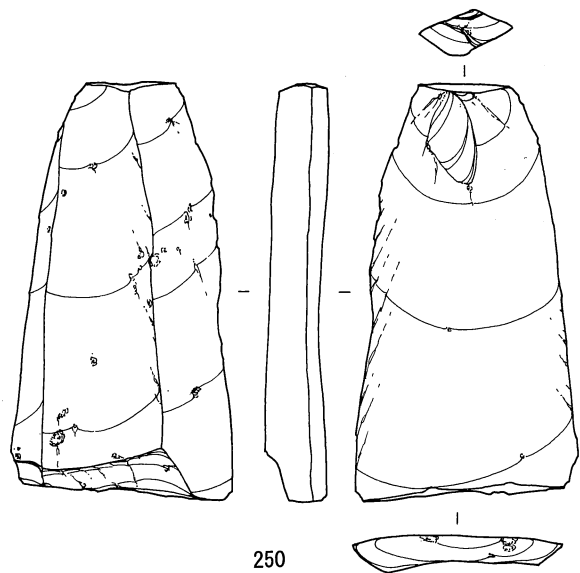

250
B1 An
BL11 31.49g
IV上 V-Q 1002

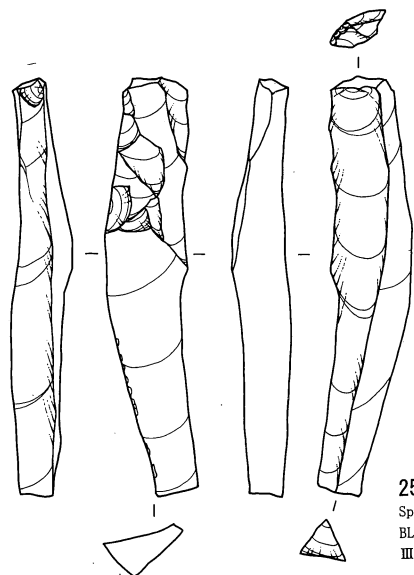

251
Sp ST
BL22 7.5g
III IX-W 297

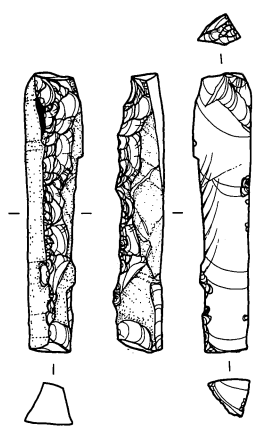

252
Sp Ob SWHD
BL22 4.44g
III IX-W 300

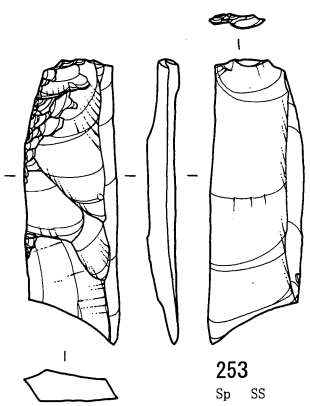

253
Sp SS
BL22 4.32g
IV上 IX-W 159

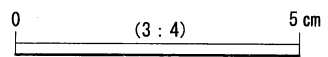

石器実測図 42 (石刃 3・削片) (西岡A遺跡)

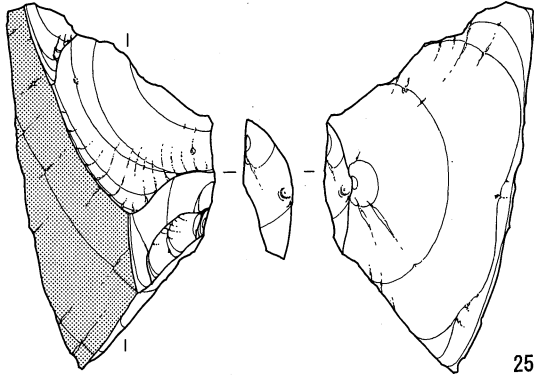

254
 Fl An
 BL15 19.13g
 III V-Q 10

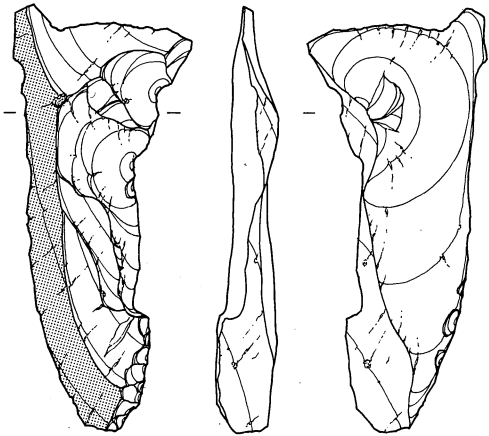

255
 Fl An
 BL15 12.28g
 III V-Q 64

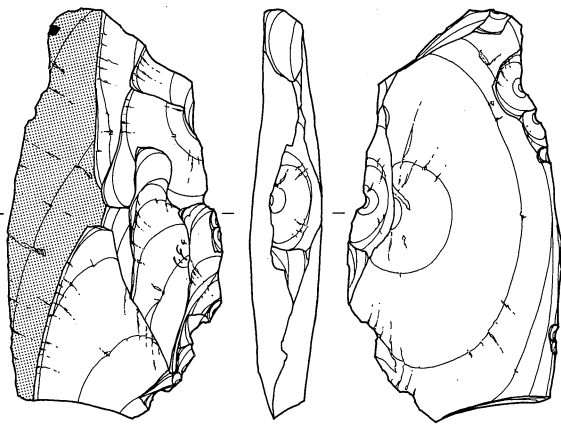

256
 Fl An
 BL12 32.97g
 III V-L 33

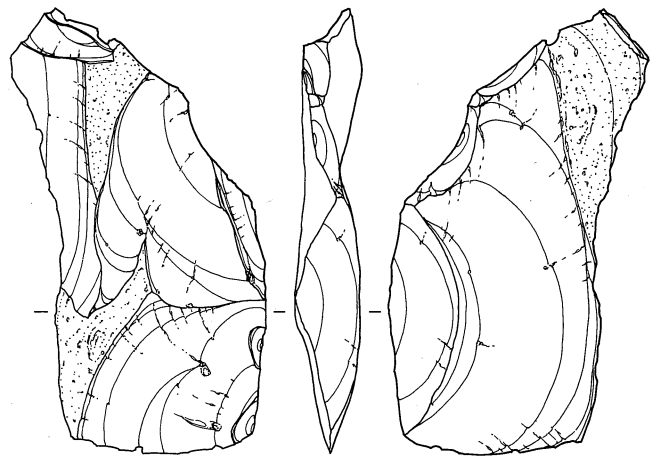

257
 Fl An
 BL17 26.96g
 III V-Q 131

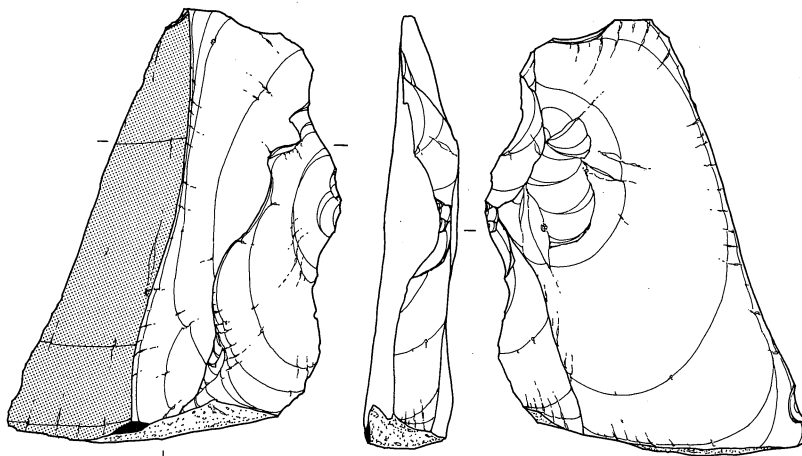

258
 Fl An
 BL13 56.65g
 IV上 V-Q 975

0 (3 : 4) 5 cm

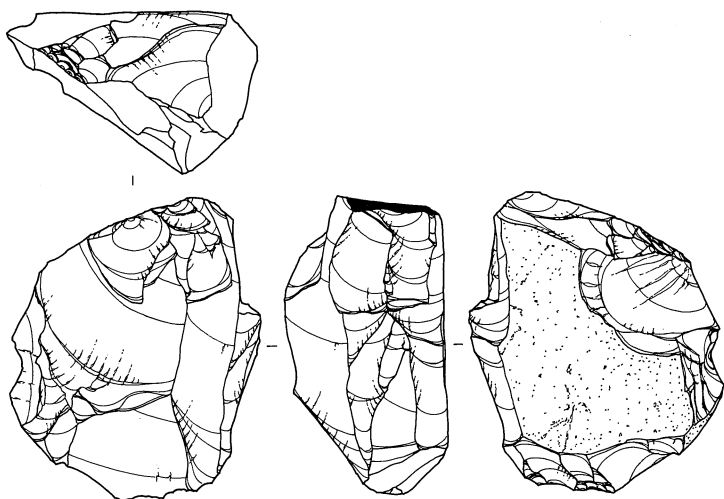

259
Co ST
BL5 90.89g
IV V-R 296

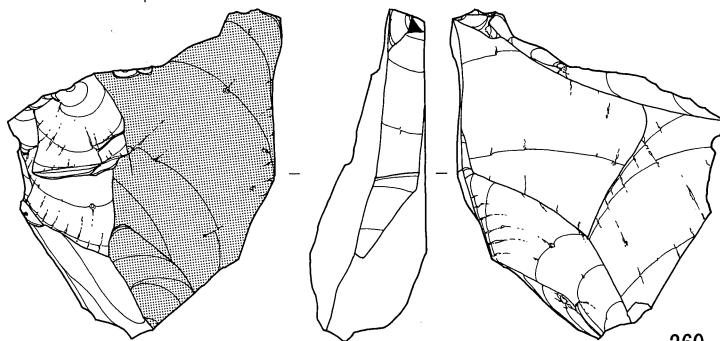
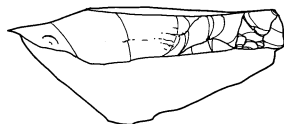
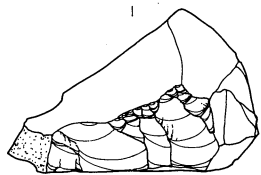

260
Co An
BL7 55.33g
III V-R 37

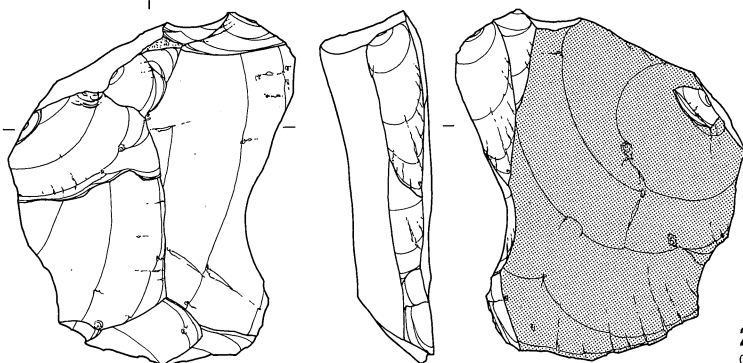
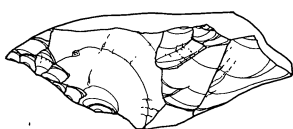

261
Co An
BL17 66.77g
IV V-Q 178



0 (2 : 3) 5cm

石器実測図 44 (石核 1) (西岡 A 遺跡)

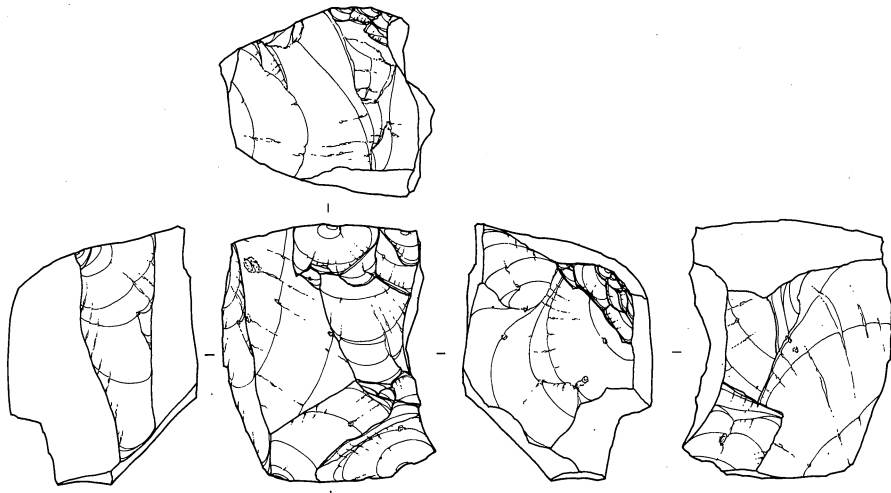

262
Co An
BL12 79g
III V-Q 422

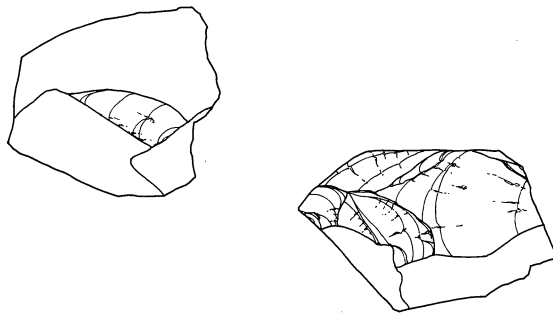

263
Co An
BL12 65.84g
III V-L 19

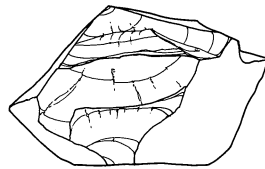
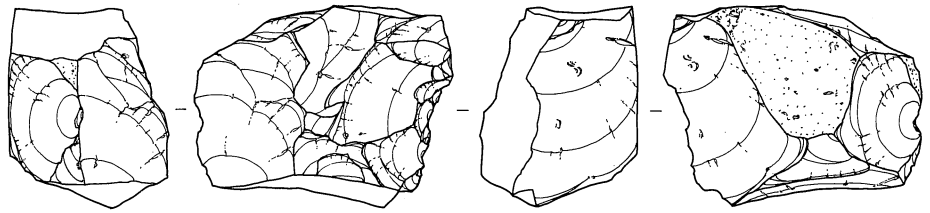

264
Co An
BL15 60.44g
III V-Q 81

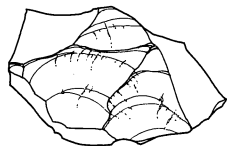
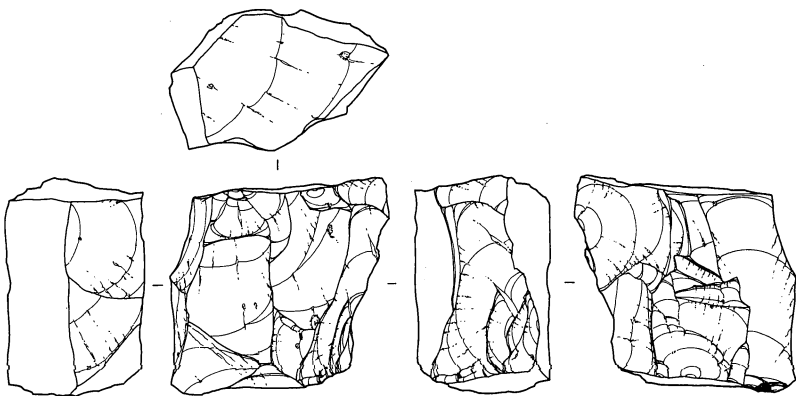

0 (2:3) 5cm

石器実測図 45 (石核 2) (西岡 A 遺跡)

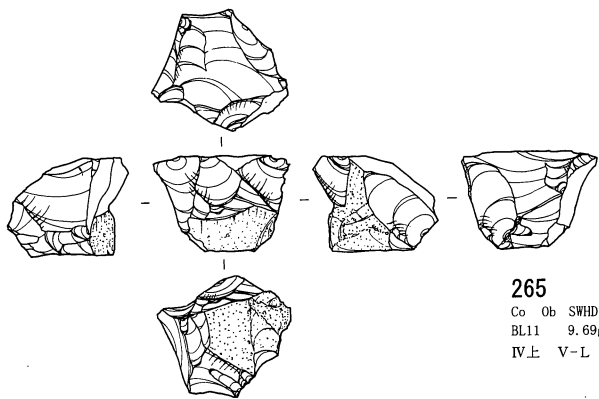

265
Co Ob SWHD
BL11 9.69g
IV上 V-L 157

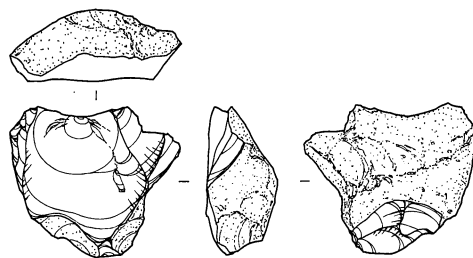

266
Co Ob WDHY
BL14 10.66g
IV上 V-Q 740

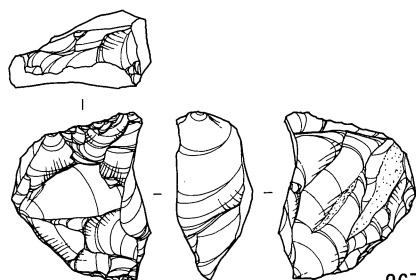

267
Co Ob TSTY
BL7 9.86g
III V-R 10

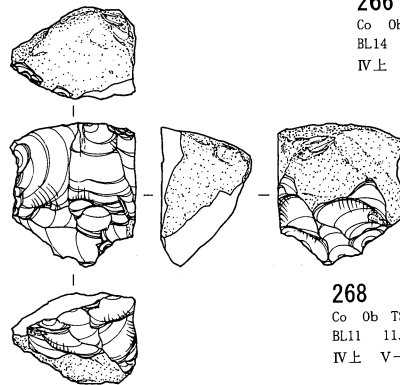

268
Co Ob TSTY
BL11 11.21g
IV上 V-L 174

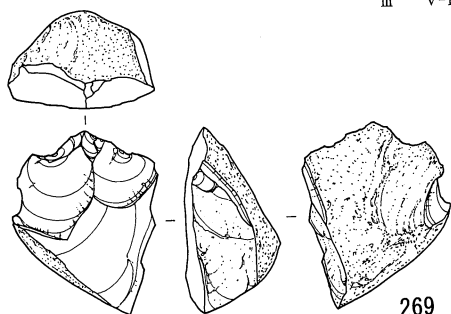

269
Co Ch
BL25 17.82g
III XIV-H 315

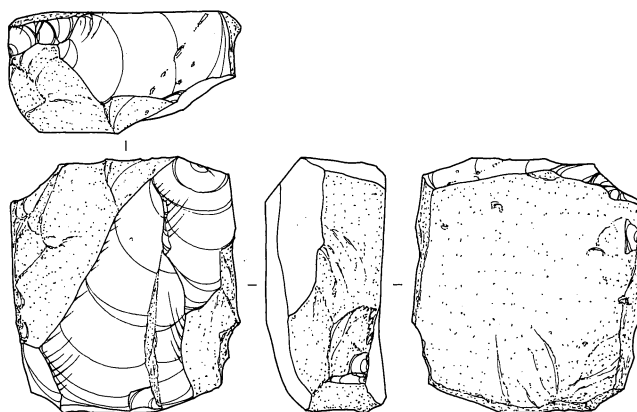

270
Co Ob WDTY
BL25 70.32g
III XIV-H 78



271
Co An
BL12 178.29g
III V-L 34

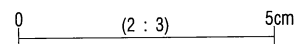

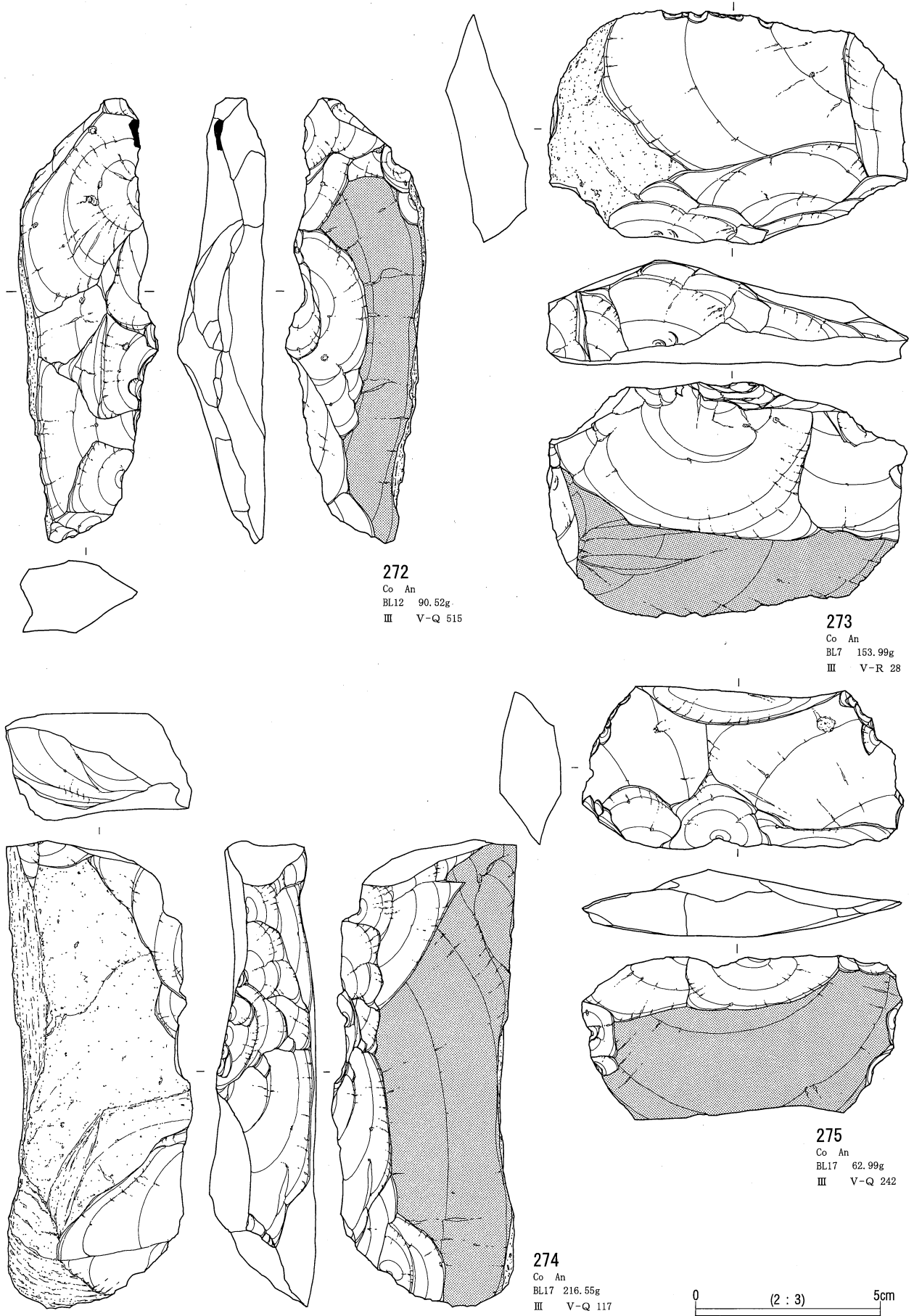

石器実測図 47 (石核 4) (西岡A遺跡)

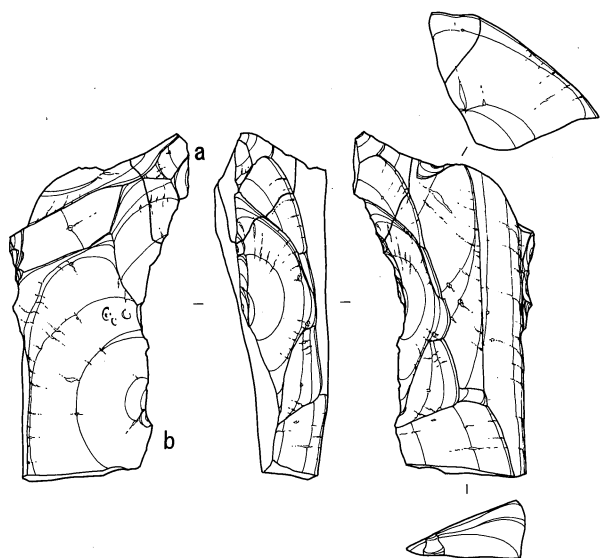

276a 276b
 Co 破 Co An
 BL15 1.66g BL15 43.03g
 III V-Q 337 III V-Q 364

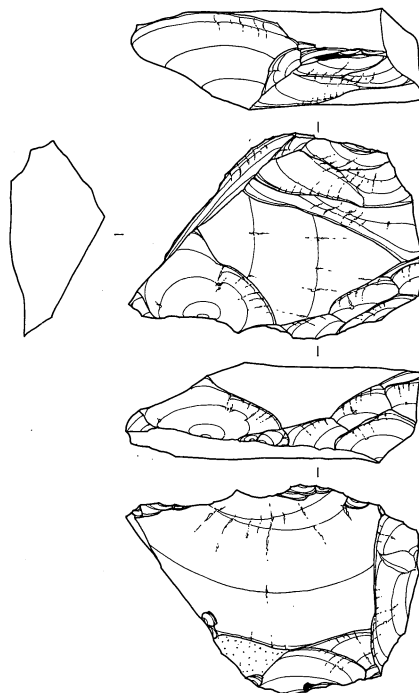

277
 Co An
 BL15 41.46g
 III V-Q 360

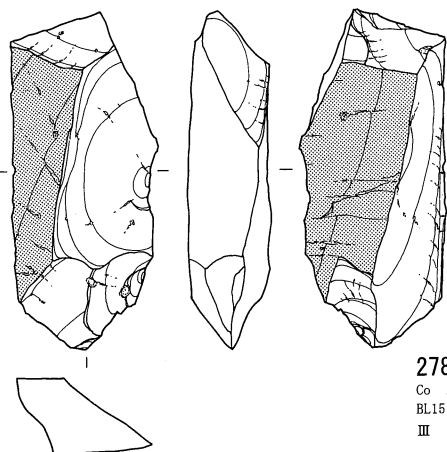

278
 Co An
 BL15 29.65g
 III V-Q 366

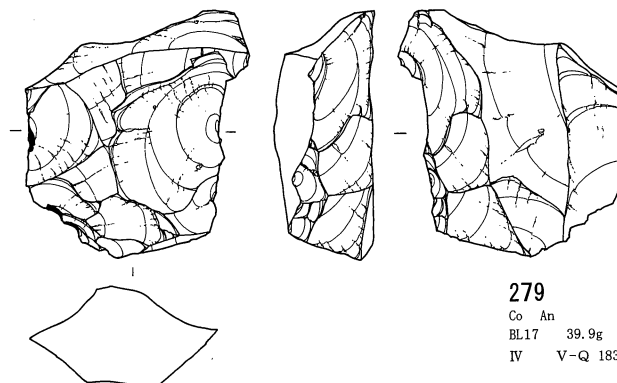

279
 Co An
 BL17 39.9g
 IV V-Q 183

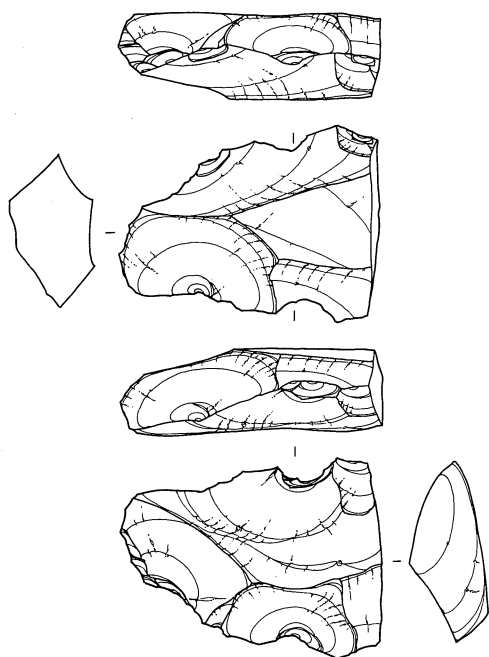

280
 Co An
 BL15 31.14g
 III V-Q 328

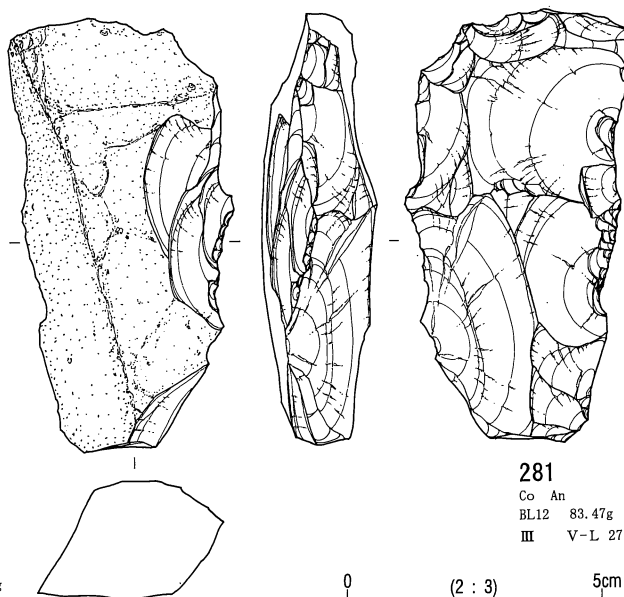

281
 Co An
 BL12 83.47g
 III V-L 27

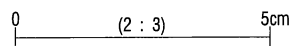

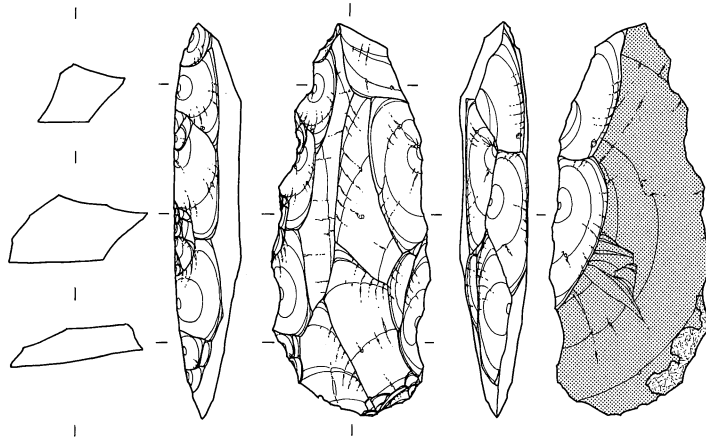

282
Co An
BL15 32.09g
III V-Q 352

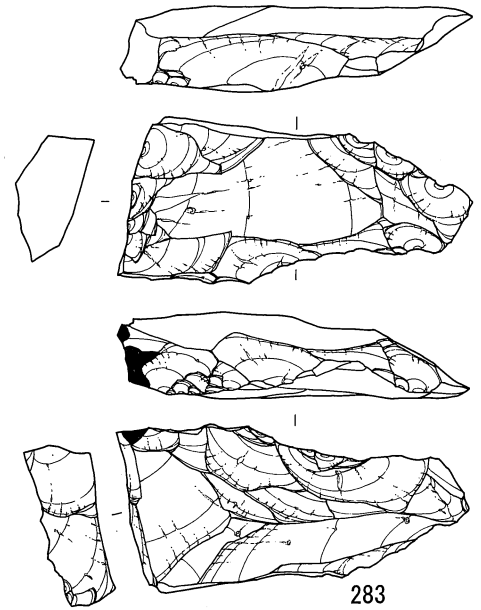

283
Co An
BL12 38.01g
V b V-Q 1106

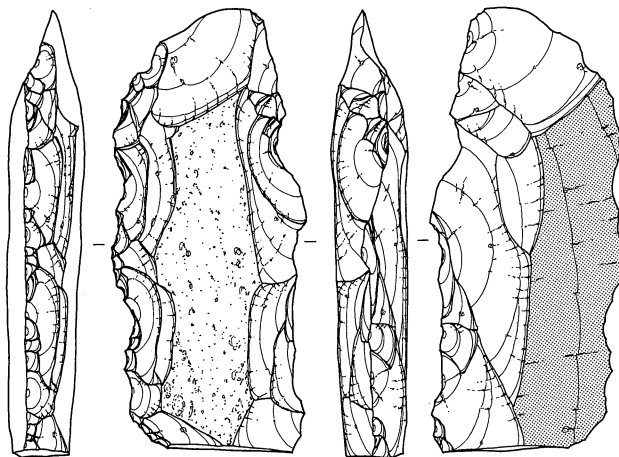

284
Co An
BL15 54.45g
III V-Q 347

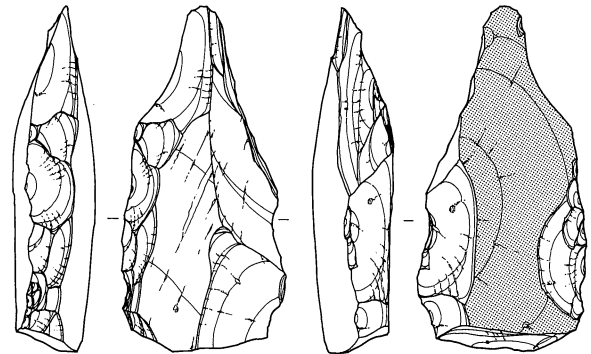

285
Co An
BL15 33.57g
III V-Q 388

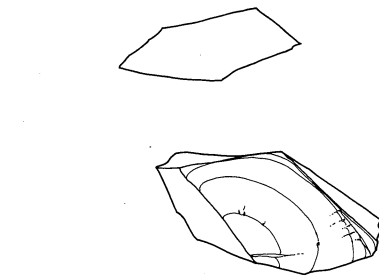

286
Co An
BL15 55.6g
III V-Q 346

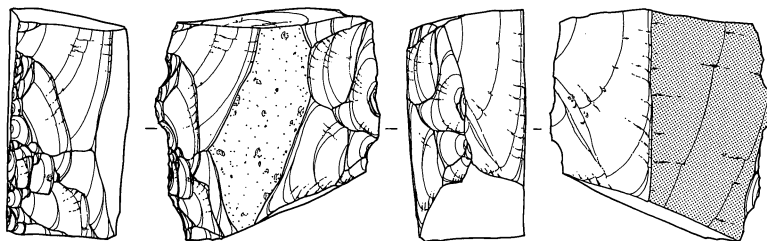

287
Co An
BL13 29.74g
IV F V-Q 741

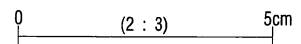
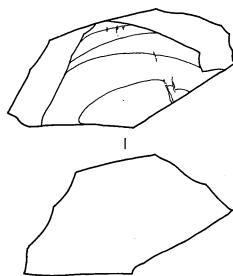

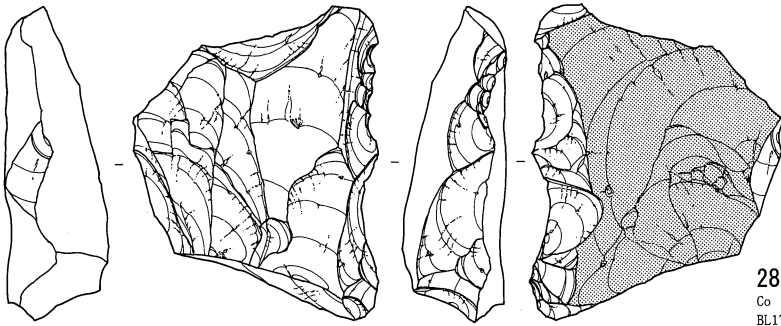

288
Co An
BL17 54.18g
III V-Q 223

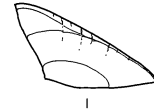

289a
Co 破
BL13 13.13g
III V-Q 554

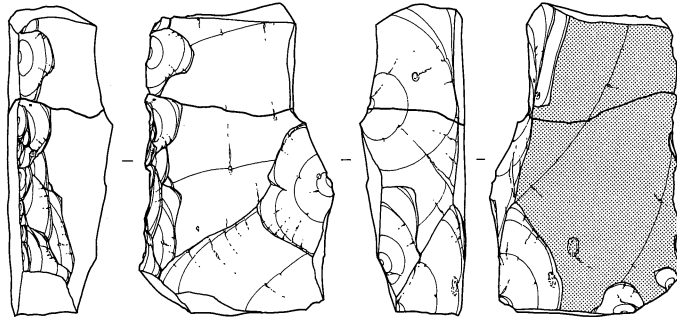

289b
Co An
BL14 38.73g
III V-Q 615

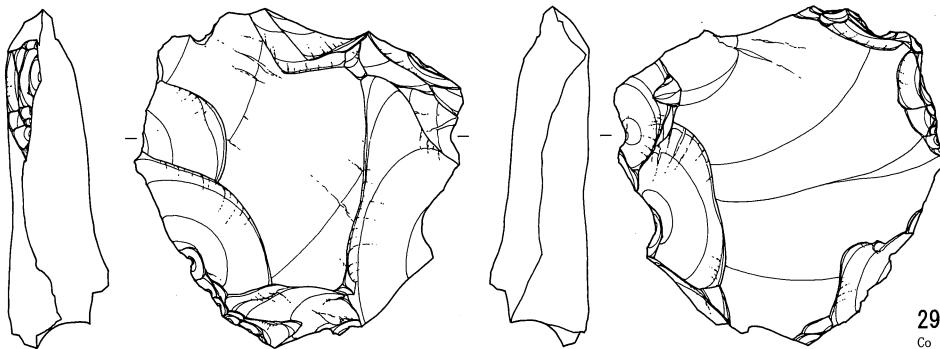

290
Co TS
BL21 69.97g
V a IX-W 279

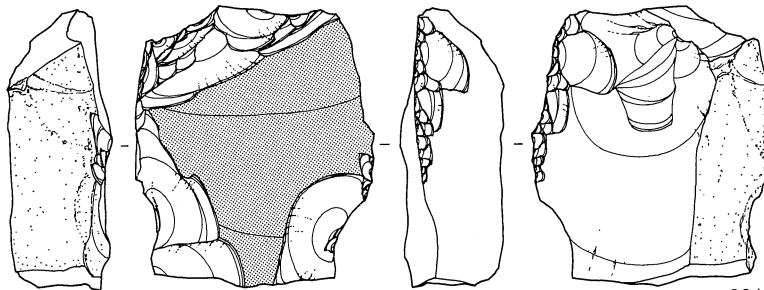
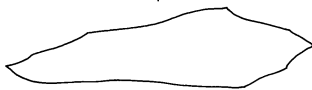

291
Co SS
BL18 55.22g
IVF IX-N 319

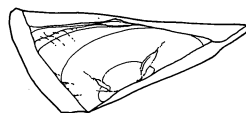

0 (2 : 3) 5cm

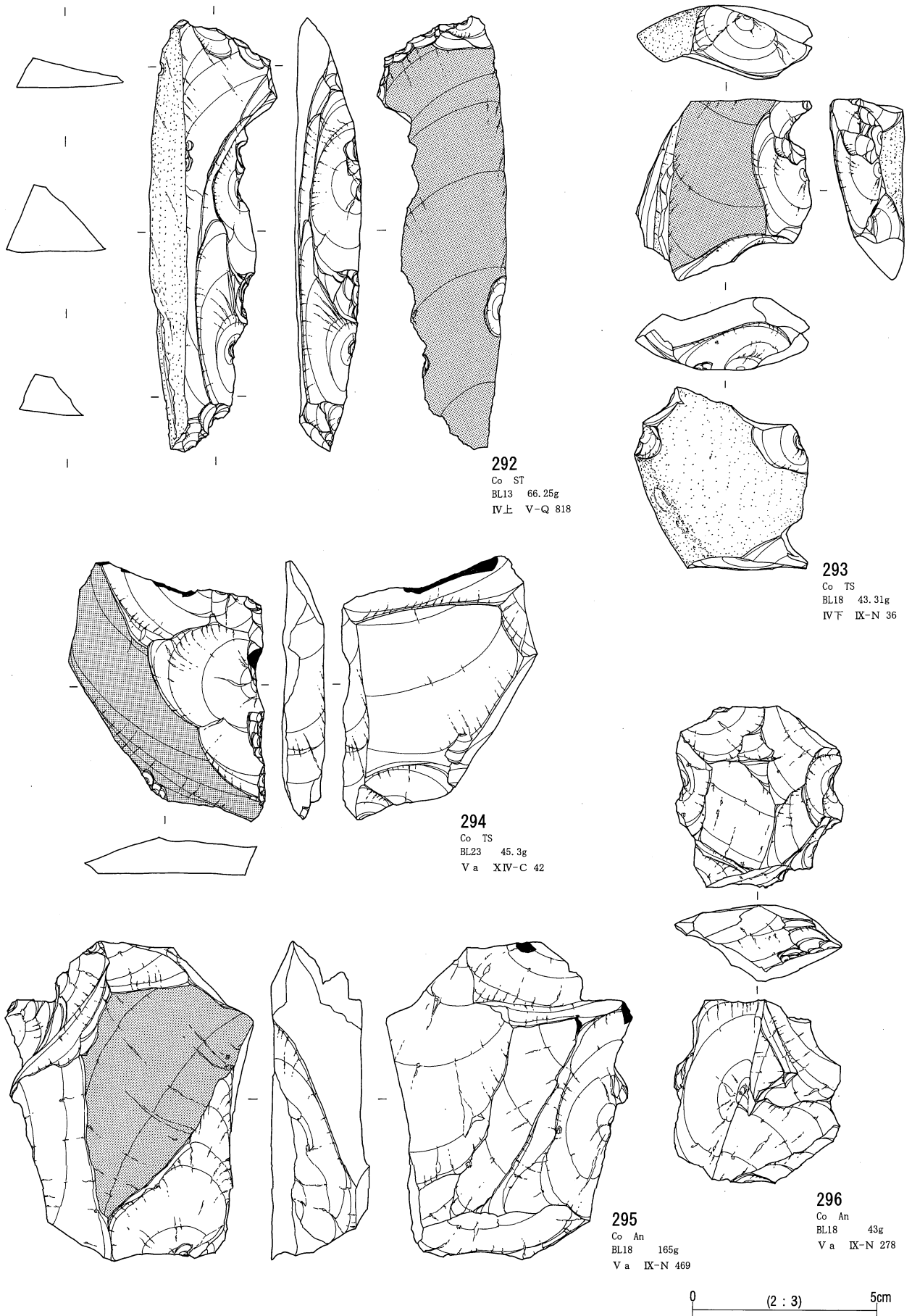

石器実測図 51 (石核 8) (西岡A遺跡)

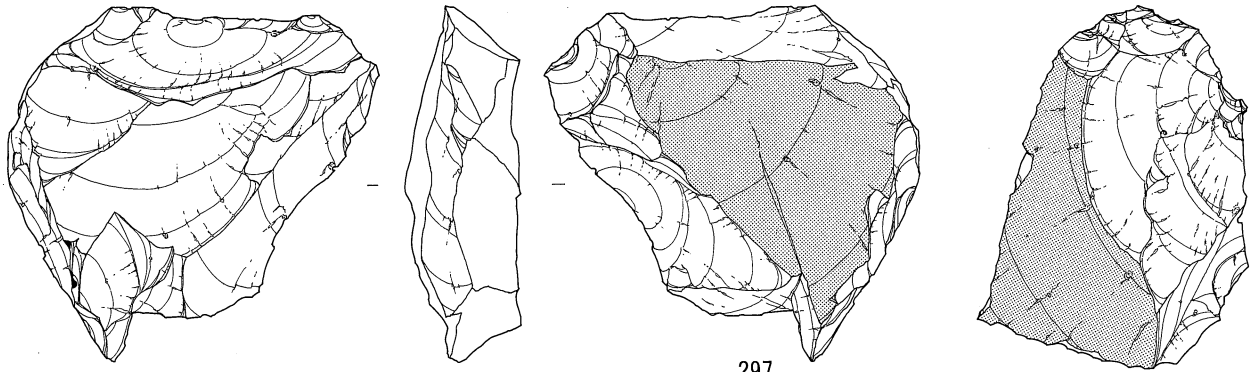

297
Co An
BL18 111.09g
IV上 IX-N 441

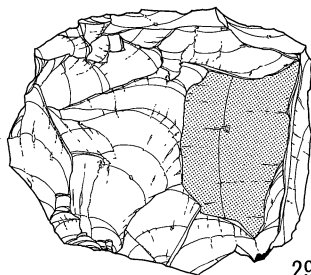
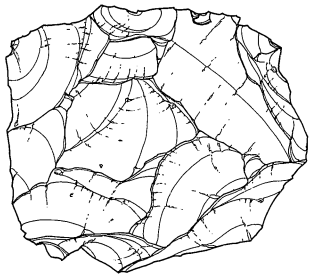
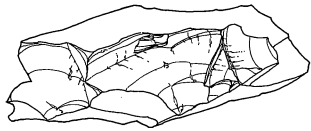

298
Co An
BL18 86.3g
V a IX-N 235

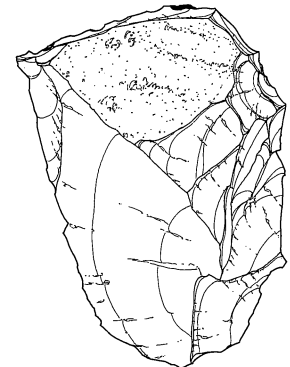
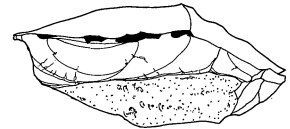

299
Co An
BL18 81.48g
III IX-N 88

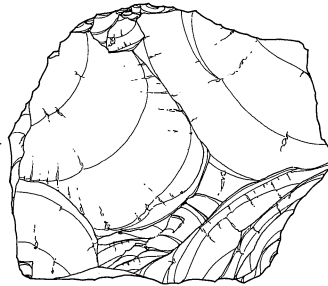
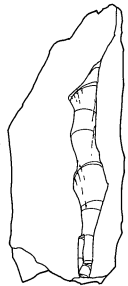
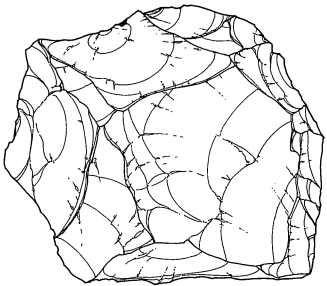

300
Co An
BL18 85.02g
V a IX-N 324

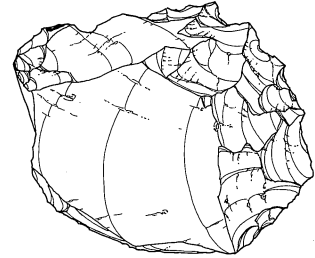
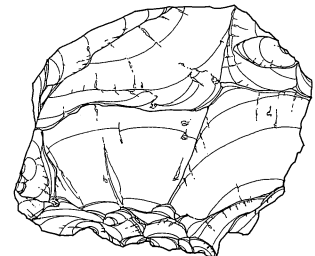

302
Co An
BL18 79.89g
V a IX-N 219

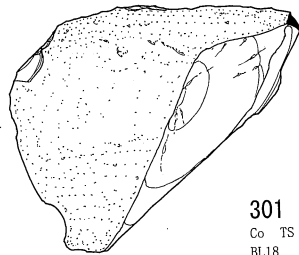
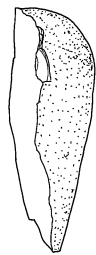

301
Co TS
BL18 36.38g
IV下 IX-N 40

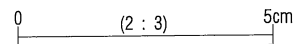

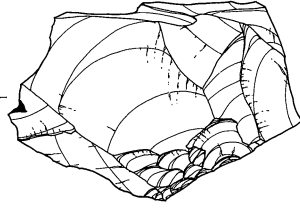
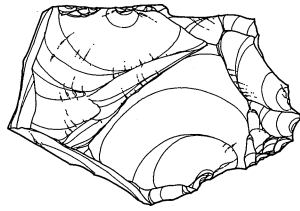
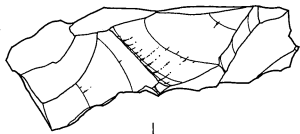

303
Co ST
BL22 35.3g
Va XIV-C 55

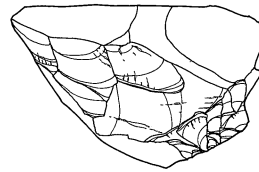
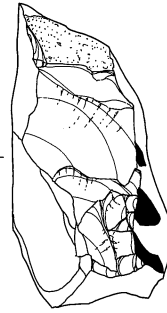
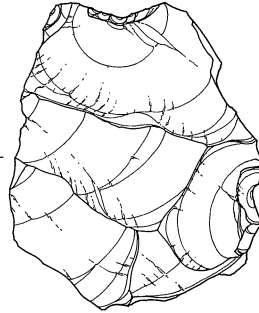
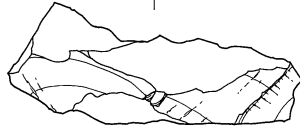

304
Co TS
BL18 90.01g
III IX-N 15

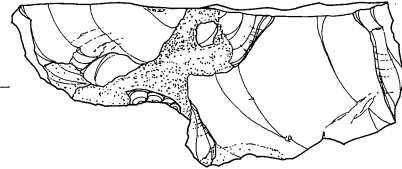
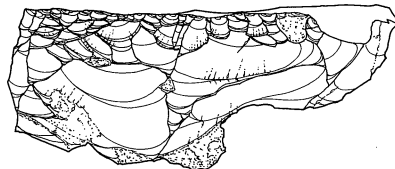
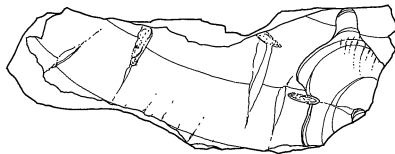

305
Co Ag
BL3 56.76g
III V-S 179

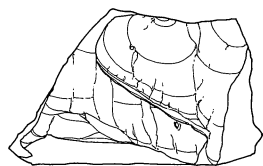
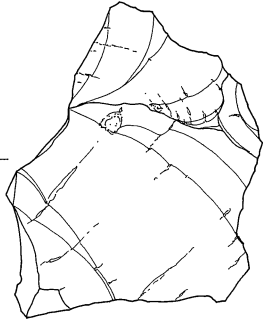
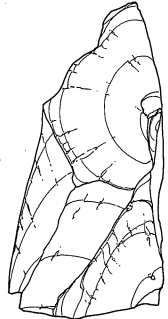
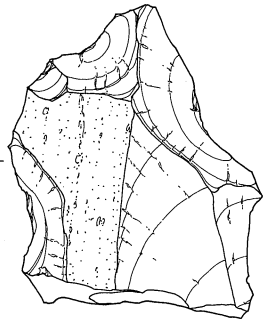

306
Co An
BL20 87.06g
III IX-W 46

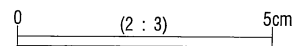

石器実測図 53 (石核 10) (西岡 A 遺跡)

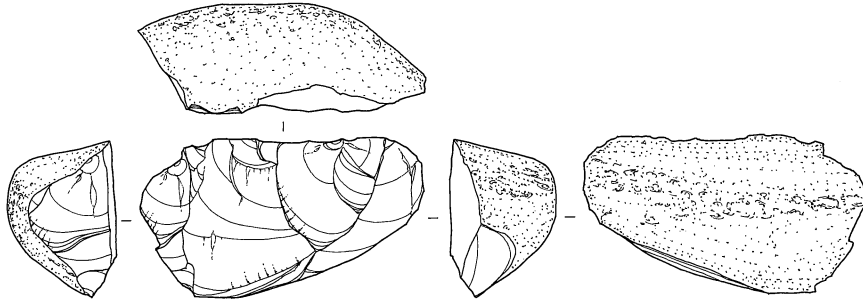

307
Co Ch
BL18 38.23g
III IX-M 4

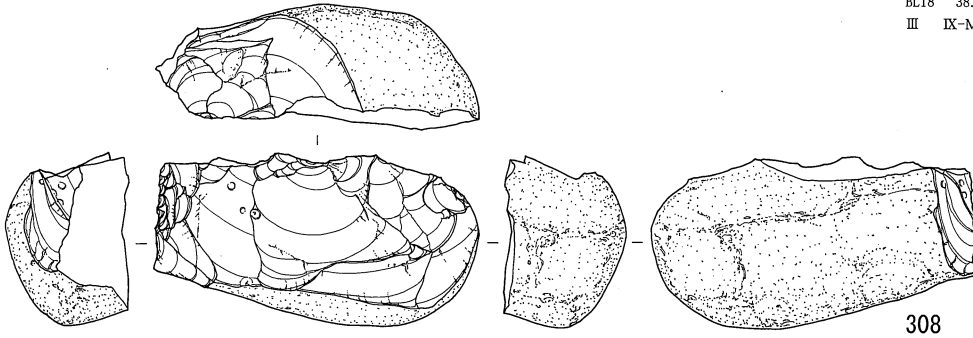

308
Co Ch
BL23 60.98g
V b XIV-C 21

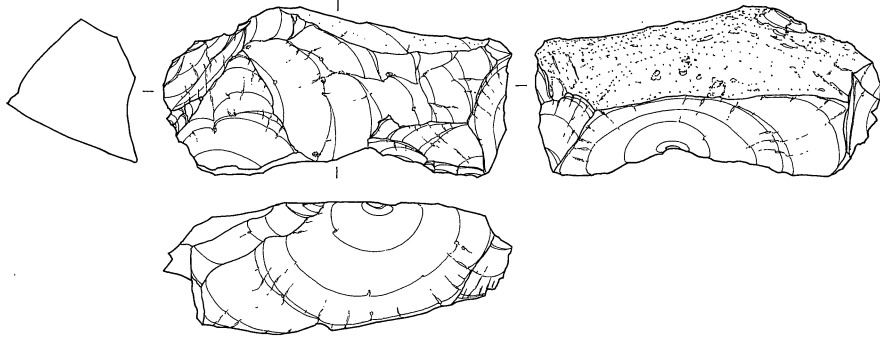

309
Co An
BL20 56.79g
III IX-W 13

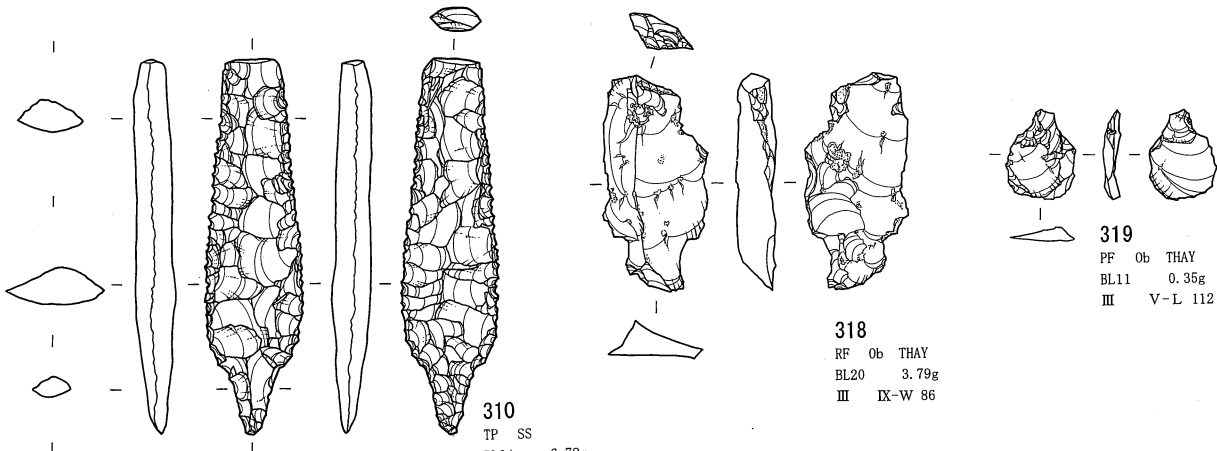
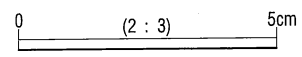

310
TP SS
BL24 6.78g
III XIV-C 10

318
RF Ob THAY
BL20 3.79g
III IX-W 86

319
PF Ob THAY
BL11 0.35g
III V-L 112

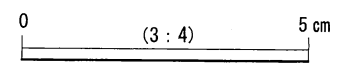

石器実測図 54 (石核 11・有茎尖頭器・剝片・尖頭器調整剝片) (西岡A遺跡)

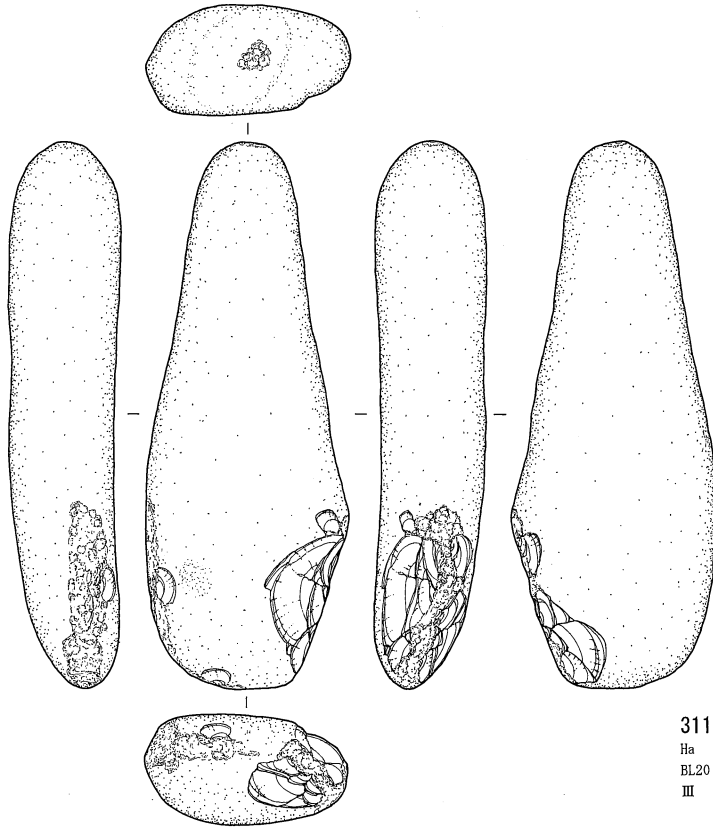

311
 Ha Sa
 BL20 1030.71g
 III IX-W 16

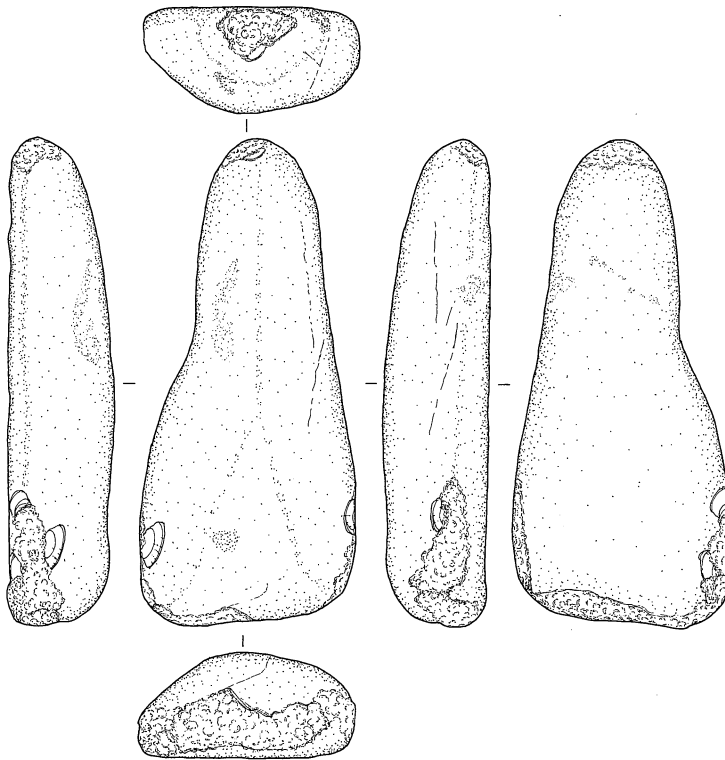

312
 Ha Sa
 BL20 870.68g
 III IX-W 15

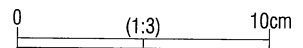

石器実測図 55 (敲石 1) (西岡 A 遺跡)

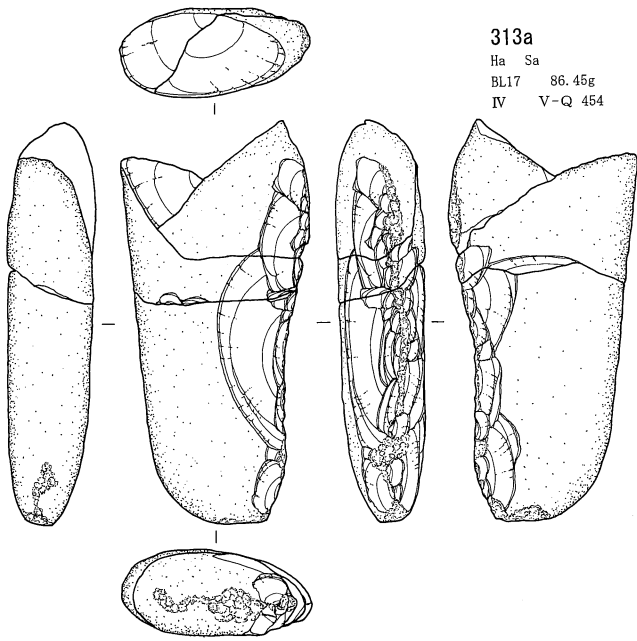

313a
Ha Sa
BL17 86.45g
IV V-Q 454

313b
Ha Sa
BL17 122.05g
IV V-Q 448

313c
Ha Sa
BL17 287.31g
III V-Q 136

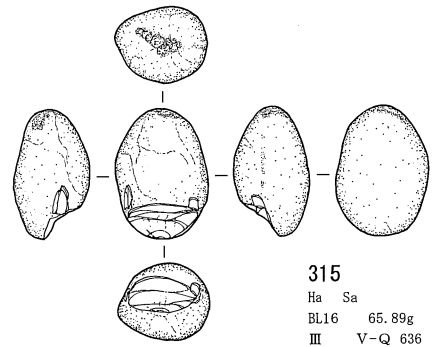

315
Ha Sa
BL16 65.89g
III V-Q 636

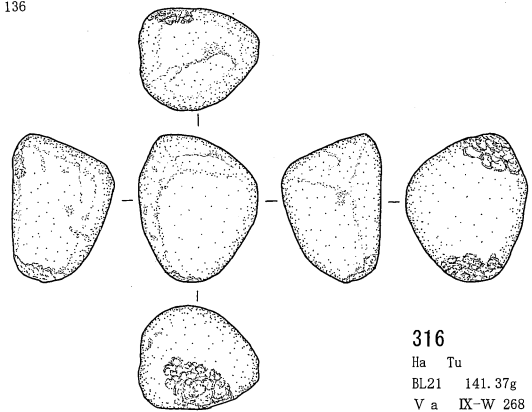

316
Ha Tu
BL21 141.37g
V a IX-W 268

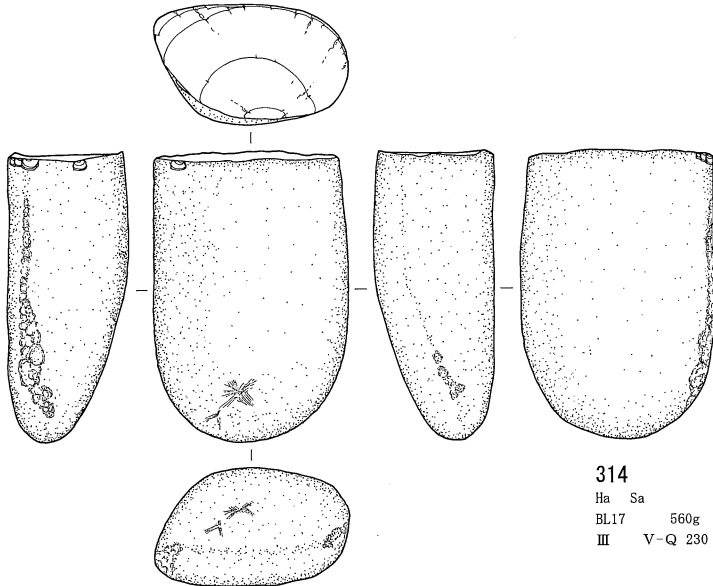

314
Ha Sa
BL17 560g
III V-Q 230

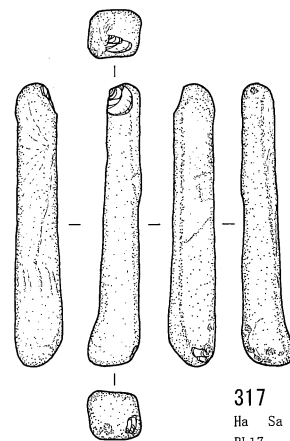

317
Ha Sa
BL17 57.76g
III V-Q 134

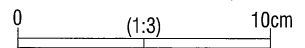

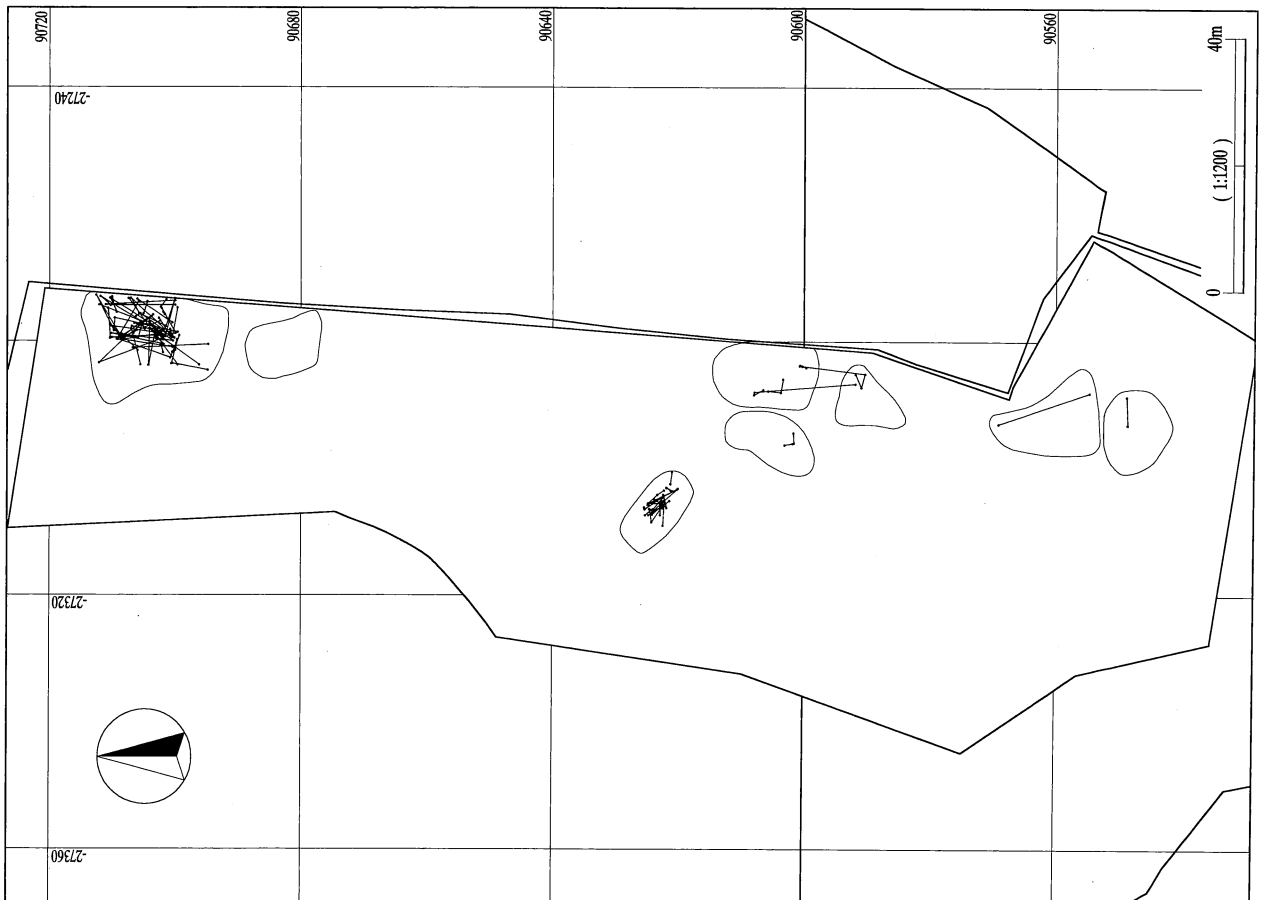

接合資料分布図（全石材）（西岡 A 遺跡）

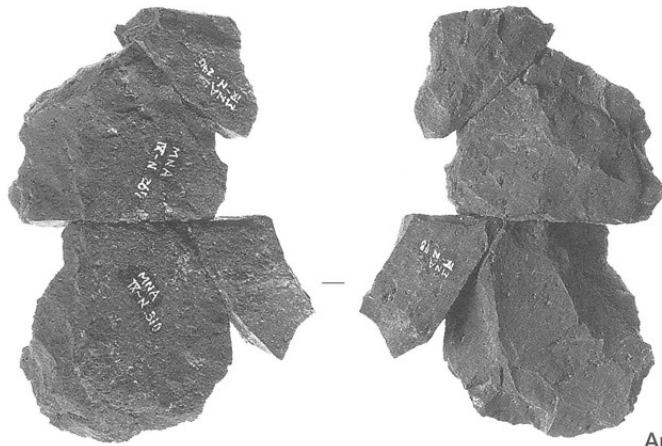

An-62



2

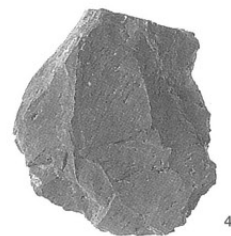

4



An-62 集合写真

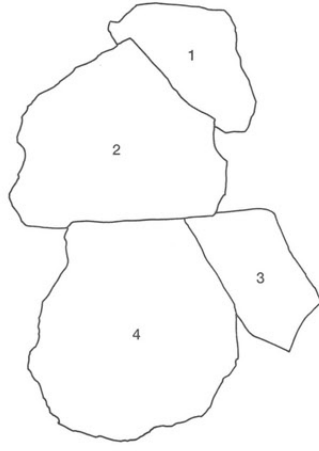

An-62

剥離順序	遺物番号	ブロック	出土層位	器種	重量g	打面	作業面
1	IX-N296	18	V b	Sc	21.8	正面	上
2	IX-N267	18	V a	Sc	81.6		
3	IX-N78	18	Ⅲ	Fl	23	正面	右
4	IX-N310	18	V a	Co	77.3		

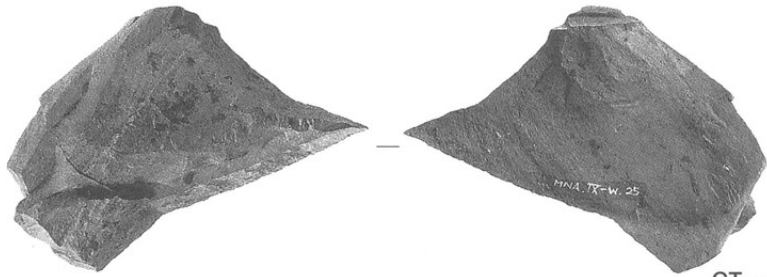

GT-4

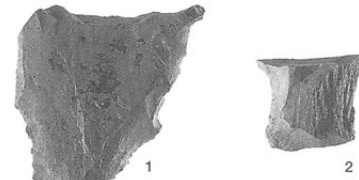

1

2

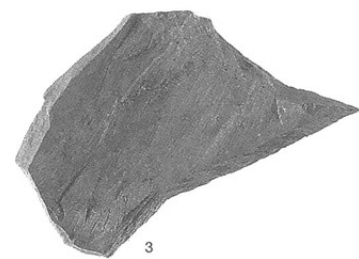

3

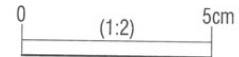

GT-4 集合写真

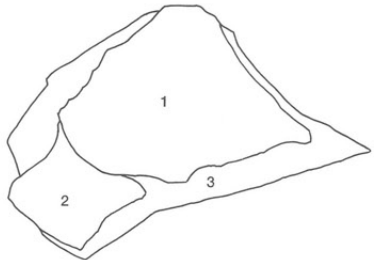

GT-4

剥離順序	遺物番号	ブロック	出土層位	器種	重量g	打面	作業面
1	IX-W75	20	Ⅲ	Sc	45	上	正面
2	IX-W231	20	Ⅳ上	Sc	11.3	上	正面
3	IX-W25	20	Ⅲ	Fl	82.3	上	正面

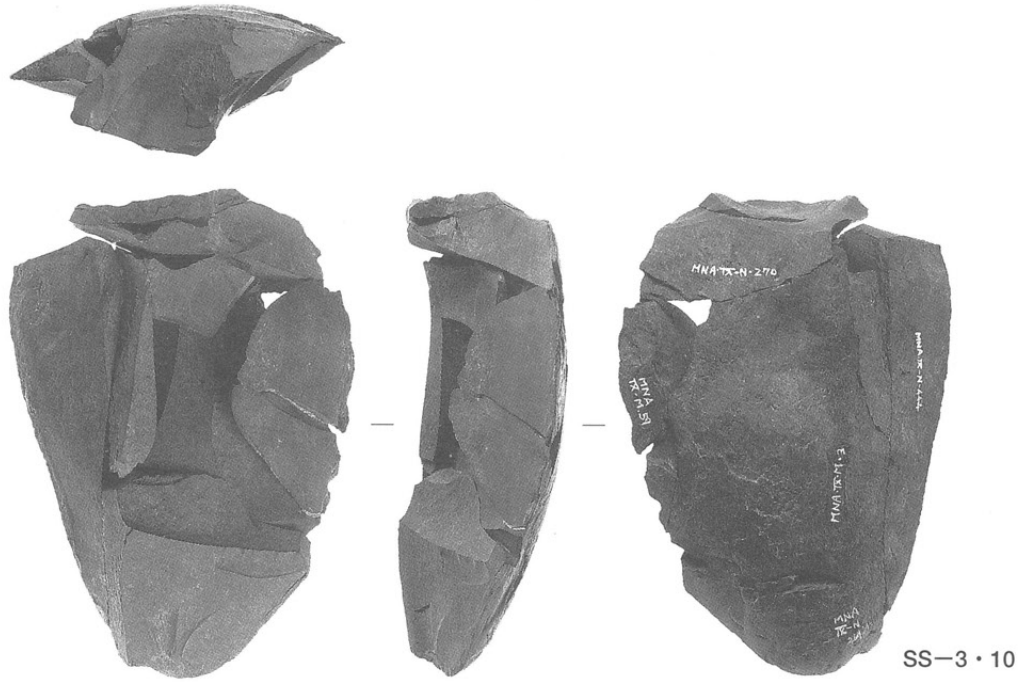

SS-3・10

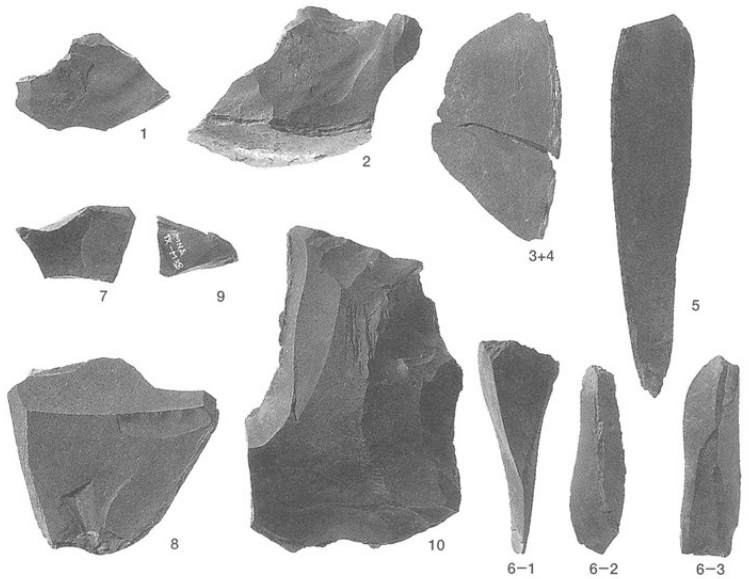
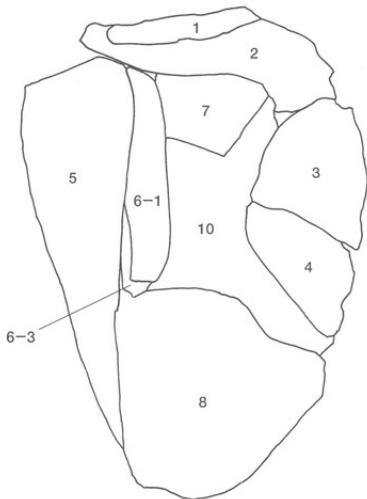

0 (1:2) 5cm

SS-3・10 集合写真

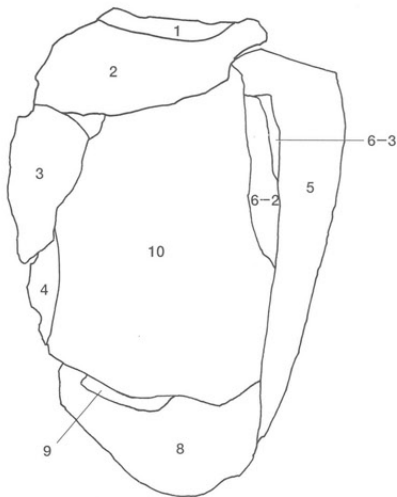

SS-3

剥離順序	遺物番号	ブロック	出土層位	器種	重量g	打面	作業面
1	IX-N161	18	Vb	Fl	5.49	正面	上
2	IX-N270	18	IV上	Fl	32.9	正面	上
3	IX-M59	18	Va	Fl	12.5	上	正面
4	IX-M21	18	Va	Fl	6.87	上	正面
5	IX-N444	18	IV上	Fl	38	上	左
6	SS-10						左
7	IX-M52	18	Va	Fl	5.65	上	正面
8	IX-N214	18	Va	Fl	61.8	上	正面
9	IX-M58	18	Vb	Fl	1.31	裏面	下
10	IX-M3	18	IV下	Co	129		

SS-10

剥離順序	遺物番号	ブロック	出土層位	器種	重量g	打面	作業面
6-1	IX-N144	18	IV下	Fl	9.33	上	左
6-2	IX-M156	18	III	Fl	6.23	上	裏面
6-3	IX-N154	18	IV下	Pe	12.5		

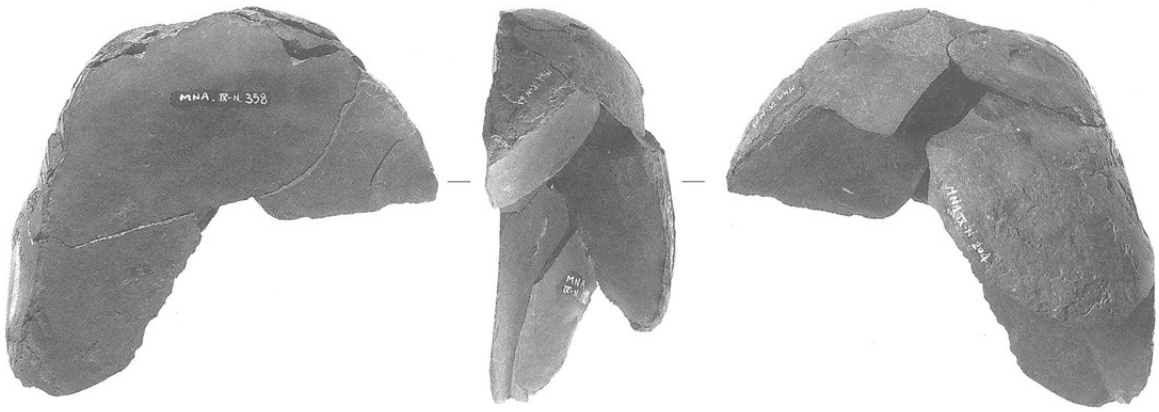

SS-4

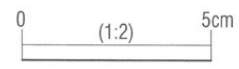
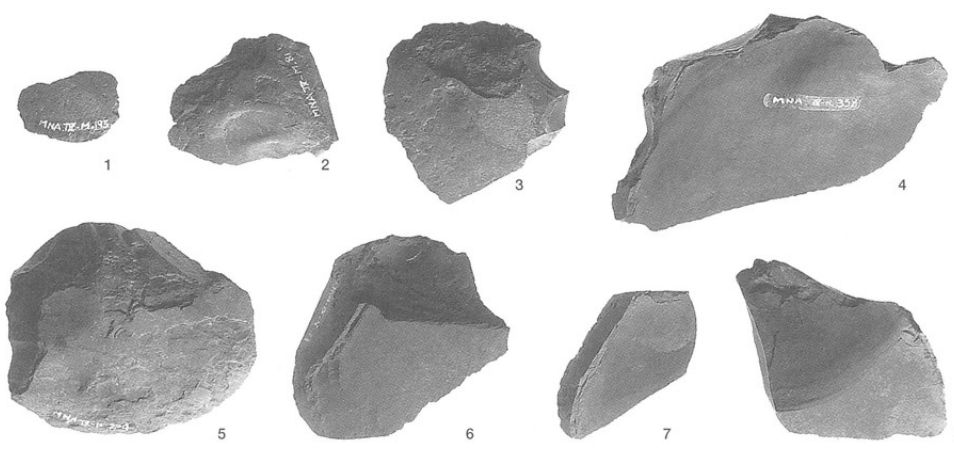
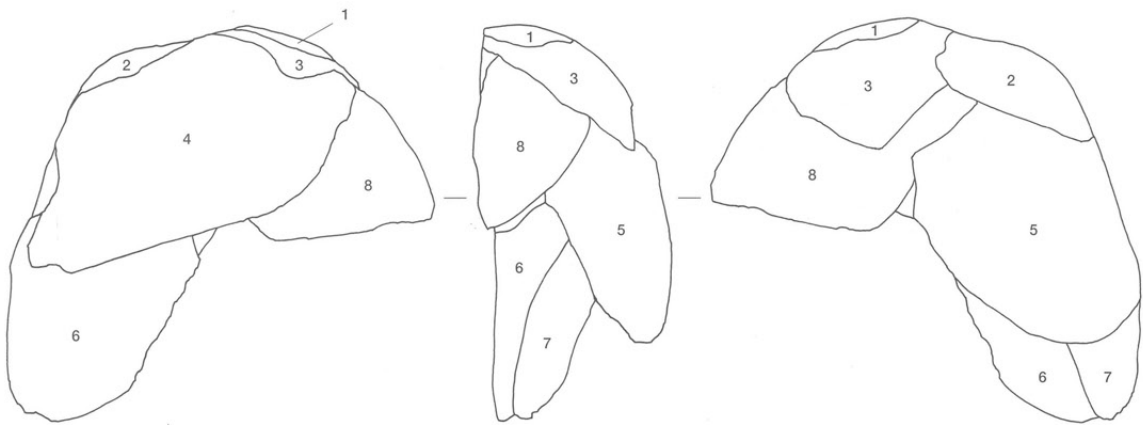

SS-4 集合写真

剥離順序	遺物番号	ブロック	出土層位	器種	重量g	打面	作業面
1	IX-M195	18	IV上	FI	2.26	正面	上
2	IX-M81	18	IV上	FI	17.5	正面	上
3	IX-M100	18	IV下	FI	30.8	正面	上
4	IX-N358	18	Vb	FI	92.8	上	正面
5	IX-N204	18	Va	FI	94.6	上	裏面
6	IX-N33	18	Va	UF	37.2	上	正面
7	IX-N372	18	III	FI	13.8	上	正面
8	IX-N65	18	IV下	FI	56.7	上	正面

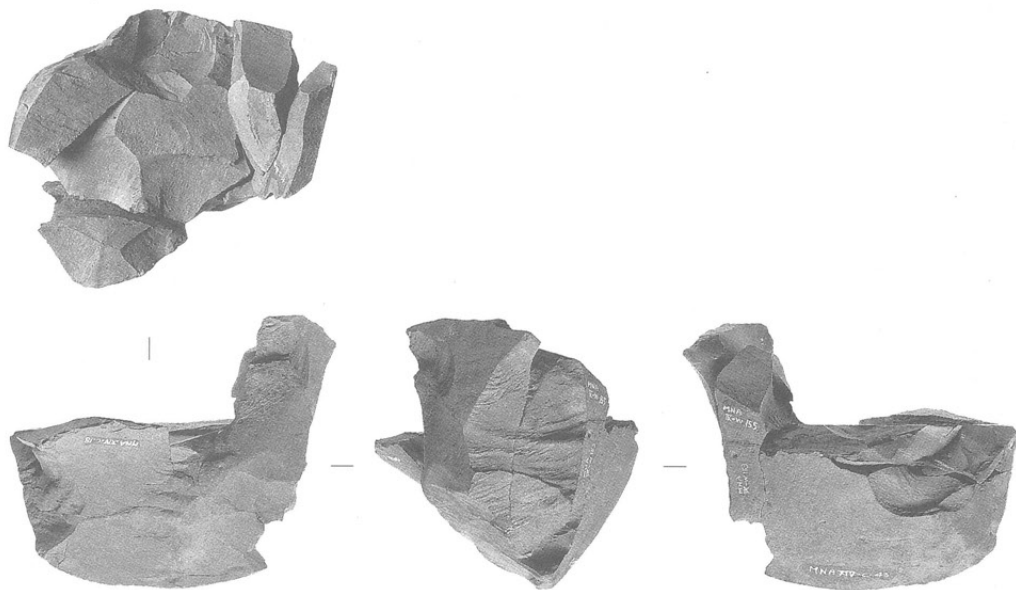

TS-3・16

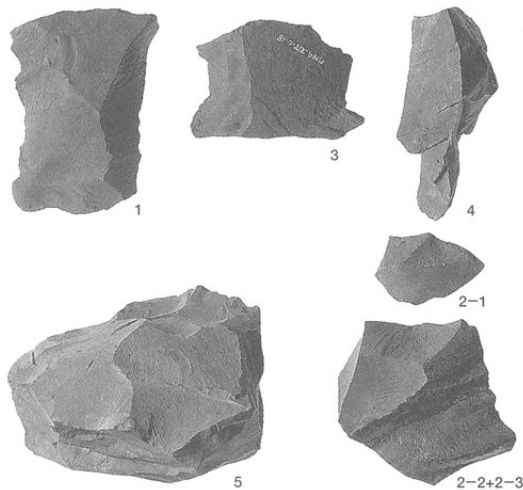
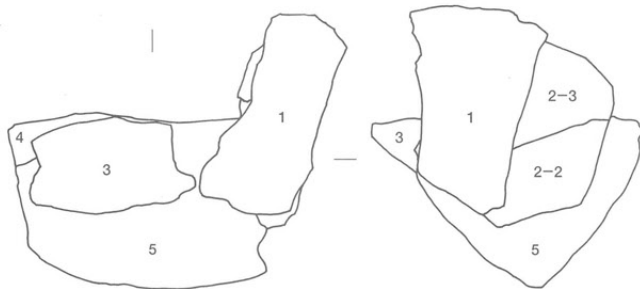
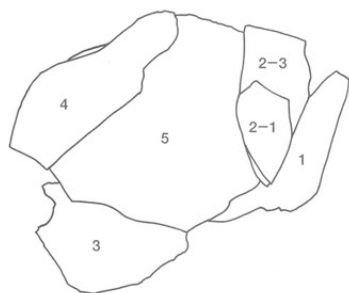

TS-3・16 集合写真

TS-3

剥離順序	遺物番号	ブロック	出土層位	器種	重量g	打面	作業面
1	XIV-C54	22	V a	Fl	86.9	上	右
2	TS-16					上	右
3	XIV-C18	23	IV下	Fl	66.2	上	正面
4	XIV-C37	23	V a	Fl	42.9	正面	上
5	XIV-C43	23	V a	Co	643		

TS-16

剥離順序	遺物番号	ブロック	出土層位	器種	重量g	打面	作業面
2-1	IX-W154	22	IV上	Fl	11.1	右	上
2-2	IX-W153	22	IV下	Fl	38.7	上	右
2-3	IX-W155	22	V a	Co	74.2		

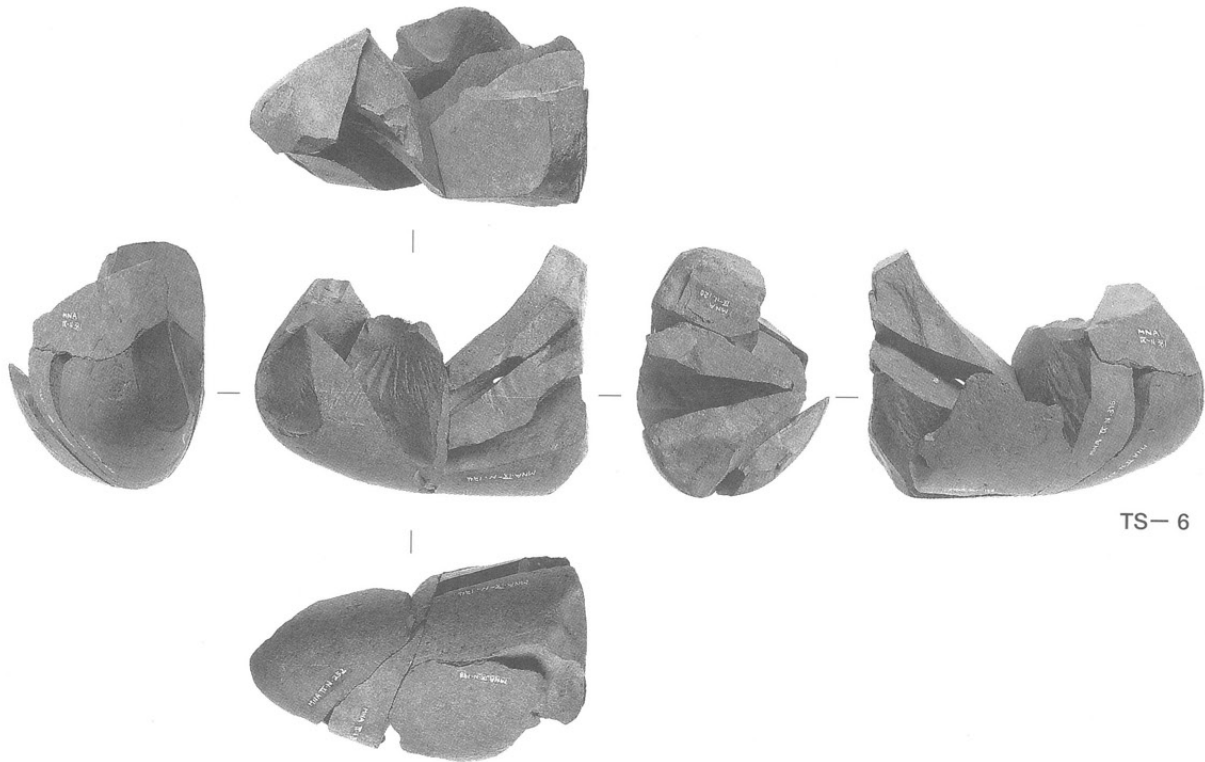

TS-6

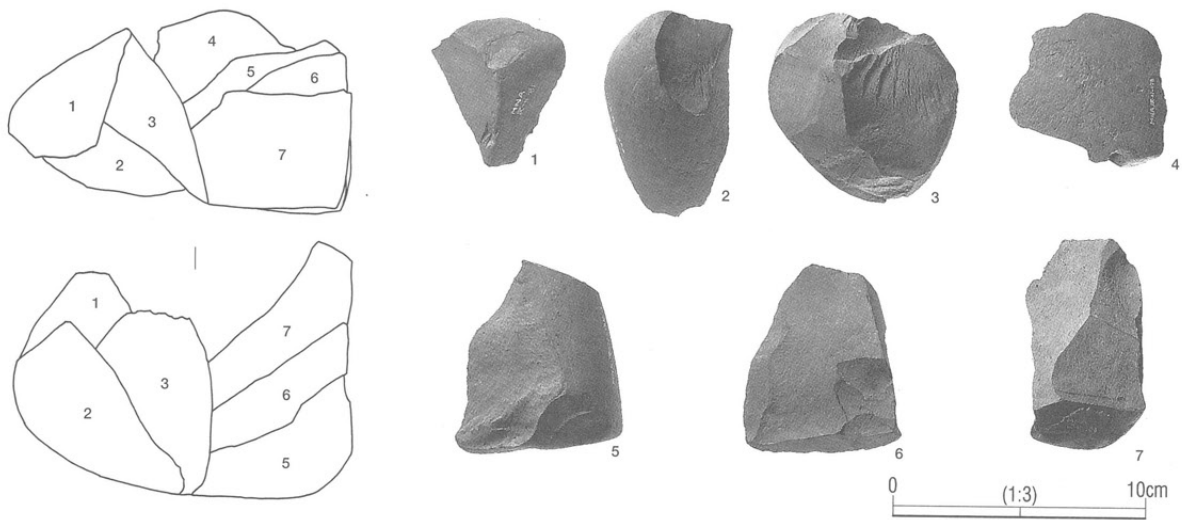

TS-6 集合写真

TS-6

剥離順序	遺物番号	ブロック	出土層位	器種	重量g	打面	作業面
1	IX-N381	18	IV下	F1	43.5	正面	上
2	IX-N252	18	V b	F1	146	上	左
3	IX-N376	18	V a	F1	175	上	左
4	IX-N198	18	IV下	F1	65.3	左	裏面
5	IX-N124	18	V a	F1	143	左	下
6	IX-N382	18	IV下	F1	93.7	左	下
7	IX-N120	18	IV下	F1	134	左	下

長野県埋蔵文化財センター発掘調査報告書 48

上信越自動車道埋蔵文化財発掘調査報告書15

— 信濃町内 その1 —

貫ノ木遺跡・西岡A遺跡

旧石器時代

遺構・遺物図版編

発行 平成 12 年 3 月 31 日
発行者 日本道路公団
長野県教育委員会
(財)長野県文化振興事業団
長野県埋蔵文化財センター
TEL 026-274-3891 FAX 274-3892
印刷 カシヨ株式会社
TEL 026-251-0510 FAX 251-0500

