

上信越自動車道  
埋蔵文化財発掘調査報告書 15

—信濃町内 その1—

かん の き 遺 跡  
貫 ノ 木 遺 跡  
にし おか  
西 岡 A 遺 跡

旧石器時代

遺構・遺物図版編

2000

日 本 道 路 公 団  
長 野 県 教 育 委 員 会  
長 野 県 埋 蔵 文 化 財 セ ン タ ー



上信越自動車道  
埋蔵文化財発掘調査報告書 15

—信濃町内 その1—

かん の き  
貫 ノ 木 遺 跡  
にし おか  
西 岡 A 遺 跡

旧石器時代

遺構・遺物図版編

2000

日 本 道 路 公 団  
長 野 県 教 育 委 員 会  
長 野 県 埋 蔵 文 化 財 セ ン タ ー

## 凡 例

1. 本書に掲載した実測図は原則として下記のとおりである。また、それぞれの図版右下隅にスケールを付した。

主な遺構実測図

全体図 1:800・1:1000・1:1200・1:2000      ブロック 1:40・1:80・1:100・1:120

礫群 1:40・1:60・1:80

主な遺物実測図

中・小形石器 3:4      大形石器 2:3・1:2・1:3

2. 本書に掲載した遺物写真の縮尺は下記のとおりである。  
1:1・3:4・2:3・1:2を原則とした。それぞれのプレートの右下隅に縮尺を示した。
3. ブロック別の遺物分布図に付した石器実測図の縮尺は原則として1:2であるが、大形石器については1:3他のものも含まれる。
4. ブロック別の遺物分布図の中で、平面分布は器種によって記号を変えてある。それぞれの記号は以下のとおりである。また、平面図の遺物に付された番号は遺物実測図の番号と対応する。

|   |          |   |            |   |        |   |           |
|---|----------|---|------------|---|--------|---|-----------|
| ◇ | ナイフ形石器   | ■ | 楔形石器       | Ⓝ | 挟入削器   | Ⓒ | 磨石        |
| ▽ | 台形石器     | Ⓛ | 石刃         | ⓓ | 鋸歯縁状削器 | Ⓦ | 砥石        |
| ● | 貝殻状刃器    | ○ | 2次加工のある剥片  | Ⓢ | 削片     | Ⓐ | 台石        |
| ◆ | 槍先形尖頭器   | ● | 微細剥離痕のある剥片 | Ⓣ | 折断剥片   | Ⓜ | 原石        |
| ▲ | 斧形石器     | □ | 石核         | △ | 角錐状石器  | Ⓤ | 有孔石製品     |
| ☆ | 削器       | * | 敲石         | Ⓜ | 細石核    | ▲ | 斧形石器関係の剥片 |
| ★ | 搔器・搔器状石器 | ◇ | 剥片尖頭器      | ⓑ | 細石刃    | ● | 剥片・破片     |
| Ⓟ | 彫器       | ◆ | 有茎尖頭器      | Ⓟ | 凹石・礫器  | ◇ | 礫         |
| Ⓠ | 揉錐器      | ◆ | 厚刃搔器       |   |        |   |           |

5. ブロック別の遺物分布図の中で、垂直分布は出土層位によって記号をかえてある。それぞれの記号は以下のとおりである。

|   |                 |   |                  |
|---|-----------------|---|------------------|
| ▲ | IV層・IV上面～IV下部   | □ | Vb層・Vb上面～Vb下部・V層 |
| Ⓞ | Va層・Va層上面～Va層下部 | ・ | その他              |

6. 接合資料の分布図で描かれている線は、石器分布図では剥離された順番で、礫分布図では遺物番号順に結ばれている。
7. 石器実測図・表・図中の器種・石材・黒曜石産地の略称は以下のとおりである。

器種略称

|     |        |    |           |    |        |      |          |
|-----|--------|----|-----------|----|--------|------|----------|
| Kn  | ナイフ形石器 | Pe | 楔形石器      | DS | 鋸歯縁状削器 | Wh   | 砥石       |
| Tr  | 台形石器   | B1 | 石刃        | Sp | 削片     | An   | 台石       |
| SB  | 貝殻状刃器  | RF | 2次加工のある剥片 | CF | 折断剥片   | 原石   | 原石       |
| Po  | 槍先形尖頭器 | UF | 微細剥離のある剥片 | Bo | 角錐状石器  | 有孔   | 有孔石製品    |
| Ax  | 斧形石器   | Co | 石核        | MC | 細石核    | AF   | 斧形石器調整剥片 |
| Sc  | 削器     | Ha | 敲石        | MB | 細石刃    | Ax 刃 | 斧形石器刃部破片 |
| ES  | 搔器     | 剥尖 | 剥片尖頭器     | Ps | 凹石     | PF   | 尖頭器調整剥片  |
| ESS | 搔器状石器  | TP | 有茎尖頭器     | PT | 礫器     | Fl   | 剥片       |
| Gr  | 彫器     | NS | 挟入削器      | GS | 磨石     | Ch   | 破片       |
| Dr  | 揉錐器    | AS | 厚刃搔器      |    |        |      |          |

その他それぞれの器種の破片には略称の後に破という文字を付してある。

石材略称

|    |         |    |       |    |     |    |         |
|----|---------|----|-------|----|-----|----|---------|
| Ob | 黒曜石     | TS | 凝灰質頁岩 | Se | 蛇紋岩 | Rh | 流紋岩     |
| An | 無斑晶質安山岩 | GT | 緑色凝灰岩 | Qu | 石英  | Ho | ホルンフェルス |
| SS | 珪質頁岩    | Ag | 玉髄    | Cr | 水晶  | Gr | 花崗岩     |
| Sh | 頁岩      | Ch | チャート  | Sl | 粘板岩 | Ge | 下呂石     |
| ST | 珪質凝灰岩   | Sa | 砂岩    | Ja | 鉄石英 | 安山 | その他の安山岩 |

黒曜石産地群記号

| 都道府県 | エリア    | 判別群    | 記号   | 都道府県 | エリア    | 判別群   | 記号   | 都道府県 | エリア  | 判別群 | 記号   |
|------|--------|--------|------|------|--------|-------|------|------|------|-----|------|
| 長野   | 和田(WD) | 鷹山群    | WDTY | 長野   | 和田(WO) | ブドウ沢群 | WOBD | 長野   | 蓼科   | 冷山群 | TSTY |
|      |        | 小深沢群   | WDKB |      |        | 牧ヶ沢群  | WOMS |      |      |     |      |
|      |        | 土屋橋北群  | WDTK |      |        | 高松沢群  | WOTM |      |      |     |      |
|      |        | 土屋橋西群  | WDTN |      |        | 諏訪    | 星ヶ台群 |      |      |     |      |
|      |        | 土屋橋南群  | WDTM |      |        |       |      |      |      |     |      |
|      |        | 芙蓉ライト群 | WDHY |      | 青森     | 深浦    | 八森山群 |      |      |     |      |
| 古峠群  | WDHT   | 東京     | 神津島  | 恩馳島群 | KZOB   | 秋田    | 男鹿   | 金ヶ崎群 | OGKS |     |      |

石器実測図・表・図中の出土層位は、上面・上部・中部・下部を上面・上・中・下に省略してある。また、「層」の文字も省略して表記した。

8. 石器実測図に付したキャプションの見方は以下のとおりである。

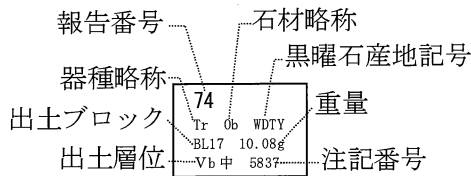

9. 石器実測図中のスクリーントーンは薄いものが、主要剥離面以外のポジ面および、石核にみられるポジ面を、濃いものが砥石等の磨面および、斧形石器の方向不明の研磨面をあらわす。また、発掘調査時と思われる新しい剥離面は黒く塗りつぶしてある。

10. 石器の長さ・幅・厚さの計測方法は以下のとおりである。

長さ・幅：石器の主軸方向を上下の基準として方眼紙に置き、長方形を想定し、上下（縦方向）長さ、左右（横方向）を幅とした。

厚さ：最も厚い箇所を、主要剥離面から垂直方向で計測した。



## 図版目次

|   |   |
|---|---|
| <p>貫ノ木遺跡第1地点 BL 石器全点……………図版 1</p> <p>貫ノ木遺跡第1地点 ブロック配置図……………図版 2</p> <p>貫ノ木遺跡第1地点 礫群……………図版 3</p> <p>貫ノ木遺跡第1地点 礫群配置図……………図版 4</p> <p>貫ノ木遺跡第1地点 遺物分布図<br/>ブロック……………図版 5</p> <p>貫ノ木遺跡第1地点 石器実測図</p> <p>ナイフ形石器……………図版 19</p> <p>台形石器……………図版 26</p> <p>槍先形尖頭器……………図版 27</p> <p>角錐状石器……………図版 29</p> <p>斧形石器……………図版 30</p> <p>彫器……………図版 31</p> <p>揉錐器……………図版 33</p> <p>搔器……………図版 34</p> <p>搔器状石器……………図版 42</p> <p>削器……………図版 43</p> <p>楔形石器・2次加工のある剥片……………図版 44</p> <p>敲石……………図版 45</p> <p>石核……………図版 47</p> <p>貫ノ木遺跡第1地点 接合資料分布図……………図版 51</p> <p>貫ノ木遺跡第2地点 BL 石器全点……………図版 52</p> <p>貫ノ木遺跡第2地点 ブロック配置図……………図版 53</p> <p>貫ノ木遺跡第2地点 礫群……………図版 54</p> <p>貫ノ木遺跡第2地点 礫群配置図……………図版 55</p> <p>貫ノ木遺跡第2地点 遺物分布図<br/>ブロック……………図版 56</p> <p>貫ノ木遺跡第2地点 石器実測図</p> <p>ナイフ形石器……………図版 113</p> <p>台形石器……………図版 128</p> <p>貝殻状刃器……………図版 132</p> <p>槍先形尖頭器……………図版 133</p> <p>斧形石器……………図版 137</p> <p>彫器……………図版 140</p> | <p>揉錐器・搔器……………図版 150</p> <p>楔形石器……………図版 165</p> <p>細石刃……………図版 166</p> <p>敲石……………図版 167</p> <p>磨石……………図版 171</p> <p>石核……………図版 172</p> <p>貫ノ木遺跡第2地点 接合資料分布図……………図版 184</p> <p>貫ノ木遺跡第2地点 接合資料……………図版 187</p> <p>貫ノ木遺跡第3地点 BL 石器全点……………図版 191</p> <p>貫ノ木遺跡第3地点 ブロック配置図……………図版 192</p> <p>貫ノ木遺跡第3地点 礫群……………図版 193</p> <p>貫ノ木遺跡第3地点 礫群配置図……………図版 194</p> <p>貫ノ木遺跡第3地点 遺物分布図<br/>ブロック……………図版 195</p> <p>貫ノ木遺跡第3地点 石器実測図</p> <p>ナイフ形石器……………図版 223</p> <p>台形石器……………図版 231</p> <p>貝殻状刃器……………図版 241</p> <p>槍先形尖頭器……………図版 244</p> <p>斧形石器……………図版 245</p> <p>彫器……………図版 253</p> <p>搔器……………図版 256</p> <p>搔器状石器……………図版 259</p> <p>厚刃搔器……………図版 260</p> <p>削器……………図版 262</p> <p>楔形石器……………図版 266</p> <p>細石刃……………図版 268</p> <p>砥石……………図版 269</p> <p>敲石……………図版 271</p> <p>石核……………図版 273</p> <p>貫ノ木遺跡第3地点 接合資料分布図……………図版 295</p> <p>貫ノ木遺跡第3地点 接合資料……………図版 298</p> <p>貫ノ木遺跡第4地点 BL 石器全点……………図版 306</p> <p>貫ノ木遺跡第4地点 ブロック配置図……………図版 307</p> |
|---|---|

|           |                 |            |         |                   |        |
|-----------|-----------------|------------|---------|-------------------|--------|
| 貫ノ木遺跡第4地点 | 礫群……………         | 図版 308     | 西岡 A 遺跡 | BL 石器全点……………      | 図版 483 |
| 貫ノ木遺跡第4地点 | 礫群配置図……………      | 図版 309     | 西岡 A 遺跡 | ブロック配置図……………      | 図版 484 |
| 貫ノ木遺跡第4地点 | 遺物分布図           |            | 西岡 A 遺跡 | 礫群……………           | 図版 485 |
|           | ブロック……………       | 図版 310     | 西岡 A 遺跡 | 礫群配置図……………        | 図版 486 |
| 貫ノ木遺跡第4地点 | 石器実測図           |            | 西岡 A 遺跡 | 遺物分布図ブロック……………    | 図版 487 |
|           | ナイフ形石器……………     | 図版 376     | 西岡 A 遺跡 | 石器実測図             |        |
|           | 台形石器……………       | 図版 386     |         | ナイフ形石器……………       | 図版 517 |
|           | 貝殻状刃器……………      | 図版 393     |         | 台形石器……………         | 図版 527 |
|           | 槍先形尖頭器……………     | 図版 396     |         | 槍先形尖頭器……………       | 図版 528 |
|           | 斧形石器……………       | 図版 397     |         | 角錐状石器……………        | 図版 533 |
|           | 彫器……………         | 図版 404     |         | 彫器……………           | 図版 534 |
|           | 揉錐器……………        | 図版 405     |         | 搔器……………           | 図版 538 |
|           | 搔器……………         | 図版 406     |         | 削器……………           | 図版 543 |
|           | 搔器状石器……………      | 図版 413     |         | 挟入削器……………         | 図版 552 |
|           | 厚刃削器……………       | 図版 416     |         | 揉錐器……………          | 図版 554 |
|           | 削器……………         | 図版 417     |         | 楔形石器……………         | 図版 555 |
|           | 鋸齒縁石器・楔形石器…………… | 図版 427     |         | 石刃……………           | 図版 556 |
|           | 石刃……………         | 図版 436     |         | 削片……………           | 図版 558 |
|           | 折断剥片・砥石……………    | 図版 437・460 |         | 剥片……………           | 図版 559 |
|           | 凹石……………         | 図版 439     |         | 石核……………           | 図版 560 |
|           | 敲石……………         | 図版 440     |         | 有茎尖頭器・剥片・尖頭器調整剥片… | 図版 570 |
|           | 磨石……………         | 図版 442     |         | 敲石……………           | 図版 571 |
|           | 石核……………         | 図版 444     | 西岡 A 遺跡 | 接合資料分布図……………      | 図版 573 |
| 貫ノ木遺跡第4地点 | 接合資料分布図…        | 図版 461     | 西岡 A 遺跡 | 接合資料……………         | 図版 574 |
| 貫ノ木遺跡第4地点 | 接合資料……………       | 図版 464     |         |                   |        |

# 貫ノ木遺跡 第1地点

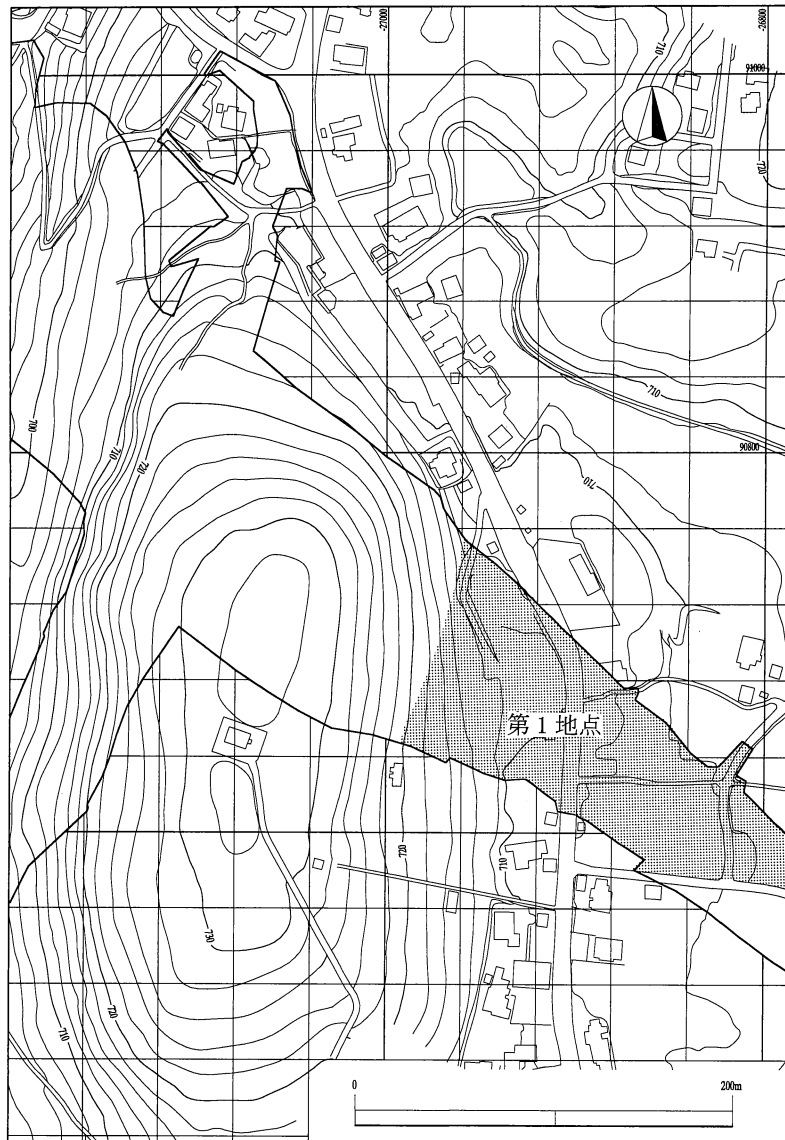



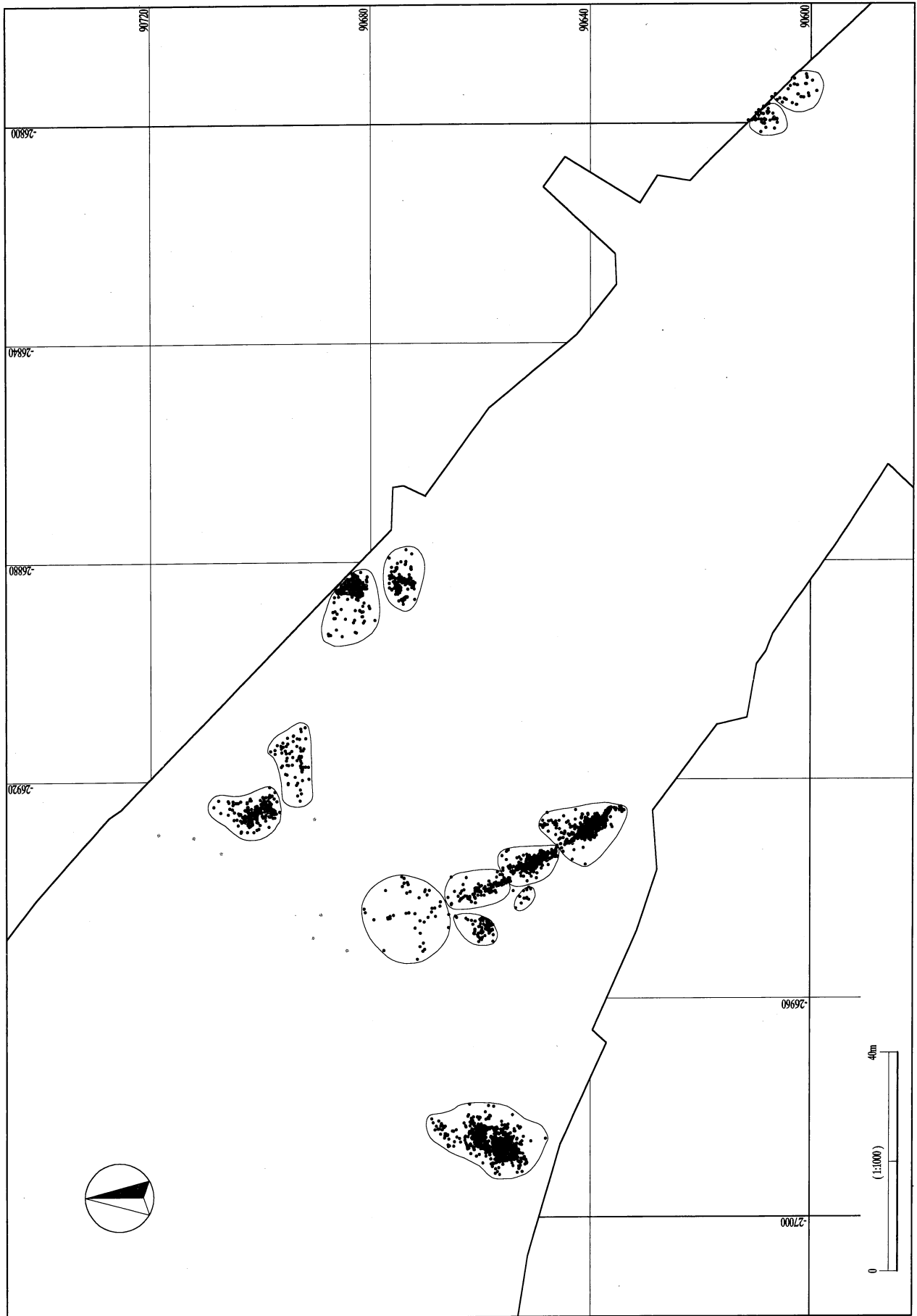

第1地点 BL石器全点 (貫ノ木遺跡)

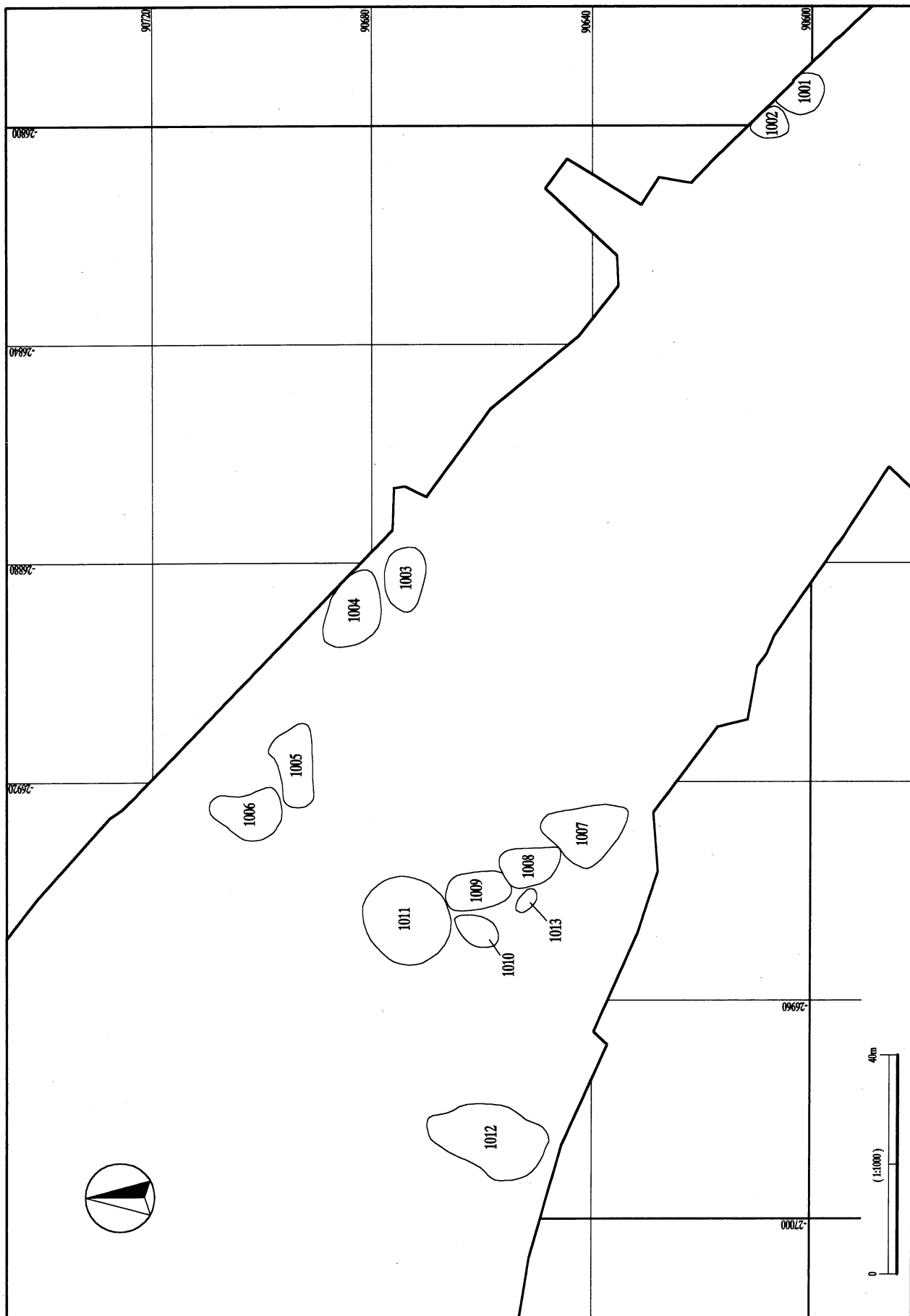

第1地点 ブロック配置図 (貫ノ木遺跡)

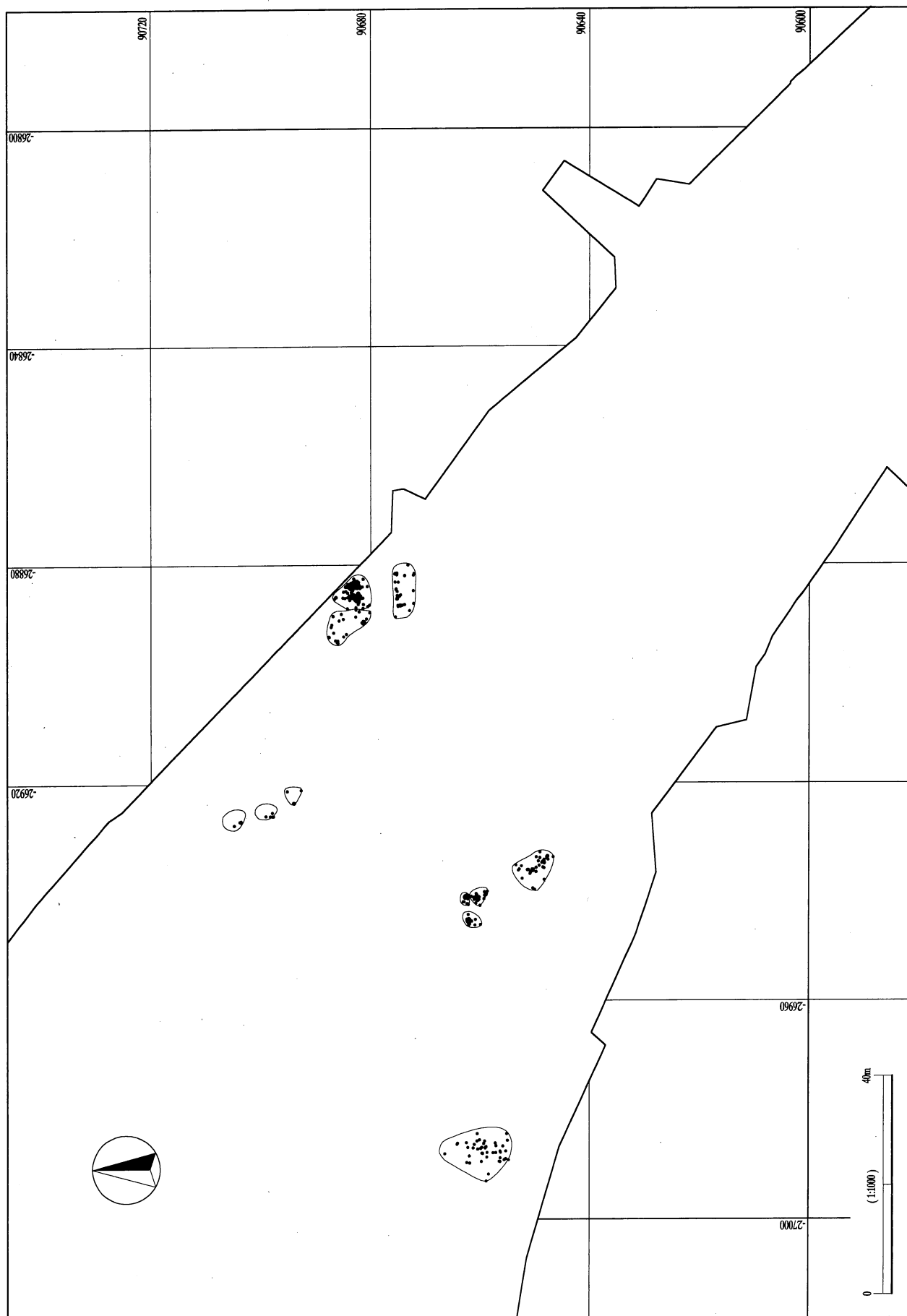

第1地点 礫群（礫群範囲入り）（貫ノ木遺跡）



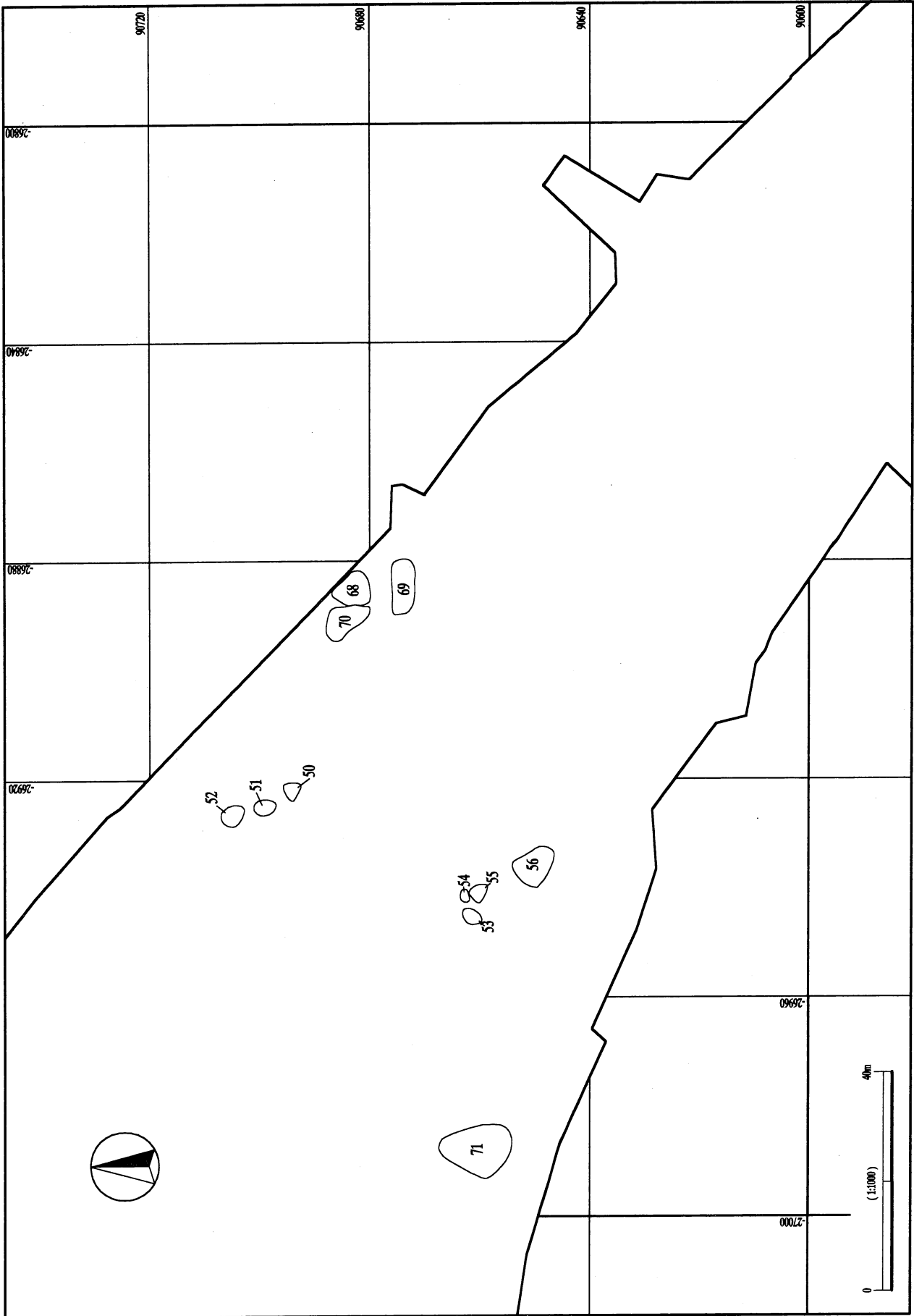

第1地点 礫群配置図 (貫ノ木遺跡)

BL 1001

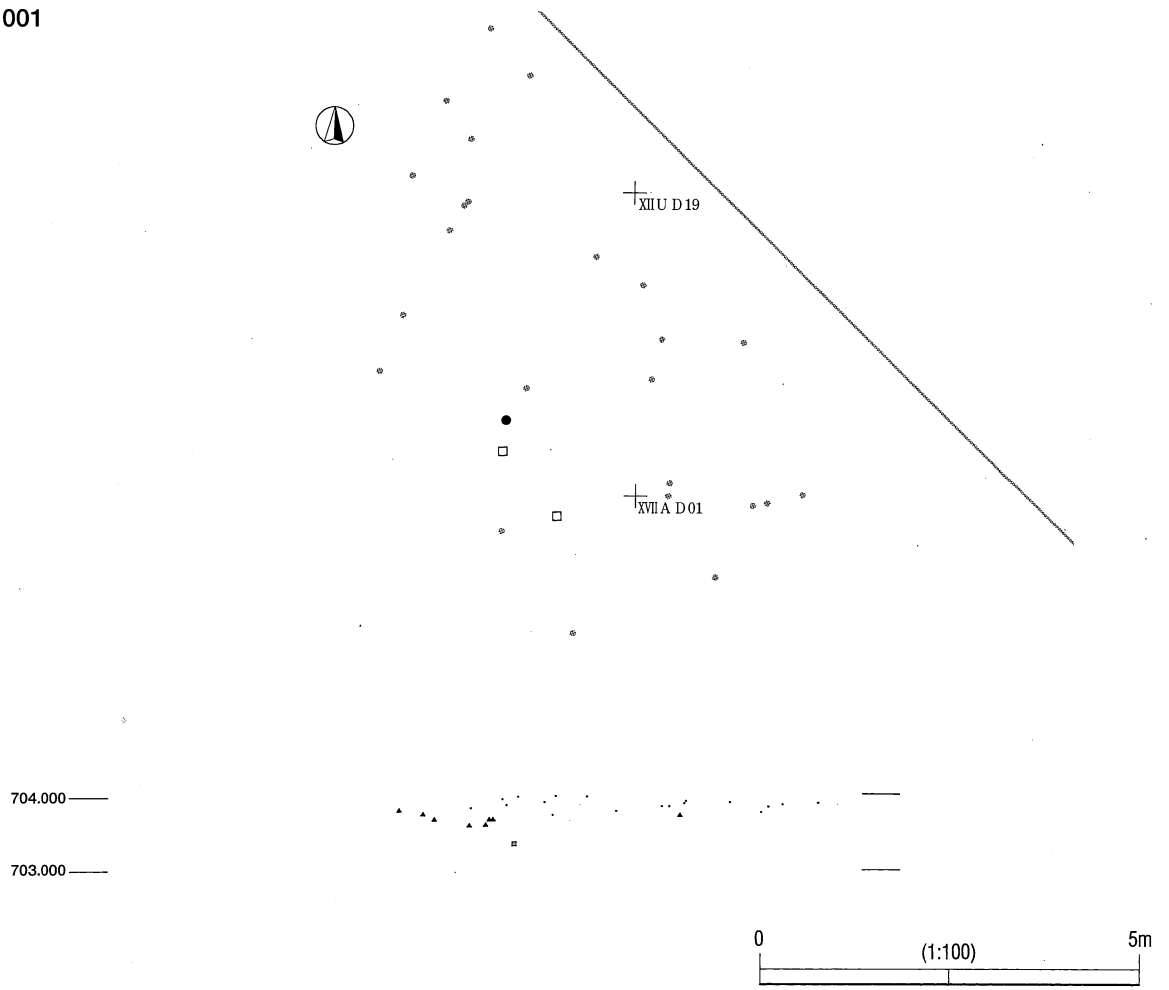

BL1002

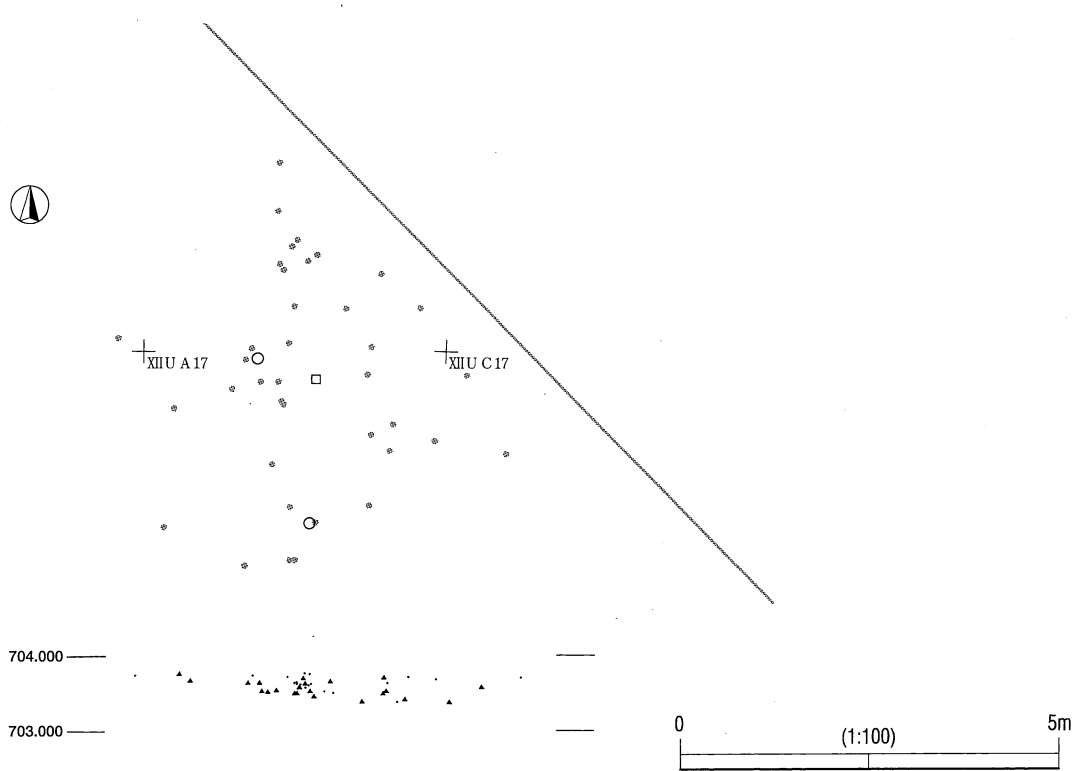

第 1 地点 BL1001・1002 遺物分布図 (貫ノ木遺跡)

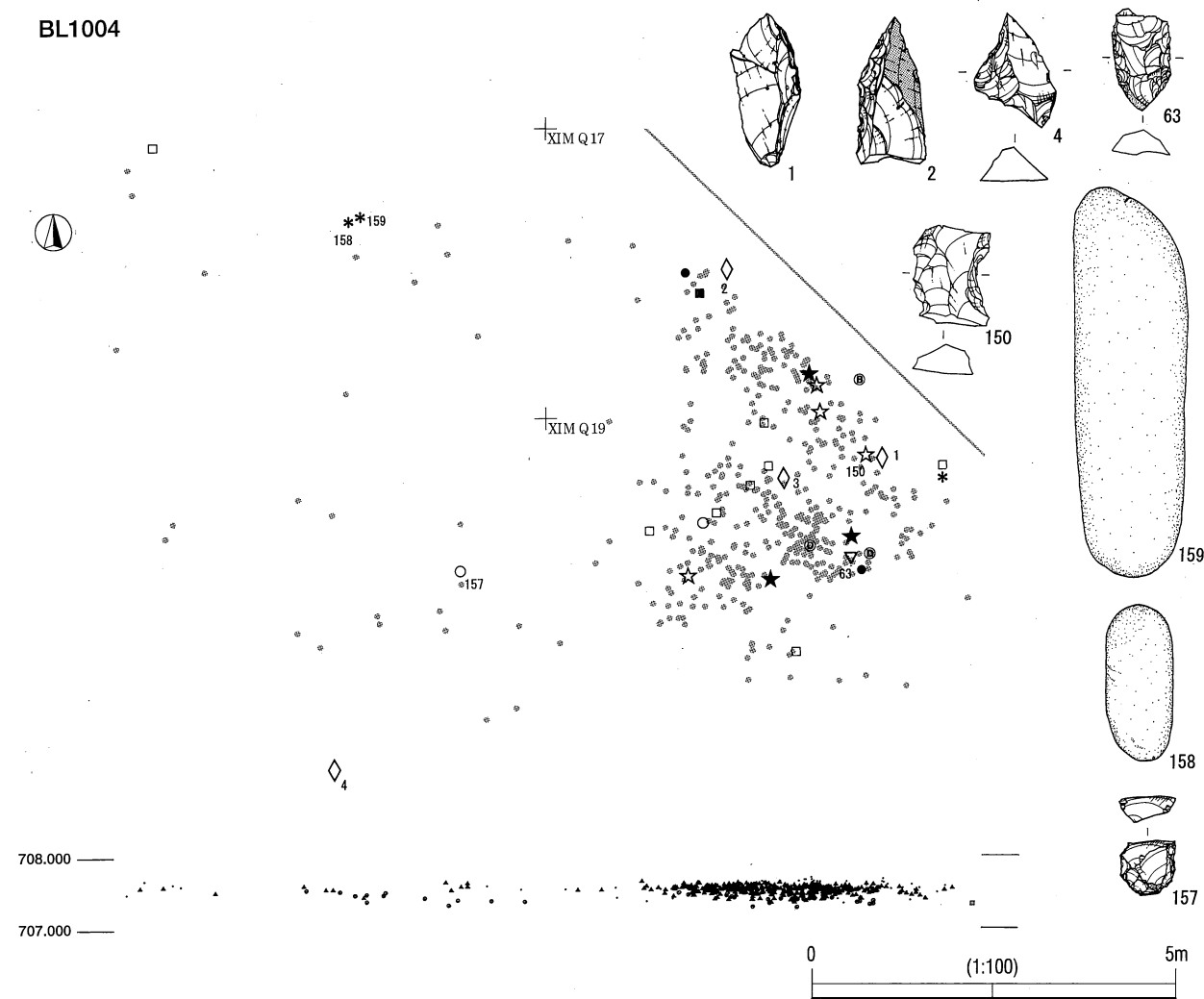
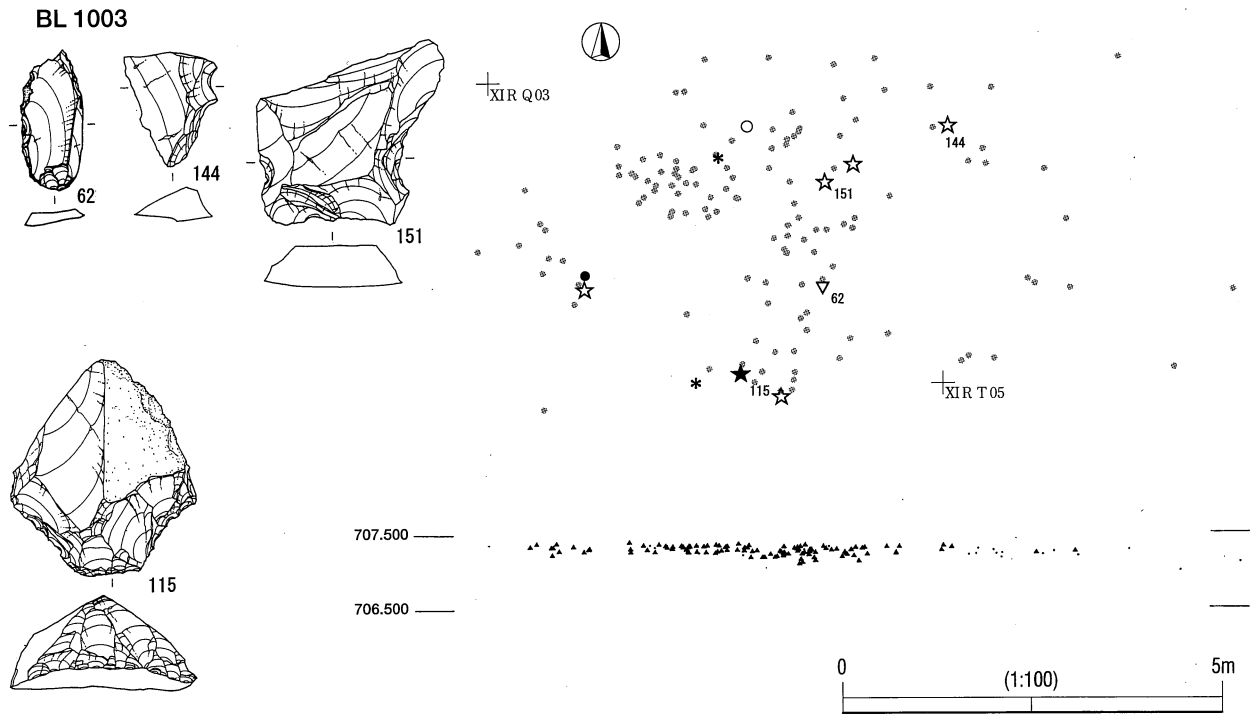

第1地点 BL1003・1004 遺物分布図 (貫ノ木遺跡)



BL 1005

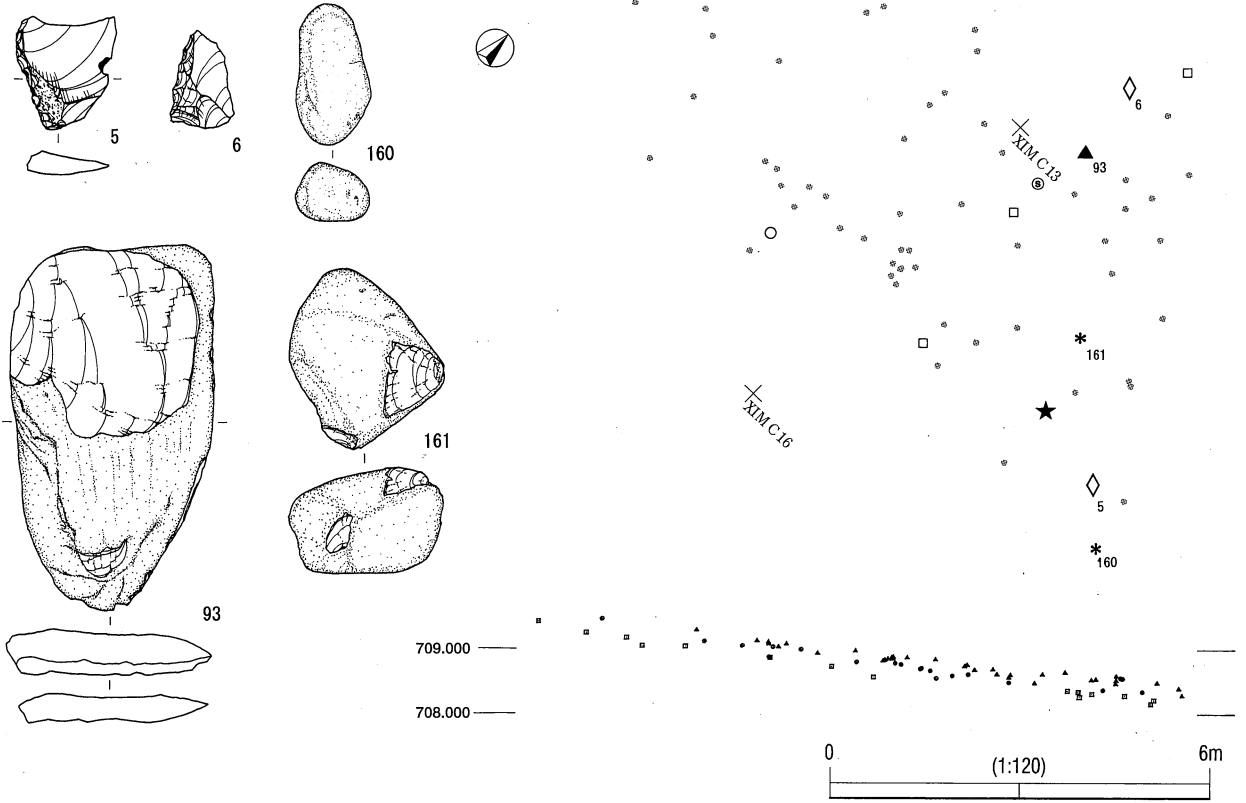

BL 1006

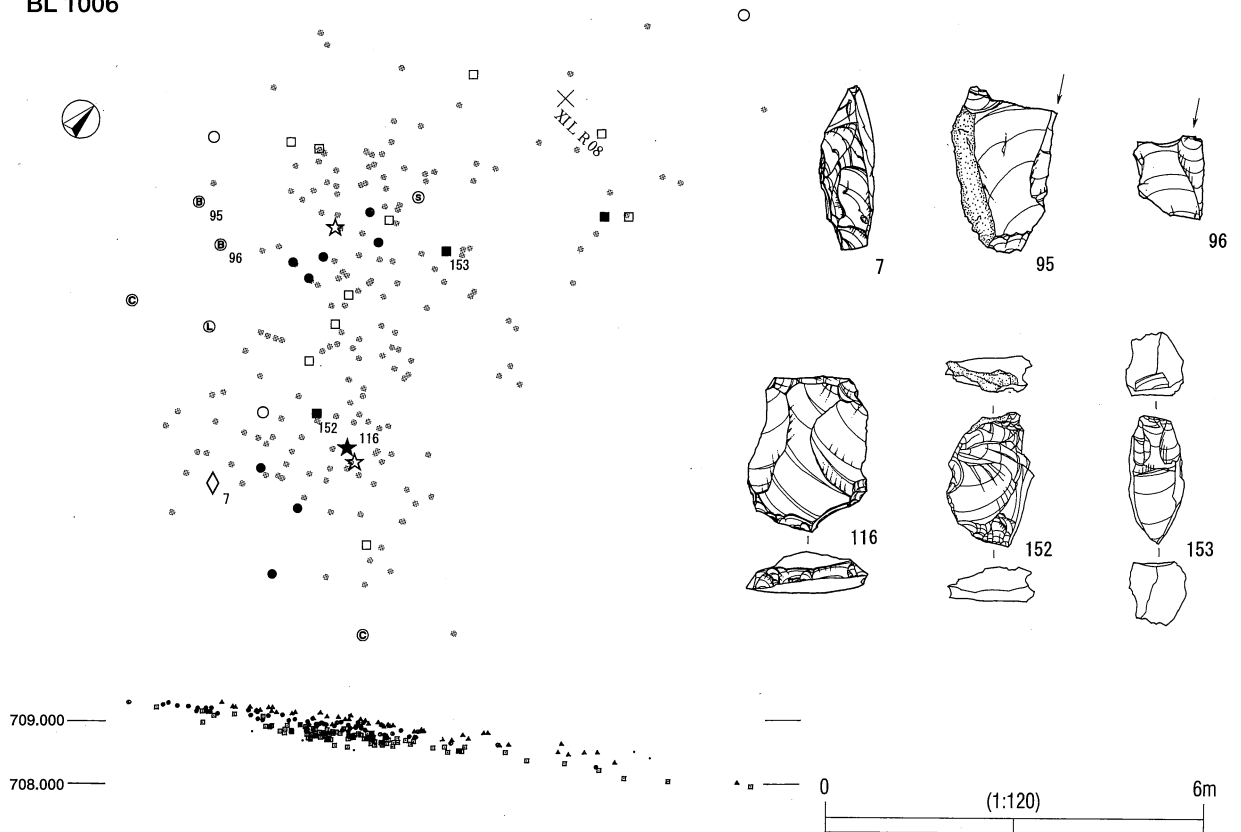

第1地点 BL1005・1006 遺物分布図 (貫ノ木遺跡)

BL 1007

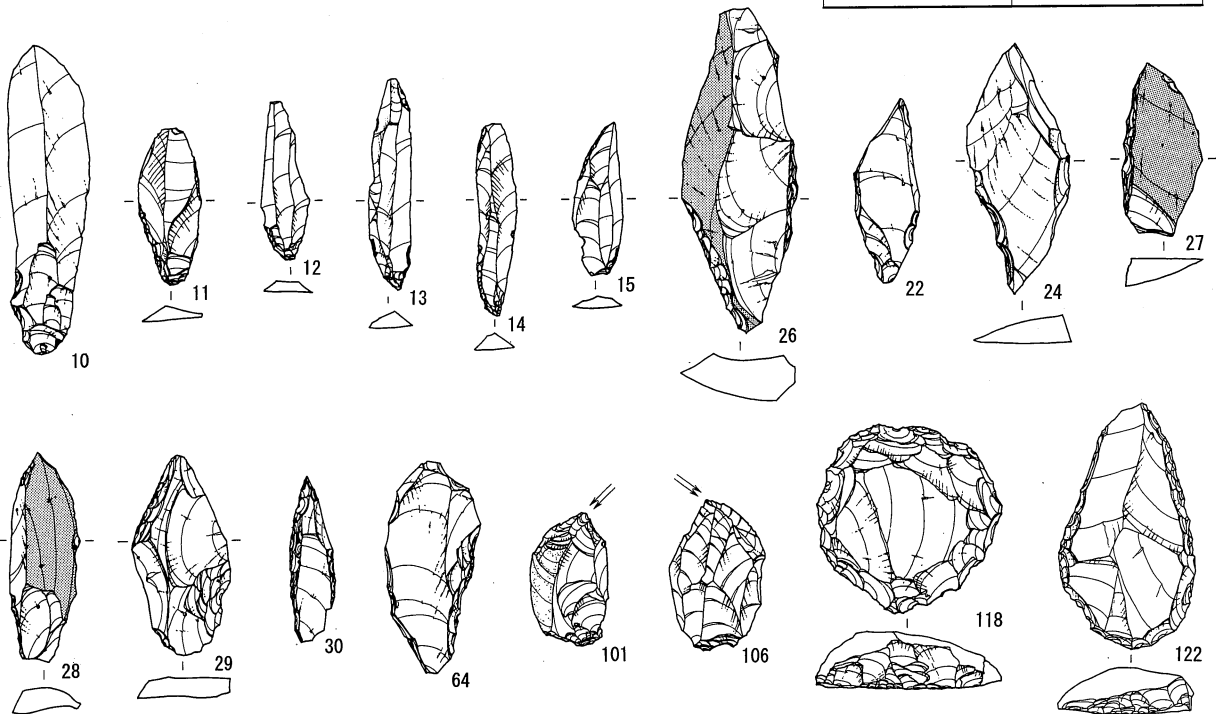
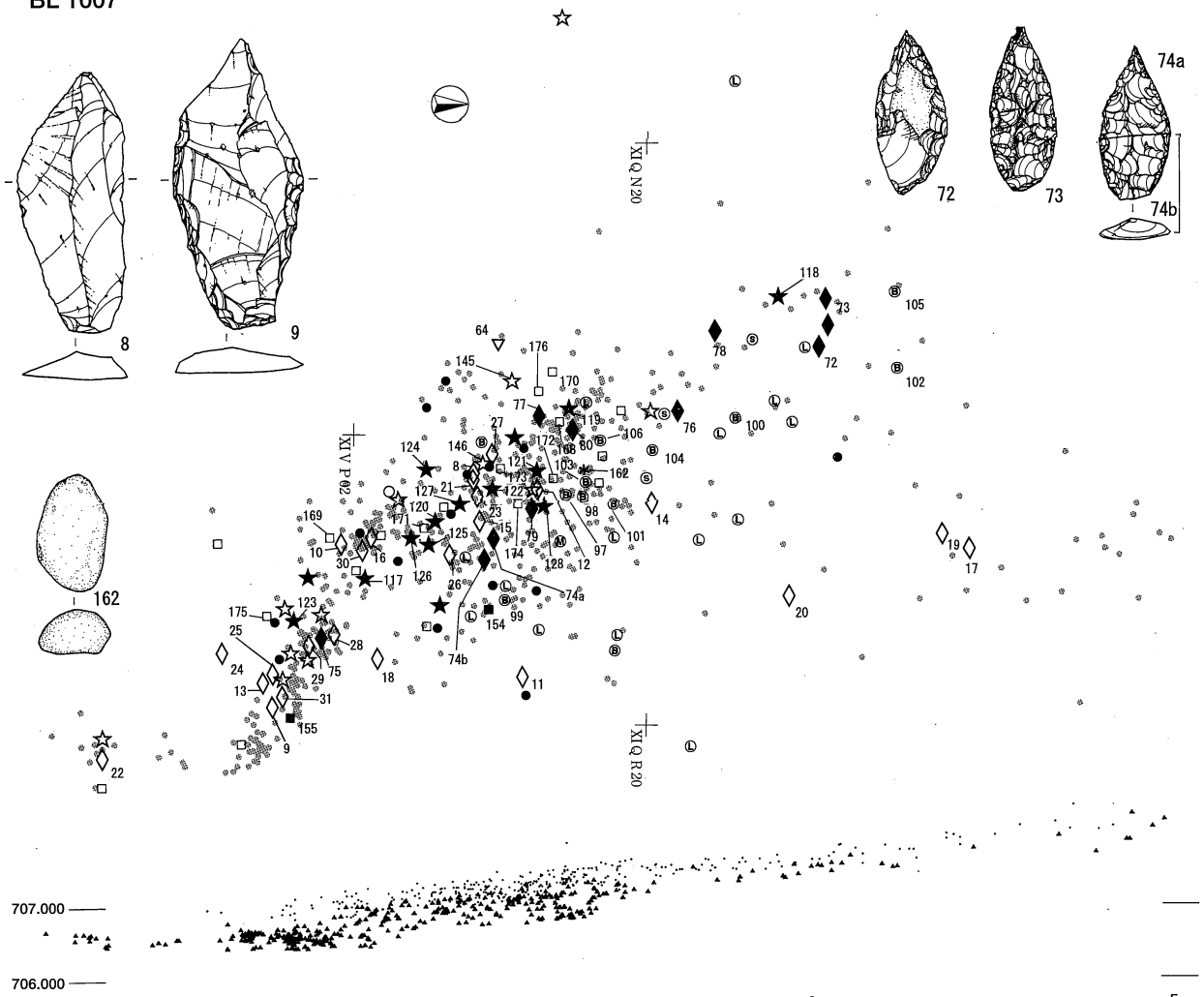

第1地点 BL1007 遺物分布図 (貫ノ木遺跡)

BL 1008

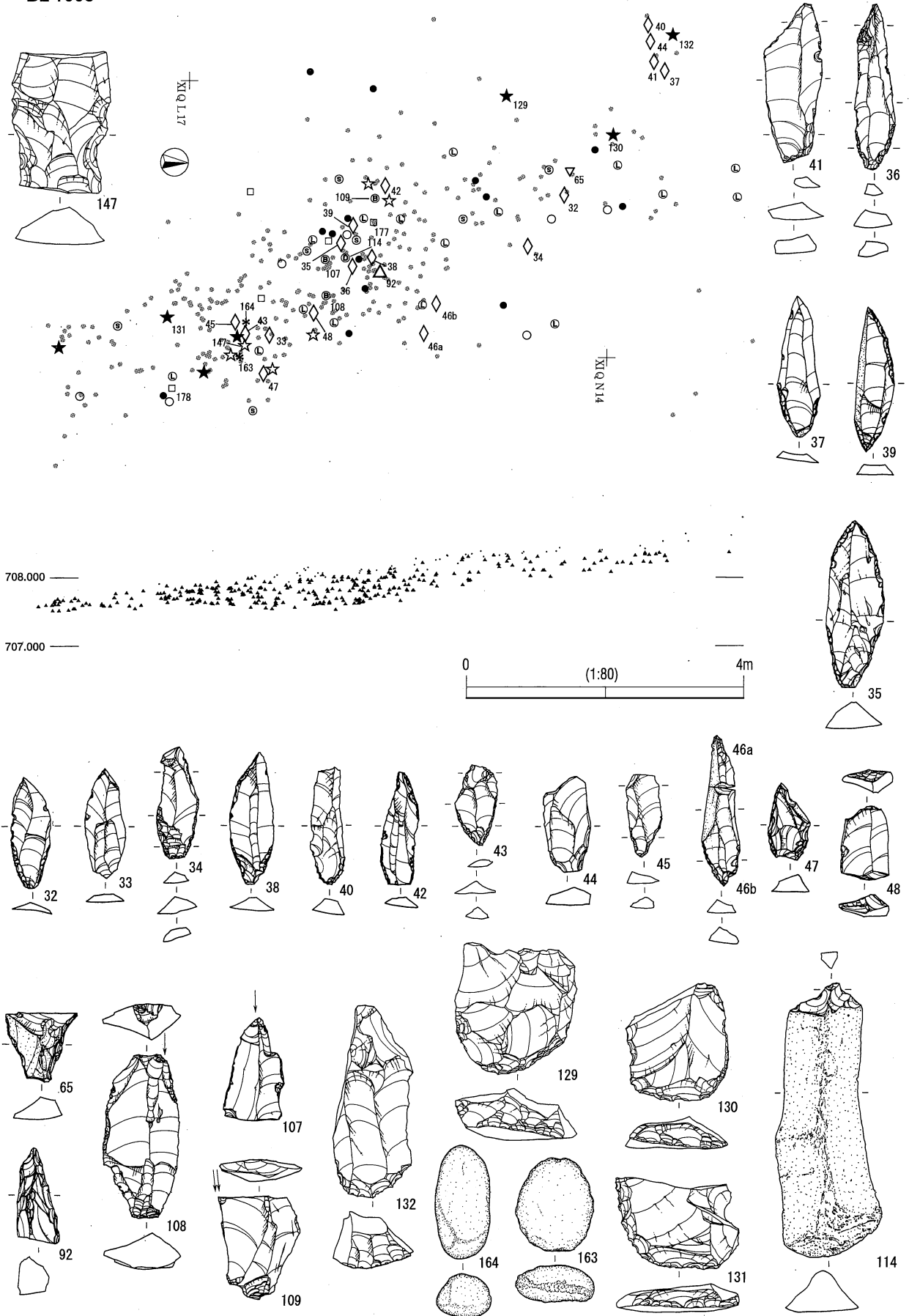

第1地点 BL1008 遺物分布図 (貫ノ木遺跡)



BL 1009

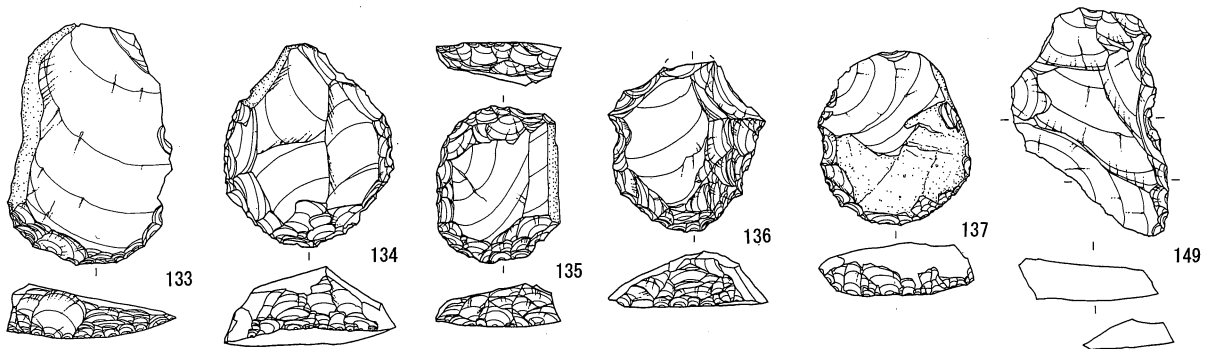
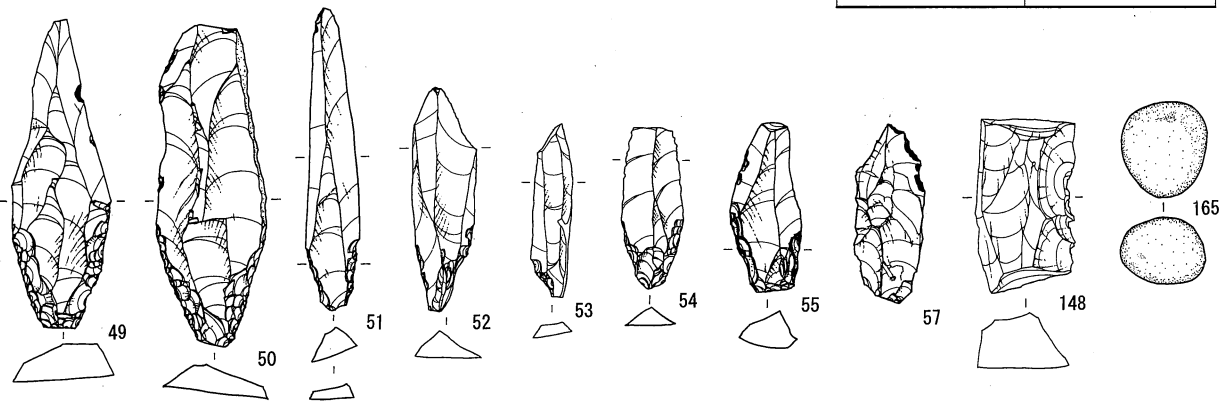

第1地点 BL1009 遺物分布図 (貫ノ木遺跡)

BL 1010

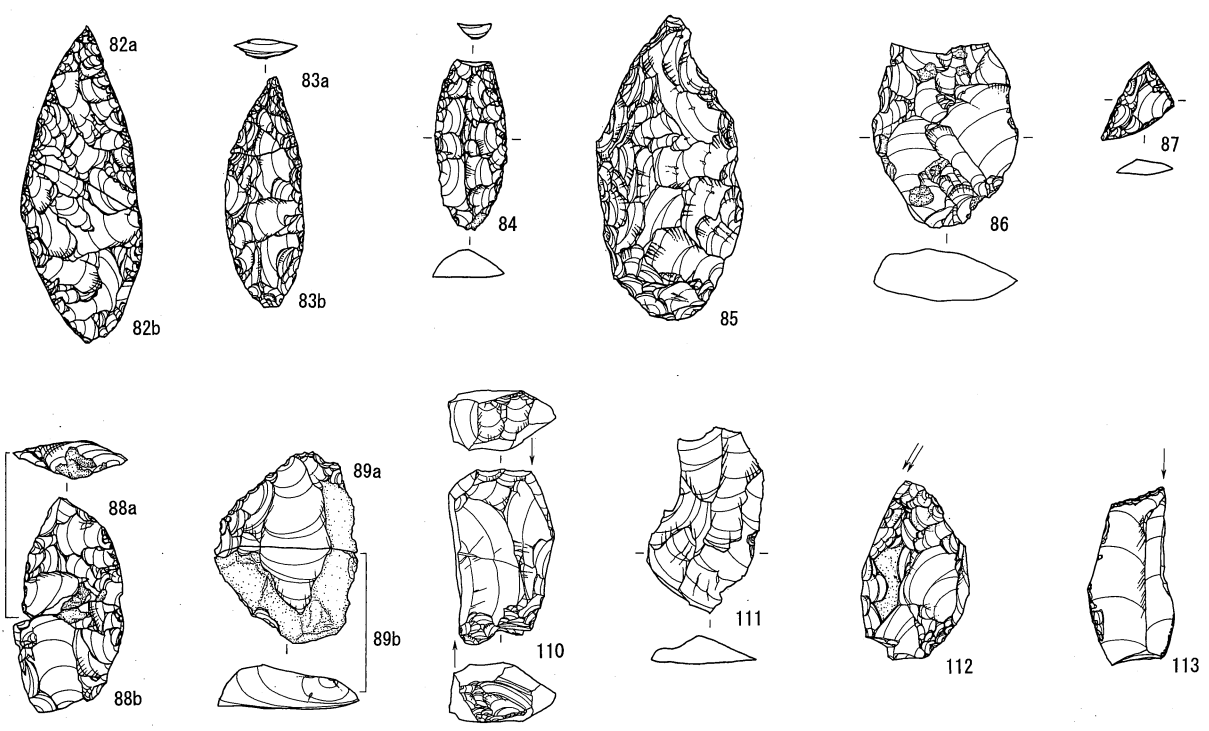
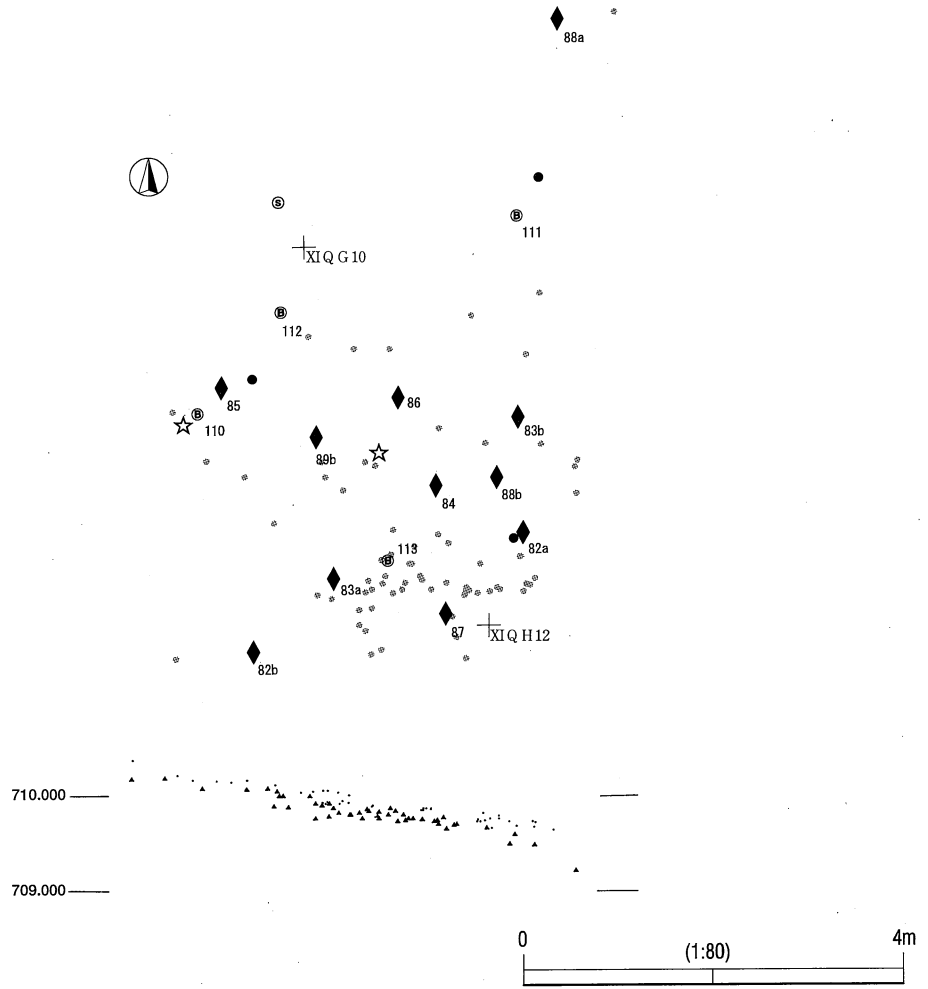

第 1 地点 BL1010 遺物分布図 (貫ノ木遺跡)

BL 1011

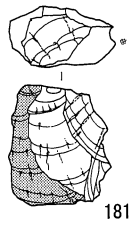

XIQ H03

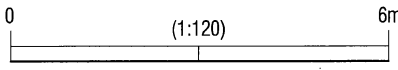
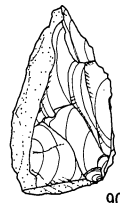
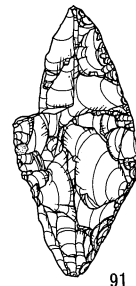

711.000

181

709.000

BL 1013

XIQ I 14

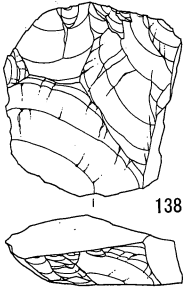

★ 138 167

189

XIQ J 16

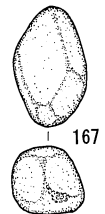

709.000

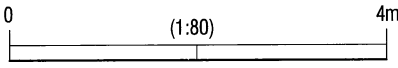

708.000

第1地点 BL1011・1013 遺物分布図 (貫ノ木遺跡)

BL 1012

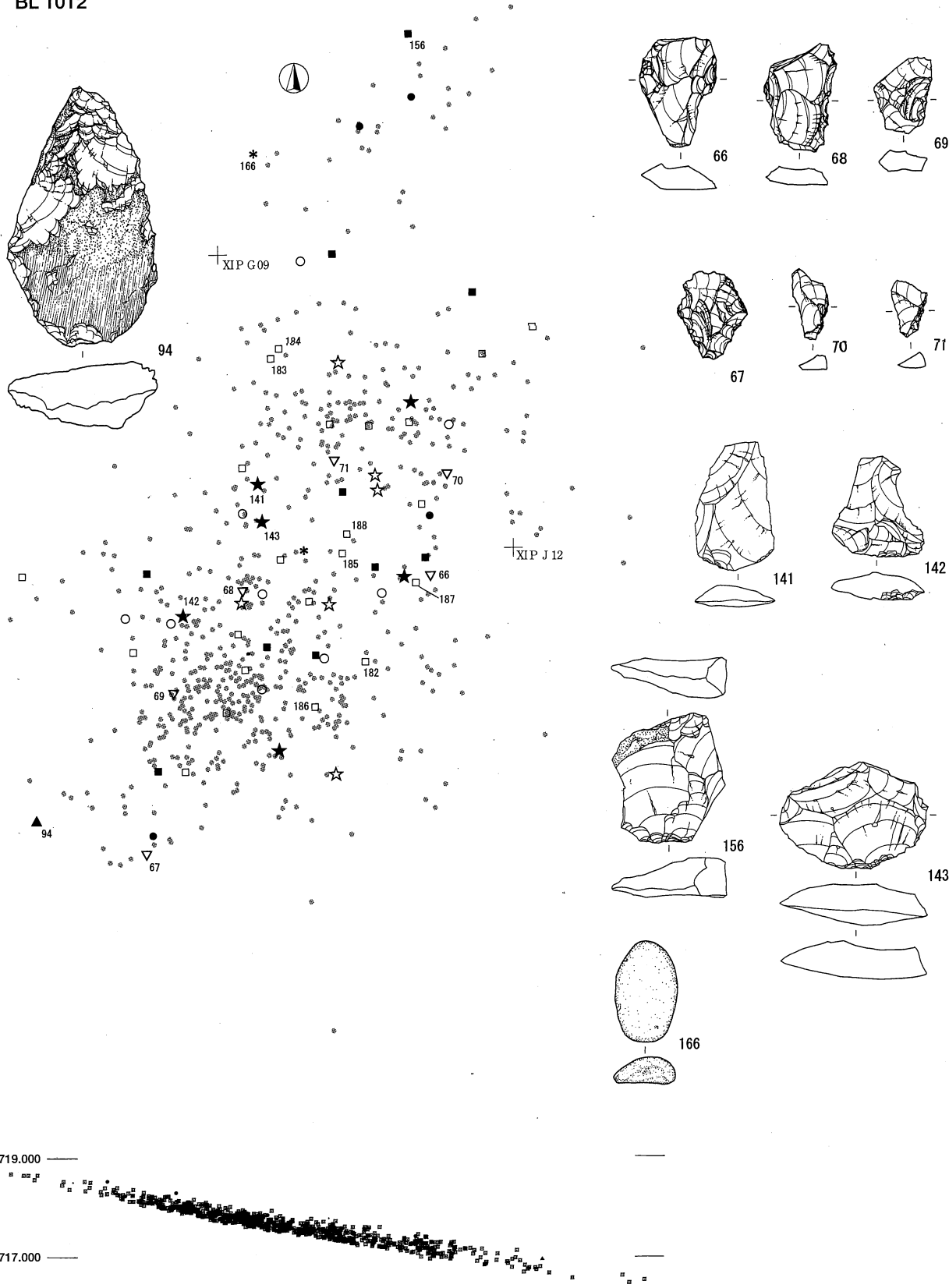

第1地点 BL1012 遺物分布図 (貫ノ木遺跡)



第 1 地点 SH 50・51・52・53 遺物分布図 (貫ノ木遺跡)

SH 56

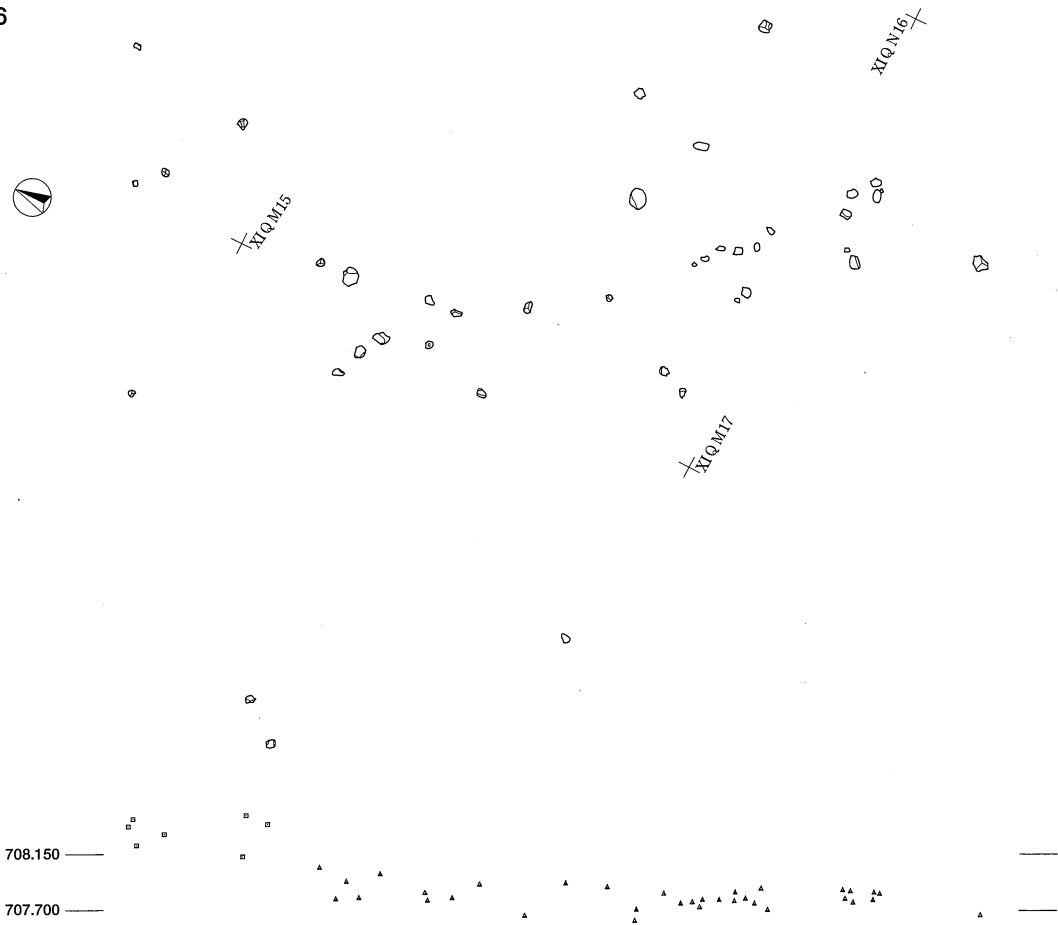

SH 69

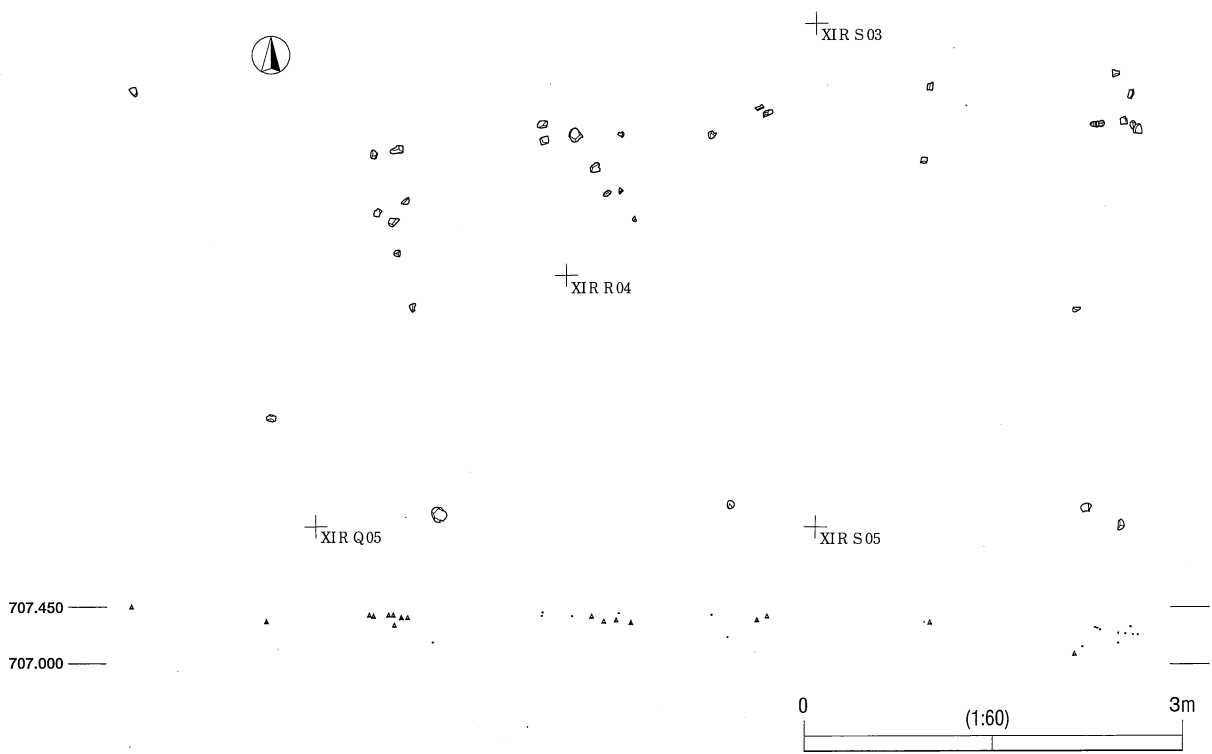

第1地点 SH 56・69 遺物分布図 (貫ノ木遺跡)

SH 68

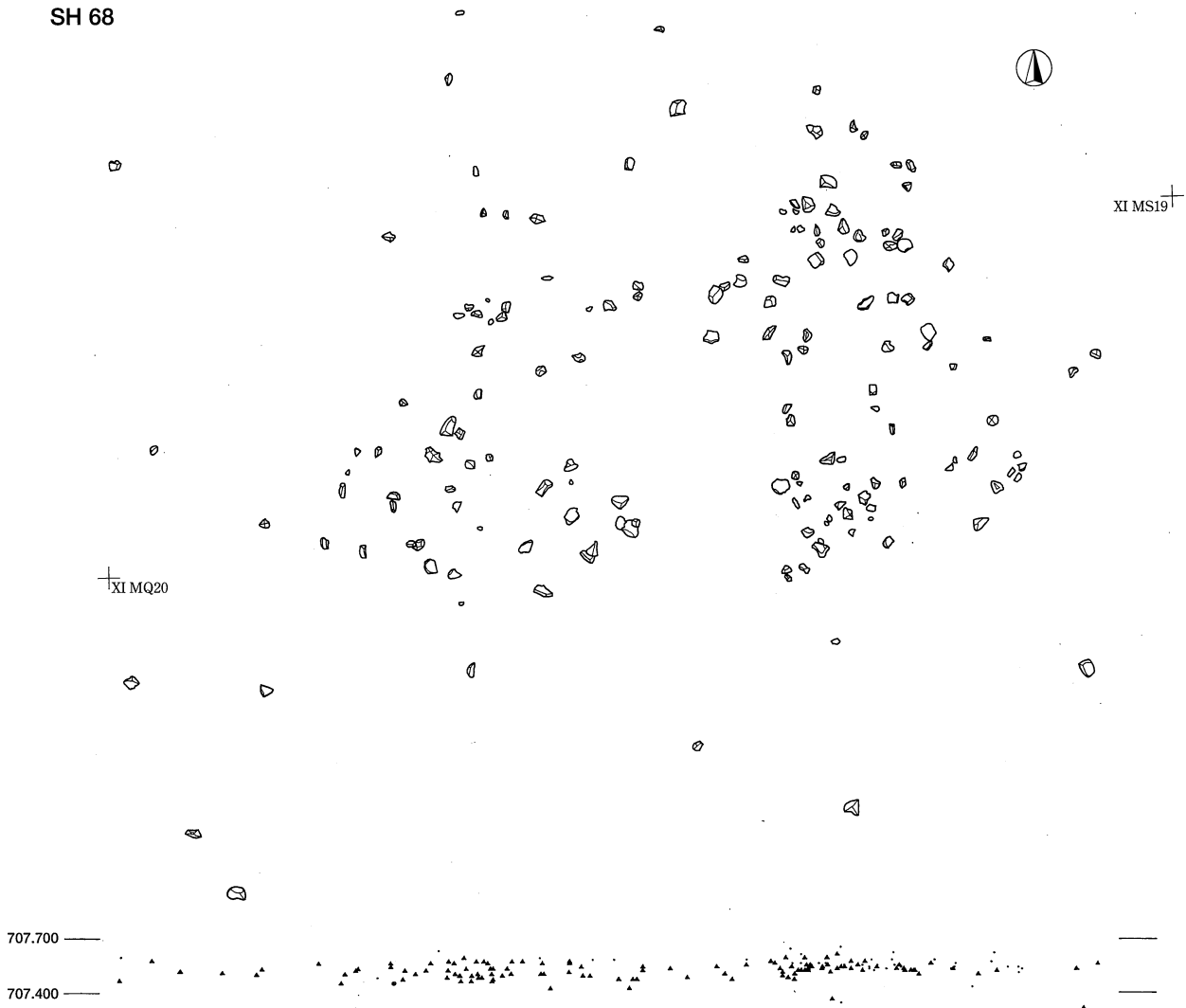

SH 54

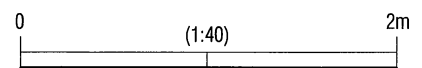
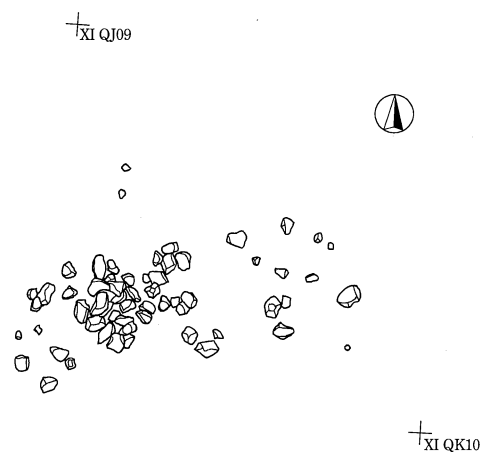

第 1 地点 SH 54・68 遺物分布図 (貫ノ木遺跡)

SH 70



第 1 地点 SH 70 遺物分布図 (貫ノ木遺跡)



SH 71

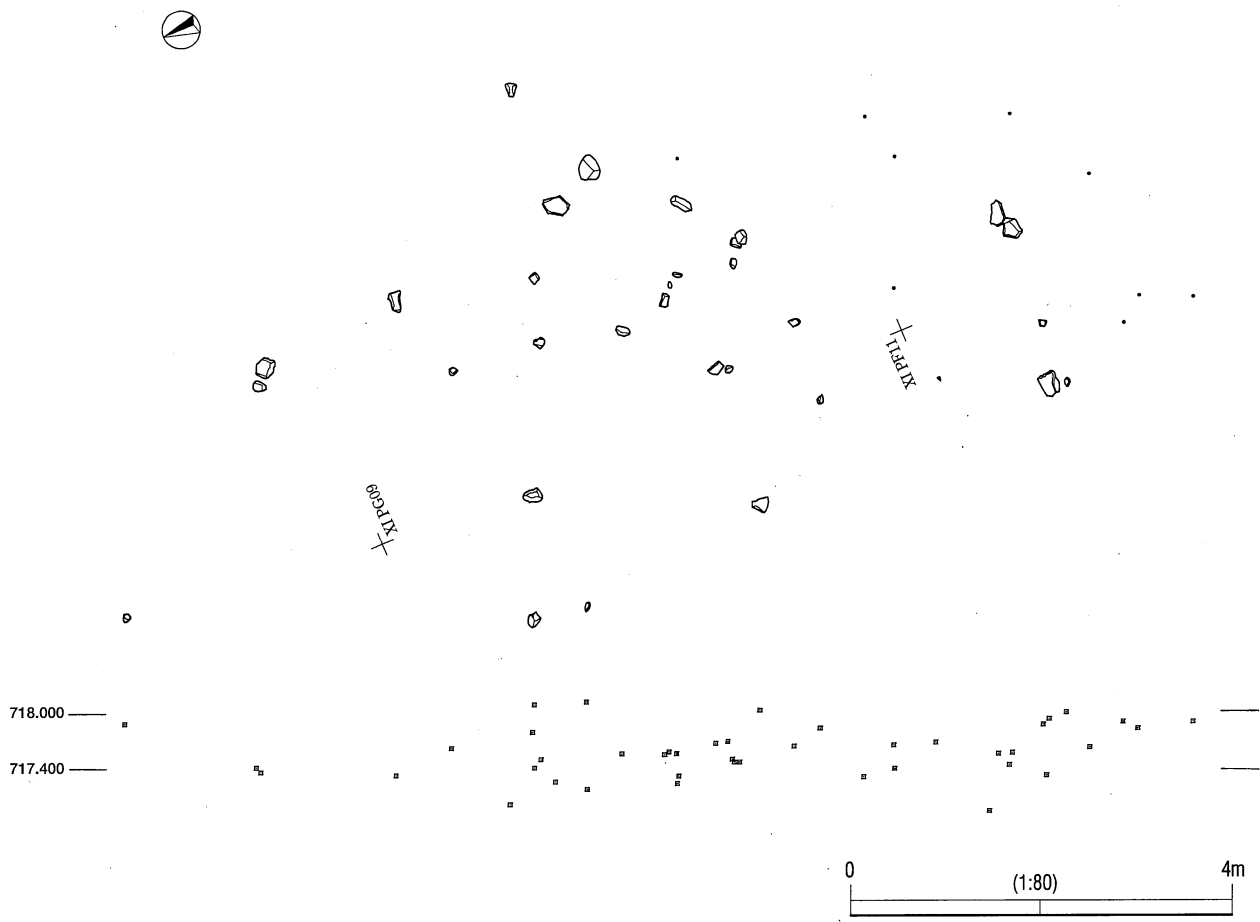

SH 55

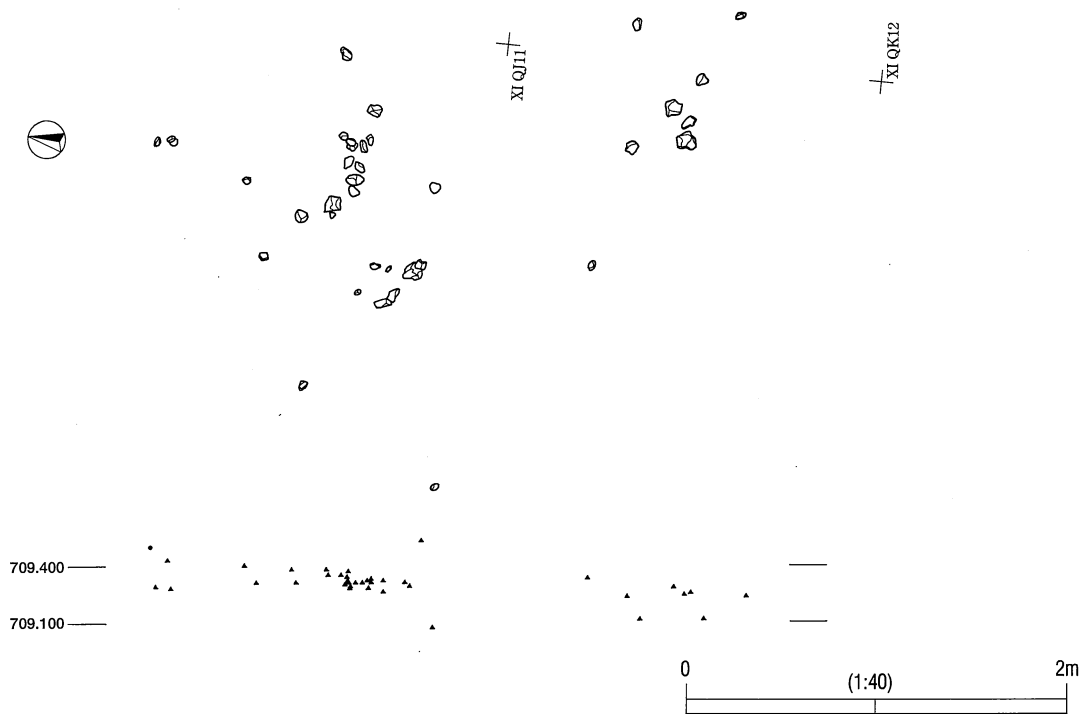

第1地点 SH 55・71 遺物分布図 (貫ノ木遺跡)

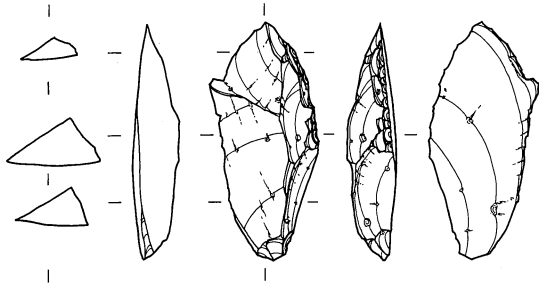

1  
Kn An  
BL1004 4.52g  
III XI-M 240

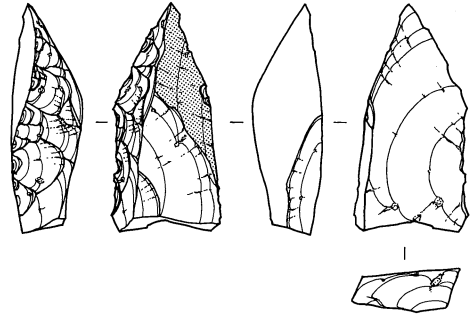

2  
Kn An  
BL1004 8.29g  
IV XI-M 209

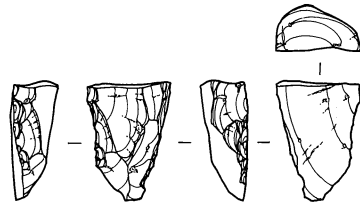

3  
Kn An  
BL1004 2.37g  
IV XI-M 123

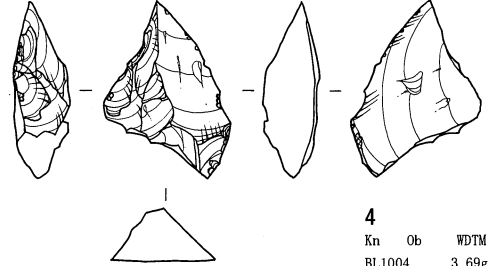

4  
Kn Ob WDTM  
BL1004 3.69g  
IV XI-R 136

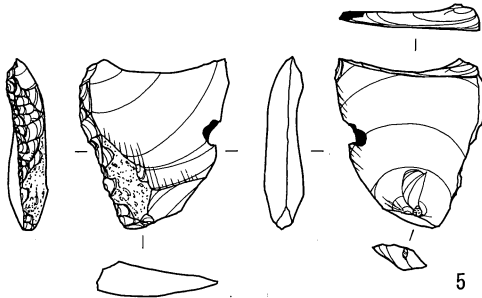

5  
Kn Ob WDTY  
BL1005 3.62g  
IV上 XI-M 4

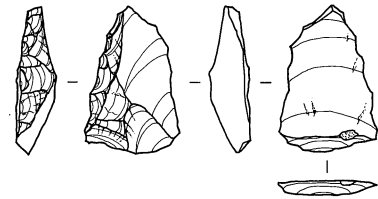

6  
Kn Tu  
BL1005 1.86g  
V b XI-M 67

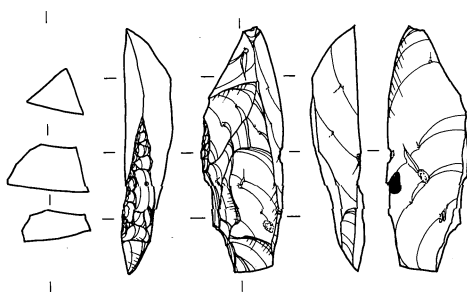

7  
Kn Ob WDTY  
BL1006 3.91g  
V a XI-L 110

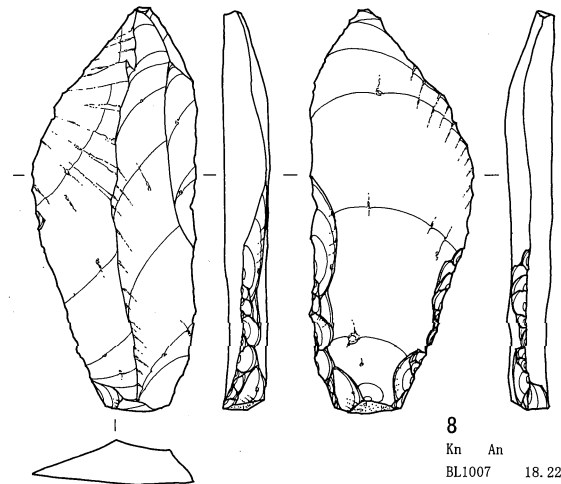

8  
Kn An  
BL1007 18.22g  
II XI-V 479

0 (3:4) 5 cm

第1地点 石器実測図1 (ナイフ形石器1) (貫ノ木遺跡)

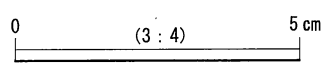
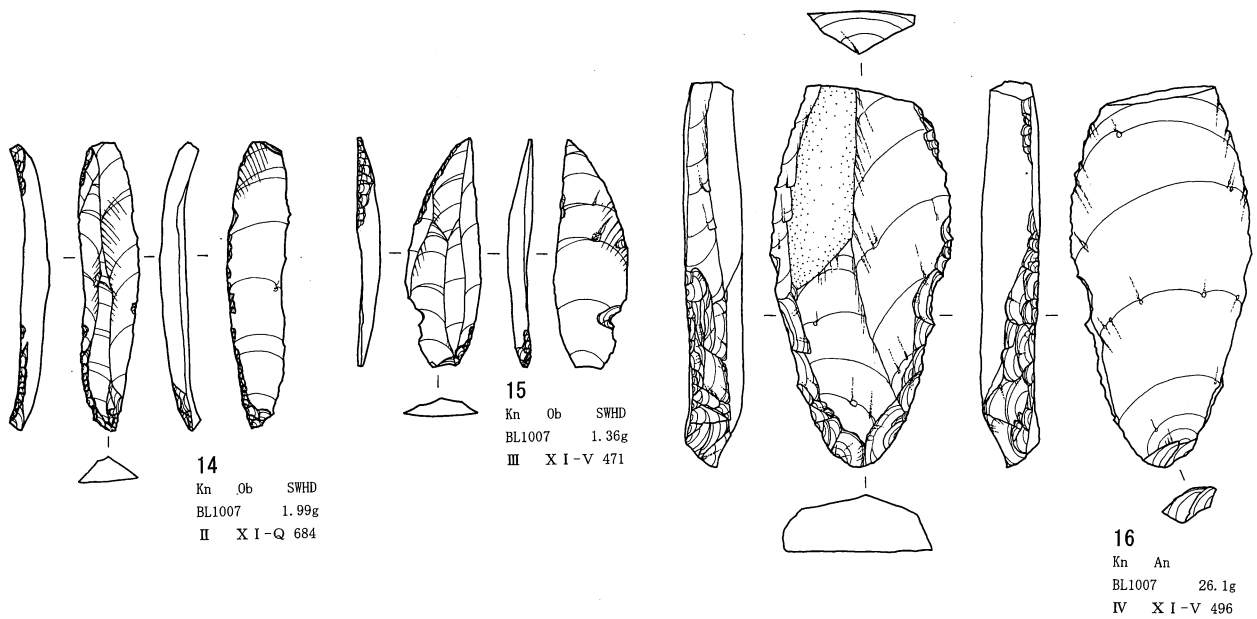
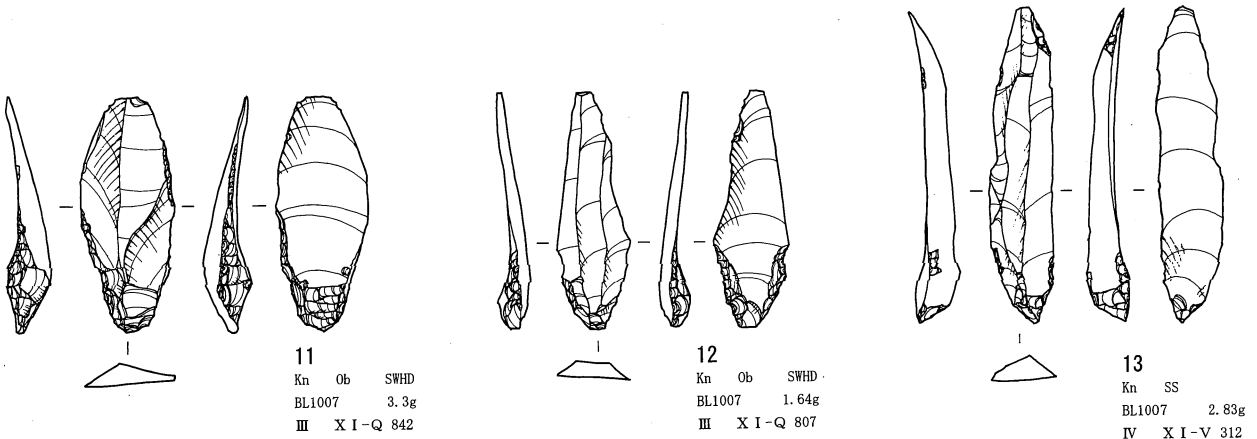
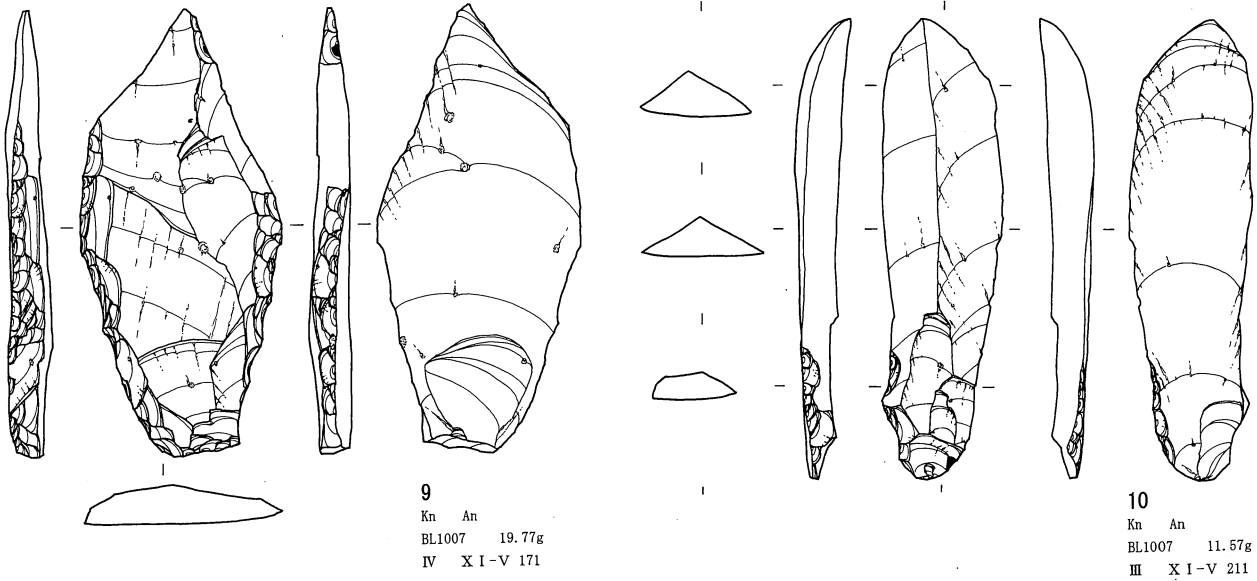

第1地点 石器実測図2 (ナイフ形石器2) (貫ノ木遺跡)

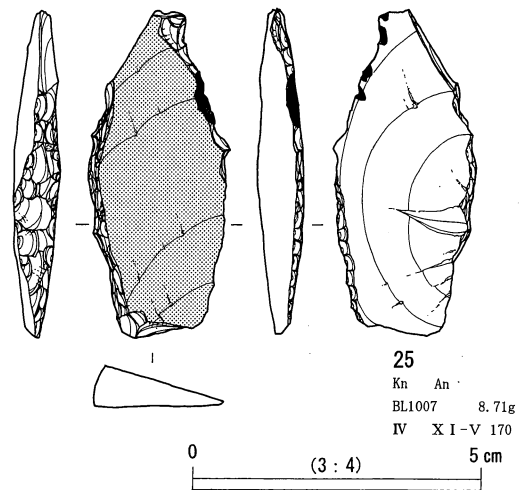
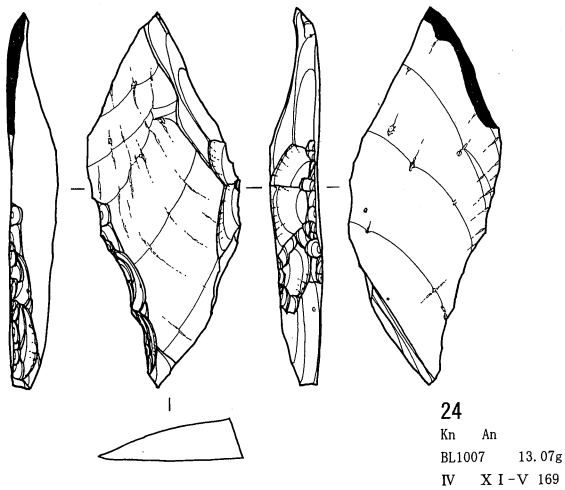
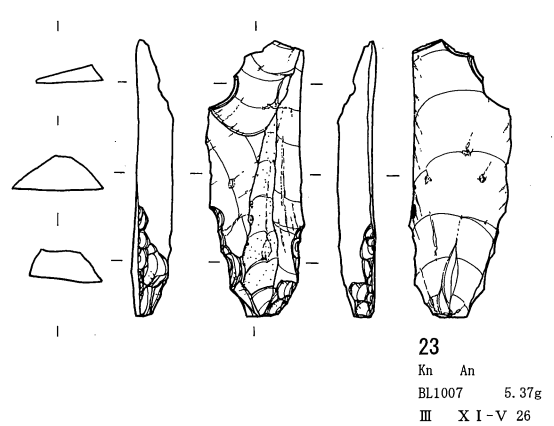
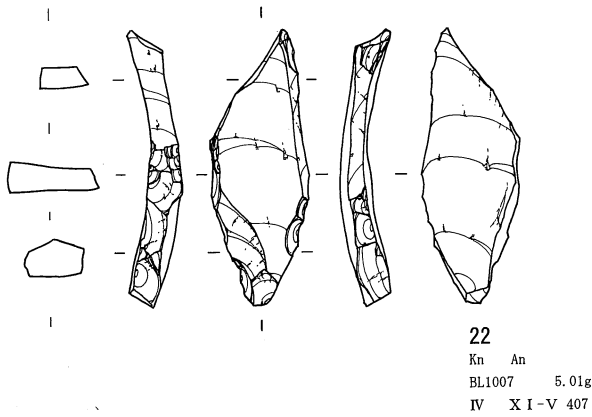
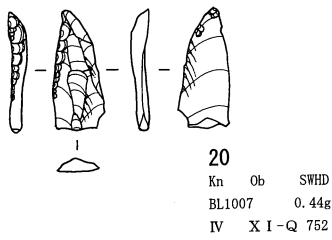
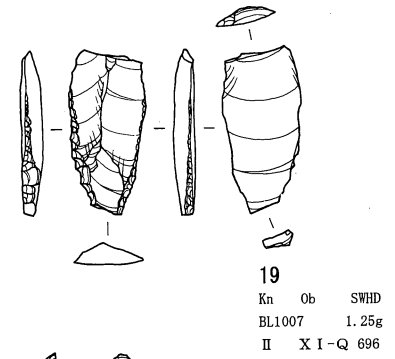
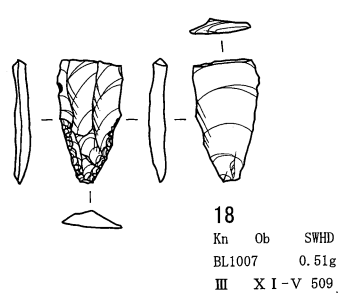
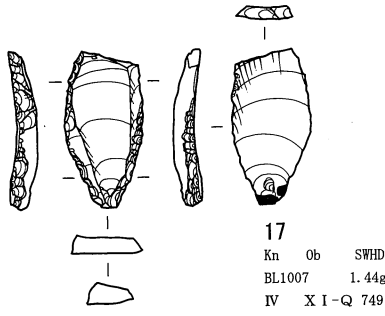

第1地点 石器実測図3 (ナイフ形石器3) (貫ノ木遺跡)

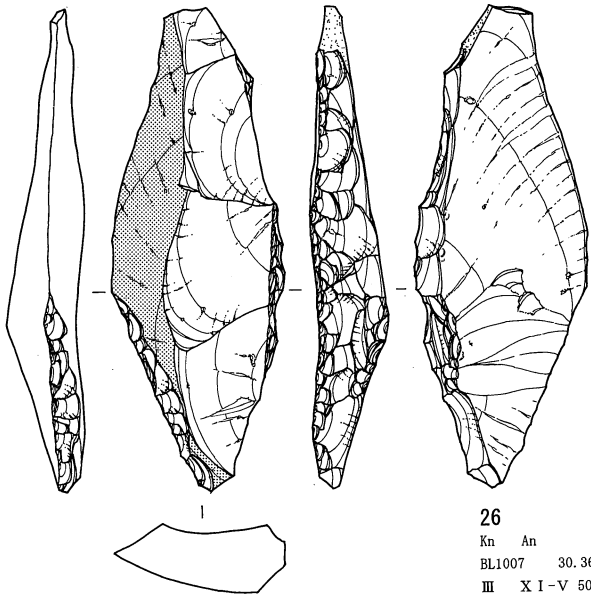

26  
Kn An  
BL1007 30.36g  
III XI-V 50

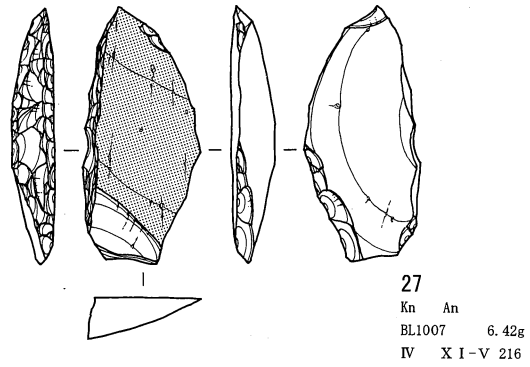

27  
Kn An  
BL1007 6.42g  
IV XI-V 216

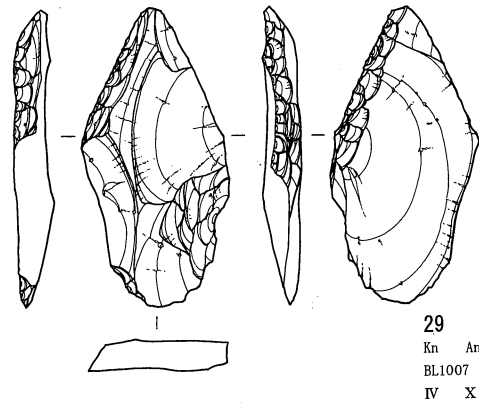

29  
Kn An  
BL1007 8.03g  
IV XI-V 290

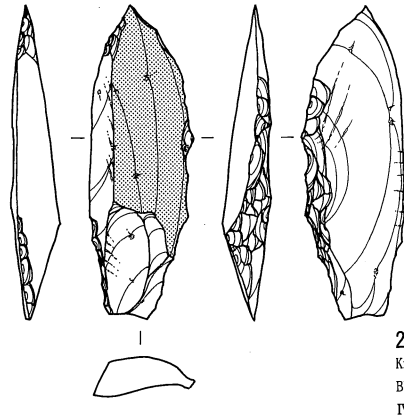

28  
Kn An  
BL1007 7.78g  
IV XI-V 239

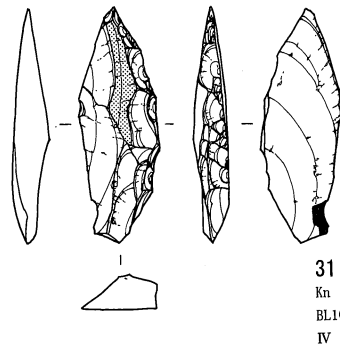

31  
Kn An  
BL1007 3.02g  
IV XI-V 367

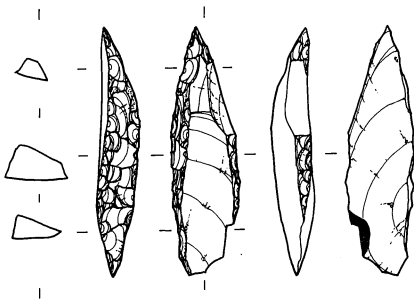

30  
Kn An  
BL1007 3.14g  
IV XI-V 425

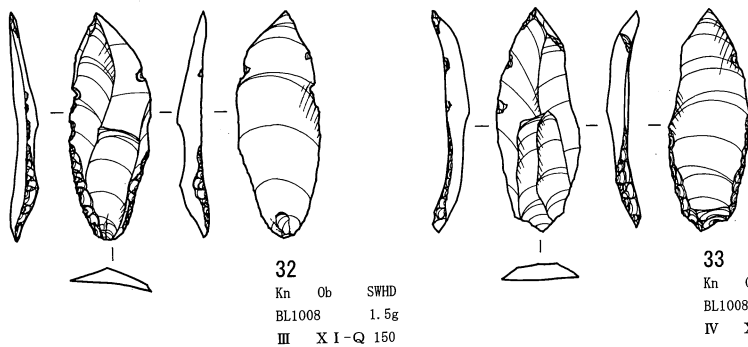

32  
Kn Ob SWHD  
BL1008 1.5g  
III XI-Q 150

33  
Kn Ob SWHD  
BL1008 1.69g  
IV XI-Q 535

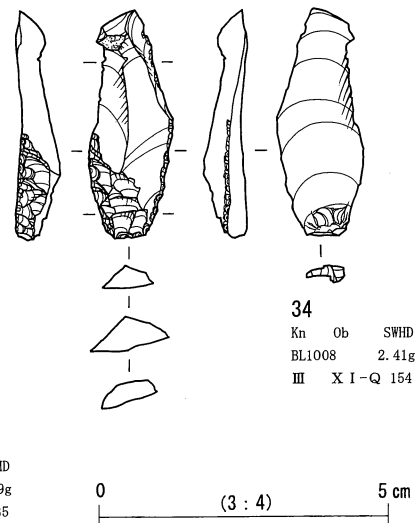

34  
Kn Ob SWHD  
BL1008 2.41g  
III XI-Q 154

0 (3:4) 5 cm

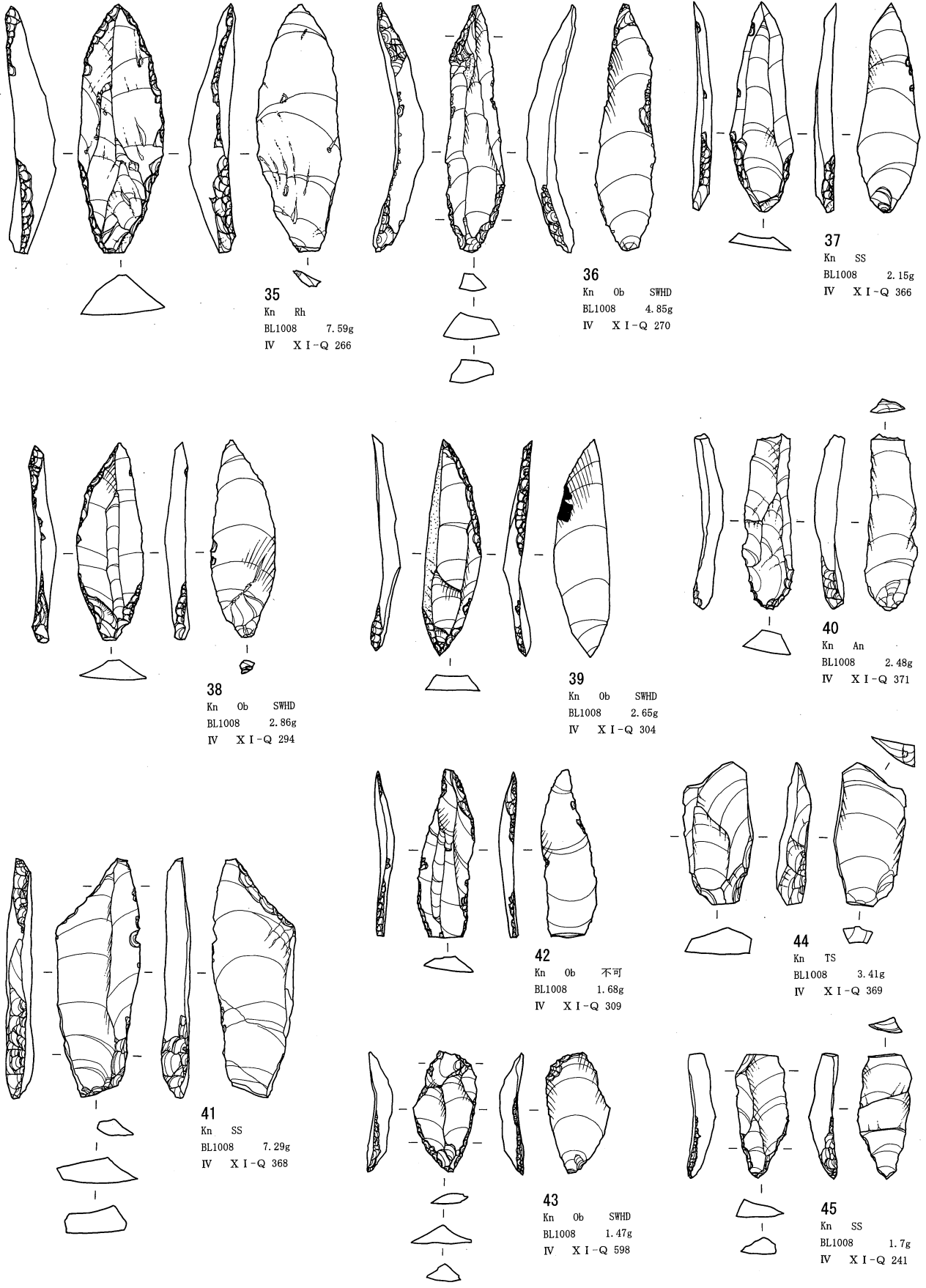

第1地点 石器実測図5 (ナイフ形石器5) (貫ノ木遺跡)

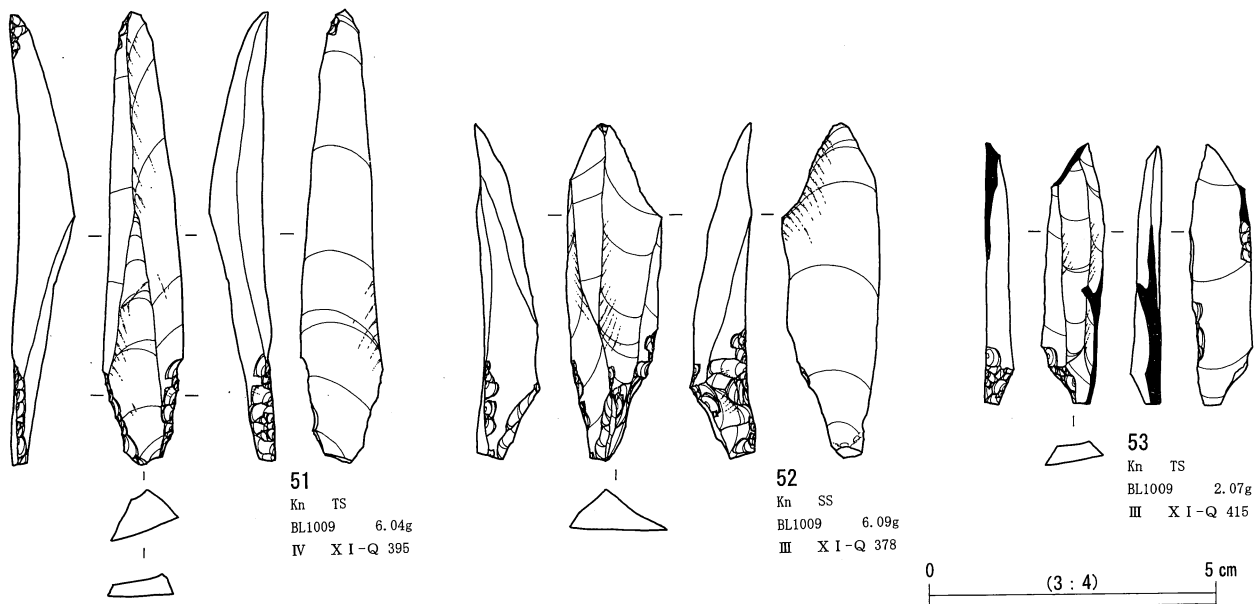
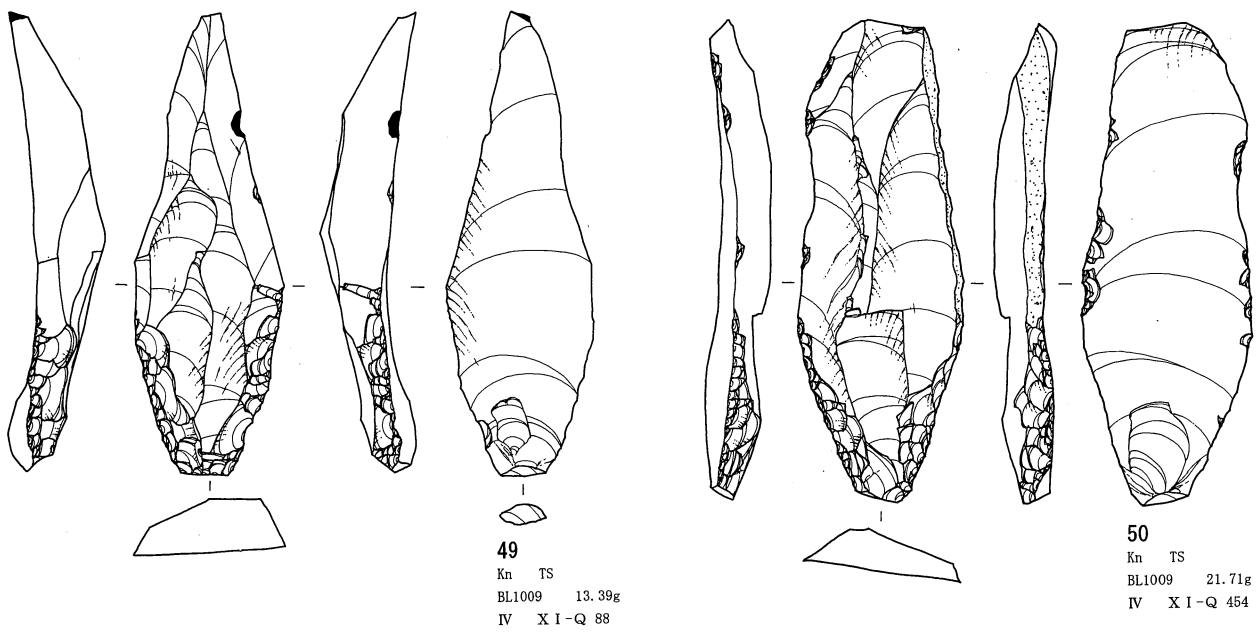
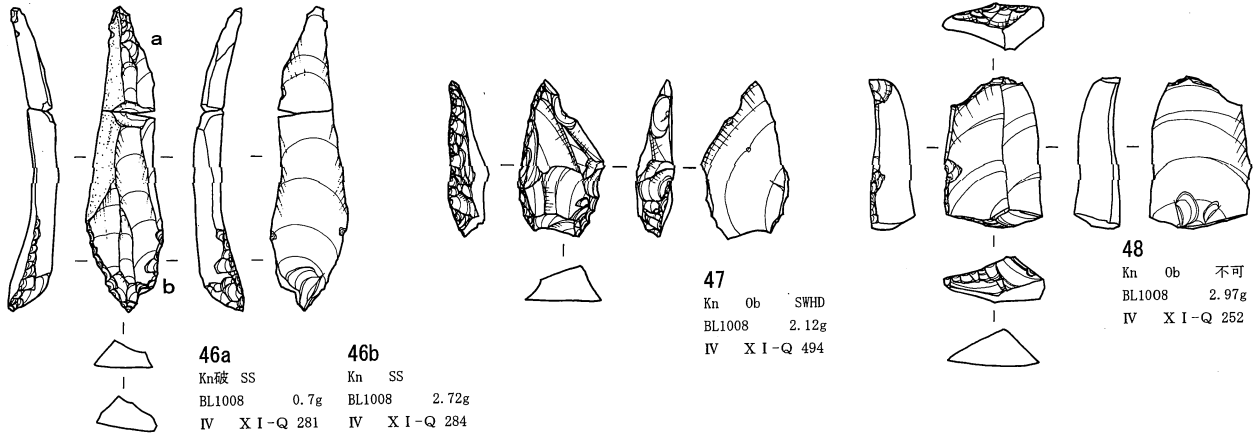

第1地点 石器実測図6 (ナイフ形石器6) (貫ノ木遺跡)

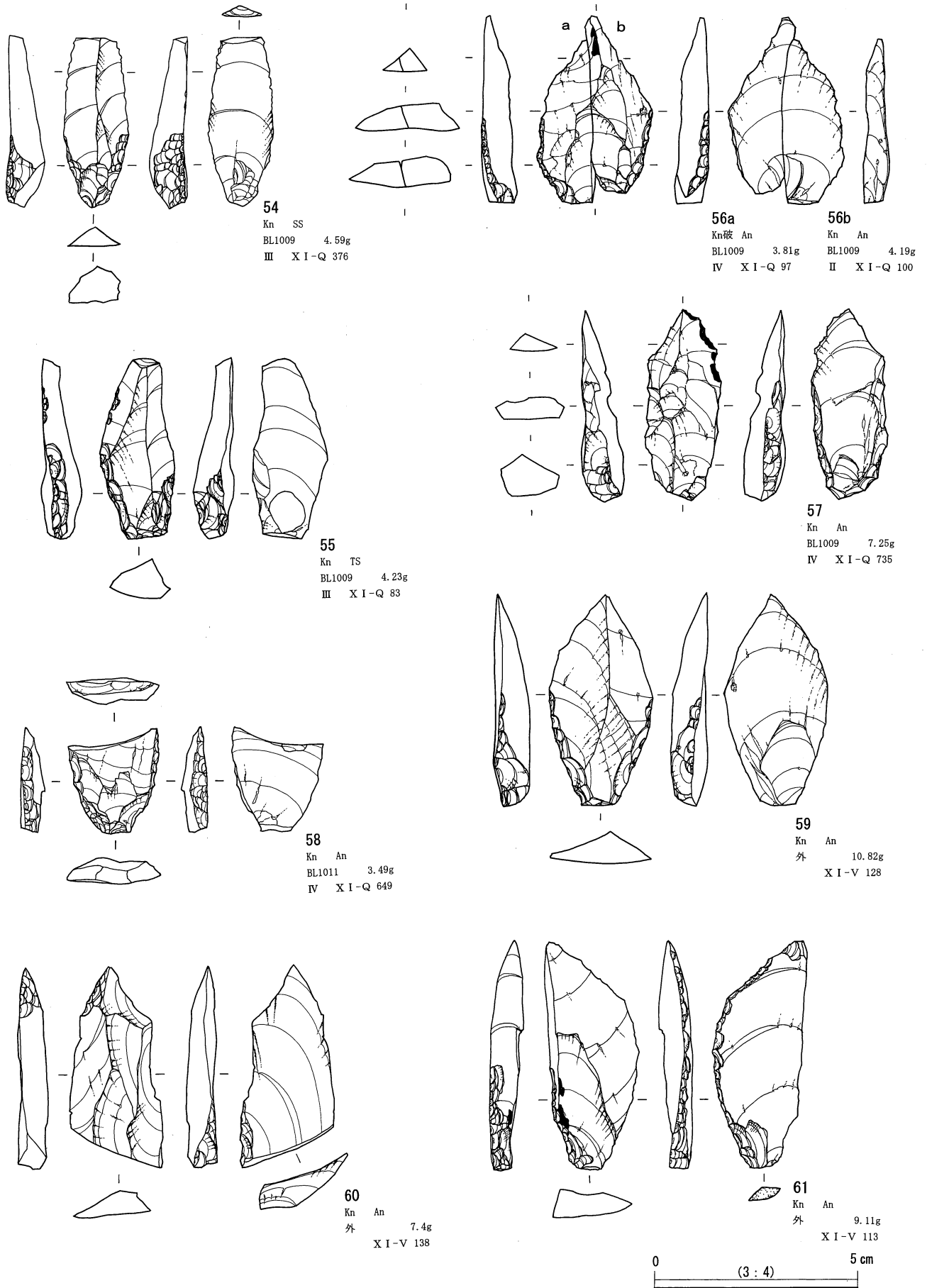

第1地点 石器実測図7 (ナイフ形石器7) (貫ノ木遺跡)



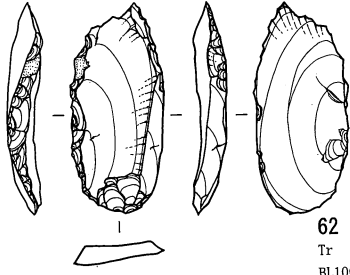

62  
Tr Ag  
BL1003 2.55g  
IV XI-R 13

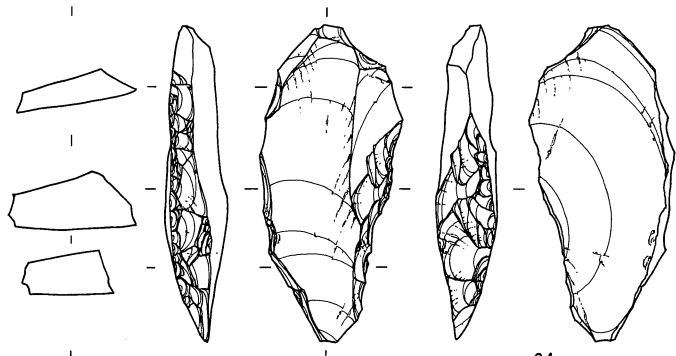

64  
Tr An  
BL1007 13.77g  
III XI-V 446

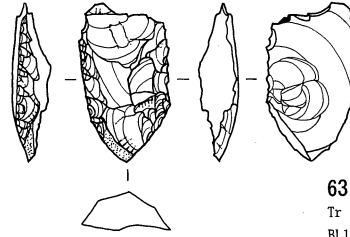

63  
Tr SS  
BL1004 1.92g  
IV XI-M 146

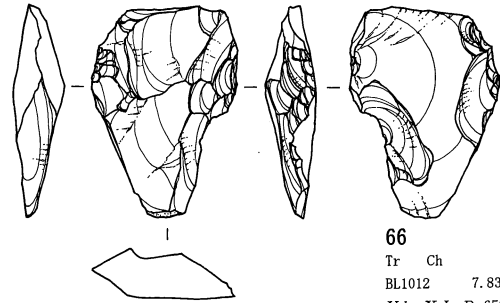

66  
Tr Ch  
BL1012 7.83g  
V b XI-P 652

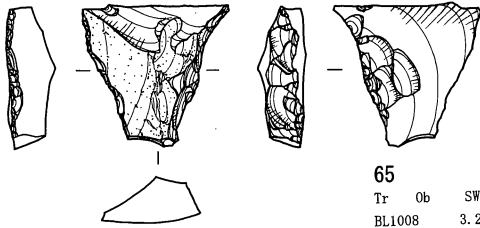

65  
Tr Ob SWHD  
BL1008 3.23g  
IV XI-Q 348

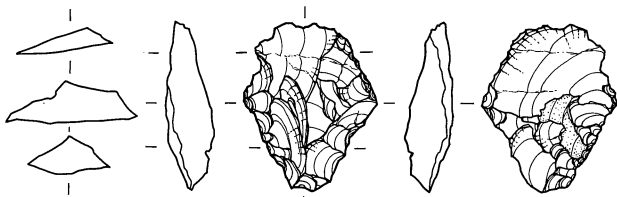

67  
Tr Ch  
BL1012 3.7g  
V b XI-P 17

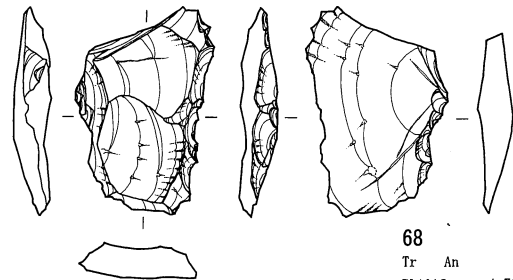

68  
Tr An  
BL1012 4.71g  
V b XI-P 134

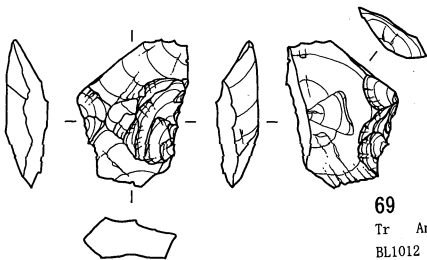

69  
Tr An  
BL1012 3.24g  
V b XI-P 675

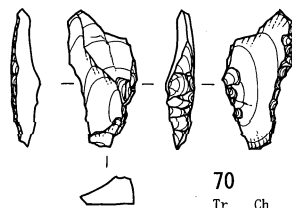

70  
Tr Ch  
BL1012 0.95g  
V b XI-P 276

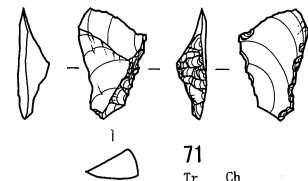

71  
Tr Ch  
BL1012 0.74g  
V b XI-P 585

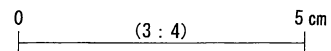

第1地点 石器実測図 8 (台形石器) (貫ノ木遺跡)

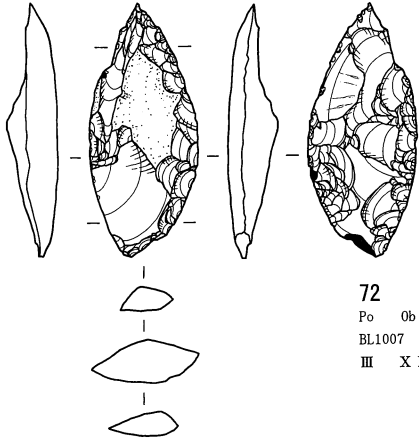

72  
Po Ob WDTY  
BL1007 4.97g  
III XI-Q 635

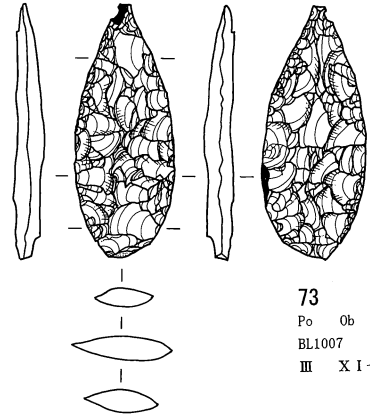

73  
Po Ob SWHD  
BL1007 3.69g  
III XI-Q 637

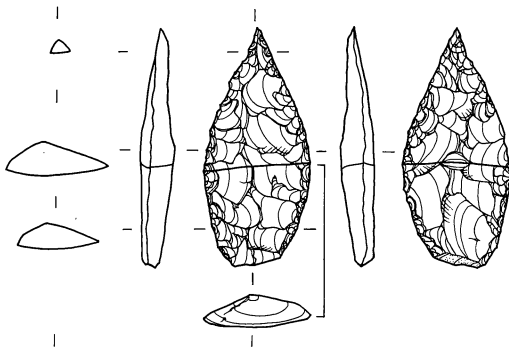

74a  
Po Ob SWHD  
BL1007 1.64g  
III XI-V 37

74b  
Po破 Ob  
BL1007 1.72g  
III XI-V 57

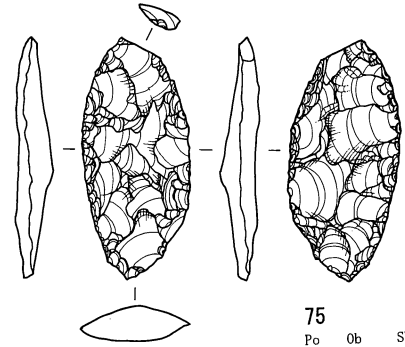

75  
Po Ob SWHD  
BL1007 4.11g  
IV XI-V 288

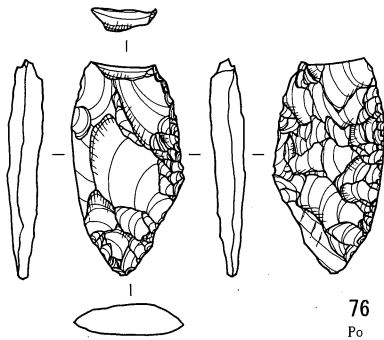

76  
Po Ob SWHD  
BL1007 3.78g  
II XI-Q 682

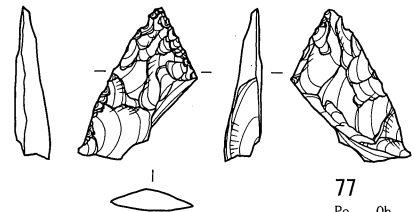

77  
Po Ob SWHD  
BL1007 1.55g  
II XI-Q 672

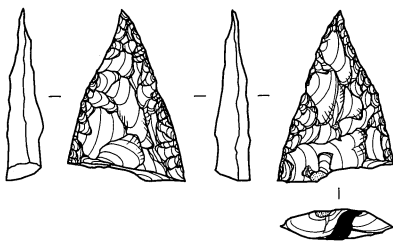

78  
Po Ob WOTM  
BL1007 2.55g  
IV XI-Q 856

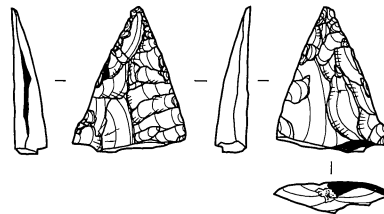

79  
Po Ob WDTY  
BL1007 1.73g  
IV XI-Q 815

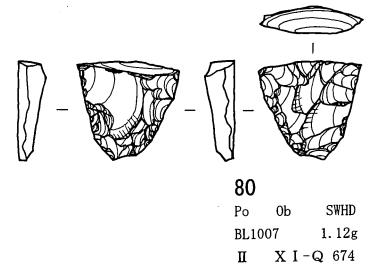

80  
Po Ob SWHD  
BL1007 1.12g  
II XI-Q 674

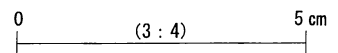

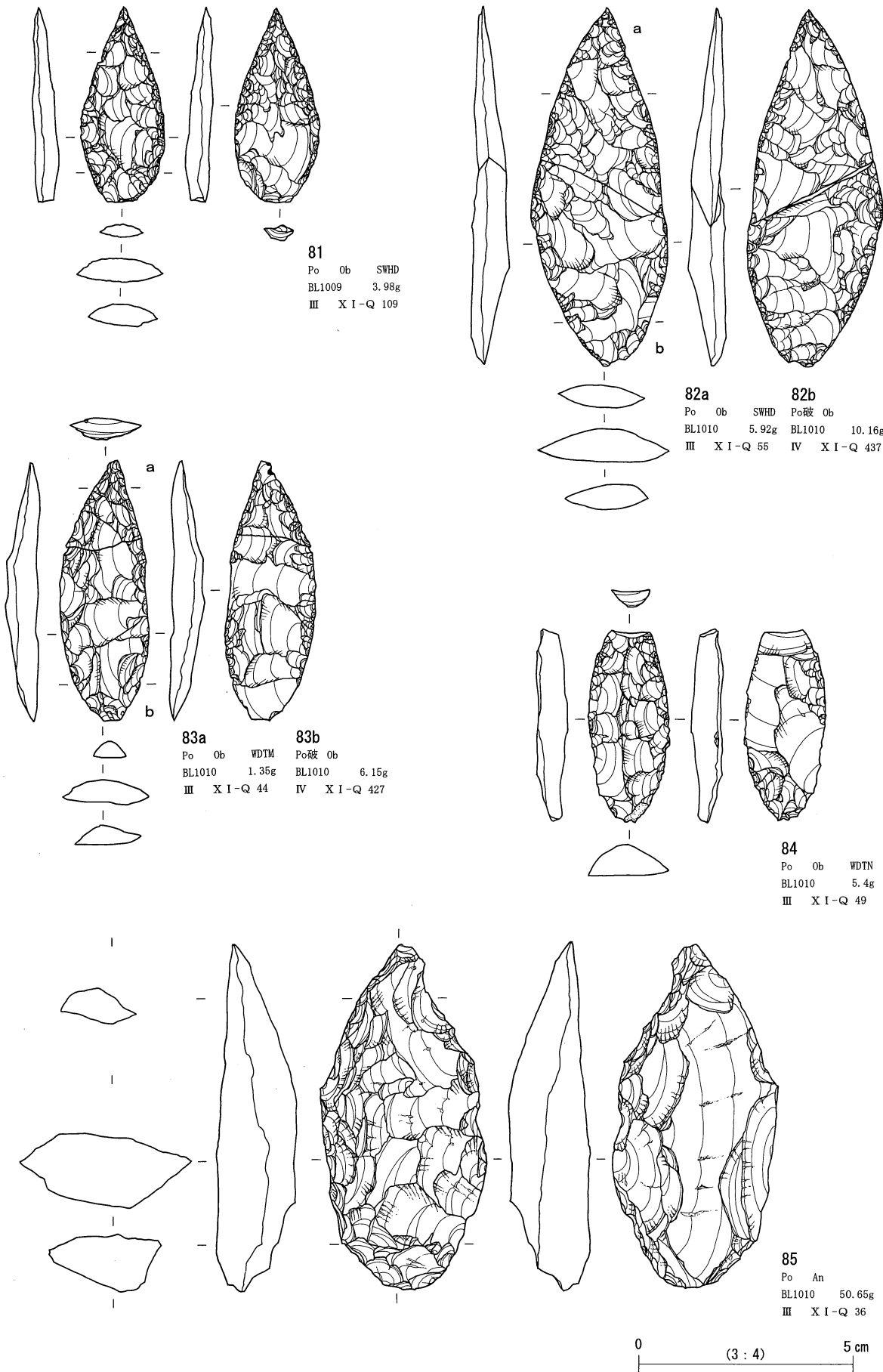

81  
Po Ob SWHD  
BL1009 3.98g  
III XI-Q 109

82a 82b  
Po Ob SWHD Po破 Ob  
BL1010 5.92g BL1010 10.16g  
III XI-Q 55 IV XI-Q 437

83a 83b  
Po Ob WDTM Po破 Ob  
BL1010 1.35g BL1010 6.15g  
III XI-Q 44 IV XI-Q 427

84  
Po Ob WDTN  
BL1010 5.4g  
III XI-Q 49

85  
Po An  
BL1010 50.65g  
III XI-Q 36

0 (3 : 4) 5 cm

第1地点 石器実測図 10 (槍先形尖頭器 2) (貫ノ木遺跡)

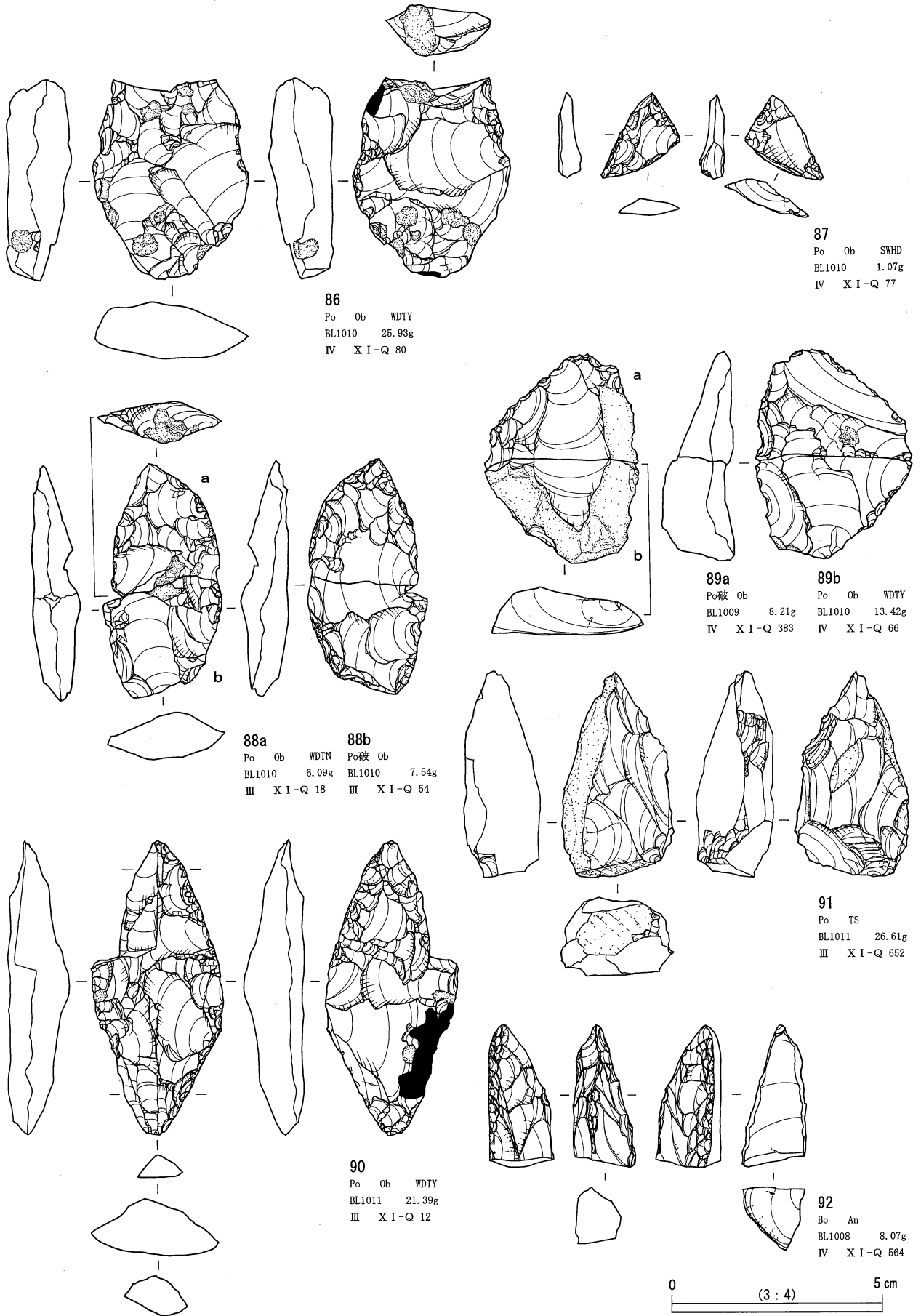

第1地点 石器実測図 11 (槍先形尖頭器 3・角錐状石器) (貫ノ木遺跡)

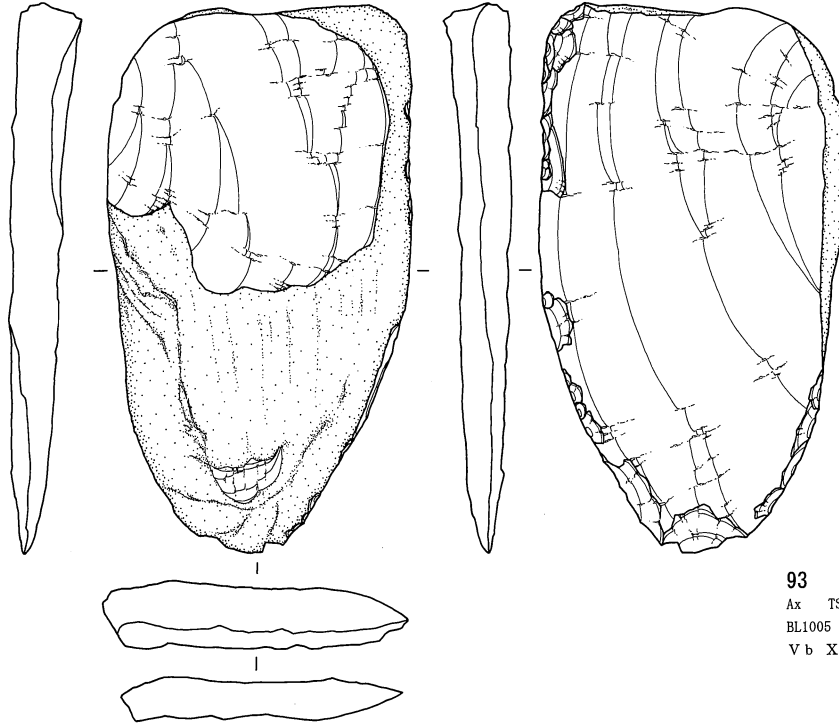

93

Ax TS  
BL1005 79.58g  
V b X I-M 66

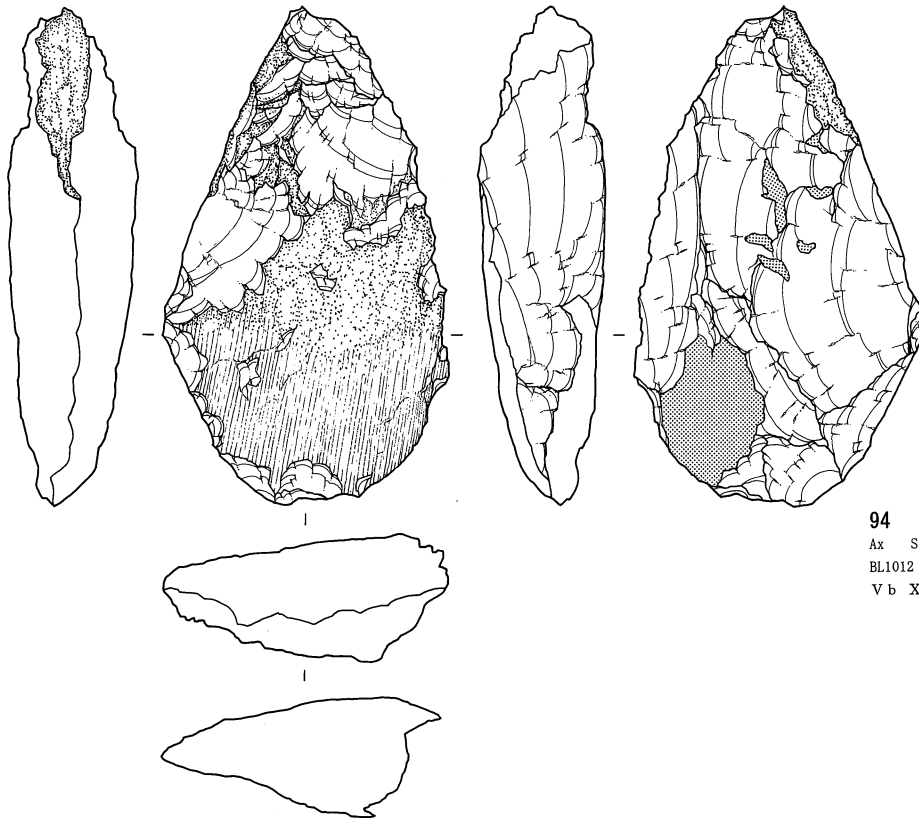

94

Ax Se  
BL1012 101.52g  
V b X I-P 407

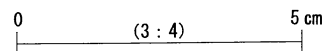

第1地点 石器実測図12 (斧形石器) (貫ノ木遺跡)

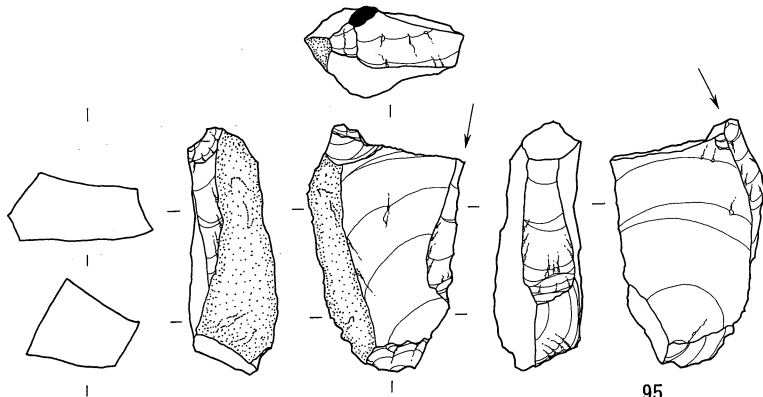

95

Gr An  
BL1006 17.66g  
Va XI-L 93

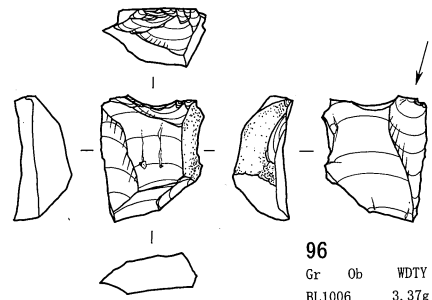

96

Gr Ob WDTY  
BL1006 3.37g  
Va XI-L 94

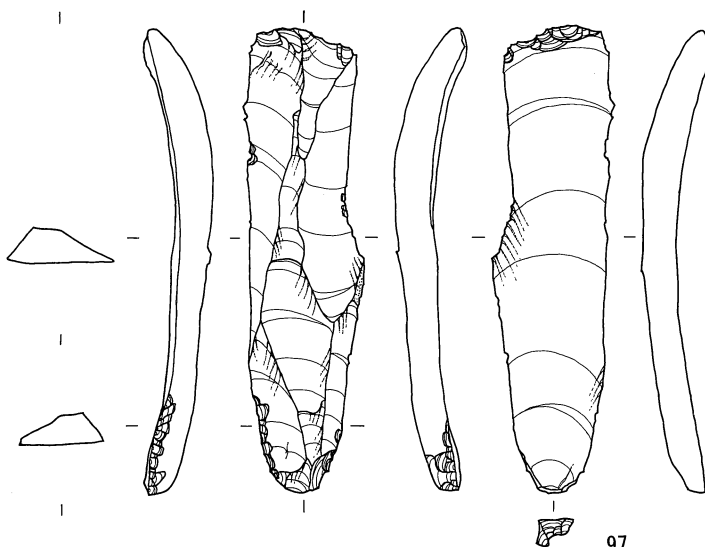

97

Gr SS  
BL1007 12.79g  
III XI-Q 776

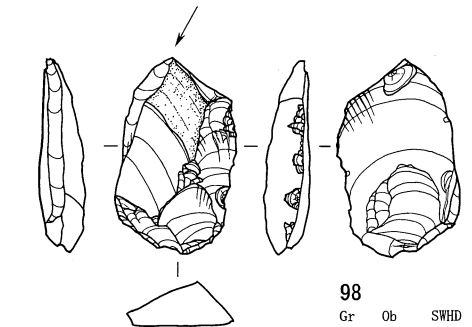

98

Gr Ob SWHD  
BL1007 5.48g  
III XI-Q 775

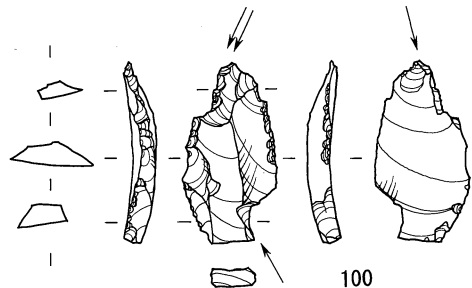

100

Gr Ob SWHD  
BL1007 2.33g  
IV XI-Q 859

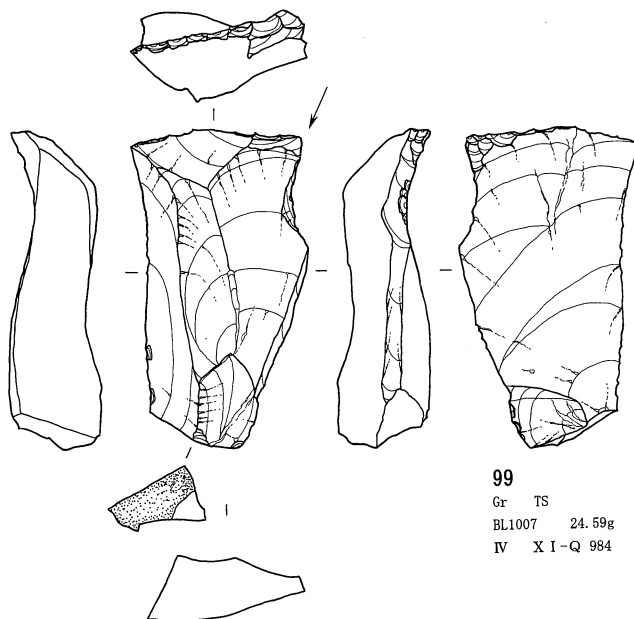

99

Gr TS  
BL1007 24.59g  
IV XI-Q 984

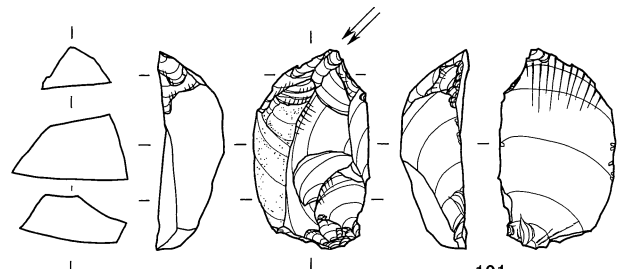

101

Gr Ob SWHD  
BL1007 7.39g  
IV XI-Q 795

0 (3:4) 5 cm

第1地点 石器実測図 13 (彫器1) (貫ノ木遺跡)

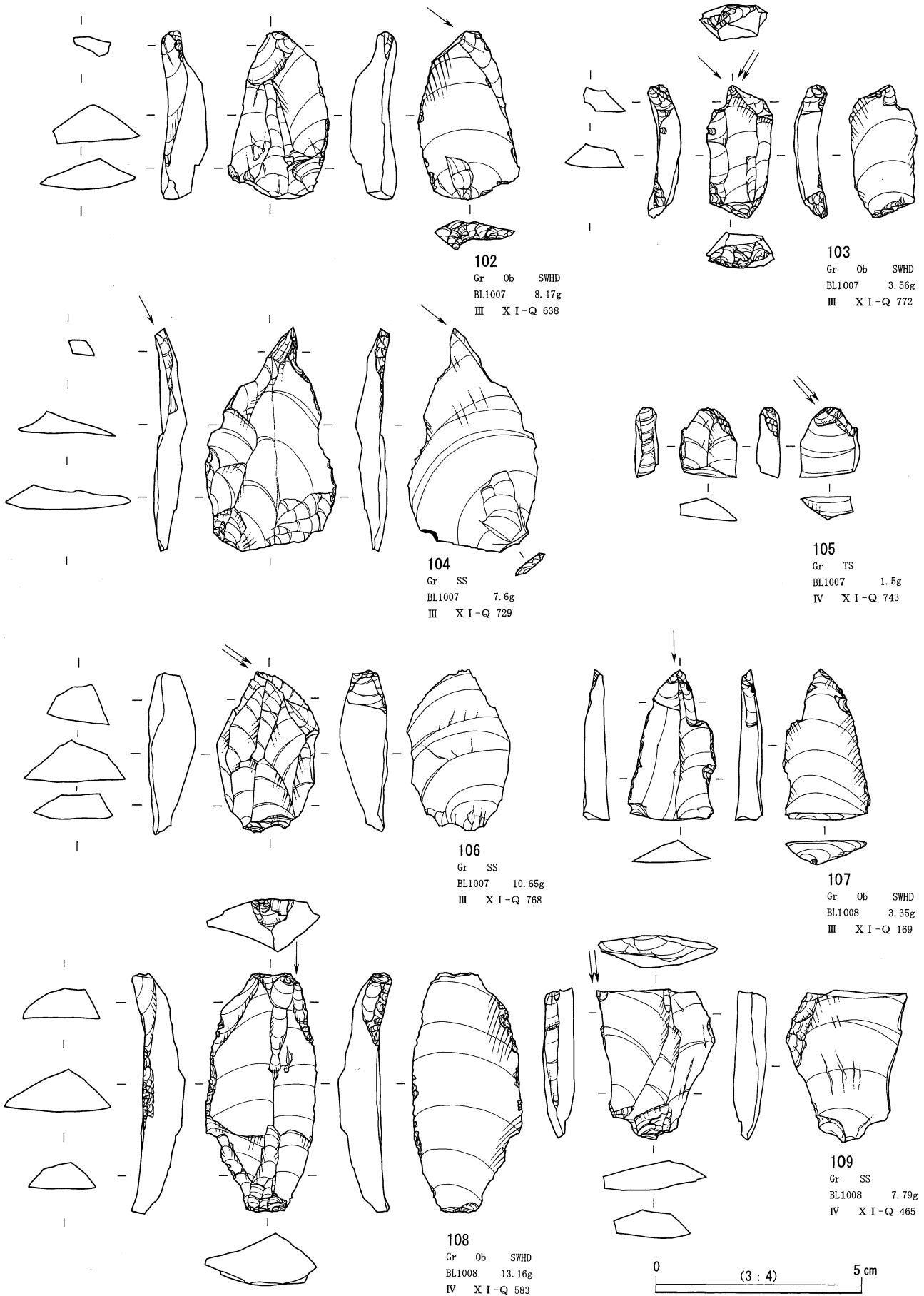

第1地点 石器実測図 14 (彫器 2) (貫ノ木遺跡)

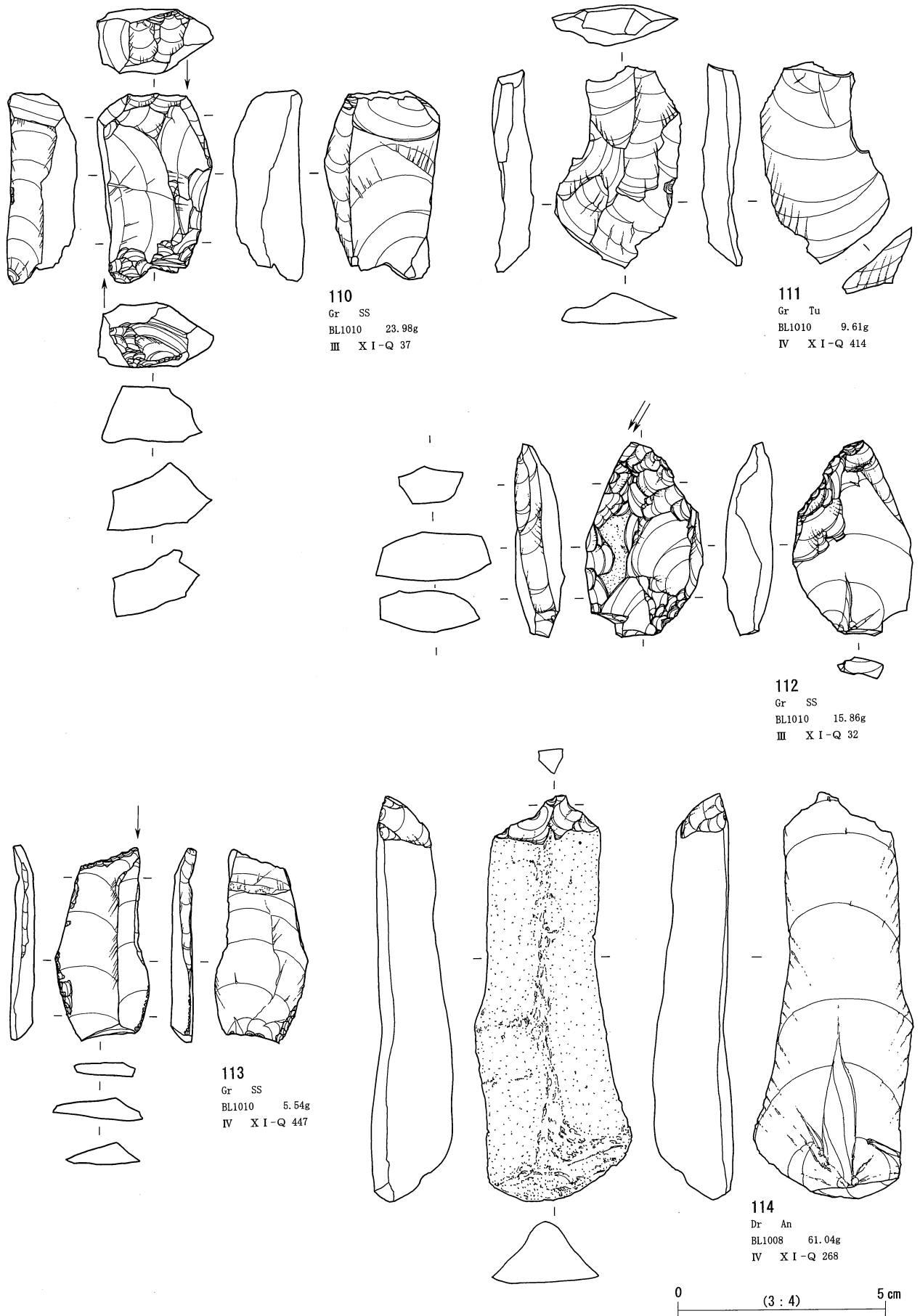

第1地点 石器実測図 15 (彫器 3・揉錐器) (貫ノ木遺跡)



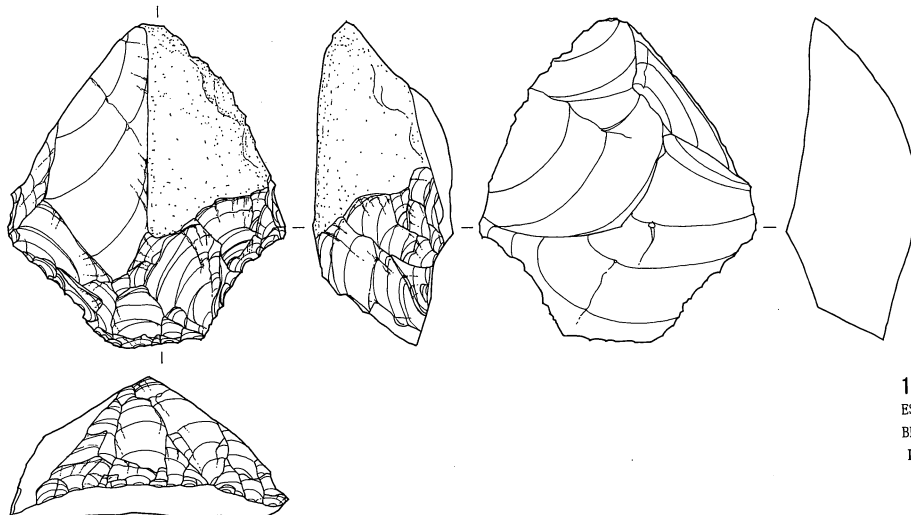

115  
 ES An  
 BL1003 52.72g  
 I XI-R 67

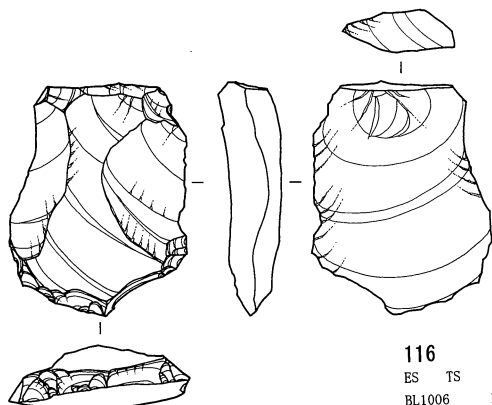

116  
 ES TS  
 BL1006 12.9g  
 Va XI-L 69

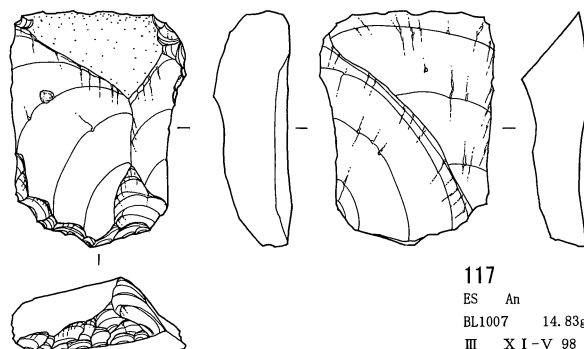

117  
 ES An  
 BL1007 14.83g  
 III XI-V 98

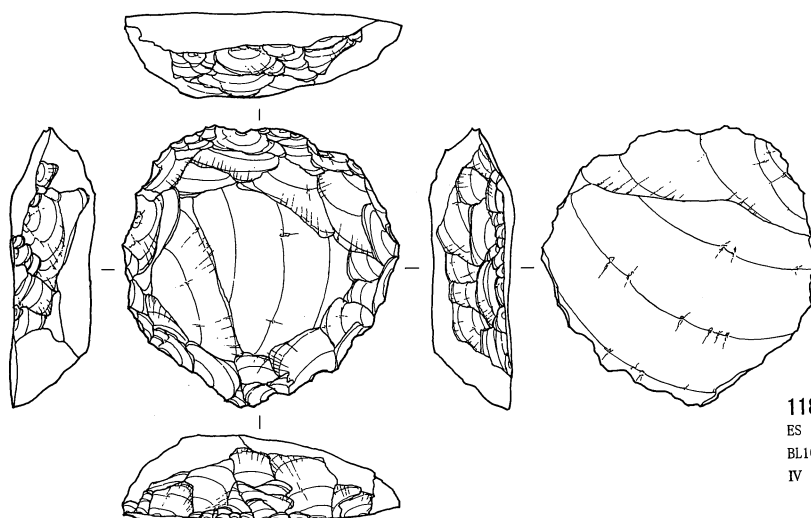

118  
 ES An  
 BL1007 38.93g  
 IV XI-Q 845

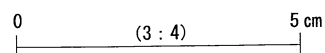

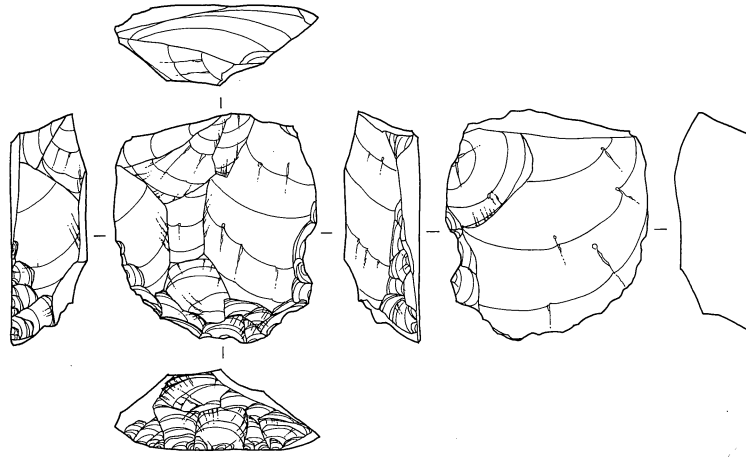

119  
 ES An  
 BL1007 21.07g  
 IV XI-Q 923

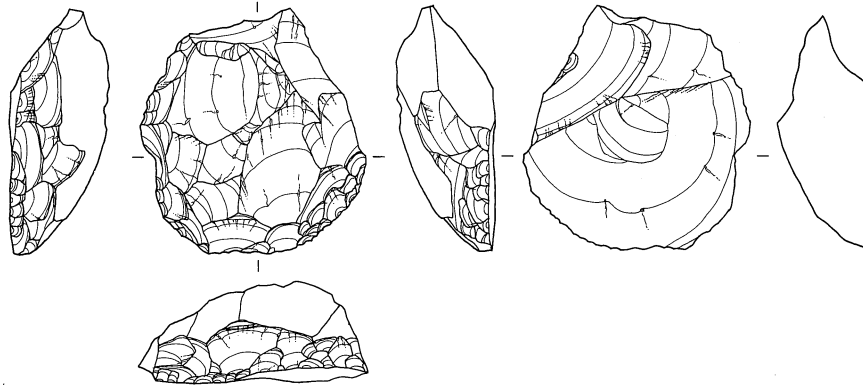

120  
 ES An  
 BL1007 26.95g  
 IV XI-V 469

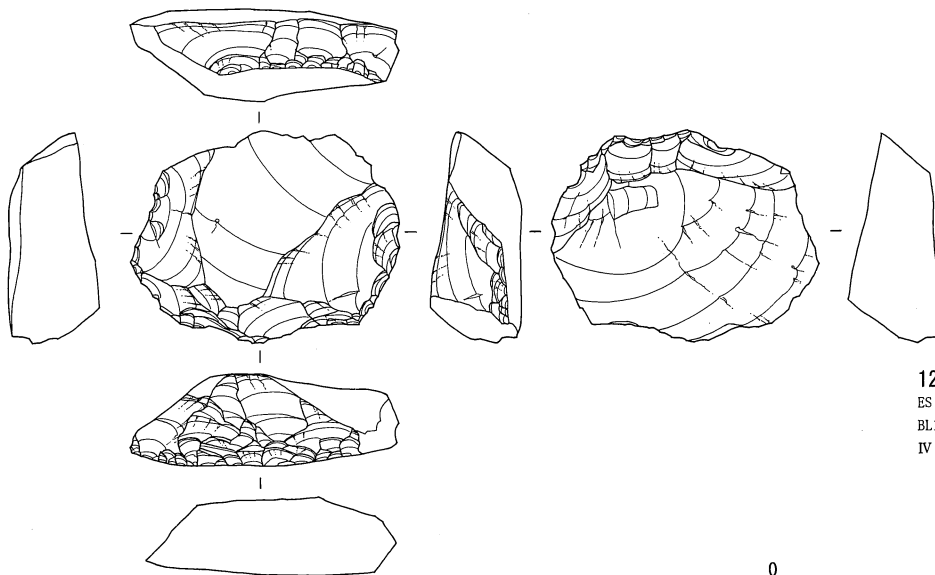

121  
 ES An  
 BL1007 31.25g  
 IV XI-Q 944

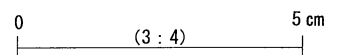

第1地点 石器実測図 17 (搔器 2) (貫ノ木遺跡)

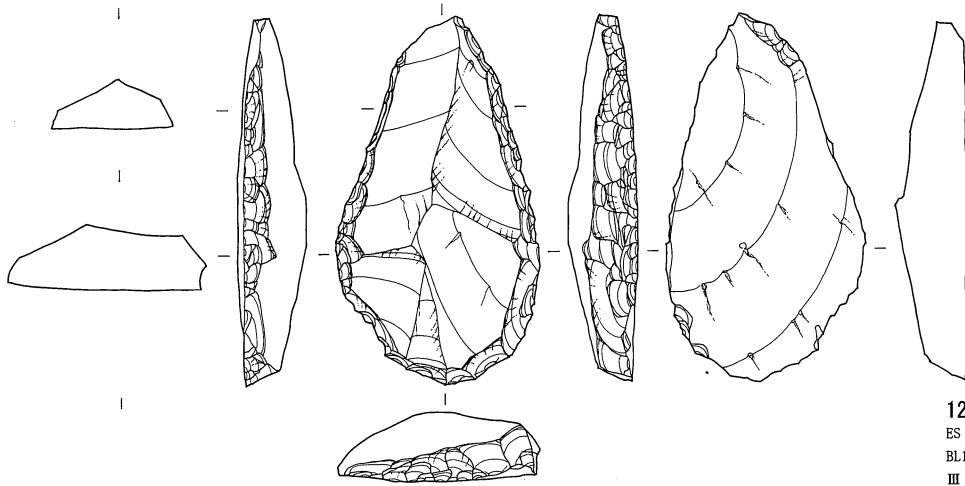

122  
 ES An  
 BL1007 27.14g  
 III XI-V 17

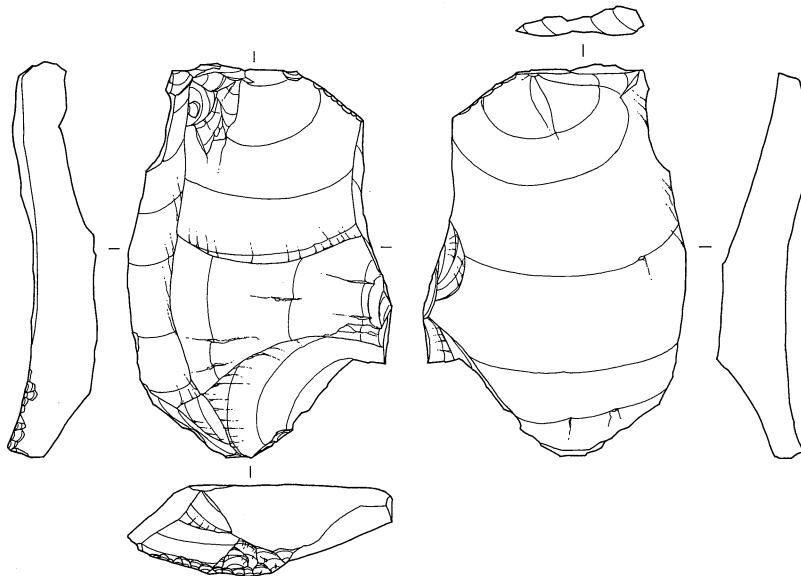

123  
 ES An  
 BL1007 40.24g  
 III XI-V 165

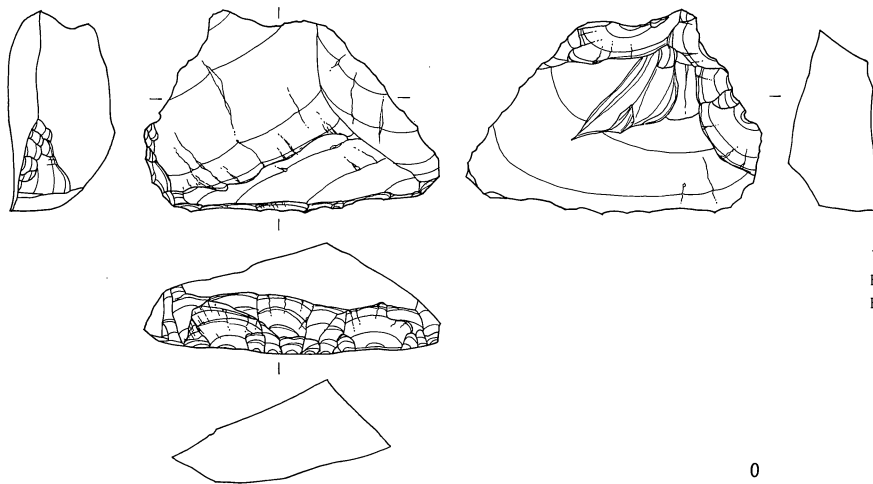

124  
 ES An  
 BL1007 30.02g  
 II XI-V 33

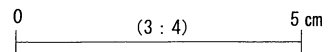

第1地点 石器実測図 18 (搔器 3) (貫ノ木遺跡)

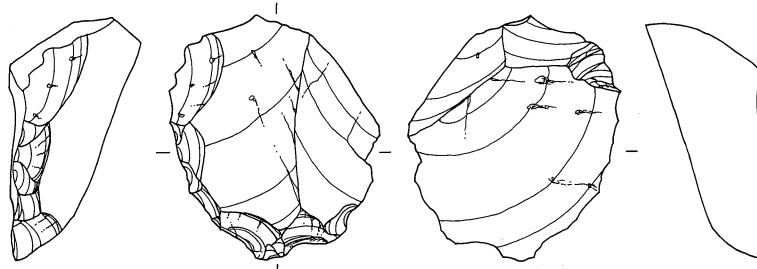

125  
 ES An  
 BL1007 24.51g  
 II XI-V 46

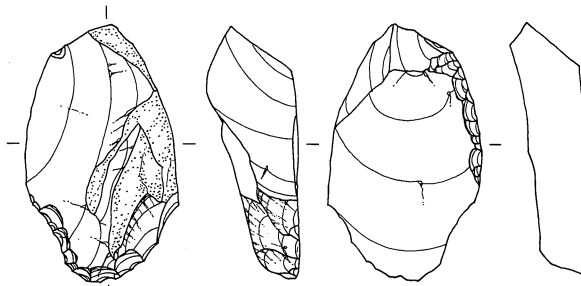

126  
 ES An  
 BL1007 15.3g  
 III XI-V 86

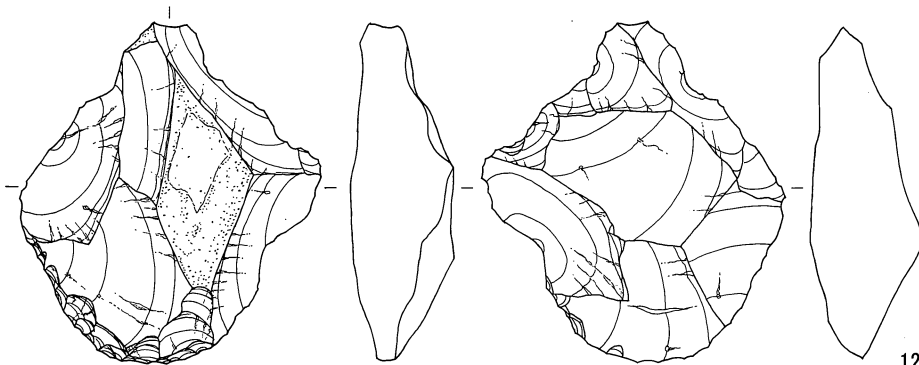

127  
 ES An  
 BL1007 40.82g  
 IV XI-V 148

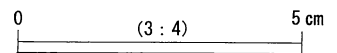

第1地点 石器実測図19 (搔器4) (貫ノ木遺跡)

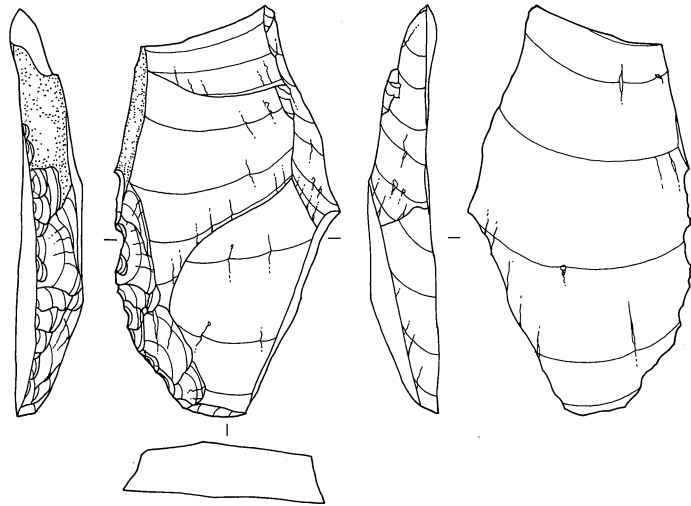

128  
 ES An  
 BL1007 32.82g  
 IV XI-Q 968

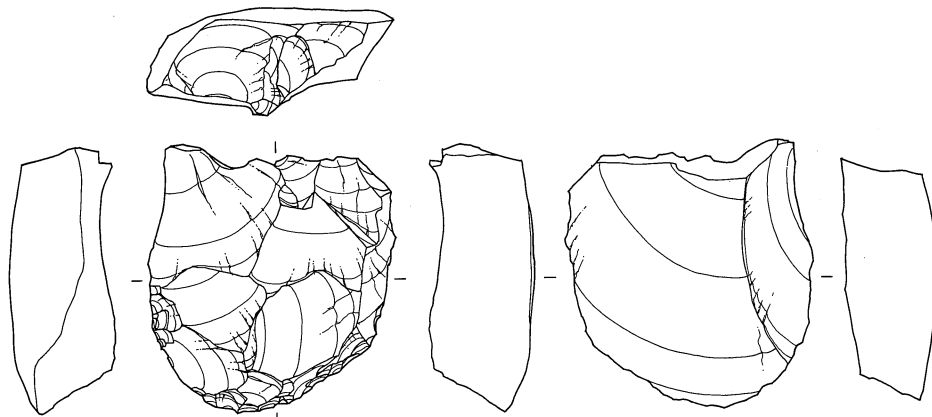

129  
 ES An  
 BL1008 39.32g  
 IV XI-Q 339

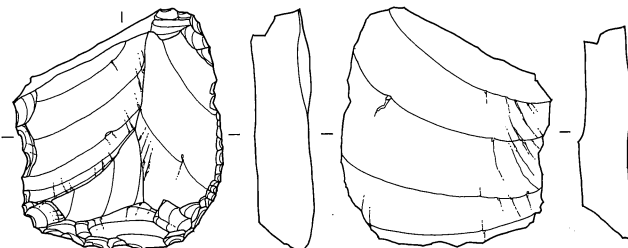
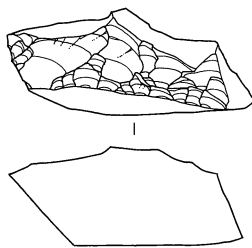

130  
 ES An  
 BL1008 16.52g  
 IV XI-Q 361

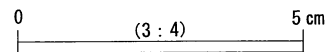
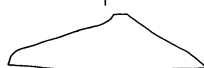

第1地点 石器実測図 20 (搔器 5) (貫ノ木遺跡)

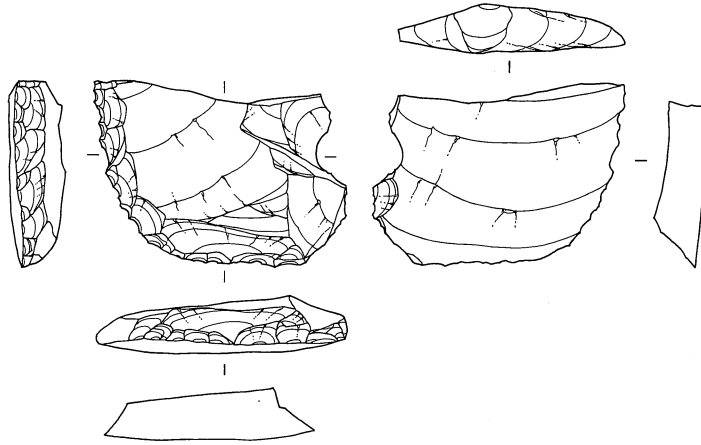

131  
 ES An  
 BL1008 16.13g  
 IV XI-Q 228

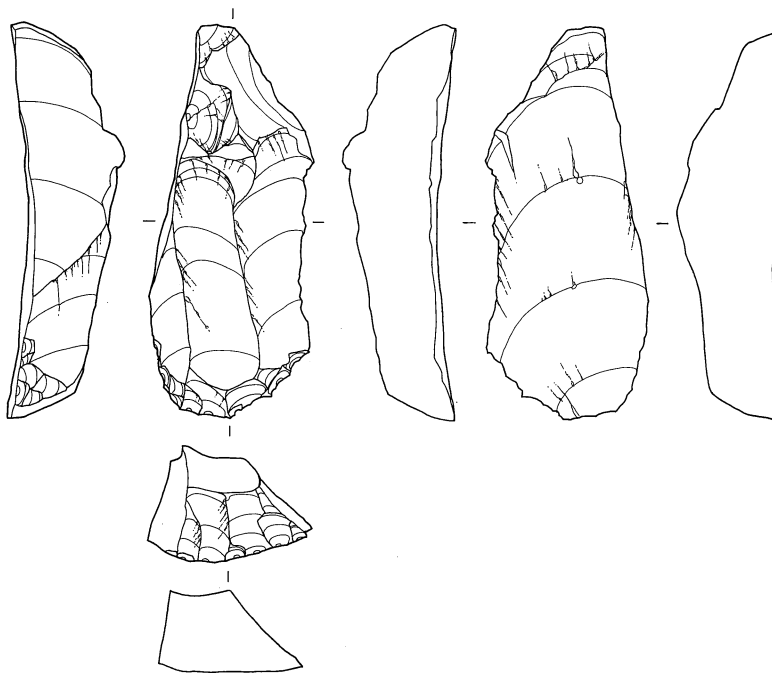

132  
 ES An  
 BL1008 31.96g  
 IV XI-Q 119

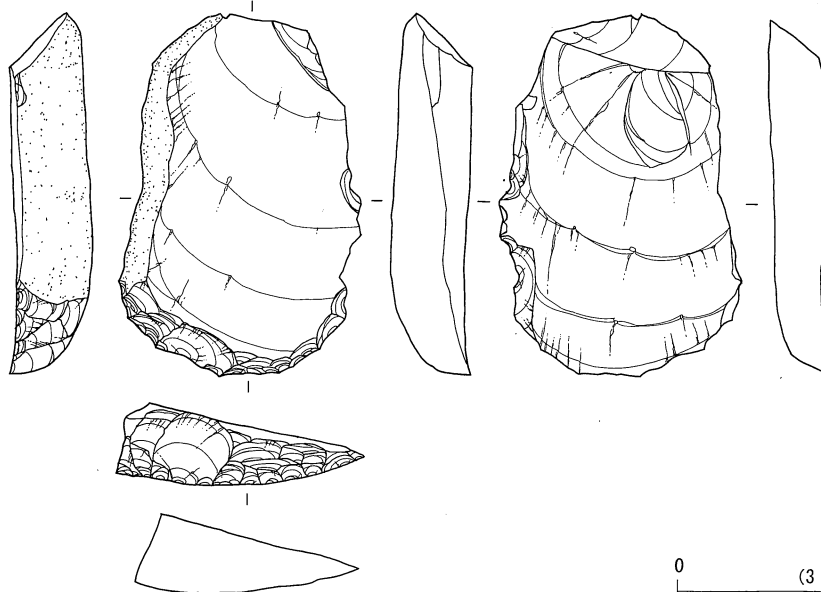

133  
 ES An  
 BL1009 39.22g  
 III XI-Q 105

0 (3 : 4) 5 cm

第1地点 石器実測図 21 (搔器 6) (貫ノ木遺跡)

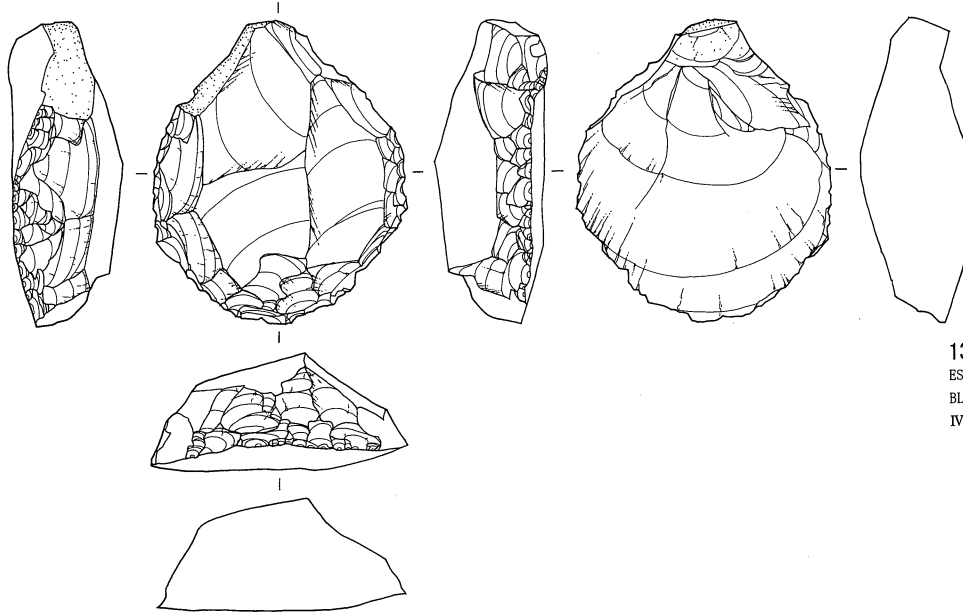

134  
 ES TS  
 BL1009 49.97g  
 IV XI-Q 391

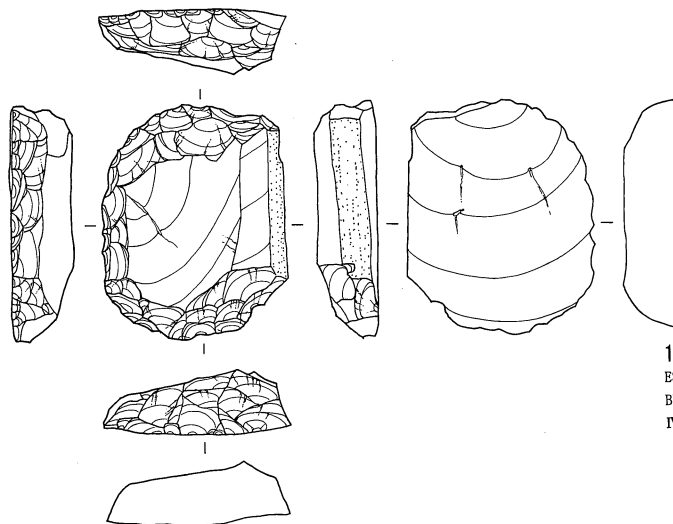

135  
 ES An  
 BL1009 17.62g  
 IV XI-Q 392

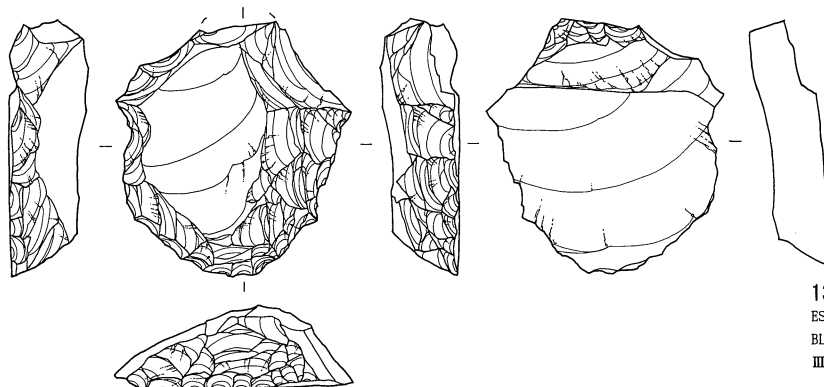

136  
 ES An  
 BL1009 23.63g  
 III XI-Q 101

0 (3 : 4) 5 cm

第1地点 石器実測図 22 (搔器 7) (貫ノ木遺跡)

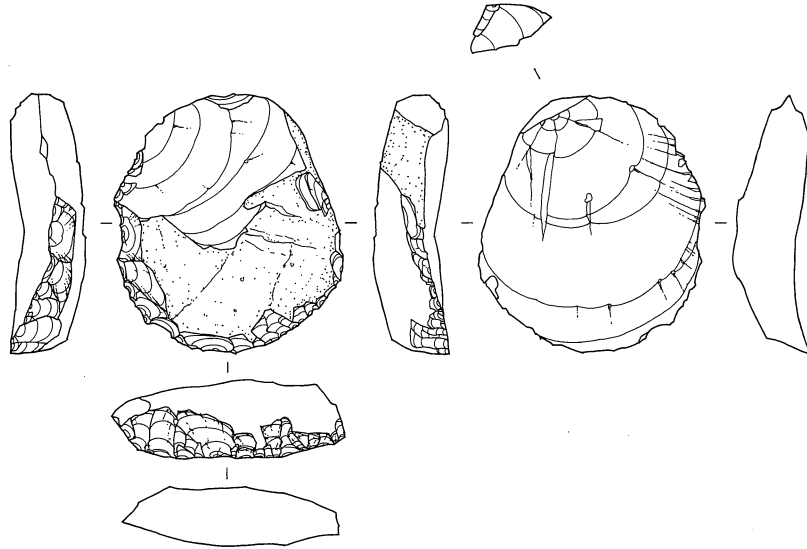

137  
 ES An  
 BL1009 23.97g  
 IV XI-Q 90

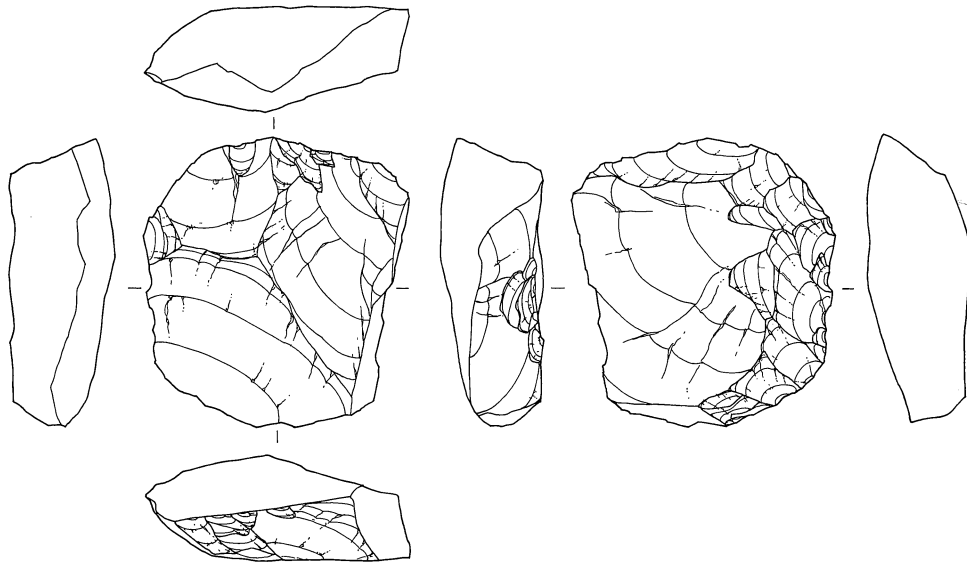

138  
 ES An  
 BL1013 47.74g  
 IV XI-Q 517

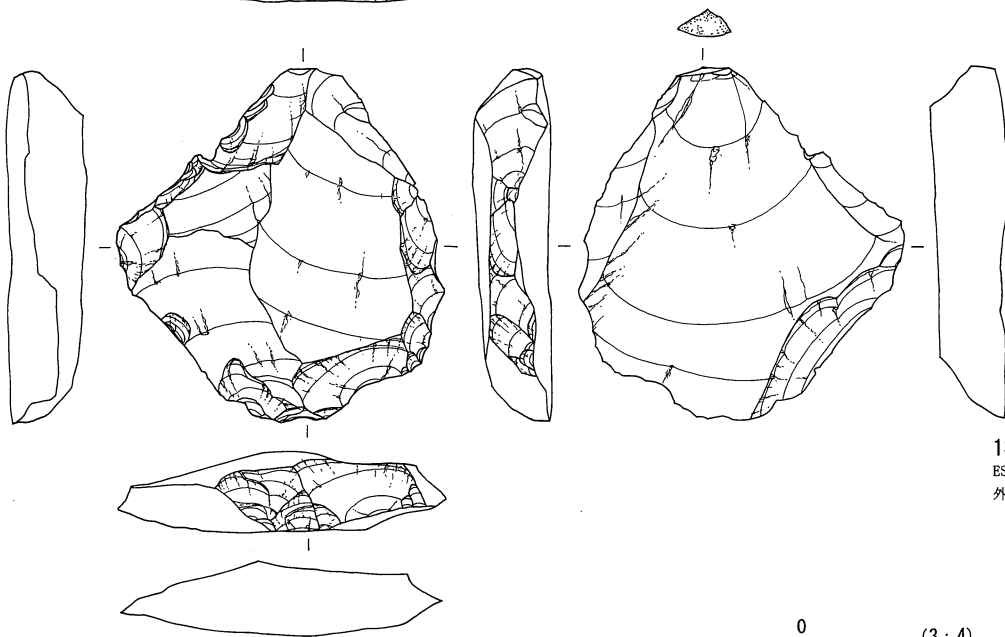

139  
 ES An  
 外 47.75g  
 XI-V 136

0 (3:4) 5 cm

第1地点 石器実測図 23 (搔器 8) (貫ノ木遺跡)



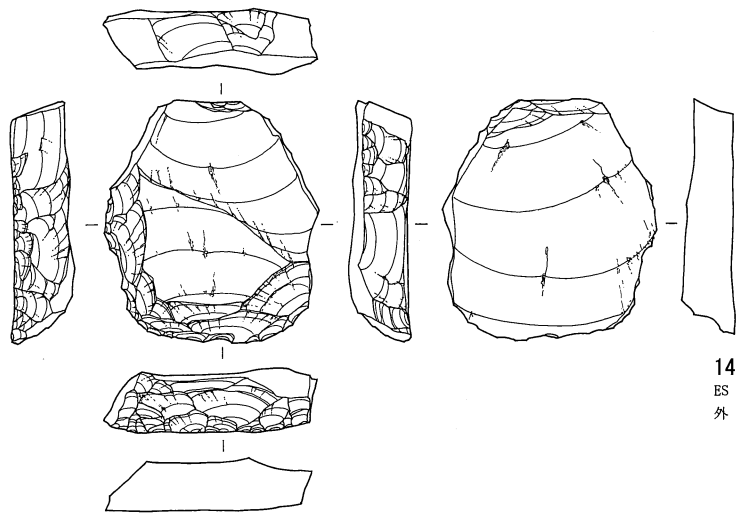

140  
ES An  
外 23.96g  
XI-V 125

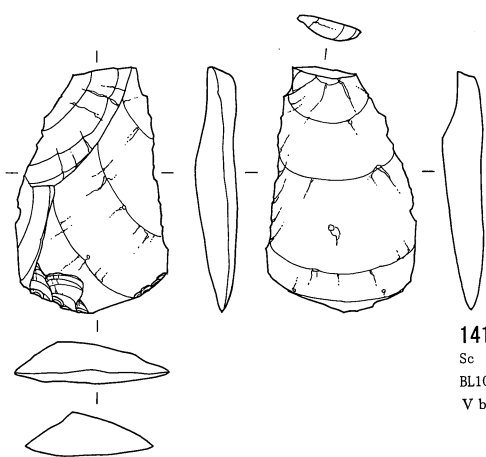

141  
Sc An  
BL1012 6.96g  
Vb XI-P 570

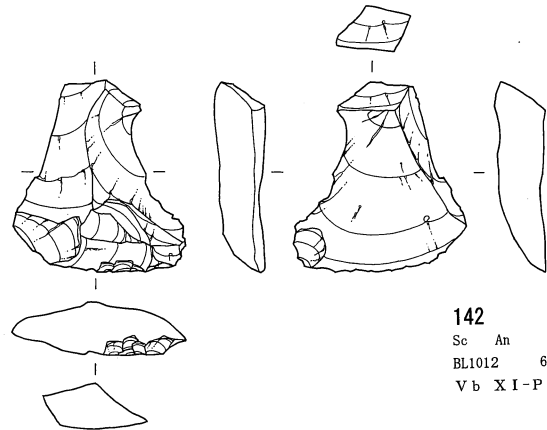

142  
Sc An  
BL1012 6.55g  
Vb XI-P 685

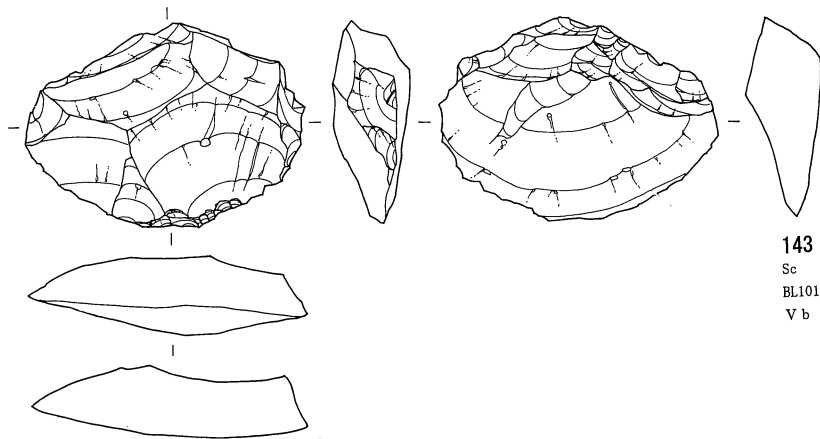

143  
Sc An  
BL1012 18.84g  
Vb XI-P 543

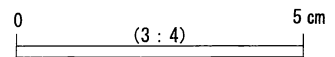

第1地点 石器実測図 24 (搔器9・搔器状石器) (貫ノ木遺跡)

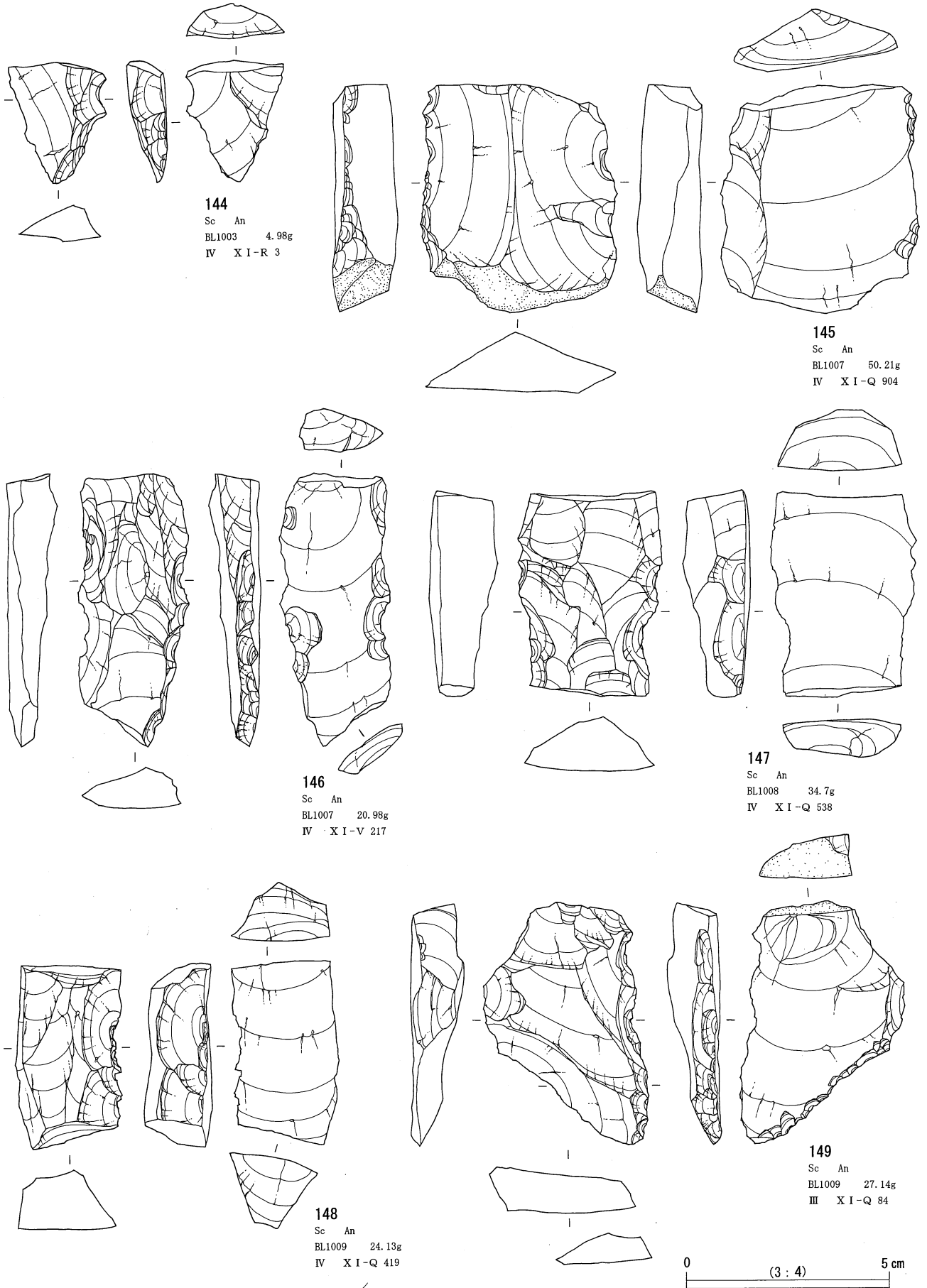

第1地点 石器実測図 25 (削器 1) (貫ノ木遺跡)

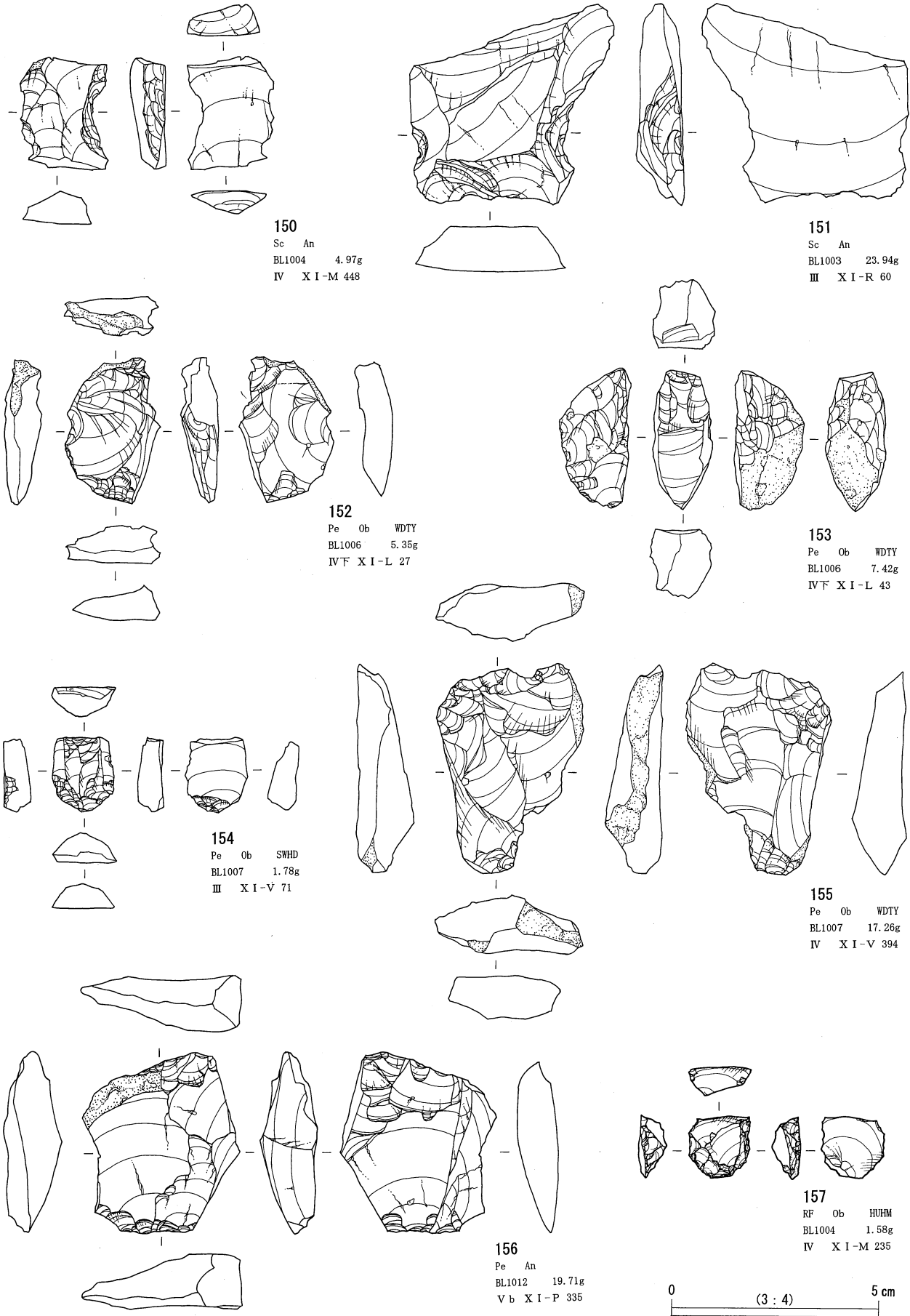

第1地点 石器実測図 26 (削器 2・楔形石器・2次加工のある剥片) (貫ノ木遺跡)

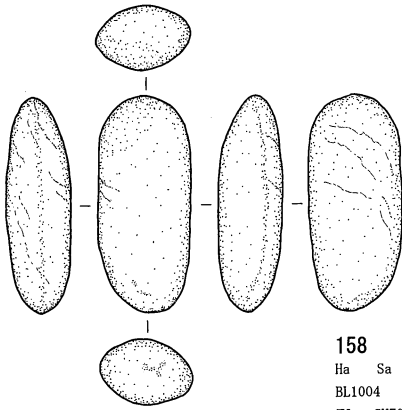

158  
Ha Sa  
BL1004 123.22g  
IV SH70 13

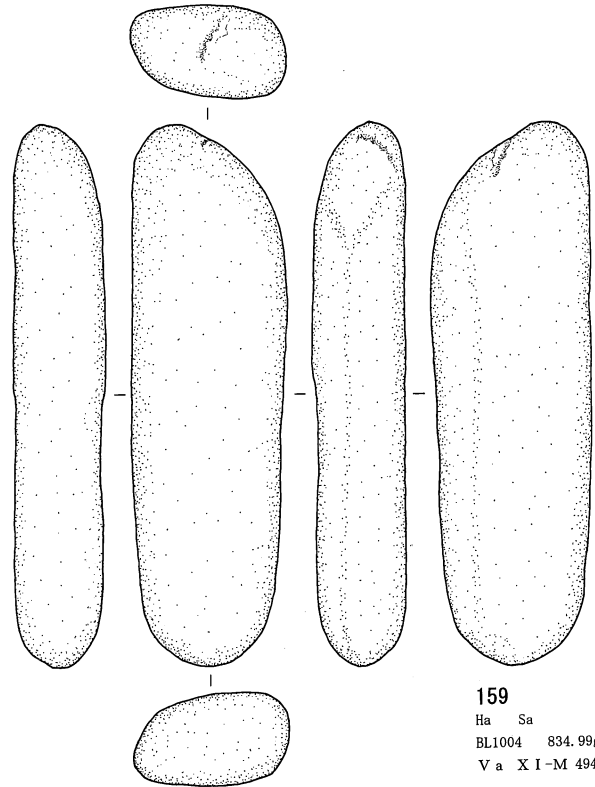

159  
Ha Sa  
BL1004 834.99g  
Va XI-M 494

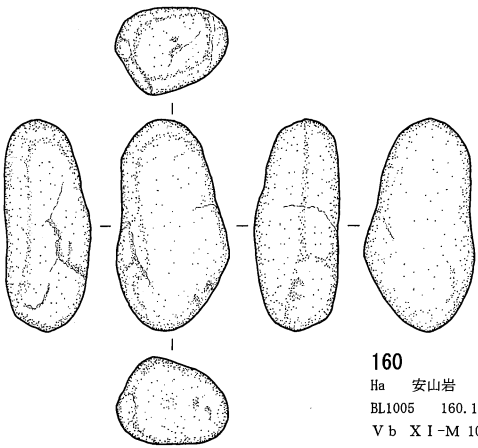

160  
Ha 安山岩  
BL1005 160.17g  
Vb XI-M 10

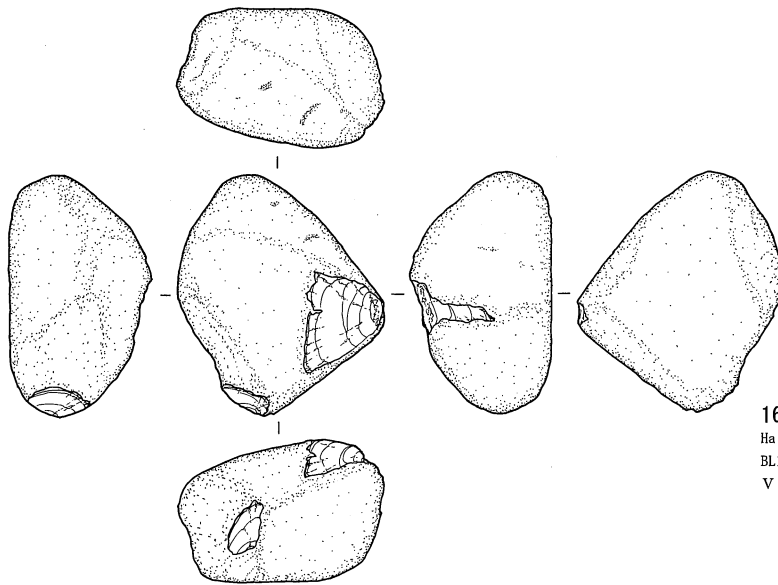

161  
Ha 安山岩  
BL1005 286.25g  
Vb XI-M 11

0 (1:3) 10cm

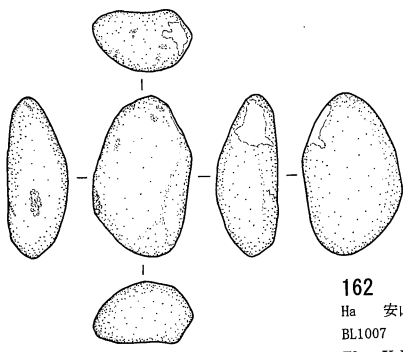

162  
Ha 安山岩  
BL1007 65.51g  
IV XI-Q 868

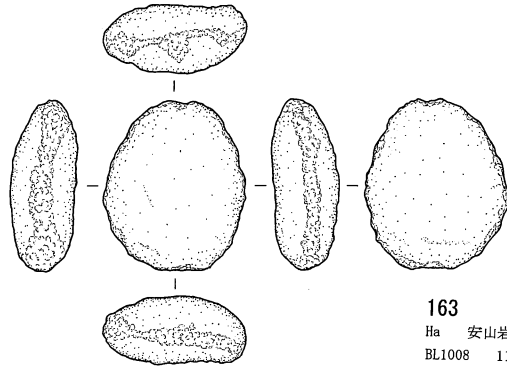

163  
Ha 安山岩  
BL1008 112.66g  
IV XI-Q 496

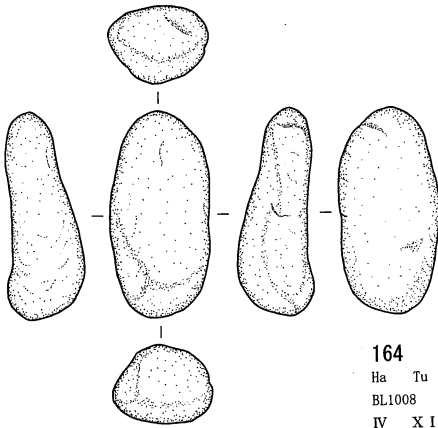

164  
Ha Tu  
BL1008 129.74g  
IV XI-Q 242

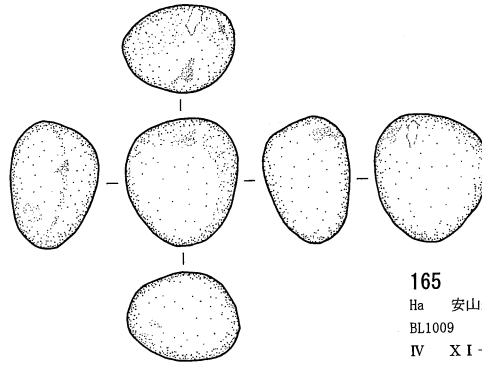

165  
Ha 安山岩  
BL1009 103.91g  
IV XI-Q 386

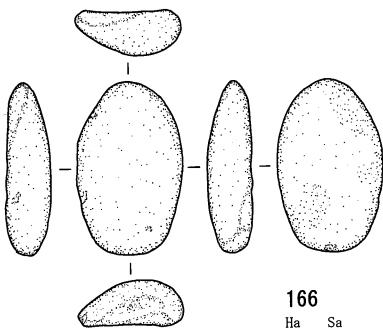

166  
Ha Sa  
BL1012 65.79g  
V b XI-P 406

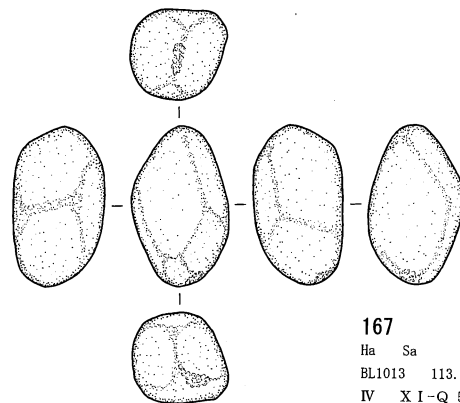

167  
Ha Sa  
BL1013 113.91g  
IV XI-Q 516

0 (1:3) 10cm

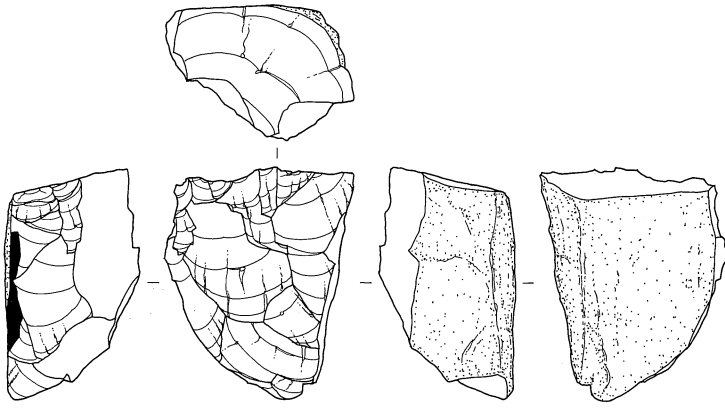

168  
Co An  
BL1007 44.93g  
III XI-Q 932

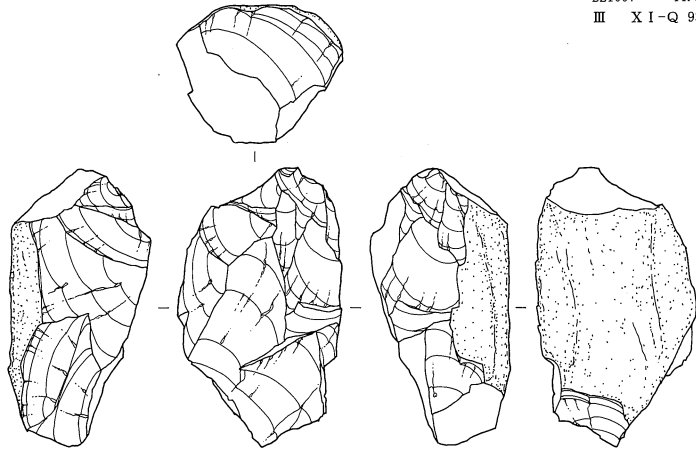

170  
Co An  
BL1007 47.36g  
IV XI-Q 927

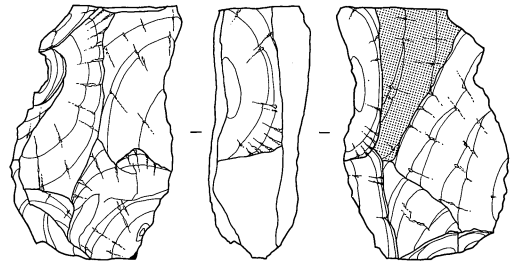

169  
Co An  
BL1007 33.1g  
III XI-V 502

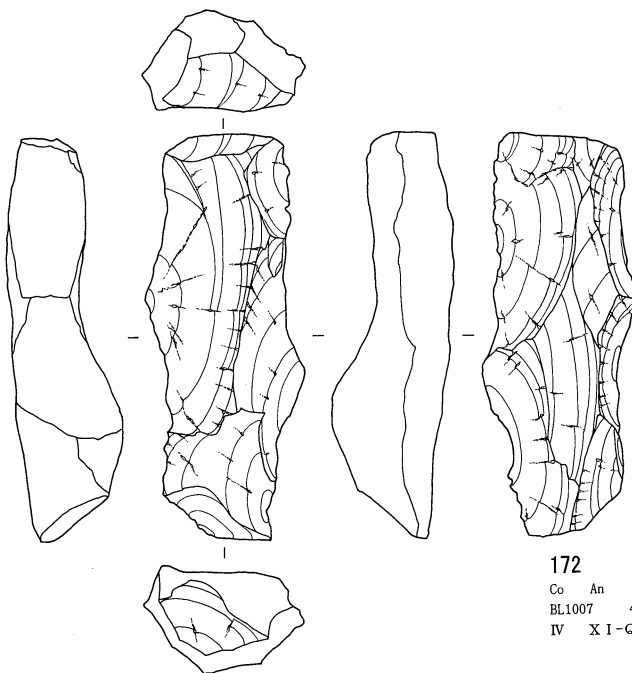

172  
Co An  
BL1007 49.99g  
IV XI-Q 954

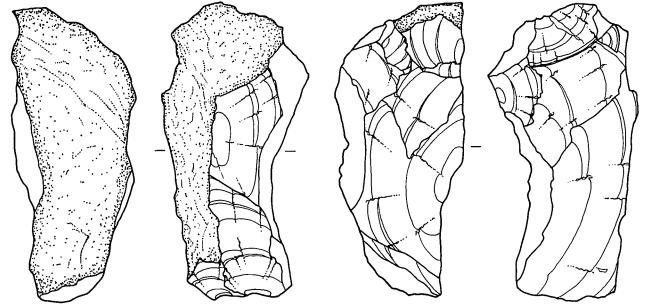

171  
Co An  
BL1007 44.18g  
III XI-V 468

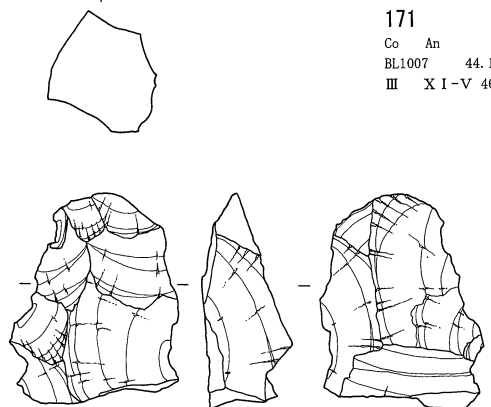

173  
Co An  
BL1007 20.48g  
IV XI-V 278

0 (2:3) 5cm

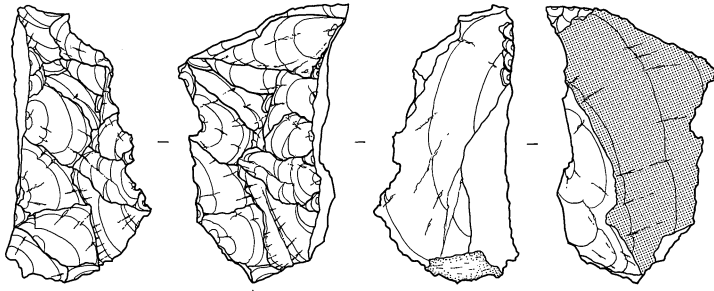

174  
Co An  
BL1007 38.25g  
III XI-Q 809

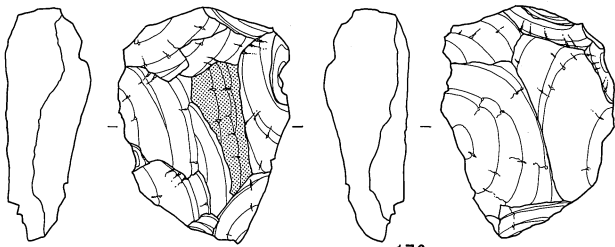

176  
Co An  
BL1007 24.42g  
II XI-Q 659

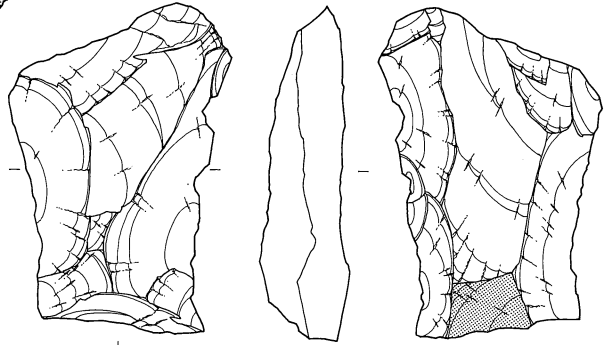

175  
Co An  
BL1007 46.79g  
III XI-V 166

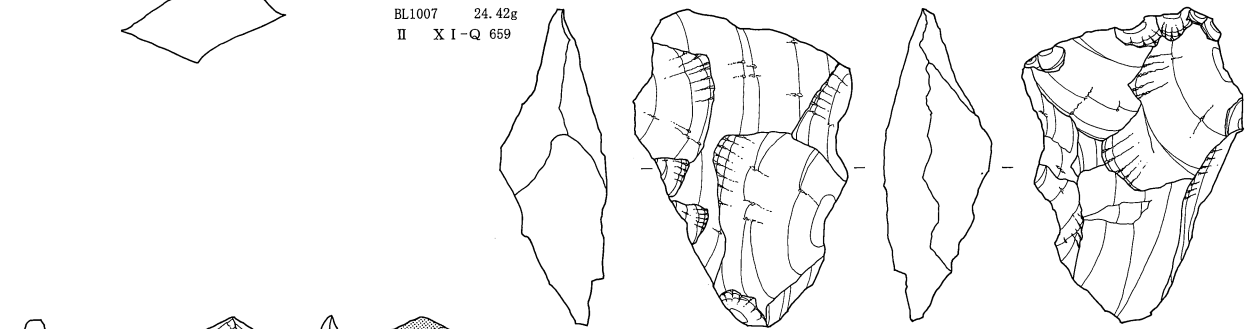

177  
Co An  
BL1008 37.19g  
IV XI-Q 302

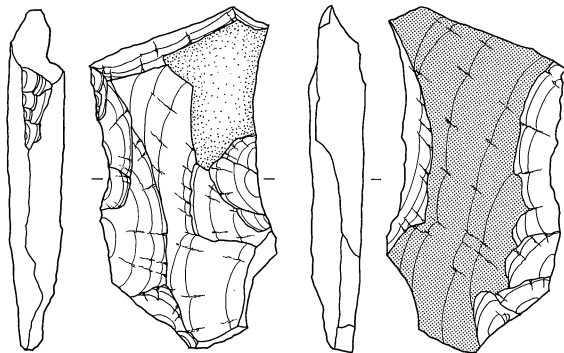

178  
Co An  
BL1008 29.3g  
IV XI-Q 205

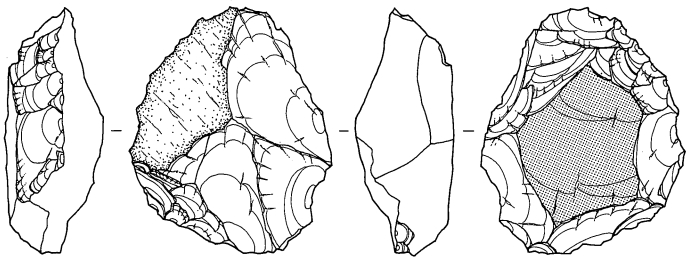
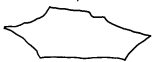

179  
Co An  
BL1009 35.4g  
IV XI-Q 390

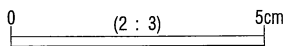

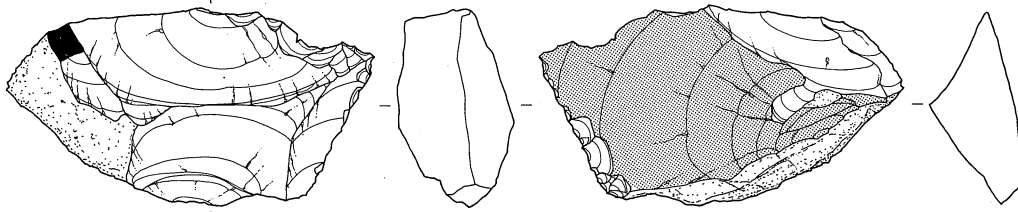
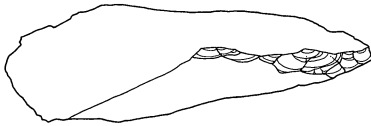

180

Co An  
BL1009 48.1g  
IV XI-Q 394

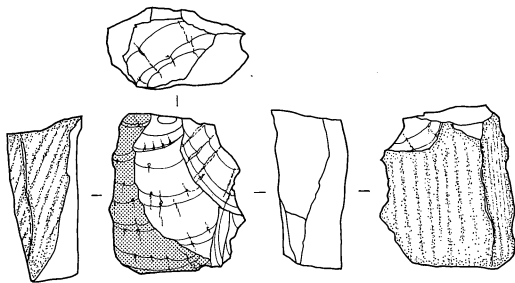
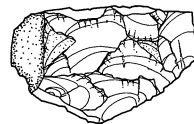
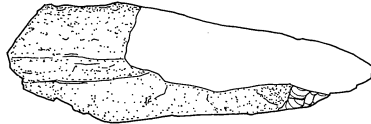

181

Co An  
BL1011 13.97g  
IV XI-Q 411

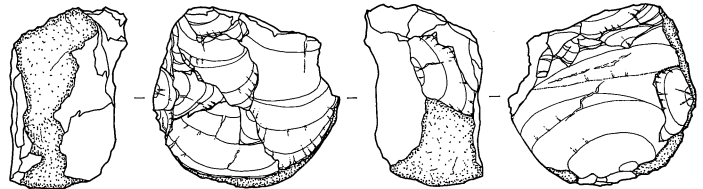

182

Co Ch  
BL1012 34.15g  
V b XI-P 221

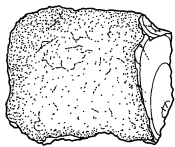
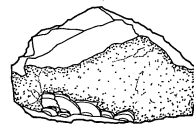

183

Co Ch  
BL1012 19.31g  
V b XI-P 307

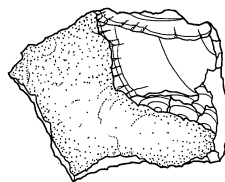
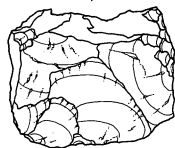
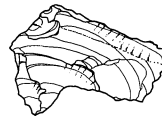

184

Co Ch  
BL1012 11.96g  
V b XI-P 308

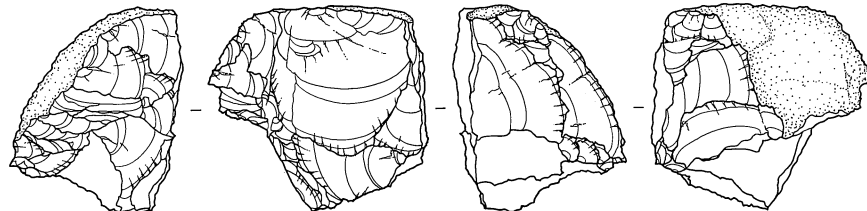

185

Co Ch  
BL1012 54.35g  
V b XI-P 576

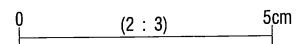
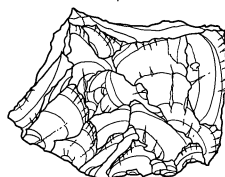



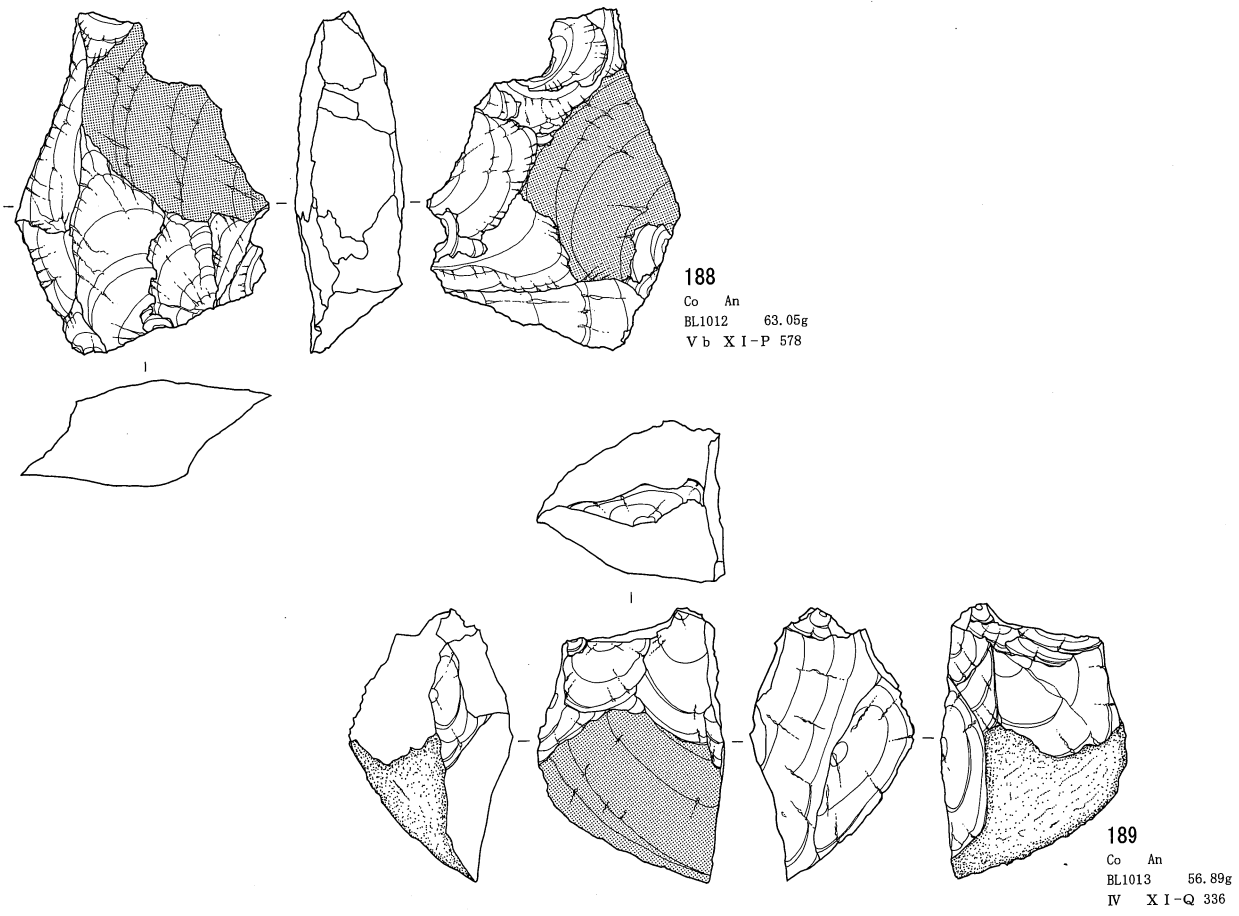
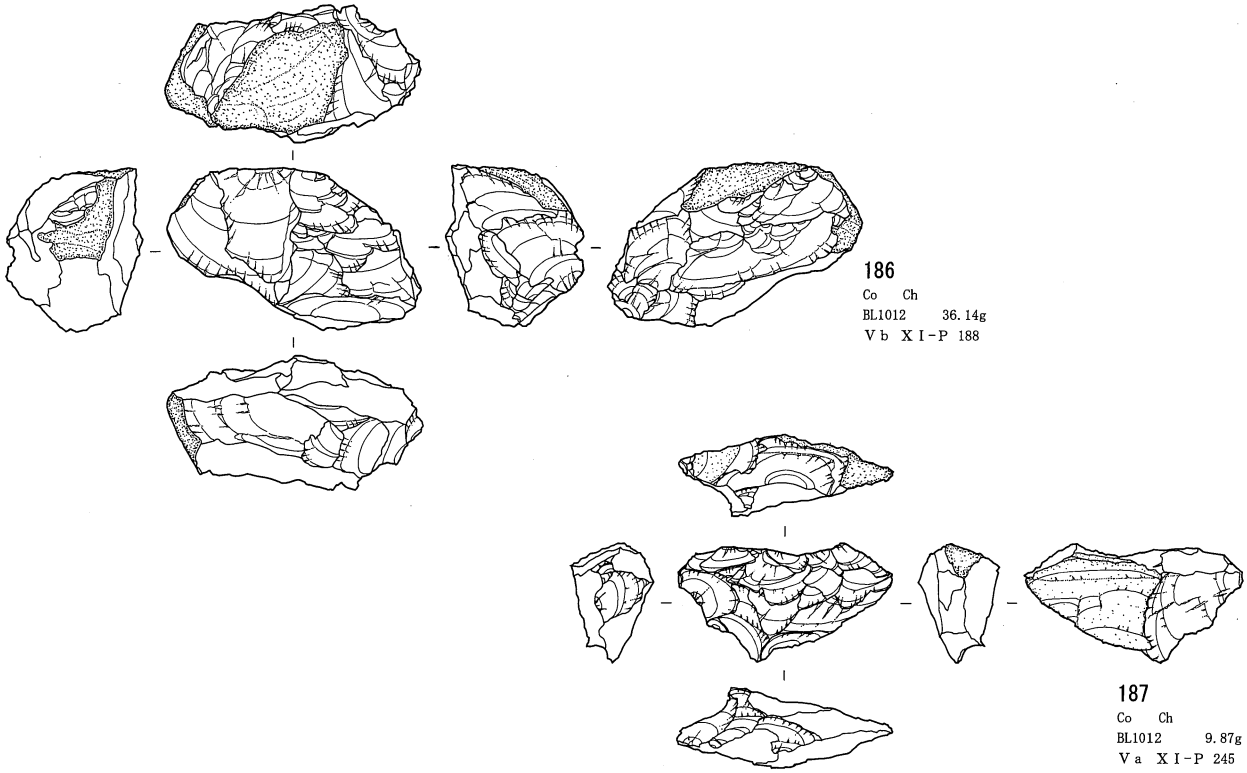

0 (2 : 3) 5cm

第1地点 石器実測図 32 (石核 4) (貫ノ木遺跡)

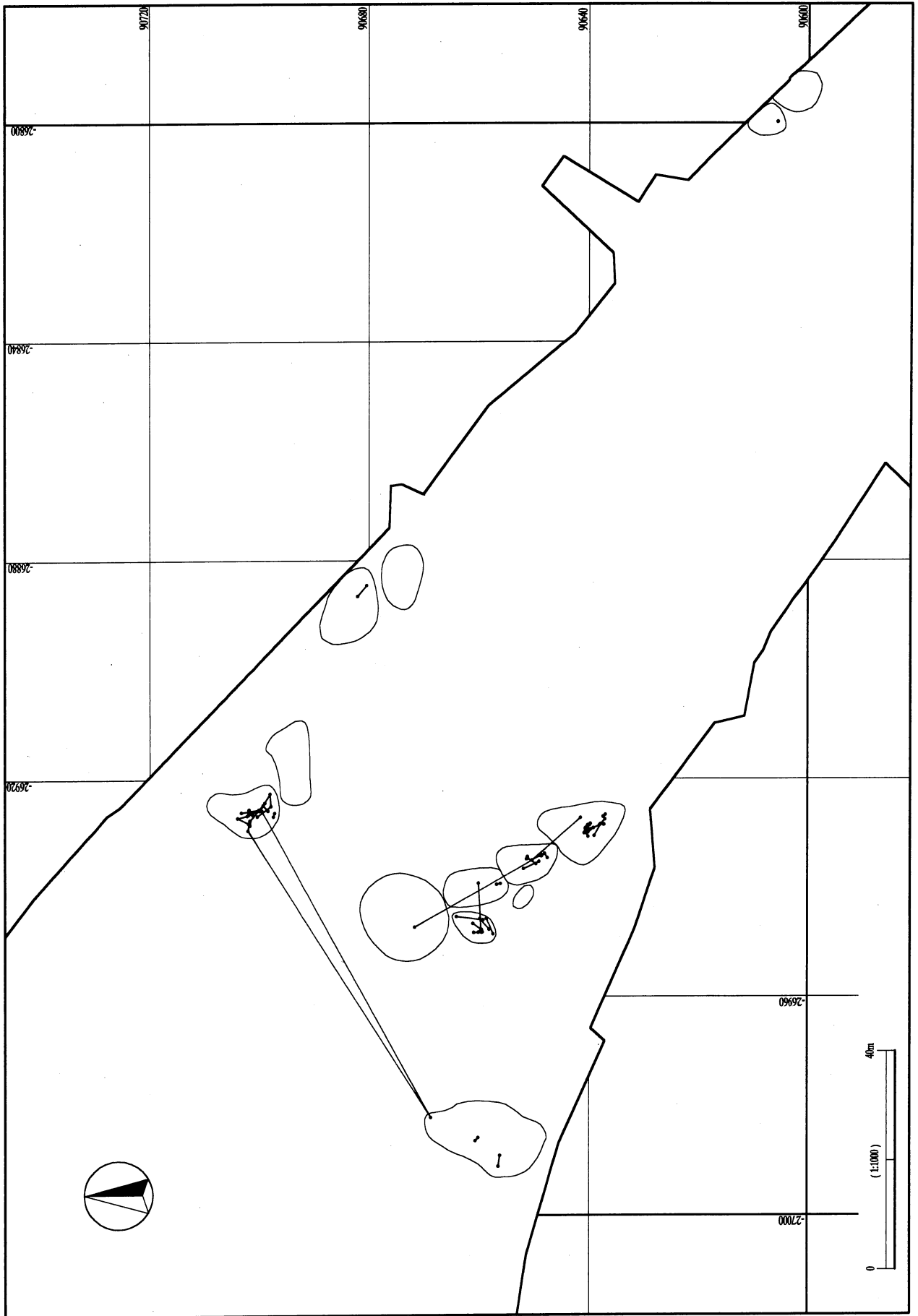

第 1 地点 接合資料分布図 (全石材) (貫ノ木遺跡)

# 貫ノ木遺跡 第2地点

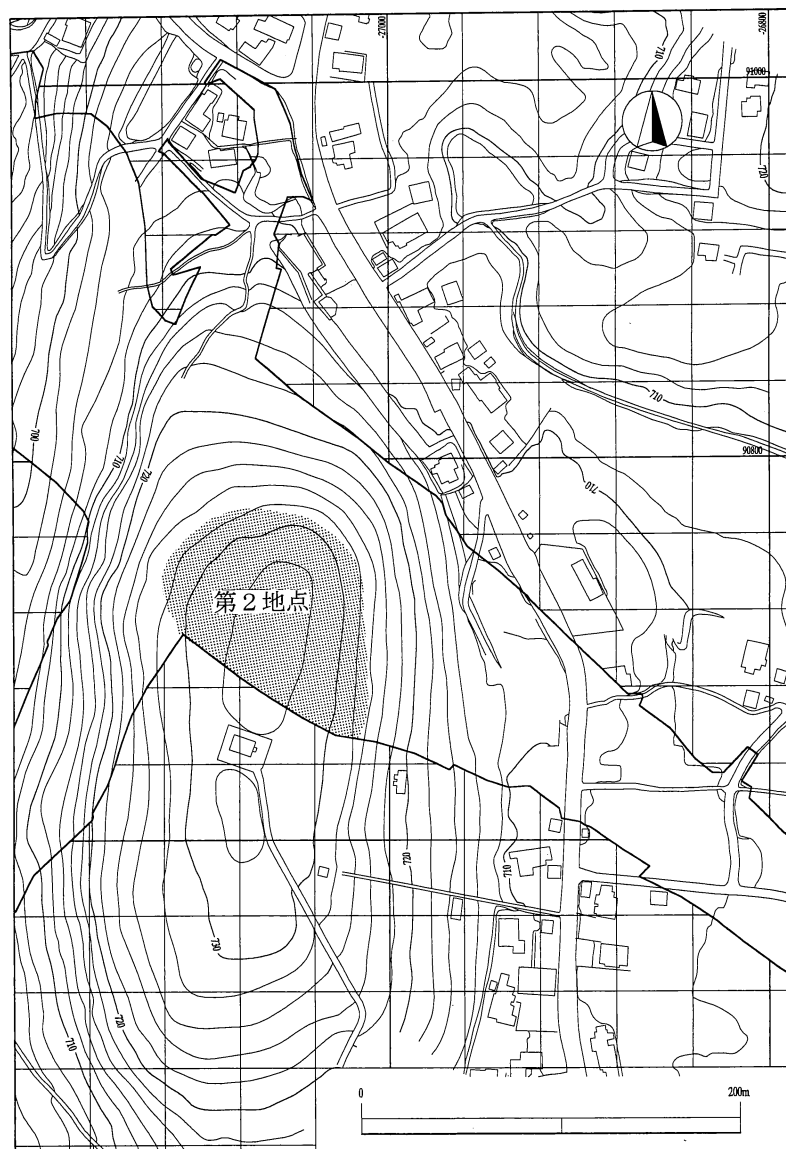

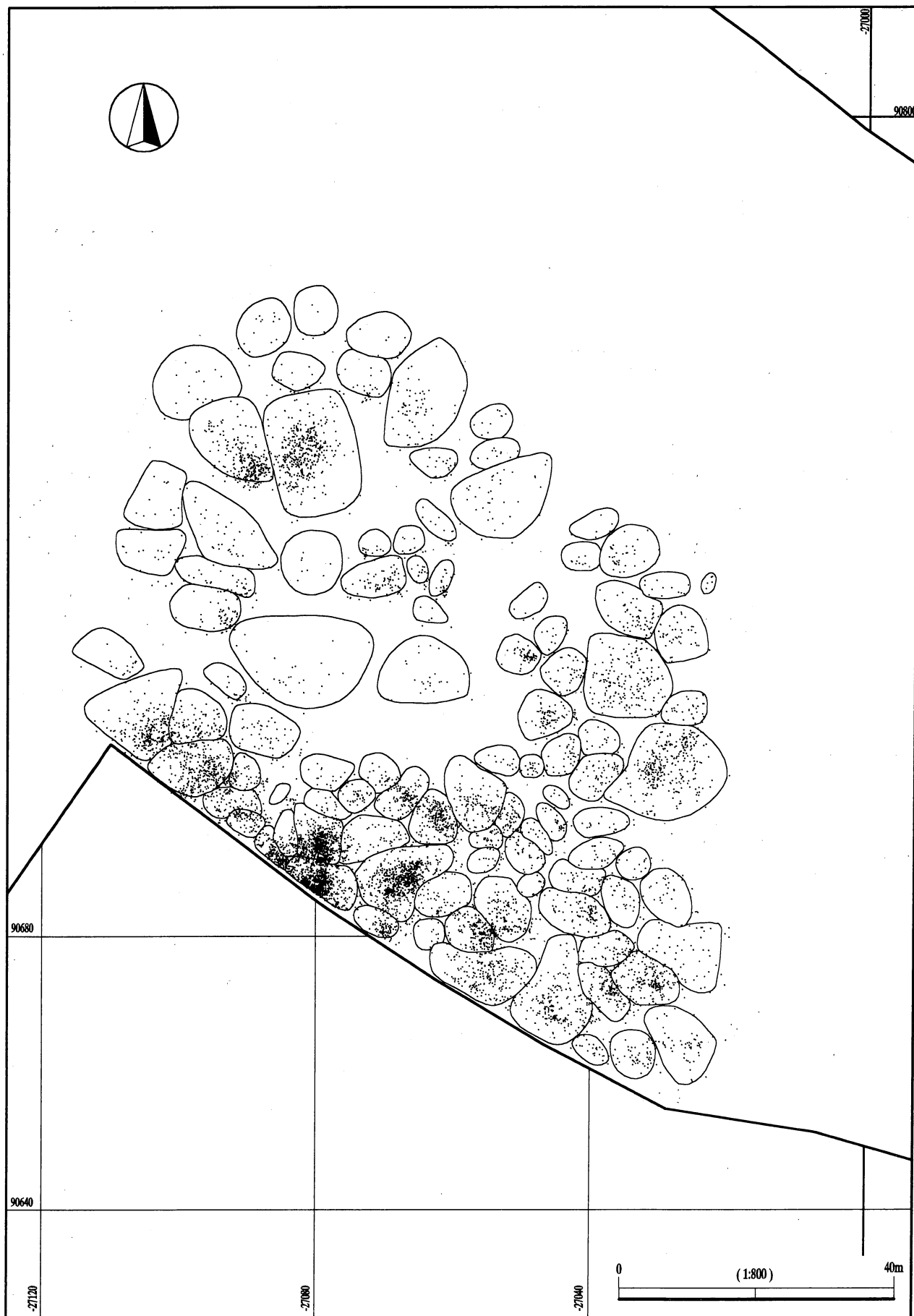

第2地点 BL石器全点 (貫ノ木遺跡)

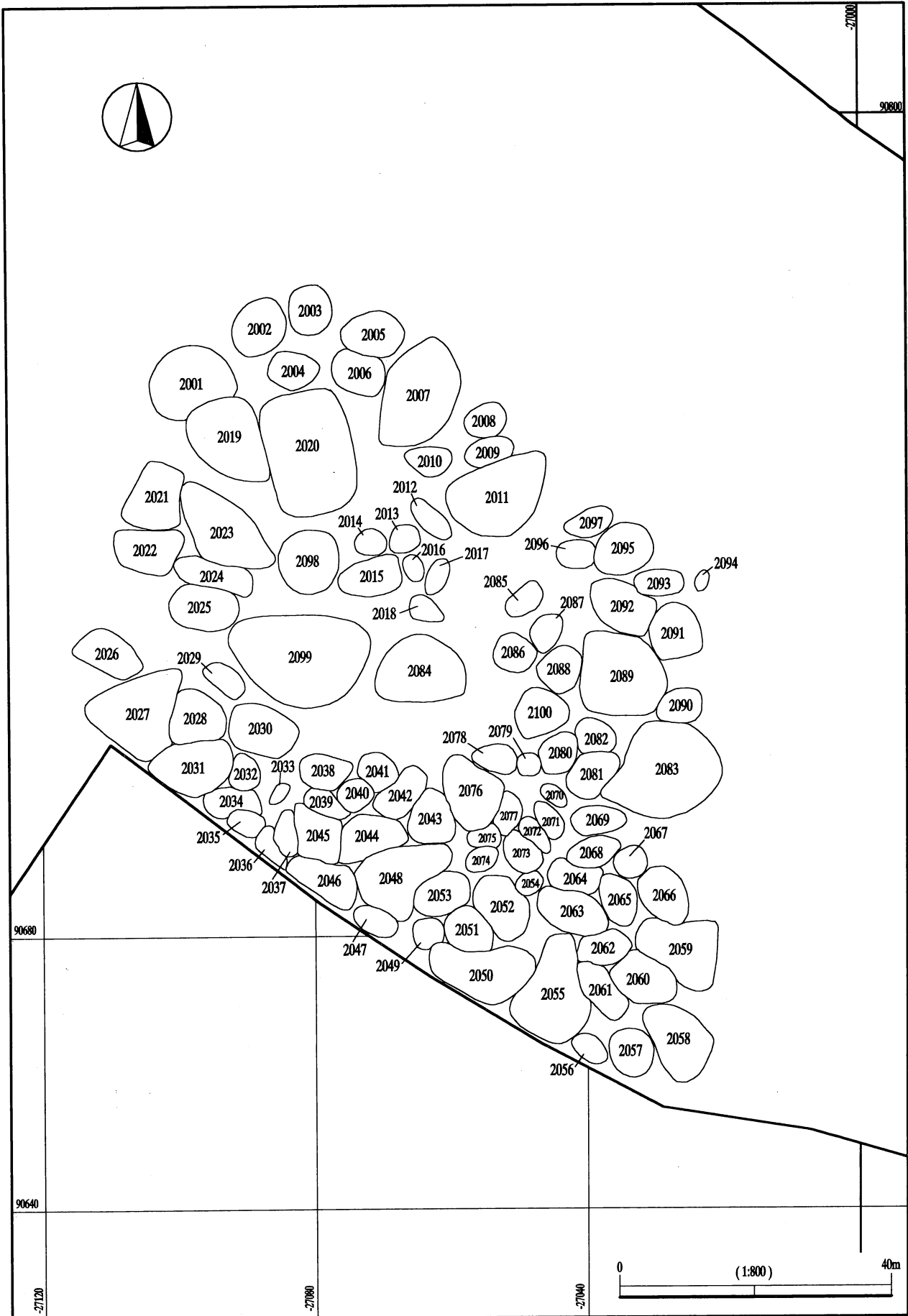

第2地点 ブロック配置図 (貫ノ木遺跡)

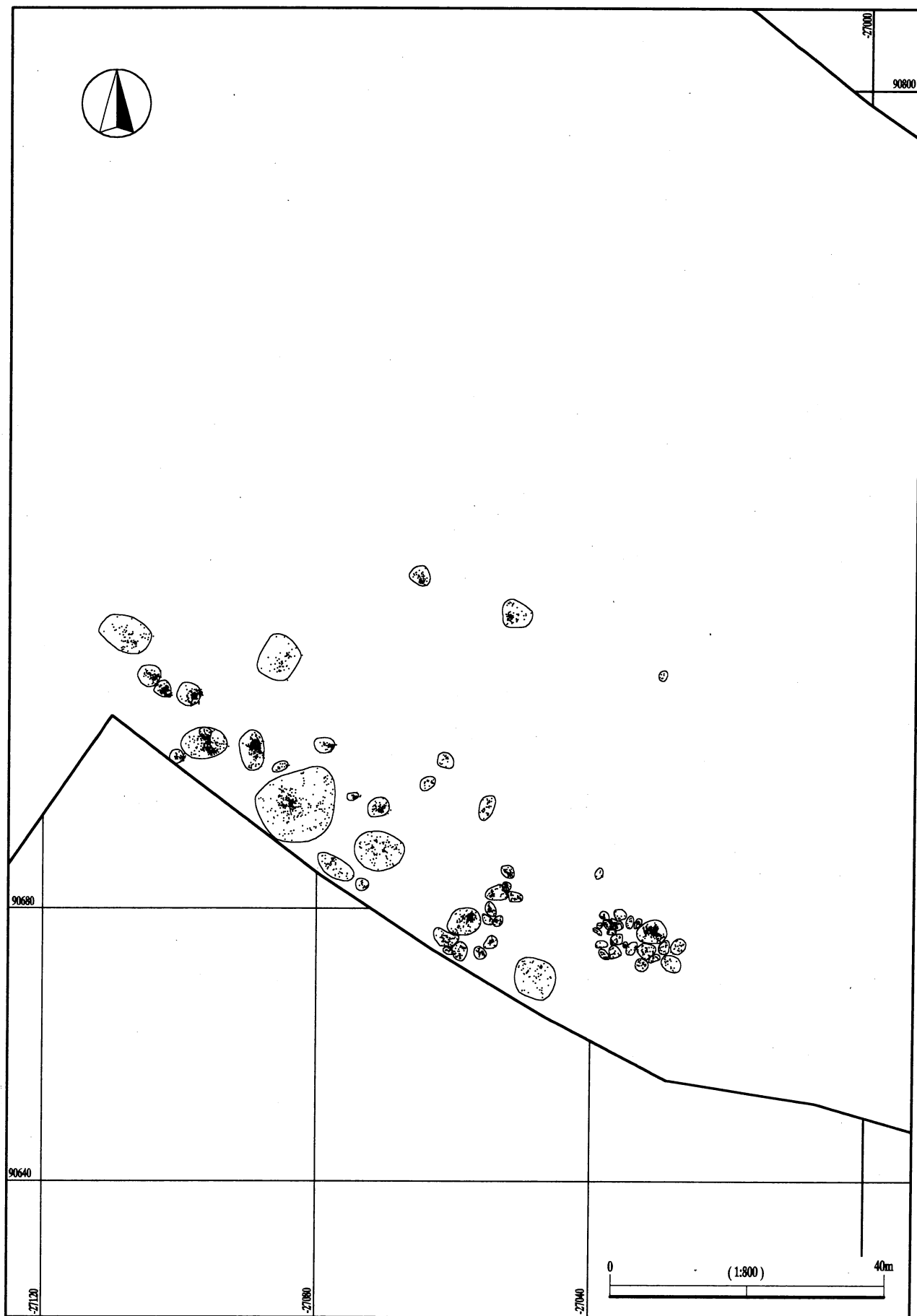

第2地点 礫分布図 (貫ノ木遺跡)

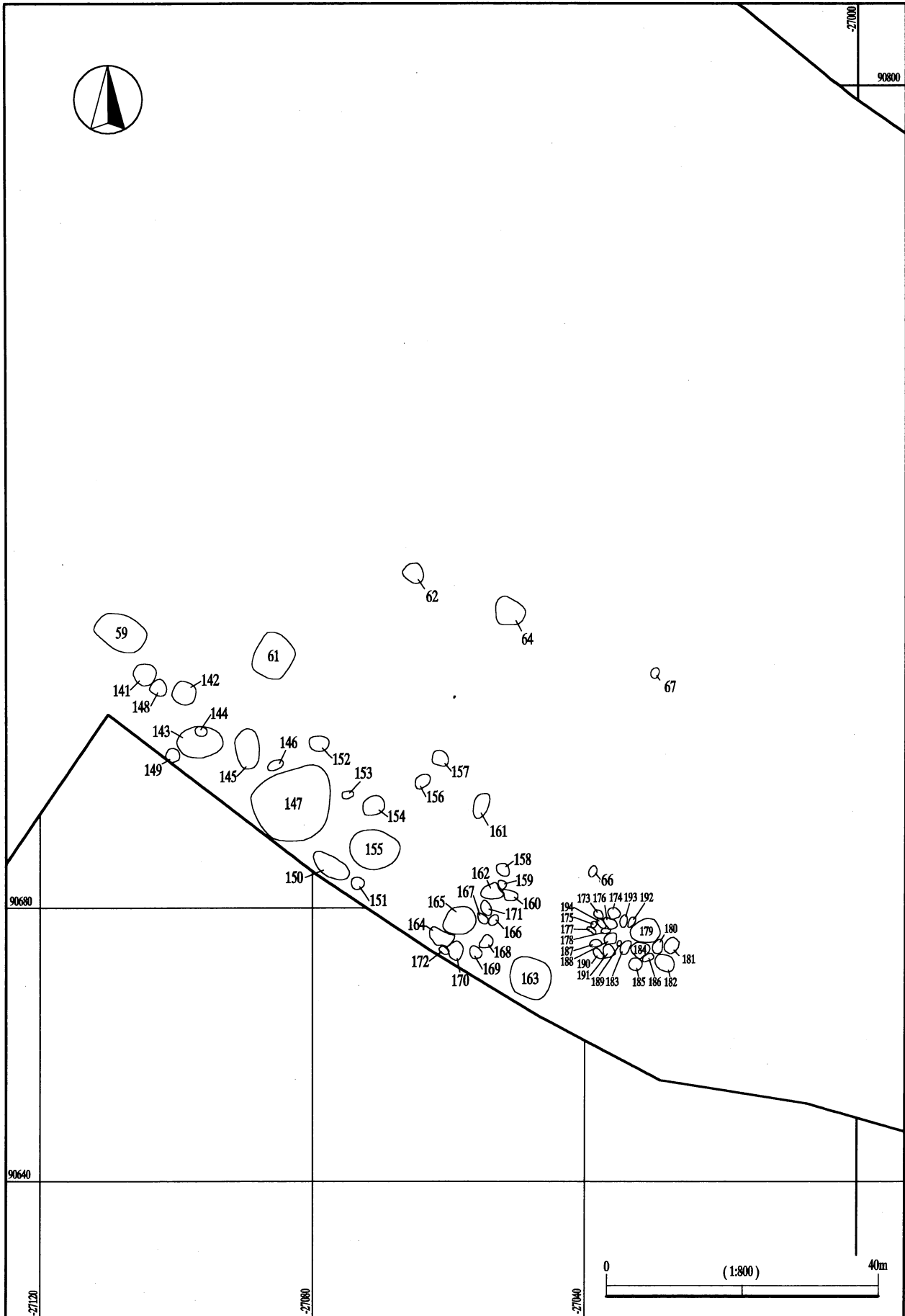

第2地点 礫群配置図 (貫ノ木遺跡)

BL 2001

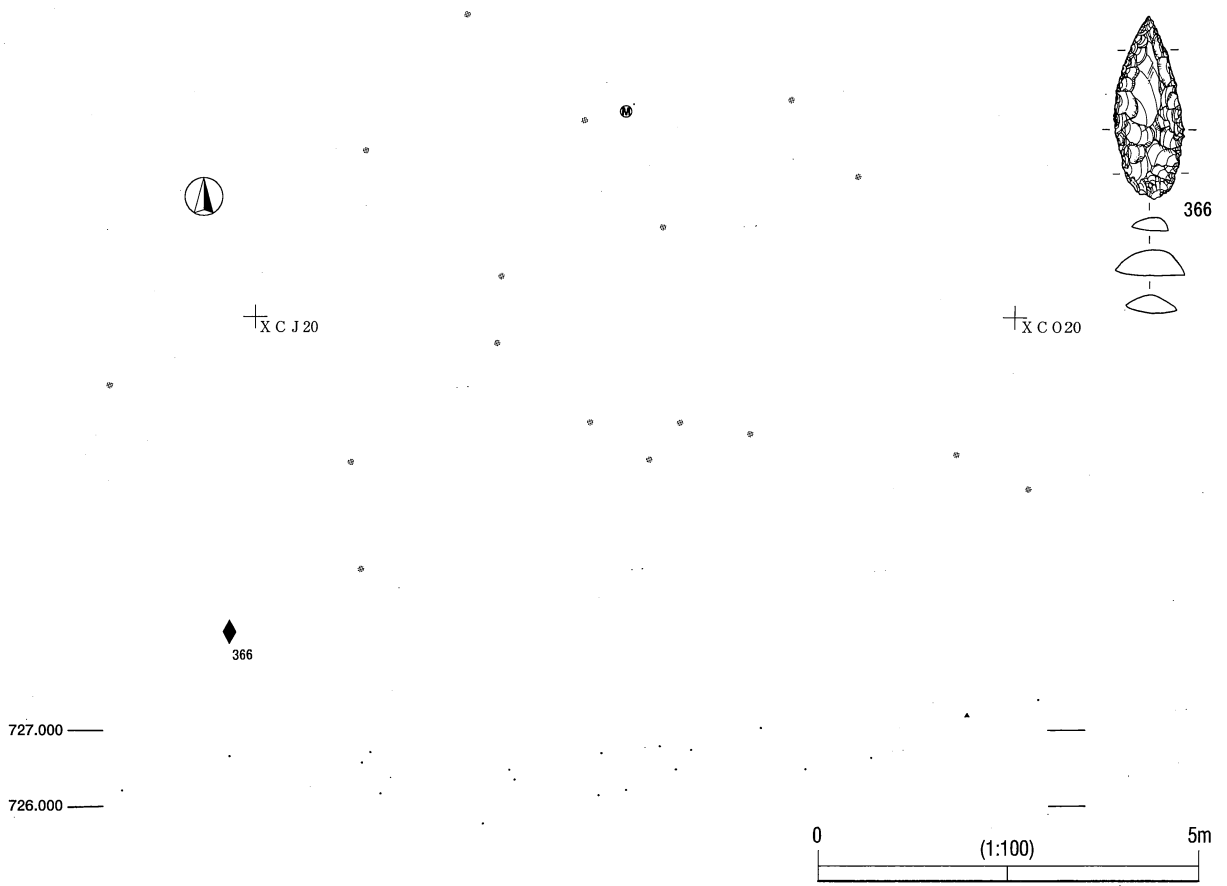

BL 2002

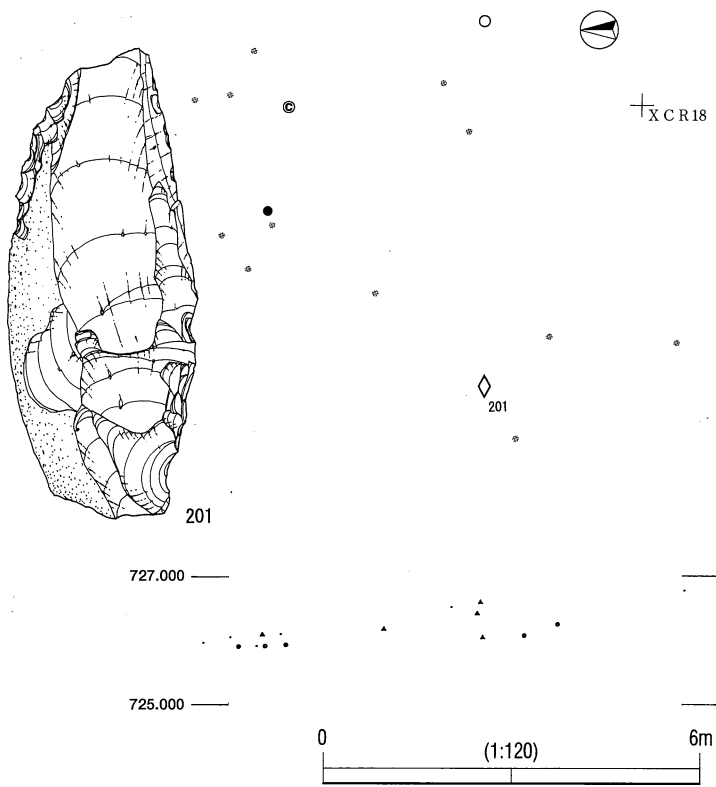

BL 2003

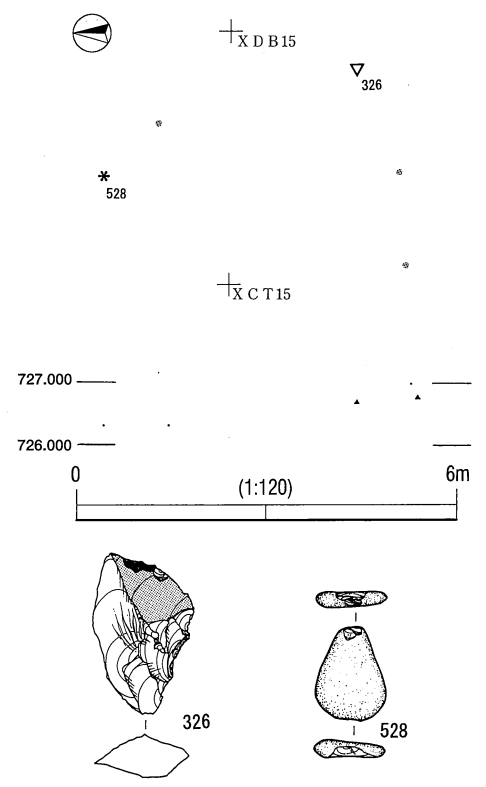

第 2 地点 BL2001・2002・2003 遺物分布図 (貫ノ木遺跡)



BL 2004

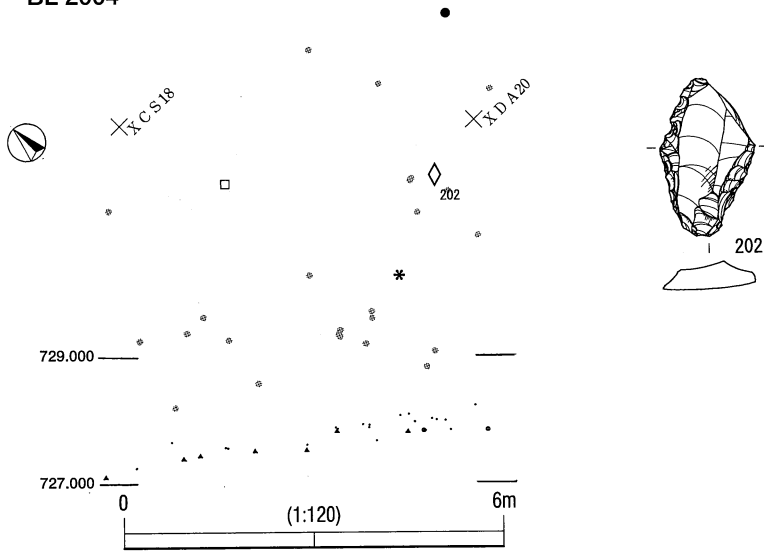

BL 2005

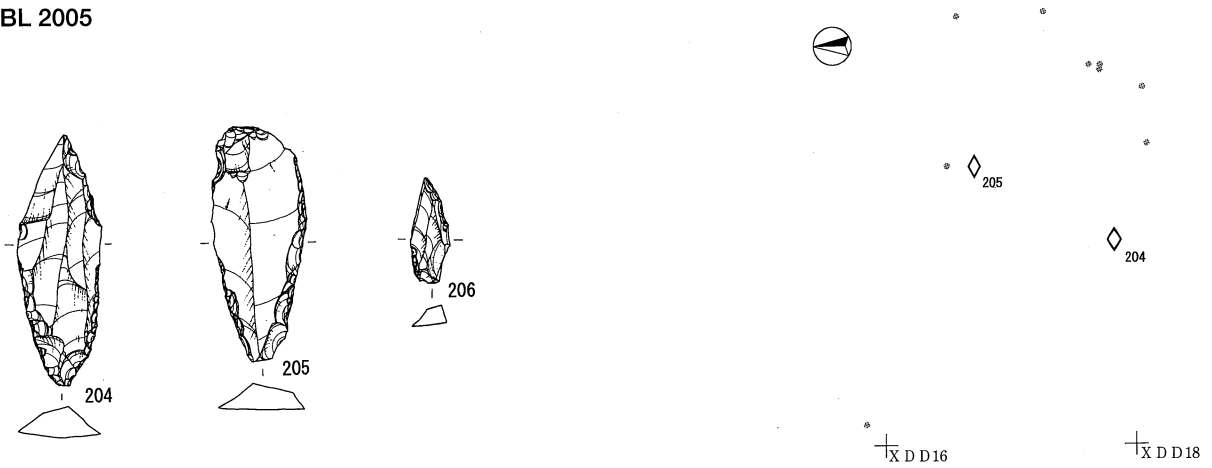

BL 2006

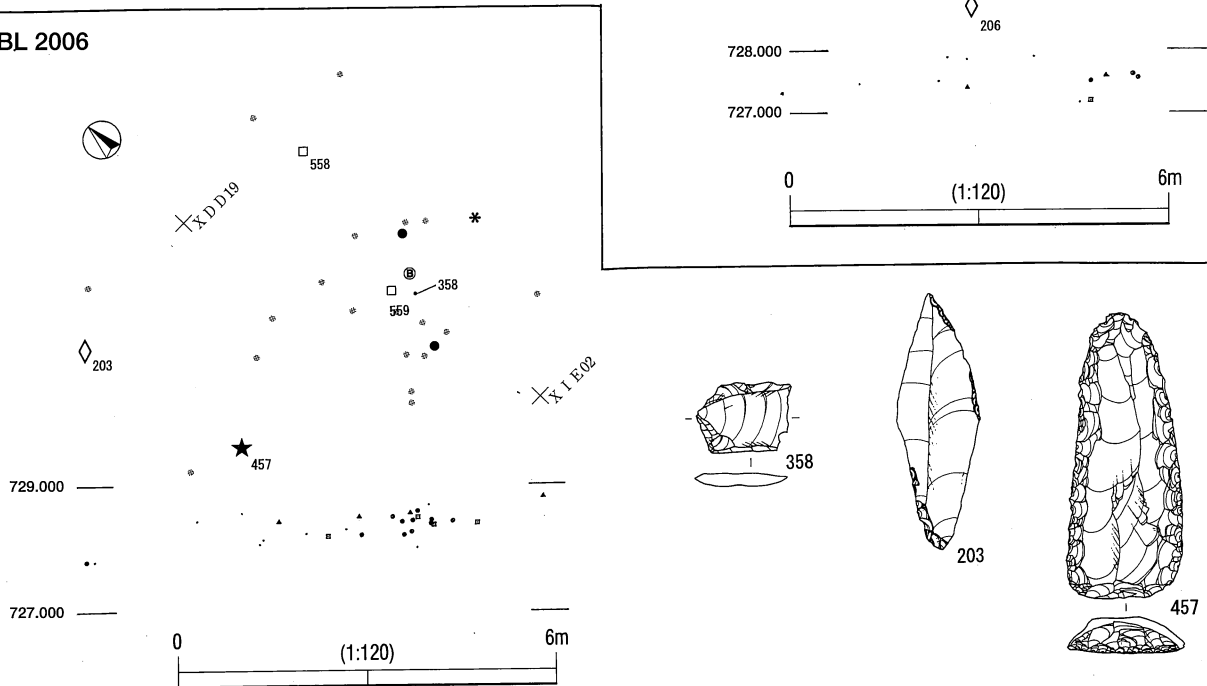

第2地点 BL2004・2005・2006 遺物分布図 (貫ノ木遺跡)

BL 2007

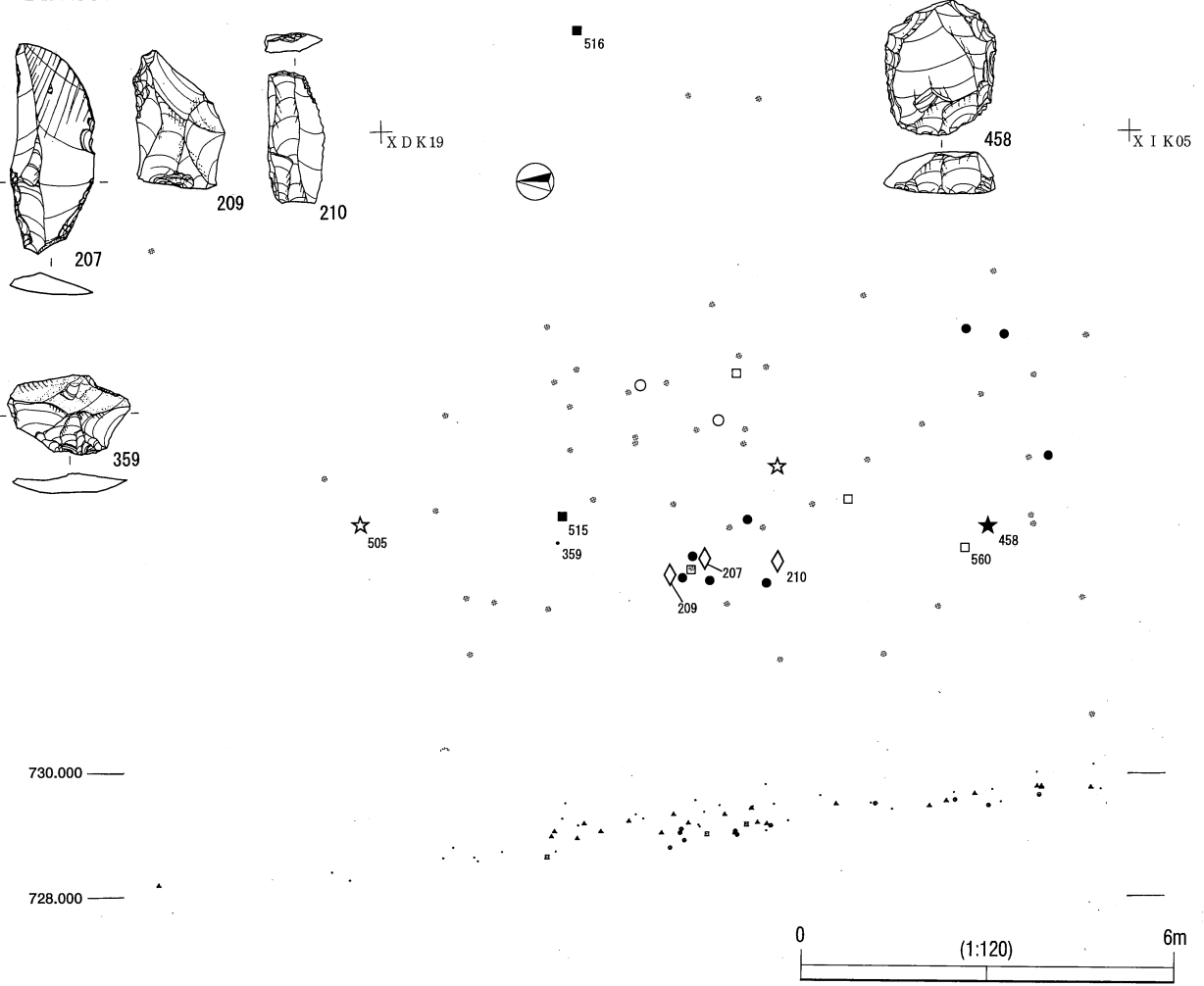

BL 2008

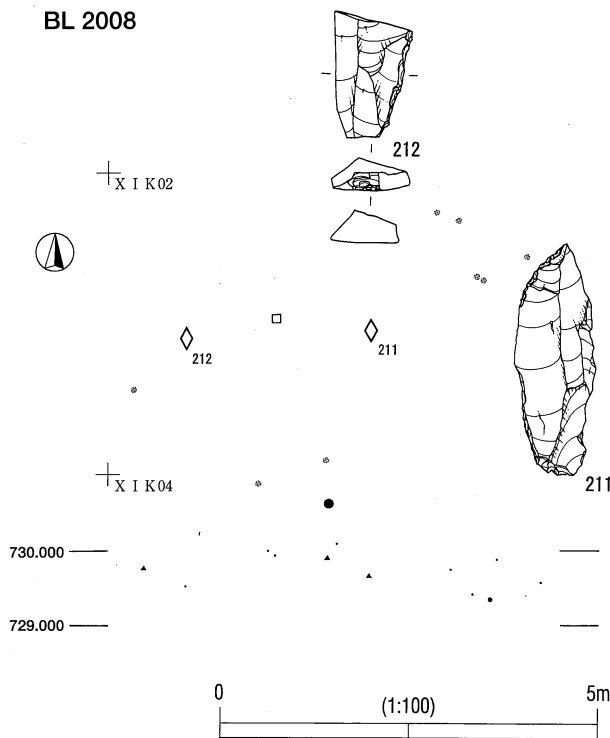

BL 2009

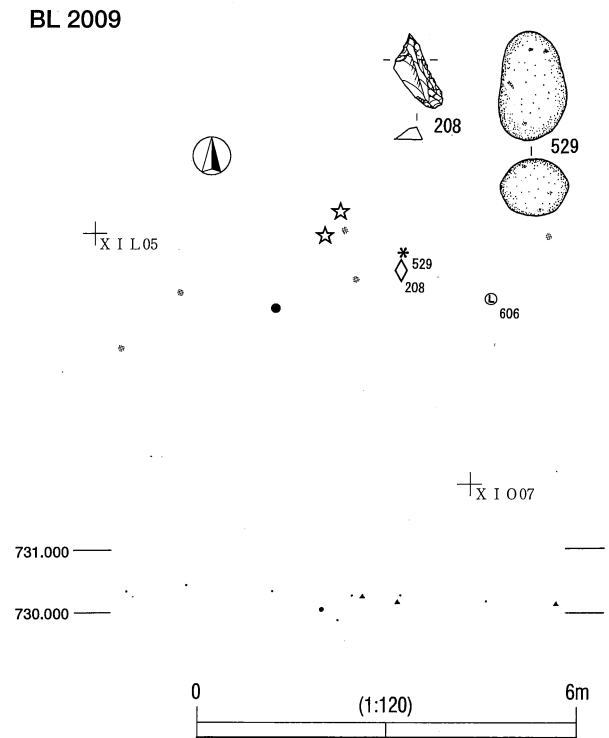

第2地点 BL2007・2008・2009 遺物分布図 (貫ノ木遺跡)

BL 2010

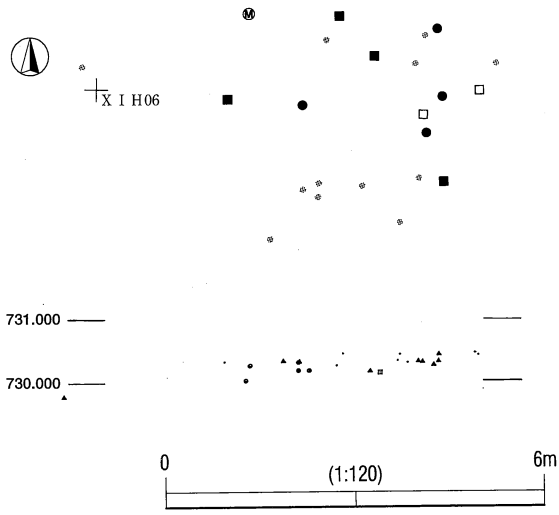

BL 2012

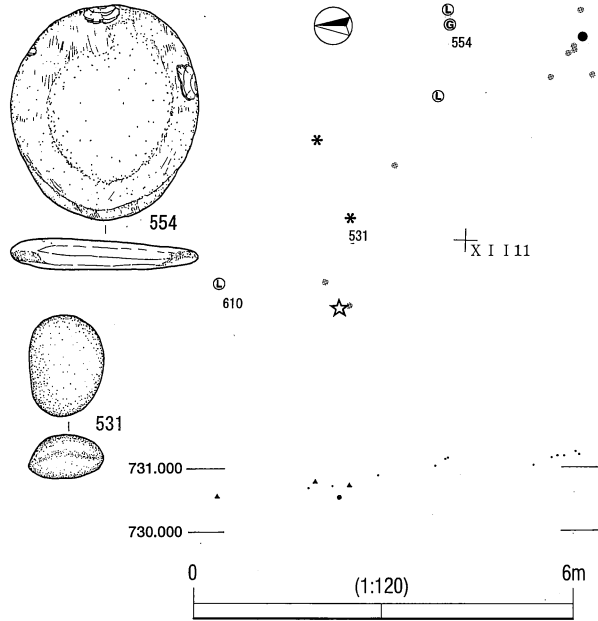

BL 2011



第 2 地点 BL2010・2011・2012 遺物分布図 (貫ノ木遺跡)

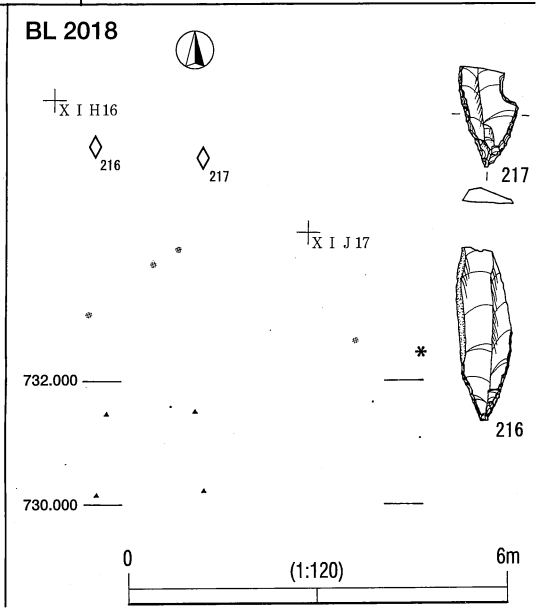
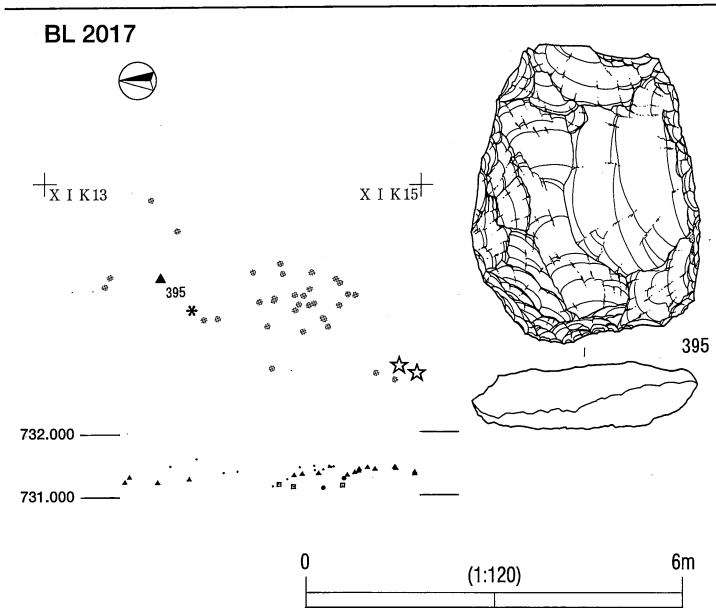
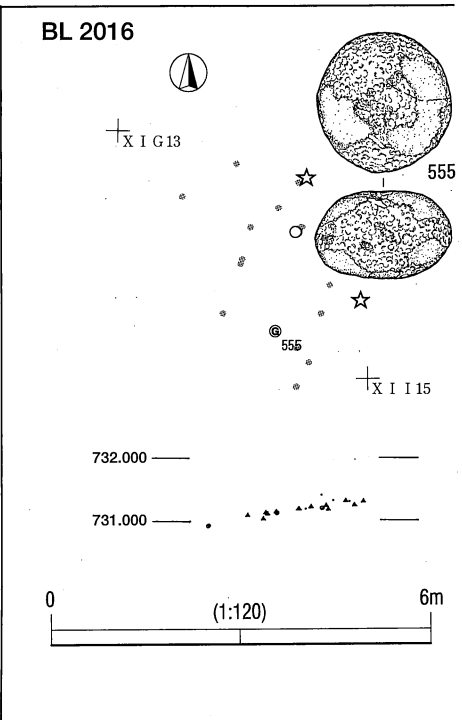
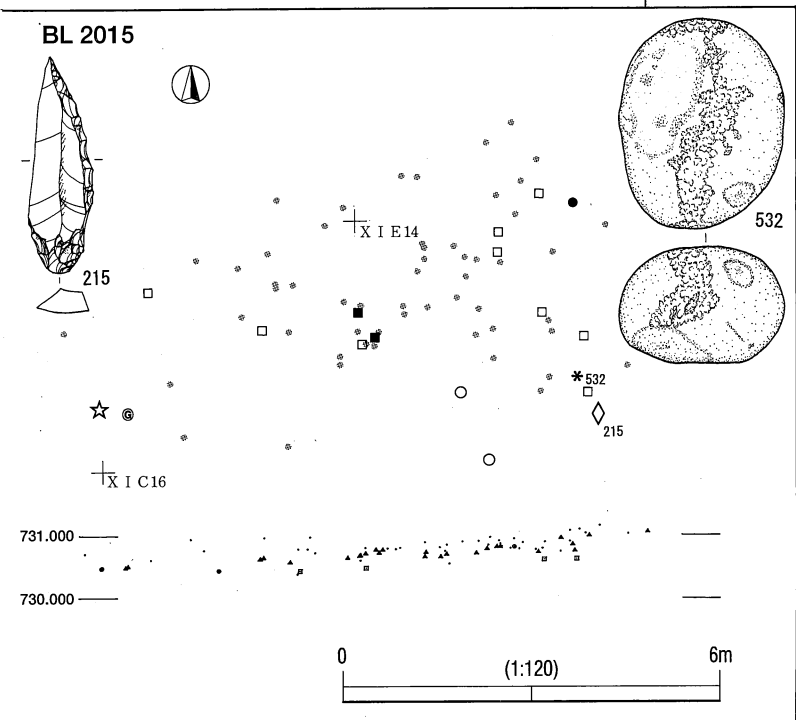
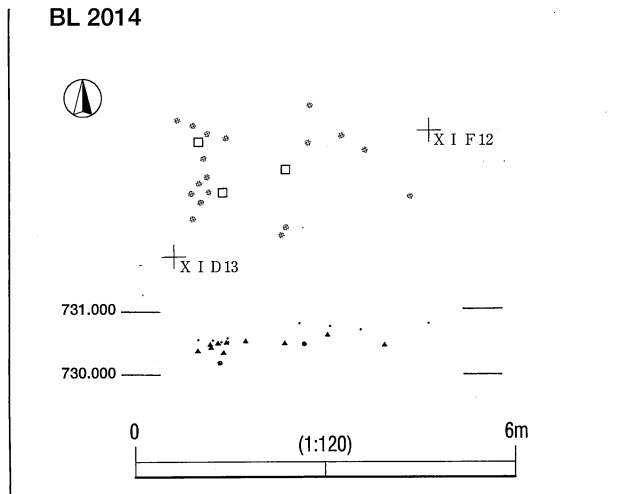
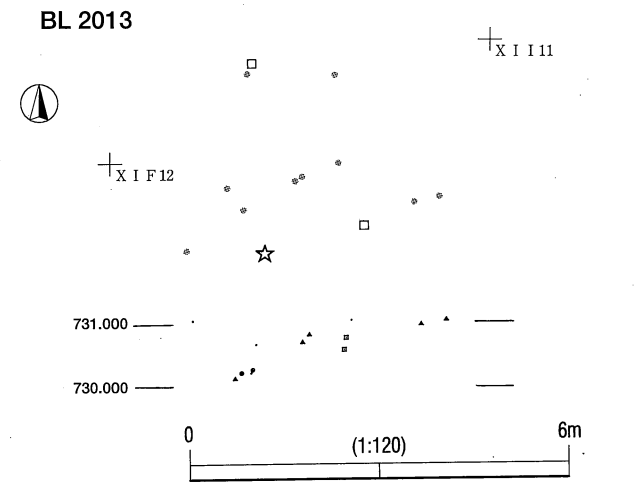

第 2 地点 BL2013・2014・2015・2016・2017・2018 遺物分布図 (貫ノ木遺跡)

BL 2019

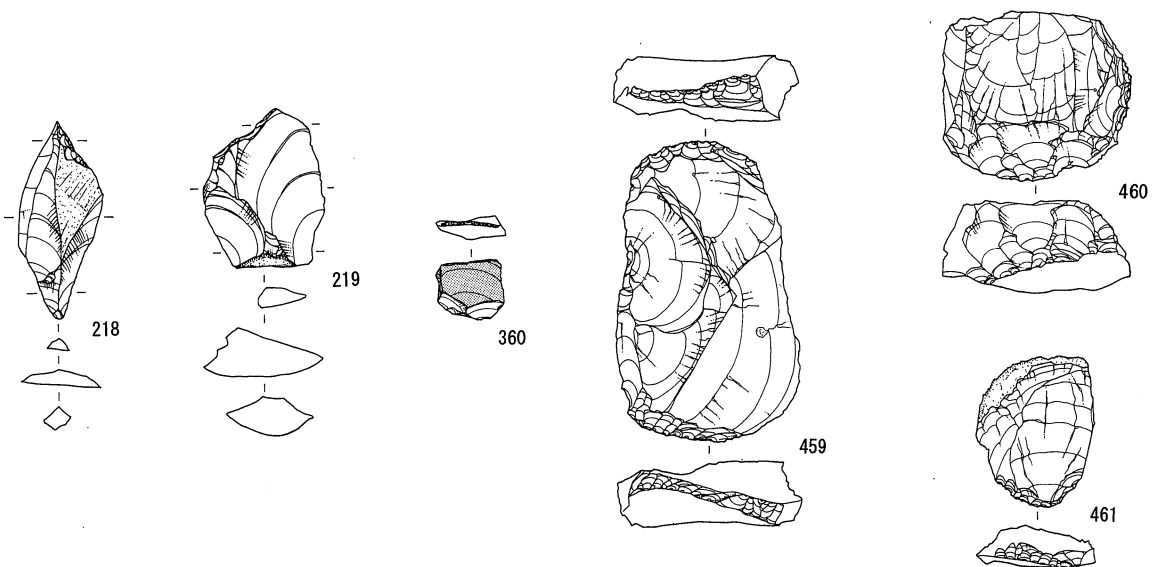
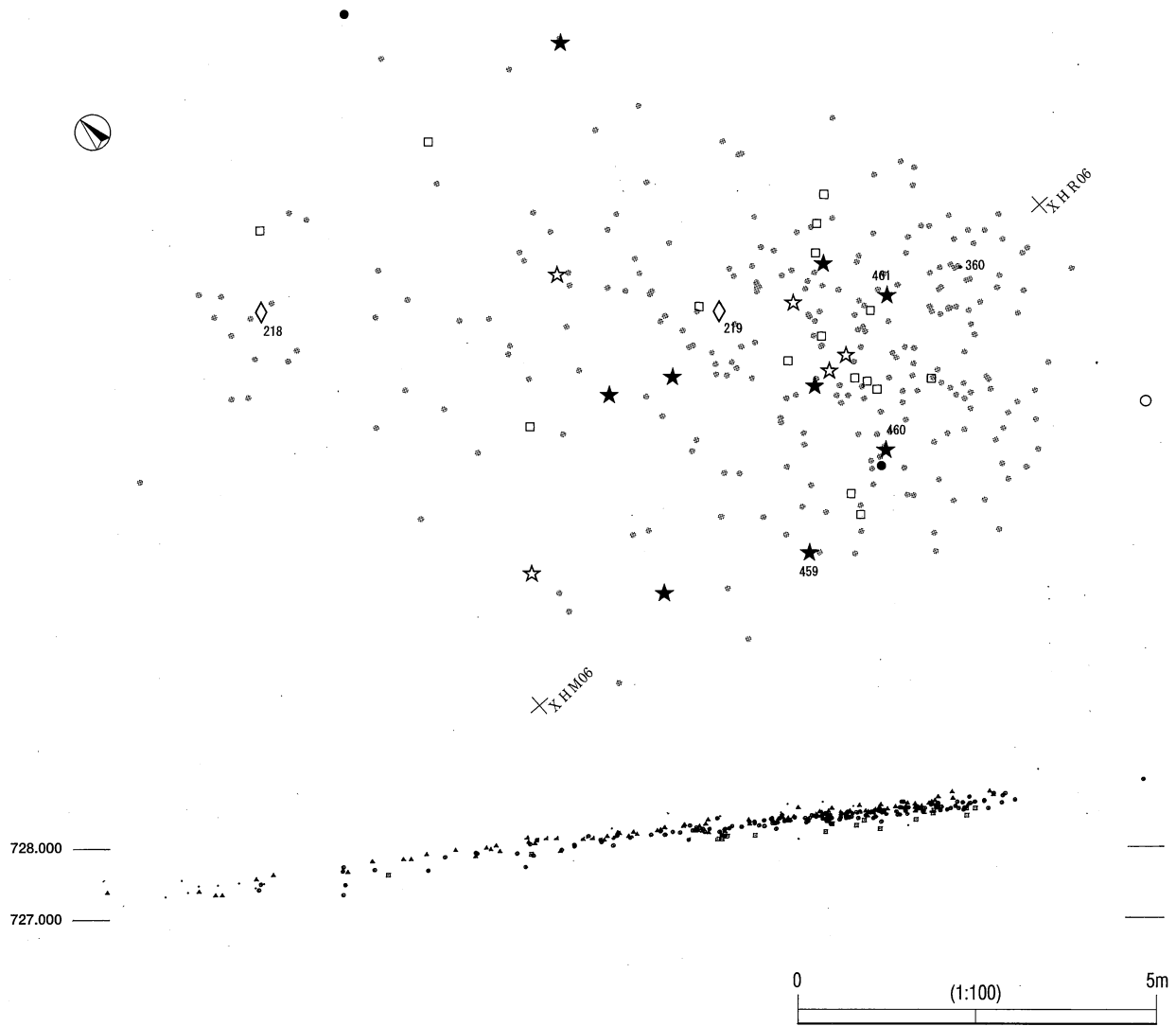

第2地点 BL2019 遺物分布図 (貫ノ木遺跡)

BL 2020

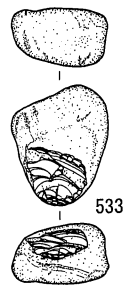
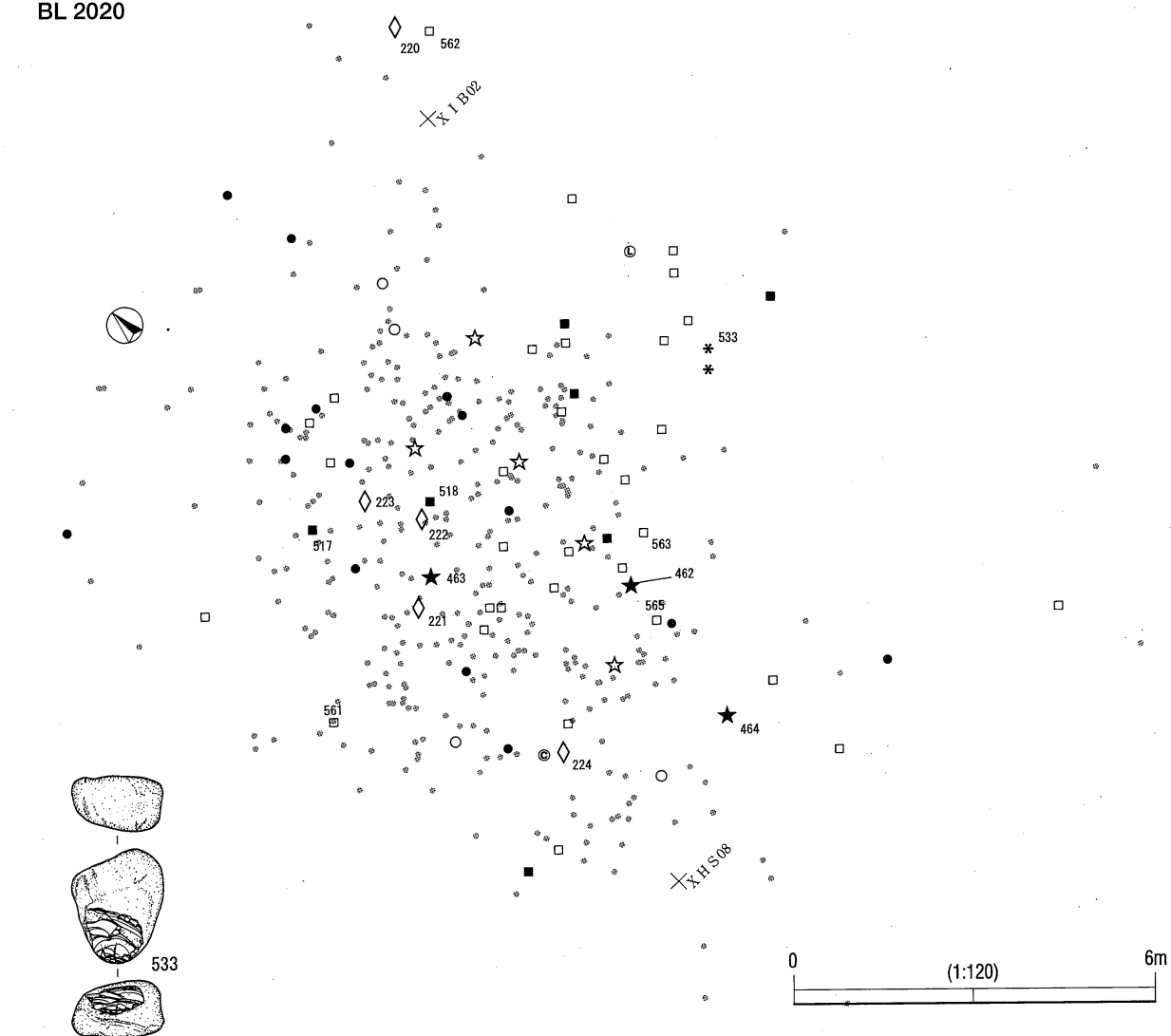

729.000 —  
 728.000 —

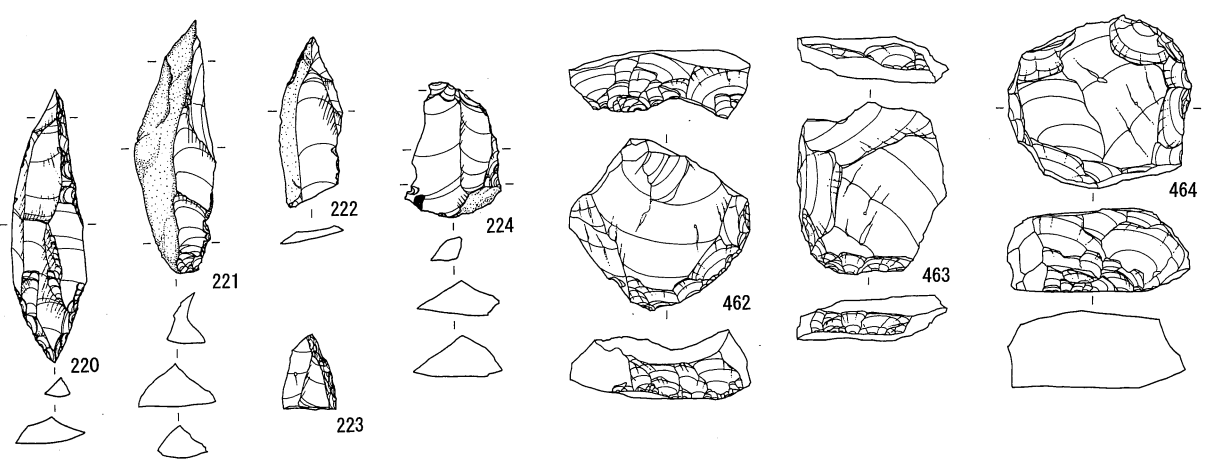

第2地点 BL2020 遺物分布図 (貫ノ木遺跡)

BL 2021

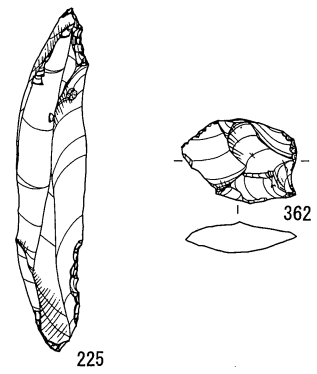
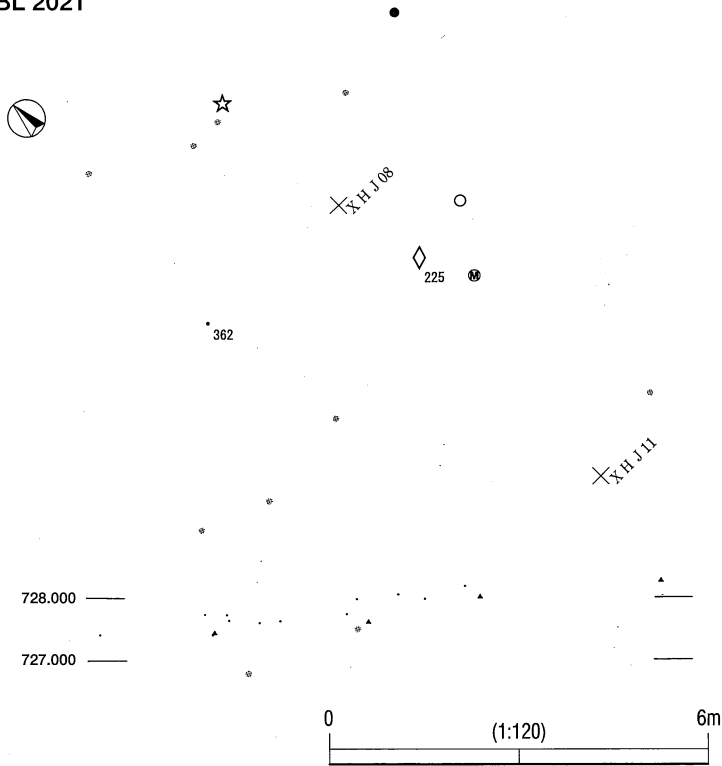

BL 2022

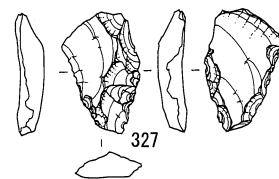
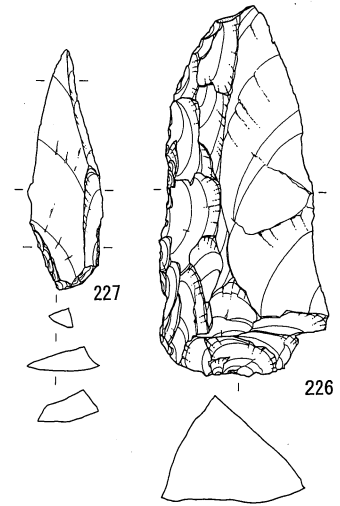
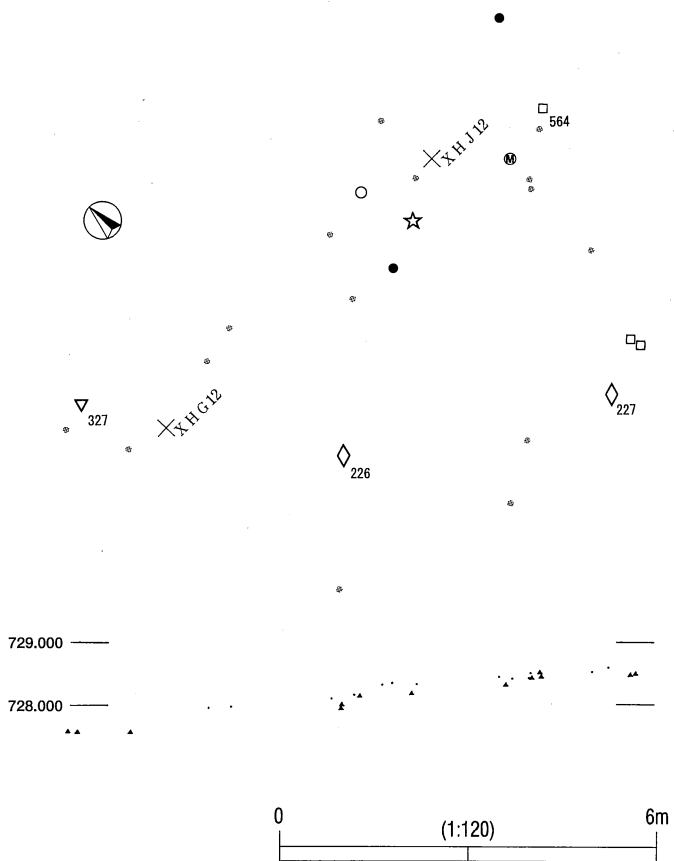

第 2 地点 BL2021・2022 遺物分布図 (貫ノ木遺跡)

BL 2023

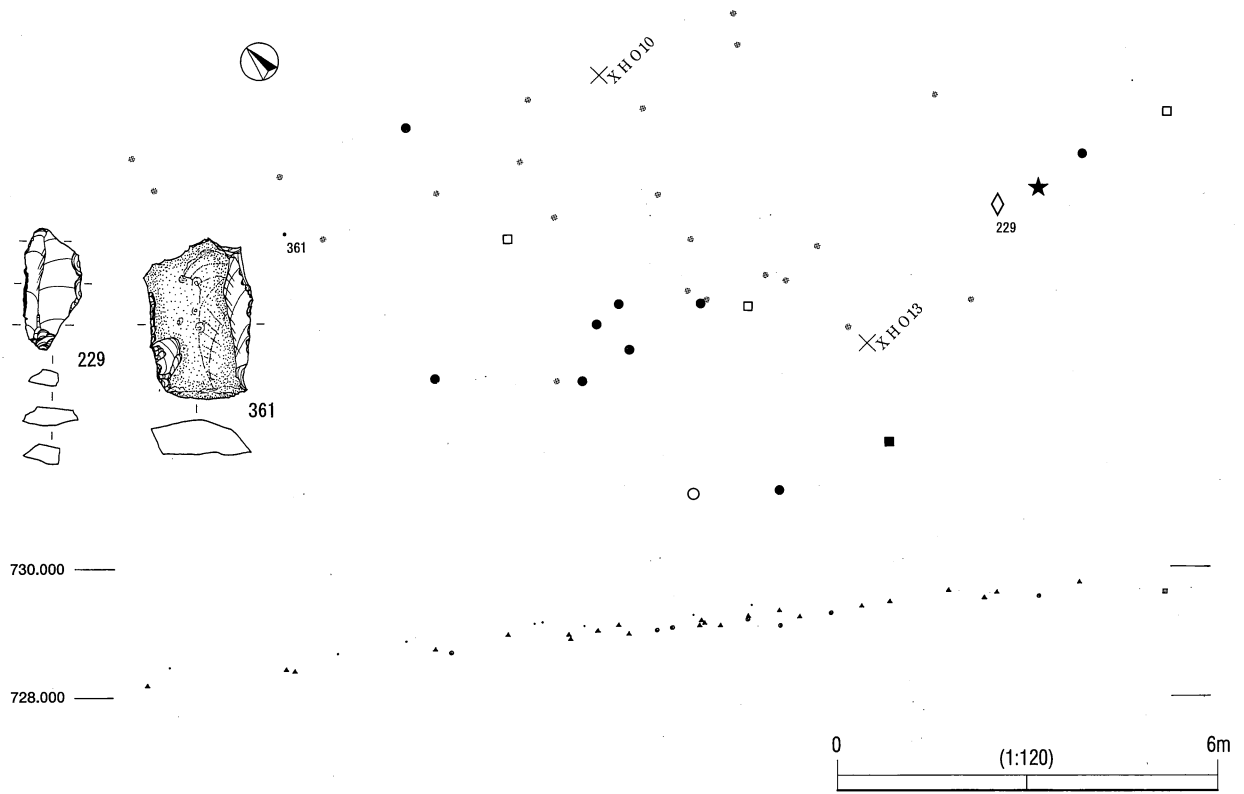

BL 2024

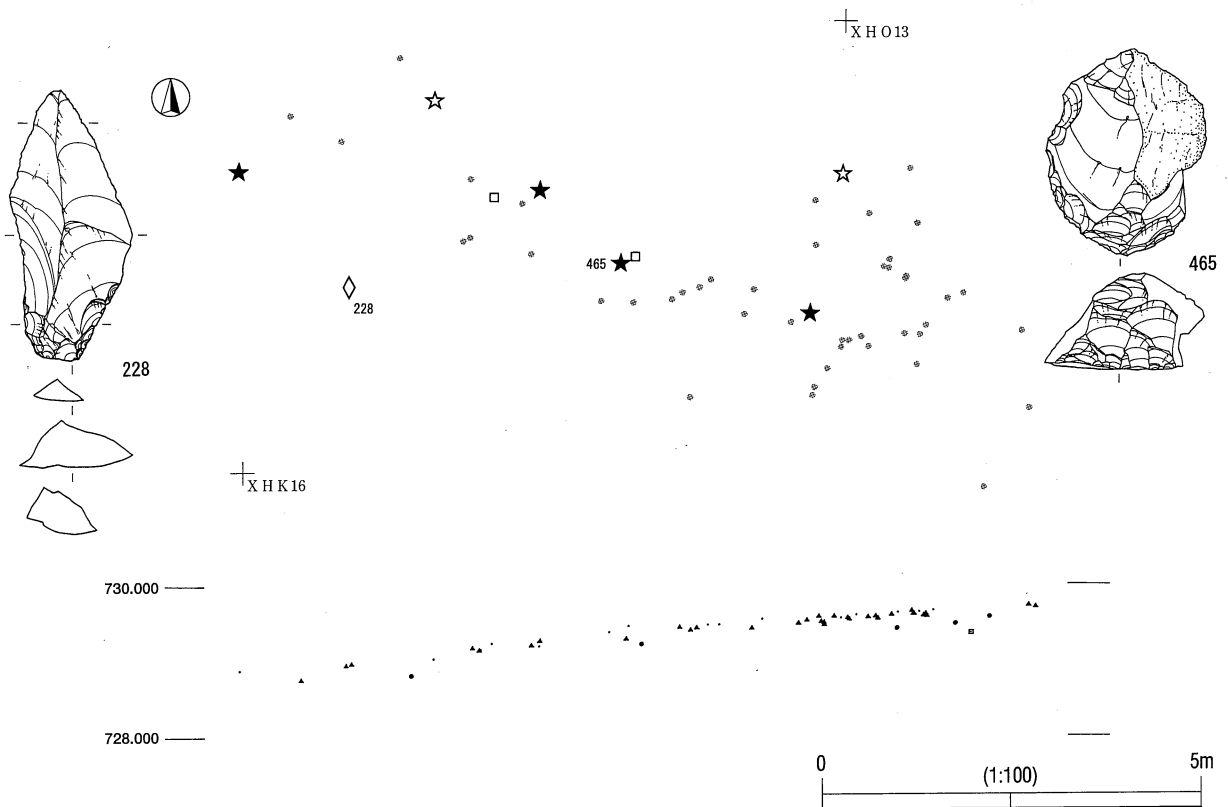

第2地点 BL2023・2024 遺物分布図 (貫ノ木遺跡)



BL 2025

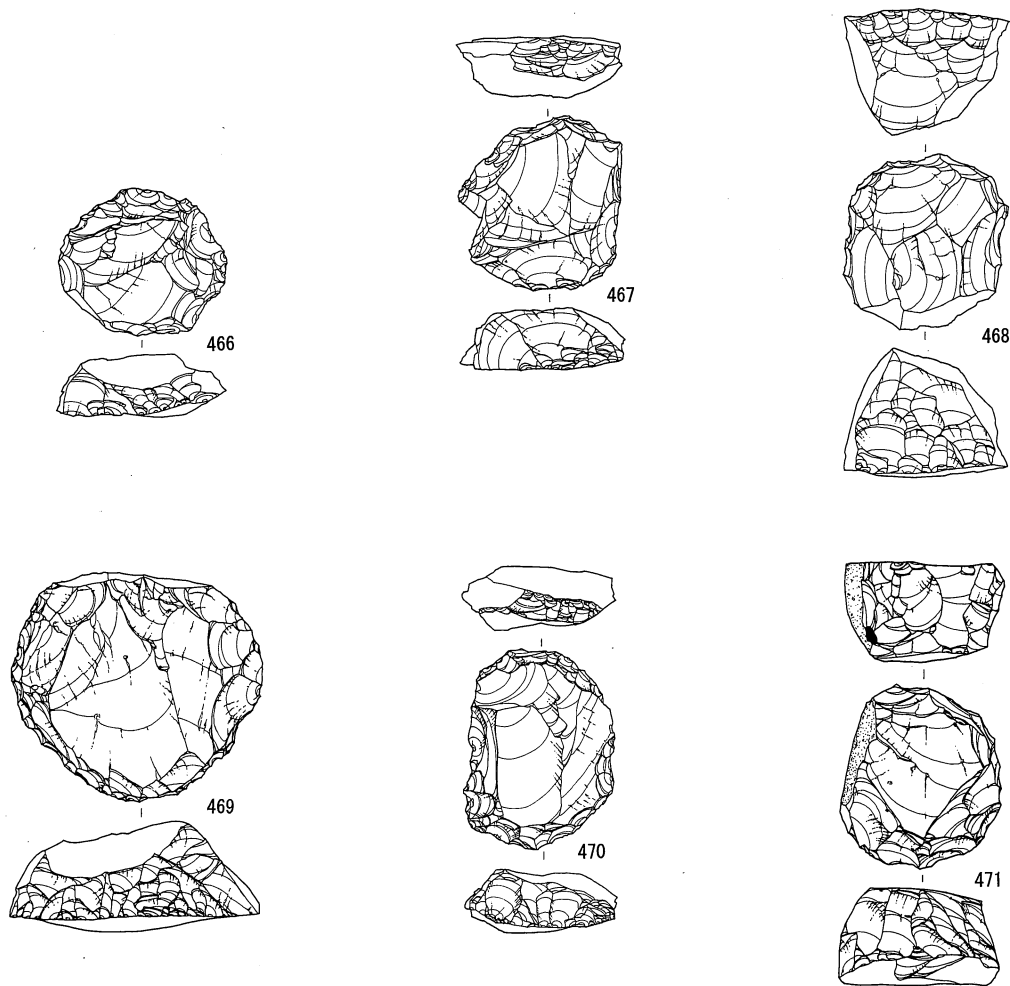
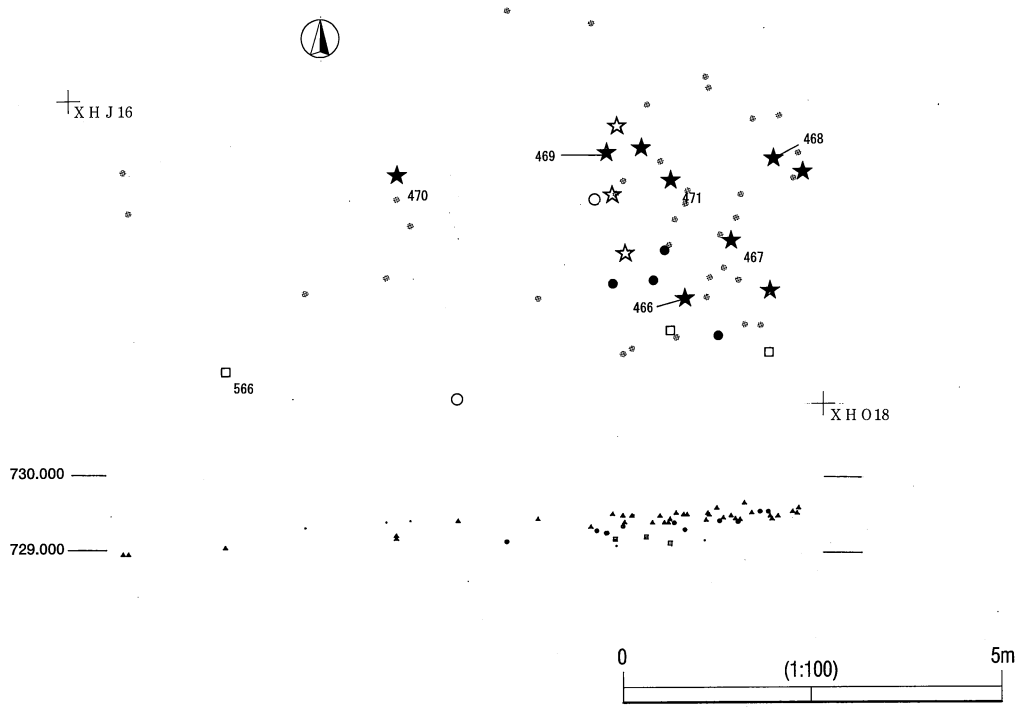

第 2 地点 BL2025 遺物分布図 (貫ノ木遺跡)

BL 2026

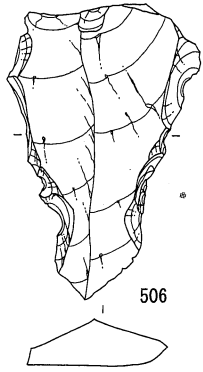

+ XHD19



☆ 507

☆ 506

+ XMH01

728.500

727.500

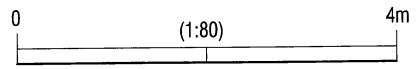

BL 2028

+ XMJ04

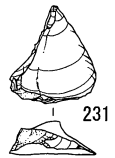

231

+ XMM06

◇ 231

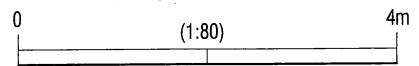

730.000

729.000

第2地点 BL2026・2028 遺物分布図 (貫ノ木遺跡)

BL 2027

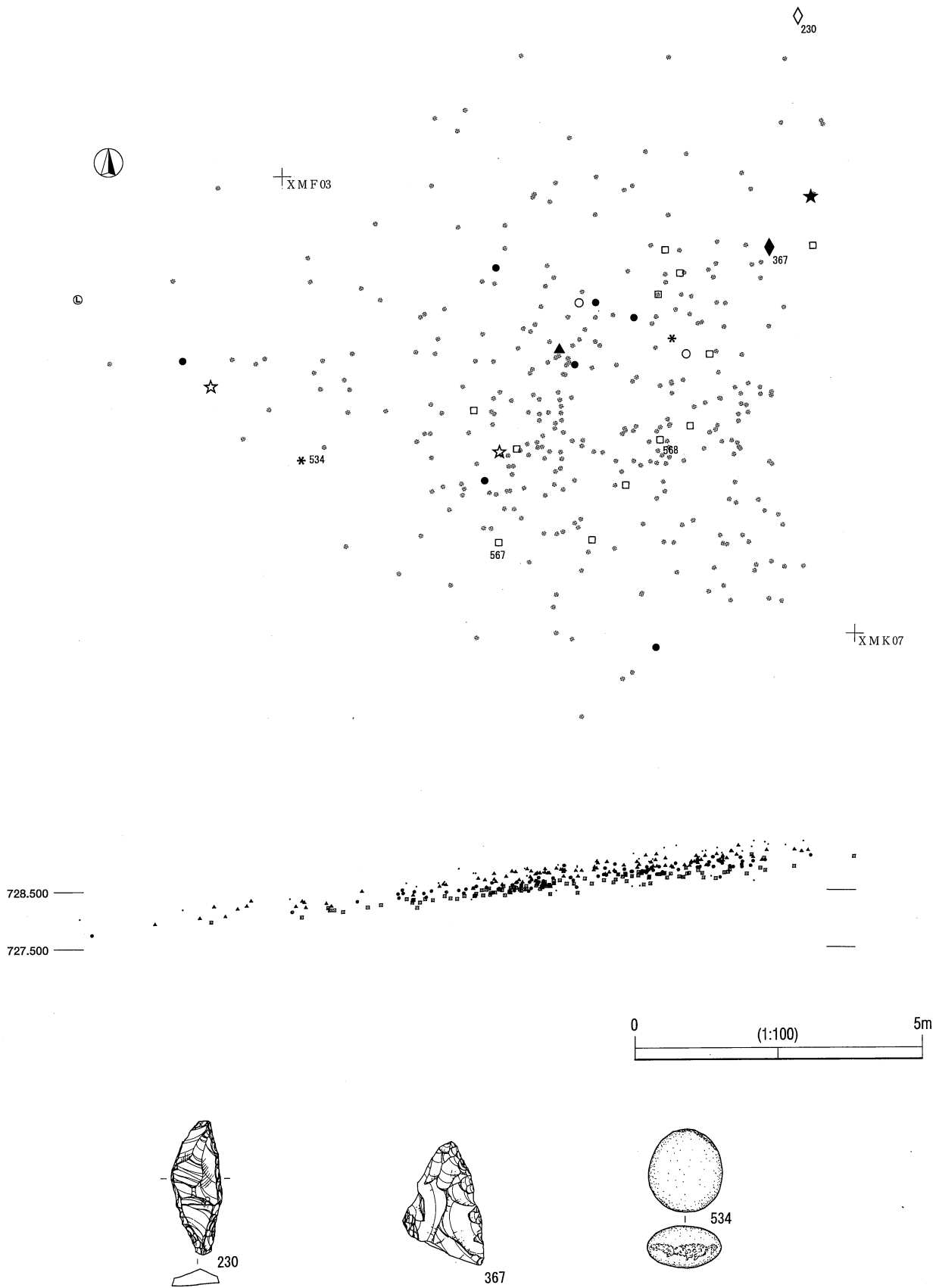

第2地点 BL2027 遺物分布図 (貫ノ木遺跡)

BL 2029

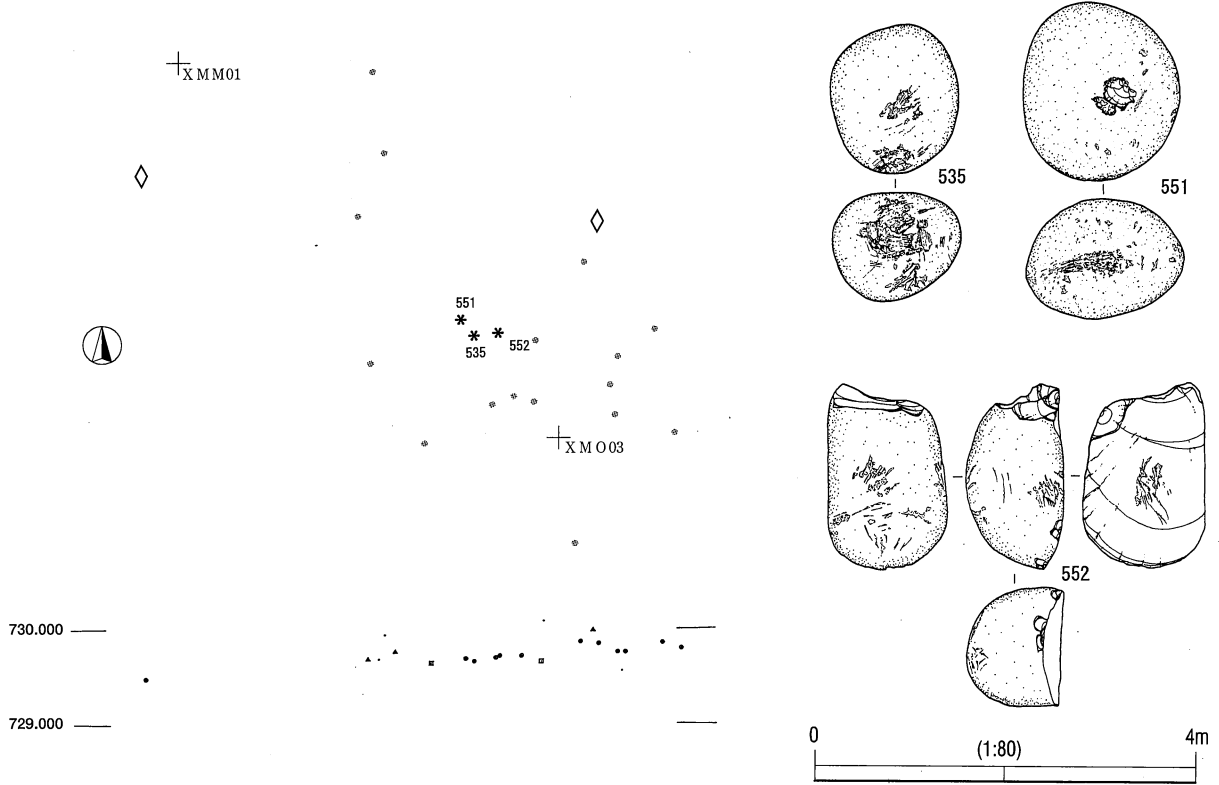

BL 2030

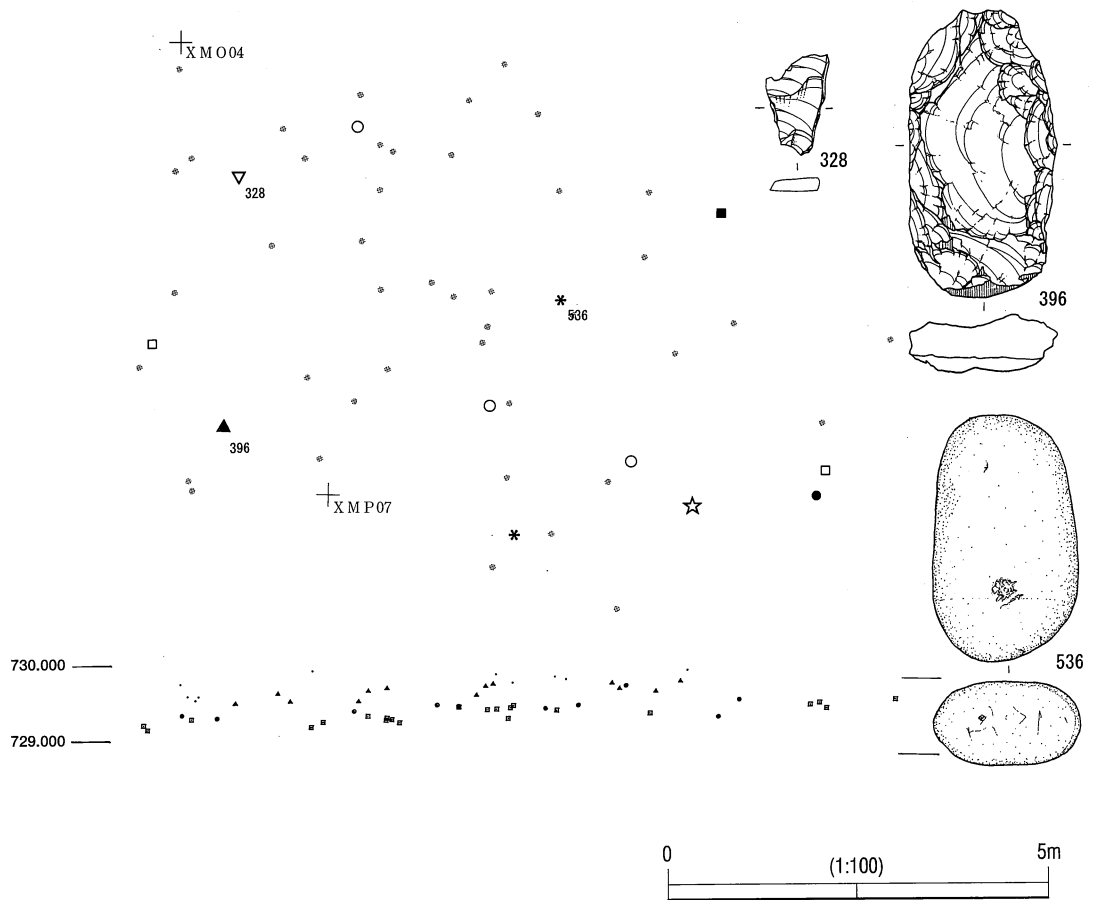

第2地点 BL2029・2030 遺物分布図 (貫ノ木遺跡)

BL 2031

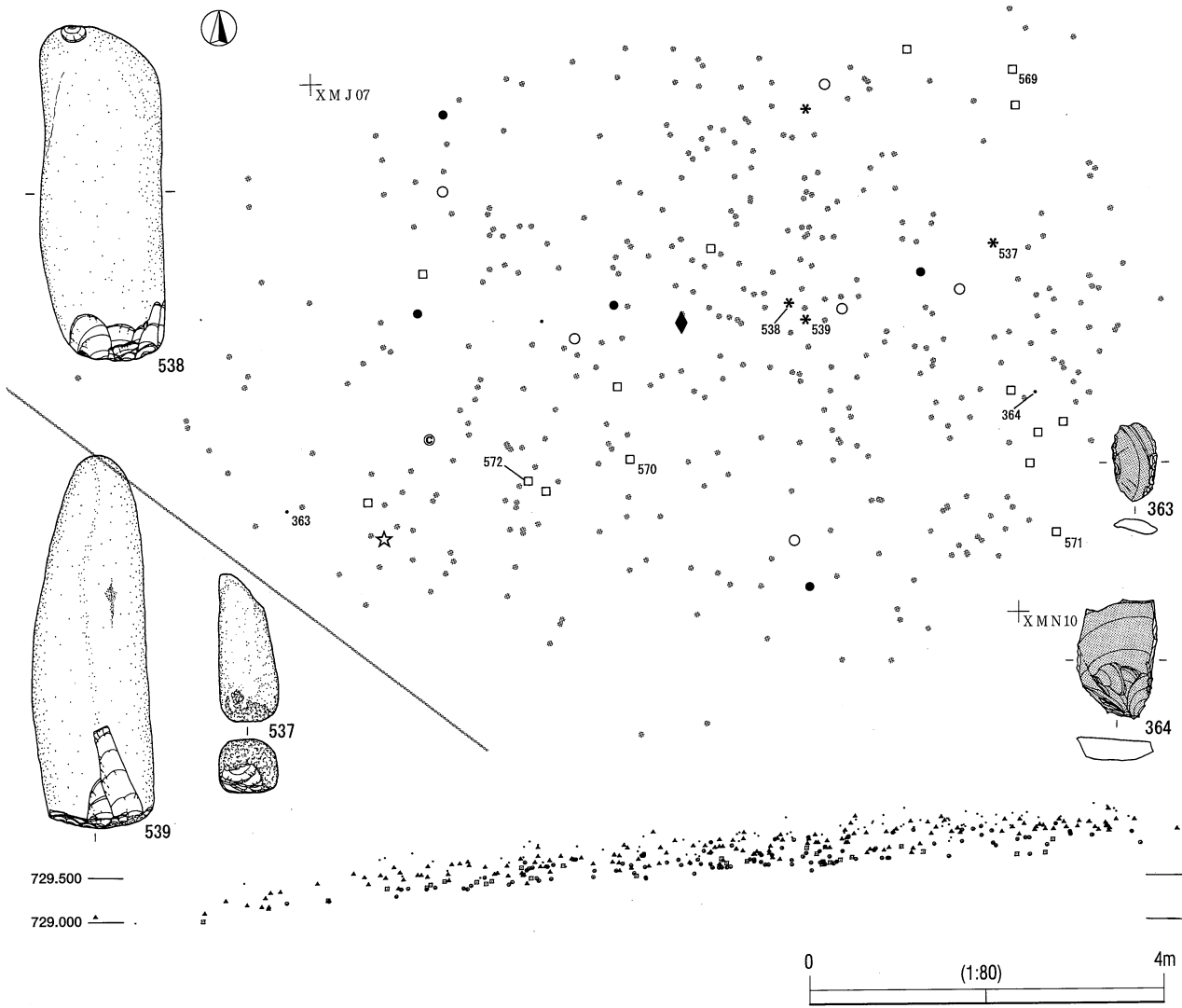

BL 2032

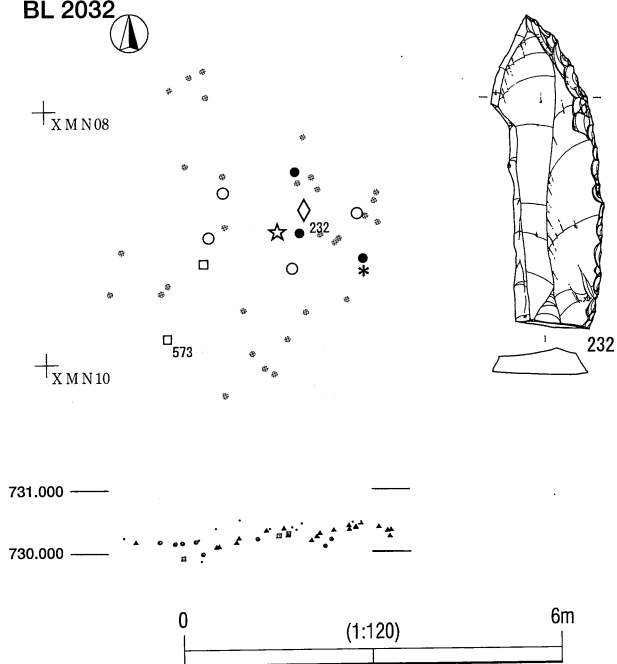

BL 2033

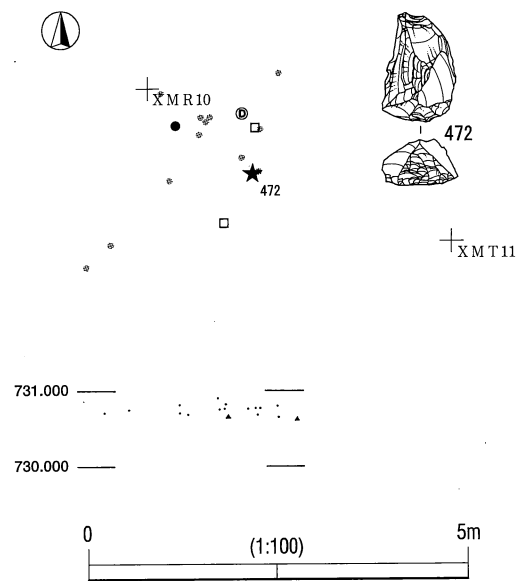

第2地点 BL2031・2032・2033 遺物分布図 (貫ノ木遺跡)

BL 2034

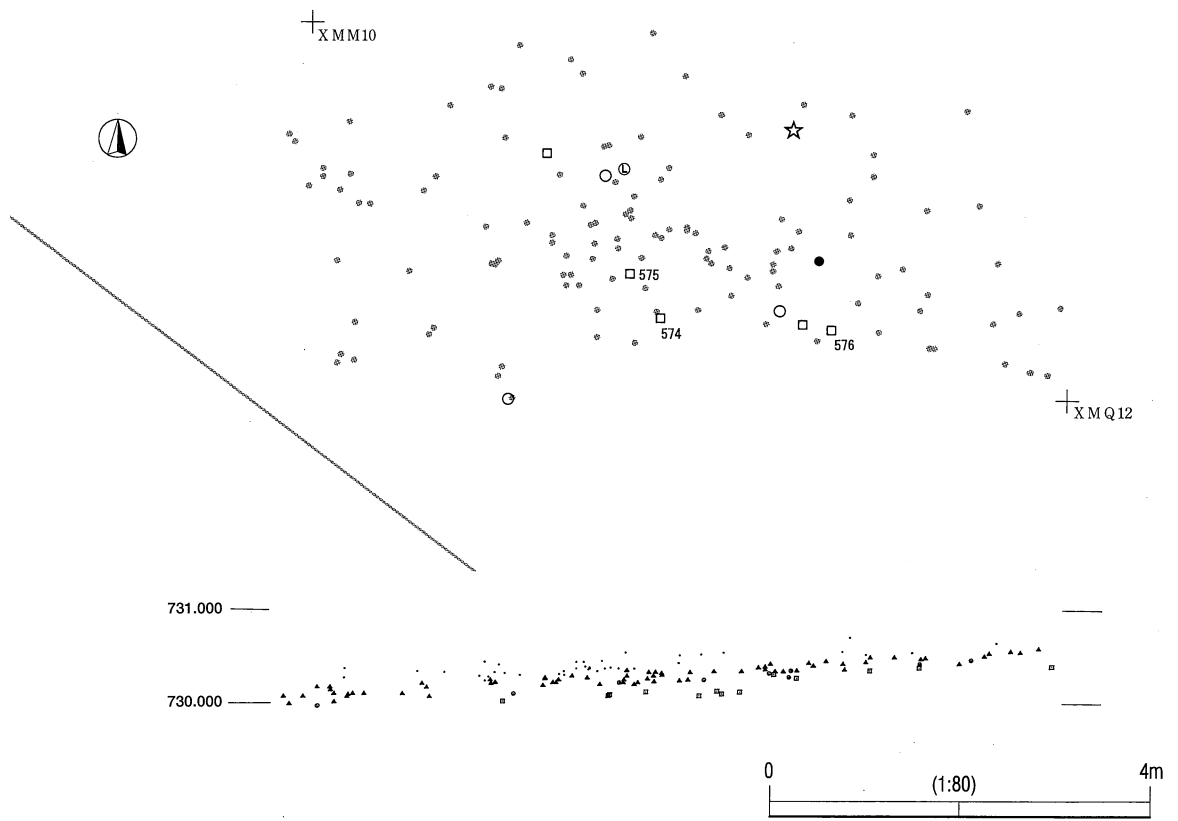

BL 2035

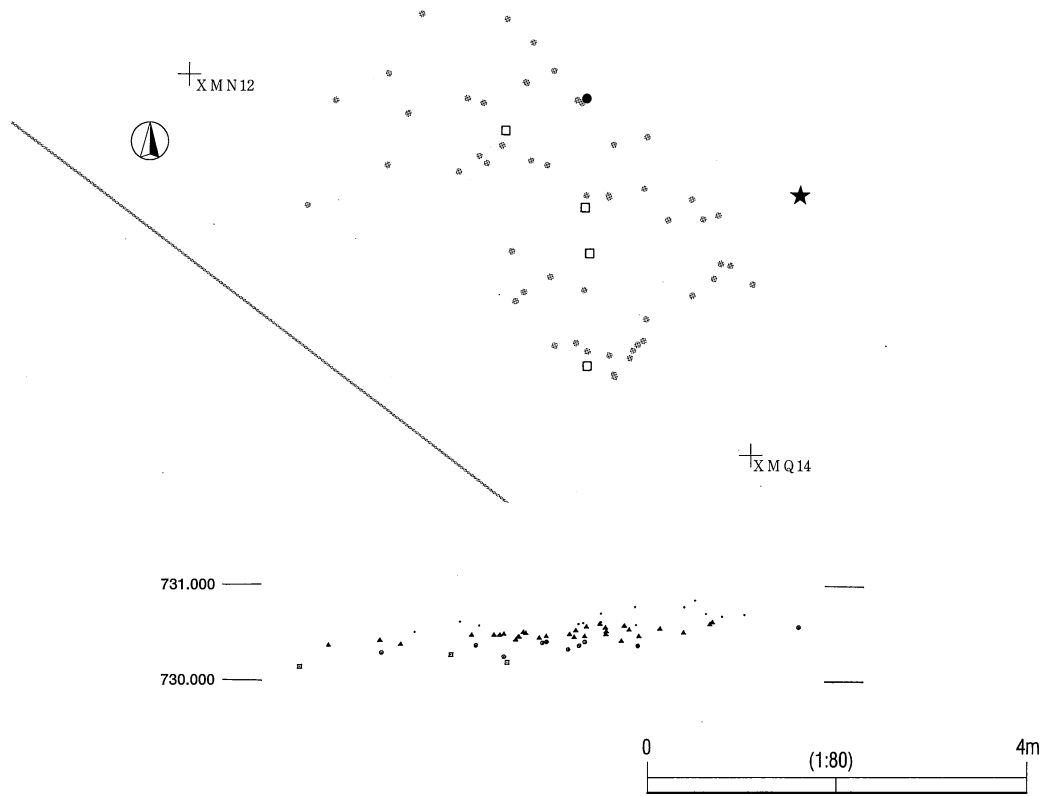

第 2 地点 BL2034・2035 遺物分布図 (貫ノ木遺跡)

BL 2036

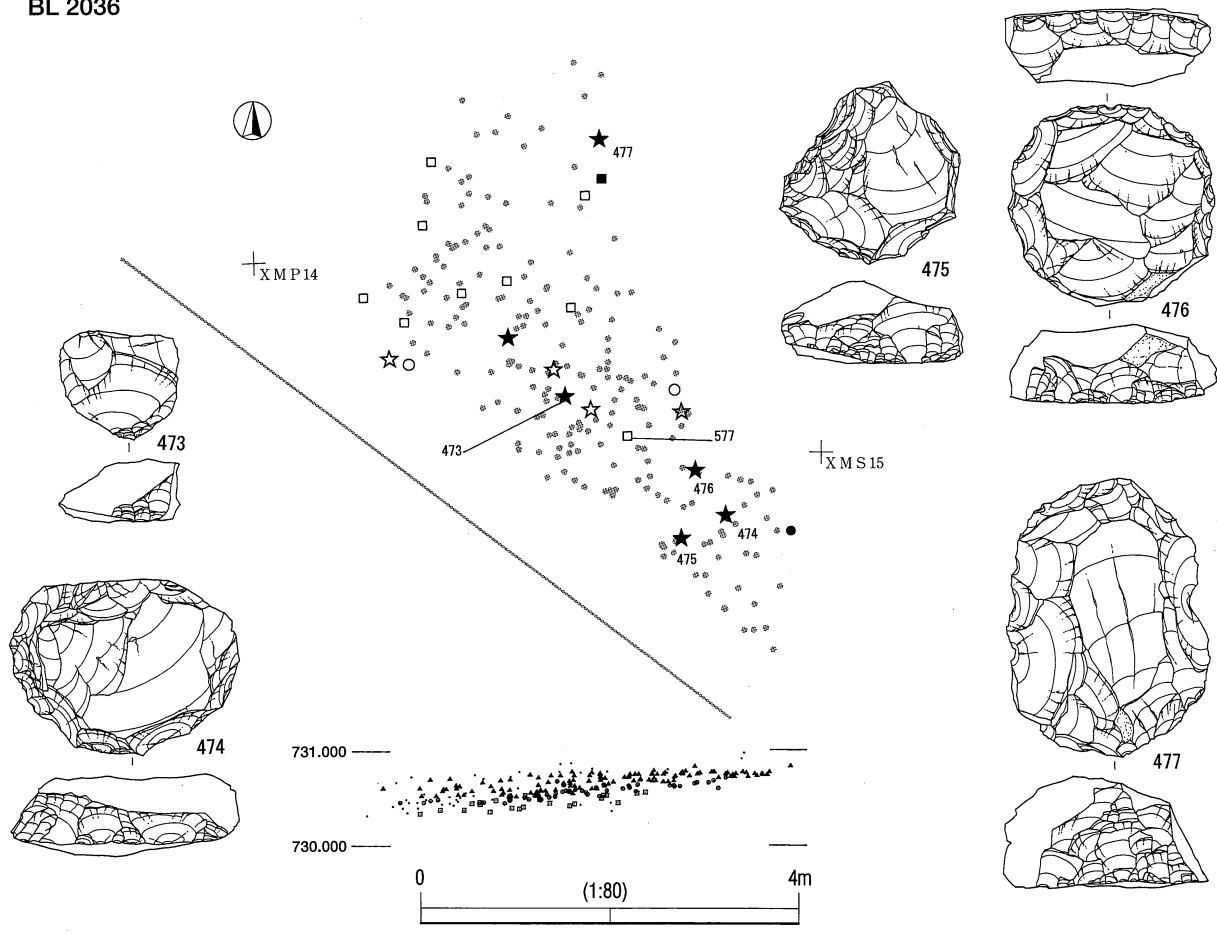

BL 2037

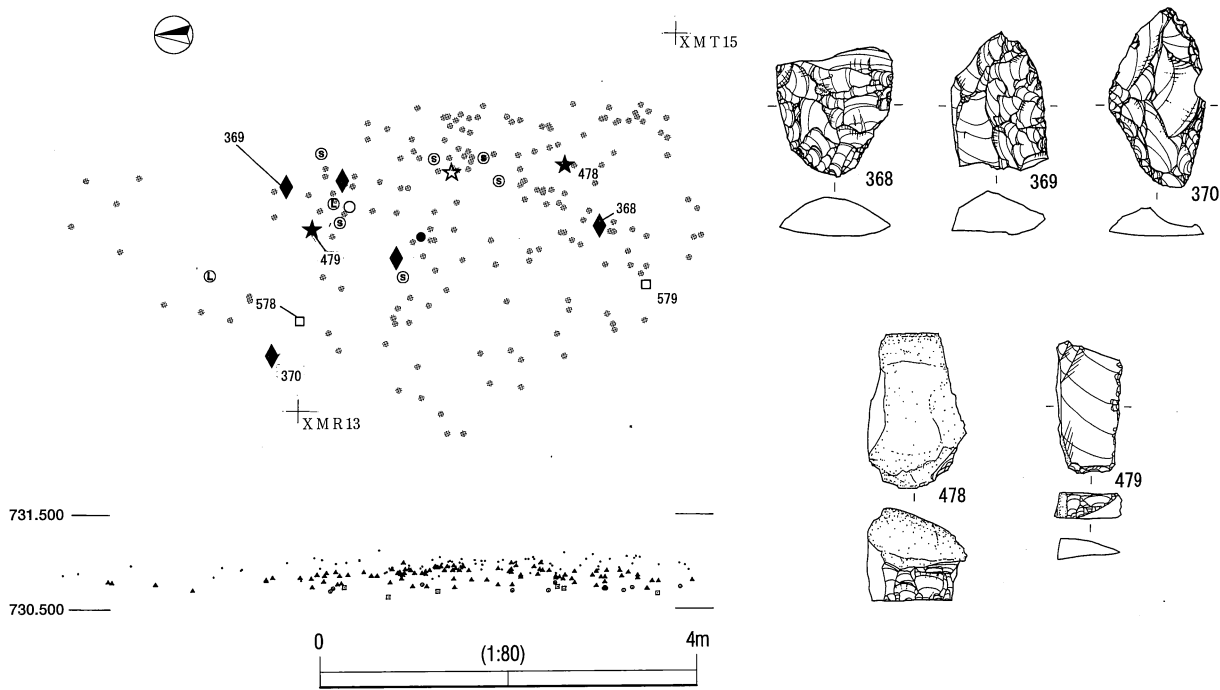

第2地点 BL2036・2037 遺物分布図 (貫ノ木遺跡)

BL 2038

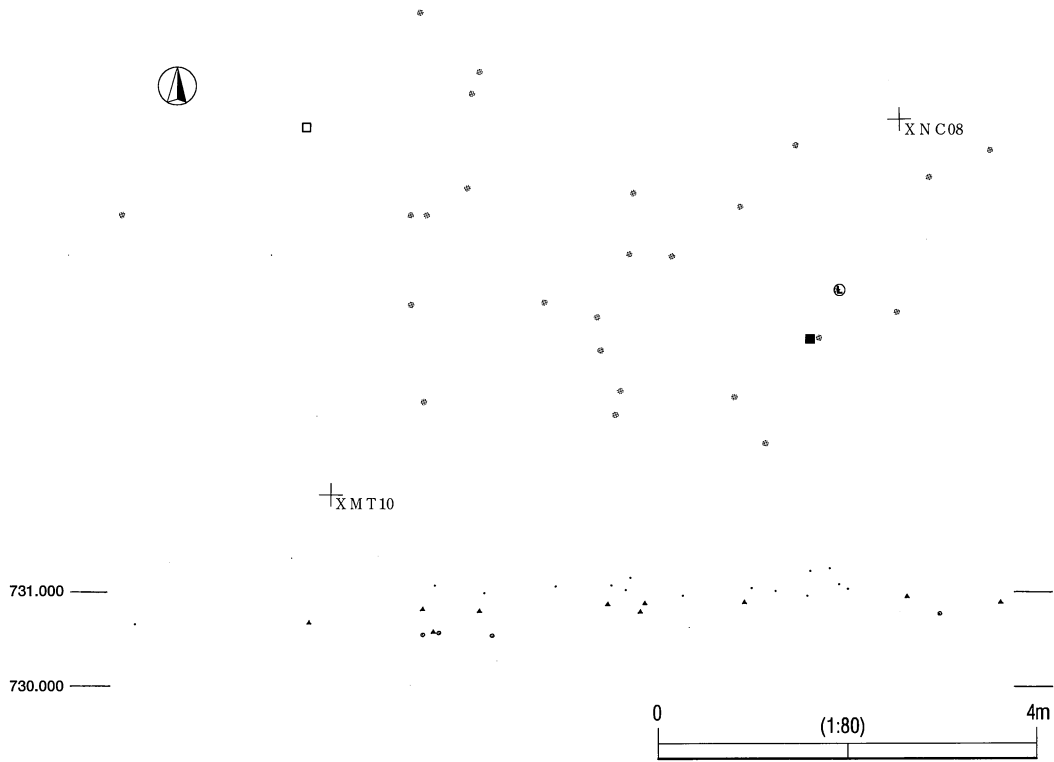

BL 2039

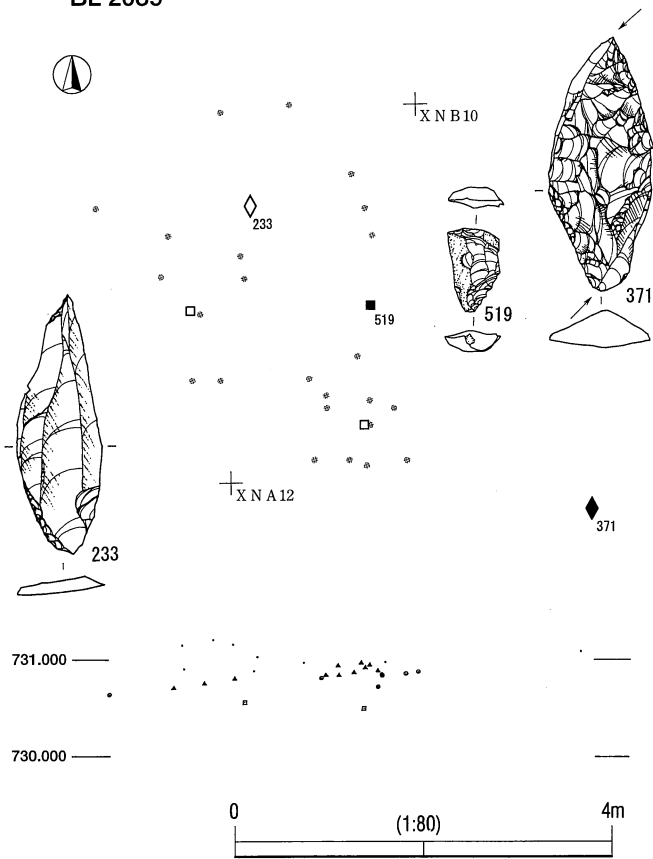

BL 2040

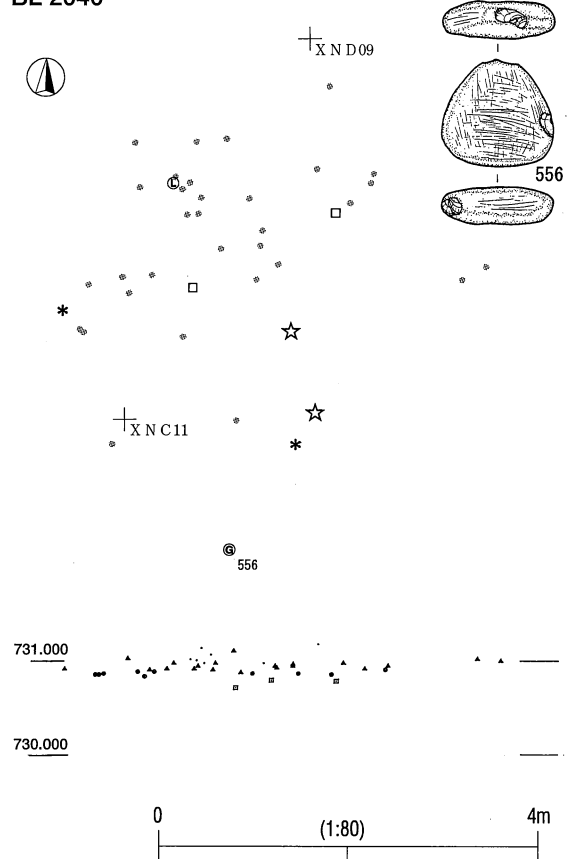

第 2 地点 BL2038・2039・2040 遺物分布図 (貫ノ木遺跡)



BL 2041

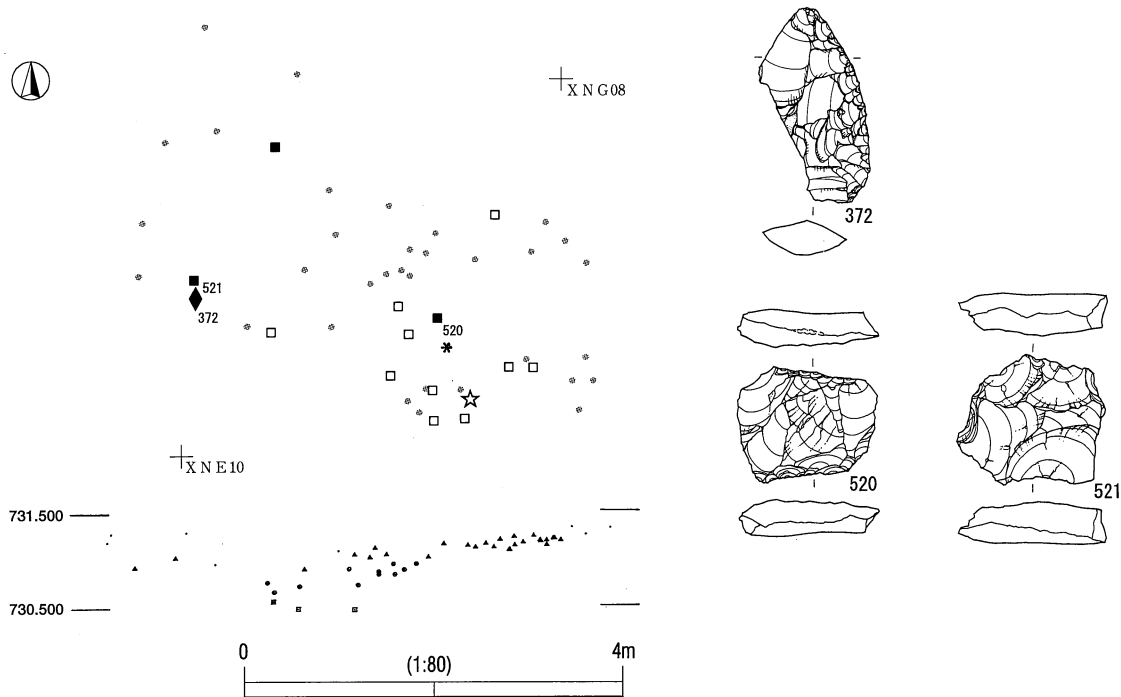

BL 2042

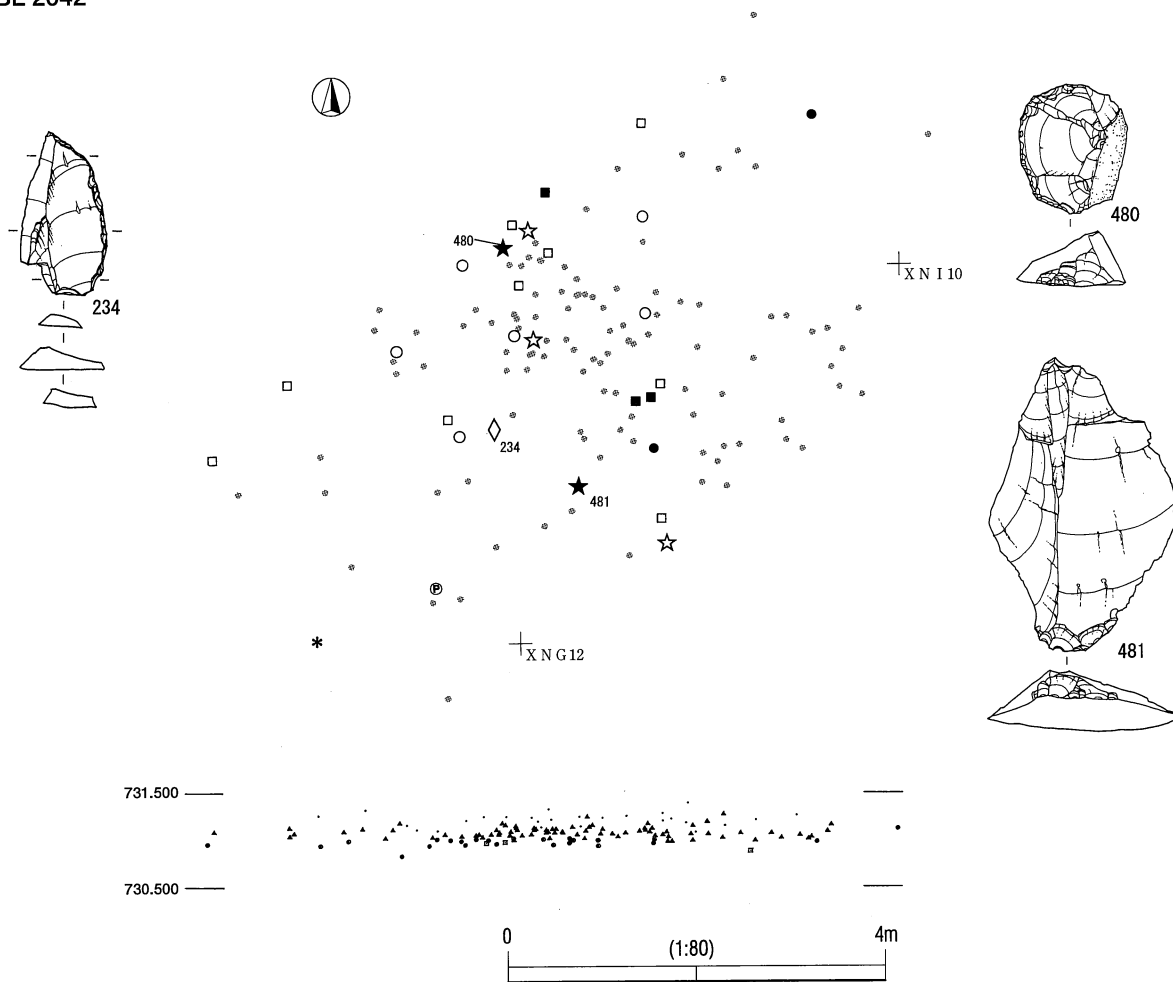

第2地点 BL2041・2042 遺物分布図 (貫ノ木遺跡)

BL 2043

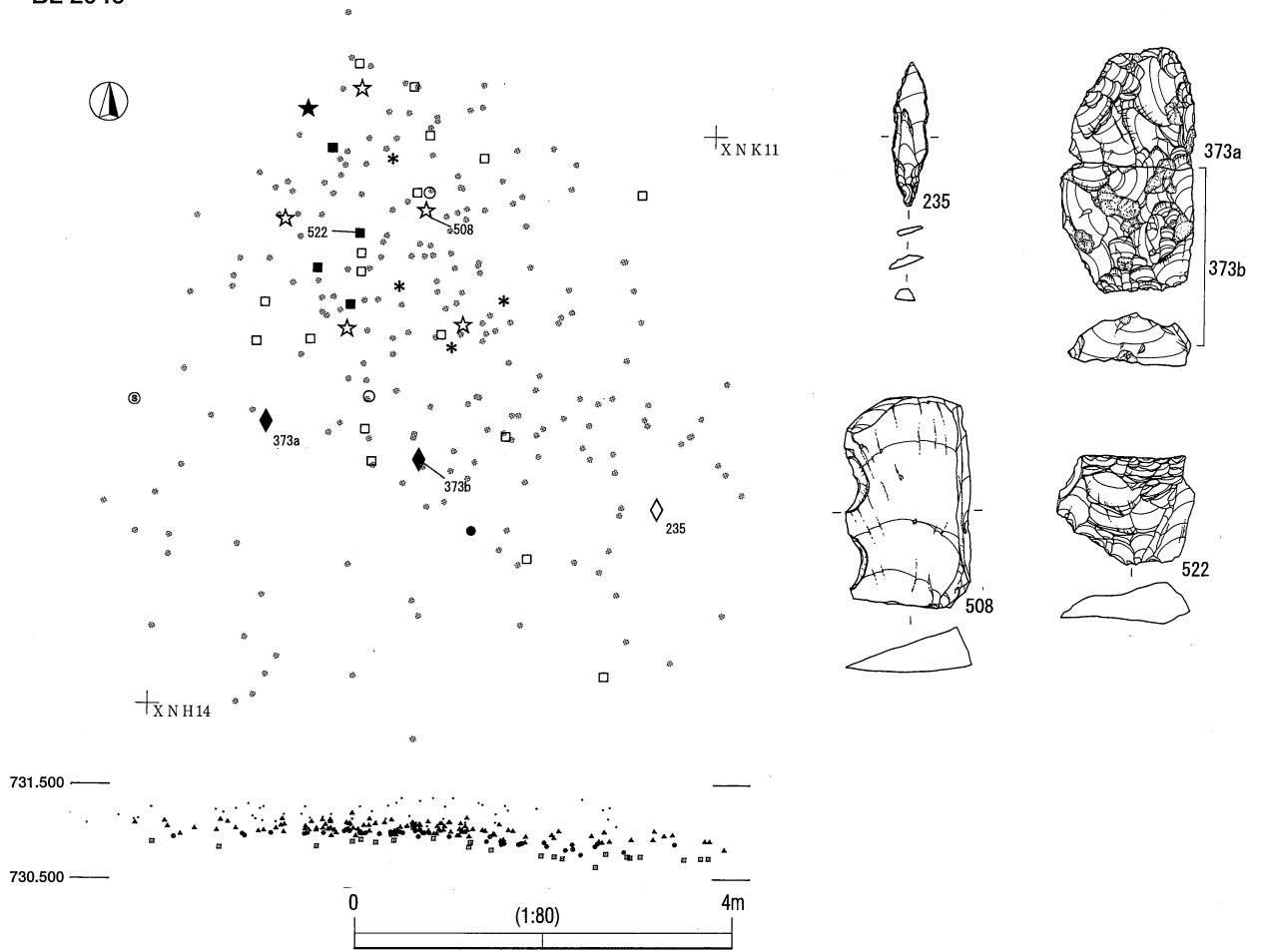

BL 2044

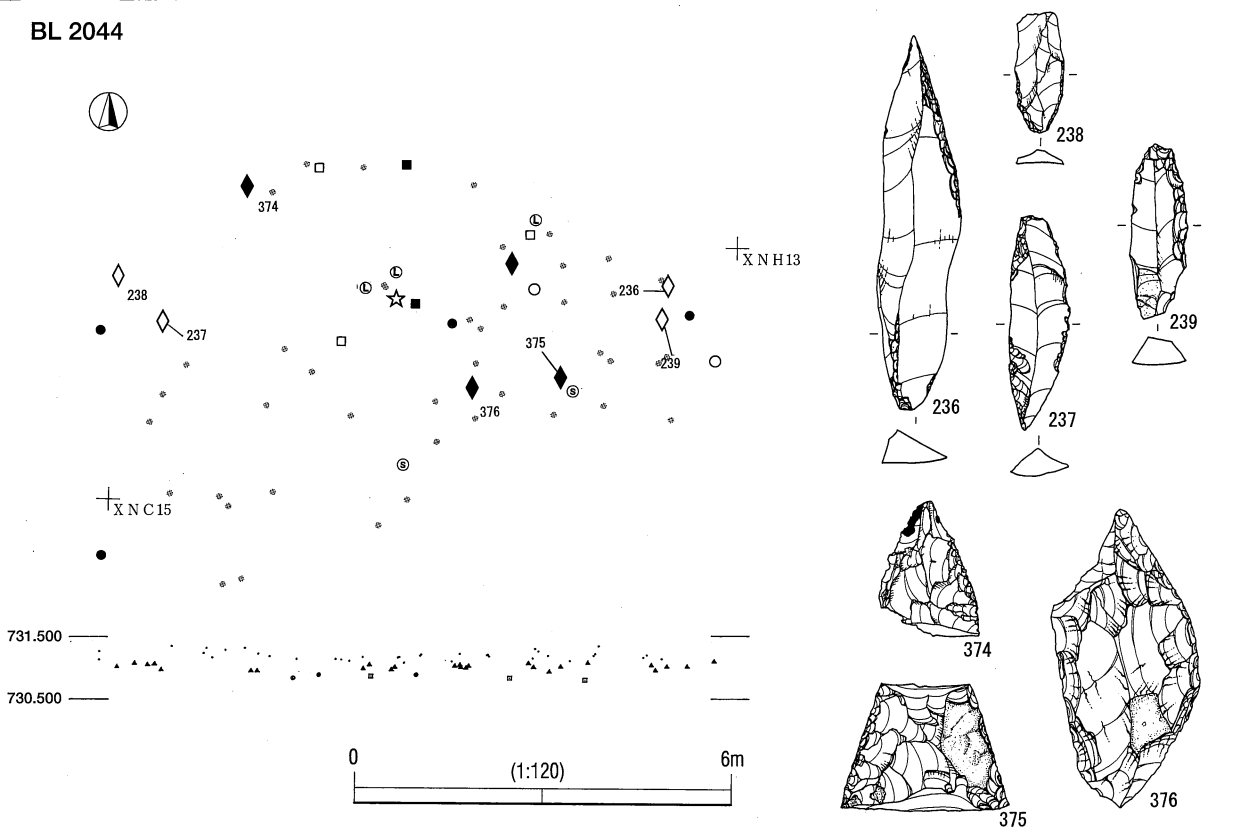

第 2 地点 BL2043・2044 遺物分布図 (貫ノ木遺跡)

BL 2045

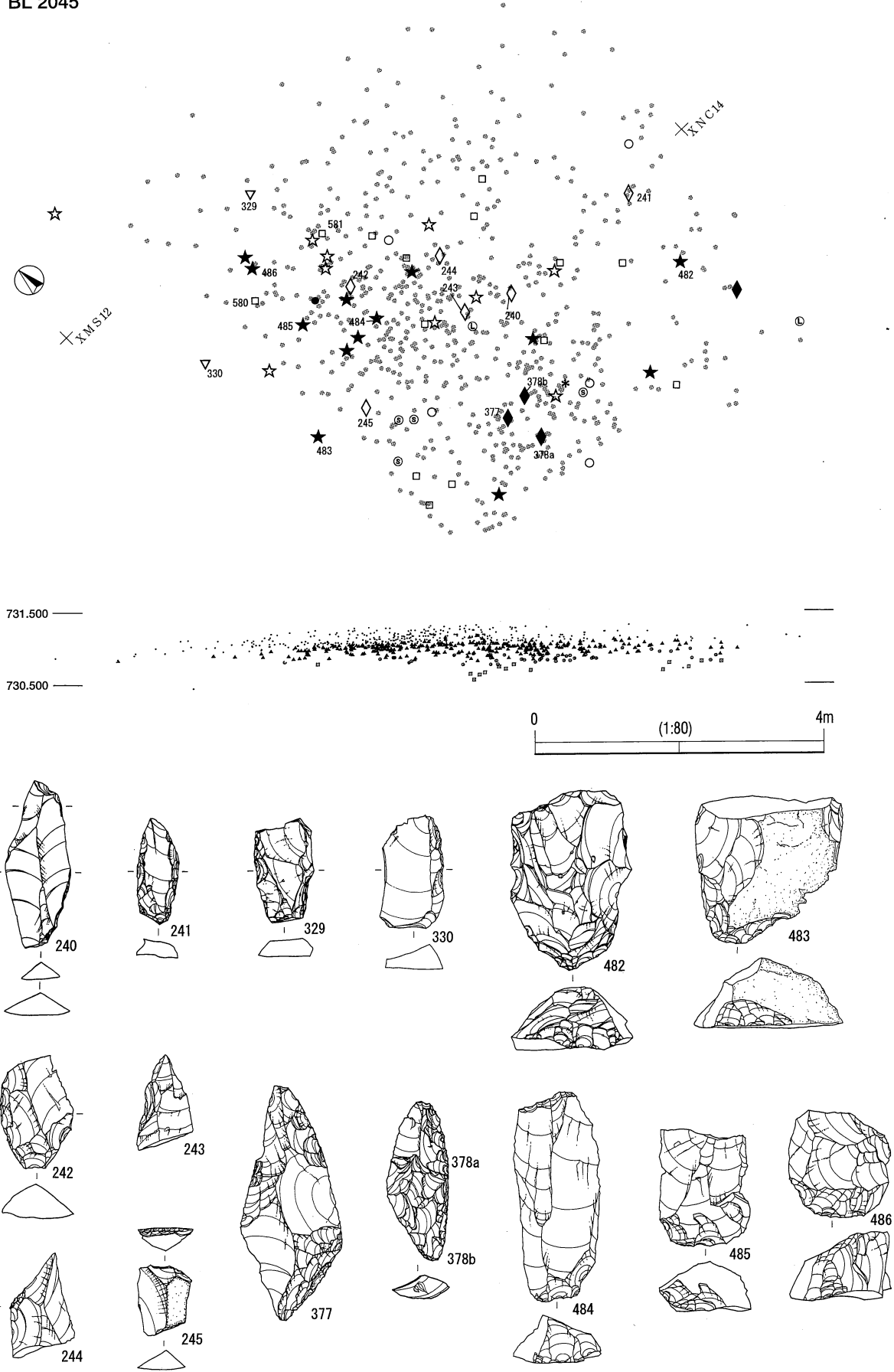

第 2 地点 BL2045 遺物分布図 (貫ノ木遺跡)

BL 2046

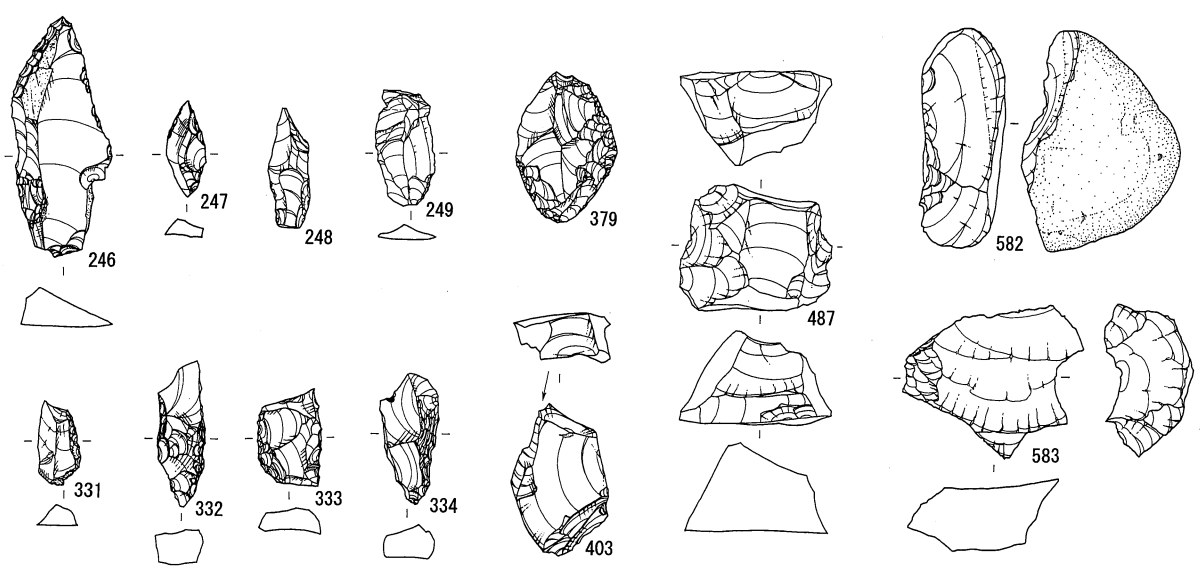
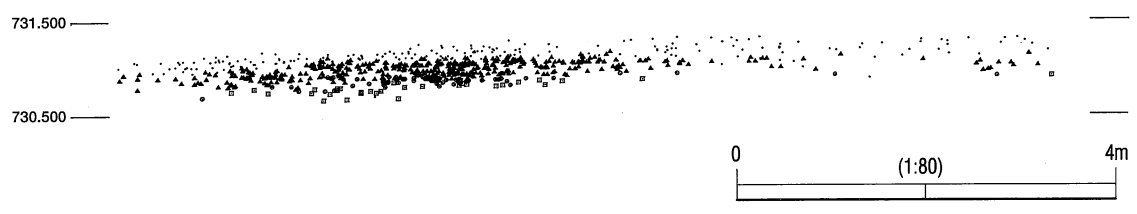
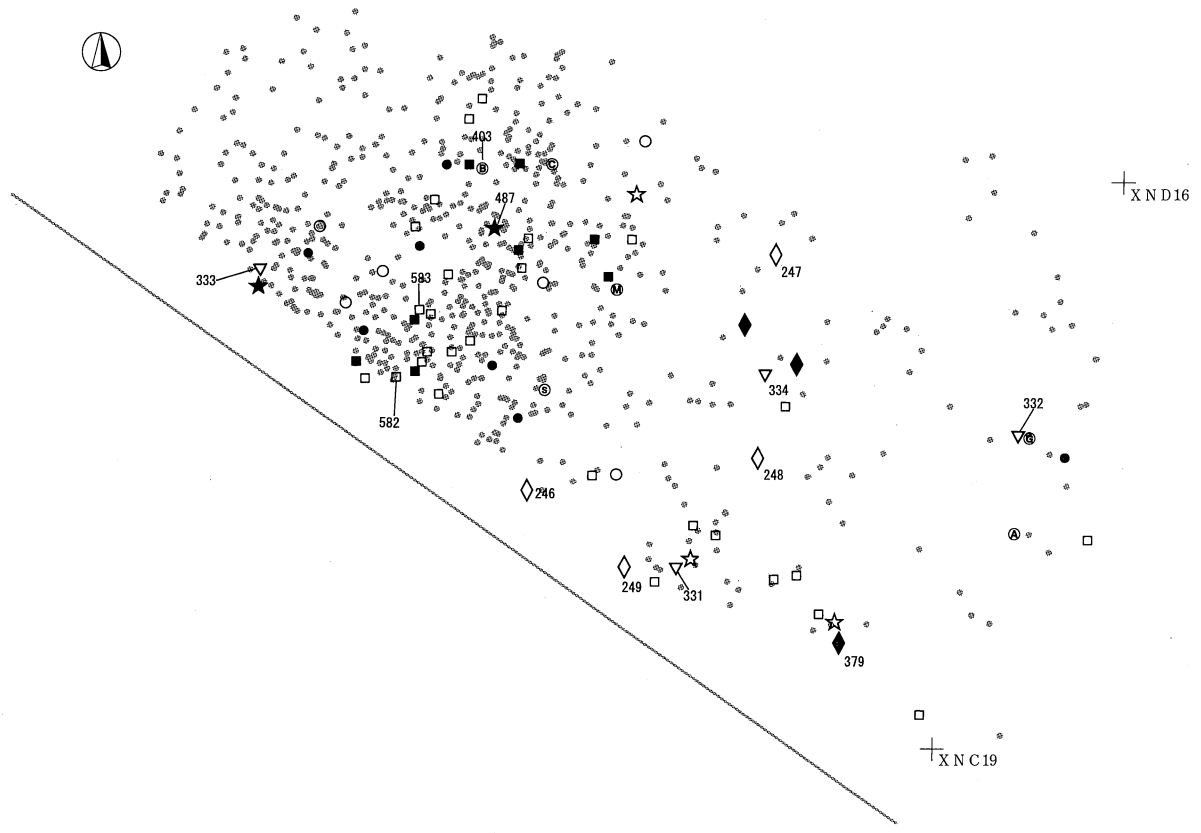

第2地点 BL2046 遺物分布図 (貫ノ木遺跡)

BL 2047

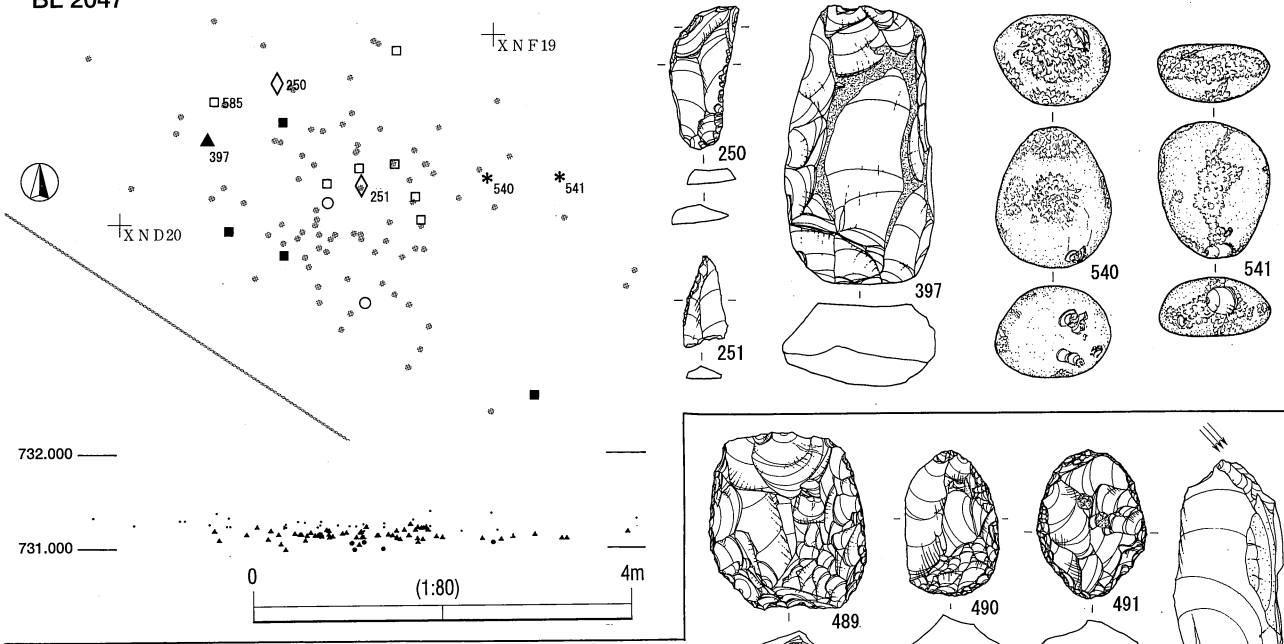

BL 2048

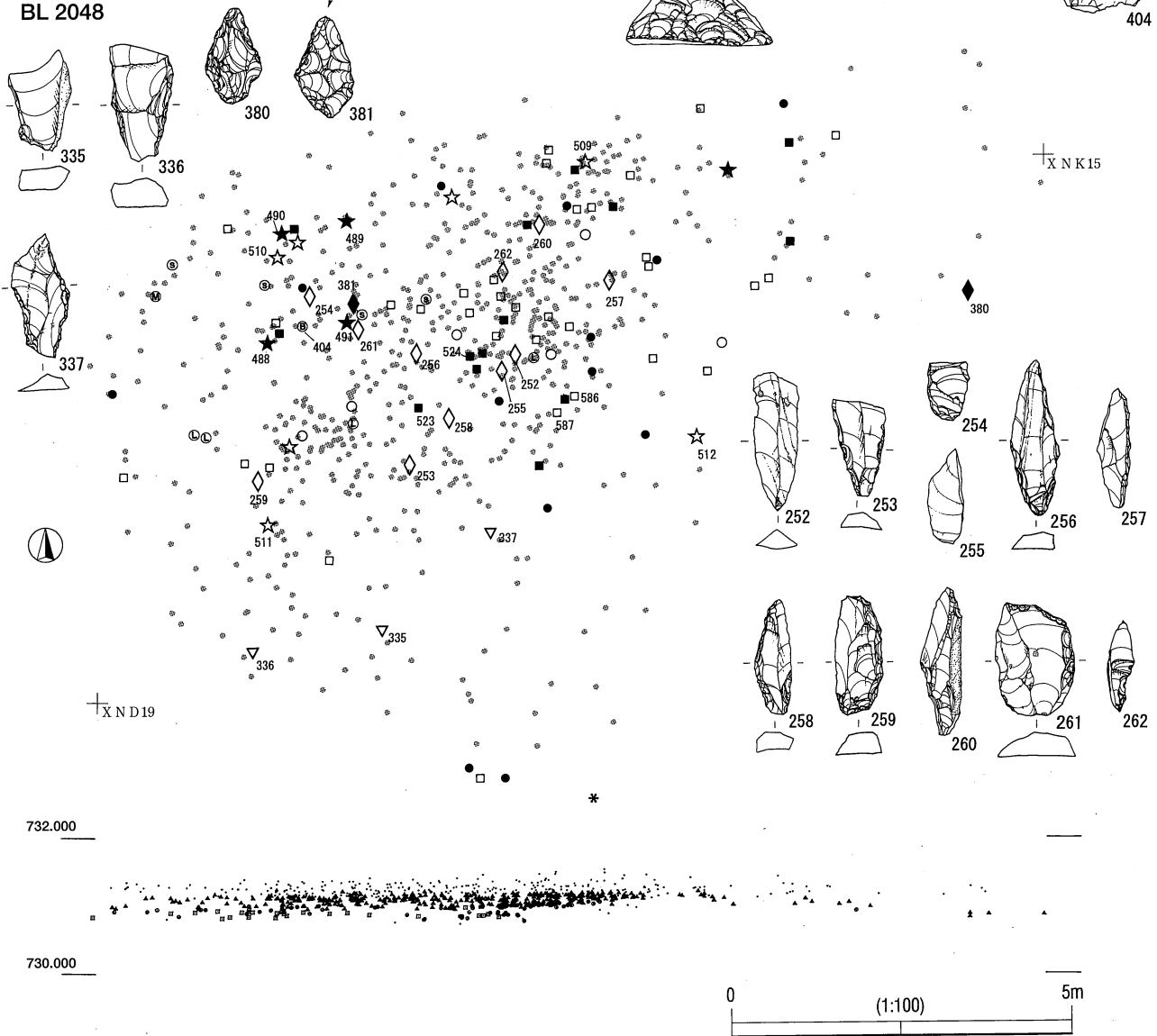

第2地点 BL2047・2048 遺物分布図 (貫ノ木遺跡)

BL 2049

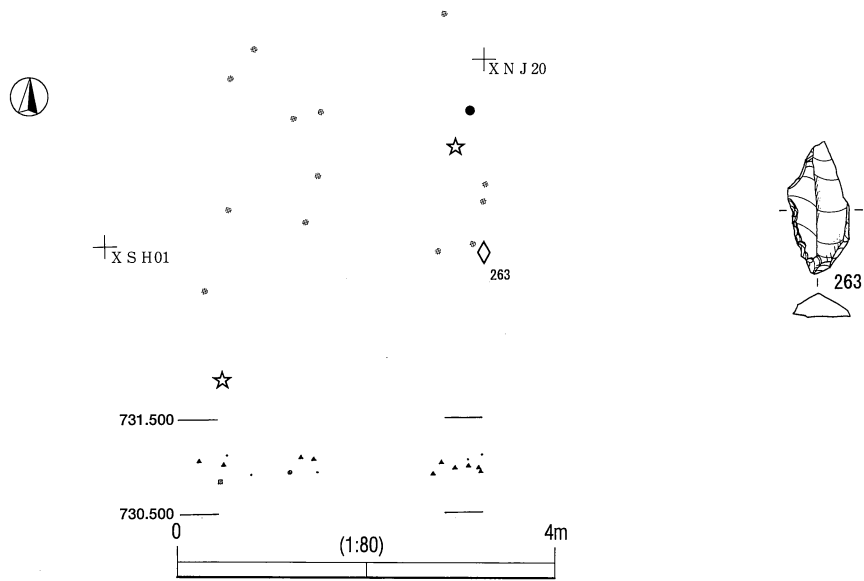

BL 2050

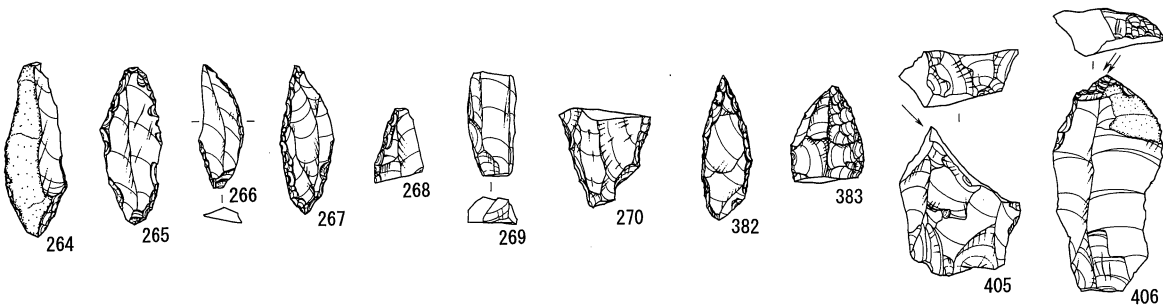
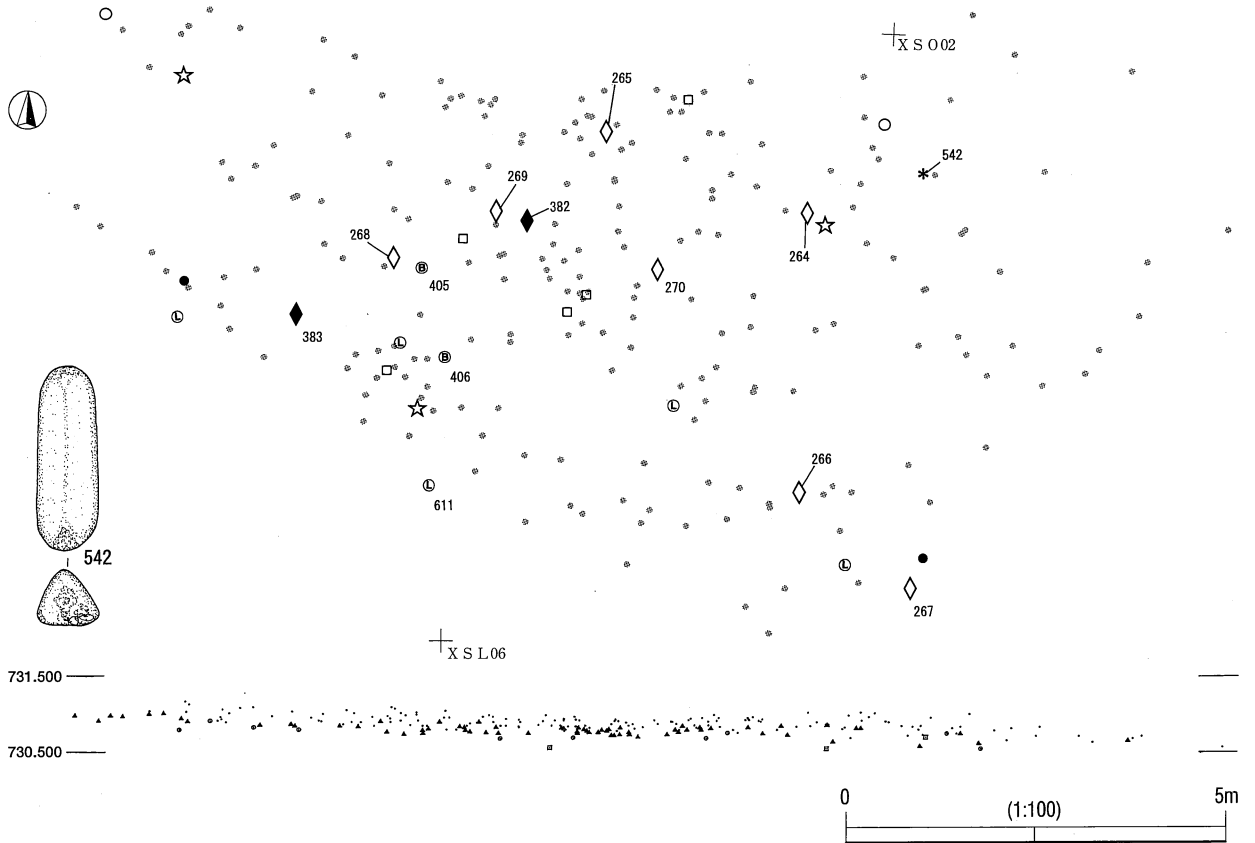

第 2 地点 BL2049・2050 遺物分布図 (貫ノ木遺跡)

BL 2051

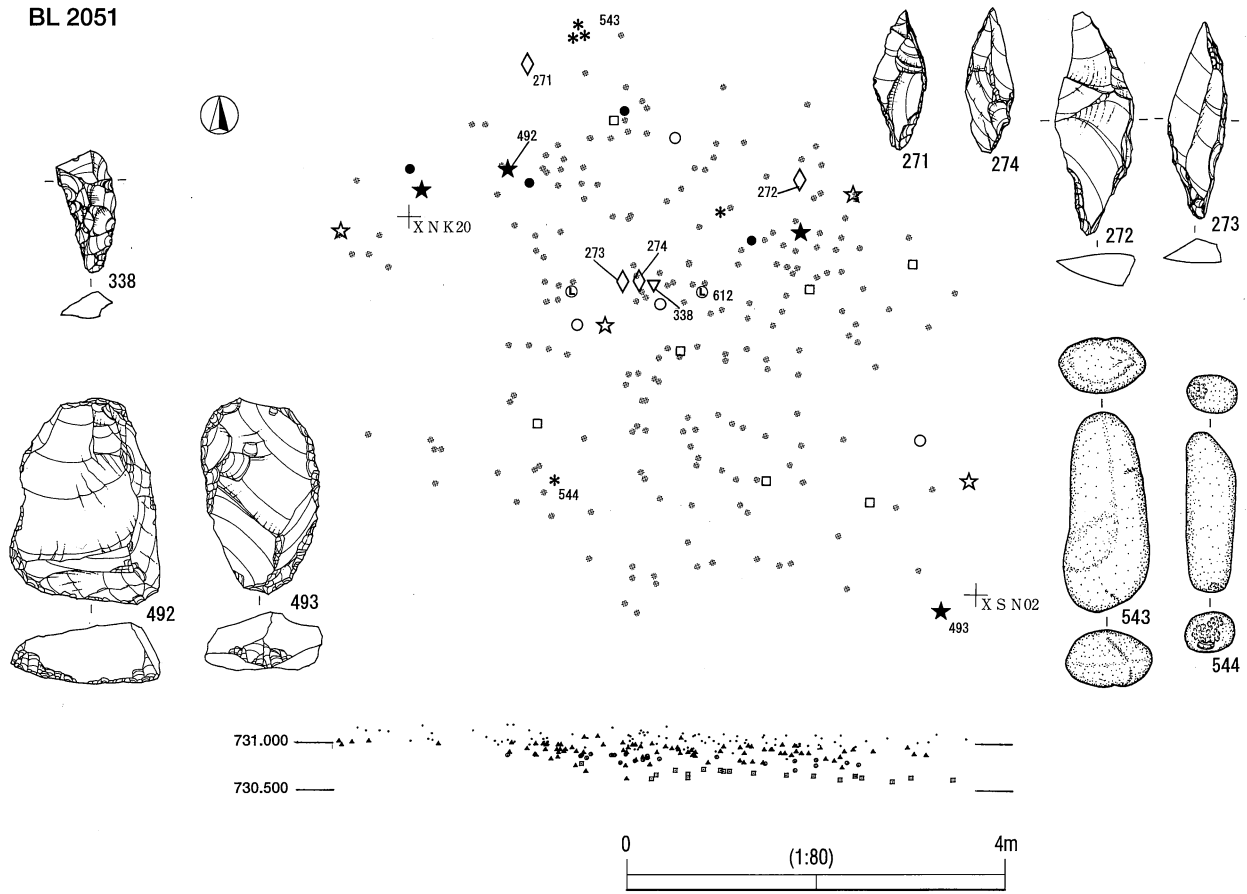

BL 2052

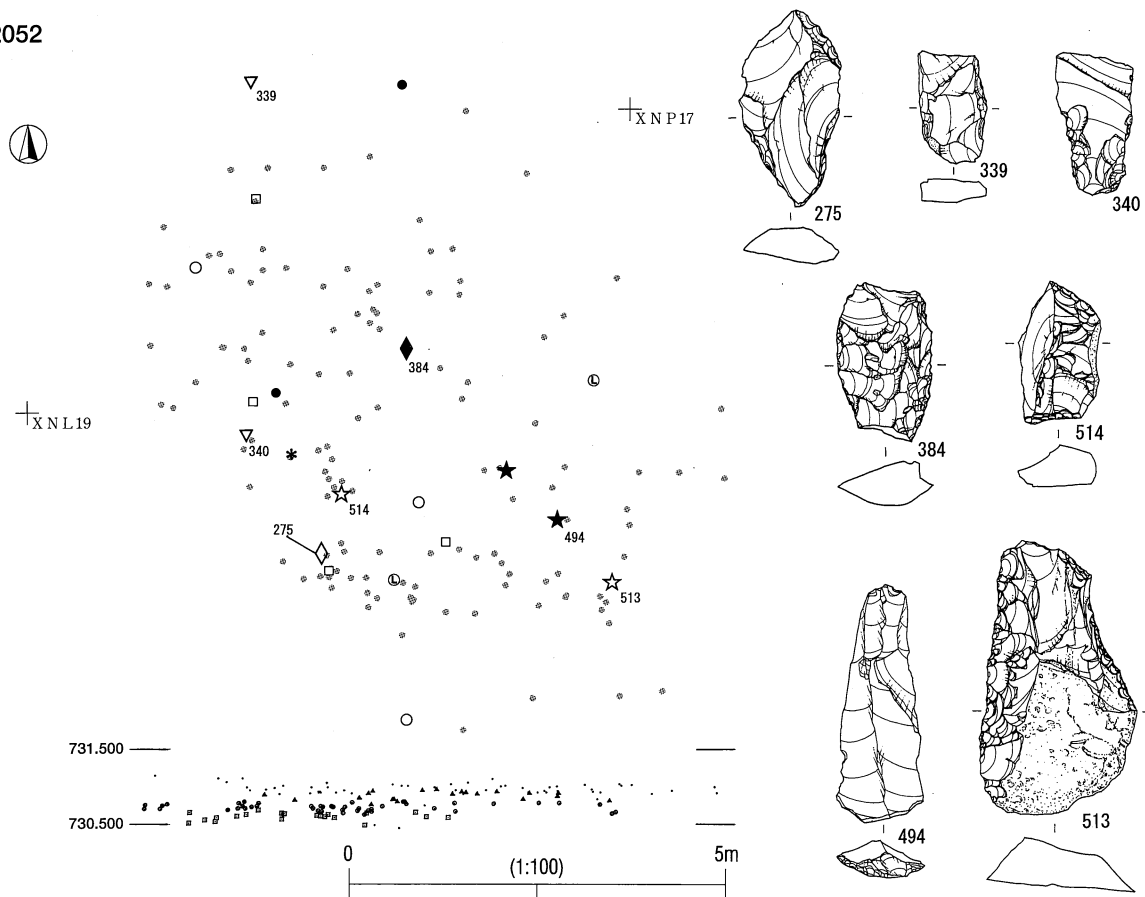

第2地点 BL2051・2052 遺物分布図 (貫ノ木遺跡)

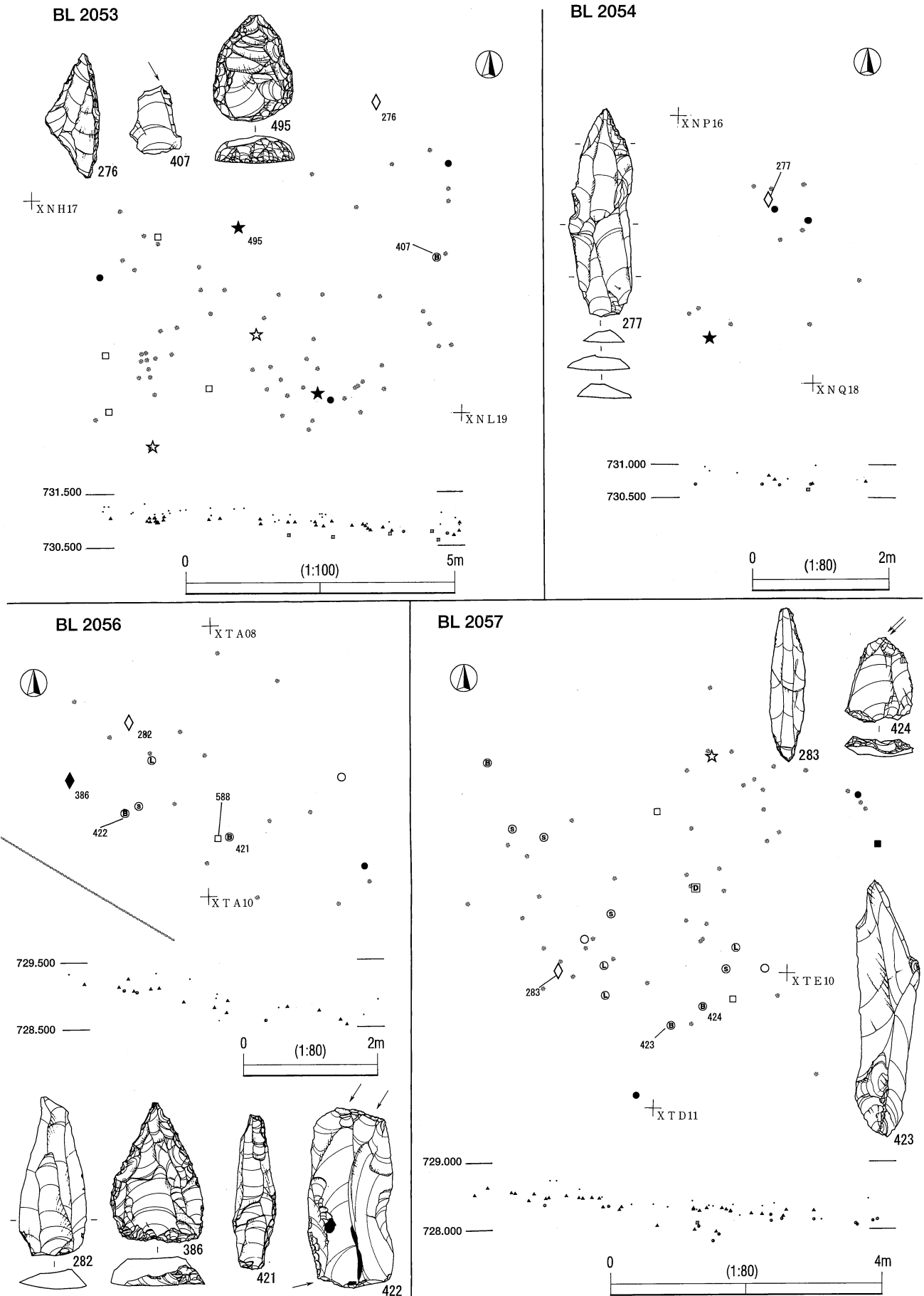

第2地点 BL2053・2054・2056・2057 遺物分布図 (貫ノ木遺跡)



BL 2055



第2地点 BL2055 遺物分布図 (貫ノ木遺跡)

BL 2058

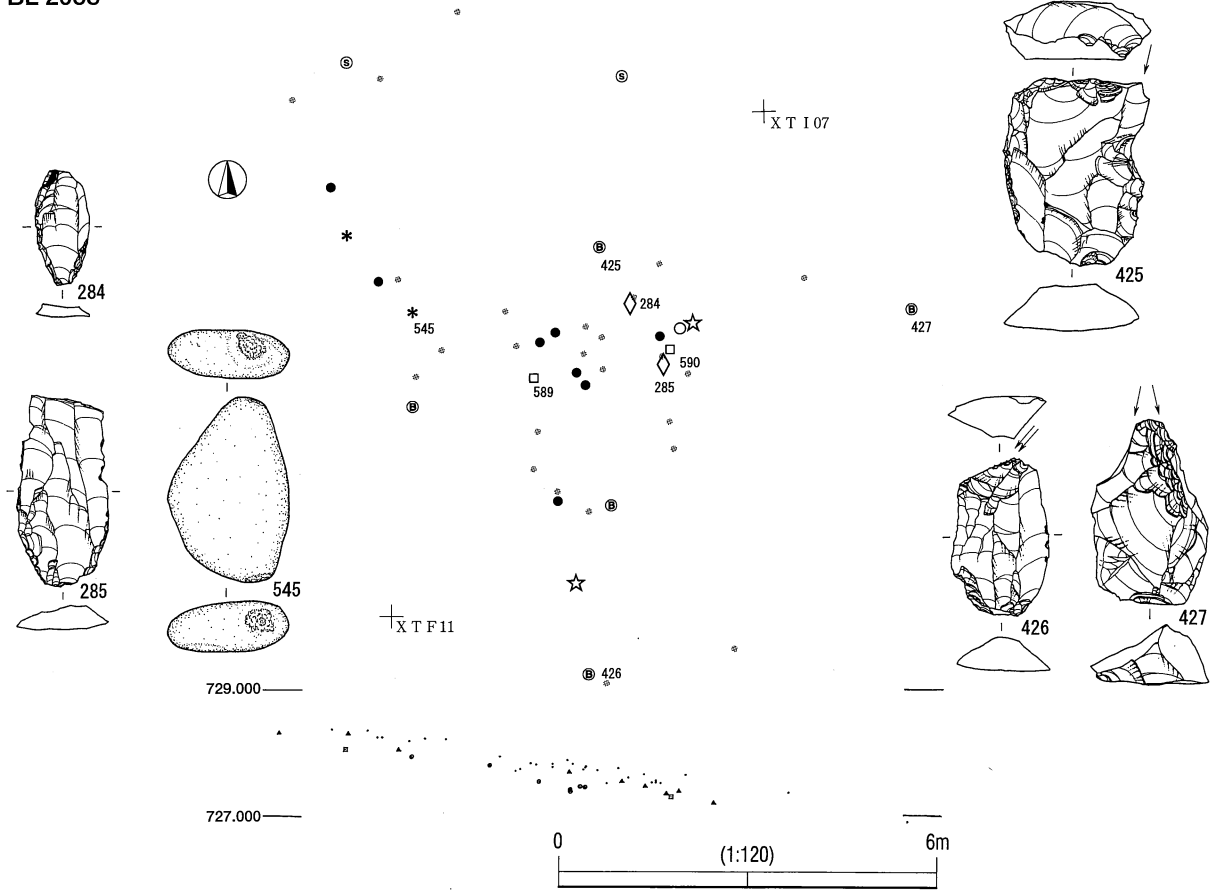

BL 2059

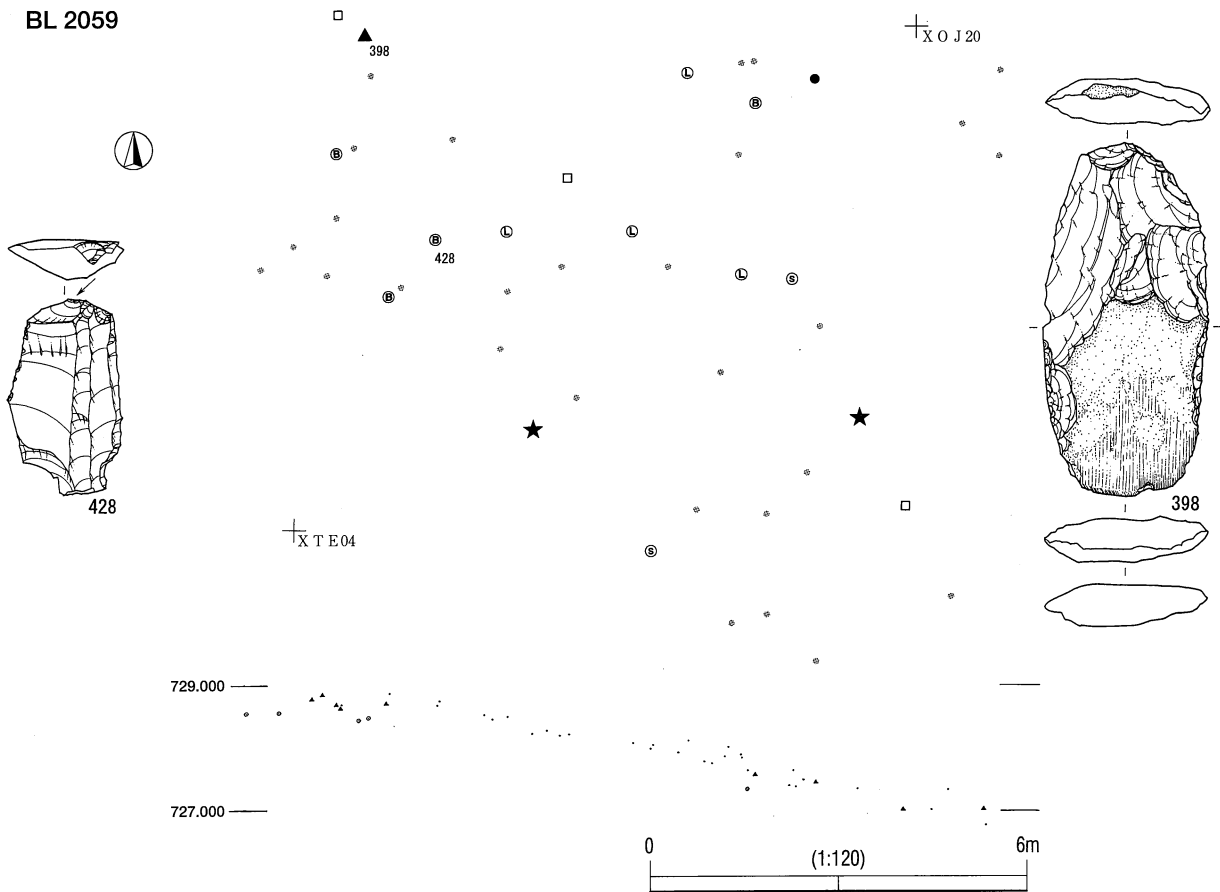

第 2 地点 BL2058・2059 遺物分布図 (貫ノ木遺跡)

BL 2060

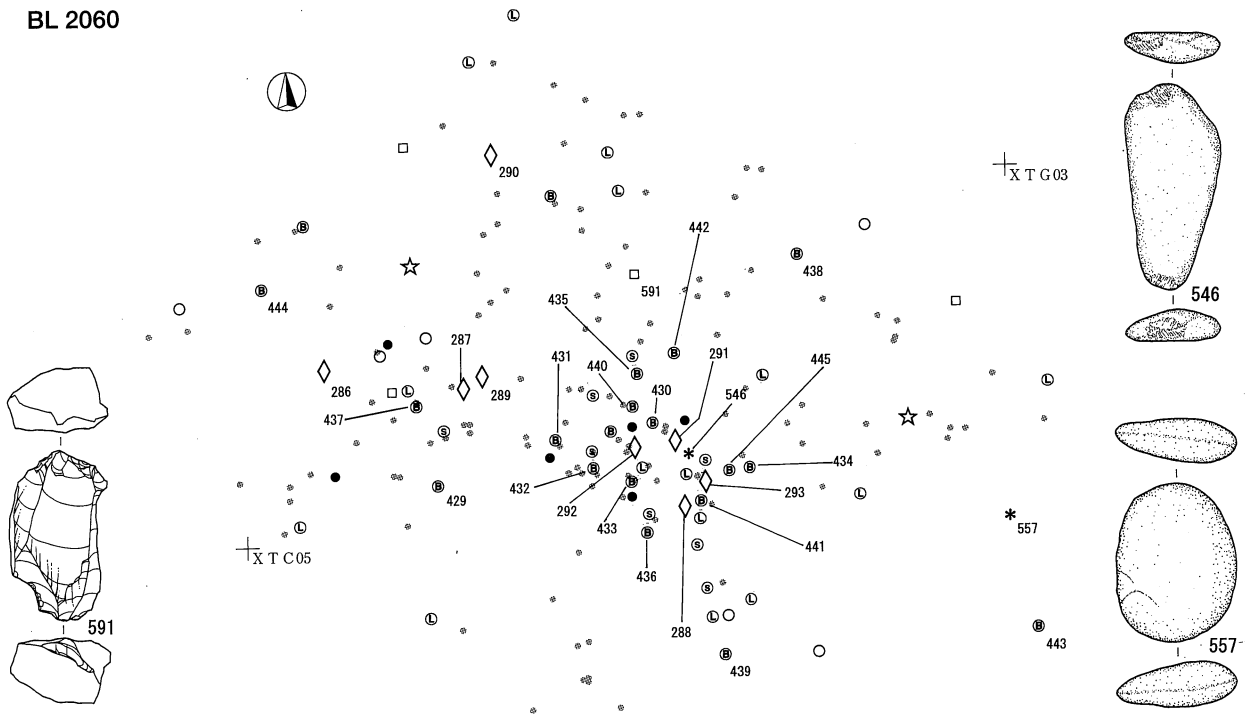

729.000

728.000

0 (1:80) 4m

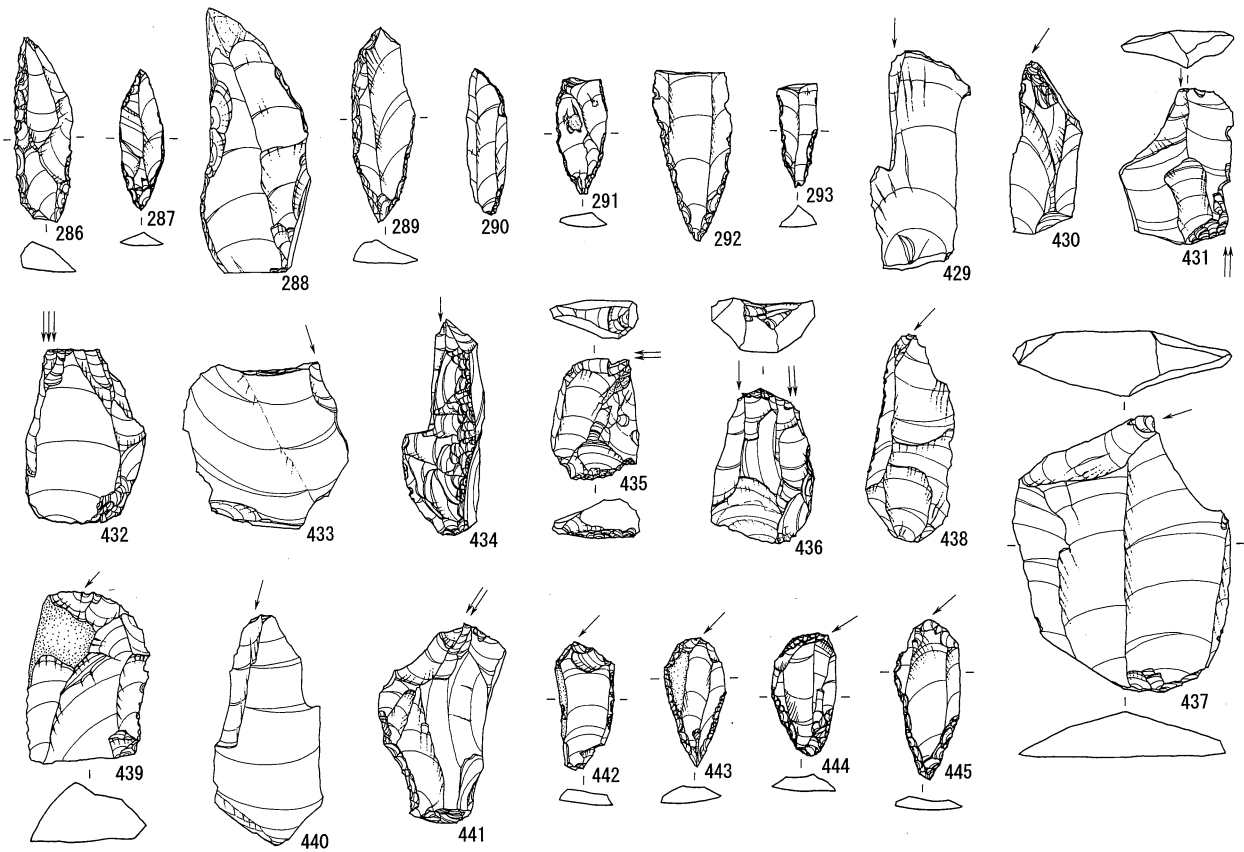

第 2 地点 BL2060 遺物分布図 (貫ノ木遺跡)

BL 2061



BL 2062

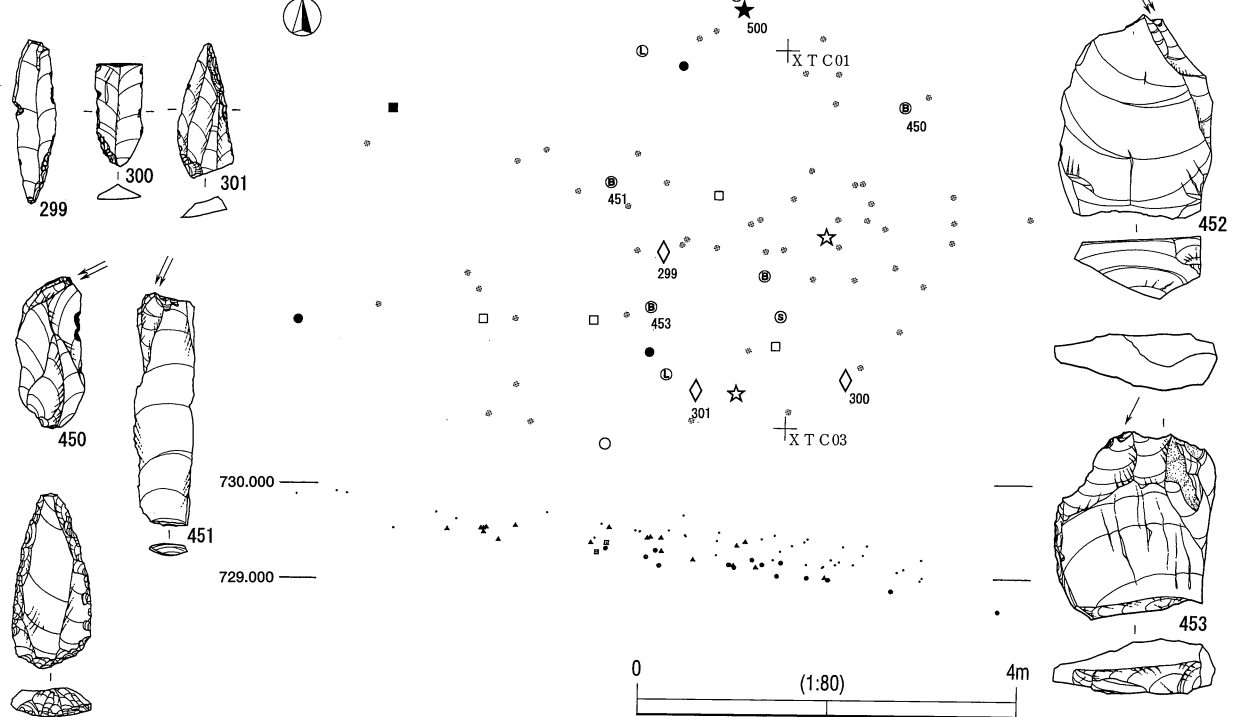

第 2 地点 BL2061・2062 遺物分布図 (貫ノ木遺跡)

BL 2063

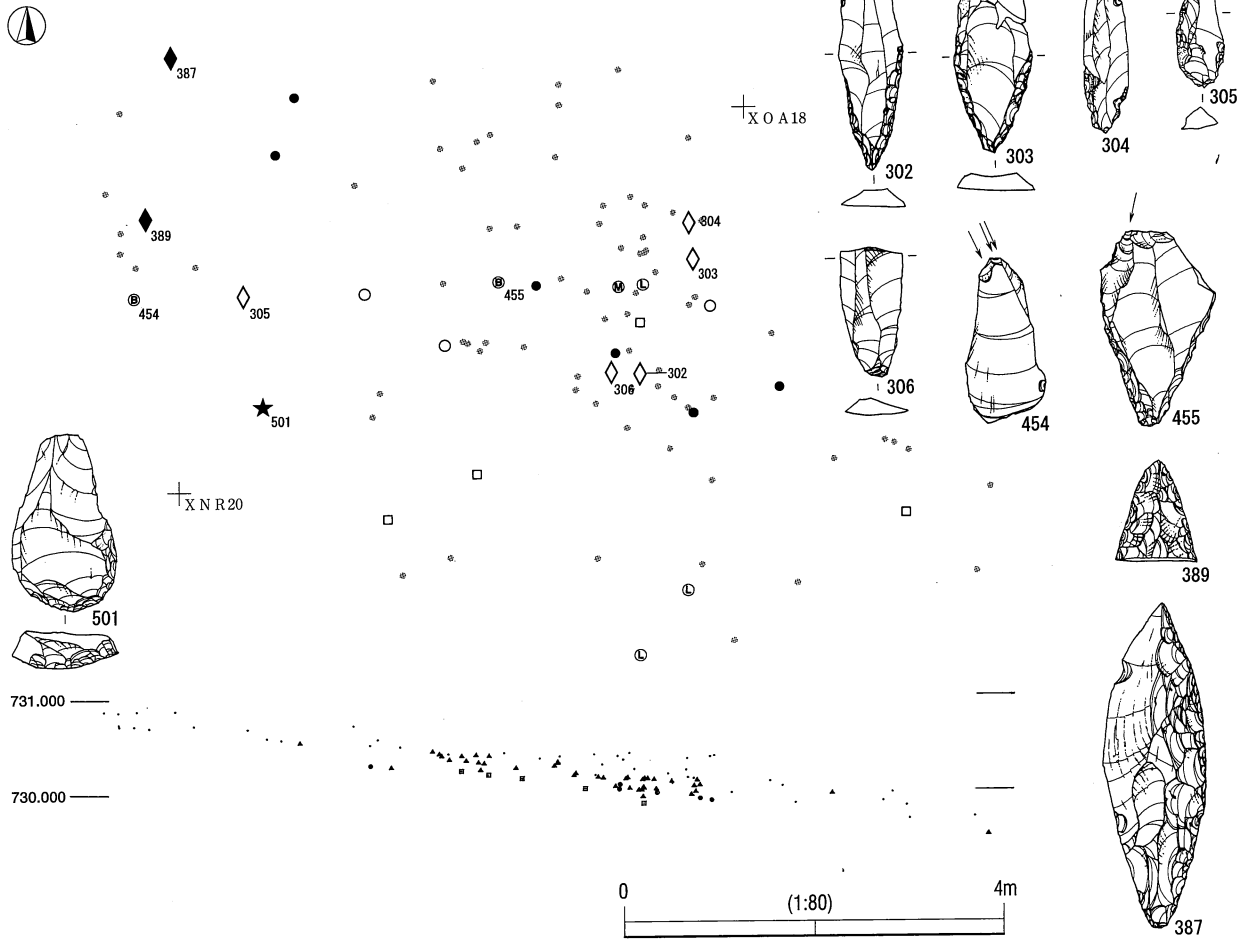

BL 2064

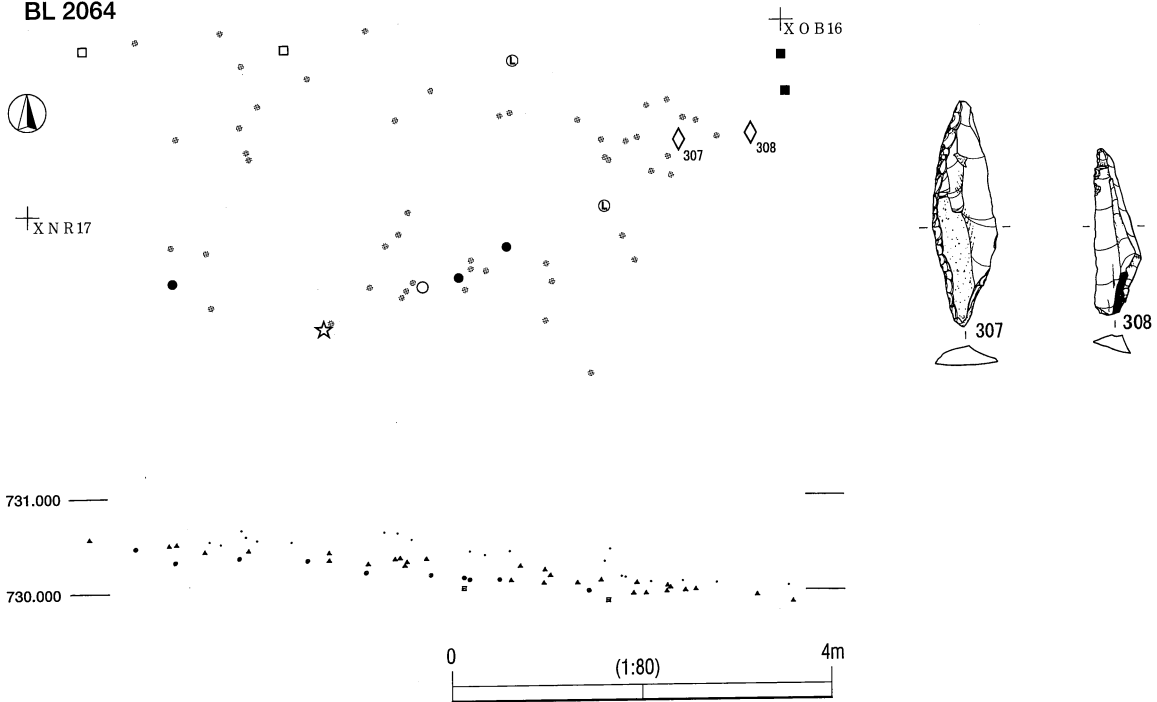

第2地点 BL2063・2064 遺物分布図 (貫ノ木遺跡)

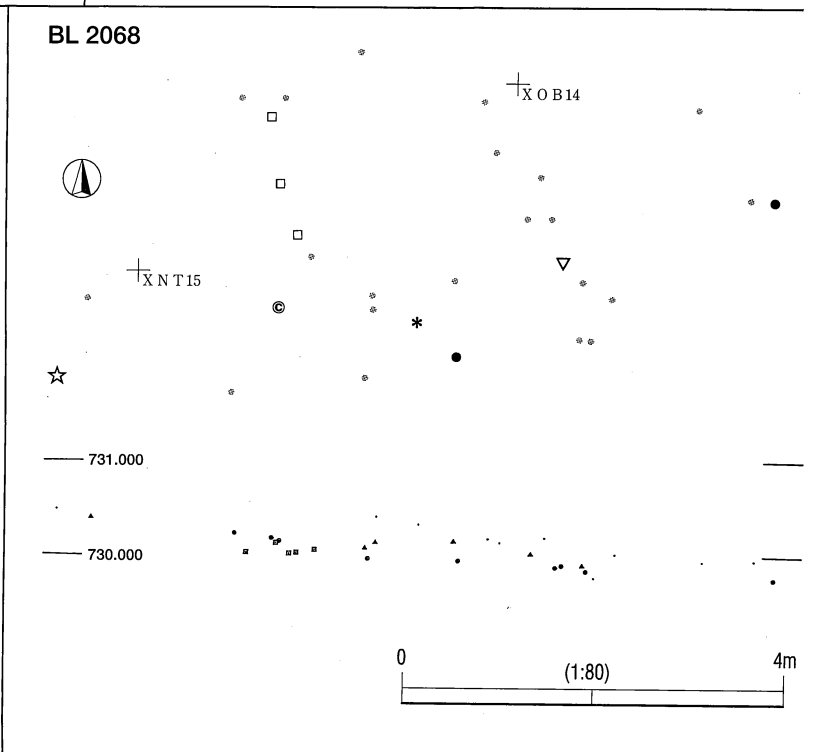
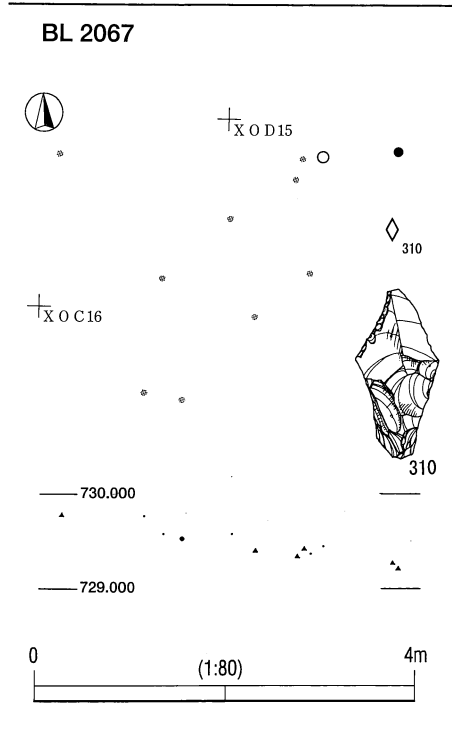
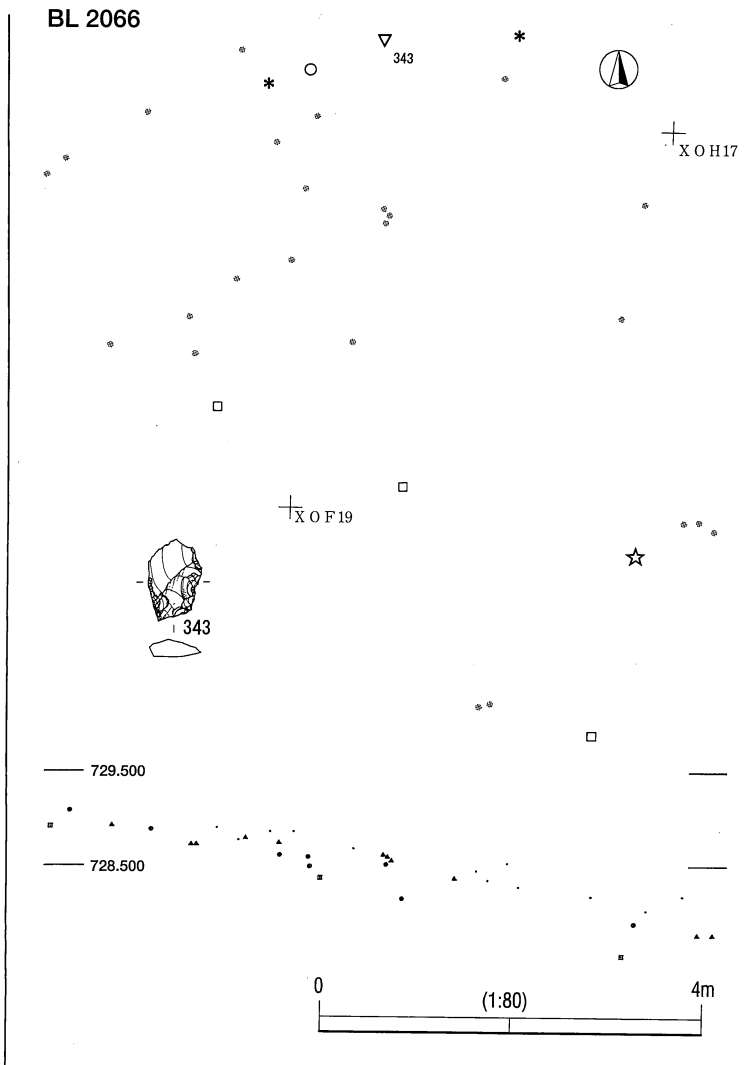
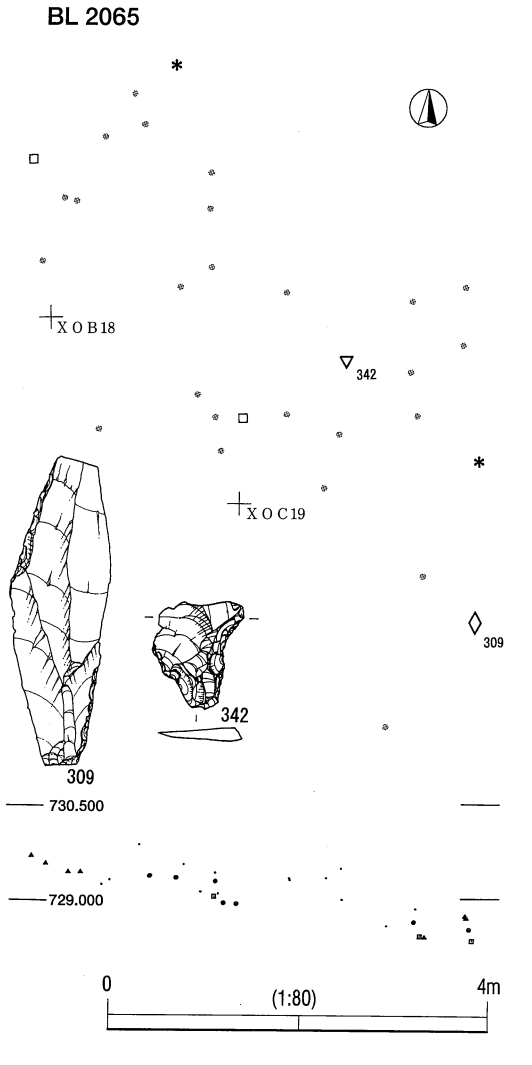

第 2 地点 BL2065・2066・2067・2068 遺物分布図 (貫ノ木遺跡)

BL 2069

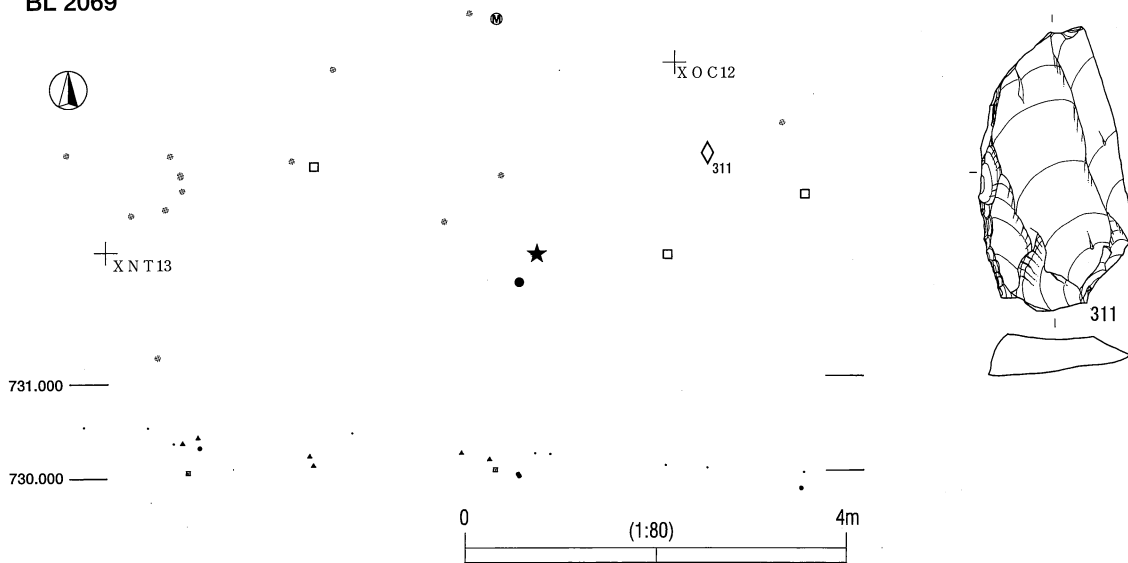

BL 2070

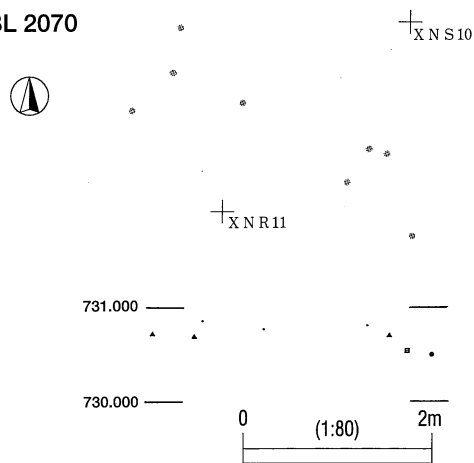

BL 2071

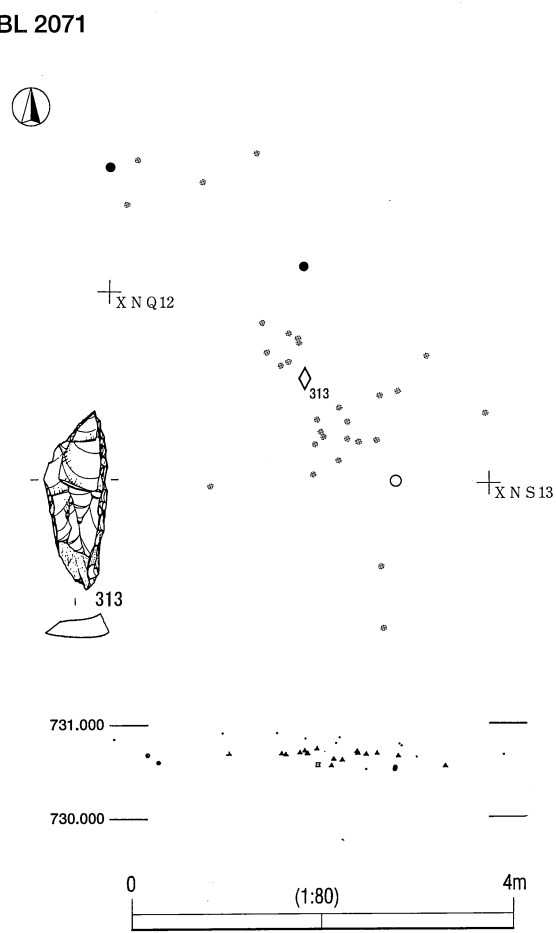

BL 2072

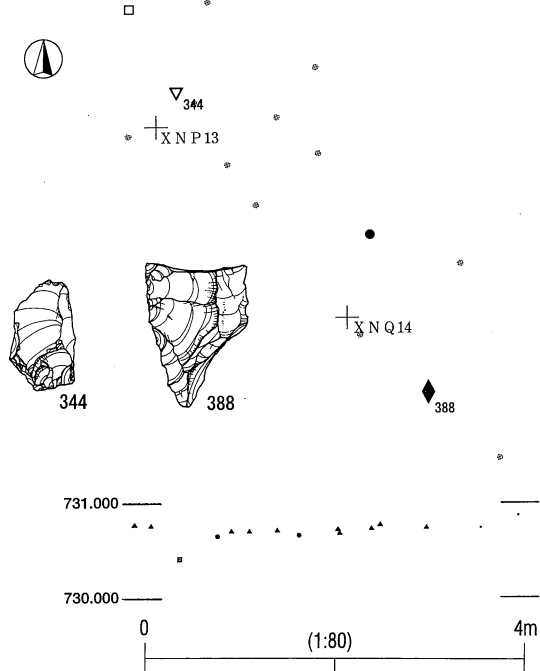

第 2 地点 BL2069・2070・2071・2072 遺物分布図 (貫ノ木遺跡)

BL 2073

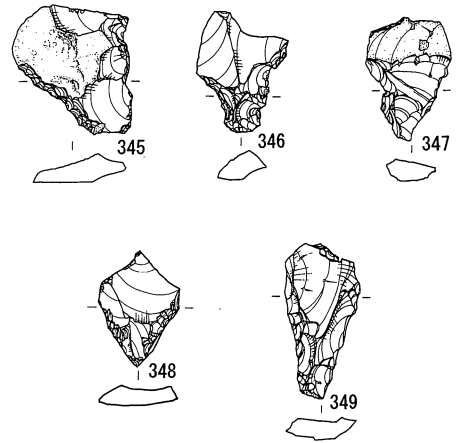
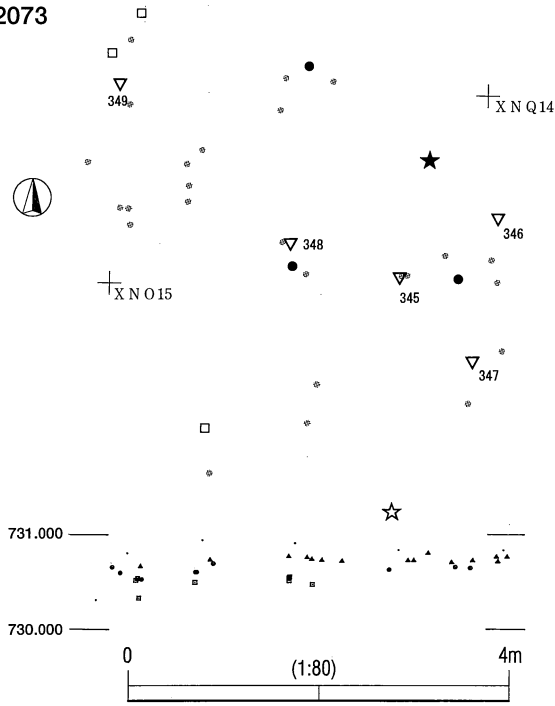

BL 2074

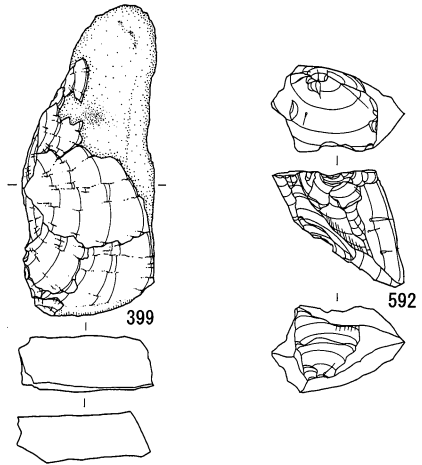
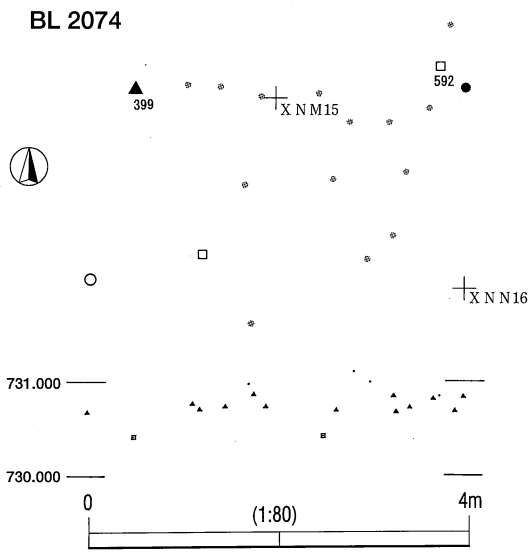

BL 2075

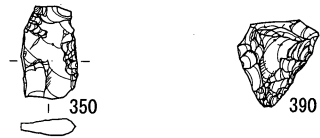
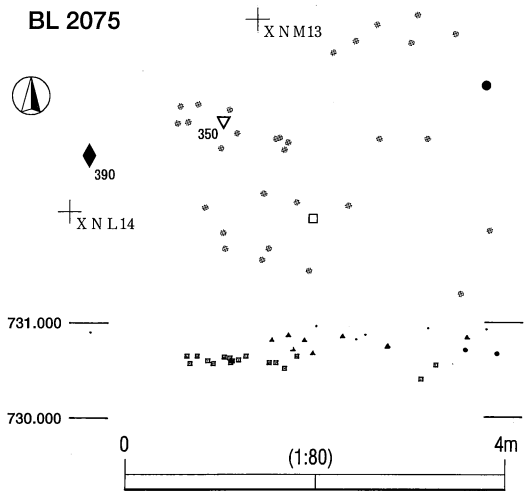

第 2 地点 BL2073・2074・2075 遺物分布図 (貫ノ木遺跡)



BL 2076

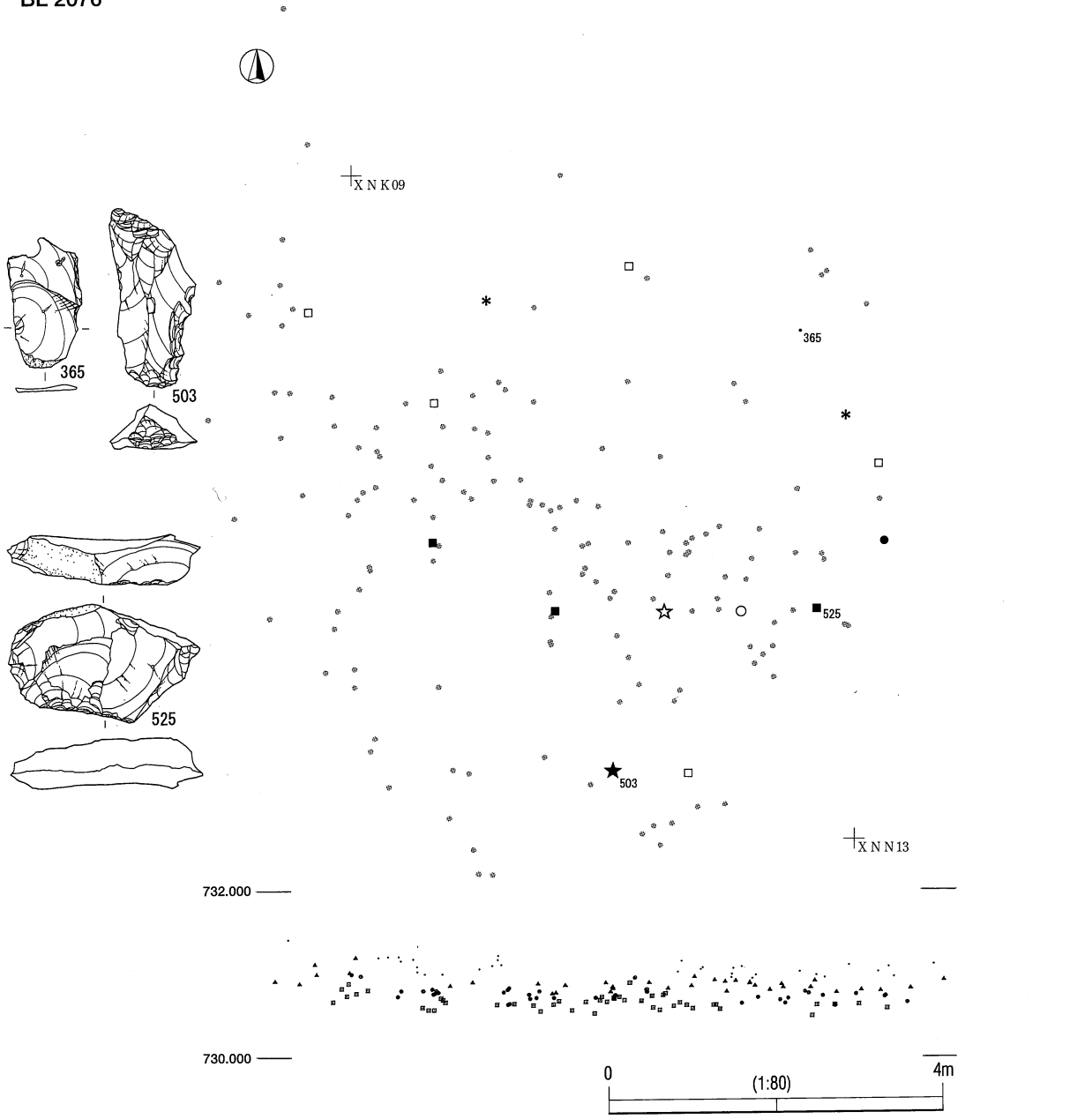

BL 2077

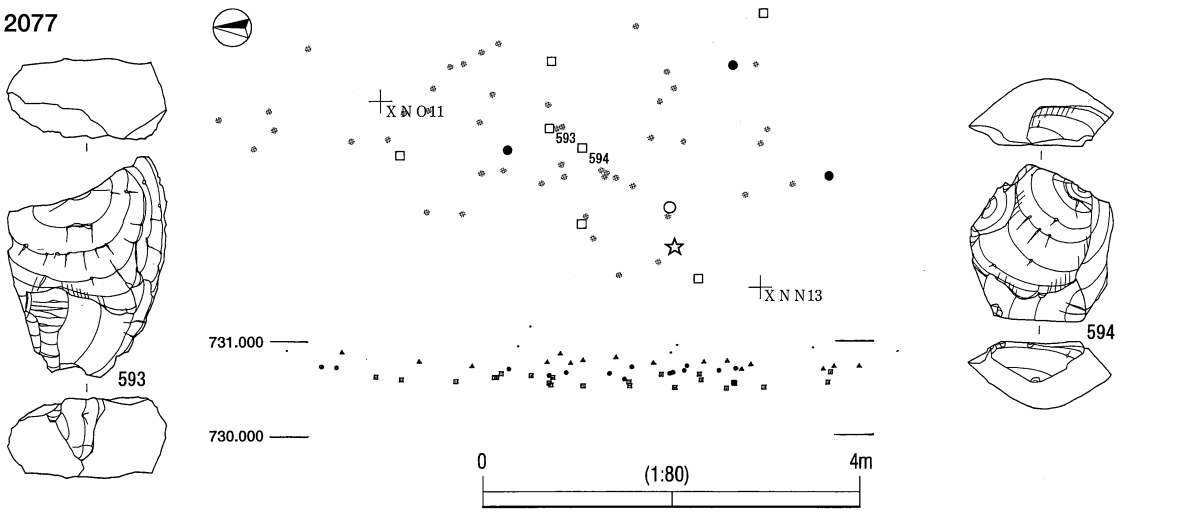

第2地点 BL2076・2077 遺物分布図 (貫ノ木遺跡)

BL 2078

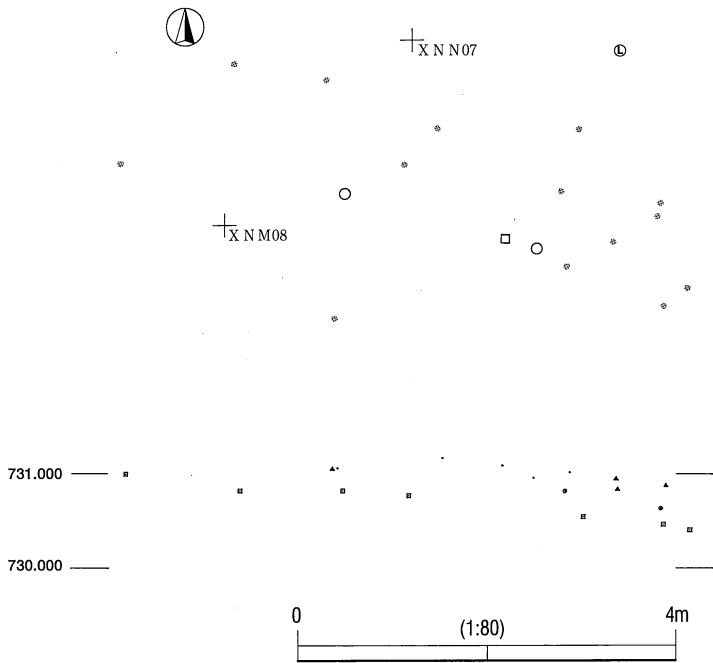

BL 2079

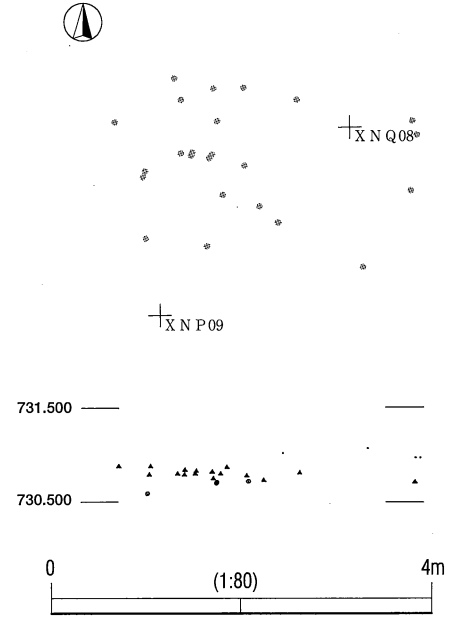

BL 2080

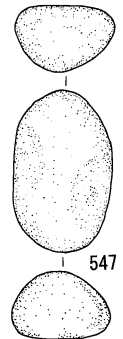
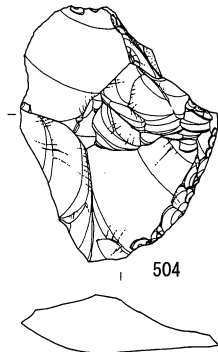
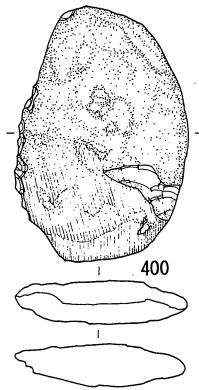
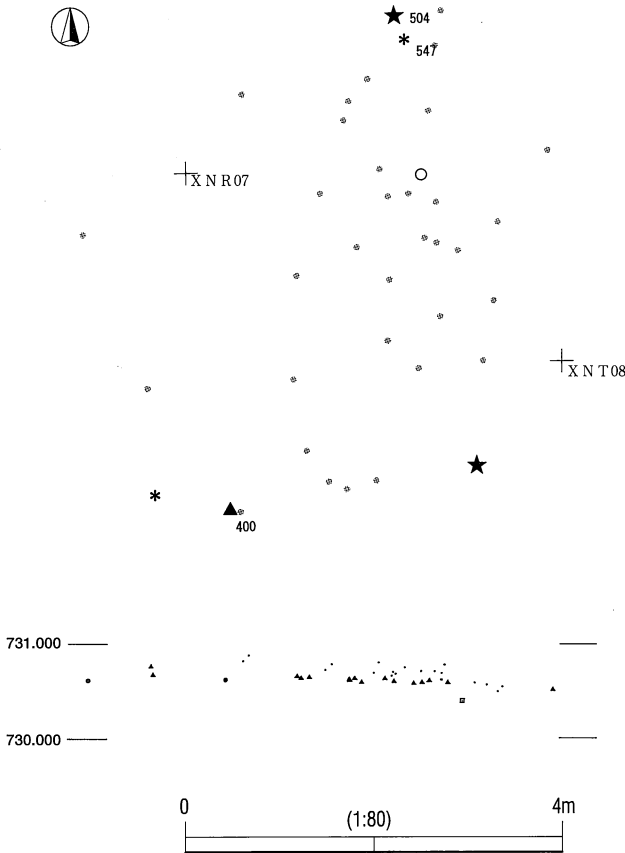

第2地点 BL2078・2079・2080 遺物分布図 (貫ノ木遺跡)

BL 2081

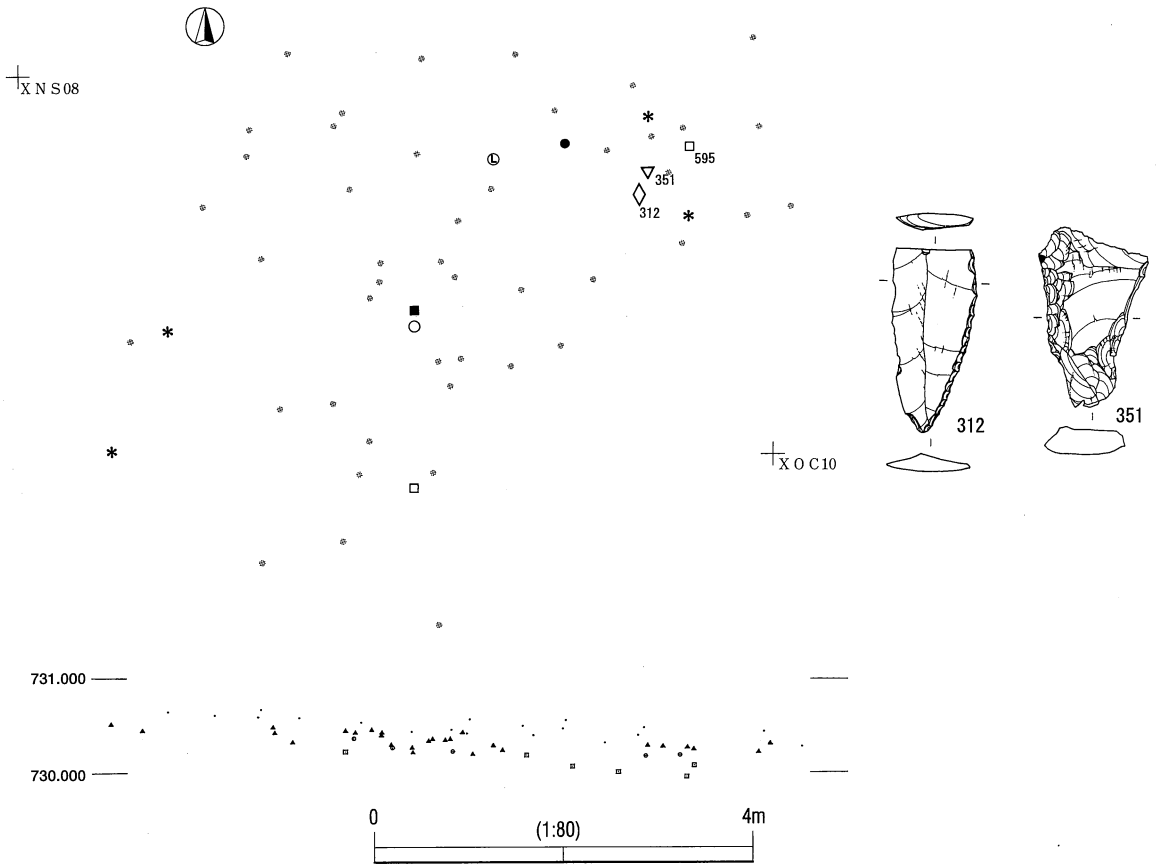

BL 2082

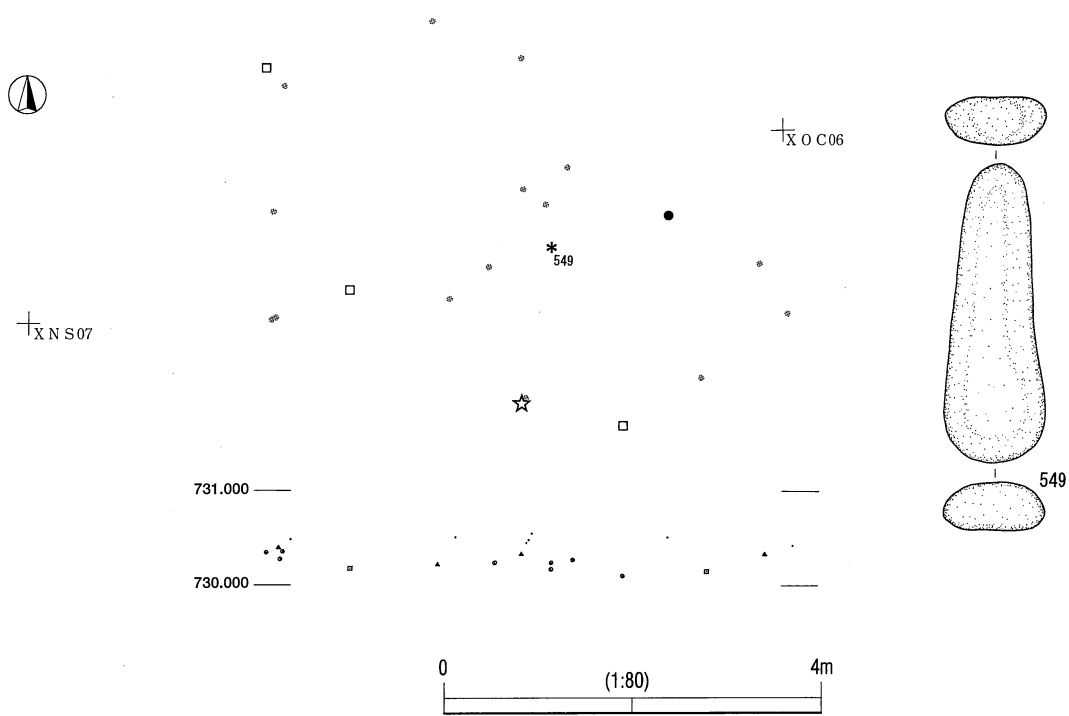

第 2 地点 BL2081・2082 遺物分布図 (貫ノ木遺跡)

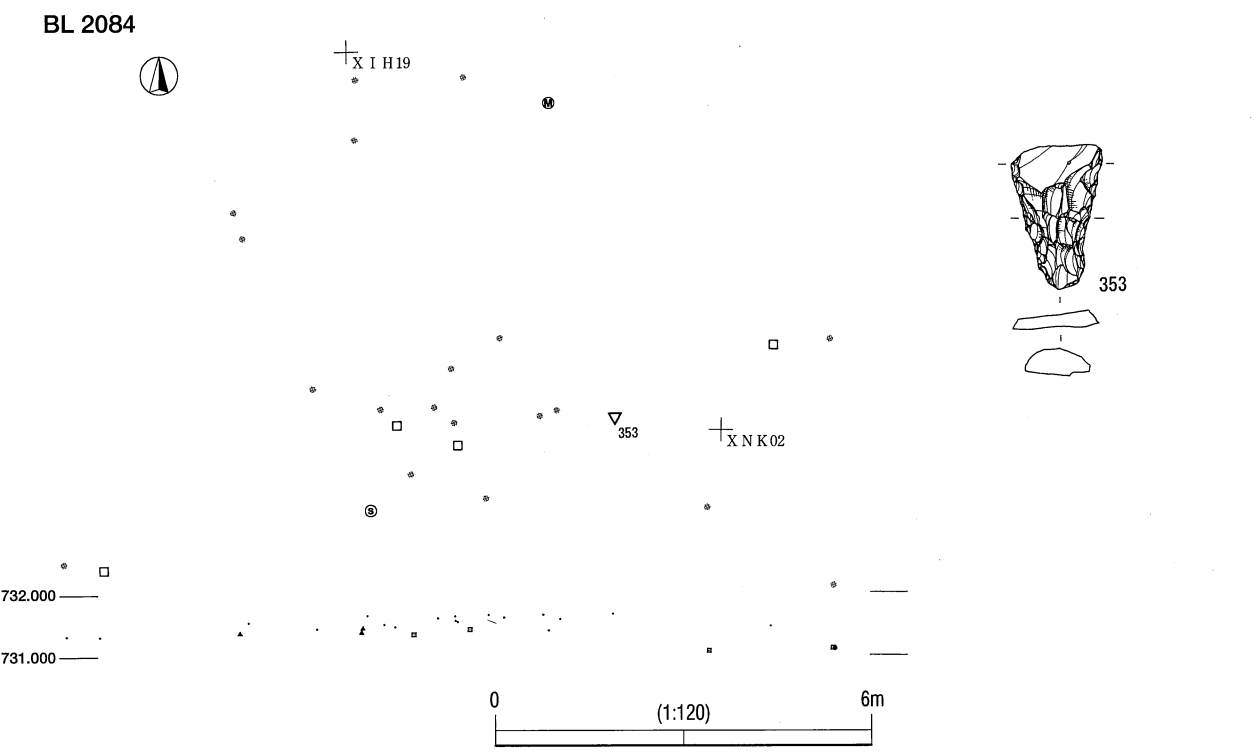

第2地点 BL2083・2084 遺物分布図 (貫ノ木遺跡)

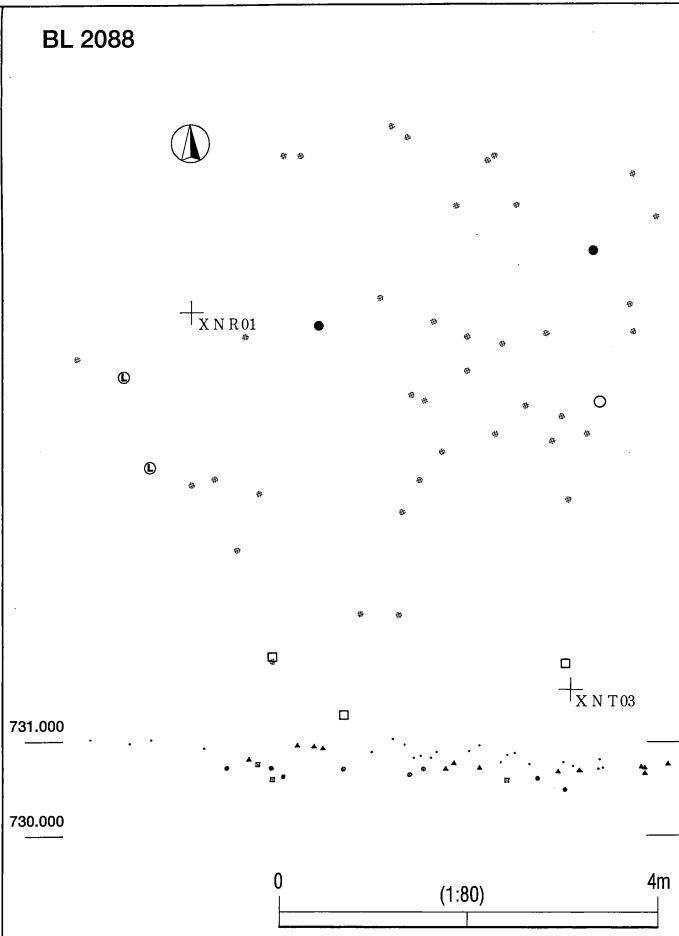
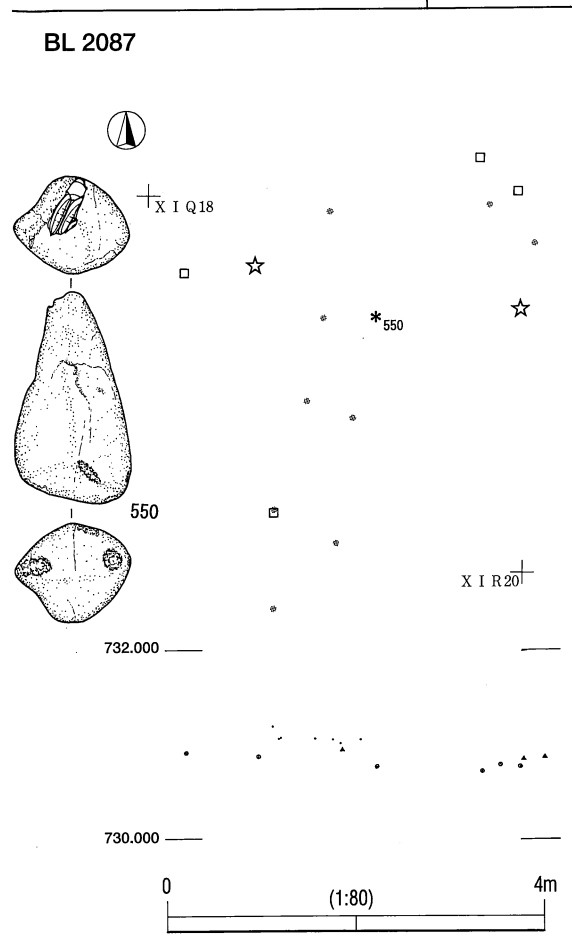
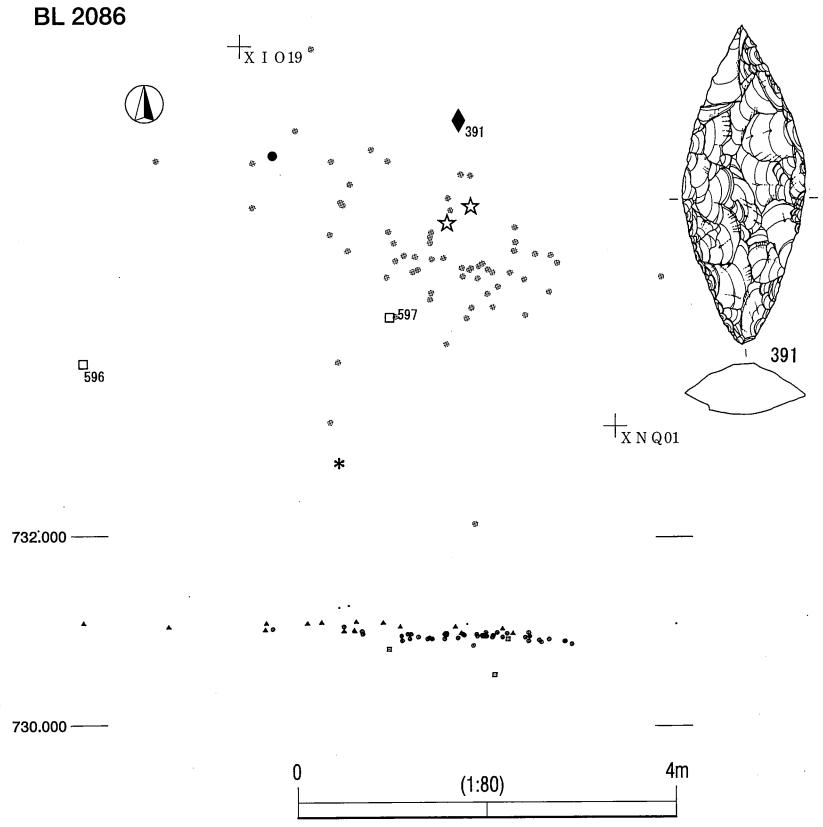
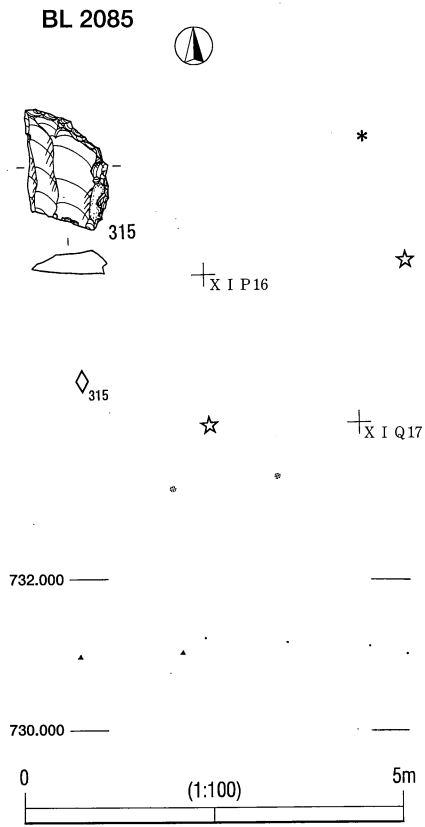

第 2 地点 BL2085・2086・BL2087・2088 遺物分布図 (貫ノ木遺跡)

BL 2089



X J F 19

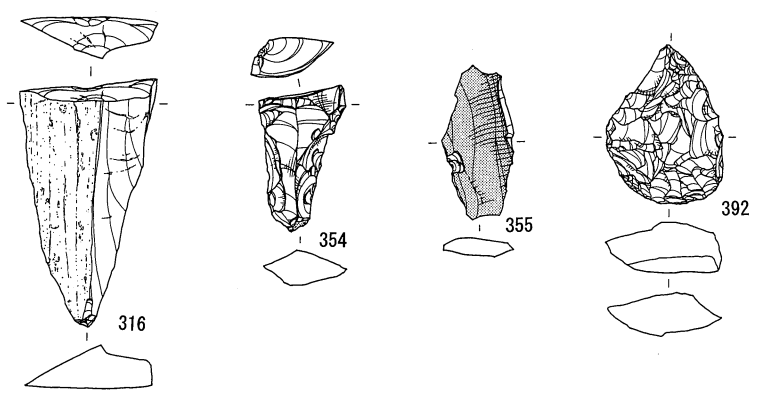
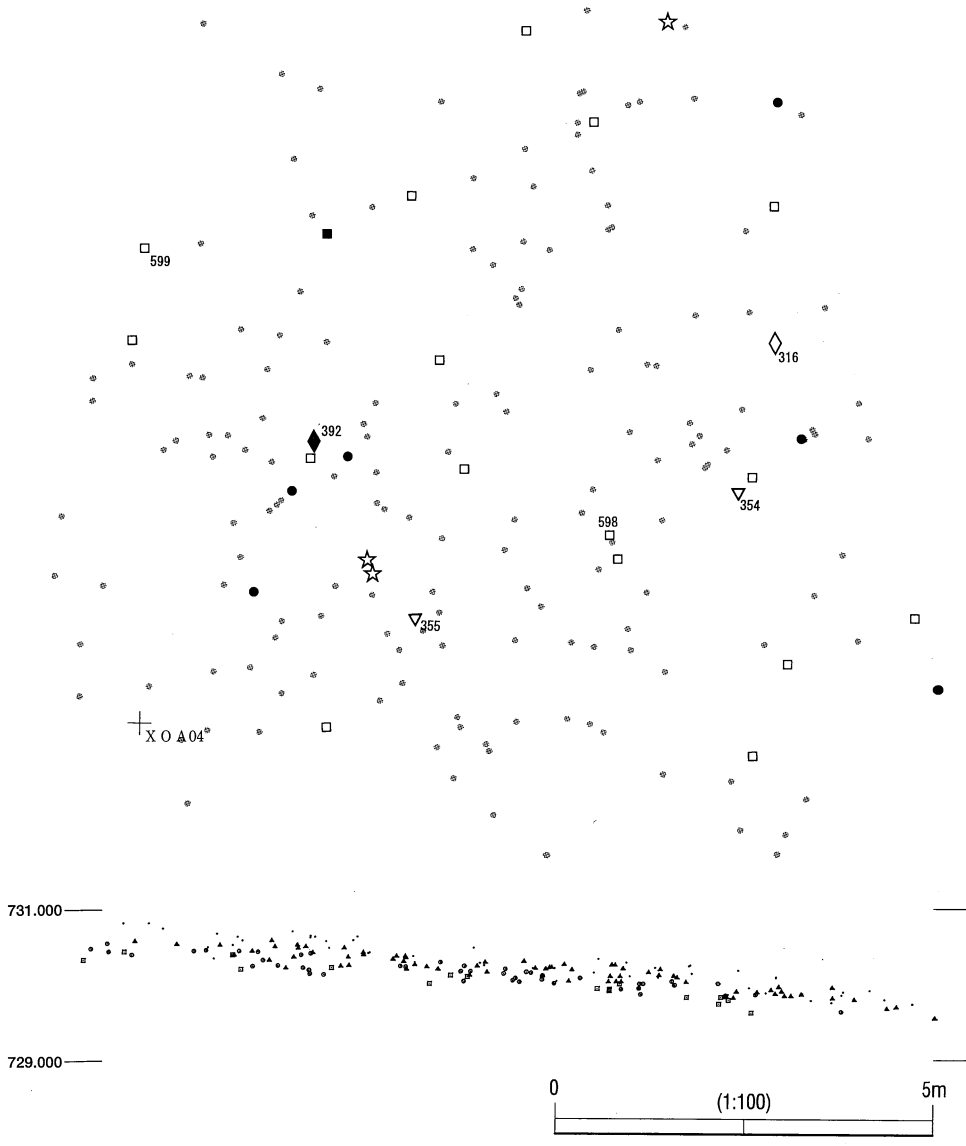

第2地点 BL2089 遺物分布図 (貫ノ木遺跡)

BL 2090

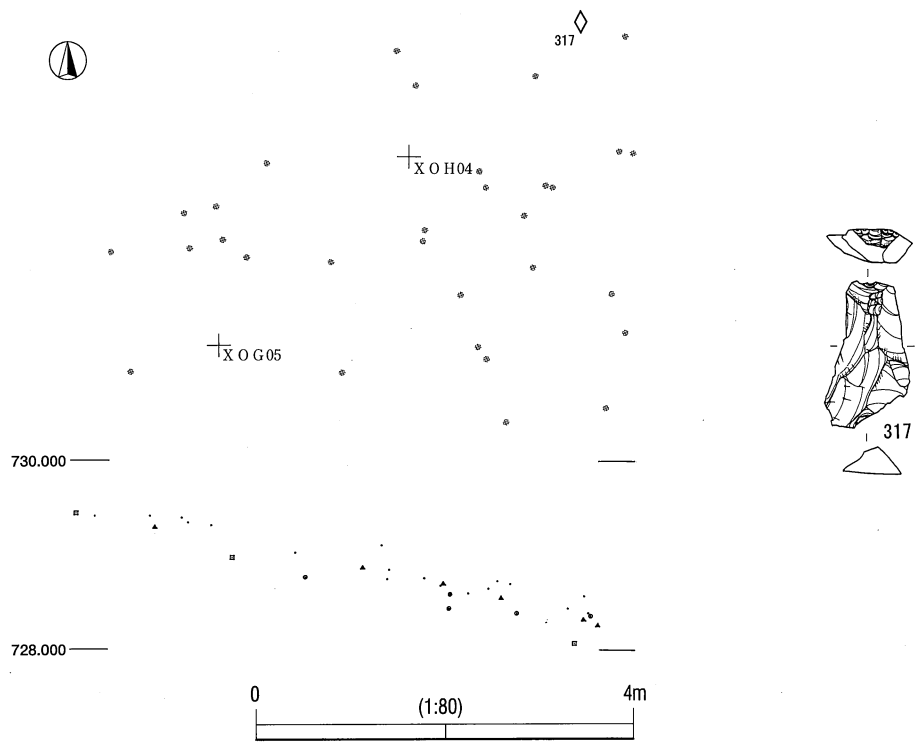

BL 2091

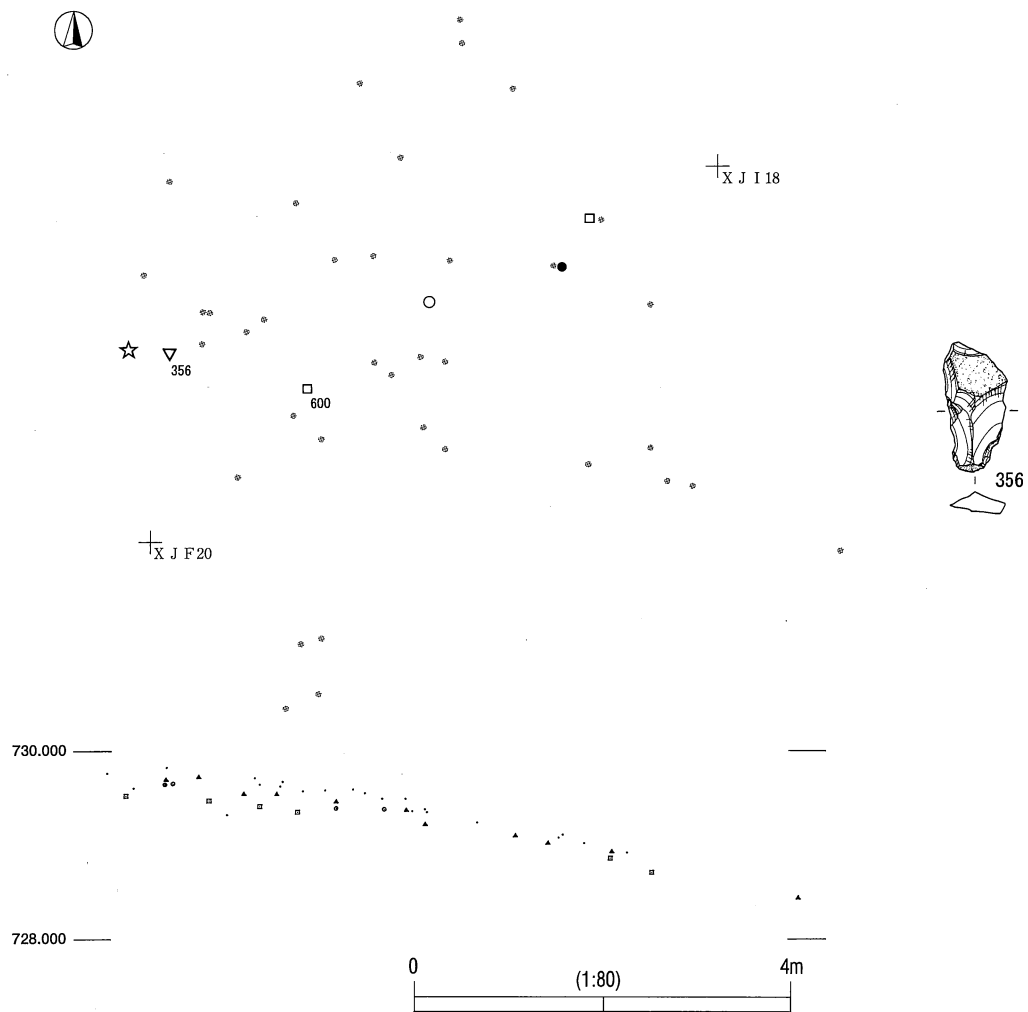

第2地点 BL2090・2091 遺物分布図 (貫ノ木遺跡)

BL 2092

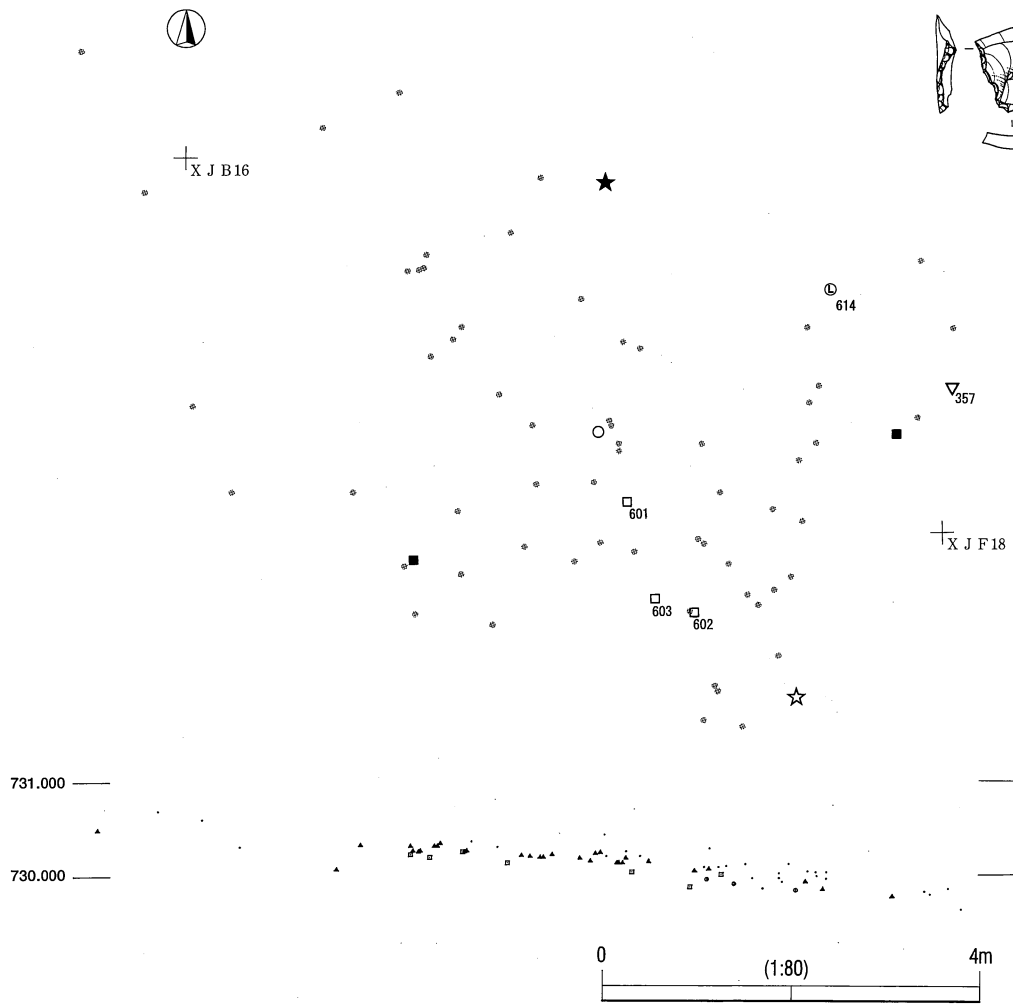

BL 2093

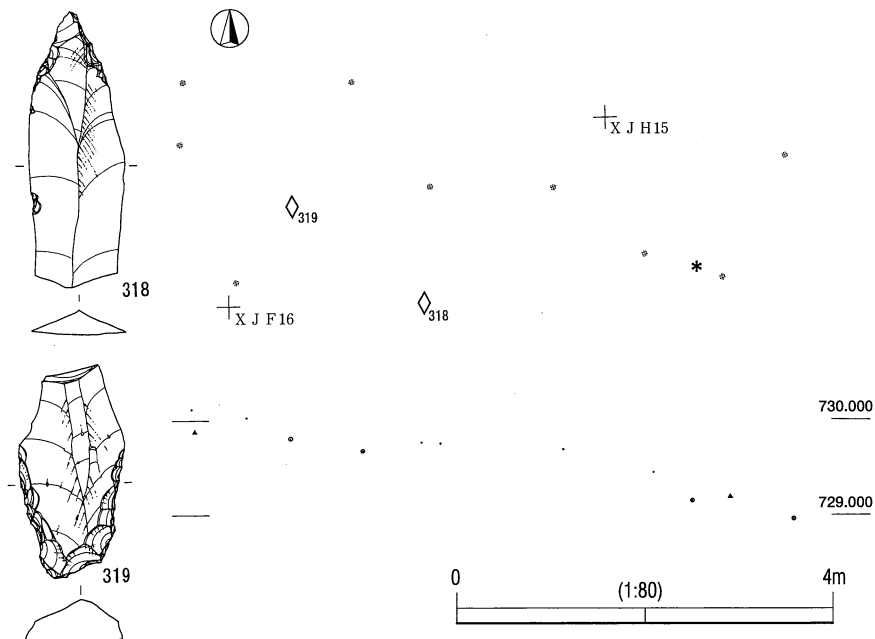

BL 2094

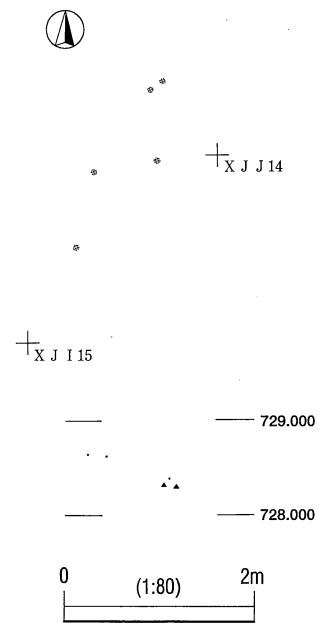

第 2 地点 BL2092・2093・2094 遺物分布図 (貫ノ木遺跡)



BL 2095

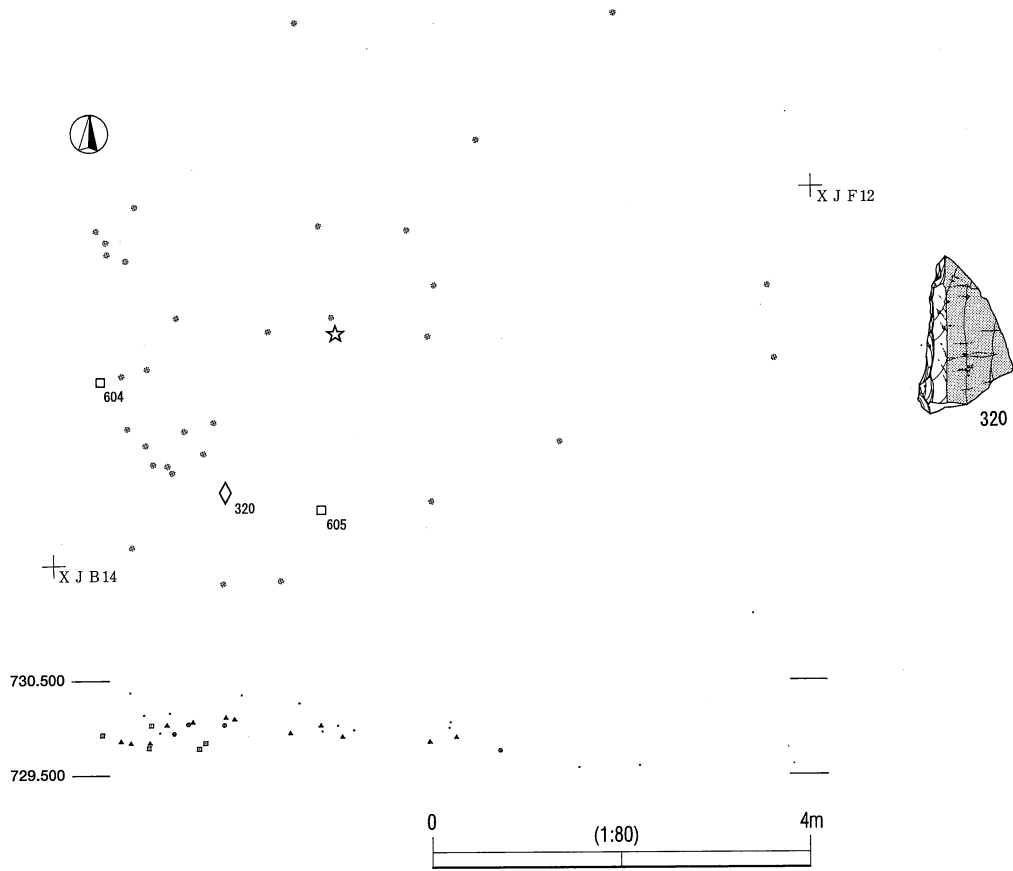

BL 2096

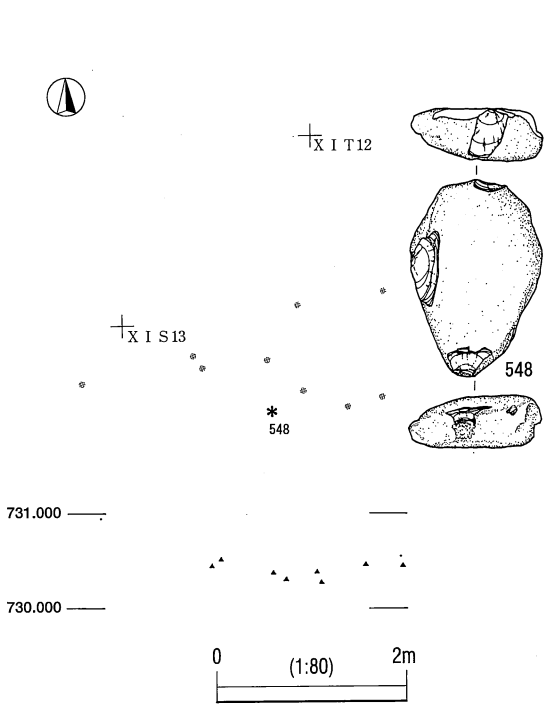

BL 2097

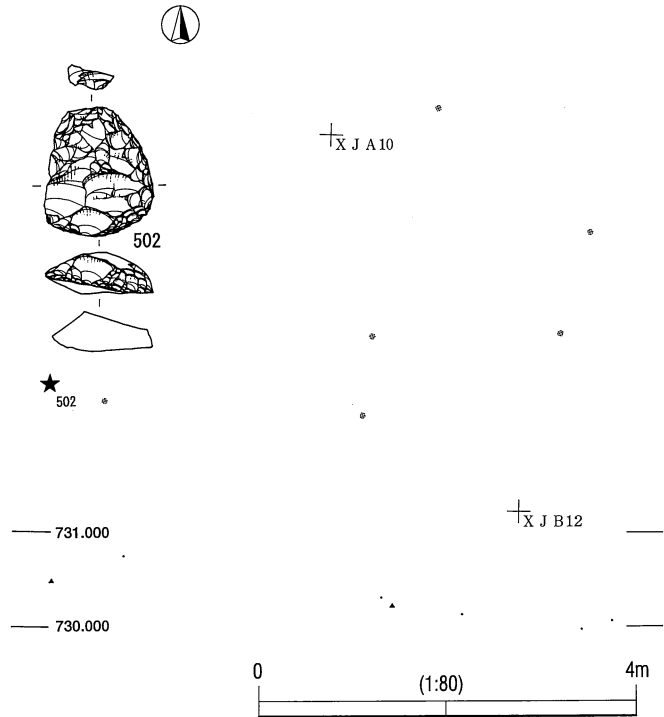

第2地点 BL2095・2096・2097 遺物分布図 (貫ノ木遺跡)

BL 2098

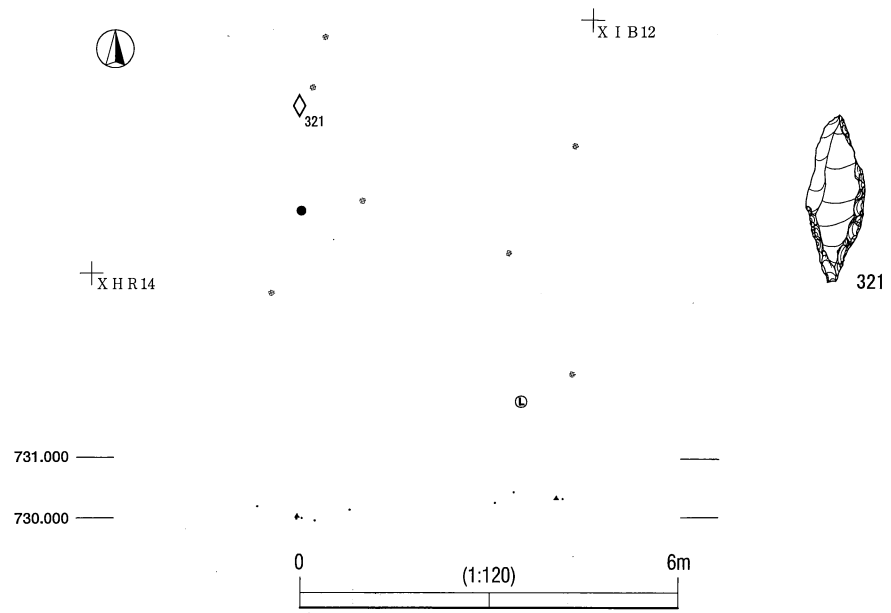

BL 2099

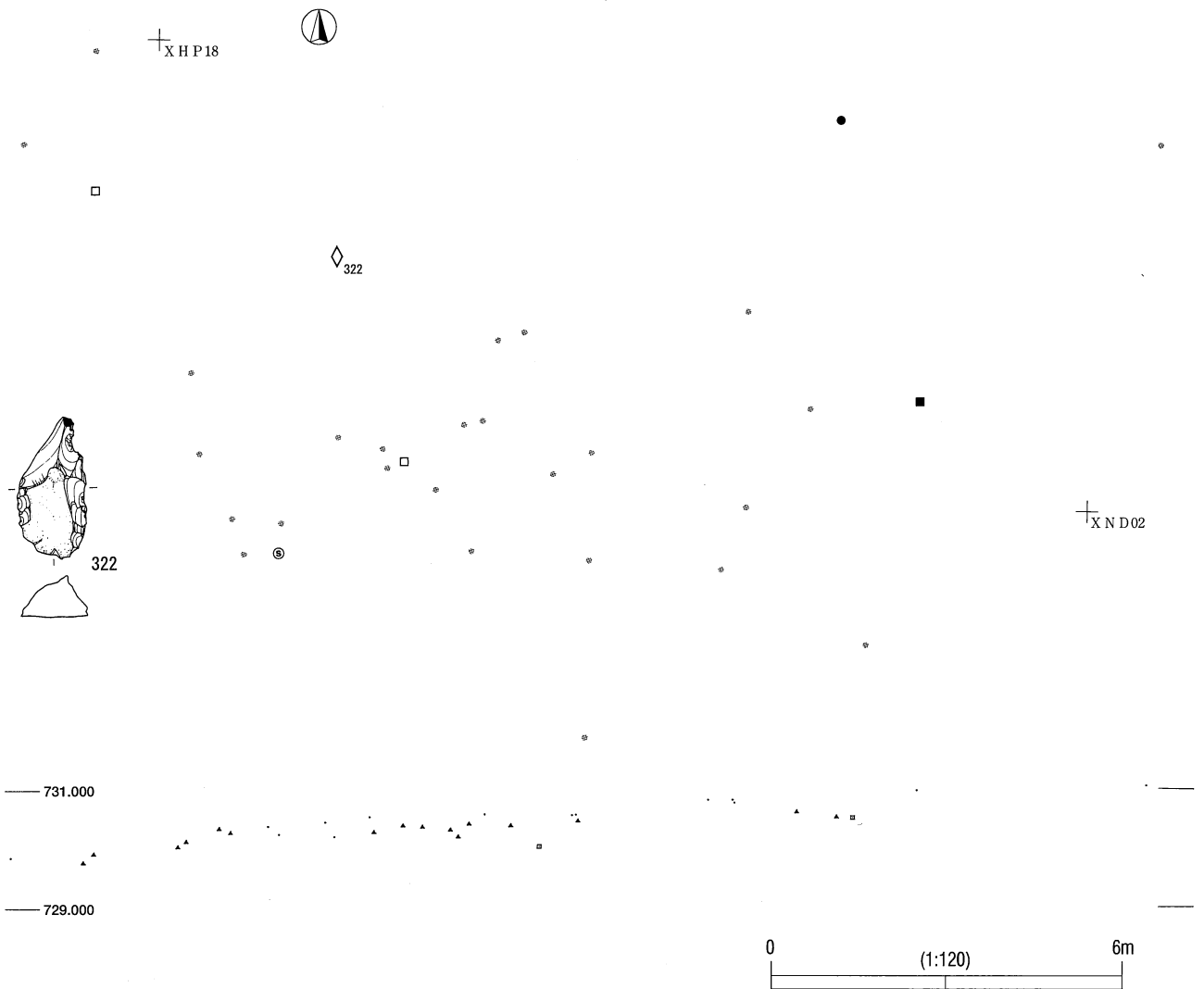

第 2 地点 BL2098・2099 遺物分布図 (貫ノ木遺跡)

BL 2100

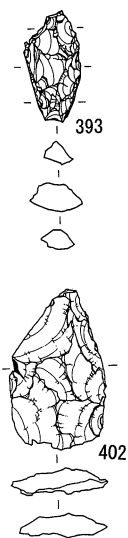

XNT03



393

402

XNP06

732.000

730.000

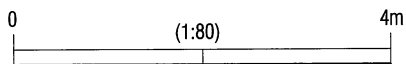

第 2 地点 BL2100 遺物分布図 (貫ノ木遺跡)

SH 59

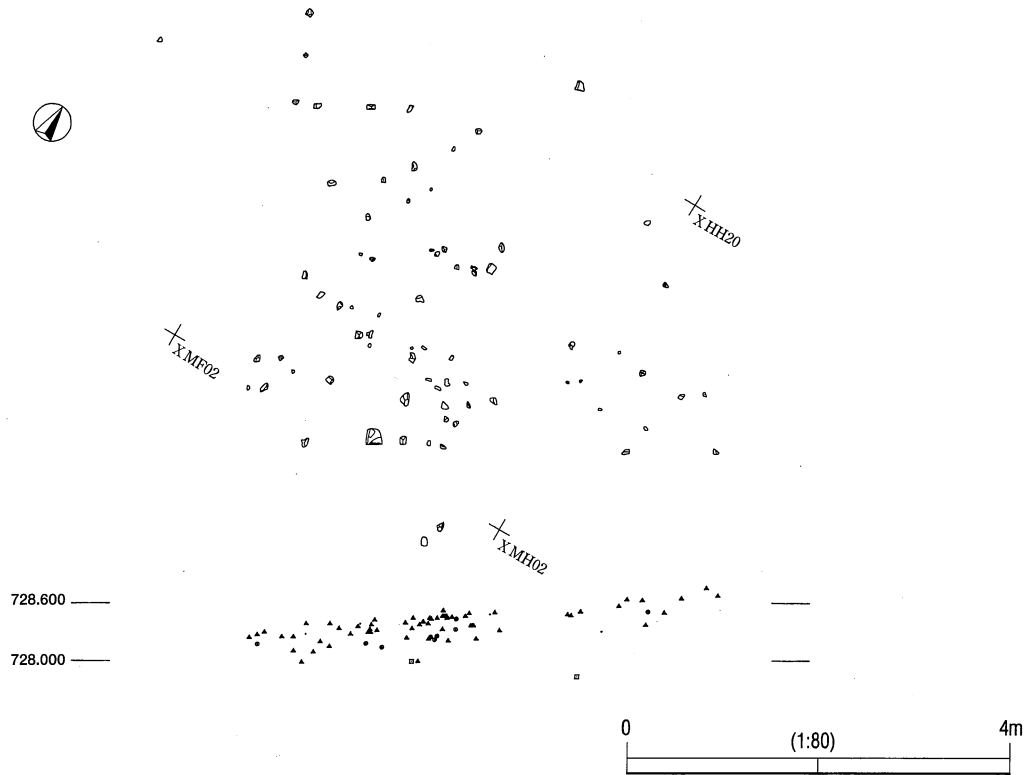

SH 64

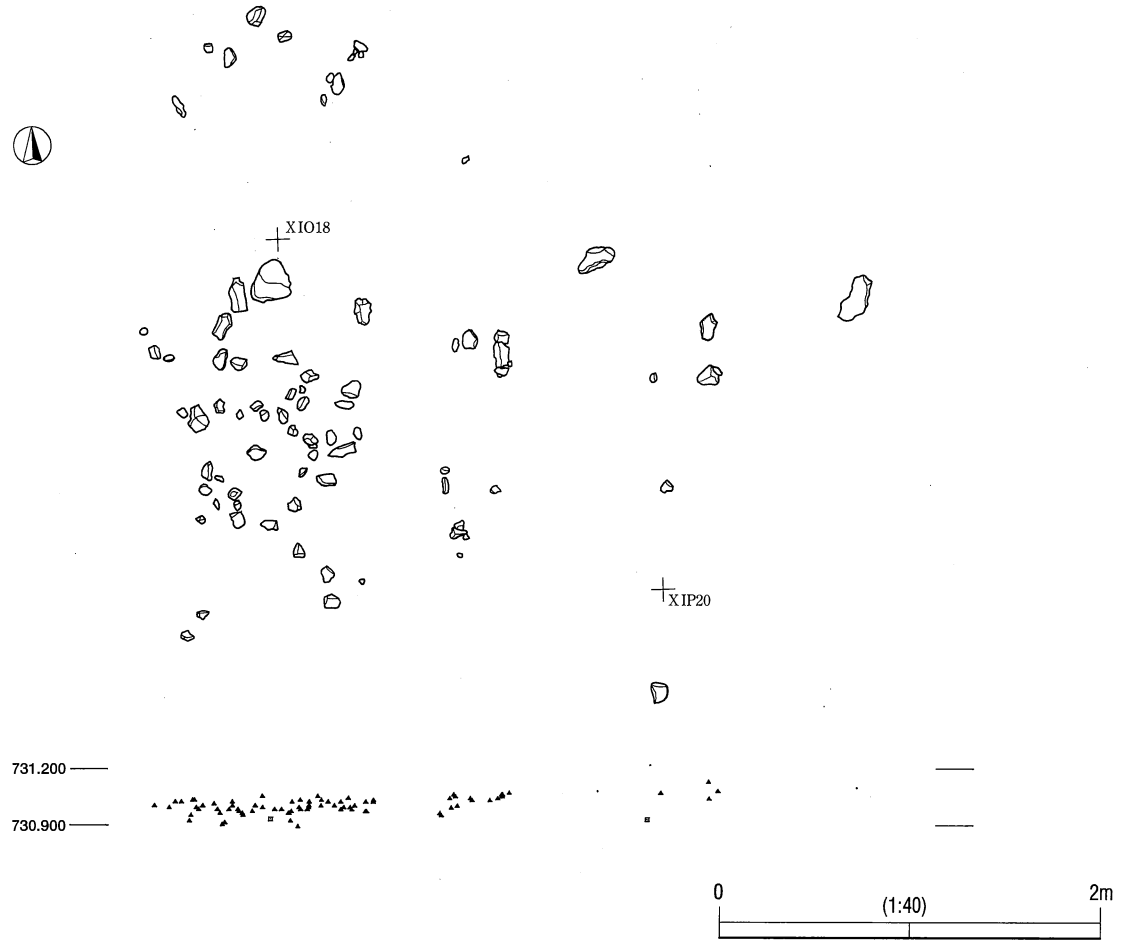

第2地点 SH 59・64 遺物分布図 (貫ノ木遺跡)

SH 61

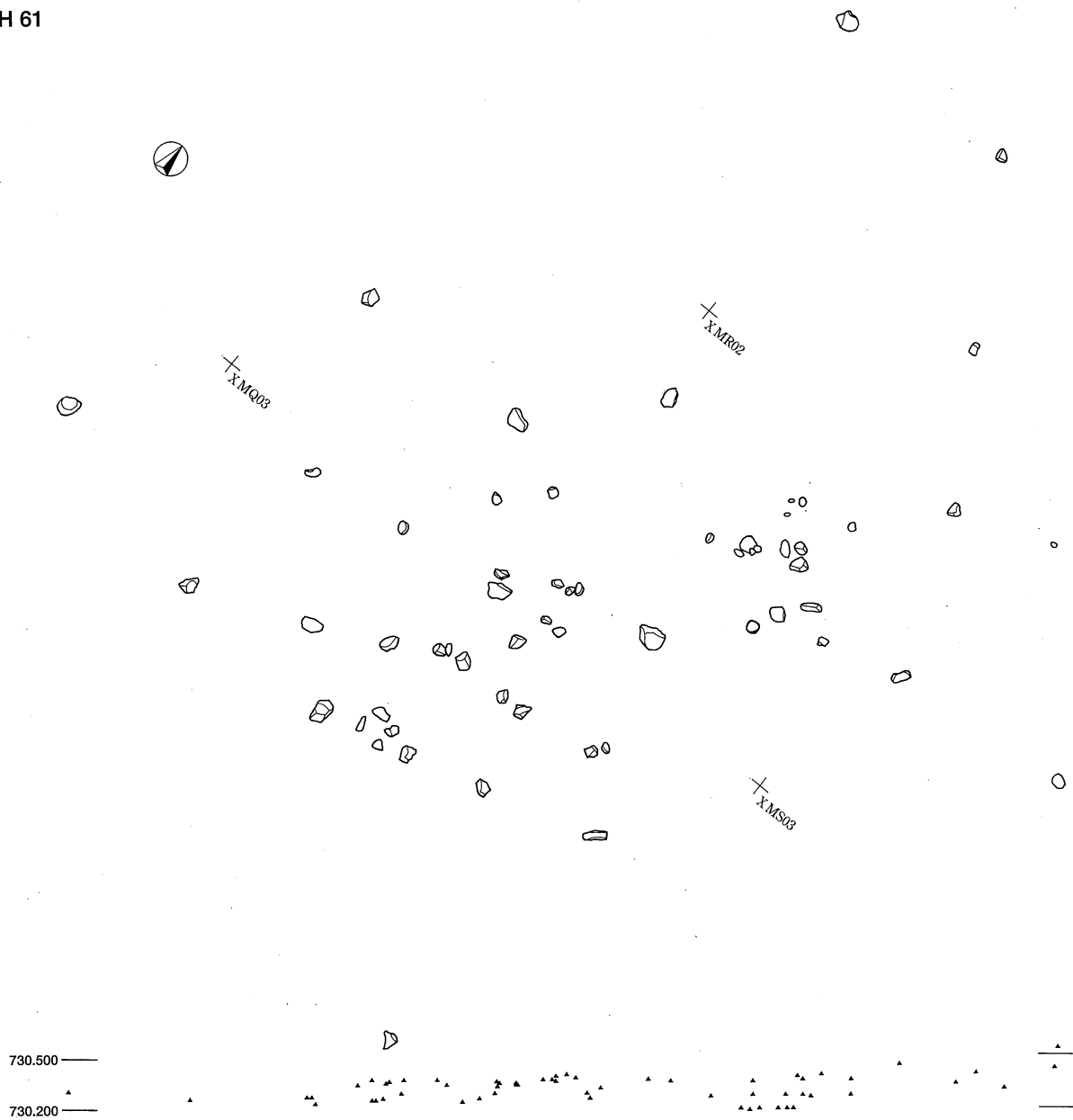

SH 62

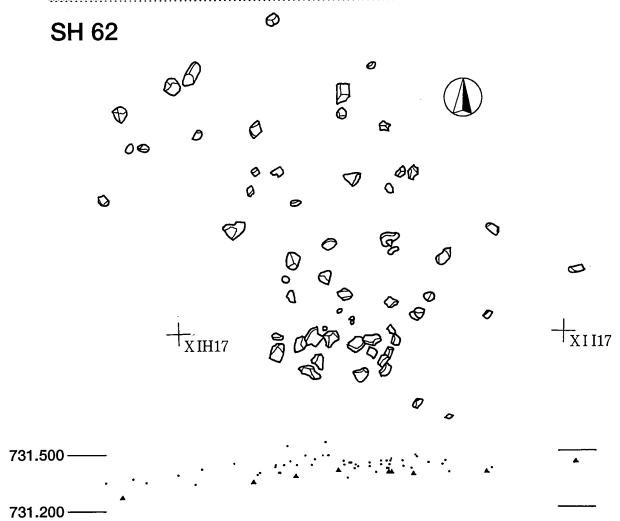

SH 66

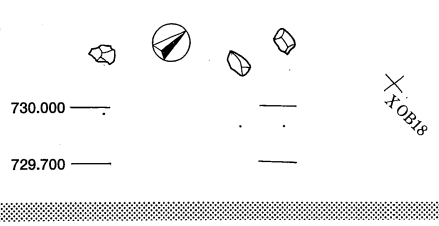

SH 67

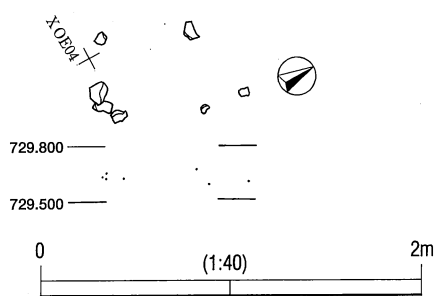

第2地点 SH 61・62・66・67 遺物分布図 (貫ノ木遺跡)

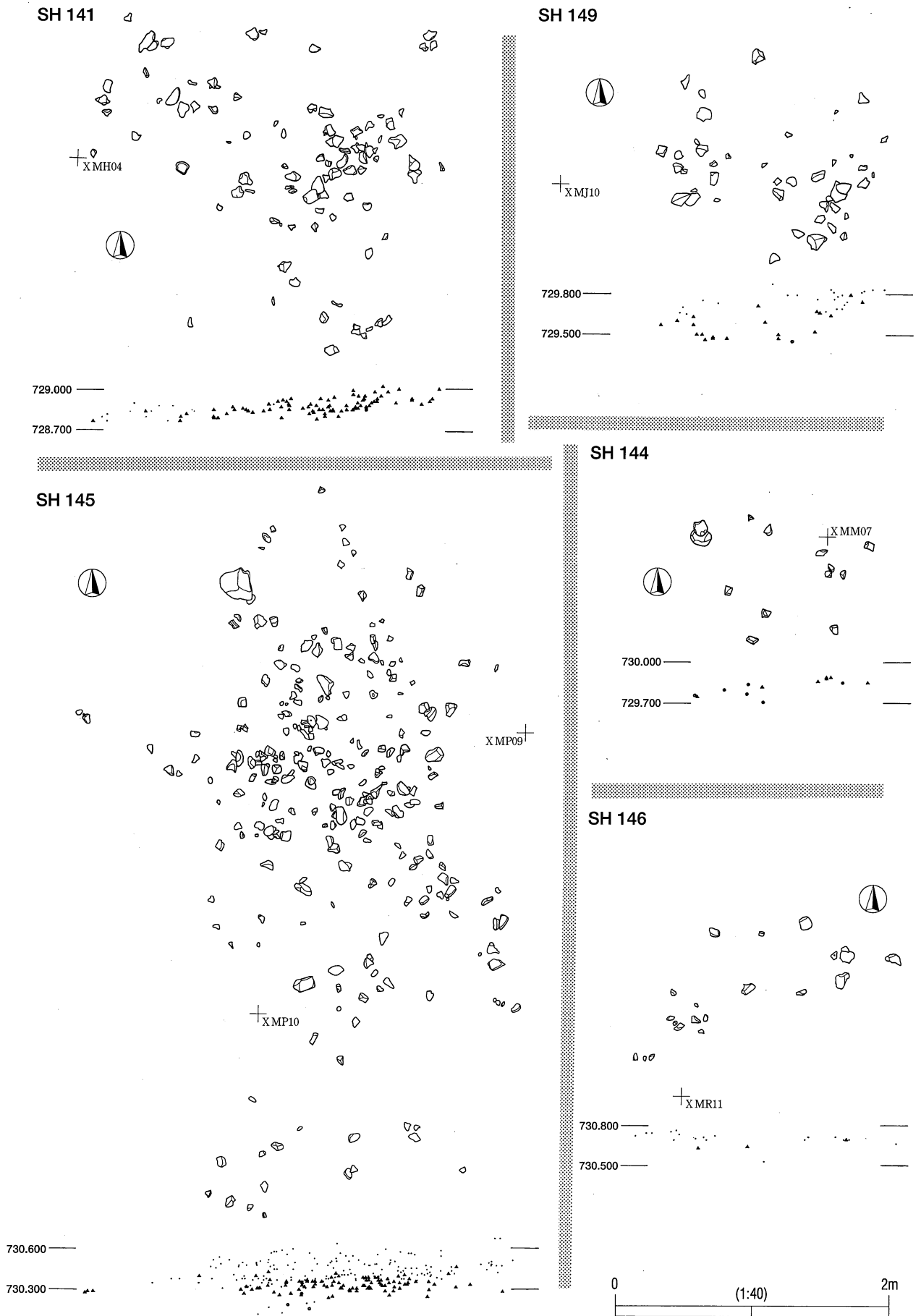

第2地点 SH 141・144・145・146・149 遺物分布図 (貫ノ木遺跡)

SH 143

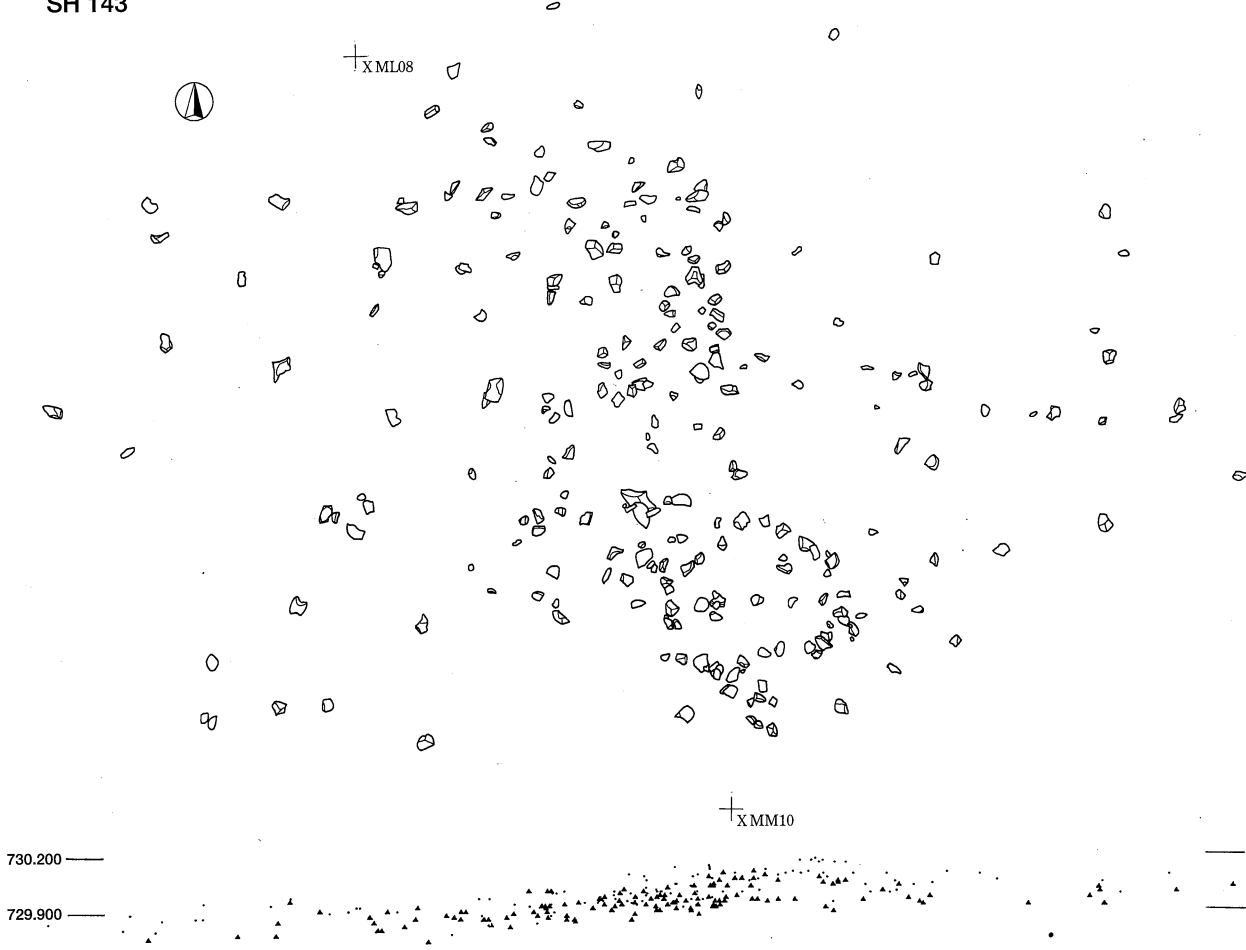

SH 142

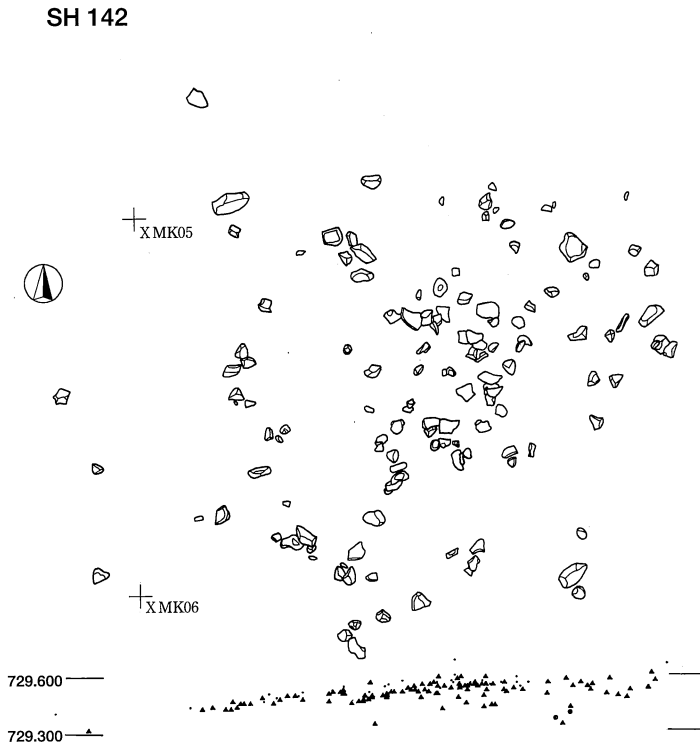

SH 148

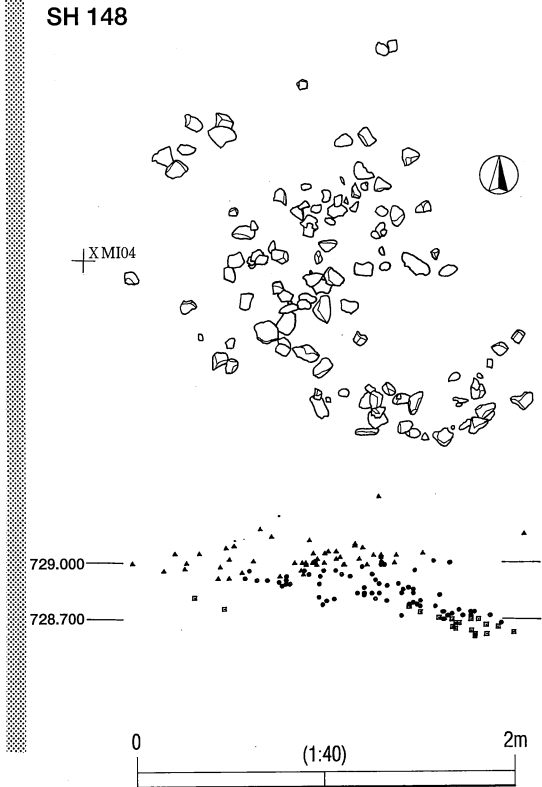

第2地点 SH 142・143・148 遺物分布図 (貫ノ木遺跡)

SH 147

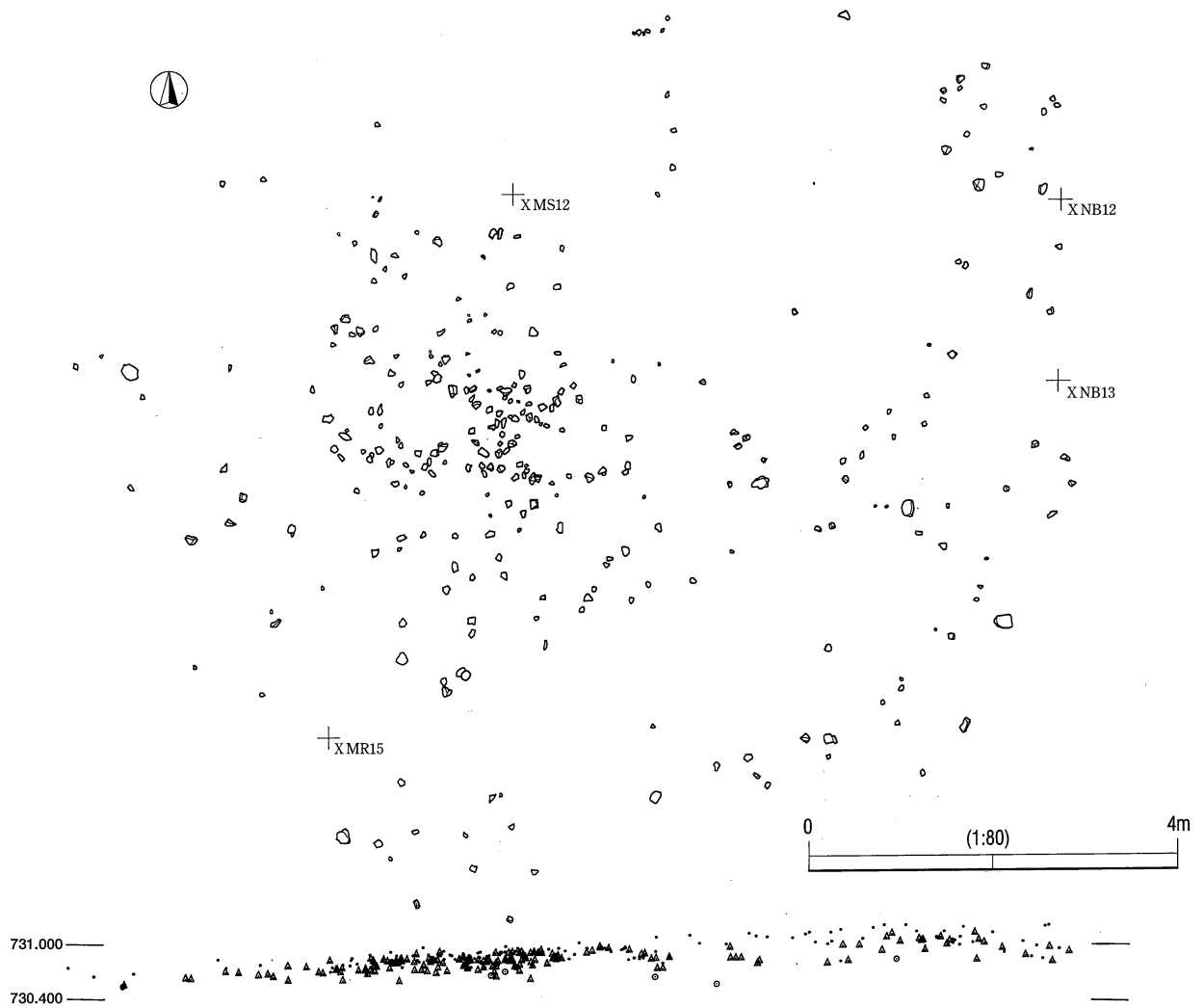

SH 147

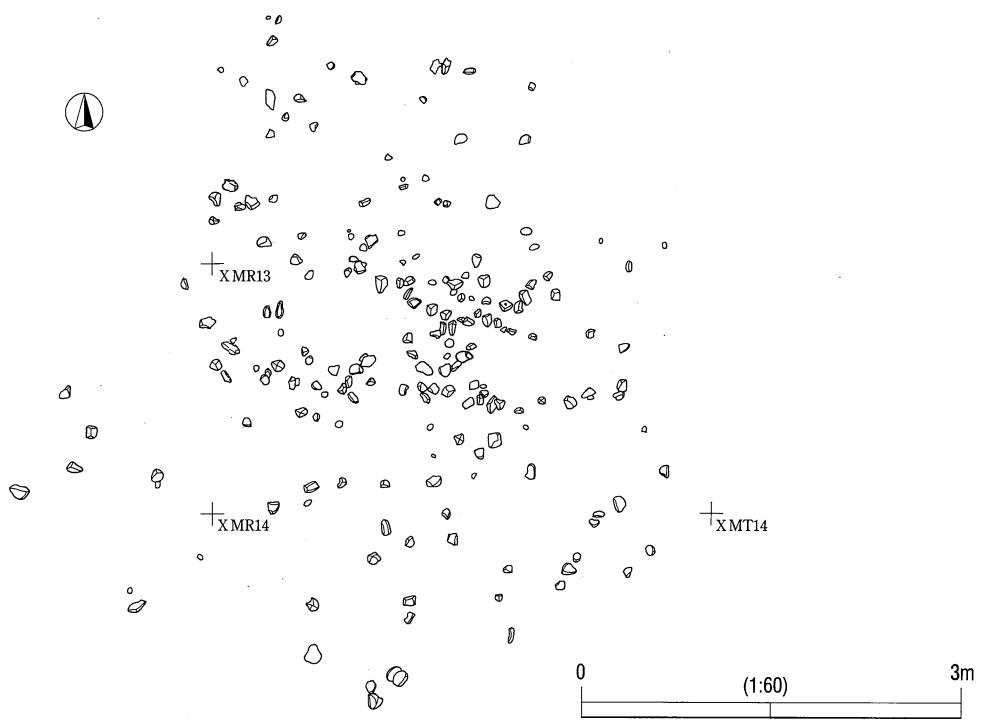

第2地点 SH 147 遺物分布図 (貫ノ木遺跡)



SH 150

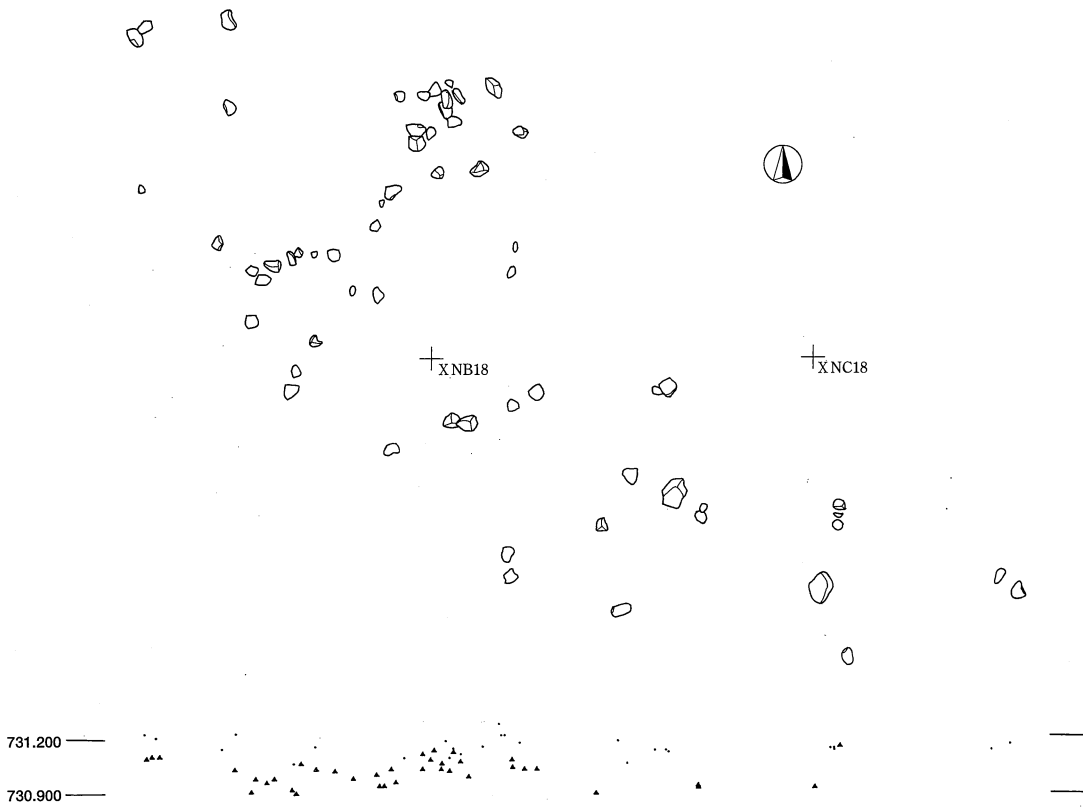

SH 161

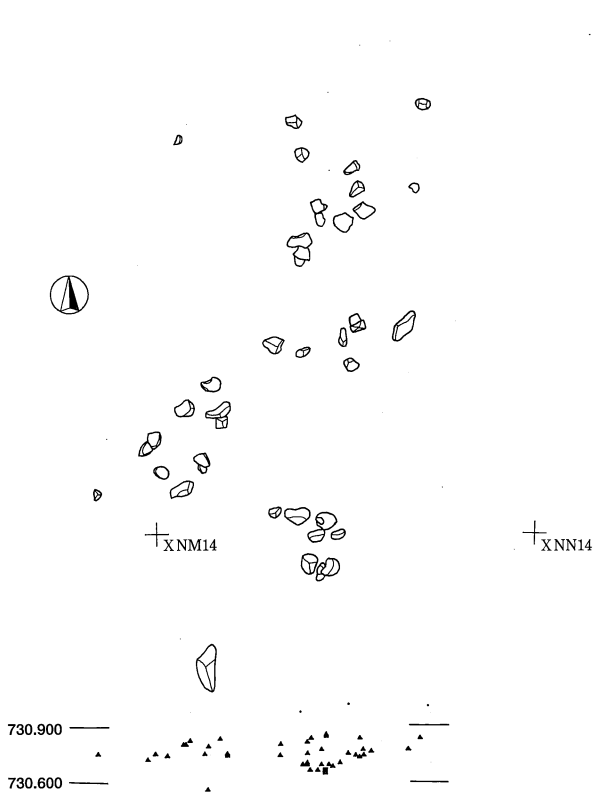

SH 152

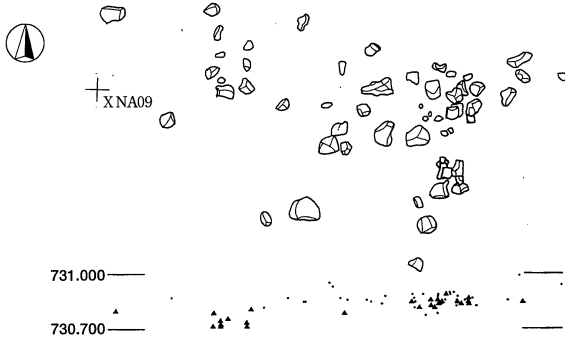

SH 153

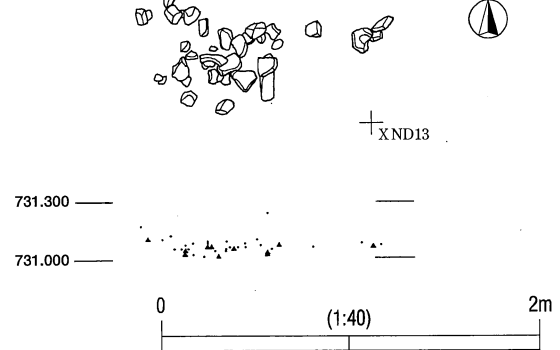

第2地点 SH 150・152・153・161 遺物分布図 (貫ノ木遺跡)

SH 155

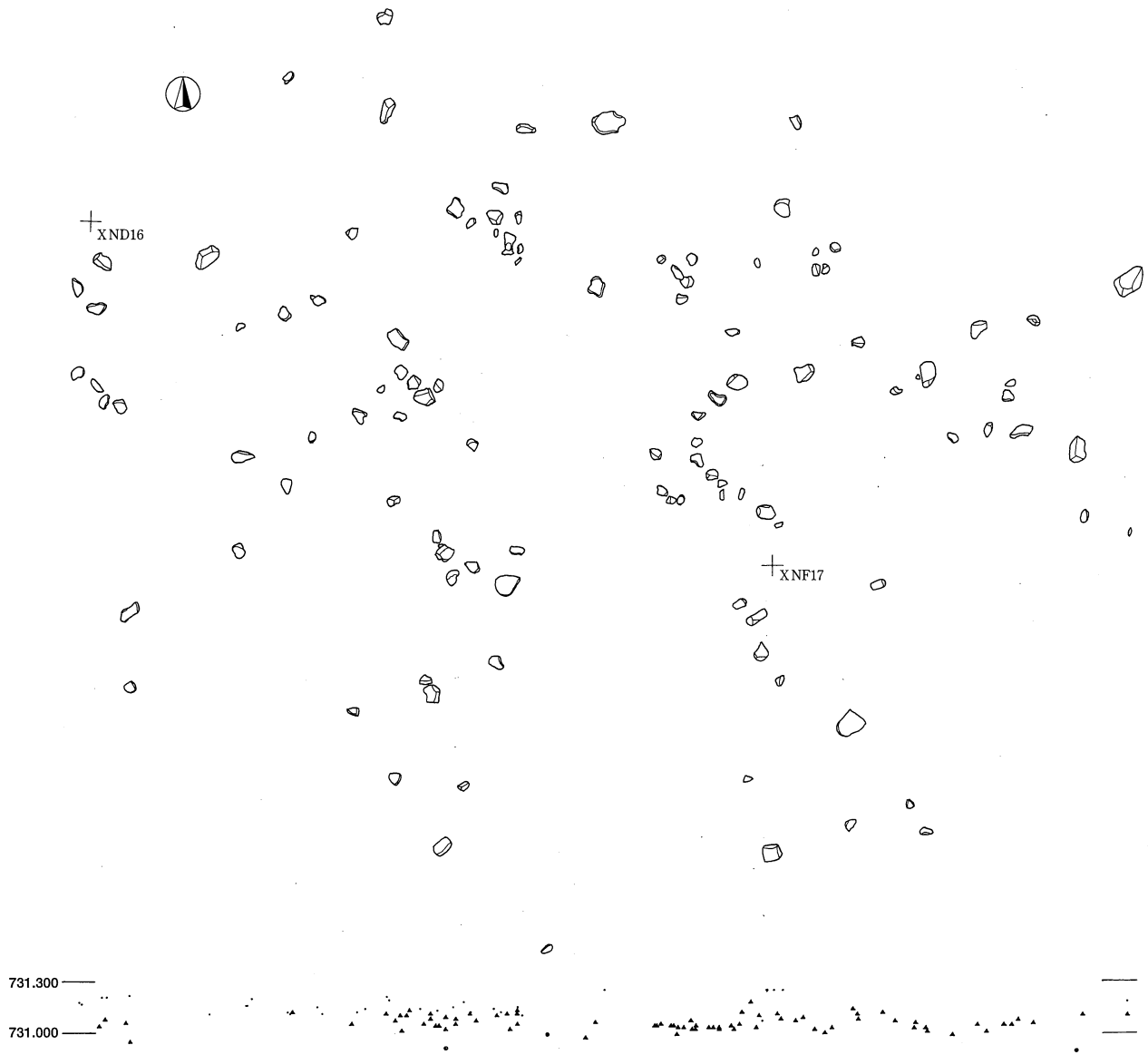

SH 162

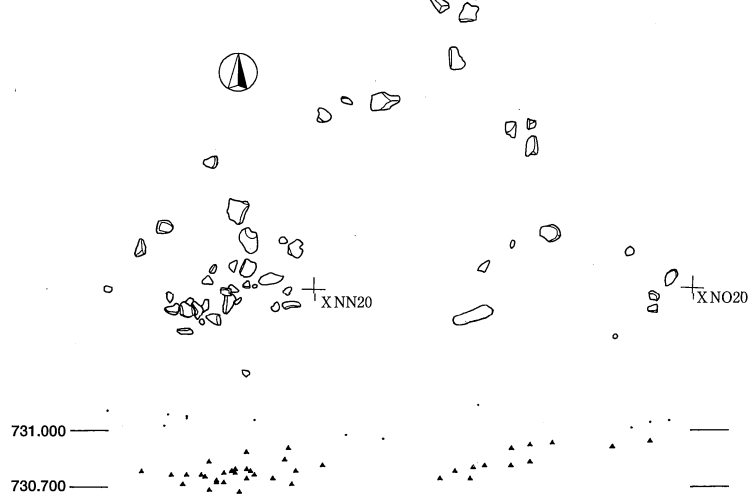

SH 151

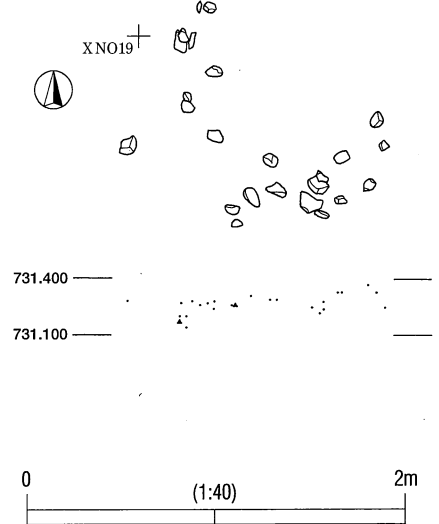

第2地点 SH 151・155・162 遺物分布図 (貫ノ木遺跡)

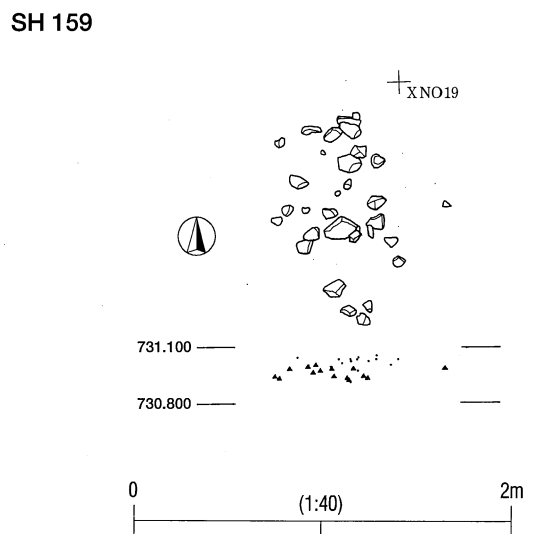
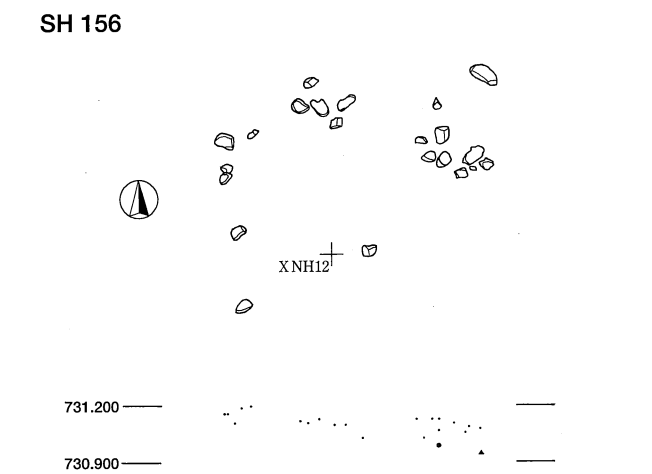
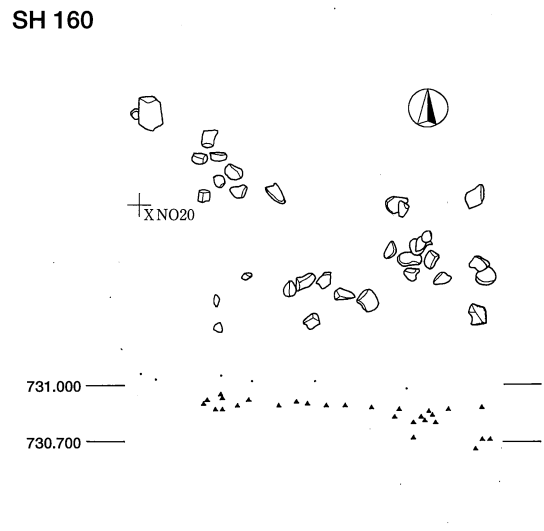
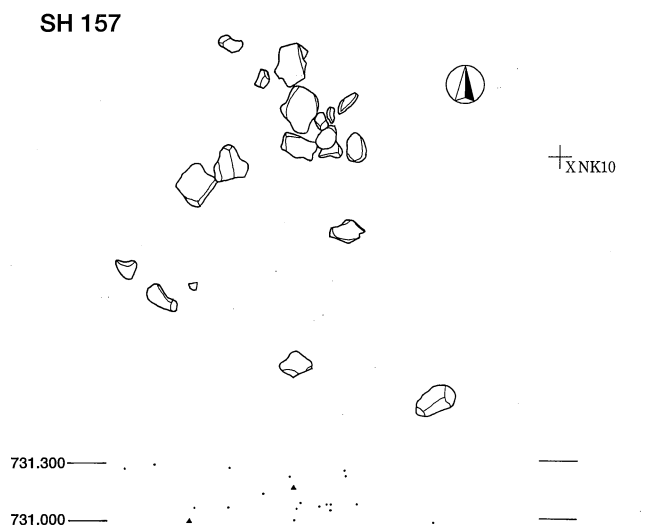
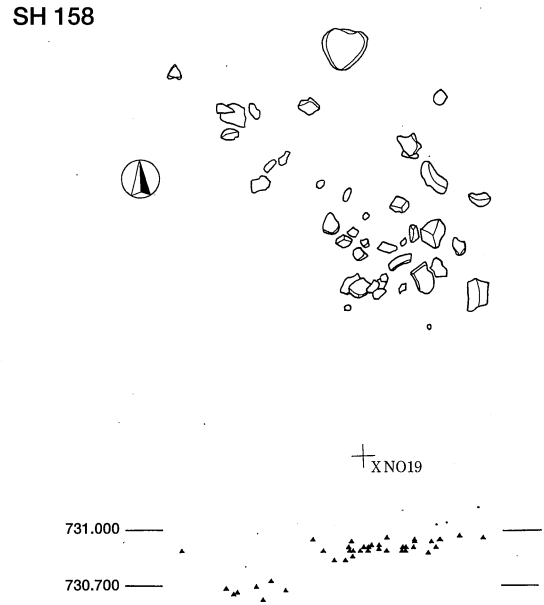
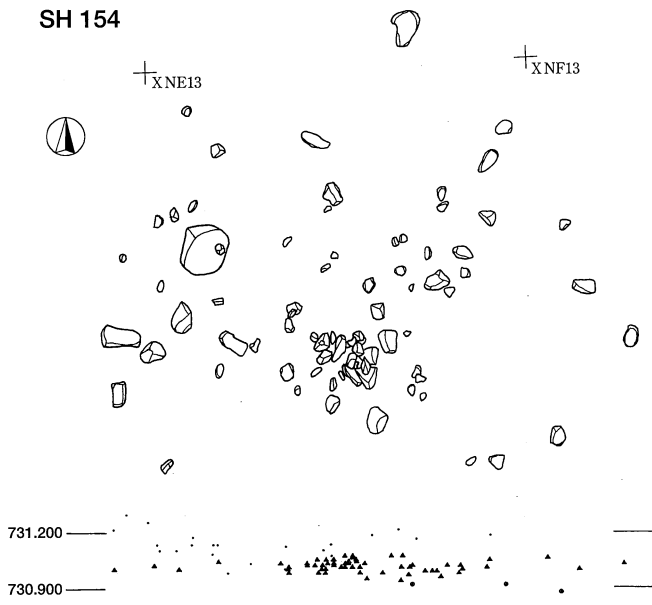

第2地点 SH 154・156・157・158・159・160 遺物分布図 (貫ノ木遺跡)

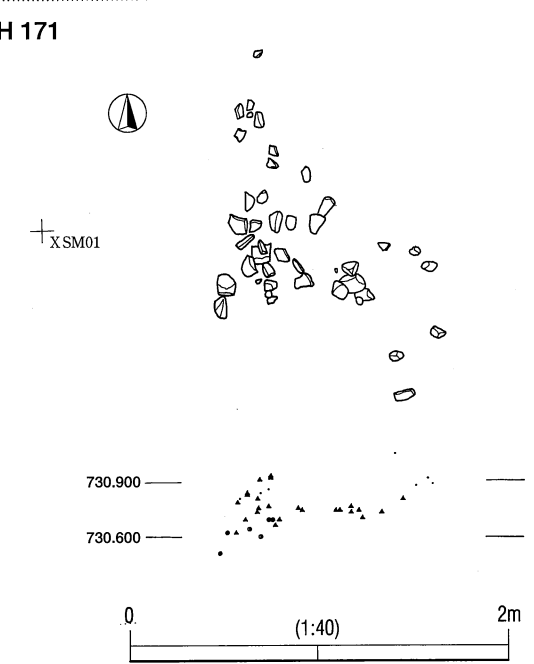
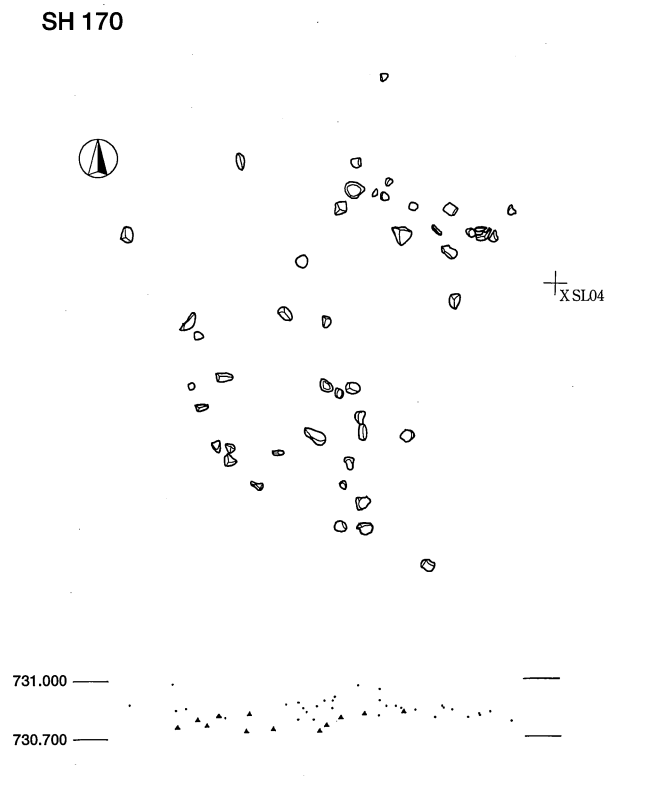
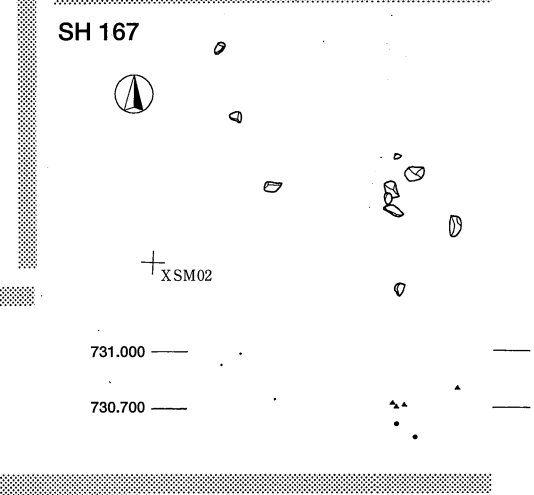
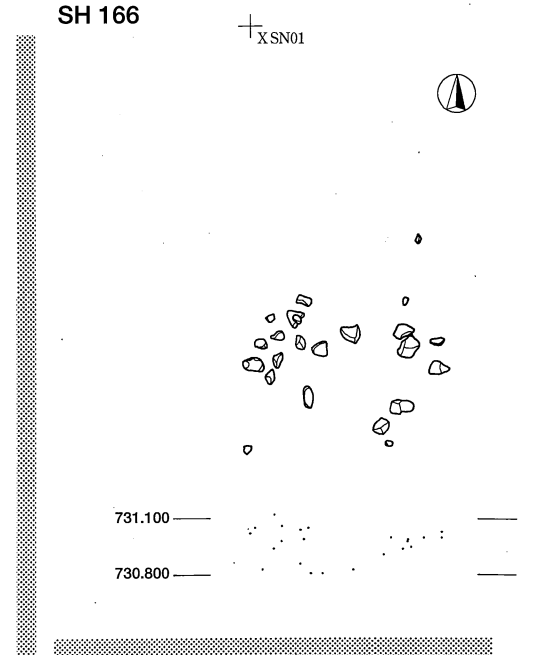
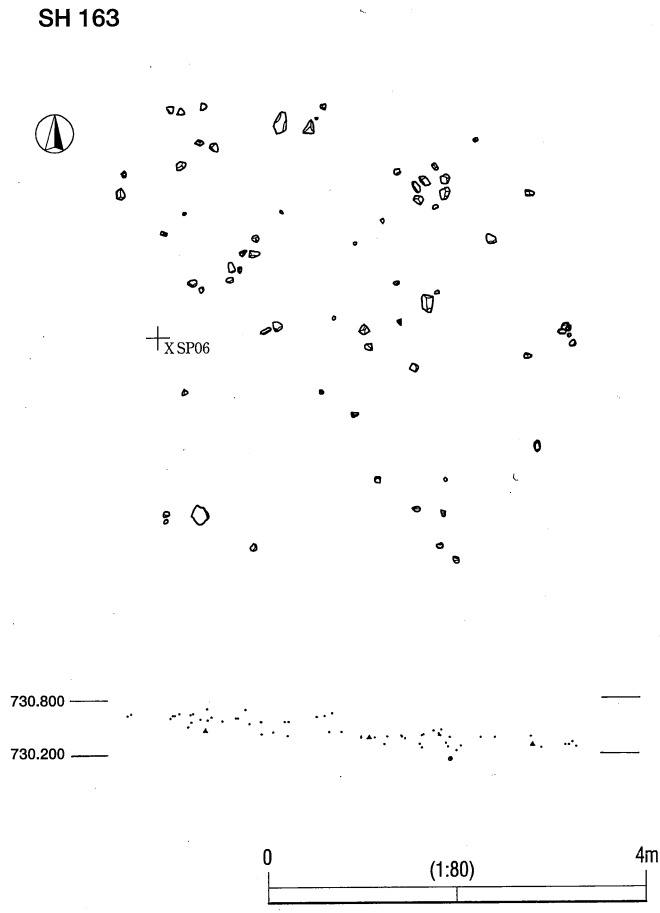

第2地点 SH 163・166・167・170・171 遺物分布図 (貫ノ木遺跡)

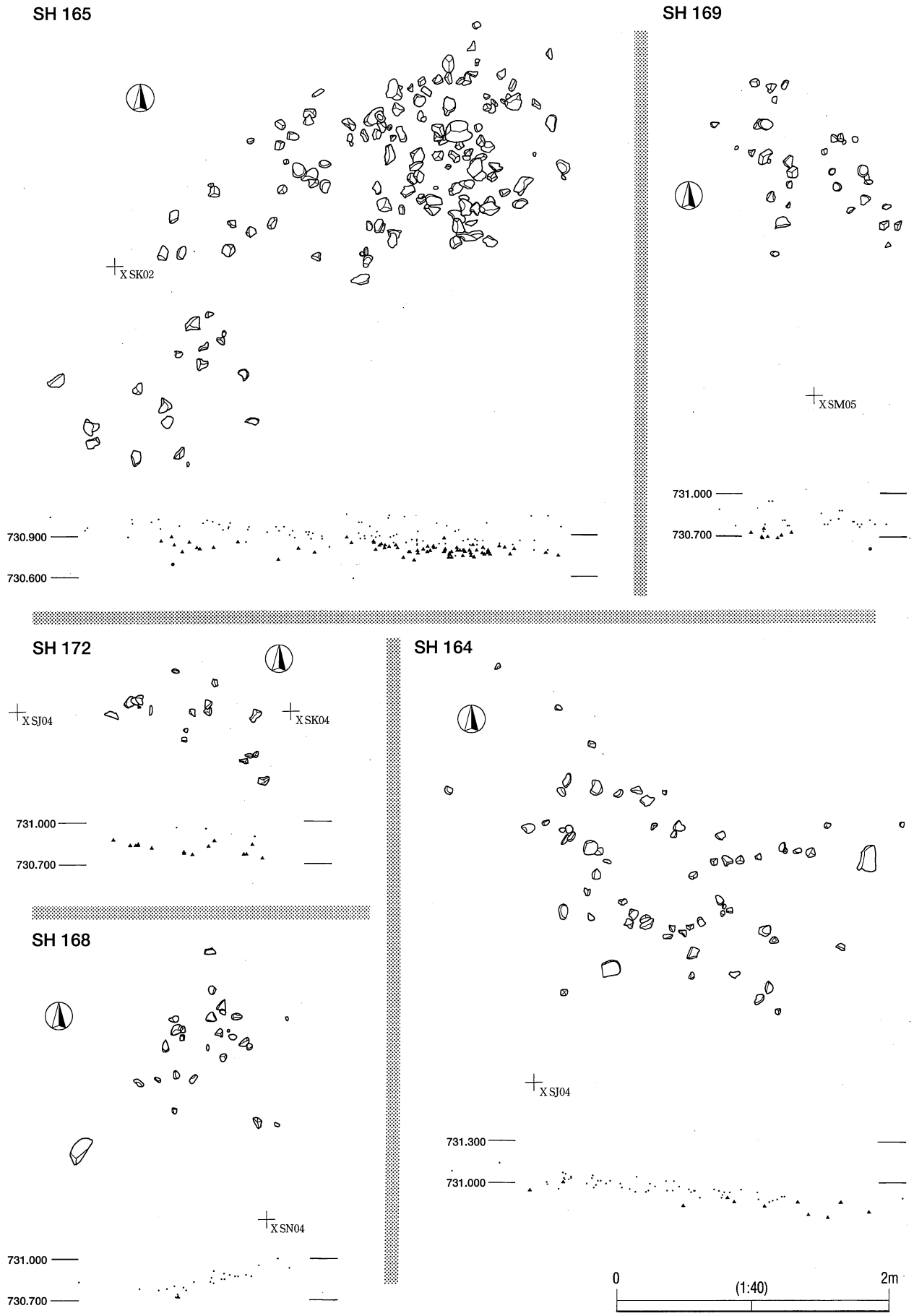

第2地点 SH 164・165・168・169・172 遺物分布図 (貫ノ木遺跡)

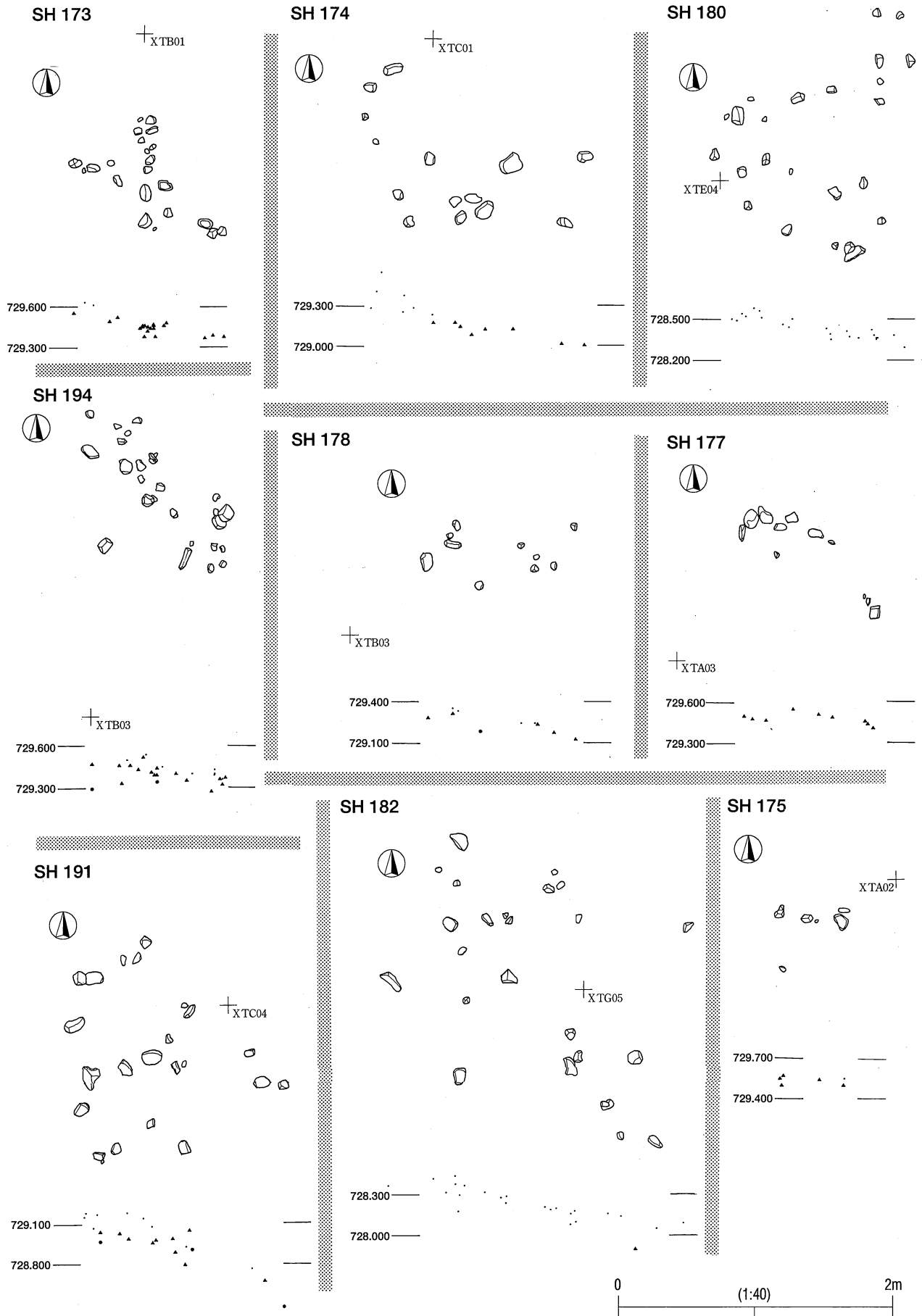

第2地点 SH 173・174・175・177・178・180・182・191・194 遺物分布図 (貫ノ木遺跡)

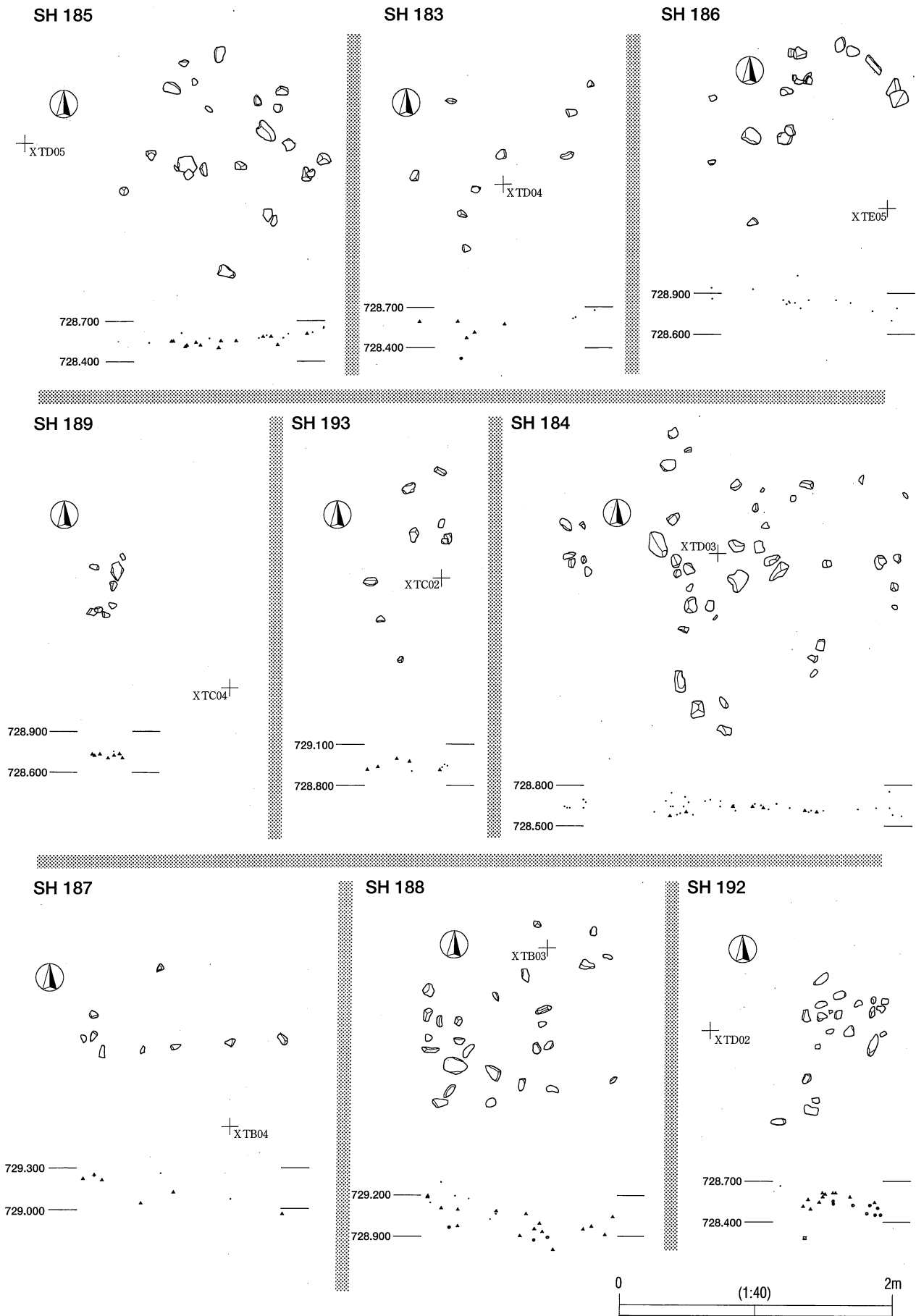

第2地点 SH 183・184・185・186・187・188・189・192・193 遺物分布図 (貫ノ木遺跡)

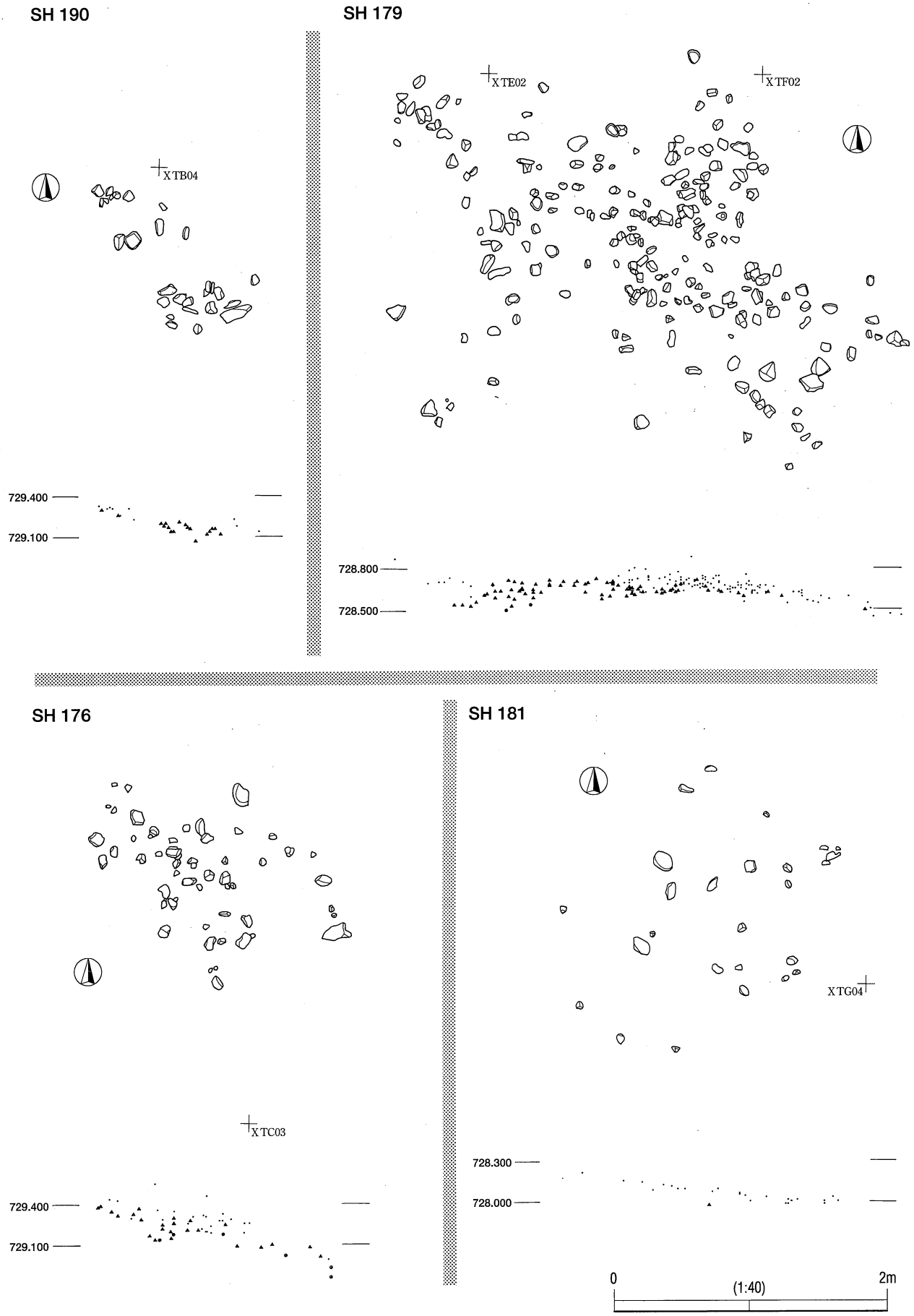

第2地点 SH 176・179・181・190 遺物分布図 (貫ノ木遺跡)



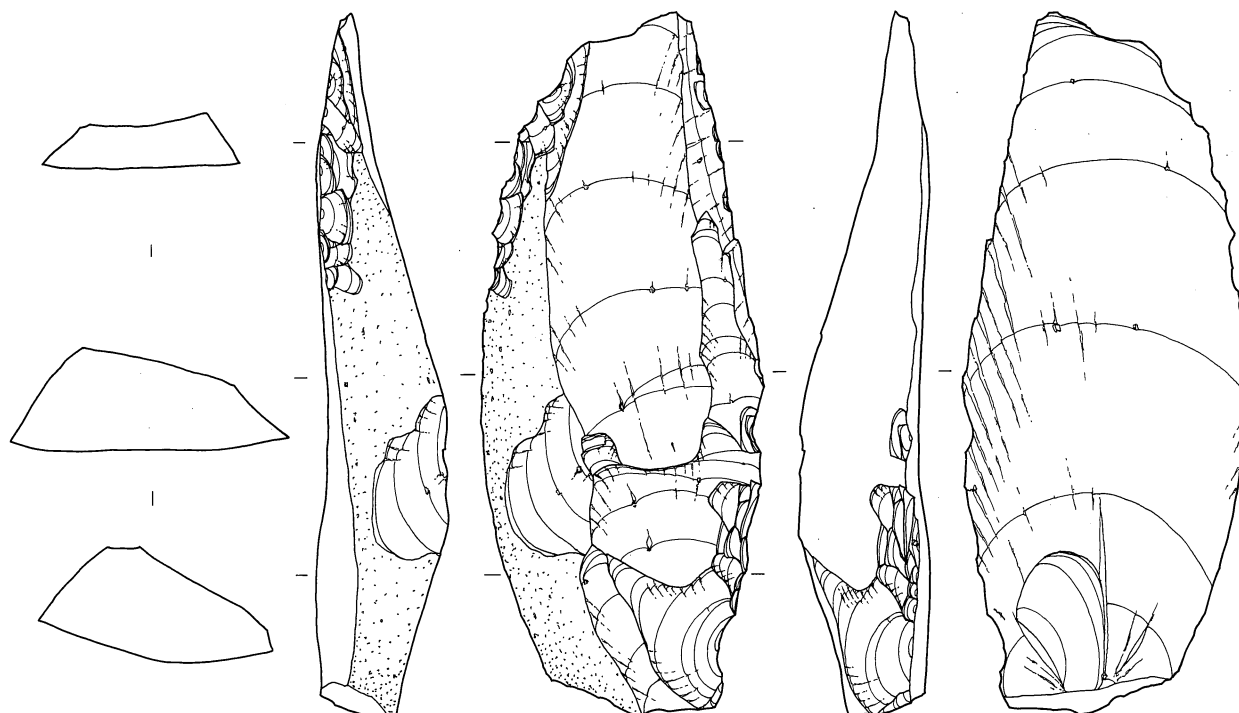

201  
Kn An  
BL2002 120.36g  
IV X-C 100

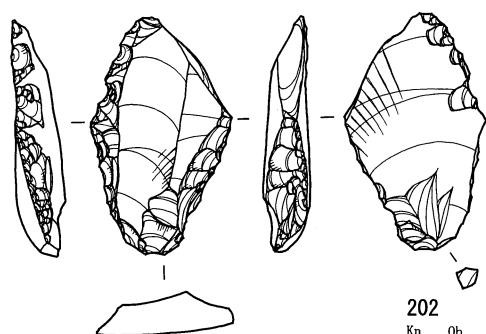

202  
Kn Ob SWHD  
BL2004 7.02g  
III X-C 134

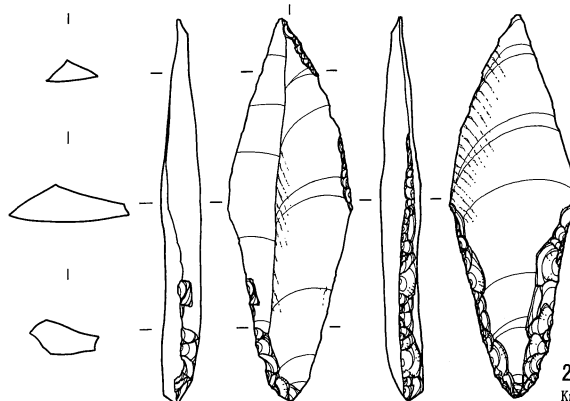

203  
Kn TS  
BL2006 7.27g  
V a X-D 49

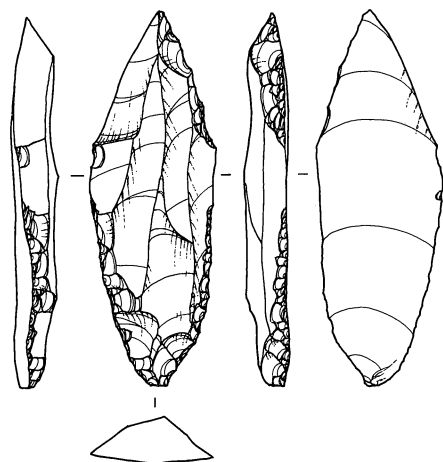

204  
Kn SS  
BL2005 10.65g  
IV X-D 71

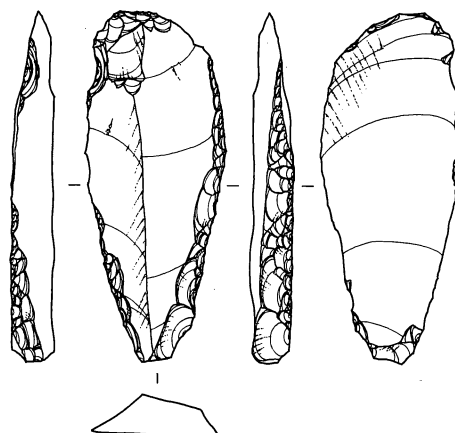

205  
Kn SS  
BL2005 11.21g  
IV X-D 48

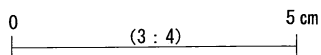

第2地点 石器実測図1 (ナイフ形石器1) (貫ノ木遺跡)

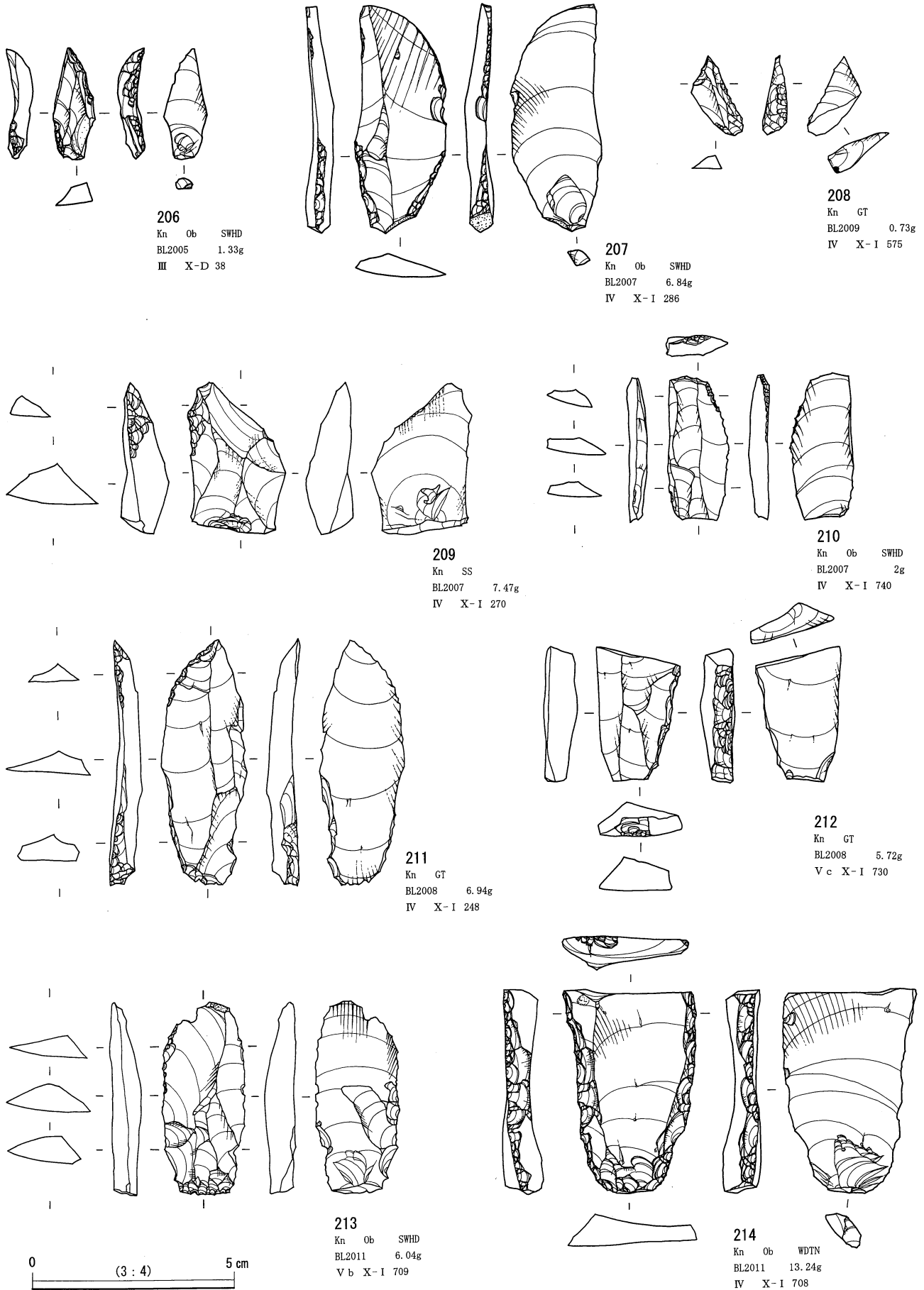

第2地点 石器実測図2 (ナイフ形石器2) (貫ノ木遺跡)

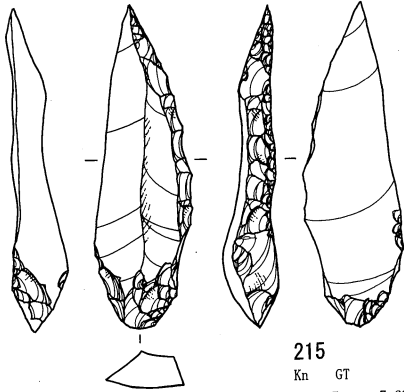

215  
Kn GT  
BL2015 7.69g  
III X-I 89

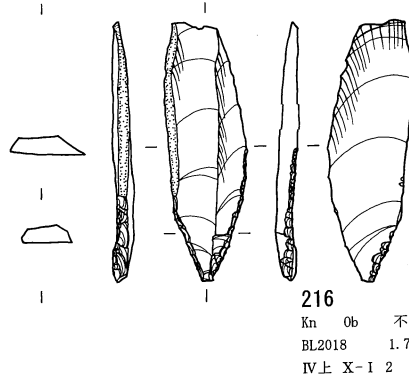

216  
Kn Ob 不可  
BL2018 1.78g  
IV上 X-I 2

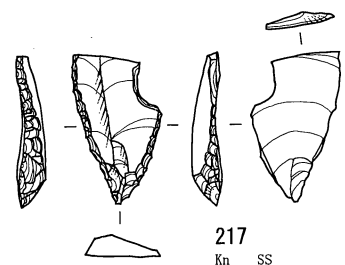

217  
Kn SS  
BL2018 1.25g  
IV上 X-I 1

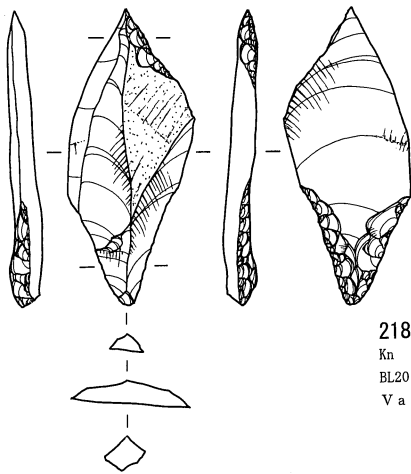

218  
Kn Ob WDKB  
BL2019 3.94g  
V a X-H 775

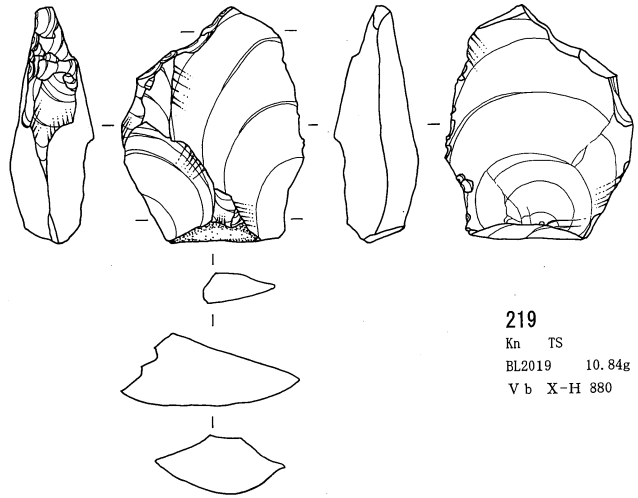

219  
Kn TS  
BL2019 10.84g  
V b X-H 880

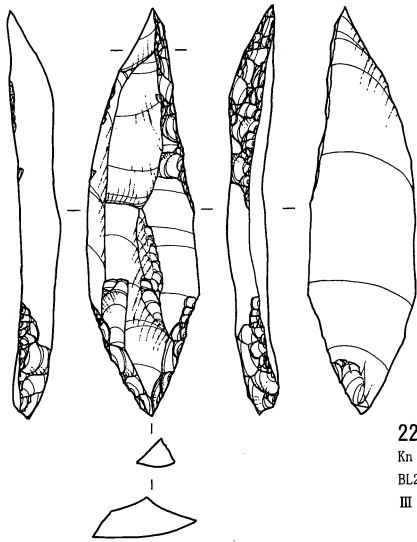

220  
Kn SS  
BL2020 9.74g  
III X-I 298

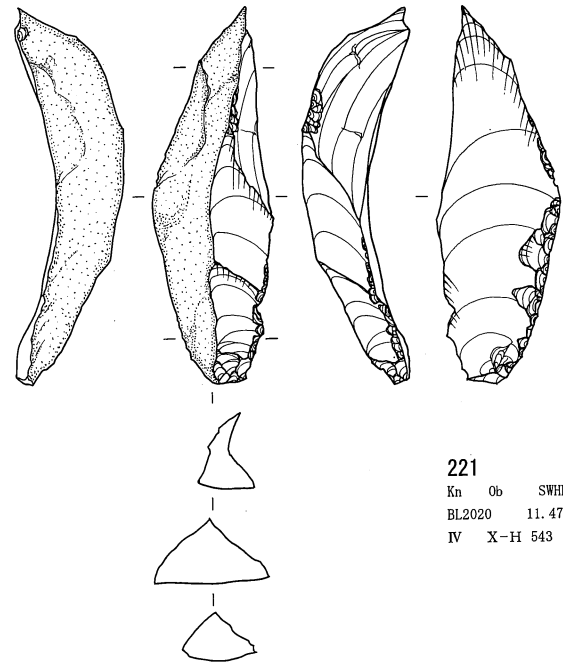

221  
Kn Ob SWHD  
BL2020 11.47g  
IV X-H 543

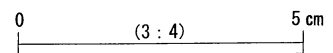

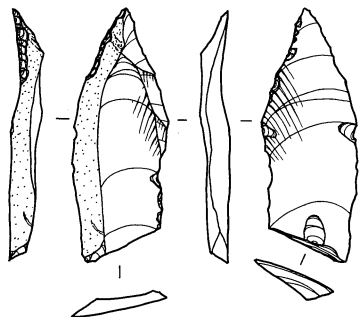

222  
Kn Ob SWHD  
BL2020 2.05g  
V a X-H 615

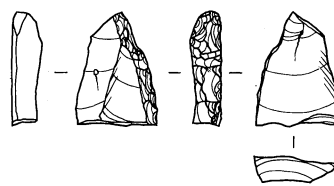

223  
Kn Ob 不可  
BL2020 1.38g  
IV X-H 371

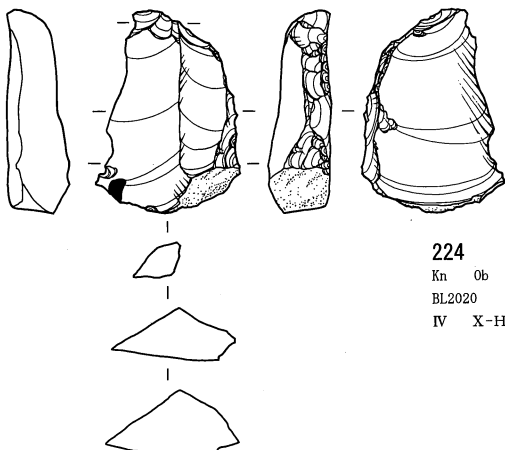

224  
Kn Ob SWHD  
BL2020 7.37g  
IV X-H 310

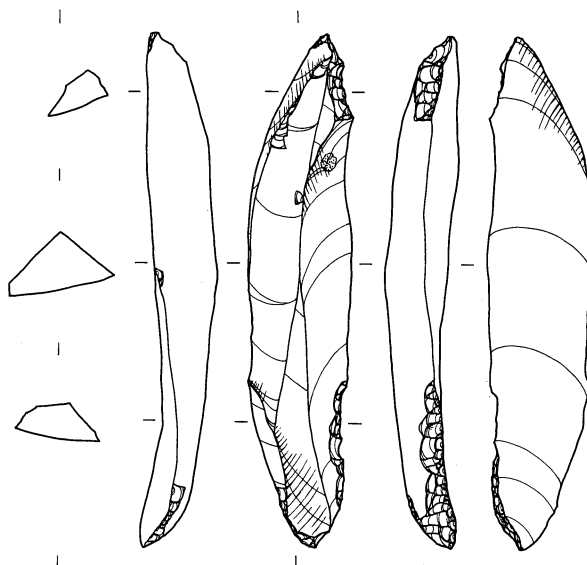

225  
Kn Ob WDKB  
BL2021 11.88g  
III X-H 21

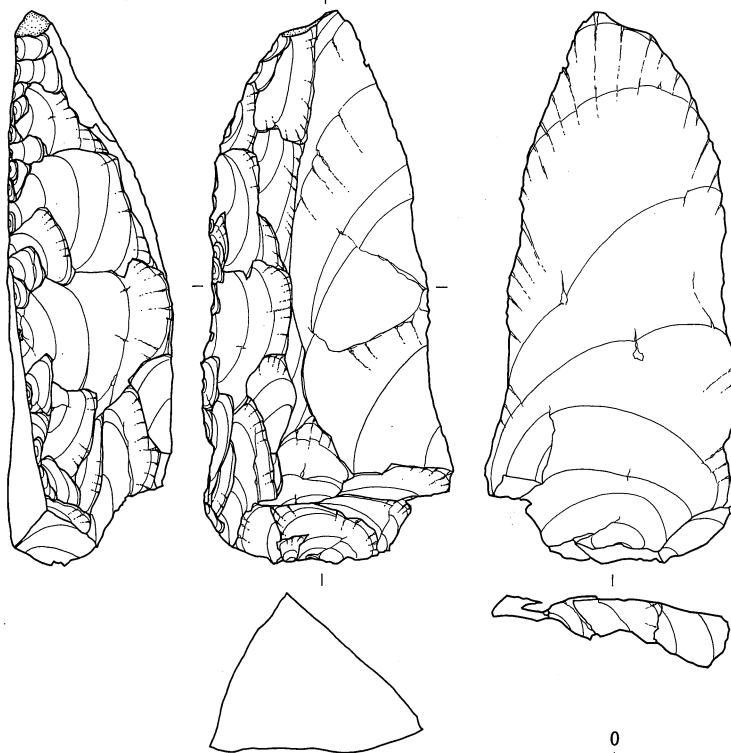

226  
Kn An  
BL2022 105.21g  
IV X-H 82

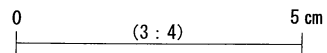

第2地点 石器実測図4 (ナイフ形石器4) (貫ノ木遺跡)

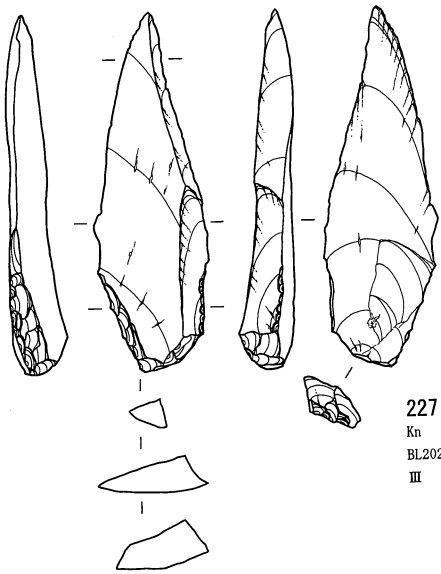

227  
Kn An  
BL2022 7.89g  
III X-H 28

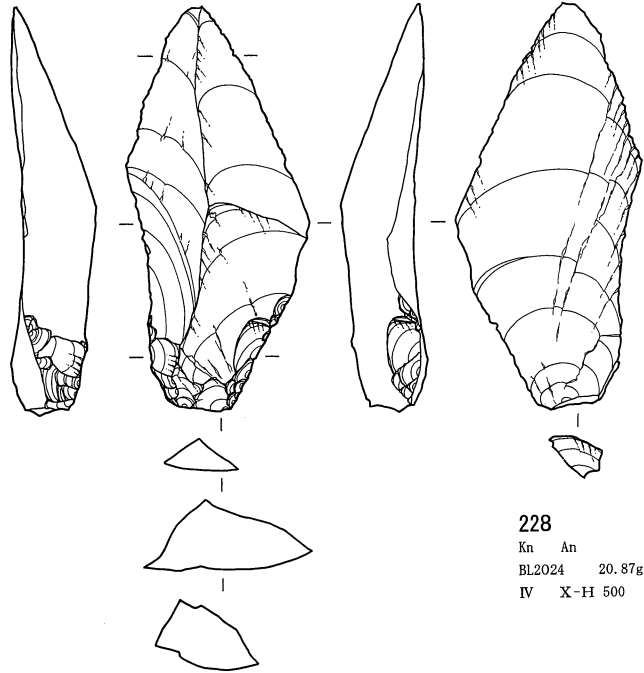

228  
Kn An  
BL2024 20.87g  
IV X-H 500

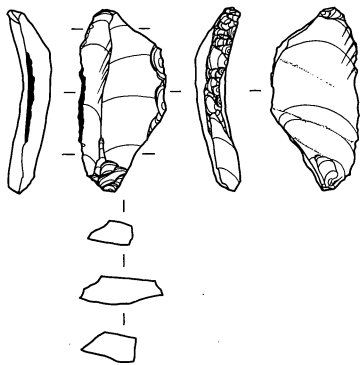

229  
Kn Ob SWHD  
BL2023 2.45g  
IV X-H 478

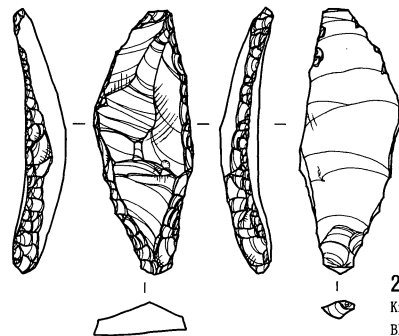

230  
Kn Ob TSTY  
BL2027 4.63g  
V b X-M 505

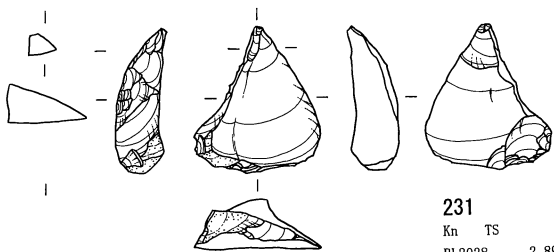

231  
Kn TS  
BL2028 2.89g  
IV X-M 1010

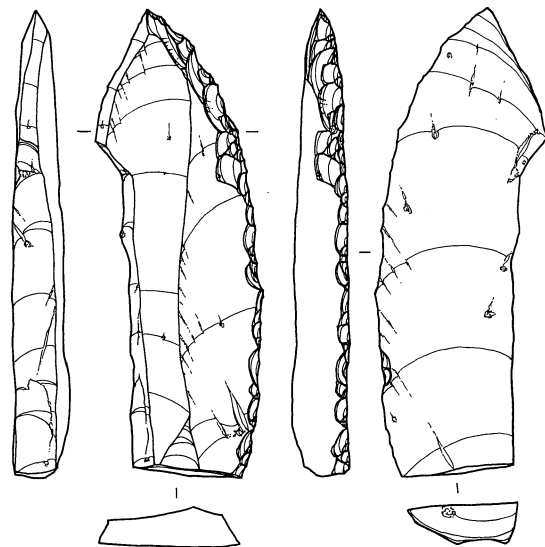

232  
Kn An  
BL2032 23.53g  
III X-M 539

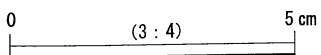

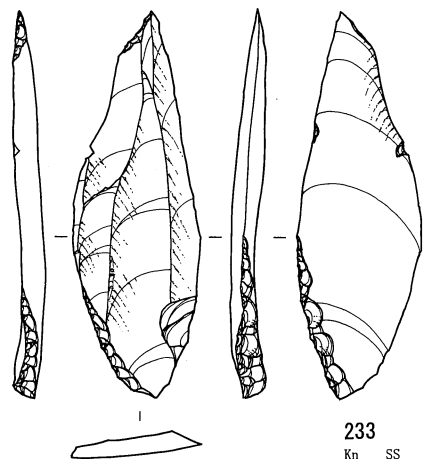

233  
Kn SS  
BL2039 5.69g  
V b X-N 2971

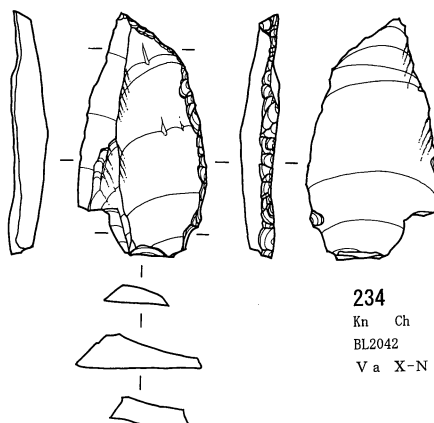

234  
Kn Ch  
BL2042 5.55g  
V a X-N 2876

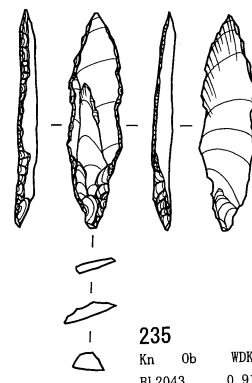

235  
Kn Ob WDKB  
BL2043 0.91g  
IV X-N 991

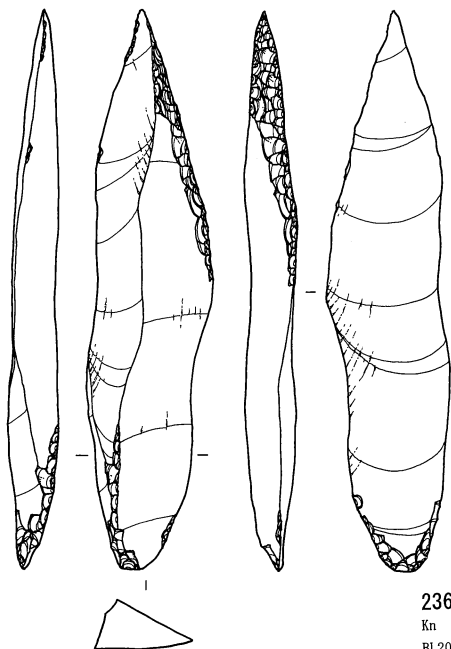

236  
Kn GT  
BL2044 14.67g  
IV X-N 2043

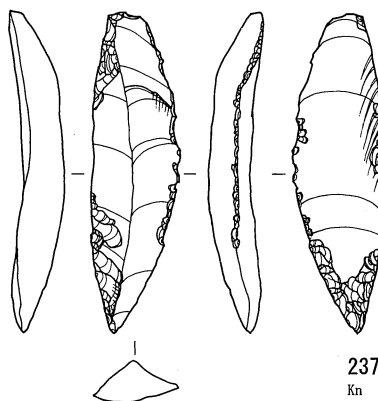

237  
Kn Ob SWHD  
BL2044 4.96g  
IV X-N 2341

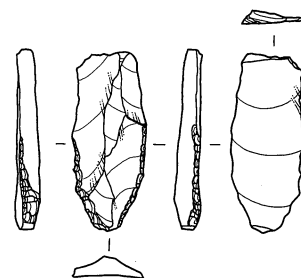

238  
Kn SS  
BL2044 1.5g  
IV X-N 1862

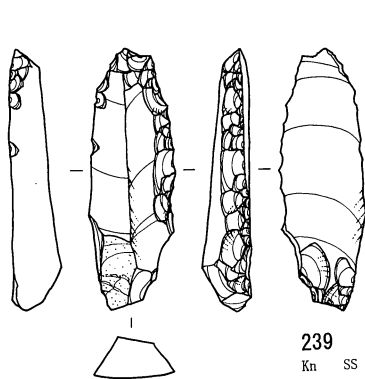

239  
Kn SS  
BL2044 5.88g  
III X-N 1108

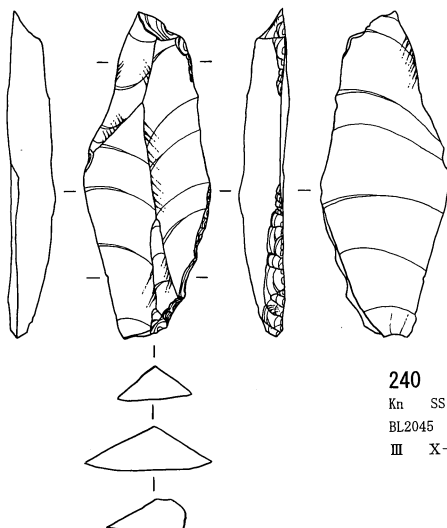

240  
Kn SS  
BL2045 7.47g  
III X-N 350

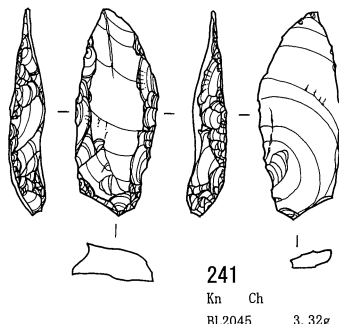

241  
Kn Ch  
BL2045 3.32g  
IV X-N 2539

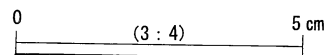

第2地点 石器実測図6 (ナイフ形石器6) (貫ノ木遺跡)

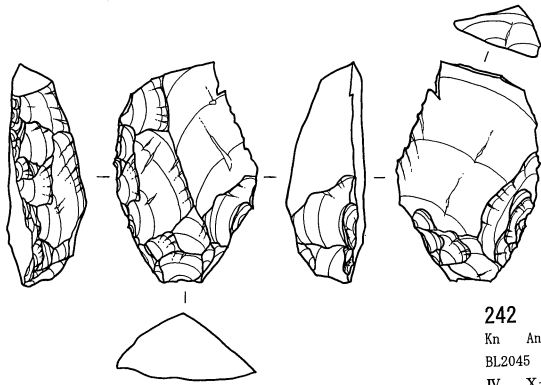

242  
Kn An  
BL2045 11.68g  
IV X-M 2155

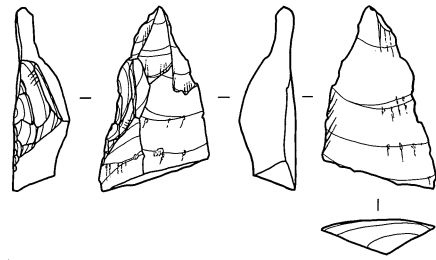

243  
Kn An  
BL2045 3.86g  
III X-N 230

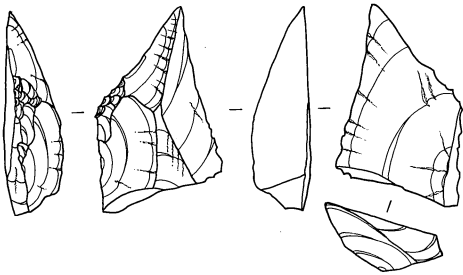

244  
Kn An  
BL2045 5.68g  
III X-N 237

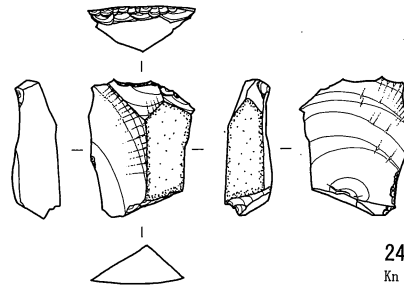

245  
Kn SS  
BL2045 2.97g  
III X-M 2694

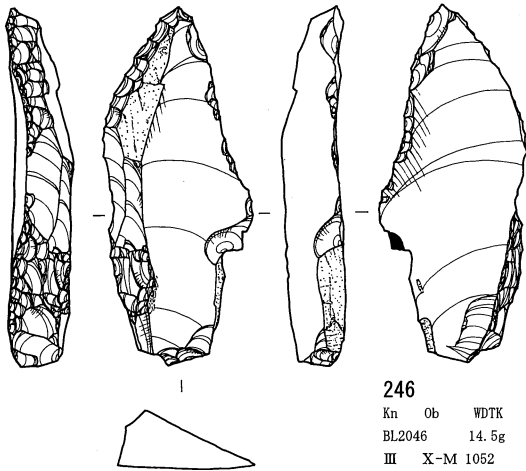

246  
Kn Ob WDTK  
BL2046 14.5g  
III X-M 1052

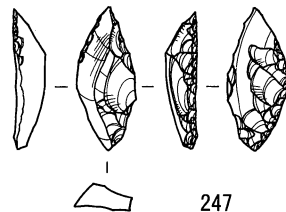

247  
Kn Ob WDTY  
BL2046 1.03g  
III X-N 189

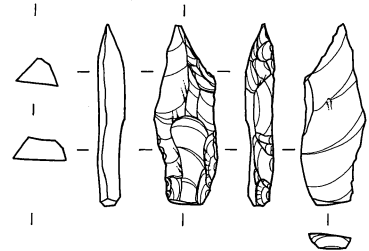

248  
Kn An  
BL2046 1.47g  
III X-N 179

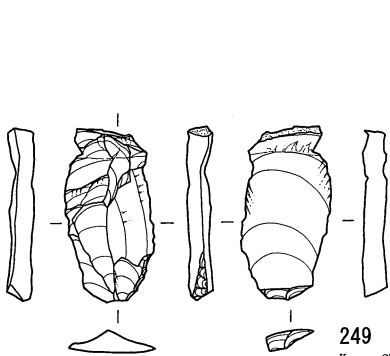

249  
Kn Ch  
BL2046 1.91g  
III X-N 3353

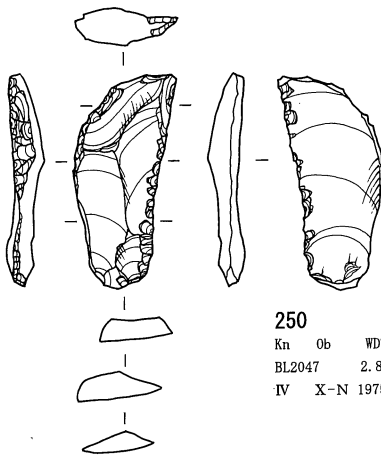

250  
Kn Ob WDTY  
BL2047 2.85g  
IV X-N 1975

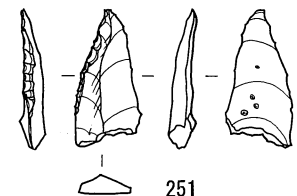

251  
Kn Ob 不可  
BL2047 0.69g  
III X-N 573

0 (3:4) 5 cm

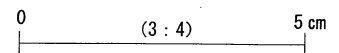
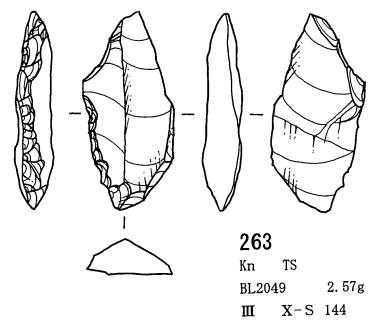
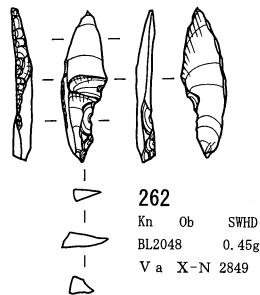
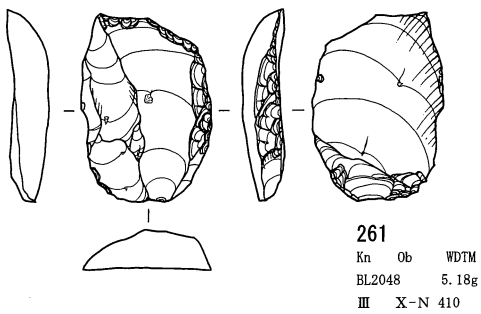
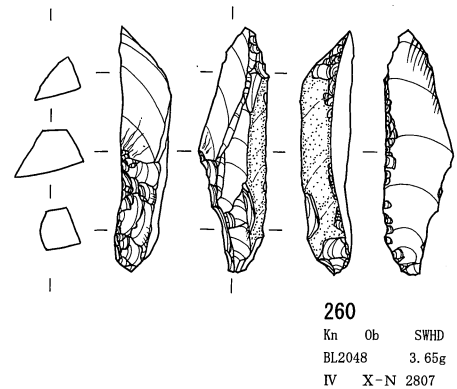
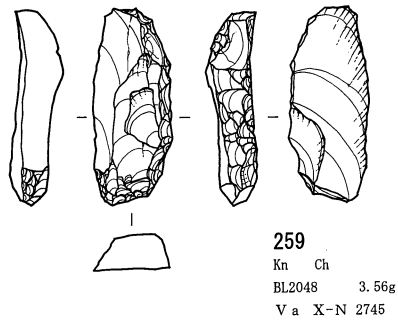
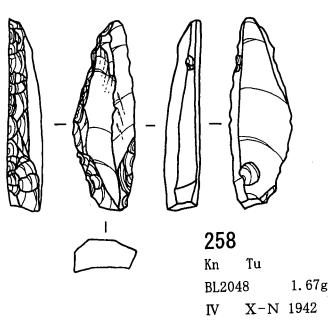
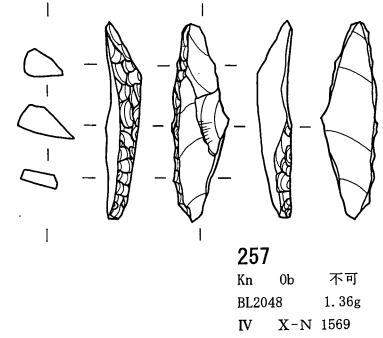
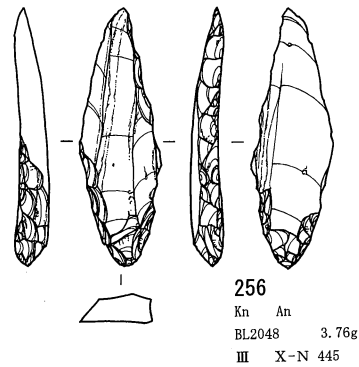
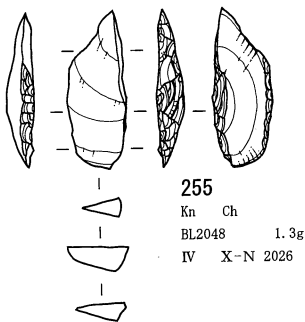
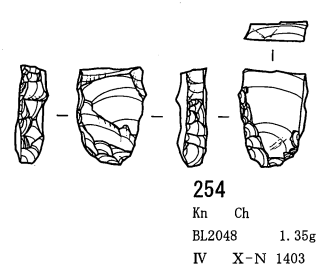
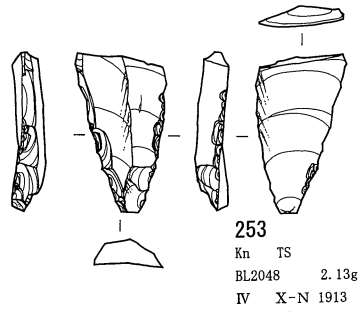
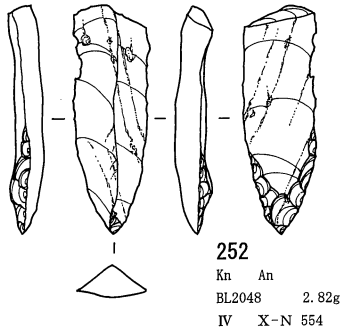



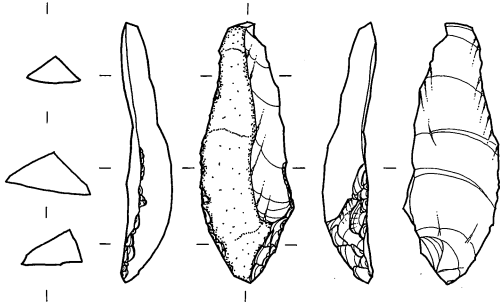

264  
Kn Tu  
BL2050 4.44g  
III X-S 246

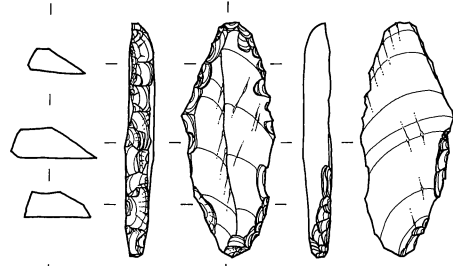

265  
Kn SS  
BL2050 3.41g  
IV X-S 537

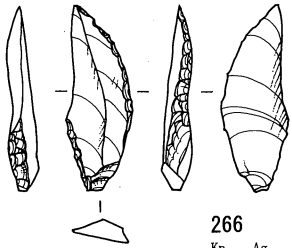

266  
Kn Ag  
BL2050 1.52g  
III X-S 265

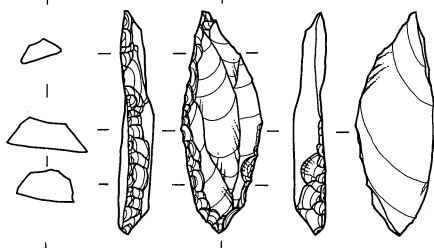

267  
Kn Ch  
BL2050 2.81g  
III X-S 269

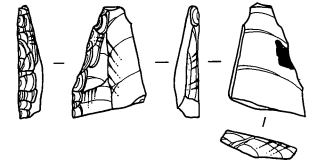

268  
Kn TS  
BL2050 0.8g  
III X-S 178

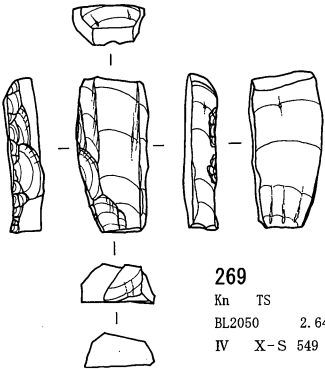

269  
Kn TS  
BL2050 2.64g  
IV X-S 549

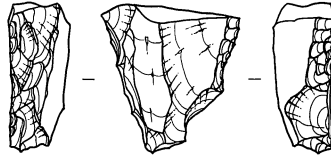

270  
Kn An  
BL2050 6.47g  
III X-S 226

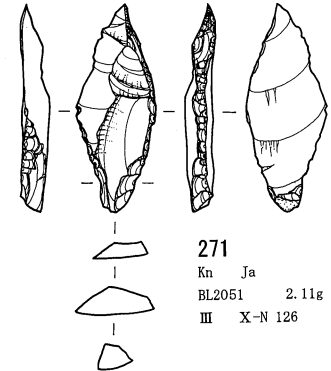

271  
Kn Ja  
BL2051 2.11g  
III X-N 126

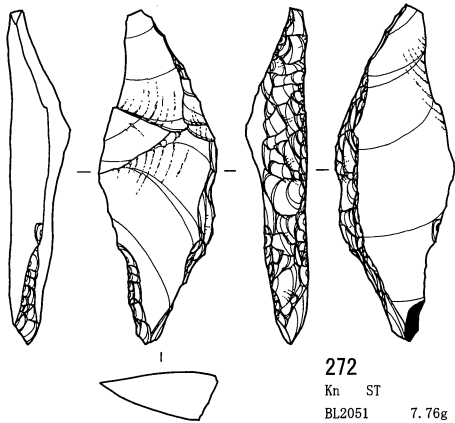

272  
Kn ST  
BL2051 7.76g  
III X-N 2611

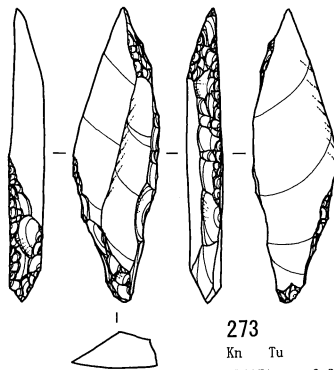

273  
Kn Tu  
BL2051 3.25g  
III X-N 2459

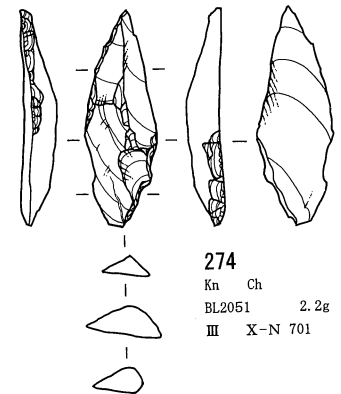

274  
Kn Ch  
BL2051 2.2g  
III X-N 701

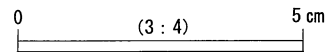

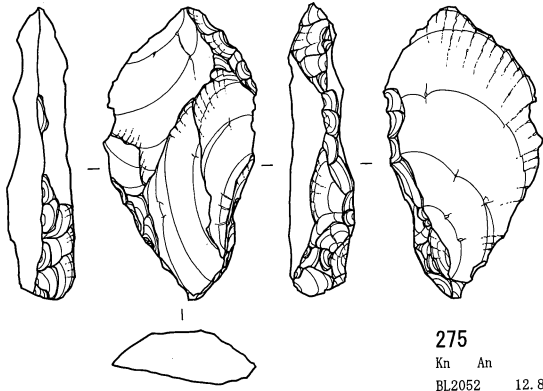

275  
Kn An  
BL2052 12.84g  
III X-N 723

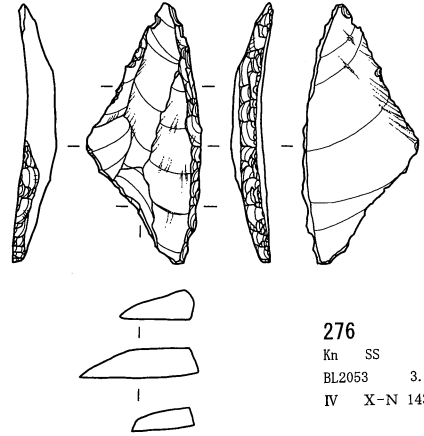

276  
Kn SS  
BL2053 3.75g  
IV X-N 1433

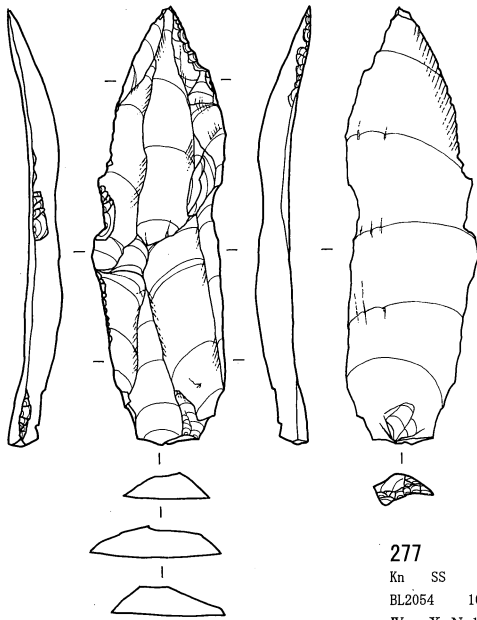

277  
Kn SS  
BL2054 10.23g  
IV X-N 1288

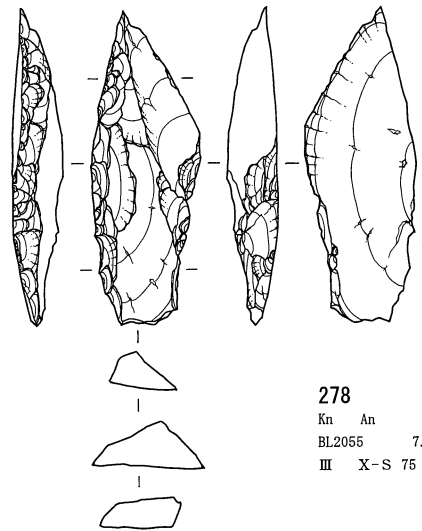

278  
Kn An  
BL2055 7.6g  
III X-S 75

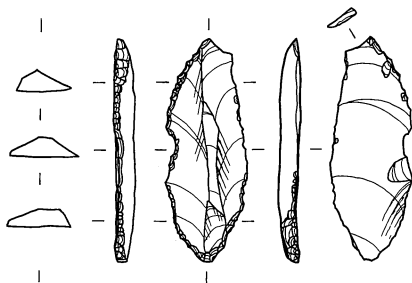

279  
Kn Ob SWHD  
BL2055 1.66g  
V a X-S 644

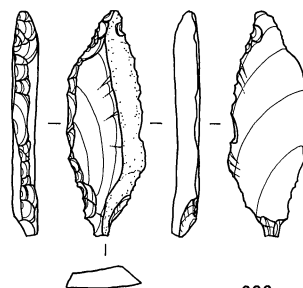

280  
Kn Tu  
BL2055 2.07g  
III X-S 71

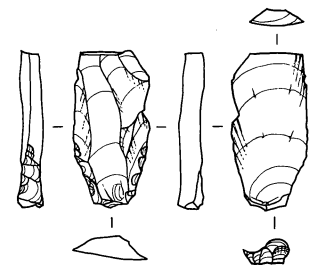

281  
Kn SS  
BL2055 1.31g  
IV X-S 581

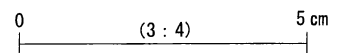

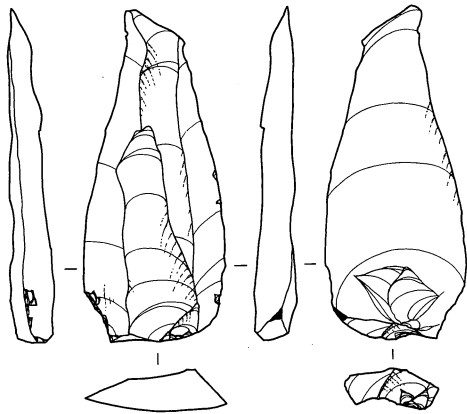

282  
Kn SS  
BL2056 9.74g  
IV X-S 508

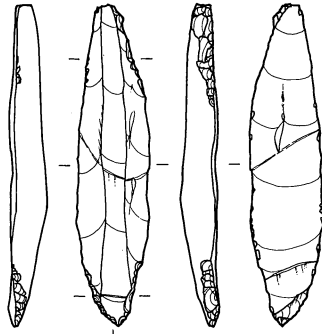

283  
Kn SS  
BL2057 4.41g  
III X-T 90

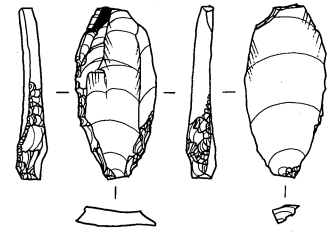

284  
Kn SS  
BL2058 1.67g  
III X-T 52

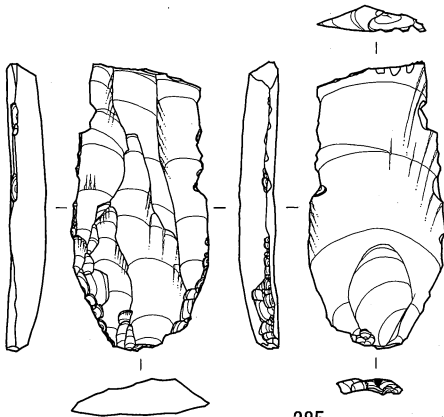

285  
Kn TS  
BL2058 7.55g  
III X-T 54

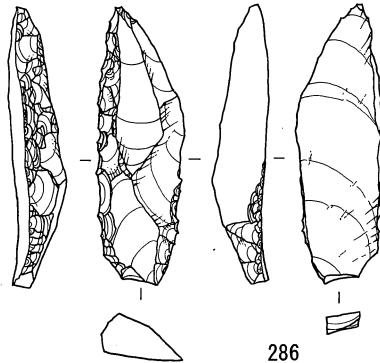

286  
Kn SS  
BL2060 5.38g  
IV X-T 479

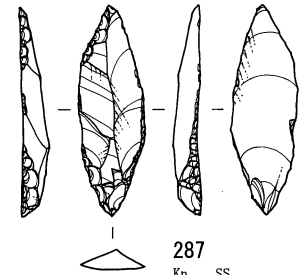

287  
Kn SS  
BL2060 1.51g  
III X-T 172

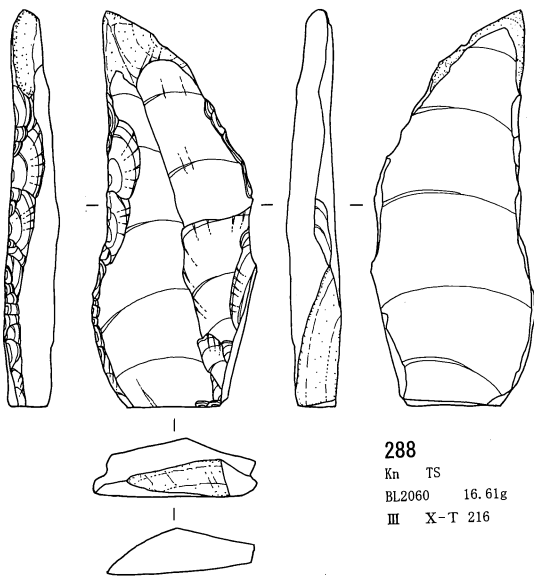

288  
Kn TS  
BL2060 16.61g  
III X-T 216

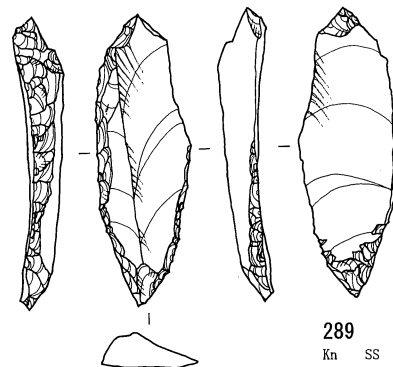

289  
Kn SS  
BL2060 4.94g  
III X-T 170

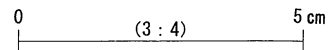

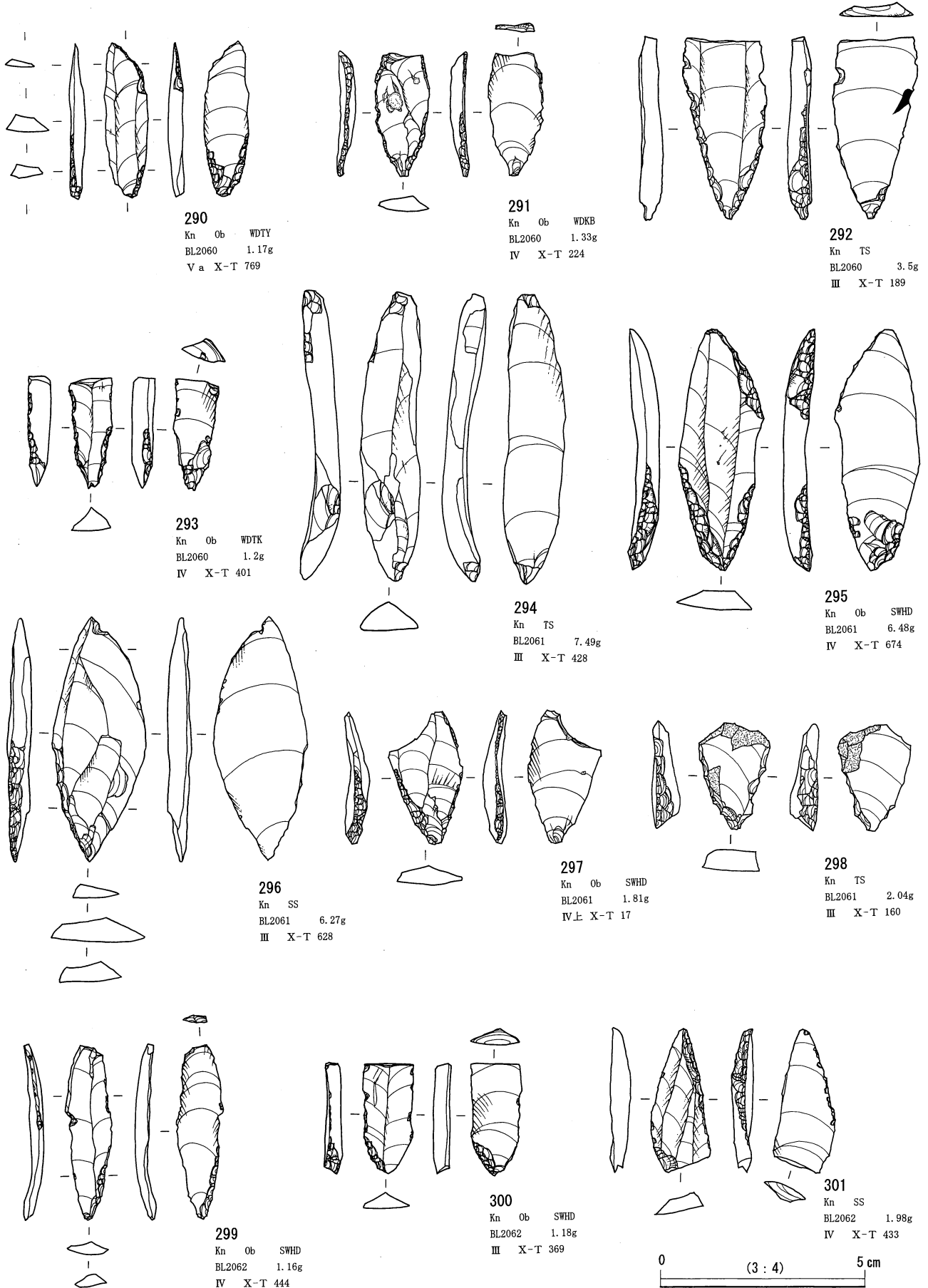

第2地点 石器実測図 12 (ナイフ形石器 12) (貫ノ木遺跡)

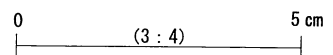
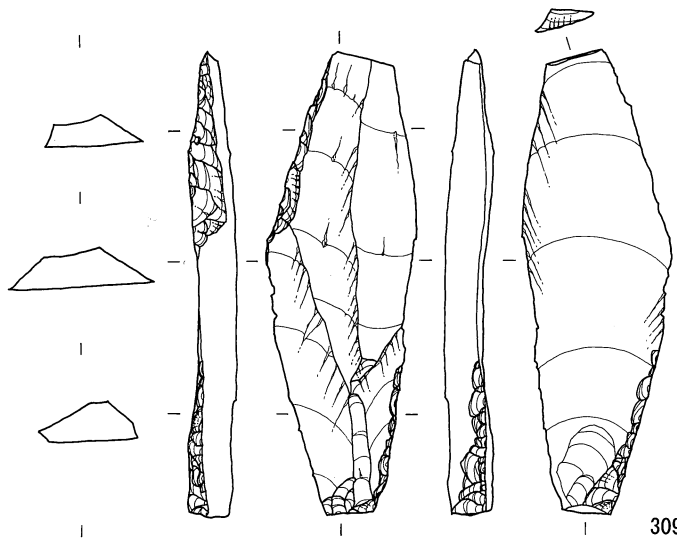
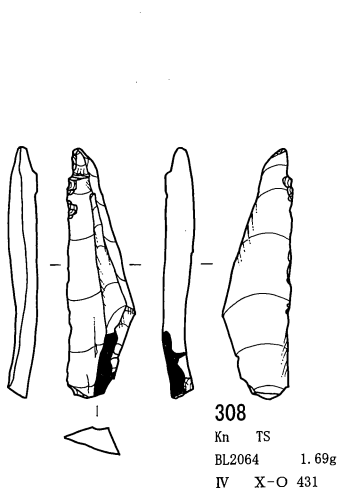
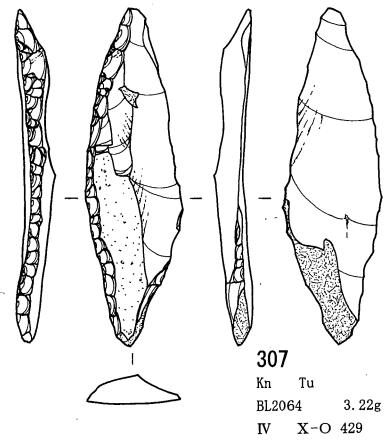
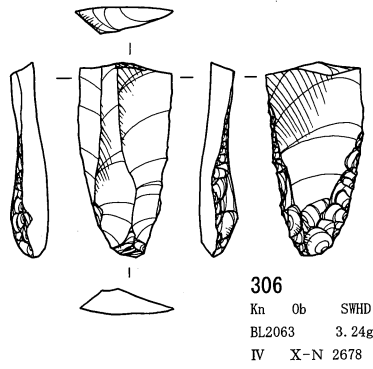
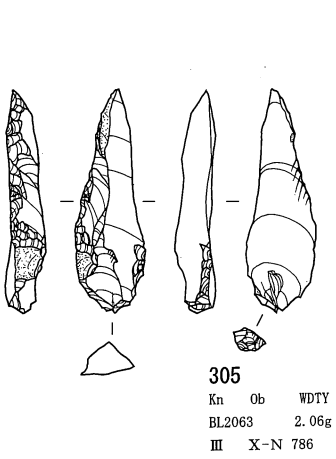
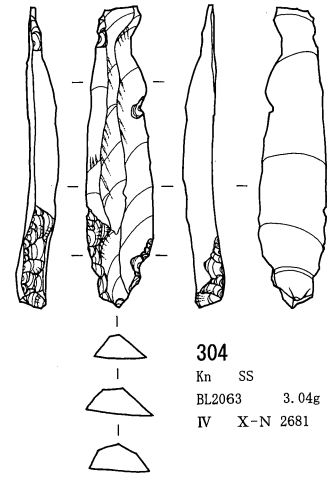
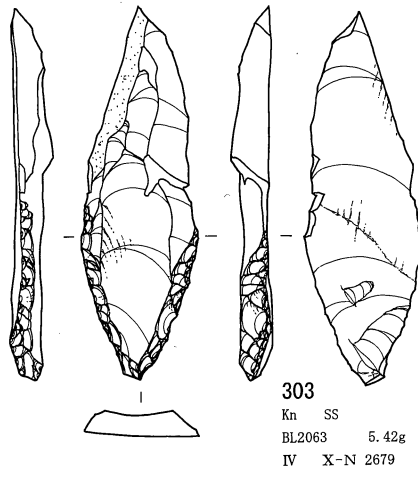
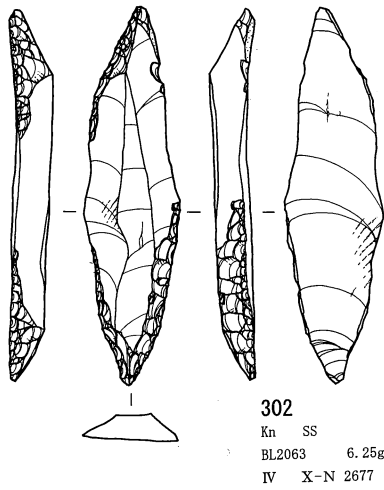

第2地点 石器実測図 13 (ナイフ形石器 13) (貫ノ木遺跡)

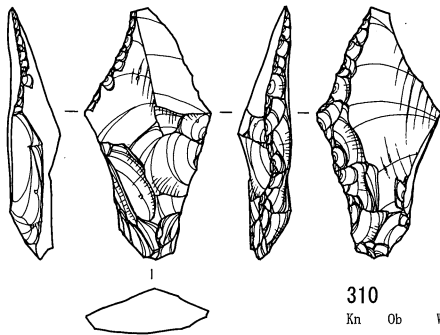

310  
Kn Ob WOTM  
BL2067 6.01g  
IV X-O 444

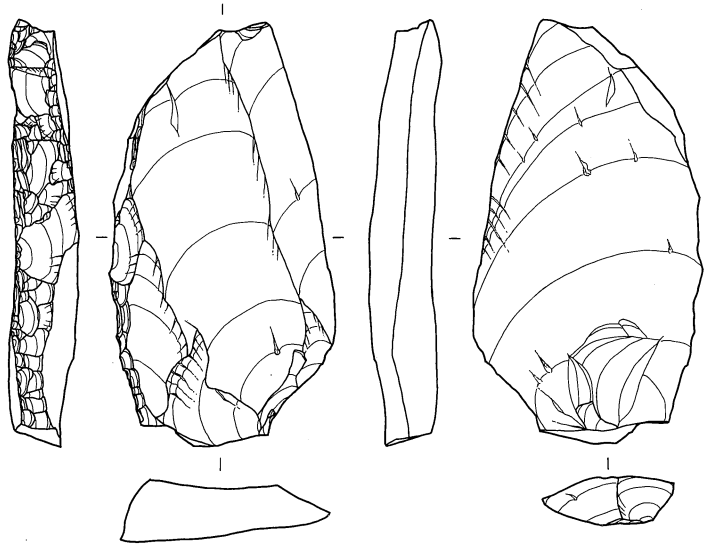

311  
Kn Tu  
BL2069 33.61g  
III X-O 424

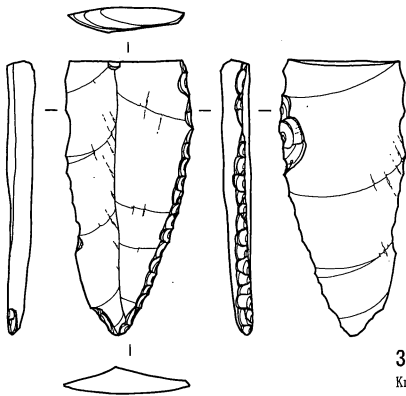

312  
Kn Ge  
BL2081 4.81g  
III X-O 100

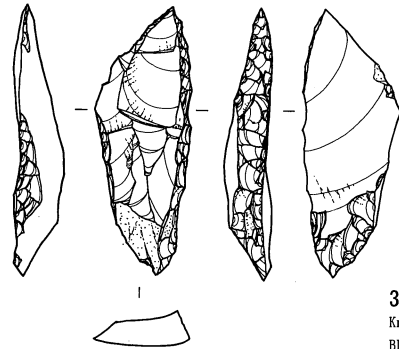

313  
Kn Ch  
BL2071 5.45g  
III X-N 1263

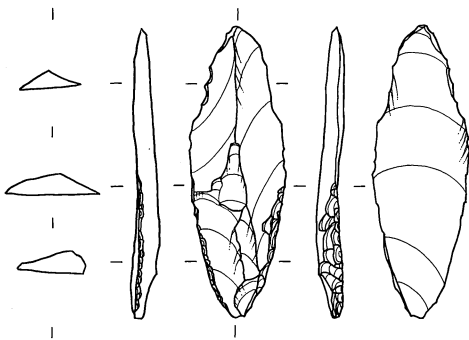

314  
Kn TS  
BL2083 2.65g  
V a X-O 556

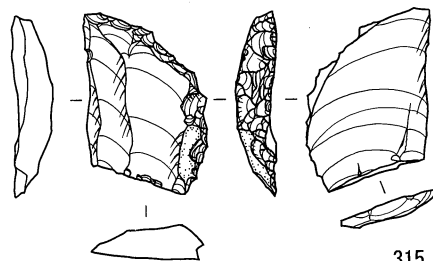

315  
Kn Ob WDTK  
BL2085 4.13g  
IV X-I 503

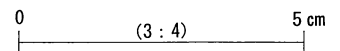

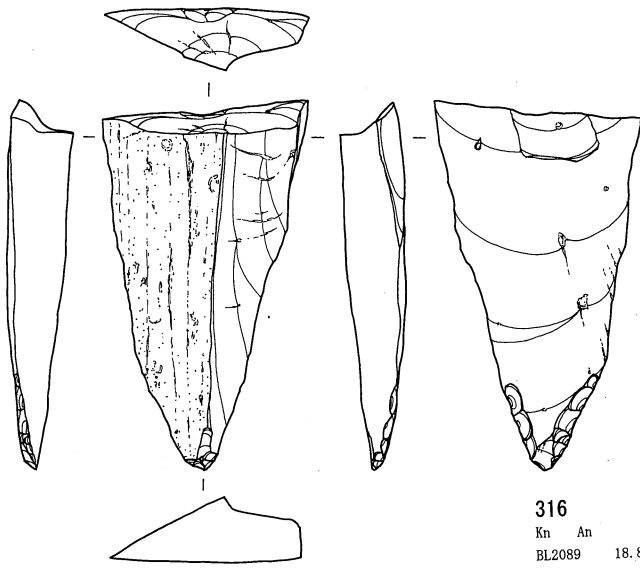

316  
Kn An  
BL2089 18.87g  
IV X-O 463

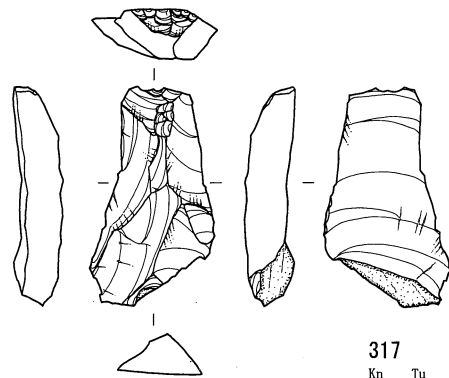

317  
Kn Tu  
BL2090 4.92g  
III X-O 357

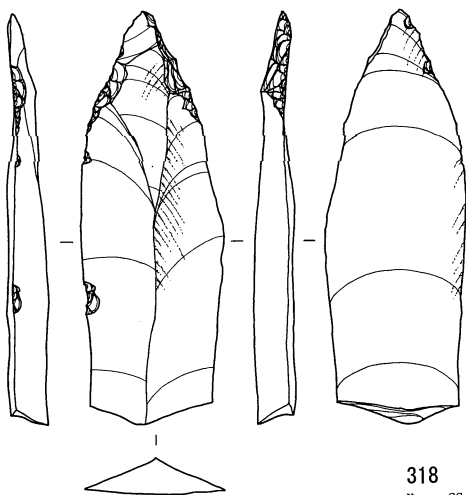

318  
Kn SS  
BL2093 11.47g  
III X-J 98

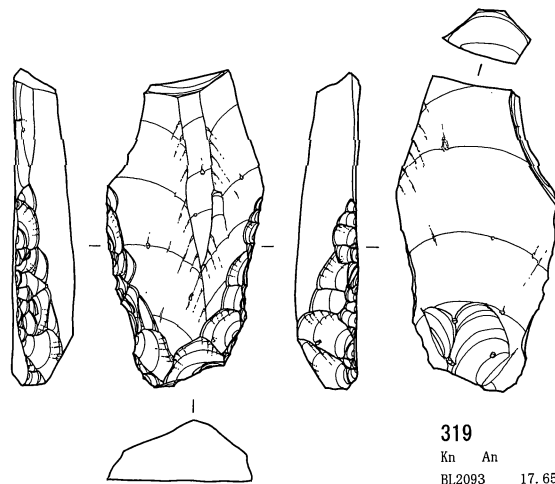

319  
Kn An  
BL2093 17.65g  
Va X-J 37

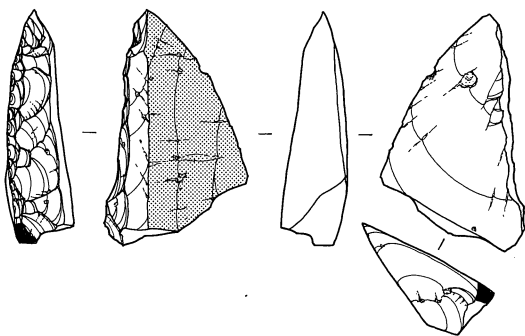

320  
Kn An  
BL2095 8.88g  
IV X-J 171

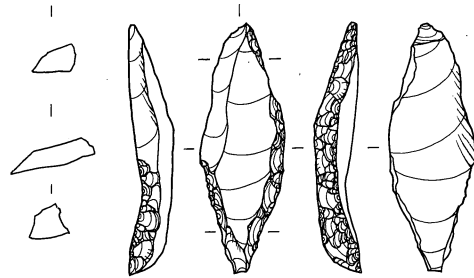

321  
Kn Ob WDTY  
BL2098 3g  
III X-H 242

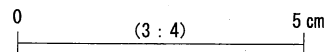

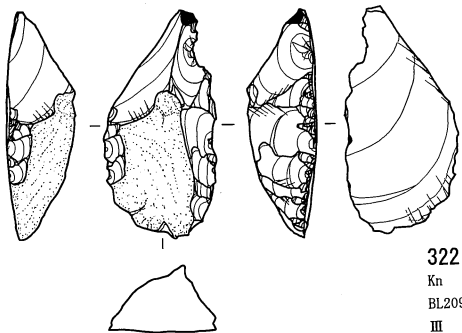

322  
Kn SS  
BL2099 6.49g  
III X-H 562

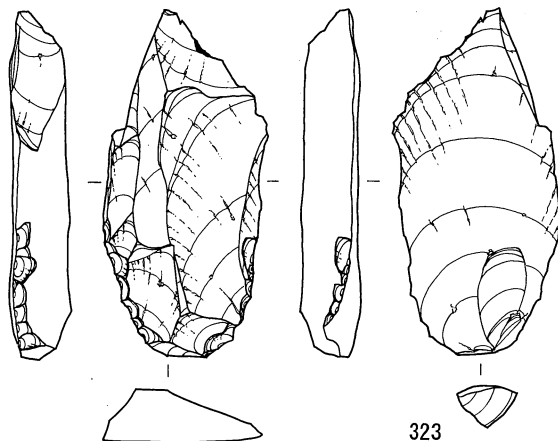

323  
Kn An  
外 17.55g  
III X-C 20

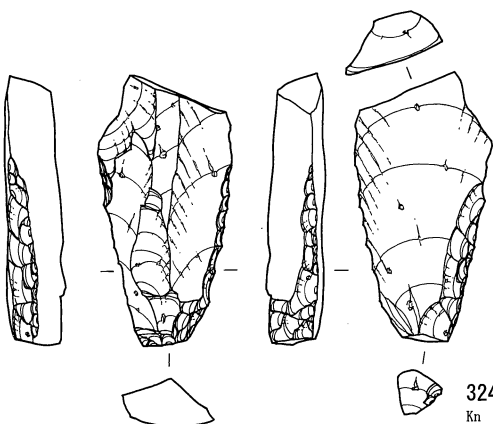

324  
Kn An  
外 11.29g  
III X-G 2

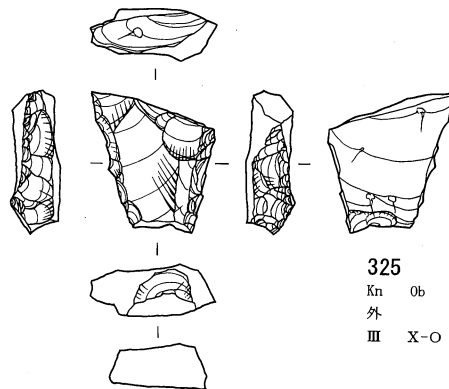

325  
Kn Ob SWHD  
外 4.31g  
III X-O 294

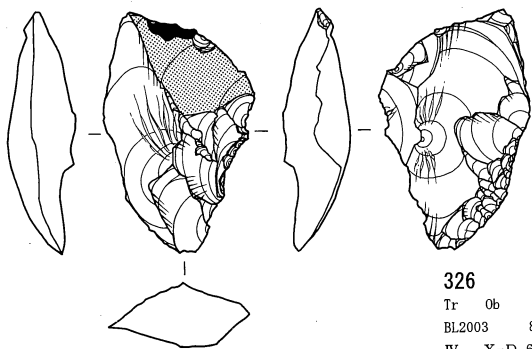

326  
Tr Ob SWHD  
BL2003 8.62g  
IV X-D 69

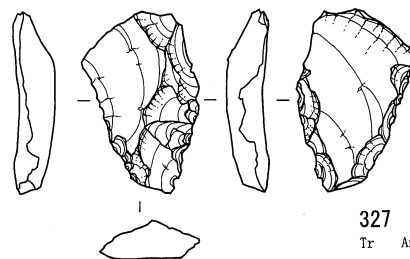

327  
Tr An  
BL2022 3.79g  
IV X-H 77

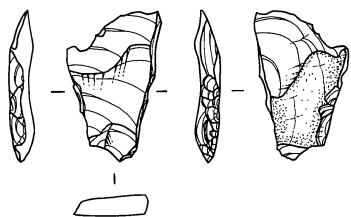

328  
Tr SS  
BL2030 1.63g  
IV X-M 353

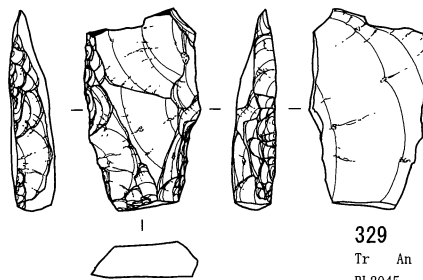

329  
Tr An  
BL2045 5.53g  
III X-M 857

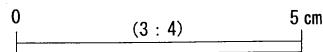



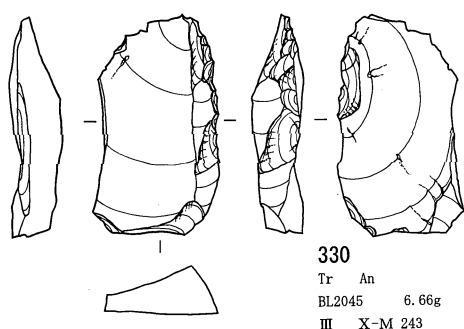

330  
Tr An  
BL2045 6.66g  
III X-M 243

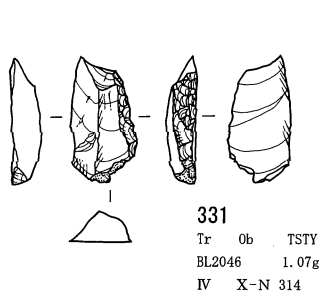

331  
Tr Ob TSTY  
BL2046 1.07g  
IV X-N 314

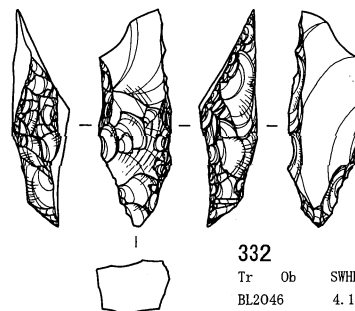

332  
Tr Ob SWHD  
BL2046 4.1g  
IV X-N 2564

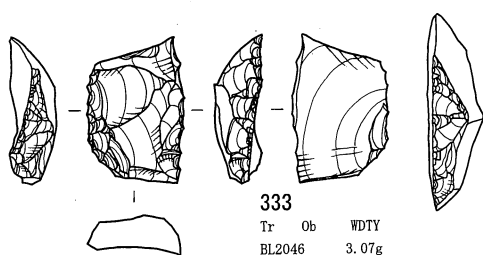

333  
Tr Ob WDTY  
BL2046 3.07g  
III X-M 171

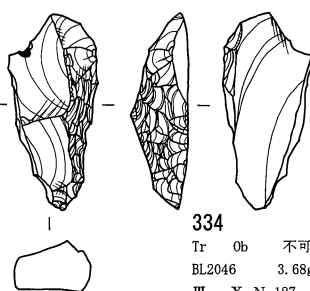

334  
Tr Ob 不可  
BL2046 3.68g  
III X-N 187

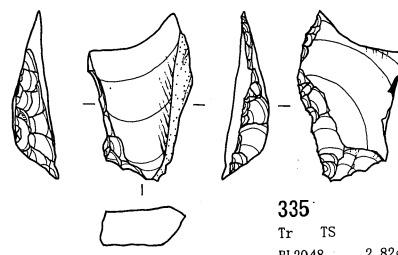

335  
Tr TS  
BL2048 2.82g  
IV X-N 2003

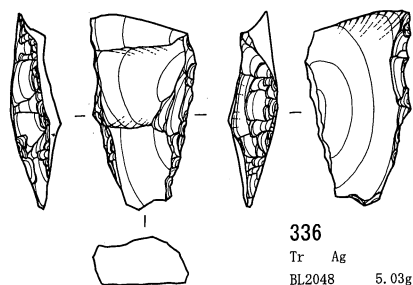

336  
Tr Ag  
BL2048 5.03g  
V b X-N 2803

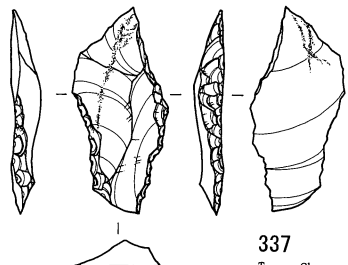

337  
Tr Ch  
BL2048 2.33g  
IV X-N 1919

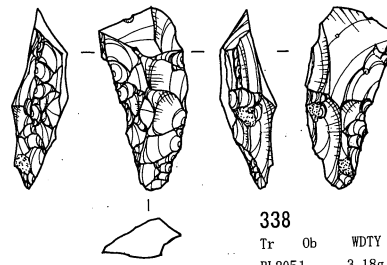

338  
Tr Ob WDTY  
BL2051 3.18g  
V a X-N 2620

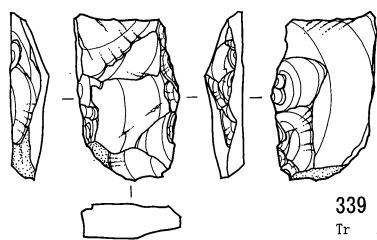

339  
Tr An  
BL2052 4.1g  
III X-N 1429

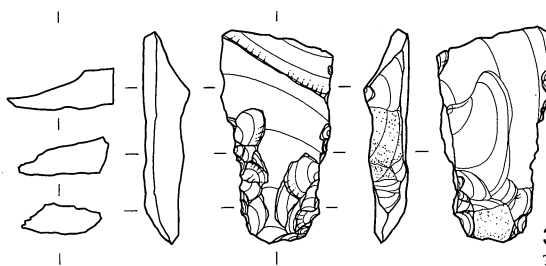

340  
Tr Ch  
BL2052 5g  
V a X-N 3003

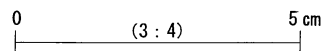

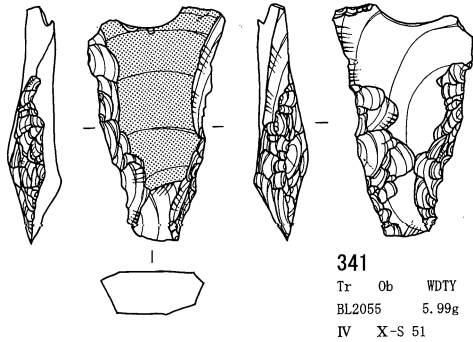

**341**  
Tr Ob WDTY  
BL2055 5.99g  
IV X-S 51

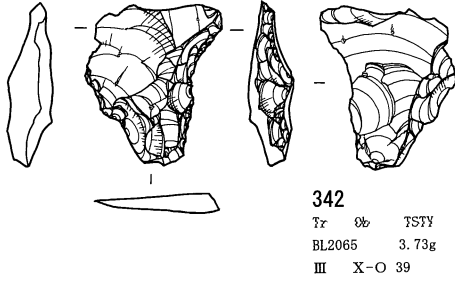

**342**  
Tr Ob TSTY  
BL2065 3.73g  
III X-O 39

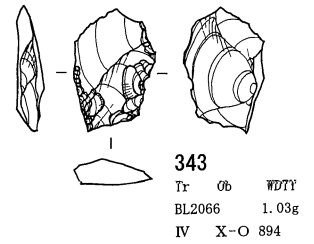

**343**  
Tr Ob WDTY  
BL2066 1.03g  
IV X-O 894

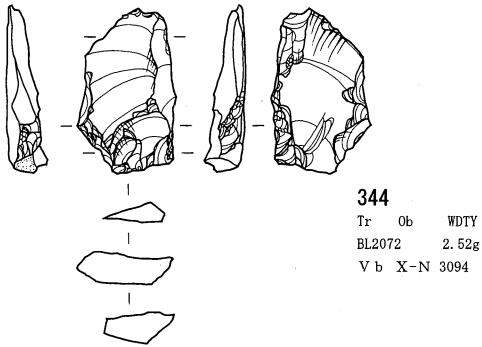

**344**  
Tr Ob WDTY  
BL2072 2.52g  
V b X-N 3094

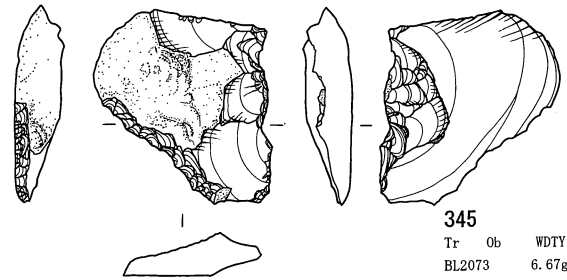

**345**  
Tr Ob WDTY  
BL2073 6.67g  
III X-N 1254

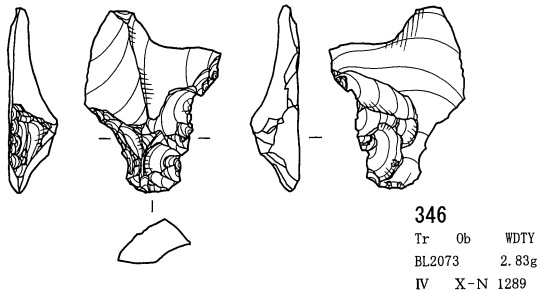

**346**  
Tr Ob WDTY  
BL2073 2.83g  
IV X-N 1289

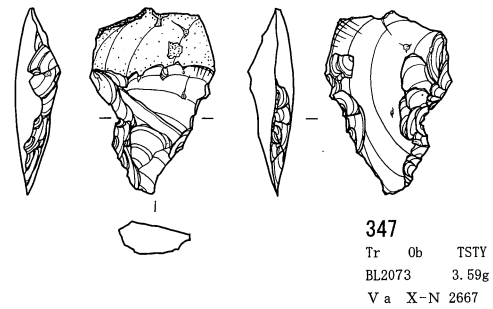

**347**  
Tr Ob TSTY  
BL2073 3.59g  
V a X-N 2667

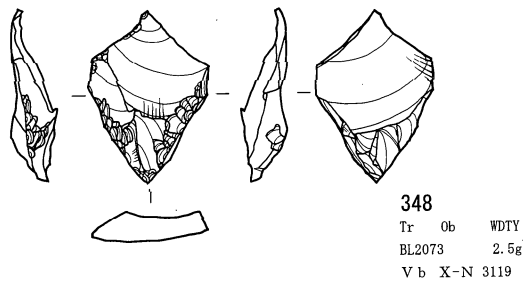

**348**  
Tr Ob WDTY  
BL2073 2.5g  
V b X-N 3119

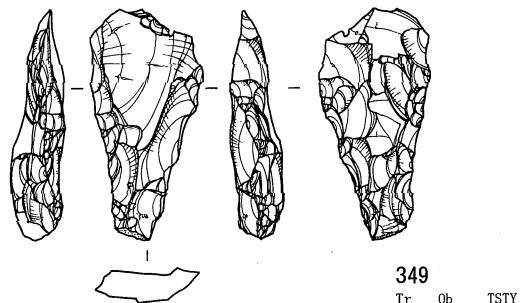

**349**  
Tr Ob TSTY  
BL2073 4.79g  
V a X-N 3090

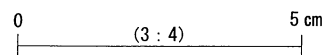

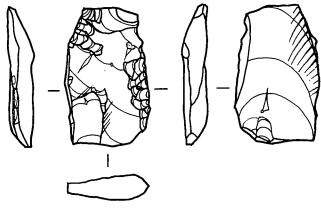

350  
Tr Ob TSTY  
BL2075 1.7g  
V b X-N 3319

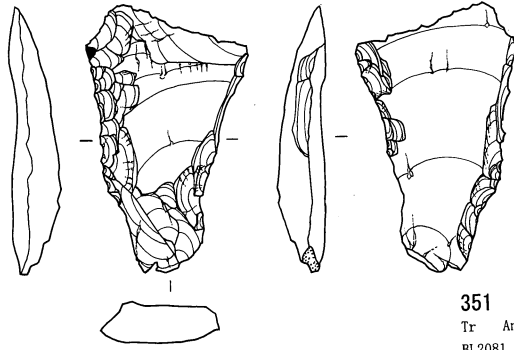

351  
Tr An  
BL2081 7.81g  
V a X-O 581

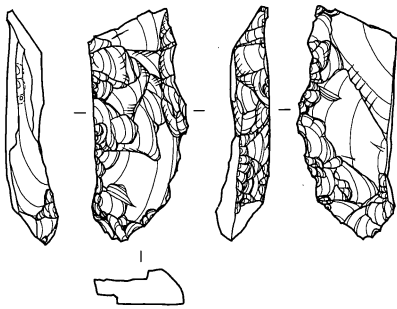

352  
Tr Ob WDTY  
BL2083 4.7g  
III X-O 304

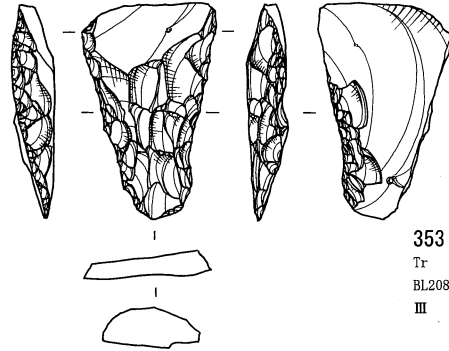

353  
Tr Ob WDTY  
BL2084 5.34g  
III X-N 345

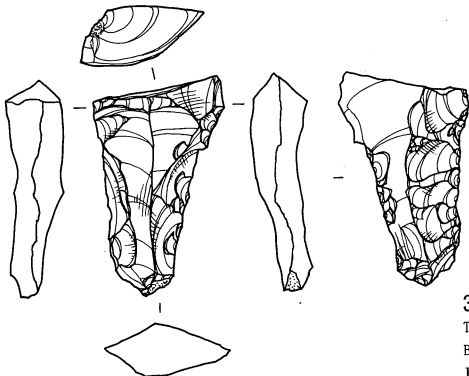

354  
Tr Ob WDTY  
BL2089 6.1g  
III X-O 7

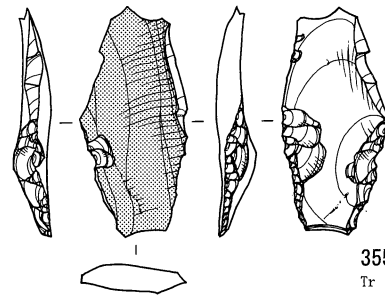

355  
Tr Ob WDTY  
BL2089 3.64g  
III X-O 193

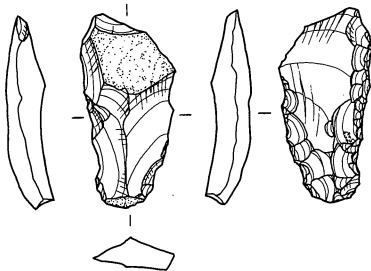

356  
Tr Ob WDTY  
BL2091 2.99g  
III X-J 138

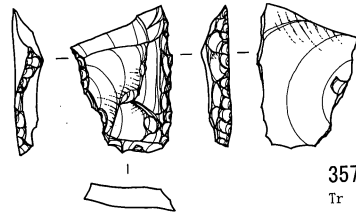

357  
Tr Ag  
BL2092 2.08g  
III X-J 87

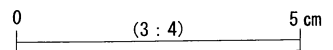

第2地点 石器実測図 19 (台形石器 4) (貫ノ木遺跡)

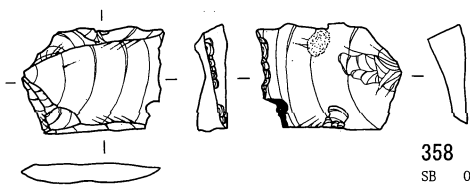

358  
SB Ob SWHD  
BL2006 2.02g  
V c X-D 104

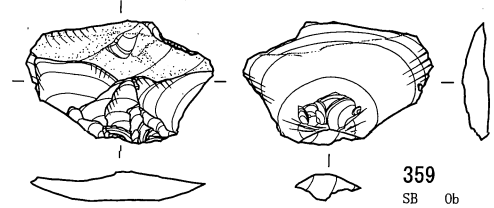

359  
SB Ob SWHD  
BL2007 2.6g  
V b X-D 99

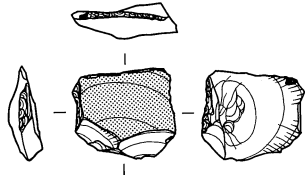

360  
SB Ob SWHD  
BL2019 1.17g  
V a X-H 722

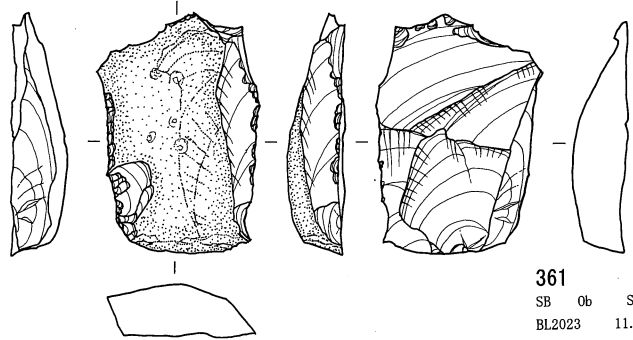

361  
SB Ob SWHD  
BL2023 11.42g  
IV X-H 551

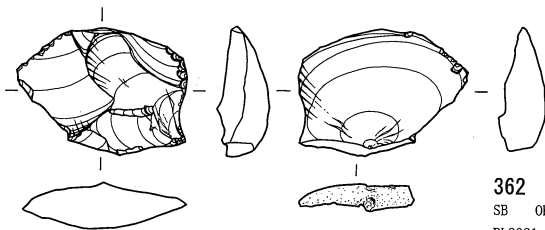

362  
SB Ob SWHD  
BL2021 3.76g  
IV X-H 61

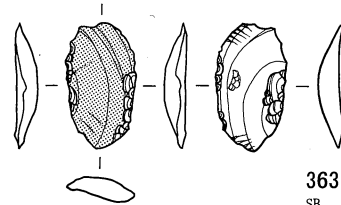

363  
SB Ob WDTM  
BL2031 0.83g  
V a X-M 1116

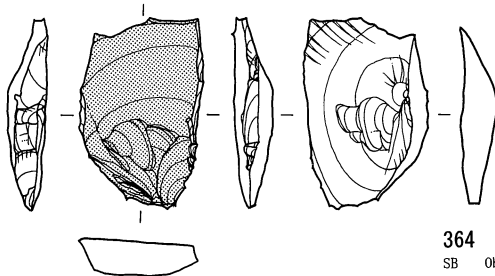

364  
SB Ob SWHD  
BL2031 4.46g  
IV X-M 1468

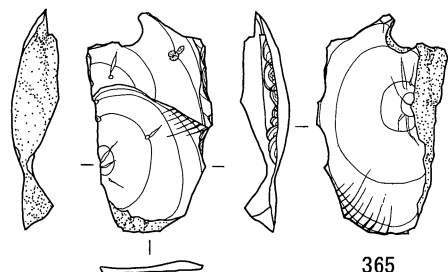

365  
SB Ob WDTY  
BL2076 4.23g  
V a X-N 3175

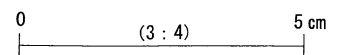

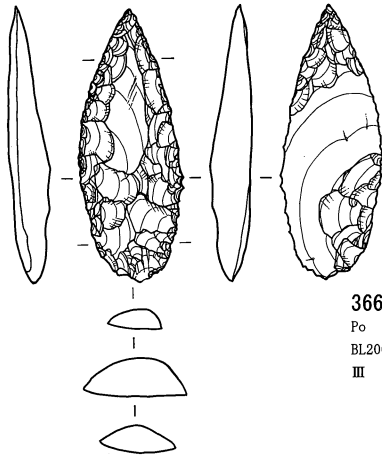

366  
Po SS  
BL2001 4.9g  
III X-H 3

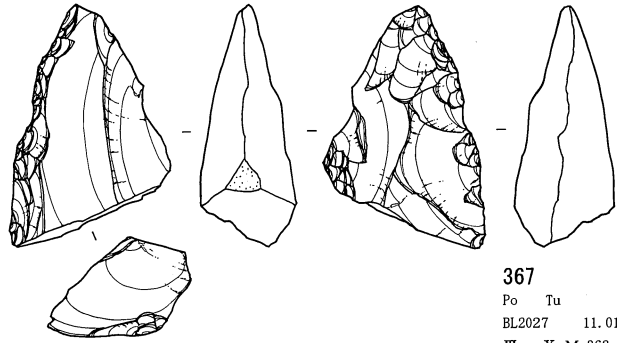

367  
Po Tu  
BL2027 11.01g  
III X-M 362

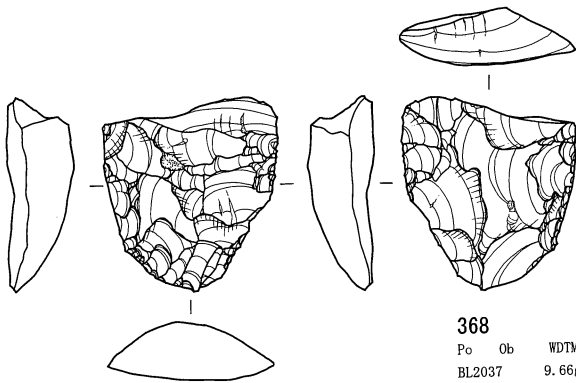

368  
Po Ob WDTM  
BL2037 9.66g  
III X-M 648

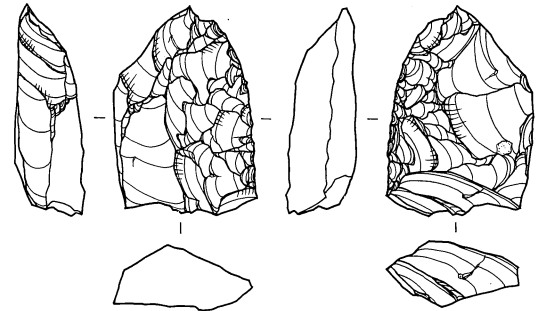

369  
Po Ob WDTM  
BL2037 9.41g  
III X-M 245

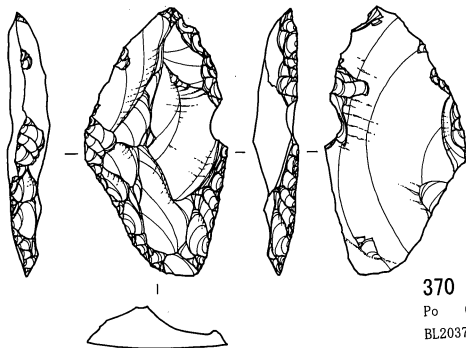

370  
Po Ch  
BL2037 7.1g  
IV X-M 610

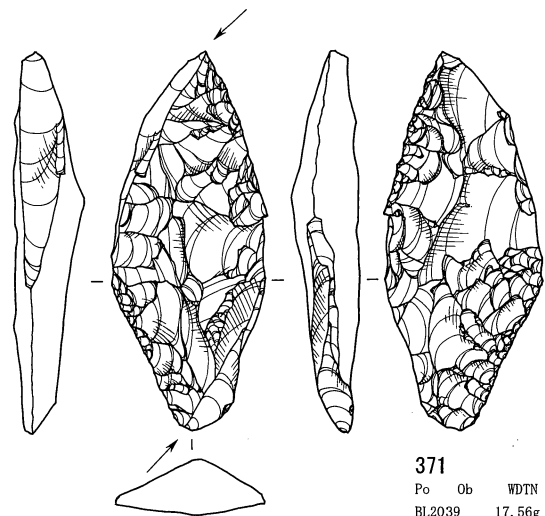

371  
Po Ob WDTN  
BL2039 17.56g  
III X-N 1140

0 (3 : 4) 5 cm

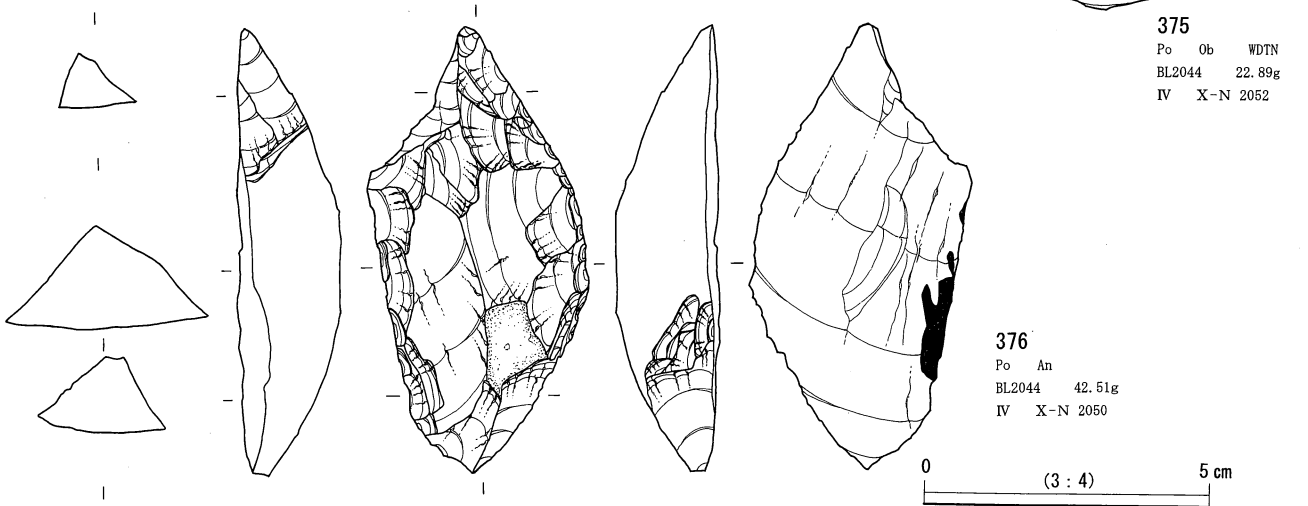
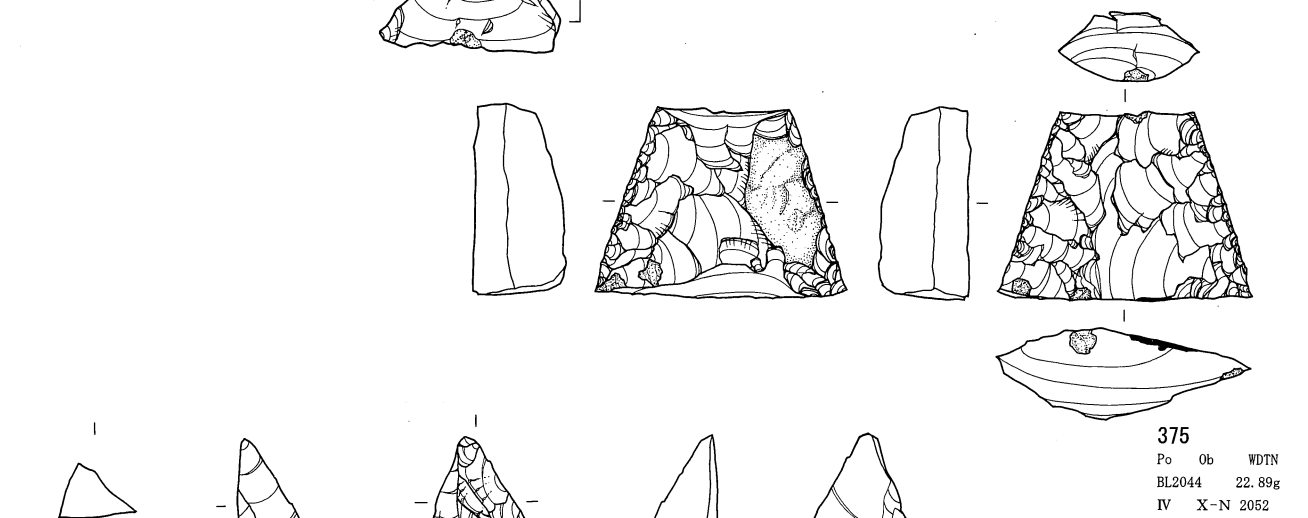
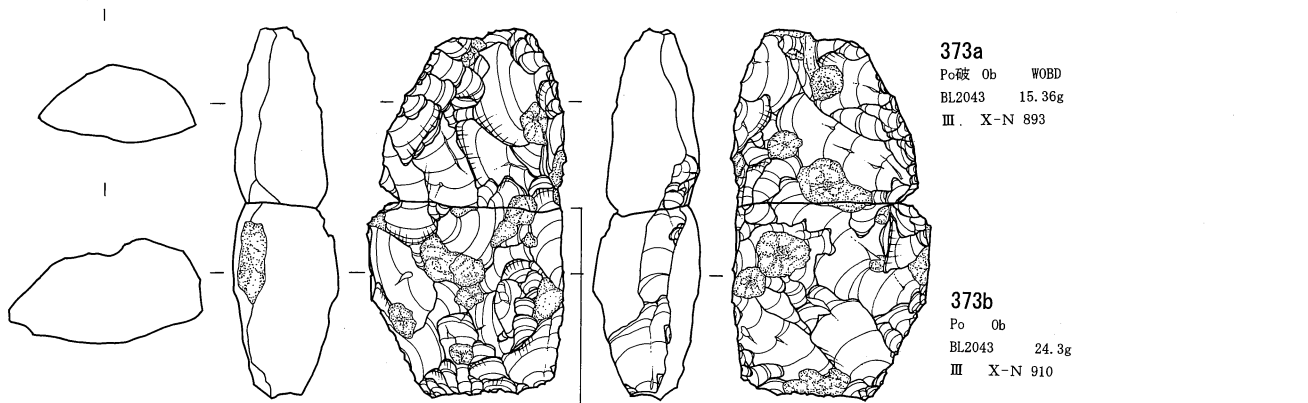
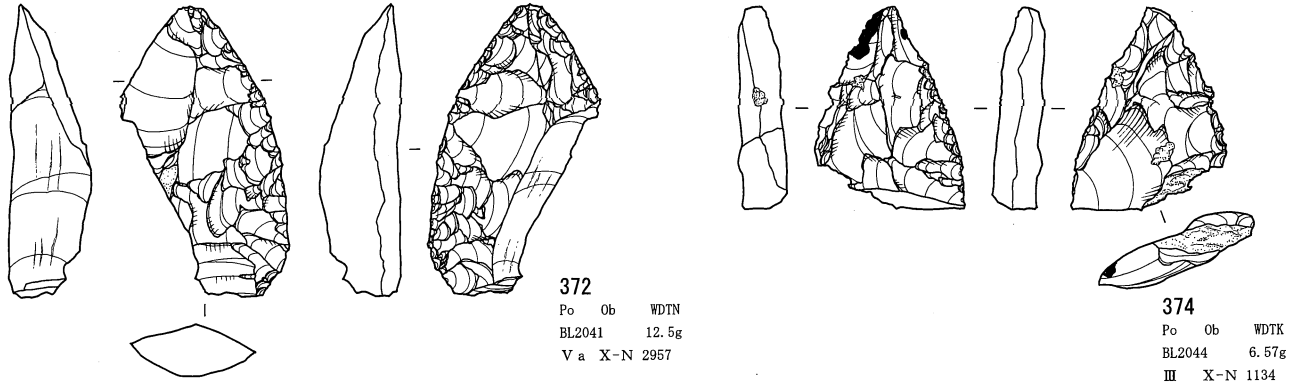

第2地点 石器実測図 22 (槍先形尖頭器 2) (貫ノ木遺跡)

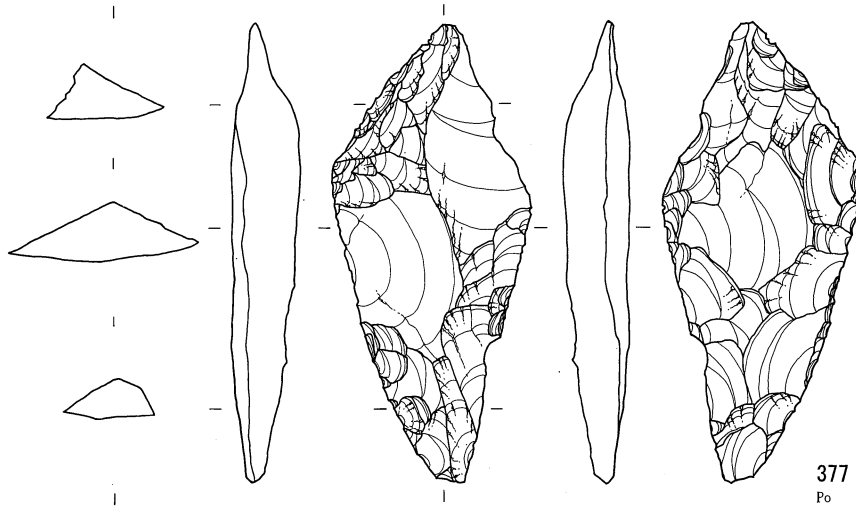

377  
Po An  
BL2045 24.15g  
III X-M 741

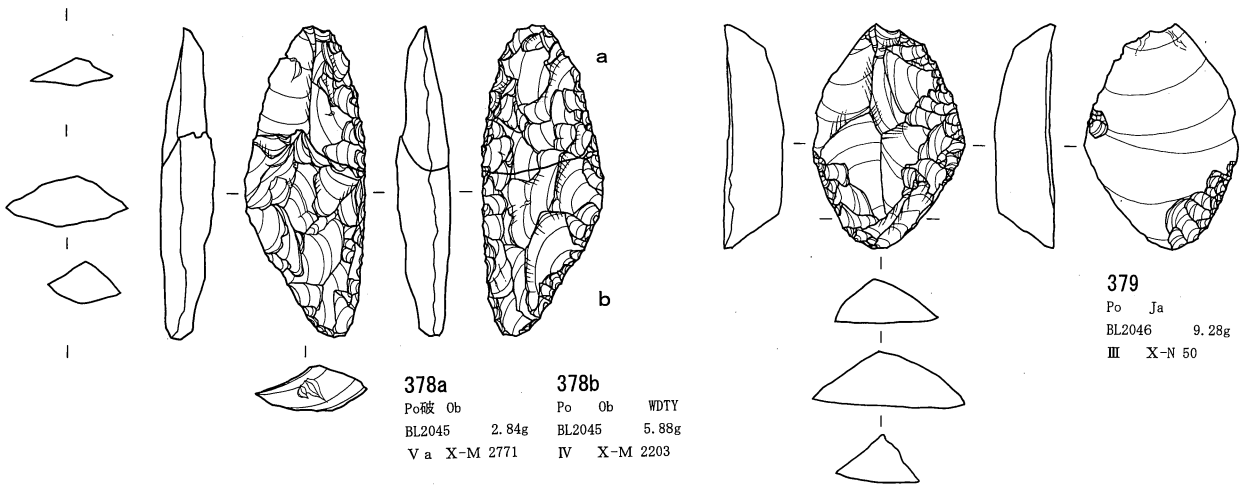

378a  
Po破 Ob  
BL2045 2.84g  
V a X-M 2771

378b  
Po Ob WDTY  
BL2045 5.88g  
IV X-M 2203

379  
Po Ja  
BL2046 9.28g  
III X-N 50

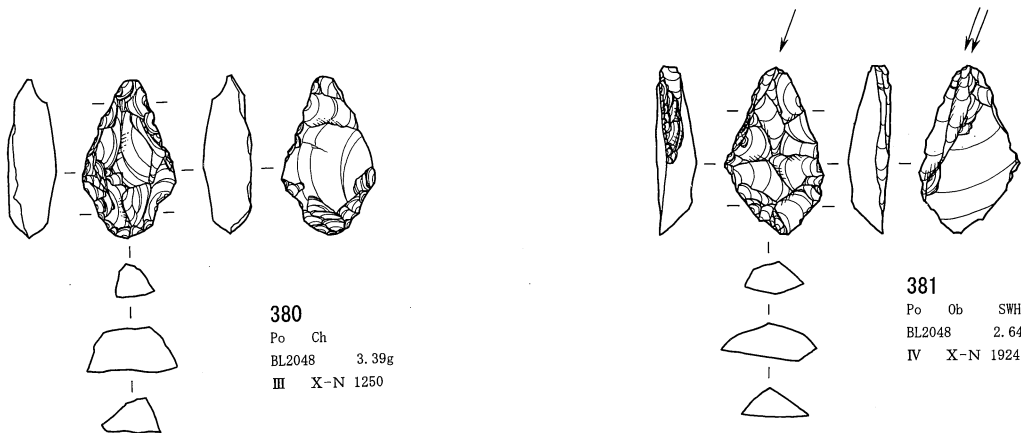

380  
Po Ch  
BL2048 3.39g  
III X-N 1250

381  
Po Ob SWHD  
BL2048 2.64g  
IV X-N 1924

0 (3 : 4) 5 cm

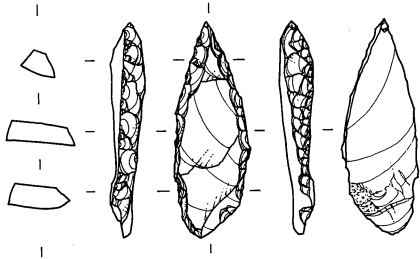

382  
Po Ja  
BL2050 2.07g  
IV X-S 548

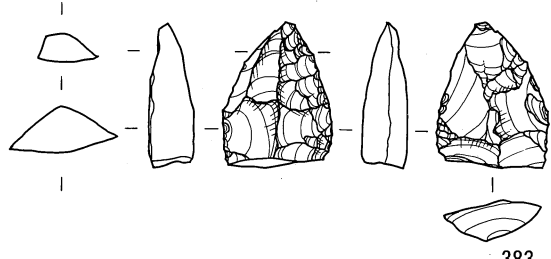

383  
Po Ob SWHD  
BL2050 3.27g  
V a X-S 622

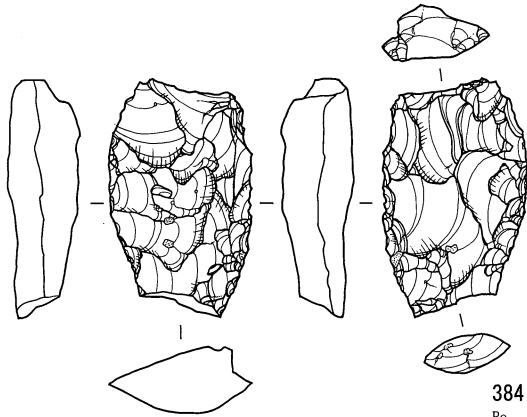

384  
Po Ob WOTM  
BL2052 11.9g  
III X-N 3060

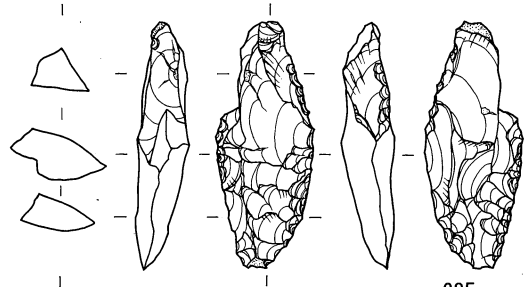

385  
Po Ob TSTY  
BL2055 5.06g  
V a X-S 652

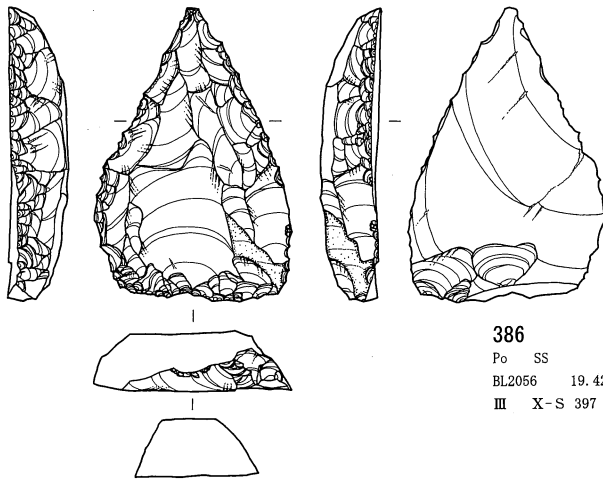

386  
Po SS  
BL2056 19.42g  
III X-S 397

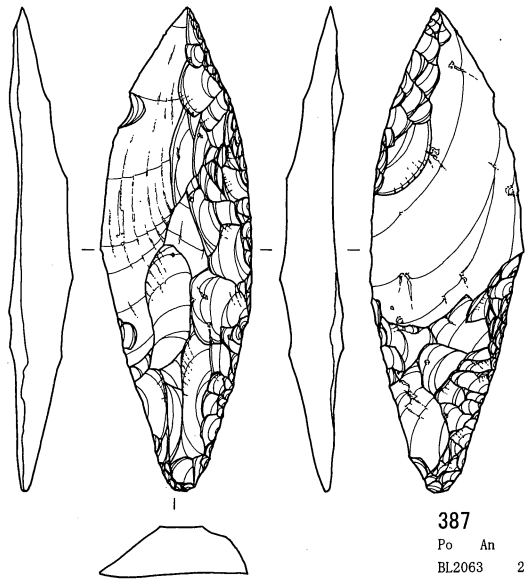

387  
Po An  
BL2063 21.19g  
III X-N 793

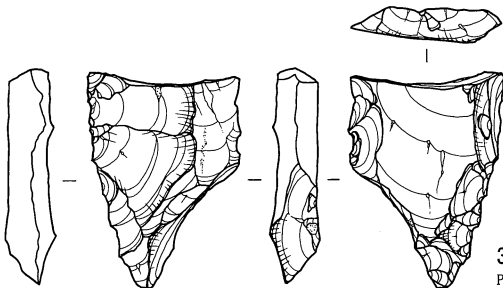

388  
Po Ob TSTY  
BL2072 7.2g  
IV X-N 1290

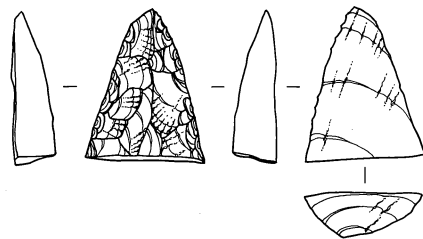

389  
Po An  
BL2063 3.4g  
III X-N 780

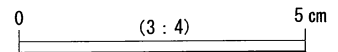

第2地点 石器実測図 24 (槍先形尖頭器 4) (貫ノ木遺跡)



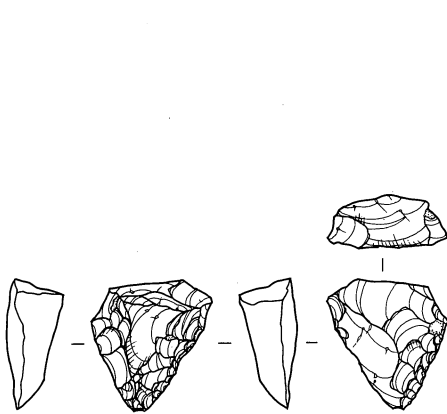

390  
Po Ob WOTM  
BL2075 3.55g  
III X-N 1235

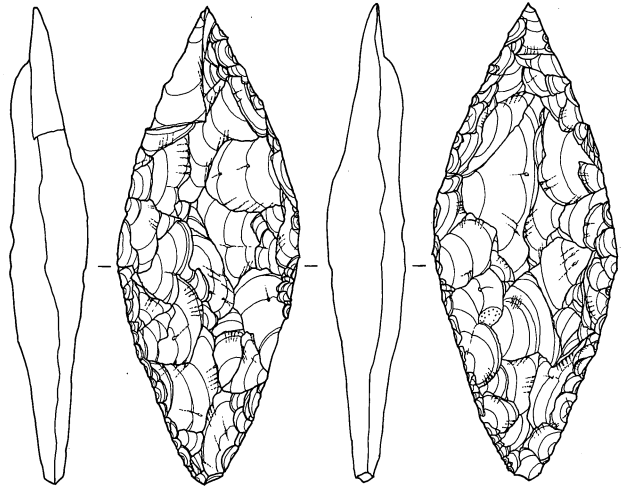

391  
Po An  
BL2086 27.4g  
IV X-I 627

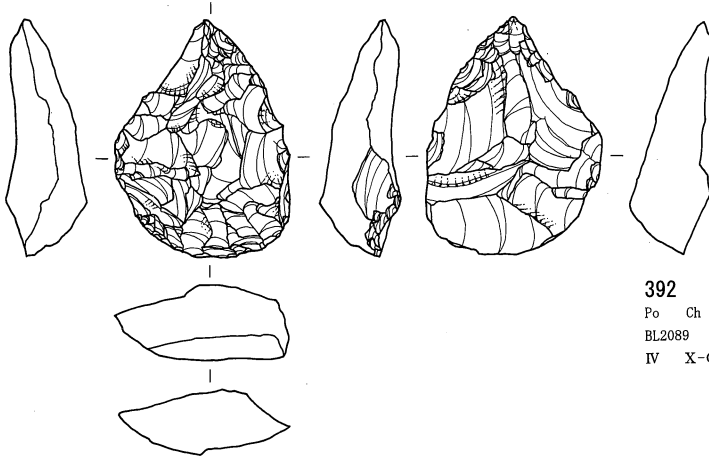

392  
Po Ch  
BL2089 14.53g  
IV X-O 381

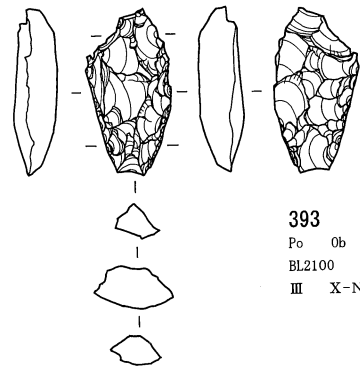

393  
Po Ob SWHD  
BL2100 2.91g  
III X-N 3193

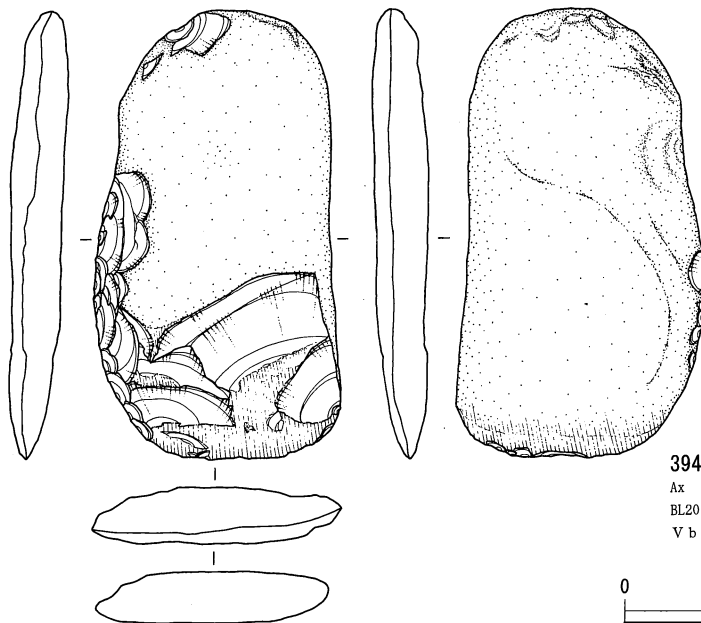

394  
Ax TS  
BL2011 49.32g  
V b X-I 710

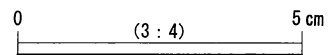

第2地点 石器実測図 25 (槍先形尖頭器 5・斧形石器 1) (貫ノ木遺跡)

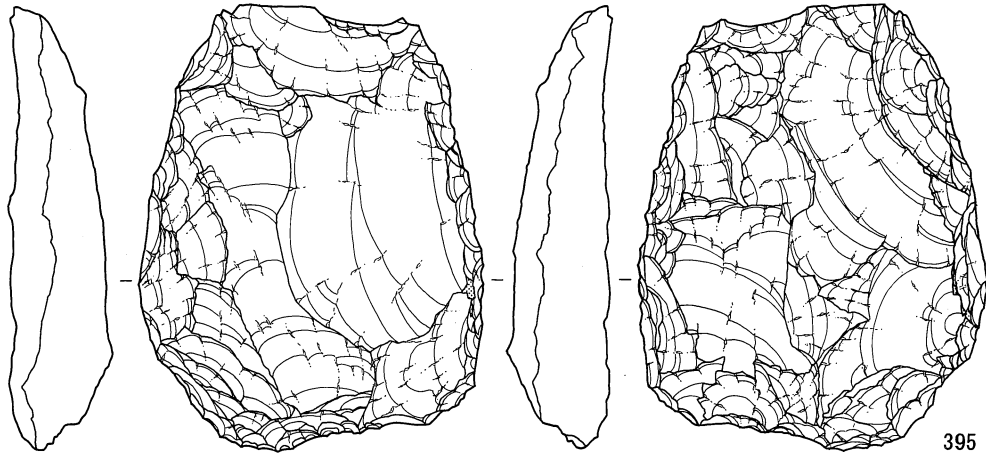

395  
Ax An  
BL2017 92.69g  
IV X-I 803

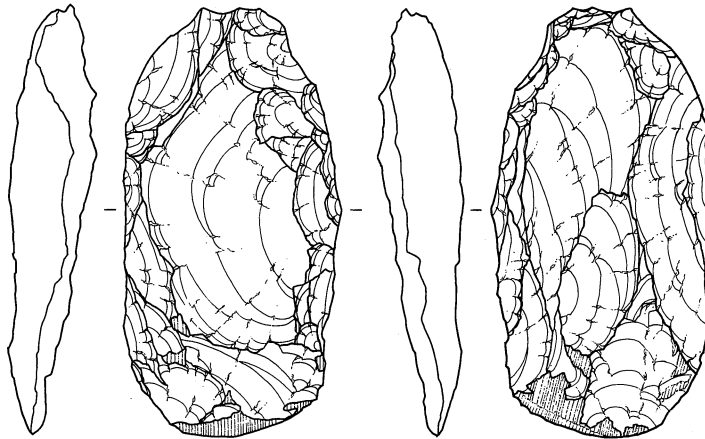

396  
Ax Se  
BL2030 42.46g  
V a X-M 465

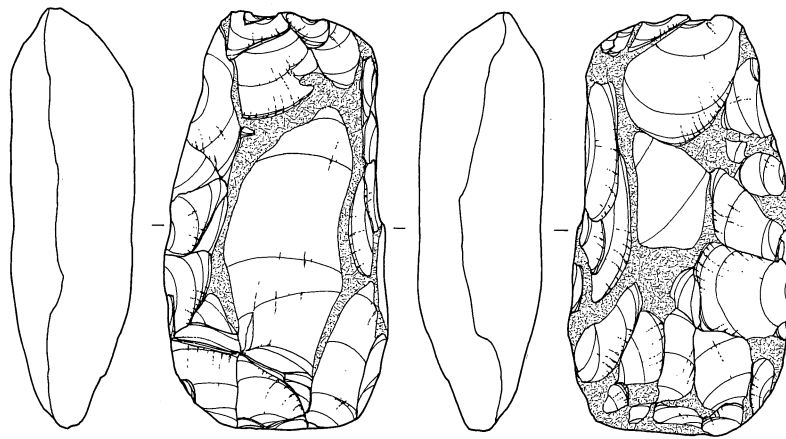

397  
Ax TS  
BL2047 75.56g  
III X-N 566

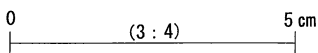

第2地点 石器実測図 26 (斧形石器 2) (貫ノ木遺跡)

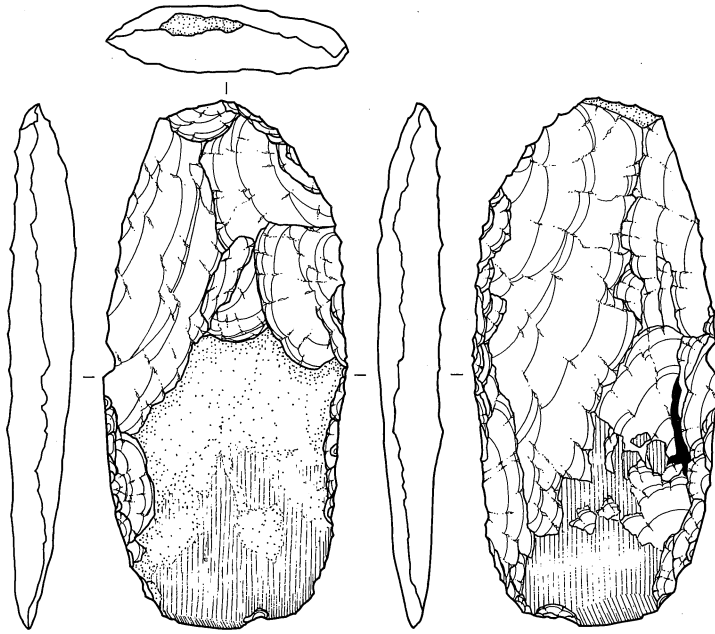

398  
 Ax Se  
 BL2059 52.51g  
 Va X-O 496

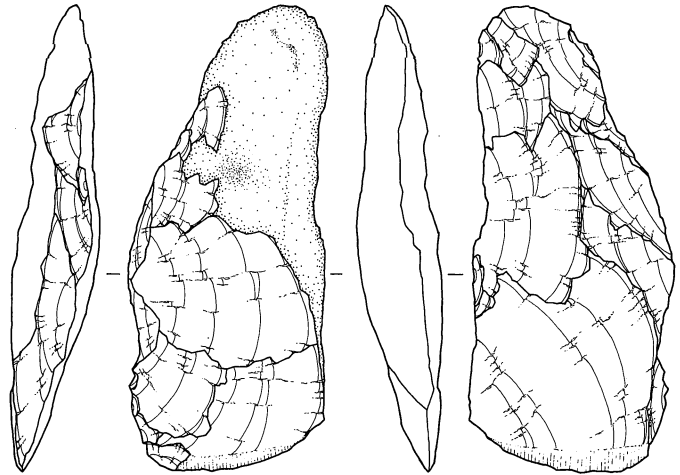
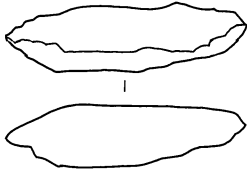

399  
 Ax Se  
 BL2074 45.85g  
 Vb X-N 2987

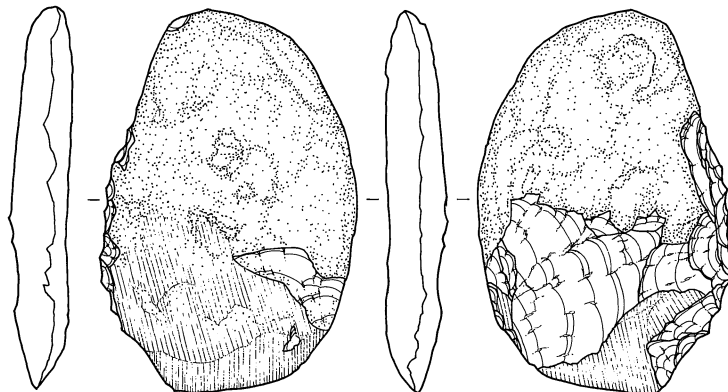
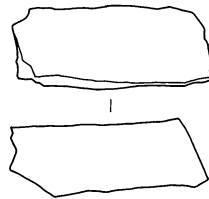

400  
 Ax Se  
 BL2080 40.88g  
 Va X-N 2706

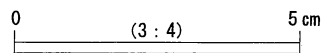
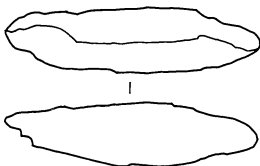

第2地点 石器実測図 27 (斧形石器 3) (貫ノ木遺跡)

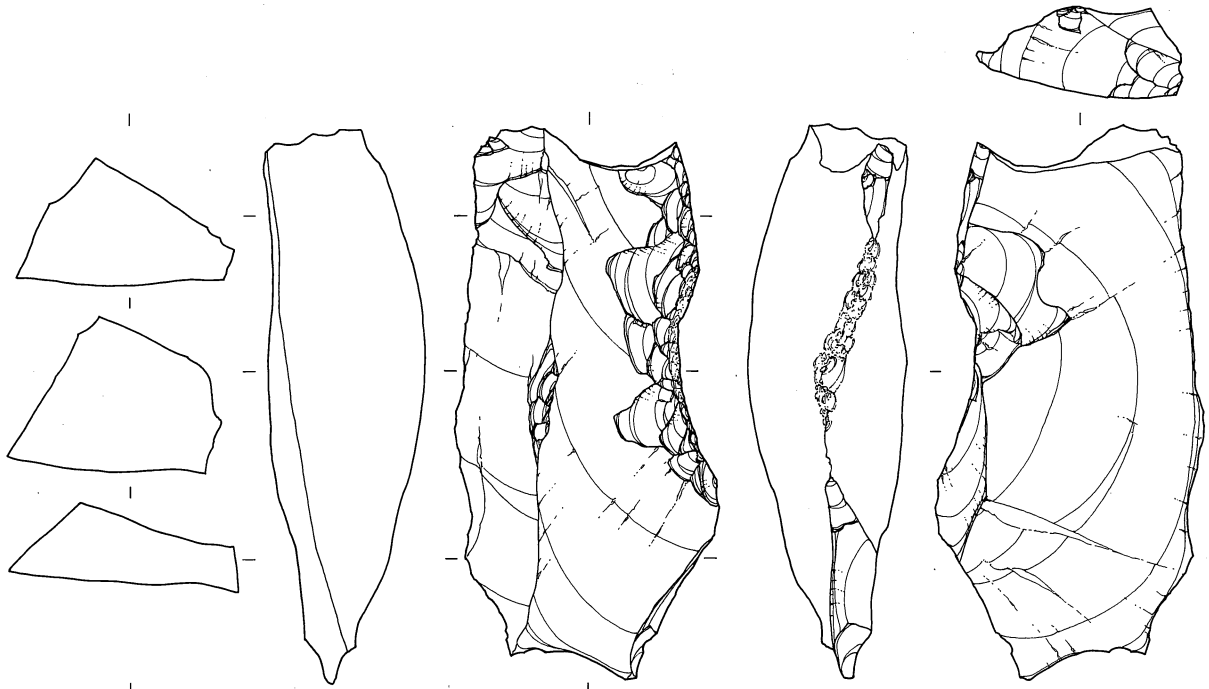

401  
Ax GT  
BL2083 117.25g  
V a X-O 910

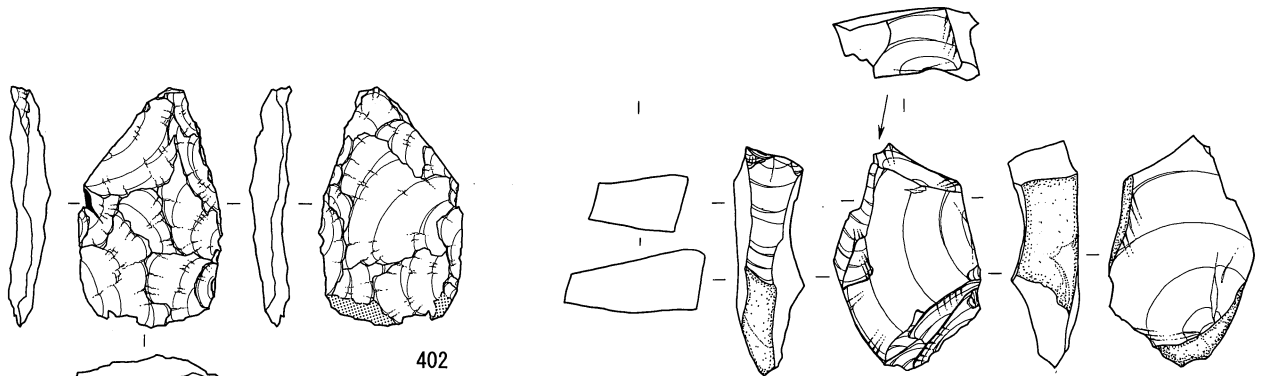

402  
Ax Se  
BL2100 7.14g  
V b X-N 3204

403  
Gr SS  
BL2046 11.55g  
IV X-M 2259

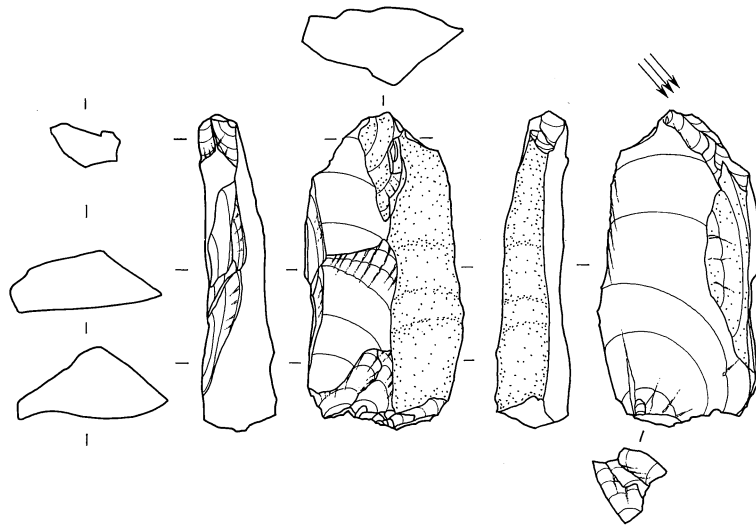

404  
Gr TS  
BL2048 19.67g  
IV X-N 1402

0 (3 : 4) 5 cm

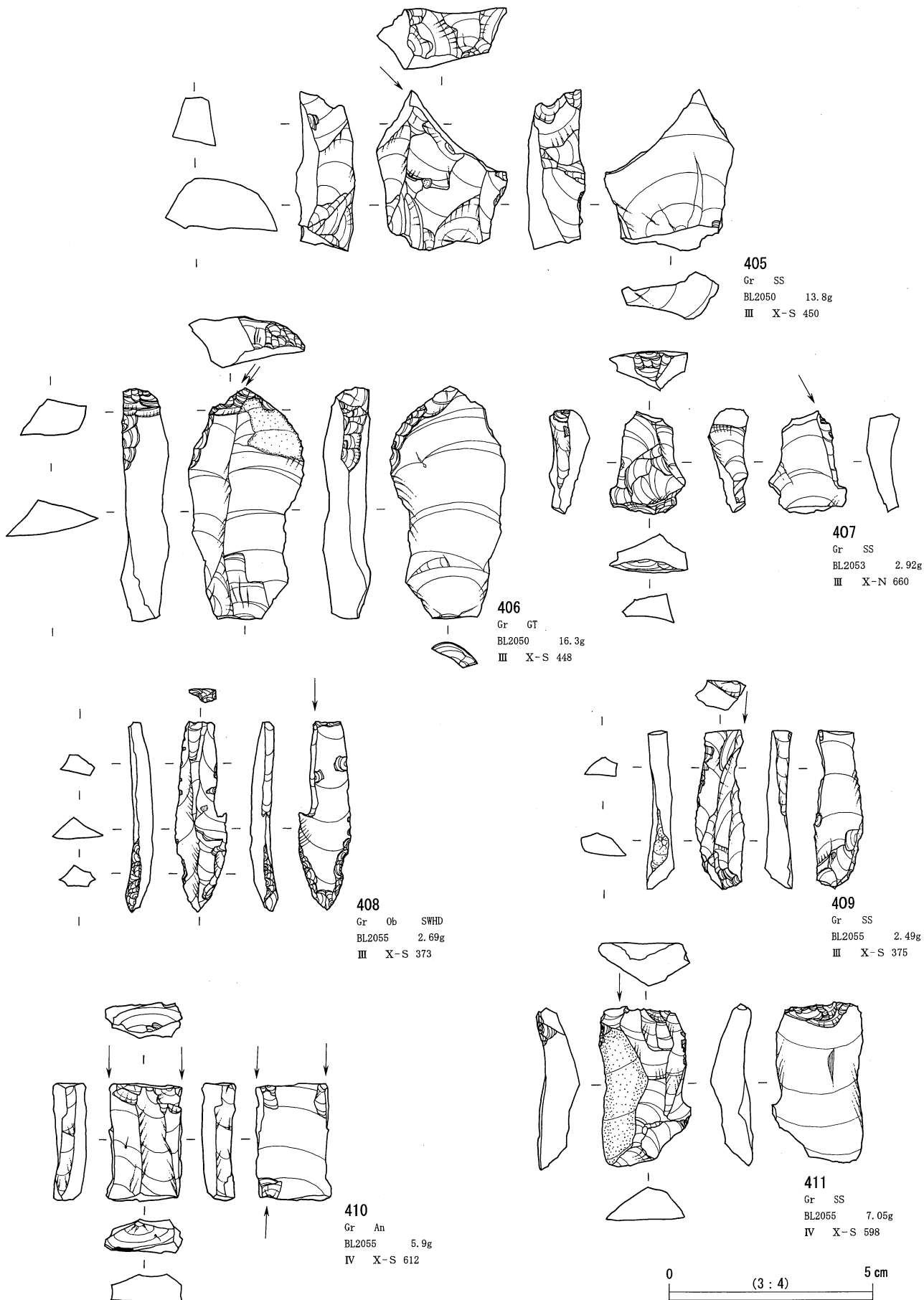

第2地点 石器実測図 29 (彫器 2) (貫ノ木遺跡)

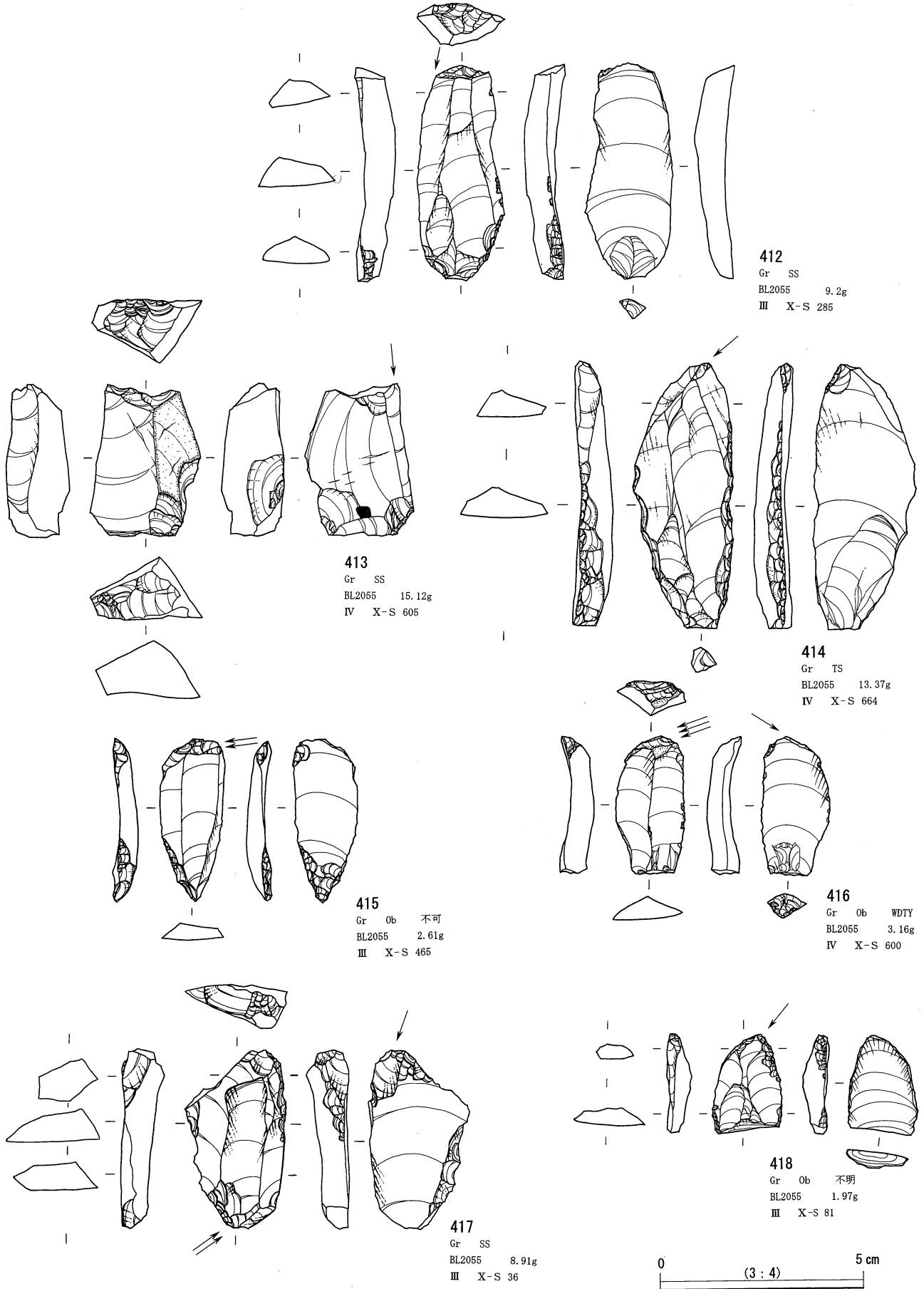

第2地点 石器実測図 30 (彫器 3) (貫ノ木遺跡)

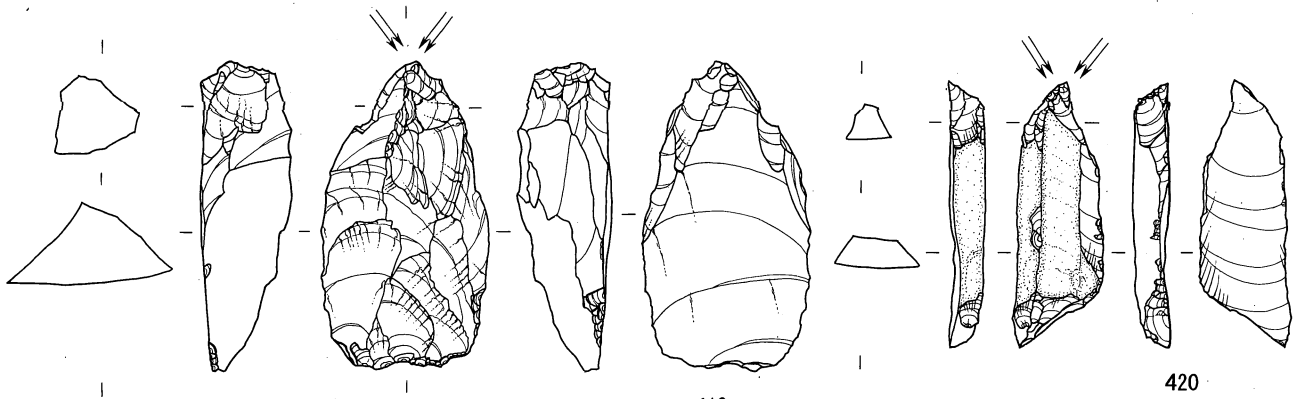

419  
Gr SS  
BL2055 22.89g  
III X-S 361

420  
Gr Ob 不可  
BL2055 4.9g  
III X-S 377

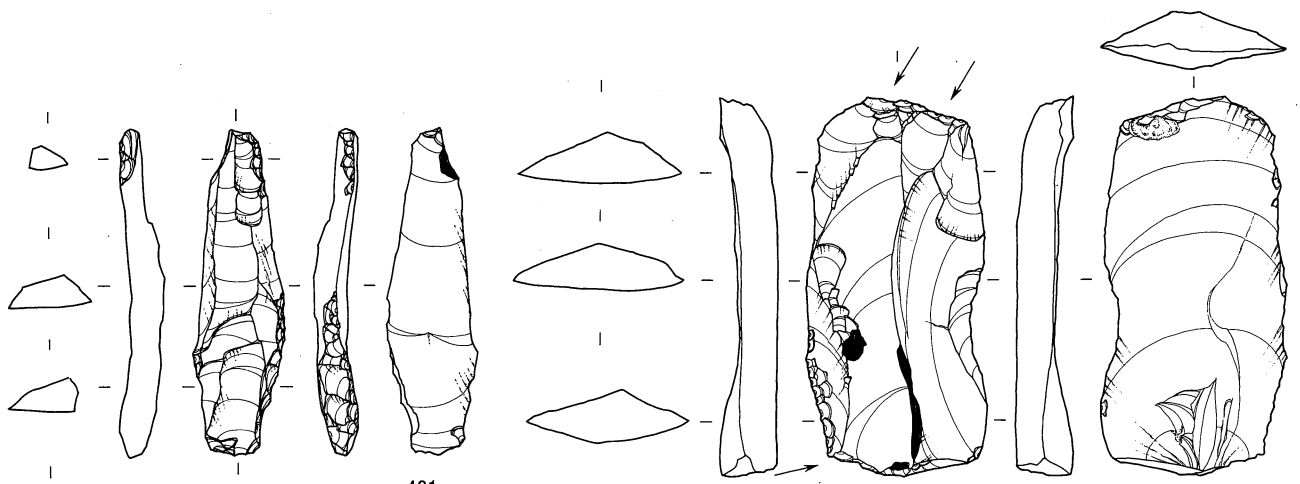

421  
Gr SS  
BL2056 4.22g  
IV X-T 330

422  
Gr SS  
BL2056 23.22g  
Va X-S 645

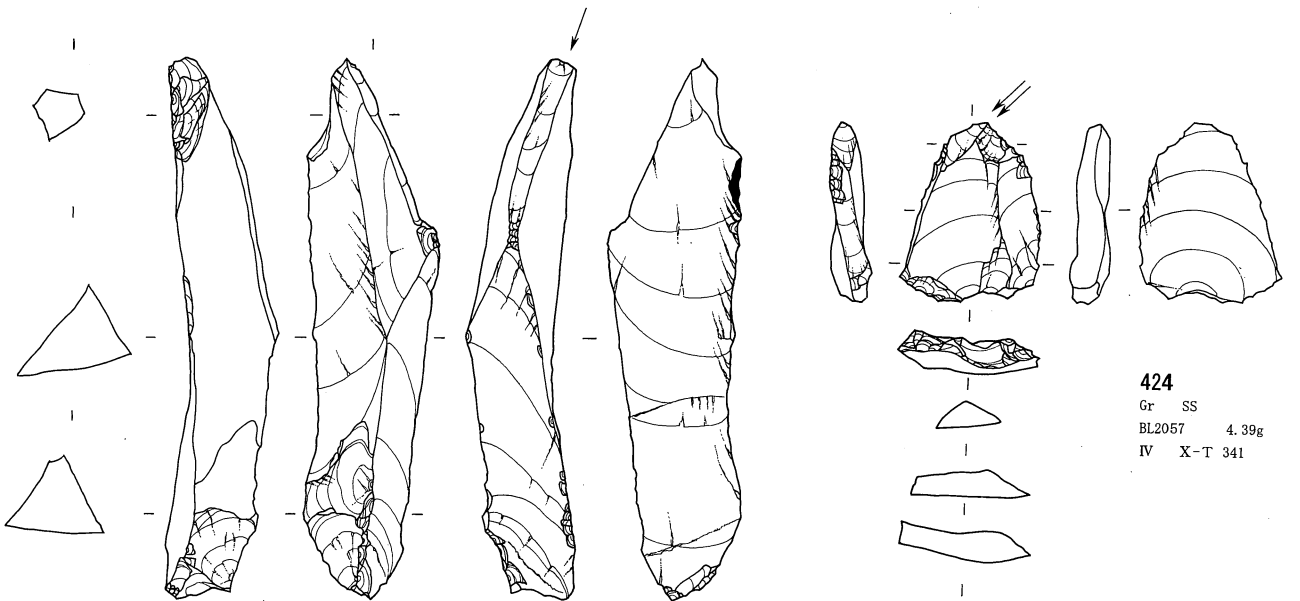

423  
Gr SS  
BL2057 26.03g  
III X-T 307

424  
Gr SS  
BL2057 4.39g  
IV X-T 341

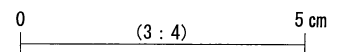

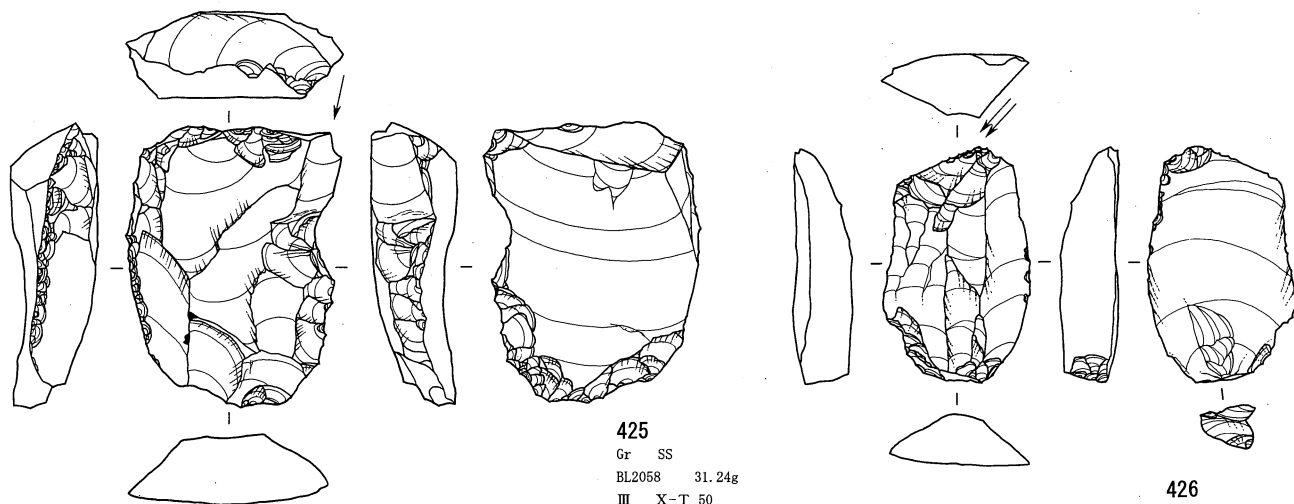

425  
Gr SS  
BL2058 31.24g  
III X-T 50

426  
Gr SS  
BL2058 10.45g  
Va X-T 357



427  
Gr SS  
BL2058 19.32g  
III X-T 326

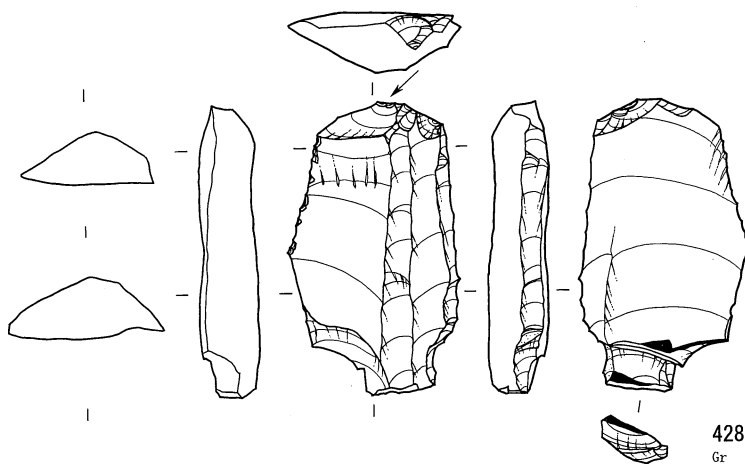

428  
Gr Tu  
BL2059 16.41g  
III X-T 389

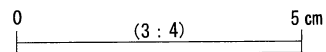



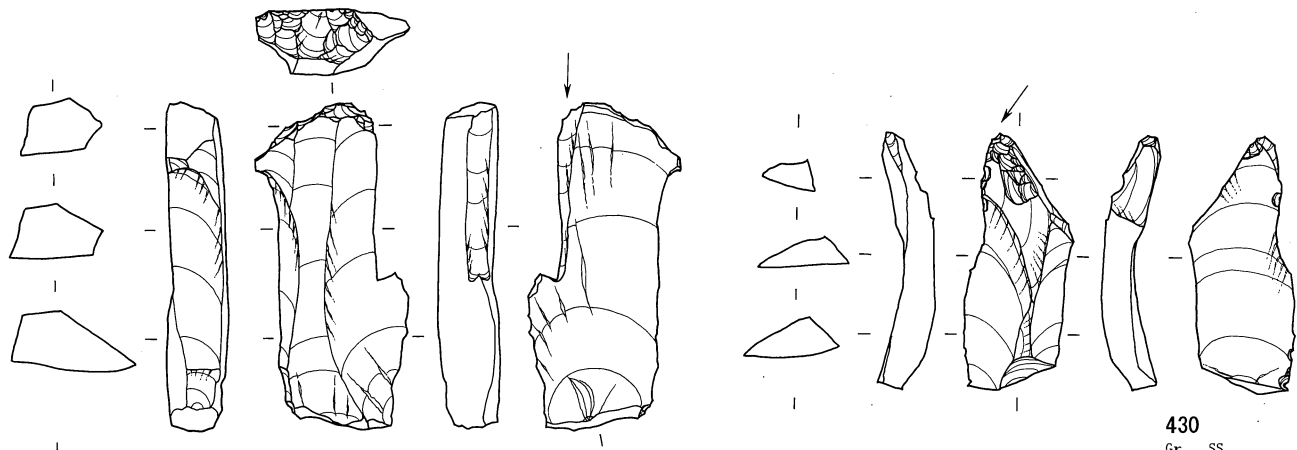

429  
Gr TS  
BL2060 15.71g  
III X-T 176

430  
Gr SS  
BL2060 4.87g  
III X-T 82

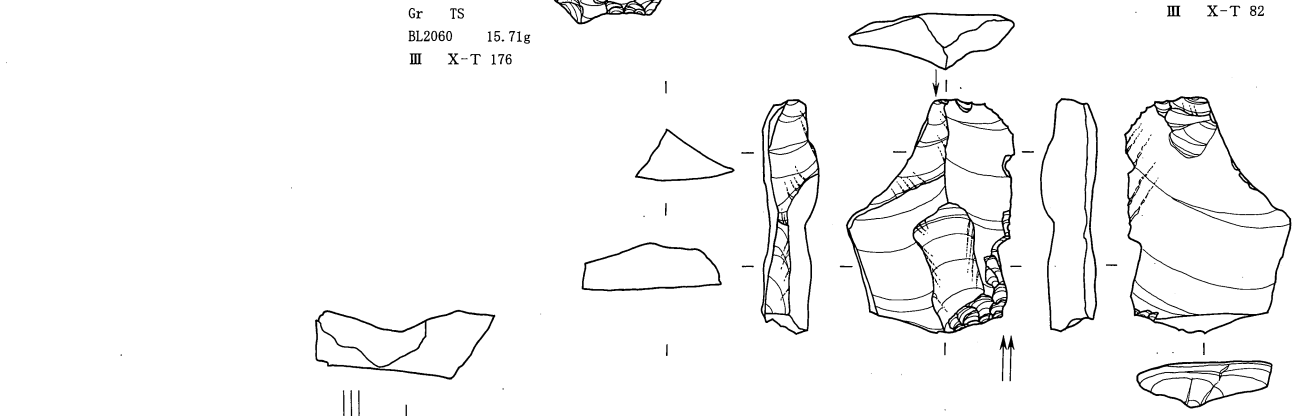

431  
Gr TS  
BL2060 8.46g  
III X-T 181

432  
Gr SS  
BL2060 15.29g  
III X-T 380

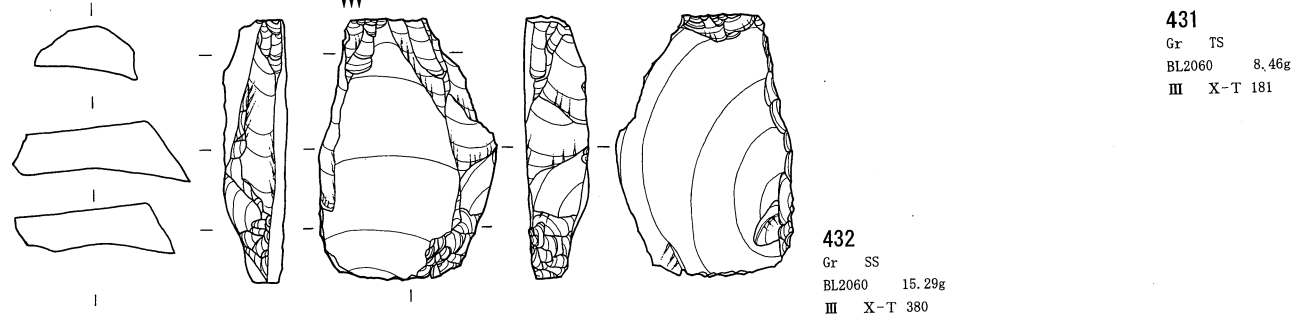

433  
Gr SS  
BL2060 20.15g  
IV X-T 404

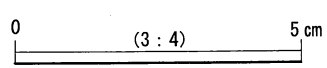

第2地点 石器実測図 33 (彫器 6) (貫ノ木遺跡)

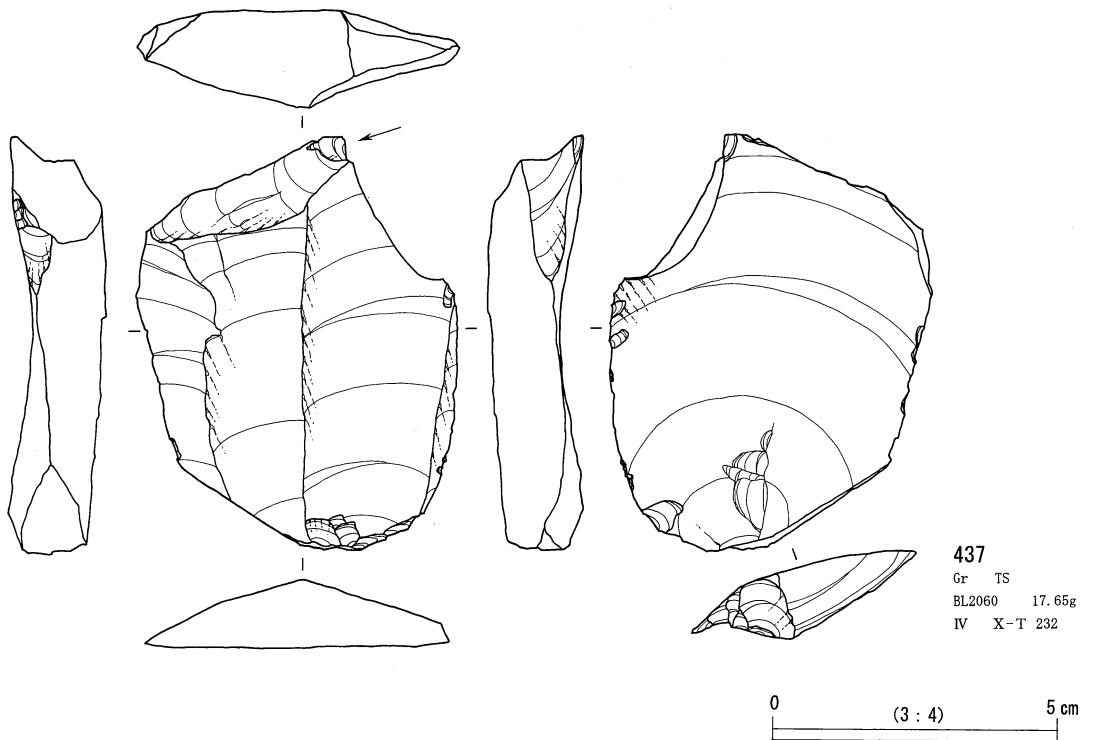
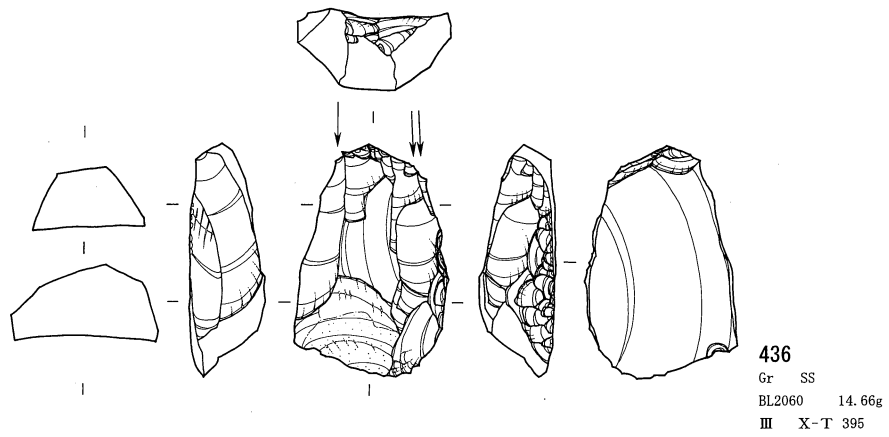
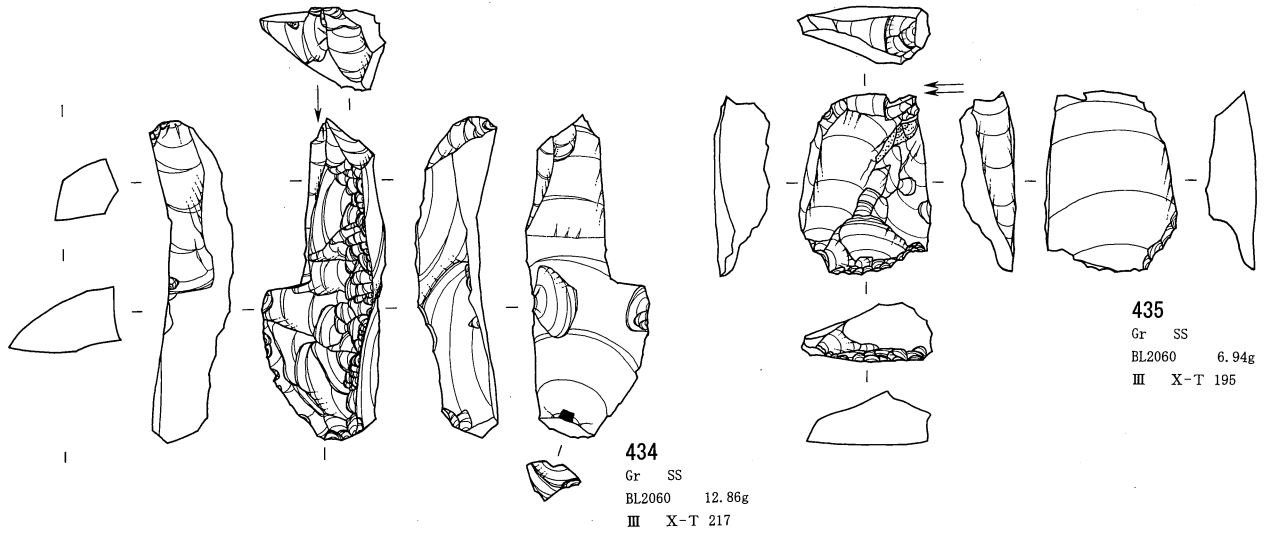

第2地点 石器実測図 34 (彫器7) (貫ノ木遺跡)

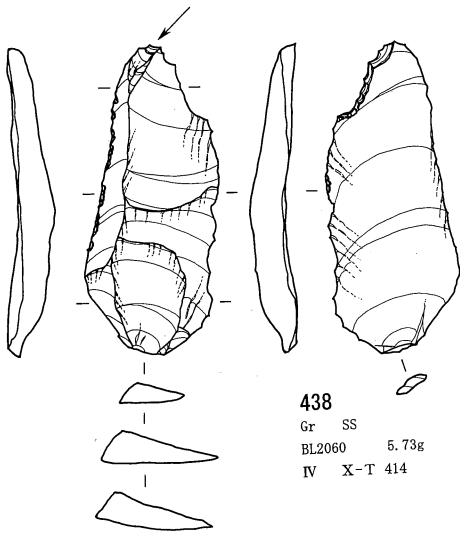

438  
Gr SS  
BL2060 5.73g  
IV X-T 414

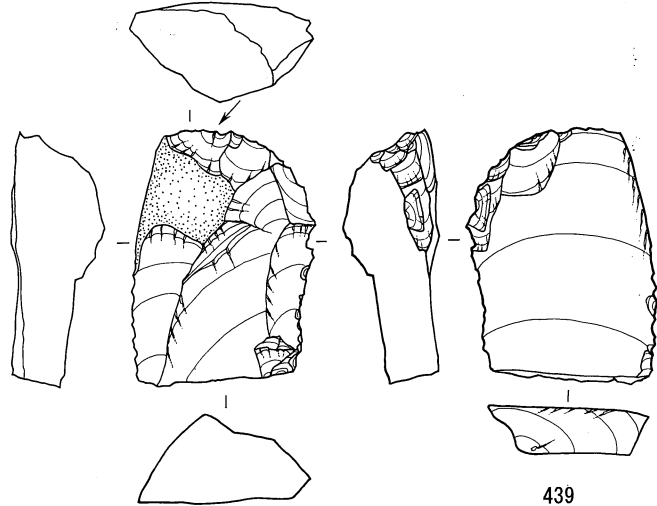

439  
Gr TS  
BL2060 21.25g  
III X-T 220

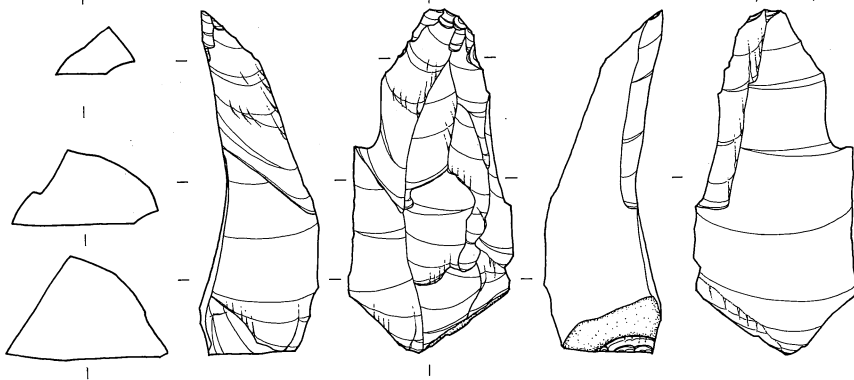

440  
Gr GT  
BL2060 27.13g  
III X-T 191

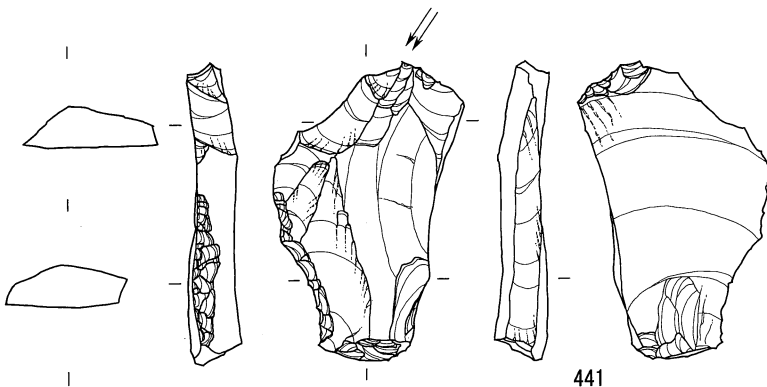

441  
Gr SS  
BL2060 14.45g  
III X-T 385

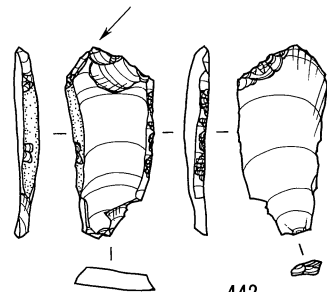

442  
Gr Ob WDTY  
BL2060 1.43g  
III X-T 196

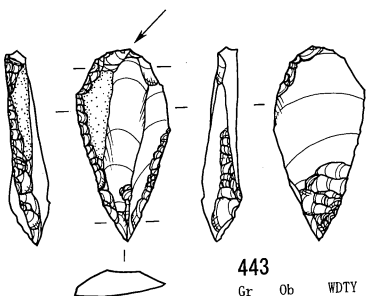

443  
Gr Ob WDTY  
BL2060 2.51g  
III X-T 717

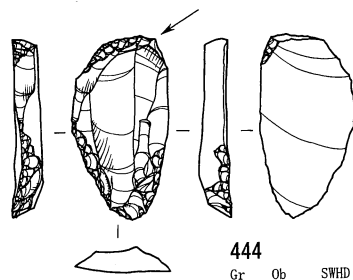

444  
Gr Ob SWHD  
BL2060 3.02g  
III X-T 708

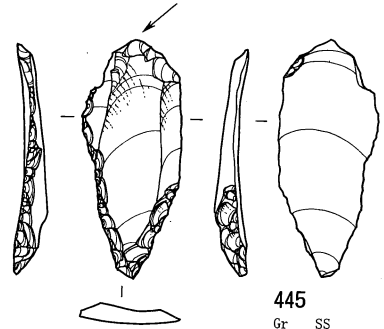

445  
Gr SS  
BL2060 2.42g  
IV X-T 400

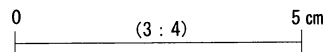



446  
Gr TS  
BL2061 23.87g  
III X-T 74

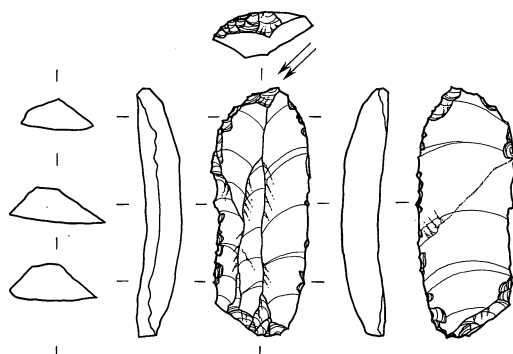

447  
Gr Ch  
BL2061 4.98g  
III X-T 627

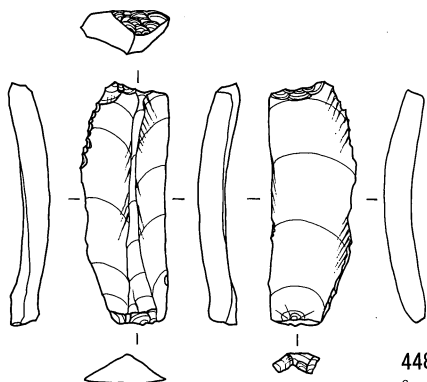

448  
Gr SS  
BL2061 3.13g  
IV上 X-T 21

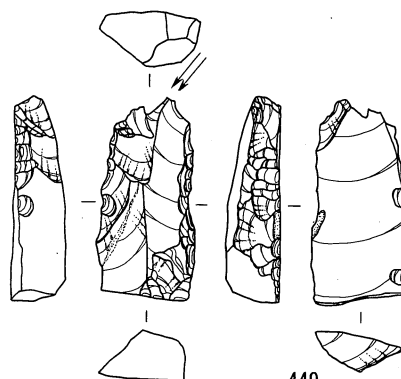

449  
Gr SS  
BL2061 6.24g  
IV X-T 165

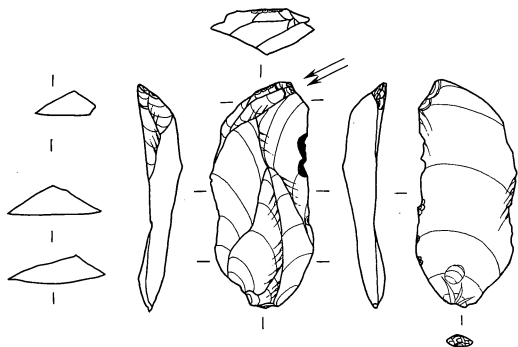

450  
Gr Ob WDTY  
BL2062 3.33g  
III X-T 725

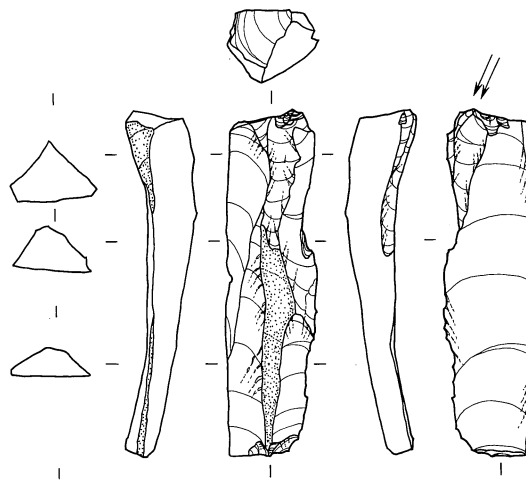

451  
Gr SS  
BL2062 8.12g  
IV X-T 699

0 (3 : 4) 5 cm

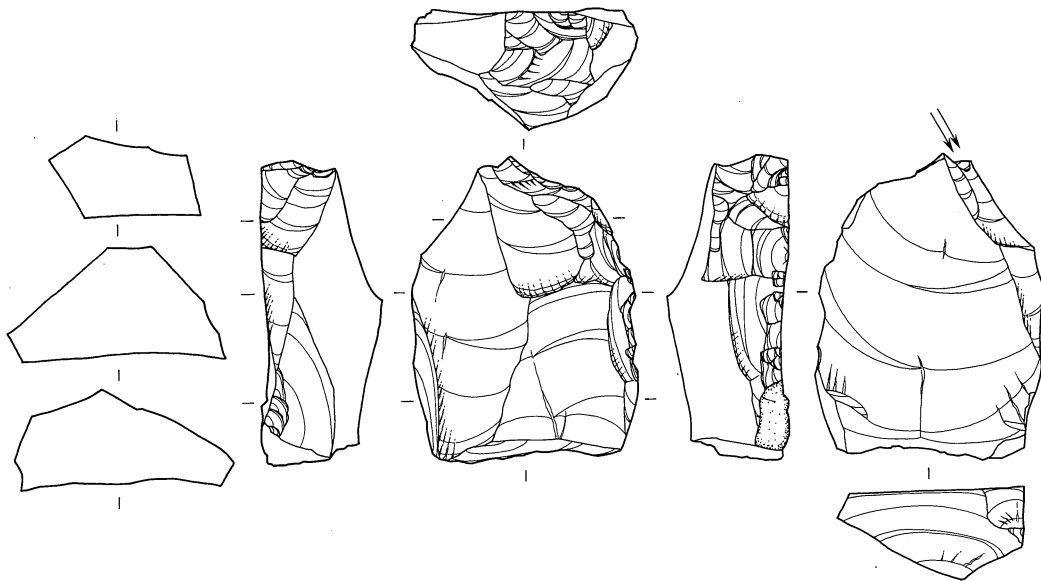

452  
Gr Tu  
BL2062 44.42g  
IV X-O 878

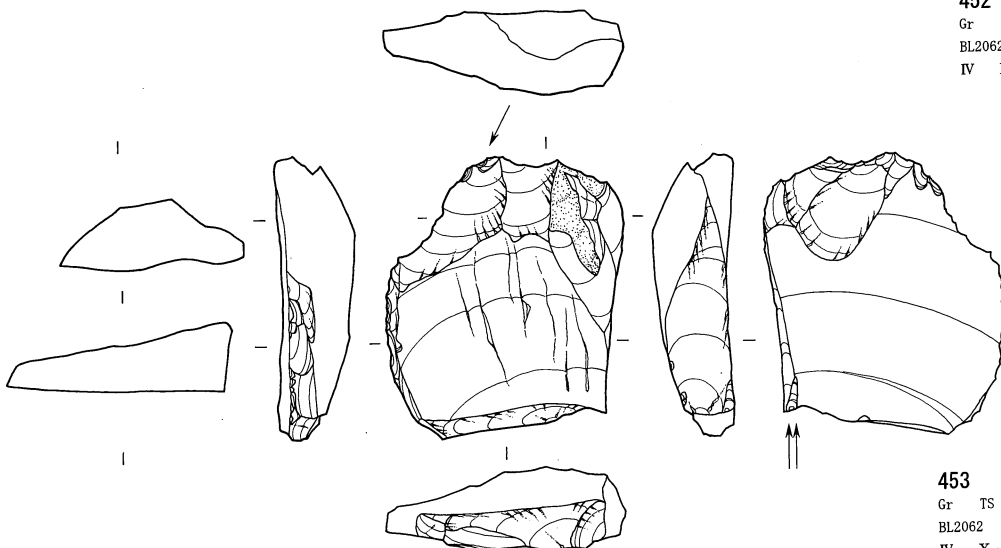

453  
Gr TS  
BL2062 27.87g  
IV X-T 446

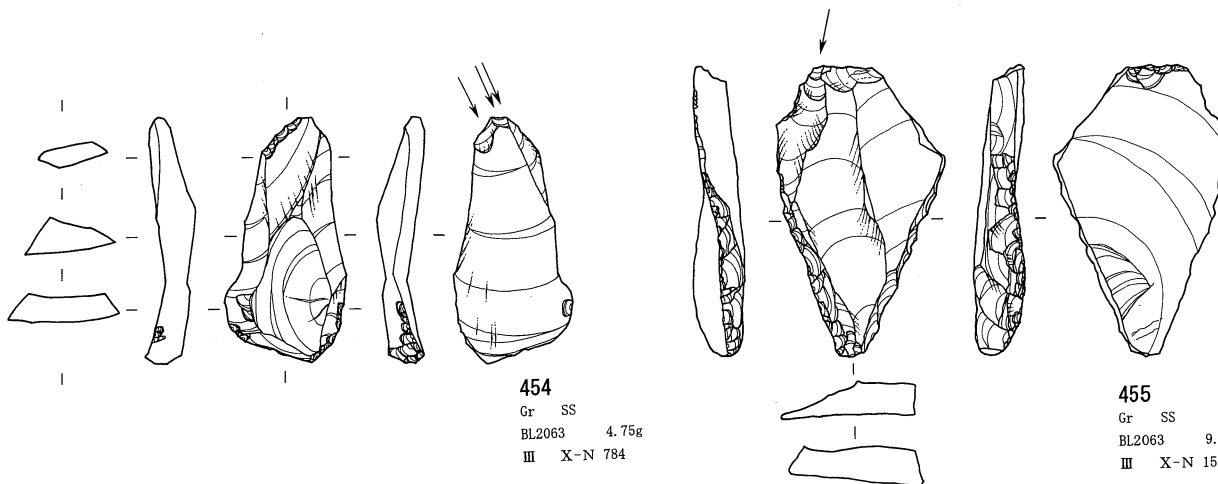

454  
Gr SS  
BL2063 4.75g  
III X-N 784

455  
Gr SS  
BL2063 9.91g  
III X-N 1512

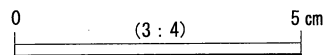

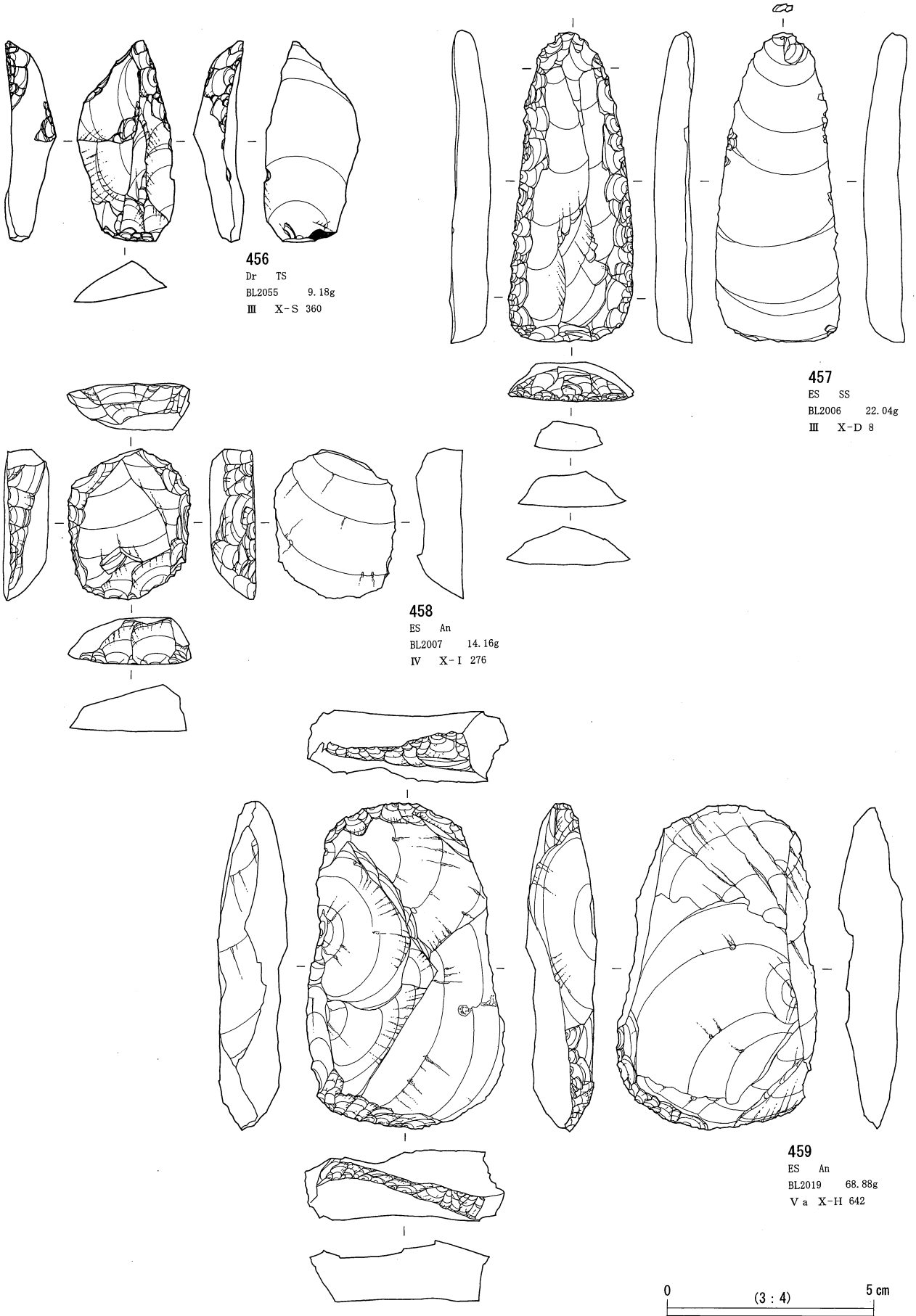

456  
Dr TS  
BL2055 9.18g  
III X-S 360

457  
ES SS  
BL2006 22.04g  
III X-D 8

458  
ES An  
BL2007 14.16g  
IV X-I 276

459  
ES An  
BL2019 68.88g  
V a X-H 642

0 (3 : 4) 5 cm

第2地点 石器実測図 38 (揉錐器・搔器 1) (貫ノ木遺跡)

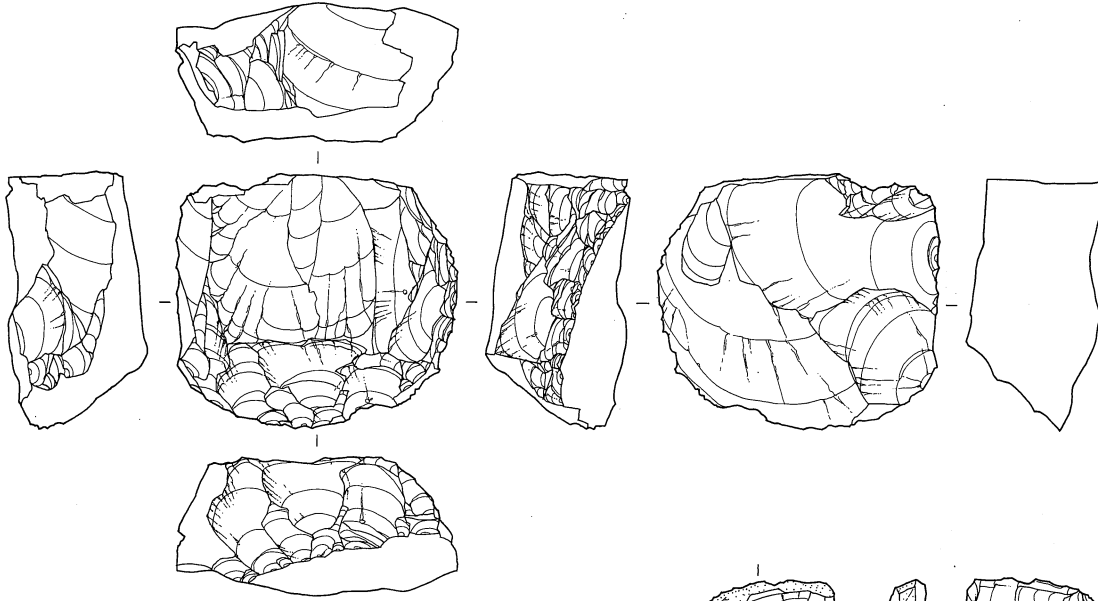

460  
 ES An  
 BL2019 69.85g  
 Va X-H 669

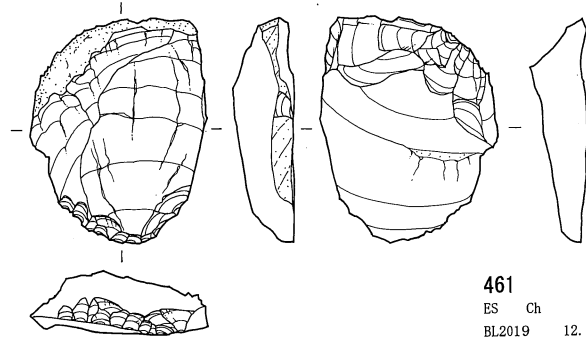

461  
 ES Ch  
 BL2019 12.71g  
 Va X-H 728

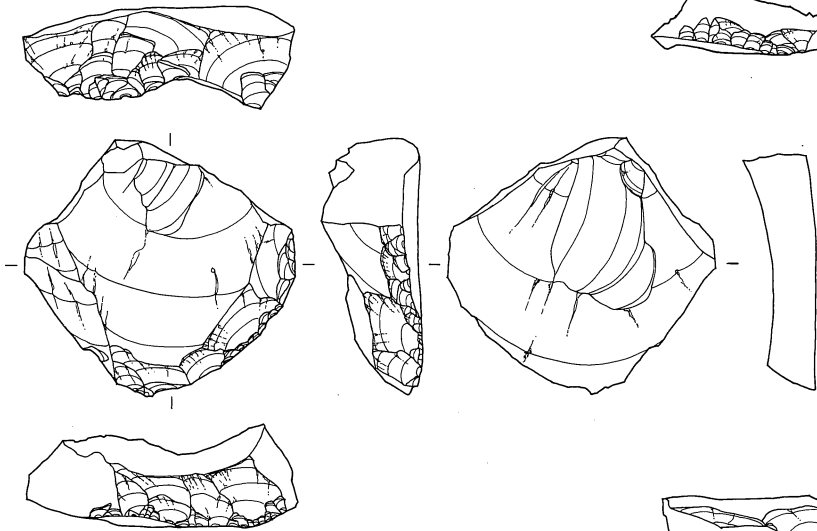

462  
 ES An  
 BL2020 29.43g  
 IV X-H 968

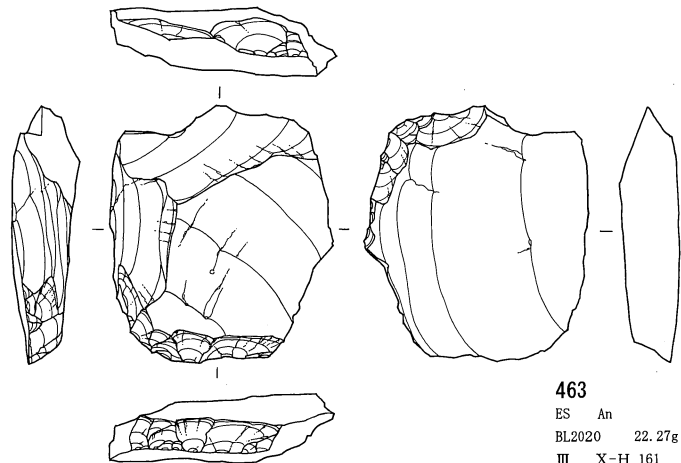

463  
 ES An  
 BL2020 22.27g  
 III X-H 161

0 (3:4) 5 cm

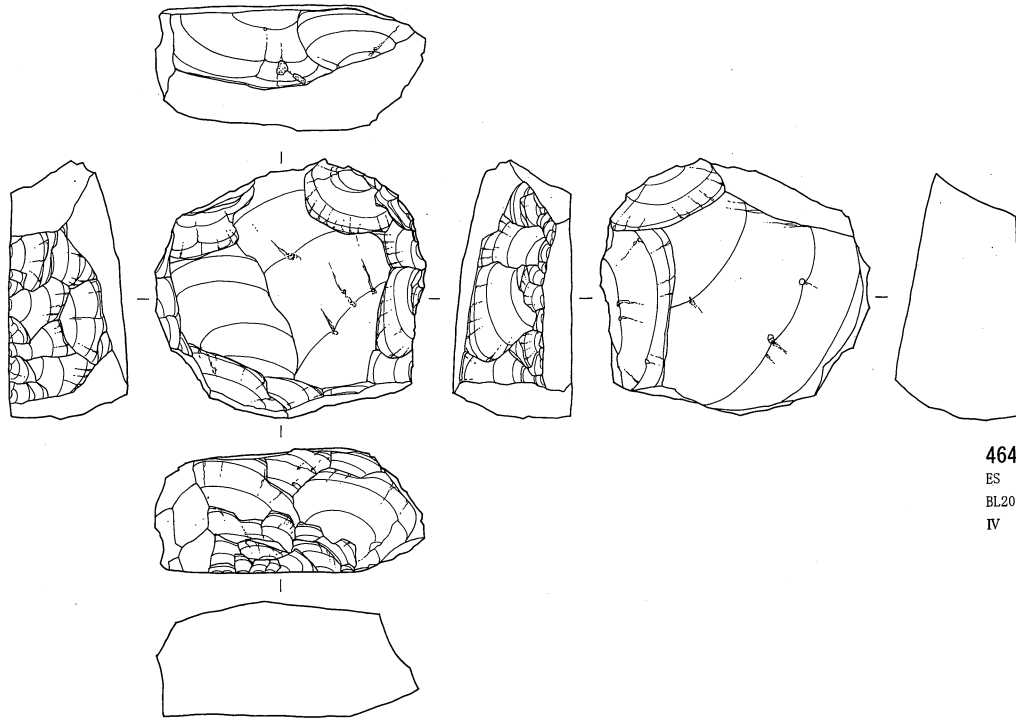

464  
 ES An  
 BL2020 59.9g  
 IV X-H 980

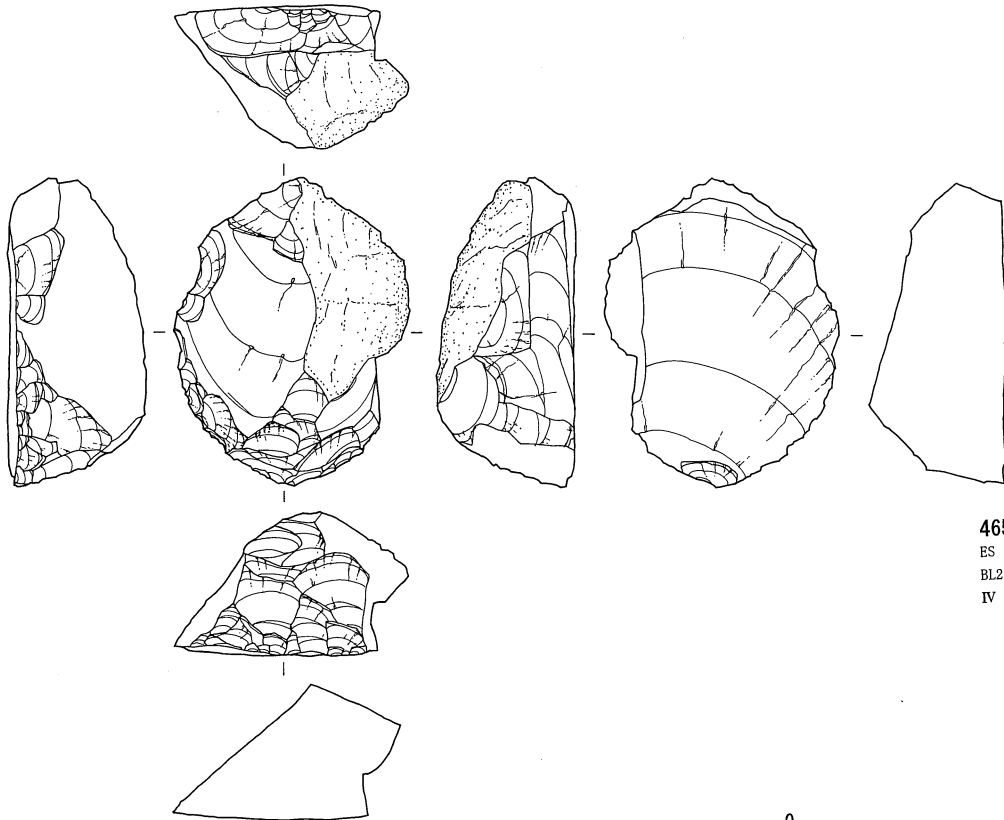

465  
 ES An  
 BL2024 54.81g  
 IV X-H 496

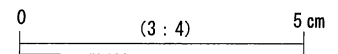

第2地点 石器実測図 40 (搔器 3) (貫ノ木遺跡)



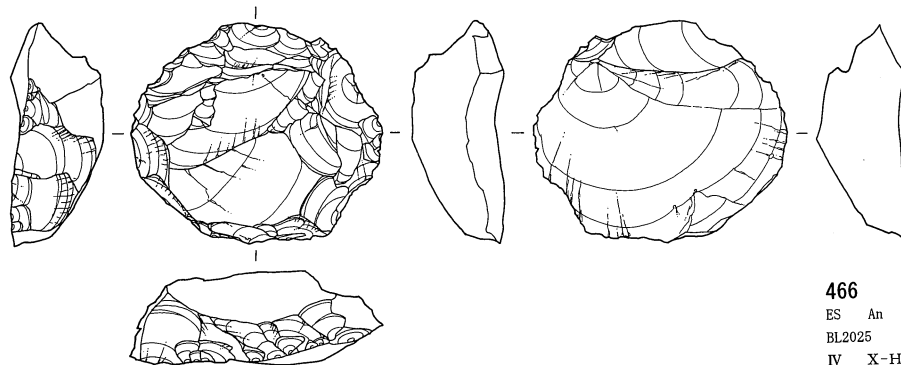

466  
 ES An  
 BL2025 28.34g  
 IV X-H 249

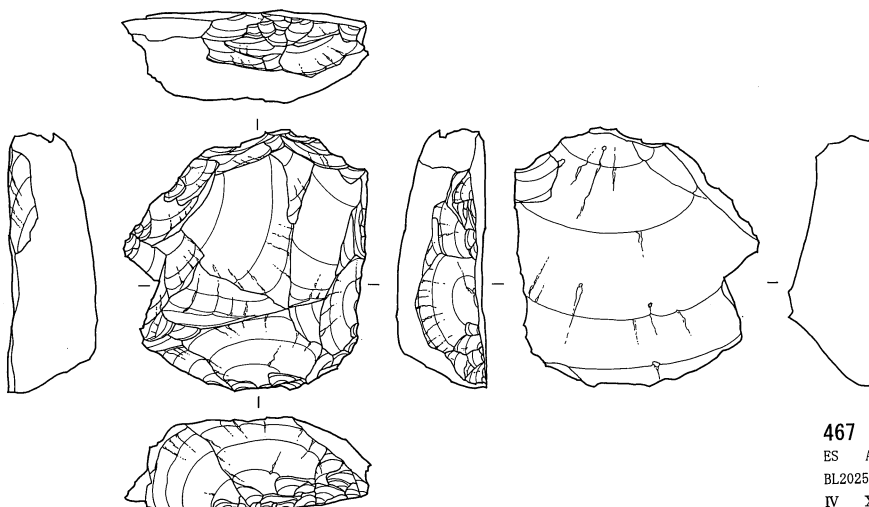

467  
 ES An  
 BL2025 34.8g  
 IV X-H 509

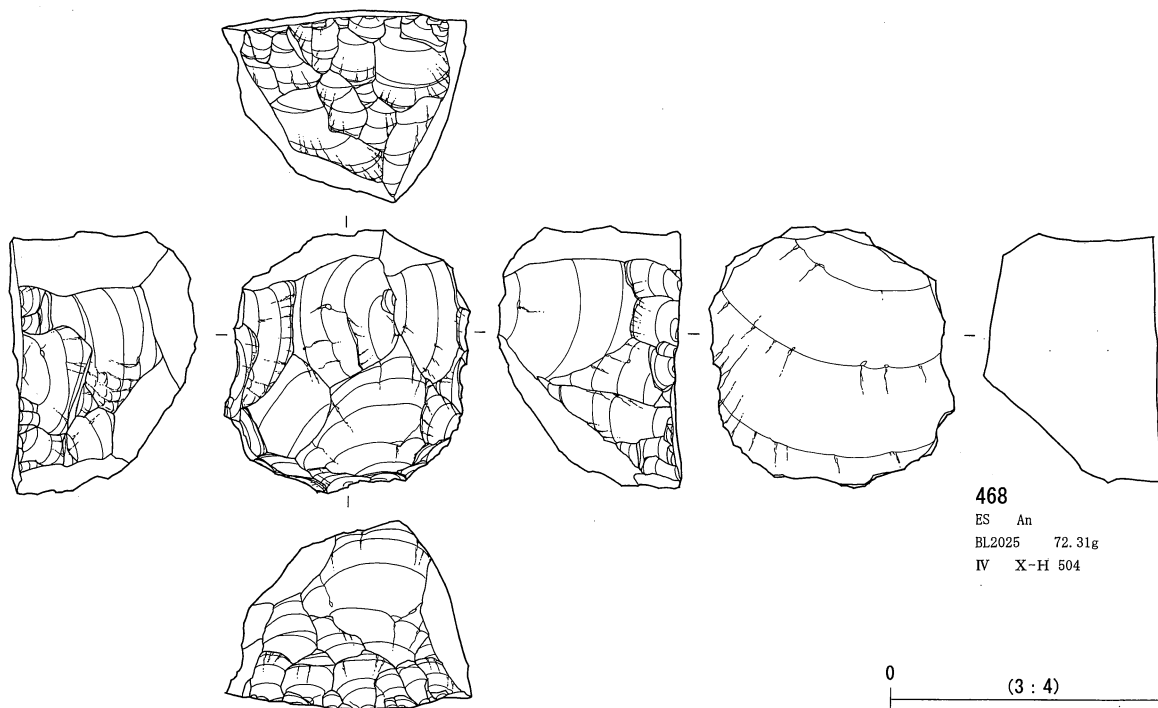

468  
 ES An  
 BL2025 72.31g  
 IV X-H 504

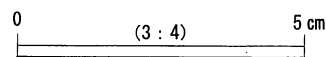

第2地点 石器実測図 41 (搔器 4) (貫ノ木遺跡)

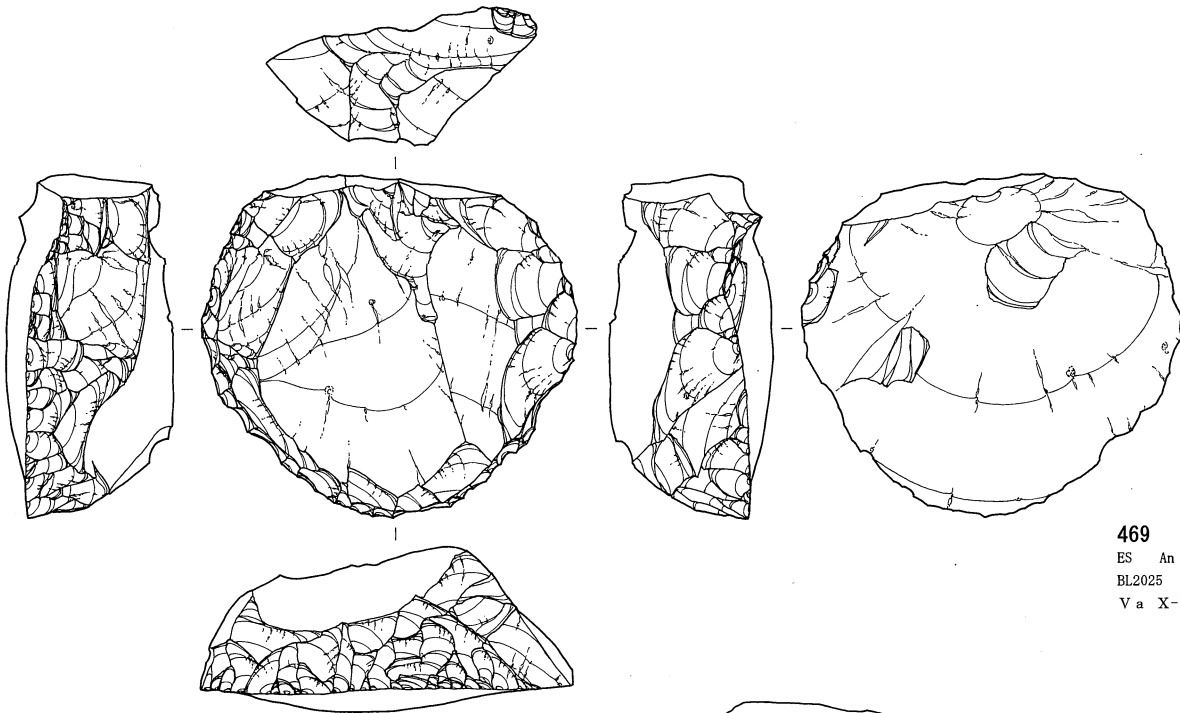

469  
 ES An  
 BL2025 125.47g  
 V a X-H 822

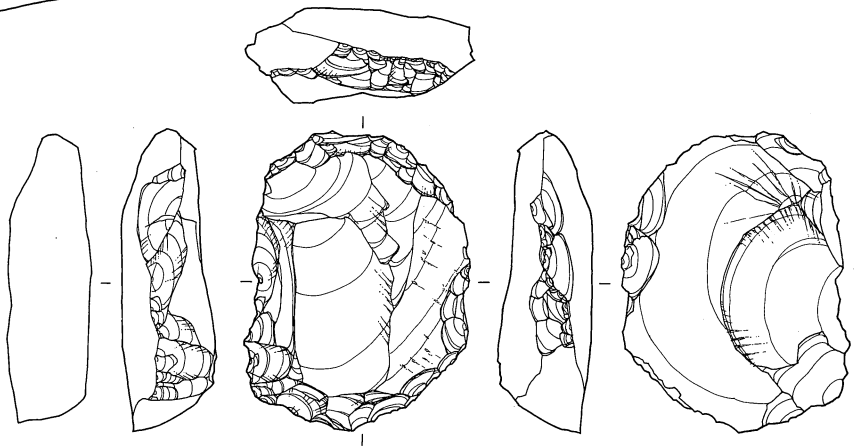

470  
 ES SS  
 BL2025 38.16g  
 IV X-H 513

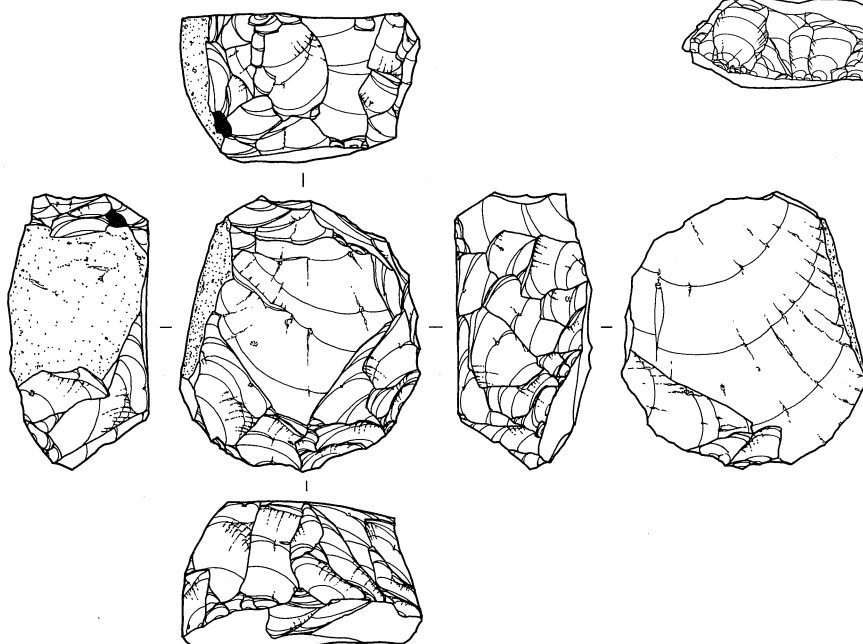

471  
 ES An  
 BL2025 66.99g  
 V b X-H 862

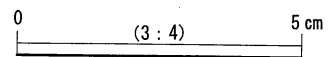

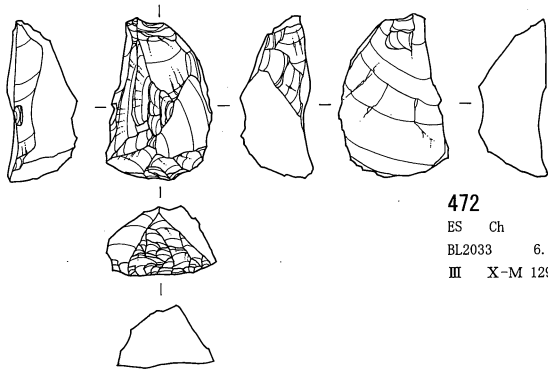

472  
ES Ch  
BL2033 6.44g  
III X-M 129

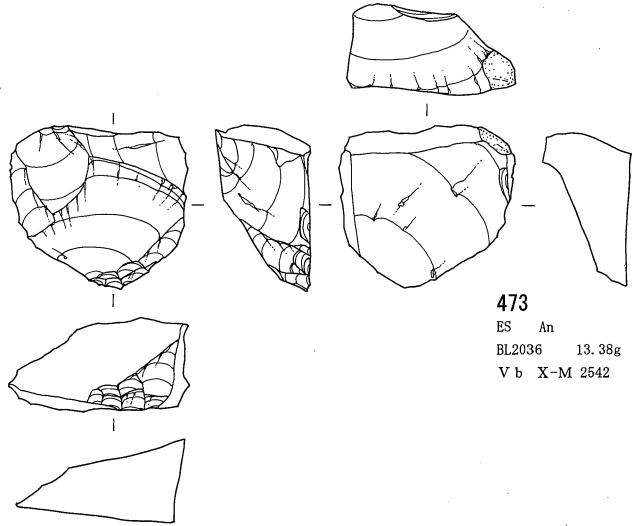

473  
ES An  
BL2036 13.38g  
V b X-M 2542

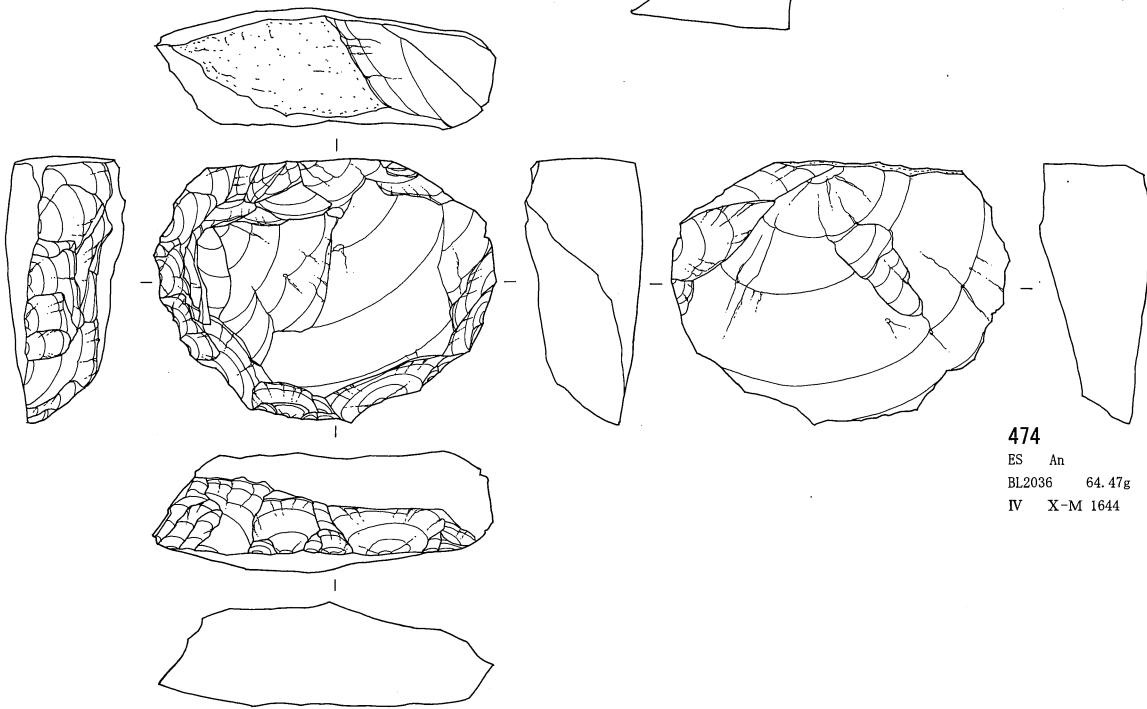

474  
ES An  
BL2036 64.47g  
IV X-M 1644

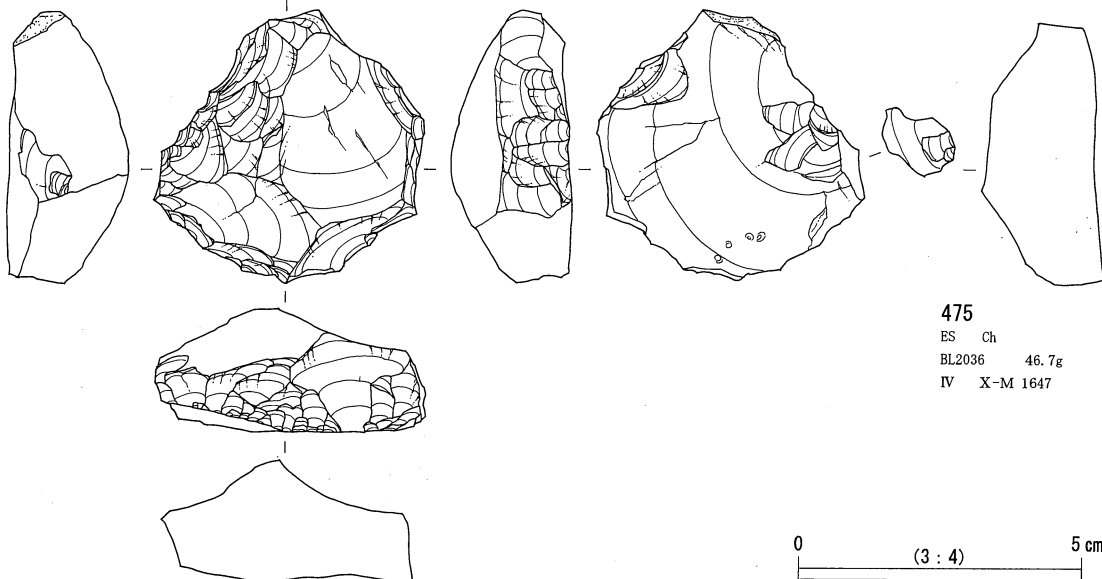

475  
ES Ch  
BL2036 46.7g  
IV X-M 1647

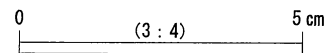

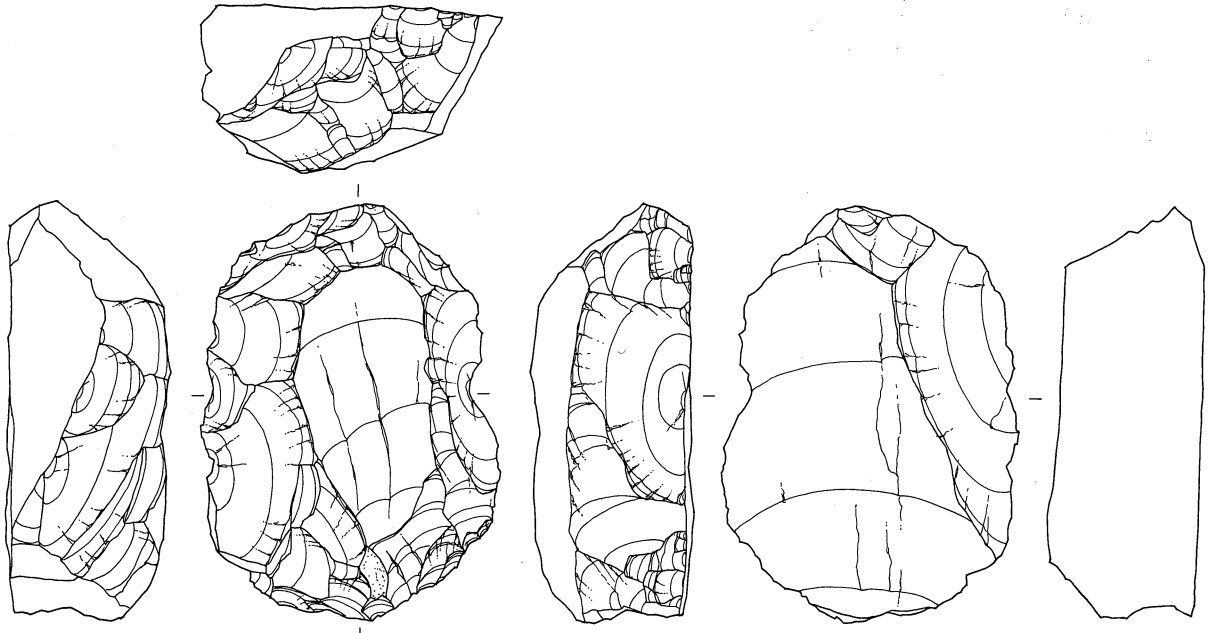

476  
 ES An  
 BL2036 120.77g  
 Va X-M 2111

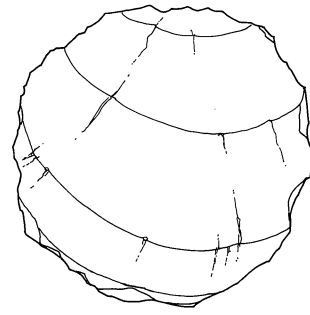
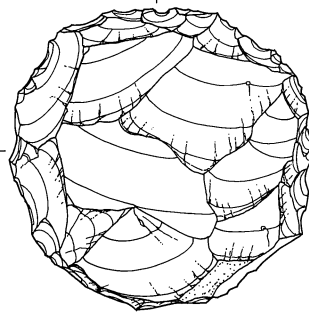
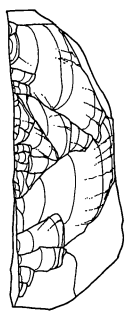
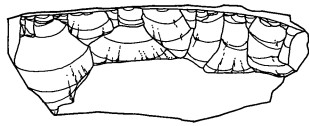
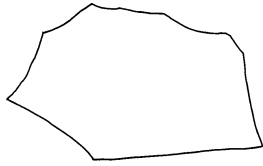
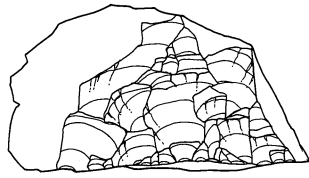

477  
 ES An  
 BL2036 64.14g  
 Va X-M 2133

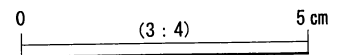
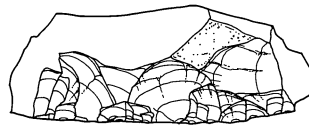

第2地点 石器実測図 44 (搔器 7) (貫ノ木遺跡)

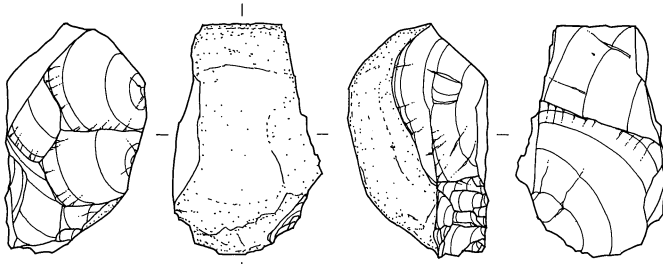

478

ES Ch  
BL2037 27.58g  
V b X-M 2553

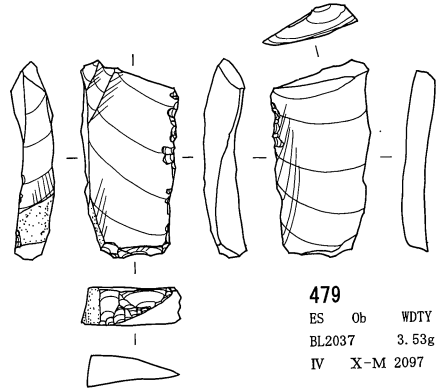
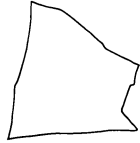
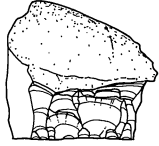

479

ES Ob WDTY  
BL2037 3.53g  
IV X-M 2097

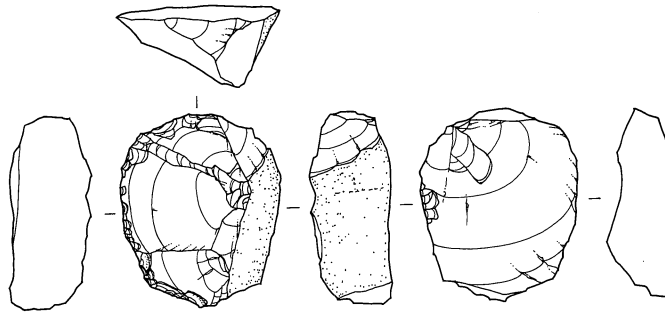

480

ES Ch  
BL2042 11.66g  
III X-N 1043

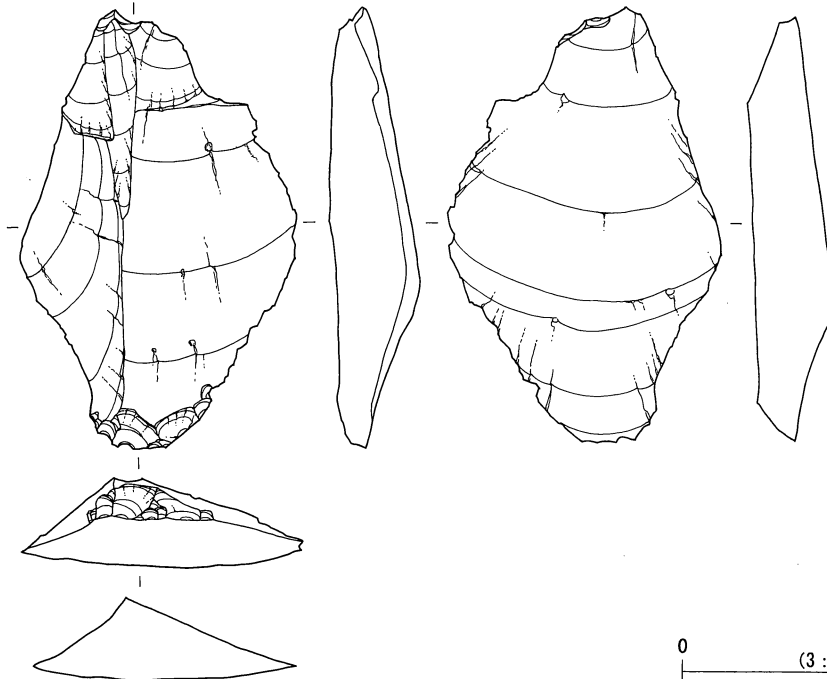
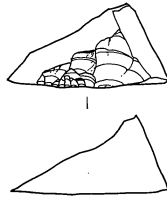

481

ES An  
BL2042 35.45g  
III X-N 1053

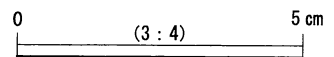

第2地点 石器実測図45 (搔器8) (貫ノ木遺跡)

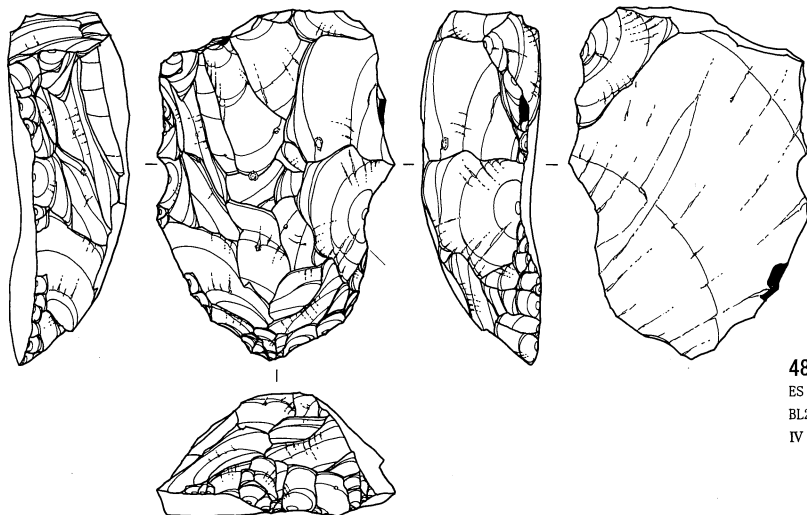

482  
 ES An  
 BL2045 57.54g  
 IV X-N 1871

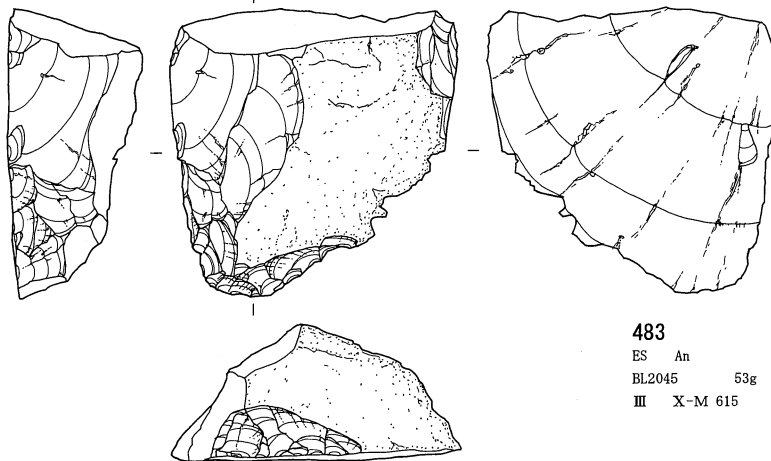

483  
 ES An  
 BL2045 53g  
 III X-M 615

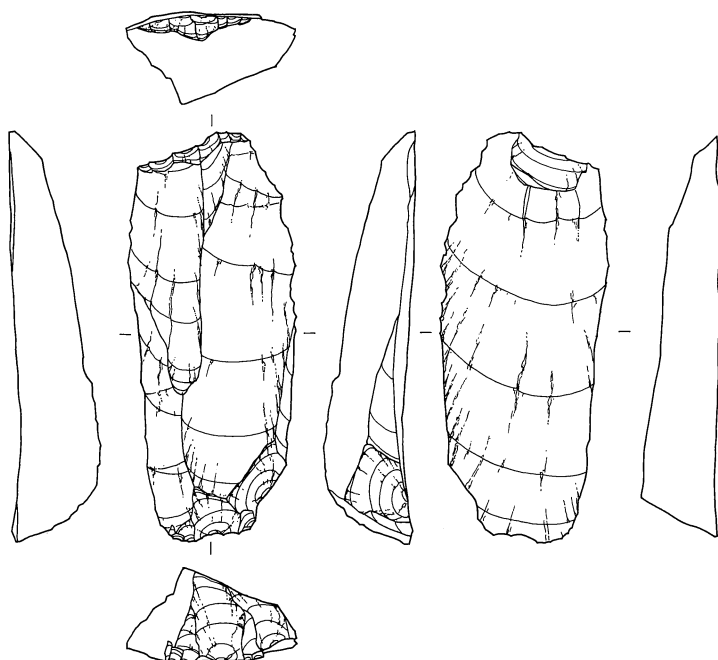

484  
 ES An  
 BL2045 26.28g  
 IV X-M 1184

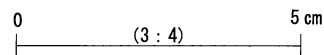

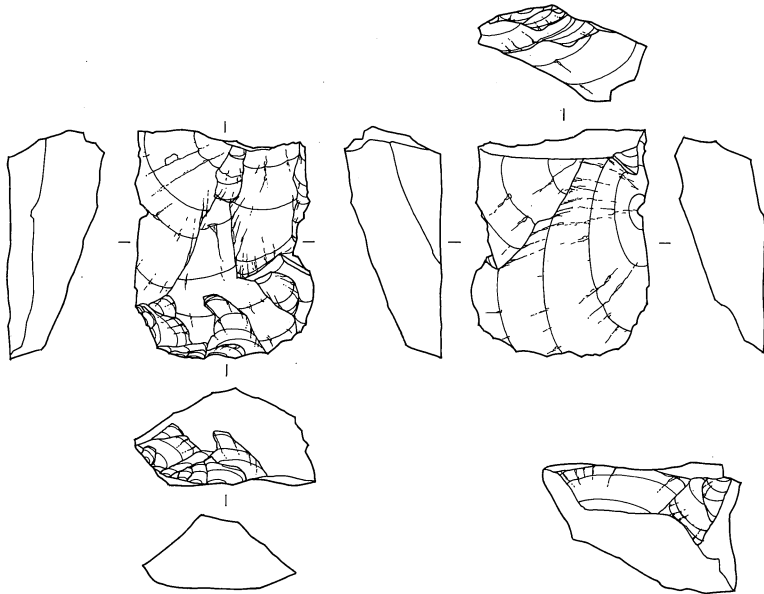

485  
 ES An  
 BL2045 18.82g  
 IV X-M 2755

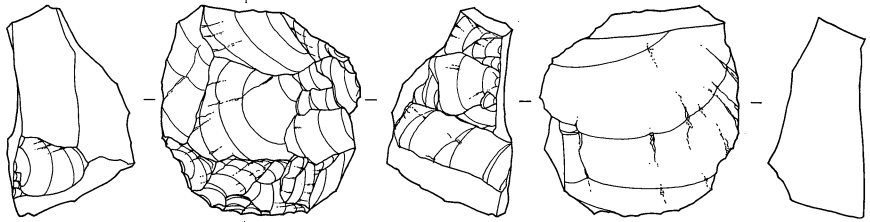

486  
 ES An  
 BL2045 27.88g  
 III X-M 849

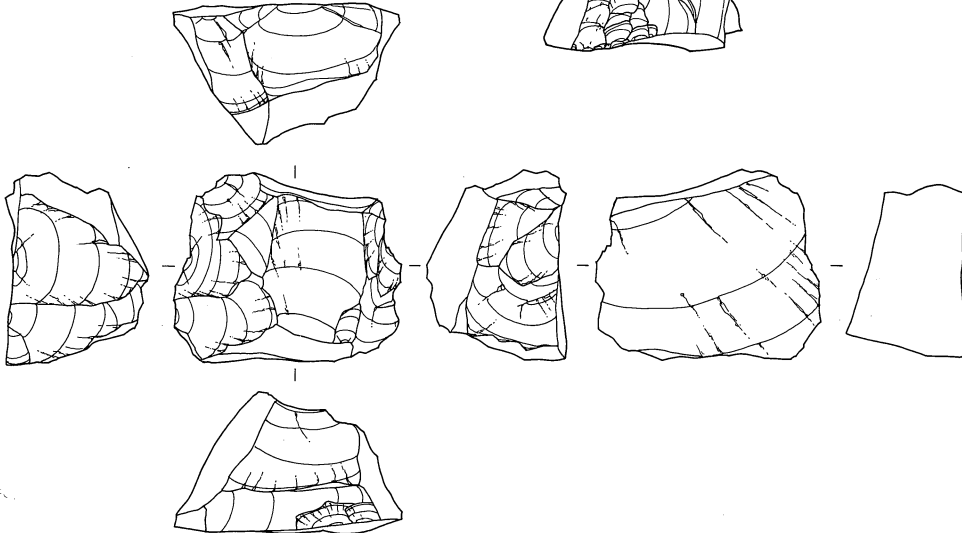

487  
 ES An  
 BL2046 33.8g  
 IV X-M 2271

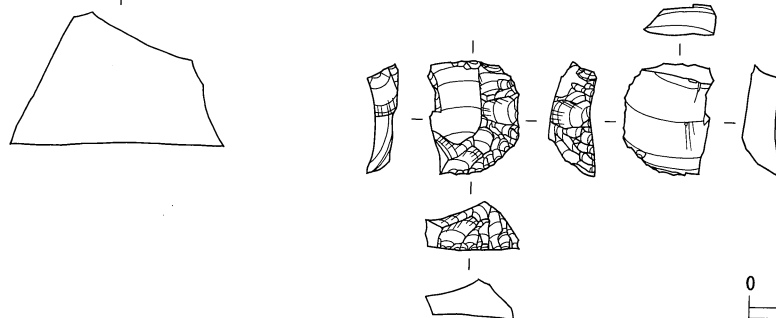

488  
 ES Ob WDTN  
 BL2048 2.13g  
 III X-N 377

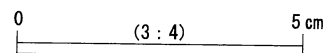

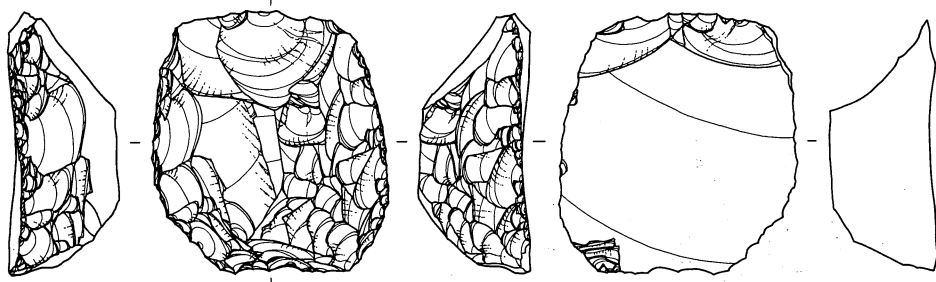

489  
ES SS  
BL2048 36.31g  
IV X-N 1394

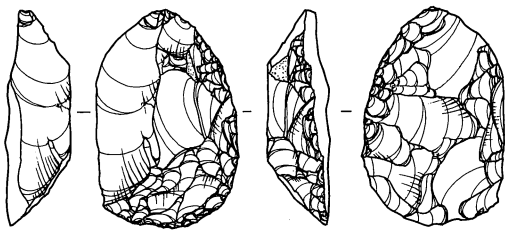

490  
ES Ob  
BL2048 9.96g  
III X-N 1360

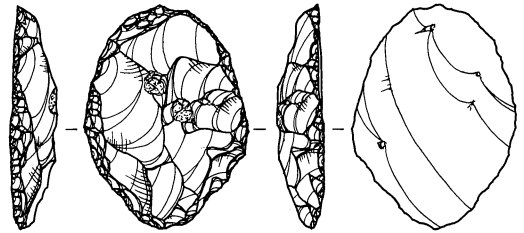

491  
ES Ob WDTM  
BL2048 7.97g  
III X-N 409

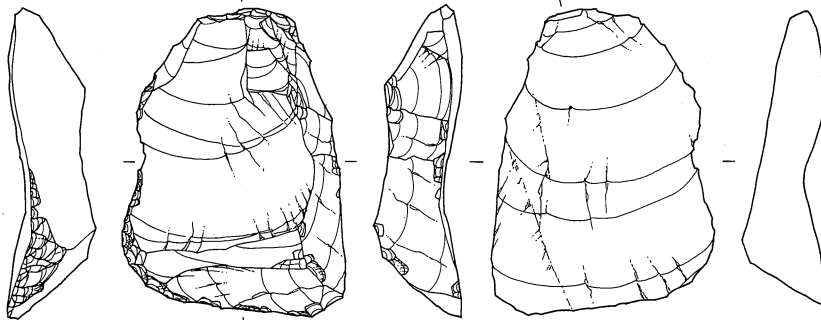

492  
ES Ch  
BL2051 27.05g  
IV X-N 2490

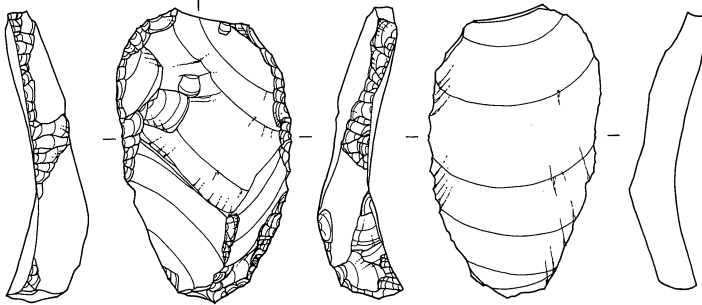
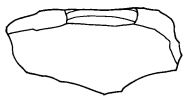

493  
ES TS  
BL2051 15.36g  
III X-S 213

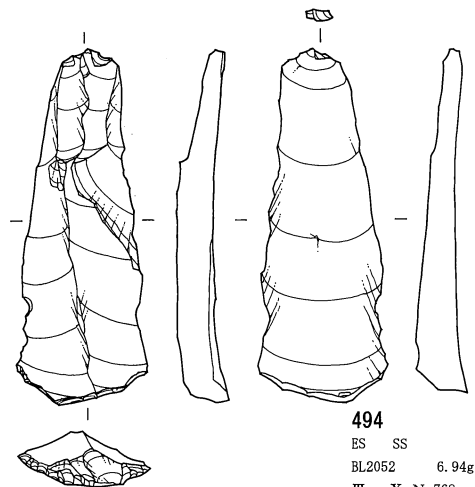

494  
ES SS  
BL2052 6.94g  
III X-N 768

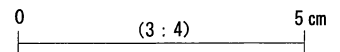



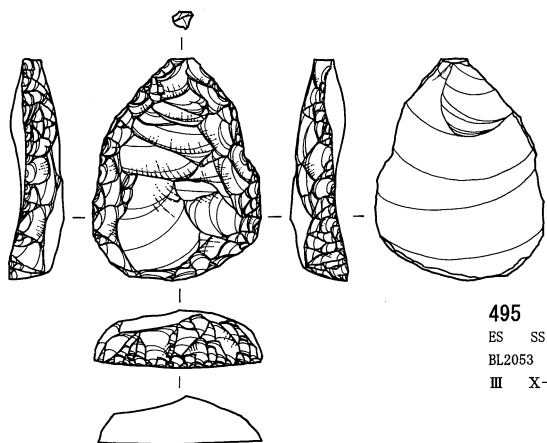

495  
ES SS  
BL2053 11.59g  
III X-N 658

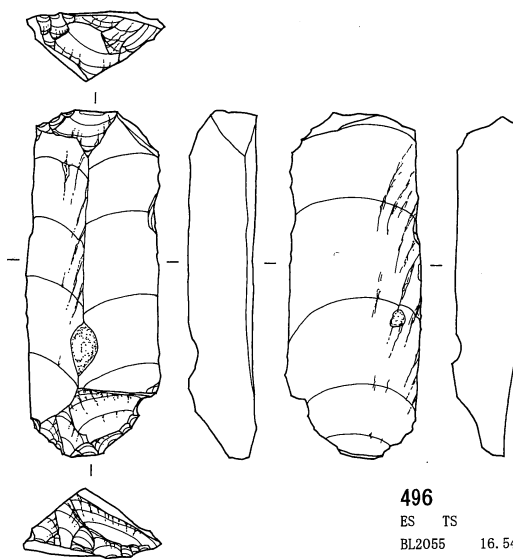

496  
ES TS  
BL2055 16.54g  
III X-S 40

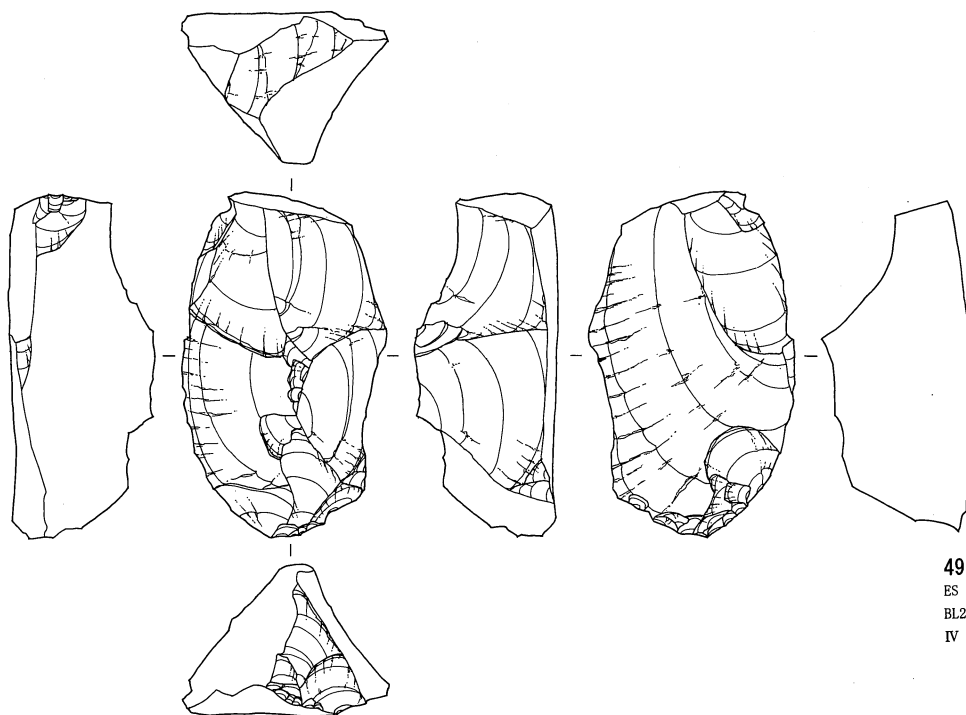

497  
ES Tu  
BL2055 46.39g  
IV X-S 607

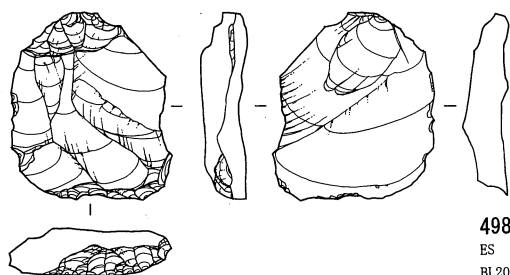

498  
ES SS  
BL2061 7.32g  
IV上 X-T 13

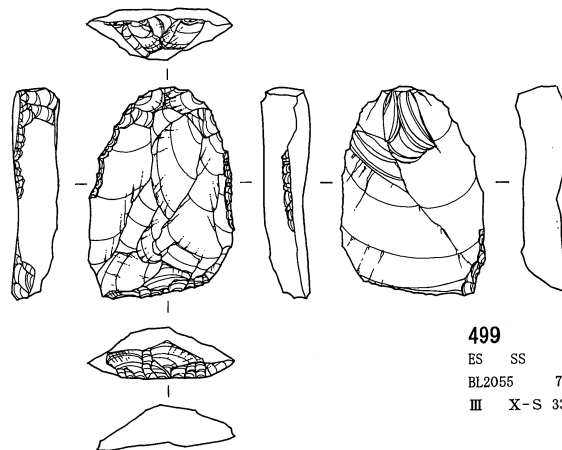

499  
ES SS  
BL2055 7.64g  
III X-S 337

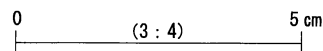

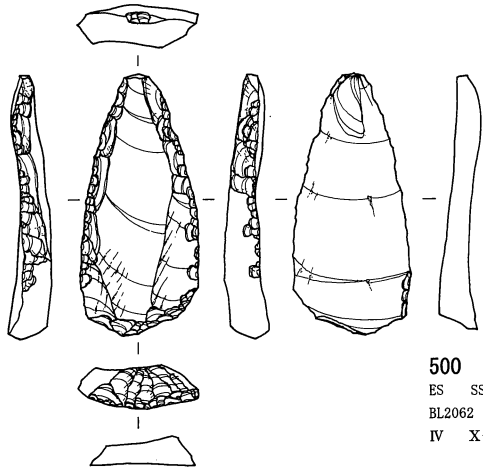

500  
ES SS  
BL2062 5.66g  
IV X-O 879

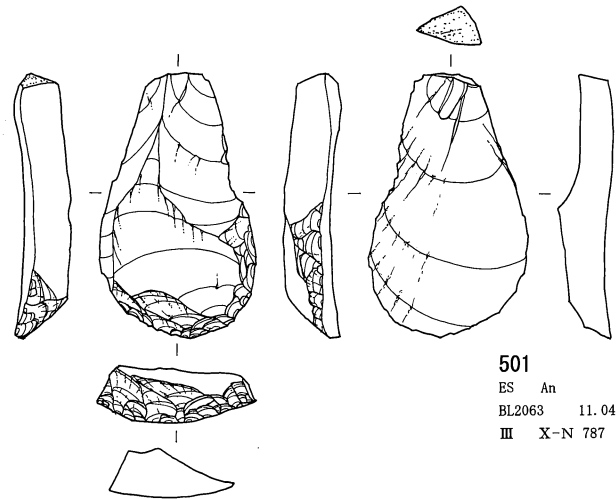

501  
ES An  
BL2063 11.04g  
III X-N 787

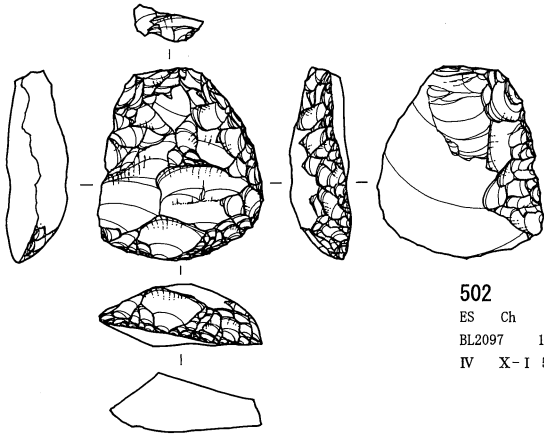

502  
ES Ch  
BL2097 11.91g  
IV X-I 563

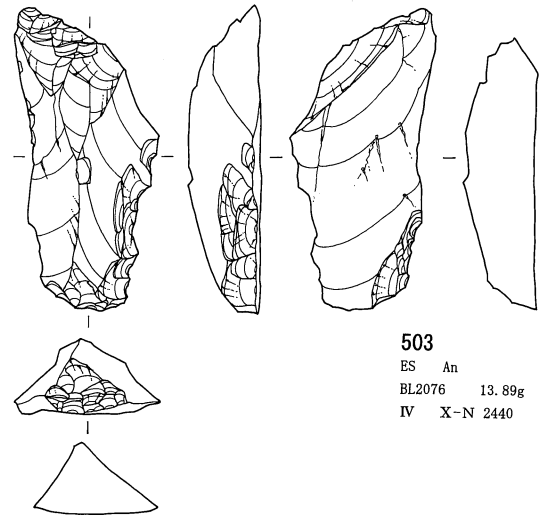

503  
ES An  
BL2076 13.89g  
IV X-N 2440

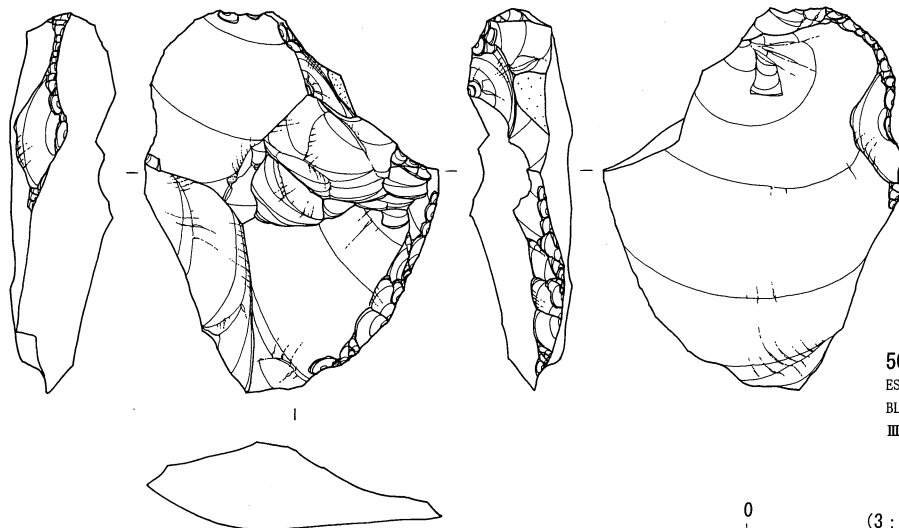

504  
ES TS  
BL2080 50.73g  
III X-N 1485

0 (3:4) 5 cm

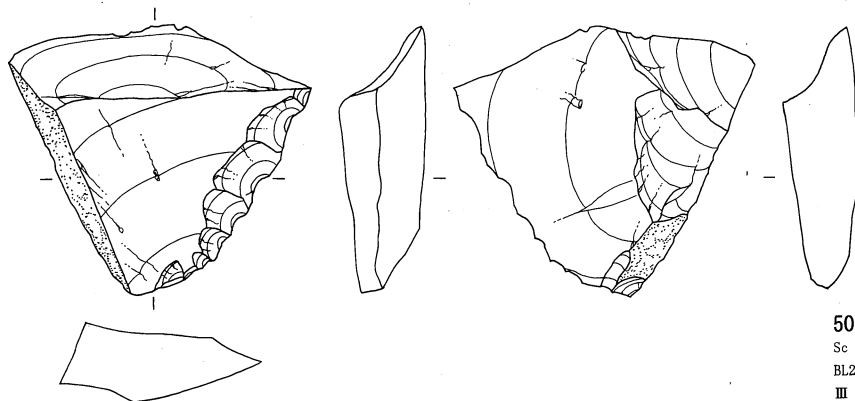

505

Sc An  
BL2007 26.75g  
III X-D 29

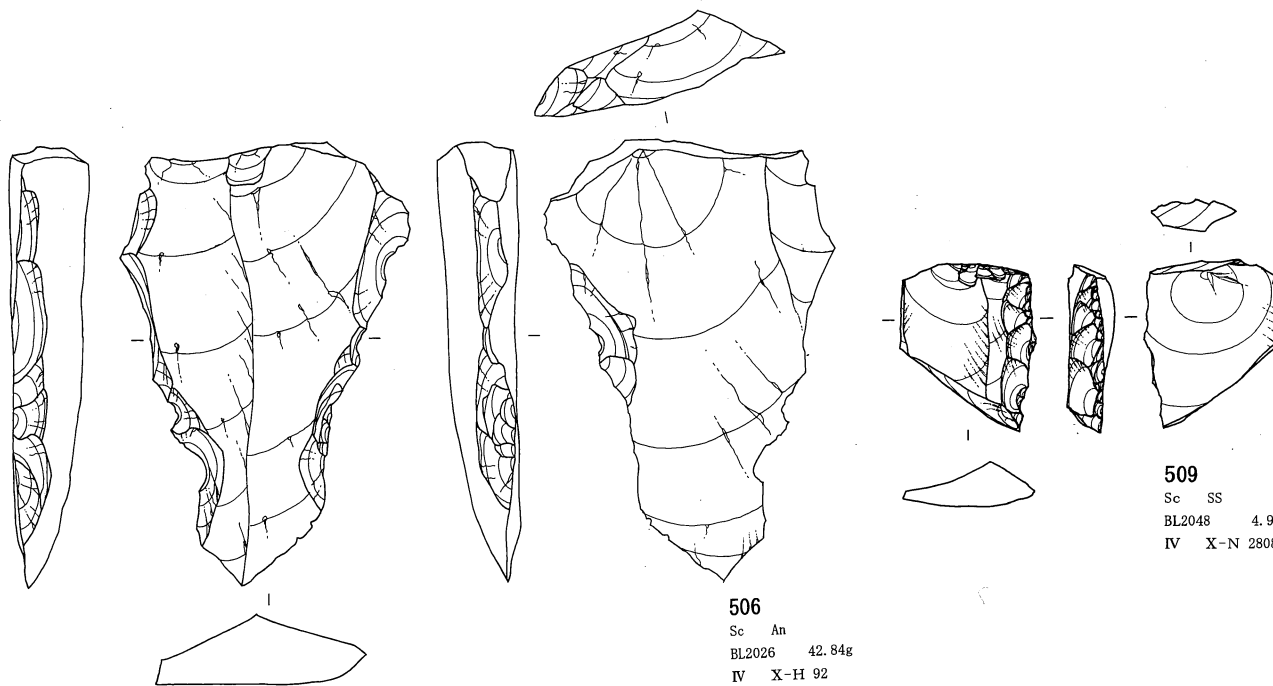

506

Sc An  
BL2026 42.84g  
IV X-H 92

509

Sc SS  
BL2048 4.95g  
IV X-N 2808

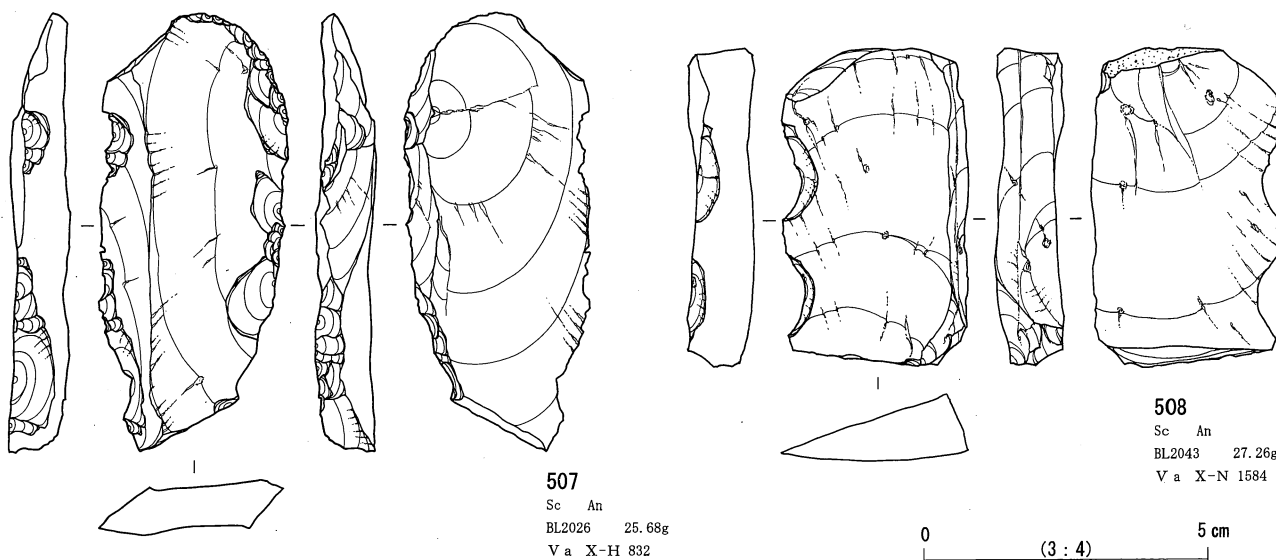

507

Sc An  
BL2026 25.68g  
V a X-H 832

508

Sc An  
BL2043 27.26g  
V a X-N 1584

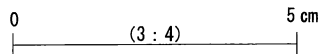

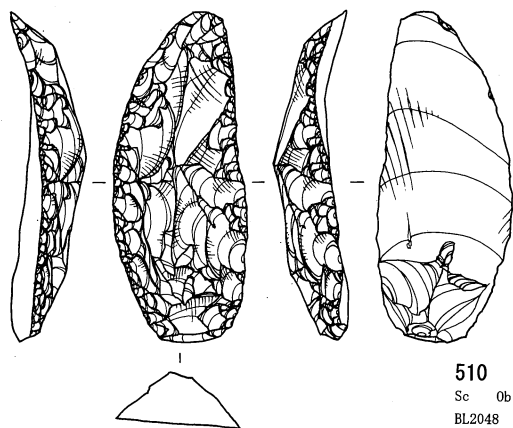

510  
Sc Ob WDTM  
BL2048 11.93g  
IV X-N 1562

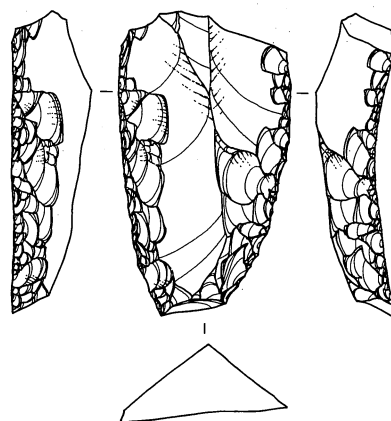

511  
Sc SS  
BL2048 19.42g  
IV X-N 538

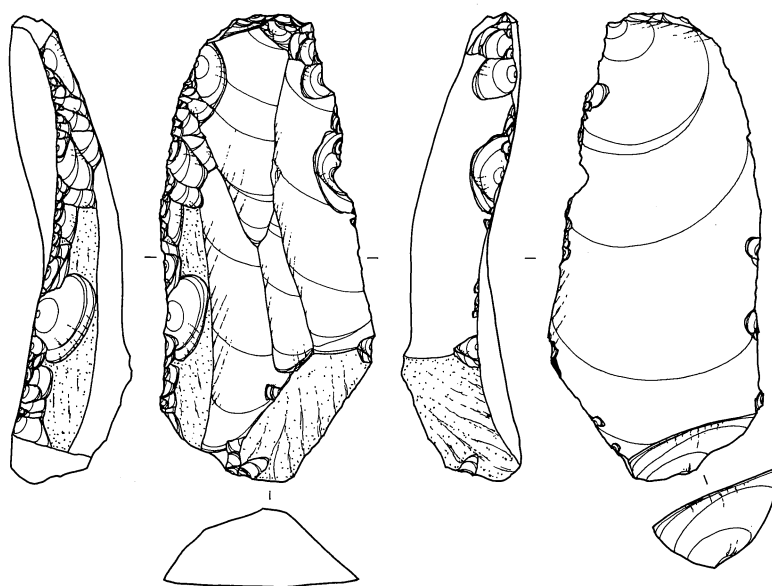

512  
Sc SS  
BL2048 45.4g  
IV X-N 666

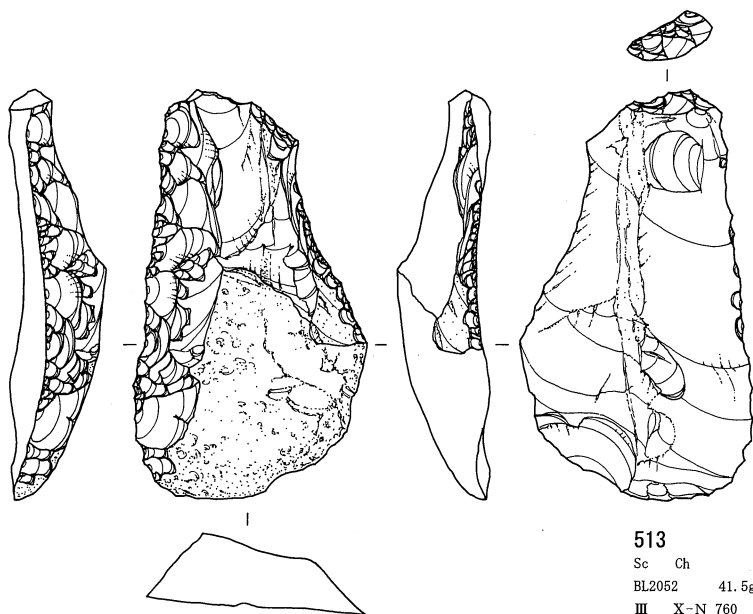

513  
Sc Ch  
BL2052 41.5g  
III X-N 760

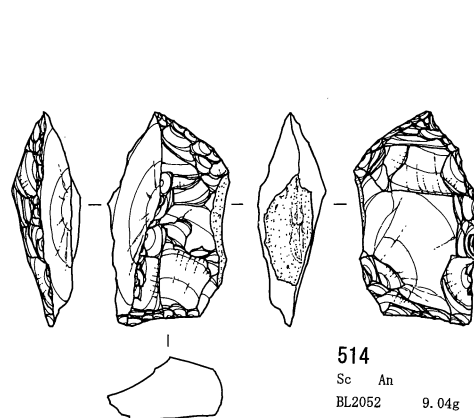

514  
Sc An  
BL2052 9.04g  
Va X-N 2622

0 (3:4) 5 cm

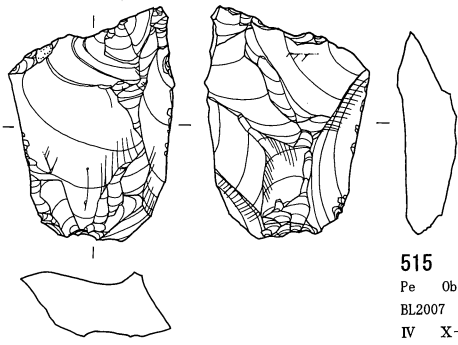

**515**  
Pe Ob SWHD  
BL2007 12.35g  
IV X-D 46

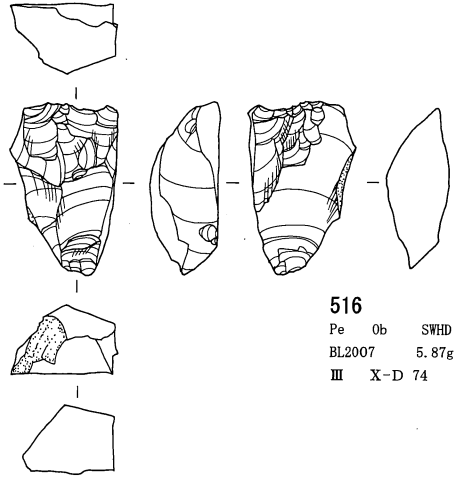

**516**  
Pe Ob SWHD  
BL2007 5.87g  
III X-D 74

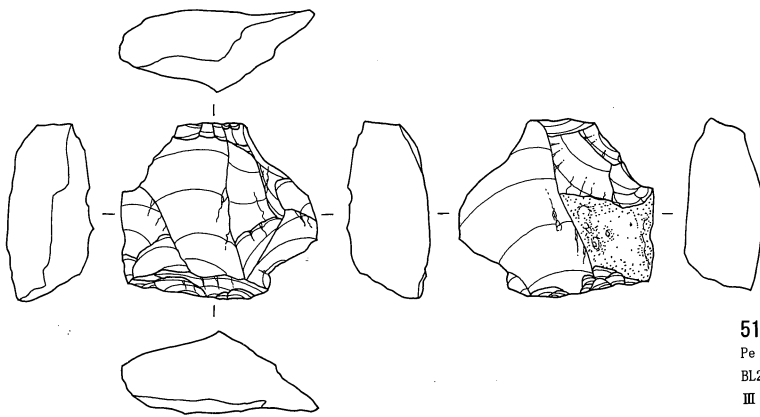

**517**  
Pe An  
BL2020 14.11g  
III X-H 113

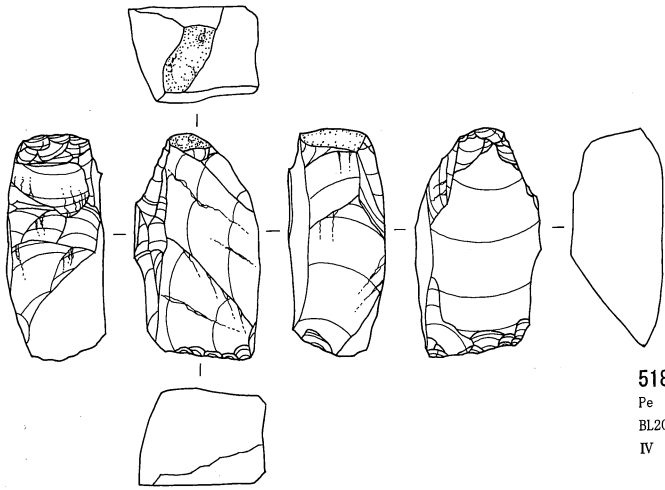

**518**  
Pe An  
BL2020 18.41g  
IV X-H 351

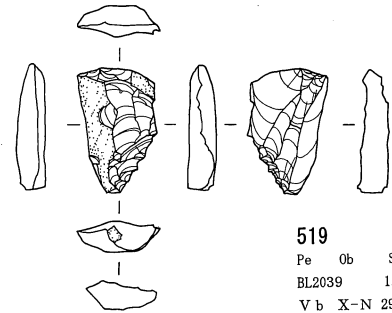

**519**  
Pe Ob SWHD  
BL2039 1.41g  
V b X-N 2970

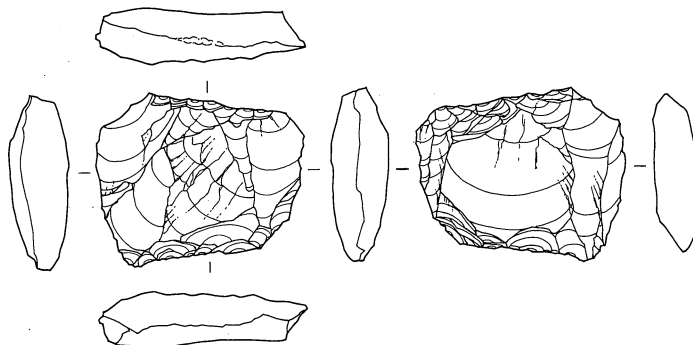

**520**  
Pe An  
BL2041 11.52g  
IV X-N 1072

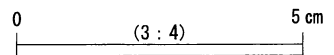

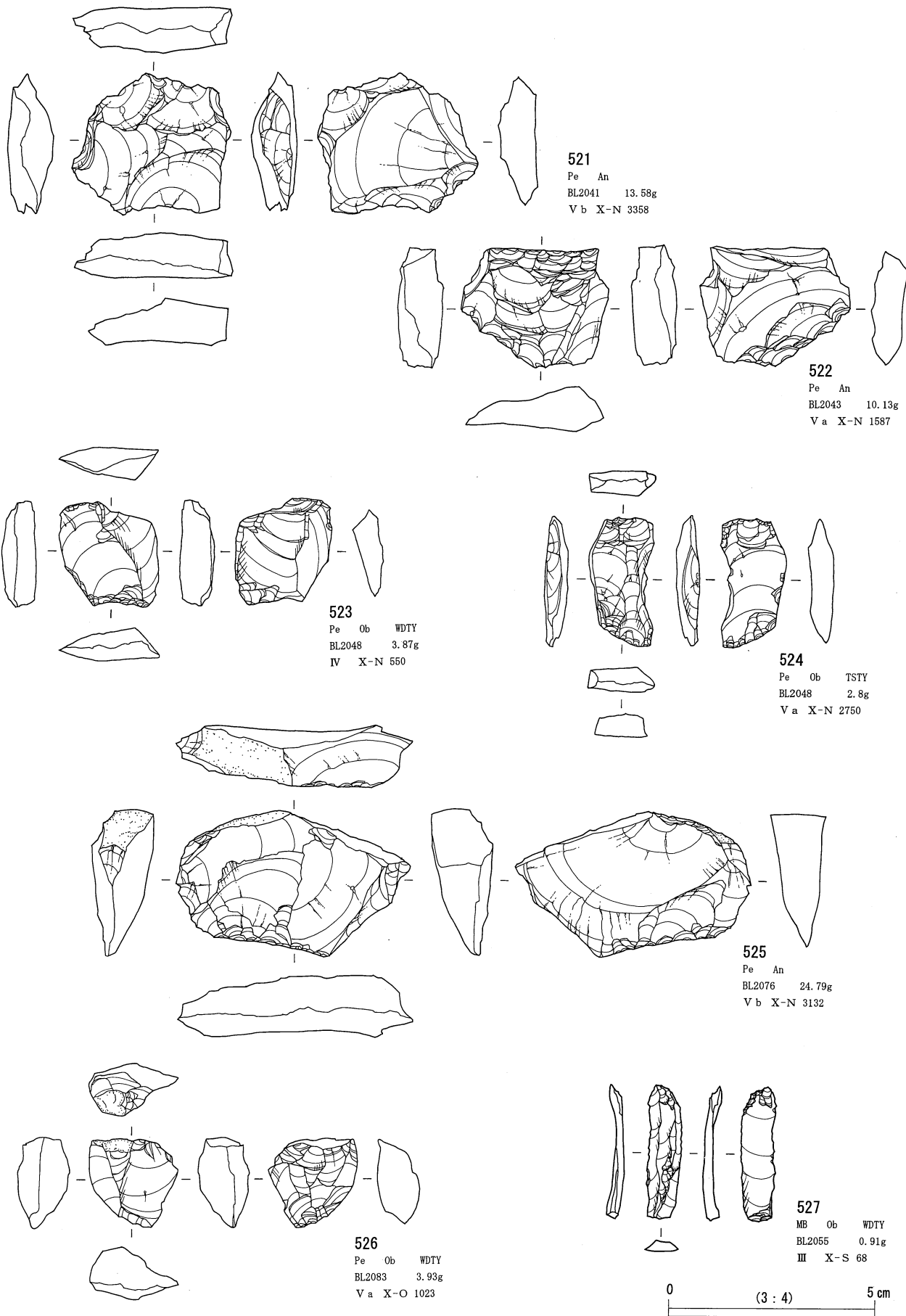

第2地点 石器実測図 54 (楔形石器 2・細石刃) (貫ノ木遺跡)

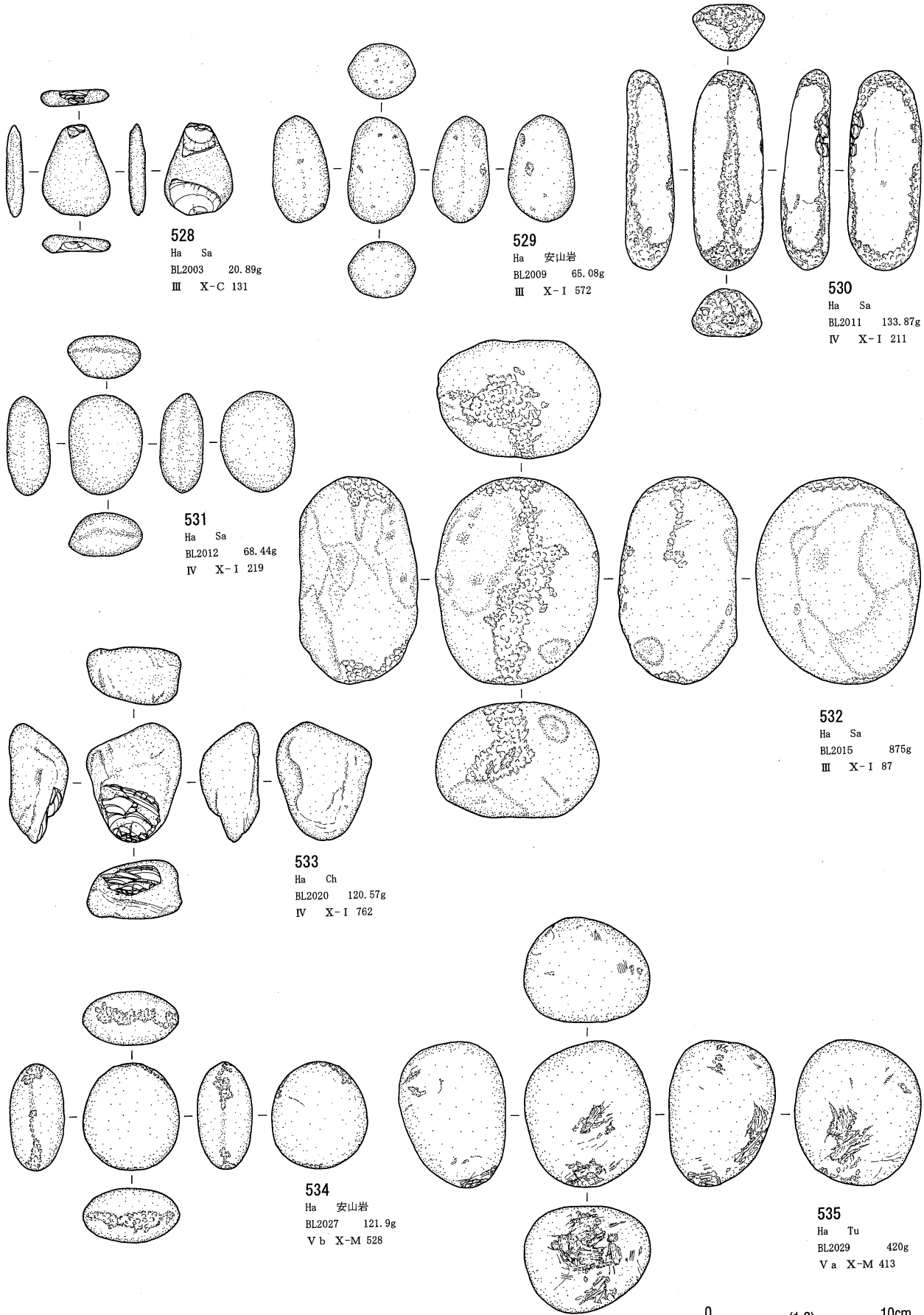

第2地点 石器実測図 55 (敲石1) (貫ノ木遺跡)

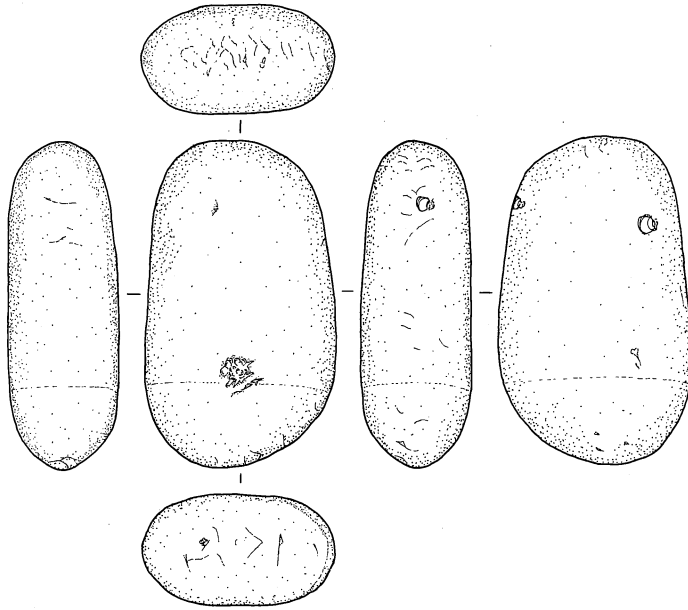

536  
Ha Tu  
BL2030 715g  
V b X-M 421

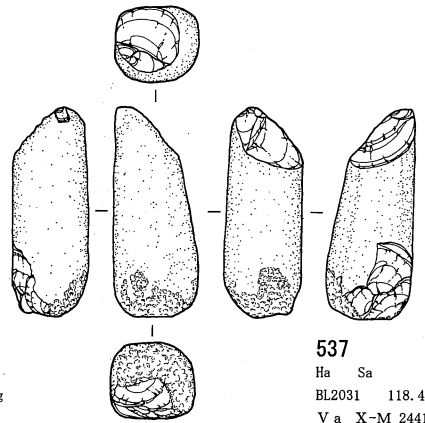

537  
Ha Sa  
BL2031 118.46g  
V a X-M 2441

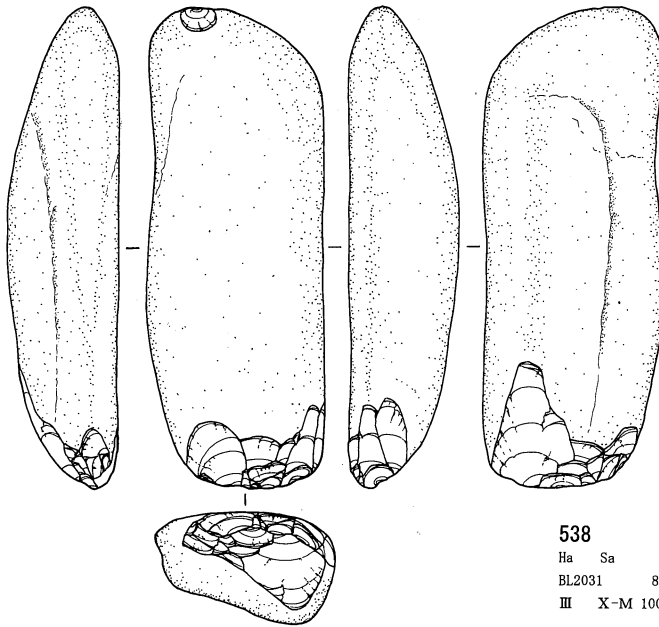

538  
Ha Sa  
BL2031 820g  
III X-M 1001

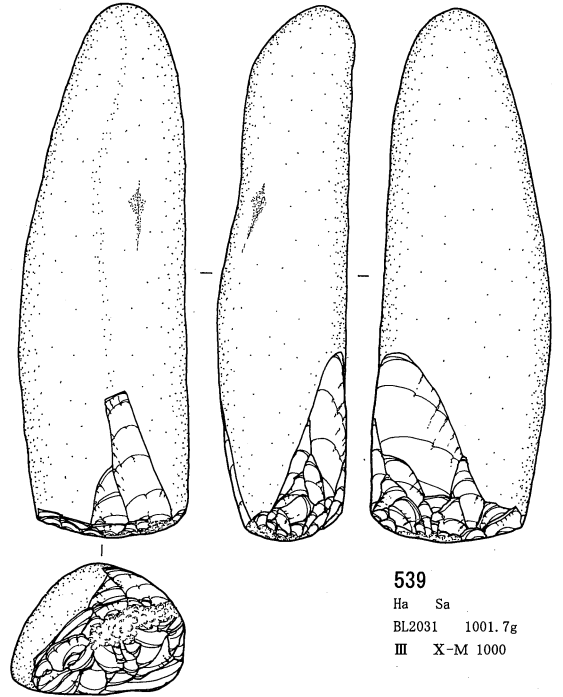

539  
Ha Sa  
BL2031 1001.7g  
III X-M 1000

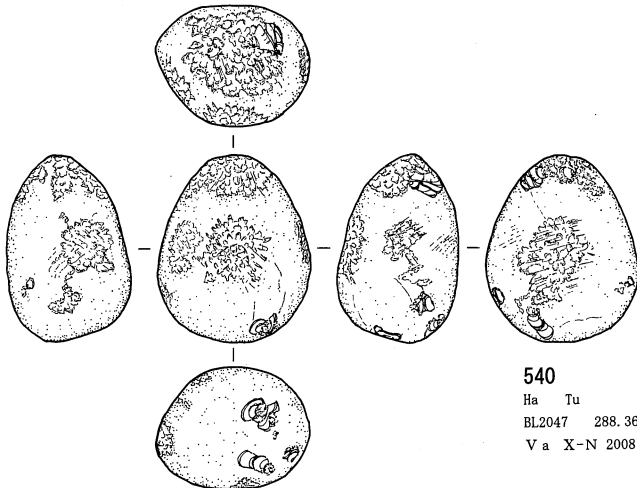

540  
Ha Tu  
BL2047 288.36g  
V a X-N 2008

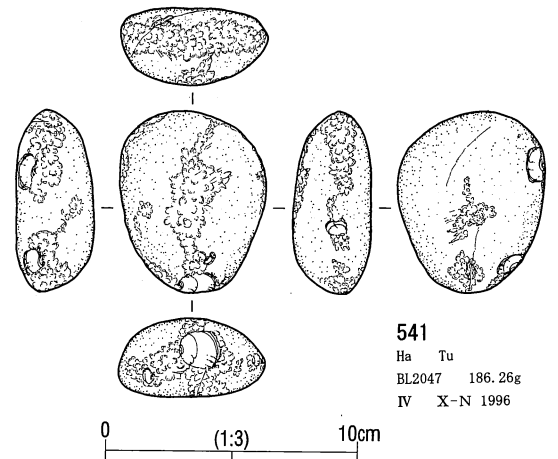

541  
Ha Tu  
BL2047 186.26g  
IV X-N 1996

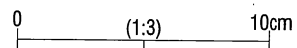



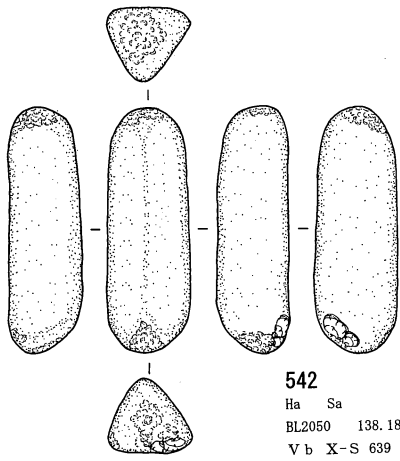

542  
Ha Sa  
BL2050 138.18g  
V b X-S 639

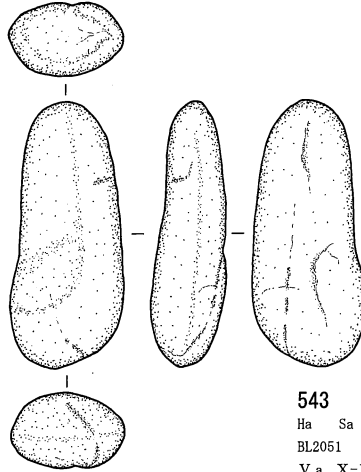

543  
Ha Sa  
BL2051 170.91g  
V a X-N 2995

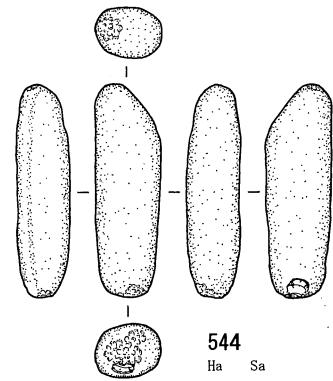

544  
Ha Sa  
BL2051 80.6g  
IV X-S 523

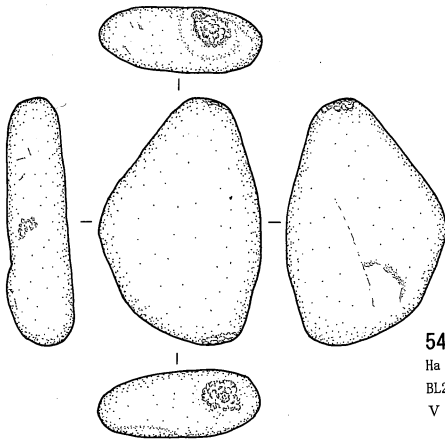

545  
Ha Sa  
BL2058 223.92g  
V a X-T 623

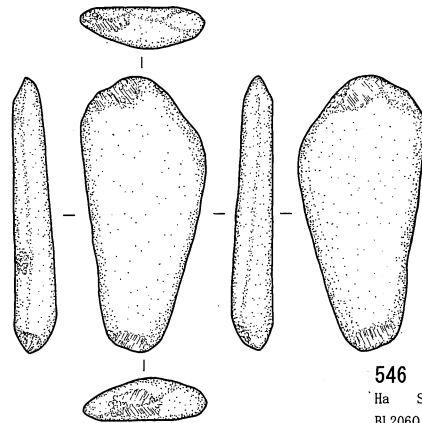

546  
Ha Sa  
BL2060 114.07g  
III X-T 213

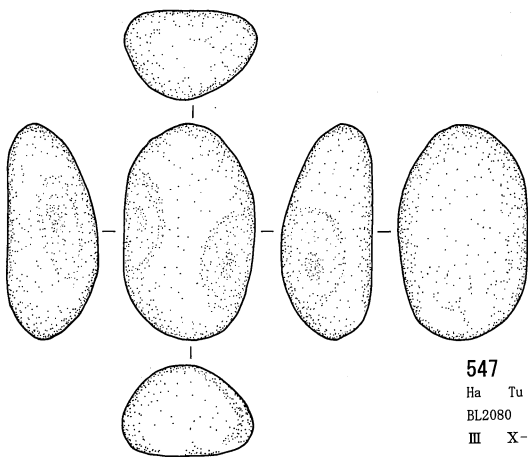

547  
Ha Tu  
BL2080 215g  
III X-N 1484

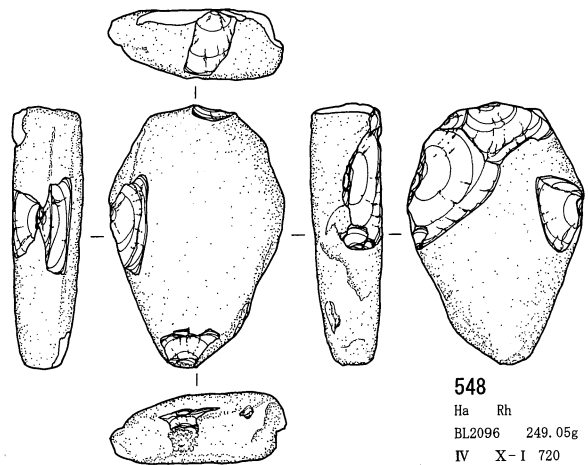

548  
Ha Rh  
BL2096 249.05g  
IV X-I 720

0 (1:3) 10cm

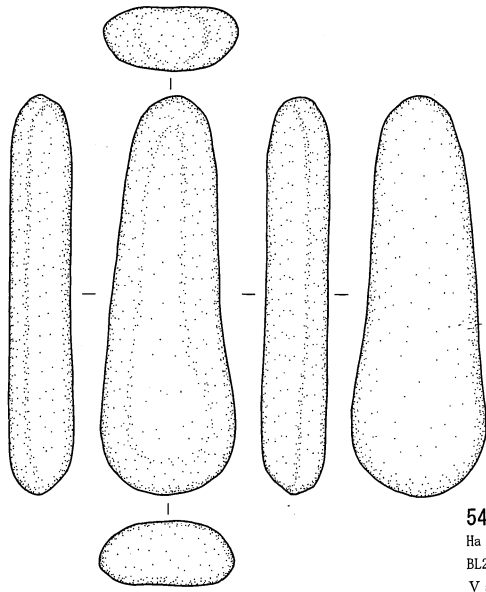

549  
Ha Sa  
BL2082 300g  
Va X-O 585

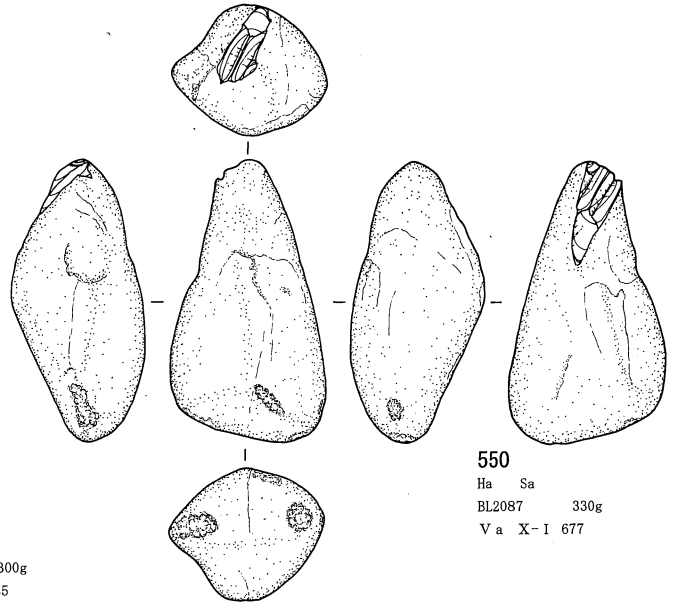

550  
Ha Sa  
BL2087 330g  
Va X-I 677



551  
Ha Tu  
BL2029 660g  
Va X-M 414

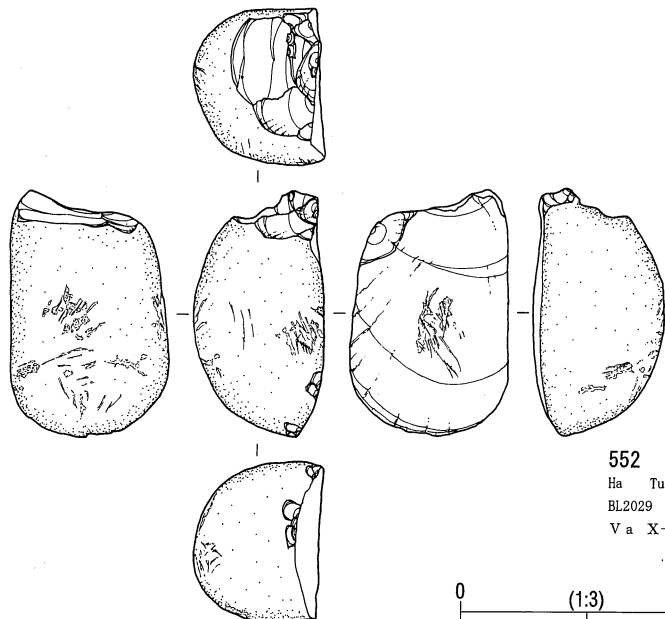

552  
Ha Tu  
BL2029 454.82g  
Va X-M 412

0 (1:3) 10cm

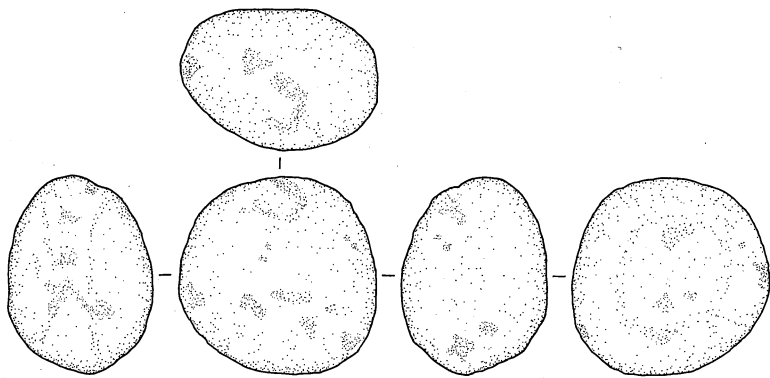

553  
GS 安山岩  
BL2011 400g  
IV X-I 714

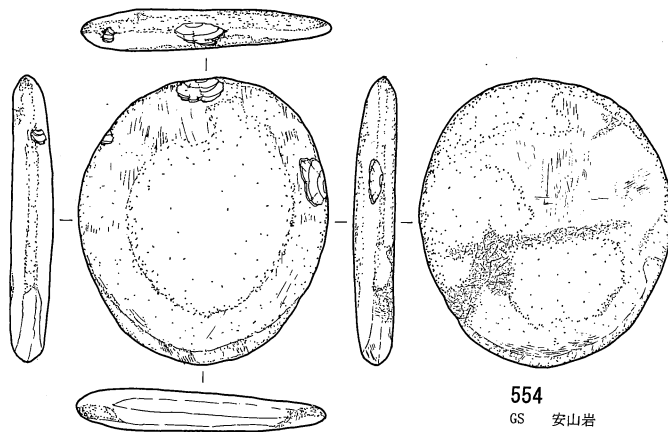

554  
GS 安山岩  
BL2012 269.62g  
III X-I 193

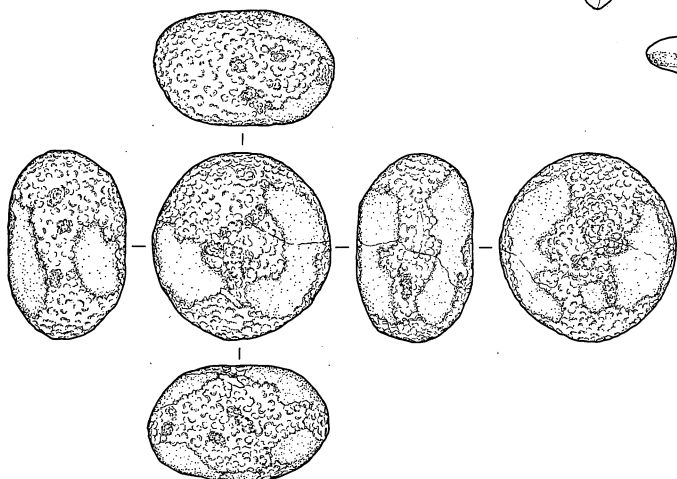

555  
GS ST  
BL2016 340g  
Va X-I 171

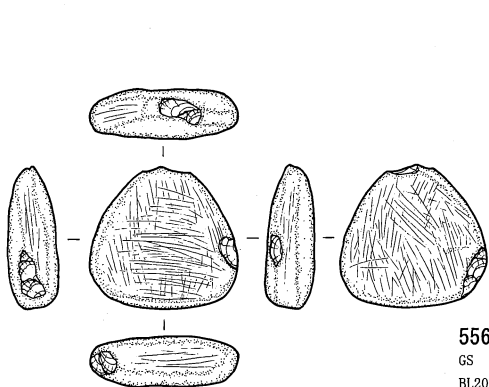

556  
GS TS  
BL2040 75.16g  
IV X-N 1173

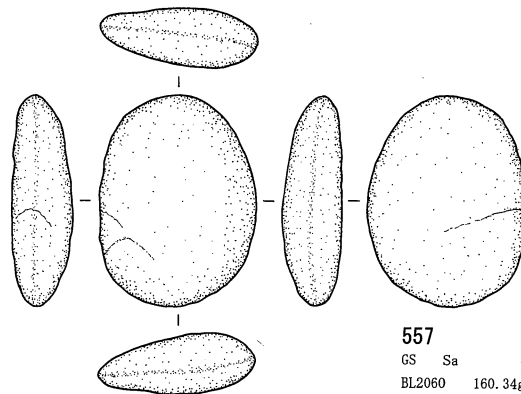

557  
GS Sa  
BL2060 160.34g  
III X-T 261

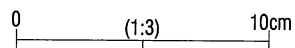

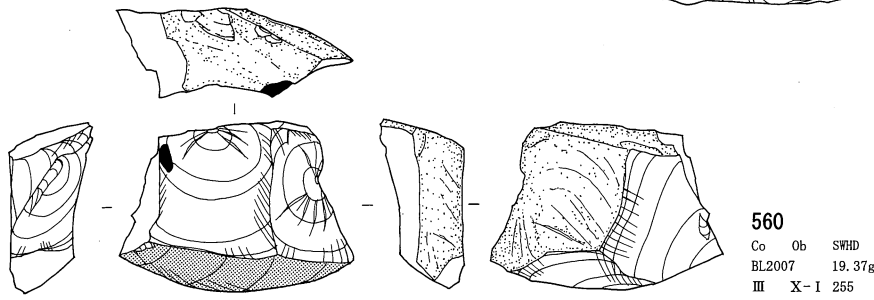
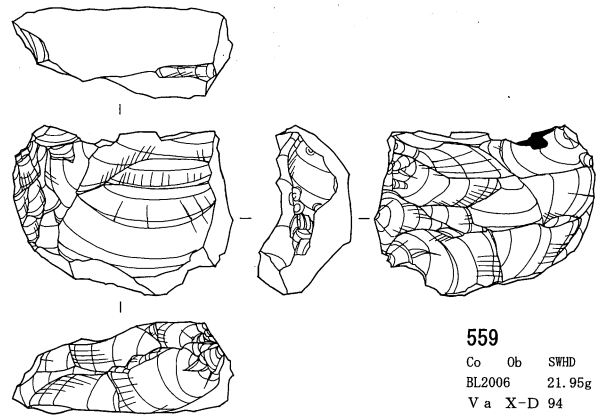
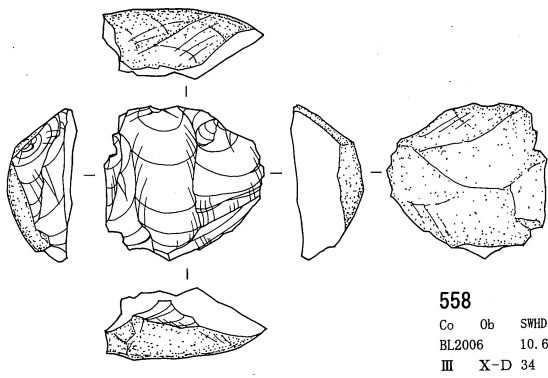

0 (2:3) 5cm

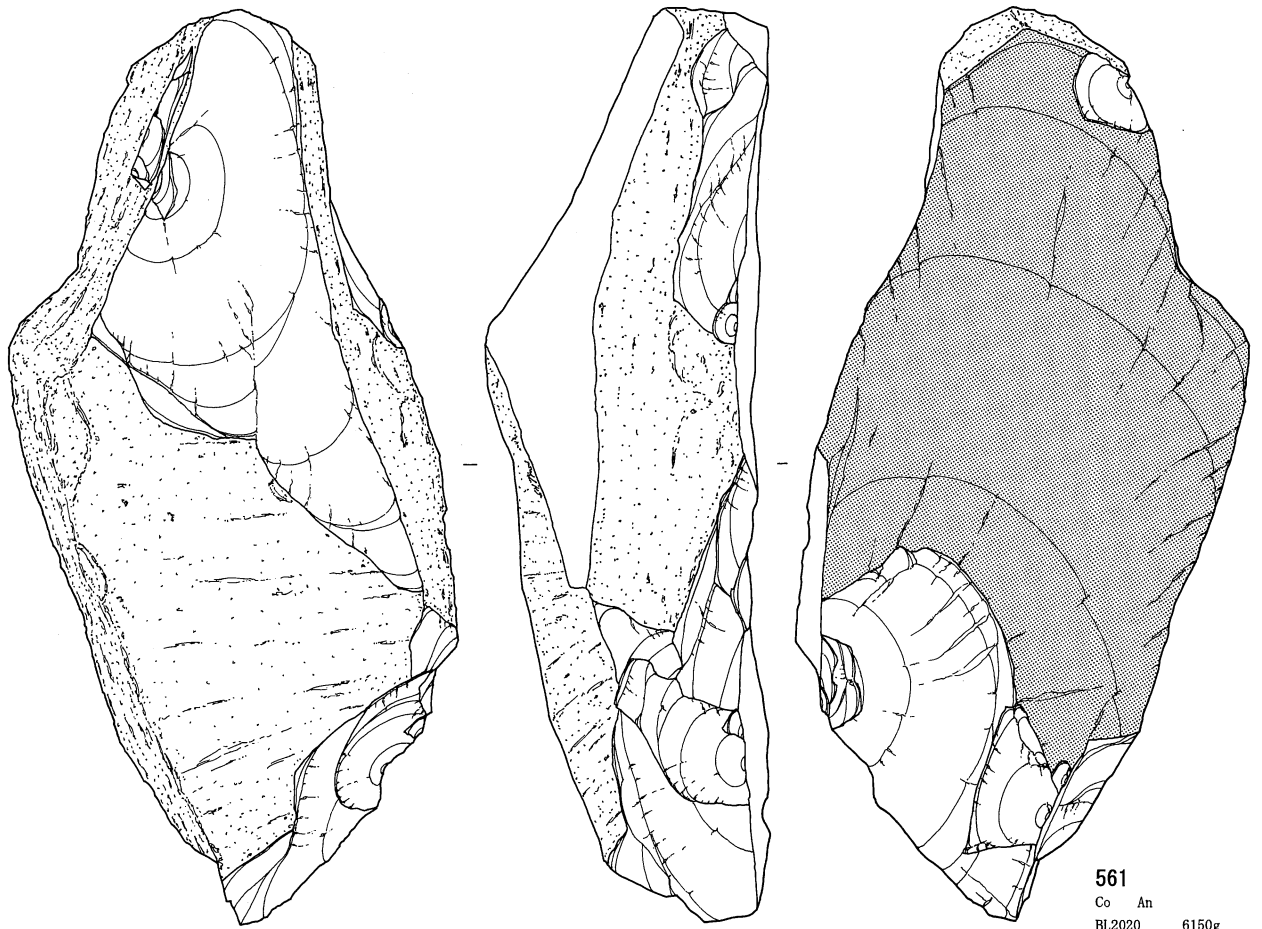

0 (1:3) 10cm

第2地点 石器実測図 60 (石核1) (貫ノ木遺跡)

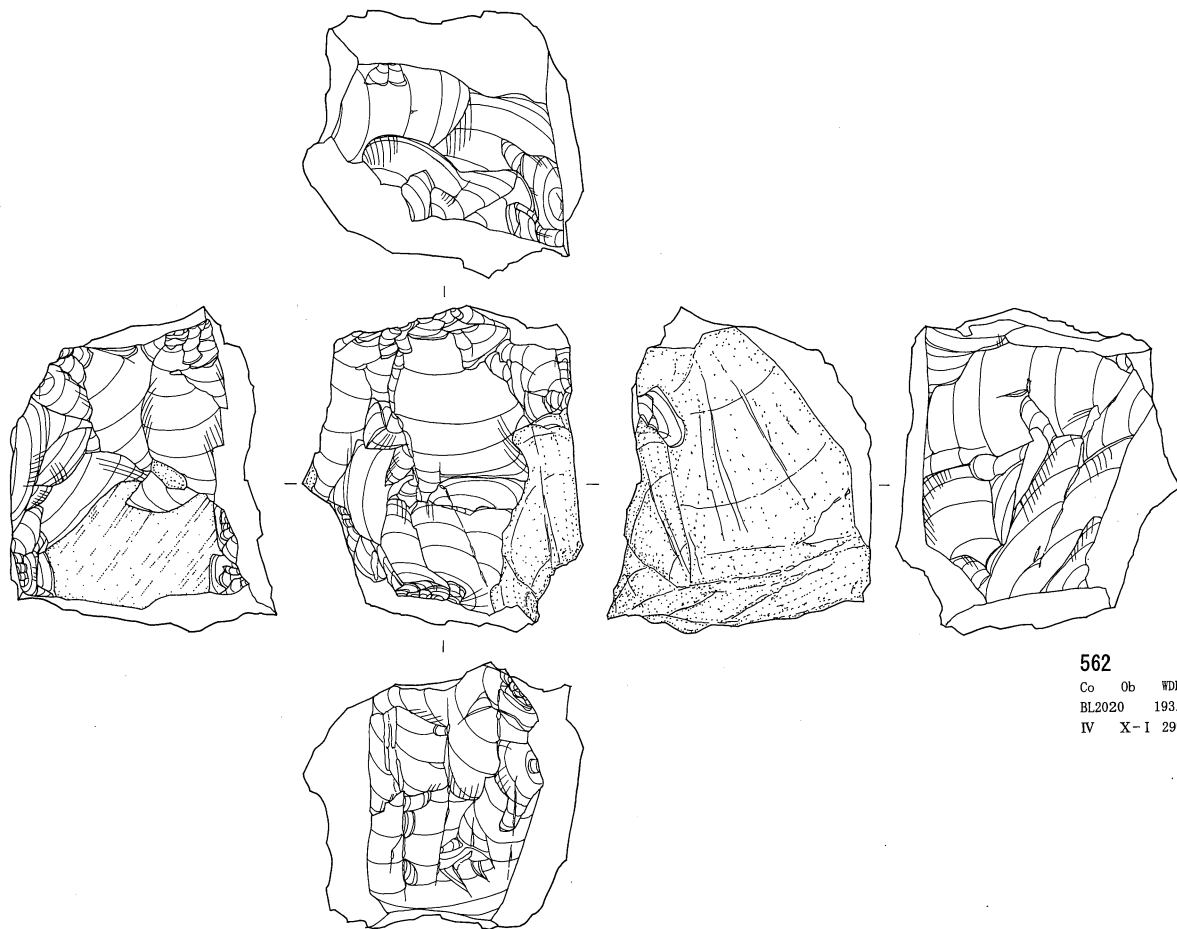

**562**  
 Co Ob WDKB  
 BL2020 193.05g  
 IV X-I 299

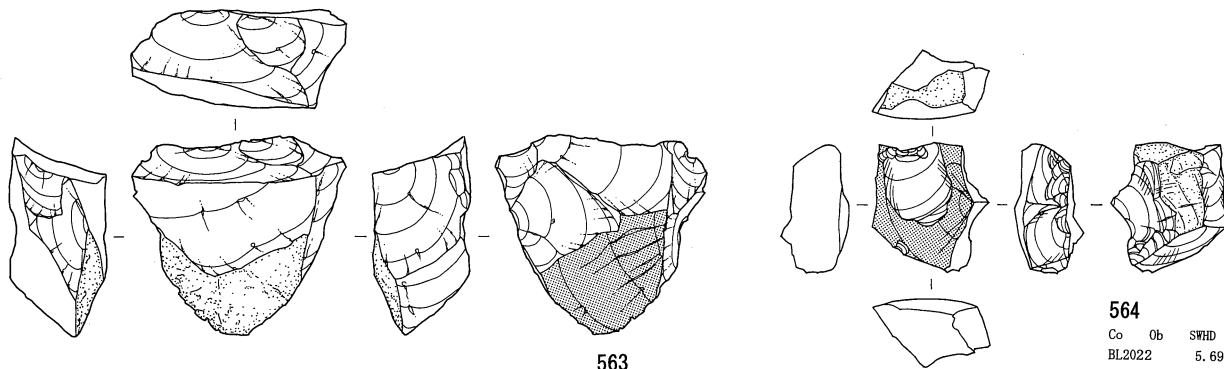

**563**  
 Co An  
 BL2020 27.48g  
 IV X-H 967

**564**  
 Co Ob SWHD  
 BL2022 5.69g  
 IV X-H 67

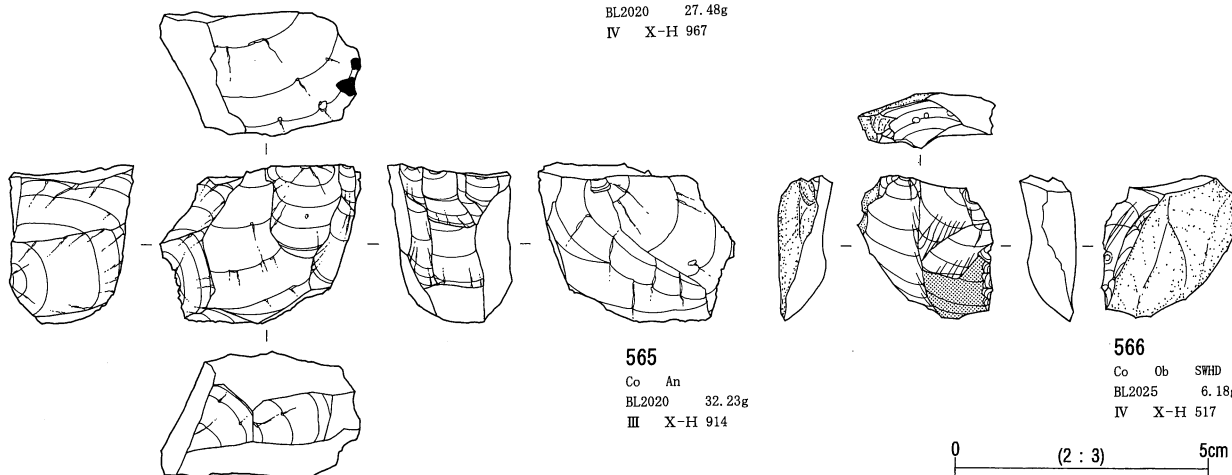

**565**  
 Co An  
 BL2020 32.23g  
 III X-H 914

**566**  
 Co Ob SWHD  
 BL2025 6.18g  
 IV X-H 517

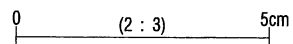

第2地点 石器実測図61 (石核2) (貫ノ木遺跡)

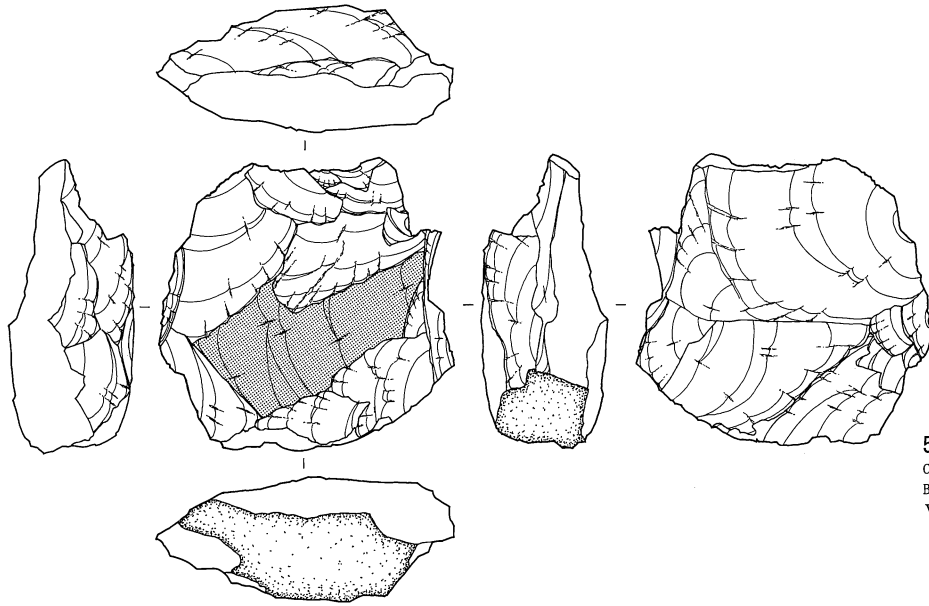

567  
 Co An  
 BL2027 77.84g  
 V a X-M 2459

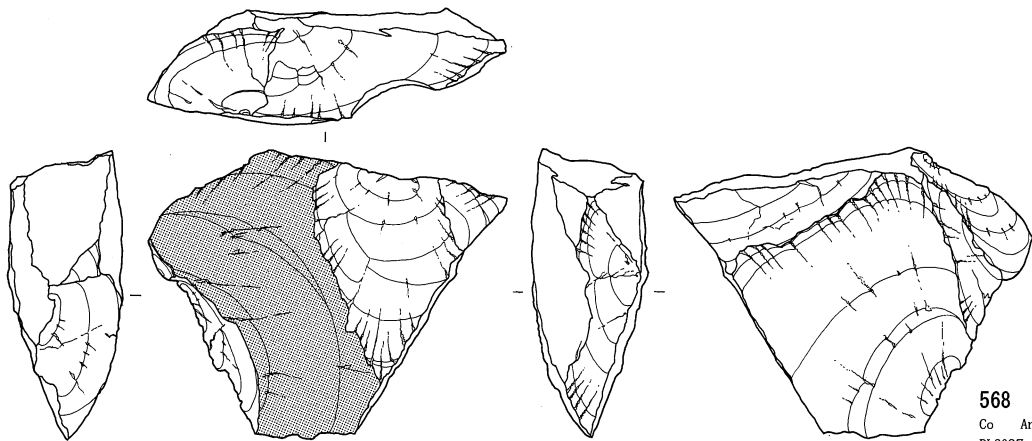

568  
 Co An  
 BL2027 82.06g  
 V b X-M 1911

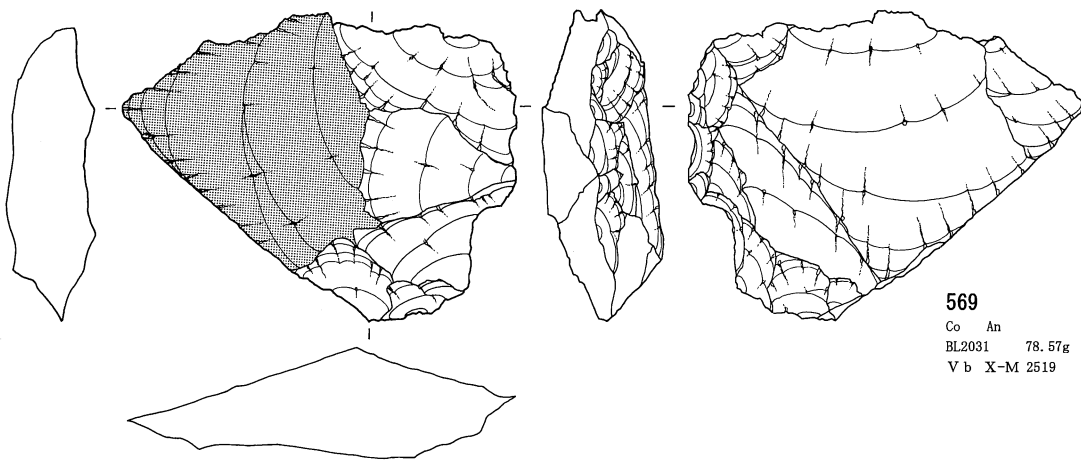

569  
 Co An  
 BL2031 78.57g  
 V b X-M 2519

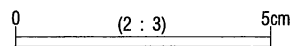

第2地点 石器実測図 62 (石核 3) (貫ノ木遺跡)

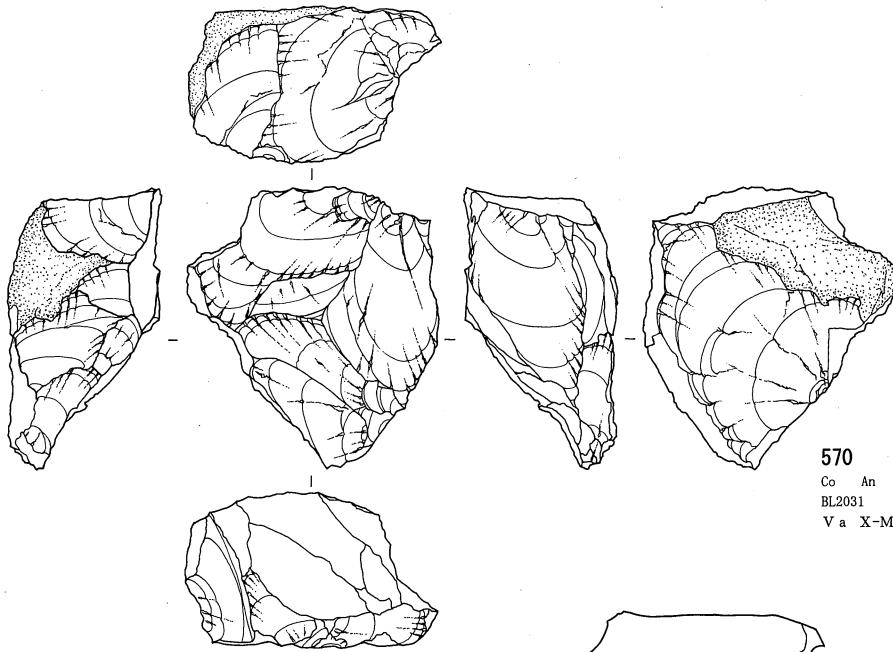

570  
Co An  
BL2031 76.48g  
Va X-M 2035

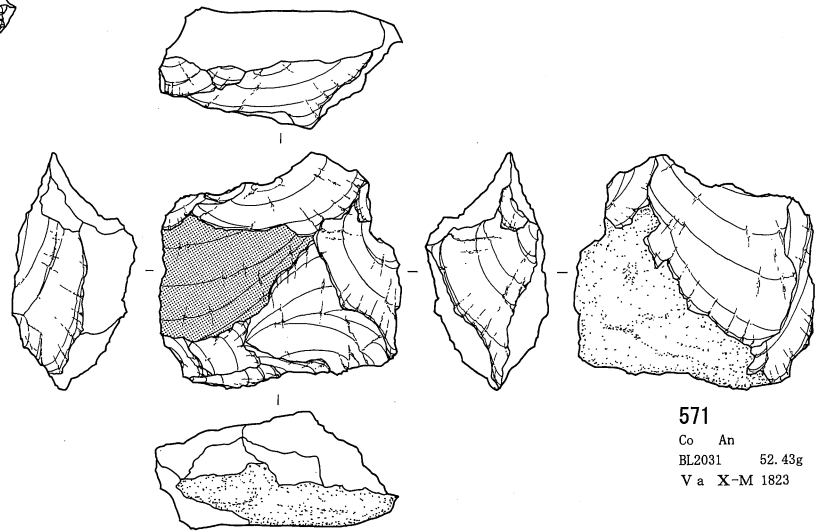

571  
Co An  
BL2031 52.43g  
Va X-M 1823

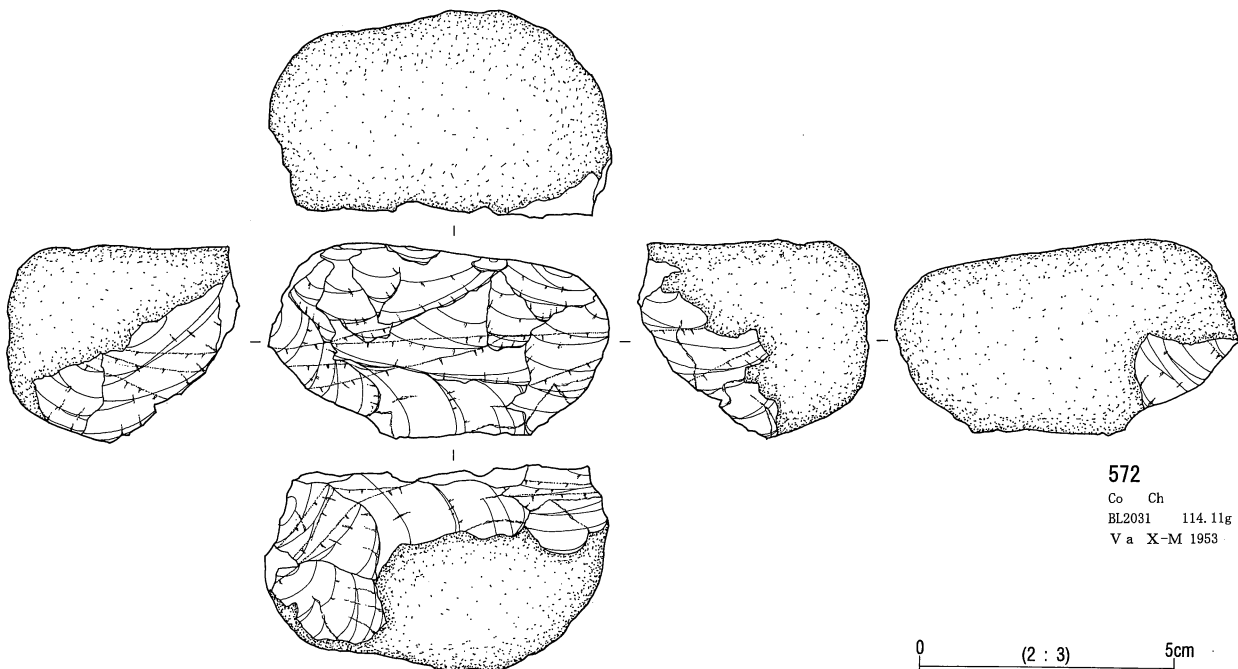

572  
Co Ch  
BL2031 114.11g  
Va X-M 1953

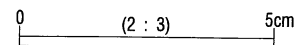

第2地点 石器実測図 63 (石核4) (貫ノ木遺跡)

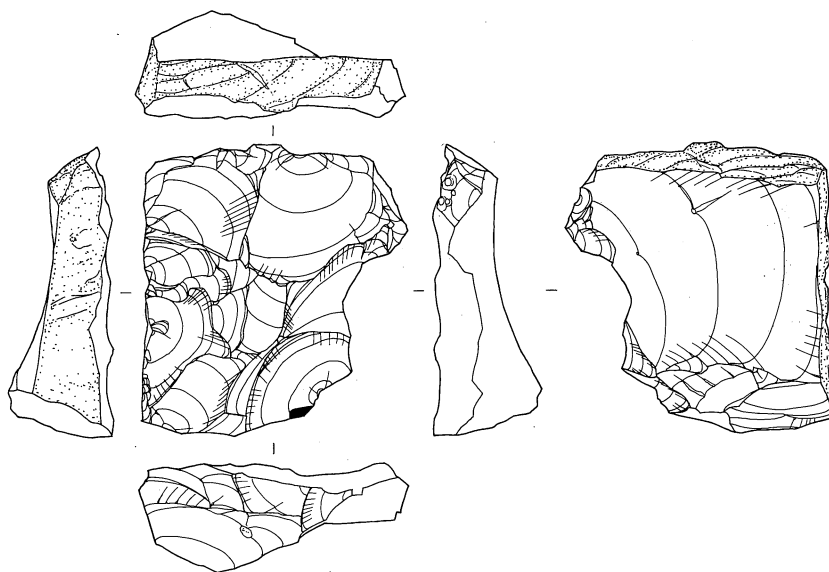

573  
Co Ob WDM  
BL2032 43.99g  
V a X-M 2044

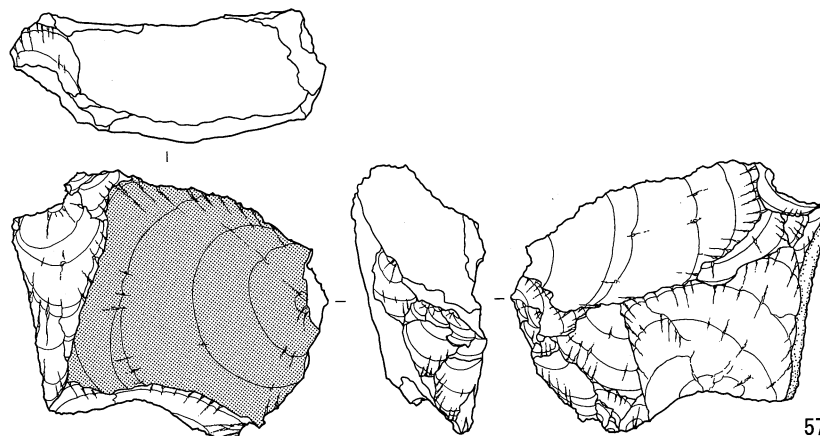

574  
Co An  
BL2034 65.06g  
IV X-M 1786

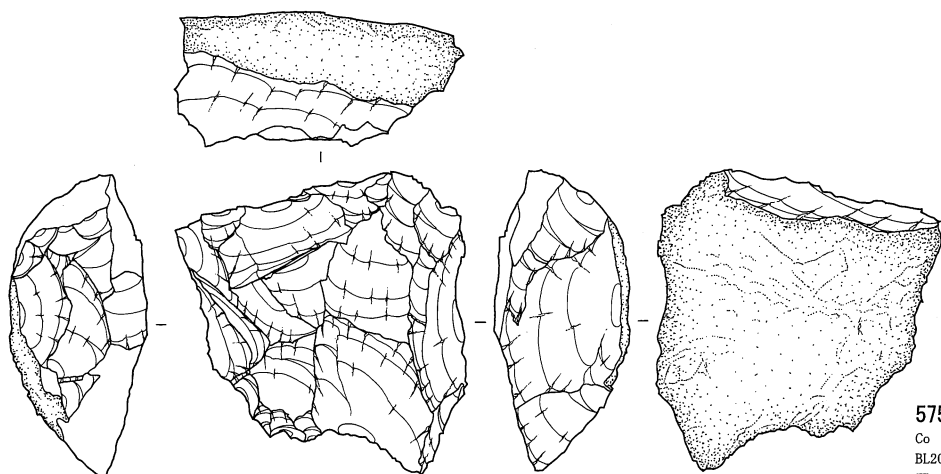

575  
Co An  
BL2034 91.18g  
III X-M 205

0 (2 : 3) 5cm



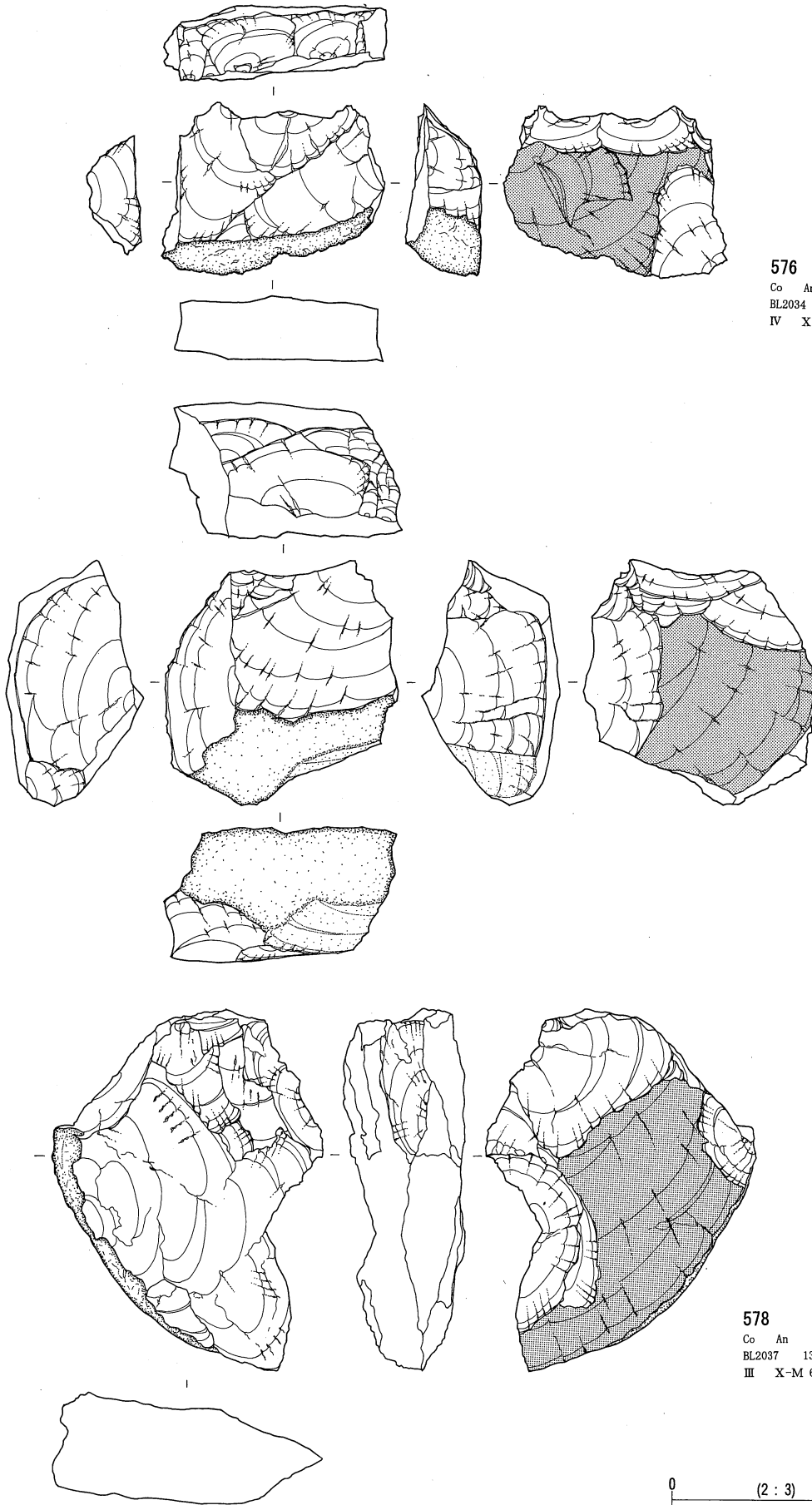

576  
Co An  
BL2034 43.66g  
IV X-M 978

577  
Co An  
BL2036 109.59g  
V a X-M 2127

578  
Co An  
BL2037 138.78g  
III X-M 632

第2地点 石器実測図 65 (石核6) (貫ノ木遺跡)

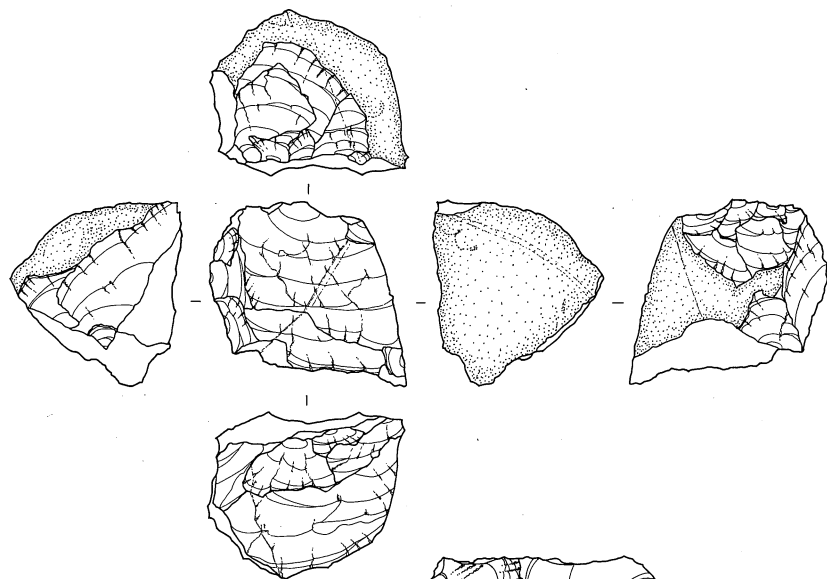

579  
Co Ch  
BL2037 49.68g  
IV X-M 1696

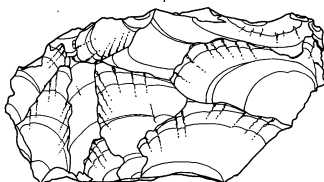
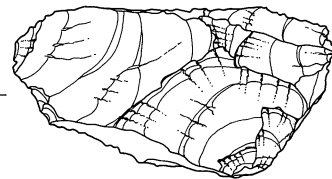
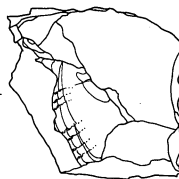
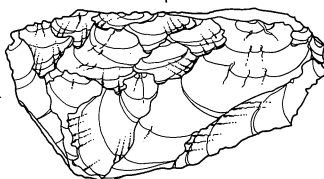
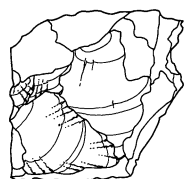
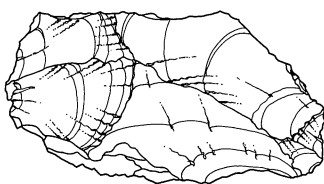
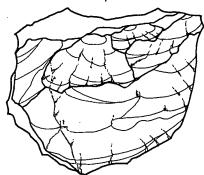

580  
Co An  
BL2045 79.08g  
III X-M 2712

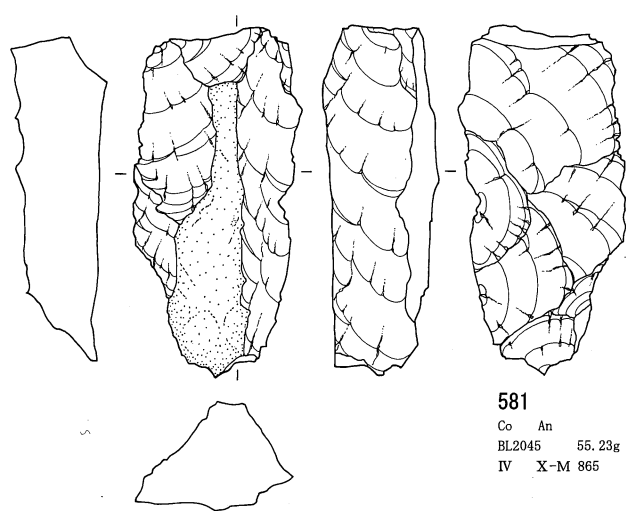

581  
Co An  
BL2045 55.23g  
IV X-M 865

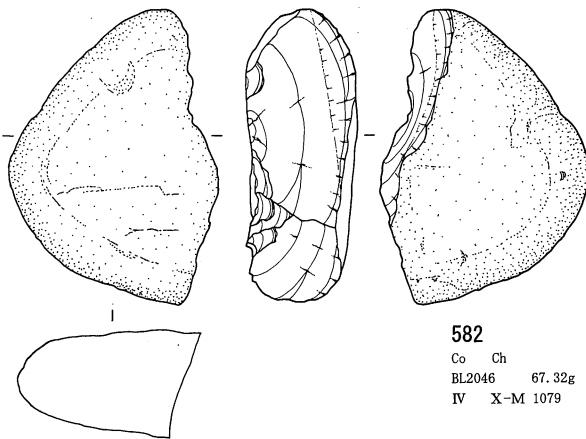

582  
Co Ch  
BL2046 67.32g  
IV X-M 1079

0 (2:3) 5cm

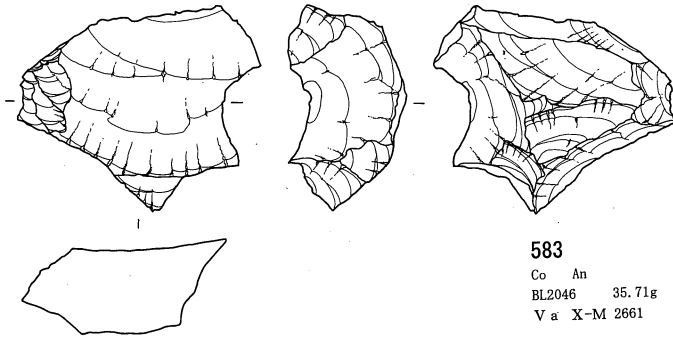

583  
Co An  
BL2046 35.71g  
V a X-M 2661

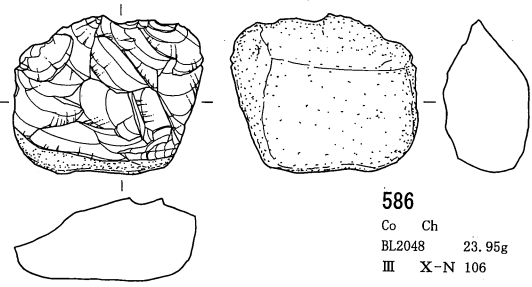

586  
Co Ch  
BL2048 23.95g  
III X-N 106

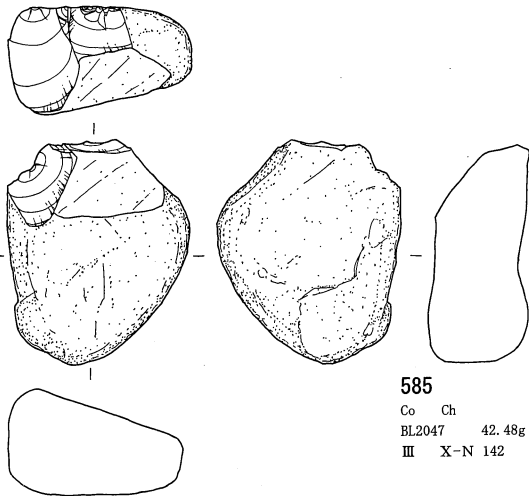

585  
Co Ch  
BL2047 42.48g  
III X-N 142

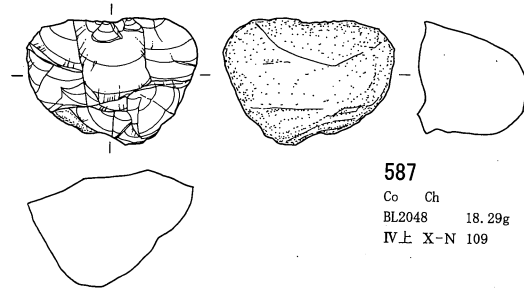

587  
Co Ch  
BL2048 18.29g  
IV上 X-N 109

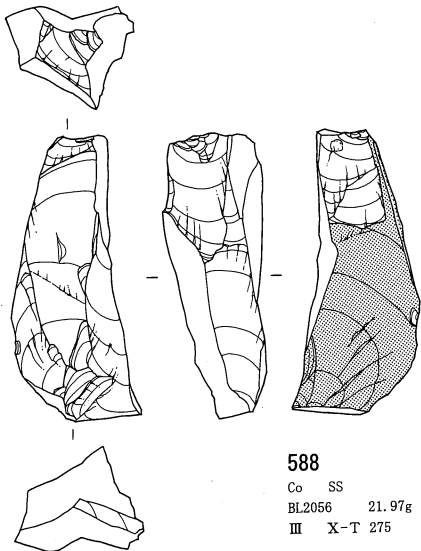

588  
Co SS  
BL2056 21.97g  
III X-T 275

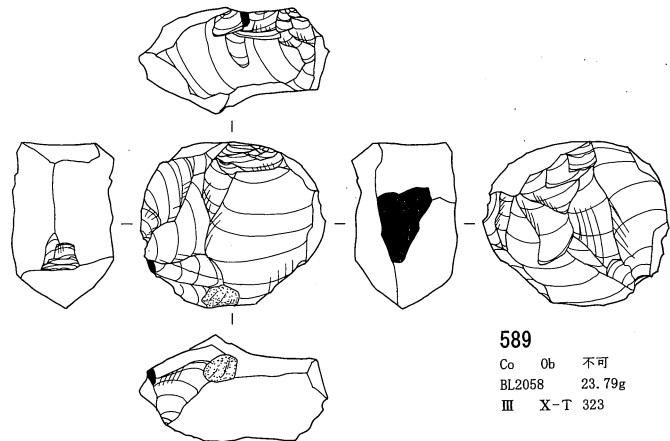

589  
Co Ob 不可  
BL2058 23.79g  
III X-T 323

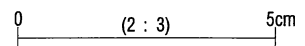

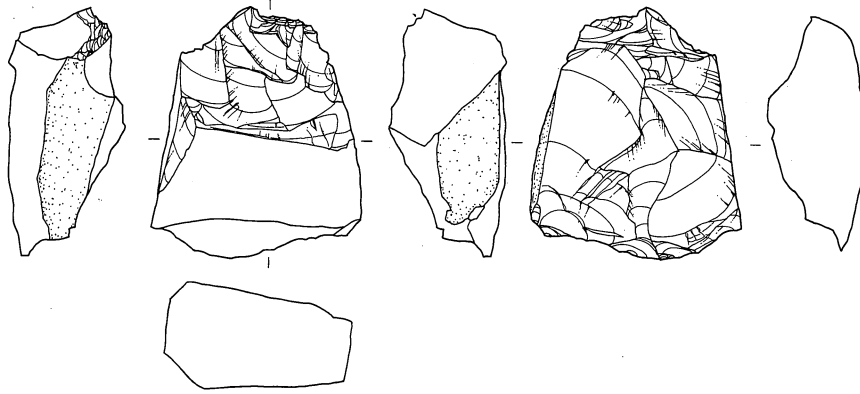

590  
Co SS  
BL2058 42.78g  
IV下 X-T 64

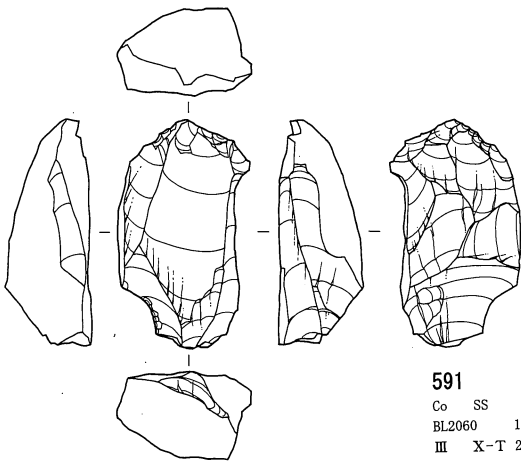

591  
Co SS  
BL2060 17.39g  
III X-T 204

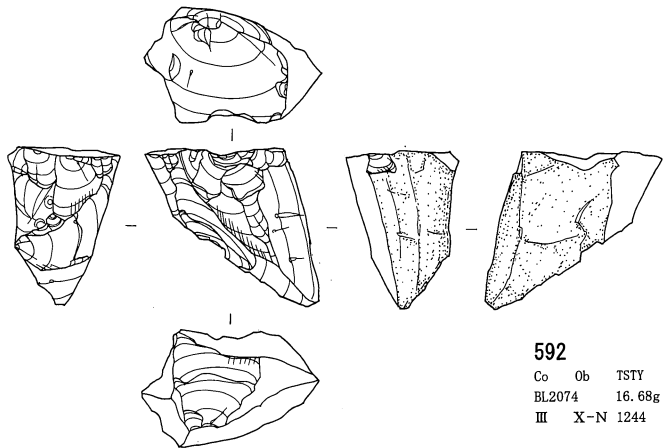

592  
Co Ob TSTY  
BL2074 16.68g  
III X-N 1244

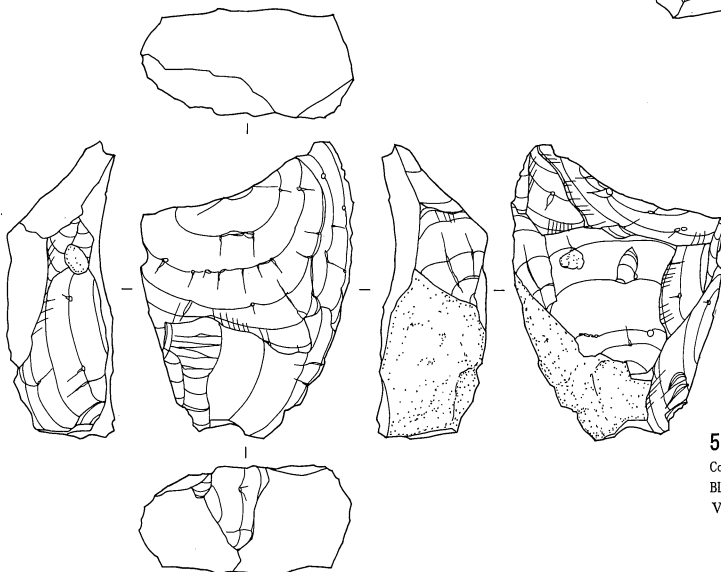

593  
Co Ob TSTY  
BL2077 41.49g  
V b X-N 3110

0 (2:3) 5cm

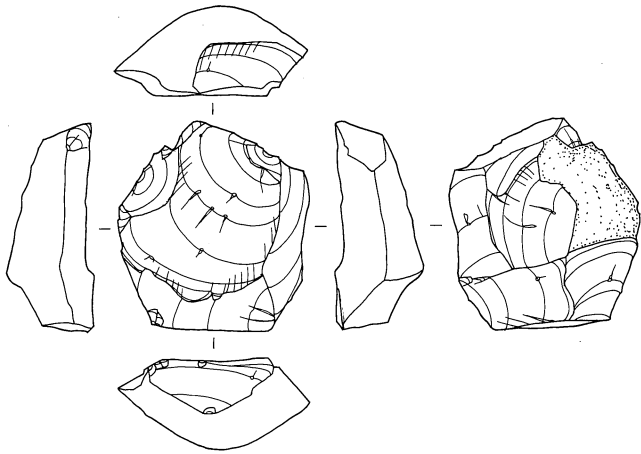

594  
Co Ob TSTY  
BL2077 20.86g  
V b X-N 3111

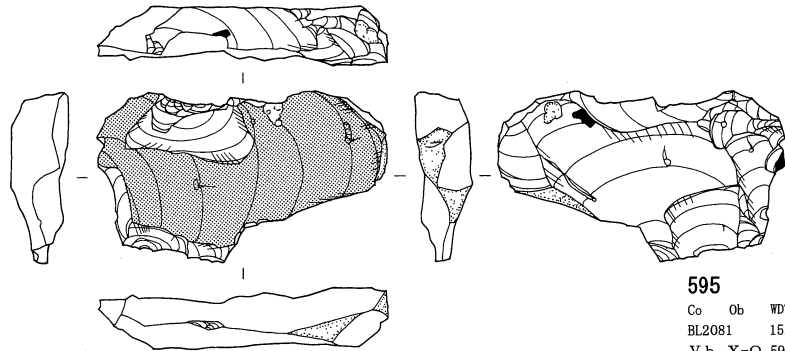

595  
Co Ob WDTY  
BL2081 15.68g  
V b X-O 596

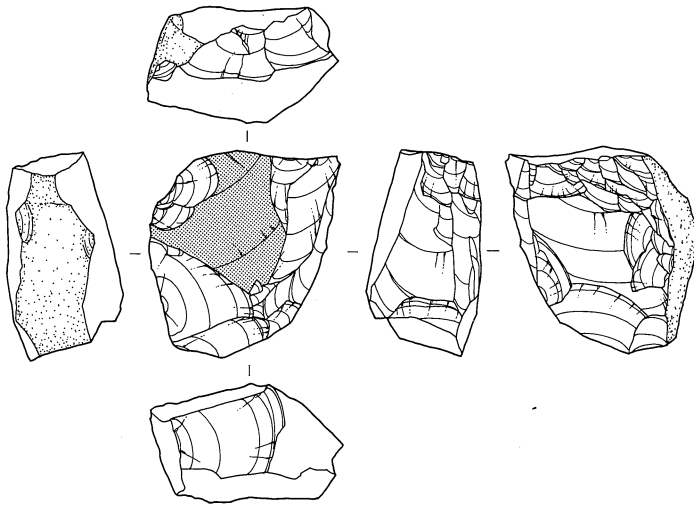

596  
Co TS  
BL2086 36.98g  
IV X-I 48

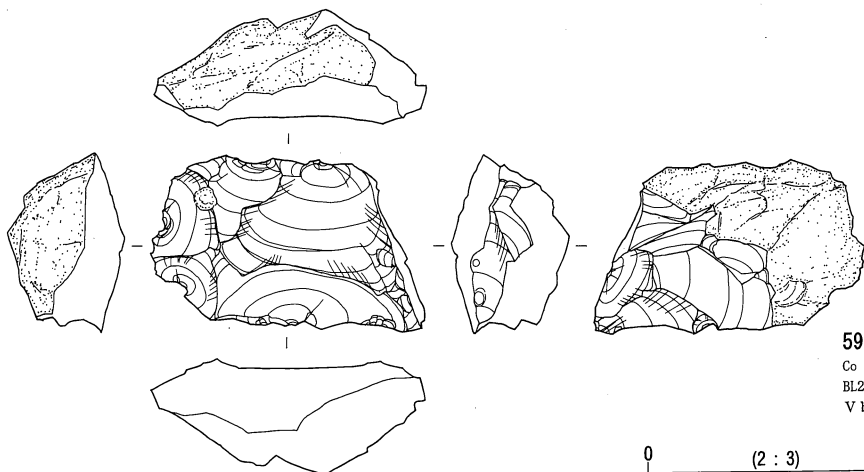

597  
Co Ob WDTY  
BL2086 29.25g  
V b X-I 662

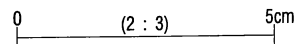

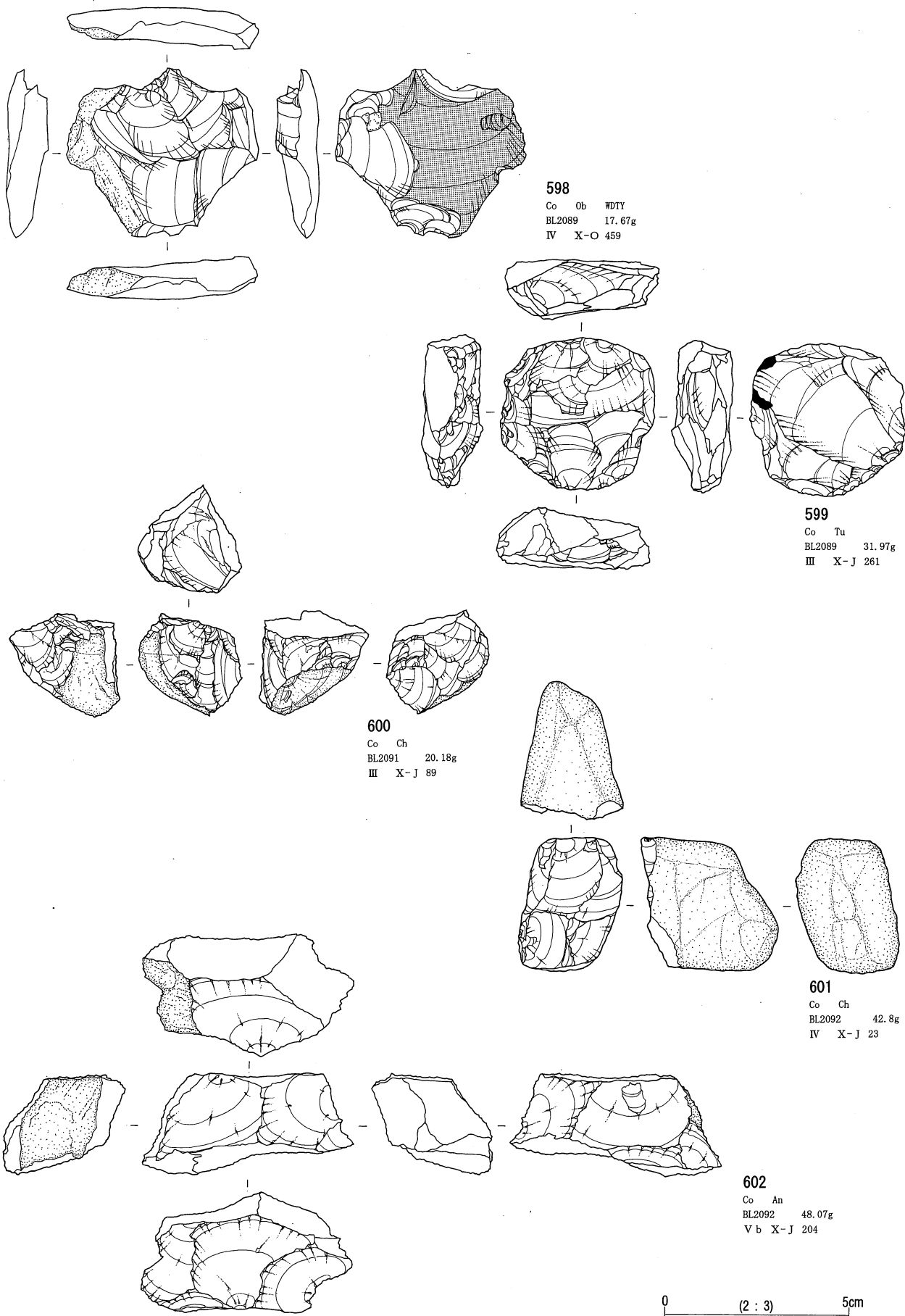

第2地点 石器実測図70(石核11)(貫ノ木遺跡)

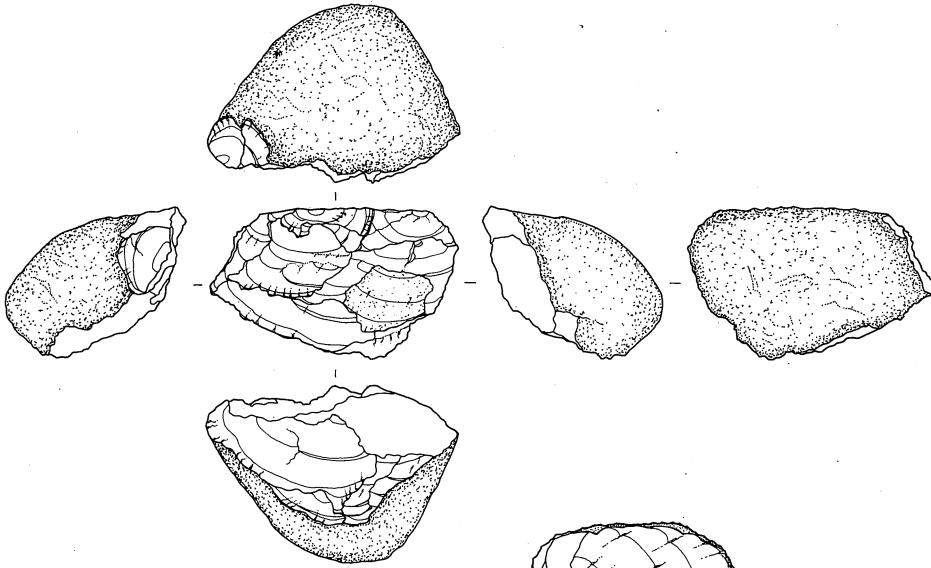

603  
Co Ch  
BL2092 47.15g  
III X-J 135

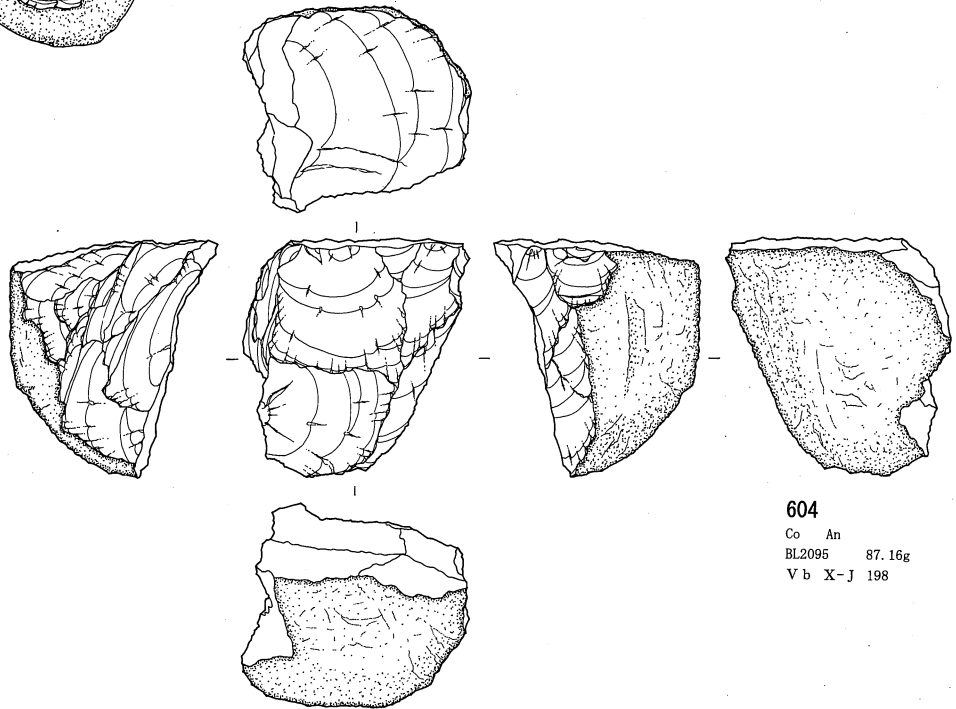

604  
Co An  
BL2095 87.16g  
V b X-J 198

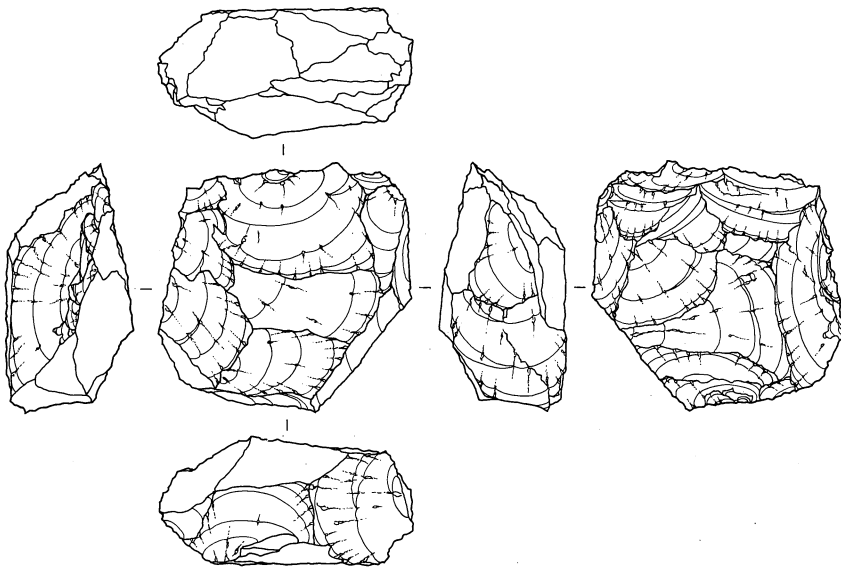

605  
Co An  
BL2095 72.1g  
IV X-J 70

0 (2 : 3) 5cm

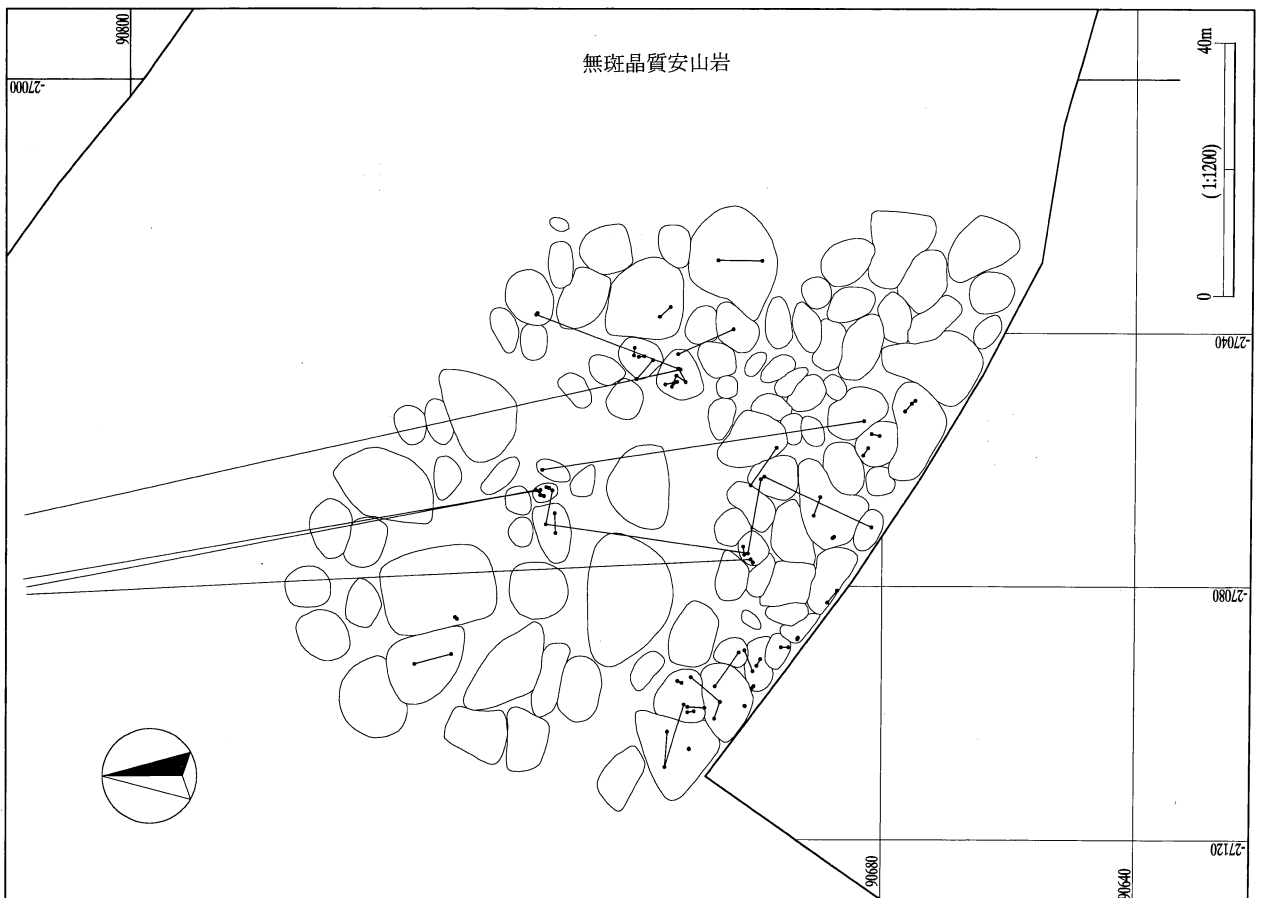
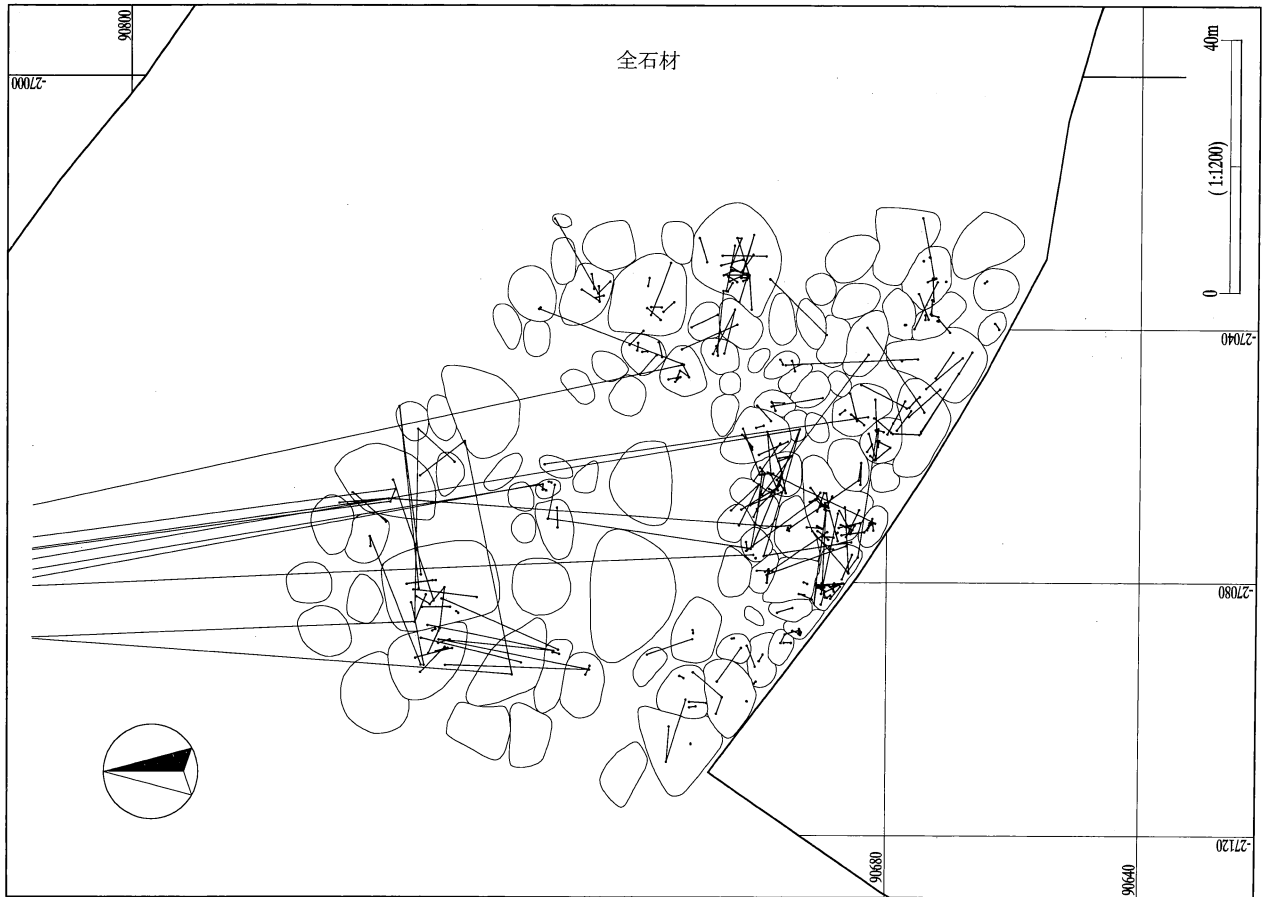

第2地点 接合資料分布図1 (貫ノ木遺跡)



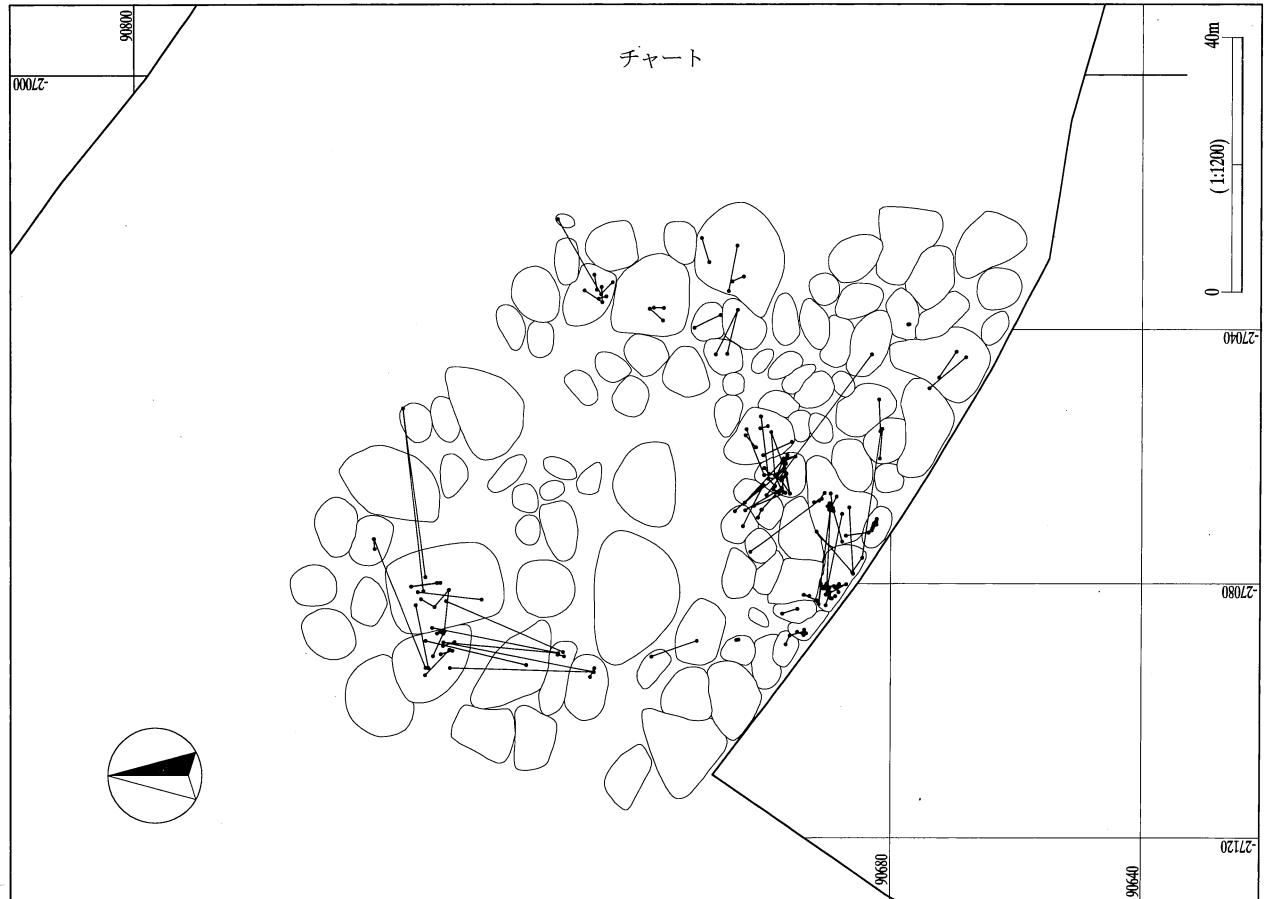
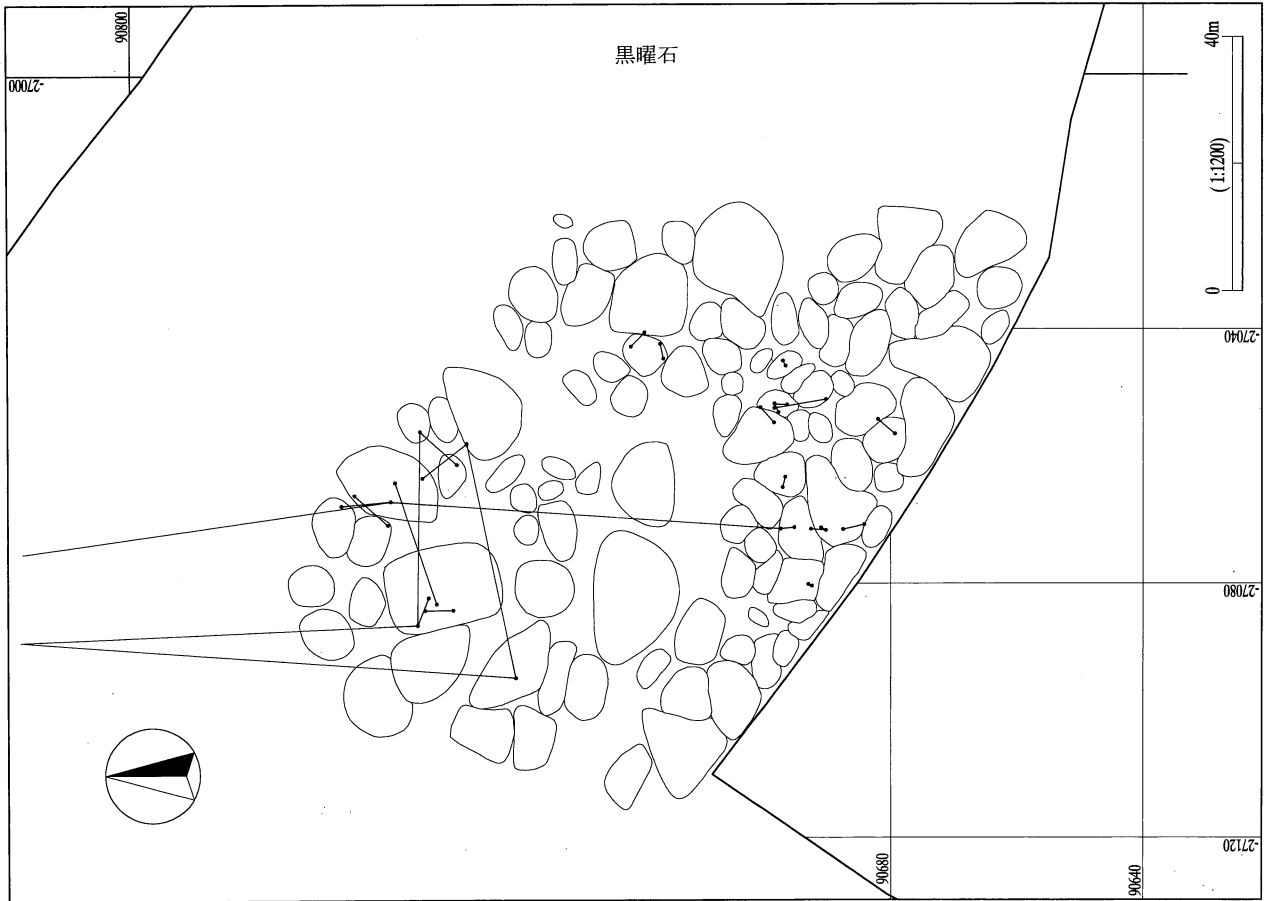

第2地点 接合資料分布図2 (貫ノ木遺跡)

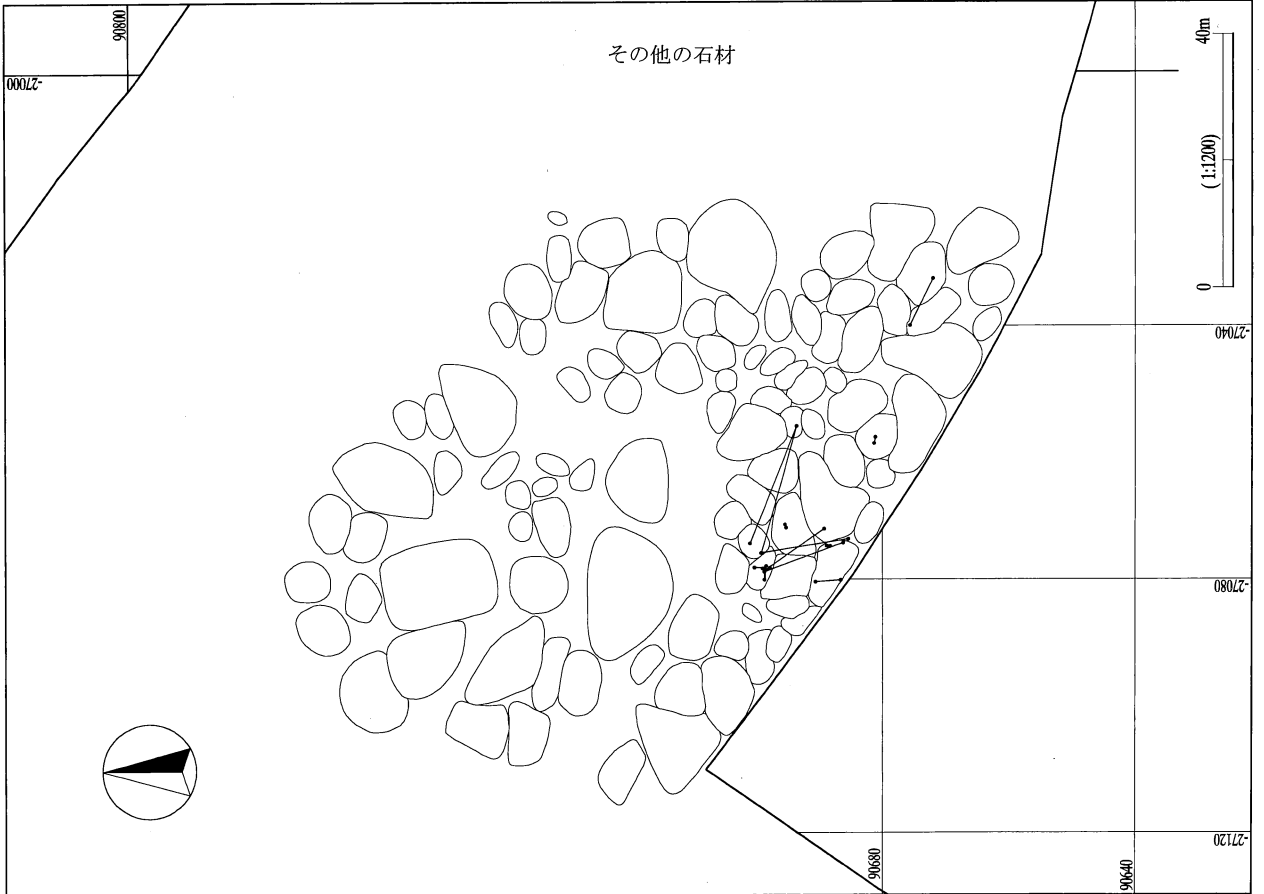
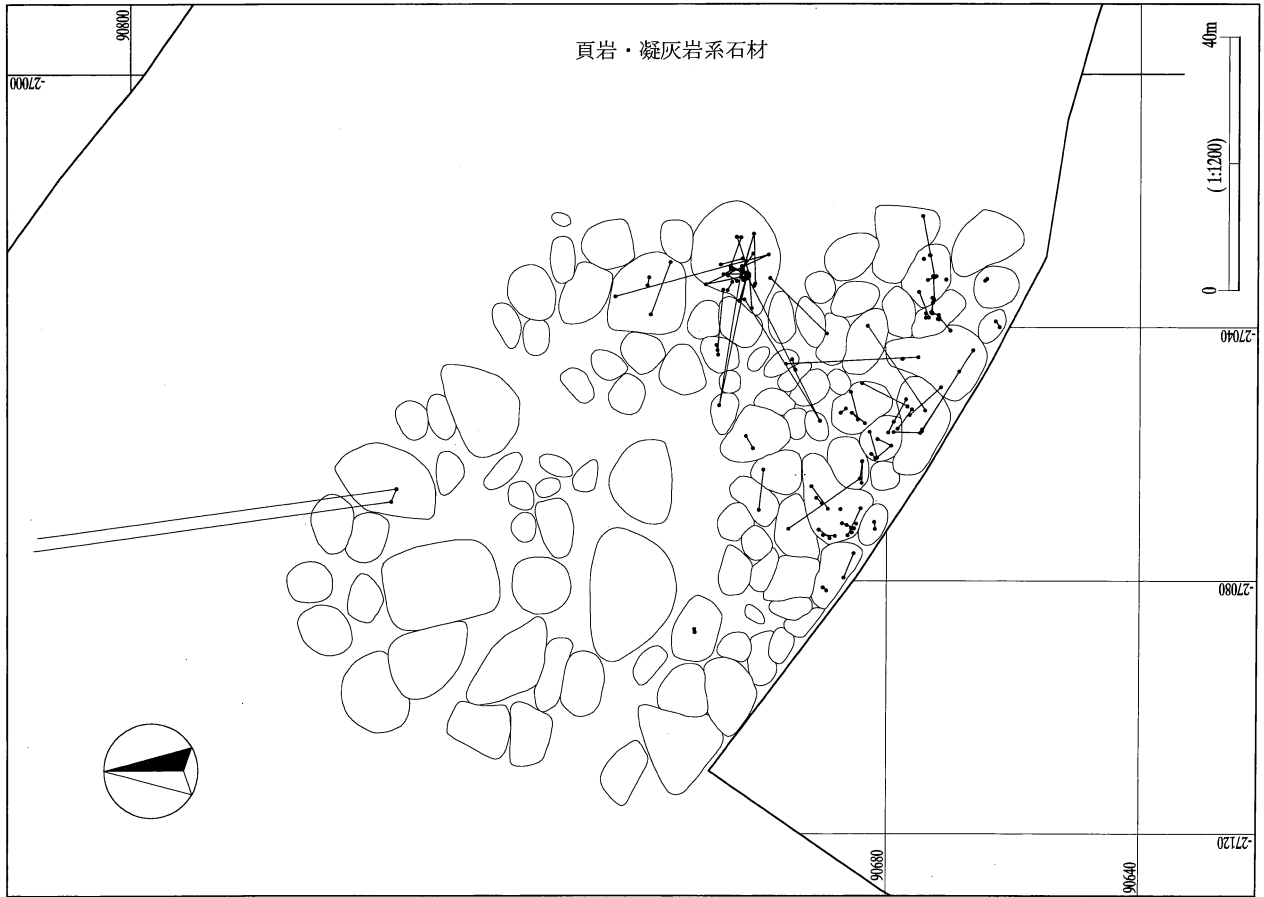

第2地点 接合資料分布図3 (貫ノ木遺跡)

Ch-74

| 剥離順序 | 遺物番号    | ブロック | 出土層位 | 器種 | 重量g  | 打面 | 作業面 |
|------|---------|------|------|----|------|----|-----|
| 1    | X-N2906 | 2043 | V a  | Fl | 1.54 | 右  | 上   |
| 2    | X-N993  | 2043 | IV   | Fl | 3.99 | 正面 | 左   |
| 3    | X-N2944 | 2043 | V b  | Fl | 6.23 | 裏面 | 右   |
| 4    | Ch-227  |      |      |    |      | 右  | 裏面  |
| 5    | X-N980  | 2043 | IV   | Fl | 2.61 | 下  | 裏面  |
| 6    | X-N986  | 2043 | IV   | Fl | 4.4  | 下  | 裏面  |
| 7    | X-N913  | 2043 | III  | Fl | 1.71 | 下  | 裏面  |
| 8    | X-N3325 | 2076 | V b  | Fl | 44.6 | 下  | 裏面  |
| 9    | X-N1009 | 2043 | IV   | Fl | 8.85 | 下  | 裏面  |
| 10   | Ch-228  |      |      |    |      | 裏面 | 下   |

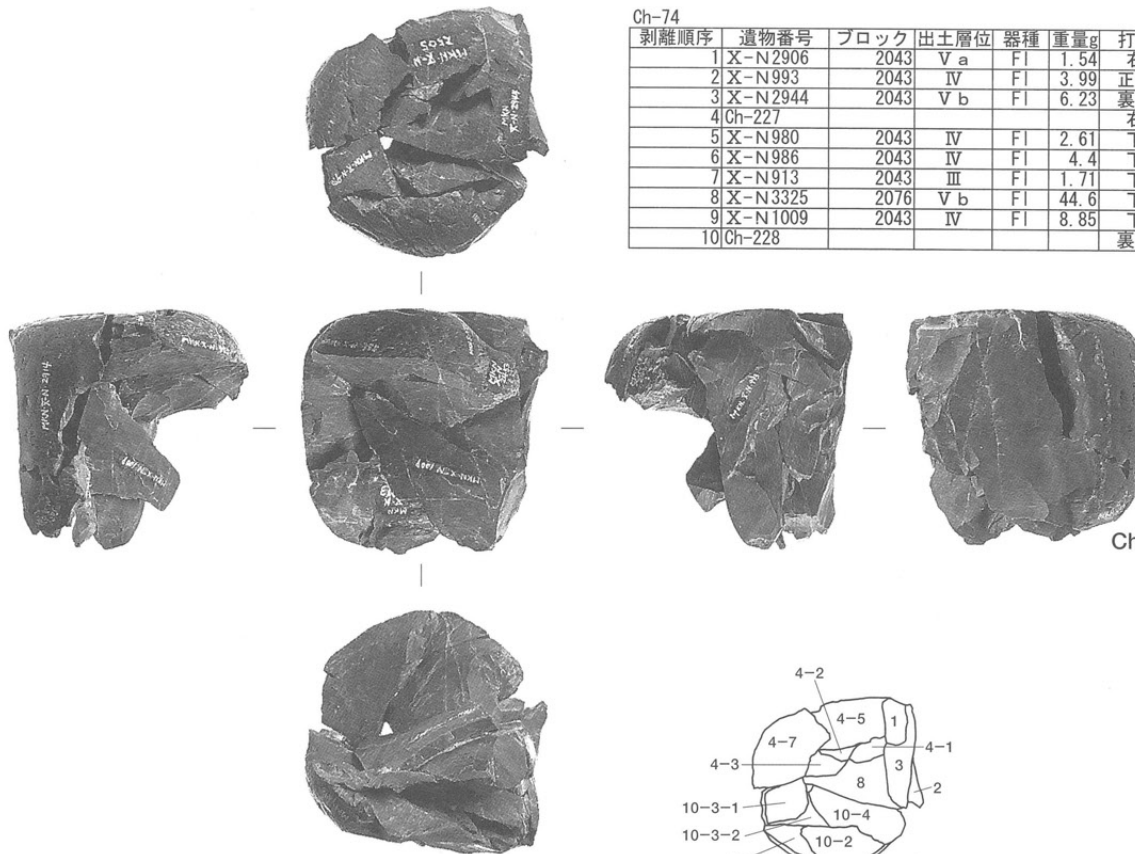

Ch-74  
227  
228  
229

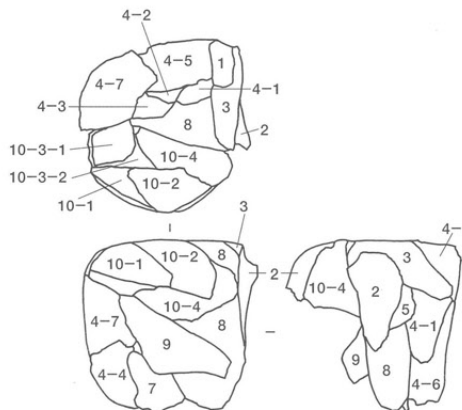

Ch-227

| 剥離順序 | 遺物番号    | ブロック | 出土層位 | 器種 | 重量g  | 打面 | 作業面 |
|------|---------|------|------|----|------|----|-----|
| 4-1  | X-N2985 | 2043 | V b  | Fl | 12.8 | 上  | 正面  |
| 4-2  | X-N2186 | 2043 | IV   | Fl | 11.1 | 上  | 正面  |
| 4-3  | X-N1033 | 2043 | V a  | Fl | 2.02 | 上  | 正面  |
| 4-4  | X-N2211 | 2043 | V a  | Fl | 4.12 | 左  | 正面  |
| 4-5  | X-N2505 | 2043 | IV   | Fl | 25.7 |    |     |
| 4-6  | X-N1095 | 2042 | IV   | Fl | 23.3 |    |     |
| 4-7  | X-N2914 | 2043 | V a  | Co | 33.4 |    |     |

Ch-228

| 剥離順序 | 遺物番号    | ブロック | 出土層位 | 器種 | 重量g  | 打面 | 作業面 |
|------|---------|------|------|----|------|----|-----|
| 10-1 | X-N955  | 2043 | IV   | Fl | 7.33 | 下  | 正面  |
| 10-2 | X-N983  | 2043 | IV   | Fl | 8.16 | 下  | 正面  |
| 10-3 | Ch-229  |      |      |    |      | 下  | 右   |
| 10-4 | X-N2453 | 2076 | IV   | Co | 25.5 |    |     |

Ch-229

| 剥離順序   | 遺物番号    | ブロック | 出土層位 | 器種 | 重量g  | 打面 | 作業面 |
|--------|---------|------|------|----|------|----|-----|
| 10-3-1 | X-N970  | 2043 | IV   | Fl | 1.57 | 右  | 上   |
| 10-3-2 | X-N2167 | 2043 | IV   | Co | 9.44 |    |     |

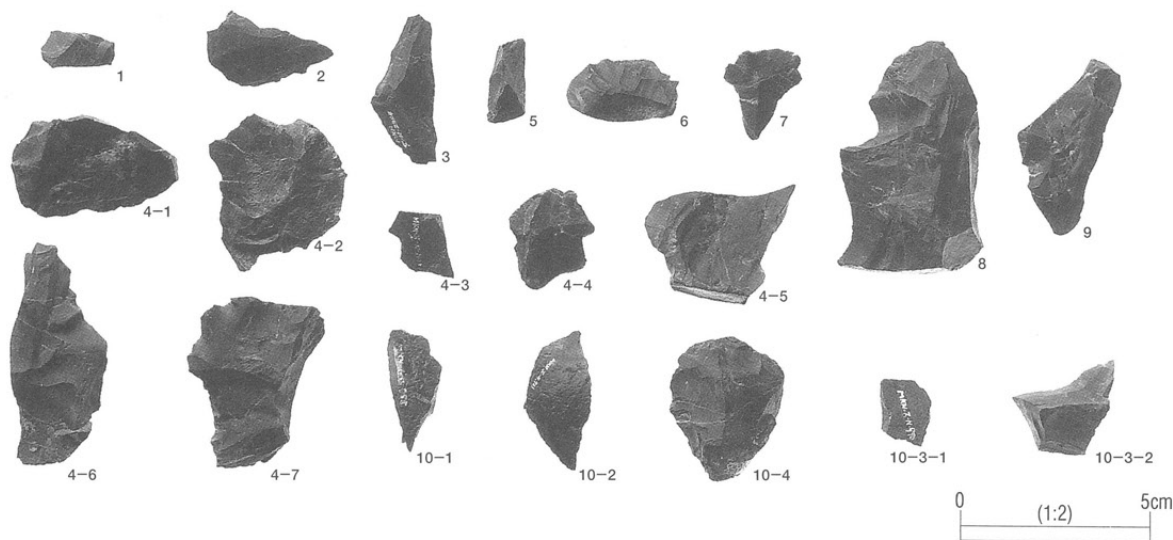

Ch-74・227・228・229 集合写真

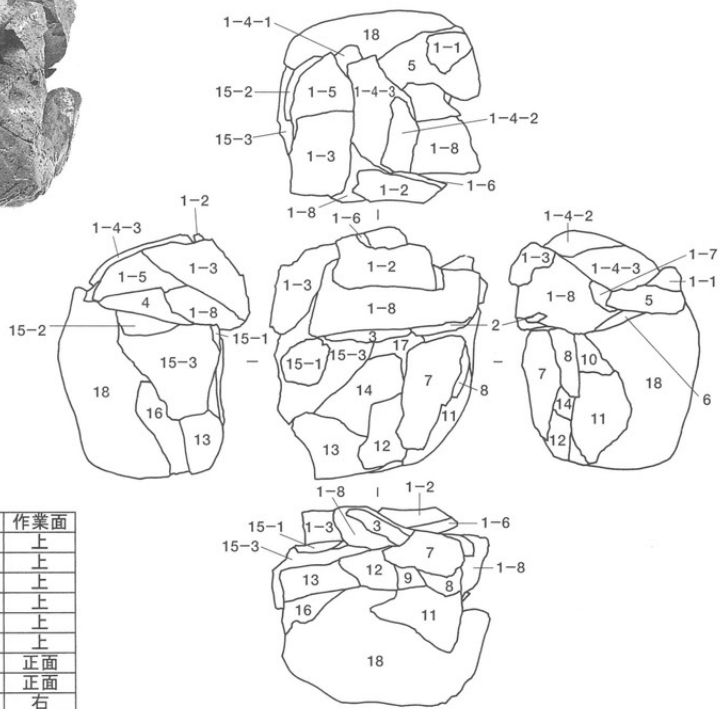
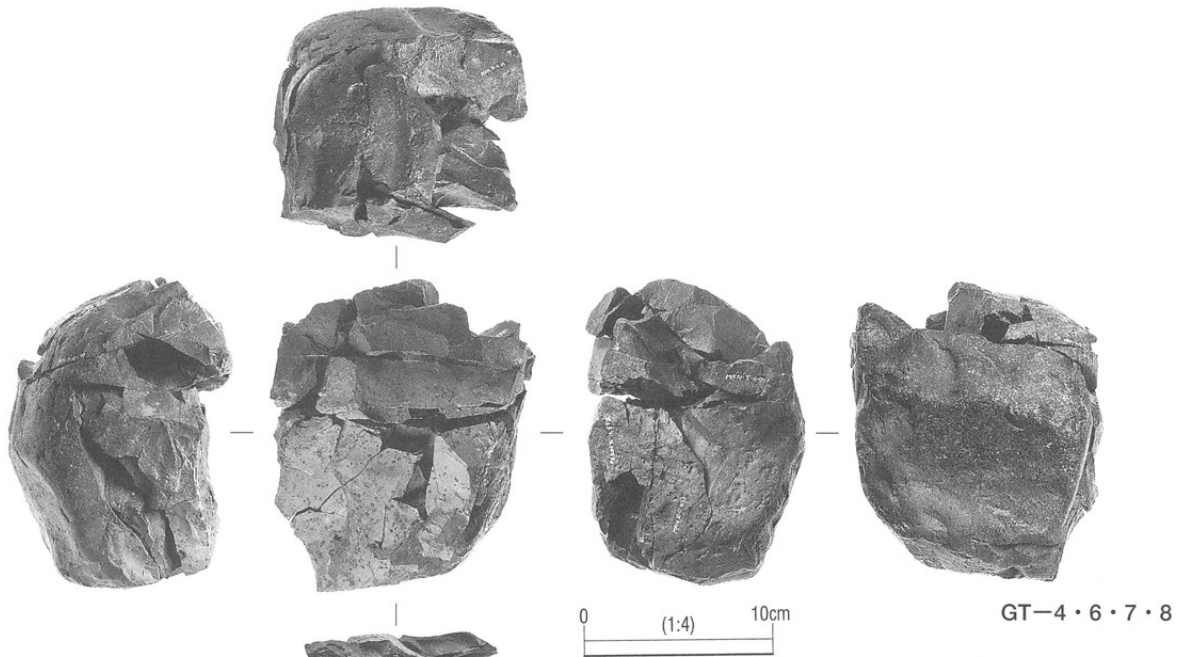

GT-4

| 剥離順序 | 遺物番号    | ブロック | 出土層位 | 器種 | 重量g  | 打面 | 作業面 |
|------|---------|------|------|----|------|----|-----|
| 1    | GT-6    |      |      |    |      | 右  | 上   |
| 2    | X-O906  | 2083 | V b  | Fl | 2.03 | 右  | 上   |
| 3    | X-O907  | 2083 | V b  | Fl | 3.39 | 右  | 上   |
| 4    | X-O552  | 2083 | V a  | Fl | 38.9 | 右  | 上   |
| 5    | X-O921  | 2083 | V a  | Fl | 43.6 | 右  | 上   |
| 6    | X-O175  | 2083 | IV   | Fl | 13   | 右  | 上   |
| 7    | X-O579  | 2083 | V a  | Fl | 44.8 | 上  | 正面  |
| 8    | X-O176  | 2083 | IV   | Fl | 23.5 | 上  | 正面  |
| 9    | X-O489  | 2083 | IV   | Fl | 17.6 | 上  | 右   |
| 10   | X-O141  | 2083 | III  | Fl | 19.3 | 上  | 右   |
| 11   | X-O453  | 2083 | IV   | Fl | 52.3 | 上  | 右   |
| 12   | X-O177  | 2083 | IV   | Fl | 25.4 | 右  | 正面  |
| 13   | X-O178  | 2083 | IV   | Fl | 65.9 | 右  | 正面  |
| 14   | X-O558  | 2083 | V a  | Co | 60.1 | 右  | 正面  |
| 15   | GT-8    |      |      |    |      |    |     |
| 16   | X-O909  | 2083 | V b  | Sc | 103  | 下  | 正面  |
| 17   | X-O910  | 2083 | V a  | Ax | 117  | 下  | 正面  |
| 18   | X-O1015 | 2083 | V b  | Co | 1340 |    |     |

GT-6

| 剥離順序 | 遺物番号    | ブロック | 出土層位 | 器種 | 重量g  | 打面 | 作業面 |
|------|---------|------|------|----|------|----|-----|
| 1-1  | X-O25   | 2083 | III  | Fl | 9.26 | 上  | 下   |
| 1-2  | X-O180  | 2083 | IV   | Fl | 31.6 | 上  | 正面  |
| 1-3  | X-N3181 | 2078 | V b  | Fl | 77.5 | 下  | 左   |
| 1-4  | GT-7    |      |      |    |      | 右  | 上   |
| 1-5  | X-O179  | 2083 | IV   | Fl | 61.5 | 上  | 正面  |
| 1-6  | X-O197  | 2083 | III  | Fl | 9.73 | 上  | 正面  |
| 1-7  | X-O1009 | 2083 | V b  | Fl | 11.1 | 裏面 | 上   |
| 1-8  | X-J254  | 2089 | V a  | Co | 353  |    |     |

GT-7

| 剥離順序  | 遺物番号    | ブロック | 出土層位 | 器種 | 重量g  | 打面 | 作業面 |
|-------|---------|------|------|----|------|----|-----|
| 1-4-1 | X-O249  | 2083 | III  | Fl | 5.71 | 裏面 | 下   |
| 1-4-2 | X-N2428 | 2074 | IV   | Fl | 13.4 | 下  | 左   |
| 1-4-3 | X-O49   | 2083 | IV   | Co | 124  |    |     |

GT-8

| 剥離順序 | 遺物番号   | ブロック | 出土層位 | 器種 | 重量g  | 打面 | 作業面 |
|------|--------|------|------|----|------|----|-----|
| 15-1 | X-O503 | 2083 | V a  | Fl | 3.79 | 上  | 正面  |
| 15-2 | X-O903 | 2083 | IV   | Fl | 5.26 | 裏面 | 上   |
| 15-3 | X-O902 | 2083 | V a  | Co | 170  |    |     |

第2地点 接合資料2 (GT-4・6・7・8) (貫ノ木遺跡)

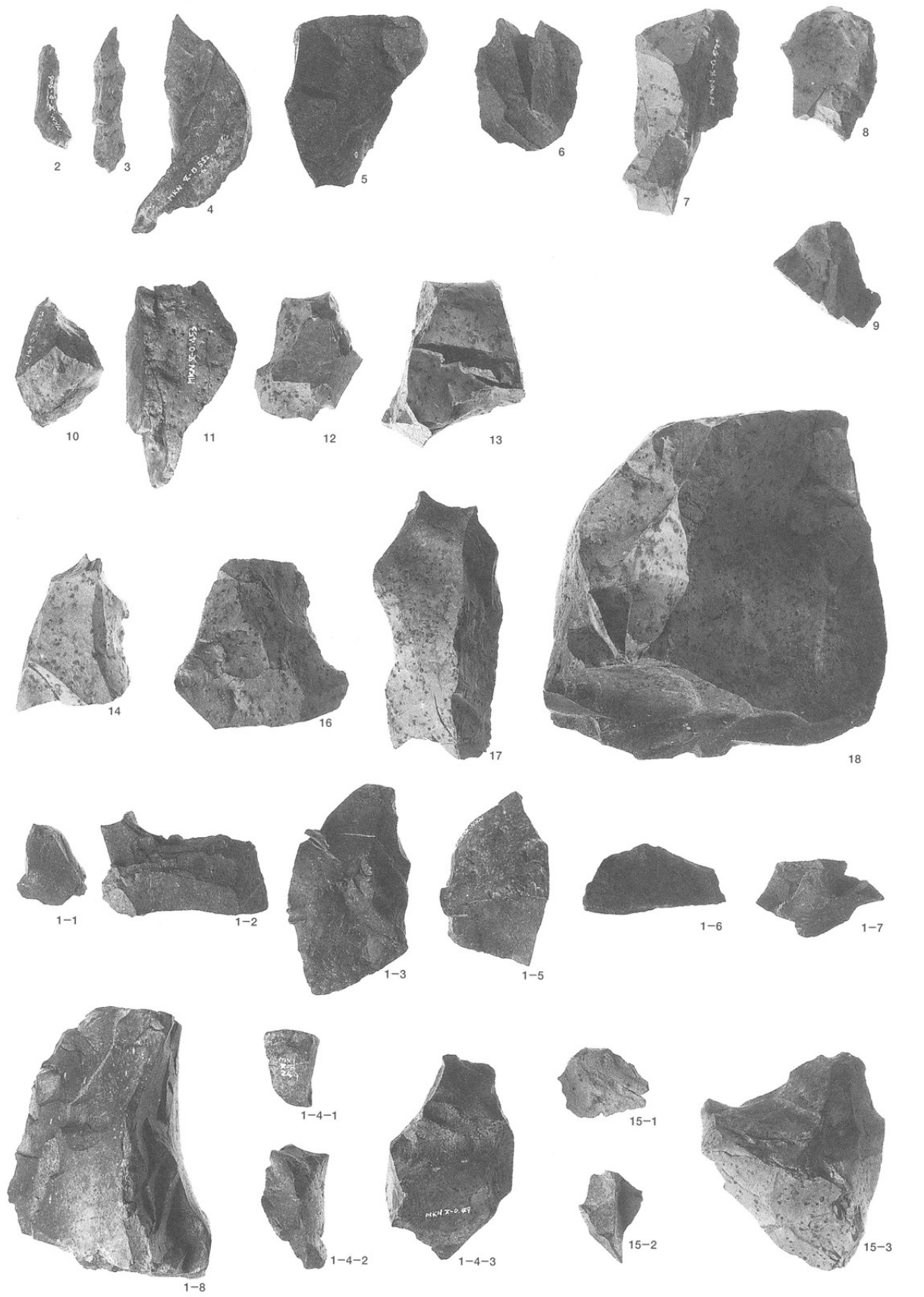

Ch-4・6・7・8 集合写真

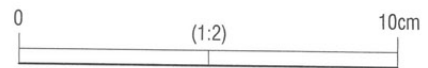

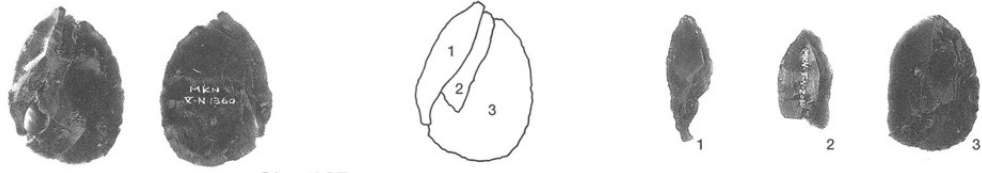

Ob-127

Ob-127

| 剥離順序 | 遺物番号    | ブロック | 出土層位 | 器種 | 重量g  | 打面 | 作業面 |
|------|---------|------|------|----|------|----|-----|
| 1    | X-N1118 | 2044 | III  | Sp | 1.24 | 上  | 正面  |
| 2    | X-N2086 | 2048 | IV   | Sp | 1.4  | 上  | 正面  |
| 3    | X-N1360 | 2048 | III  | ES | 9.96 |    |     |



Ob-127 集合写真

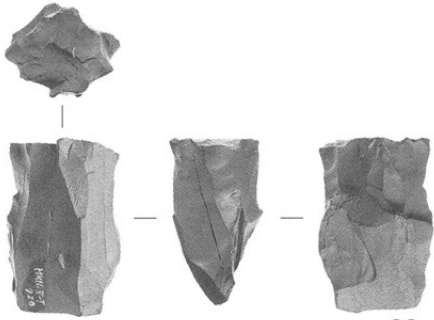

SS-20

SS-20

| 剥離順序 | 遺物番号   | ブロック | 出土層位 | 器種 | 重量g  | 打面 | 作業面 |
|------|--------|------|------|----|------|----|-----|
| 1    | X-T403 | 2060 | IV   | UF | 5.77 | 上  | 正面  |
| 2    | X-T720 | 2059 | IV   | Co | 39.1 |    |     |



SS-20 集合写真

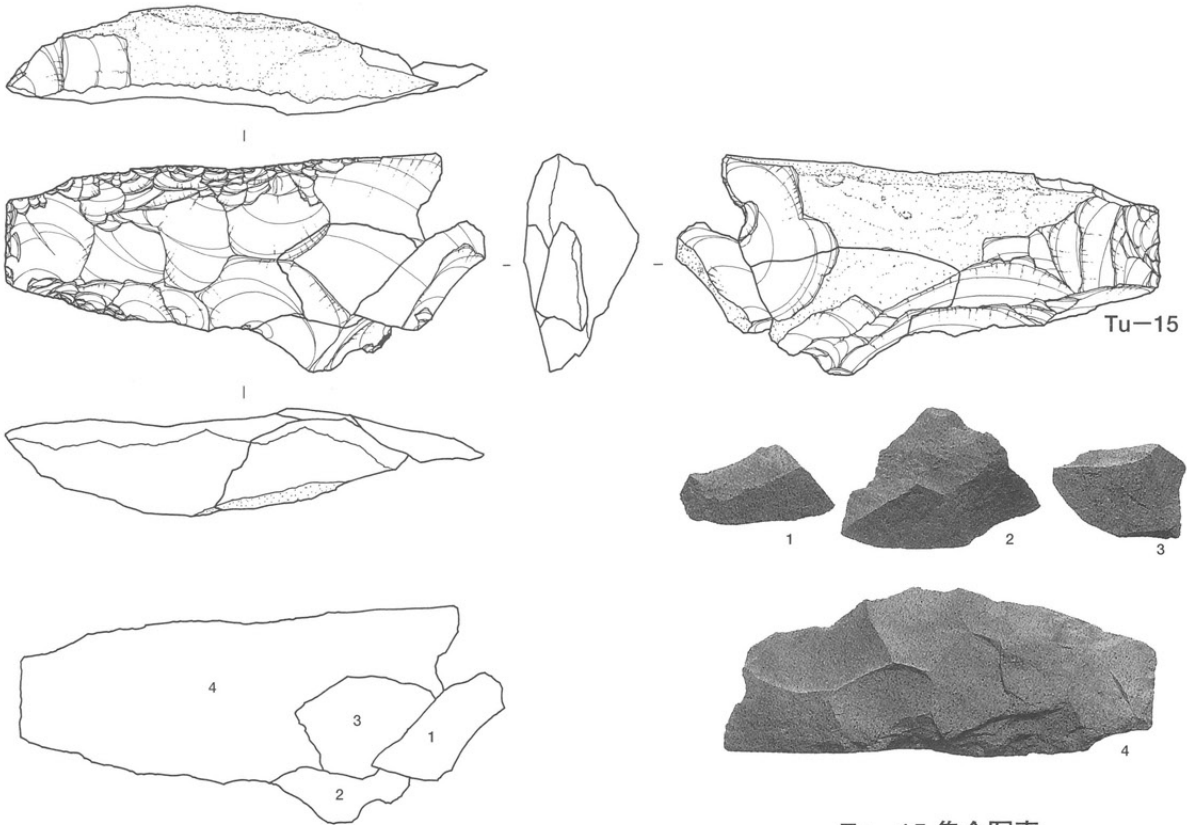

Tu-15

Tu-15 集合写真

Tu-15

| 剥離順序 | 遺物番号    | ブロック | 出土層位 | 器種 | 重量g  | 打面 | 作業面 |
|------|---------|------|------|----|------|----|-----|
| 1    | X-N3294 | 2044 | V b  | Fl | 4.69 | 右  | 正面  |
| 2    | X-N2268 | 2053 | IV   | Fl | 19.6 | 正面 | 下   |
| 3    | X-N2277 | 2053 | IV   | Fl | 5.69 | 下  | 正面  |
| 4    | X-N2267 | 2053 | IV   | Co | 150  |    |     |



# 貫ノ木遺跡 第3地点

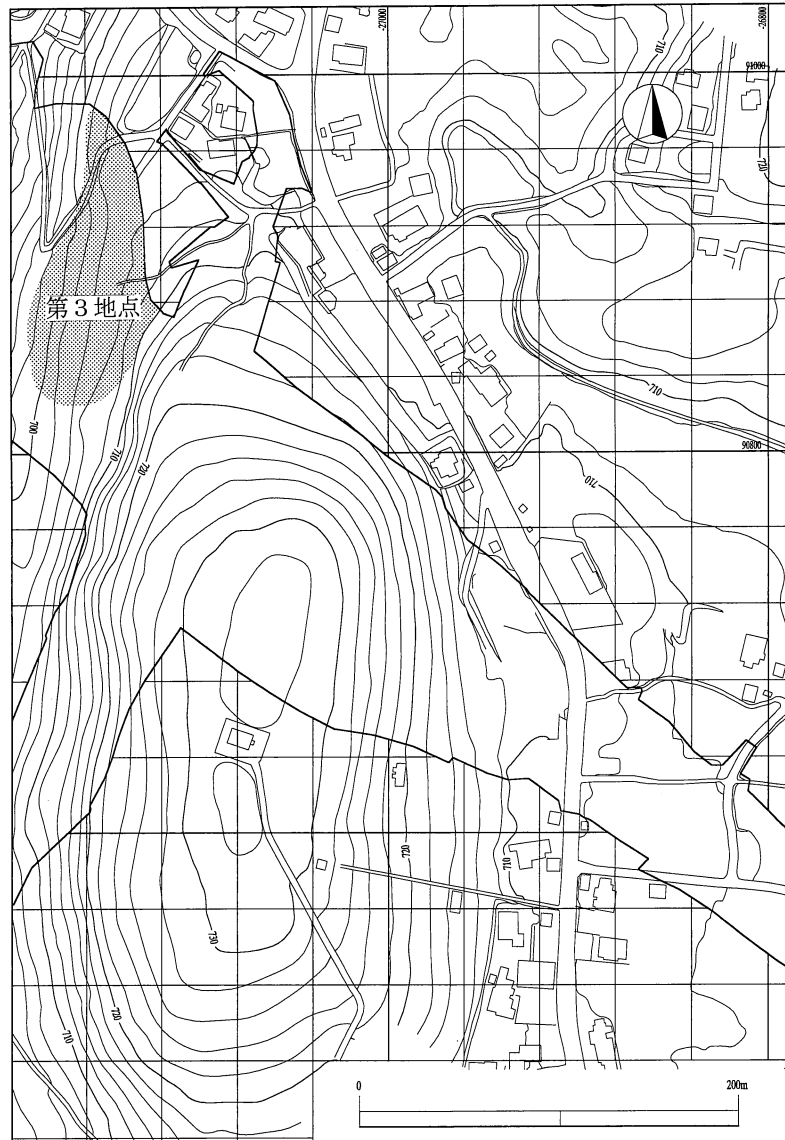



第3地点 BL石器全点 (貫ノ木遺跡)



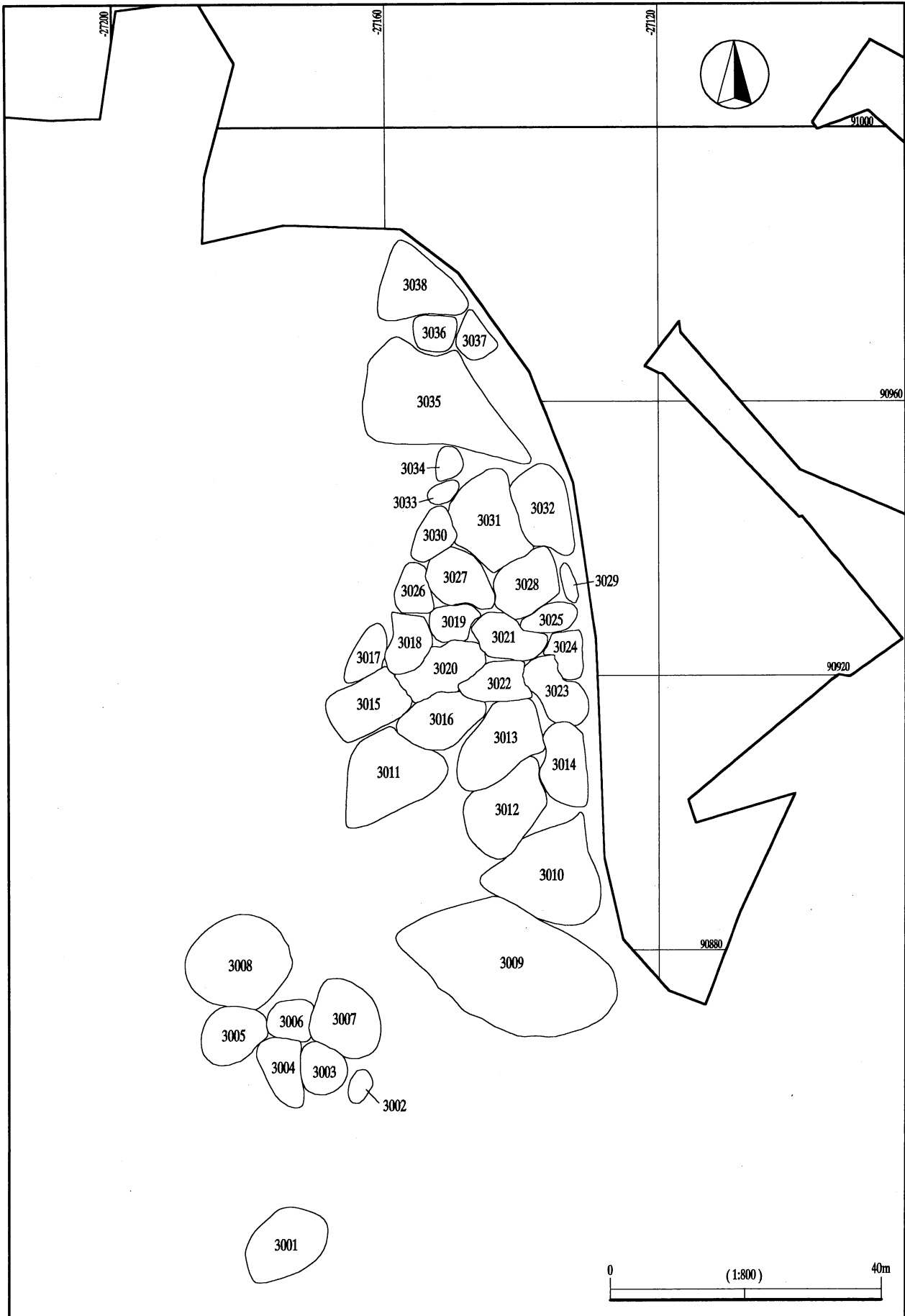

第3地点 ブロック配置図 (貫ノ木遺跡)

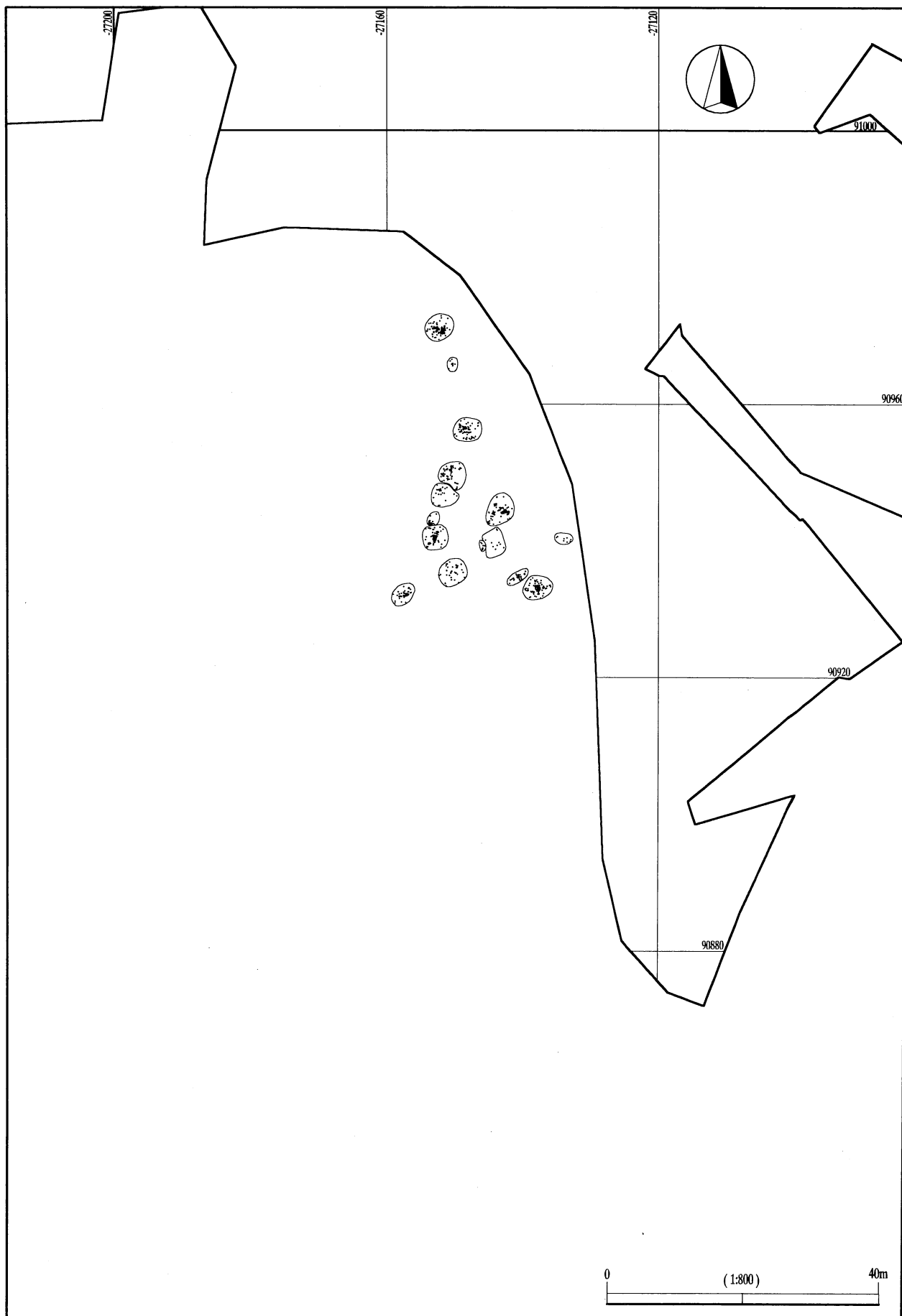

第3地点 礫分布図 (貫ノ木遺跡)

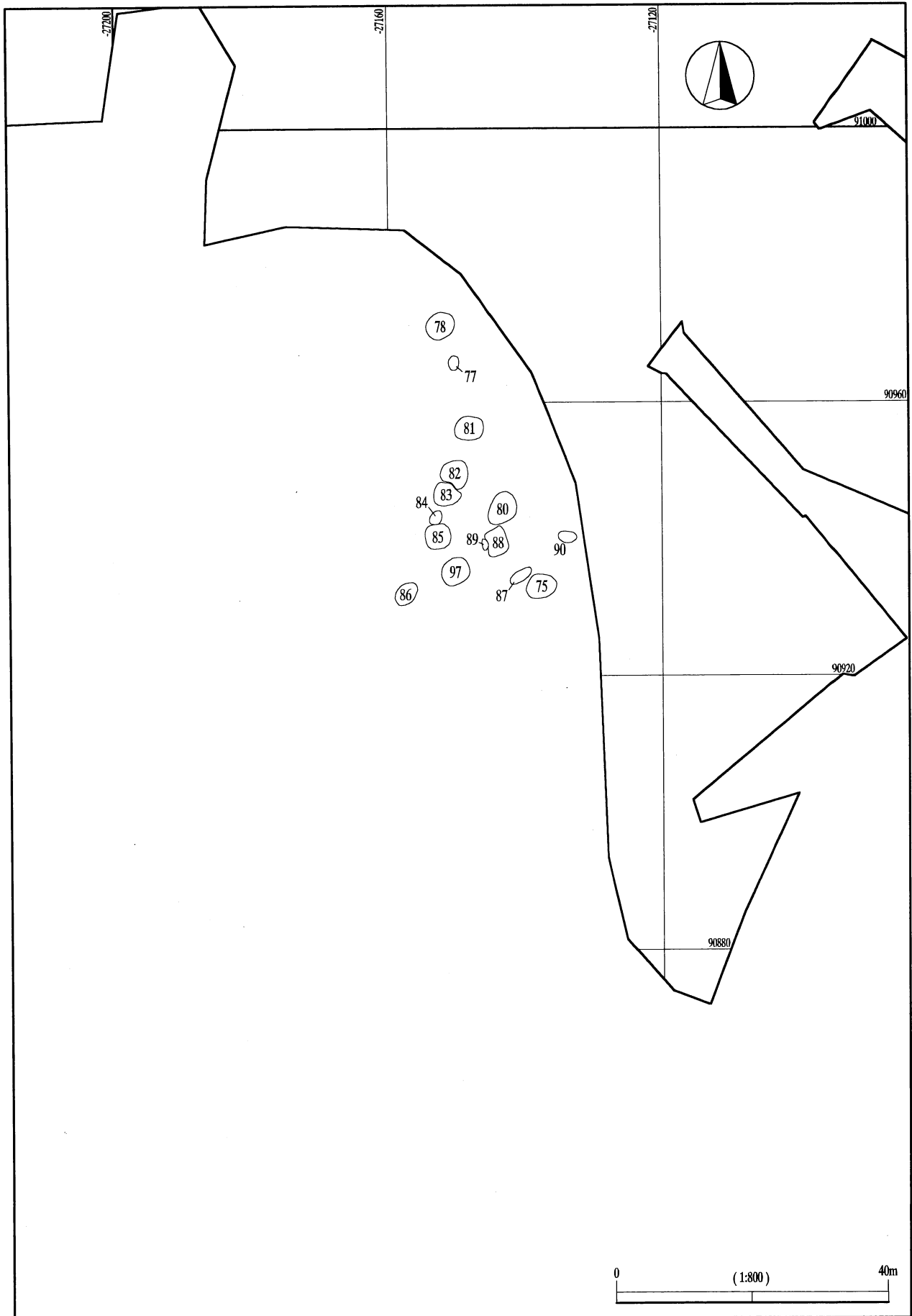

第3地点 礫群配置図 (貫ノ木遺跡)

BL 3001

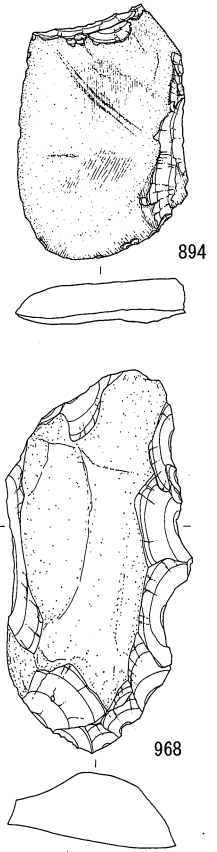
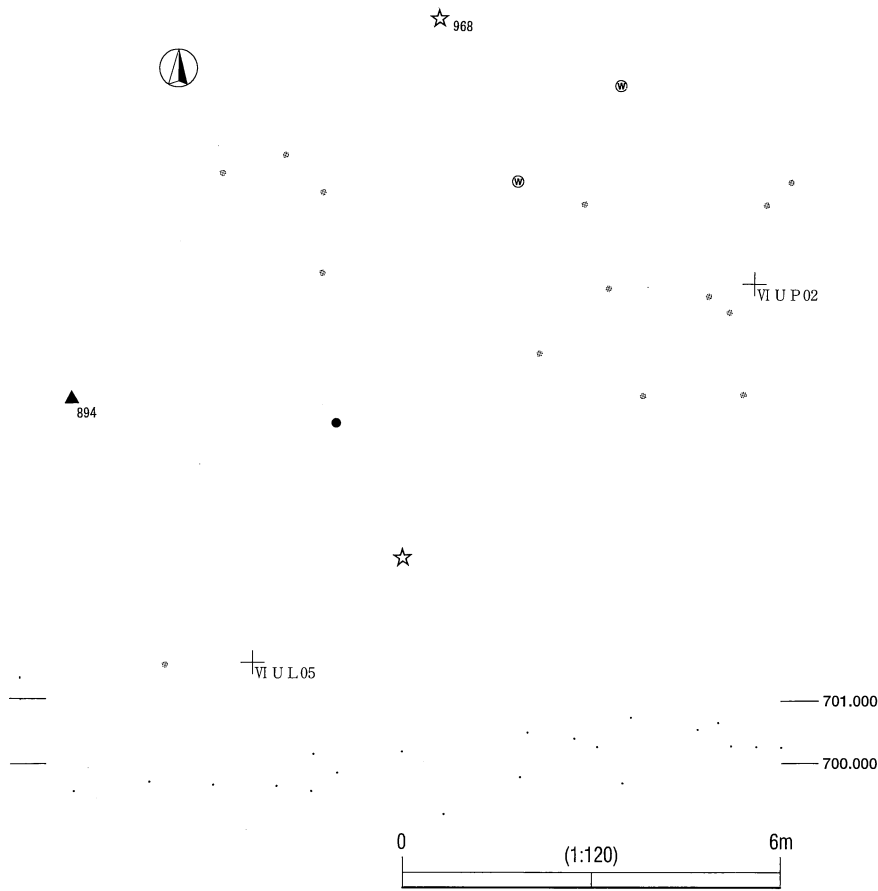

BL 3002

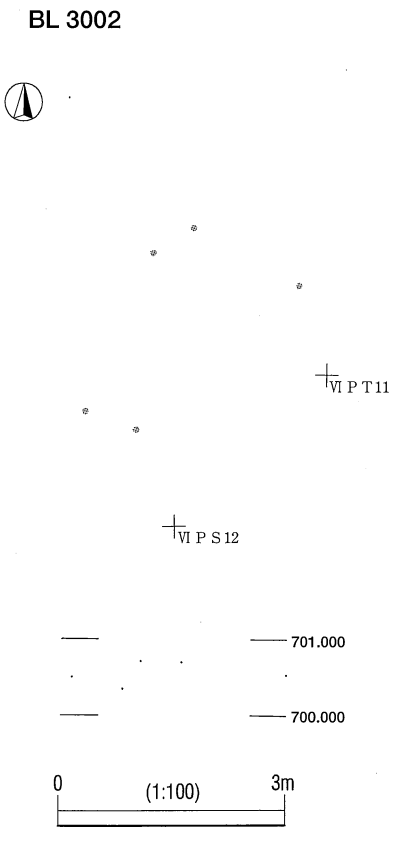

BL 3003

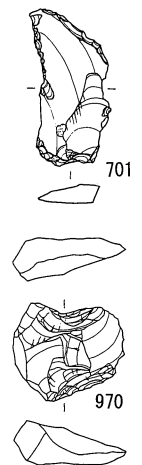
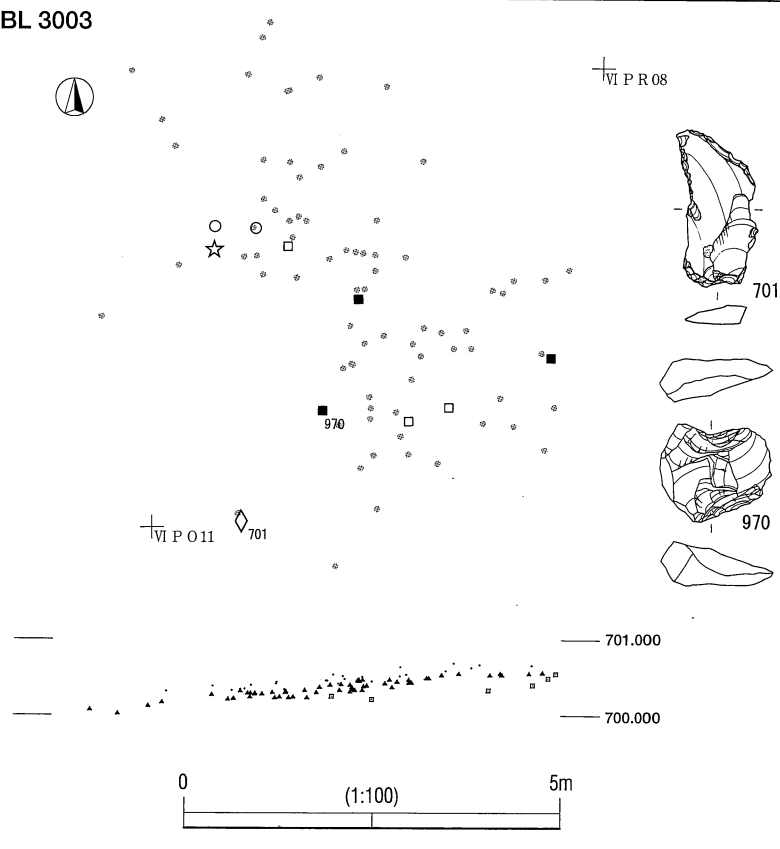

第3地点 BL3001・3002・3003 遺物分布図 (貫ノ木遺跡)

BL 3004

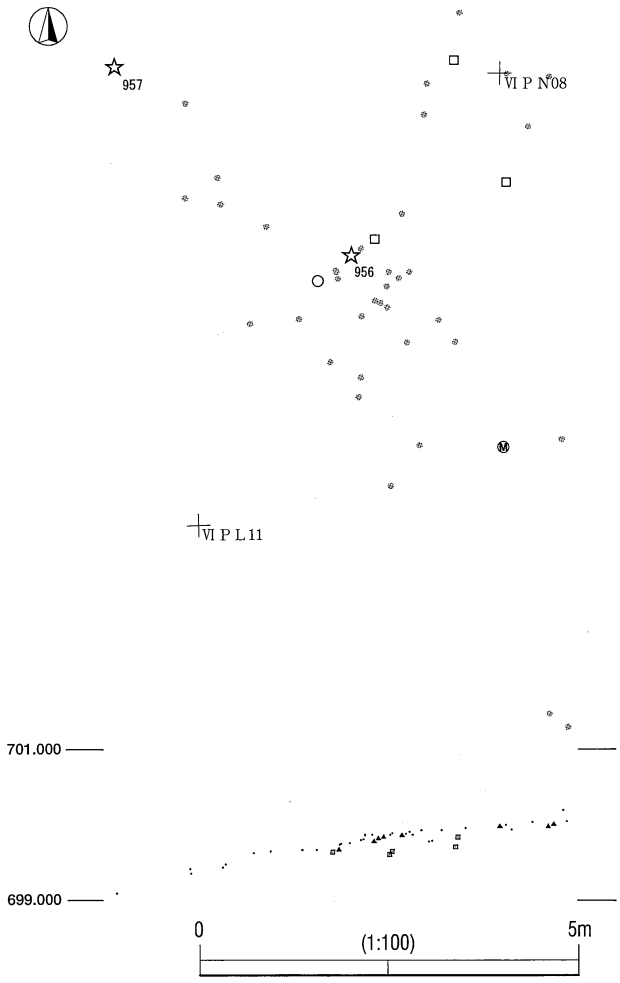
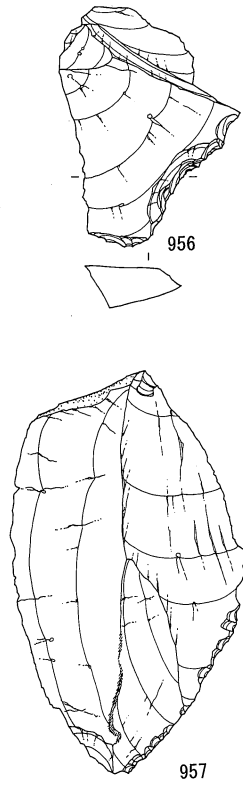

BL 3005

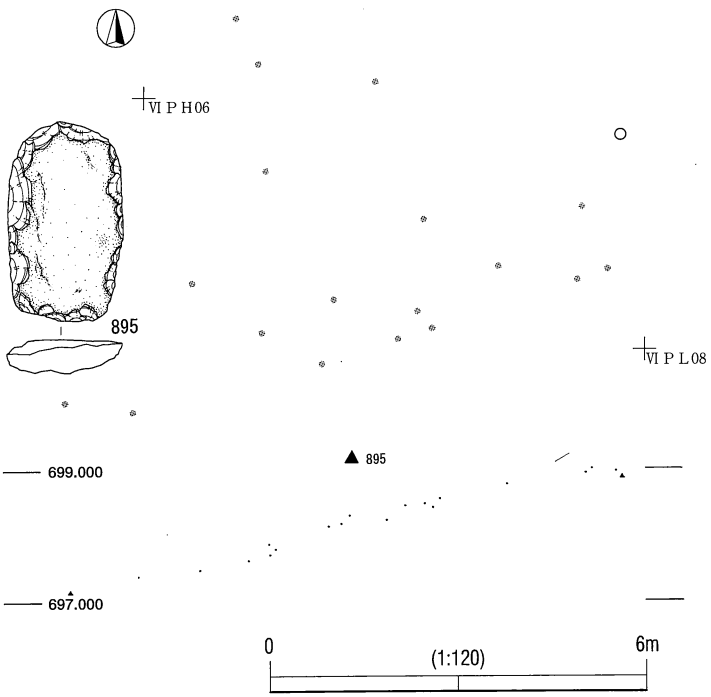

BL 3006

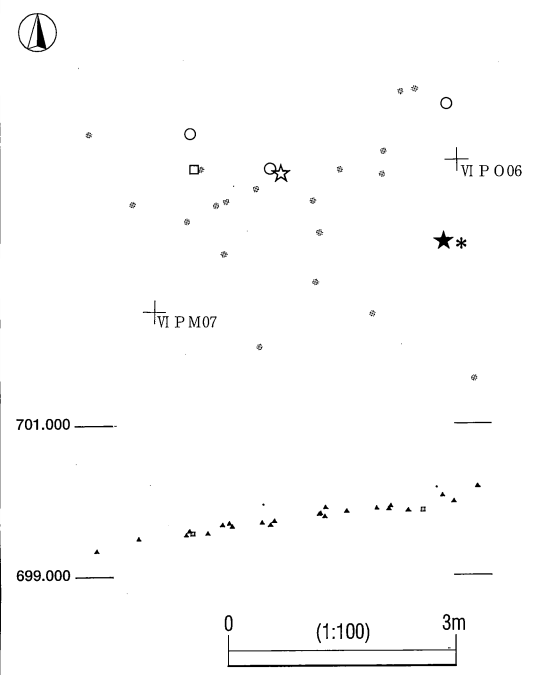

第3地点 BL3004・3005・3006 遺物分布図 (貫ノ木遺跡)

BL 3007

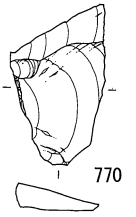
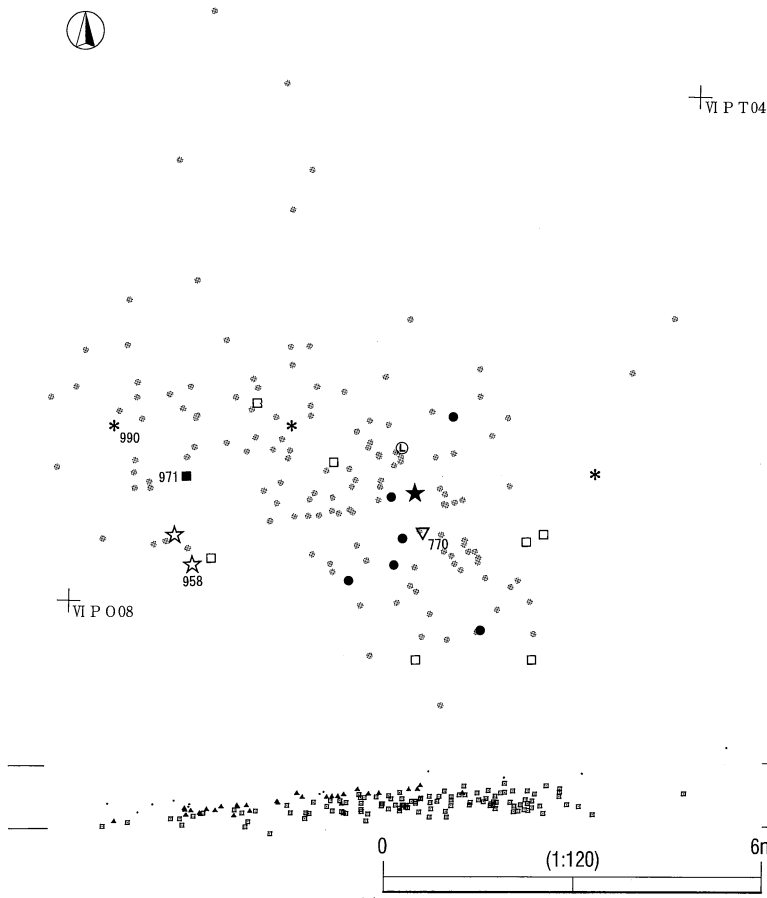
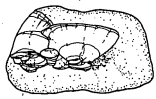
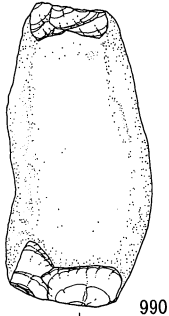
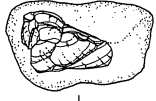
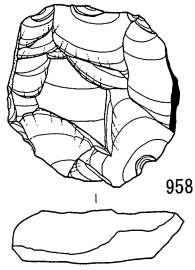

BL 3008

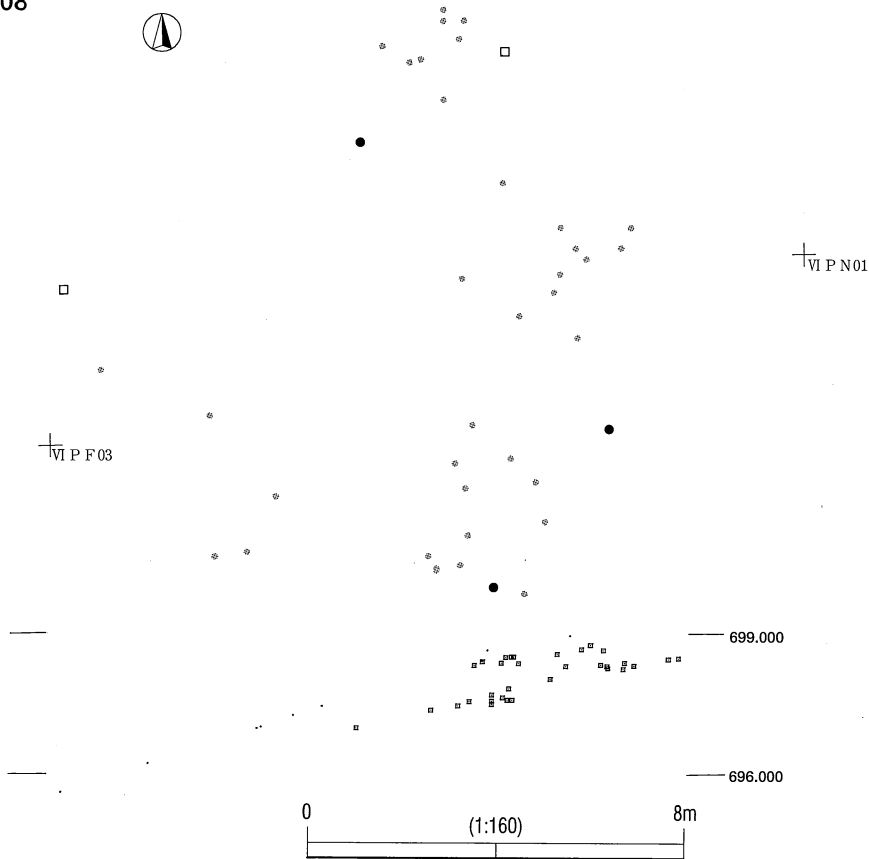

第 3 地点 BL3007・3008 遺物分布図 (貫ノ木遺跡)

BL 3009

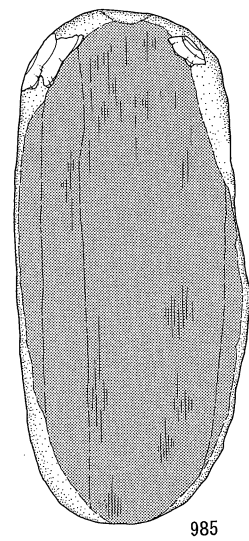
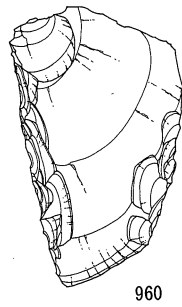
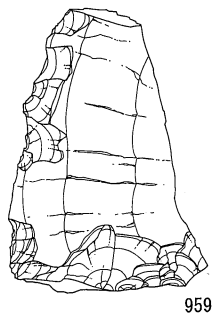
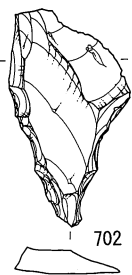
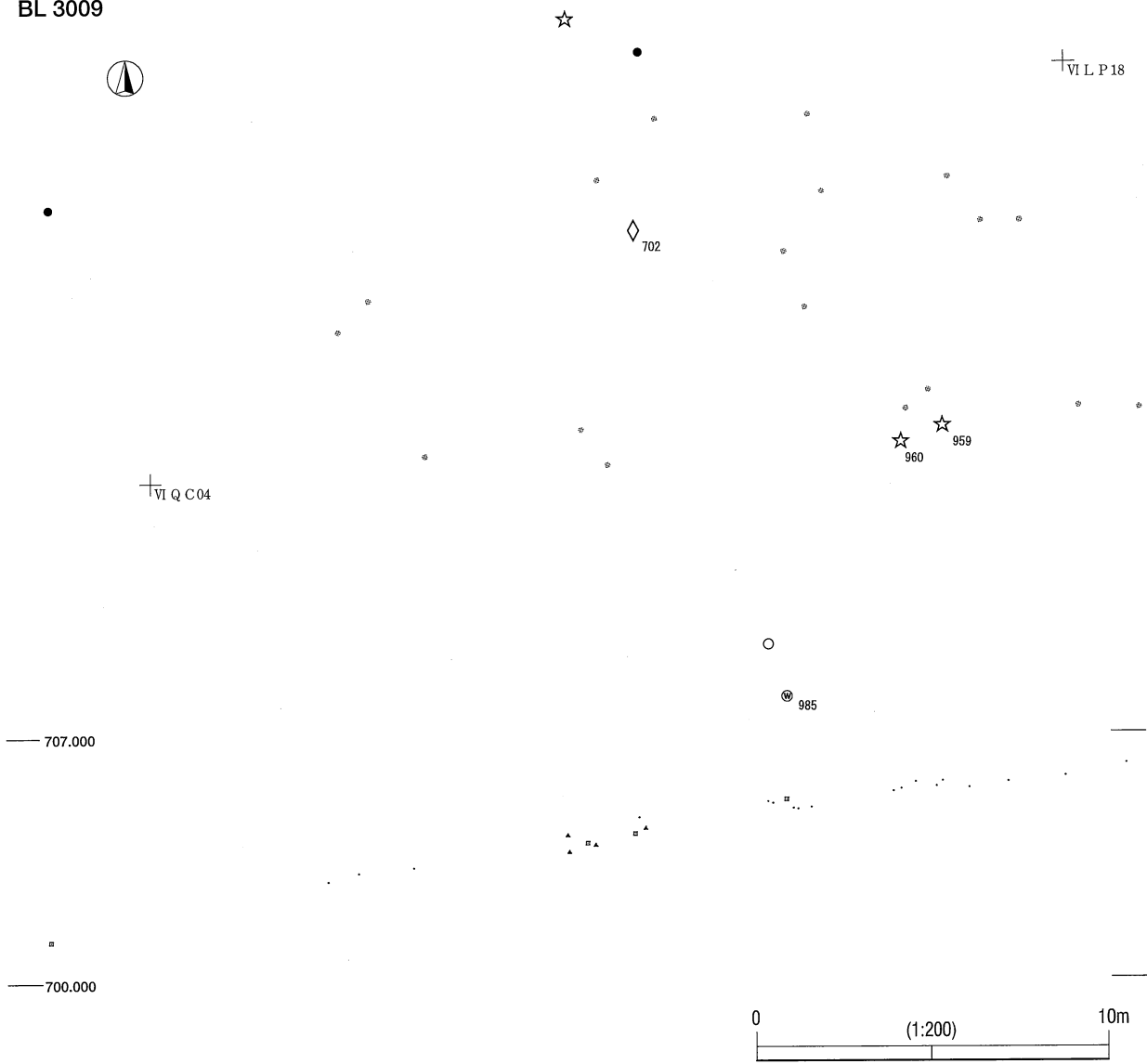

第 3 地点 BL3009 遺物分布図 (貫ノ木遺跡)

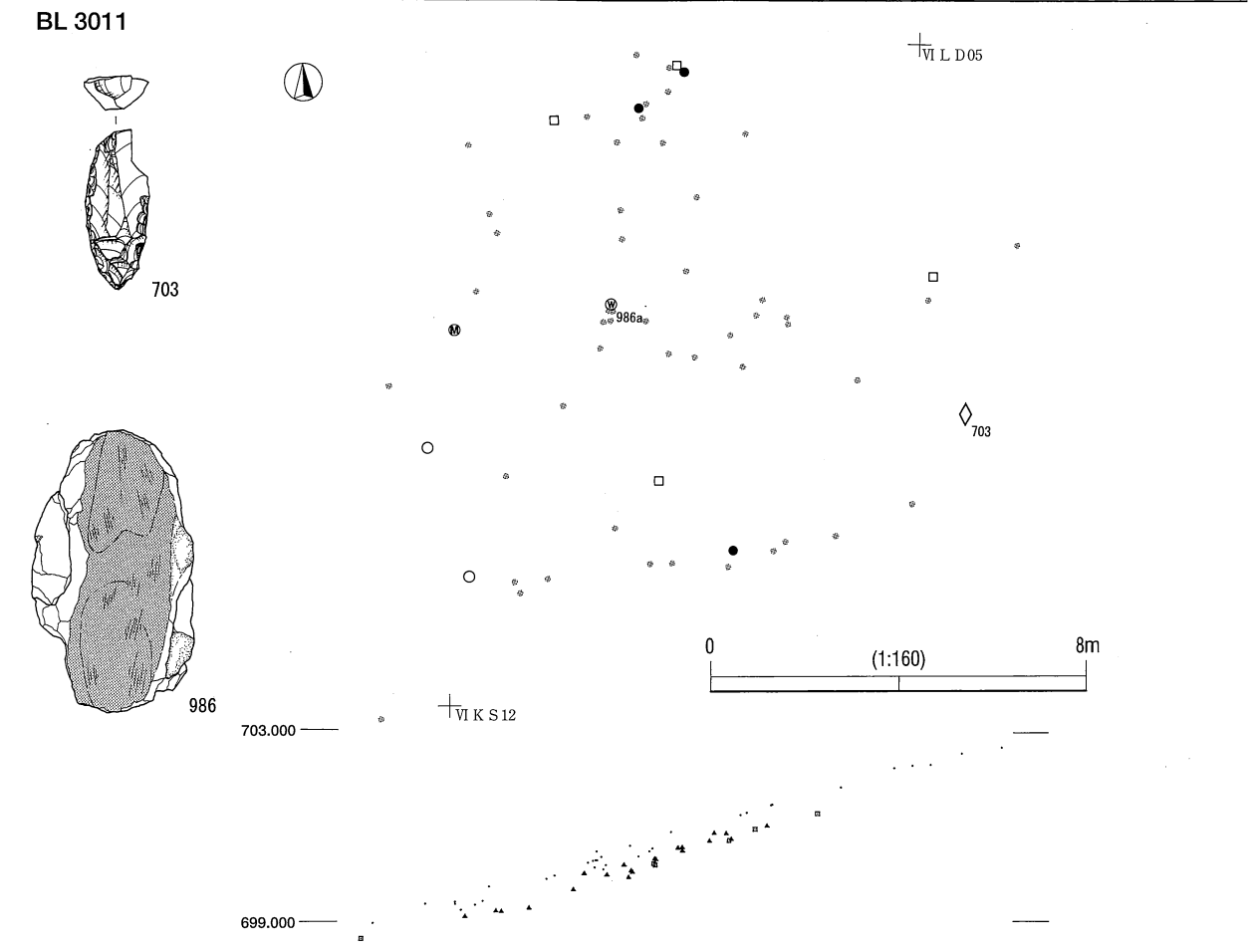
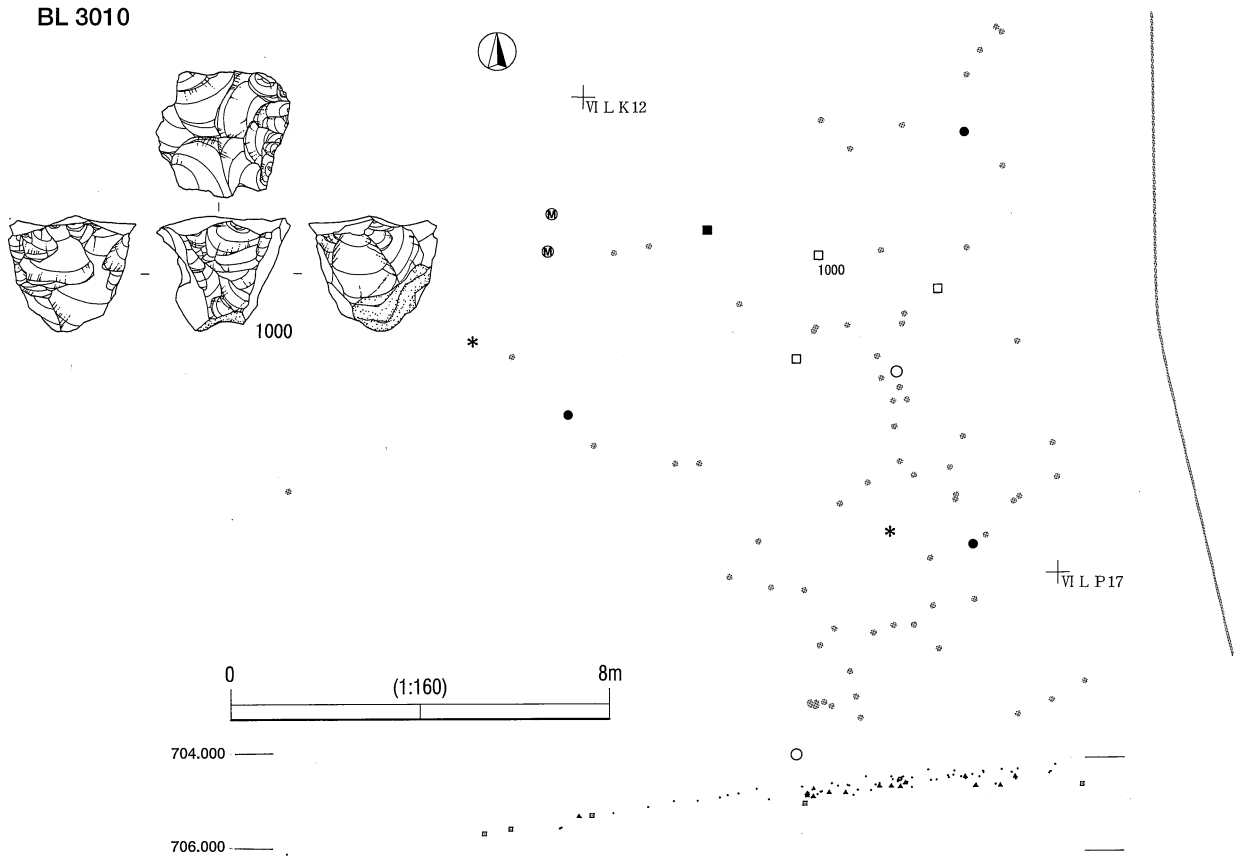

第3地点 BL3010・3011 遺物分布図 (貫ノ木遺跡)



BL 3012

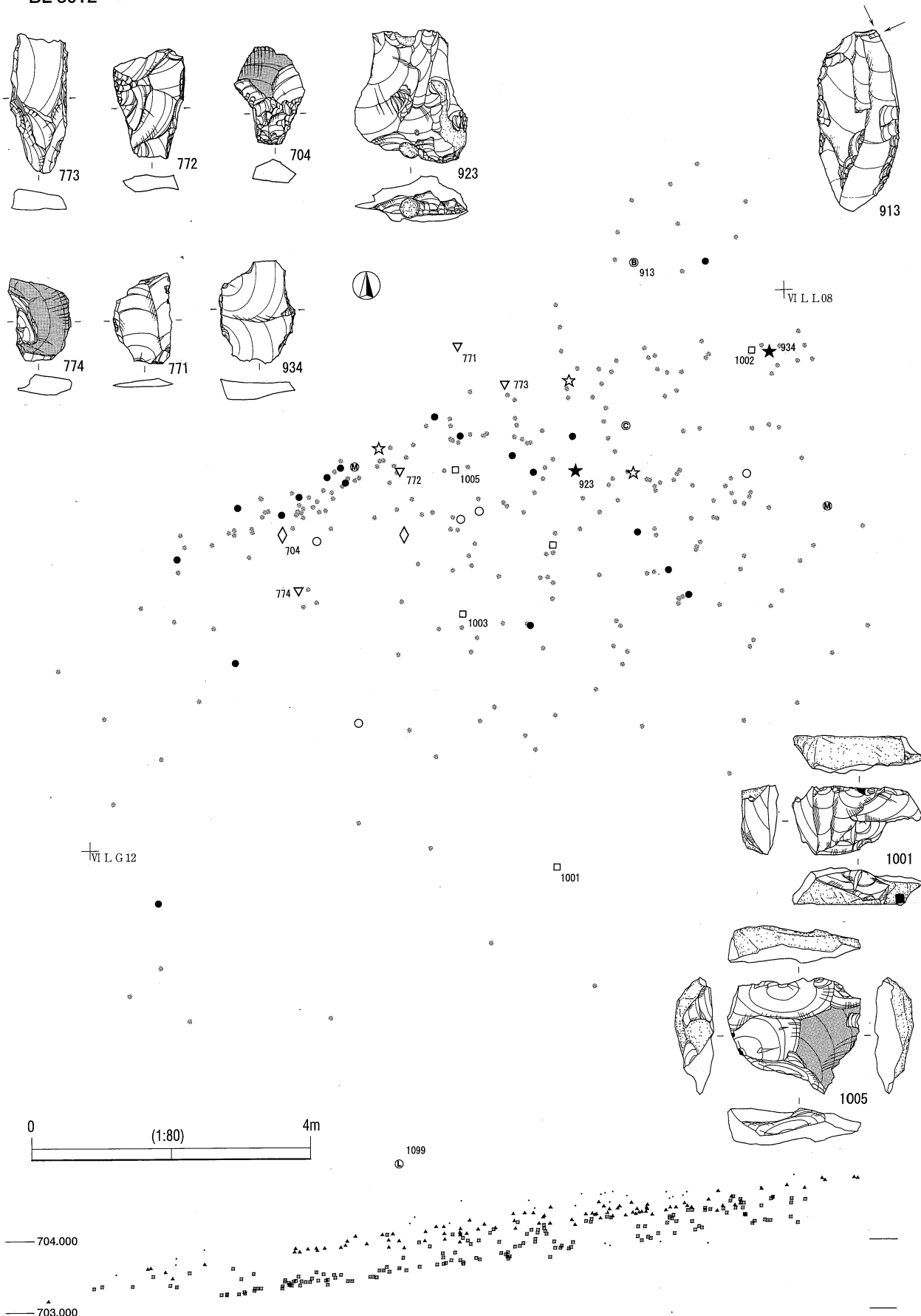

第3地点 BL3012 遺物分布図 (貫ノ木遺跡)

BL 3013

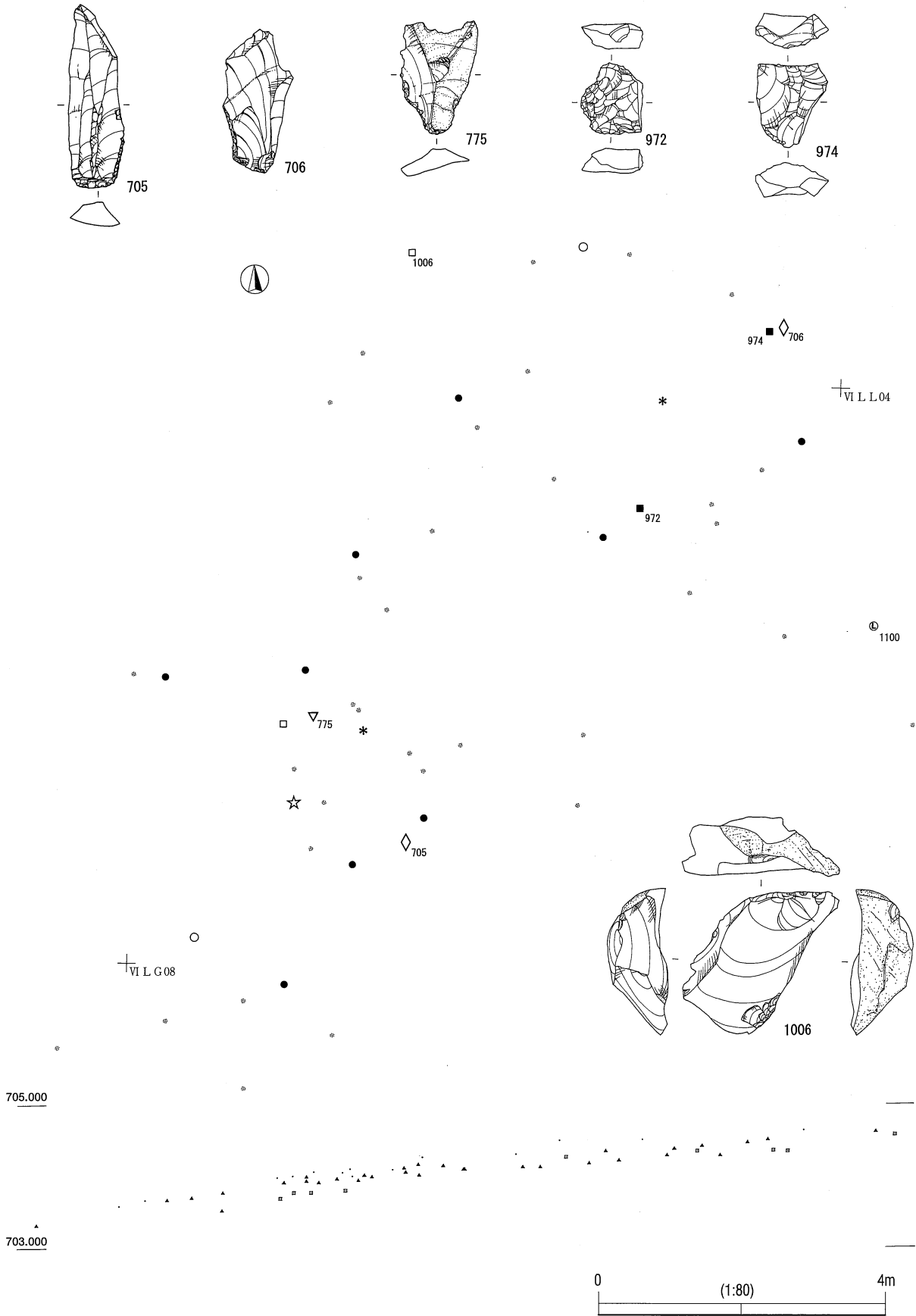

第3地点 BL3013 遺物分布図 (貫ノ木遺跡)

BL 3014

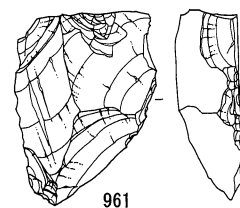
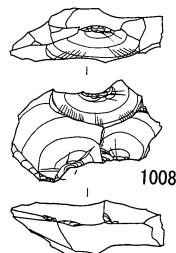
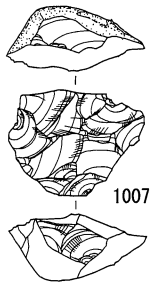
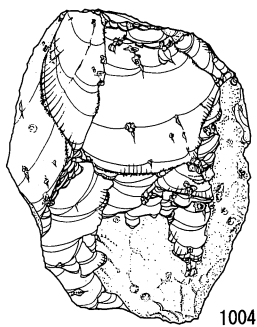
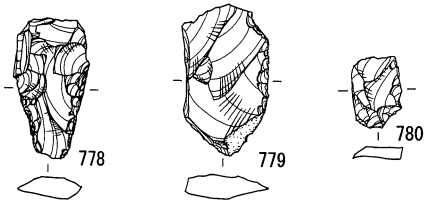
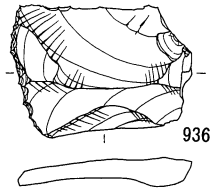
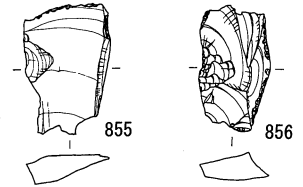
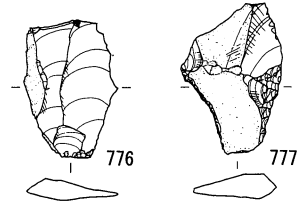
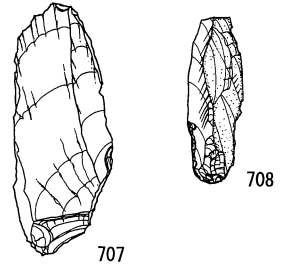
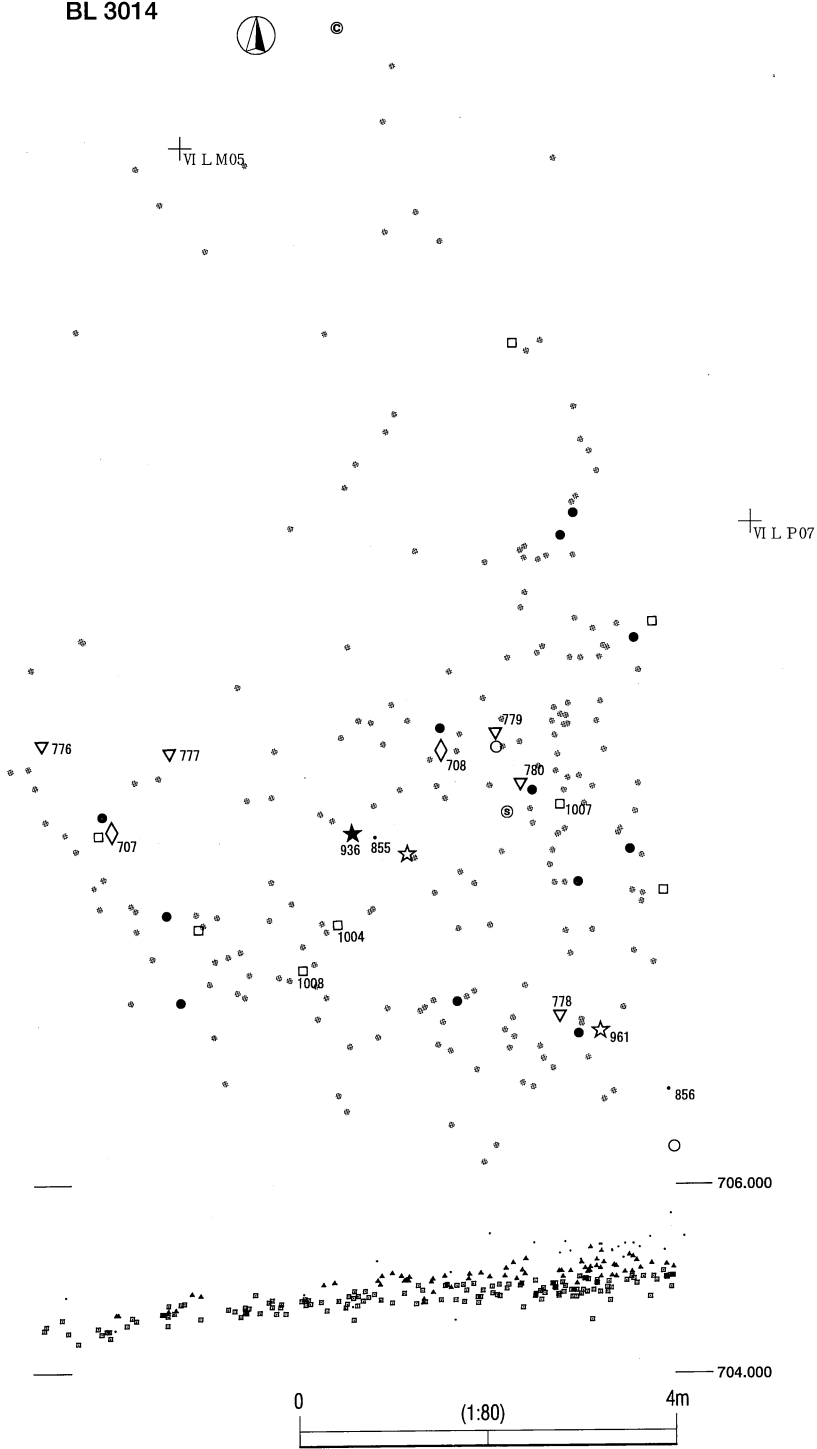

第3地点 BL3014 遺物分布図 (貫ノ木遺跡)

BL 3015

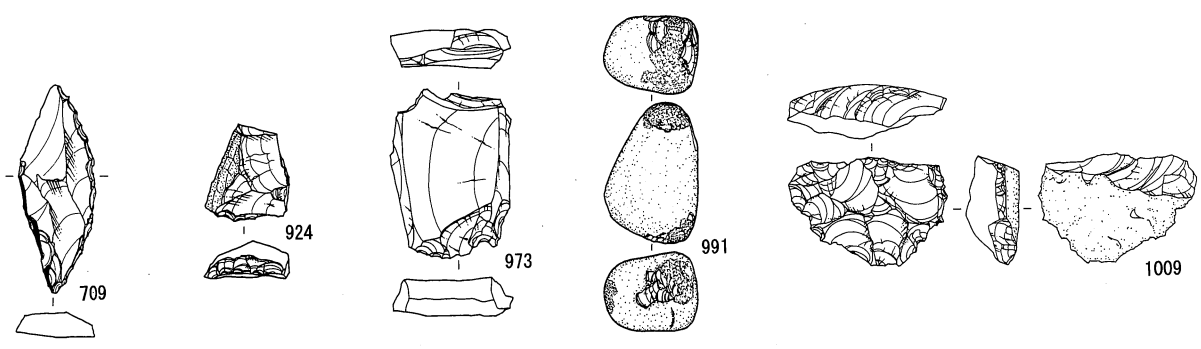

第3地点 BL3015 遺物分布図 (貫ノ木遺跡)

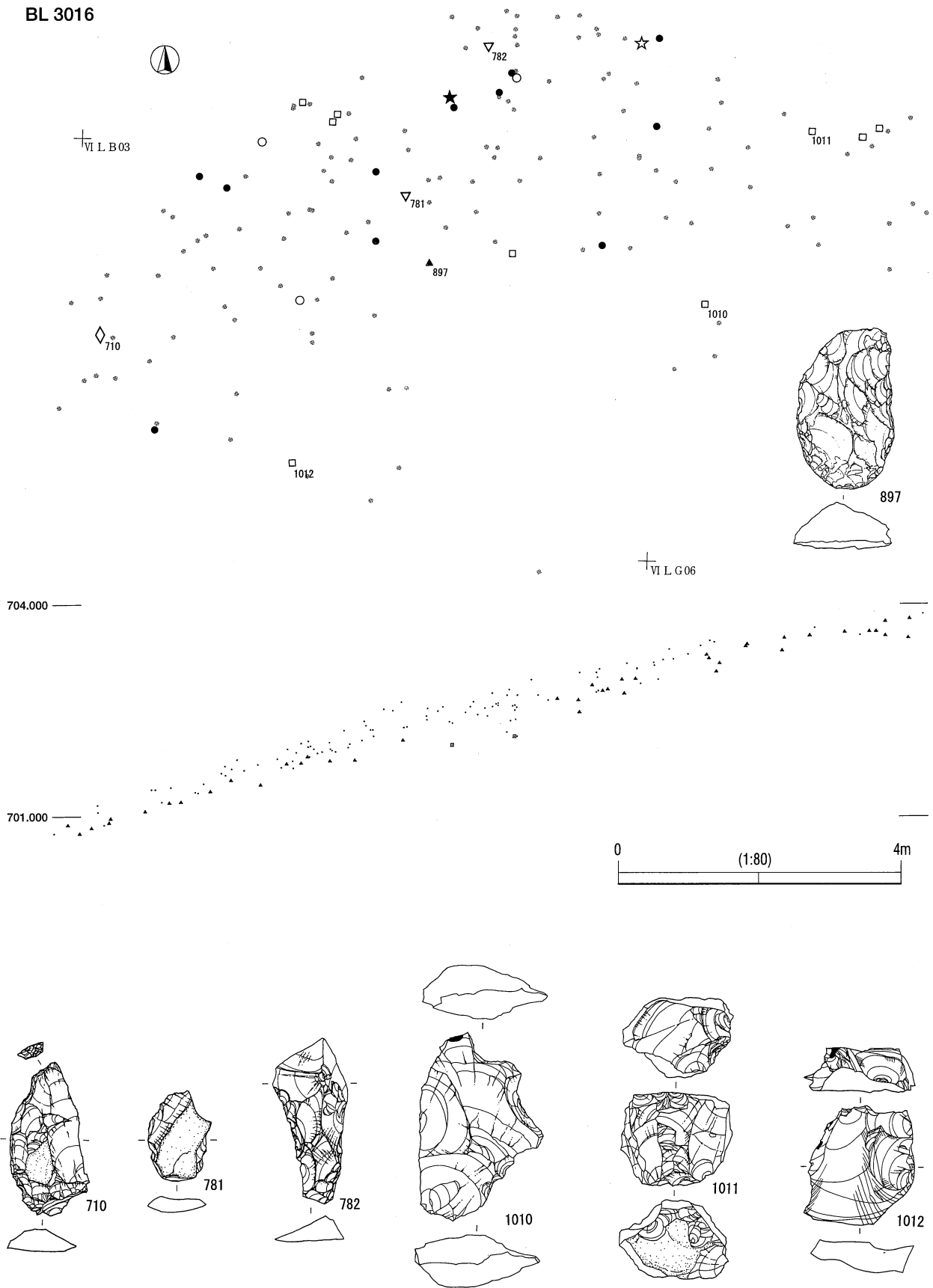

第3地点 BL3016 遺物分布図 (貫ノ木遺跡)

BL 3017

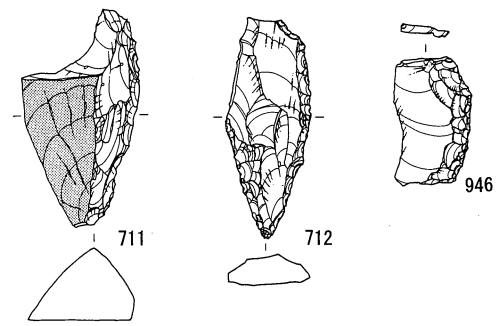
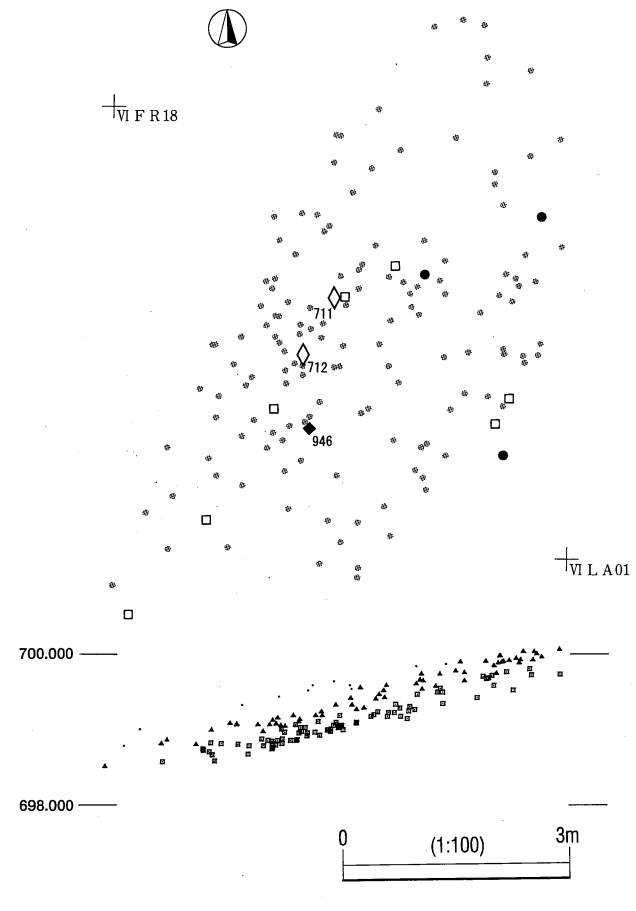

BL 3018

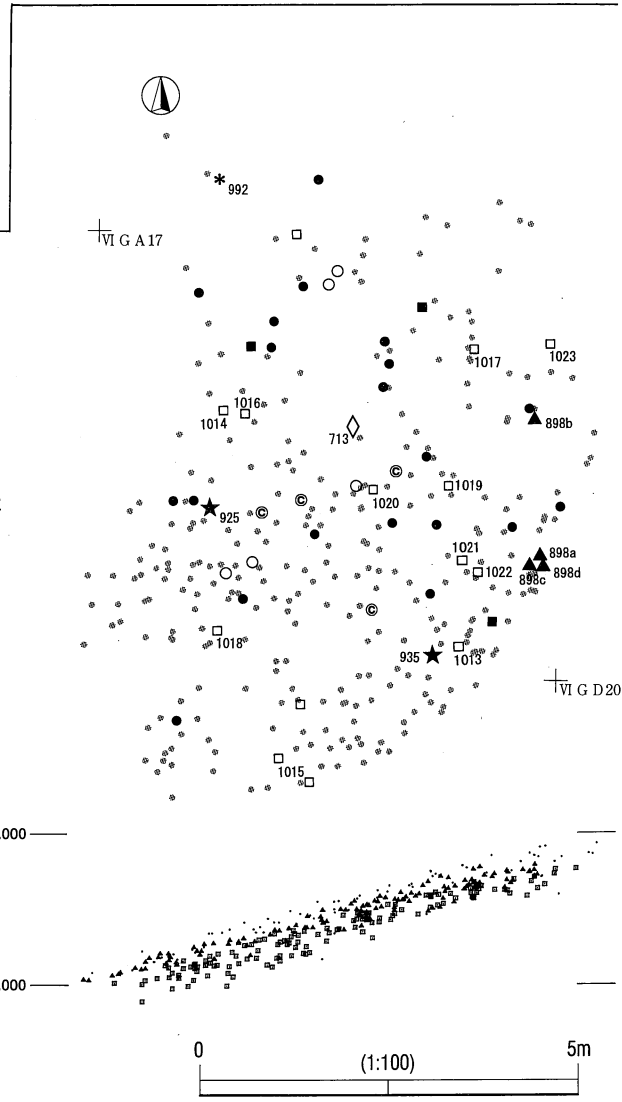
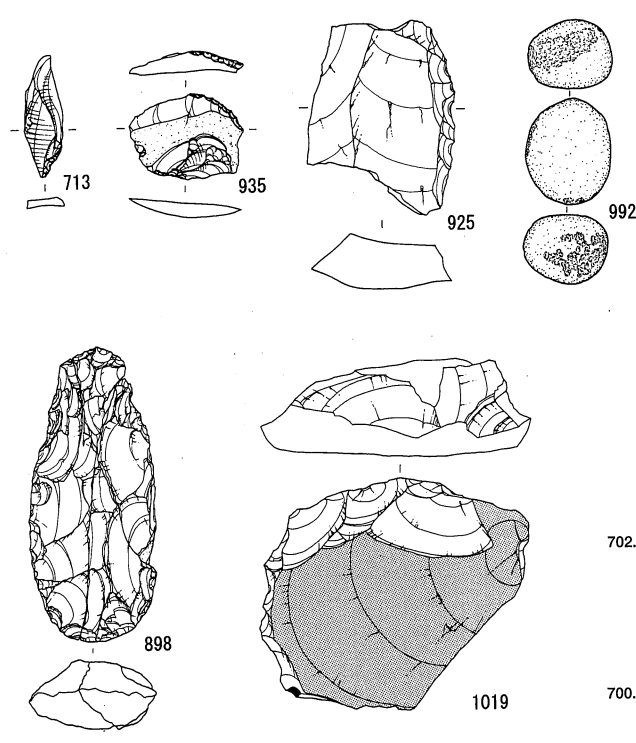

第3地点 BL3017・3018 遺物分布図 (貫ノ木遺跡)

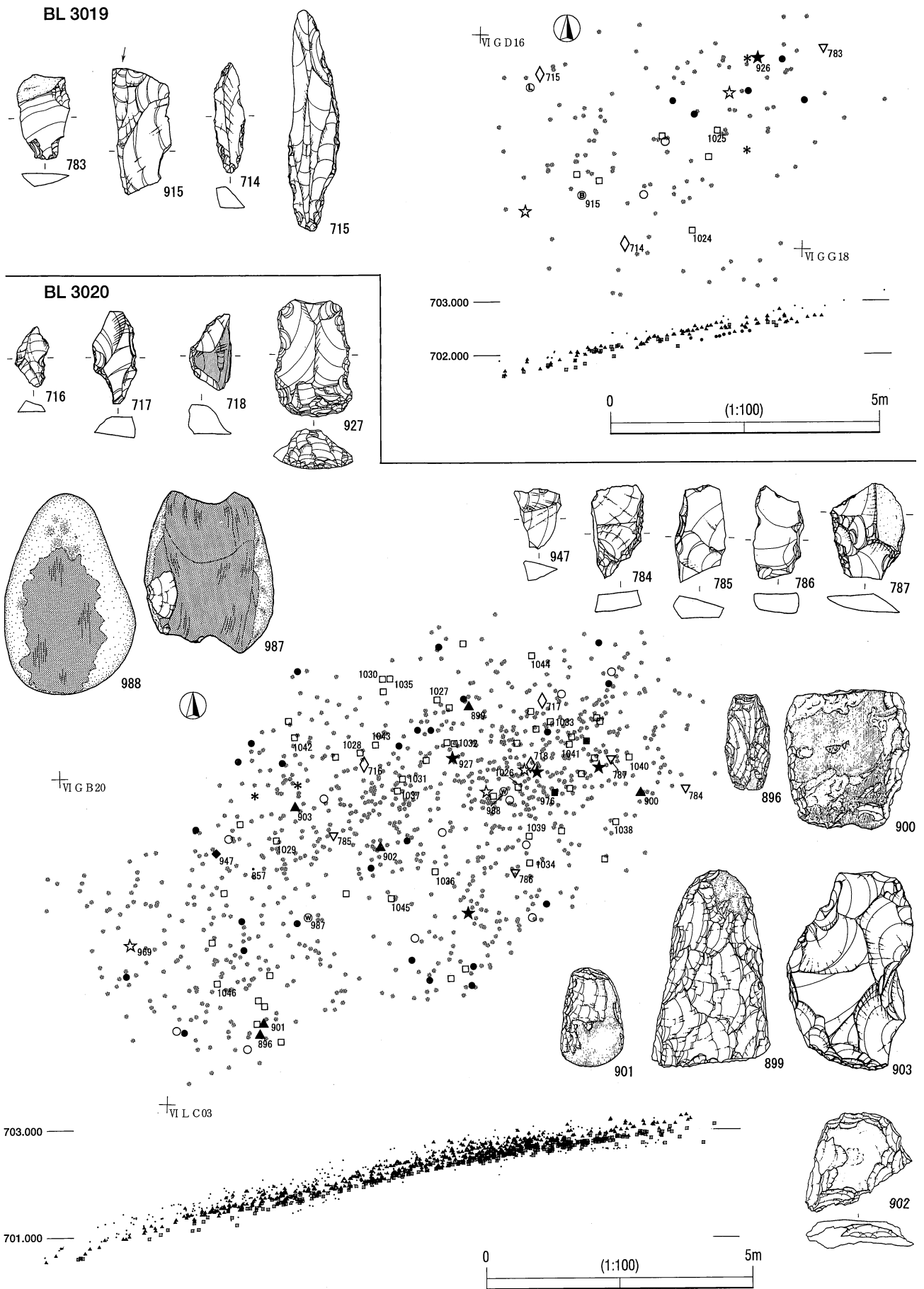

第3地点 BL3019・3020 遺物分布図 (貫ノ木遺跡)

BL 3021

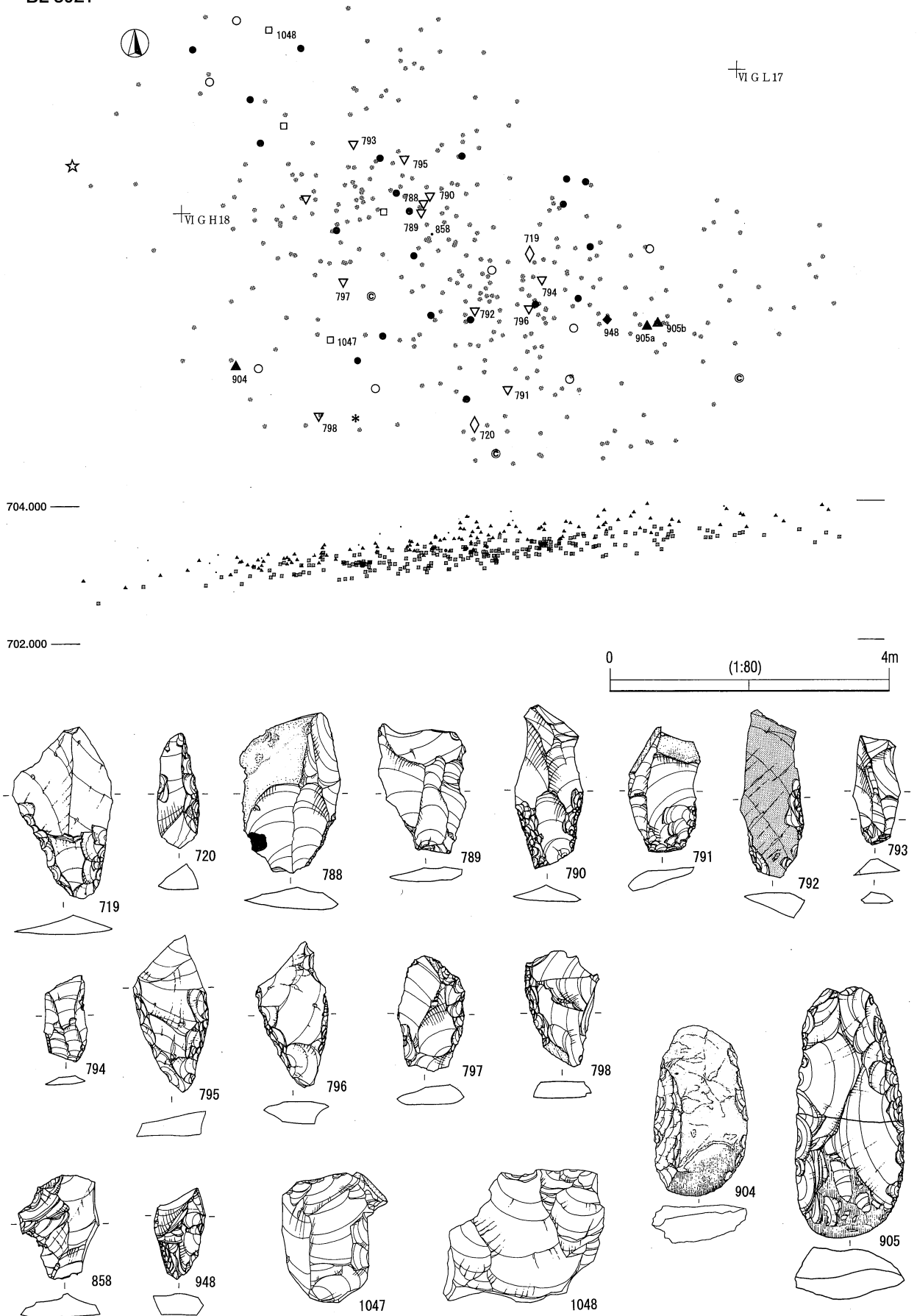

第3地点 BL3021 遺物分布図 (貫ノ木遺跡)



BL 3022

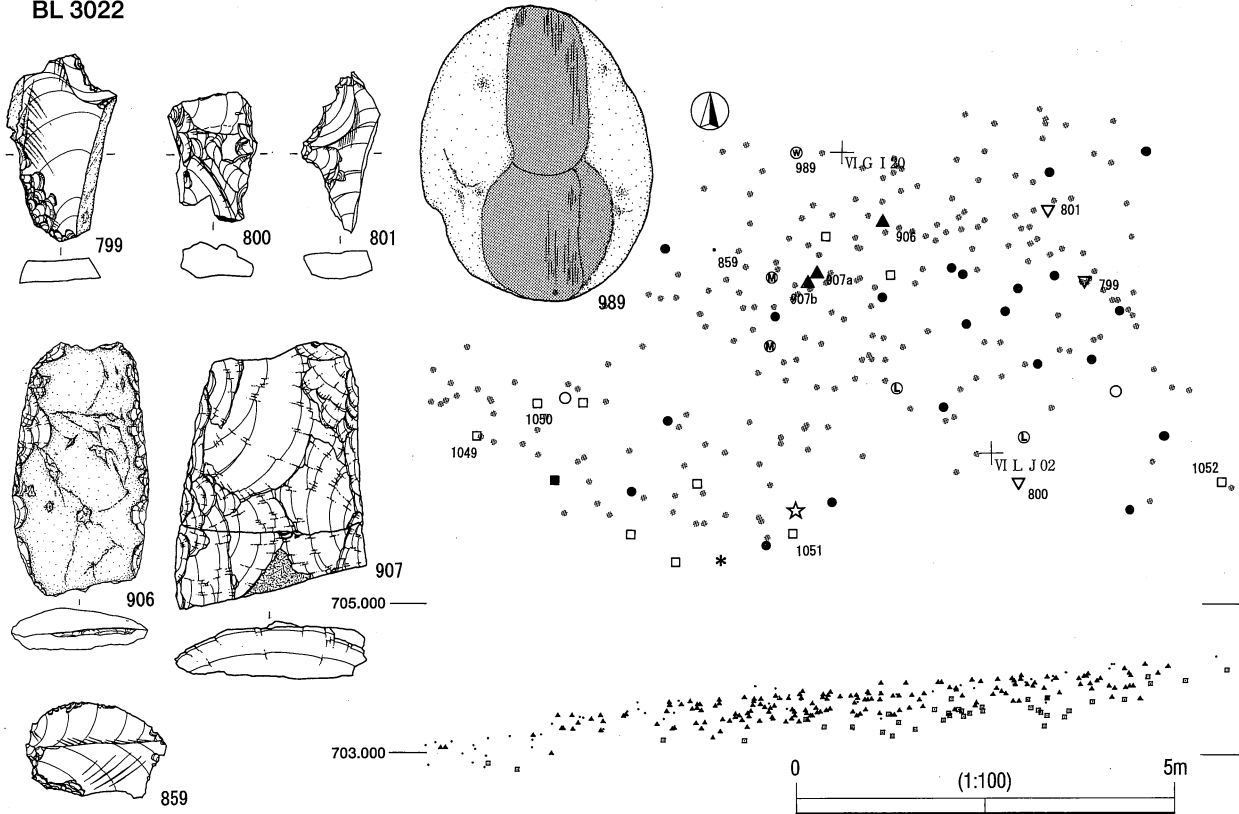

BL 3023

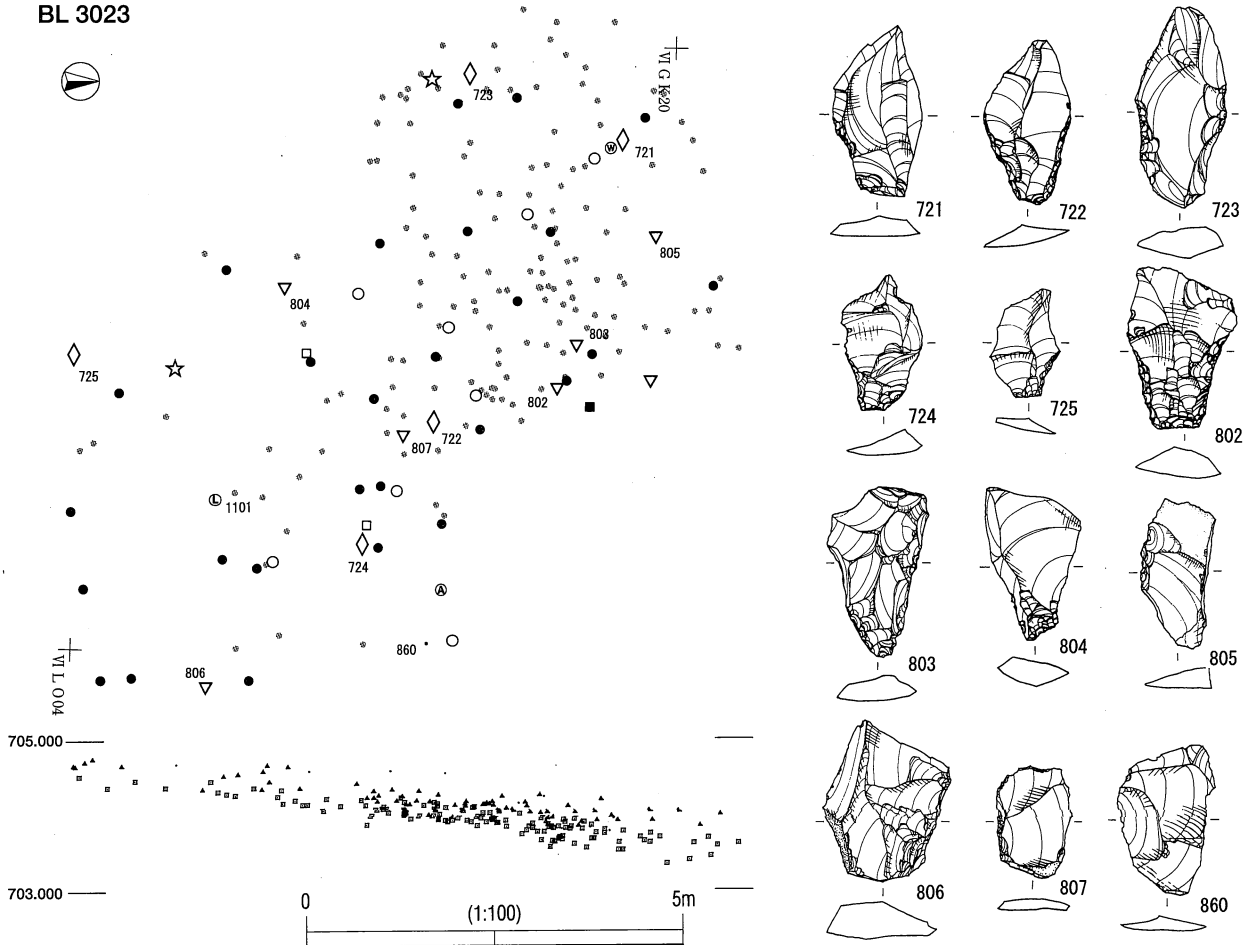

第3地点 BL3022・3023 遺物分布図 (貫ノ木遺跡)

BL 3024

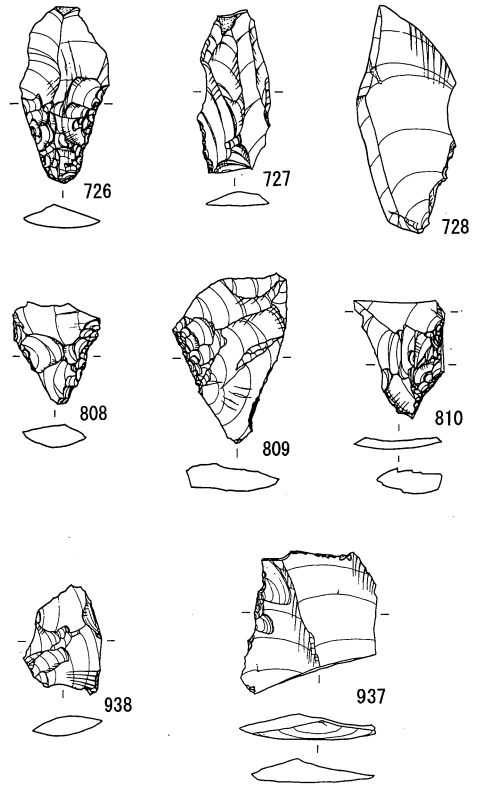
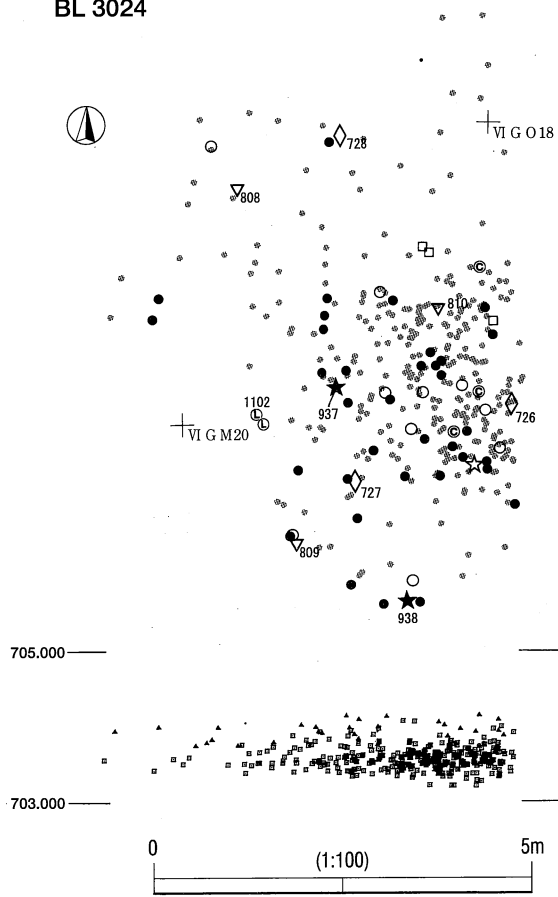

BL 3025

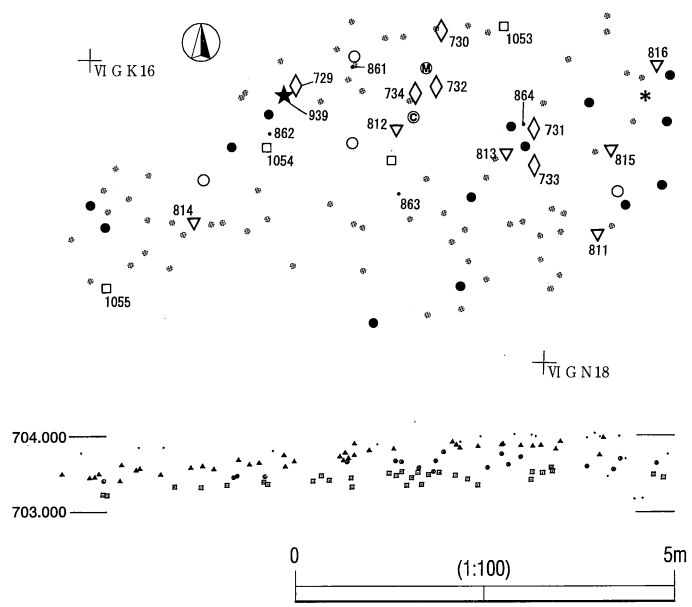
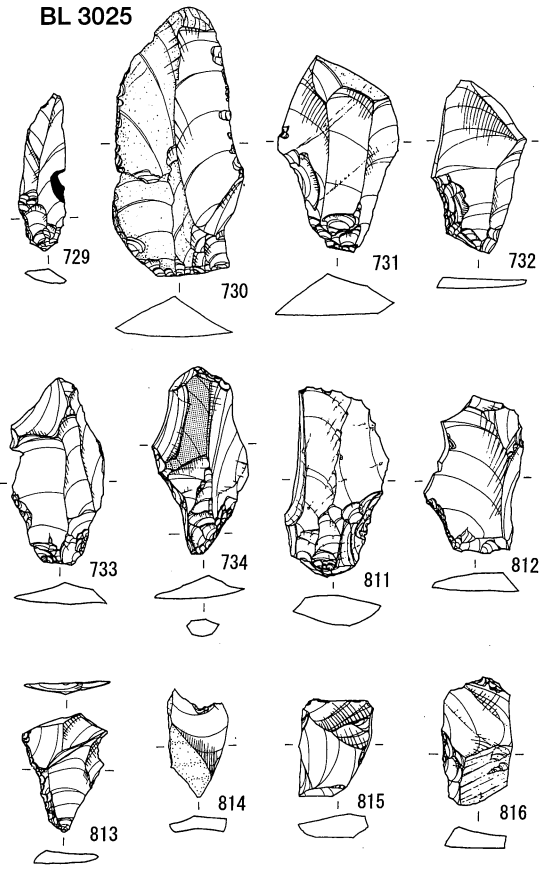

第3地点 BL3024・3025 遺物分布図 (貫ノ木遺跡)

BL 3026

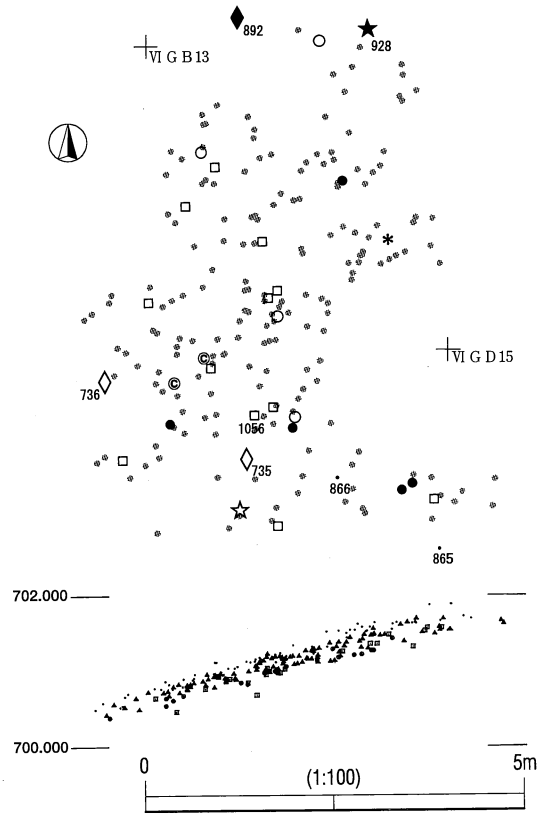
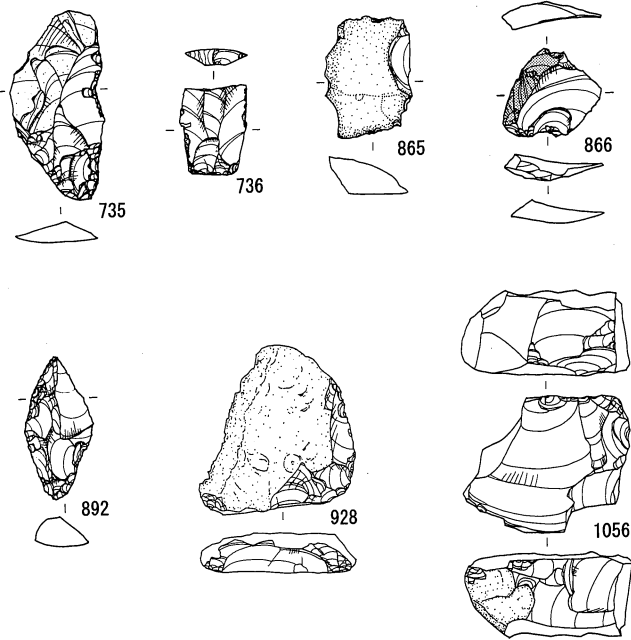

BL 3027

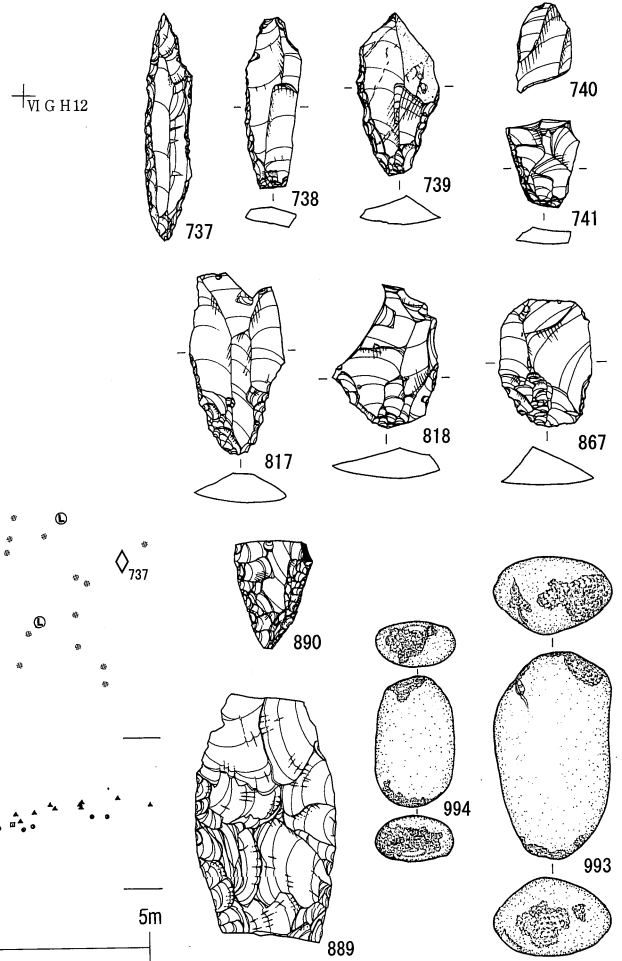
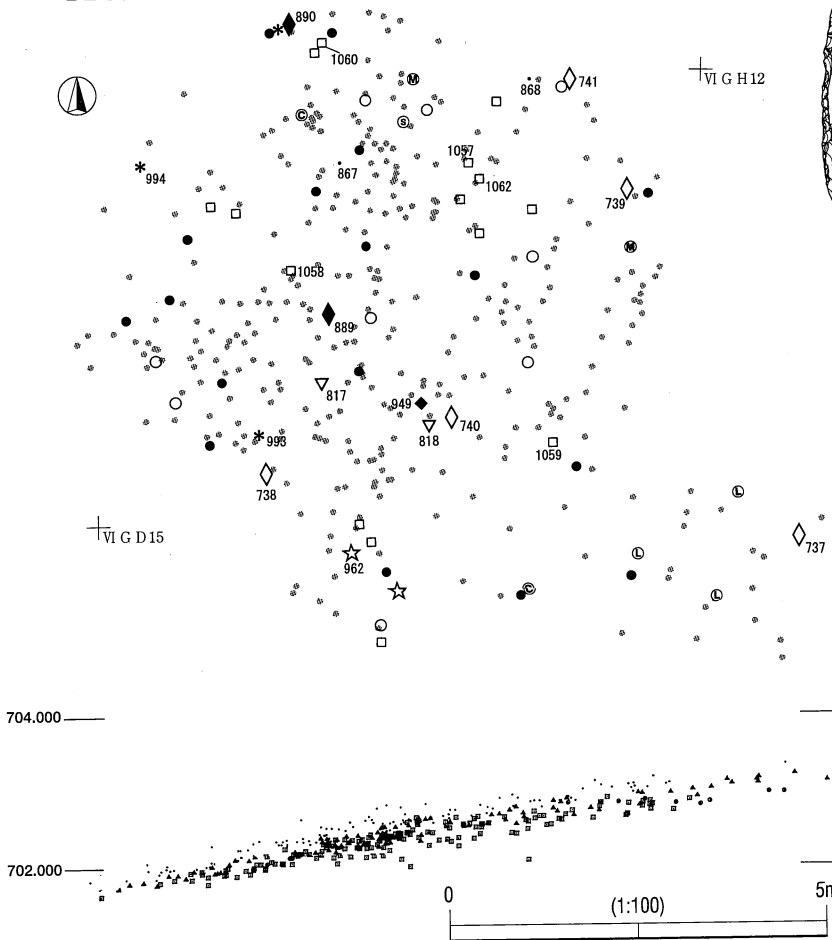

第3地点 BL3026・3027 遺物分布図 (貫ノ木遺跡)

BL 3028



第3地点 BL3028 遺物分布図 (貫ノ木遺跡)

BL 3029



VI G M14

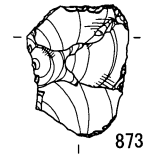
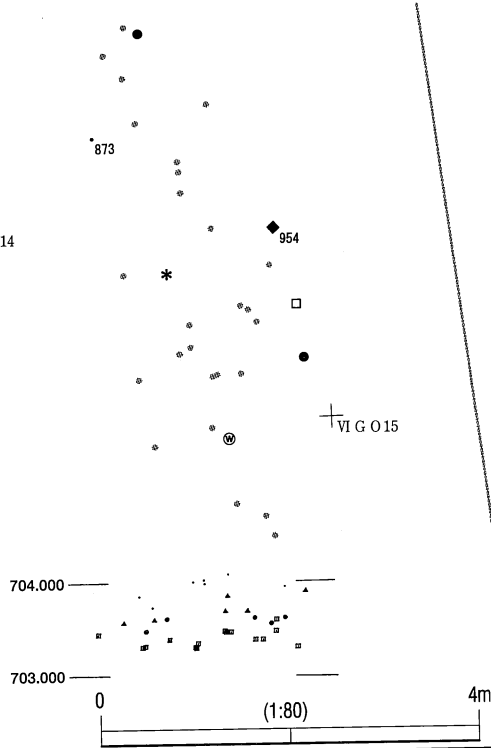

873

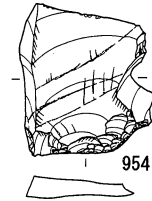

954

BL 3030

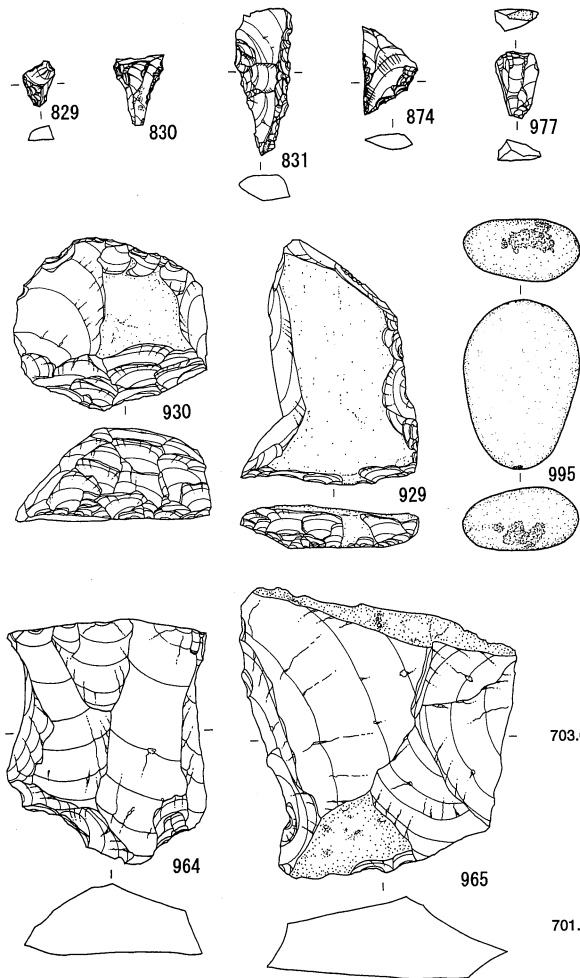

VI G F09

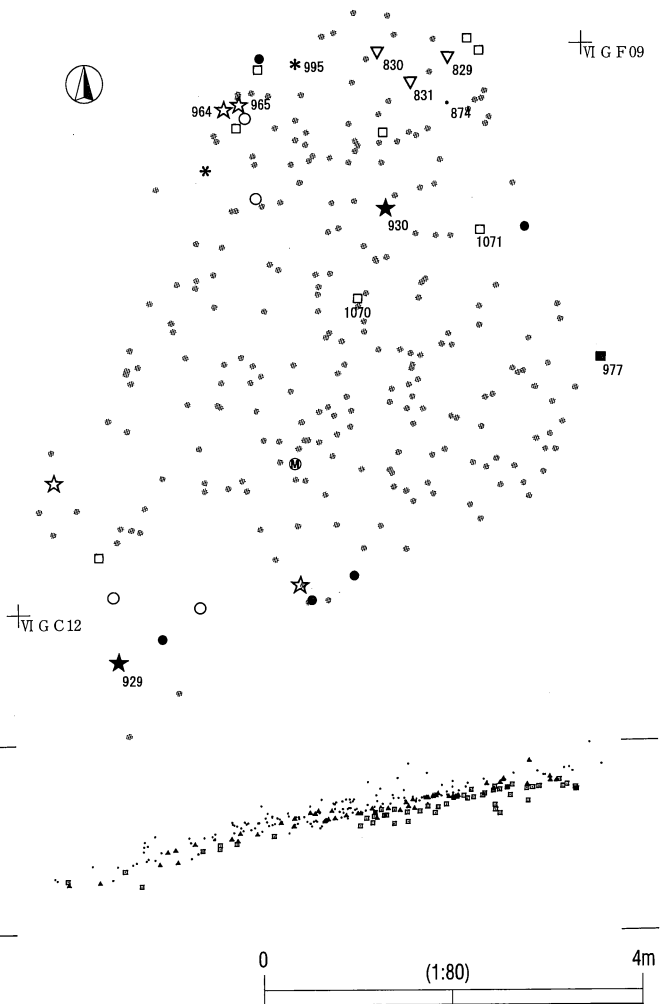

VI G C12

第3地点 BL3029・3030 遺物分布図 (貫ノ木遺跡)

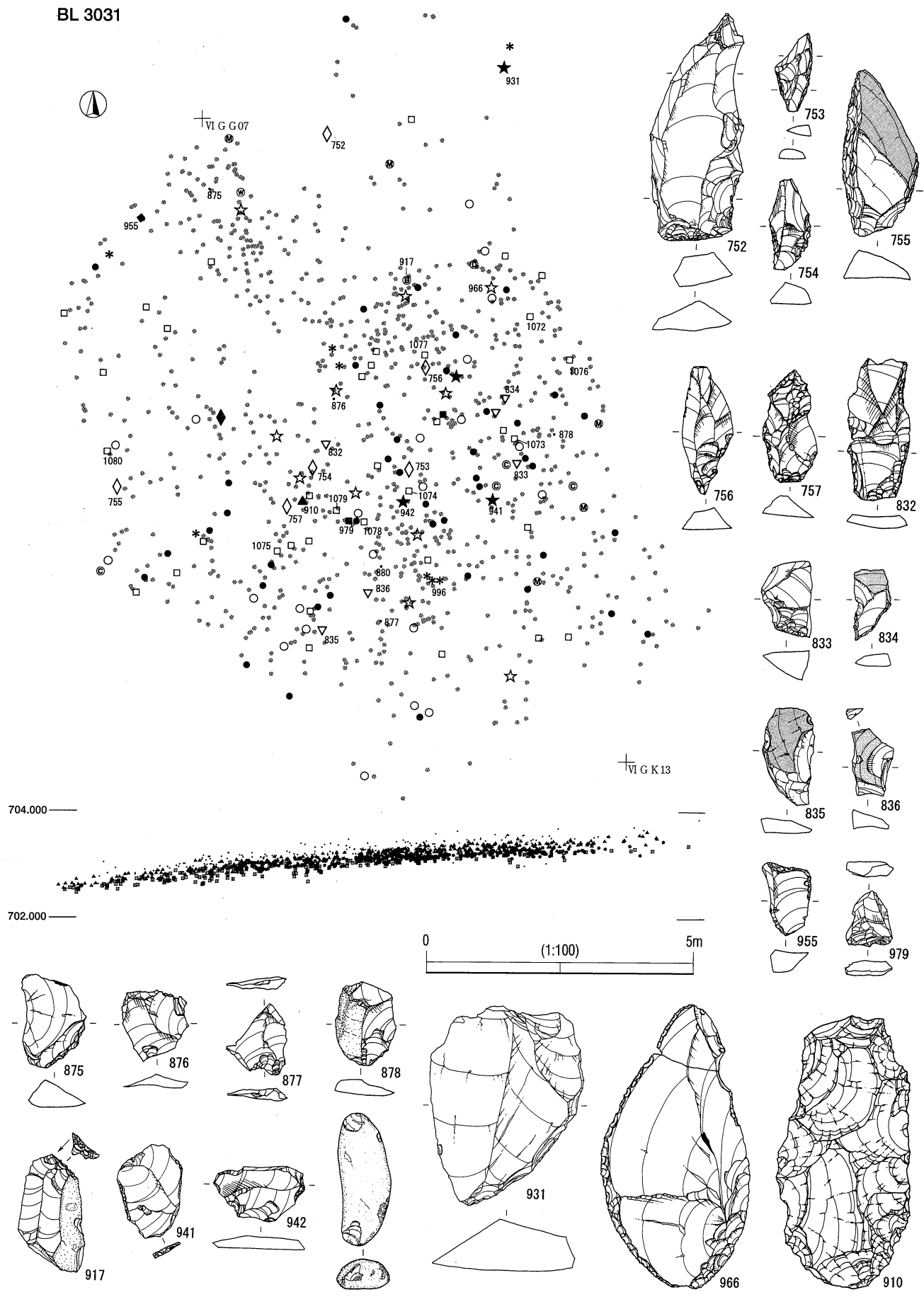

第3地点 BL3031 遺物分布図 (貫ノ木遺跡)

BL 3032

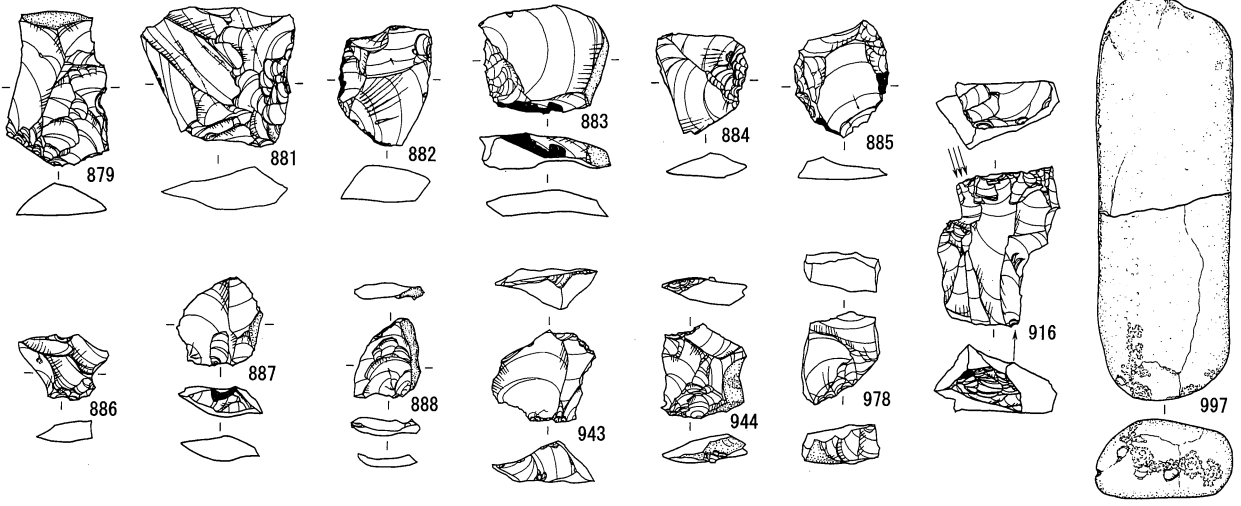
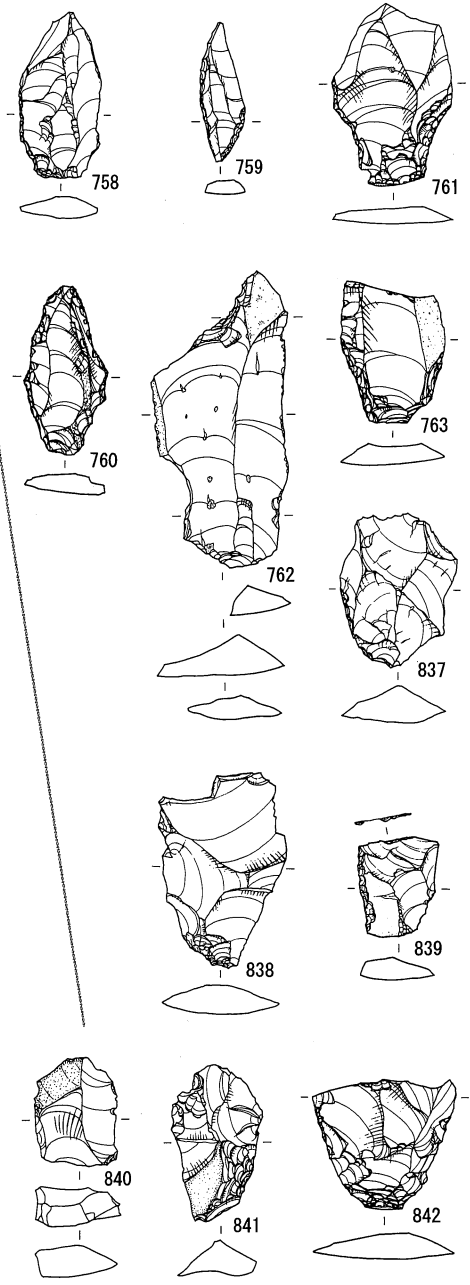
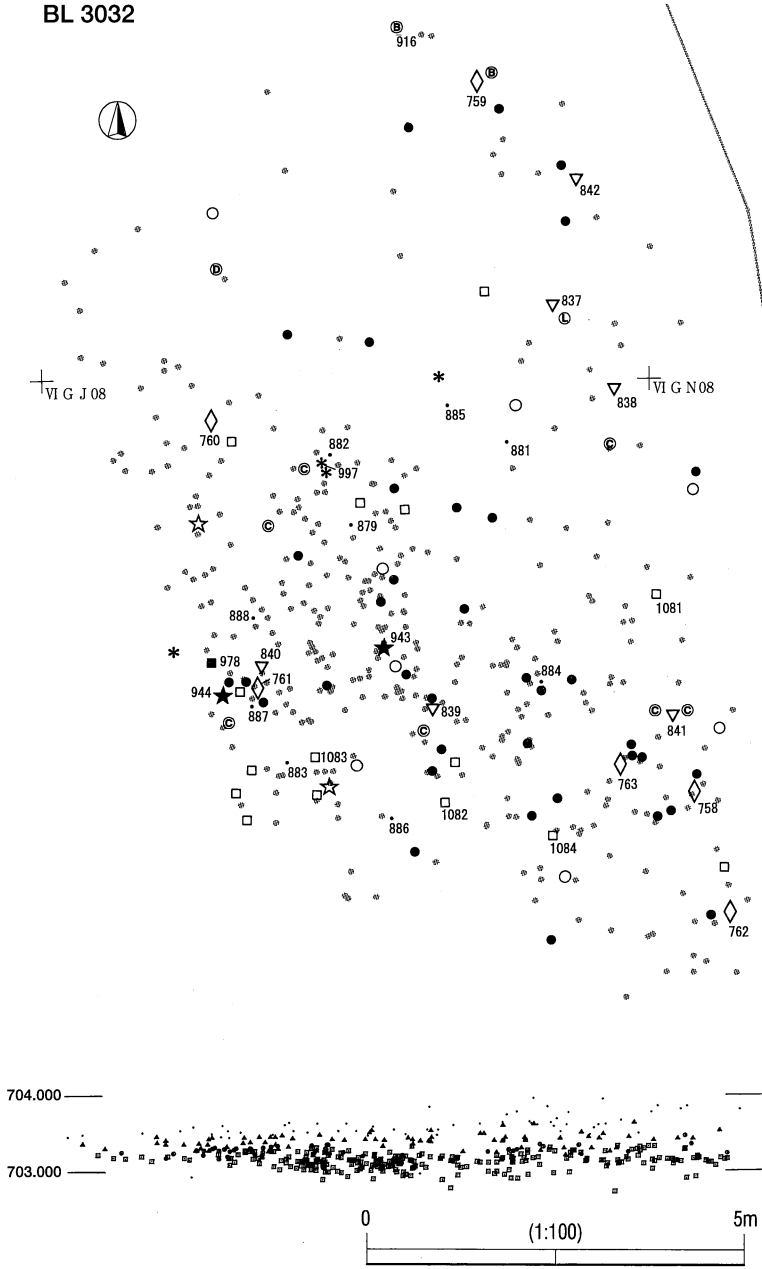

第3地点 BL3032 遺物分布図 (貫ノ木遺跡)

BL 3033

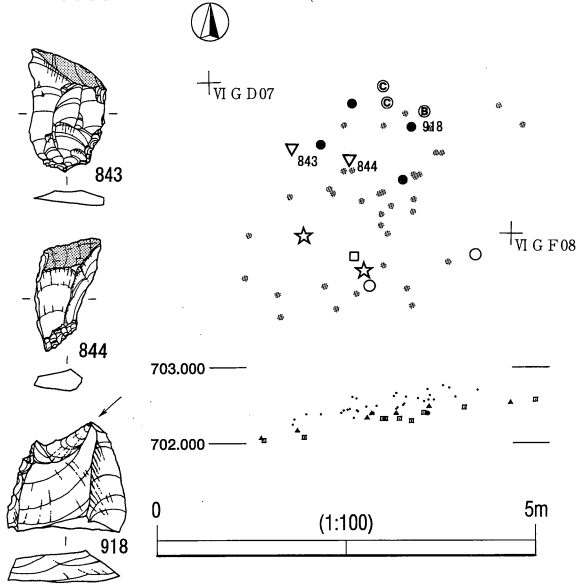

BL 3034

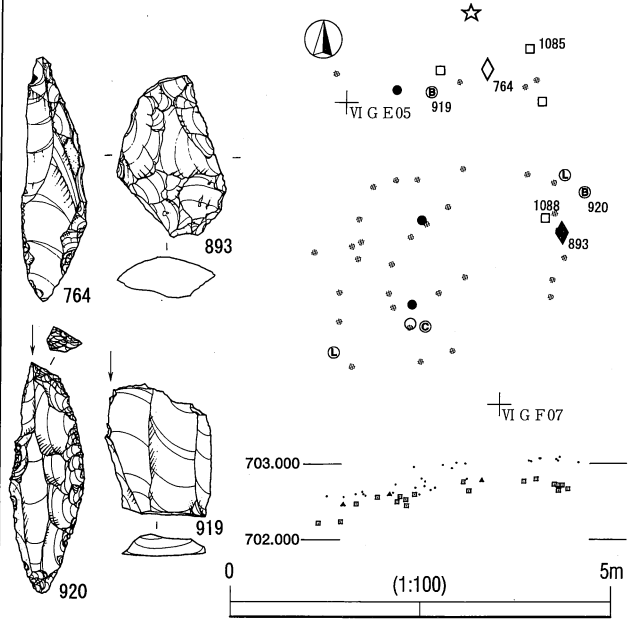

BL 3035

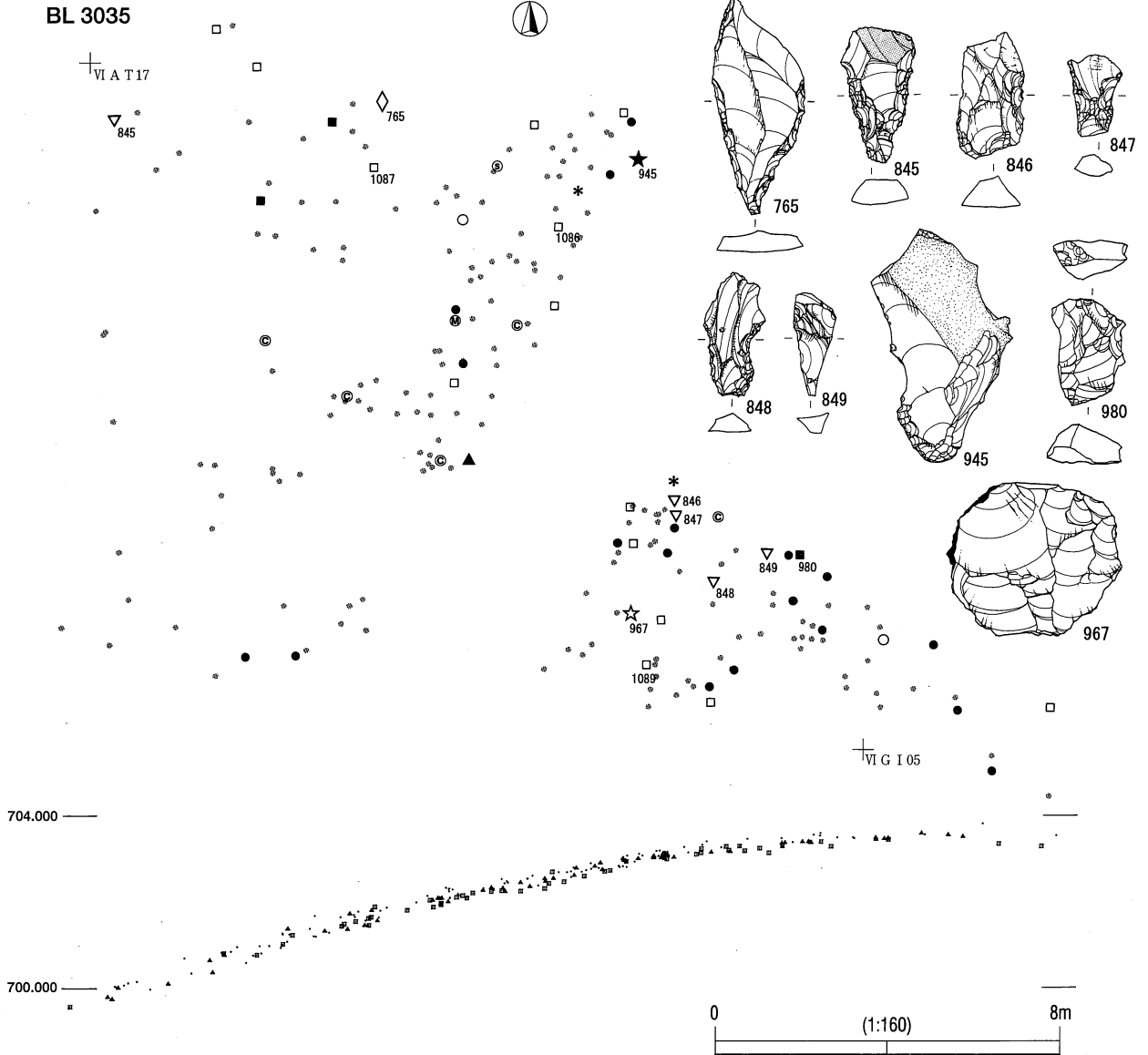

第3地点 BL3033・3034・3035 遺物分布図 (貫ノ木遺跡)



BL 3036

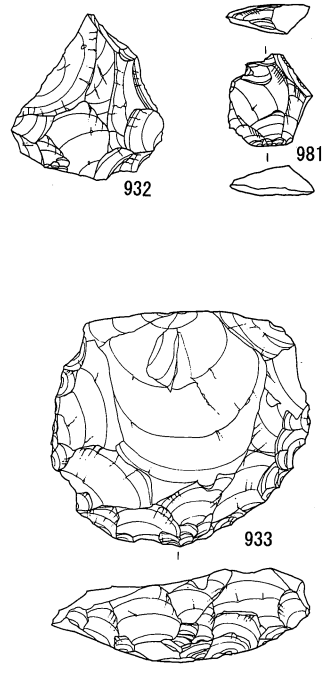
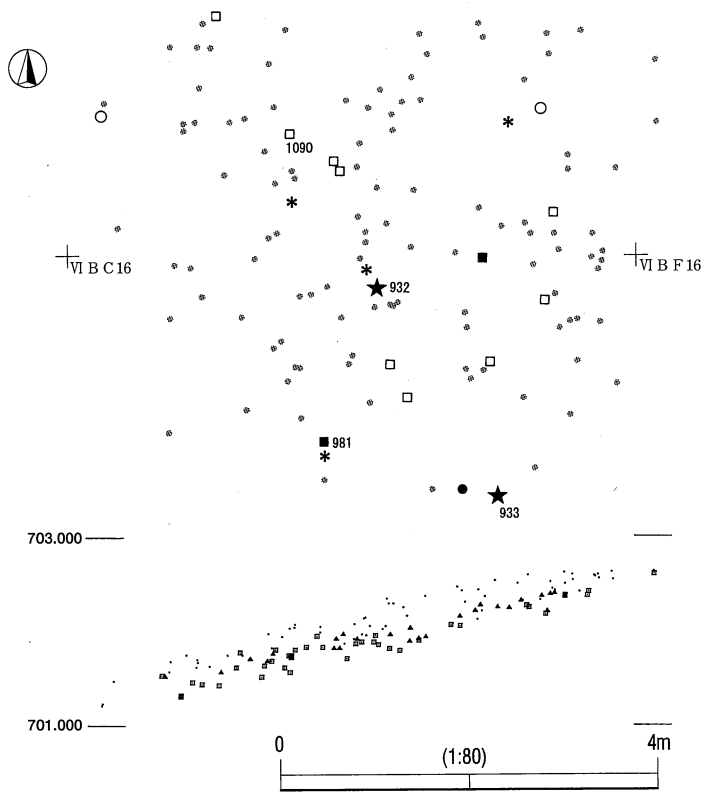

BL 3037

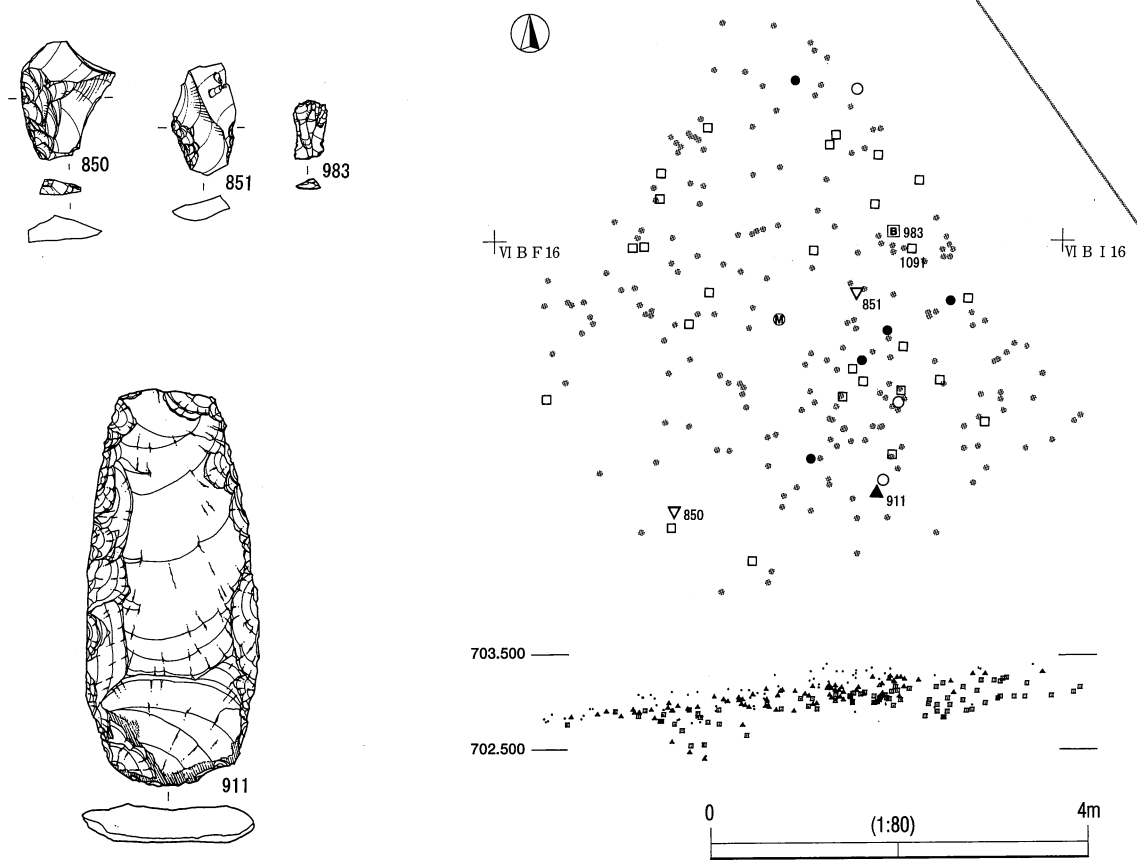

第3地点 BL3036・3037 遺物分布図 (貫ノ木遺跡)

BL 3038

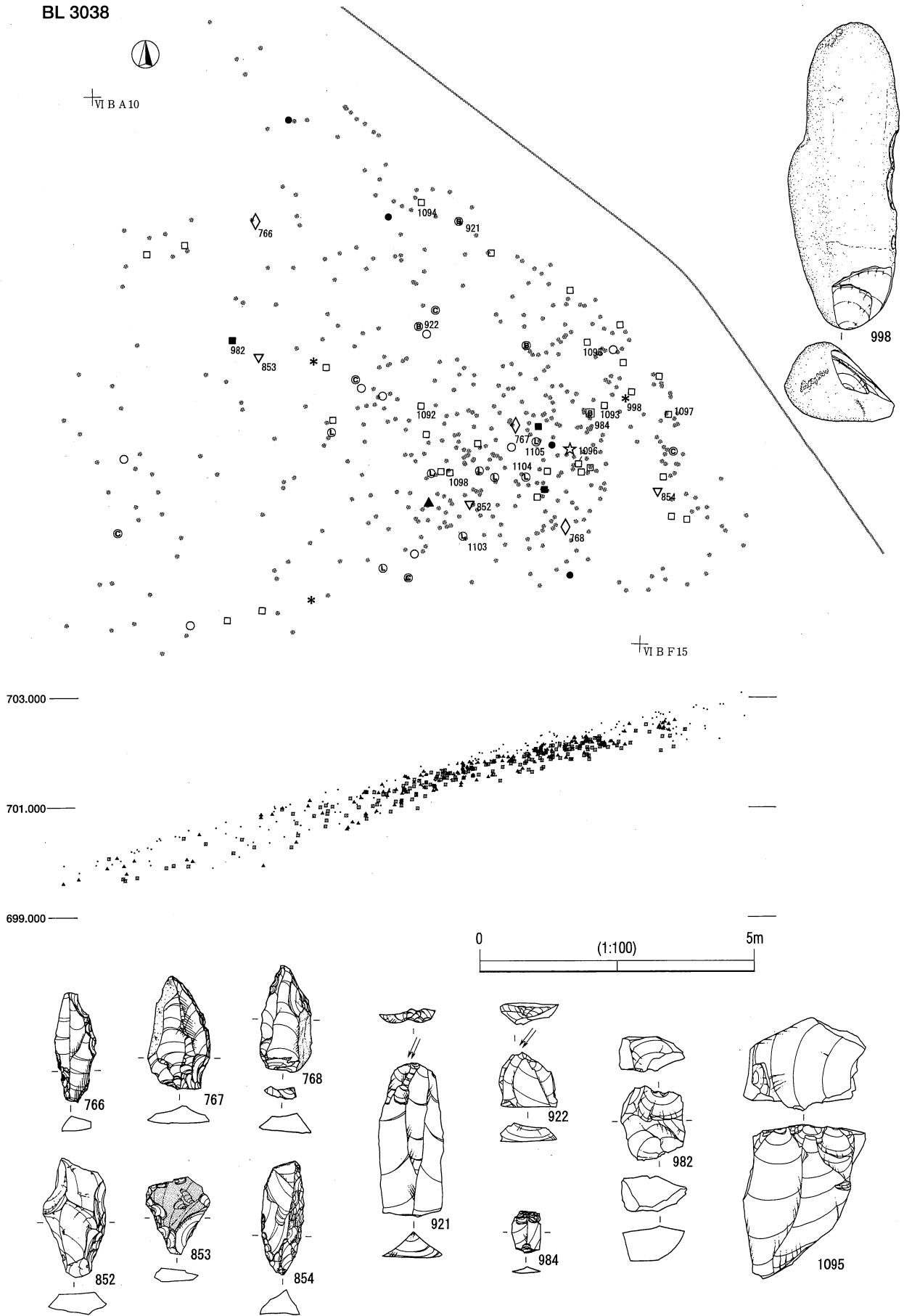

第3地点 BL3038 遺物分布図 (貫ノ木遺跡)

SH 75

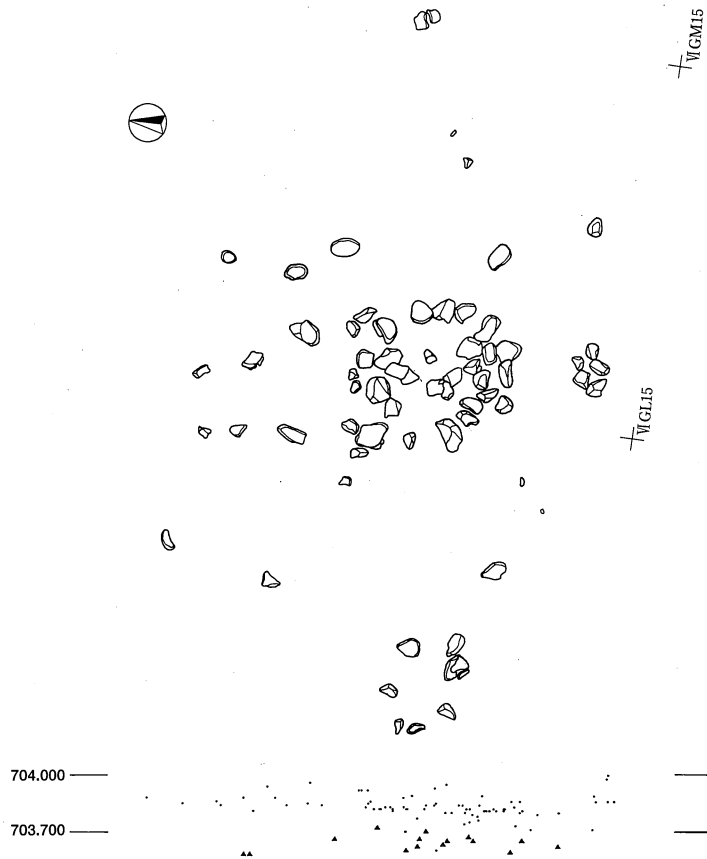

SH 77

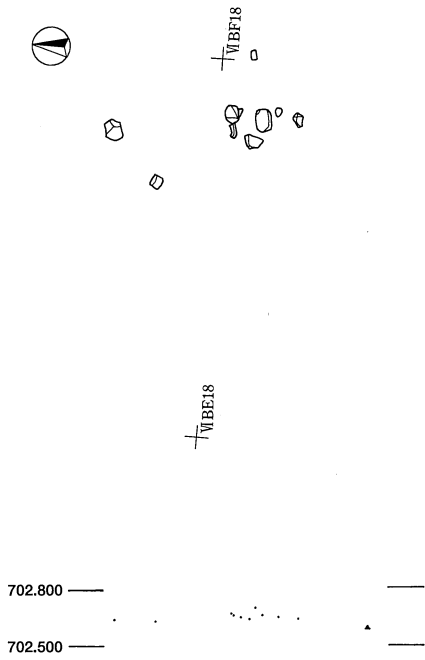

SH 78

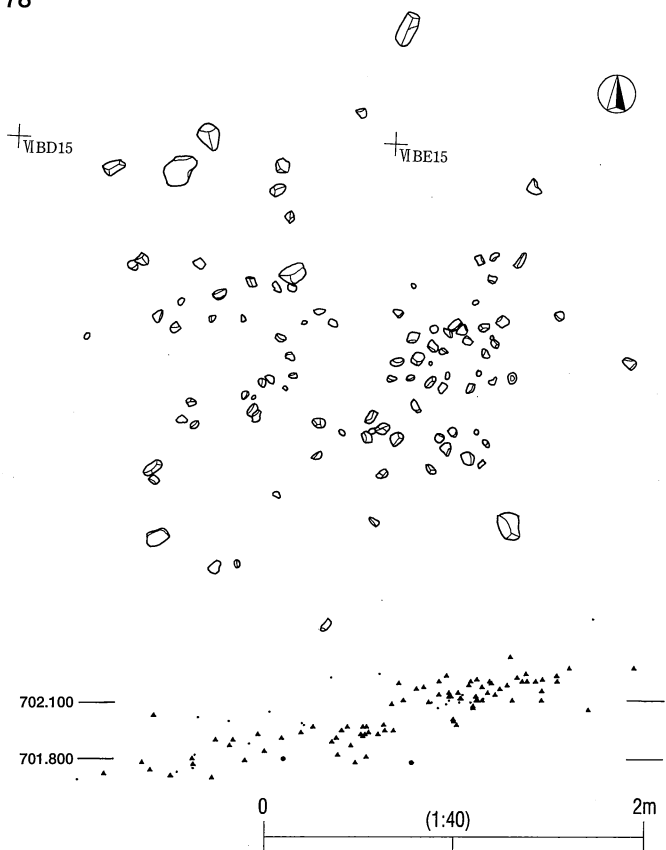

第3地点 SH 75・77・78 遺物分布図 (貫ノ木遺跡)

SH 80

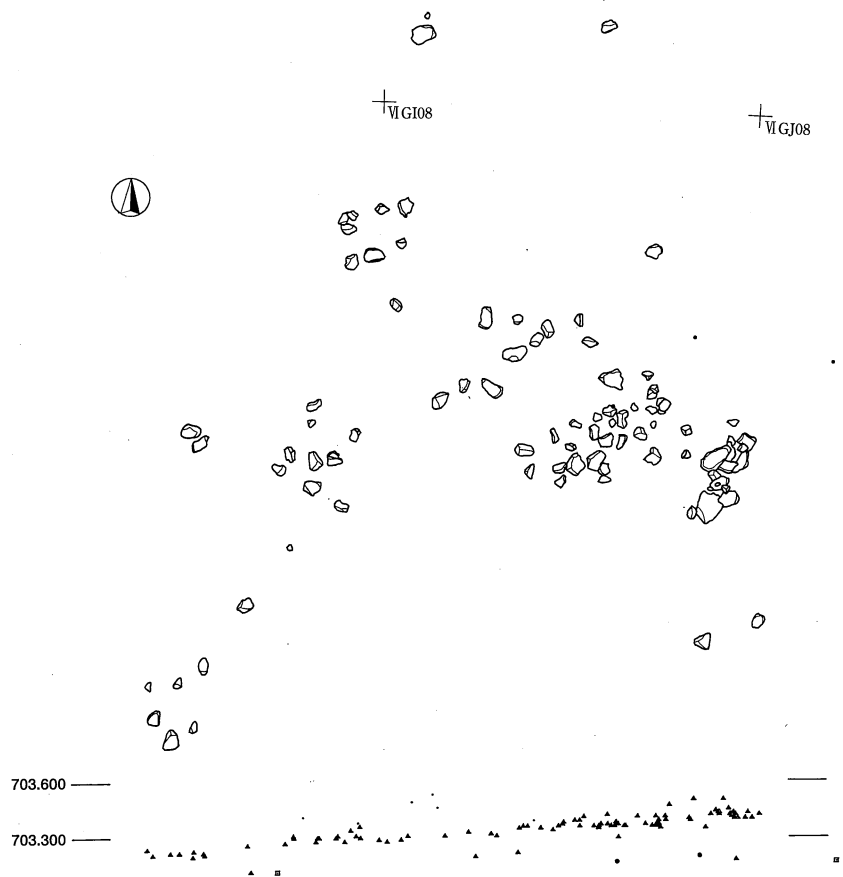

SH 81

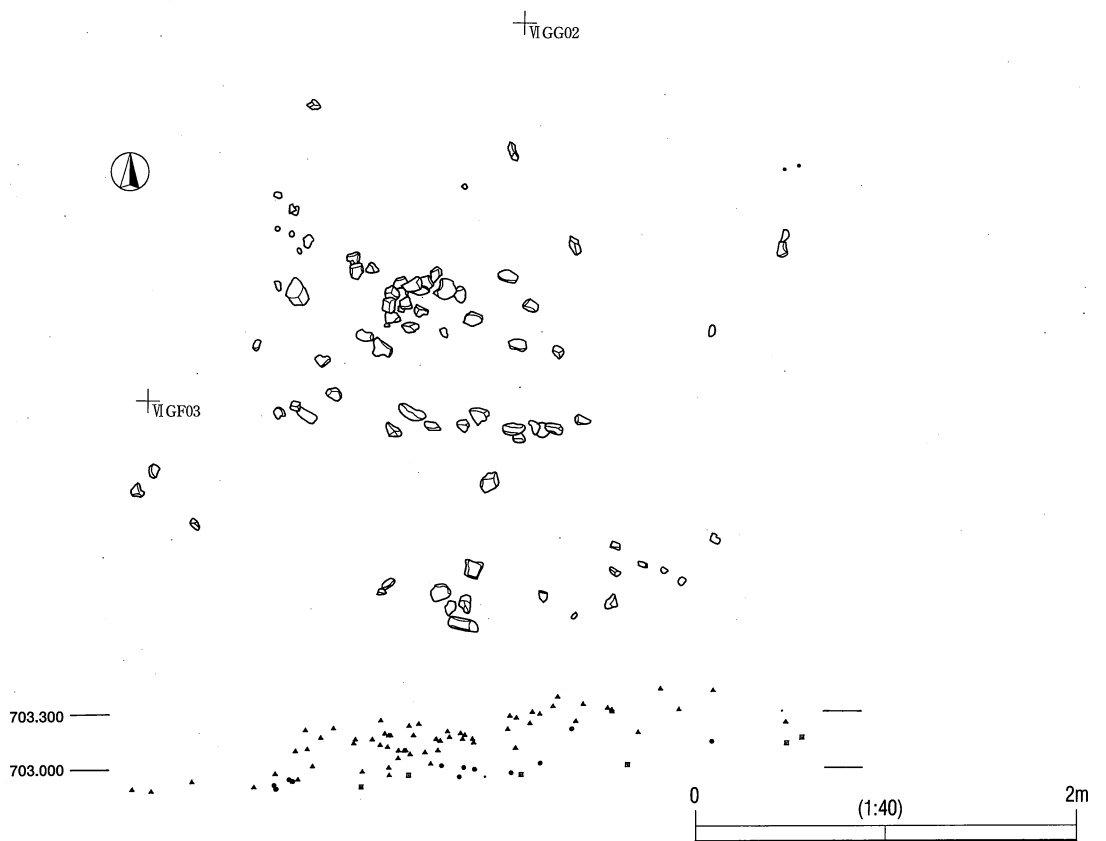

第3地点 SH 80・81 遺物分布図 (貫ノ木遺跡)

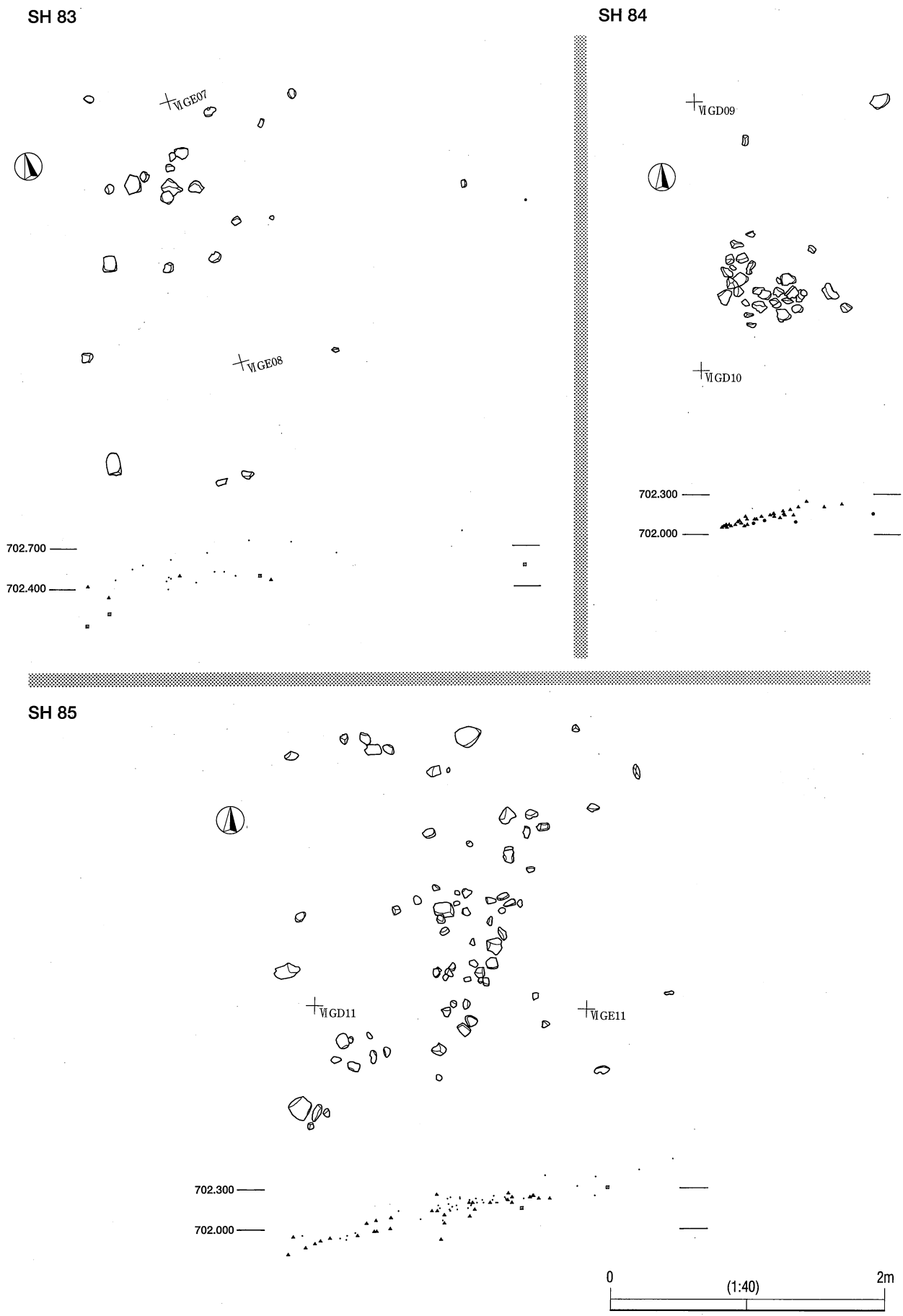

第3地点 SH 83・84・85 遺物分布図 (貫ノ木遺跡)

SH 86

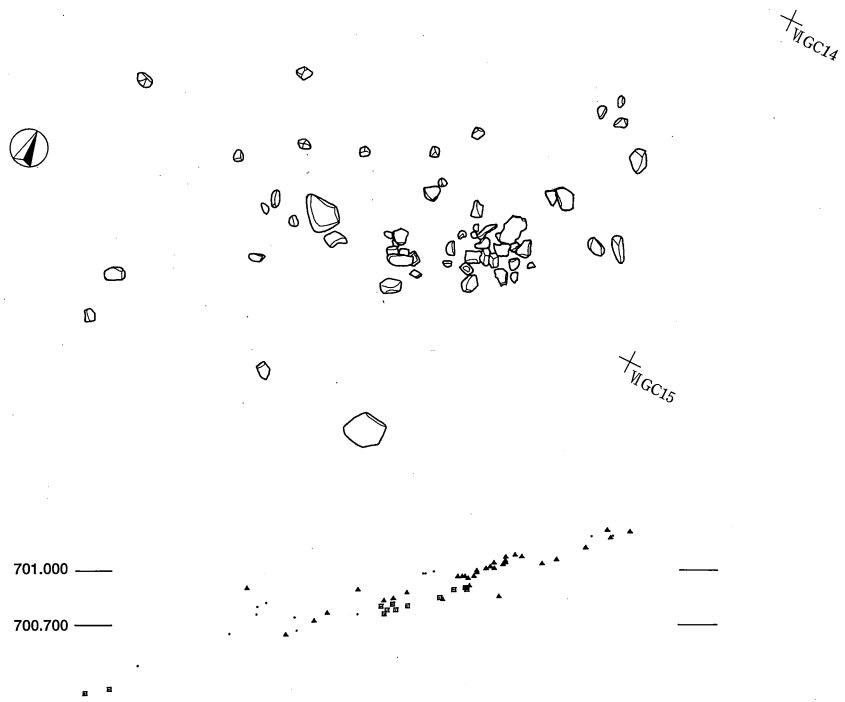

SH 88

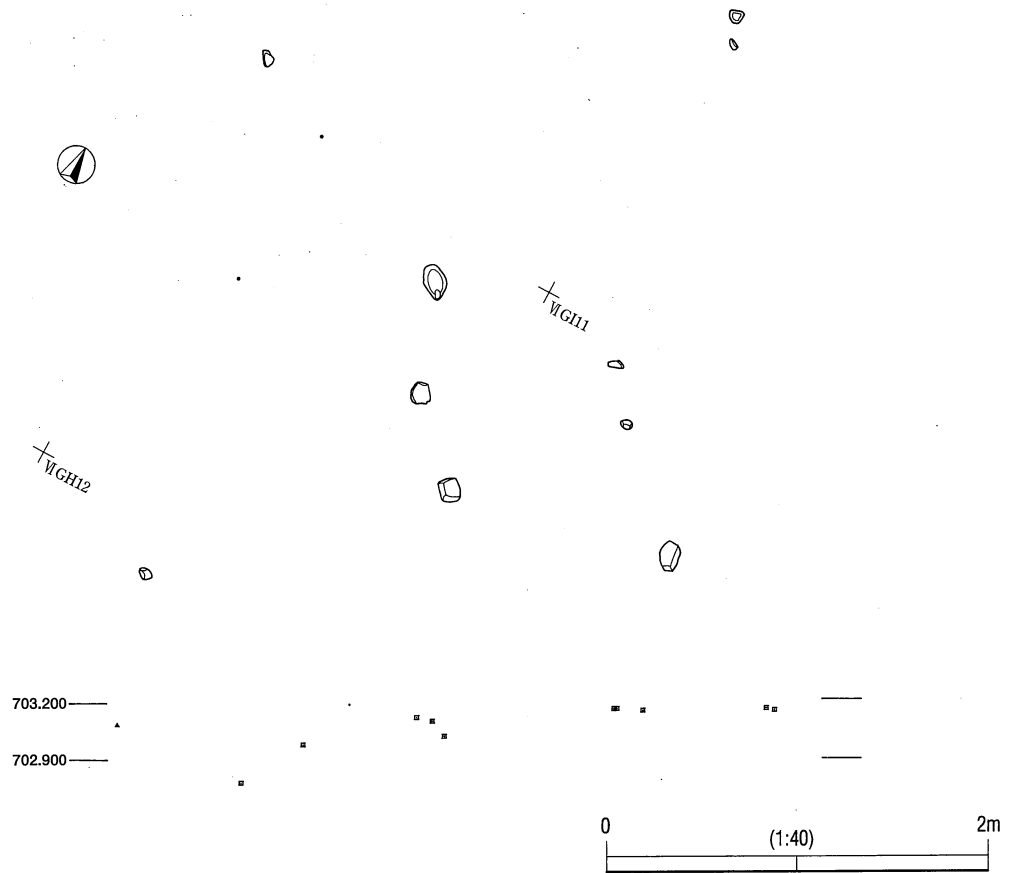

第3地点 SH 86・88 遺物分布図 (貫ノ木遺跡)

SH 97

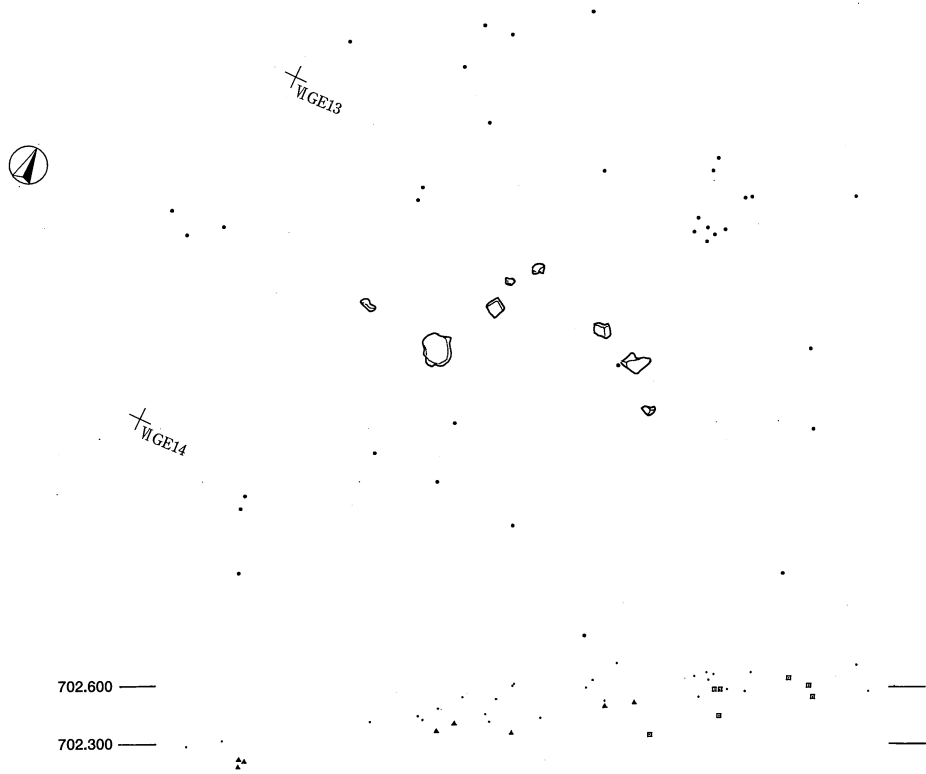

SH 90

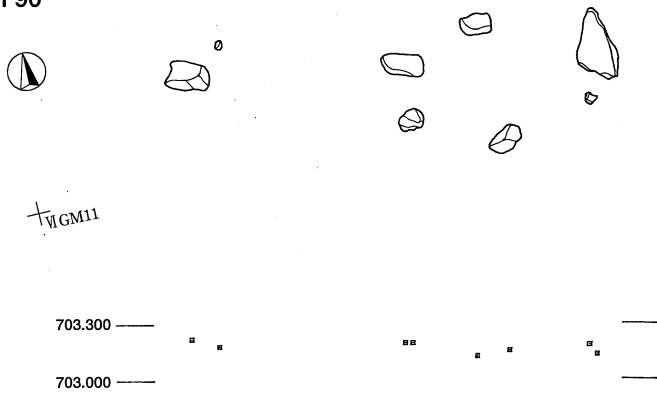

SH 89

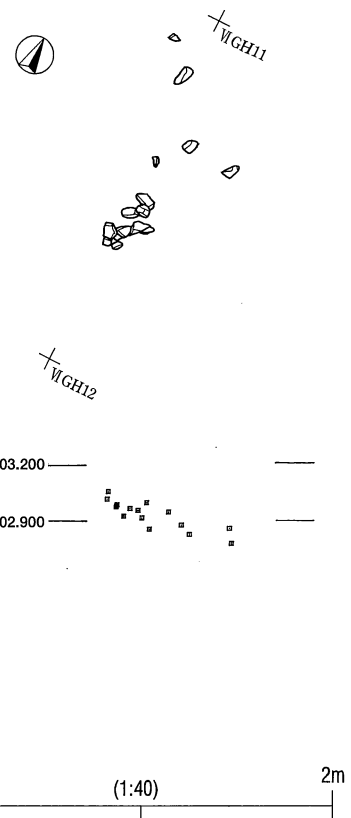

SH 87

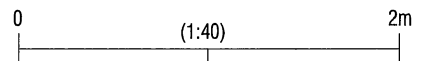
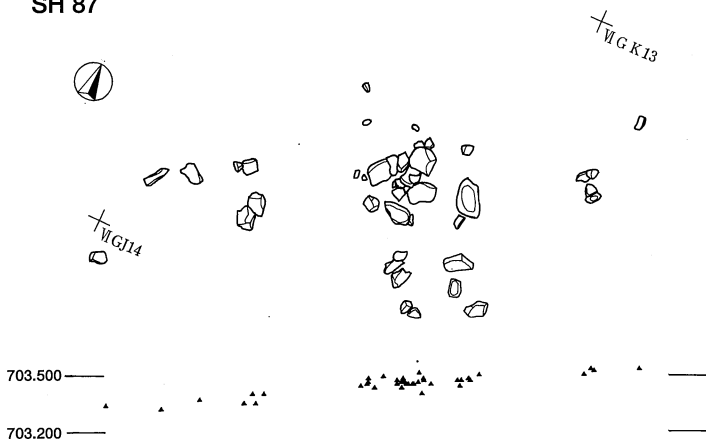

第3地点 SH 87・89・90・97 遺物分布図 (貫ノ木遺跡)

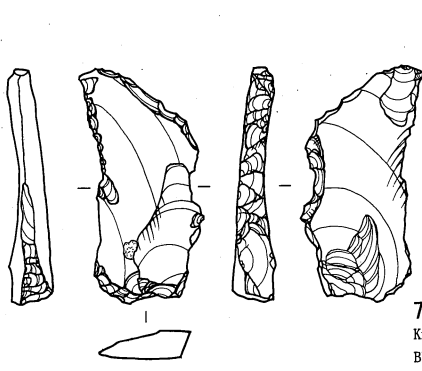

701  
Kn Ob WDTY  
BL3003 5.77g  
III VI-P 147

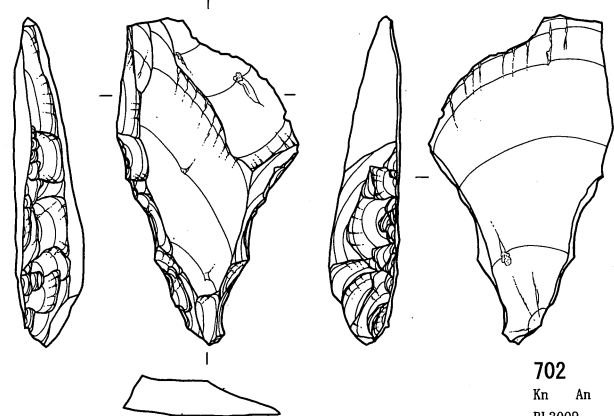

702  
Kn An  
BL3009 15.81g  
V VI-L 1844

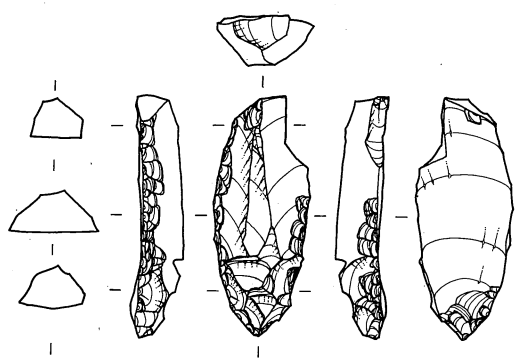

703  
Kn SS  
BL3011 5.63g  
III VI-L 378

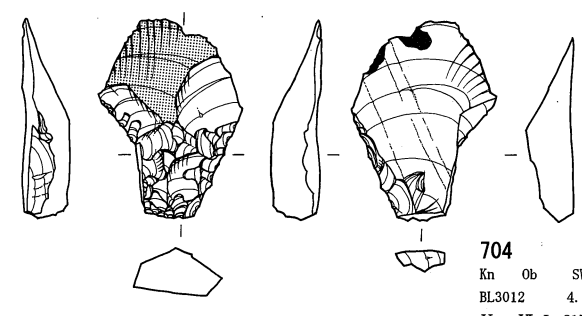

704  
Kn Ob SWHD  
BL3012 4.52g  
V VI-L 2156

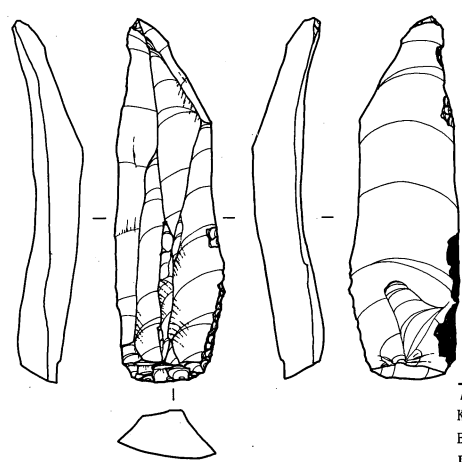

705  
Kn Ch  
BL3013 10.68g  
IV VI-L 840

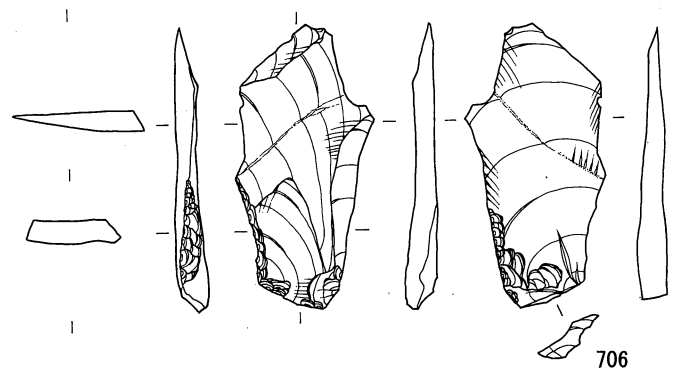

706  
Kn Ob SWHD  
BL3013 3.97g  
V VI-L 1548

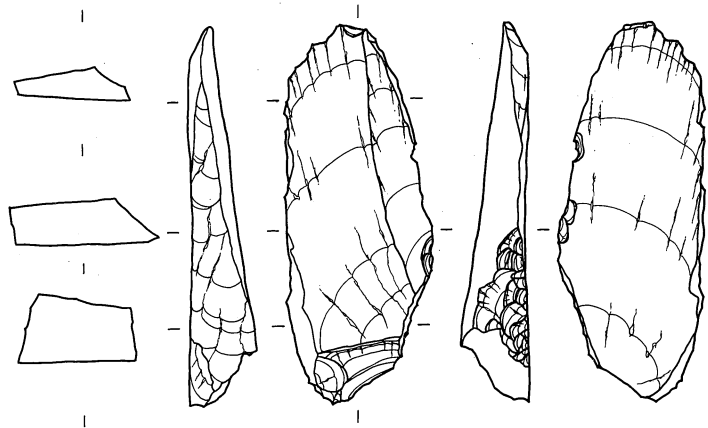

707  
Kn An  
BL3014 18.86g  
V VI-L 1912

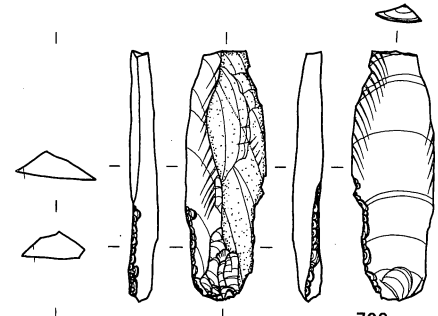

708  
Kn Ob SWHD  
BL3014 2.4g  
V VI-L 1569

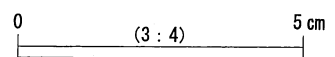

第3地点 石器実測図1 (ナイフ形石器1) (貫ノ木遺跡)



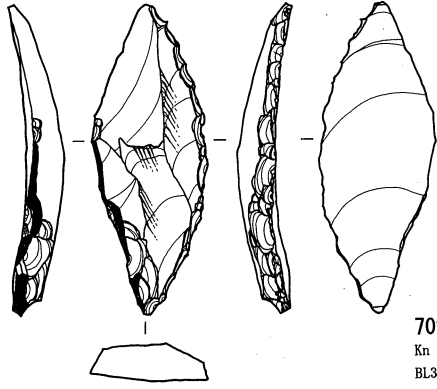

709  
Kn An  
BL3015 6.55g  
IV VI-L 993

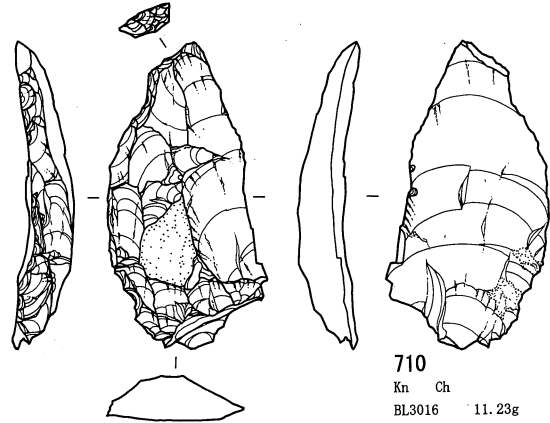

710  
Kn Ch  
BL3016 11.23g  
III VI-L 607

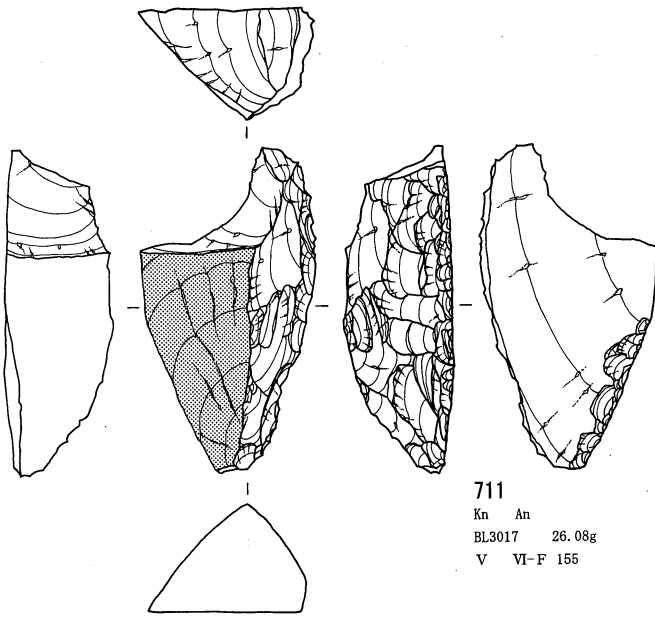

711  
Kn An  
BL3017 26.08g  
V VI-F 155

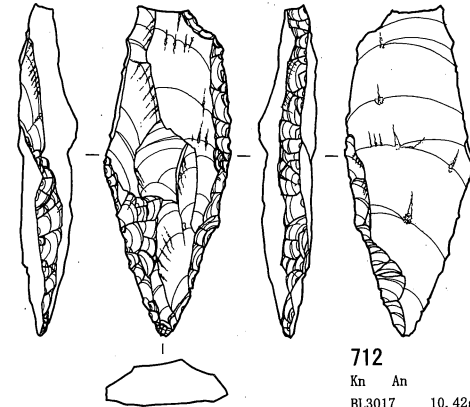

712  
Kn An  
BL3017 10.42g  
V VI-F 176

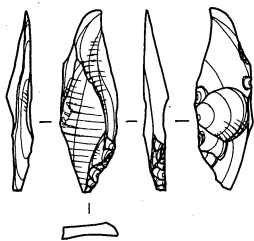

713  
Kn Ob SWHD  
BL3018 1.05g  
V VI-G 1557

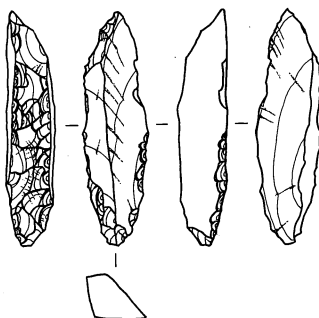

714  
Kn An  
BL3019 3.52g  
IV VI-G 1077

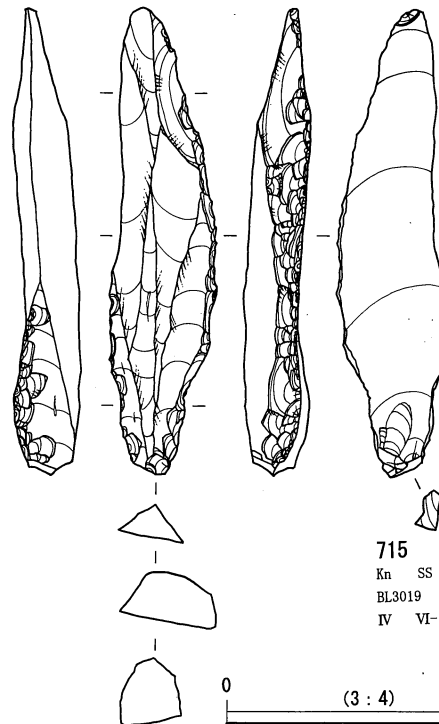

715  
Kn SS  
BL3019 14.37g  
IV VI-G 4071

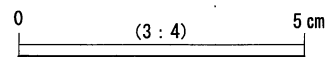

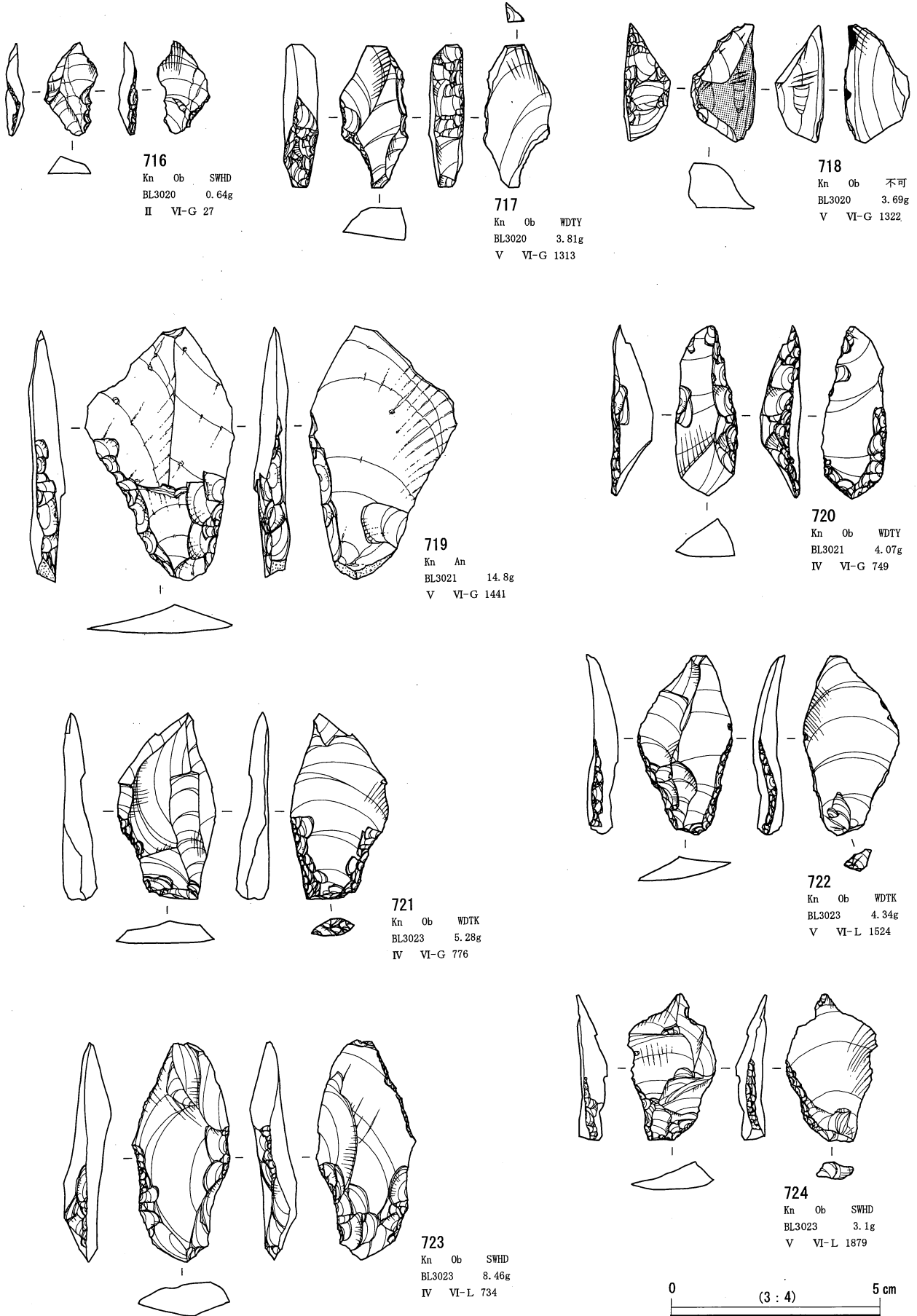

第3地点 石器実測図3 (ナイフ形石器3) (貫ノ木遺跡)

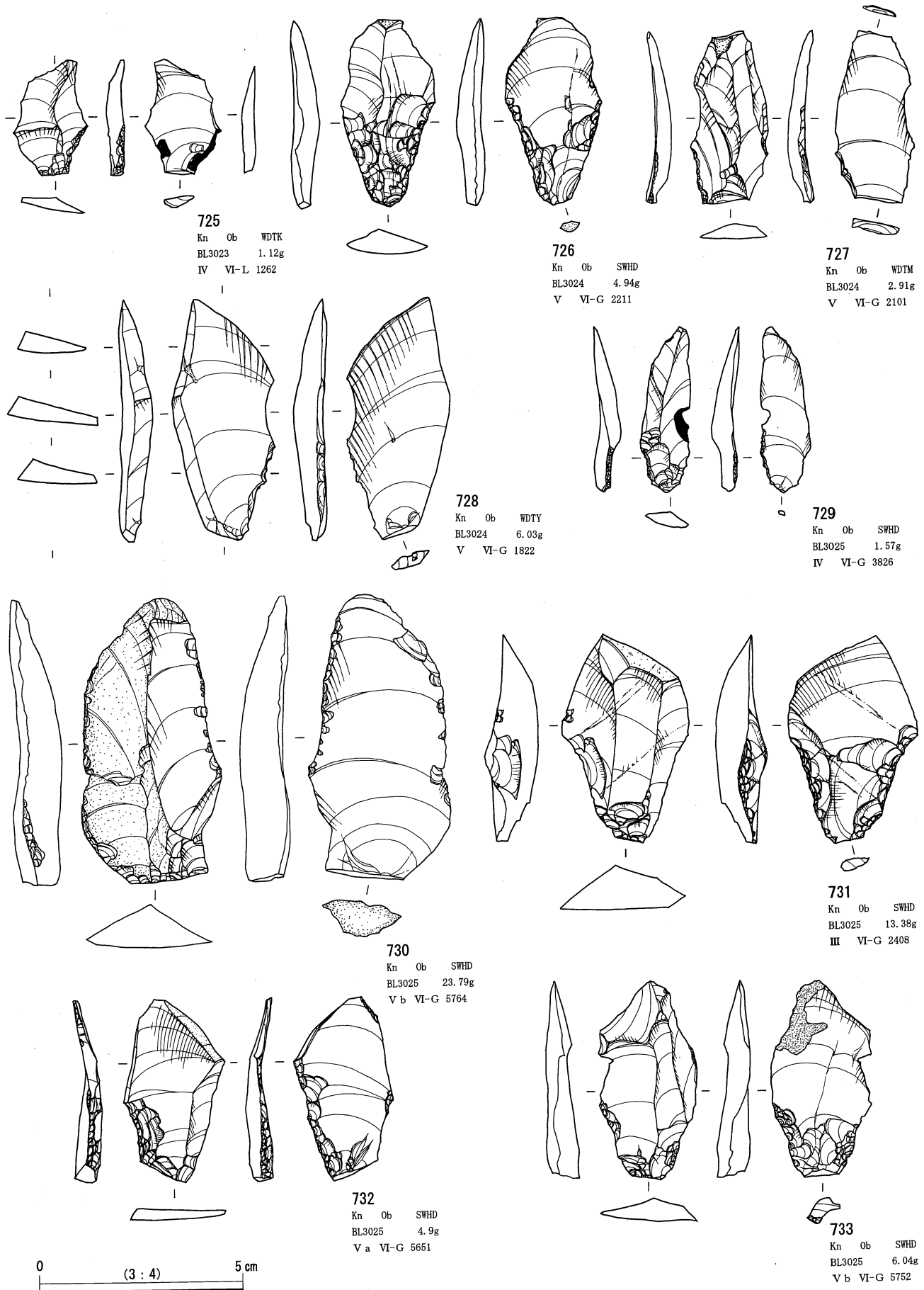

第3地点 石器実測図4 (ナイフ形石器4) (貫ノ木遺跡)

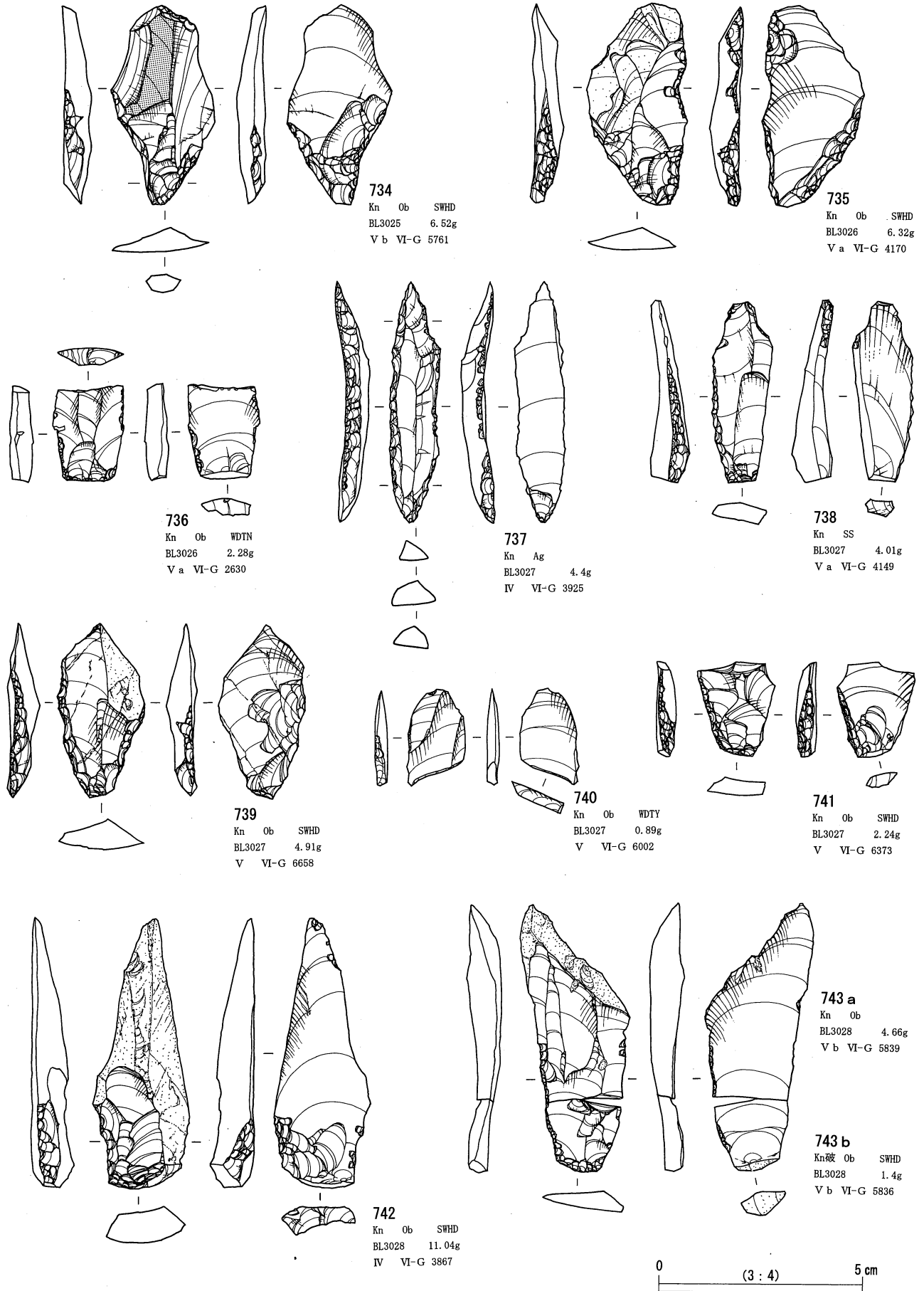

第3地点 石器実測図5 (ナイフ形石器5) (貫ノ木遺跡)

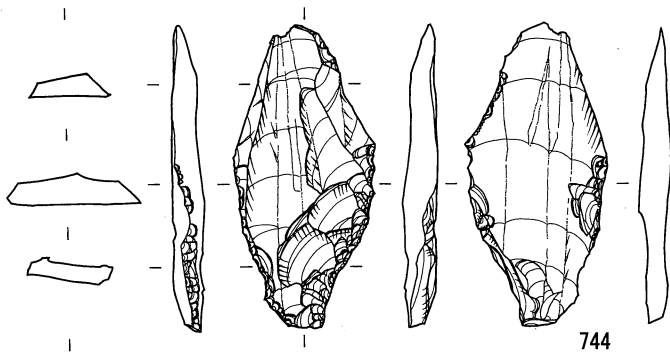

744  
Kn Ob SWHD  
BL3028 6.55g  
V c VI-G 6036

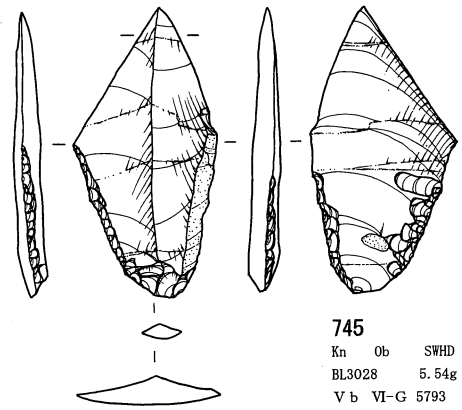

745  
Kn Ob SWHD  
BL3028 5.54g  
V b VI-G 5793

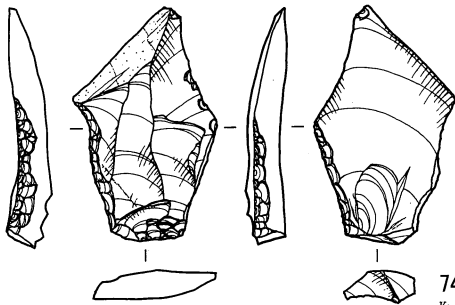

746  
Kn Ob SWHD  
BL3028 4.95g  
III VI-G 2695

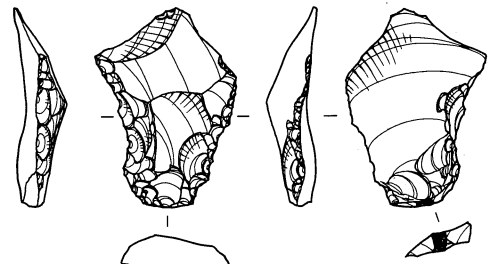

747  
Kn Ob WDTN  
BL3028 3.82g  
IV VI-G 3874

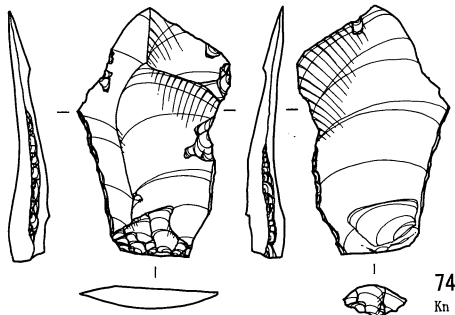

748  
Kn Ob SWHD  
BL3028 4.26g  
V a VI-G 5662

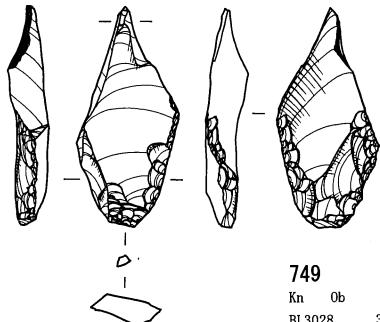

749  
Kn Ob SWHD  
BL3028 3.16g  
V b VI-G 5822

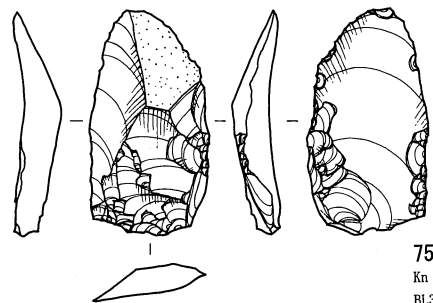

750  
Kn Ob WDTN  
BL3028 5.26g  
V b VI-G 5890

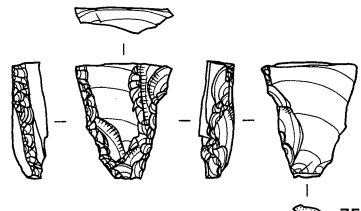

751  
Kn Ob 不可  
BL3028 1.59g  
III VI-G 2720

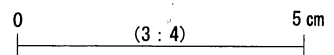

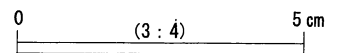
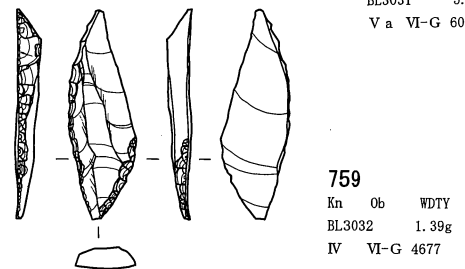
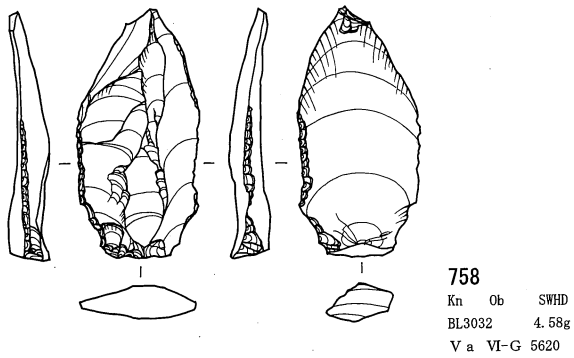
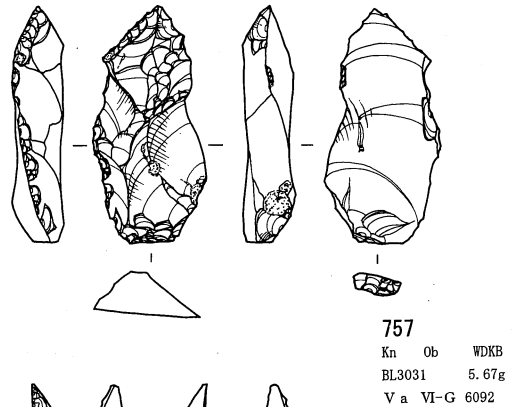
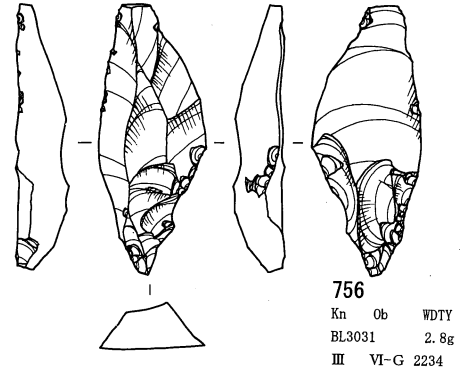
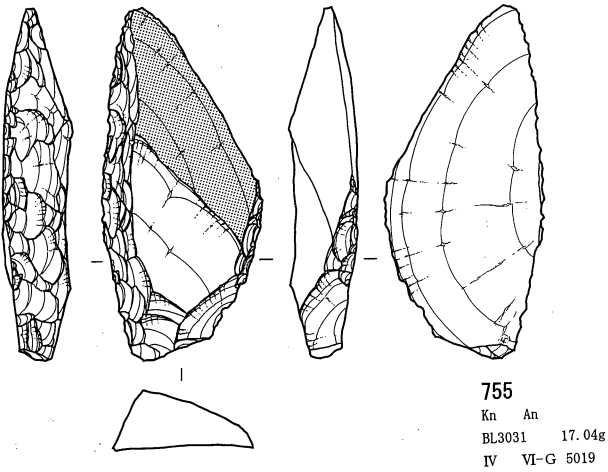
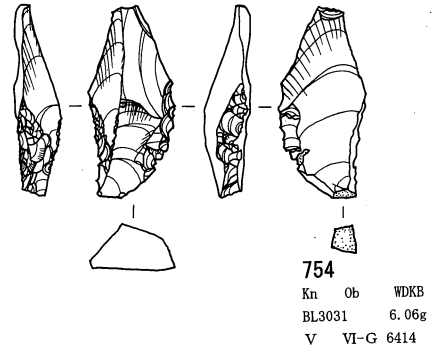
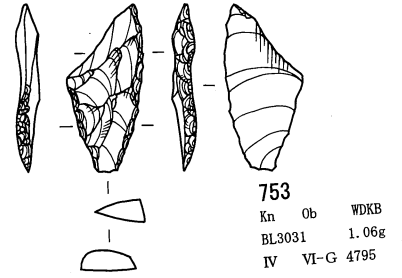
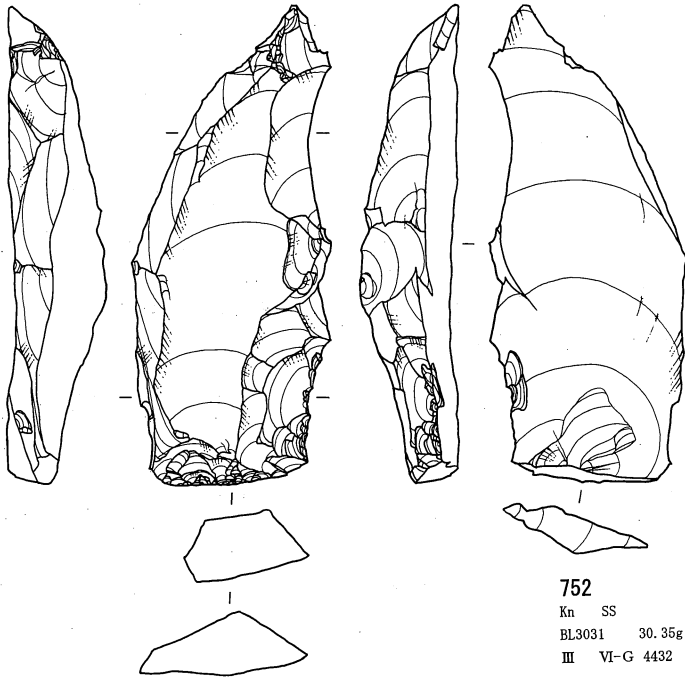

第3地点 石器実測図7 (ナイフ形石器7) (貫ノ木遺跡)

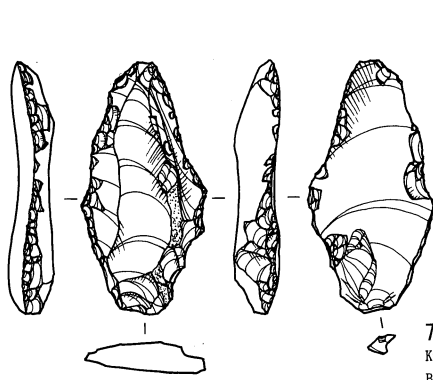

760  
Kn Ob WDTY  
BL3032 6.12g  
V a VI-G 5313

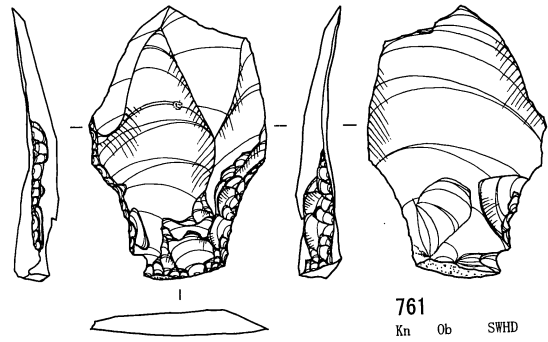

761  
Kn Ob SWHD  
BL3032 7.52g  
V b VI-G 6440

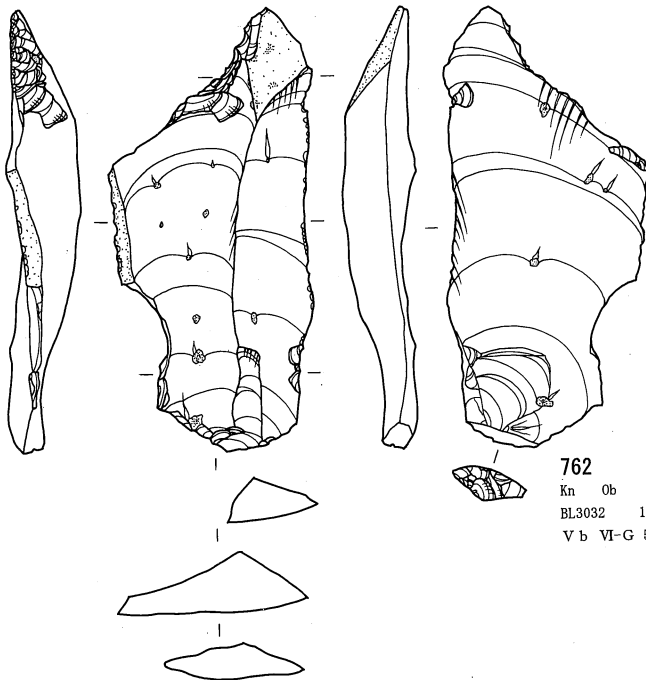

762  
Kn Ob WDTY  
BL3032 19.63g  
V b VI-G 5720

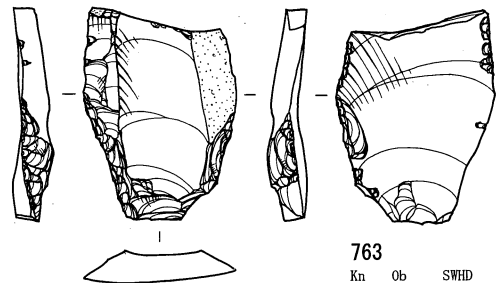

763  
Kn Ob SWHD  
BL3032 5.44g  
V b VI-G 5689

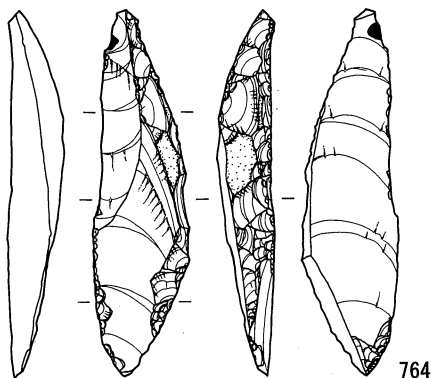

764  
Kn SS  
BL3034 6.86g  
IV VI-G 4932

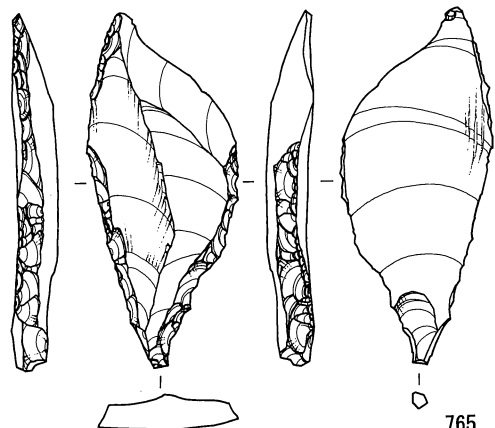

765  
Kn SS  
BL3035 10.95g  
III VI-B 952

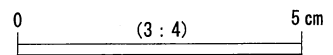

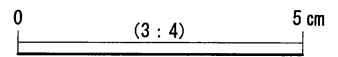
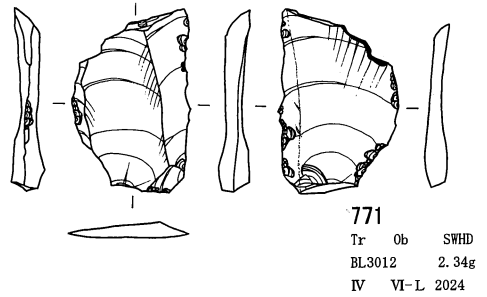
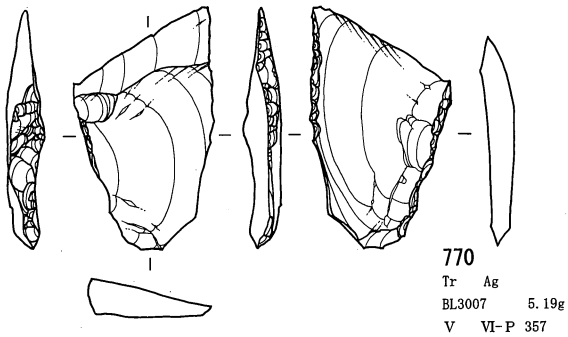
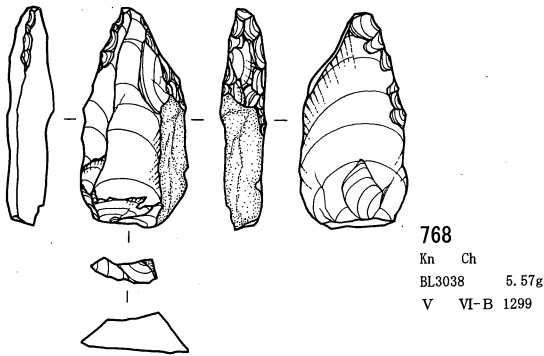
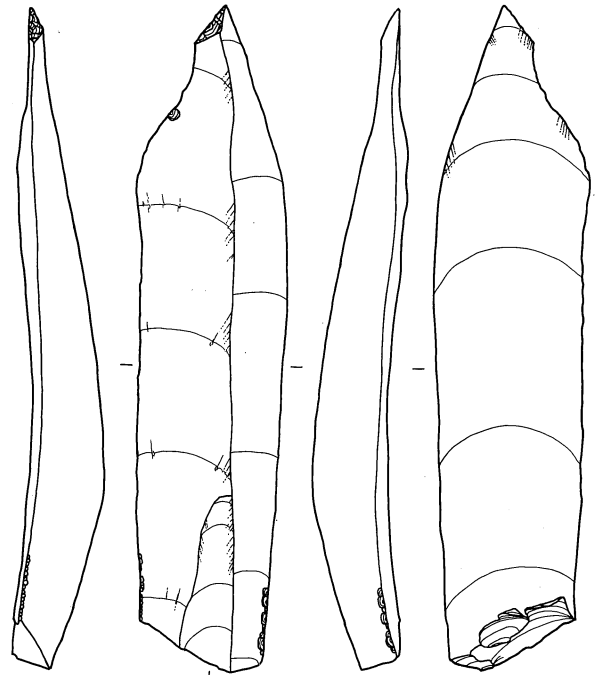
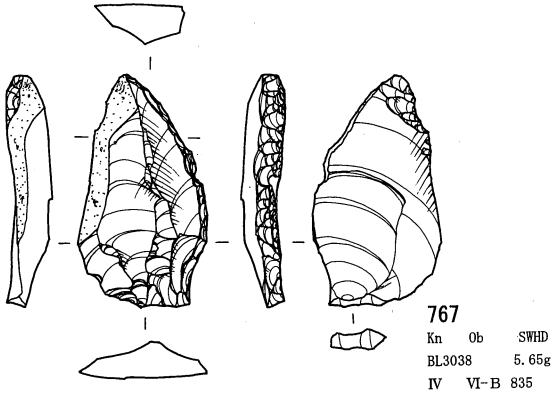
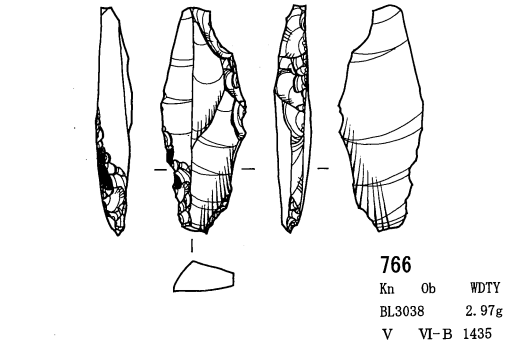

第3地点 石器実測図9 (ナイフ形石器9・台形石器1) (貫ノ木遺跡)



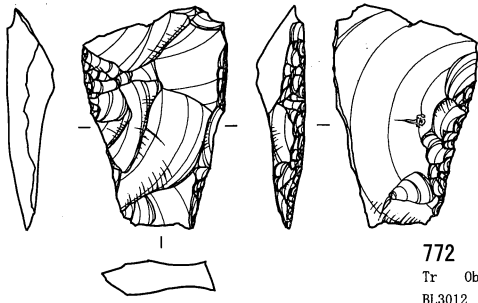

772  
Tr Ob WDTY  
BL3012 6.28g  
V VI-L 2061

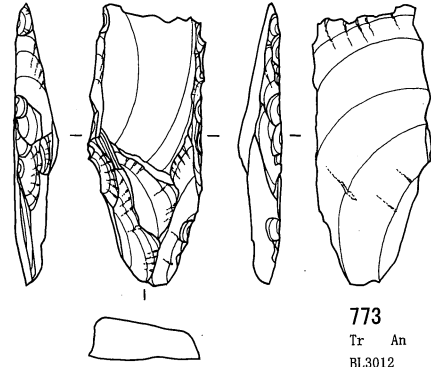

773  
Tr An  
BL3012 6.59g  
V VI-L 2049

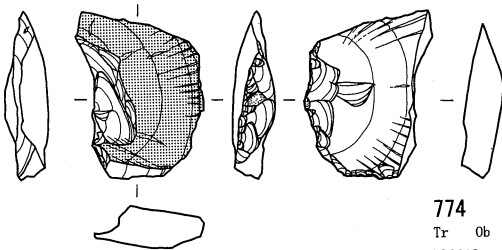

774  
Tr Ob WDTY  
BL3012 3.86g  
V VI-L 2136

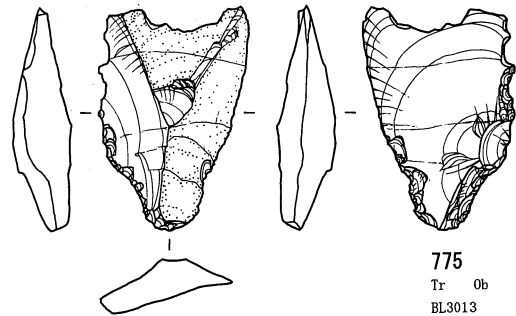

775  
Tr Ob SWHD  
BL3013 5.31g  
III VI-L 51

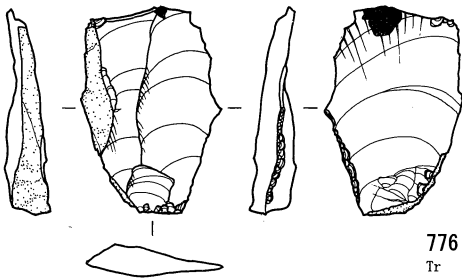

776  
Tr Ob WDKB  
BL3014 4.06g  
V VI-L 1824

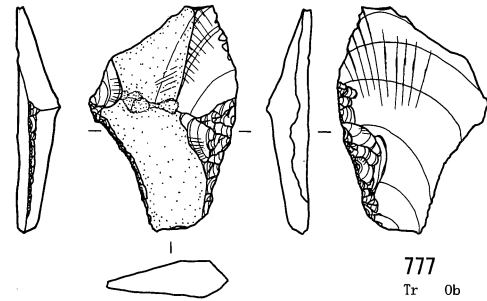

777  
Tr Ob SWHD  
BL3014 4.27g  
V VI-L 1356

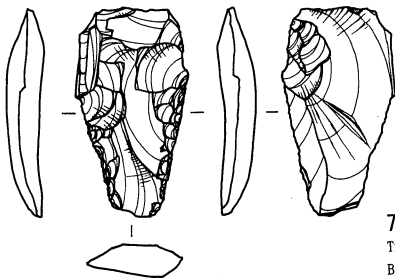

778  
Tr Ob WDKB  
BL3014 4.1g  
V VI-L 2009

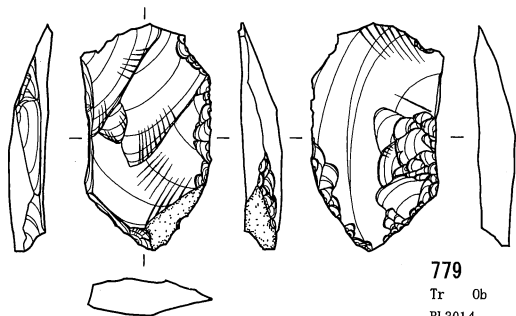

779  
Tr Ob WDKB  
BL3014 5.33g  
V VI-L 1811

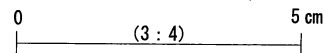

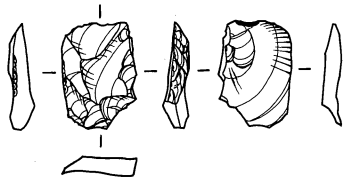

780

Tr Ob WDKB  
BL3014 0.88g  
IV VI-L 1288

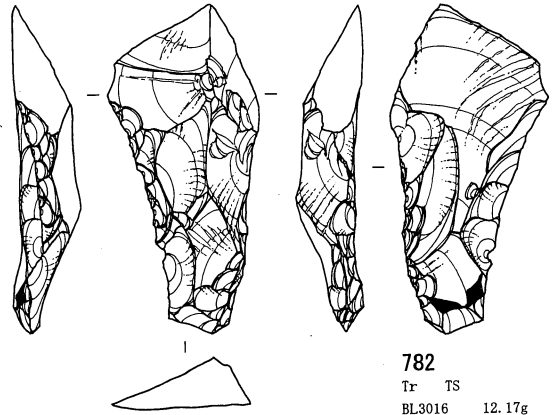

782

Tr TS  
BL3016 12.17g  
III VI-L 413

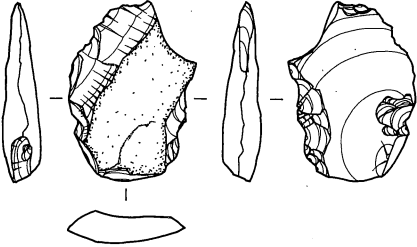

781

Tr Cr  
BL3016 3.99g  
IV VI-L 1020

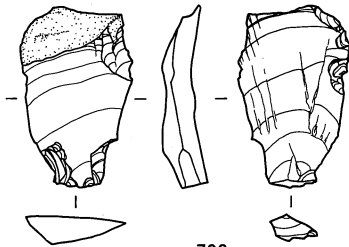

783

Tr Ob SWHD  
BL3019 2.97g  
IV VI-G 3950

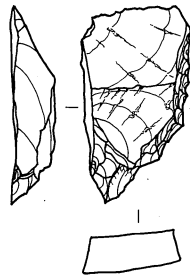

784

Tr An  
BL3020 4.81g  
IV VI-G 212

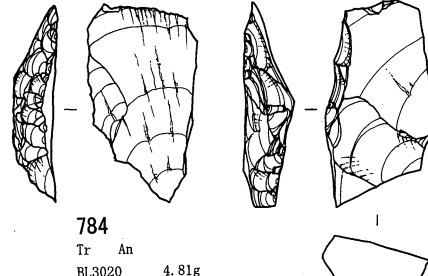

785

Tr TS  
BL3020 5g  
IV VI-G 441

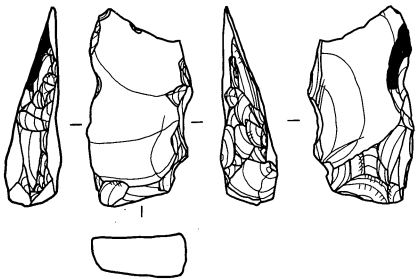

786

Tr TS  
BL3020 5.59g  
IV VI-G 637

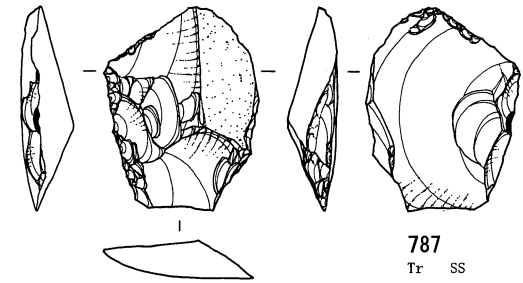

787

Tr SS  
BL3020 7.74g  
V VI-G 1367

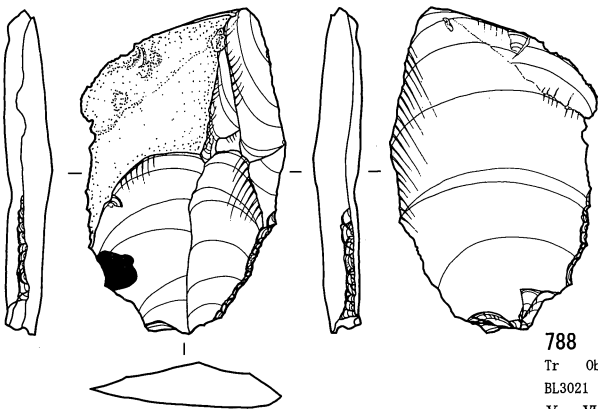

788

Tr Ob SWHD  
BL3021 13.36g  
V VI-G 1005

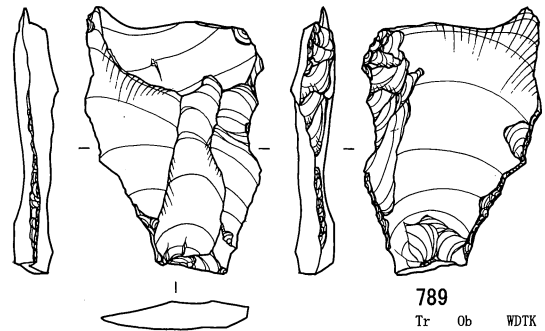

789

Tr Ob WDKB  
BL3021 7.32g  
IV VI-G 694

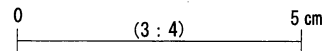

第3地点 石器実測図 11 (台形石器 3) (貫ノ木遺跡)

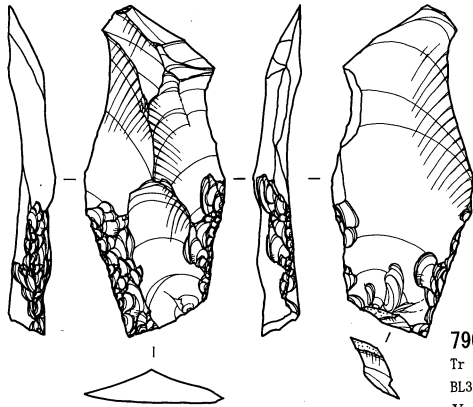

790  
Tr Ob SWHD  
BL3021 7.83g  
V VI-G 1142

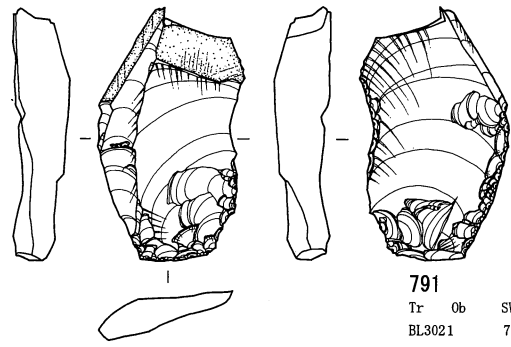

791  
Tr Ob SWHD  
BL3021 7.4g  
III VI-G 746

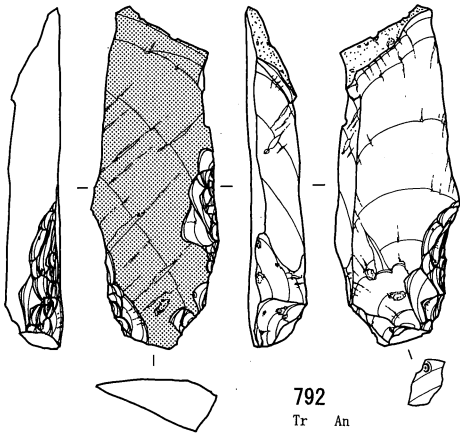

792  
Tr An  
BL3021 11.45g  
V VI-G 1422

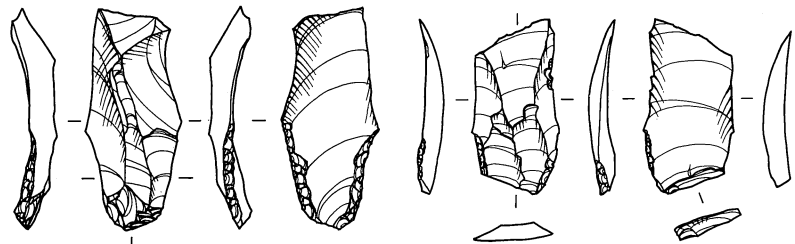

793  
Tr Ob SWHD  
BL3021 3.1g  
V b VI-G 5915

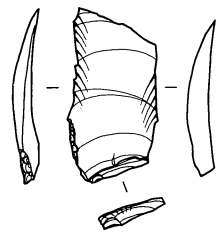

794  
Tr Ob SWHD  
BL3021 1.34g  
V VI-G 1697

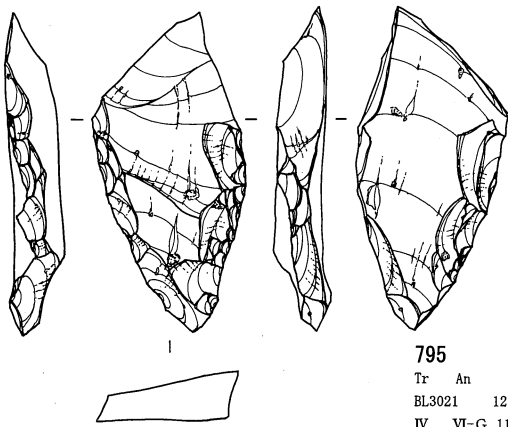

795  
Tr An  
BL3021 12.43g  
IV VI-G 1146

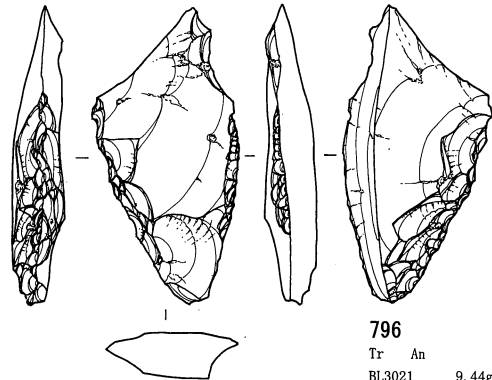

796  
Tr An  
BL3021 9.44g  
V VI-G 1696

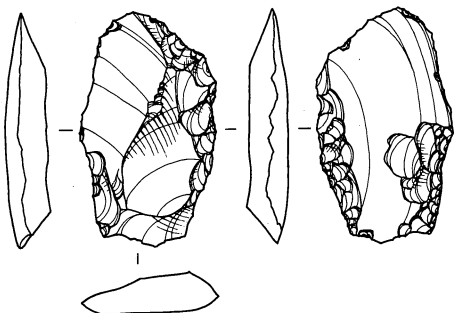

797  
Tr Ob SWHD  
BL3021 6.36g  
IV VI-G 701

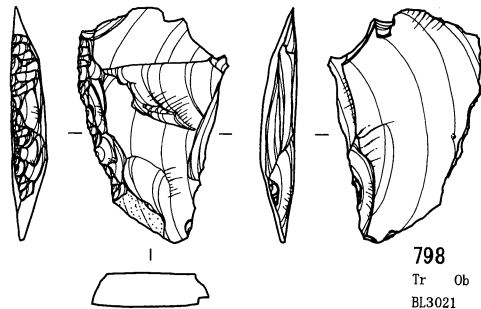

798  
Tr Ob WDKB  
BL3021 5.85g  
V VI-G 1015

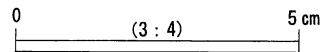

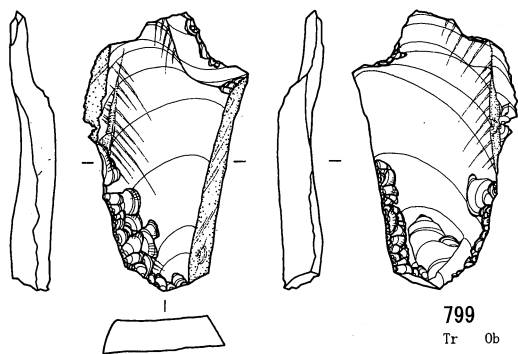

799  
Tr Ob SWHD  
BL3022 6.1g  
IV VI-G 1017

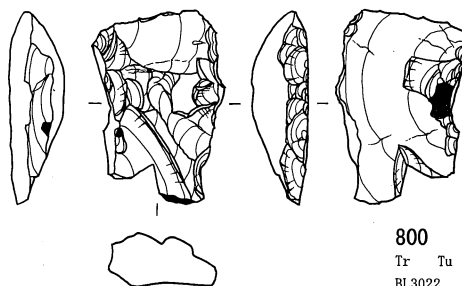

800  
Tr Tu  
BL3022 5.46g  
IV VI-L 1228

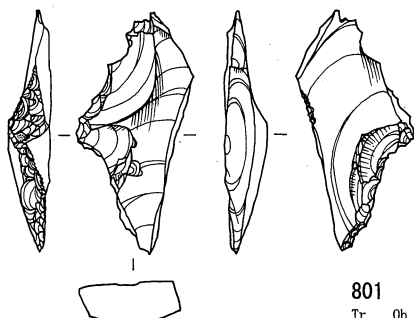

801  
Tr Ob SWHD  
BL3022 3.67g  
III VI-G 12

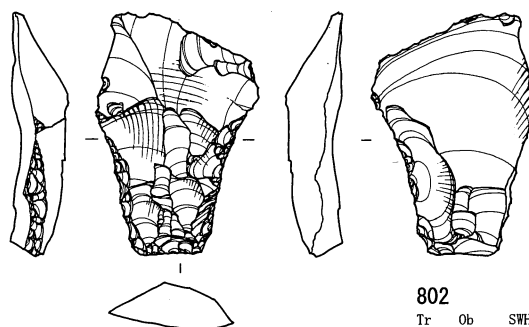

802  
Tr Ob SWHD  
BL3023 7.44g  
V VI-G 1842

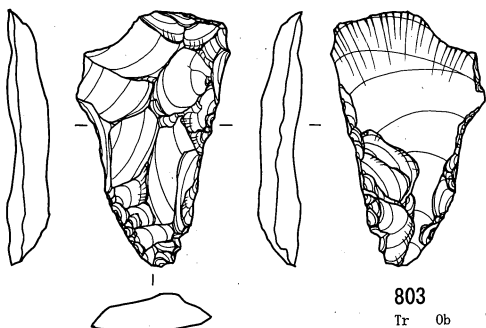

803  
Tr Ob WDKB  
BL3023 6.26g  
V VI-G 1060

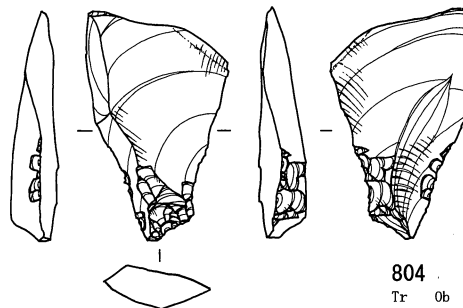

804  
Tr Ob SWHD  
BL3023 4.75g  
V VI-L 1641

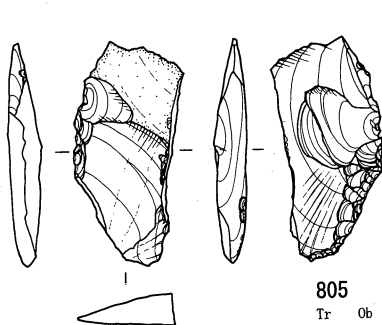

805  
Tr Ob SWHD  
BL3023 3.33g  
IV VI-G 1019

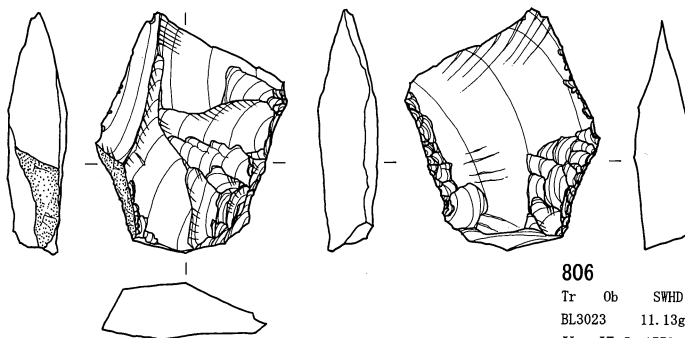

806  
Tr Ob SWHD  
BL3023 11.13g  
V VI-L 1570

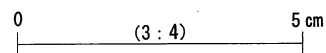

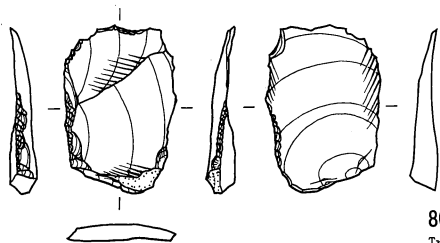

807  
Tr Ob WDKB  
BL3023 2.11g  
V VI-L 1751

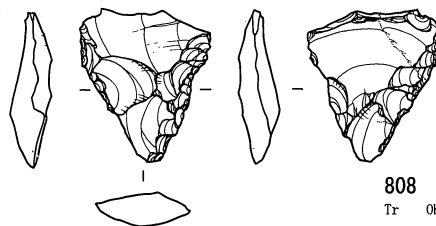

808  
Tr Ob SWHD  
BL3024 2.71g  
IV VI-G 1036

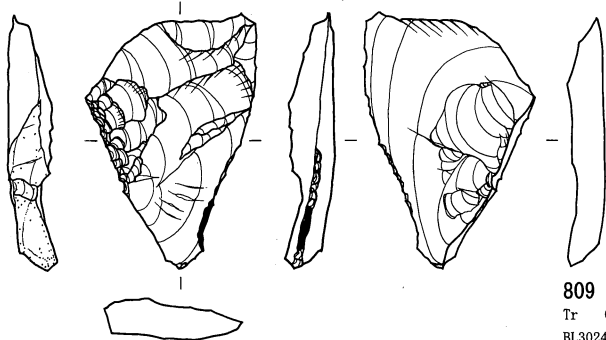

809  
Tr Ob SWHD  
BL3024 6.72g  
V VI-G 1483

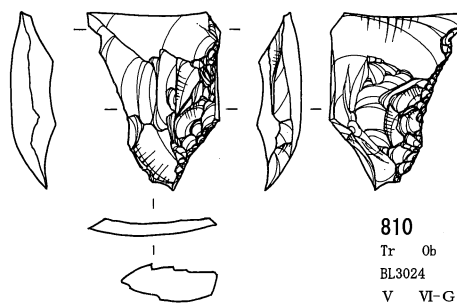

810  
Tr Ob SWHD  
BL3024 3.55g  
V VI-G 2180

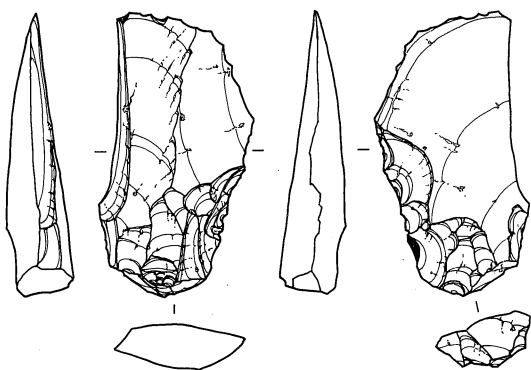

811  
Tr An  
BL3025 11g  
III VI-G 2406

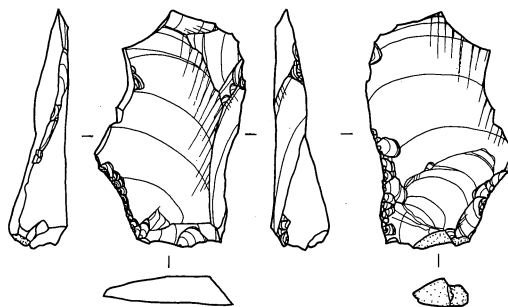

812  
Tr Ob SWHD  
BL3025 5.21g  
IV VI-G 3828

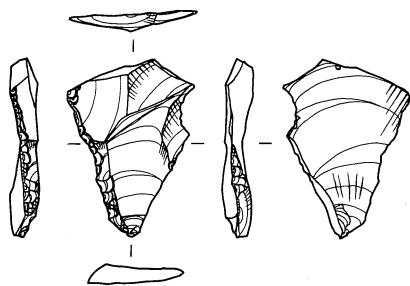

813  
Tr Ob WDKB  
BL3025 1.85g  
IV VI-G 2962

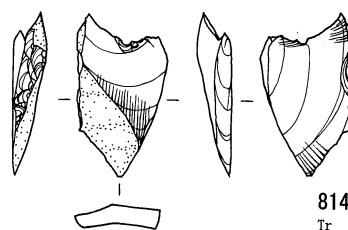

814  
Tr Ob SWHD  
BL3025 1.55g  
IV VI-G 3808

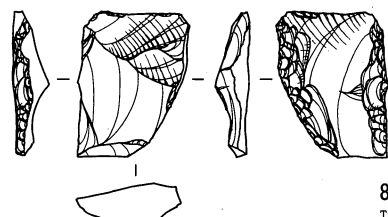

815  
Tr Ob WDKB  
BL3025 2.59g  
III VI-G 5927

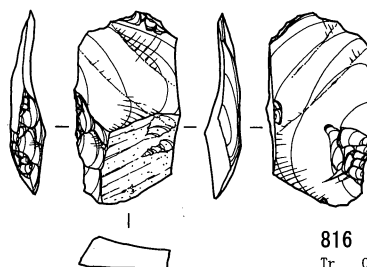

816  
Tr Ob SWHD  
BL3025 3.12g  
V b VI-G 5746

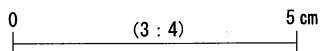

第3地点 石器実測図 14 (台形石器 6) (貫ノ木遺跡)

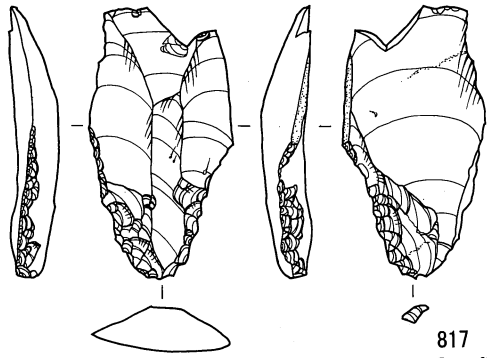

817  
Tr Ob  
BL3027 7.54g  
III VI-G 4022

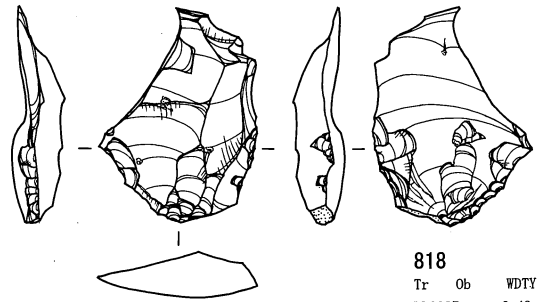

818  
Tr Ob WDTY  
BL3027 6.43g  
V VI-G 6000

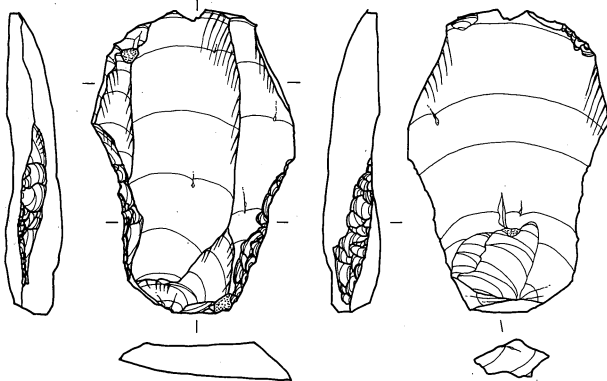

819  
Tr Ob WDKB  
BL3028 14.11g  
V b VI-G 5866

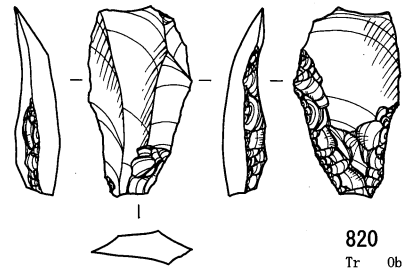

820  
Tr Ob WDTN  
BL3028 3.1g  
III VI-G 5924

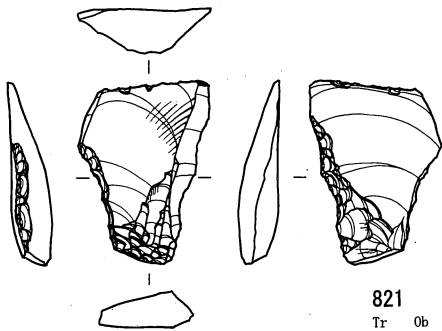

821  
Tr Ob SWHD  
BL3028 3.57g  
III VI-G 2742

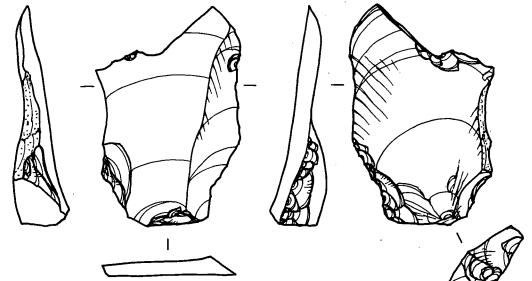

822  
Tr Ob SWHD  
BL3028 5g  
V b VI-G 5944

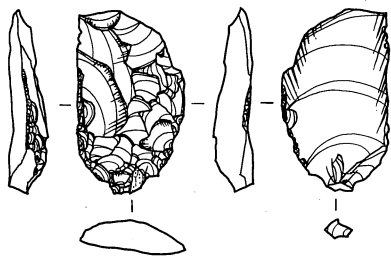

823  
Tr Ob SWHD  
BL3028 2.81g  
IV VI-G 3886

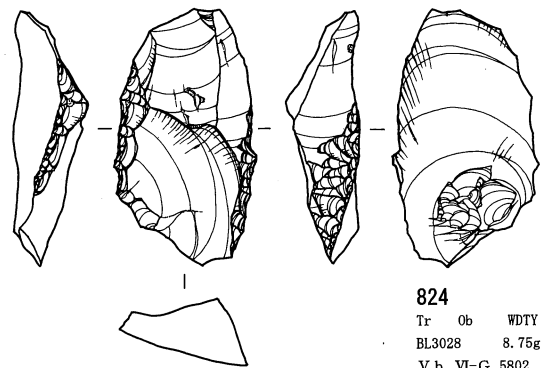

824  
Tr Ob WDTY  
BL3028 8.75g  
V b VI-G 5802

0 (3:4) 5 cm

第3地点 石器実測図 15 (台形石器 7) (貫ノ木遺跡)

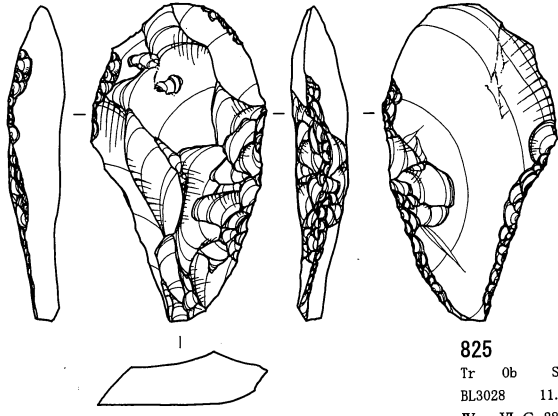

**825**  
Tr Ob SWHD  
BL3028 11.37g  
IV VI-G 2898

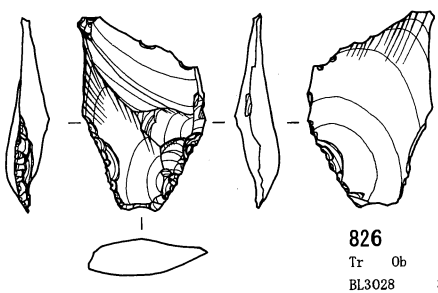

**826**  
Tr Ob SWHD  
BL3028 3.11g  
IV VI-G 2383

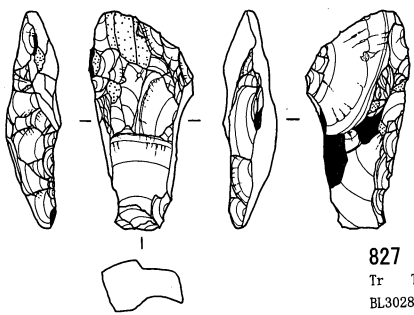

**827**  
Tr Tu  
BL3028 4.18g  
IV VI-G 2916

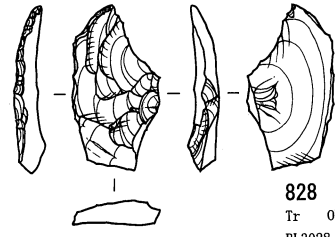

**828**  
Tr Ob WDTN  
BL3028 1.49g  
V b VI-G 5870



**829**  
Tr Ob WDTY  
BL3030 0.21g  
IV VI-G 5008

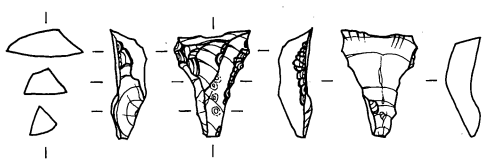

**830**  
Tr Ob WDTK  
BL3030 0.78g  
V VI-G 6175

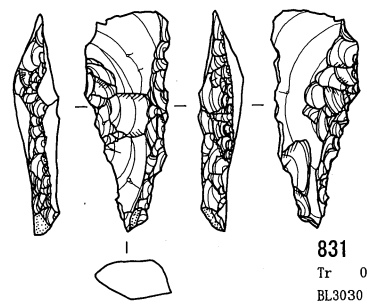

**831**  
Tr Ob WDTY  
BL3030 3.27g  
III VI-G 2436

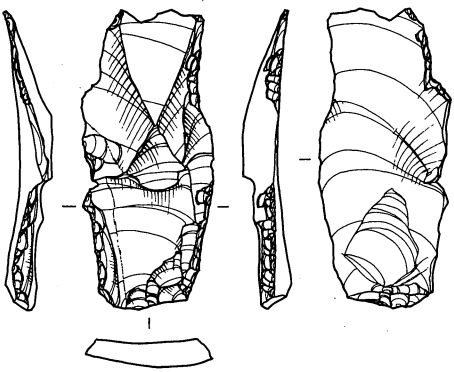

**832**  
Tr Ob SWHD  
BL3031 6.58g  
V a VI-G 6087

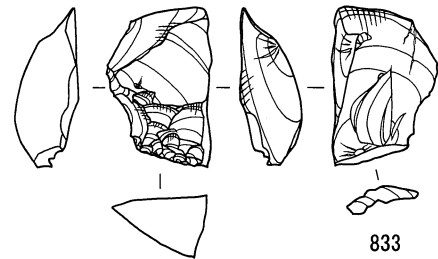

**833**  
Tr Ob SWHD  
BL3031 4.18g  
IV VI-G 4763

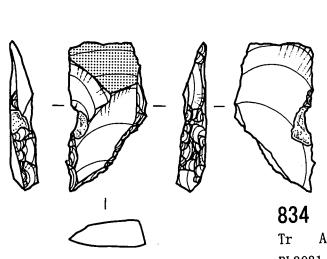

**834**  
Tr Ag  
BL3031 1.58g  
IV VI-G 4753

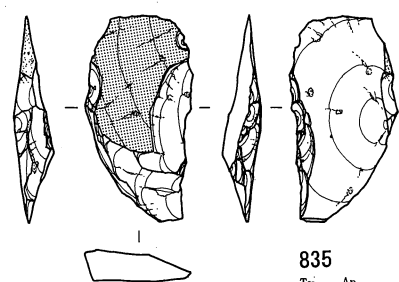

**835**  
Tr An  
BL3031 4.58g  
V VI-G 6408

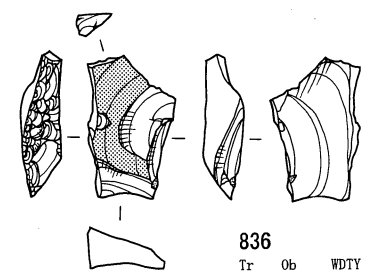

**836**  
Tr Ob WDTY  
BL3031 1.91g  
IV VI-G 4847

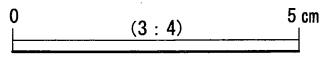

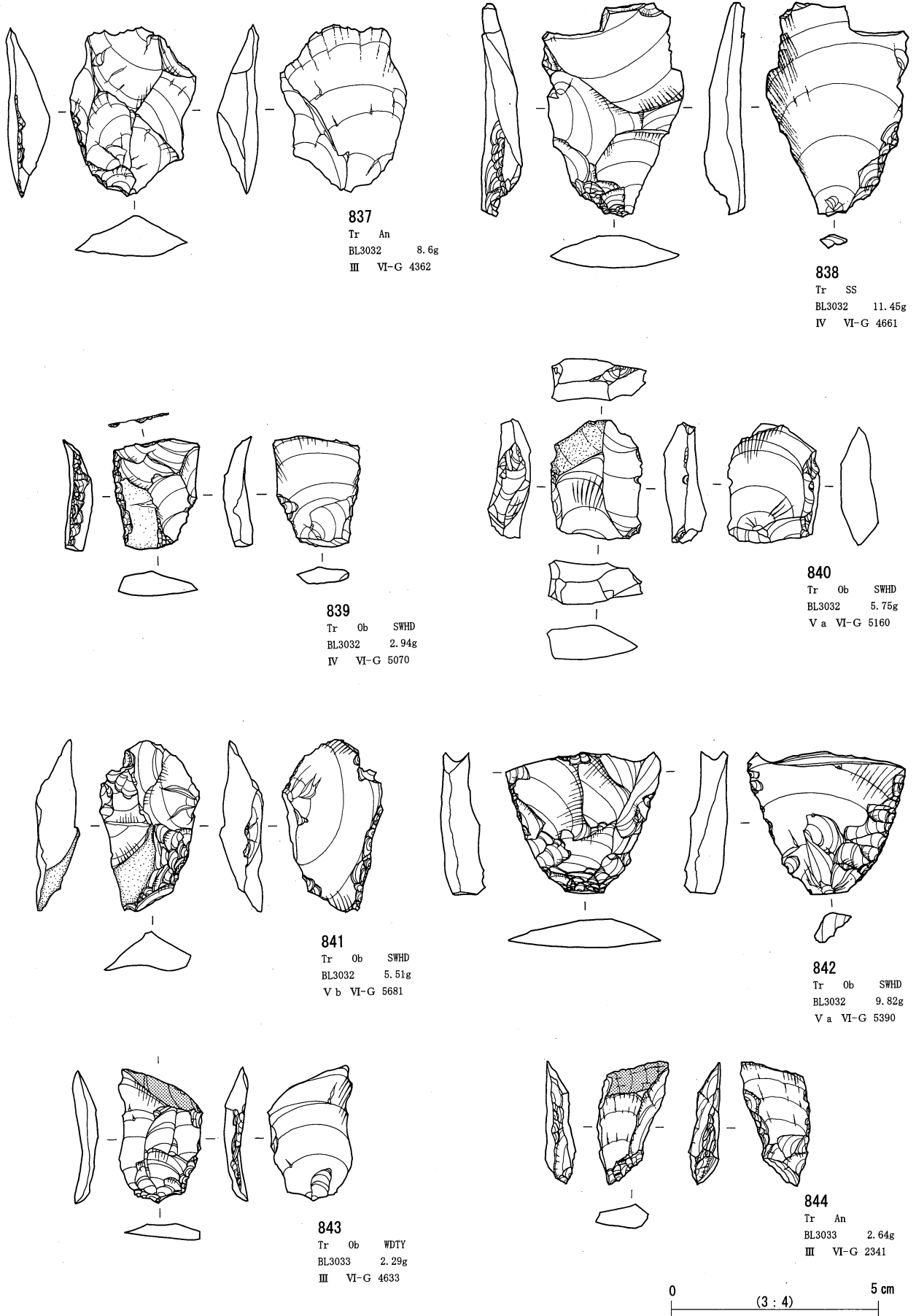

第3地点 石器実測図 17 (台形石器 9) (貫ノ木遺跡)



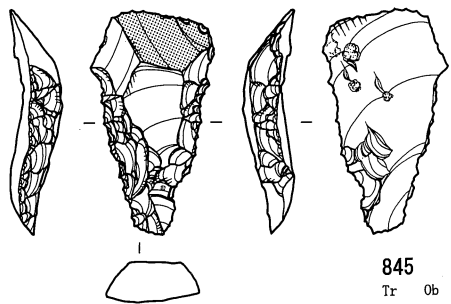

845  
Tr Ob WDTY  
BL3035 4.8g  
IV VI-A 10

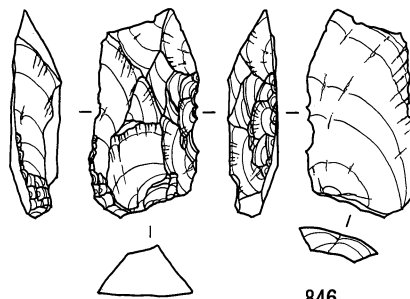

846  
Tr An  
BL3035 5.61g  
III VI-G 2379

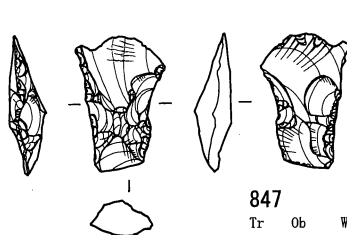

847  
Tr Ob WDTY  
BL3035 1.27g  
III VI-G 2377

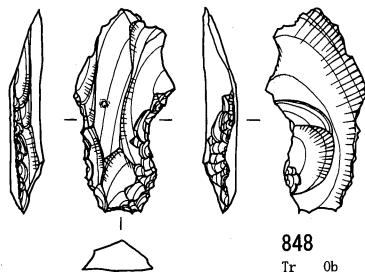

848  
Tr Ob WDTY  
BL3035 2.45g  
III VI-G 2375

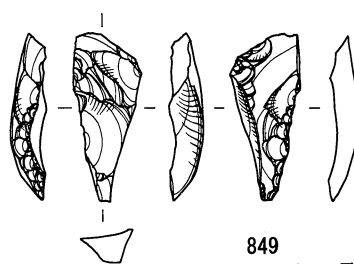

849  
Tr Ob 不可  
BL3035 1.46g  
V VI-G 6563

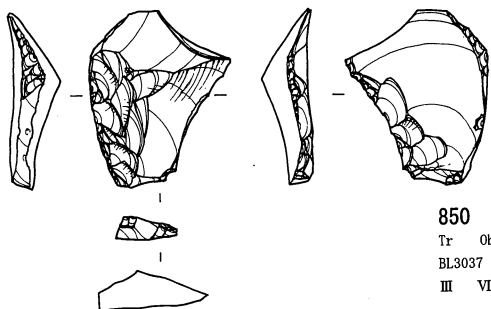

850  
Tr Ob WDTM  
BL3037 4.22g  
III VI-B 577

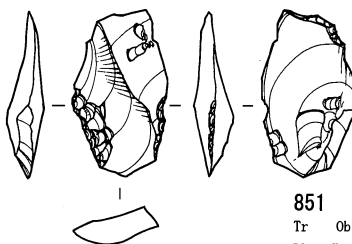

851  
Tr Ob WDKB  
BL3037 1.85g  
III VI-B 557

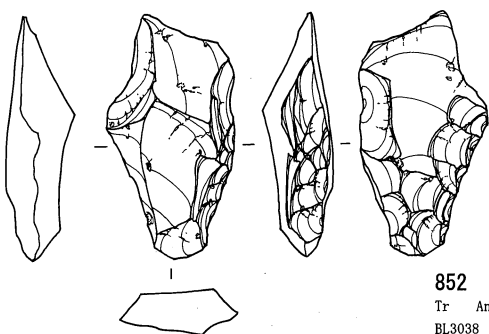

852  
Tr An  
BL3038 9.65g  
V VI-B 1376

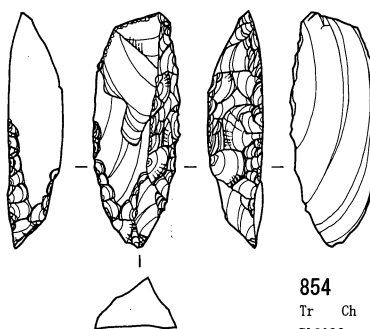

854  
Tr Ch  
BL3038 5.02g  
III VI-B 667

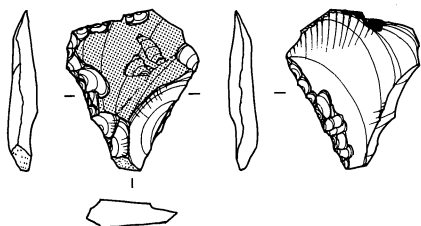

853  
Tr Ob SWHD  
BL3038 2.37g  
III VI-B 768

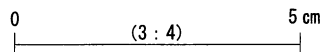

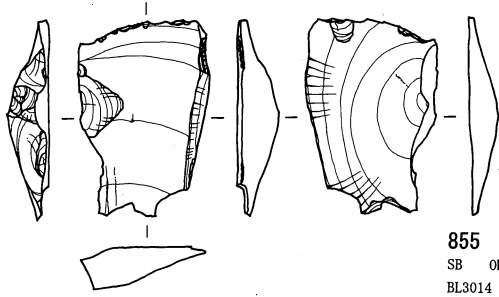

855  
SB Ob WDTY  
BL3014 3.53g  
IV VI-L 1297

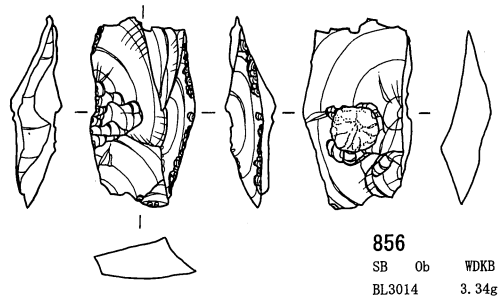

856  
SB Ob WDKB  
BL3014 3.34g  
IV VI-L 1315

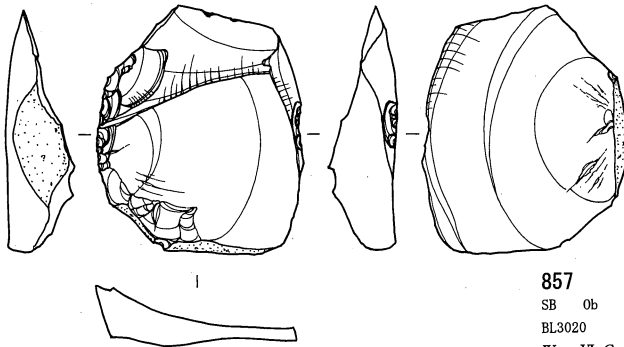

857  
SB Ob SWHD  
BL3020 9.92g  
IV VI-G 396

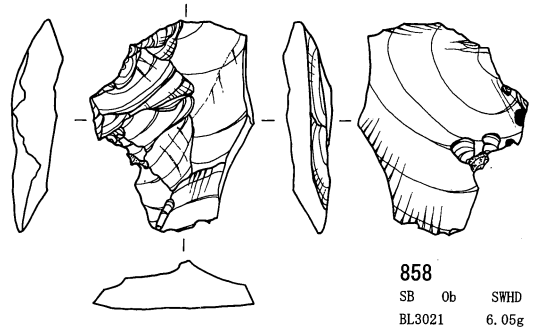

858  
SB Ob SWHD  
BL3021 6.05g  
V VI-G 1144

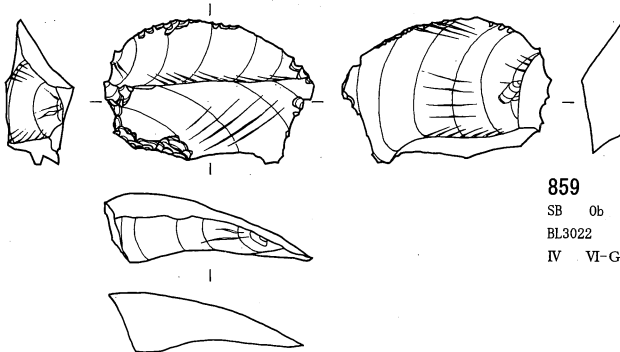

859  
SB Ob WDTK  
BL3022 7.3g  
IV VI-G 709

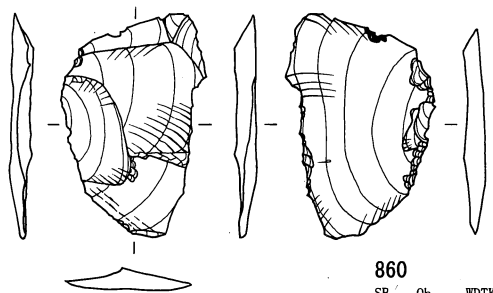

860  
SB Ob WDTK  
BL3023 2.47g  
V VI-L 1876

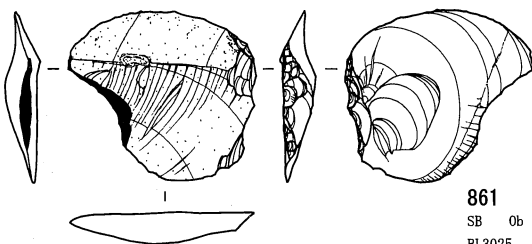

861  
SB Ob 不可  
BL3025 5.13g  
V b VI-G 5882

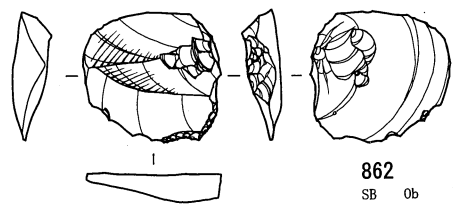

862  
SB Ob WDTK  
BL3025 3.17g  
V b VI-G 5896

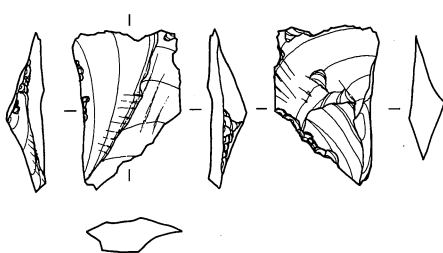

863  
SB Ob SWHD  
BL3025 1.86g  
V b VI-G 5757

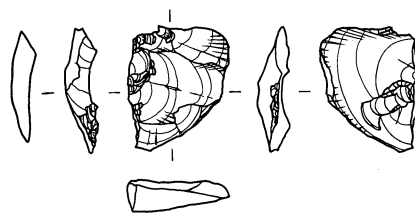

864  
SB Ob SWHD  
BL3025 1.54g  
IV VI-G 2963

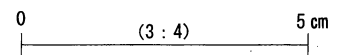

第3地点 石器実測図 19 (貝殻状刃器 1) (貫ノ木遺跡)

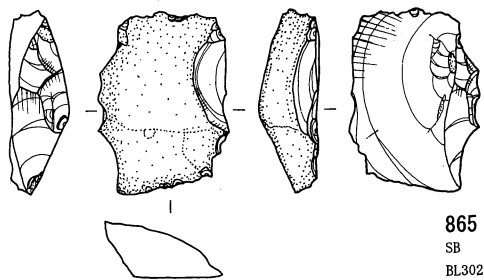

865  
SB Ob SWHD  
BL3026 5.76g  
IV VI-G 4073

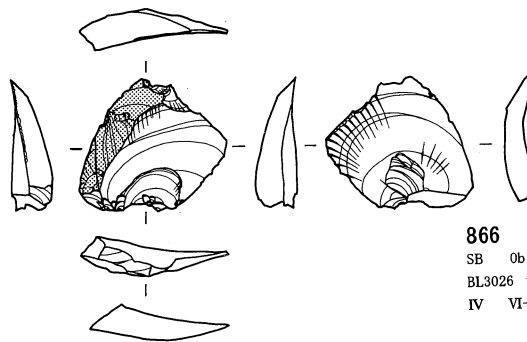

866  
SB Ob SWHD  
BL3026 2.12g  
IV VI-G 4083

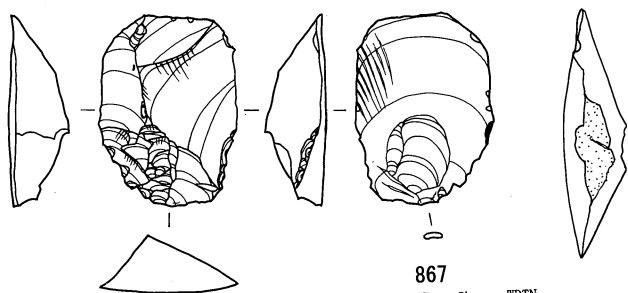

867  
SB Ob WDTN  
BL3027 6.47g  
V VI-G 5490

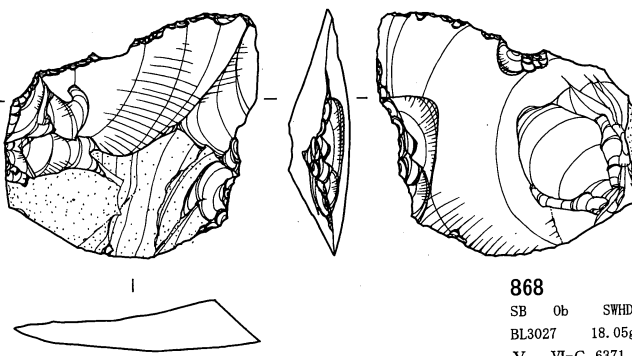

868  
SB Ob SWHD  
BL3027 18.05g  
V VI-G 6371

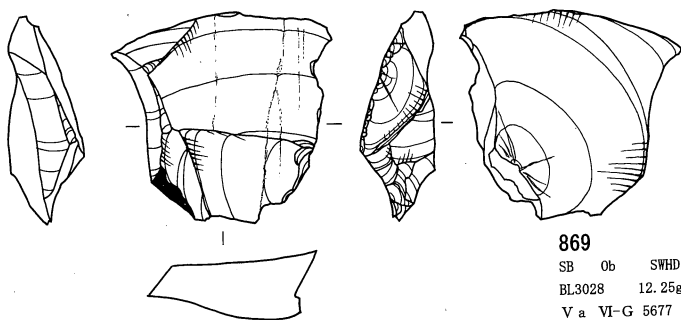

869  
SB Ob SWHD  
BL3028 12.25g  
V a VI-G 5677

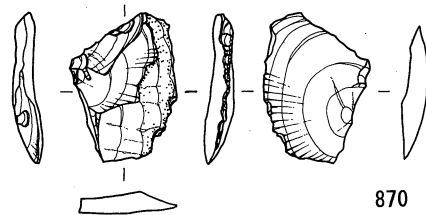

870  
SB Ob TSTY  
BL3028 1.84g  
V b VI-G 5807

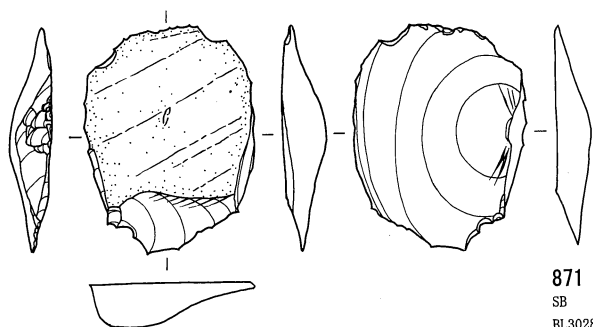

871  
SB Ob SWHD  
BL3028 6.56g  
V b VI-G 5820

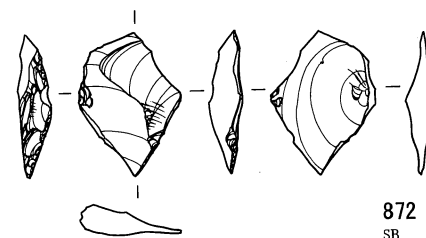

872  
SB Ob WDTN  
BL3028 1.34g  
V b VI-G 5821

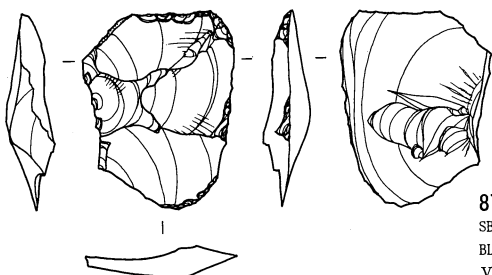

873  
SB Ob SWHD  
BL3029 6.09g  
V b VI-G 5735

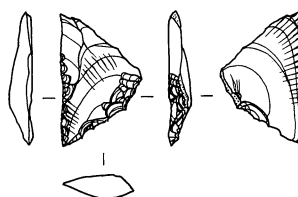

874  
SB Ob WDTY  
BL3030 0.86g  
III VI-G 2430

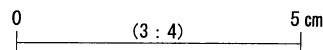

第3地点 石器実測図 20 (貝殻状刃器 2) (貫ノ木遺跡)

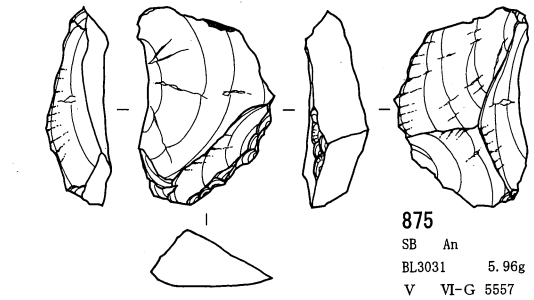

**875**  
SB An  
BL3031 5.96g  
V VI-G 5557

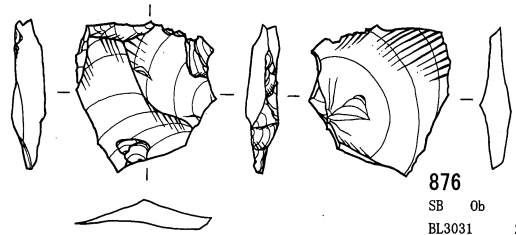

**876**  
SB Ob WDTY  
BL3031 2.29g  
V a VI-G 6085

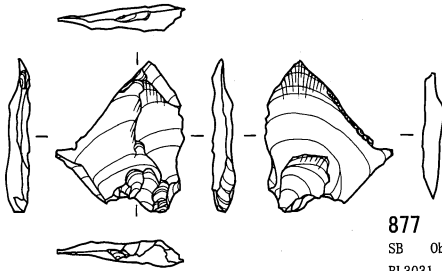

**877**  
SB Ob WDTY  
BL3031 1.37g  
IV VI-G 4848

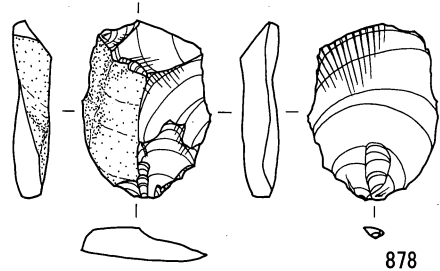

**878**  
SB Ob SWHD  
BL3031 3.54g  
IV VI-G 4709

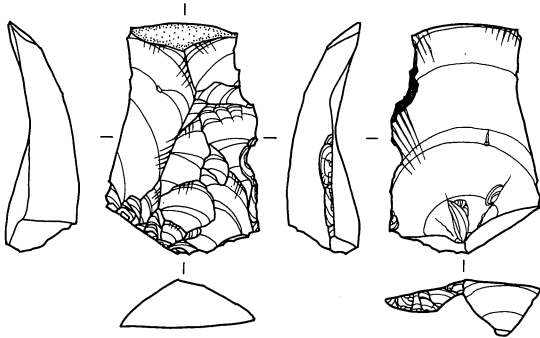

**879**  
SB Ob WDTN  
BL3032 9.03g  
V b VI-G 5409

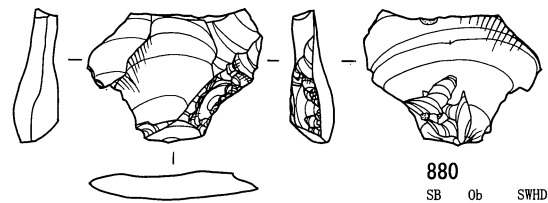

**880**  
SB Ob SWHD  
BL3031 3.35g  
III VI-G 4470

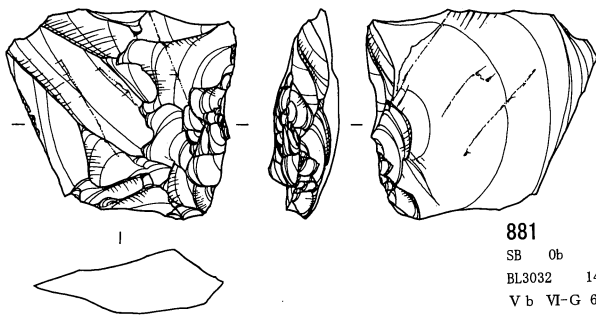

**881**  
SB Ob SWHD  
BL3032 14.79g  
V b VI-G 6206

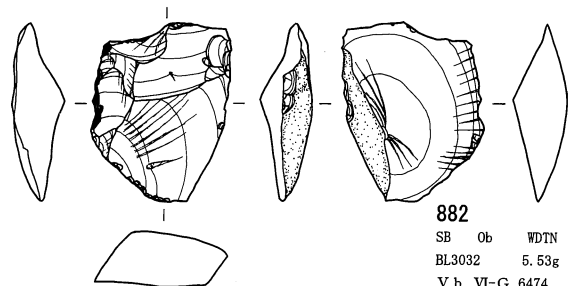

**882**  
SB Ob WDTN  
BL3032 5.53g  
V b VI-G 6474

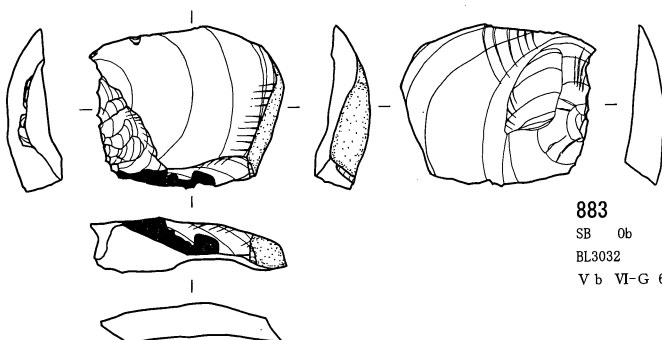

**883**  
SB Ob WDTY  
BL3032 6.58g  
V b VI-G 6447

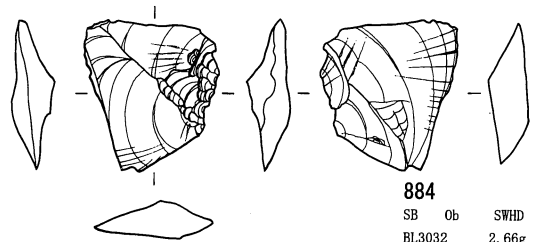

**884**  
SB Ob SWHD  
BL3032 2.66g  
V b VI-G 6797

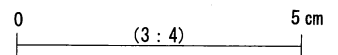

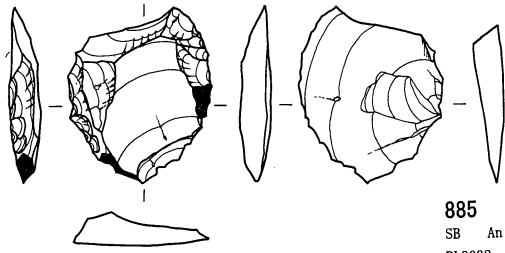

885  
SB An  
BL3032 3.61g  
V b VI-G 6736

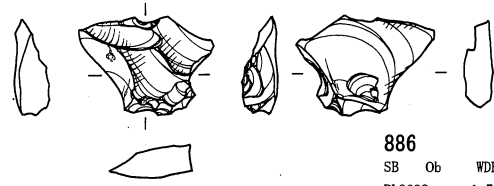

886  
SB Ob WDKB  
BL3032 1.78g  
V b VI-G 6701

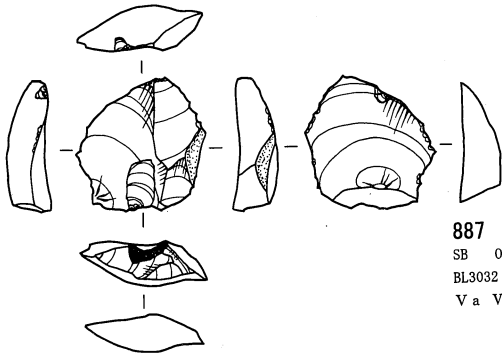

887  
SB Ob SWHD  
BL3032 2.81g  
V a VI-G 5163

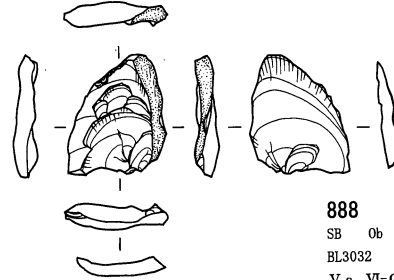

888  
SB Ob WDTY  
BL3032 0.98g  
V a VI-G 5159

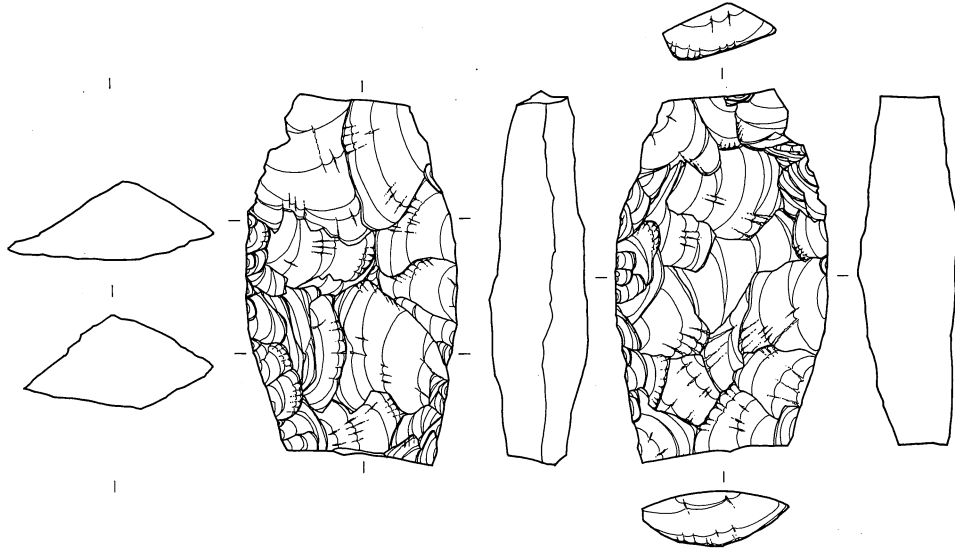

889  
Po An  
BL3027 43.12g  
III VI-G 6581

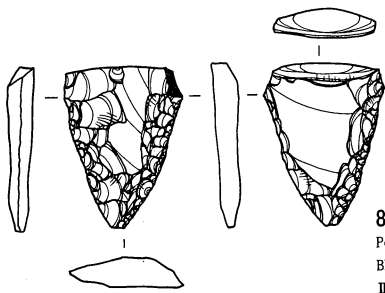

890  
Po Ob SWHD  
BL3027 2.57g  
III VI-G 2500

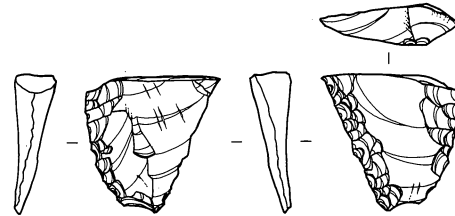

891  
Po TS  
BL3028 3.07g  
III VI-G 2730

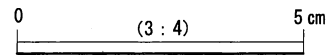

第3地点 石器実測図 22 (貝殻状刃器 4・槍先形尖頭器 1) (貫ノ木遺跡)

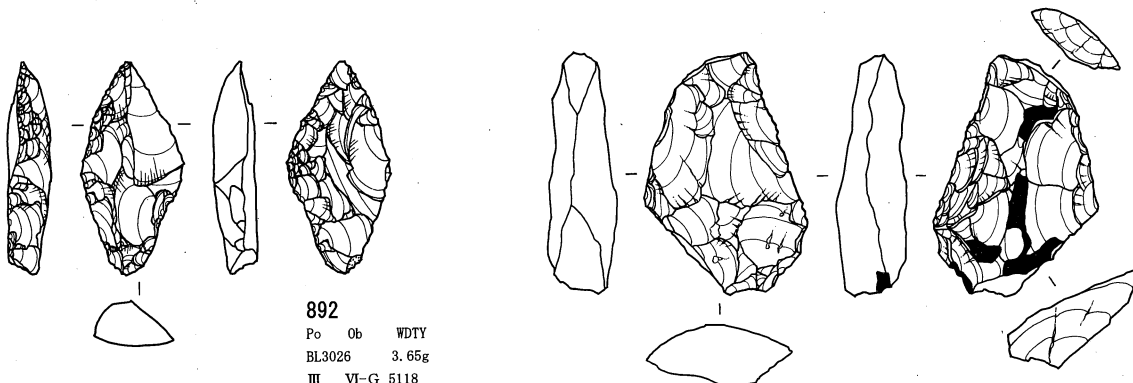

892  
Po Ob WDTY  
BL3026 3.65g  
III VI-G 5118

893  
Po Tu  
BL3034 10.42g  
III VI-G 4645

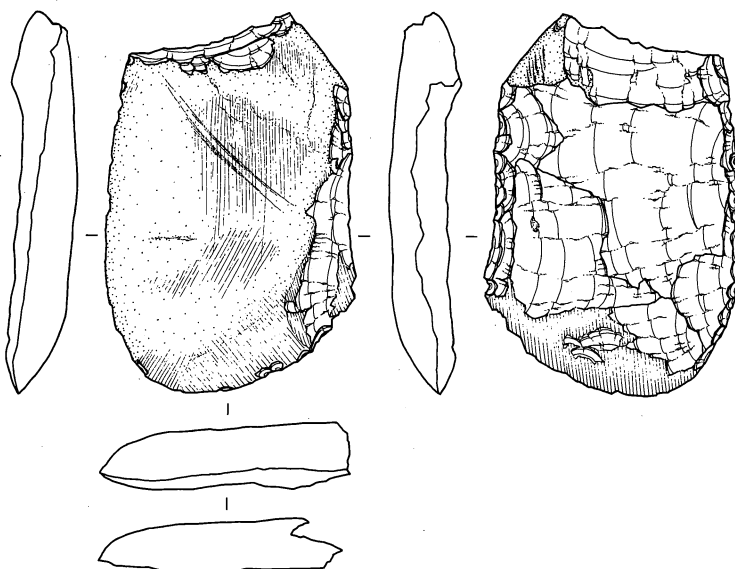

894  
Ax Se  
BL3001 44.47g  
II VI-U 48

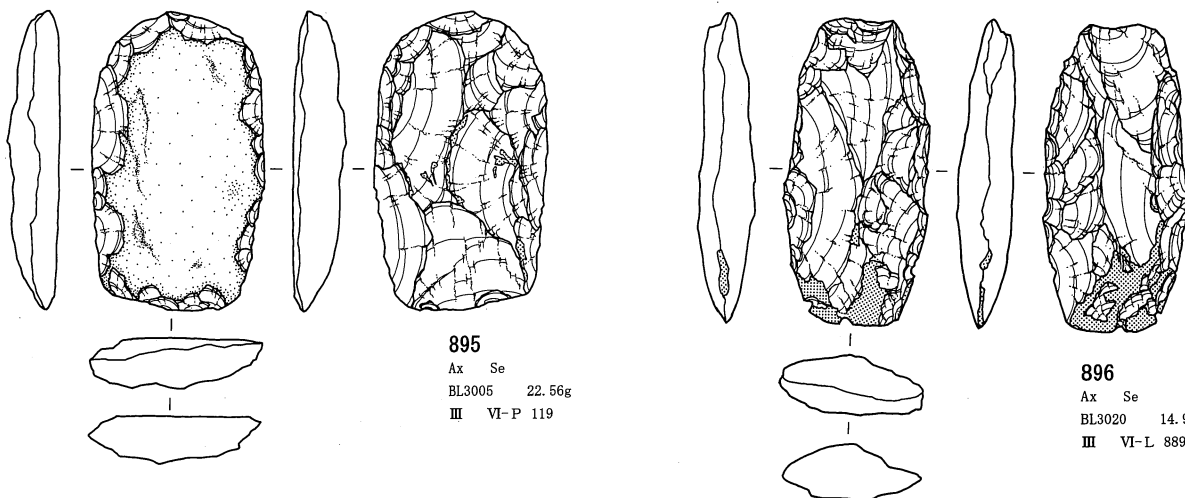

895  
Ax Se  
BL3005 22.56g  
III VI-P 119

896  
Ax Se  
BL3020 14.93g  
III VI-L 889

0 (3 : 4) 5 cm

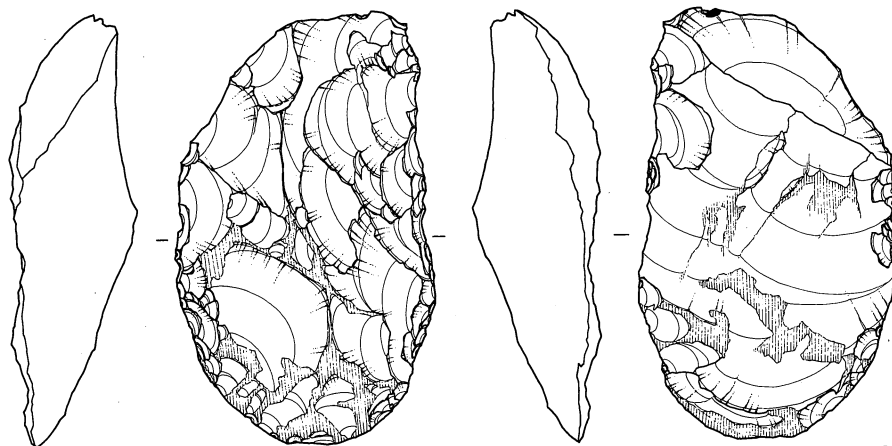

897  
 Ax S1  
 BL3016 221.6g  
 III VI-L 360

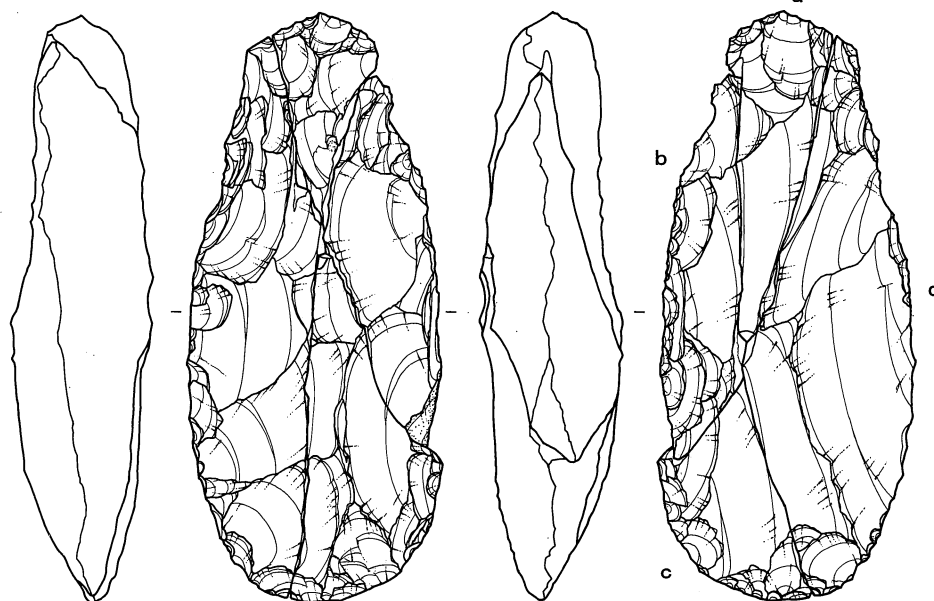
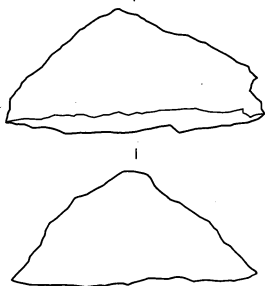

898a  
 Ax破 Sa  
 BL3018 45.72g  
 V VI-G 1230

898b  
 Ax破 Sa  
 BL3018 64.5g  
 III VI-G 75

898c  
 Ax破 Sa  
 BL3018 72.02g  
 III VI-G 1232

898d  
 Ax Sa  
 BL3018 169.23g  
 III VI-G 1231

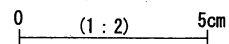
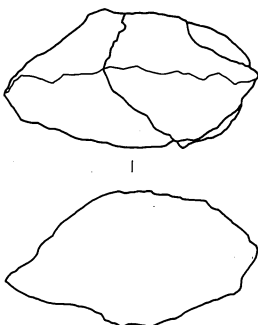

第3地点 石器実測図 24 (斧形石器 2) (貫ノ木遺跡)

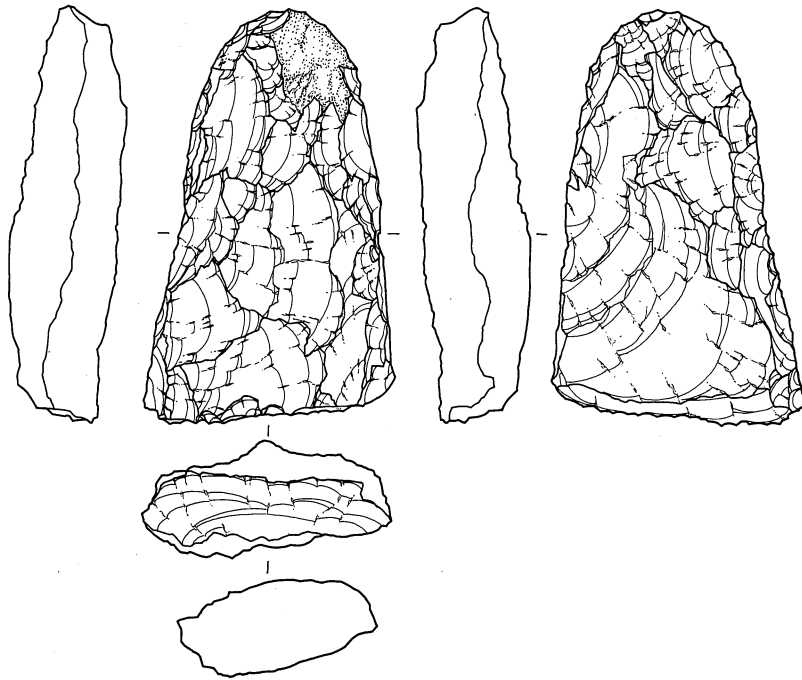

899  
 Ax Se  
 BL3020 238.02g  
 V VI-G 1097

0 (1:2) 5cm

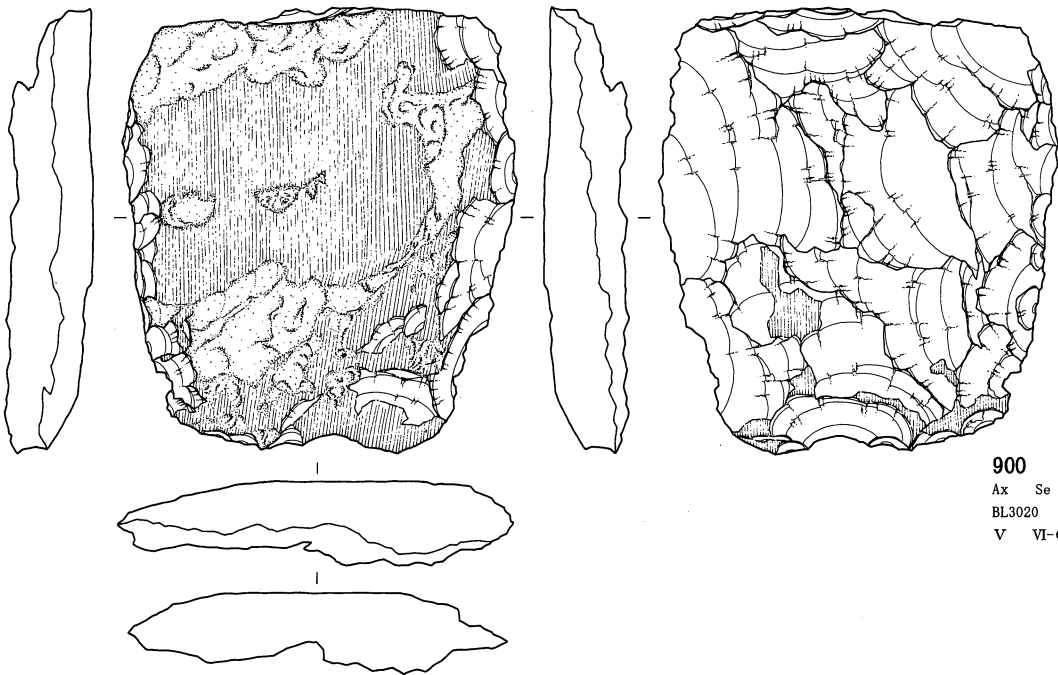

900  
 Ax Se  
 BL3020 106.89g  
 V VI-G 1372

0 (3:4) 5cm

第3地点 石器実測図 25 (斧形石器 3) (貫ノ木遺跡)



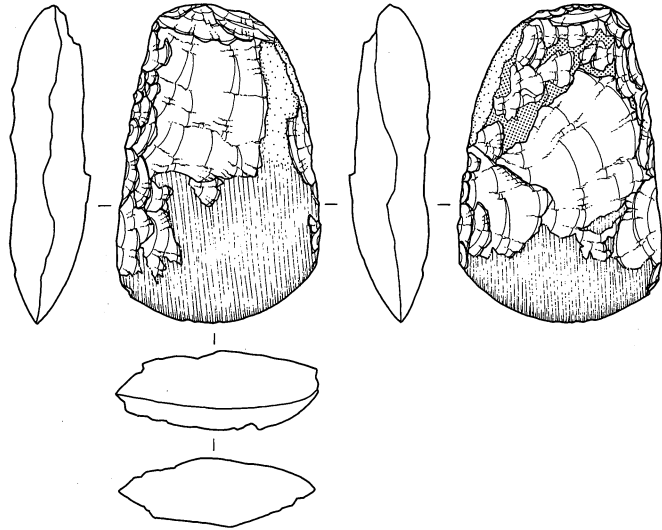

901  
 Ax Se  
 BL3020 32.94g  
 IV VI-L 1623

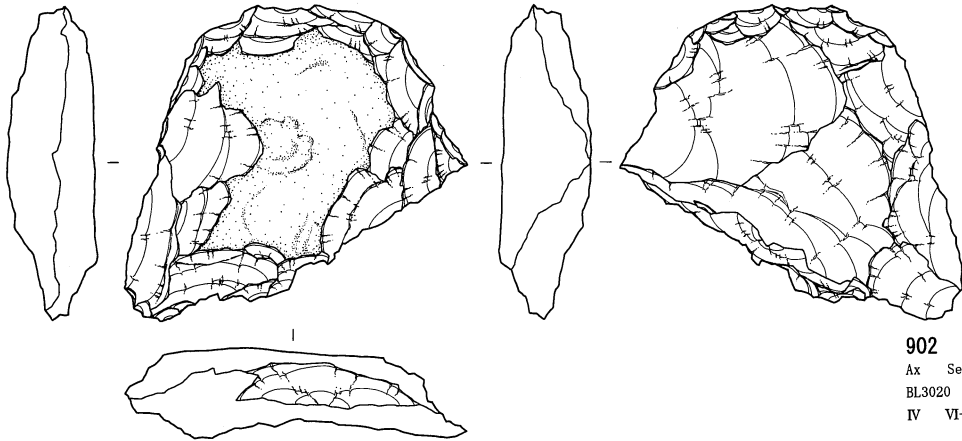

902  
 Ax Se  
 BL3020 50.13g  
 IV VI-G 466

0 (3 : 4) 5 cm

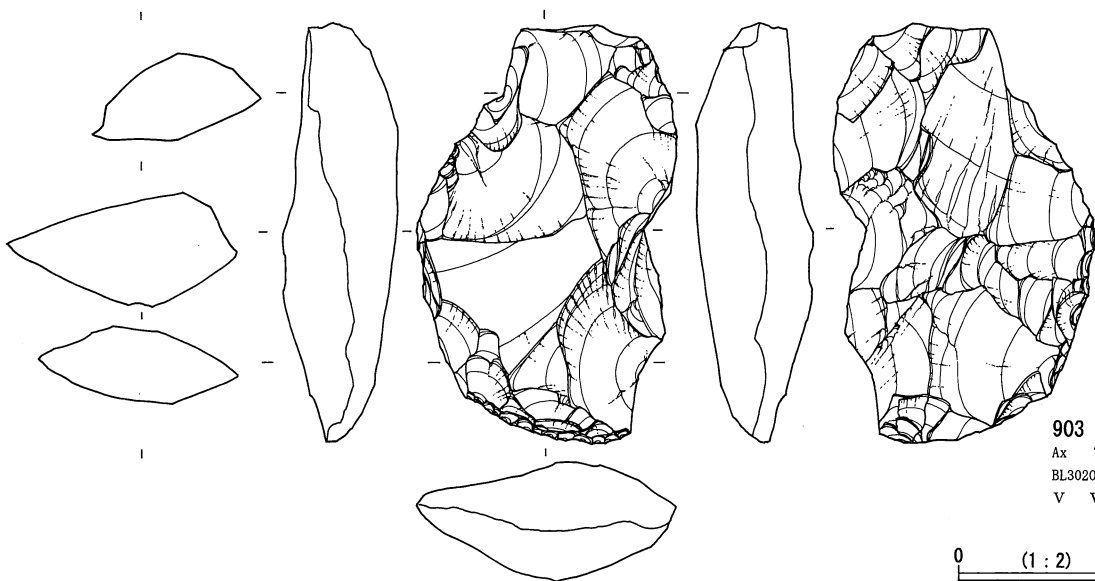

903  
 Ax Tu  
 BL3020 204.17g  
 V VI-G 924

0 (1 : 2) 5 cm

第3地点 石器実測図 26 (斧形石器 4) (貫ノ木遺跡)

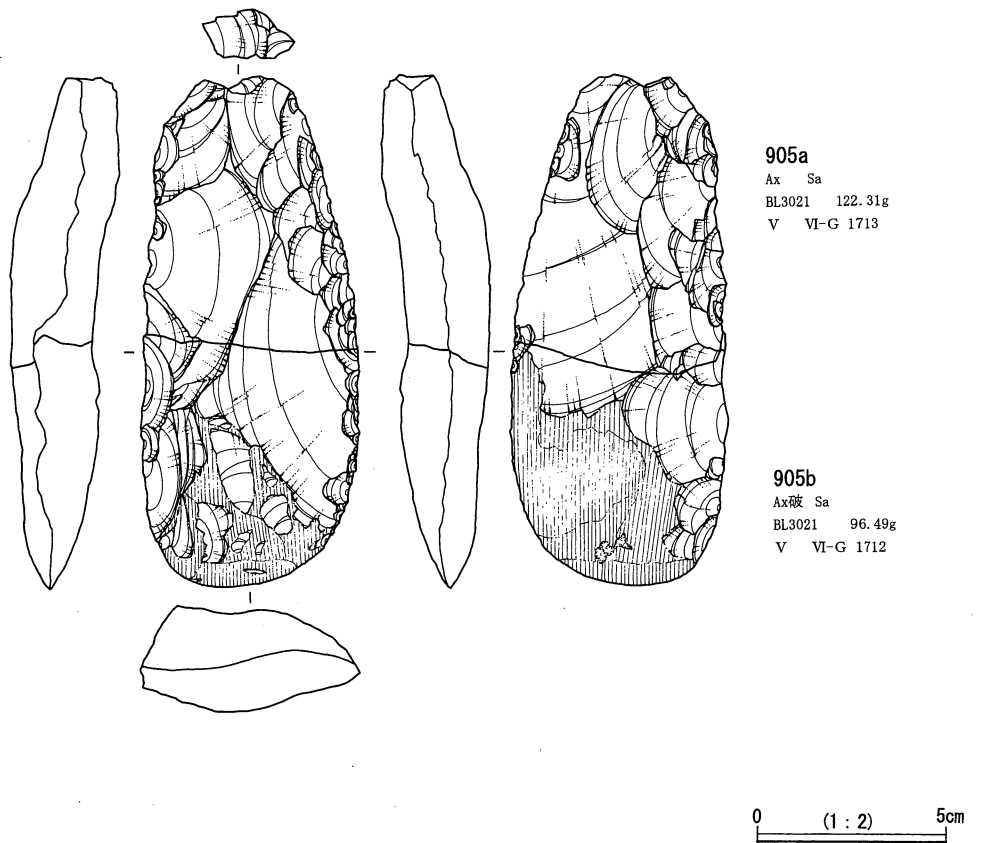
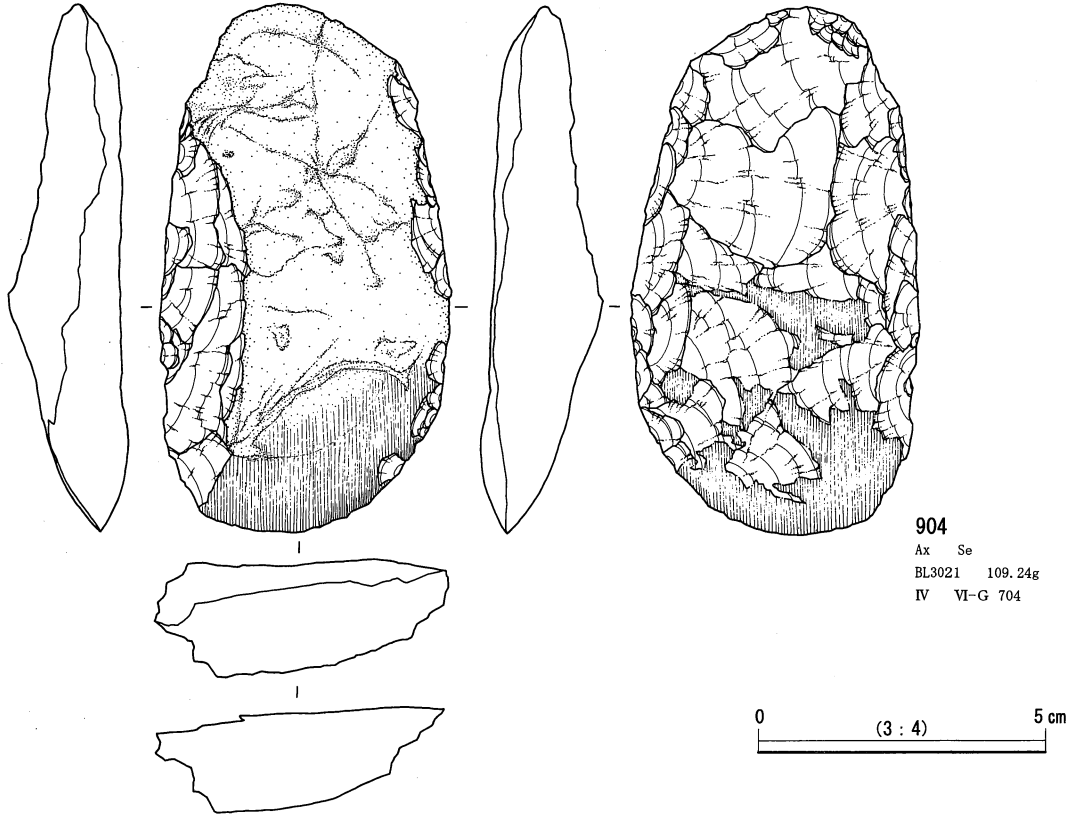

第3地点 石器実測図 27 (斧形石器 5) (貫ノ木遺跡)

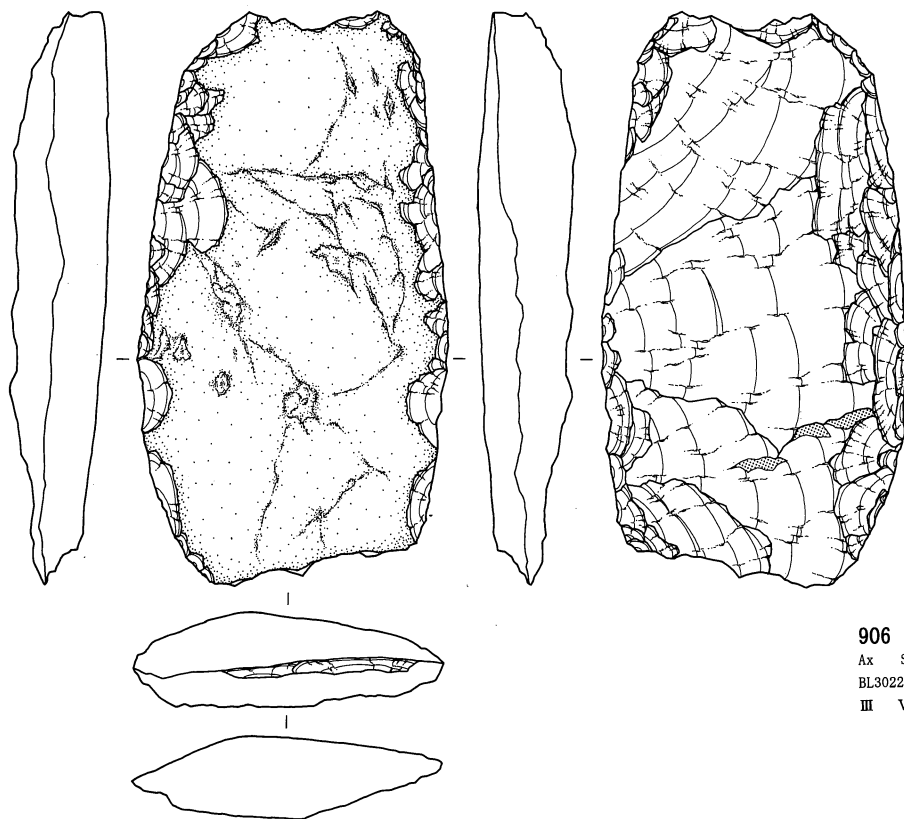

906  
Ax Se  
BL3022 119.61g  
III VI-G 232

0 (3 : 4) 5cm

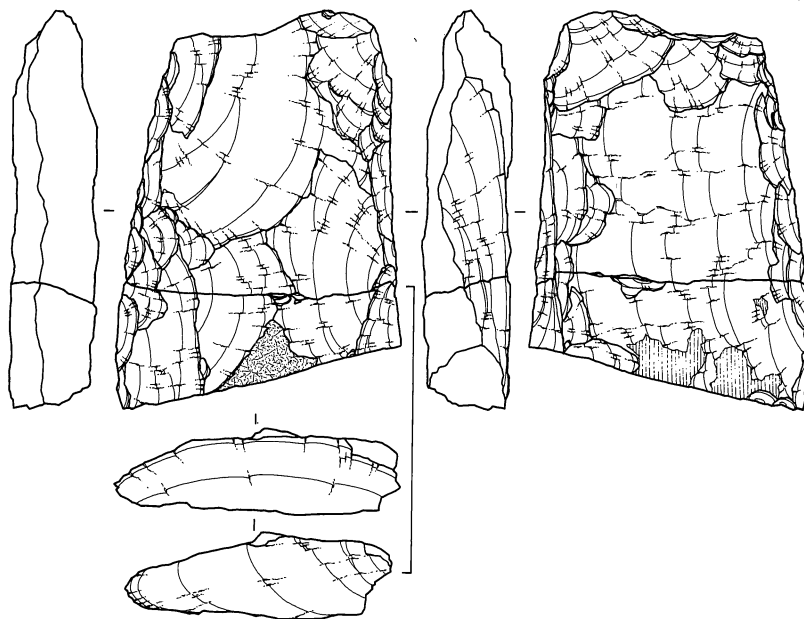

907a  
Ax Se  
BL3022 172.77g  
IV VI-G 718

907b  
Ax破 Se  
BL3022 82.27g  
IV VI-G 717

0 (1 : 2) 5cm

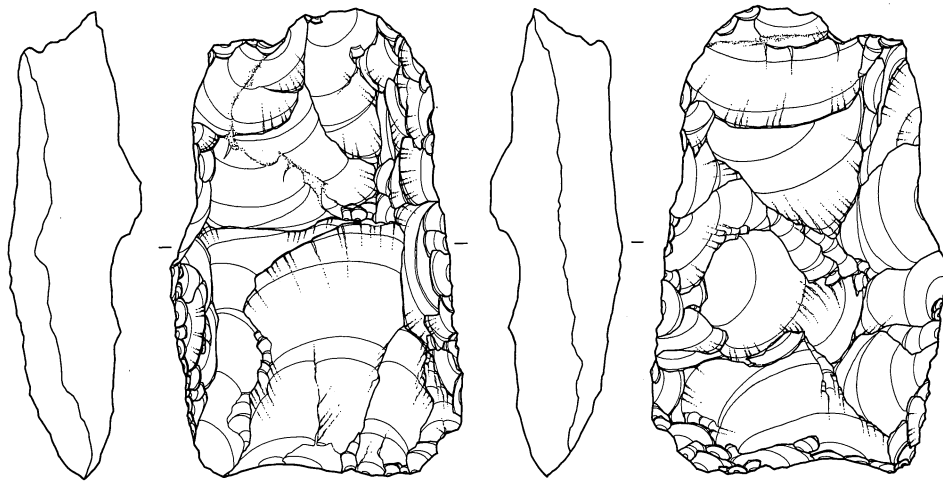

908  
 Ax TS  
 BL3028 88.26g  
 IV VI-G 2904

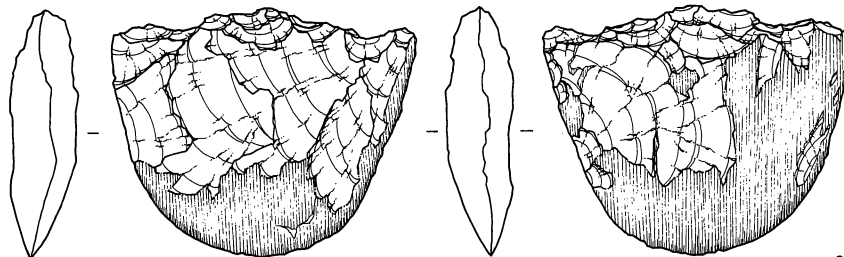
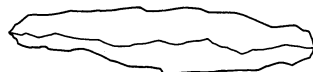
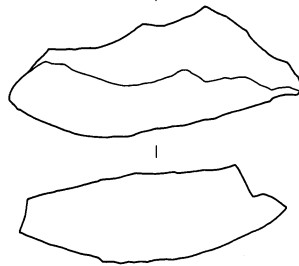

909  
 Ax Se  
 BL3028 30.57g  
 V b VI-G 5799

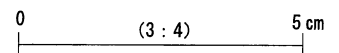

第3地点 石器実測図 29 (斧形石器 7) (貫ノ木遺跡)

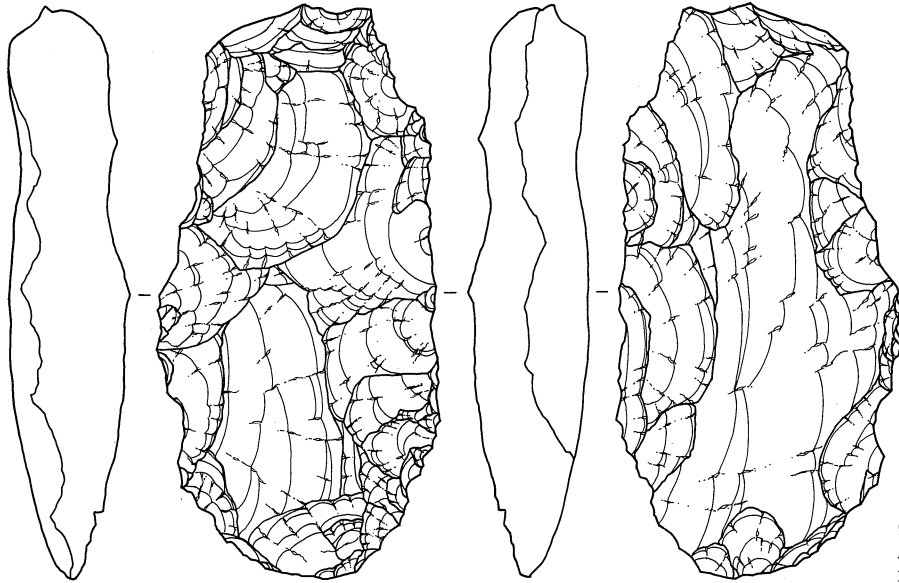

910  
 Ax Sa  
 BL3031 105.24g  
 V a VI-G 6093

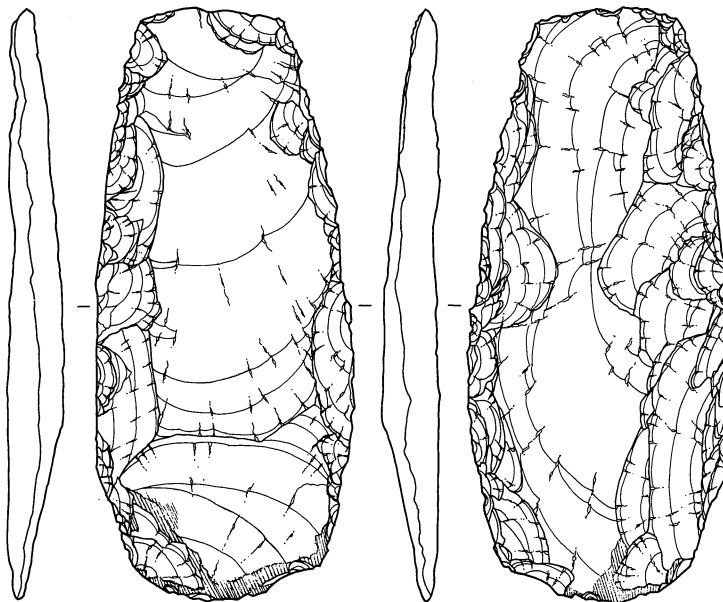

911  
 Ax Sa  
 BL3037 52.88g  
 V VI-B 1262

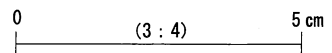

第3地点 石器実測図 30 (斧形石器 8) (貫ノ木遺跡)

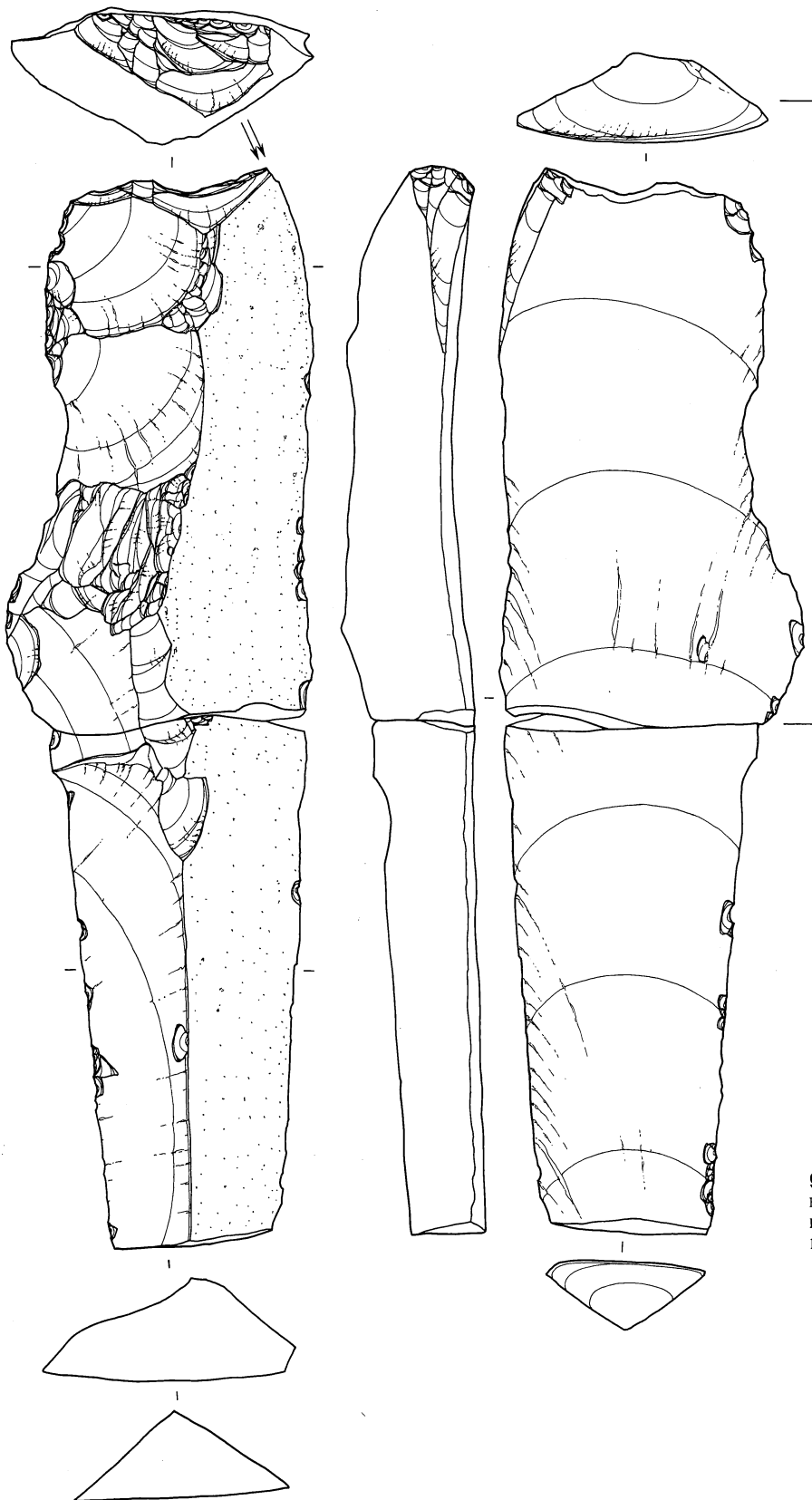

912a  
 Gr TS  
 BL3028 140.16g  
 III VI-G 2749

912b  
 B1 TS  
 BL3028 89.99g  
 IV VI-G 2913

0 (3 : 4) 5 cm

第3地点 石器実測図 31 (彫器 1) (貫ノ木遺跡)

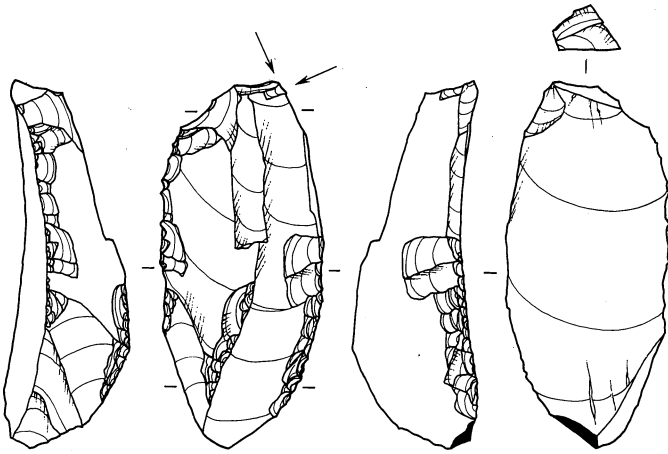

913  
Gr TS  
BL3012 24.65g  
IV VI-L 1366

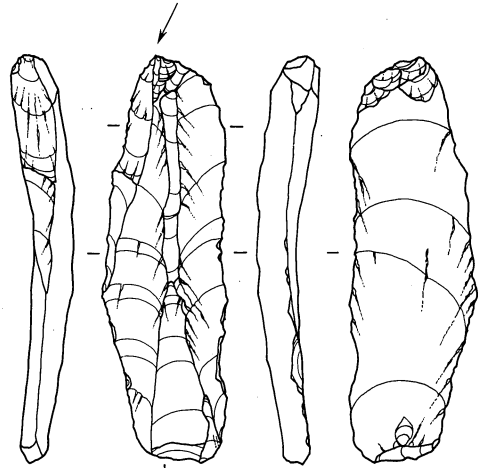
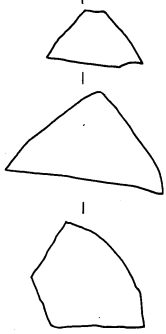

914  
Gr TS  
BL3028 11.89g  
IV VI-G 2897

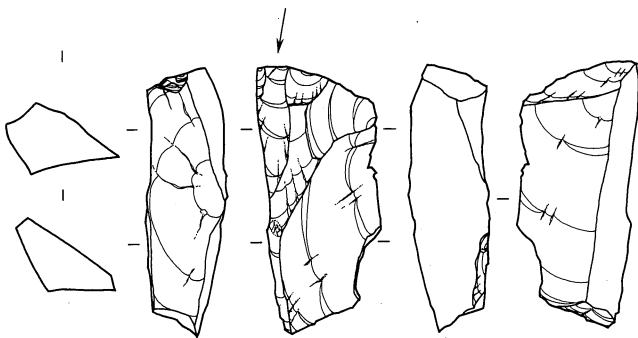
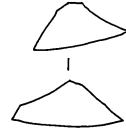

915  
Gr An  
BL3019 11.79g  
IV VI-G 4064

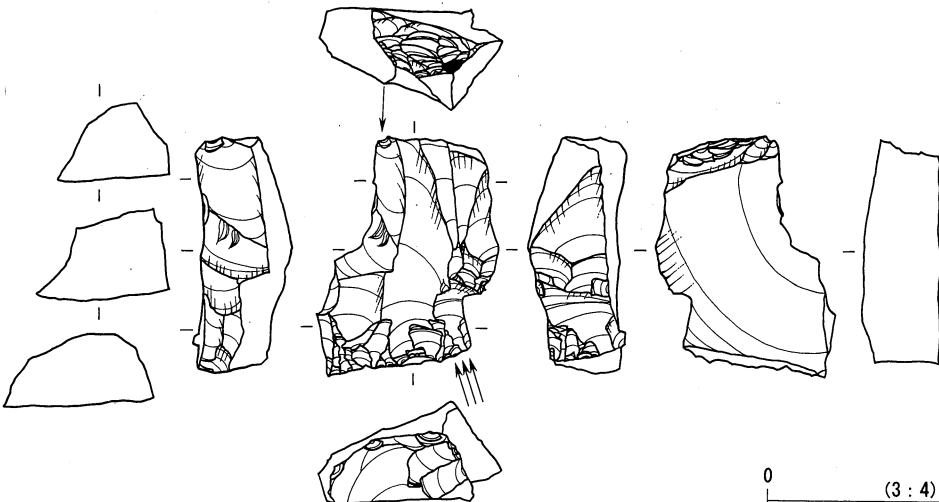

916  
Gr SS  
BL3032 17.34g  
III VI-G 6559

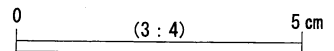

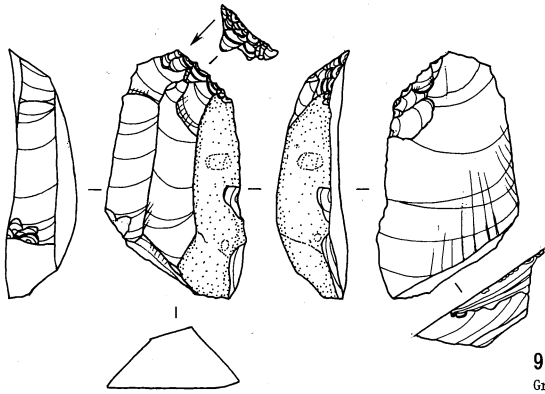

917  
Gr Ob WDTY  
BL3031 9.88g  
III VI-G 2257

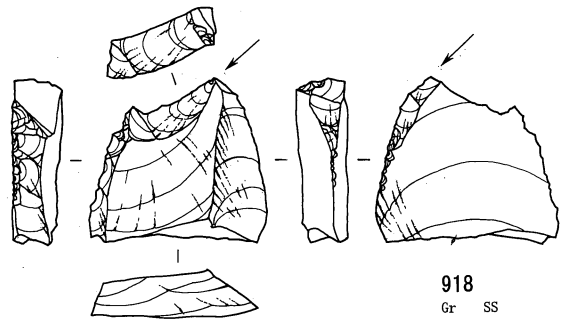

918  
Gr SS  
BL3033 7.47g  
III VI-G 2329

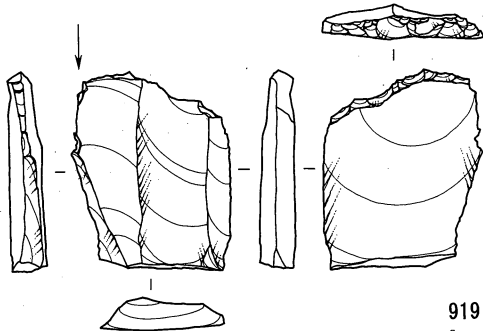

919  
Gr TS  
BL3034 5.35g  
III VI-G 2320

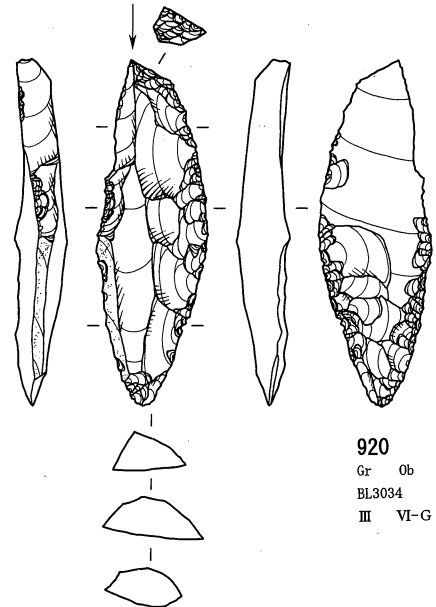

920  
Gr Ob SWHD  
BL3034 7.45g  
III VI-G 4646

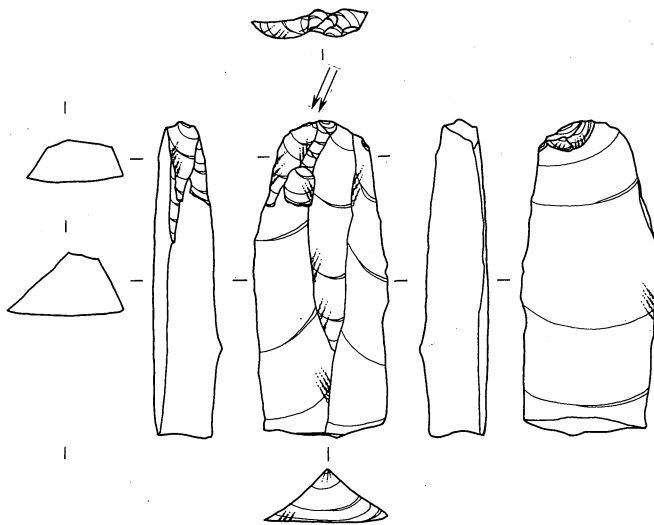

921  
Gr TS  
BL3038 12.65g  
IV VI-B 1220

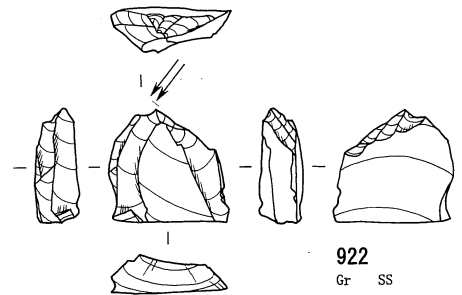

922  
Gr SS  
BL3038 3.28g  
III VI-B 737

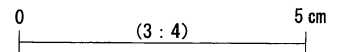



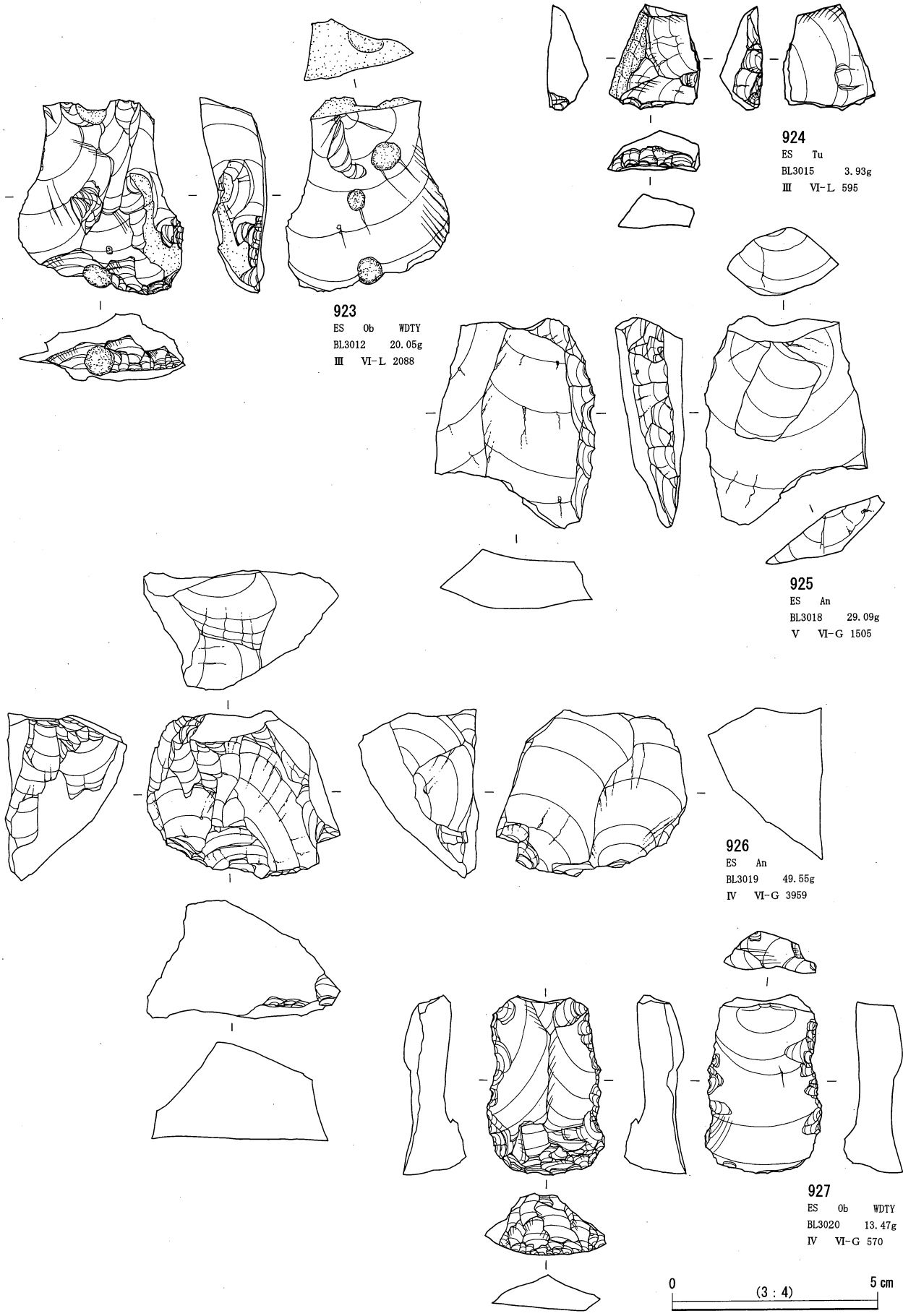

第3地点 石器実測図 34 (搔器 1) (貫ノ木遺跡)

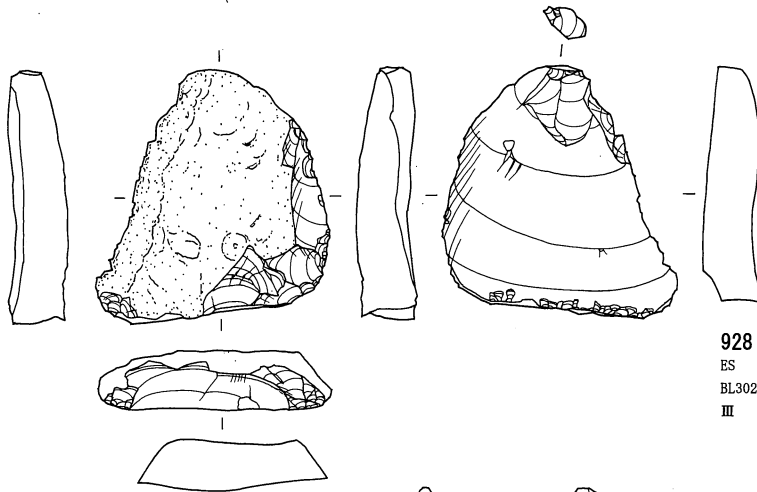

928  
 ES Ob WDTY  
 BL3026 16.72g  
 III VI-G 4597

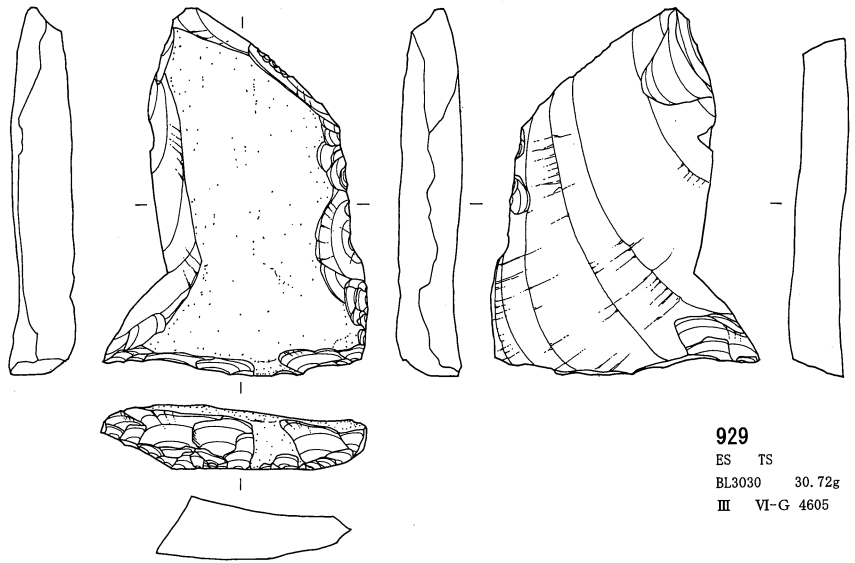

929  
 ES TS  
 BL3030 30.72g  
 III VI-G 4605

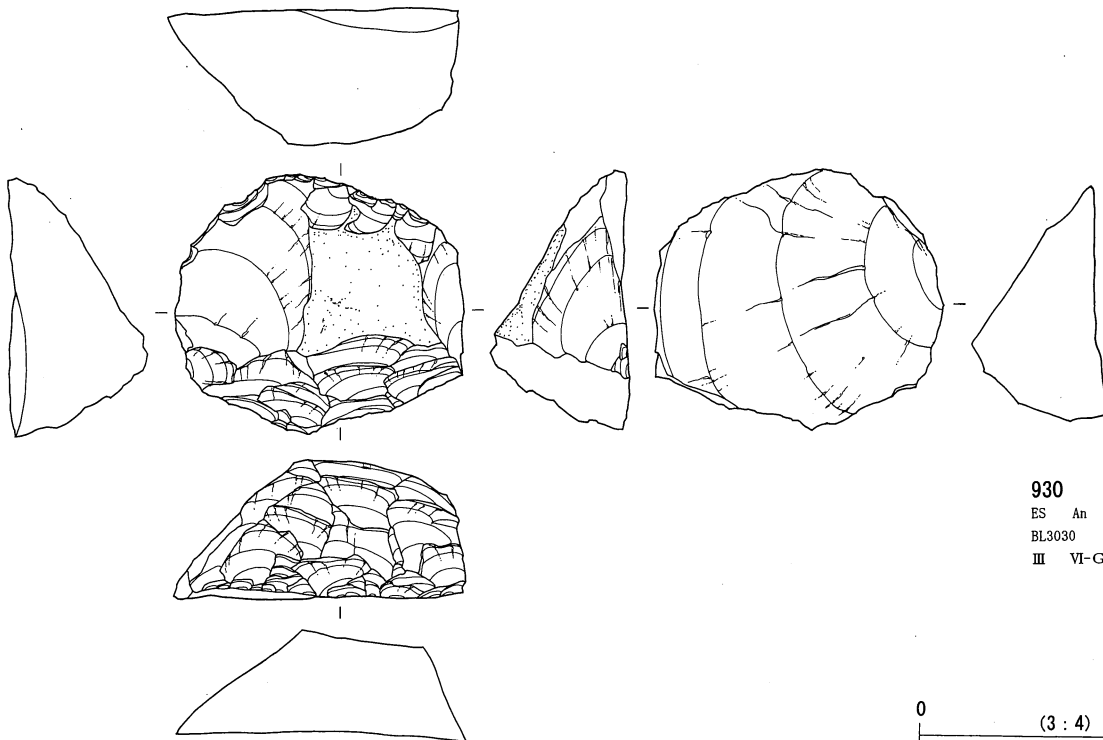

930  
 ES An  
 BL3030 47.87g  
 III VI-G 2426

0 (3 : 4) 5 cm

第3地点 石器実測図 35 (搔器 2) (貫ノ木遺跡)

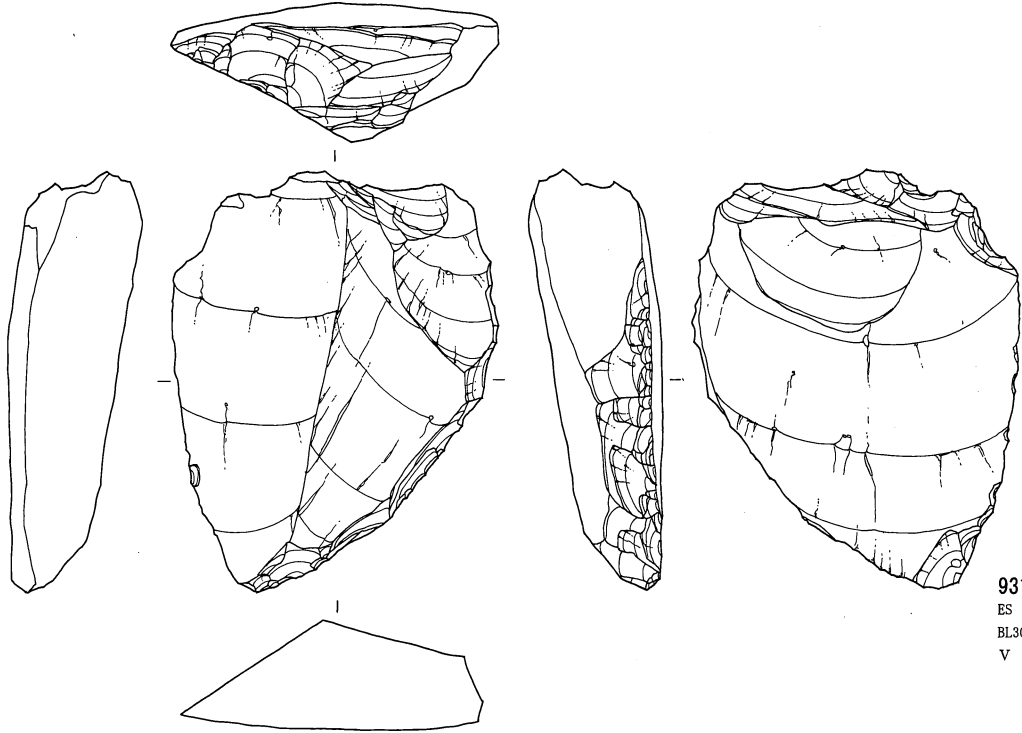

931  
 ES An  
 BL3031 83.57g  
 V VI-G 5599

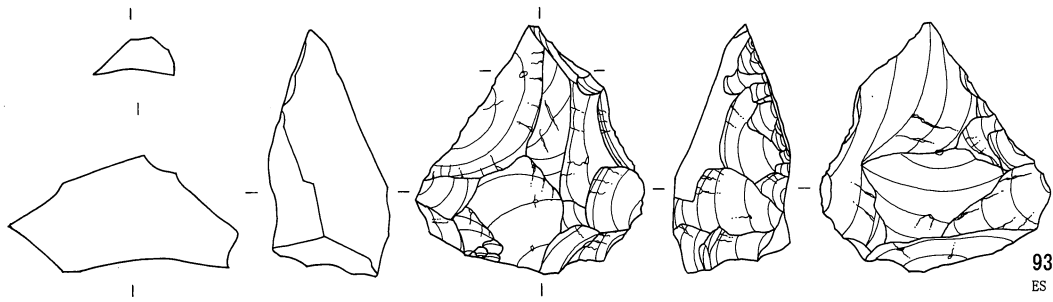

932  
 ES An  
 BL3036 26.55g  
 V VI-B 907

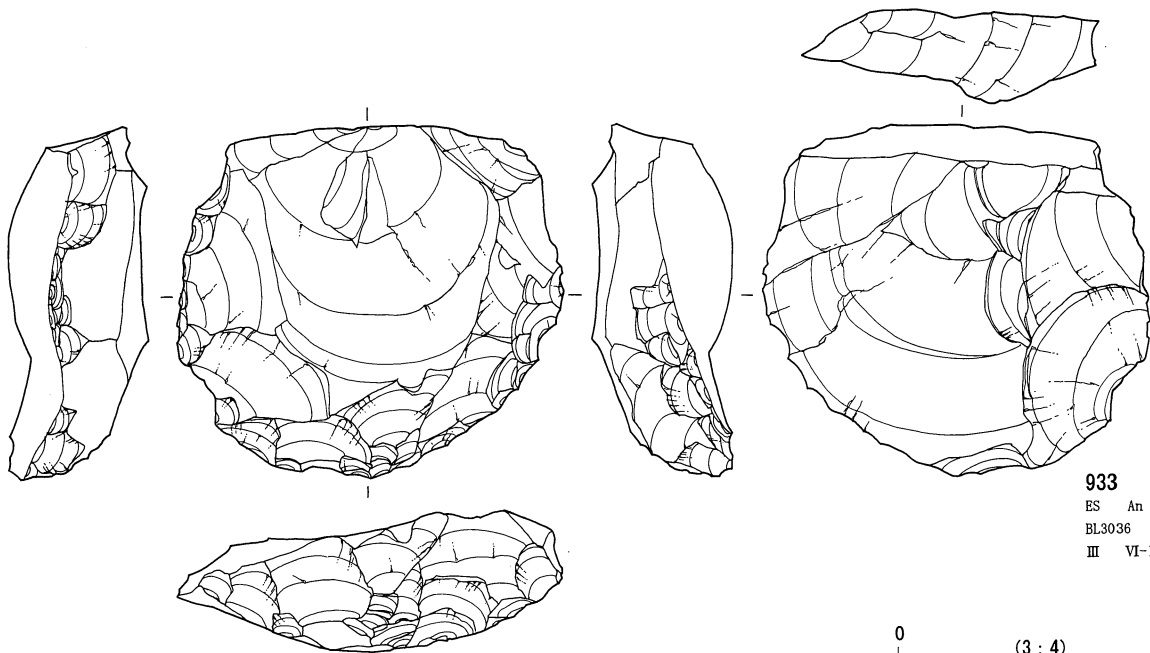

933  
 ES An  
 BL3036 97.96g  
 III VI-B 505

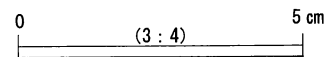

第3地点 石器実測図 36 (搔器 3) (貫ノ木遺跡)

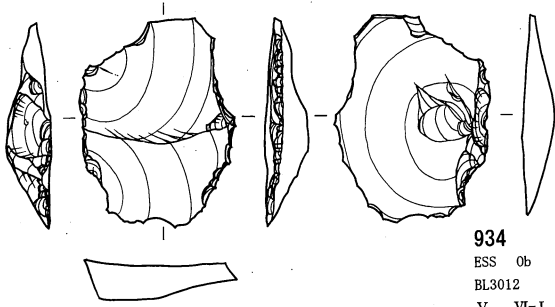

934  
ESS Ob WDTY  
BL3012 5.05g  
V VI-L 1905

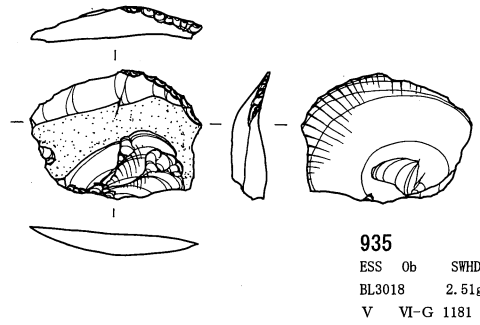

935  
ESS Ob SWHD  
BL3018 2.51g  
V VI-G 1181

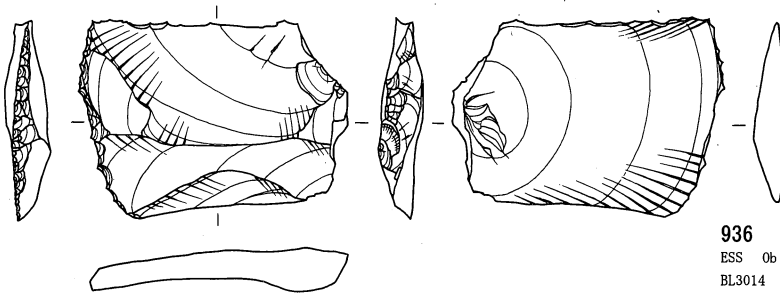

936  
ESS Ob WDTY  
BL3014 10.07g  
V VI-L 1352

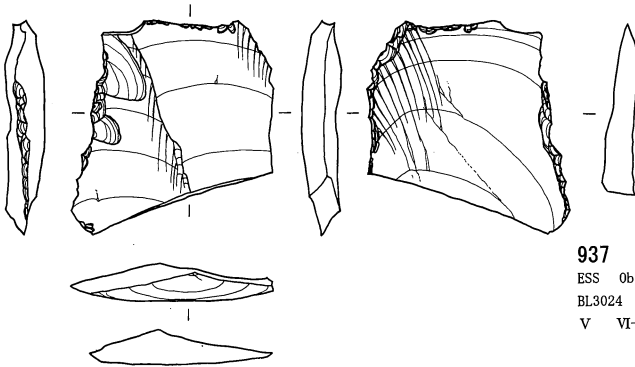

937  
ESS Ob SWHD  
BL3024 6.94g  
V VI-G 1856

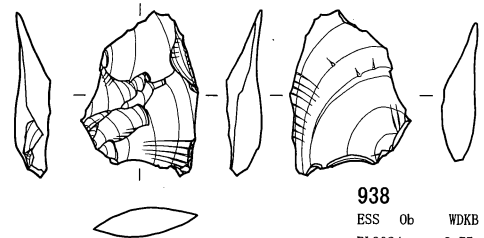

938  
ESS Ob WDKB  
BL3024 2.75g  
V VI-L 1525

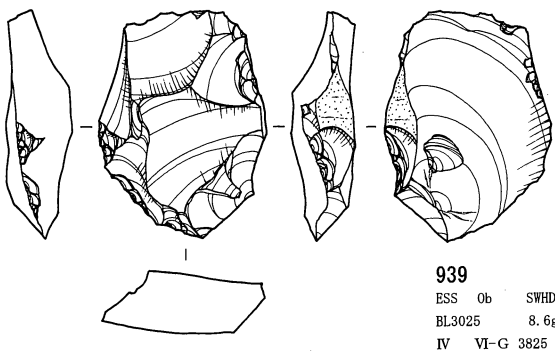

939  
ESS Ob SWHD  
BL3025 8.6g  
IV VI-G 3825

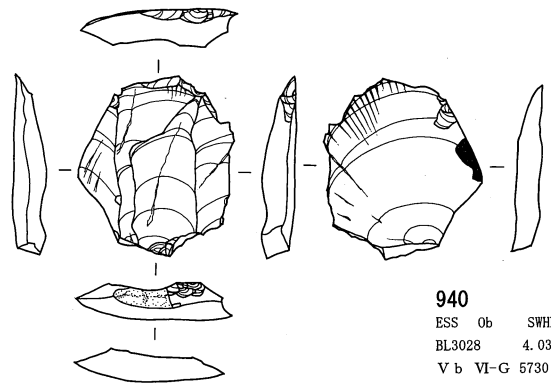

940  
ESS Ob SWHD  
BL3028 4.03g  
V b VI-G 5730

0 (3 : 4) 5 cm

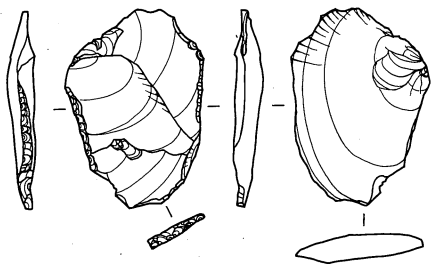

941  
ESS Ob SWHD  
BL3031 3.31g  
IV VI-G 4768

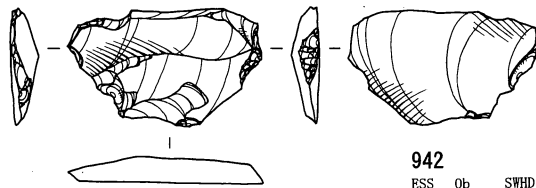

942  
ESS Ob SWHD  
BL3031 2.81g  
V b VI-G 6422

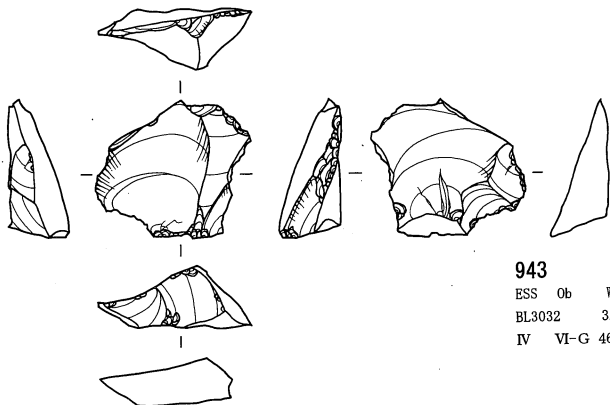

943  
ESS Ob WDTY  
BL3032 3.81g  
IV VI-G 4667

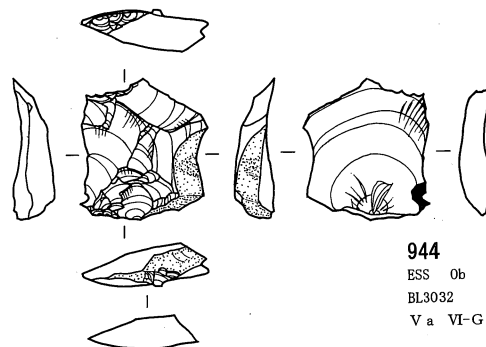

944  
ESS Ob WDTY  
BL3032 2.79g  
V a VI-G 5165

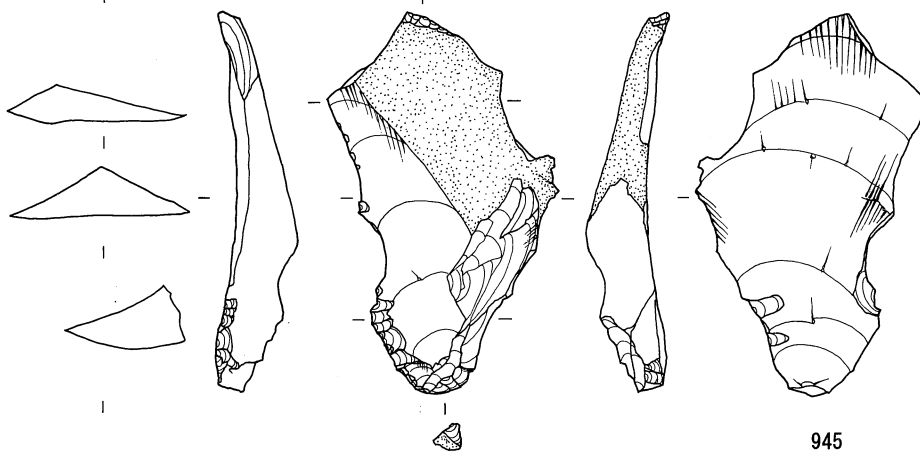

945  
ESS Ob WDTY  
BL3035 16.55g  
III VI-B 581

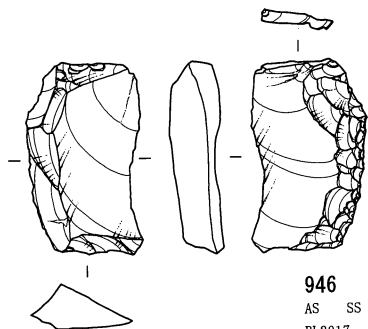

946  
AS SS  
BL3017 5.28g  
III VI-F 7

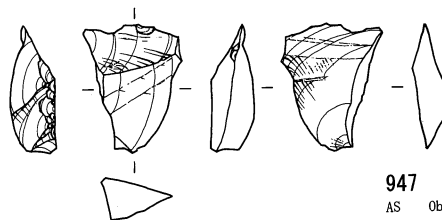

947  
AS Ob SWHD  
BL3020 1.32g  
IV VI-G 144

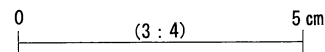

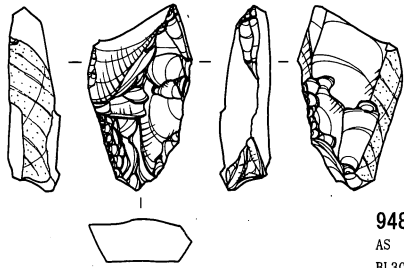

948  
AS Ob SWHD  
BL3021 4.36g  
V VI-G 1703

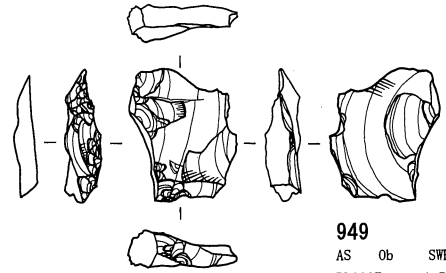

949  
AS Ob SWHD  
BL3027 1.59g  
IV VI-G 4033

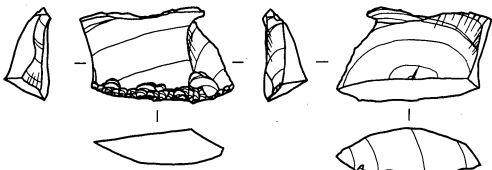

950  
AS Ob SWHD  
BL3028 2.35g  
III VI-G 2681

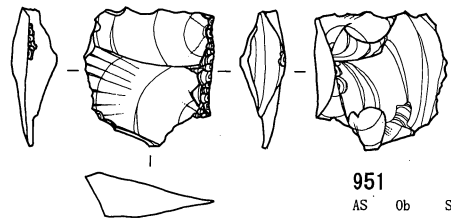

951  
AS Ob SWHD  
BL3028 2.36g  
IV VI-G 2943

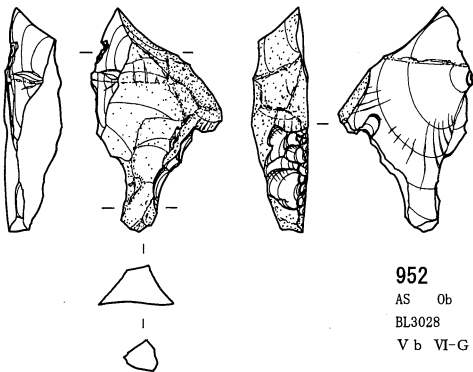

952  
AS Ob 不可  
BL3028 5.44g  
V b VI-G 5888

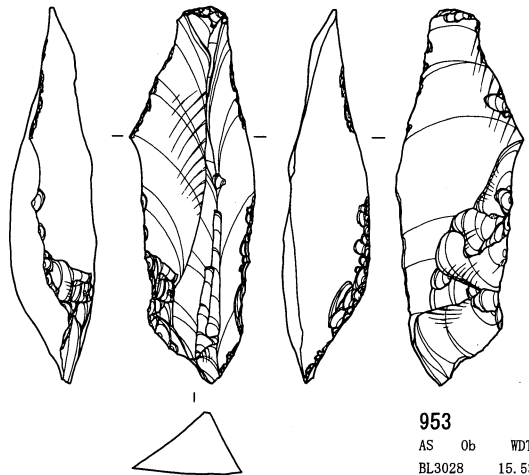

953  
AS Ob WDTY  
BL3028 15.53g  
V b VI-G 5823

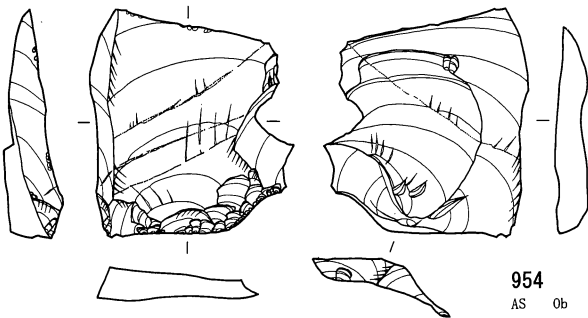

954  
AS Ob SWHD  
BL3029 8.13g  
V b VI-G 5739

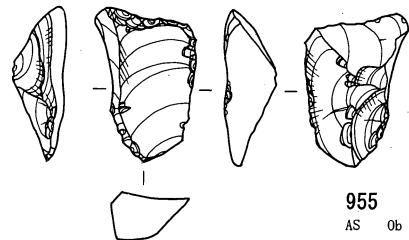

955  
AS Ob WDTM  
BL3031 2.97g  
V VI-G 5567

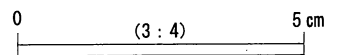

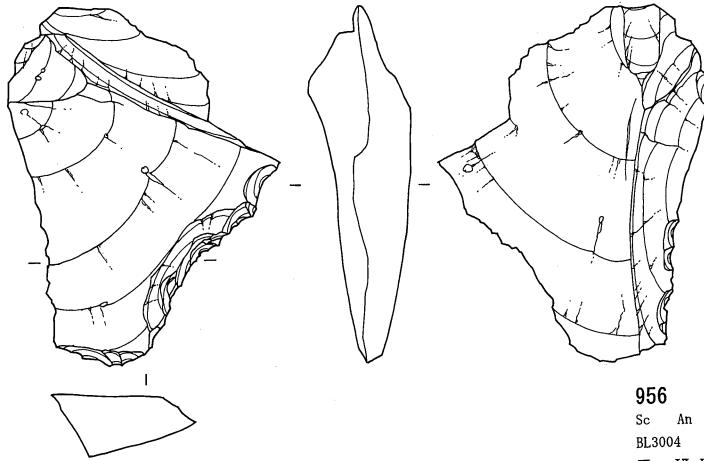

956  
 Sc An  
 BL3004 29.05g  
 III VI-P 134

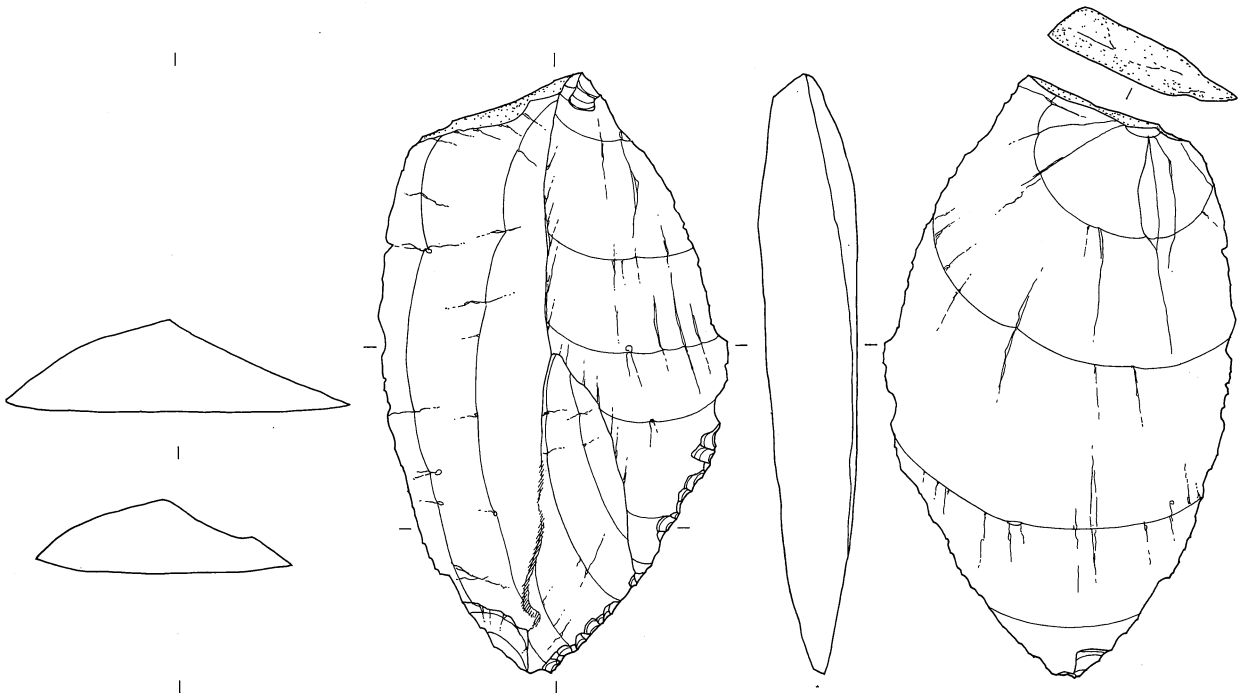

957  
 Sc An  
 BL3004 94.49g  
 III VI-P 128

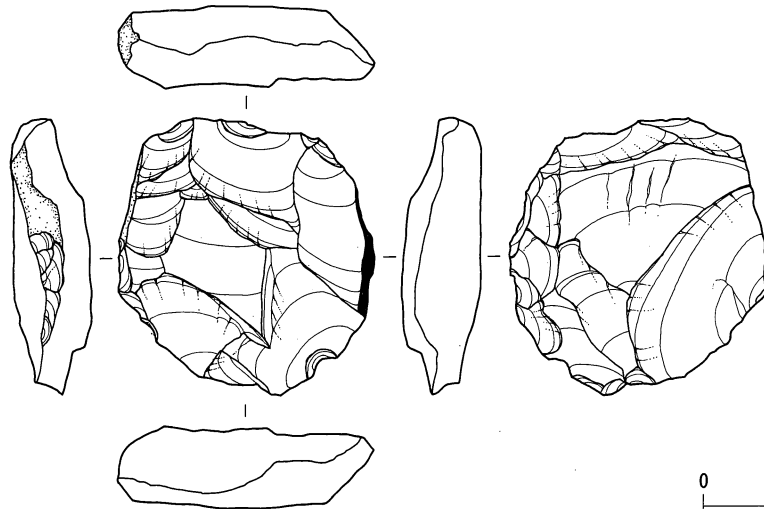

958  
 Sc TS  
 BL3007 31.15g  
 IV VI-P 190

0 (3 : 4) 5 cm

第3地点 石器実測図 40 (削器 1) (貫ノ木遺跡)

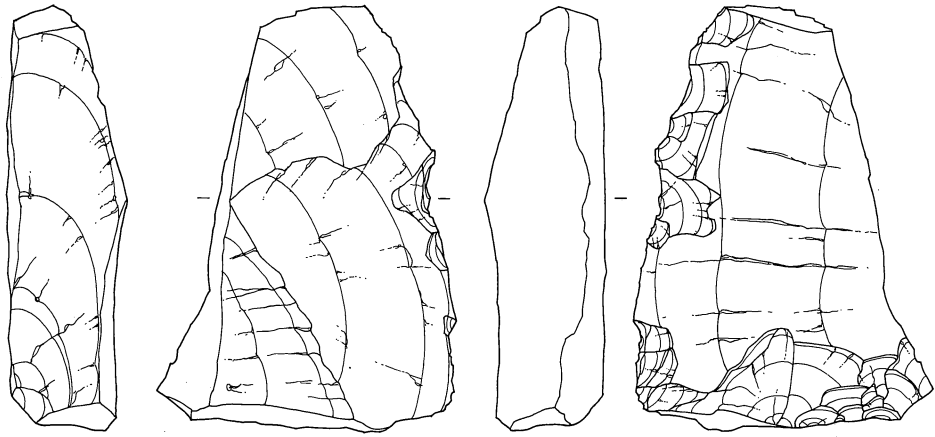

959  
 Sc An  
 BL3009 79.86g  
 II VI-Q 32

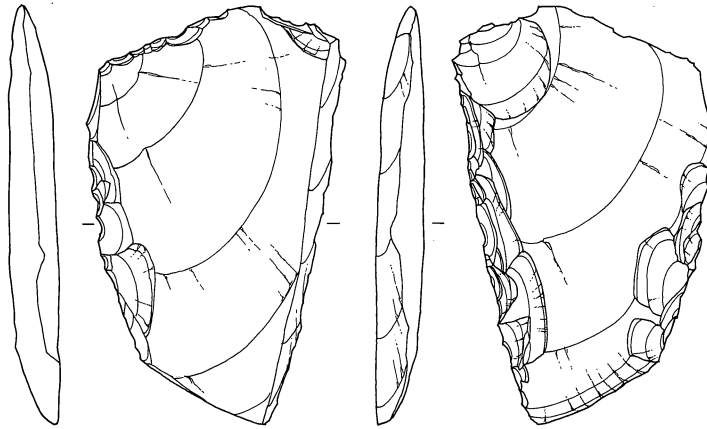
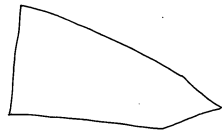

960  
 Sc Tu  
 BL3009 31.82g  
 II VI-Q 30

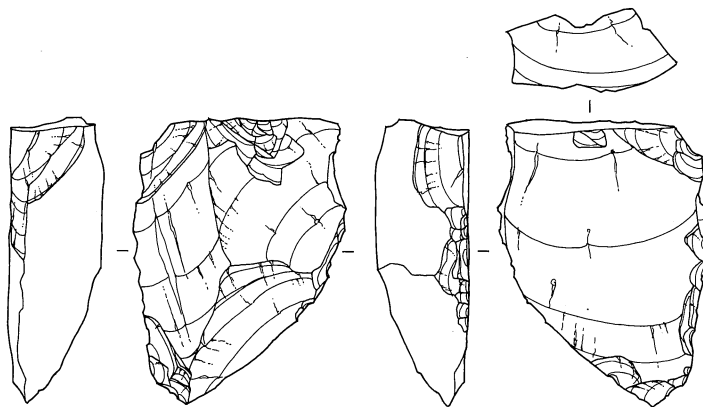
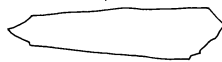

961  
 Sc An  
 BL3014 31.92g  
 V VI-L 2010

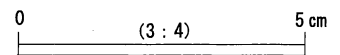

第3地点 石器実測図 41 (削器 2) (貫ノ木遺跡)



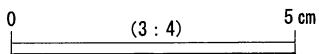
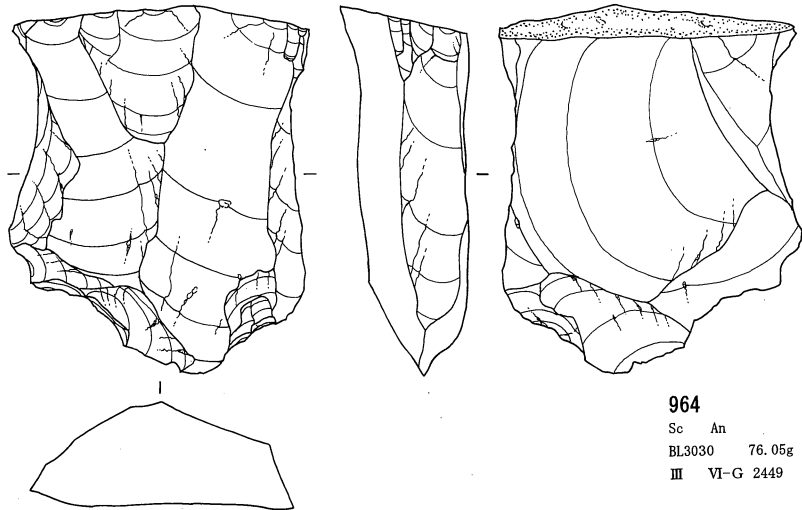
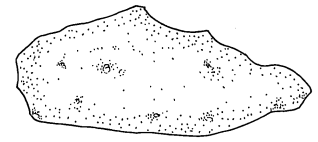
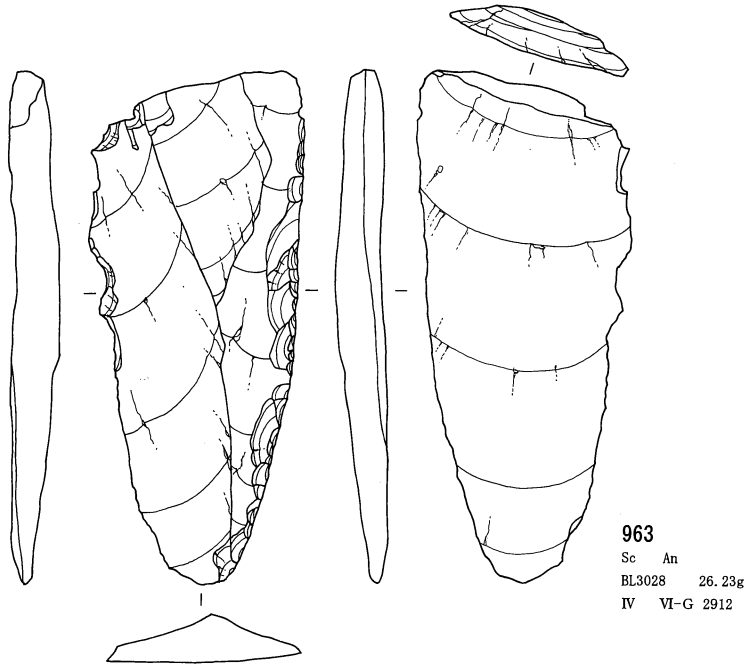
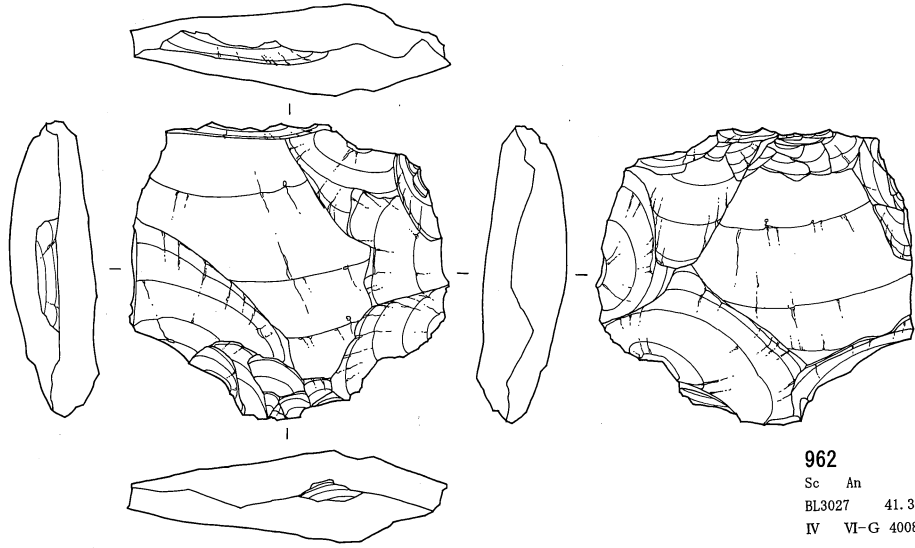

第3地点 石器実測図 42 (削器 3) (貫ノ木遺跡)

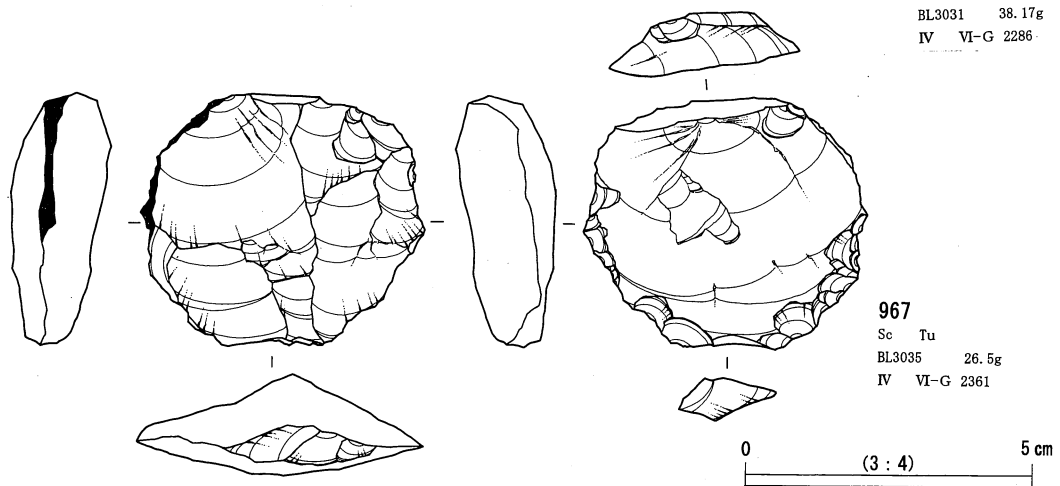
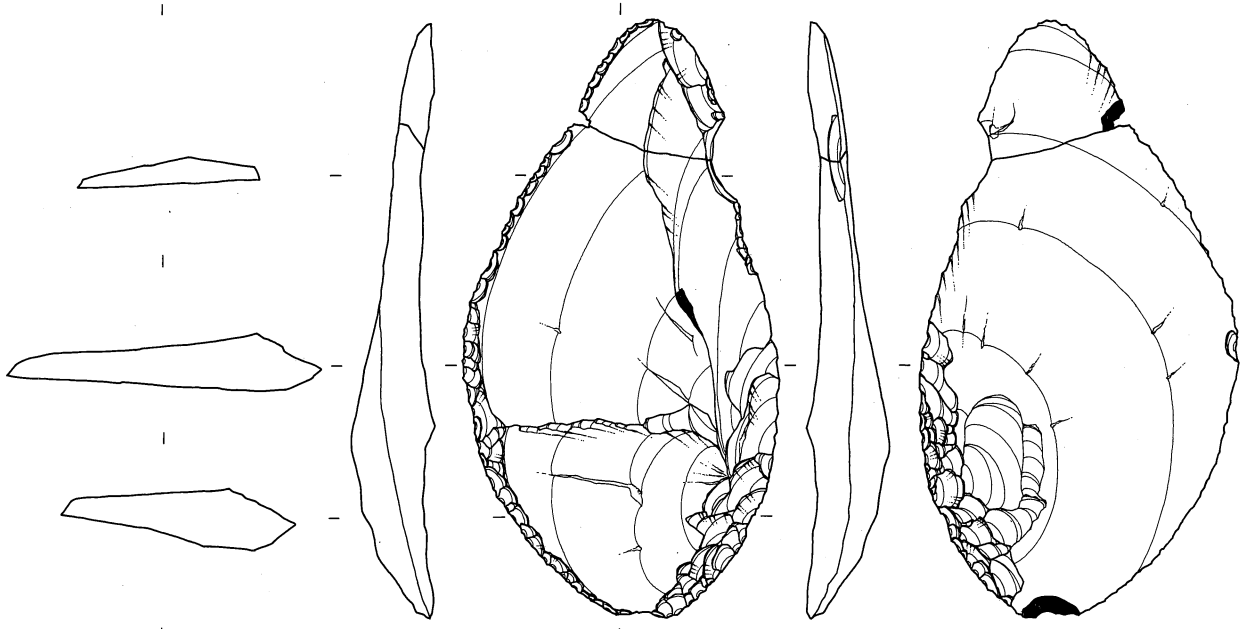
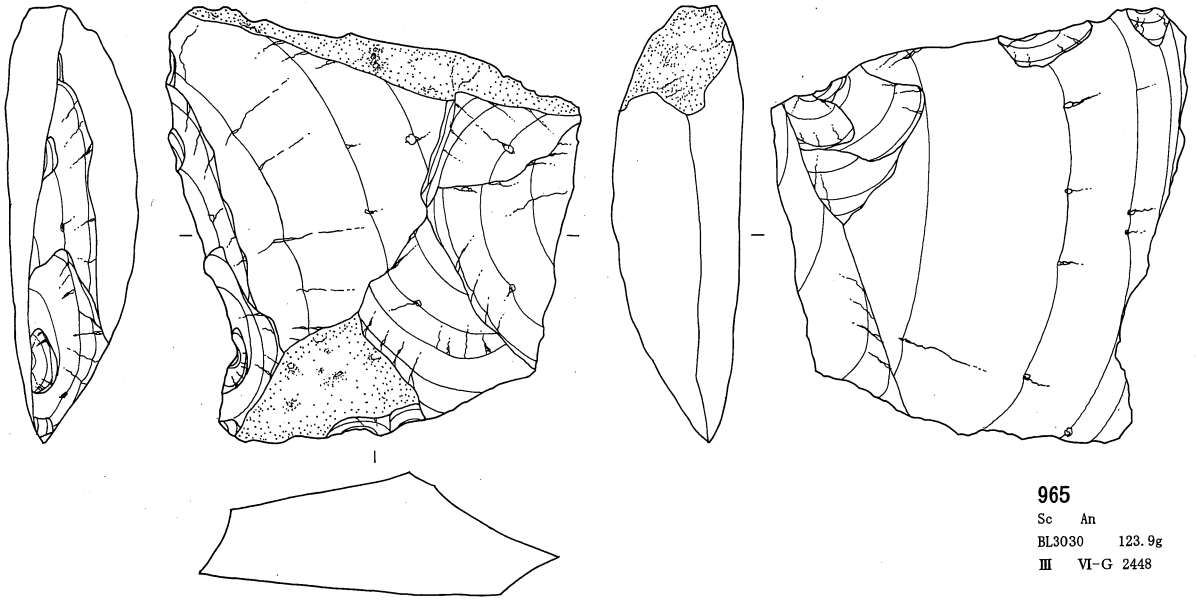

第3地点 石器実測図 43 (削器 4) (貫ノ木遺跡)

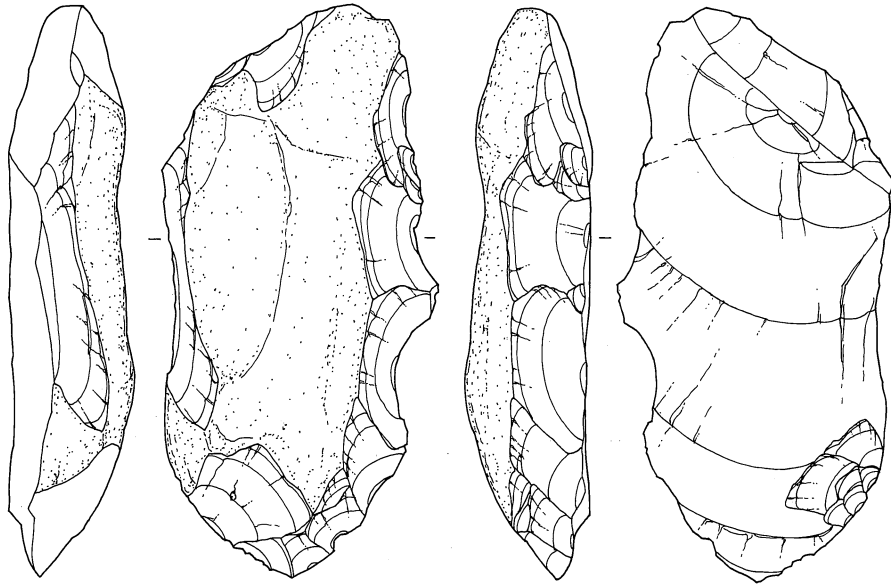

968  
 Sc An  
 BL3001 101.78g  
 II VI-P 350

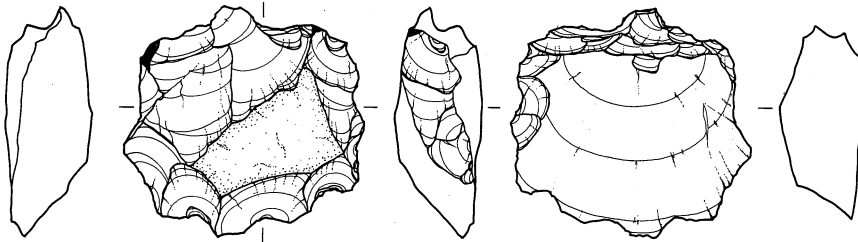
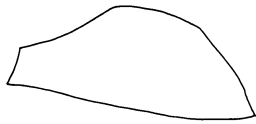

969  
 Sc TS  
 BL3020 25.25g  
 III VI-L 436

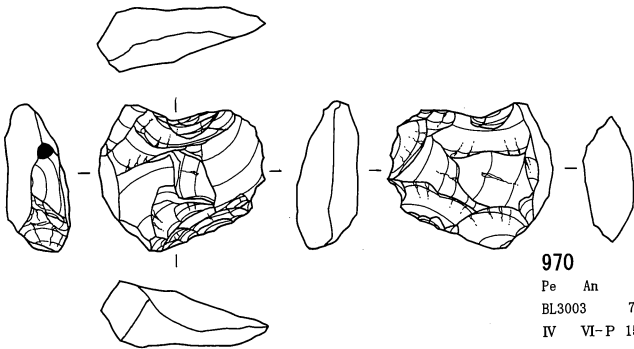

970  
 Pe An  
 BL3003 7.04g  
 IV VI-P 154

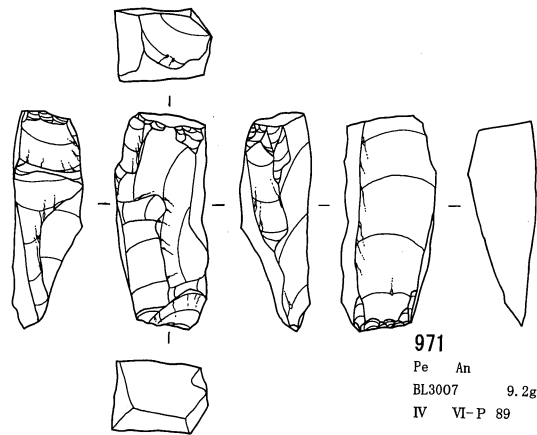

971  
 Pe An  
 BL3007 9.2g  
 IV VI-P 89

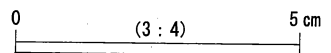

第3地点 石器実測図 44 (削器5・楔形石器1) (貫ノ木遺跡)

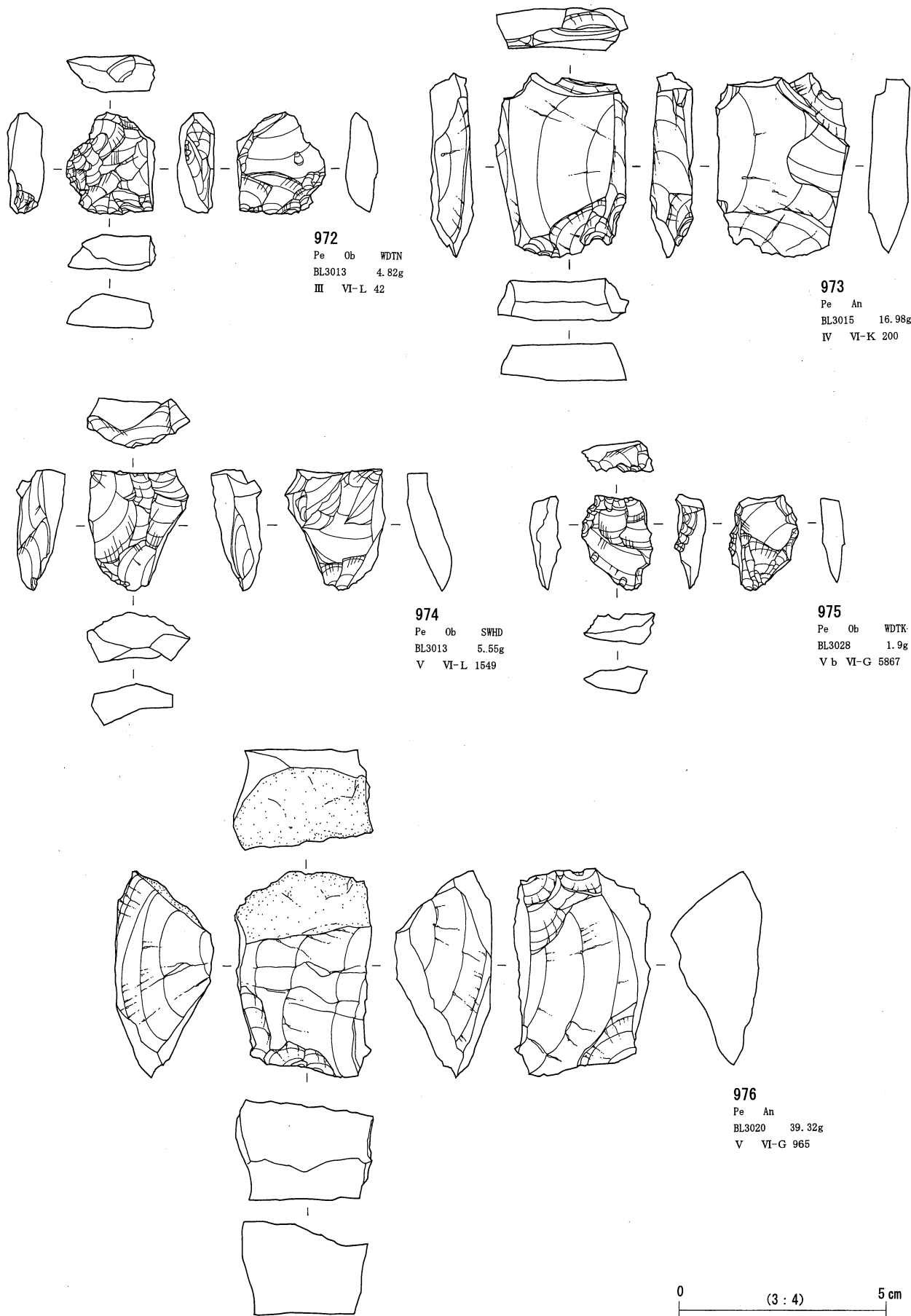

第3地点 石器実測図 45 (楔形石器 2) (貫ノ木遺跡)

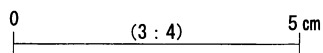
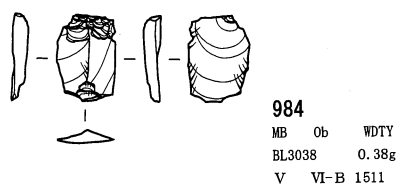
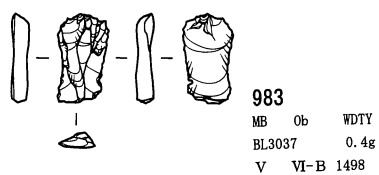
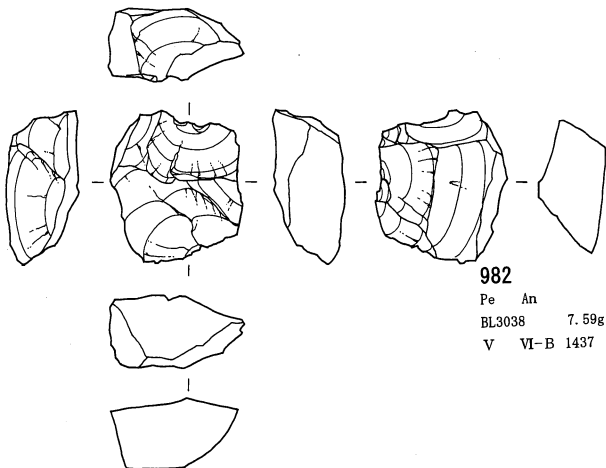
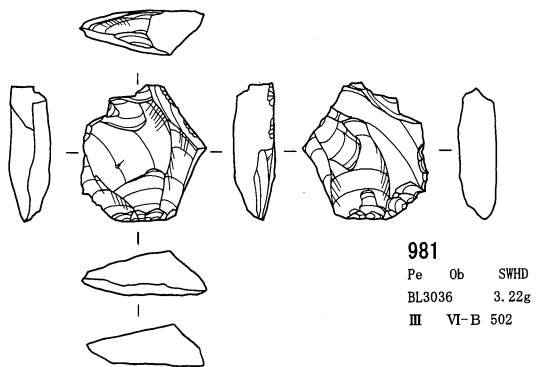
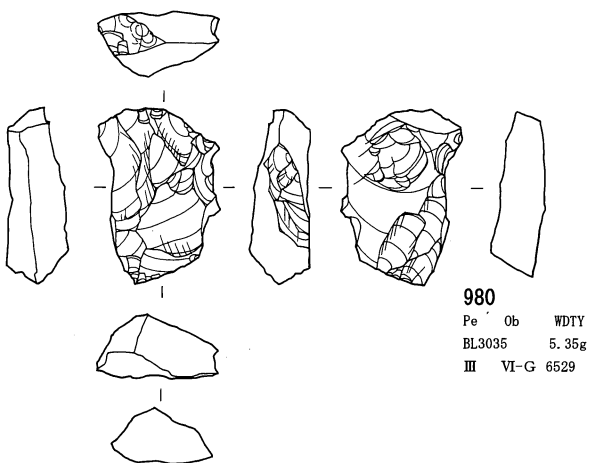
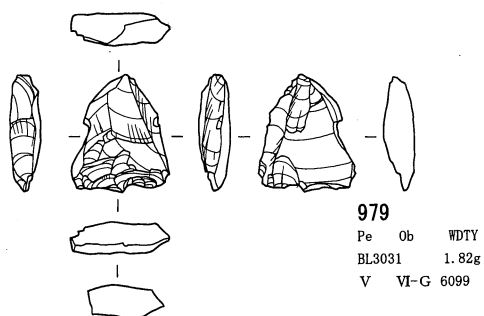
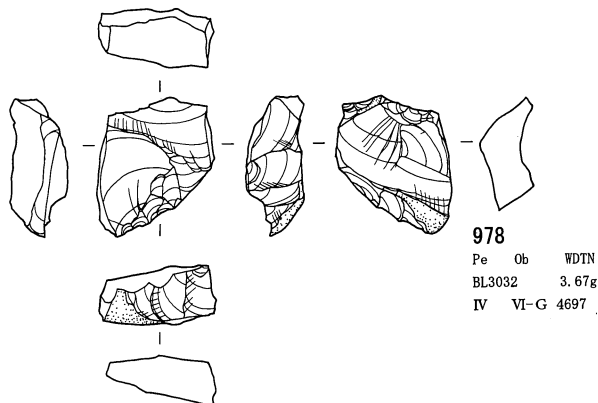
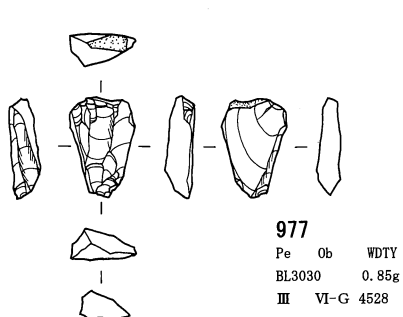

第3地点 石器実測図 46 (楔形石器 3・細石刃) (貫ノ木遺跡)

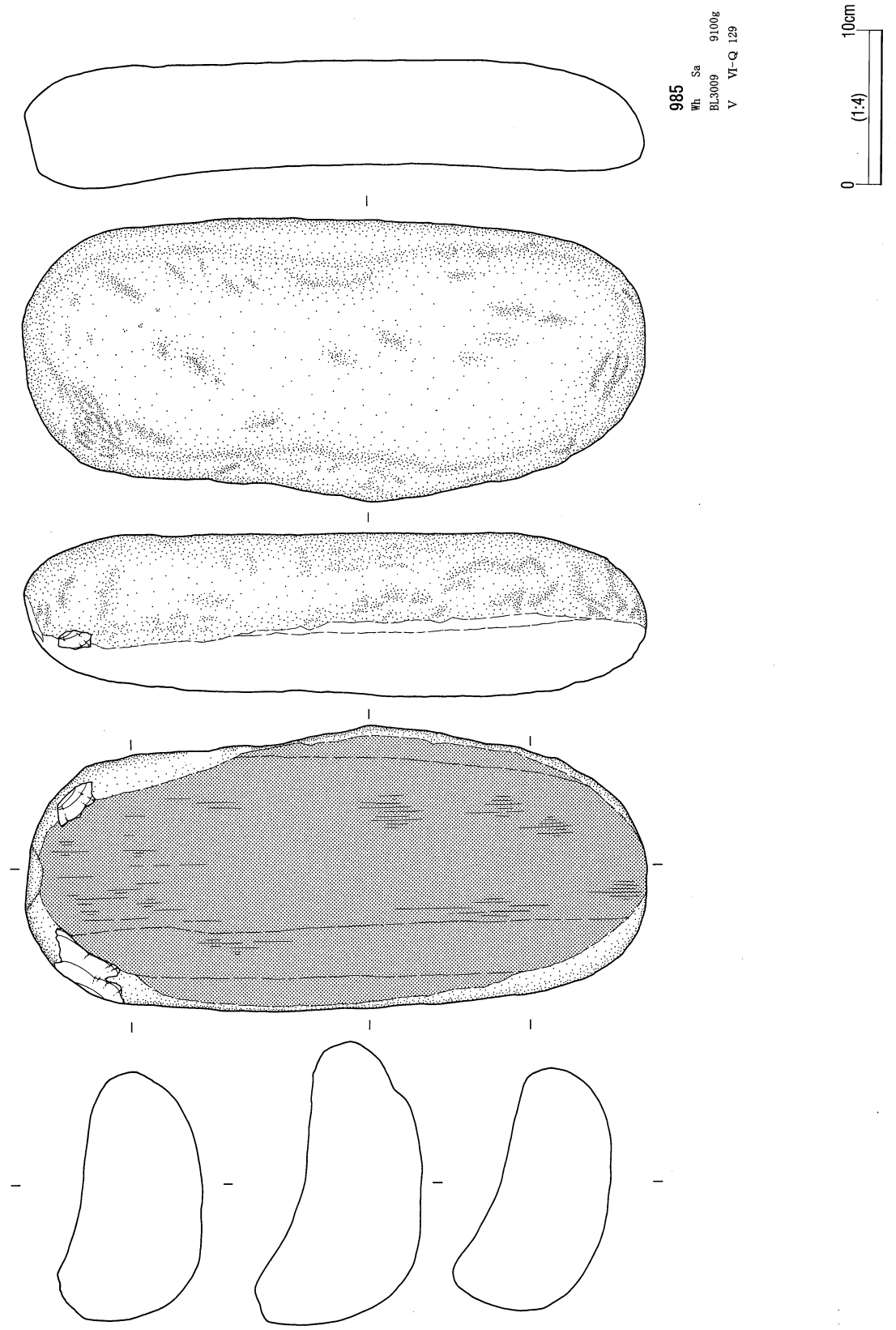

第3地点 石器実測図 47 (砥石 1) (貫ノ木遺跡)

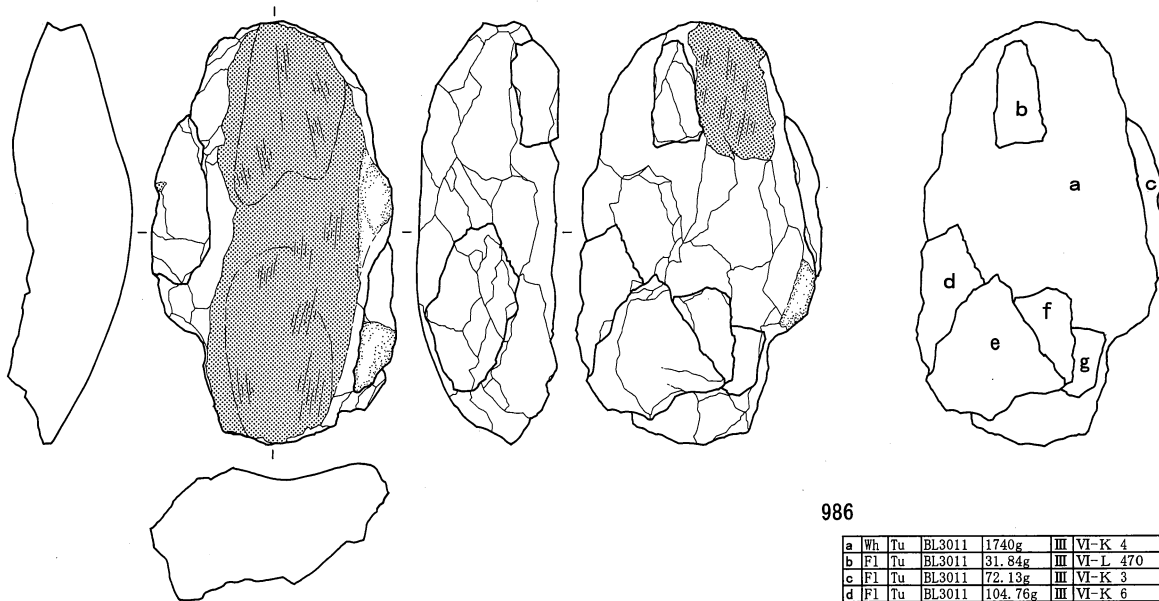

986

|   |    |    |        |         |     |          |
|---|----|----|--------|---------|-----|----------|
| a | Wh | Tu | BL3011 | 1740g   | III | VI-K 4   |
| b | Fl | Tu | BL3011 | 31.84g  | III | VI-L 470 |
| c | Fl | Tu | BL3011 | 72.13g  | III | VI-K 3   |
| d | Fl | Tu | BL3011 | 104.76g | III | VI-K 6   |
| e | Fl | Tu | BL3011 | 96.97g  | III | VI-K 5   |
| f | Fl | Tu | BL3011 | 16.92g  | III | VI-K 8   |
| g | Fl | Tu | BL3011 | 13.22g  | III | VI-K 7   |

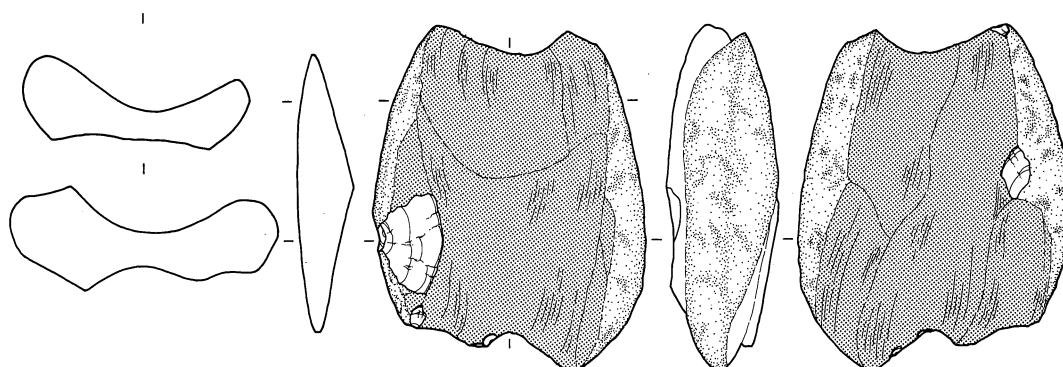

987

Wh Sa  
BL3020 1352g  
IV VI-L 1045

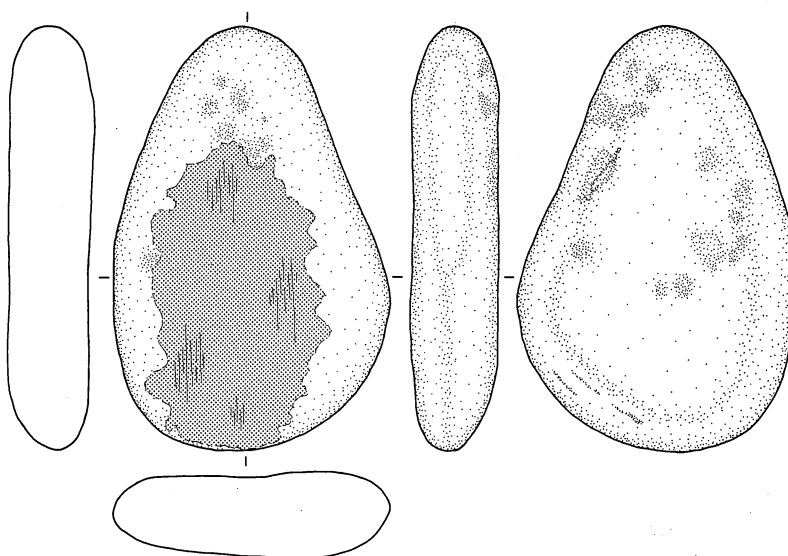

988

Wh Sa  
BL3020 2090g  
V VI-G 1282

0 (1:4) 10cm

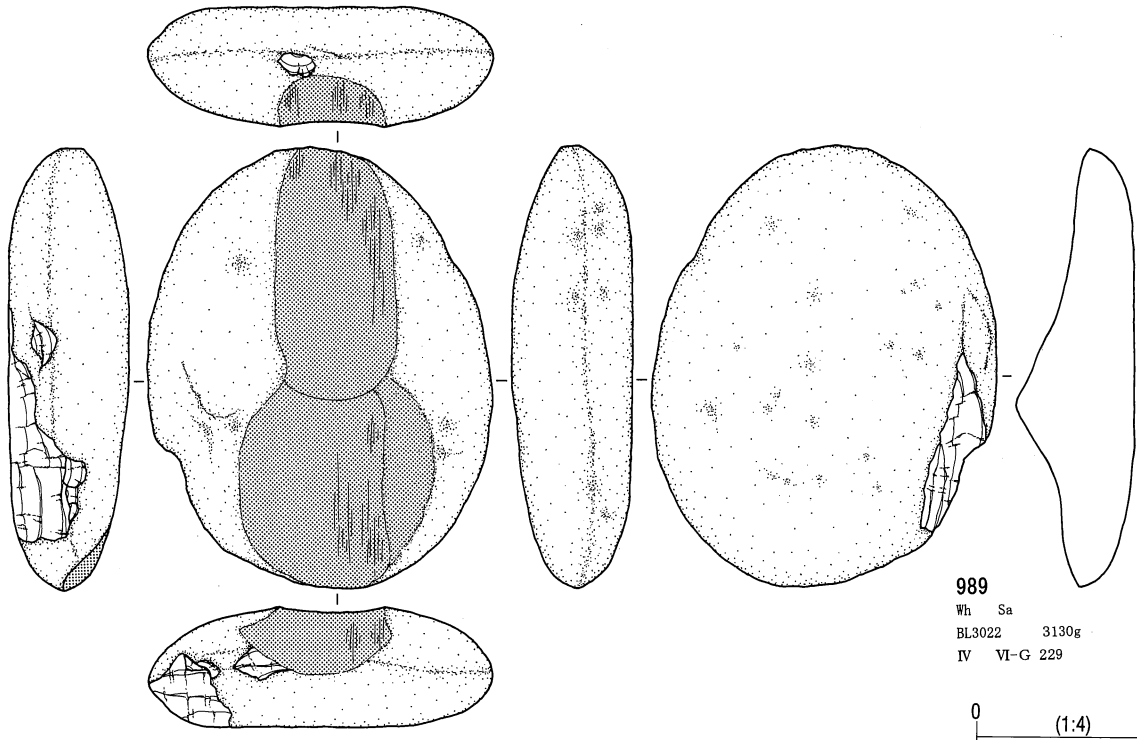

989  
Wh Sa  
BL3022 3130g  
IV VI-G 229

0 (1:4) 10cm

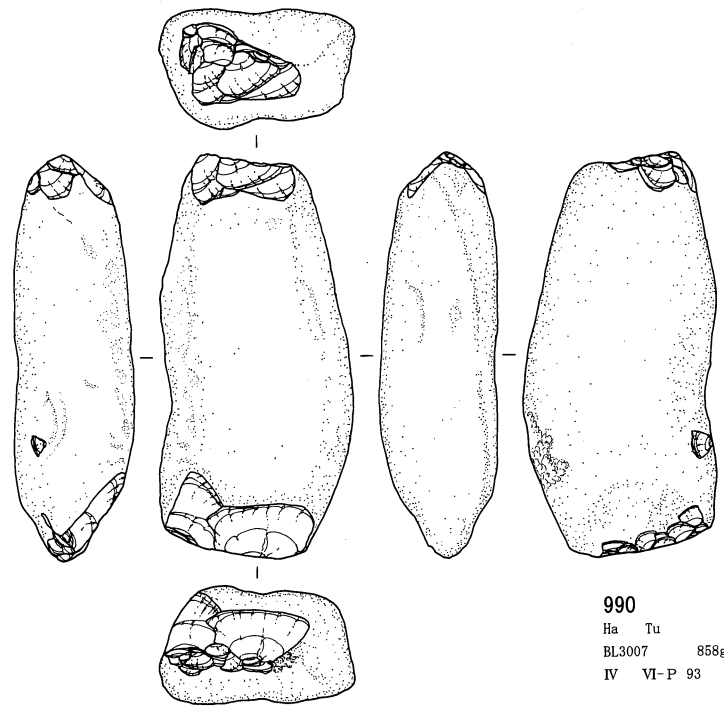

990  
Ha Tu  
BL3007 858g  
IV VI-P 93

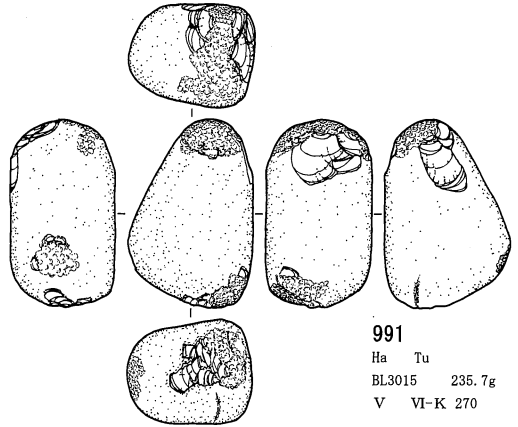

991  
Ha Tu  
BL3015 235.7g  
V VI-K 270

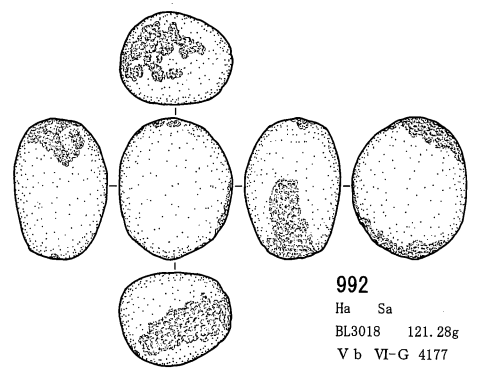

992  
Ha Sa  
BL3018 121.28g  
V b VI-G 4177

0 (1:3) 10cm

第3地点 石器実測図 49 (砥石3・敲石1) (貫ノ木遺跡)



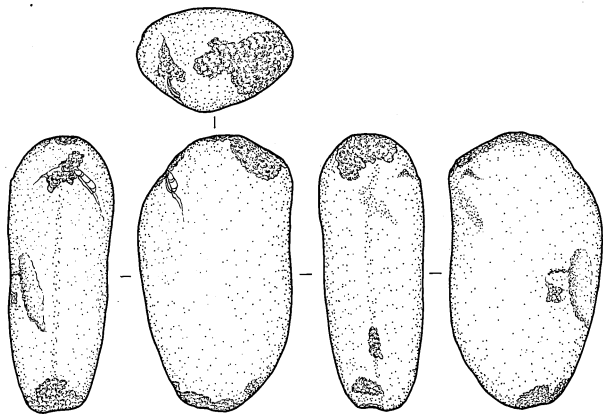

993  
Ha Sa  
BL3027 350g  
V VI-G 5989

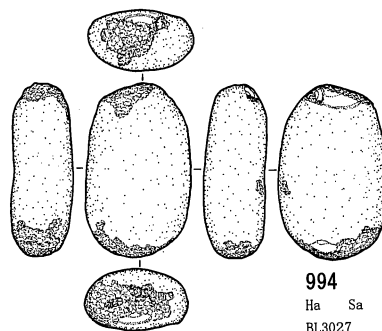

994  
Ha Sa  
BL3027 91.96g  
III VI-G 4602

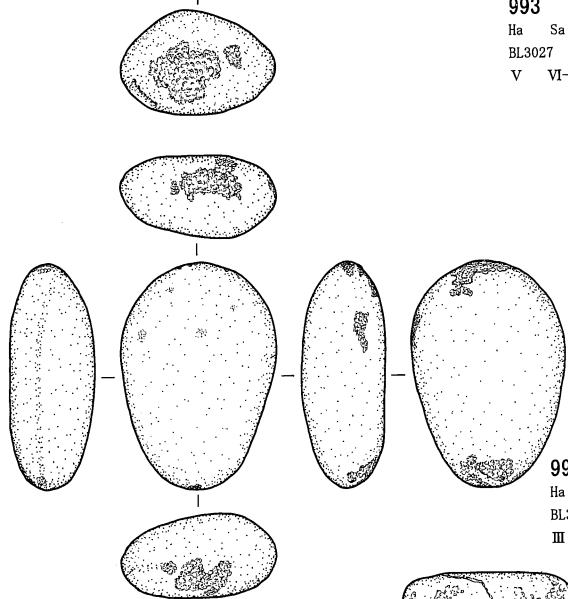

995  
Ha Sa  
BL3030 229.86g  
III VI-G 2441

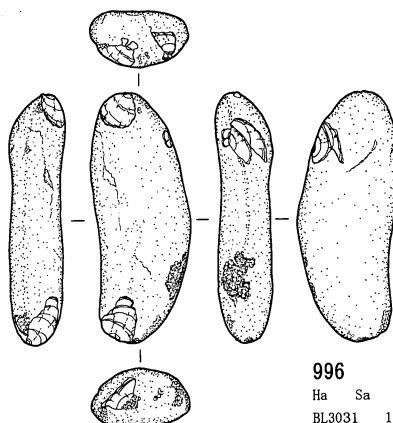

996  
Ha Sa  
BL3031 110.08g  
V a VI-G 5907

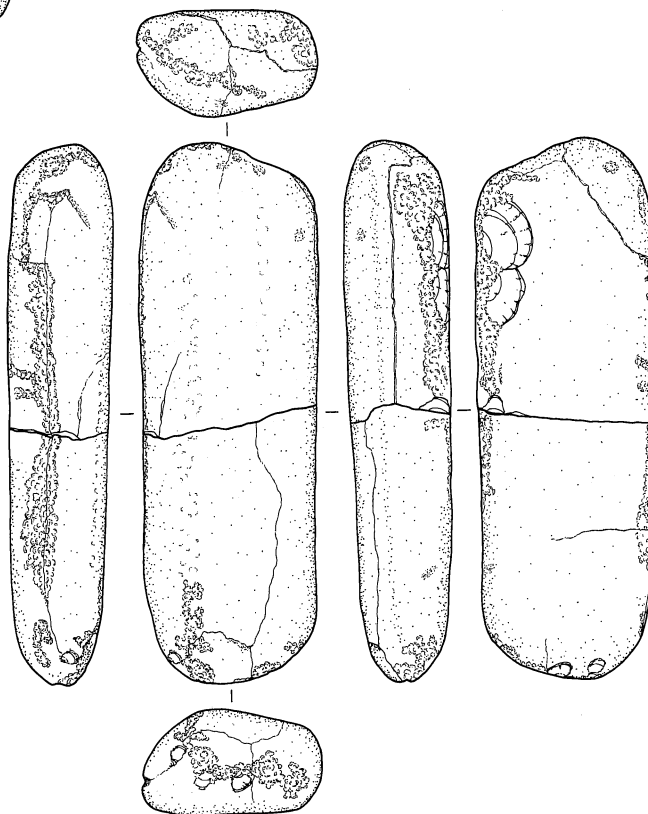

997  
Ha Sa  
BL3032 460g  
V b SH92 1

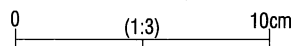

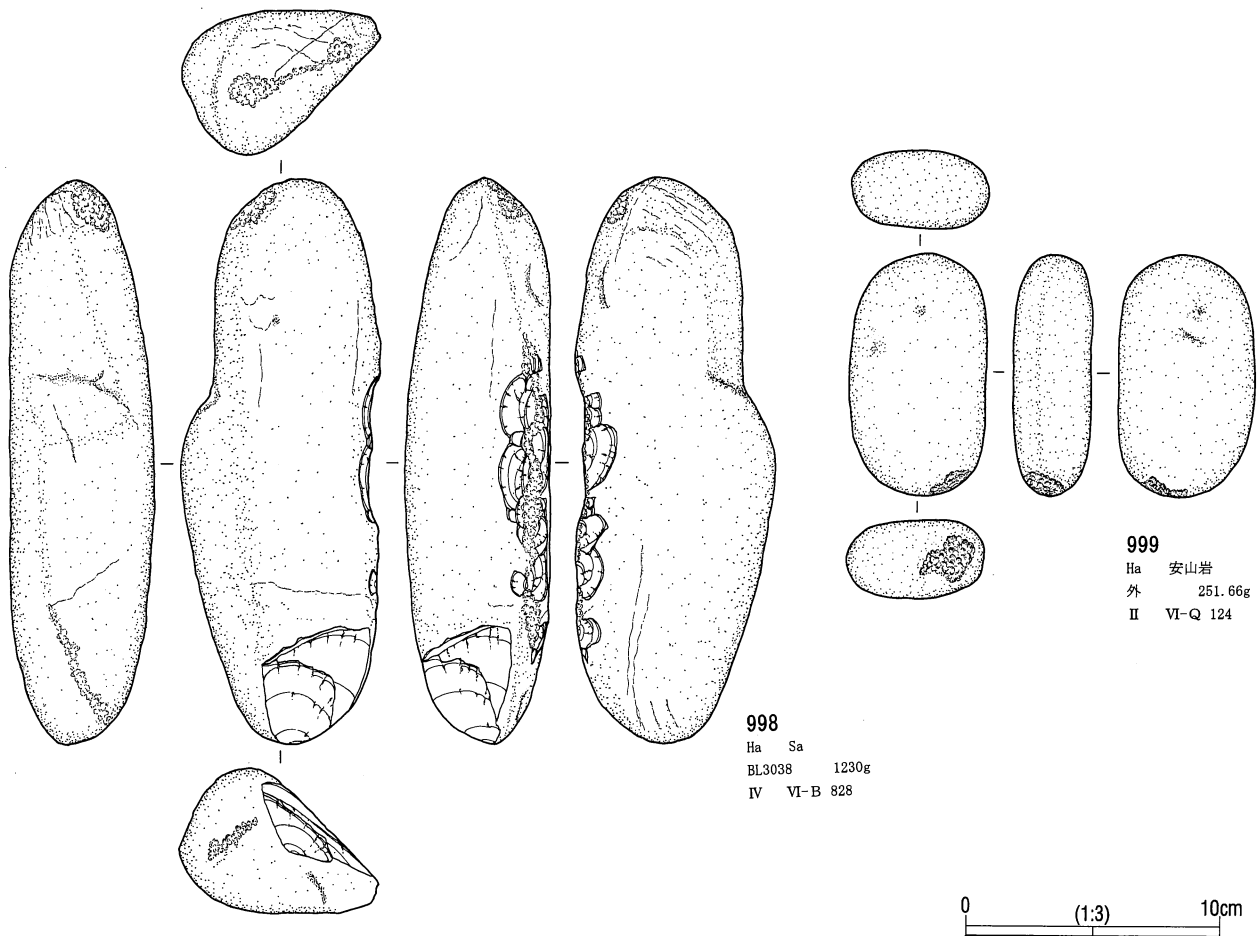

998  
Ha Sa  
BL3038 1230g  
IV VI-B 828

999  
Ha 安山岩  
外 251.66g  
II VI-Q 124

0 (1:3) 10cm

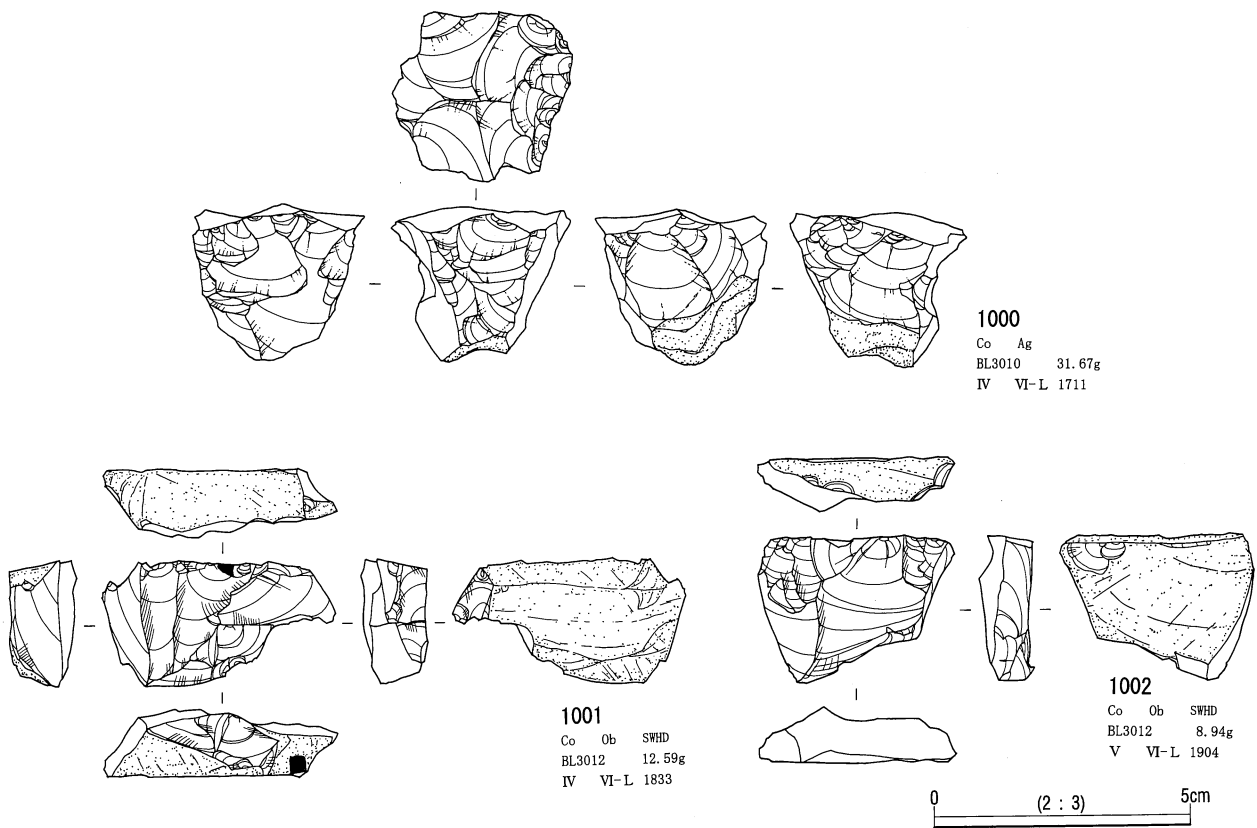

1000  
Co Ag  
BL3010 31.67g  
IV VI-L 1711

1001  
Co Ob SWHD  
BL3012 12.59g  
IV VI-L 1833

1002  
Co Ob SWHD  
BL3012 8.94g  
V VI-L 1904

0 (2:3) 5cm

第3地点 石器実測図 51 (敲石3・石核1) (貫ノ木遺跡)

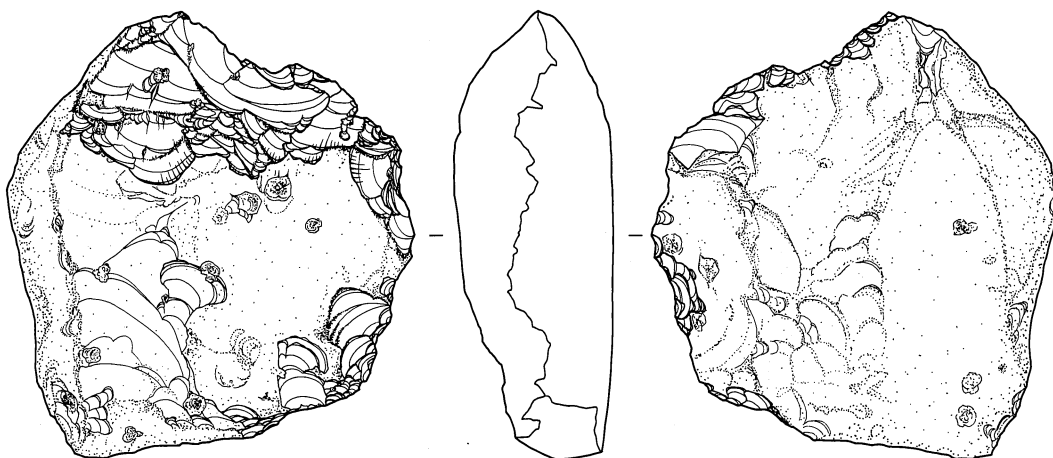

1003  
 Co Ob WDTY  
 BL3012 542.64g  
 V VI-L 1937

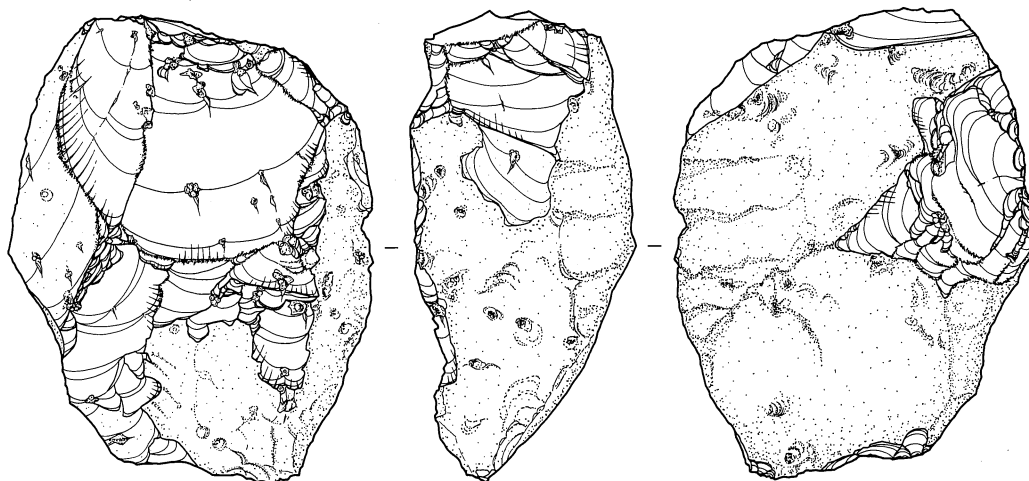
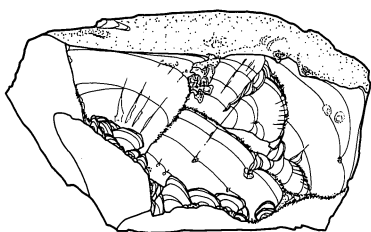

1004  
 Co Ob WDTY  
 BL3014 730.77g  
 V VI-L 1918

0 (1 : 2) 5cm

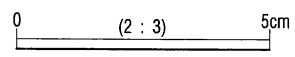
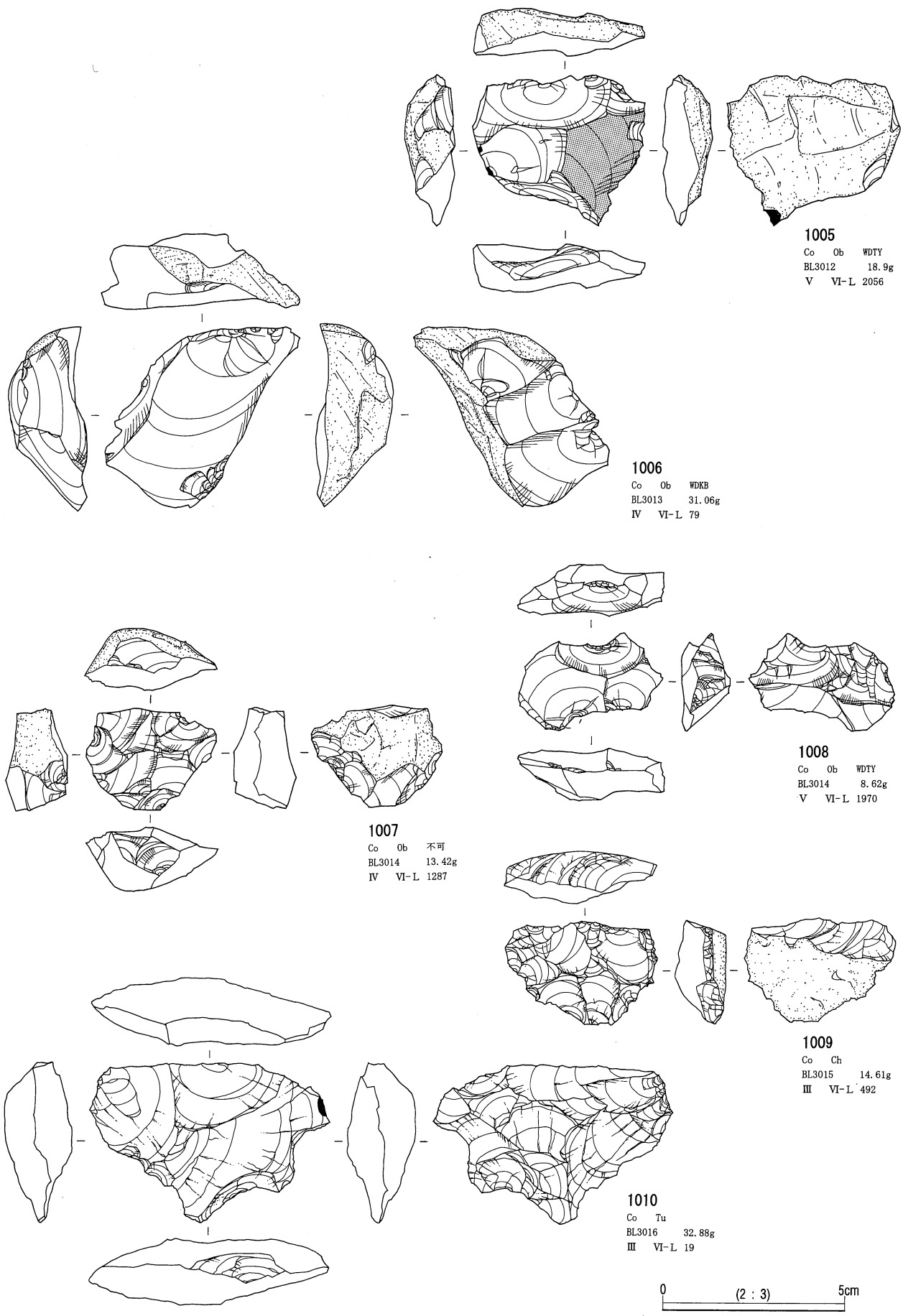

第3地点 石器実測図 53 (石核3) (貫ノ木遺跡)

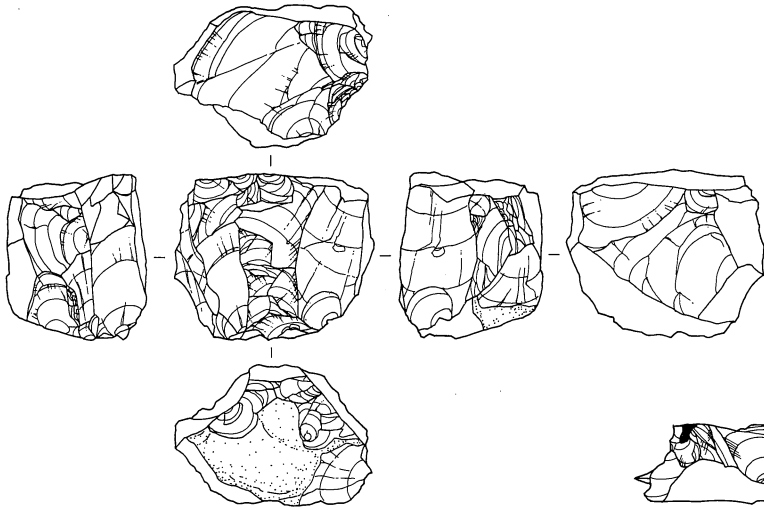

1011  
Co Ch  
BL3016 44.6g  
IV VI-L 67

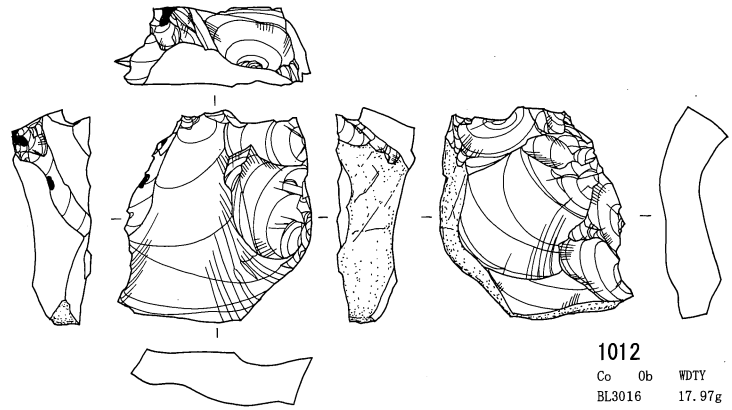

1012  
Co Ob WDTV  
BL3016 17.97g  
III VI-L 467

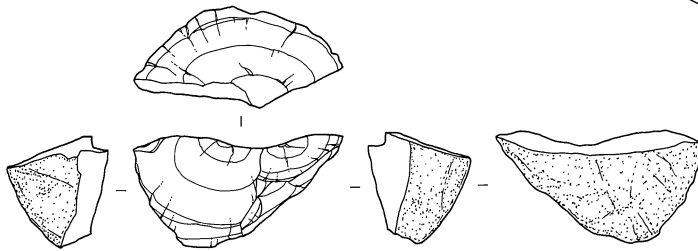

1013  
Co Tu  
BL3018 10.54g  
III VI-G 84

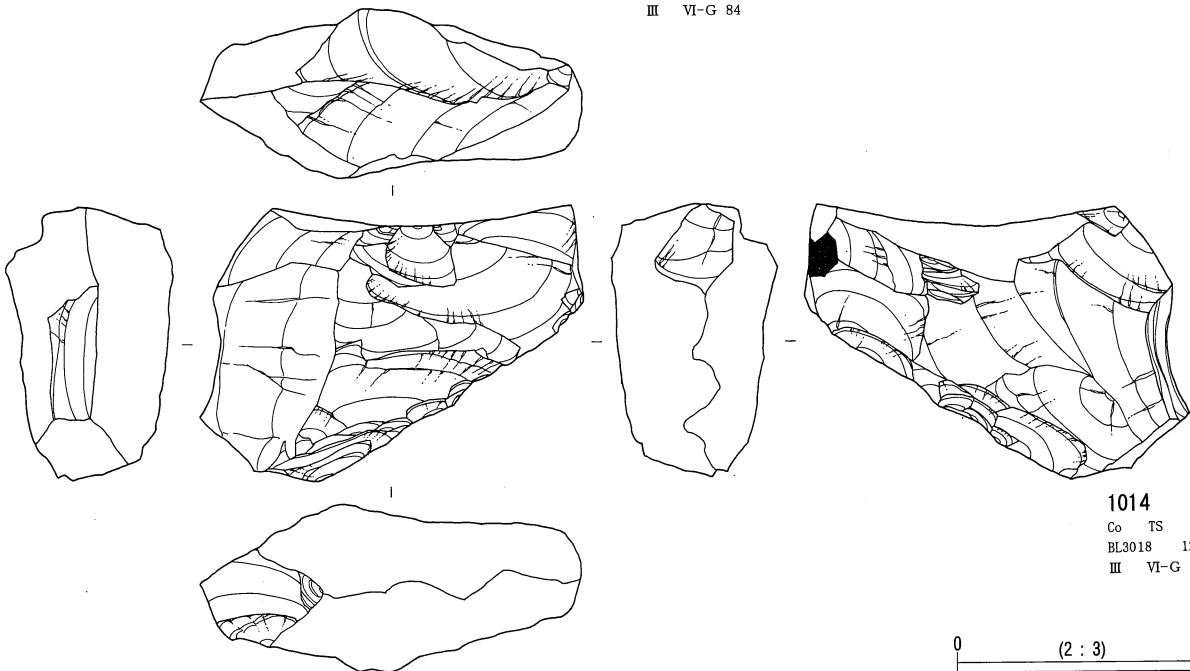

1014  
Co TS  
BL3018 122.38g  
III VI-G 115

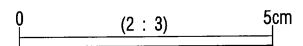

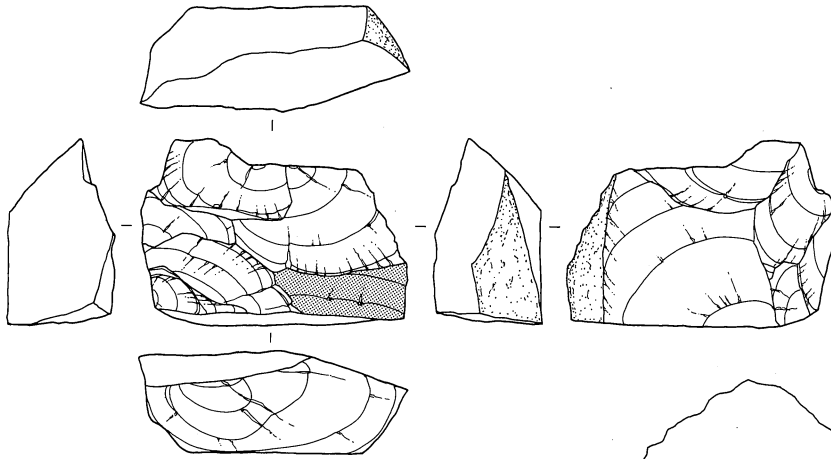

1015  
Co An  
BL3018 40.3g  
III VI-G 109

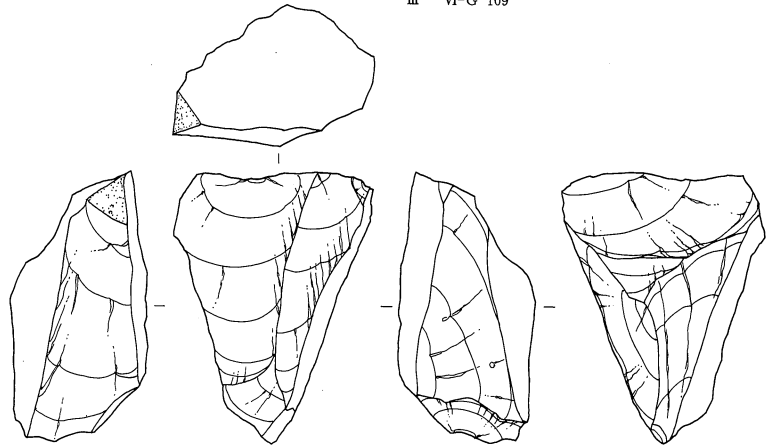

1016  
Co An  
BL3018 41.92g  
IV VI-G 1087

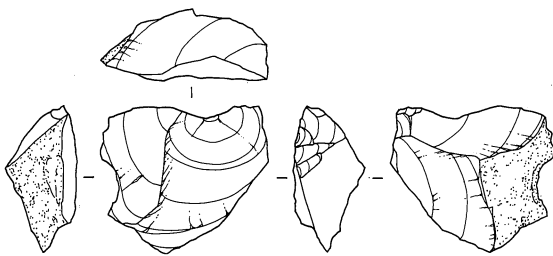

1017  
Co Ag  
BL3018 6.89g  
V VI-G 908

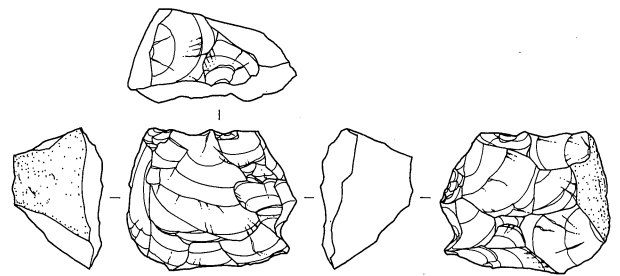

1018  
Co Ch  
BL3018 16.5g  
V VI-G 1188

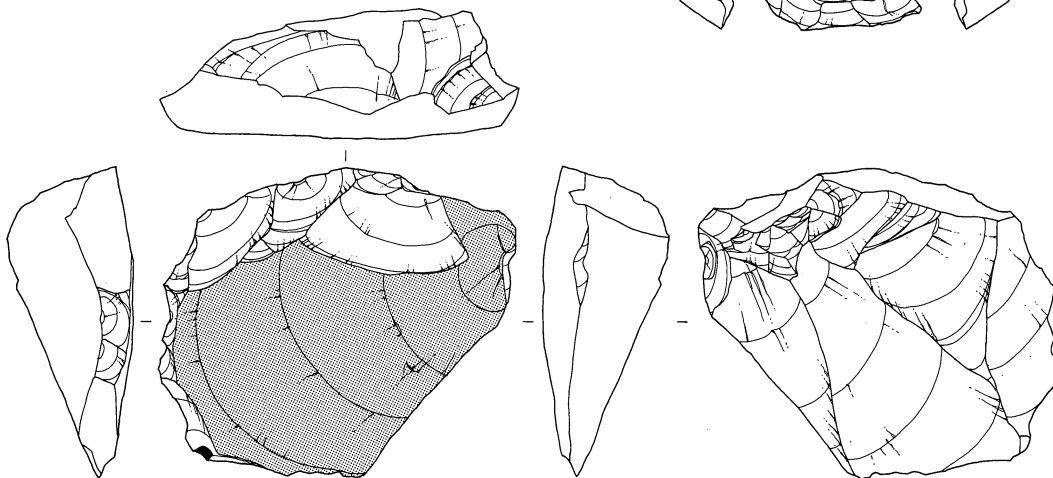

1019  
Co TS  
BL3018 81.51g  
V VI-G 1202

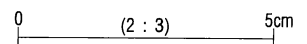

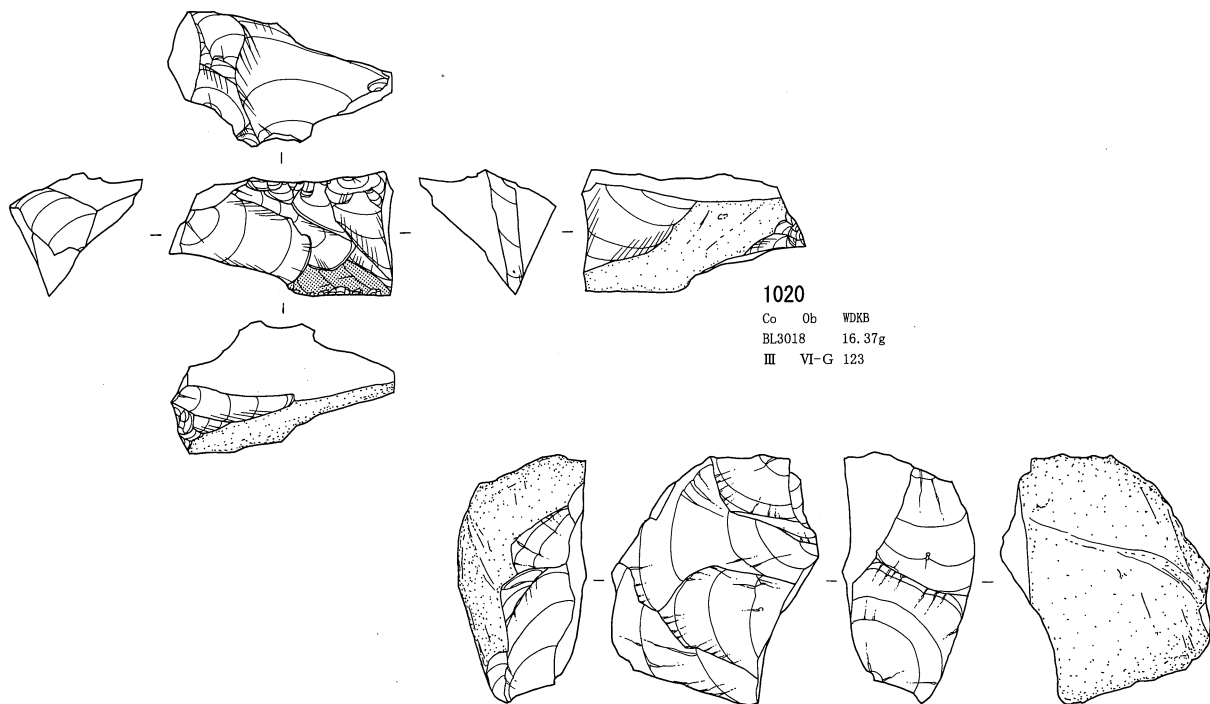

1020  
Co Ob WDKB  
BL3018 16.37g  
III VI-G 123

1021  
Co An  
BL3018 50.26g  
IV VI-G 350

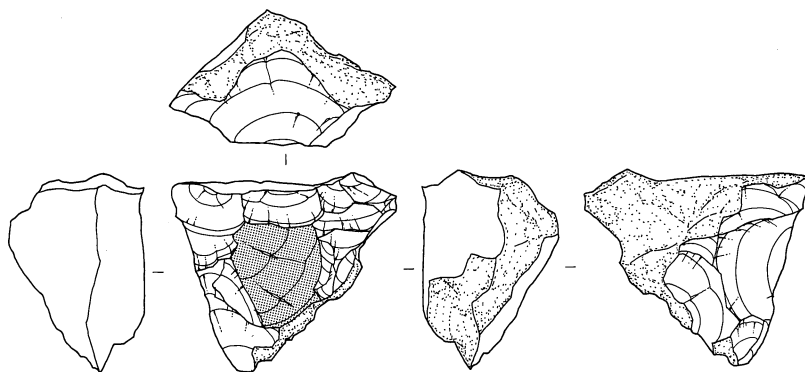

1022  
Co Ag  
BL3018 26.99g  
IV VI-G 366

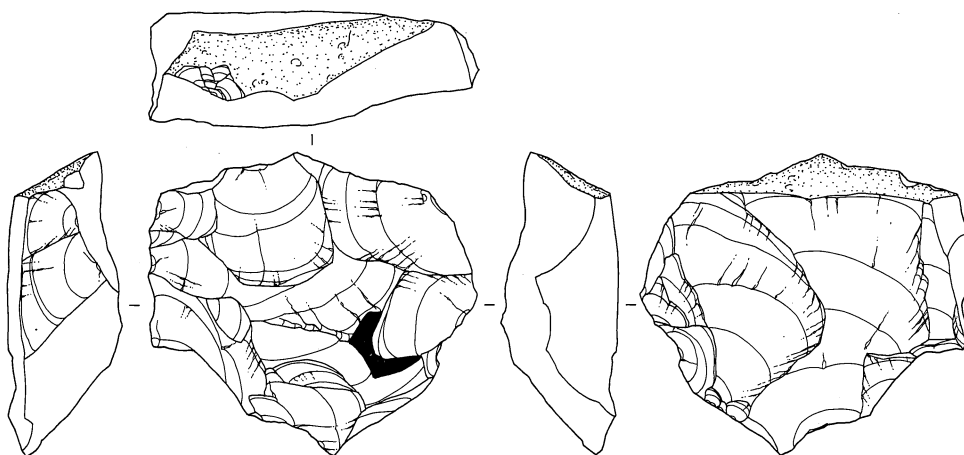

1023  
Co Tu  
BL3018 64.16g  
V VI-G 906

0 (2:3) 5cm

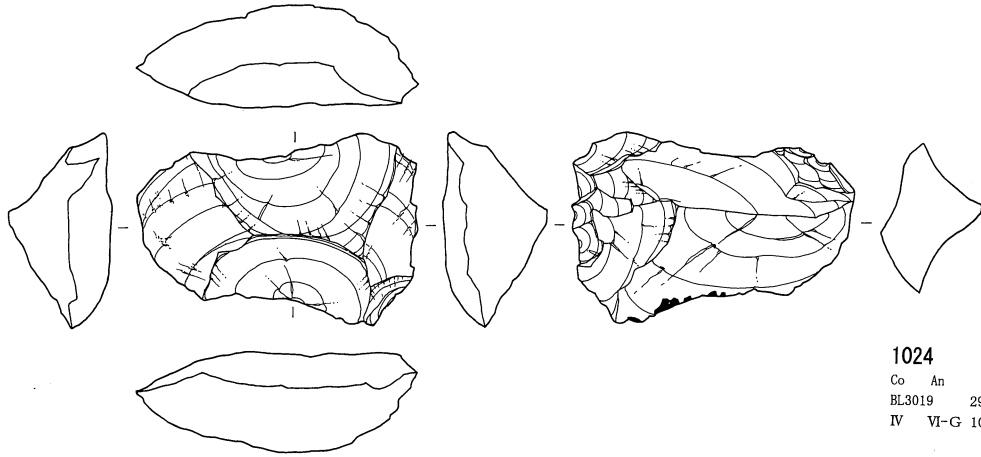

1024  
Co An  
BL3019 29.57g  
IV VI-G 1079

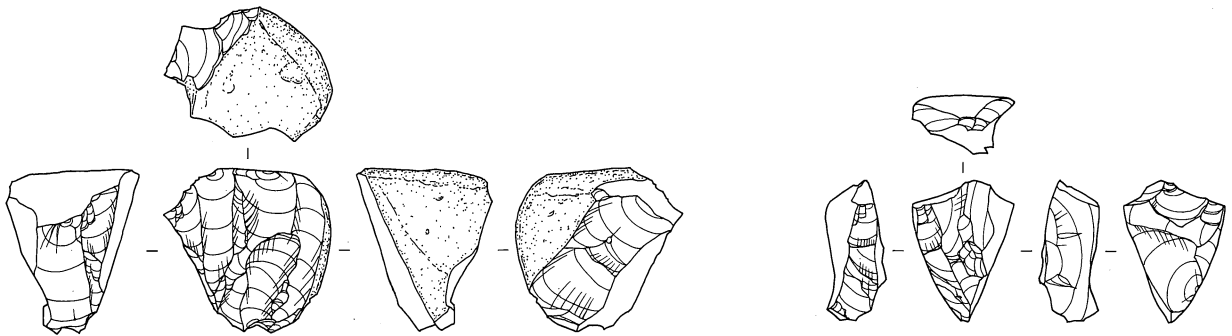

1025  
Co Ob WDTY  
BL3019 19.87g  
IV VI-G 3985

1026  
Co Ob SWHD  
BL3020 4.14g  
IV VI-G 188

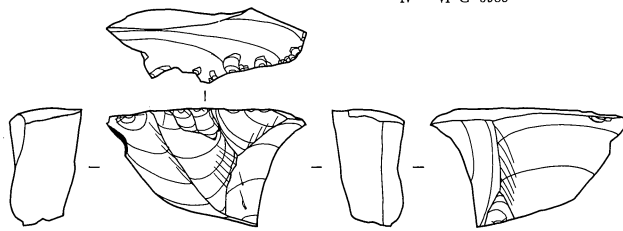

1027  
Co Ob SWHD  
BL3020 8.47g  
IV VI-G 495

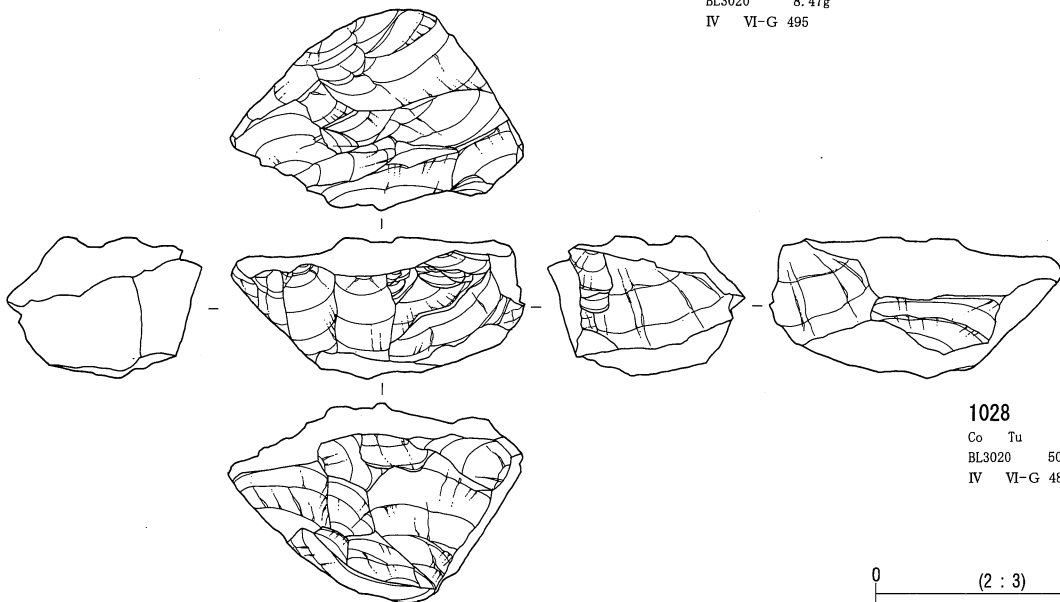

1028  
Co Tu  
BL3020 50.62g  
IV VI-G 486

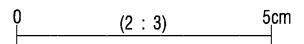

第3地点 石器実測図 57 (石核7) (貫ノ木遺跡)



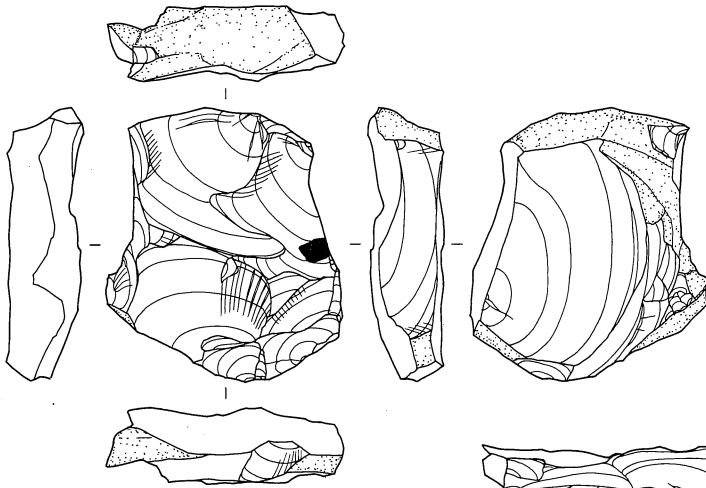

1029  
Co Ob WKB  
BL3020 29.69g  
IV VI-G 404

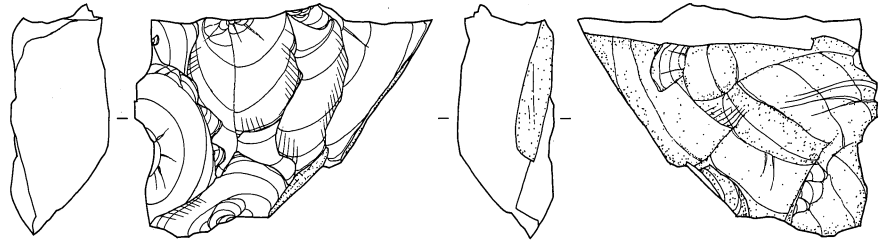
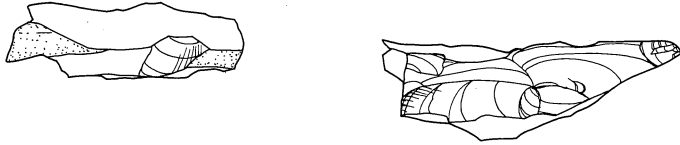

1030  
Co Ob SWHD  
BL3020 32.76g  
IV VI-G 489

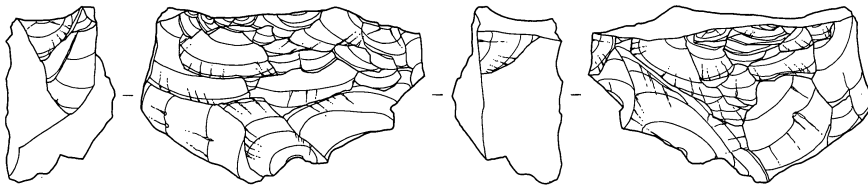
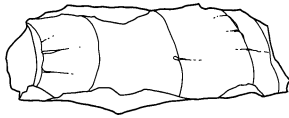

1031  
Co An  
BL3020 33.66g  
IV VI-G 548

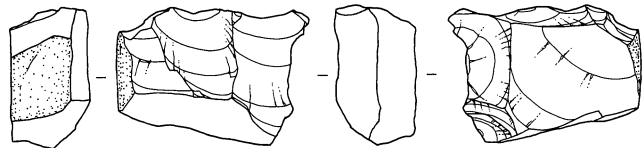

1032  
Co An  
BL3020 17.12g  
IV VI-G 569

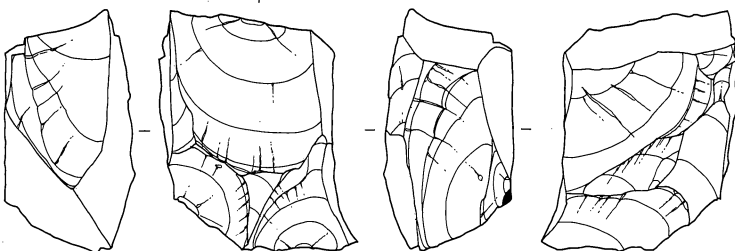
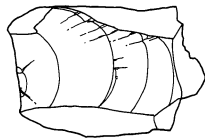

1033  
Co An  
BL3020 48.57g  
IV VI-G 616

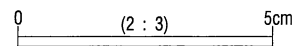

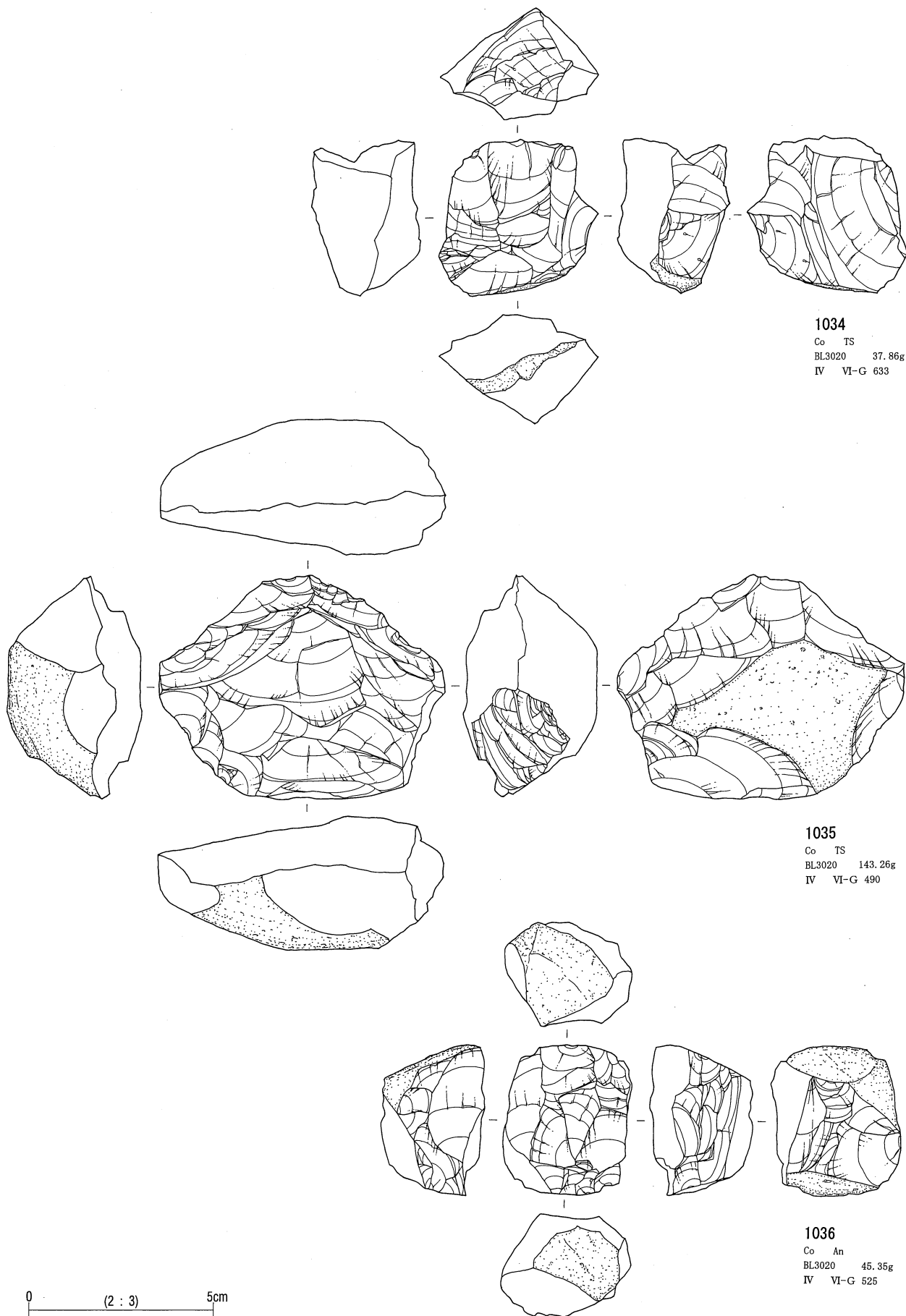

1034  
Co TS  
BL3020 37.86g  
IV VI-G 633

1035  
Co TS  
BL3020 143.26g  
IV VI-G 490

1036  
Co An  
BL3020 45.35g  
IV VI-G 525

0 (2:3) 5cm

第3地点 石器実測図 59 (石核9) (貫ノ木遺跡)

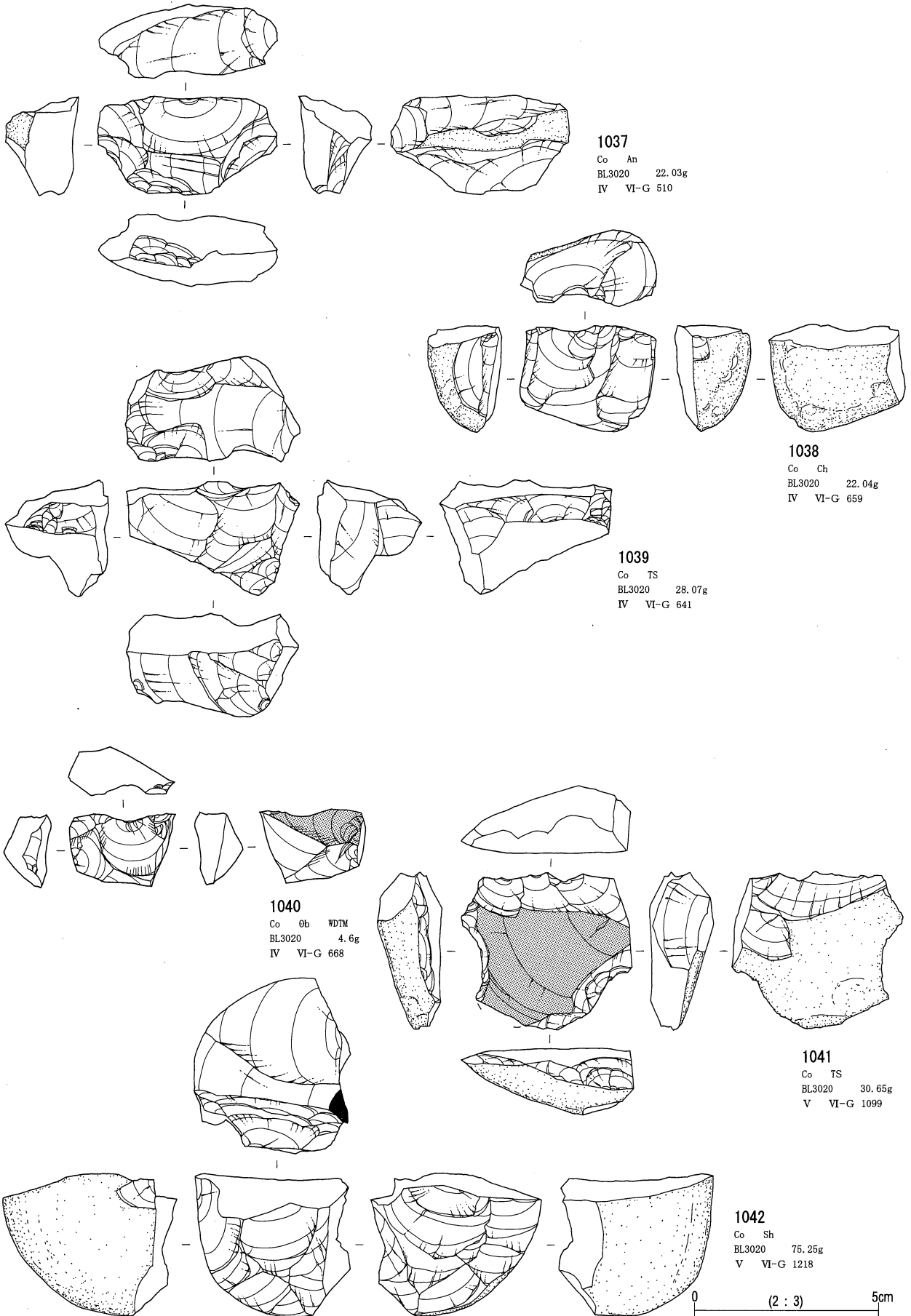

第3地点 石器実測図 60 (石核 10) (貫ノ木遺跡)

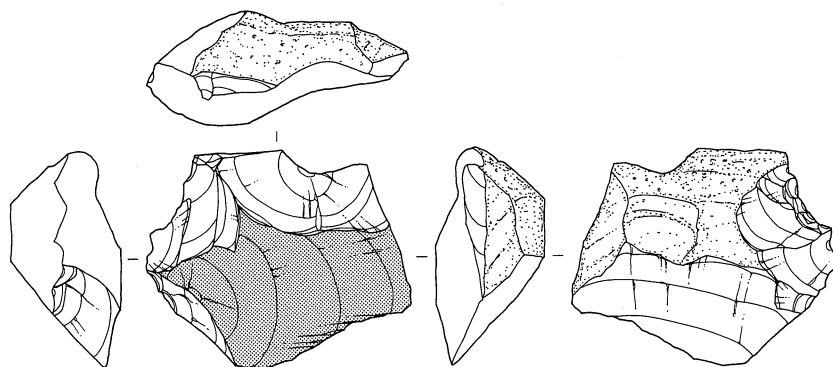

1043  
Co TS  
BL3020 35.2g  
V VI-G 1235

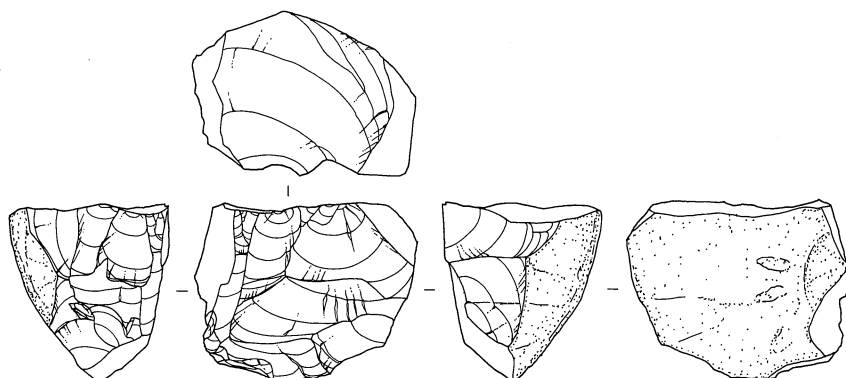

1044  
Co TS  
BL3020 49.57g  
V VI-G 1309

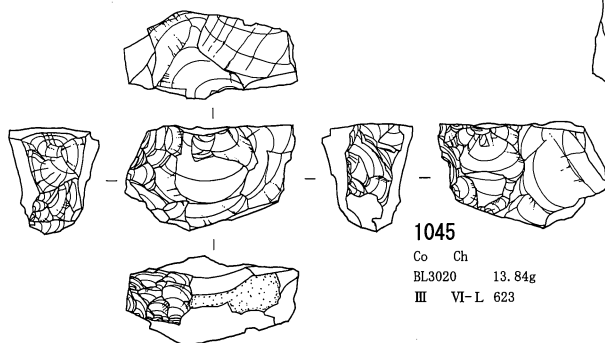

1045  
Co Ch  
BL3020 13.84g  
III VI-L 623

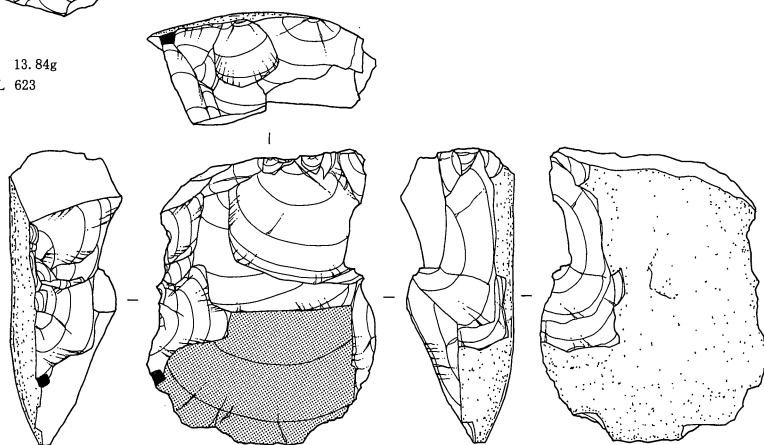

1046  
Co Sh  
BL3020 50.9g  
IV VI-L 1023

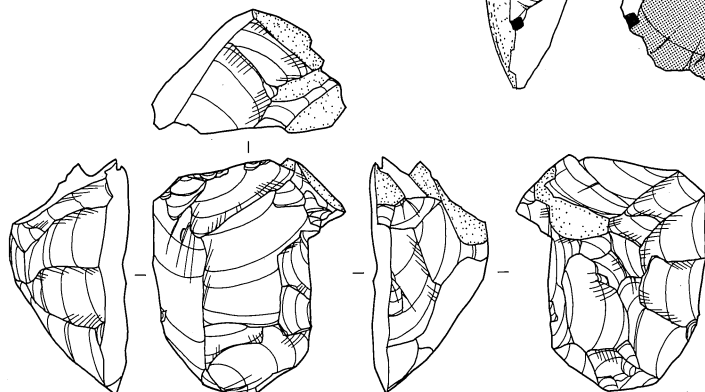

1047  
Co Ob WDKB  
BL3021 28.19g  
V VI-G 1134

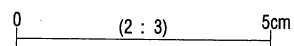

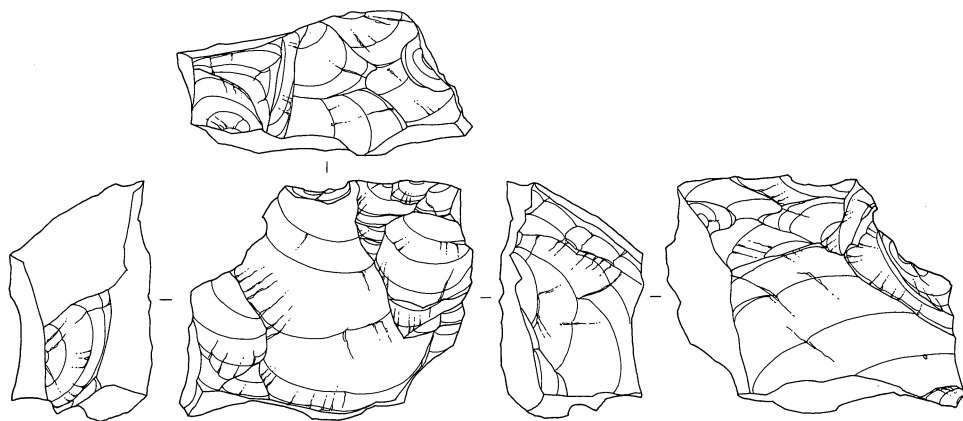

1048

Co An  
 BL3021 75.03g  
 V VI-G 5948

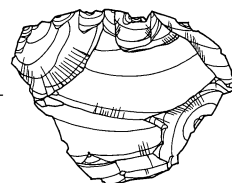
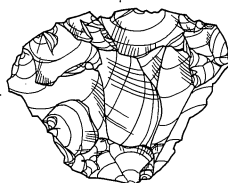
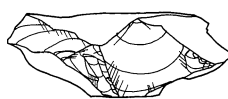

1049

Co Ob WOTM  
 BL3022 19.63g  
 III VI-L 1138

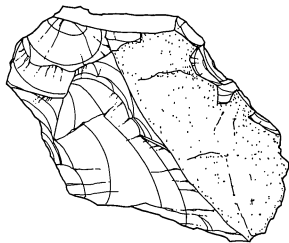
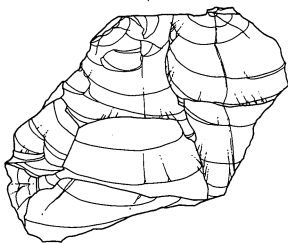
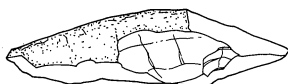

1050

Co Ch  
 BL3022 31.41g  
 IV VI-L 787

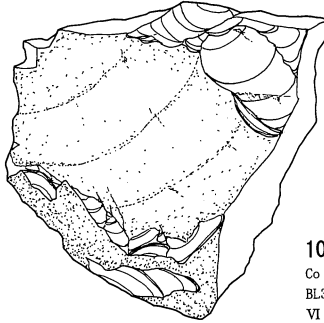
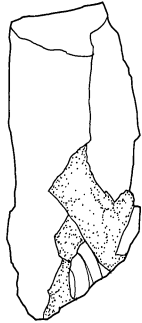
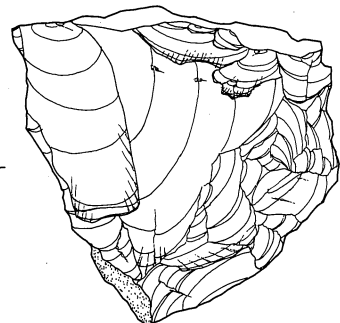
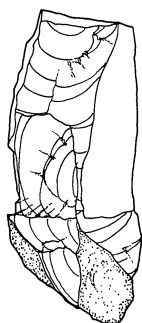
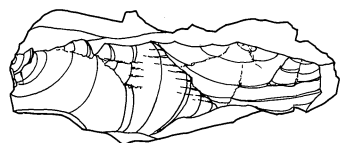

1051

Co Ch  
 BL3022 99.93g  
 VI VI-L 1852

0 (2:3) 5cm

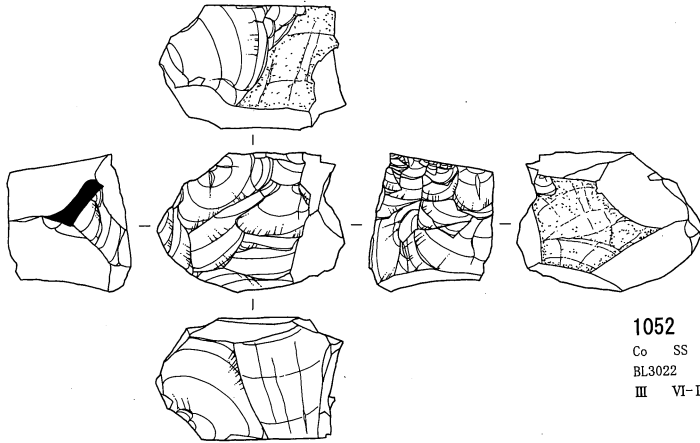

1052  
Co SS  
BL3022 26.91g  
III VI-L 731

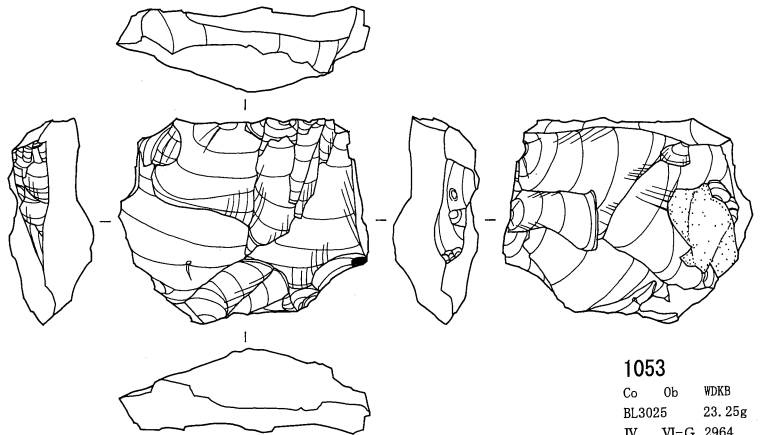

1053  
Co Ob WDKB  
BL3025 23.25g  
IV VI-G 2964

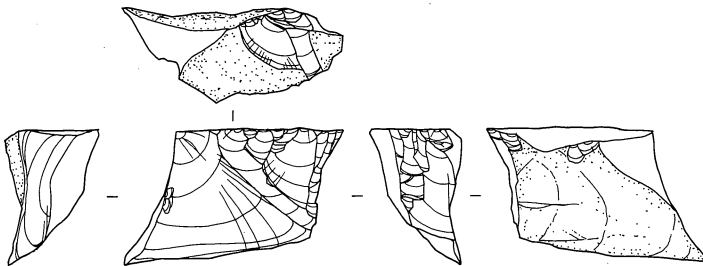

1054  
Co Ob SWHD  
BL3025 11.98g  
V b VI-G 5897

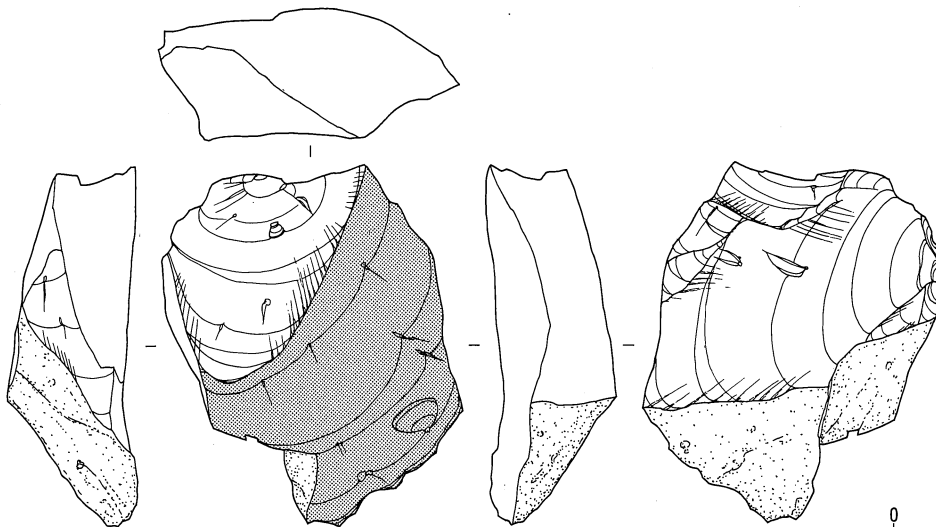

1055  
Co Ob WDTY  
BL3025 65.89g  
V b VI-G 5900

0 (2 : 3) 5cm

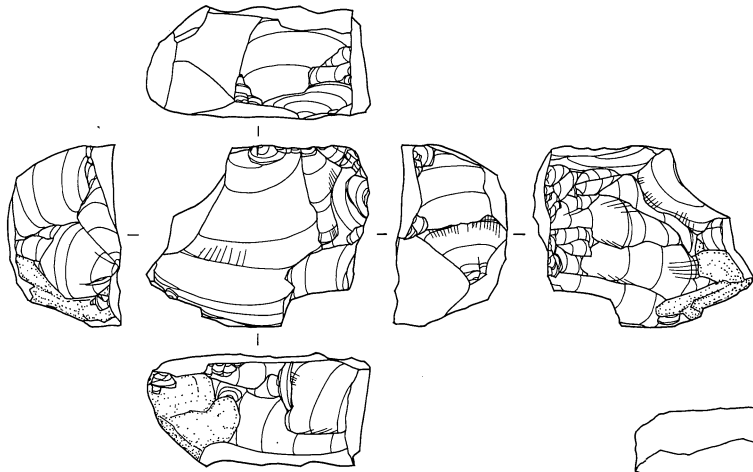

1056  
 Co Ob WDKB  
 BL3026 35.03g  
 V VI-G 5975

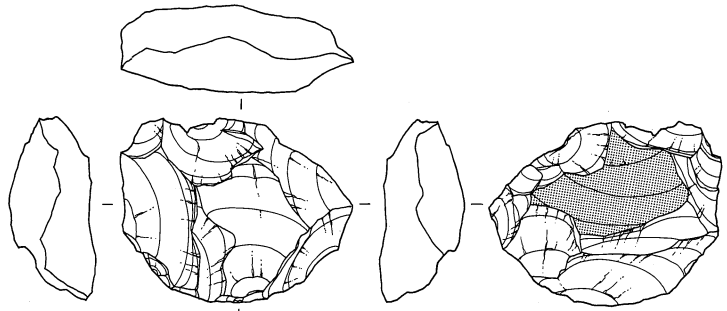

1057  
 Co An  
 BL3027 26.32g  
 V VI-G 5482

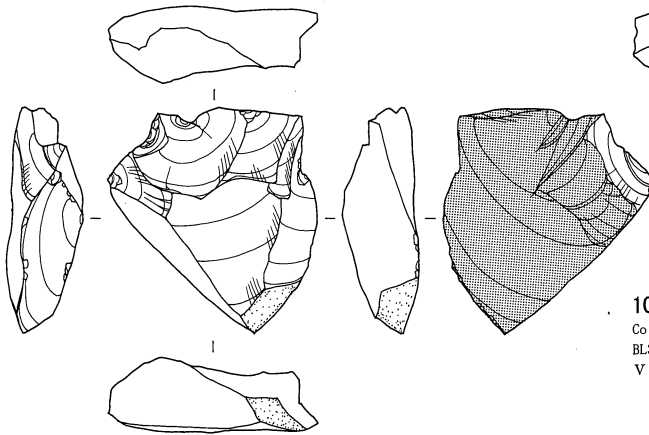

1058  
 Co Ob SWHD  
 BL3027 17.54g  
 V VI-G 5493

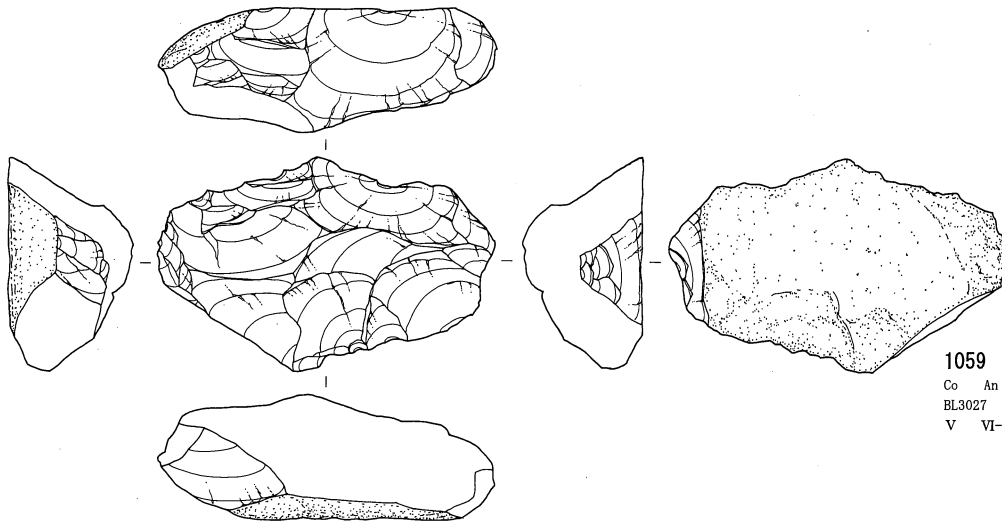

1059  
 Co An  
 BL3027 58.59g  
 V VI-G 6028

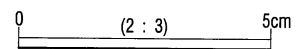

第3地点 石器実測図 64 (石核 14) (貫ノ木遺跡)

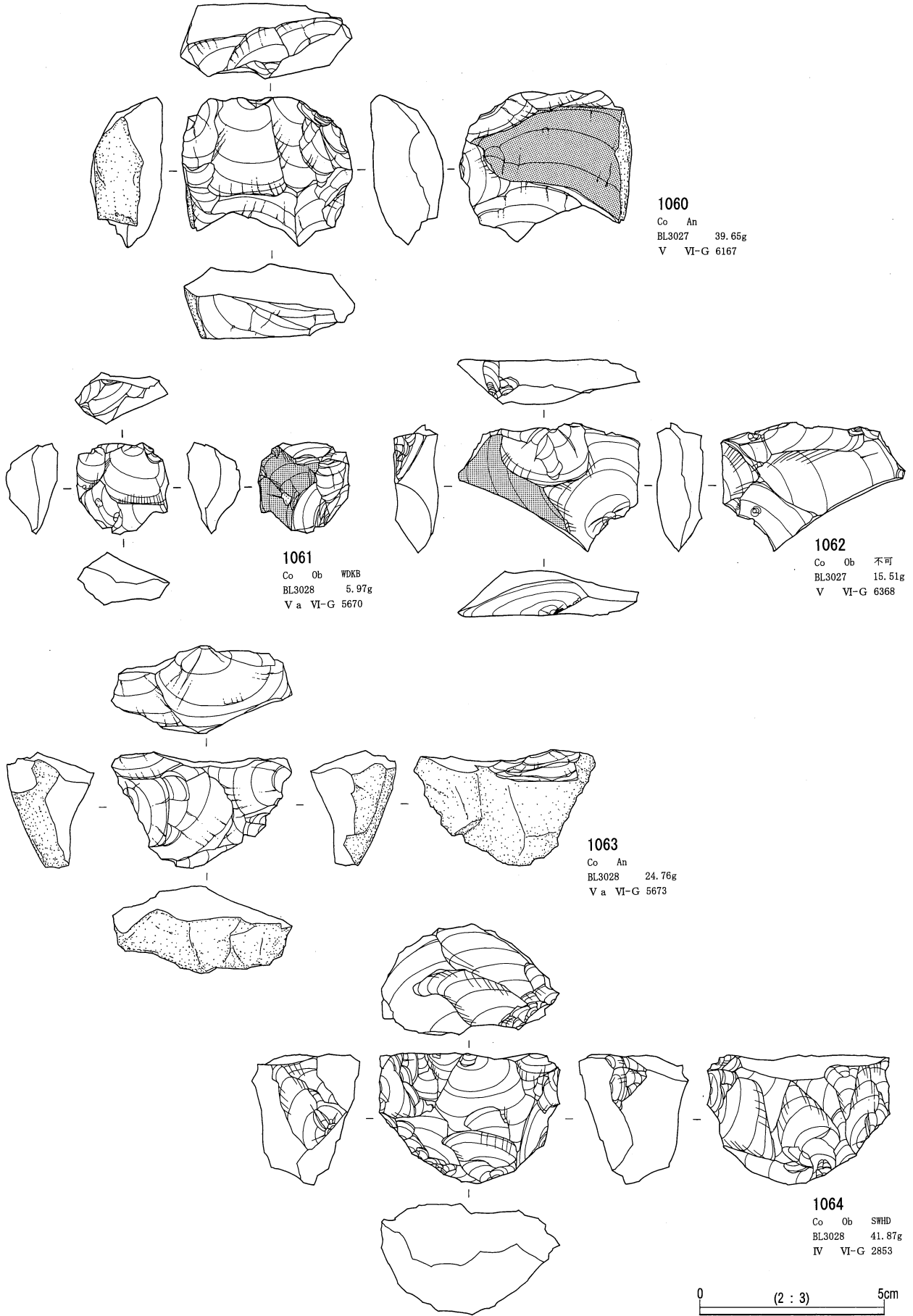

第3地点 石器実測図 65 (石核 15) (貫ノ木遺跡)



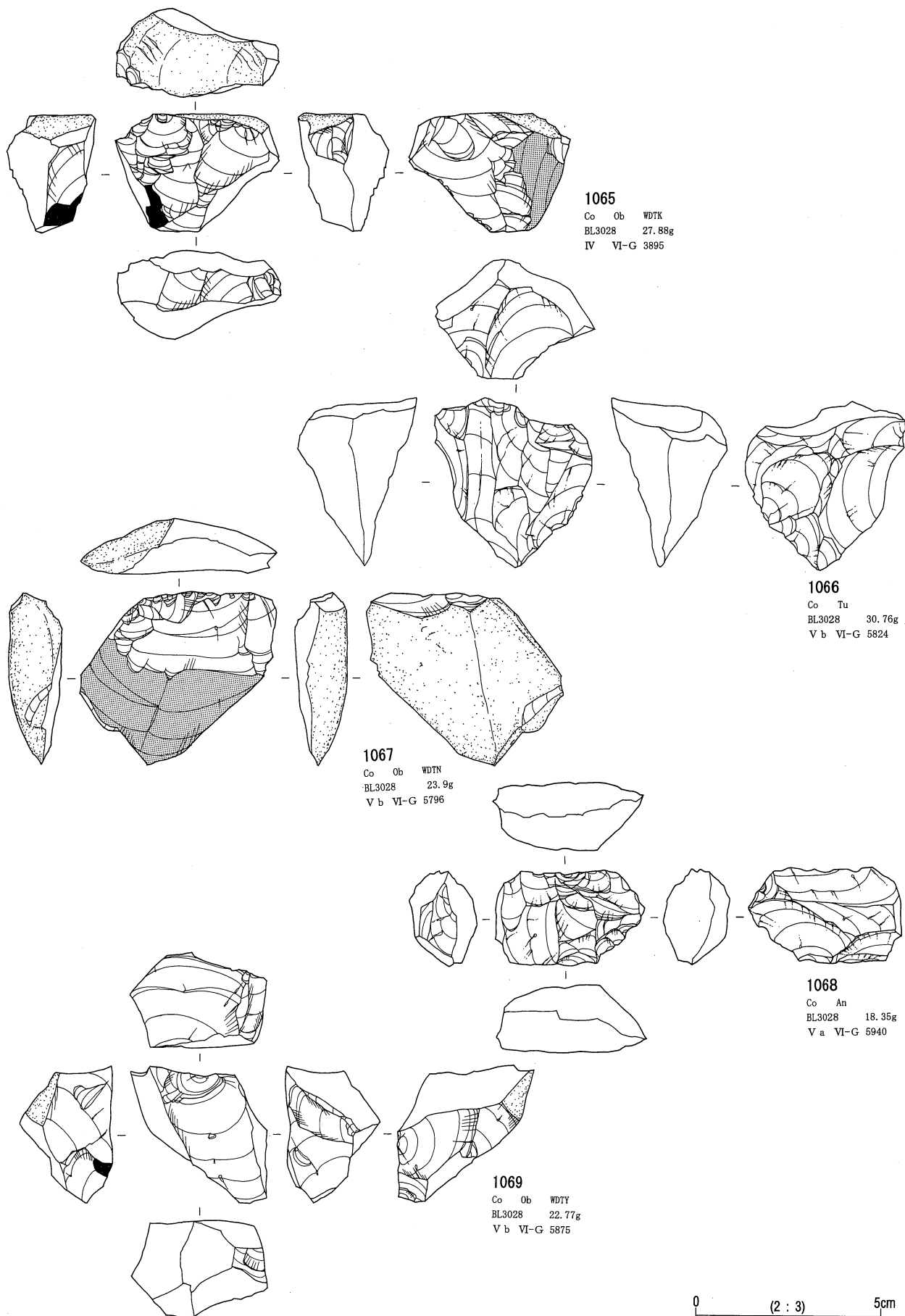

0 (2 : 3) 5cm

第3地点 石器実測図66(石核16)(貫ノ木遺跡)

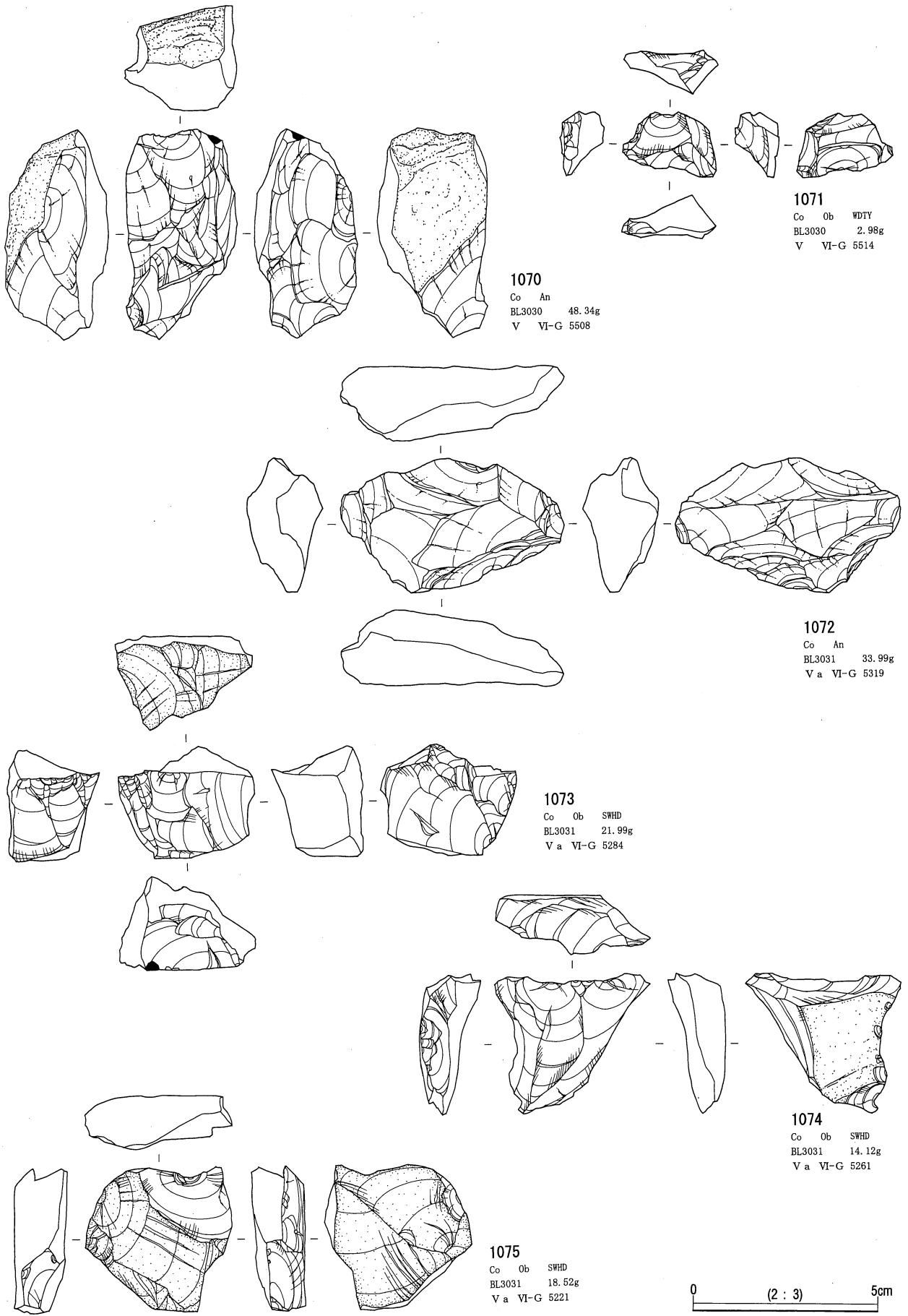

第3地点 石器実測図 67 (石核 17) (貫ノ木遺跡)

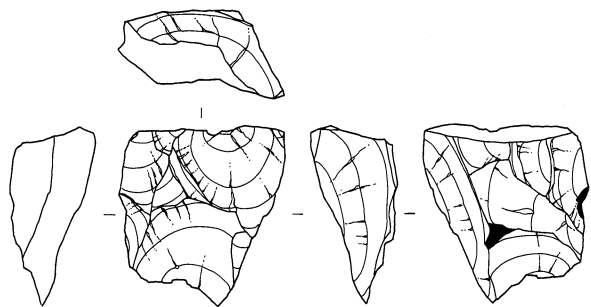

1076  
Co An  
BL3031 13.44g  
V a VI-G 5323

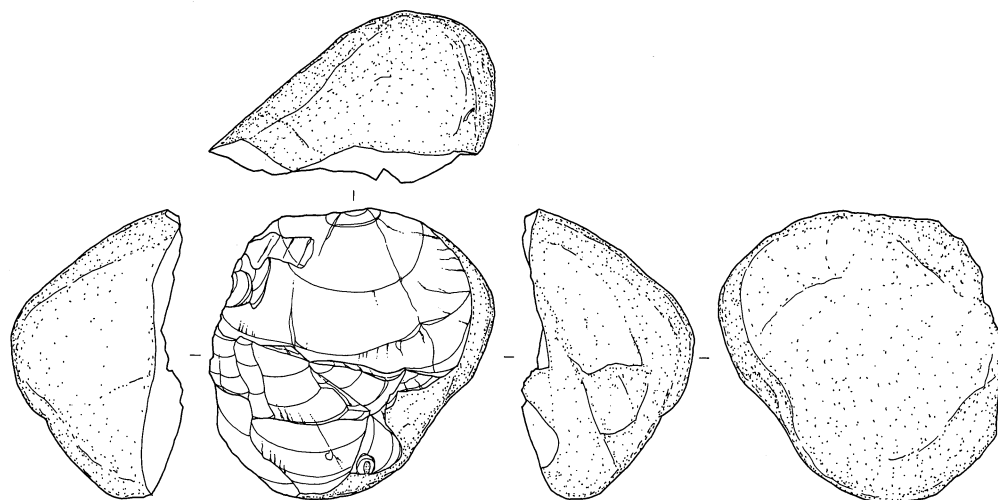

1077  
Co Ch  
BL3031 90.18g  
V a VI-G 5351

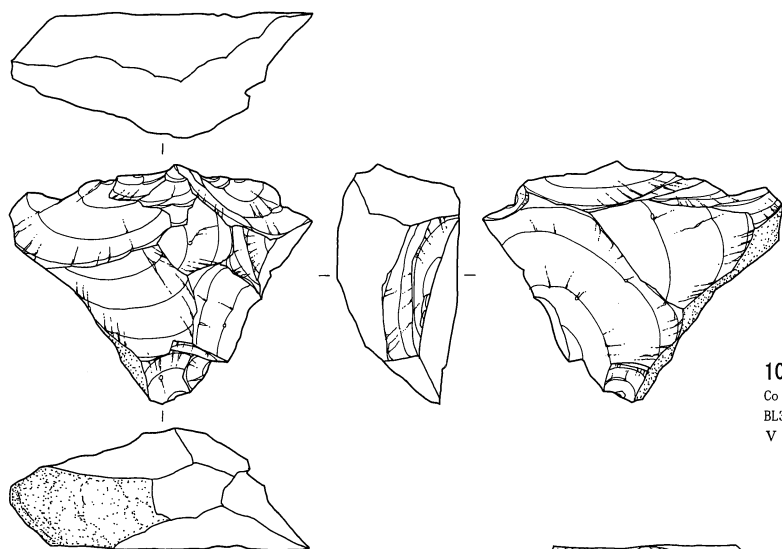

1078  
Co An  
BL3031 46.64g  
V VI-G 6100

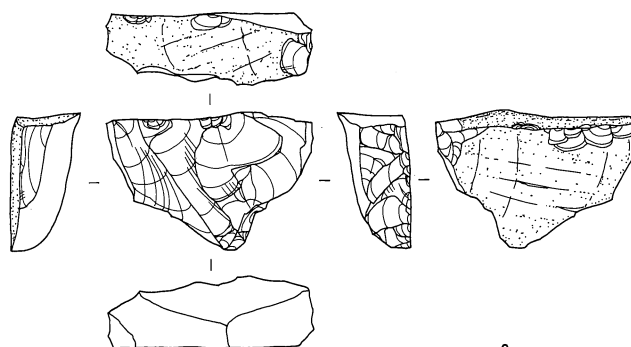

1079  
Co Ob SWHD  
BL3031 12.11g  
V a VI-G 6097

0 (2 : 3) 5cm

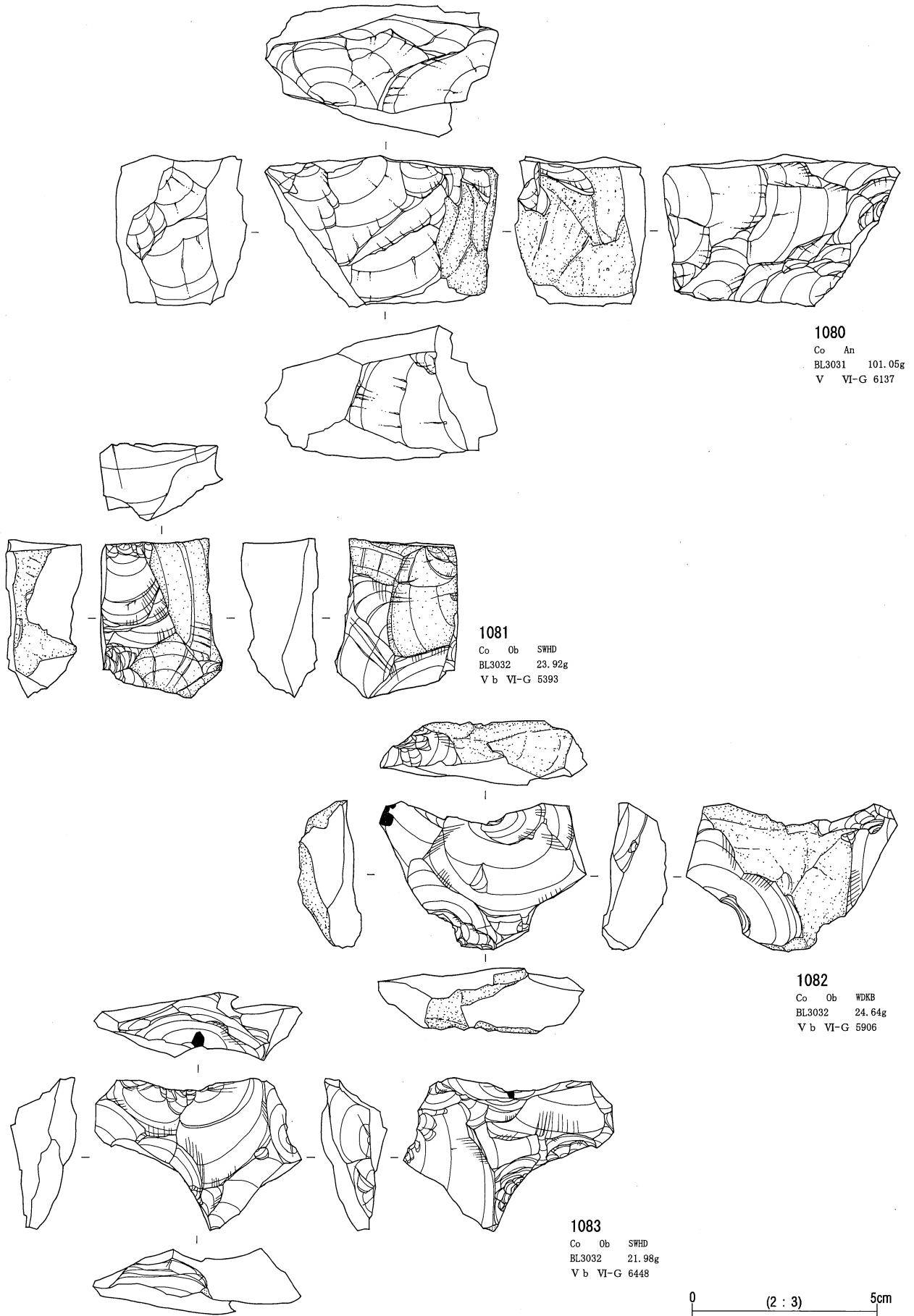

第3地点 石器実測図 69 (石核 19) (貫ノ木遺跡)

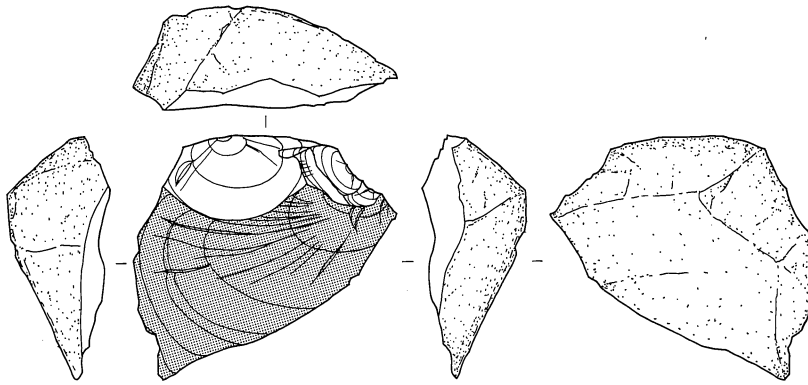

1084  
Co Ob SWHD  
BL3032 26.32g  
V b VI-G 5698

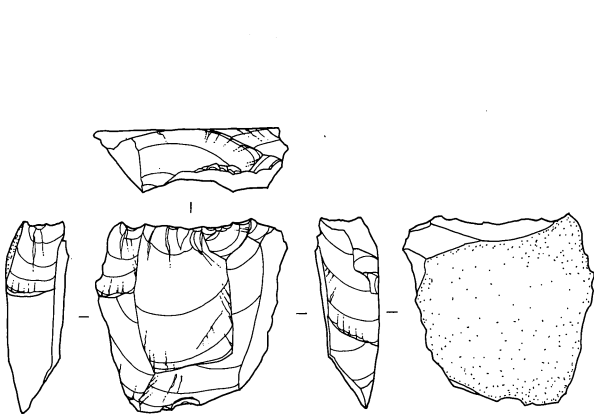

1085  
Co SS  
BL3034 18.03g  
V VI-G 6188

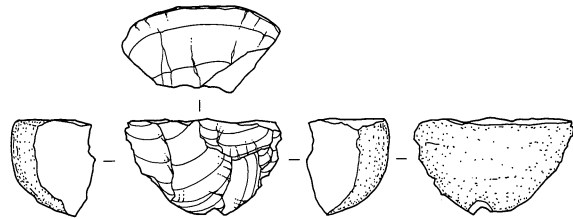

1086  
Co SS  
BL3035 8.45g  
IV VI-B 978

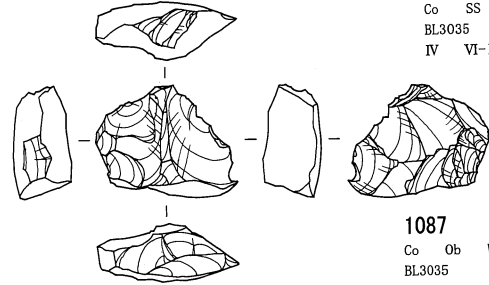

1087  
Co Ob WDTN  
BL3035 4.85g  
V VI-B 1457

0 (2:3) 5cm

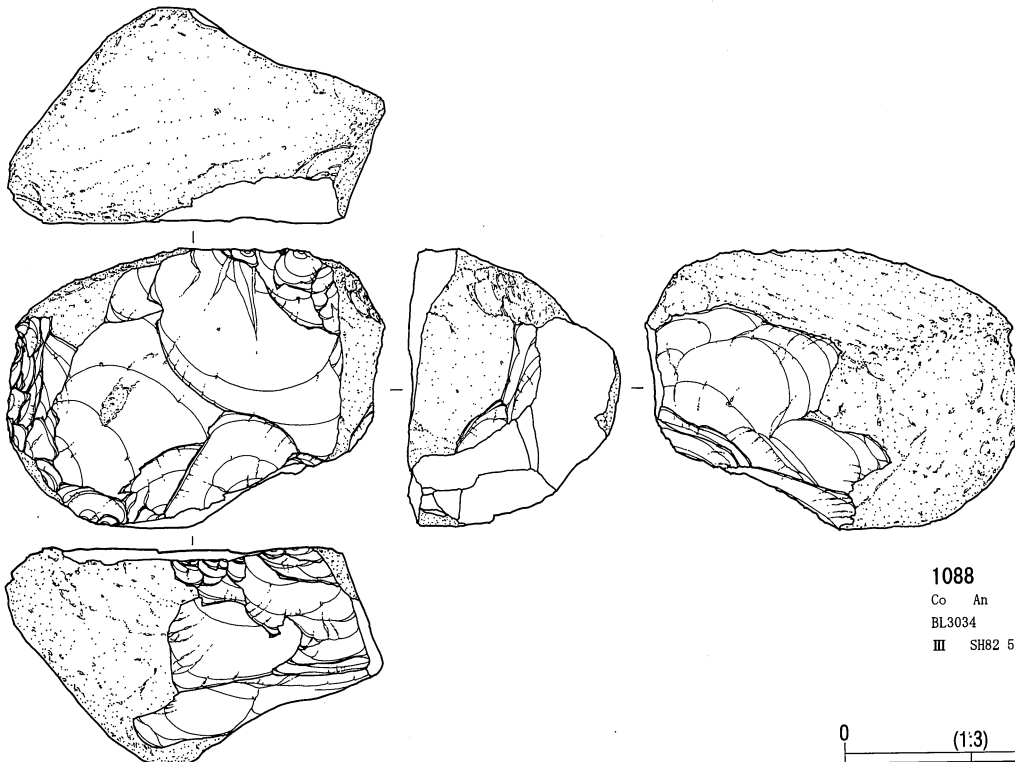

1088  
Co An  
BL3034 1520g  
III SH82 59

0 (1:3) 10cm

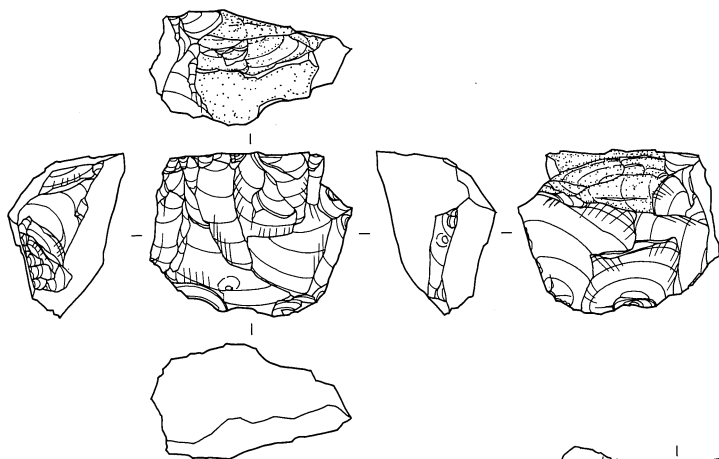

1089  
Co Ob WOTM  
BL3035 21.88g  
III VI-G 2369

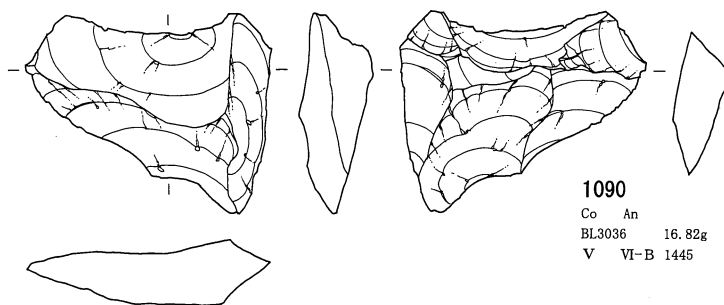

1090  
Co An  
BL3036 16.82g  
V VI-B 1445

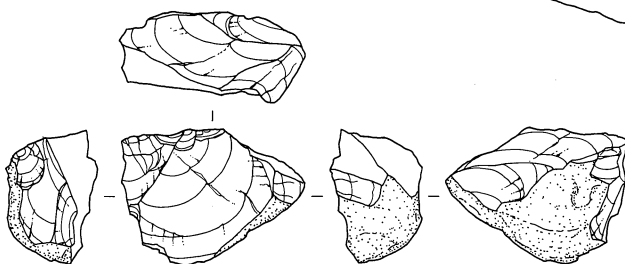

1091  
Co Ch  
BL3037 15.37g  
V VI-B 1269

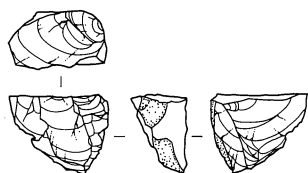

1092  
Co Ch  
BL3038 2.5g  
IV VI-B 798

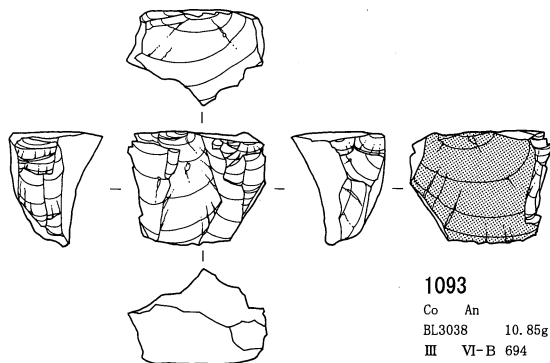

1093  
Co An  
BL3038 10.85g  
III VI-B 694

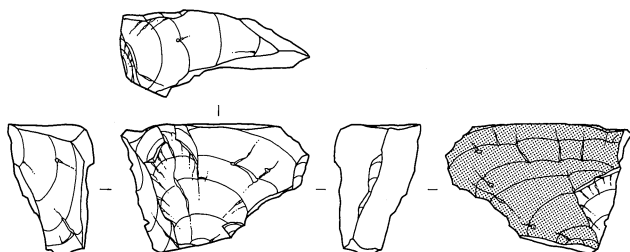

1094  
Co An  
BL3038 11.69g  
III VI-B 739

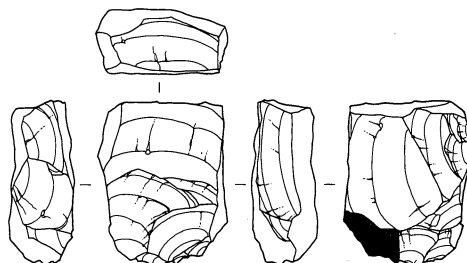

1095  
Co Tu  
BL3038 10.55g  
V VI-B 822

0 (2:3) 5cm

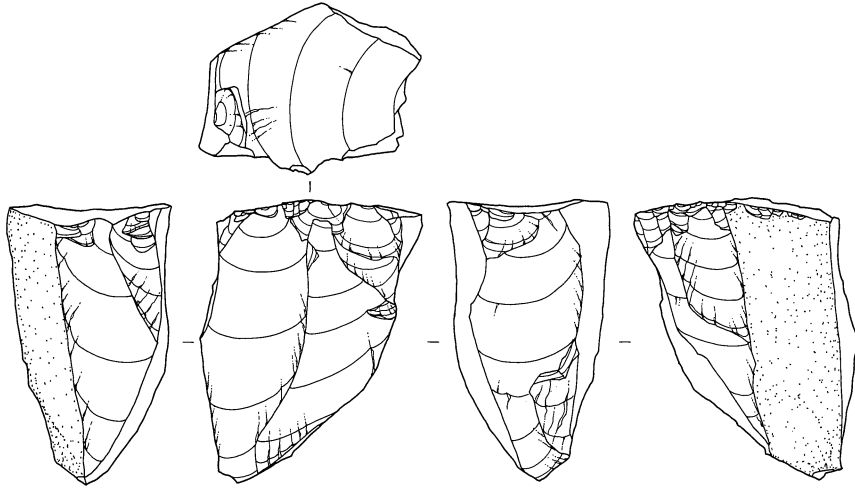

1096  
 Co SS  
 BL3038 76.51g  
 V VI-B 1313

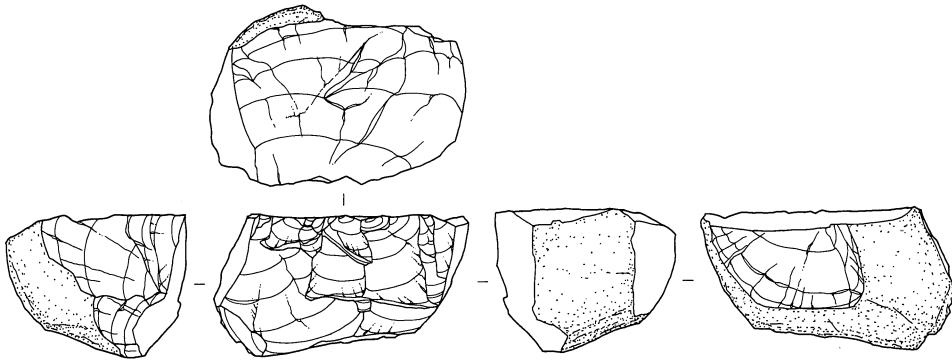

1097  
 Co Ch  
 BL3038 60.88g  
 III VI-B 1169

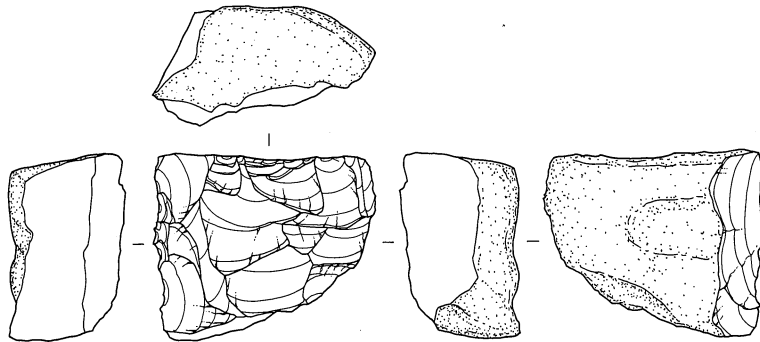

1098  
 Co Tu  
 BL3038 39.46g  
 V VI-B 1515

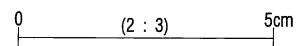

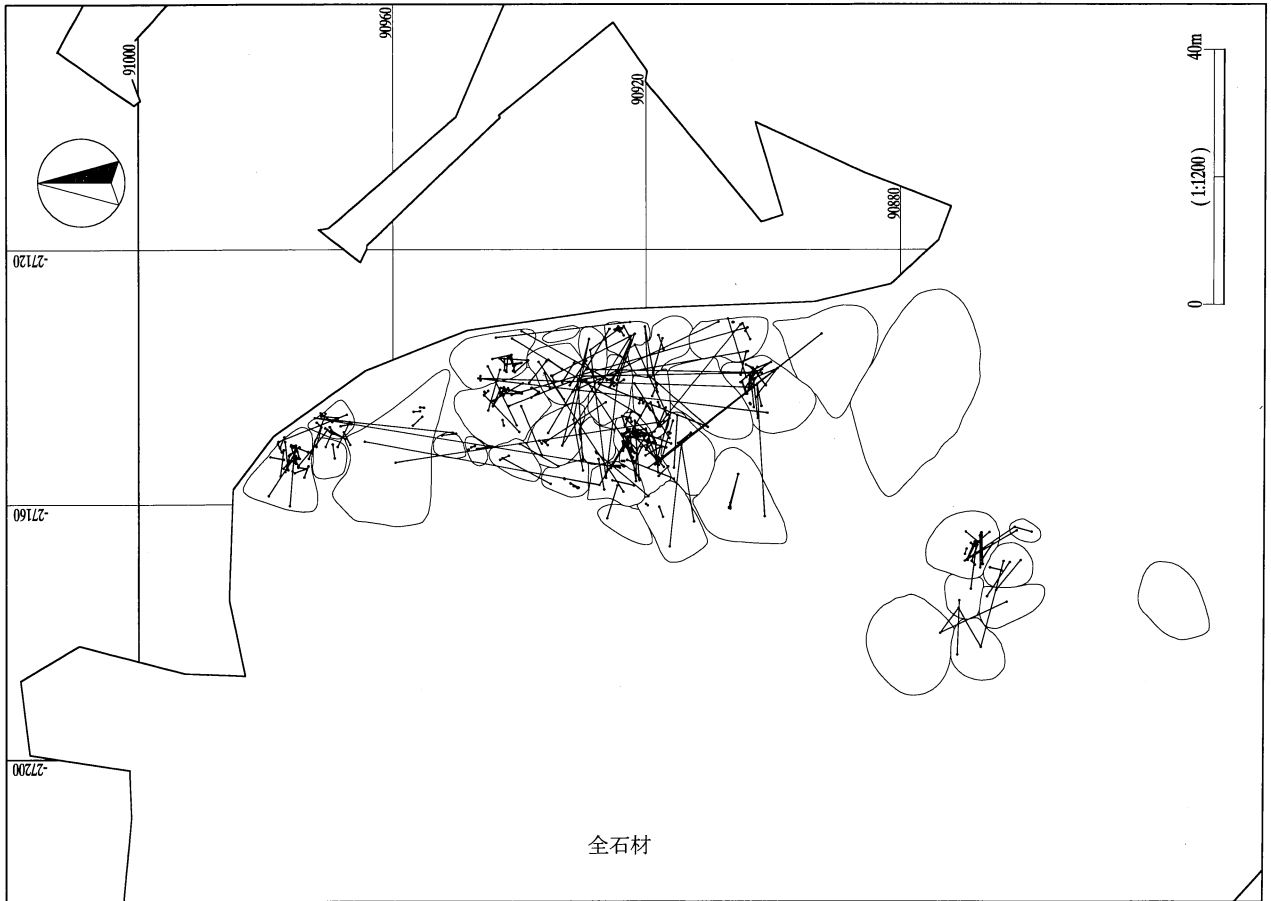

全石材

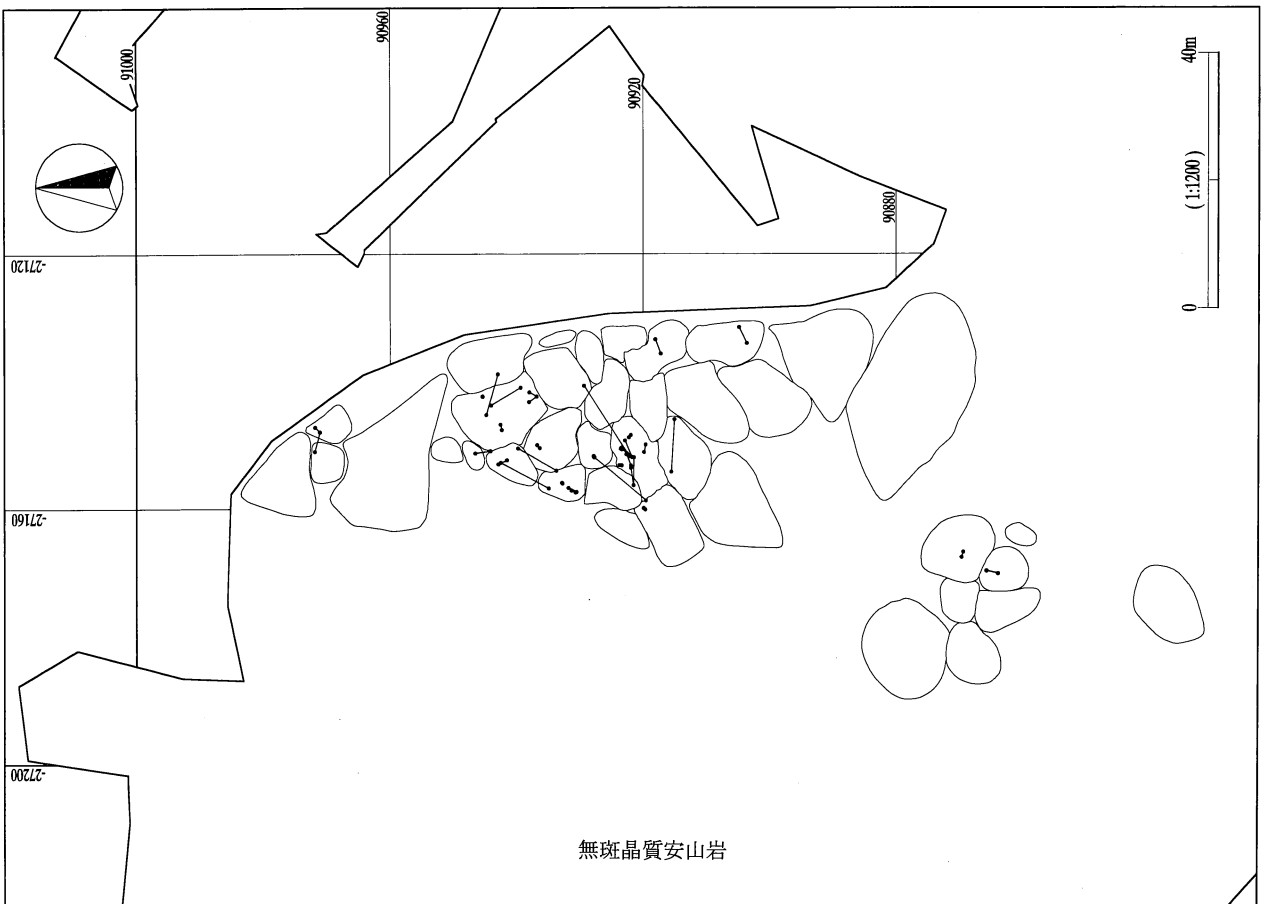

無斑晶質安山岩

第3地点 接合資料分布図1 (貫ノ木遺跡)



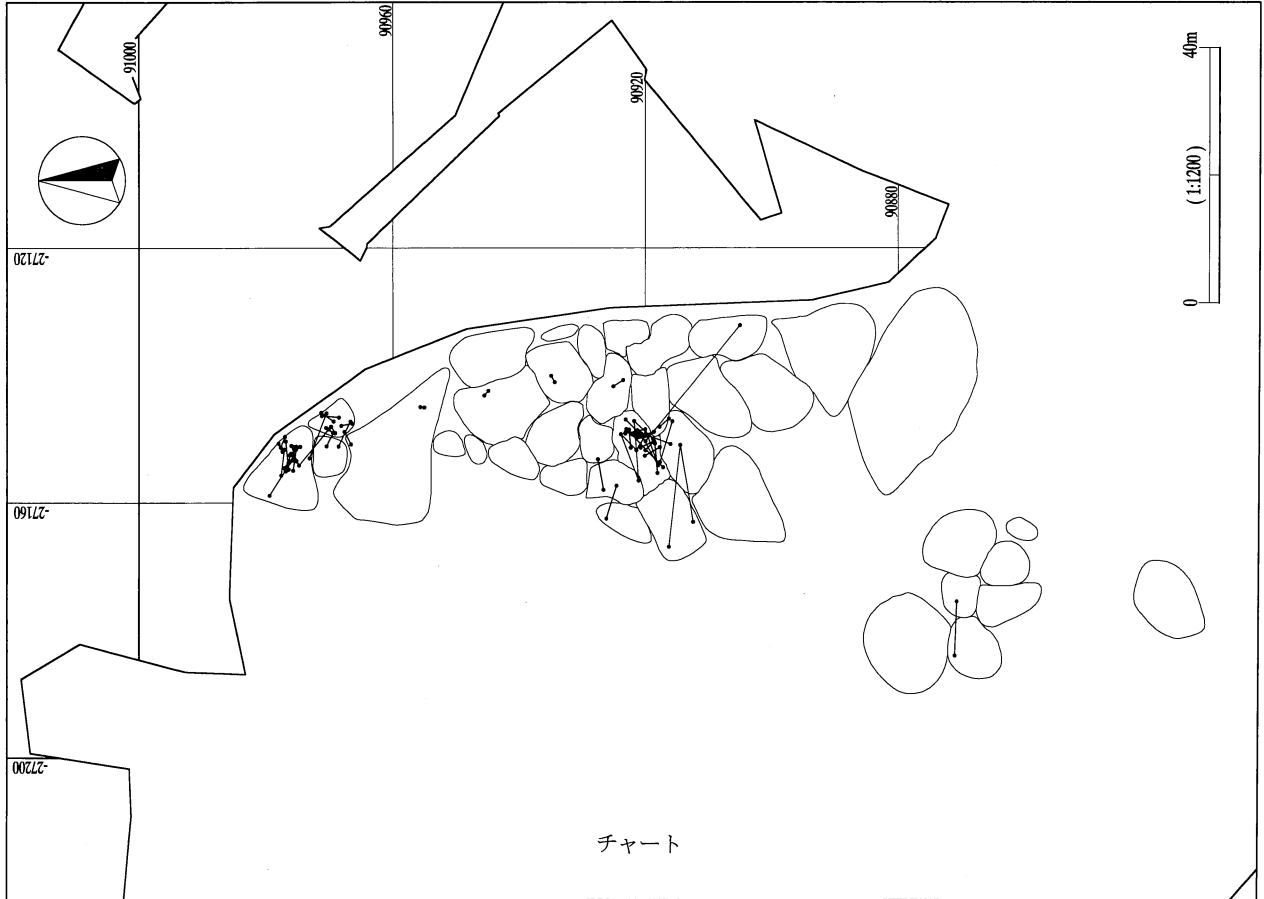
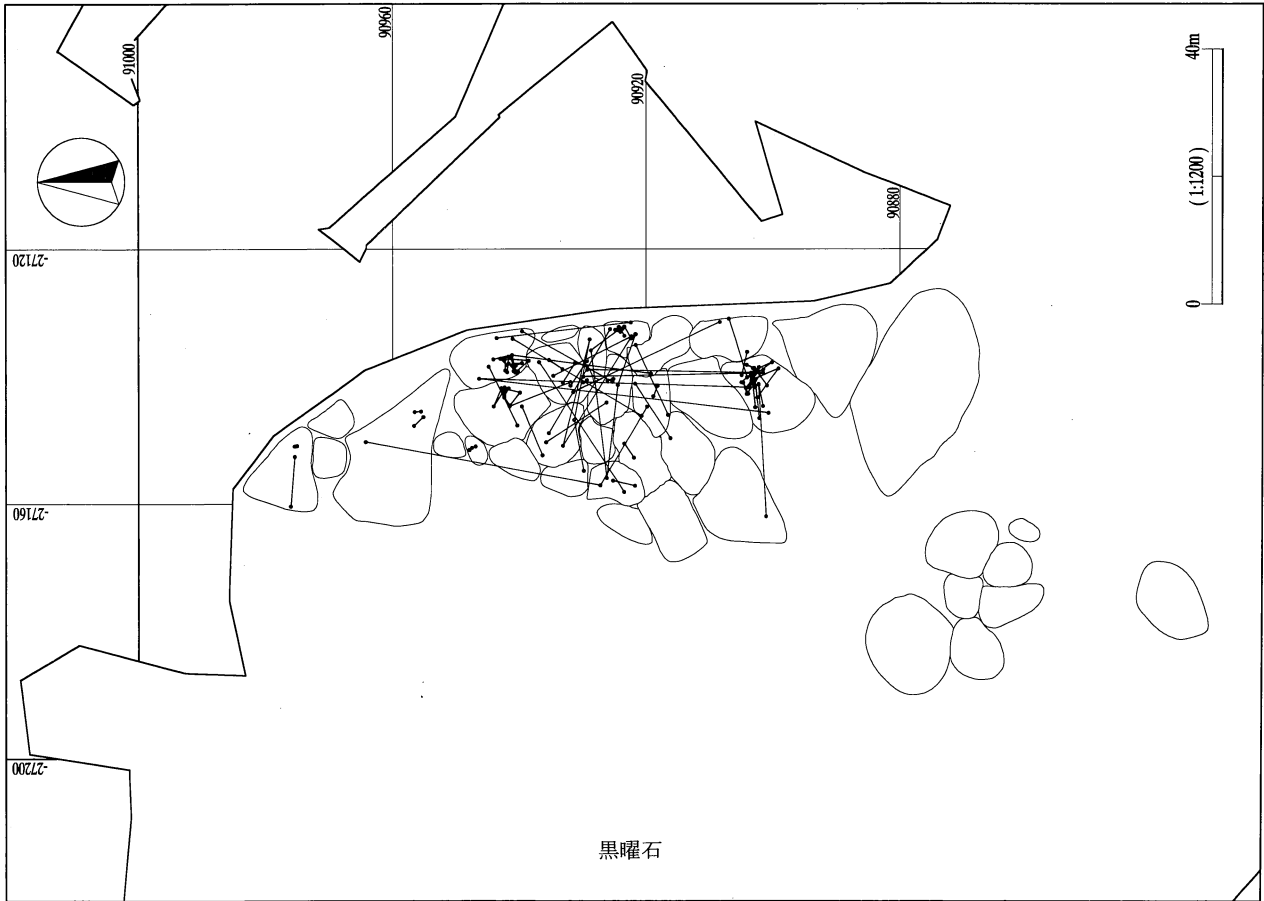

第3地点 接合資料分布図2 (貫ノ木遺跡)

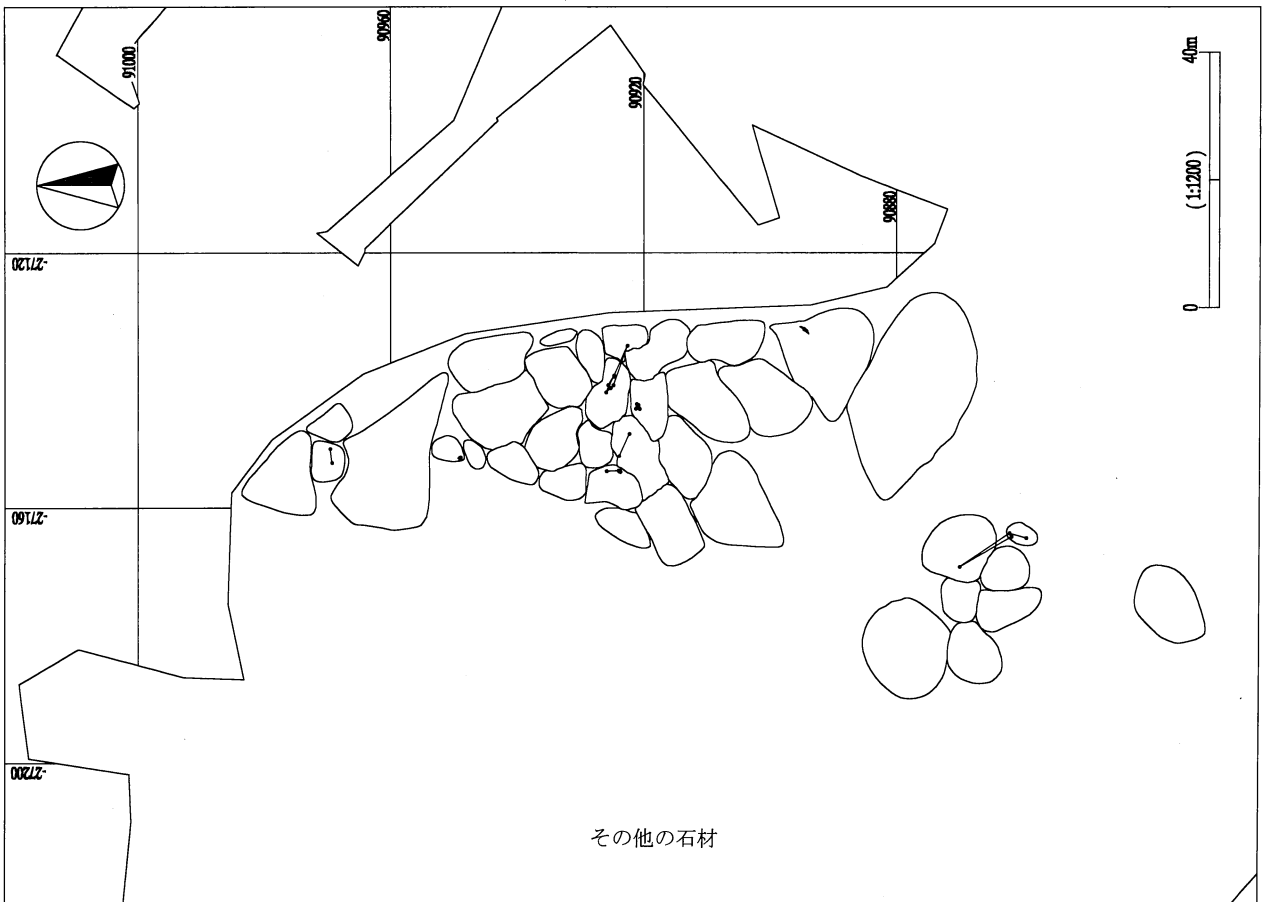
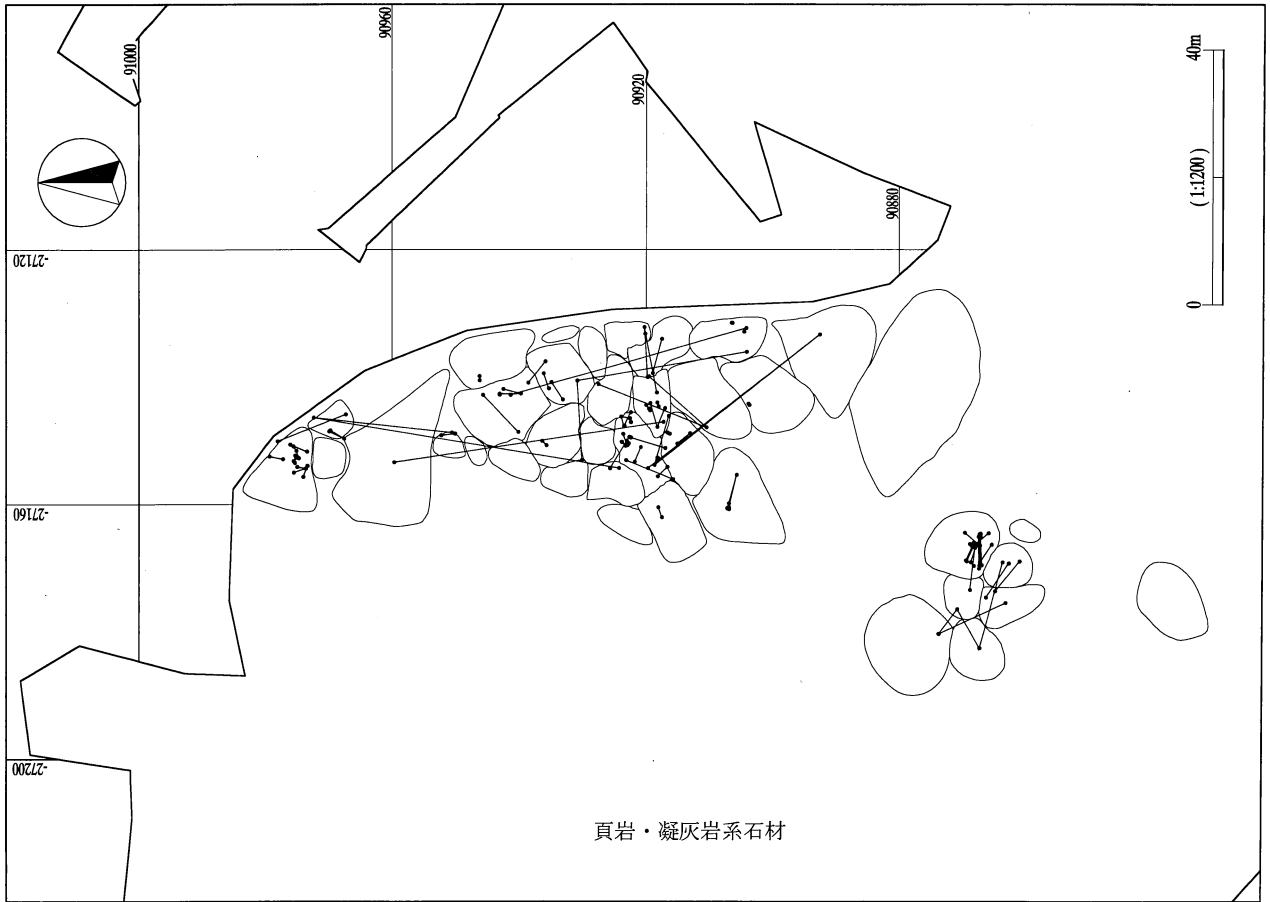

第3地点 接合資料分布図3 (貫ノ木遺跡)

Ch-113

| 剥離順序 | 遺物番号     | ブロック | 出土層位 | 器種 | 重量g  | 打面 | 作業面 |
|------|----------|------|------|----|------|----|-----|
| 1    | VI-G1245 | 3020 | V    | Fl | 0.85 | 正面 | 上   |
| 2    | VI-G1289 | 3020 | V    | Fl | 5.2  | 上  | 左   |
| 3    | VI-L1150 | 3020 | IV   | Fl | 20.3 | 上  | 正面  |
| 4    | VI-G205  | 3020 | III  | UF | 13.2 | 上  | 正面  |
| 5    | VI-G582  | 3020 | IV   | Fl | 48.2 | 上  | 正面  |
| 6    | VI-L892  | 3020 | IV   | Co | 43.2 |    |     |
| 7    | VI-L1146 | 3020 | IV   | Fl | 3.44 | 下  | 正面  |
| 8    | VI-G1609 | 3020 | VI   | Co | 147  |    |     |



Ch-113

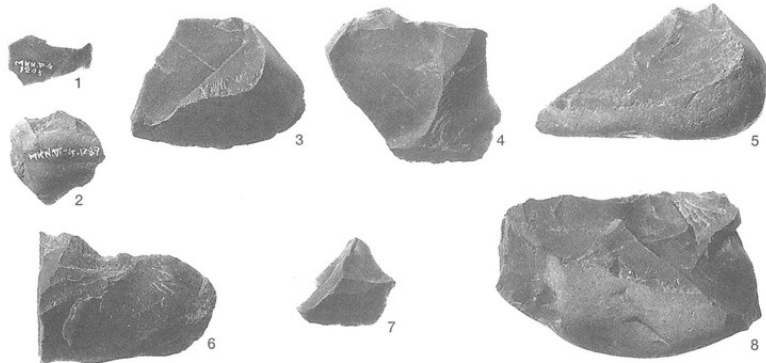
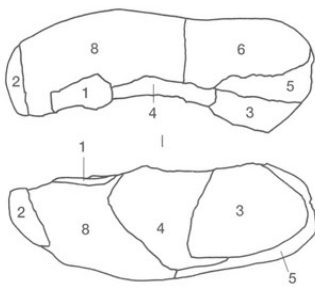

Ch-113 集合写真

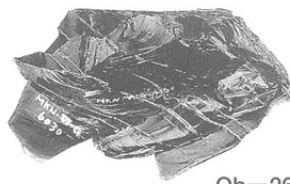
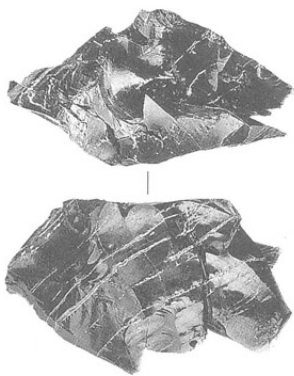

Ob-26

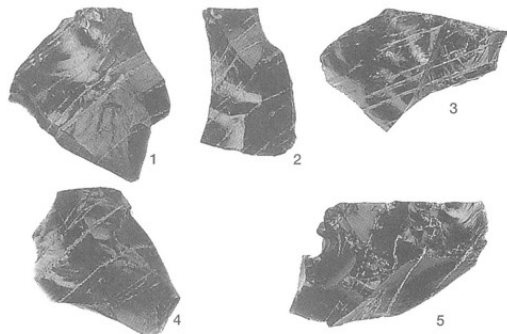

Ob-26 集合写真

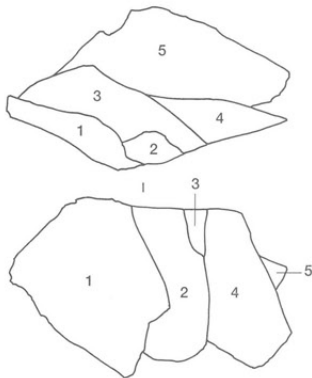

Ob-26

| 剥離順序 | 遺物番号     | ブロック | 出土層位 | 器種 | 重量g  | 打面 | 作業面 |
|------|----------|------|------|----|------|----|-----|
| 1    | VI-G1881 | 3024 | V    | UF | 17.2 | 上  | 正面  |
| 2    | VI-G2833 | 3027 | III  | Fl | 10.3 | 上  | 正面  |
| 3    | VI-G5644 | 3025 | V a  | UF | 13.3 | 上  | 正面  |
| 4    | VI-G6030 | 3027 | V    | UF | 13.5 | 上  | 正面  |
| 5    | VI-G4160 | 3026 | V a  | Fl | 23.2 | 裏面 | 上   |

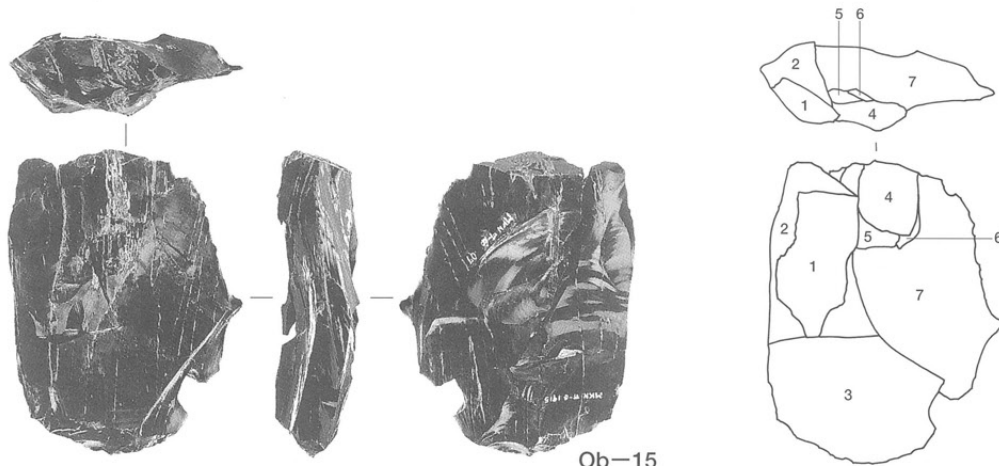

Ob-15

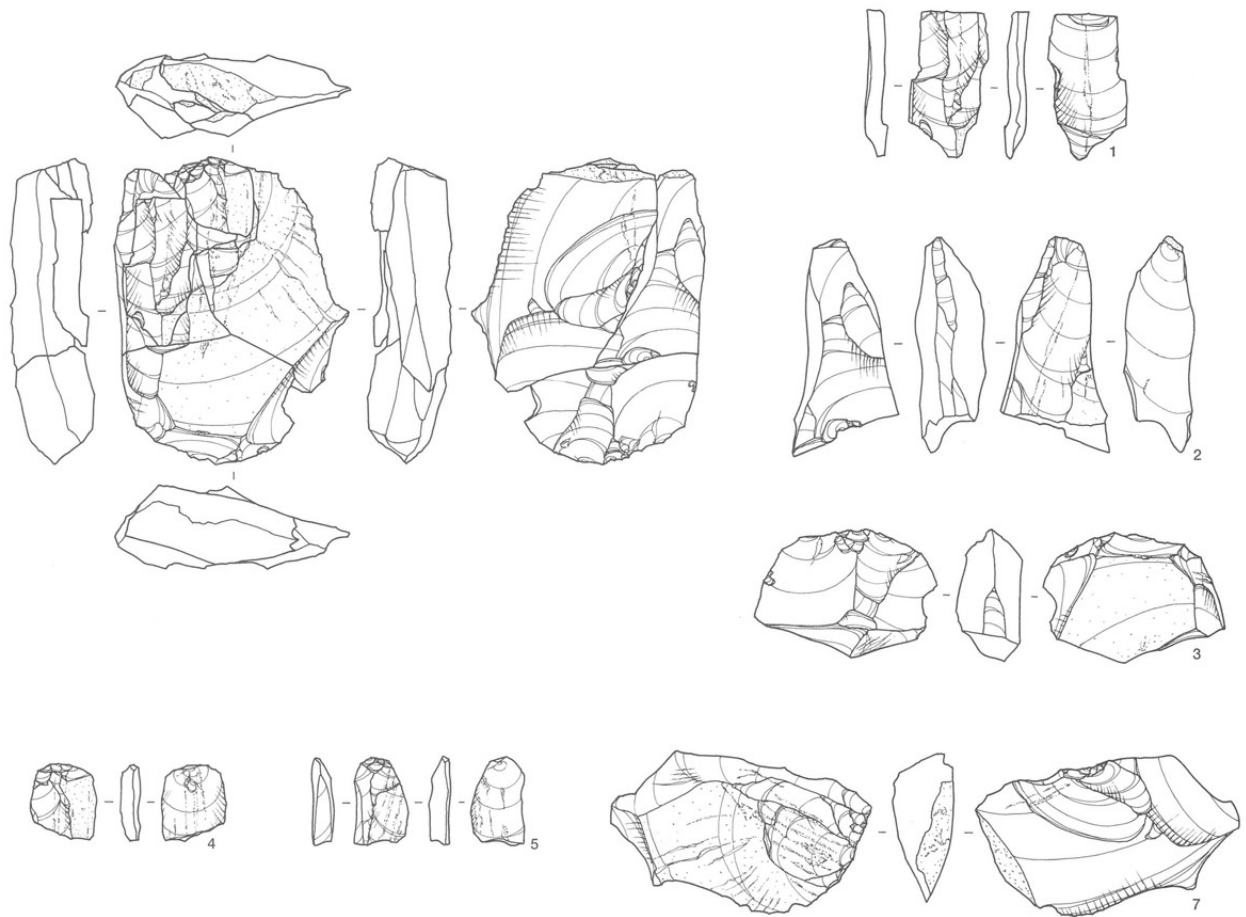

0 (1:2) 5cm

Ob-15

| 剥離順序 | 遺物番号     | ブロック | 出土層位 | 器種 | 重量g  | 打面 | 作業面 |
|------|----------|------|------|----|------|----|-----|
| 1    | VI-G1862 | 3024 | V    | Fl | 3.02 | 上  | 左   |
| 2    | VI-G1909 | 3024 | V    | Fl | 18.4 | 上  | 左   |
| 3    | VI-G1915 | 3024 | V    | Fl | 22.9 | 上  | 左   |
| 4    | VI-G1043 | 3024 | IV   | Fl | 1.64 | 上  | 正面  |
| 5    | VI-G1906 | 3024 | V    | Fl | 1.76 | 上  | 正面  |
| 6    | VI-G1866 | 3024 | V    | Fl | 0.88 | 上  | 正面  |
| 7    | VI-G1907 | 3024 | V    | Co | 32.5 |    |     |

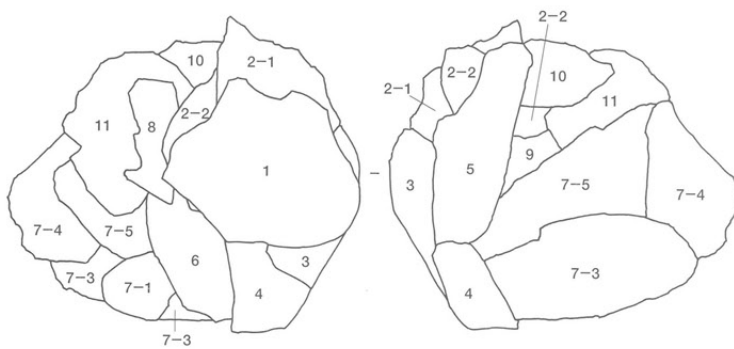
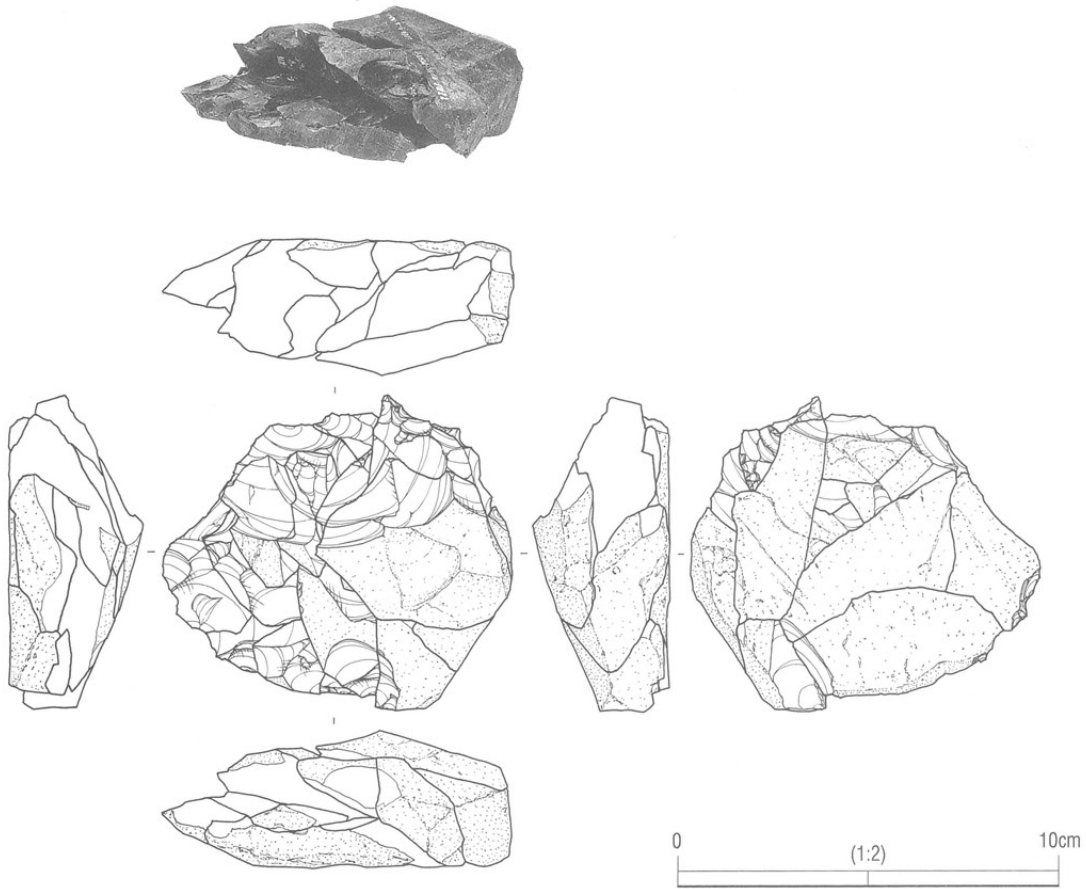
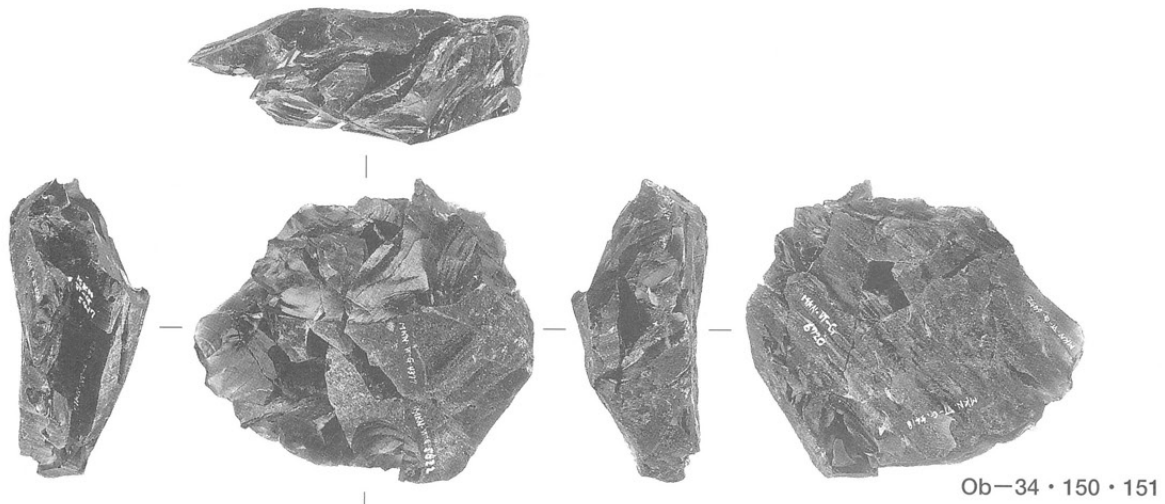

第3地点 接合資料3 (Ob-34 · 150 · 151) (貫ノ木遺跡)

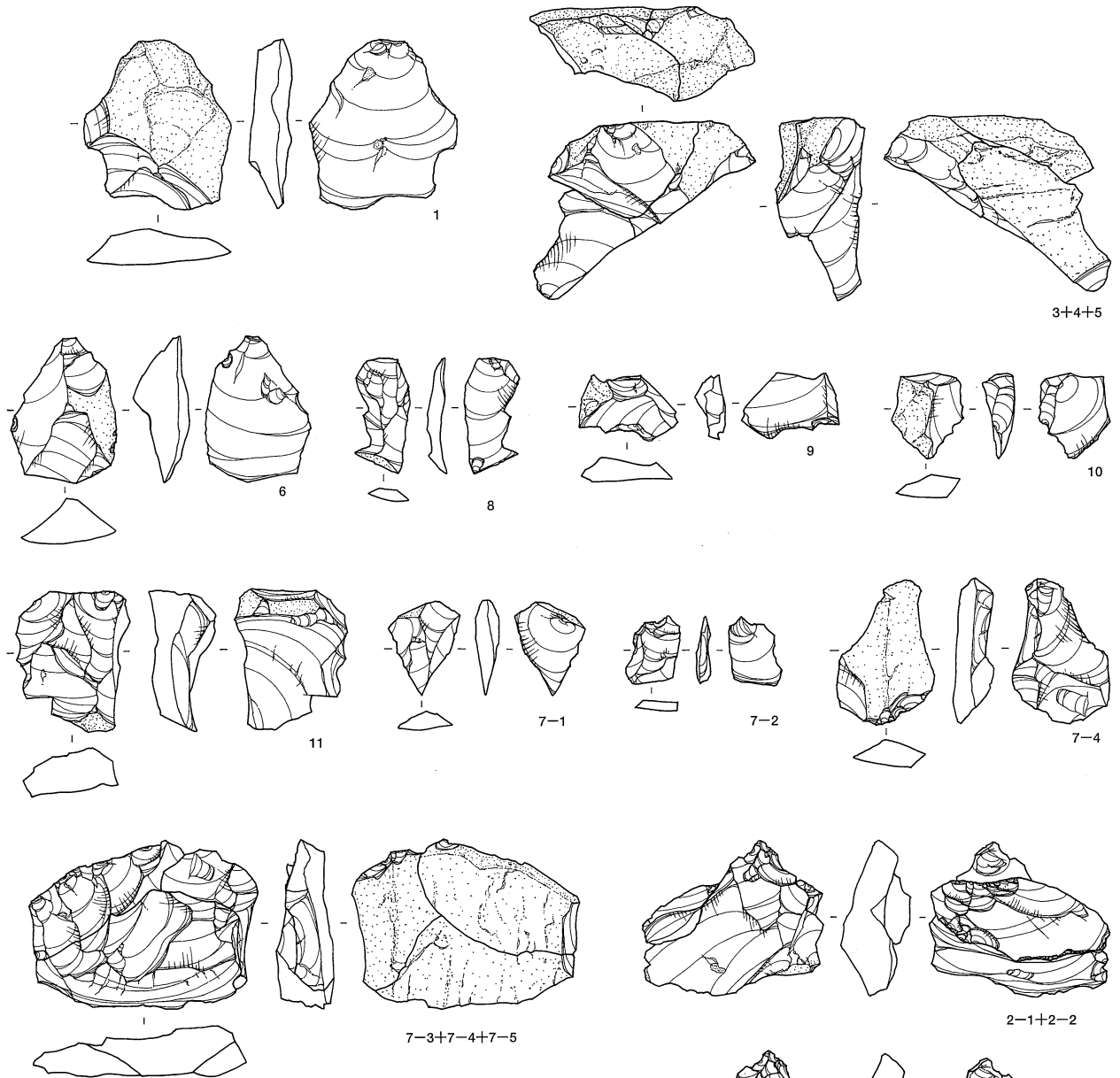

Ob-34

| 剥離順序 | 遺物番号     | ブロック | 出土層位 | 器種 | 重量g  | 打面 | 作業面 |
|------|----------|------|------|----|------|----|-----|
| 1    | VI-G4377 | 3032 | Ⅲ    | Fl | 20.9 | 右  | 正面  |
| 2    | Ob-150   |      |      |    |      | 上  | 裏面  |
| 3    | VI-G5174 | 3032 | V a  | Co | 16.9 | 上  | 裏面  |
| 4    | VI-G5622 | 3028 | V a  | Fl | 16.3 | 下  | 正面  |
| 5    | VI-G6720 | 3032 | V b  | Fl | 11.6 | 下  | 正面  |
| 6    | VI-G6453 | 3032 | V b  | UF | 12.9 | 下  | 正面  |
| 7    | Ob-151   |      |      |    |      | 下  | 裏面  |
| 8    | VI-G5169 | 3032 | V a  | Fl | 1.8  | 上  | 正面  |
| 9    | VI-G4672 | 3032 | Ⅳ    | Fl | 3.07 | 上  | 右   |
| 10   | VI-G4671 | 3032 | Ⅳ    | Fl | 3.24 | 裏面 | 上   |
| 11   | VI-G5417 | 3032 | V b  | Co | 21.5 |    |     |

Ob-150

| 剥離順序 | 遺物番号     | ブロック | 出土層位 | 器種 | 重量g  | 打面 | 作業面 |
|------|----------|------|------|----|------|----|-----|
| 2-1  | VI-G6696 | 3032 | V b  | UF | 16   | 上  | 裏面  |
| 2-2  | VI-L734  | 3023 | Ⅳ    | Kn | 8.46 |    |     |

Ob-151

| 剥離順序 | 遺物番号     | ブロック | 出土層位 | 器種 | 重量g  | 打面 | 作業面 |
|------|----------|------|------|----|------|----|-----|
| 7-1  | VI-G2858 | 3032 | Ⅳ    | Fl | 2.33 | 上  | 正面  |
| 7-2  | VI-G6706 | 3032 | V b  | Fl | 1.15 | 下  | 正面  |
| 7-3  | VI-G5418 | 3032 | V b  | Fl | 13.5 | 下  | 裏面  |
| 7-4  | VI-G6452 | 3032 | V b  | Fl | 8.13 | 上  | 裏面  |
| 7-5  | VI-G6707 | 3032 | V b  | Co | 25.3 |    |     |

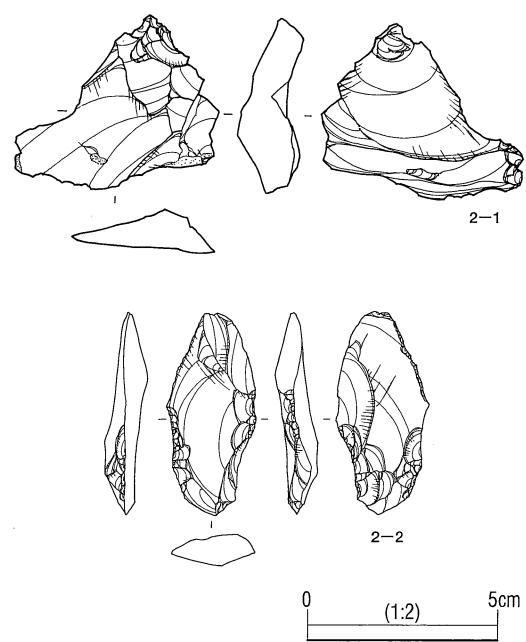

第3地点 接合資料4 (Ob-34・150・151) (貫ノ木遺跡)

Ob-45

| 剥離順序 | 遺物番号     | ブロック | 出土層位 | 器種 | 重量g  | 打面 | 作業面 |
|------|----------|------|------|----|------|----|-----|
| 1    | VI-G1897 | 3024 | V    | Fl | 11.9 | 正面 | 上   |
| 2    | VI-G737  | 3021 | IV   | Fl | 6.12 | 正面 | 上   |
| 3    | VI-G1497 | 3018 | IV   | UF | 2.12 | 下  | 右   |
| 4    | VI-G5759 | 3025 | V b  | Co | 27.3 |    |     |
| 5    | VI-G1908 | 3024 | V    | Co | 30.3 |    |     |

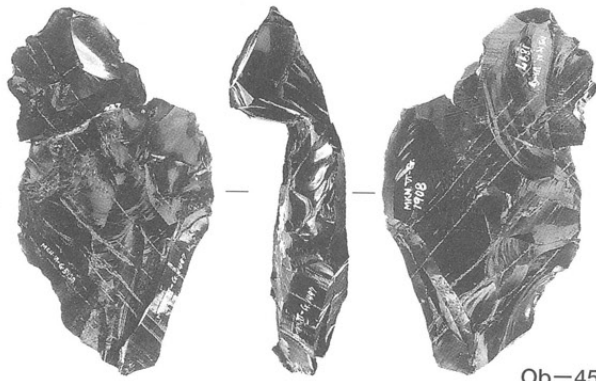

Ob-45

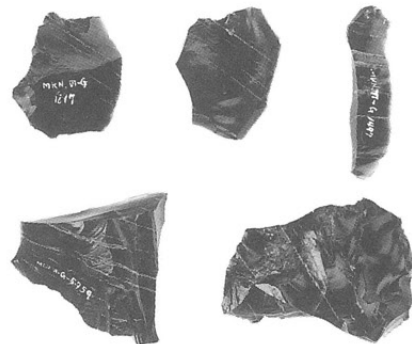
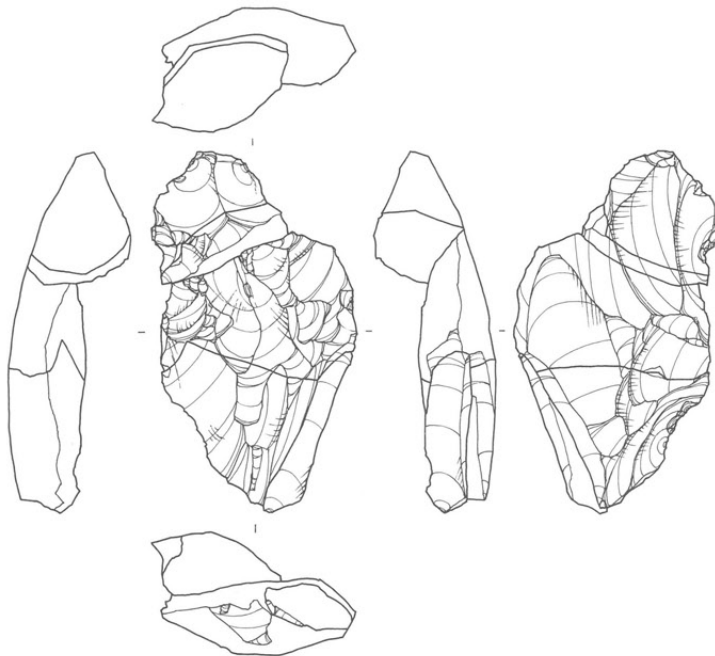
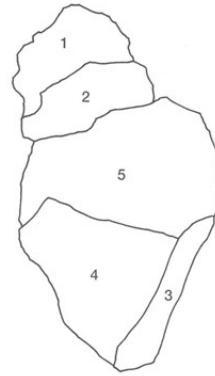

Ob-45 集合写真

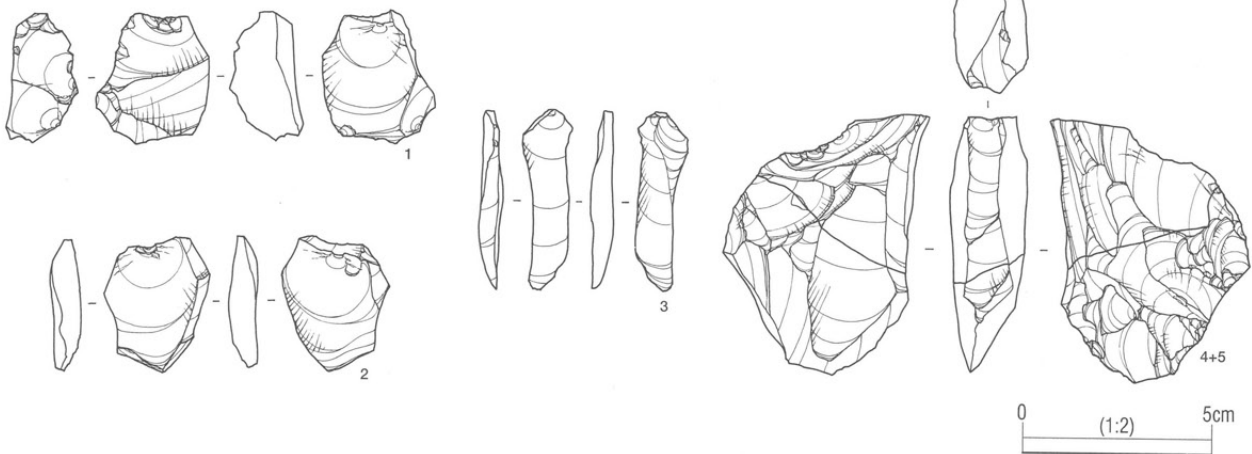

第3地点 接合資料5 (Ob-45) (貫ノ木遺跡)

Ob-56

| 剥離順序 | 遺物番号     | ブロック | 出土層位 | 器種 | 重量g  | 打面 | 作業面 |
|------|----------|------|------|----|------|----|-----|
| 1    | Ob-152   |      |      |    |      |    |     |
| 2    | VI-G2223 | 3031 | III  | Fl | 1.88 | 上  | 正面  |
| 3    | VI-G2244 | 3031 | III  | Fl | 4.5  | 上  | 正面  |
| 4    | VI-G5332 | 3031 | V a  | Tr | 8.59 | 上  | 正面  |
| 5    | VI-G6434 | 3031 | V b  | Fl | 7.08 |    |     |
| 6    | VI-G5282 | 3031 | V a  | Co | 34   |    |     |

Ob-152

| 剥離順序 | 遺物番号     | ブロック | 出土層位 | 器種 | 重量g  | 打面 | 作業面 |
|------|----------|------|------|----|------|----|-----|
| 1-1  | VI-G5188 | 3031 | V a  | Fl | 2.59 | 上  | 右   |
| 1-2  | VI-G6214 | 3031 | V b  | Co | 31.3 |    |     |
| 1-3  | VI-G4799 | 3031 | IV   | Fl | 6.35 | 左  | 下   |

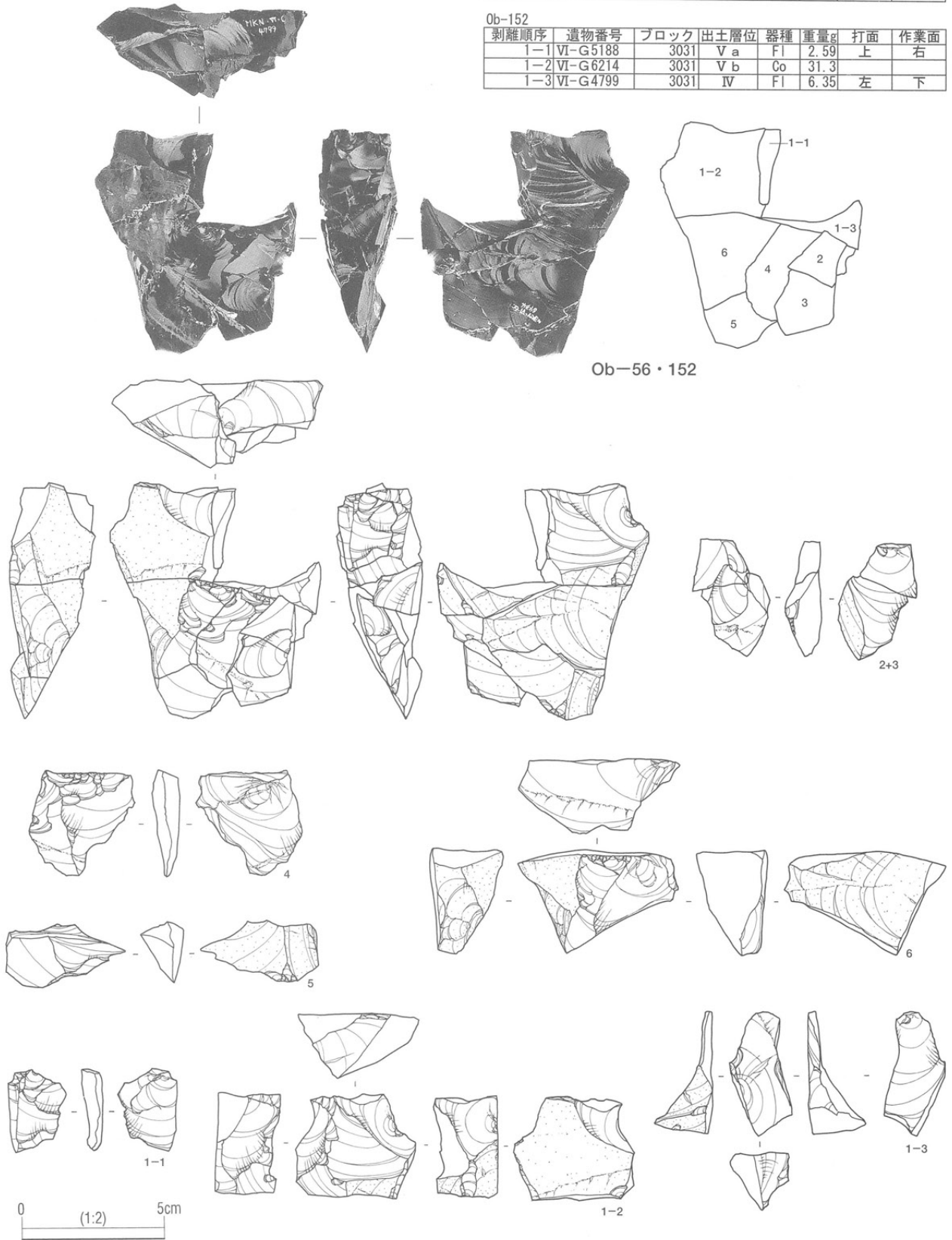

第3地点 接合資料6 (Ob-56 · 152) (貫ノ木遺跡)



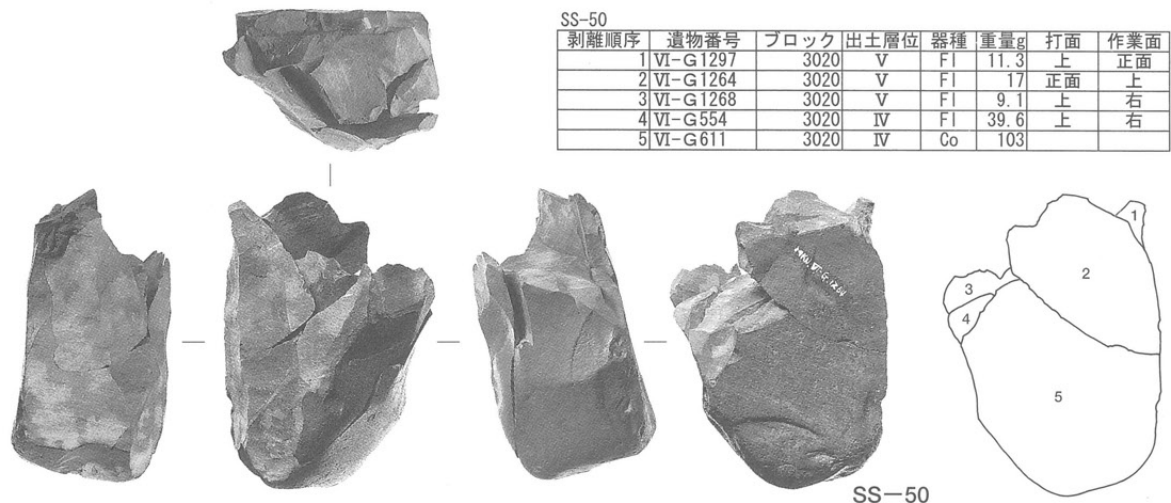

SS-50

| 剥離順序 | 遺物番号     | ブロック | 出土層位 | 器種 | 重量g  | 打面 | 作業面 |
|------|----------|------|------|----|------|----|-----|
| 1    | VI-G1297 | 3020 | V    | Fl | 11.3 | 上  | 正面  |
| 2    | VI-G1264 | 3020 | V    | Fl | 17   | 正面 | 上   |
| 3    | VI-G1268 | 3020 | V    | Fl | 9.1  | 上  | 右   |
| 4    | VI-G554  | 3020 | IV   | Fl | 39.6 | 上  | 右   |
| 5    | VI-G611  | 3020 | IV   | Co | 103  |    |     |

SS-50

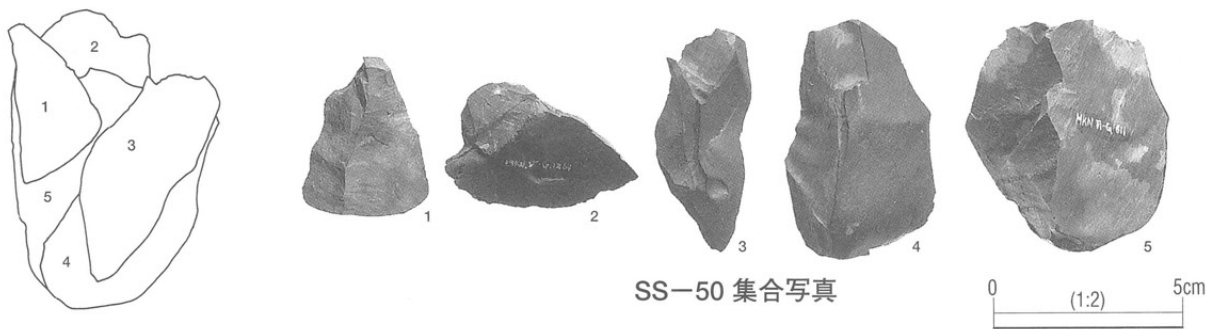

SS-50 集合写真

0 (1:2) 5cm



TS-14

TS-14

| 剥離順序 | 遺物番号    | ブロック | 出土層位 | 器種 | 重量g  | 打面 | 作業面 |
|------|---------|------|------|----|------|----|-----|
| 1    | VI-P108 | 3008 | Ⅲ    | Fl | 18.3 | 上  | 正面  |
| 2    | VI-P54  | 3006 | Ⅳ    | Fl | 39.4 | 上  | 正面  |
| 3    | VI-P120 | 3005 | Ⅲ    | Fl | 36   | 上  | 正面  |
| 4    | VI-P219 | 3003 | Ⅳ    | Fl | 17.8 | 上  | 正面  |

TS-14 集合写真

0 (1:2) 5cm

TS-57

| 剥離順序 | 遺物番号     | ブロック | 出土層位 | 器種 | 重量g  | 打面 | 作業面 |
|------|----------|------|------|----|------|----|-----|
| 1    | VI-G1184 | 3018 | V    | UF | 51.8 | 左  | 正面  |
| 2    | VI-B1203 | 3037 | IV   | FI | 20.1 | 左  | 正面  |
| 3    | VI-G6183 | 3034 | V    | FI | 82.9 | 上  | 左   |
| 4    | VI-G6182 | 3034 | V    | FI | 24.5 | 上  | 左   |
| 5    | VI-G6187 | 3034 | V    | Co | 79.5 |    |     |

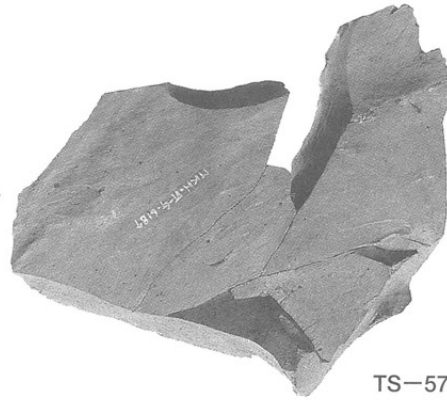

TS-57

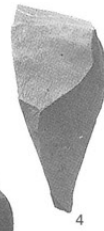
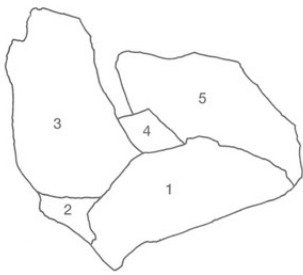

TS-57 集合写真



# 貫ノ木遺跡 第4地点

