

上信越自動車道  
埋蔵文化財発掘調査報告書15

—信濃町内 その1—

ひなたばやし  
日向林 B 遺跡

ひなたばやし  
日向林 A 遺跡

なな つ ぐり  
七ツ栗 遺跡

おお だいら  
大平 B 遺跡

旧石器時代

図版編

2000

日本道路公団  
長野県教育委員会  
長野県埋蔵文化財センター

上信越自動車道  
埋蔵文化財発掘調査報告書15

—信濃町内 その1—

ひなたばやし  
日向林 B 遺跡

ひなたばやし  
日向林 A 遺跡

なな つ ぐり  
七ツ栗 遺跡

おお だいら  
大平 B 遺跡

旧石器時代

図版編

2000

日本道路公団  
長野県教育委員会  
長野県埋蔵文化財センター

## 凡 例

1. 本書に掲載した実測図は原則として下記のとおりである。また、それぞれの図版右下隅にスケールを付した。

主な遺構実測図

全体図 1 : 400・1 : 500・1 : 800・1 : 1000      ブロック 1 : 80      大きなブロック  
1 : 160

礫群 1 : 40・1 : 80

主な遺物実測図

中・小形石器 3 : 4      大形石器 1 : 2・1 : 3

2. 本書に掲載した遺物写真の縮尺は下記のとおりである。  
1 : 1・3 : 4・1 : 2で、それぞれのプレートの右下隅に示した。
3. ブロック別の遺物分布図に付した石器実測図の縮尺は原則として1 : 2であるが、大形石器については1 : 3のものも含まれる。
4. ブロック別の遺物分布図の中で、平面分布は器種によって記号を変えてある。それぞれの記号は以下のとおりである。また、平面図の遺物に付された番号は遺物実測図の番号と対応する。

◇	ナイフ形石器	■	楔形石器	㊟	抉入削器	㊿	磨石
▽	台形石器	㊿	石刃	㊿	鋸齒縁状削器	㊿	砥石
●	貝殻状刃器	○	2次加工のある剥片	㊿	削片	㊿	台石
◆	槍先形尖頭器	●	微細剥離のある剥片	㊿	折断剥片	㊿	原石
▲	斧形石器	□	石核	△	角錐状石器	㊿	有孔石製品
☆	削器	*	敲石	㊿	細石核	▲	斧形石器関係の剥片
★	搔器・搔器状石器	◇	剥片尖頭器	㊿	細石刃	●	剥片・碎片
㊿	彫器	◆	有茎尖頭器	㊿	凹石・礫器	◇	礫
㊿	揉錐器	◆	厚刃搔器				

5. ブロック別の遺物分布図の中で、垂直分布は出土層位によって記号をかえてある。それぞれの記号は以下のとおりである。
6. 接合資料の分布図で描かれている線は、石器分布図では剥離された順番で、礫分布図では遺物番号順に結ばれている。

△	IV層・IV上面～IV下部	◻	Vb層・Vb上面～Vb下部・V層
○	Va層・Va層上面～Va層下部	・	その他

7. 石器実測図・表・図中の器種・石材・黒曜石産地の略称は以下のとおりである。

器種略称

Kn	ナイフ形石器	Pe	楔形石器	DS	鋸齒縁状削器	Wh	砥石
Tr	台形石器	Bl	石刃	Sp	削片	An	台石
SB	貝殻状刃器	RF	2次加工のある剥片	CF	折断剥片	原石	原石
Po	槍先形尖頭器	UF	微細剥離のある剥片	Bo	角錐状石器	有孔	有孔石製品

Ax	斧形石器	Co	石核	MC	細石核	AF	斧形石器調整剥片
Sc	削器	Ha	敲石	MB	細石刃	Ax刃	斧形石器刃部破片
ES	搔器	剝尖	剝片尖頭器	Ps	凹石	PF	ポイントフレーク
ESS	搔器状石器	TP	有茎尖頭器	PT	礫器	Fl	剥片
Gr	彫器	NS	抉入削器	GS	磨石	Ch	破片
Dr	揉錐器	AS	厚刃搔器				

その他それぞれの器種の破片には略称の後に破という文字を付してある。

#### 石材略称

Ob	黒曜石	TS	凝灰質頁岩	Se	蛇紋岩	Rh	流紋岩
An	無斑晶質安山岩	GT	緑色凝灰岩	Qu	石英	Ho	ホルンフェルス
SS	珪質頁岩	Ag	玉髓	Cr	水晶	Gr	花崗岩
Sh	頁岩	Ch	チャート	Sl	粘板岩	Ge	下呂石
ST	珪質凝灰岩	Sa	砂岩	Ja	鉄石英	安山	その他の安山岩

黒曜石産地群記号については第6章第6節の第89表の産地記号の記号を用いることとする。

- 石器実測図・表・図中の出土層位は、上面・上部・中部・下部を上面・上・中・下に省略してある。また、「層」の文字も省略して表記した。
- 器実測図に付したキャプションの見方は以下のとおりである。

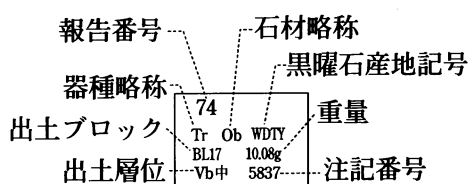

- 石器実測図中のスクリーントーンは薄いものが、主要剥離面以外のポジ面および、石核にみられるポジ面を、濃いものが砥石等の磨面および、斧形石器の方向不明の研磨面をあらわす。また、発掘調査時と思われる新しい剥離面は黒く塗りつぶしてある。
- 石器の長さ・幅・厚さの計測方法は以下のとおりである。  
長さ・幅：石器の主軸方向を上下の基準として方眼紙に置き、長方形を想定し、上下（縦方向）長さ、左右（横方向）を幅とした。  
厚さ：最も厚い箇所を、主要剥離面から垂直方向で計測した。

## 図版目次

図版 1	日向林 I 石器文化	全体図 1	図版31	日向林 I 石器文化	BL23・BL24遺物分布図
図版 2	日向林 I 石器文化	全体図 2	図版32	日向林 I 石器文化	BL25・BL26遺物分布図
図版 3	日向林 I 石器文化	全体図 3	図版33	日向林 I 石器文化	BL27・BL28遺物分布図
図版 4	日向林 I 石器文化	全体図 4	図版34	日向林 I 石器文化	BL29・BL30遺物分布図
図版 5	日向林 I 石器文化	全体図 5	図版35	日向林 I 石器文化	ブロック外遺物分布図
図版 6	日向林 I 石器文化	全体図 6	図版36	日向林 I 石器文化	石器実測図 1 (斧形石器 1)
図版 7	日向林 I 石器文化	全体図 7	図版37	日向林 I 石器文化	石器実測図 2 (斧形石器 2)
図版 8	日向林 I 石器文化	全体図 8	図版38	日向林 I 石器文化	石器実測図 3 (斧形石器 3)
図版 9	日向林 I 石器文化	BL1遺物分布図	図版39	日向林 I 石器文化	石器実測図 4 (斧形石器 4)
図版10	日向林 I 石器文化	BL2・BL3遺物分布図	図版40	日向林 I 石器文化	石器実測図 5 (斧形石器 5)
図版11	日向林 I 石器文化	BL4・BL6遺物分布図	図版41	日向林 I 石器文化	石器実測図 6 (斧形石器 6)
図版12	日向林 I 石器文化	BL5遺物分布図	図版42	日向林 I 石器文化	石器実測図 7 (斧形石器 7)
図版13	日向林 I 石器文化	BL7・BL10遺物分布図	図版43	日向林 I 石器文化	石器実測図 8 (斧形石器 8)
図版14	日向林 I 石器文化	BL10遺物分布図 (斧形石器集中)	図版44	日向林 I 石器文化	石器実測図 9 (斧形石器 9)
図版15	日向林 I 石器文化	BL8遺物分布図	図版45	日向林 I 石器文化	石器実測図10 (斧形石器10)
図版16	日向林 I 石器文化	BL9遺物分布図	図版46	日向林 I 石器文化	石器実測図11 (斧形石器11)
図版17	日向林 I 石器文化	BL11遺物分布図	図版47	日向林 I 石器文化	石器実測図12 (斧形石器12)
図版18	日向林 I 石器文化	BL12遺物分布図	図版48	日向林 I 石器文化	石器実測図13 (斧形石器13)
図版19	日向林 I 石器文化	BL13・BL15遺物分布図			
図版20	日向林 I 石器文化	BL14遺物分布図 1			
図版21	日向林 I 石器文化	BL14遺物分布図 2 (斧形石器集中)			
図版22	日向林 I 石器文化	BL16遺物分布図			
図版23	日向林 I 石器文化	BL17遺物分布図			
図版24	日向林 I 石器文化	BL17出土石器			
図版25	日向林 I 石器文化	BL18遺物分布図			
図版26	日向林 I 石器文化	BL18出土石器			
図版27	日向林 I 石器文化	BL19・BL21遺物分布図			
図版28	日向林 I 石器文化	BL20遺物分布図			
図版29	日向林 I 石器文化	BL20出土石器			
図版30	日向林 I 石器文化	BL22遺物分布図			

- 図版49 日向林 I 石器文化 石器実測図14  
 (斧形石器14)
- 図版50 日向林 I 石器文化 石器実測図15  
 (斧形石器15)
- 図版51 日向林 I 石器文化 石器実測図16  
 (斧形石器16)
- 図版52 日向林 I 石器文化 石器実測図17  
 (斧形石器17)
- 図版53 日向林 I 石器文化 石器実測図18  
 (斧形石器18)
- 図版54 日向林 I 石器文化 石器実測図19  
 (斧形石器19)
- 図版55 日向林 I 石器文化 石器実測図20  
 (斧形石器20)
- 図版56 日向林 I 石器文化 石器実測図21  
 (斧形石器21)
- 図版57 日向林 I 石器文化 石器実測図22  
 (斧形石器22)
- 図版58 日向林 I 石器文化 石器実測図23  
 (斧形石器22・斧形石器刃部破片 1)
- 図版59 日向林 I 石器文化 石器実測図24  
 (斧形石器刃部破片 2・斧形石器製作剥  
 片 1)
- 図版60 日向林 I 石器文化 石器実測図25  
 (斧形石器製作剥片 2・蛇紋岩原石)
- 図版61 日向林 I 石器文化 石器実測図26  
 (台形石器 1)
- 図版62 日向林 I 石器文化 石器実測図27  
 (台形石器 2)
- 図版63 日向林 I 石器文化 石器実測図28  
 (台形石器 3)
- 図版64 日向林 I 石器文化 石器実測図29  
 (台形石器 4)
- 図版65 日向林 I 石器文化 石器実測図30  
 (台形石器 5)
- 図版66 日向林 I 石器文化 石器実測図31  
 (台形石器 6)
- 図版67 日向林 I 石器文化 石器実測図32  
 (台形石器 7)
- 図版68 日向林 I 石器文化 石器実測図33  
 (台形石器 8)
- 図版69 日向林 I 石器文化 石器実測図34  
 (台形石器 9・ナイフ形石器)
- 図版70 日向林 I 石器文化 石器実測図35  
 (搔器状石器 1)
- 図版71 日向林 I 石器文化 石器実測図36  
 (搔器状石器 2)
- 図版72 日向林 I 石器文化 石器実測図37  
 (搔器状石器 3)
- 図版73 日向林 I 石器文化 石器実測図38  
 (搔器状石器 4)
- 図版74 日向林 I 石器文化 石器実測図39  
 (搔器状石器 5)
- 図版75 日向林 I 石器文化 石器実測図40  
 (搔器状石器 6)
- 図版76 日向林 I 石器文化 石器実測図41  
 (搔器状石器 7)
- 図版77 日向林 I 石器文化 石器実測図42  
 (搔器状石器 8)
- 図版78 日向林 I 石器文化 石器実測図43  
 (搔器状石器 9)
- 図版79 日向林 I 石器文化 石器実測図44  
 (搔器状石器10)
- 図版80 日向林 I 石器文化 石器実測図45  
 (搔器状石器11)
- 図版81 日向林 I 石器文化 石器実測図46  
 (搔器状石器12)
- 図版82 日向林 I 石器文化 石器実測図47  
 (搔器状石器13)
- 図版83 日向林 I 石器文化 石器実測図48  
 (搔器状石器14)
- 図版84 日向林 I 石器文化 石器実測図49  
 (搔器状石器15)
- 図版85 日向林 I 石器文化 石器実測図50  
 (搔器状石器16)
- 図版86 日向林 I 石器文化 石器実測図51  
 (搔器状石器17)
- 図版87 日向林 I 石器文化 石器実測図52  
 (搔器状石器18)

図版88	日向林 I 石器文化 (貝殻状刃器 1)	石器実測図53	図版108	日向林 I 石器文化 (貝殻状刃器21)	石器実測図73
図版89	日向林 I 石器文化 (貝殻状刃器 2)	石器実測図54	図版109	日向林 I 石器文化 (貝殻状刃器22)	石器実測図74
図版90	日向林 I 石器文化 (貝殻状刃器 3)	石器実測図55	図版110	日向林 I 石器文化 (貝殻状刃器23)	石器実測図75
図版91	日向林 I 石器文化 (貝殻状刃器 4)	石器実測図56	図版111	日向林 I 石器文化 (貝殻状刃器24)	石器実測図76
図版92	日向林 I 石器文化 (貝殻状刃器 5)	石器実測図57	図版112	日向林 I 石器文化 (貝殻状刃器25)	石器実測図77
図版93	日向林 I 石器文化 (貝殻状刃器 6)	石器実測図58	図版113	日向林 I 石器文化 (貝殻状刃器26)	石器実測図78
図版94	日向林 I 石器文化 (貝殻状刃器 7)	石器実測図59	図版114	日向林 I 石器文化 (貝殻状刃器27)	石器実測図79
図版95	日向林 I 石器文化 (貝殻状刃器 8)	石器実測図60	図版115	日向林 I 石器文化 (貝殻状刃器28)	石器実測図80
図版96	日向林 I 石器文化 (貝殻状刃器 9)	石器実測図61	図版116	日向林 I 石器文化 (貝殻状刃器29)	石器実測図81
図版97	日向林 I 石器文化 (貝殻状刃器10)	石器実測図62	図版117	日向林 I 石器文化 (貝殻状刃器30)	石器実測図82
図版98	日向林 I 石器文化 (貝殻状刃器11)	石器実測図63	図版118	日向林 I 石器文化 (貝殻状刃器31)	石器実測図83
図版99	日向林 I 石器文化 (貝殻状刃器12)	石器実測図64	図版119	日向林 I 石器文化 (貝殻状刃器32)	石器実測図84
図版100	日向林 I 石器文化 (貝殻状刃器13)	石器実測図65	図版120	日向林 I 石器文化 (削器 1)	石器実測図85
図版101	日向林 I 石器文化 (貝殻状刃器14)	石器実測図66	図版121	日向林 I 石器文化 (削器 2)	石器実測図86
図版102	日向林 I 石器文化 (貝殻状刃器15)	石器実測図67	図版122	日向林 I 石器文化 (削器 3)	石器実測図87
図版103	日向林 I 石器文化 (貝殻状刃器16)	石器実測図68	図版123	日向林 I 石器文化 (削器 4)	石器実測図88
図版104	日向林 I 石器文化 (貝殻状刃器17)	石器実測図69	図版124	日向林 I 石器文化 (削器 5)	石器実測図89
図版105	日向林 I 石器文化 (貝殻状刃器18)	石器実測図70	図版125	日向林 I 石器文化 (削器 6・挟入削器 1)	石器実測図90
図版106	日向林 I 石器文化 (貝殻状刃器19)	石器実測図71	図版126	日向林 I 石器文化 (挟入削器 2)	石器実測図91
図版107	日向林 I 石器文化 (貝殻状刃器20)	石器実測図72	図版127	日向林 I 石器文化 (挟入削器 3)	石器実測図92

図版128	日向林 I 石器文化	石器実測図93 (鋸齒縁状削器 1)	図版147	日向林 I 石器文化	石器実測図112 (石核 7)
図版129	日向林 I 石器文化	石器実測図94 (鋸齒縁状削器 2)	図版148	日向林 I 石器文化	石器実測図113 (石核 8)
図版130	日向林 I 石器文化	石器実測図95 (鋸齒縁状削器 3)	図版149	日向林 I 石器文化	石器実測図114 (石核 9)
図版131	日向林 I 石器文化	石器実測図96 (鋸齒縁状削器 4)	図版150	日向林 I 石器文化	石器実測図115 (石核10)
図版132	日向林 I 石器文化	石器実測図97 (厚刃搔器 1)	図版151	日向林 I 石器文化	石器実測図116 (石核11)
図版133	日向林 I 石器文化	石器実測図98 (厚刃搔器 2)	図版152	日向林 I 石器文化	石器実測図117 (石核12)
図版134	日向林 I 石器文化	石器実測図99 (厚刃搔器 3)	図版153	日向林 I 石器文化	石器実測図118 (石核13)
図版135	日向林 I 石器文化	石器実測図100 (彫器 1)	図版154	日向林 I 石器文化	石器実測図119 (敲石 1)
図版136	日向林 I 石器文化	石器実測図101 (彫器 2・揉錐器 1)	図版155	日向林 I 石器文化	石器実測図120 (敲石 2)
図版137	日向林 I 石器文化	石器実測図102 (揉錐器 2・楔形石器)	図版156	日向林 I 石器文化	石器実測図121 (敲石 3)
図版138	日向林 I 石器文化	石器実測図103 (2次加工のある剥片・微細剥離のある剥片 1)	図版157	日向林 I 石器文化	石器実測図122 (敲石 4)
図版139	日向林 I 石器文化	石器実測図104 (微細剥離のある剥片 2)	図版158	日向林 I 石器文化	石器実測図123 (敲石 5・磨石 1)
図版140	日向林 I 石器文化	石器実測図105 (微細剥離のある剥片 3)	図版159	日向林 I 石器文化	石器実測図124 (磨石 2)
図版141	日向林 I 石器文化	石器実測図106 (石核 1)	図版160	日向林 I 石器文化	石器実測図125 (砥石)
図版142	日向林 I 石器文化	石器実測図107 (石核 2)	図版161	日向林 I 石器文化	石器実測図126 (有孔石製品)
図版143	日向林 I 石器文化	石器実測図108 (石核 3)	図版162	日向林 I 石器文化	石器使用痕観察部 位 1
図版144	日向林 I 石器文化	石器実測図109 (石核 4)	図版163	日向林 I 石器文化	石器使用痕観察部 位 2
図版145	日向林 I 石器文化	石器実測図110 (石核 5)	図版164	日向林 I 石器文化	接合資料 1
図版146	日向林 I 石器文化	石器実測図111 (石核 6)	図版165	日向林 I 石器文化	接合資料 2
			図版166	日向林 I 石器文化	接合資料 3
			図版167	日向林 I 石器文化	接合資料 4
			図版168	日向林 I 石器文化	接合資料 5
			図版169	日向林 I 石器文化	接合資料 6



図版170	日向林 I 石器文化	接合資料 7	図版210	日向林 II a 石器文化	BL1遺物分布図
図版171	日向林 I 石器文化	接合資料 8	図版211	日向林 II a 石器文化	石器実測図 1
図版172	日向林 I 石器文化	接合資料 9	図版212	日向林 II a 石器文化	石器実測図 2
図版173	日向林 I 石器文化	接合資料10	図版213	日向林 II a 石器文化	石器実測図 3
図版174	日向林 I 石器文化	接合資料11	図版214	日向林 II a 石器文化	接合資料
図版175	日向林 I 石器文化	接合資料12	図版215	日向林 II b 石器文化	全体図
図版176	日向林 I 石器文化	接合資料13	図版216	日向林 II b 石器文化	BL1・BL2遺物 分布図
図版177	日向林 I 石器文化	接合資料14	図版217	日向林 II b 石器文化	BL2出土石器
図版178	日向林 I 石器文化	接合資料15	図版218	日向林 II b 石器文化	BL3遺物分布図
図版179	日向林 I 石器文化	接合資料16	図版219	日向林 II b 石器文化	石器実測図 1
図版180	日向林 I 石器文化	接合資料17	図版220	日向林 II b 石器文化	石器実測図 2
図版181	日向林 I 石器文化	接合資料18	図版221	日向林 II b 石器文化	石器実測図 3
図版182	日向林 I 石器文化	接合資料19	図版222	日向林 II b 石器文化	石器実測図 4
図版183	日向林 I 石器文化	接合資料20	図版223	日向林 II b 石器文化	石器実測図 5
図版184	日向林 I 石器文化	接合資料21	図版224	日向林 II b 石器文化	石器実測図 6
図版185	日向林 I 石器文化	接合資料22	図版225	日向林 II b 石器文化	石器実測図 7
図版186	日向林 I 石器文化	接合資料23	図版226	日向林 II b 石器文化	石器実測図 8
図版187	日向林 I 石器文化	接合資料24	図版227	日向林 II b 石器文化	石器実測図 9
図版188	日向林 I 石器文化	接合資料25	図版228	日向林IV石器文化	全体図
図版189	日向林 I 石器文化	接合資料26	図版229	日向林IV石器文化	BL1・BL2遺物分 布図
図版190	日向林 I 石器文化	接合資料27	図版230	日向林IV石器文化	BL3・BL4遺物分 布図
図版191	日向林 I 石器文化	接合資料28	図版231	日向林IV石器文化	石器実測図 1
図版192	日向林 I 石器文化	接合資料29	図版232	日向林IV石器文化	石器実測図 2
図版193	日向林 I 石器文化	接合資料30	図版233	日向林IV石器文化	石器実測図 3
図版194	日向林 I 石器文化	接合資料31	図版234	日向林A遺跡	その他の石器分布図
図版195	日向林 I 石器文化	接合資料32	図版235	日向林A遺跡	その他石器実測図 1
図版196	日向林 I 石器文化	接合資料33	図版236	日向林A遺跡	その他石器実測図 2
図版197	日向林 I 石器文化	接合資料34	図版237	七ツ栗 I 石器文化	全体図
図版198	日向林 I 石器文化	接合資料35	図版238	七ツ栗 I 石器文化	BL1・BL2遺物分 布図
図版199	日向林 I 石器文化	接合資料36	図版239	七ツ栗 I 石器文化	BL3遺物分布図
図版200	日向林 I 石器文化	接合資料37	図版240	七ツ栗 I 石器文化	BL4・BL5遺物分 布図
図版201	日向林 I 石器文化	接合資料38	図版241	七ツ栗 I 石器文化	ブロック外遺物分 布図
図版202	日向林 I 石器文化	接合資料39	図版242	七ツ栗 I 石器文化	礫分布図
図版203	日向林III石器文化	全体図	図版243	七ツ栗 I 石器文化	SH1・SH2遺物分
図版204	日向林III石器文化	BL1遺物分布図			
図版205	日向林III石器文化	石器実測図 1			
図版206	日向林III石器文化	石器実測図 2			
図版207	日向林III石器文化	石器実測図 3			
図版208	日向林III石器文化	石器実測図 4			
図版209	日向林 II a 石器文化	全体図			

布図		図版272	七ツ栗II石器文化	石器実測図13	
図版244	七ツ栗I石器文化	SH3・SH4遺物分布図	図版273	七ツ栗II石器文化	石器実測図14
布図		図版274	七ツ栗遺跡	その他石器実測図	
図版245	七ツ栗I石器文化	石器実測図1	図版275	大平I石器文化	全体図
図版246	七ツ栗I石器文化	石器実測図2	図版276	大平I石器文化	BL1遺物分布図
図版247	七ツ栗I石器文化	石器実測図3	図版277	大平I石器文化	BL2遺物分布図
図版248	七ツ栗I石器文化	石器実測図4	図版278	大平I石器文化	BL3遺物分布図
図版249	七ツ栗I石器文化	石器実測図5	図版279	大平I石器文化	BL4遺物分布図
図版250	七ツ栗I石器文化	石器実測図6	図版280	大平I石器文化	BL5・BL6遺物分布図
図版251	七ツ栗I石器文化	石器実測図7	図版281	大平I石器文化	SH1遺物分布図
図版252	七ツ栗I石器文化	石器実測図8	図版282	大平I石器文化	石器実測図1
図版253	七ツ栗I石器文化	接合資料	図版283	大平I石器文化	石器実測図2
図版254	七ツ栗II石器文化	全体図	図版284	大平I石器文化	石器実測図3
図版255	七ツ栗II石器文化	BL1遺物分布図	図版285	大平I石器文化	石器実測図4
図版256	七ツ栗II石器文化	BL2遺物分布図	図版286	大平I石器文化	石器実測図5
図版257	七ツ栗II石器文化	BL2出土石器・BL3遺物分布図	図版287	大平I石器文化	石器実測図6
図版258	七ツ栗II石器文化	ブロック外遺物分布図	図版288	大平I石器文化	石器実測図7
図版259	七ツ栗II石器文化	SH1遺物分布図	図版289	大平I石器文化	石器実測図8
図版260	七ツ栗II石器文化	石器実測図1	図版290	大平I石器文化	石器実測図9
図版261	七ツ栗II石器文化	石器実測図2	図版291	大平I石器文化	石器実測図10
図版262	七ツ栗II石器文化	石器実測図3	図版292	大平I石器文化	石器実測図11
図版263	七ツ栗II石器文化	石器実測図4	図版293	大平I石器文化	石器実測図12
図版264	七ツ栗II石器文化	石器実測図5	図版294	大平I石器文化	石器実測図13
図版265	七ツ栗II石器文化	石器実測図6	図版295	大平I石器文化	石器実測図14
図版266	七ツ栗II石器文化	石器実測図7	図版296	大平II石器文化	全体図
図版267	七ツ栗II石器文化	石器実測図8	図版297	大平II石器文化	BL1・BL2遺物分布図
図版268	七ツ栗II石器文化	石器実測図9	図版298	大平II石器文化	石器実測図
図版269	七ツ栗II石器文化	石器実測図10	図版299	大平B遺跡	その他の石器分布図
図版270	七ツ栗II石器文化	石器実測図11	図版300	大平B遺跡	その他の石器実測図
図版271	七ツ栗II石器文化	石器実測図12			

### 写真図版目次

PL 1	日向林B遺跡調査状況1	PL 6	日向林B遺跡調査状況6
PL 2	日向林B遺跡調査状況2	PL 7	日向林B遺跡調査状況7
PL 3	日向林B遺跡調査状況3	PL 8	日向林B遺跡調査状況8
PL 4	日向林B遺跡調査状況4	PL 9	日向林B遺跡調査状況9
PL 5	日向林B遺跡調査状況5	PL10	日向林I石器文化 石器1

PL11	日向林 I 石器文化	石器 2	PL51	日向林 I 石器文化	石器42
PL12	日向林 I 石器文化	石器 3	PL52	日向林 I 石器文化	石器43
PL13	日向林 I 石器文化	石器 4	PL53	日向林 I 石器文化	石器44
PL14	日向林 I 石器文化	石器 5	PL54	日向林 I 石器文化	石器45
PL15	日向林 I 石器文化	石器 6	PL55	日向林 I 石器文化	石器46
PL16	日向林 I 石器文化	石器 7	PL56	日向林 I 石器文化	石器47
PL17	日向林 I 石器文化	石器 8	PL57	日向林 I 石器文化	石器48
PL18	日向林 I 石器文化	石器 9	PL58	日向林 I 石器文化	石器49
PL19	日向林 I 石器文化	石器10	PL59	日向林 I 石器文化	石器50
PL20	日向林 I 石器文化	石器11	PL60	日向林 I 石器文化	石器51
PL21	日向林 I 石器文化	石器12	PL61	日向林 I 石器文化	石器52
PL22	日向林 I 石器文化	石器13	PL62	日向林 I 石器文化	石器53
PL23	日向林 I 石器文化	石器14	PL63	日向林 I 石器文化	石器54
PL24	日向林 I 石器文化	石器15	PL64	日向林 I 石器文化	石器55
PL25	日向林 I 石器文化	石器16	PL65	日向林 I 石器文化	石器56
PL26	日向林 I 石器文化	石器17	PL66	日向林 I 石器文化	石器57
PL27	日向林 I 石器文化	石器18	PL67	日向林 I 石器文化	石器の使用痕
PL28	日向林 I 石器文化	石器19	PL68	日向林 I 石器文化	石器の使用痕
PL29	日向林 I 石器文化	石器20	PL69	日向林 I 石器文化	石器の使用痕
PL30	日向林 I 石器文化	石器21	PL70	日向林 I 石器文化	石器の使用痕
PL31	日向林 I 石器文化	石器22	PL71	日向林 I 石器文化	石器の使用痕
PL32	日向林 I 石器文化	石器23	PL72	日向林 I 石器文化	石器の使用痕
PL33	日向林 I 石器文化	石器24	PL73	日向林 I 石器文化	石器の使用痕
PL34	日向林 I 石器文化	石器25	PL74	日向林 I 石器文化	石器の使用痕
PL35	日向林 I 石器文化	石器26	PL75	日向林 I 石器文化	石器の使用痕
PL36	日向林 I 石器文化	石器27	PL76	日向林 I 石器文化	石器の使用痕
PL37	日向林 I 石器文化	石器28	PL77	日向林III石器文化	石器
PL38	日向林 I 石器文化	石器29	PL78	日向林A遺跡調査状況 1	
PL39	日向林 I 石器文化	石器30	PL79	日向林II a 石器文化	石器 1
PL40	日向林 I 石器文化	石器31	PL80	日向林II b 石器文化	石器 1
PL41	日向林 I 石器文化	石器32	PL81	日向林II b 石器文化	石器 2
PL42	日向林 I 石器文化	石器33	PL82	日向林II b 石器文化	石器 3
PL43	日向林 I 石器文化	石器34	PL83	日向林II b 石器文化	石器 4
PL44	日向林 I 石器文化	石器35	PL84	日向林II b 石器文化	石器 5
PL45	日向林 I 石器文化	石器36	PL85	日向林IV石器文化	石器 1
PL46	日向林 I 石器文化	石器37	PL86	日向林IV石器文化	石器 2
PL47	日向林 I 石器文化	石器38	PL87	日向林A遺跡	その他旧石器時代の石器
PL48	日向林 I 石器文化	石器39	PL88	七ツ栗遺跡調査状況 1	
PL49	日向林 I 石器文化	石器40	PL89	七ツ栗遺跡調査状況 2	
PL50	日向林 I 石器文化	石器41	PL90	七ツ栗 I 石器文化	石器 1

PL91	七ツ栗 I 石器文化	石器 2	PL101	大平 I 石器文化	石器 1
PL92	七ツ栗 II 石器文化	石器 1	PL102	大平 I 石器文化	石器 2
PL93	七ツ栗 II 石器文化	石器 2	PL103	大平 I 石器文化	石器 3
PL94	七ツ栗 II 石器文化	石器 3	PL104	大平 I 石器文化	石器 4
PL95	七ツ栗 II 石器文化	石器 4	PL105	大平 II 石器文化	石器 1
PL96	七ツ栗 II 石器文化	石器 5	PL106	大平 II 石器文化	石器 2
PL97	七ツ栗 II 石器文化	石器 6	PL107	大平 B 遺跡	その他旧石器時代の石器
PL98	七ツ栗遺跡	その他旧石器時代の石器	PL108	大平 B 遺跡	接合資料 1
PL99	大平 B 遺跡調査状況 1		PL109	大平 B 遺跡	接合資料 2
PL100	大平 B 遺跡調査状況 2				

# 遺構・遺物図版

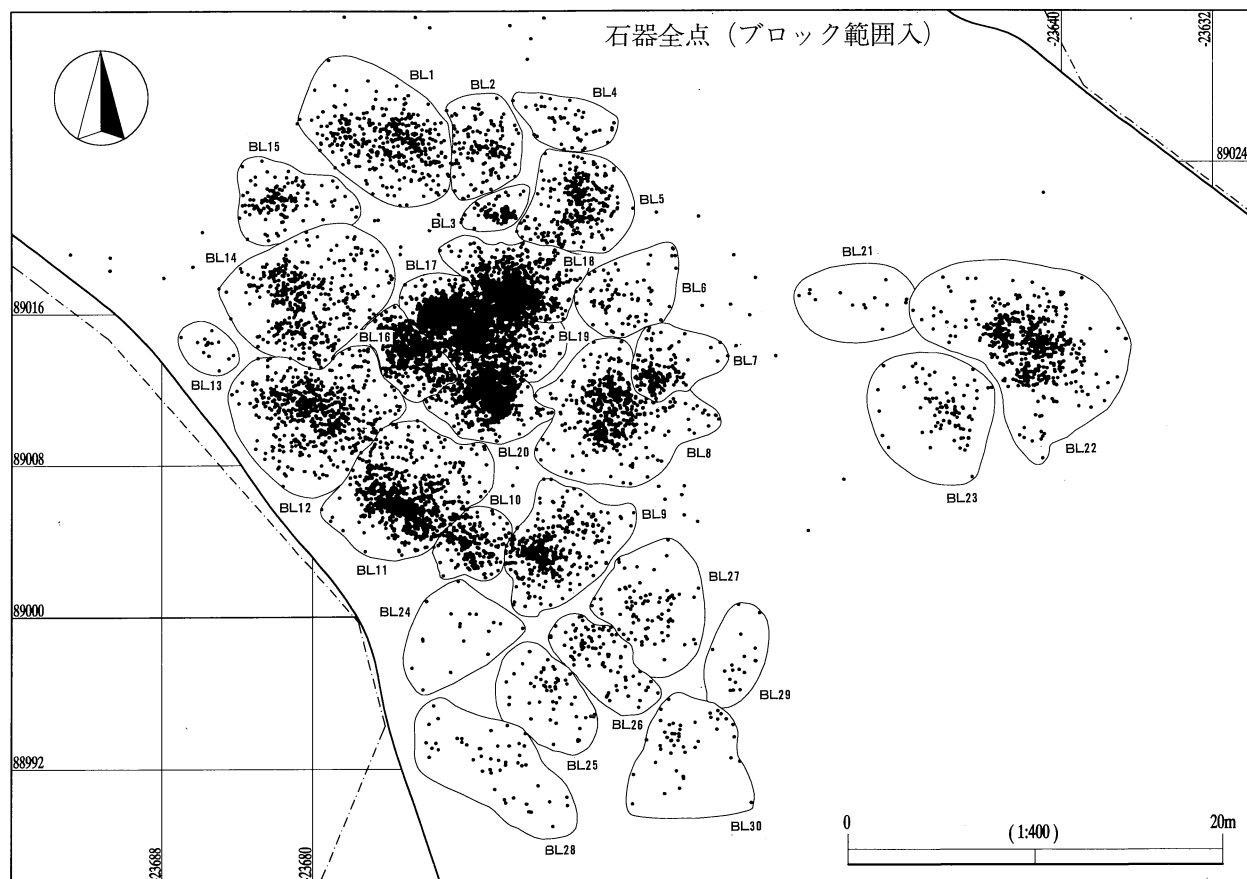
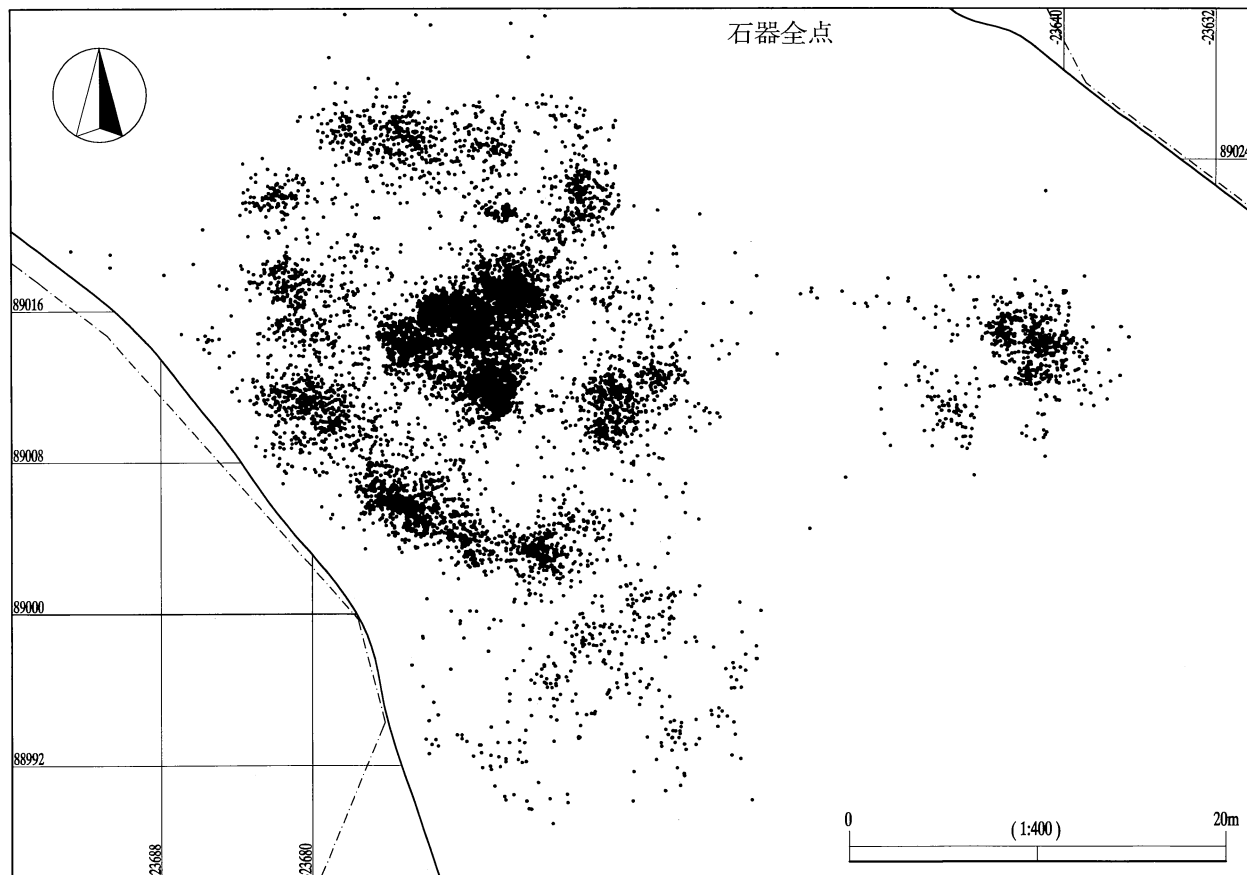

日向林 I 石器文化 全体図 1

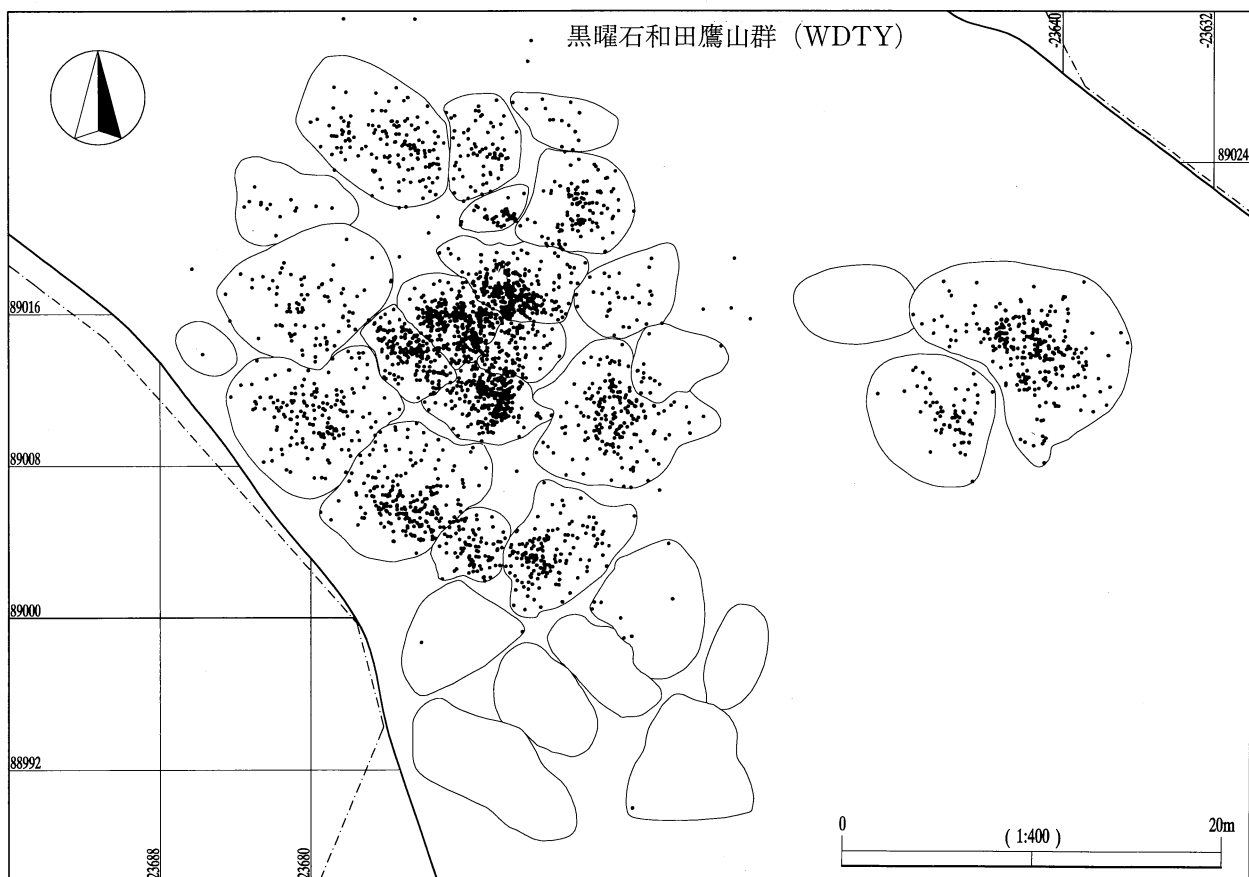
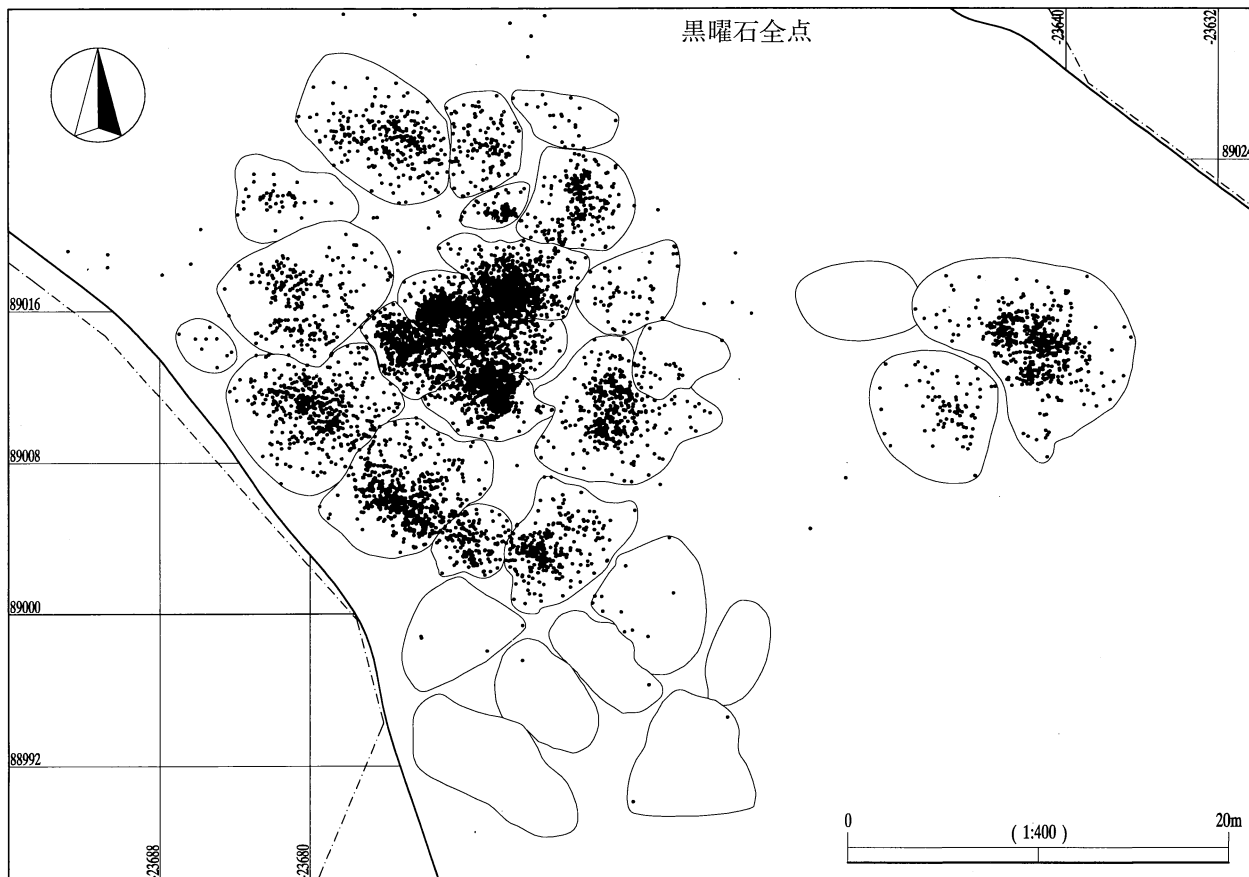

日向林 I 石器文化 全体図 2

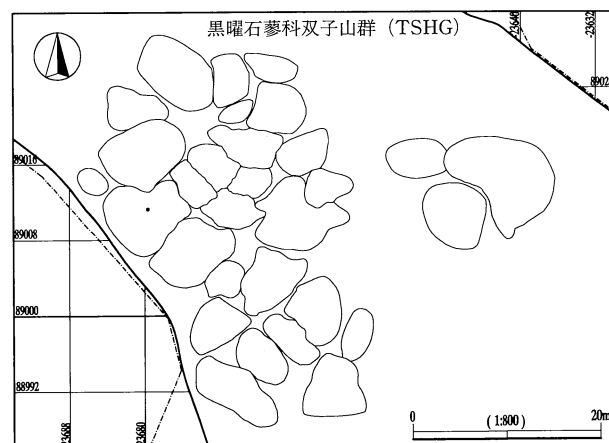
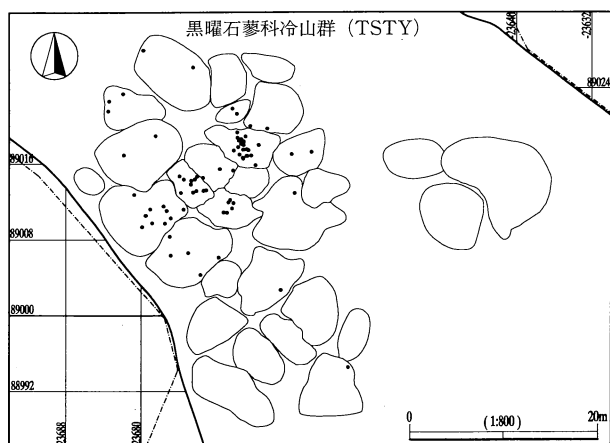
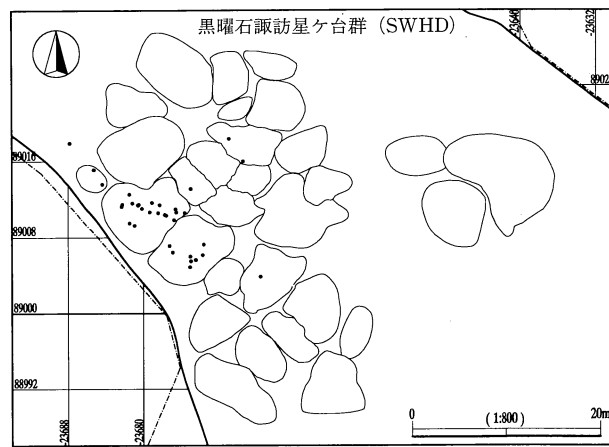
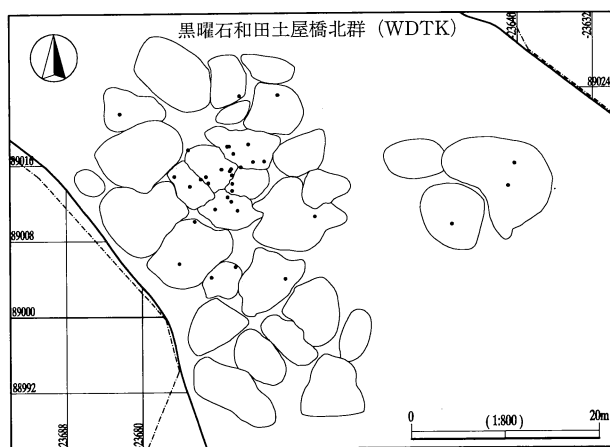
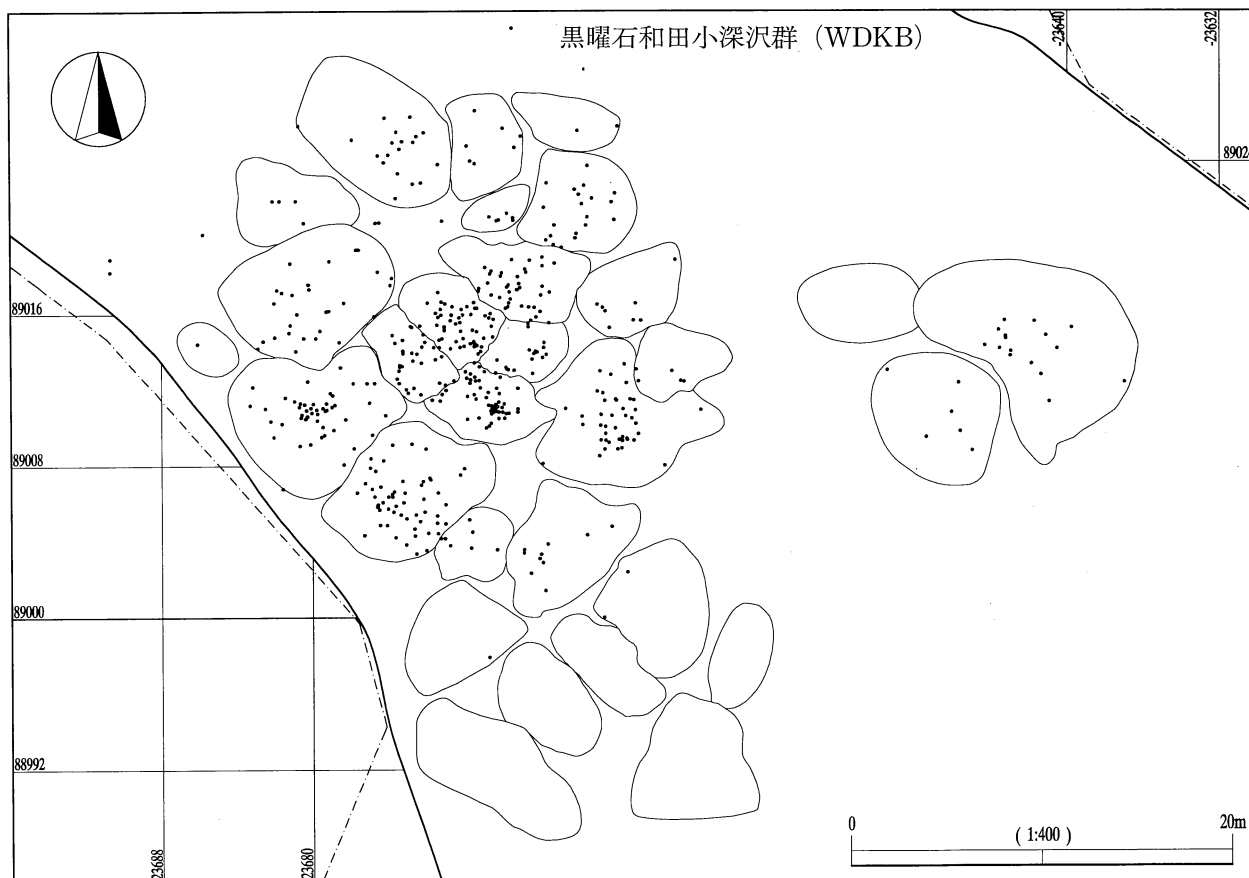

日向林 I 石器文化 全体図 3



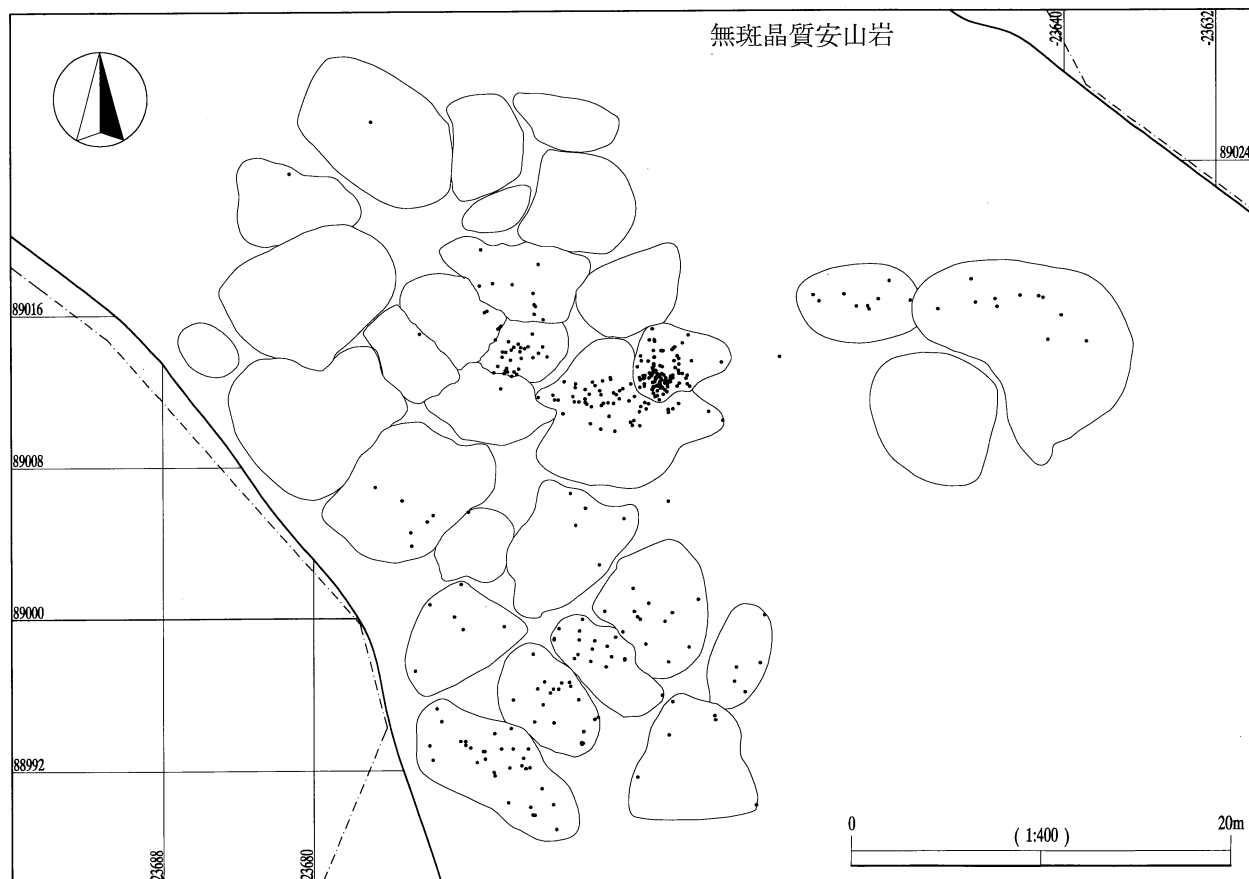
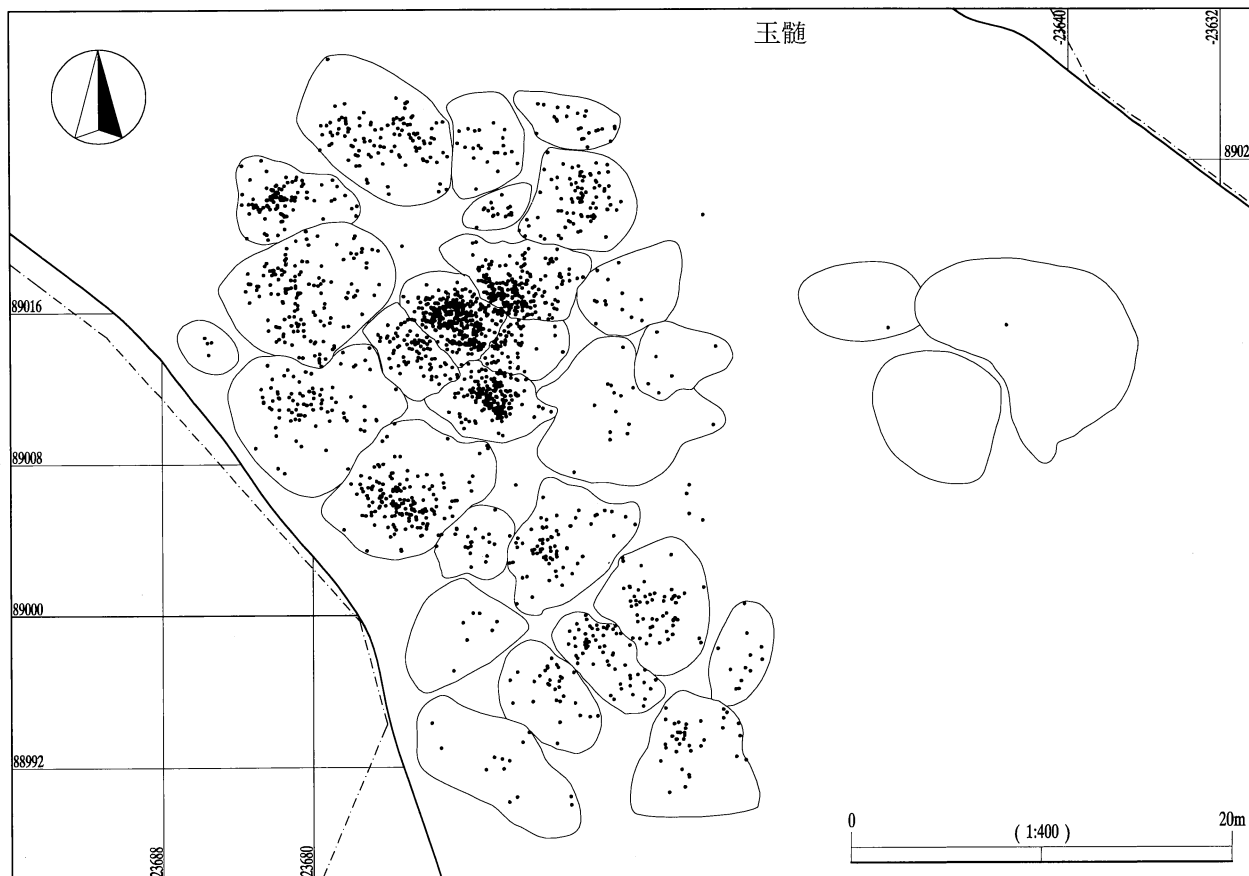

日向林 I 石器文化 全体図 4

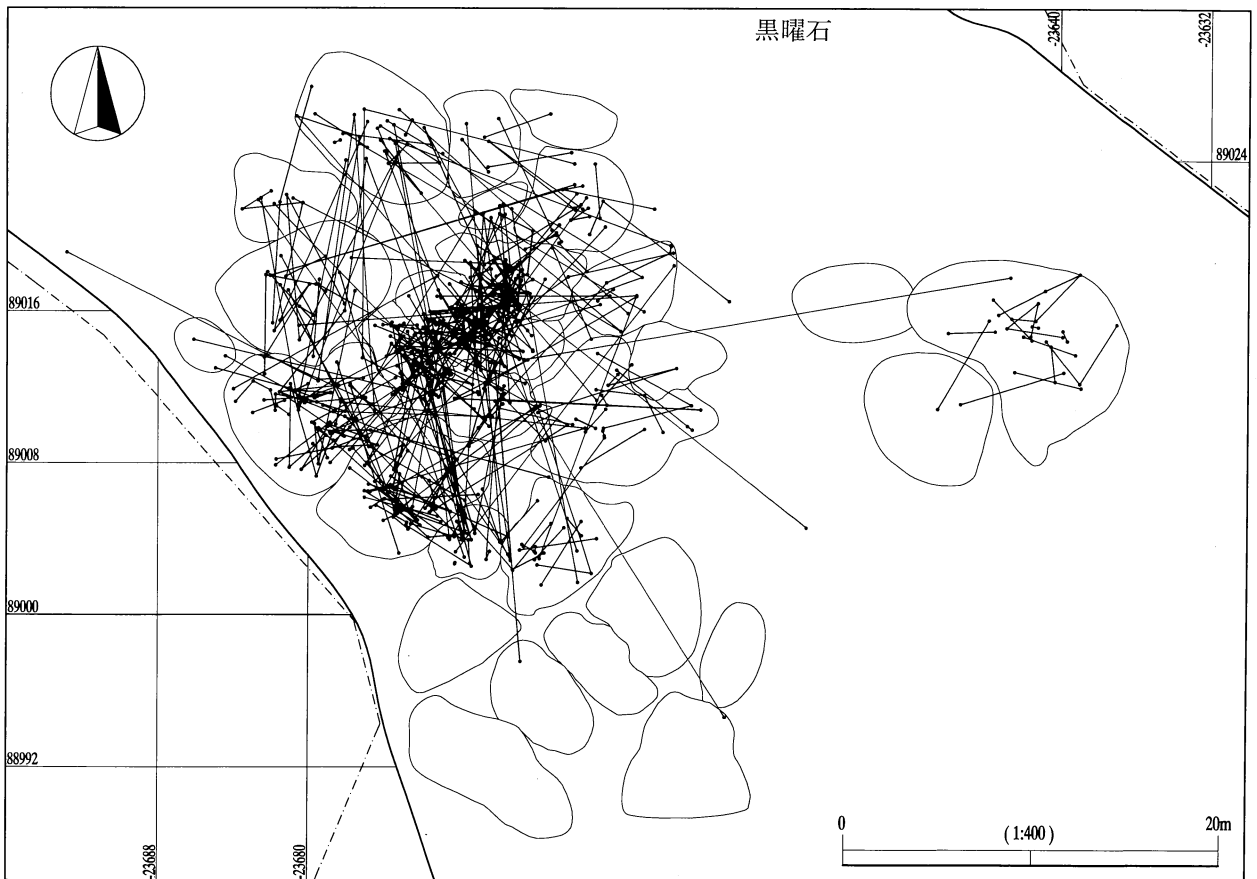
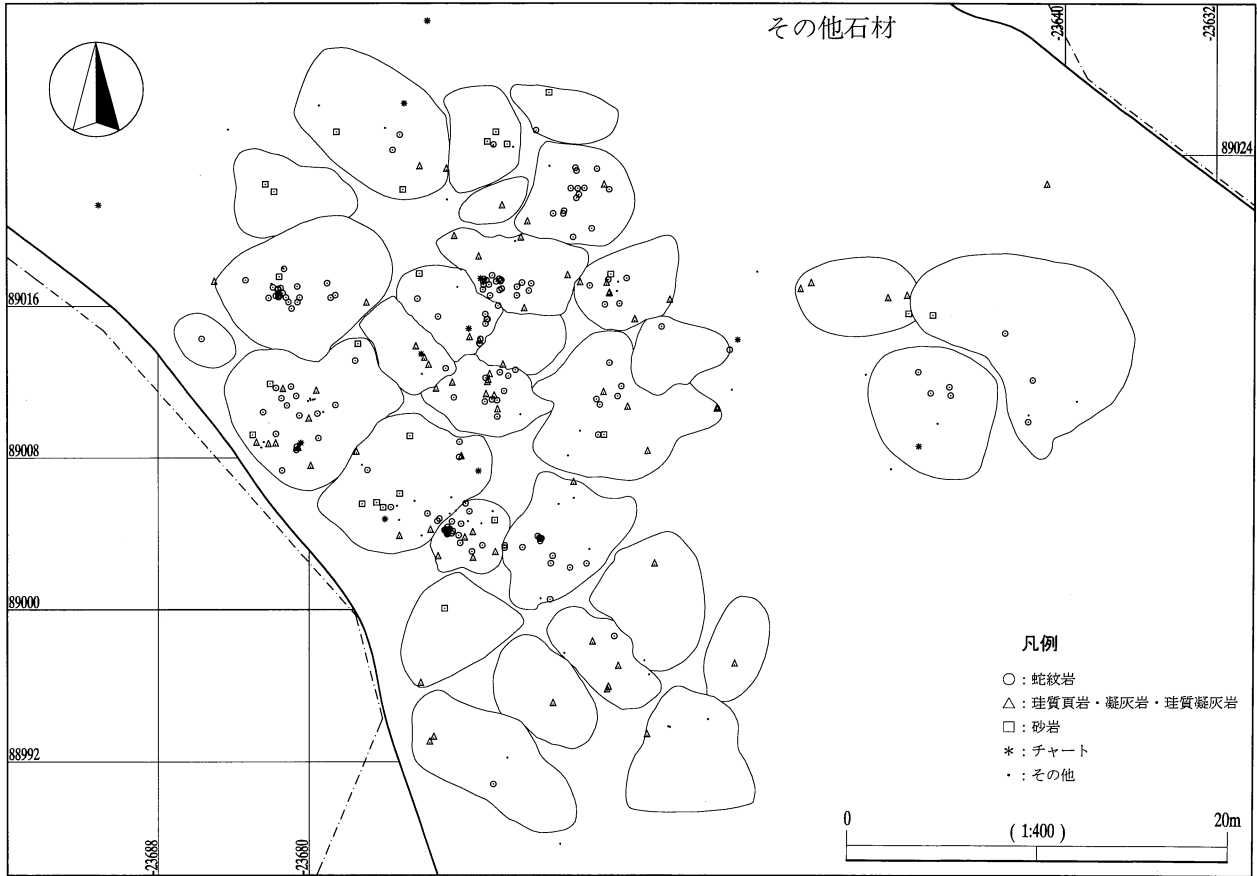

日向林 I 石器文化 全体図 5

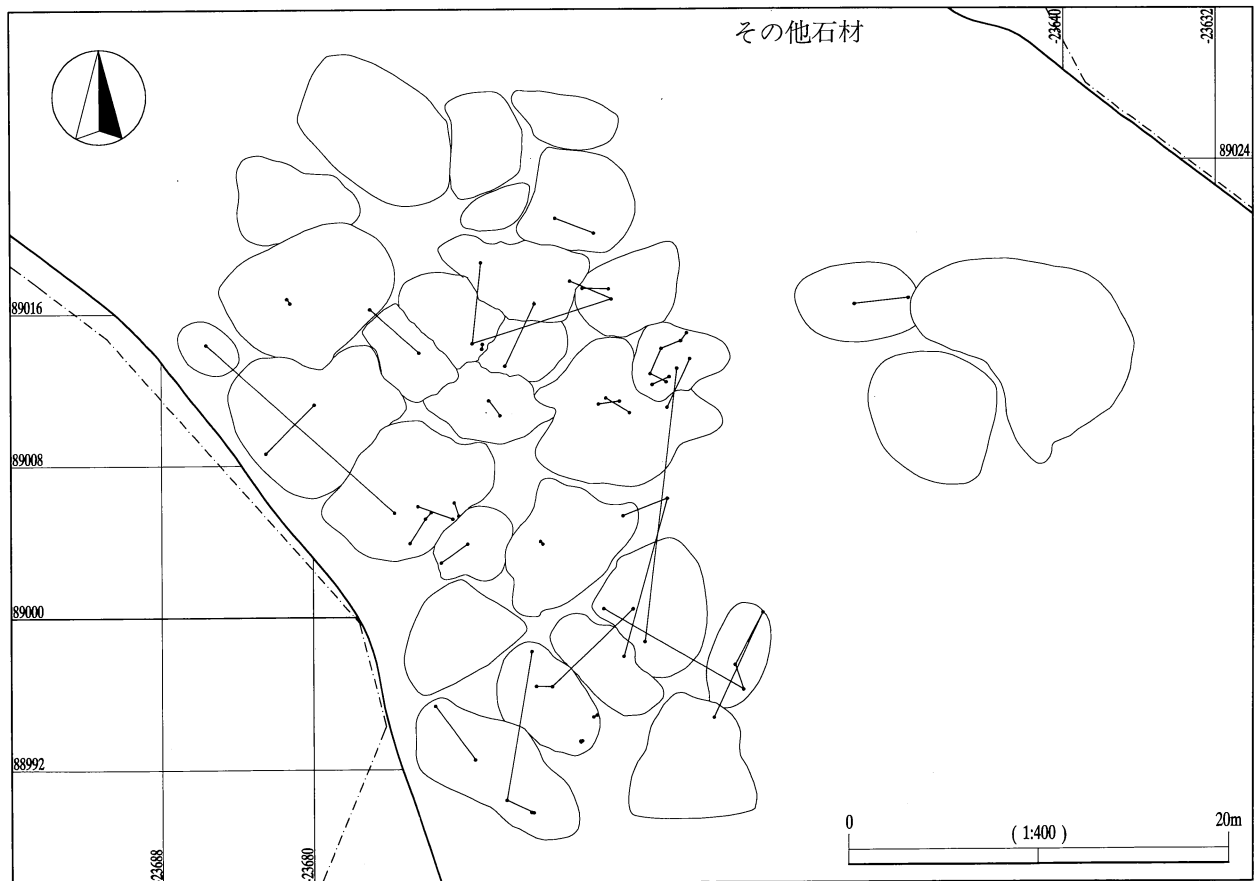
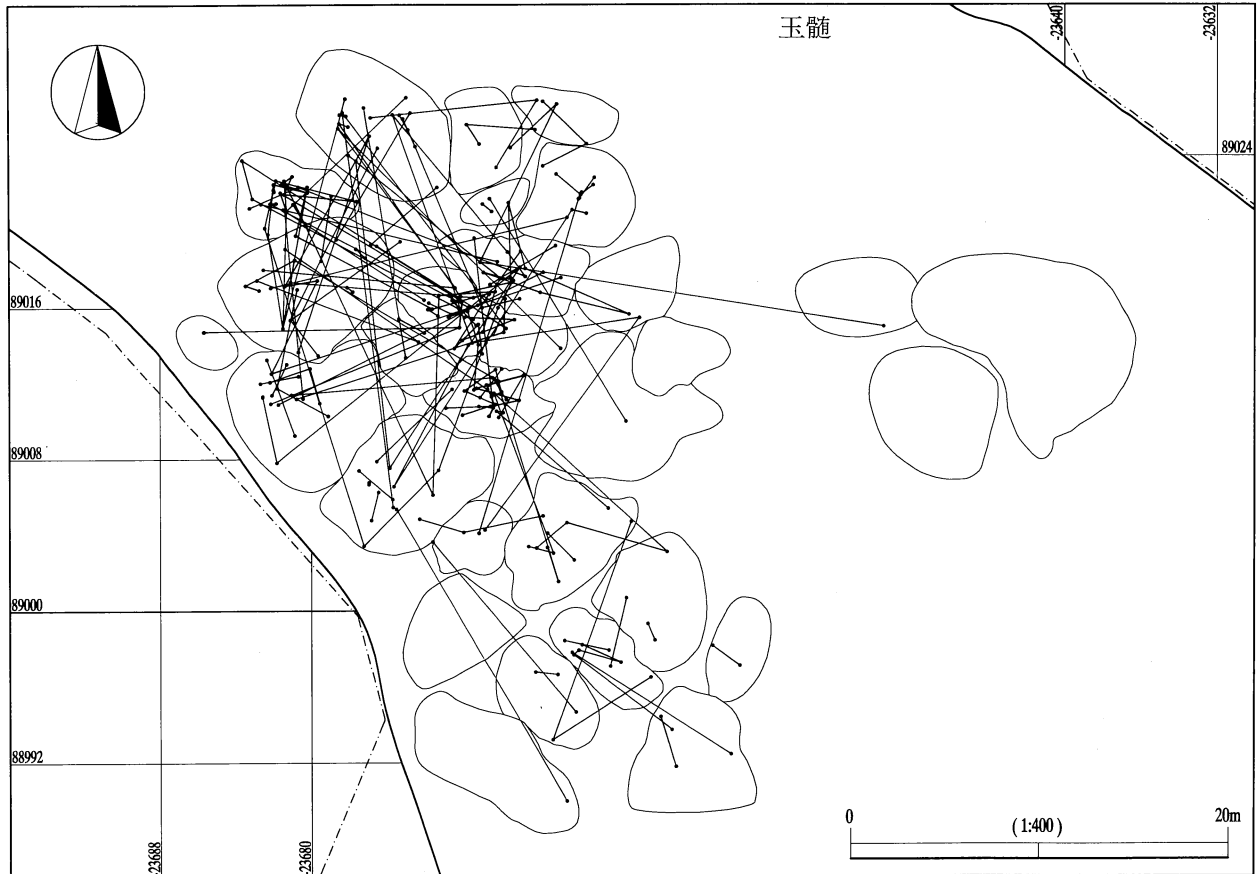

日向林 I 石器文化 全体図 6

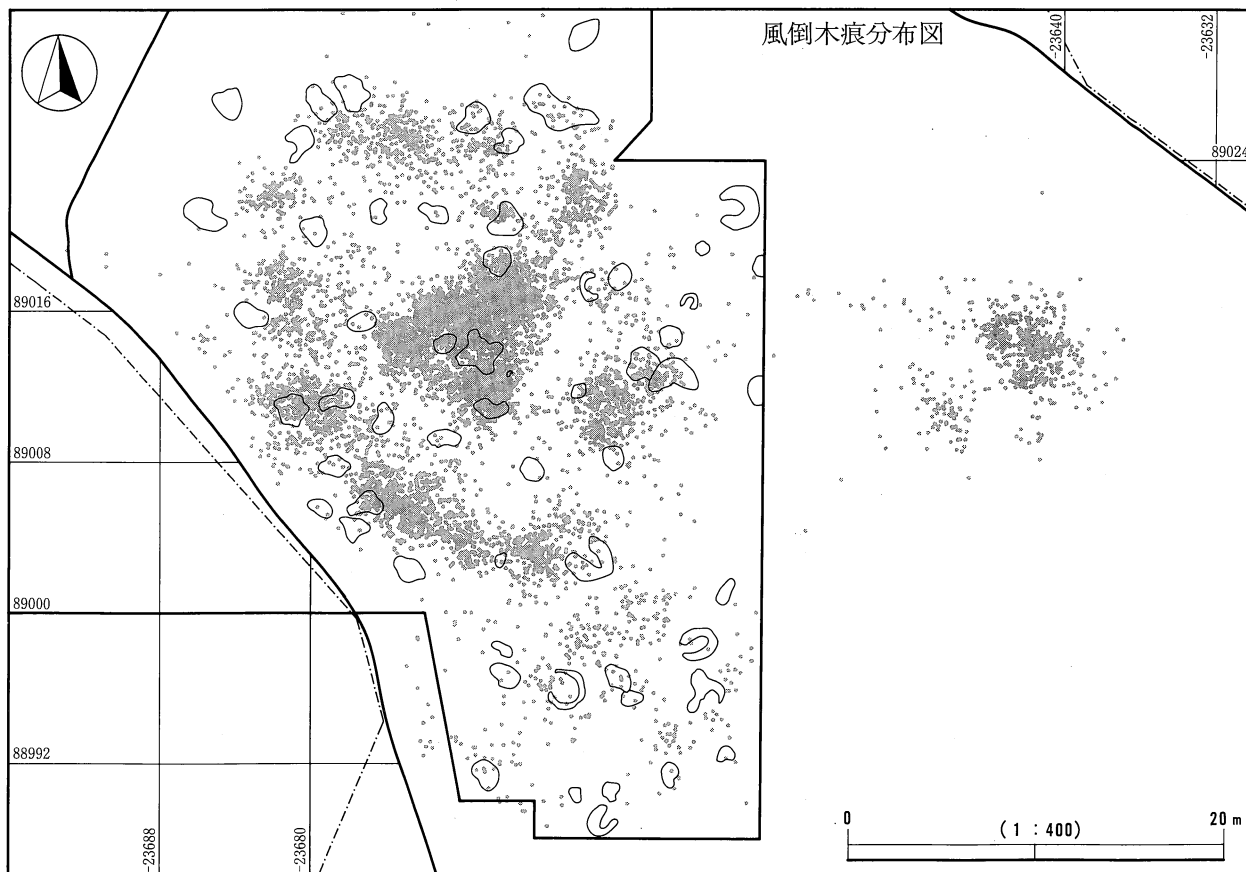
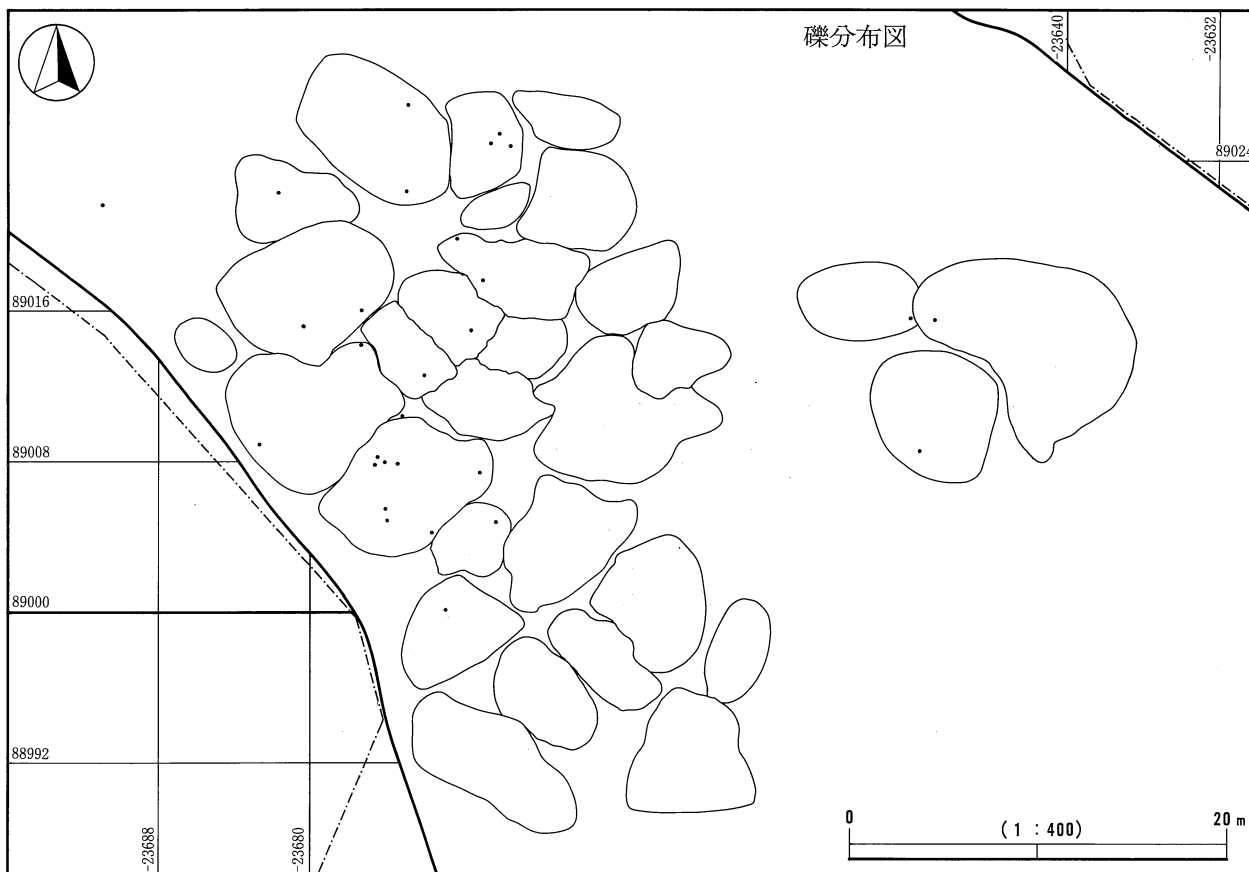

日向林 I 石器文化 全体図 7

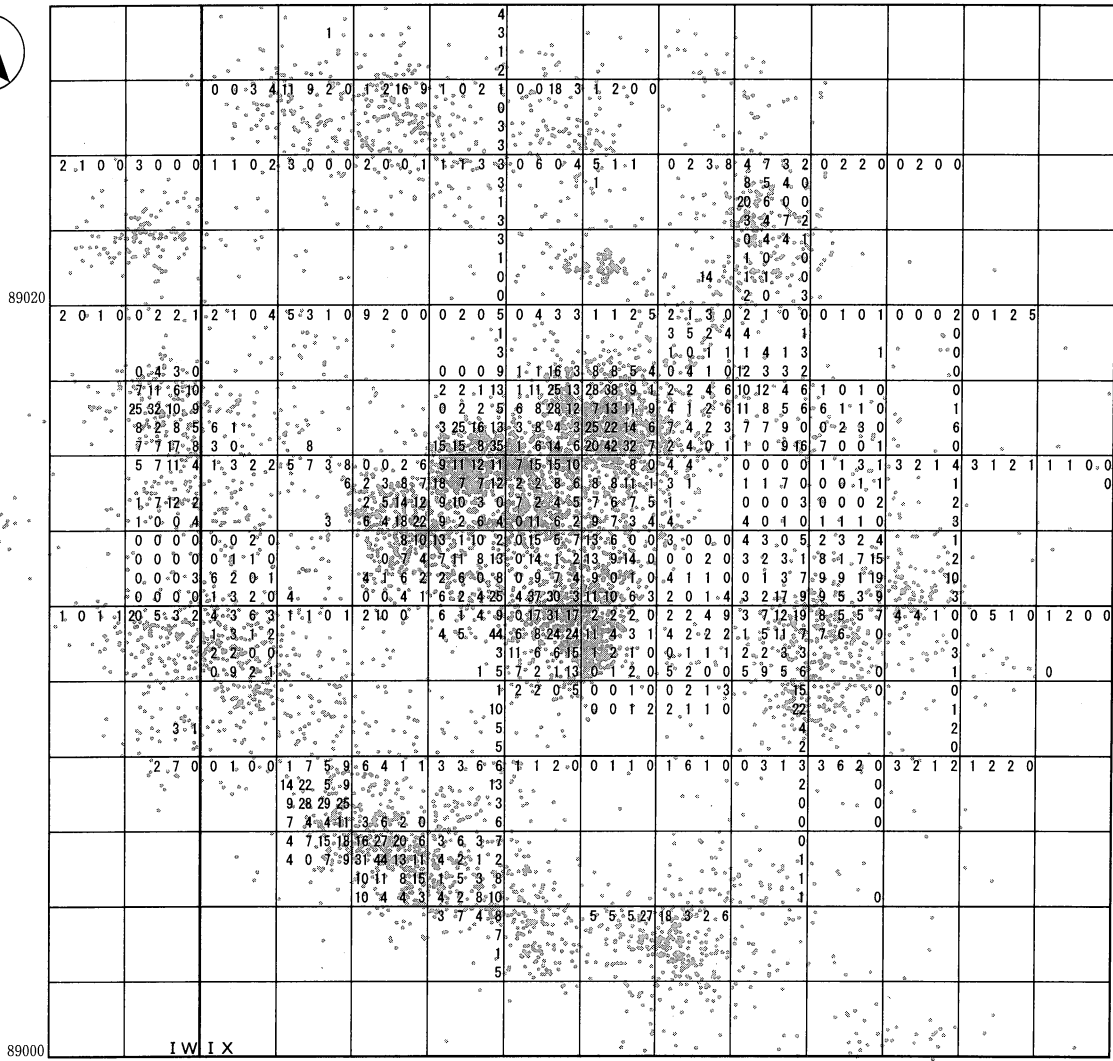

微細遺物分布図

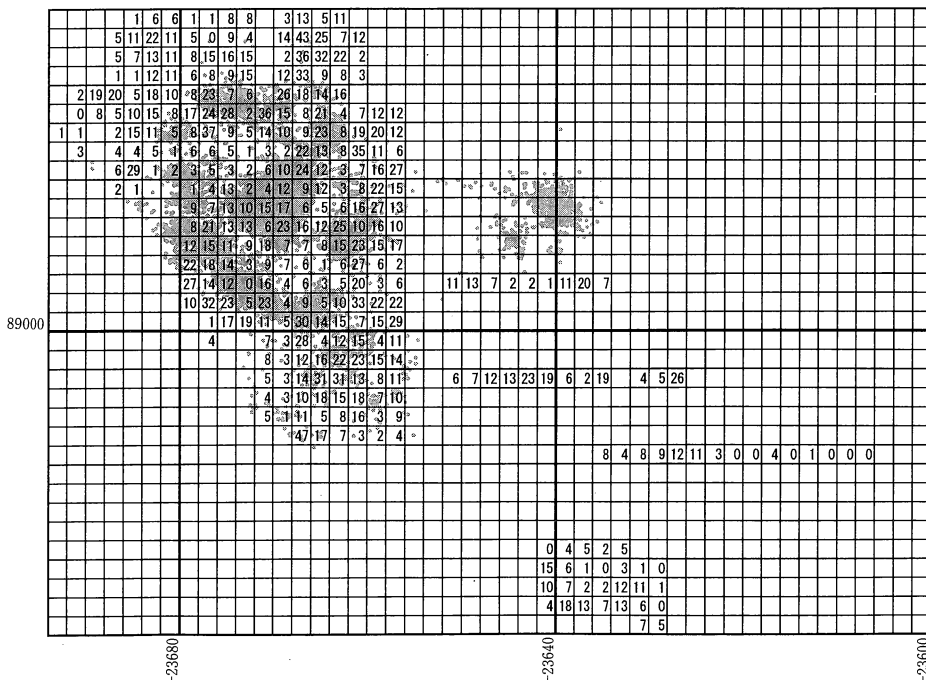

炭化粒子分布図

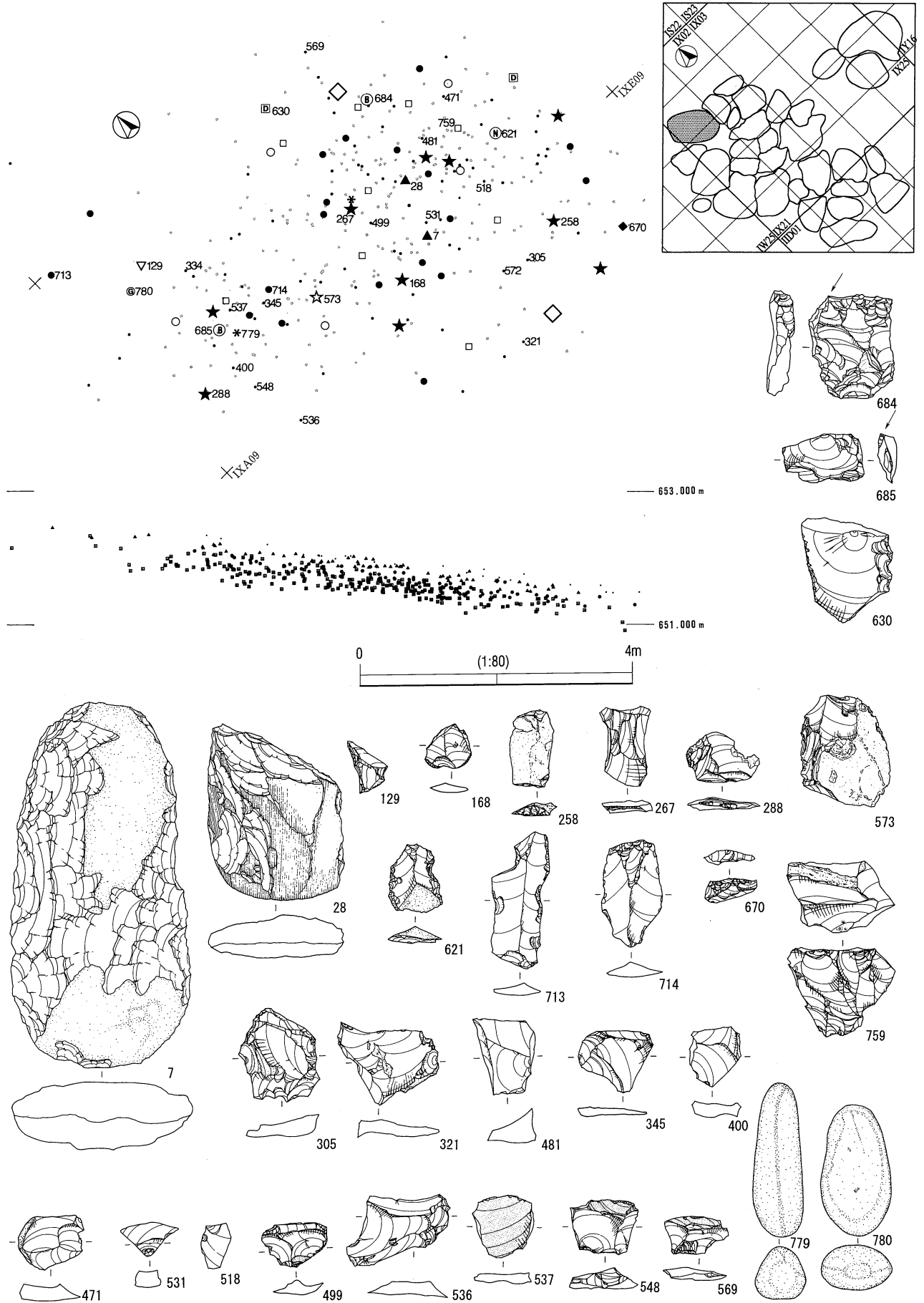

日向林 I 石器文化 BL1遺物分布図

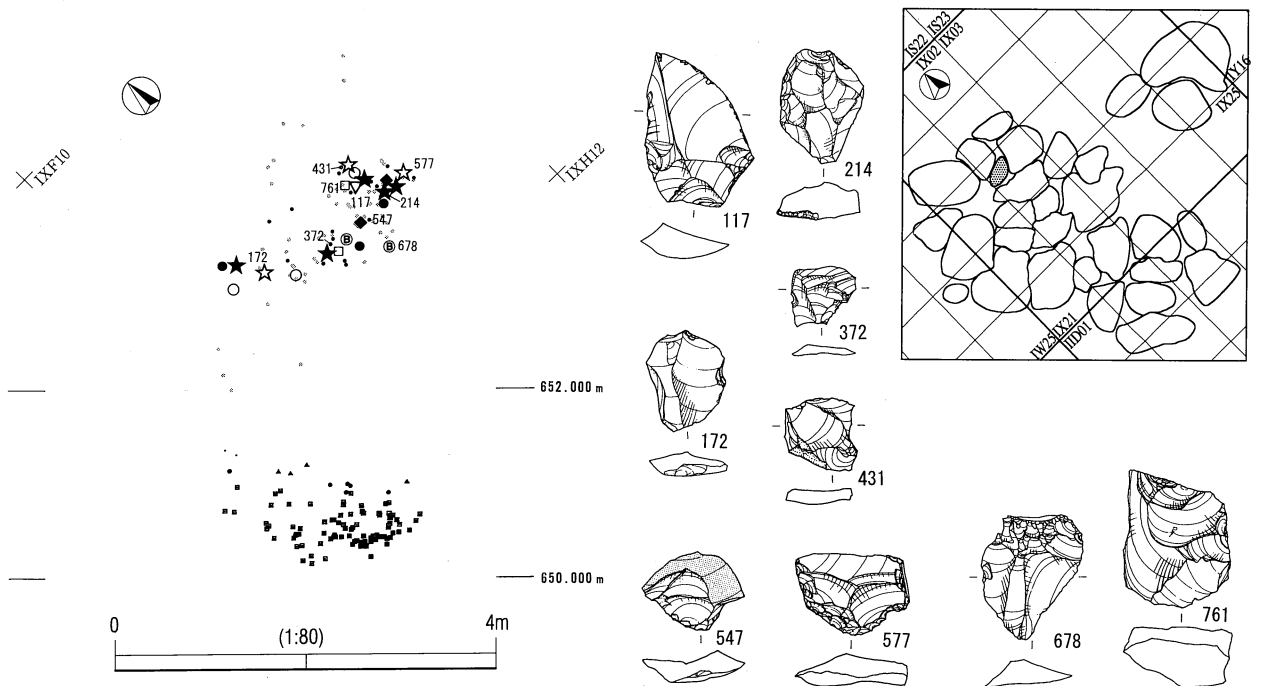
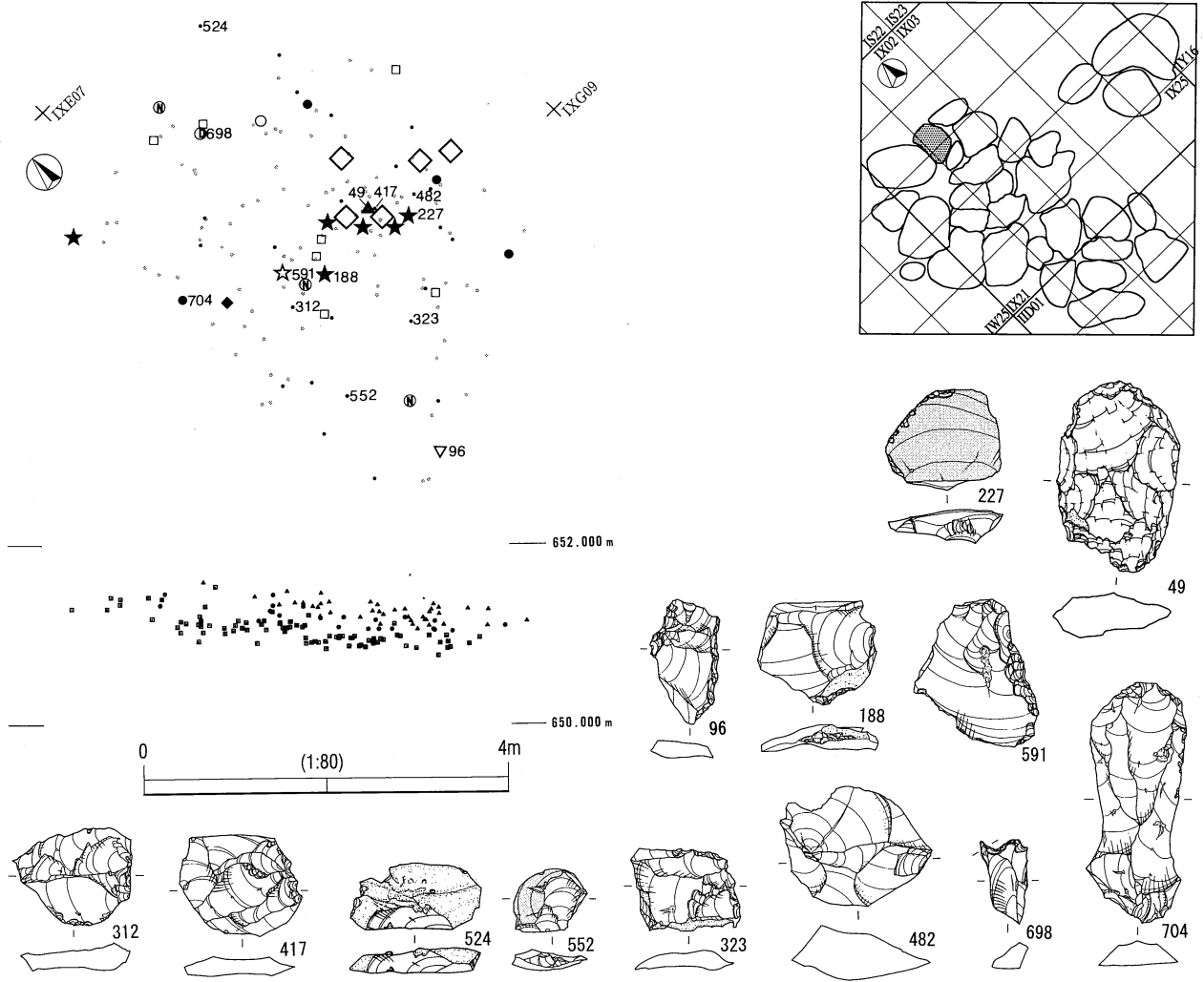

日向林 I 石器文化 BL2・BL3遺物分布図 (上:BL2・下:BL3)

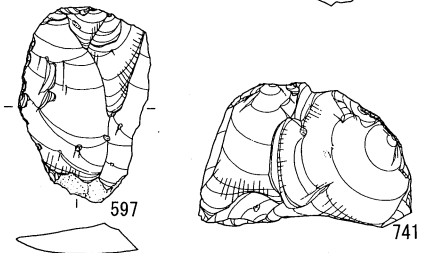
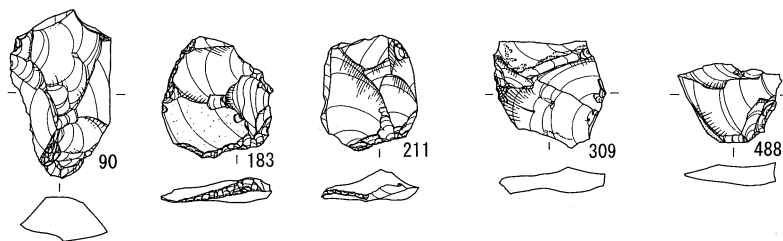
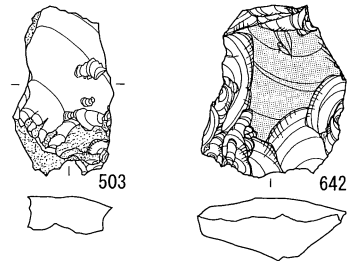
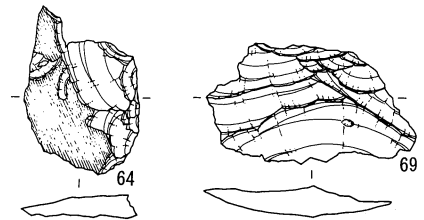
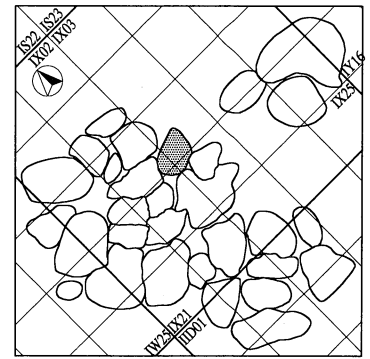
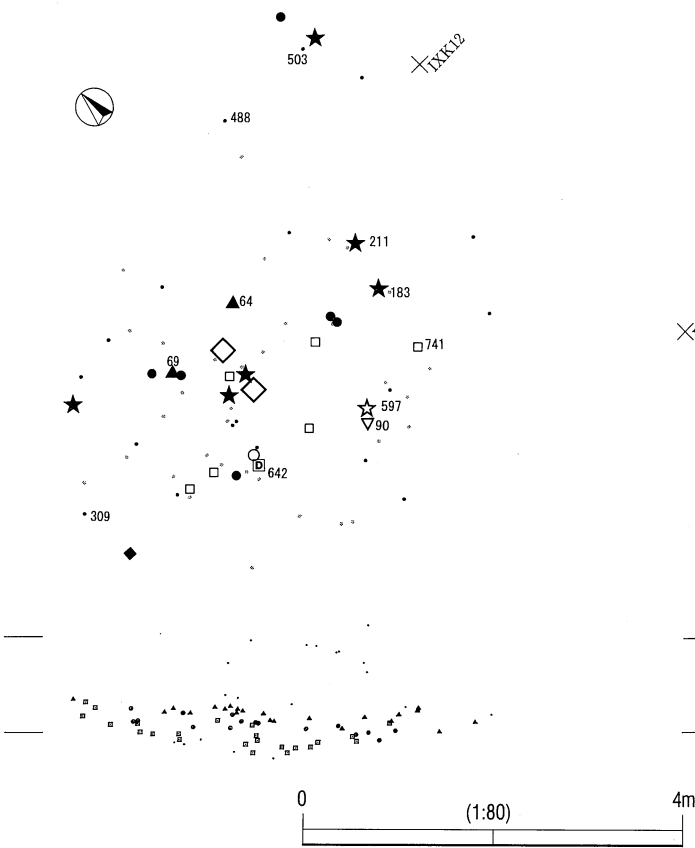
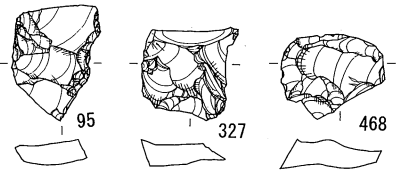
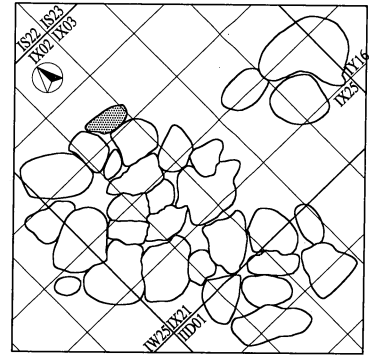
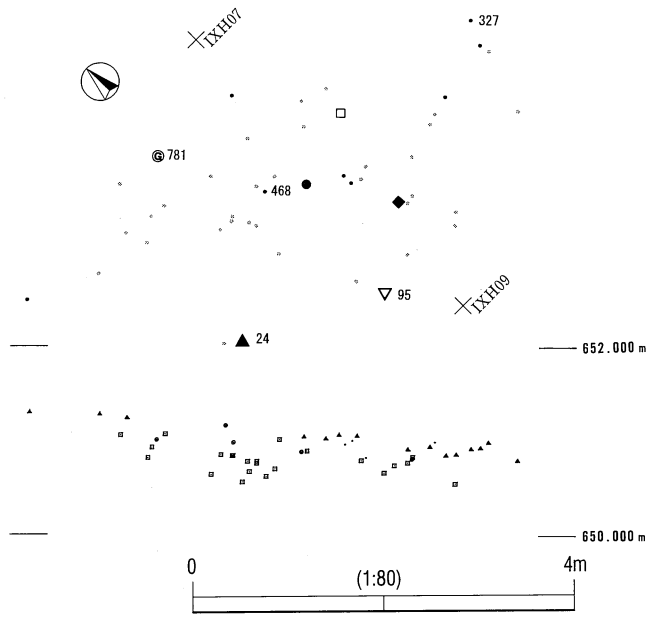

日向林 I 石器文化 BL4・BL6遺物分布図 (上: BL4・下: BL6)



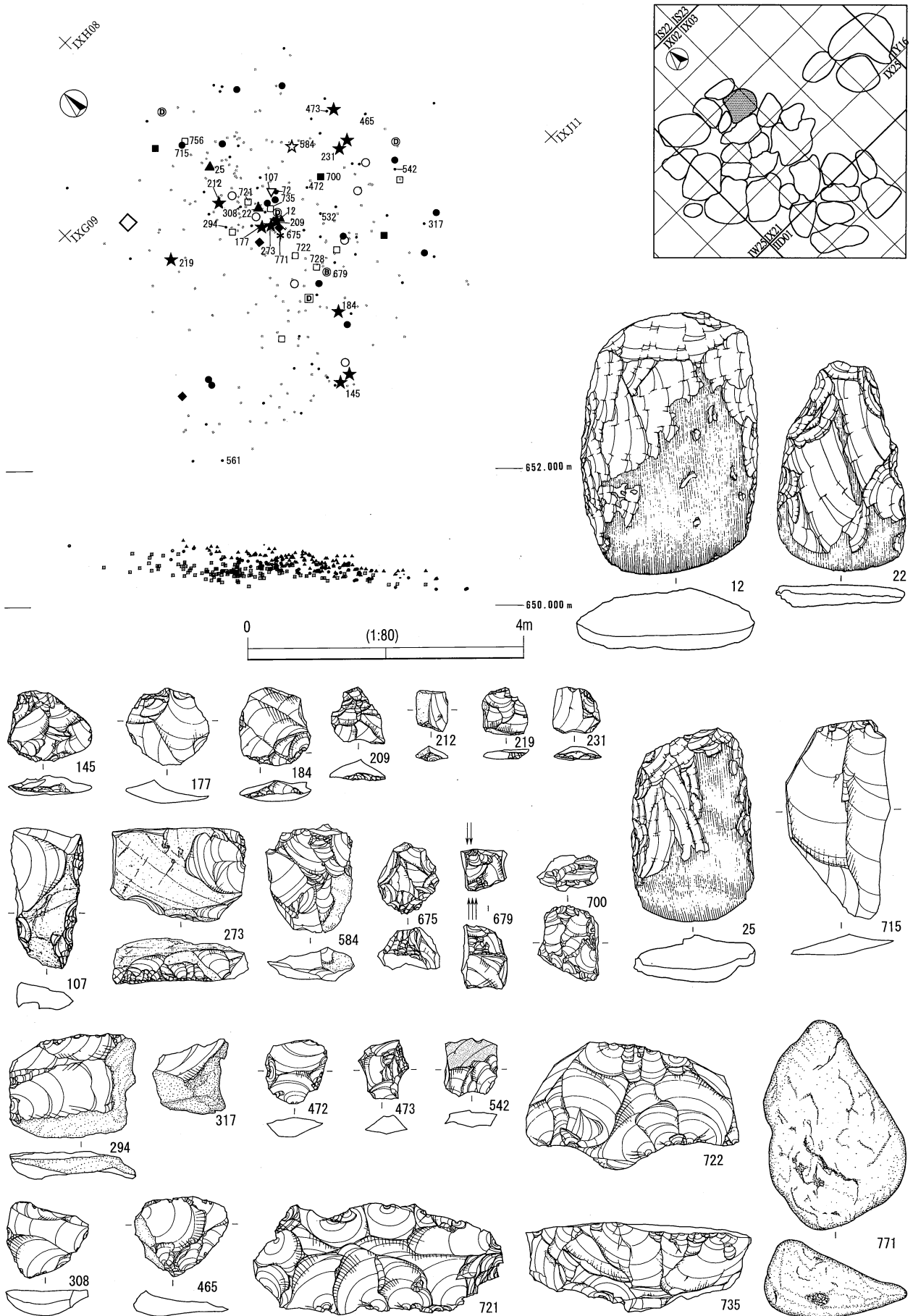

日向林 I 石器文化 BL5遺物分布図

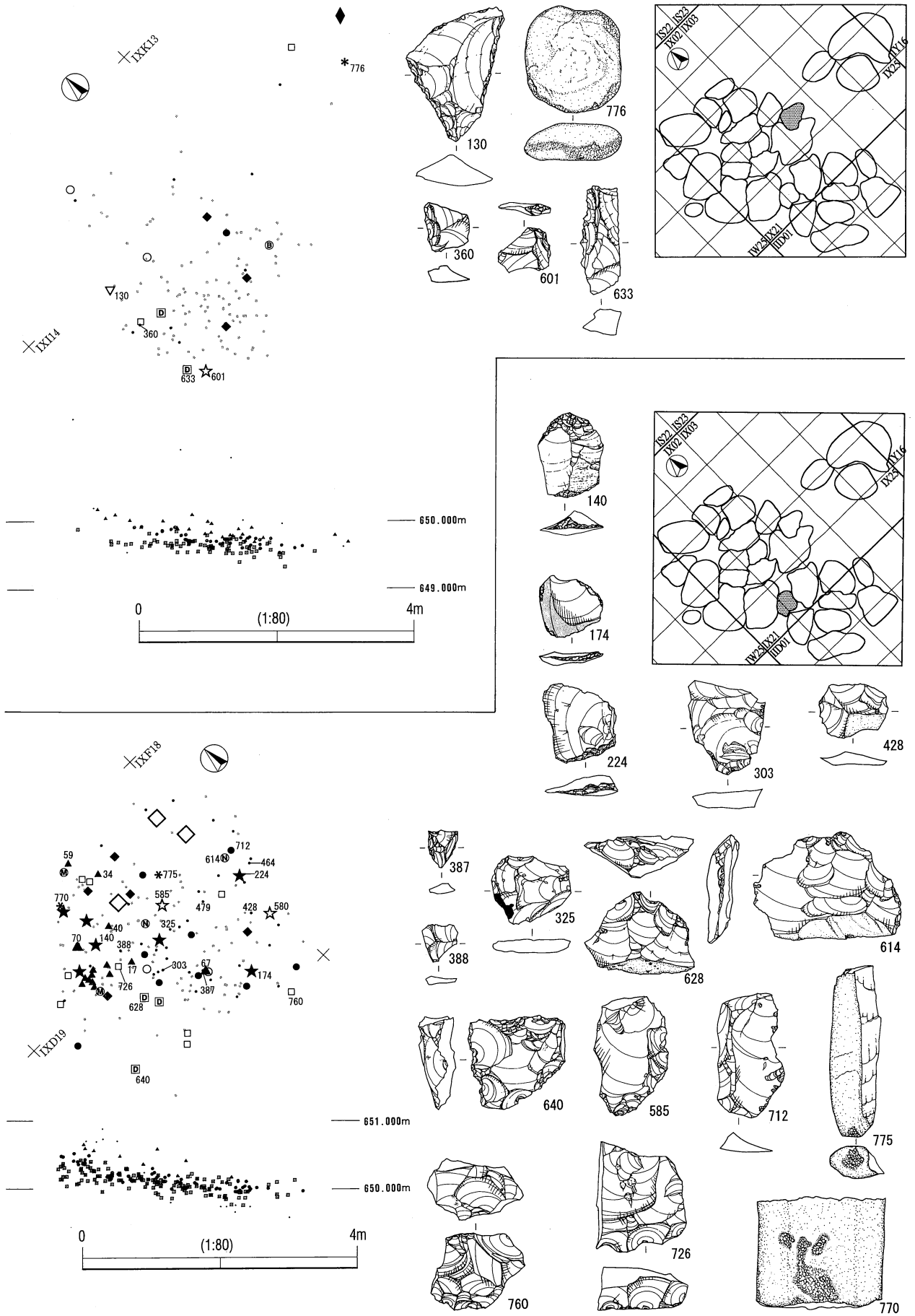

日向林 I 石器文化 BL7・BL10遺物分布図 (上: BL7・下: BL10)

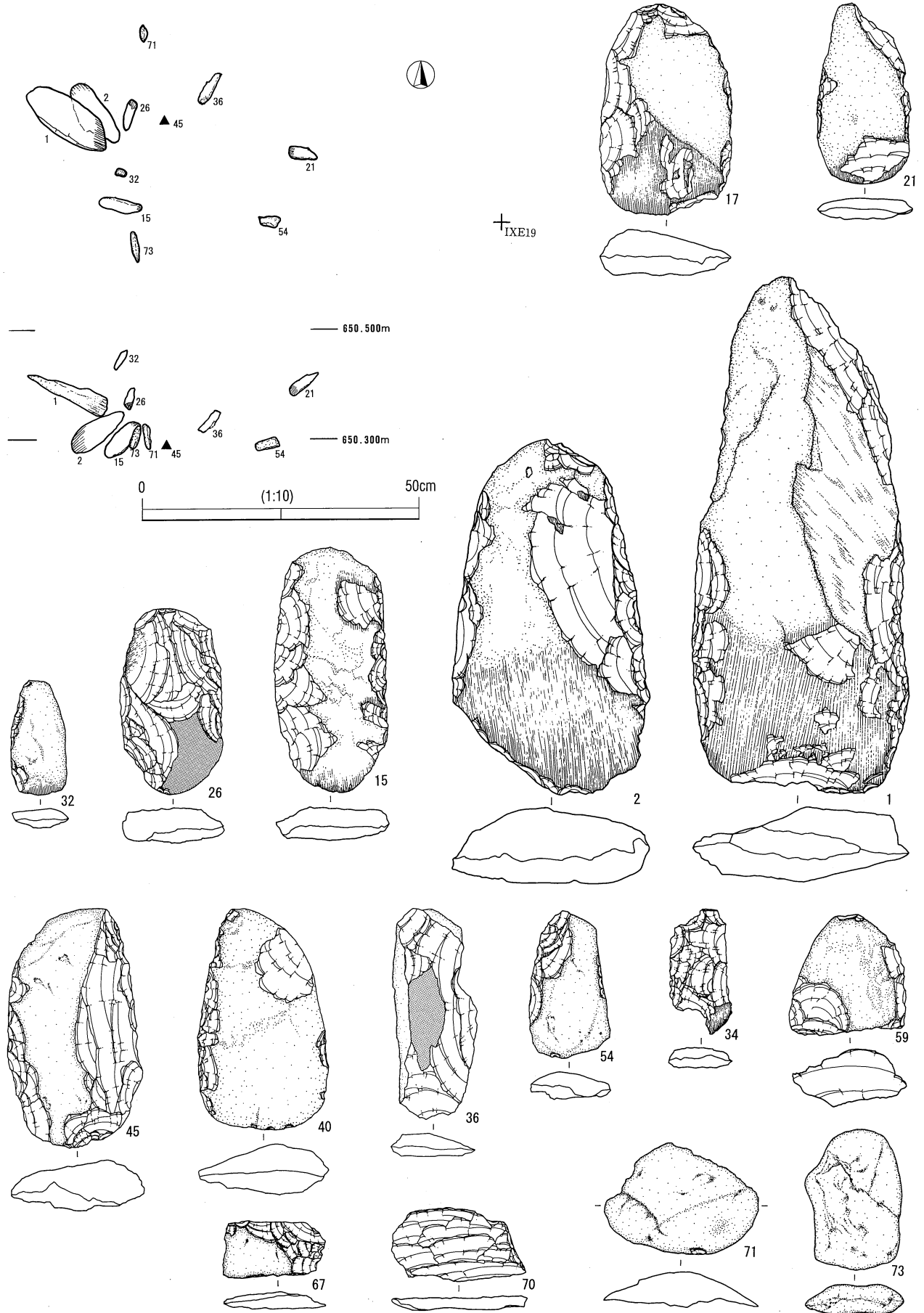

日向林 I 石器文化 BL10遺物分布図 (斧形石器集中)

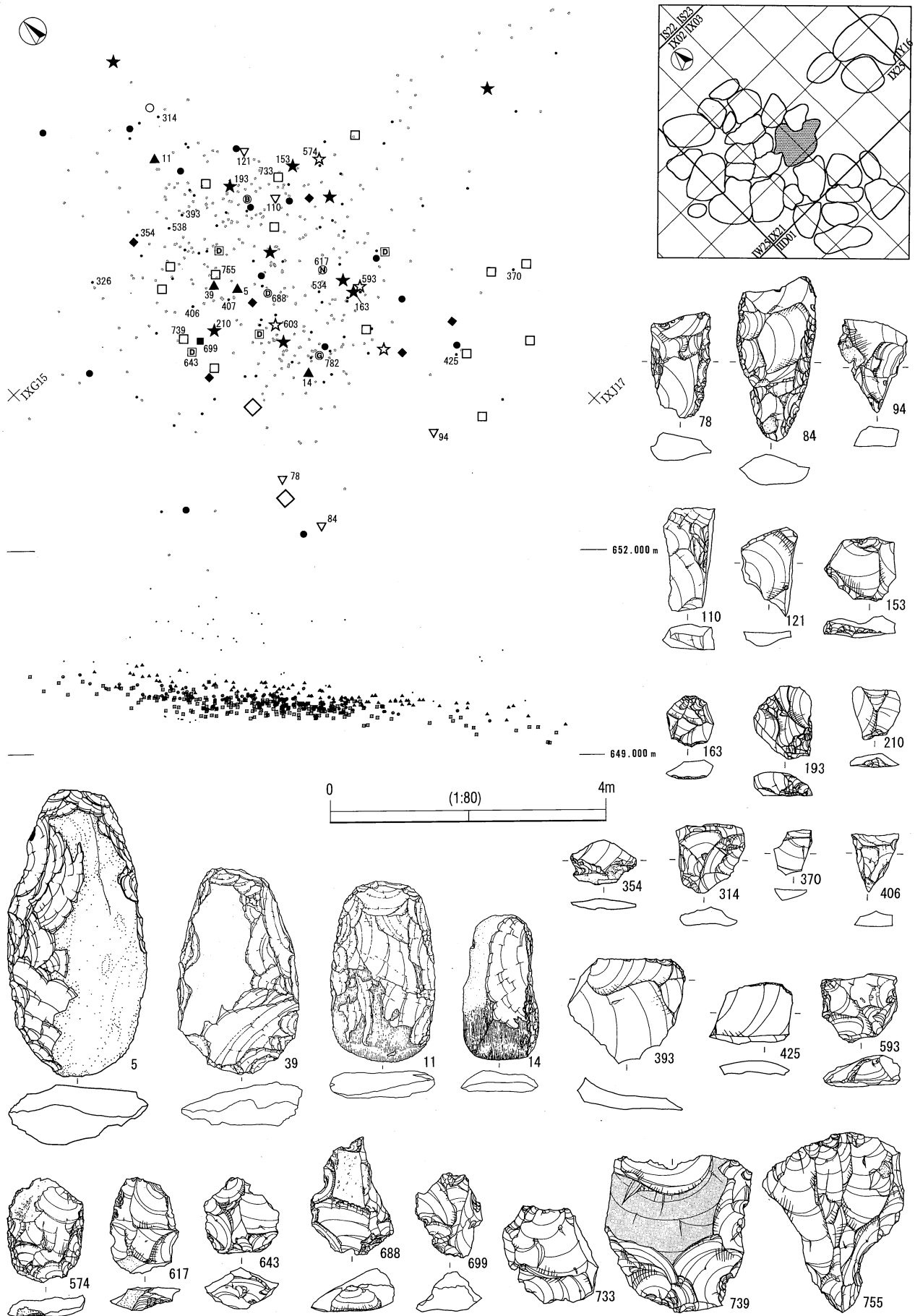

日向林 I 石器文化 BL8遺物分布図

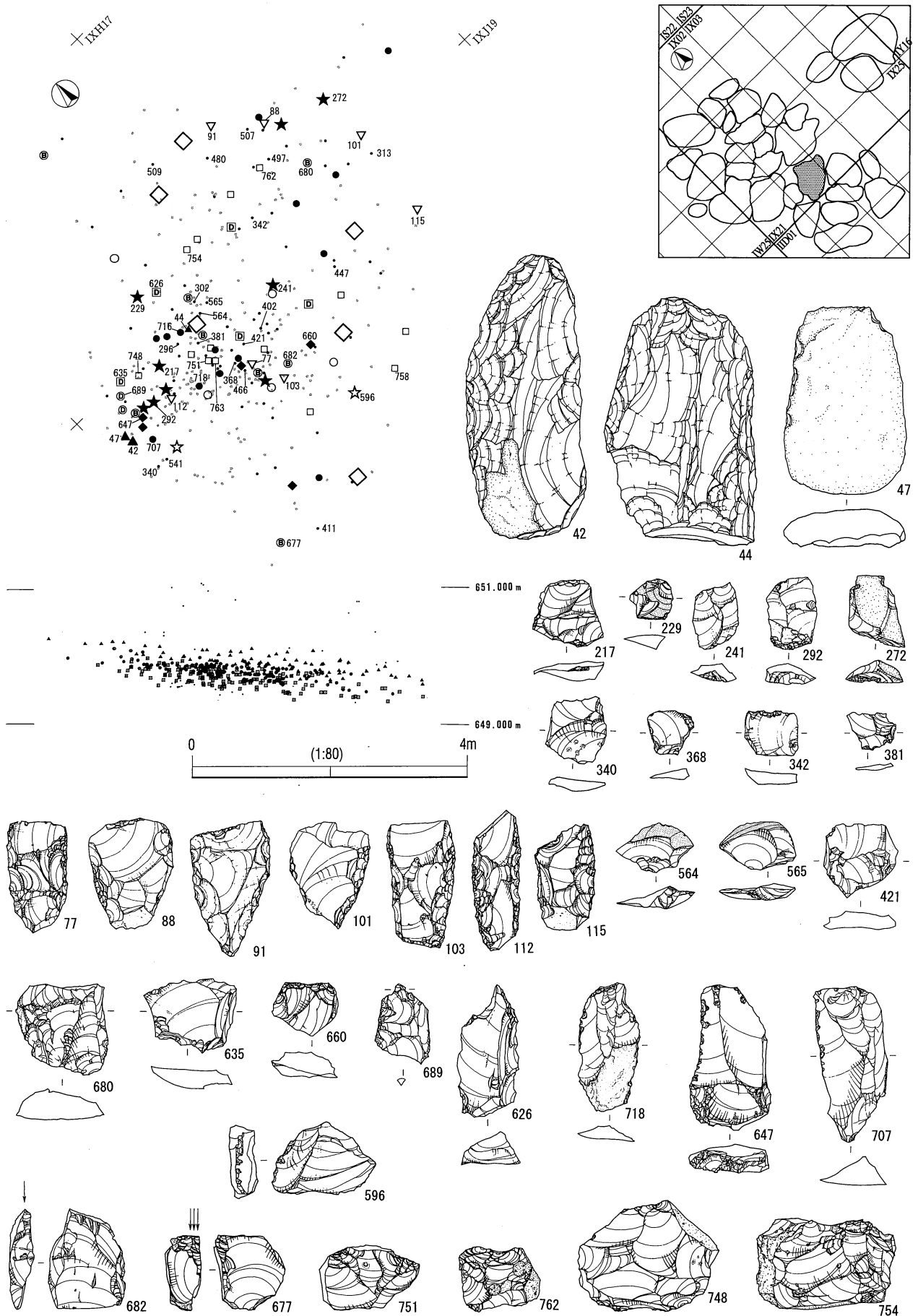

日向林 I 石器文化 BL9遺物分布図

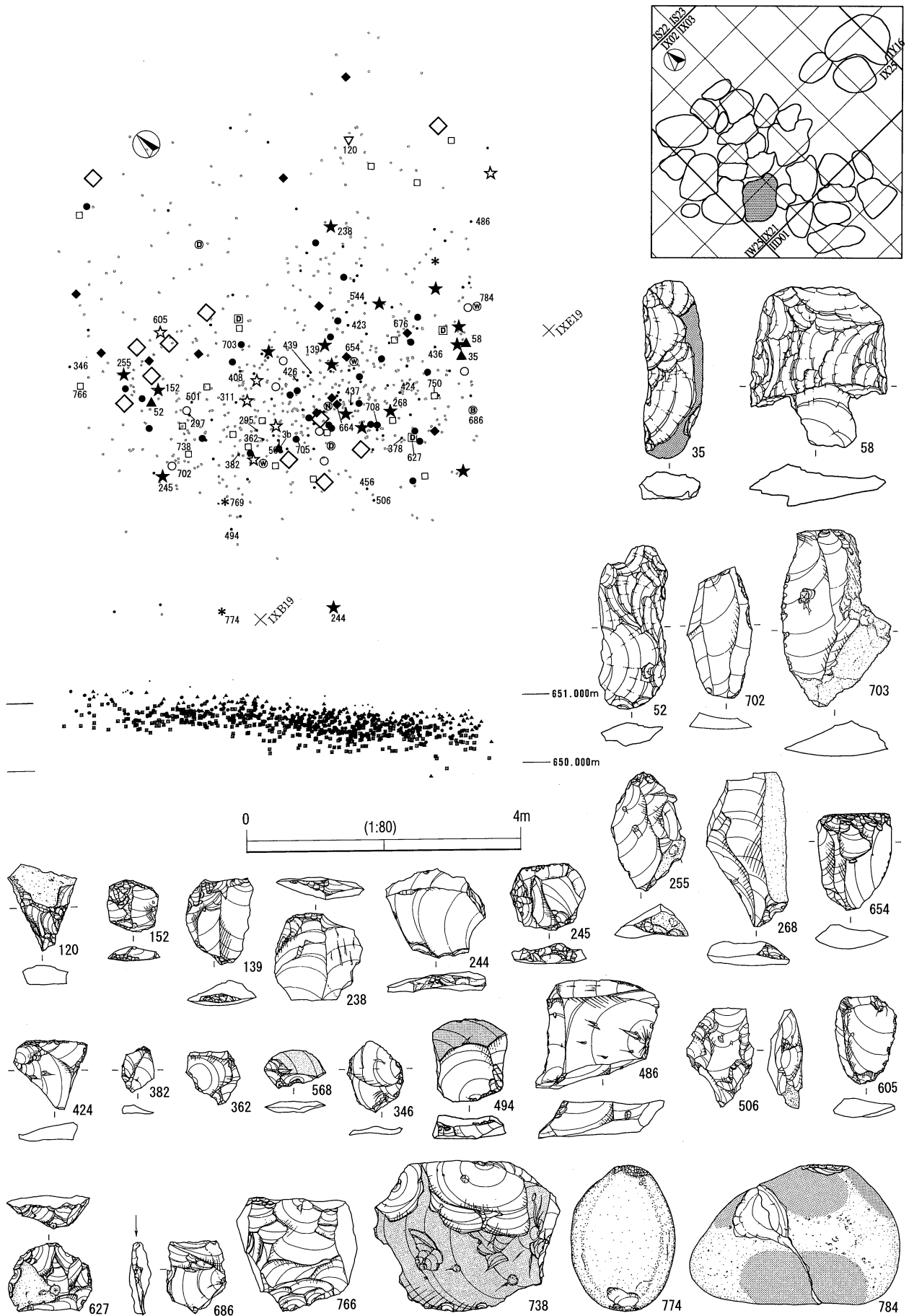

日向林 I 石器文化 BL11遺物分布図

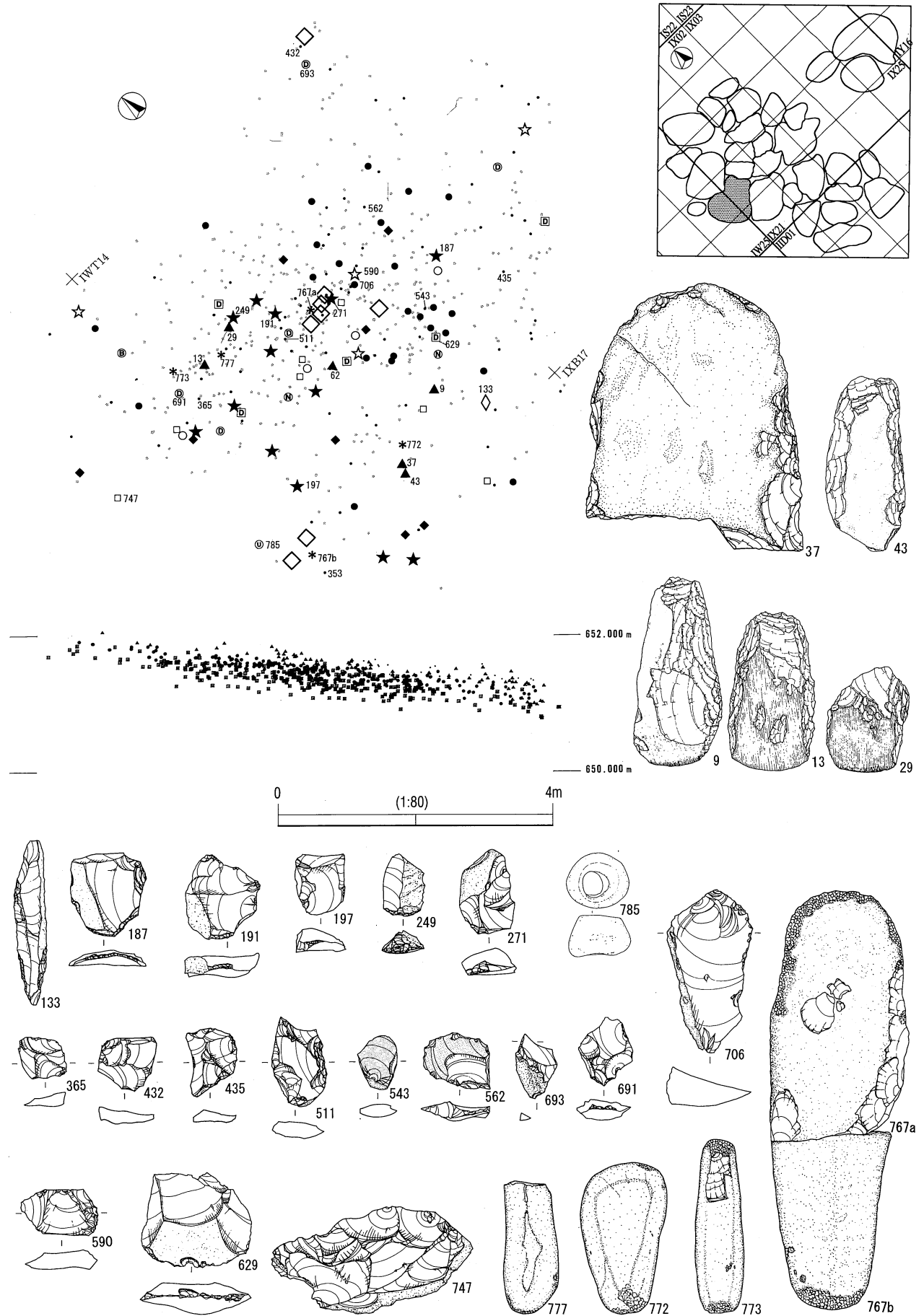

日向林 I 石器文化 BL12遺物分布図

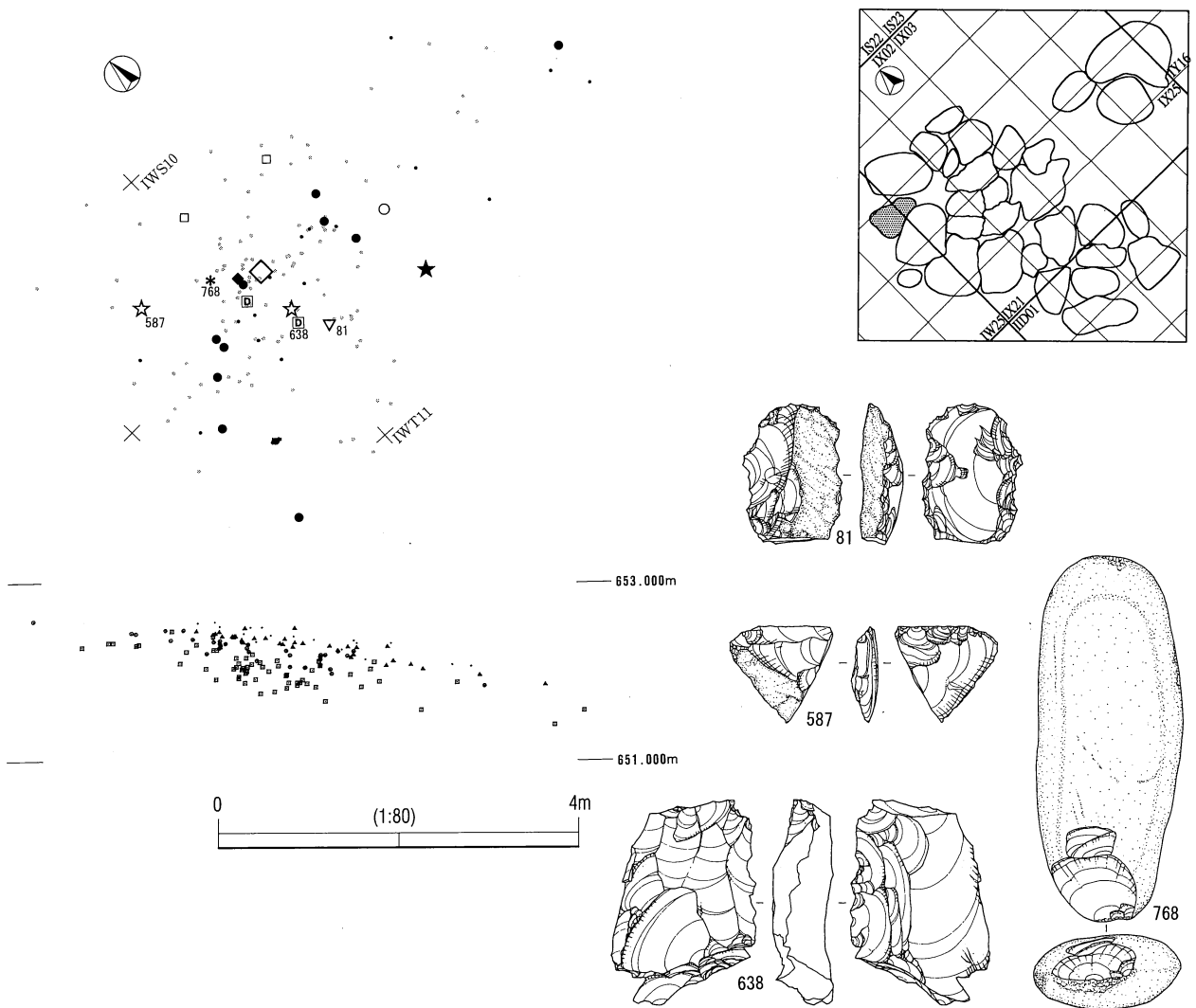
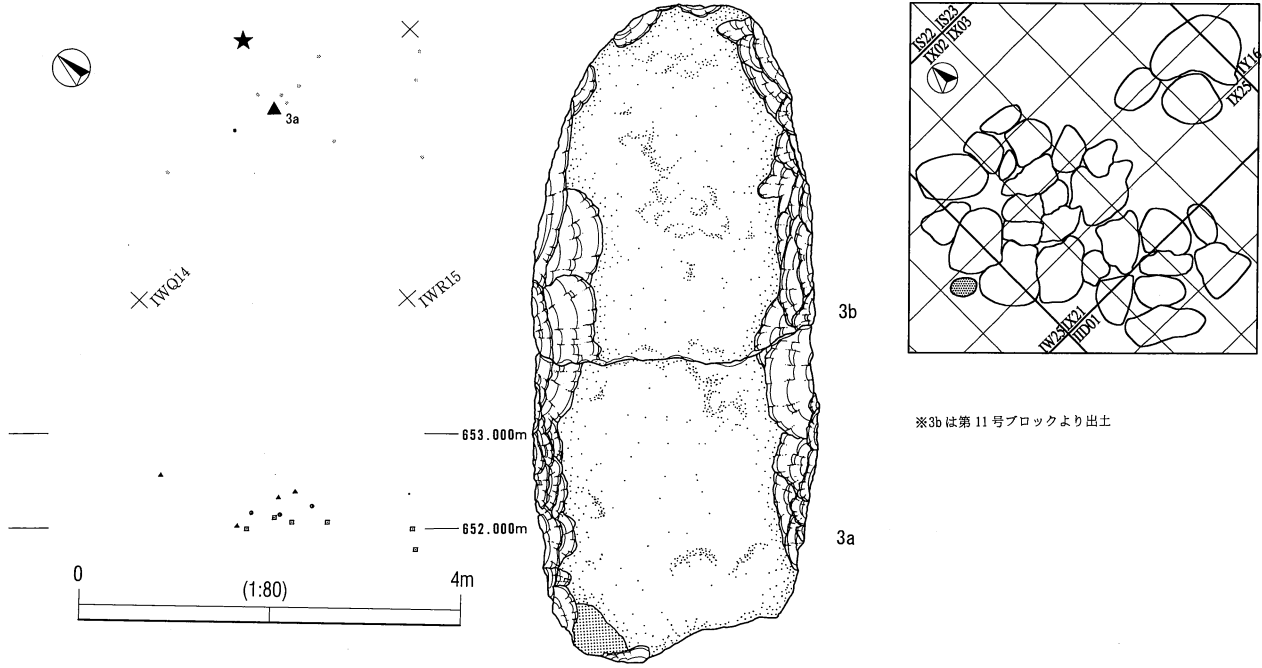

日向林I石器文化 BL13・BL15遺物分布図 (上:BL13・下:BL15)





日向林 I 石器文化 BL14遺物分布図 1

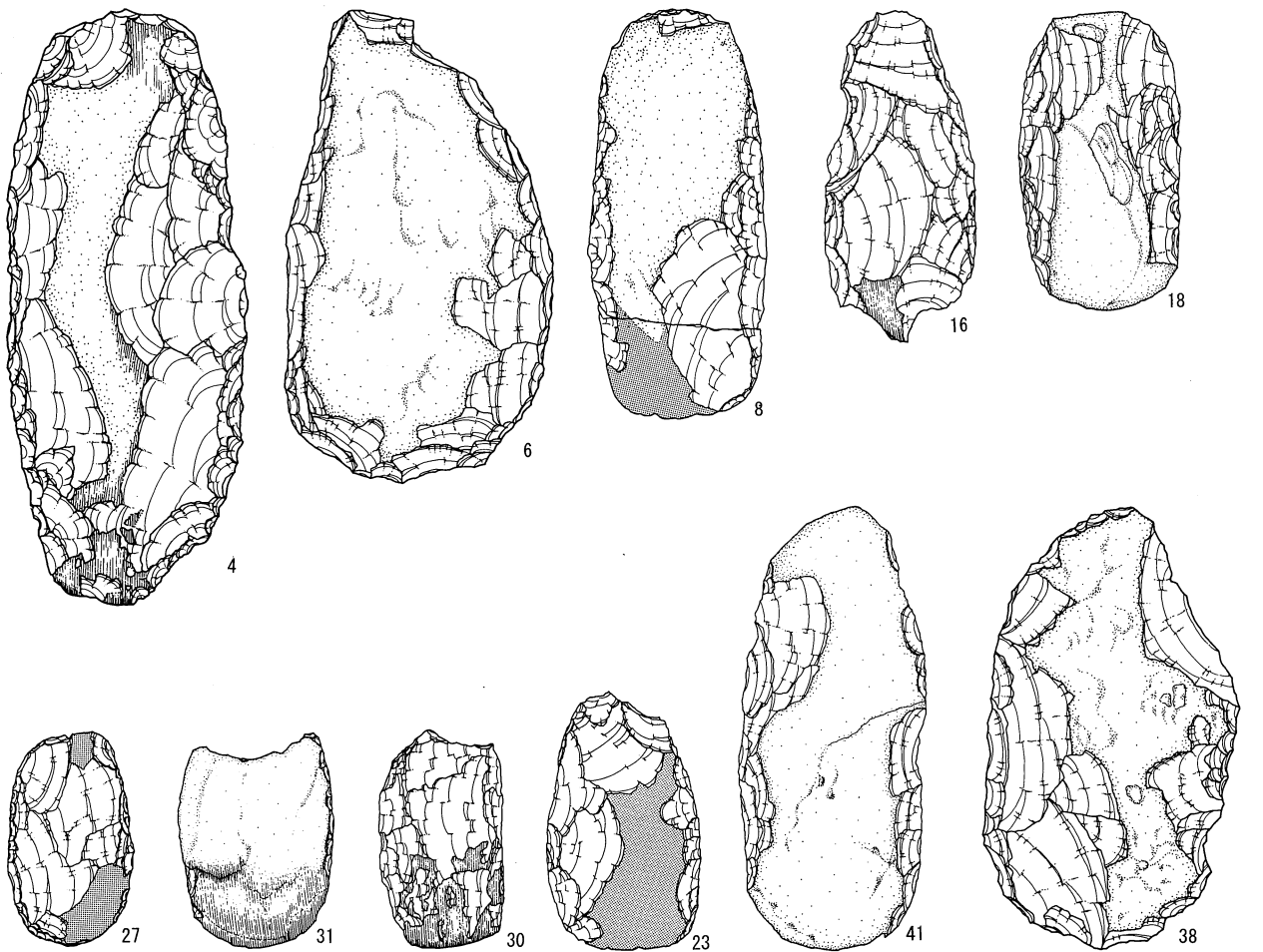
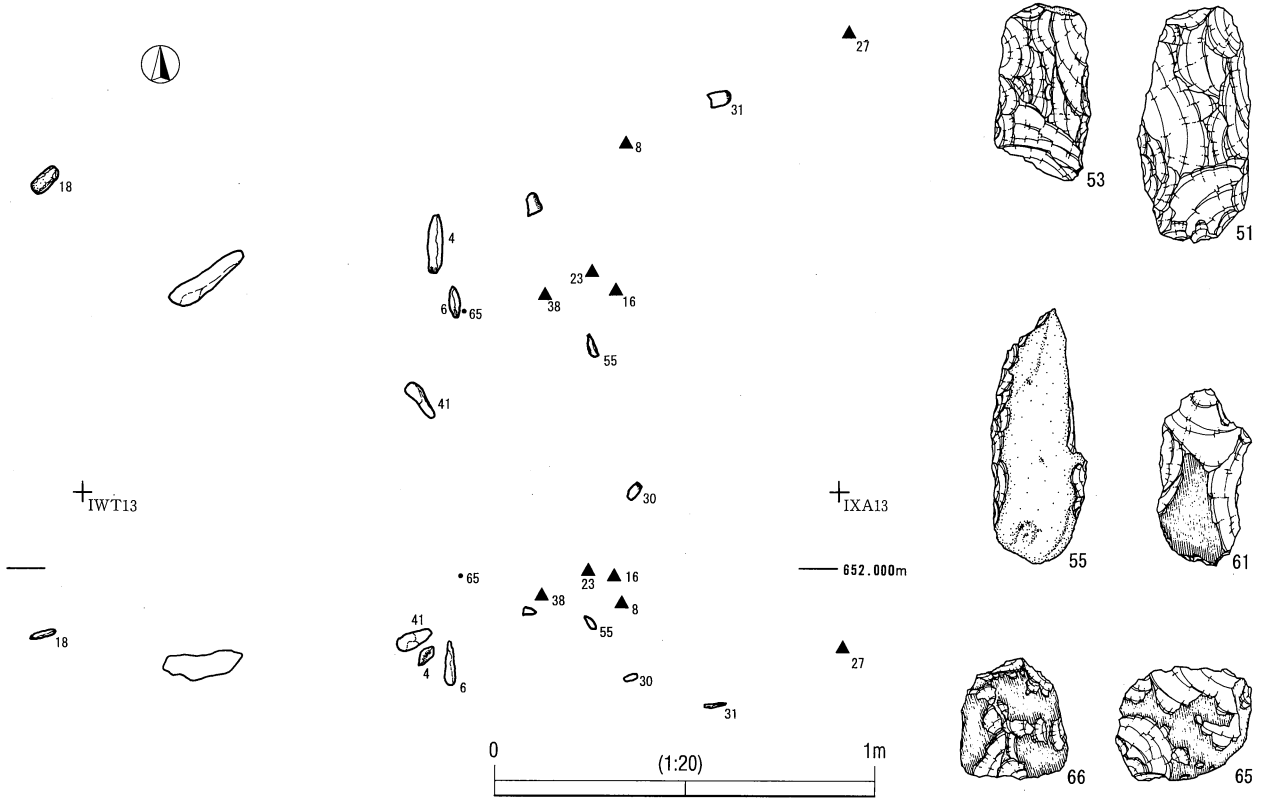

日向林 I 石器文化 BL14遺物分布図 2 (斧形石器集中)

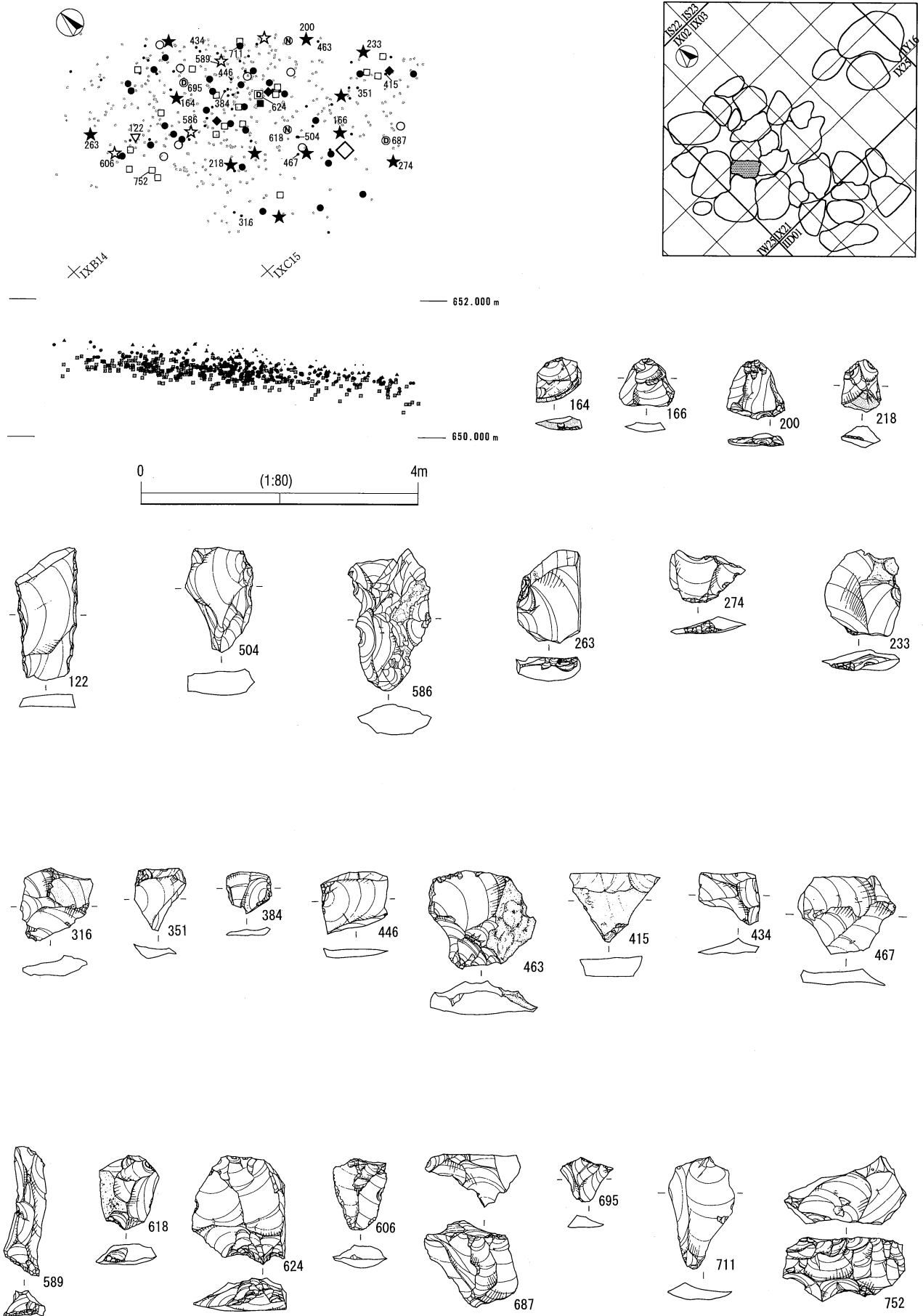

日向林 I 石器文化 BL16遺物分布図

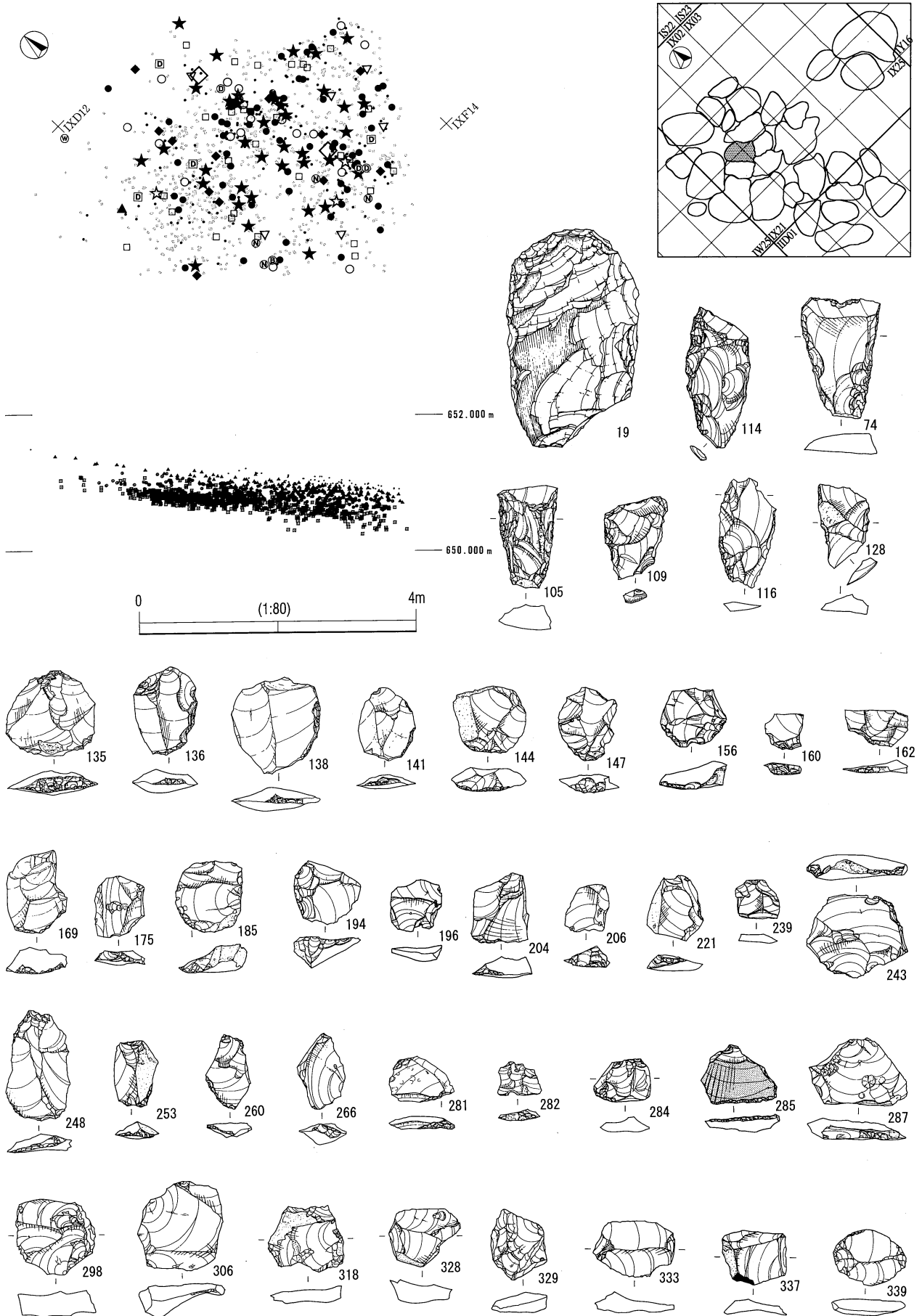

日向林 I 石器文化 BL17遺物分布図

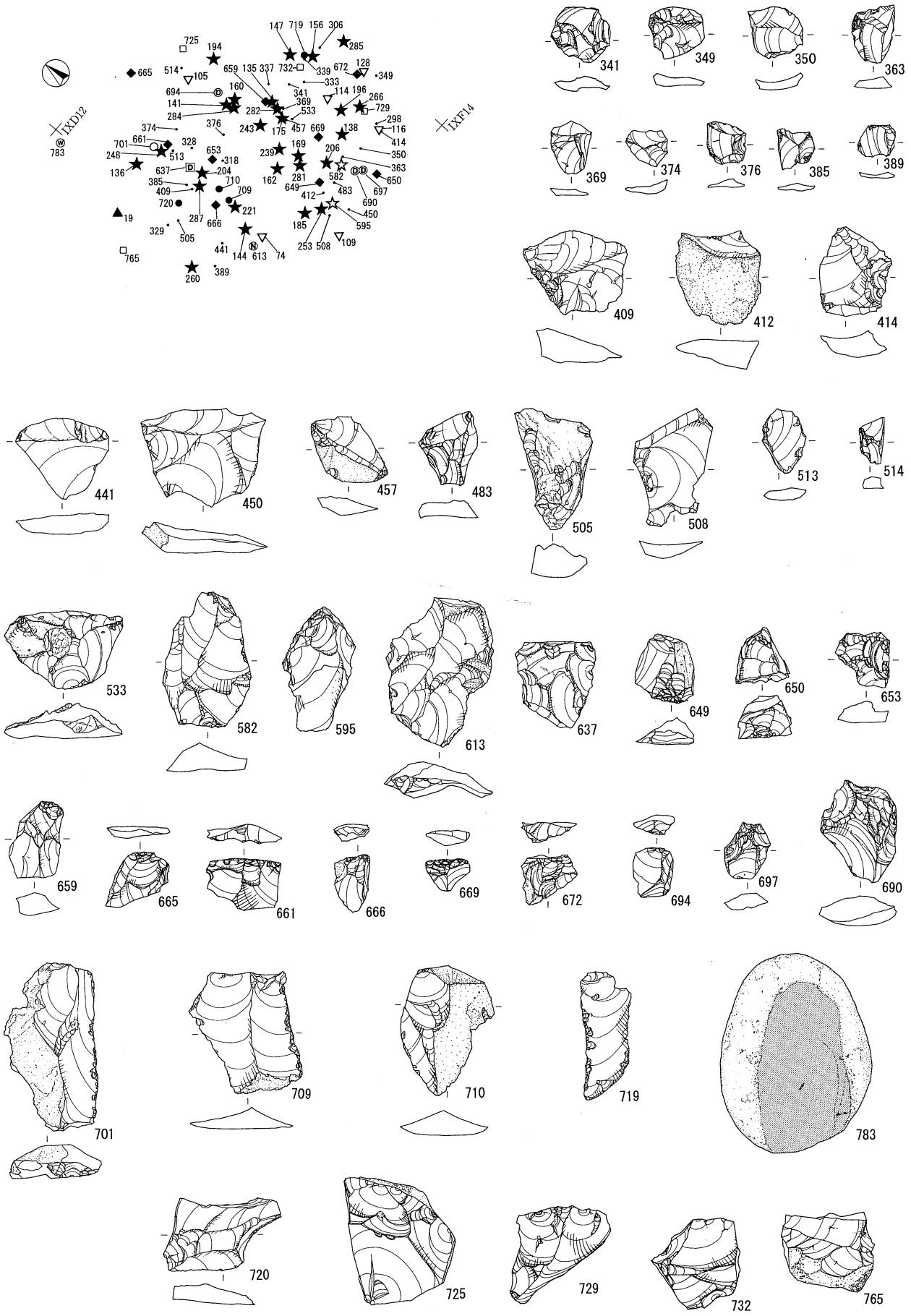

日向林 I 石器文化 BL17出土石器

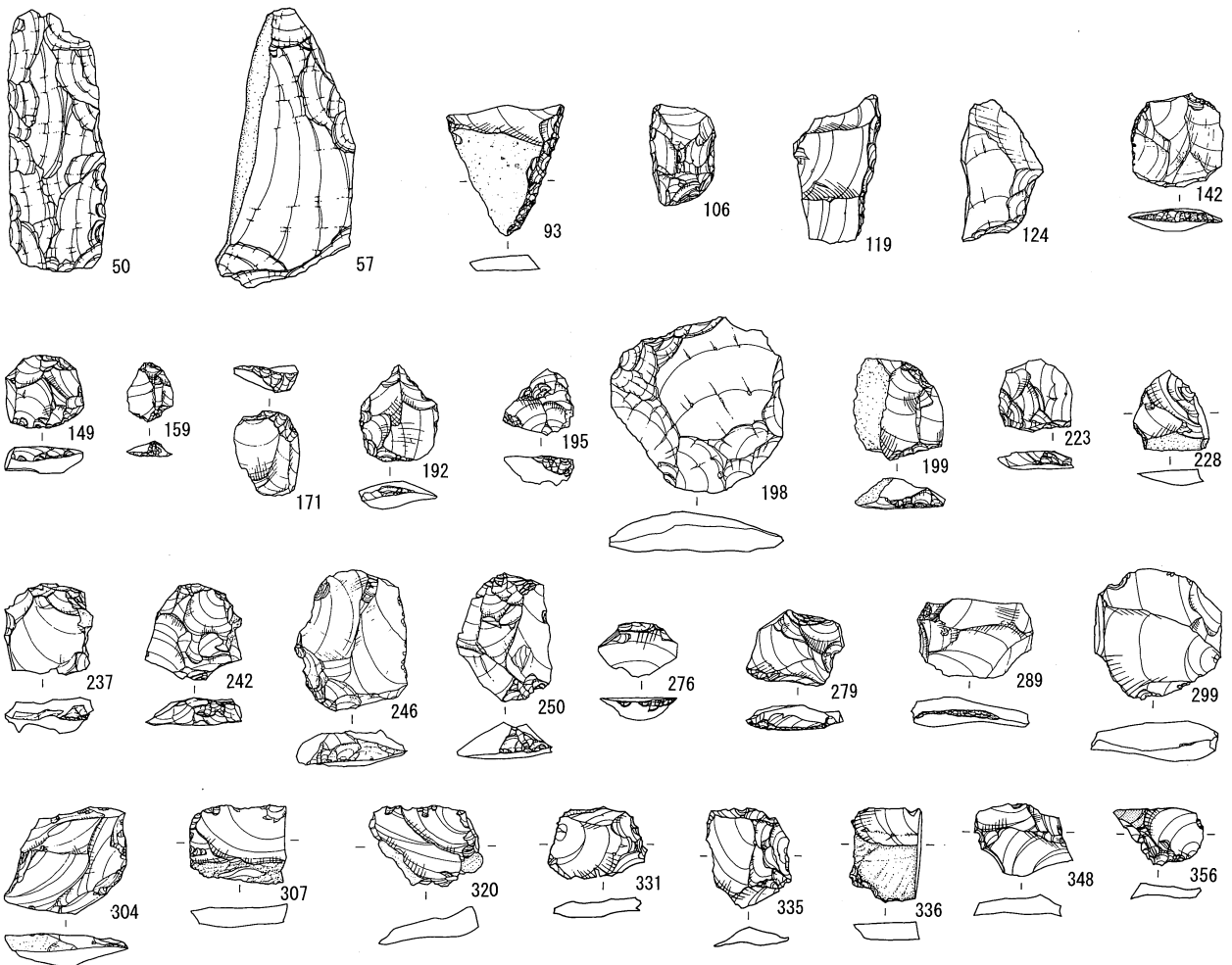
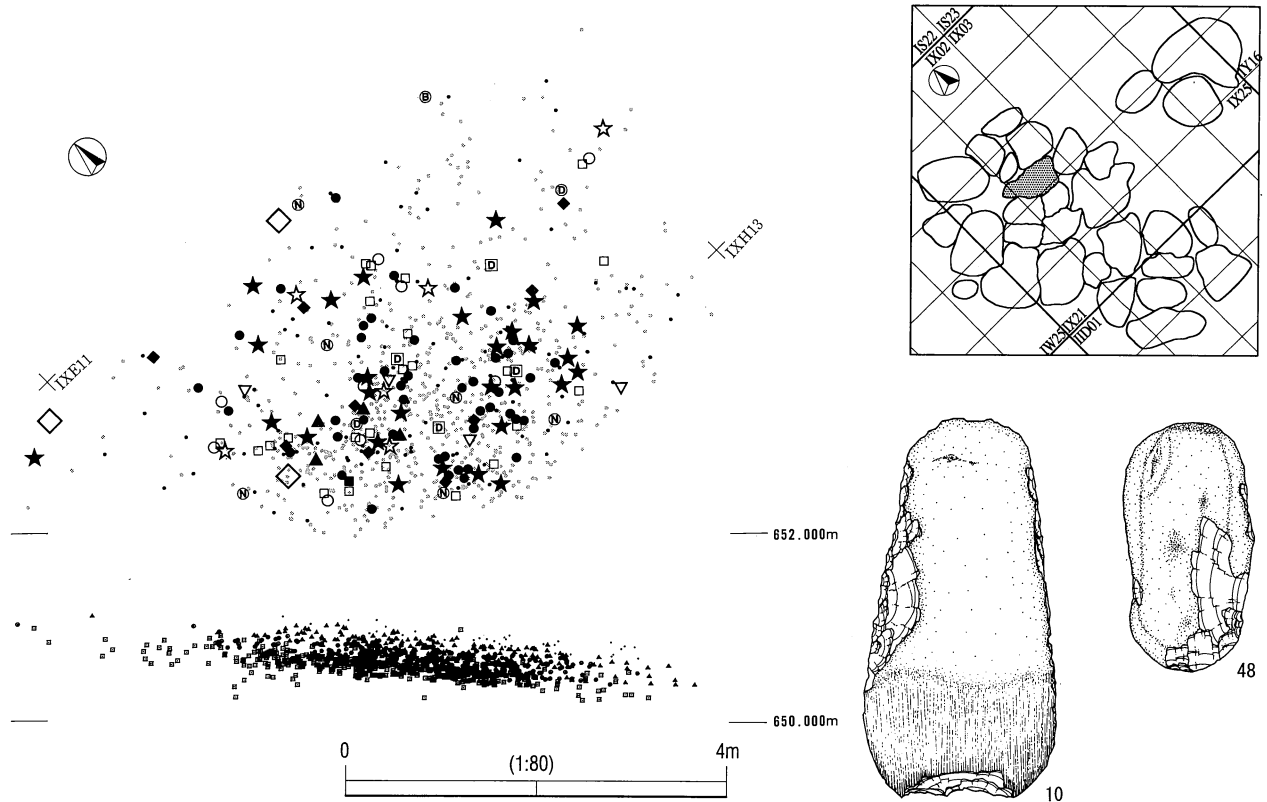

日向林 I 石器文化 BL18遺物分布図

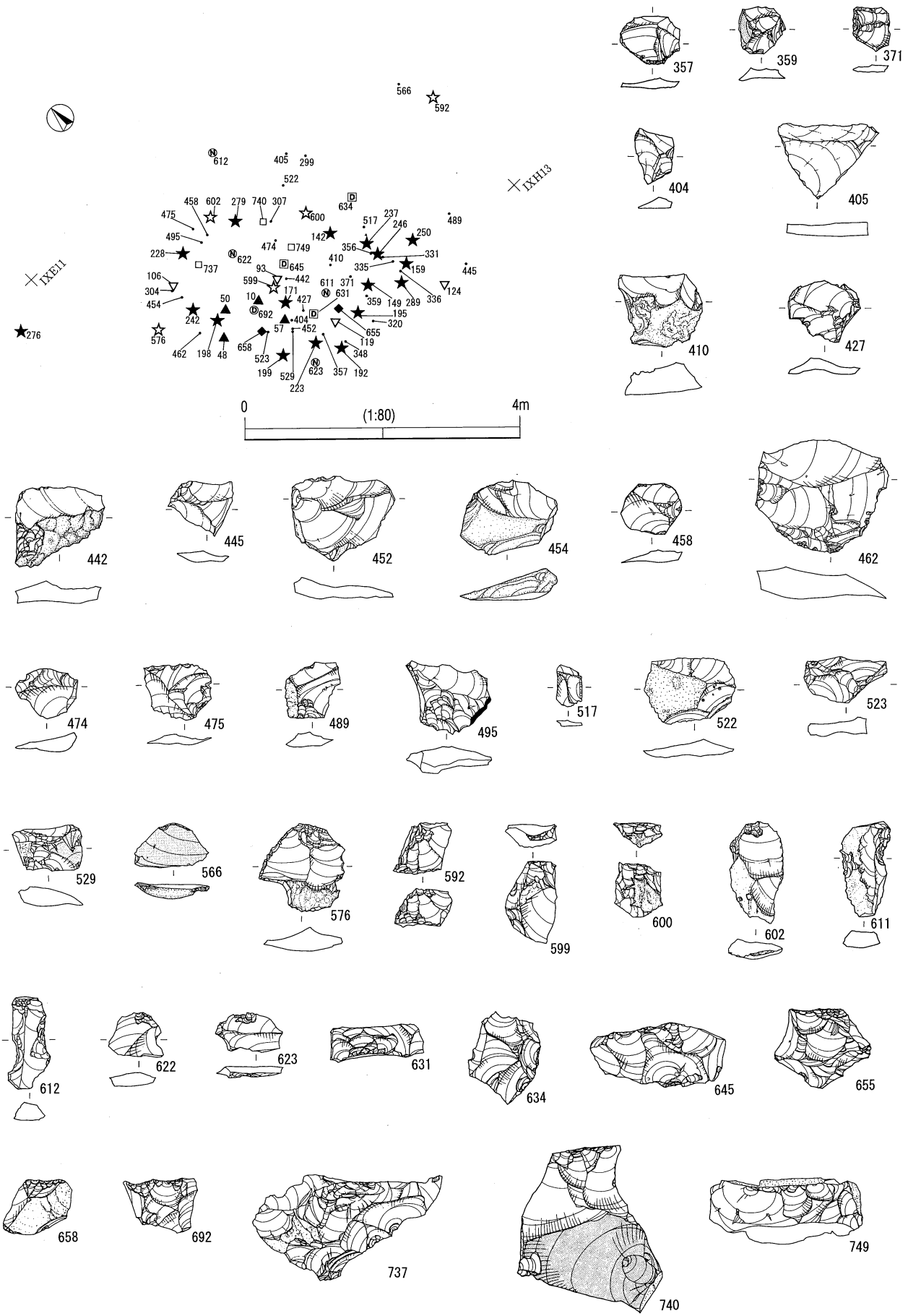

日向林 I 石器文化 BL18出土石器

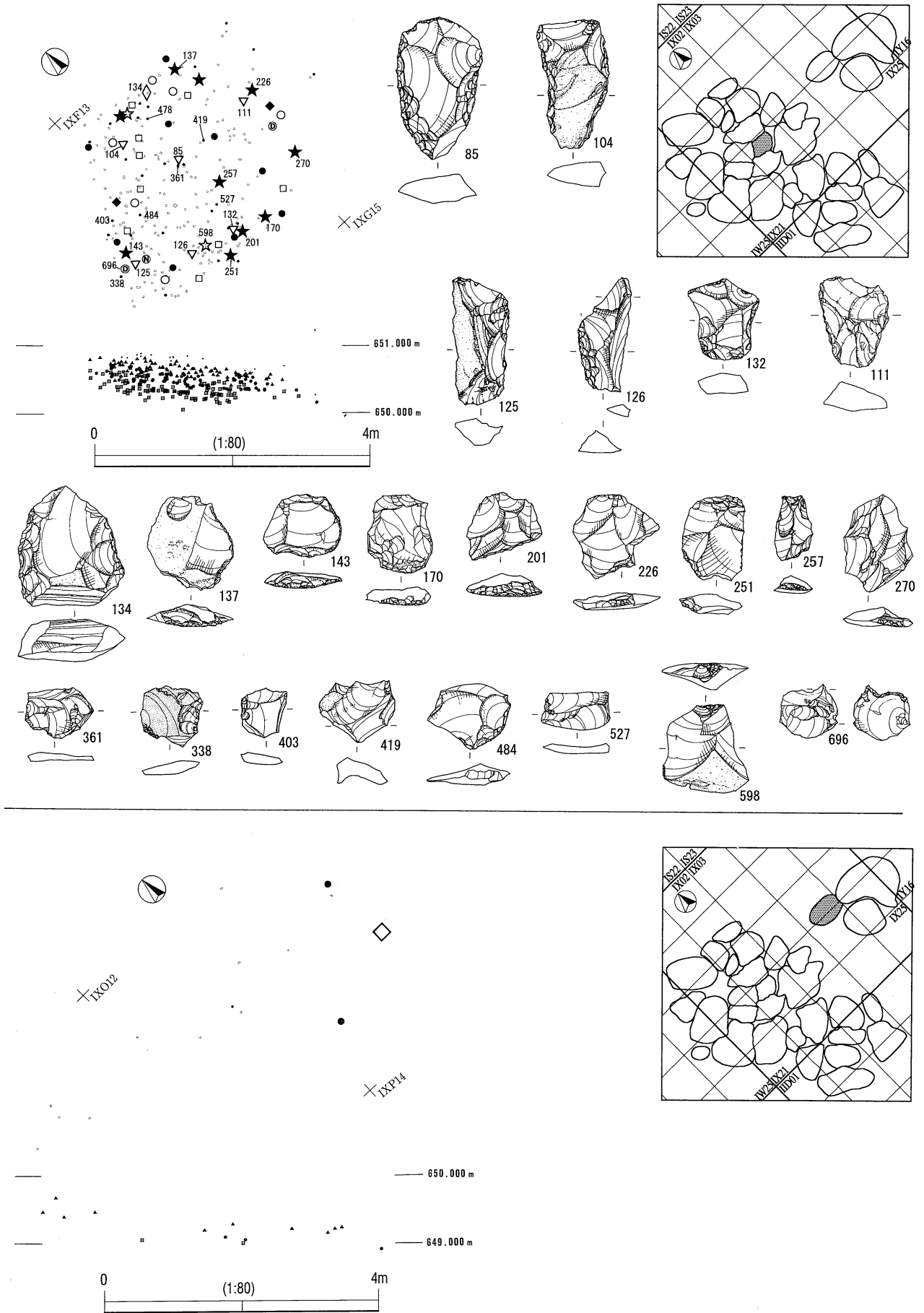

日向林 I 石器文化 BL19・BL21遺物分布図 (上: BL19・下: BL21)



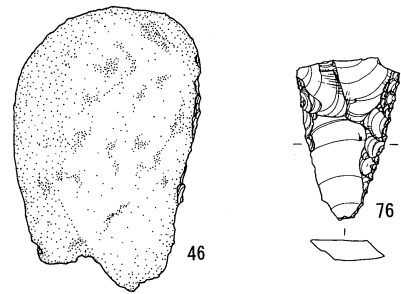
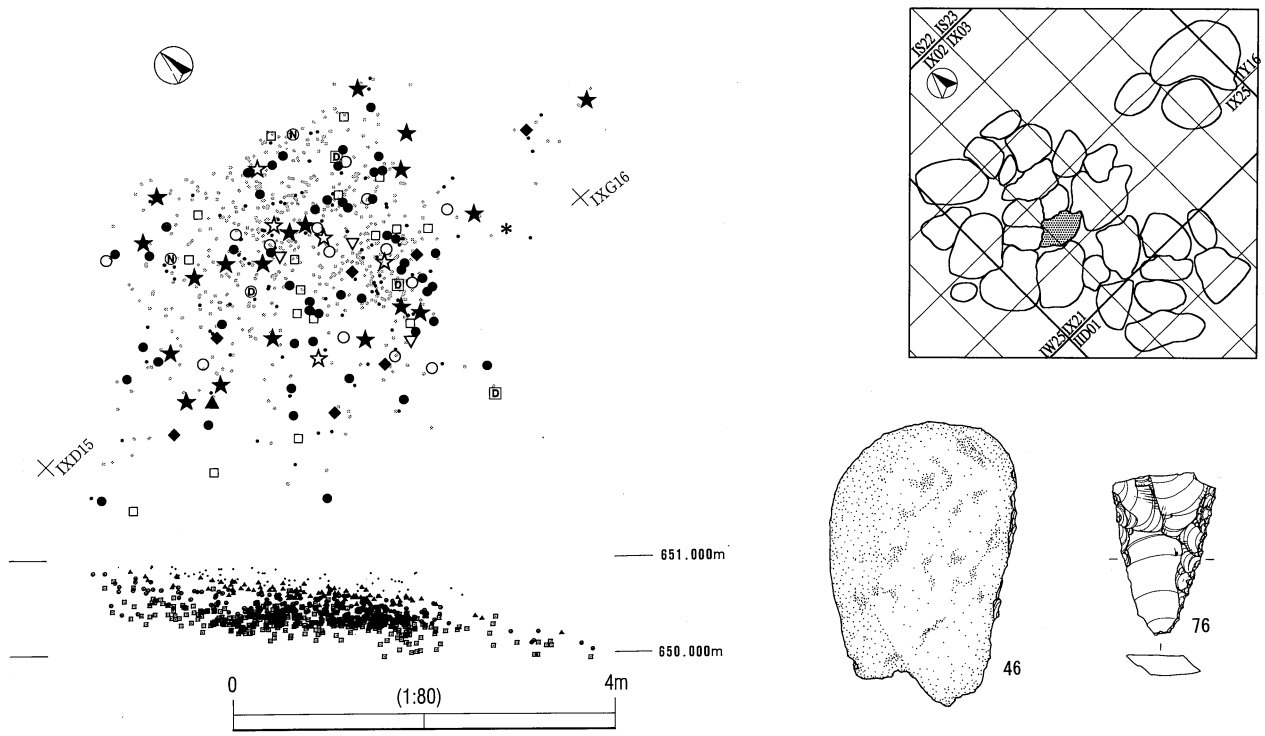

日向林 I 石器文化 BL20遺物分布図

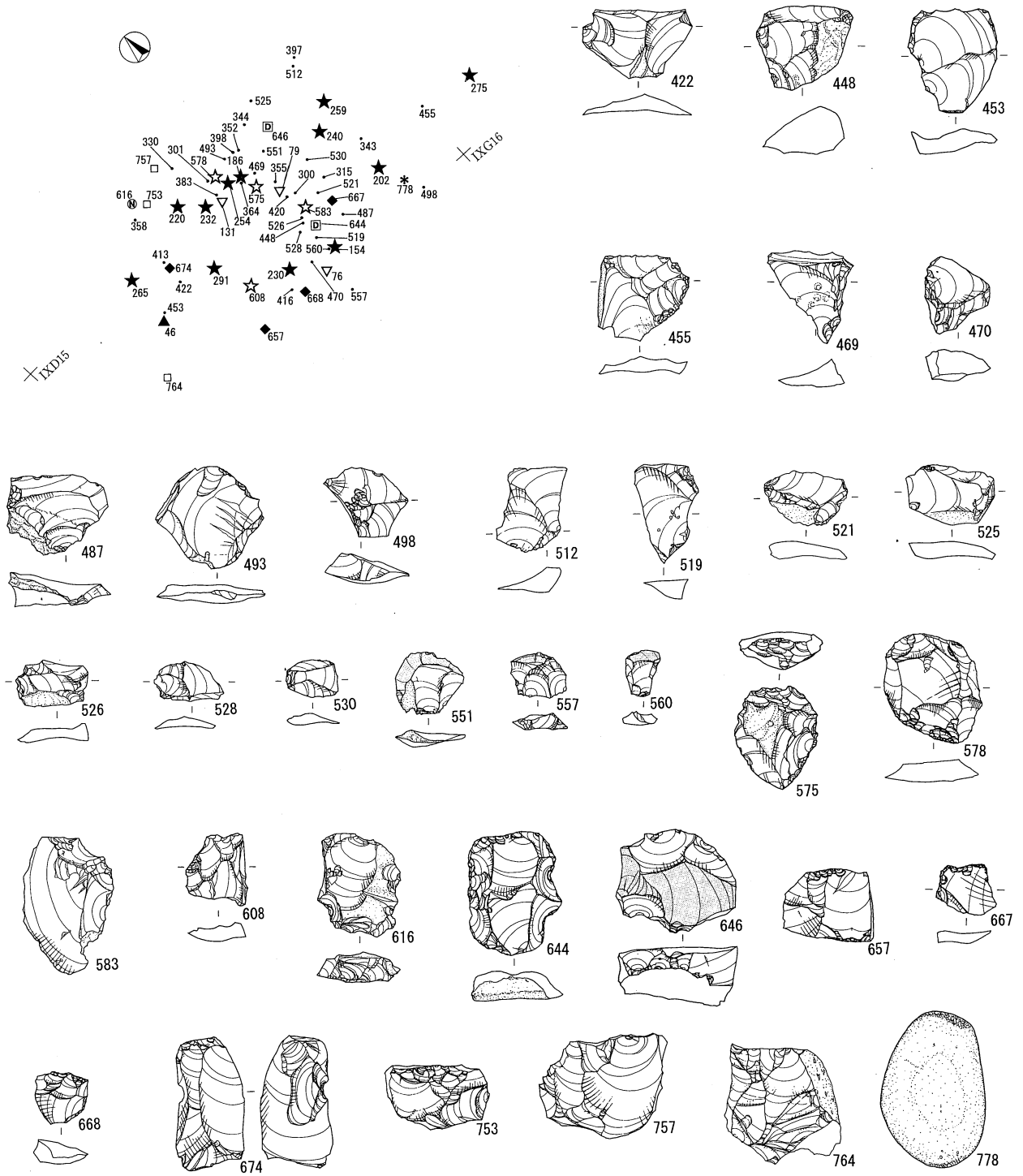

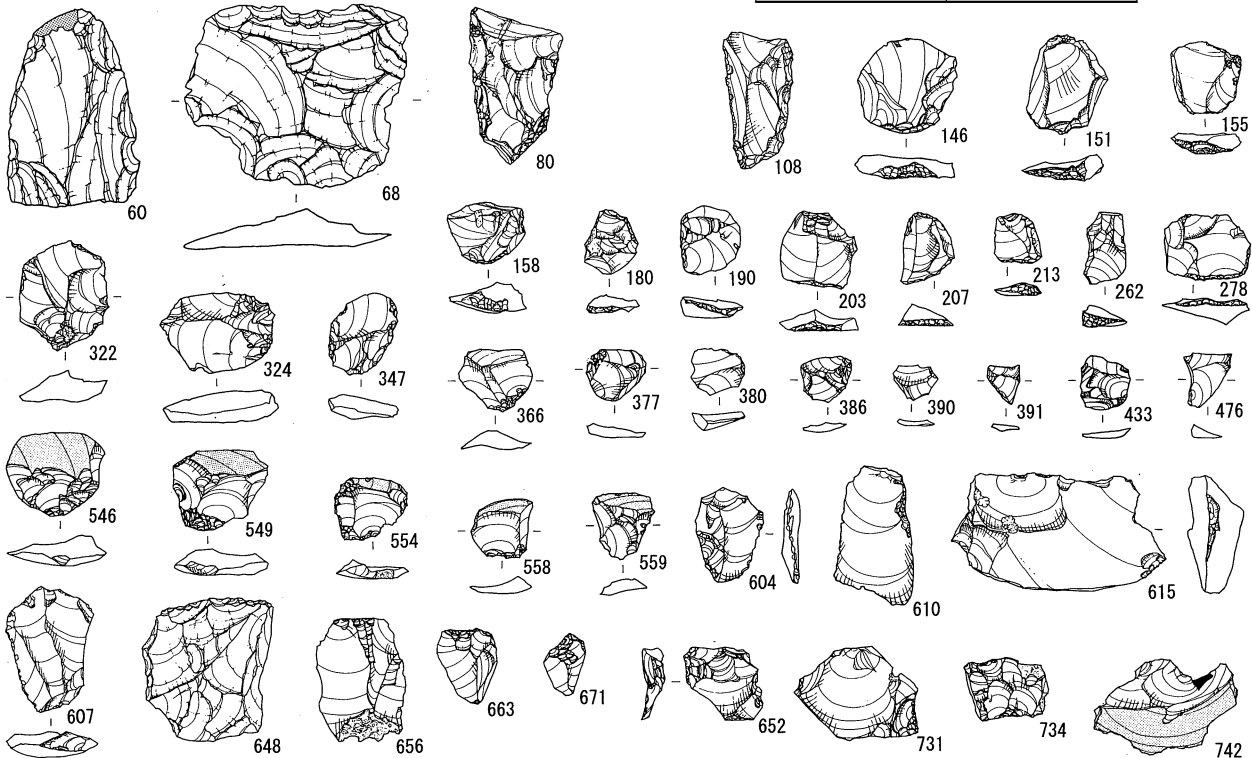
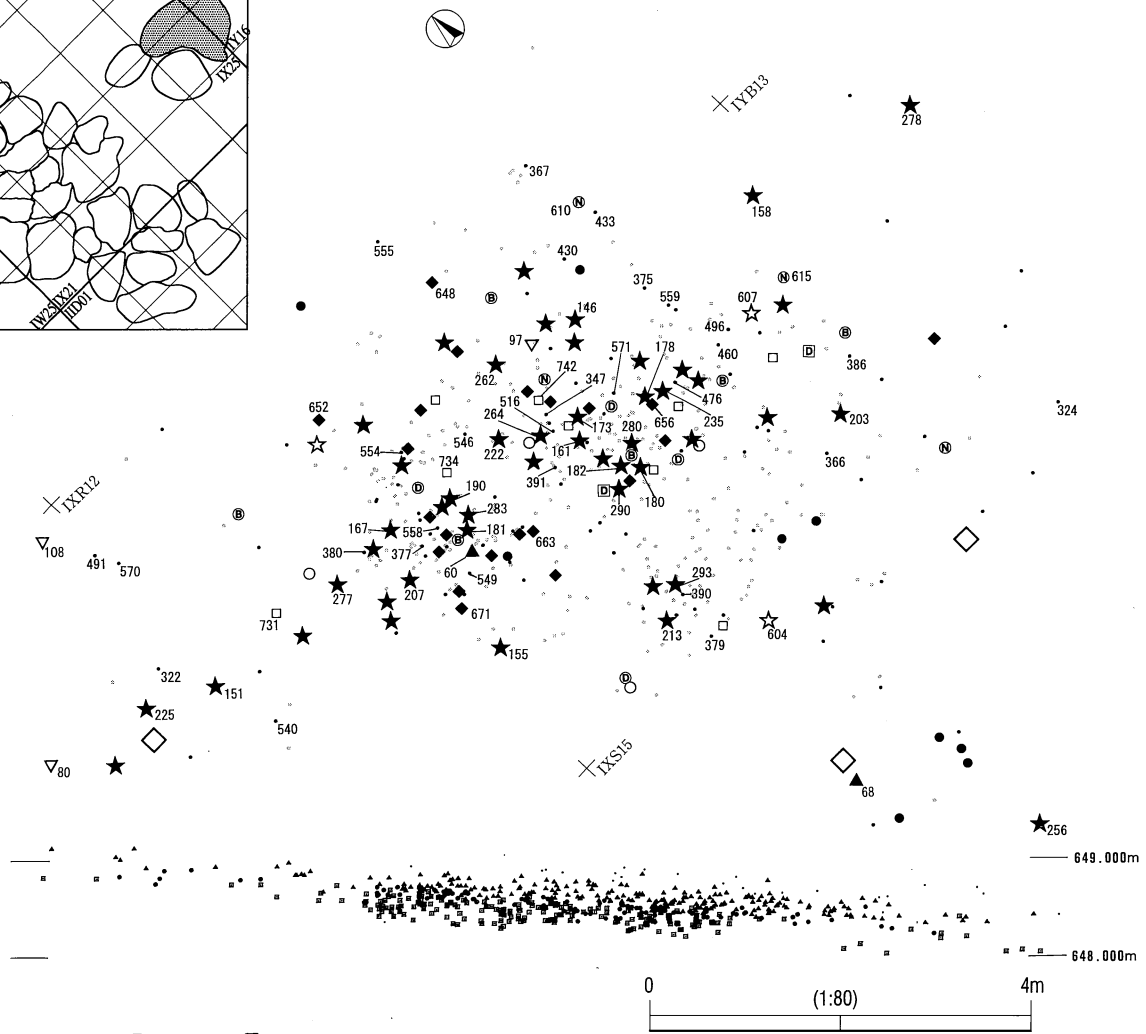
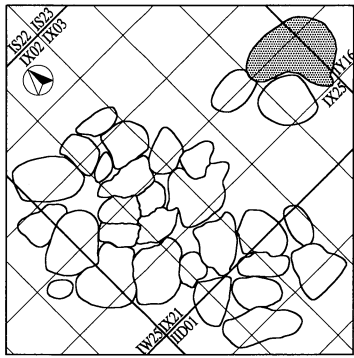

日向林 I 石器文化 BL22遺物分布図

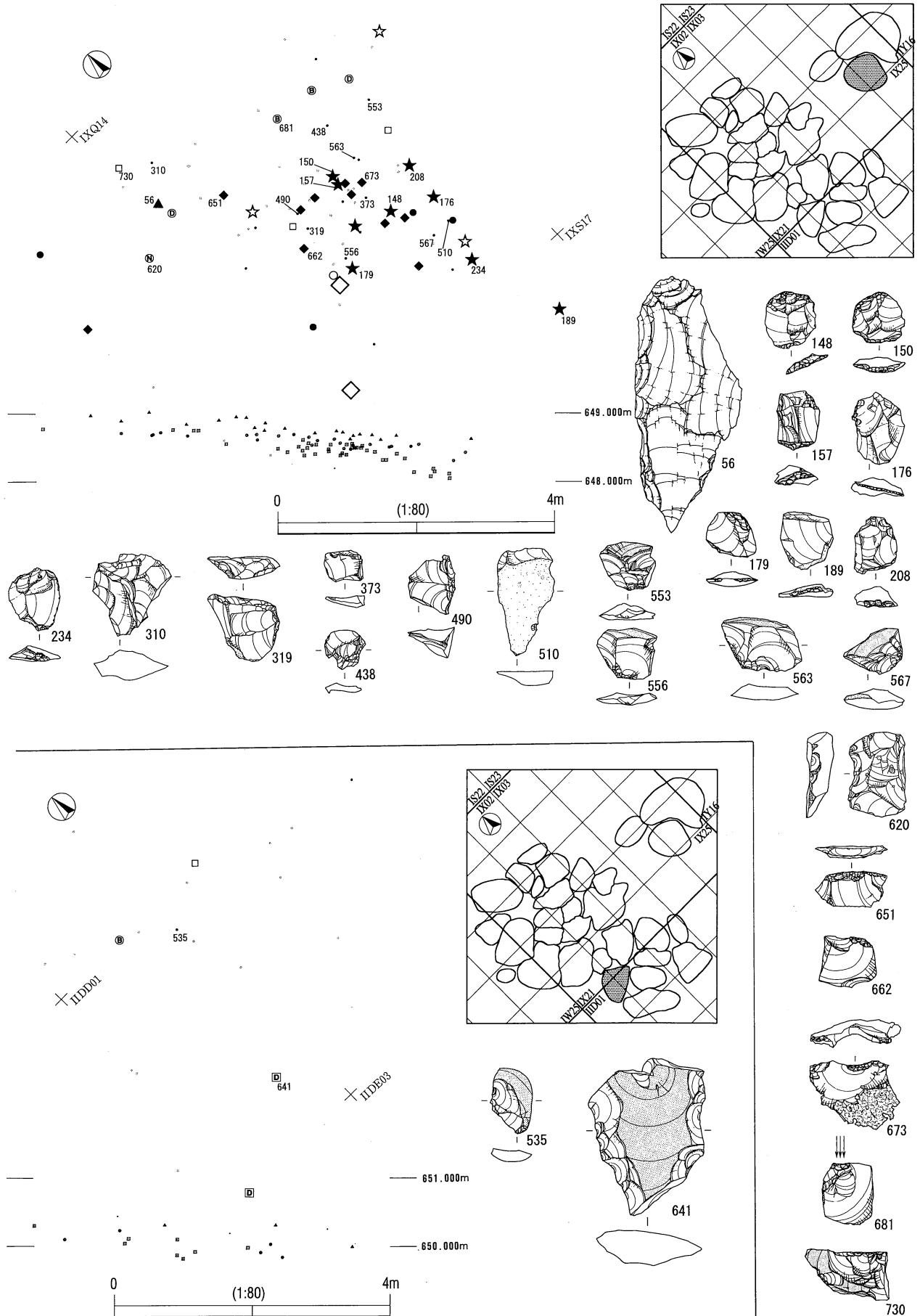

日向林 I 石器文化 BL23・BL24遺物分布図 (上: BL23・下: BL24)

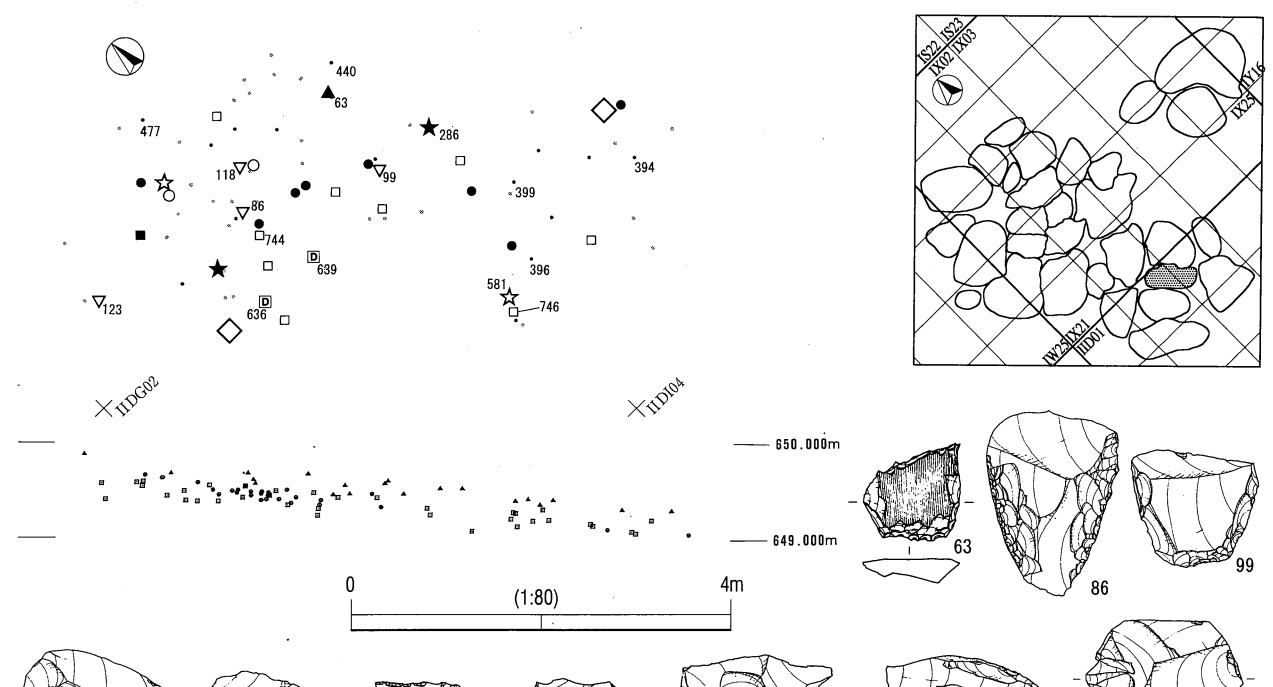
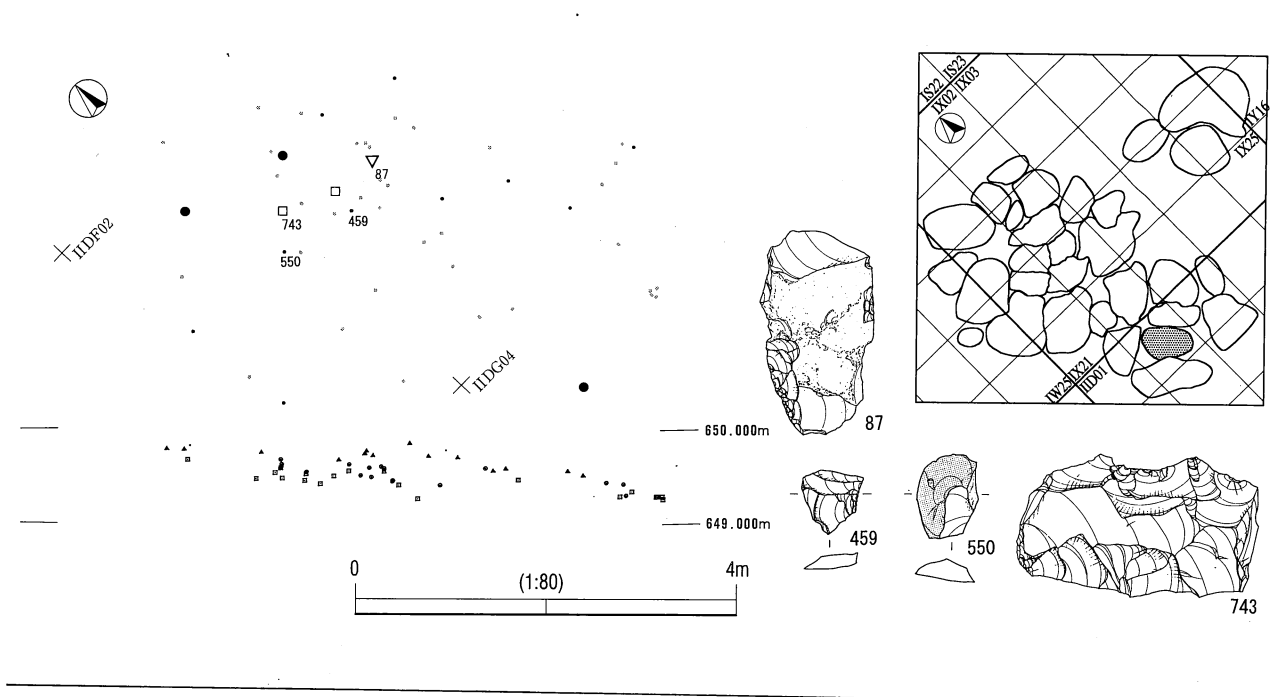

日向林I石器文化 BL25・BL26遺物分布図（上：BL25・下：BL26）

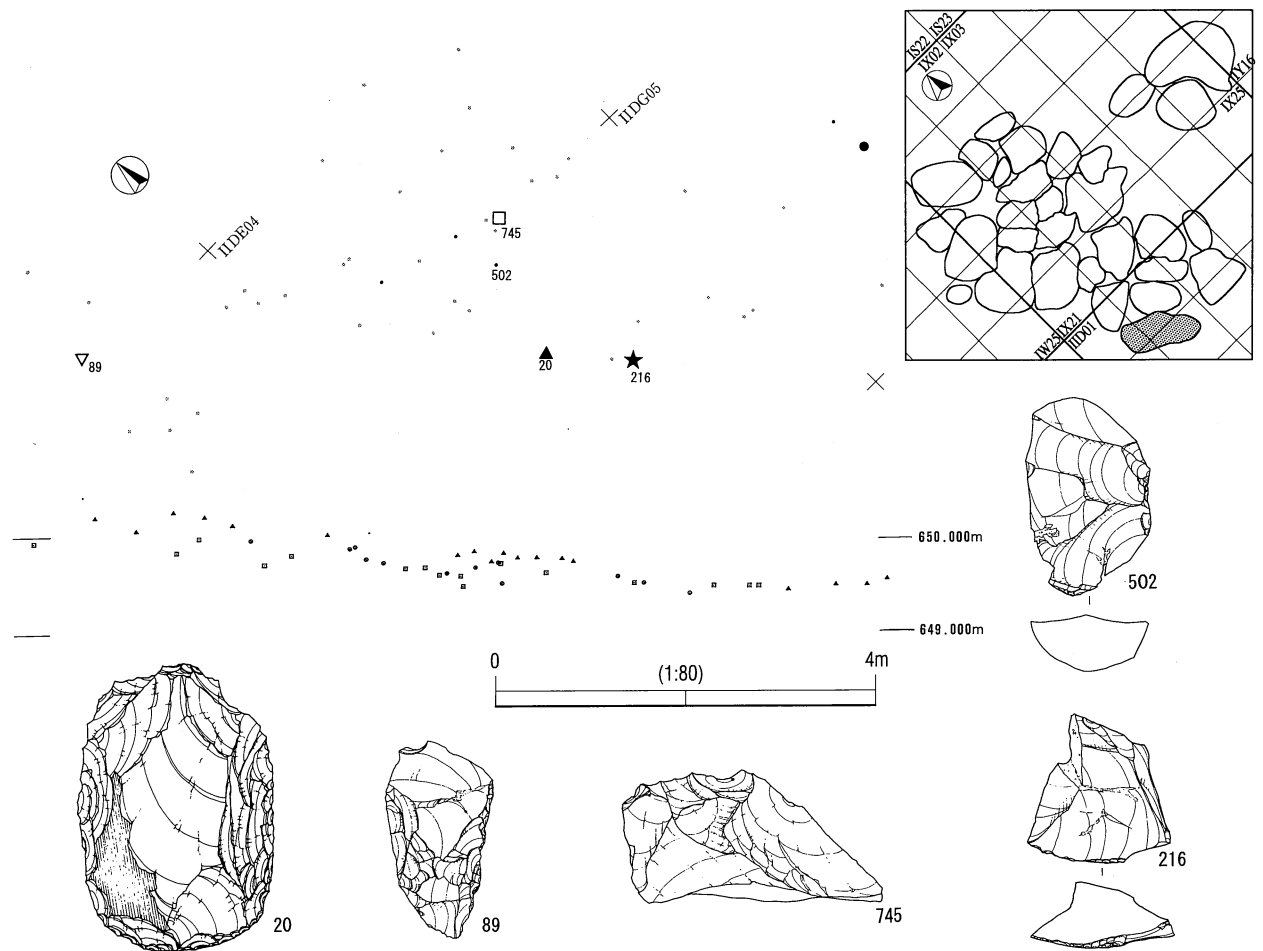
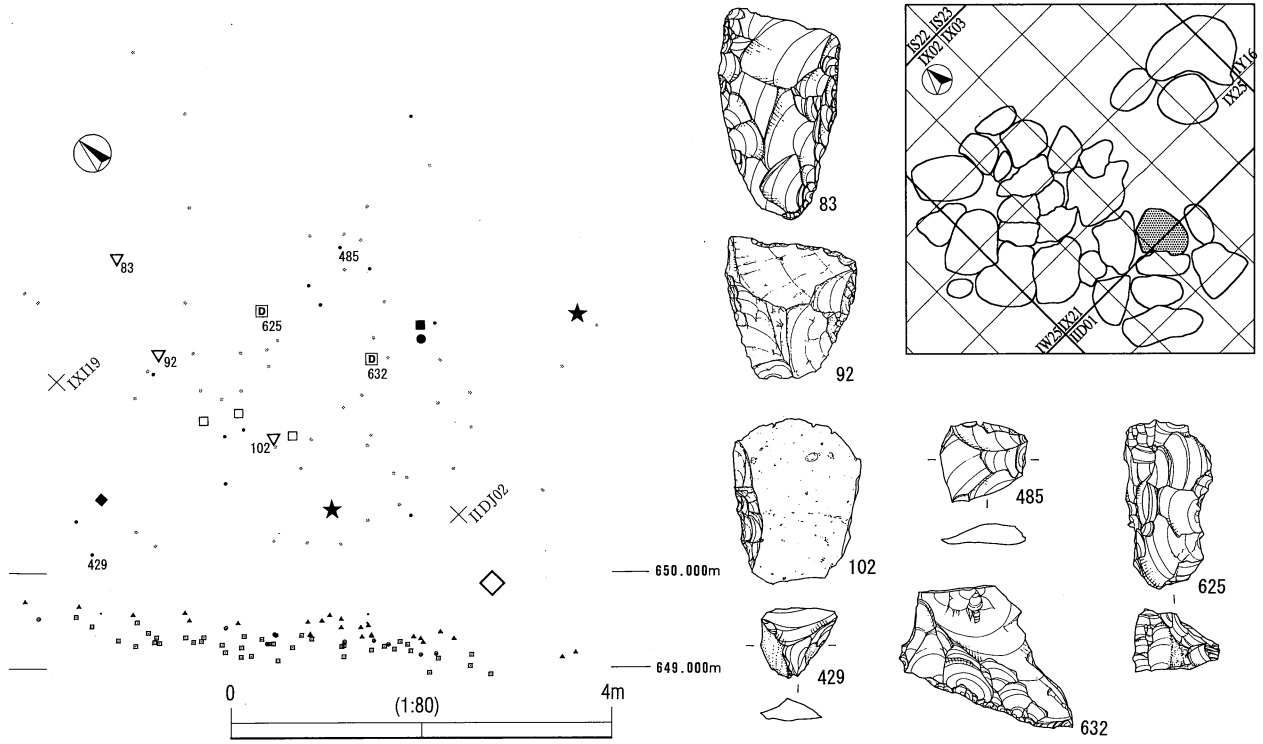

日向林I石器文化 BL27・BL28遺物分布図（上：BL27・下：BL28）

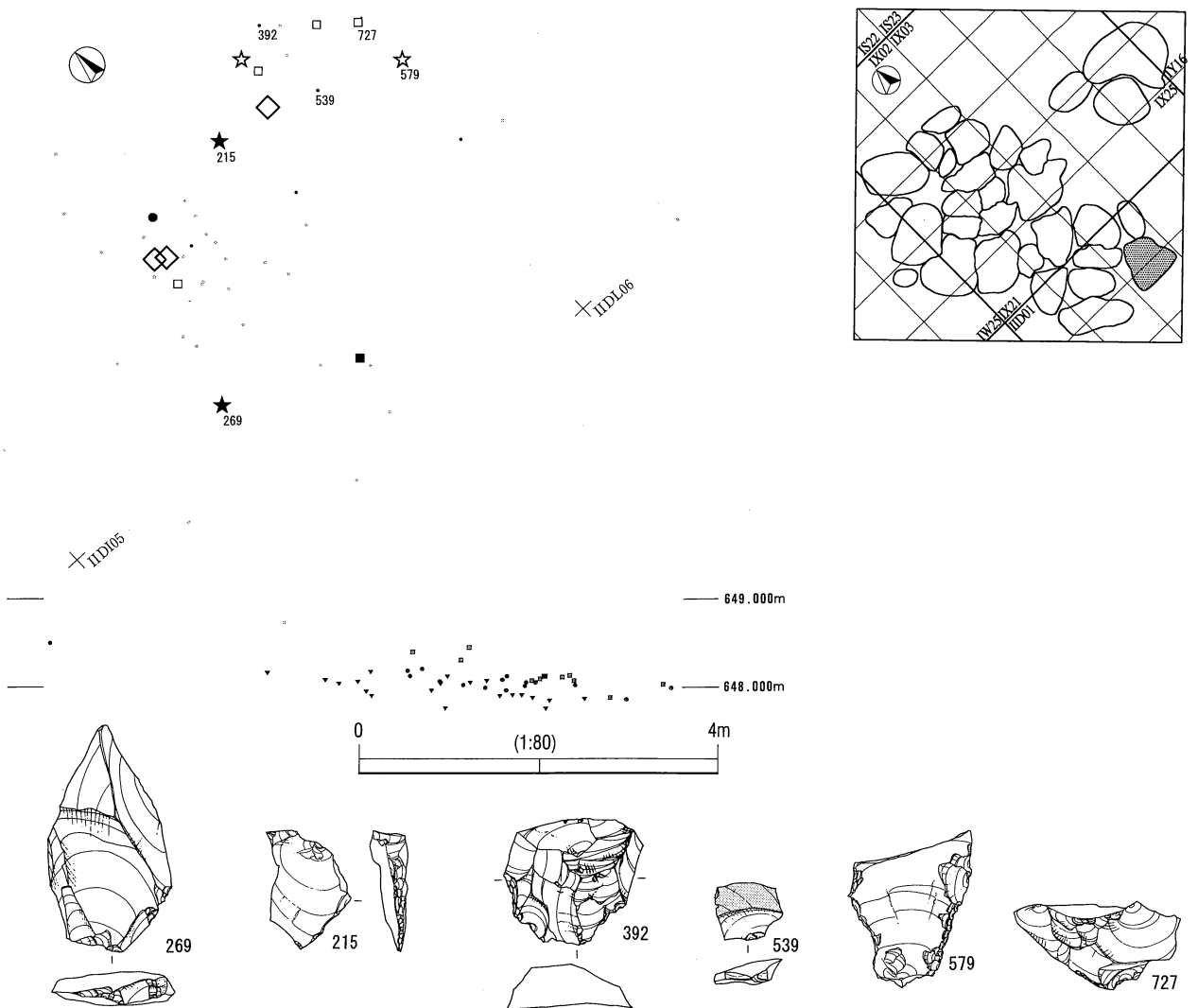
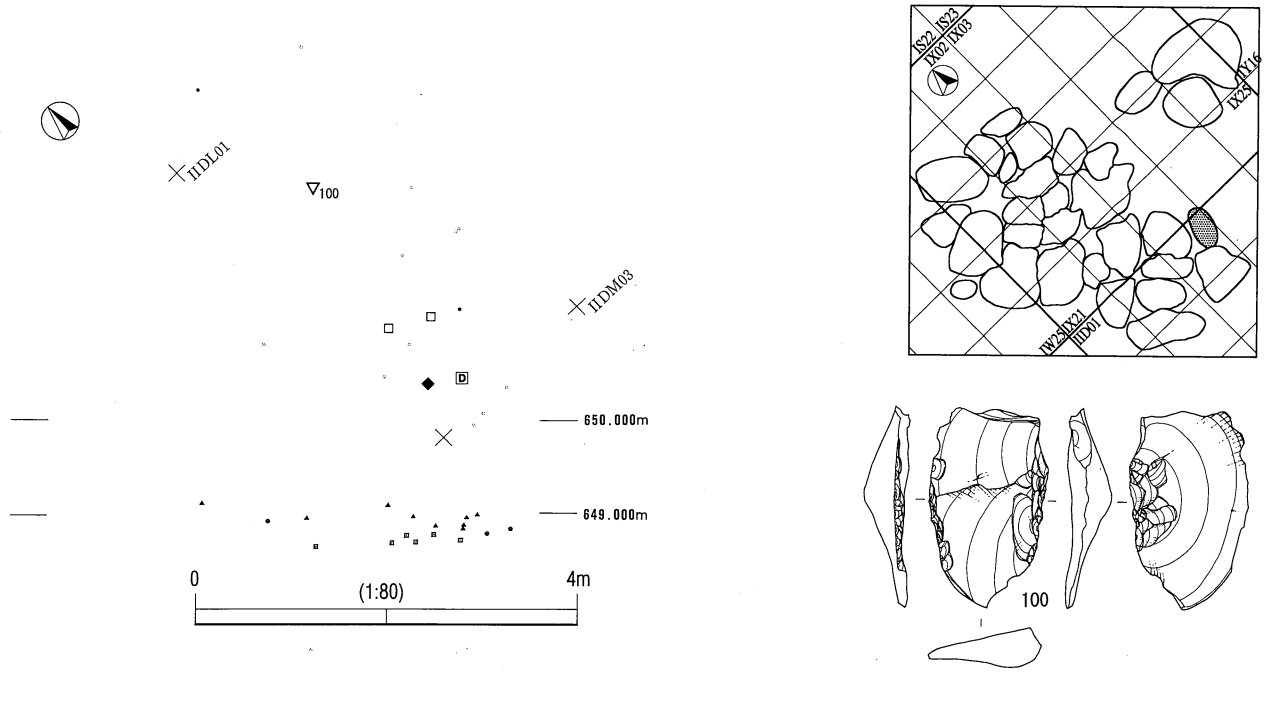

日向林 I 石器文化 BL29・BL30遺物分布図 (上：BL29・下：BL30)

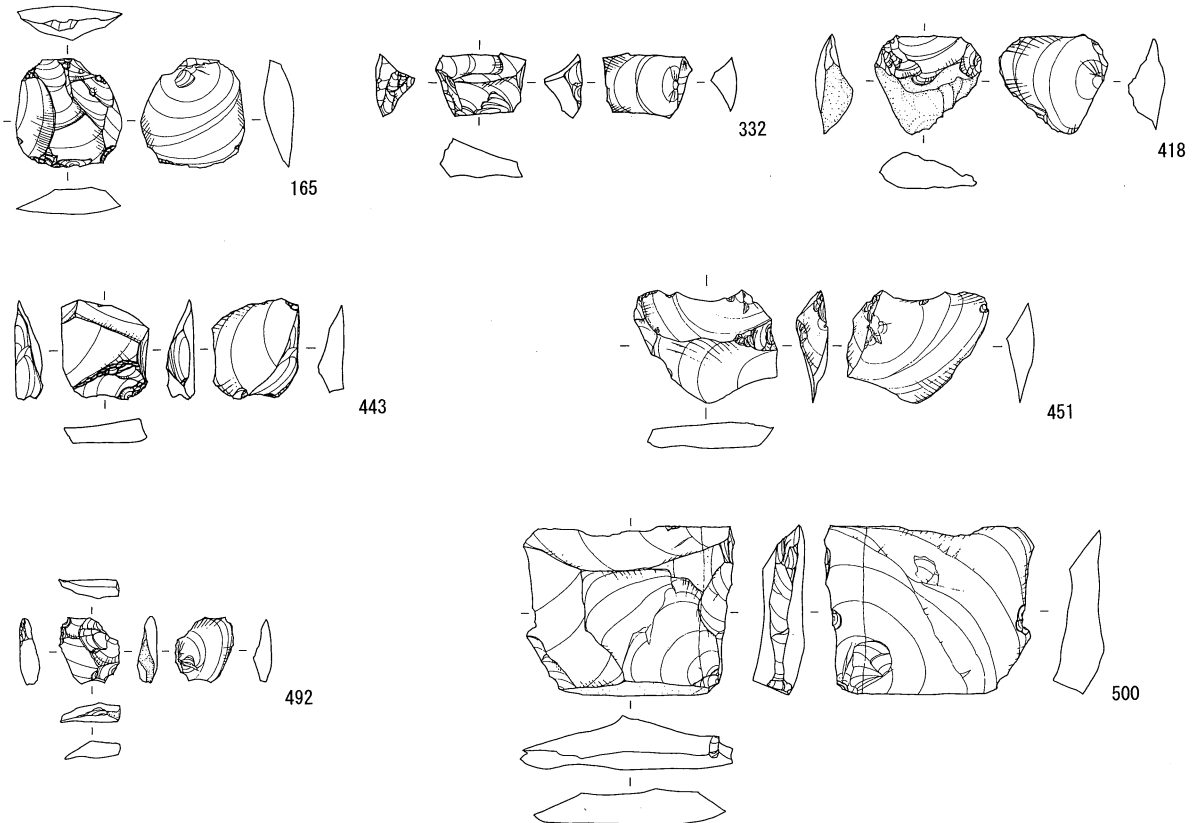

日向林I石器文化 ブロック外遺物分布図



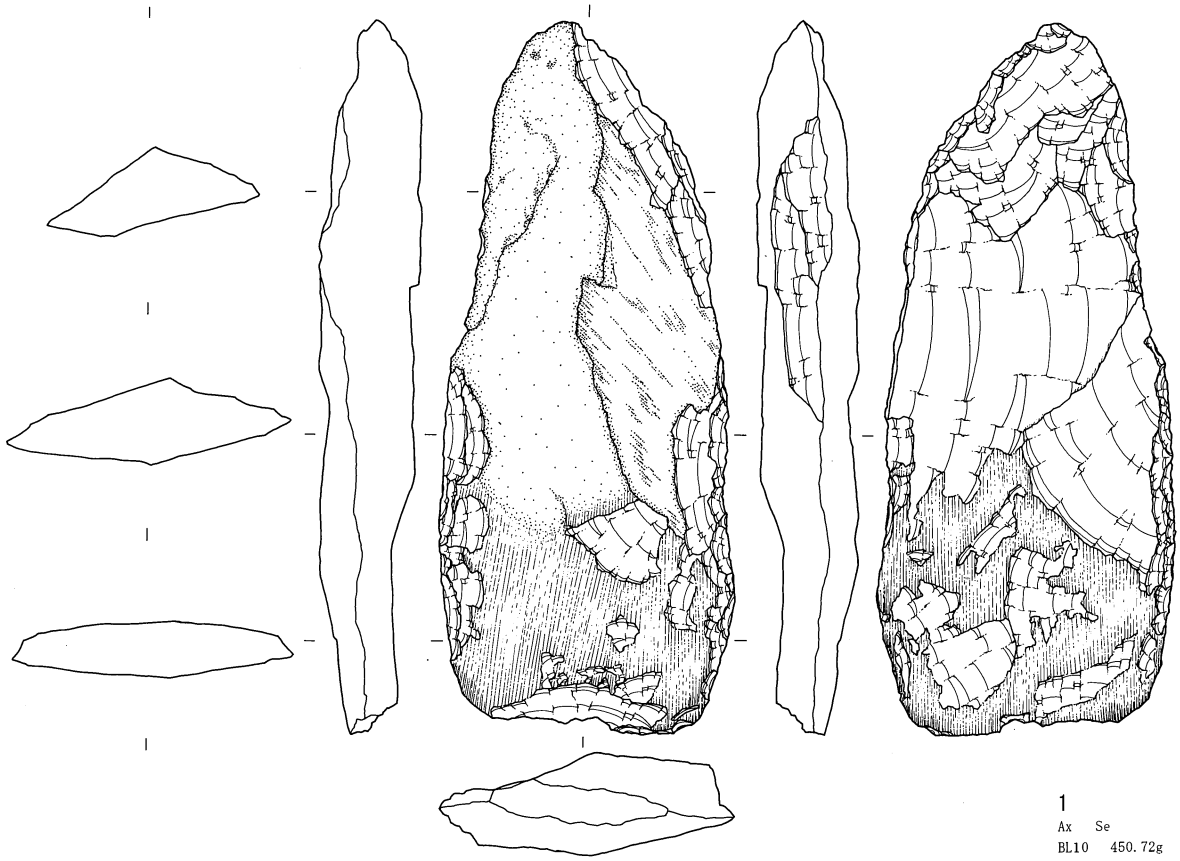

1  
 Ax Se  
 BL10 450.72g  
 Vb上 1908

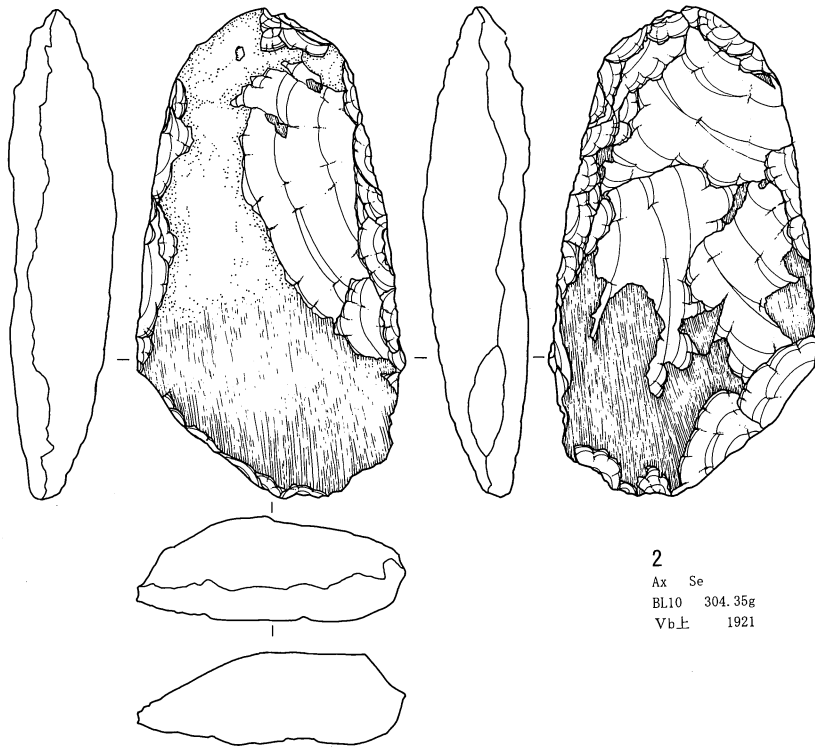

2  
 Ax Se  
 BL10 304.35g  
 Vb上 1921

0 (1 : 2) 10 cm

日向林 I 石器文化 石器実測図 1 (斧形石器 1)

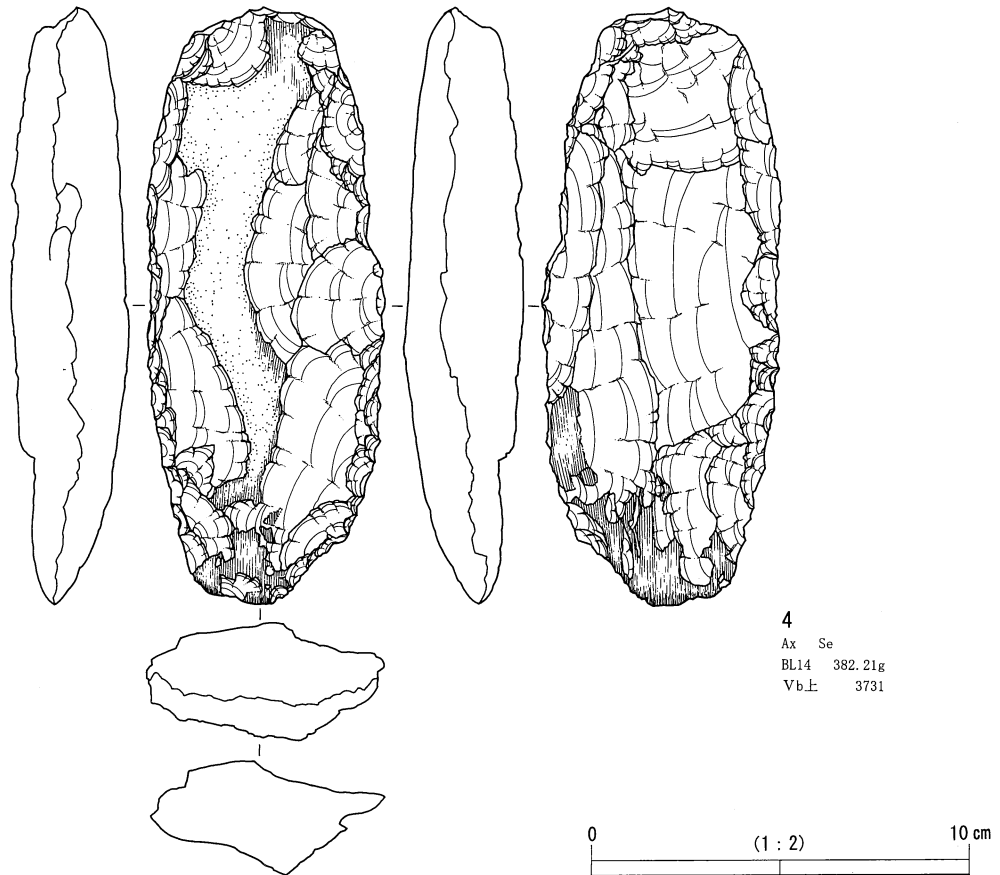
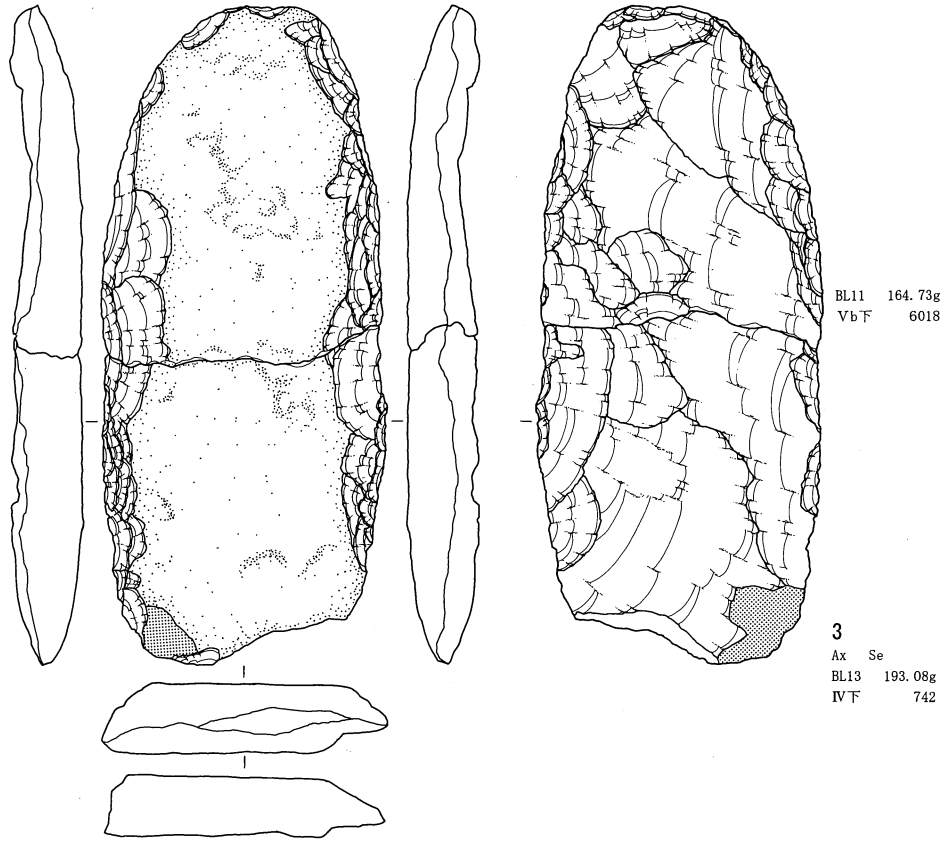

日向林 I 石器文化 石器実測図 2 (斧形石器 2)

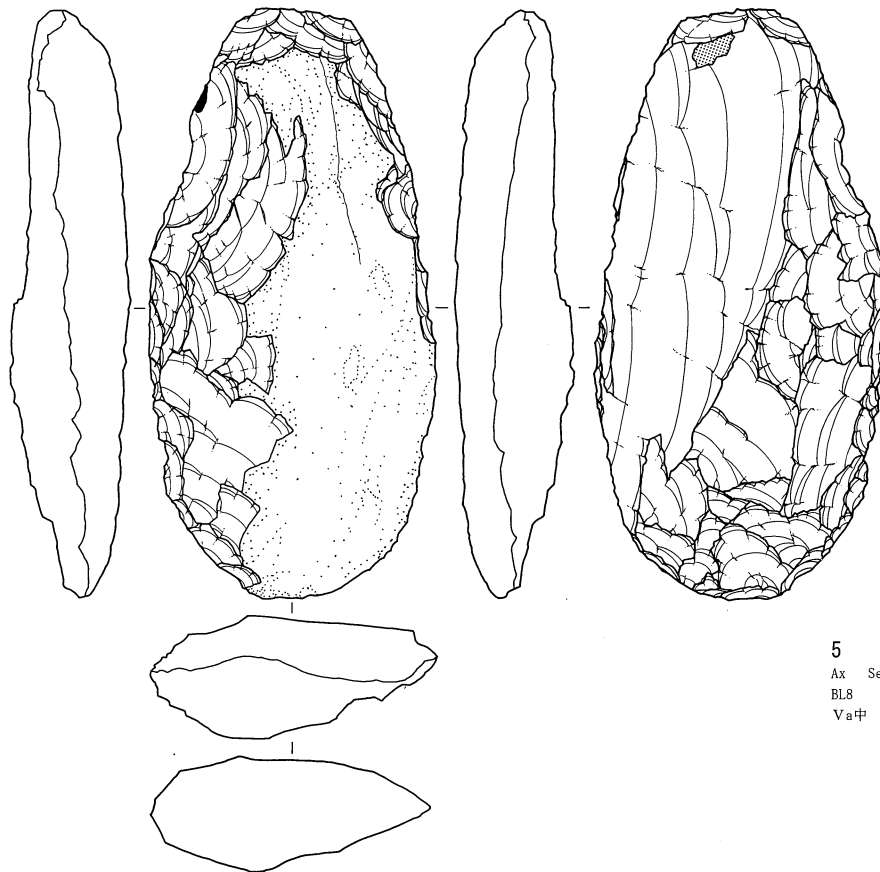

5  
 Ax Se  
 BL8 413.54g  
 Va中 7448

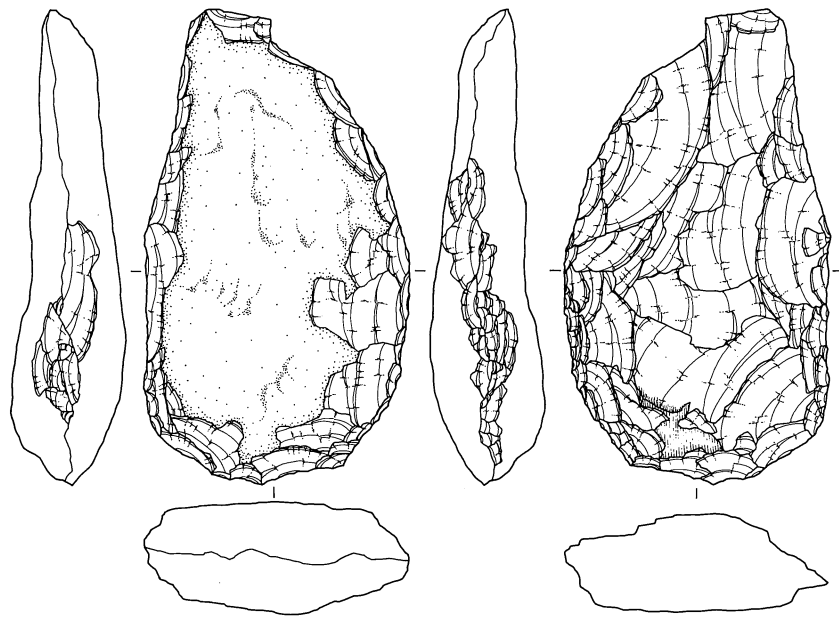

6  
 Ax Se  
 BL14 321.21g  
 Vb中 3730

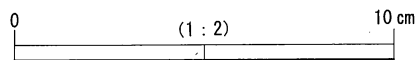

日向林 I 石器文化 石器実測図 3 (斧形石器 3)

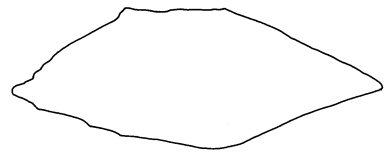
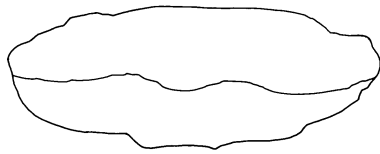
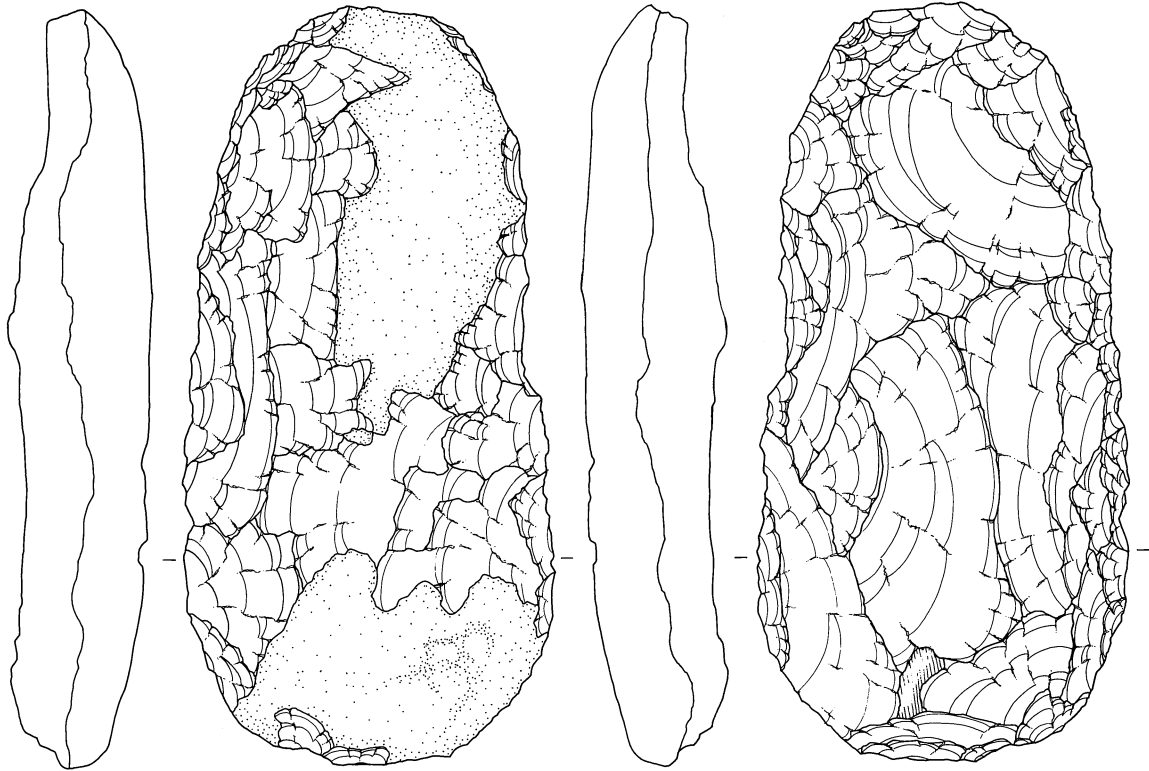

7

Ax	Se
BL1	288.91g
Va下	3846

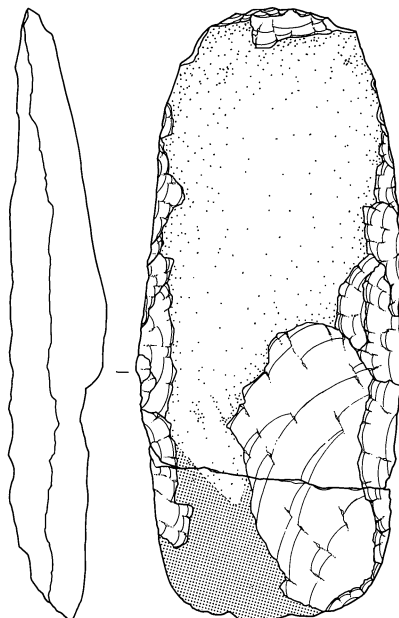

BL14	90.08g
IVF	1679

8

Ax	Se
BL14	23.07g
Va上	3732

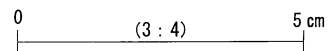

日向林 I 石器文化 石器実測図 4 (斧形石器 4)

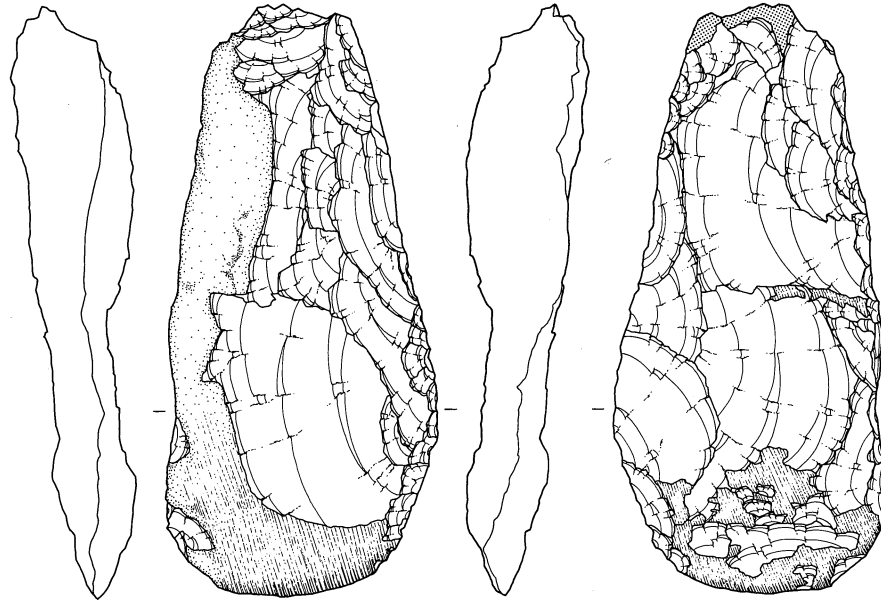

9  
 Ax Se  
 BL12 89.76g  
 Vb中 1553

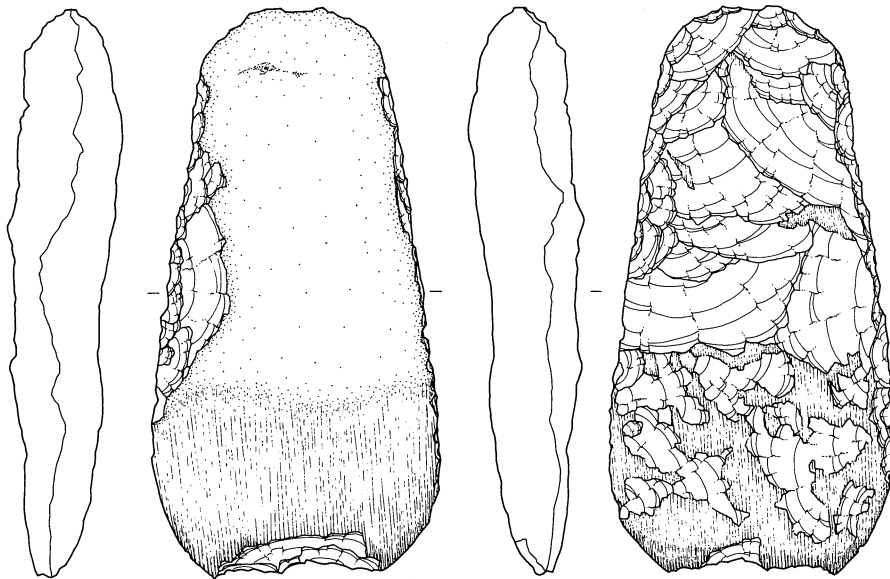

10  
 Ax Se  
 BL18 127.11g  
 Vb上 4079



0 (3:4) 5 cm

日向林 I 石器文化 石器実測図 5 (斧形石器 5)

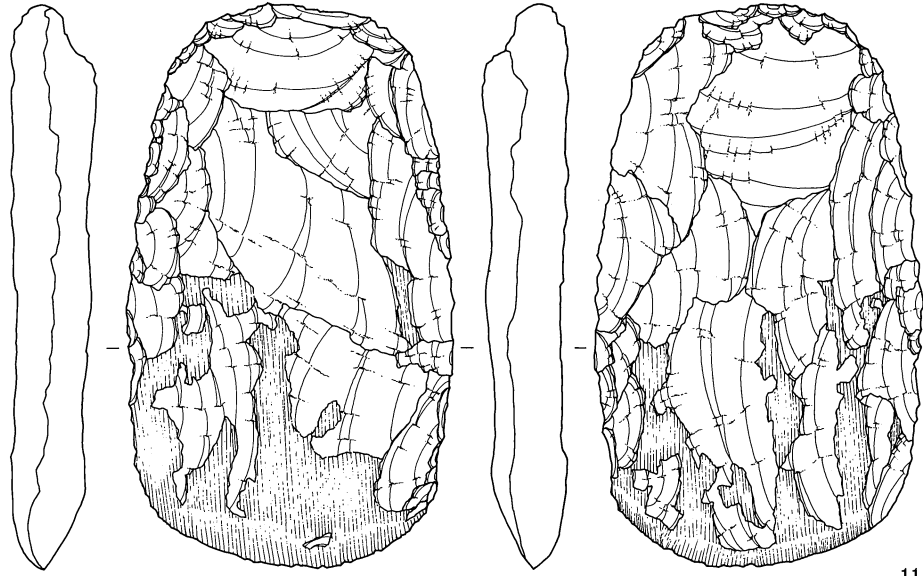

11  
 Ax Se  
 BL8 121.02g  
 Vb上 8028

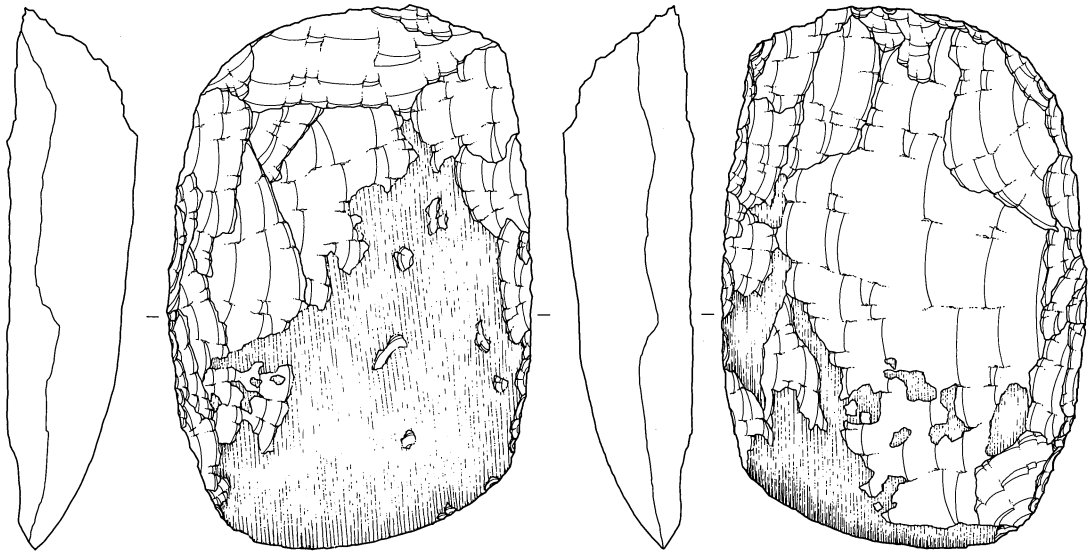

12  
 Ax Se  
 BL5 198.1g  
 Va中 3464

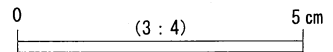

日向林I石器文化 石器実測図6 (斧形石器6)

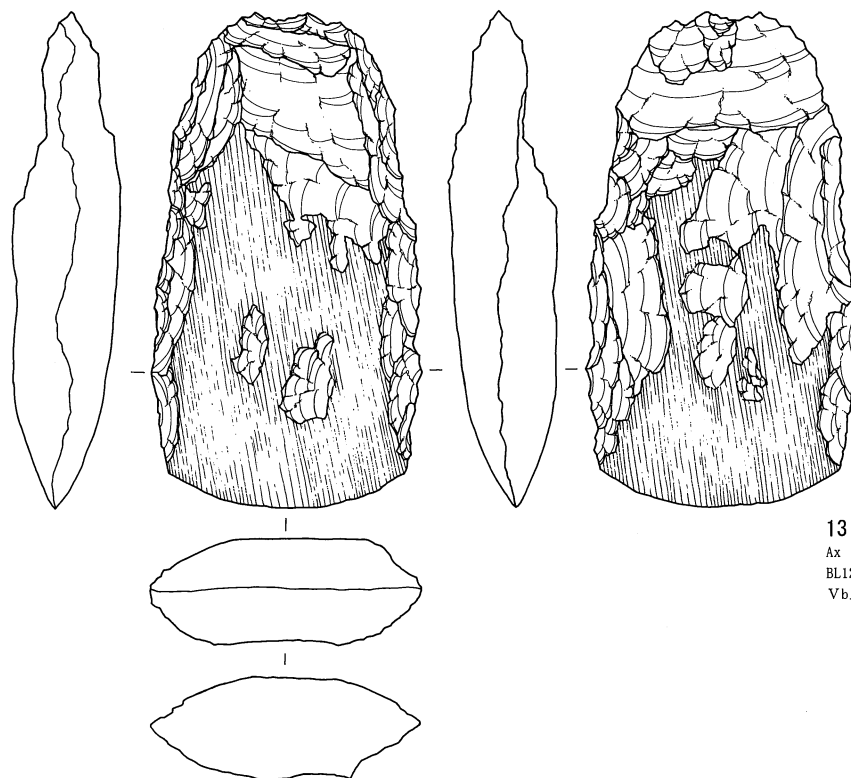

13  
 Ax Se  
 BL12 105.69g  
 Vb上 3962

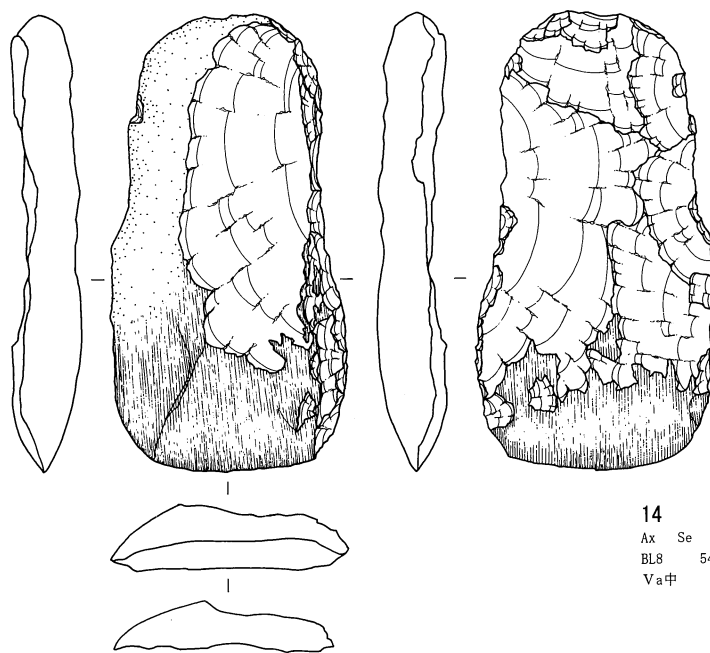

14  
 Ax Se  
 BL8 54.36g  
 Va中 8070

0 (3:4) 5 cm

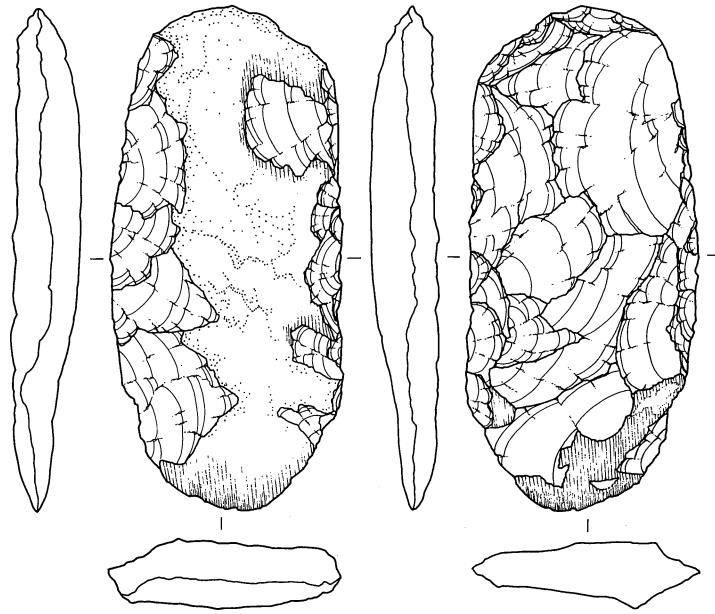

15  
 Ax Se  
 BL10 55.61g  
 Vb上 6307

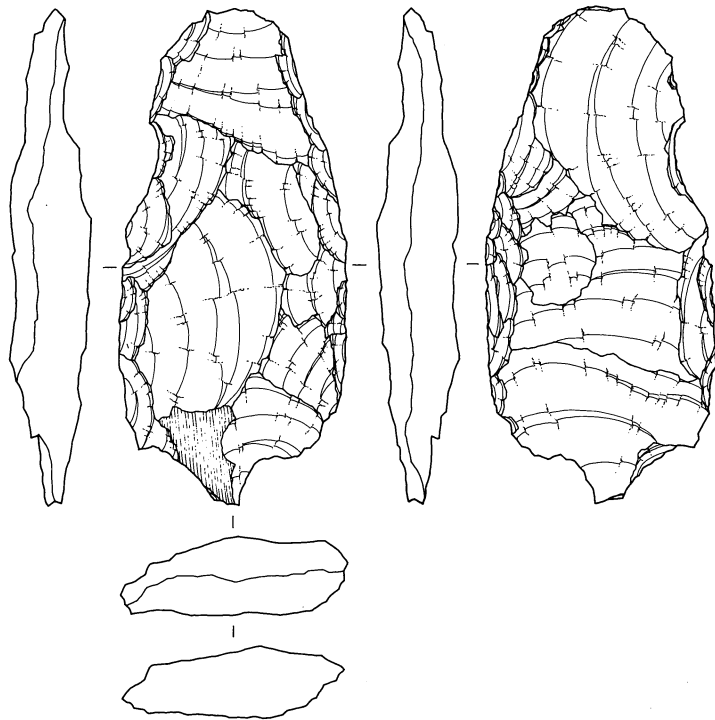

16  
 Ax Se  
 BL14 51.39g  
 IV下 1676

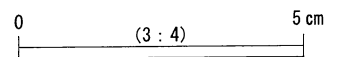

日向林 I 石器文化 石器実測図 8 (斧形石器 8)



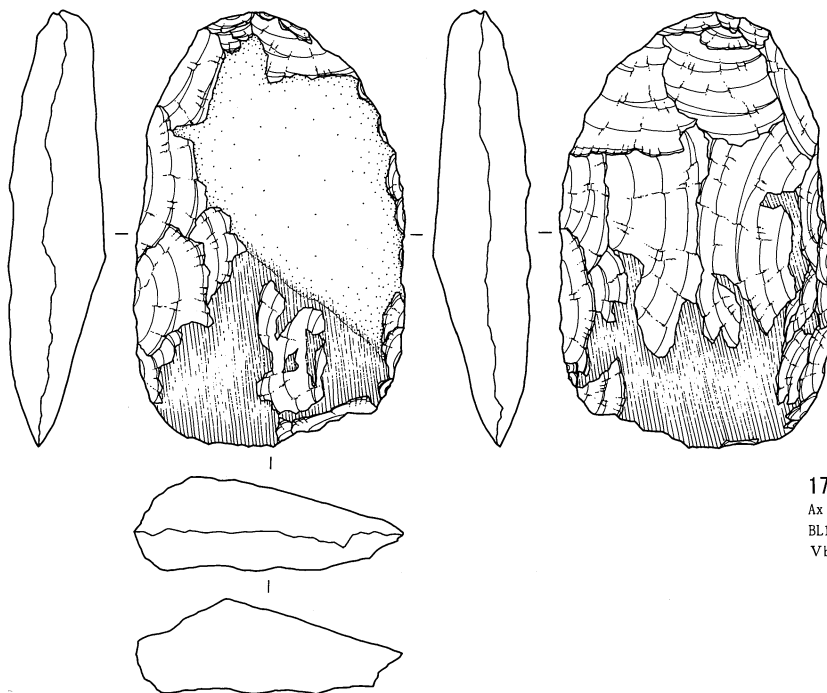

17  
 Ax Se  
 BL10 82.56g  
 Vb上面 8243

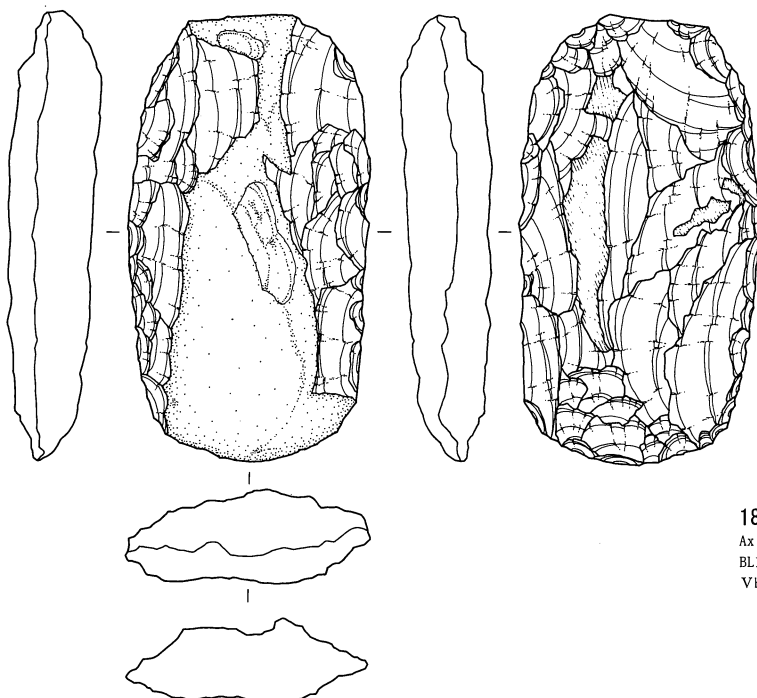

18  
 Ax Se  
 BL14 73.46g  
 Vb上面 3733

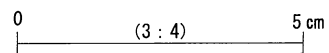

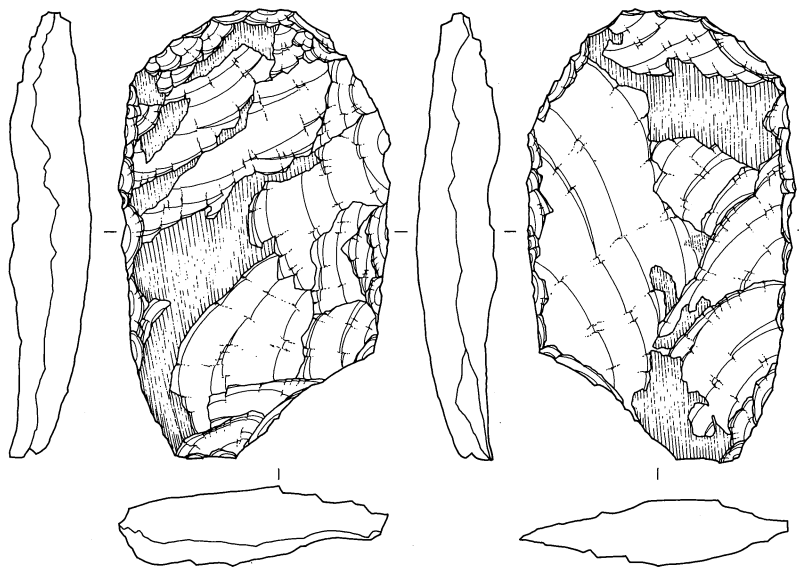

19  
Ax Se  
BL17 58.8g  
Va中 3550

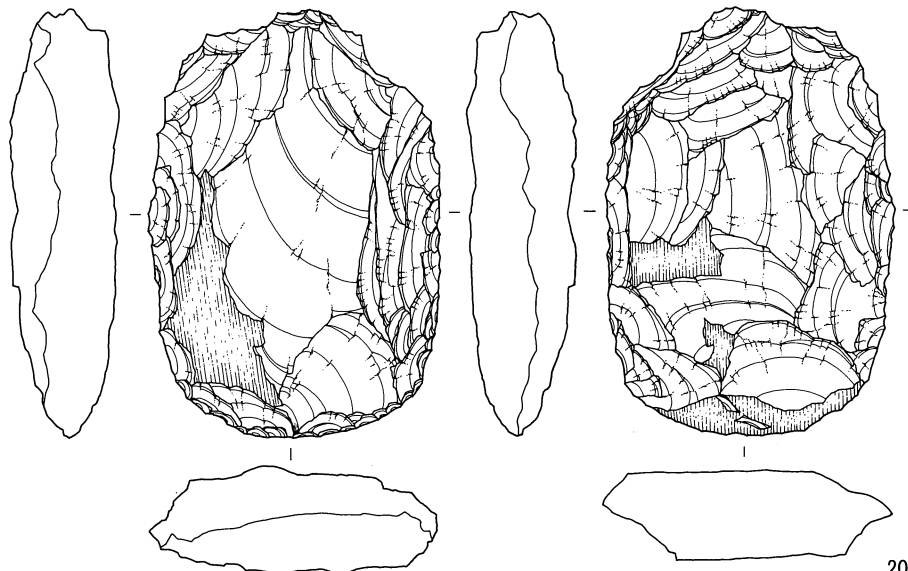

20  
Ax Se  
BL28 101.31g  
Vb上面 8449

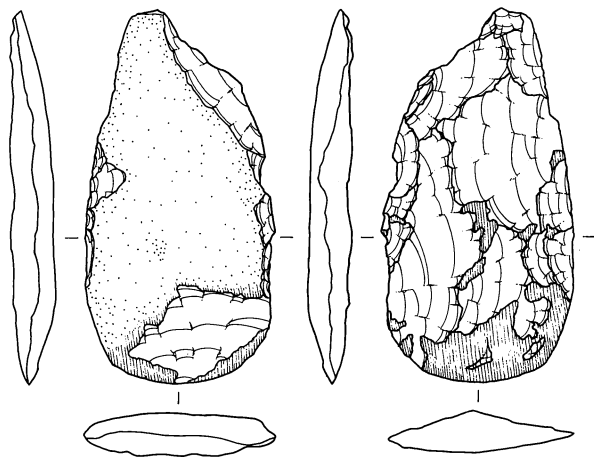

21  
Ax Se  
BL10 22.11g  
Va中 3932

0 (3:4) 5 cm

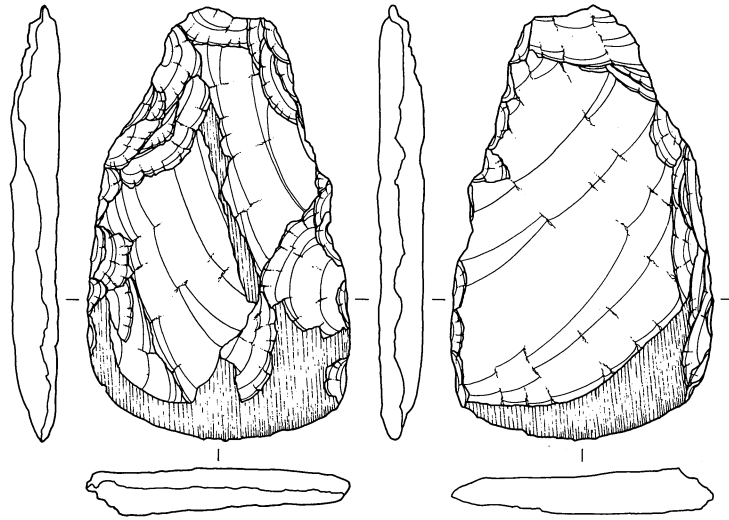

22  
 Ax Se  
 BL5 38.85g  
 Va上面 1504

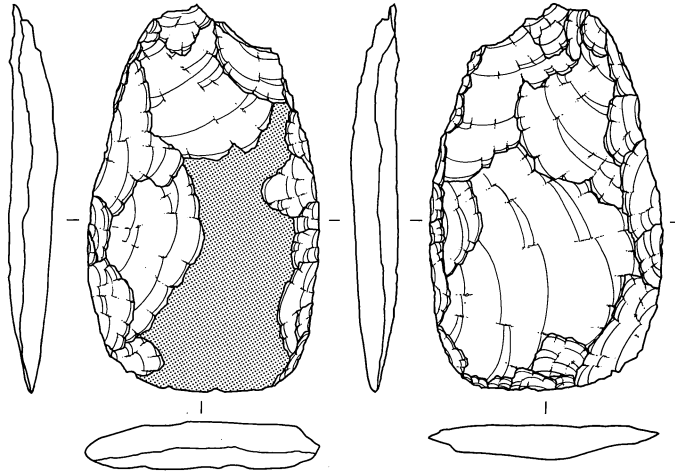

23  
 Ax Se  
 BL14 30.58g  
 IV下 1677

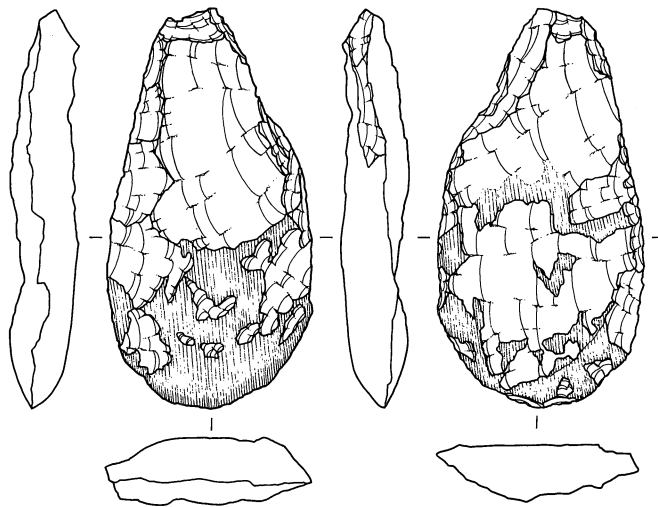

24  
 Ax Se  
 BL4 35.7g  
 Vb下 6923

0 (3:4) 5 cm

日向林 I 石器文化 石器実測図11 (斧形石器11)

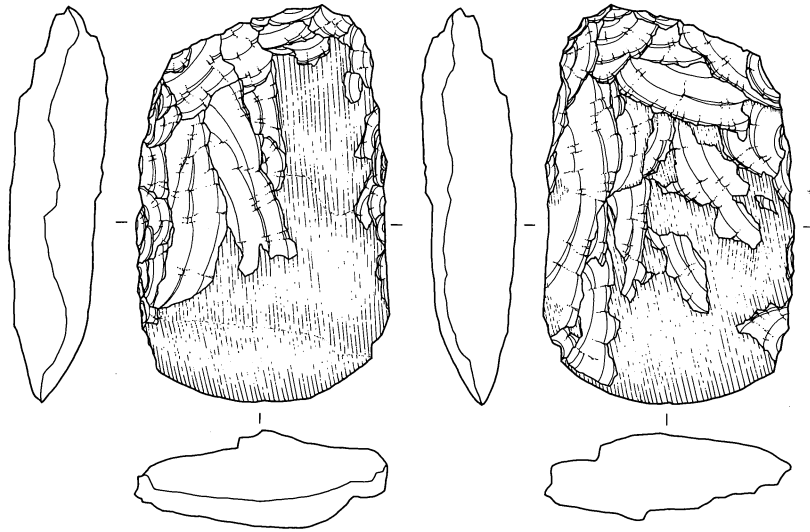

25  
 Ax Se  
 BL5 60.61g  
 Vb上 5652

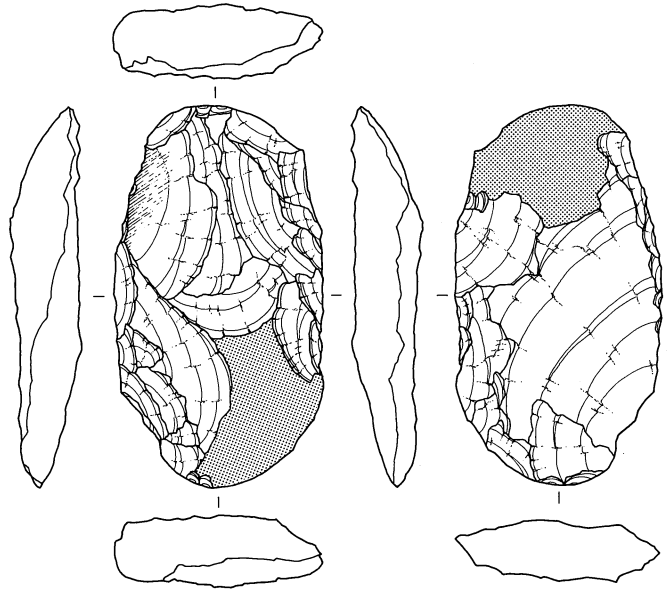

26  
 Ax Se  
 BL10 35.76g  
 Vb上 1907

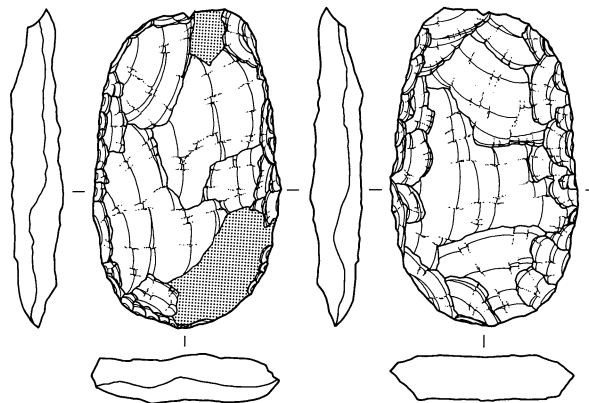

27  
 Ax Se  
 BL14 23.16g  
 Va上 2093

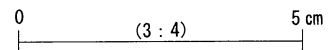

日向林 I 石器文化 石器実測図12 (斧形石器12)

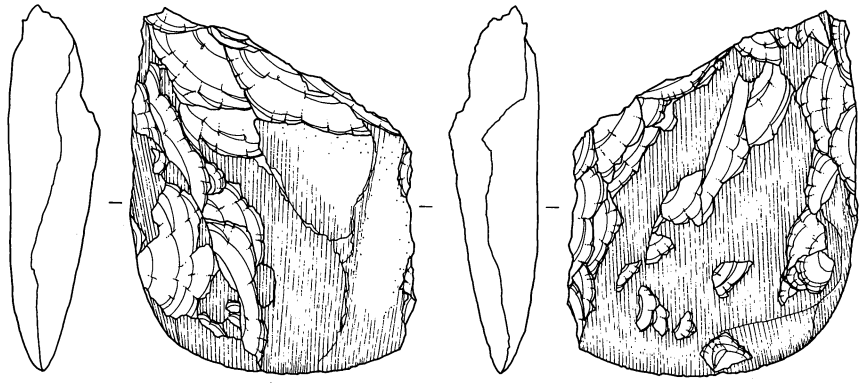

28  
 Ax Se  
 BL1 61.07g  
 Vb中 5706

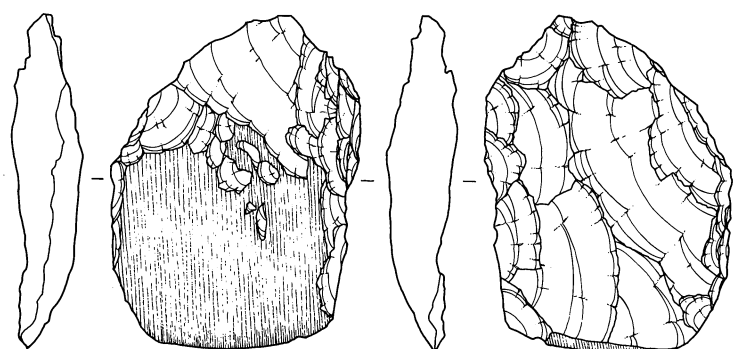
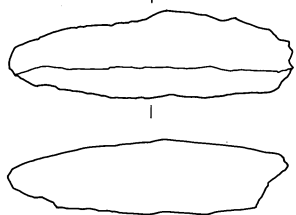

29  
 Ax Se  
 BL12 33.64g  
 Vb上 4701

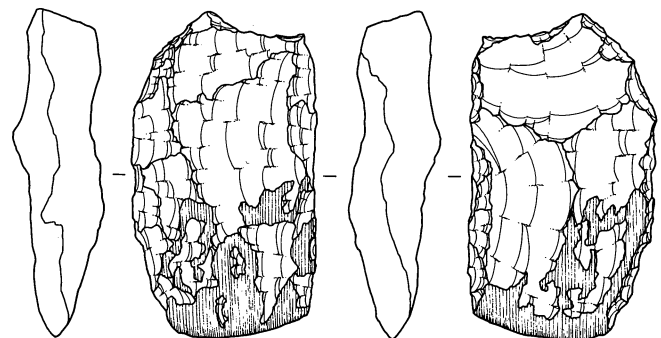
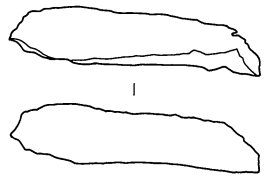

30  
 Ax Se  
 BL14 38.02g  
 Vb中 6174

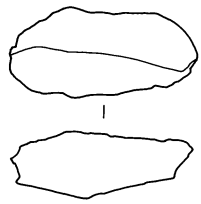

0 (3 : 4) 5 cm

日向林 I 石器文化 石器実測図13 (斧形石器13)

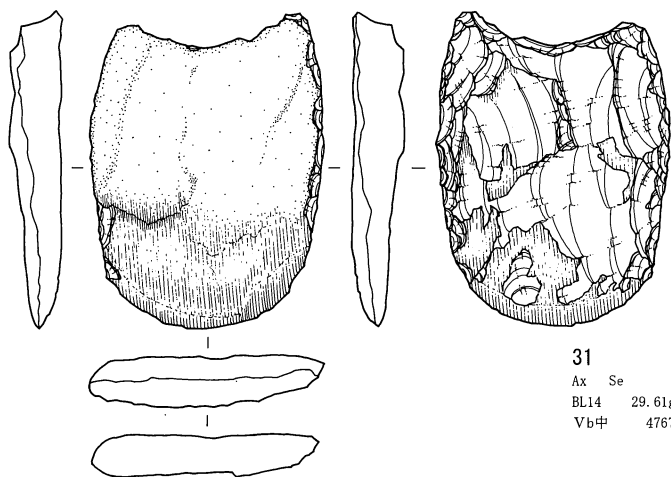

31  
Ax Se  
BL14 29.61g  
Vb中 4767

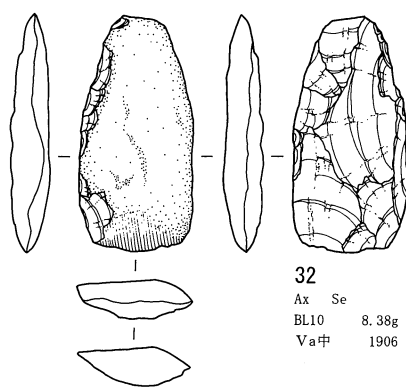

32  
Ax Se  
BL10 8.38g  
Va中 1906

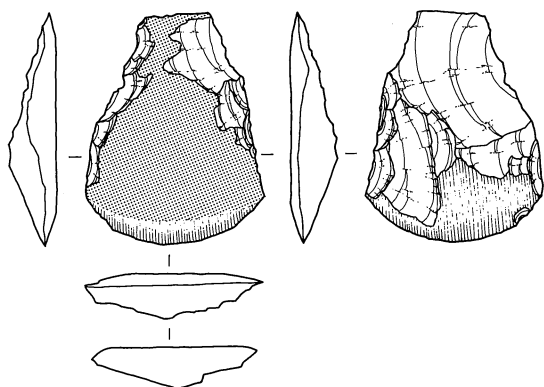

33  
Ax Se  
BL18 9.6g  
IV下 10001

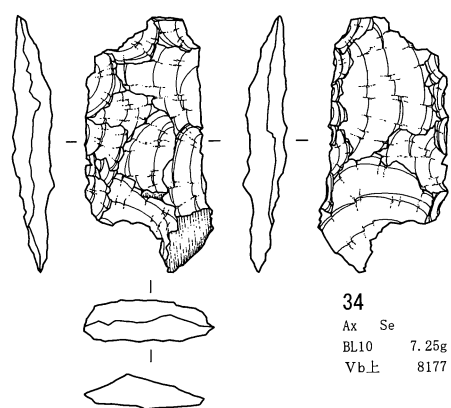

34  
Ax Se  
BL10 7.25g  
Vb上 8177

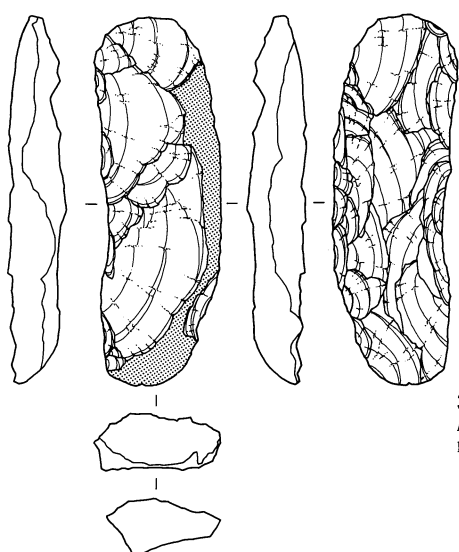

35  
Ax Se  
BL11 17.46g  
Vb上面 1903

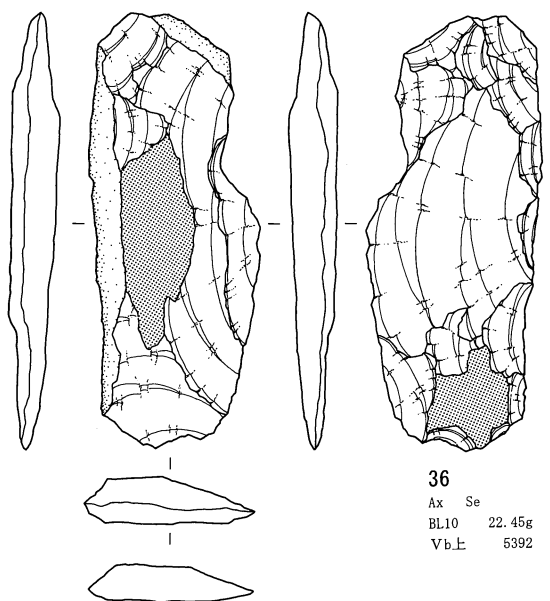

36  
Ax Se  
BL10 22.45g  
Vb上 5392

0 (3:4) 5 cm

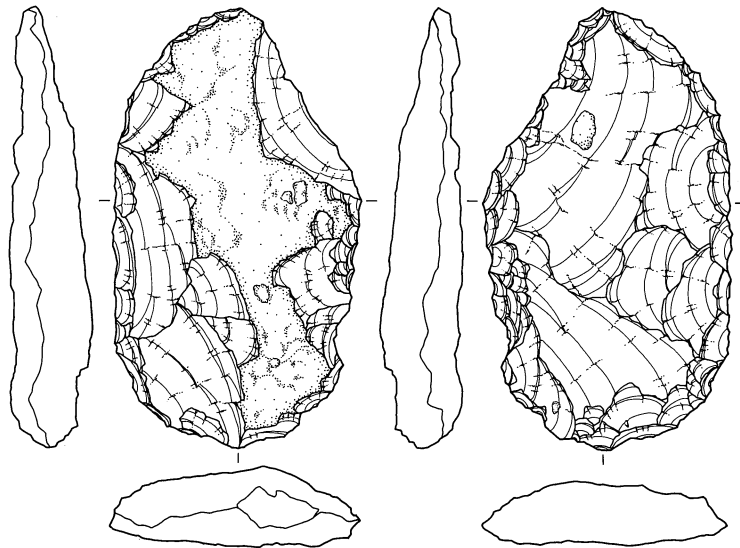
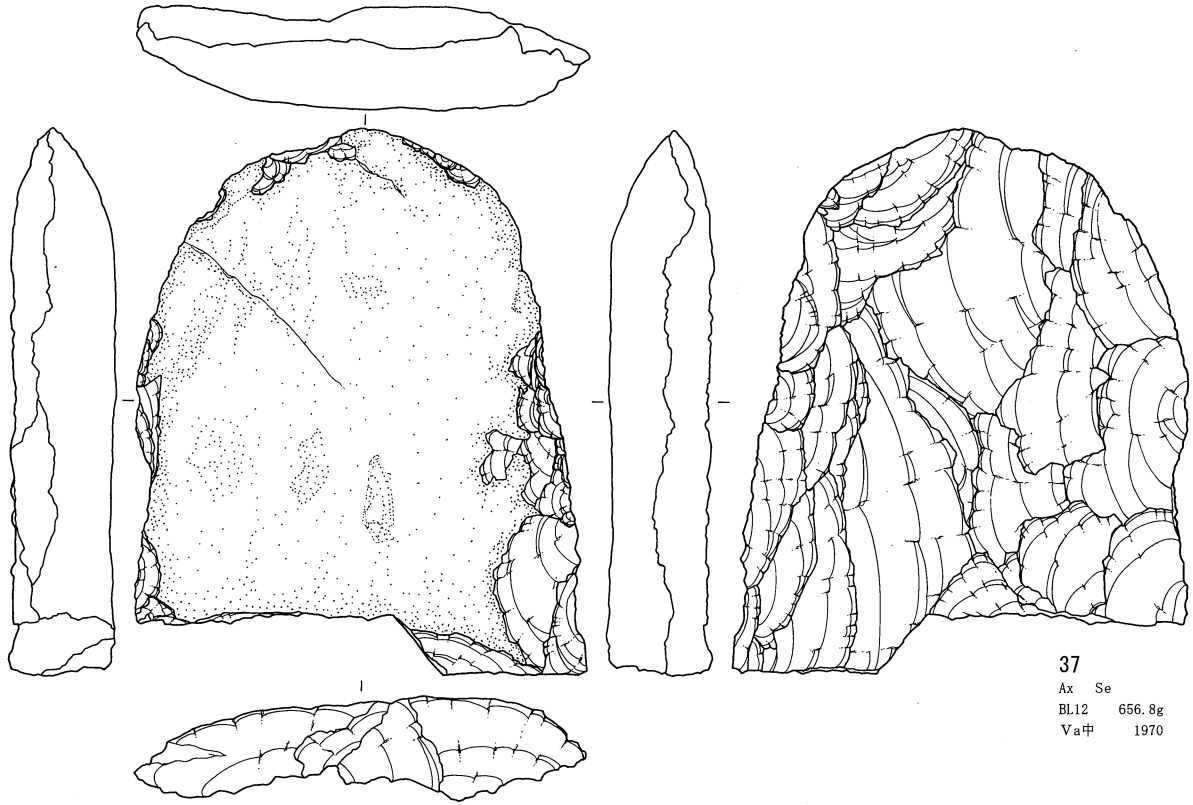

0 (1:2) 10 cm

日向林 I 石器文化 石器実測図15 (斧形石器15)

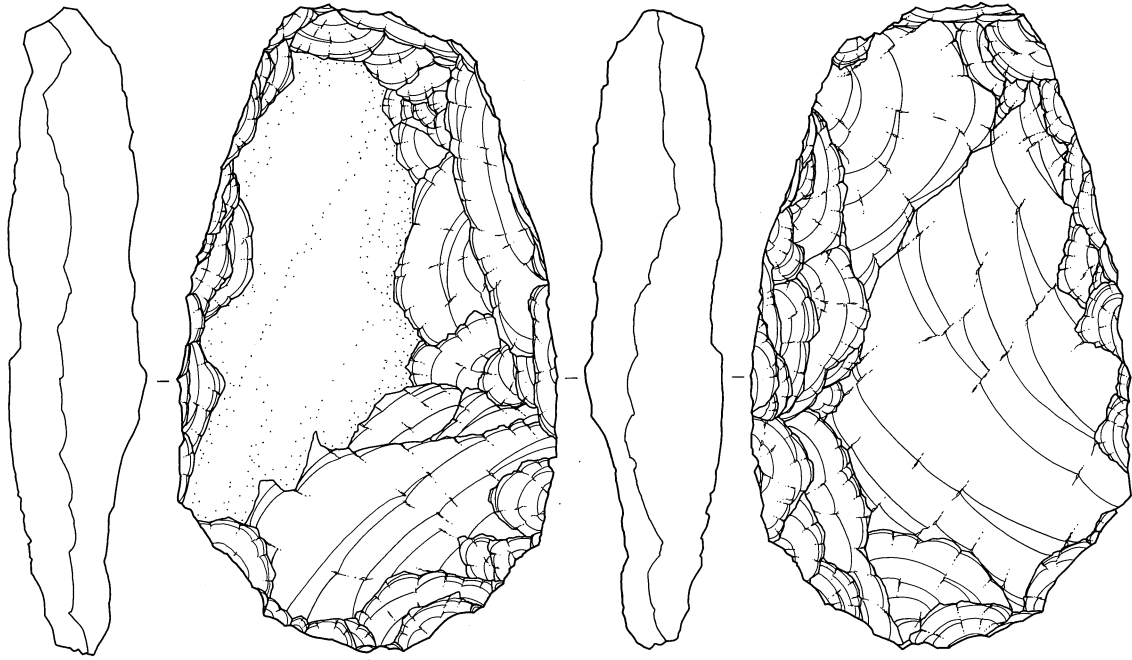

39  
 Ax Se  
 BL8 211.16g  
 IV下 7447

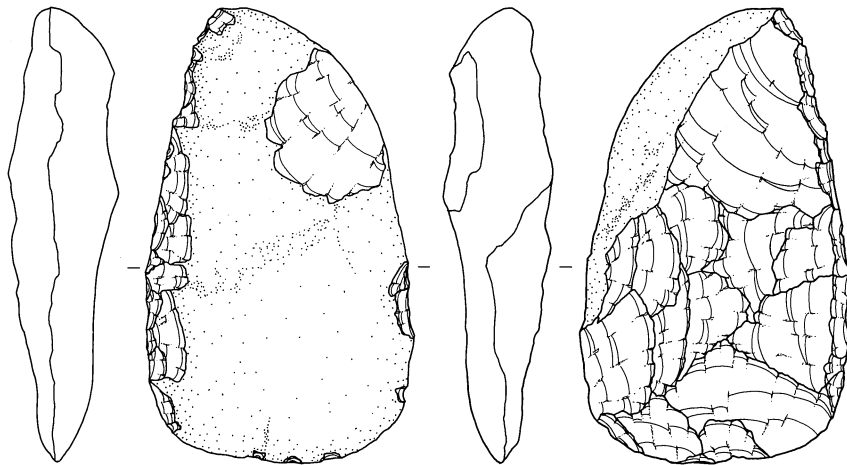
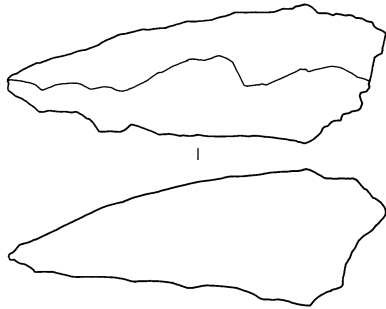

40  
 Ax Se  
 BL10 83.47g  
 Va下 8191

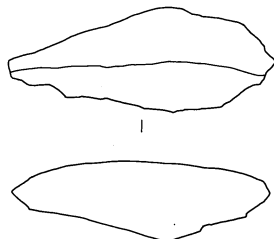

0 (3:4) 5 cm

日向林 I 石器文化 石器実測図16 (斧形石器16)



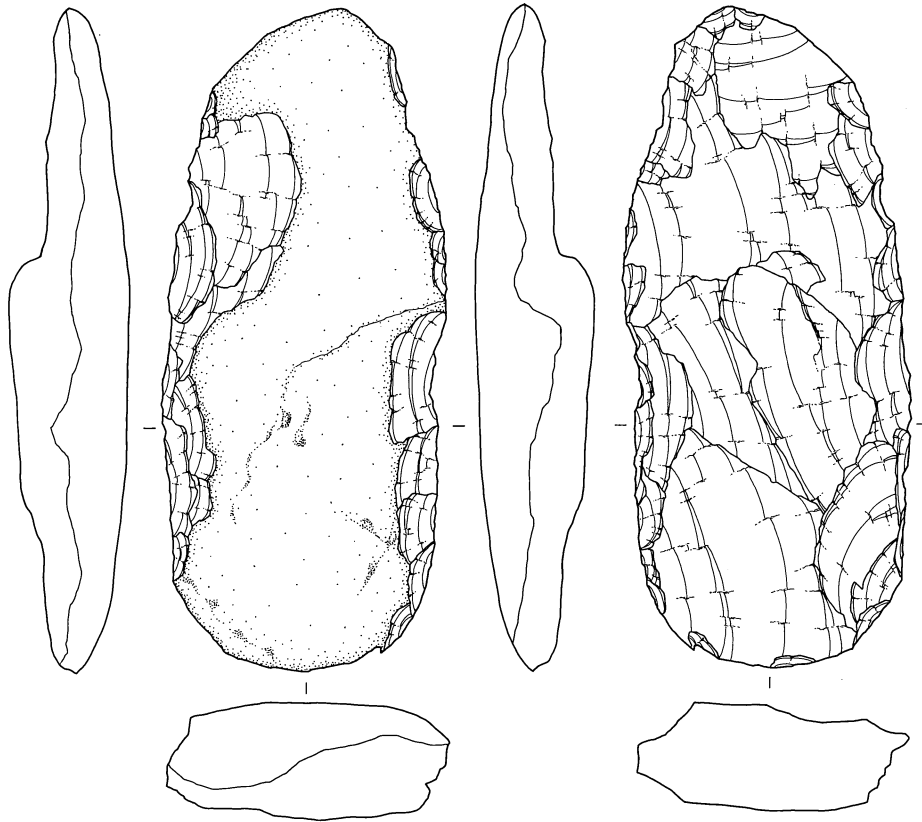

41  
 Ax Se  
 BL14 149.23g  
 Vb上 3728

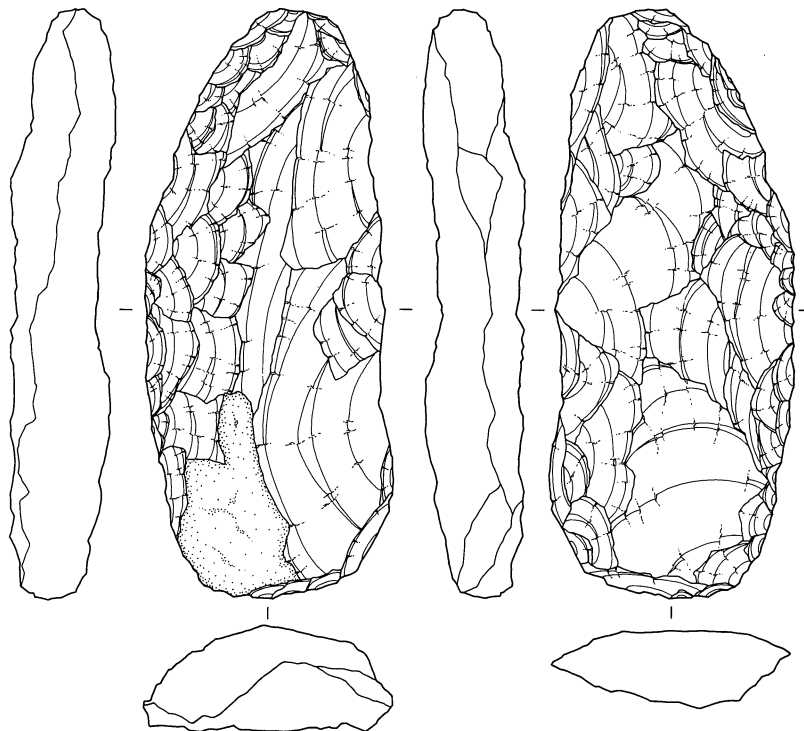

42  
 Ax Se  
 BL9 100.72g  
 Va下 8221

0 (3 : 4) 5 cm

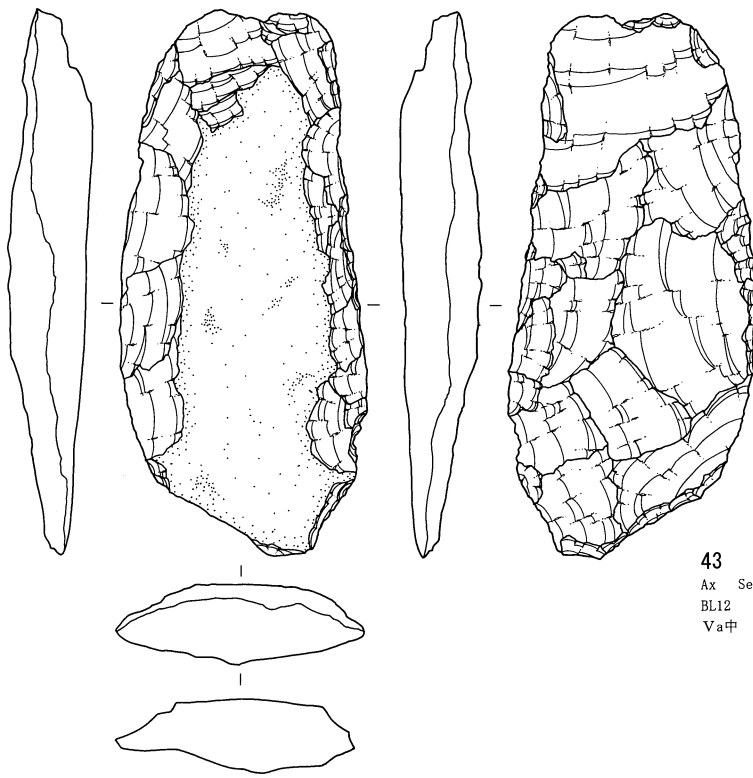

43  
 Ax Se  
 BL12 72.73g  
 Va中 1971

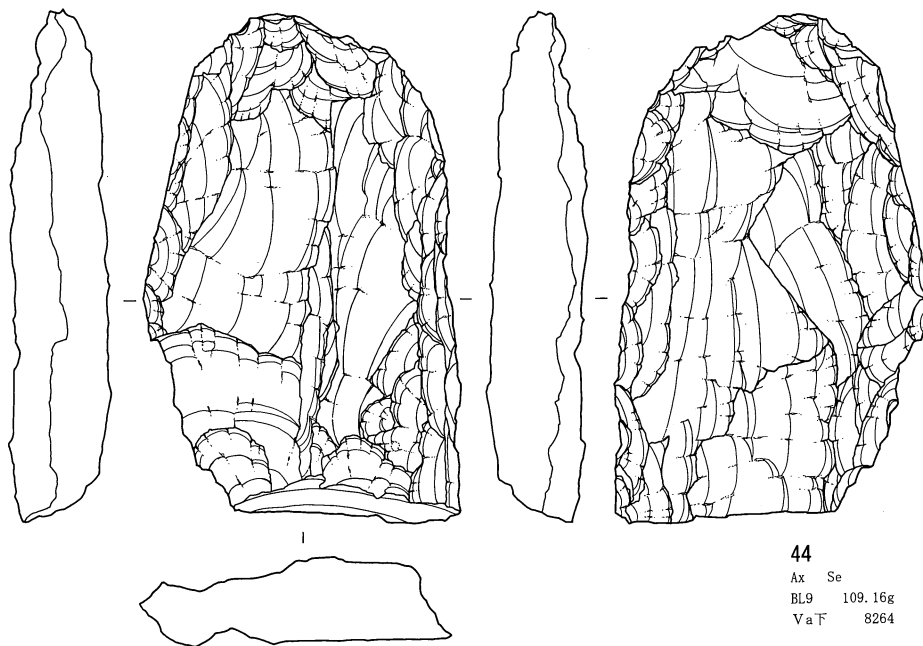

44  
 Ax Se  
 BL9 109.16g  
 Va下 8264

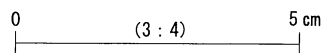

日向林 I 石器文化 石器実測図18 (斧形石器18)

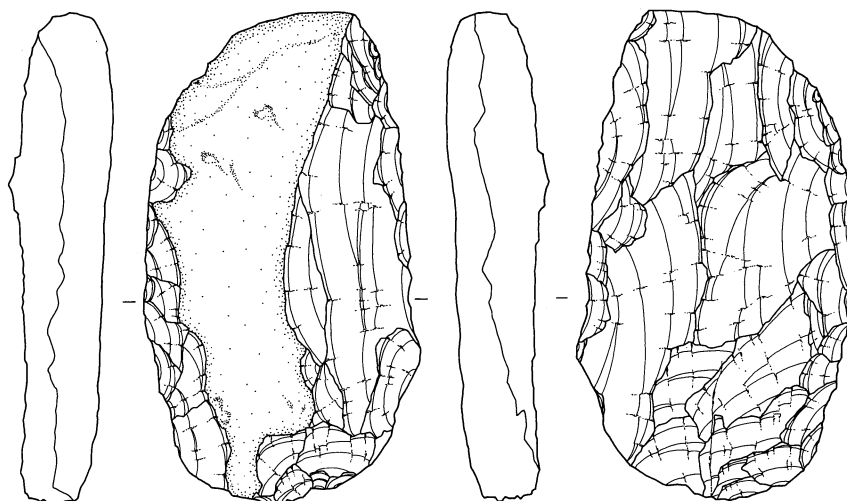

45  
 Ax Se  
 BL10 82.63g  
 Vb.上 6306

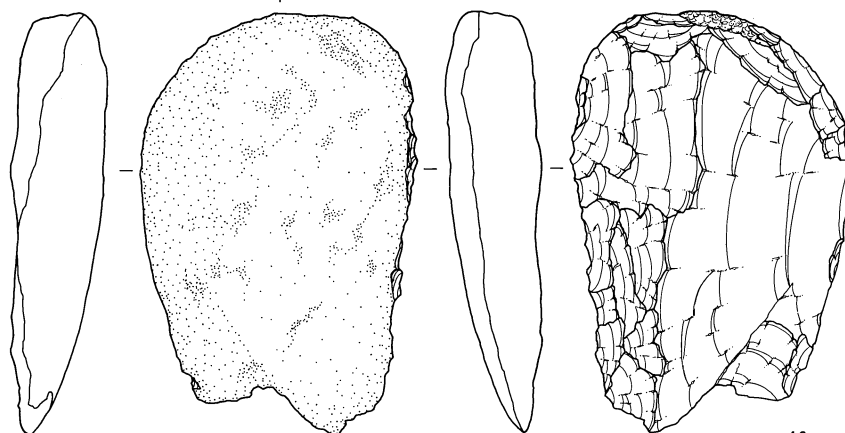
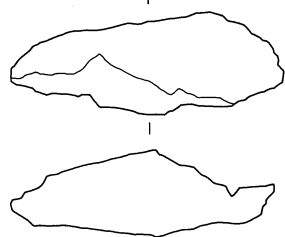

46  
 Ax Se  
 BL20 78.13g  
 Vb.上 4993

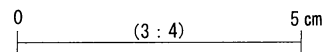

日向林 I 石器文化 石器実測図19 (斧形石器19)

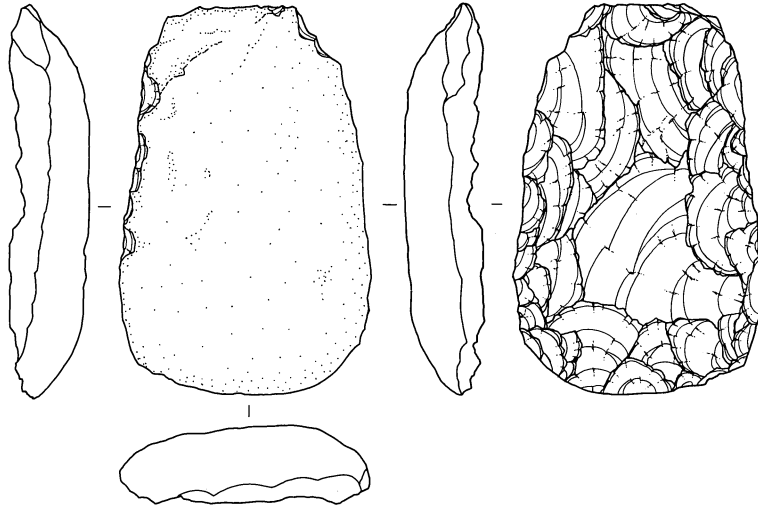

47  
Ax Se  
BL9 55.31g  
Vb上面 8220

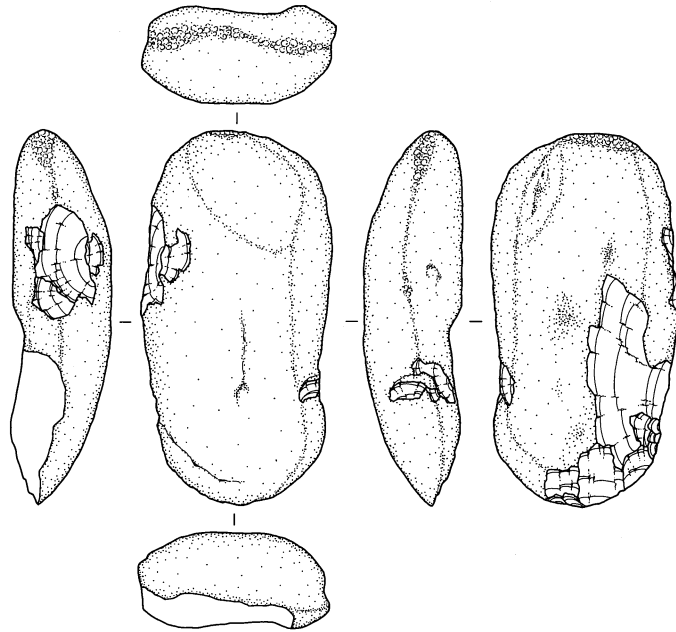

48  
Ax Se  
BL18 58.96g  
Vb中 5524

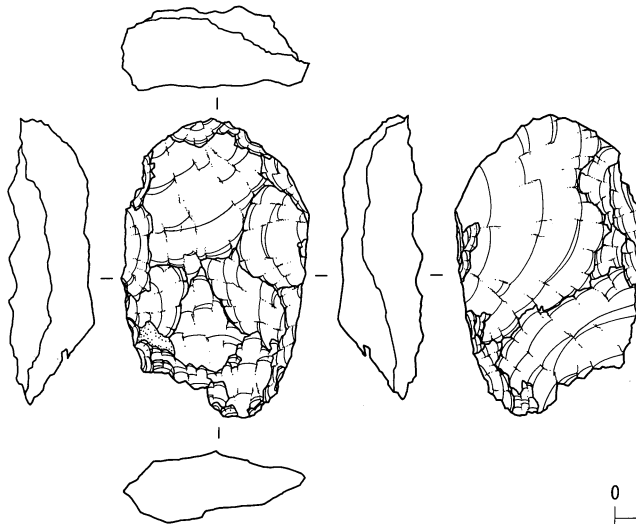

49  
Ax Se  
BL2 26.06g  
Vb下 6699

0 (3 : 4) 5 cm

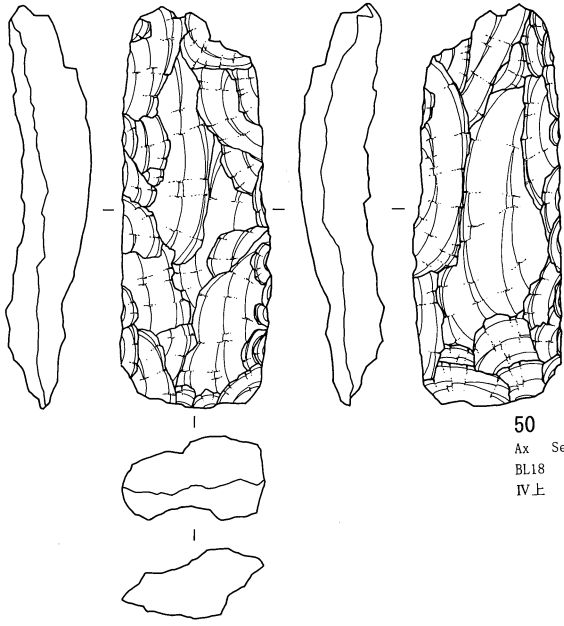

50  
Ax Se  
BL18 28.37g  
IV上 575

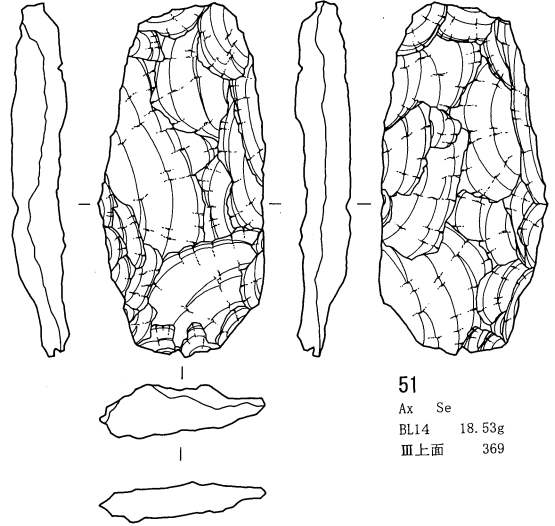

51  
Ax Se  
BL14 18.53g  
III上面 369

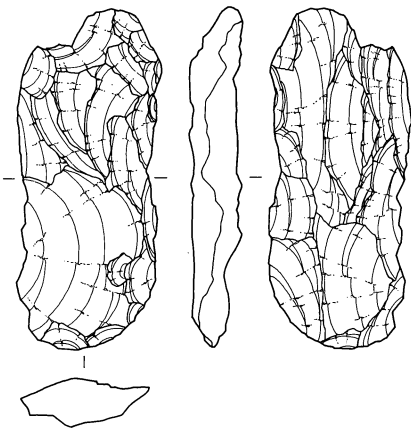

52  
Ax Se  
BL11 15.07g  
VaF 1532

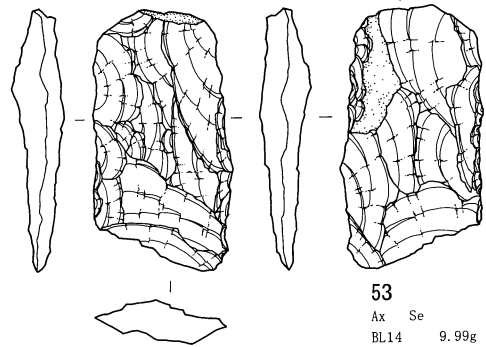

53  
Ax Se  
BL14 9.99g  
Va中 3519

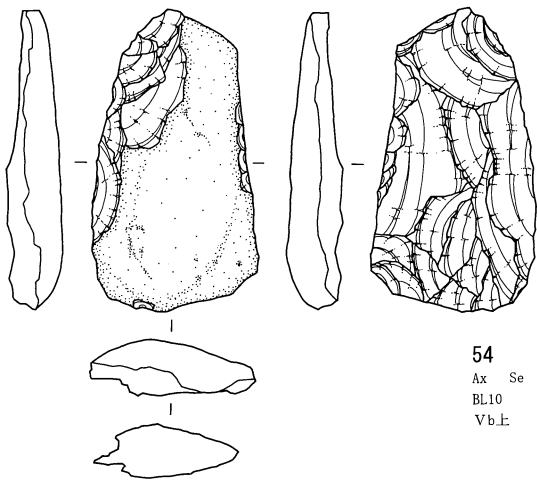

54  
Ax Se  
BL10 16.2g  
Vb上 3933

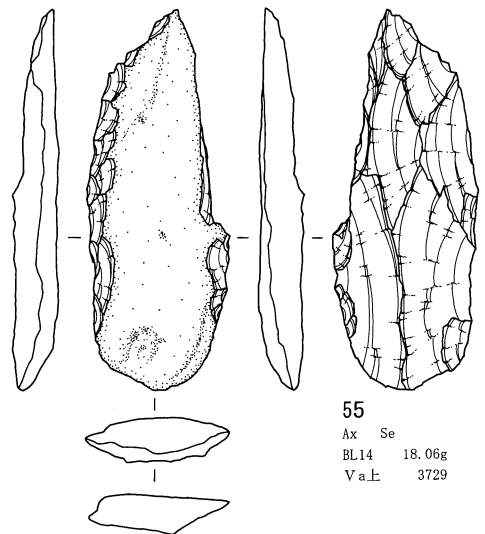

55  
Ax Se  
BL14 18.06g  
Va上 3729

0 (3:4) 5 cm

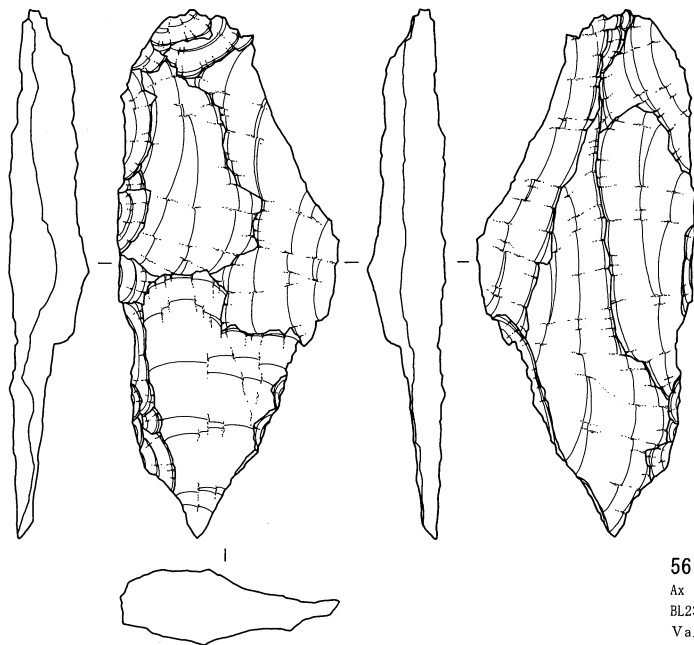

56  
 Ax Se  
 BL23 38.65g  
 Va上 9508

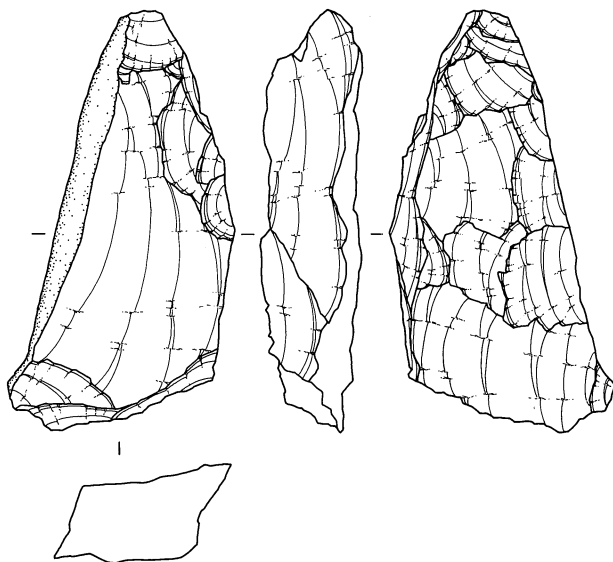

57  
 Ax Se  
 BL18 54.61g  
 Va下 4051

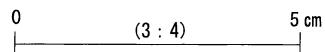

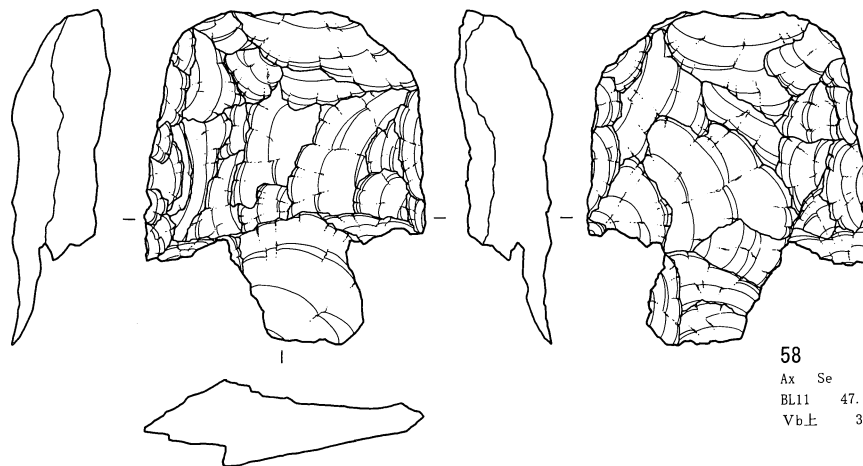

58  
Ax Se  
BL11 47.52g  
Vb上 3929

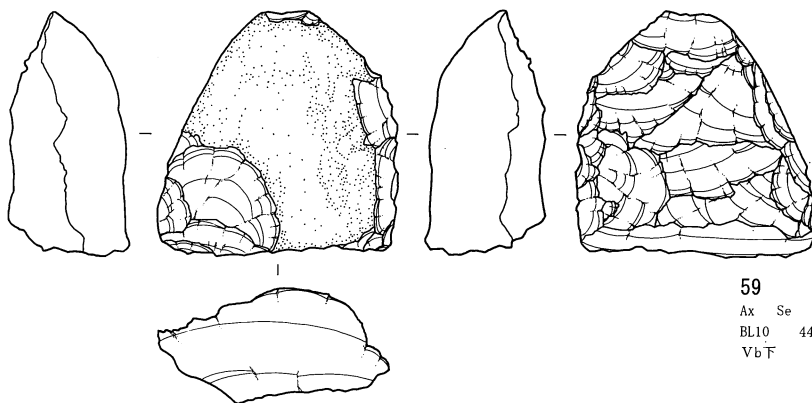

59  
Ax Se  
BL10 44.93g  
Vb下 6646

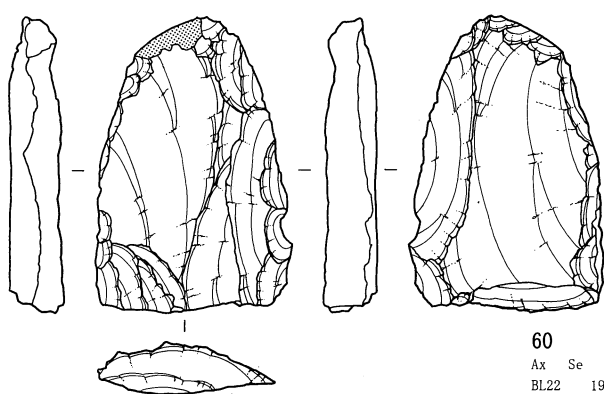

60  
Ax Se  
BL22 19.66g  
Va上 9189

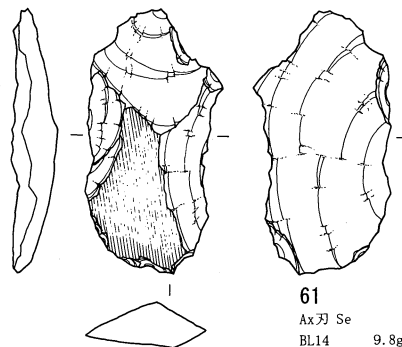

61  
Ax刃 Se  
BL14 9.8g  
Va上面 1774

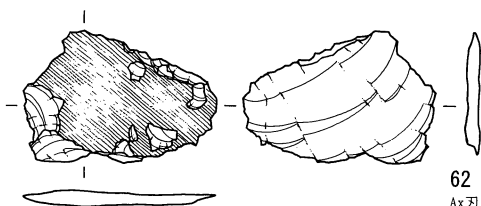

62  
Ax刃 Se  
BL12 2.58g  
Va上面 778

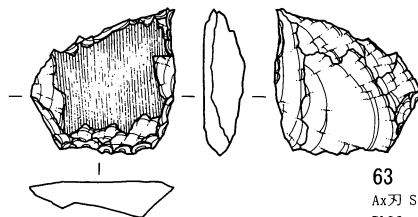

63  
Ax刃 Se  
BL26 5.74g  
IV下 7658

0 (3:4) 5 cm

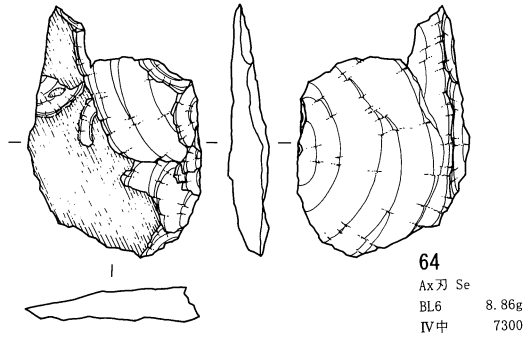

64  
Ax刃 Se  
BL6 8.86g  
IV中 7300

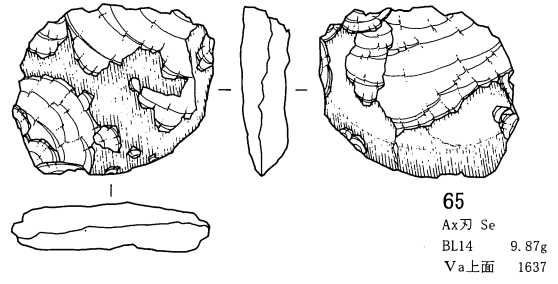

65  
Ax刃 Se  
BL14 9.87g  
Va上面 1637

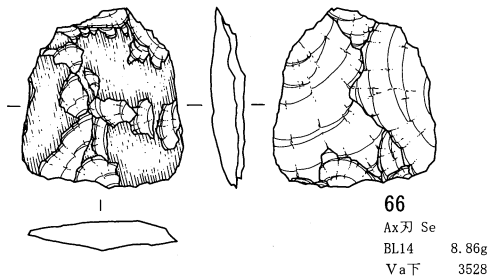

66  
Ax刃 Se  
BL14 8.86g  
Va下 3528

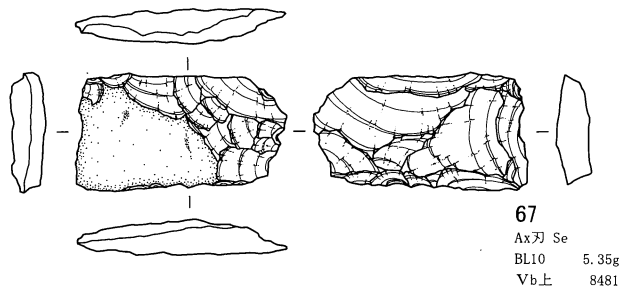

67  
Ax刃 Se  
BL10 5.35g  
Vb上 8481

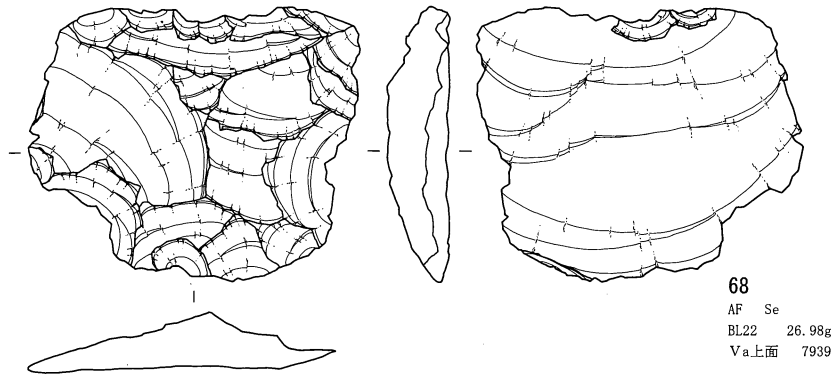

68  
AF Se  
BL22 26.98g  
Va上面 7939

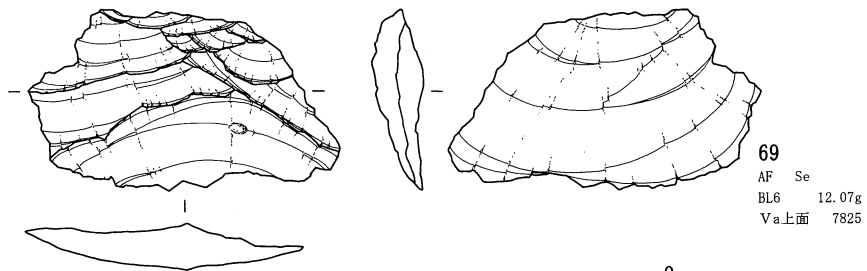

69  
AF Se  
BL6 12.07g  
Va上面 7825

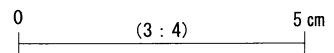

日向林 I 石器文化 石器実測図24 (斧形石器刃部破片 2・斧形石器製作剥片 1)



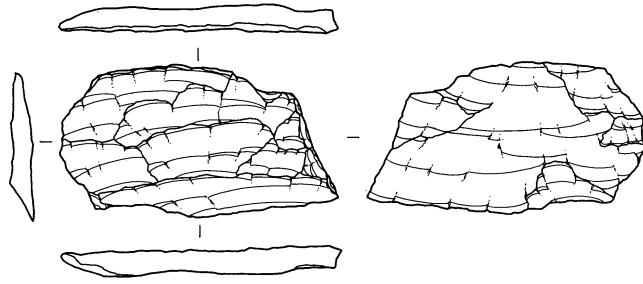

70  
AF Se  
BL10 7.32g  
Va下 3930

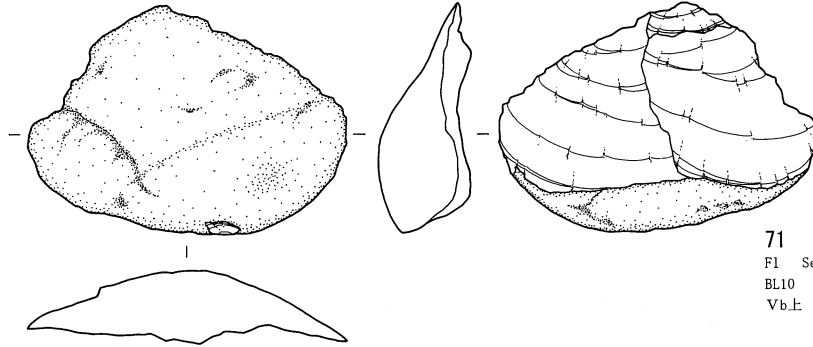

71  
F1 Se  
BL10 33.63g  
Vb上 3931

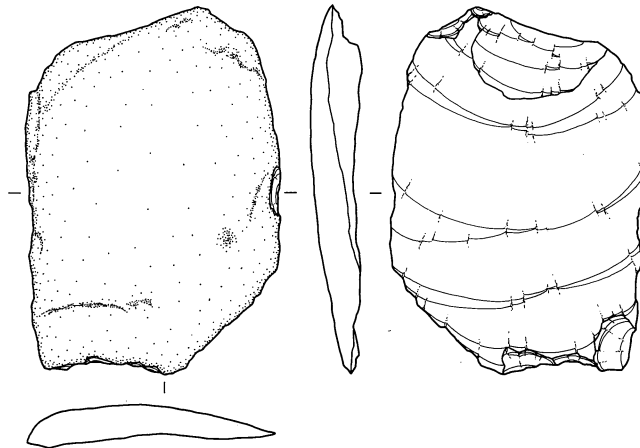

72  
F1 Se  
BL5 29.38g  
Va上面 1506

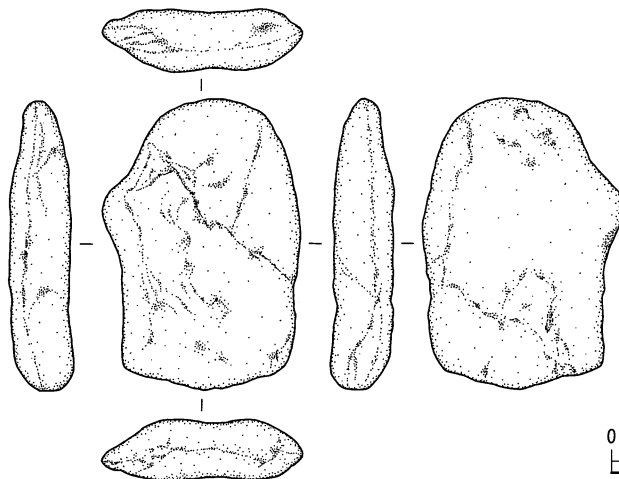

73  
原石 Se  
BL10 30.05g  
Vb上 3934

0 (3 : 4) 5 cm

日向林 I 石器文化 石器実測図25 (斧形石器製作剥片 2・蛇紋岩原石)

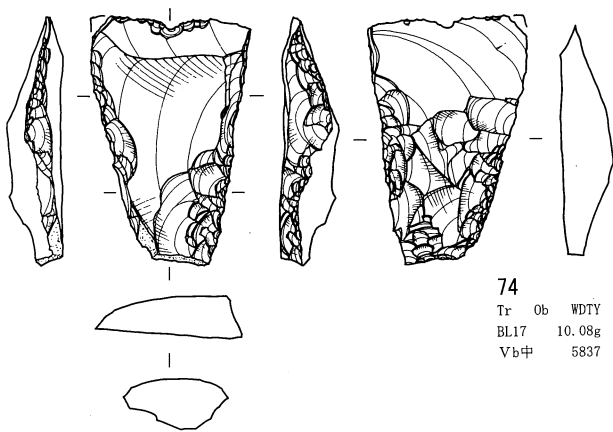

74  
Tr Ob WDTY  
BL17 10.08g  
Vb中 5837

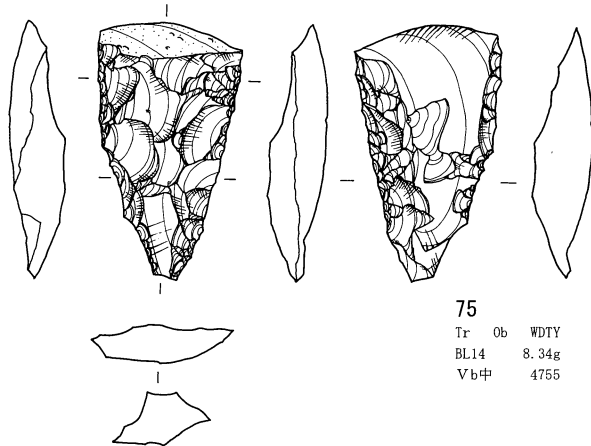

75  
Tr Ob WDTY  
BL14 8.34g  
Vb中 4755

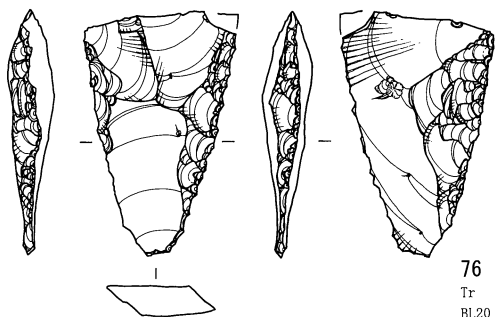

76  
Tr Ob WDTY  
BL20 7.3g  
Vb中 5159

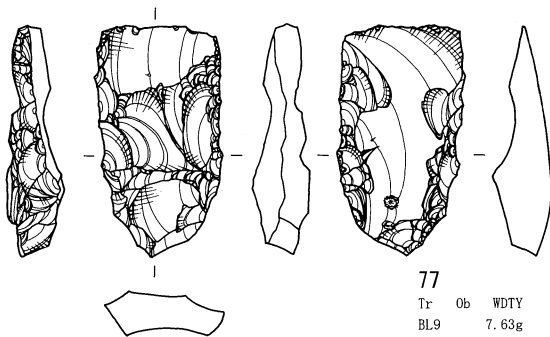

77  
Tr Ob WDTY  
BL9 7.63g  
Vb下 8777

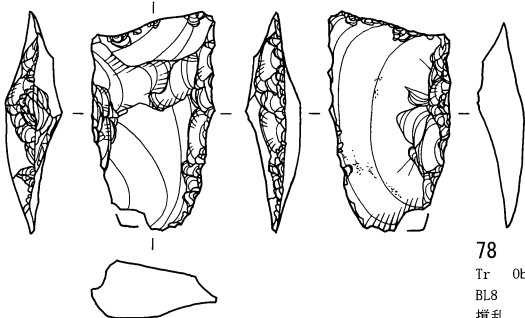

78  
Tr Ob WDTY  
BL8 6.68g  
攪乱 7198

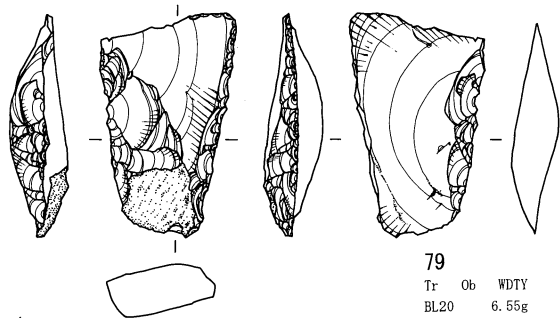

79  
Tr Ob WDTY  
BL20 6.55g  
IV下 3074

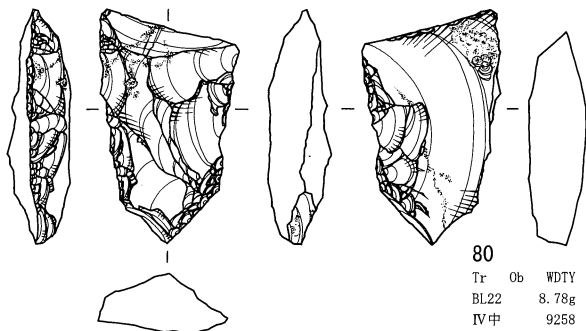

80  
Tr Ob WDTY  
BL22 8.78g  
IV中 9258

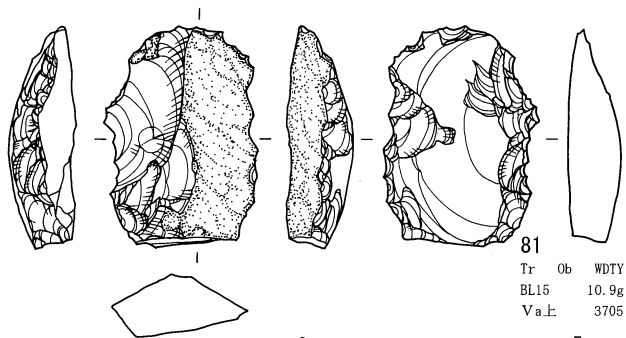

81  
Tr Ob WDTY  
BL15 10.9g  
Va上 3705

0 (3 : 4) 5 cm

日向林 I 石器文化 石器実測図26 (台形石器 1)

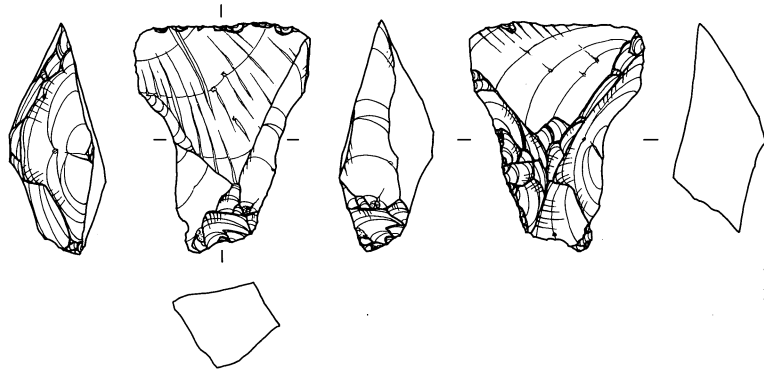

82  
Tr Ob  
BL14 11.8g  
Vb上 3525

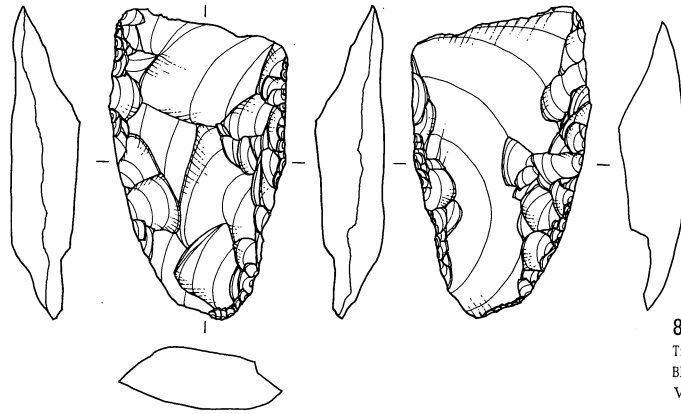

83  
Tr Ag  
BL27 19.34g  
Vb上 8482

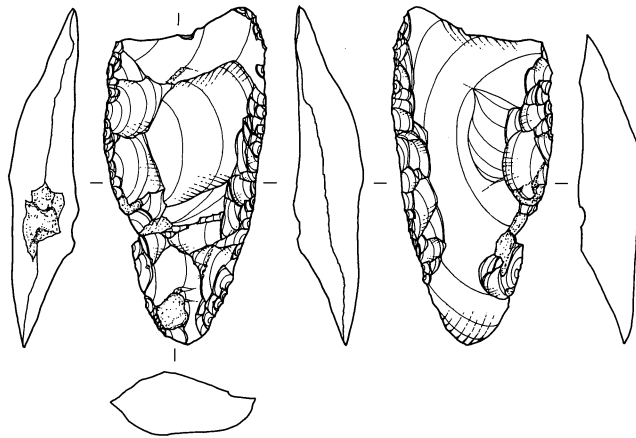

84  
Tr Ag  
BL8 16.08g  
Vb上 8478

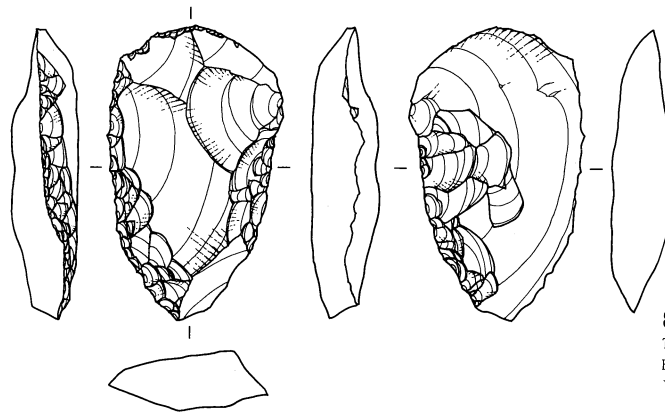

85  
Tr Ag  
BL19 15.84g  
Vb中 5250

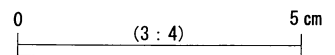

日向林 I 石器文化 石器実測図27 (台形石器 2)

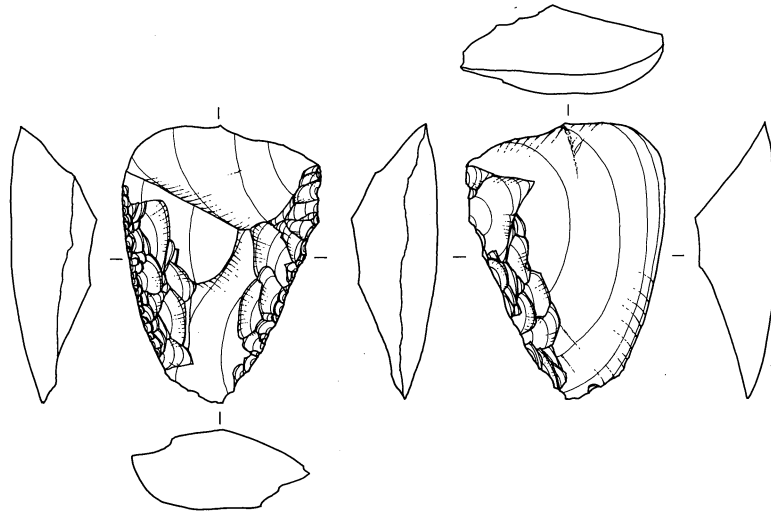

86  
Tr Ag  
BL26 20.83g  
Va中 8327

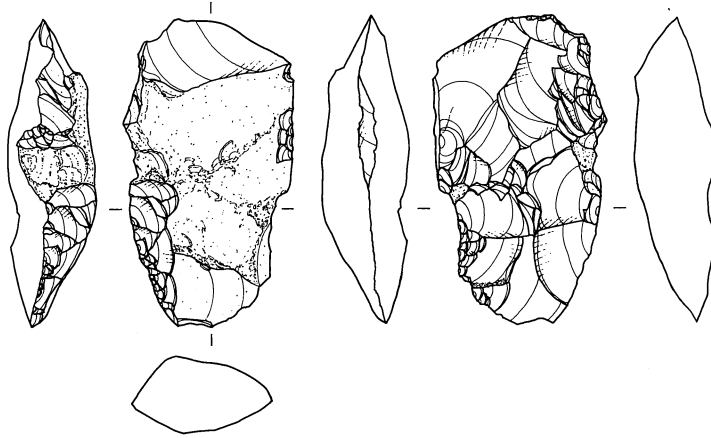

87  
Tr Ag  
BL25 22.75g  
Va下 8353

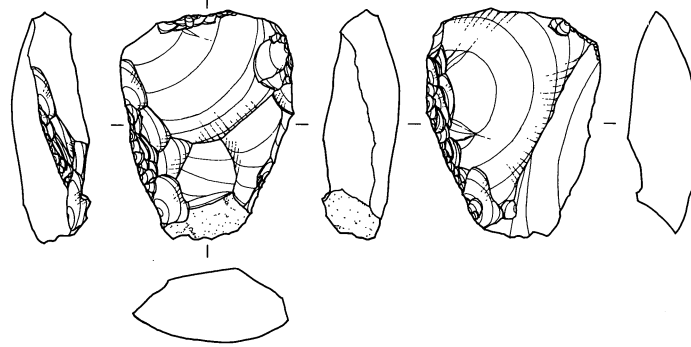

88  
Tr Ag  
BL9 15.74g  
IV中 7411

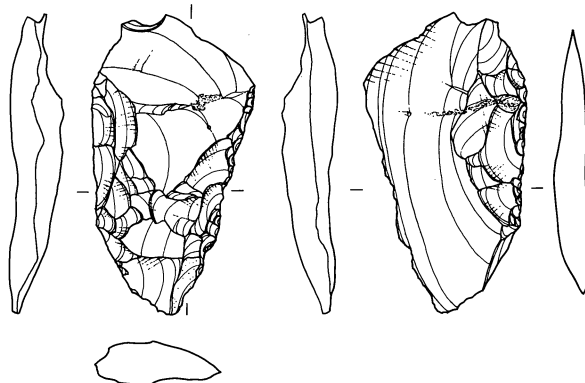

89  
Tr Ag  
BL28 9.59g  
III上 8450

0 (3:4) 5 cm

日向林 I 石器文化 石器実測図28 (台形石器 3)

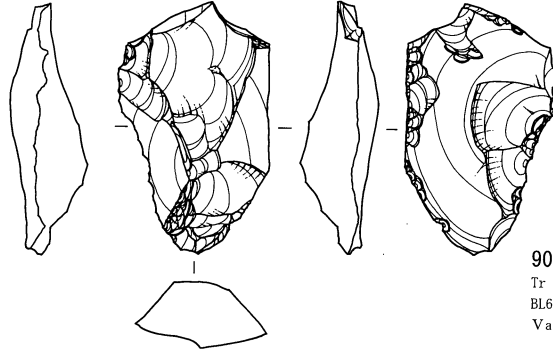

90  
Tr Ag  
BL6 10.8g  
Va上 7835

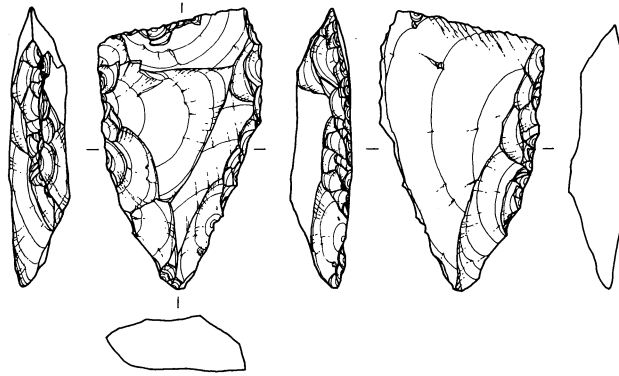

91  
Tr An  
BL9 13.55g  
IV中 7183

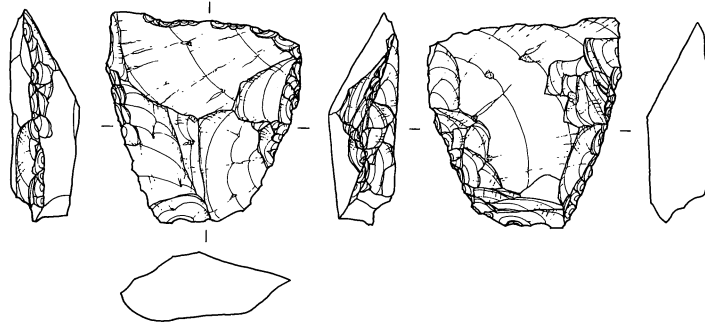

92  
Tr An  
BL27 13.75g  
Vb上 8483

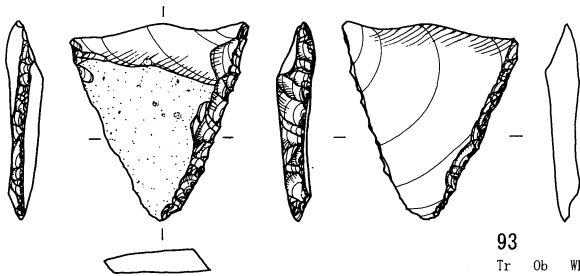

93  
Tr Ob WDTY  
BL18 4.07g  
Vb中 6237

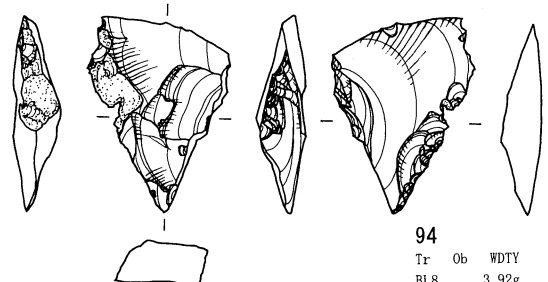

94  
Tr Ob WDTY  
BL8 3.92g  
攪乱 7195

0 (3 : 4) 5 cm

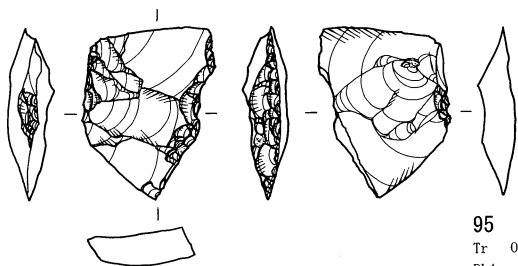

95  
Tr Ob WDTY  
BL4 4.49g  
Vb中 5658

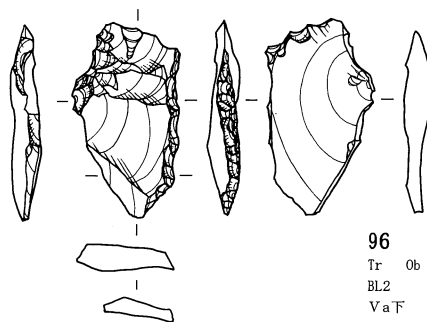

96  
Tr Ob WDTY  
BL2 2.53g  
Va下 3487

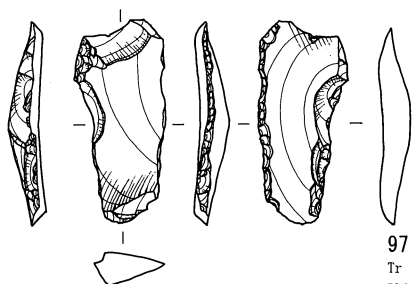

97  
Tr Ob WDTY  
BL22 2.53g  
IV下 8954

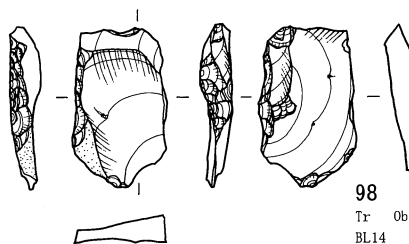

98  
Tr Ob WDTY  
BL14 2.15g  
IV下 764

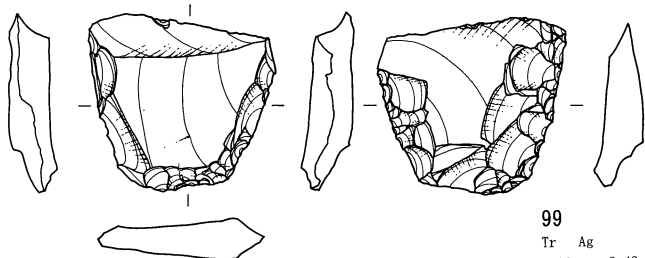

99  
Tr Ag  
BL26 8.49g  
Va下 8339

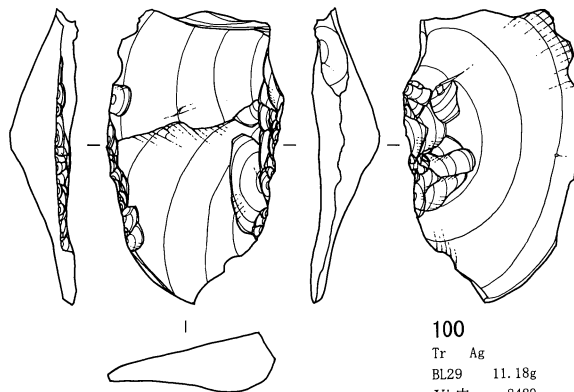

100  
Tr Ag  
BL29 11.18g  
Vb中 8429

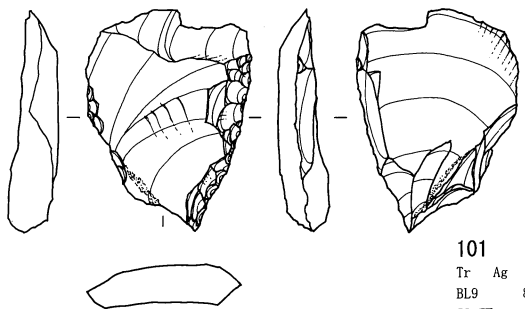

101  
Tr Ag  
BL9 8.99g  
Va下 7732

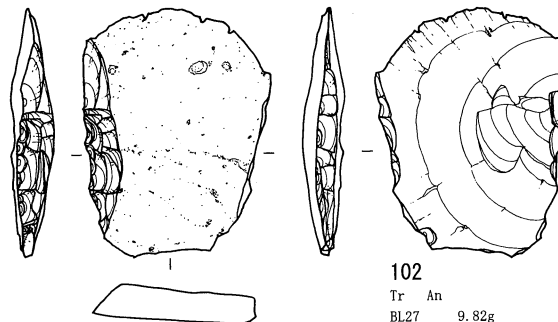

102  
Tr An  
BL27 9.82g  
Vb上 8438

0 (3 : 4) 5 cm

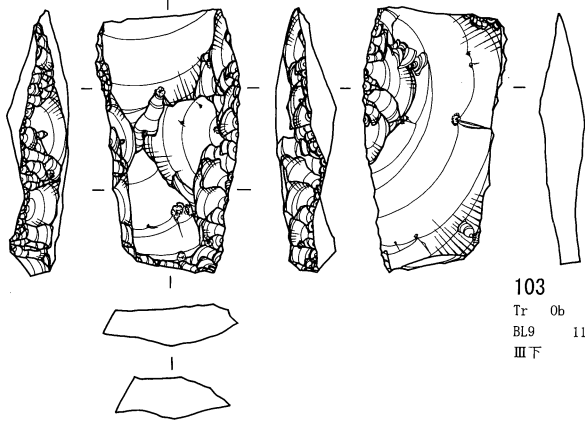

103  
Tr Ob WDTY  
BL9 11.55g  
III下 7150

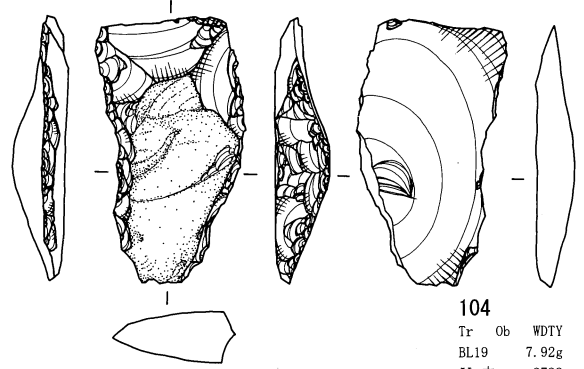

104  
Tr Ob WDTY  
BL19 7.92g  
Va中 2728

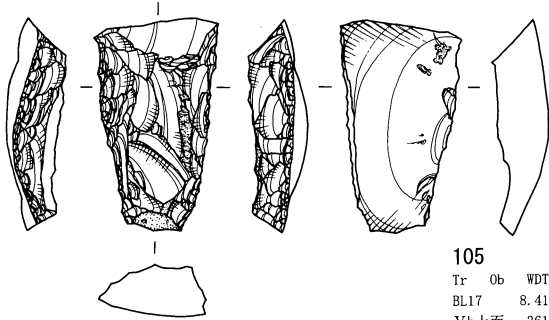

105  
Tr Ob WDTY  
BL17 8.41g  
Vb上面 3618

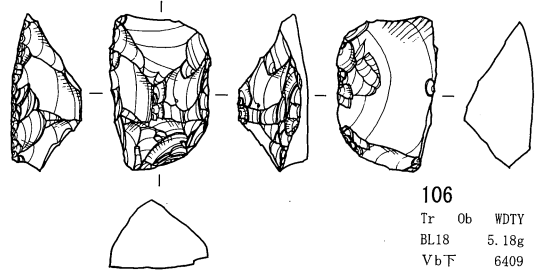

106  
Tr Ob WDTY  
BL18 5.18g  
Vb下 6409

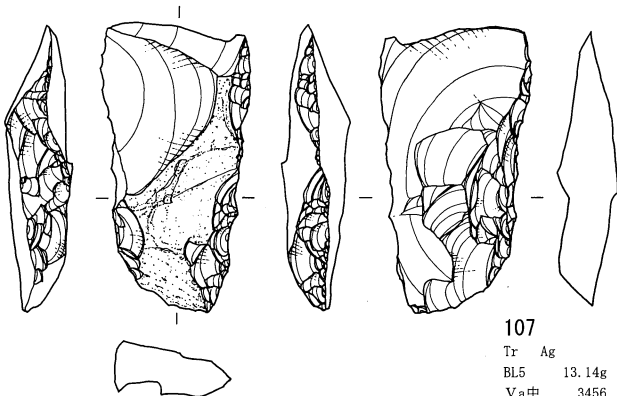

107  
Tr Ag  
BL5 13.14g  
Va中 3456

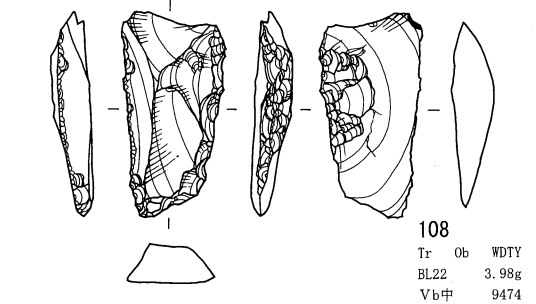

108  
Tr Ob WDTY  
BL22 3.98g  
Vb中 9474

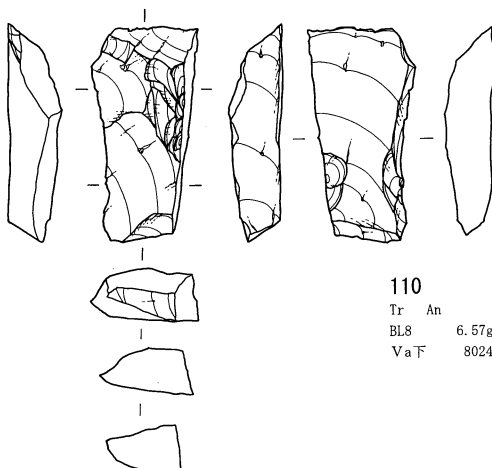

110  
Tr An  
BL8 6.57g  
Va下 8024

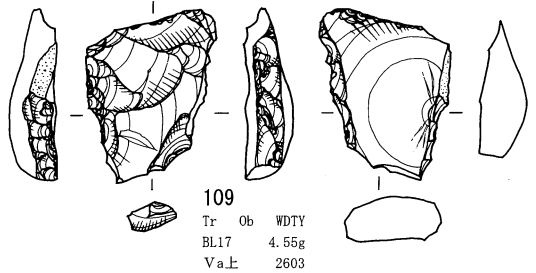

109  
Tr Ob WDTY  
BL17 4.55g  
Va上 2603

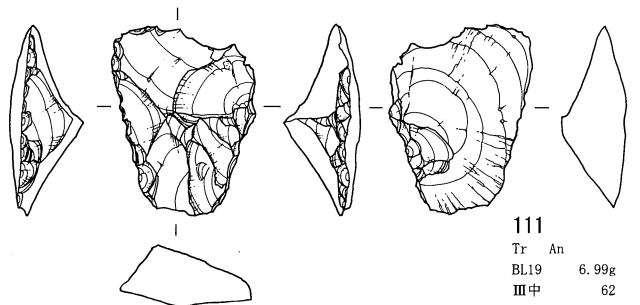

111  
Tr An  
BL19 6.99g  
III中 62

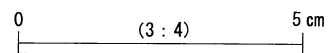

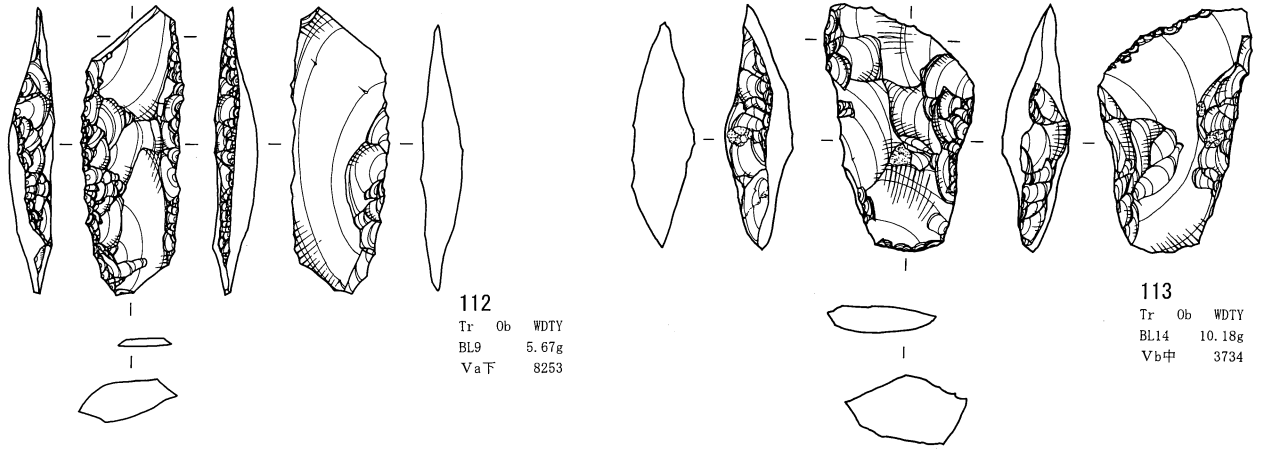

112  
Tr Ob WDTY  
BL9 5.67g  
Va下 8253

113  
Tr Ob WDTY  
BL14 10.18g  
Vb中 3734

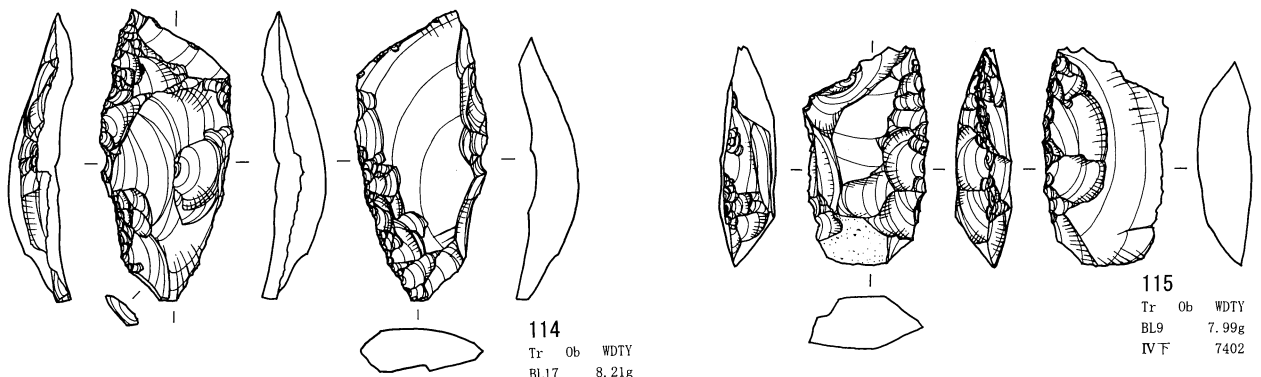

114  
Tr Ob WDTY  
BL17 8.21g  
Vb上 5077

115  
Tr Ob WDTY  
BL9 7.99g  
IV下 7402

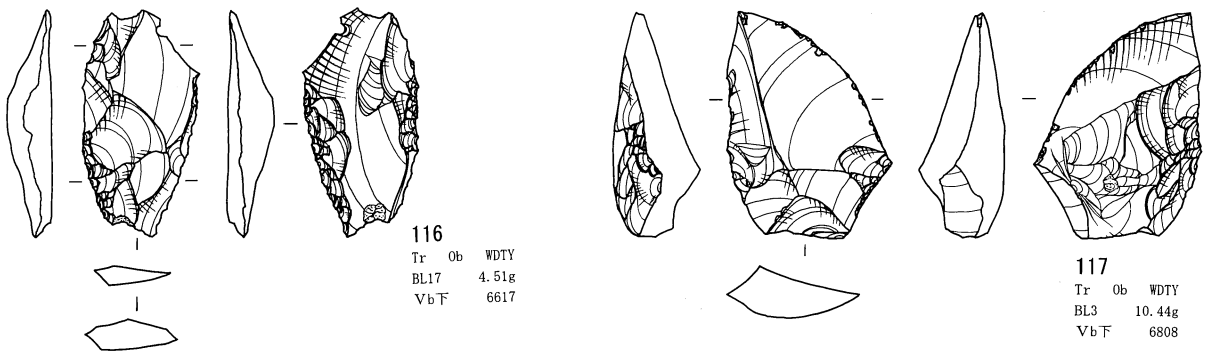

116  
Tr Ob WDTY  
BL17 4.51g  
Vb下 6617

117  
Tr Ob WDTY  
BL3 10.44g  
Vb下 6808

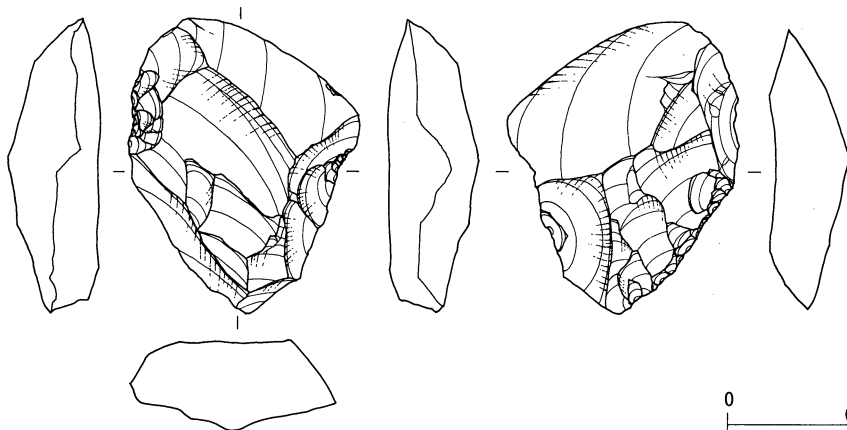

118  
Tr Ag  
BL26 25.3g  
Vb上面 8441

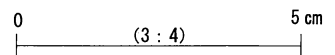

日向林 I 石器文化 石器实测图32 (台形石器 7)



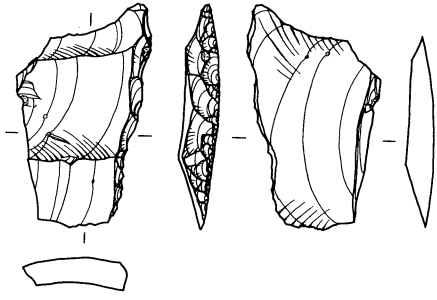

119  
Tr Ob WDTY  
BL18 4.18g  
Va中 3245

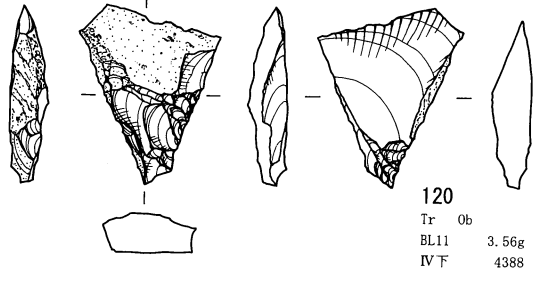

120  
Tr Ob  
BL11 3.56g  
IV下 4388

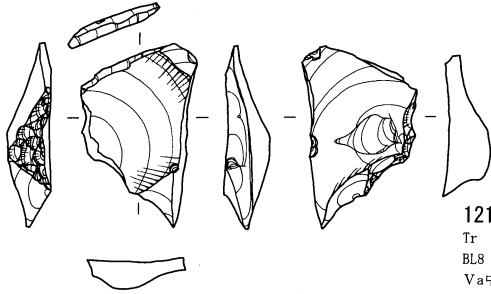

121  
Tr Ob WDTY  
BL8 3.4g  
Va中 8027

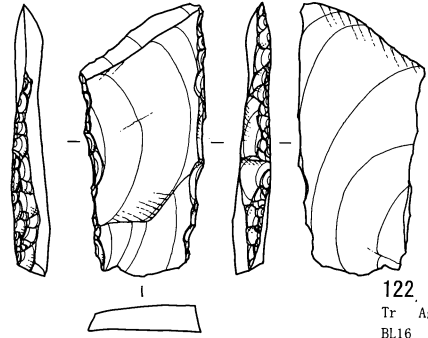

122  
Tr Ag  
BL16 6.33g  
Vb上 2270

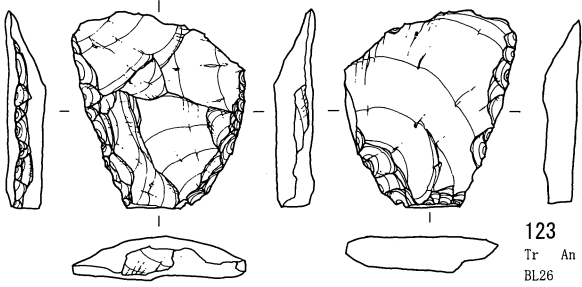

123  
Tr An  
BL26 6.26g  
Vb上 8446

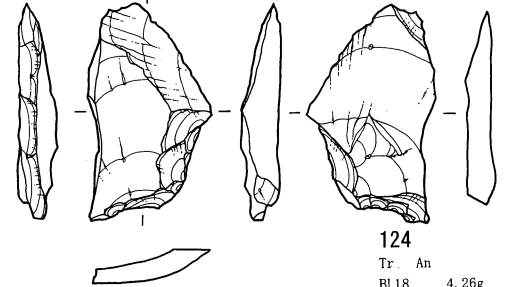

124  
Tr An  
BL18 4.26g  
IV下 1003

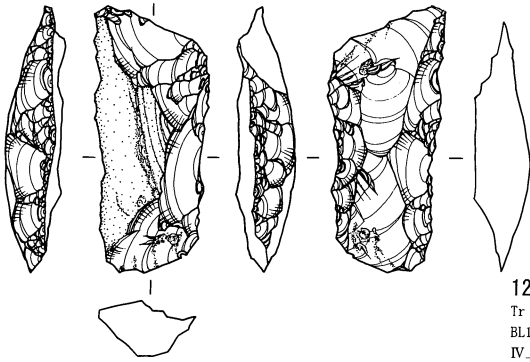

125  
Tr Ob WDTY  
BL19 8.19g  
IV上面 70

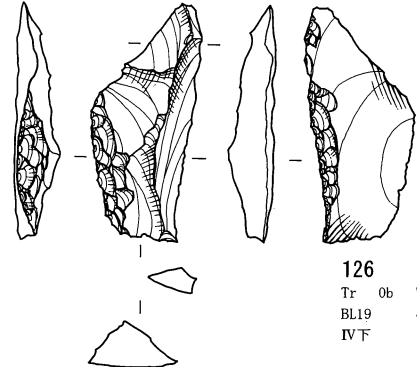

126  
Tr Ob WDTY  
BL19 4.2g  
IV下 1137

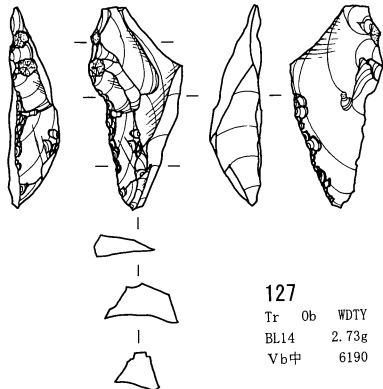

127  
Tr Ob WDTY  
BL14 2.73g  
Vb中 6190

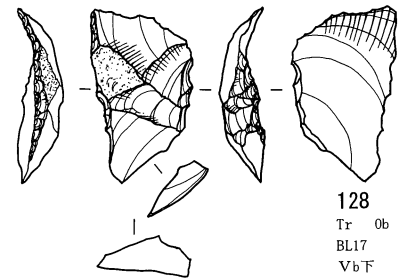

128  
Tr Ob WDTY  
BL17 2.76g  
Vb下 6834

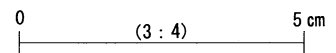

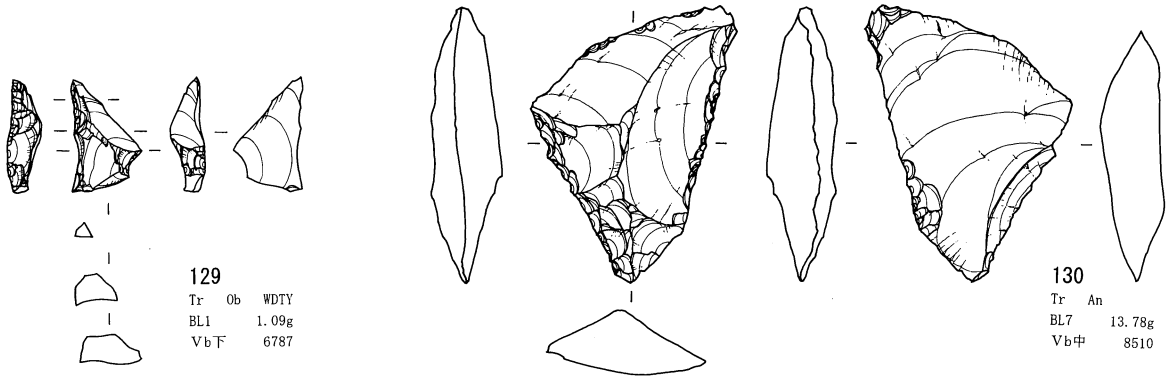

129  
Tr Ob WDTY  
BL1 1.09g  
Vb下 6787

130  
Tr An  
BL7 13.78g  
Vb中 8510

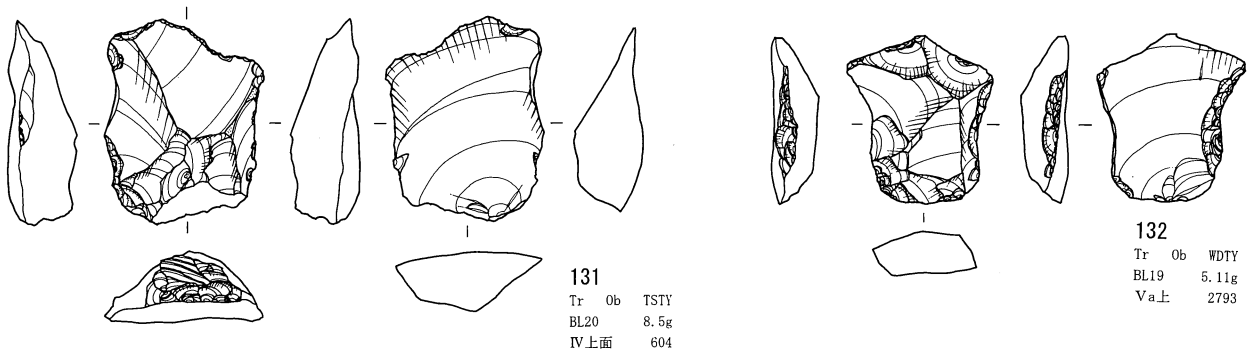

131  
Tr Ob TSTY  
BL20 8.5g  
IV上面 604

132  
Tr Ob WDTY  
BL19 5.11g  
Va上 2793

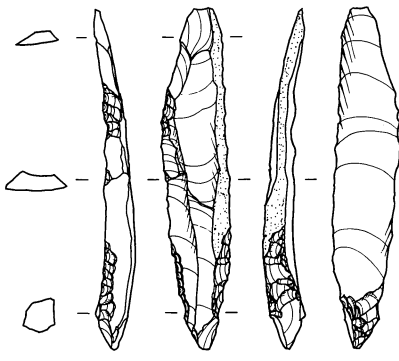

133  
Kn Ob WDTY  
BL12 3.05g  
III上 252

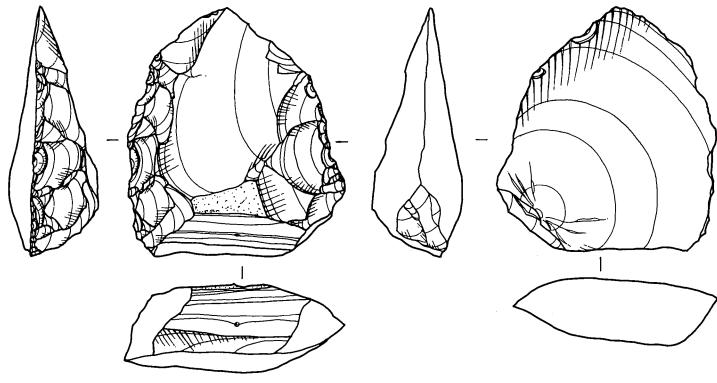

134  
Kn Ob WDTY  
BL19 19.85g  
Va中 2761

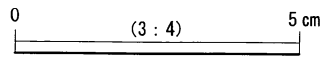

日向林 I 石器文化 石器実測図34 (台形石器9・ナイフ形石器)

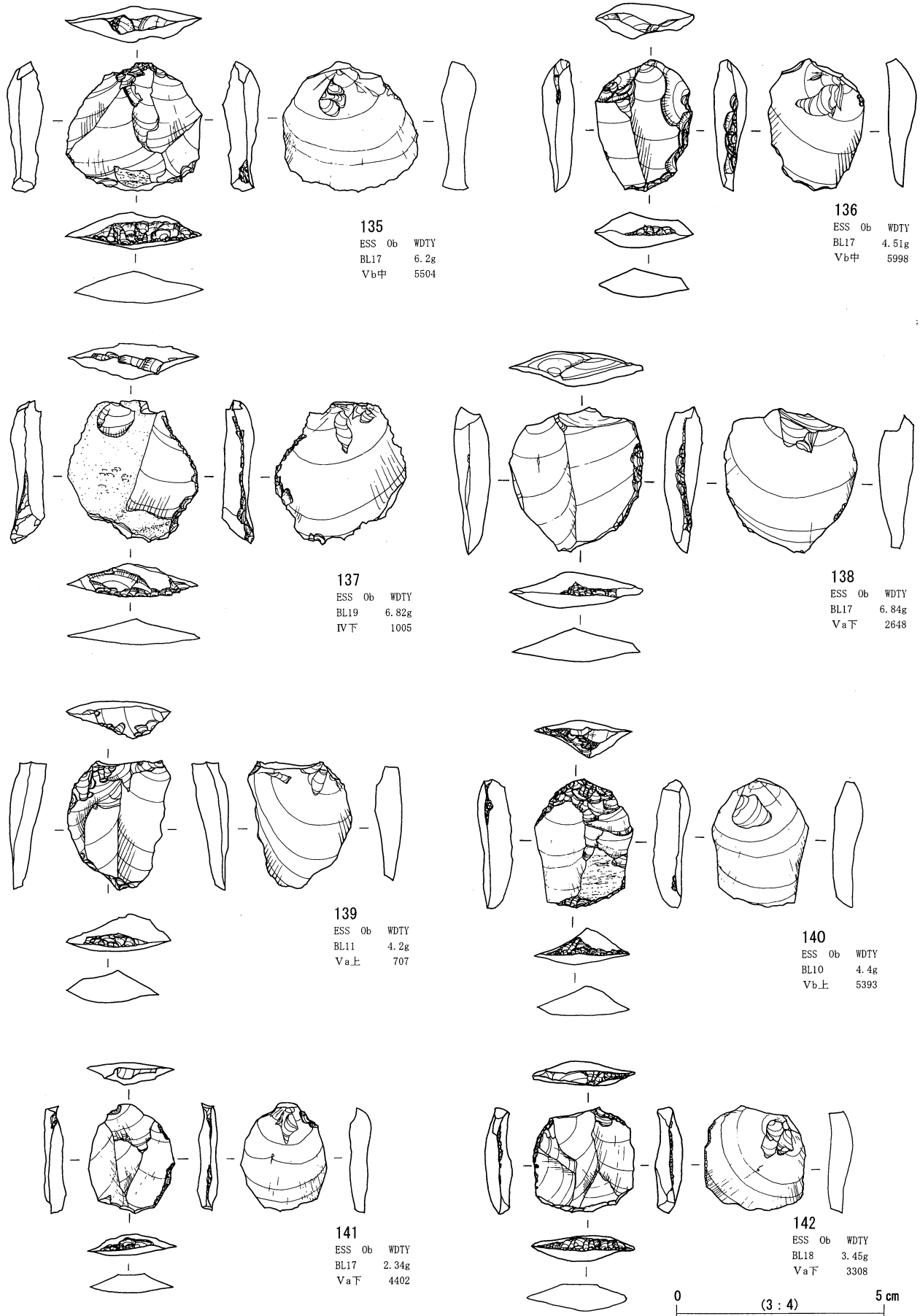

日向林 I 石器文化 石器実測図35 (搔器状石器 1)

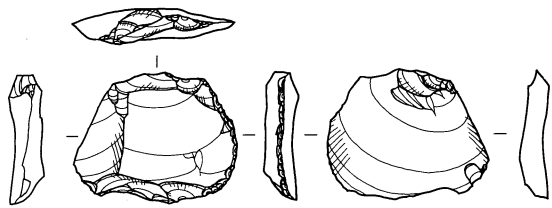

143  
 ESS Ob WDTY  
 BL19 3.03g  
 IV下 2713

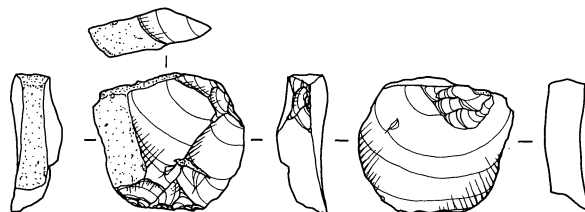

144  
 ESS Ob WDTY  
 BL17 4.65g  
 Vb中 5836

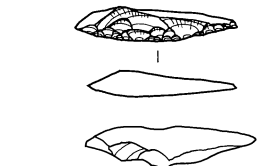

145  
 ESS Ob WDTY  
 BL5 4.13g  
 VaF 3440

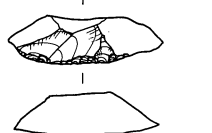

146  
 ESS Ob WDTY  
 BL22 3.3g  
 IV中 8410

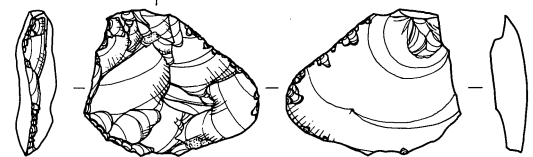

147  
 ESS Ob WDTY  
 BL17 2.57g  
 Vb上 5474

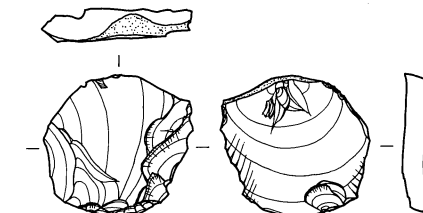

148  
 ESS Ob WDTY  
 BL23 1.43g  
 Va上 9454



149  
 ESS Ob WDTY  
 BL18 2.85g  
 IV中 1290



150  
 ESS Ob WDTY  
 BL23 1.39g  
 Va上 7533

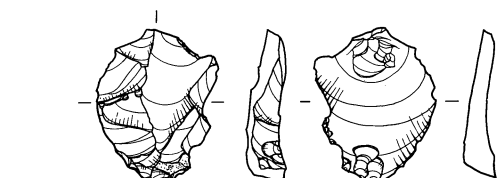

151  
 ESS Ob WDTY  
 BL22 2.76g  
 IV中 7522

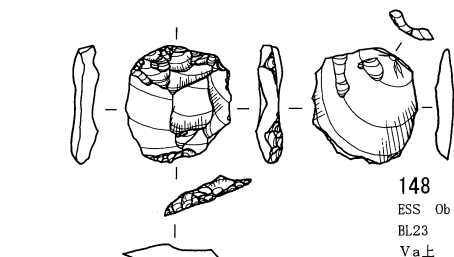

152  
 ESS Ob WDTY  
 BL11 1.84g  
 IVF 723

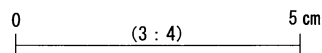
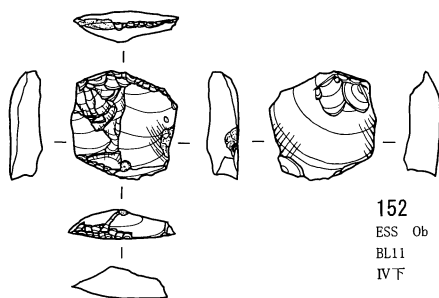
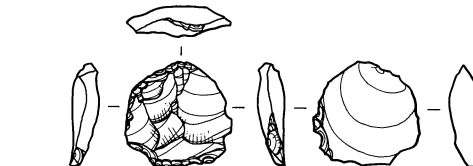
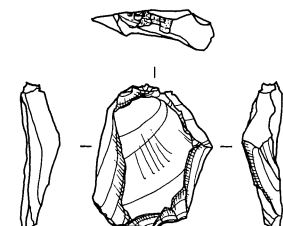
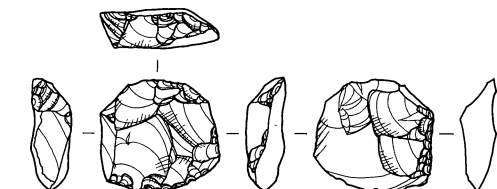

日向林 I 石器文化 石器実測図36 (搔器状石器 2)

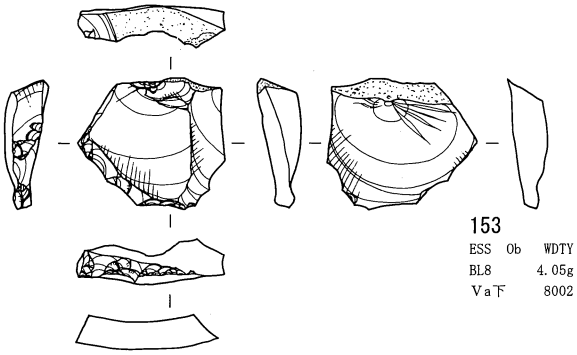

153  
ESS Ob WDTY  
BL8 4.05g  
Va下 8002

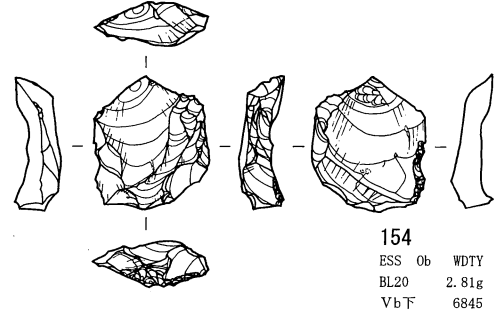

154  
ESS Ob WDTY  
BL20 2.81g  
Vb下 6845

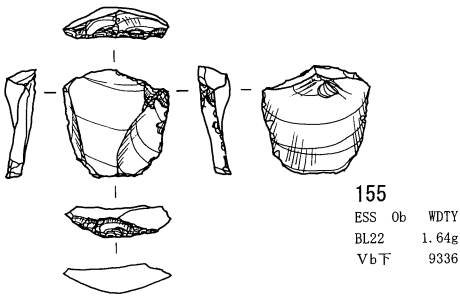

155  
ESS Ob WDTY  
BL22 1.64g  
Vb下 9336

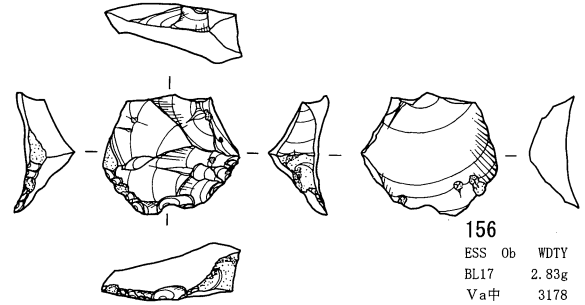

156  
ESS Ob WDTY  
BL17 2.83g  
Va中 3178

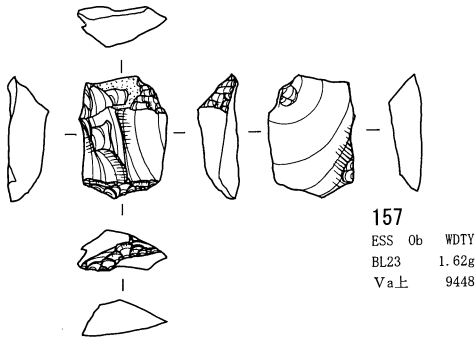

157  
ESS Ob WDTY  
BL23 1.62g  
Va上 9448

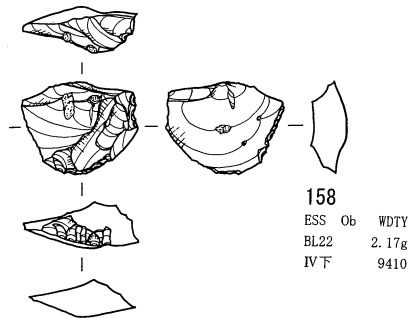

158  
ESS Ob WDTY  
BL22 2.17g  
IV下 9410

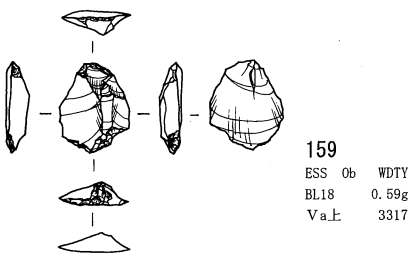

159  
ESS Ob WDTY  
BL18 0.59g  
Va上 3317

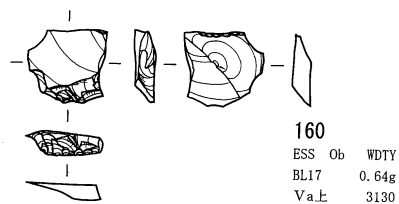

160  
ESS Ob WDTY  
BL17 0.64g  
Va上 3130

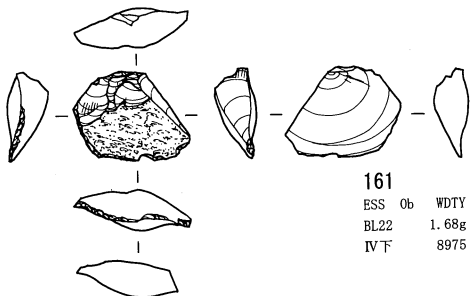

161  
ESS Ob WDTY  
BL22 1.68g  
IV下 8975

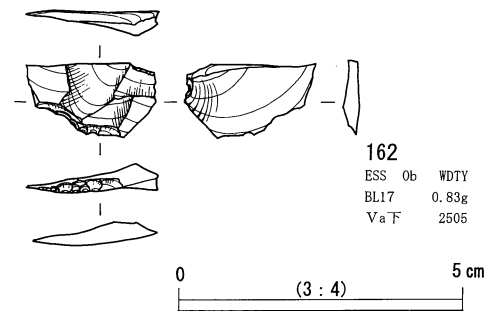

162  
ESS Ob WDTY  
BL17 0.83g  
Va下 2505

0 (3 : 4) 5 cm

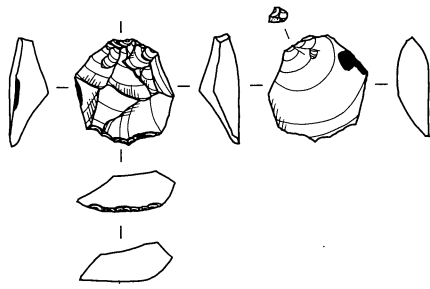

163  
ESS Ob WDTY  
BL8 1.47g  
Vb上 8464

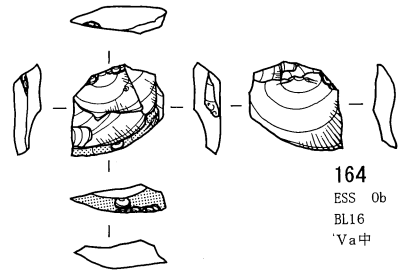

164  
ESS Ob WDKB  
BL16 1.01g  
Va中 2302

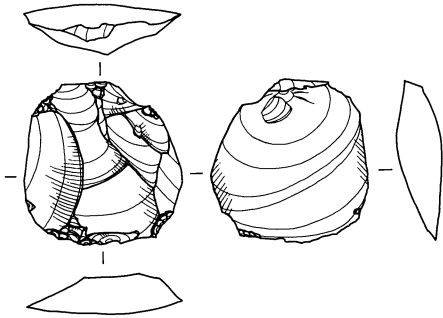

165  
ESS Ob WDTY  
外 5.66g  
III中 504

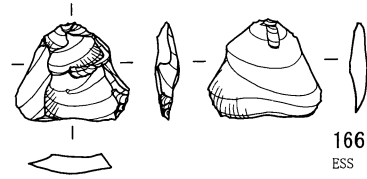

166  
ESS Ob WDTY  
BL16 0.88g  
Va下 2358

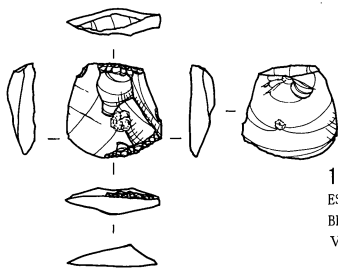

167  
ESS Ob WDKB  
BL22 1.06g  
Vb下 9143

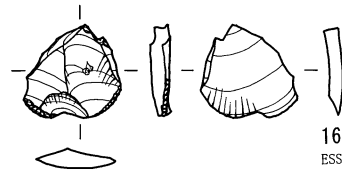

168  
ESS Ob WDKB  
BL1 0.79g  
IV中 1731

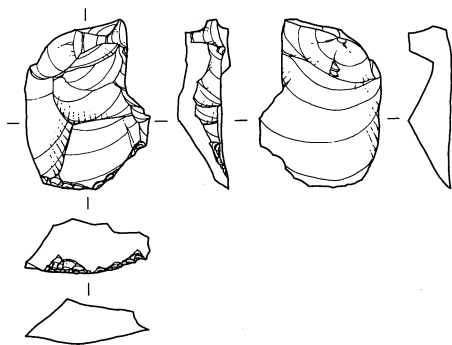

169  
ESS Ag  
BL17 4.66g  
Va下 2626

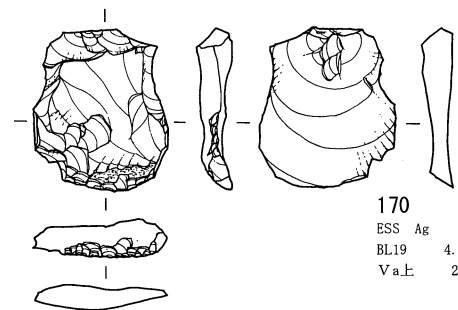

170  
ESS Ag  
BL19 4.02g  
Va上 2797

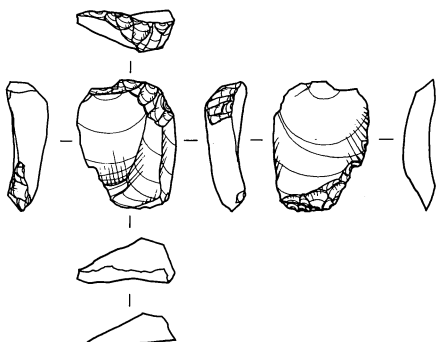

171  
ESS Ob WDTY  
BL18 2.12g  
Vb下 4691

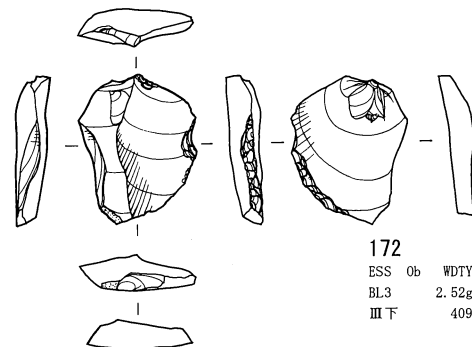

172  
ESS Ob WDTY  
BL3 2.52g  
III下 409

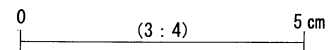

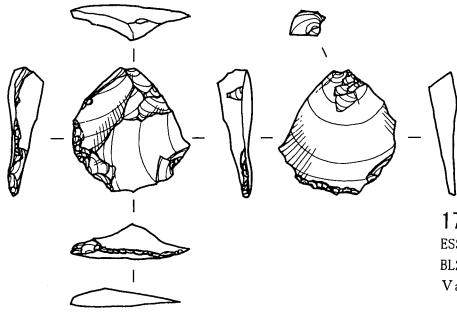

173  
ESS Ob WDTY  
BL22 1.51g  
Va下 9222

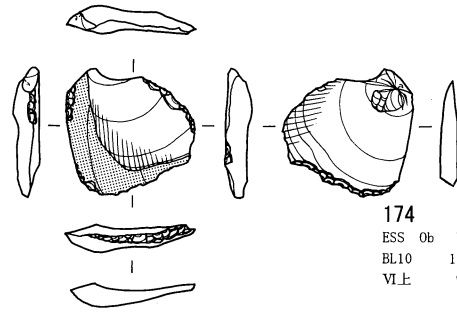

174  
ESS Ob WDTY  
BL10 1.65g  
VI上 9568

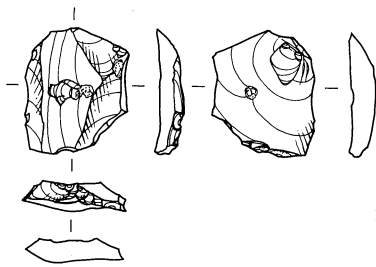

175  
ESS Ob WDTY  
BL17 2.07g  
Va中 2630

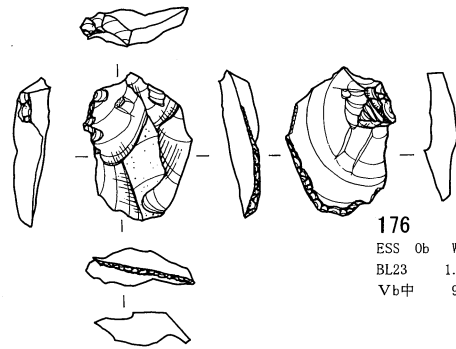

176  
ESS Ob WDTY  
BL23 1.87g  
Vb中 9457

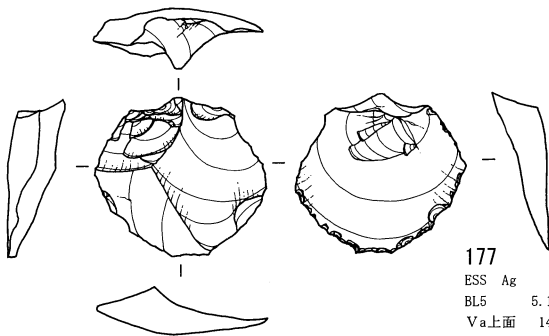

177  
ESS Ag  
BL5 5.13g  
Va上面 1477

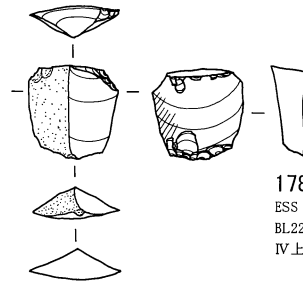

178  
ESS Ob WDTY  
BL22 1.08g  
IV上 7493

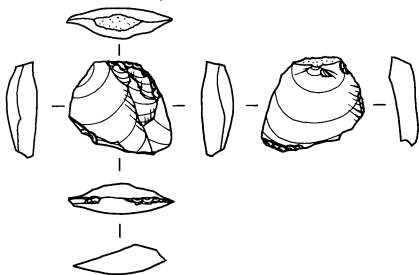

179  
ESS Ob WDTY  
BL23 1.14g  
IV下 7539

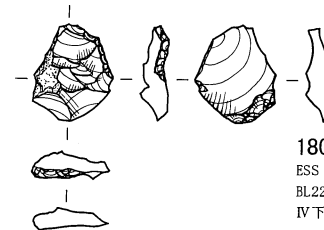

180  
ESS Ob WDTY  
BL22 0.83g  
IV下 9260

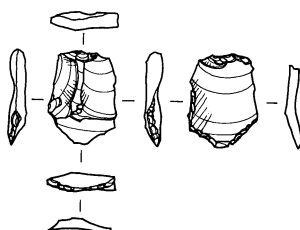

181  
ESS Ob WDTY  
BL22 0.58g  
IV中 8997

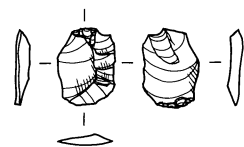

182  
ESS Ob WDTY  
BL22 0.29g  
IV下 8972

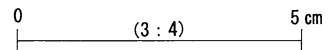

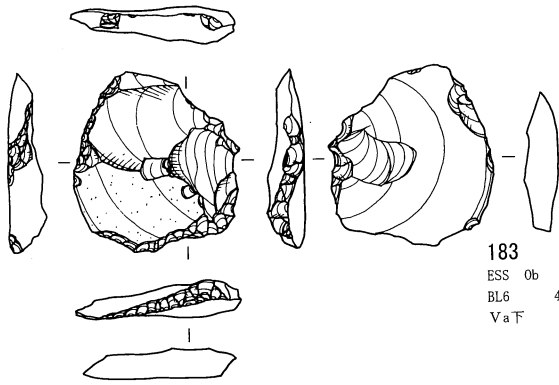

183  
ESS Ob WDTY  
BL6 4.35g  
Va下 7969

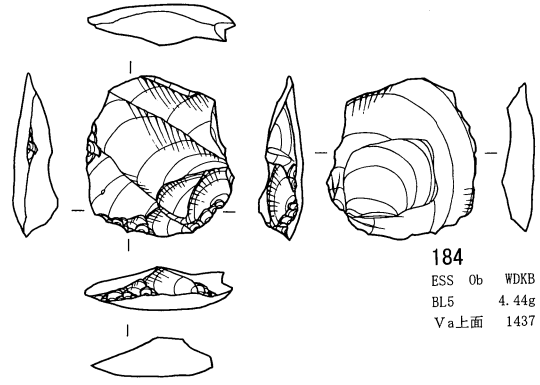

184  
ESS Ob WDKB  
BL5 4.44g  
Va上面 1437

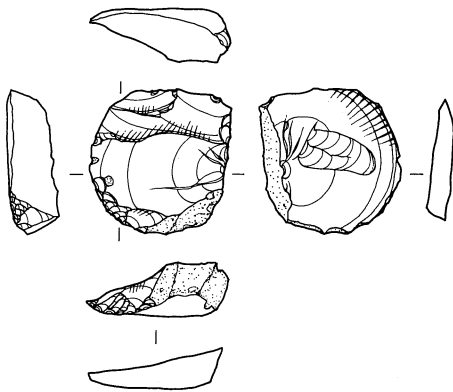

185  
ESS Ob WDTY  
BL17 3.61g  
III上 152

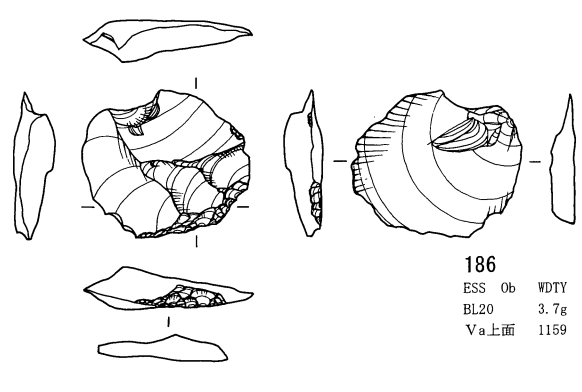

186  
ESS Ob WDTY  
BL20 3.7g  
Va上面 1159

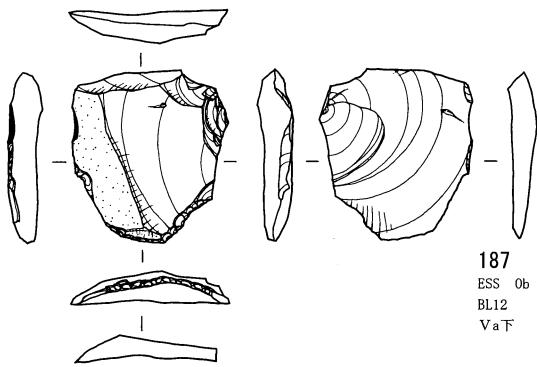

187  
ESS Ob TSTY  
BL12 3.33g  
Va下 2210

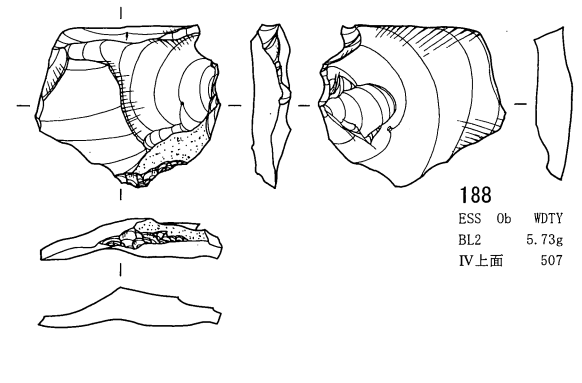

188  
ESS Ob WDTY  
BL2 5.73g  
IV上面 507

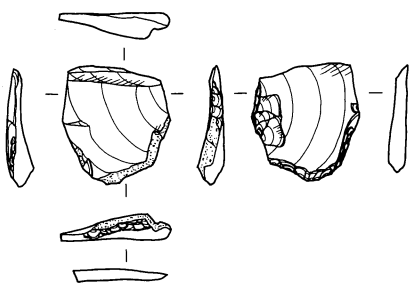

189  
ESS Ob WDTY  
BL23 1.02g  
III上 7625

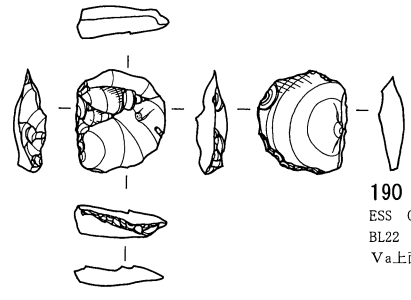

190  
ESS Ob WDTY  
BL22 1.18g  
Va上面 9103

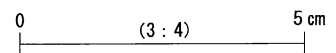



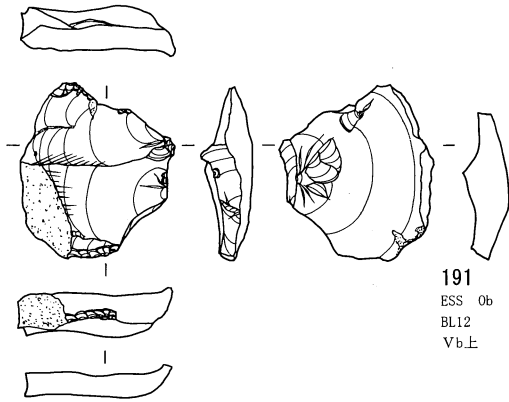

191  
ESS Ob WDTY  
BL12 5.36g  
Vb上 4732

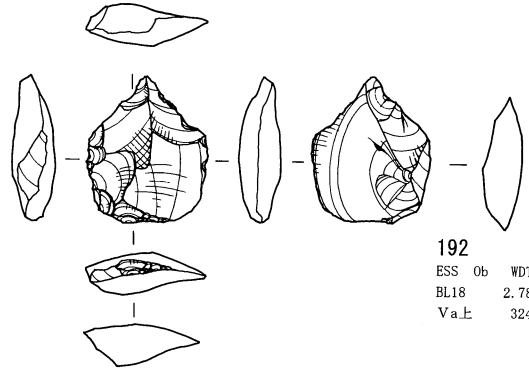

192  
ESS Ob WDTY  
BL18 2.78g  
Va上 3241

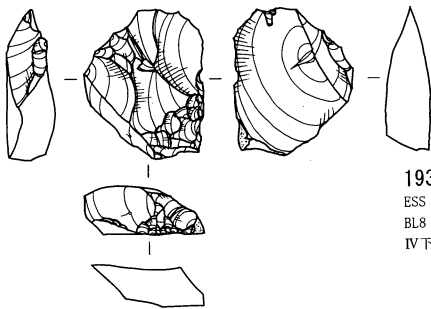

193  
ESS Ob WDTY  
BL8 4.04g  
IV下 7460

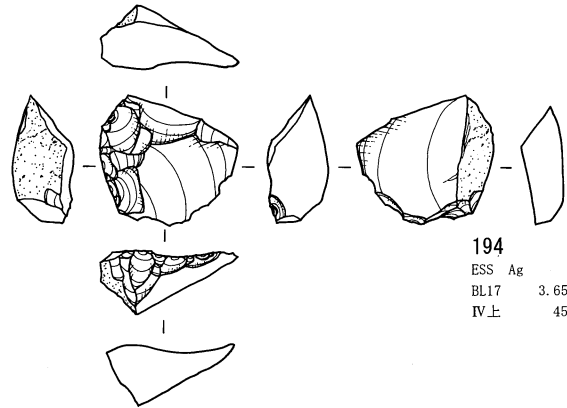

194  
ESS Ag  
BL17 3.65g  
IV上 452

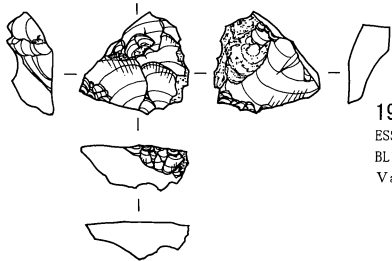

195  
ESS Ob WDTY  
BL18 2.13g  
Va上 3268

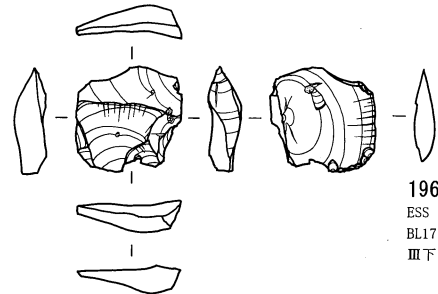

196  
ESS Ob WDTY  
BL17 1.17g  
III下 19

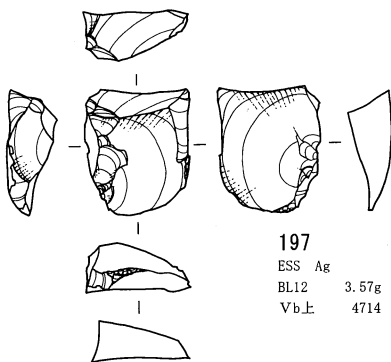

197  
ESS Ag  
BL12 3.57g  
Vb上 4714

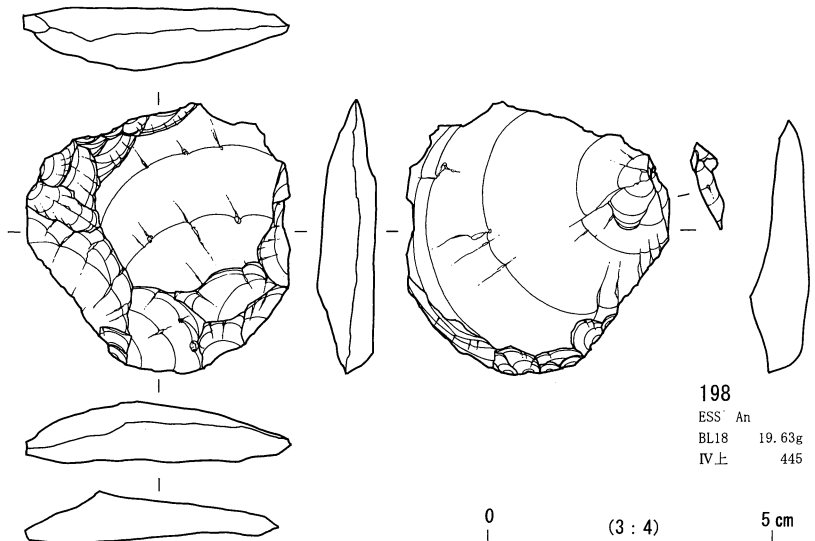

198  
ESS An  
BL18 19.63g  
IV上 445

0 (3 : 4) 5 cm

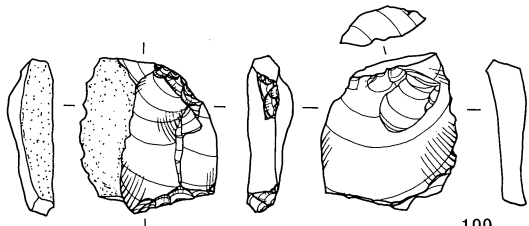

199  
ESS Ob WDTY  
BL18 4.18g  
IV上面 463

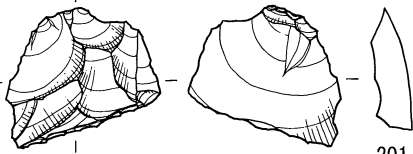

201  
ESS Ob WDTY  
BL19 3.82g  
Va下 2798

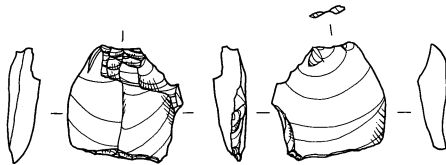

203  
ESS Ob WDTY  
BL22 1.52g  
IV中 7486

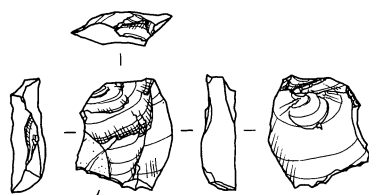

205  
ESS Ob WDTY  
BL14 1.85g  
Va下 3680

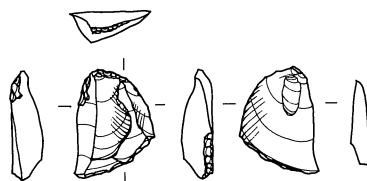
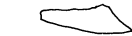

207  
ESS Ob WDTY  
BL22 0.95g  
III下 7941

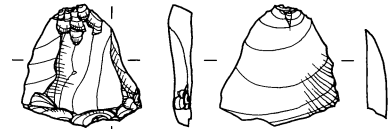

200  
ESS Ob WDTY  
BL16 1.46g  
Va上面 903

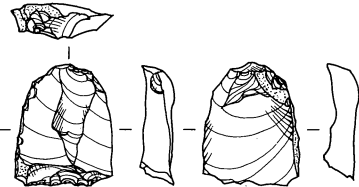

202  
ESS Ob WDTY  
BL20 2.36g  
IV下 7469

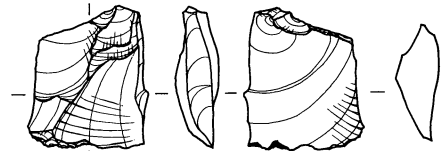

204  
ESS Ob 不可  
BL17 3.35g  
Vb上 3599

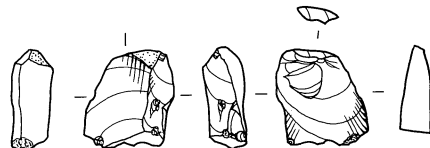
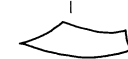

206  
ESS Ob WDTY  
BL17 1.62g  
Vb上 5231

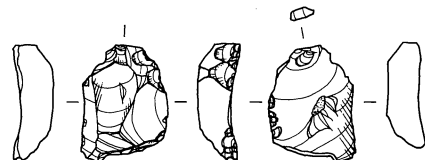
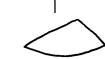

208  
ESS Ob WDTY  
BL23 1.79g  
Va上 7528

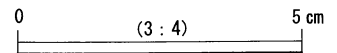
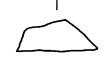

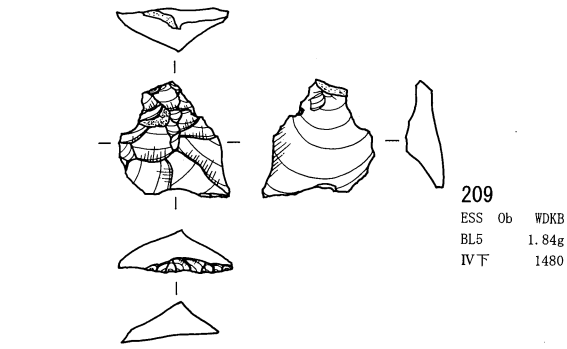

209  
ESS Ob WDKB  
BL5 1.84g  
IV F 1480

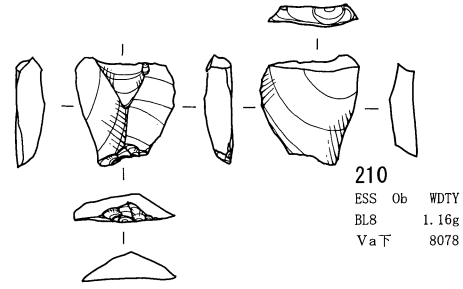

210  
ESS Ob WDTY  
BL8 1.16g  
Va F 8078

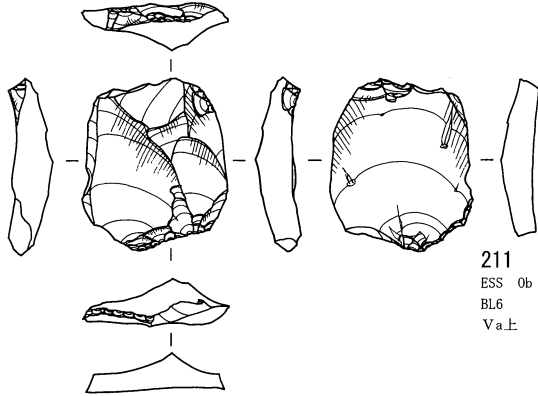

211  
ESS Ob TSTY  
BL6 3.99g  
Va上 7913

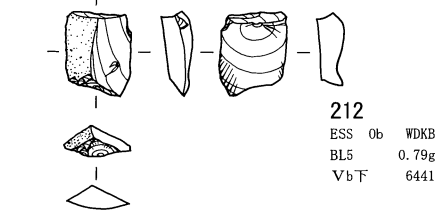

212  
ESS Ob WDKB  
BL5 0.79g  
Vb F 6441

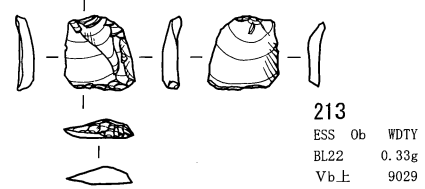

213  
ESS Ob WDTY  
BL22 0.33g  
Vb上 9029

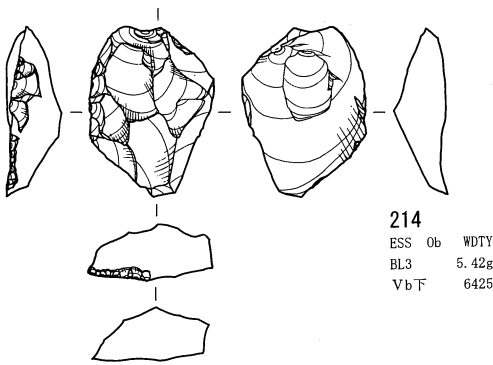

214  
ESS Ob WDTY  
BL3 5.42g  
Vb F 6425

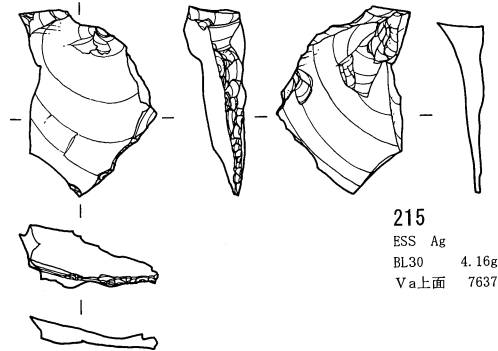

215  
ESS Ag  
BL30 4.16g  
Va上 7637

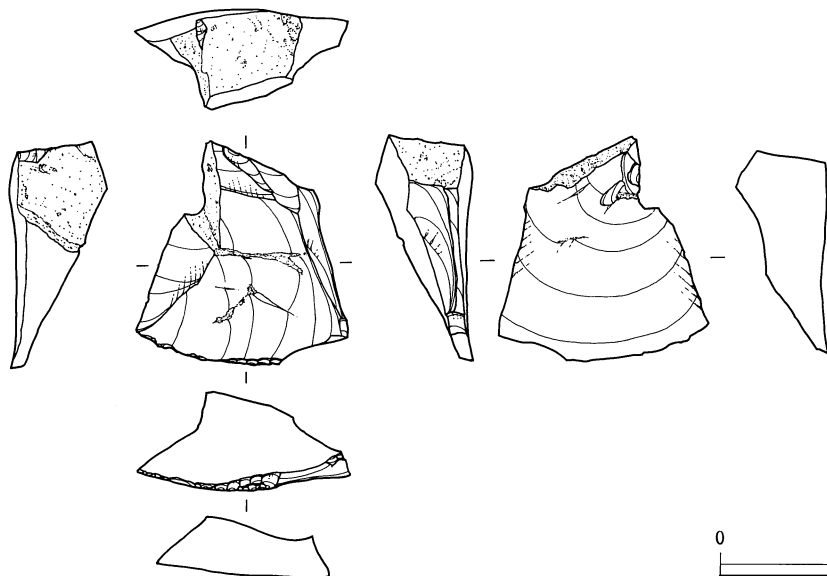

216  
ESS Ag  
BL28 13.56g  
Vb上 9113

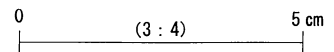

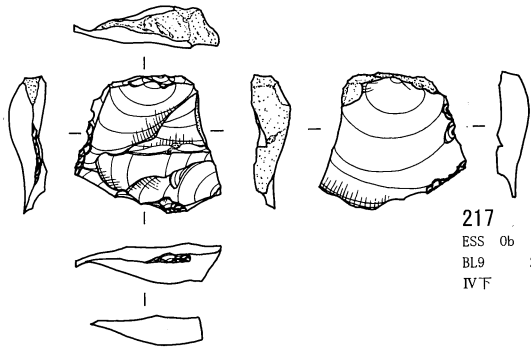

217  
ESS Ob WDTY  
BL9 2.91g  
IV下 7373

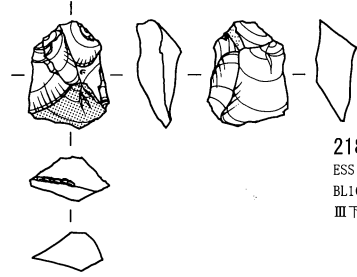

218  
ESS Ob WDTY  
BL16 1.49g  
III下 200

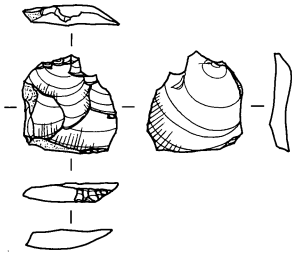

219  
ESS Ob WDTY  
BL5 0.89g  
Va上面 1468

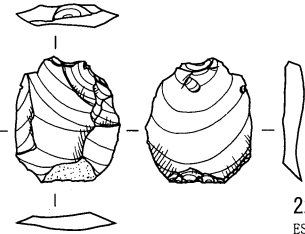

220  
ESS Ob WDTY  
BL20 1.21g  
Vb中 5024

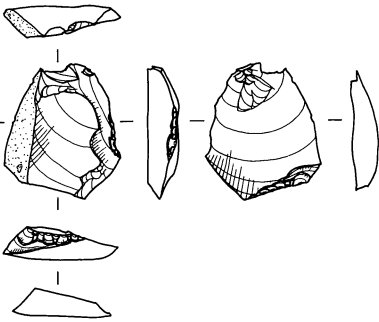

221  
ESS Ob WDTY  
BL17 2.33g  
Vb下 6463

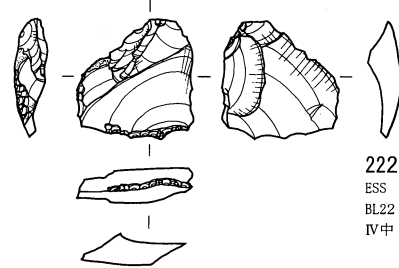

222  
ESS Ob WDTY  
BL22 2.12g  
IV中 9208

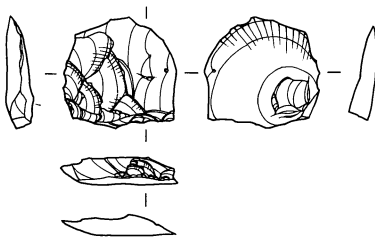

223  
ESS Ob WDTY  
BL18 1.61g  
Va上 4077

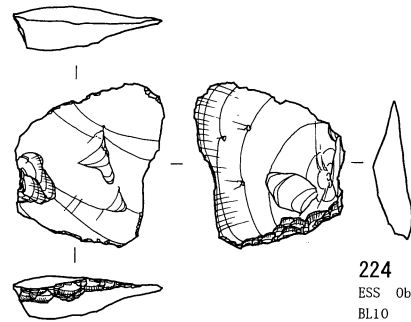

224  
ESS Ob WDTY  
BL10 3.04g  
Va下 8250

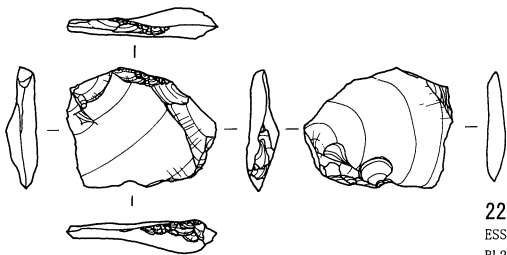

225  
ESS Ob WDTY  
BL22 2.04g  
IV下 9478

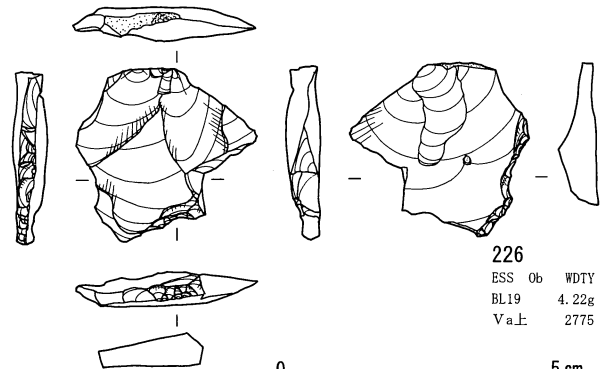

226  
ESS Ob WDTY  
BL19 4.22g  
Va上 2775

0 (3:4) 5 cm

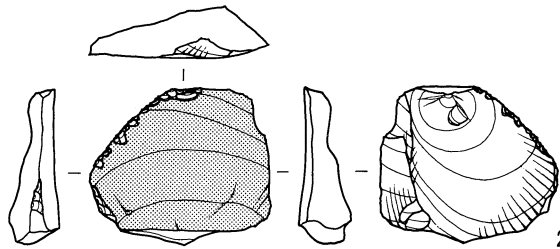

227  
ESS Ob WDTY  
BL2 6.23g  
Vb下 6450

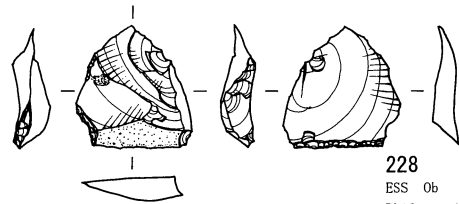

228  
ESS Ob WDTY  
BL18 1.72g  
IV下 1374

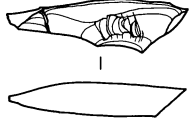

229  
ESS Ob WDTY  
BL9 1.1g  
IV下 7387

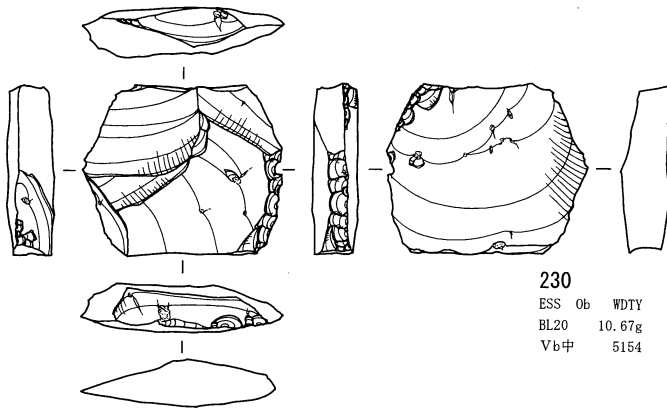

230  
ESS Ob WDTY  
BL20 10.67g  
Vb中 5154

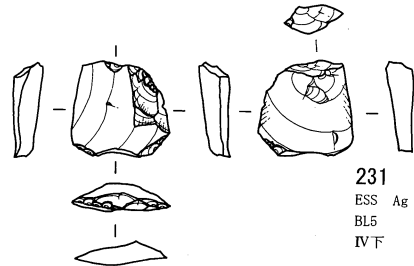

231  
ESS Ag WDTY  
BL5 1.32g  
IV下 7875

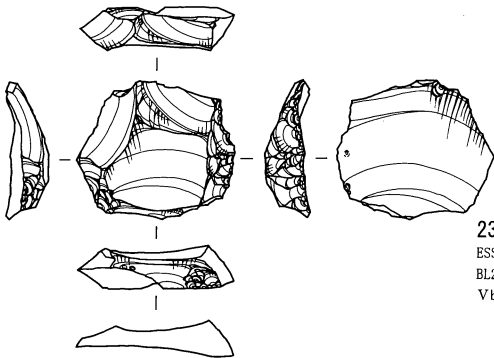

232  
ESS Ob WDTY  
BL20 3.88g  
Vb上 5199

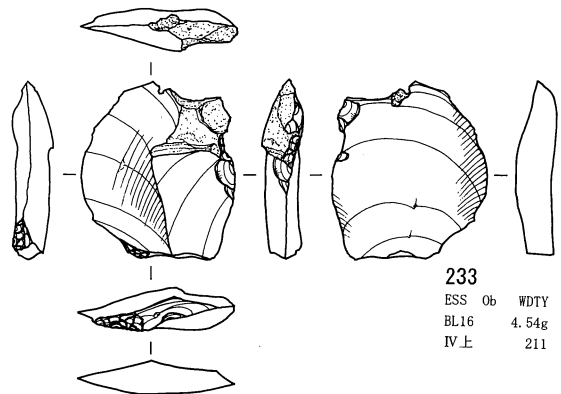

233  
ESS Ob WDTY  
BL16 4.54g  
IV上 211

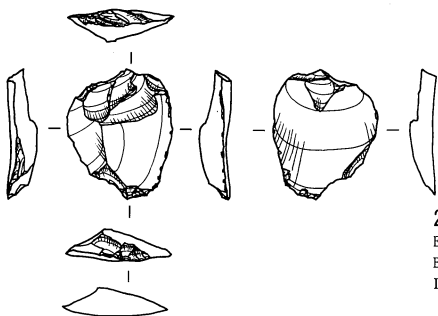

234  
ESS Ob WDTY  
BL23 1.64g  
IV上 7534

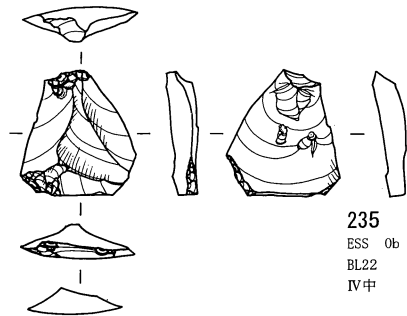

235  
ESS Ob WDKB  
BL22 1.96g  
IV中 8965

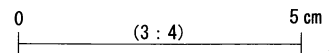

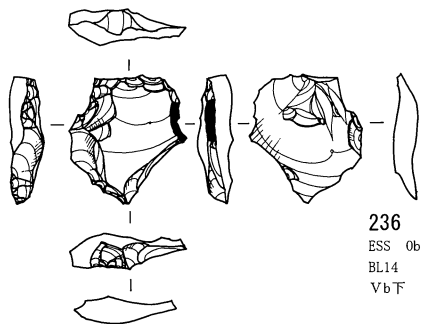

236  
ESS Ob TSTY  
BL14 2.11g  
VbF 6215

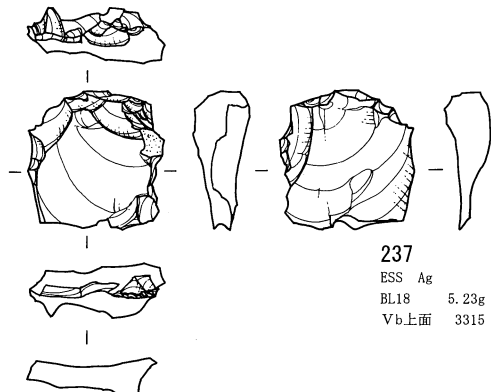

237  
ESS Ag  
BL18 5.23g  
Vb上面 3315

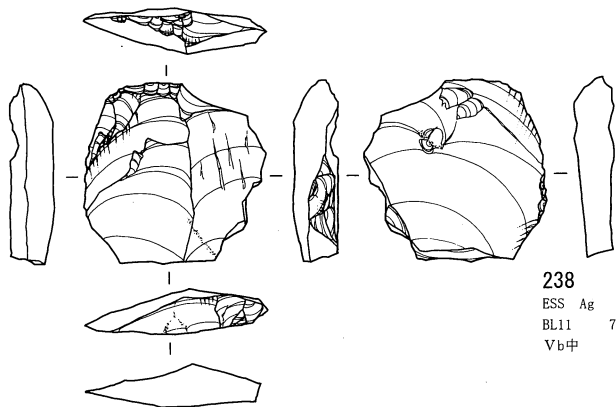

238  
ESS Ag  
BL11 7.42g  
Vb中 6034

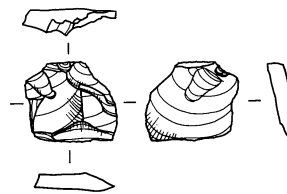

239  
ESS Ob WDTY  
BL17 0.72g  
IV中 1049

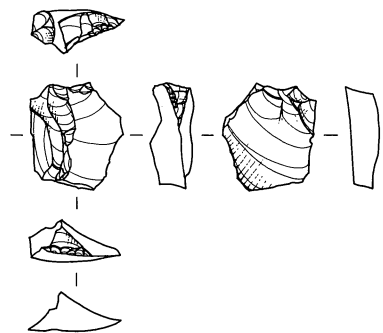

240  
ESS Ag  
BL20 1.98g  
VaF 2887

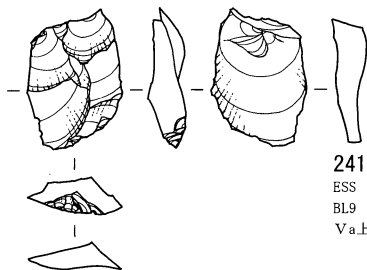

241  
ESS Ag  
BL9 1.99g  
Va上 8153

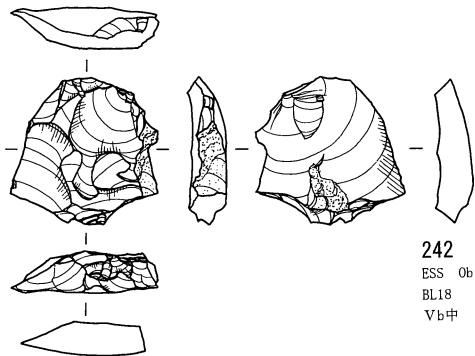

242  
ESS Ob WDTY  
BL18 4.45g  
Vb中 5543

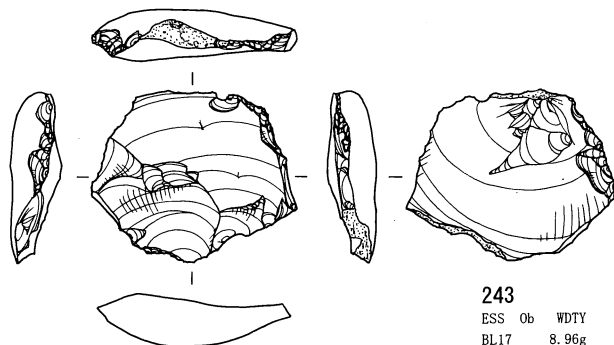

243  
ESS Ob WDTY  
BL17 8.96g  
Vb中 5259

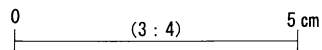

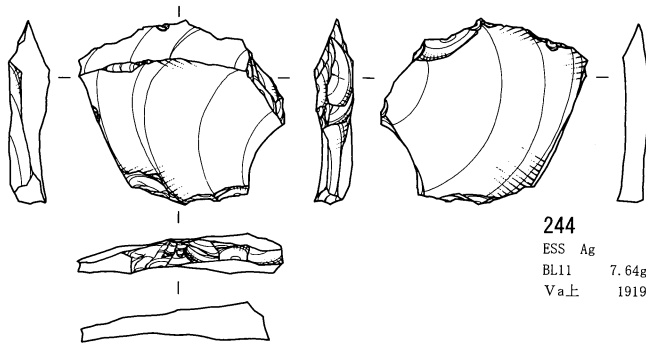

244  
ESS Ag  
BL11 7.64g  
Va上 1919

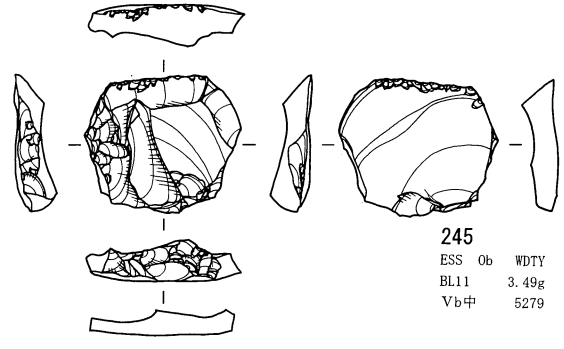

245  
ESS Ob WDTY  
BL11 3.49g  
Vb中 5279

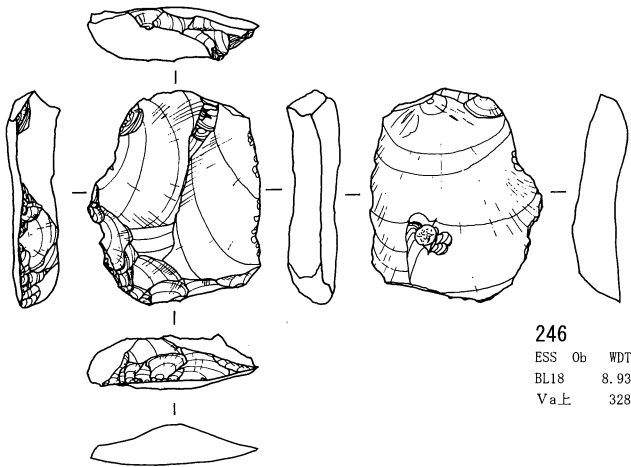

246  
ESS Ob WDTY  
BL18 8.93g  
Va上 3288

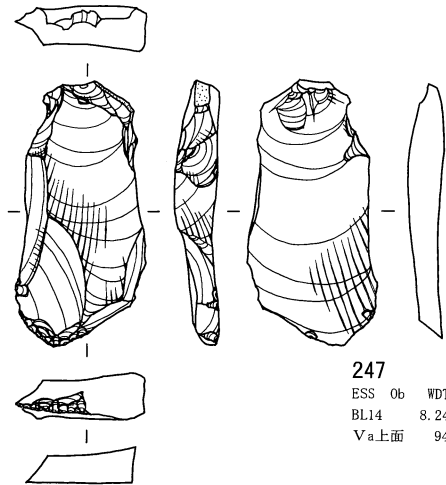

247  
ESS Ob WDTY  
BL14 8.24g  
Va上面 948

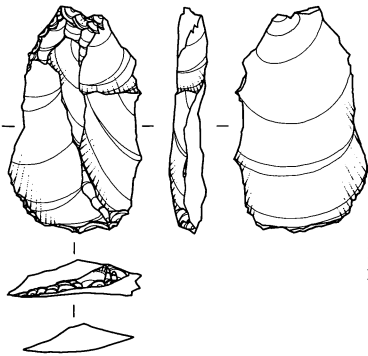

248  
ESS Ag  
BL17 4.97g  
Va上 3623

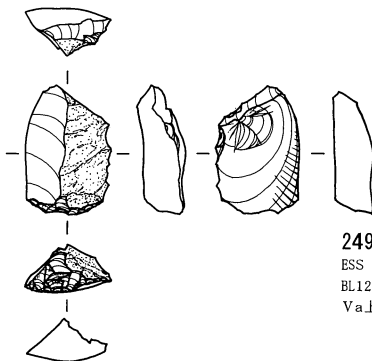

249  
ESS Ob WDTY  
BL12 2.25g  
Va上面 771

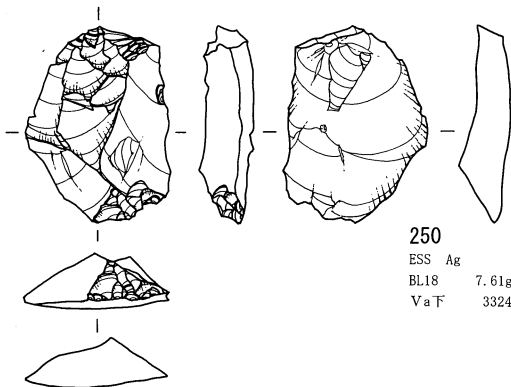

250  
ESS Ag  
BL18 7.61g  
Va下 3324

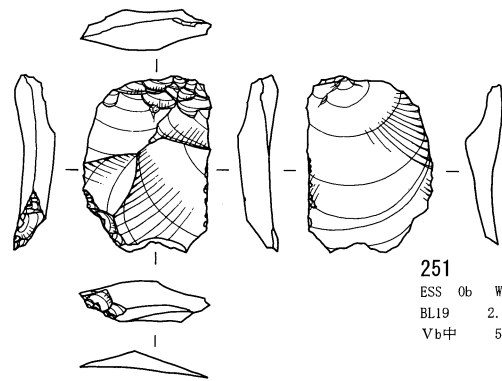

251  
ESS Ob WDTY  
BL19 2.96g  
Vb中 5132

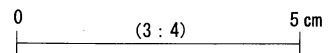

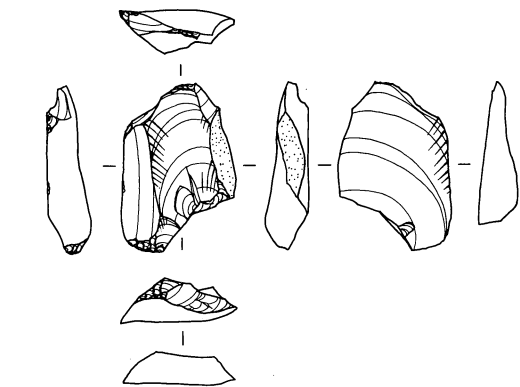

252  
ESS Ob WDTY  
BL14 2.99g  
Va上 3685

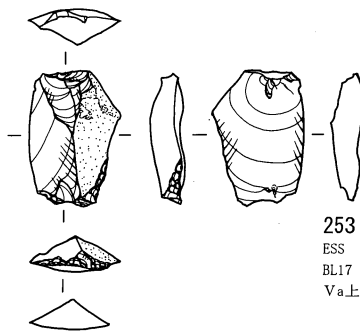

253  
ESS Ob WDKB  
BL17 1.92g  
Va上面 2904

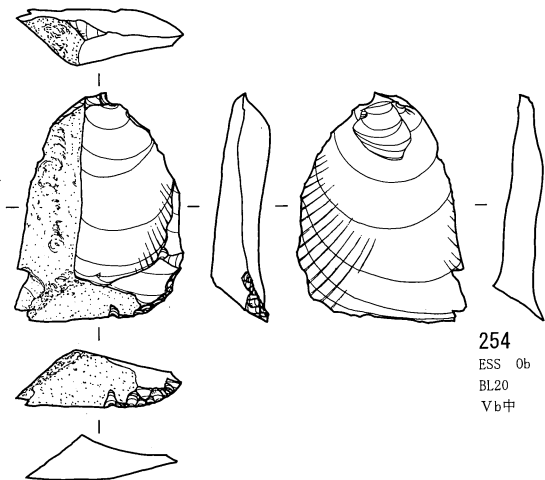

254  
ESS Ob WDTY  
BL20 8.06g  
Vb中 5445

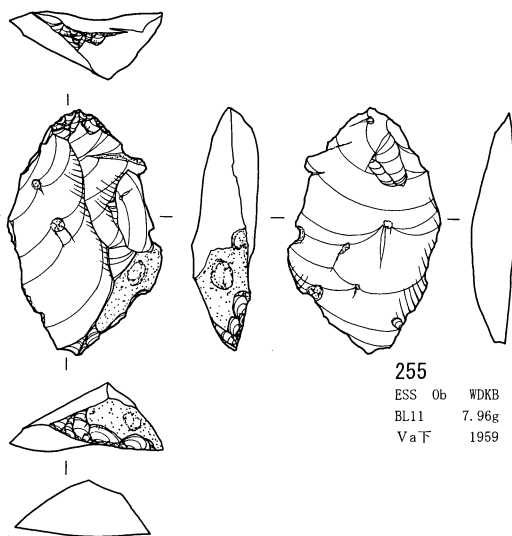

255  
ESS Ob WDKB  
BL11 7.96g  
Va下 1959

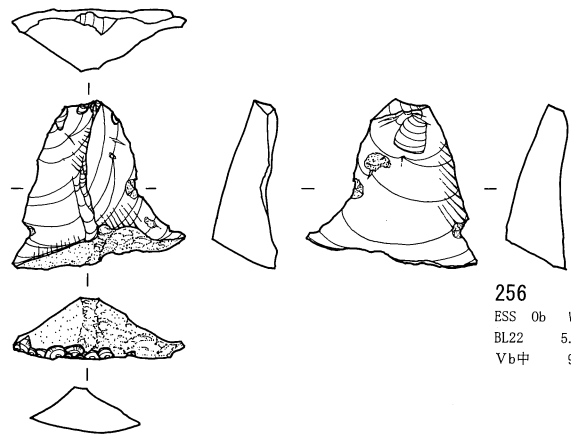

256  
ESS Ob WDTY  
BL22 5.04g  
Vb中 9427

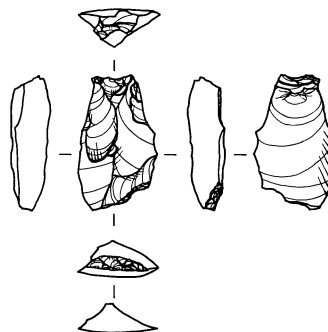

257  
ESS Ob WDTY  
BL19 1.59g  
Vb中 5121

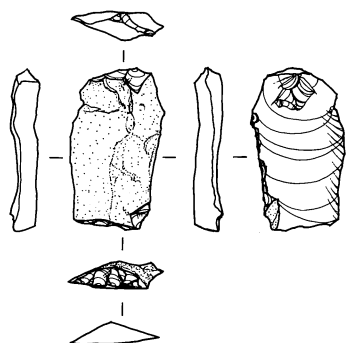

258  
ESS Ob WDTY  
BL1 2.04g  
IV中 348

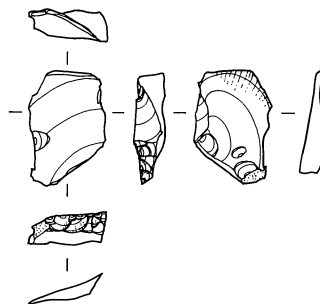

259  
ESS Ag  
BL20 1.16g  
Va下 4366

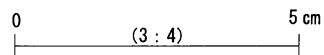

日向林 I 石器文化 石器実測図48 (搔器状石器14)



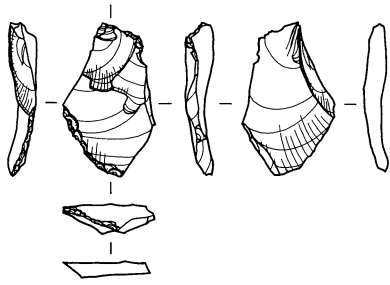

260  
ESS Ob WDTY  
BL17 1.37g  
Vb中 4825

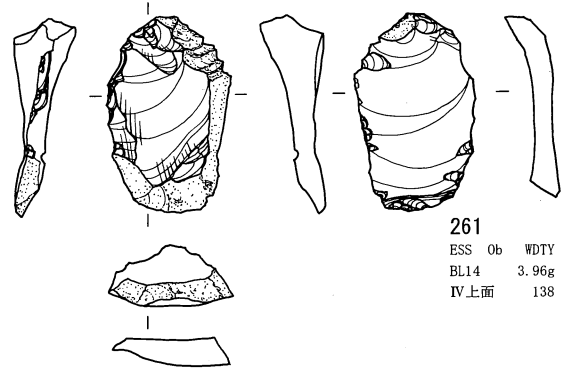

261  
ESS Ob WDTY  
BL14 3.96g  
IV上面 138

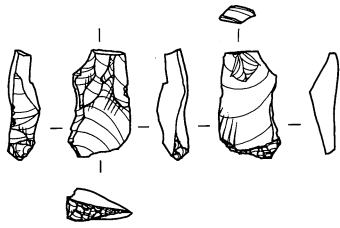

262  
ESS Ob WDTY  
BL22 0.99g  
IV下 8955

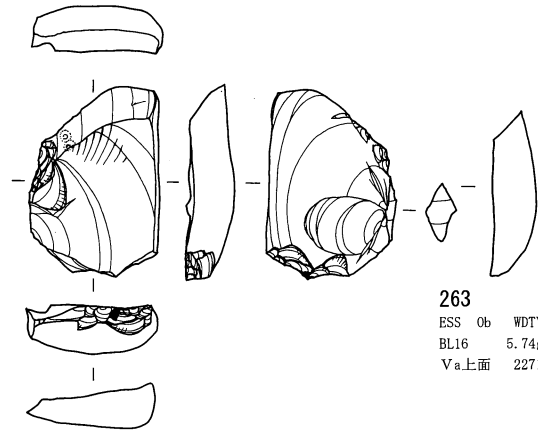

263  
ESS Ob WDTY  
BL16 5.74g  
Va上面 2271

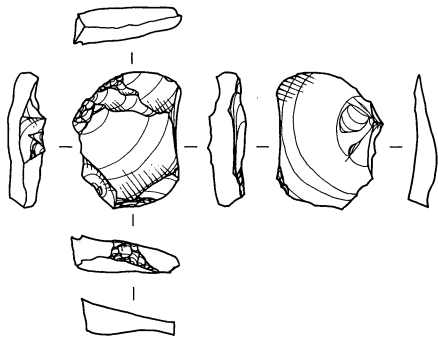

264  
ESS Ob WDTY  
BL22 1.93g  
Va下 9212

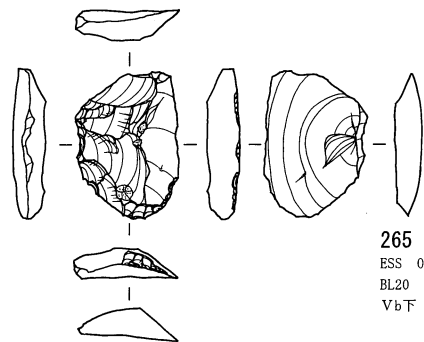

265  
ESS Ob WDTY  
BL20 2.18g  
Vb下 6660

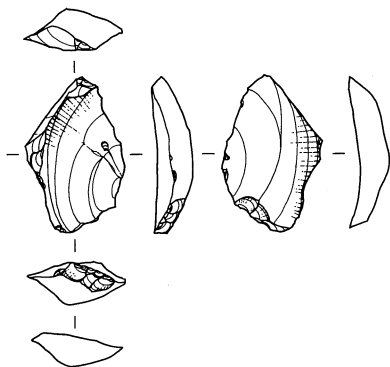

266  
ESS Ag  
BL17 2.41g  
Vb上面 4218

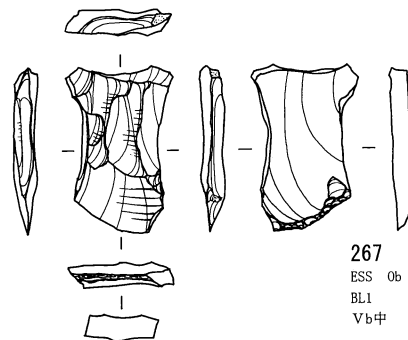

267  
ESS Ob WDTY  
BL1 2.55g  
Vb中 6759

0 (3:4) 5 cm

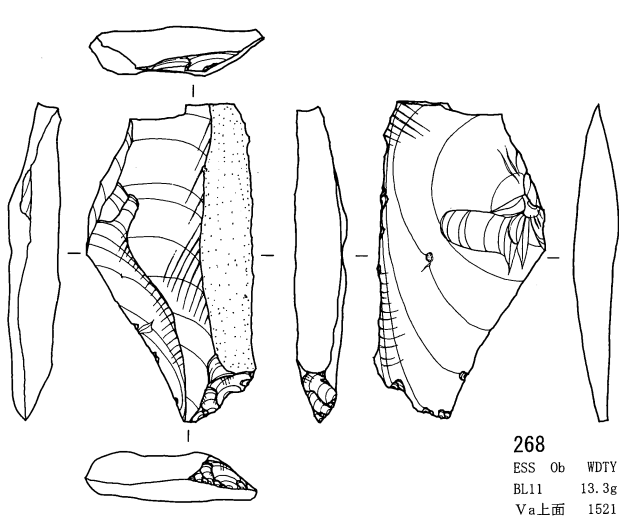

268  
ESS Ob WDTY  
BL11 13.3g  
Va上面 1521

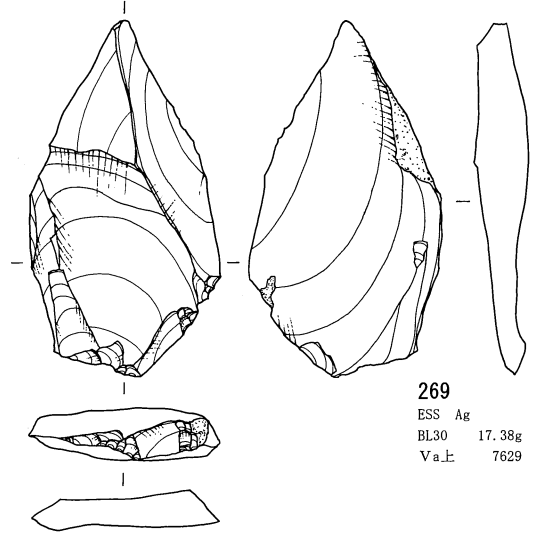

269  
ESS Ag  
BL30 17.38g  
Va上 7629

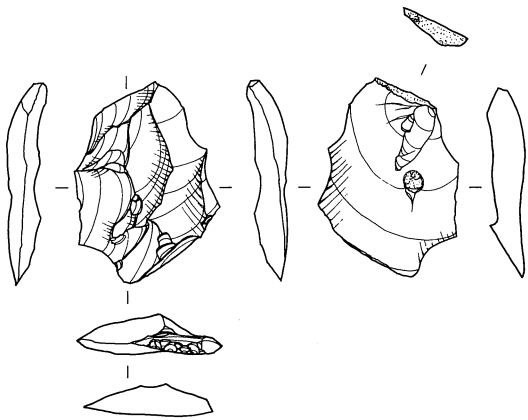

270  
ESS Ob WDTY  
BL19 3.78g  
Va上面 7805

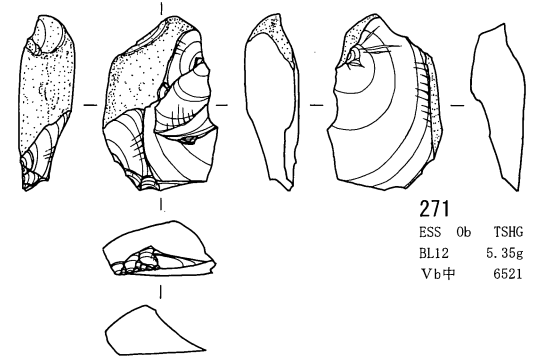

271  
ESS Ob TSHG  
BL12 5.35g  
Vb中 6521

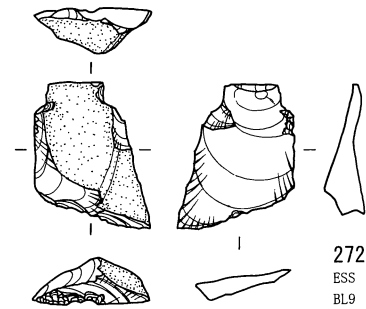

272  
ESS Ob WDKB  
BL9 2.26g  
IV上 7190

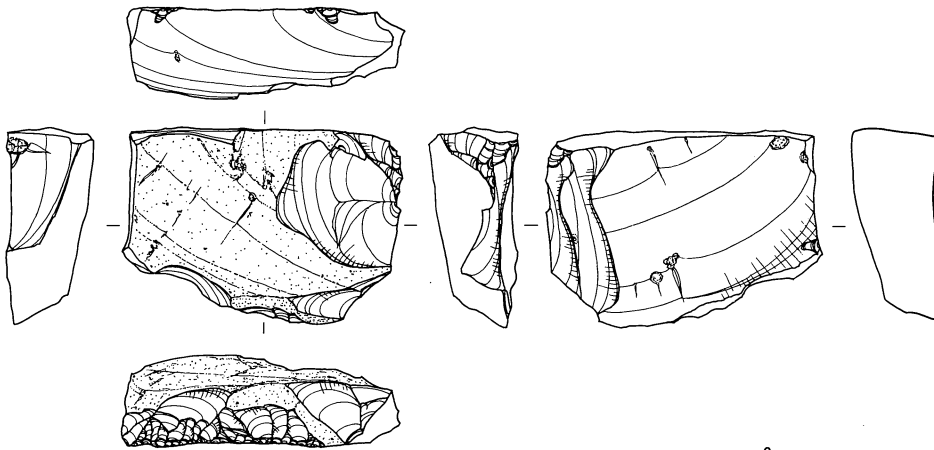

273  
ESS Ob WDTY  
BL5 32.12g  
Va中 3465

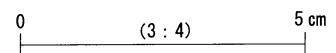

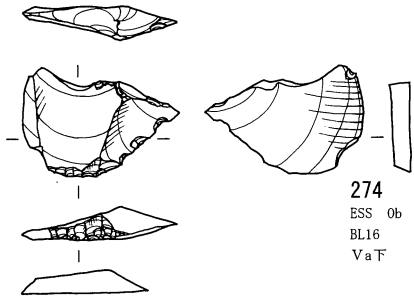

274  
ESS Ob WDTY  
BL16 1.76g  
Va下 2347

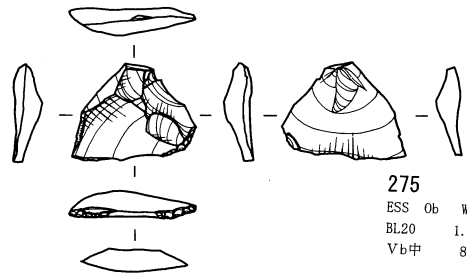

275  
ESS Ob WDTY  
BL20 1.06g  
Vb中 8698

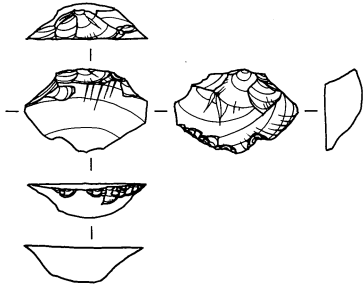

276  
ESS Ob WDTY  
BL18 1.61g  
Vb上面 3545

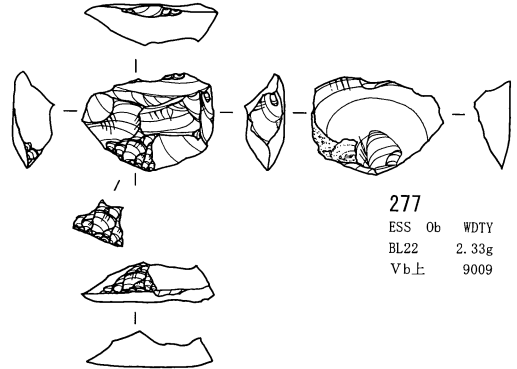

277  
ESS Ob WDTY  
BL22 2.33g  
Vb上 9009

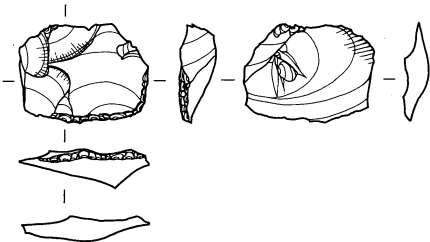

278  
ESS Ob WDTY  
BL22 2.13g  
Va中 9520

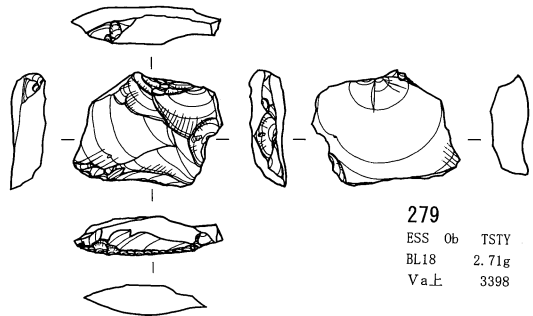

279  
ESS Ob TSTY  
BL18 2.71g  
Va上 3398

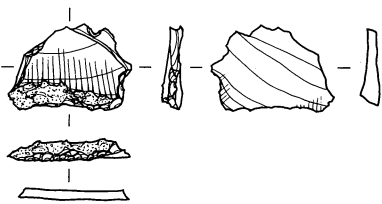

280  
ESS Ob WDTY  
BL22 0.95g  
Vb上 9381

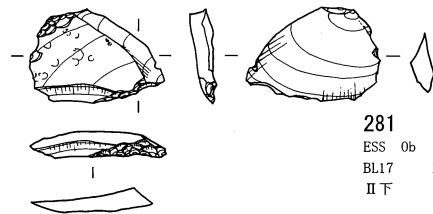

281  
ESS Ob WDTY  
BL17 1.34g  
II下 13

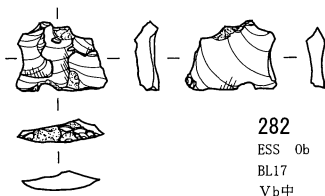

282  
ESS Ob WDTY  
BL17 0.6g  
Vb中 5054

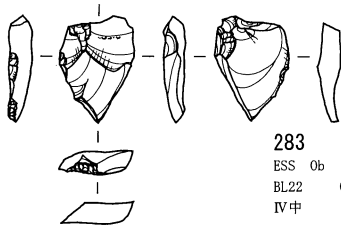

283  
ESS Ob WDTY  
BL22 0.93g  
IV中 8407

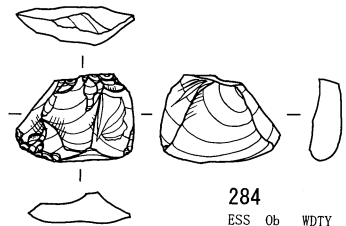

284  
ESS Ob WDTY  
BL17 1.94g  
Va下 3139

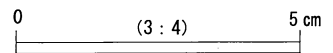

日向林 I 石器文化 石器実測図51 (搔器状石器17)

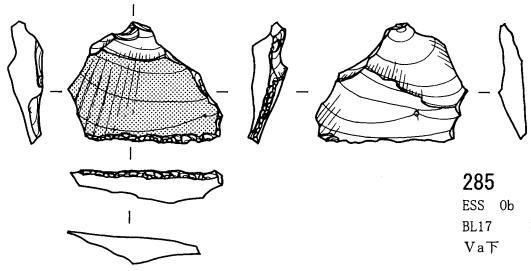

285  
 ESS Ob WDTY  
 BL17 1.99g  
 Va下 2620

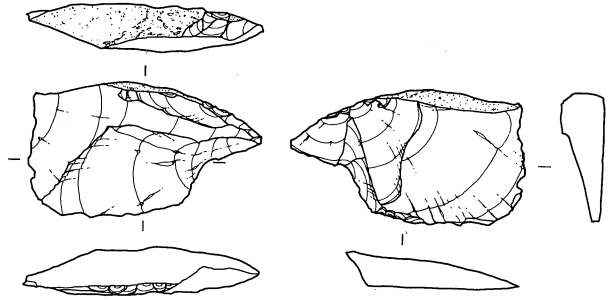

286  
 ESS An  
 BL26 6.7g  
 Vb上 8484

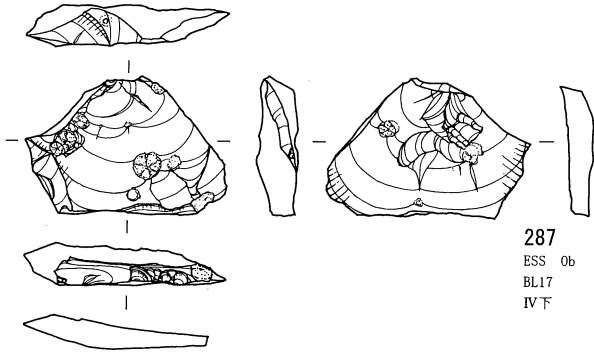

287  
 ESS Ob WDTY  
 BL17 4.7g  
 IV下 895

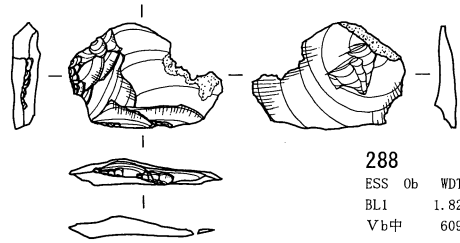

288  
 ESS Ob WDTY  
 BL1 1.82g  
 Vb中 6091

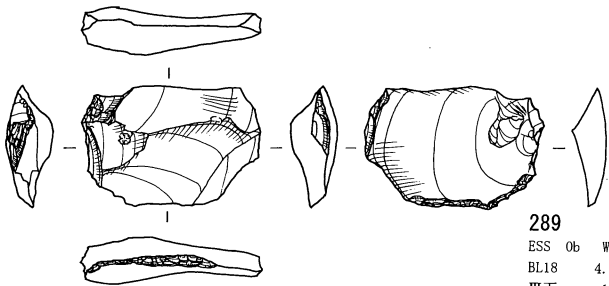

289  
 ESS Ob WDTY  
 BL18 4.09g  
 III下 1299

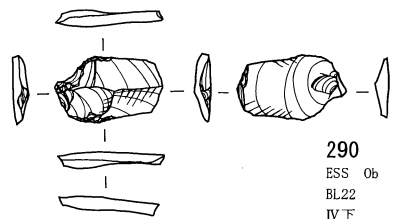

290  
 ESS Ob WDTY  
 BL22 0.47g  
 IV下 9046

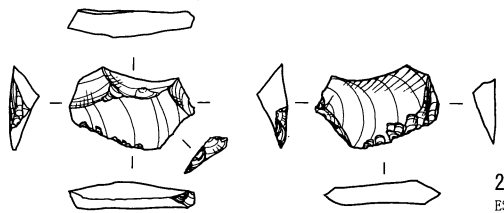

291  
 ESS Ob WDTY  
 BL20 1.18g  
 Va下 3097

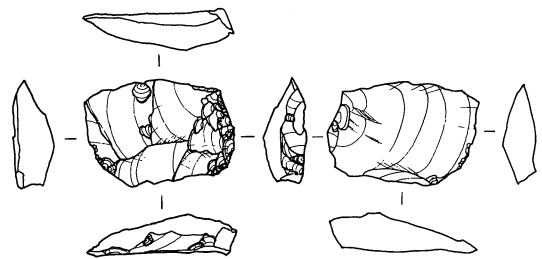

292  
 ESS Ob WDTY  
 BL9 2.74g  
 IV中 7353

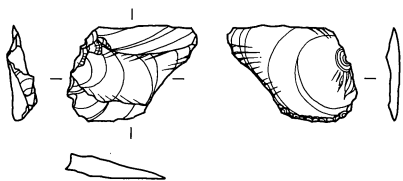

293  
 ESS Ob WDTY  
 BL22 0.94g  
 IV下 9372

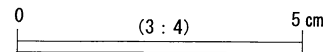

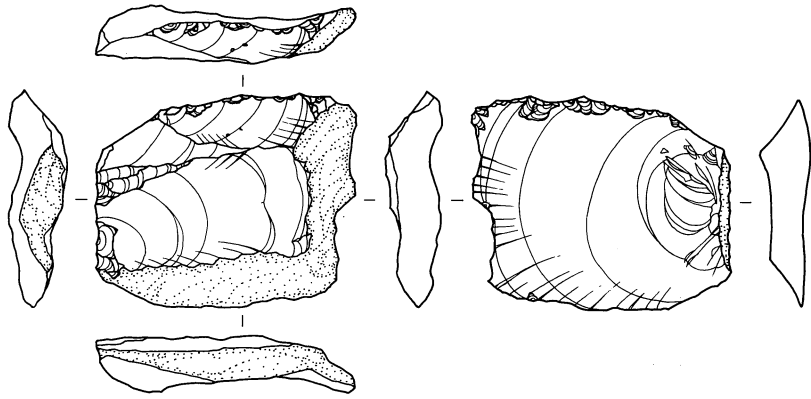

294  
 SB Ob WDTY  
 BL5 16.88g  
 Vb中 5633

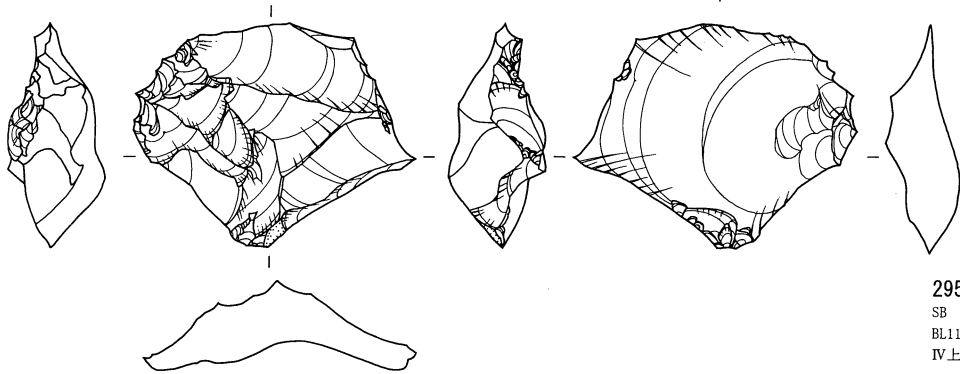

295  
 SB Ob WDTY  
 BL11 16.2g  
 IV上 269

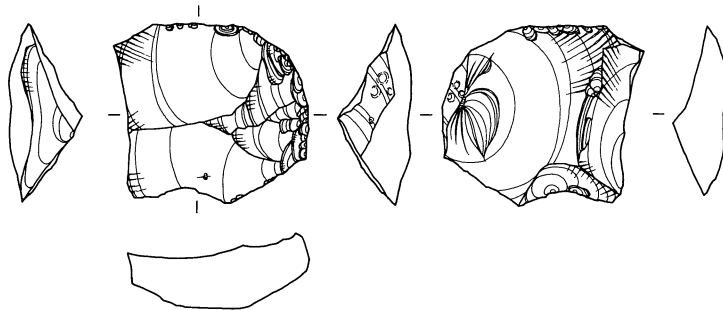

296  
 SB Ob WDTY  
 BL9 11.06g  
 攪乱 7012

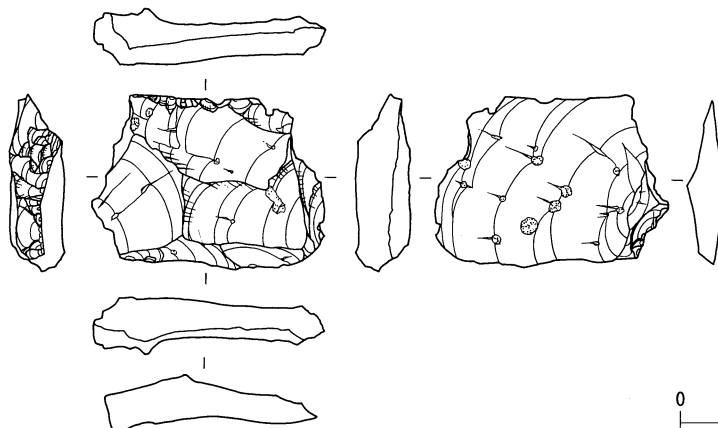

297  
 SB Ob WDTY  
 BL11 8.1g  
 III中 267

0 (3:4) 5 cm

日向林 I 石器文化 石器実測図53 (貝殻状刃器 1)

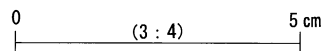
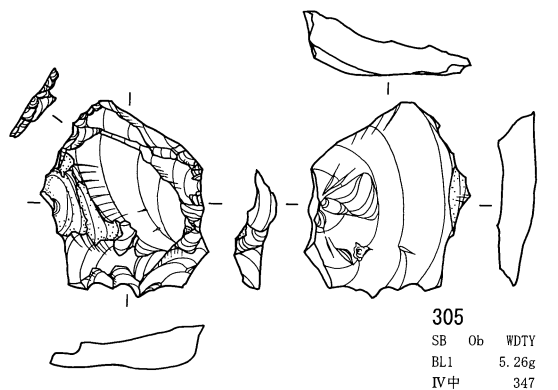
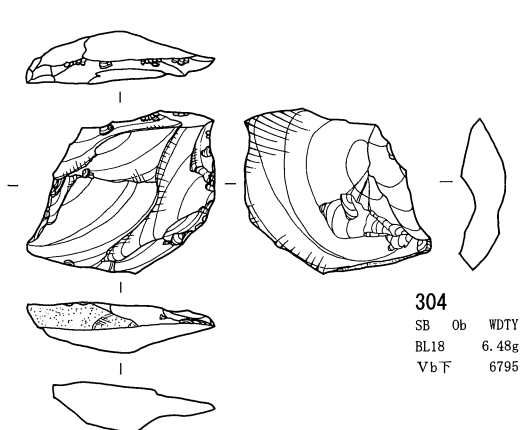
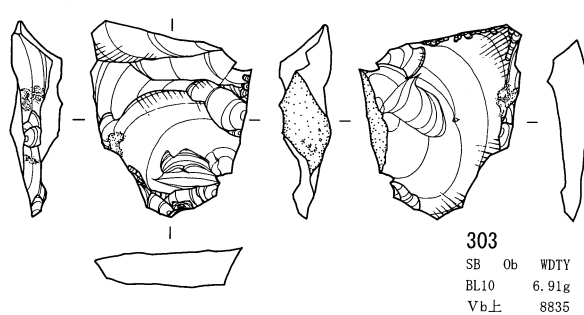
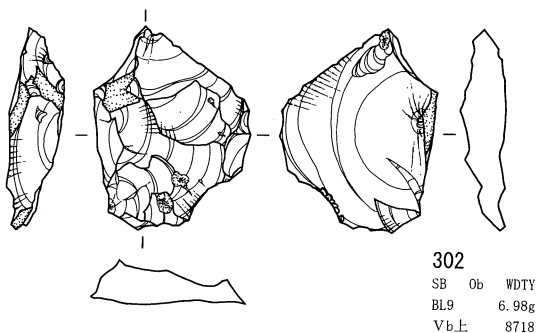
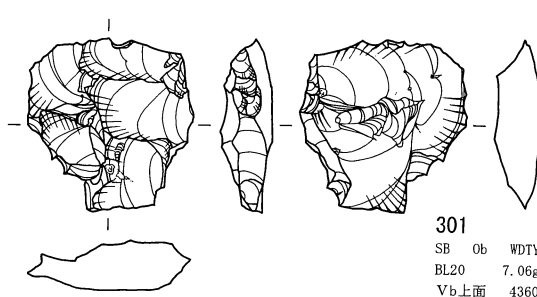
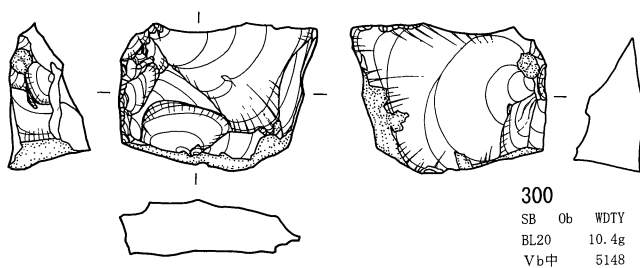
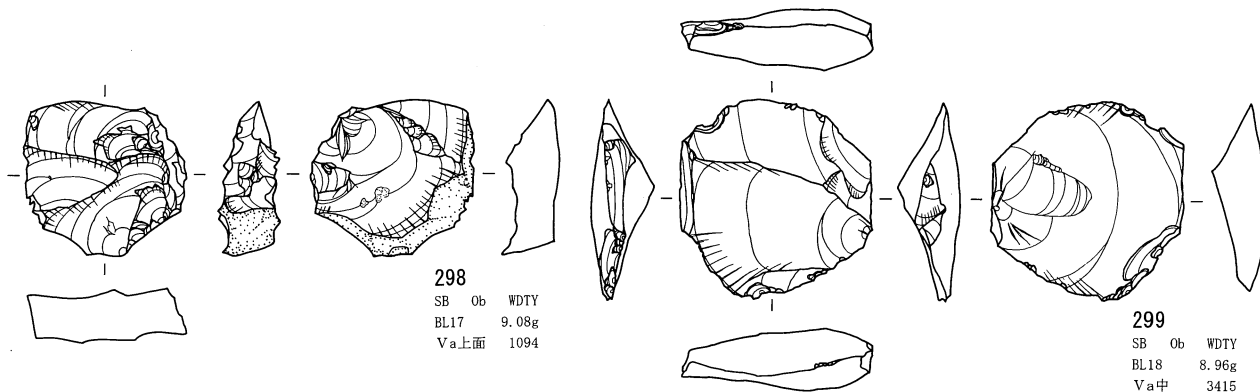

日向林 I 石器文化 石器実測図54 (貝殻状刃器 2)

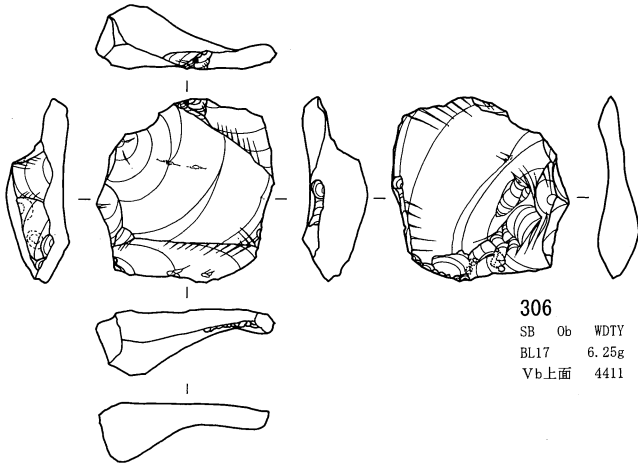

306  
SB Ob WDTY  
BL17 6.25g  
Vb上面 4411

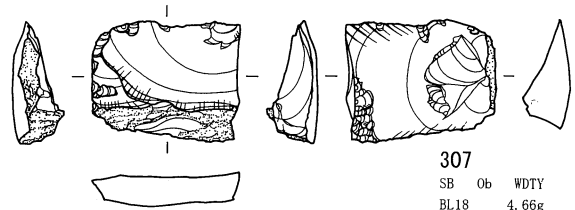

307  
SB Ob WDTY  
BL18 4.66g  
IV F 1362

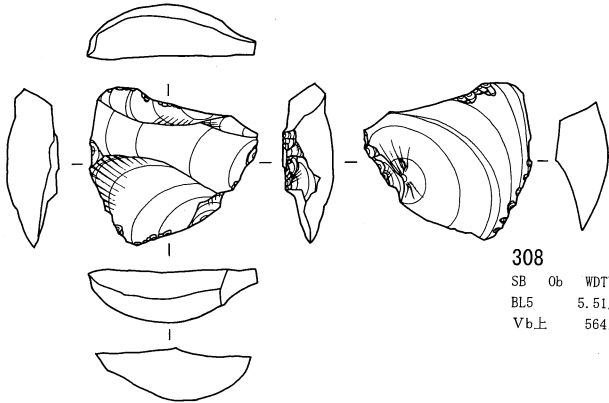

308  
SB Ob WDTY  
BL5 5.51g  
Vb上 5641

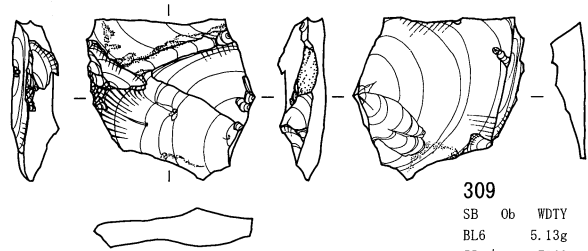

309  
SB Ob WDTY  
BL6 5.13g  
Va中 7962

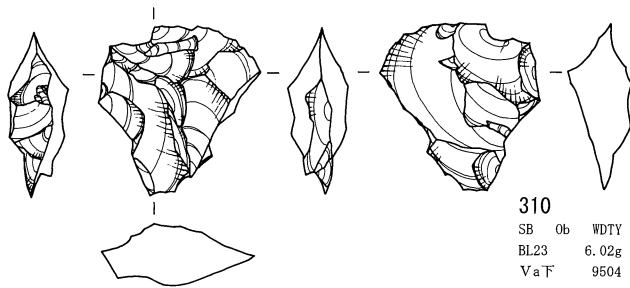

310  
SB Ob WDTY  
BL23 6.02g  
Va F 9504

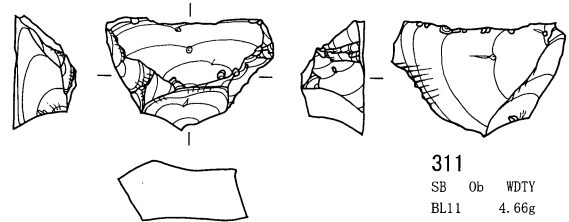

311  
SB Ob WDTY  
BL11 4.66g  
Vb F 6635

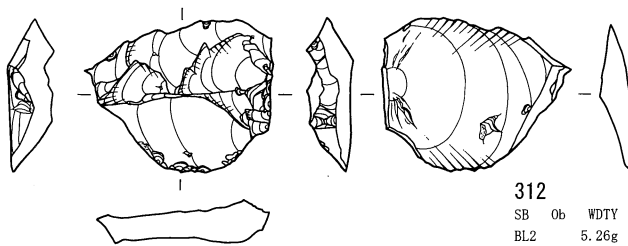

312  
SB Ob WDTY  
BL2 5.26g  
Vb中 5973

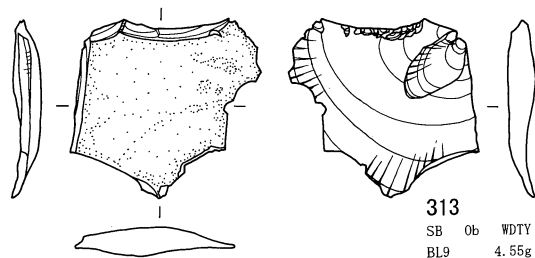

313  
SB Ob WDTY  
BL9 4.55g  
III F 7142

0 (3:4) 5 cm

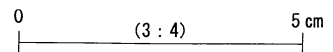
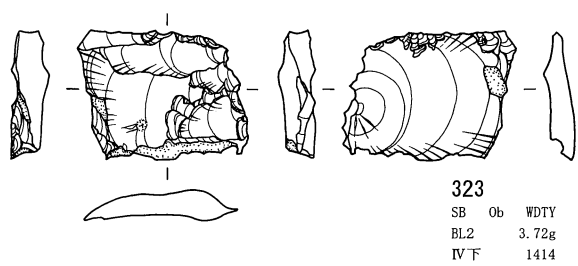
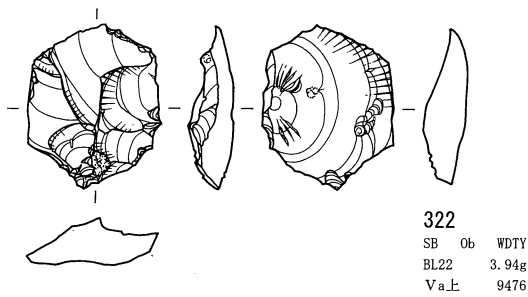
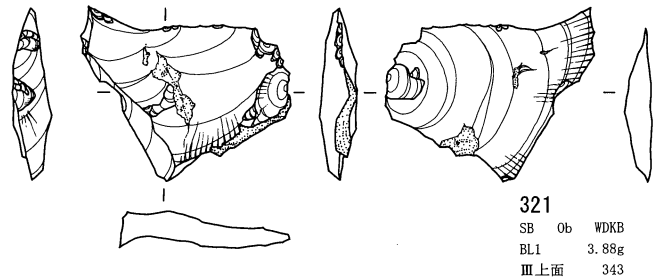
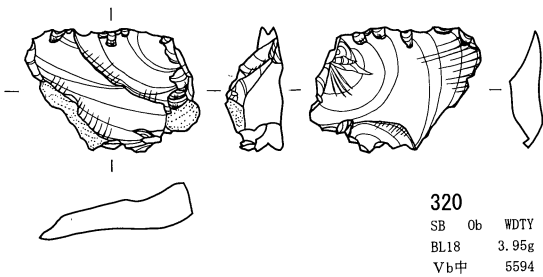
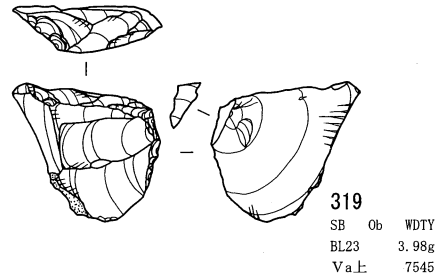
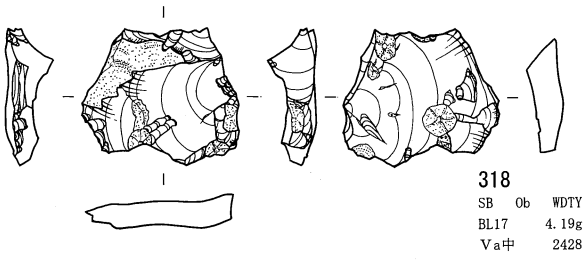
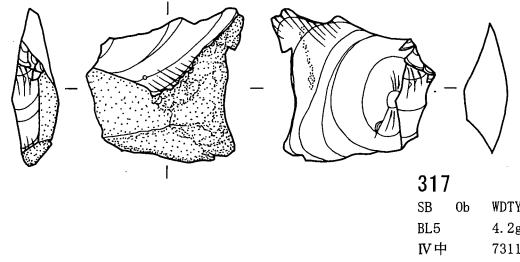
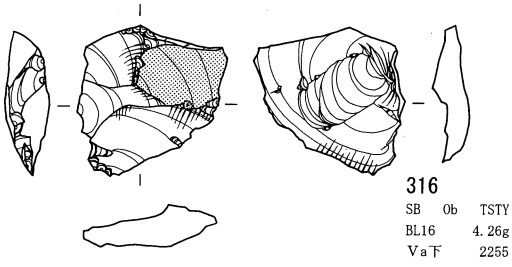
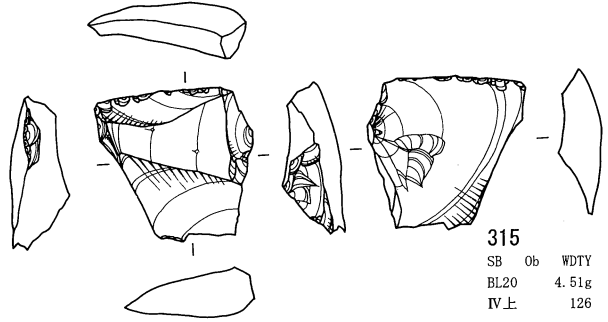
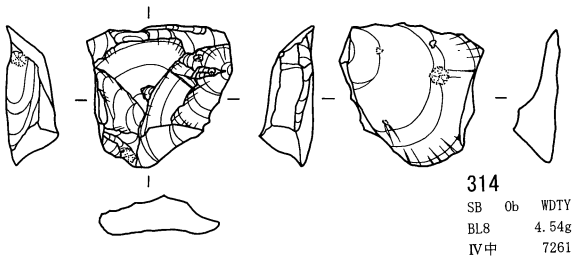



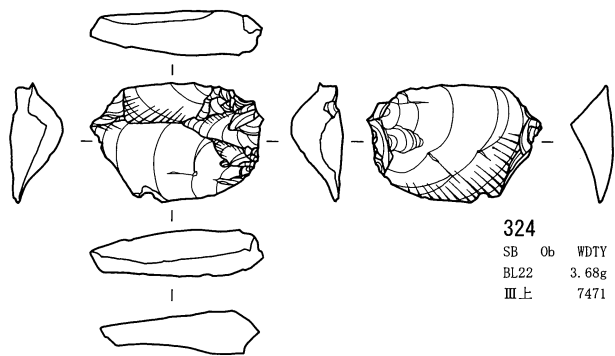

324  
SB Ob WDTY  
BL22 3.68g  
III上 7471

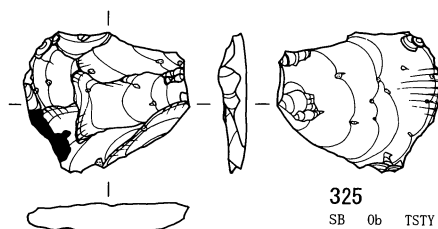

325  
SB Ob TSTY  
BL10 3.64g  
Va上面 7370

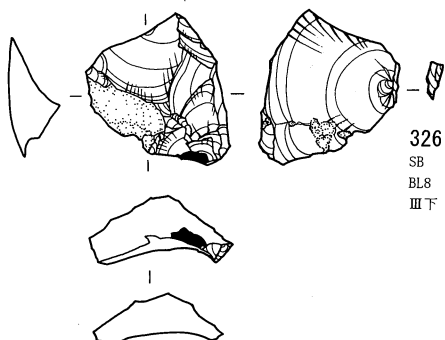

326  
SB Ob WDTY  
BL8 3.62g  
III下 7253

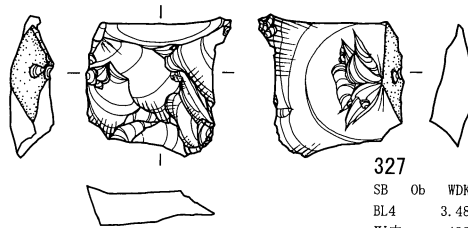

327  
SB Ob WDKB  
BL4 3.48g  
IV中 4321

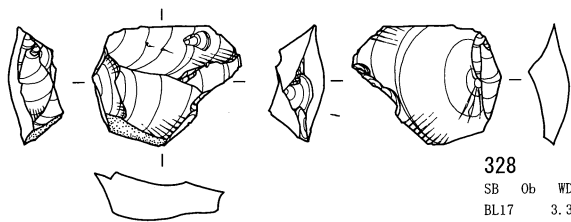

328  
SB Ob WDTY  
BL17 3.32g  
Va上面 975

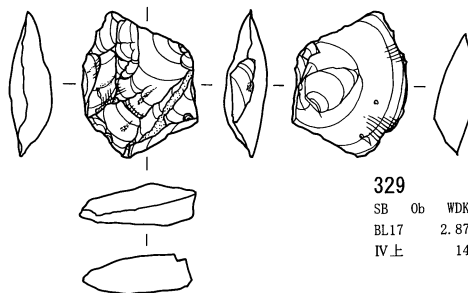

329  
SB Ob WDKB  
BL17 2.87g  
IV上 140

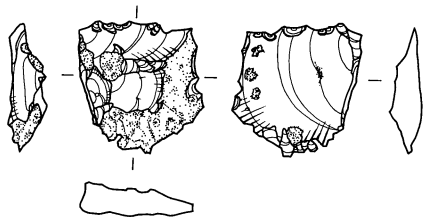

330  
SB Ob WDTK  
BL20 2.73g  
Va中 2823

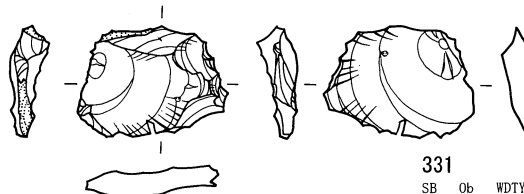

331  
SB Ob WDTY  
BL18 2.65g  
Vb中 5597

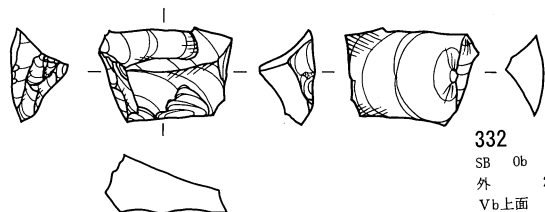

332  
SB Ob SWHD  
外 2.65g  
Vb上面 4447

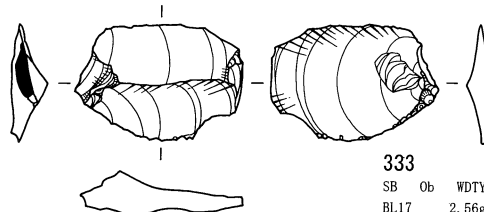

333  
SB Ob WDTY  
BL17 2.56g  
Vb上 5066

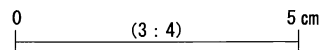

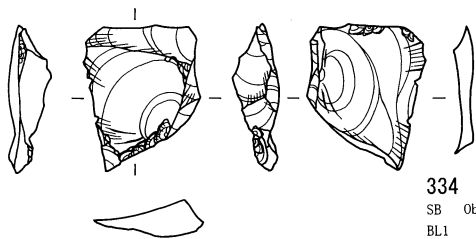

334  
SB Ob WDTY  
BL1 2.44g  
Vb下 6099

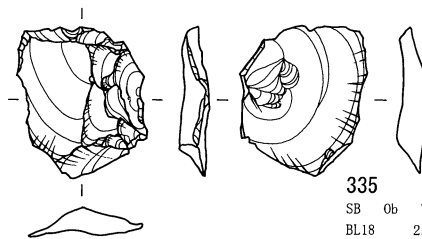

335  
SB Ob WDTY  
BL18 2.41g  
IV中 1293

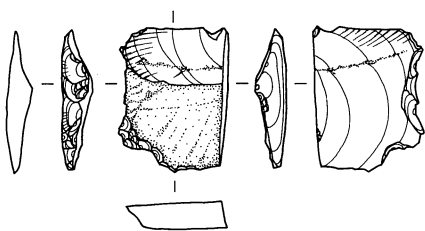

336  
SB Ob WDTK  
BL18 2.38g  
II下 1300

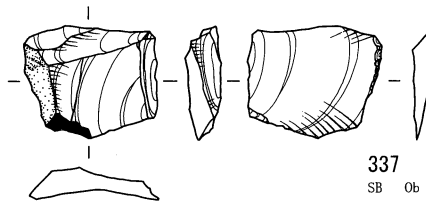

337  
SB Ob WDTY  
BL17 2.37g  
Vb下 6397

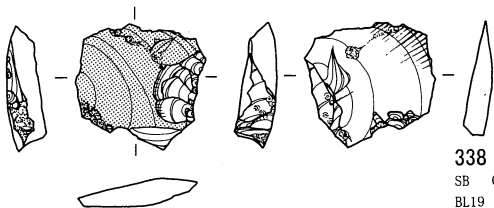

338  
SB Ob WDTY  
BL19 2.37g  
III中 71

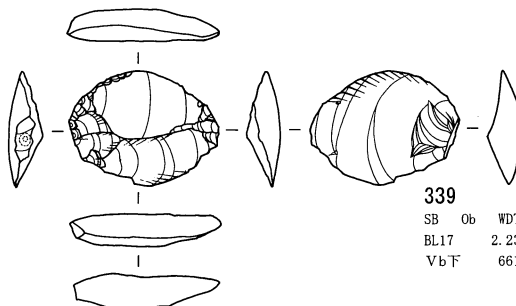

339  
SB Ob WDTY  
BL17 2.23g  
Vb下 6610

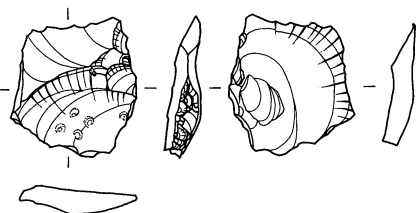

340  
SB Ob WDTY  
BL9 2.27g  
III下 7153

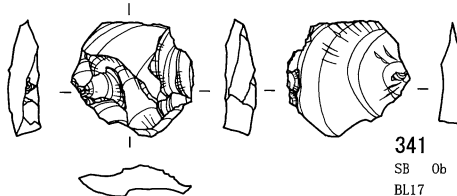

341  
SB Ob WDTY  
BL17 2.18g  
Va上 2609

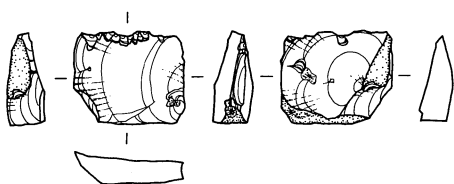

342  
SB Ob WDTY  
BL9 2.2g  
Va中 8129

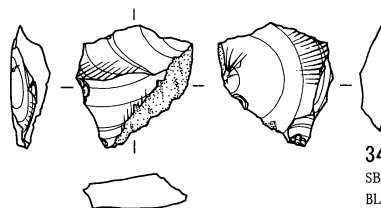

343  
SB Ob WDTY  
BL20 2.03g  
Va中 8103

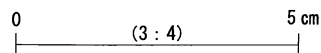

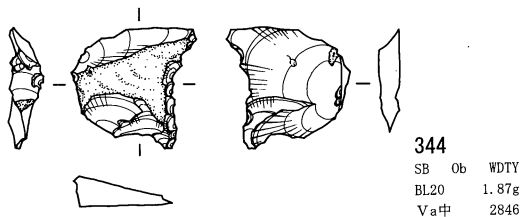

344  
SB Ob WDTY  
BL20 1.87g  
Va中 2846

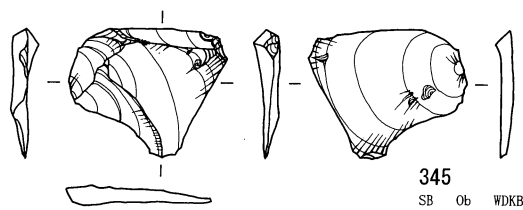

345  
SB Ob WDKB  
BL1 1.82g  
Vb下 6576

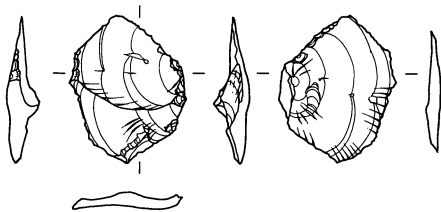

346  
SB Ob WDTY  
BL11 1.8g  
Va上面 850

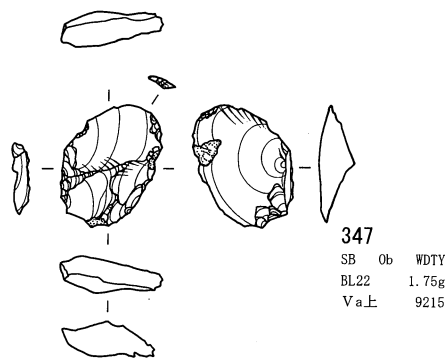

347  
SB Ob WDTY  
BL22 1.75g  
Va上 9215

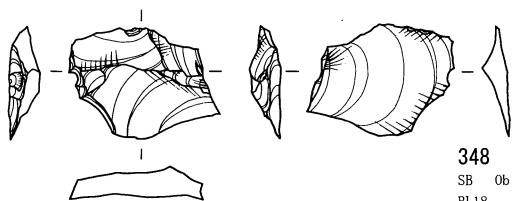

348  
SB Ob WDTY  
BL18 1.74g  
IV下 3246

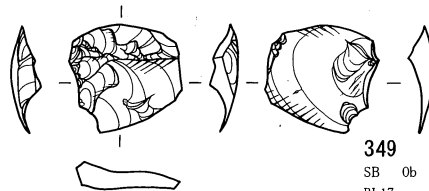

349  
SB Ob TSTY  
BL17 1.58g  
Va中 2692

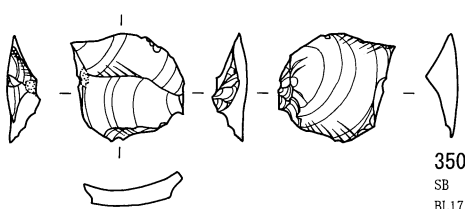

350  
SB Ob WDTY  
BL17 1.68g  
Vb中 5448

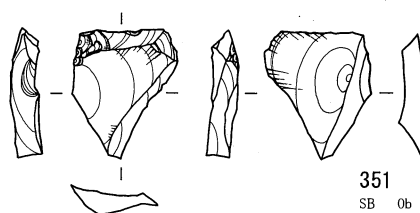

351  
SB Ob WDTY  
BL16 1.56g  
Va上面 877

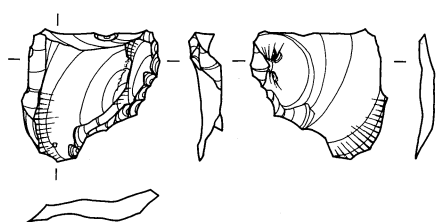

352  
SB Ob WDTY  
BL20 1.73g  
Va中 2866

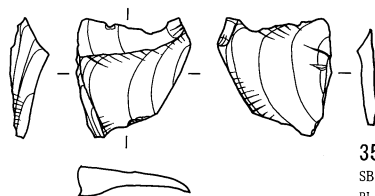

353  
SB Ob WDTY  
BL12 1.54g  
Va下 6773

0 (3:4) 5 cm

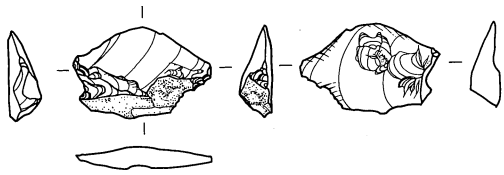

354  
SB Ob WDTY  
BL8 1.53g  
Vb中 8576

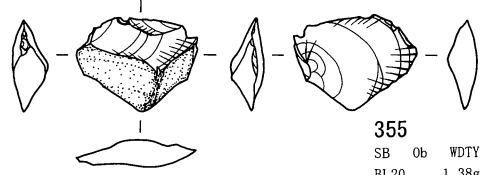

355  
SB Ob WDTY  
BL20 1.38g  
Vb中 5176

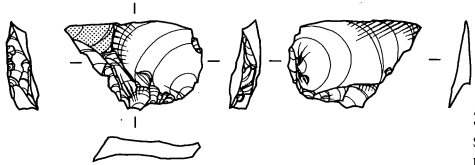

356  
SB Ob WDTY  
BL18 1.34g  
Va中 3289

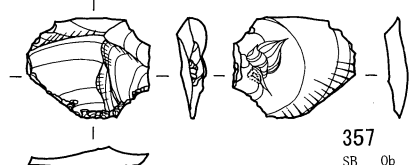

357  
SB Ob WDTY  
BL18 1.3g  
Va上 3253

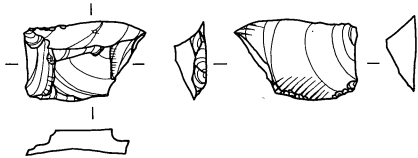

358  
SB Ob WDKB  
BL20 1.3g  
Va上面 1212

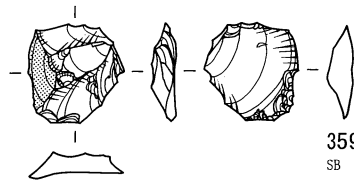

359  
SB Ob WDTY  
BL18 1.22g  
Va下 3277

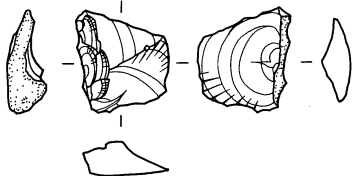

360  
SB Ob WDTY  
BL7 1.23g  
Va上 7882

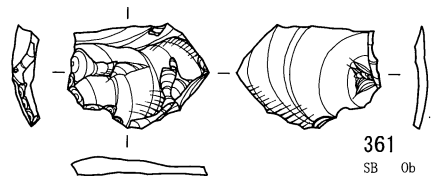

361  
SB Ob WDTY  
BL19 1.19g  
Vb中 5114

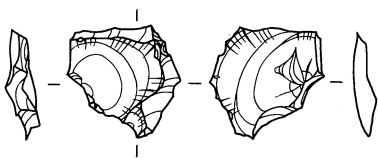

362  
SB Ob WDTY  
BL11 1.23g  
Va中 1834

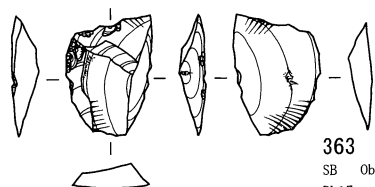

363  
SB Ob WDTY  
BL17 1.16g  
III下 29

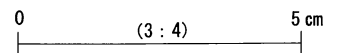

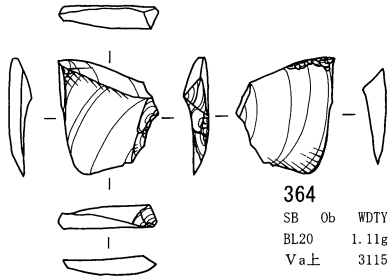

**364**  
SB Ob WDTY  
BL20 1.11g  
Va上 3115

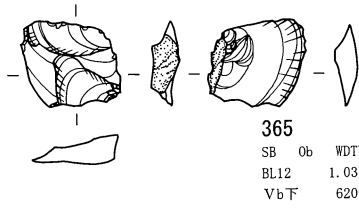

**365**  
SB Ob WDTY  
BL12 1.03g  
Vb下 6209

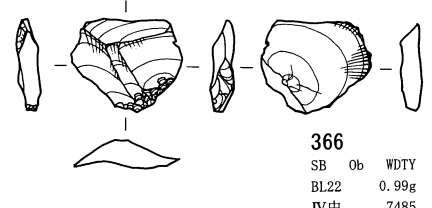

**366**  
SB Ob WDTY  
BL22 0.99g  
IV中 7485

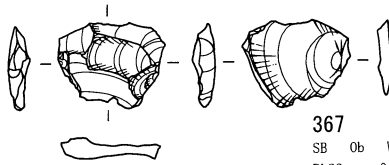

**367**  
SB Ob WDTY  
BL22 0.88g  
Va下 9307

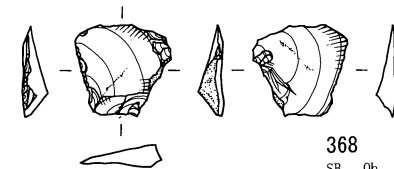

**368**  
SB Ob WDTY  
BL9 0.75g  
Vb下 8870

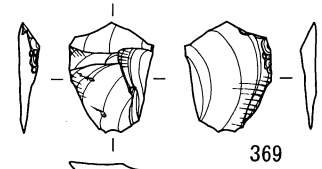

**369**  
SB Ob WDTY  
BL17 0.66g  
Va上 980

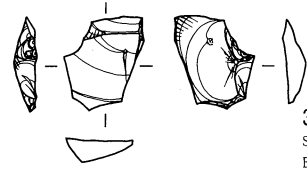

**370**  
SB Ob WDTY  
BL8 0.65g  
IV中 8690

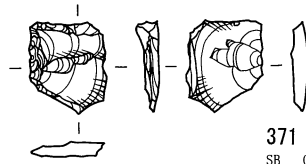

**371**  
SB Ob TSTY  
BL18 0.65g  
IV下 1329

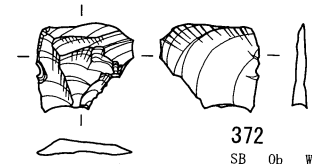

**372**  
SB Ob WDTY  
BL3 0.62g  
Vb下 6816

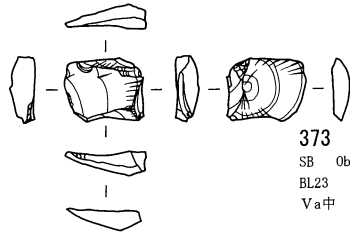

**373**  
SB Ob WDTY  
BL23 0.57g  
Va中 9451

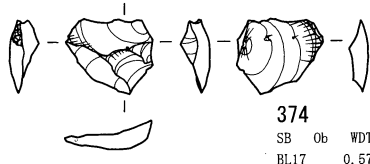

**374**  
SB Ob WDTY  
BL17 0.57g  
Va下 3577

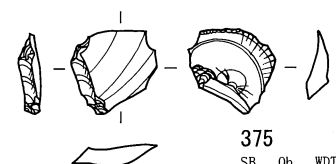

**375**  
SB Ob WDTY  
BL22 0.57g  
Vb中 9300

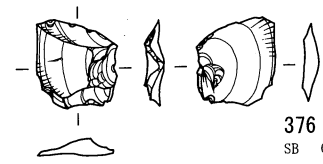

**376**  
SB Ob WDTY  
BL17 0.56g  
Va下 4399

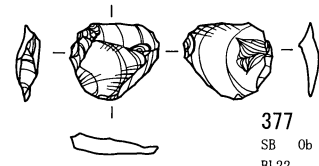

**377**  
SB Ob WDTY  
BL22 0.54g  
Vb中 9282

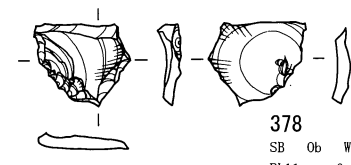

**378**  
SB Ob WDTY  
BL11 0.52g  
Va上面 673

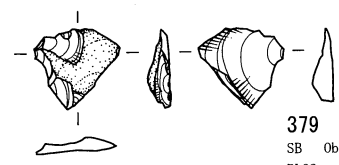

**379**  
SB Ob WDTY  
BL22 0.5g  
Vb上 9393

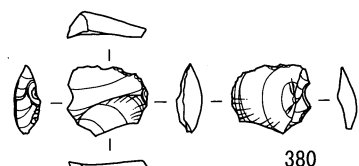

**380**  
SB Ob WDTY  
BL22 0.49g  
Vb上 9106

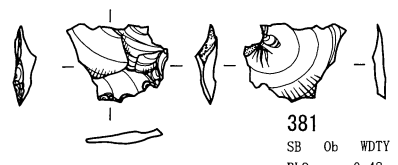

**381**  
SB Ob WDTY  
BL9 0.48g  
Va中 7714

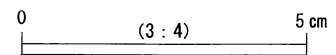

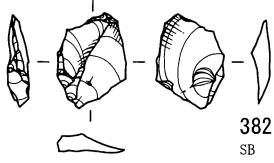

382  
SB Ob WDTY  
BL11 0.46g  
Vb上面 3859

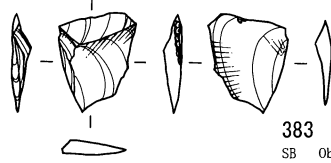

383  
SB Ob WDTY  
BL20 0.46g  
Va上 3114



384  
SB Ob WDTY  
BL16 0.45g  
Vb上 2396

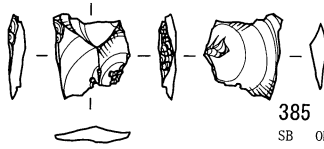

385  
SB Ob WDTY  
BL17 0.41g  
Vb中 5749

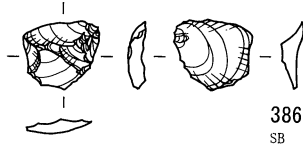

386  
SB Ob WDTY  
BL22 0.39g  
IV上 7477

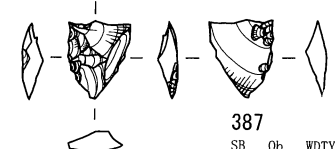

387  
SB Ob WDTY  
BL10 0.39g  
Vb上 8860

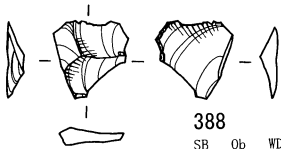

388  
SB Ob WDTY  
BL10 0.35g  
Vb上 8838

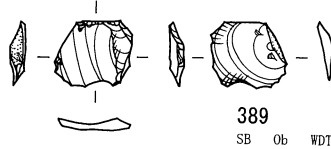

389  
SB Ob WDTY  
BL17 0.3g  
Va下 4147

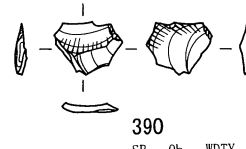

390  
SB Ob WDTY  
BL22 0.16g  
IV下 9080

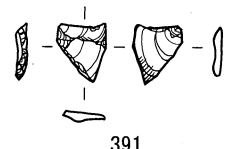

391  
SB Ob WDTY  
BL22 0.14g  
Vb上 9271

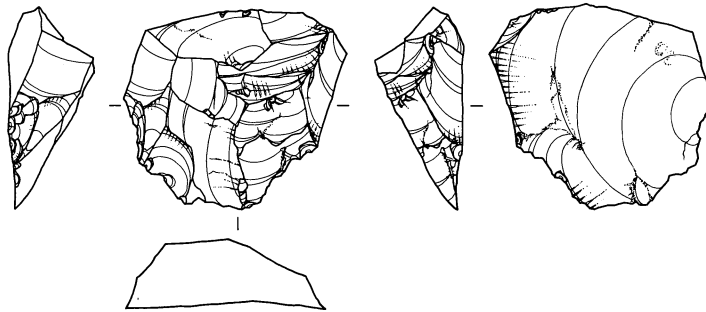

392  
SB Ag  
BL30 15.39g  
Vb中 8944



393  
SB Ag  
BL8 11.77g  
Vb下 8579

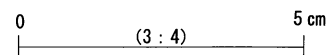

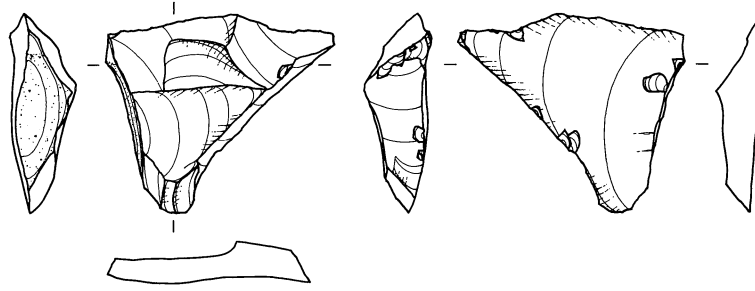

394  
SB Ag  
BL26 10.72g  
Vb上 8943

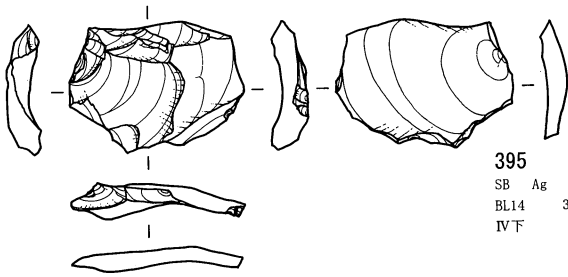

395  
SB Ag  
BL14 3.45g  
IV下 1680

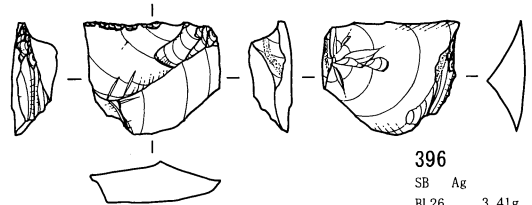

396  
SB Ag  
BL26 3.41g  
Vb上 8910

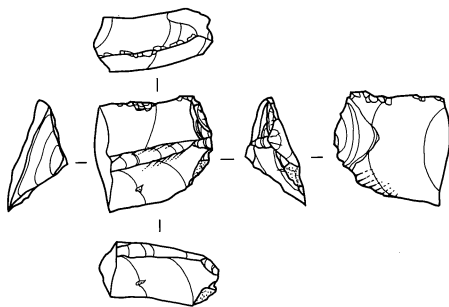

397  
SB Ag  
BL20 2.86g  
Va上面 1610

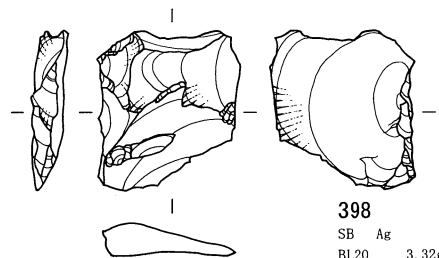

398  
SB Ag  
BL20 3.32g  
Vb中 5174

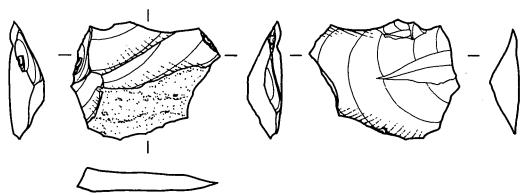

399  
SB Ag  
BL26 2.64g  
IV上 7662

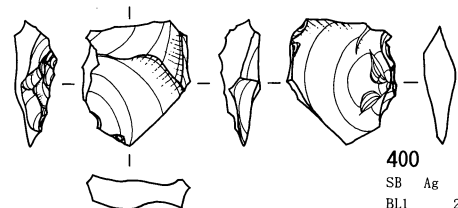

400  
SB Ag  
BL1 2.42g  
Va下 3784

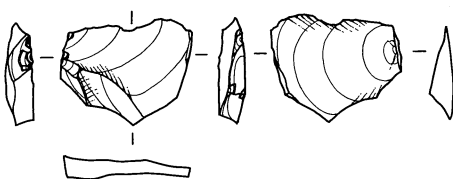

401  
SB Ag  
BL14 1.66g  
Vb上面 3982

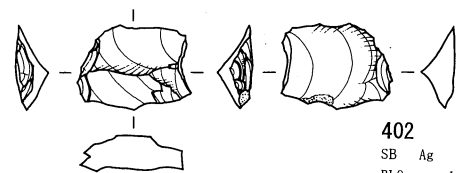

402  
SB Ag  
BL9 1.57g  
IV下 7394

0 (3 : 4) 5 cm

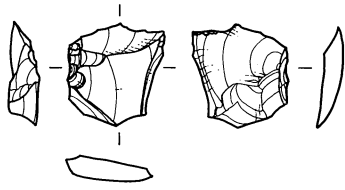

403  
SB Ag  
BL19 1.32g  
IV下 1093

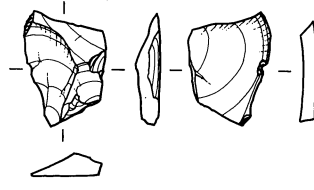

404  
SB Ag  
BL18 0.96g  
Va下 3369

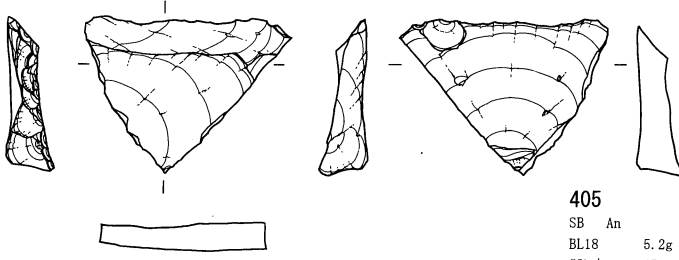

405  
SB An  
BL18 5.2g  
Vb中 4503

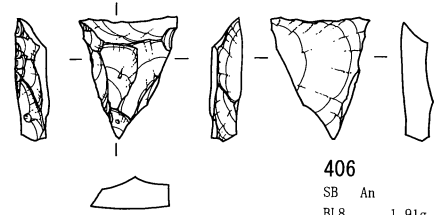

406  
SB An  
BL8 1.91g  
Va中 8082

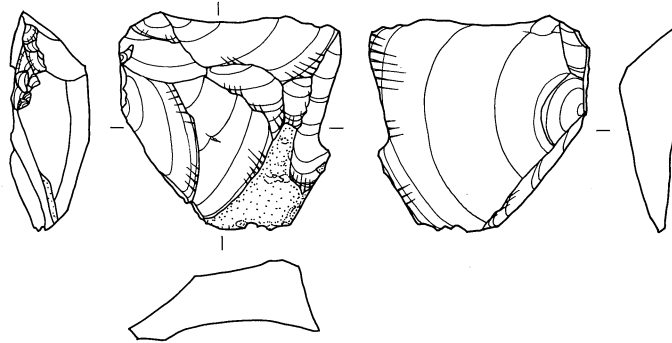

407  
SB Ob WDTY  
BL8 16.04g  
Vb上 8626

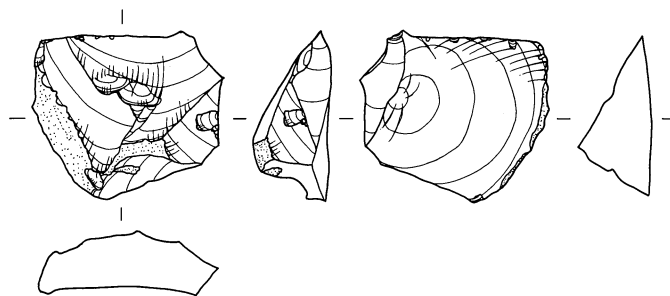

408  
SB Ob WDTY  
BL11 10.55g  
Va上 724

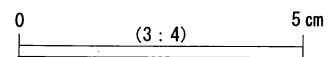

日向林 I 石器文化 石器実測図64 (貝殻状刃器12)



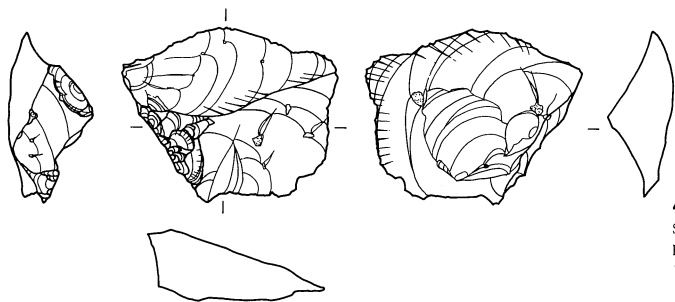

409  
SB Ob WDTY  
BL17 8.95g  
Vb上面 2419

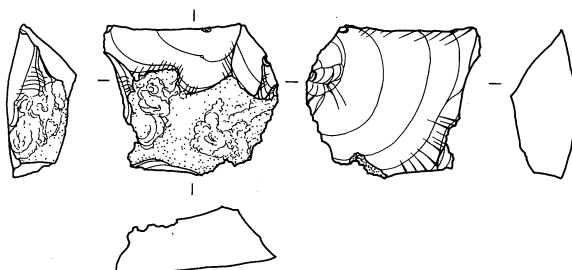

410  
SB Ob WDTY  
BL18 8.46g  
Va上面 1330

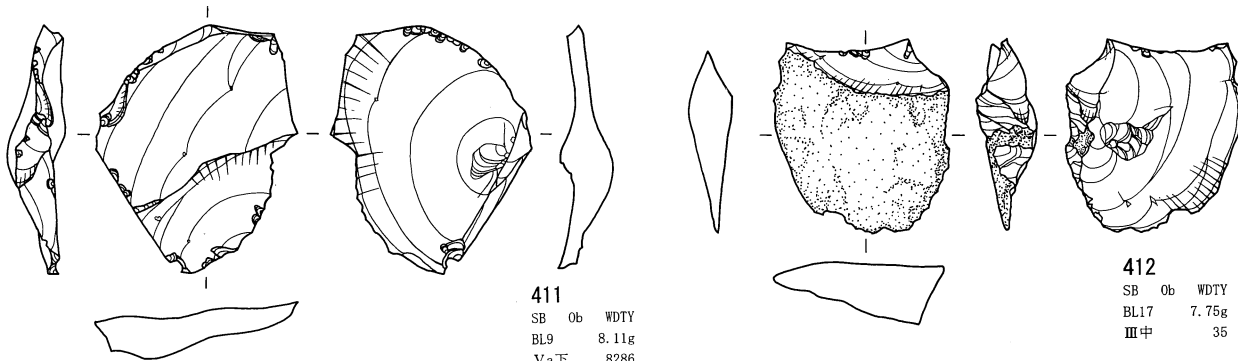

411  
SB Ob WDTY  
BL9 8.11g  
Va下 6286

412  
SB Ob WDTY  
BL17 7.75g  
III中 35

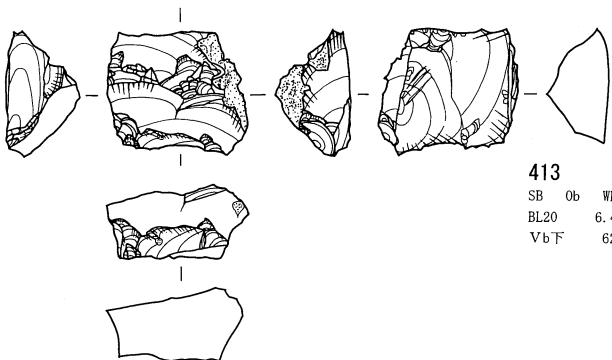

413  
SB Ob WDTY  
BL20 6.42g  
Vb下 6270

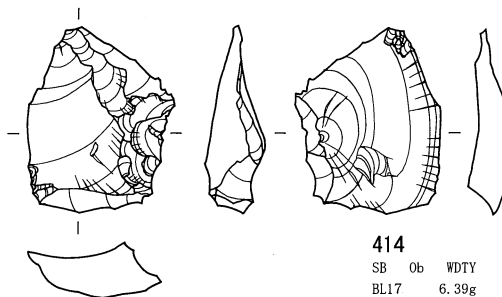

414  
SB Ob WDTY  
BL17 6.39g  
Va下 2677

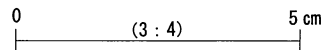

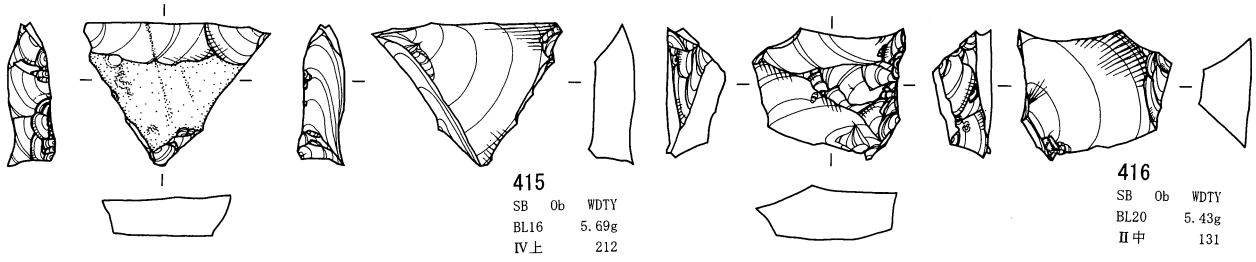

415  
SB Ob WDTY  
BL16 5.69g  
IV上 212

416  
SB Ob WDTY  
BL20 5.43g  
II中 131

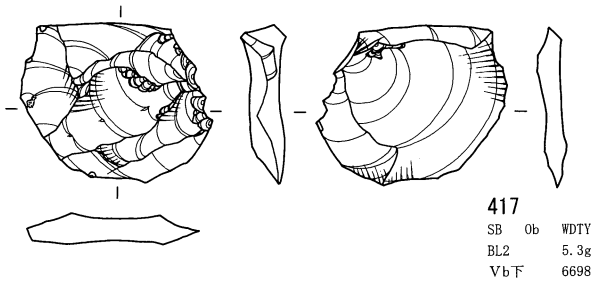

417  
SB Ob WDTY  
BL2 5.3g  
Vb下 6698

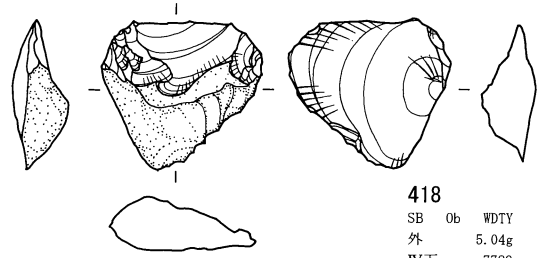

418  
SB Ob WDTY  
外 5.04g  
IV下 7789

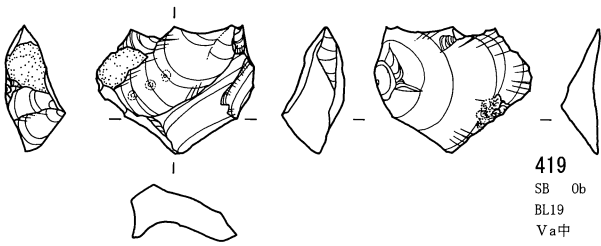

419  
SB Ob WDTY  
BL19 3.98g  
Va中 2776

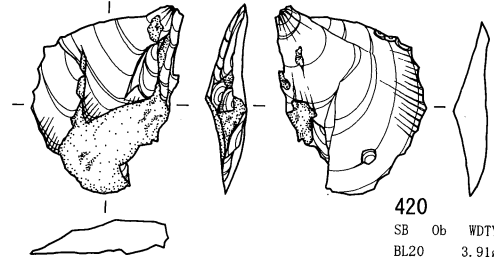

420  
SB Ob WDTY  
BL20 3.91g  
III下 119

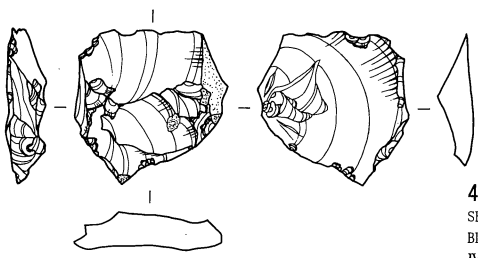

421  
SB Ob WDTY  
BL9 3.82g  
IV下 7385

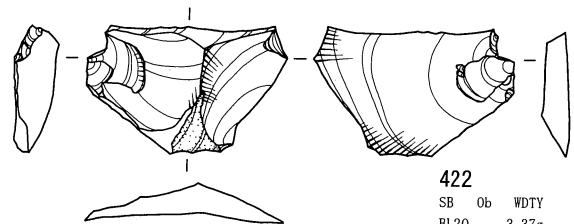

422  
SB Ob WDTY  
BL20 3.37g  
Va上面 1246

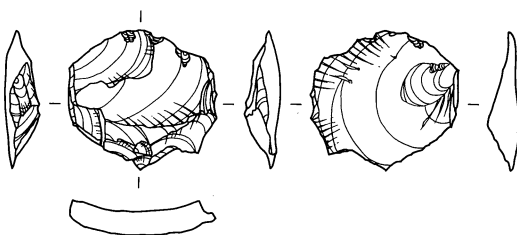

423  
SB Ob WDTY  
BL11 3.33g  
IV中 620

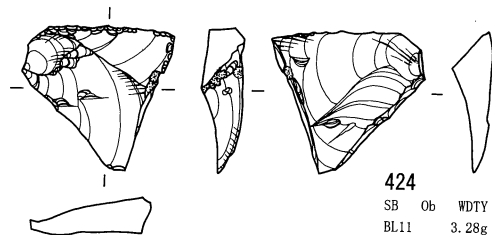

424  
SB Ob WDTY  
BL11 3.28g  
Va下 3899

0 (3:4) 5 cm

日向林 I 石器文化 石器実測図66 (貝殻状刃器14)

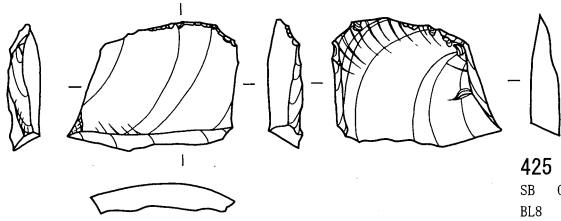

425  
SB Ob WDTY  
BL8 3.16g  
IV中 7194

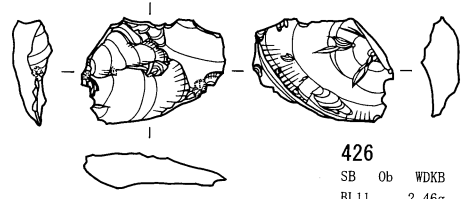

426  
SB Ob WDKB  
BL11 2.46g  
Va下 3869

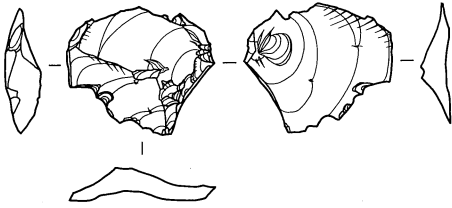

427  
SB Ob TSTY  
BL18 2.38g  
Vb下 6800

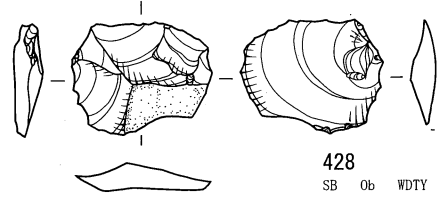

428  
SB Ob WDTY  
BL10 1.92g  
Va下 8383

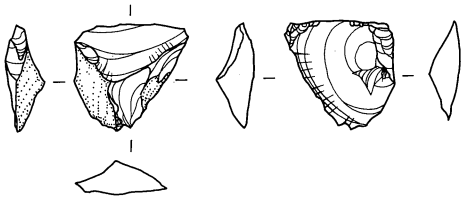

429  
SB Ob WDTY  
BL27 1.84g  
Vb上 8902

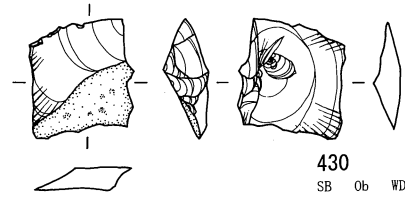

430  
SB Ob WDTK  
BL22 1.83g  
IV中 8961

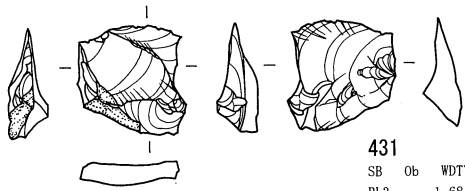

431  
SB Ob WDTY  
BL3 1.68g  
Vb中 5623

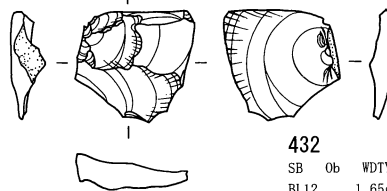

432  
SB Ob WDTY  
BL12 1.65g  
Va下 2120

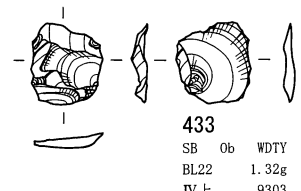

433  
SB Ob WDTY  
BL22 1.32g  
IV上 9303

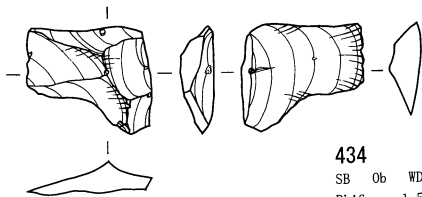

434  
SB Ob WDKB  
BL16 1.59g  
Vb中 6052

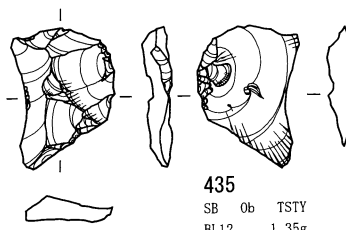

435  
SB Ob TSTY  
BL12 1.35g  
III下 239

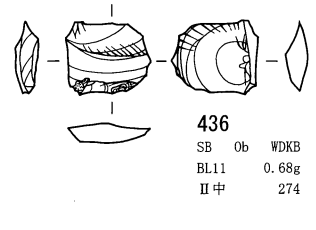

436  
SB Ob WDKB  
BL11 0.68g  
II中 274

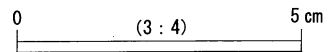

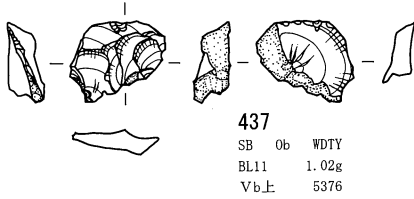

437  
SB Ob WDTY  
BL11 1.02g  
Vb上 5376

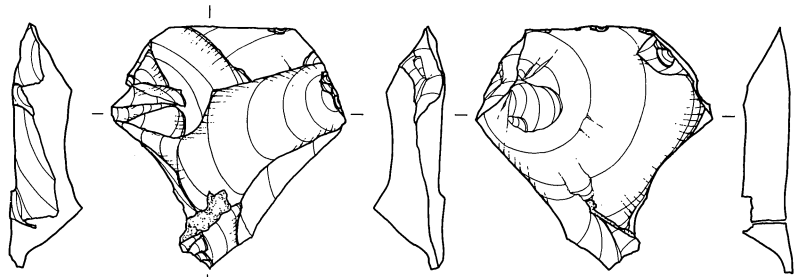

440  
SB Ag  
BL26 15.72g  
IV下 7657

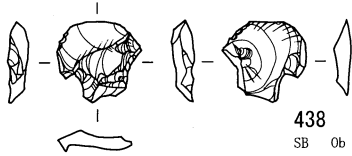

438  
SB Ob WDTY  
BL23 0.6g  
Va中 9434

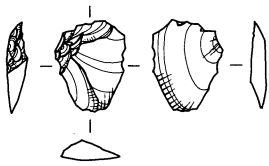

439  
SB Ob SWHD  
BL11 0.49g  
Vb中 5763

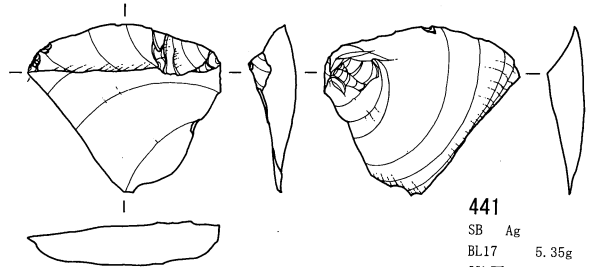

441  
SB Ag  
BL17 5.35g  
Vb下 6458

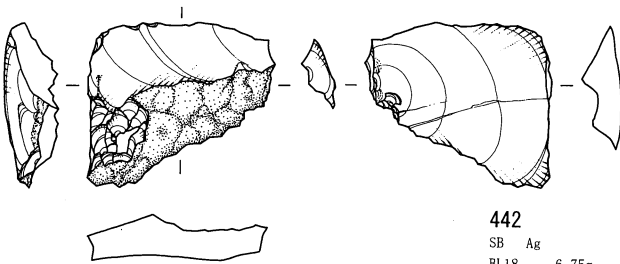

442  
SB Ag  
BL18 6.75g  
Vb上面 4064

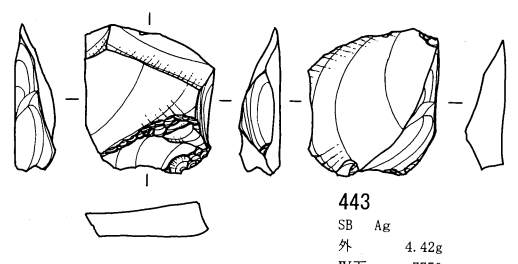

443  
SB Ag  
外 4.42g  
IV下 7750

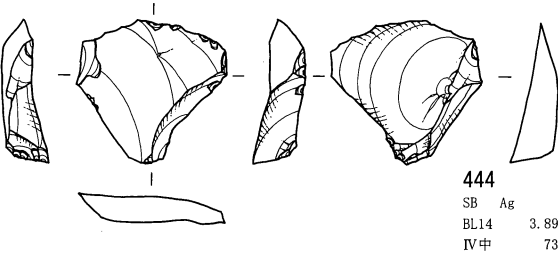

444  
SB Ag  
BL14 3.89g  
IV中 736

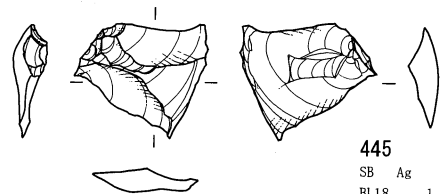

445  
SB Ag  
BL18 1.91g  
IV中 1002

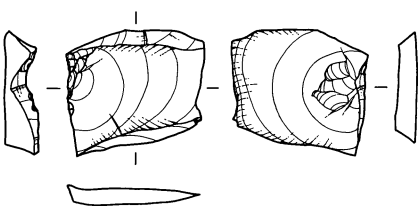

446  
SB Ag  
BL16 2.89g  
Vb中 4941

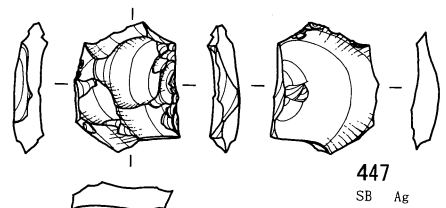

447  
SB Ag  
BL9 2.05g  
IV下 7726

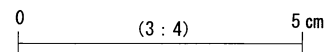

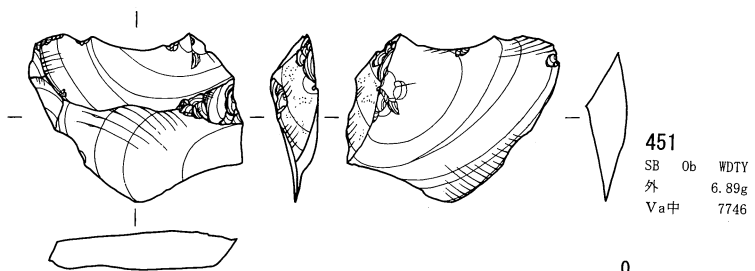
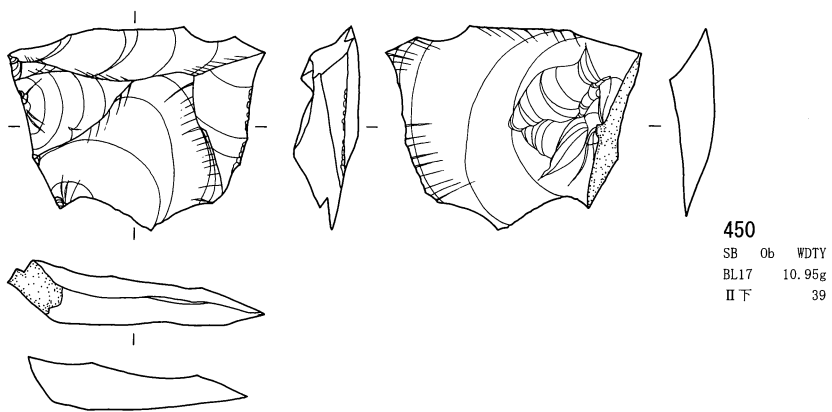
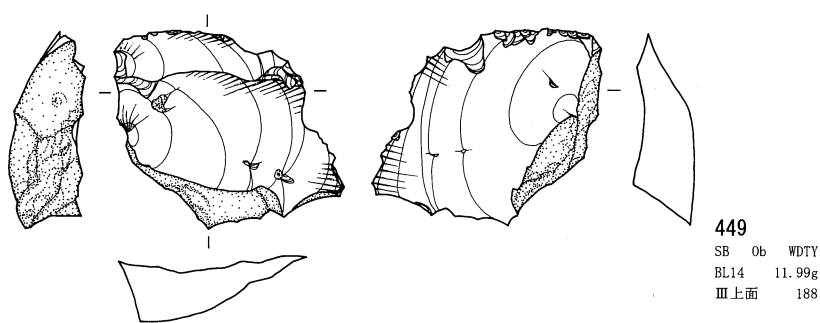
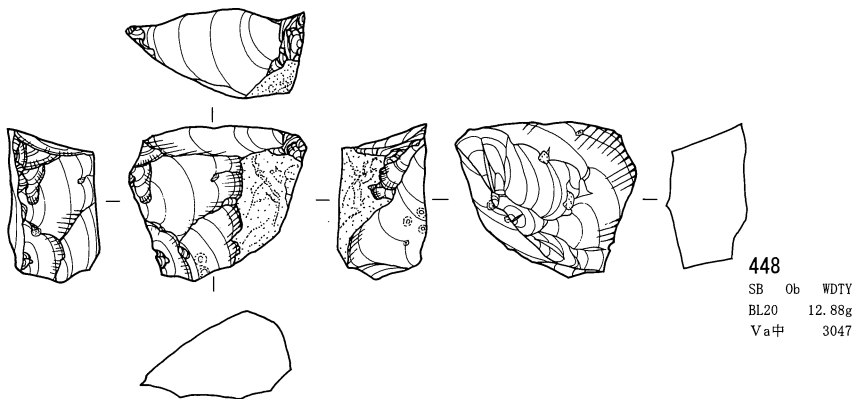

0 (3:4) 5 cm

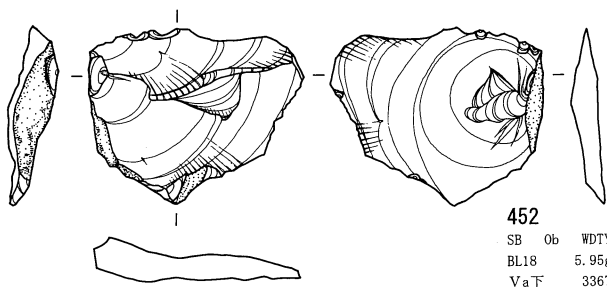

452  
SB Ob WDTY  
BL18 5.95g  
Va下 3367

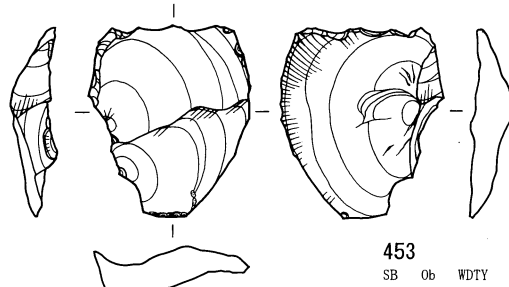

453  
SB Ob WDTY  
BL20 5.01g  
Vb下 6657

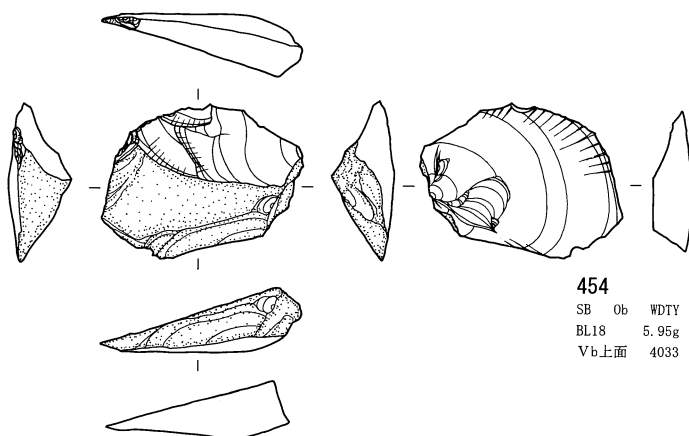

454  
SB Ob WDTY  
BL18 5.95g  
Vb上面 4033

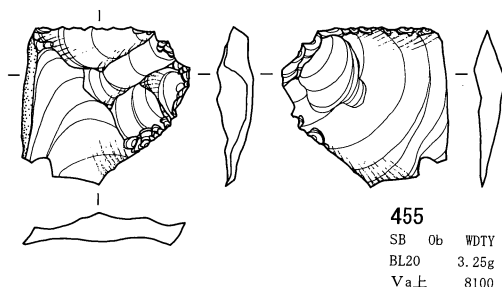

455  
SB Ob WDTY  
BL20 3.25g  
Va上 8100

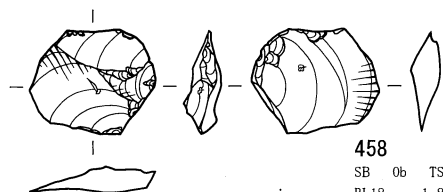

458  
SB Ob TSTY  
BL18 1.89g  
Vb下 6796

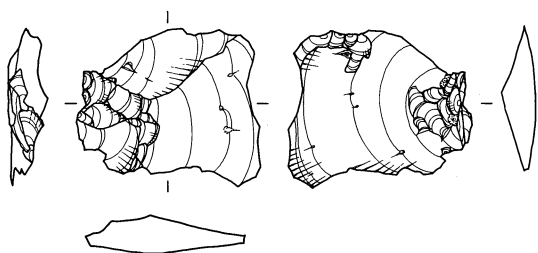

456  
SB Ob WDKB  
BL11 4.19g  
III下 273

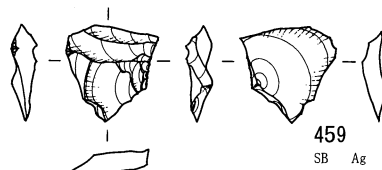

459  
SB Ag  
BL25 0.87g  
Va上面 7685

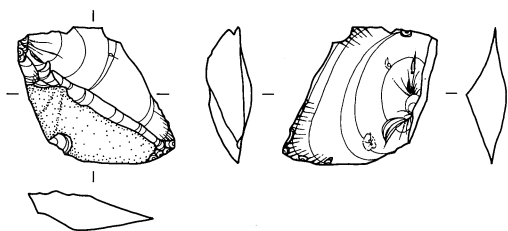

457  
SB Ob WDTY  
BL17 3.63g  
Vb上 4212

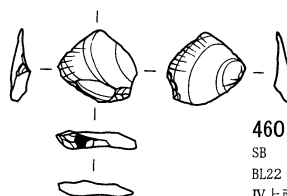

460  
SB Ob WDTY  
BL22 0.35g  
IV上面 9059

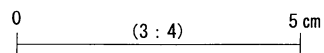

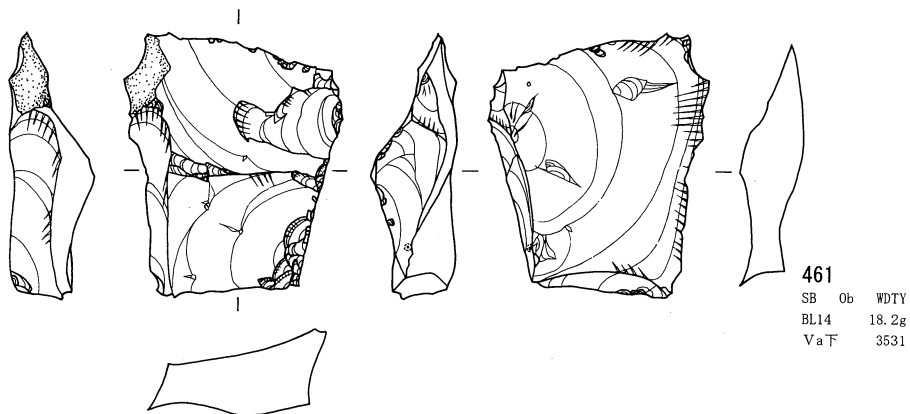

461  
SB Ob WDTY  
BL14 18.2g  
Va下 3531

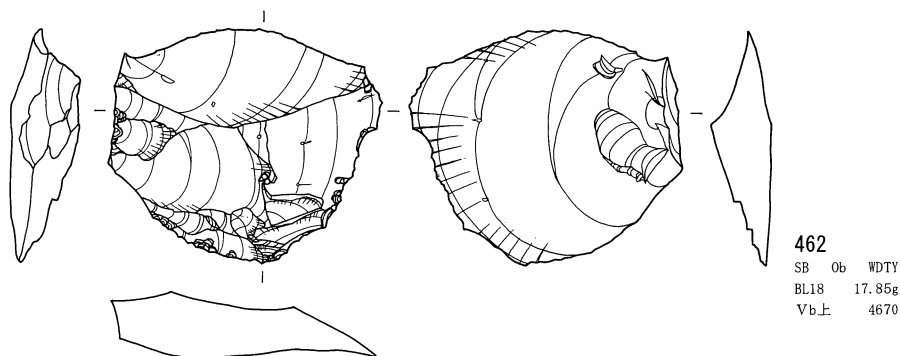

462  
SB Ob WDTY  
BL18 17.85g  
Vb上 4670

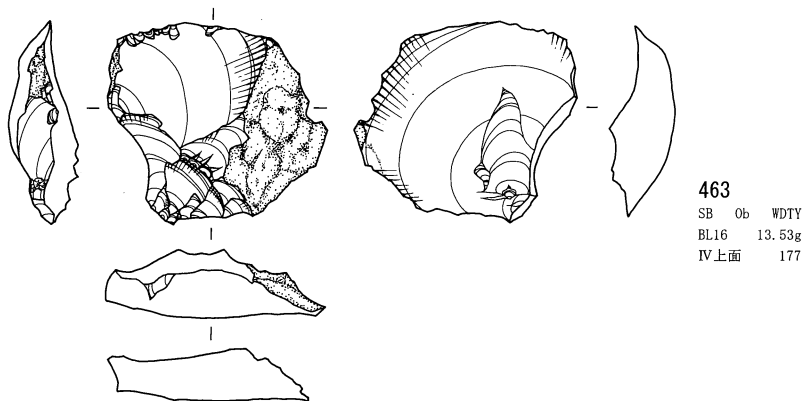

463  
SB Ob WDTY  
BL16 13.53g  
IV上面 177

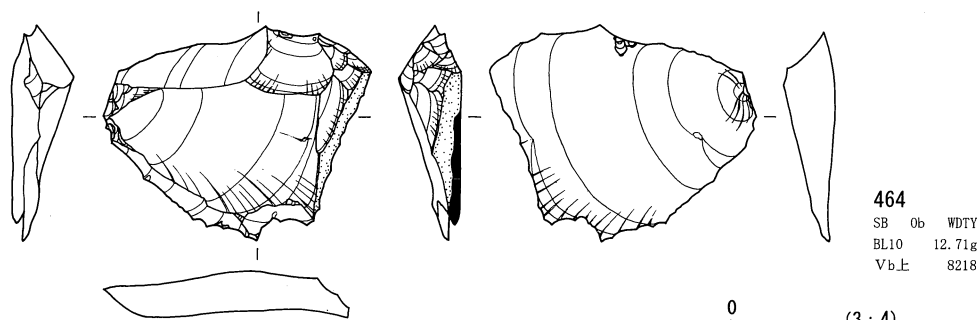

464  
SB Ob WDTY  
BL10 12.71g  
Vb上 8218

0 (3:4) 5 cm

日向林 I 石器文化 石器実測図71 (貝殻状刃器19)

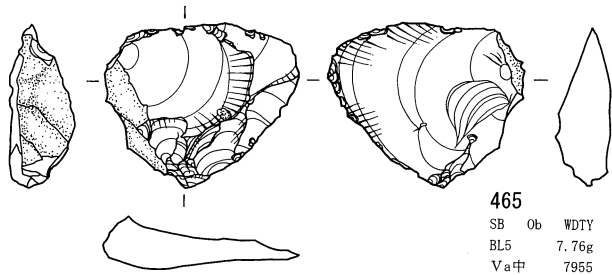

465  
SB Ob WDTY  
BL5 7.76g  
Va中 7955

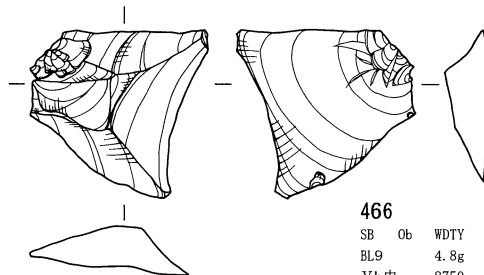

466  
SB Ob WDTY  
BL9 4.8g  
Vb中 8750

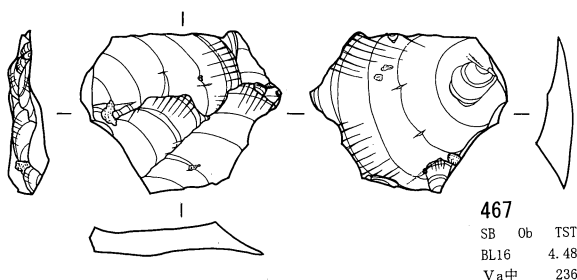

467  
SB Ob TSTY  
BL16 4.48g  
Va中 2363

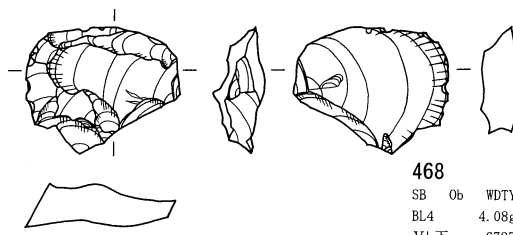

468  
SB Ob WDTY  
BL4 4.08g  
Vb下 6727

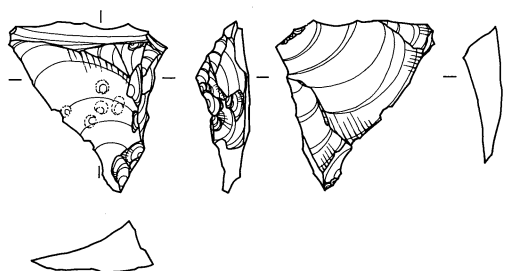

469  
SB Ob TSTY  
BL20 3.62g  
Va下 3077

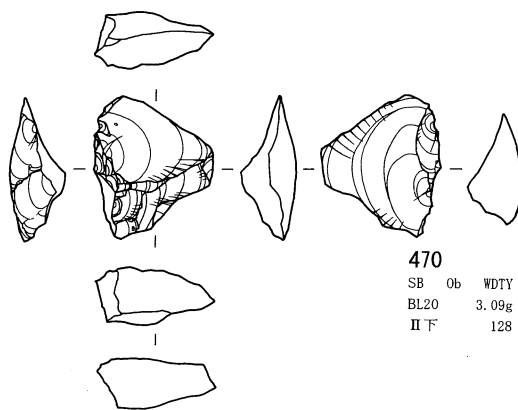

470  
SB Ob WDTY  
BL20 3.09g  
II下 128

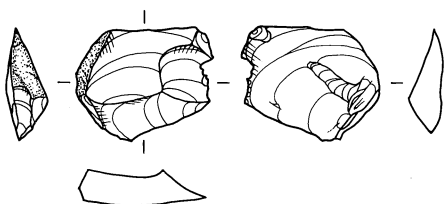

471  
SB Ob WDTY  
BL1 2.69g  
Va下 3760

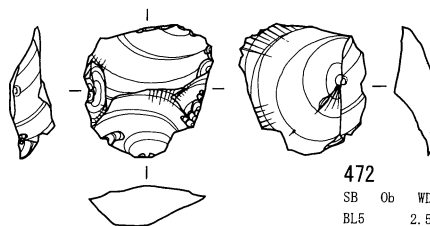

472  
SB Ob WDTY  
BL5 2.58g  
IV上 398

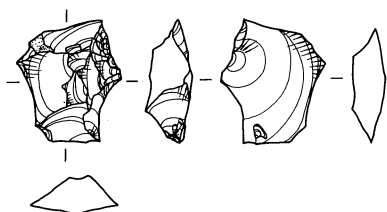

473  
SB Ob WDTY  
BL5 2.18g  
IV中 7319

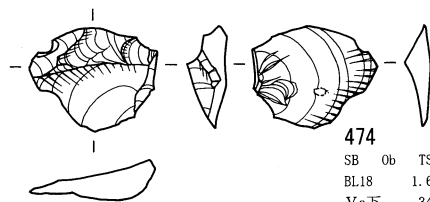

474  
SB Ob TSTY  
BL18 1.68g  
Va下 3402

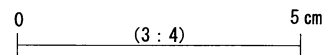



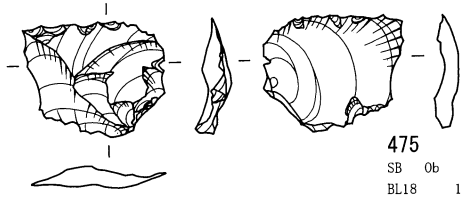

475  
SB Ob WDTY  
BL18 1.64g  
Vb下 6797

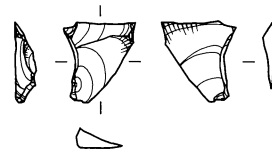

476  
SB Ob WDTY  
BL22 0.32g  
Vb上 9238

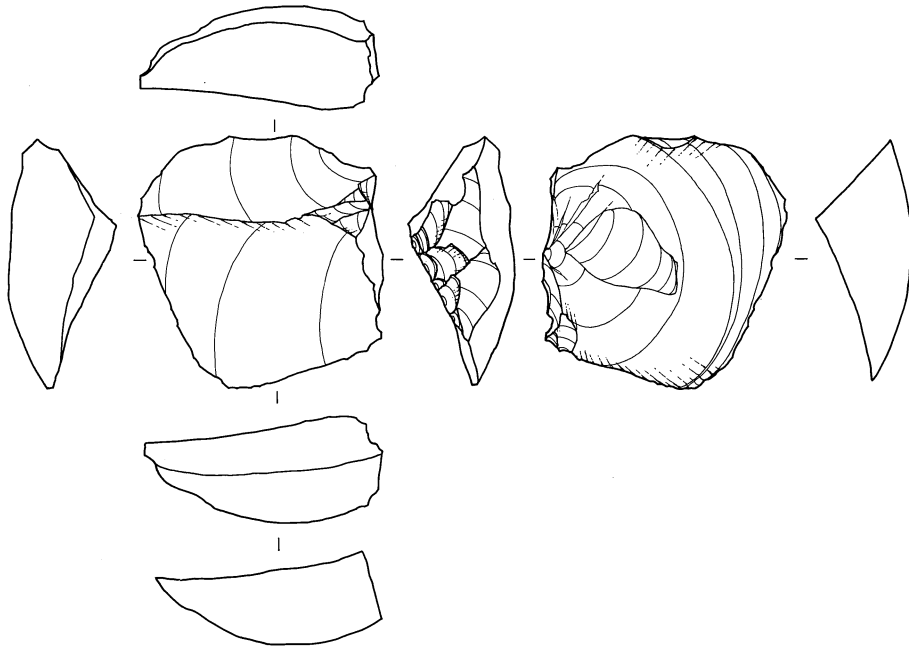

477  
SB Ag  
BL26 23.58g  
Va上面 7679

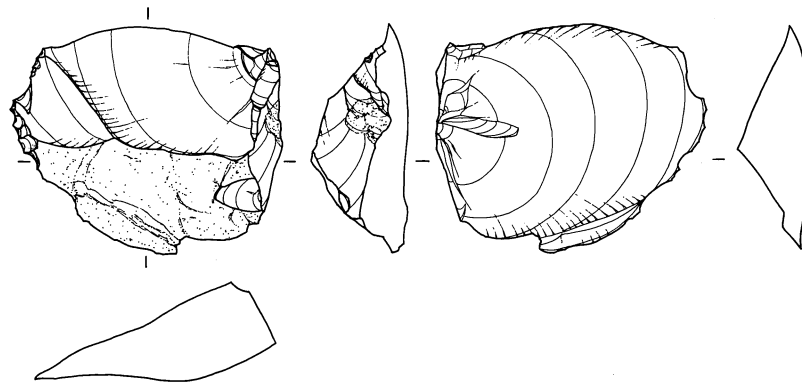

478  
SB Ag  
BL19 22.78g  
Vb上 5108

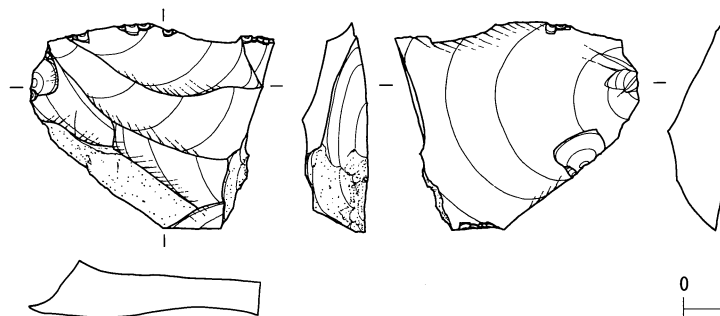

479  
SB Ag  
BL10 16.97g  
Va上面 7707

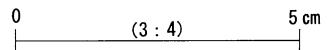

日向林 I 石器文化 石器実測図73 (貝殻状刃器21)

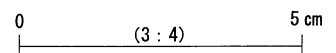
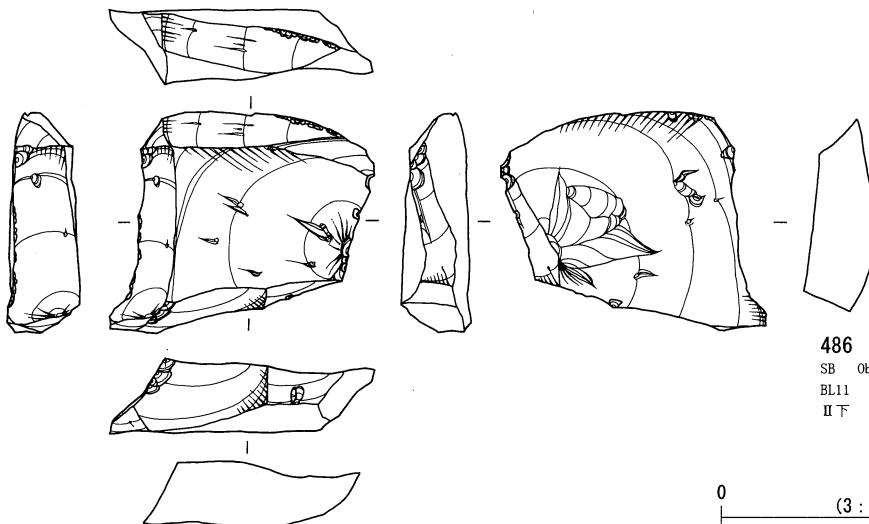
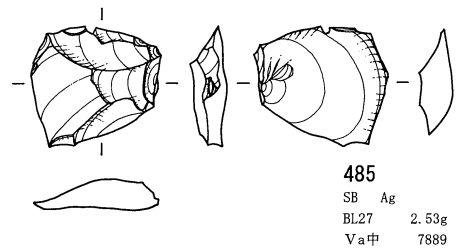
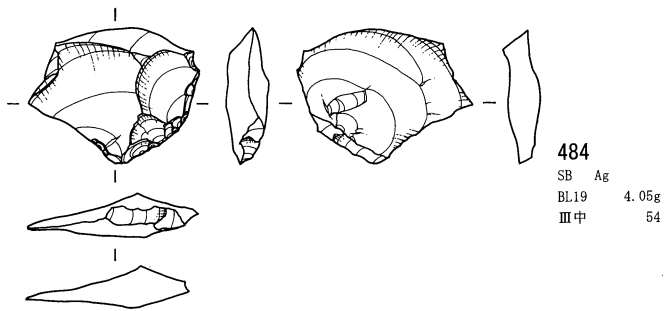
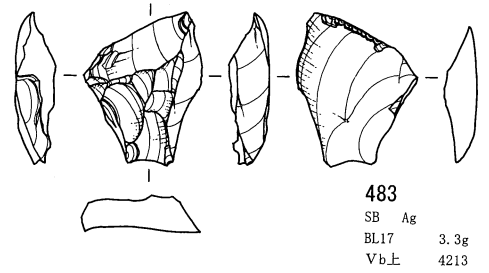
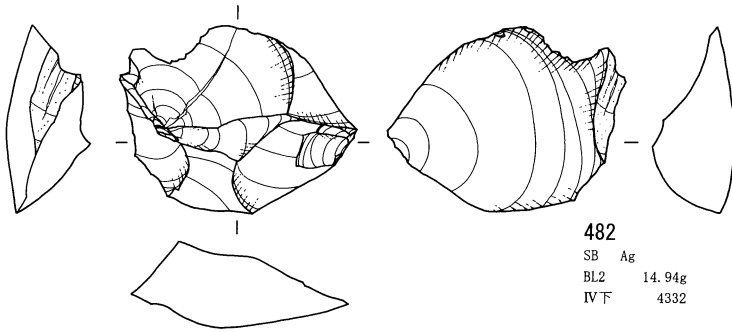
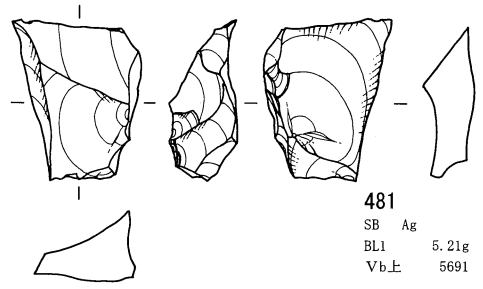
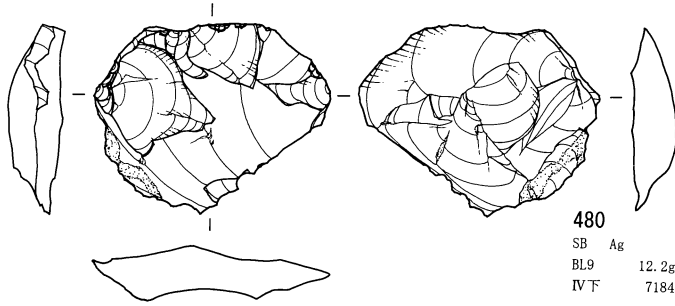

日向林 I 石器文化 石器実測図74 (貝殻状刃器22)

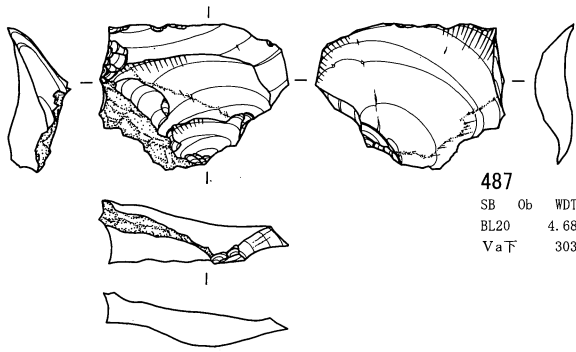

487  
SB Ob WDTY  
BL20 4.68g  
Va下 3039

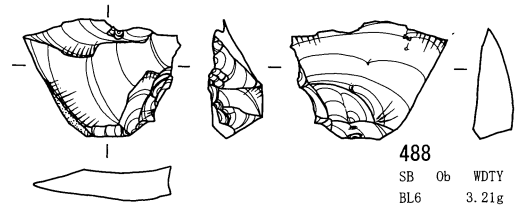

488  
SB Ob WDTY  
BL6 3.21g  
攪乱 7050

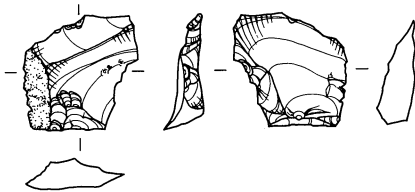

489  
SB Ob WDTY  
BL18 2.12g  
II中 498

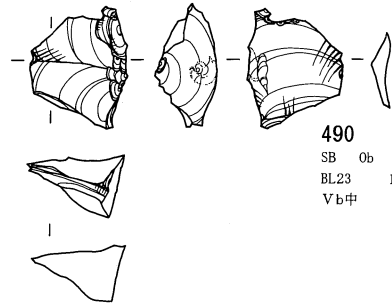

490  
SB Ob WDTY  
BL23 1.91g  
Vb中 9443

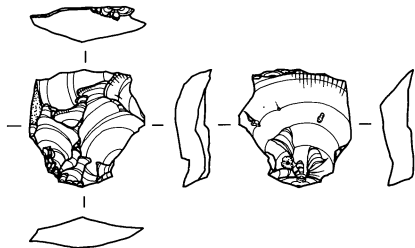

491  
SB Ob WDTY  
BL22 1.89g  
Vb中 9473

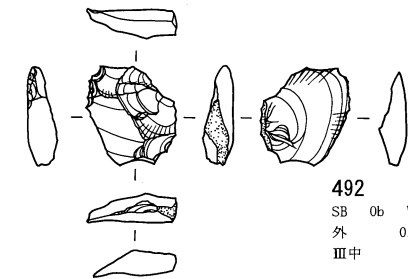

492  
SB Ob WDTY  
外 0.96g  
III中 327

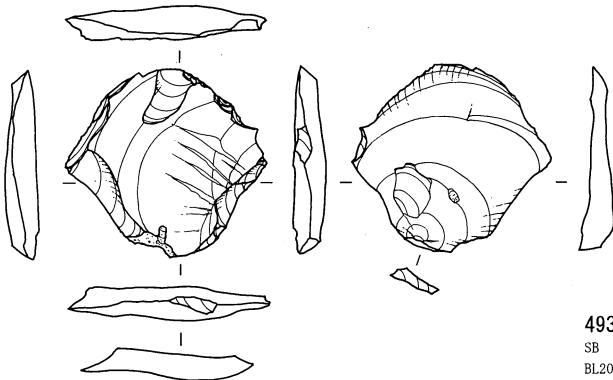

493  
SB Ag  
BL20 5.06g  
II下 97

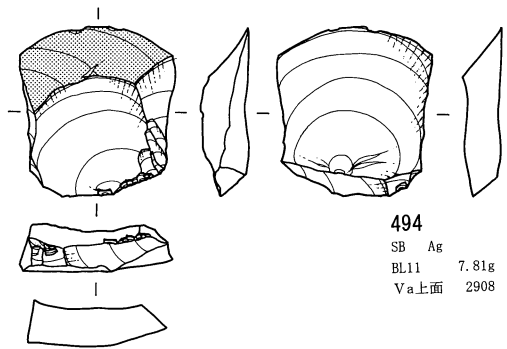

494  
SB Ag  
BL11 7.81g  
Va上面 2908

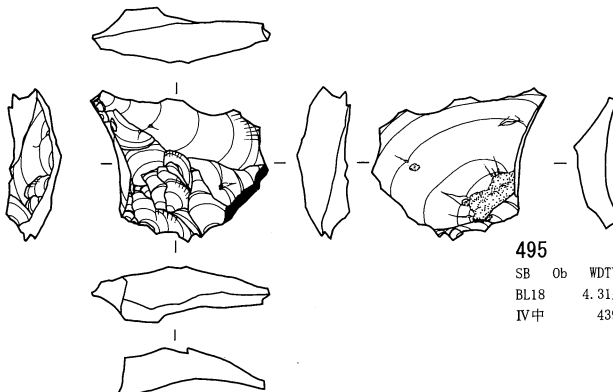

495  
SB Ob WDTY  
BL18 4.31g  
IV中 439

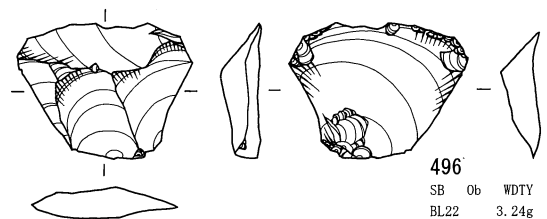

496  
SB Ob WDTY  
BL22 3.24g  
Vb下 9297

0 (3:4) 5 cm

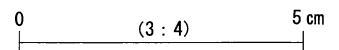
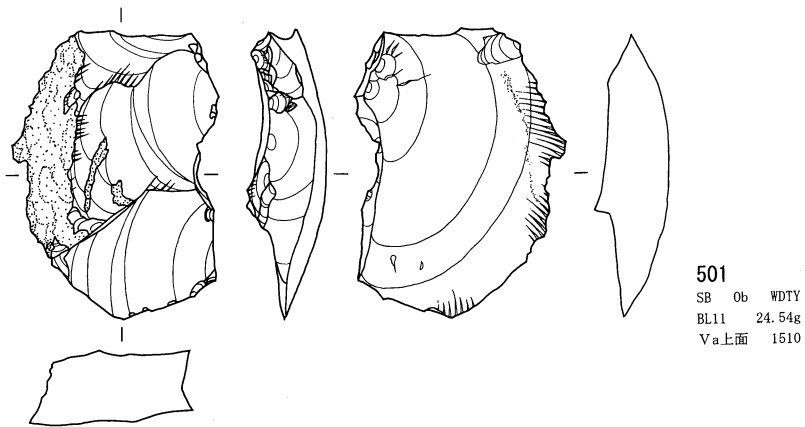
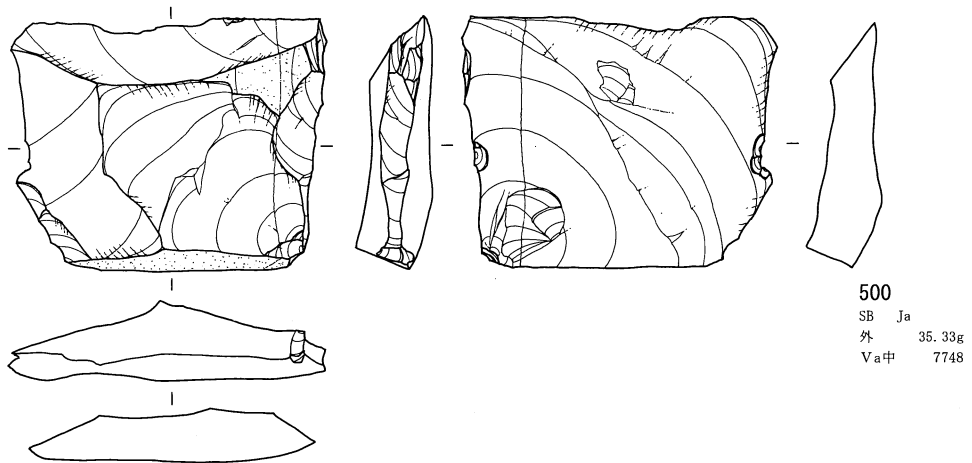
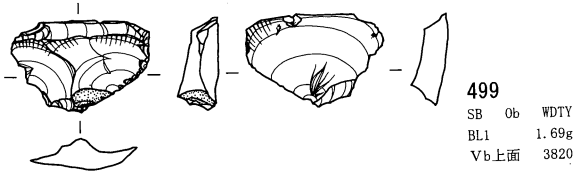
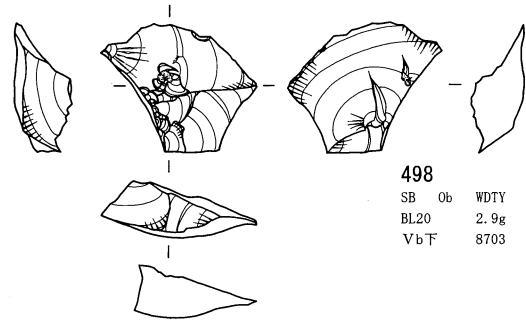
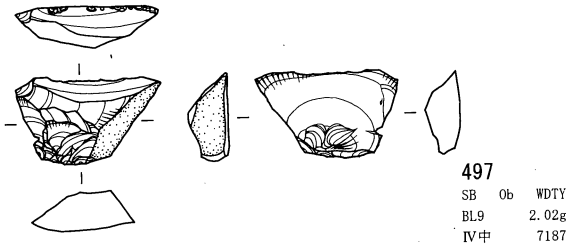

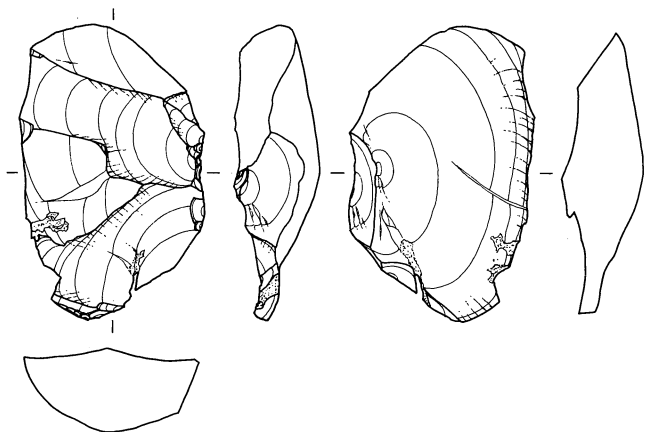

502  
SB Ag  
BL28 22.33g  
Va上面 7692

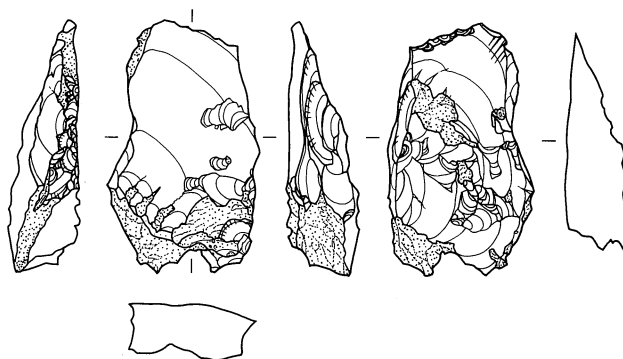

503  
SB Ob WDKB  
BL6 13.02g  
Va上 7751

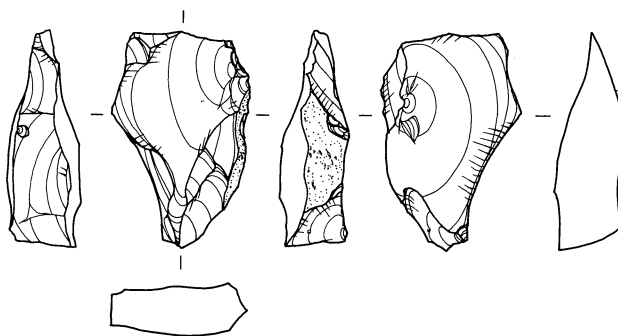

504  
SB Ob  
BL16 9.54g  
Va下 2366

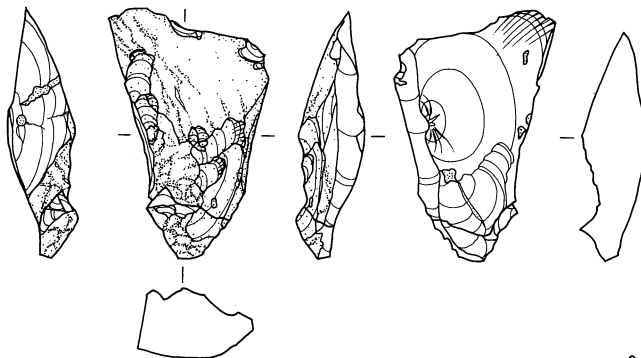

505  
SB Ob WDTY  
BL17 11.42g  
Vb中 4851

0 (3:4) 5 cm

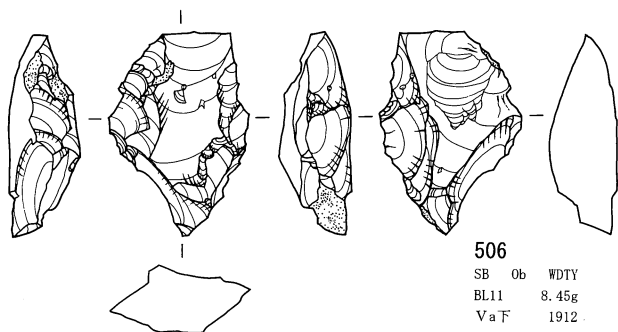

506  
SB Ob WDTY  
BL11 8.45g  
Va下 1912

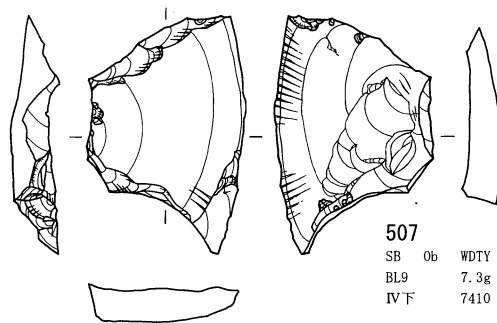

507  
SB Ob WDTY  
BL9 7.3g  
IV下 7410

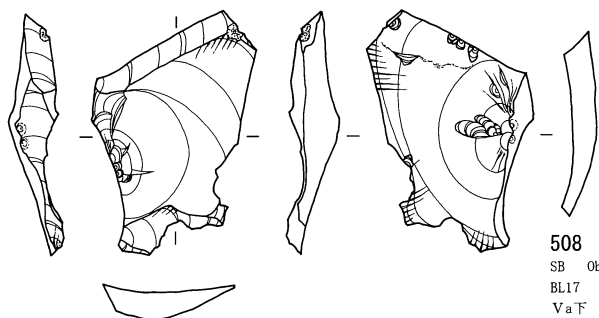

508  
SB Ob WDTY  
BL17 5.3g  
Va下 4134

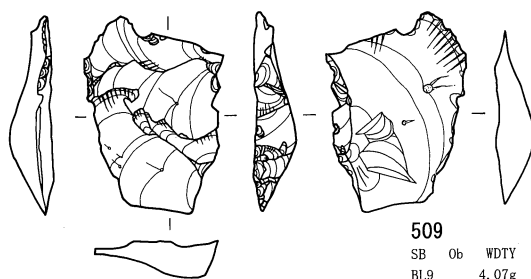

509  
SB Ob WDTY  
BL9 4.07g  
Vb中 8709

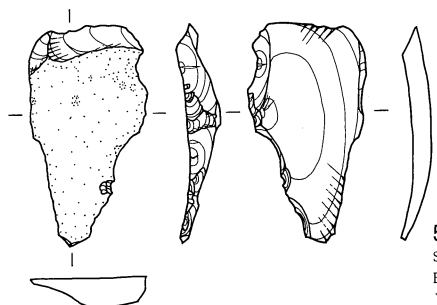

510  
SB Ob WDTY  
BL23 3.6g  
Vb中 9458

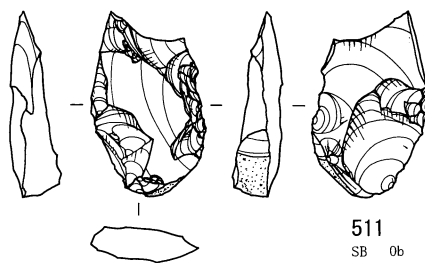

511  
SB Ob WDTY  
BL12 4.32g  
IV下 759

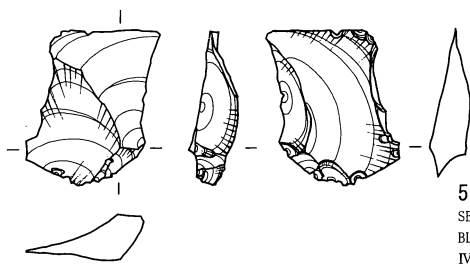

512  
SB Ob WDTY  
BL20 3.07g  
IV上 1152

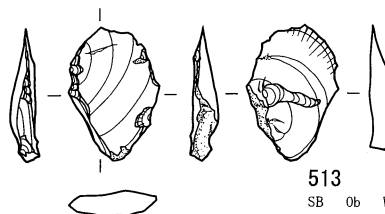

513  
SB Ob WDTY  
BL17 1.44g  
Vb下 6530

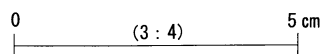

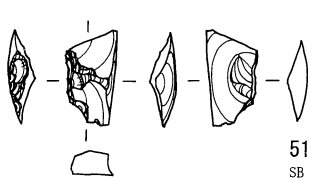

514  
SB Ob WDTY  
BL17 0.53g  
Vb中 4650

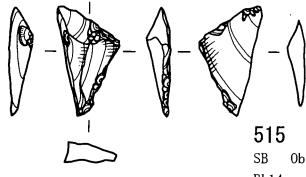

515  
SB Ob WDTY  
BL14 0.55g  
Va下 3691



516  
SB Ob WDTY  
BL22 0.43g  
Vb下 9325

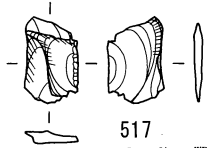

517  
SB Ob WDTY  
BL18 0.2g  
Va上 3313

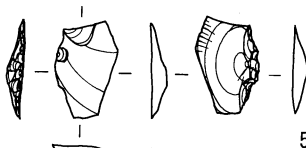

518  
SB Ob WDTY  
BL1 0.43g  
Vb中 6134

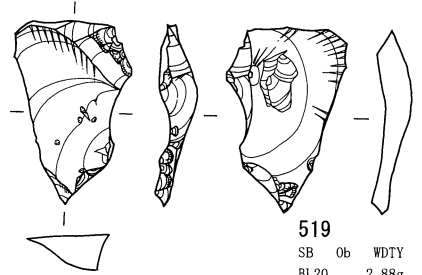

519  
SB Ob WDTY  
BL20 2.88g  
Vb下 6673

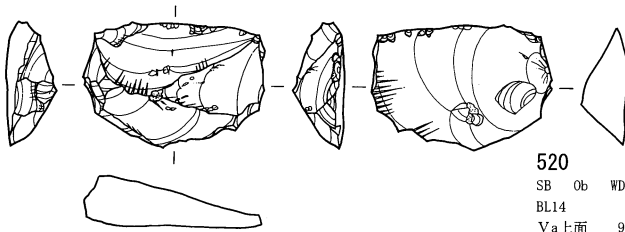

520  
SB Ob WDTY  
BL14 6g  
Va上面 952

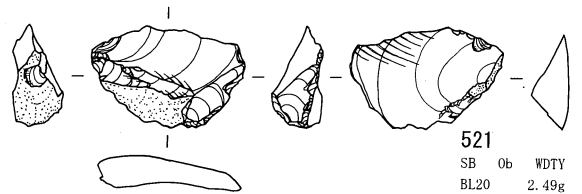

521  
SB Ob WDTY  
BL20 2.49g  
Va下 4290

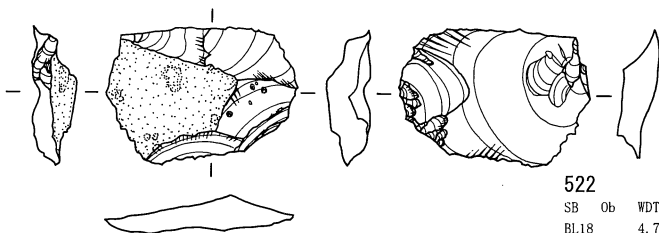

522  
SB Ob WDTY  
BL18 4.7g  
IV上 431

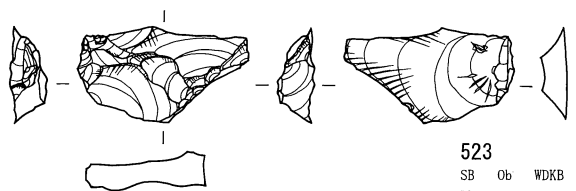

523  
SB Ob WDKB  
BL18 2.77g  
II下 465

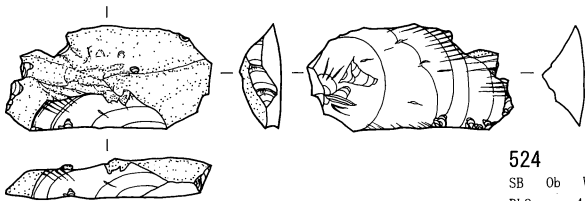

524  
SB Ob WDTY  
BL2 4.64g  
Vb中 6719

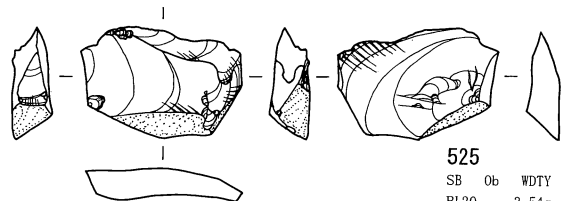

525  
SB Ob WDTY  
BL20 3.54g  
Vb中 6259

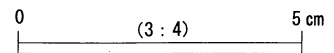

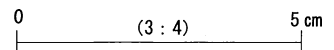
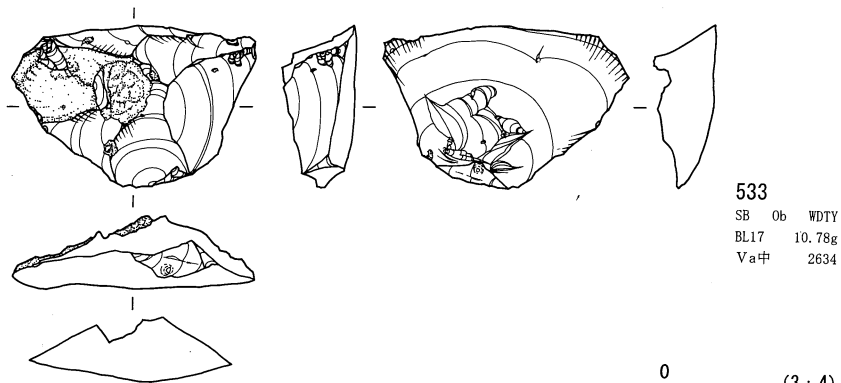
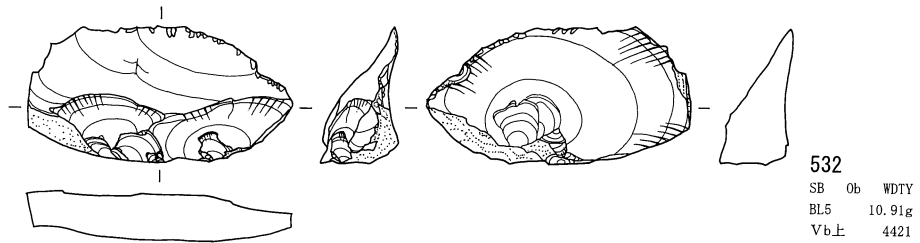
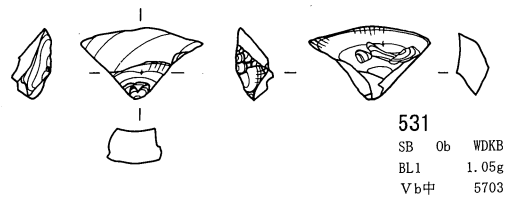
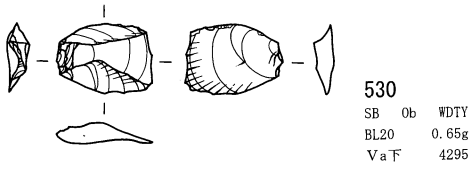
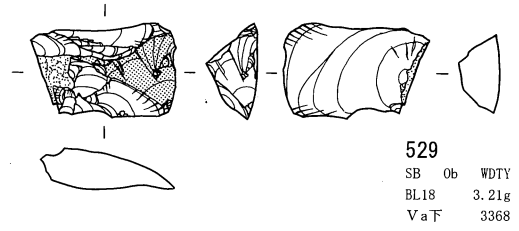
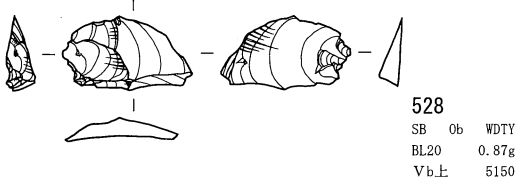
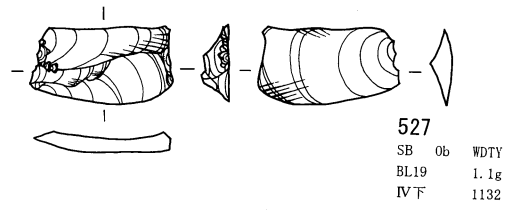
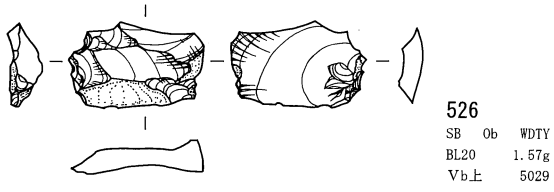



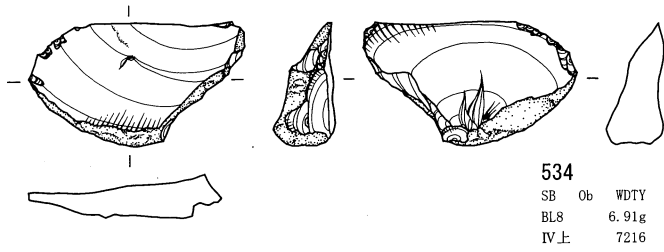

534  
SB Ob WDTY  
BL8 6.91g  
IV上 7216

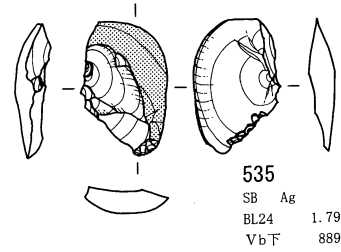

535  
SB Ag  
BL24 1.79g  
Vb下 8891

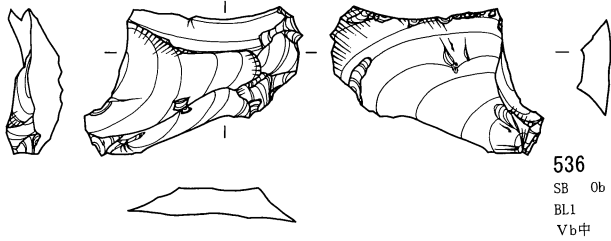

536  
SB Ob WDTY  
BL1 5.12g  
Vb中 4562

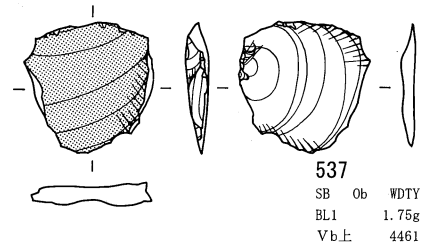

537  
SB Ob WDTY  
BL1 1.75g  
Vb上 4461

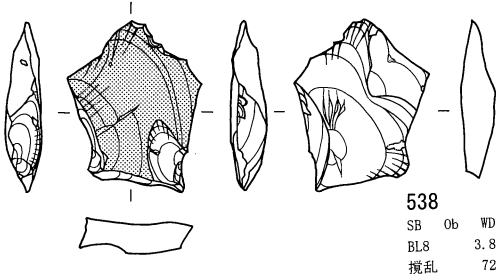

538  
SB Ob WDTY  
BL8 3.85g  
複乱 7256

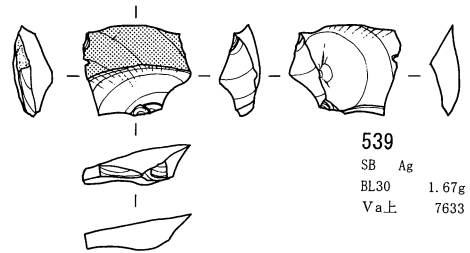

539  
SB Ag  
BL30 1.67g  
Va上 7633

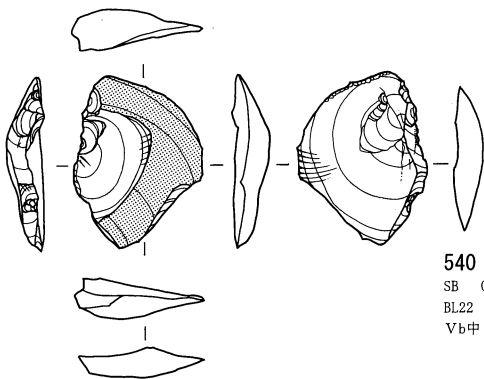

540  
SB Ob WDTY  
BL22 2.46g  
Vb中 9012

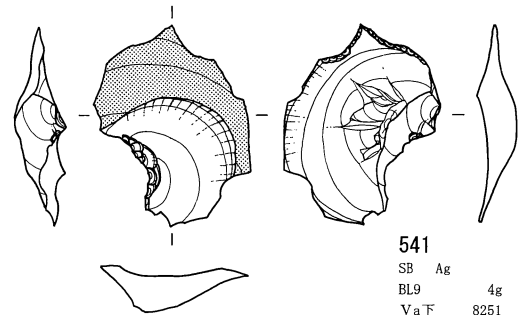

541  
SB Ag  
BL9 4g  
Va下 8251

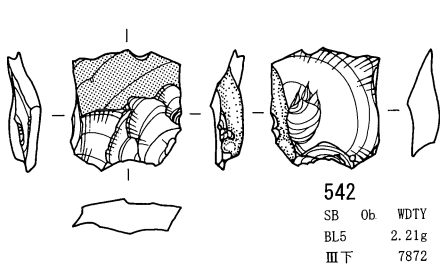

542  
SB Ob WDTY  
BL5 2.21g  
III下 7872

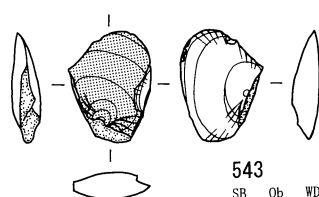

543  
SB Ob WDTY  
BL12 1.28g  
Vb上 5872

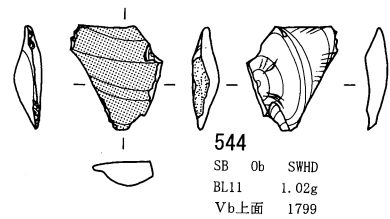

544  
SB Ob SWHD  
BL11 1.02g  
Vb上面 1799

0 (3:4) 5cm

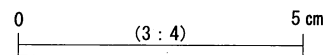
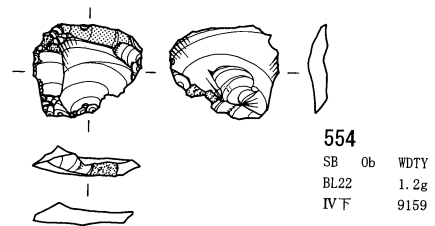
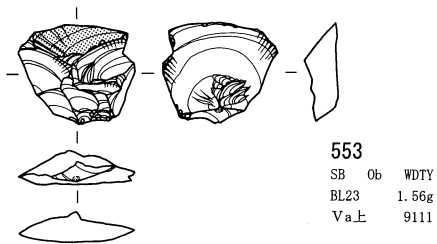
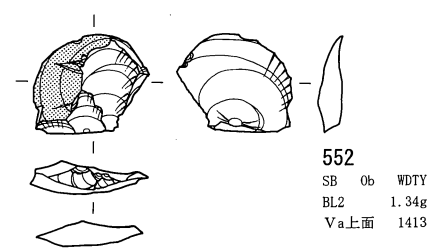
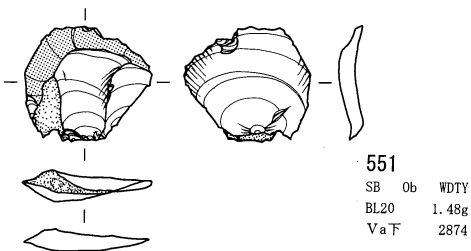
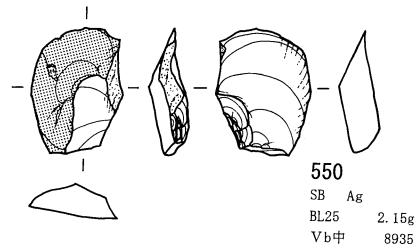
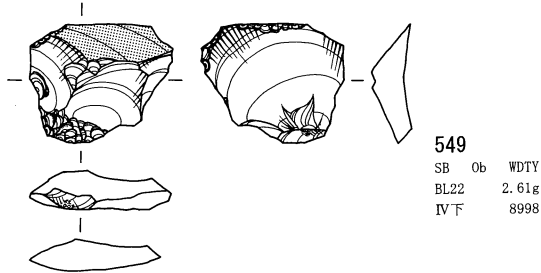
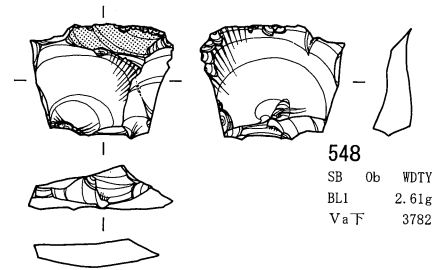
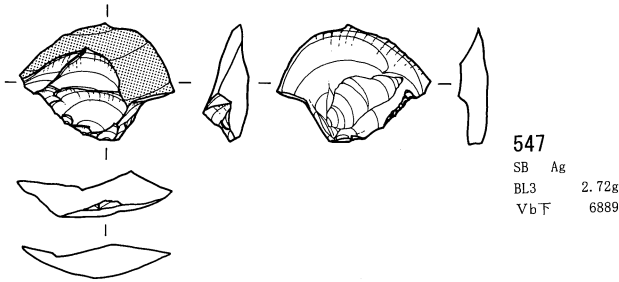
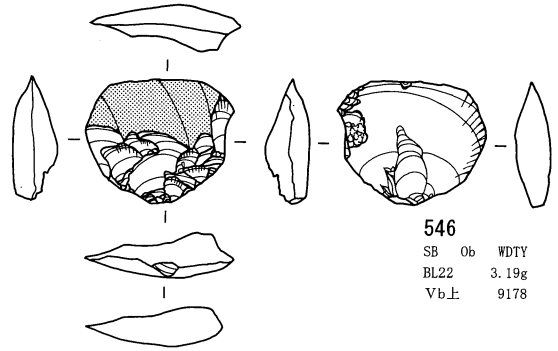
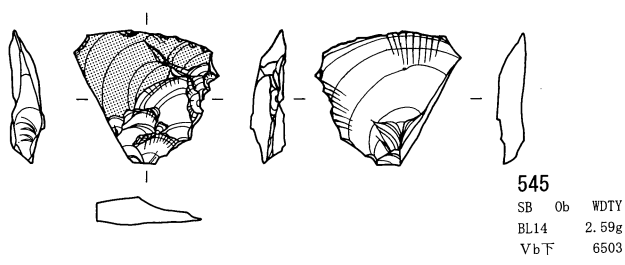

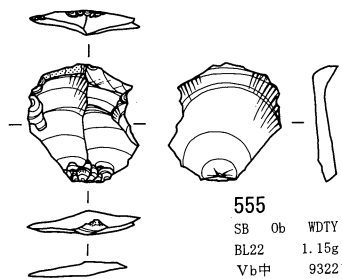

555  
SB Ob WDTY  
BL22 1.15g  
Vb中 9322

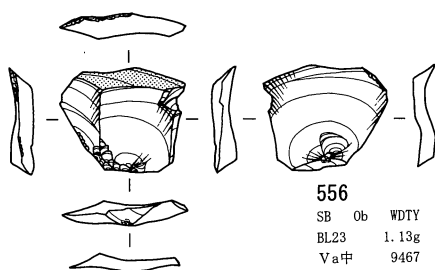

556  
SB Ob WDTY  
BL23 1.13g  
Va中 9467

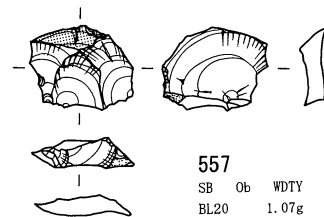

557  
SB Ob WDTY  
BL20 1.07g  
Vb下 6672

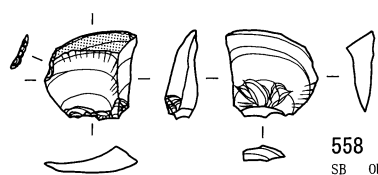

558  
SB Ob WDTY  
BL22 0.9g  
Vb下 9281

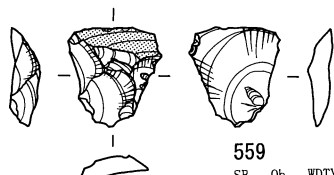

559  
SB Ob WDTY  
BL22 0.81g  
Vb中 9293

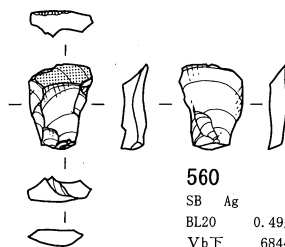

560  
SB Ag  
BL20 0.49g  
Vb下 6844

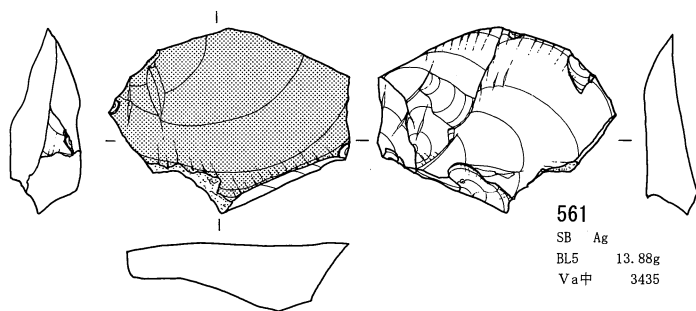

561  
SB Ag  
BL5 13.88g  
Va中 3435

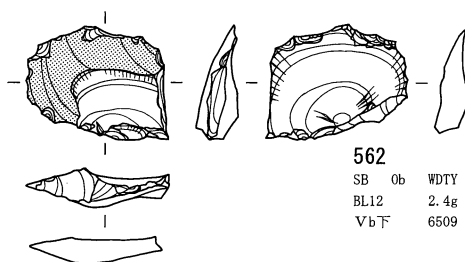

562  
SB Ob WDTY  
BL12 2.4g  
Vb下 6509

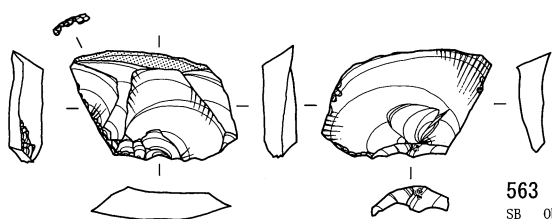

563  
SB Ob WDTY  
BL23 2.68g  
Va中 9452

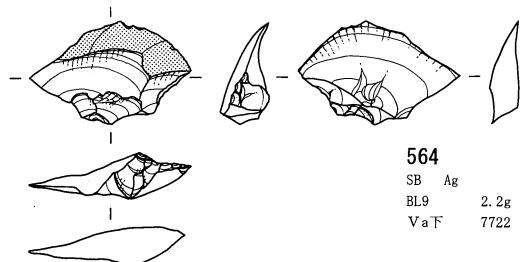

564  
SB Ag  
BL9 2.2g  
Va下 7722

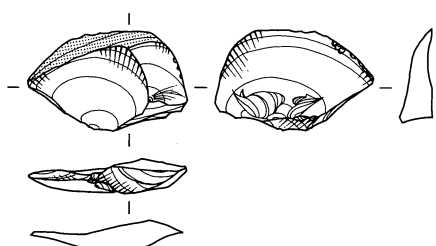

565  
SB Ob SWHD  
BL9 1.99g  
Vb上 8720

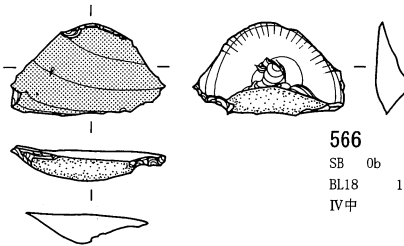

566  
SB Ob WDTY  
BL18 1.94g  
IV中 7293

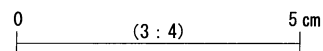

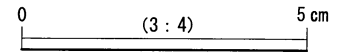
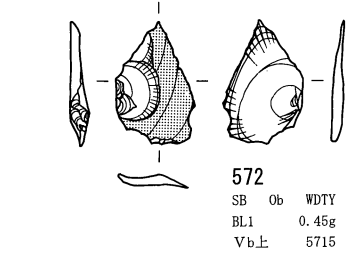
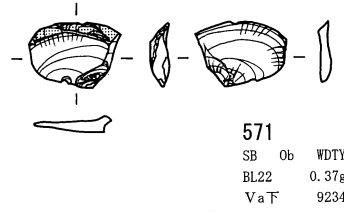
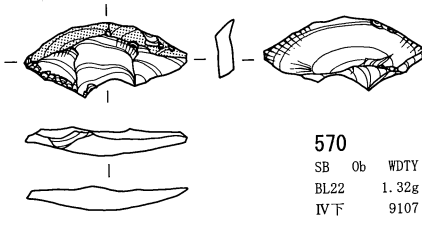
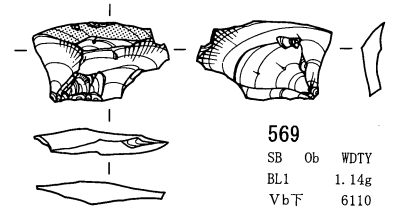
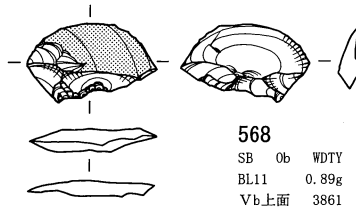
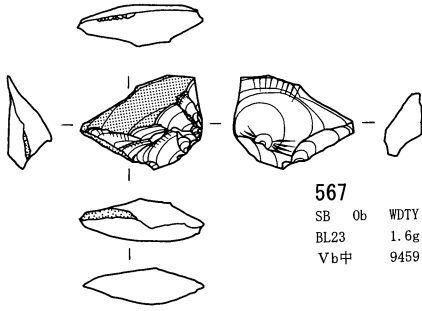

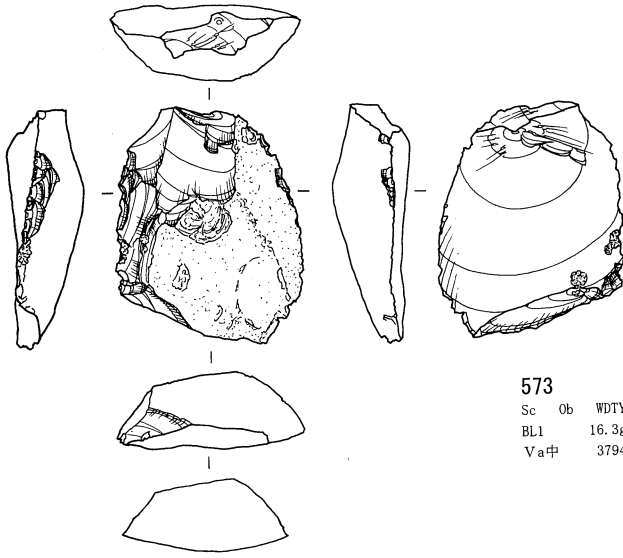

573  
 Sc Ob WDTY  
 BL1 16.3g  
 Va中 3794

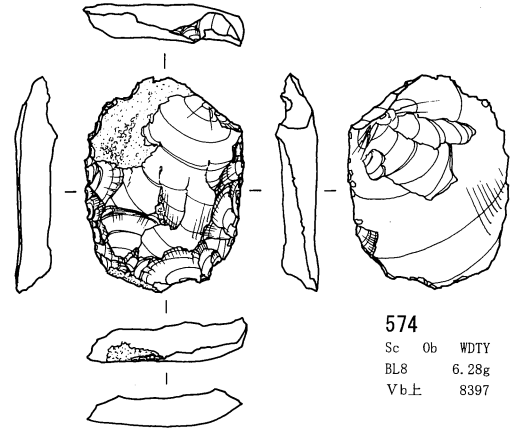

574  
 Sc Ob WDTY  
 BL8 6.28g  
 Vb上 8397

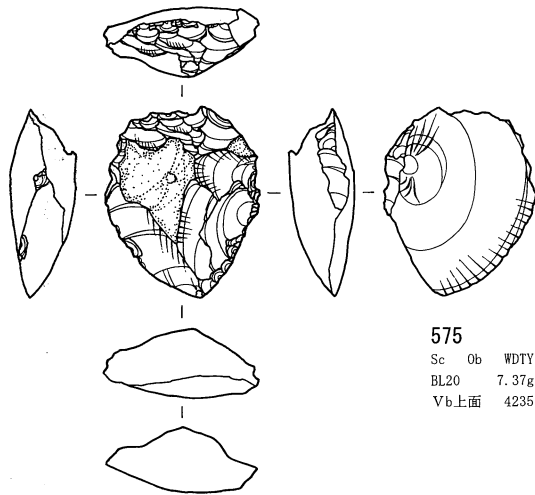

575  
 Sc Ob WDTY  
 BL20 7.37g  
 Vb上面 4235

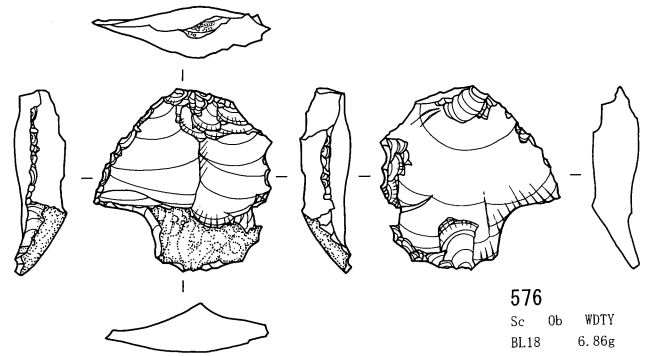

576  
 Sc Ob WDTY  
 BL18 6.86g  
 Vb上面 4032

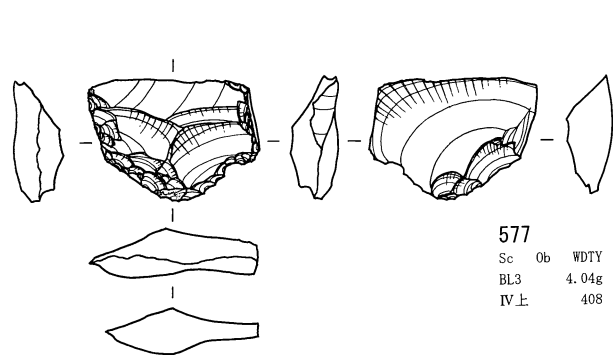

577  
 Sc Ob WDTY  
 BL3 4.04g  
 IV上 408

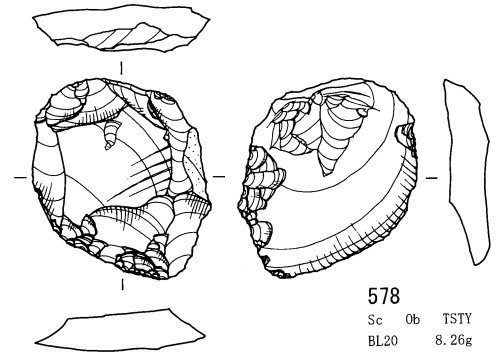

578  
 Sc Ob TSTY  
 BL20 8.26g  
 Va上面 1162

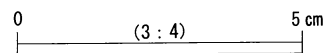

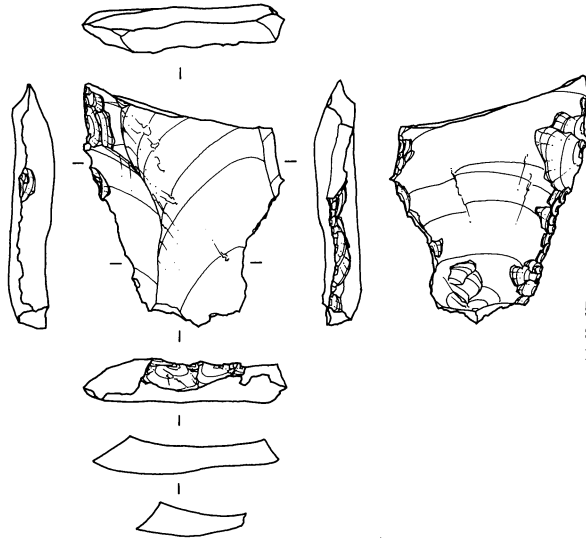

579  
 Sc Ag  
 BL30 7.88g  
 IV上 7113

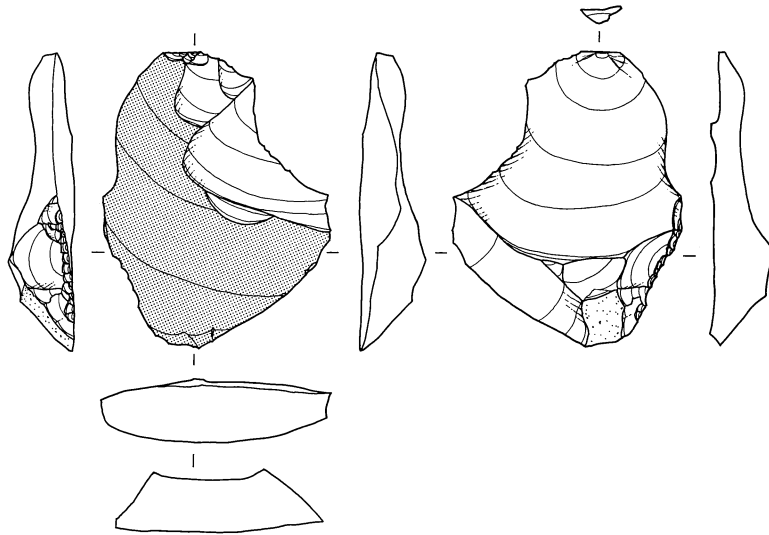

580  
 Sc SS  
 BL10 15.62g  
 Va中 8224

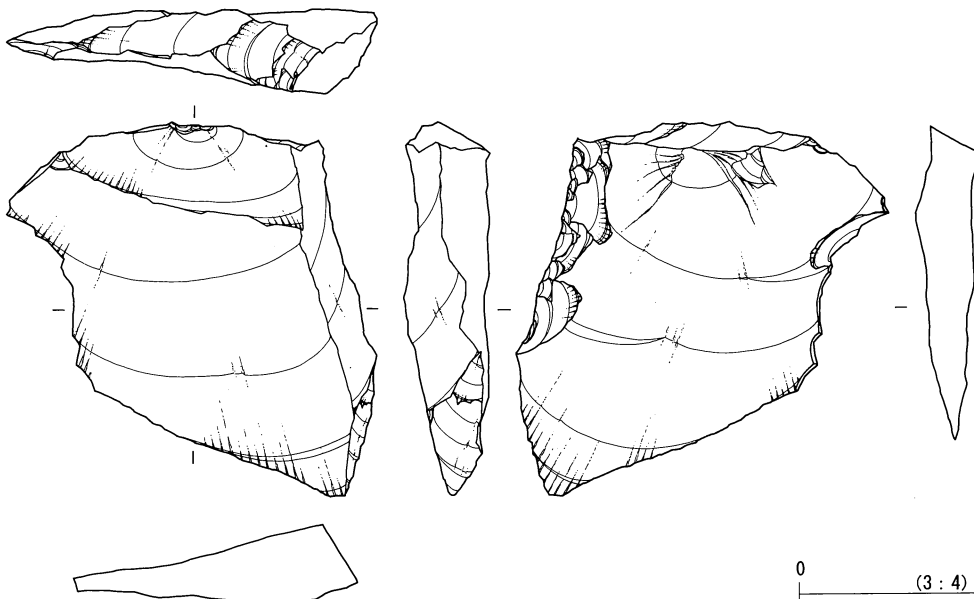

581  
 Sc Tu  
 BL26 53.33g  
 Vb中 8909

0 (3:4) 5 cm

日向林I石器文化 石器実測図86 (削器2)

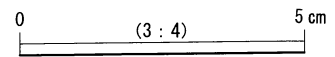
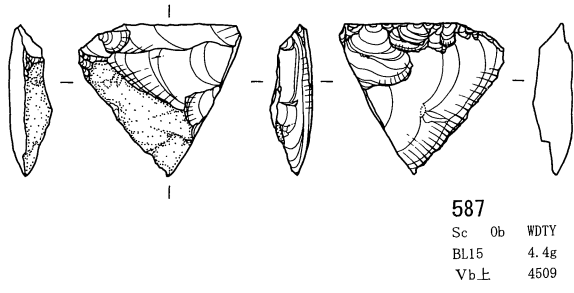
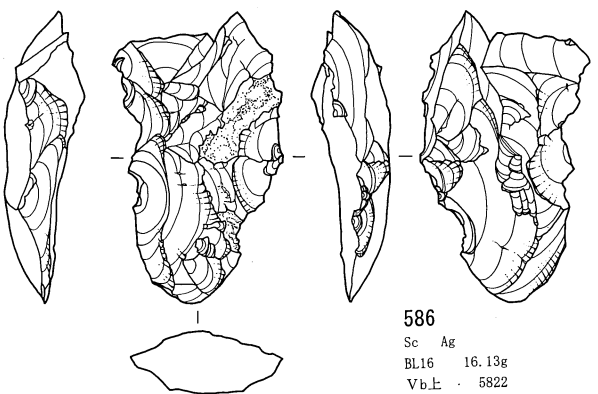
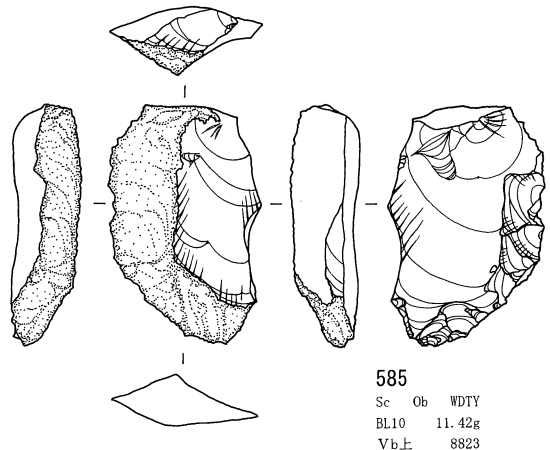
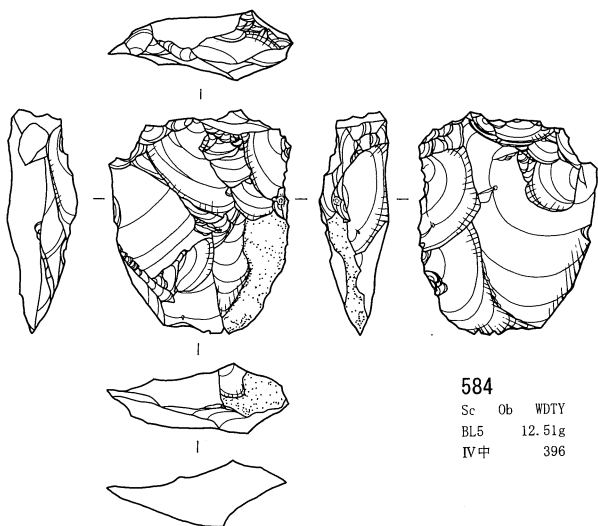
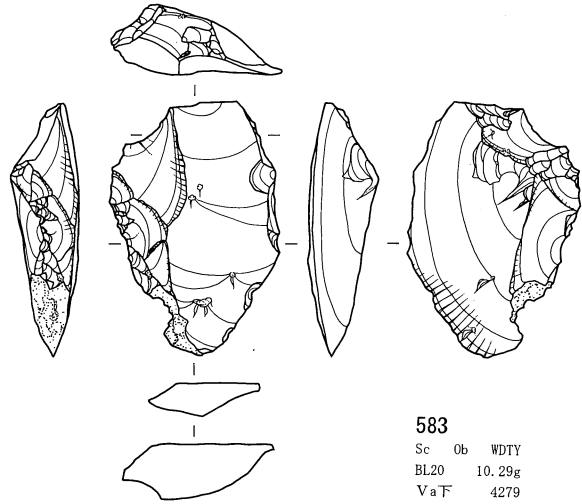
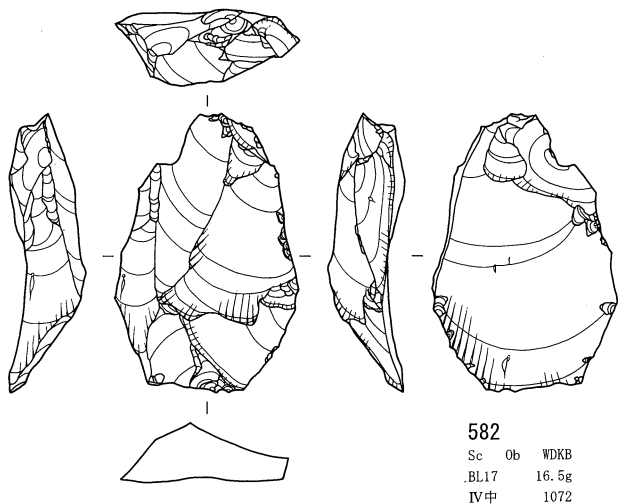

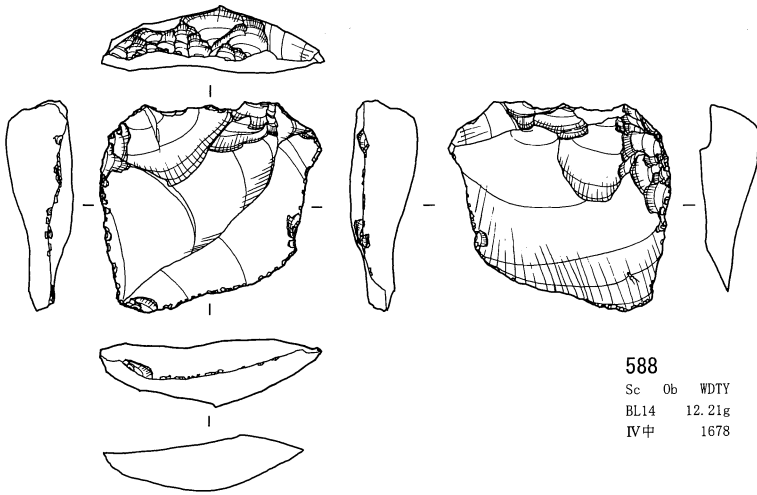

588  
Sc Ob WDTY  
BL14 12.21g  
IV中 1678

589  
Sc Ob WDTY  
BL16 4.14g  
Vb中 5835

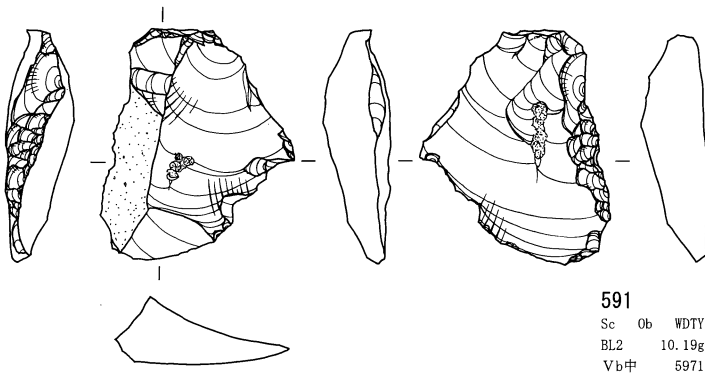

591  
Sc Ob WDTY  
BL2 10.19g  
Vb中 5971

590  
Sc Ob TSTY  
BL12 3.58g  
IV下 800

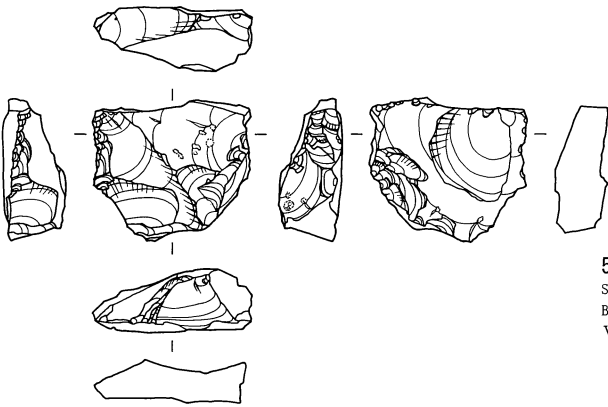

593  
Sc Ob WDKB  
BL8 7.04g  
Va中 7776

592  
Sc Ag  
BL18 4.2g  
Vb中 8500

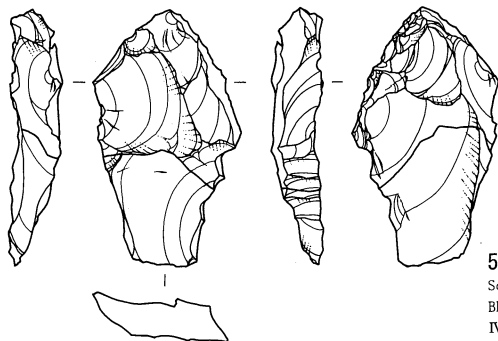

595  
Sc Ag  
BL17 2.73g  
IV中 1060

594  
Sc Ag  
BL14 3.7g  
IV下 786

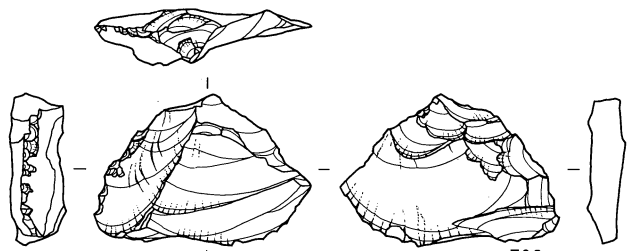

596  
Sc Ag  
BL9 7.66g  
Vb下 8788

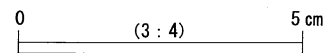



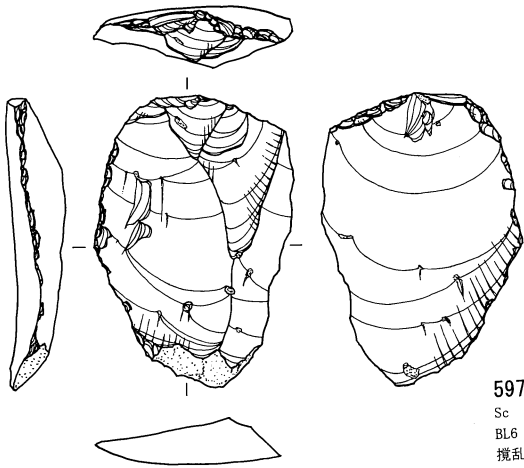

597  
Sc Ob WDKB  
BL6 14.34g  
攪乱 7044

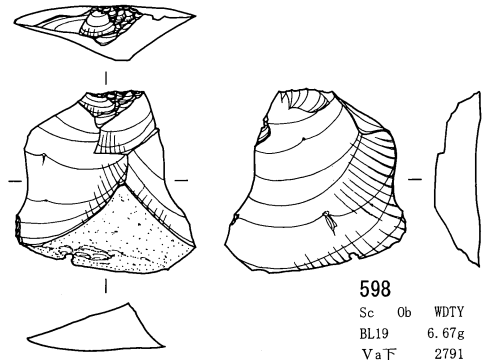

598  
Sc Ob WDTY  
BL19 6.67g  
Va下 2791

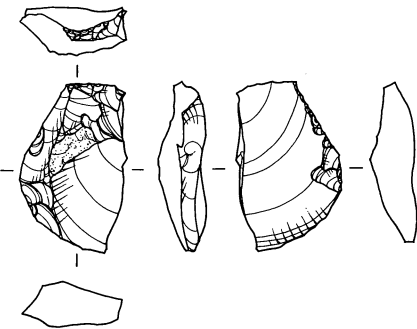

599  
Sc Ob WDTY  
BL18 4.28g  
Vb中 6234

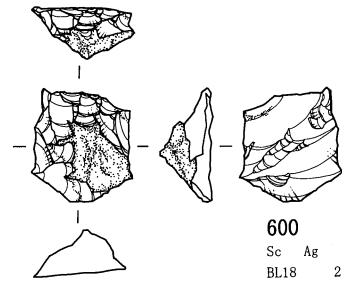

600  
Sc Ag  
BL18 2.04g  
Va中 3411

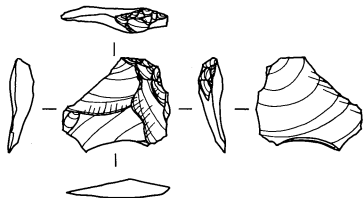

601  
Sc Ob WDTY  
BL7 0.75g  
Va中 8001

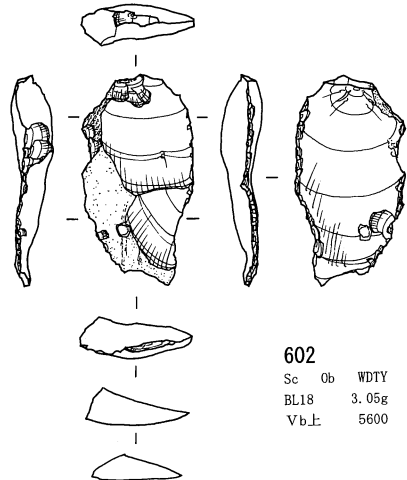

602  
Sc Ob WDTY  
BL18 3.05g  
Vb上 5600

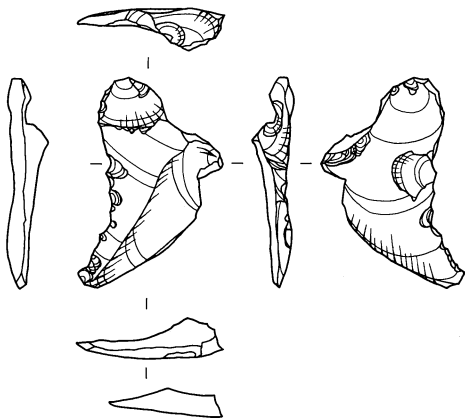

603  
Sc Ob WDTY  
BL8 2.82g  
Vb上 8633

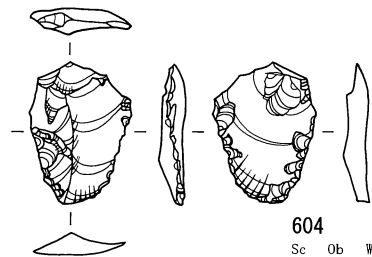

604  
Sc Ob WDTY  
BL22 1.71g  
IV下 9396

0 (3:4) 5 cm

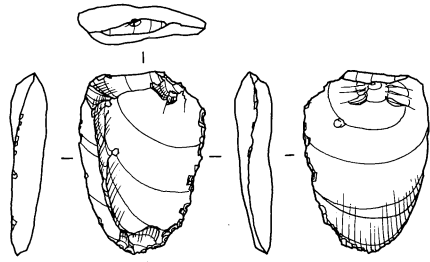

**605**  
 Sc Ob WDTY  
 BL11 3.91g  
 IV下 2231

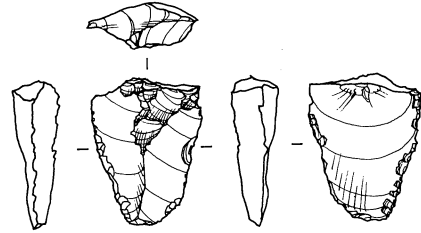

**606**  
 Sc Ob WDTY  
 BL16 2.77g  
 Vb中 5812

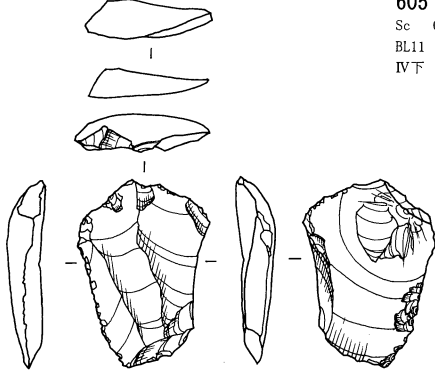

**607**  
 Sc Ob WDTY  
 BL22 4.11g  
 IV中 9098

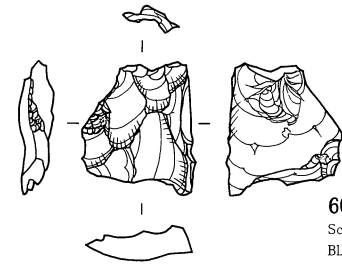

**608**  
 Sc Ob TSTY  
 BL20 2.55g  
 IV下 3093

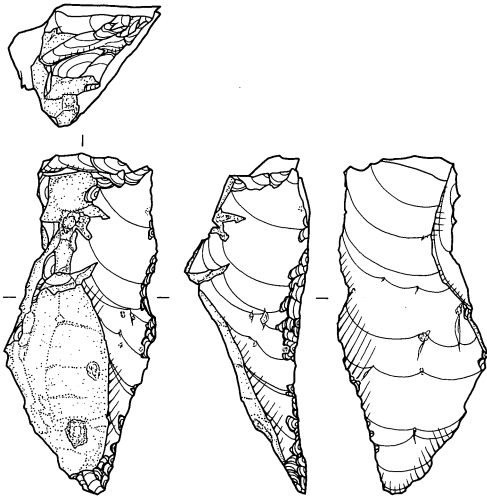

**609**  
 NS Ob WDTY  
 BL14 20.64g  
 Vb上面 3656

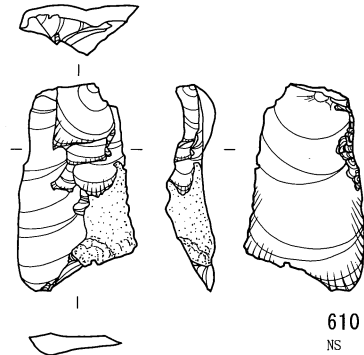

**610**  
 NS Ob WDTY  
 BL22 4.1g  
 IV下 9304

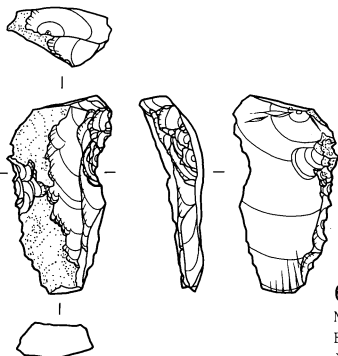

**611**  
 NS Ob WDTY  
 BL18 4.44g  
 Vb上 5568

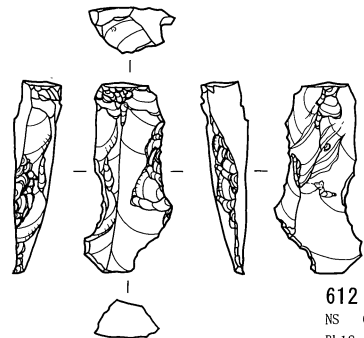

**612**  
 NS Ob WDTY  
 BL18 2.94g  
 Vb下 6619

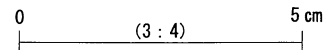

日向林 I 石器文化 石器実測図90 (削器 6・挟入削器 1)

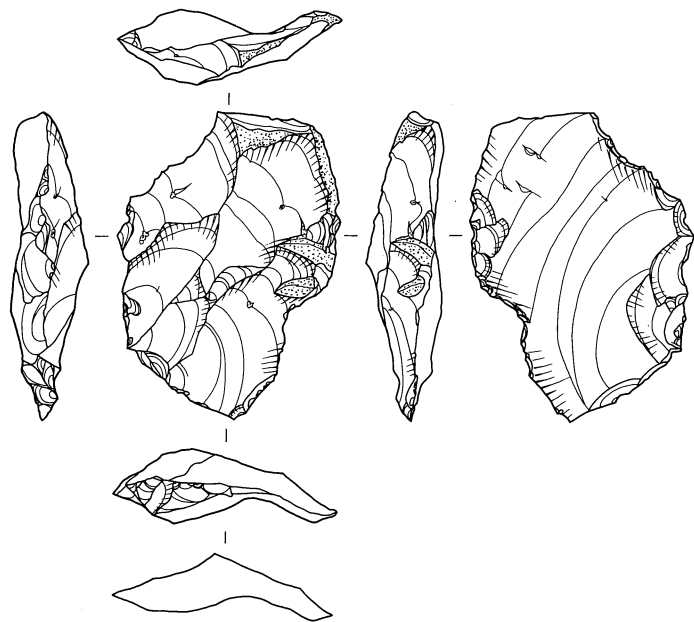

613  
 NS Ob WDTY  
 BL17 16.5g  
 Va中 2490

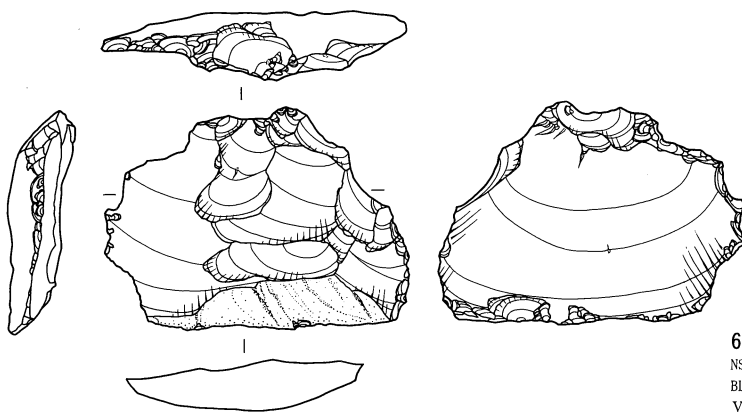

614  
 NS Ob WDTY  
 BL10 17.72g  
 Va中 8214

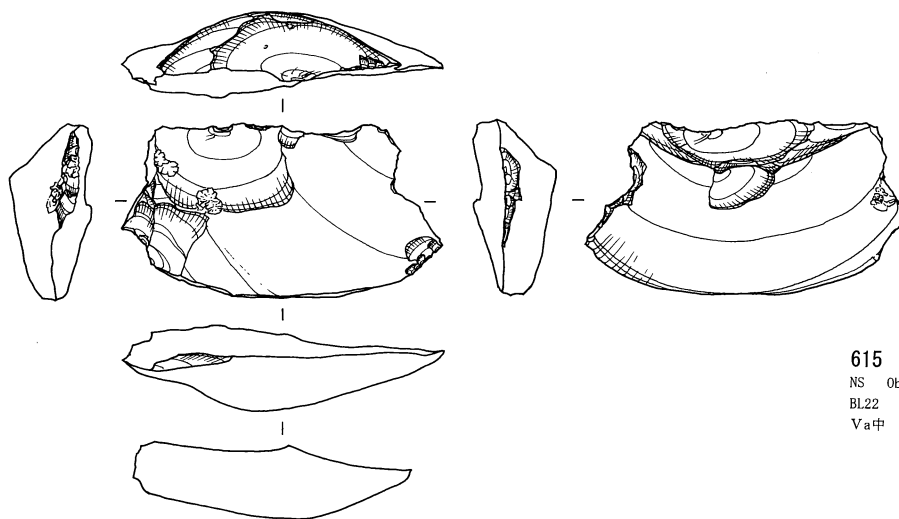

615  
 NS Ob WDTY  
 BL22 17.71g  
 Va中 9412

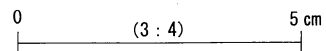

日向林 I 石器文化 石器実測図91 (抉入削器 2)

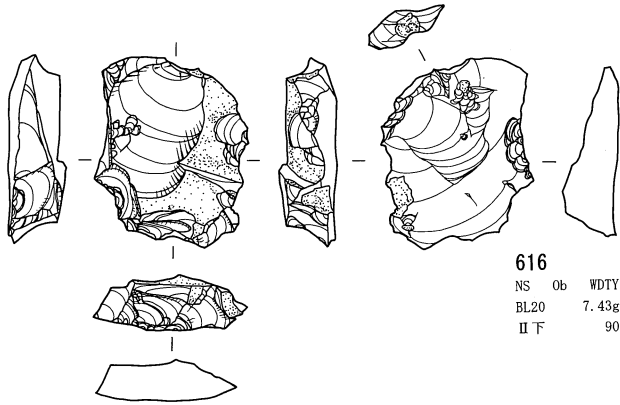

616  
NS Ob WDTY  
BL20 7.43g  
II下 90

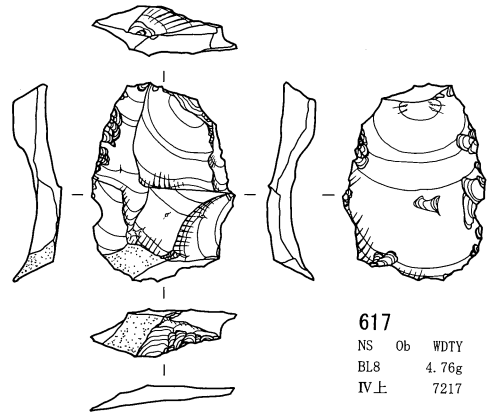

617  
NS Ob WDTY  
BL8 4.76g  
IV上 7217

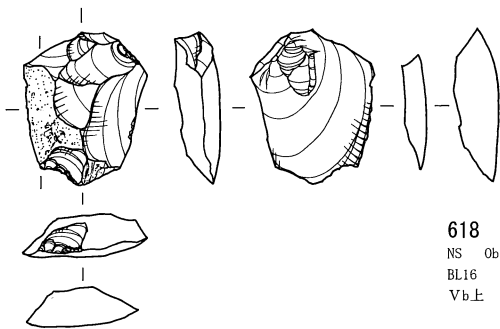

618  
NS Ob WDTY  
BL16 4.29g  
Vb上 4924

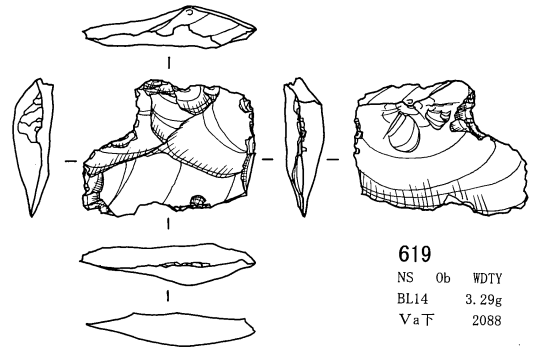

619  
NS Ob WDTY  
BL14 3.29g  
Va下 2088

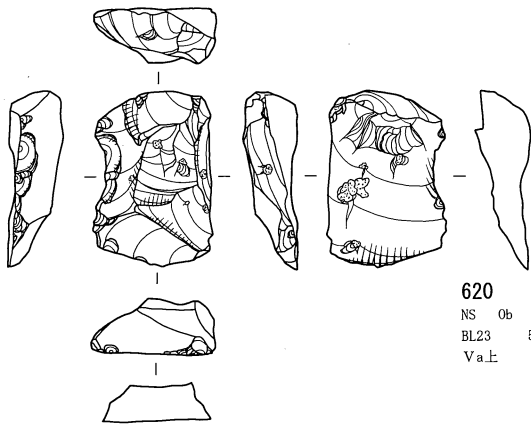

620  
NS Ob WDTY  
BL23 5.13g  
Va上 9510

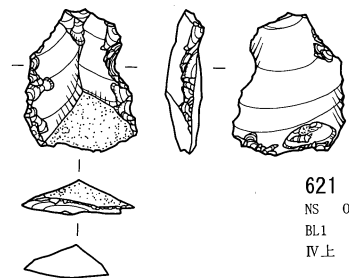

621  
NS Ob WDTY  
BL1 2.58g  
IV上 1717

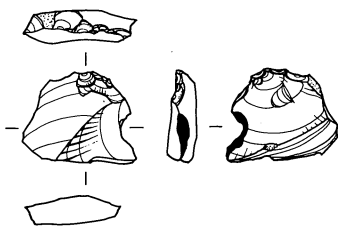

622  
NS Ob WDTY  
BL18 1.66g  
Vb中 5961

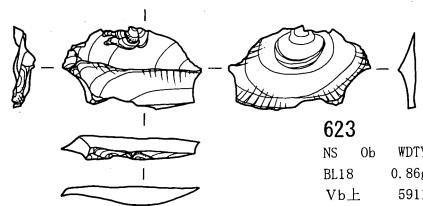

623  
NS Ob WDTY  
BL18 0.86g  
Vb上 5911

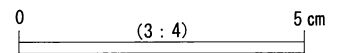

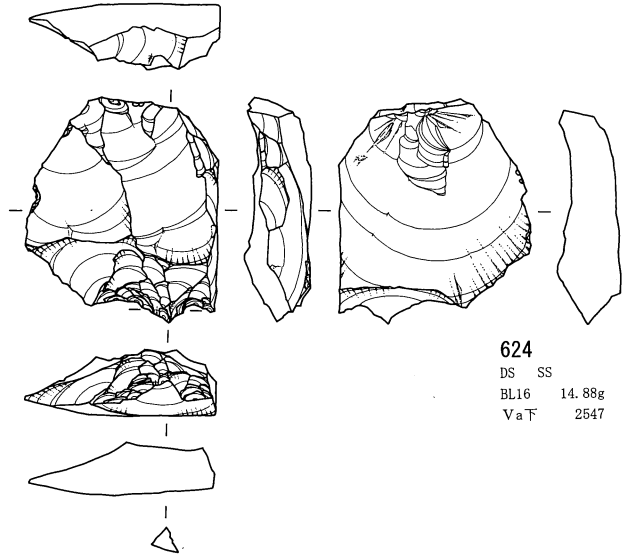

624  
DS SS  
BL16 14.88g  
Va下 2547

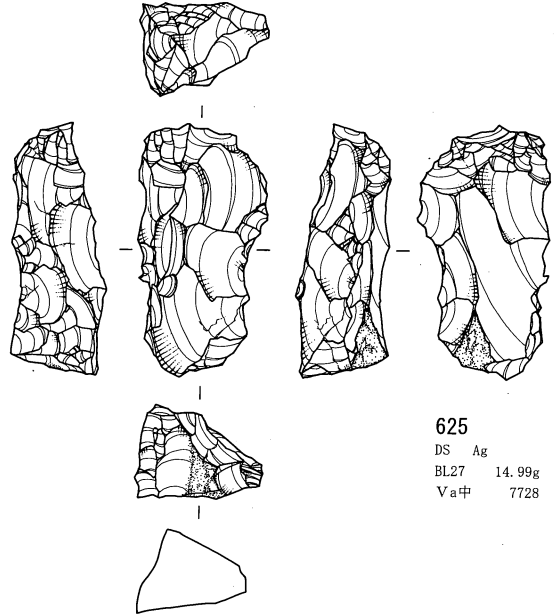

625  
DS Ag  
BL27 14.99g  
Va中 7728

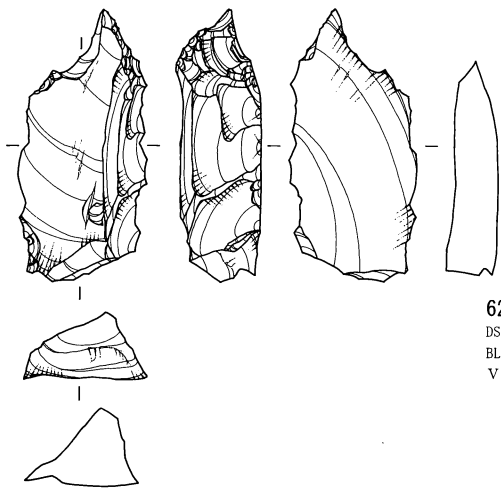

626  
DS Ag  
BL9 12.8g  
Va中 8138

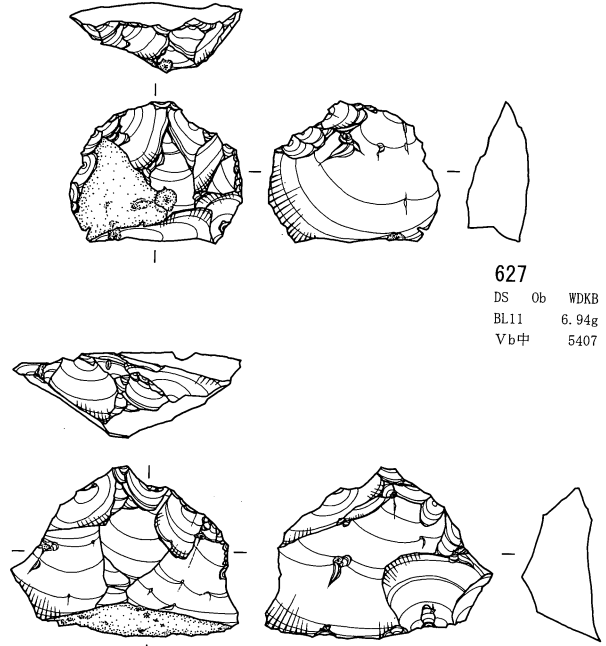

627  
DS Ob WDKB  
BL11 6.94g  
Vb中 5407

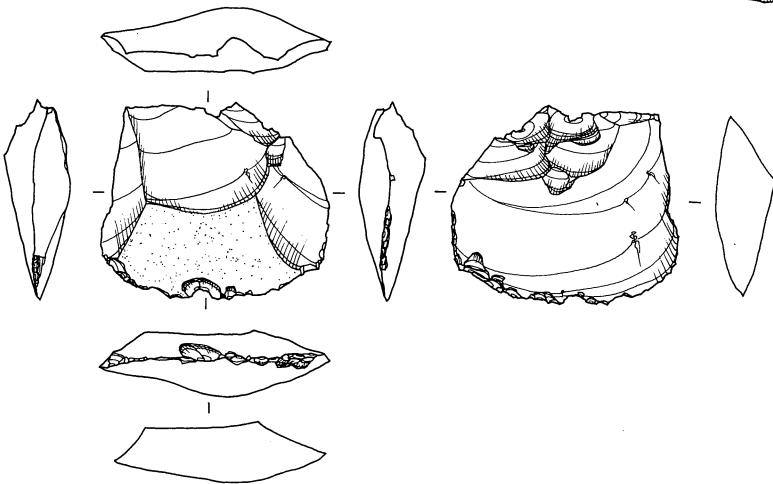

628  
DS Ob WDTY  
BL10 12.2g  
Va中 8242

629  
DS Ob TSTY  
BL12 12.69g  
Vb中 5879

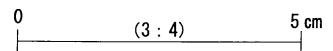

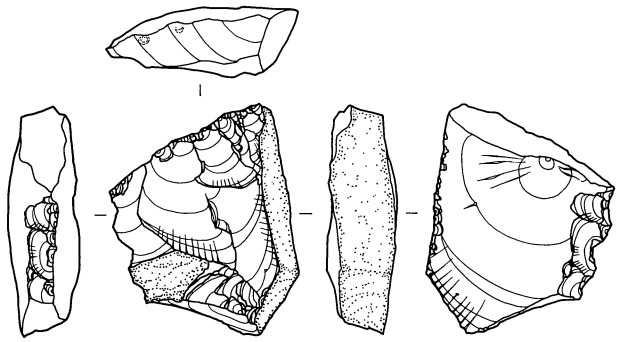

630  
DS Ob WDTY  
BL1 14.99g  
III下 519

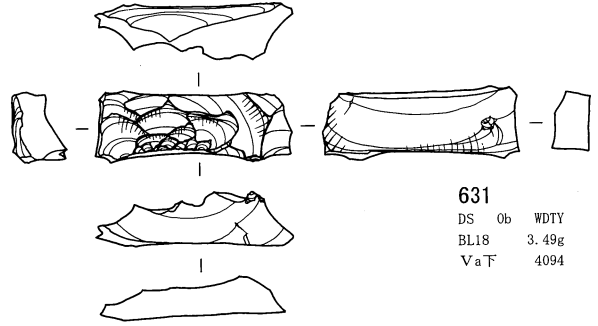

631  
DS Ob WDTY  
BL18 3.49g  
Va下 4094

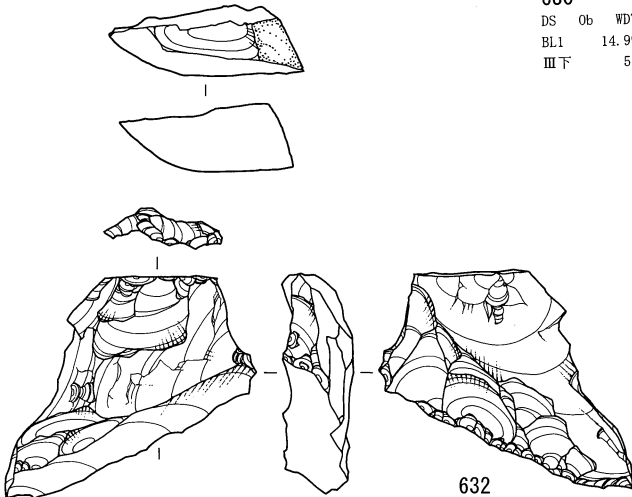

632  
DS Ag  
BL27 15.2g  
IV中 7091

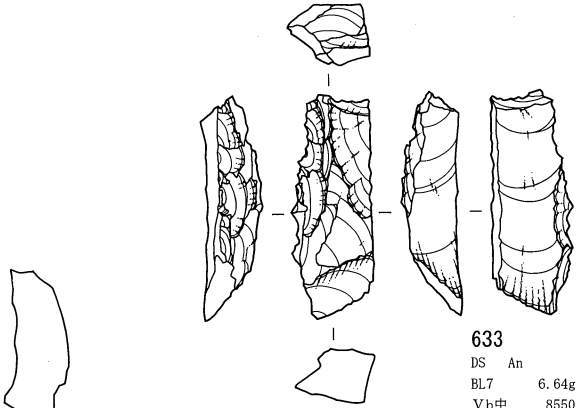

633  
DS An  
BL7 6.64g  
Vb中 8550

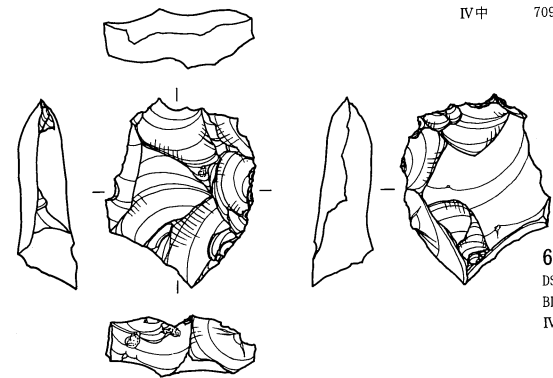

634  
DS Ob WDKB  
BL18 6.93g  
IV下 1350

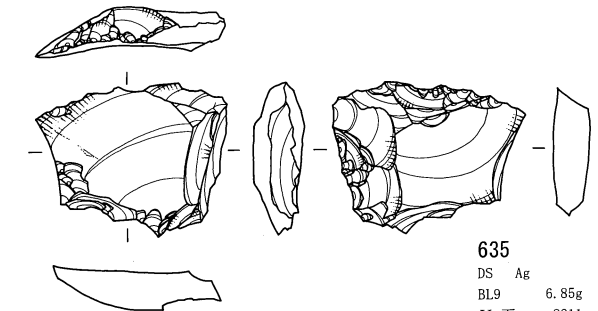

635  
DS Ag  
BL9 6.85g  
Va下 8211

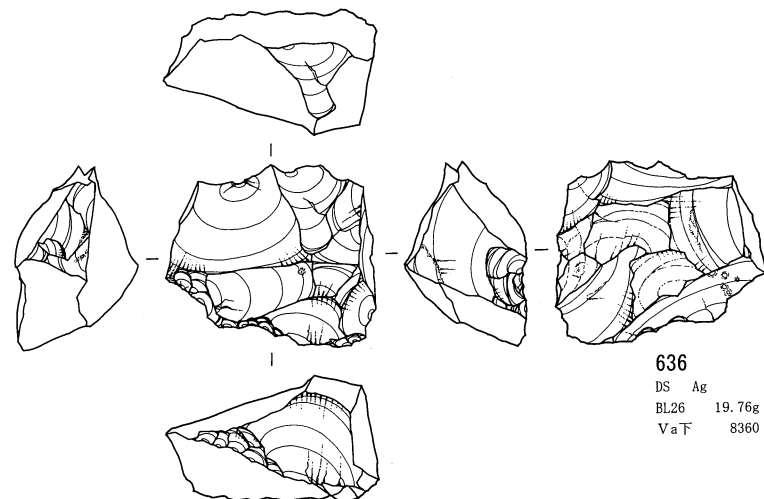

636  
DS Ag  
BL26 19.70g  
Va下 8360

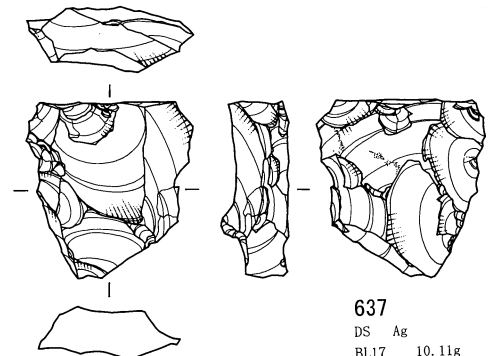

637  
DS Ag  
BL17 10.11g  
Vb上 4602

0 (3:4) 5 cm

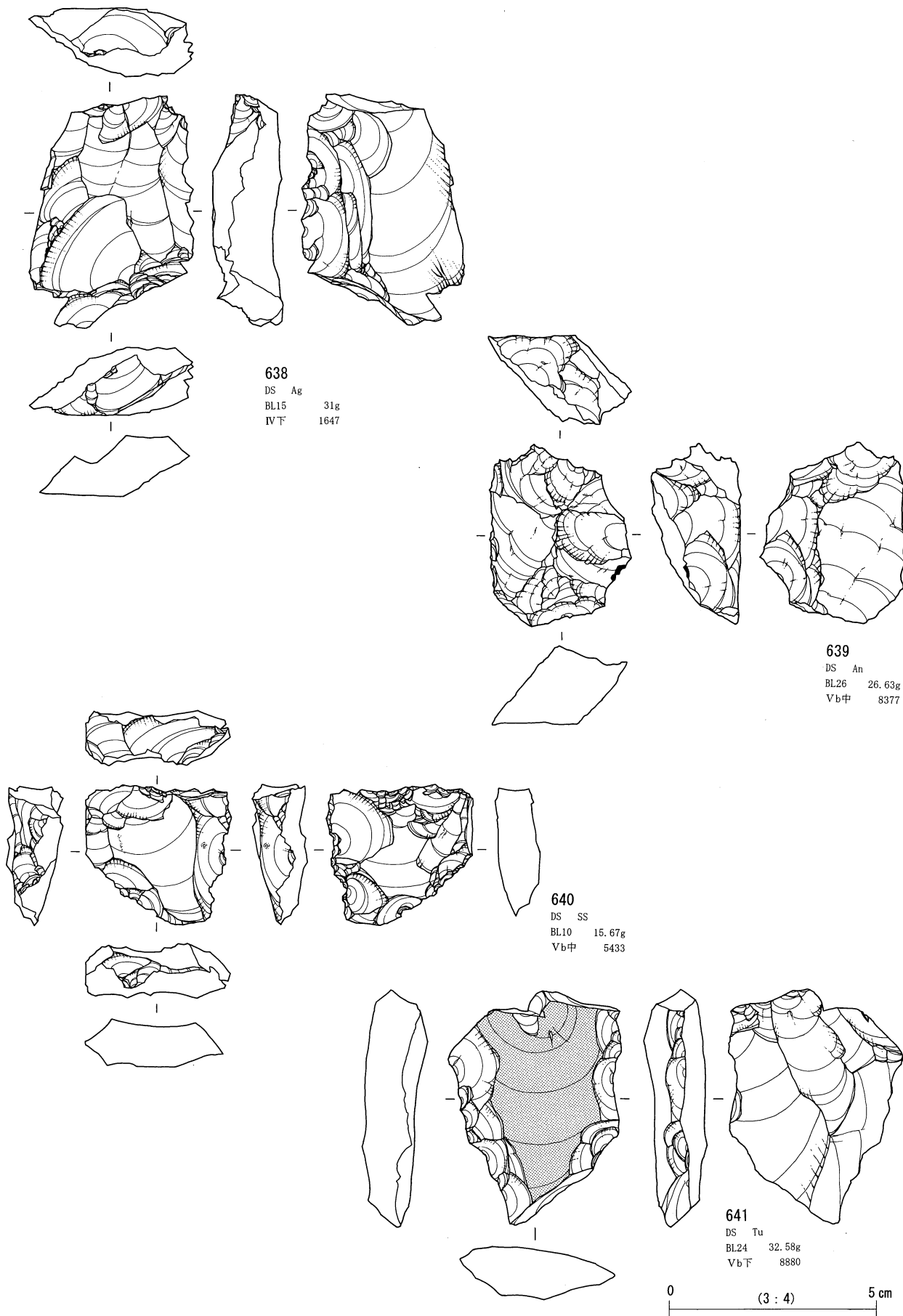

日向林 I 石器文化 石器実測図95 (鋸齒縁状削器 3)

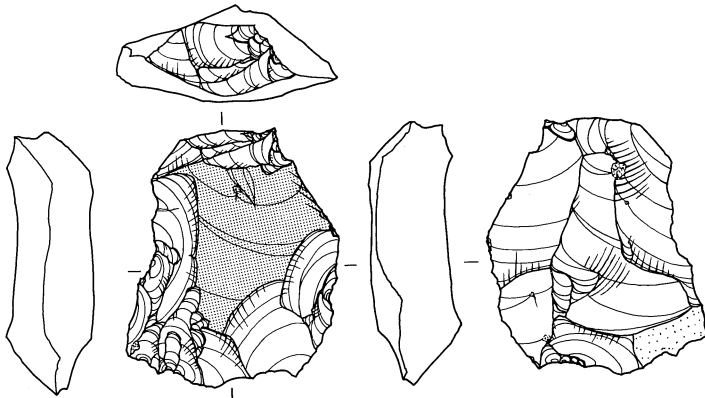

642  
 DS Ob WDTY  
 BL6 22.44g  
 Vb上 8496

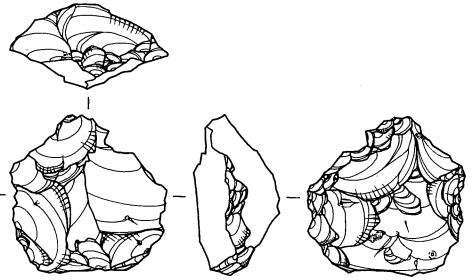
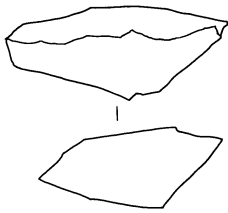

643  
 DS Ob WDKB  
 BL8 8.59g  
 Vb中 8562

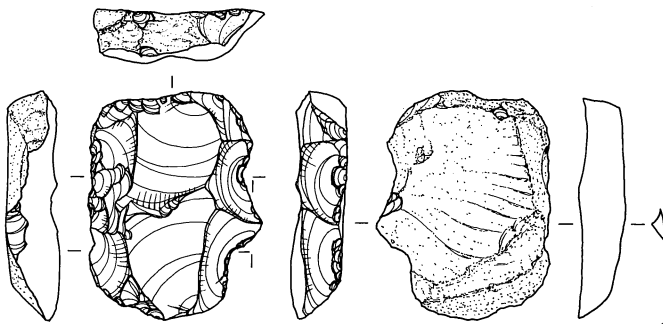

644  
 DS Ob WDTY  
 BL20 13.36g  
 Vb下 6838

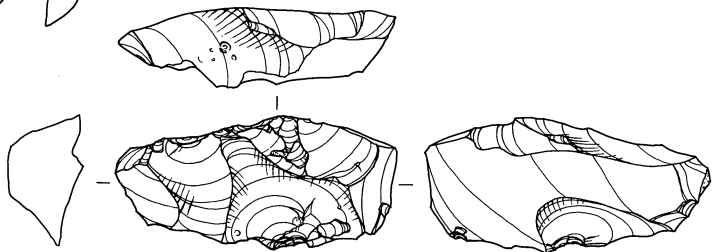
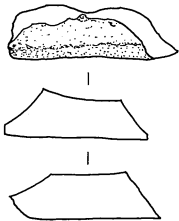

645  
 DS Ob WDTY  
 BL18 13.67g  
 Vb中 5953

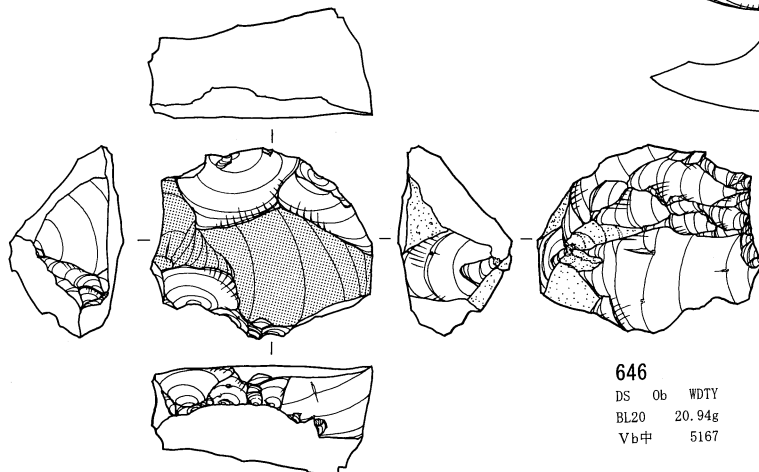

646  
 DS Ob WDTY  
 BL20 20.94g  
 Vb中 5167

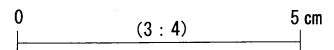

日向林 I 石器文化 石器実測図96 (鋸齒縁状削器 4)



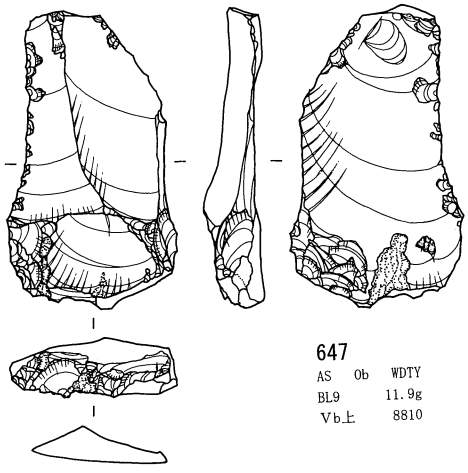

647  
AS Ob WDTY  
BL9 11.9g  
Vb上 8810

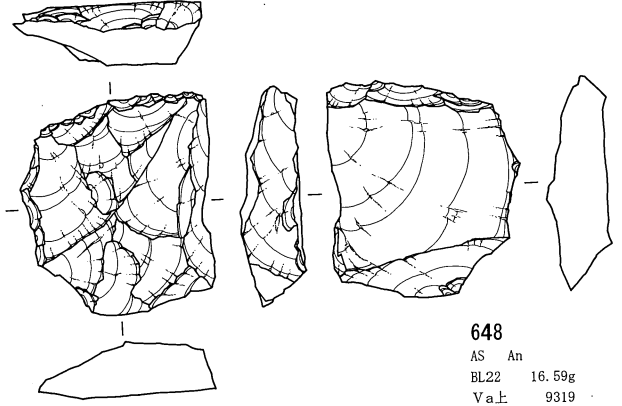

648  
AS An  
BL22 16.59g  
Va上 9319

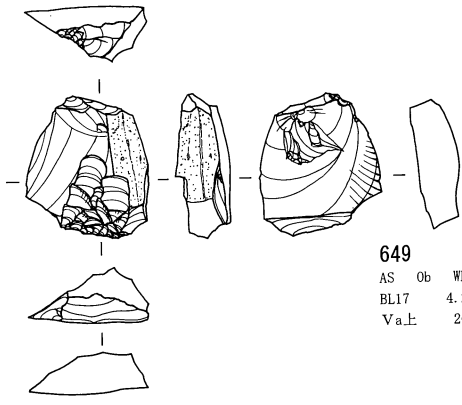

649  
AS Ob WDTY  
BL17 4.25g  
Va上 2642

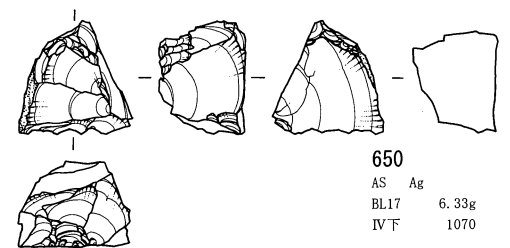

650  
AS Ag  
BL17 6.33g  
IV下 1070

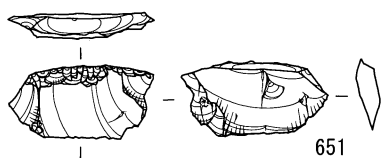

651  
AS Ob WDTY  
BL23 1.23g  
Vb中 9512

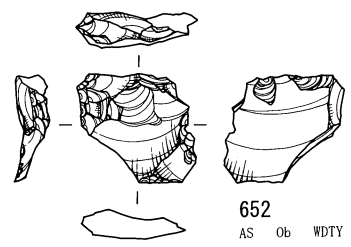

652  
AS Ob WDTY  
BL22 1.89g  
Vb上 9154

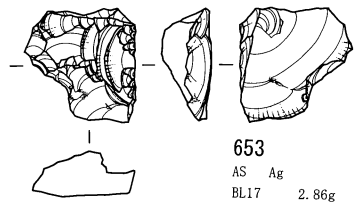

653  
AS Ag  
BL17 2.86g  
Vb上 4619

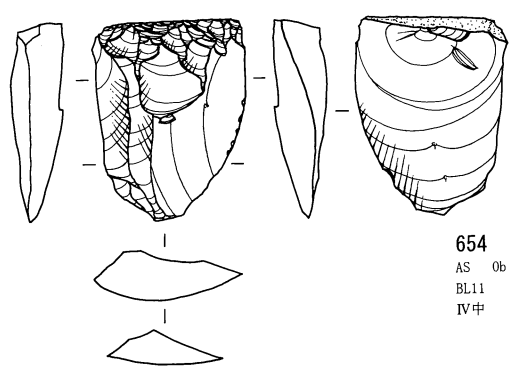

654  
AS Ob WDTY  
BL11 6.87g  
IV中 295

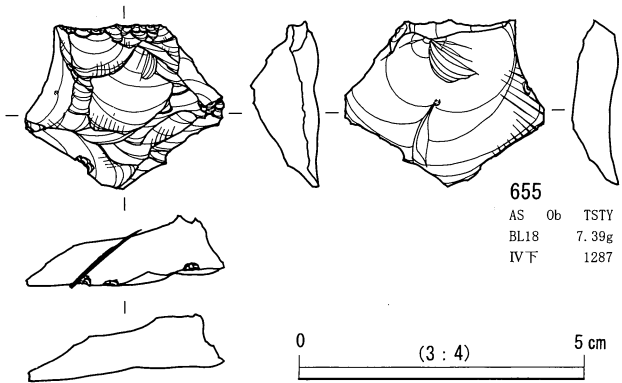

655  
AS Ob TSTY  
BL18 7.39g  
IV下 1287

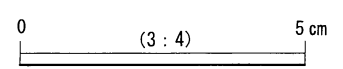

日向林 I 石器文化 石器実測図97 (厚刃搔器 1)

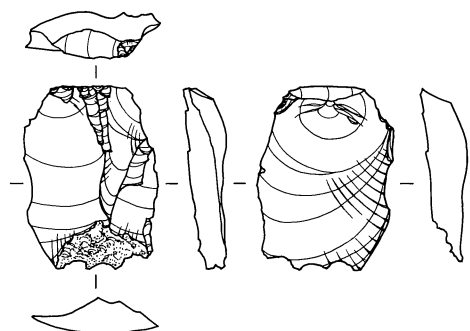

656  
AS Ob WDTY  
BL22 4.45g  
Va上 9232

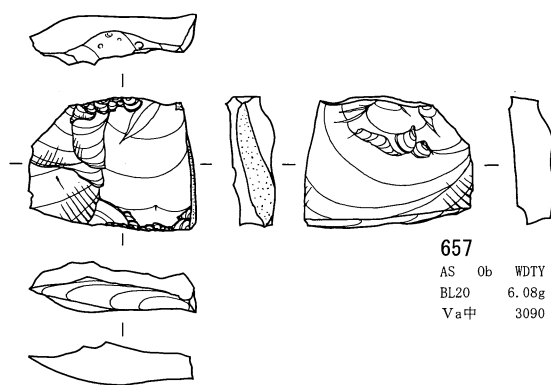

657  
AS Ob WDTY  
BL20 6.08g  
Va中 3090

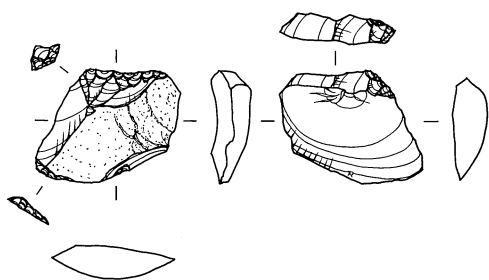

658  
AS Ob WDTY  
BL18 2.7g  
Vb中 5520

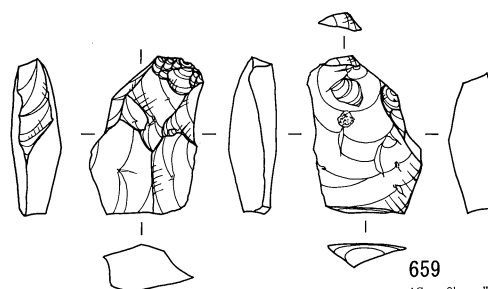

659  
AS Ob WDKB  
BL17 3.66g  
IV上 459

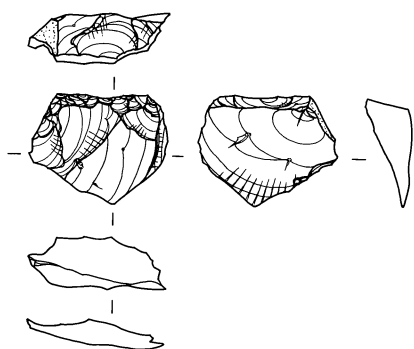

660  
AS Ob WDTY  
BL9 2.58g  
Va下 8379

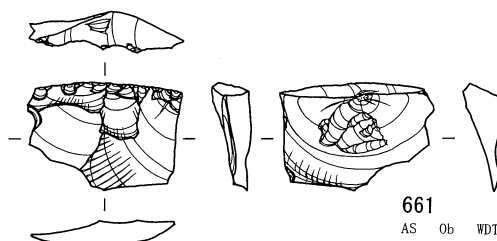

661  
AS Ob WDTY  
BL17 2.38g  
Vb下 6532

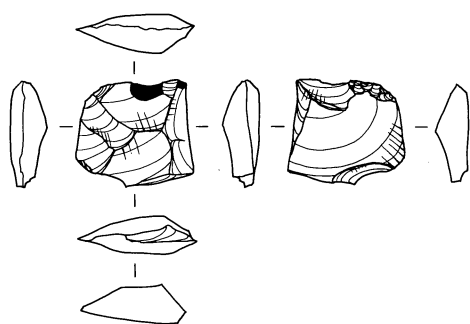

662  
AS Ob WDTY  
BL23 2.21g  
Vb下 9469

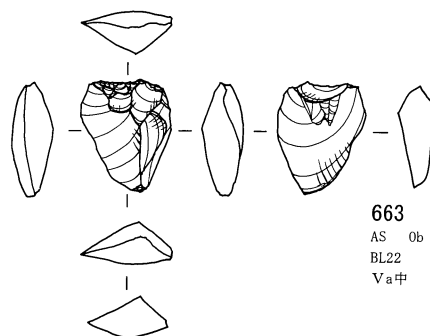

663  
AS Ob WDTY  
BL22 1.52g  
Va中 9201

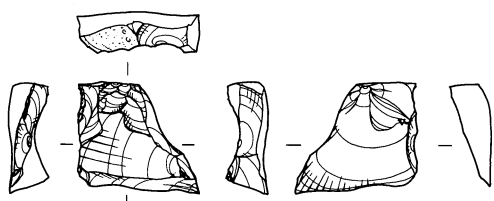

664  
AS Ob WDTY  
BL11 2.09g  
Vb中 5364

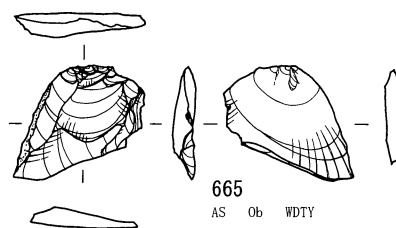

665  
AS Ob WDTY  
BL17 1.31g  
Vb上 5753

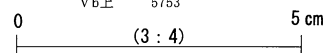

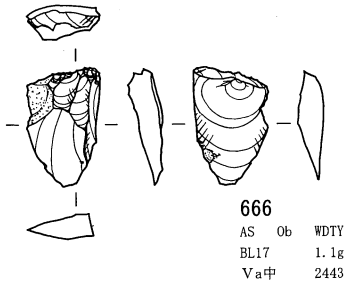

666  
AS Ob WDTY  
BL17 1.1g  
Va中 2443

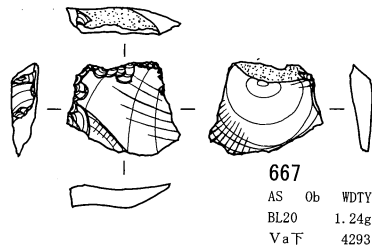

667  
AS Ob WDTY  
BL20 1.24g  
Va下 4293

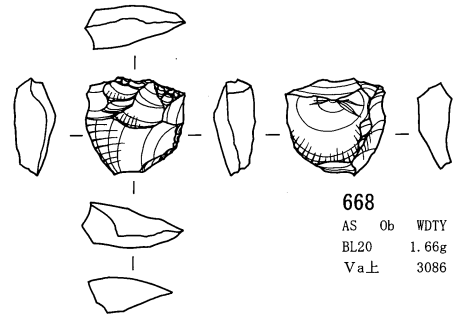

668  
AS Ob WDTY  
BL20 1.66g  
Va上 3086

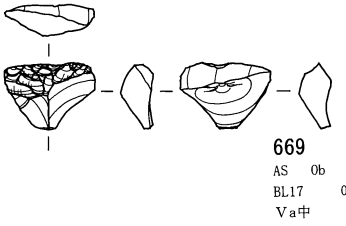

669  
AS Ob WDTY  
BL17 0.72g  
Va中 2645

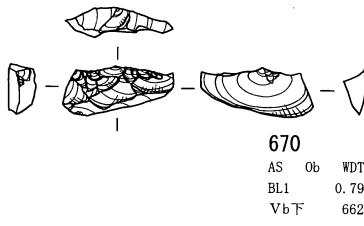

670  
AS Ob WDTY  
BL1 0.79g  
Vb下 6620

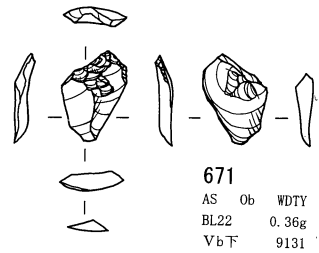

671  
AS Ob WDTY  
BL22 0.36g  
Vb下 9131

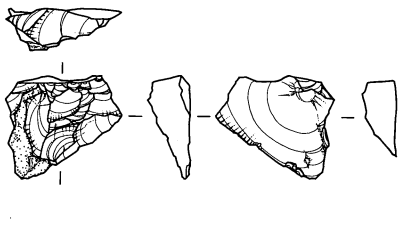

672  
AS Ag  
BL17 2.01g  
Vb上 5090

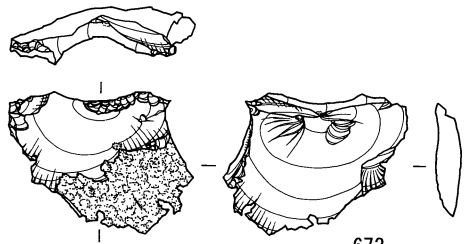

673  
AS Ob WDTY  
BL23 3.32g  
Va中 9450

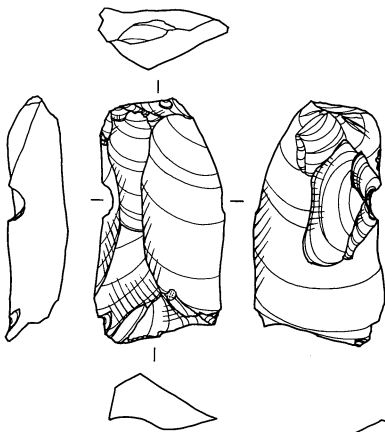

674  
AS Ob WDTY  
BL20 9.1g  
Va上面 1215

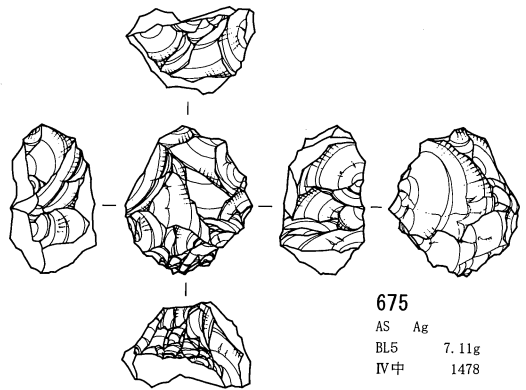

675  
AS Ag  
BL5 7.11g  
IV中 1478

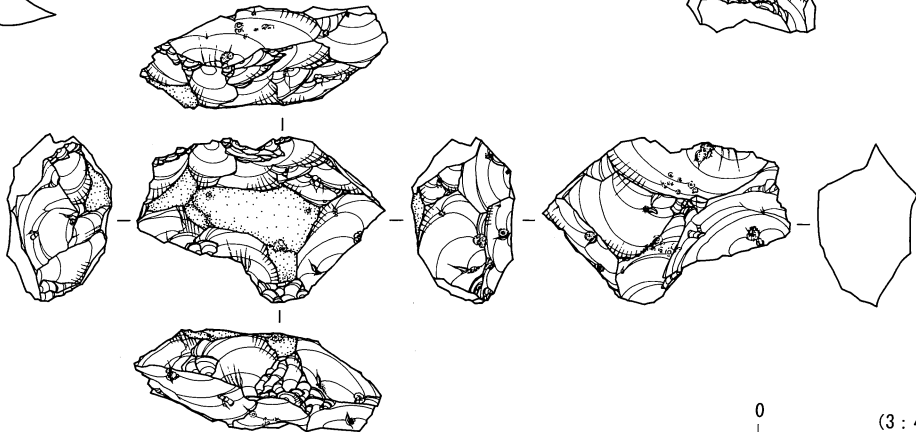

676  
AS Ob WDTY  
BL11 17.29g  
Vb上面 1813

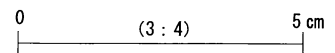

日向林 I 石器文化 石器実測図99 (厚刃搔器 3)

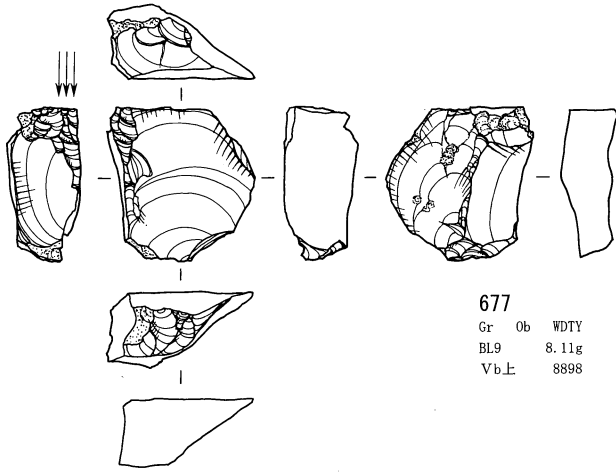

677  
Gr Ob WDTY  
BL9 8.11g  
Vb上 8898

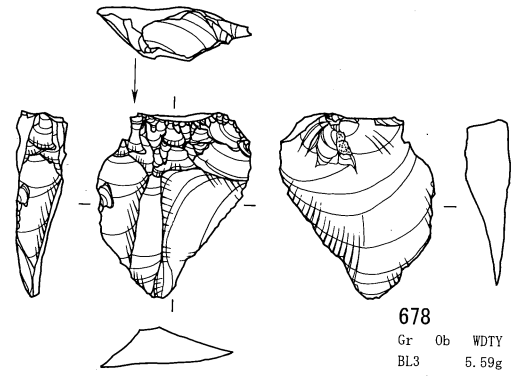

678  
Gr Ob WDTY  
BL3 5.59g  
Va上面 1424

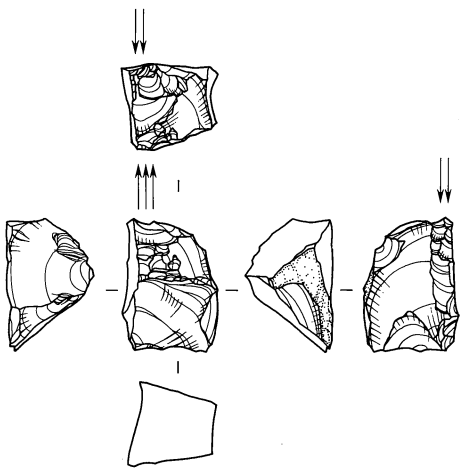

679  
Gr Ob WDTY  
BL5 5.35g  
IV下 1446

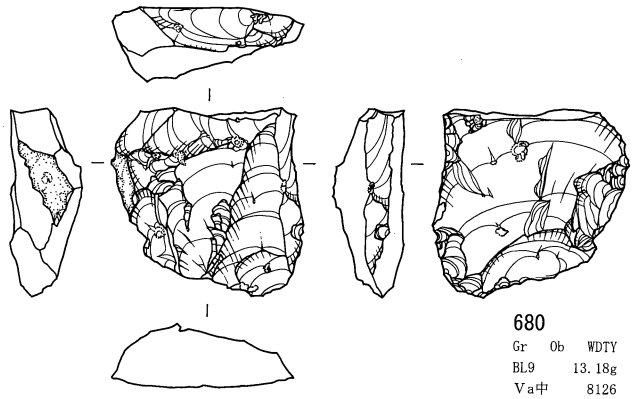

680  
Gr Ob WDTY  
BL9 13.18g  
Va中 8126

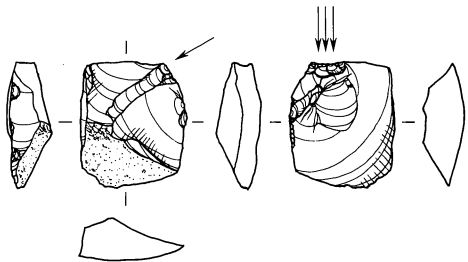

681  
Gr Ob WDTY  
BL23 3.13g  
Va上 9015

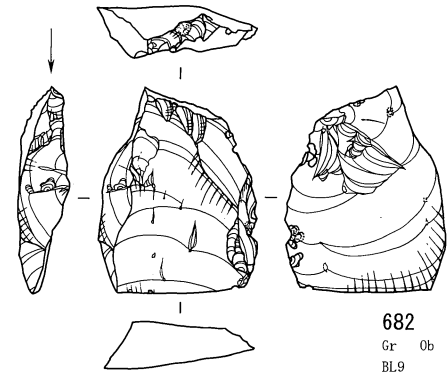

682  
Gr Ob WDTY  
BL9 8.74g  
Vb上 8290

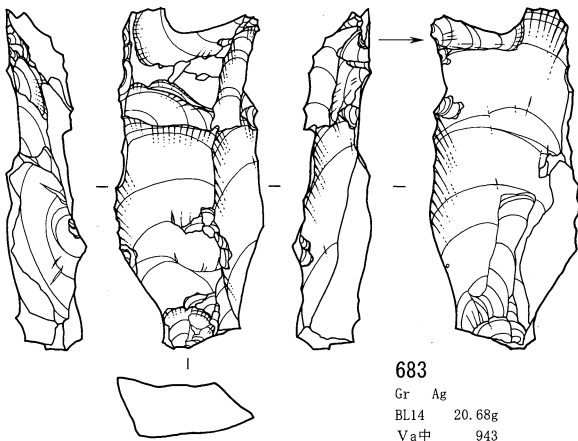

683  
Gr Ag  
BL14 20.68g  
Va中 943

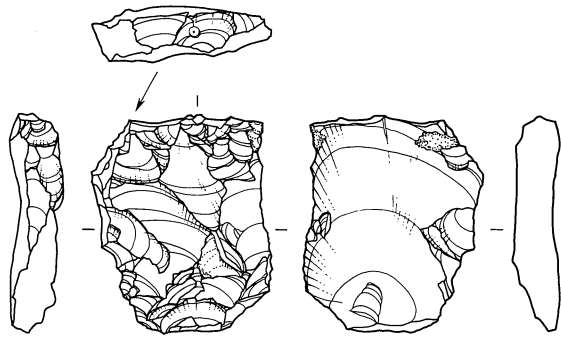

684  
Gr Ag  
BL1 12.47g  
Vb上面 3768

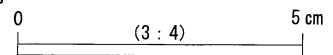

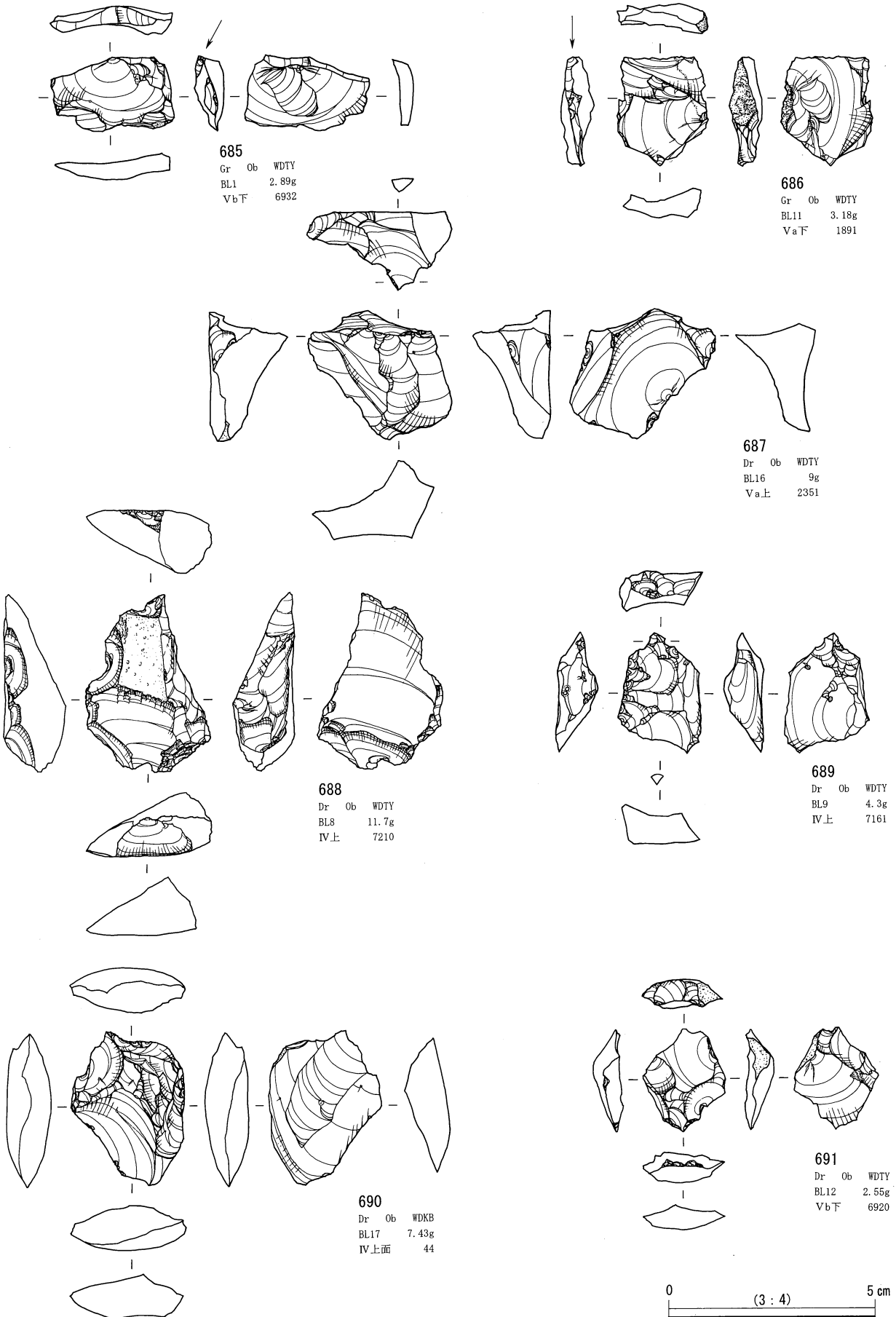

日向林 I 石器文化 石器実測図101 (彫器 2・揉錐器 1)

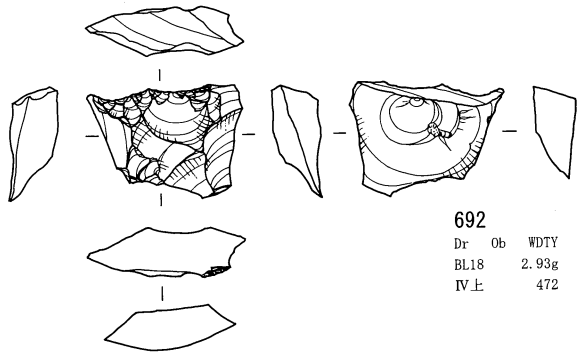

692  
Dr Ob WDTY  
BL18 2.93g  
IV上 472

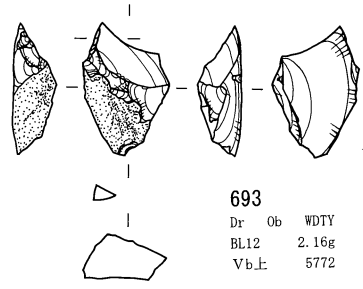

693  
Dr Ob WDTY  
BL12 2.16g  
Vb上 5772

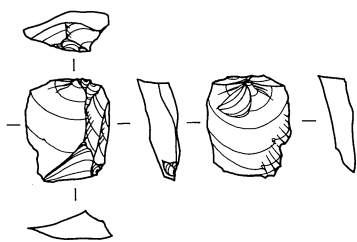

694  
Dr Ob WDTY  
BL17 1.28g  
Vb中 4648

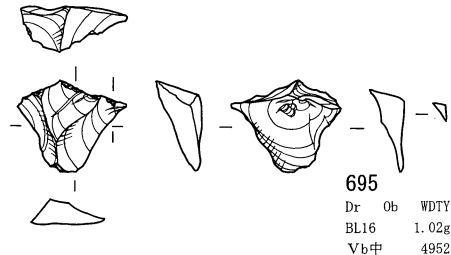

695  
Dr Ob WDTY  
BL16 1.02g  
Vb中 4952

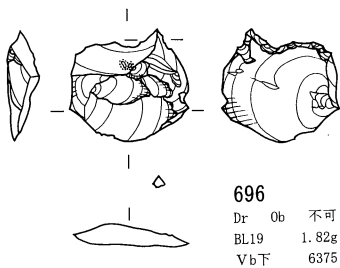

696  
Dr Ob 不可  
BL19 1.82g  
Vb下 6375

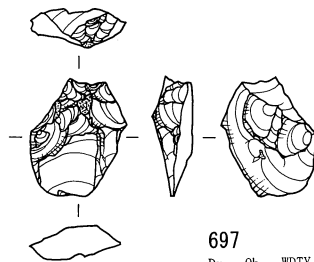

697  
Dr Ob WDTY  
BL17 1.72g  
IV中 1071

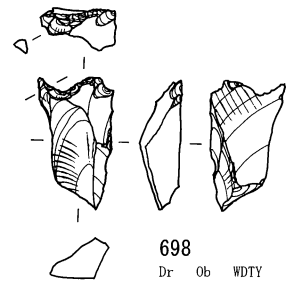

698  
Dr Ob WDTY  
BL2 1.25g  
Vb中 6718

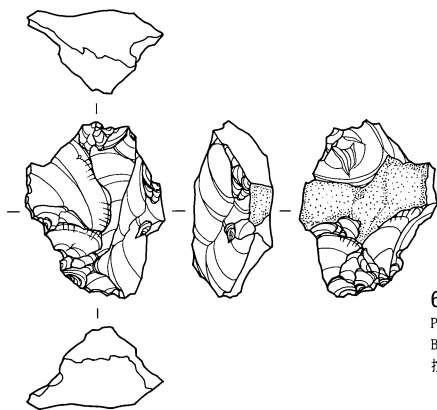

699  
Pe Ob WDTY  
BL8 7.32g  
攪乱 7025

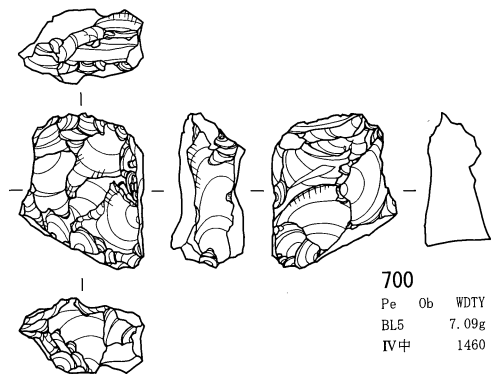

700  
Pe Ob WDTY  
BL5 7.09g  
IV中 1460

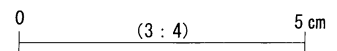

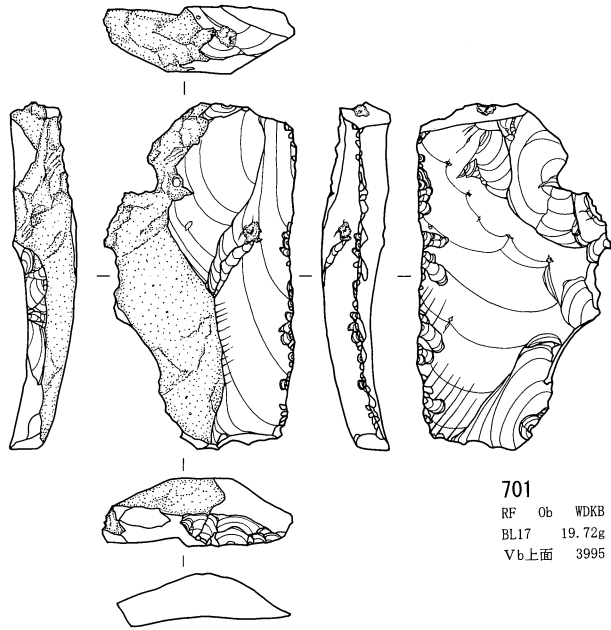

701  
RF Ob WDKB  
BL17 19.72g  
Vb上面 3995

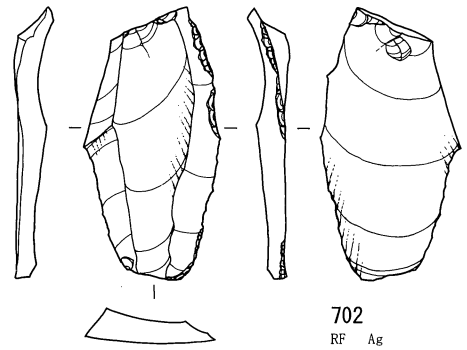

702  
RF Ag  
BL11 5.61g  
Vb上面 1948

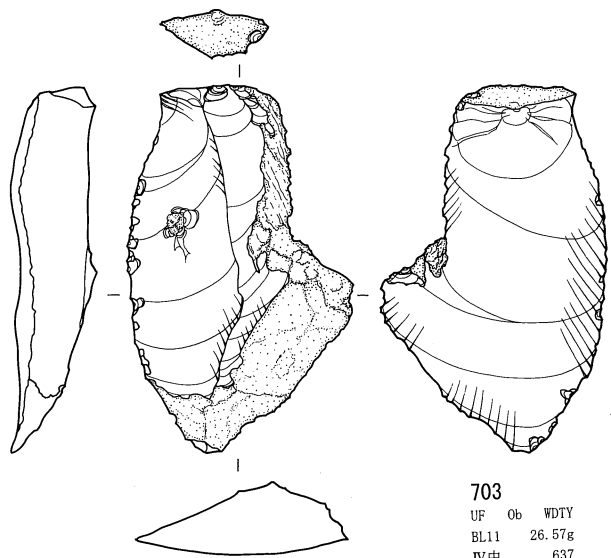

703  
UF Ob WDTY  
BL11 26.57g  
IV中 637

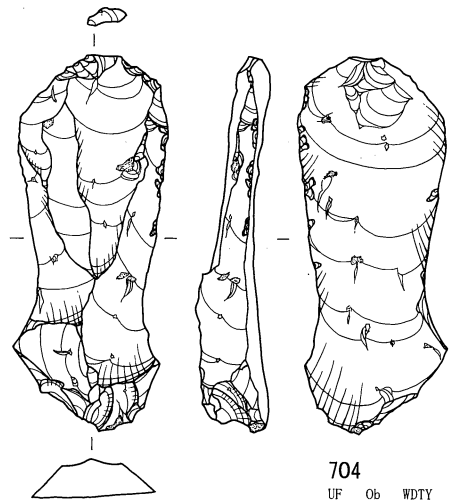

704  
UF Ob WDTY  
BL2 14.21g  
VbF 6929

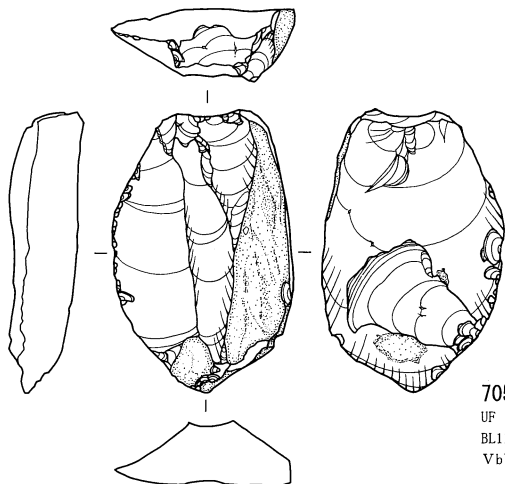

705  
UF Ob WDTY  
BL11 20.48g  
VbF 6007

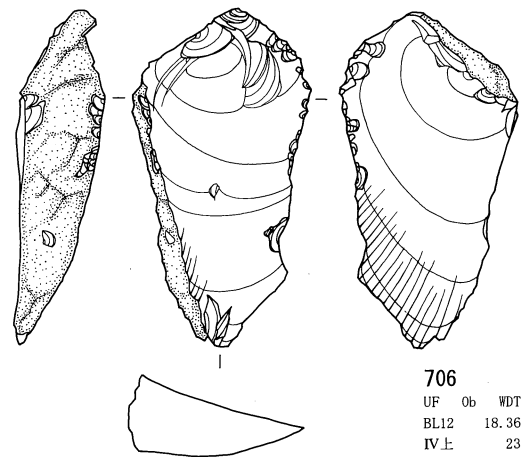

706  
UF Ob WDTY  
BL12 18.36g  
IV上 231

0 (3:4) 5 cm

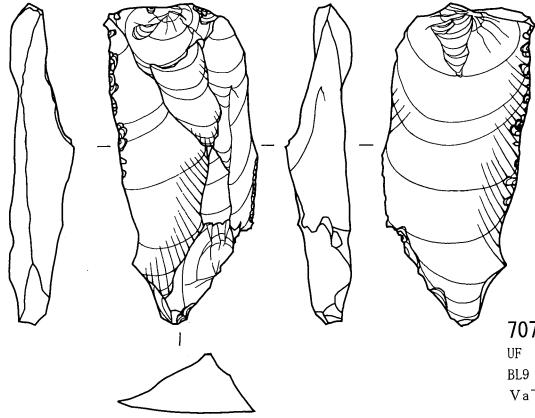

707  
 UF Ob WDTY  
 BL9 11.42g  
 Va下 8223

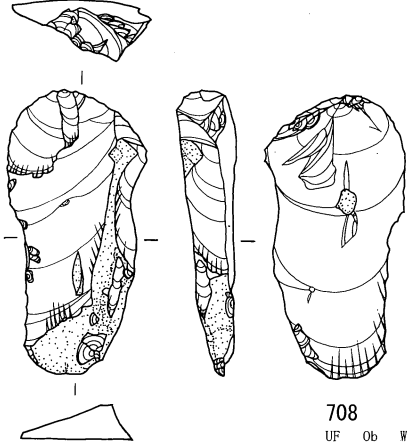

708  
 UF Ob WDTY  
 BL11 8.75g  
 Vb中 5406

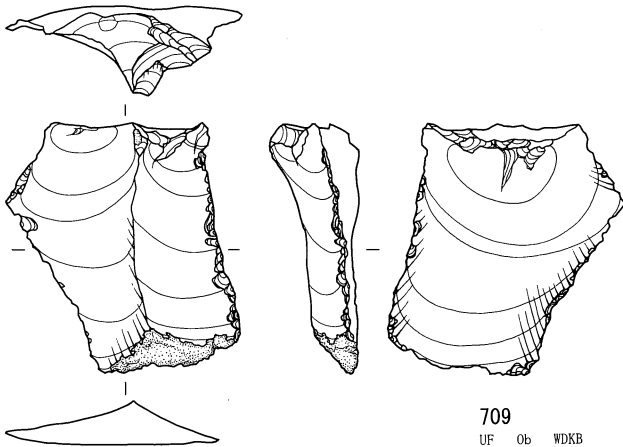

709  
 UF Ob WDKB  
 BL17 13.74g  
 Va下 2471

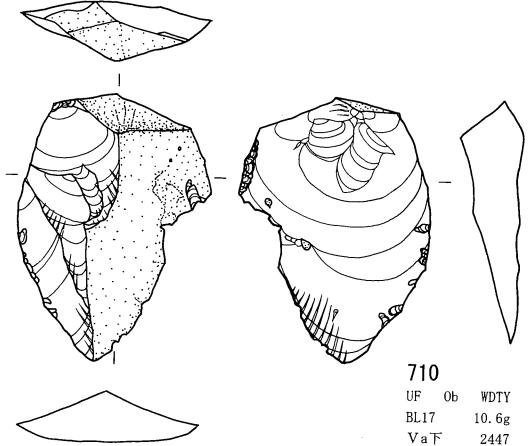

710  
 UF Ob WDTY  
 BL17 10.6g  
 Va下 2447

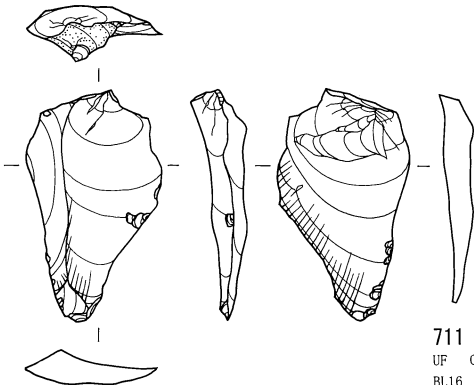

711  
 UF Ob WDTY  
 BL16 4.6g  
 IV上 169

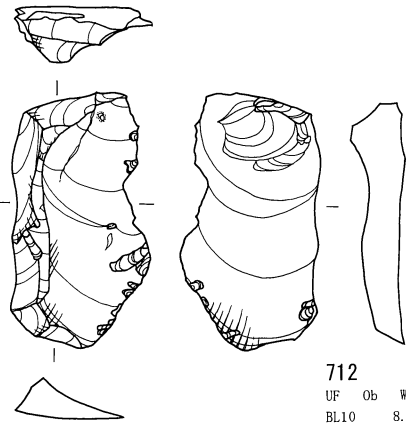

712  
 UF Ob WDTY  
 BL10 8.81g  
 Va中 8213

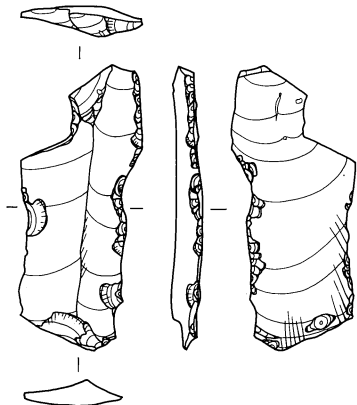

713  
 UF Ob TSTY  
 BL1 4.61g  
 IV下 1752

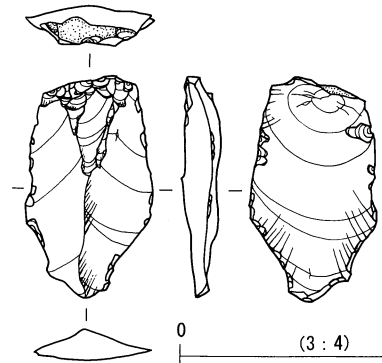

714  
 UF Ob WDTY  
 BL1 4.85g  
 Vb中 5668

0 (3:4) 5 cm

日向林I石器文化 石器実測図104 (微細剝離のある剥片2)



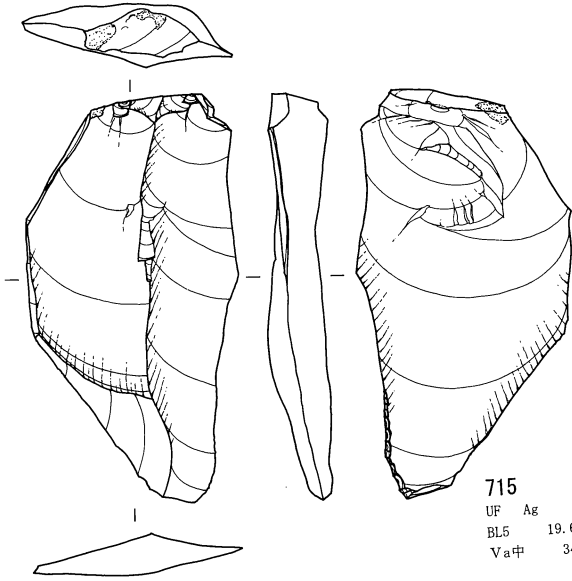

715  
UF Ag  
BL5 19.69g  
Va中 3489

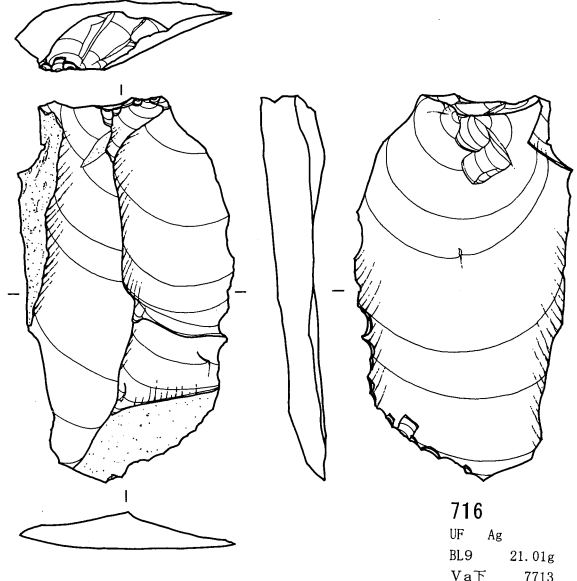

716  
UF Ag  
BL9 21.01g  
Va下 7713

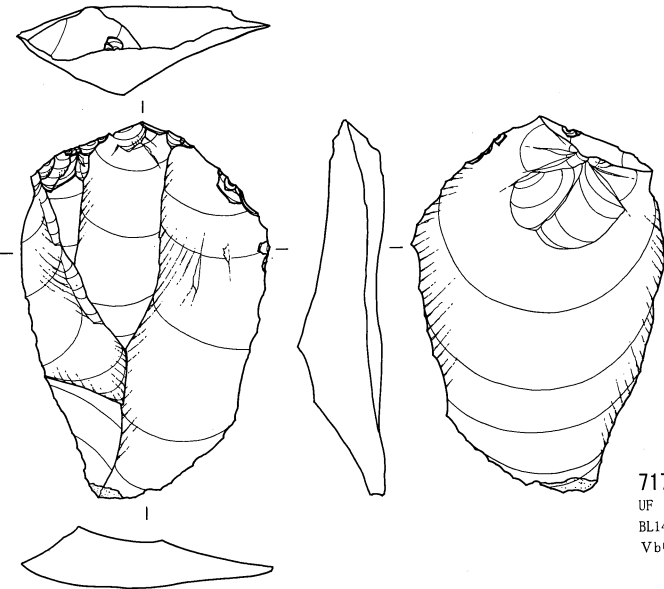

717  
UF Ag  
BL14 29.28g  
Vb中 6175

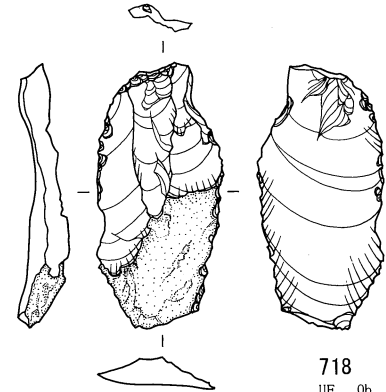

718  
UF Ob WDTY  
BL9 5.84g  
VI上 9553

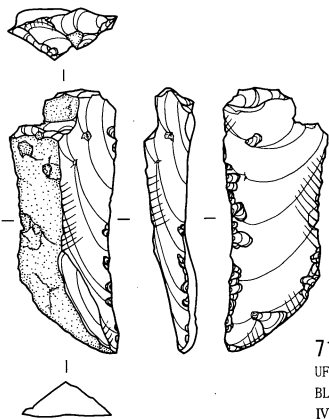

719  
UF Ob WDTY  
BL17 5.13g  
IV下 1270

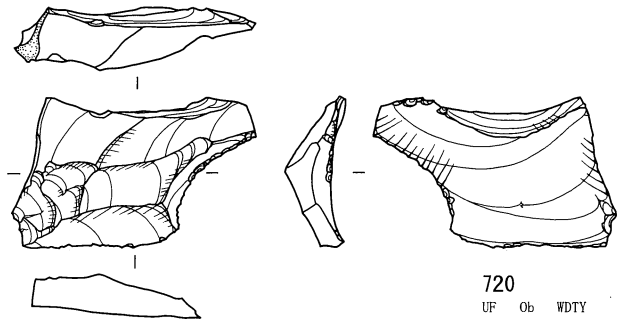

720  
UF Ob WDTY  
BL17 5.66g  
Va上 2416

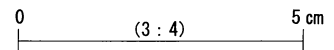

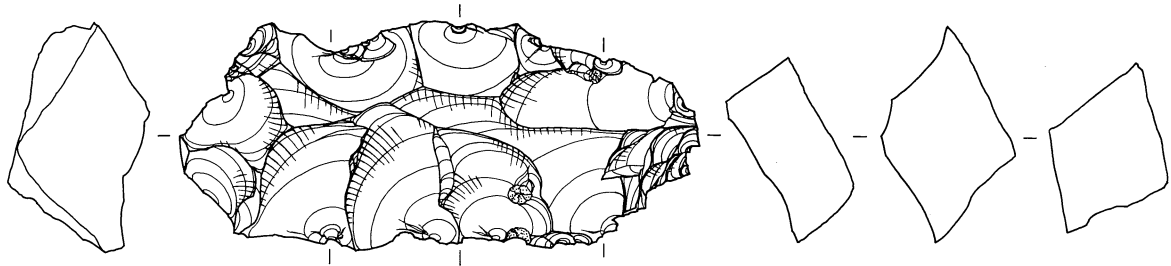

721  
Co Ob WDTY  
BL5 62.11g  
Vb中 5635

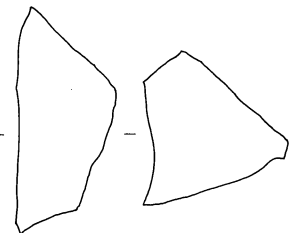
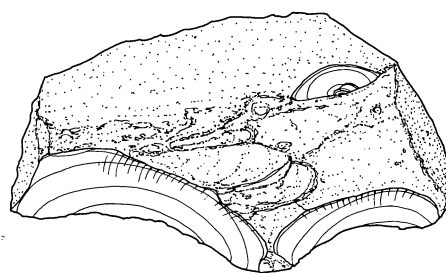
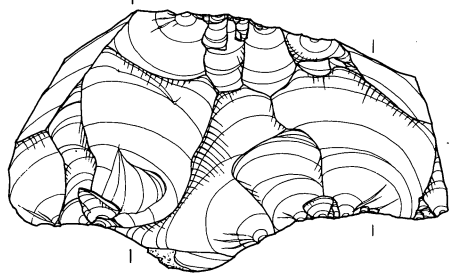
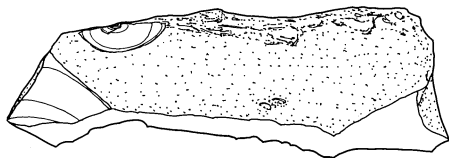
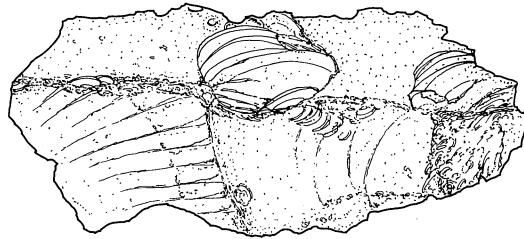

722  
Co Ob WDTY  
BL5 59.63g  
IV下 1501

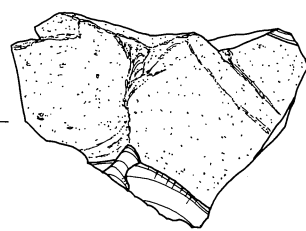
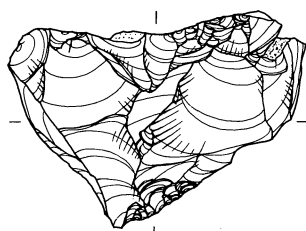
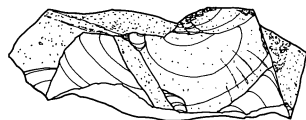
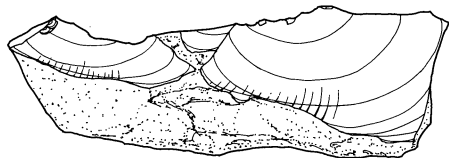

723  
Co Ob WDTY  
BL14 26.92g  
VaF 3523

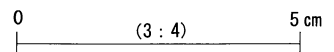

日向林 I 石器文化 石器実測図106 (石核 1)

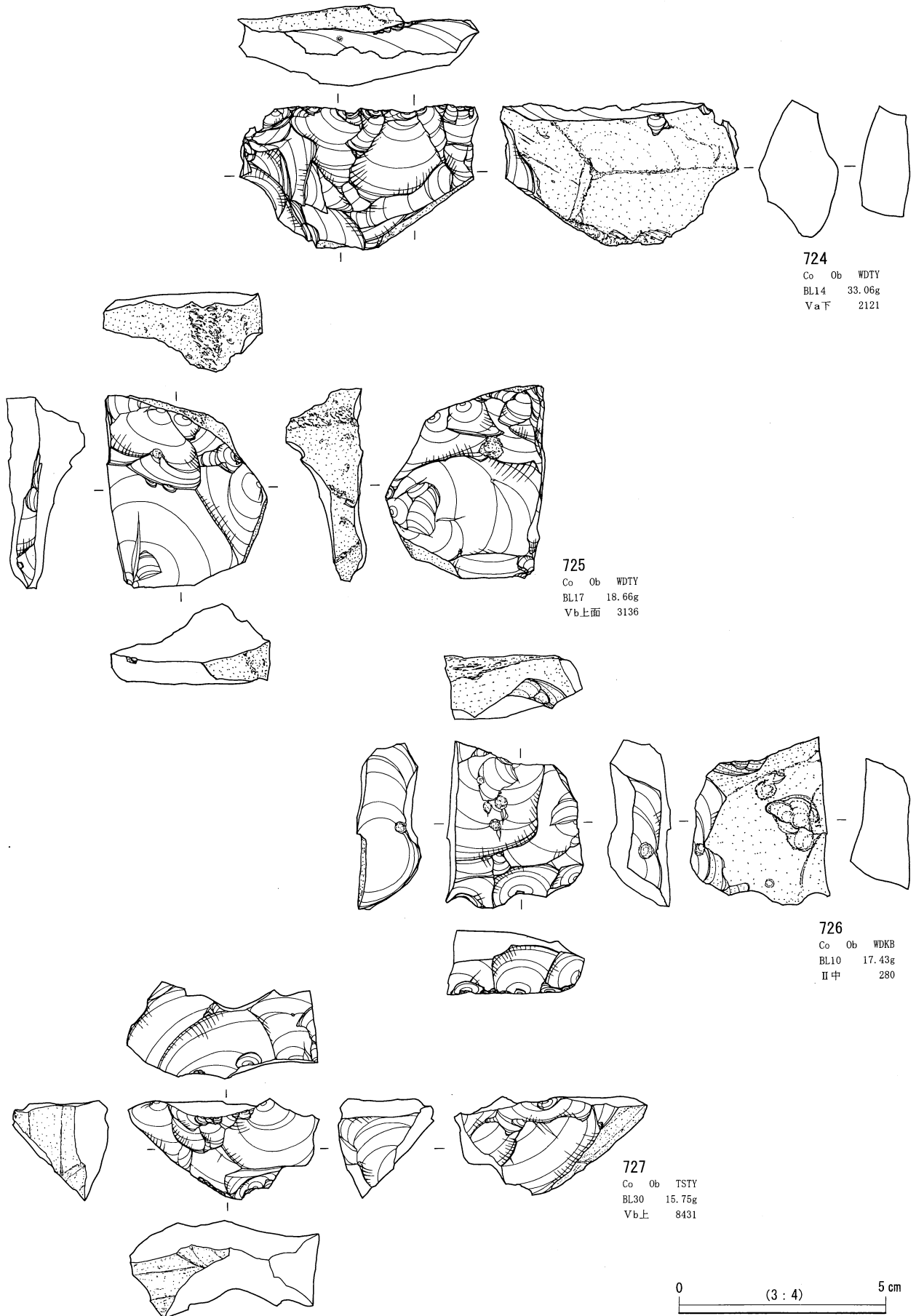

日向林 I 石器文化 石器実測図107 (石核 2)

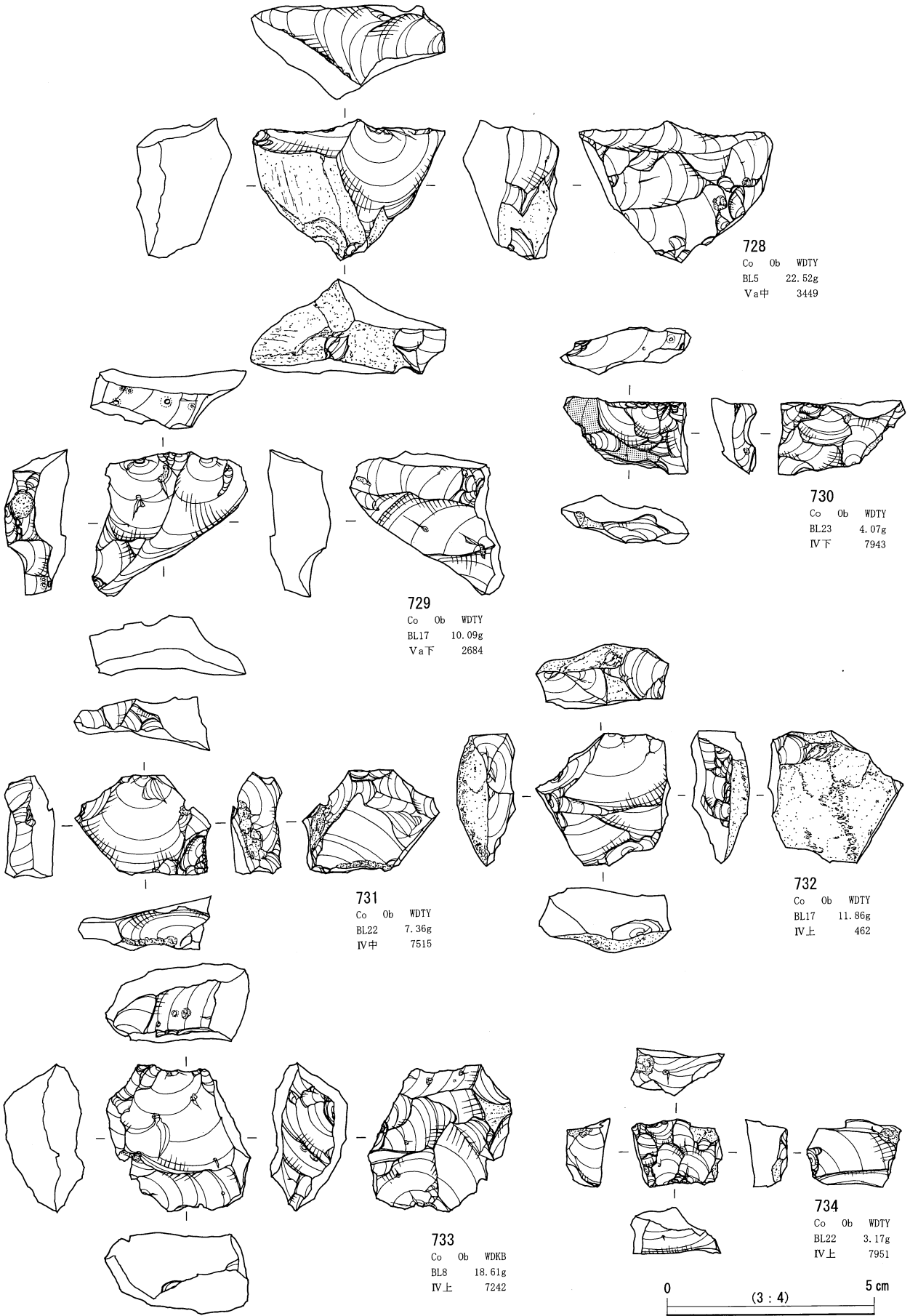

日向林 I 石器文化 石器実測図108 (石核 3)

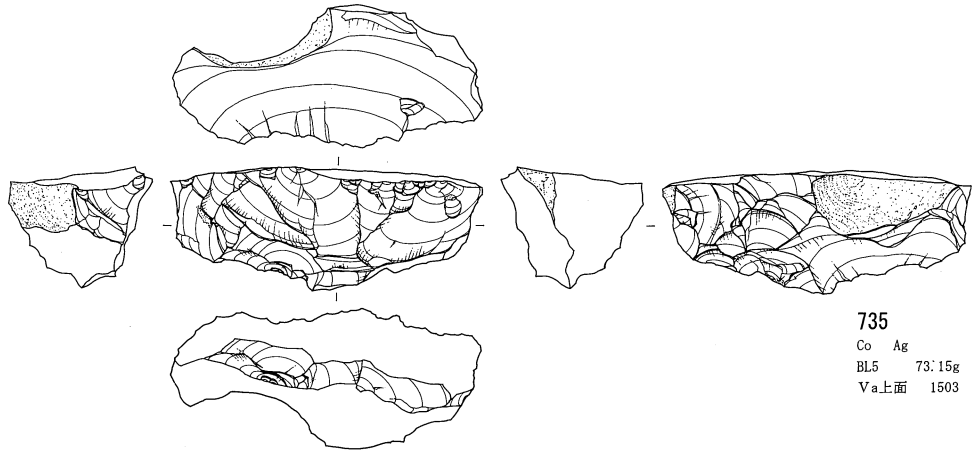

0 (1:2) 10 cm

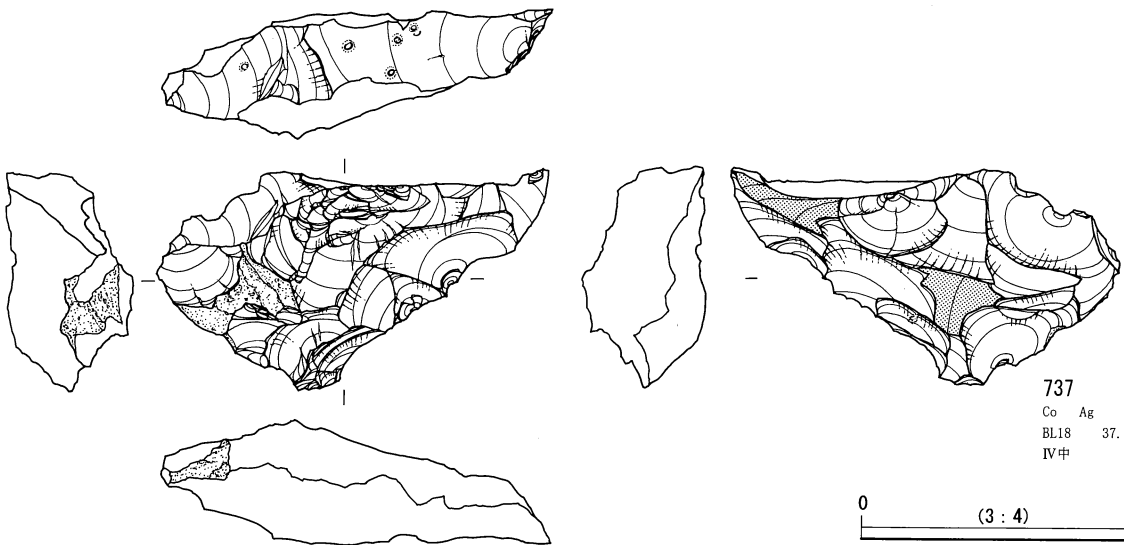
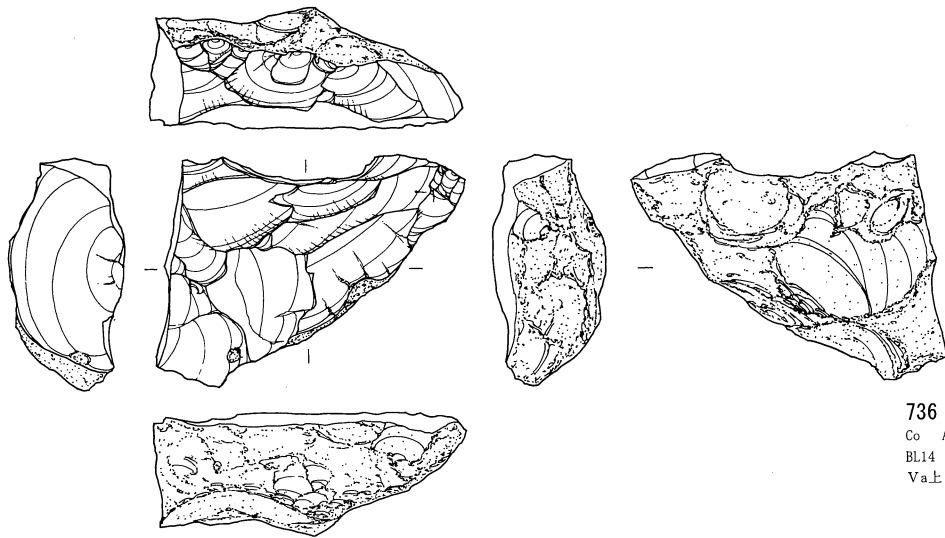

0 (3:4) 5 cm

日向林 I 石器文化 石器実測図109 (石核 4)

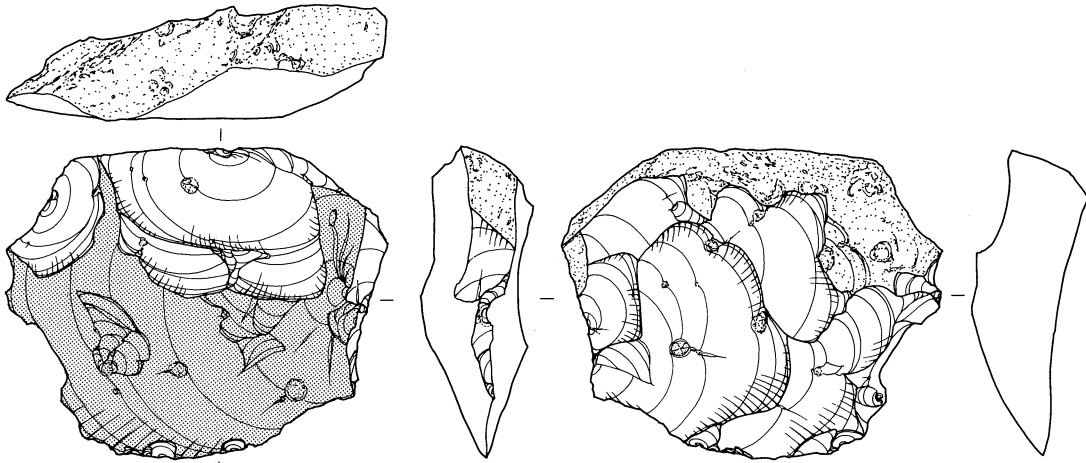

738

Co	Ob	WDTY
BL11		55.78g
VbF		5315

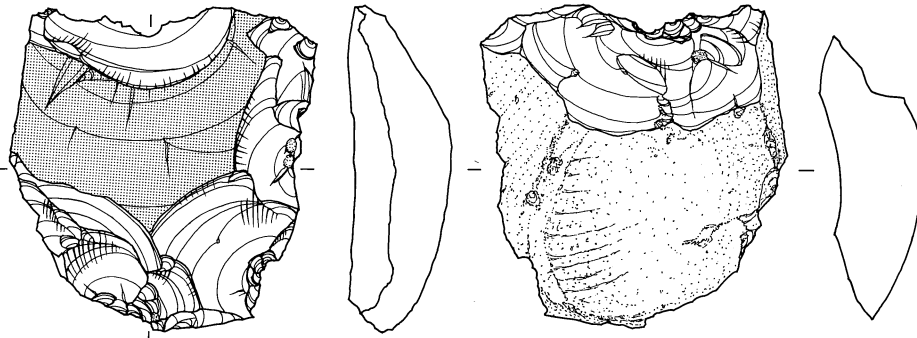

739

Co	Ob	WDTY
BL8		47.69g
VaF		8079

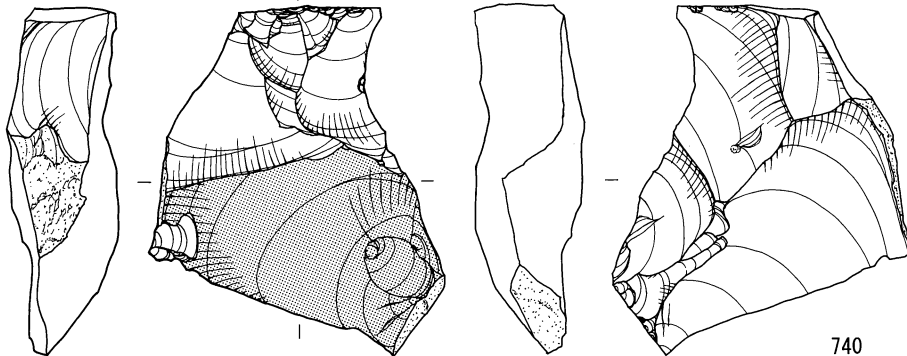
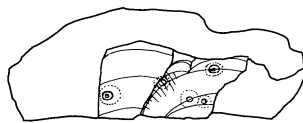

740

Co	Ob	WDTY
BL18		40.91g
Va上		3400

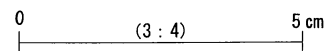

日向林 I 石器文化 石器実測図110 (石核 5)

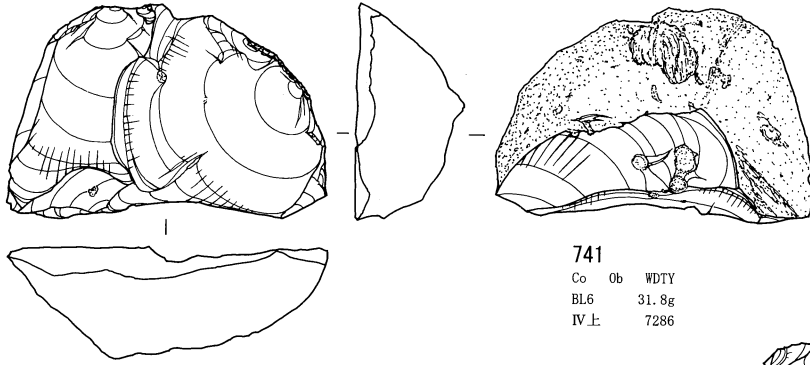

741  
Co Ob WDTY  
BL6 31.8g  
IV上 7286

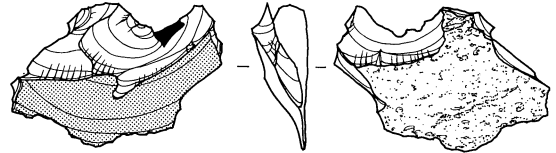

742  
Co Ob WDTY  
BL22 5.23g  
Vb上 9210

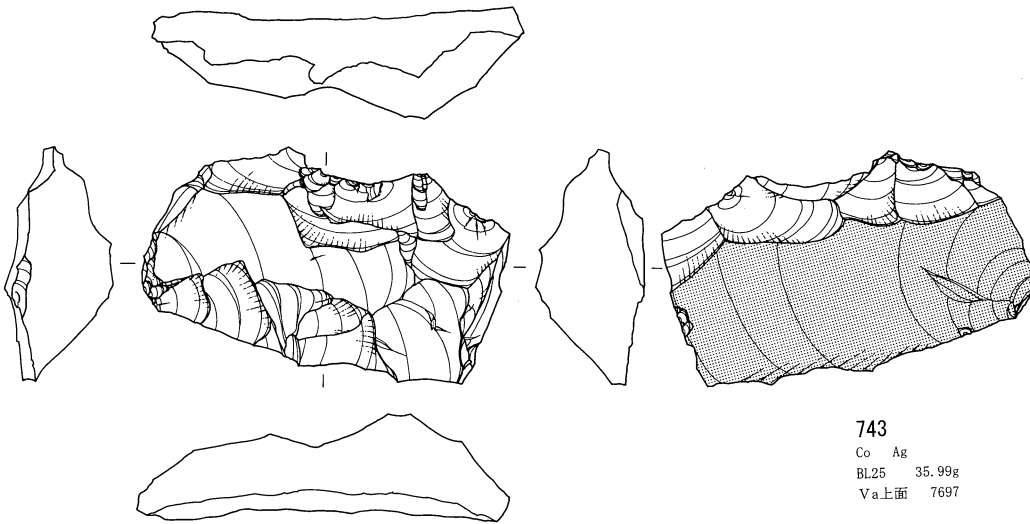

743  
Co Ag  
BL25 35.99g  
Va上面 7697

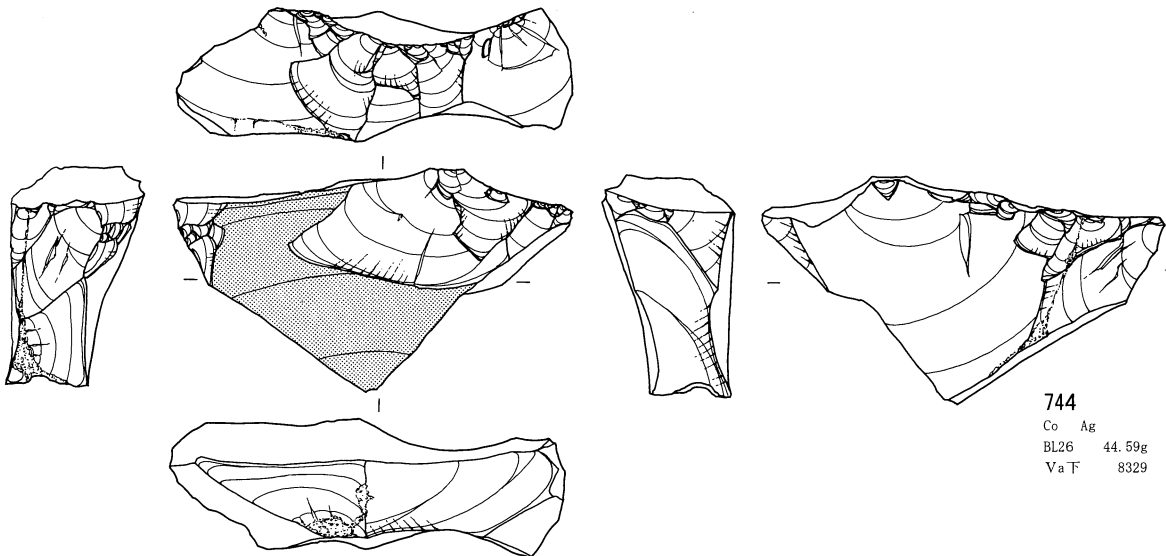

744  
Co Ag  
BL26 44.59g  
Va下 8329

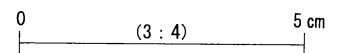

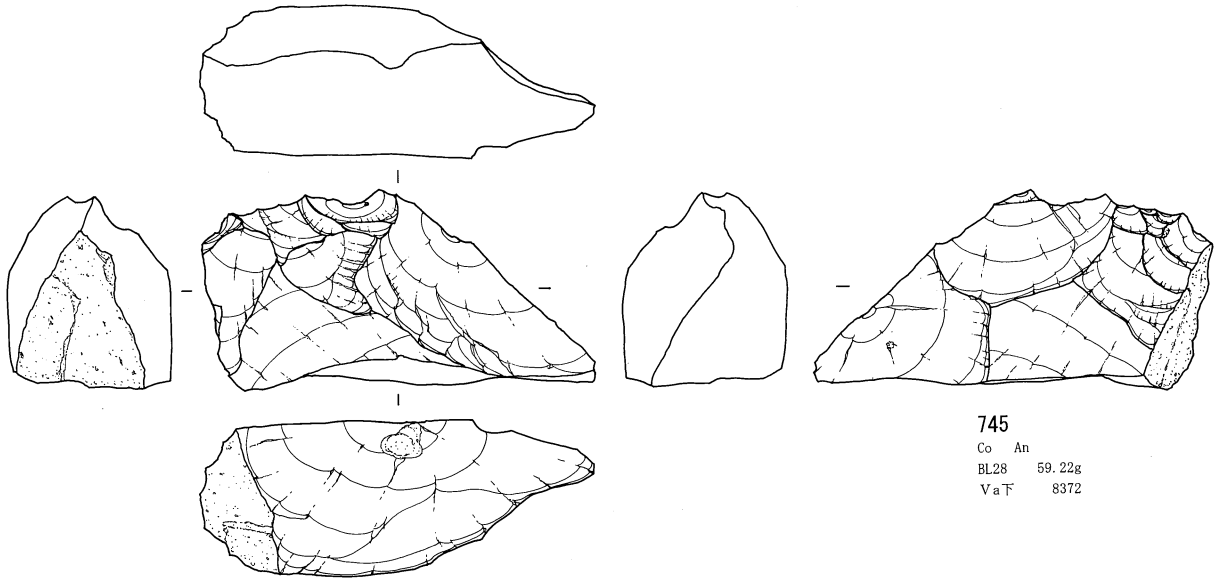

745

Co An  
 BL28 59.22g  
 Va下 8372

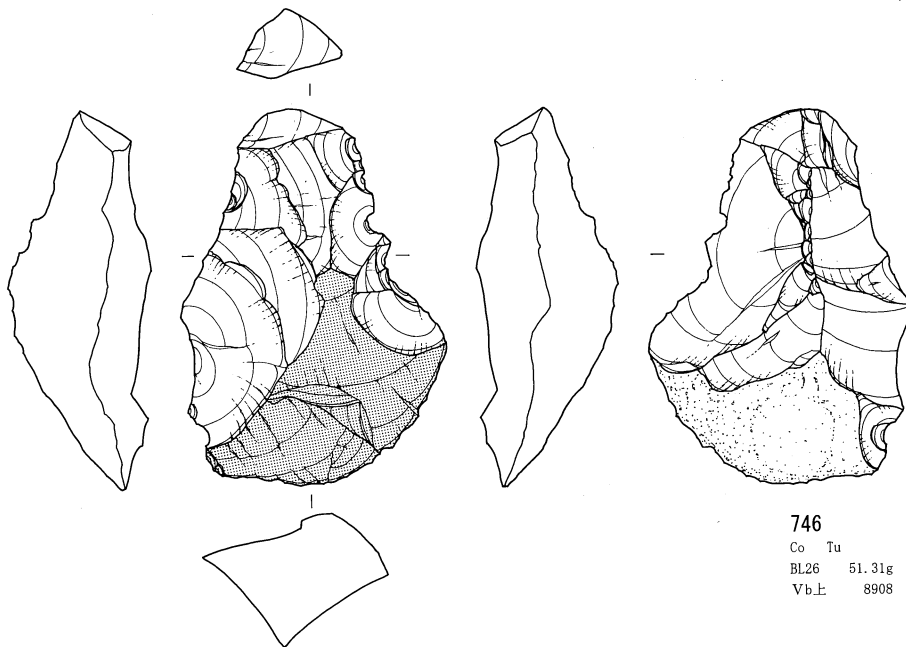

746

Co Tu  
 BL26 51.31g  
 Vb上 8908

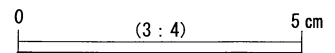

日向林 I 石器文化 石器実測図112 (石核 7)



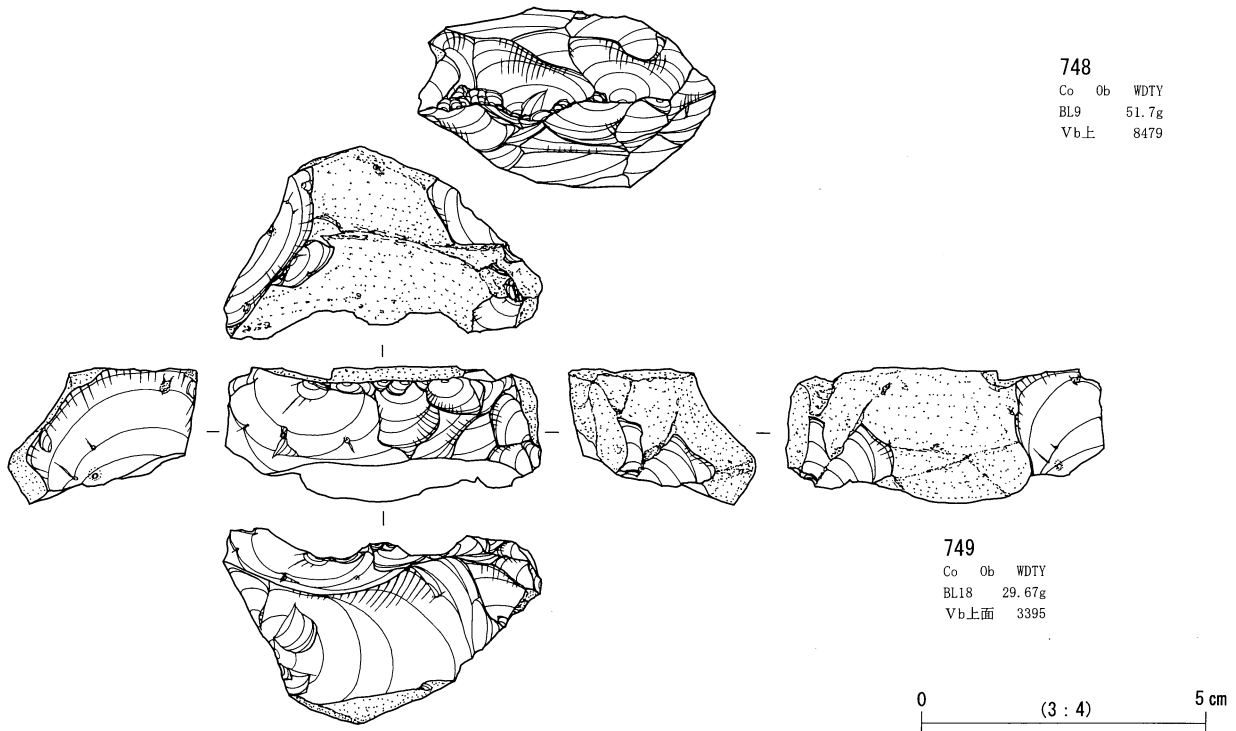
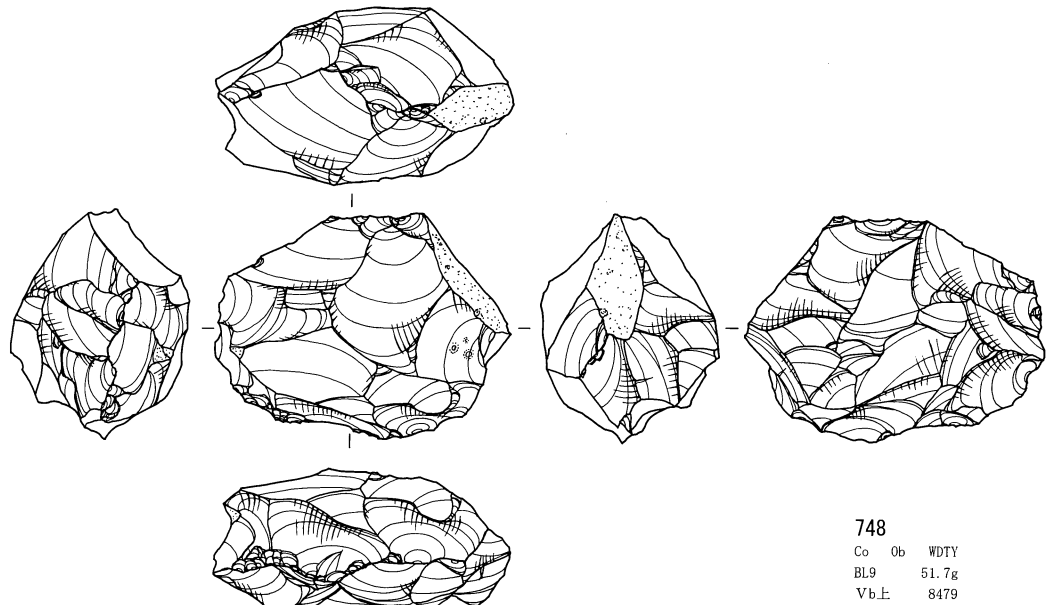
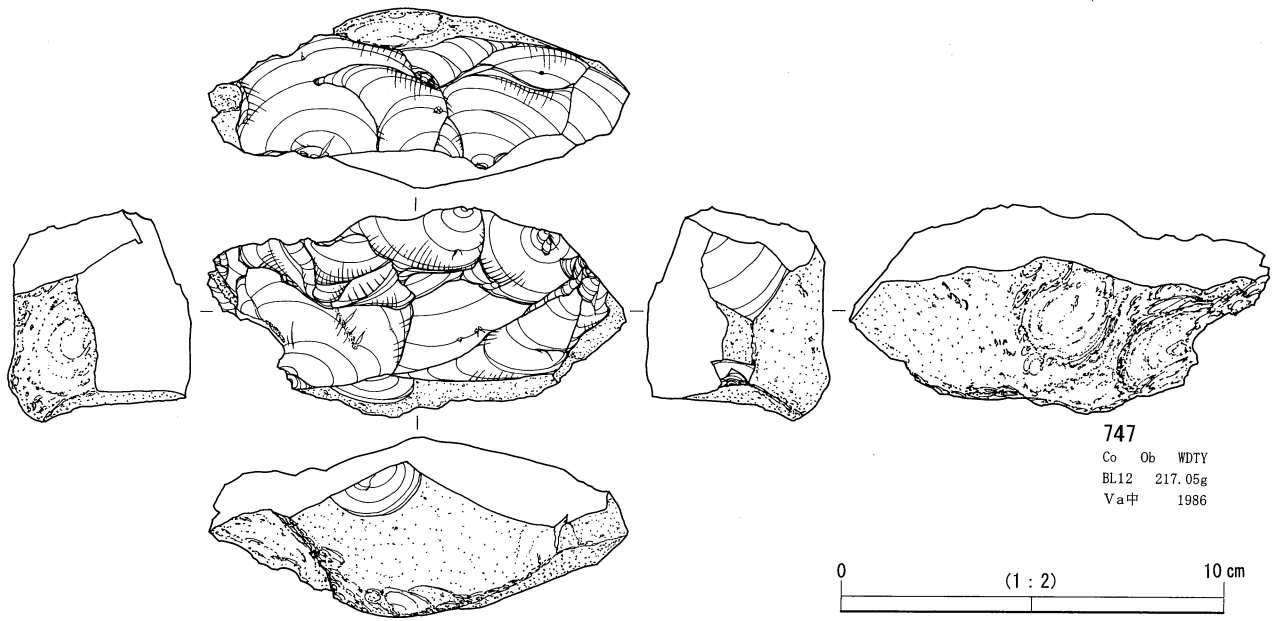

日向林 I 石器文化 石器実測図113 (石核 8)

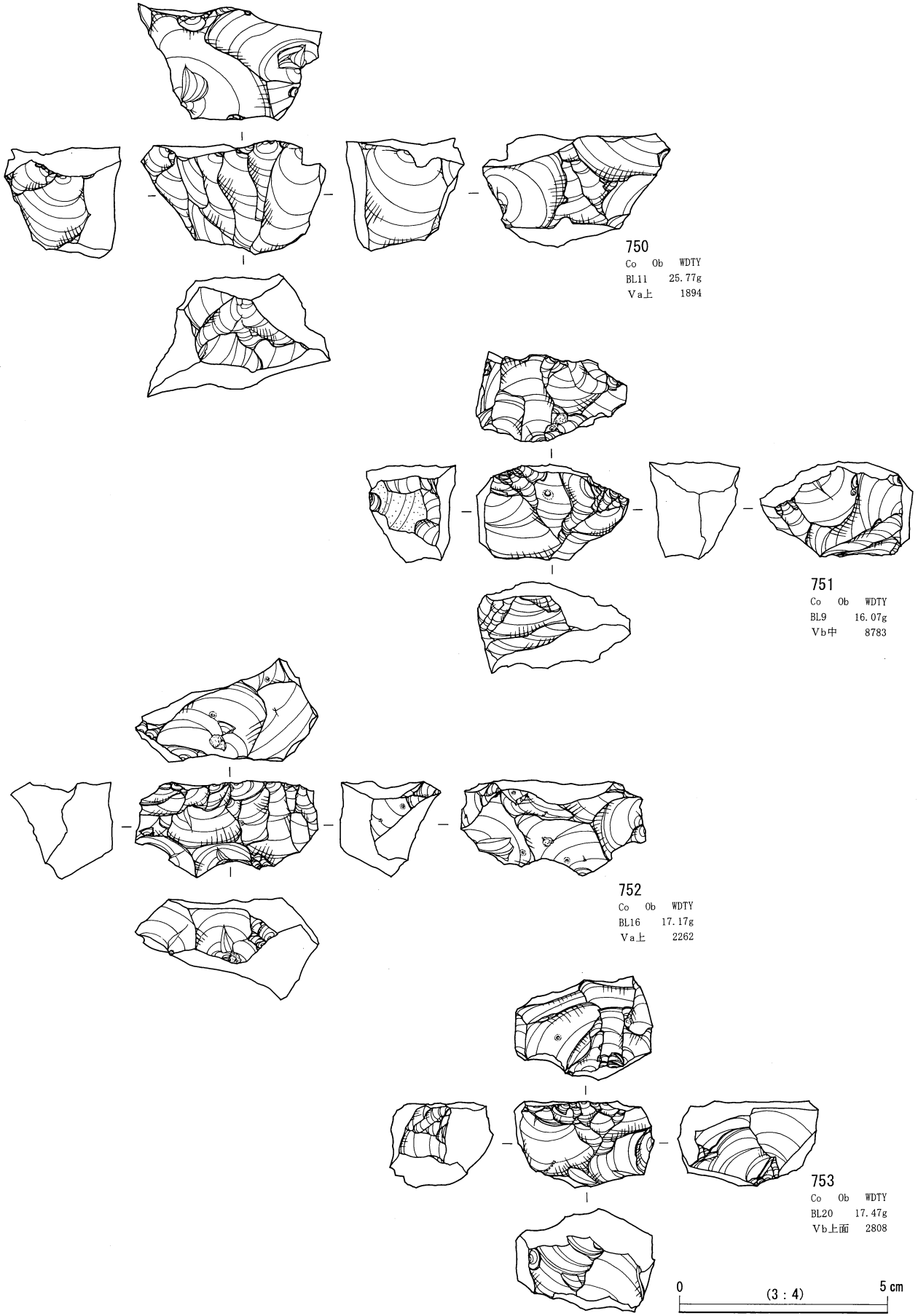

日向林 I 石器文化 石器実測図114 (石核 9)

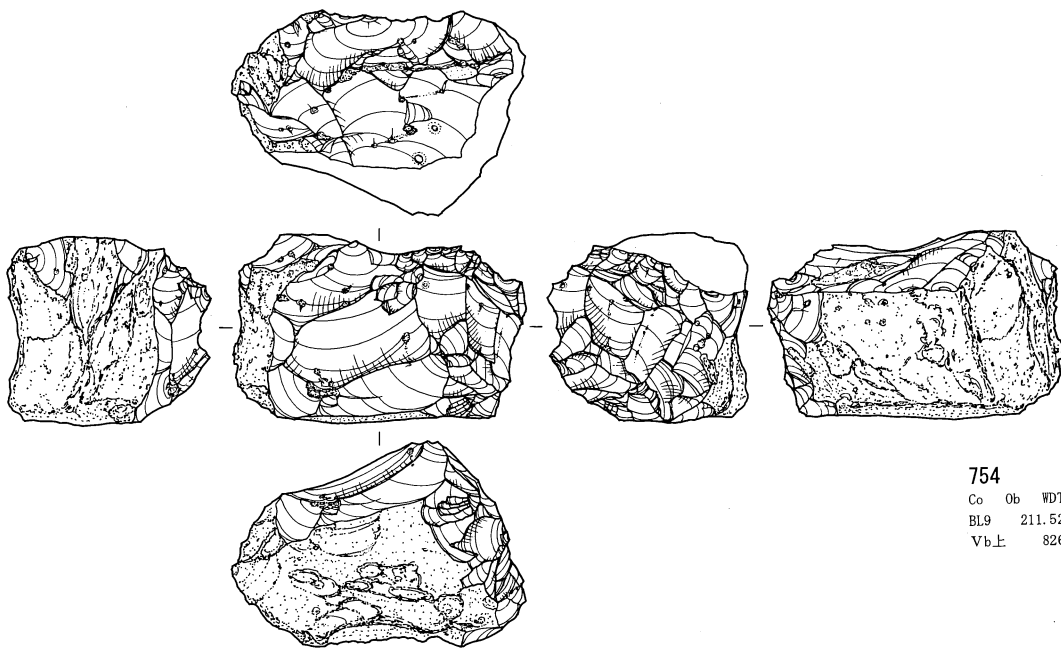

754  
 Co Ob WDTY  
 BL9 211.52g  
 Vb上 8263

0 (1 : 2) 10 cm

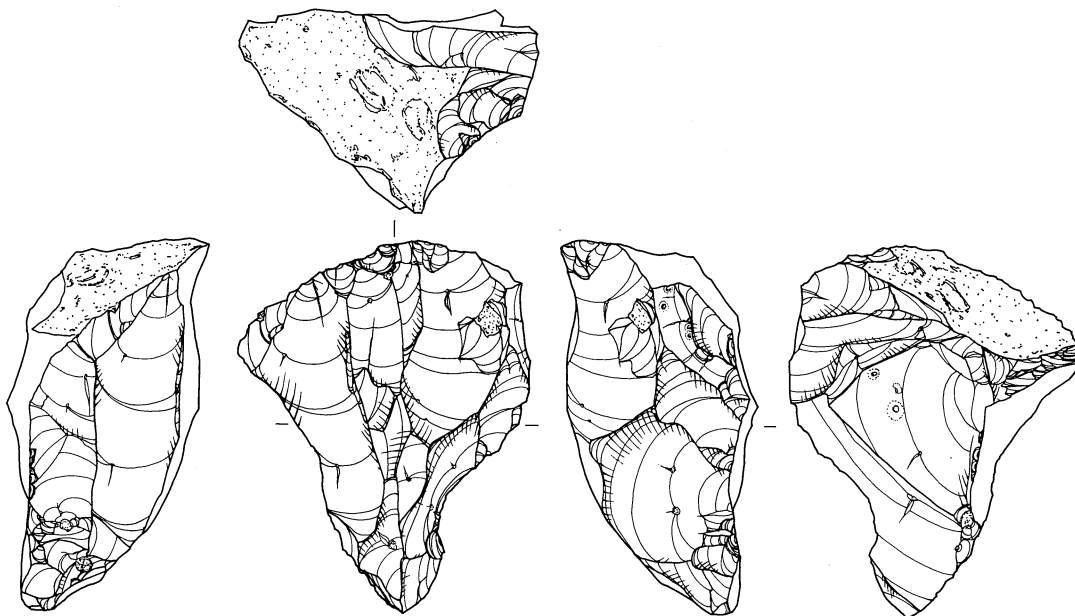

755  
 Co Ob WDTY  
 BL8 71.63g  
 Vb上 8477

0 (3 : 4) 5 cm

日向林 I 石器文化 石器実測図115 (石核10)

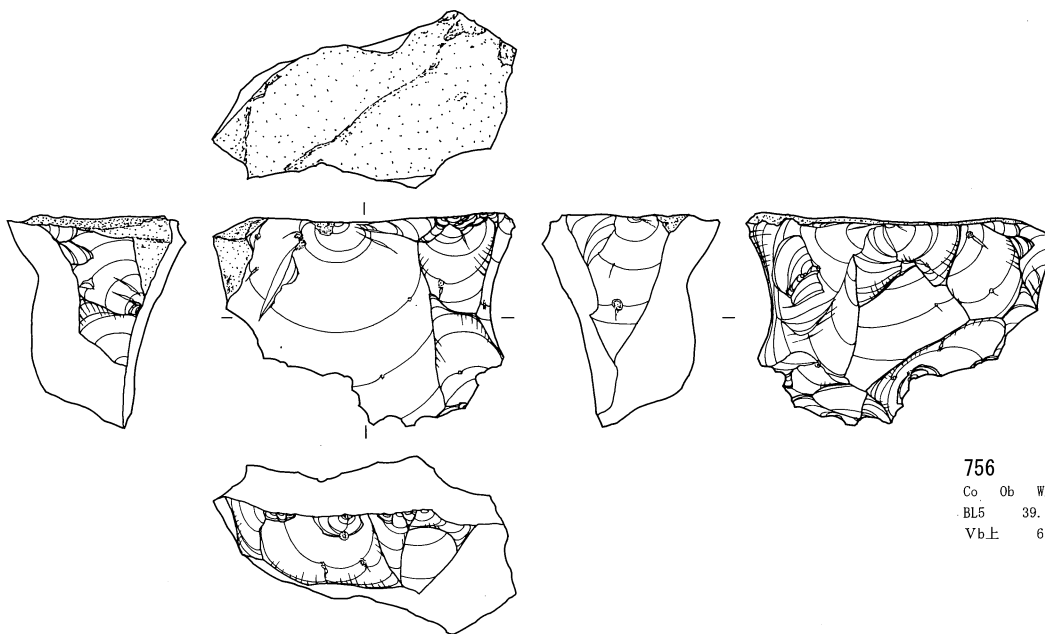

756  
Co Ob WDKB  
BL5 39.84g  
Vb上 6762

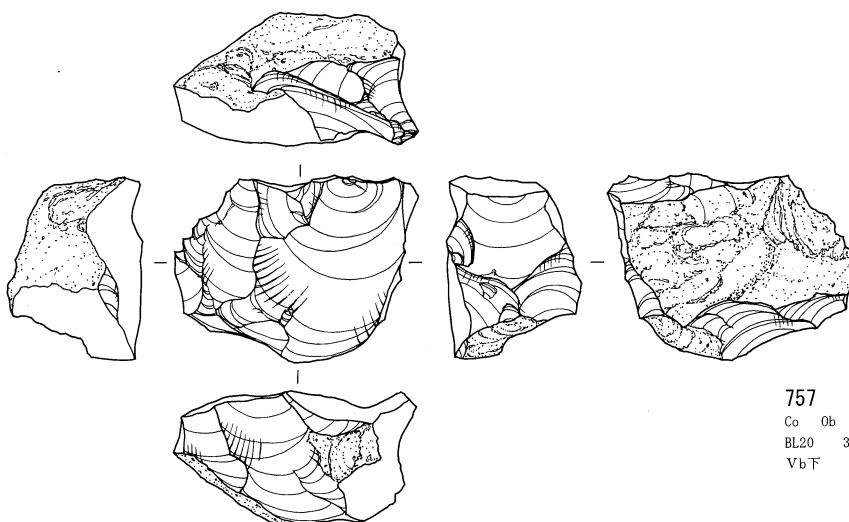

757  
Co Ob WDTY  
BL20 30.57g  
Vb下 6367

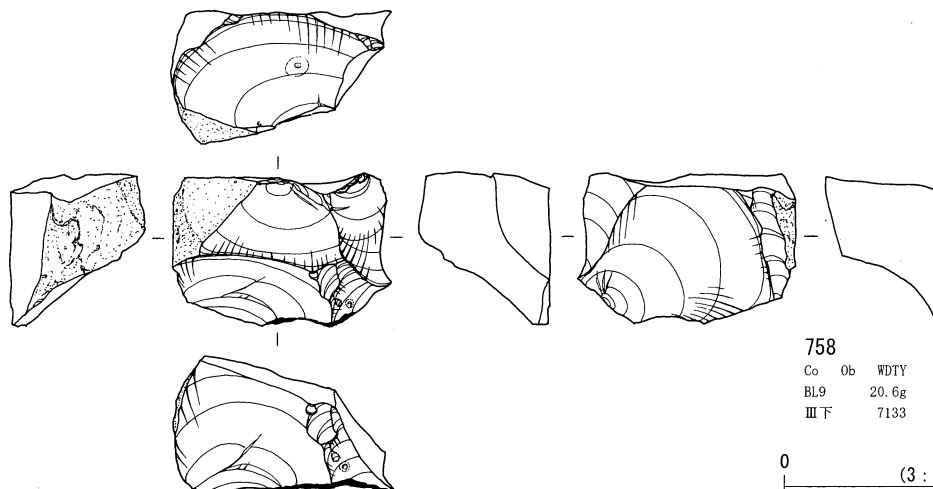

758  
Co Ob WDTY  
BL9 20.6g  
III下 7133

0 (3:4) 5 cm

日向林 I 石器文化 石器実測図116 (石核11)

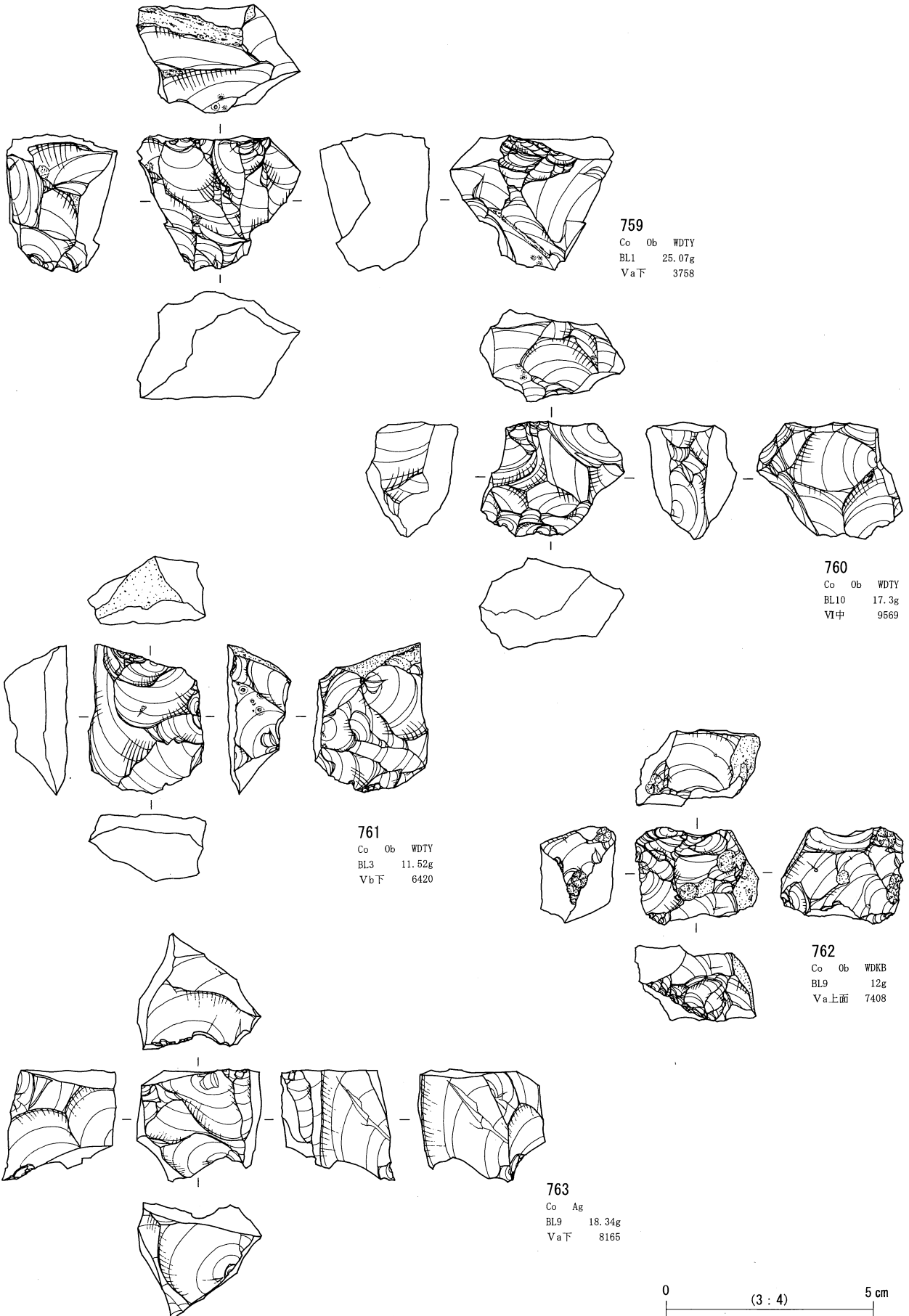

日向林 I 石器文化 石器実測図117 (石核12)

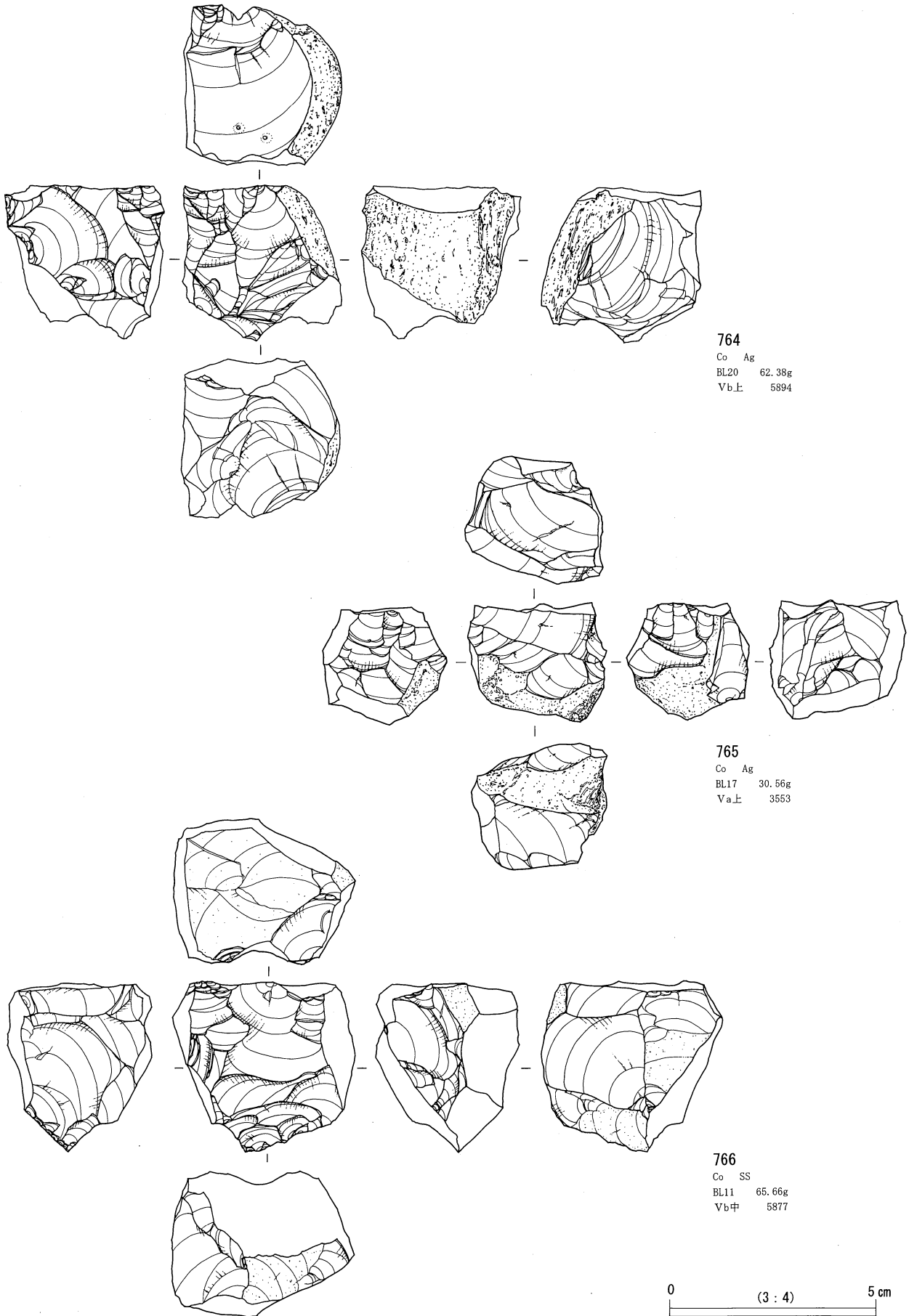

日向林 I 石器文化 石器実測図118 (石核13)

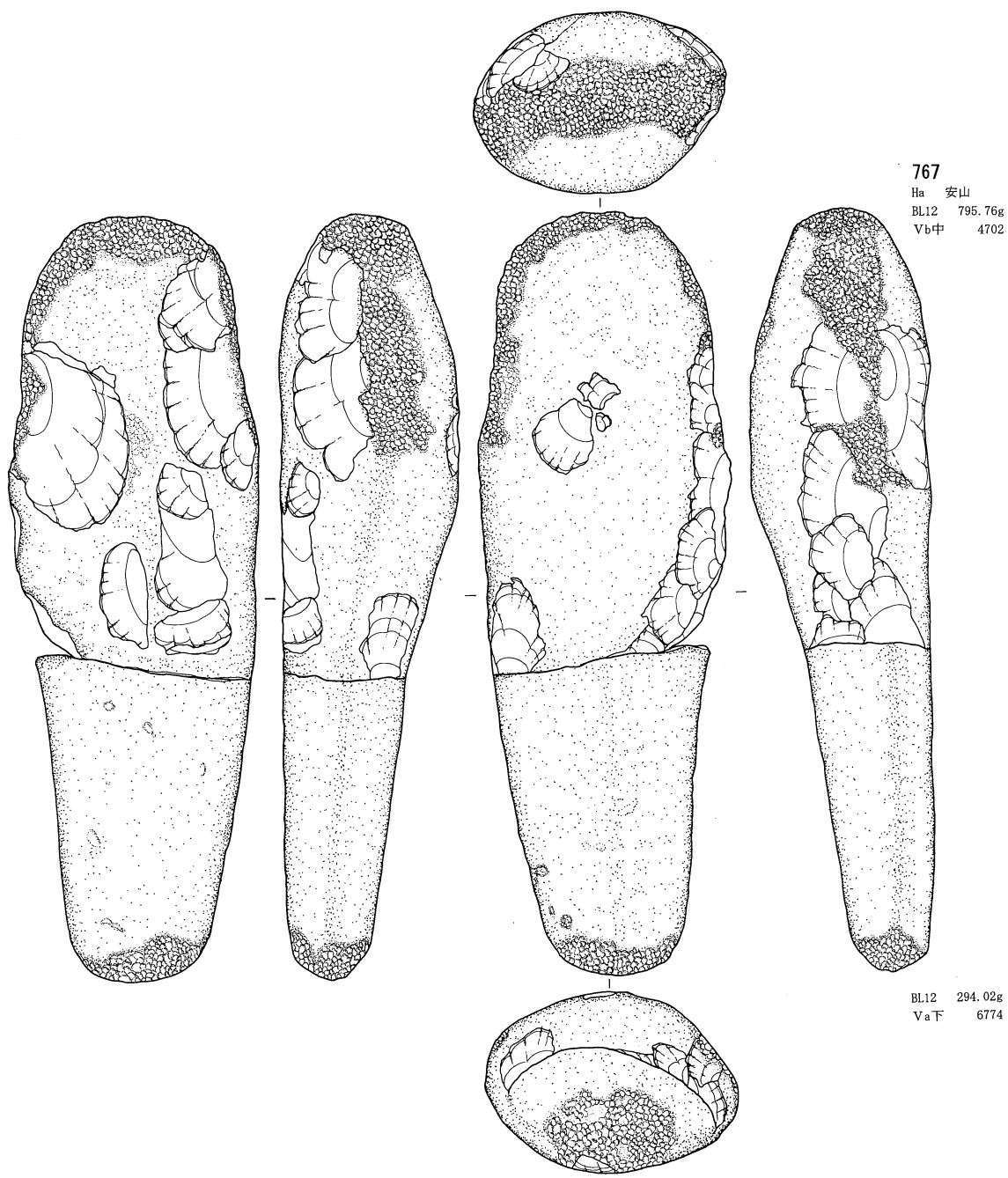

767  
 Ha 安山  
 BL12 795.76g  
 Vb中 4702

BL12 294.02g  
 Va下 6774

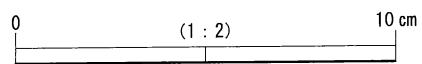

日向林 I 石器文化 石器実測図119 (敲石 1)

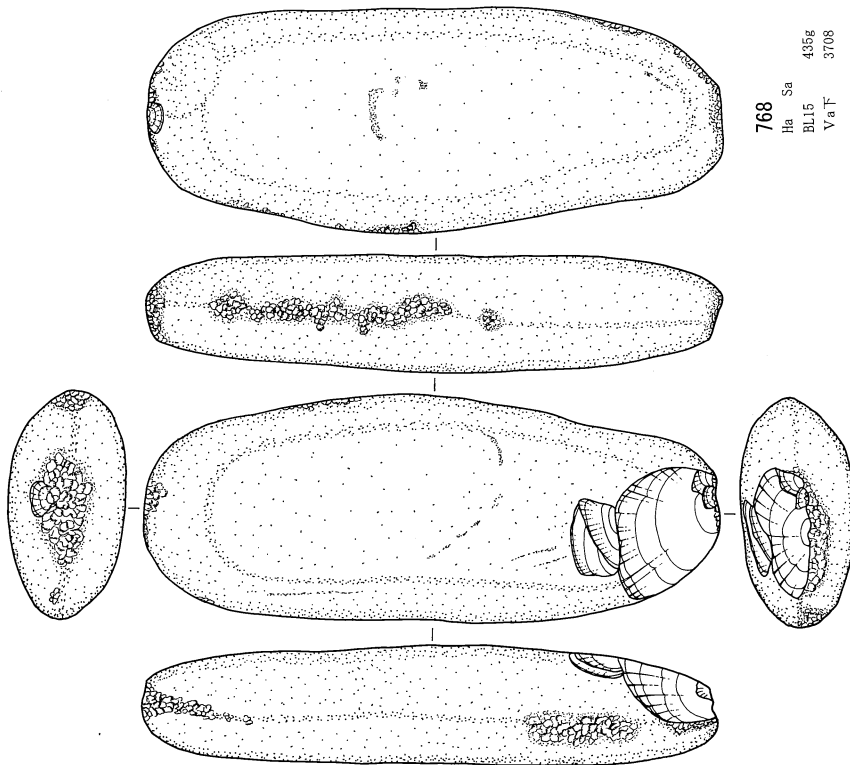
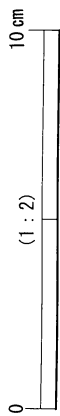
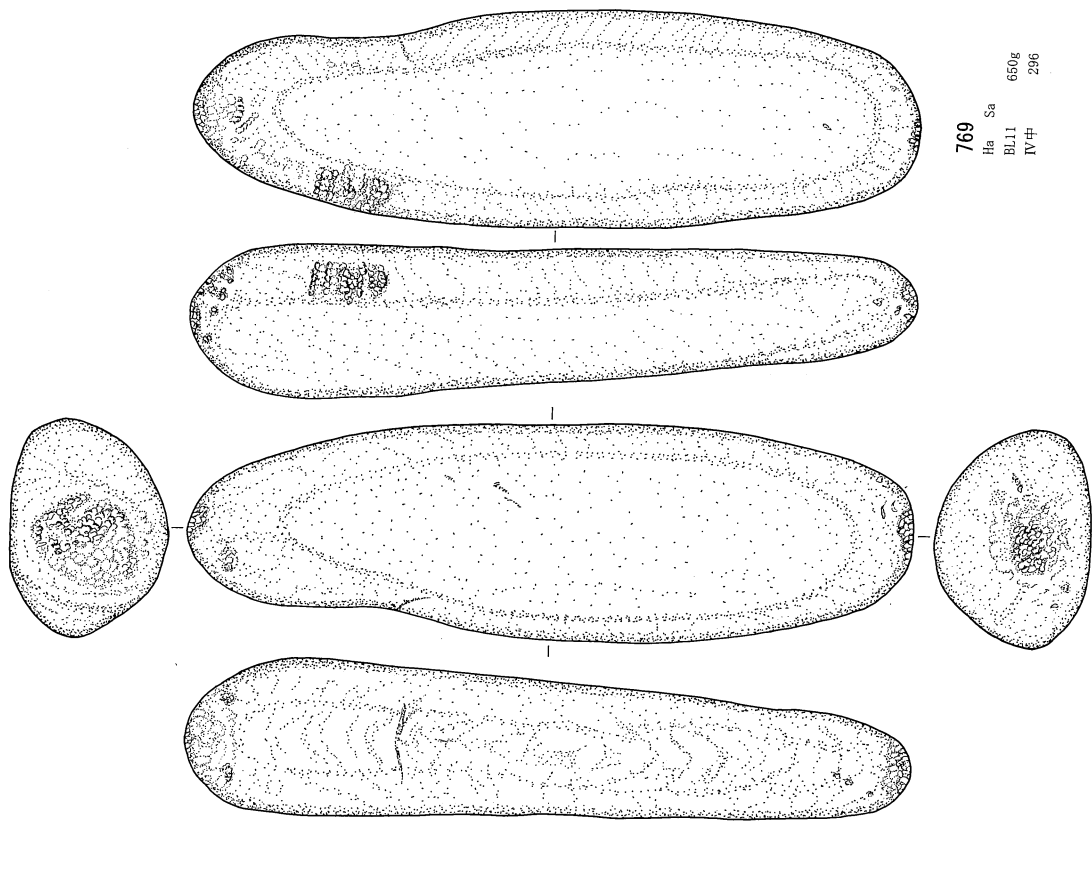

日向林 I 石器文化 石器実測図120 (敲石 2)



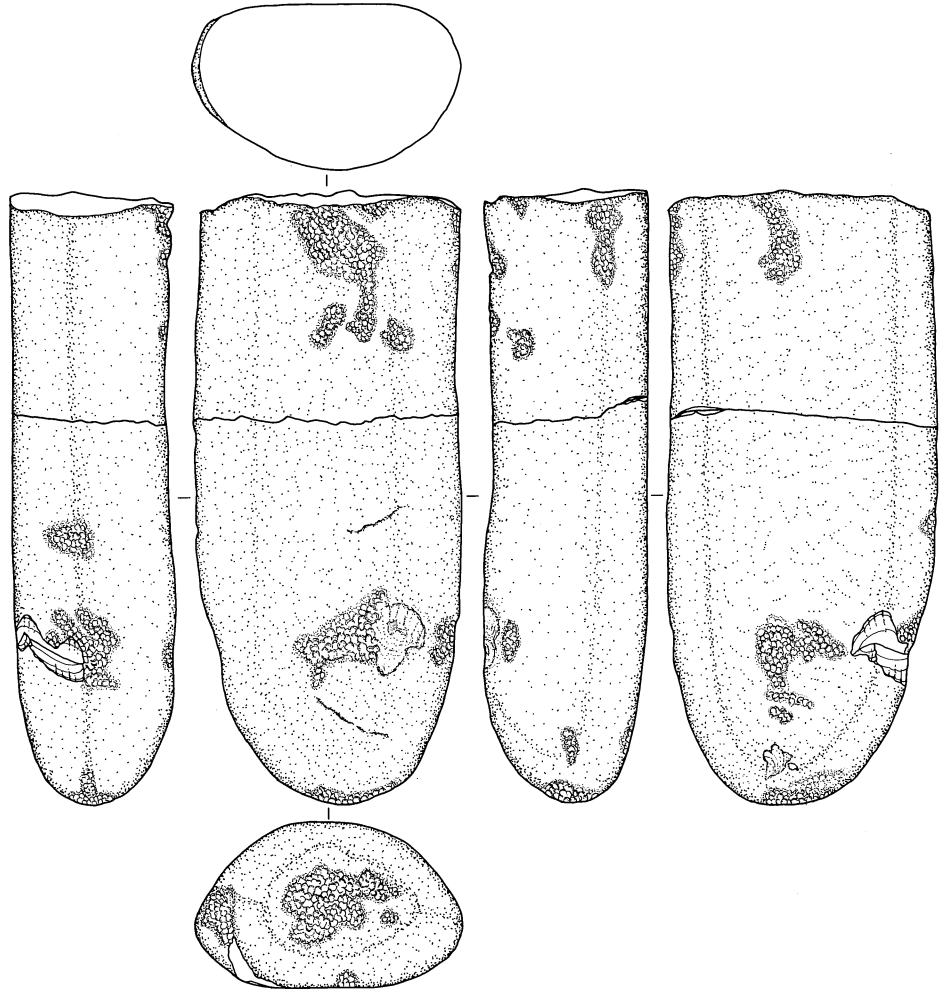

BL10 334.21g  
Vb下 5388

770  
Ha 安山  
BL11 449.21g  
Vb下 6764

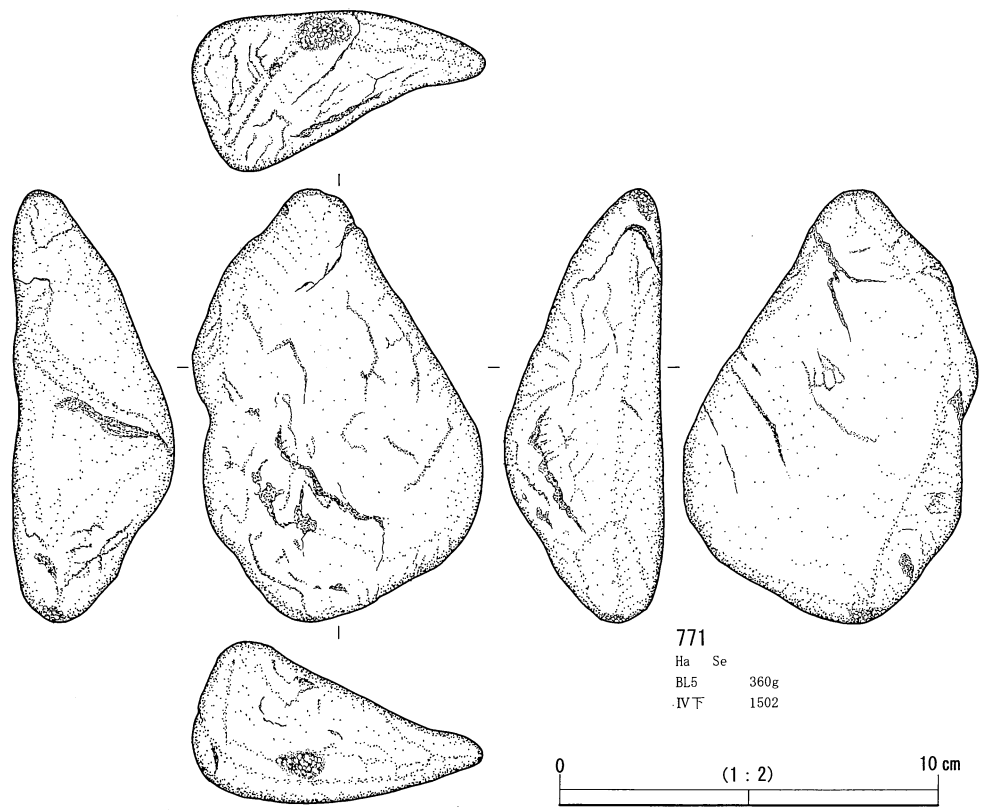

771  
Ha Se  
BL5 360g  
IV下 1502

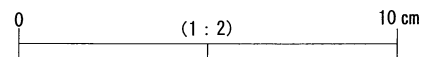

日向林 I 石器文化 石器実測図121 (敲石 3)

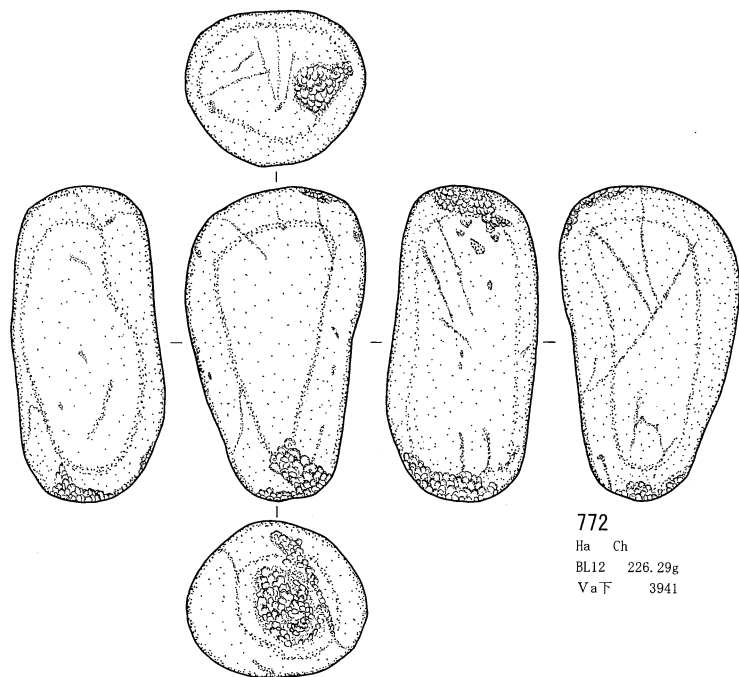

772  
Ha Ch  
BL12 226.29g  
Va下 3941

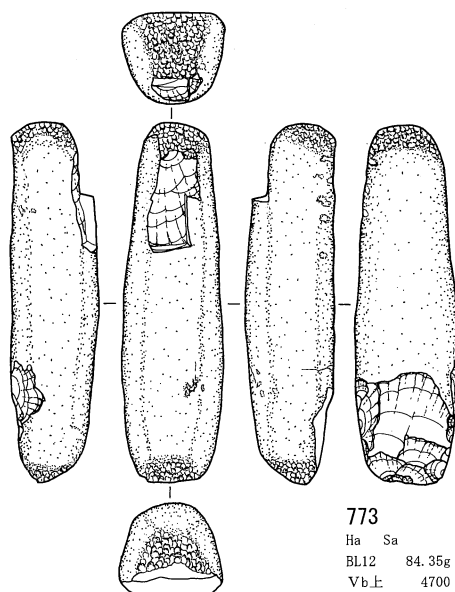

773  
Ha Sa  
BL12 84.35g  
Vb上 4700

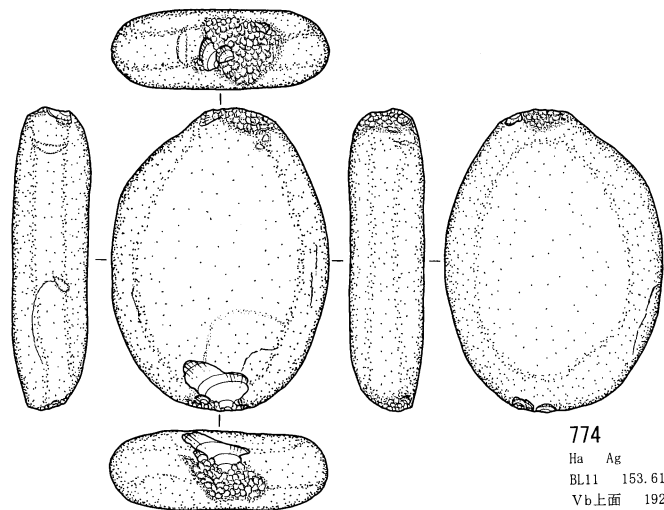

774  
Ha Ag  
BL11 153.61g  
Vb上面 1920

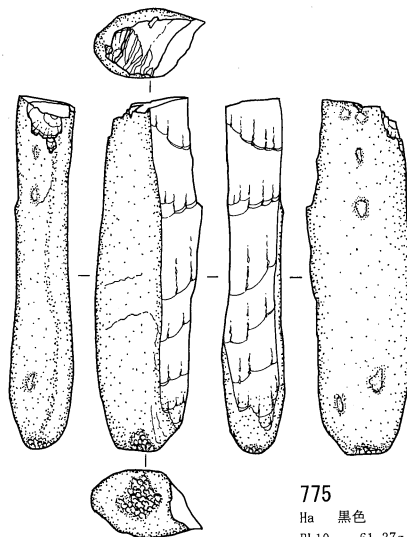

775  
Ha 黑色  
BL10 61.37g  
Va下 8181

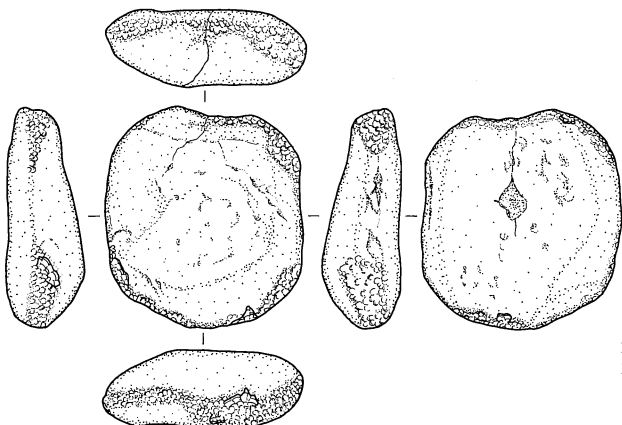

776  
Ha Se  
BL7 97.7g  
IV中 7269

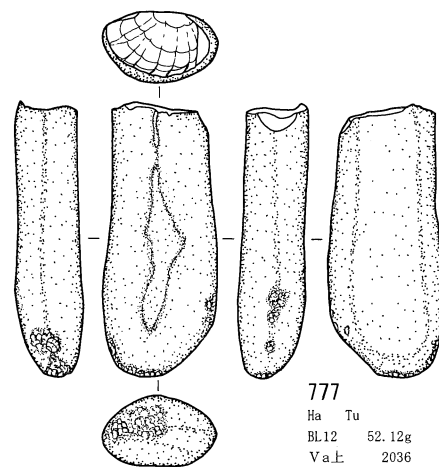

777  
Ha Tu  
BL12 52.12g  
Va上 2036

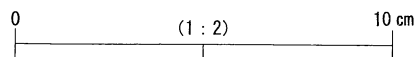

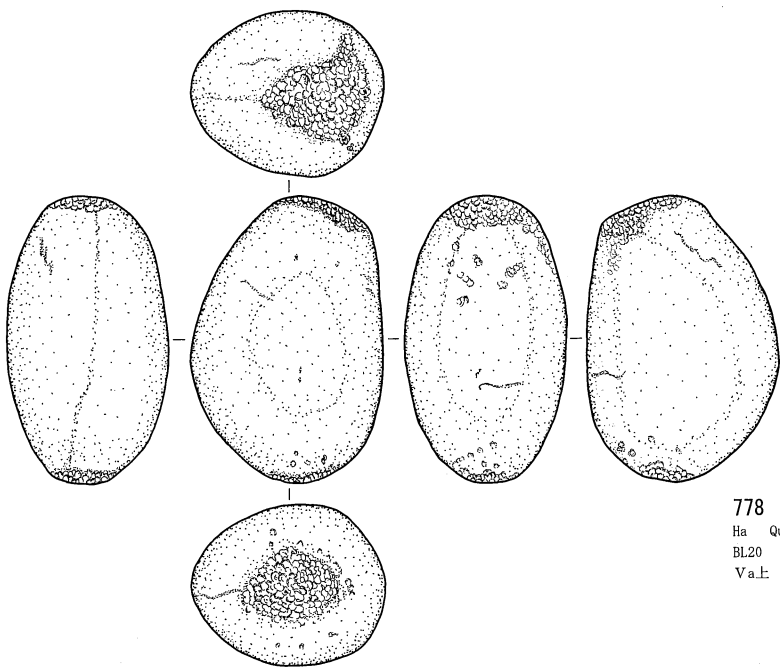

778  
Ha Qu  
BL20 235.39g  
Va上 8105

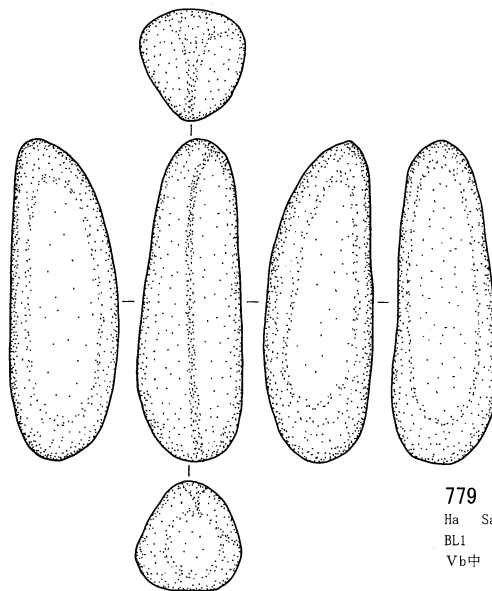

779  
Ha Sa  
BL1 97.54g  
Vb中 4463

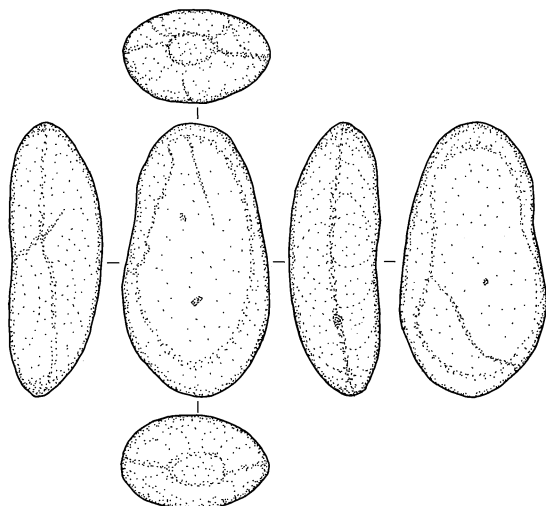

780  
GS 安山  
BL1 98.84g  
Vb下 6095

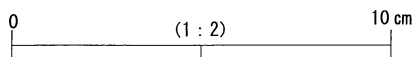

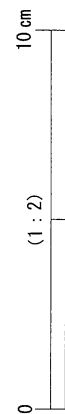
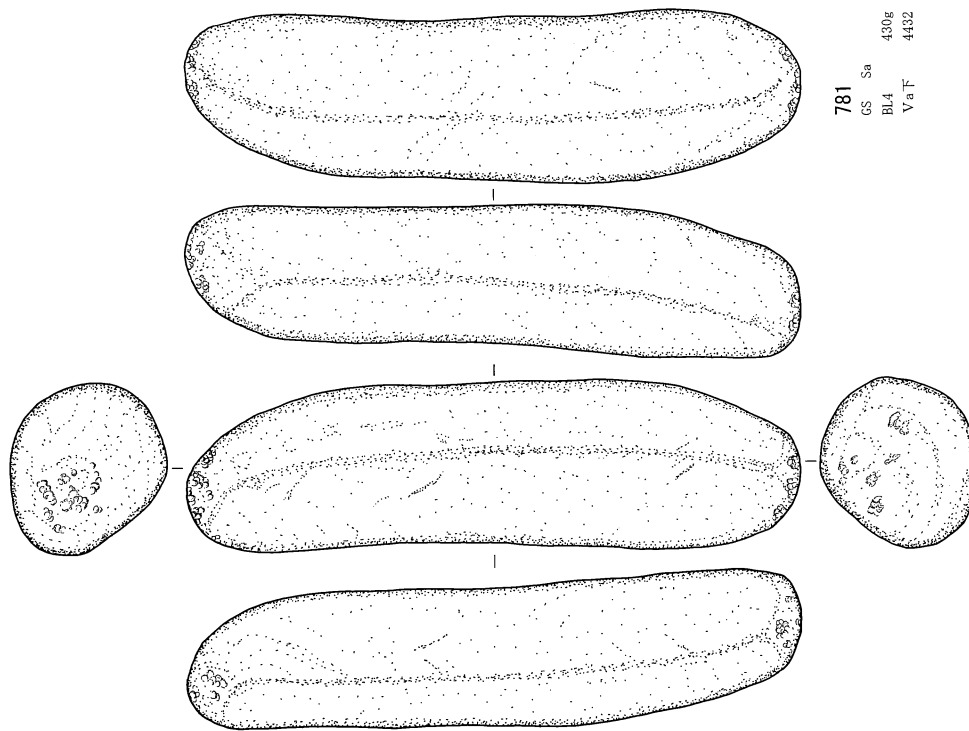
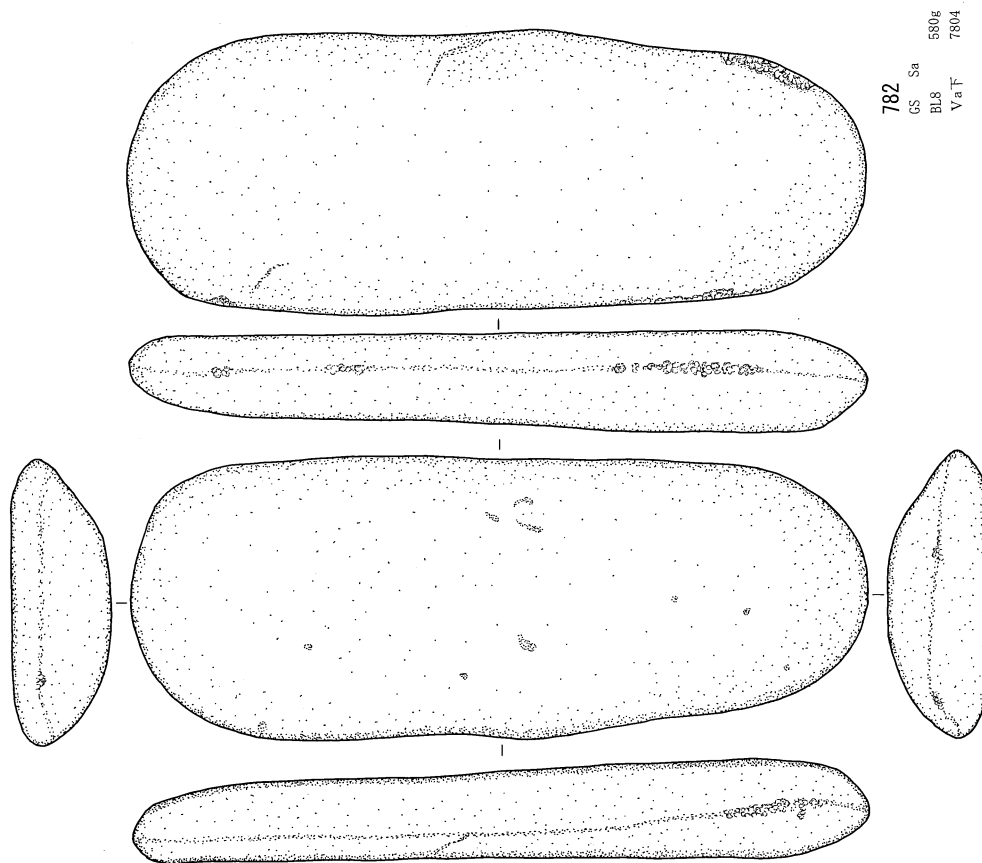

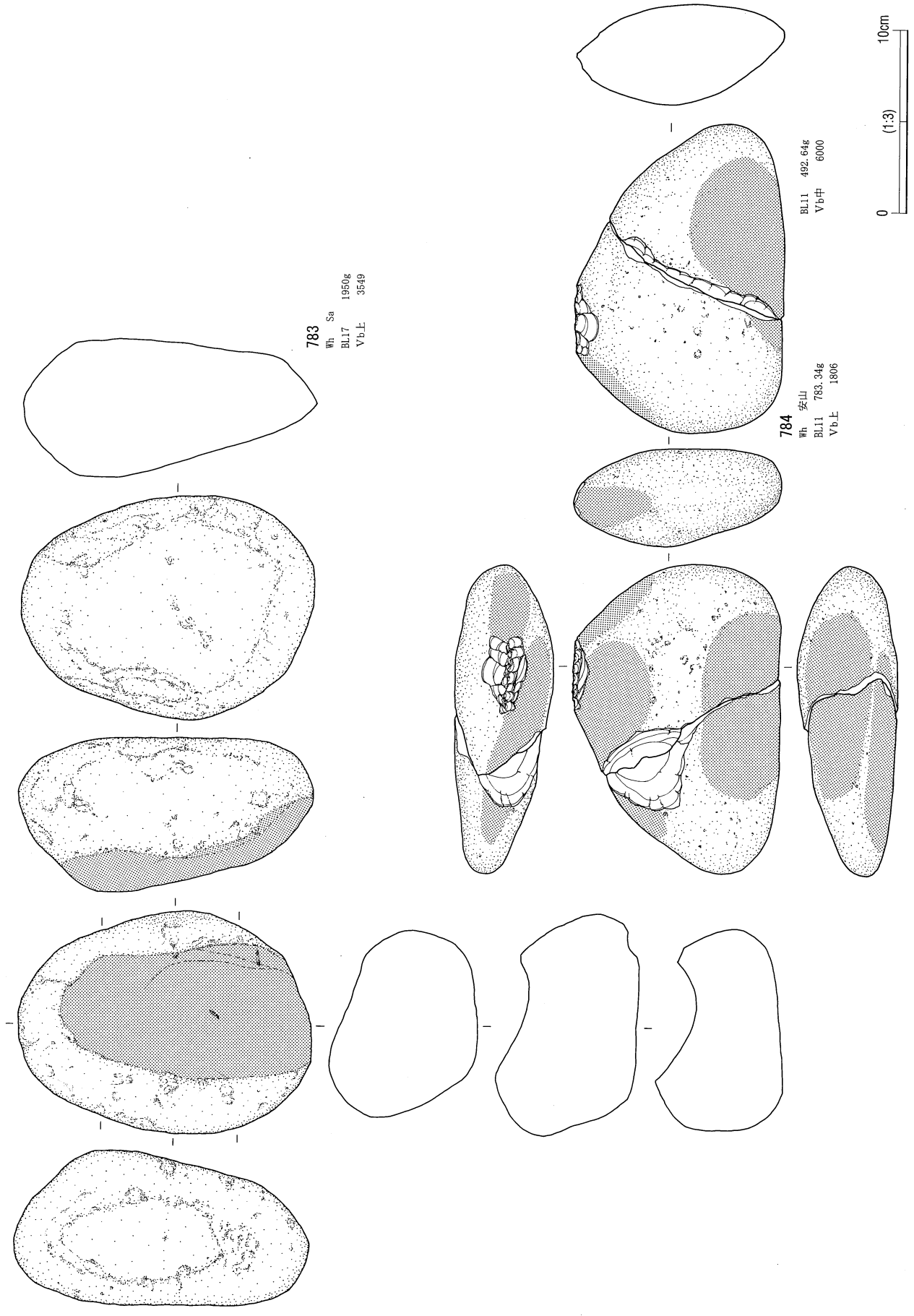

783  
Wh. Sa 1950g  
BL17 3549  
Vb.L

784  
Wh. 安山 482.64g  
BL11 6000  
Vb.中

784  
Wh. 安山 783.34g  
BL11 1806  
Vb.L

0 10cm  
(1:3)

日向林 I 石器文化 石器実測図125 (砥石)

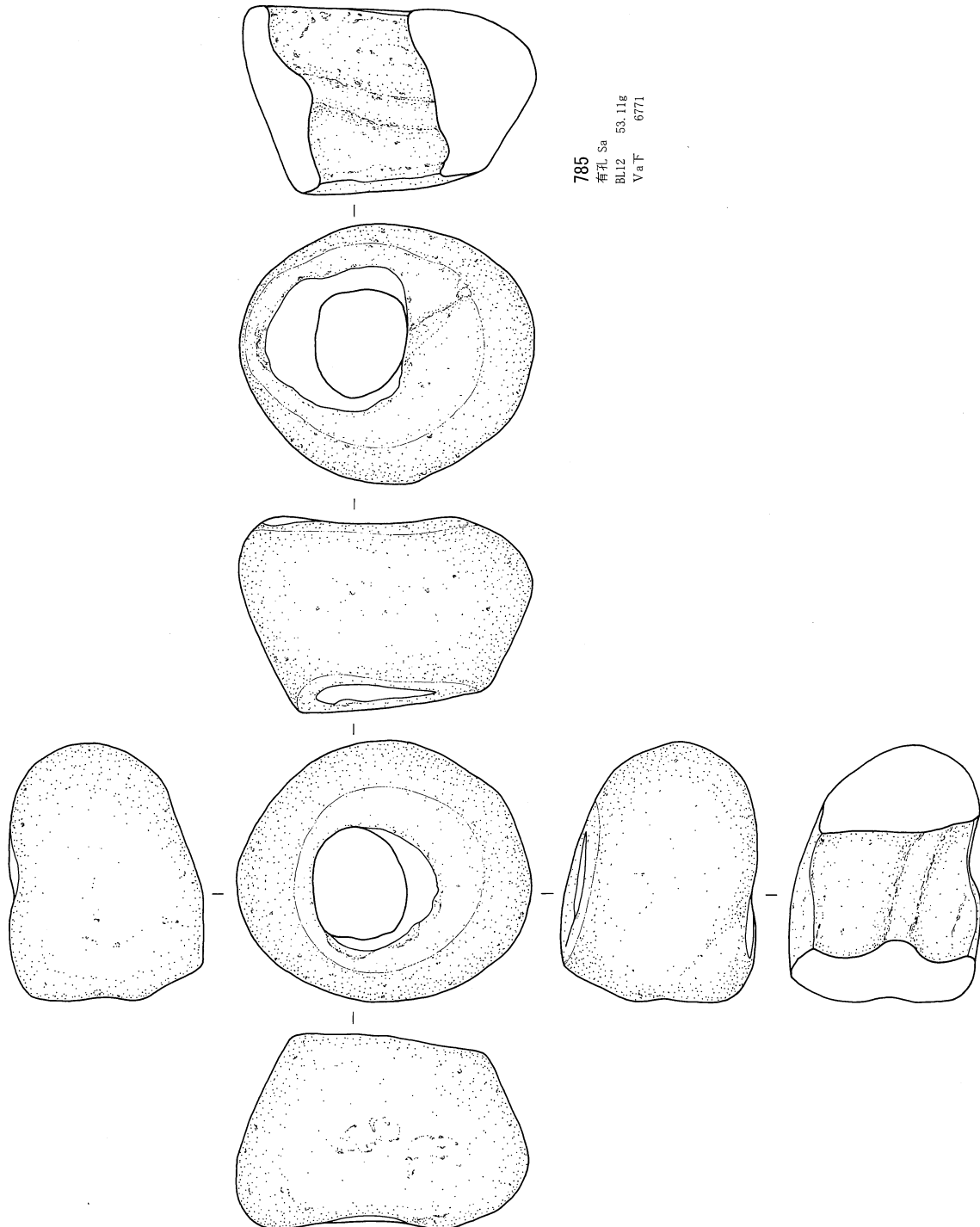

日向林 I 石器文化 石器実測図126 (有孔石製品)

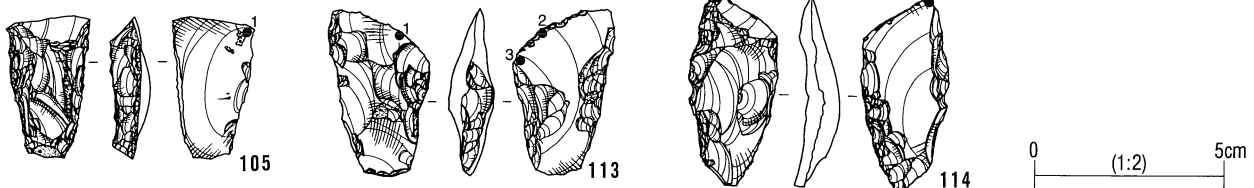
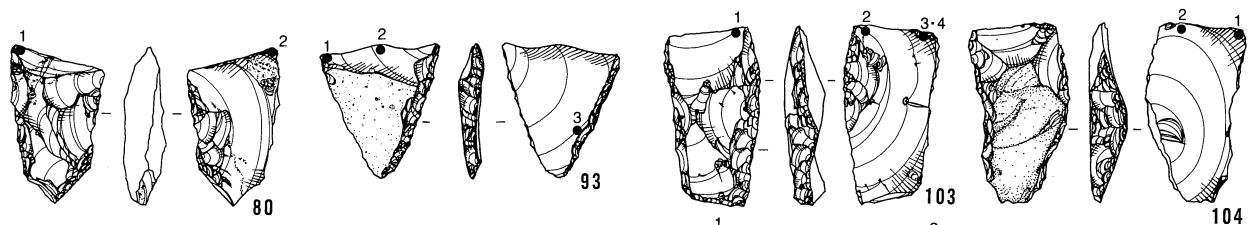
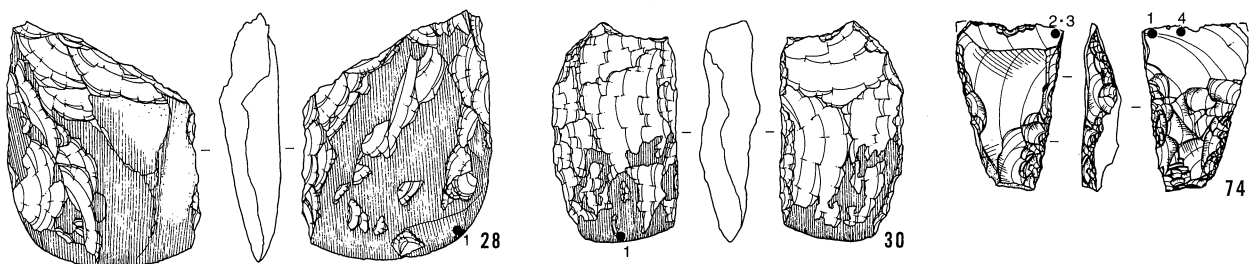
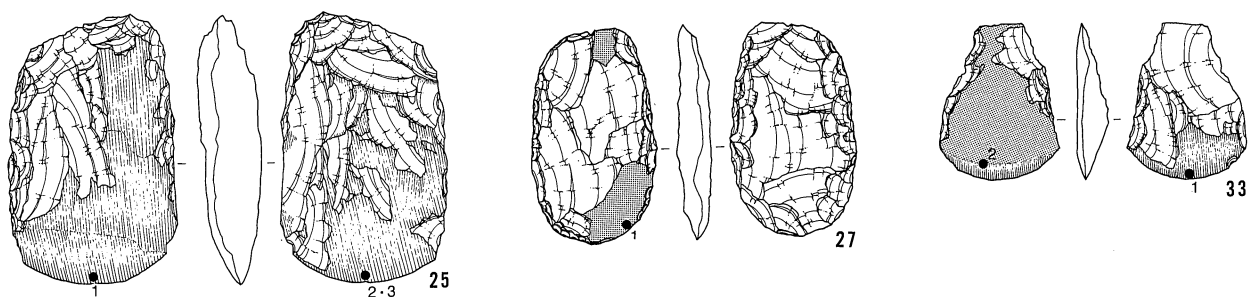
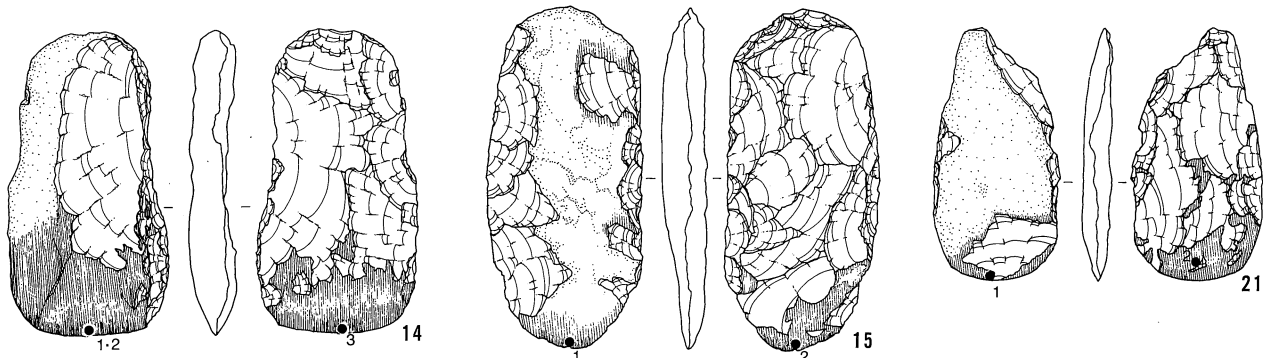
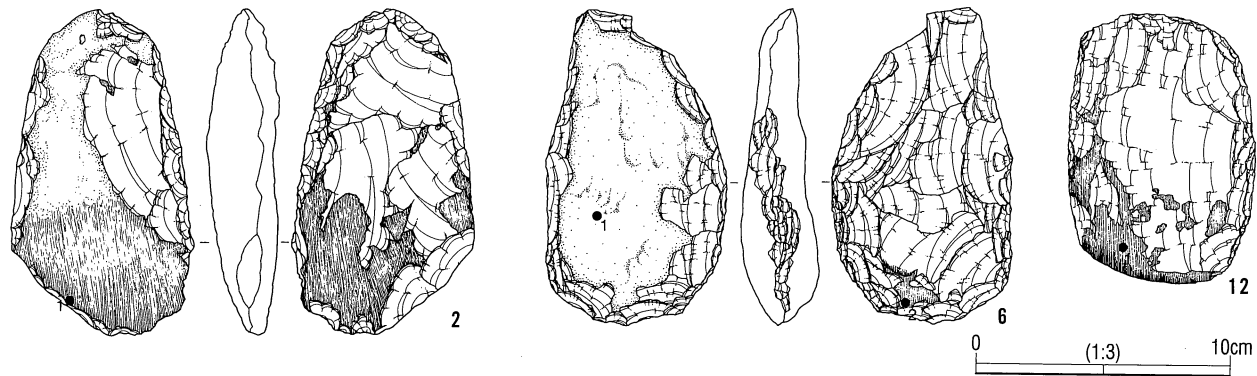

日向林 I 石器文化 石器使用痕観察部位 1

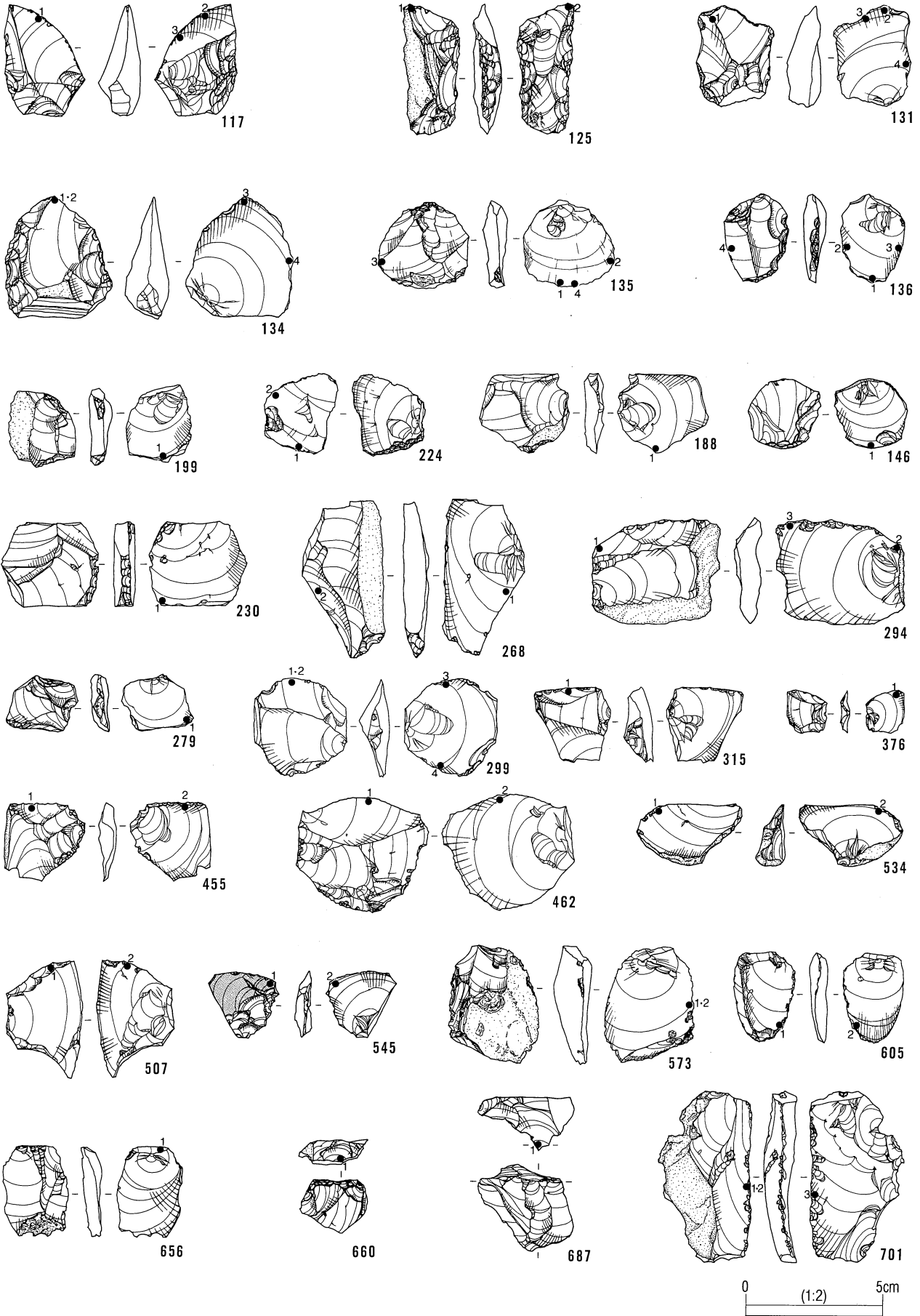

日向林 I 石器文化 石器使用痕觀察部位 2





Ob-10

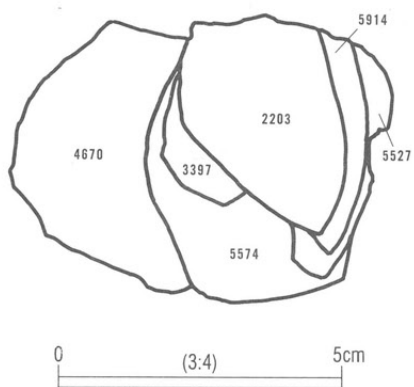

剥離順序	報告番号	遺物番号	ブロック	出土層位	器種	重量g	打面	作業面
1		2203	12	Va上	SB	7.72	上	正面
2		3397	18	Va下	SB	2.65	上	正面
3		5914	18	Vb上	SB	5.28	上	正面
4		5527	17	Vb上	UF	6.52	上	正面
5		5574	18	Vb上	UF	16.24	上	正面
6	462	4670	18	Vb上	SB	17.85	上	正面



Ob-16



剥離順序	報告番号	遺物番号	ブロック	出土層位	器種	重量g	打面	作業面
1		2602	17	Va上	Co	24.42	上	正面
2		2614	17	Va下	Co	29.2		

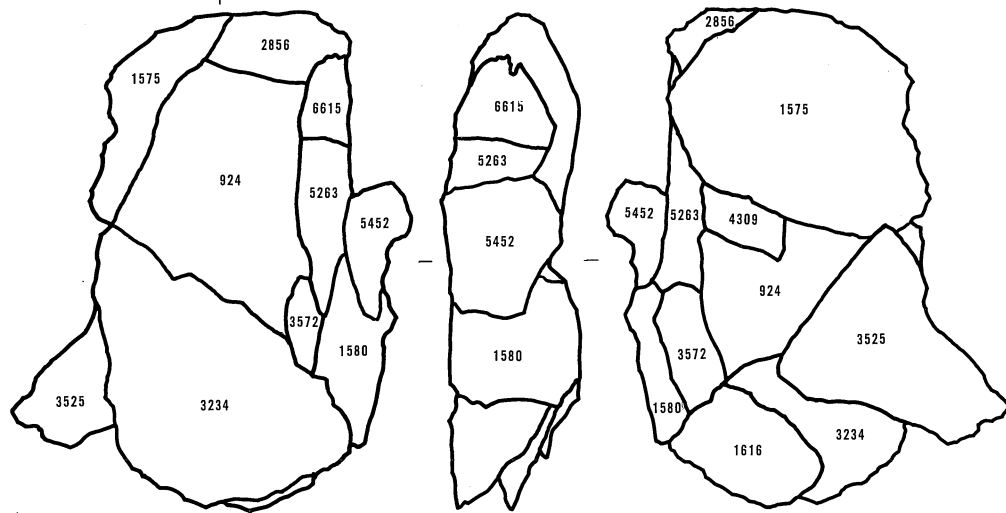
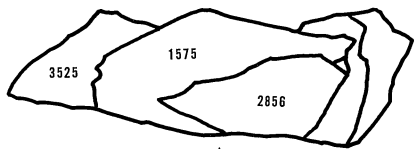
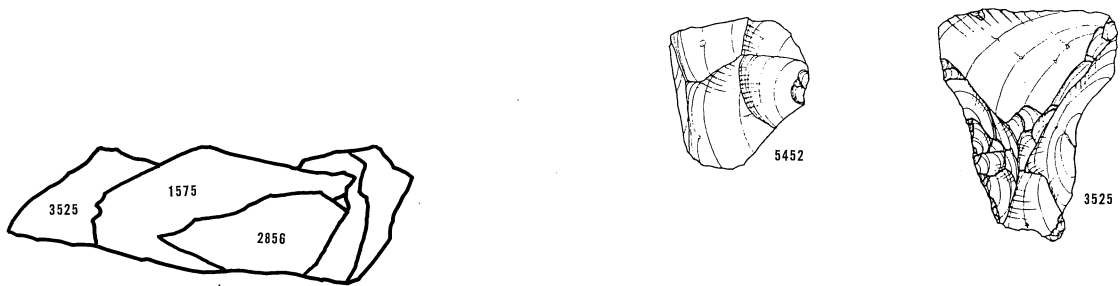
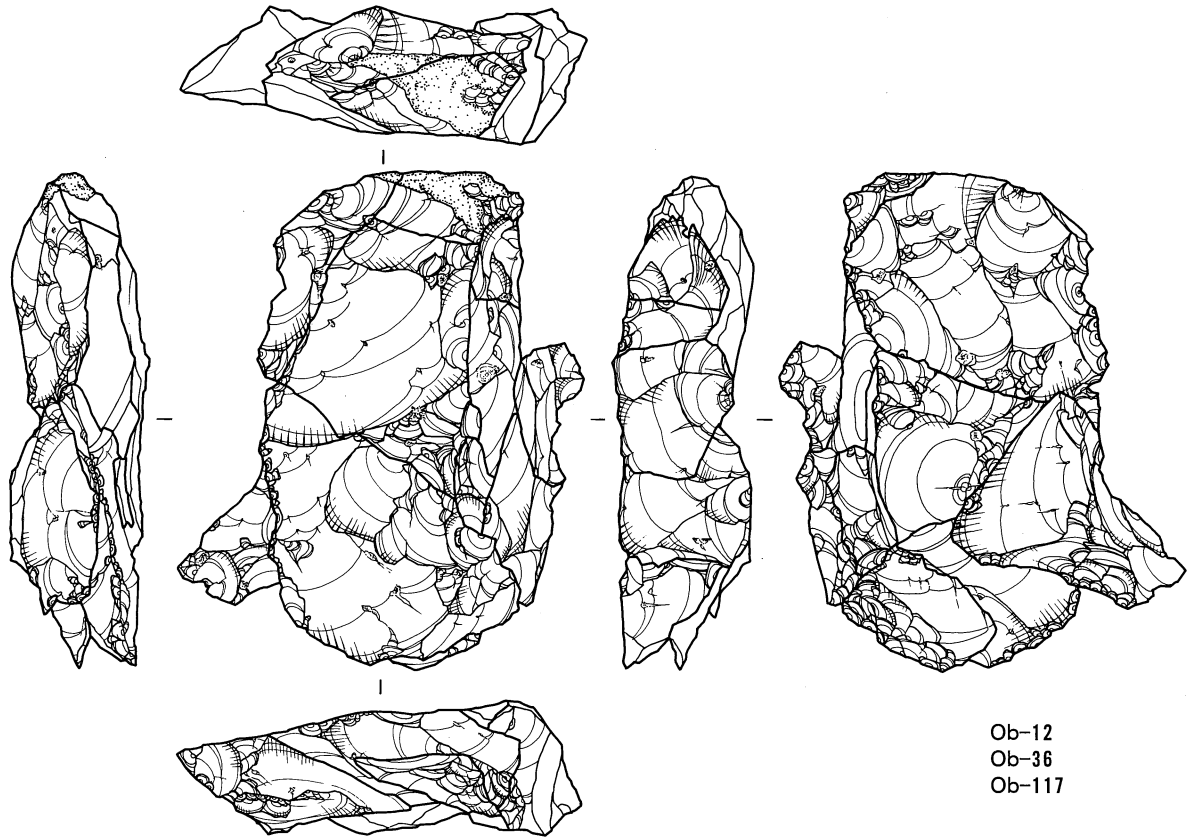

0 (3.4) 5cm

資料番号	剥離順序	報告番号	遺物番号	ブロック	出土層位	器種	重量g	打面	作業面
Ob-12	1		1616	18	Va上面	UF	2.2	正面	下
	2		3234	18	Va中	Co	20.93		

資料番号	剥離順序	報告番号	遺物番号	ブロック	出土層位	器種	重量g	打面	作業面
Ob-36	1		5452	17	Vb上	SB	2.94	裏面	右
	2		1580	17	Va上面	Fl	7.78	裏面	右
	3		5263	17	Vb中	Co	5.45	裏面	右
	4		6615	17	Vb下	Fl	1.55	裏面	右
	5		3572	17	Va下	SB	3.67	裏面	右
	6		1575	17	IV下	Fl	17.39	右	裏面
	7		2856	19	Va上	Fl	4.6	右	上
	8		4309	17	Va下	SB	1.61	右	裏面
	9		924	17	IV下	Co	21.27		

資料番号	剥離順序	報告番号	遺物番号	ブロック	出土層位	器種	重量g	打面	作業面
Ob-117	1	82	3525	14	Vb上	Tr	11.8		

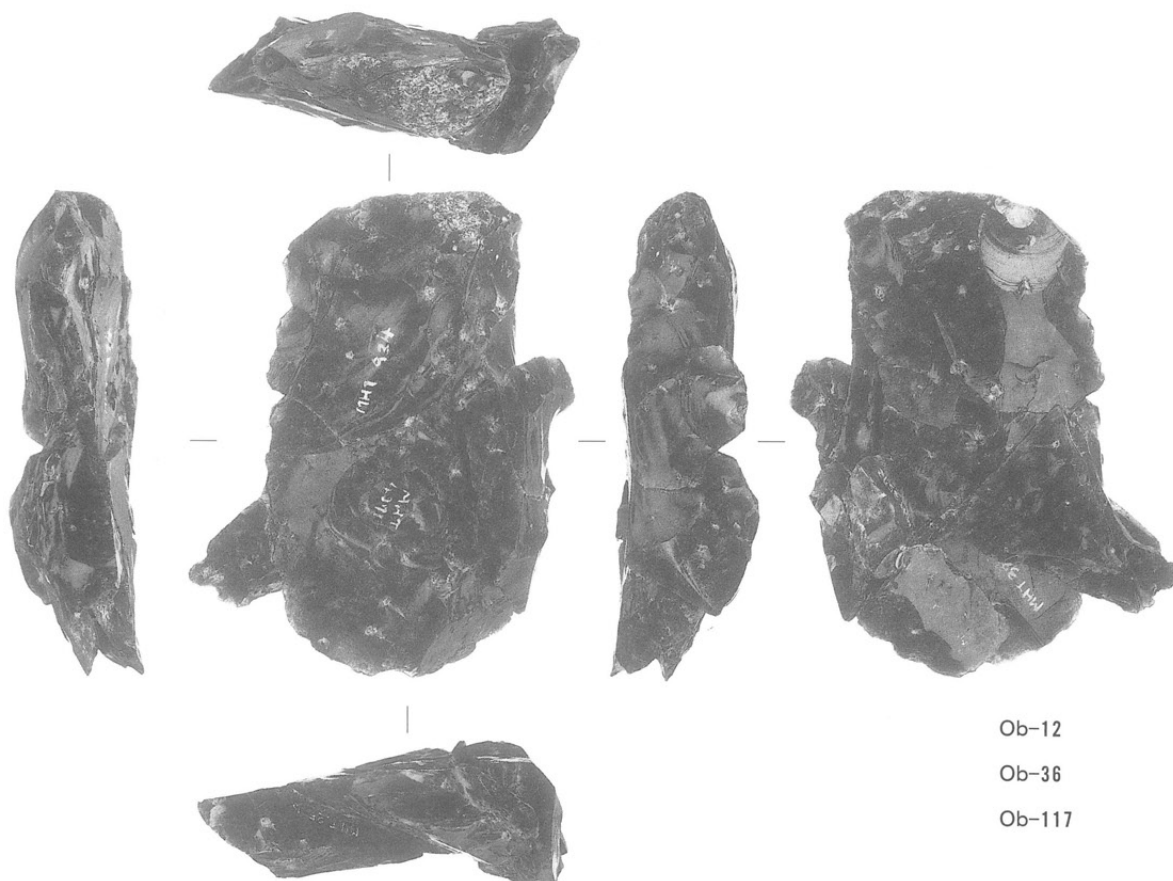

Ob-12

Ob-36

Ob-117

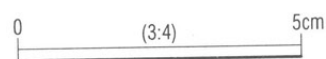



Ob-12・36・117 遺物分布図

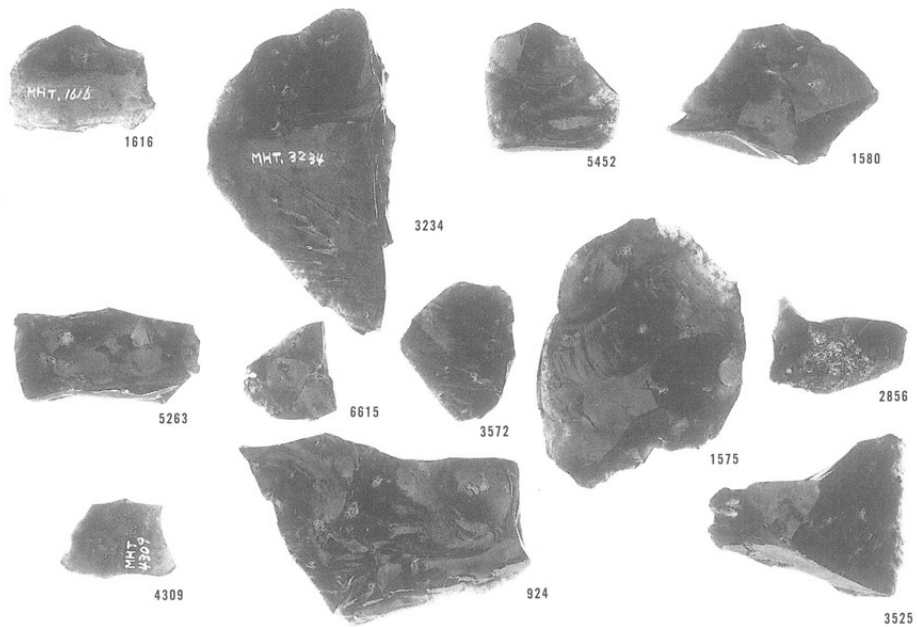

Ob-16・36・117 集合写真

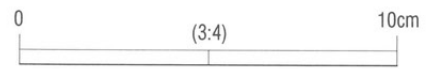



Ob-15

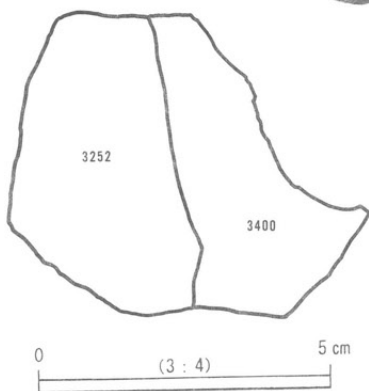

剥離順序	報告番号	遺物番号	ブロック	出土層位	器種	重量g	打面	作業面
1		3252	18	Va上	UF	27.27	上	正面
2	740	3400	18	Va上	Co	40.91	上	正面

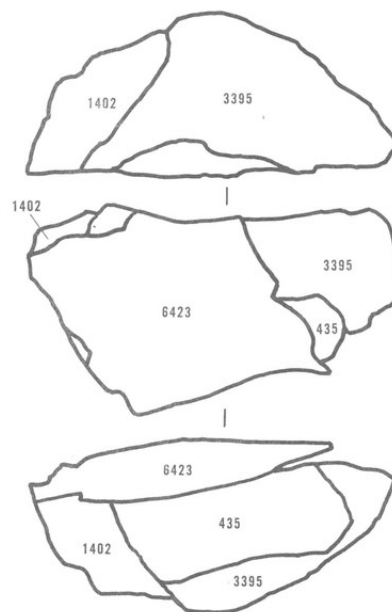
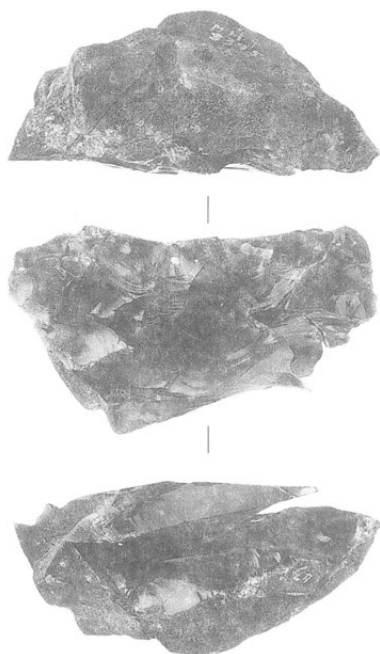

Ob-17



剥離順序	報告番号	遺物番号	ブロック	出土層位	器種	重量g	打面	作業面
1		6423	3	Vb下	Fl	12.76	上	正面
2		1402	5	Va上面	Fl	10.2	正面	左
3		435	18	Ⅲ中	Fl	5.93	左	正面
4	749	3395	18	Vb上面	Co	29.67		

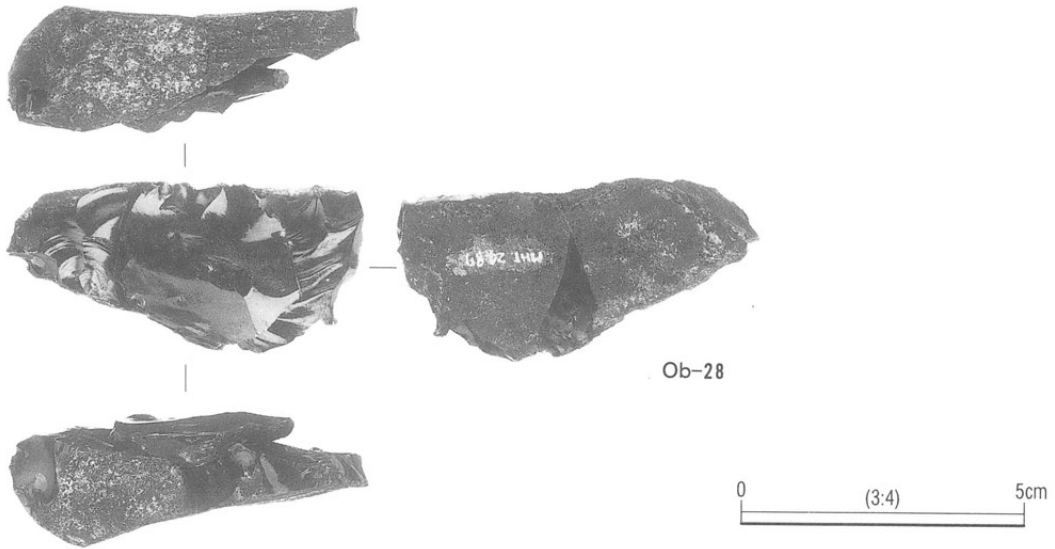

剥離順序	報告番号	遺物番号	ブロック	出土層位	器種	重量g	打面	作業面
1	243	5259	17	Vb中	ESS	8.96	上	正面
2		2715	19	Va下	Co	22.07		
3		2487	17	Va中	Co	13.1		

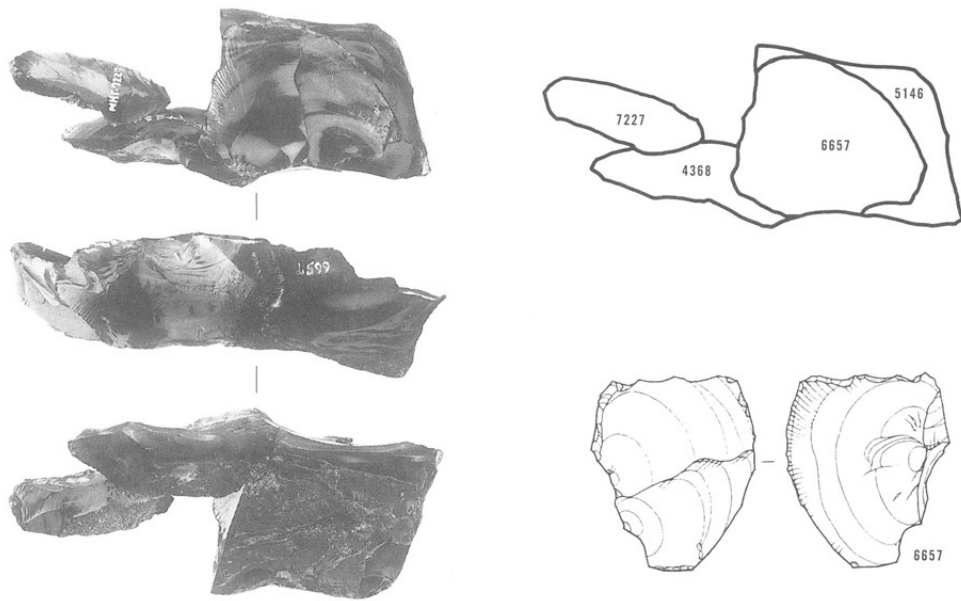

Ob-37

剥離順序	報告番号	遺物番号	ブロック	出土層位	器種	重量g	打面	作業面
1		4368	19	Va下	UF	6.68	上	正面
2	453	6657	20	Vb下	SB	5.01	正面	上
3		7227	8	IV上	Fl	2.76	左	正面
4		5146	20	Vb中	Co	17.57		

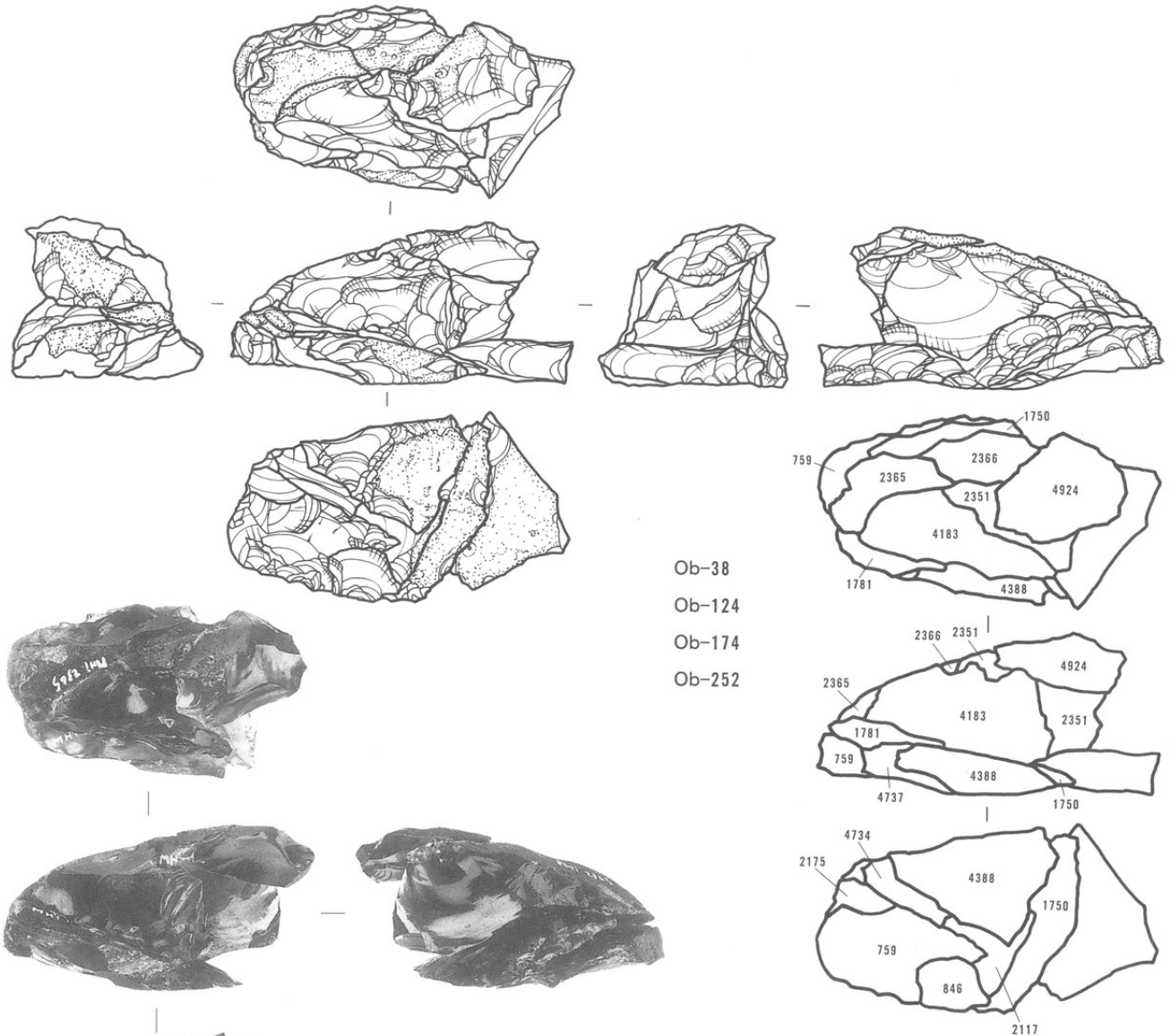

資料番号	剥離順序	報告番号	遺物番号	遺構番号	出土層位	器種	重量g	打面	作業面
Ob-38	1		846	12	IV下	Fl	0.24	裏面	下
	2		Ob-124						
	3		1750	1	IV中	SB	8.99	裏面	下
	4		2117	14	Va下	Fl	1.41	裏面	下
	5	415	212	16	IV上	SB	5.69	正面	下
	6		1781	11	Va上	SB	1.11	正面	下
	7	618	4924	16	Vb上	NS	4.29	右	上
	8		Ob-252						
	9		4183	16	Vb上面	Fl	5.26	右	正面
	10	687	2351	16	Va上	Dr	9		

資料番号	剥離順序	報告番号	遺物番号	遺構番号	出土層位	器種	重量g	打面	作業面
Ob-124	1		Ob-174						
	2		4734	12	Vb中	Fl	0.75	正面	上
	3	120	4388	11	IV下	Tr	3.56		

資料番号	剥離順序	報告番号	遺物番号	遺構番号	出土層位	器種	重量g	打面	作業面
Ob-174	1		2172	12	Va中	Fl	0.18	裏面	上
	2		2175	12	Va下	UF	0.59	裏面	上
	3	511	759	12	IV下	SB	4.32		

資料番号	剥離順序	報告番号	遺物番号	遺構番号	出土層位	器種	重量g	打面	作業面
Ob-252	1		2365	16	Va下	Fl	2.22		
	2	504	2366	16	Va下	SB	9.54		



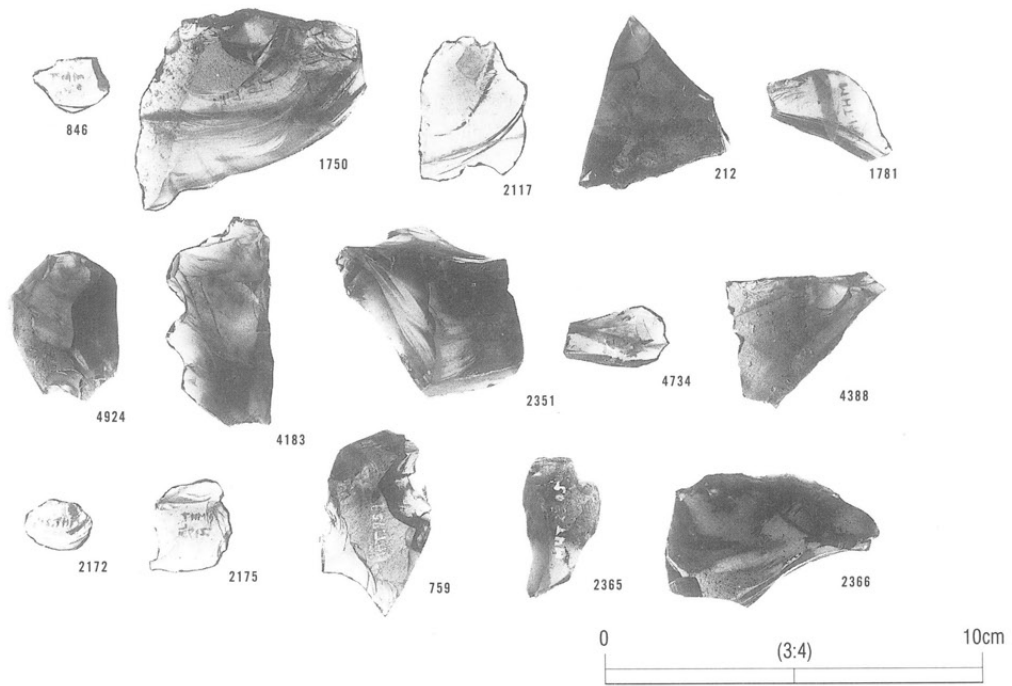

Ob-38・124・174・252 集合写真



Ob-38・124・174・252 遺物分布図



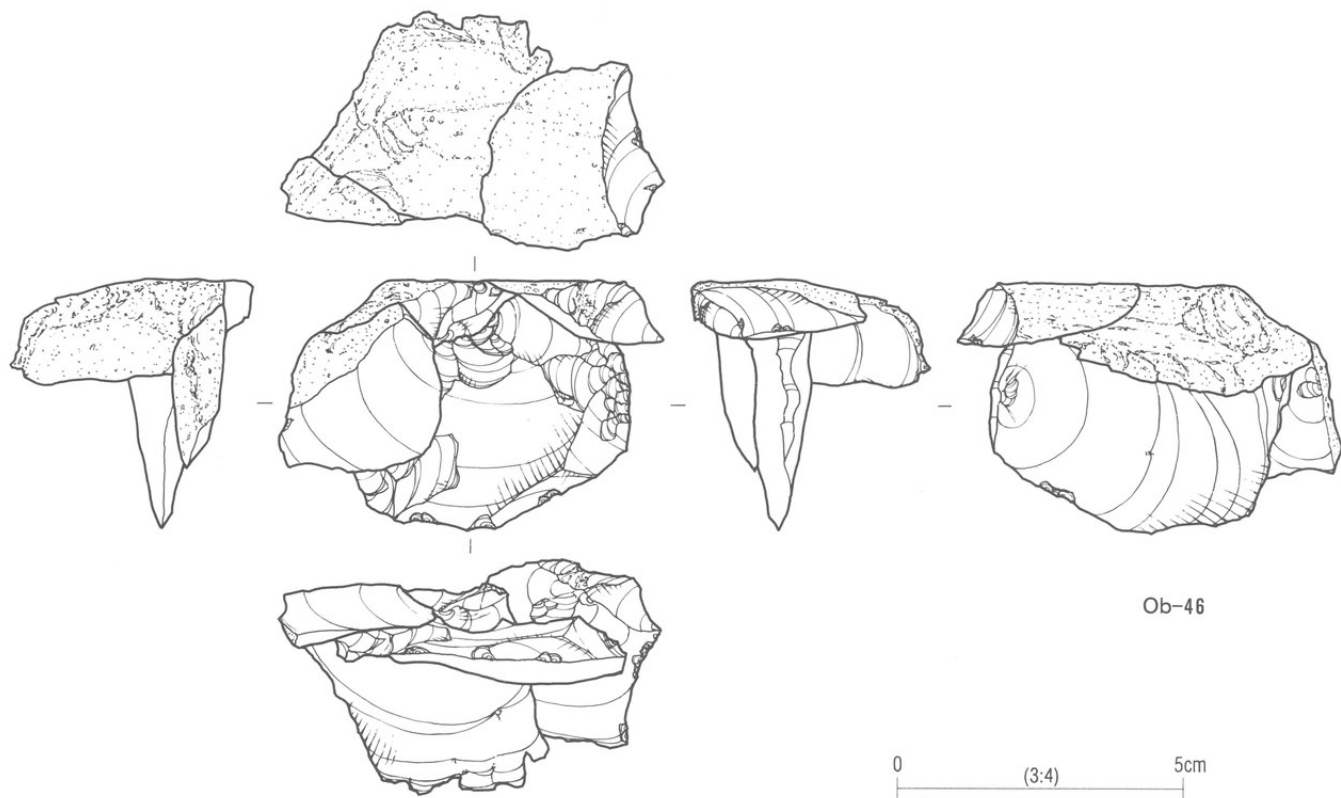

剥離順序	報告番号	遺物番号	ブロック	出土層位	器種	重量g	打面	作業面
1		990	18	IV下	UF	5.16	上	正面
2	412	35	17	Ⅲ中	SB	7.75	正面	上
3		1171	20	Va上面	Fl	19.69	正面	上
4		8111	8	Va下	UF	20.75	右	正面

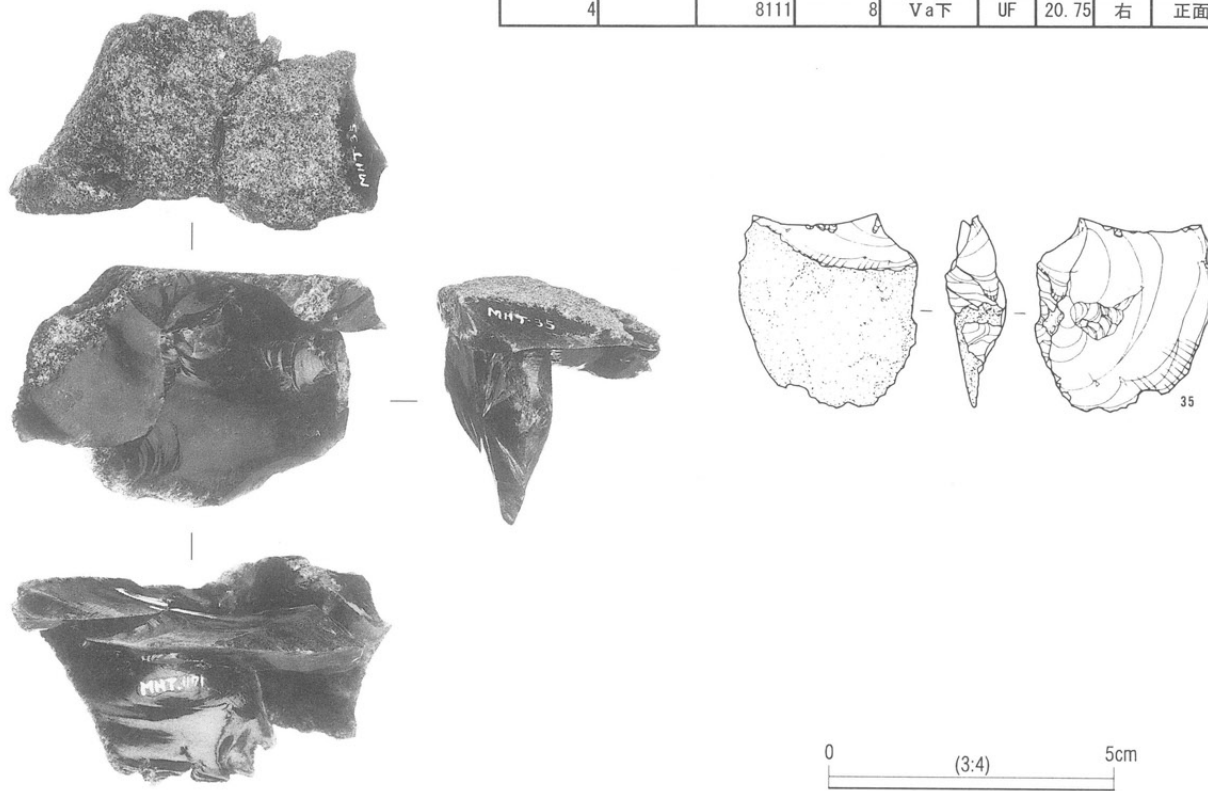

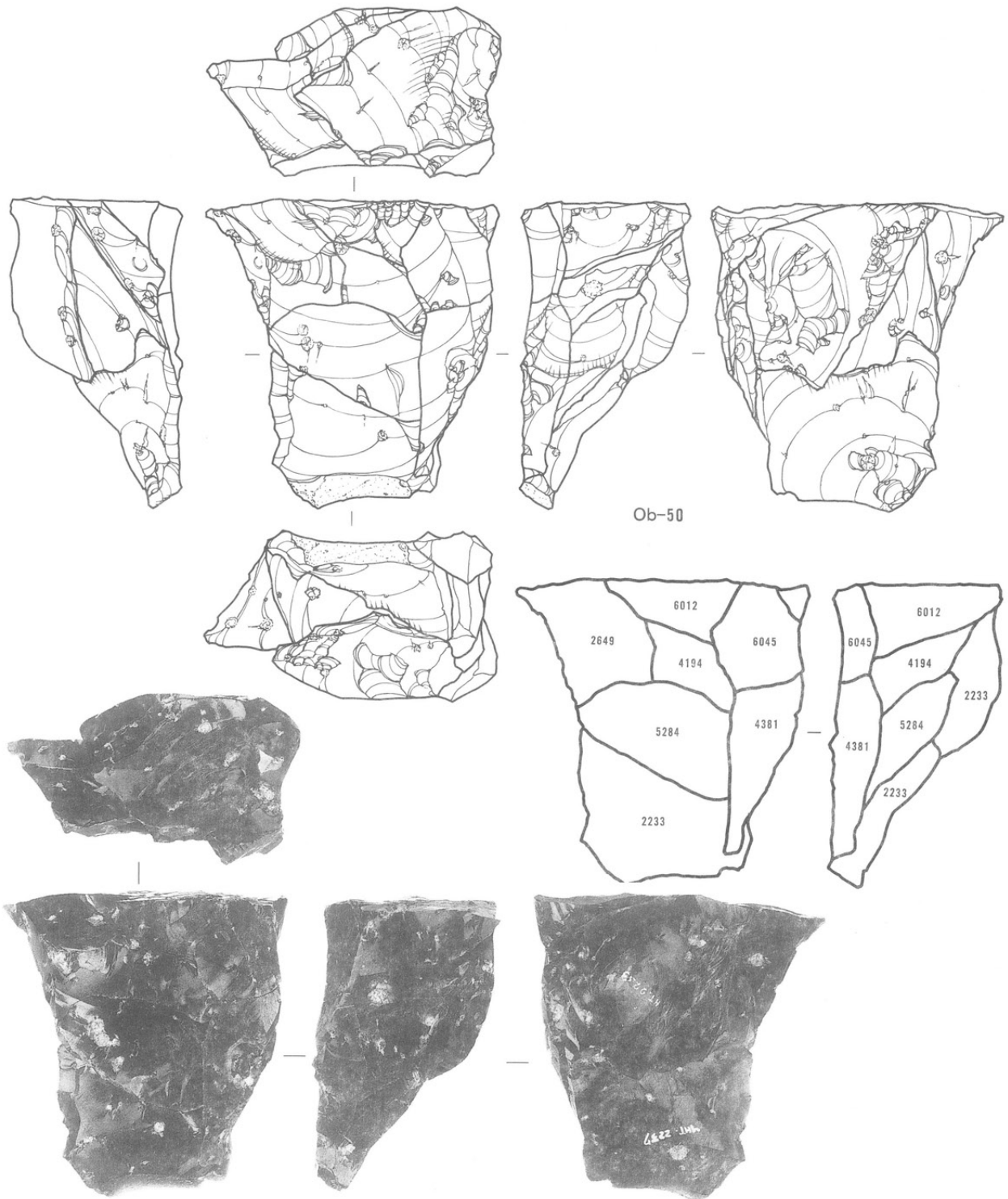

0 (3:4) 5cm

剥離順序	報告番号	遺物番号	ブロック	出土層位	器種	重量g	打面	作業面
1		6045	11	Vb中	SB	3	上	正面
2		4381	12	Vb上面	UF	4.34	上	正面
3		6012	11	Vb下	SB	17.31	右	正面
5		2649	17	Va下	SB	7.81	右	正面
4		4194	17	Vb上面	UF	15.08	右	正面
6		5284	11	Vb中	UF	29.56	右	正面
7		2237	11	Vb上面	Fl	13.9	下	正面
8		2233	11	Va中	Fl	13.98	右	正面

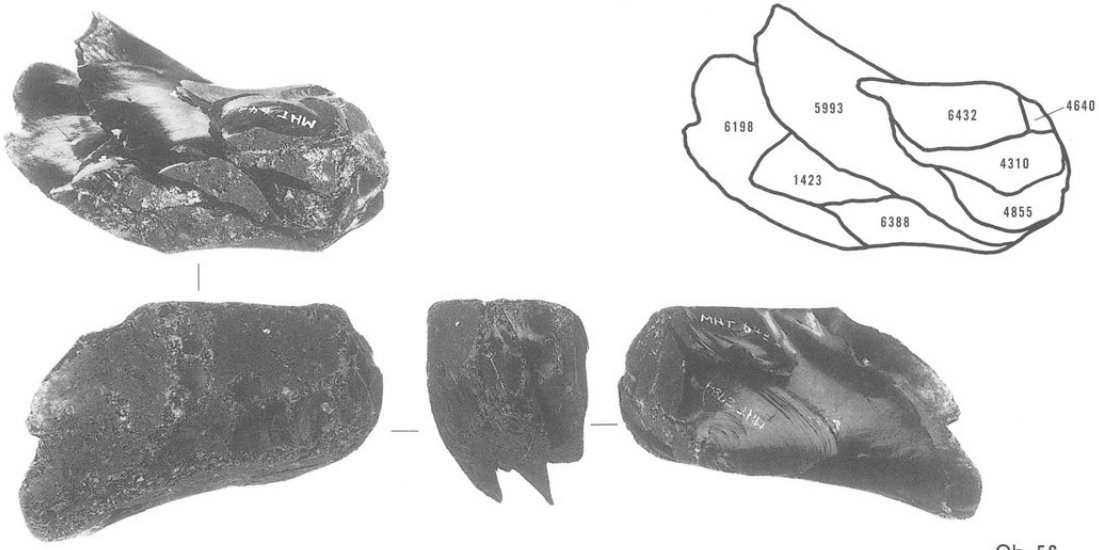

Ob-56

剥離順序	報告番号	遺物番号	ブロック	出土層位	器種	重量g	打面	作業面
1		6198	14	Vb中	Fl	21.23	上	正面
2		6388	17	Vb下	UF	11.96	上	正面
3		1423	3	Va上面	SB	1.47	上	正面
4		5993	18	Vb下	UF	18.51	上	正面
5		4117	17	Va下	Fl	0.76	上	正面
6		4855	17	Vb中	Fl	2.72	下	正面
7		2784	19	Va下	Fl	5.4	下	正面
8		4310	17	Va下	Fl	2.19	右	正面
9		4640	17	Vb中	SB	0.69	右	正面
10		6432	18	Vb下	Fl	1.48	右	正面

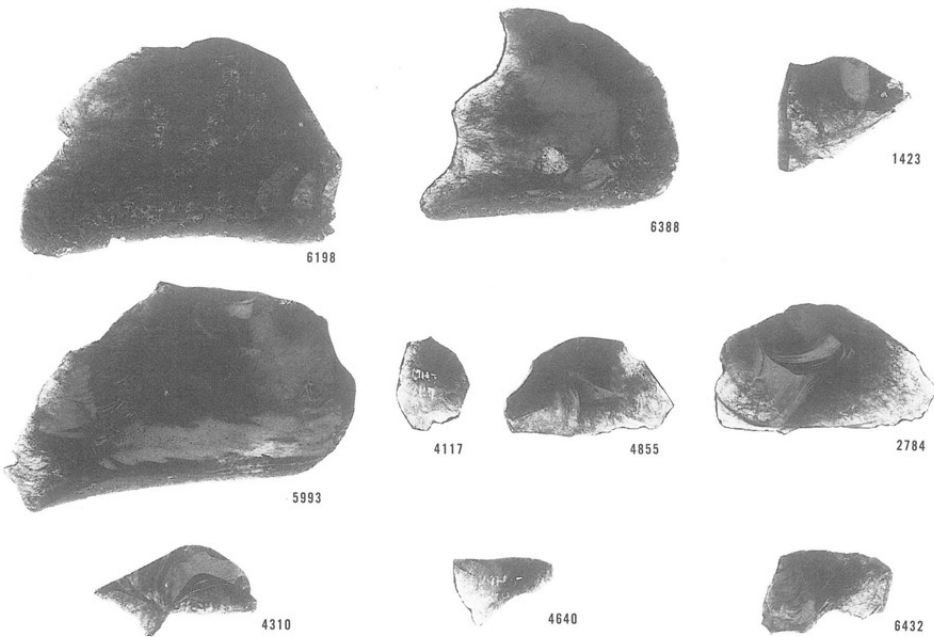
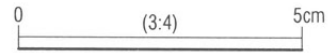
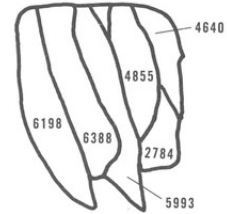

Ob-56 集合写真



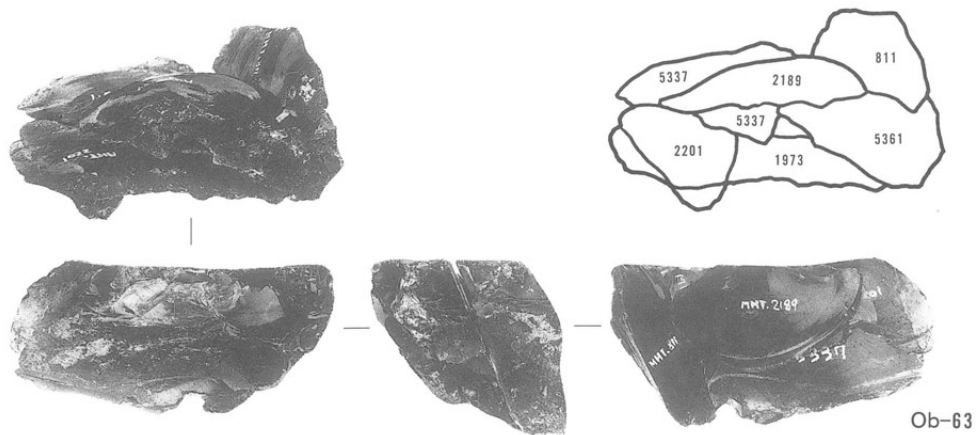

Ob-63

0 (3 : 4) 5 cm

剥離順序	報告番号	遺物番号	ブロック	出土層位	器種	重量g	打面	作業面
1		1973	12	Va下	Fl	10.51	上	正面
2		2201	12	Va中	SB	2.16	上	正面
3		852	11	IV下	Fl	1.35	上	正面
4		6040	12	Vb下	Fl	1.02	上	正面
5		5337	11	Vb中	UF	7.2	上	正面
6		5361	11	Vb中	UF	10.1	上	正面
7		2189	12	Vb上面	UF	4.21	上	正面
8		811	12	IV中	Fl	4.86	上	右

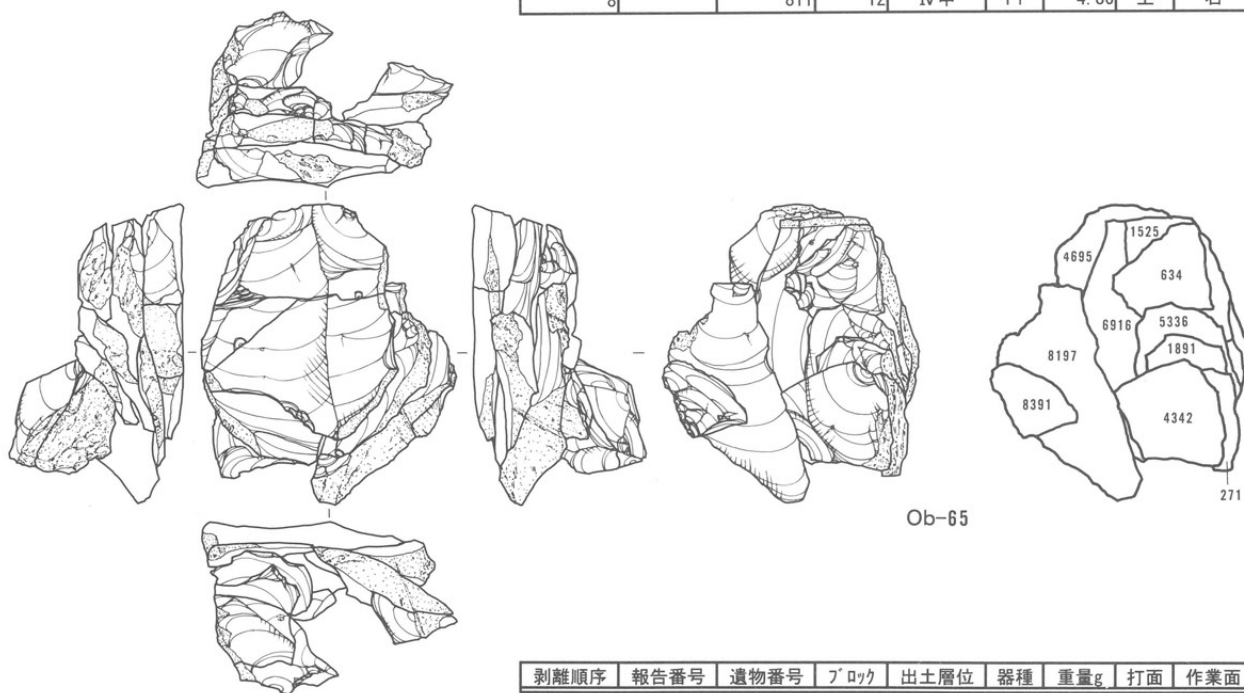

Ob-65

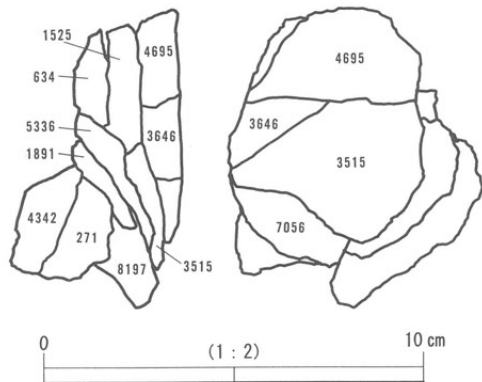

0 (1 : 2) 10 cm

剥離順序	報告番号	遺物番号	ブロック	出土層位	器種	重量g	打面	作業面
1		4695	12	Vb中	Gr	14.67	上	正面
2		3646	14	Vb上面	Fl	4.06	上	正面
3		3515	14	Va上	SB	14	上	正面
4		7056	8	I中	SB	4.99	左	正面
5		1525	11	IV下	UF	10.78	左	正面
6		6916	11	Vb下	Fl	10.04	左	正面
7		5403	11	Vb上	Fl	1.35	左	正面
8		6004	11	Vb上	Dr	5.96	左	正面
9		634	11	IV中	DS	5.25	左	正面
10		5336	11	Vb中	UF	4.84	左	正面
11	686	1891	11	Va下	Gr	3.18	左	正面
12		8197	10	Vb上	NS	11.38	上	正面
13		271	11	II下	SB	6.41		
14		4342	20	Vb上面	DS	8.52		
15		8391	20	Va下	RF	2.94	裏面	右

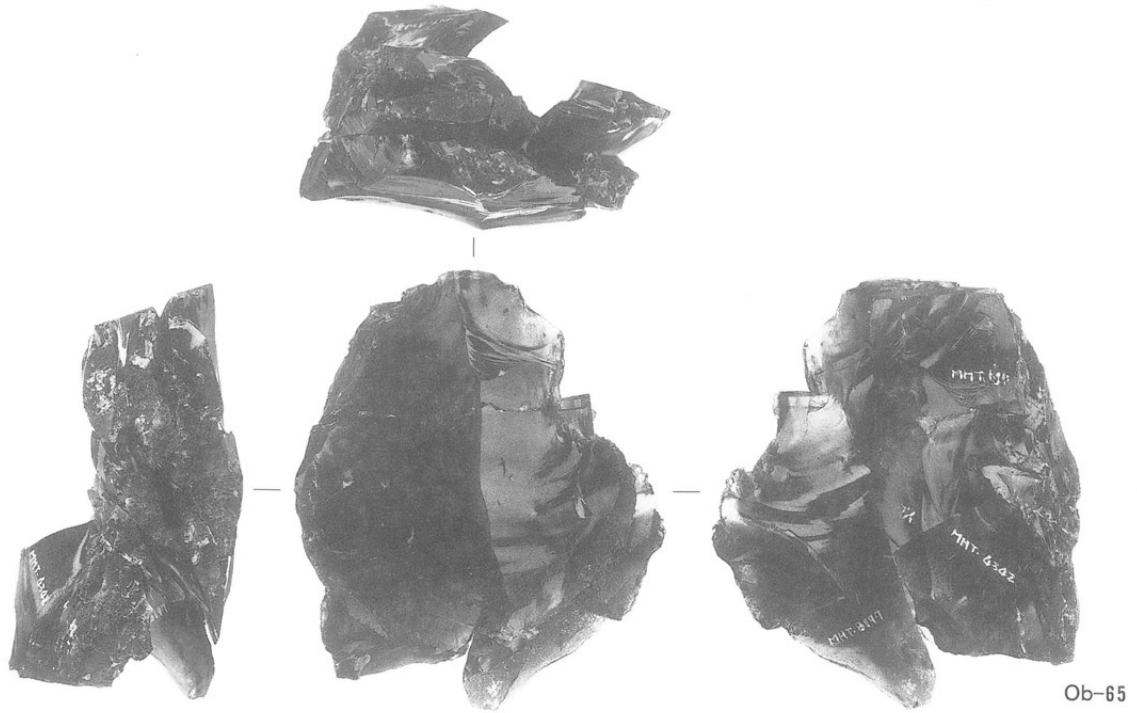

Ob-65



Ob-65 遺物分布図

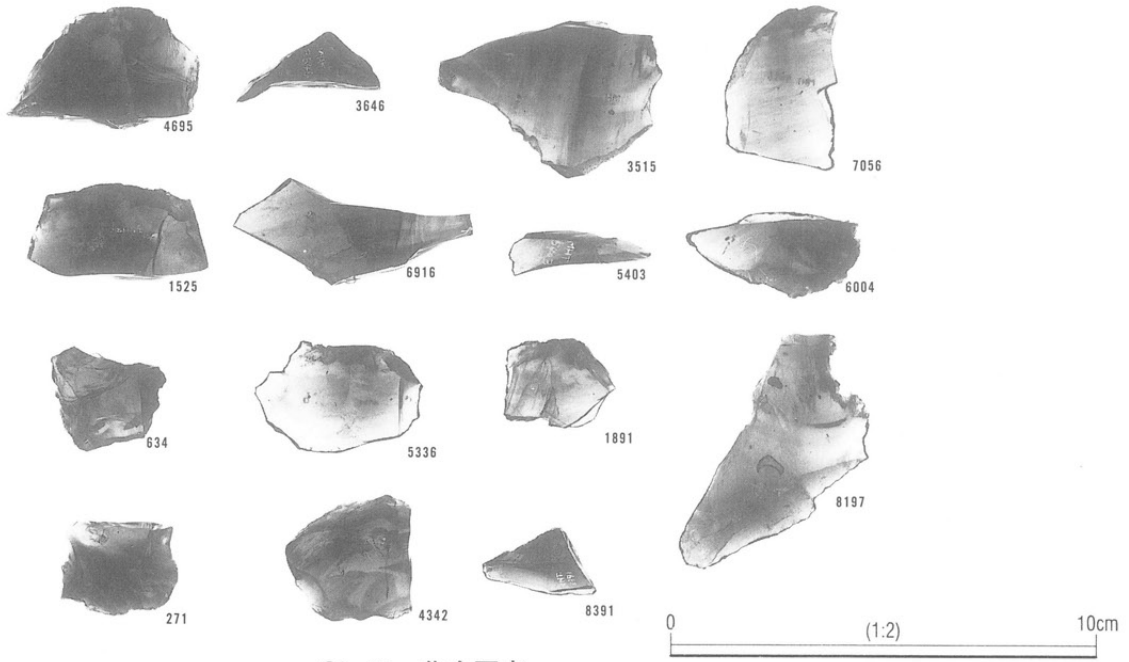

Ob-65 集合写真

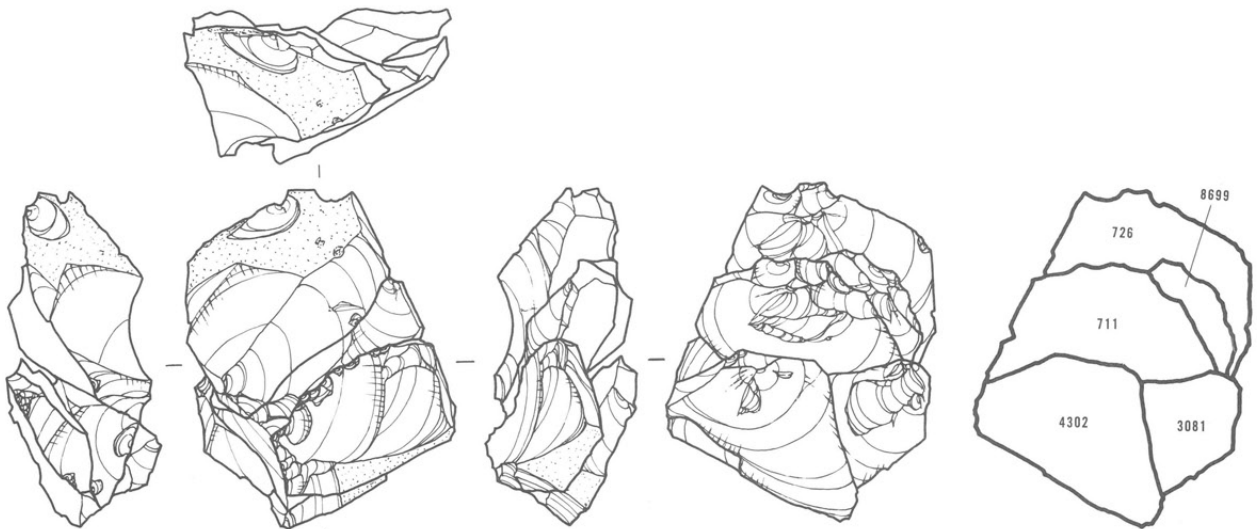

Ob-74

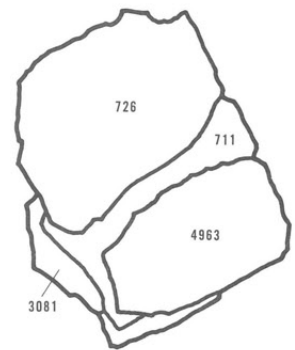

0 (3.4) 5cm

剥離順序	挿図番号	遺物番号	ブロック	出土層位	器種	重量g	打面	作業面
1		4963	17	Vb中	SB	5.25	左	正面
2		726	11	IV下	SB	12.77	上	正面
3		8699	20	Vb上	SB	2.32	上	正面
4		711	11	IV下	SB	11.46	上	正面
5		3081	20	Vb上面	SB	2.89	上	正面
6		4302	20	Vb上面	UF	5.9	上	正面

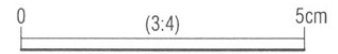
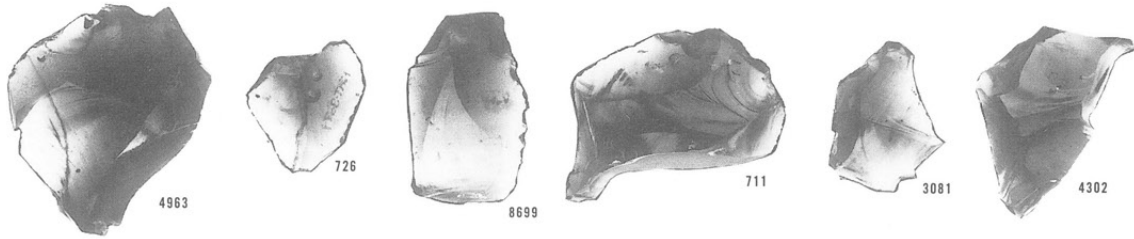
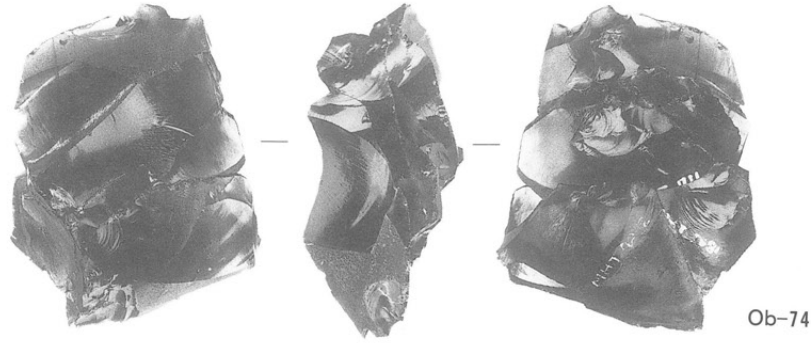

剥離順序	挿図番号	遺物番号	ブロック	出土層位	器種	重量g	打面	作業面
1		2834	20	Va上	SB	8.41	上	正面
2		9559	9	VI上	Sc	20.69	上	正面
3		5854	20	Vb上	UF	26.17	上	正面
4	709	2471	17	Va下	UF	13.74	上	正面
5		2785	19	Va上	FI	8.16	右	正面
6		8986	22	IV中	UF	6.08	右	正面

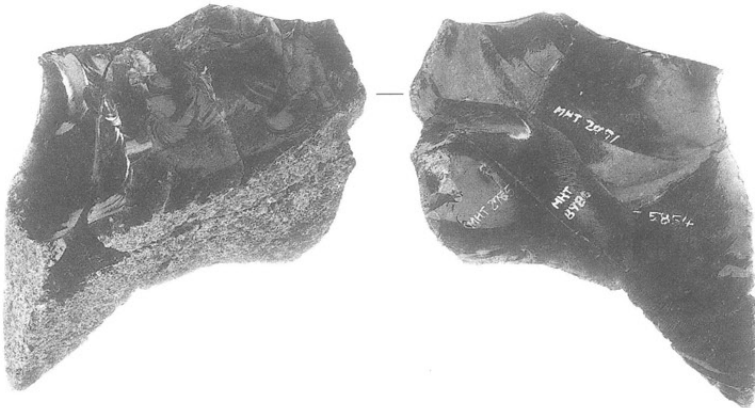

Ob-78

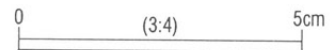

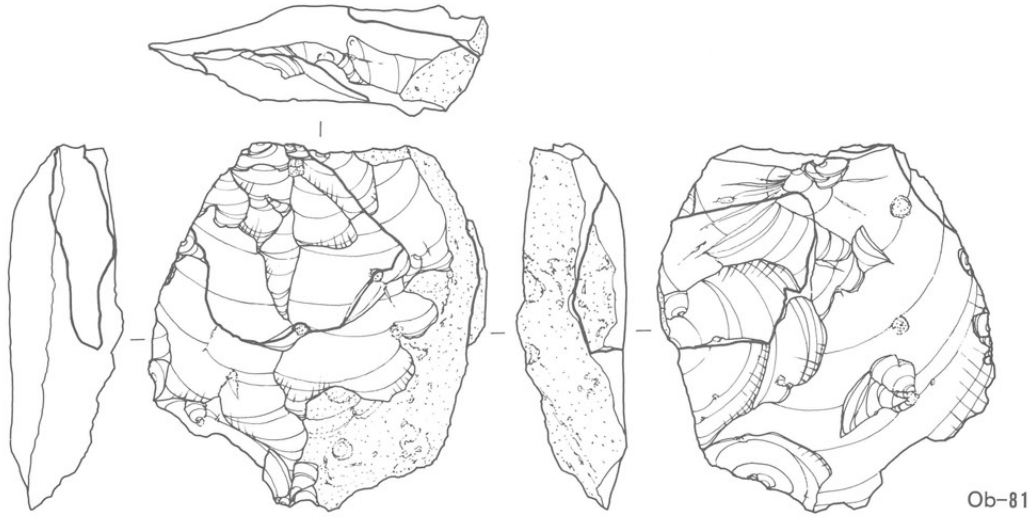

Ob-81



0 (3:4) 5cm

剥離順序	報告番号	遺物番号	ブロック	出土層位	器種	重量g	打面	作業面
1		270	11	Ⅲ中	UF	5.62	上	正面
2		3907	11	Va下	SB	4.99	右	裏面
3	738	5315	11	Vb下	Co	55.78		

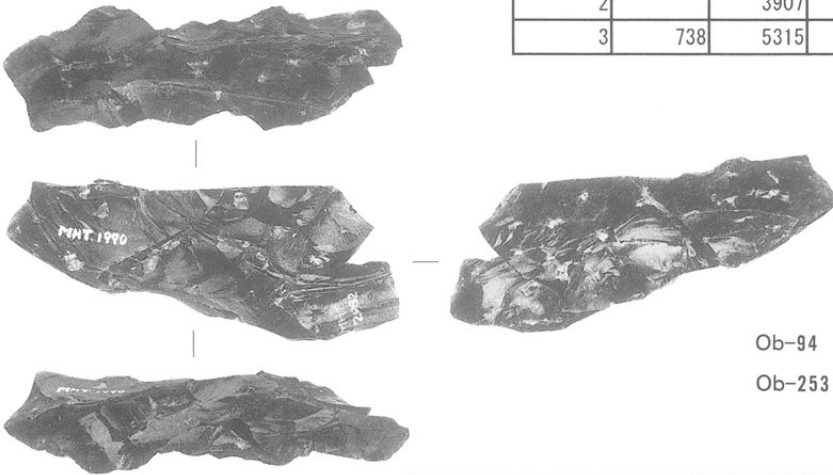

Ob-94

Ob-253

0 (3:4) 5cm

資料番号	剥離順序	報告番号	遺物番号	ブロック	出土層位	器種	重量g	打面	作業面
Ob-94	1		3530	14	Vb上面	Fl	1.03	正面	裏面
	2		6148	15	Vb下	SB	2.16	左	正面
	3		2082	14	Va下	Fl	3.65	左	正面
	4		3975	12	Vb上面	Co	8.56		

資料番号	剥離順序	報告番号	遺物番号	ブロック	出土層位	器種	重量g	打面	作業面
Ob-253	1	531	5703	1	Vb中	SB	1.05	正面	裏面
	2		1990	12	Va上	Co	7.12		



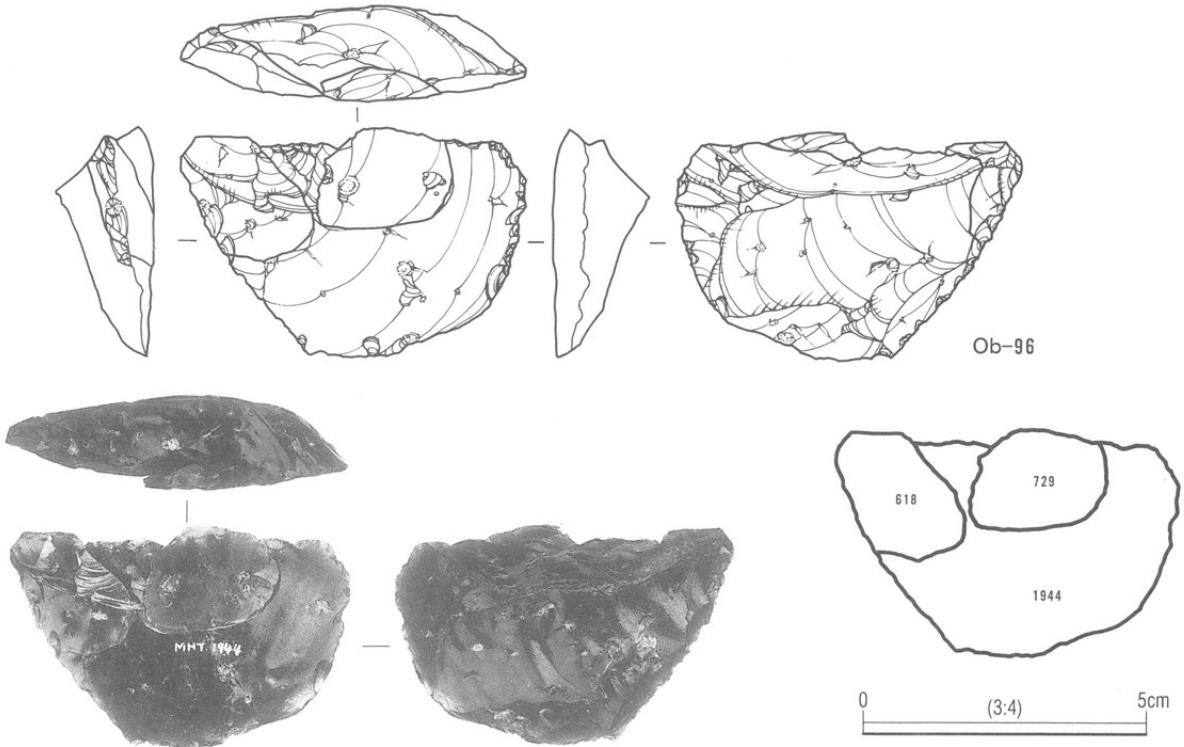

剥離順序	報告番号	遺物番号	ブロック	出土層位	器種	重量g	打面	作業面
1		729	11	Va上面	SB	1.74	上	正面
2		618	11	IV中	SB	2.58	上	正面
3		1944	11	Vb上面	Co	26.35		

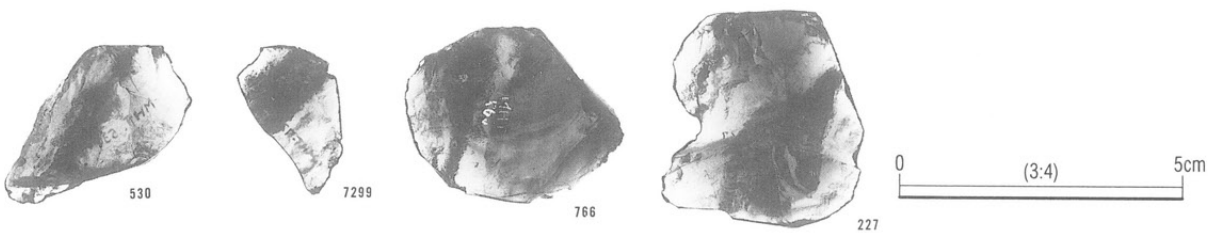
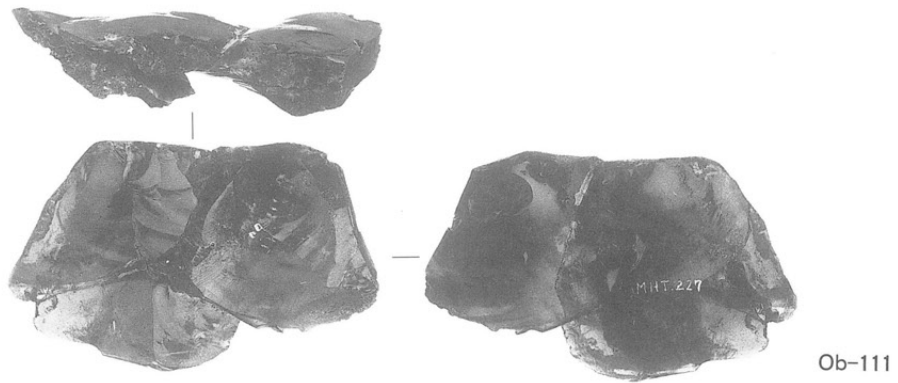

剥離順序	報告番号	遺物番号	ブロック	出土層位	器種	重量g	打面	作業面
1		530	1	IV上	SB	5.51	上	正面
2		7299	6	攪乱	SB	2.37	上	正面
3		766	12	Va上面	SB	12.32	上	正面
4		227	12	Ⅲ下	SB	12.3	上	正面

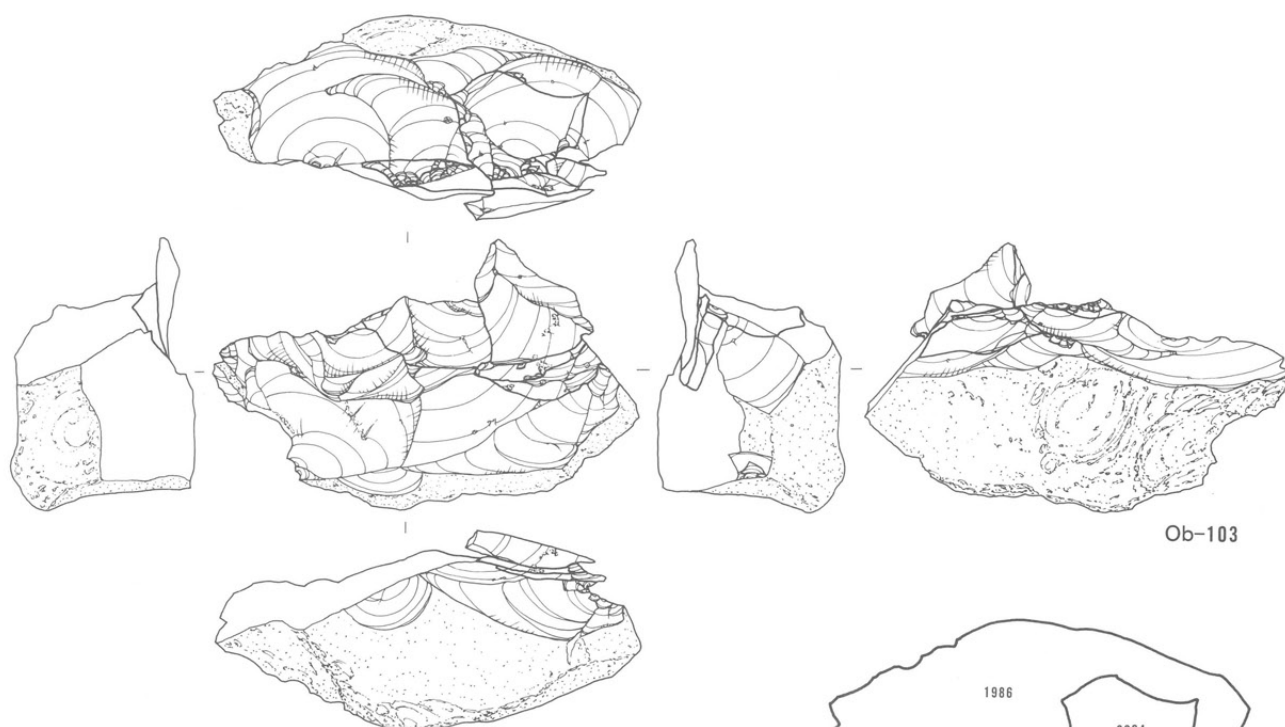

Ob-103

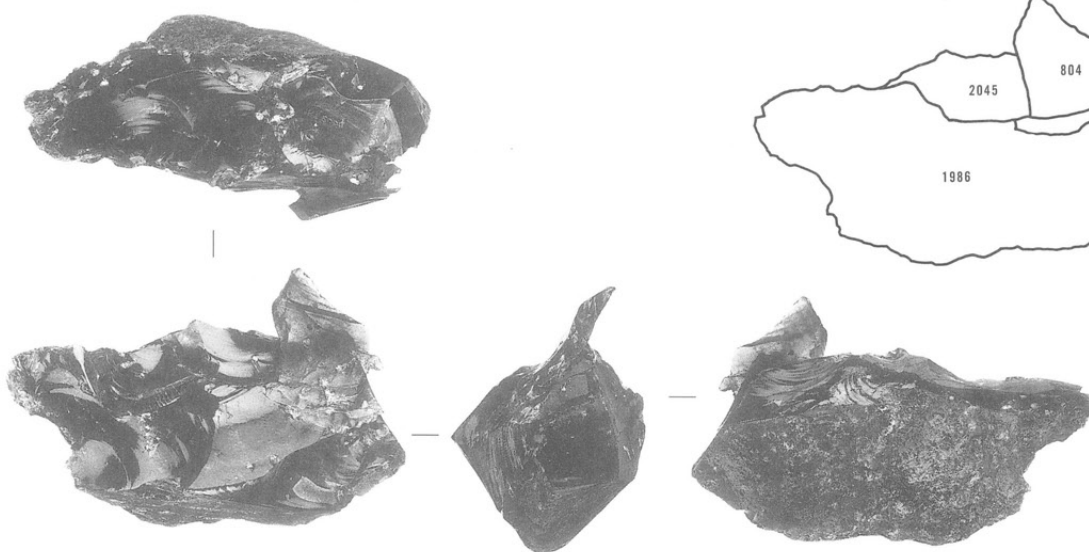

0 (1:2) 10 cm

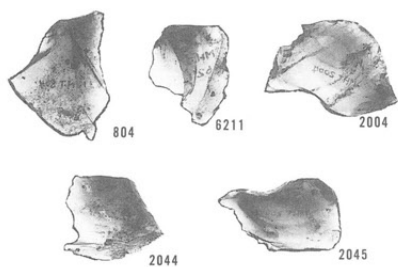

Ob-103 集合写真

剥離順序	報告番号	遺物番号	ブロック	出土層位	器種	重量g	打面	作業面
1		804	12	Va上面	SB	3.11	上	正面
2		6211	12	Vb下	SB	1.79	上	正面
3		2004	12	Va下	SB	3.32	正面	上
4		2044	12	Vb上面	Fl	2.56	上	正面
5		2045	12	Va下	SB	3.5	上	正面
6	747	1986	12	Va中	Co	217.05		

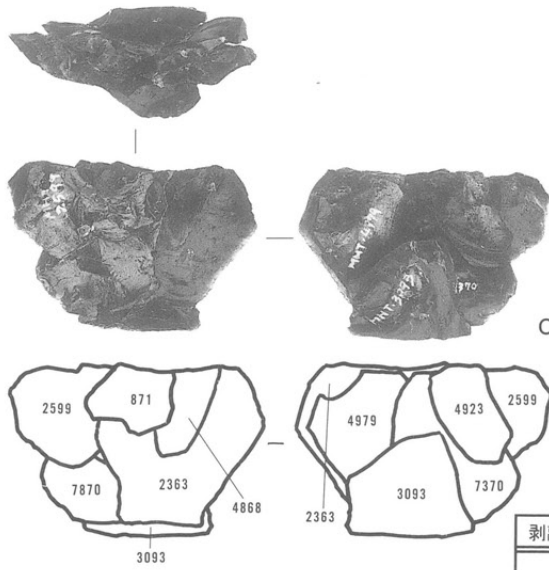

Ob-113

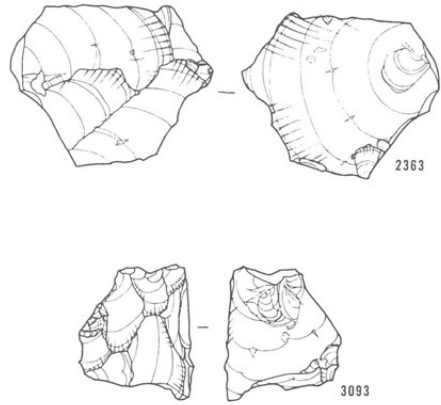

剥離順序	報告番号	遺物番号	ブロック	出土層位	器種	重量g	打面	作業面
1		871	16	Va上面	FI	0.4	上	正面
2		4868	17	Vb上	FI	0.59	上	正面
3	467	2363	16	Va中	SB	4.48	右	正面
4		4979	16	Vb上	FI	2.02	右	正面
5		2599	16	Va下	FI	1.96	上	正面
6		2342	20	Va中	FI	0.22	上	正面
7	325	7370	10	Va上面	SB	3.64	上	正面
8		4923	16	Vb上	FI	0.56	上	正面
9	608	3093	20	IV下	Sc	2.55	右	正面

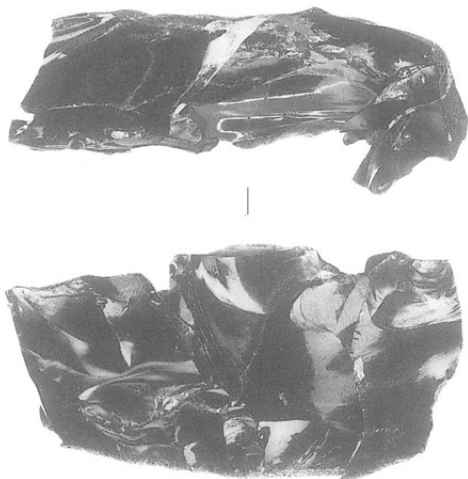

Ob-134

剥離順序	報告番号	遺物番号	ブロック	出土層位	器種	重量g	打面	作業面
1		3275	18	Va下	UF	9	上	正面
2	471	3760	1	Va下	SB	2.69	上	正面
3	304	6795	18	Vb下	SB	6.48	上	正面
4		402	5	IV上	SB	3.43	上	正面
5	722	1501	5	IV下	Co	59.63		



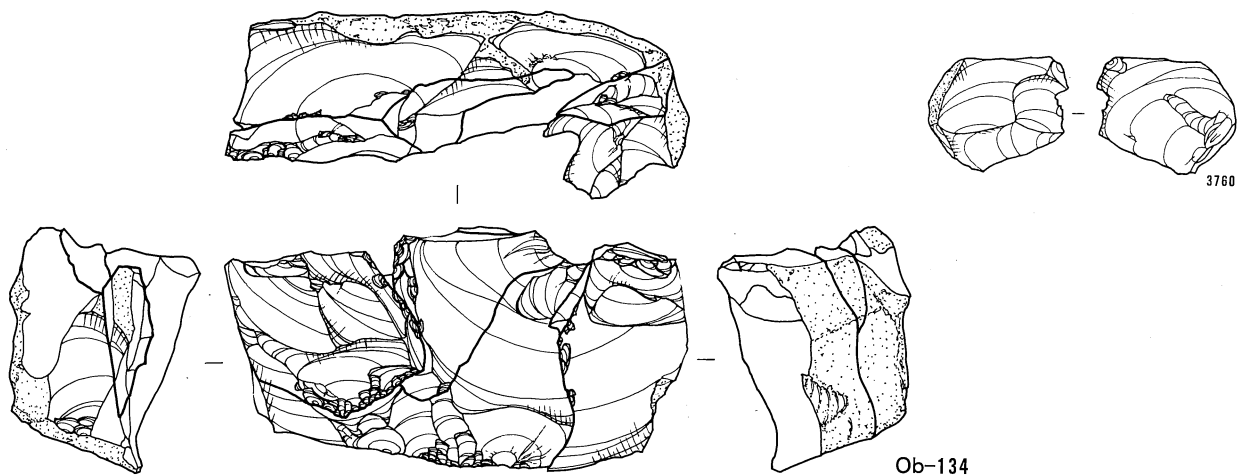

Ob-134

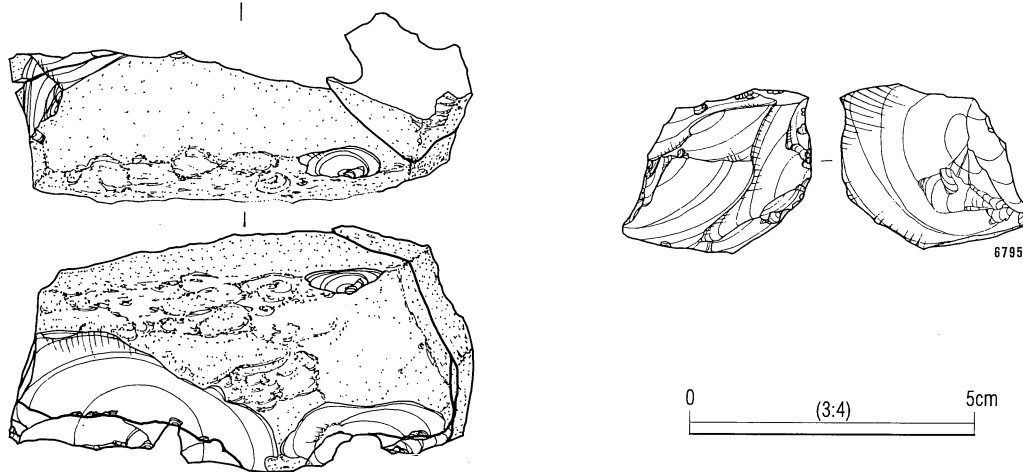

0 (3:4) 5cm



0 (3:4) 5cm

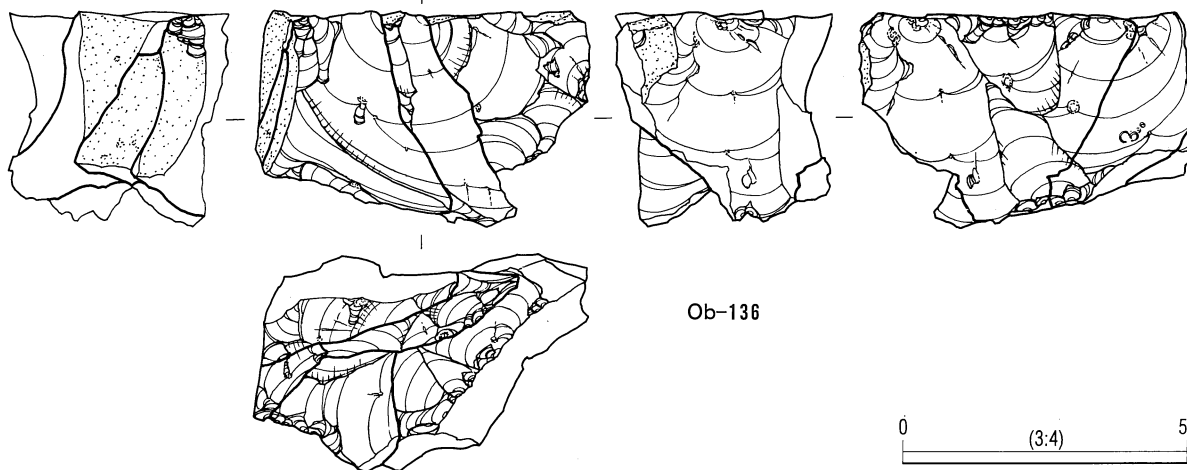

Ob-136

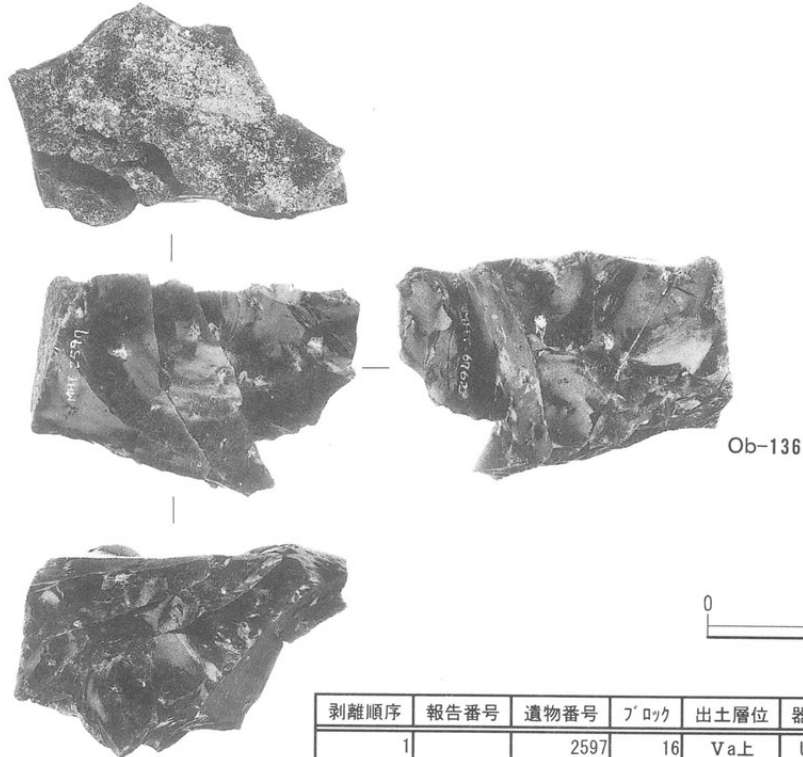

剥離順序	報告番号	遺物番号	ブロック	出土層位	器種	重量g	打面	作業面
1		2597	16	Va上	UF	8.79	上	正面
2		2340	20	Va上	Fl	2.22	上	正面
3		2183	12	Va下	SB	8.76	上	正面
4		6105	1	Vb下	Fl	12.78	上	正面
5	756	6762	5	Vb上	Co	39.84		

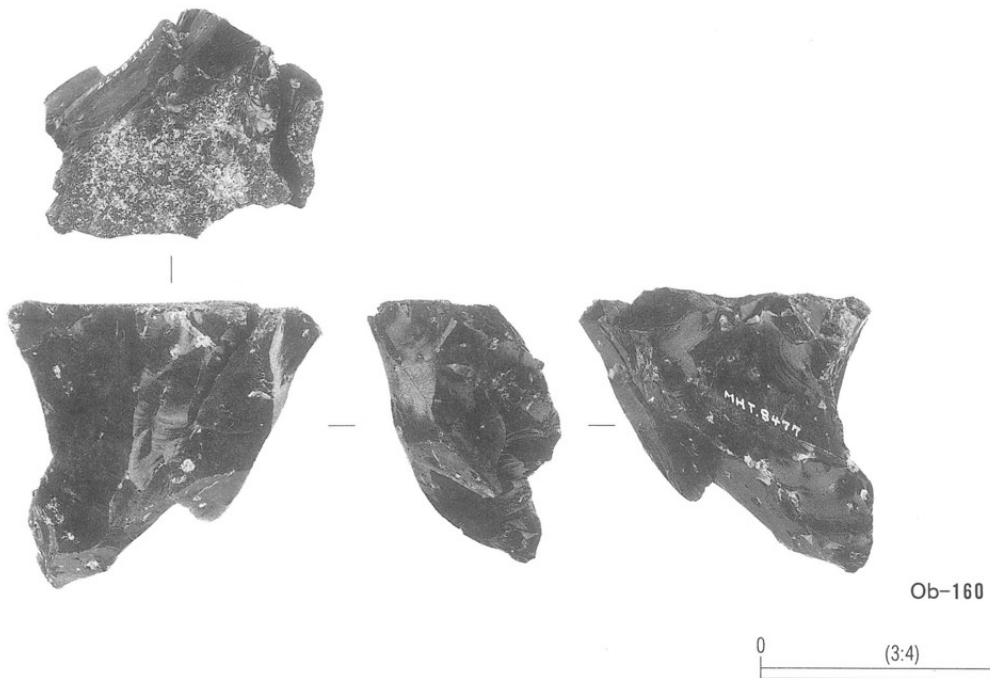

剥離順序	報告番号	遺物番号	ブロック	出土層位	器種	重量g	打面	作業面
1		3824	1	Va下	Fl	10.09	上	正面
2	755	8477	8	Vb上	Co	71.63		

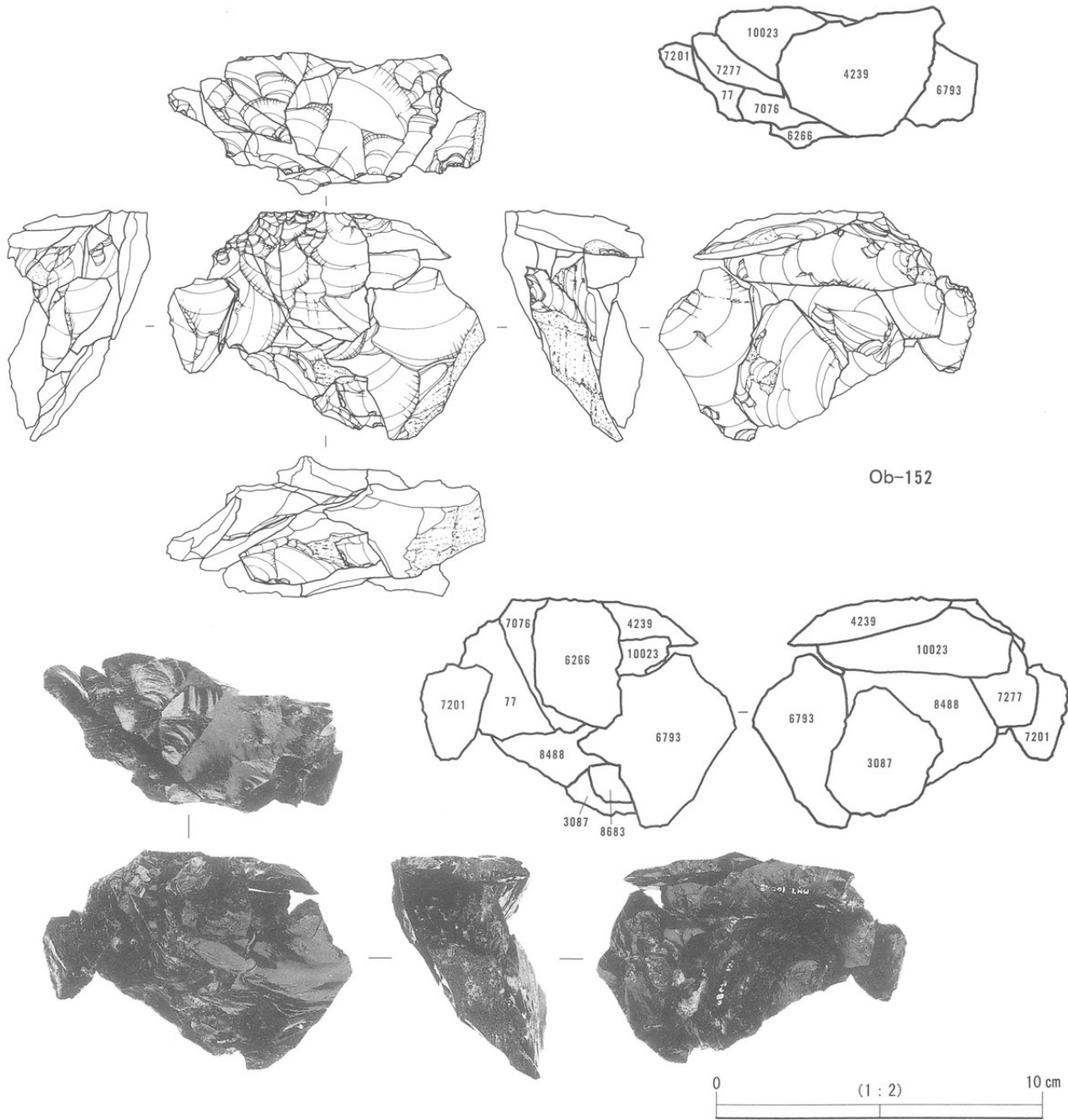

剥離順序	報告番号	遺物番号	ブロック	出土層位	器種	重量g	打面	作業面
1		7201	8	攪乱	SB	4.02	左	正面
2		6266	20	Vb下	UF	6.29	上	正面
3		7076	25	IV中	UF	10.58	上	正面
4		77	19	II下	FI	7.84	上	正面
5		4239	20	Vb上面	SB	16.8	正面	上
6		6793	18	Vb下	AS	25.38	上	正面
7		7277	6	攪乱	SB	10.73	左	正面
8		5680	1	Vb上	FI	5.32	上	正面
9		8683	6	Vb中	FI	2.26	左	正面
10		8488	6	Vb上	UF	30.2	左	正面
11	503	7751	6	Va上	SB	13.02	左	正面
12		10023	6	Va上面	UF	14.42	左	上
13		3087	20	Vb上面	FI	7.85	左	正面

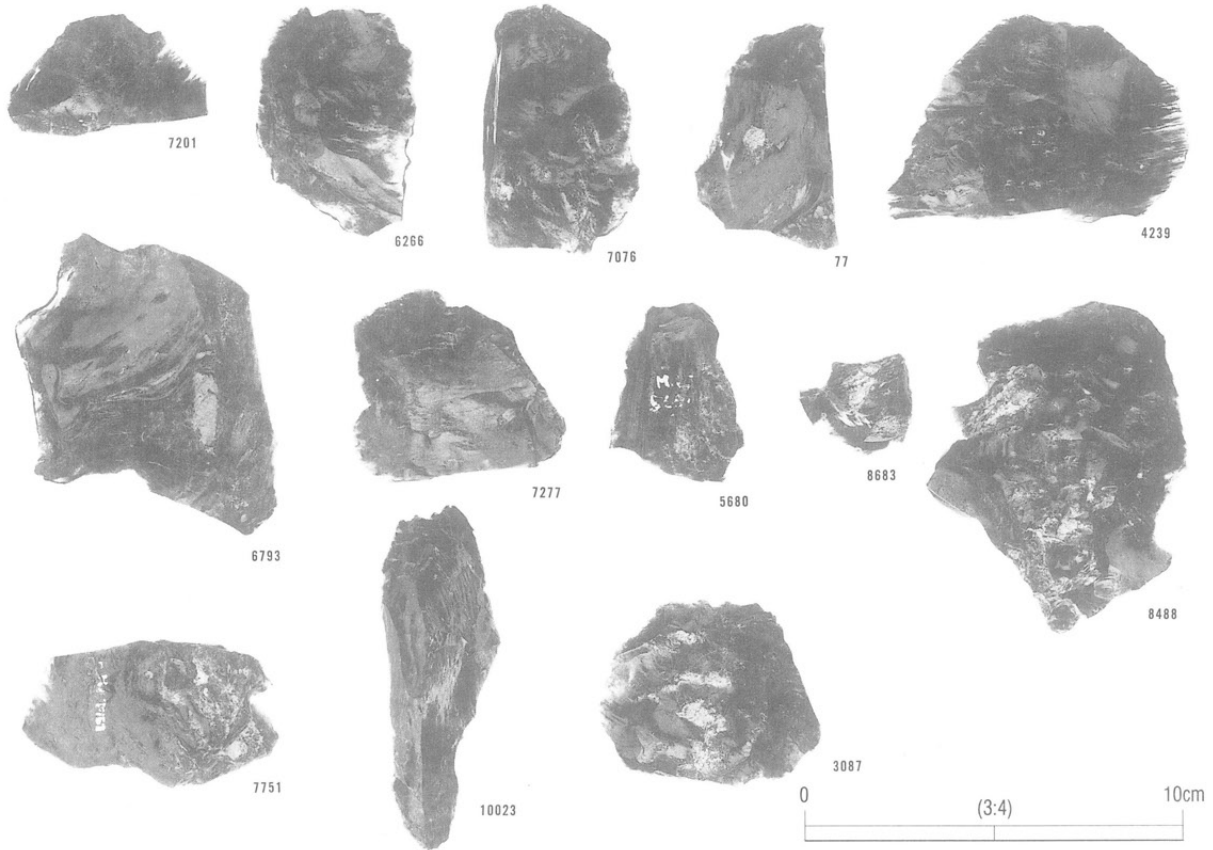

Ob-152 集合写真

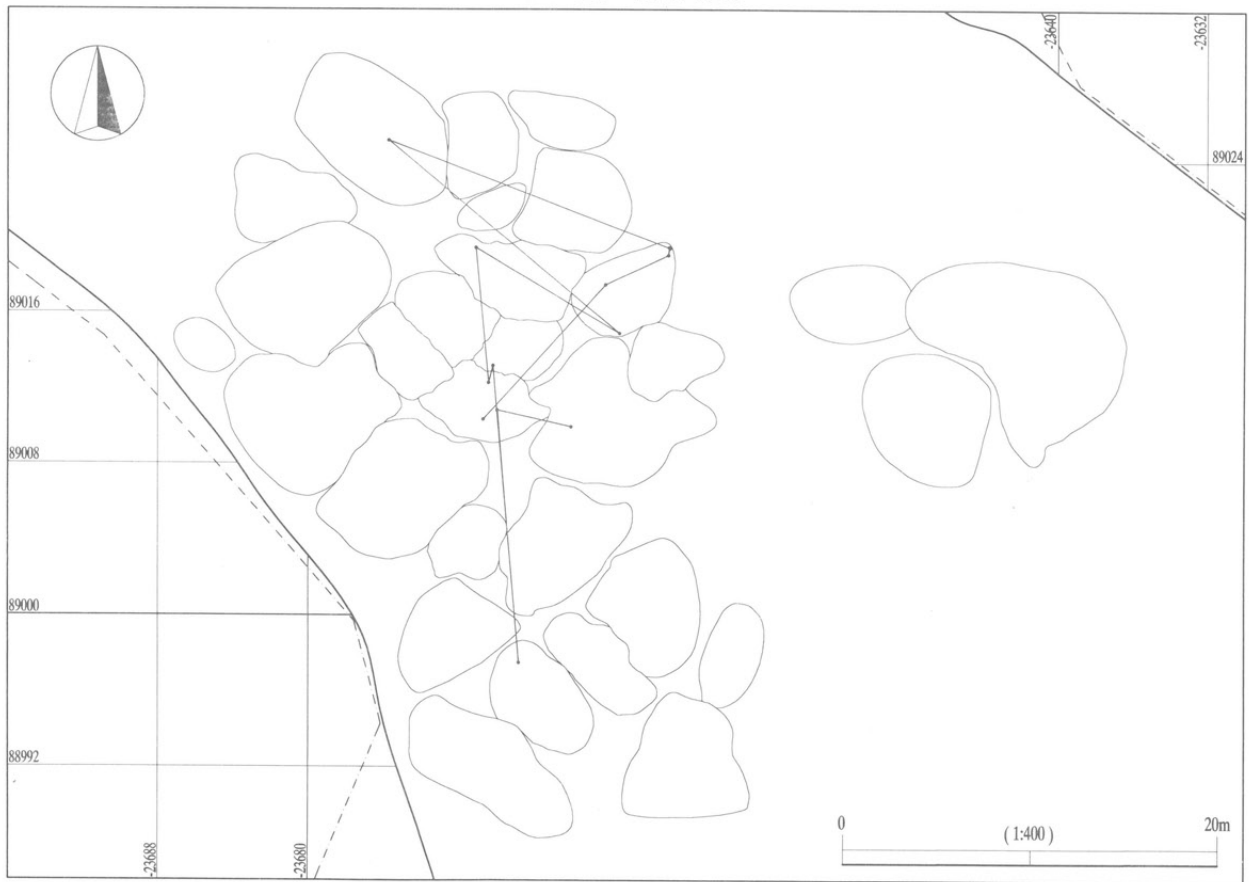

Ob-152 遺物分布図

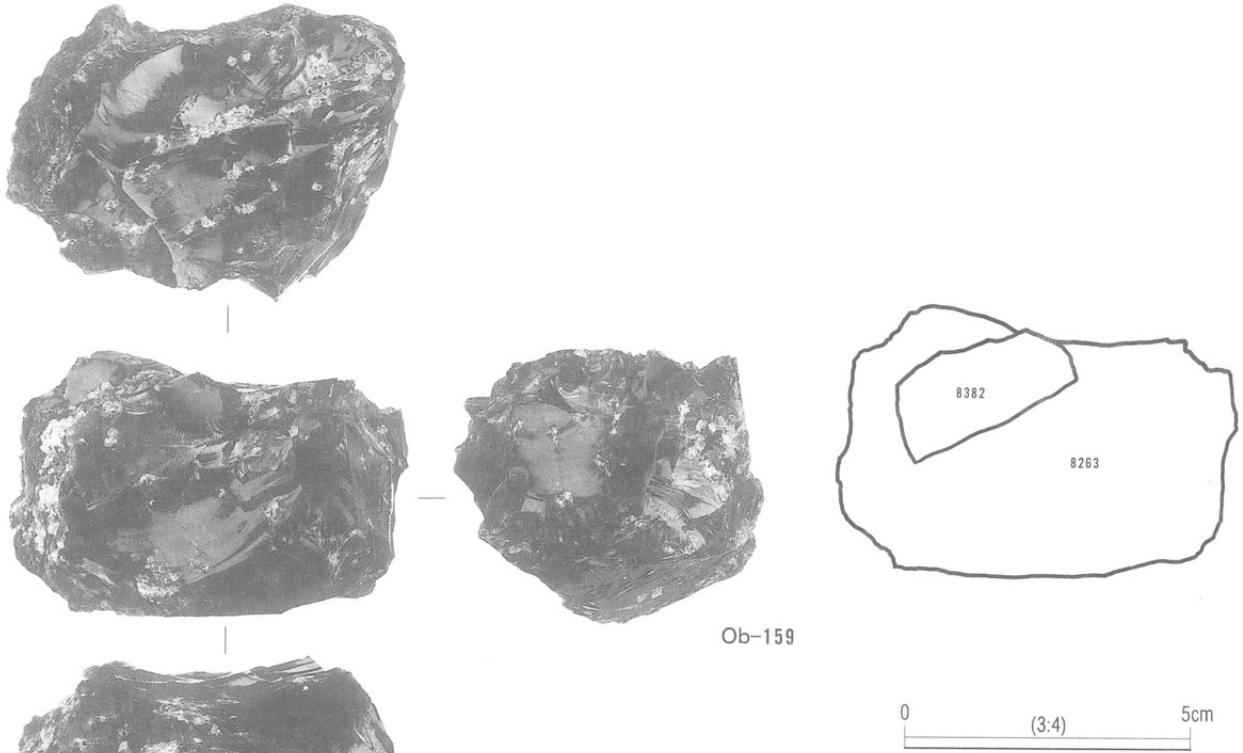

Ob-159

剥離順序	報告番号	遺物番号	ブロック	出土層位	器種	重量g	打面	作業面
1		8382	9	Va下	Fl	2.53	上	正面
2	754	8263	9	Vb上	Co	211.52		

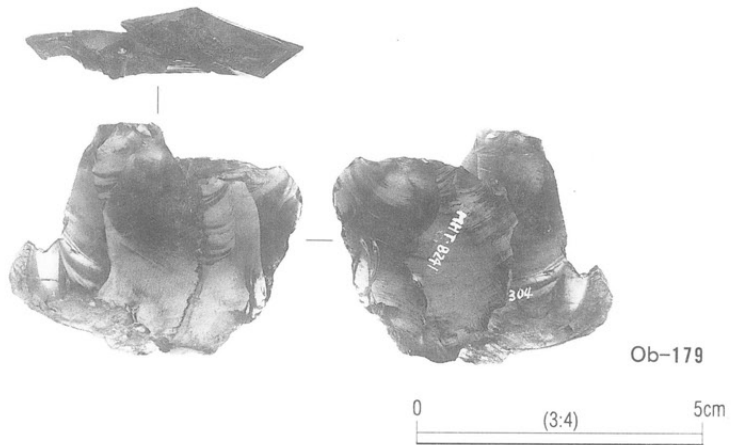

Ob-179

剥離順序	報告番号	遺物番号	ブロック	出土層位	器種	重量g	打面	作業面
1		7304	6	IV上	SB	9.47	正面	上
2		8241	10	Va中	DS	11.5	正面	上

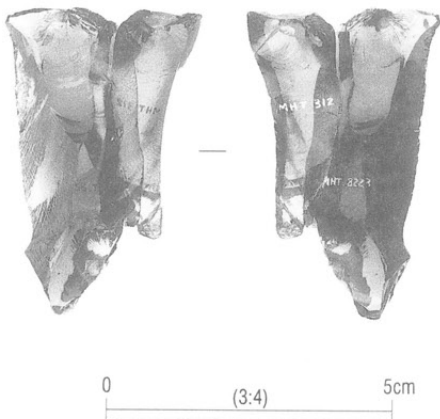

Ob-189

剥離順序	報告番号	遺物番号	遺構番号	出土層位	器種	重量g	打面	作業面
1	707	8223	9	Va下	UF	11.42	上	上
2		312	15	Ⅲ下	UF	4.33	正面	正面



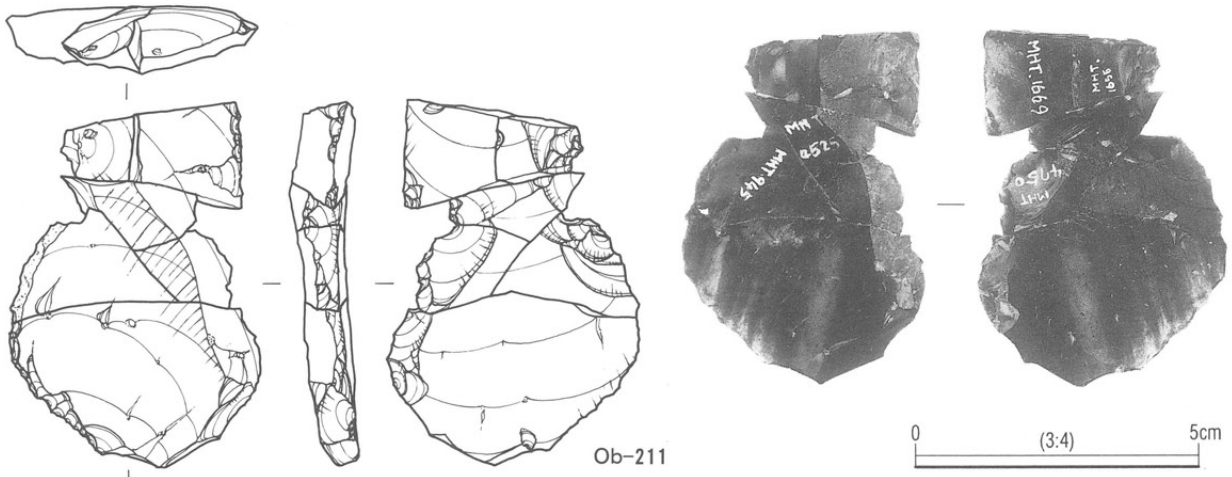

剥離順序	報告番号	遺物番号	ブロック	出土層位	器種	重量g	打面	作業面
1		1655	15	IV下	AS	1.15		
2		1669	15	IV下	SB	3.92		
3		4525	15	Vb中	RF	2.34		
4		4750	14	Vb上	RF	1.87		
5		945	14	Va上面	RF	3.49		
6		2064	12	Va中	Sc	9.69		

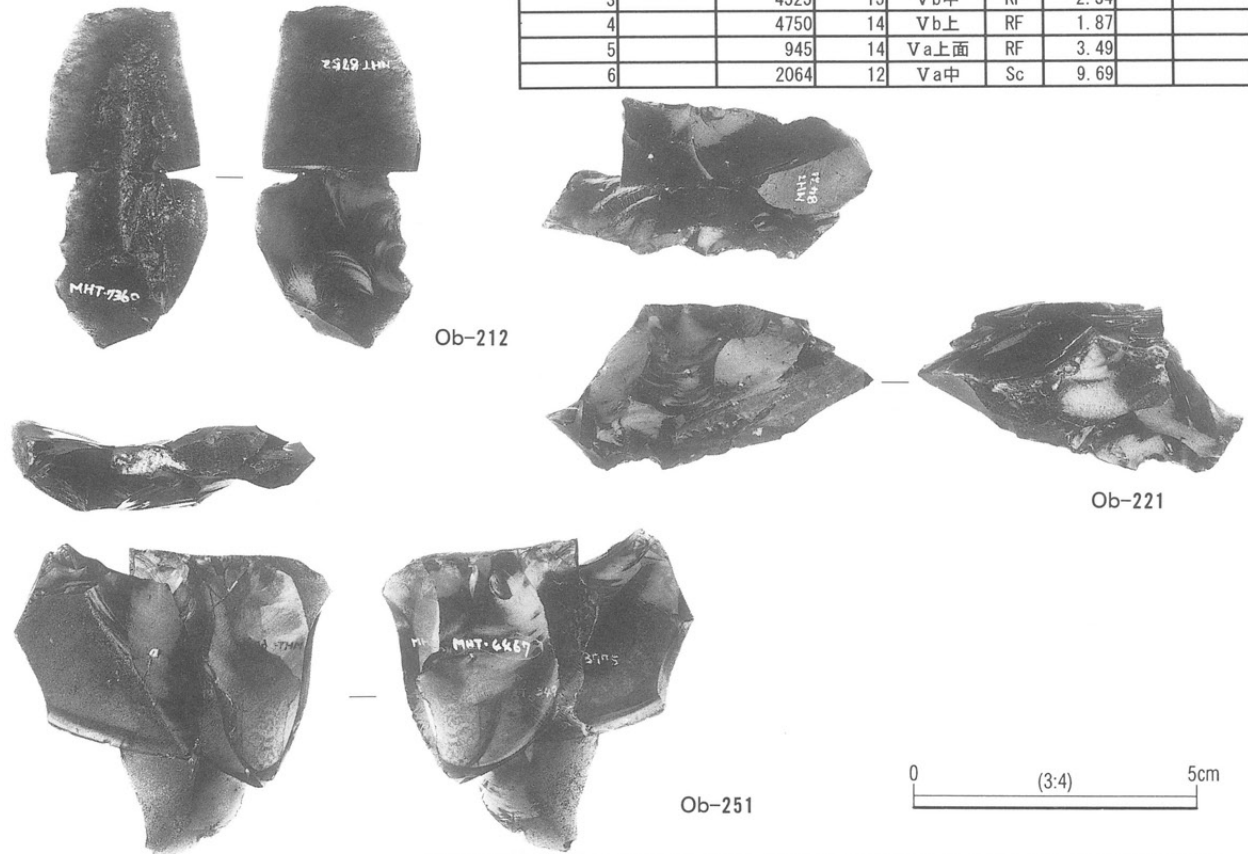

資料番号	剥離順序	挿図番号	遺物番号	ブロック	出土層位	器種	重量g	打面	作業面
Ob-212	1		7360	9	IV下	DS	10.52	上	正面
	2		8752	9	Vb中	FI	7.51	上	正面

資料番号	剥離順序	挿図番号	遺物番号	ブロック	出土層位	器種	重量g	打面	作業面
Ob-221	1		1613	17	Va上面	UF	12.77	上	正面
	2	727	8431	30	Vb上	Co	15.75		

資料番号	剥離順序	挿図番号	遺物番号	ブロック	出土層位	器種	重量g	打面	作業面
Ob-251	1		3775	1	Va下	SB	13.19	上	正面
	2		6087	1	Vb下	UF	4.29	上	正面
	3		349	1	Ⅲ中	UF	7.59	上	正面
	4		4467	1	Vb上	UF	5.91	上	正面

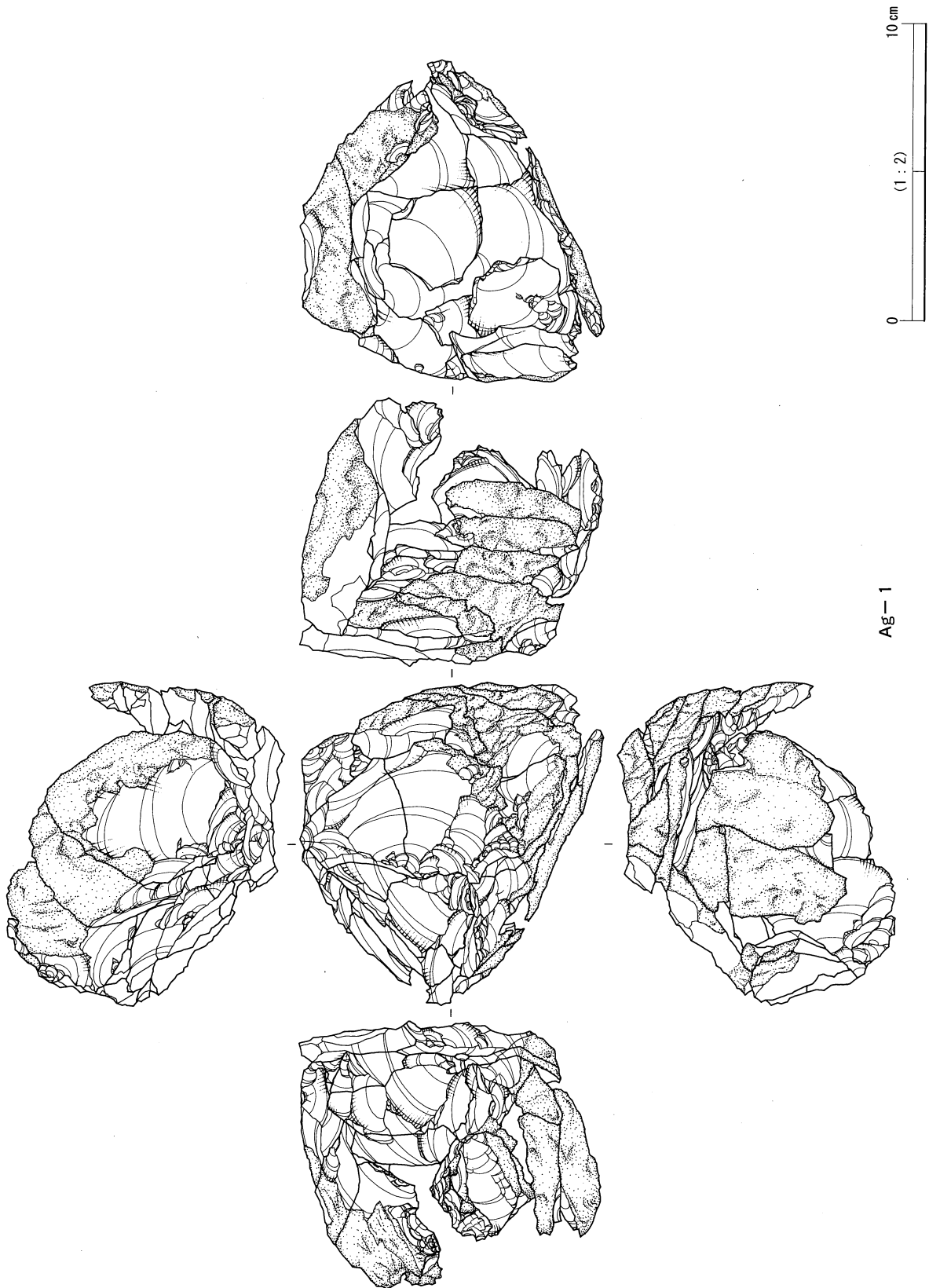



日向林 I 石器文化 接合資料27

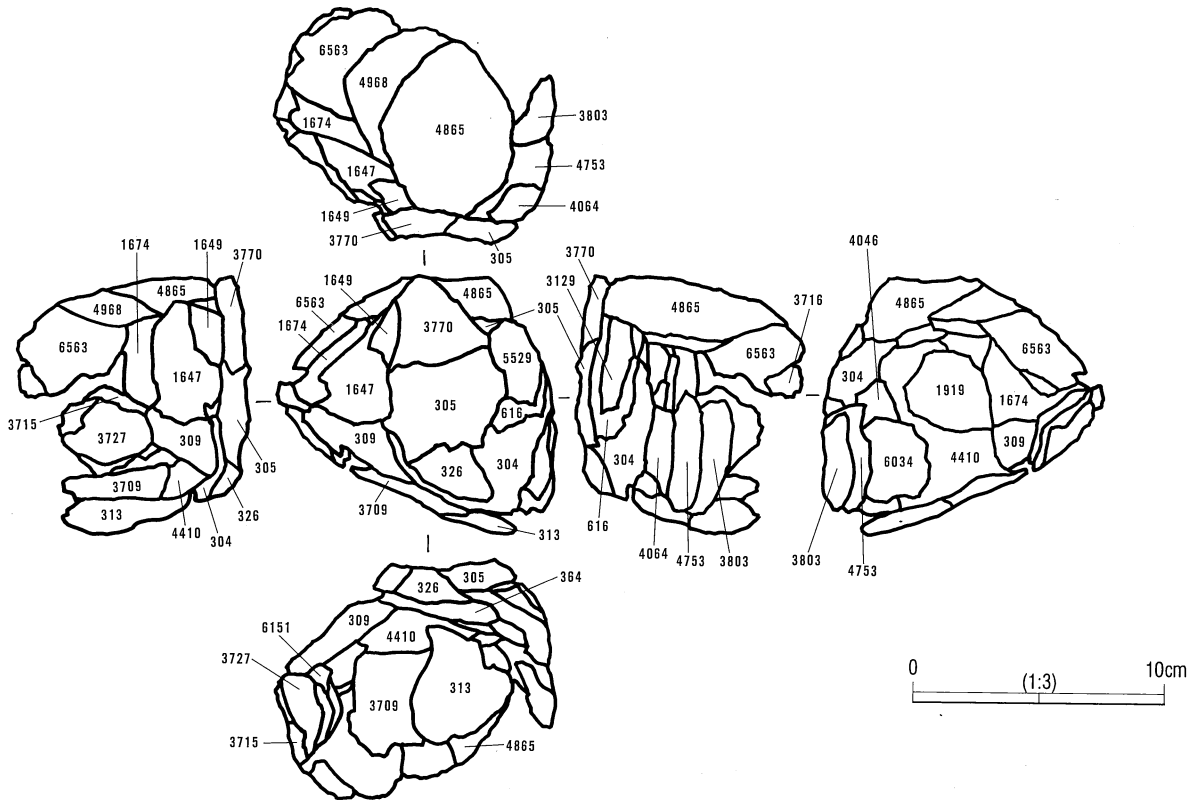

資料番号	剥離順序	報告番号	遺物番号	ブロック	出土層位	器種	重量g	打面	作業面	
Ag-1	1		3770	1	Vb上面	SB	13.2	上	正面	
	2		305	15	Ⅲ下	FI	19.14	上	正面	
	3		326	14	Ⅲ下	UF	4.86	上	正面	
	4		4865	17	Vb上	FI	75.83	正面	上	
	5		5529	18	Vb中	FI	6.1	上	正面	
	6	248	3623	17	Va上	ESS	4.97	上	正面	
	7		616	11	Ⅳ中	ESS	4.77	上	正面	
	8		304	15	Ⅲ下	FI	91.3	上	正面	
	9		Ag-86							
	10		309	15	Ⅲ下	FI	21.28	上	正面	
	11		4410	17	Vb上面	UF	39.15	上	正面	
	12		3709	15	Va下	FI	9.77	上	下	
	13		313	15	Ⅲ下	FI	14.63	上	下	
	14		4968	17	Va下	FI	23.02	正面	上	
	15		3606	17	Va下	FI	4.24	正面	上	
	16	442	4064	18	Vb上面	SB	6.75	上	正面	
	17		4046	17	Va下	SB	3.03	上	正面	
	18	238	6034	11	Vb中	ESS	7.42	上	正面	
	19	244	1919	11	Va上	ESS	7.64	上	正面	
	20		1649	15	Ⅳ下	FI	9.43	上	正面	
	21		1674	15	Ⅳ下	FI	15.93	上	正面	
	22		6563	15	Vb下	UF	27.63	正面	左	
	23		3716	15	Va下	FI	0.96	正面	左	
	24		3727	15	Va下	FI	4.03	正面	下	
	25		3715	15	Va上	FI	5.89	正面	下	
	26		6151	15	Vb中	FI	1.51	正面	下	
	27		3712	15	Va上	FI	3.22			
	28		3695	15	Vb上面	FI	5.62	正面	下	
	29		4753	14	Vb中	FI	11.25	下	正面	
	30		3803	1	Vb上面	FI	6.73	下	正面	
			1651	15	Ⅳ下	FI	1.65			

資料番号	剥離順序	挿図番号	遺物番号	ブロック	出土層位	器種	重量g	打面	作業面
Ag-86	1		1645	15	Va上面	FI	1.21		
	2		4029	17	Vb上面	FI	2.21		
	3		6936	15	Vb下	FI	0.92		
	4	638	1647	15	Ⅳ下	DS	31		

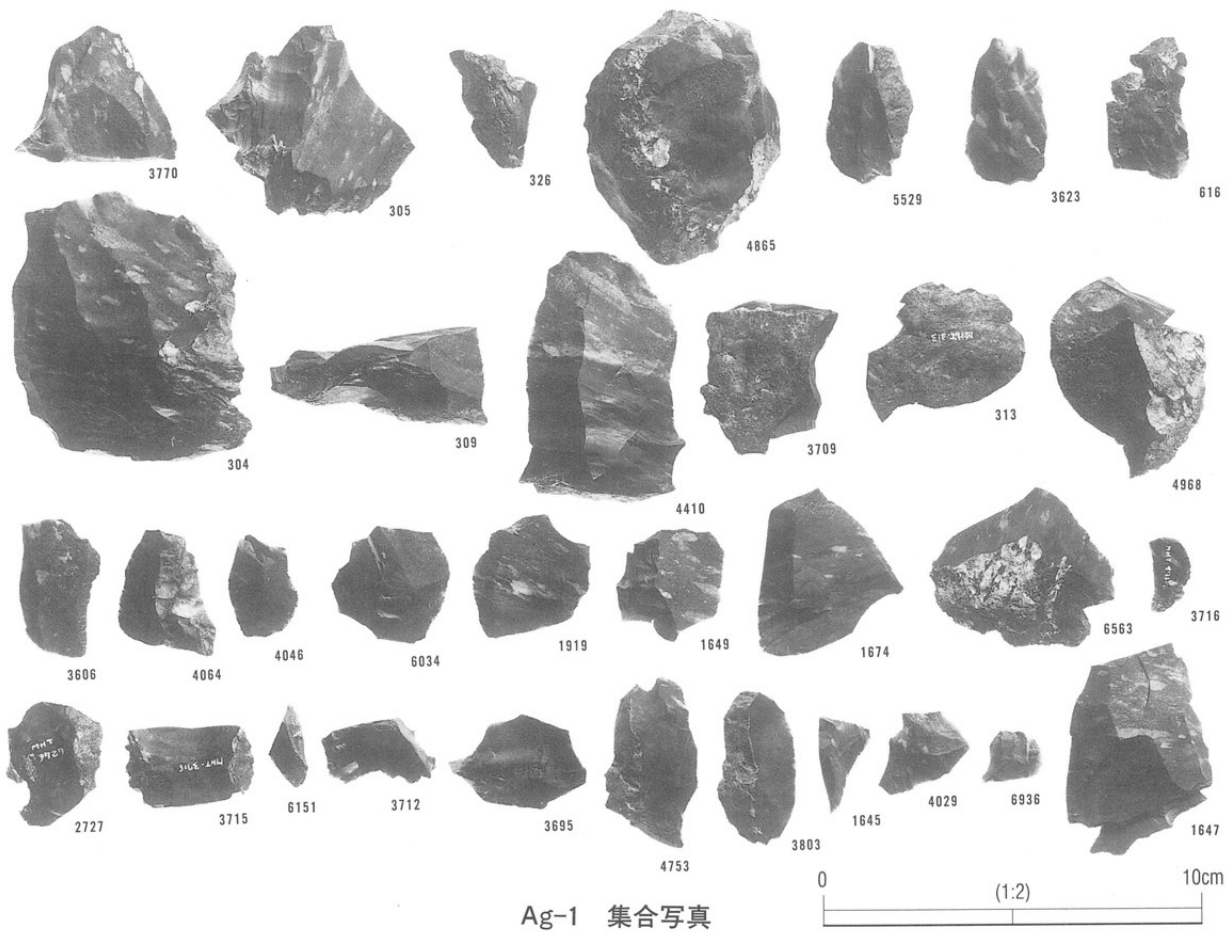

日向林 I 石器文化 接合資料29

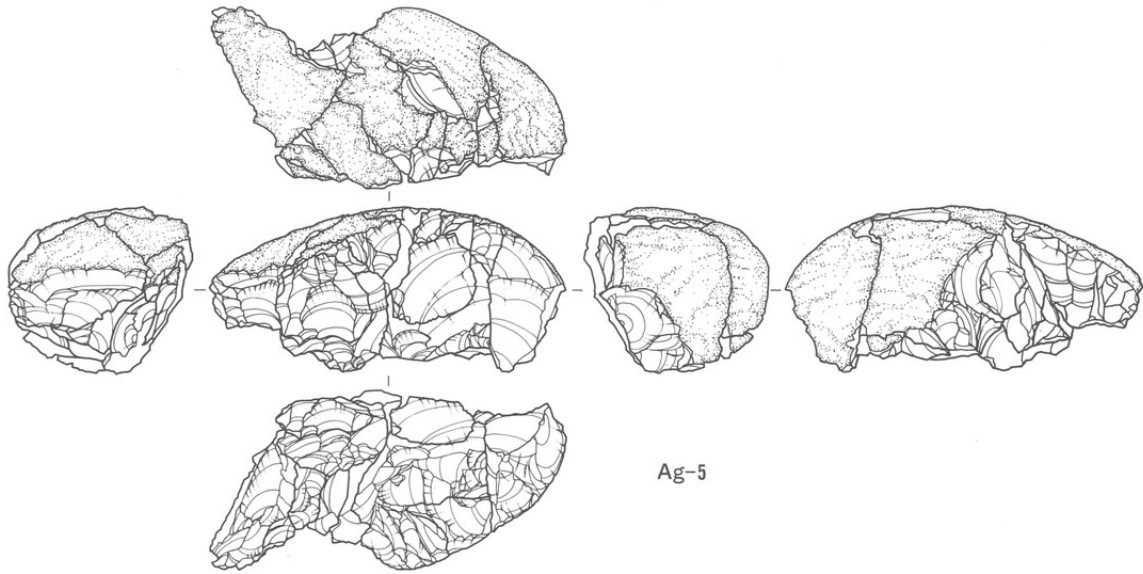

Ag-5

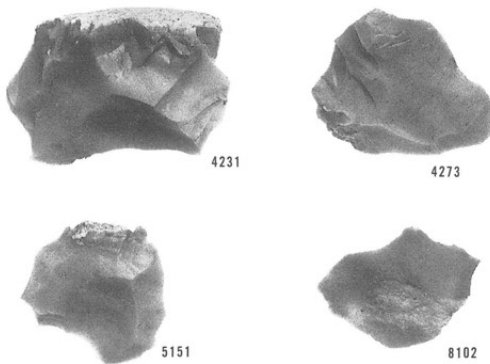
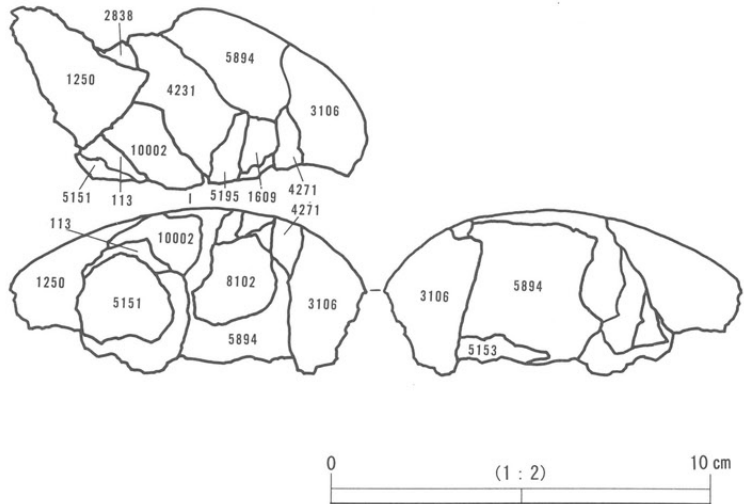
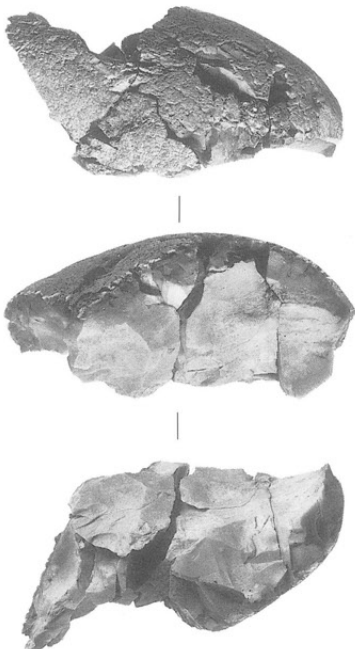

Ag-5 集合写真



剥離順序	報告番号	遺物番号	ブロック	出土層位	器種	重量g	打面	作業面
1		5151	20	Vb上	SB	3.23	上	正面
2		1250	20	Va上面	Co	18.67	下	左
3		4273	20	Va下	SB	6.71	左	正面
4		113	20	II下	Fl	2.48	左	正面
5		2838	20	Va下	Fl	1.69	下	左
6		10002	20	III下	Fl	5.9	下	左
7		105	20	III下	Fl	10.43	下	左
8		3106	20	Va上	Fl	28.2	正面	右
9		4271	20	Va下	Fl	1.58	正面	右
10		5195	20	Vb上	Fl	2.16	裏面	上
11		1609	20	Va上面	Fl	1.35	裏面	上
12		4231	20	Vb上面	Dr	18.44	裏面	上
13		8102	20	Va上	SB	2.21	上	正面
14		5153	20	Vb中	Fl	1.28	裏面	下
15	764	5894	20	Vb上	Co	62.38		

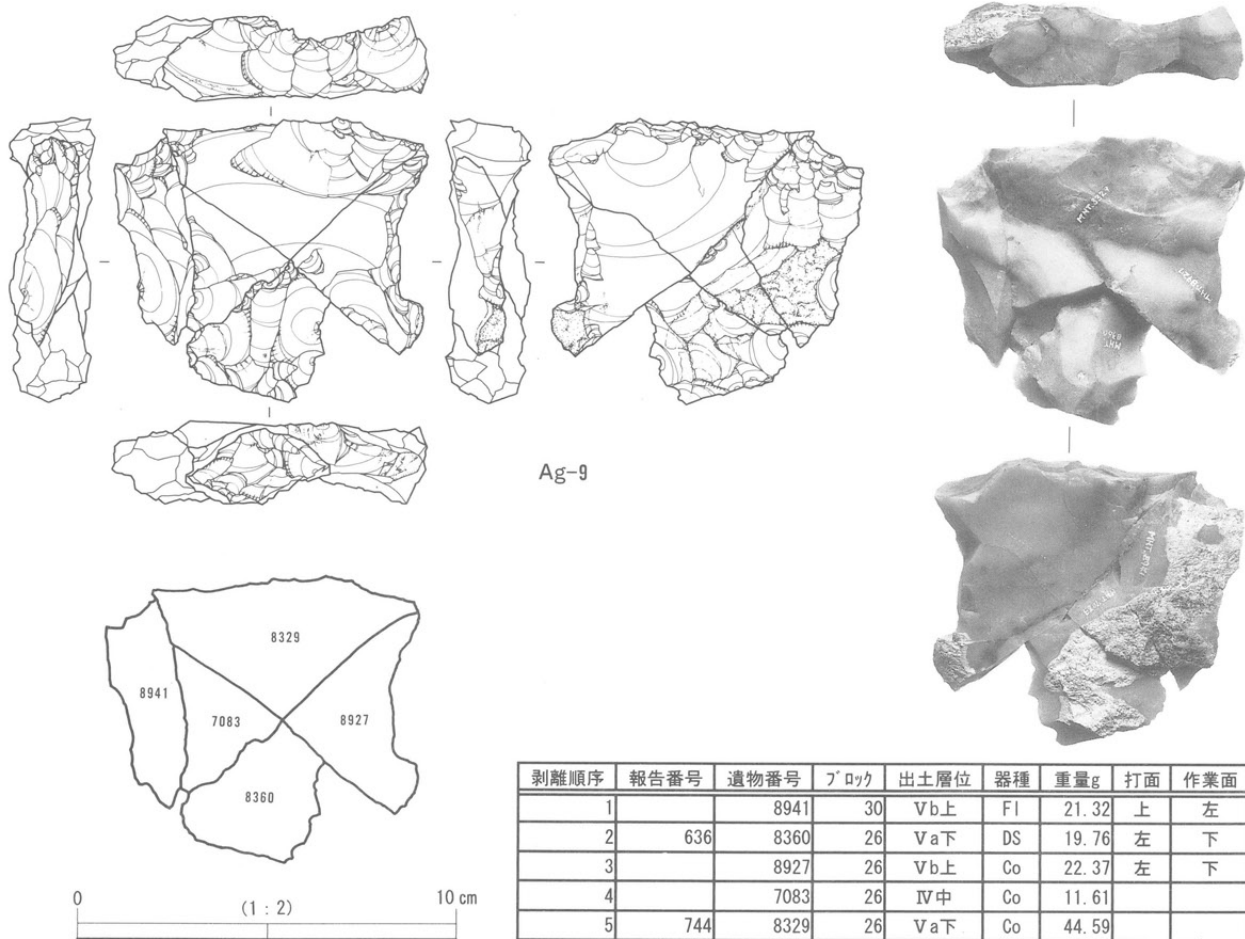
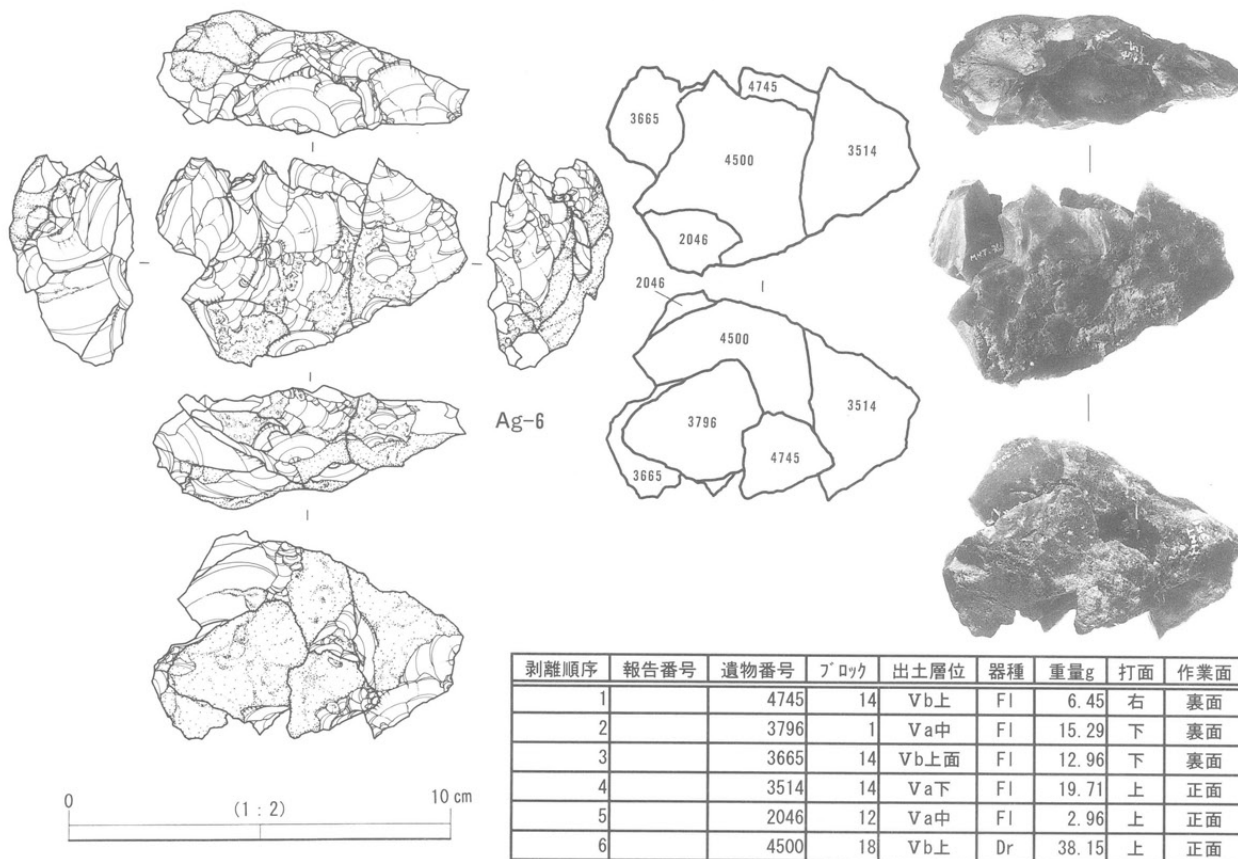

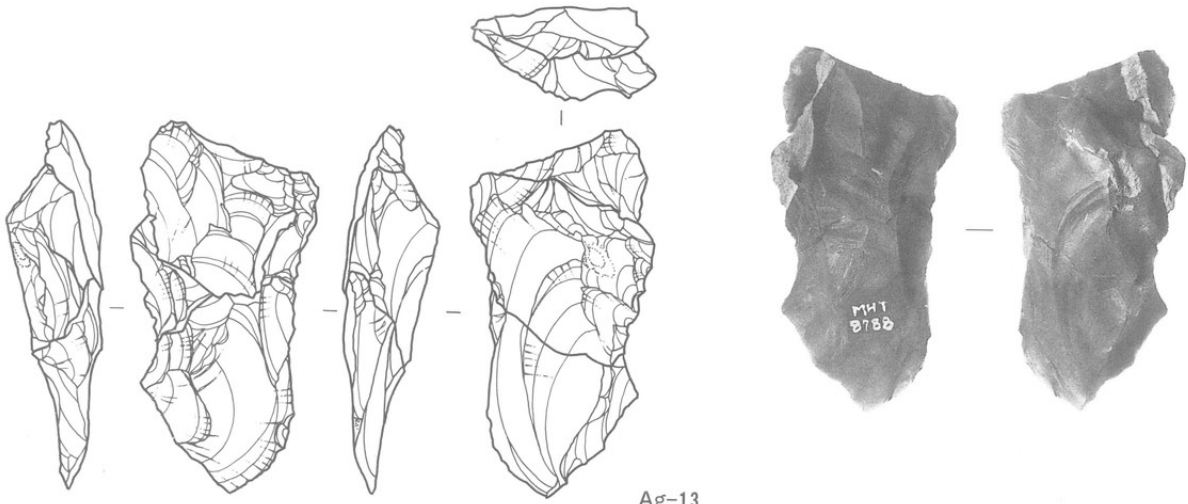

Ag-13



0 (3:4) 5cm

剥離順序	報告番号	遺物番号	ブロック	出土層位	器種	重量g	打面	作業面
1	398	5174	20	Vb中	SB	3.32	上	正面
2	596	8788	9	Vb下	Sc	7.66		
3		7168	9	IV中	DS	11.79		

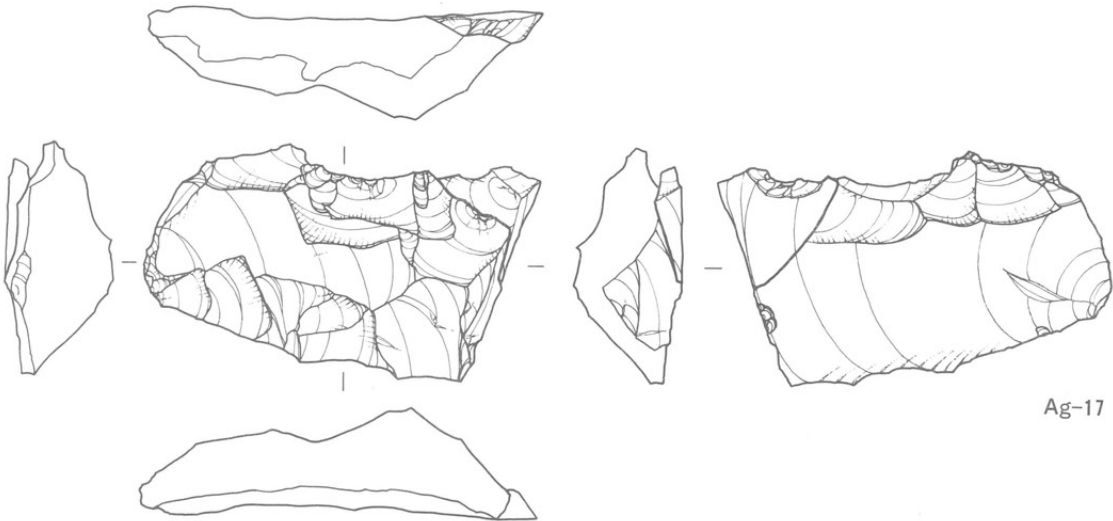

Ag-17

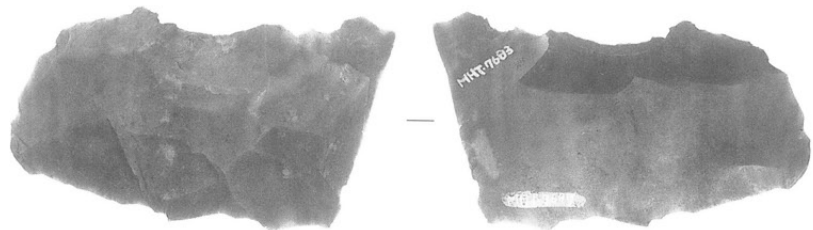

0 (3:4) 5cm

剥離順序	報告番号	遺物番号	ブロック	出土層位	器種	重量g	打面	作業面
1		7683	25	Va上面	Fl	1.13	上	裏面
2	743	7697	25	Va上面	Co	35.99		



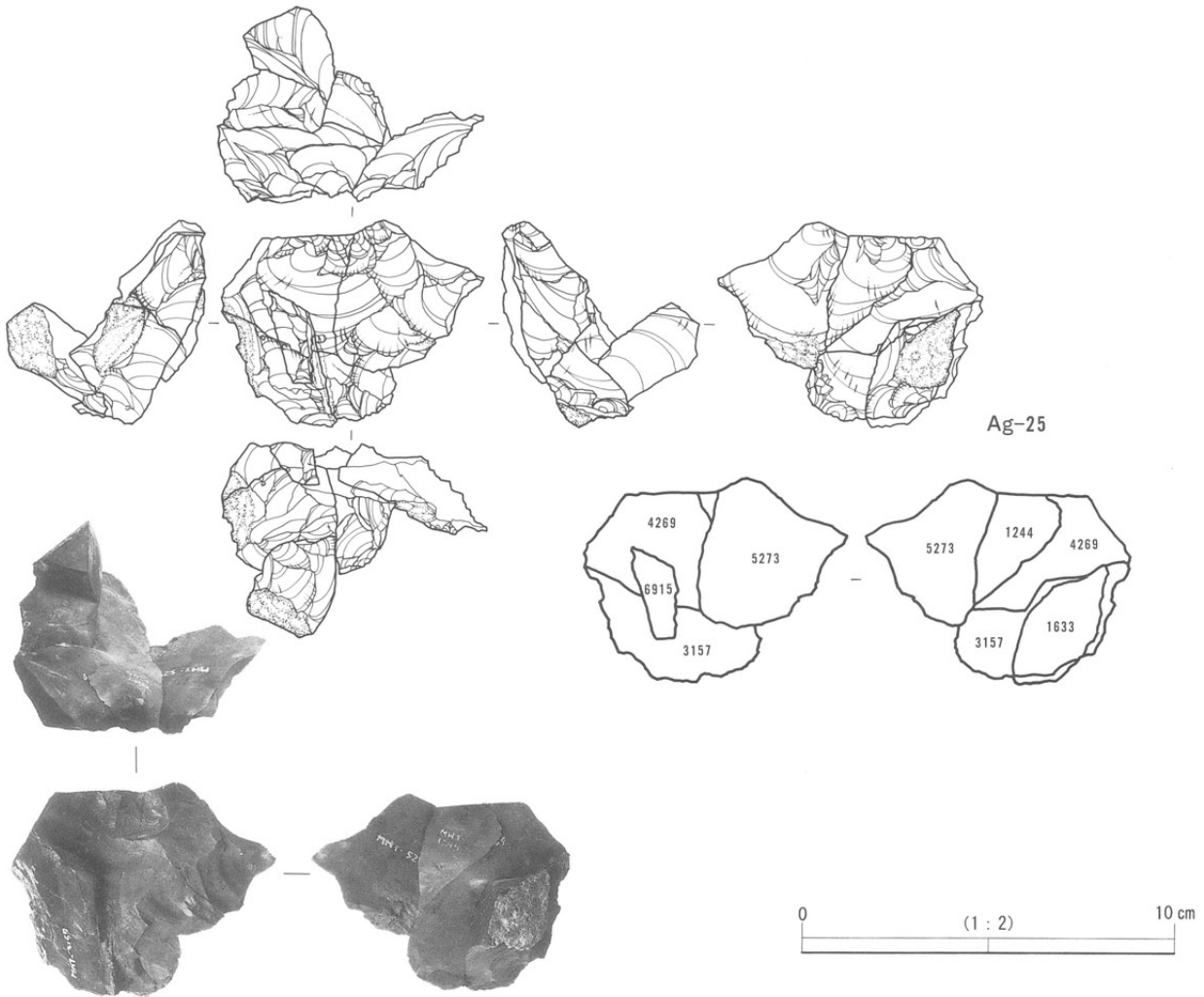

資料番号	剥離順序	報告番号	遺物番号	ブロック	出土層位	器種	重量g	打面	作業面
Ag-25	1		6415	18	Vb下	Fl	1.39	上	正面
	2		5273	20	Vb中	SB	14.62	上	正面
	3		4269	20	Va下	SB	18.92	上	正面
	4		Ag-85						
	5		1244	20	IV中	SB	3.16	上	正面

資料番号	剥離順序	報告番号	遺物番号	ブロック	出土層位	器種	重量g	打面	作業面
Ag-85	1		1633	14	Va上面	Fl	12.66	正面	下
	2		3157	17	Vb上面	Co	27.43		

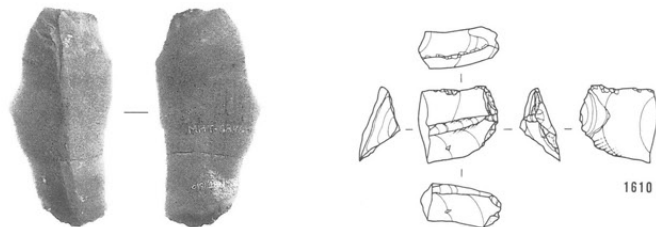
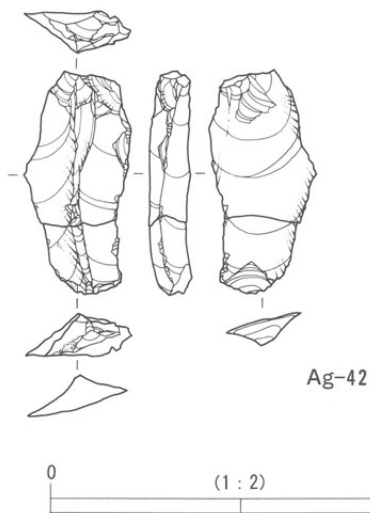

剥離順序	報告番号	遺物番号	ブロック	出土層位	器種	重量g	打面	作業面
1	397	1610	20	Va上面	SB	2.86	上	正面
2		6846	20	Vb下	UF	10.14	上	正面

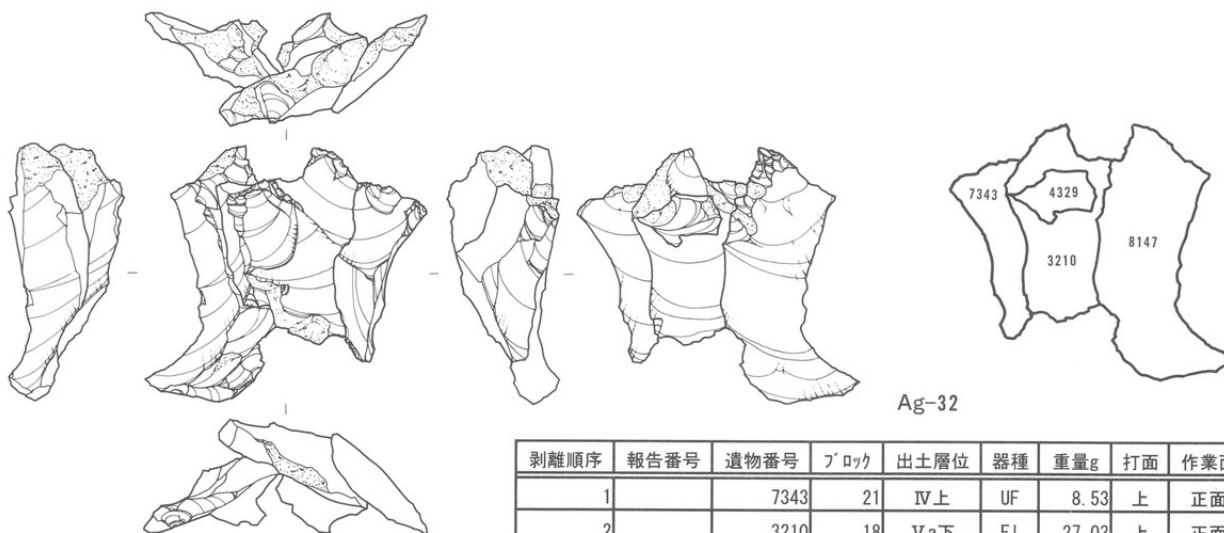

Ag-32

剥離順序	報告番号	遺物番号	ブロック	出土層位	器種	重量g	打面	作業面
1		7343	21	IV上	UF	8.53	上	正面
2		3210	18	Va下	Fl	27.03	上	正面
3		8417	4	Vb下	Fl	21.04	上	正面
4		4329	2	IV下	Fl	1.42	上	正面

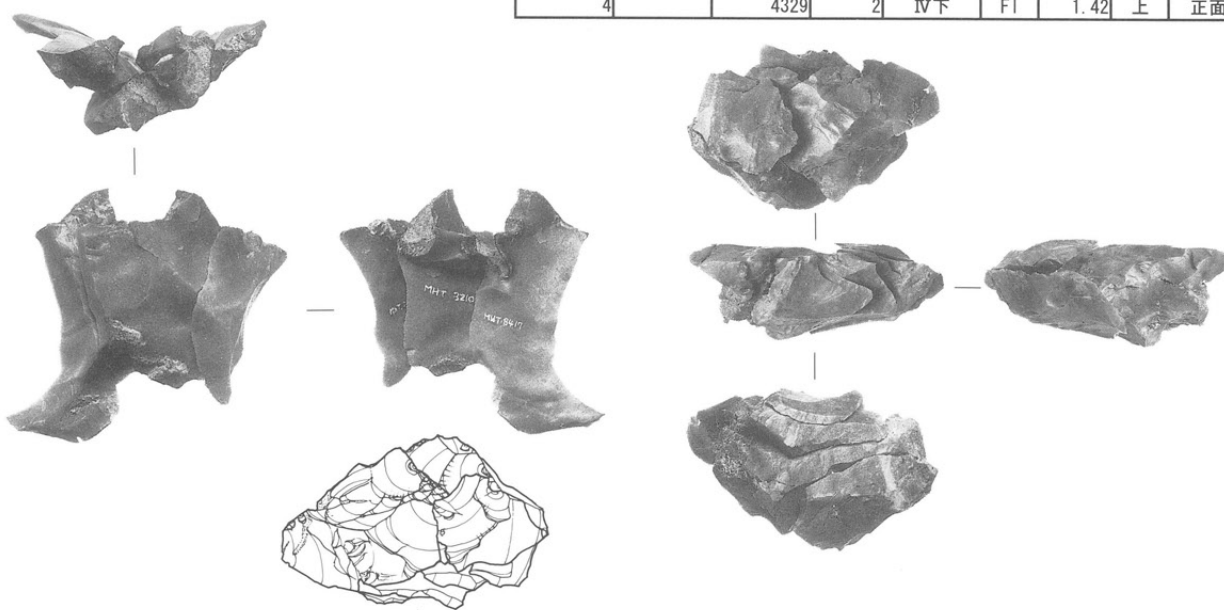

Ag-35

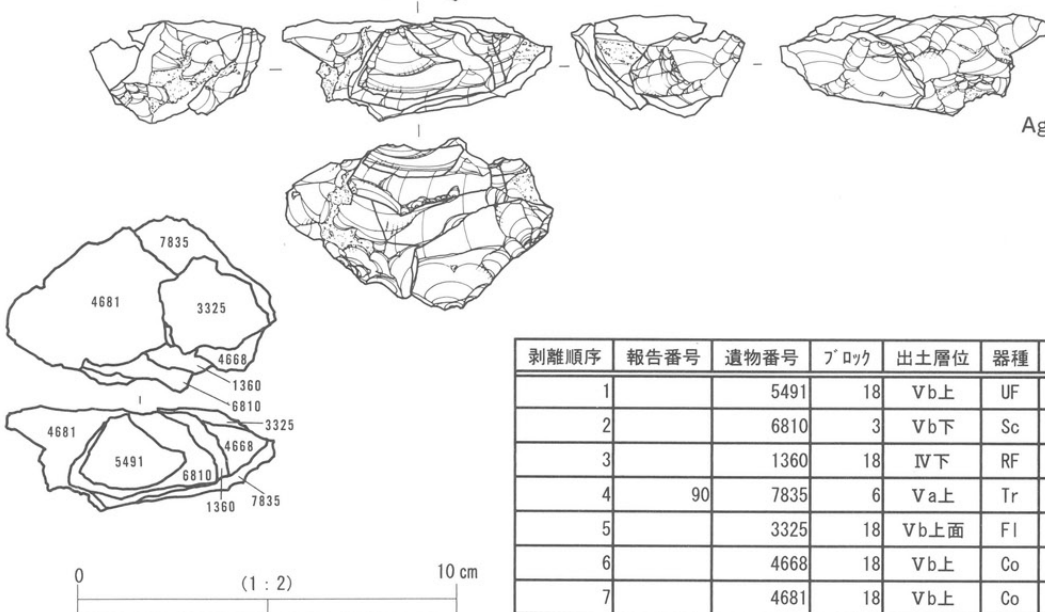

剥離順序	報告番号	遺物番号	ブロック	出土層位	器種	重量g	打面	作業面
1		5491	18	Vb上	UF	1.43	上	正面
2		6810	3	Vb下	Sc	6.46	上	正面
3		1360	18	IV下	RF	6.52	上	正面
4	90	7835	6	Va上	Tr	10.8	上	裏面
5		3325	18	Vb上面	Fl	4.19	裏面	上
6		4668	18	Vb上	Co	5.3		
7		4681	18	Vb上	Co	26.27		

0 (1:2) 10 cm

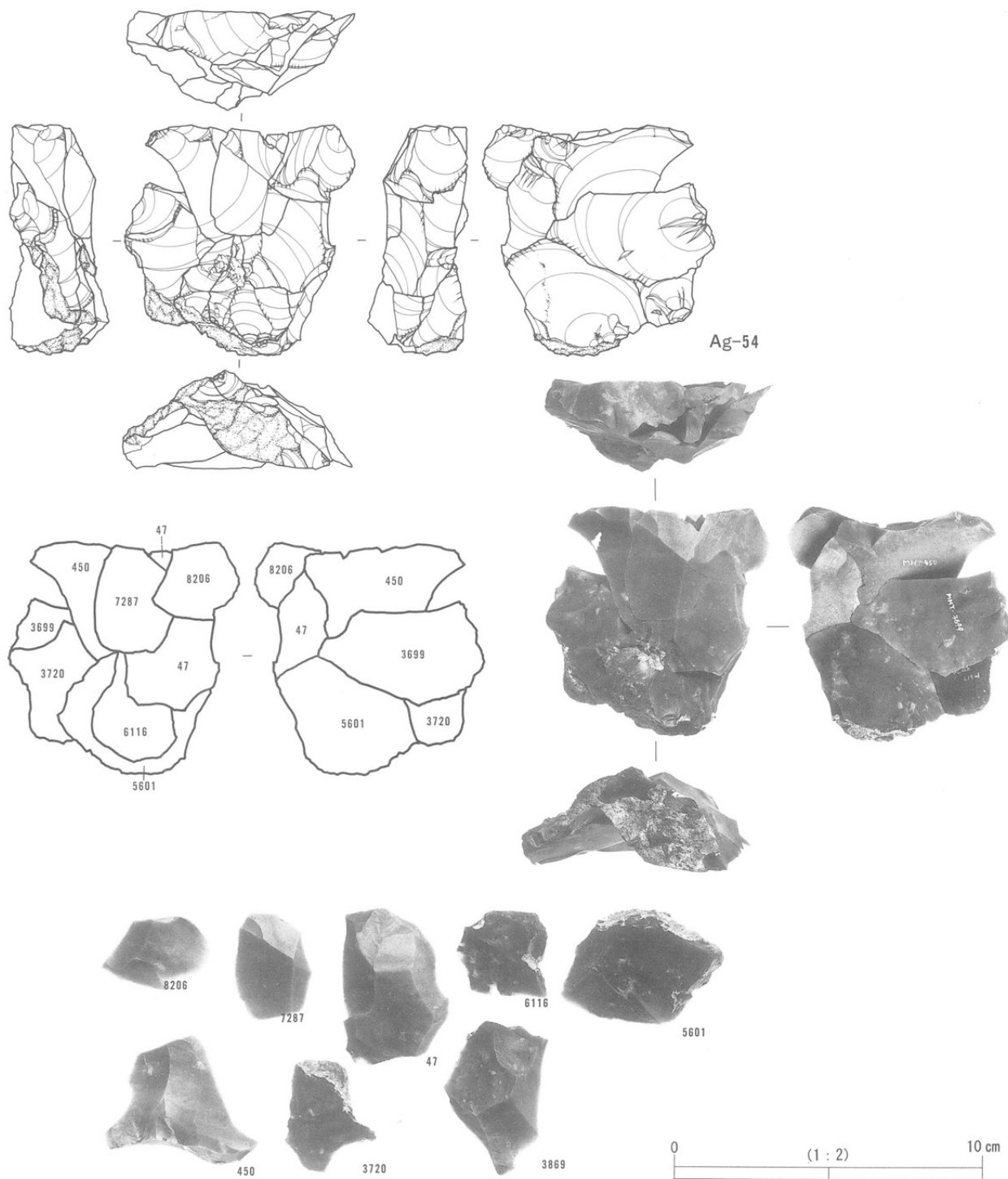

Ag-54 集合写真

剥離順序	報告番号	遺物番号	ブロック	出土層位	器種	重量g	打面	作業面
1		8206	10	Va下	Fl	5.68	上	正面
2		7287	6	IV上	Fl	7.48	上	正面
3		47	17	III下	Fl	22.09	上	正面
4		6116	1	Vb下	Fl	6.48	下	正面
5		5601	18	Vb上	UF	30.77	下	正面
6		450	18	IV上	Fl	21.22	下	正面
7		3720	15	Vb上面	UF	6.94	下	正面
8		3699	15	Va下	UF	14.44	左	正面

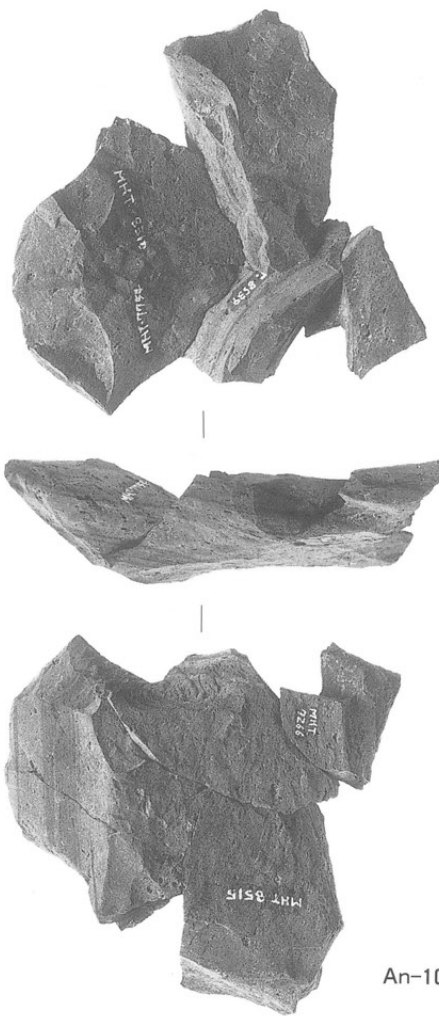
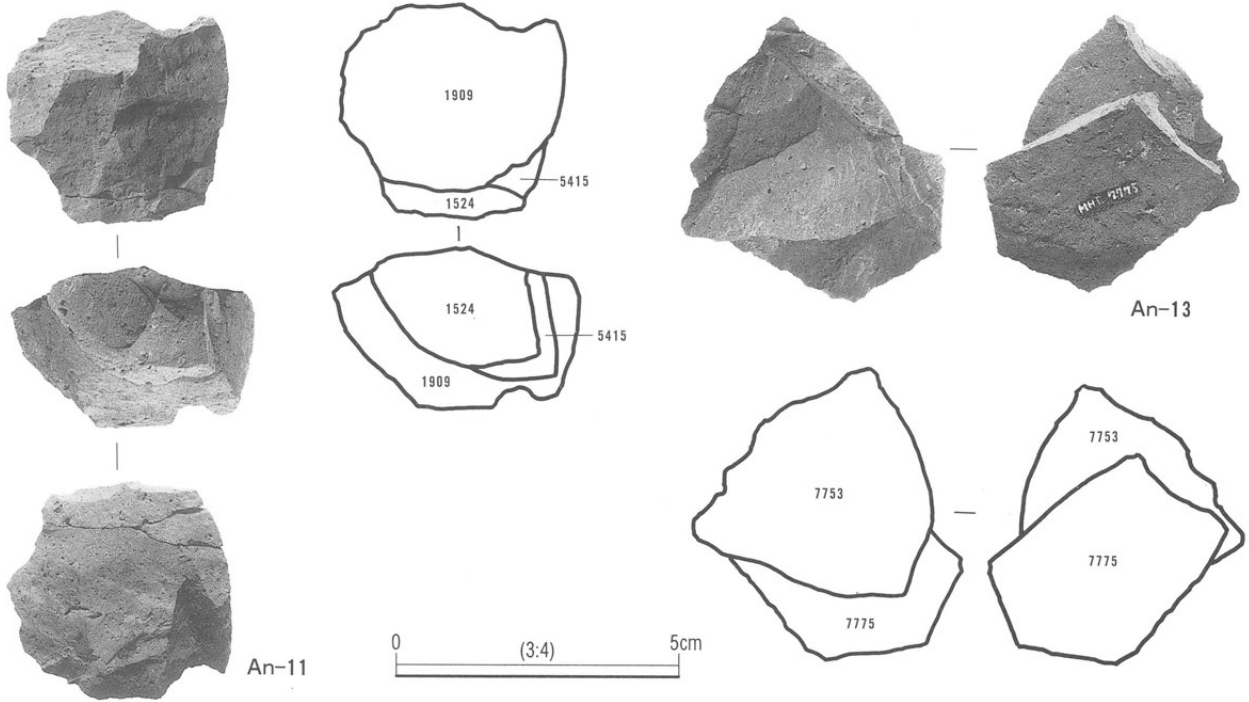

An-10

剥離順序	報告番号	遺物番号	ブロック	出土層位	器種	重量g	打面	作業面
1		7266	7	IV上	FI	5.91	上	下
2		8539	7	Vb上	FI	12.43	上	下
3		8515	7	Vb上	FI	22.28	裏面	下
4		7754	7	Va上	FI	19.45	左	下
5		8518	7	Vb上	FI	20.07	左	下

An-11

剥離順序	報告番号	遺物番号	ブロック	出土層位	器種	重量g	打面	作業面
1		1524	11	IV下	FI	3.88	上	正面
2		5415	11	Vb上	FI	1.63	上	正面
3		1909	11	Vb上面	Co	42.65		

An-13

An-10

剥離順序	報告番号	遺物番号	ブロック	出土層位	器種	重量g	打面	作業面
1		7753	7	IV下	SB	8.31	裏面	正面
2		7775	8	Va上	FI	9.76	裏面	正面

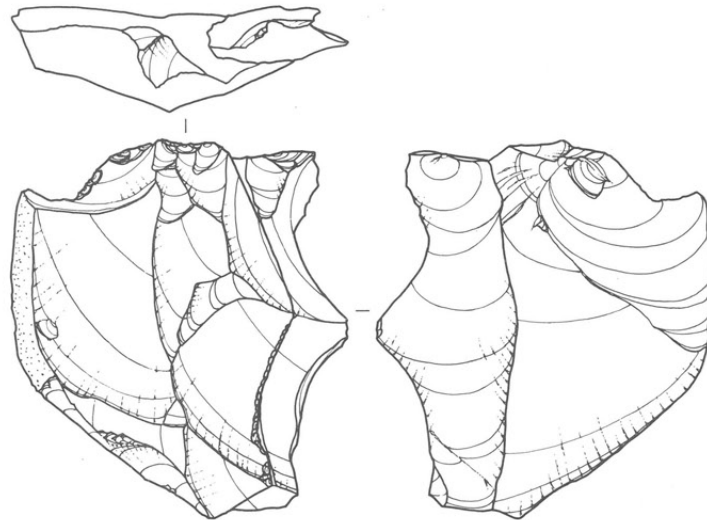

SS-2

0 (3:4) 5cm

剥離順序	報告番号	遺物番号	ブロック	出土層位	器種	重量g	打面	作業面
1		7965	6	Va下	Fl	51.72	上	正面
2		7963	6	Va中	Fl	7.45	上	正面

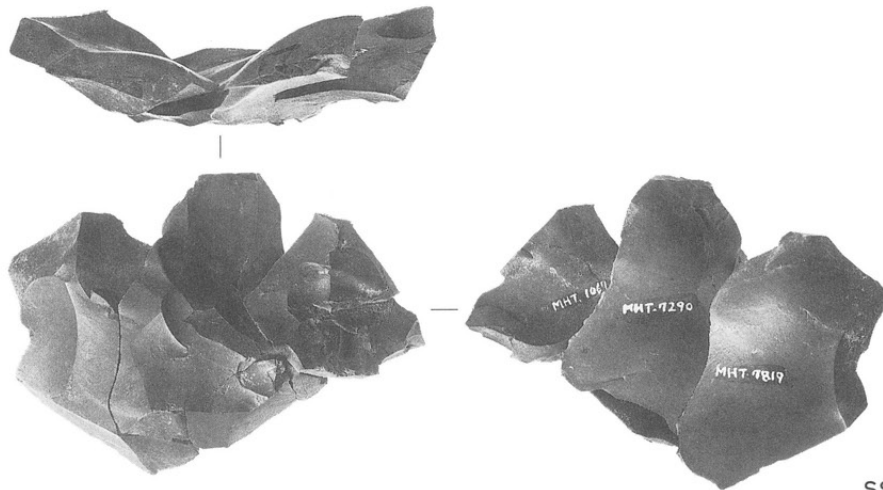

SS-3

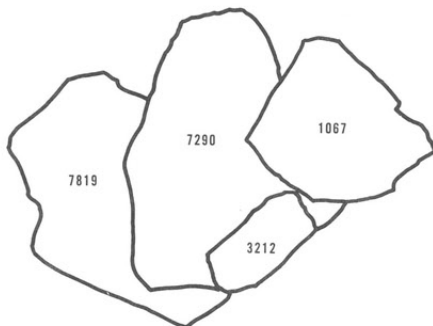

0 (3:4) 5cm

剥離順序	報告番号	遺物番号	ブロック	出土層位	器種	重量g	打面	作業面
1		3212	18	Vb上面	Fl	1.94	下	正面
2		1067	17	Va上面	Fl	8.22	正面	下
3		7290	6	攪乱	SB	18.99	上	正面
4		7819	18	IV下	RF	17.64	上	正面

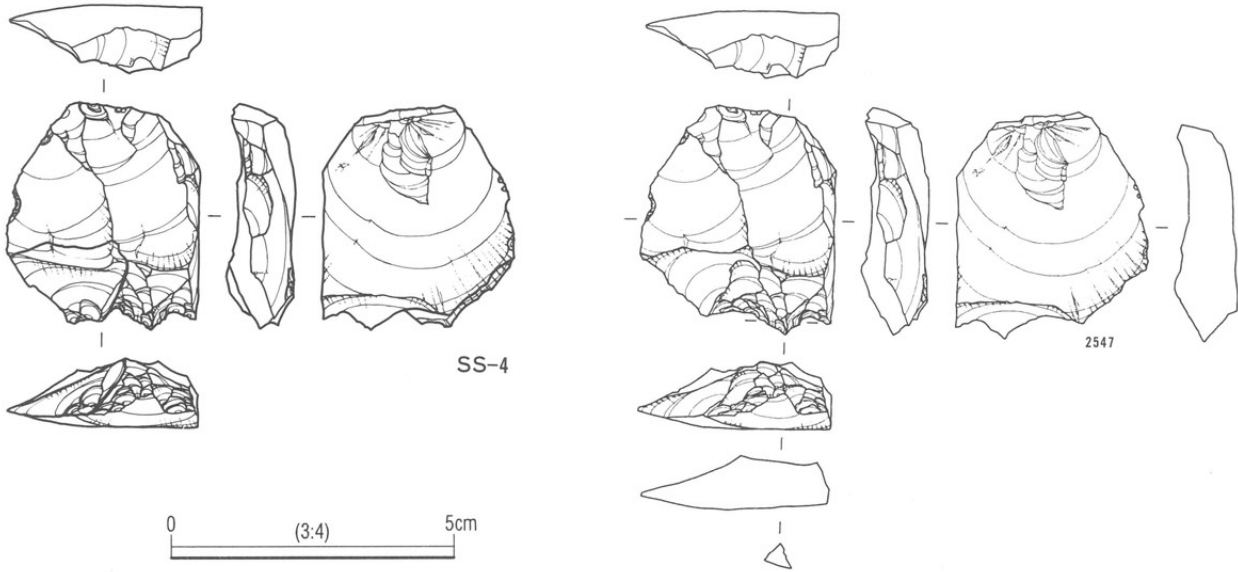

剥離順序	報告番号	遺物番号	ブロック	出土層位	器種	重量g	打面	作業面
1		5855	14	Vb中	FI	0.7	裏面	下
2	624	2547	16	Va下	DS	14.88		

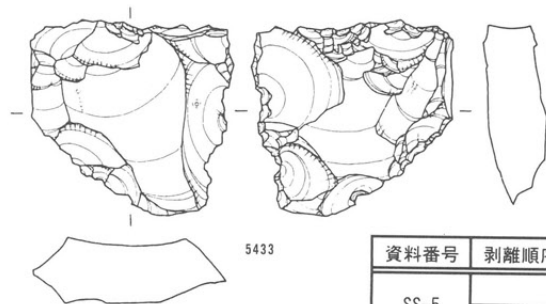
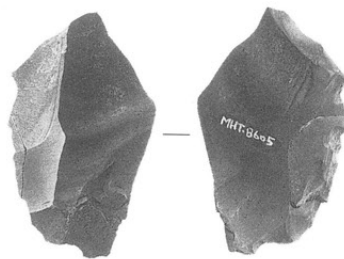
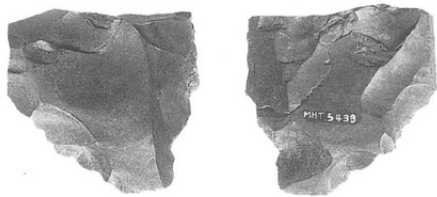
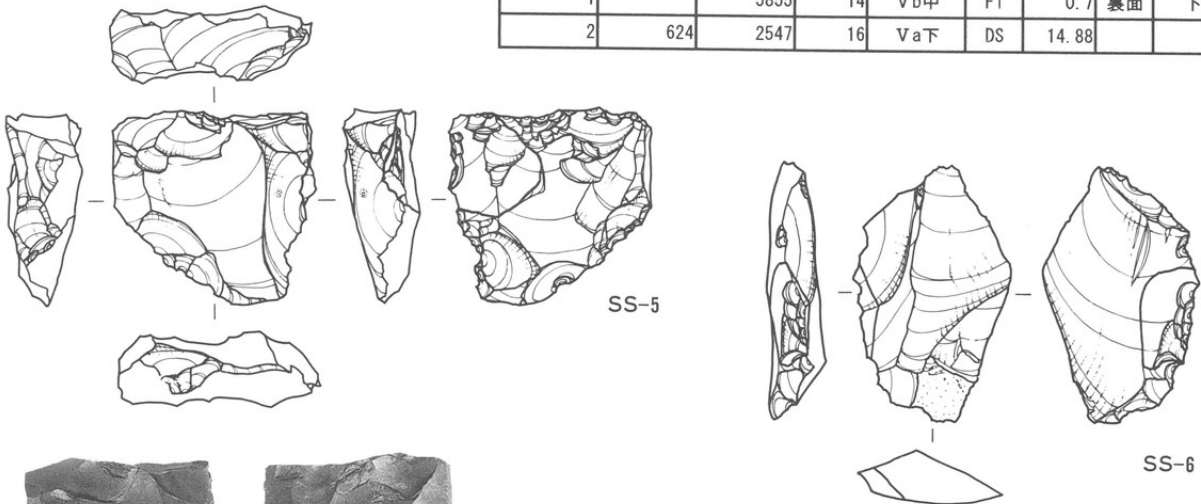

資料番号	剥離順序	報告番号	遺物番号	ブロック	出土層位	器種	重量g	打面	作業面
SS-5	1		7703	10	Va上面	FI	0.88	上	裏面
	2	640	5433	10	Vb中	DS	15.67		

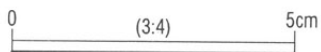

資料番号	剥離順序	報告番号	遺物番号	ブロック	出土層位	器種	重量g	打面	作業面
SS-6	1		8015	8	Va中	FI	0.67	左	裏面
	2		8605	8	Vb下	DS	9.12		

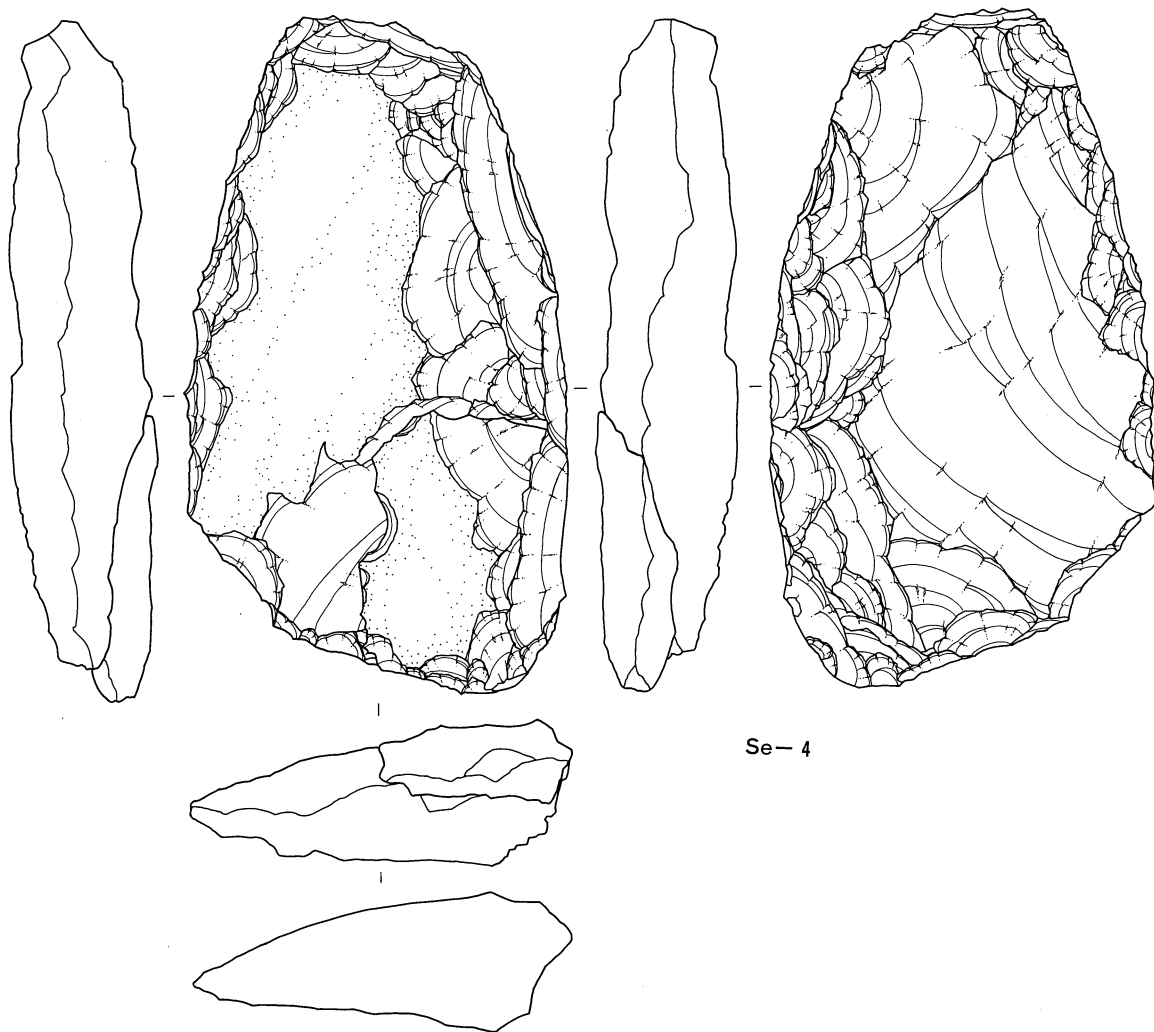

Se-4

剥離順序	報告番号	遺物番号	ブロック	出土層位	器種	重量g	打面	作業面
1		8469	8	Vb上	Fl	20.4	裏面	正面
2	39	7447	8	IV下	Ax	211.16		

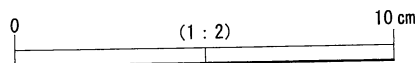

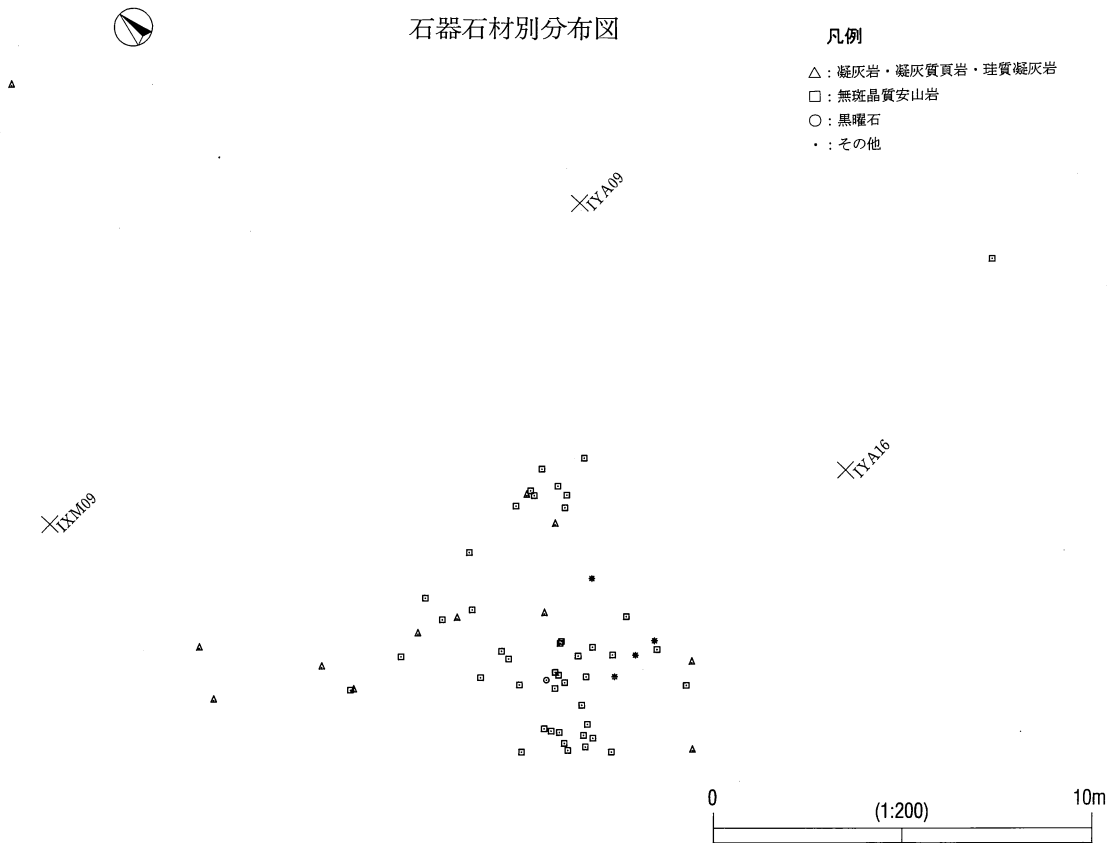
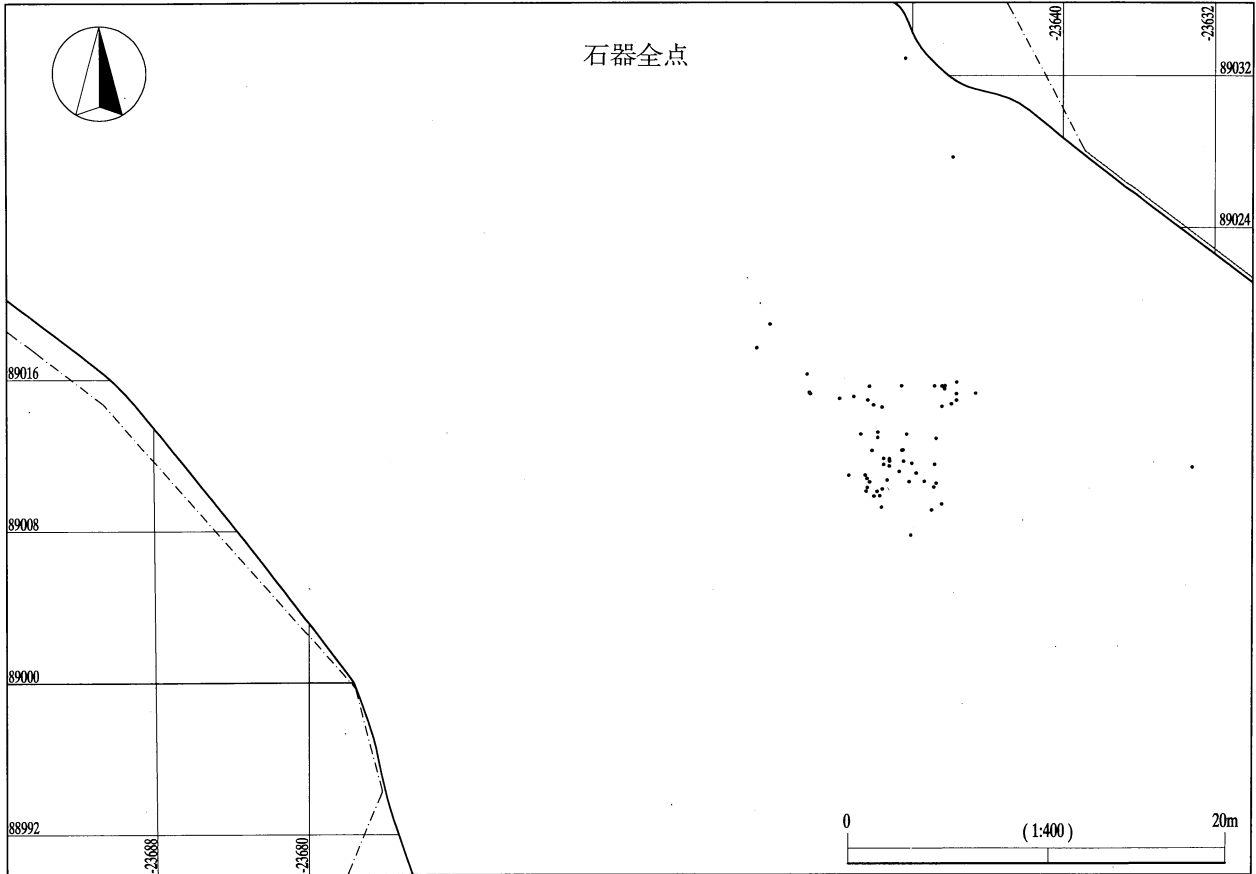

日向林III石器文化 全体図



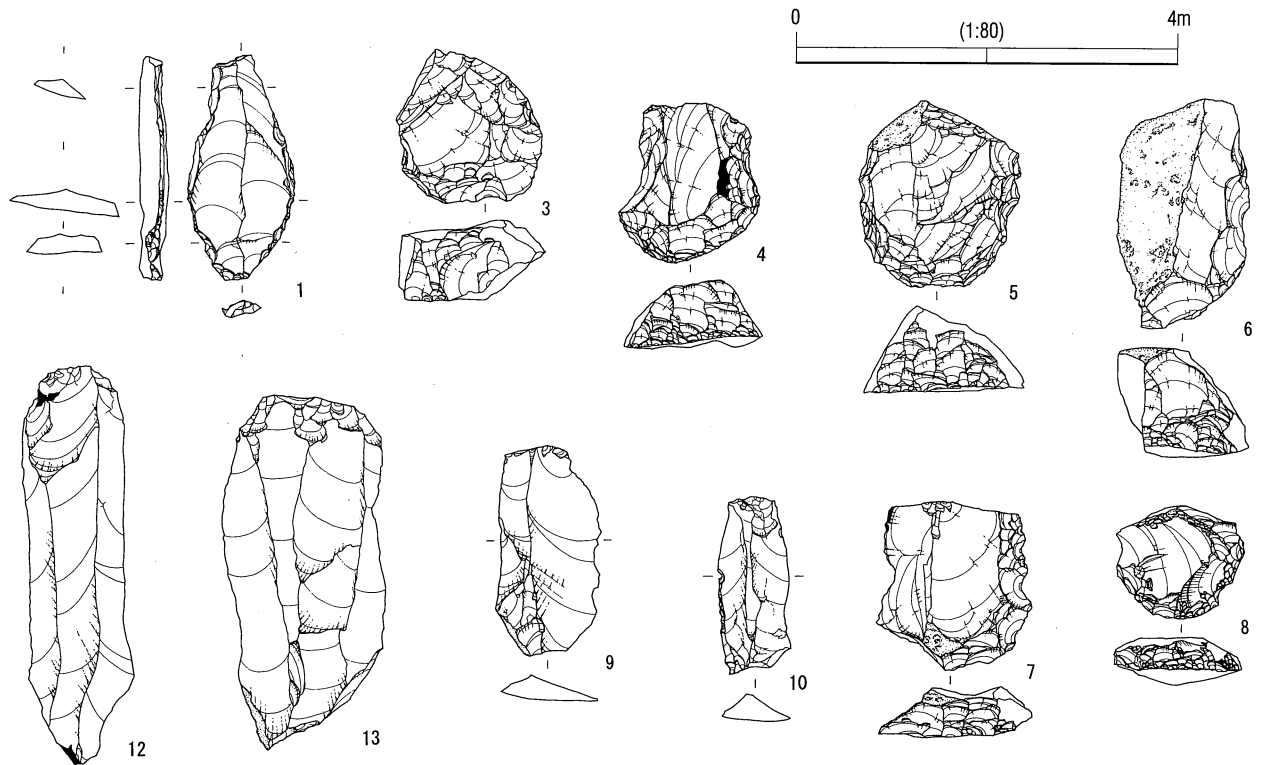
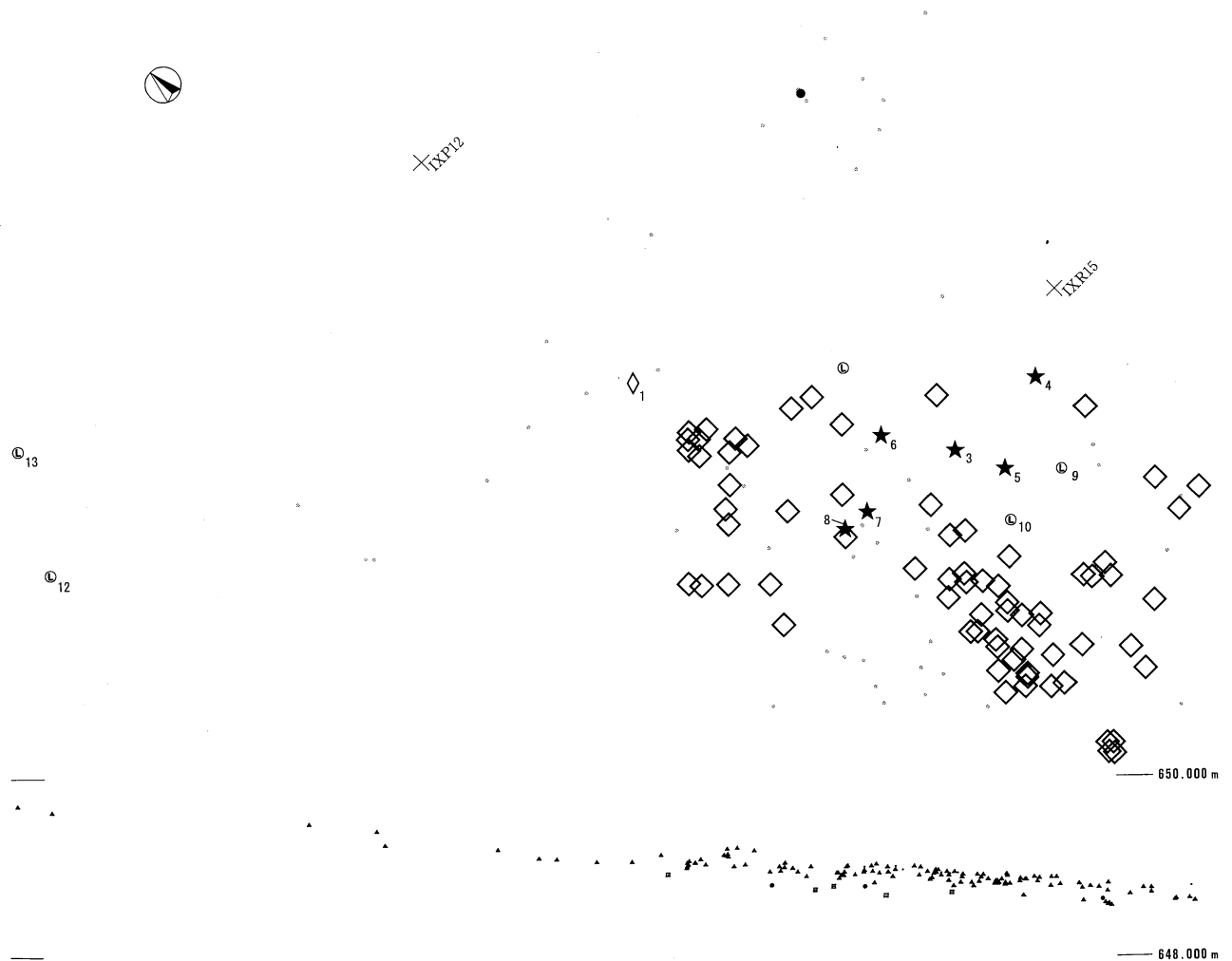

日向林III石器文化 BL1遺物分布図

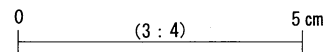
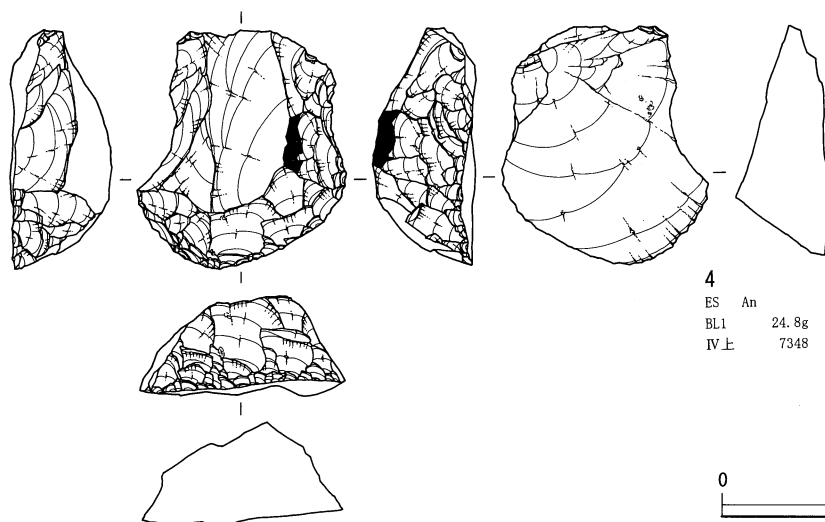
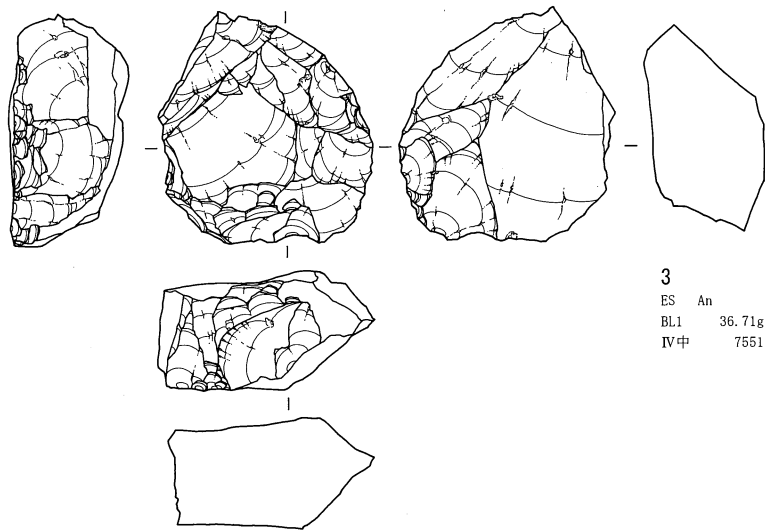
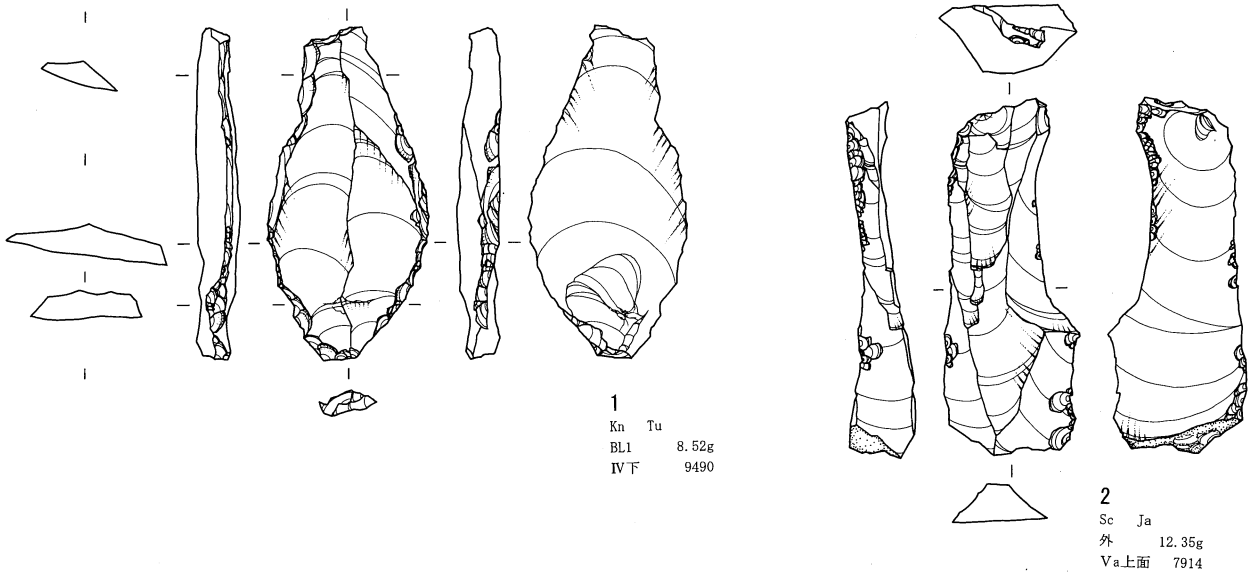

日向林III石器文化 石器実測図 1

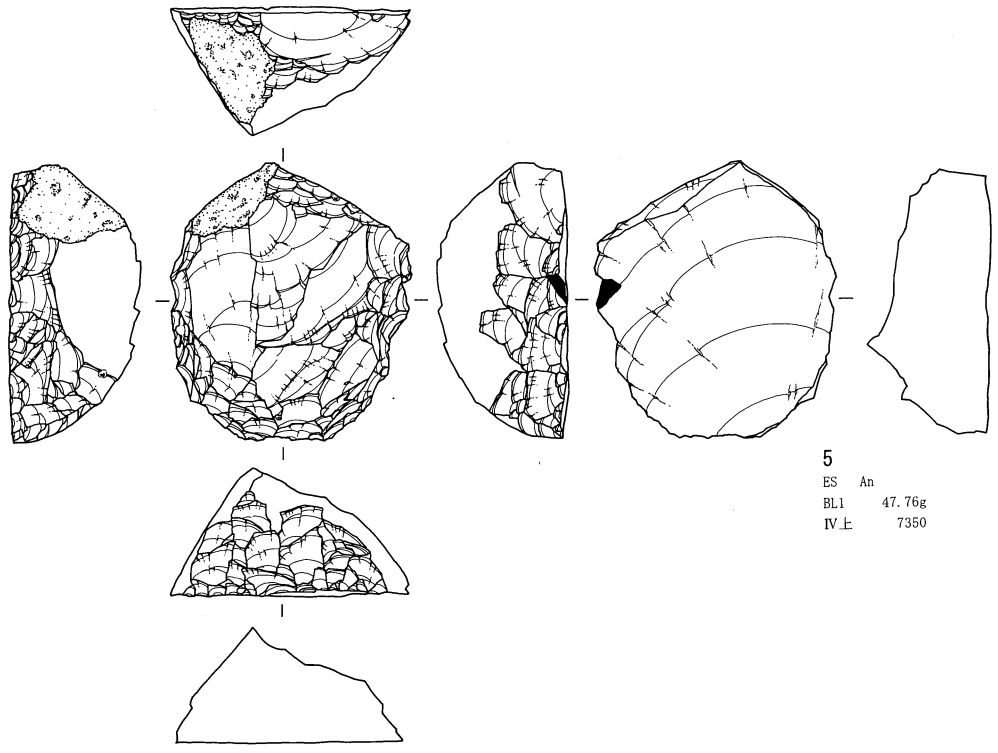

5  
 ES An  
 BL1 47.76g  
 IV上 7350

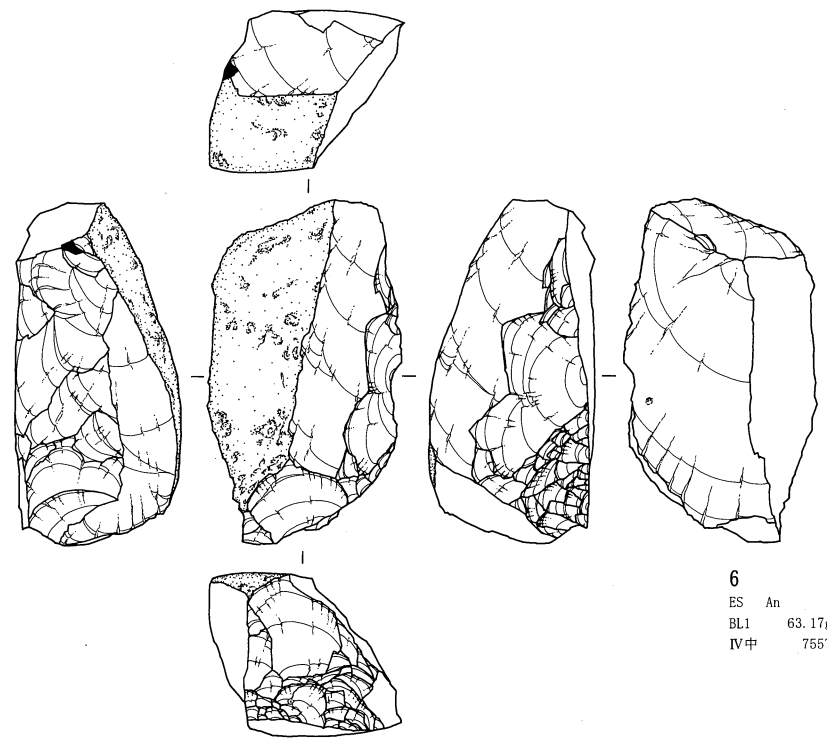

6  
 ES An  
 BL1 63.17g  
 IV中 7557

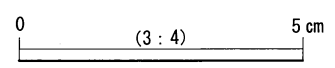

日向林III石器文化 石器実測図2

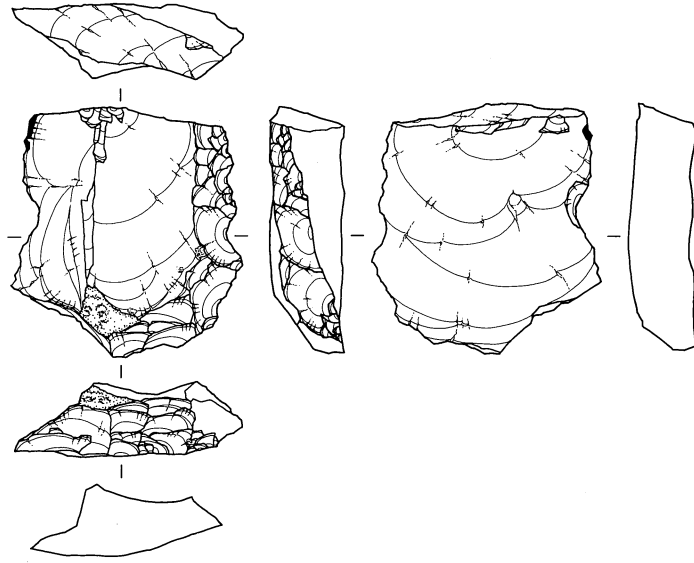

7  
ES An  
BL1 22.85g  
IV上 7335

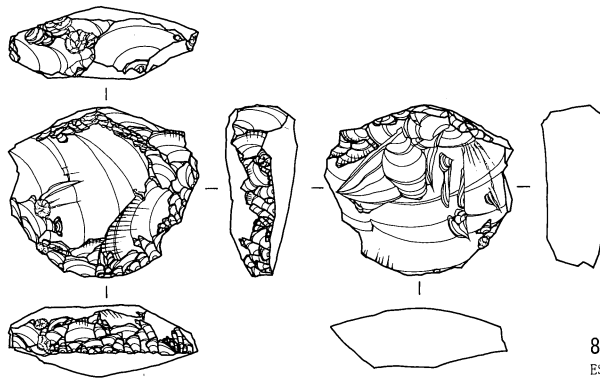

8  
ES Ob WDTY  
BL1 12.44g  
IV中 7950

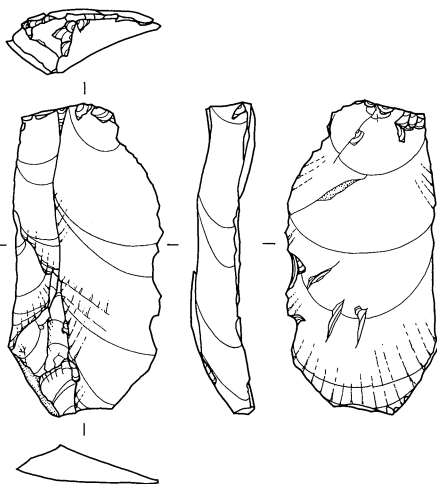

9  
Bl Ch  
BL1 11.93g  
IV下 7349

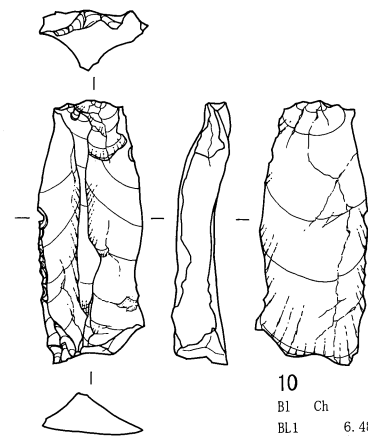

10  
Bl Ch  
BL1 6.48g  
IV上 7330

0 (3:4) 5 cm

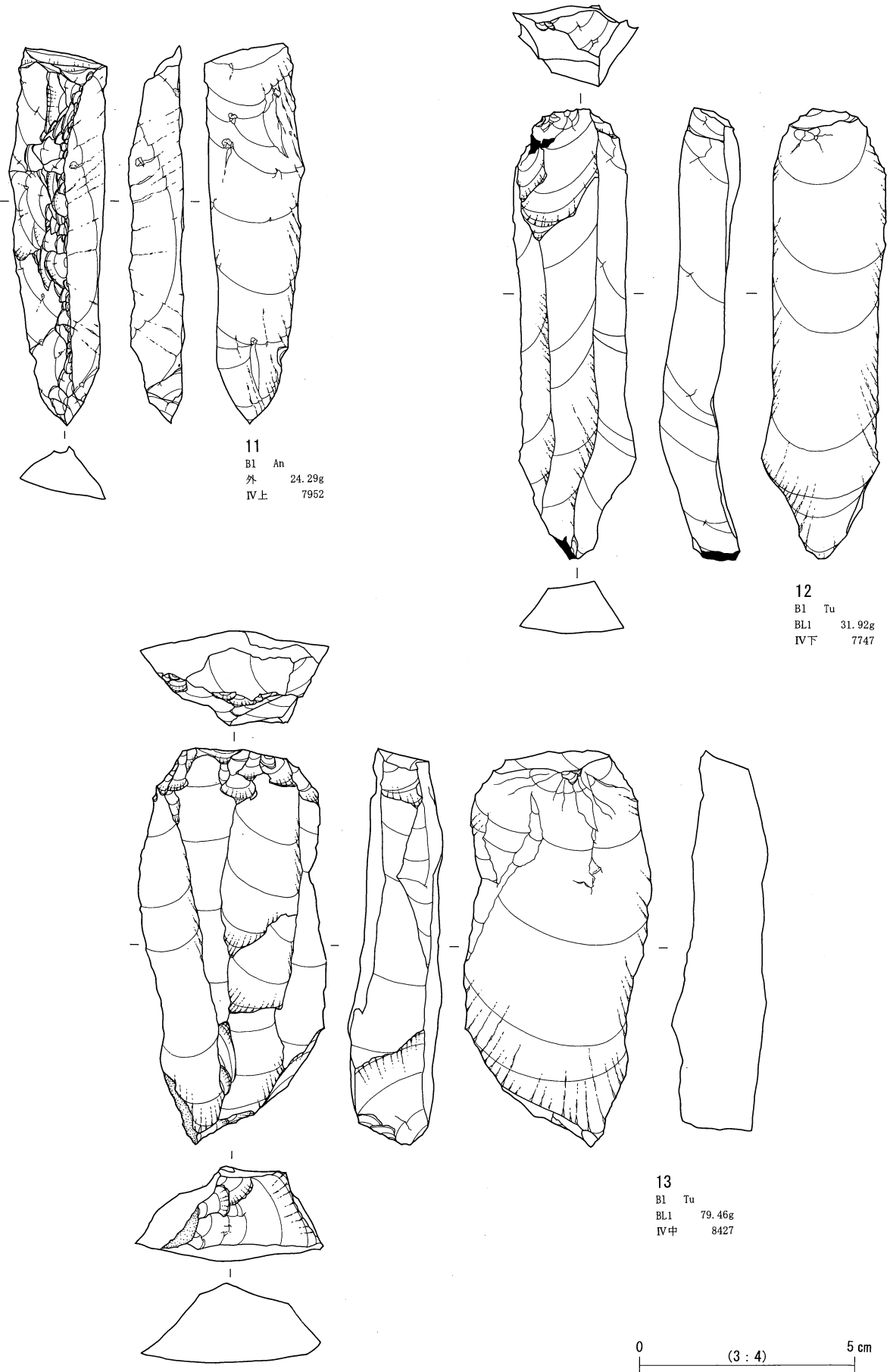

日向林III石器文化 石器実測図 4

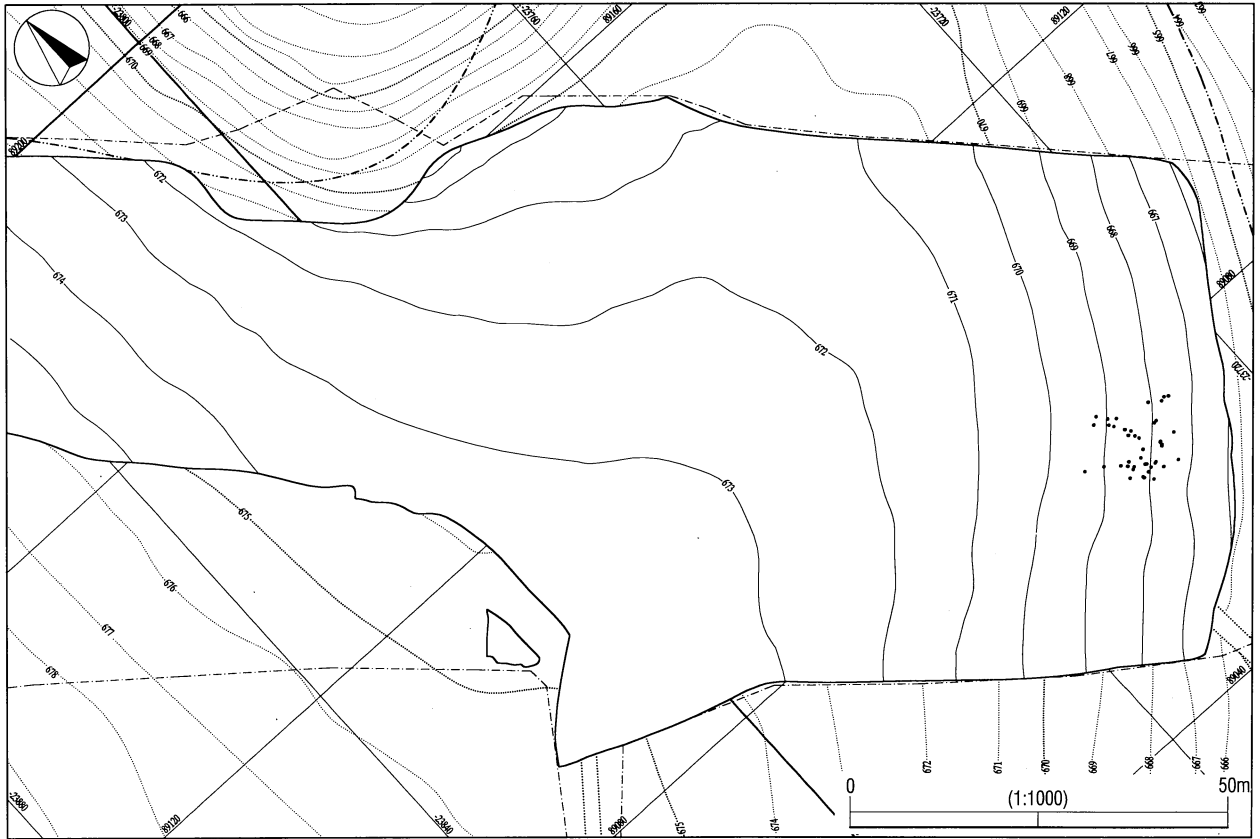

石器全点

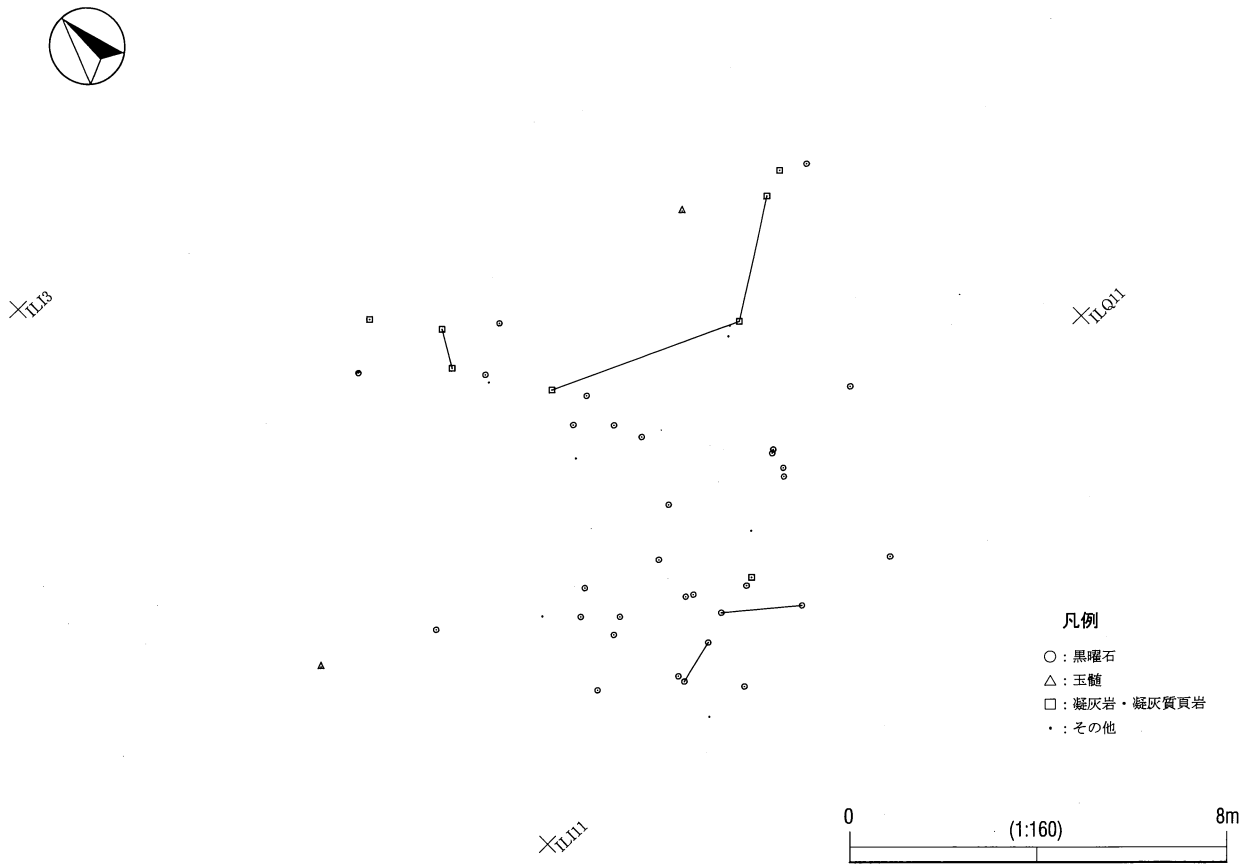

凡例

- ：黒曜石
- △：玉髄
- ：凝灰岩・凝灰質頁岩
- ・：その他

石材別・接合資料分布図  
日向林IIa石器文化 全体図



日向林IIa石器文化 BL1遺物分布図

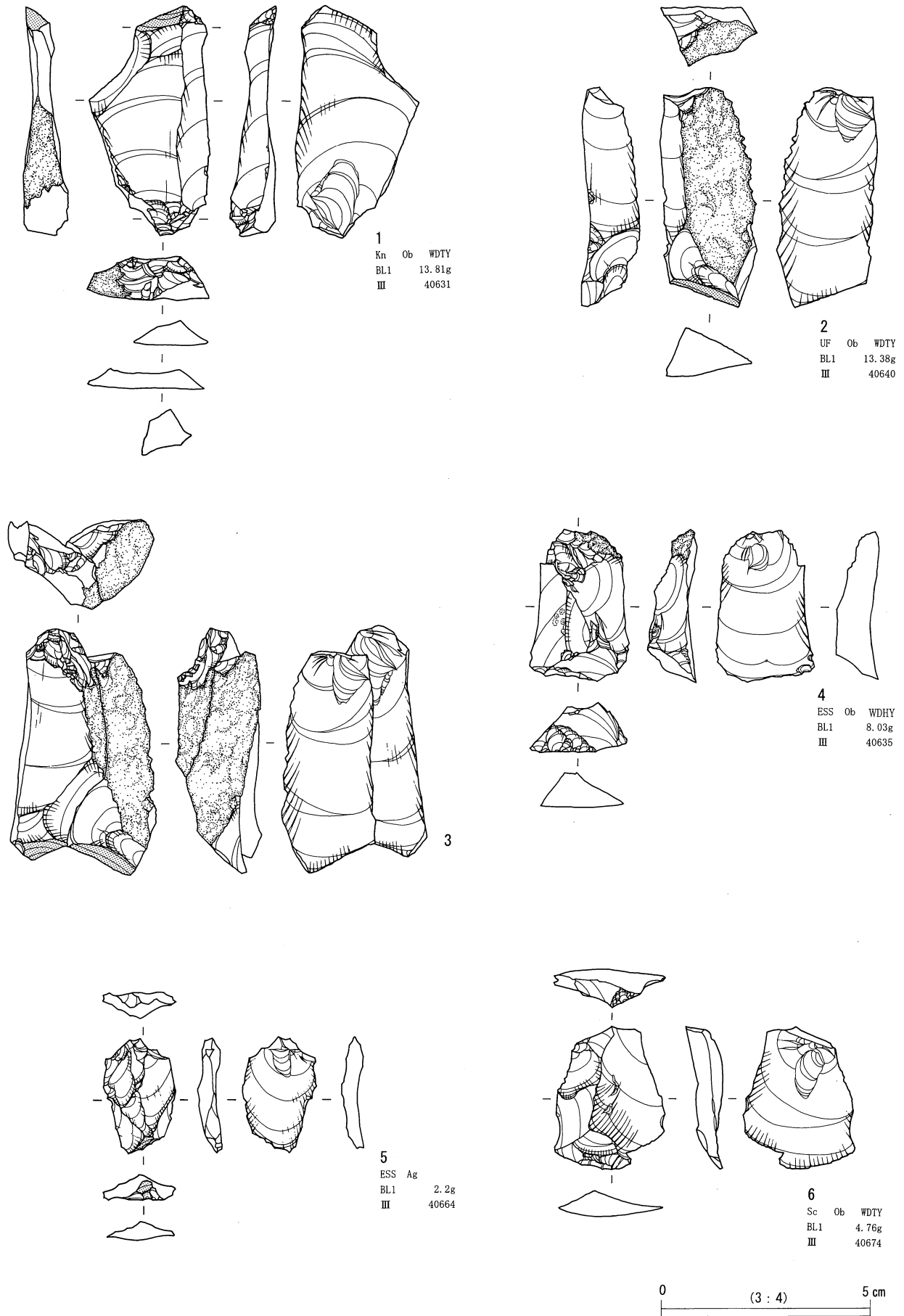

日向林IIa石器文化 石器実測図1



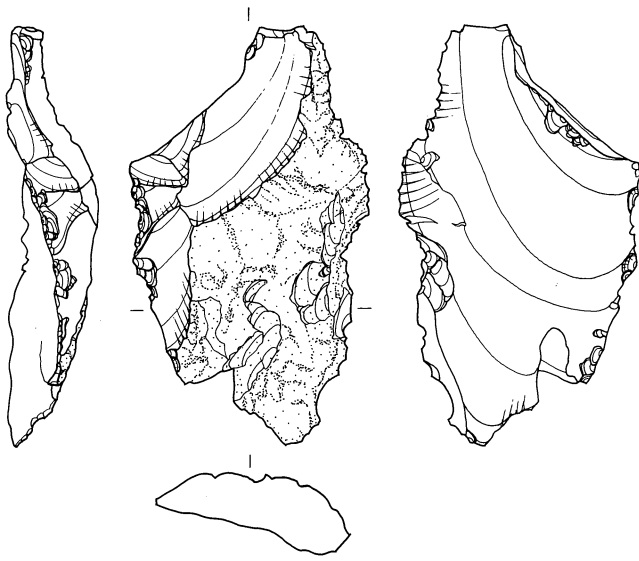

7  
Sc Ob WDTY  
BL1 28.89g  
III 40671

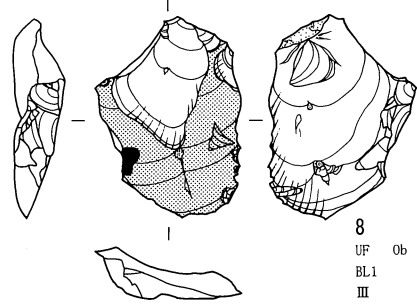

8  
UF Ob WDTY  
BL1 4.66g  
III 40653

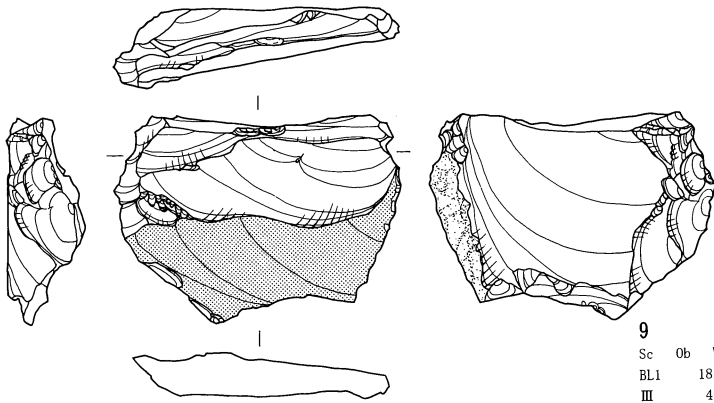

9  
Sc Ob WDTY  
BL1 18.44g  
III 40642

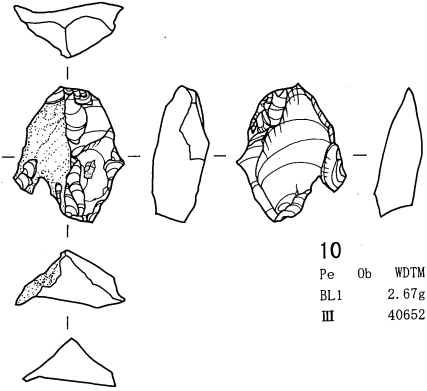

10  
Pe Ob WDTM  
BL1 2.67g  
III 40652

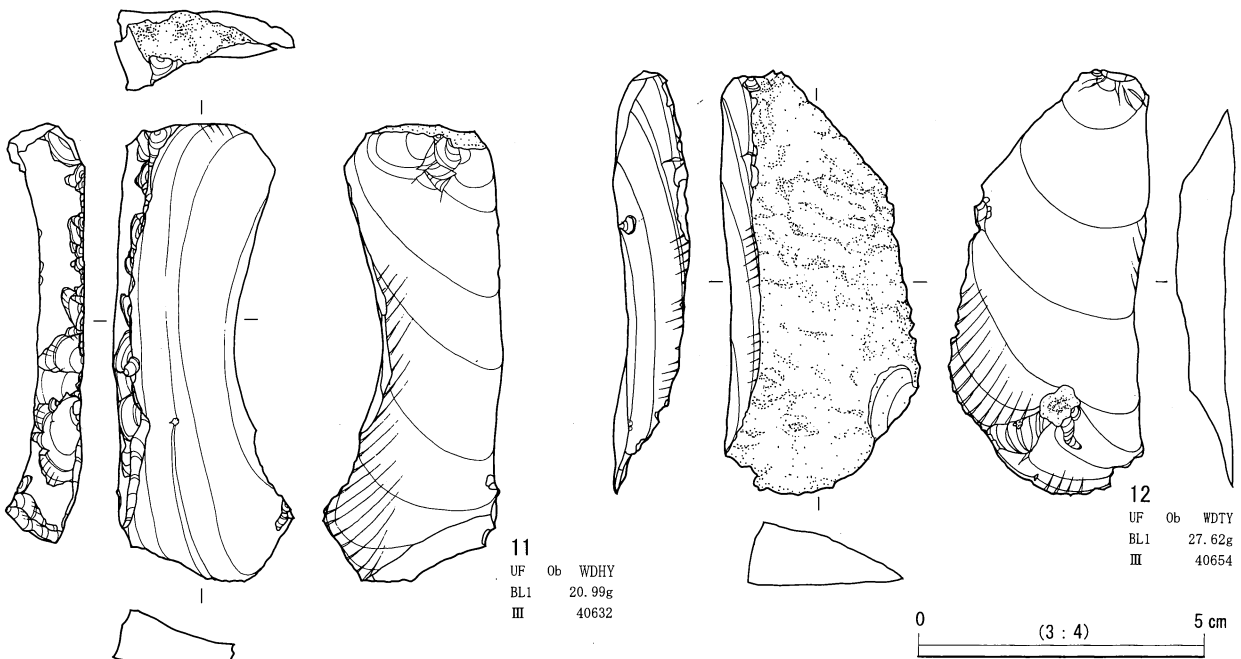

11  
UF Ob WDHY  
BL1 20.99g  
III 40632

12  
UF Ob WDTY  
BL1 27.62g  
III 40654

0 (3:4) 5 cm

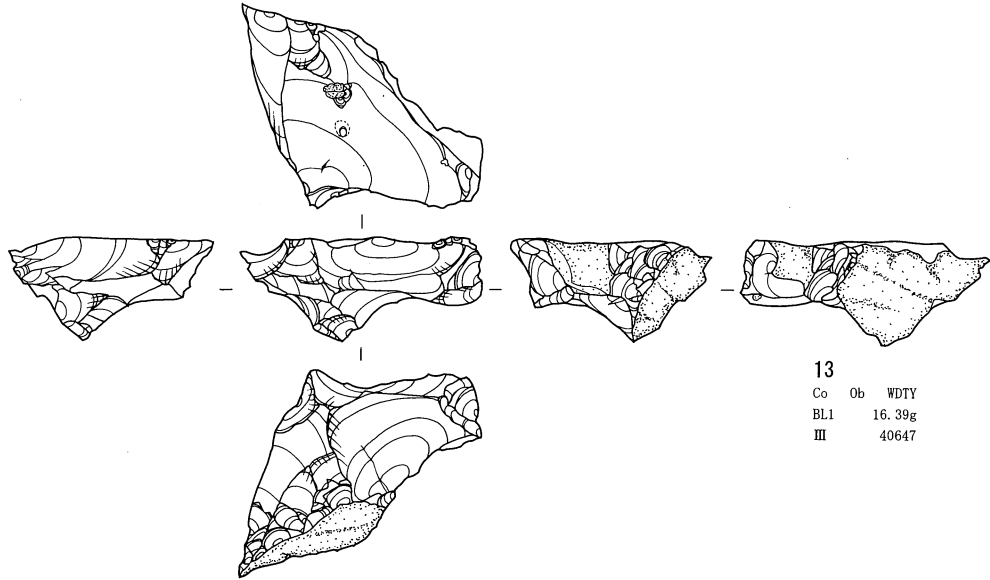

13  
Co Ob WDTY  
BL1 16.39g  
III 40647

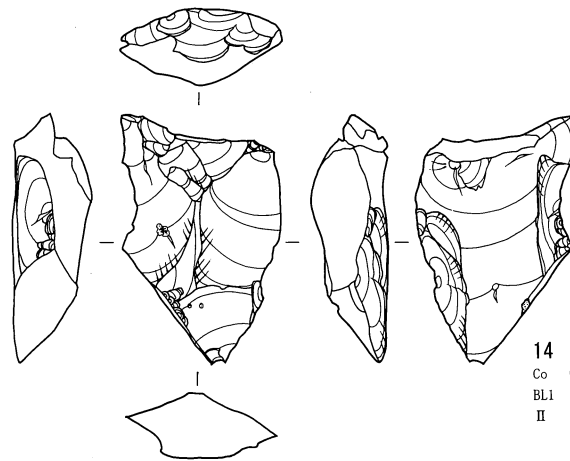

14  
Co Ob WDHY  
BL1 13.43g  
II 44429

0 (3 : 4) 5 cm

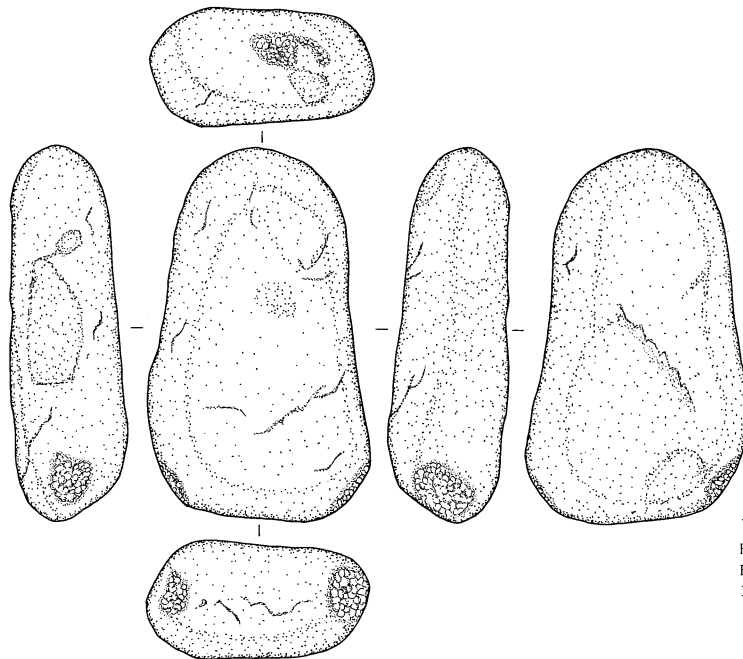

15  
Ha Sa  
BL1 262.64g  
III 40648

0 (1 : 2) 10 cm

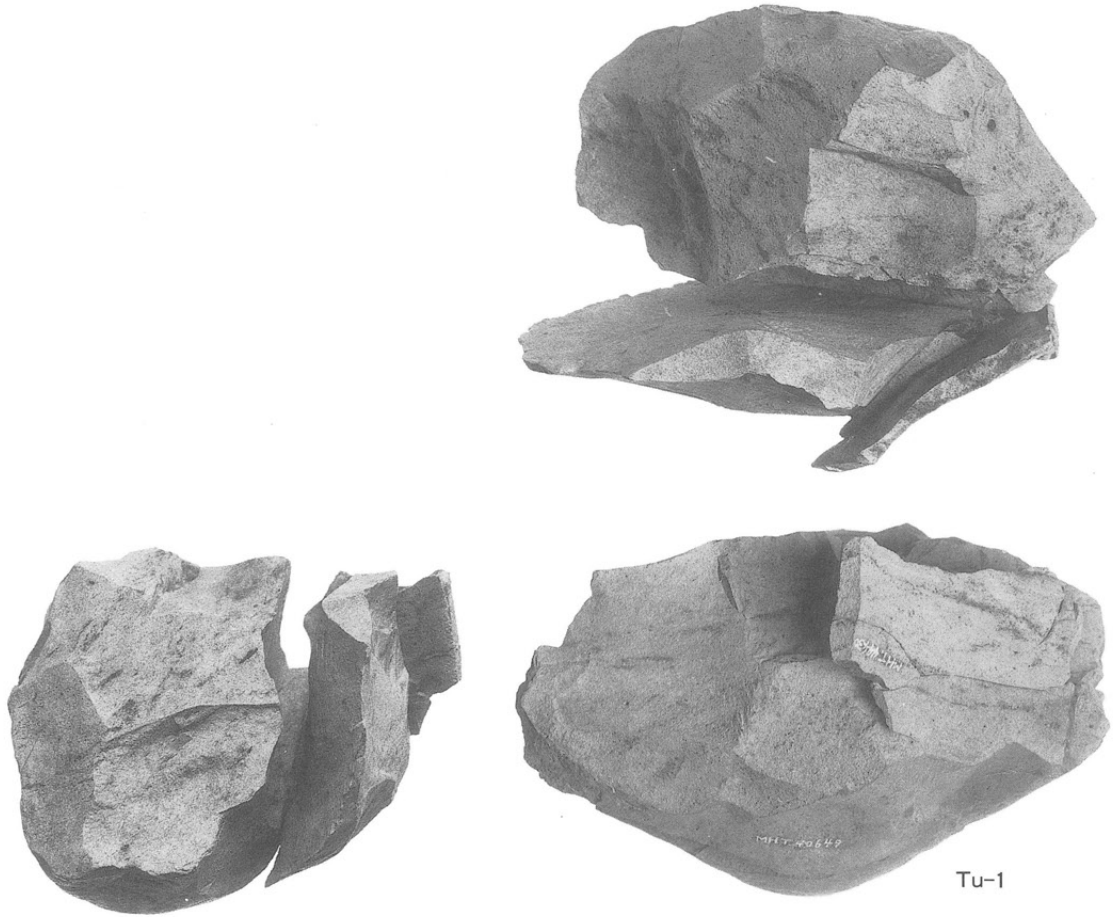

0 (3.4) 5cm

剥離順序	報告番号	遺物番号	ブロック	出土層位	器種	重量g	打面	作業面
1		44430	1	IV中	Fl	10.11	上	正面
2		40649	1	III	Fl	98.15	上	正面
3		40657	1	III	Co	338.72		



石器全点

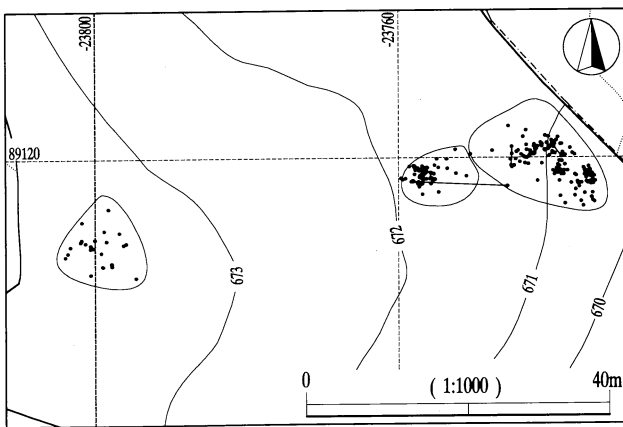

無斑晶質安山岩

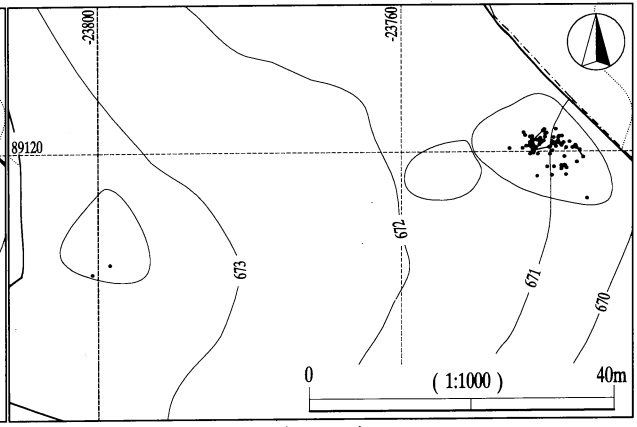

チャート

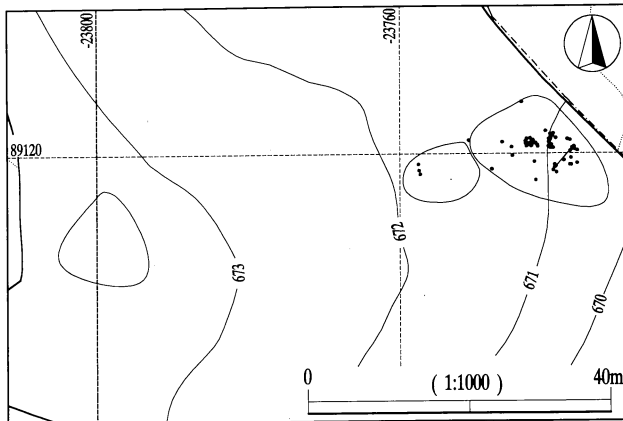

頁岩系・凝灰岩系石材

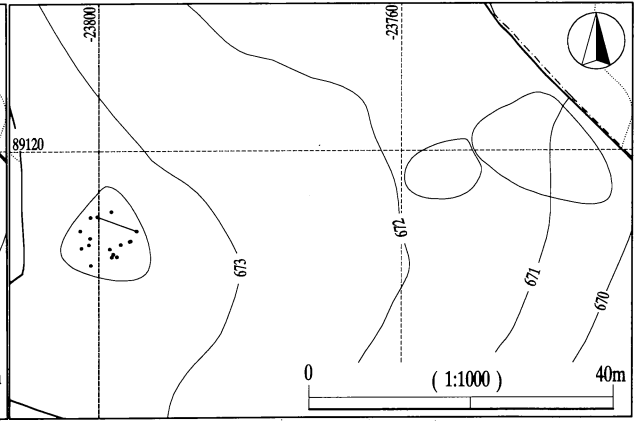

黒曜石

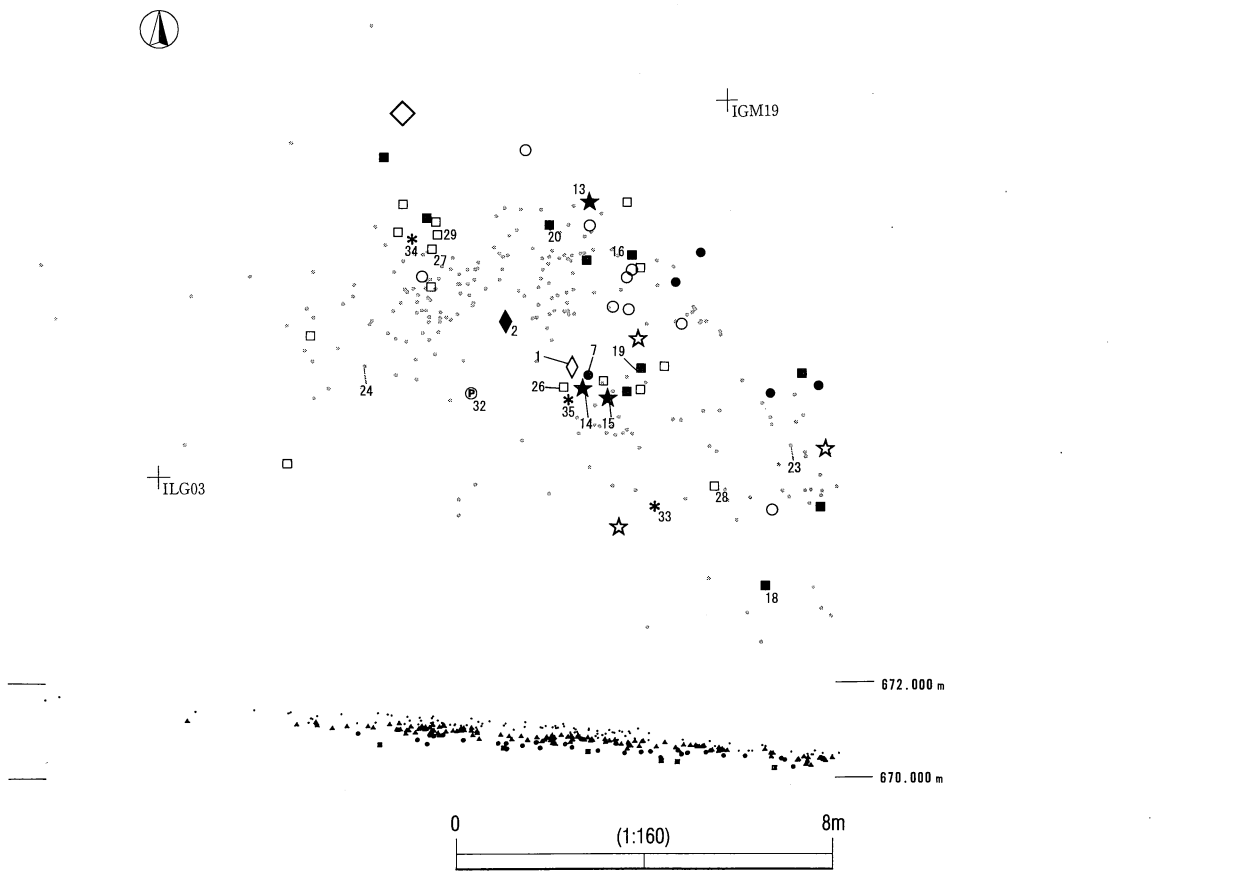
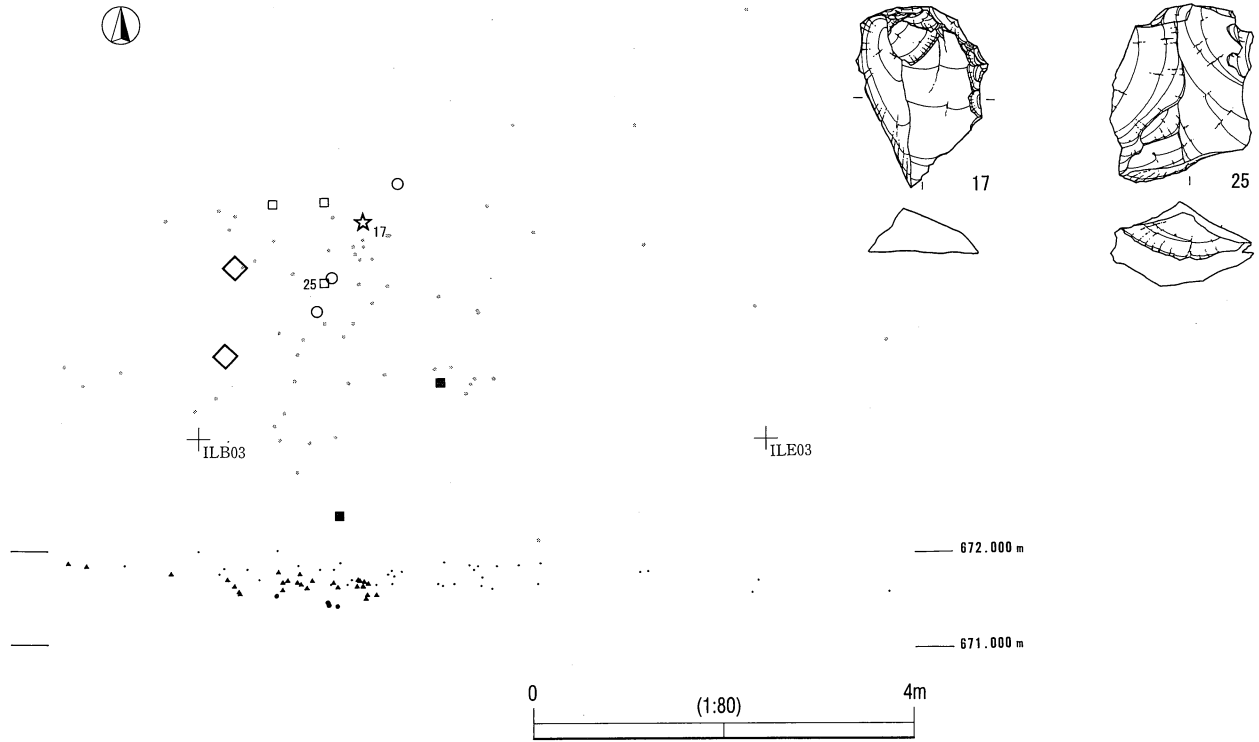

日向林IIb石器文化 BL1・BL2遺物分布図 (上：BL1・下：BL2)



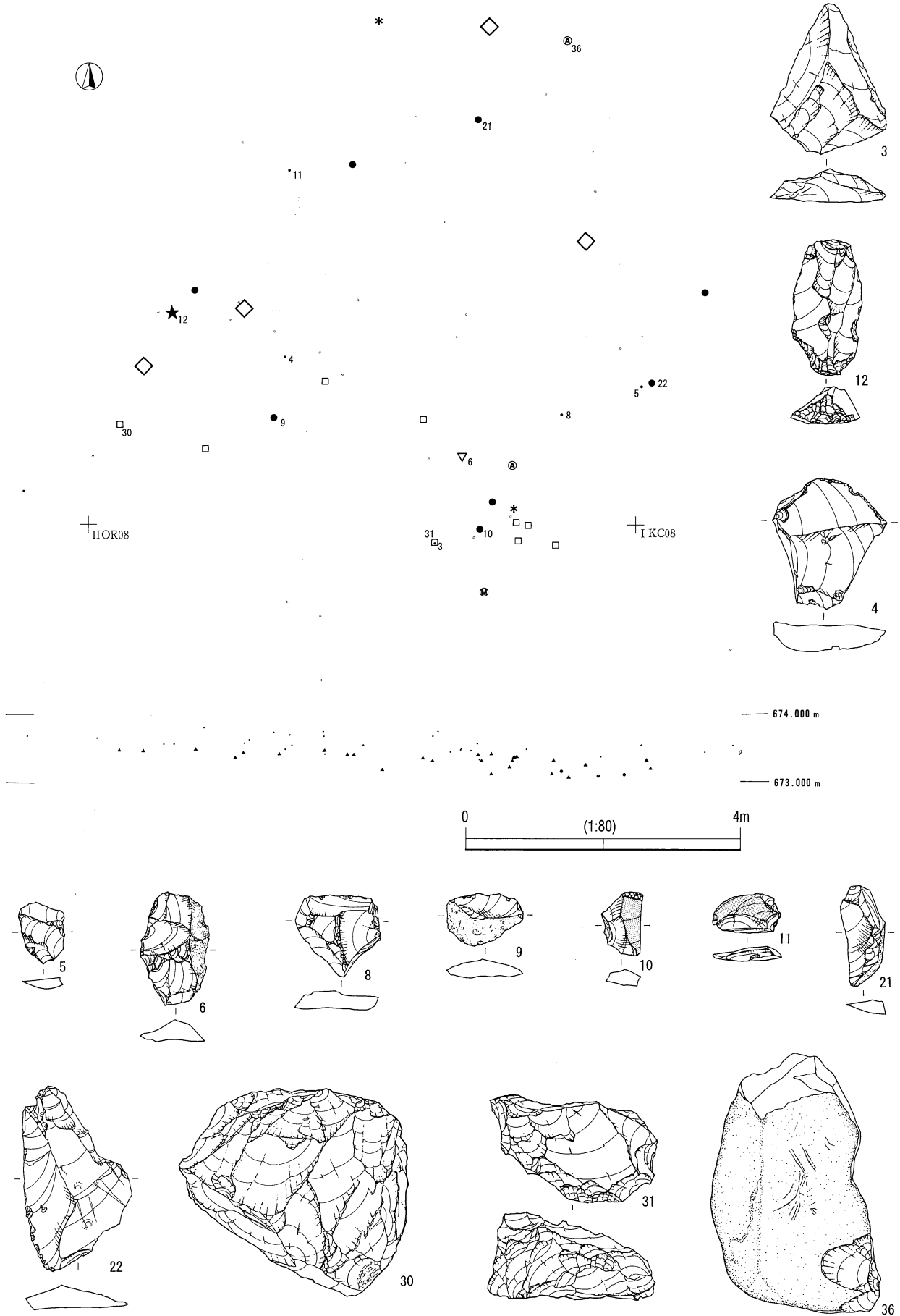

日向林IIb石器文化 BL3遺物分布図

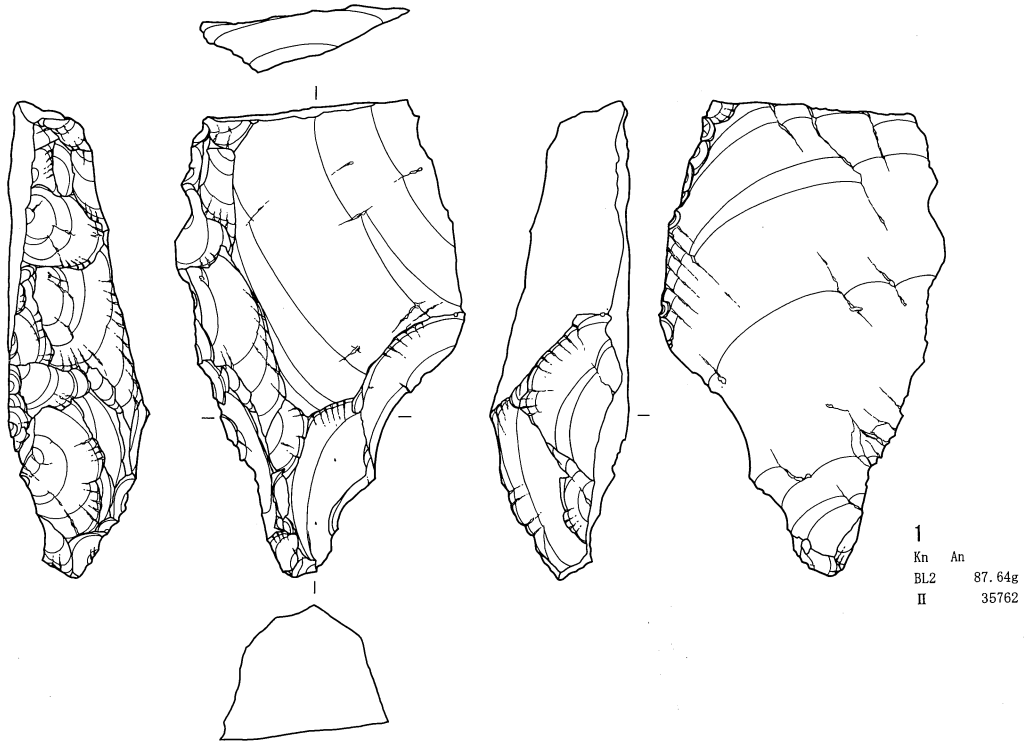

1  
 Kn An  
 BL2 87.64g  
 II 35762

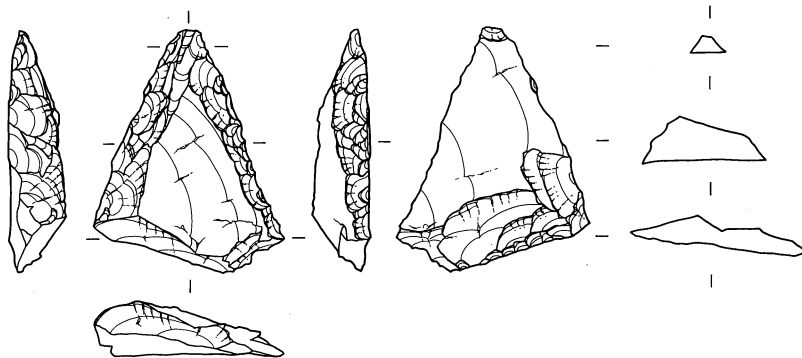

2  
 Po An  
 BL2 9.88g  
 II 35502

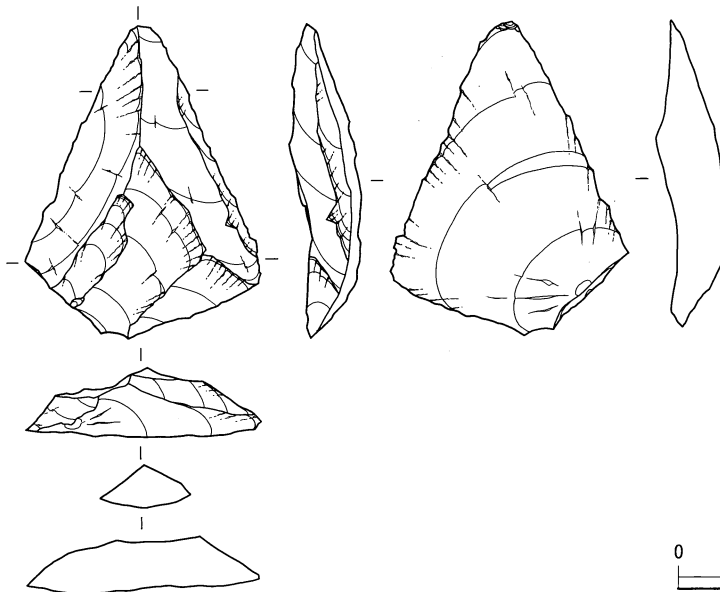

3  
 Fl An  
 BL3 19.48g  
 II 42867

0 (3 : 4) 5 cm

日向林IIb石器文化 石器実測図 1



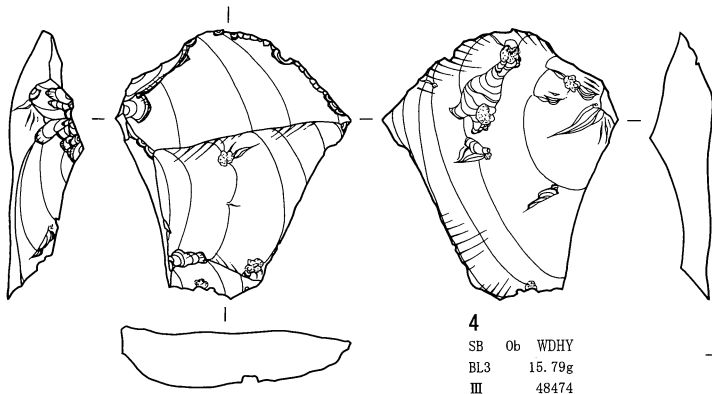

4  
SB Ob WDHY  
BL3 15.79g  
III 48474

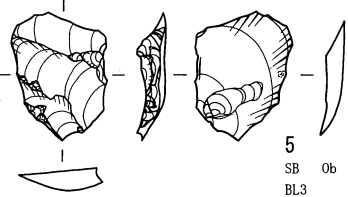

5  
SB Ob WDTY  
BL3 1.45g  
II 42902

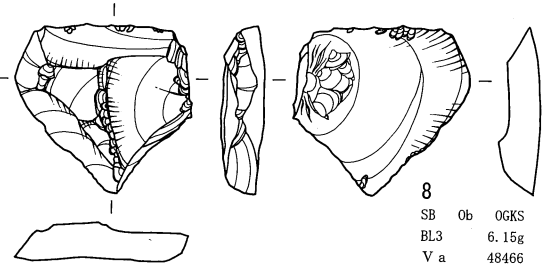

8  
SB Ob OGKS  
BL3 6.15g  
V a 48466

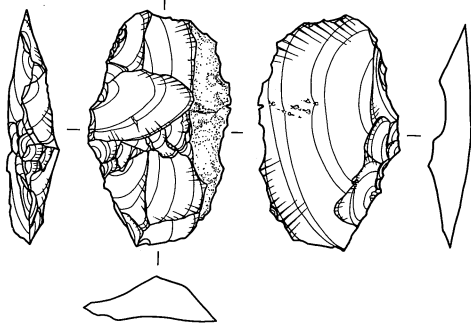

6  
Tr Ob WDTY  
BL3 6.71g  
III 46756

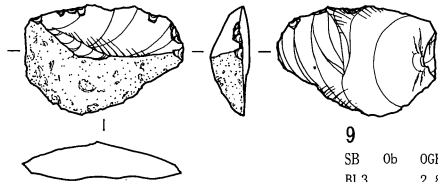

9  
SB Ob OGKS  
BL3 2.8g  
II 42852

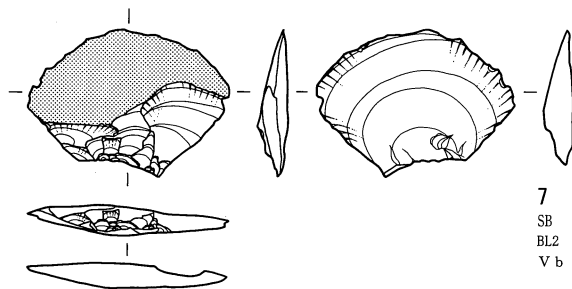

7  
SB SS  
BL2 3.49g  
V b 47675

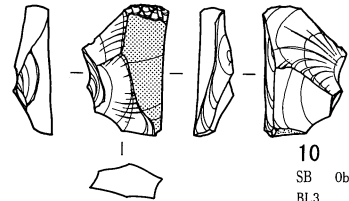

10  
SB Ob HUHM  
BL3 1.51g  
IV上 48457

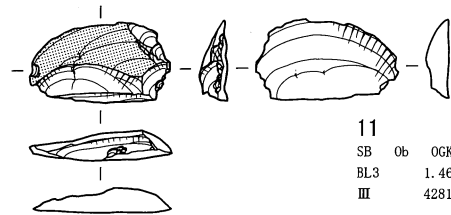

11  
SB Ob OGKS  
BL3 1.46g  
III 42810

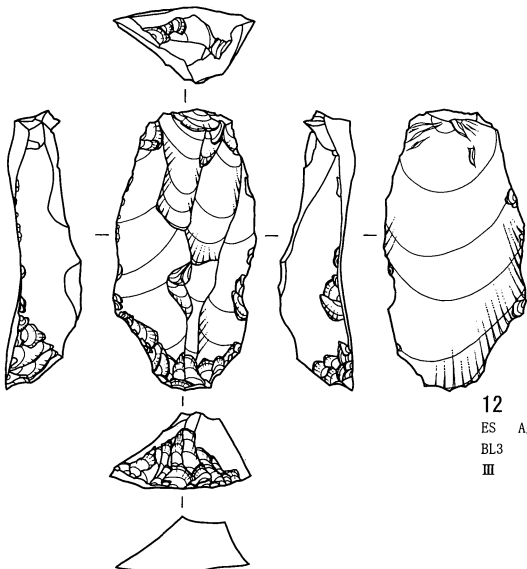

12  
ES Ag  
BL3 14.32g  
III 48472

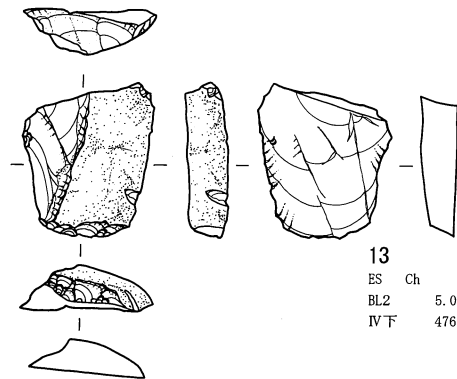

13  
ES Ch  
BL2 5.01g  
IV下 47653

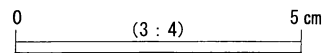

日向林IIb石器文化 石器実測図2

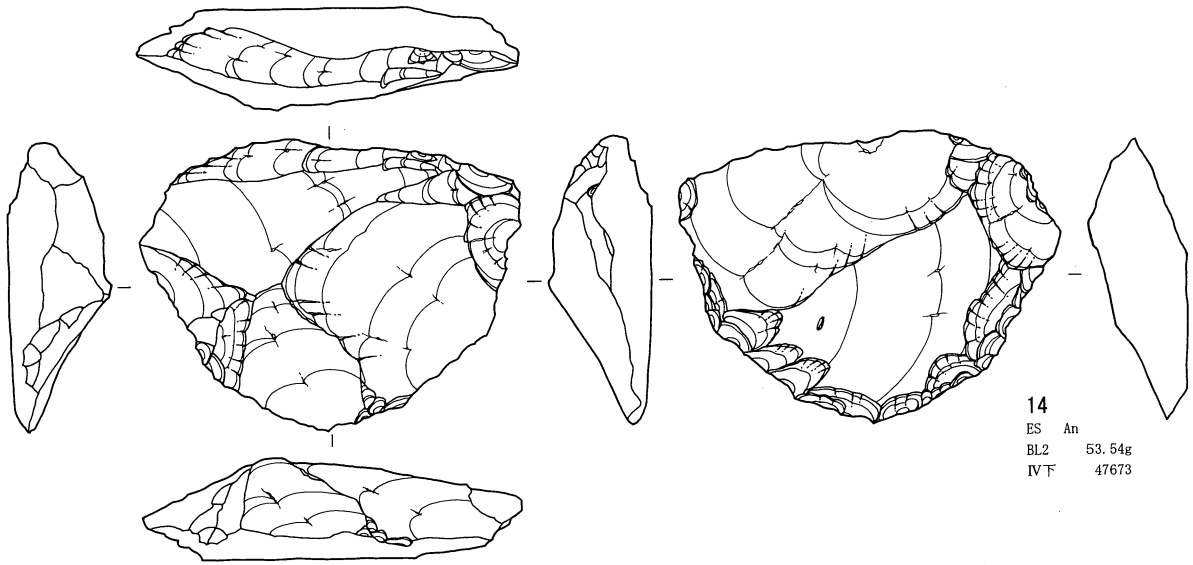

14  
ES An  
BL2 53.54g  
IV下 47673

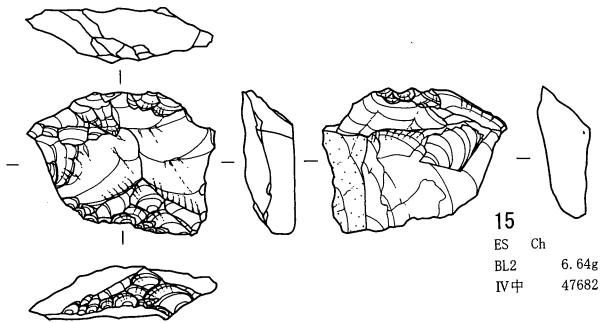

15  
ES Ch  
BL2 6.64g  
IV中 47682

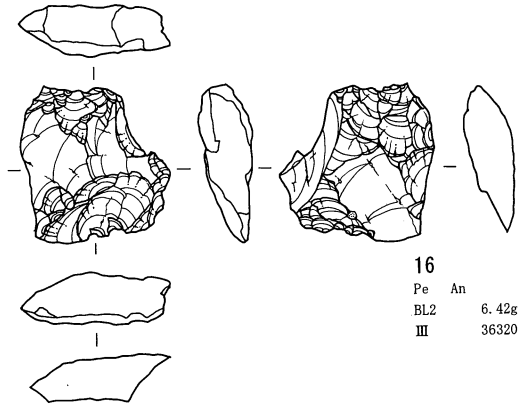

16  
Pe An  
BL2 6.42g  
III 36320

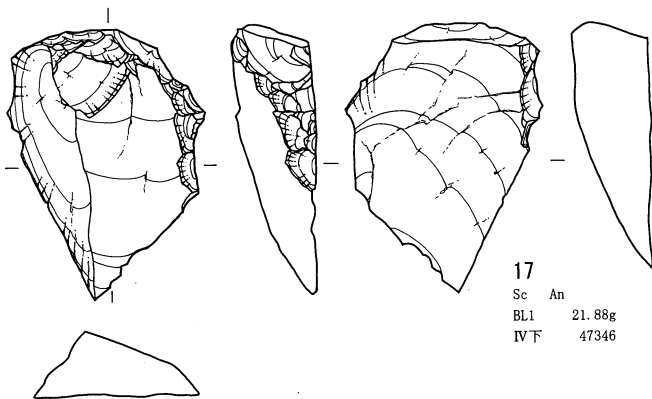

17  
Sc An  
BL1 21.88g  
IV下 47346

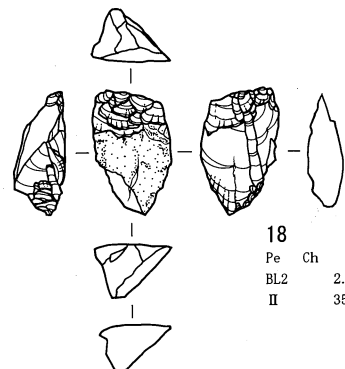

18  
Pe Ch  
BL2 2.11g  
II 35227

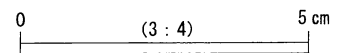

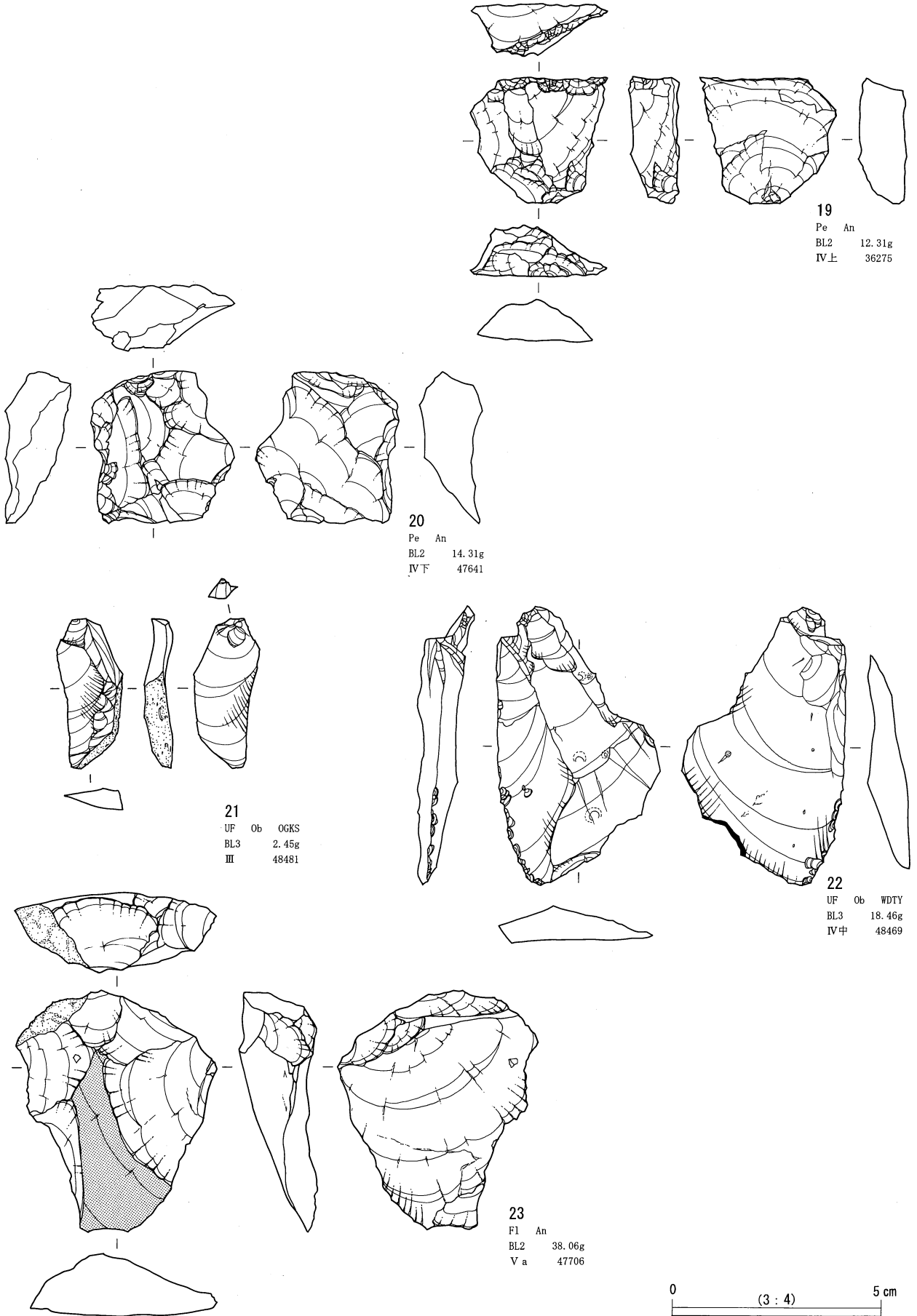

日向林IIb石器文化 石器実測図4

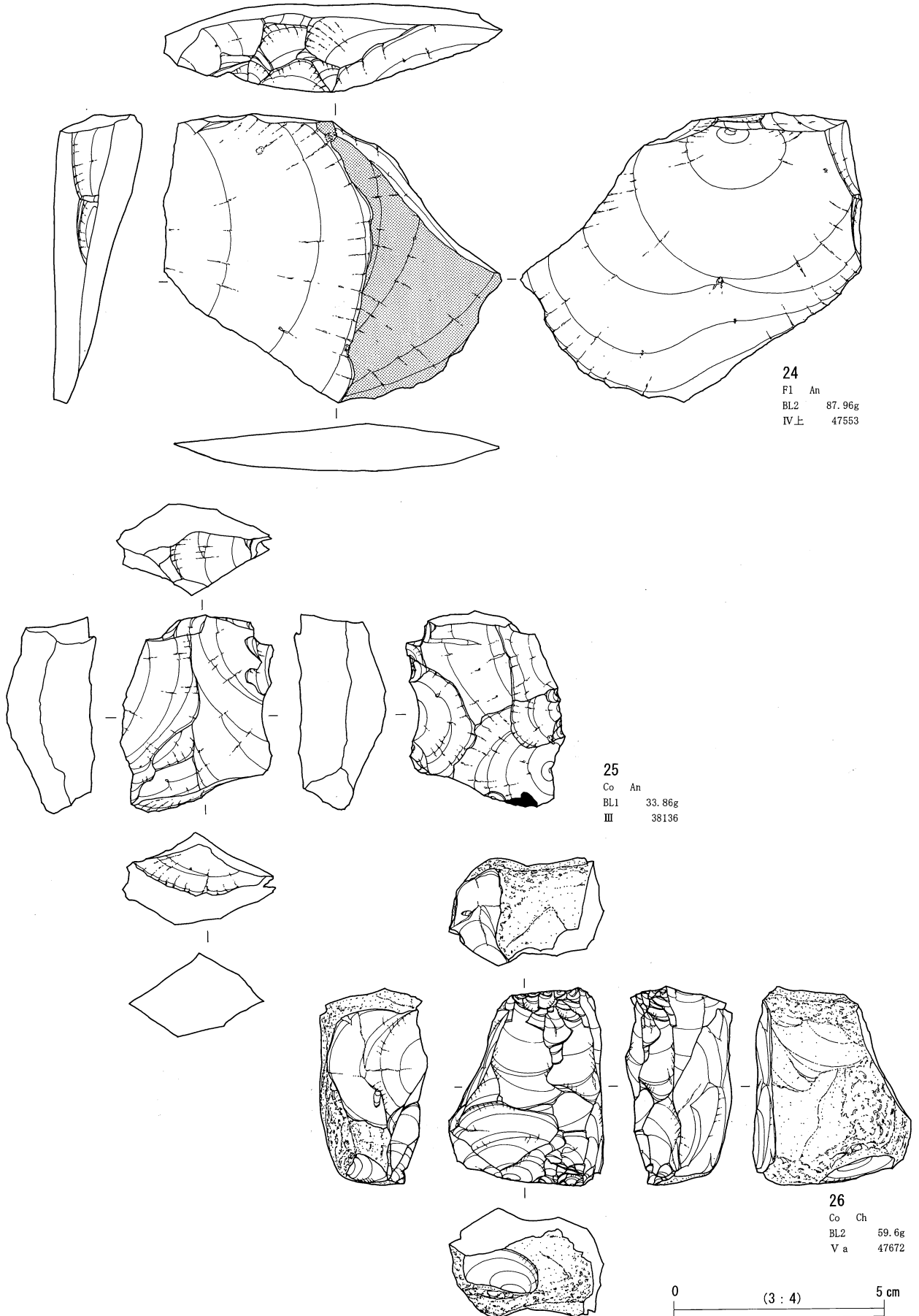

日向林IIb石器文化 石器実測図5

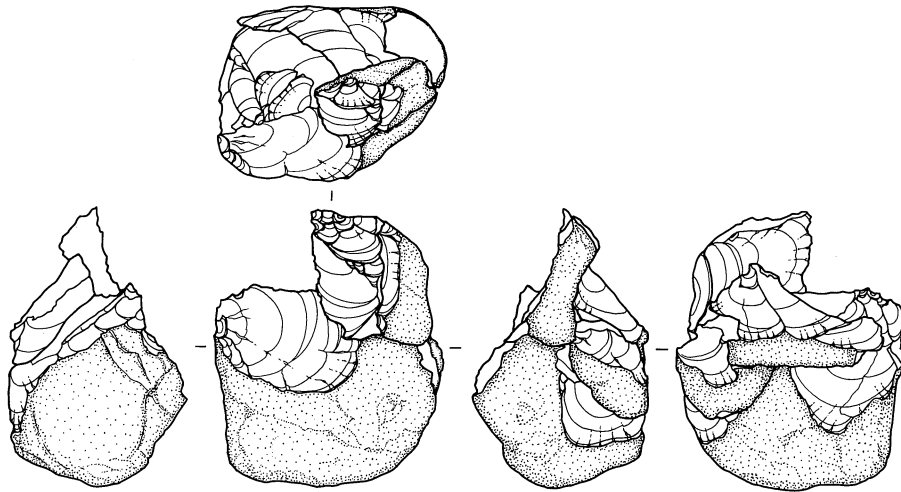

27  
Co ST  
BL2 48.24g  
Va 47562  
(註1) その他の剥片も  
接合している。

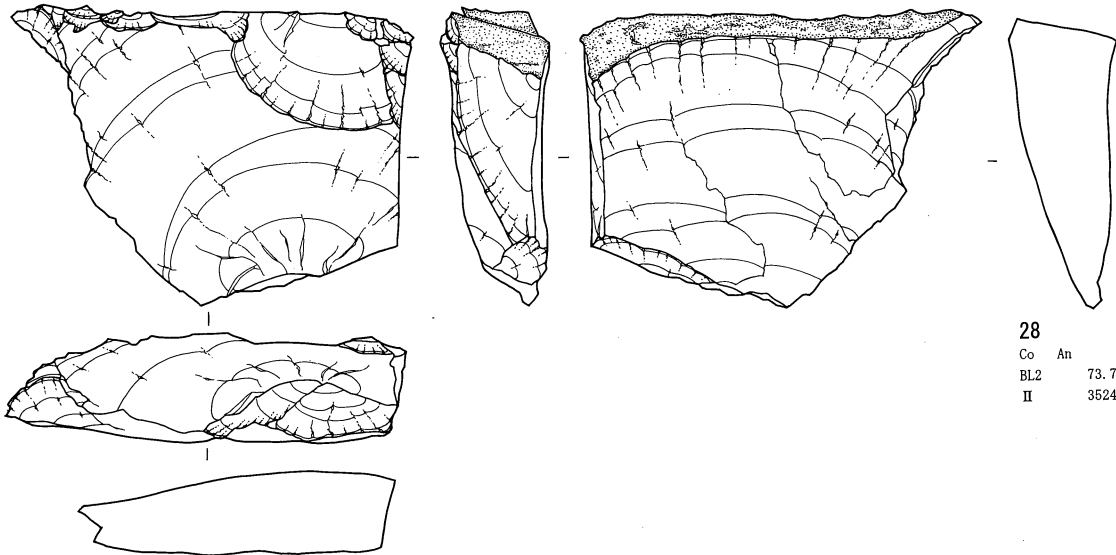

28  
Co An  
BL2 73.7g  
II 35246

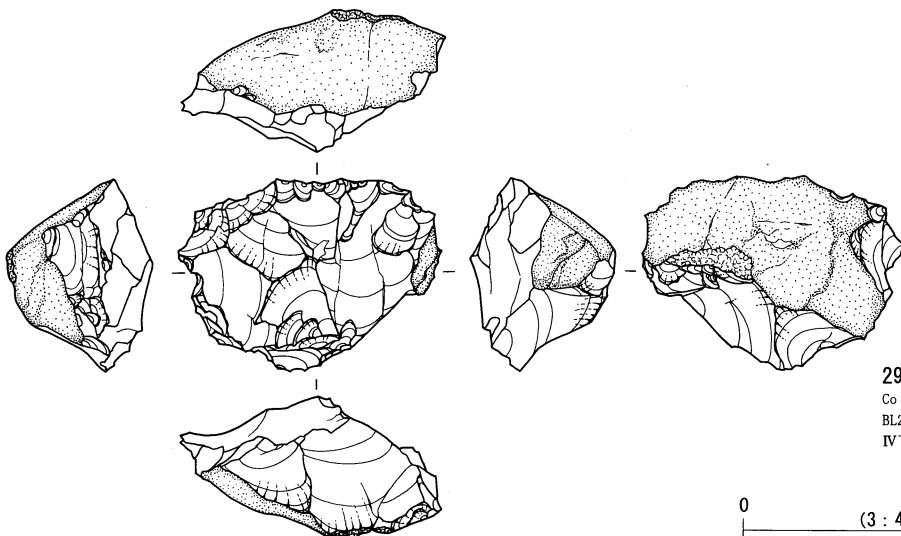

29  
Co TS  
BL2 34.67g  
IV下 48923

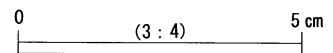

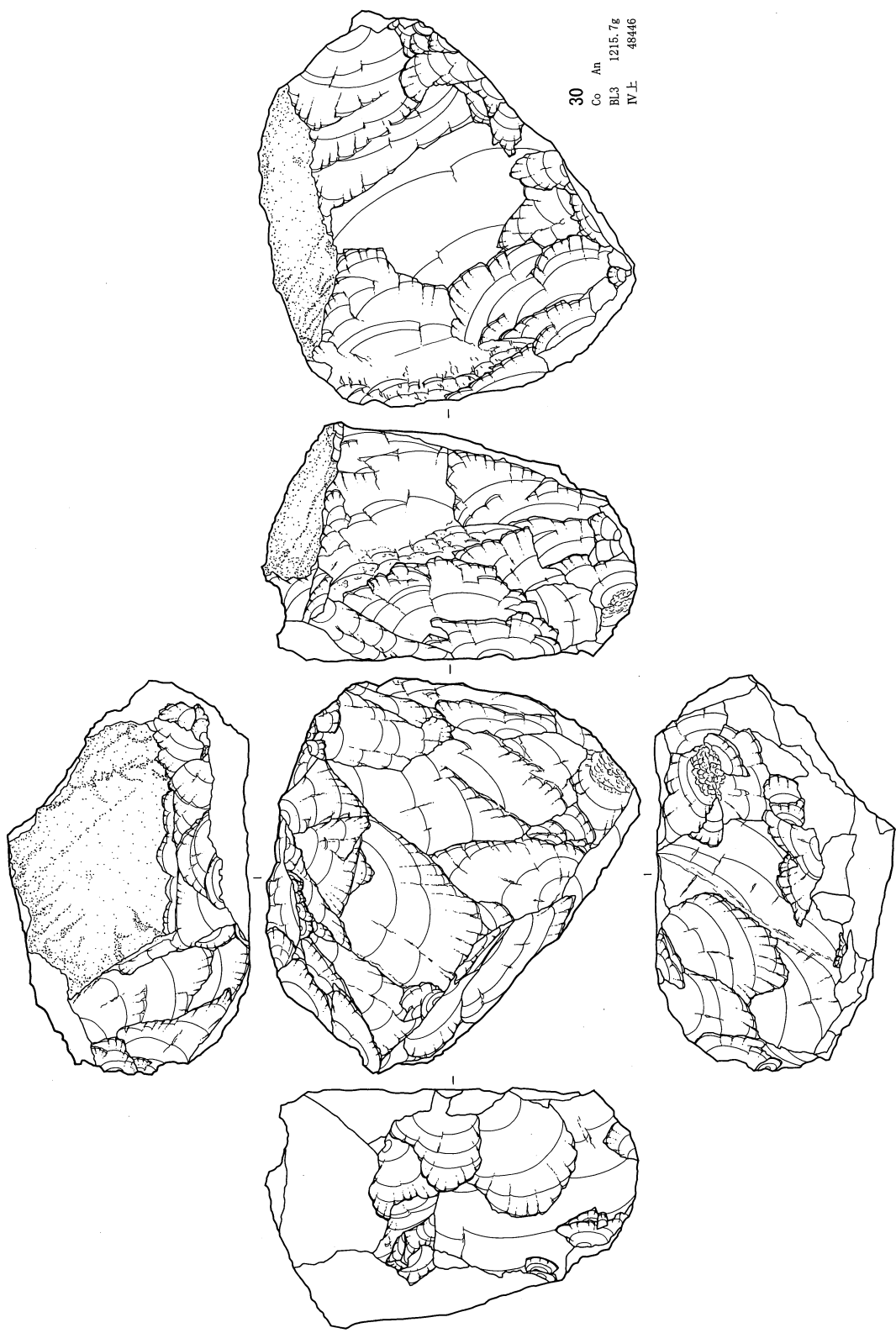

30  
Co An  
BL3 1215.7g  
IV上 48446

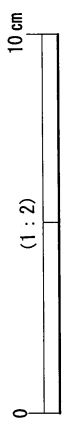

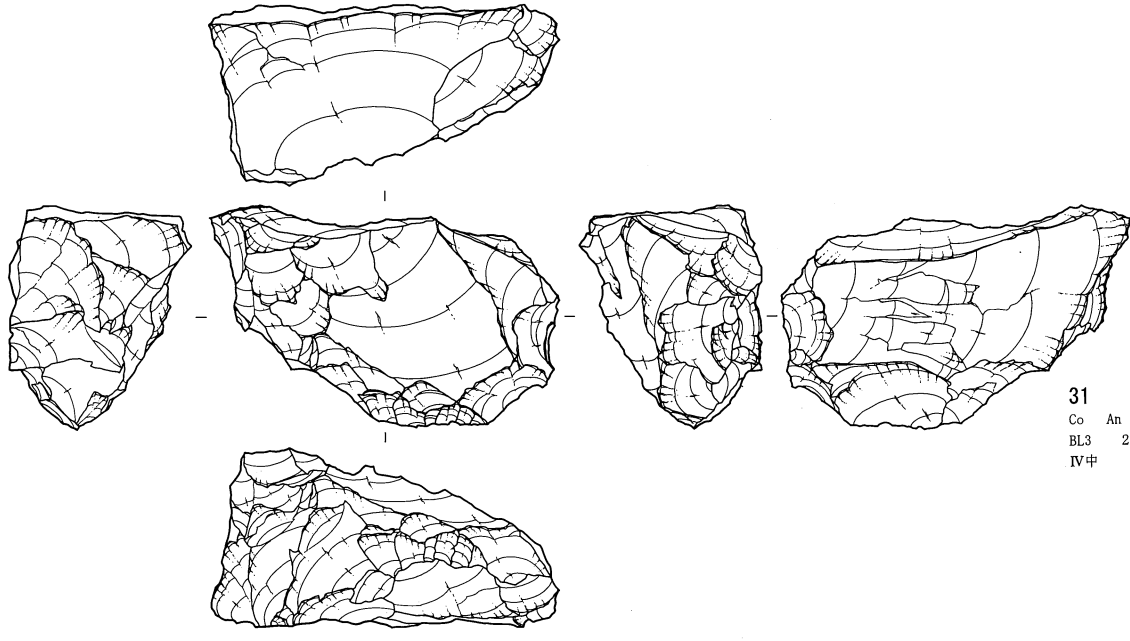

31  
Co An  
BL3 263.95g  
IV中 48455

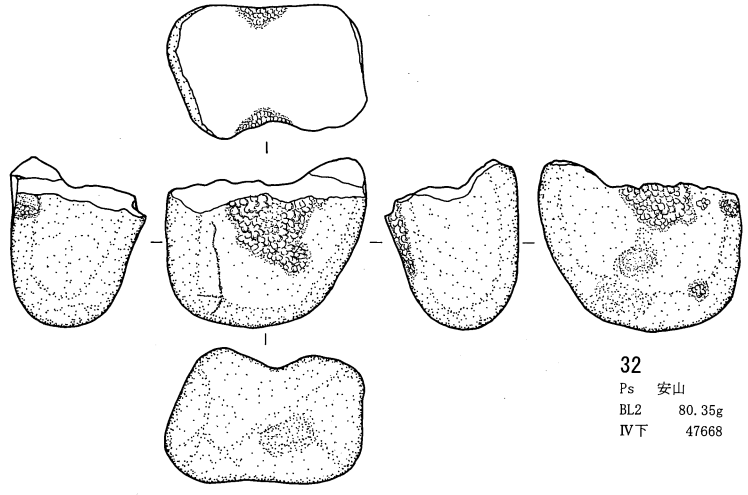

32  
Ps 安山  
BL2 80.35g  
IV下 47668

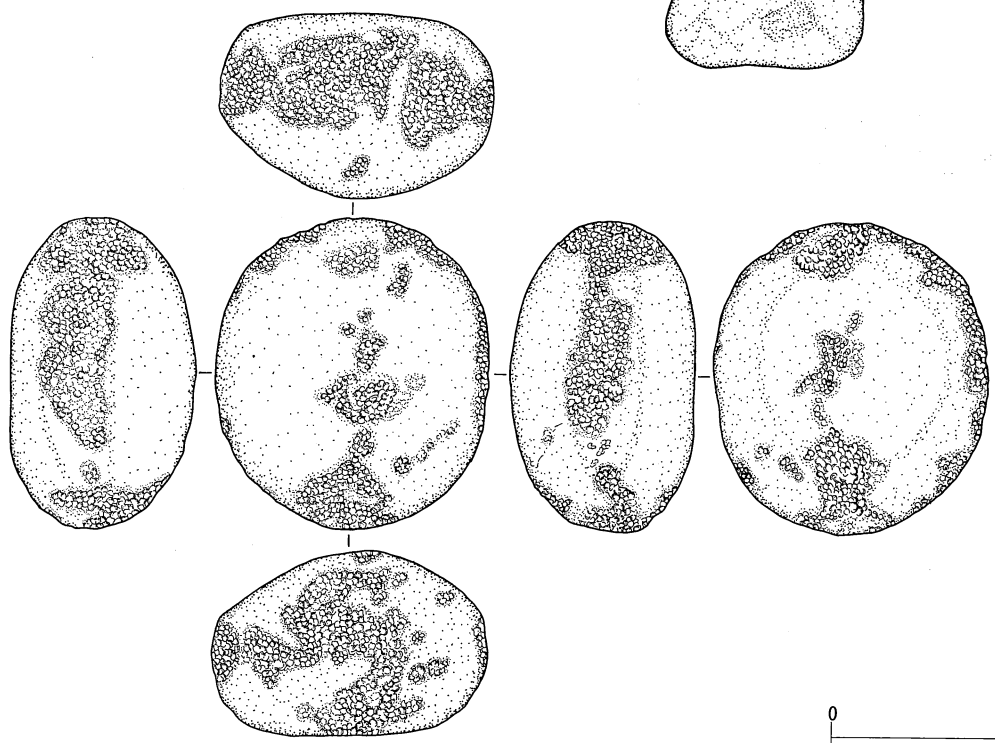

33  
Ha 安山  
BL2 434.63g  
IV下 47716

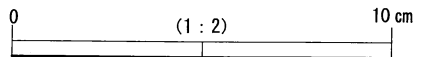

日向林IIb石器文化 石器実測図 8

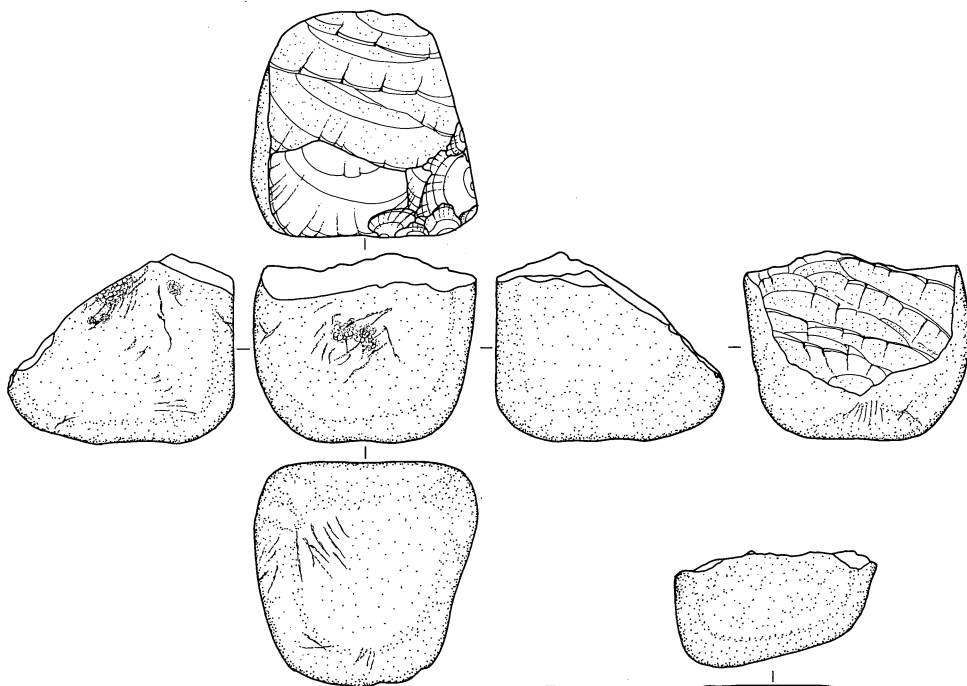

34  
Ha Sh  
BL2 260.83g  
IV下 47589

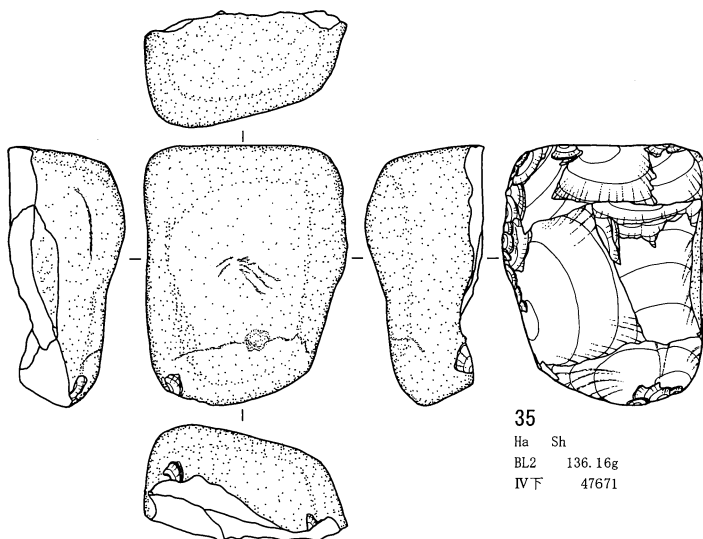

35  
Ha Sh  
BL2 136.16g  
IV下 47671

0 (1 : 2) 10 cm



36  
台石 安山  
BL3 1250.92g  
IV下 48482

0 (1 : 3) 10cm



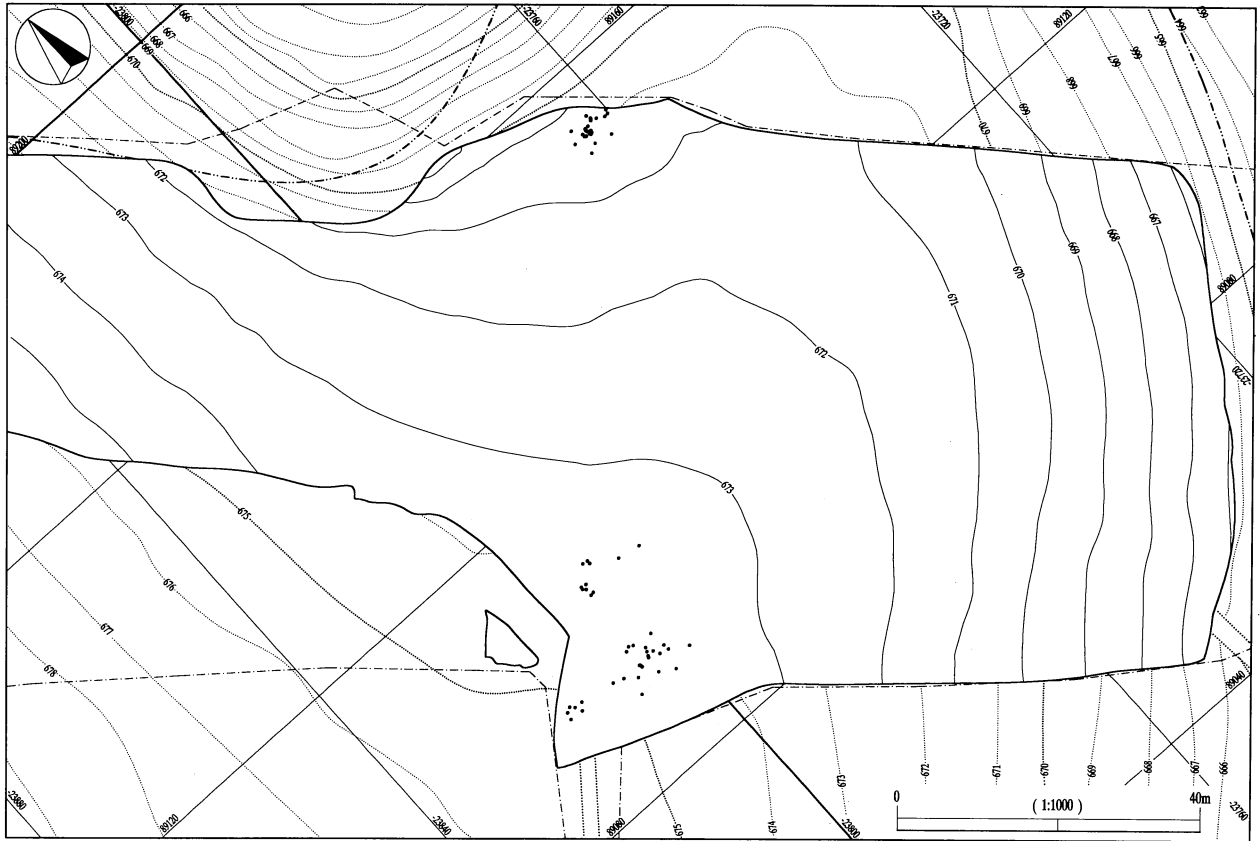

石器全点

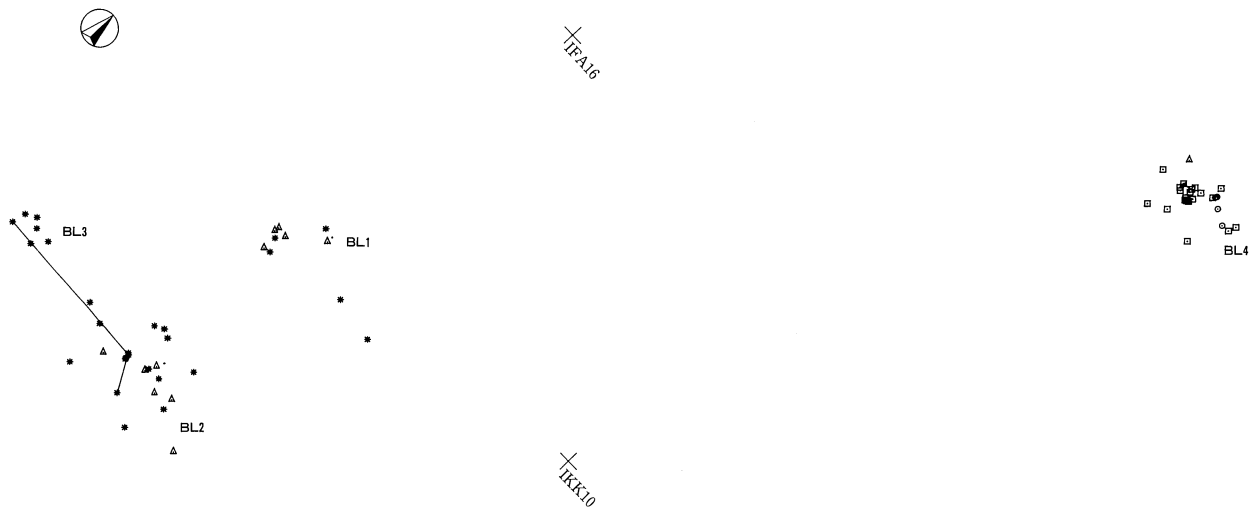

凡例

- △：珪質頁岩・凝灰質頁岩
- ：無斑晶質安山岩
- ：黒曜石
- \*：玉髄
- ・：その他

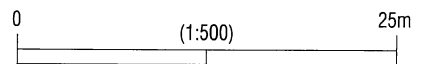

石材別・接合資料分布図

日向林IV石器文化 全体図

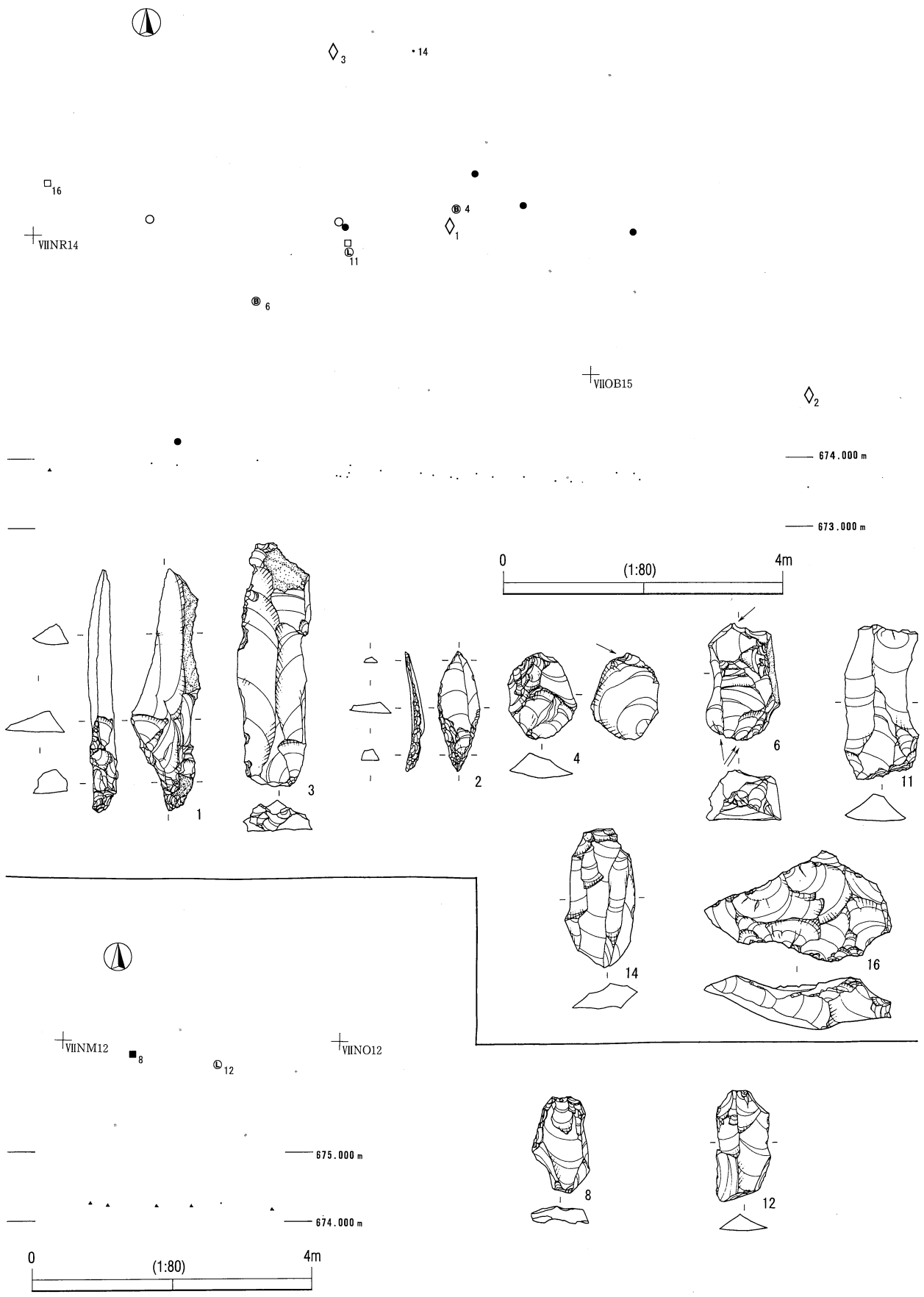

日向林IV石器文化 BL1・BL2遺物分布図 (上：BL1・下：BL2)

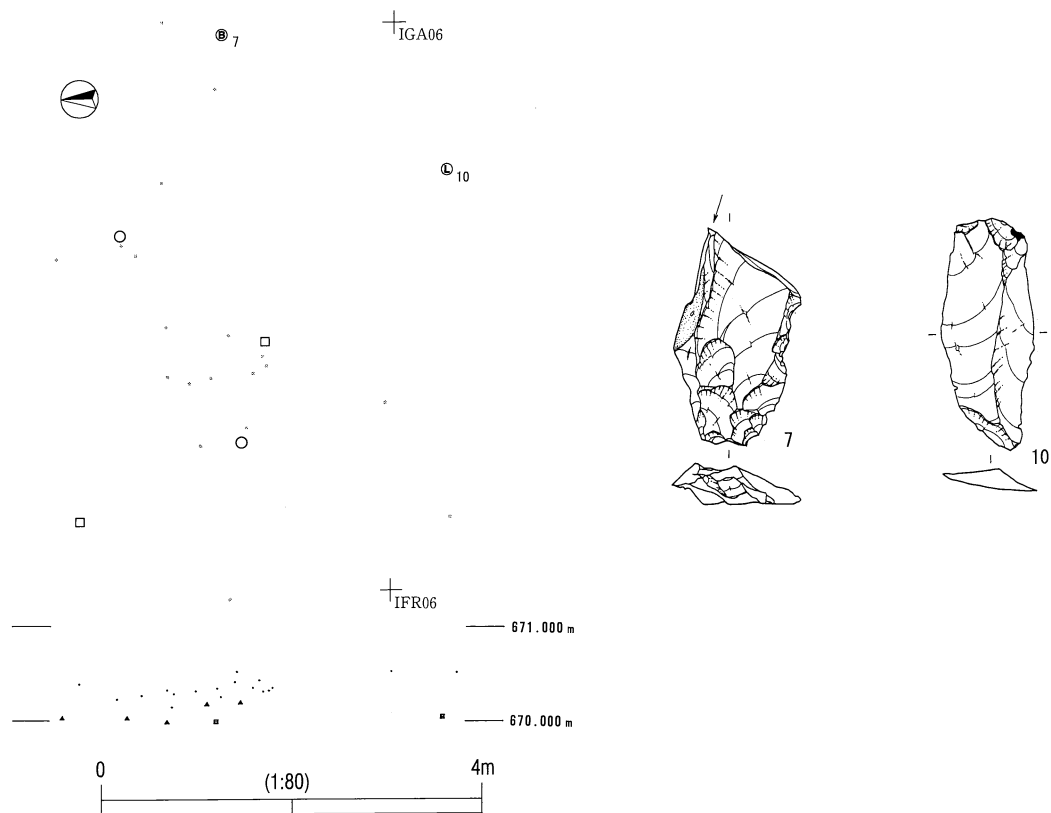
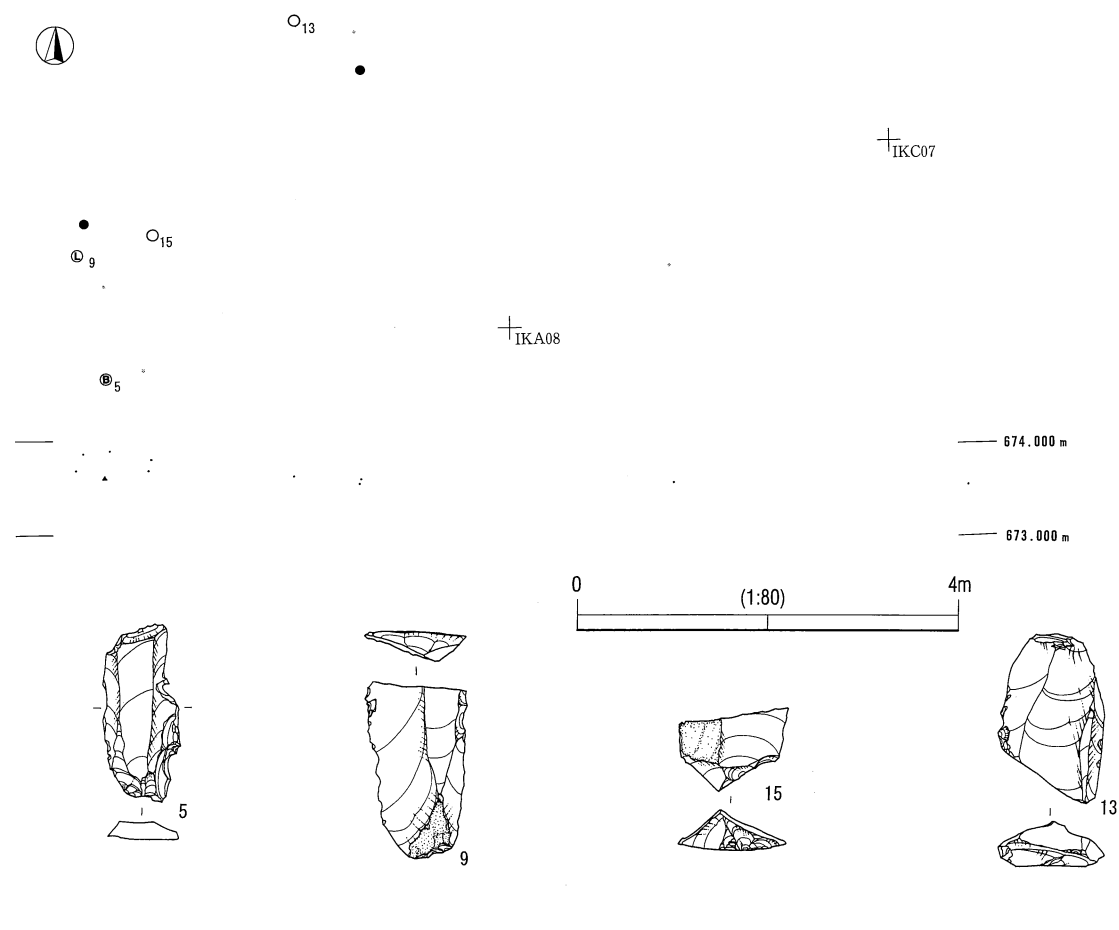

日向林IV石器文化 BL3・BL4遺物分布図 (上:BL3・下:BL4)

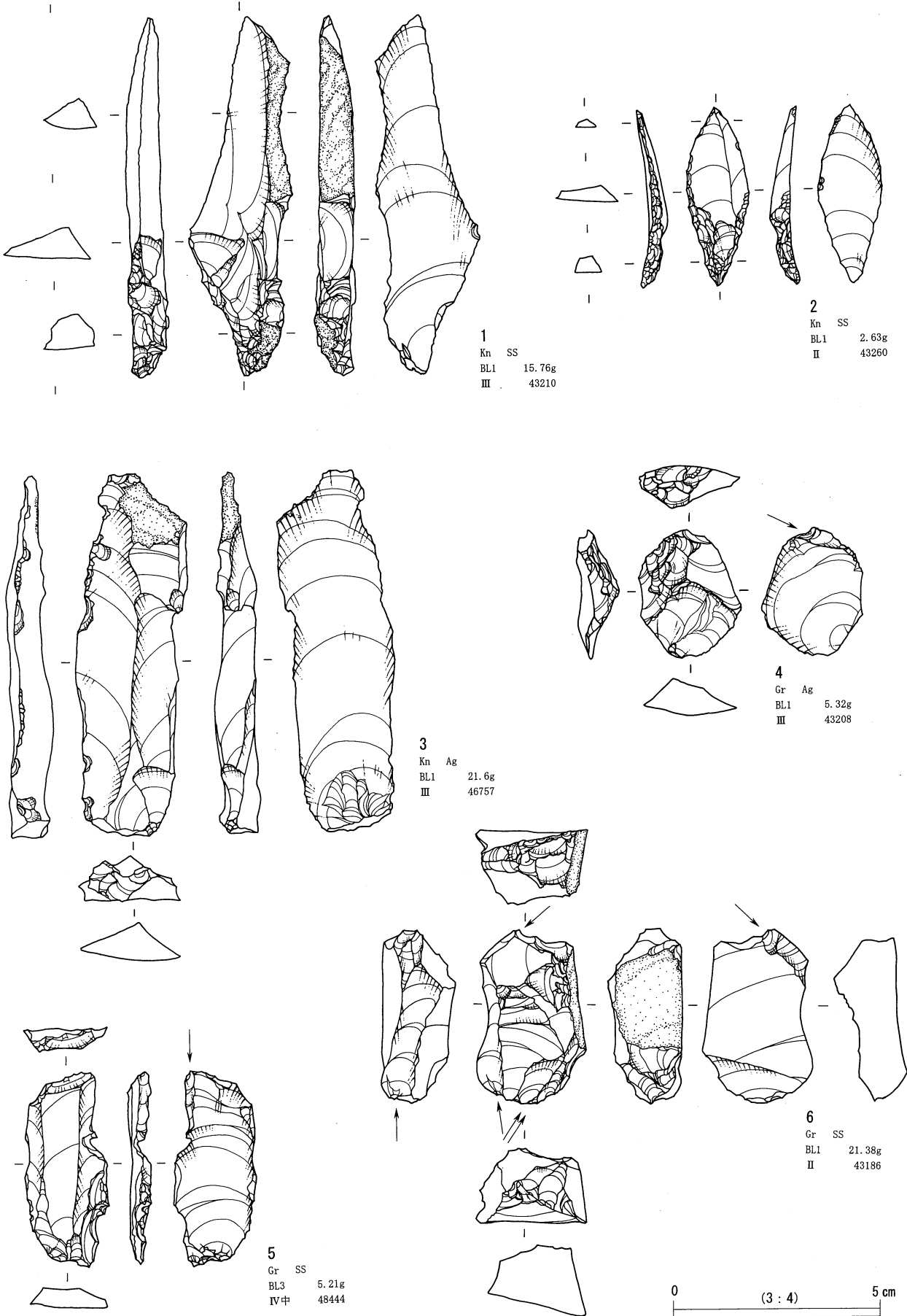

日向林IV石器文化 石器実測図1

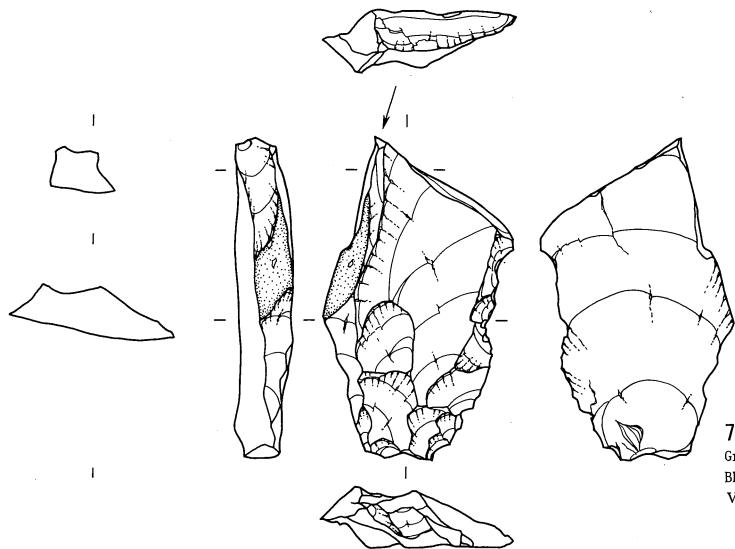

7  
Gr An  
BL4 15.97g  
V 51544

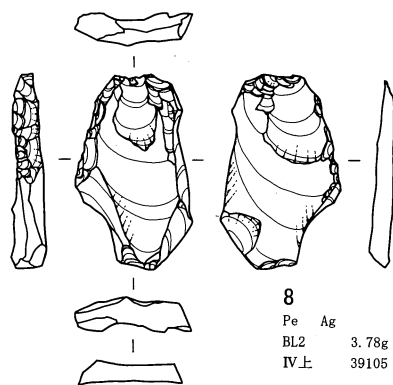

8  
Pe Ag  
BL2 3.78g  
IV上 39105

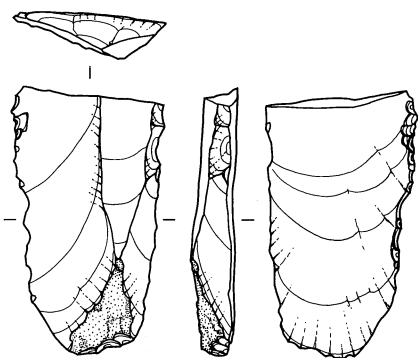

9  
B1 SS  
BL3 9.39g  
III 39108

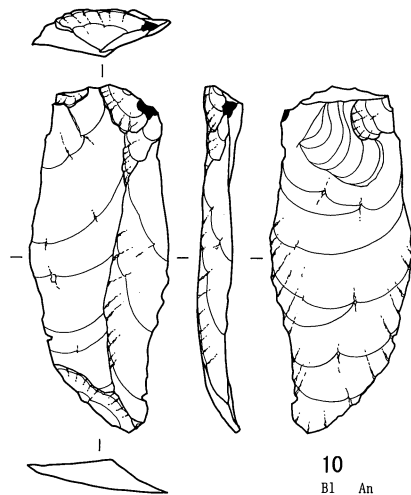

10  
B1 An  
BL4 8.88g  
V 51542

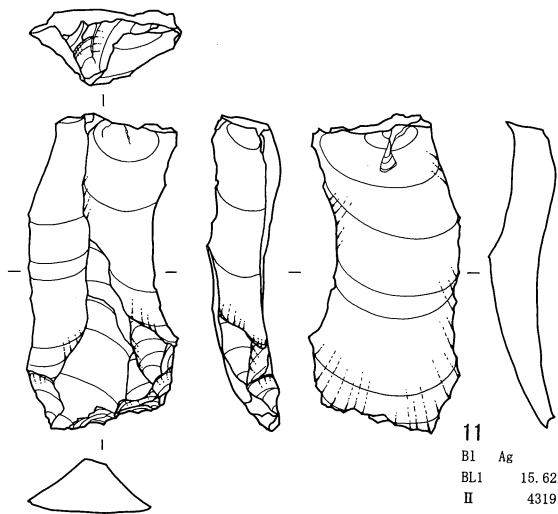

11  
B1 Ag  
BL1 15.62g  
II 43191

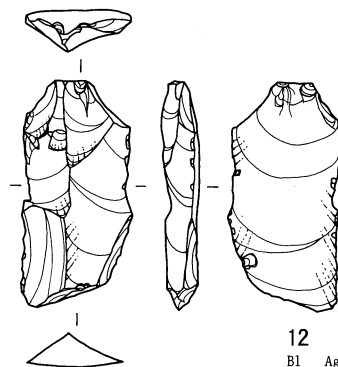

12  
B1 Ag  
BL2 5.24g  
IV上 39103

0 (3 : 4) 5 cm

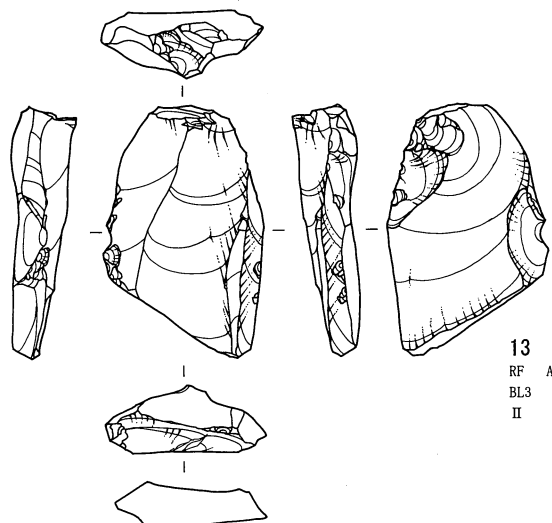

13  
RF Ag  
BL3 11.79g  
II 42800

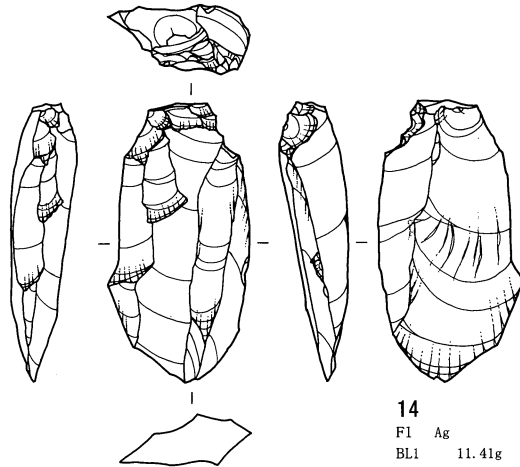

14  
F1 Ag  
BL1 11.41g  
III 43204

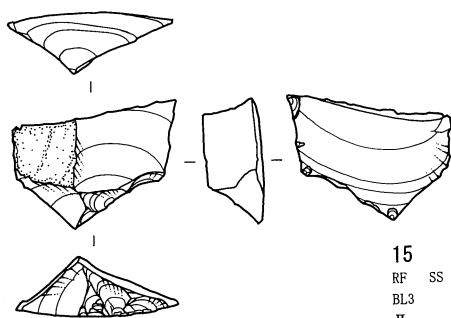

15  
RF SS  
BL3 5.1g  
II 42793

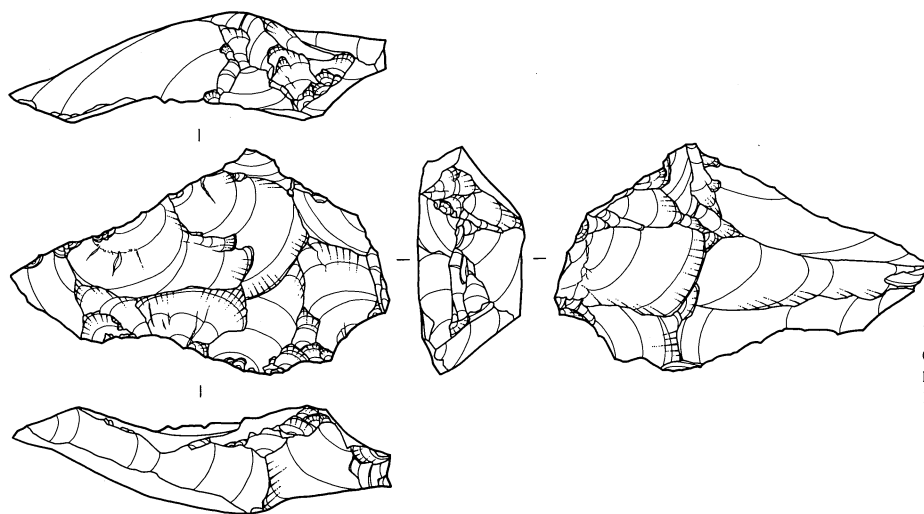

16  
Co Ag  
BL1 34.81g  
IV中 48497

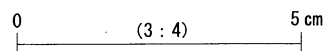

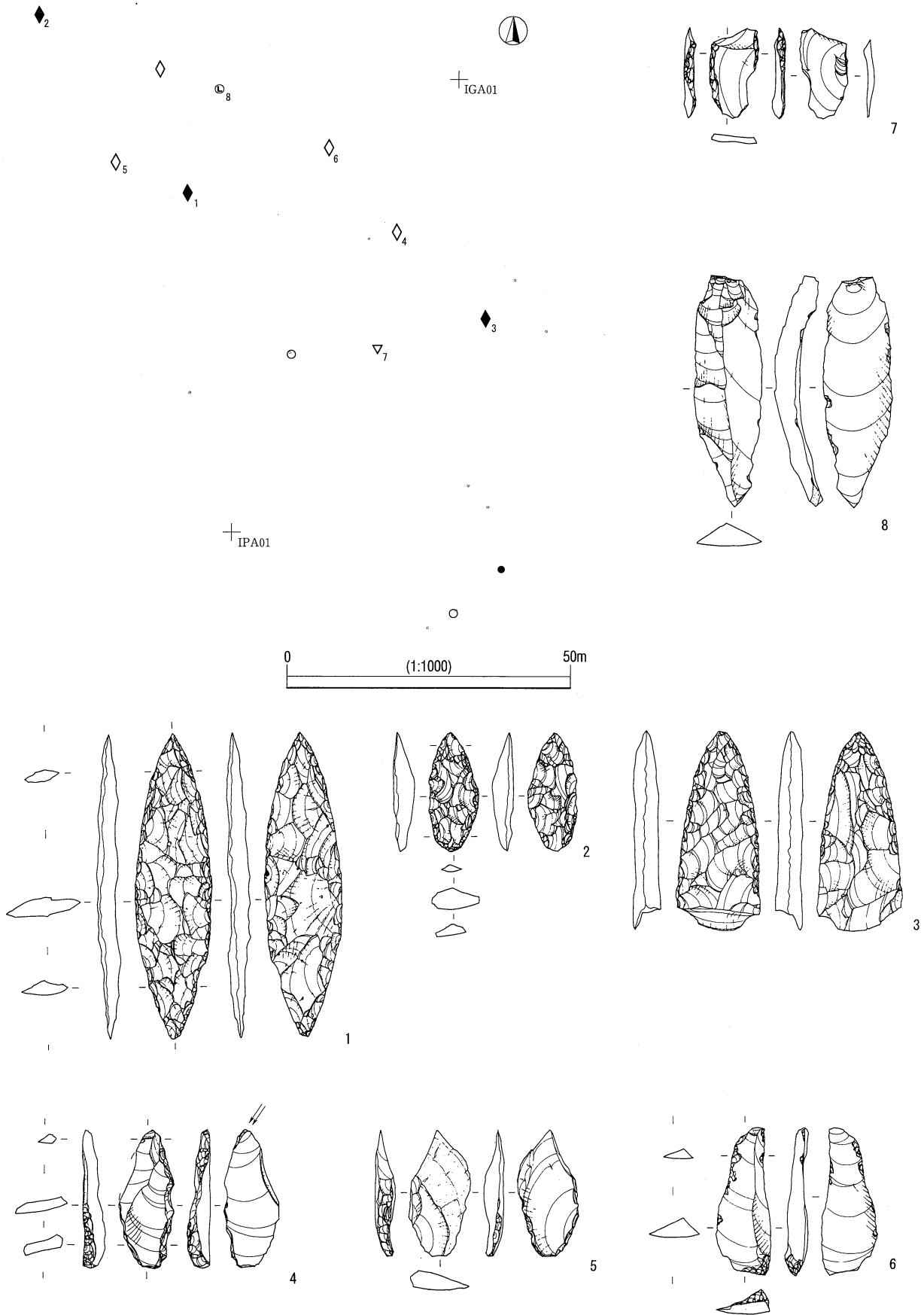

日向林A遺跡 その他の石器分布図

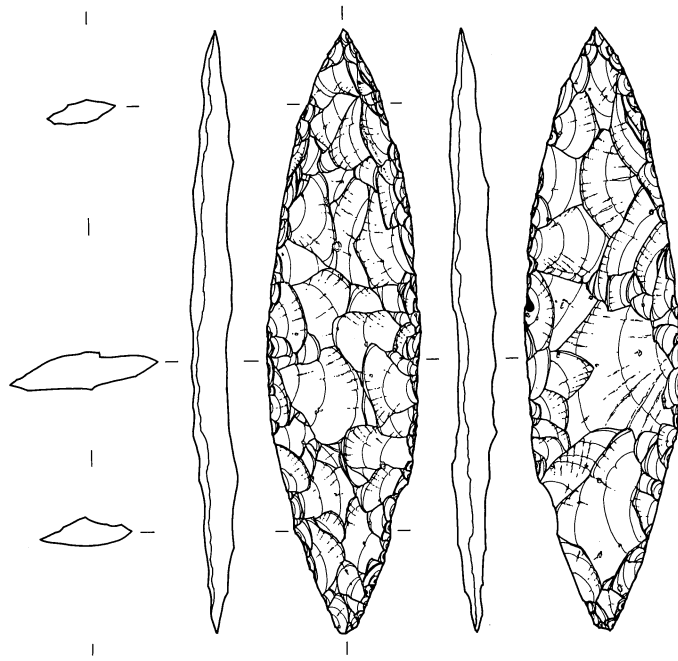

1  
Po An  
外 19.76g  
II 45665

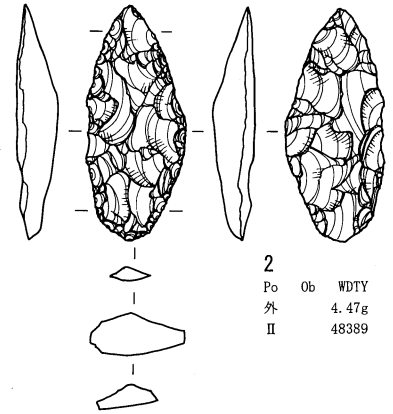

2  
Po Ob WDTY  
外 4.47g  
II 48389

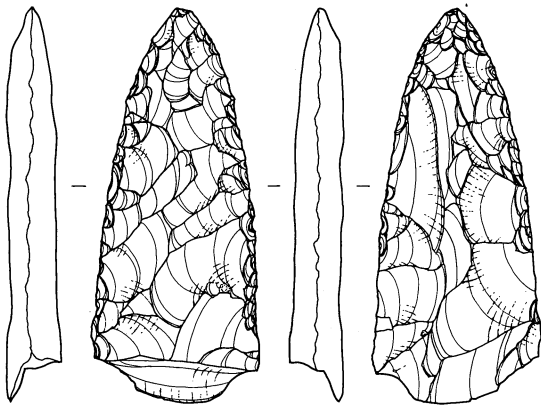

3  
Po Tu  
外 21.46g  
II 34490

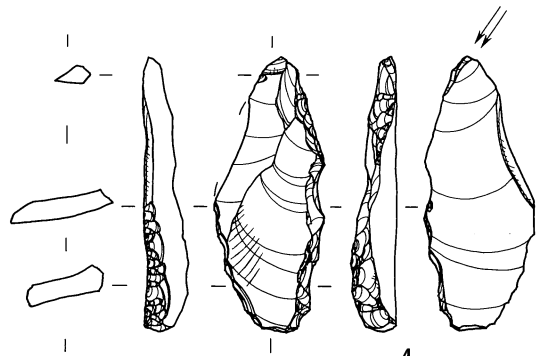

4  
Kn Ob WDTY  
外 4.43g  
II 41391

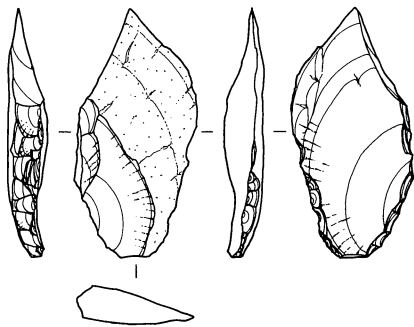

5  
Kn ST  
外 5.77g  
III 47864

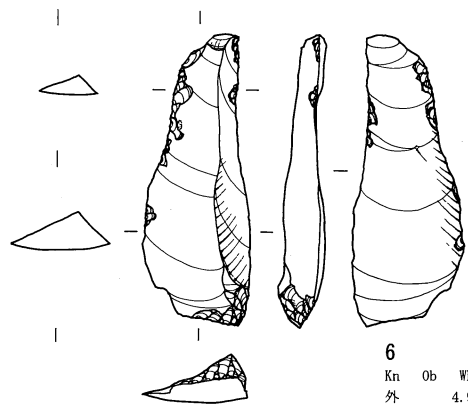

6  
Kn Ob WDTY  
外 4.97g  
II 51027

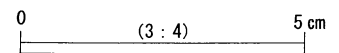



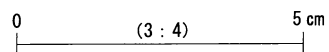
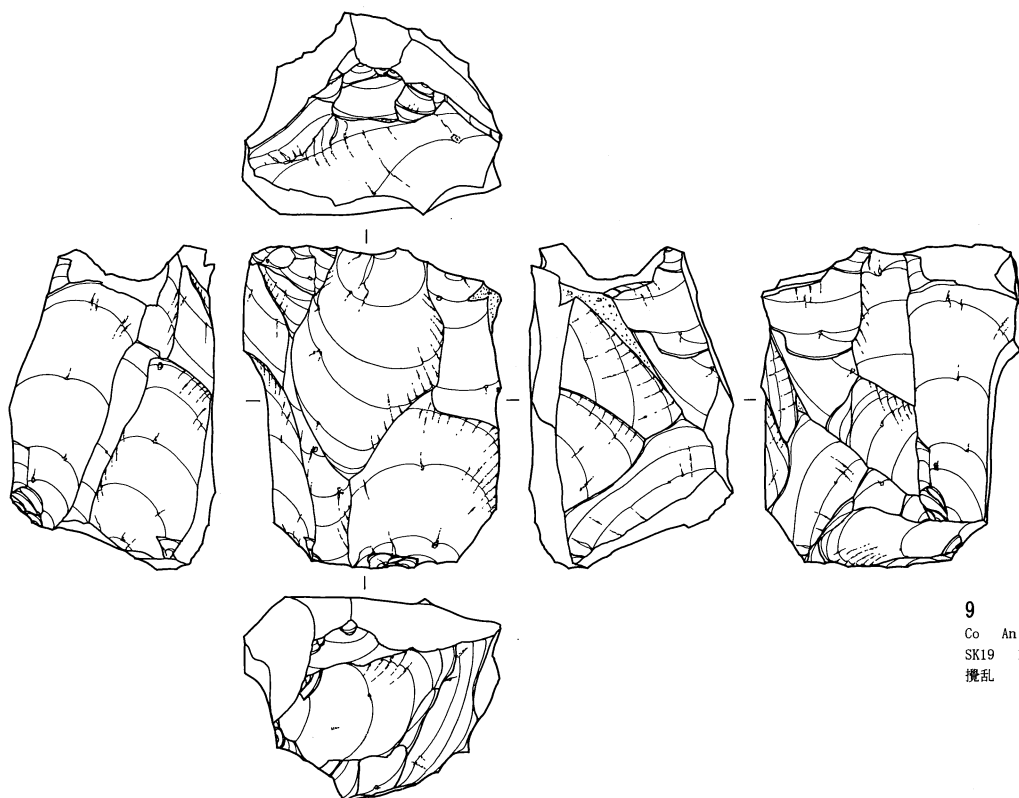
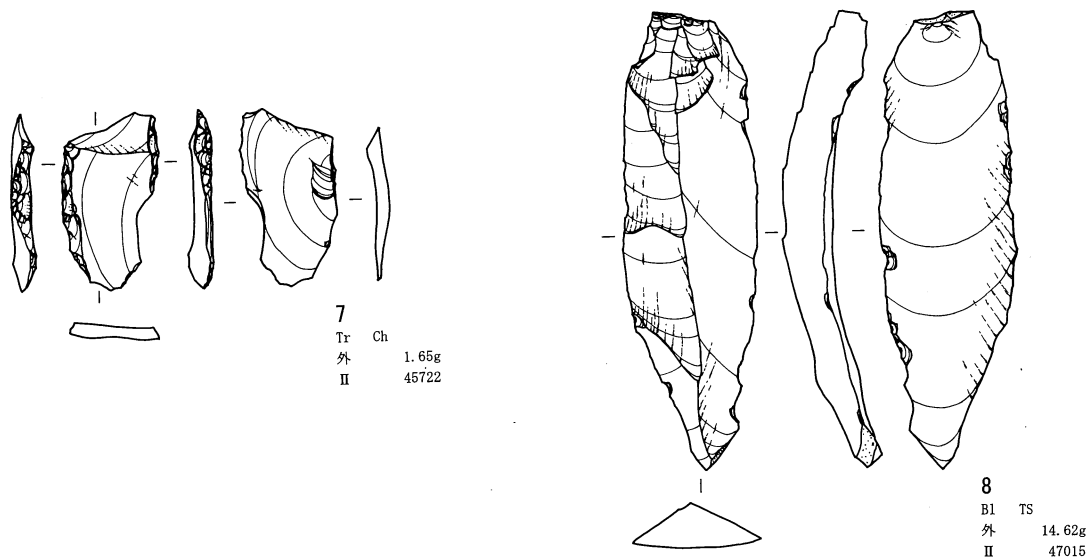

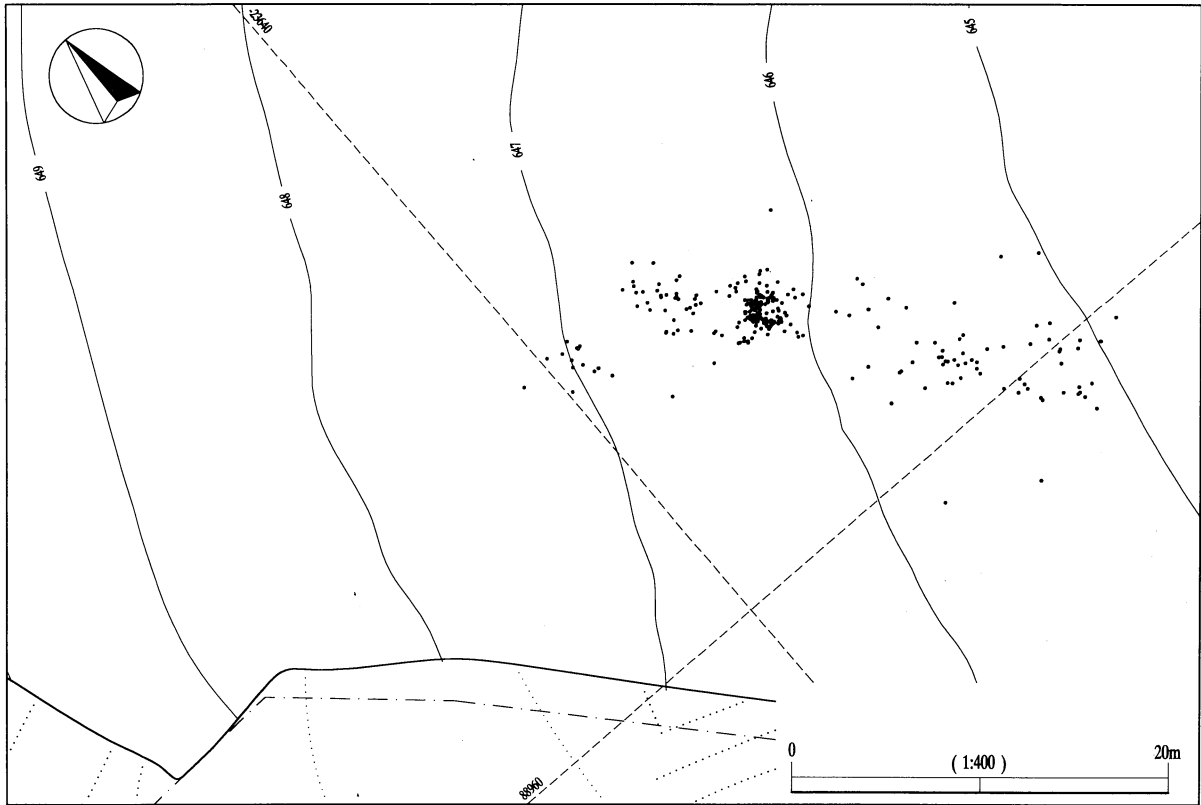

石器全点

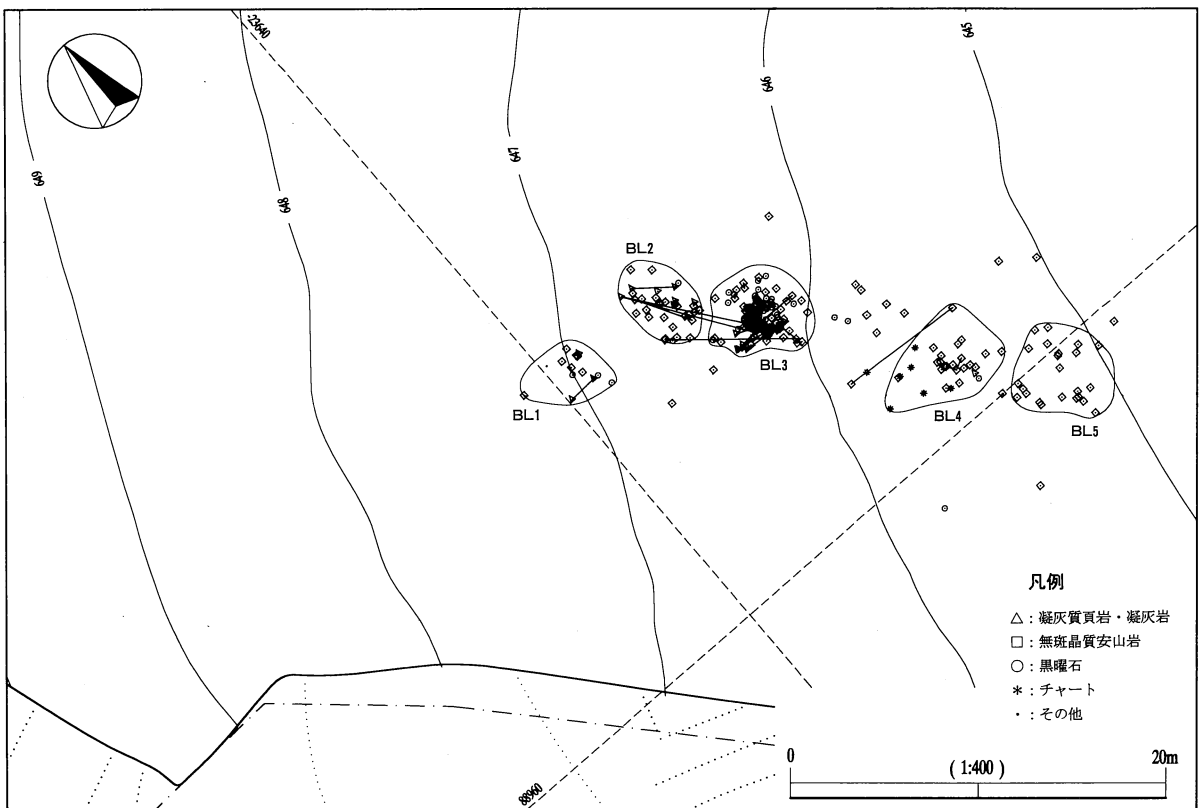

石材別・接合資料分布図

七ツ栗 I 石器文化 全体図

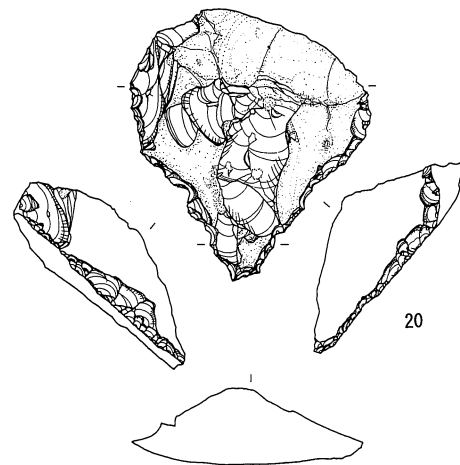
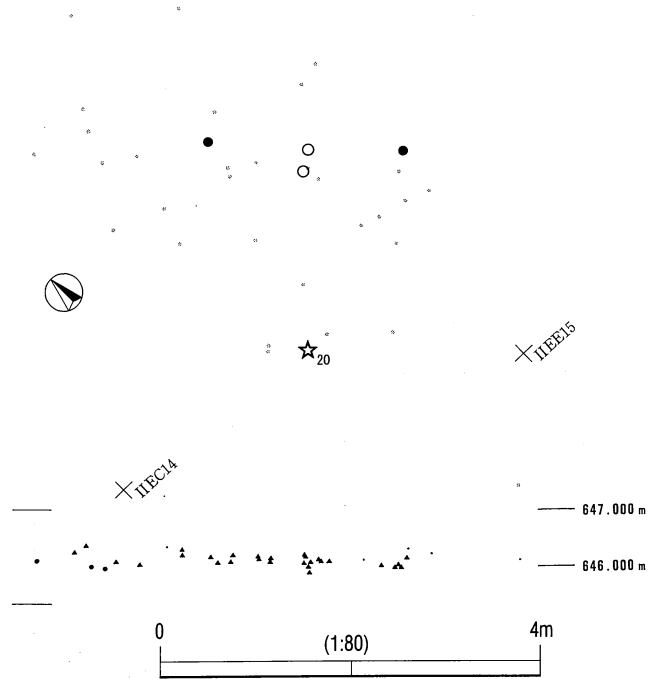
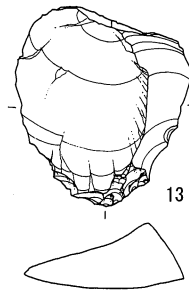
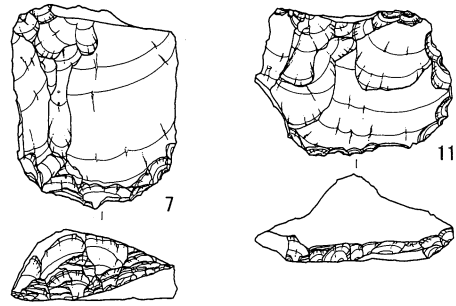
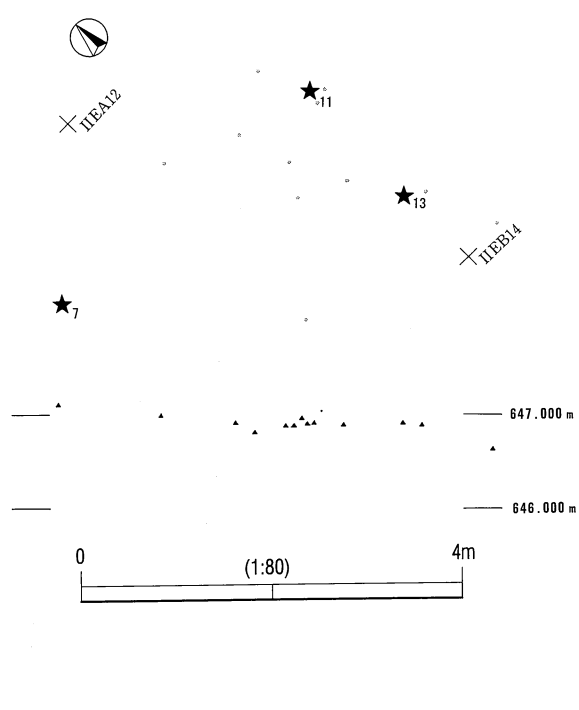

七ツ栗 I 石器文化 BL1・BL2遺物分布図 (上: BL1・下: BL2)

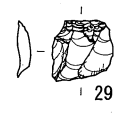
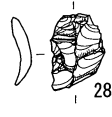
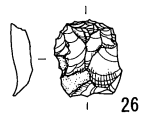
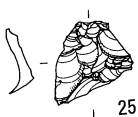
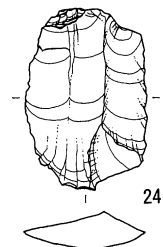
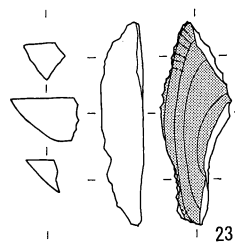
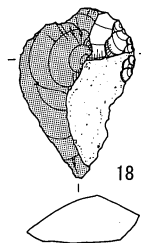
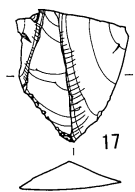
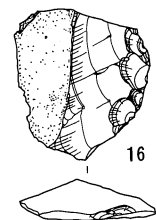
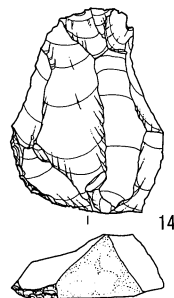
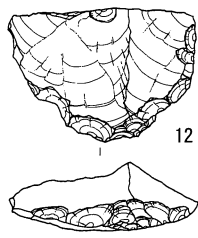
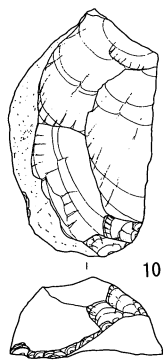
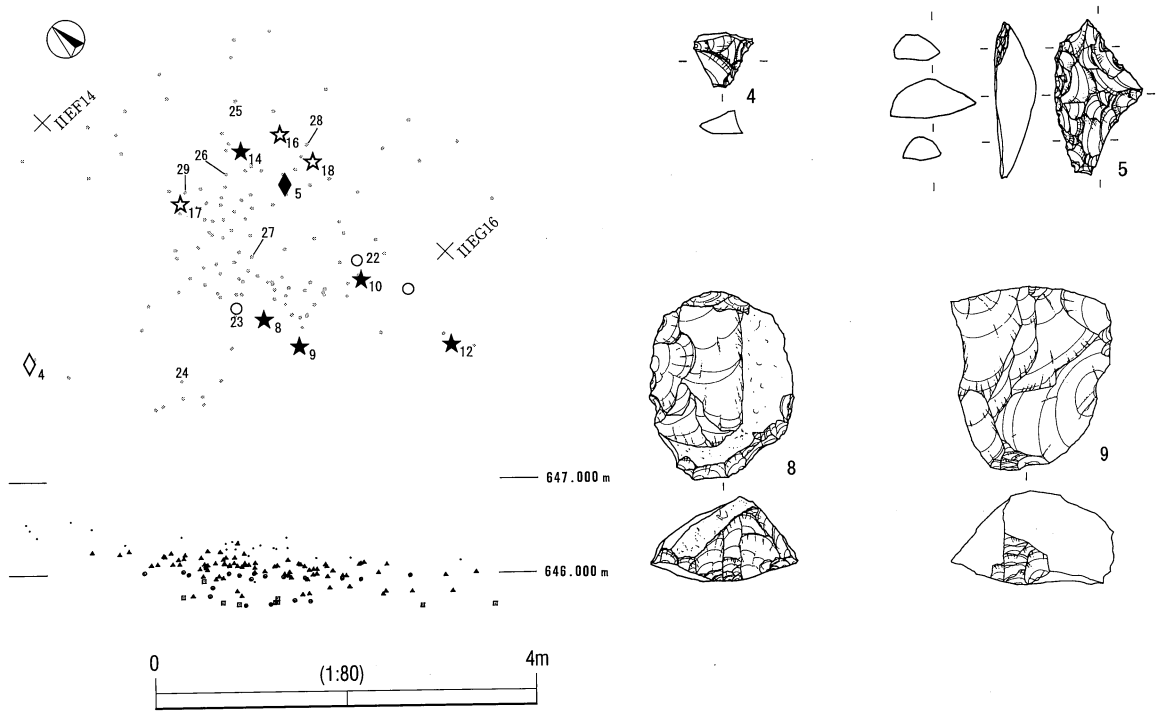

七ツ栗 I 石器文化 BL3遺物分布図

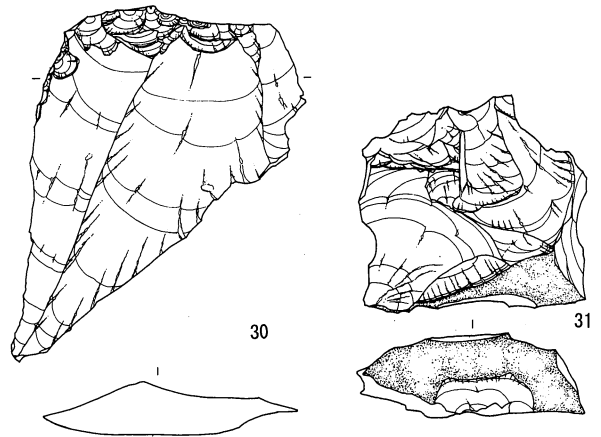
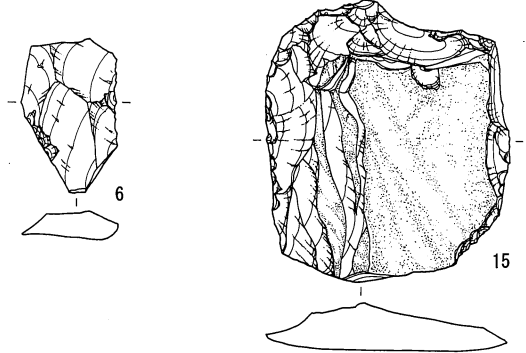
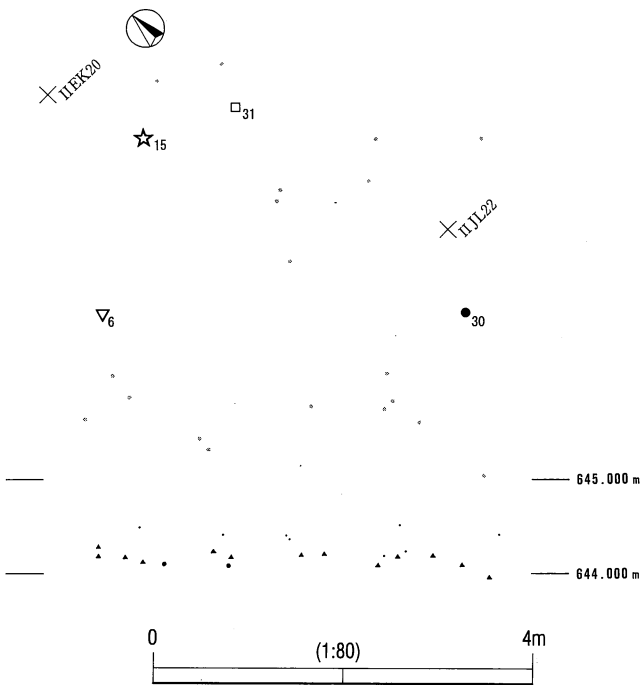
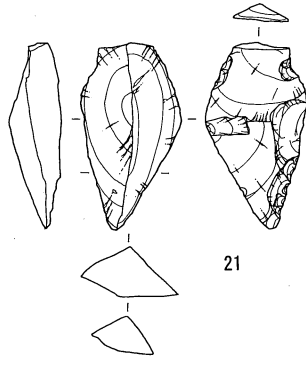
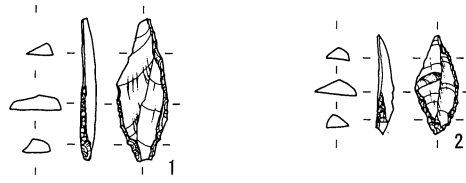
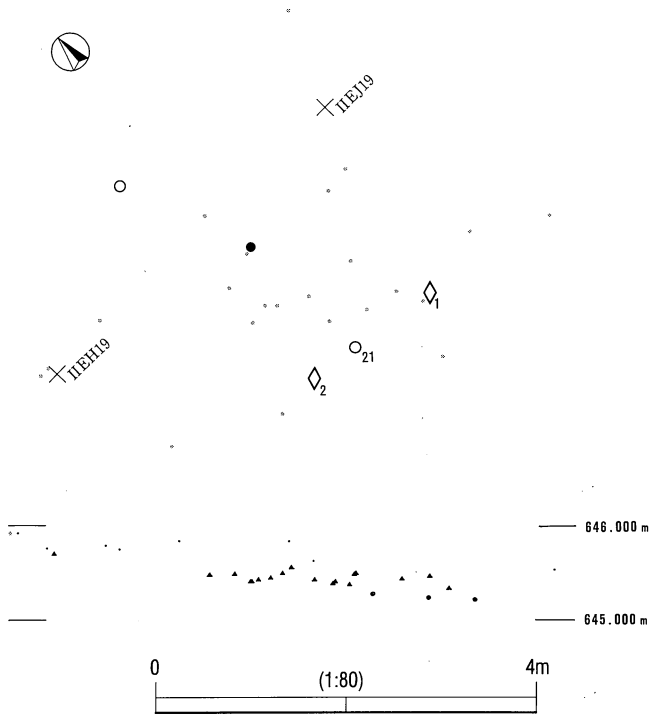

七ツ栗 I 石器文化 BL4・BL5遺物分布図 (上:BL4・下:BL5)

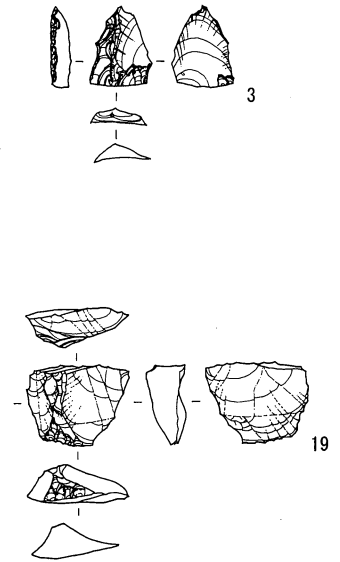
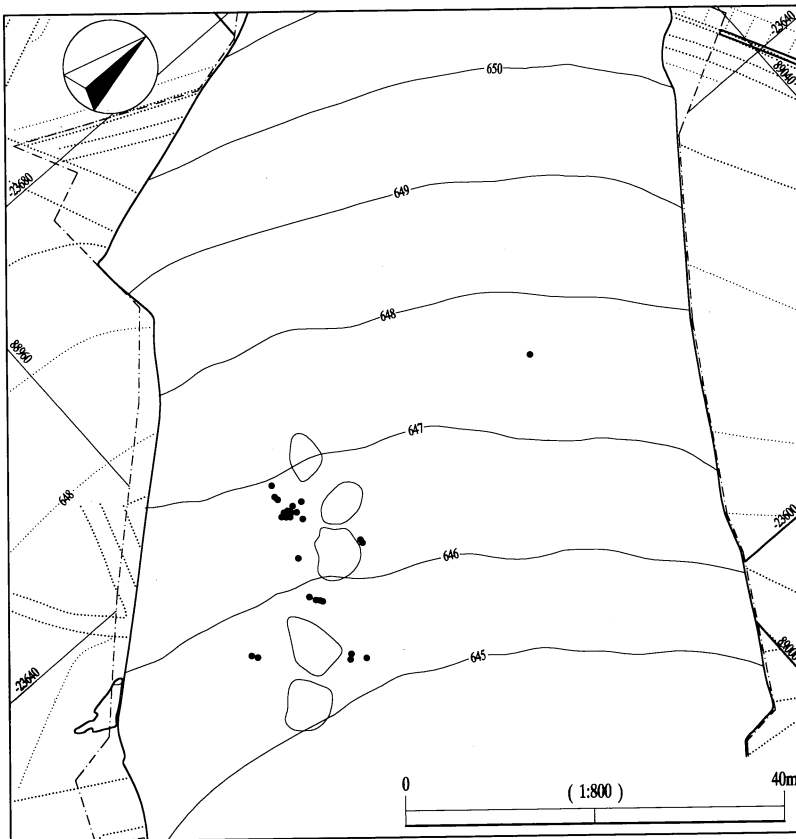

七ツ栗 I 石器文化 ブロック外遺物分布図 (上：石器・下：礫)

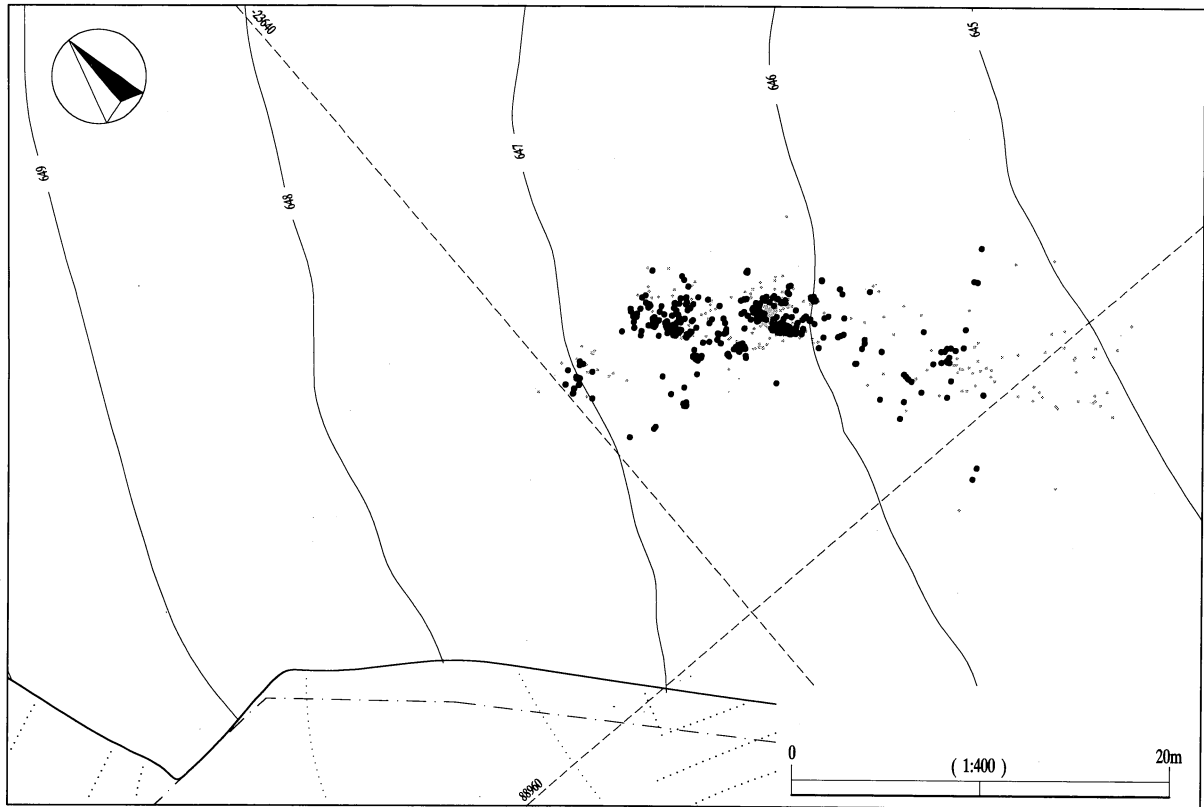

礫全点 (アミは石器)

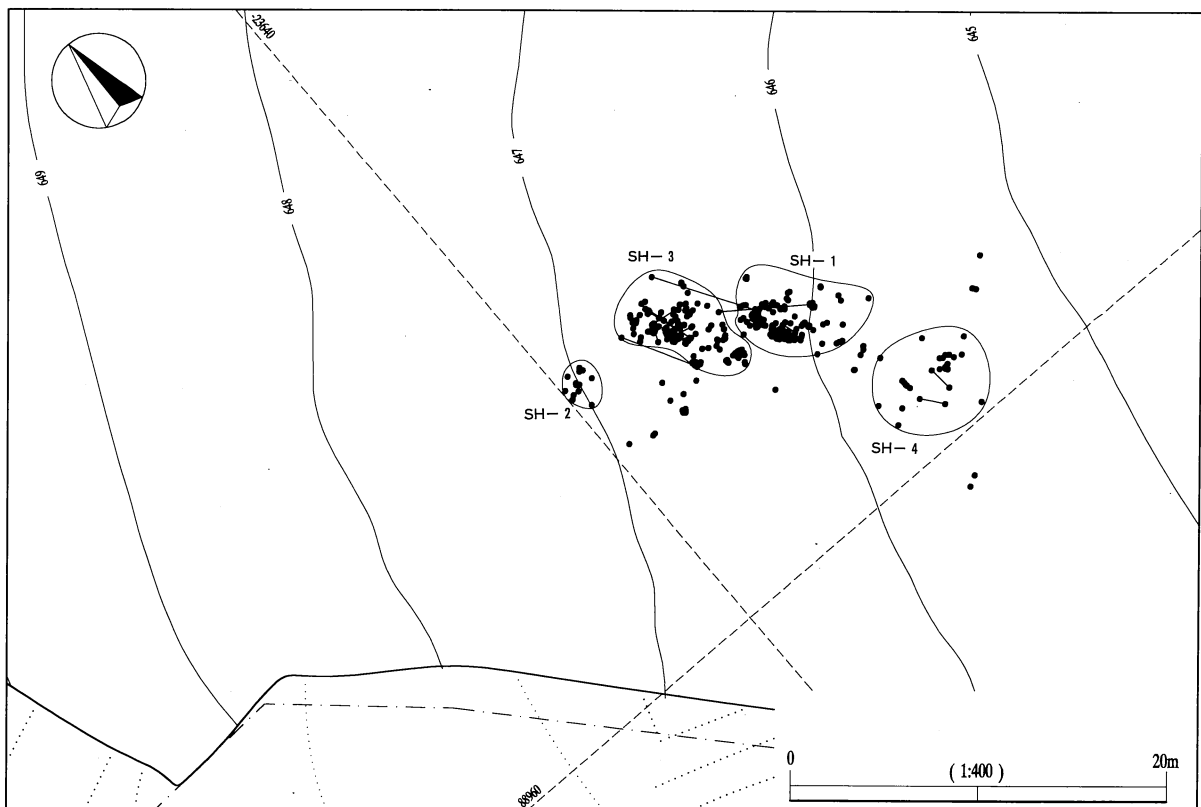

礫群範囲および礫接合資料分布図  
七ツ栗 I 石器文化 礫分布図

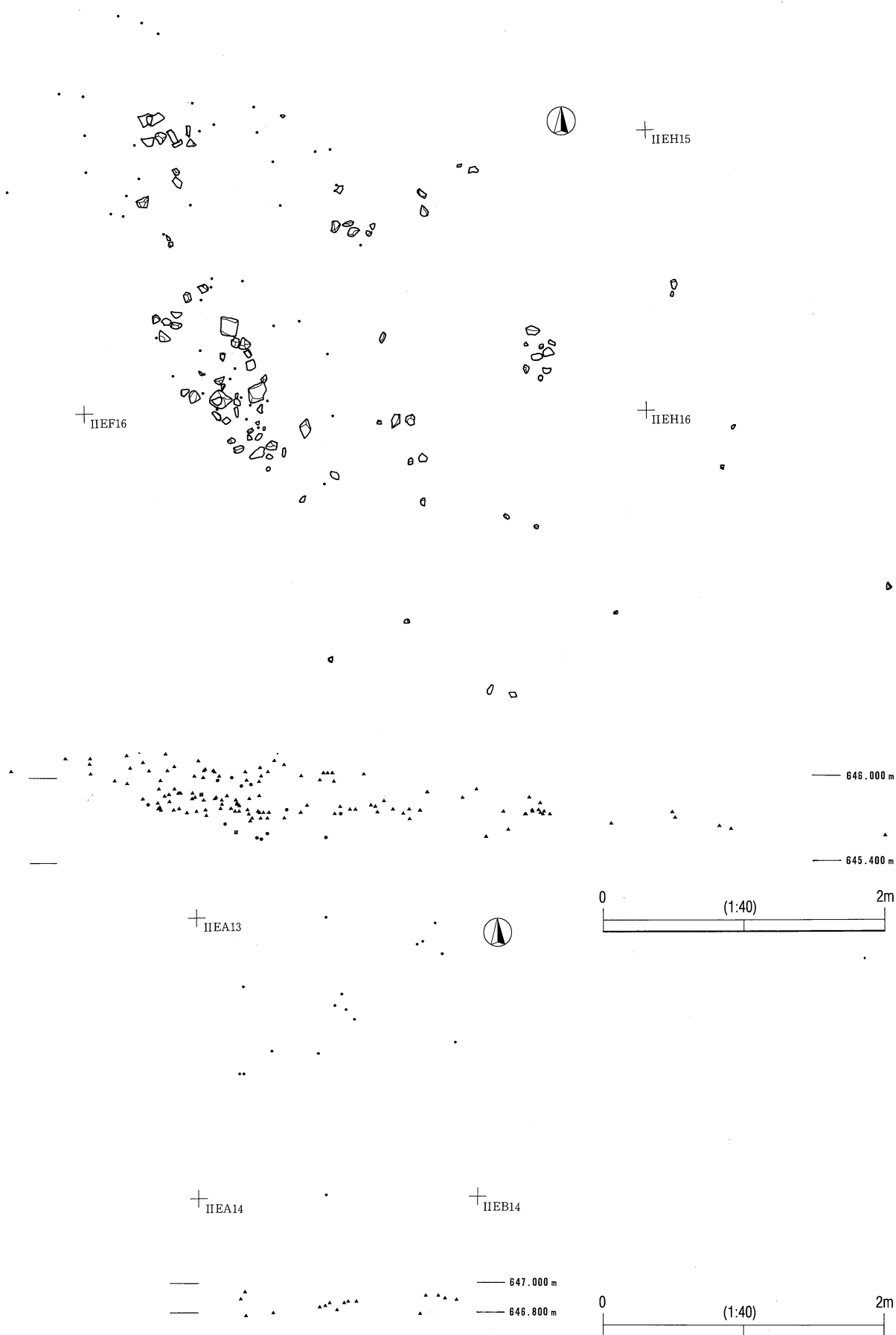

七ツ栗 I 石器文化 SH1・SH2遺物分布図 (上：SH1・下：SH2)



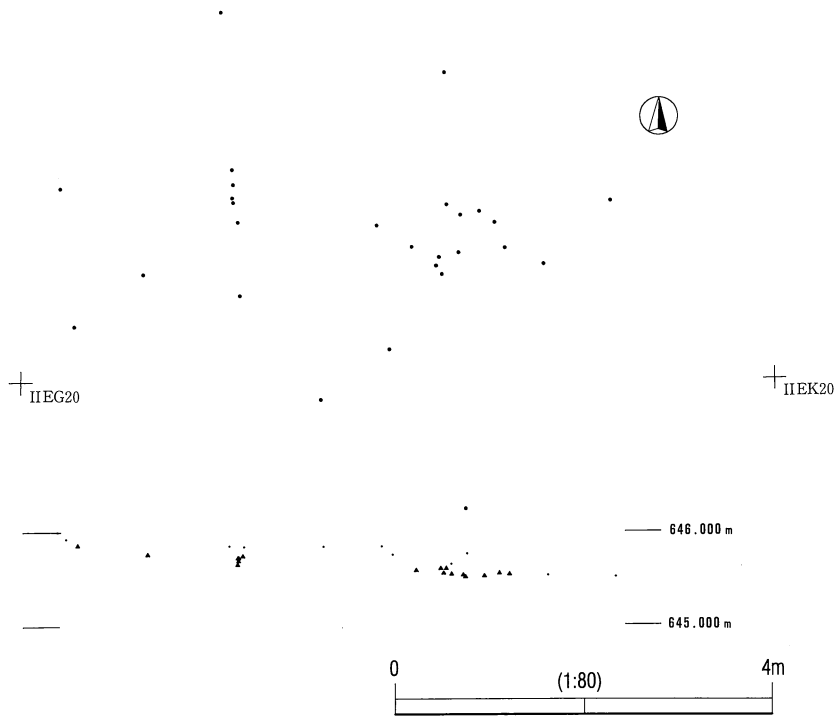
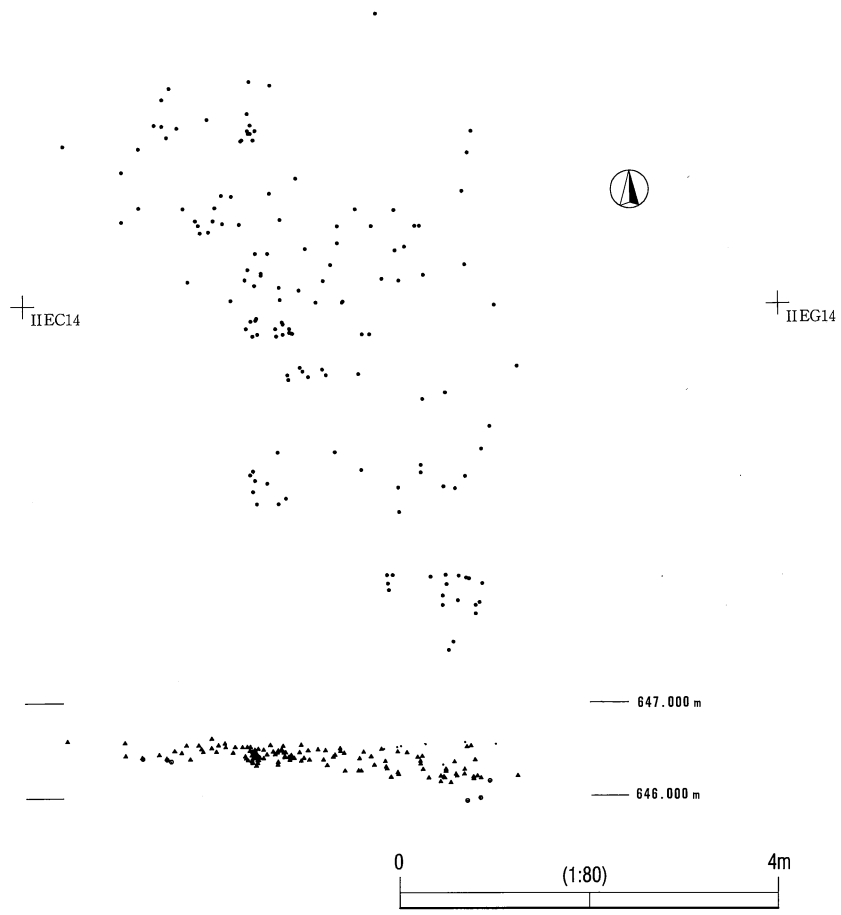

七ツ栗 I 石器文化 SH3・SH4遺物分布図 (上：SH3・下：SH4)

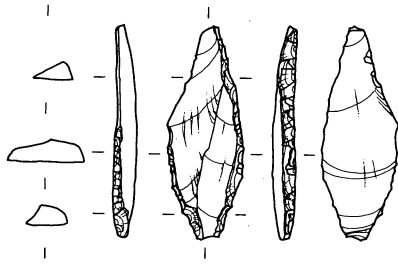

1  
Kn SS  
BL4 1.82g  
IV上 6391

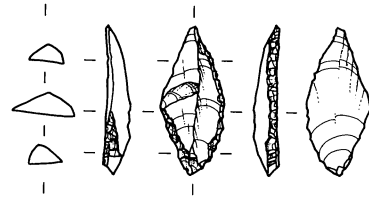

2  
Kn Ch  
BL4 0.96g  
III下 6409

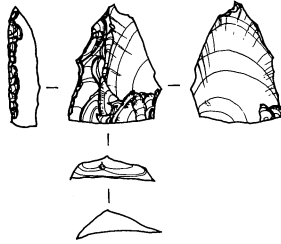

3  
Kn Ob WDTY  
外 1.37g  
IV中 7380

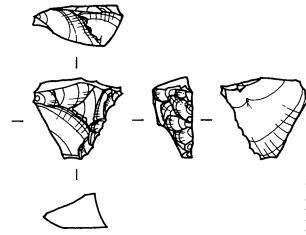

4  
Kn Ob WDTY  
BL3 1.14g  
III下 6506

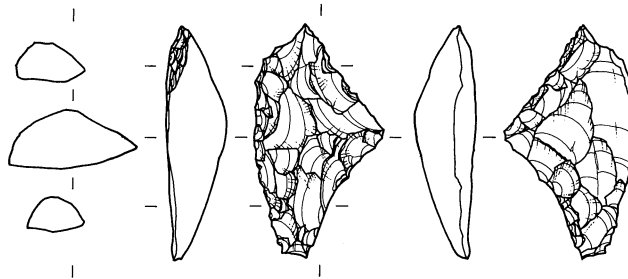

5  
Po Ch  
BL3 7.01g  
IV中 6903

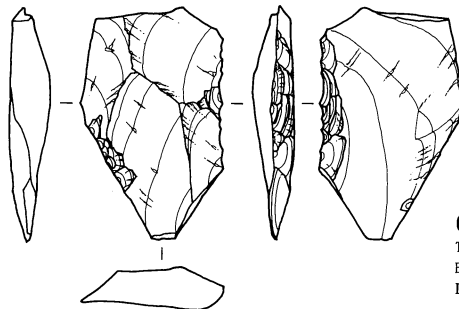

6  
Tr An  
BL5 6.84g  
IV中 5945

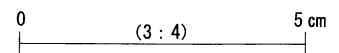

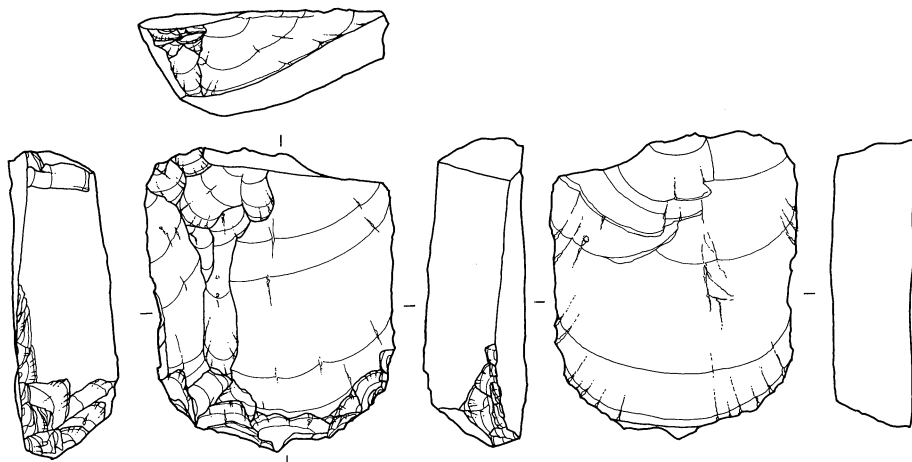

7  
 ES An  
 BL1 47.75g  
 IV中 6808

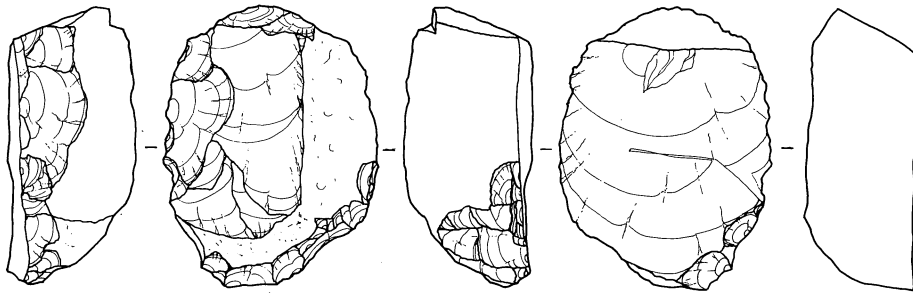
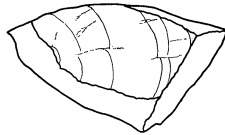
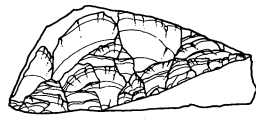

8  
 ES An  
 BL3 41.97g  
 IV下 6428

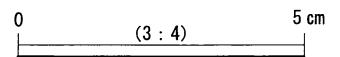

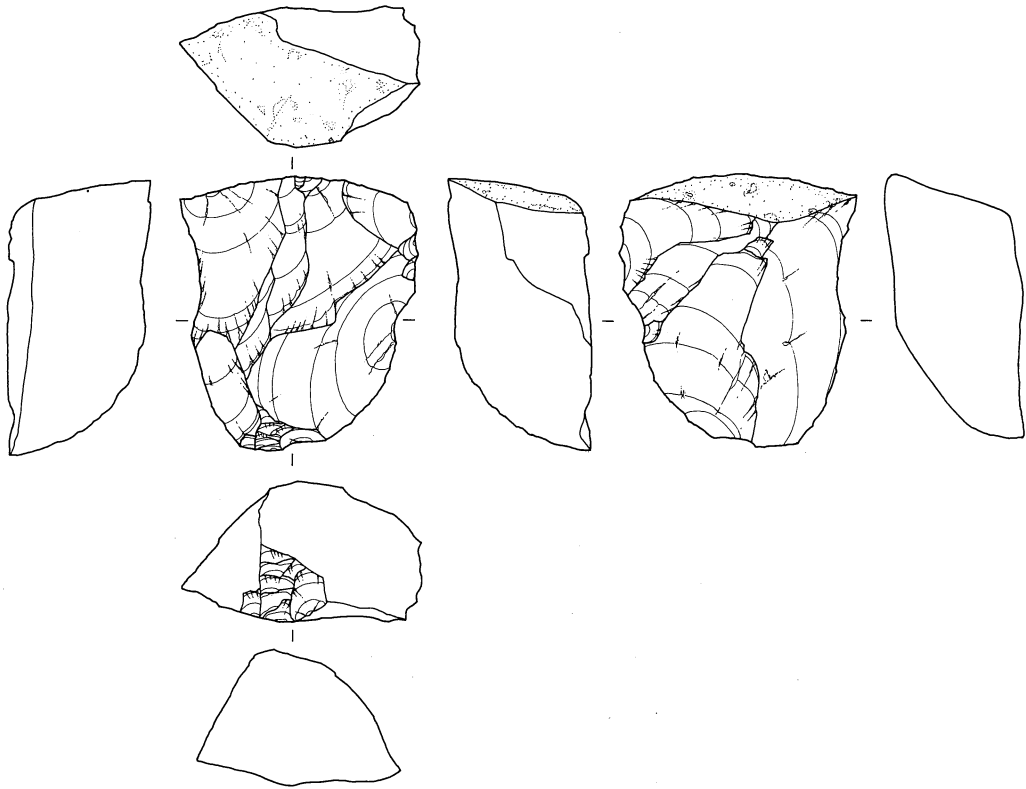

9  
 ES An  
 BL3 45.61g  
 IV中 6426

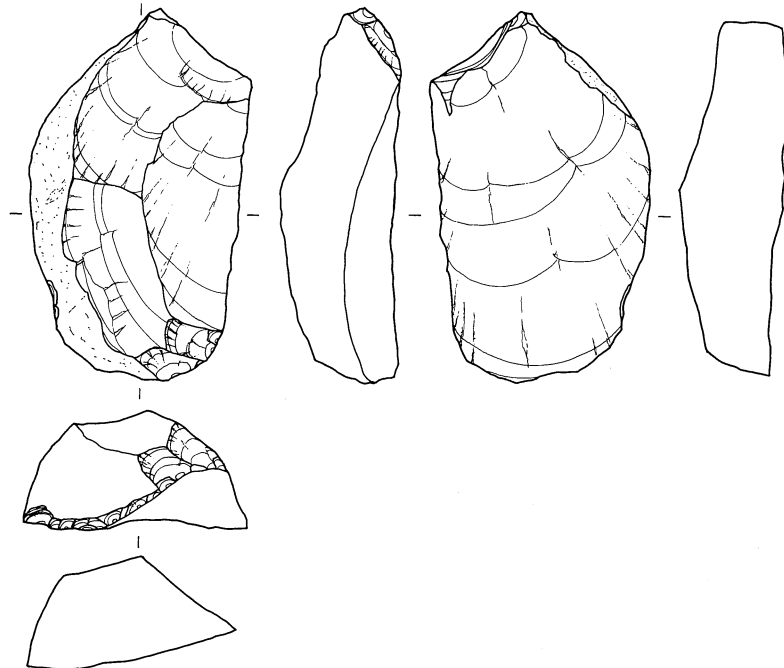

10  
 ES An  
 BL3 47.95g  
 IV上 6418

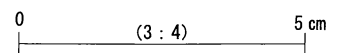

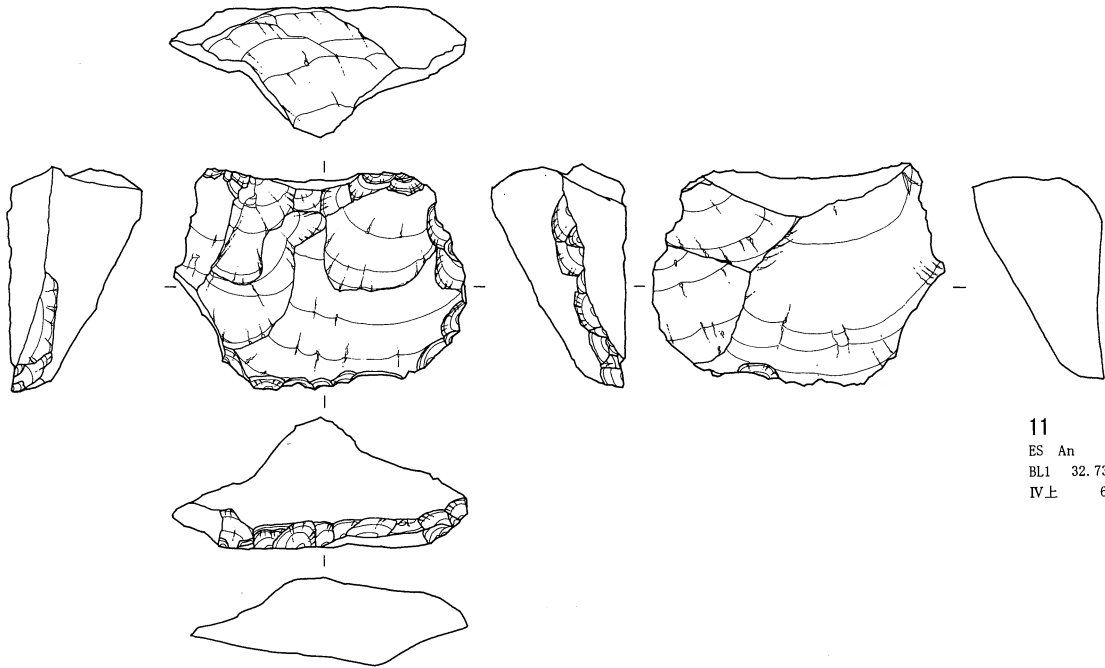

11  
 ES An  
 BL1 32.73g  
 IV上 6519

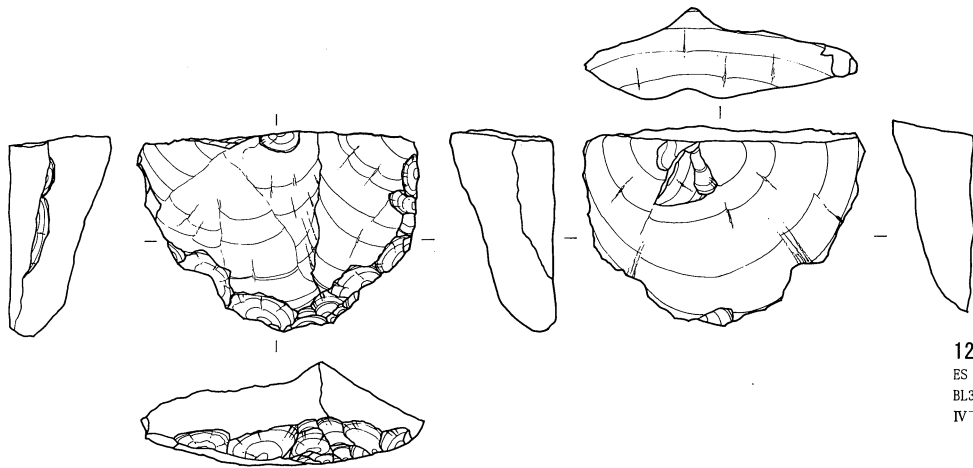

12  
 ES An  
 BL3 23.96g  
 IV下 6886

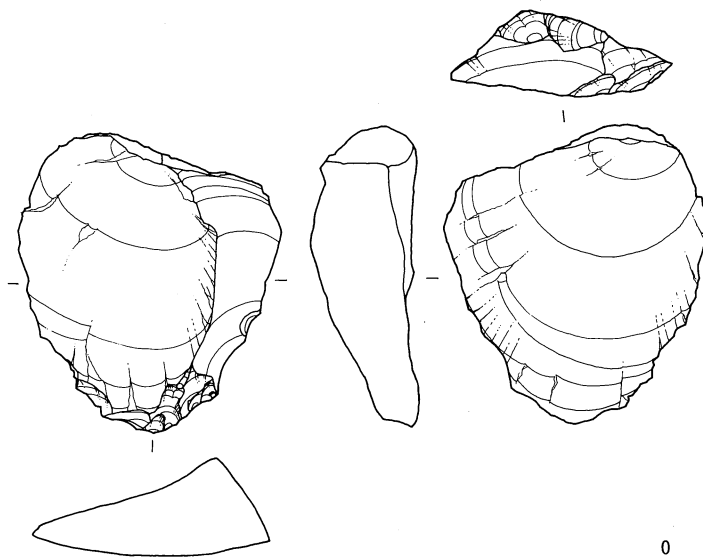

13  
 ES Tu  
 BL1 21.38g  
 IV上 6526

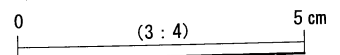

七ツ栗 I 石器文化 石器実測図 4

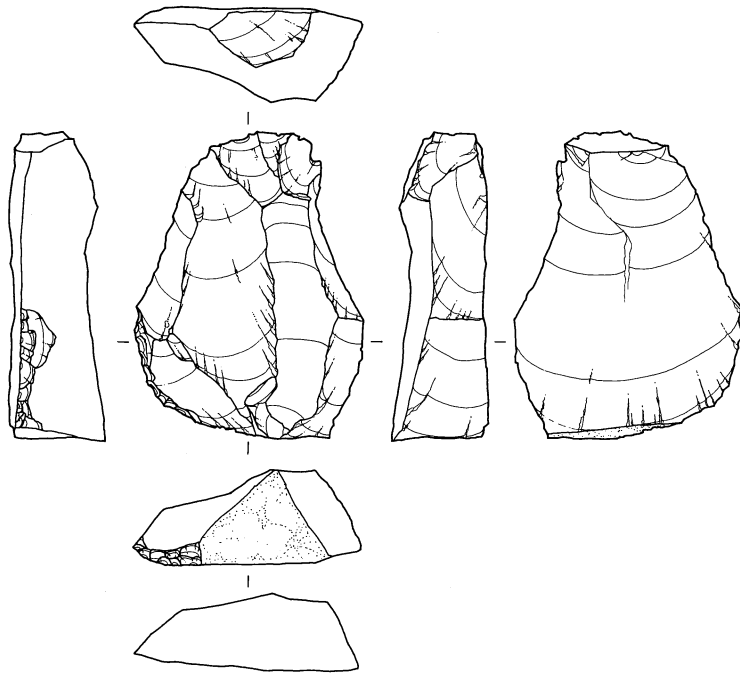

14  
 ES An  
 BL3 32.52g  
 IV中 6465

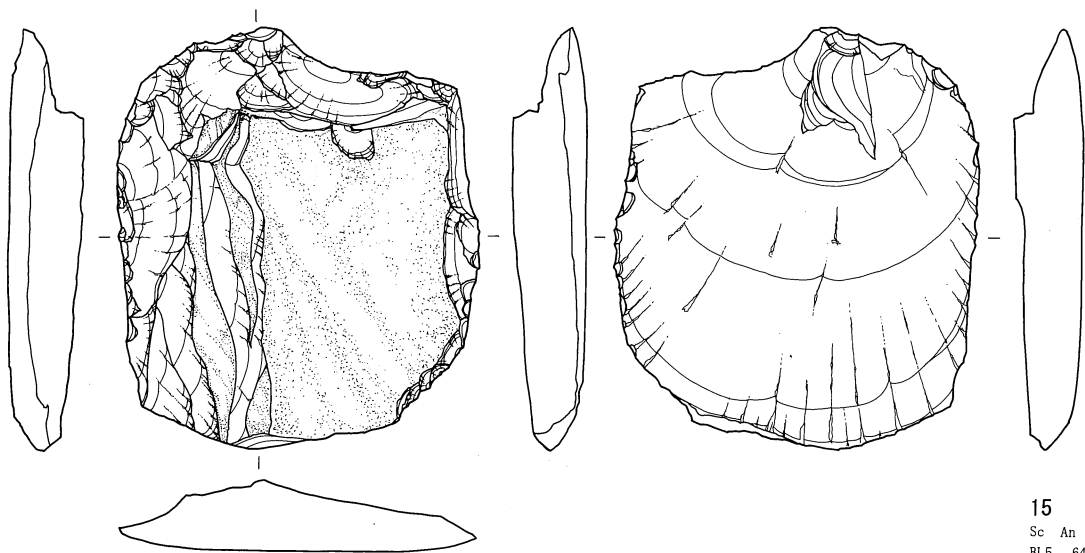

15  
 Sc An  
 BL5 64.43g  
 III中 6382

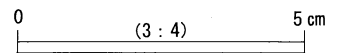

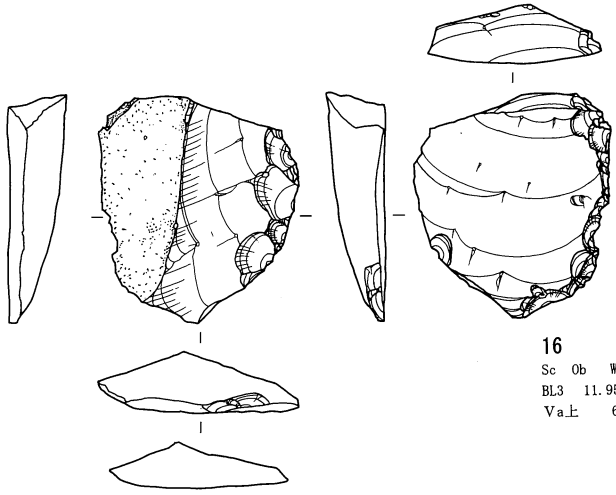

16  
Sc Ob WDTY  
BL3 11.95g  
Va上 6463

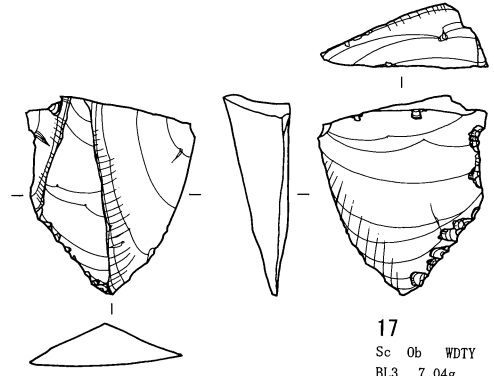

17  
Sc Ob WDTY  
BL3 7.04g  
Va中 7010

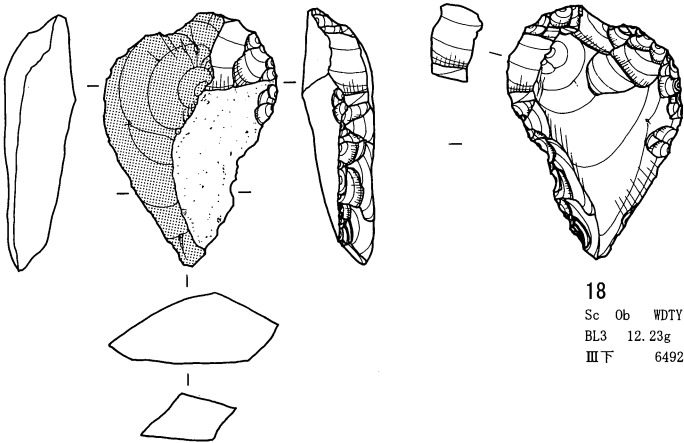

18  
Sc Ob WDTY  
BL3 12.23g  
III下 6492

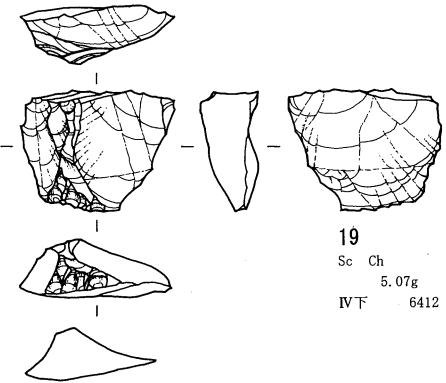

19  
Sc Ch  
5.07g  
IV下 6412

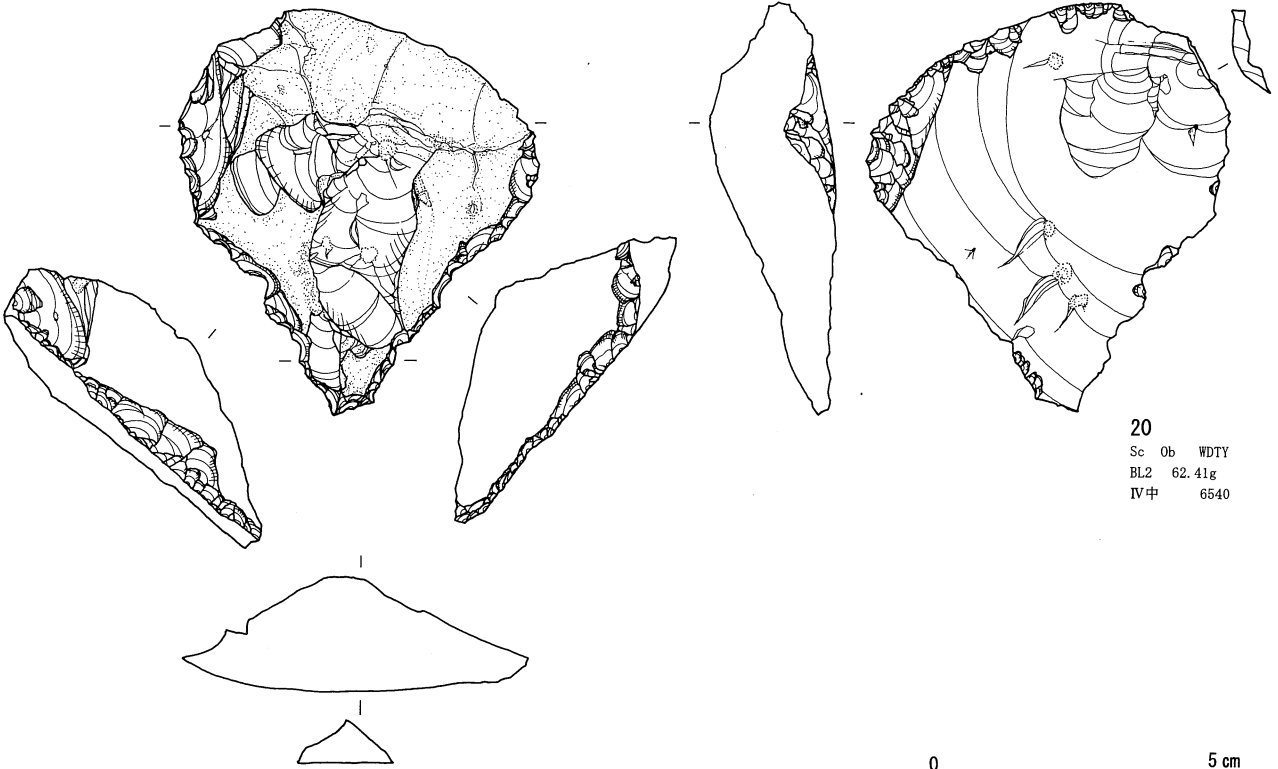

20  
Sc Ob WDTY  
BL2 62.41g  
IV中 6540

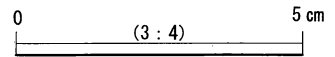

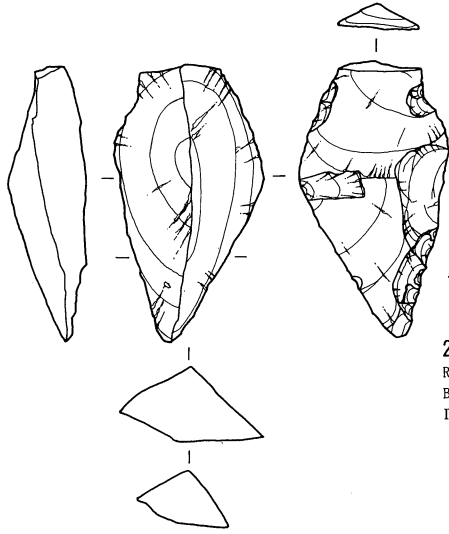

21  
RF An  
BL4 11.63g  
IV中 6394

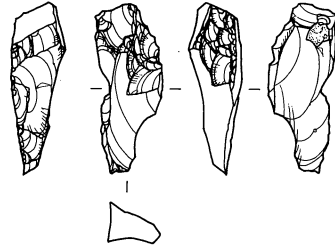

22  
RF Ob WDHY  
BL3 2.18g  
IV上 6420

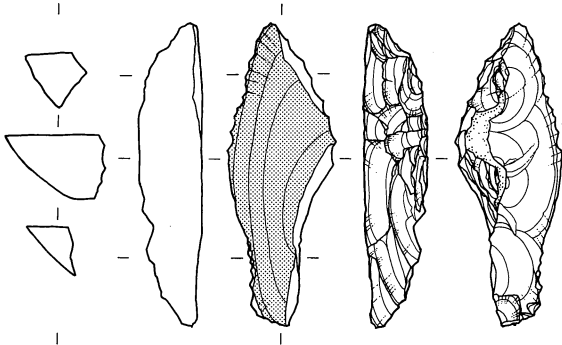

23  
RF Ta  
BL3 7.33g  
III中 6444

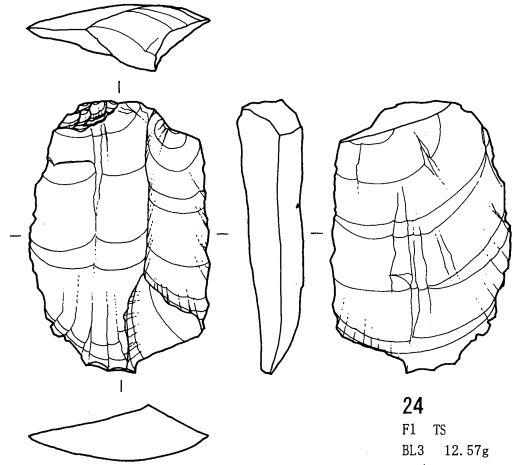

24  
F1 TS  
BL3 12.57g  
IV中 6433

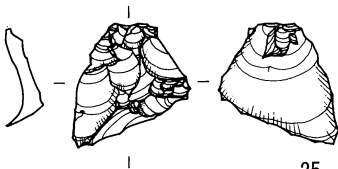

25  
PF Ob WDTY  
BL3 1.3g  
Va上 6464

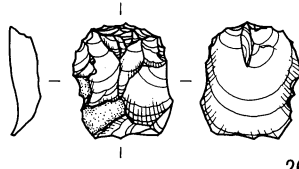

26  
PF Ob WDTY  
BL3 1.5g  
IV中 6550

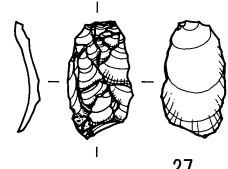

27  
PF Ob WDTY  
BL3 0.45g  
III下 6814

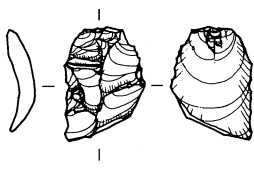

28  
PF Ob WDTY  
BL3 0.77g  
Va上 7008

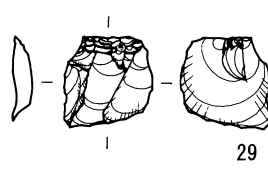

29  
PF Ob WDTY  
BL3 0.81g  
Va上 6458

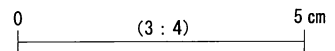



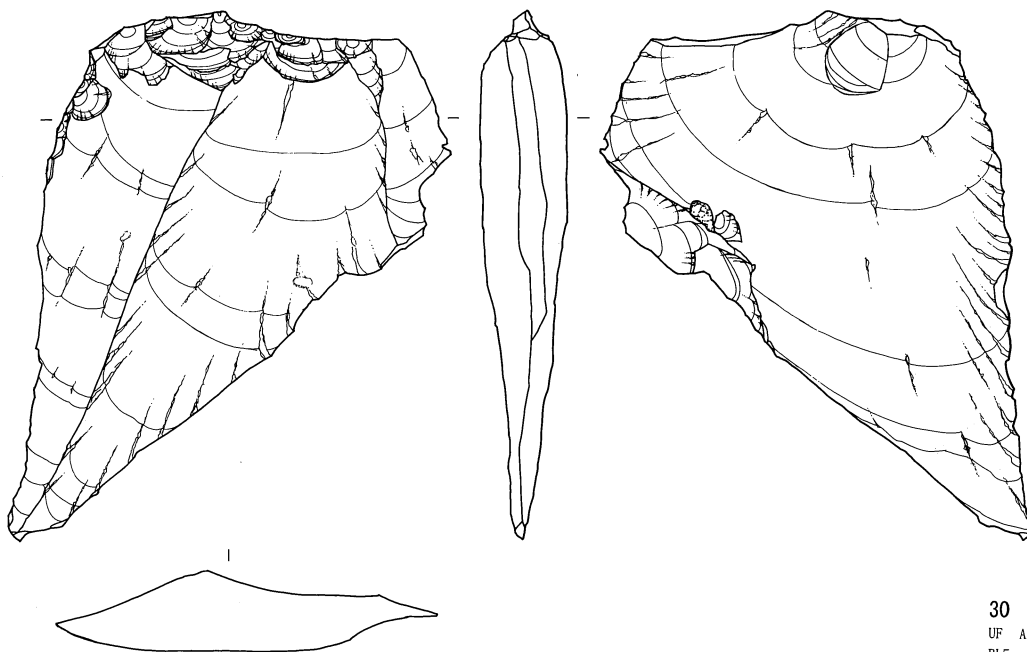

30  
 UF An  
 BL5 68.37g  
 IV上 6365

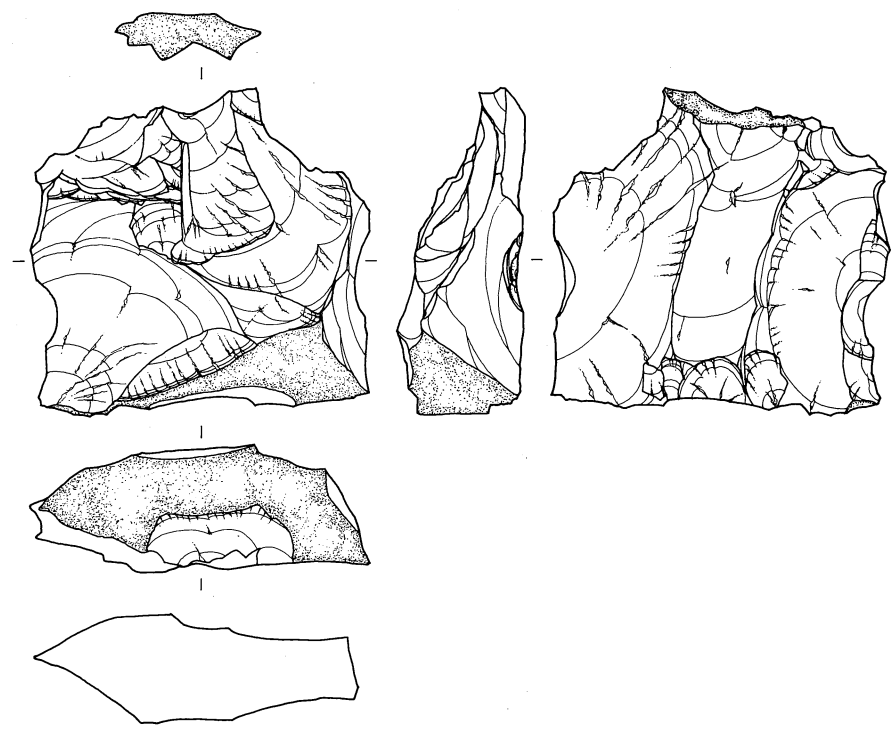

31  
 Co An  
 BL5 76.18g  
 IV上 6379

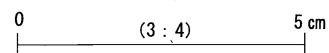

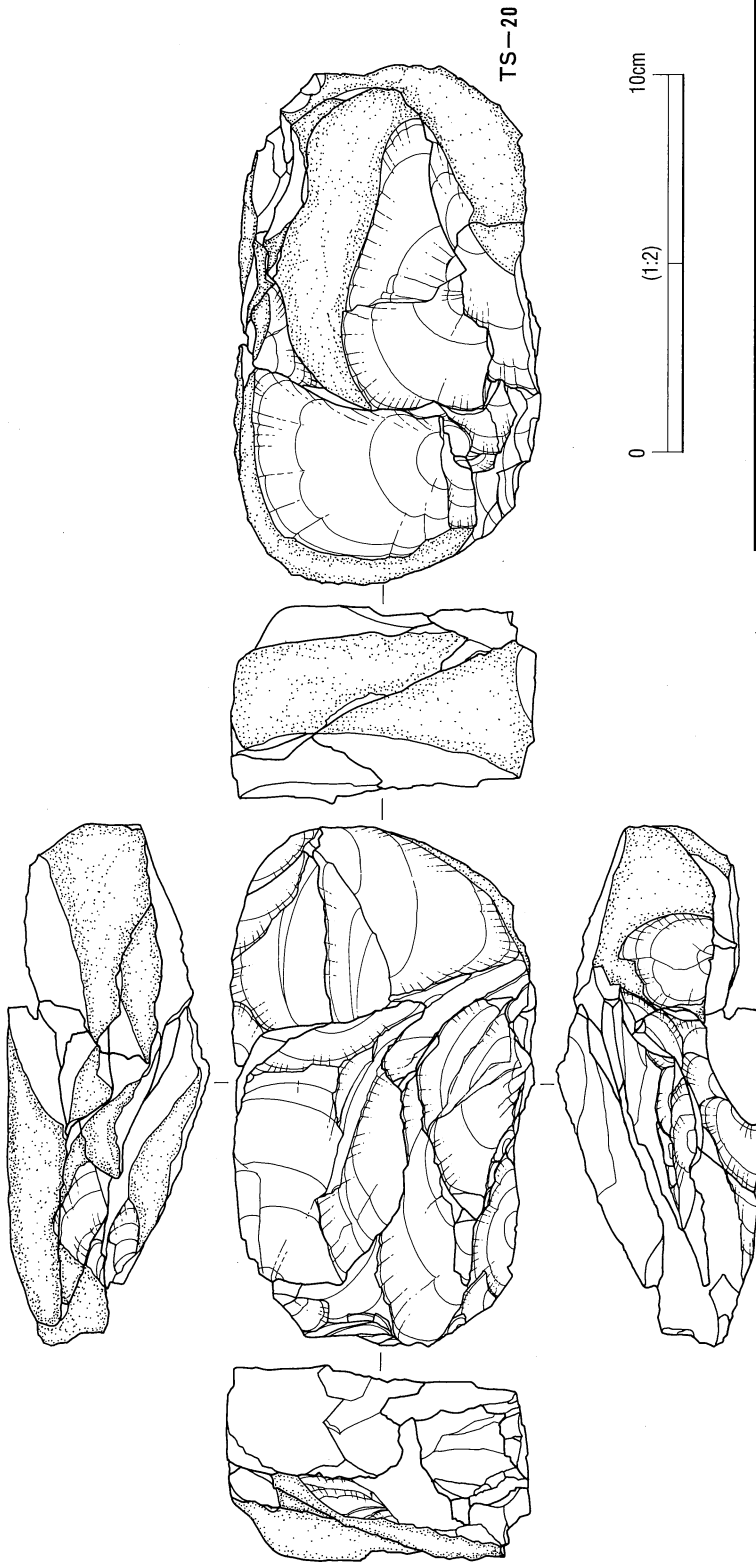

剥離順序	報告番号	遺物番号	ブロック	出土層位	器種	重量g	打面	作業面
1		7012	3	Va中	Fl	52.51	上	正面
2		6439	3	IV上	Fl	19.43	下	正面
3		6446	3	IV上	Ch	0.61	下	正面
4		6452	3	Va上	Fl	75.61	下	正面
5		7014	3	Va下	Fl	25.84	下	正面
6		6817	3	IV下	Fl	114.83	下	正面
7		6516	2	Va上	Fl	25.24	上	正面
8		6440	3	IV下	Fl	25.22	上	正面
9		6435	3	IV中	Fl	24.8	上	正面
10	88	6433	3	IV中	Fl	12.57	上	正面
11		6415	3	IV上	Fl	20.7	下	正面
12		6431	3	IV中	Fl	1.42	下	正面
13		6825	3	IV中	Fl	72.17	下	正面
14		6429	3	IV中	Fl	68.38		

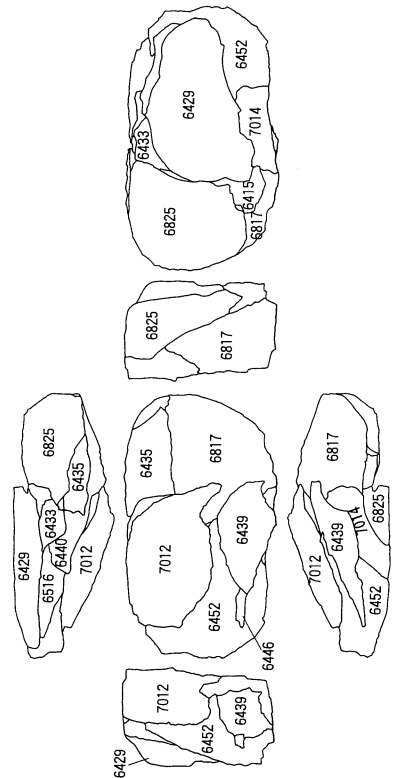

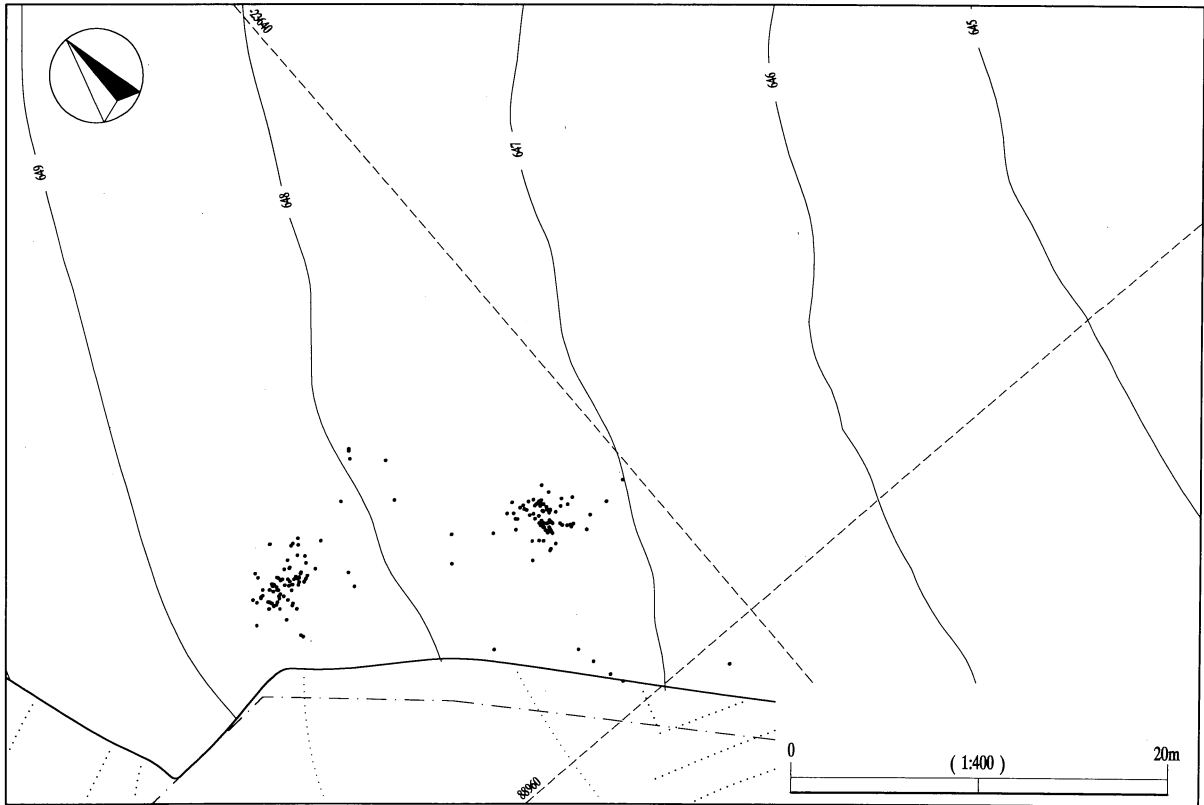

石器全点

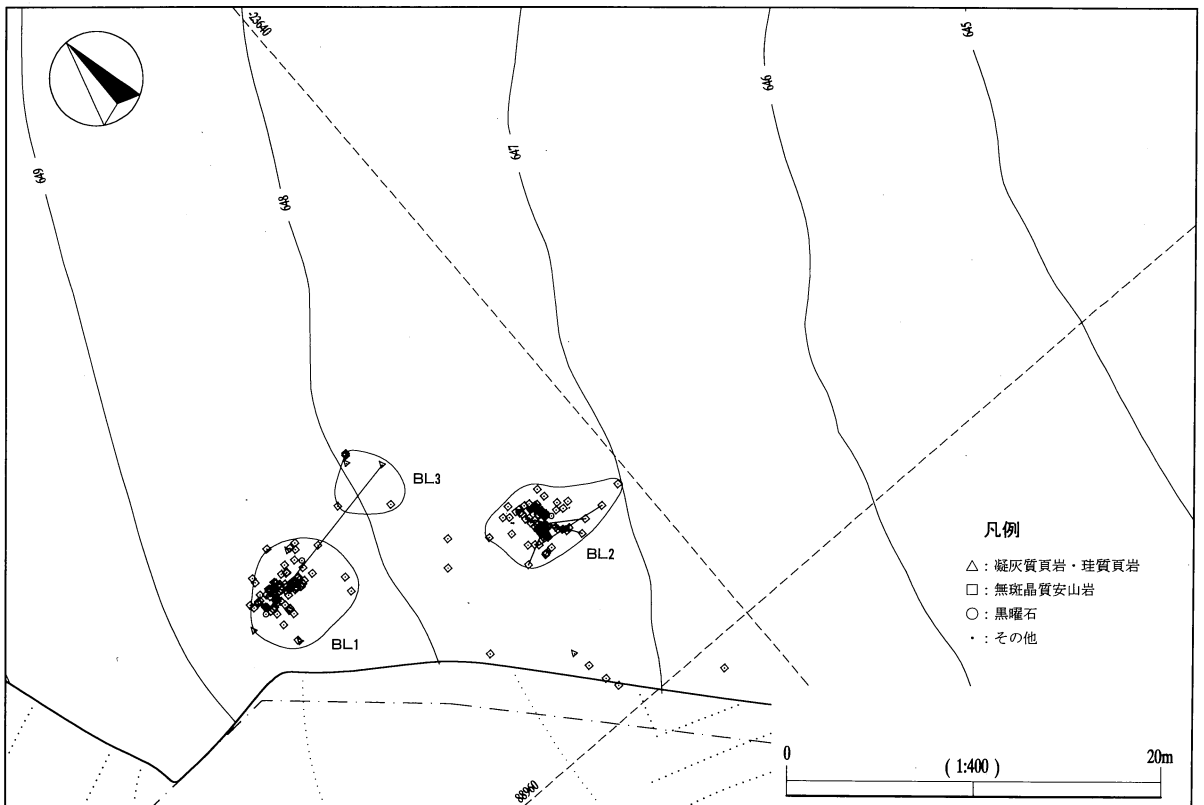

石材別・接合資料分布図

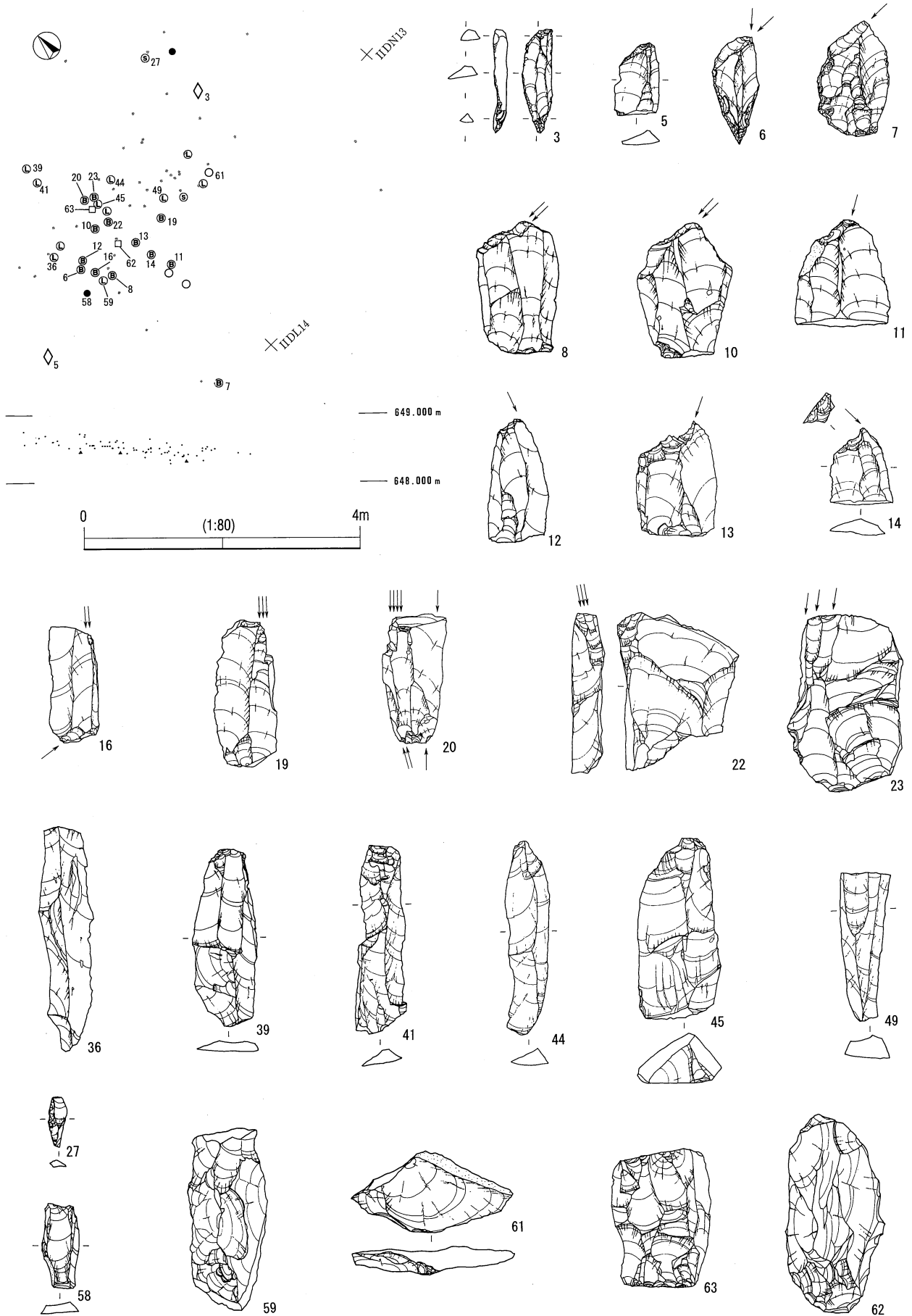

七ツ栗II石器文化 BL1遺物分布図

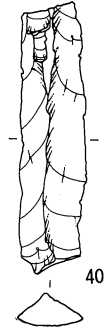
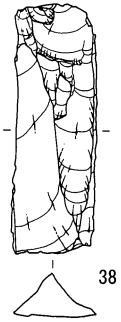
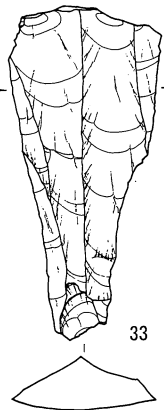
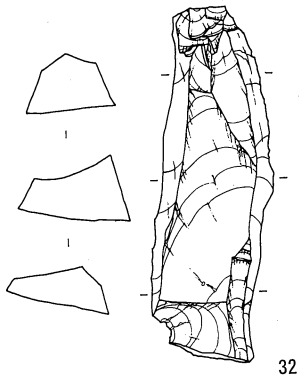
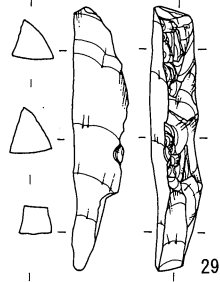
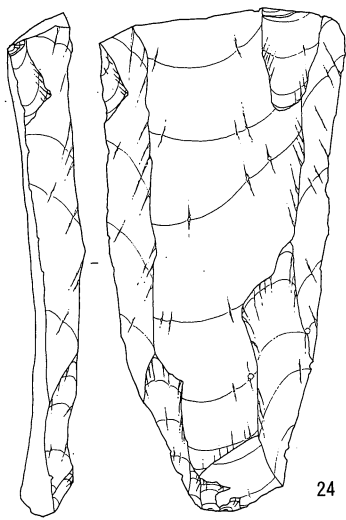
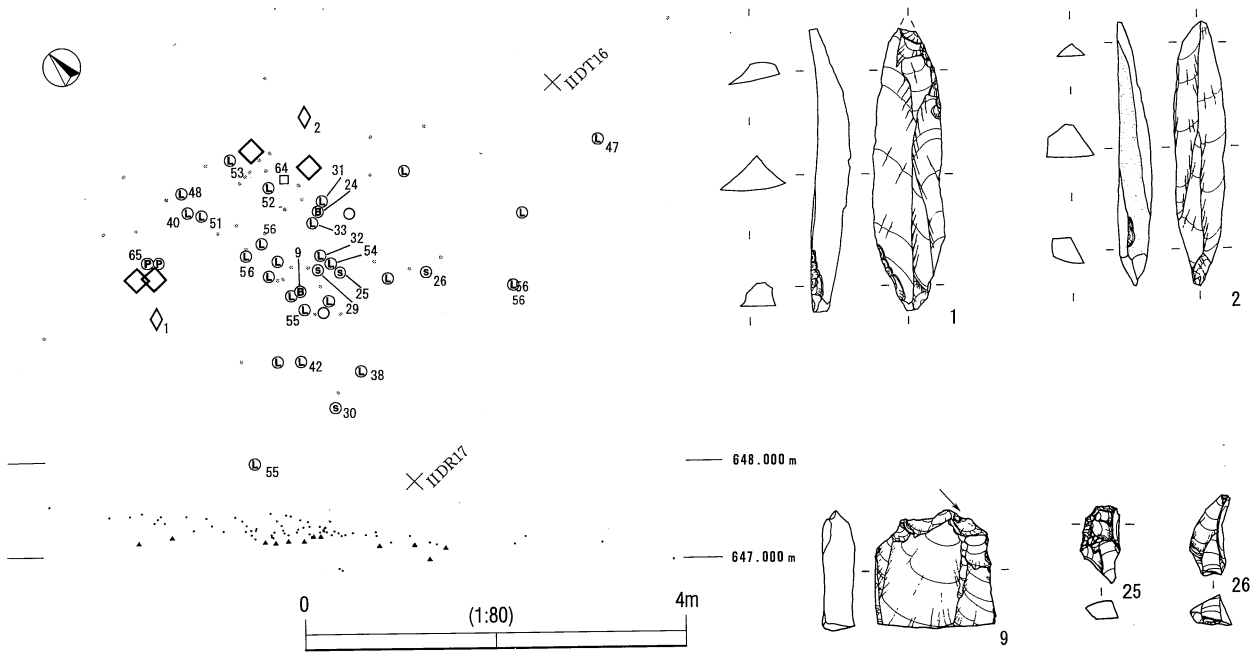

七ツ栗II石器文化 BL2遺物分布図

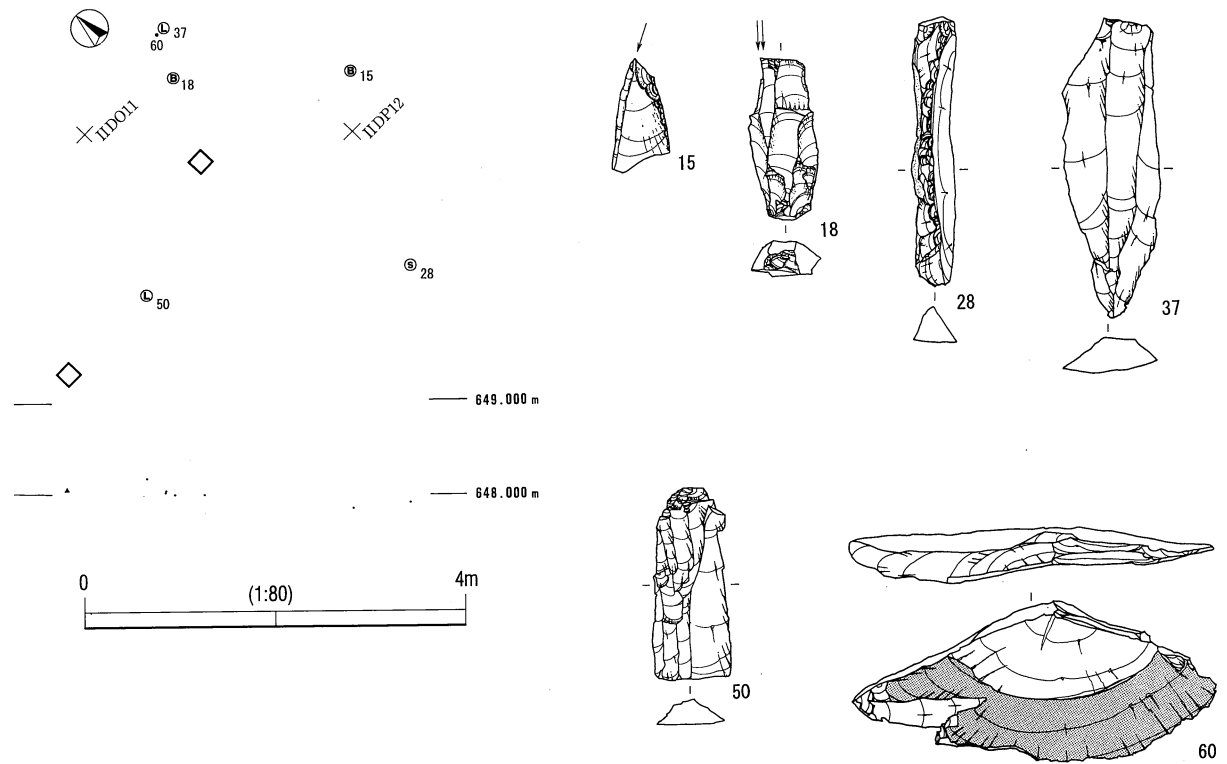
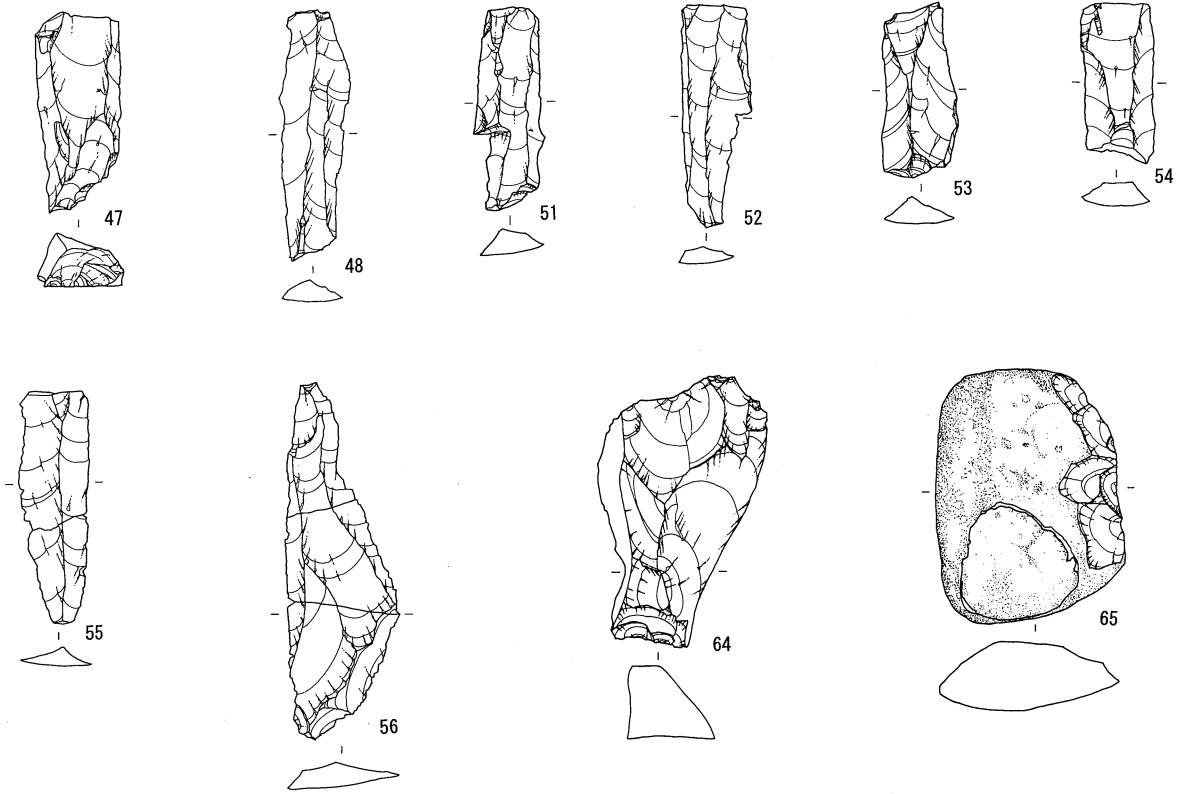

七ツ栗II石器文化 BL2出土石器・BL3遺物分布図

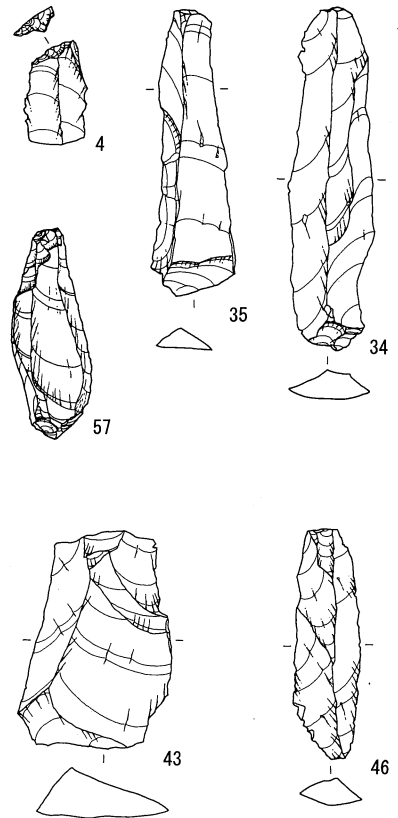
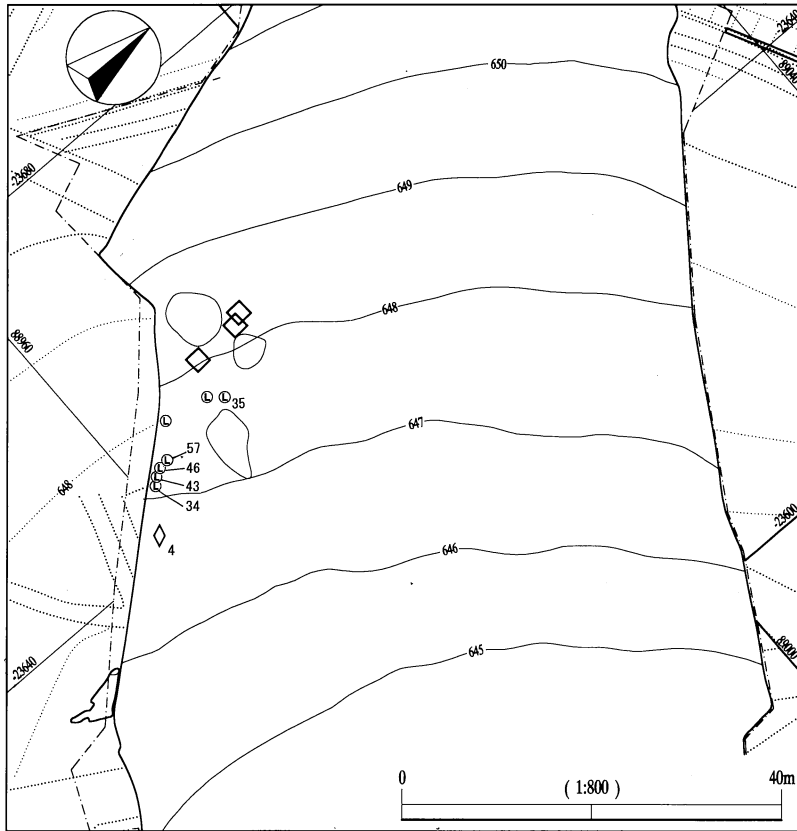

七ツ栗II石器文化 ブロック外遺物分布図

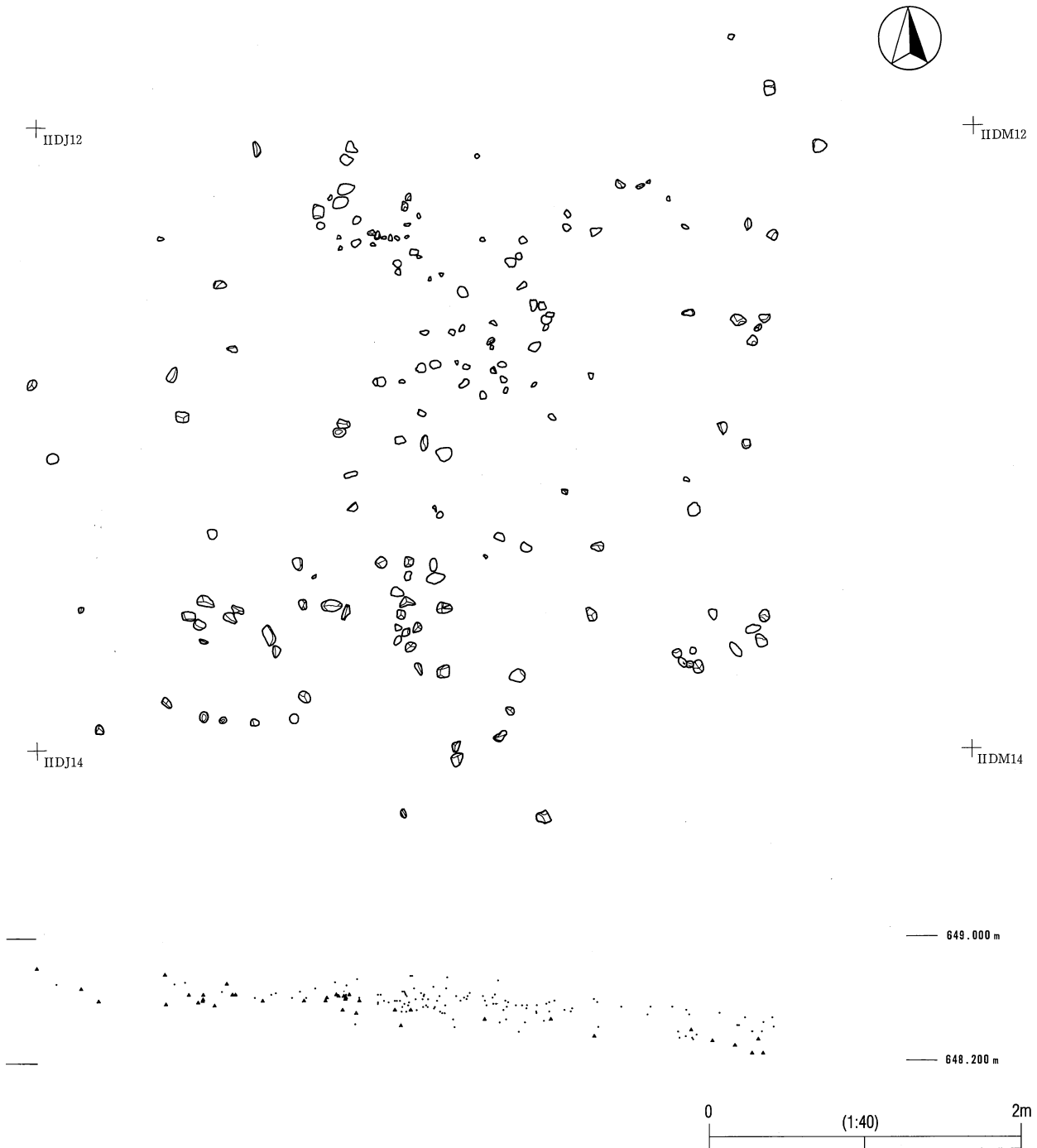
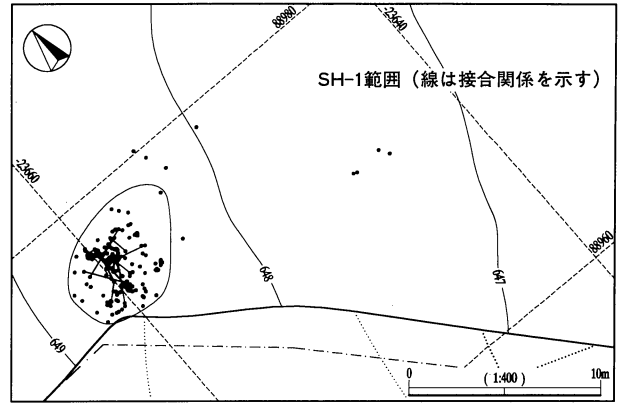
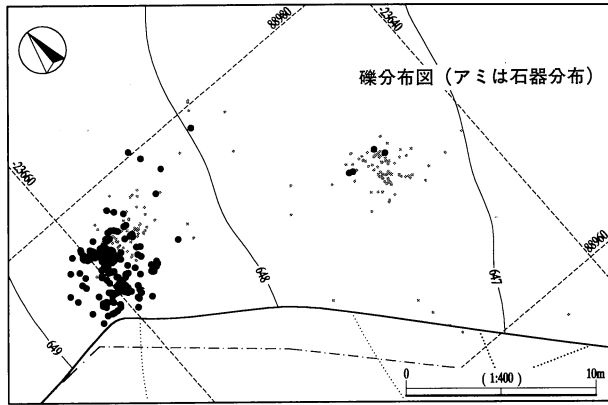

七ツ栗II石器文化 SH1遺物分布図



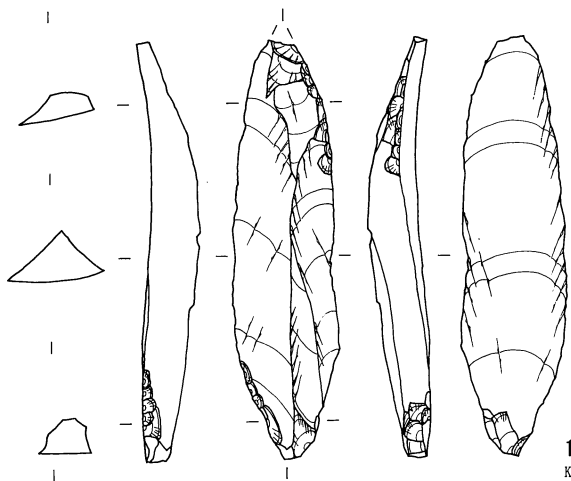

1  
Kn An  
BL2 9.83g  
Ⅲ上 4646

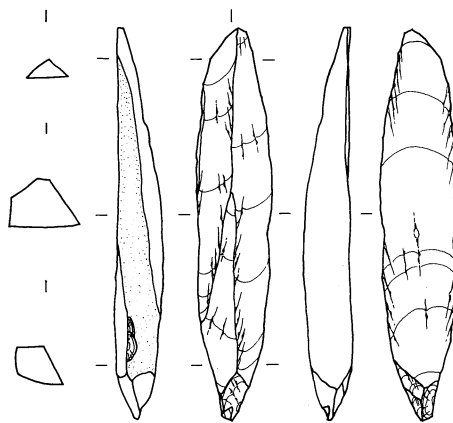

2  
Kn An  
BL2 7.39g  
Ⅱ下 4709

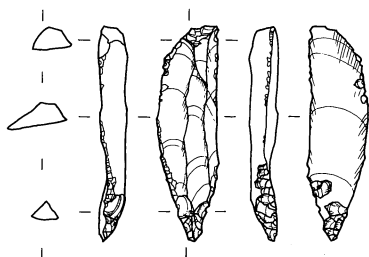

3  
Kn Ob WDTY  
BL1 1.42g  
Ⅲ上 4746

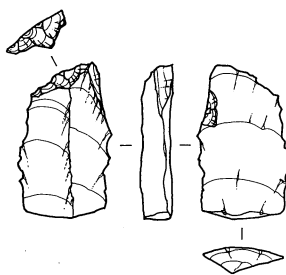

4  
Kn An  
外 2.19g  
Ⅱ上 4752

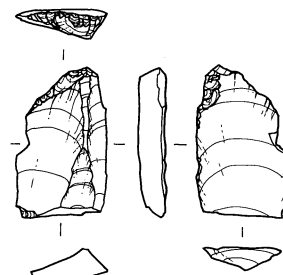

5  
Kn SS  
BL1 2.18g  
Ⅲ上 4907

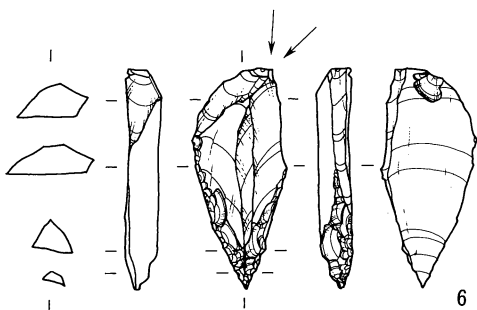

6  
Gr SS  
BL1 3.7g  
Ⅲ下 5001

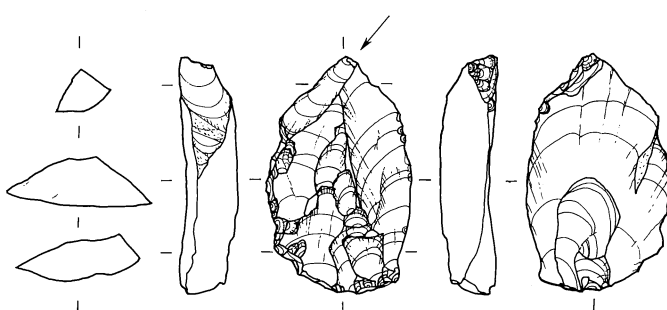

7  
Gr SS  
BL1 10.23g  
Ⅲ上 4747

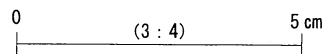

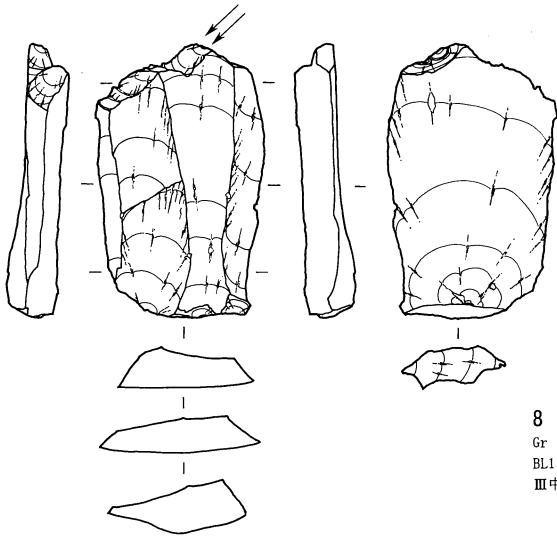

8  
Gr An  
BL1 13.32g  
III中 4957

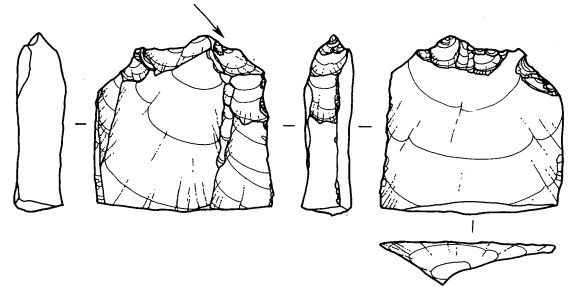

9  
Gr SS  
BL2 8.37g  
II中 4699

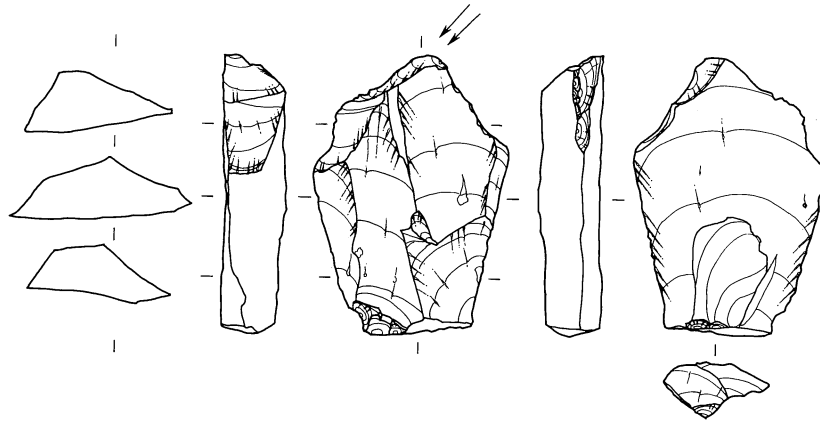

10  
Gr An  
BL1 18.5g  
III中 4950

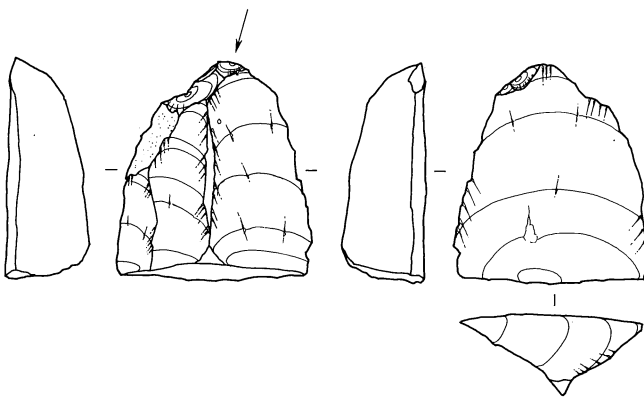

11  
Gr An  
BL1 17.02g  
III中 4955

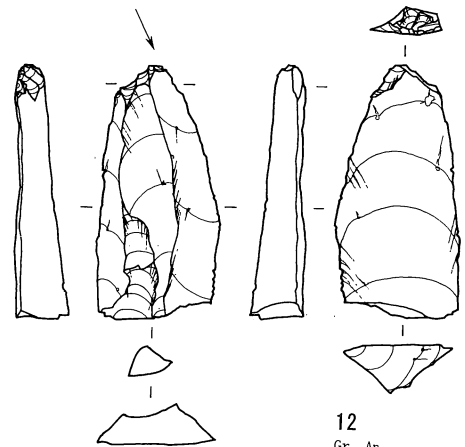

12  
Gr An  
BL1 7.91g  
II中 4962

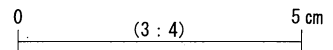

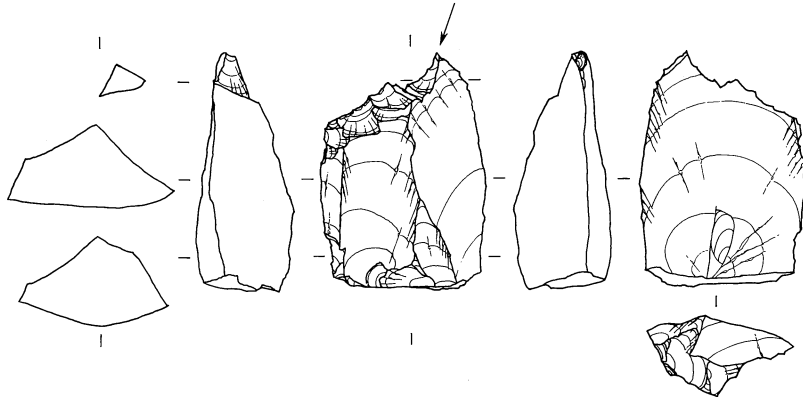

13  
Gr An  
BL1 18.28g  
III中 4953

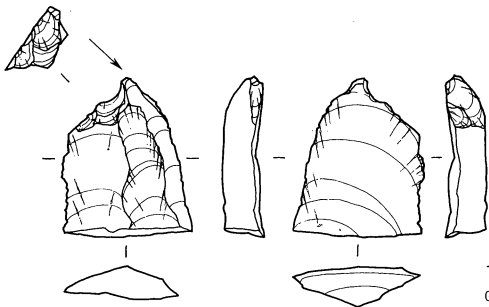

14  
Gr An  
BL1 4.16g  
II中 4954

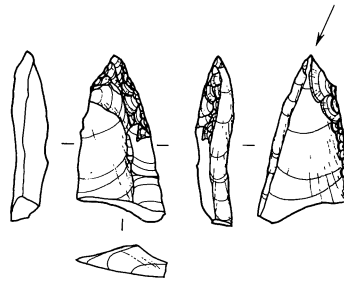

15  
Gr SS  
BL3 2.23g  
II中 4720

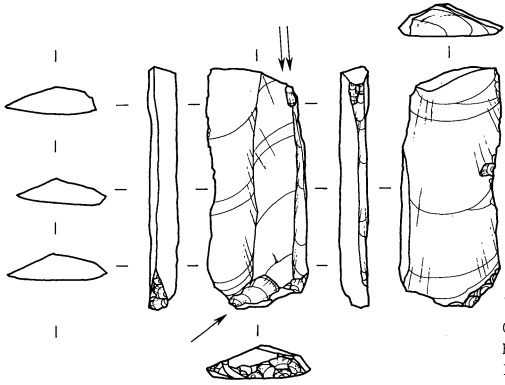

16  
Gr SS  
BL1 4.91g  
III中 4999

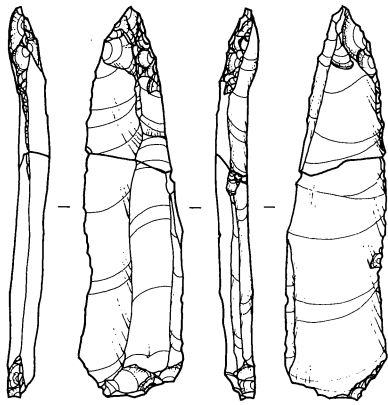

17

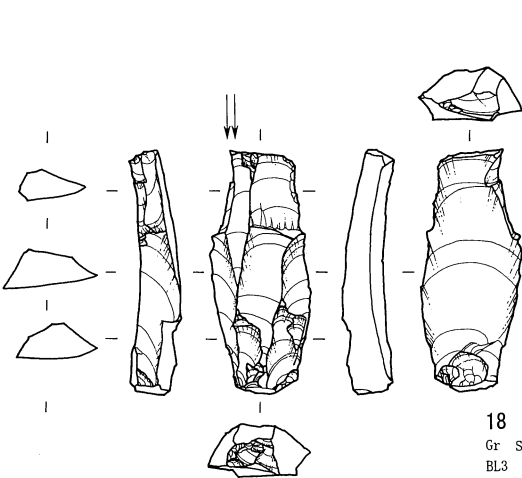

18  
Gr SS  
BL3 5.98g  
III下 4721

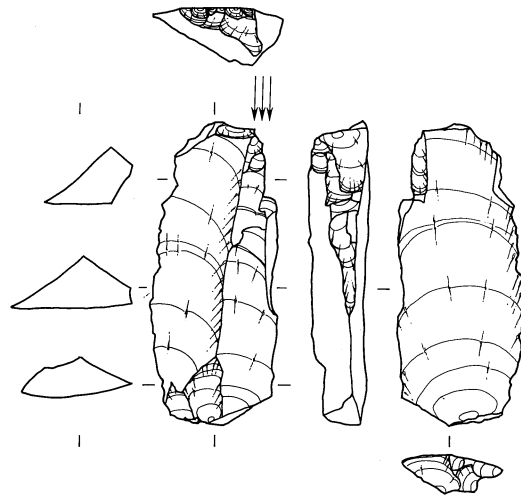

19  
Gr An  
BL1 11.58g  
III上 4934

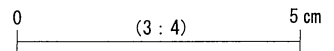

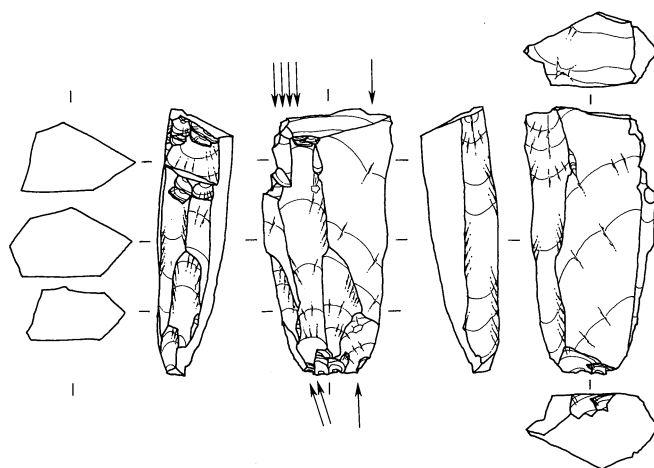

20  
Gr An  
BL1 15.39g  
Ⅲ中 4944

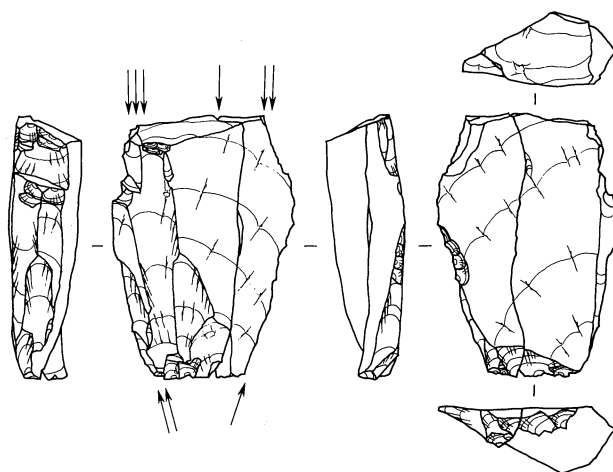

21  
Sp An Gr An  
BL1 3.89g BL1 15.39g  
Ⅱ中 4927 Ⅲ中 4944

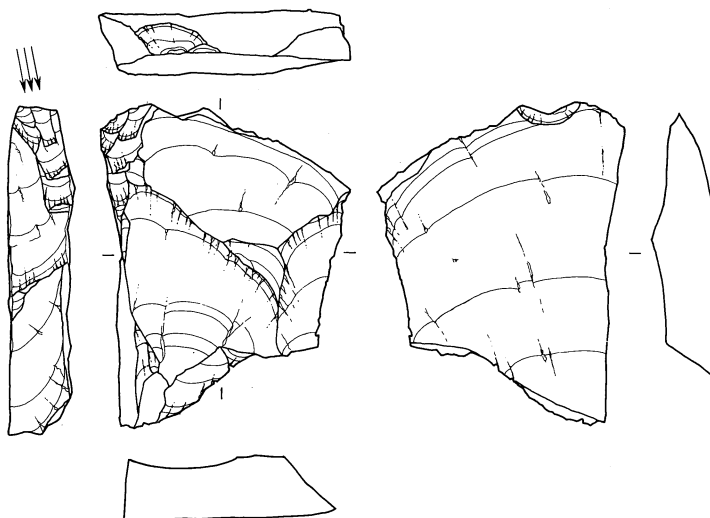

22  
Gr An  
BL1 29.42g  
Ⅲ中 4948

0 (3:4) 5 cm

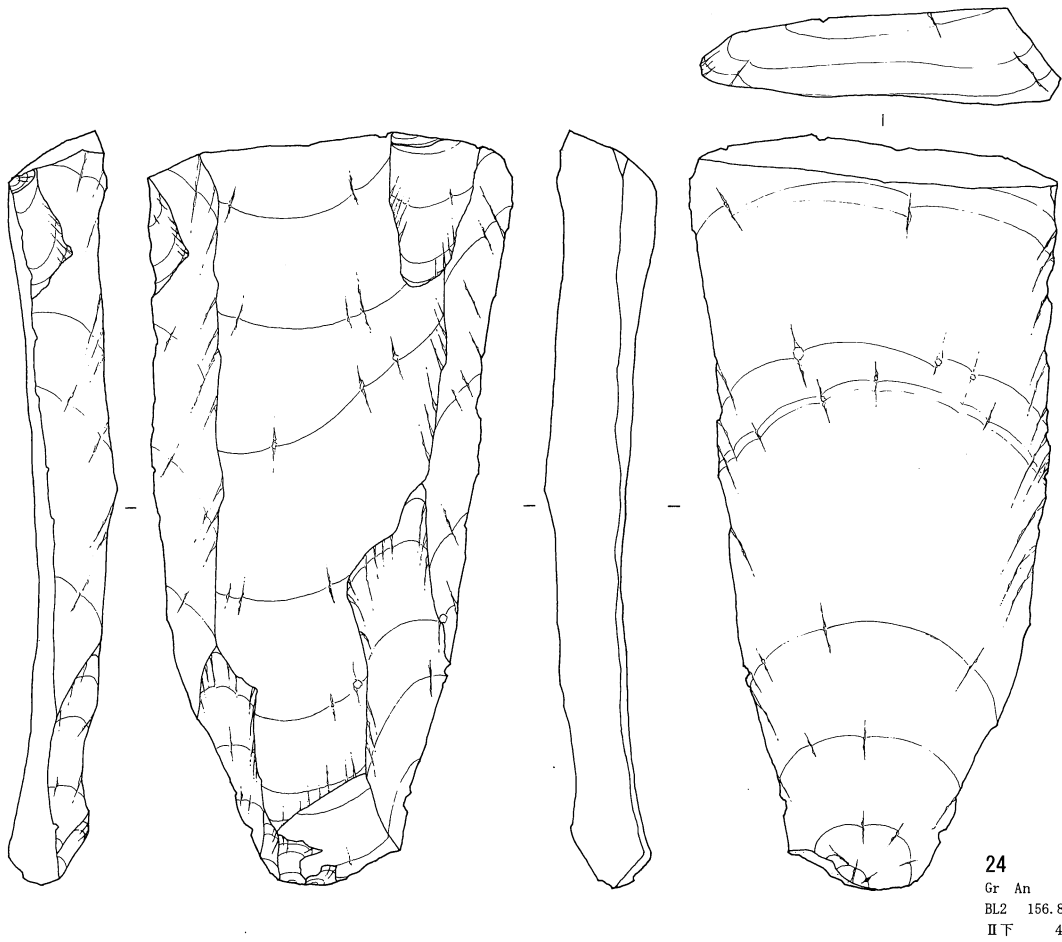
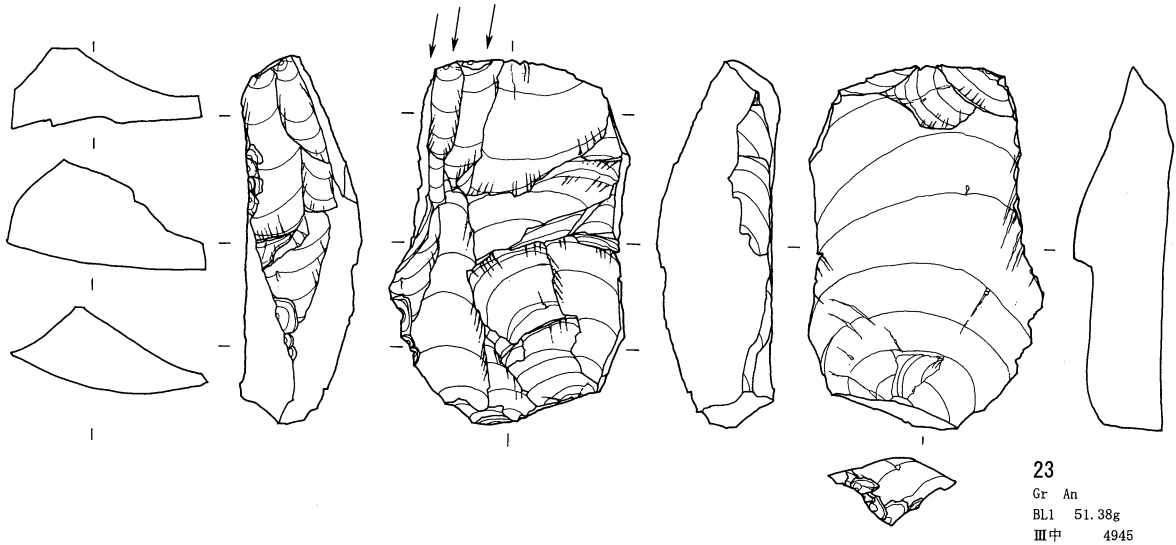

0 (3 : 4) 5 cm

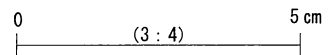
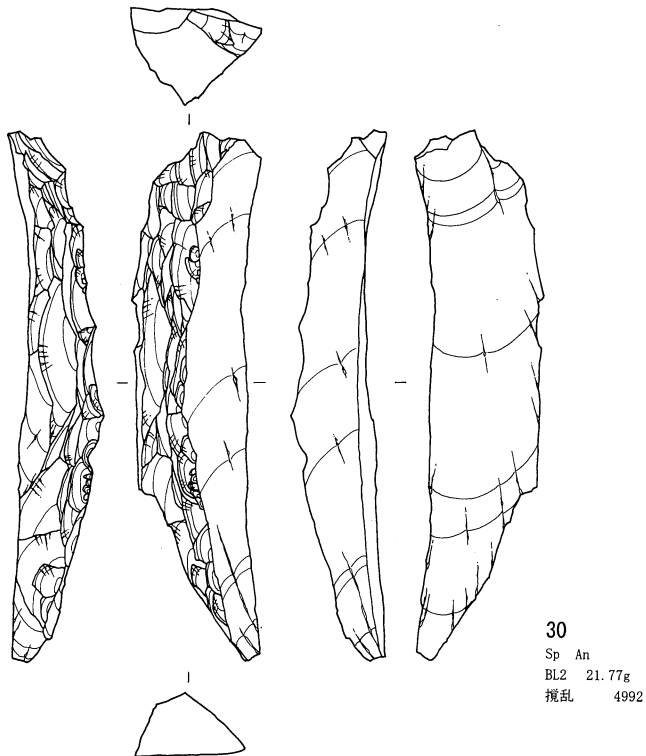
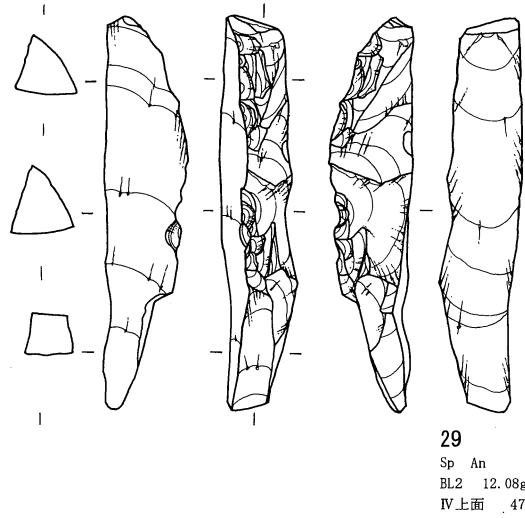
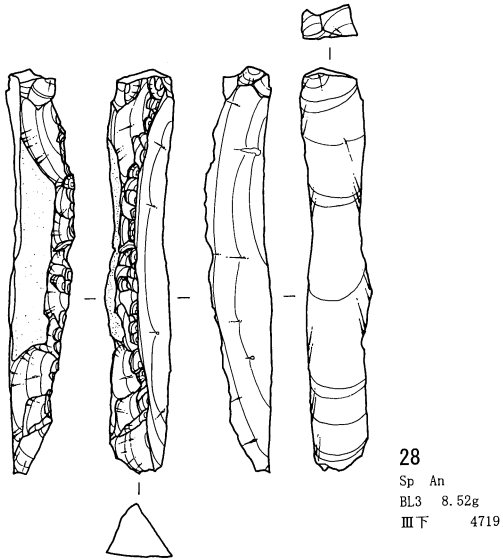
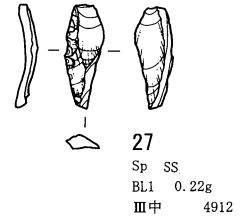
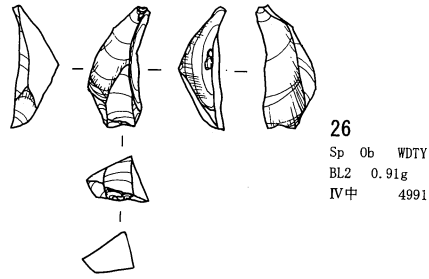
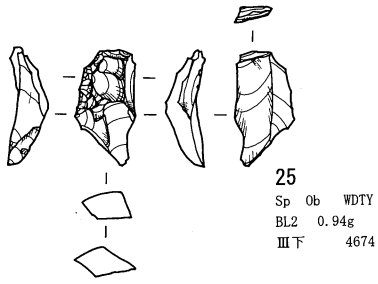

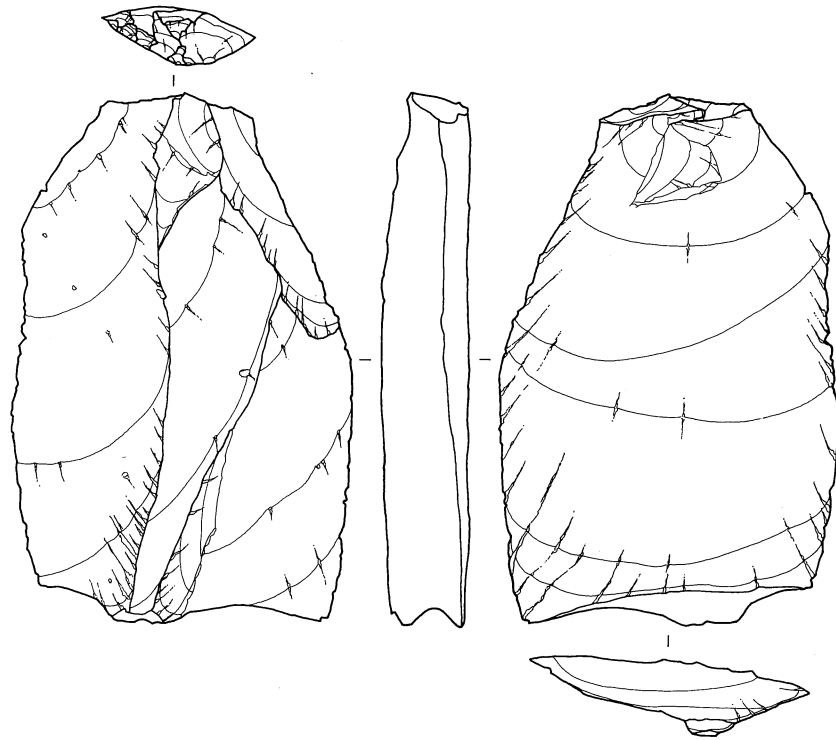

31  
 B1 An  
 BL2 90.83g  
 II下 4642

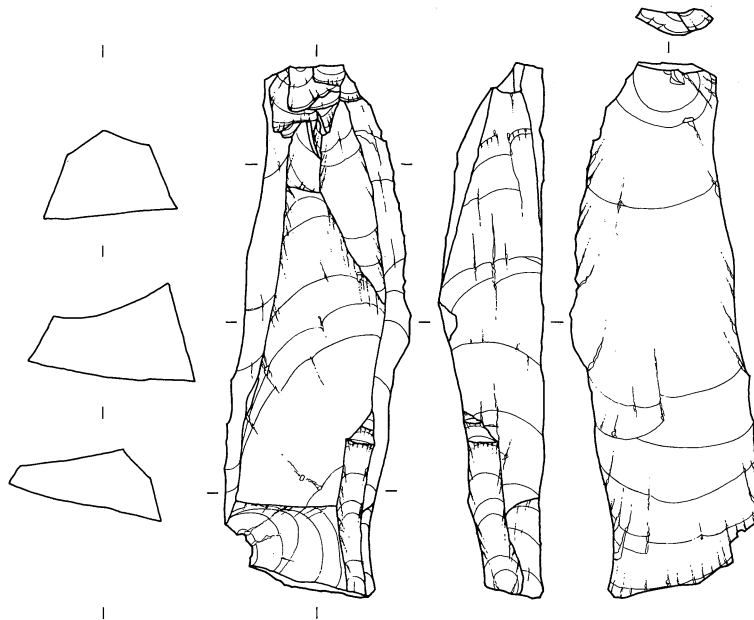

32  
 B1 An  
 BL2 47.52g  
 III下 4676

0 (3:4) 5 cm

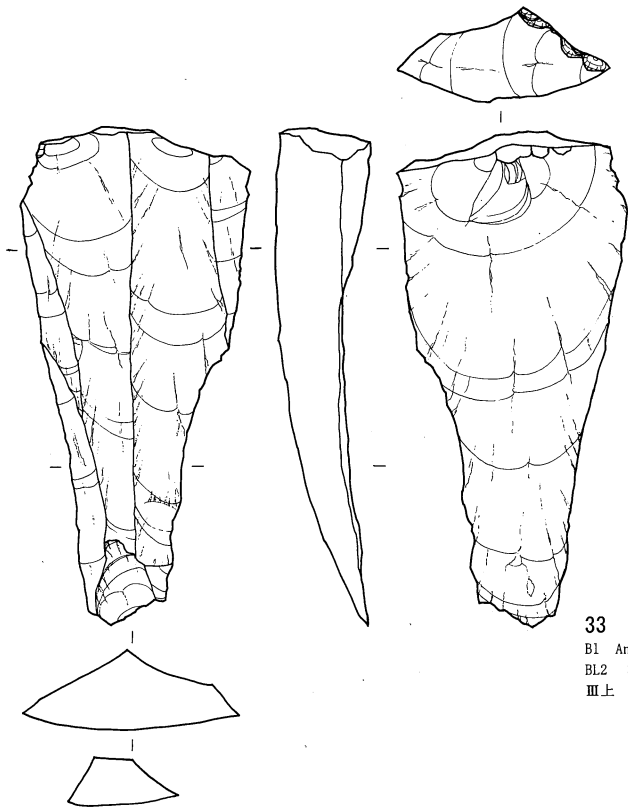

33  
 Bl An  
 BL2 37.08g  
 III上 4661

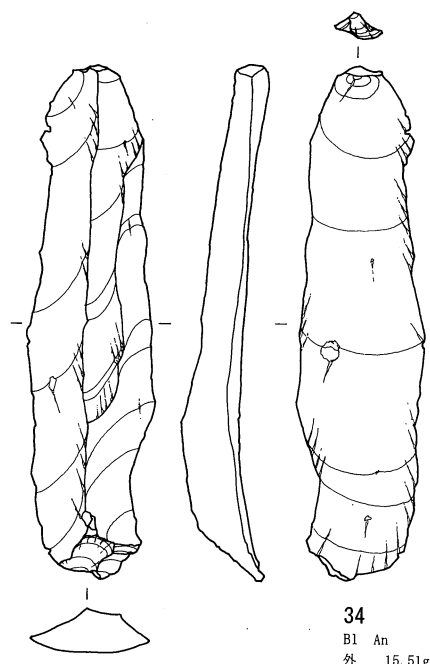

34  
 Bl An  
 外 15.51g  
 II中 4648

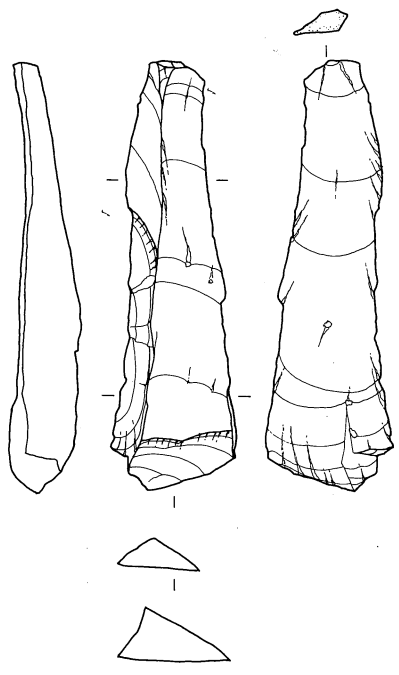

35  
 Bl An  
 外 11.79g  
 III下 4717

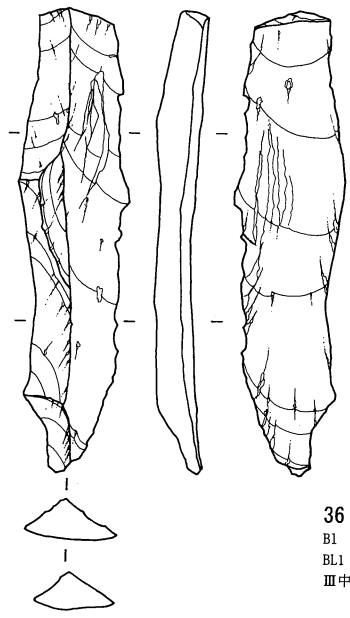

36  
 Bl An  
 BL1 9.39g  
 III中 4963

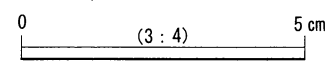



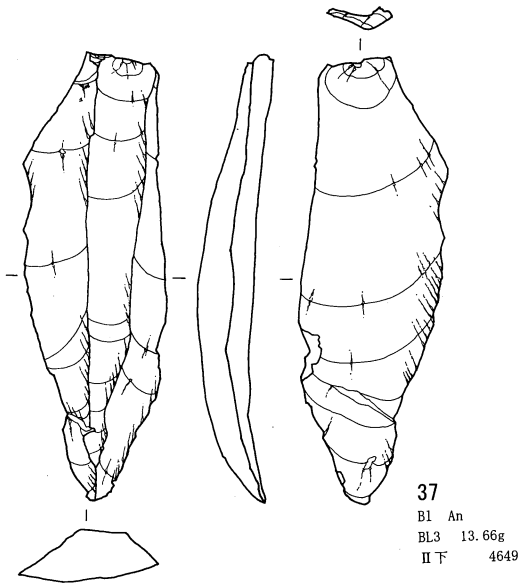

37  
 B1 An  
 BL3 13.66g  
 II下 4649

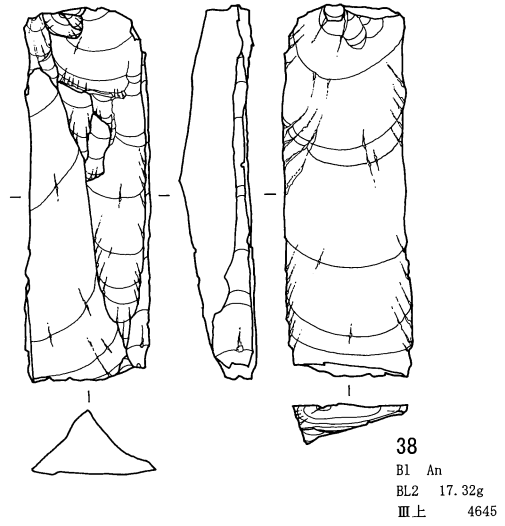

38  
 B1 An  
 BL2 17.32g  
 III上 4645

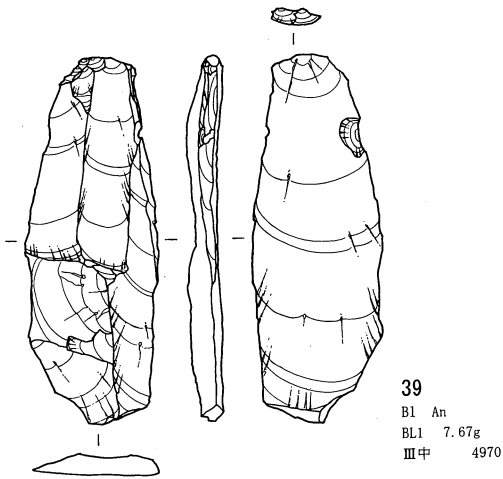

39  
 B1 An  
 BL1 7.67g  
 III中 4970

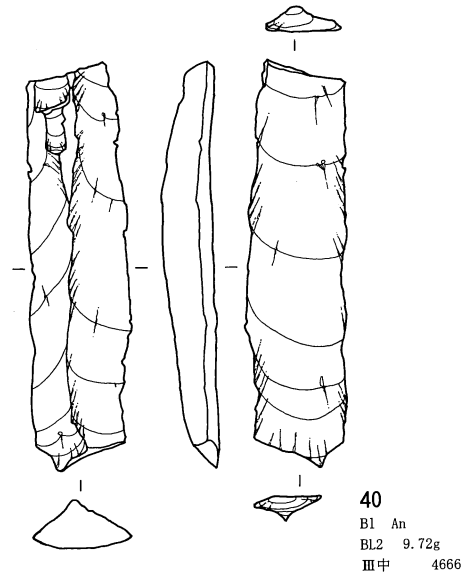

40  
 B1 An  
 BL2 9.72g  
 III中 4666

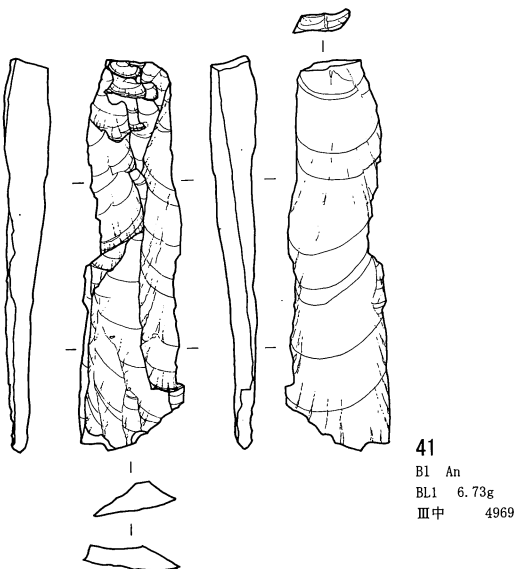

41  
 B1 An  
 BL1 6.73g  
 III中 4969

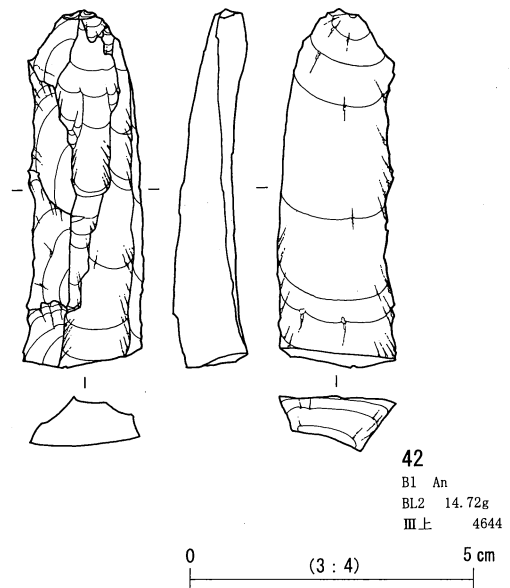

42  
 B1 An  
 BL2 14.72g  
 III上 4644

0 (3:4) 5 cm

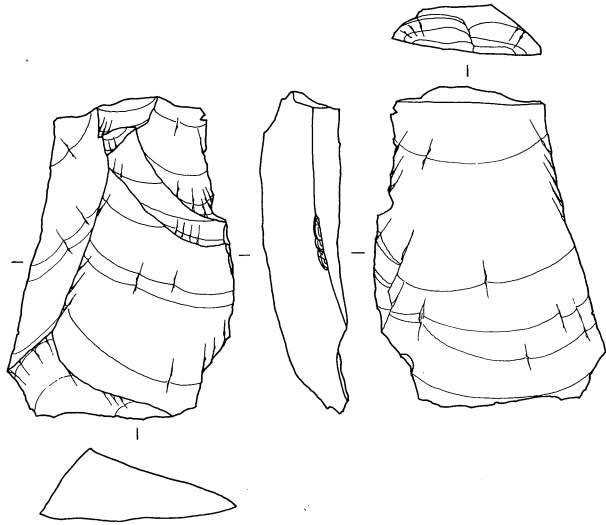

43  
B1 An  
外 25.85g  
II中 4749

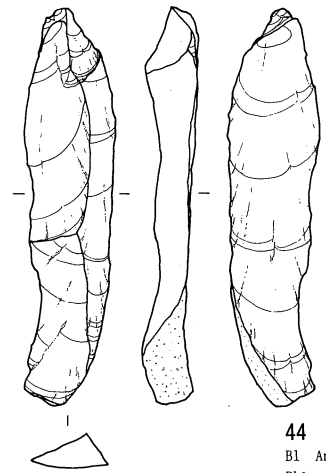

44  
B1 An  
BL1 7.37g  
II中 4942

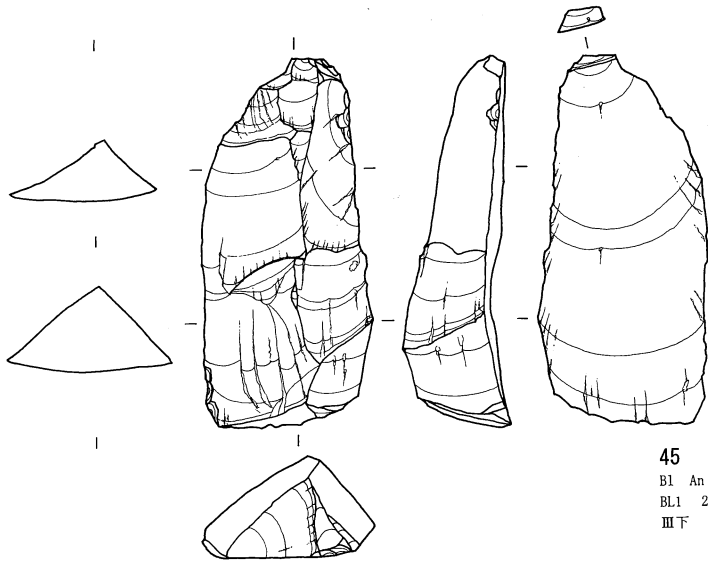

45  
B1 An  
BL1 28.17g  
III下 4996

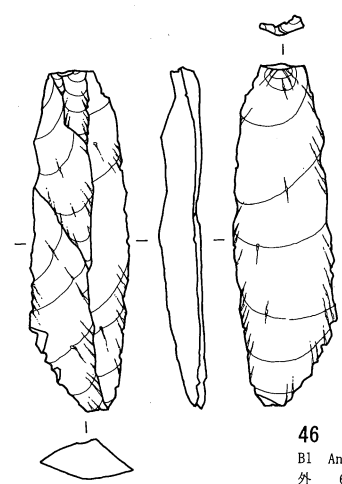

46  
B1 An  
外 6.38g  
II下 4647

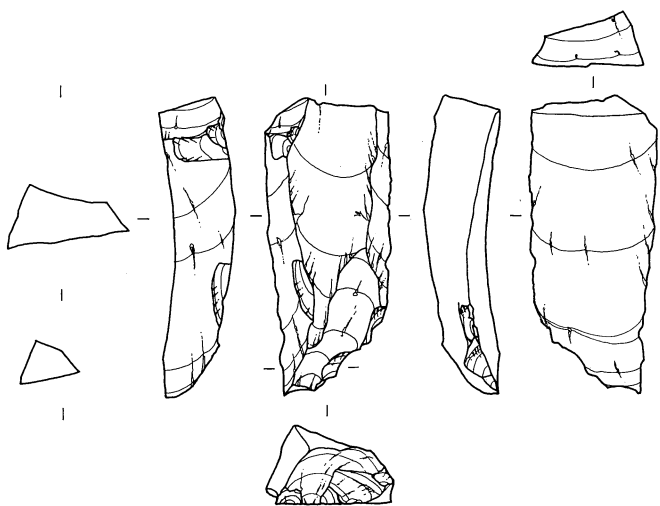

47  
B1 An  
BL2 14.49g  
II中 4713

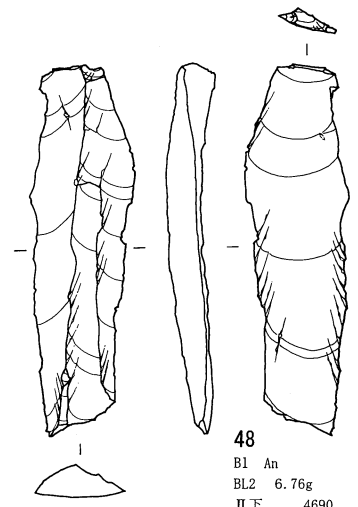

48  
B1 An  
BL2 6.76g  
II下 4690

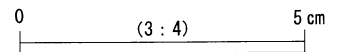

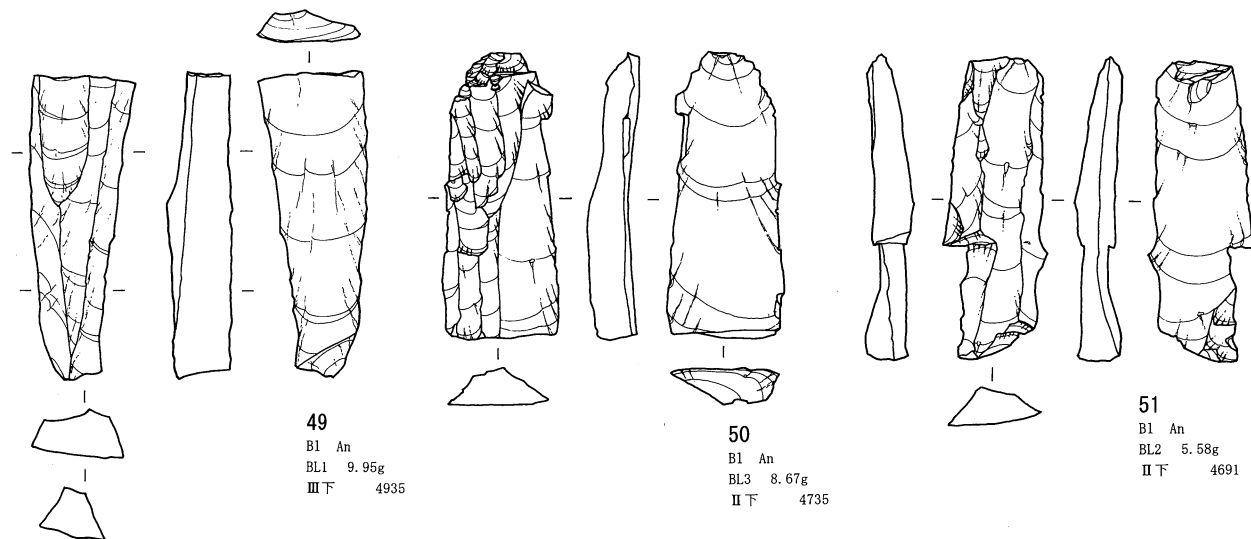

49  
B1 An  
BL1 9.95g  
III下 4935

50  
B1 An  
BL3 8.67g  
II下 4735

51  
B1 An  
BL2 5.58g  
II下 4691

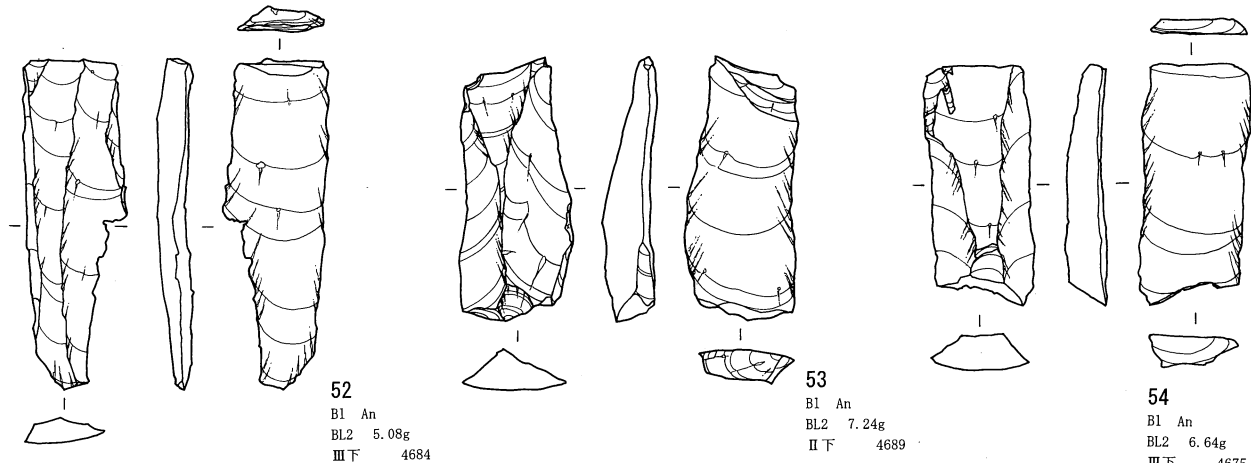

52  
B1 An  
BL2 5.08g  
III下 4684

53  
B1 An  
BL2 7.24g  
II下 4689

54  
B1 An  
BL2 6.64g  
III下 4675

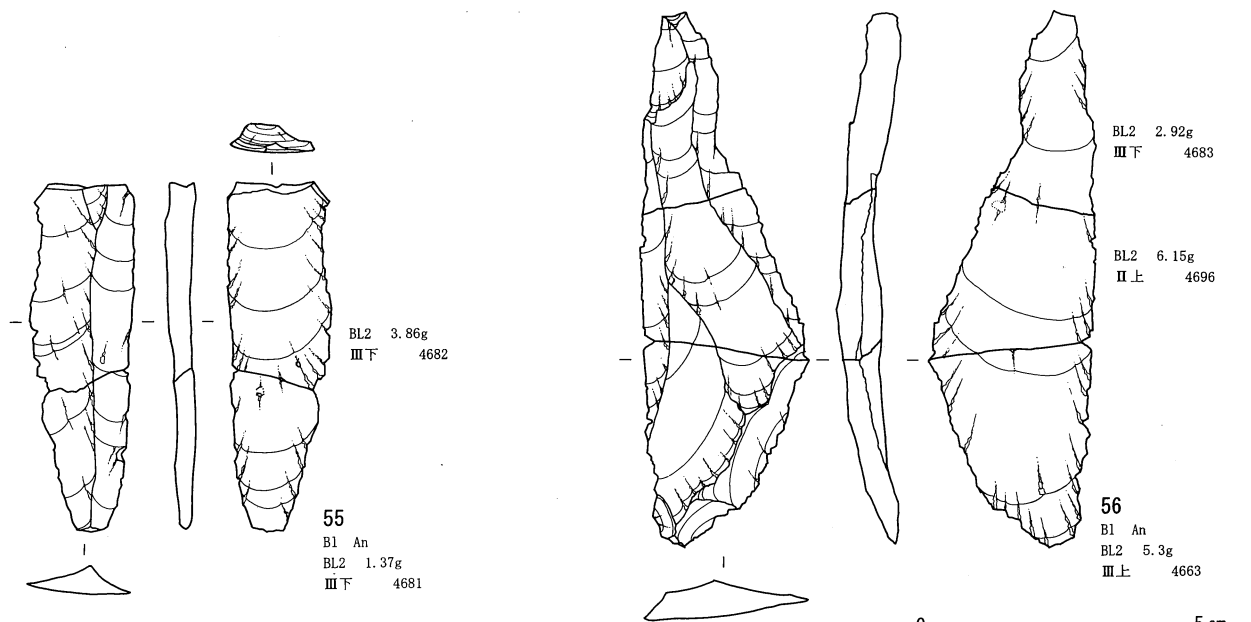

BL2 3.86g  
III下 4682

55  
B1 An  
BL2 1.37g  
III下 4681

BL2 2.92g  
III下 4683

BL2 6.15g  
II上 4696

56  
B1 An  
BL2 5.3g  
III上 4663

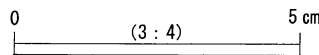

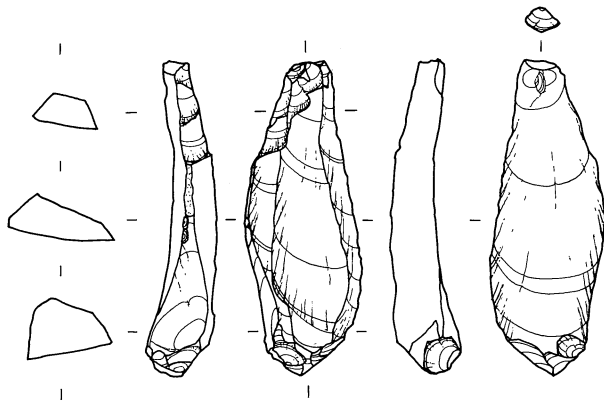

57  
 B1 TS  
 外 8.97g  
 III上 4748

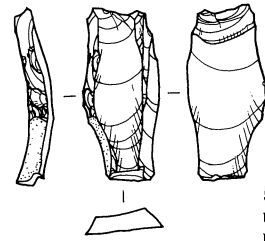

58  
 UF Ob SWHD  
 BL1 2.15g  
 II下 4960

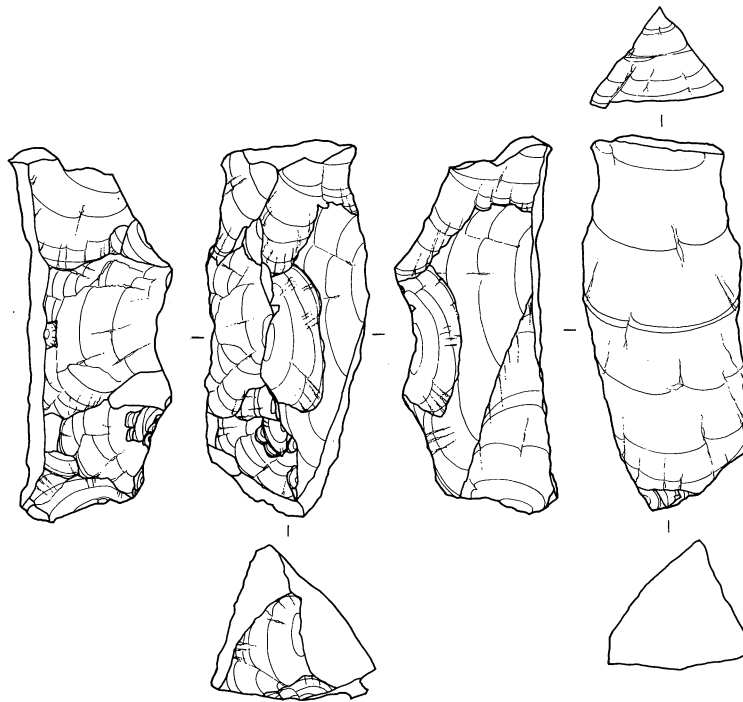

59  
 B1 An  
 BL1 45.52g  
 III上 4959

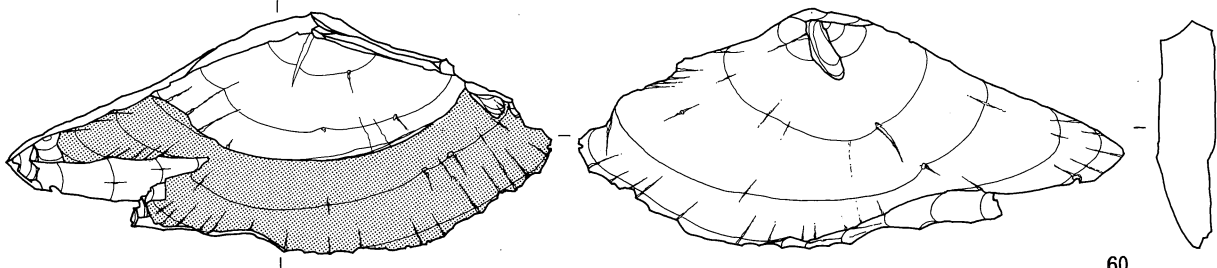
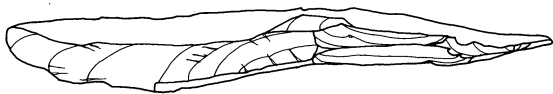

60  
 F1 An  
 BL3 36.85g  
 II下 4650

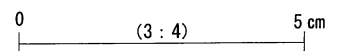

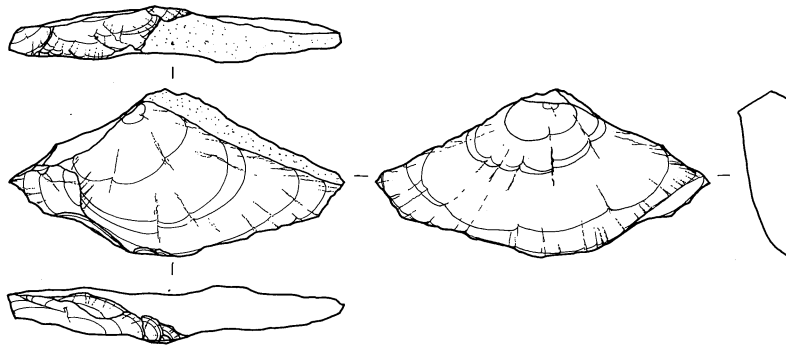

61  
RF An  
BL1 12.55g  
II中 4924

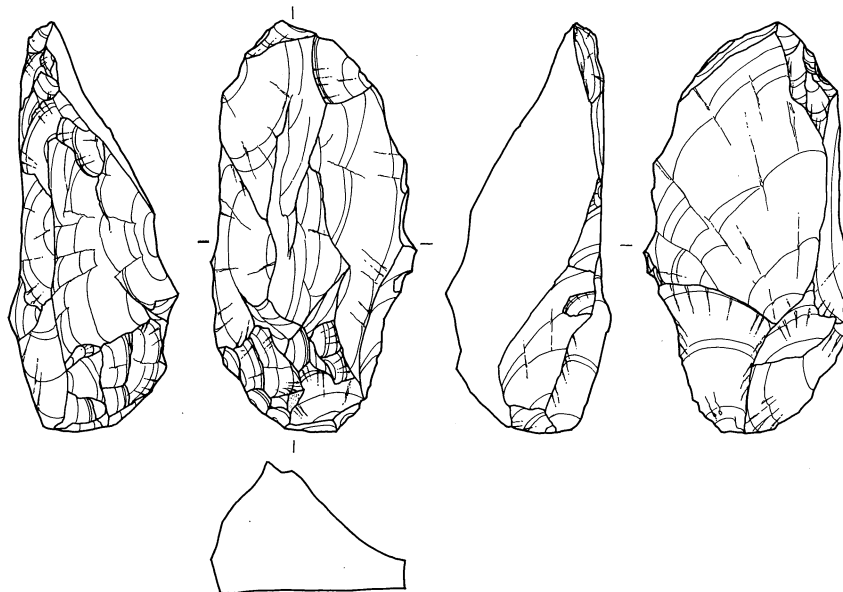

62  
Co An  
BL1 64.49g  
III上 4951

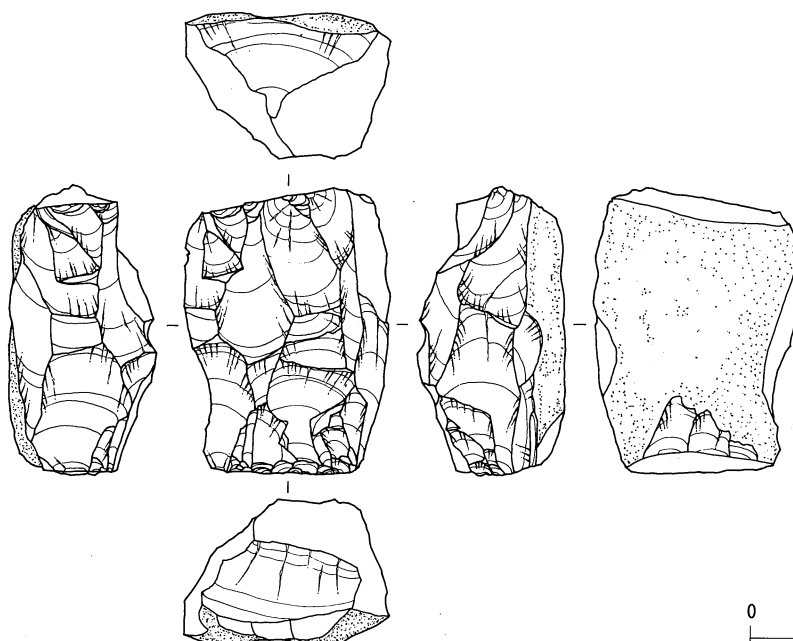

63  
Co An  
BL1 55.42g  
III下 4946

0 (3:4) 5 cm

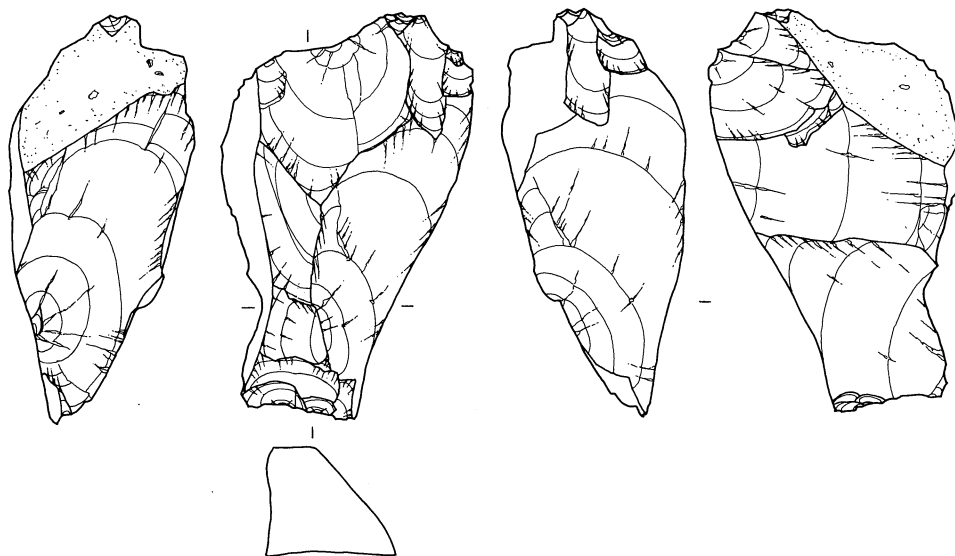

64  
Co An  
BL2 78.37g  
IV上 4704

0 (3 : 4) 5 cm

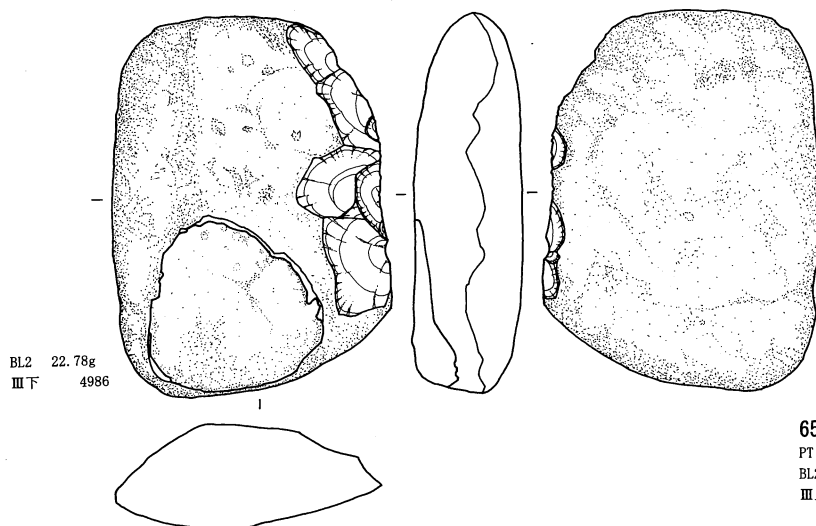

BL2 22.78g  
III下 4986

65  
PT 安山  
BL2 275.7g  
III上 4664

0 (1 : 2) 10 cm

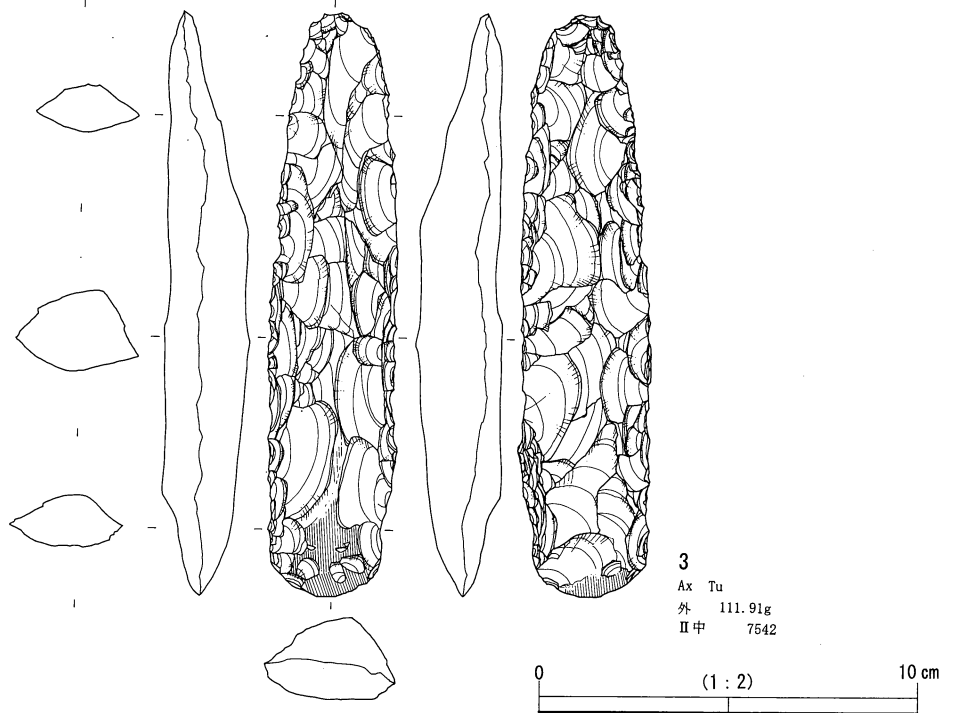
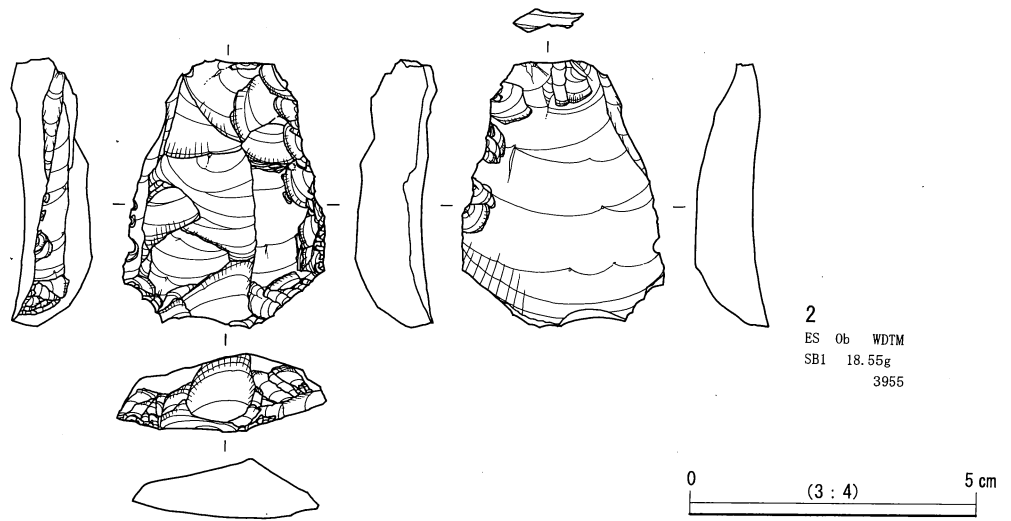
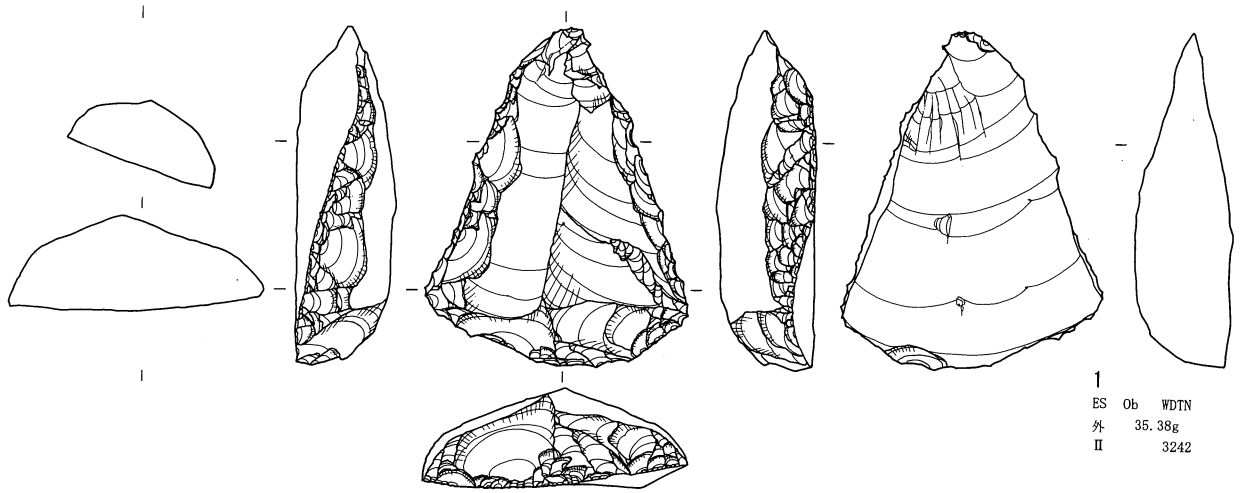

七ツ栗遺跡 その他石器実測図



石器全点

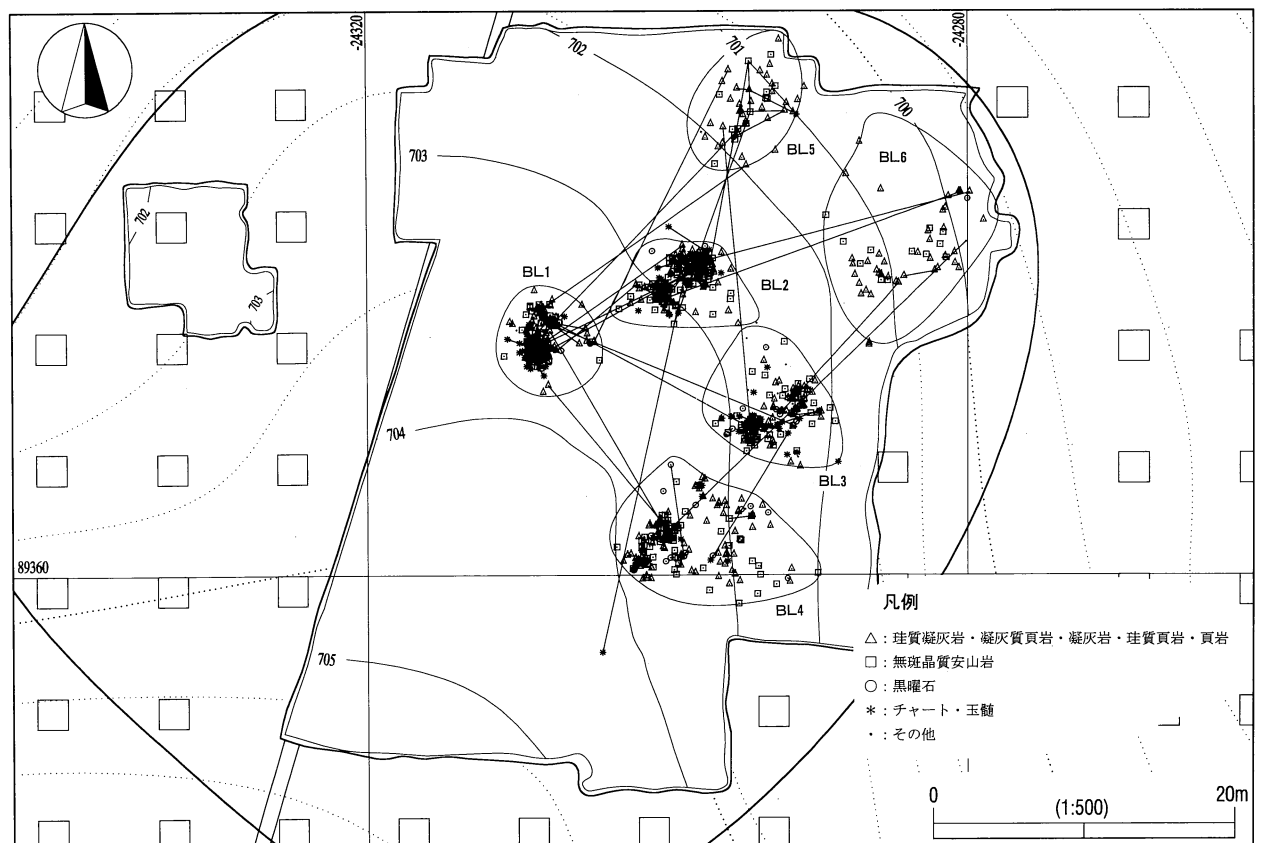

石材別・接合資料分布図  
大平I石器文化 全体図





大平 I 石器文化 BL1遺物分布図

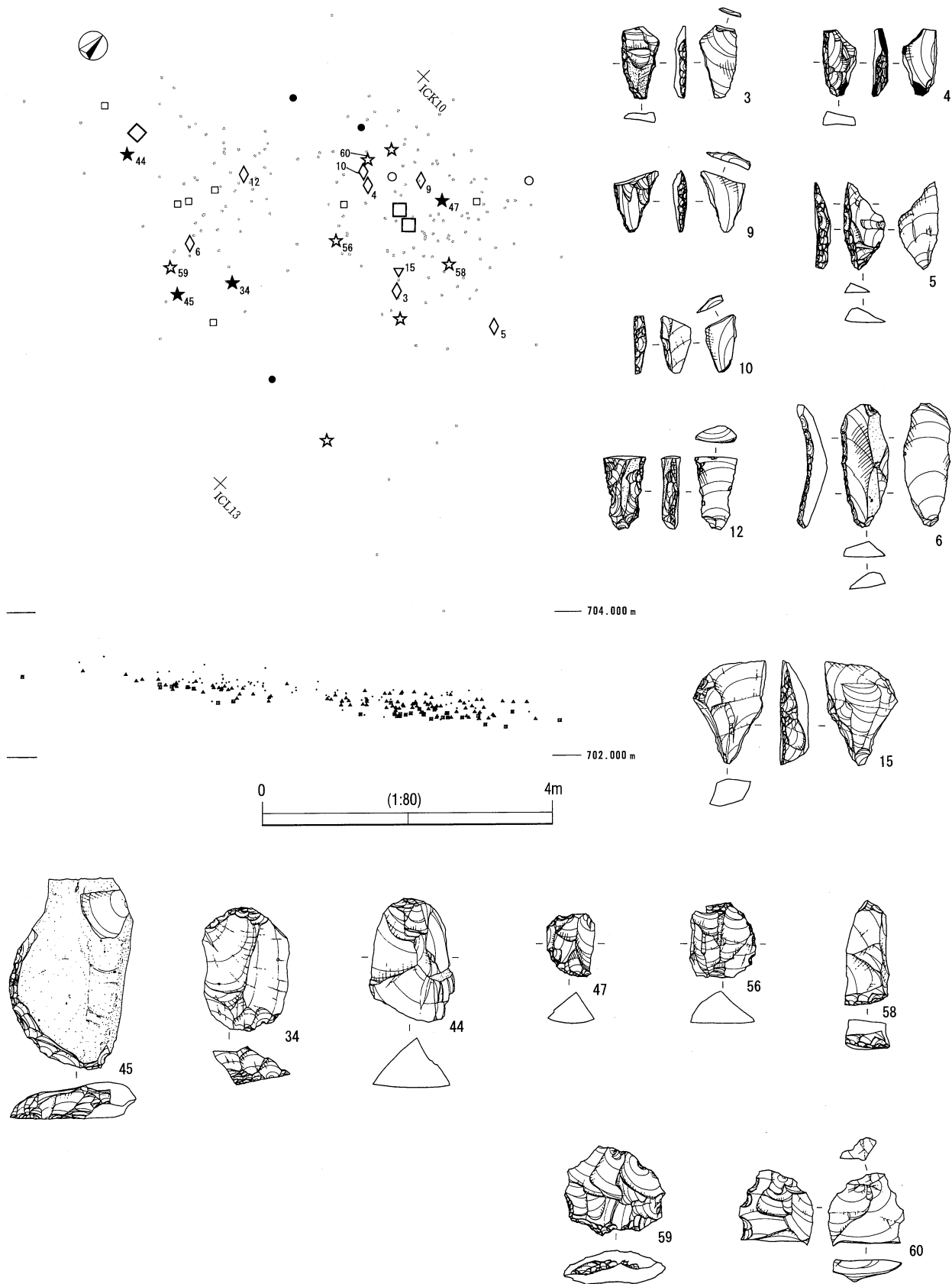

大平 I 石器文化 BL2遺物分布図

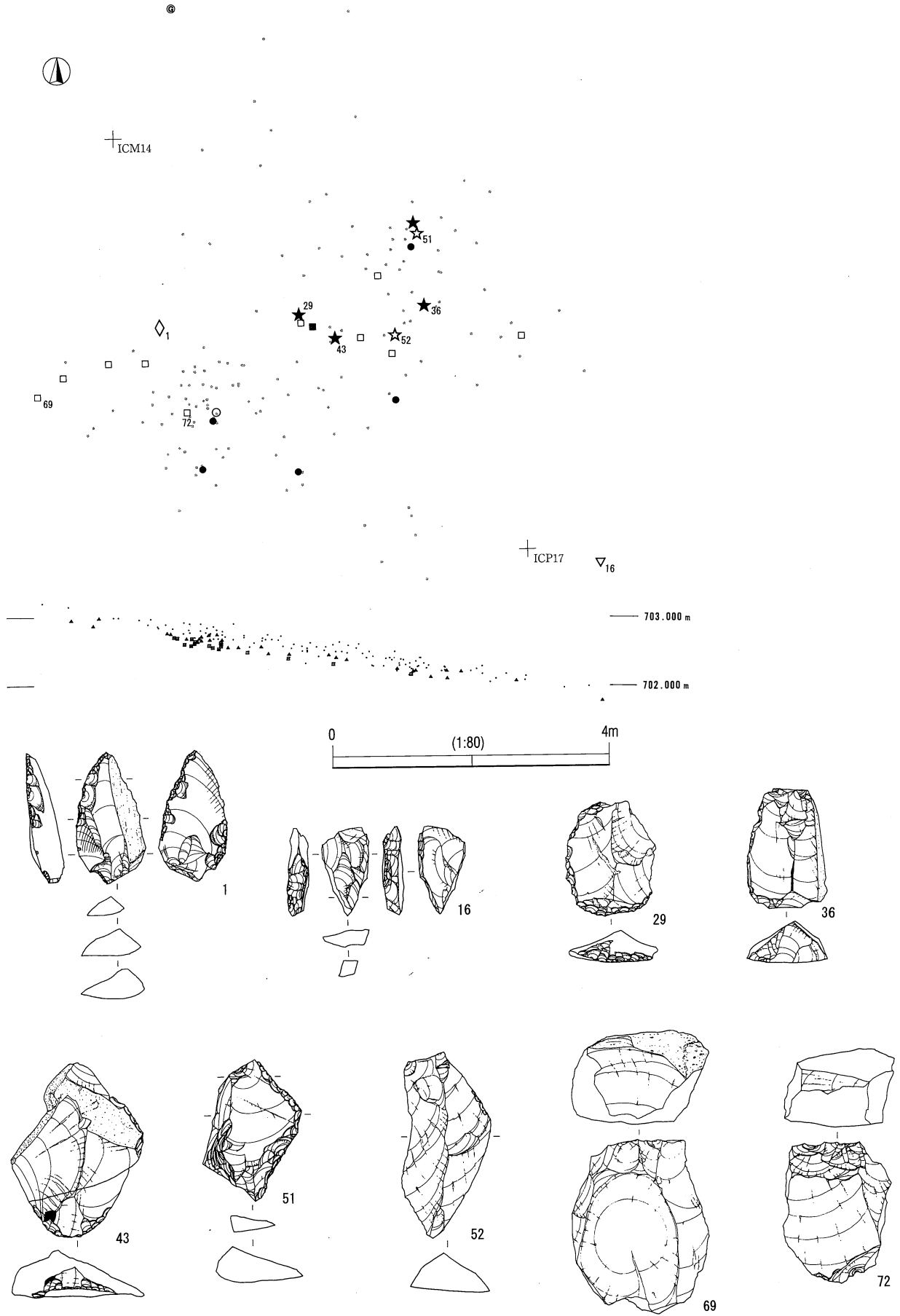

大平 I 石器文化 BL3遺物分布図



大平 I 石器文化 BL4遺物分布図

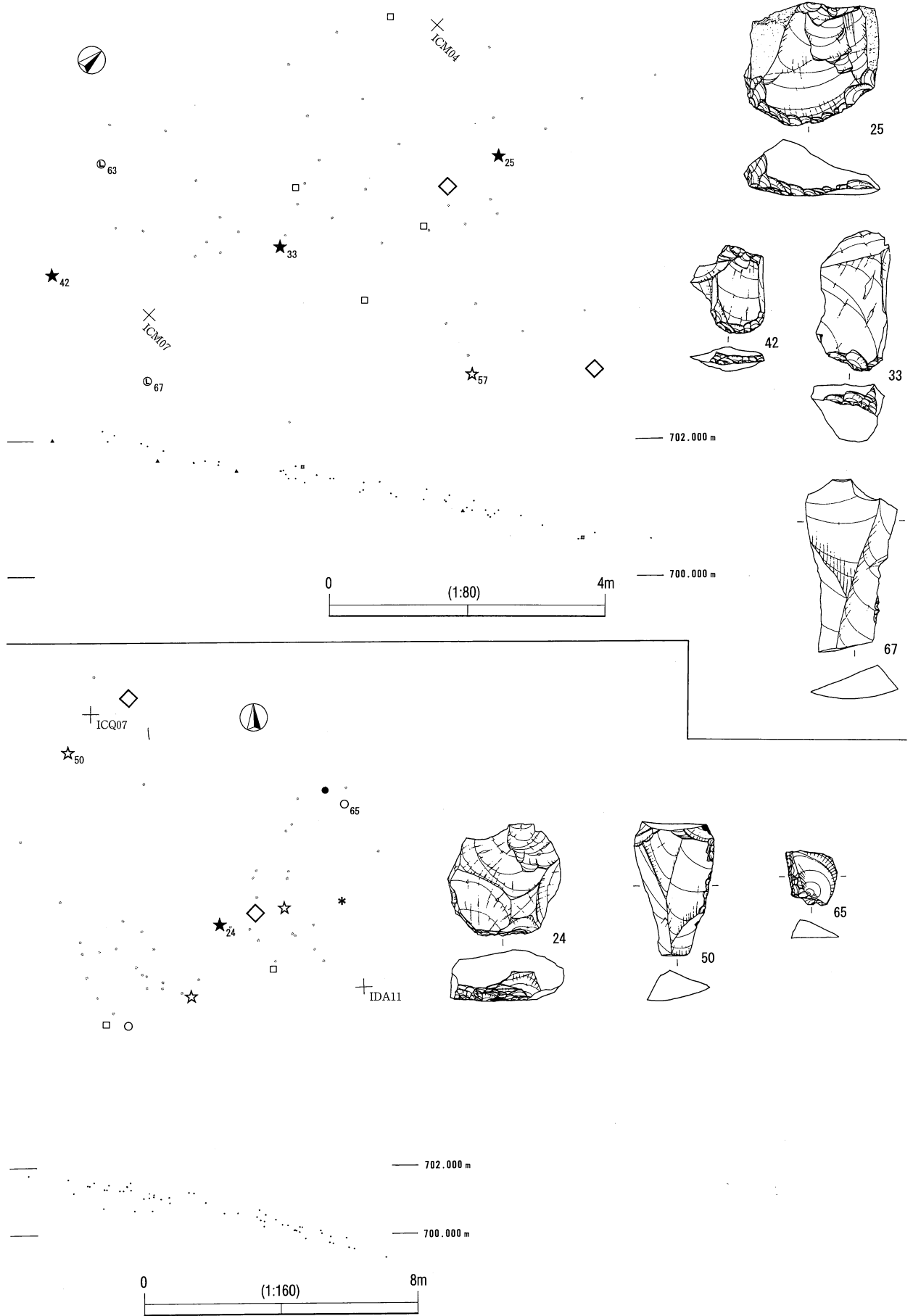

大平 I 石器文化 BL5・BL6遺物分布図 (上:BL5・下:BL6)

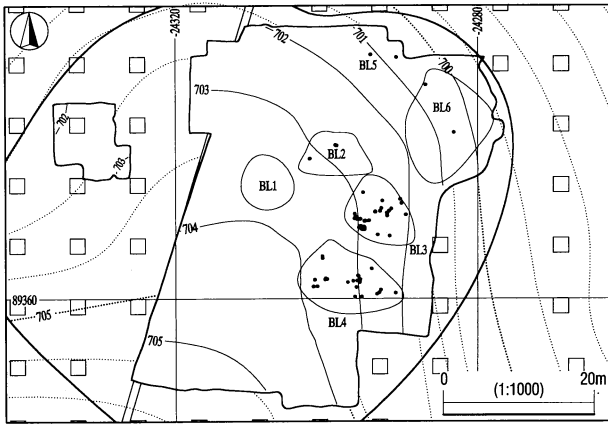

磔全点分布図

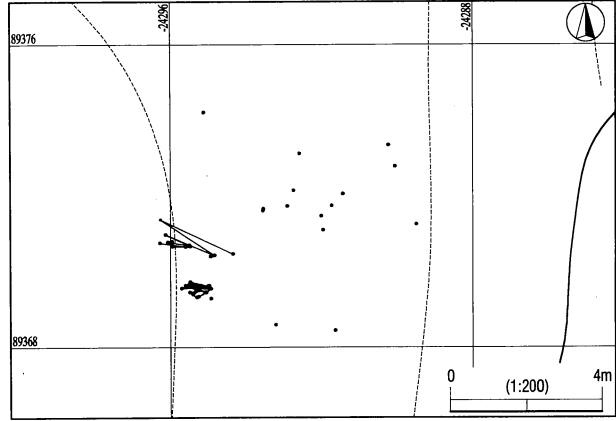

SH-1 磔接合資料分布図

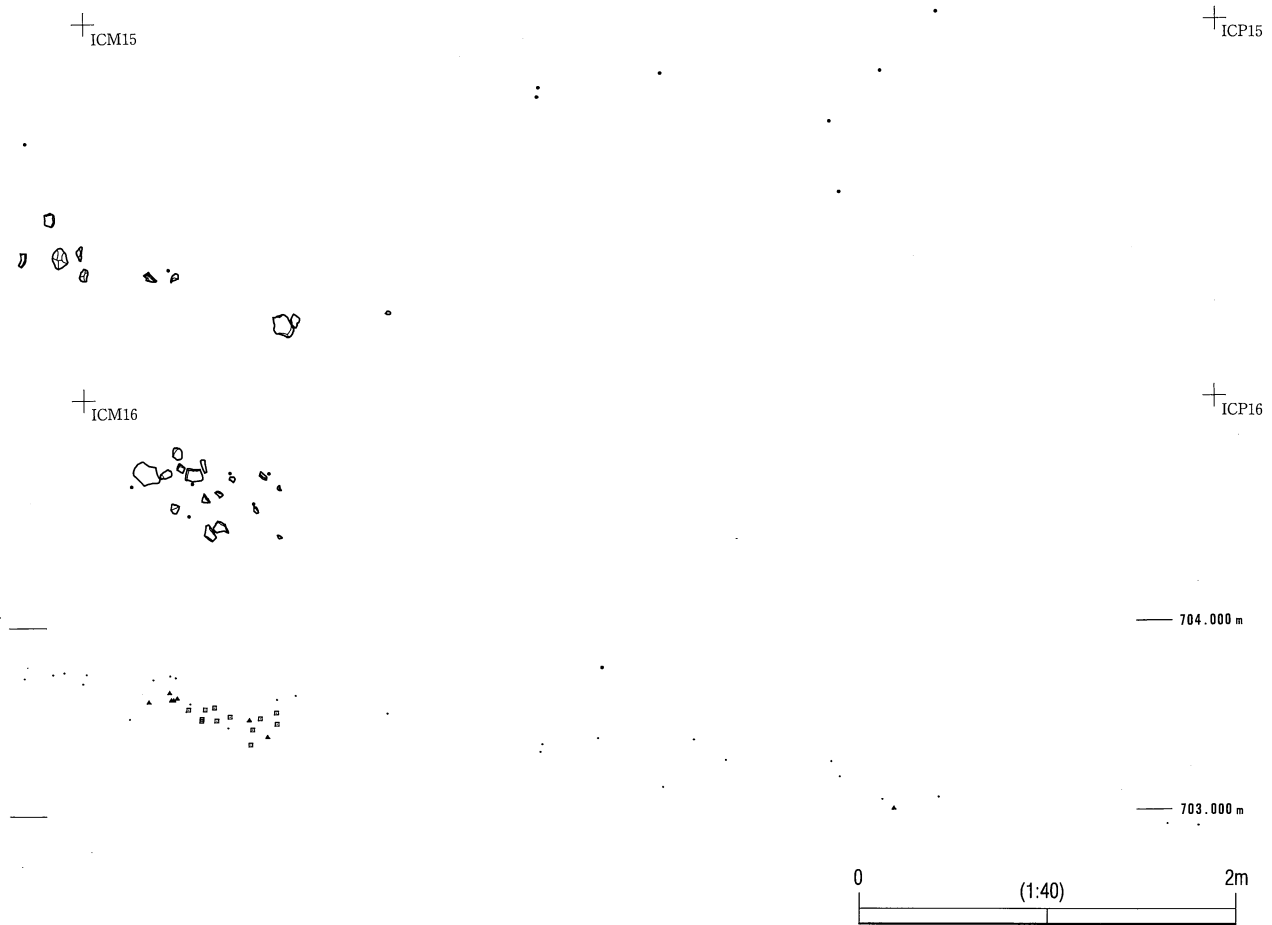

大平 I 石器文化 SH1遺物分布図

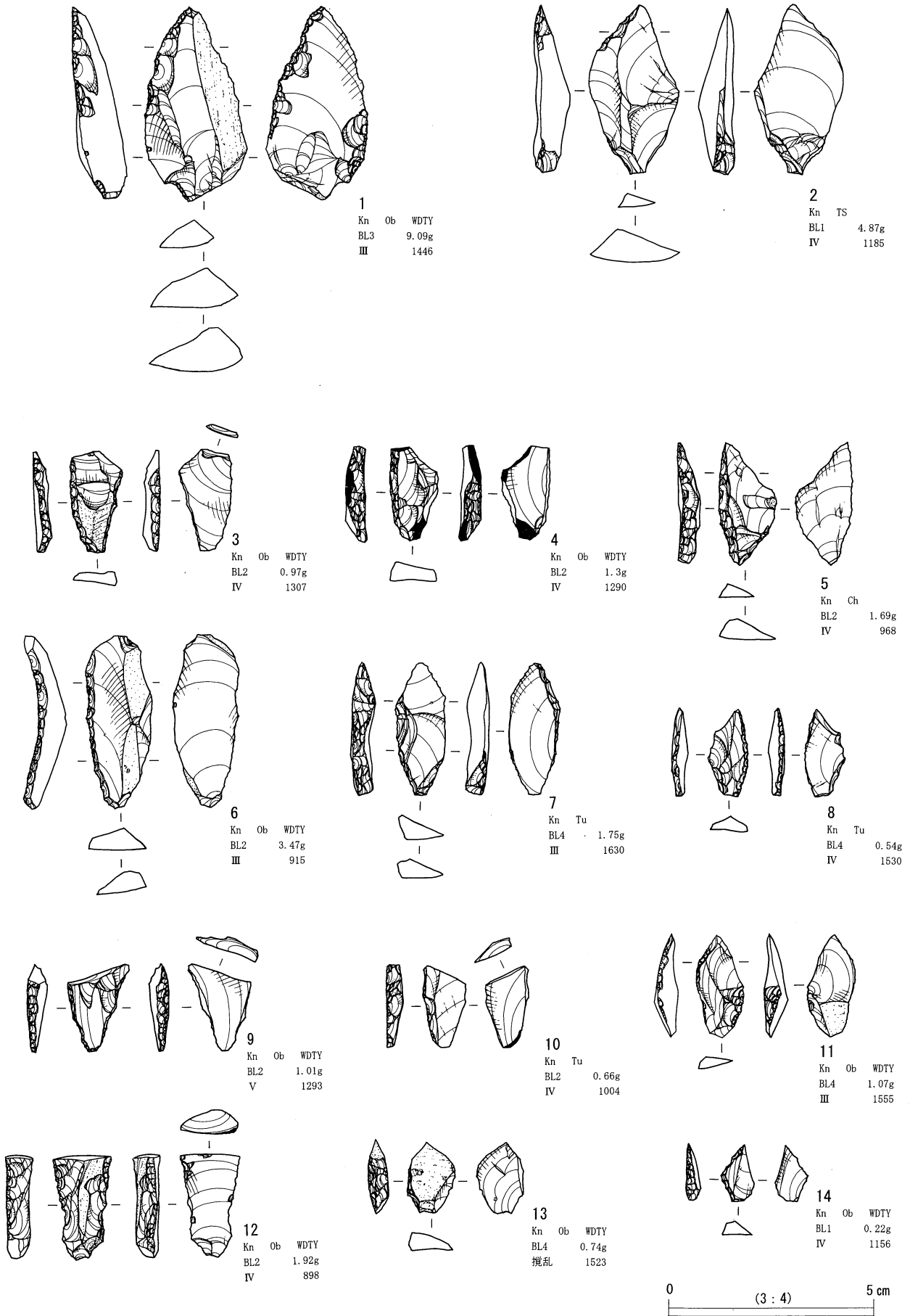

大平 I 石器文化 石器実測図 1

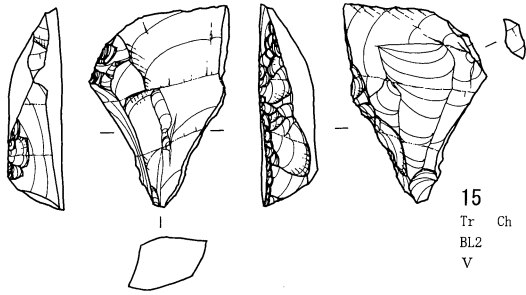

15  
Tr Ch  
BL2 7.1g  
V 984

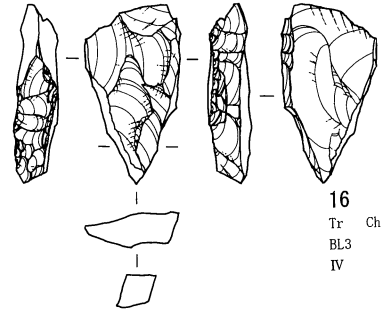

16  
Tr Ch  
BL3 3.51g  
IV 1464

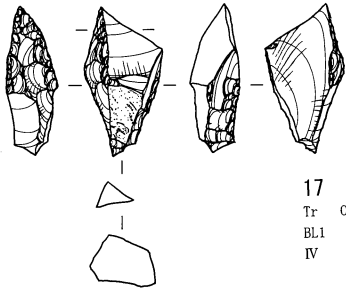

17  
Tr Ob WDTY  
BL1 1.95g  
IV 1203

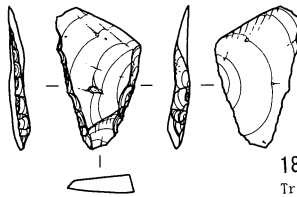

18  
Tr An  
BL4 0.83g  
III 1643

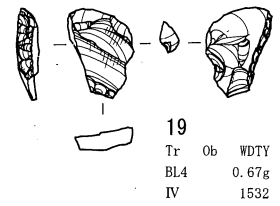

19  
Tr Ob WDTY  
BL4 0.67g  
IV 1532

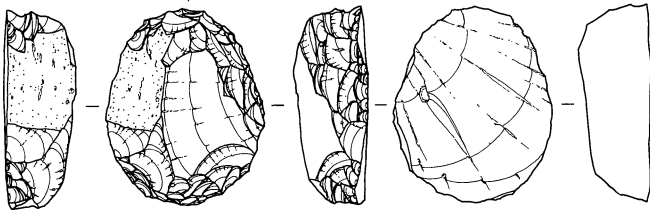

20  
ES An  
BL4 12.88g  
III 1652

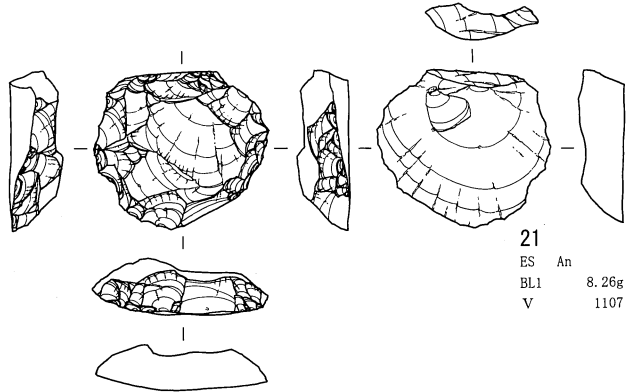
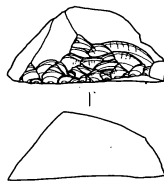

21  
ES An  
BL1 8.26g  
V 1107

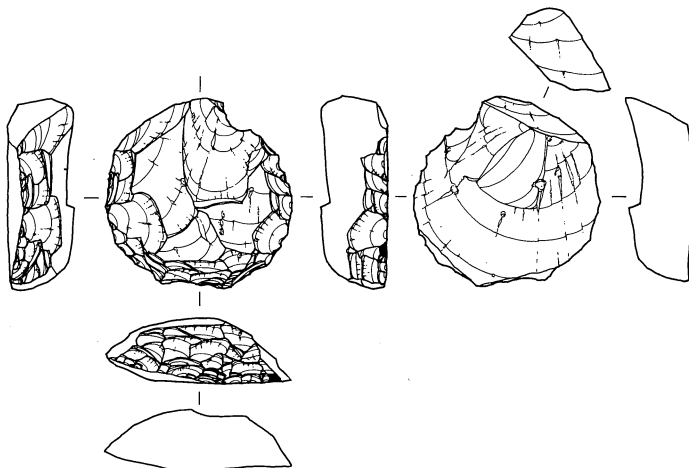

22  
ES An  
BL4 12.96g  
III 1531

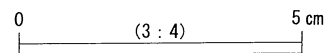



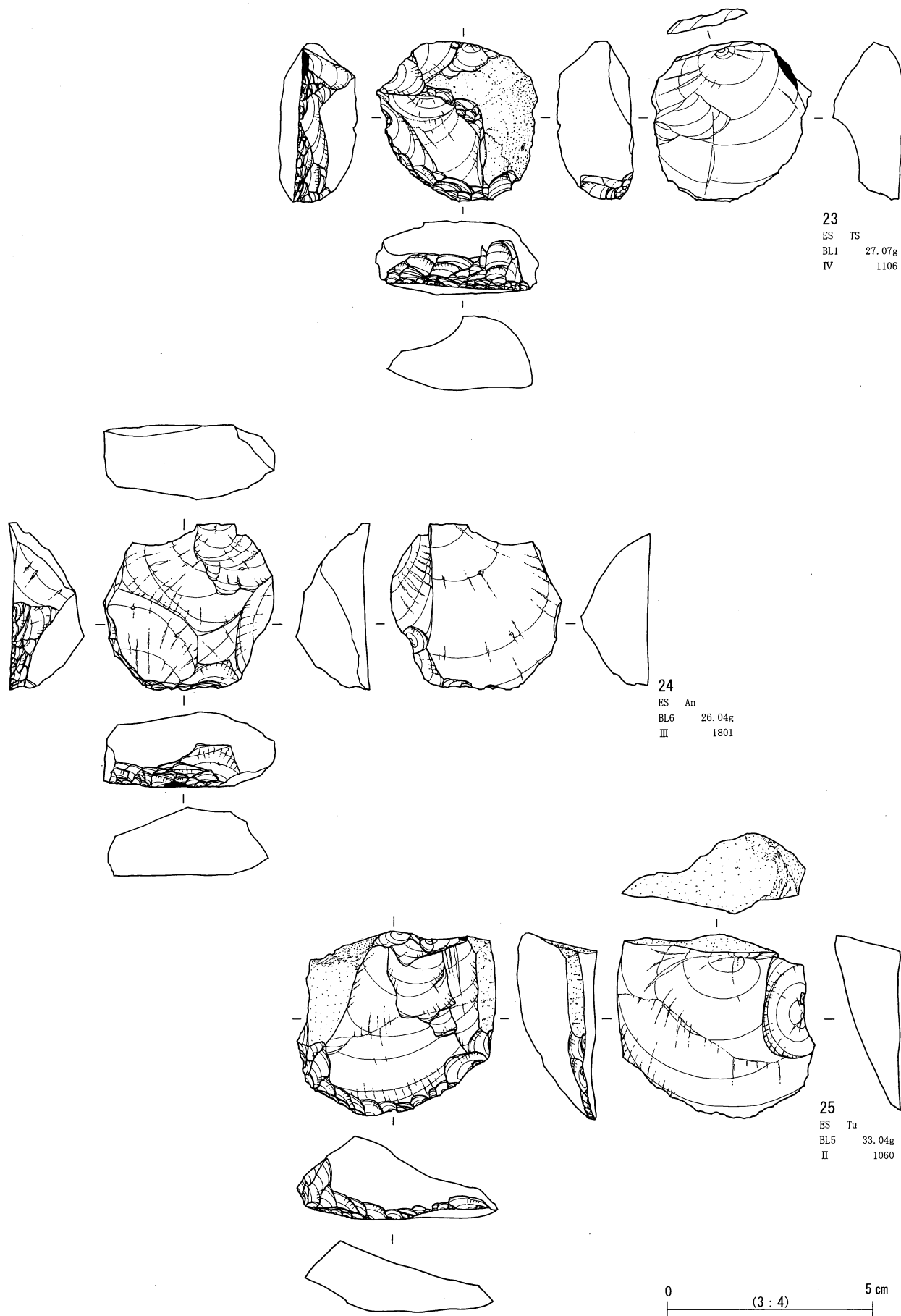

大平 I 石器文化 石器実測図 3

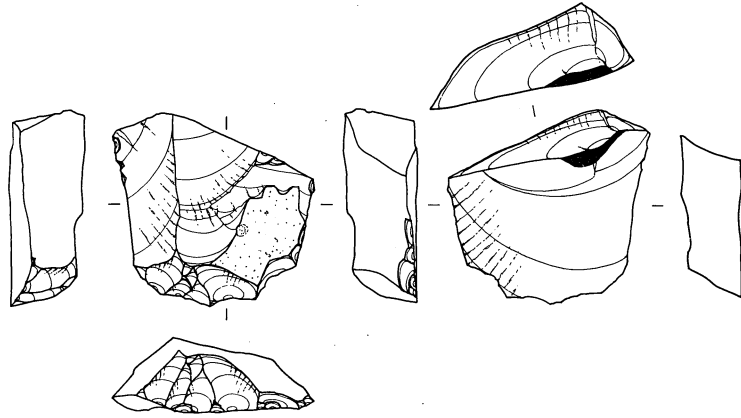

26  
 ES TS  
 BL1 13.33g  
 IV 1123

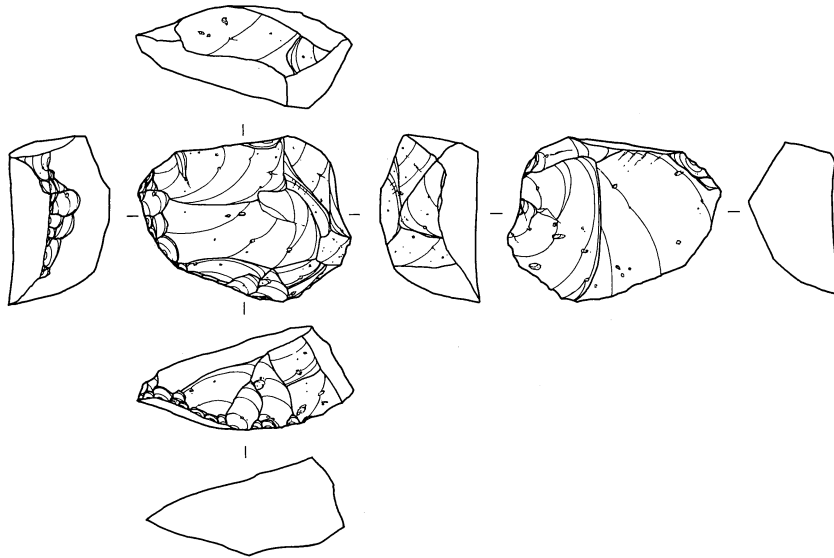

27  
 ES An  
 BL4 17.21g  
 III 1570

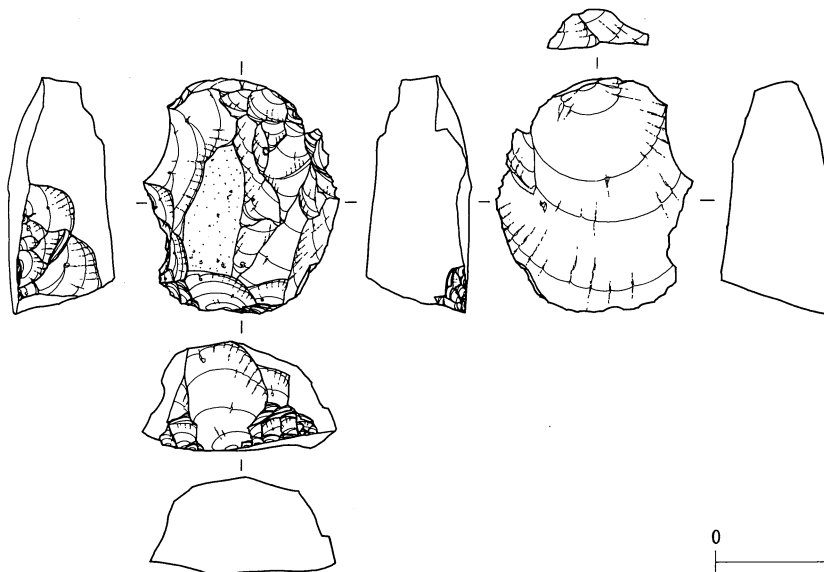

28  
 ES An  
 BL1 27.8g  
 III 1096

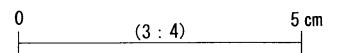

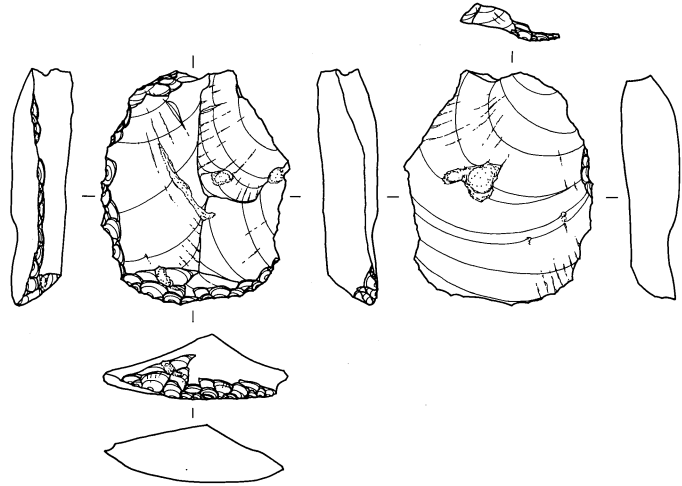

29  
 ES Tu  
 BL3 10.56g  
 III 1822

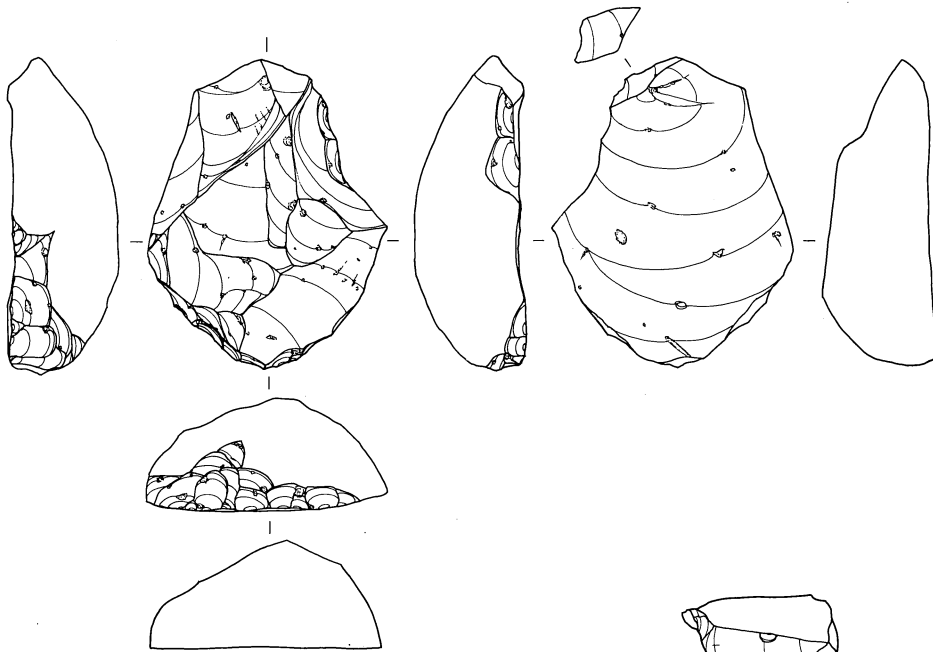

30  
 ES 安山  
 BL1 41.62g  
 V 1104

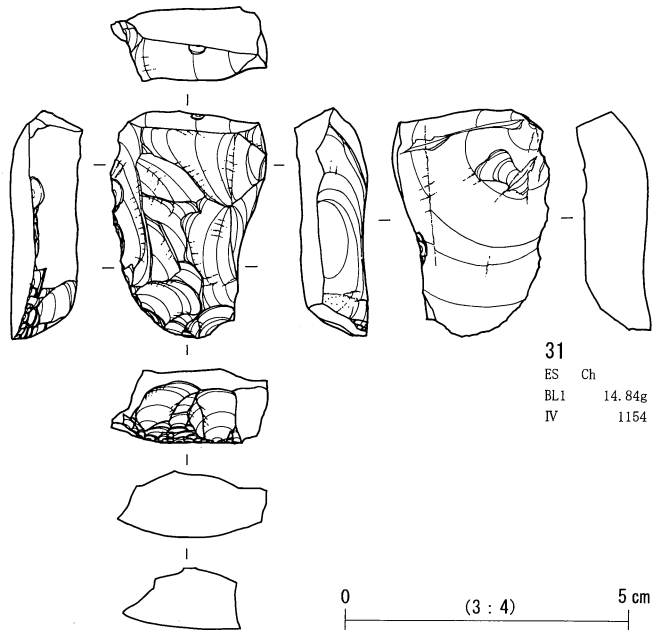

31  
 ES Ch  
 BL1 14.84g  
 IV 1154

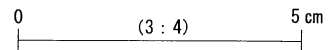



大平 I 石器文化 石器実測図 6

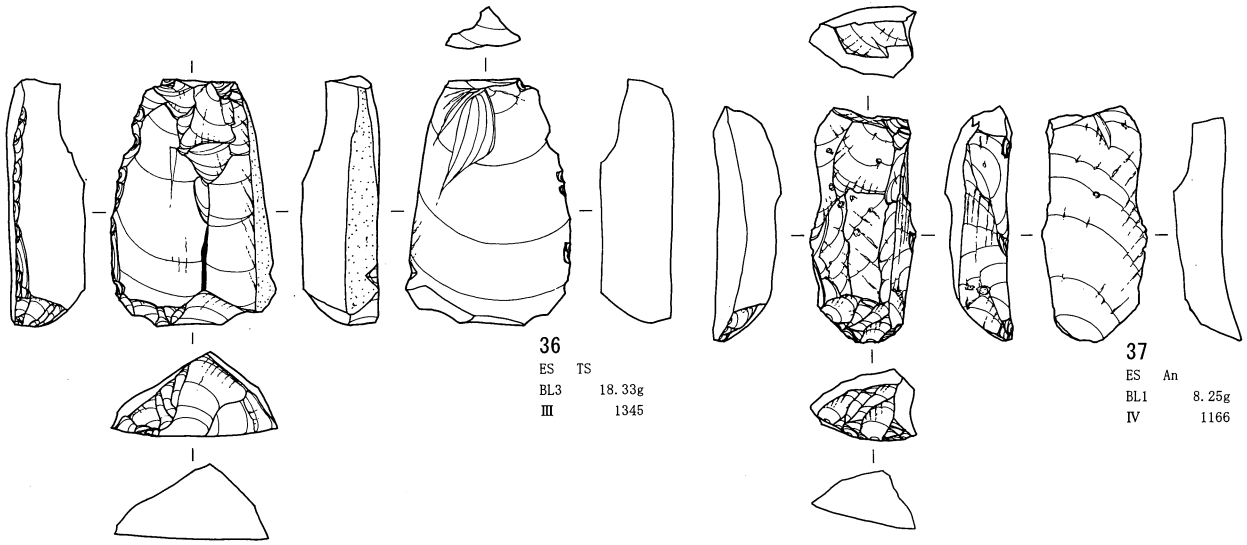

36  
ES TS  
BL3 18.33g  
III 1345

37  
ES An  
BL1 8.25g  
IV 1166

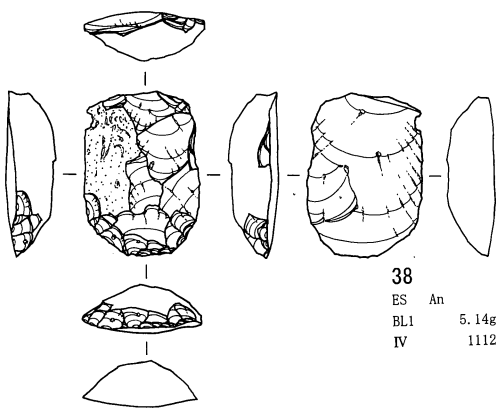

38  
ES An  
BL1 5.14g  
IV 1112

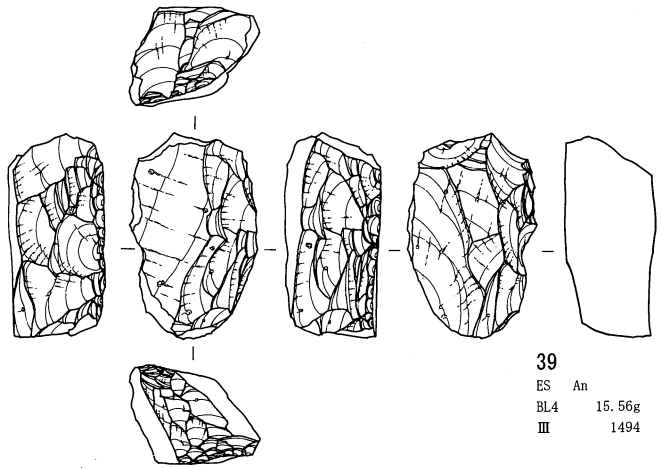

39  
ES An  
BL4 15.56g  
III 1494

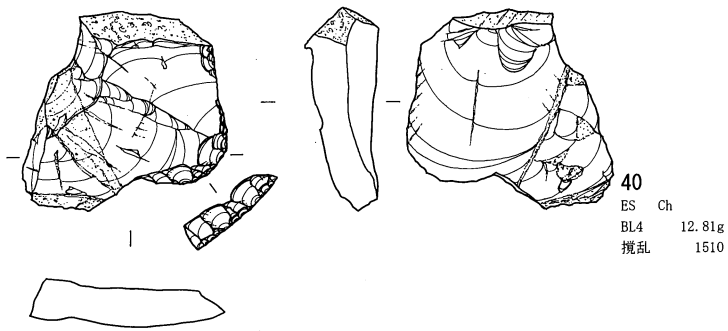

40  
ES Ch  
BL4 12.81g  
攪乱 1510

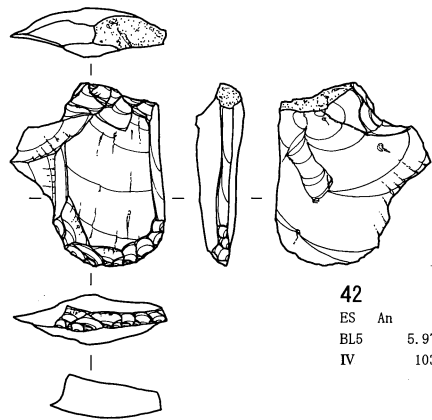

42  
ES An  
BL5 5.97g  
IV 1031

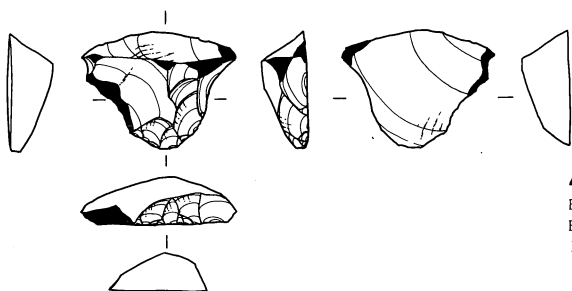

41  
ES TS  
BL4 3.31g  
II 1644

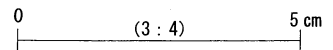

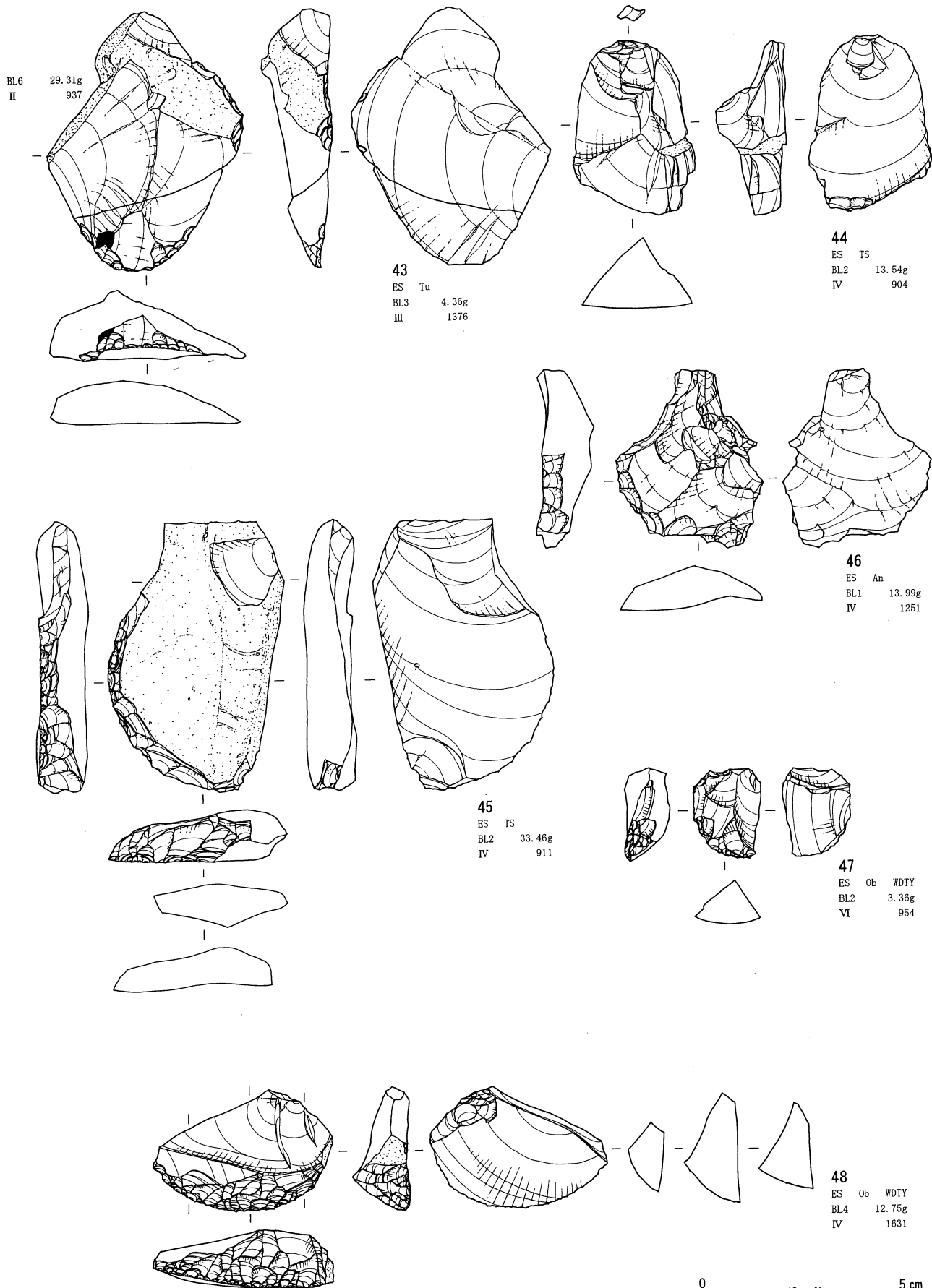

0 (3 : 4) 5 cm

大平 I 石器文化 石器実測図 8

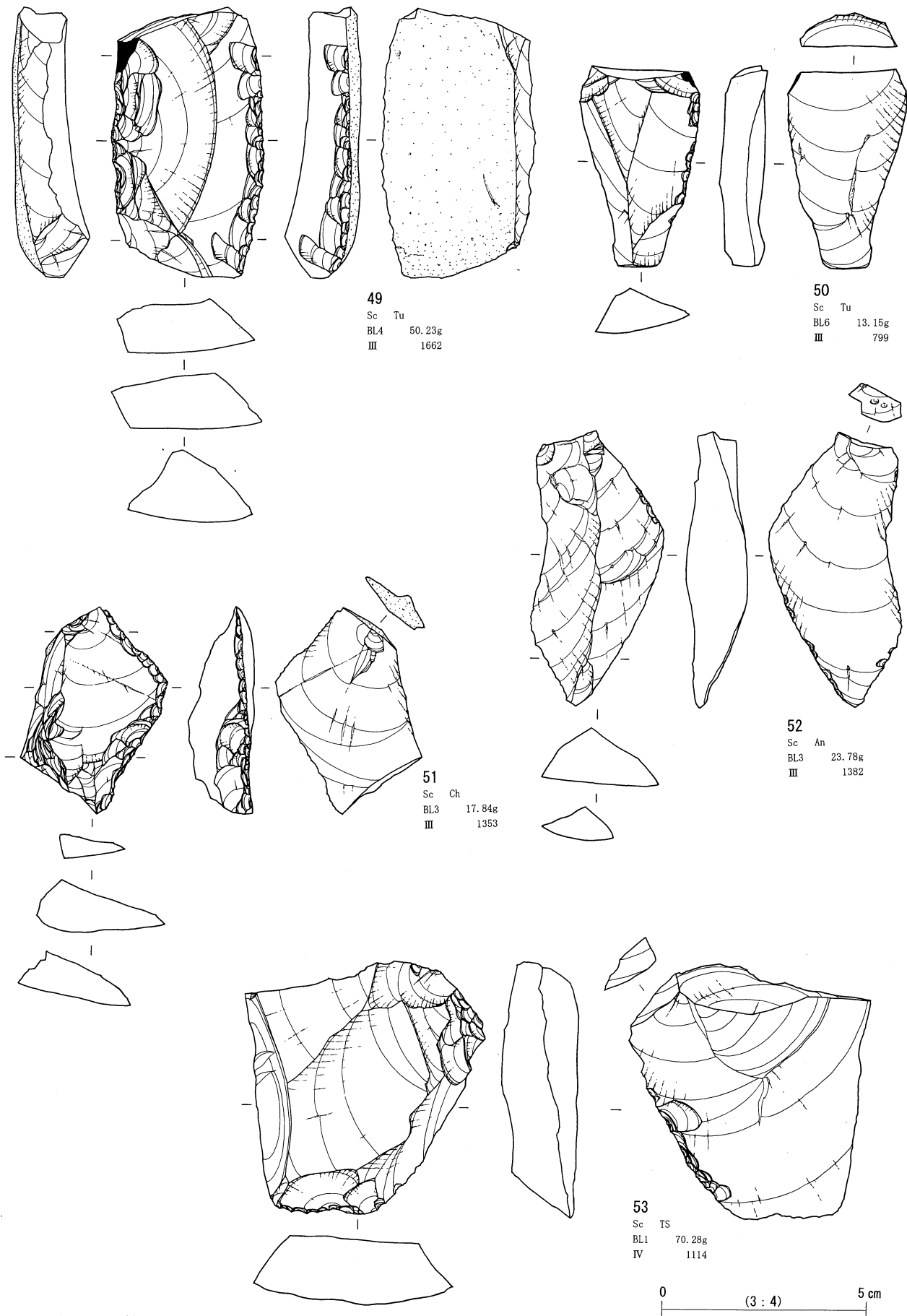

大平I 石器文化 石器実測図9

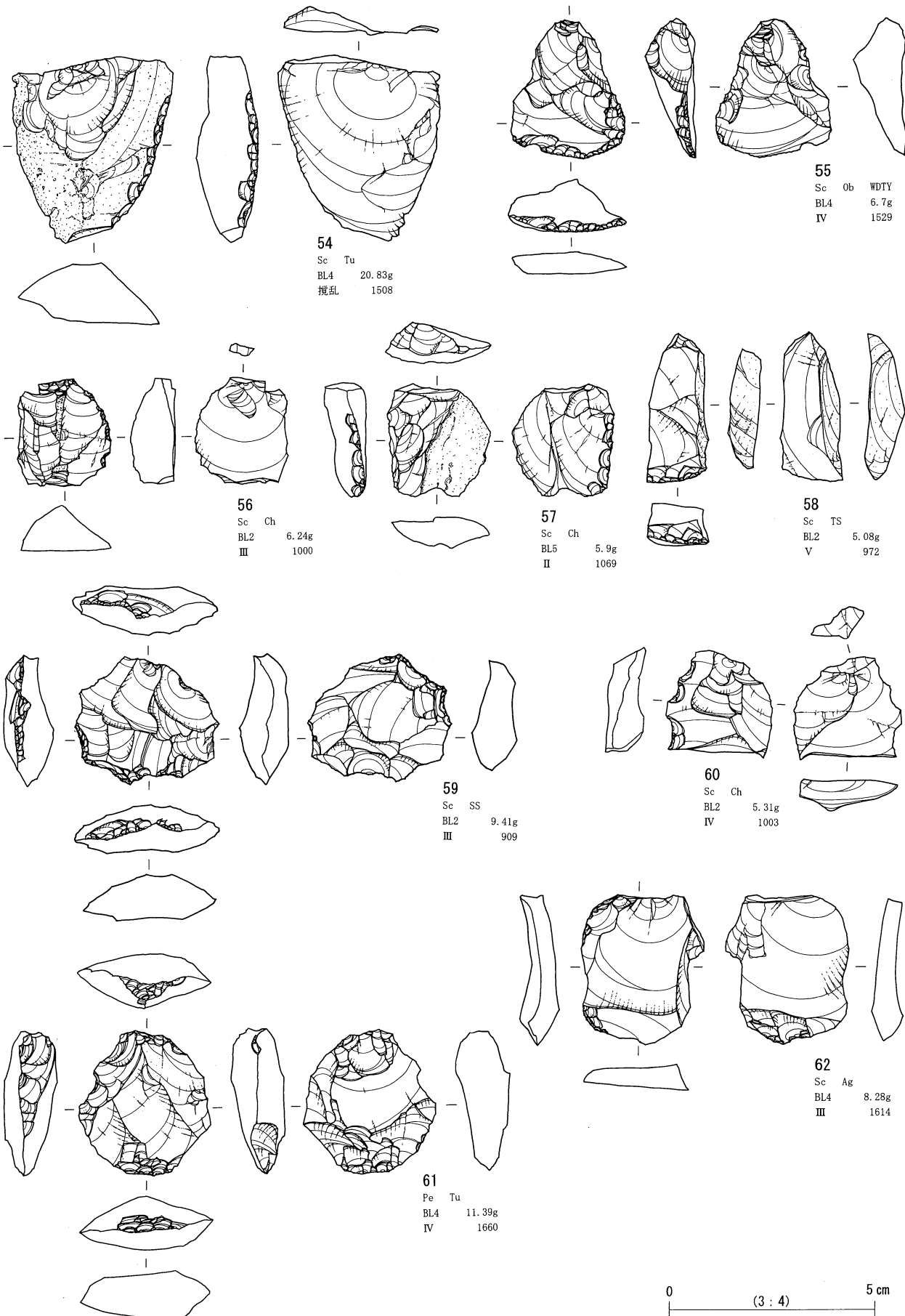

大平 I 石器文化 石器実測図10



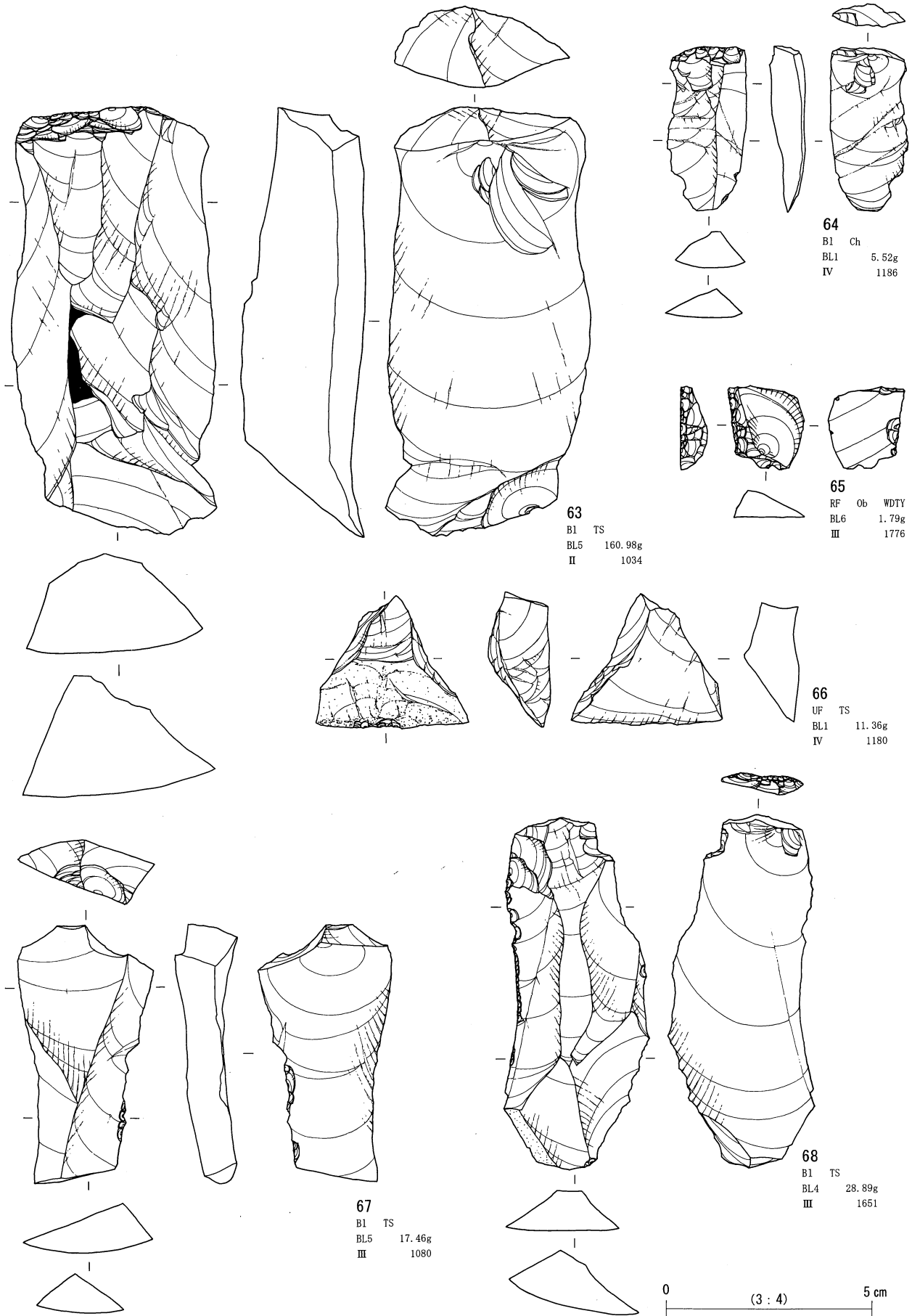

大平 I 石器文化 石器実測図11

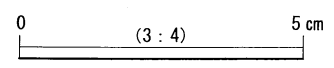
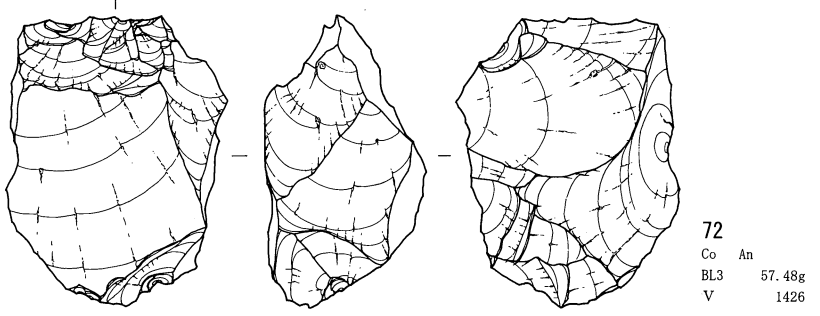
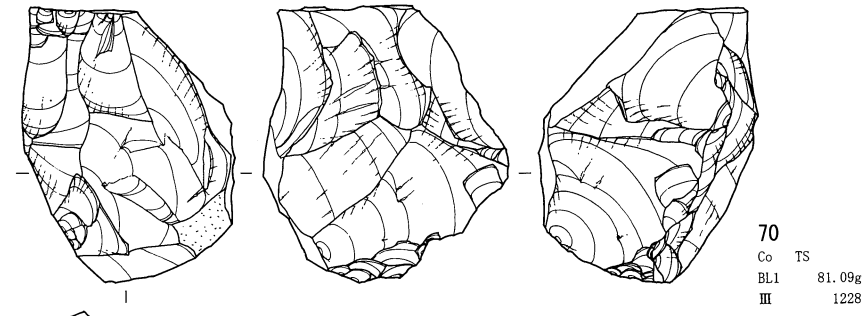
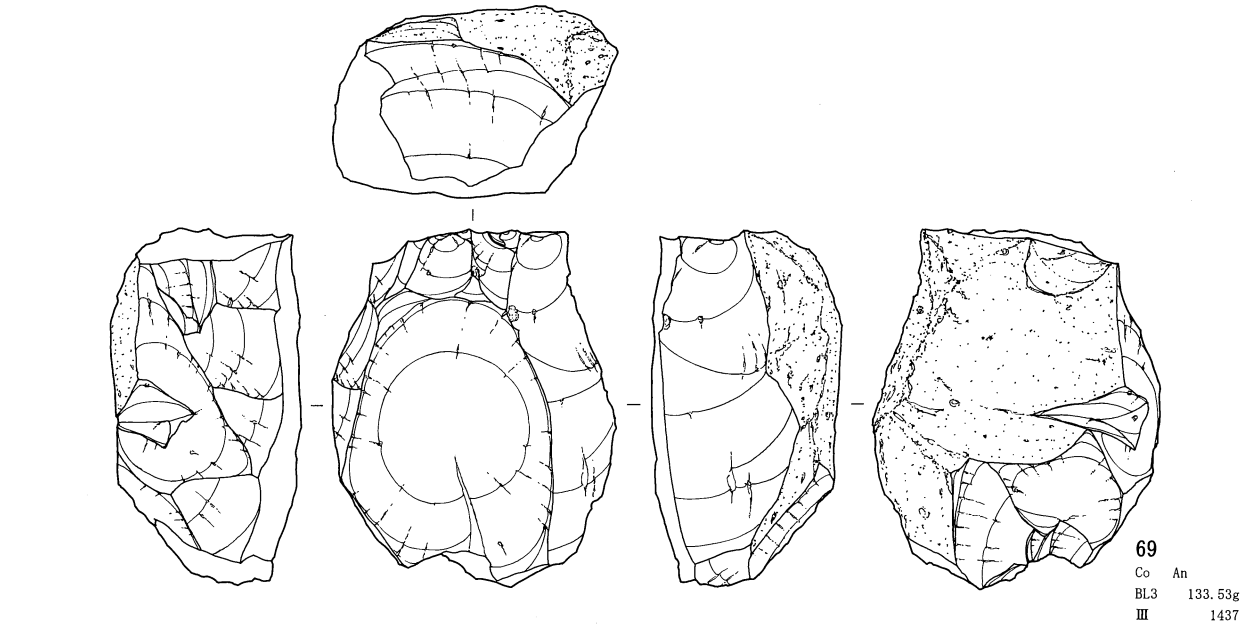

大平 I 石器文化 石器実測図12

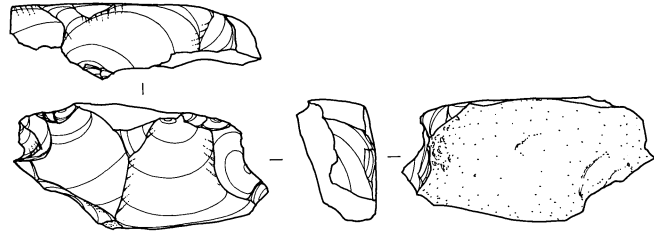

73  
Co Ch  
BL1 12.15g  
IV 1220

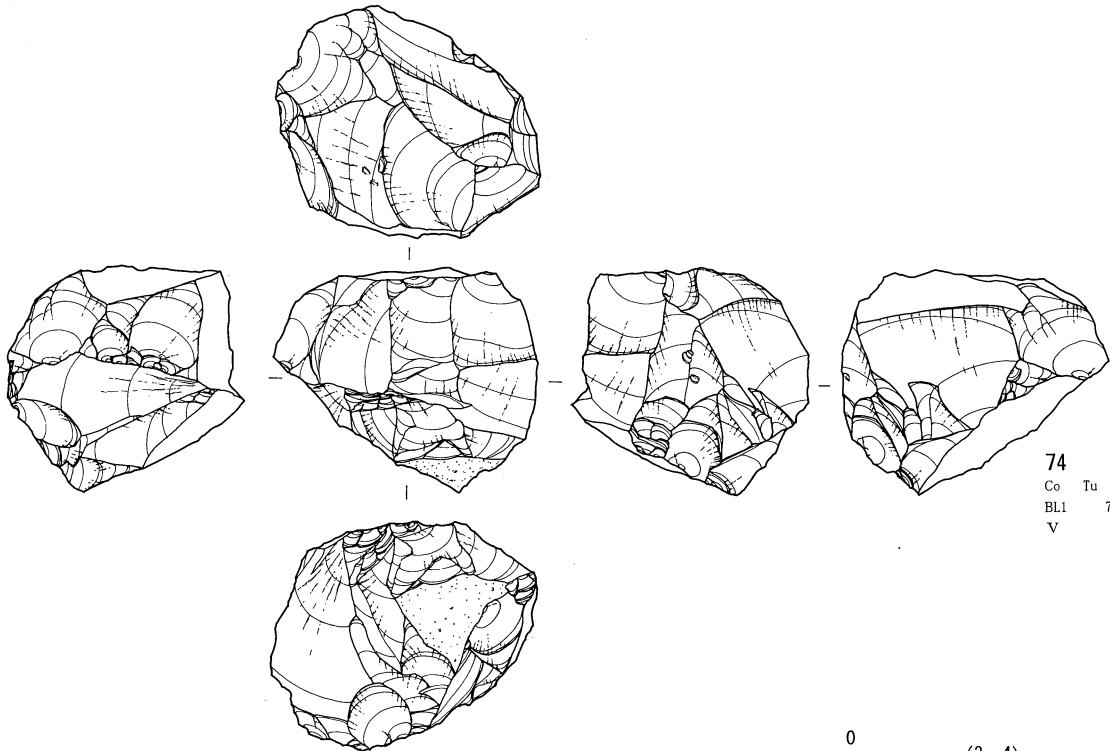

74  
Co Tu  
BL1 73.86g  
V 1088

0 (3 : 4) 5 cm

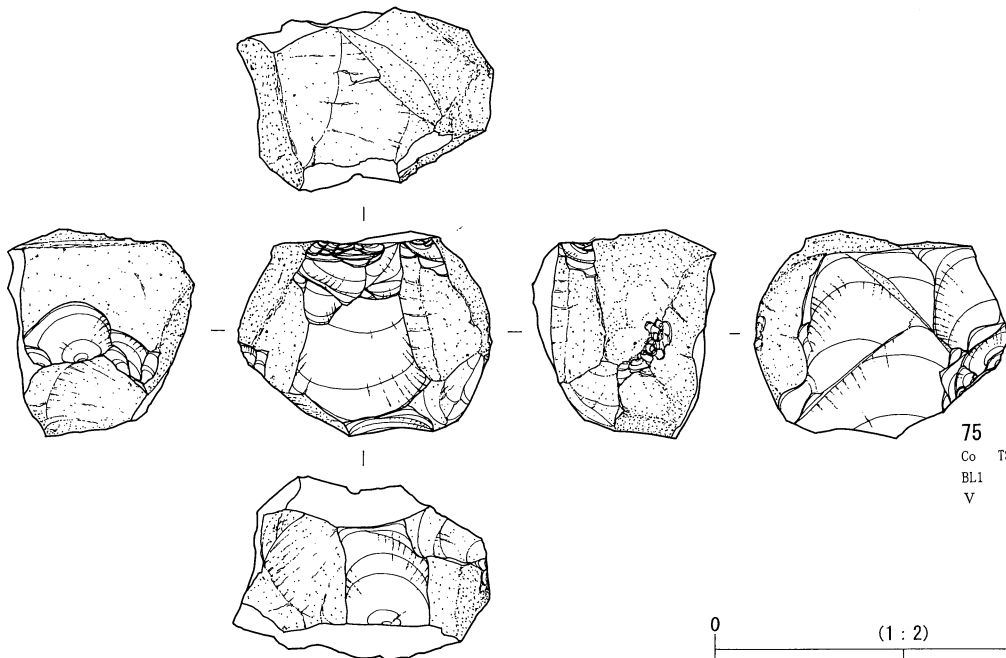

75  
Co TS  
BL1 220.55g  
V 1093

0 (1 : 2) 10 cm

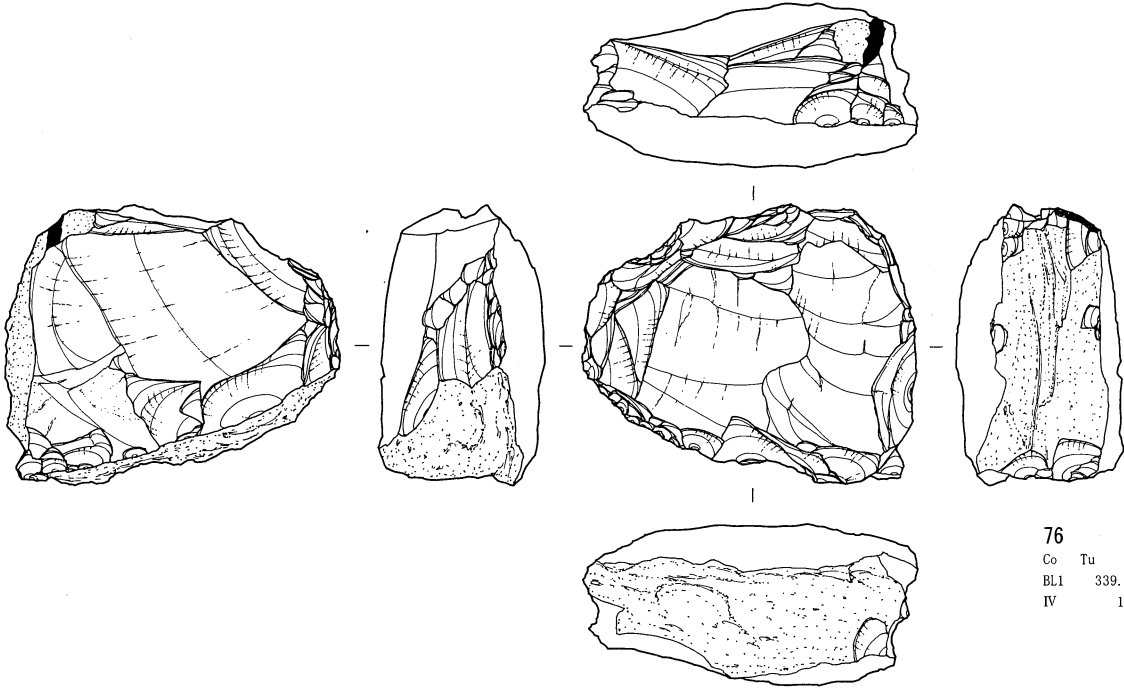

76  
 Co Tu  
 BL1 339.81g  
 IV 1111

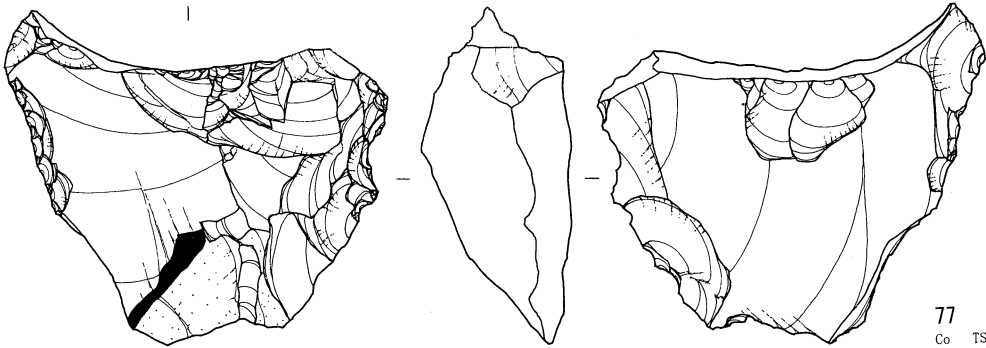
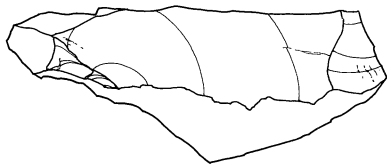

77  
 Co TS  
 BL1 75.33g  
 IV 1206

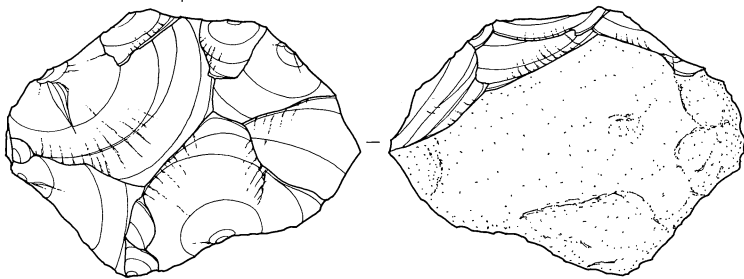

78  
 Co Tu  
 BL4 47.48g  
 III 1609

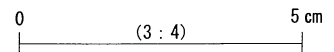



石器全点



石材別・接合資料分布図

大平II石器文化 全体図

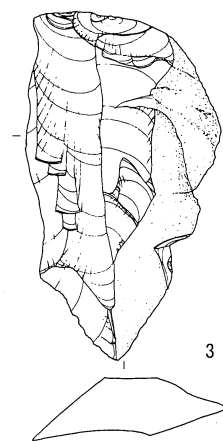
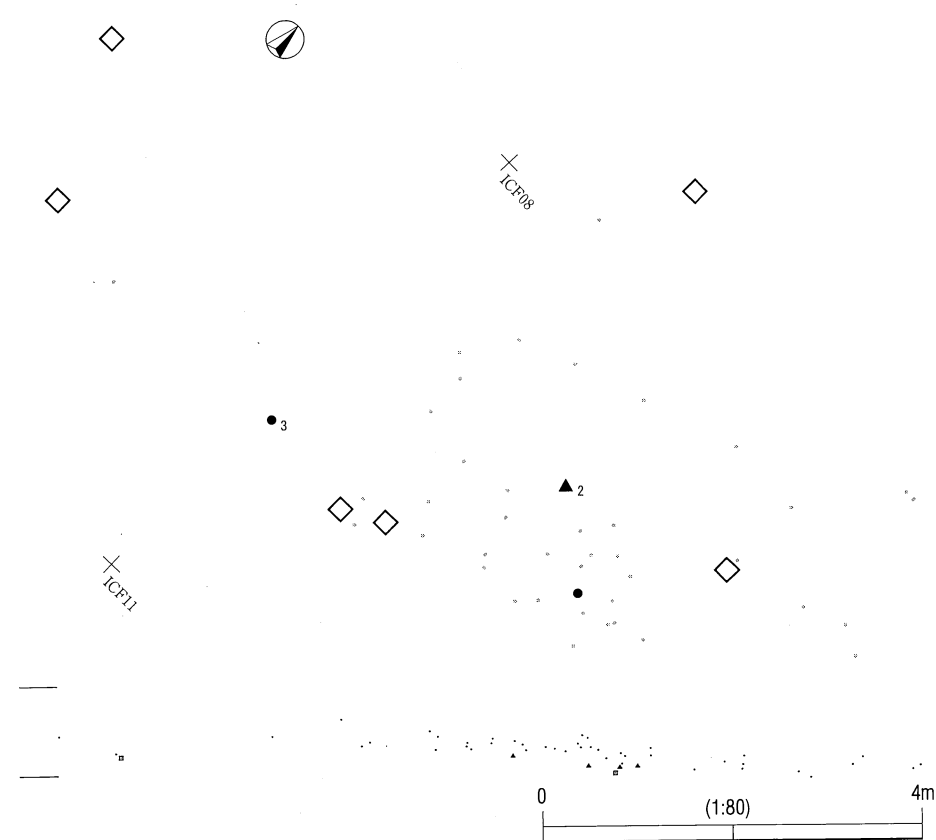
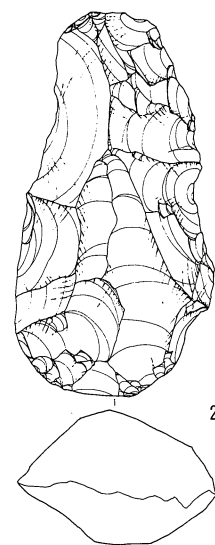
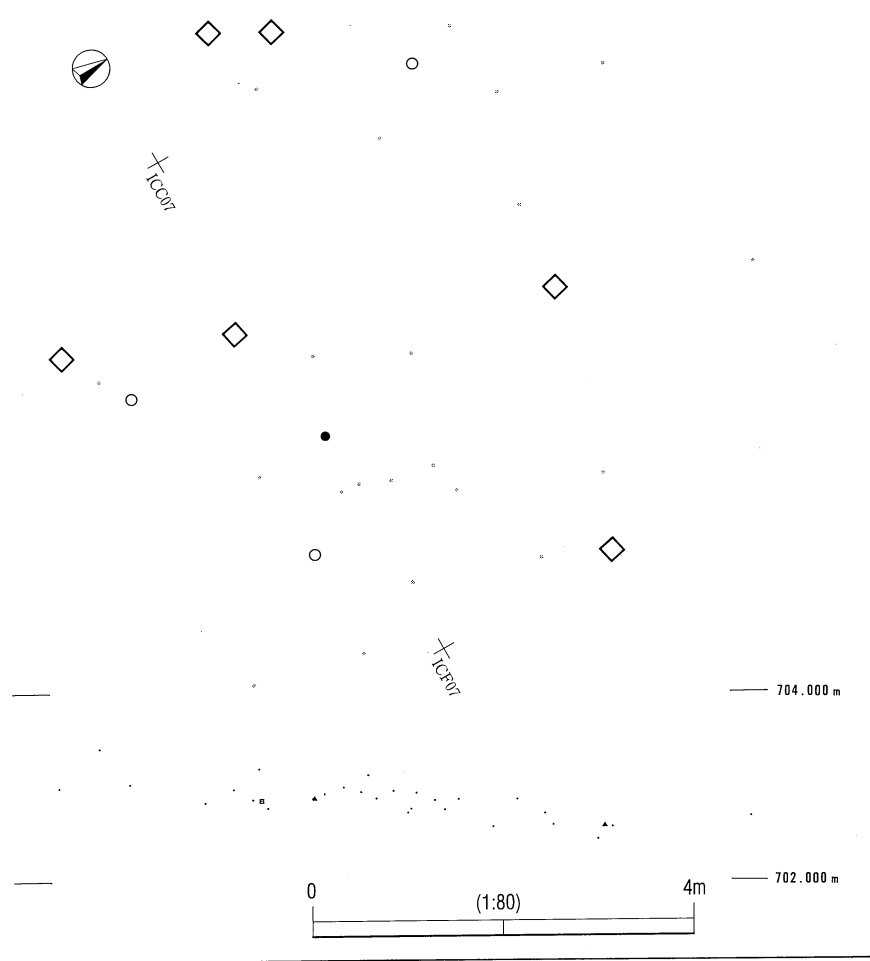

大平II石器文化 BL1・BL2遺物分布 (上:BL1・下:BL2)

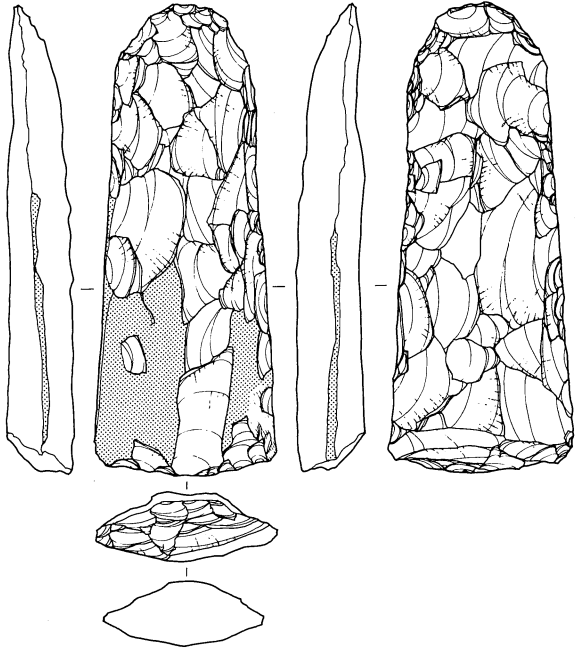

1  
Ax TS  
外 152.57g  
III 1250

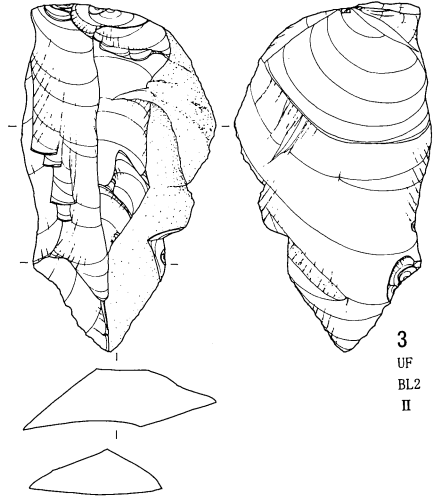

3  
UF TS  
BL2 59.45g  
II 771

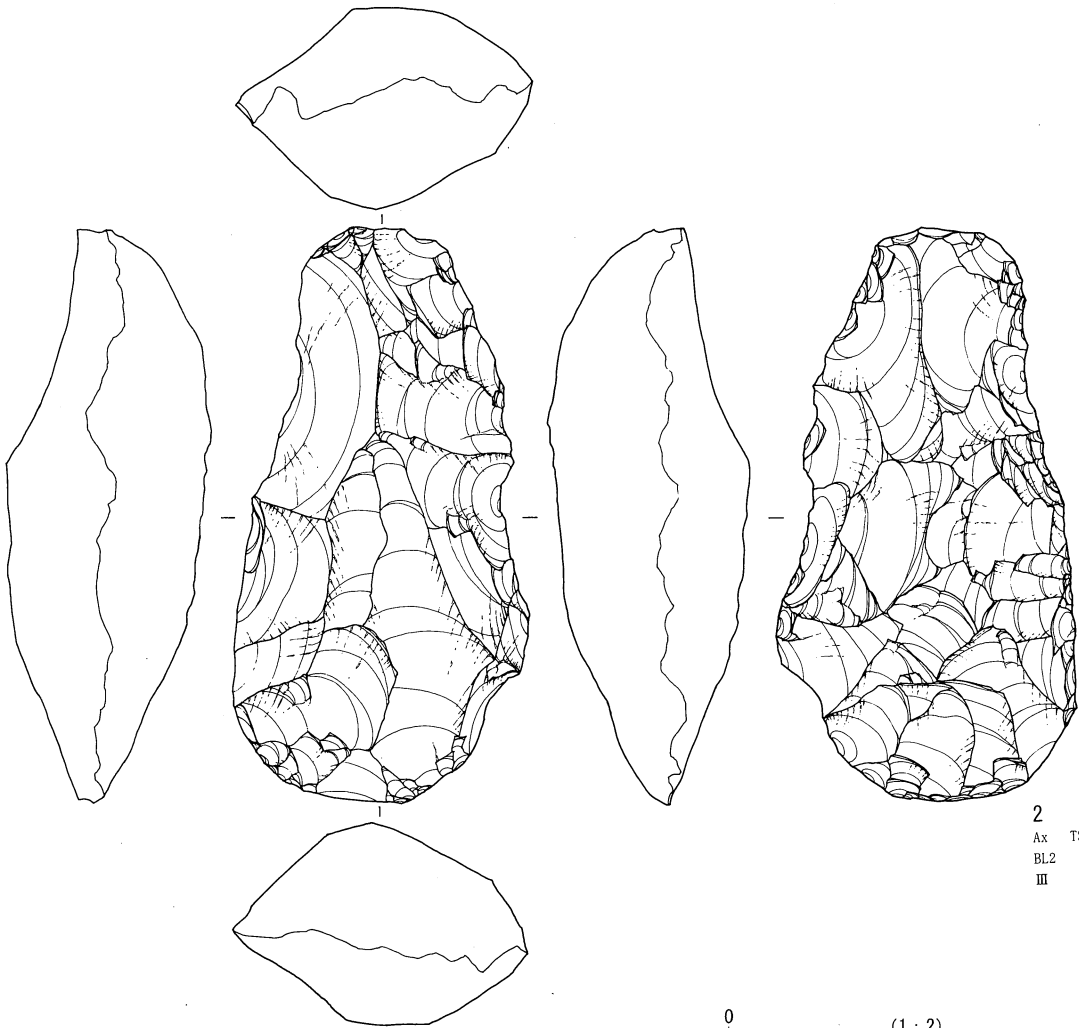

2  
Ax TS  
BL2 550.97g  
III 781

0 (1:2) 10 cm

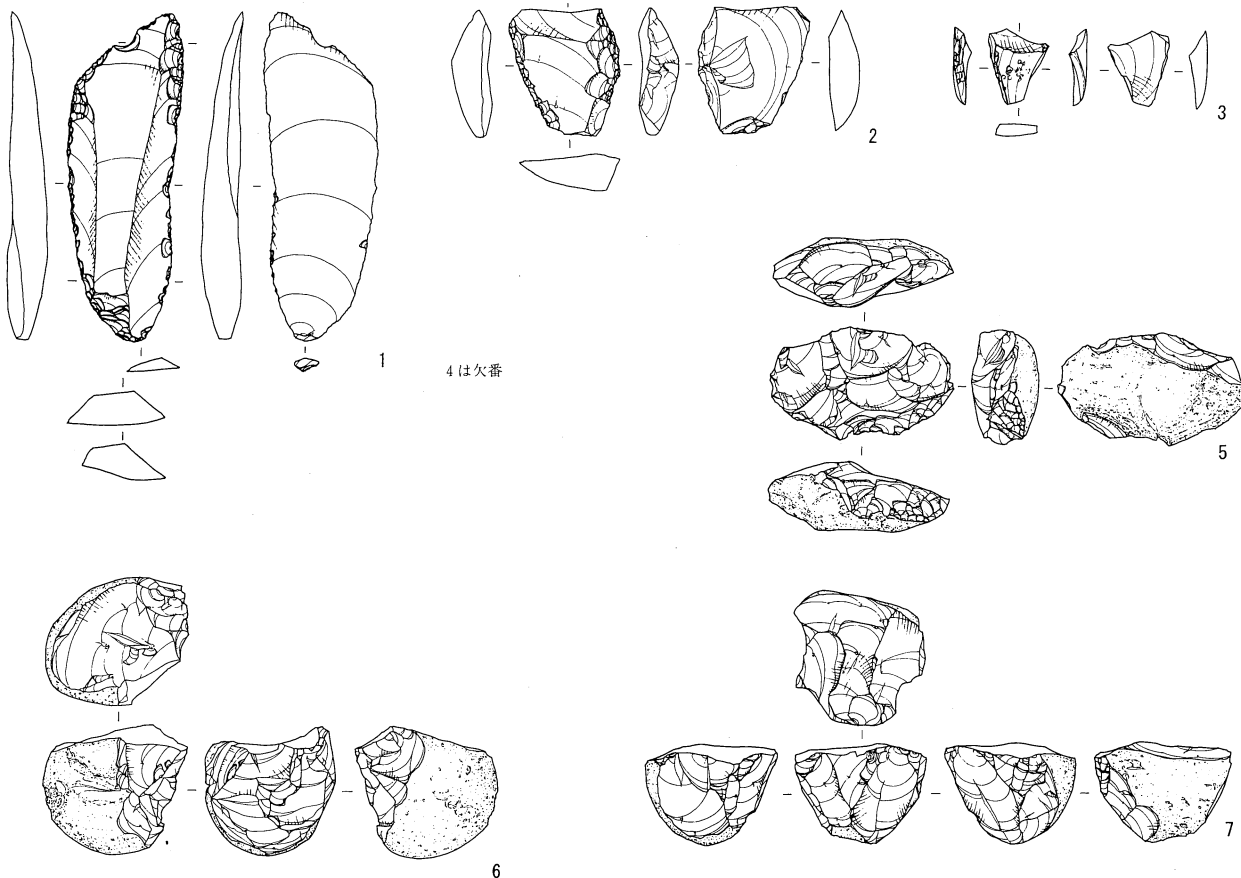
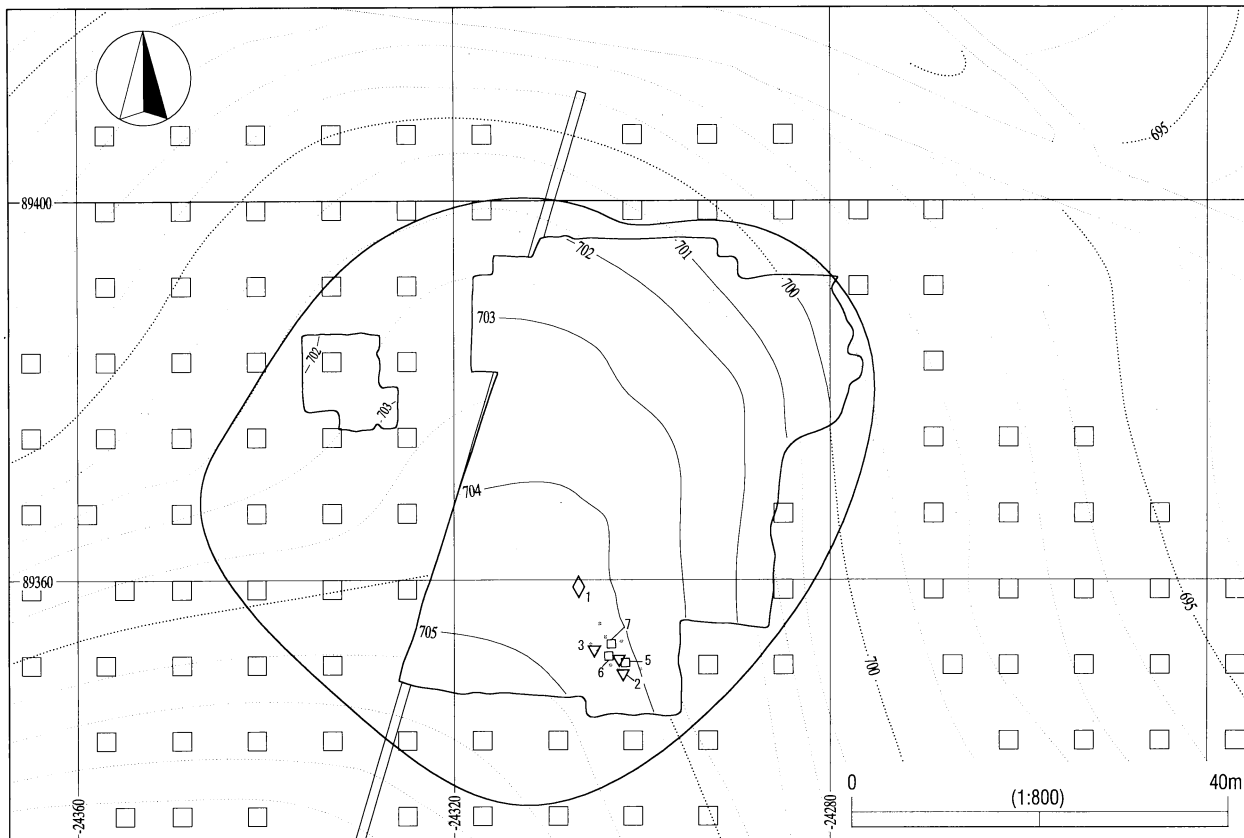

大平B遺跡 その他の石器分布図



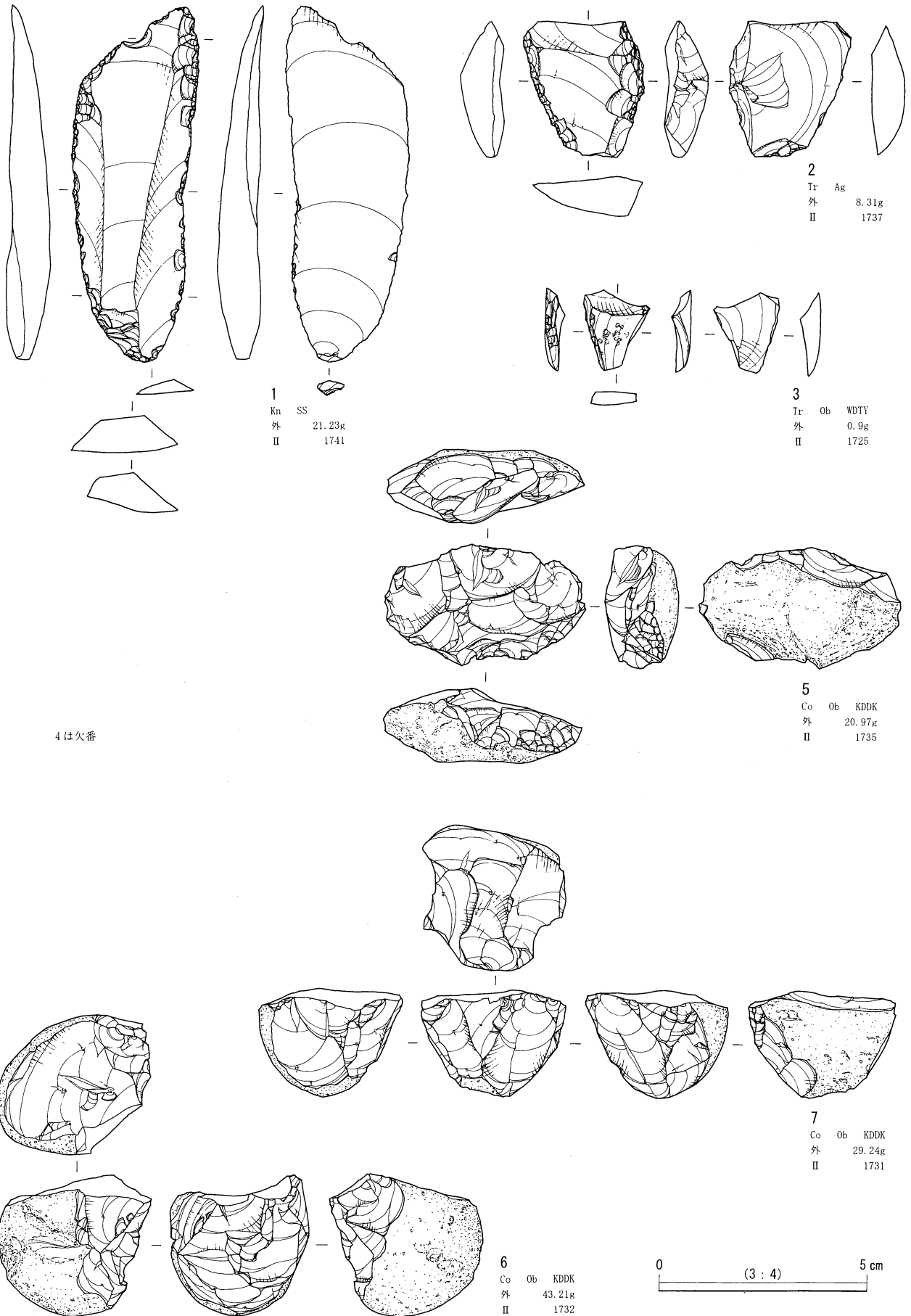

大平B遺跡 その他の石器実測図

# 写真図版



遺跡遠景  
(南より)



遺跡遠景  
(東より)

斑尾山



遺跡遠景  
(西より)



遺跡遠景  
(南東より)

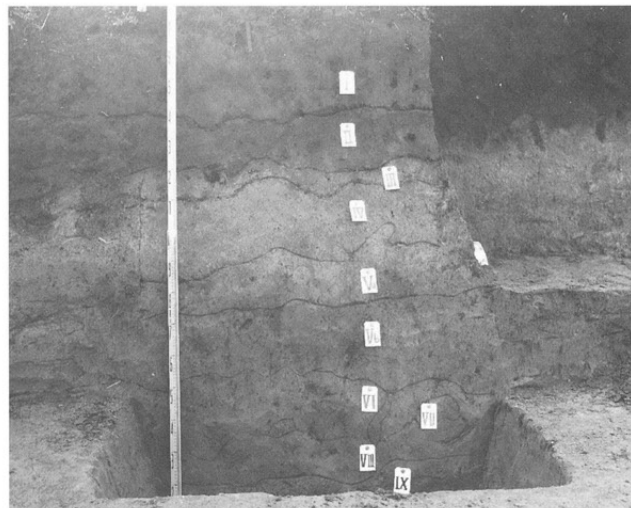
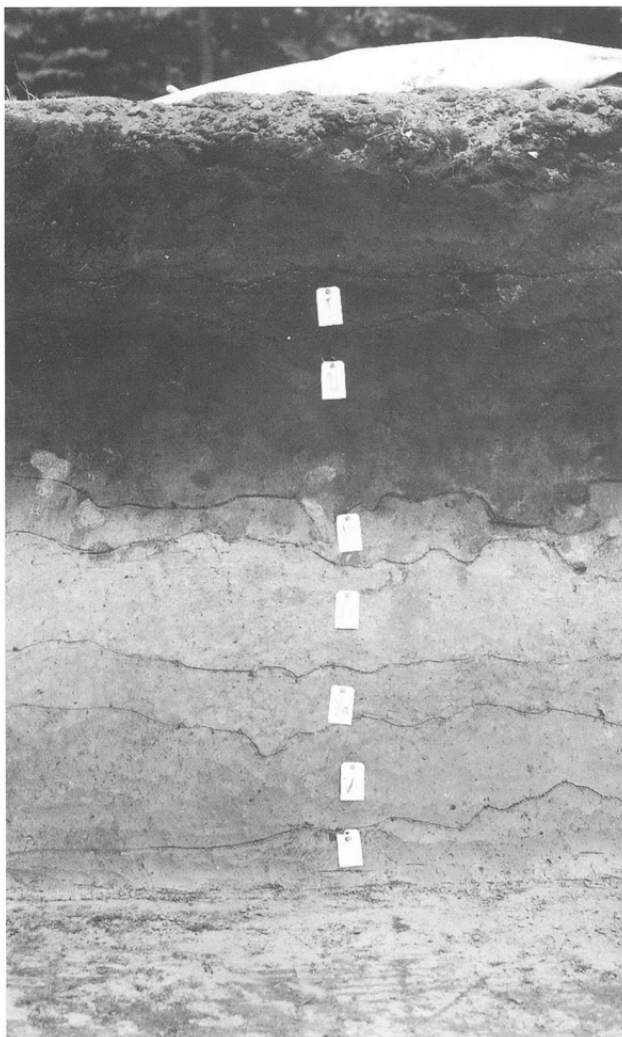

左：基本層序 1

右上：基本層序 2  
右下：火山灰分析  
サンプリング状況



左：II層～IV層上  
半部遺物出土状況  
(北より)  
平成5年度調査区

右：IV層下半部遺  
物出土状況  
(北東より)  
平成5年度調査区



左：IV層下半部遺  
物出土状況  
(南より)  
平成5年度調査区

右：Va層遺物出  
土状況(南より)  
平成5年度調査区

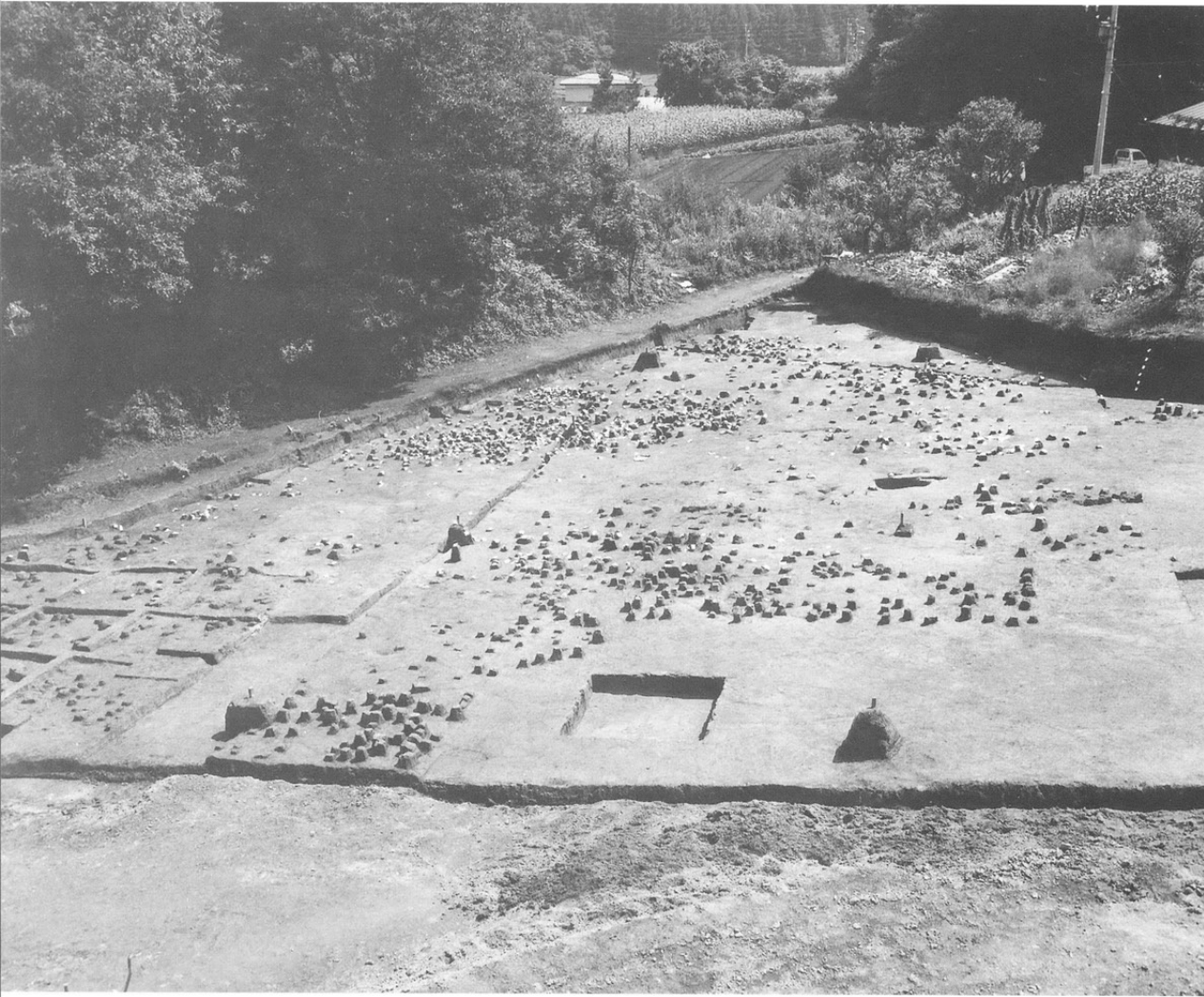

Va層遺物出土  
状況（北より）  
平成5年度調査区

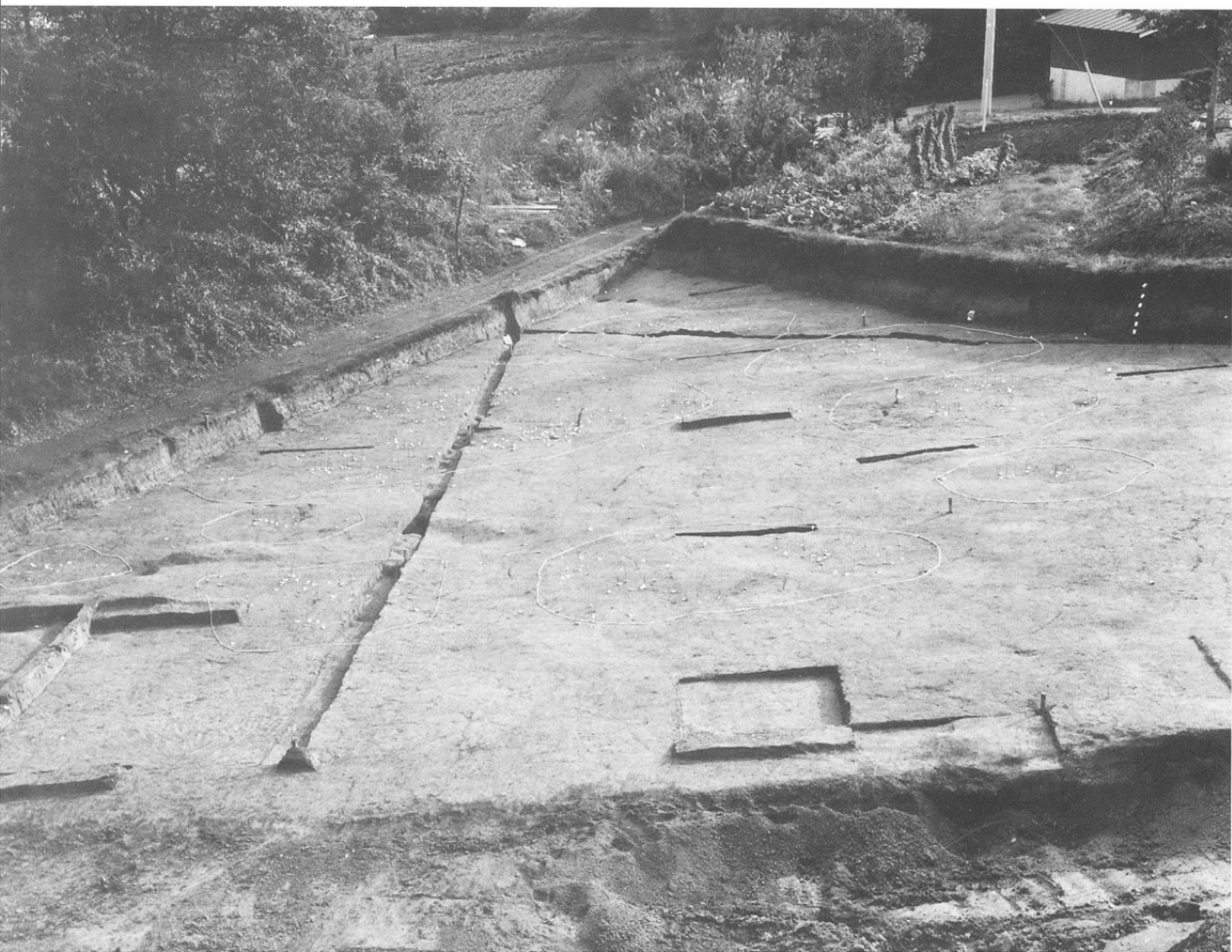

Vb層遺物分布  
状況（北より）  
平成5年度調査区

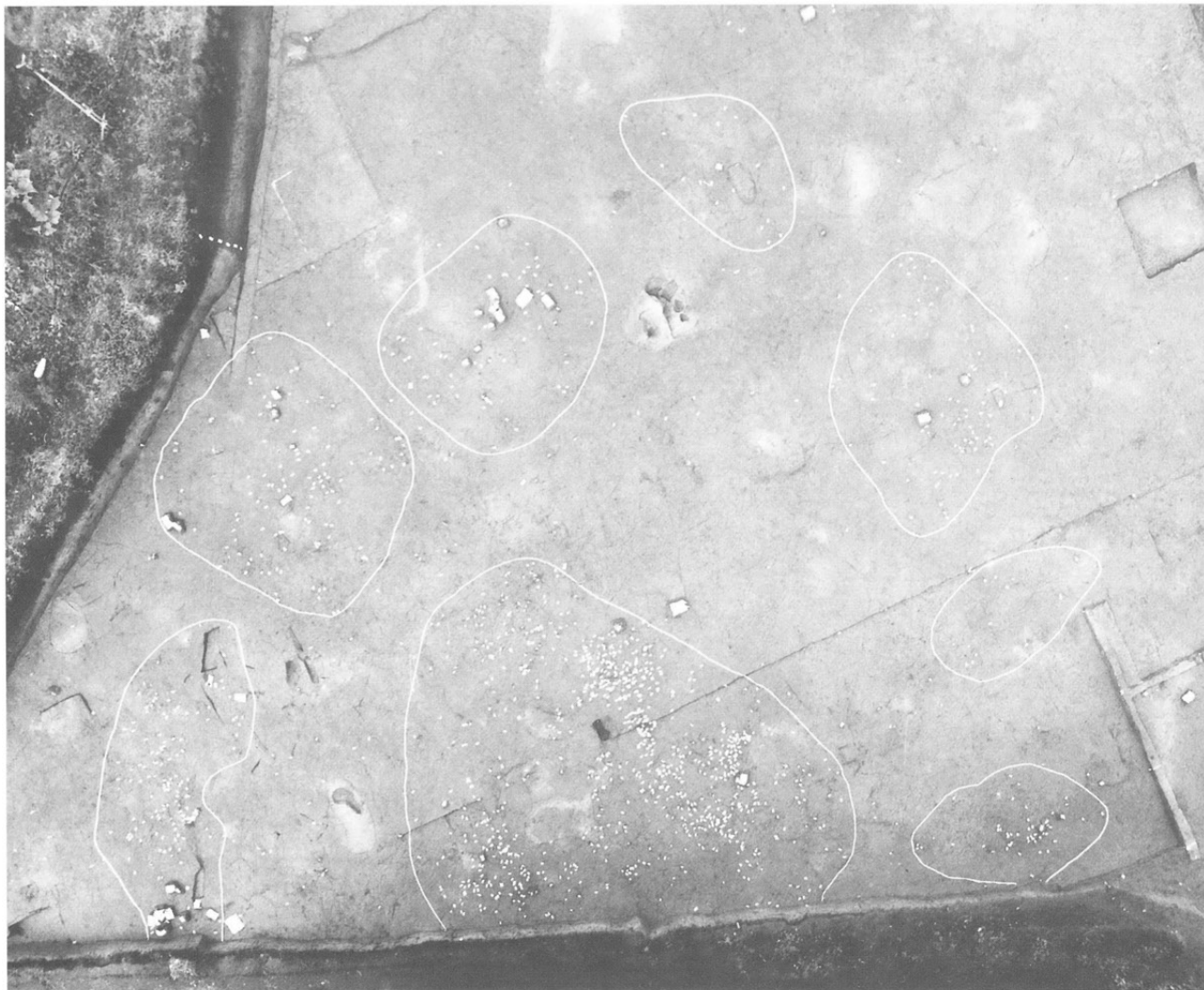

Vb層遺物分布状況  
(空撮)  
平成5年度調査区



Vb層遺物分布状況  
(空撮南東より)  
平成5年度調査区



左：Vb層遺物分布状況（南より）  
平成5年度調査区



右：環状ブロック  
群配置状況(南より)  
平成5年度調査区

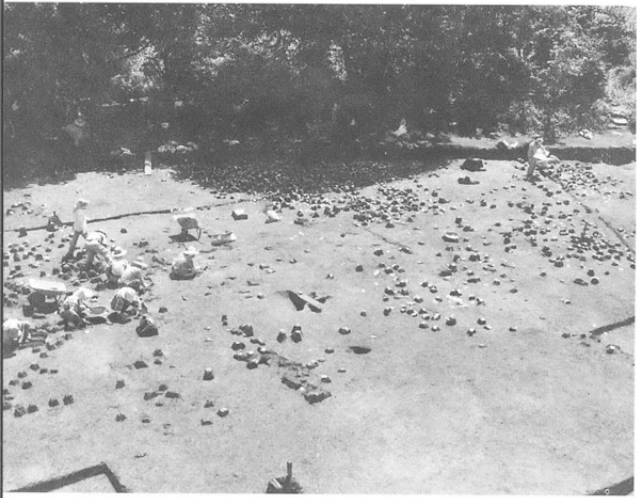

左：Va層遺物検出  
状況（北西より）  
平成5年度調査区



右：遺物検出作業  
風景 1



左：遺物検出作業  
風景 2



右：IV層上半部遺物  
分布状況  
（北より）  
平成7年度調査区



左：IV層下半部遺物  
分布状況  
（北西より）  
平成7年度調査区



右：Va層遺物分布  
状況（南東より）  
平成7年度調査区





Vb層遺物分布状況  
(空撮)  
平成7年度調査区



Vb層遺物分布状況  
(空撮南東より)  
平成7年度調査区



左：Vb層上面炭  
化粒子分布状況  
平成5年度調査区

右：Vb層上面炭  
化粒子分布状況  
平成7年度調査区

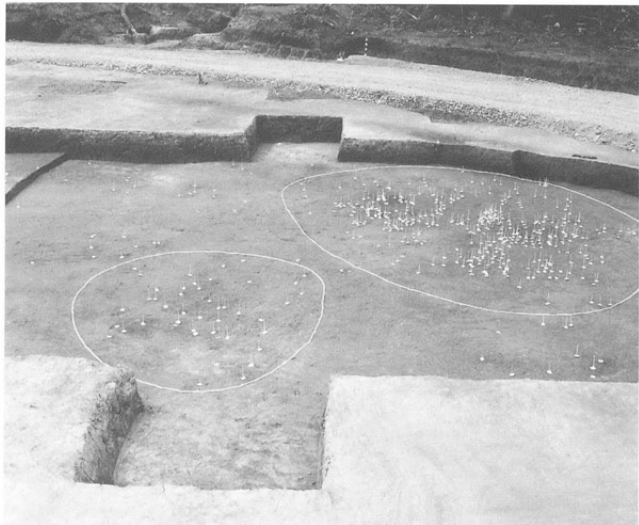

左：第16～20号  
ブロック遺物出土  
状況

右：第22・23号  
ブロック遺物分布  
状況

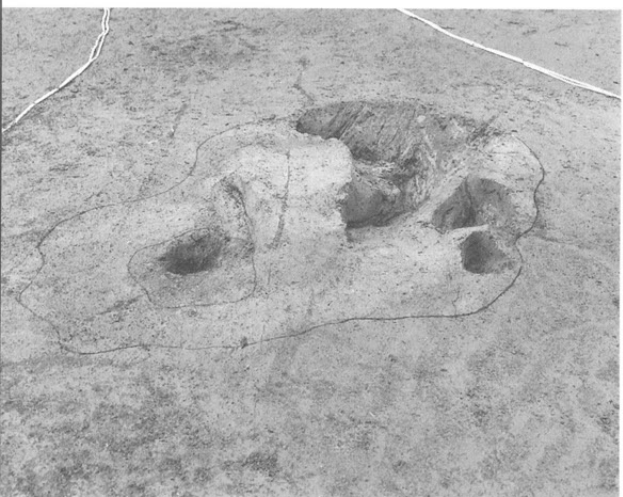

左：I XA10風倒  
木痕検出状況

右：I XB12・13  
付近風倒木痕断面



左：水洗選別作業  
風景

右：日向林III石器  
文化第1号ブロック  
遺物出土状況



左：斧形石器出土  
状況  
(報告番号9)

右上：第14号ブ  
ロック斧形石器出土  
状況

右下：第14号ブ  
ロック斧形石器出土  
状況

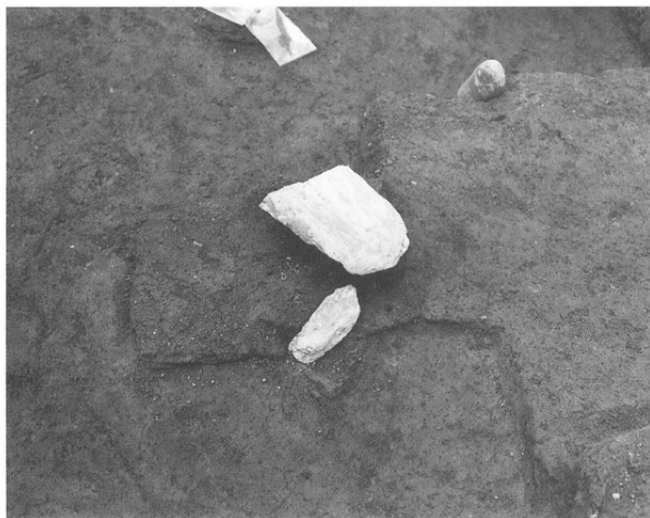
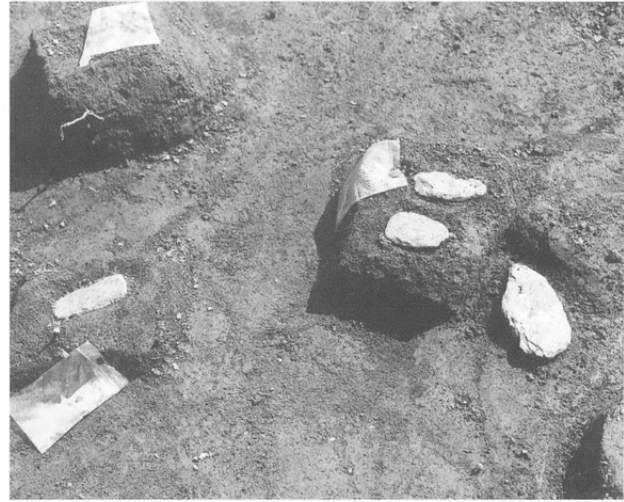

左：斧形石器・敲  
石出土状況  
(報告番号  
37・43・772)

右：第10・11号ブ  
ロック斧形石器出  
土状況

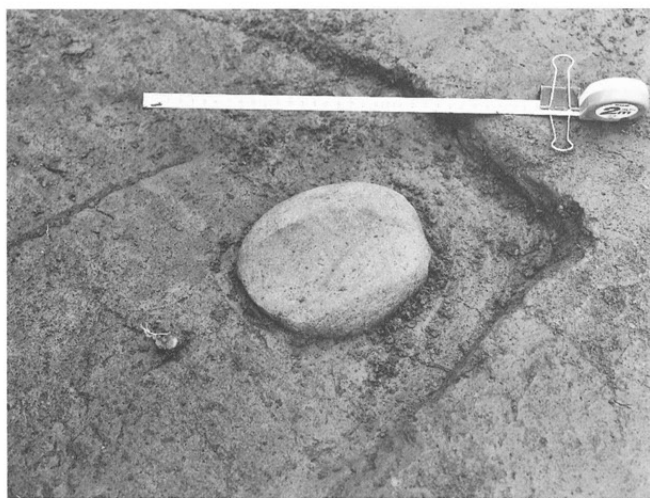

左：砥石出土状況  
(報告番号783)

右：有孔石製品  
出土状況  
(報告番号785)



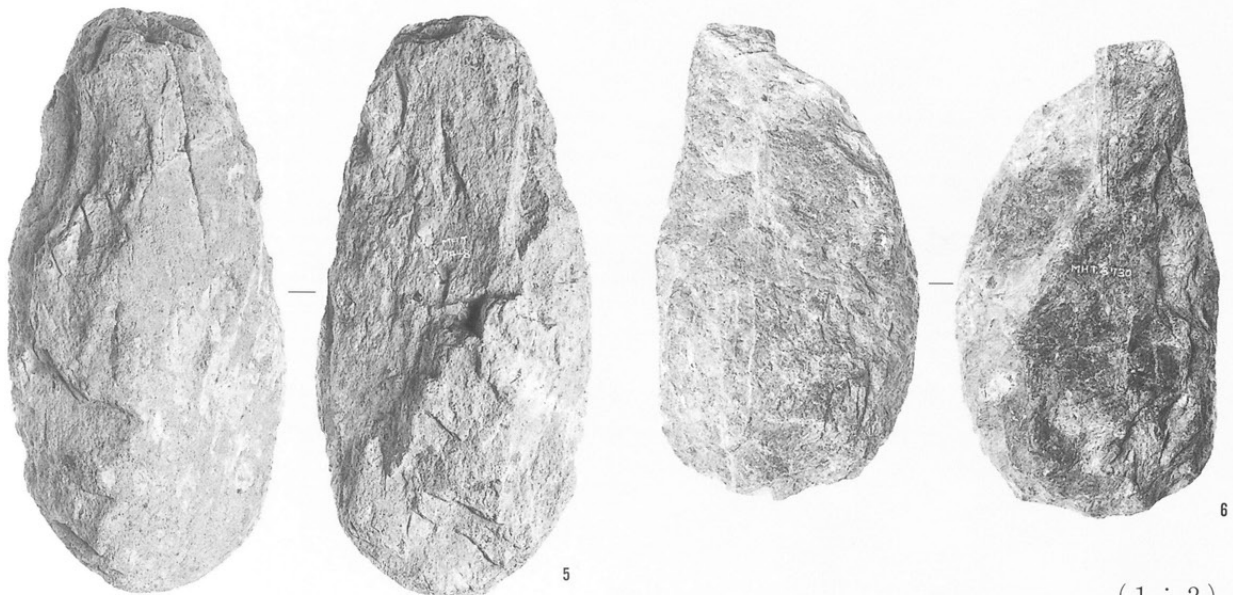
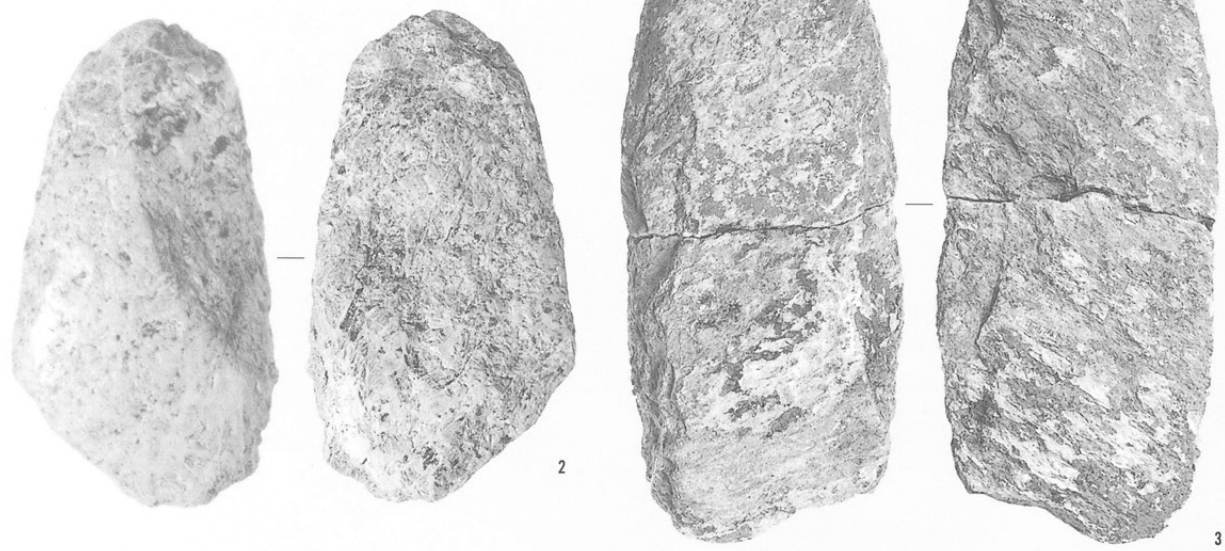

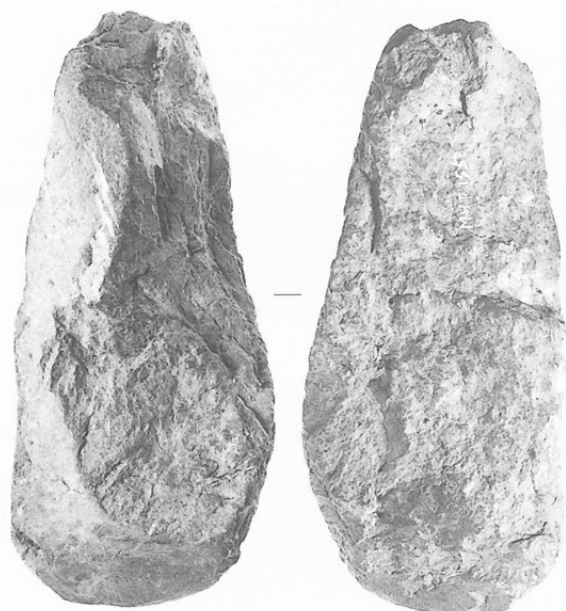
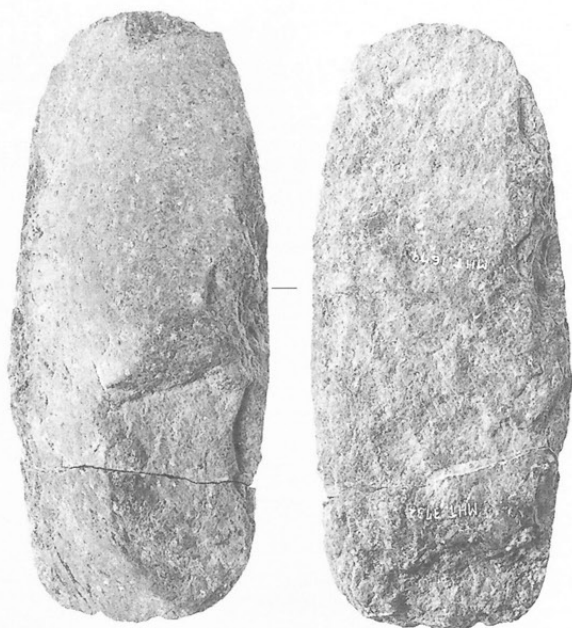
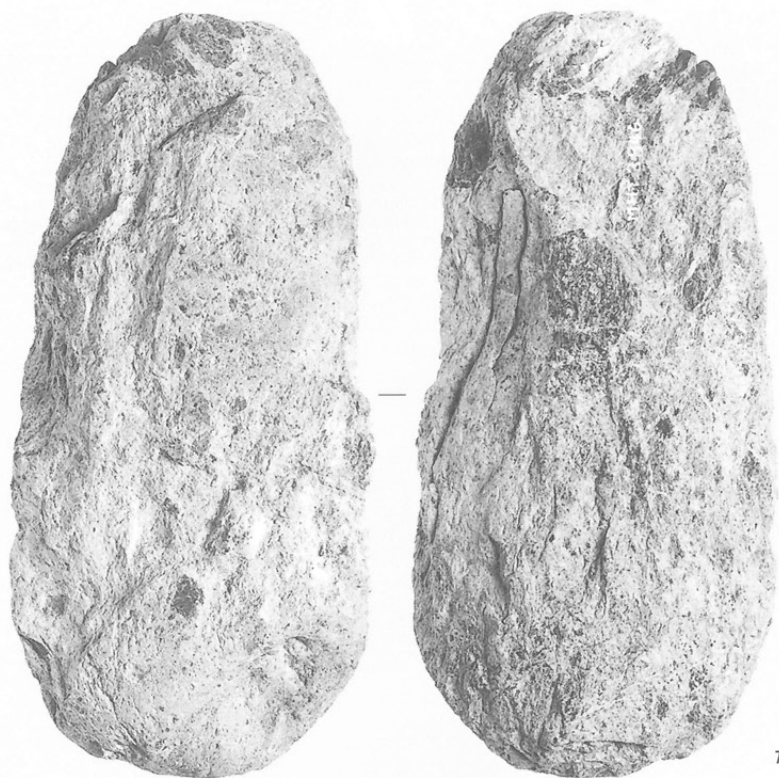

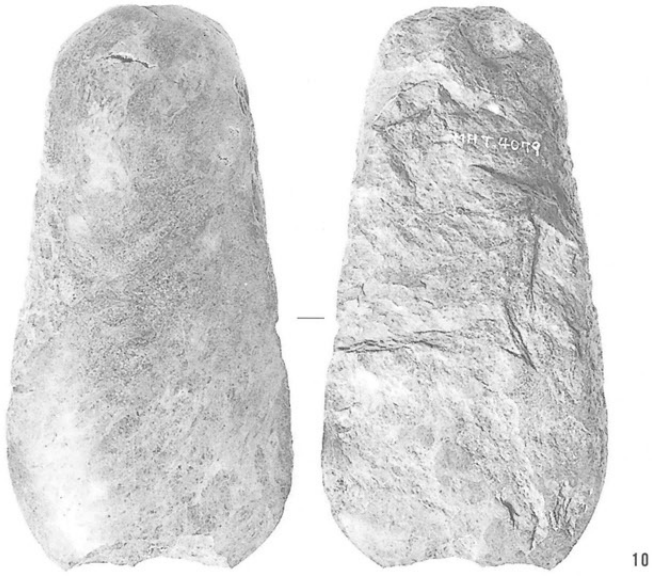

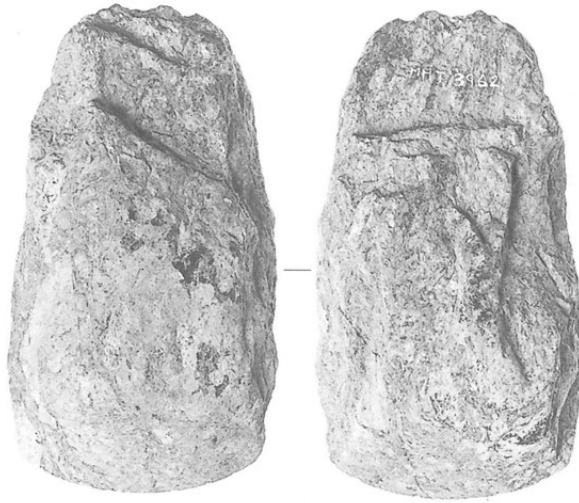

13

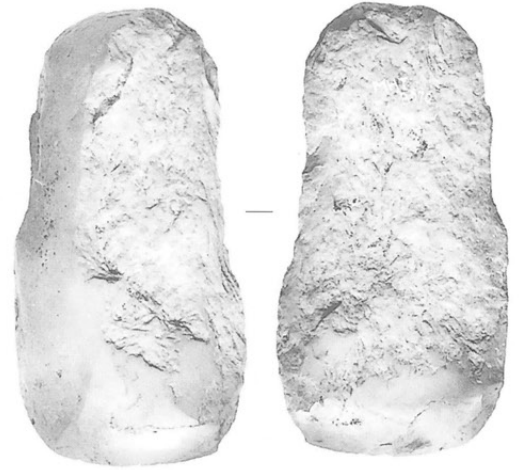

14

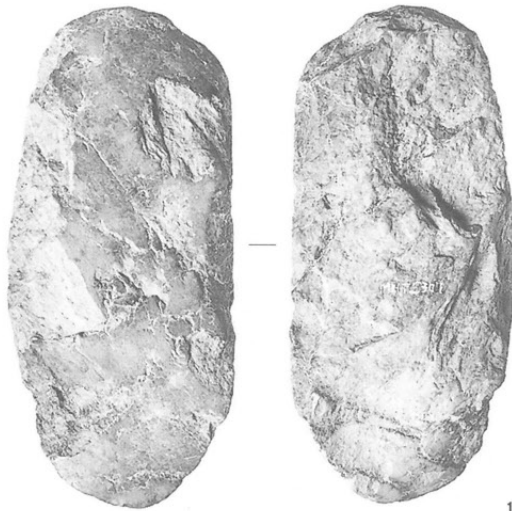

15

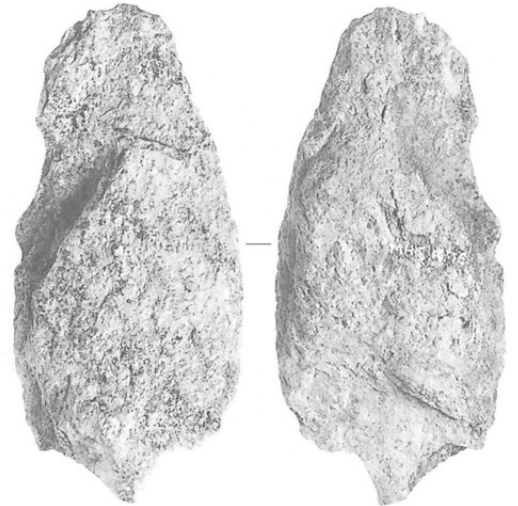

16

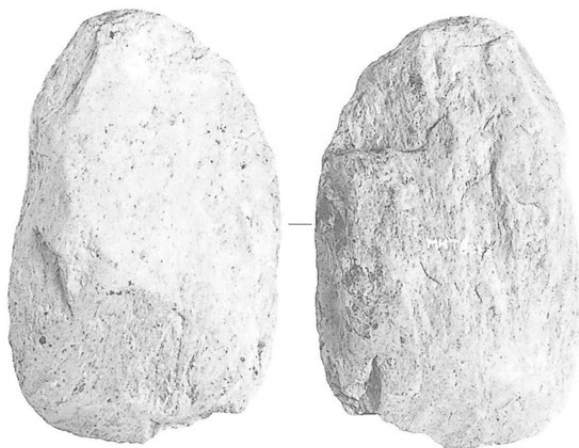

17

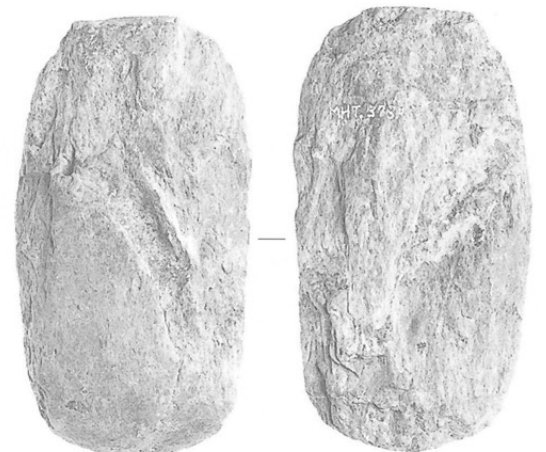

18

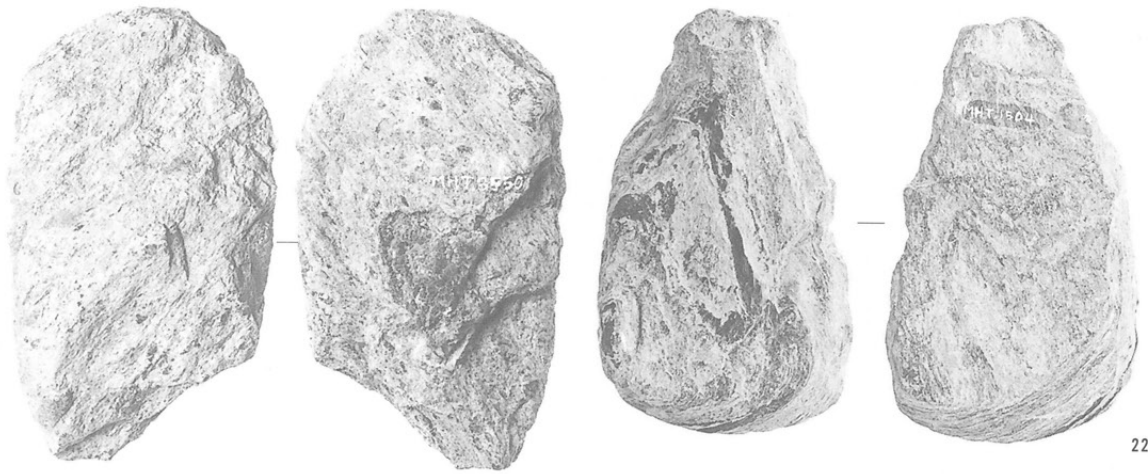

19

22



20

21

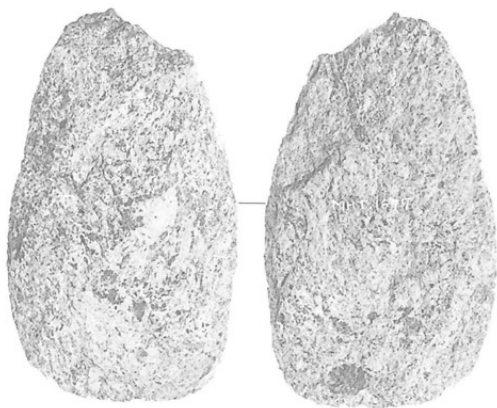

23

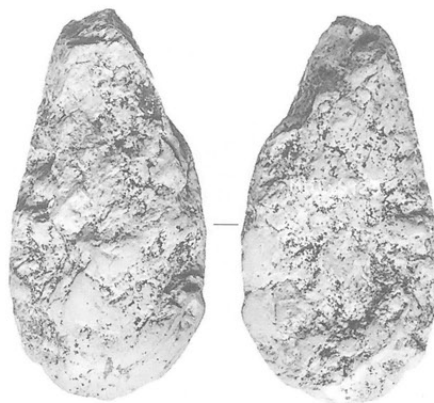

24





25

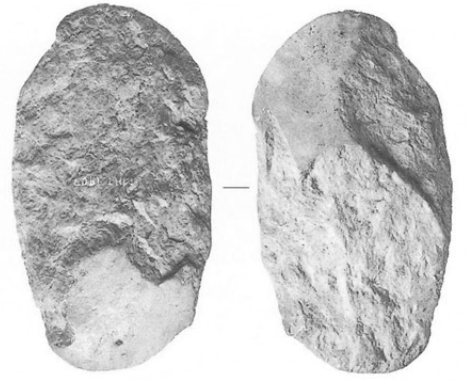

26

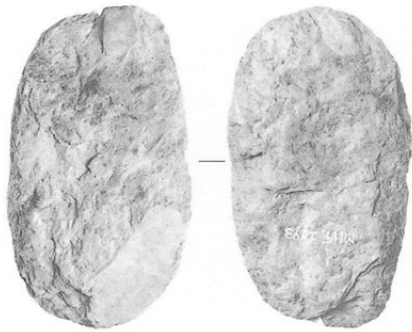

27

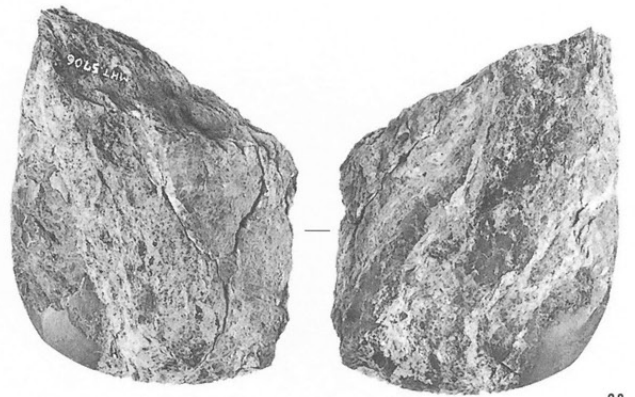

28

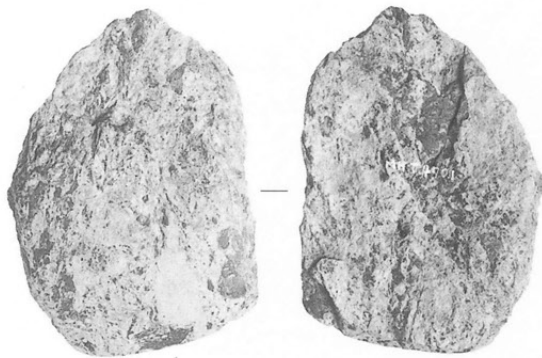

29



30



31

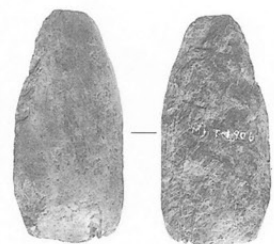

32

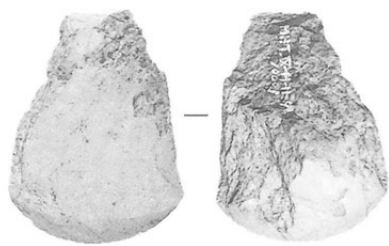

33



34

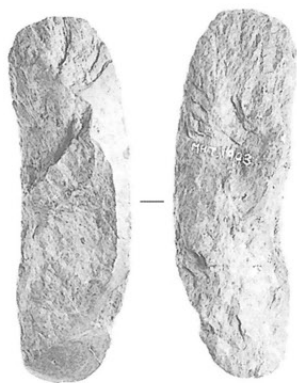

35

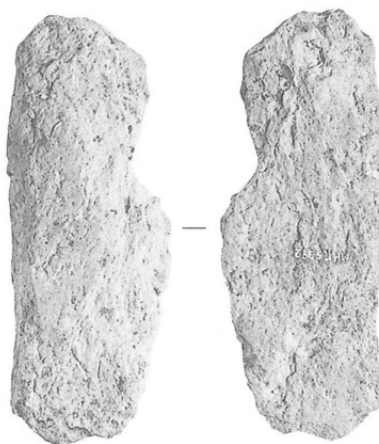

36

(3 : 4)



37

(1 : 2)



38

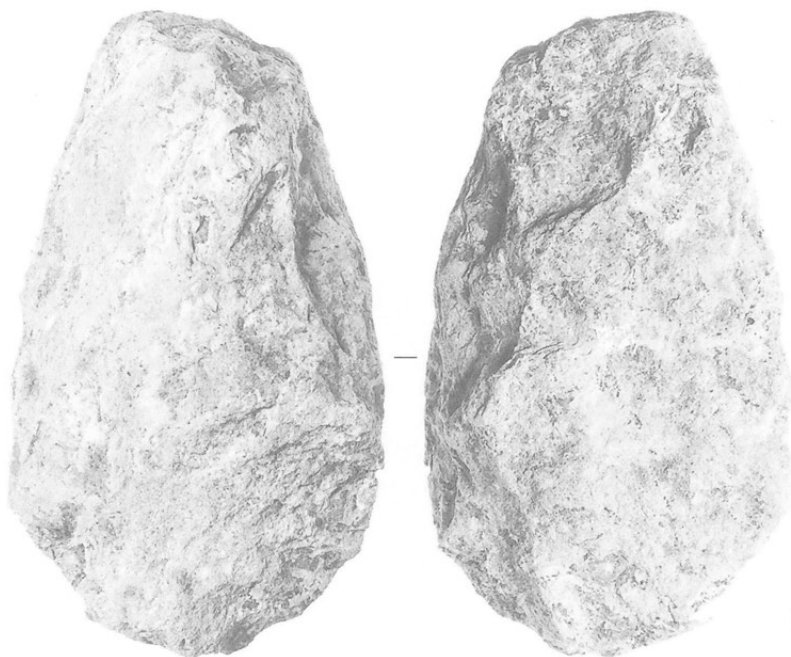

39



40



41

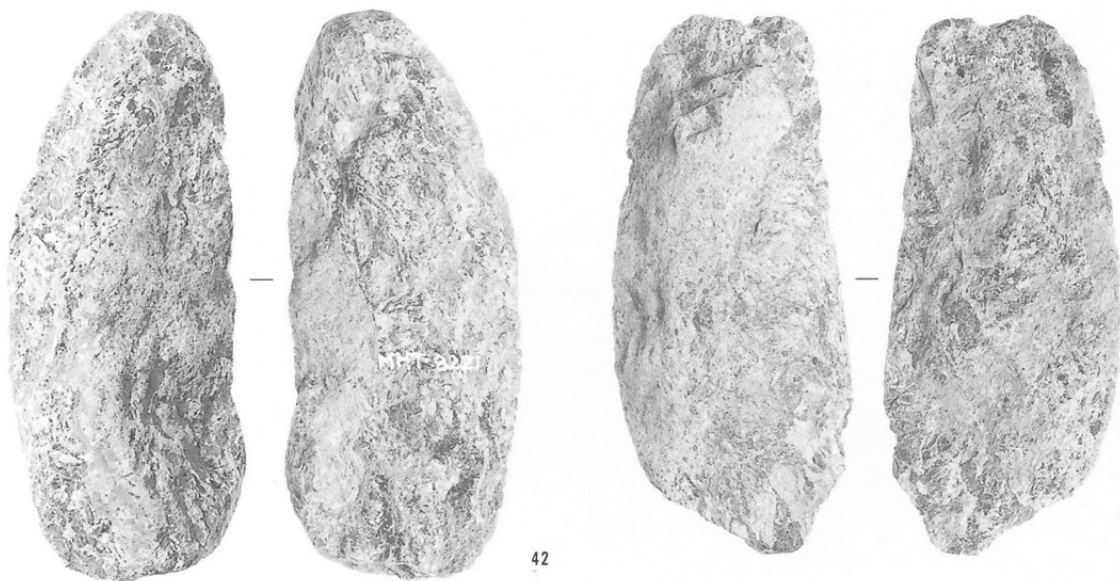

42

43

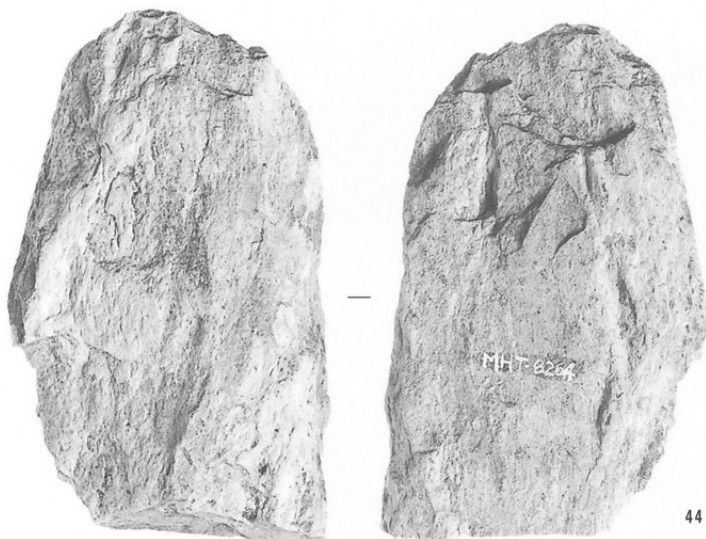

44

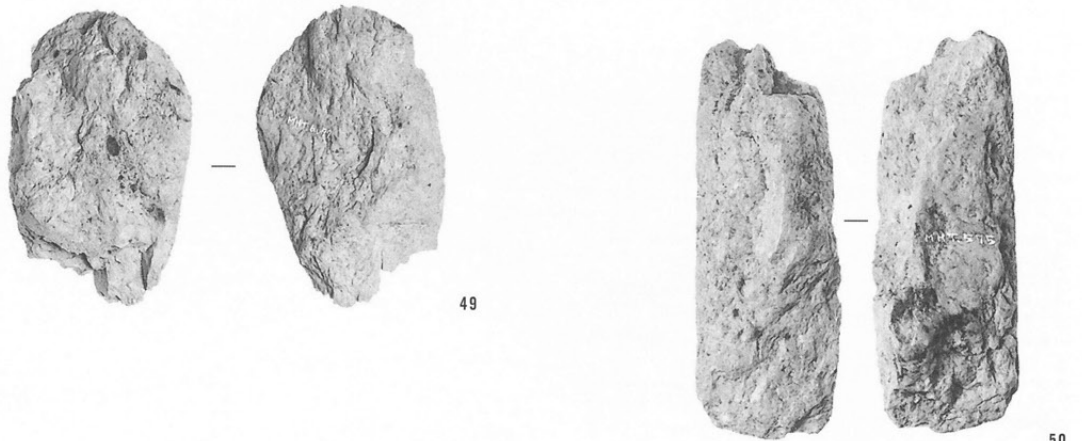
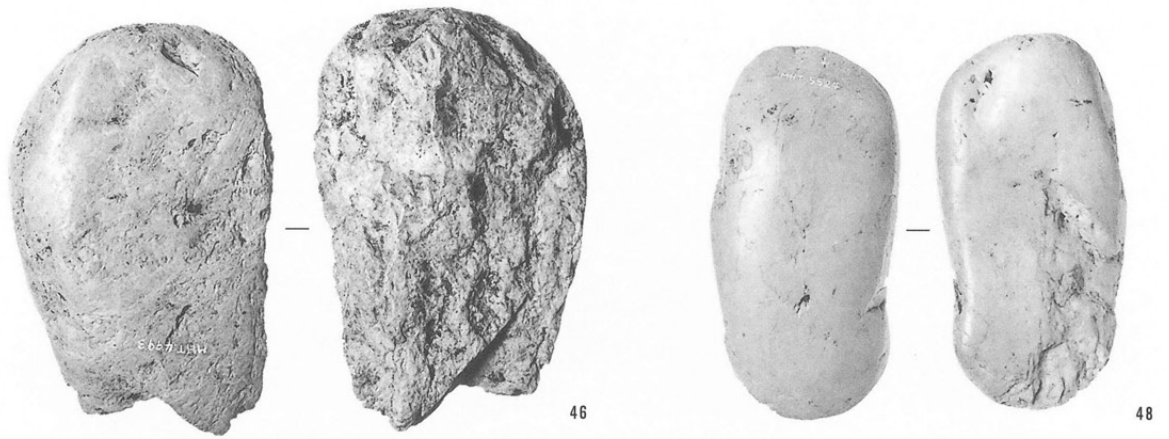
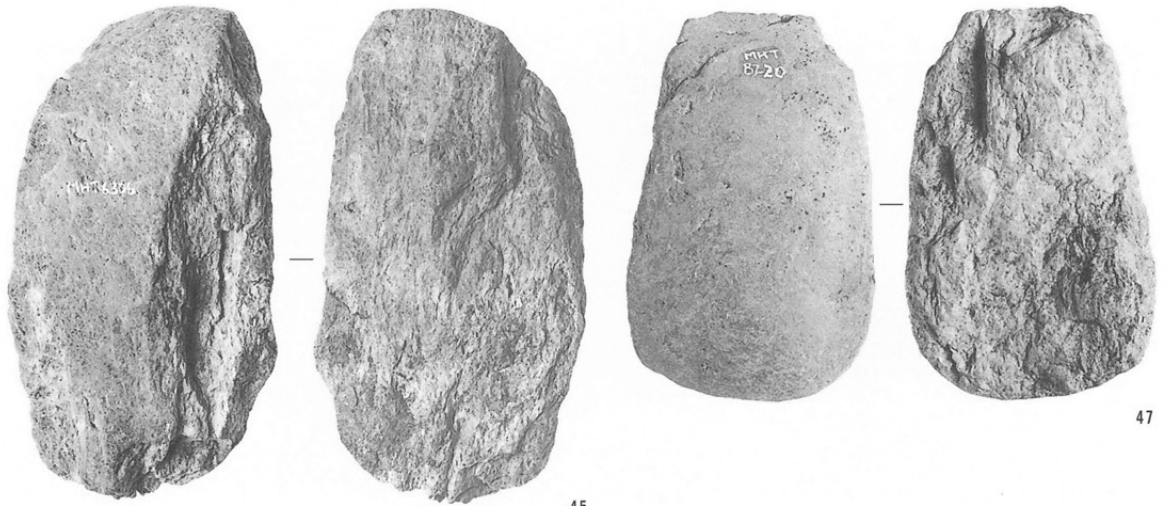

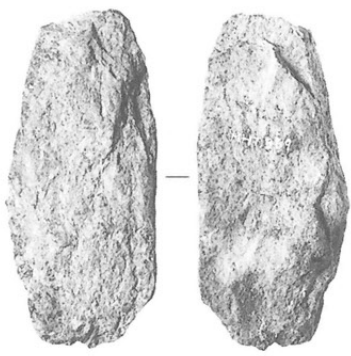

51

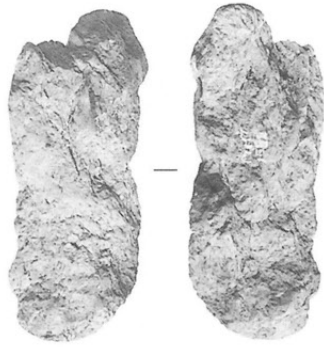

52

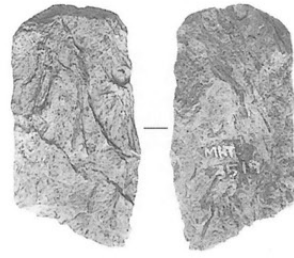

53

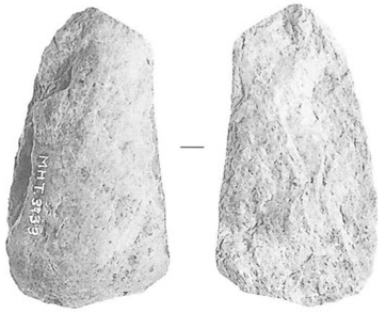

54

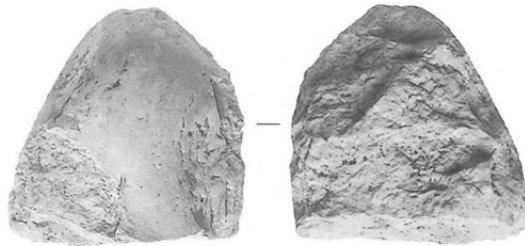

59

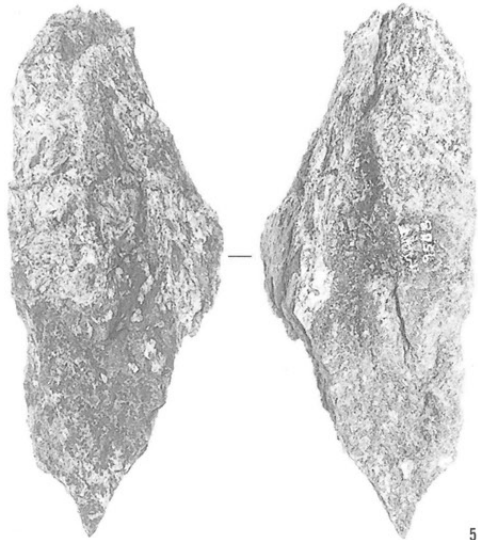

56

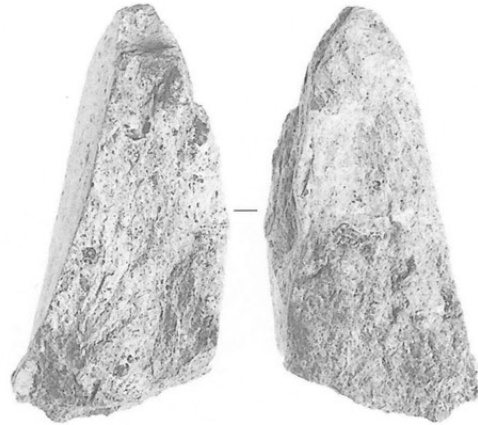

57

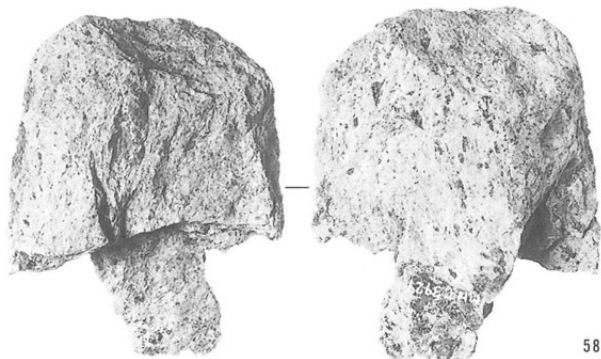

58

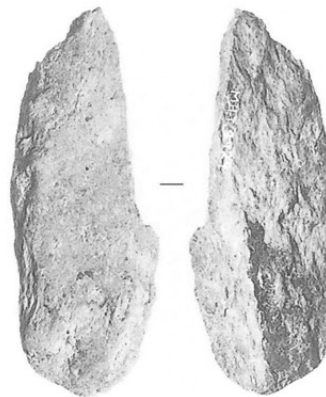

55

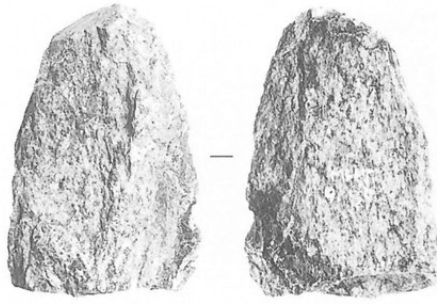

60



61



62

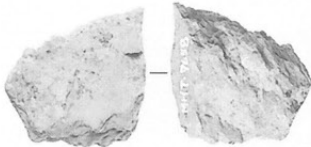

63



64

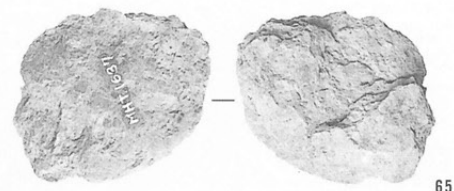

65



66

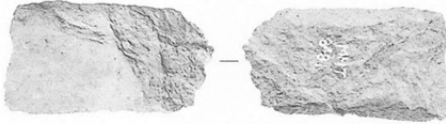

67

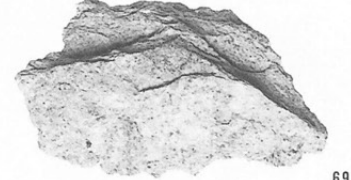

69

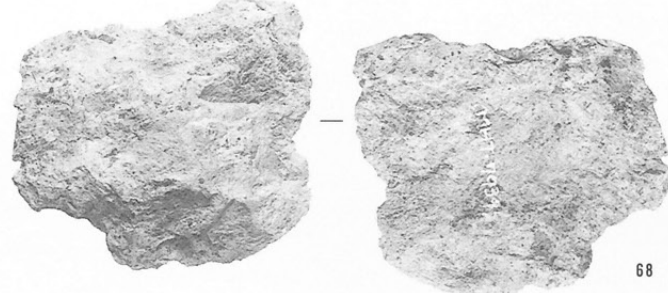

68

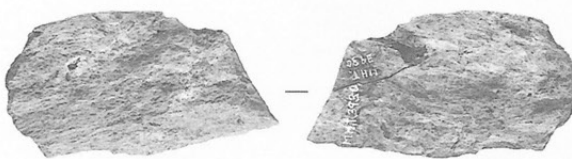

70



73



72

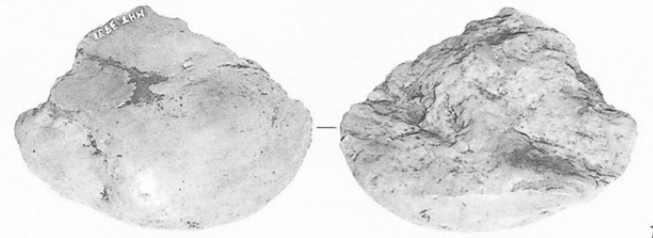

71



74

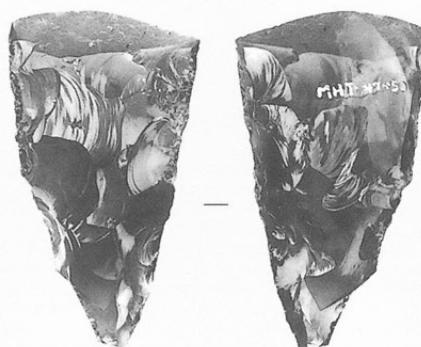

75

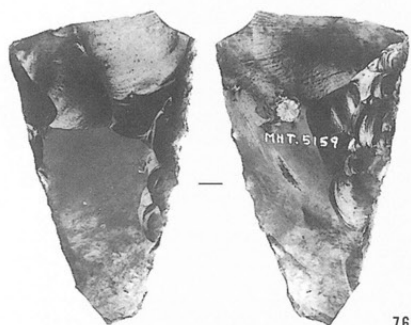

76

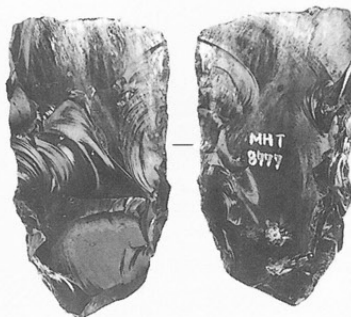

77

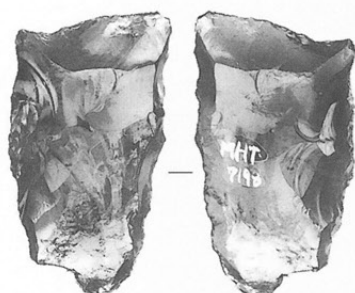

78



79

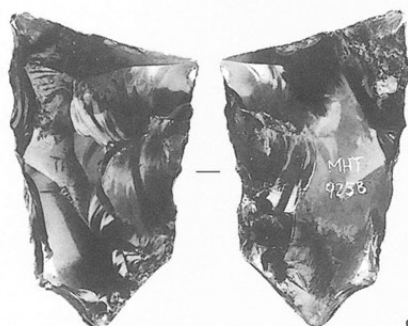

80

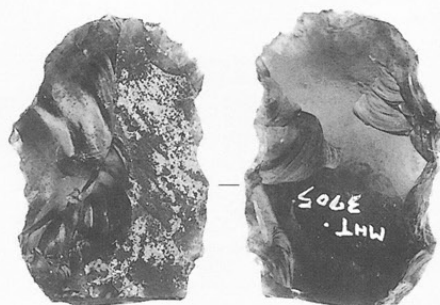

81

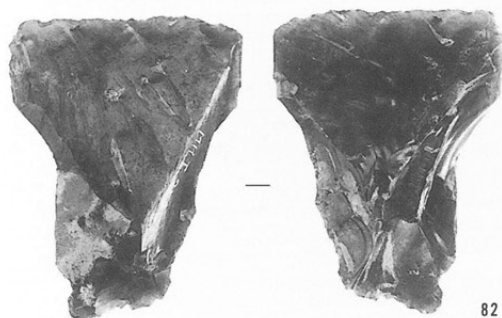

82

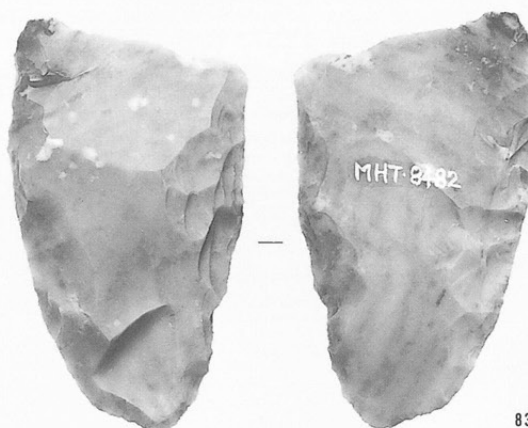

83



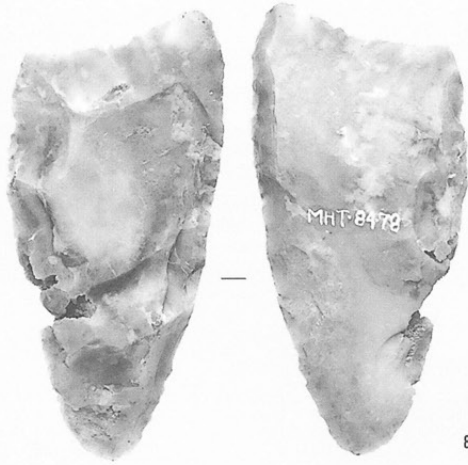

84

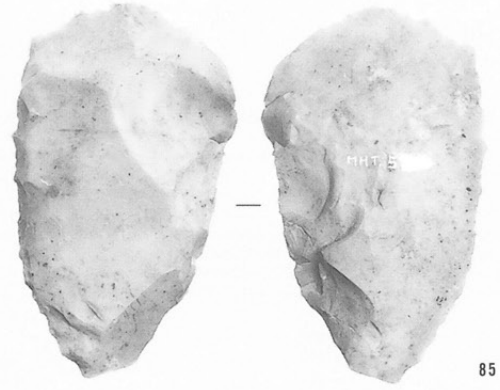

85

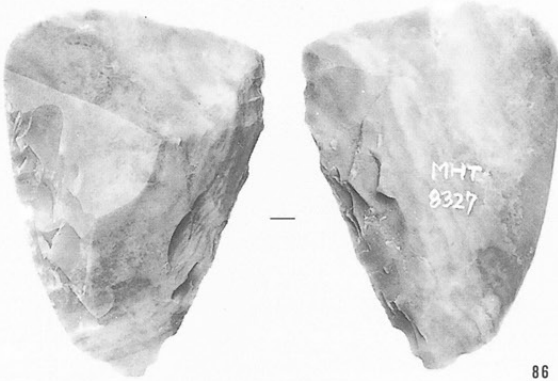

86

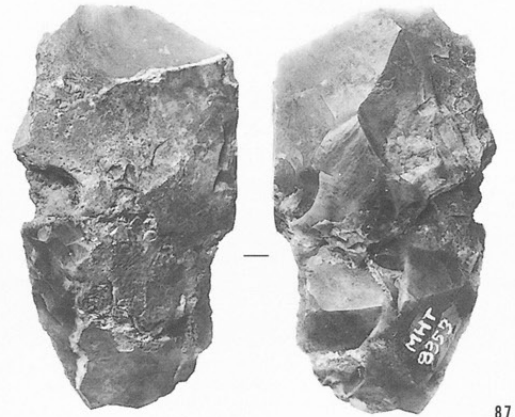

87

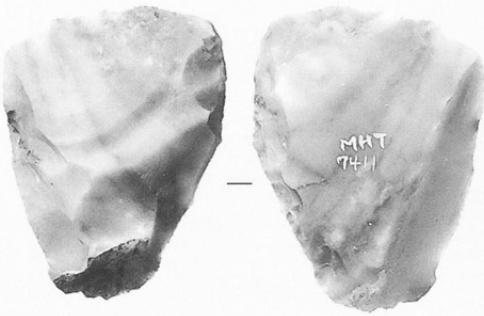

88



89

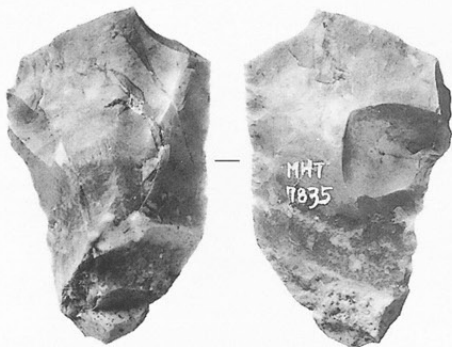

90

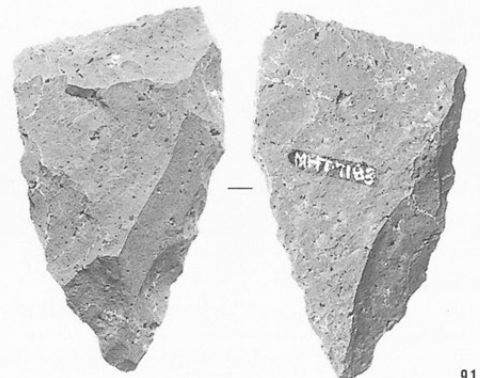

91

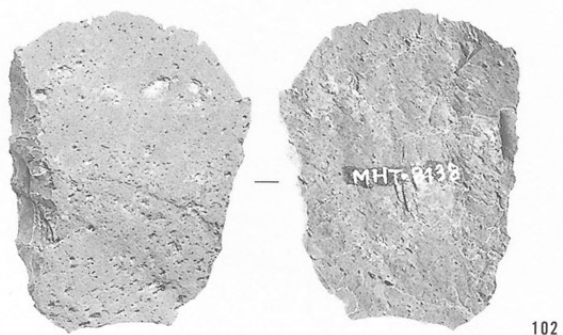
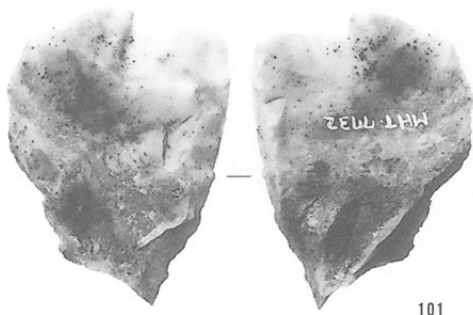
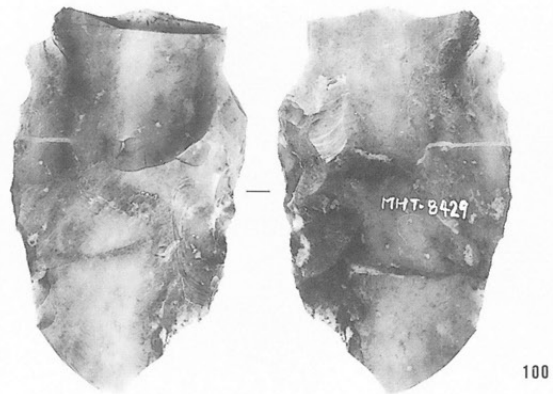
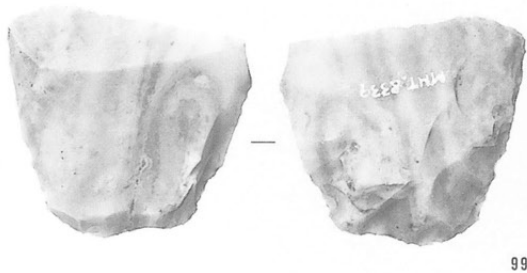
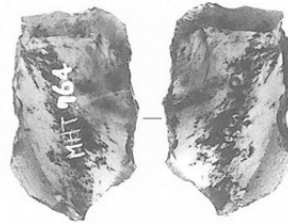
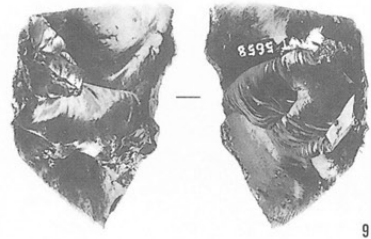
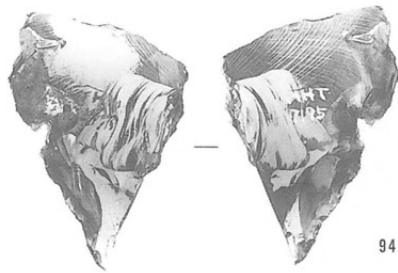
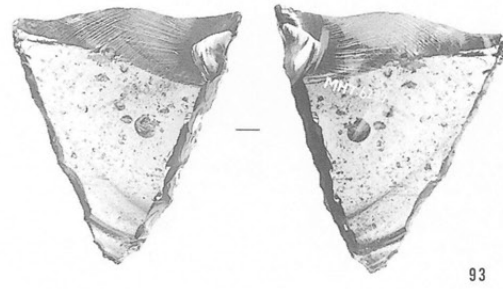



103

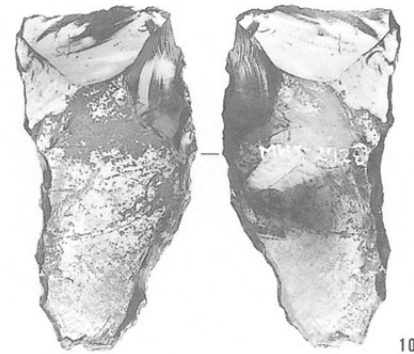

104

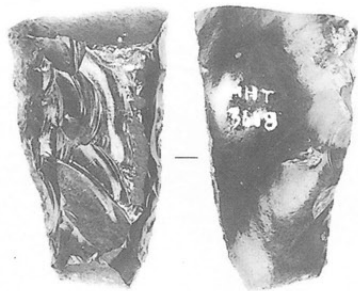

105

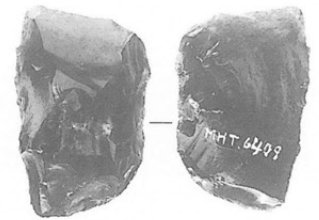

106

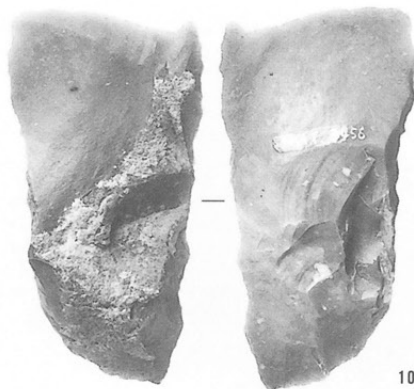

107

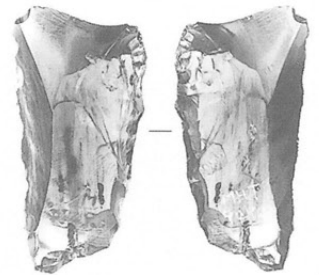

108



109



110



111

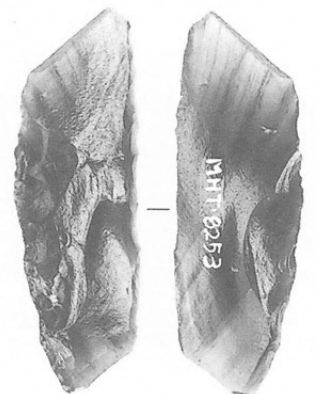

112

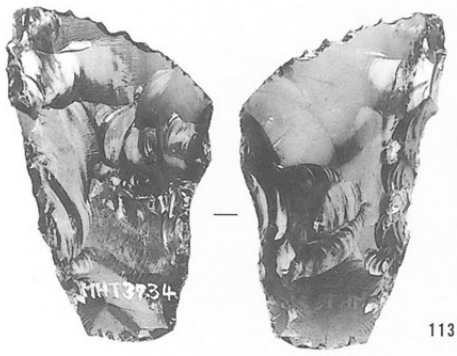

113

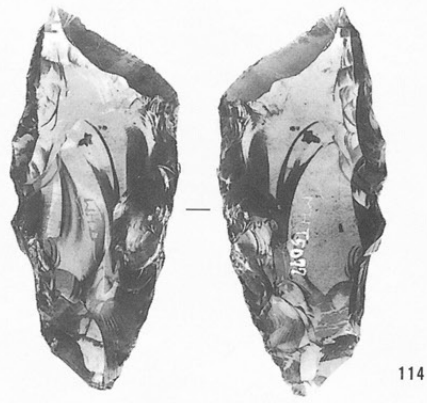

114

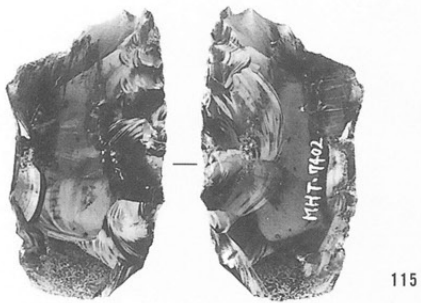

115

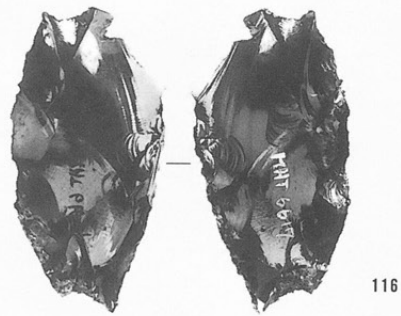

116

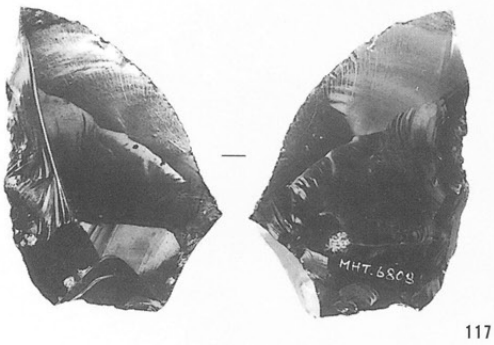

117

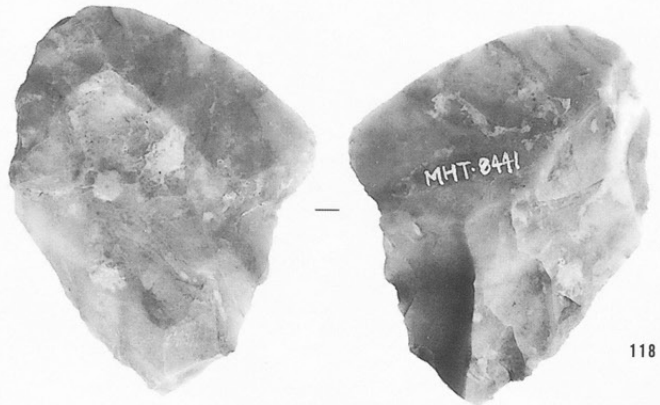

118

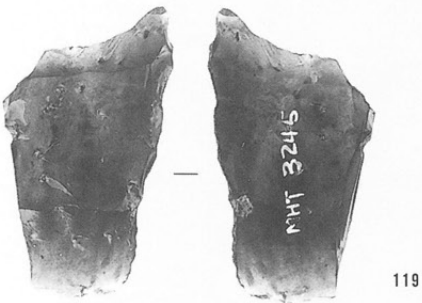

119

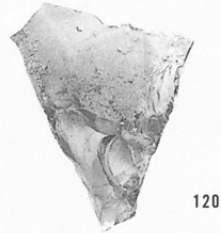

120

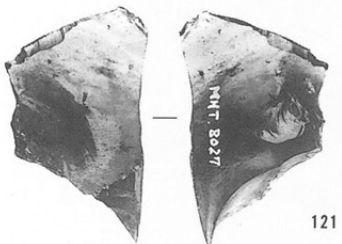

121

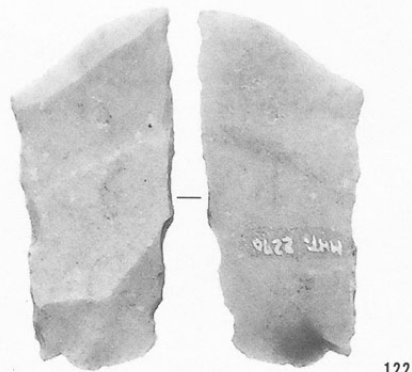

122

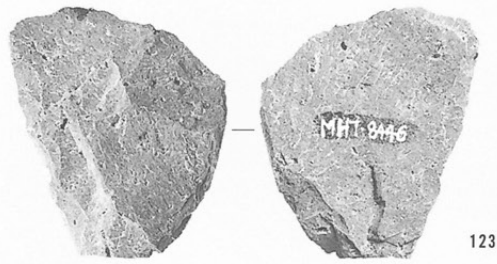

123

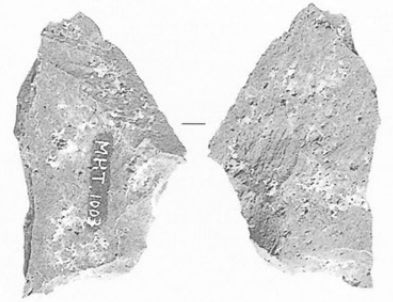

124

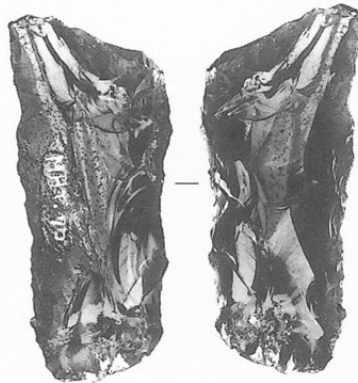

125



126

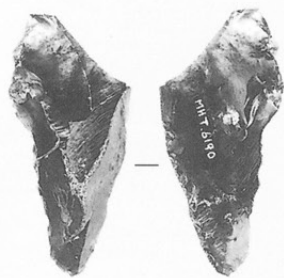

127

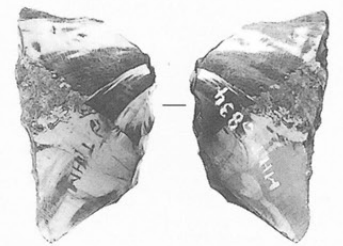

128

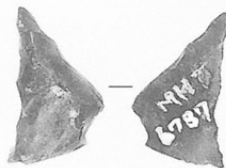

129

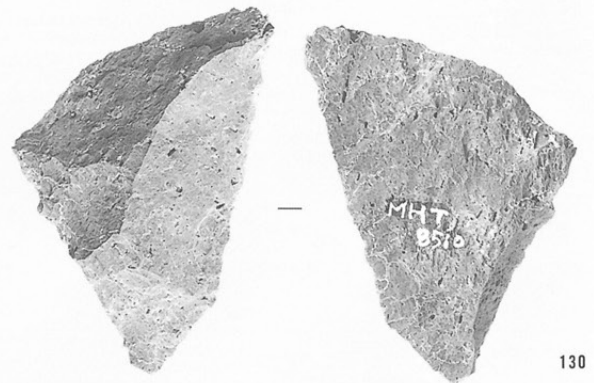

130

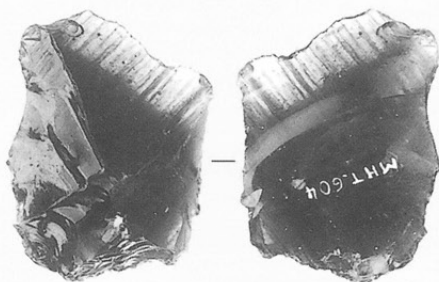

131



132

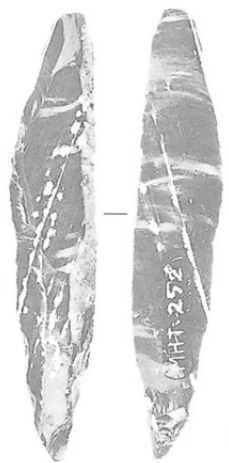

133

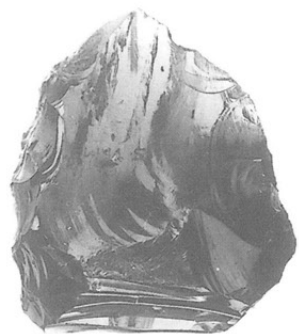

134



135



136

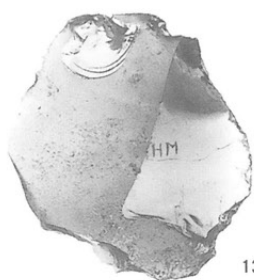

137

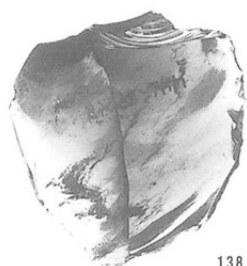

138

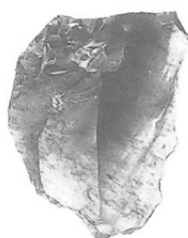

139



140



141



142



143

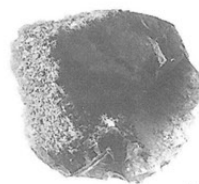

144



145



146



147

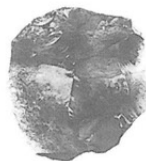

148

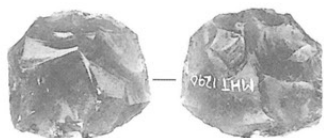

149

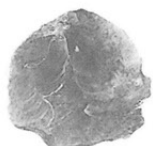

150



151



152



153



154



155



156



157

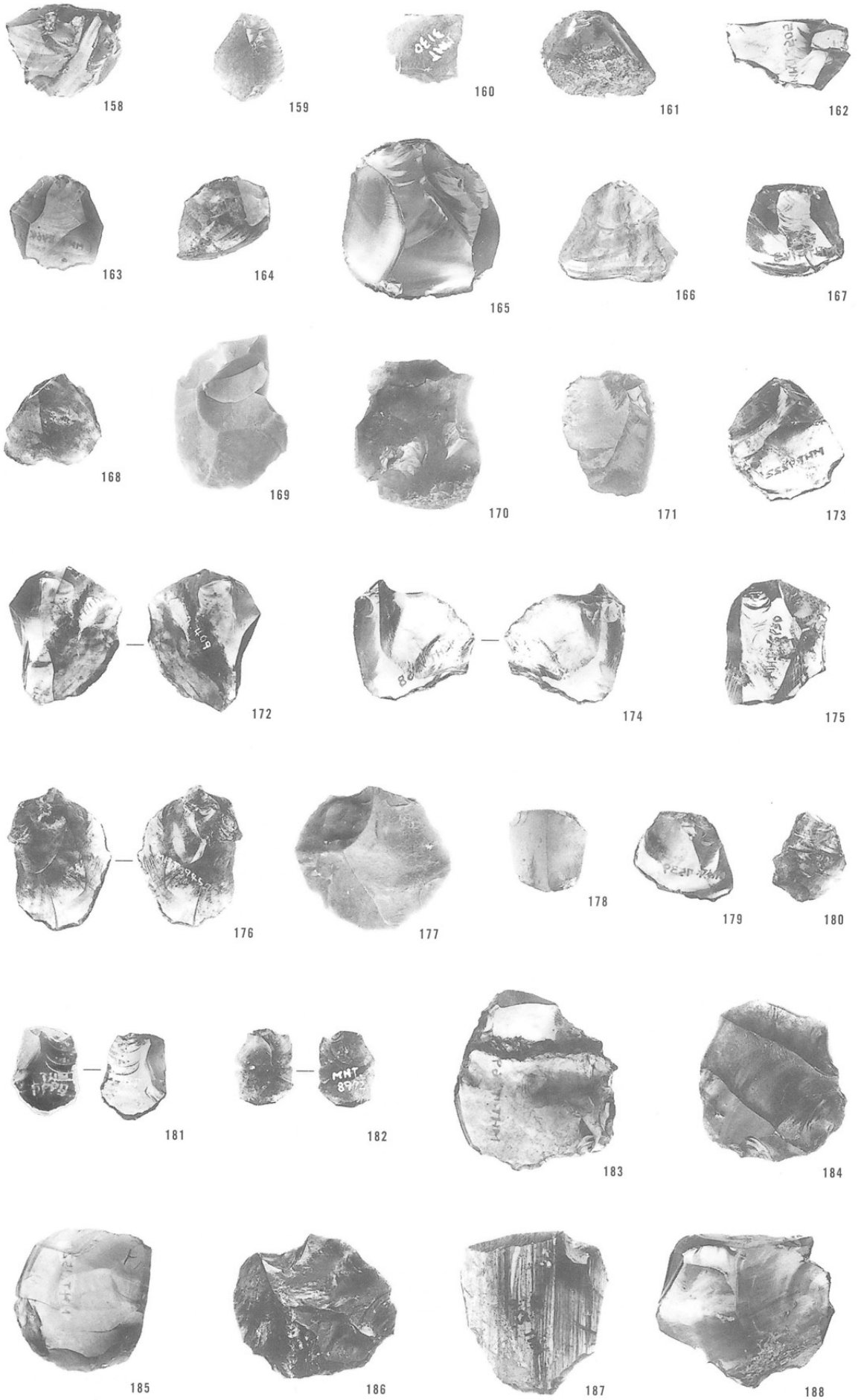



189



190

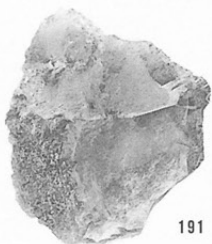

191



MHT-3241



192



193



194

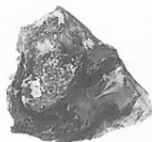

195



196

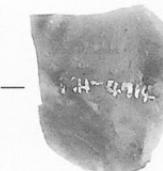
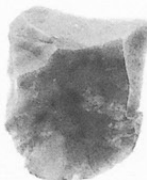

197

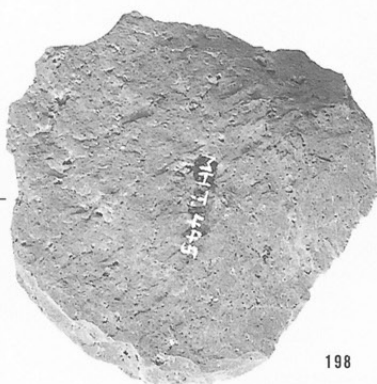
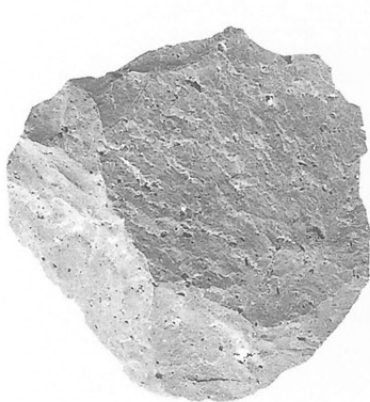

198



199



200



MHT-2172

201



202



203



204



205



206



207



208



209



210



211



212



213



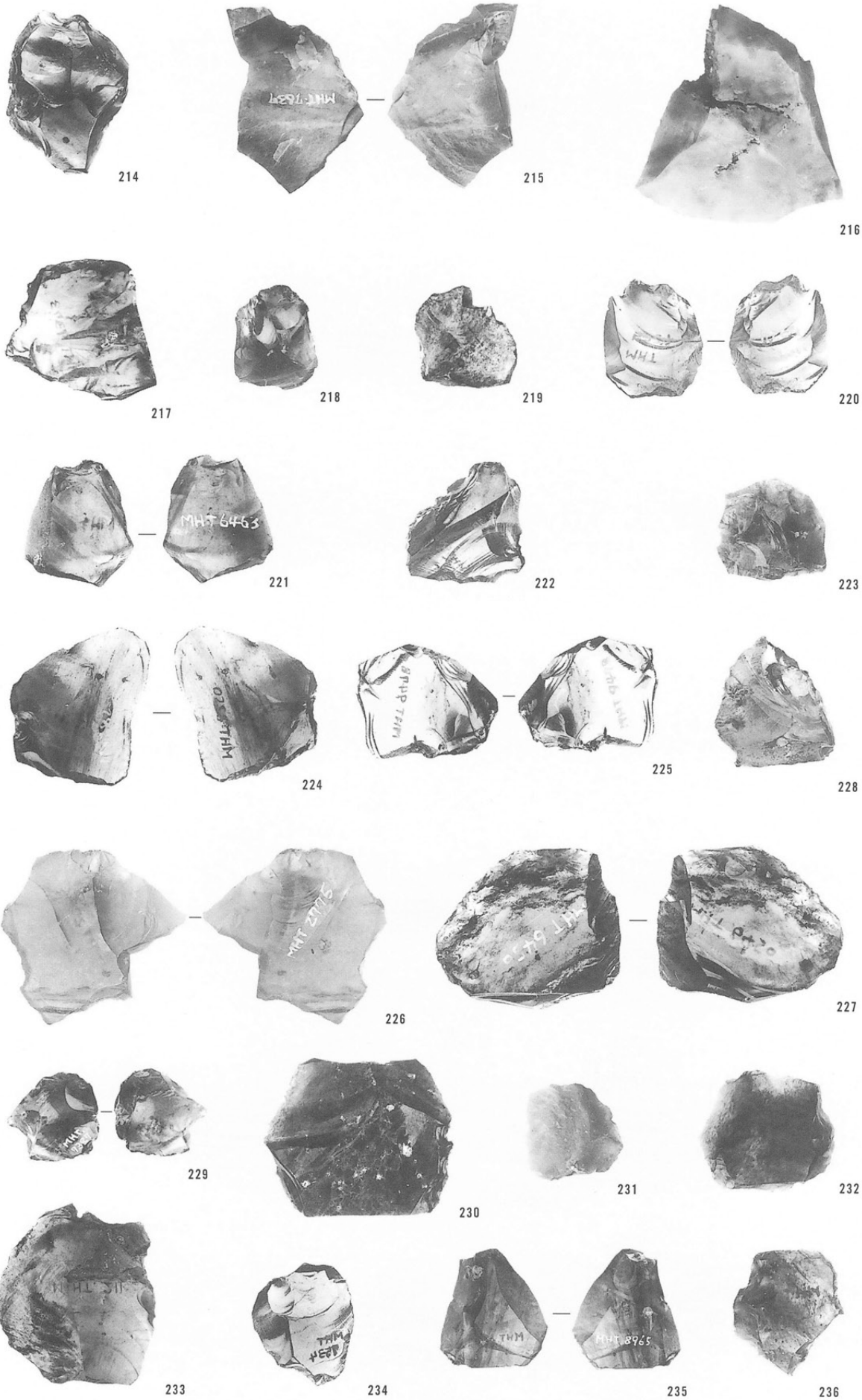



237



238



239



240



241

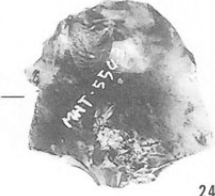
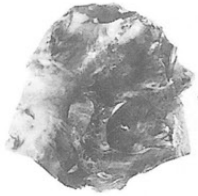

242



243



245



244



246



247



248



249



250



251



252



253



254



255



256



257



258

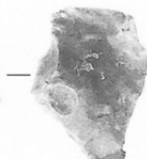

259



260



261

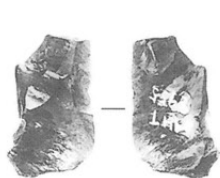

262



263



264

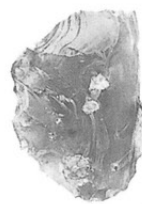

265

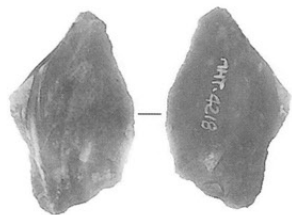

266



267



268



269



270



271



272



273



274



275

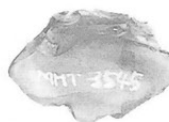

276



277



278



279



280



281



282



283



284



285



287

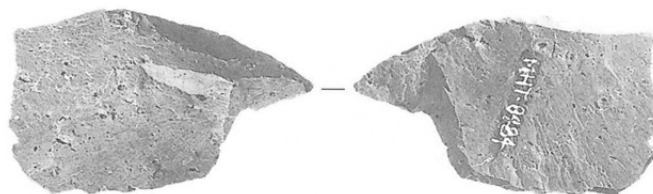

286



288

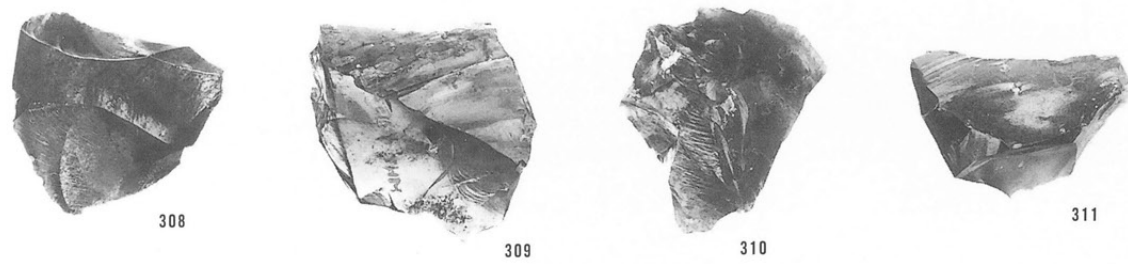
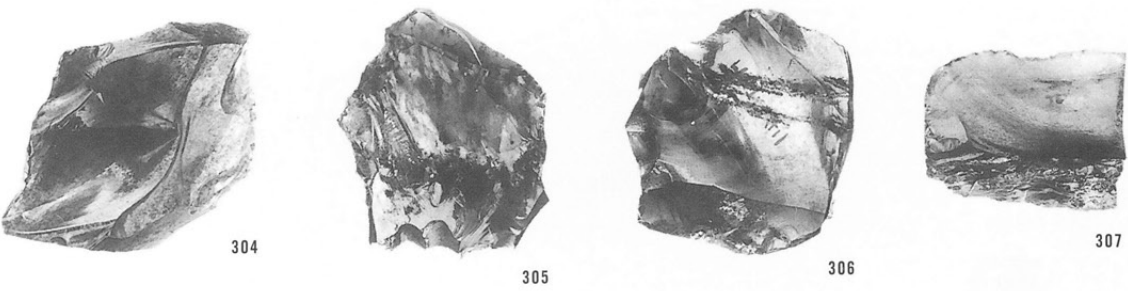
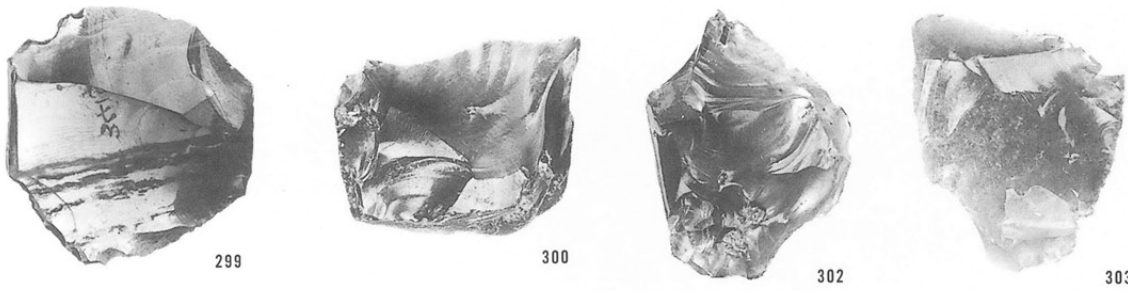
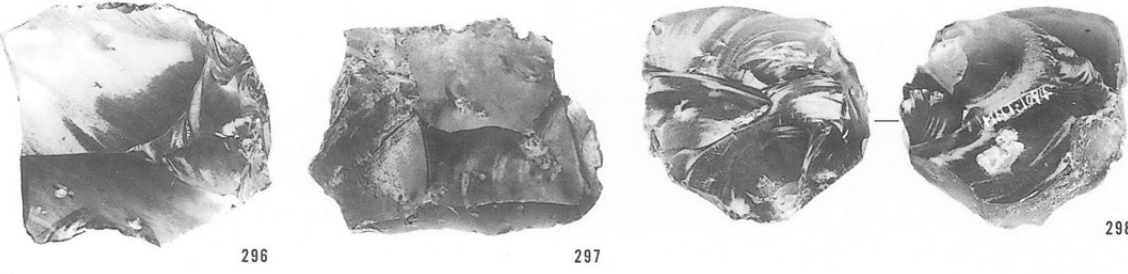
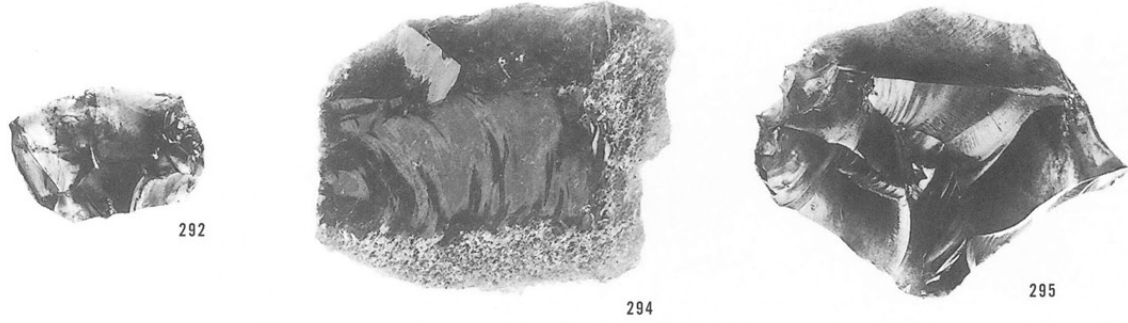
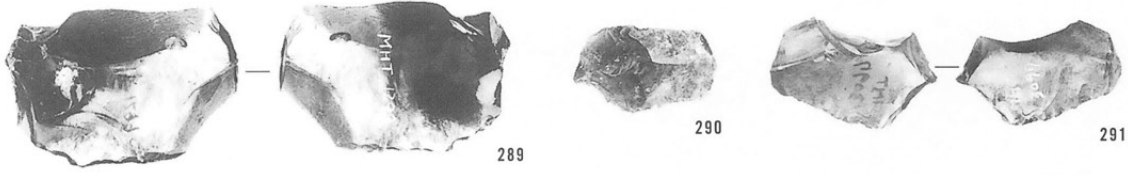

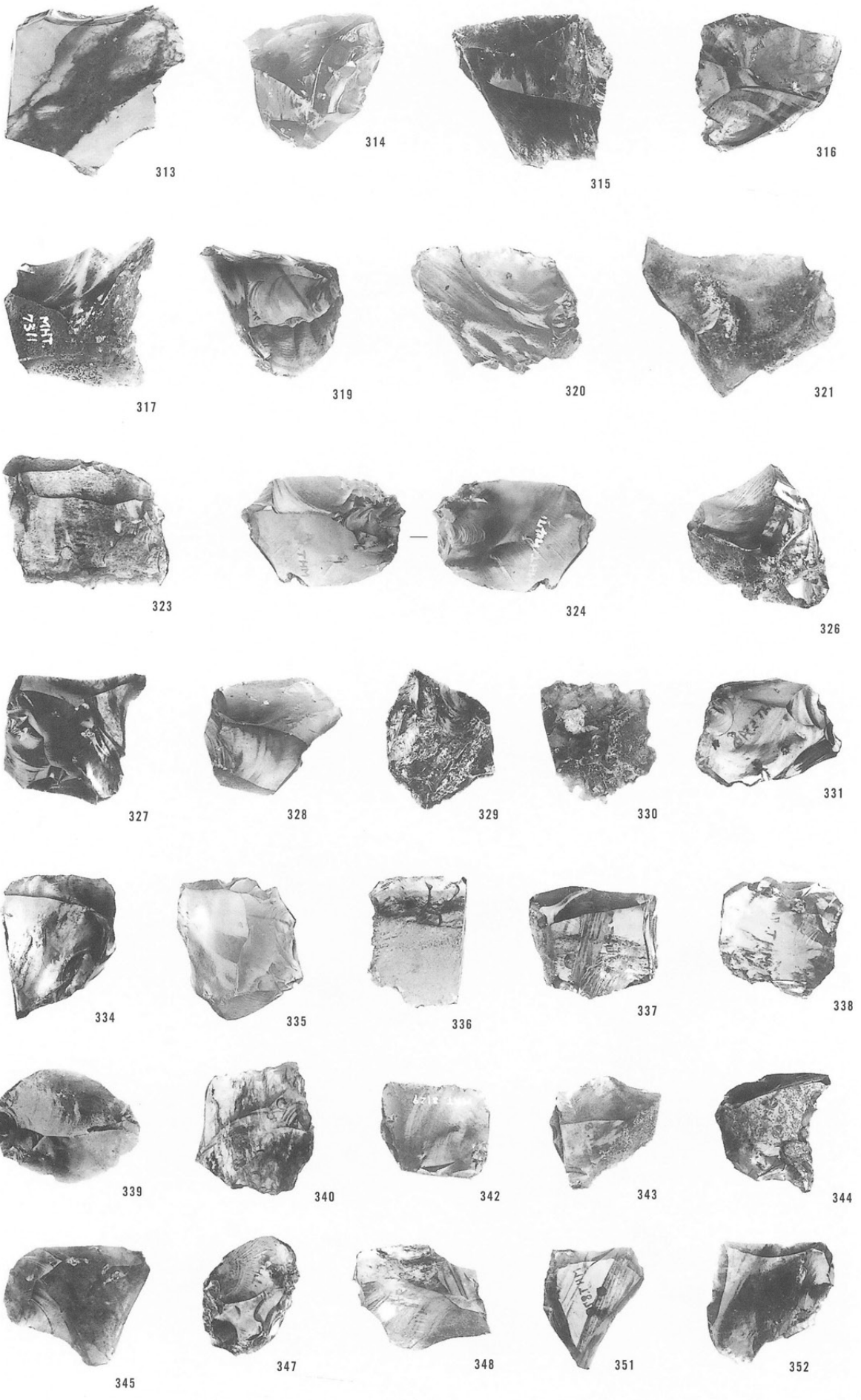



353



355



356



357



358

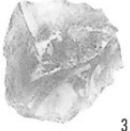

359

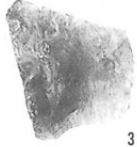

360



361



362



363



364



365

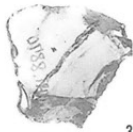

368



369



370

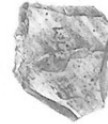

371



372



373



374



375



376



377



378



379



380



381



382



383



384



385



386



387



388



389



390



391



392

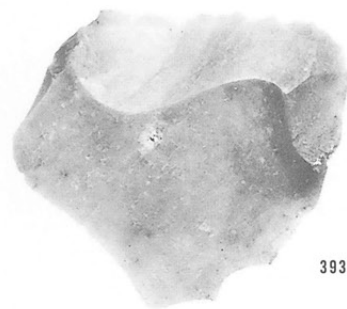

393

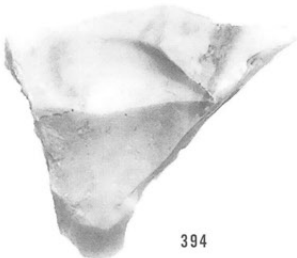

394



395

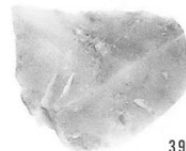

396



399

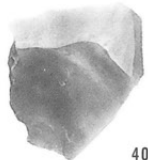

400



401



402



403

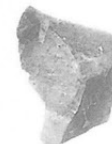

404

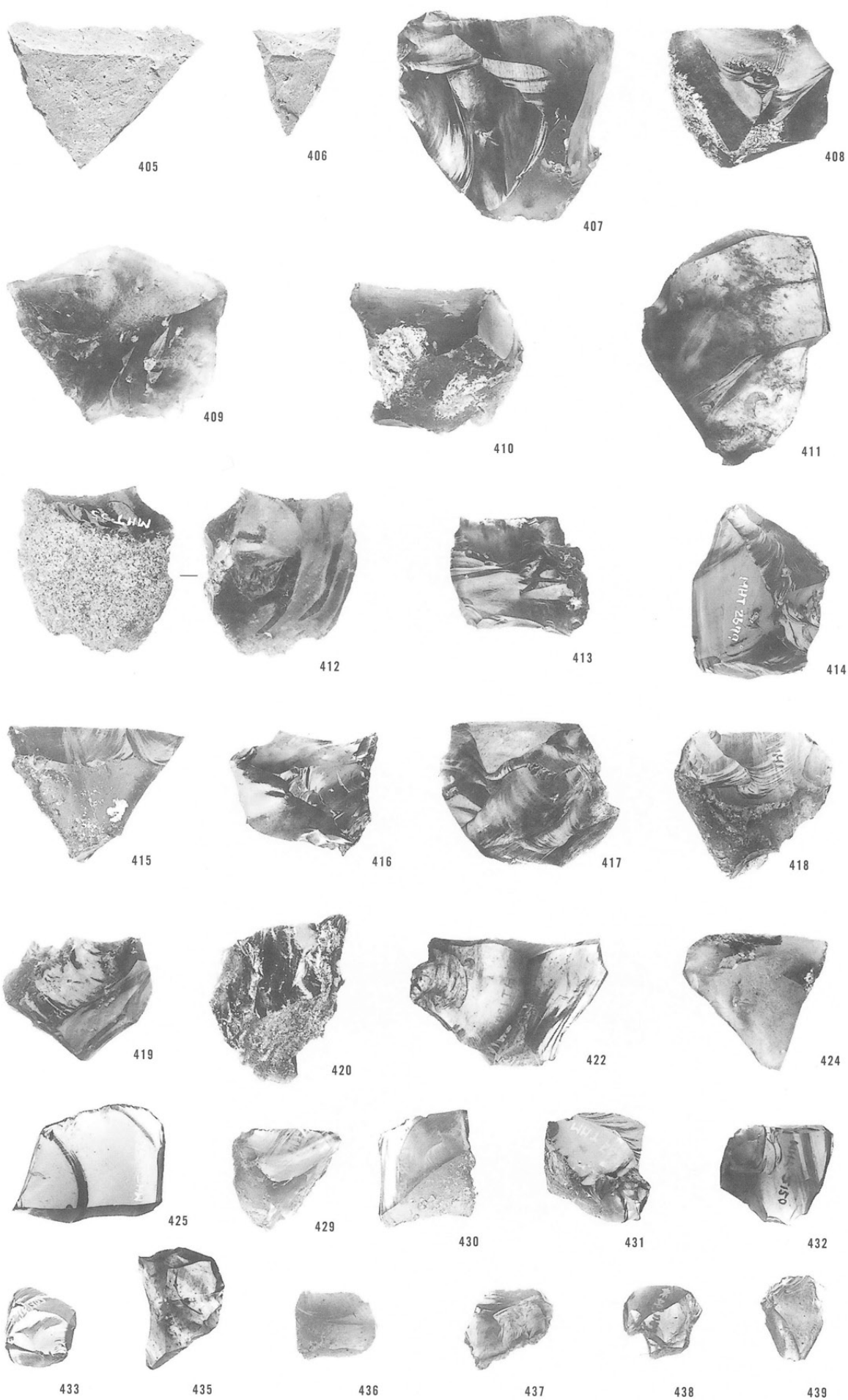

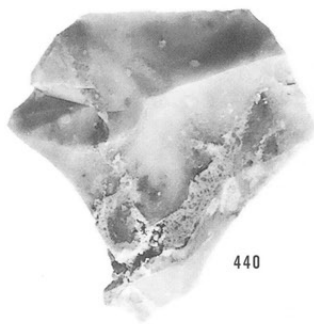

440



441

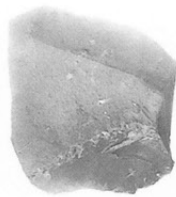

443



444



445



446



447



448

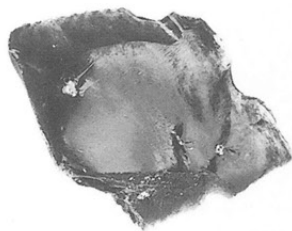

449



450

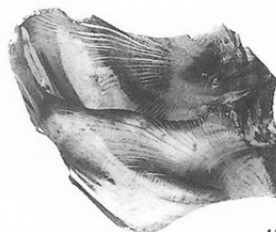

451

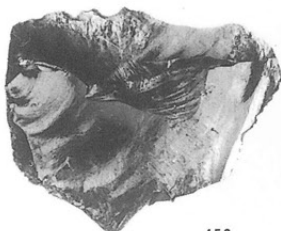

452

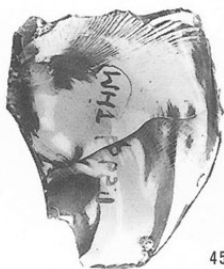

453



454



455



456



457



459



460



461



461

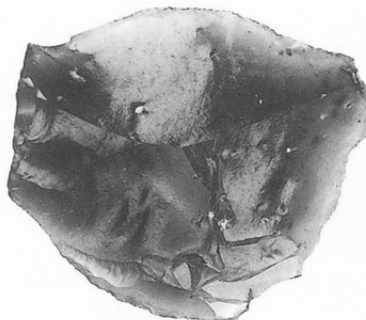

462





463

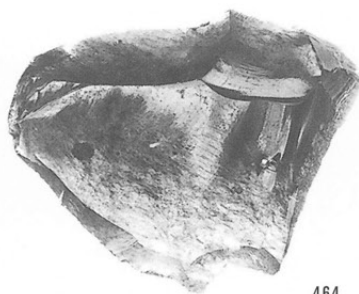

464



466



468

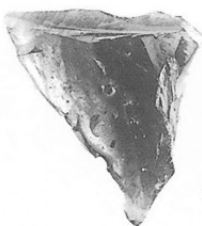

469



470

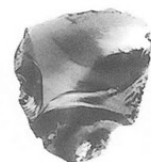

472



473



475



476



477

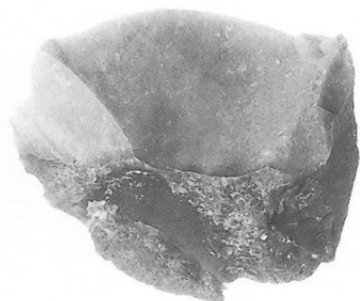

478



479



480



481



482



483

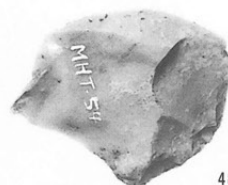

484



485



486

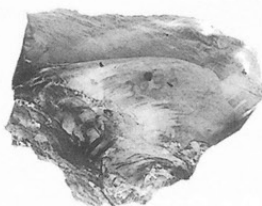

487



488



489



490

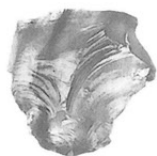

491



492



493



494



495



496



497

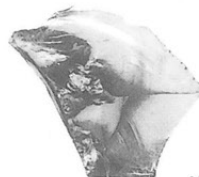

498



499



500

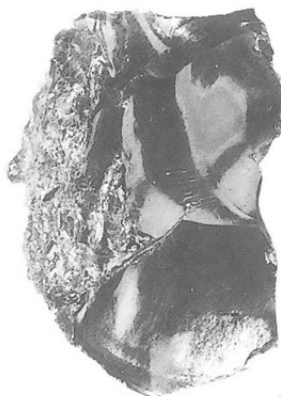

501



502



503



505



507

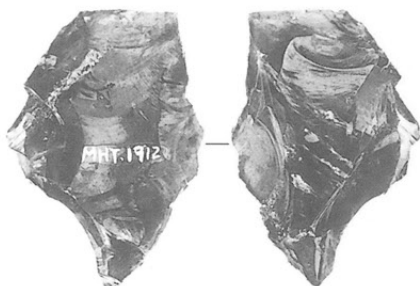

506



508

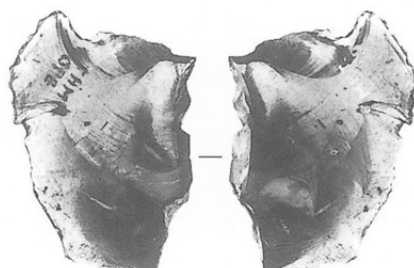

509

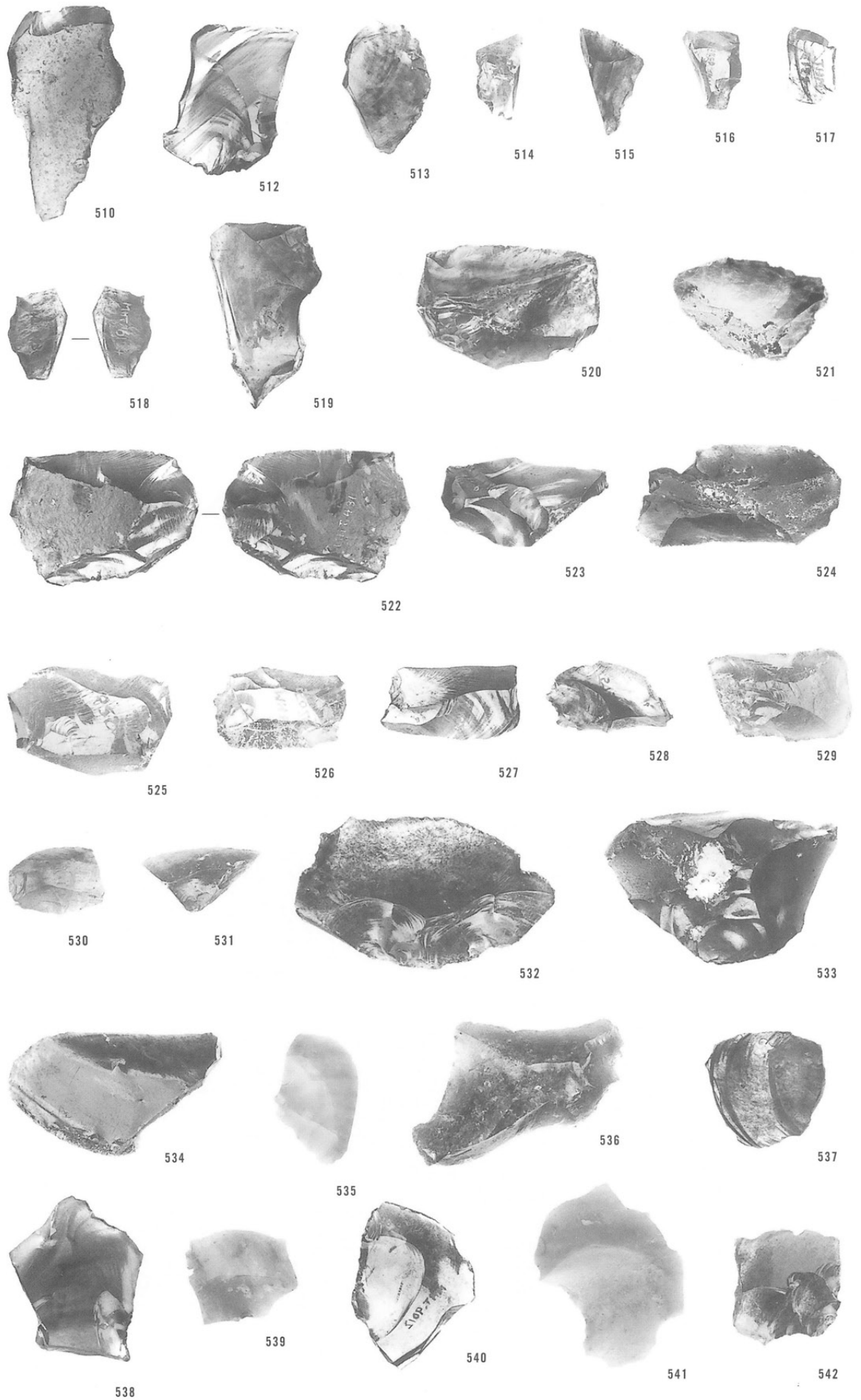



543

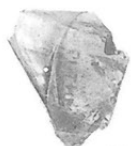

544



545



546



547



548



549

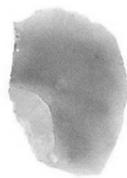

550



551



552



553



554



555



556



557



558



559



560



561



562



563



564



565



566



567



568



569



570



571



572



573



574



575

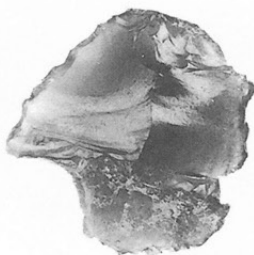

576



578

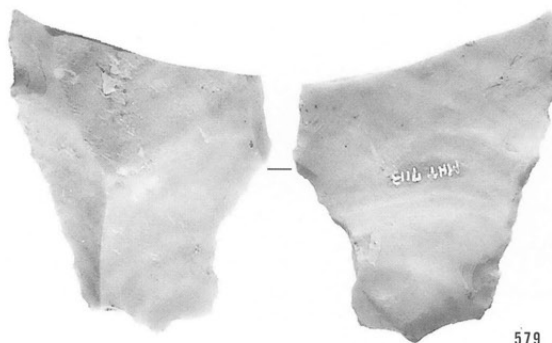
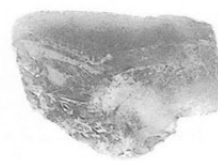

579

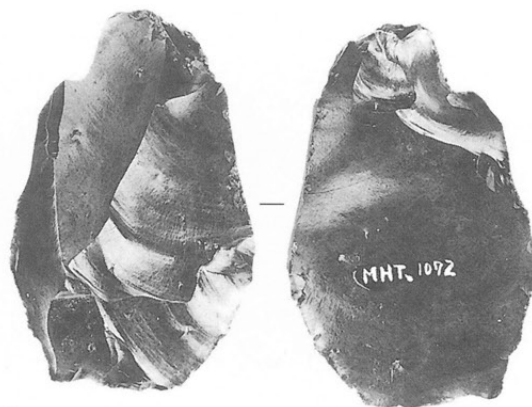

582

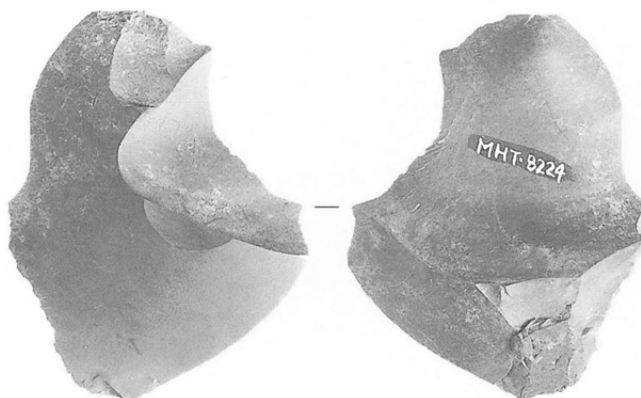

580

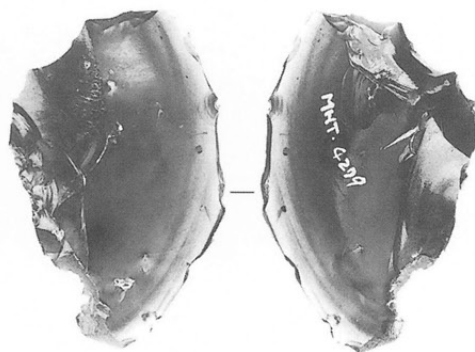

583

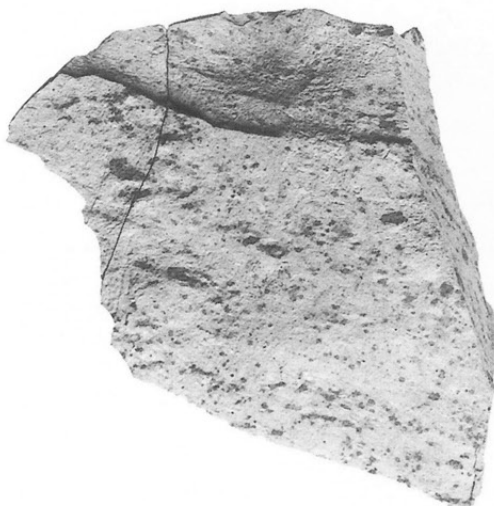

581

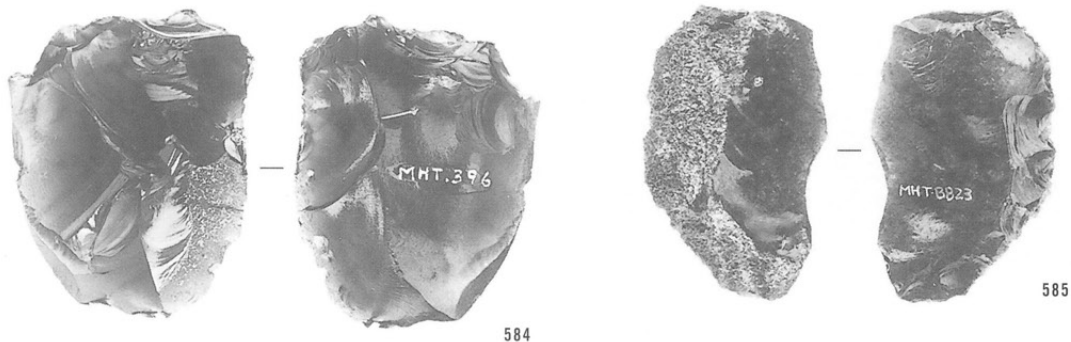

584

585

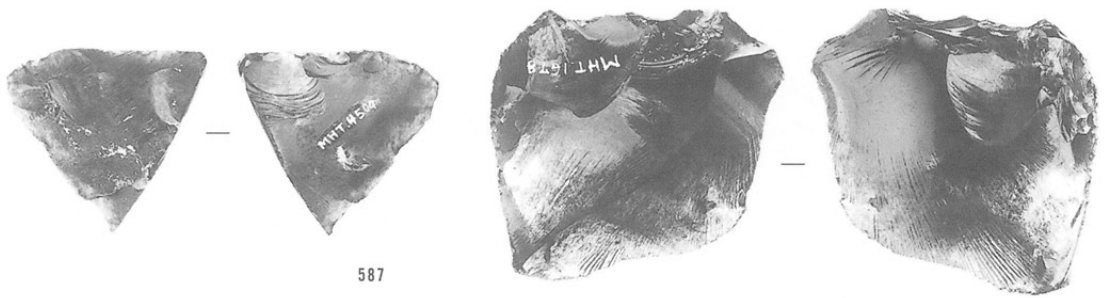

587

588

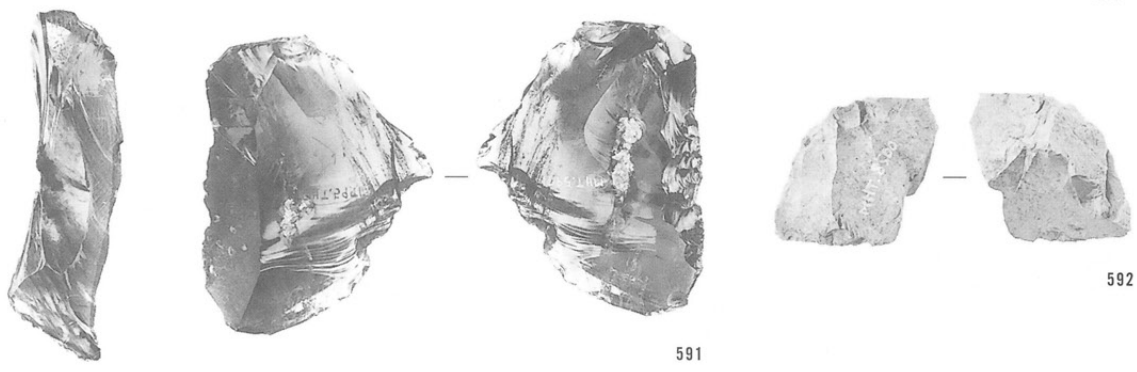

589

591

592

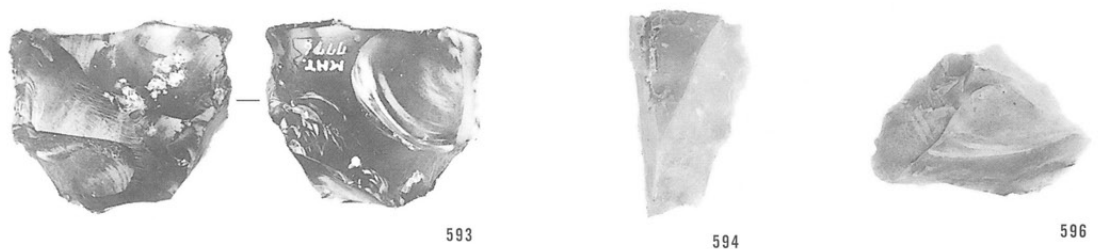

593

594

596

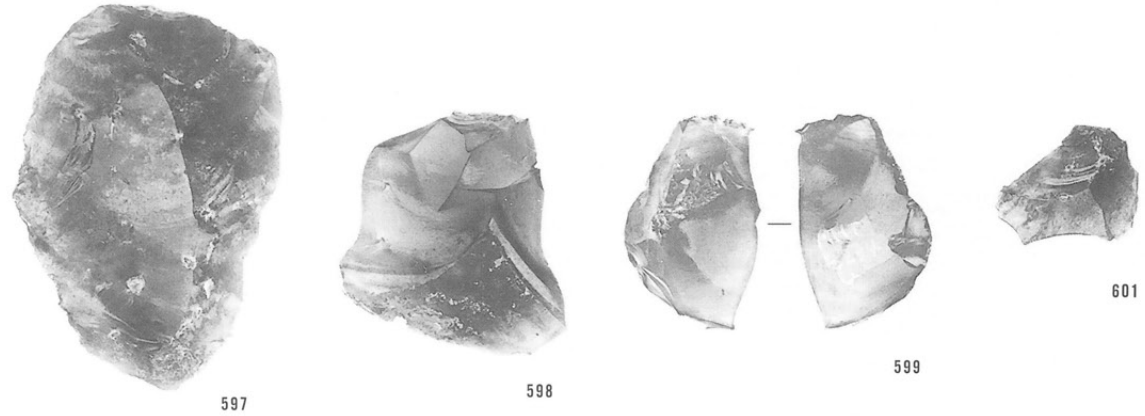

597

598

599

601

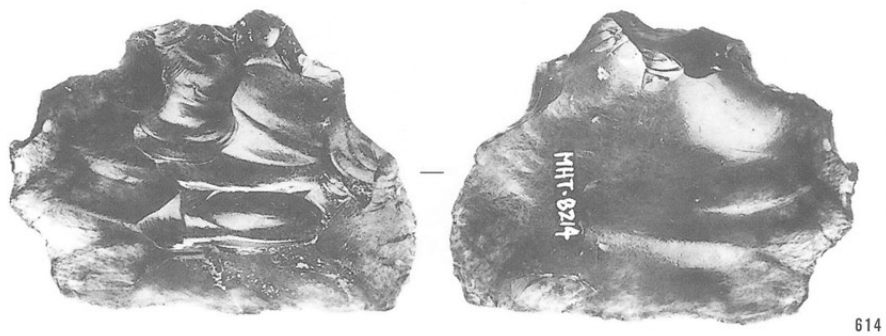
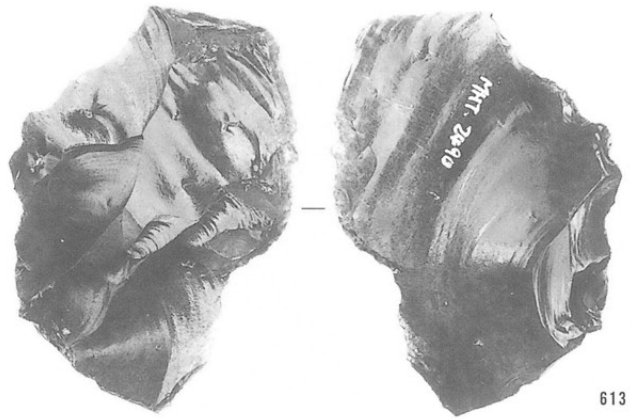
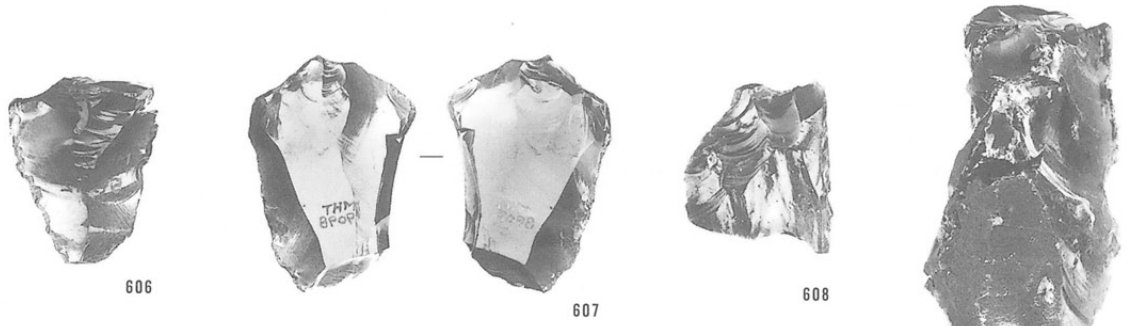



615

618



616

617

619

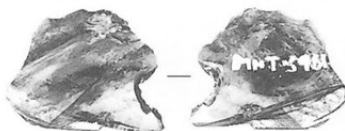

620

621

622

623



624

625

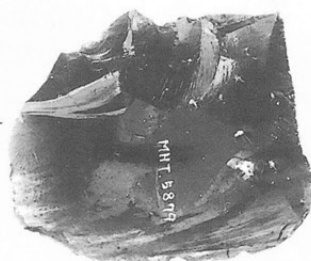
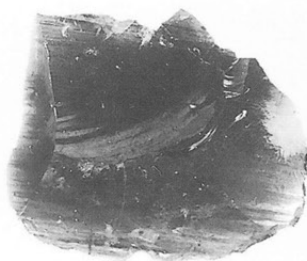
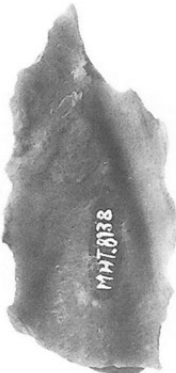

626

629



628

627



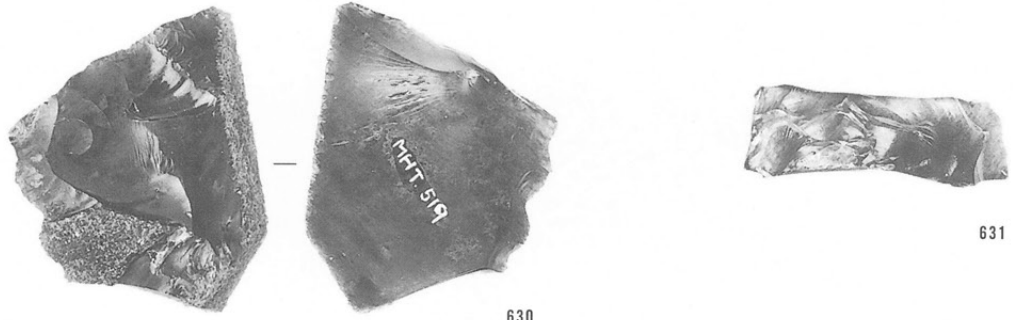

630

631

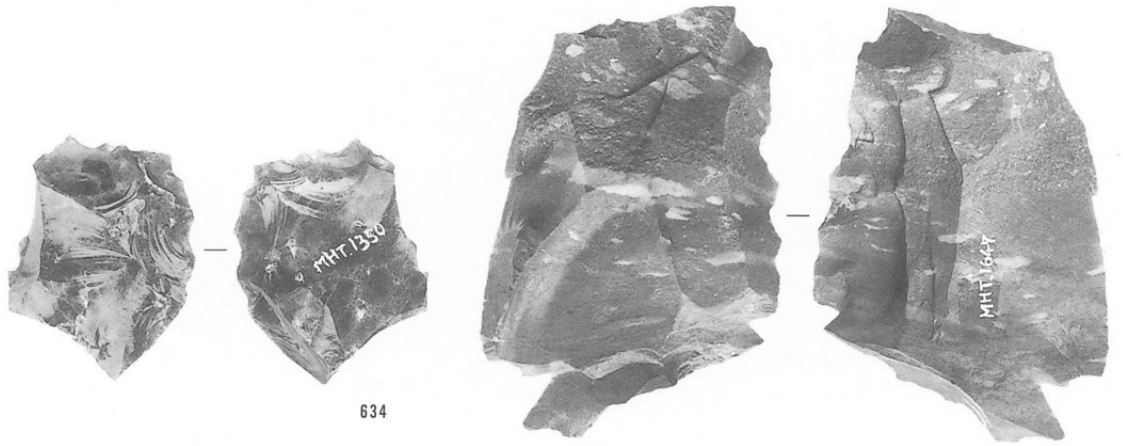

634

638

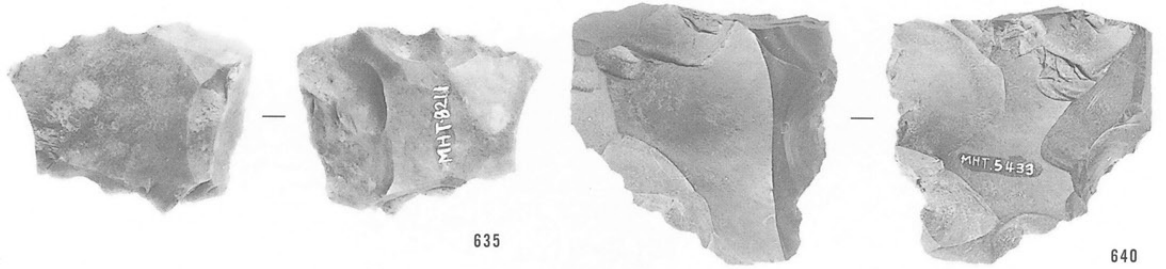

635

640



641

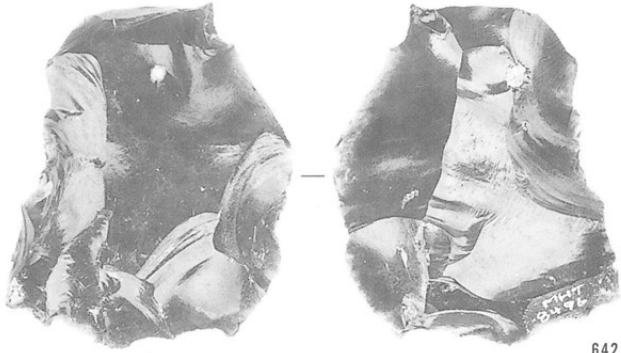

642

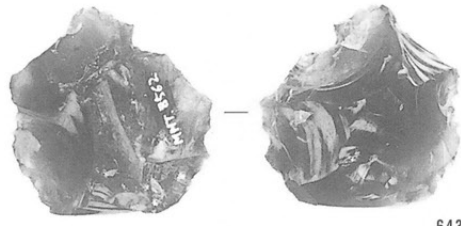

643

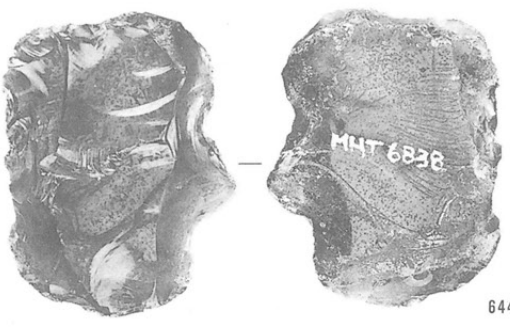
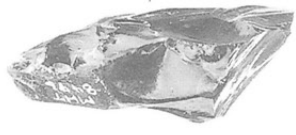

644

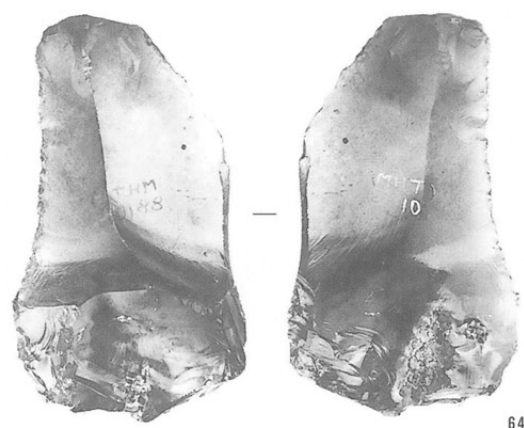

647

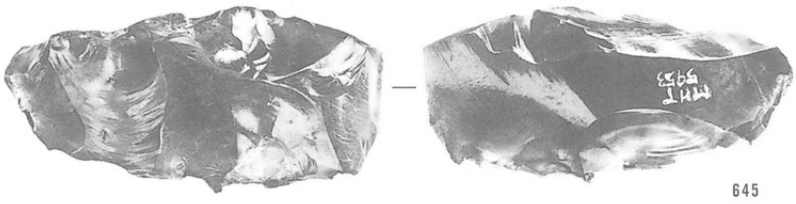

645



649

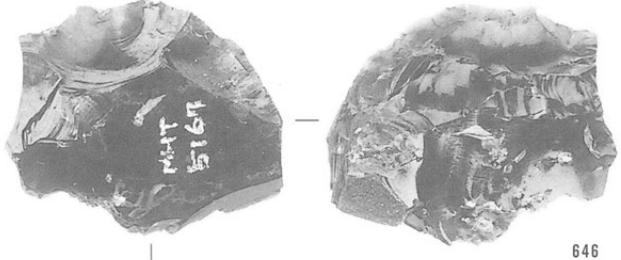

646



651



652

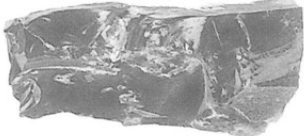

654



655



656



657

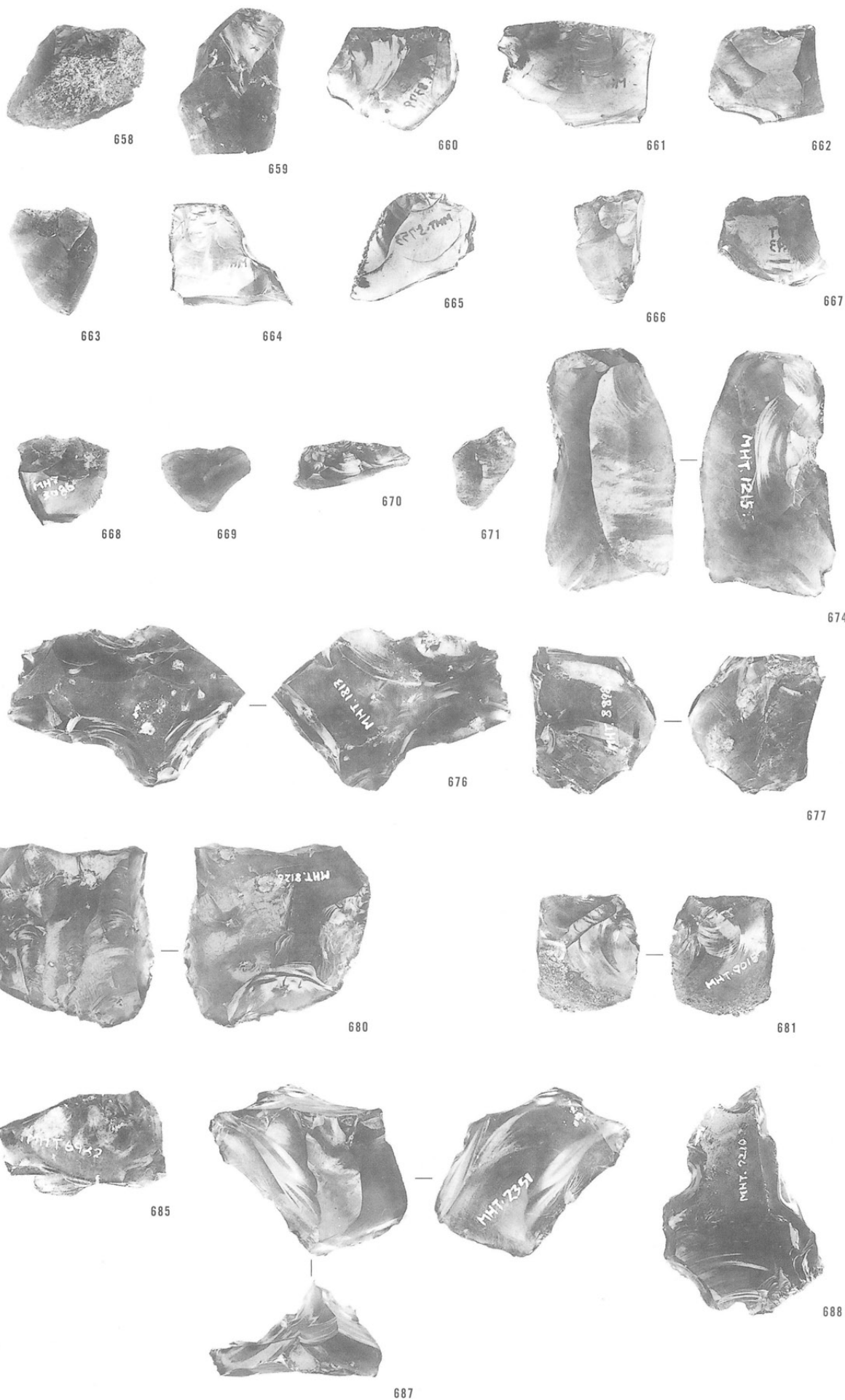

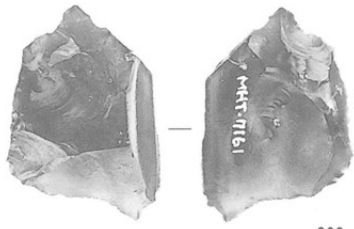

689



690

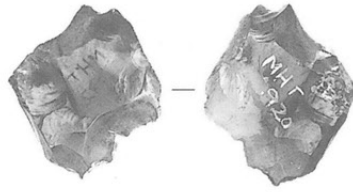

691

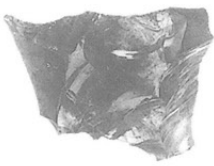

692

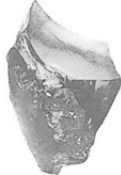

693



694

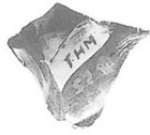

695

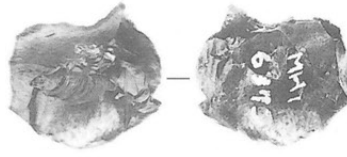

696



697



698



699



700



701



702



703

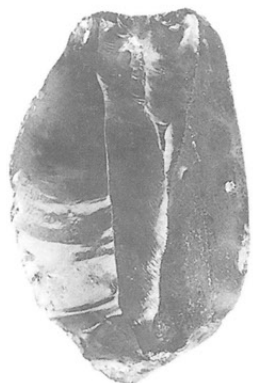

705



706



707



708



709



710



711



712



714



715



716



717



719

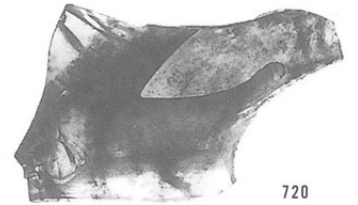

720



722

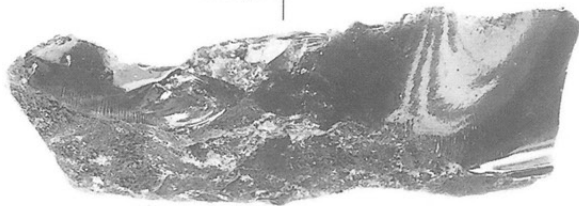

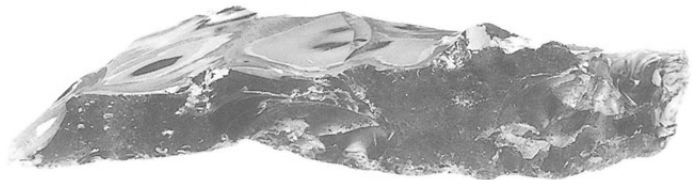
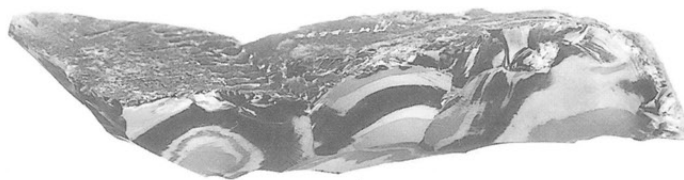

721

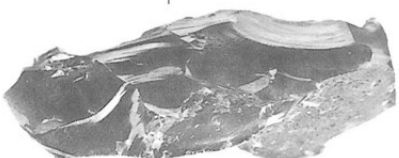
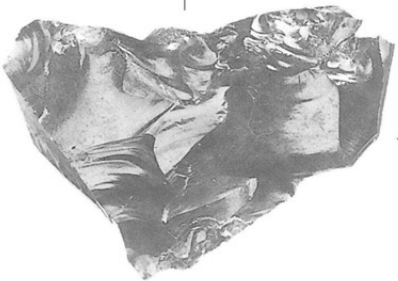

723

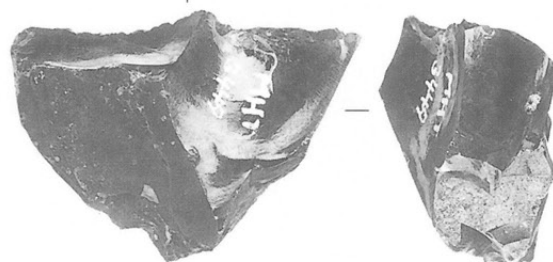
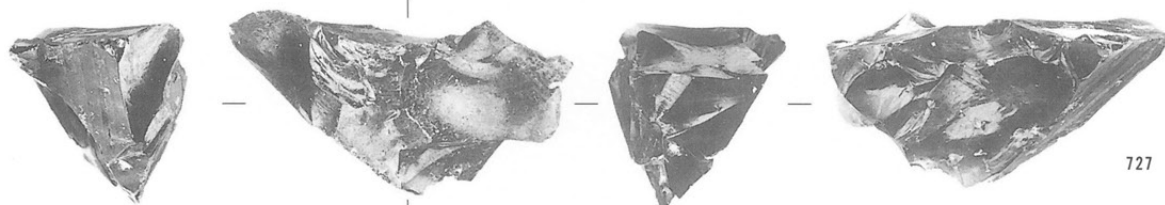
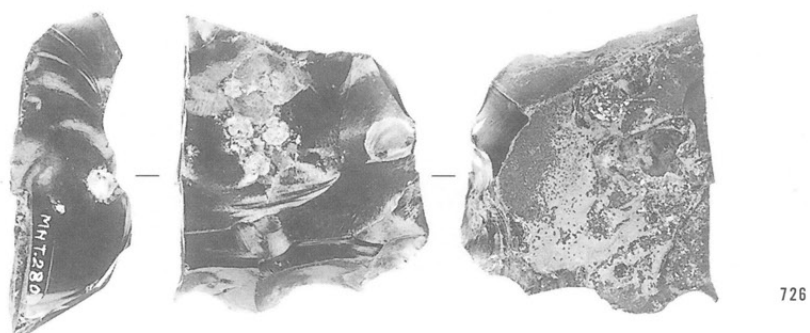
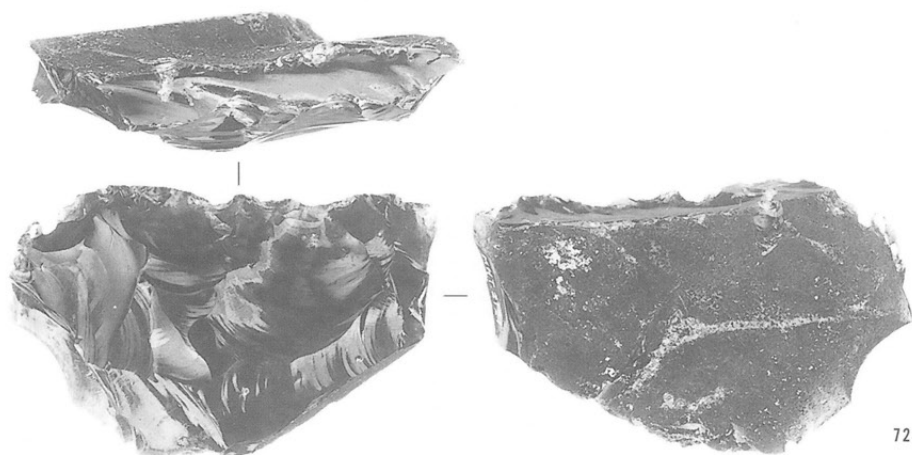

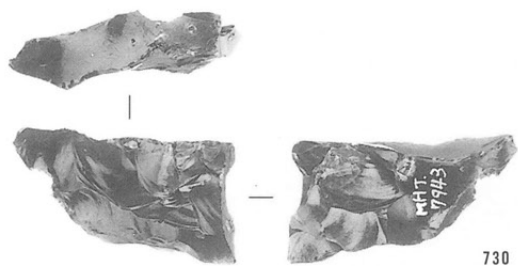

730



731



734

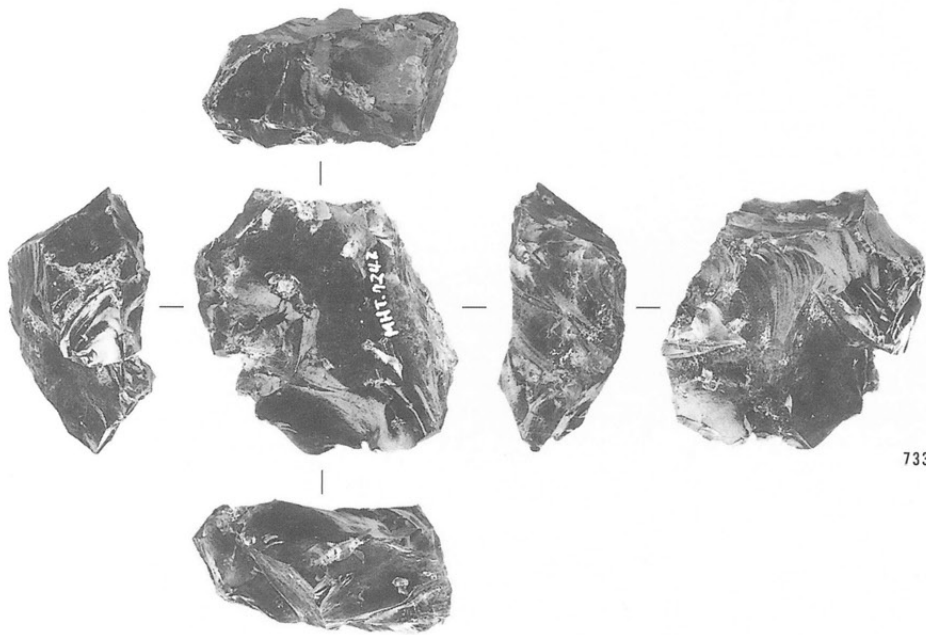

733

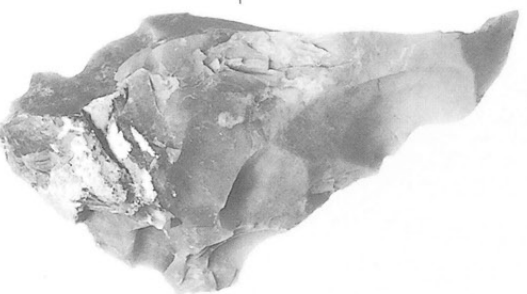
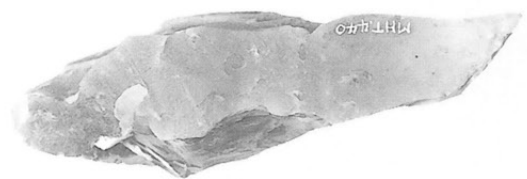

737





738

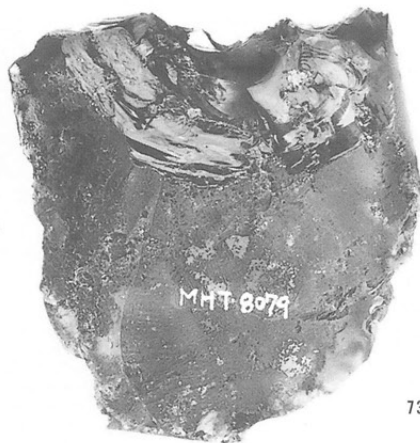
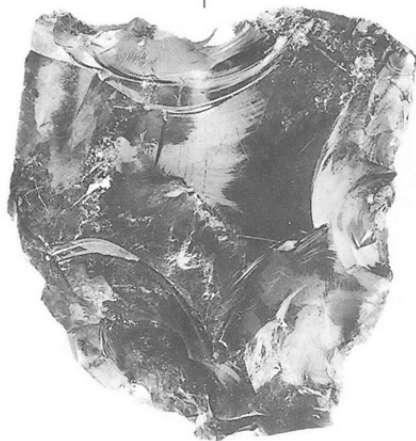

MHT-8079

739

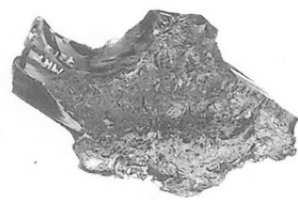
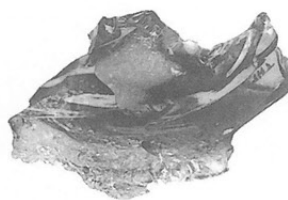

742

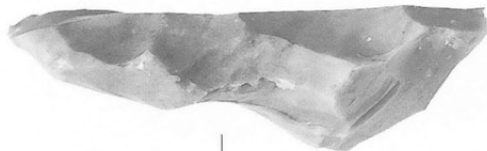

MHT-9697

743

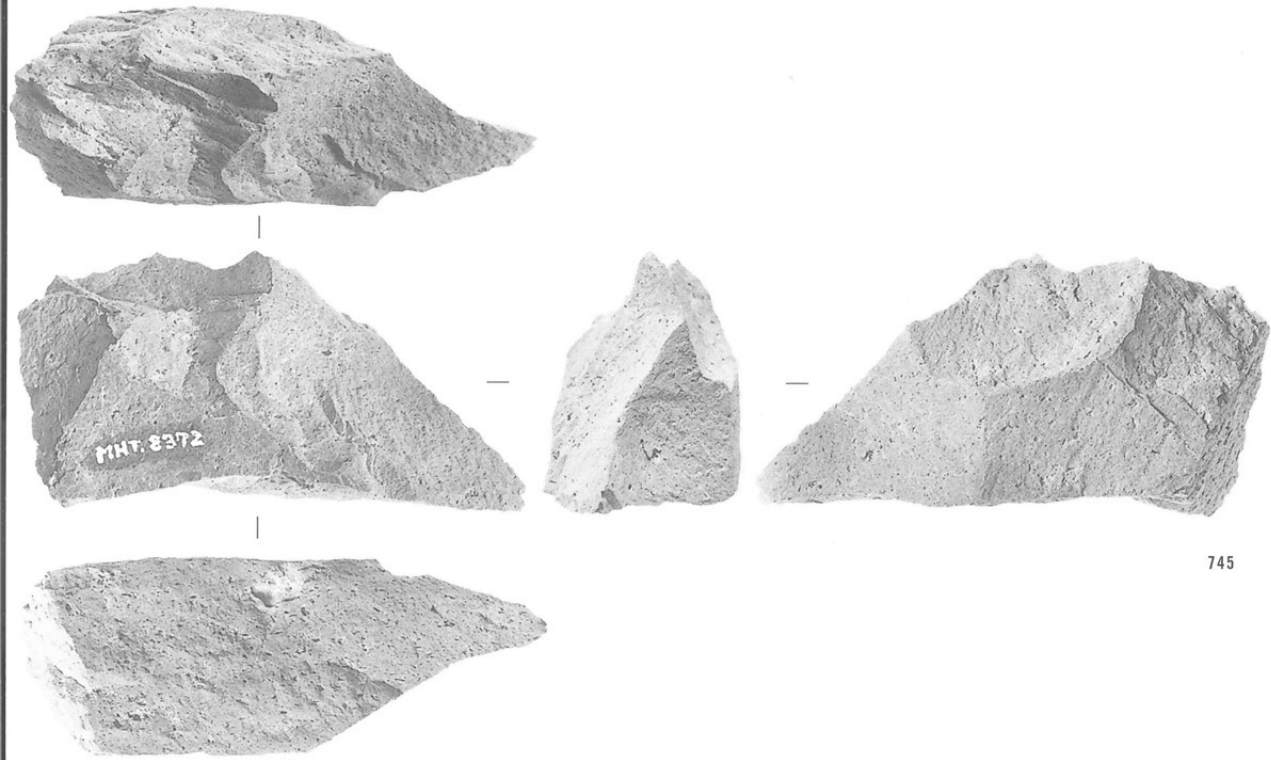

745

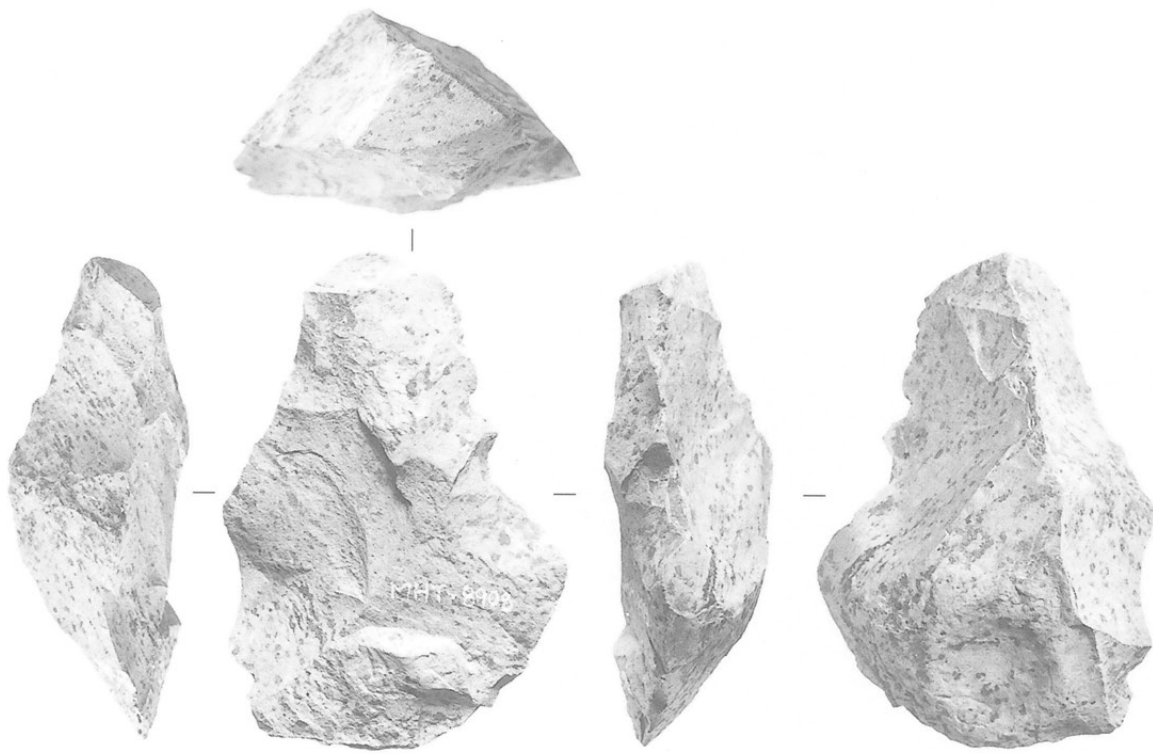

746

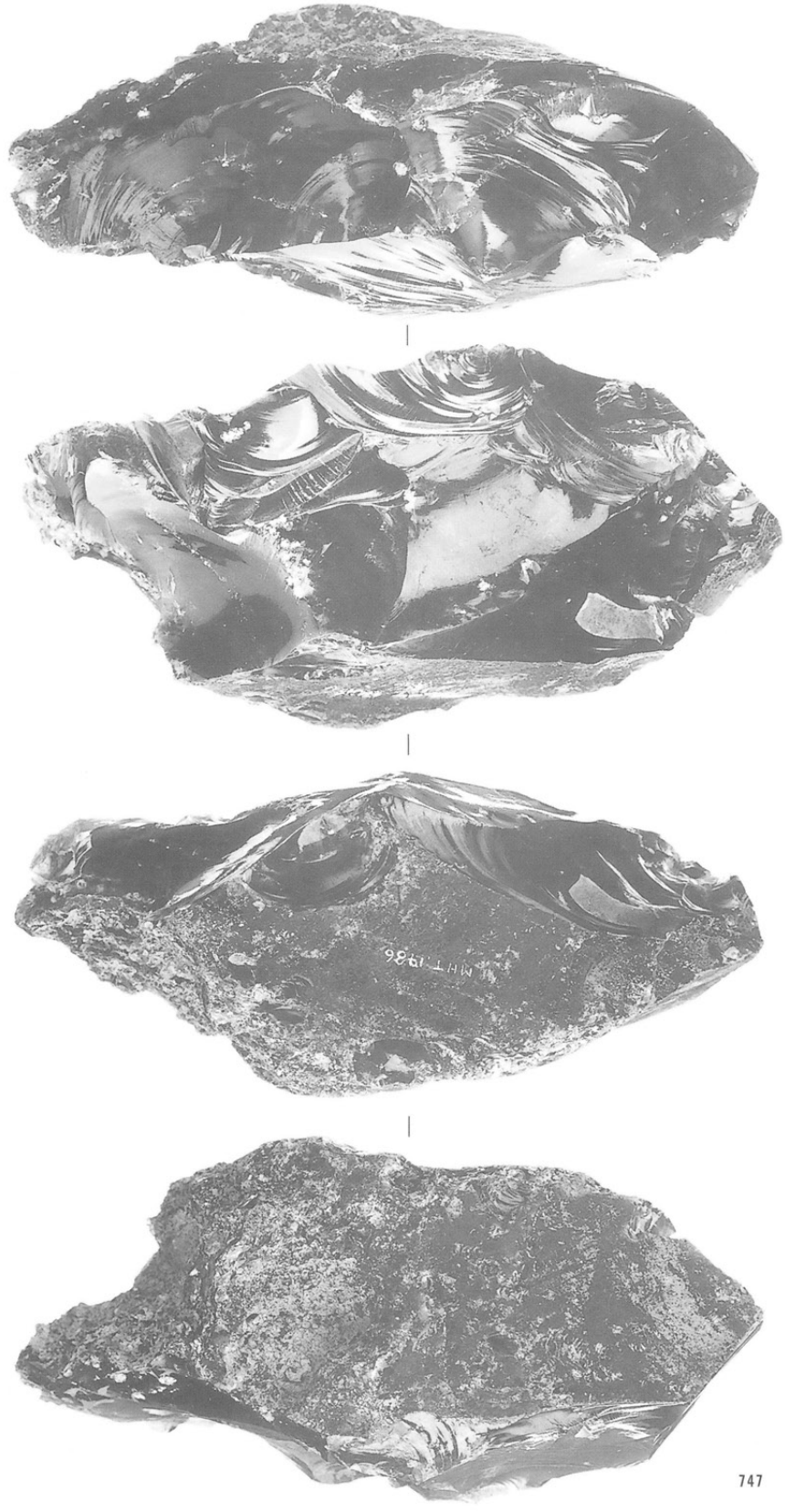

747

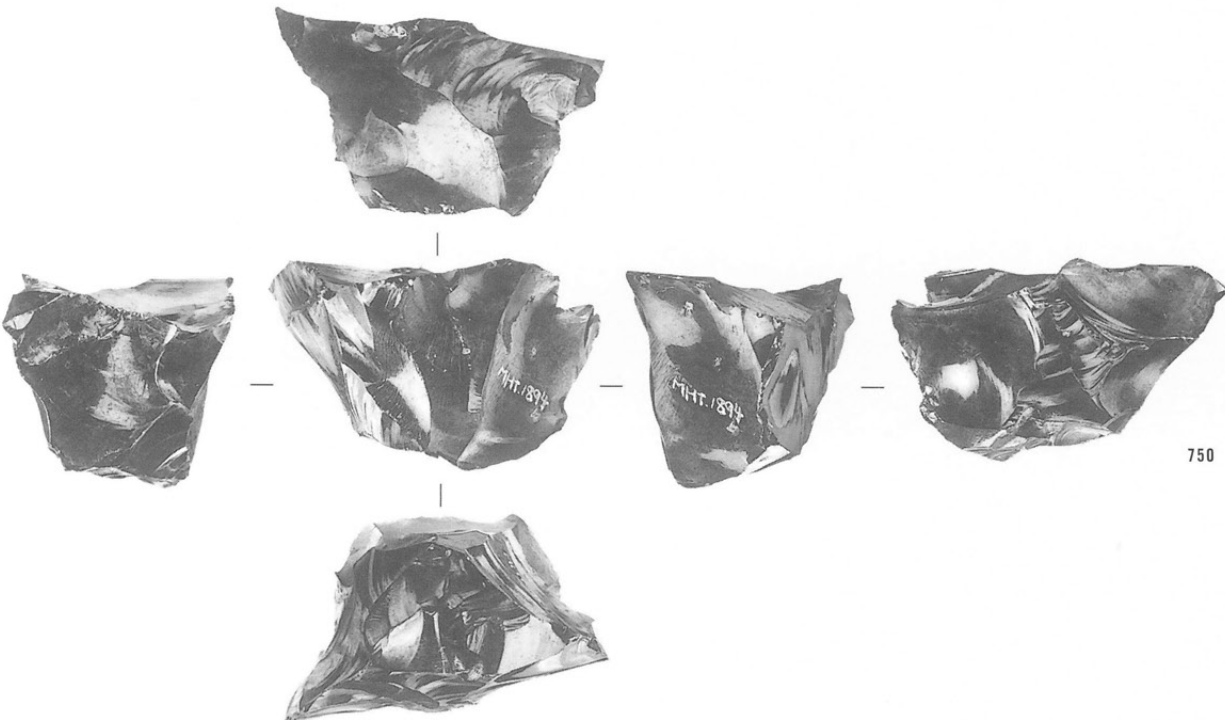
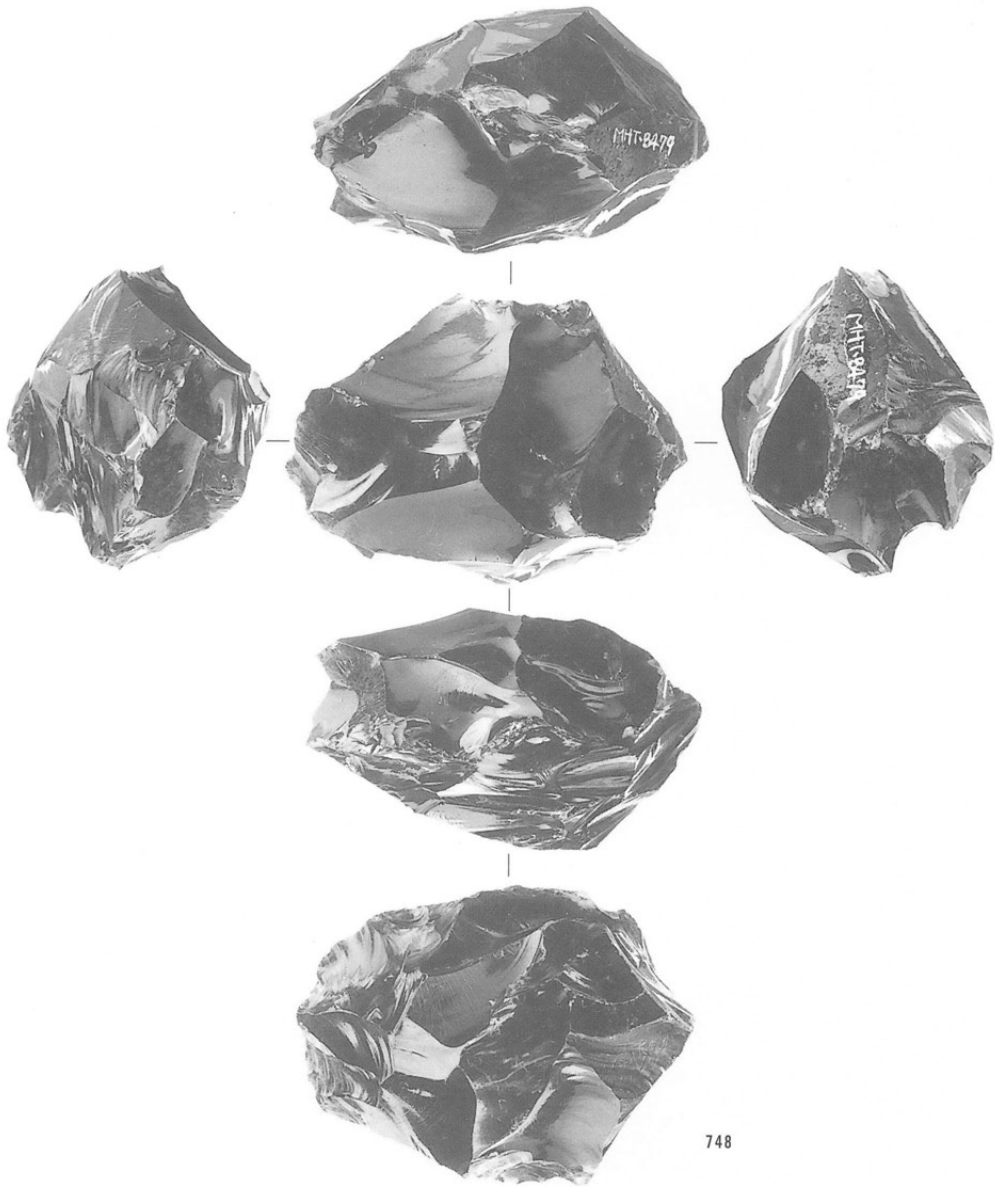

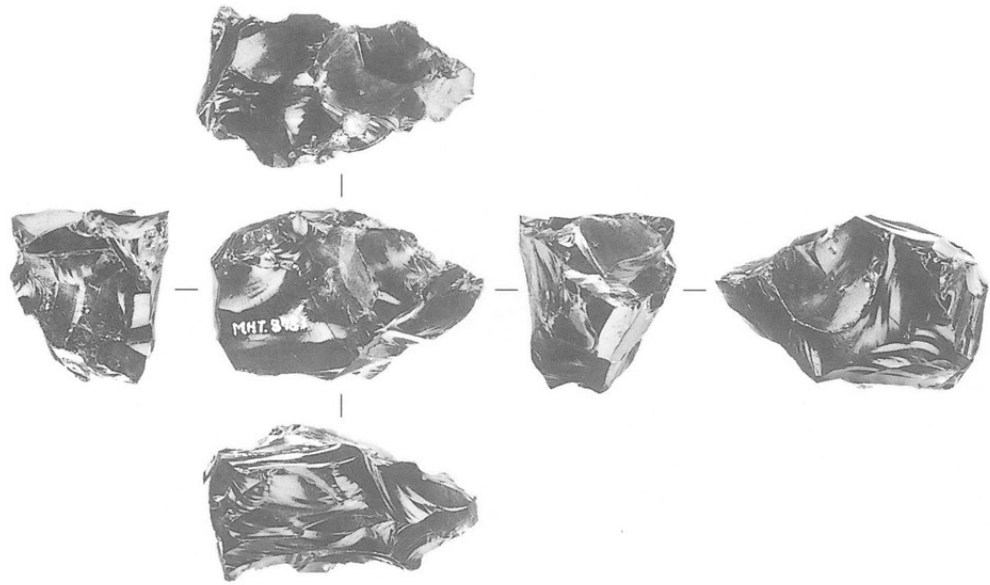

751

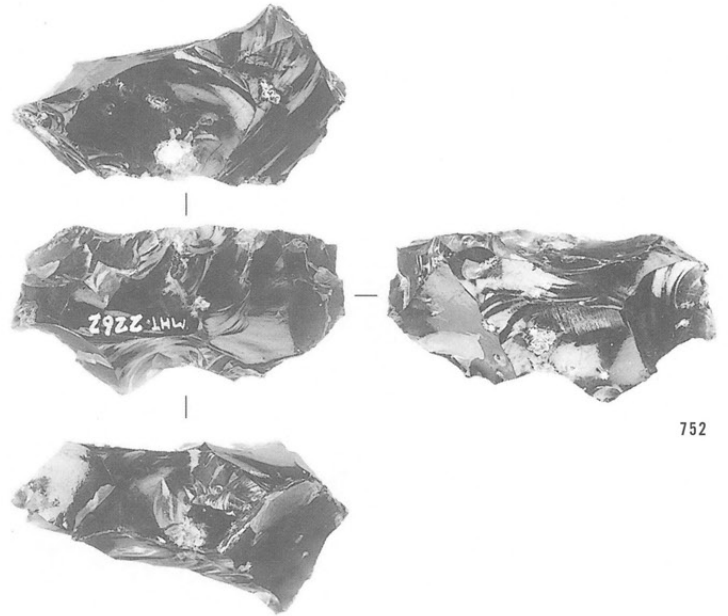

752

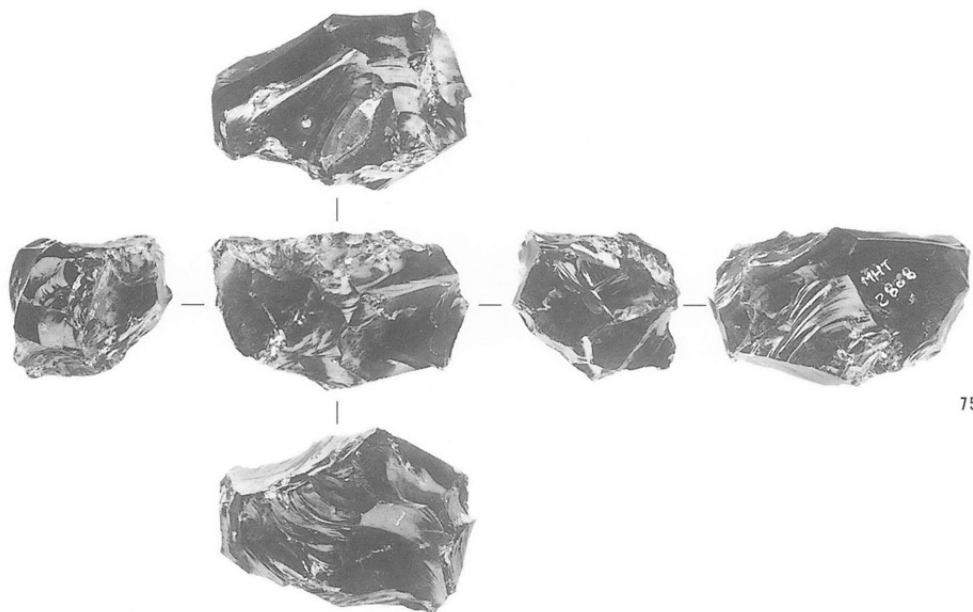

753

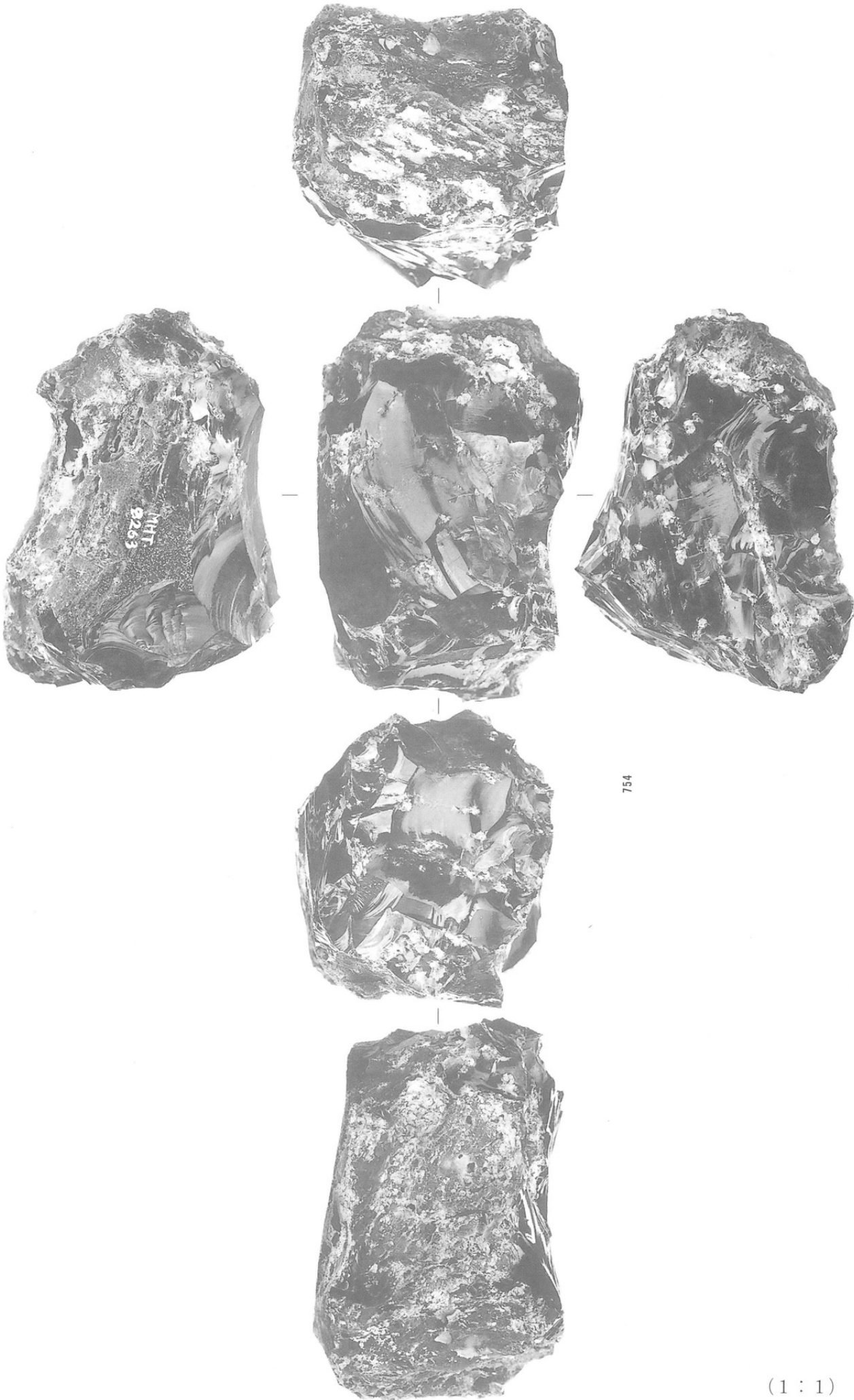

754

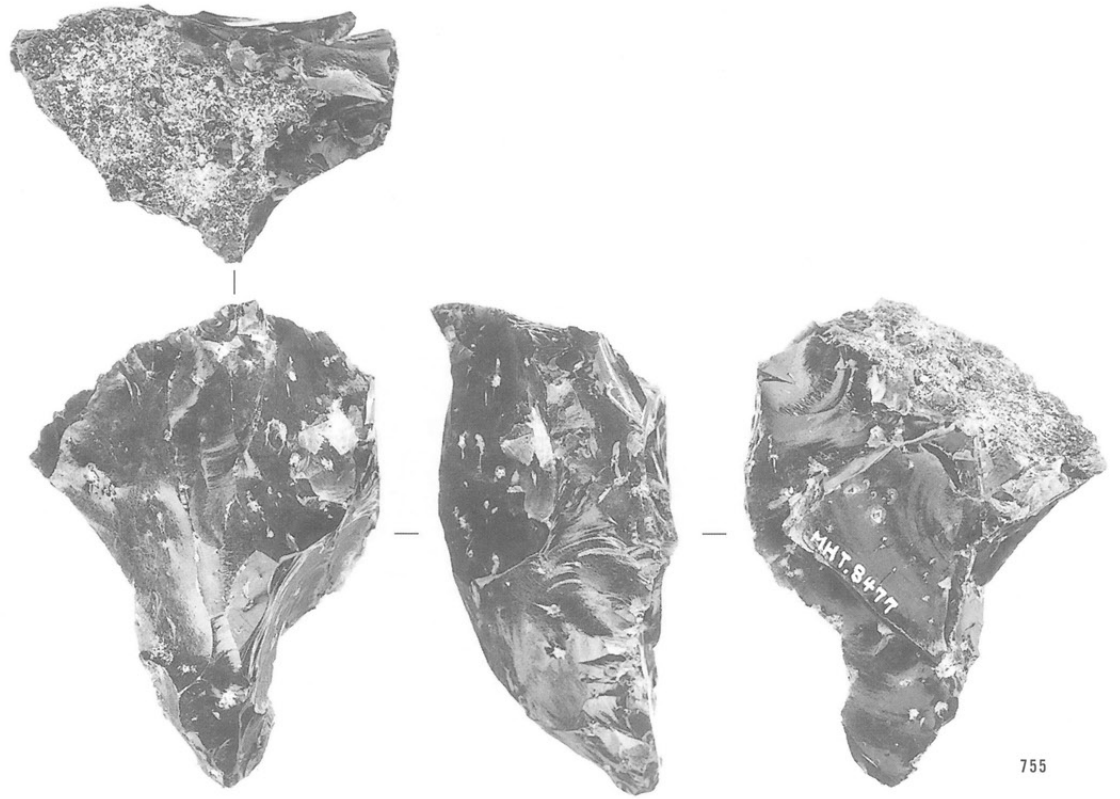

755

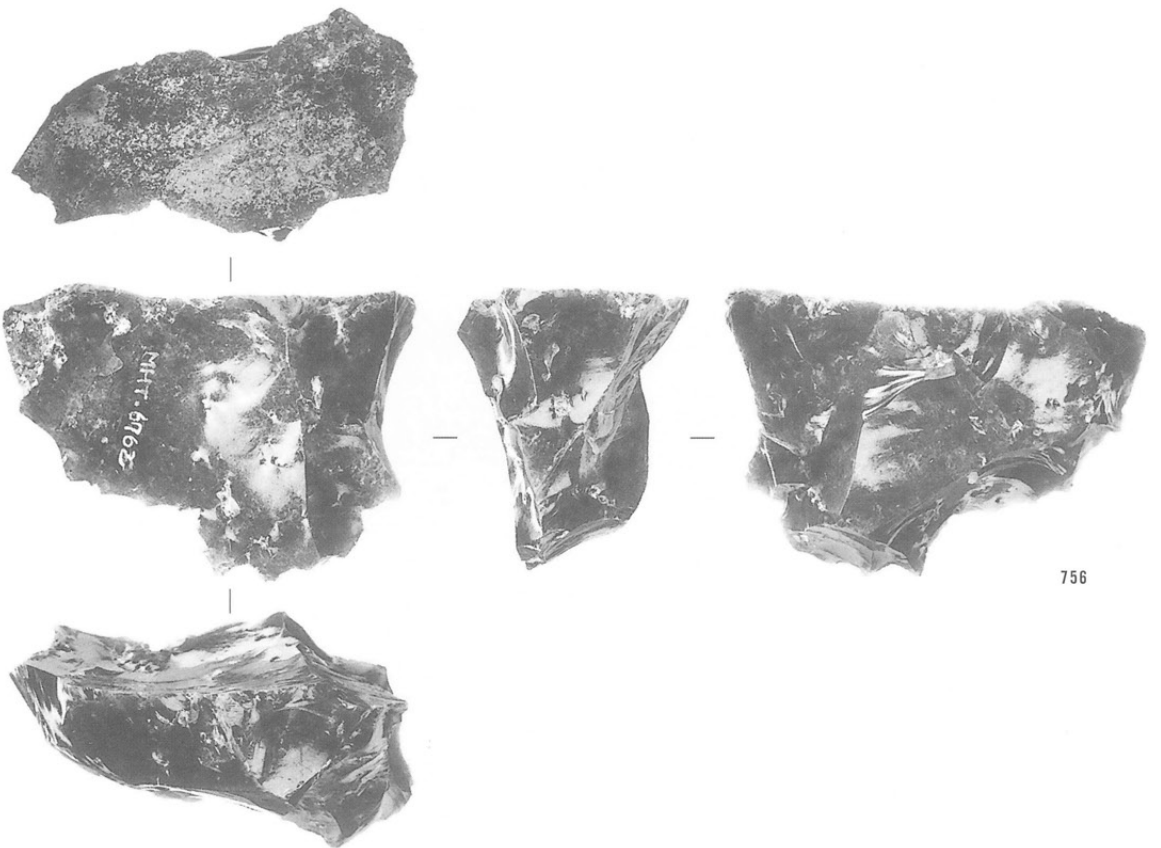

756

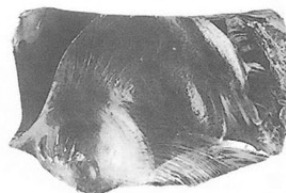
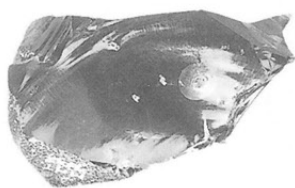

758

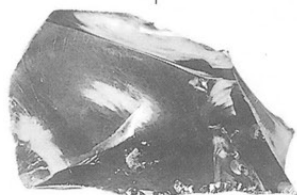

757



759





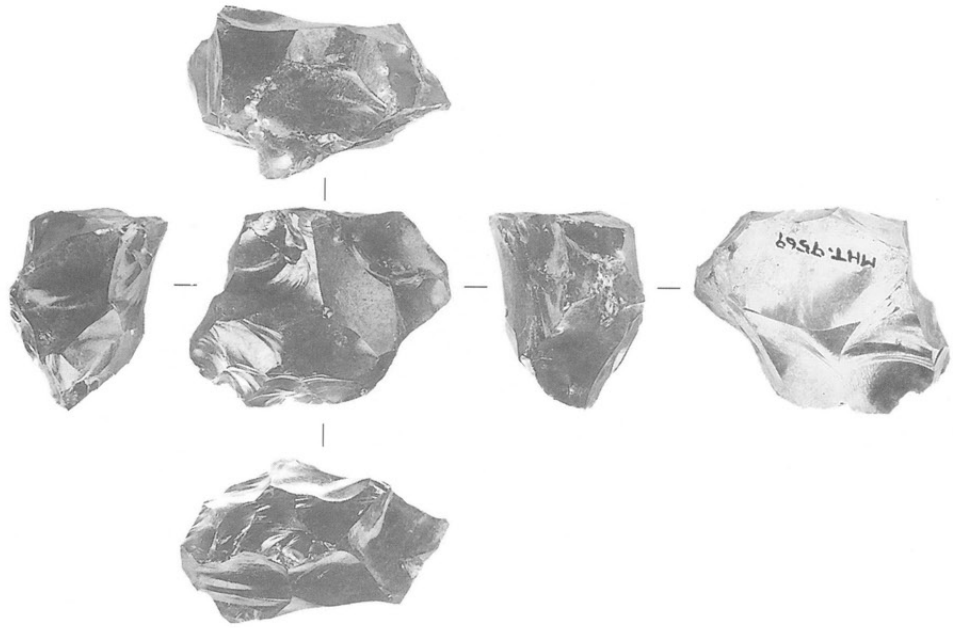

760

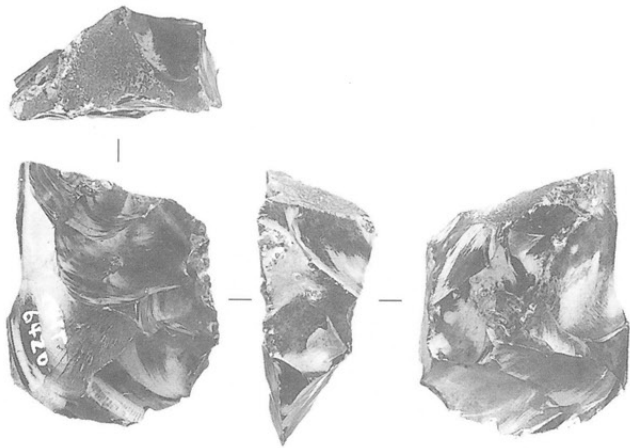

761

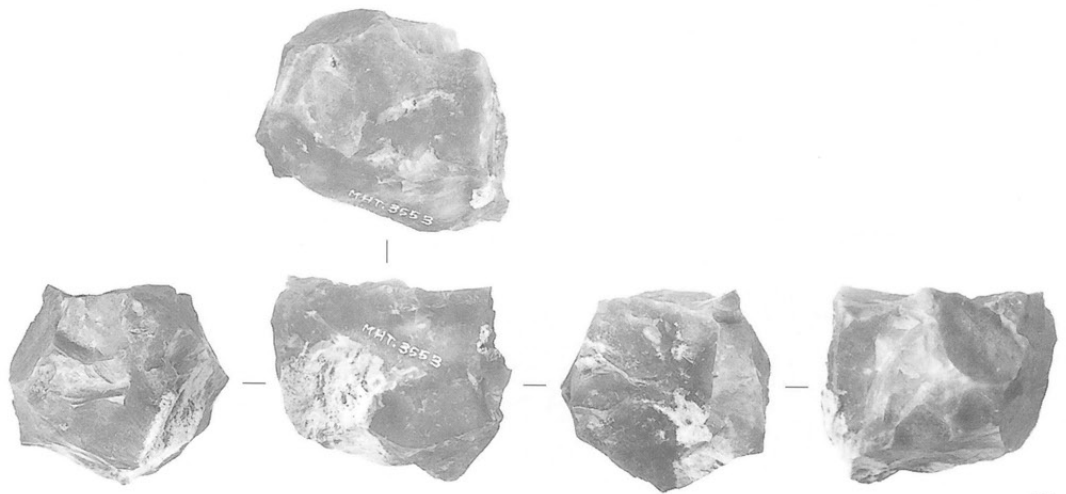

765

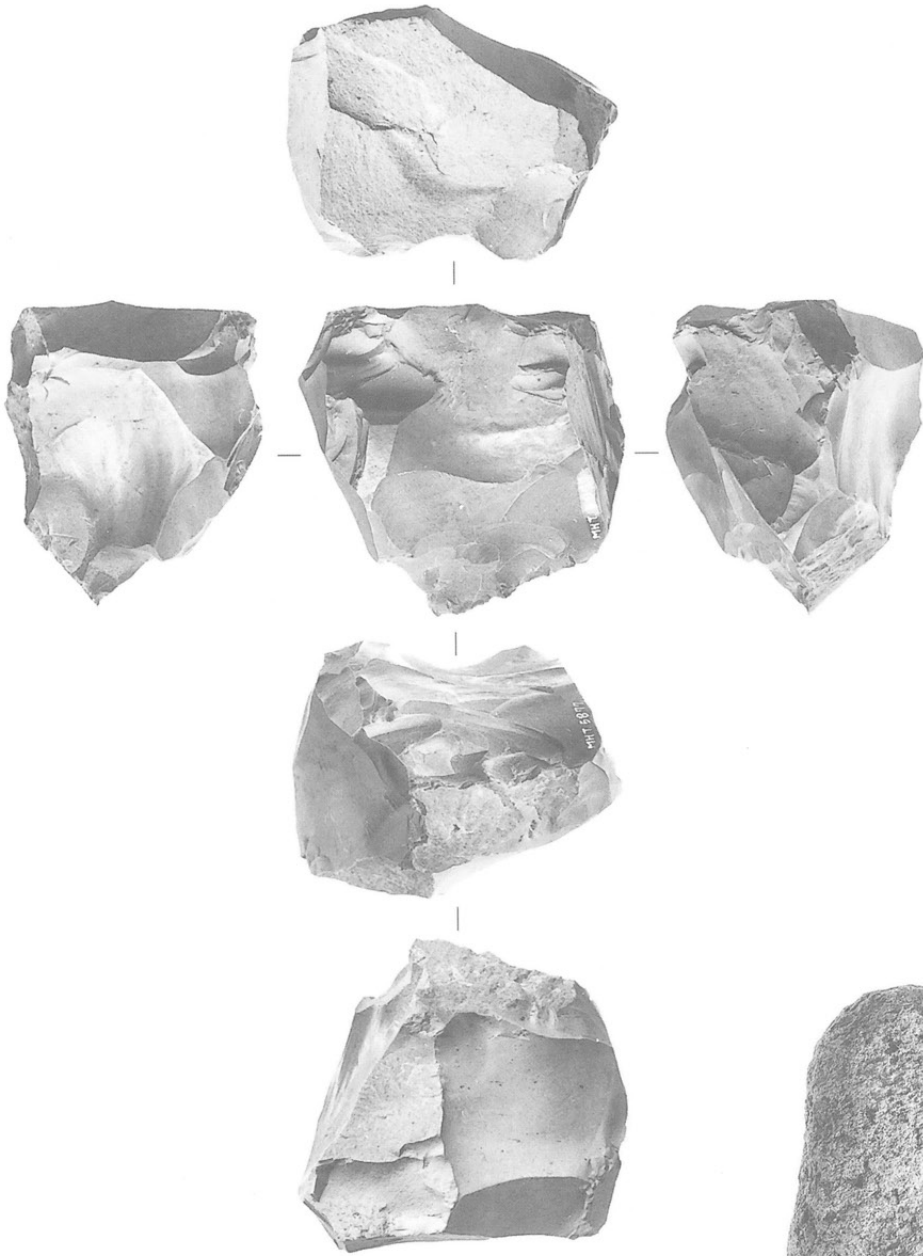

766

(1 : 1)



767

(1 : 2)



768



769



771



772



773



774



775



777



778



779



780

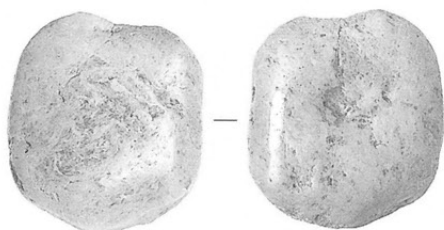

776



781



782



783



784

(1 : 2)



785

(1 : 1)

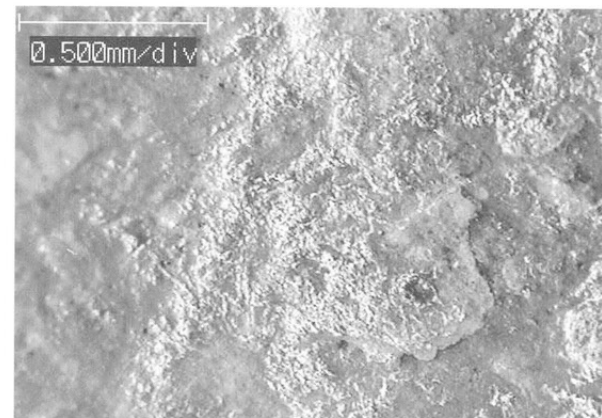
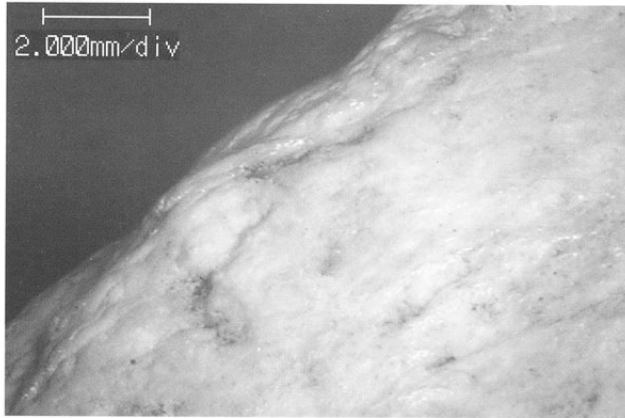

左: 2-1 (7倍)  
左に90°回転  
右: 6-1 (50倍)

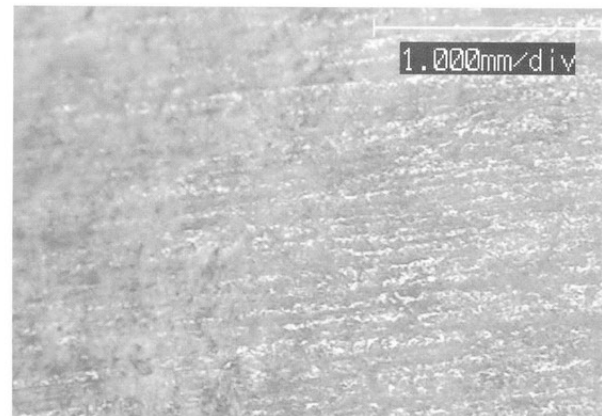
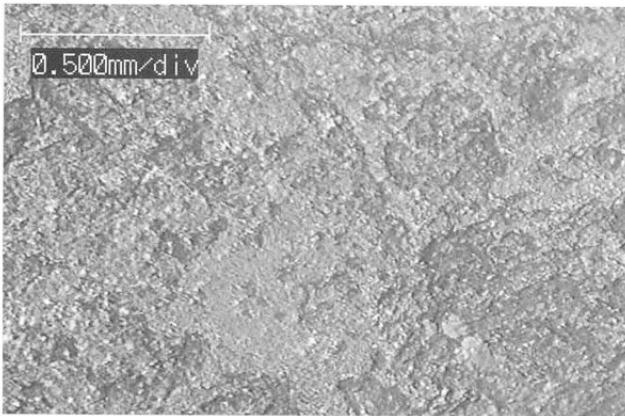

左: 6-2 (50倍)  
右: 12-1 (30倍)  
右に90°回転

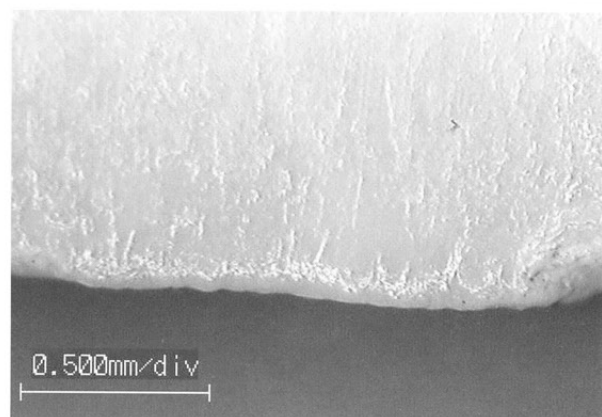
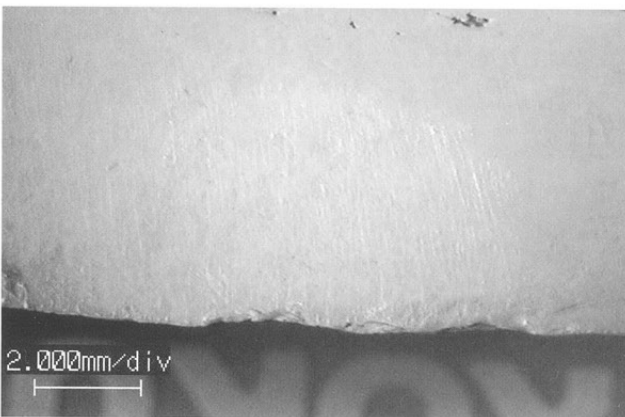

左: 14-1 (7倍)  
右: 14-2 (50倍)

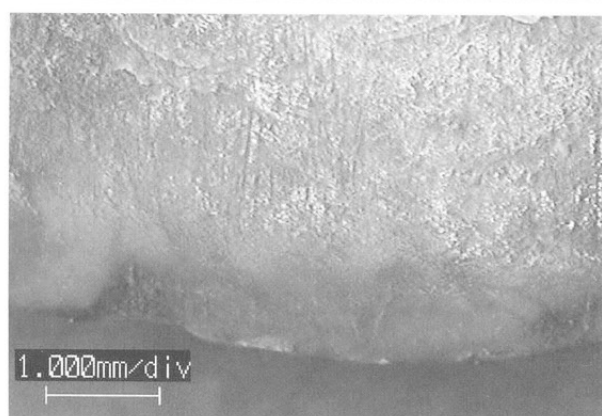
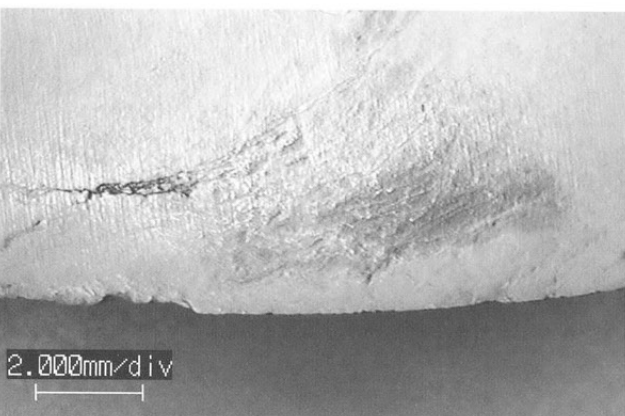

左: 14-3 (7倍)  
右: 15-1 (15倍)

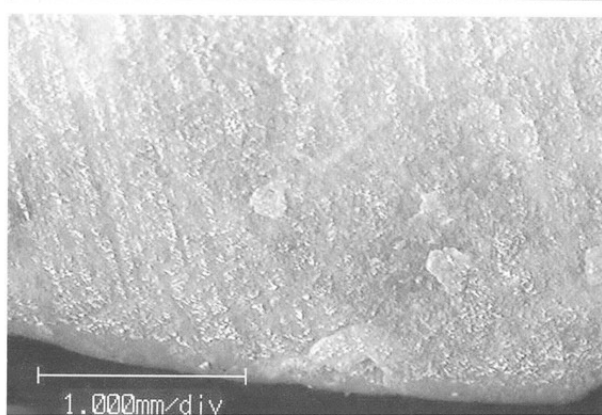
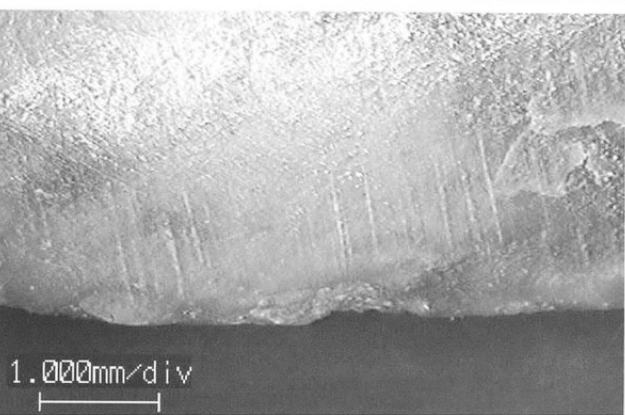

左: 15-2 (15倍)  
右: 21-1 (30倍)

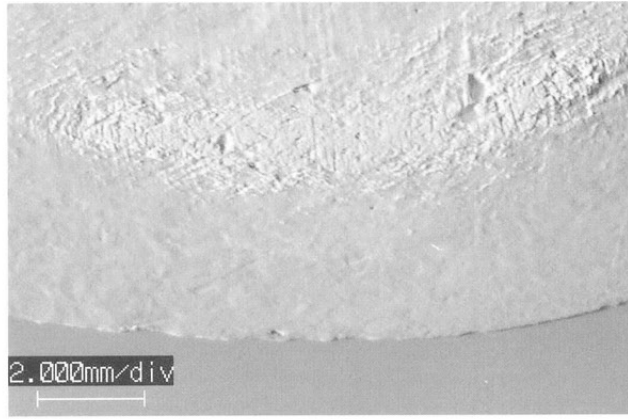
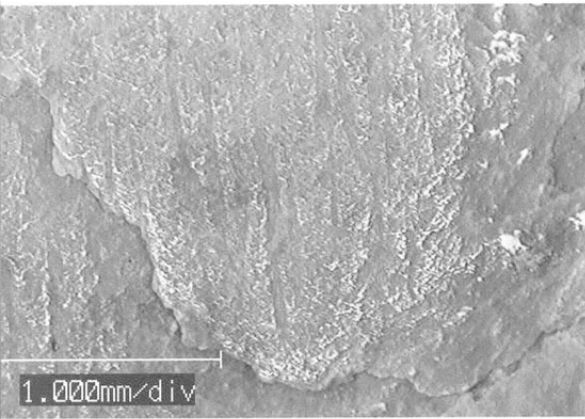

左:21-2 (30倍)  
右:25-1 (7倍)

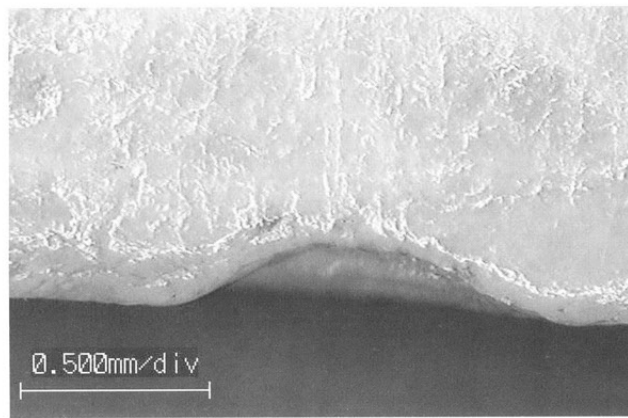

左:25-2 (7倍)  
右:25-3 (50倍)

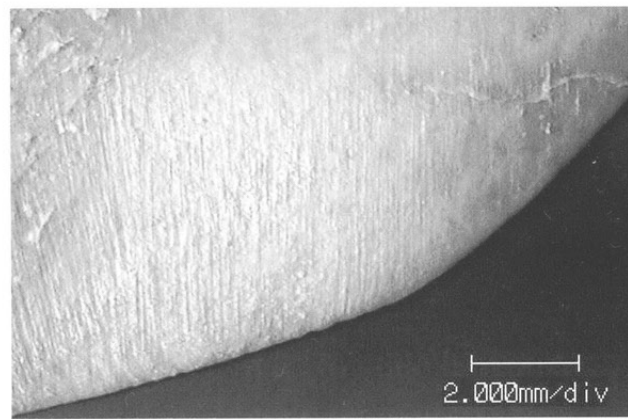
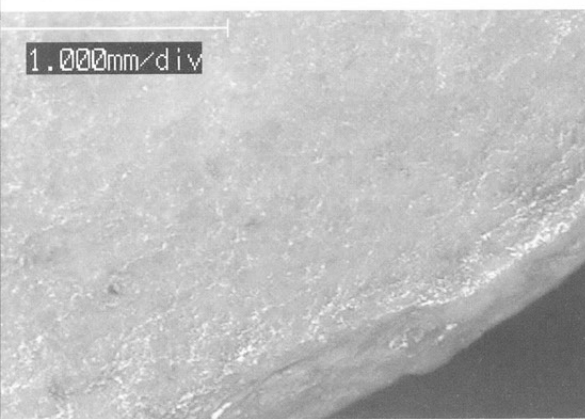

左:27-1 (30倍)  
右:28-1 (7倍)

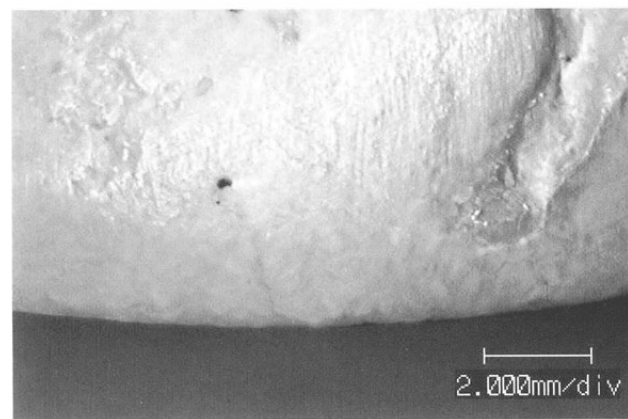
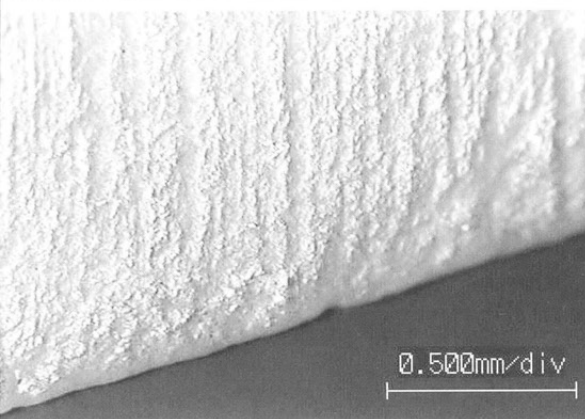

左:28-2 (50倍)  
右:30-1 (7倍)

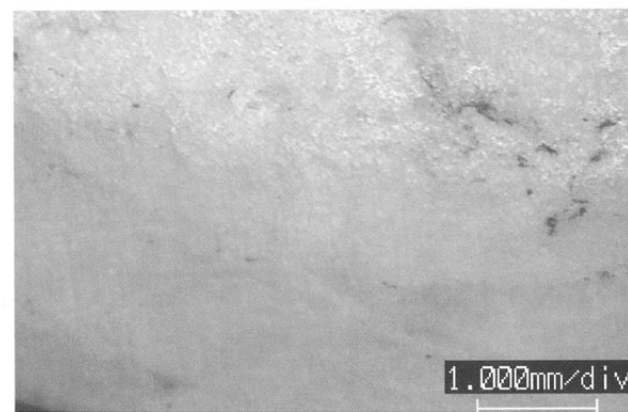
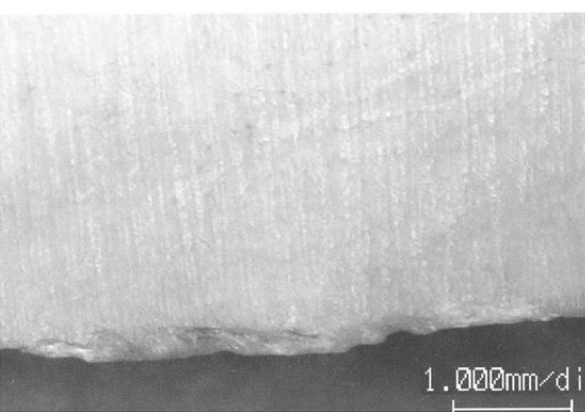

左:33-1 (30倍)  
右:33-2 (30倍)

左:74-1 (50倍)

右:74-2 (50倍)

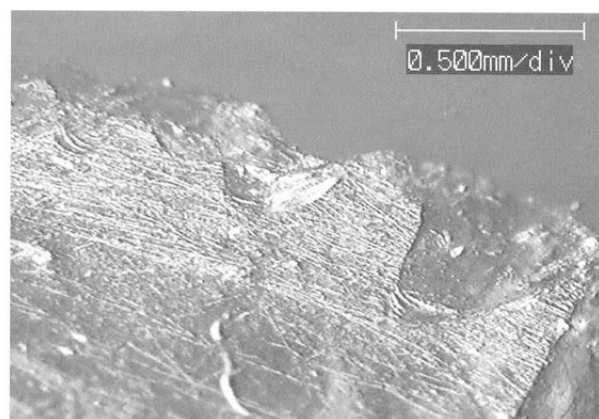

左:74-3 (15倍)

右:74-4 (15倍)

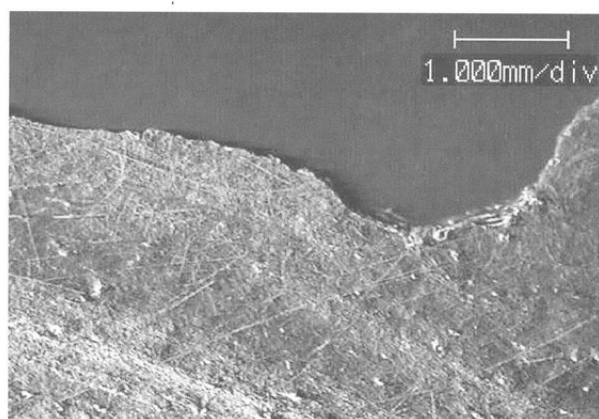
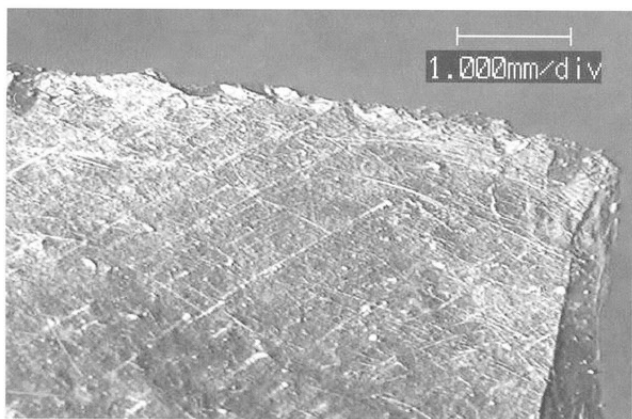

左:80-1 (30倍)

右:80-2 (15倍)

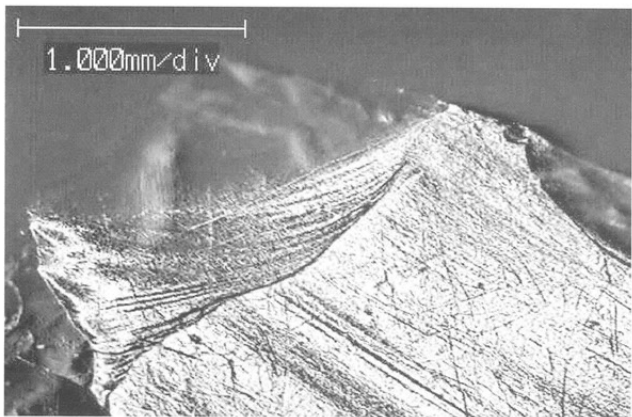

左:93-1 (50倍)

右:93-2 (30倍)

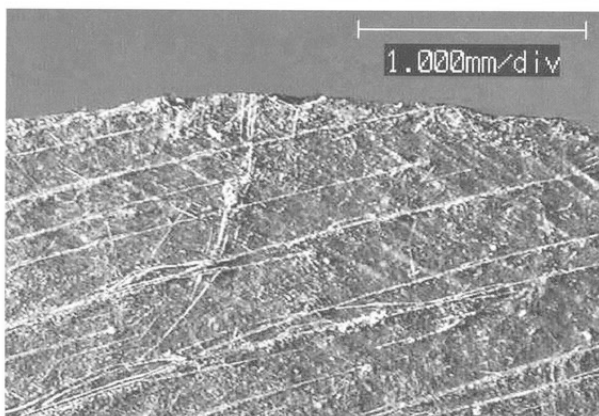
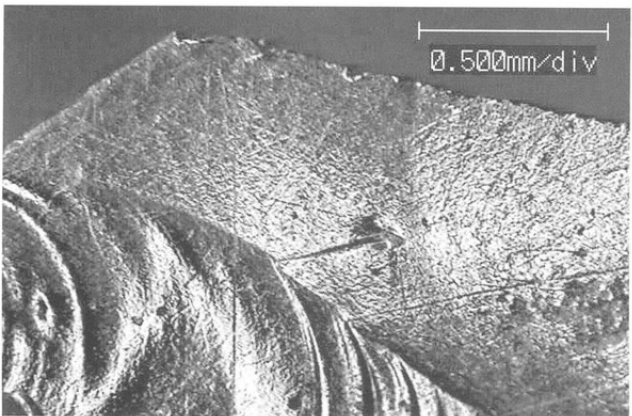

左:93-3 (50倍)

右:103-1 (30倍)

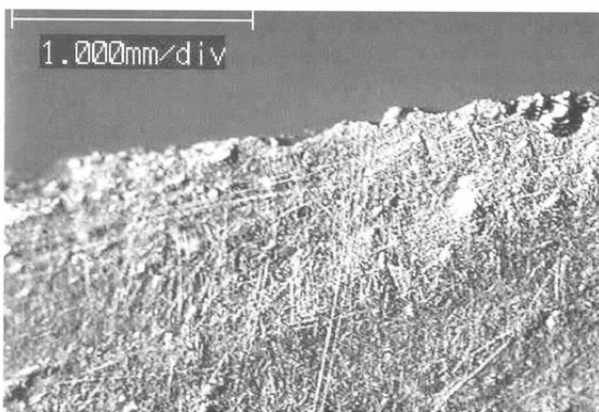
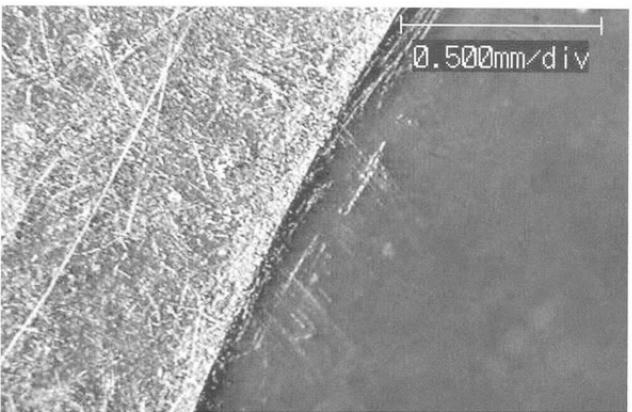

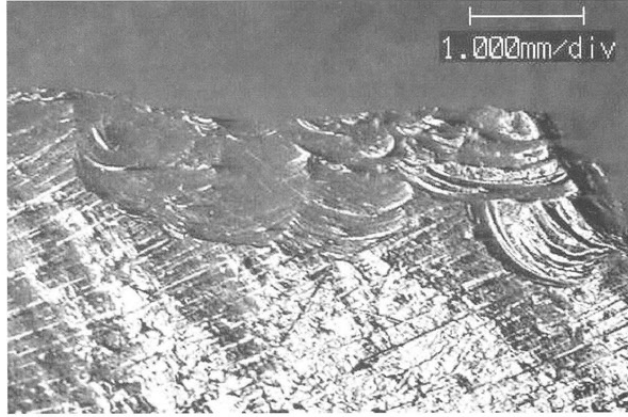
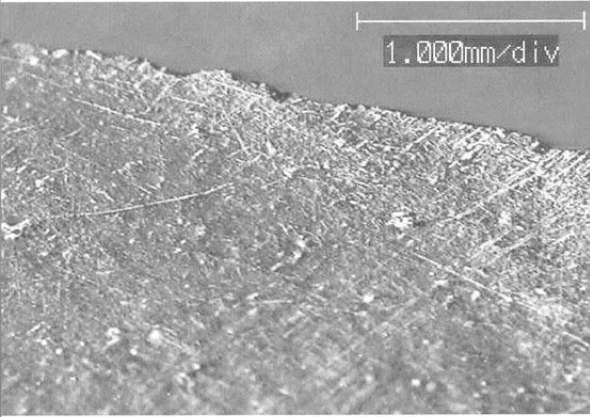

左:103-2 (30倍)  
右:103-3 (15倍)

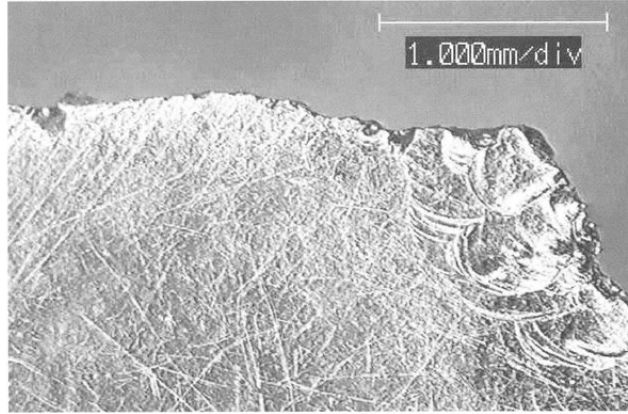
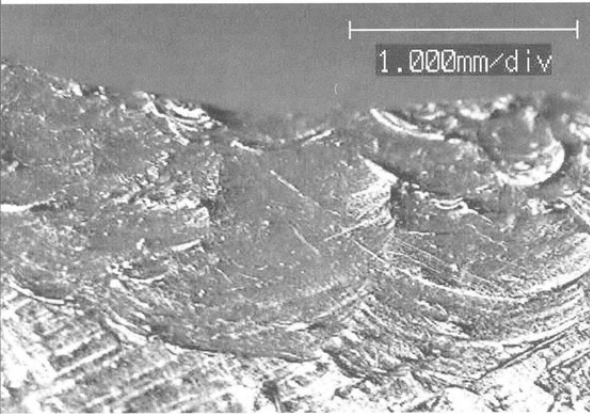

左:103-4 (30倍)  
右:104-1 (30倍)

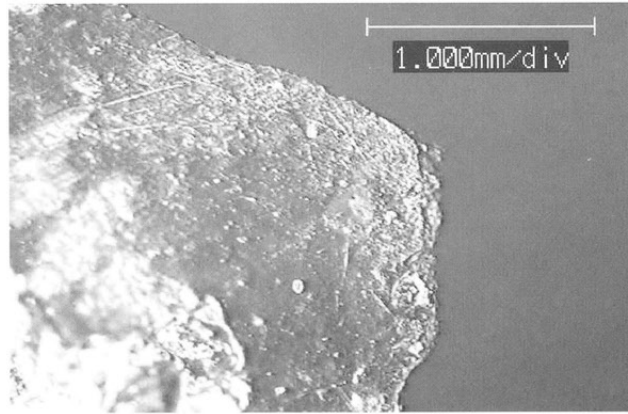
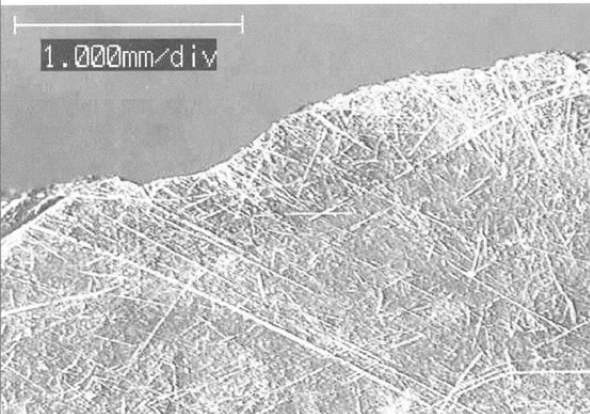

左:104-2 (30倍)  
右:105-1 (30倍)

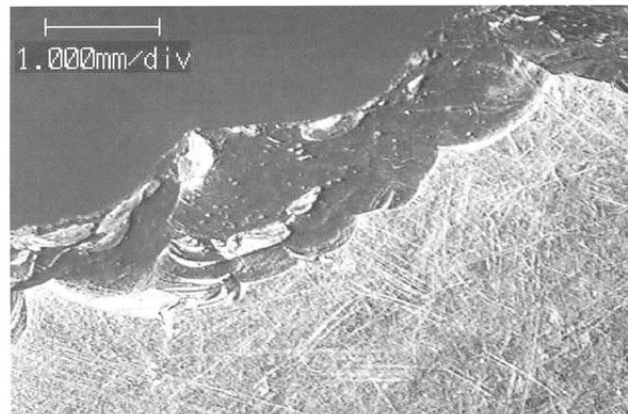
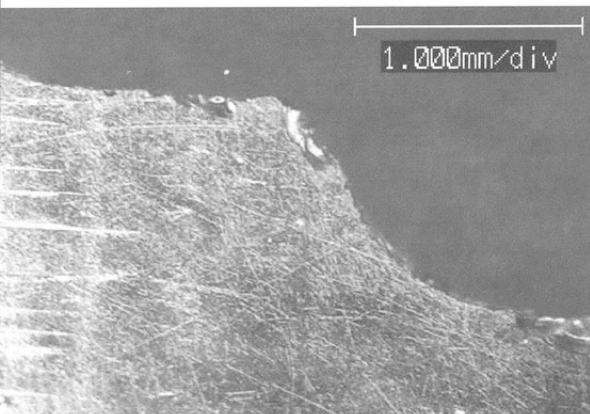

左:113-1 (30倍)  
右:113-2 (15倍)

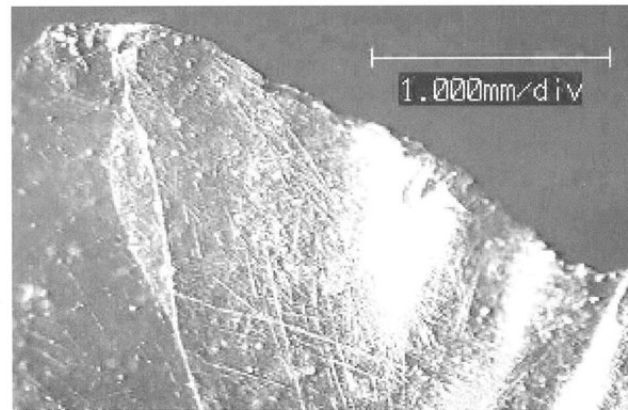
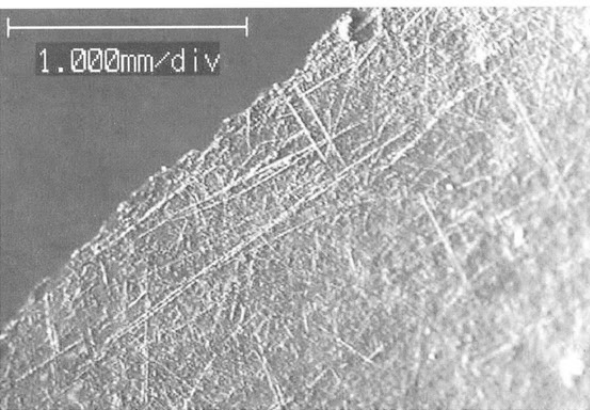

左:113-3 (30倍)  
右:114-1 (30倍)



左:114-2 (30倍)  
右:117-1 (30倍)

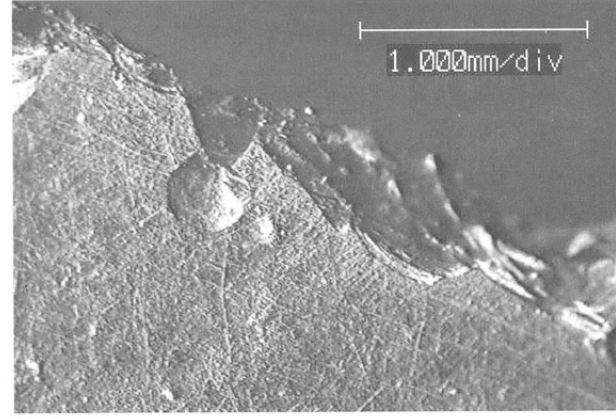
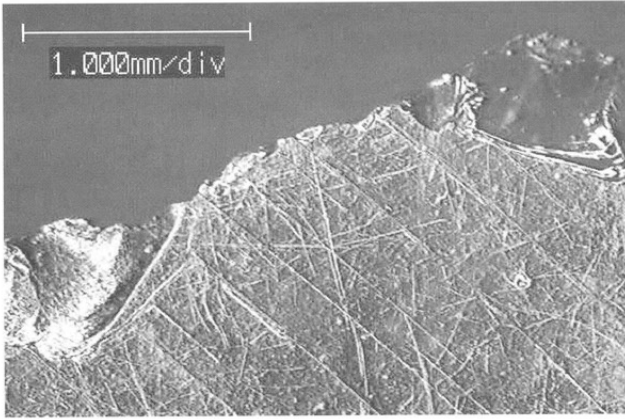

左:117-2 (30倍)  
右:117-3 (50倍)

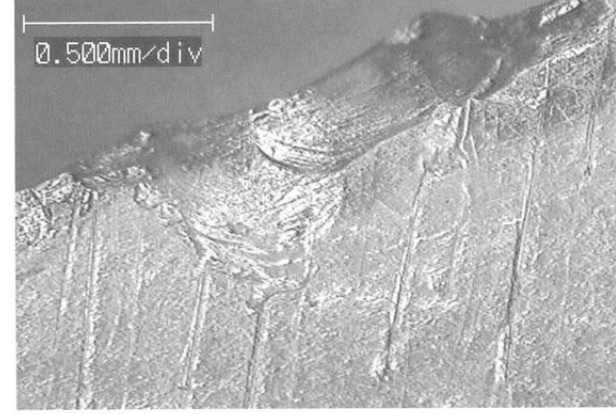
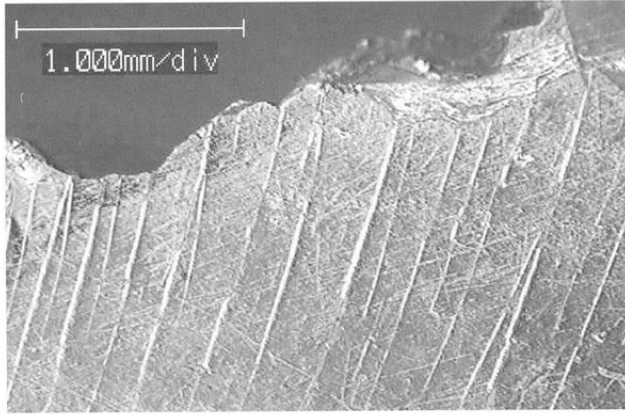

左:125-1 (15倍)  
右:125-2 (15倍)

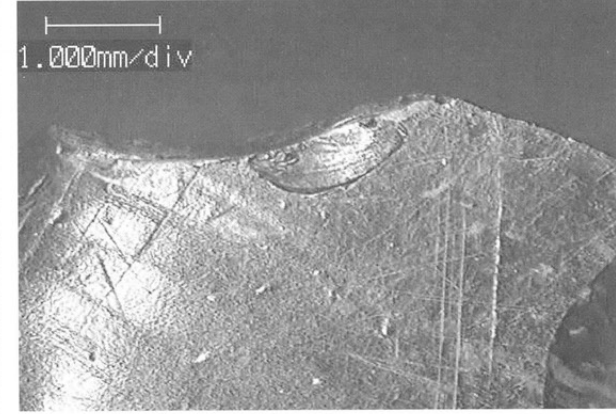
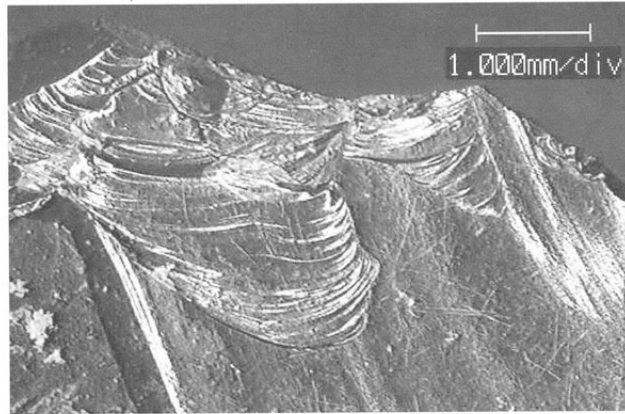

左:131-1 (15倍)  
右:131-2 (15倍)

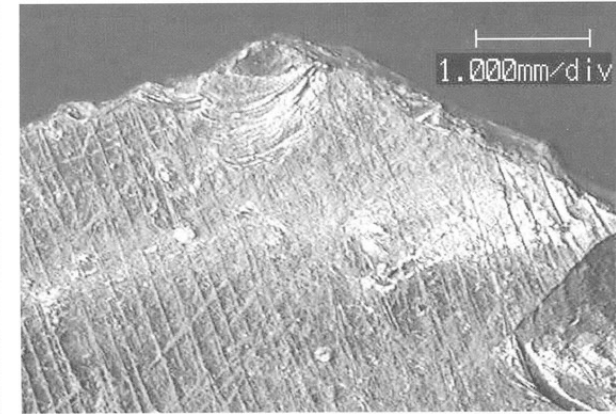
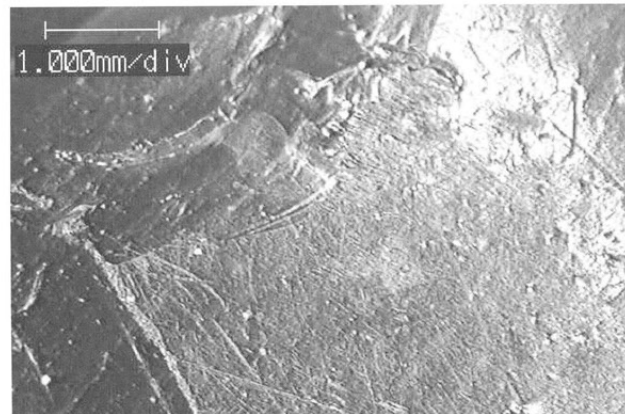

左:131-3 (50倍)  
右:131-4 (30倍)

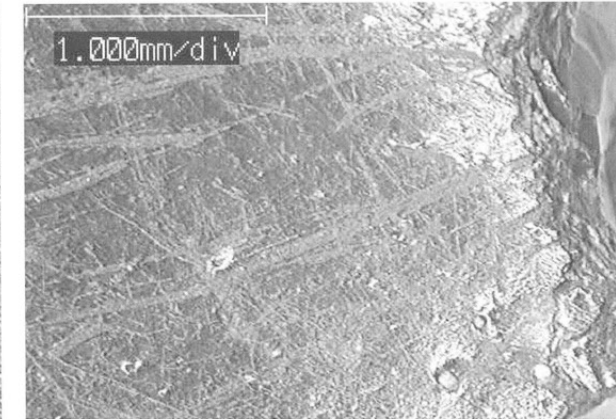
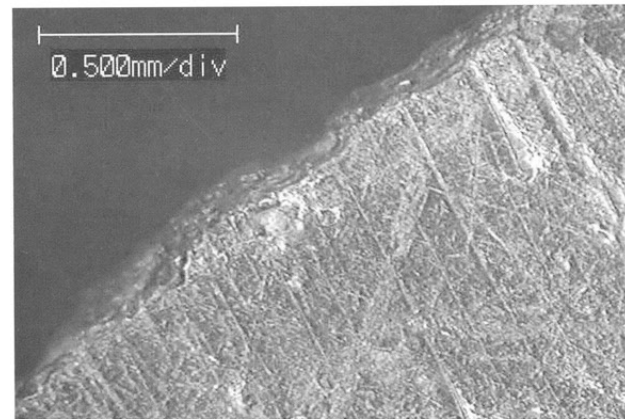

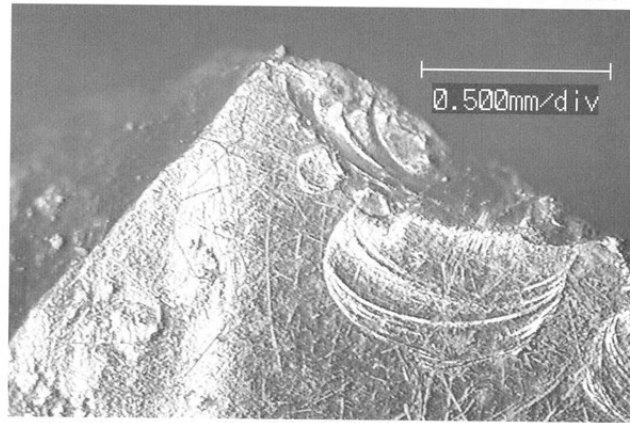
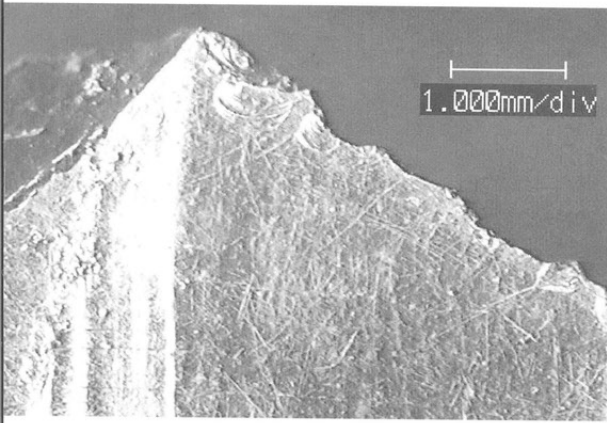

左:134-1 (15倍)  
右:134-2 (50倍)

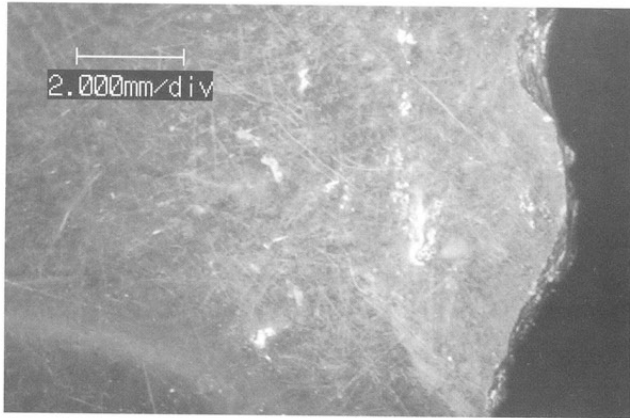
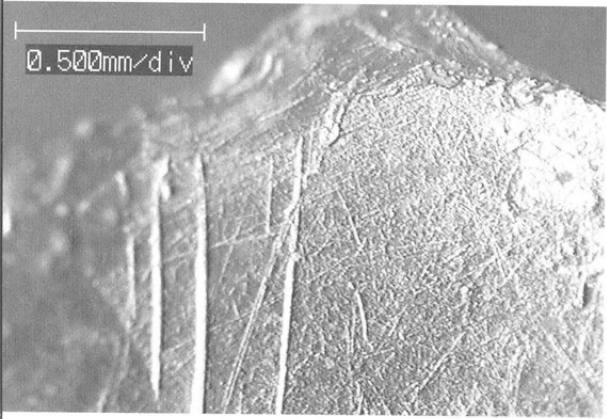

左:134-3 (50倍)  
右:134-4 (7倍)

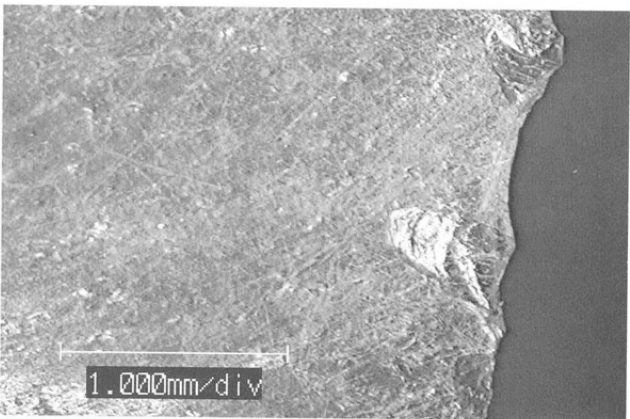
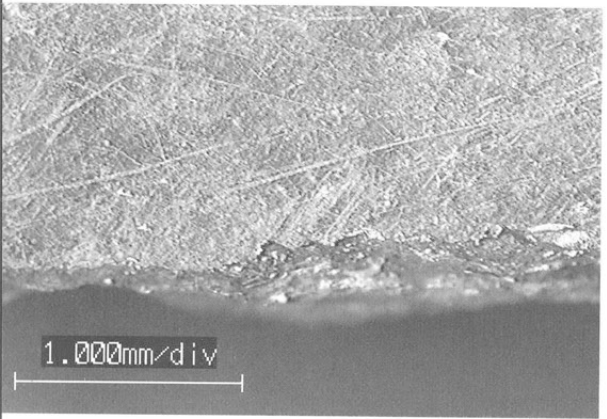

左:135-1 (30倍)  
右:135-2 (30倍)

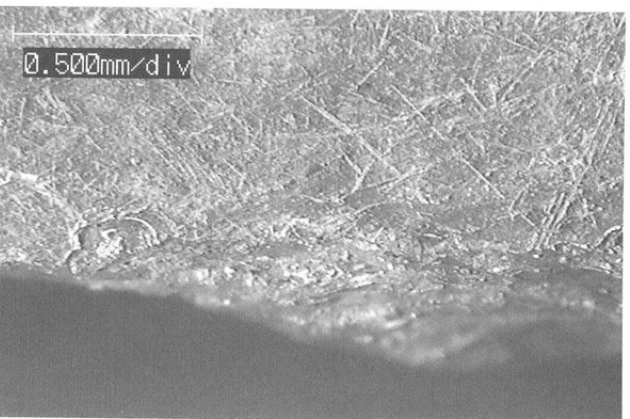
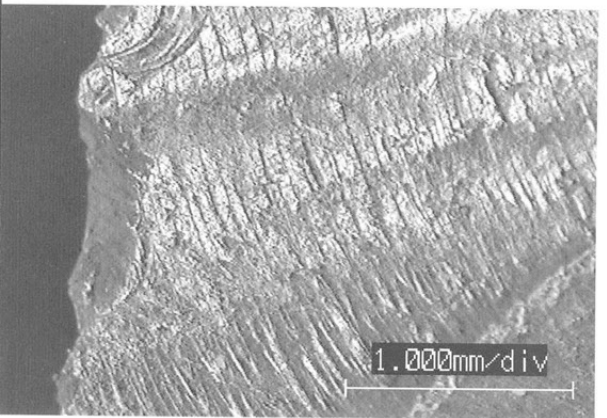

左:135-3 (30倍)  
右:135-4 (50倍)

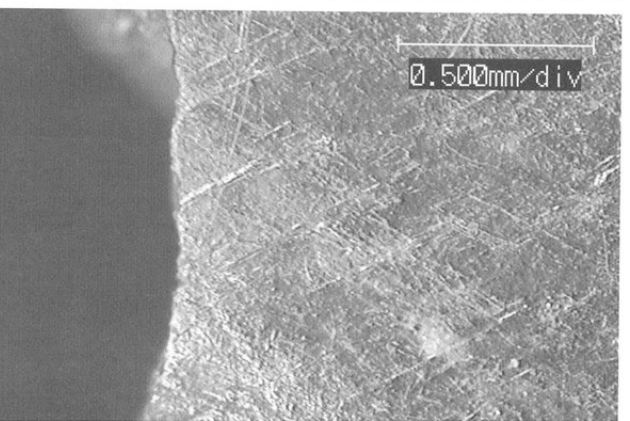
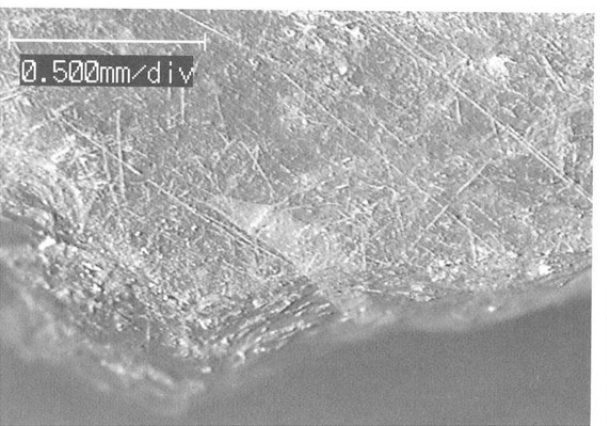

左:136-1 (50倍)  
右:136-2 (50倍)

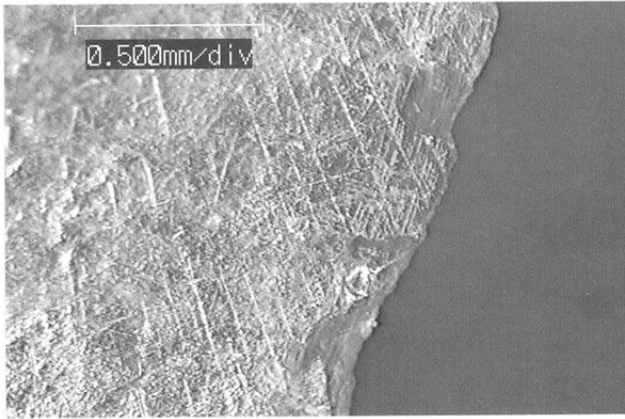

左:136-3 (50倍)  
右:136-4 (50倍)

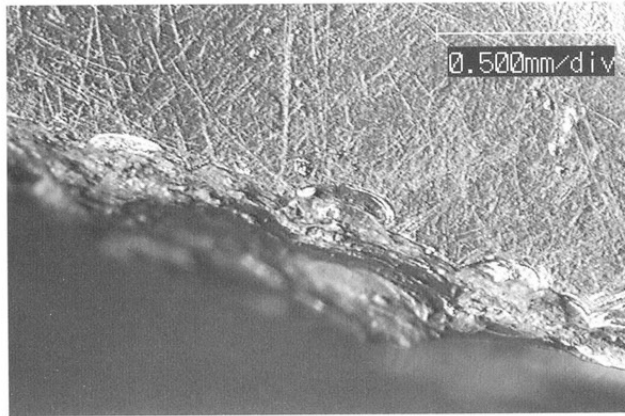
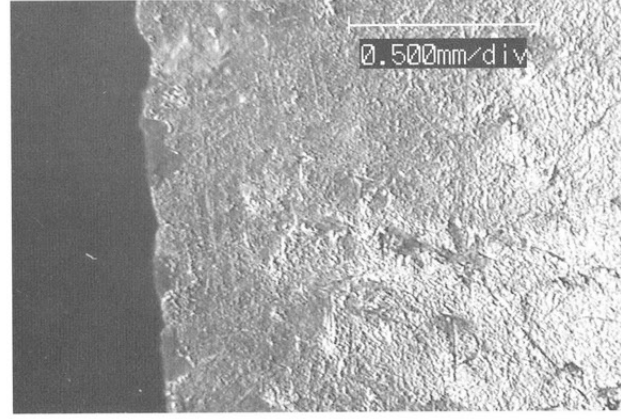

左:146-1 (50倍)  
右:188-1 (30倍)

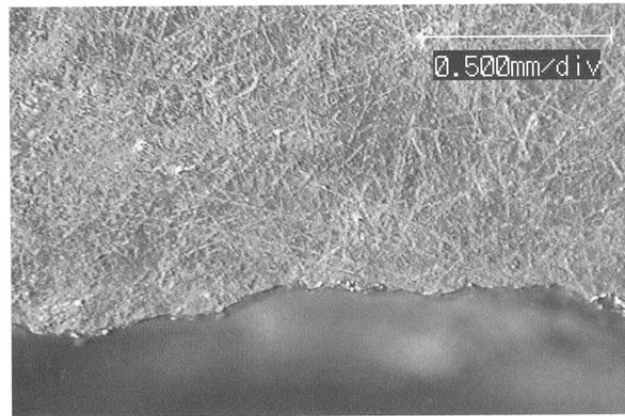
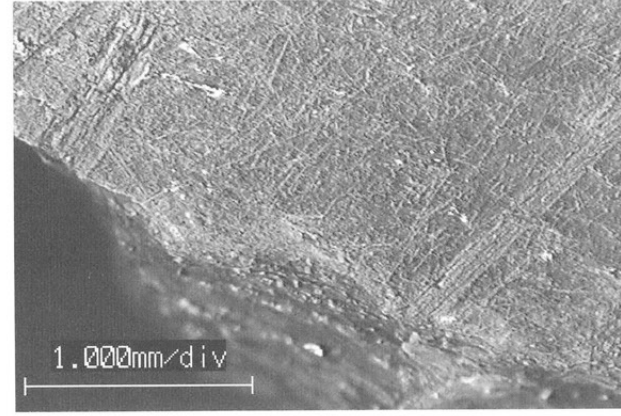

左:199-1 (50倍)  
右:224-1 (50倍)

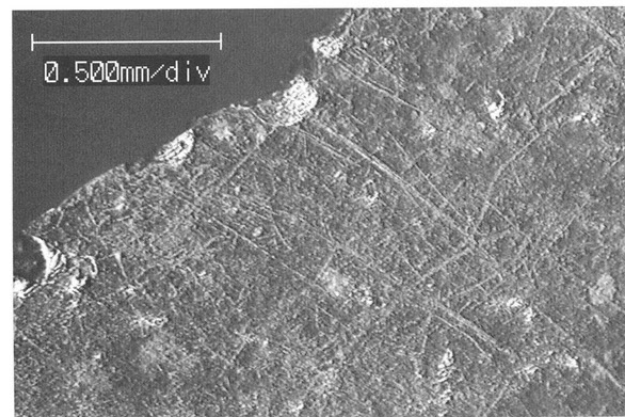
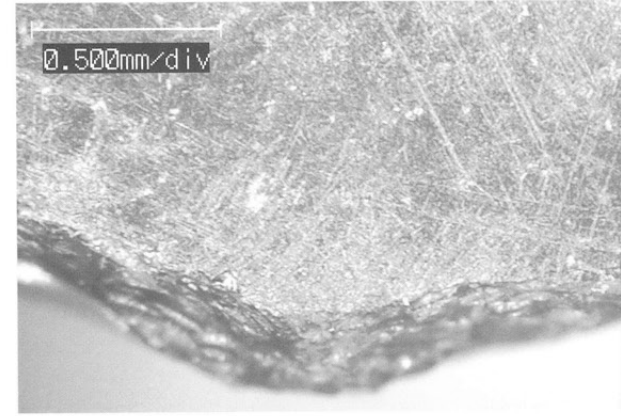

左:224-2 (50倍)  
右:230-1 (30倍)

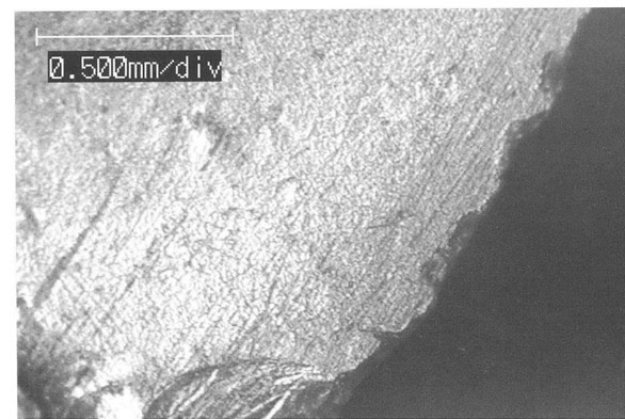
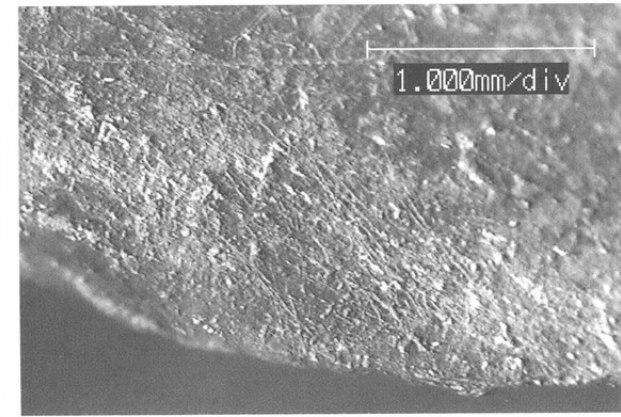

左:268-1 (50倍)  
右:268-2 (50倍)

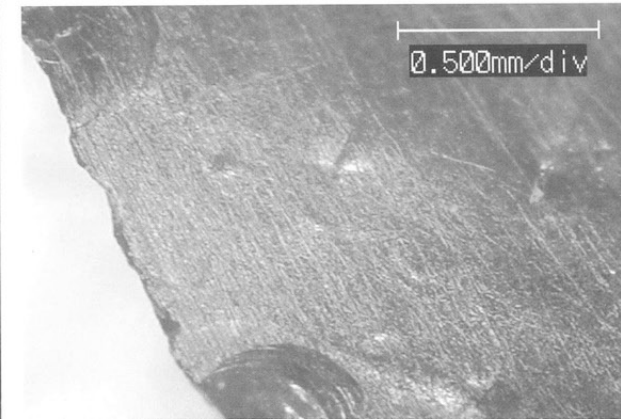

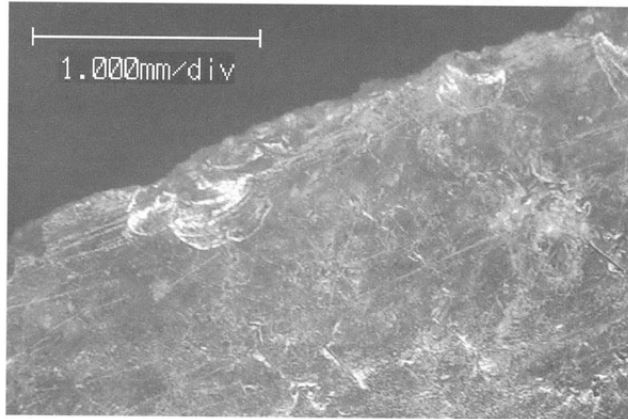
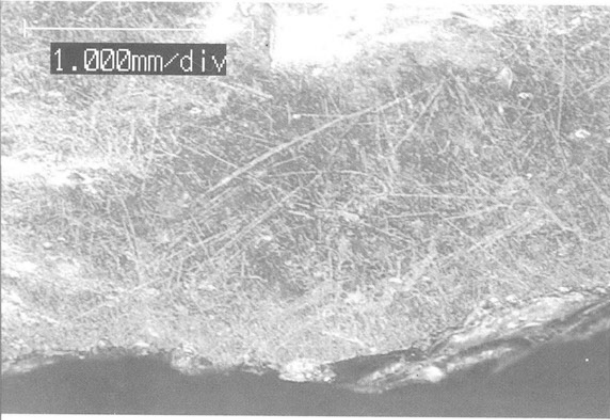

左:279- 1 (30倍)  
右:294- 1 (30倍)

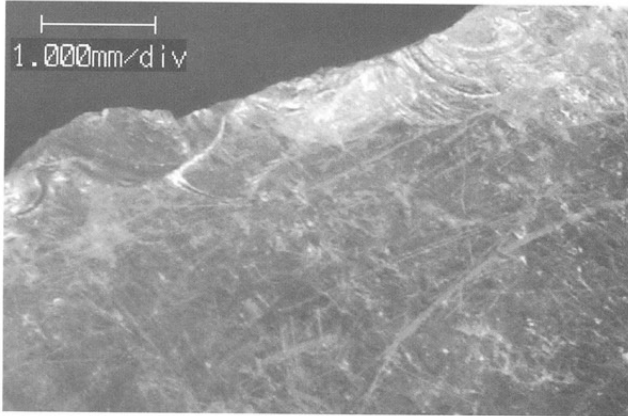
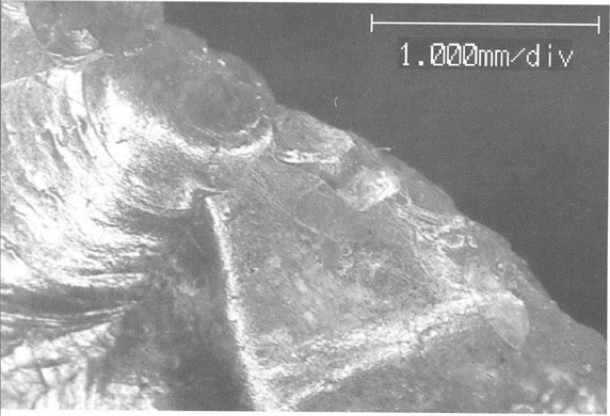

左:294- 2 (30倍)  
右:294- 3 (15倍)

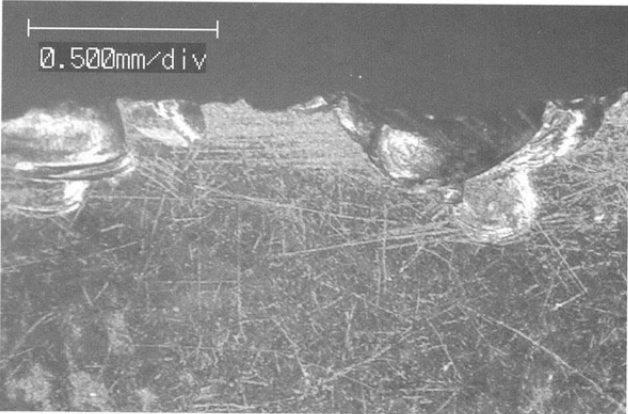

左:299- 1 (15倍)  
右:299- 2 (50倍)

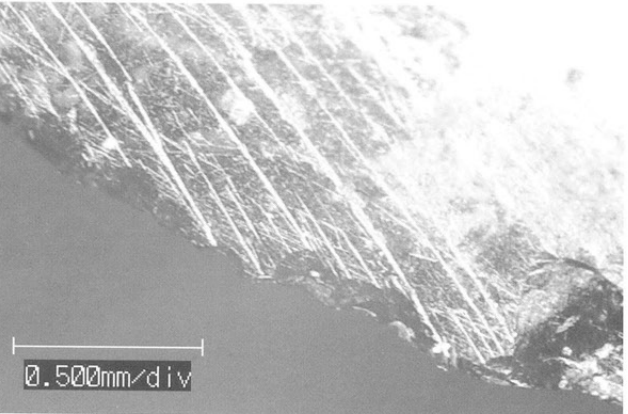

左:299- 3 (50倍)  
右:299- 4 (50倍)

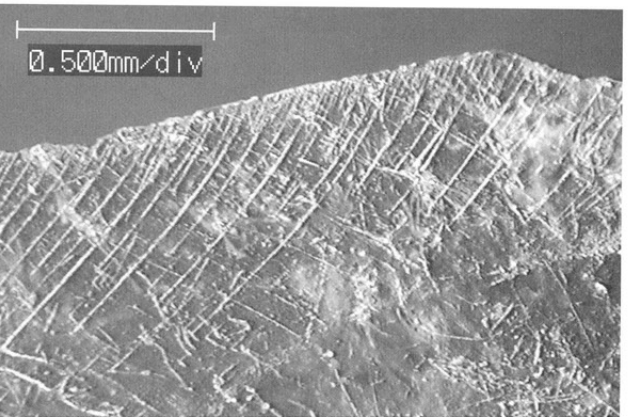
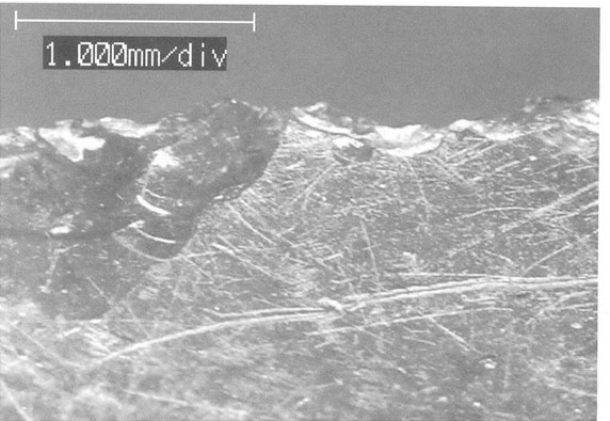

左:315- 1 (30倍)  
右:376- 1 (50倍)

左:455-1 (15倍)  
右:455-2 (15倍)

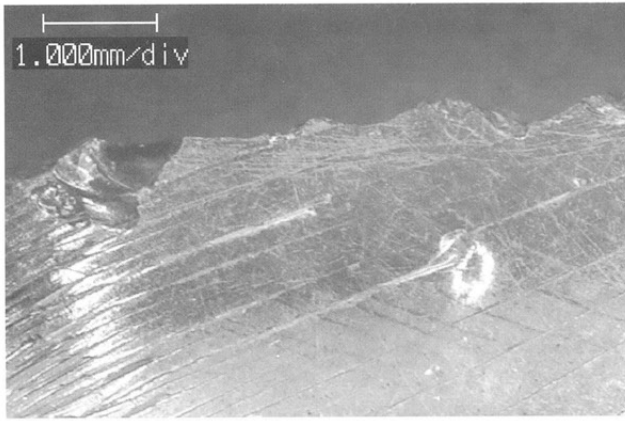

左:462-1 (50倍)  
右:462-2 (50倍)

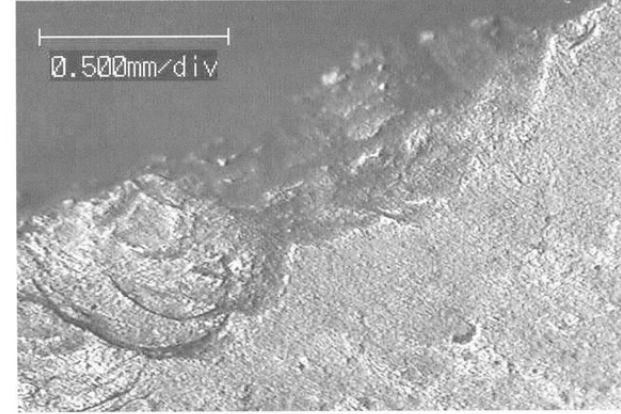
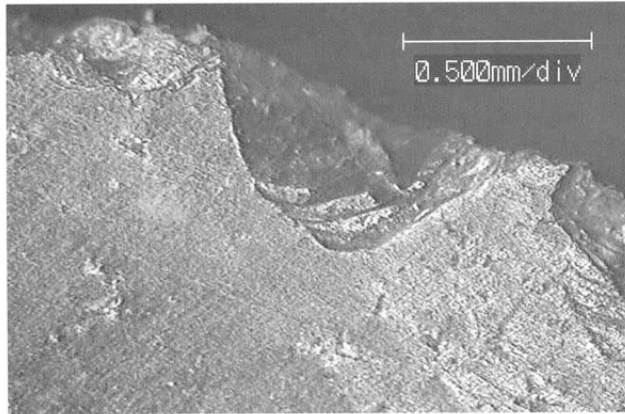

左:507-1 (30倍)  
右:507-2 (30倍)

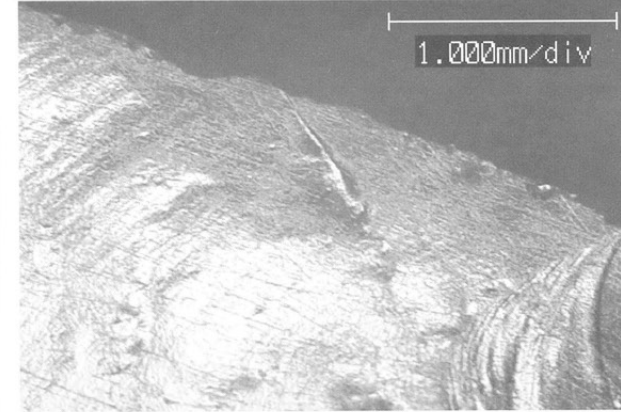
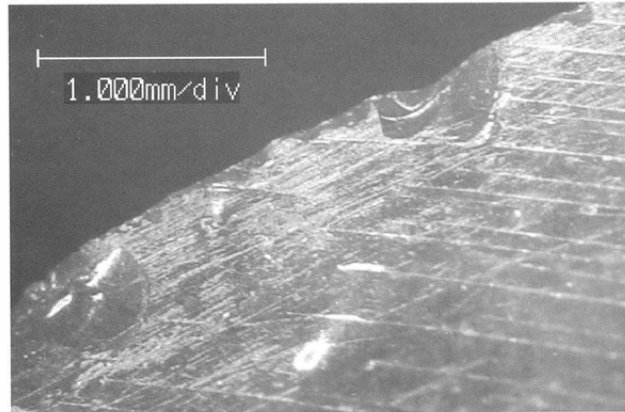

左:534-1 (15倍)  
右:534-2 (15倍)

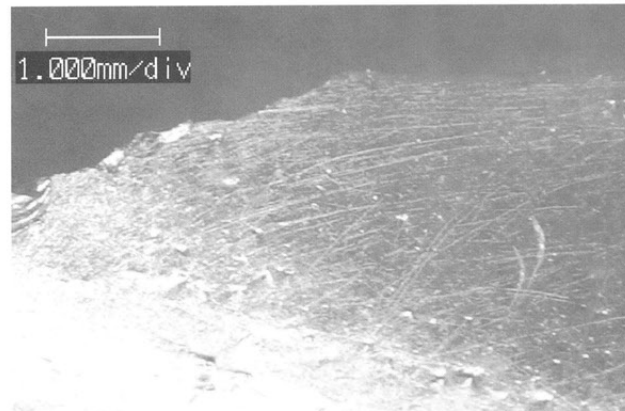

左:545-1 (15倍)  
右:545-2 (30倍)

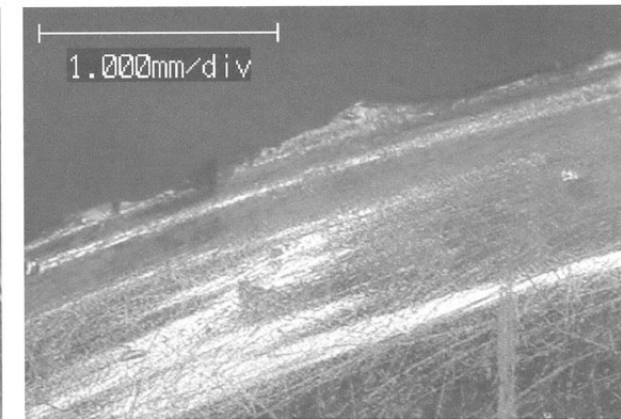
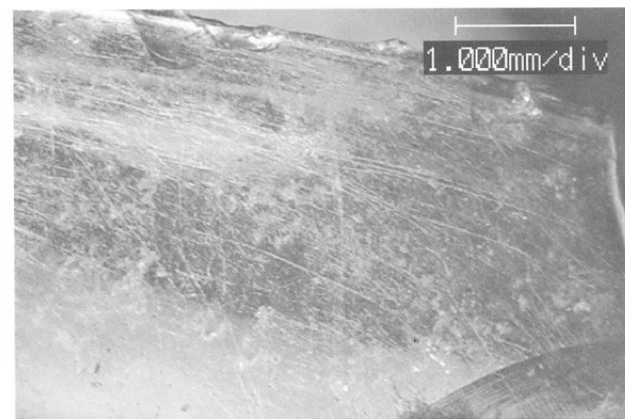

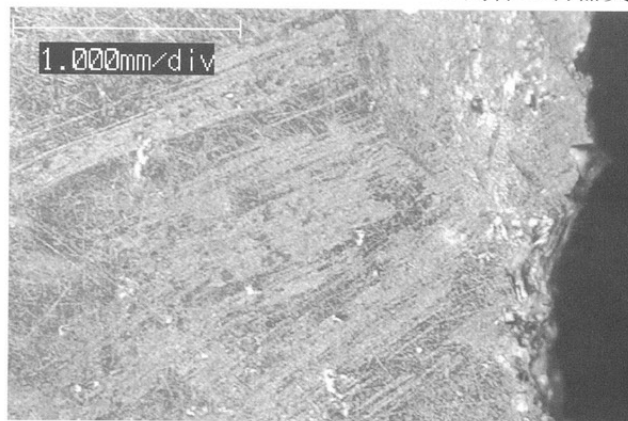
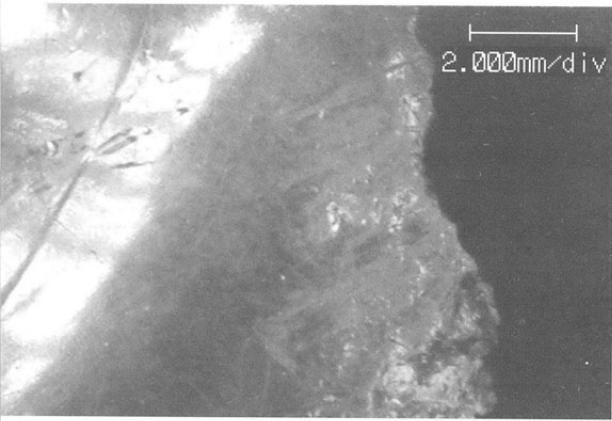

左:573-1 (7倍)  
右:573-2 (30倍)

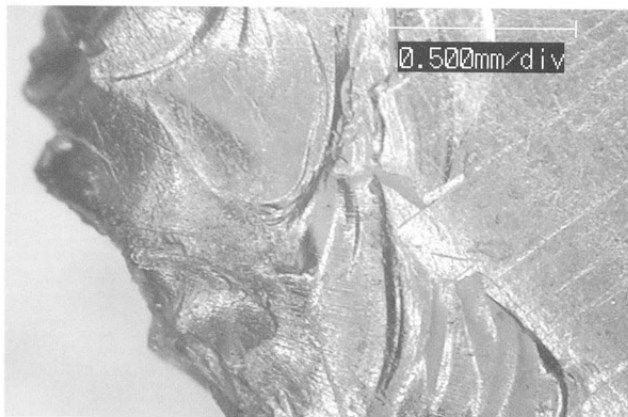
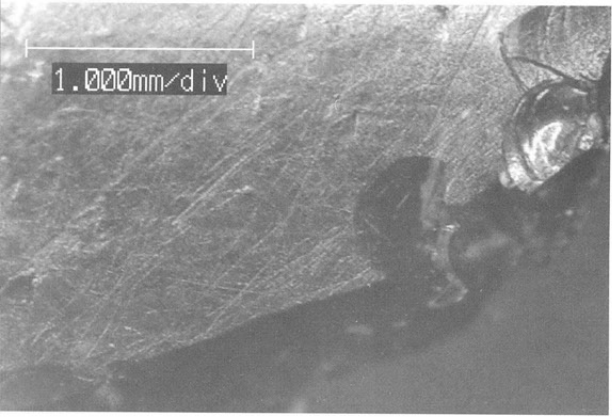

左:605-1 (30倍)  
右:605-2 (50倍)

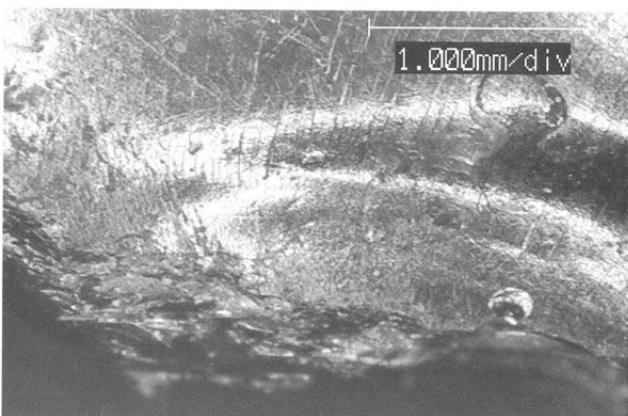
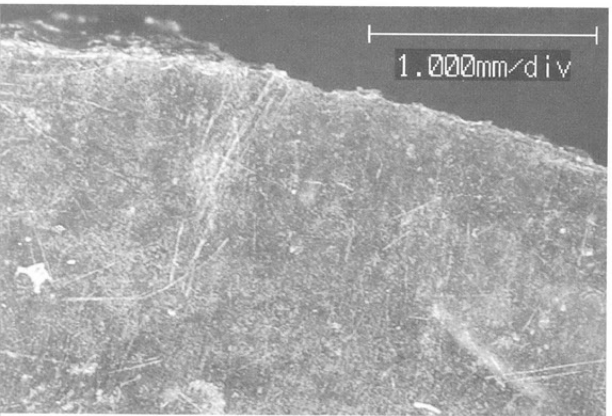

左:656-1 (30倍)  
右:660-1 (30倍)

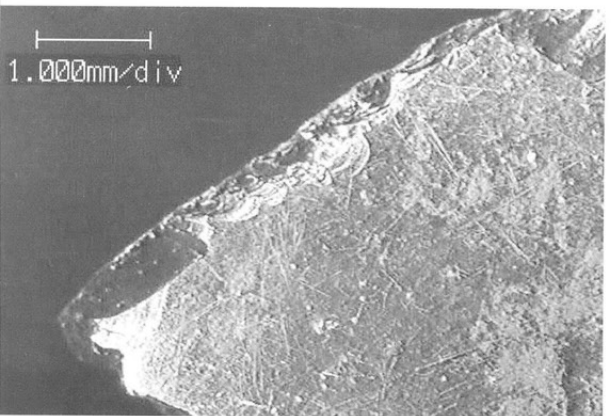

左:687-1 (15倍)  
右に90°回転  
右:701-1 (7倍)

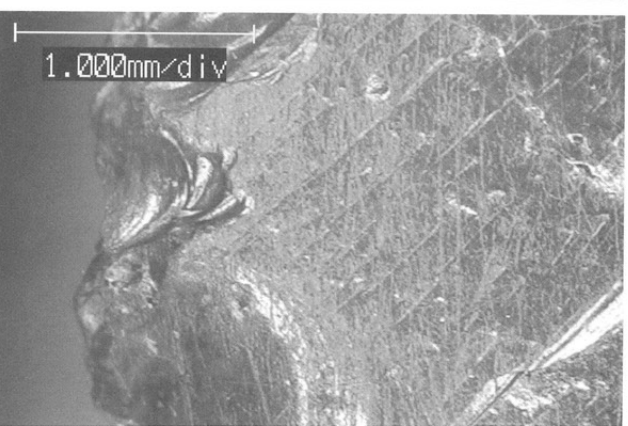

左:701-2 (30倍)  
右:701-3 (30倍)

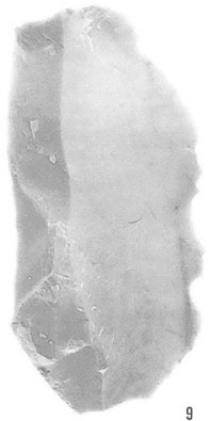
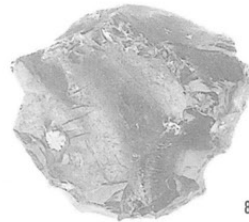

(1 : 1)



遺跡  
(空撮)

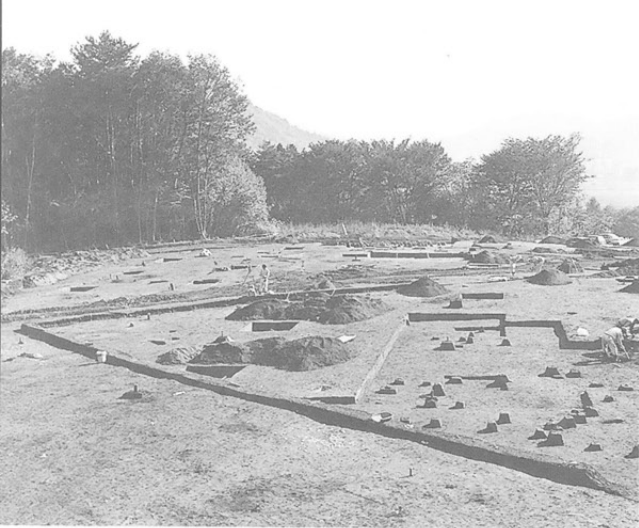

左上：旧石器面調  
査区遠景  
(東より)



左下：日向林IIa  
石器文化  
第2号ブロック  
遺物出土状況

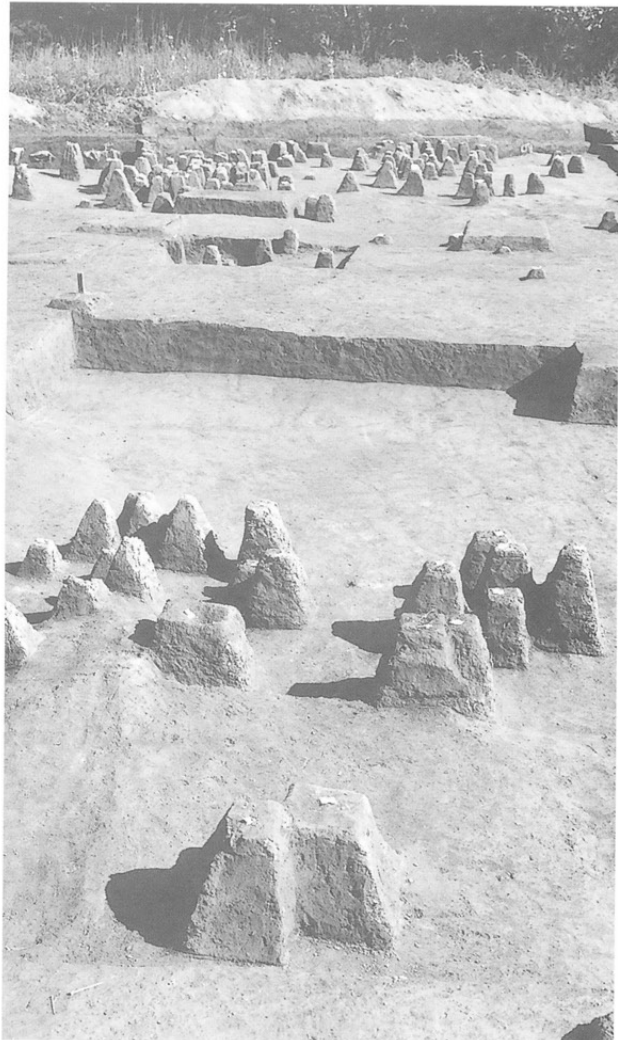

右：日向林IIa石器  
文化  
第1・2号ブロック  
遺物出土状況



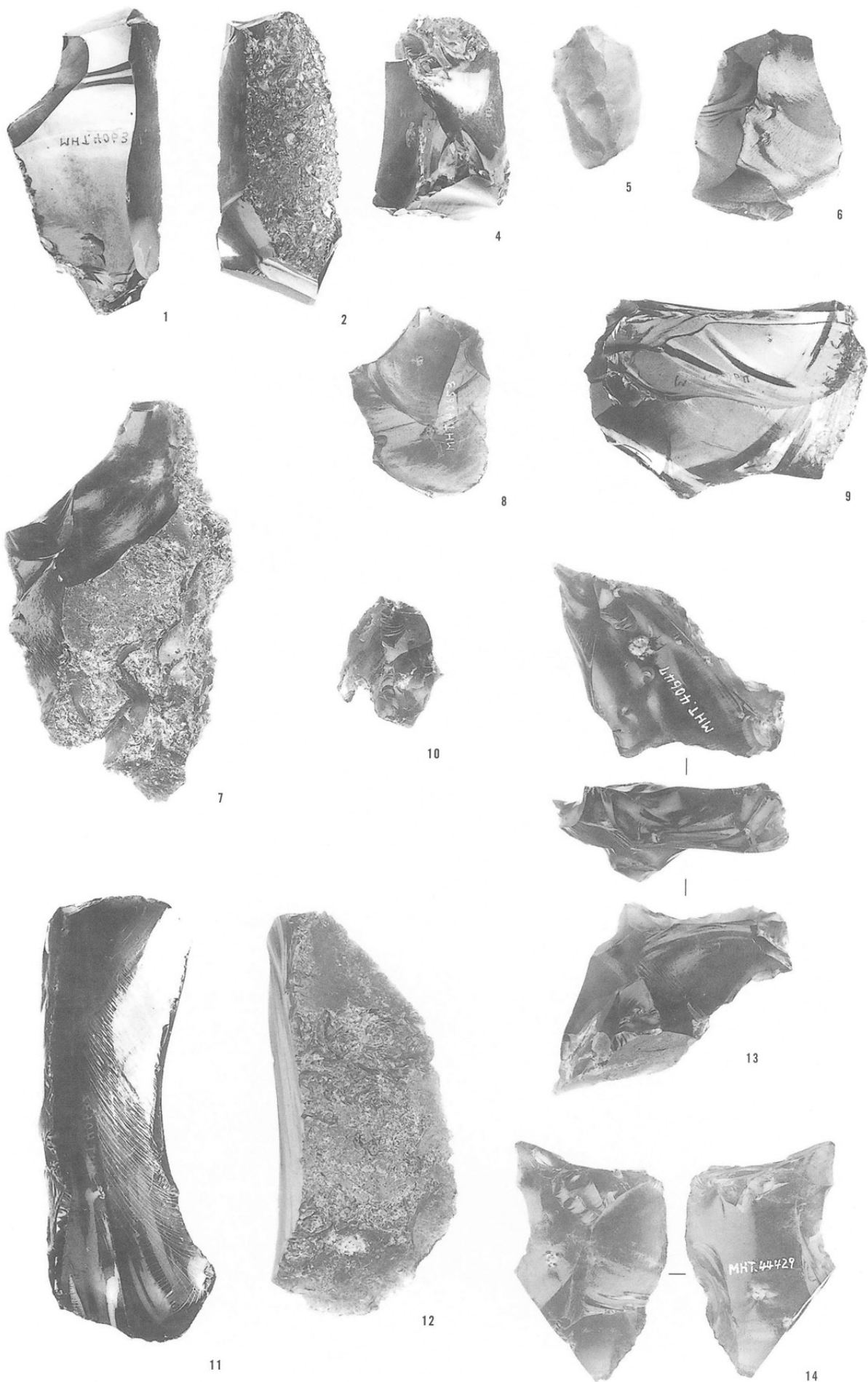



1



2

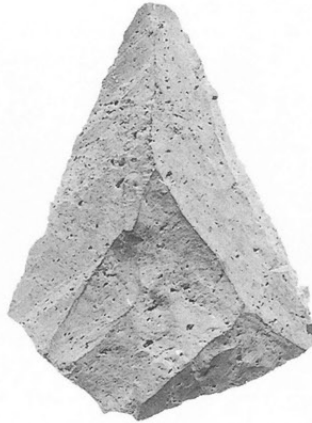

3



5

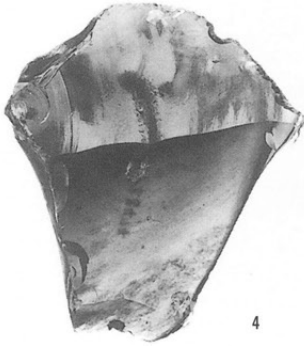

4



6

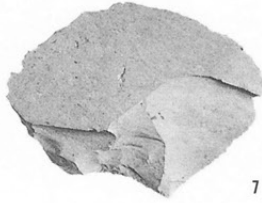

7



8



10

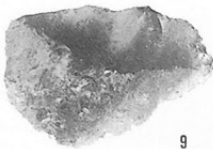

9



12



13



11

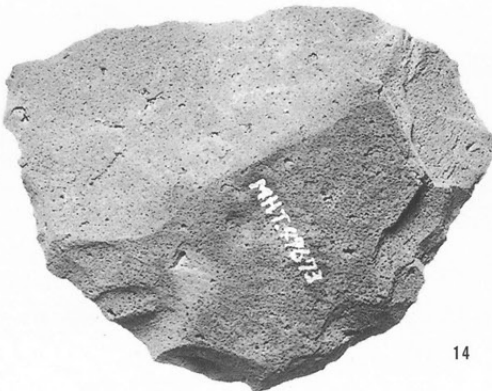
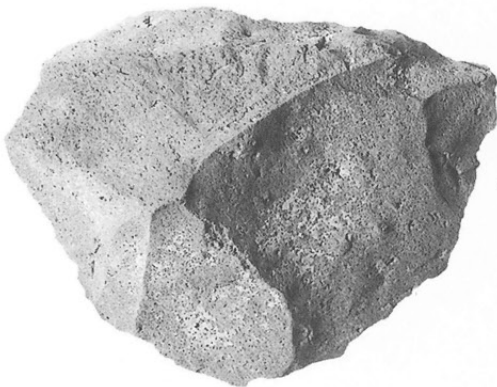

14



15



16

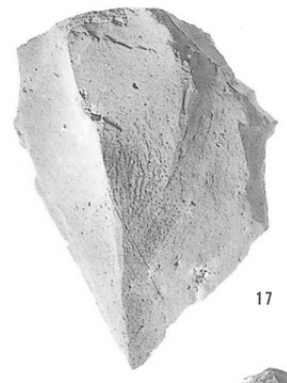

17



18



19



20



21



22



23



24

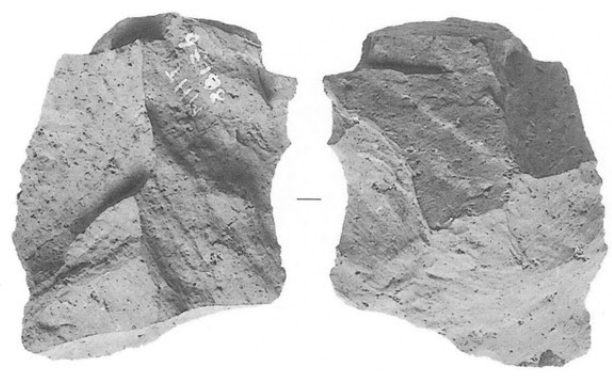

25



28



26

29

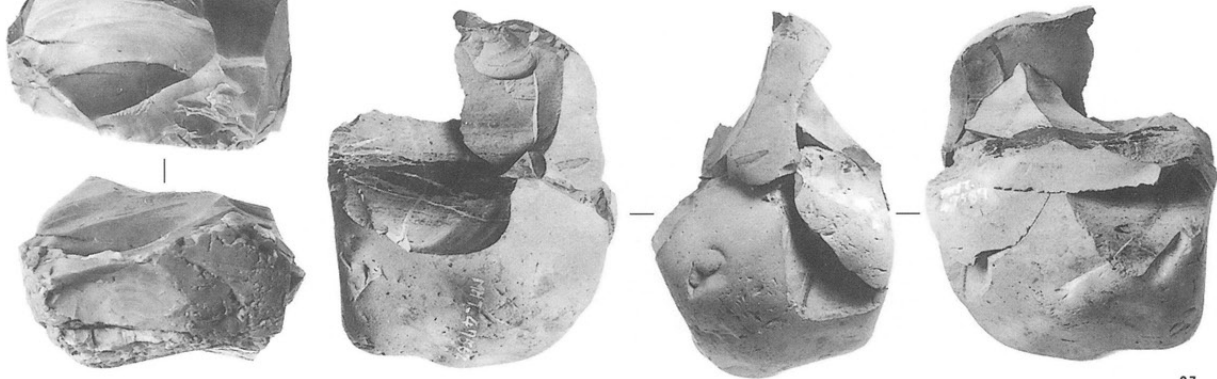

27

(1 : 1)

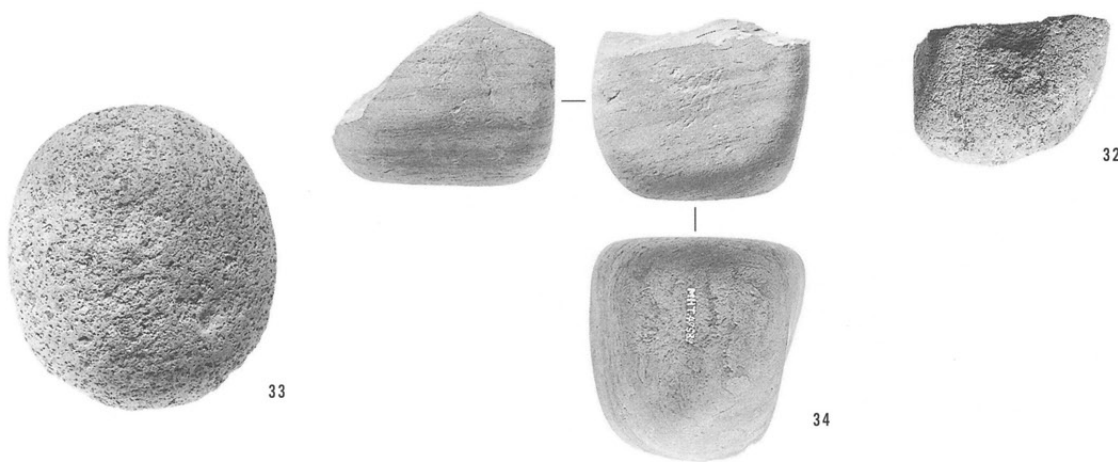

33

32

34



36

(1 : 2)

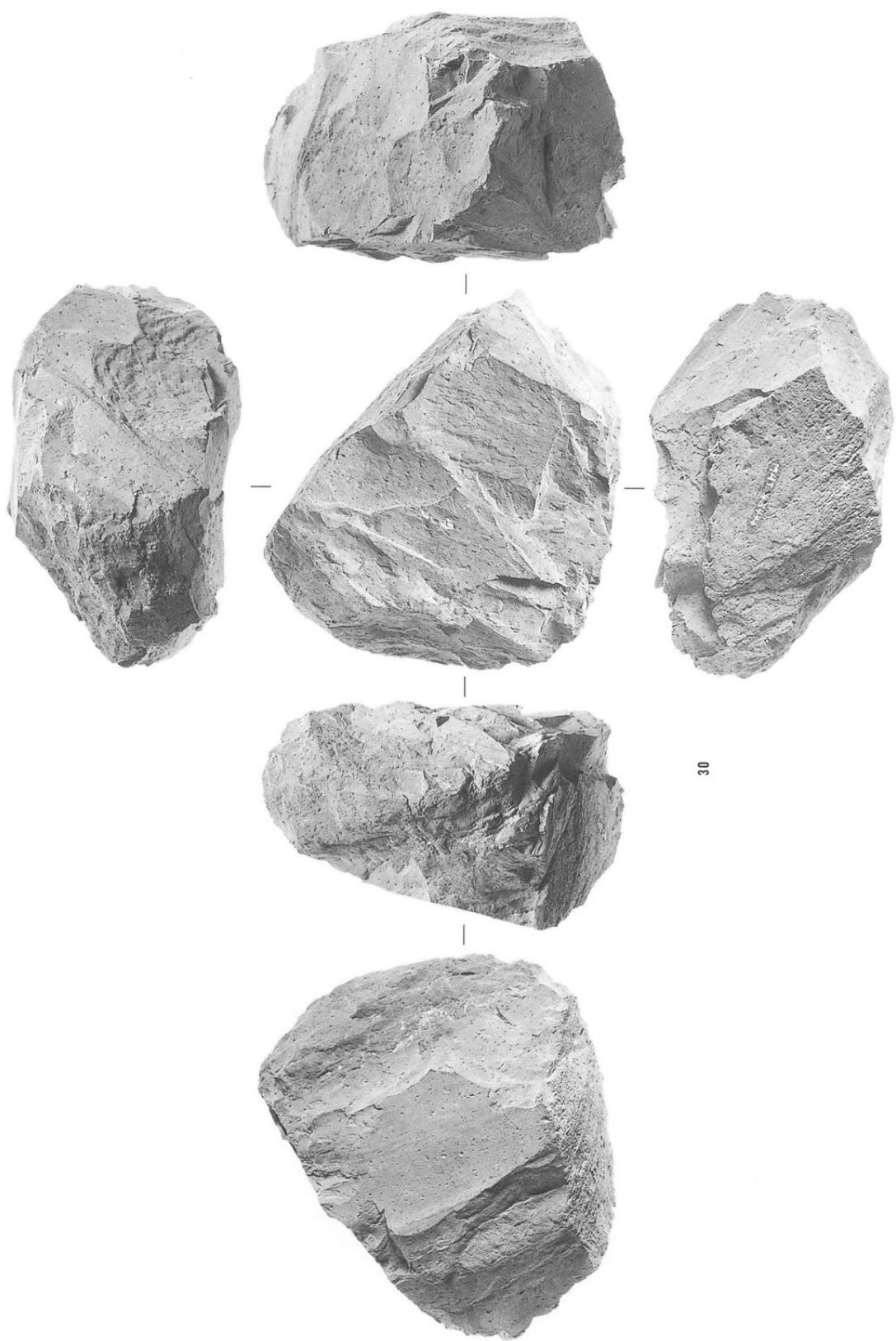

30







12

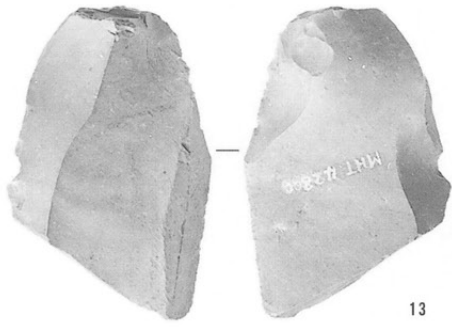

13



14

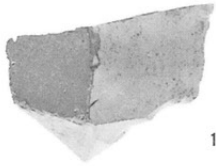

15

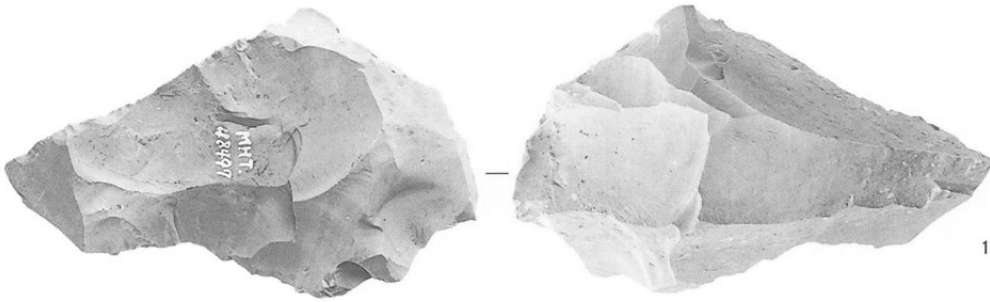

16

(1 : 1)

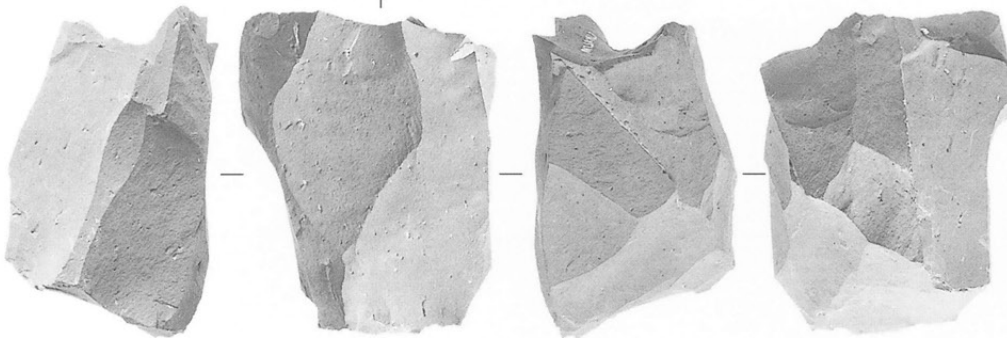

9



(3 : 4)



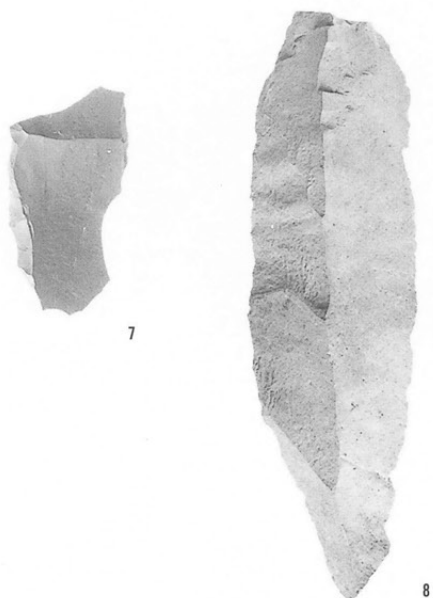
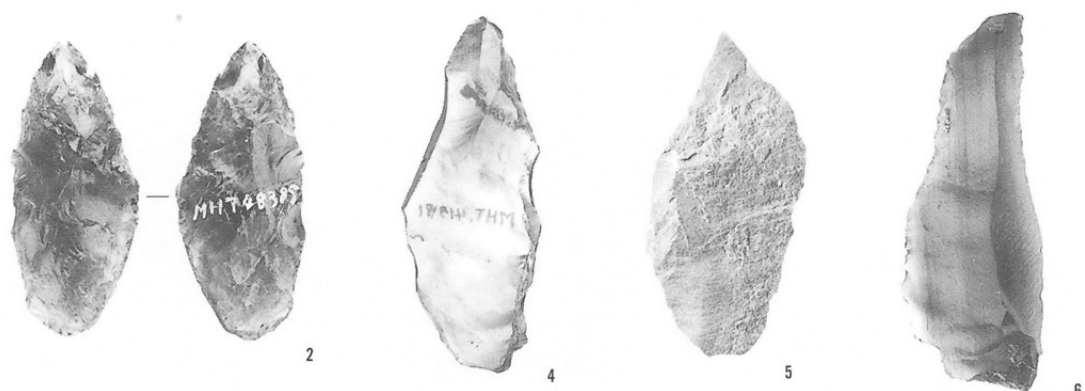
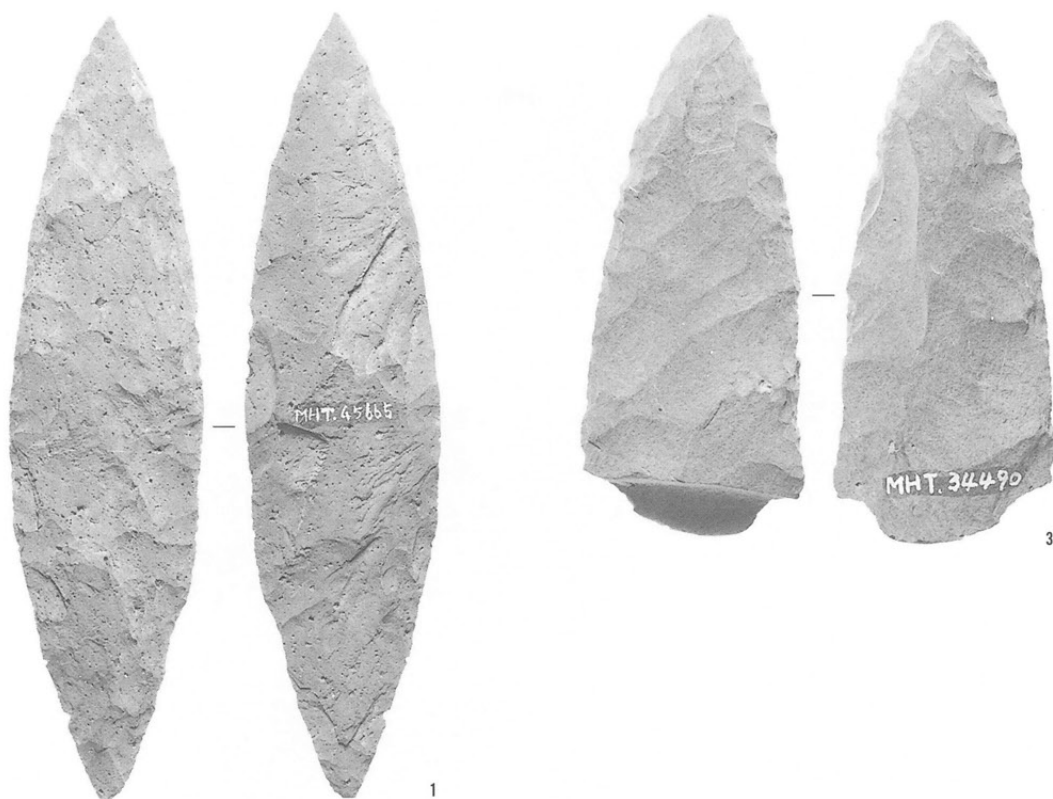



2-1区遠景  
(空撮)

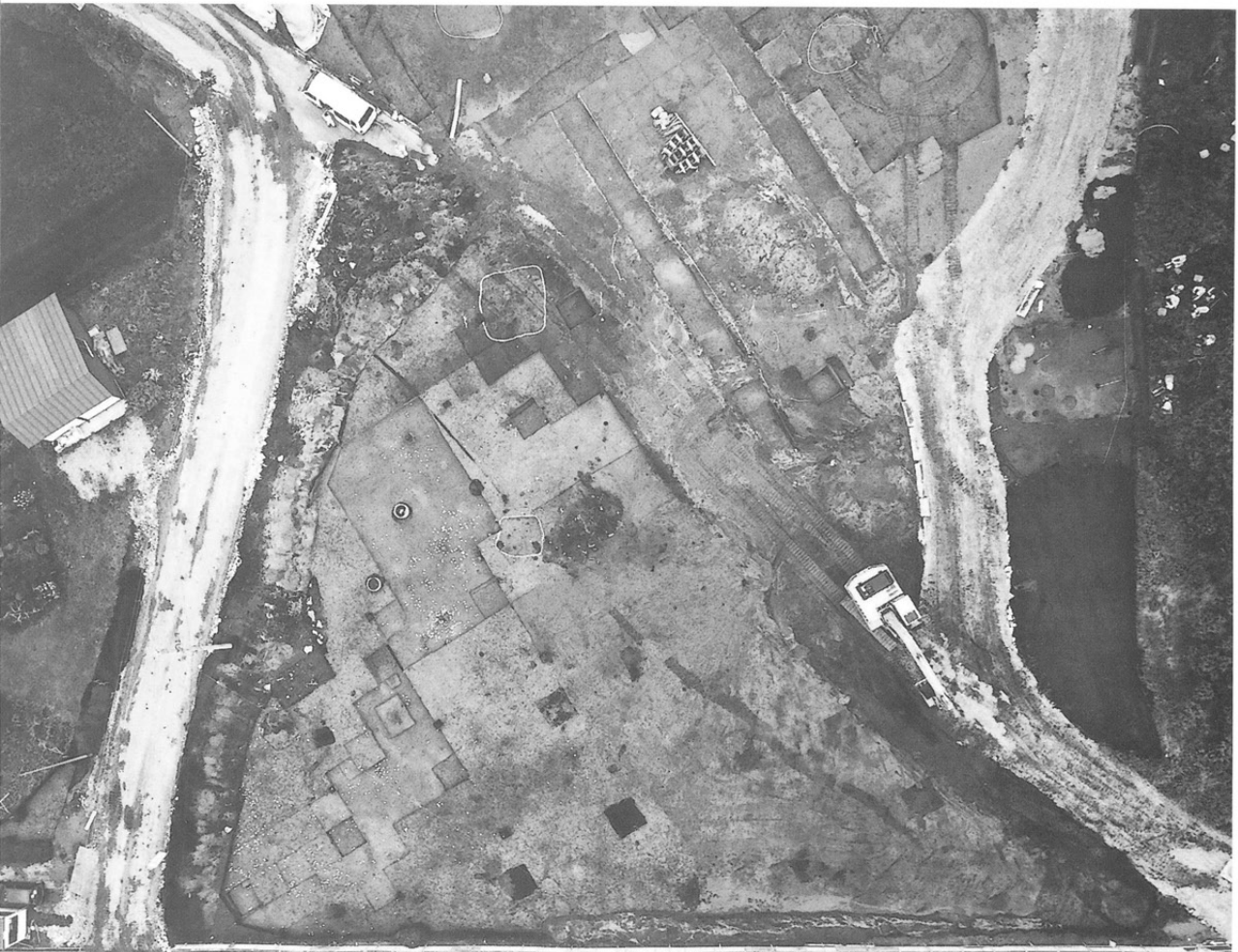

2-2区遠景  
(空撮)



左：七ツ栗Ⅰ石器文化  
第2号ブロック  
遺物出土状況  
(南より)

右：同石器文化  
第5・6号ブロック  
遺物分布状況  
(北より)



左：七ツ栗Ⅱ石器文化  
第1号ブロック・  
第1号礫群  
遺物出土状況  
(東より)

右：同石器文化  
第2号ブロック  
遺物分布状況  
(東より)

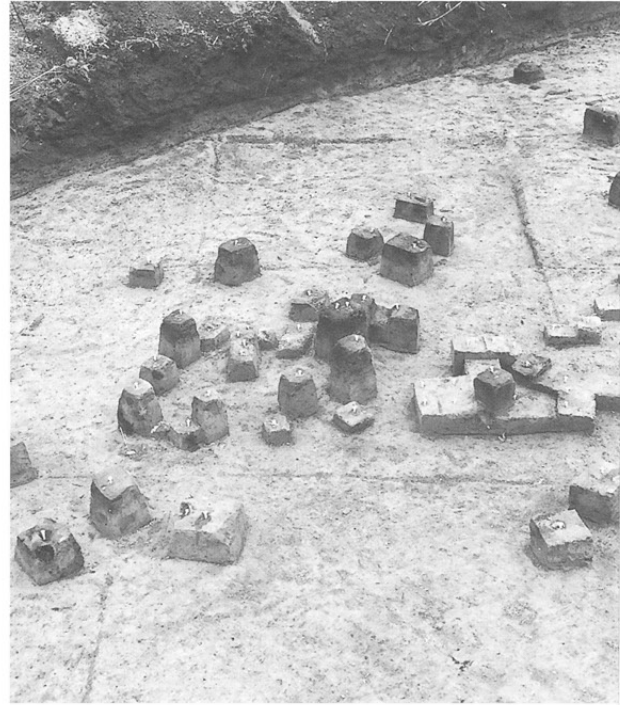

左：七ツ栗Ⅱ石器文化  
遺物出土状況  
(報告番号24・31)

右：旧石器時代その他  
神子柴型石斧出土状況  
(報告番号3)

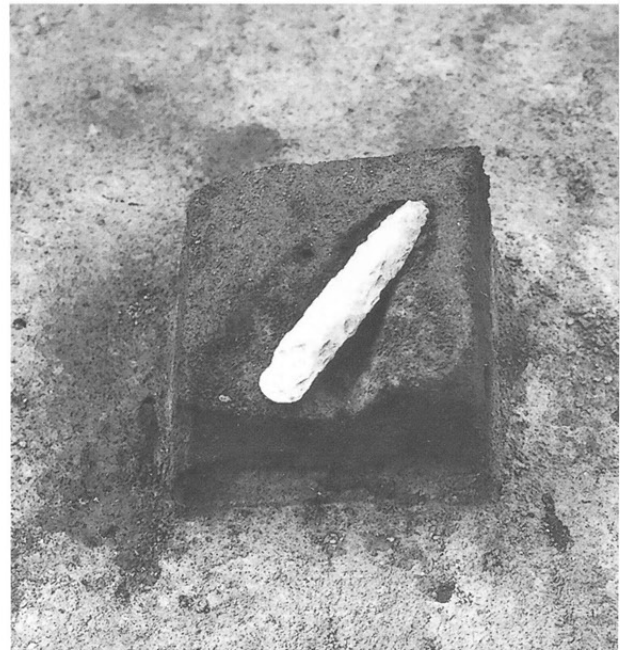

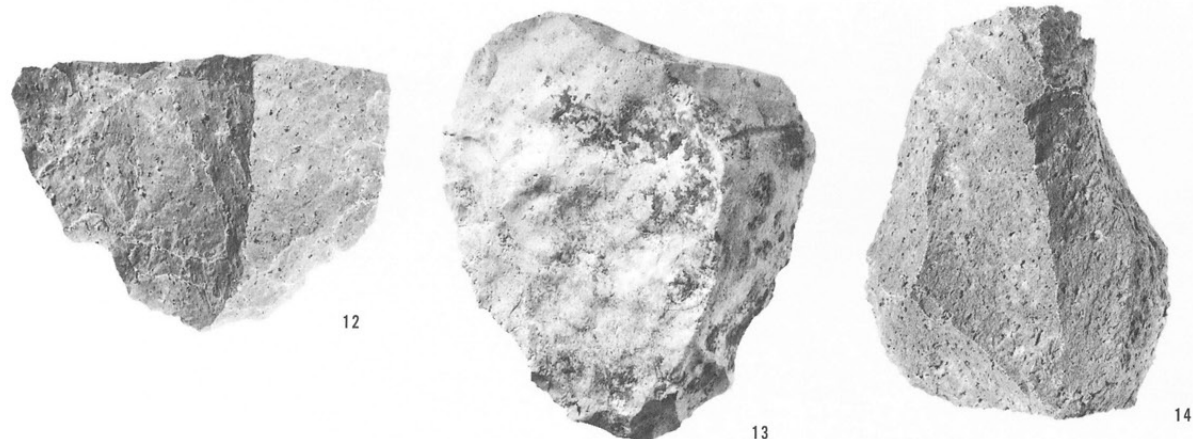
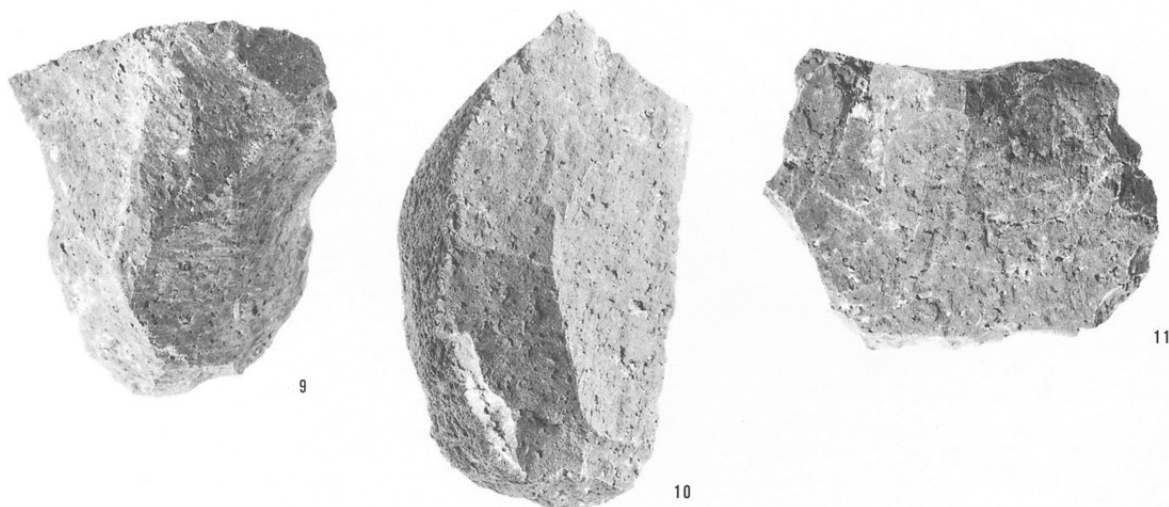
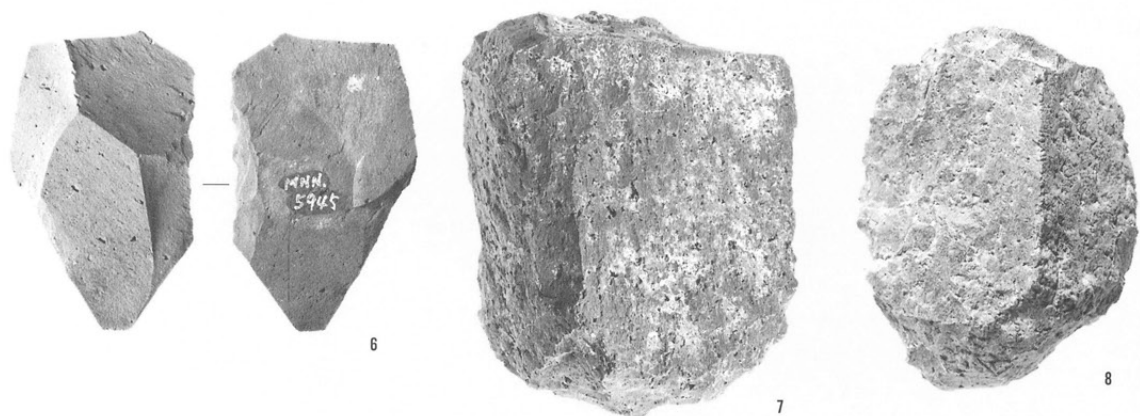
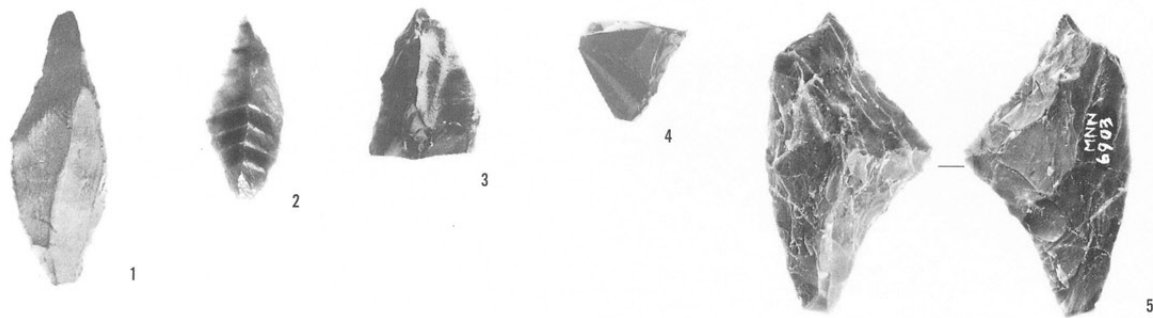

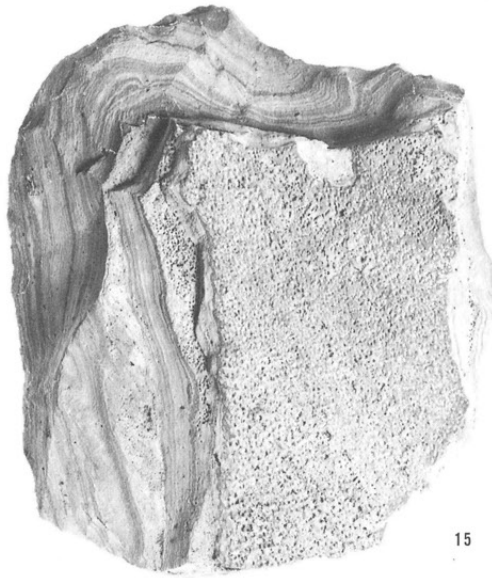

15



16

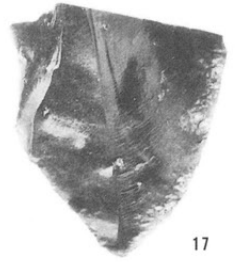

17

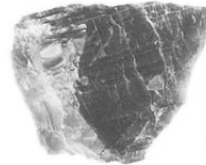

19



22

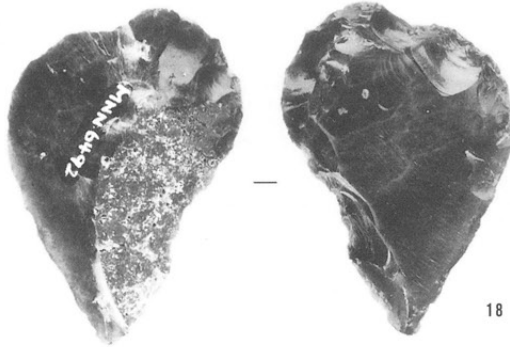

18

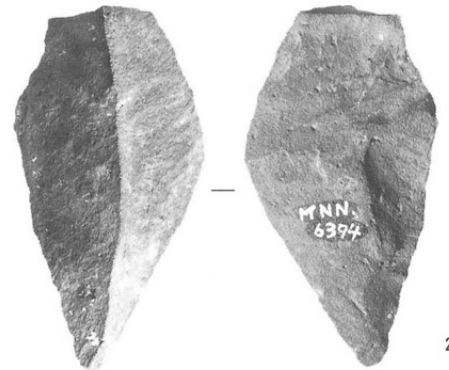

21

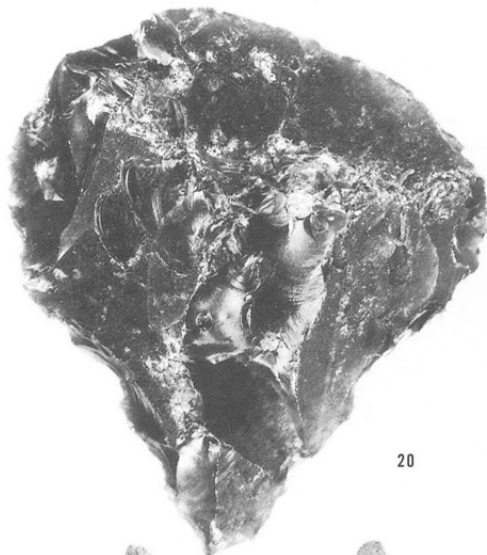

20

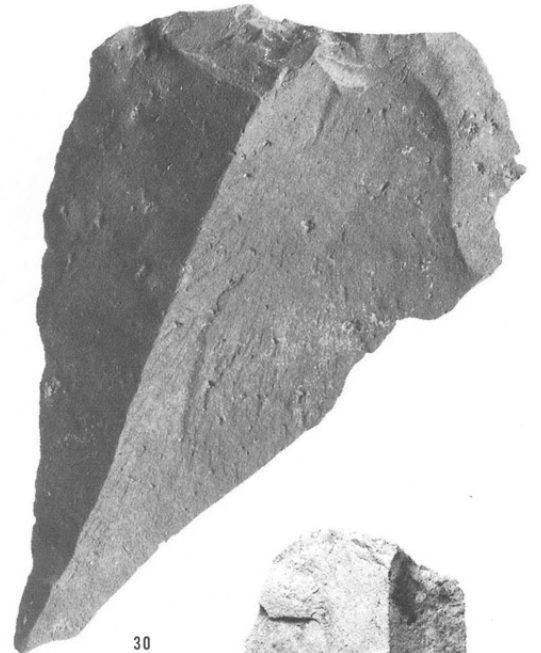

30

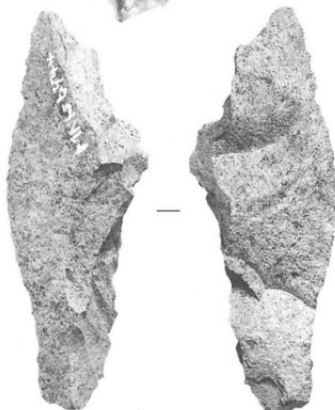

23



24

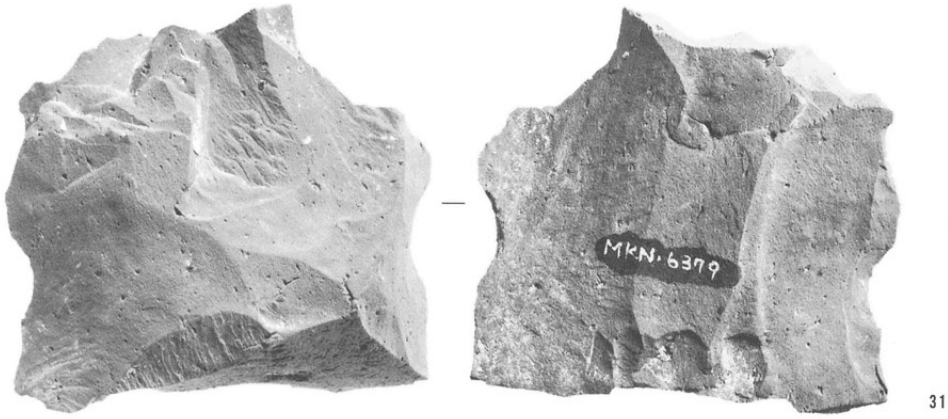

31

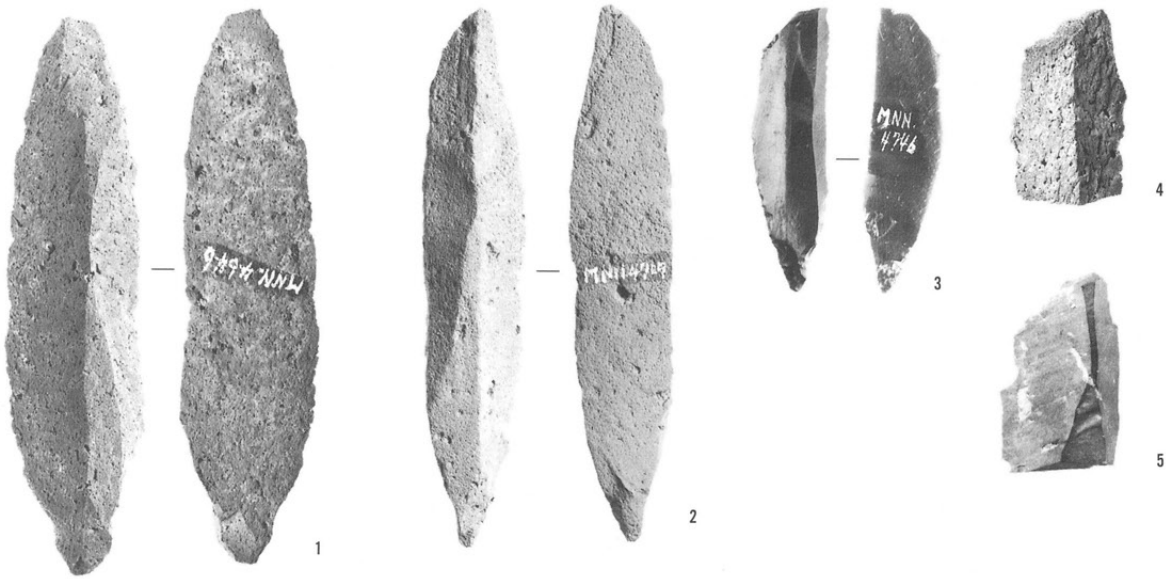

1

2

3

4

5

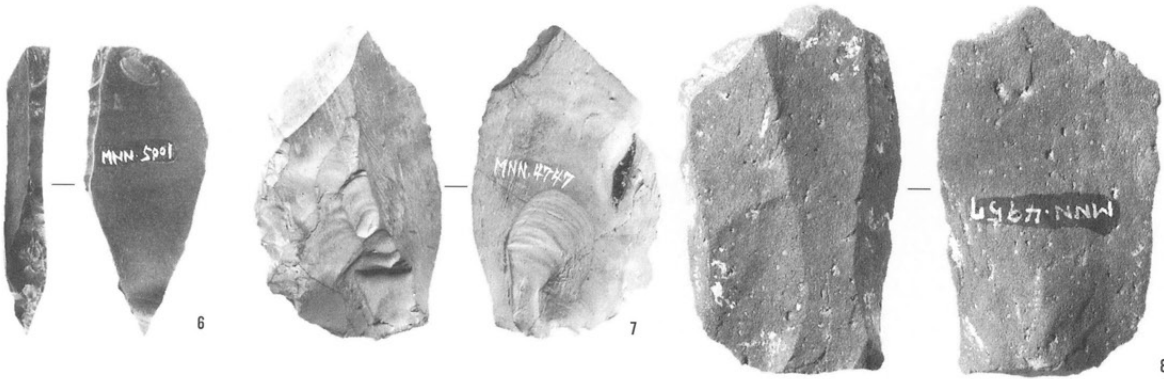

6

7

8

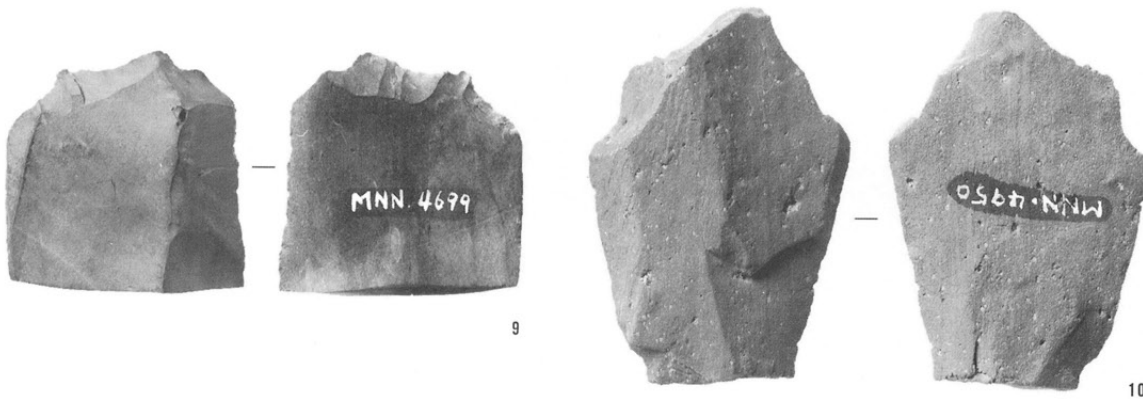

9

10

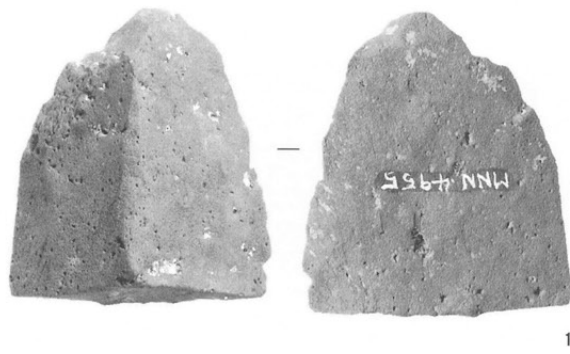

11

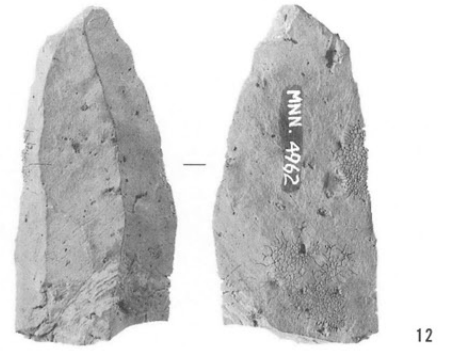

12



13



14



15

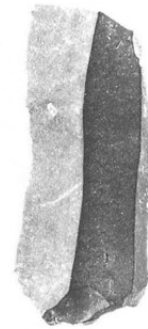

16



18

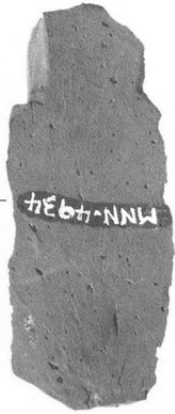

19



20

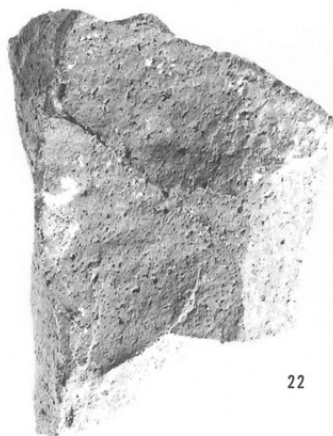

22



23



24

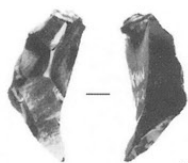

25



26



27

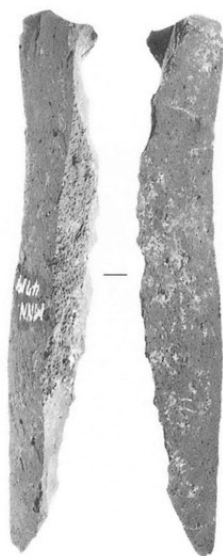

28



30

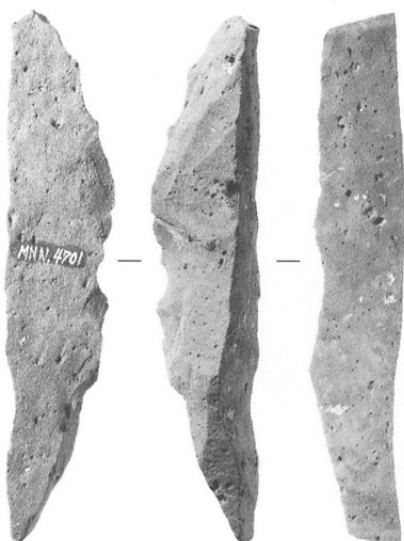

29

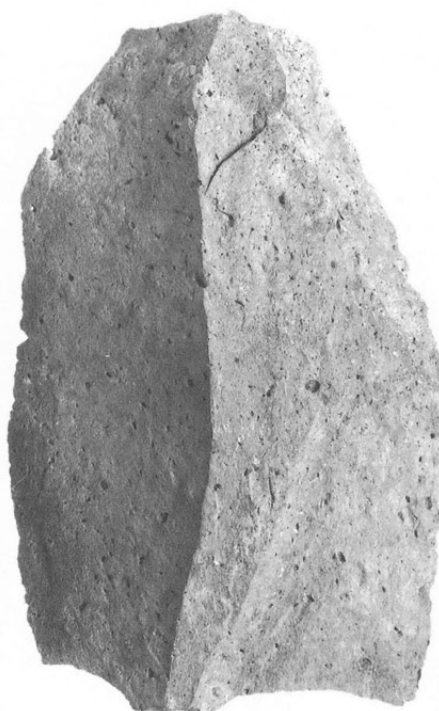

31



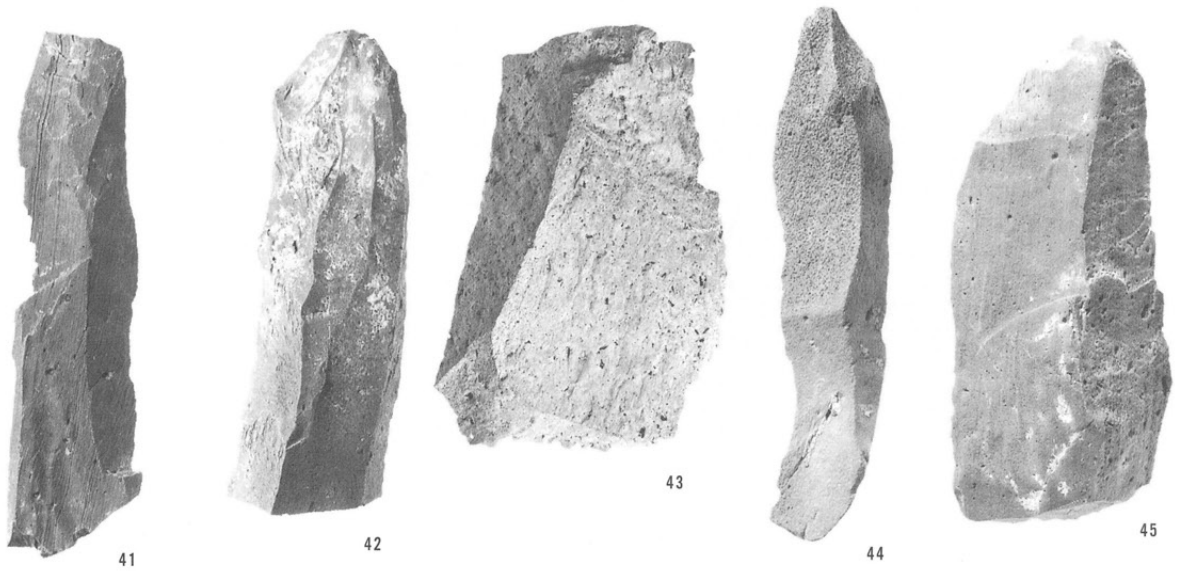
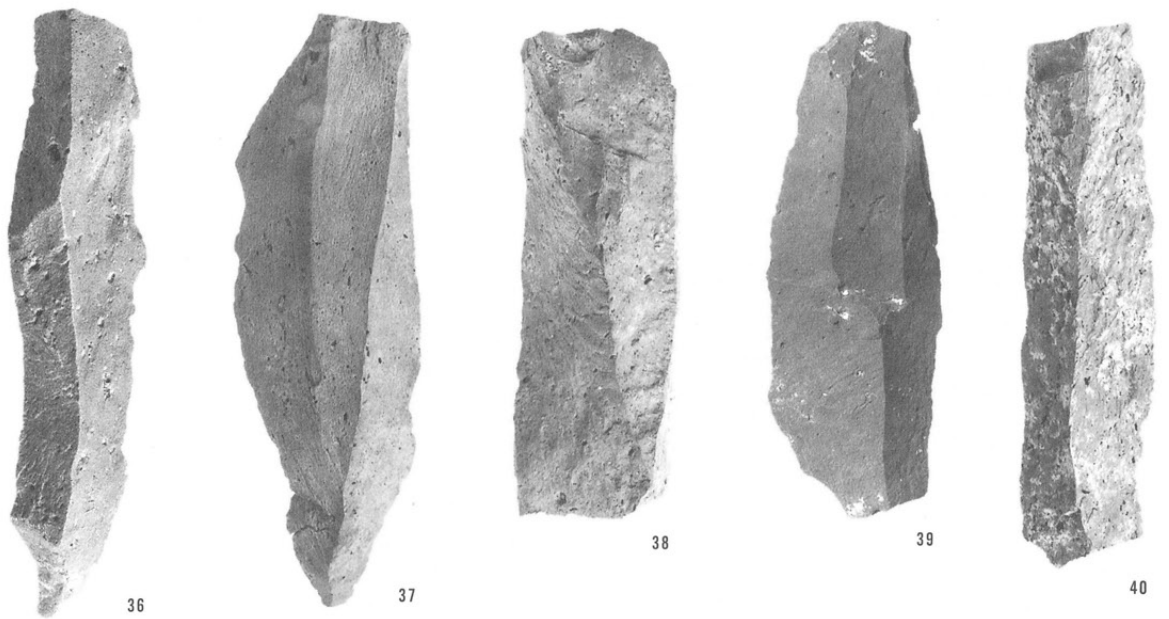
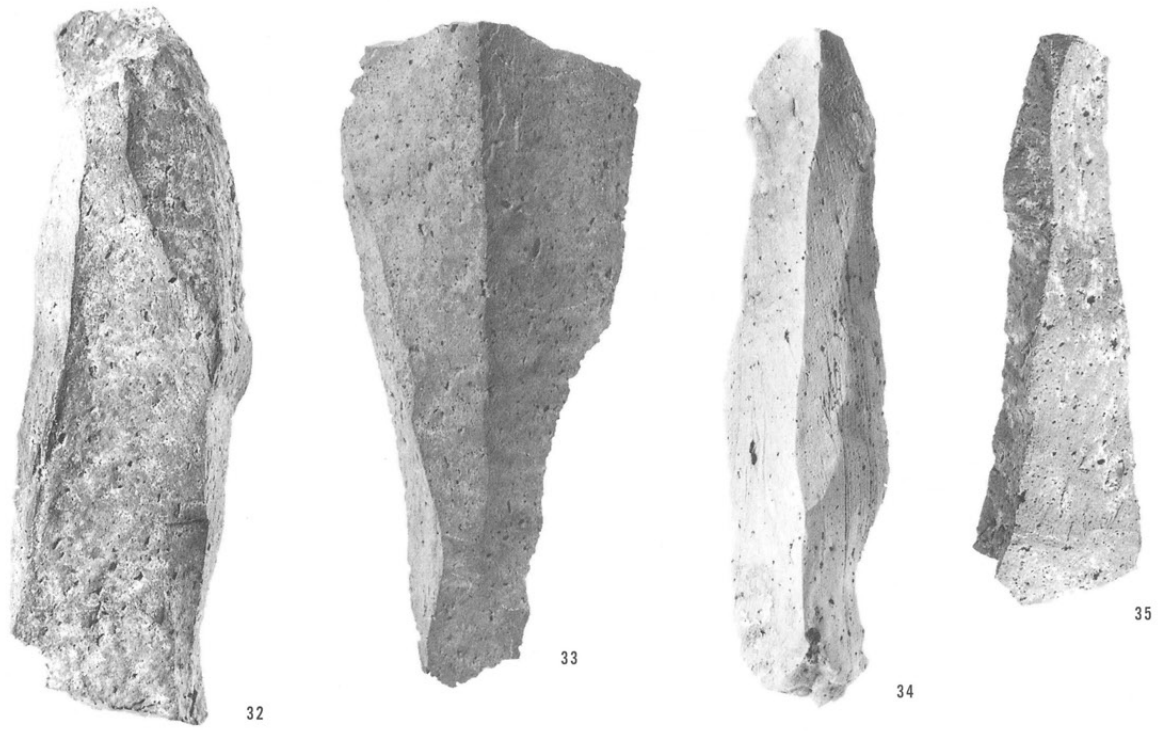

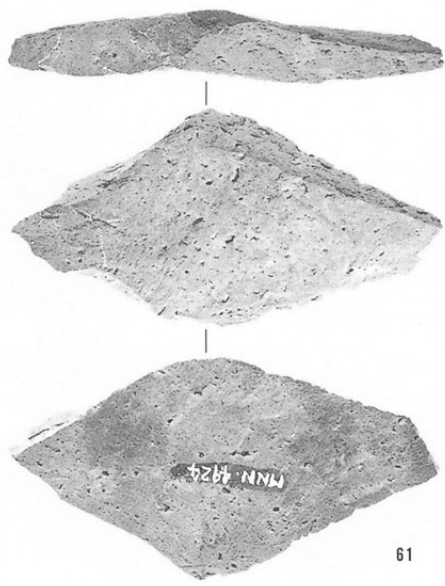
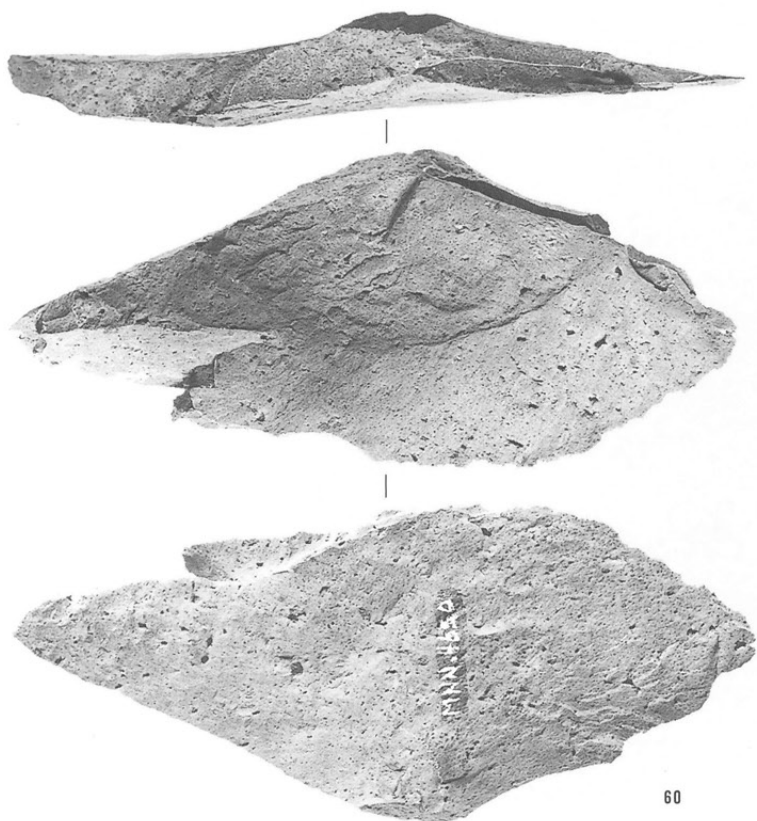
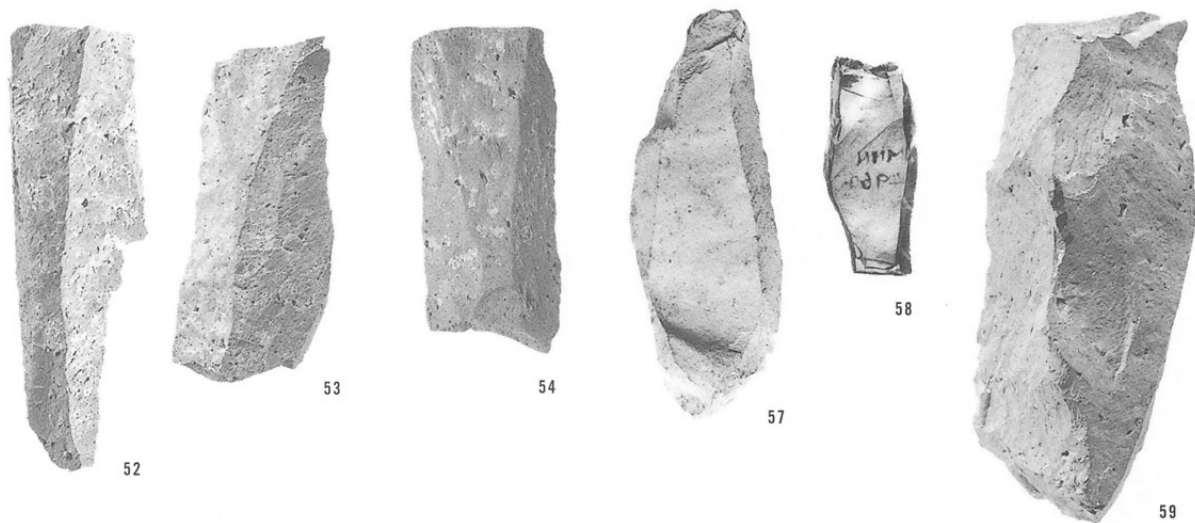
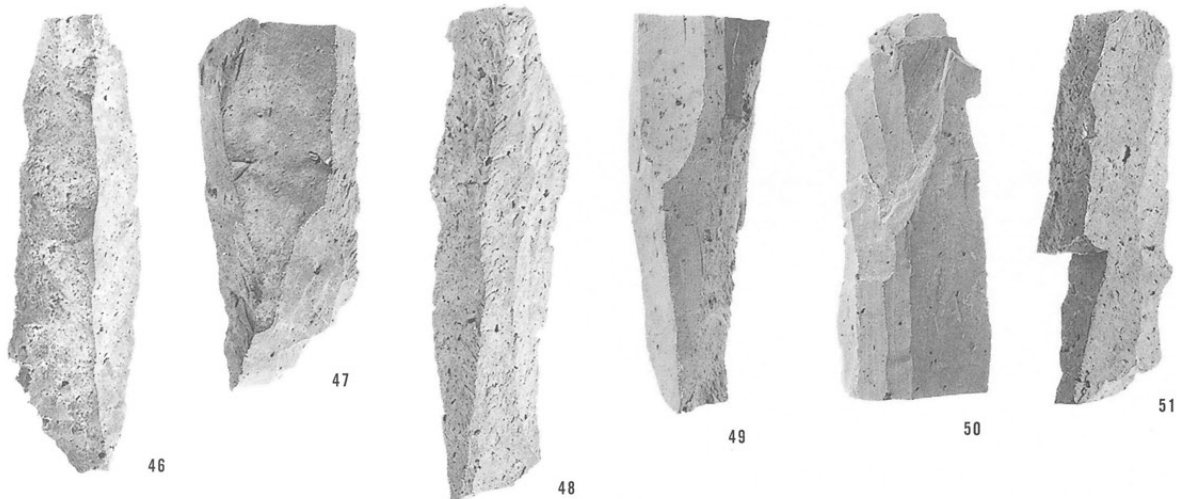

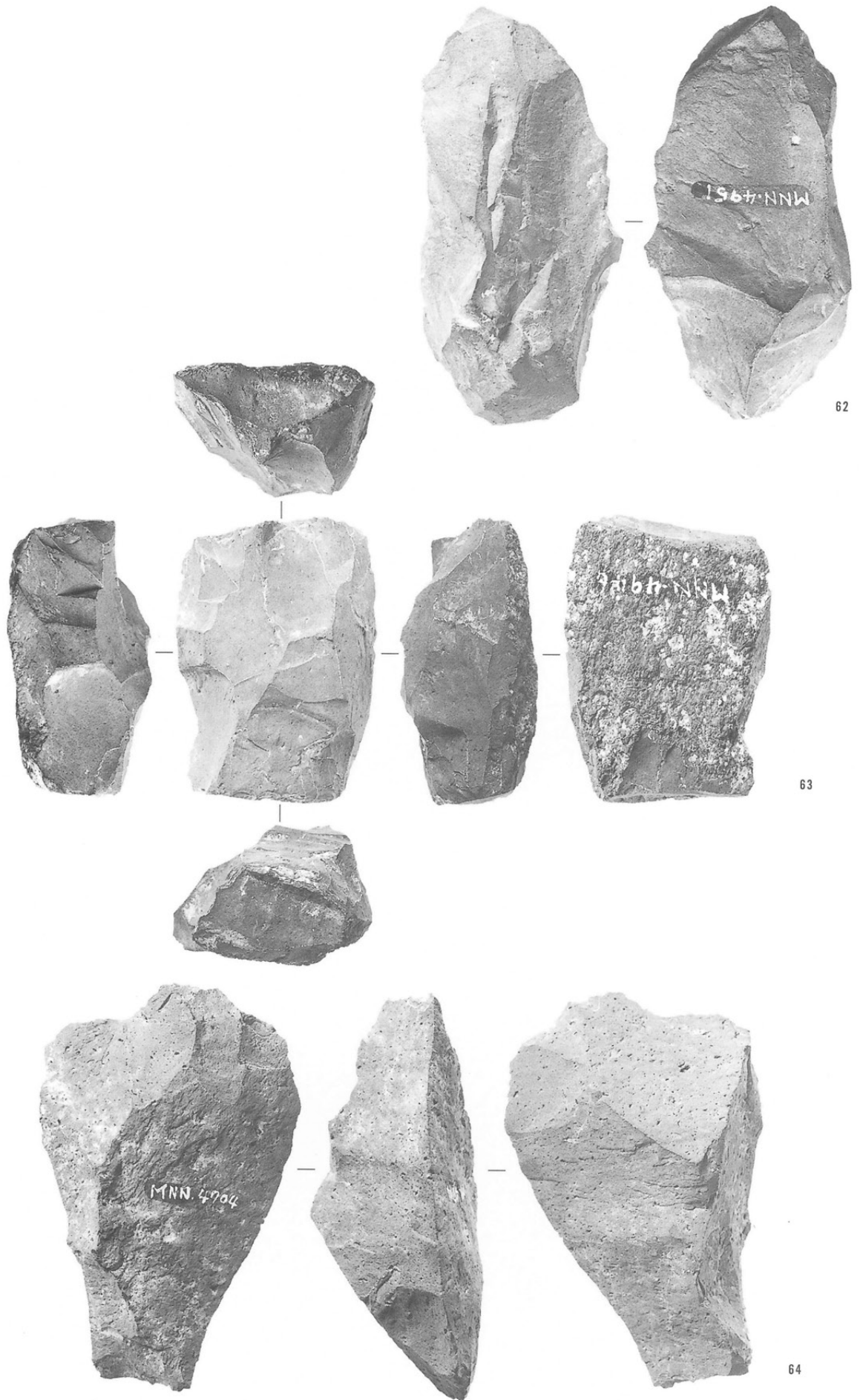

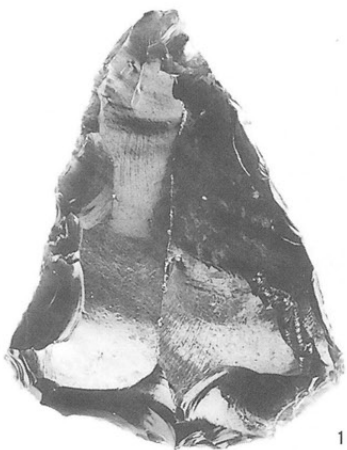



遺跡遠景  
(東より)



遺跡遠景

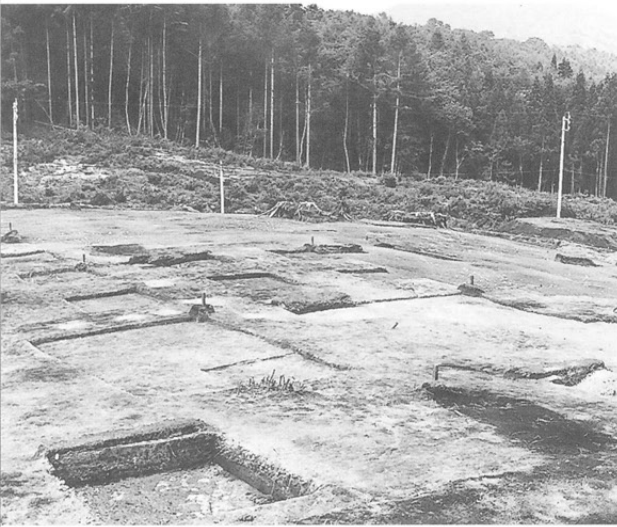

左：遺跡遠景  
(南西より)

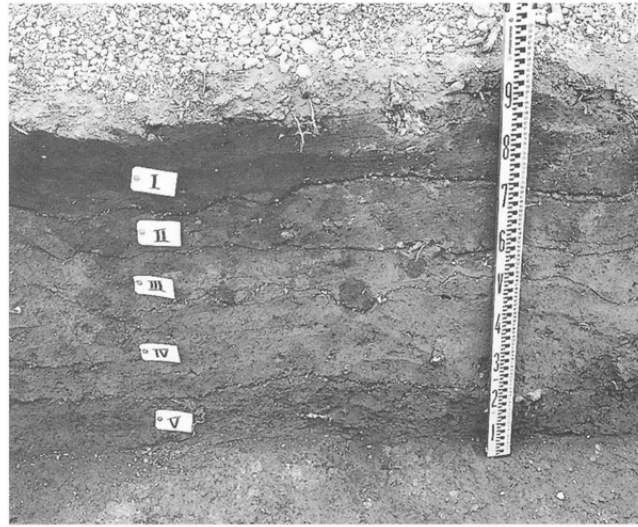

右：基本層序



左：大平I石器文化  
第2号ブロック遺物  
分布状況  
(北より)

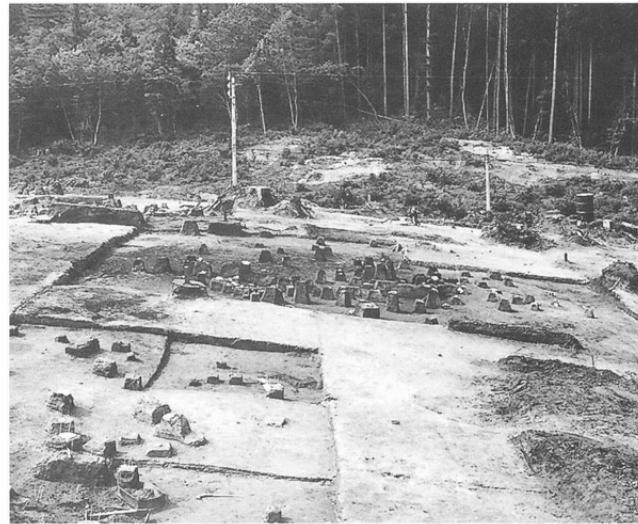

右：大平I石器文化  
第3号ブロック・第  
1号礫群  
遺物出土状況  
(南より)



左：大平I石器文化  
第1号礫群  
遺物出土状況  
(南より)



右：大平II石器文化  
石斧出土状況  
(報告番号1)



左：大平II石器文化石  
斧出土状況  
(報告番号2)



右：旧石器時代その他  
ナイフ形石器出土状況

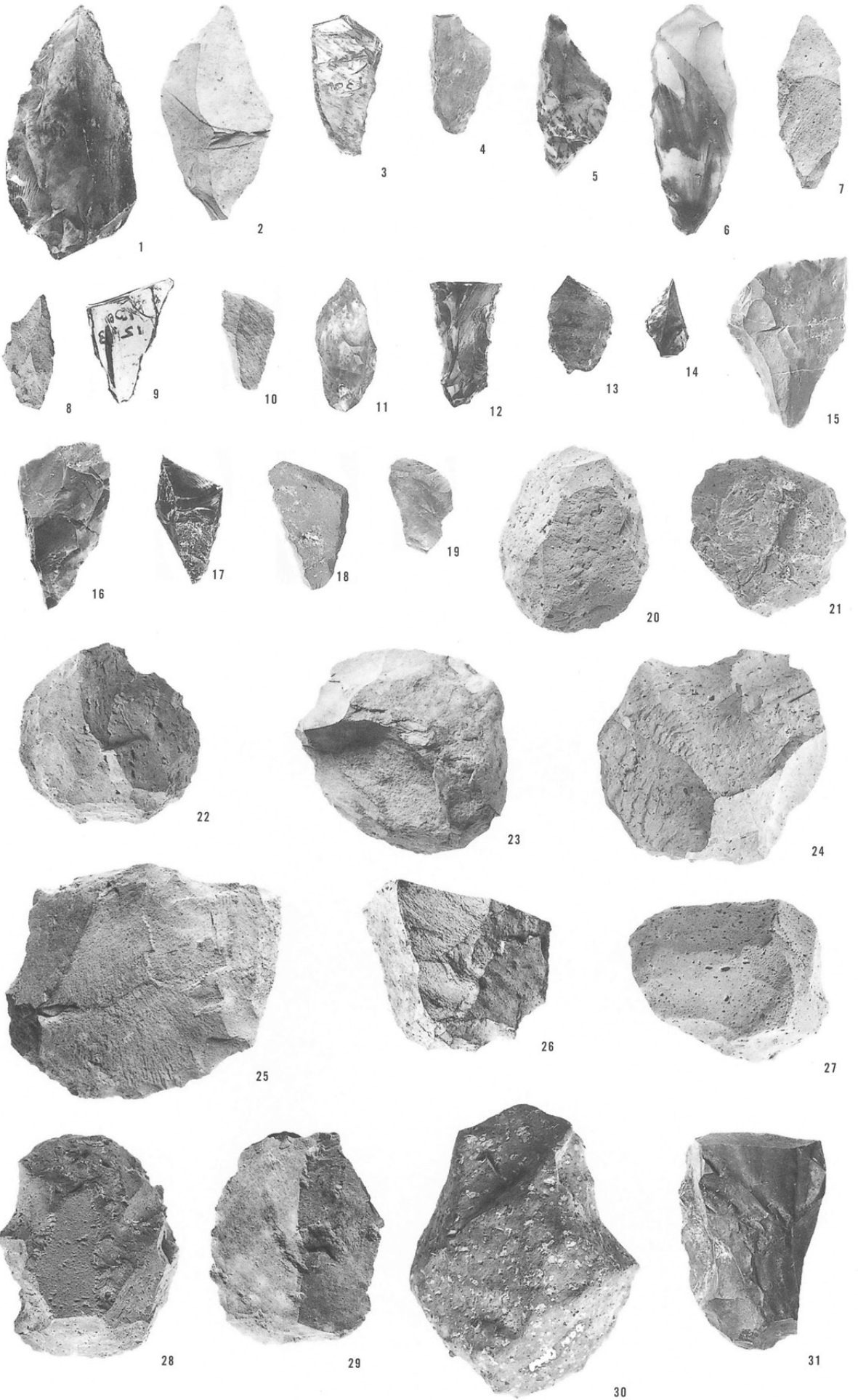

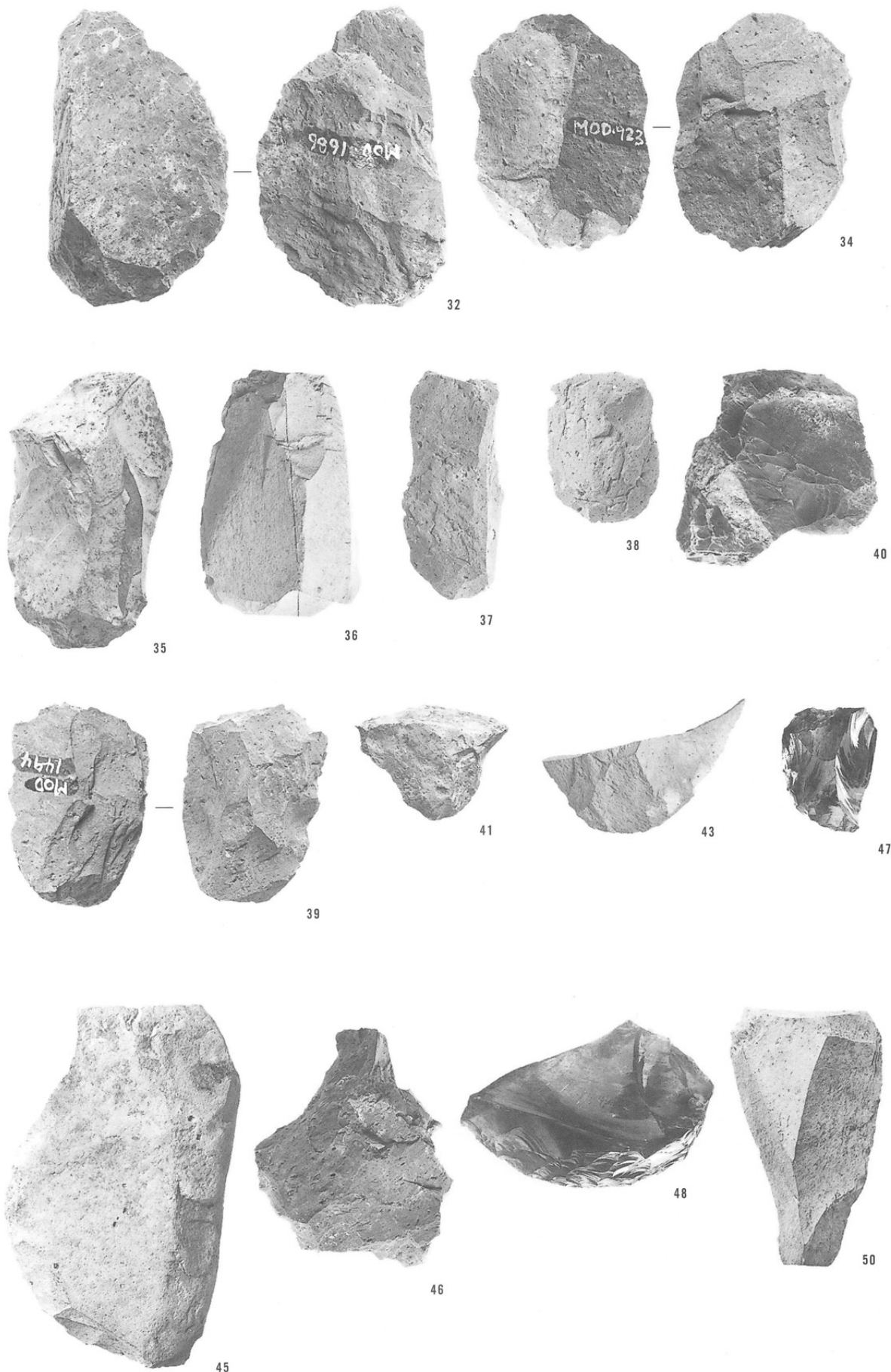





49



51



52



54

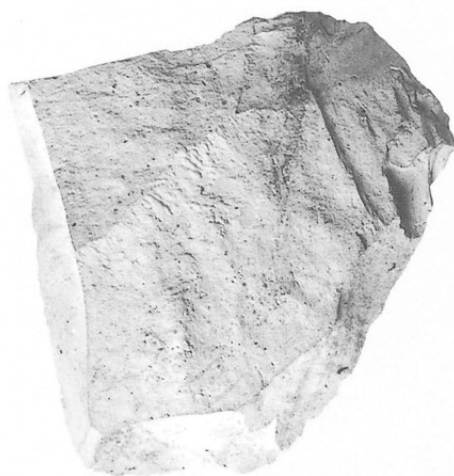

53



67



56



57



58



59

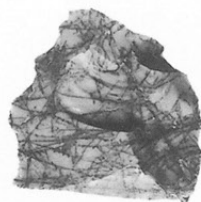

60



61



55



62



64



65



66



63

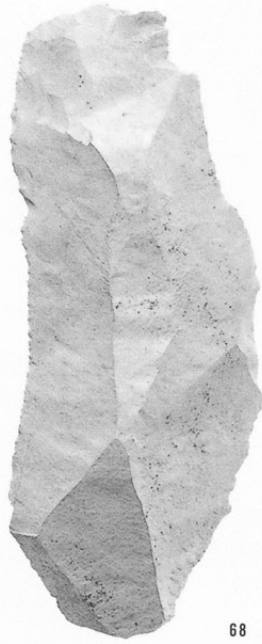

68



69

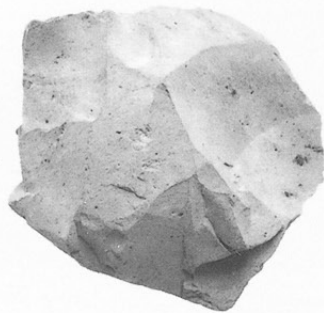

74

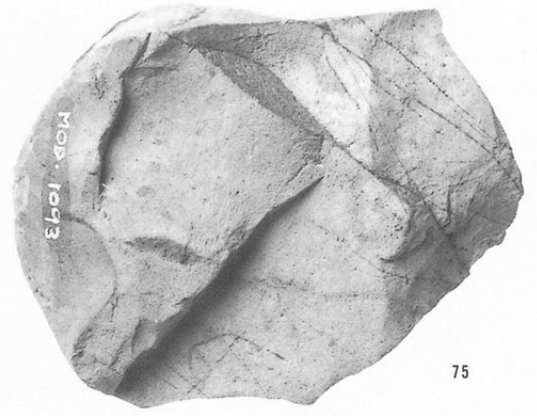
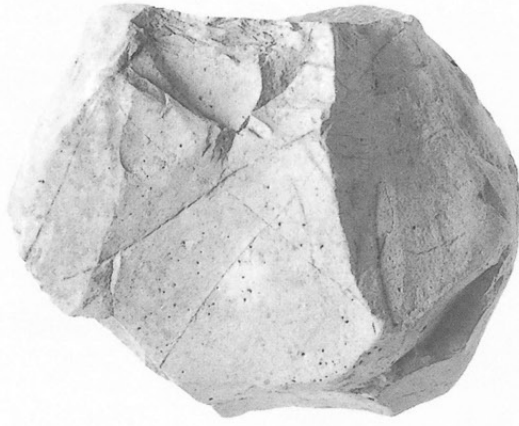

75

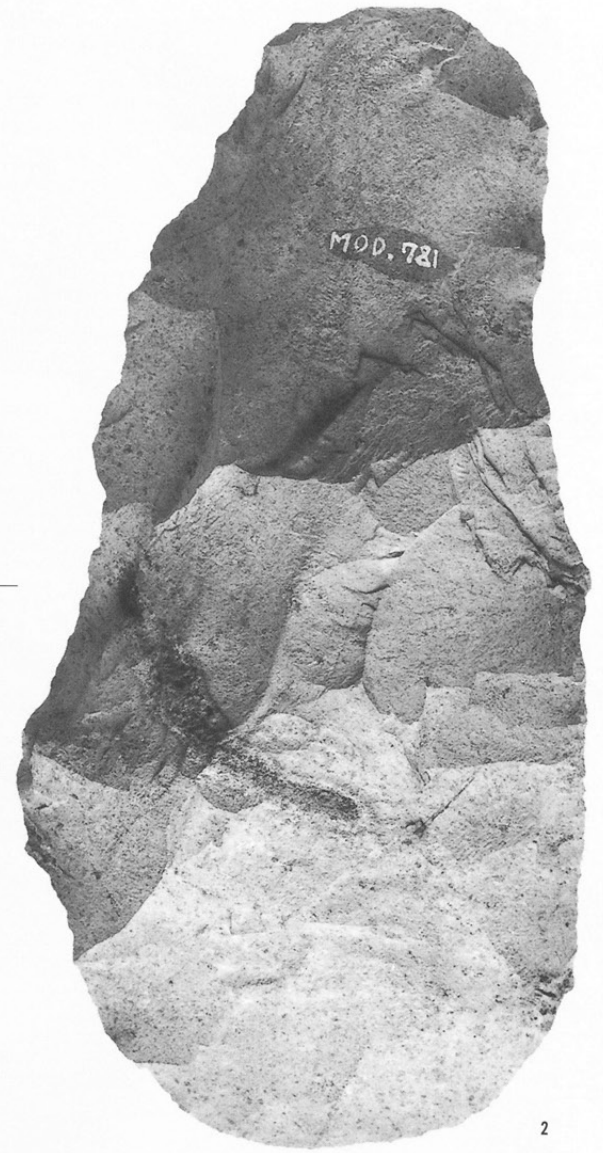
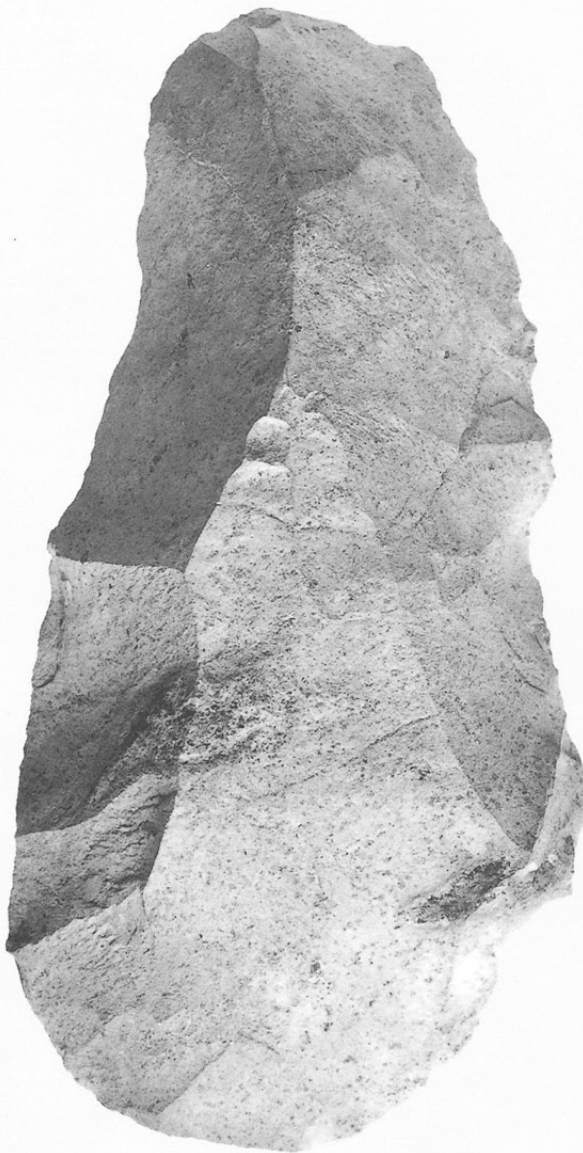

2

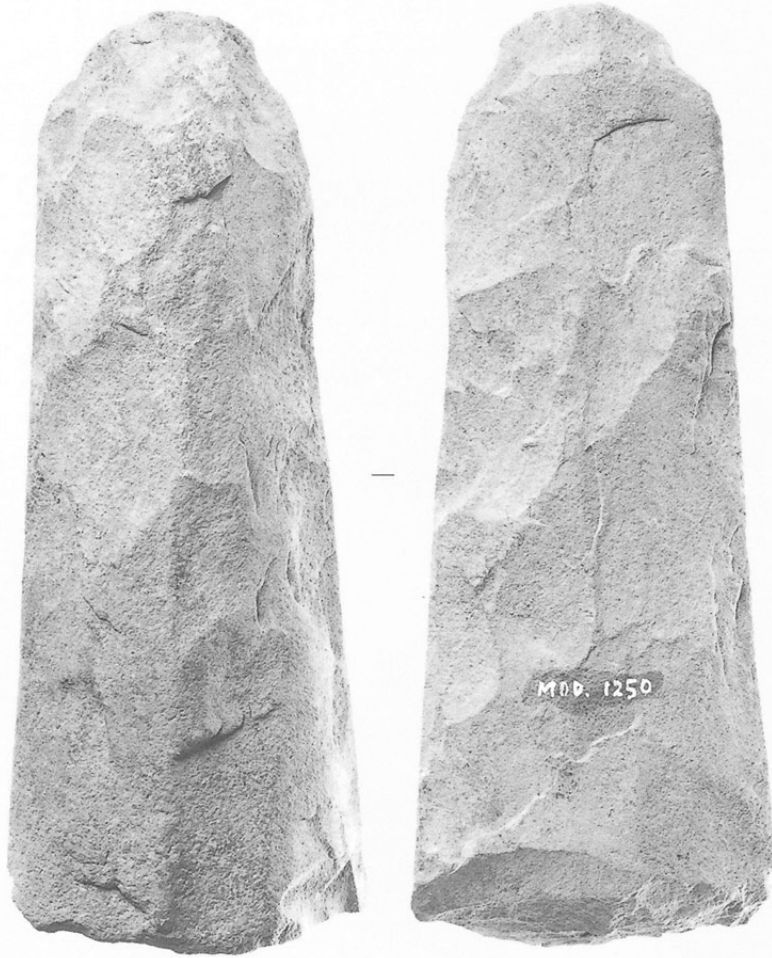

1



3





TS-3

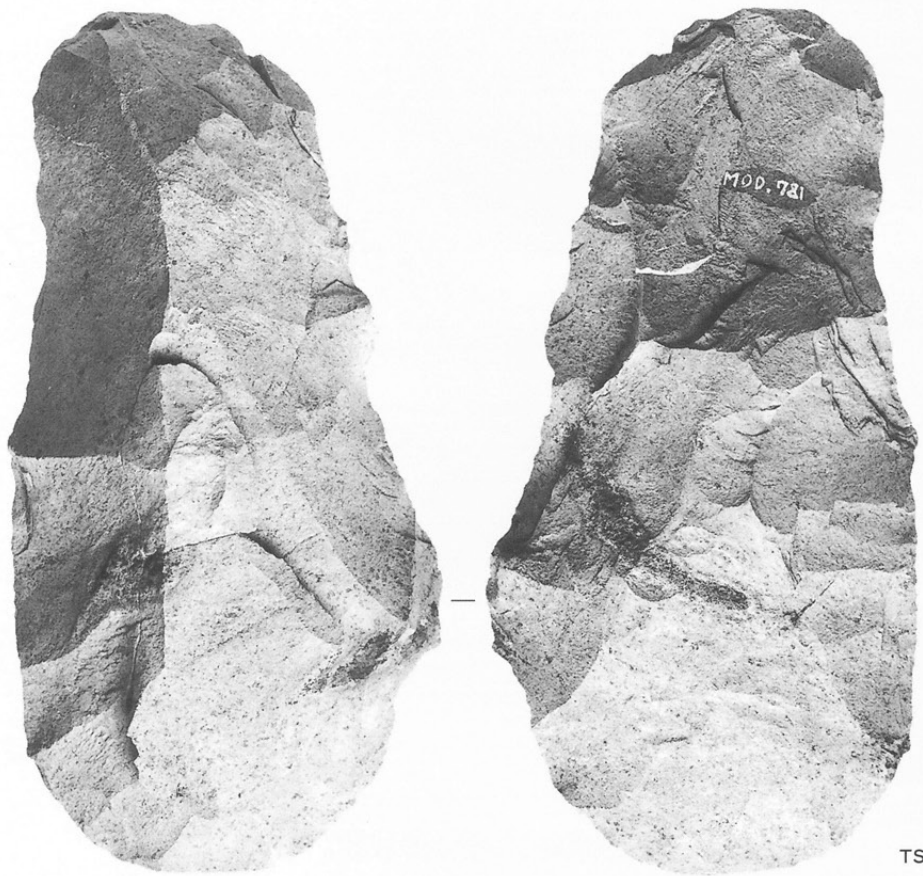

TS-6

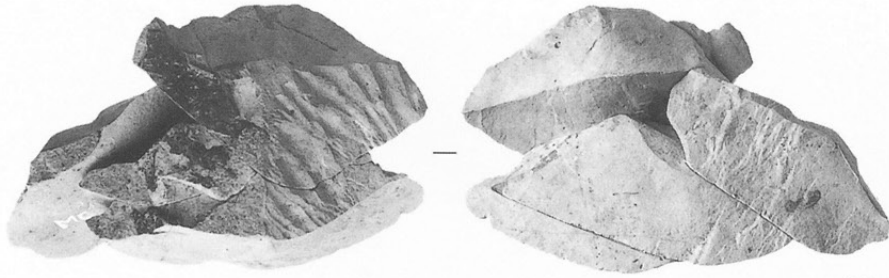

TS-7

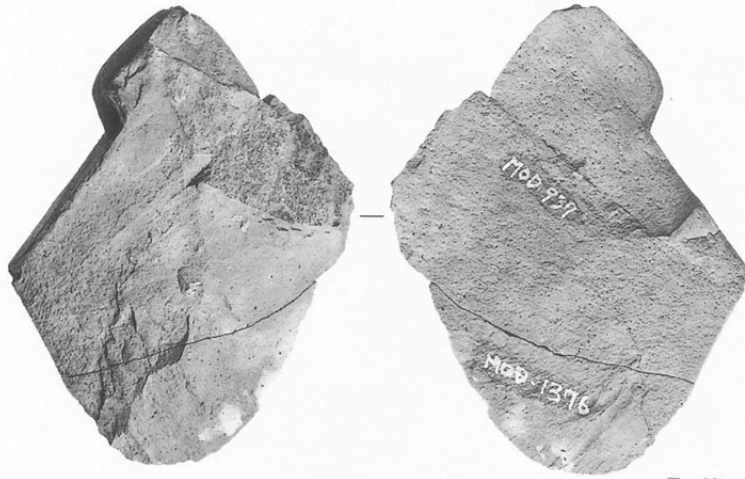

Tu-20

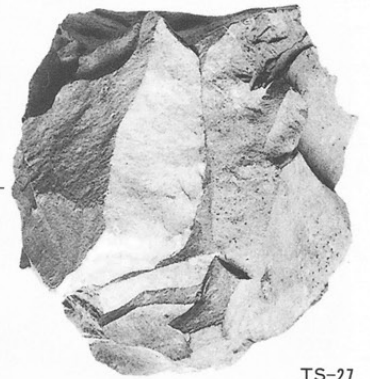
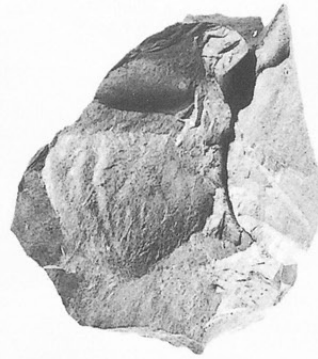
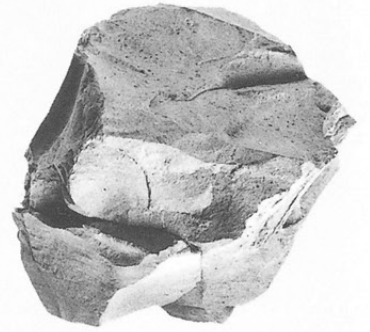

TS-27

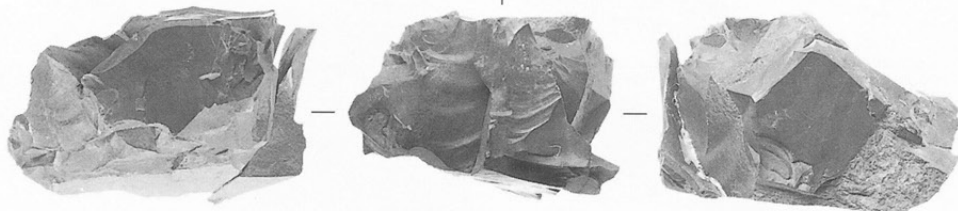

Ch-12

長野県埋蔵文化財センター発掘調査報告書 48

## 上信越自動車道埋蔵文化財発掘調査報告書15

——信濃町内 その1——

日向林B遺跡・日向林A遺跡・七ツ栗遺跡・大平B遺跡

旧石器時代

図版編

発行 平成 12 年 3 月 31 日

発行者 日 本 道 路 公 団

長 野 県 教 育 委 員 会

助 長 野 県 文 化 振 興 事 業 団

長 野 県 埋 蔵 文 化 財 セ ン タ ー

TEL 026-274-3891 FAX 274-3892

印 刷 第 一 法 規 出 版 株 式 会 社

TEL 026-226-4901 FAX 226-3993



