

上信越自動車道
埋蔵文化財発掘調査報告書12

— 長野市内その10 —

えのきだ いせき
榎田遺跡

第3分冊（遺物図版）

1999.3

日 本 道 路 公 団
長 野 県 教 育 委 員 会
長 野 県 埋 蔵 文 化 財 セ ン タ ー

上信越自動車道
埋蔵文化財発掘調査報告書12

— 長野市内その10 —

えのきだ い せき
榎田遺跡

第3分冊（遺物図版）

1999.3

日 本 道 路 公 団
長 野 県 教 育 委 員 会
長 野 県 埋 蔵 文 化 財 セ ン タ ー

第1分冊	(本文編Ⅰ)
第2分冊	(本文編Ⅱ)
第3分冊	(遺物図版)
第4分冊	(写真図版)

第3分冊 (遺物図版) 目次

I 土器

弥生時代中期土器	図版1～25
弥生時代後期～古墳時代前期土器	図版26～86
古墳時代中期～後期土器	図版87～227
須恵器	図版228～233
ミニチュア土器	図版234～235
奈良時代～平安時代土器	図版236～255
中世土器	図版256

II 石器

弥生時代石器	図版257～300
古代以降石器	図版301

III 木製品

	図版302～348
--	-----------

IV 建築部材

	図版349～373
--	-----------

V 玉類

弥生時代中期・弥生時代後期～古墳時代前期玉類	図版374
古墳時代中期以降玉類	図版375～378

VI 紡錘車

弥生時代中期・弥生時代後期～古墳時代前期紡錘車	図版379
古墳時代中期以降紡錘車	図版380～382

VII 金属製品

	図版383～385
--	-----------

VIII 鍛冶関係

	図版386～387
--	-----------

IX 土製品

	図版387
--	-------

X 土製支脚

	図版388
--	-------

XI 骨角器・鹿角切断品

	図版389～390
--	-----------

XII 木簡

	図版391～392
--	-----------

注 遺物図版の表現法については第1分冊の凡例を参照

SB113

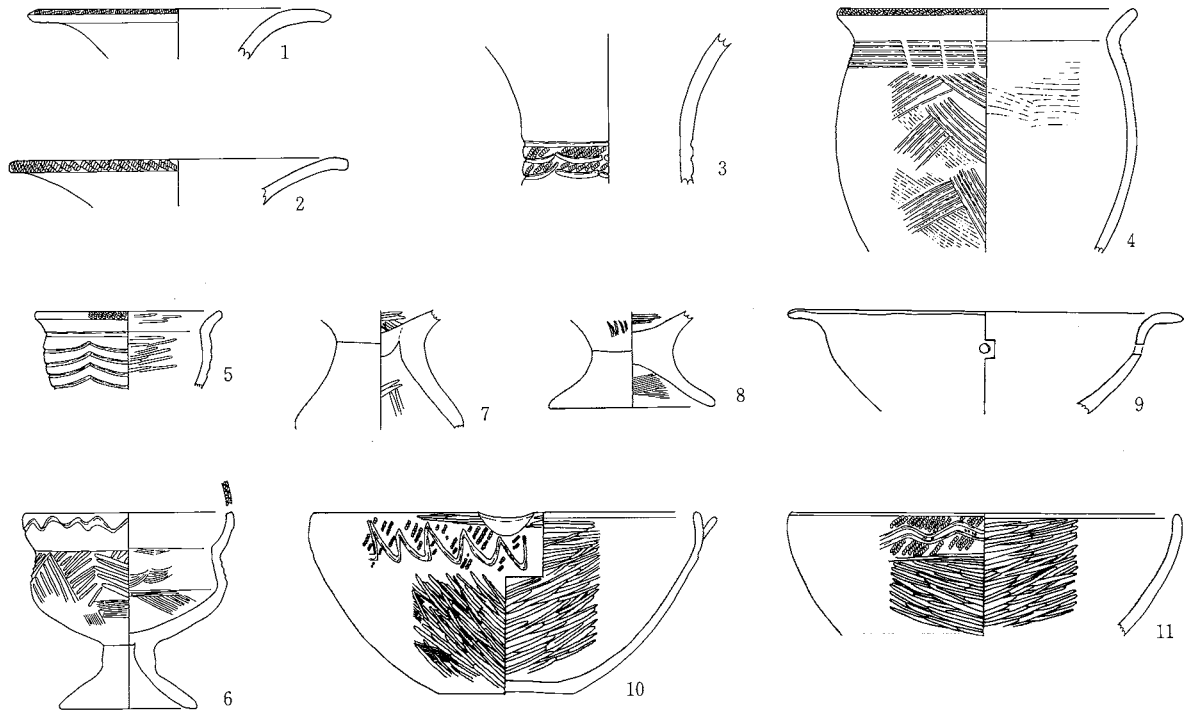

SB157-①

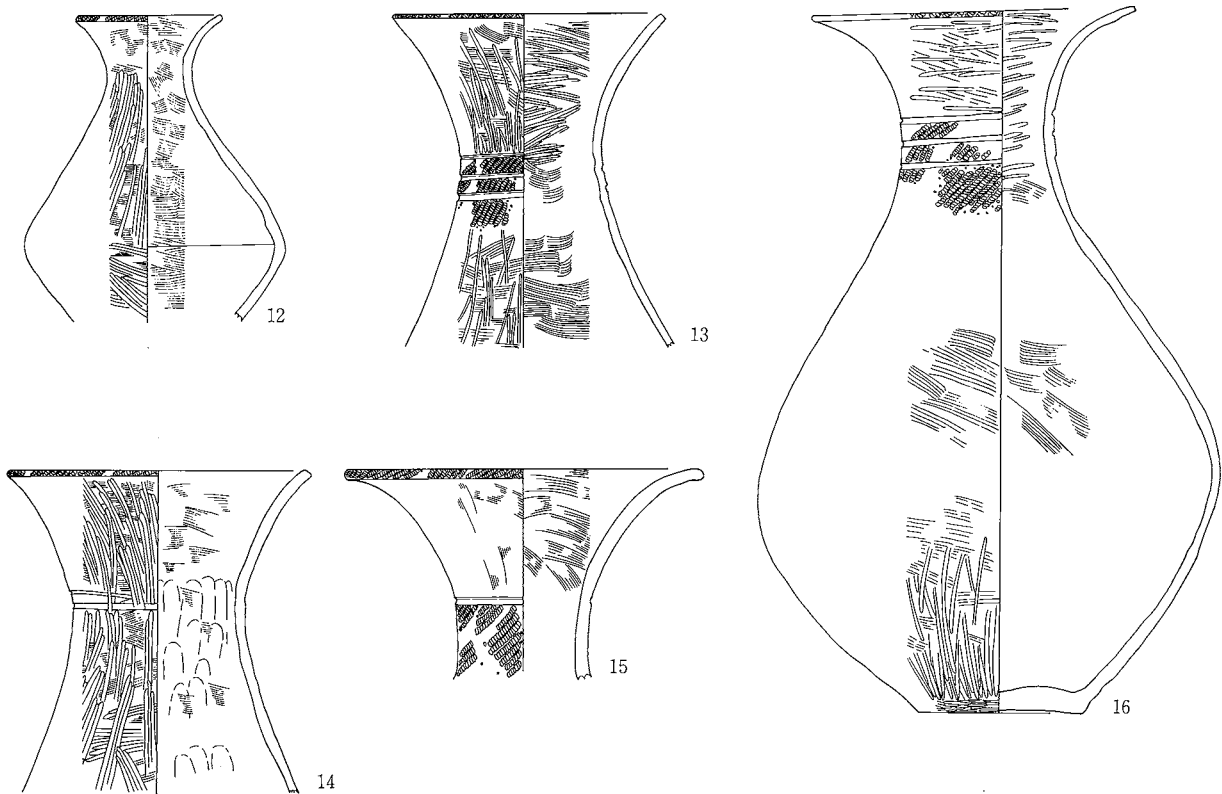

0 (1:4) 10cm

SB113・157-①

SB157-②

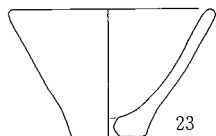
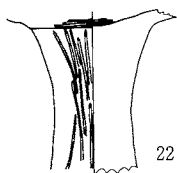
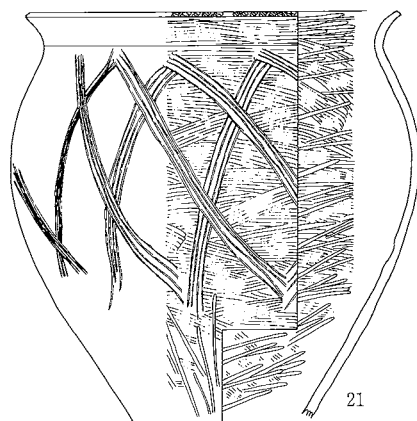
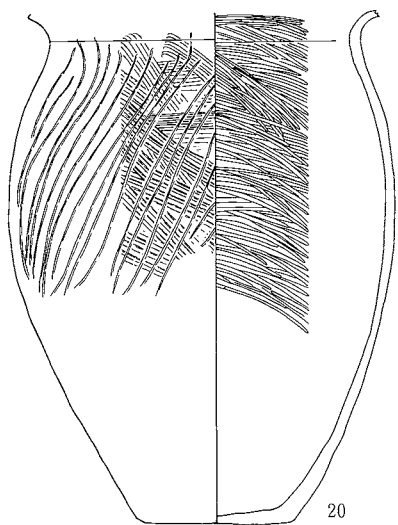
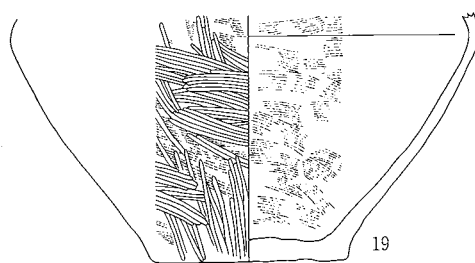
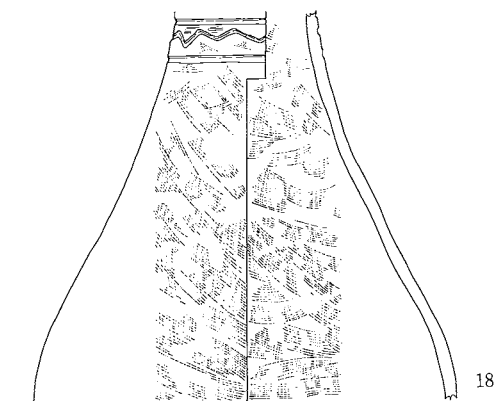
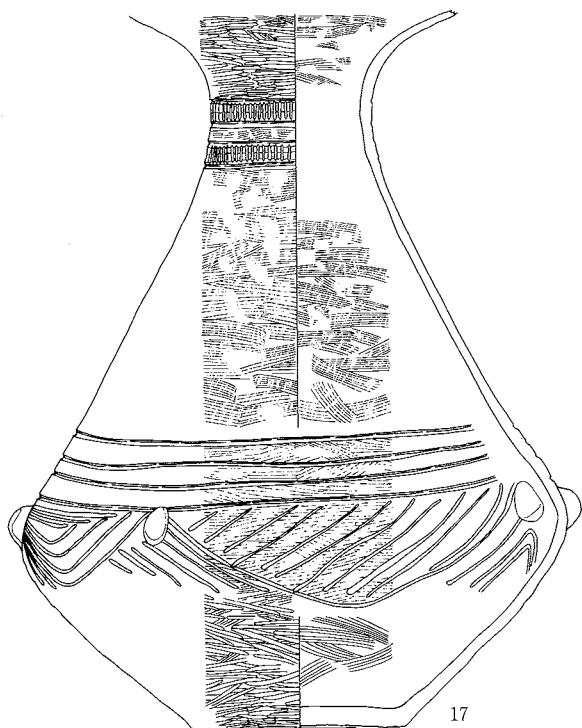

0 (1:4) 10cm

SB440-①

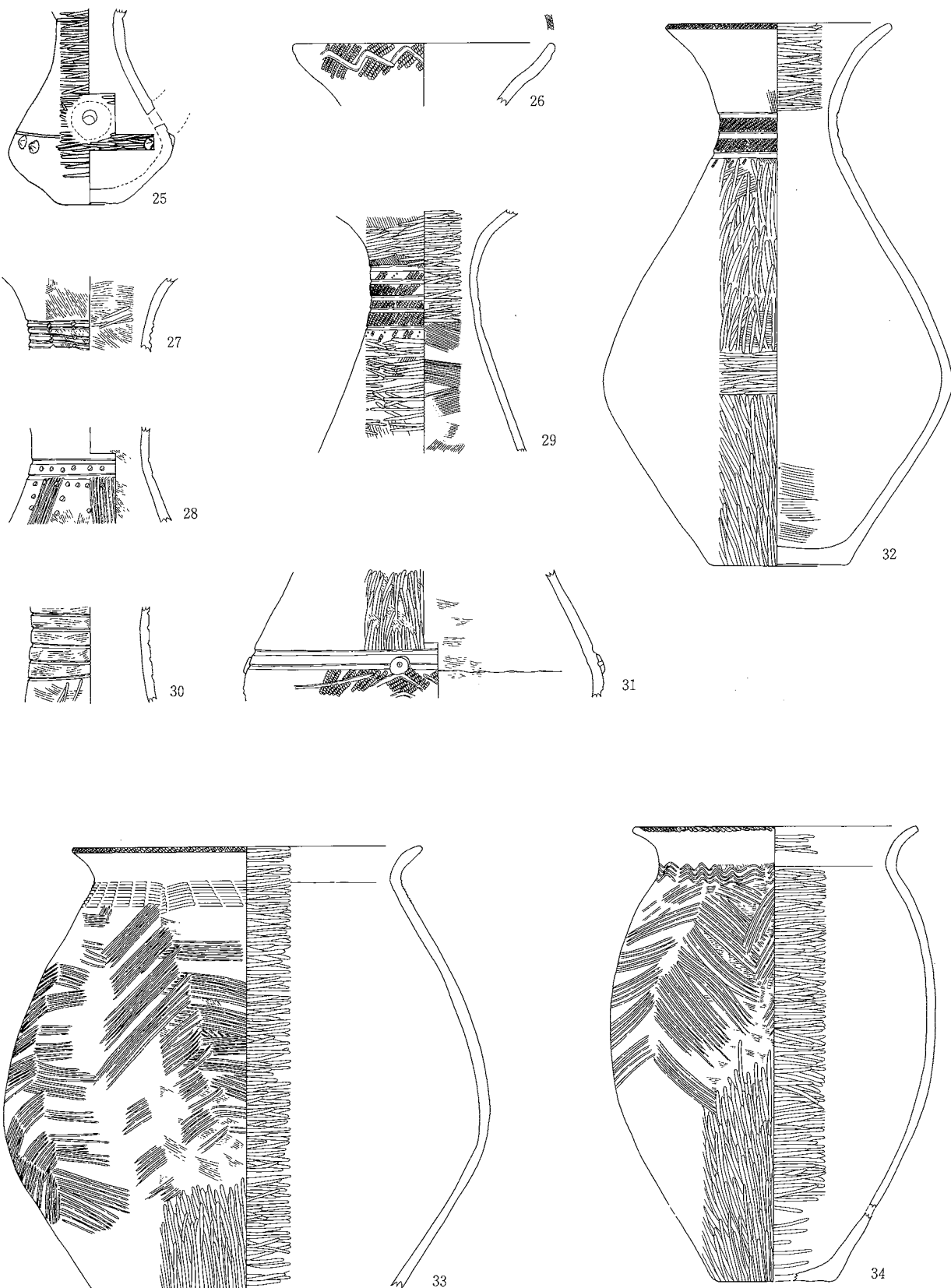

0 (1 : 4) 10cm

SB440-①

图版 4 弥生时代中期土器(4)

SB440-②

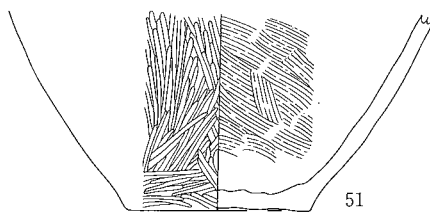
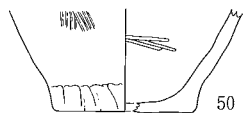
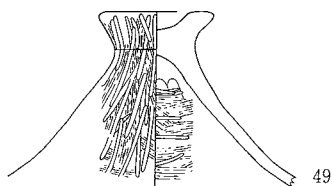
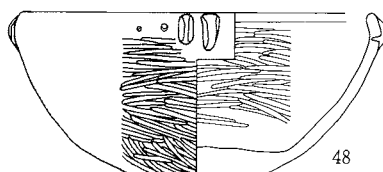
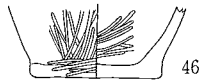
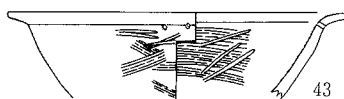
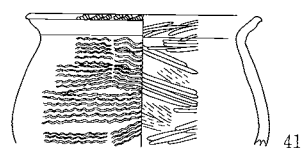
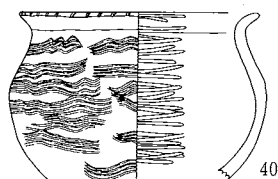
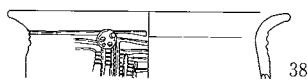
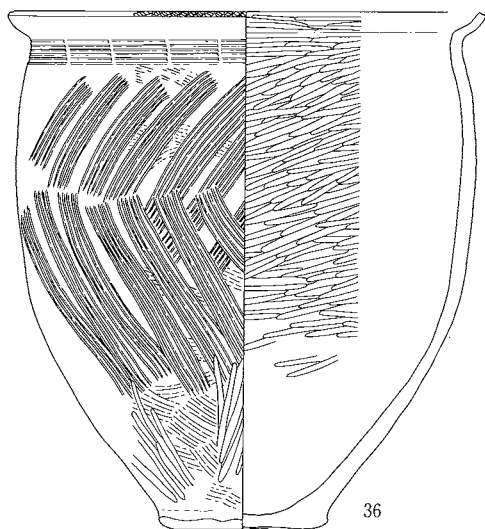
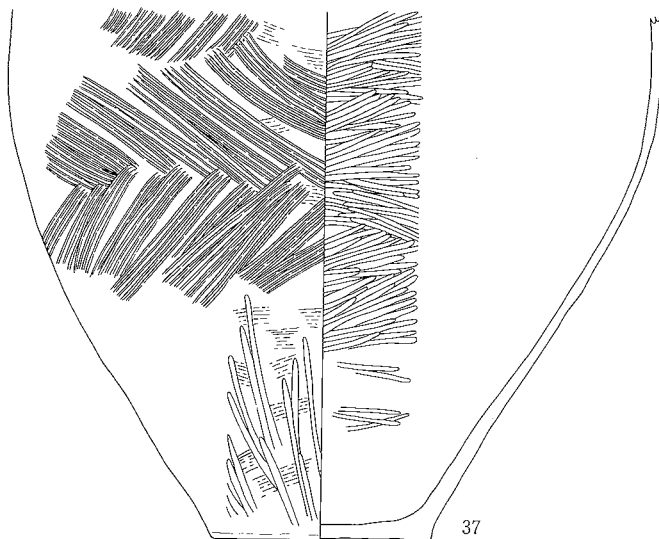
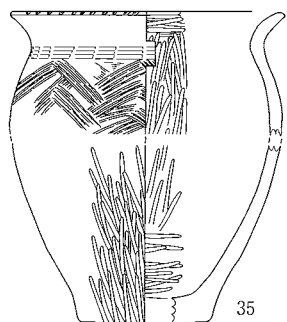

0 (1 : 4) 10cm

SB440-②

SB443-①

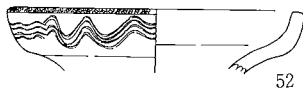

52

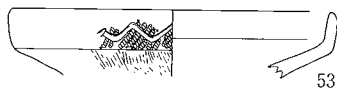

53

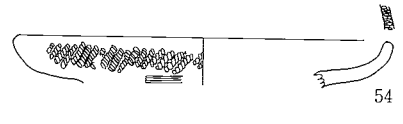

54



55

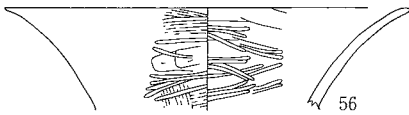

56

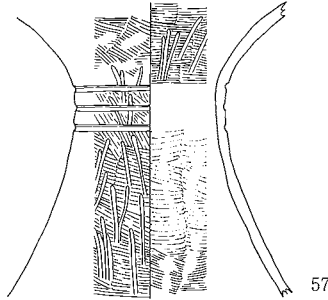

57

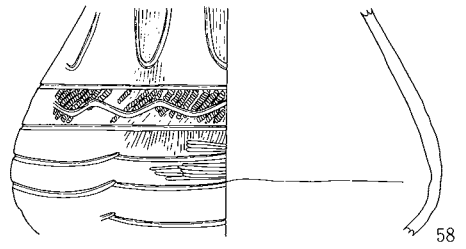

58

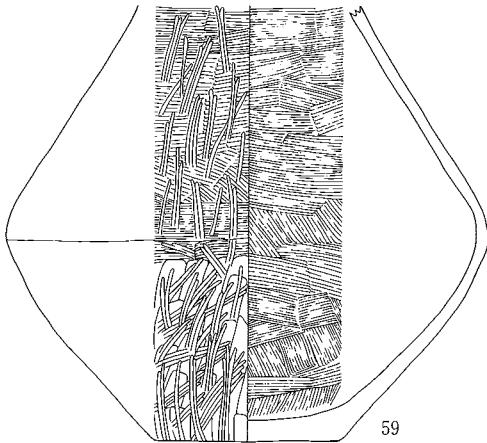

59

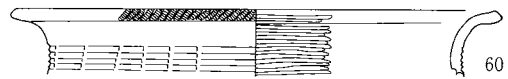

60

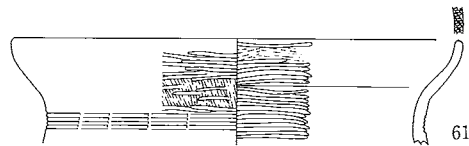

61

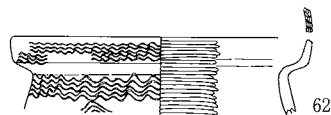

62



63

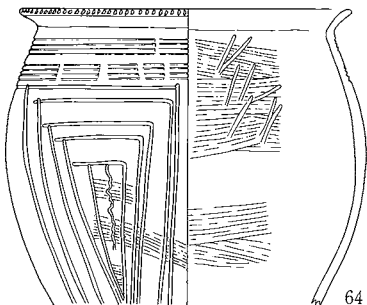

64

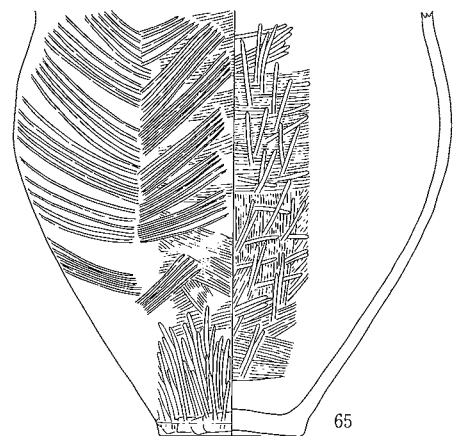

65

0 (1:4) 10cm

SB443-①

图版 6 弥生时代中期土器(6)

SB443-②

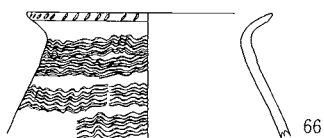

66

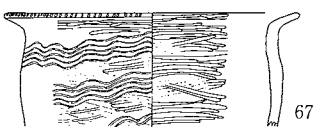

67

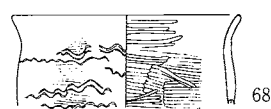

68

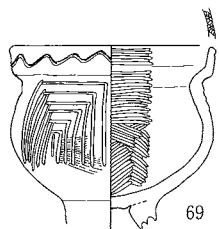

69

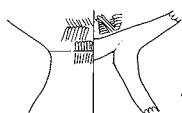

70



71

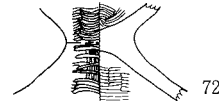

72

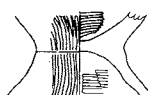

73



74



75

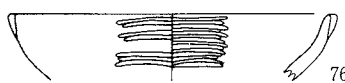

76



77

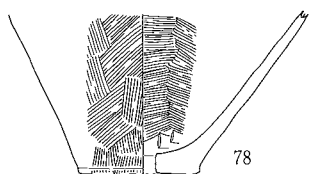

78



79

SB454

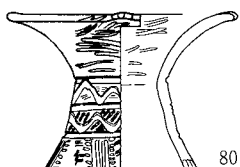

80



81



82

SB457-①

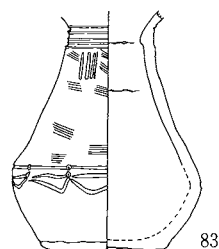

83

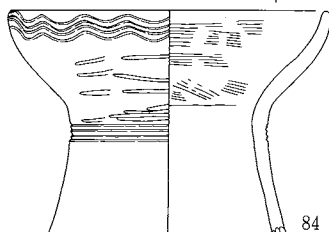

84

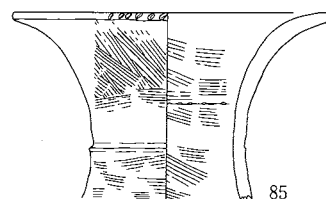

85

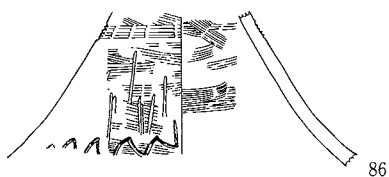

86

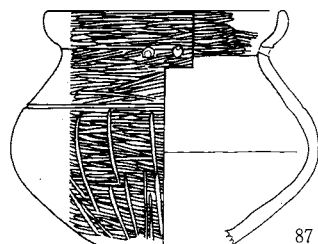

87

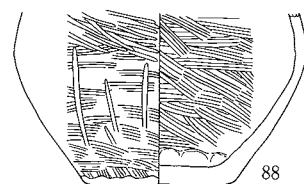

88

0 (1:4) 10cm

SB443-② · 454 · 457-①

SB457-②

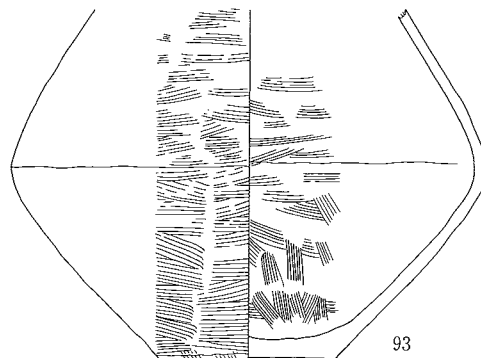
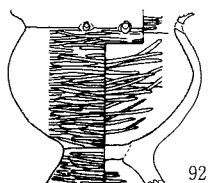
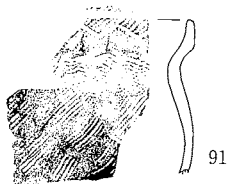
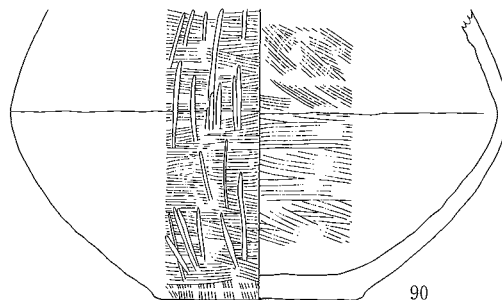
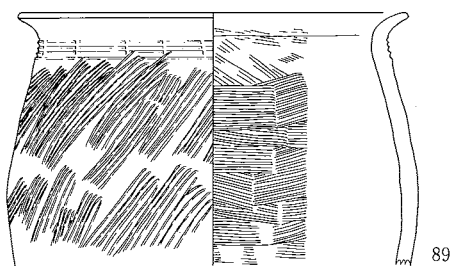

SB459

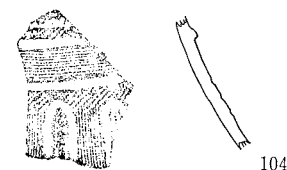
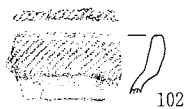
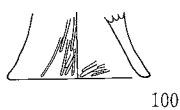
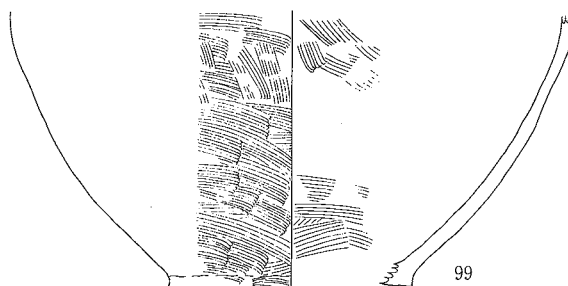
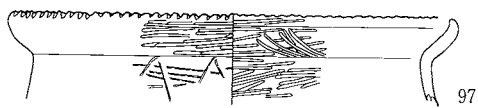
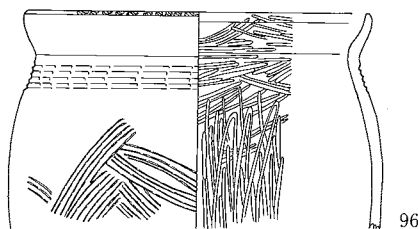
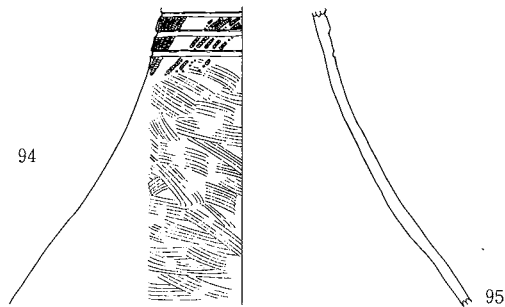
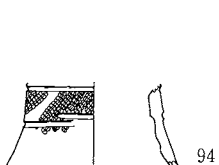

0 (1:4) 10cm

SB460

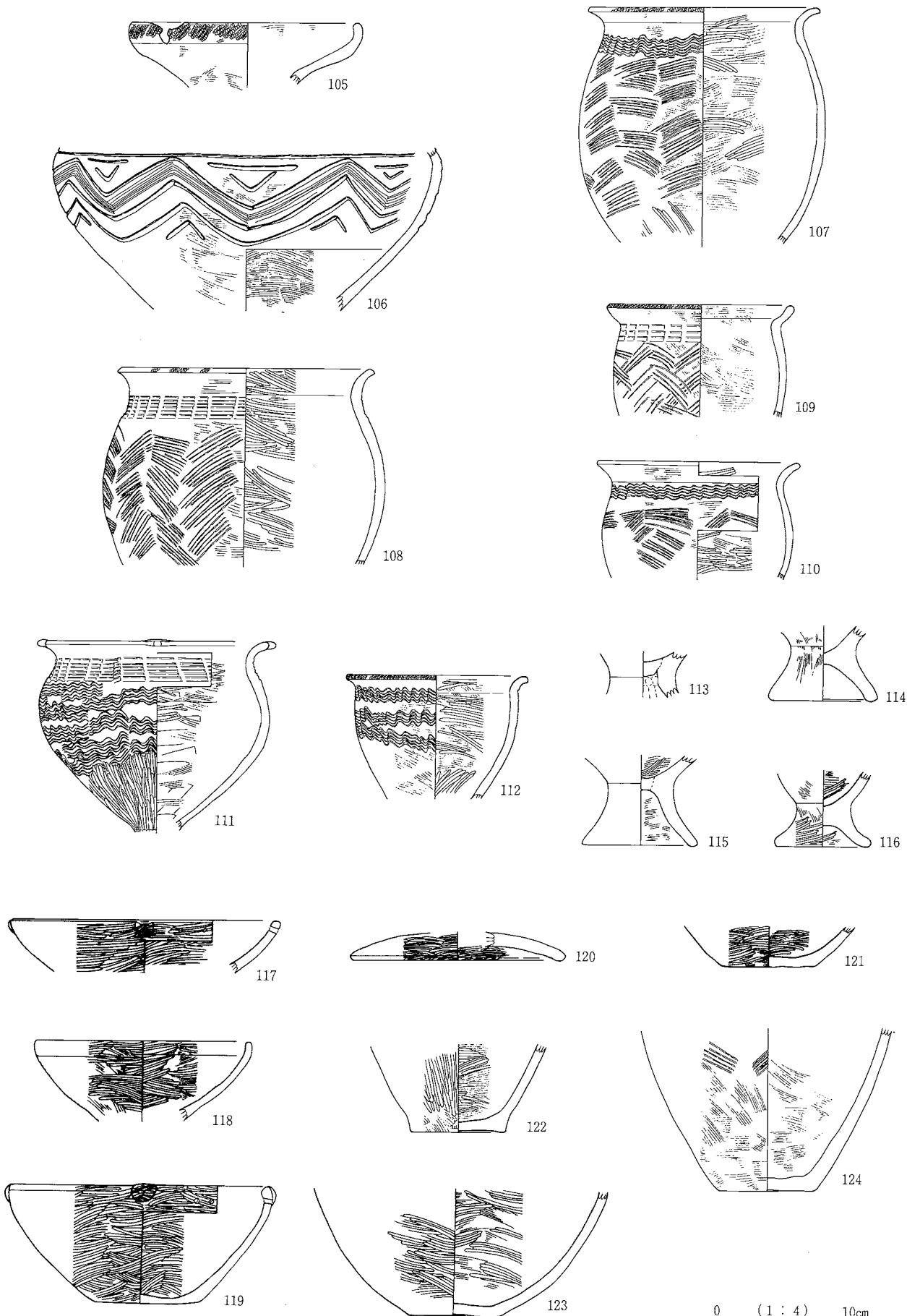

SB460

SB837-①

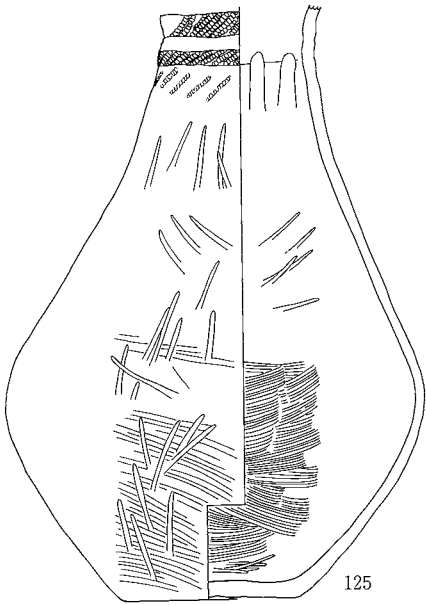

125

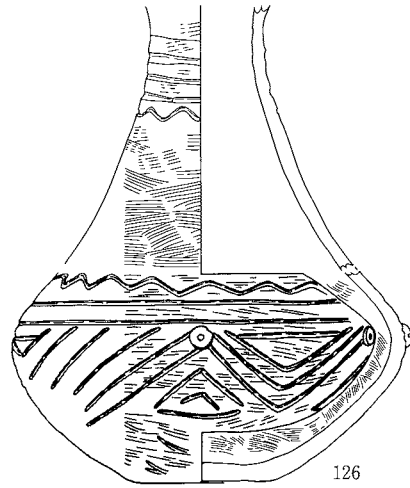

126

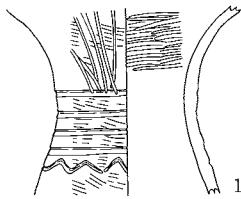

127

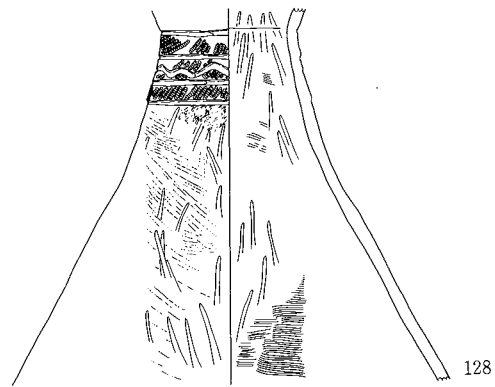

128

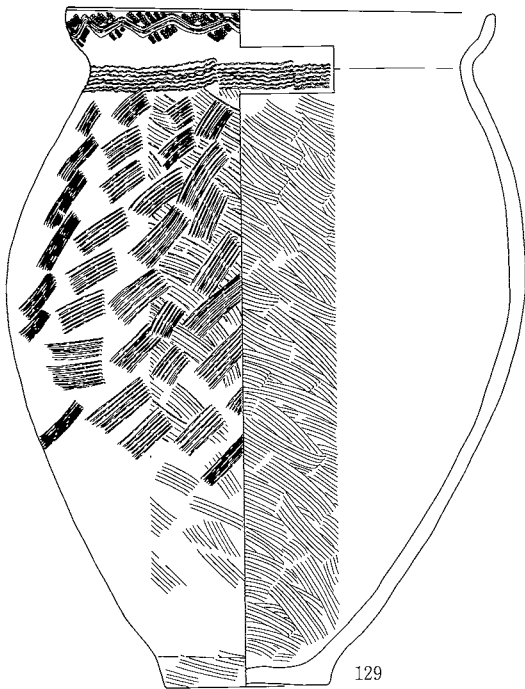

129

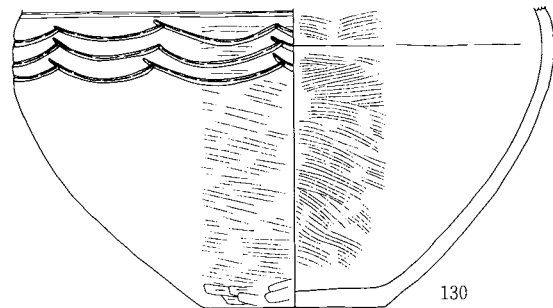

130

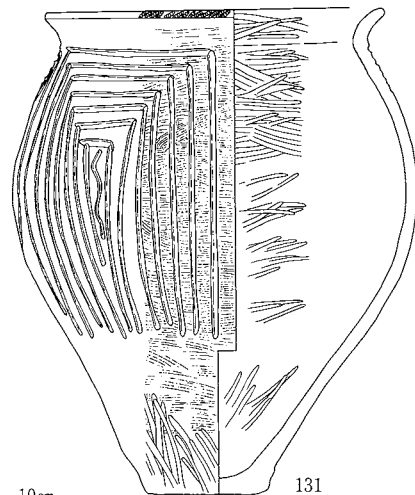

131

0 (1:4) 10cm

SB837-①

SB837-②

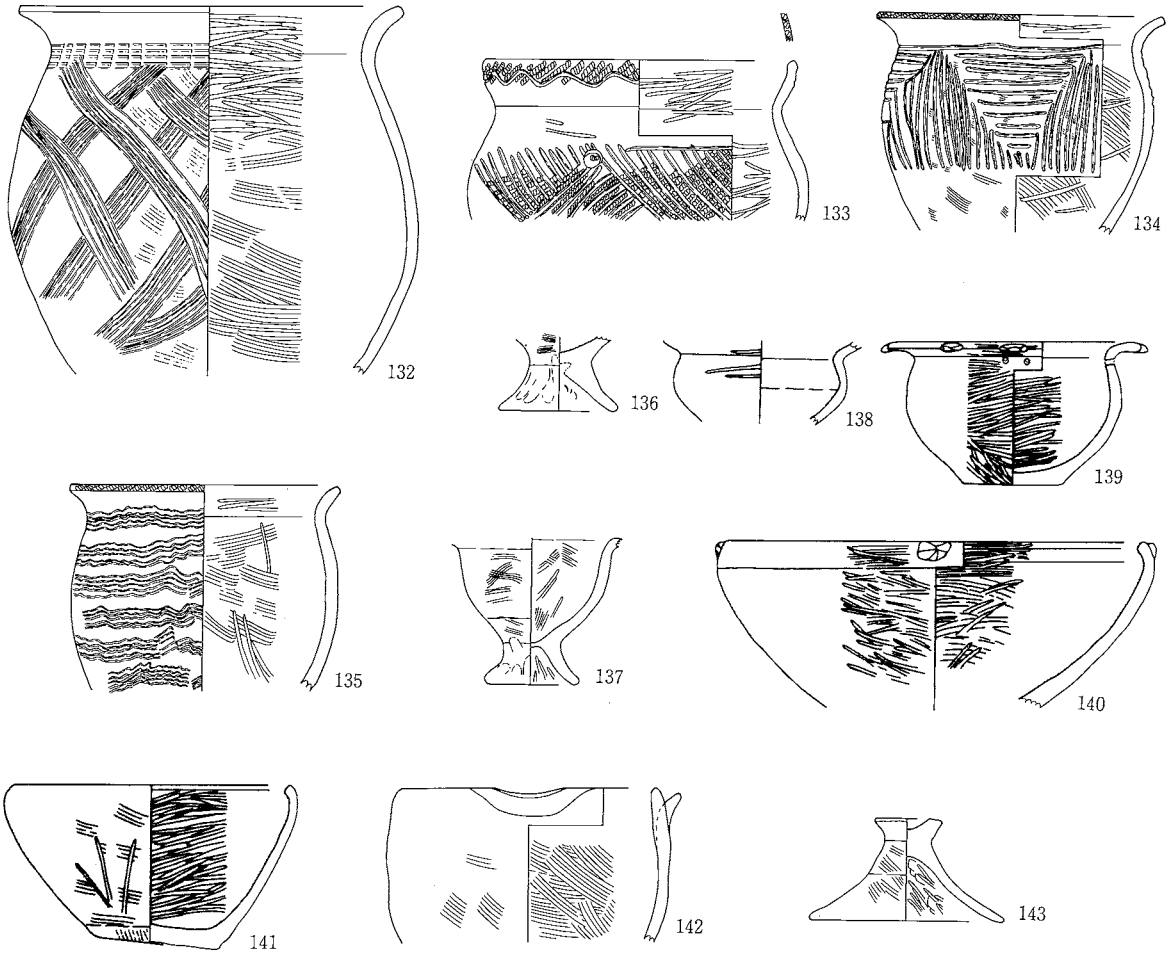

0 (1:4) 10cm

SB838-①

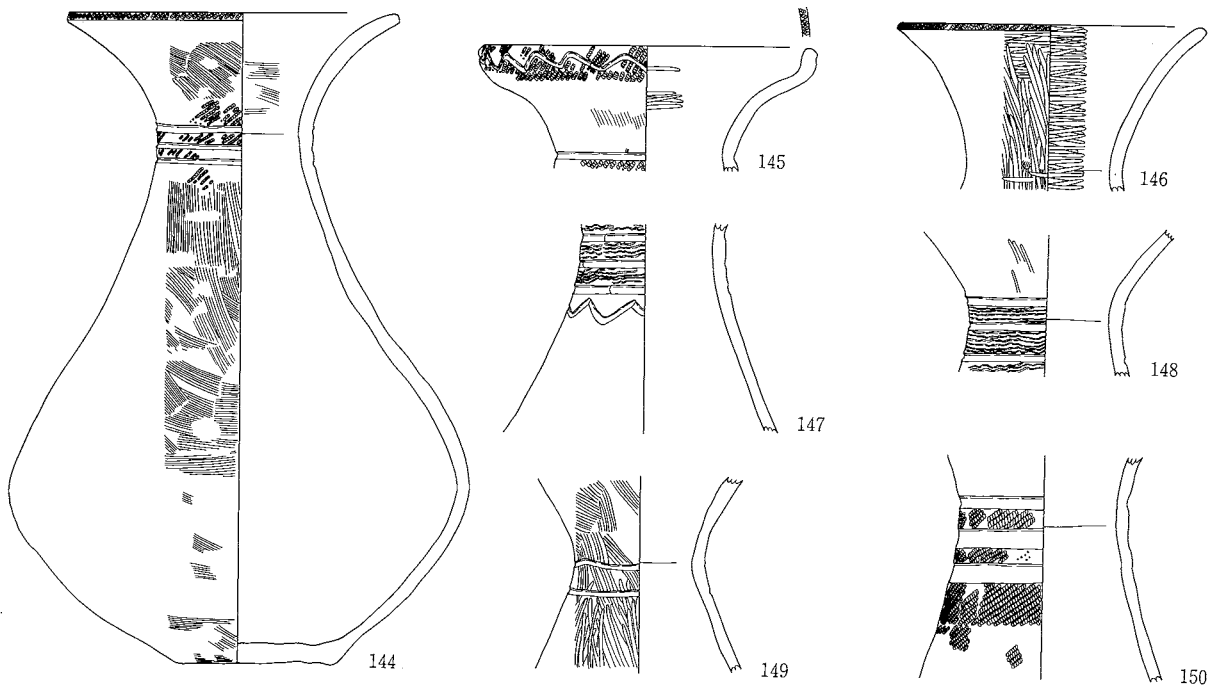

SB837-② · 838-①

SB838-②

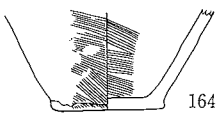
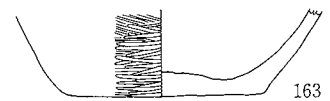
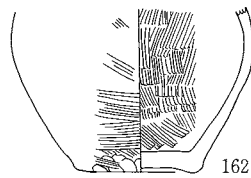
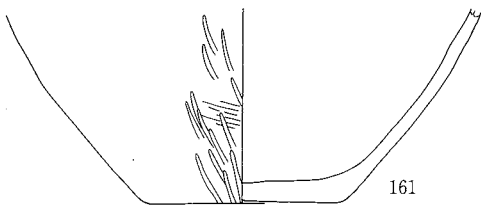
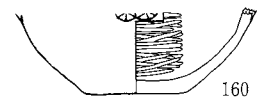
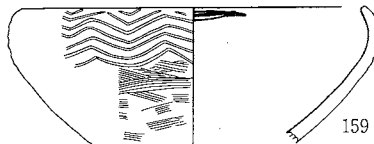
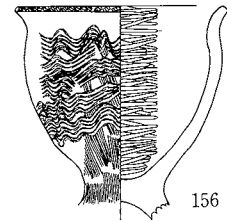
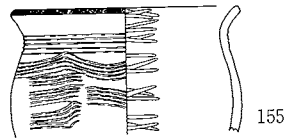
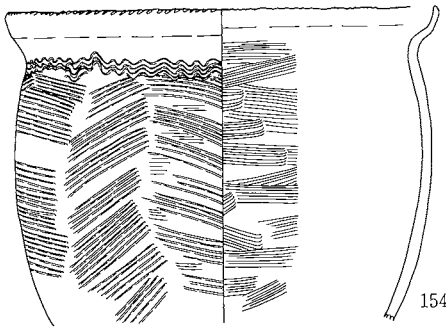
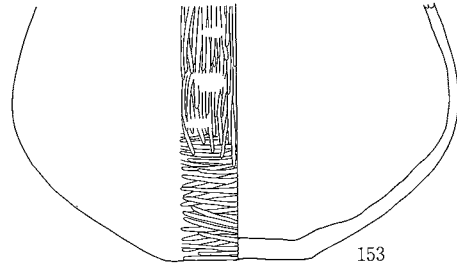
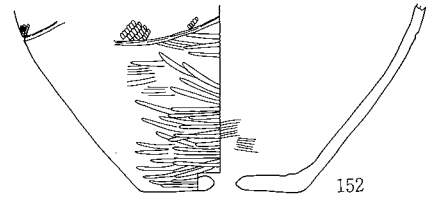
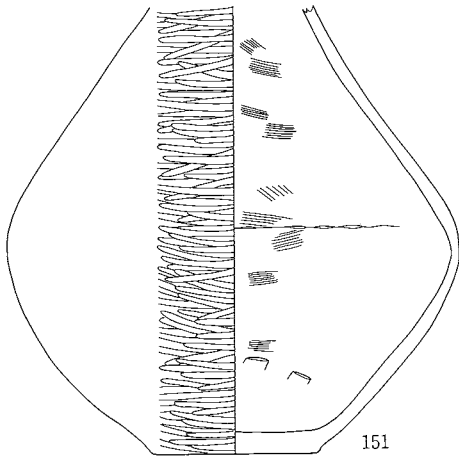

0 (1:4) 10cm

SB838-②

SB840

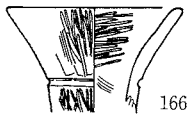

166



169

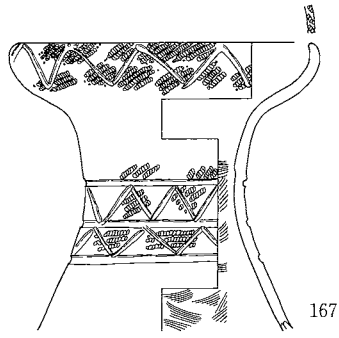

167

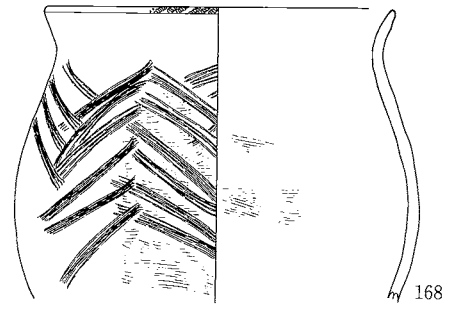

168

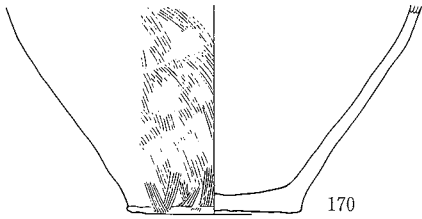

170



171



172



173

SB1468—①

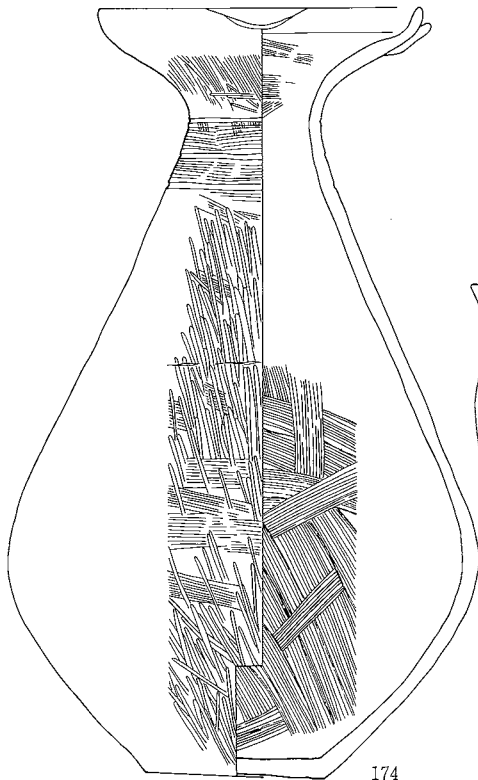

174

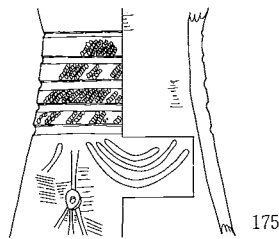

175

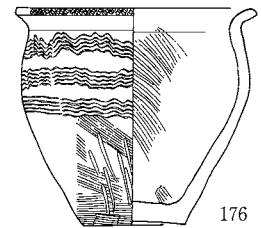

176

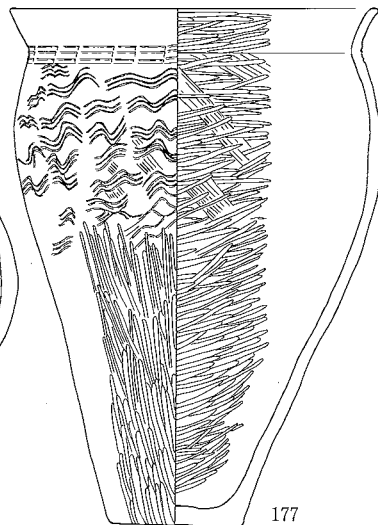

177

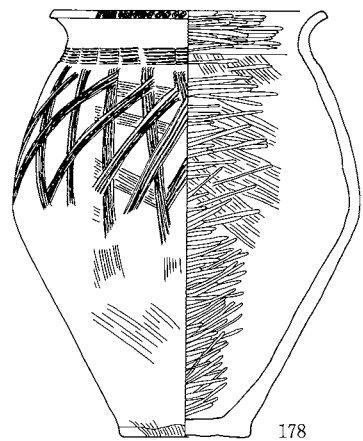

178

0 (1:4) 10cm

SB1468-②

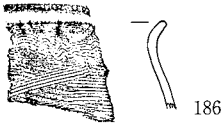
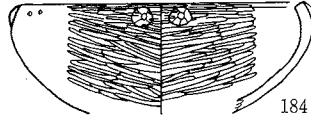
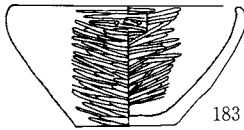
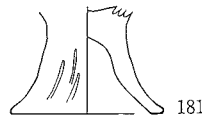
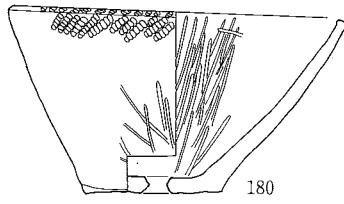
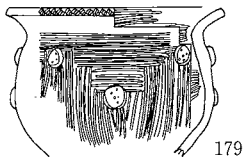

SB1469

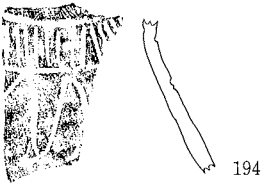
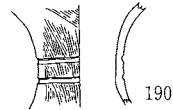
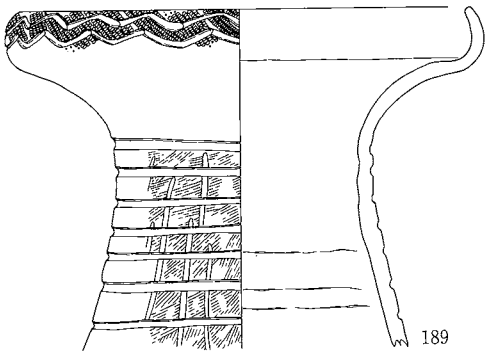

0 (1 : 4) 10cm

SB1471

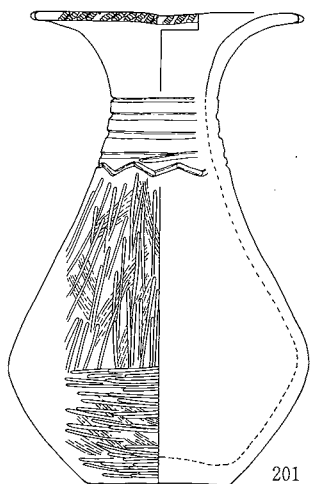

201

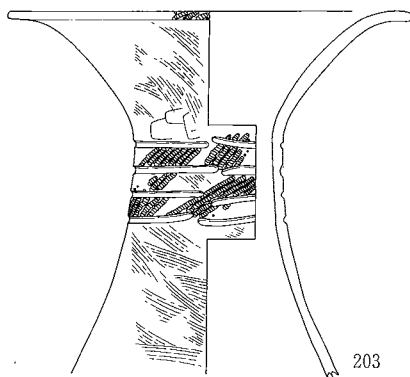

203

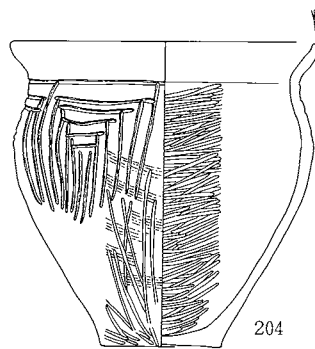

204

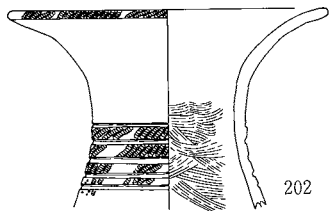

202

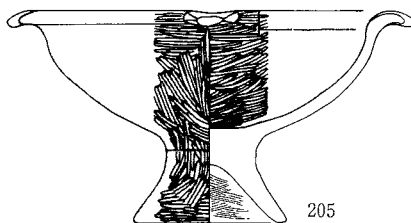

205



206

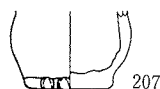

207



208



209

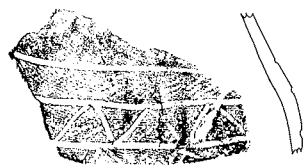

210

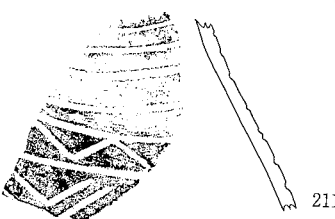

211



212



213

SB1473-①

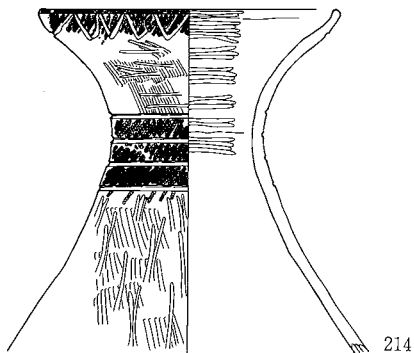

214

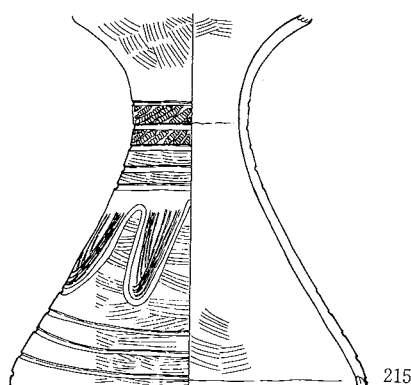

215

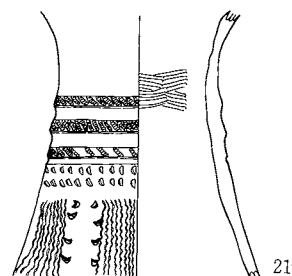

216

0 (1:4) 10cm

SB1473-②

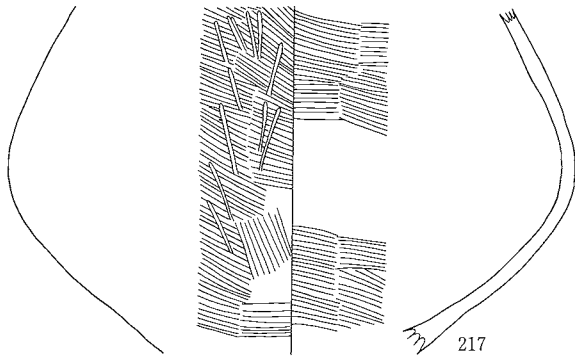

217

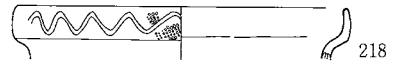

218

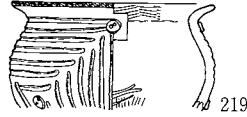

219

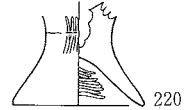

220

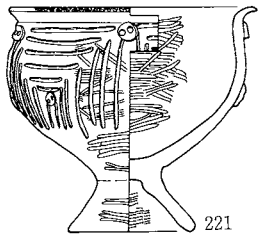

221

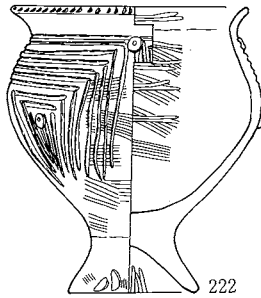

222

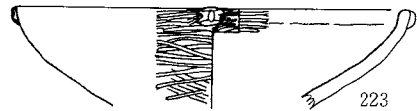

223

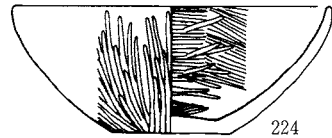

224

SB1474-①

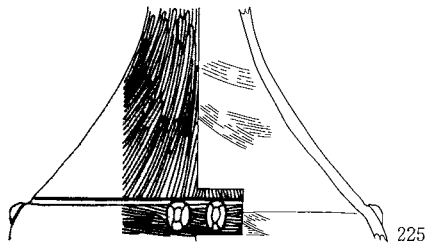

225

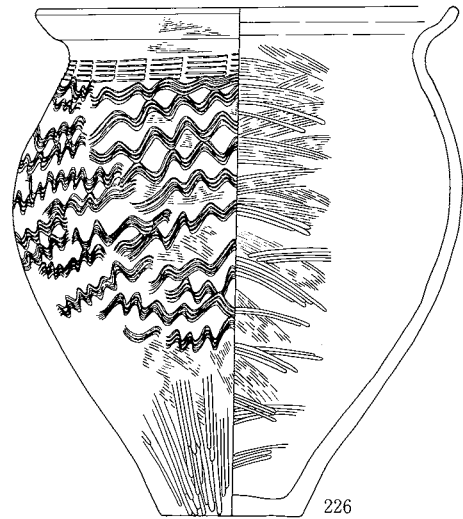

226

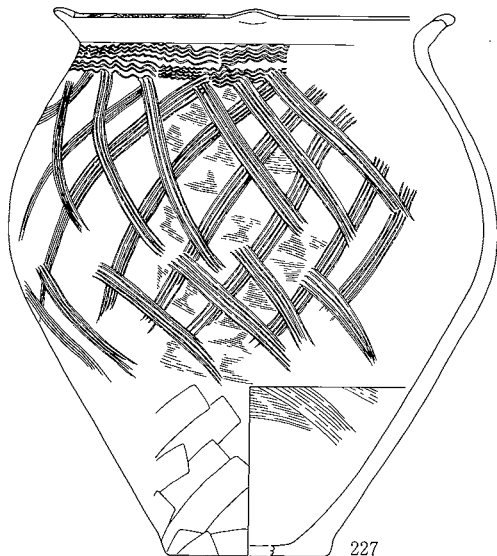

227

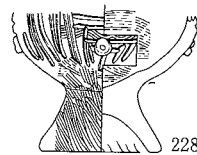

228



229

0 (1:4) 10cm

SB1474-②

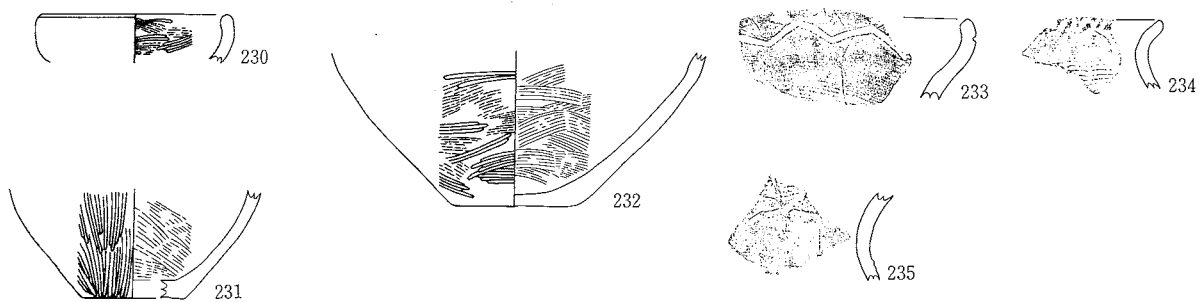

SB1478

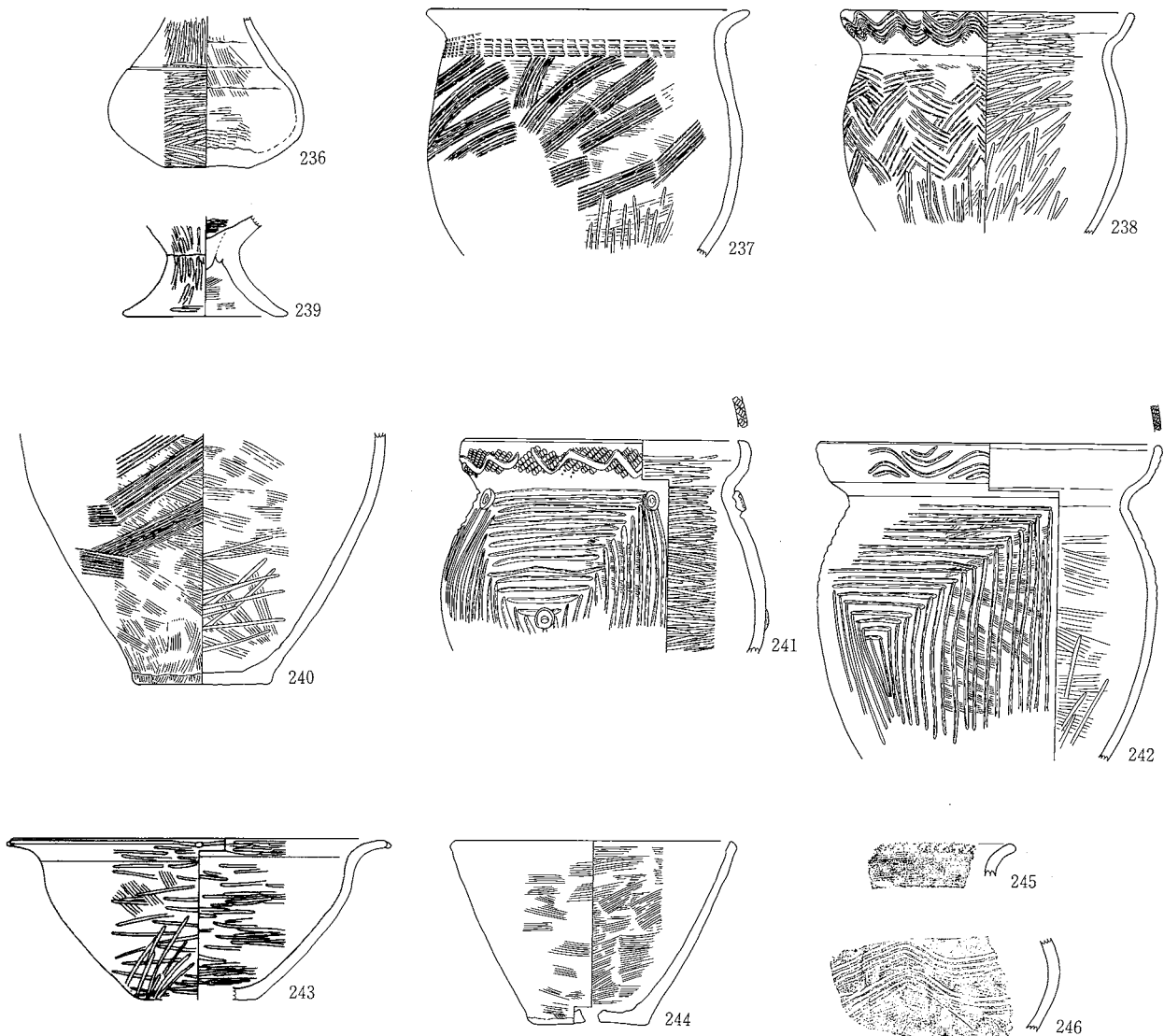

0 (1:4) 10cm

SB1482

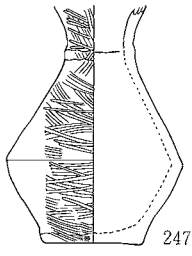

247

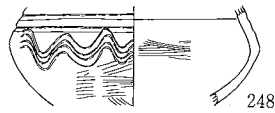

248

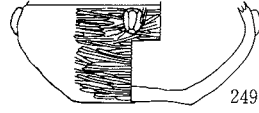

249

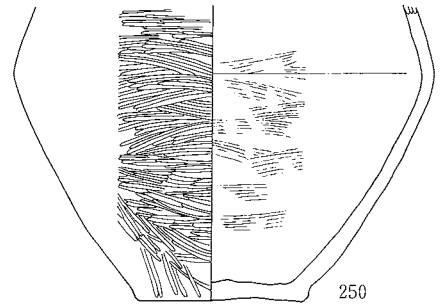

250

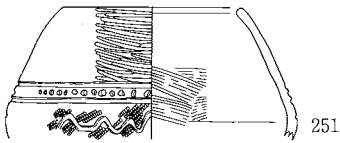

251

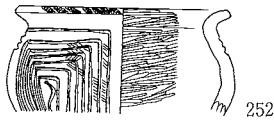

252

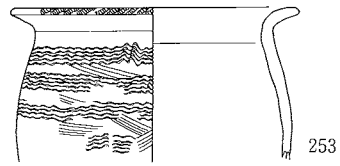

253

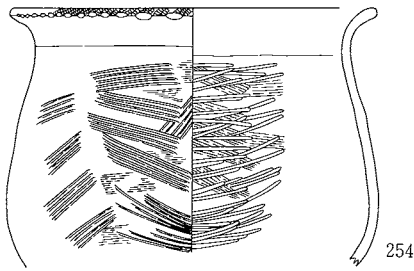

254

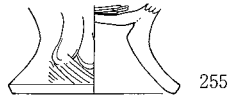

255

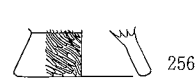

256

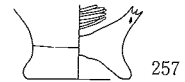

257



258

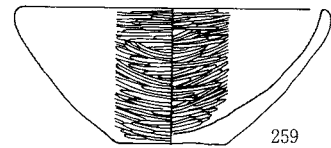

259

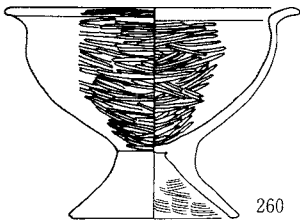

260

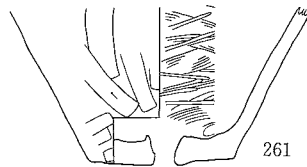

261

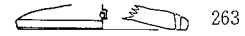

263

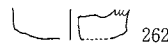

262

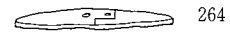

264



265

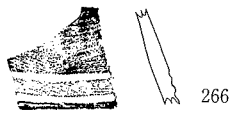

266



267



268



269



270



271



272

0 (1 : 4) 10cm

SB1482

SB1483

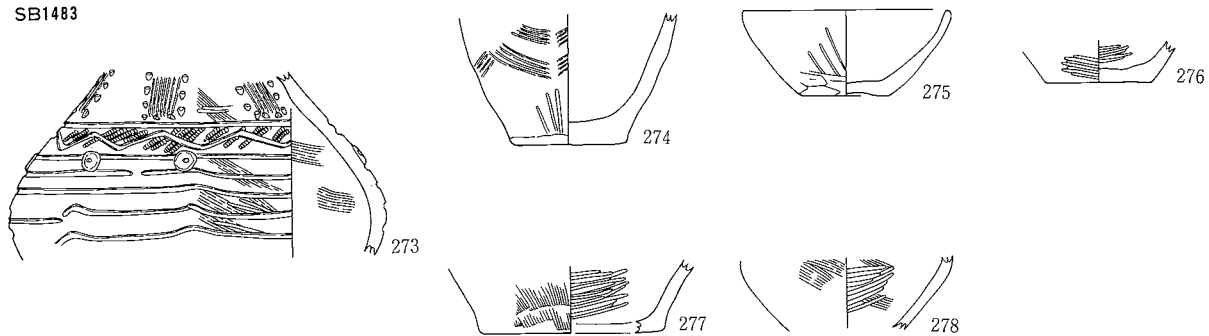

SB1484

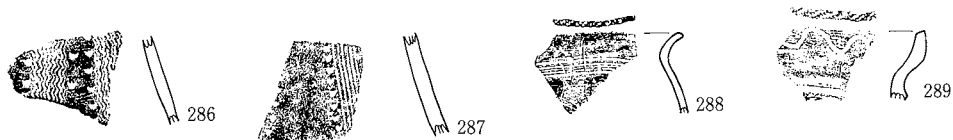
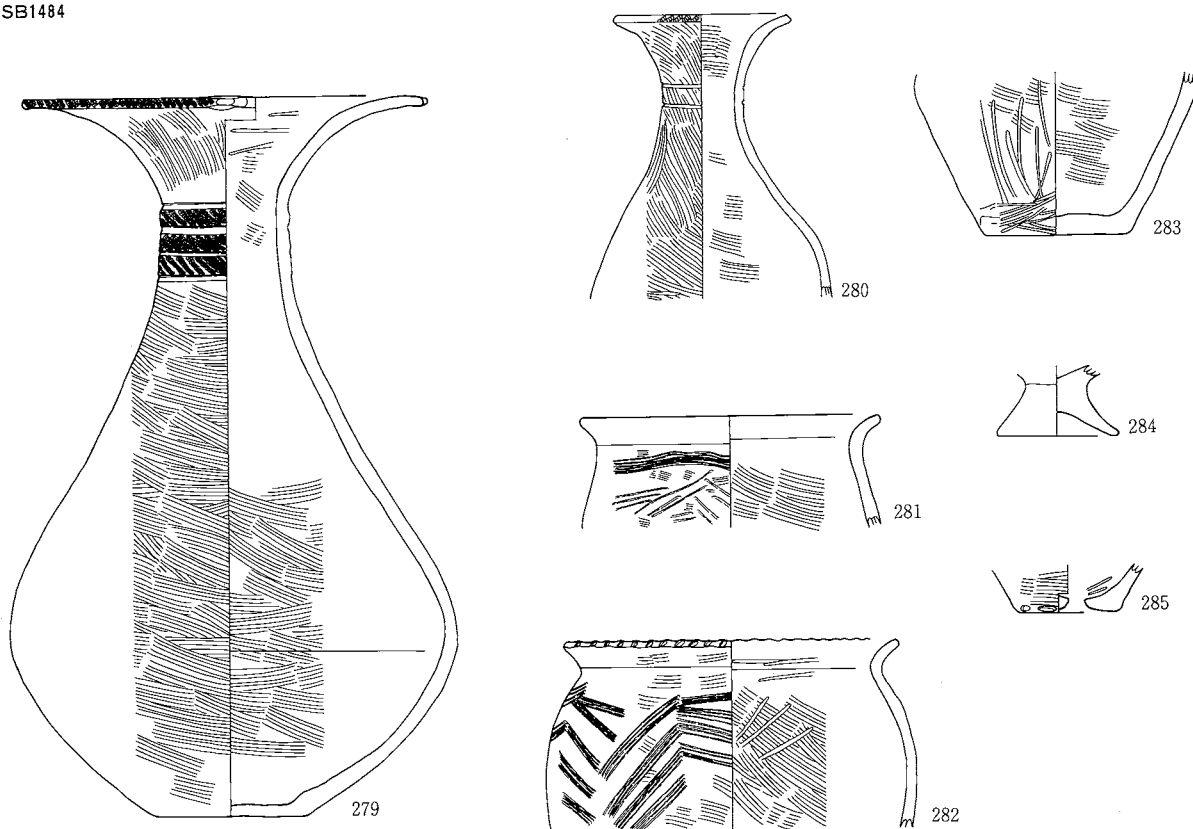

0 (1:4) 10cm

SD59



SD92

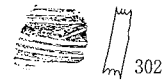
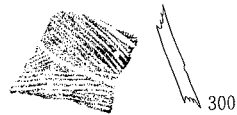
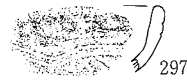
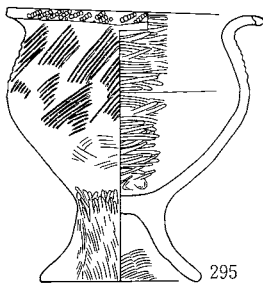
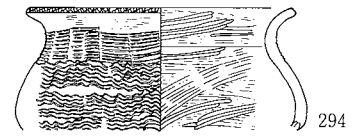
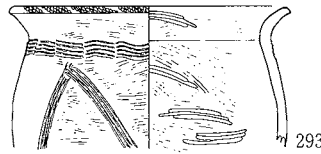
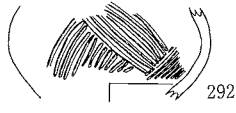
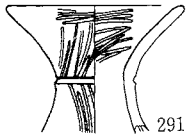

SD318-①

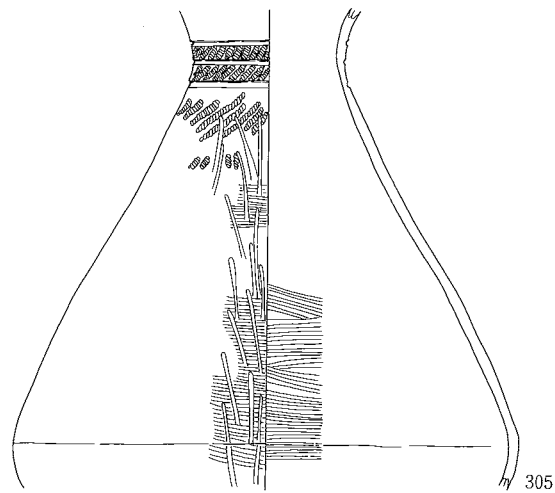
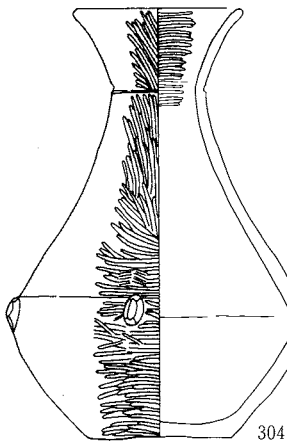
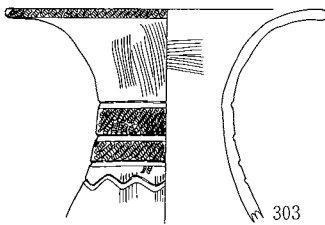

0 (1:4) 10cm

SD59 · 92 · 318-①

SD318-②

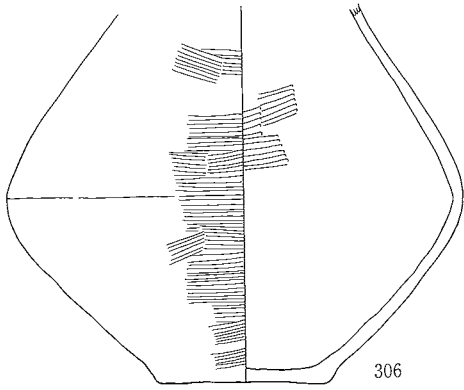

306

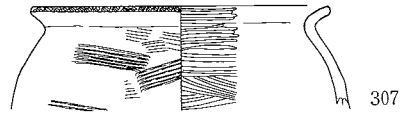

307

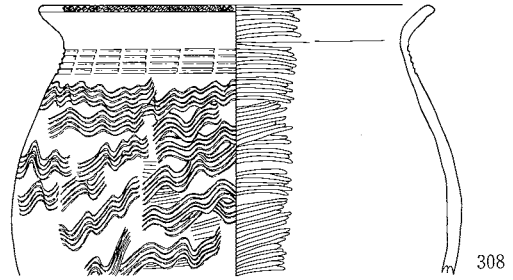

308

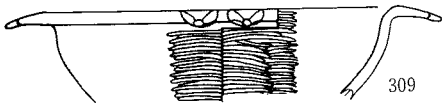

309

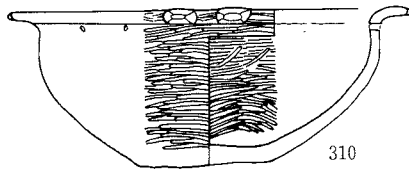

310

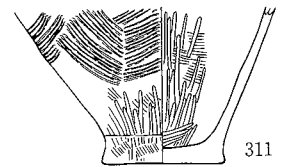

311

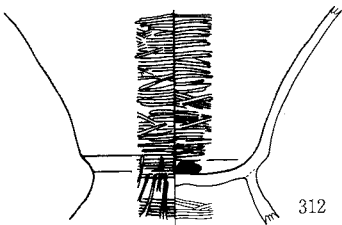

312

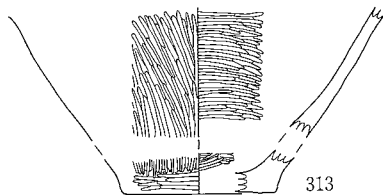

313

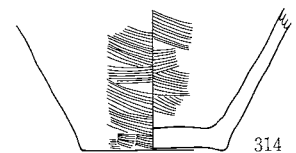

314

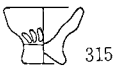

315

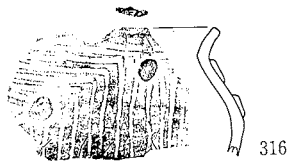

316



317

0 (1:4) 10cm

SD318-②

SK3277-①

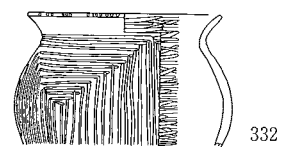
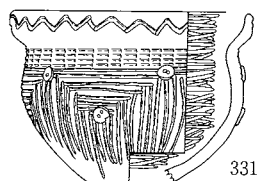
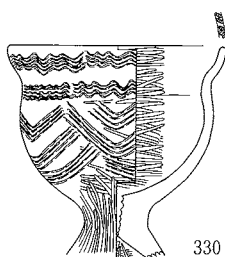
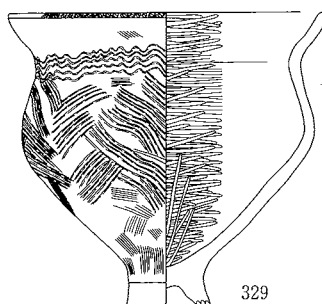
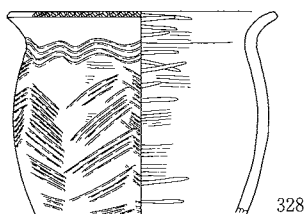
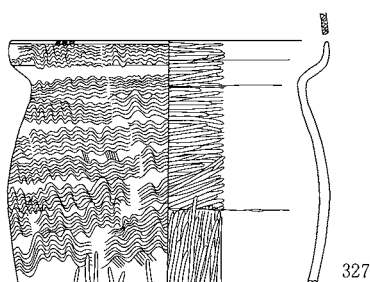
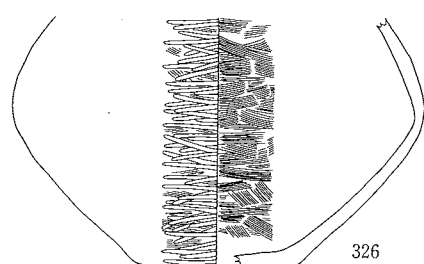
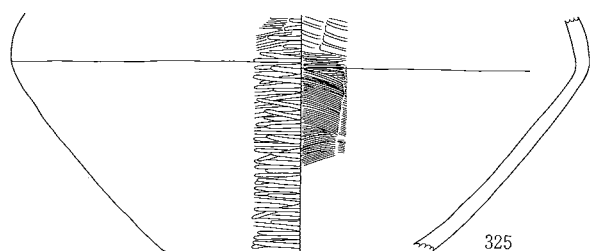
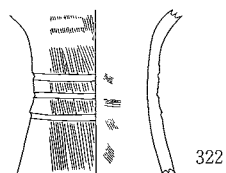
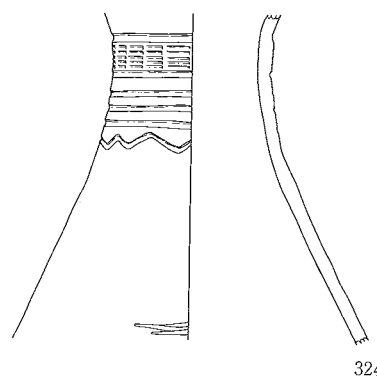
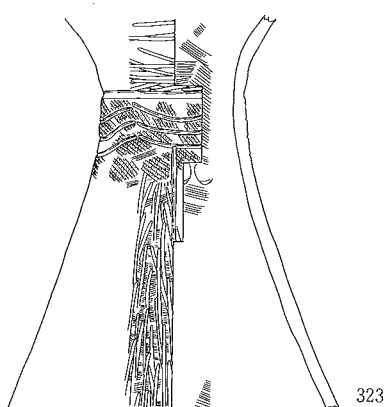
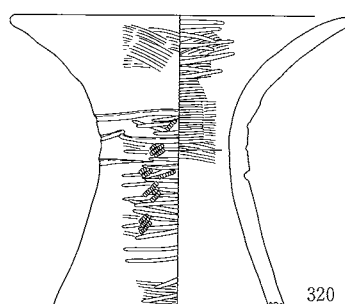
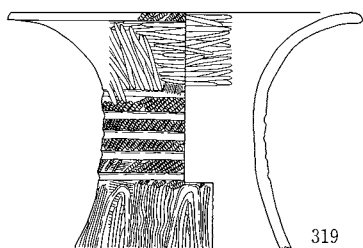
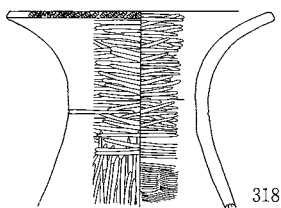

0 (1:4) 10cm

SK3277-①

SK3277-②

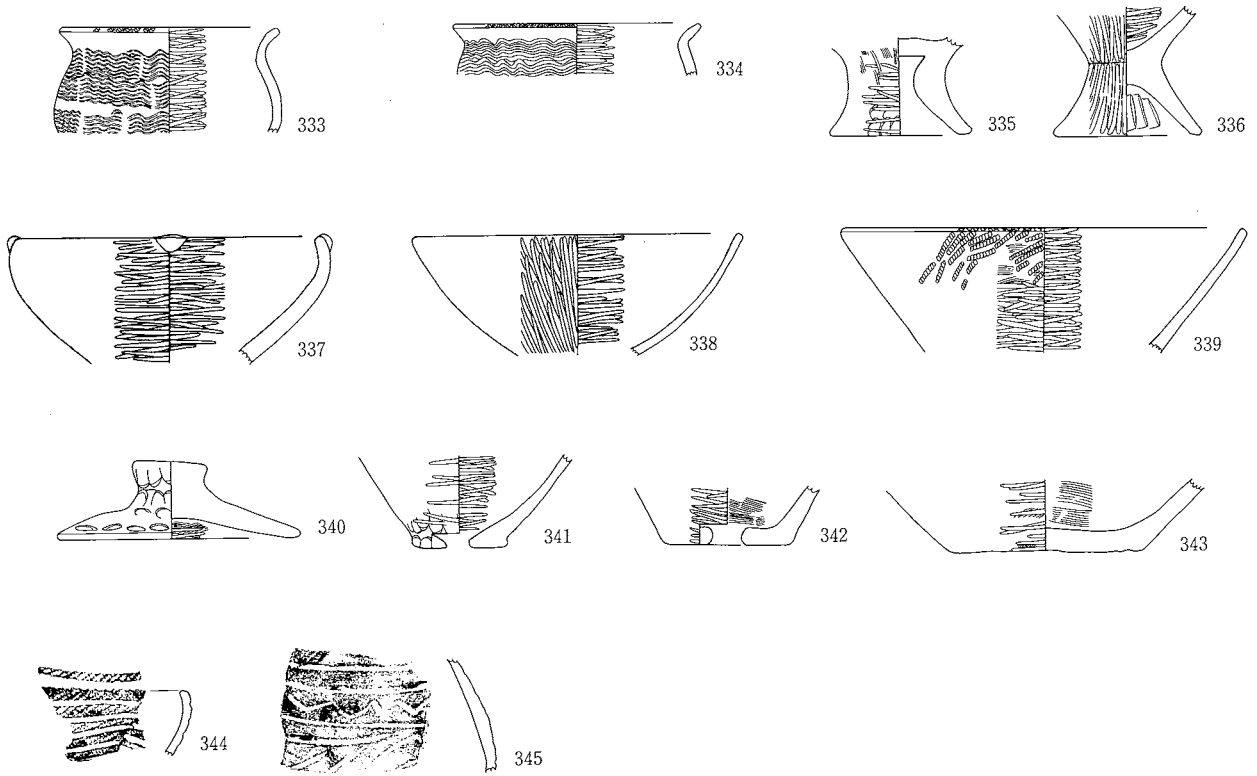

SK5495

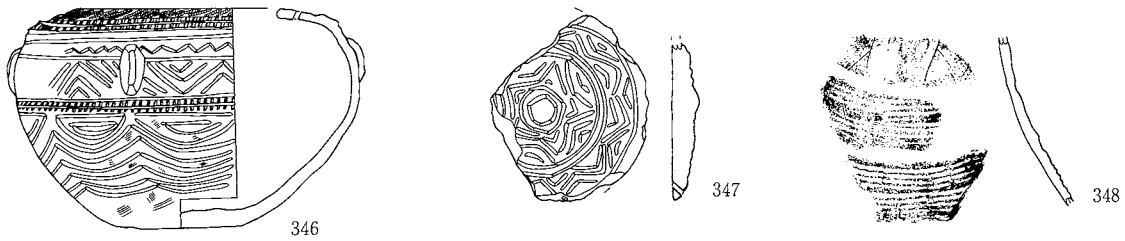

SK5497

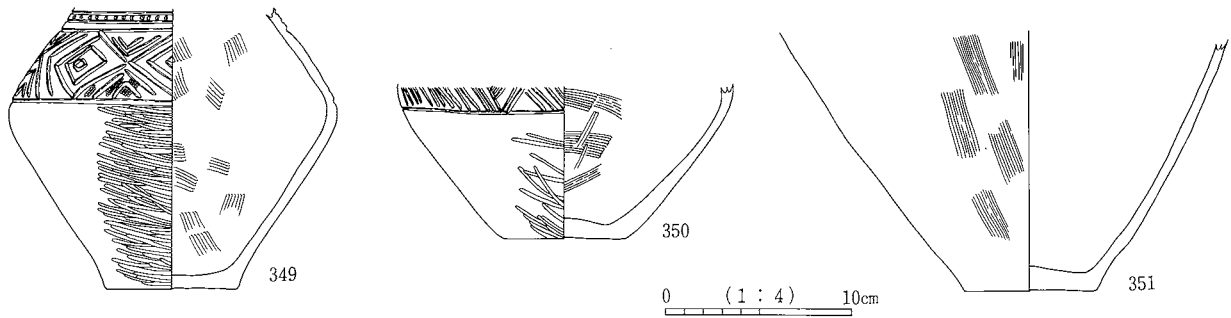

0 (1:4) 10cm

SK6004

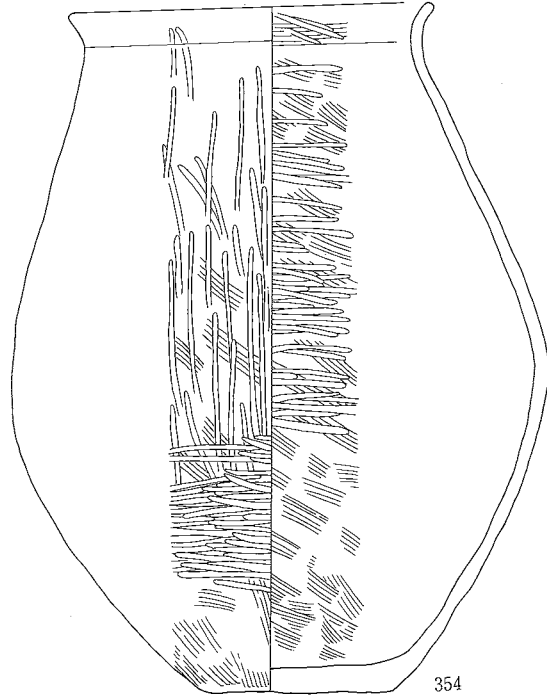
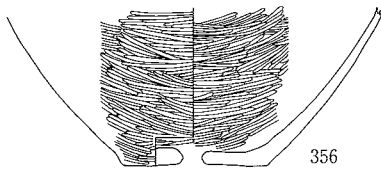
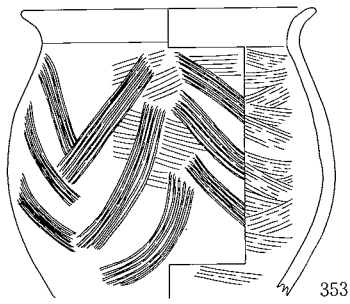
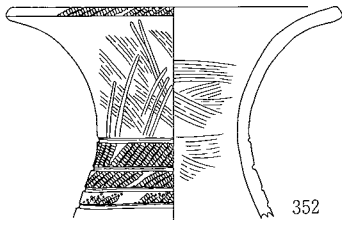

SK14706

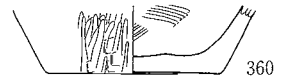
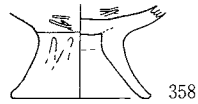
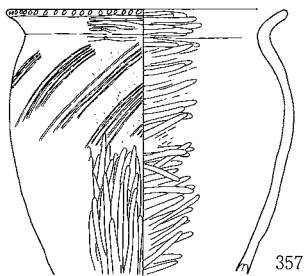

0 (1 : 4) 10cm

SK6004 · 14706

SK14711

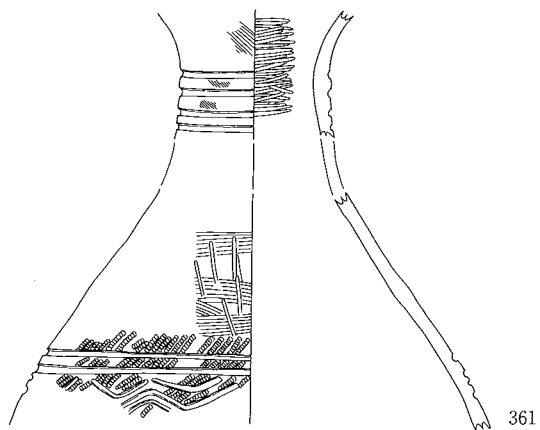

361

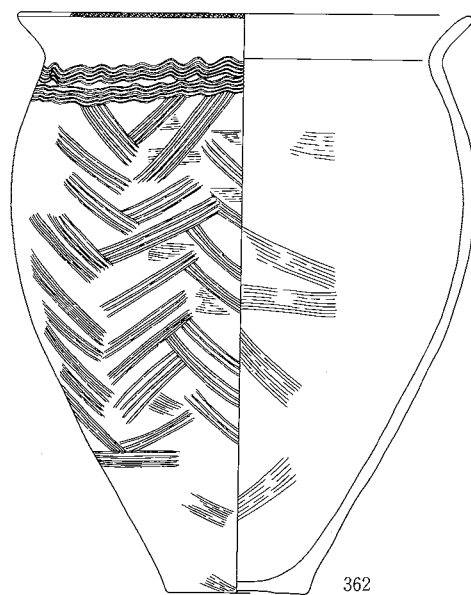

362

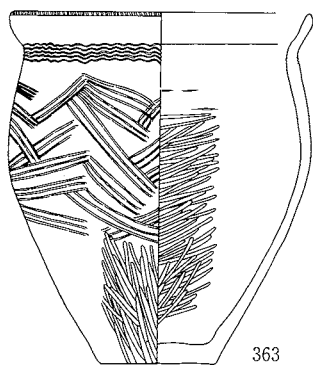

363

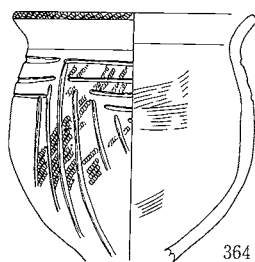

364

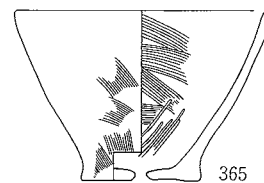

365

SK5573

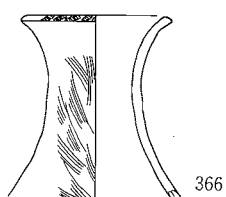

366

SK16681

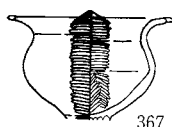

367

SK5682

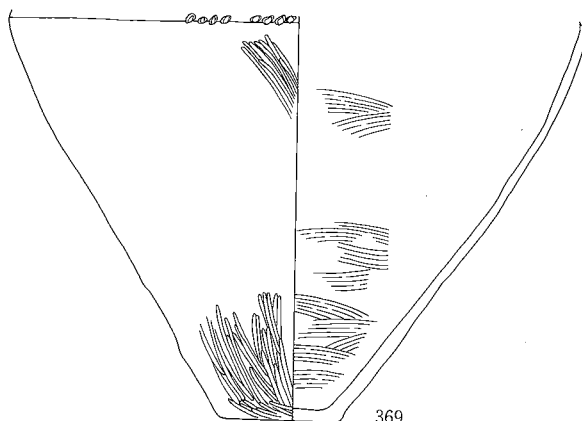

369

SK14588

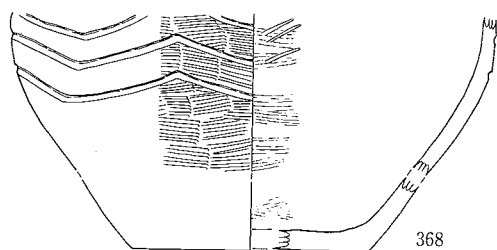

368

0 (1:4) 10cm

遺構外

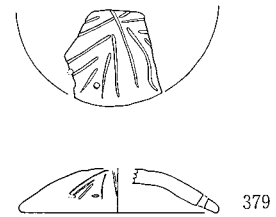
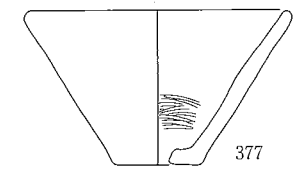
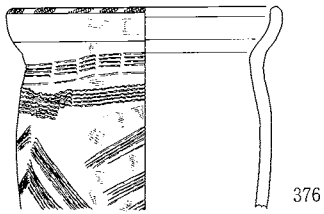
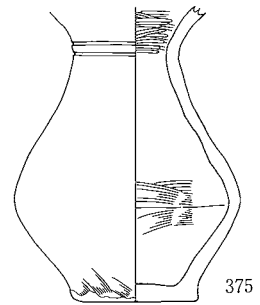
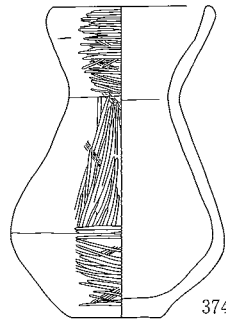
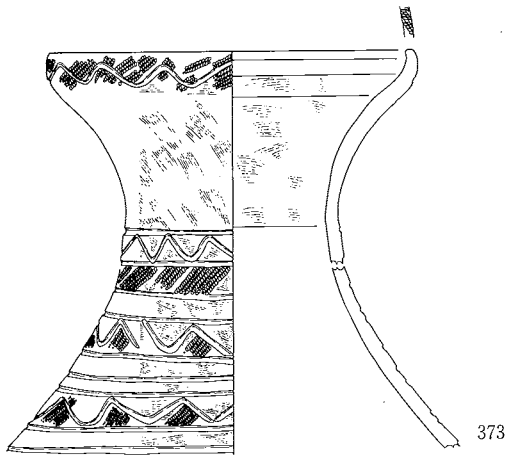
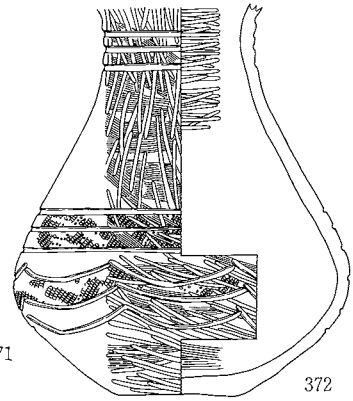
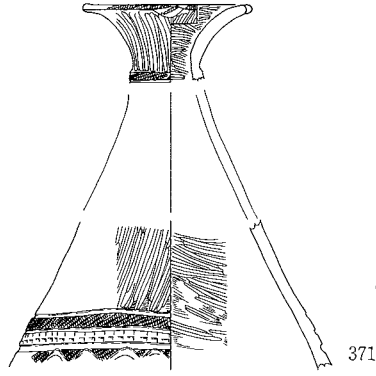
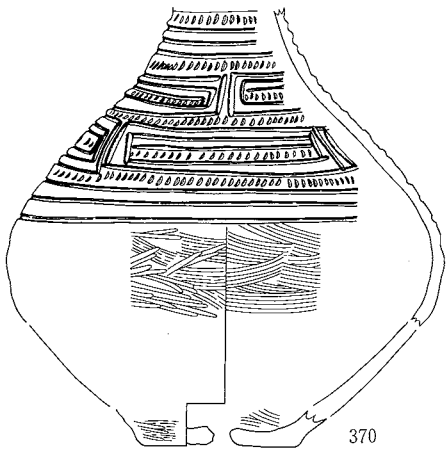

0 (1 : 4) 10cm

遺構外

SB72-①

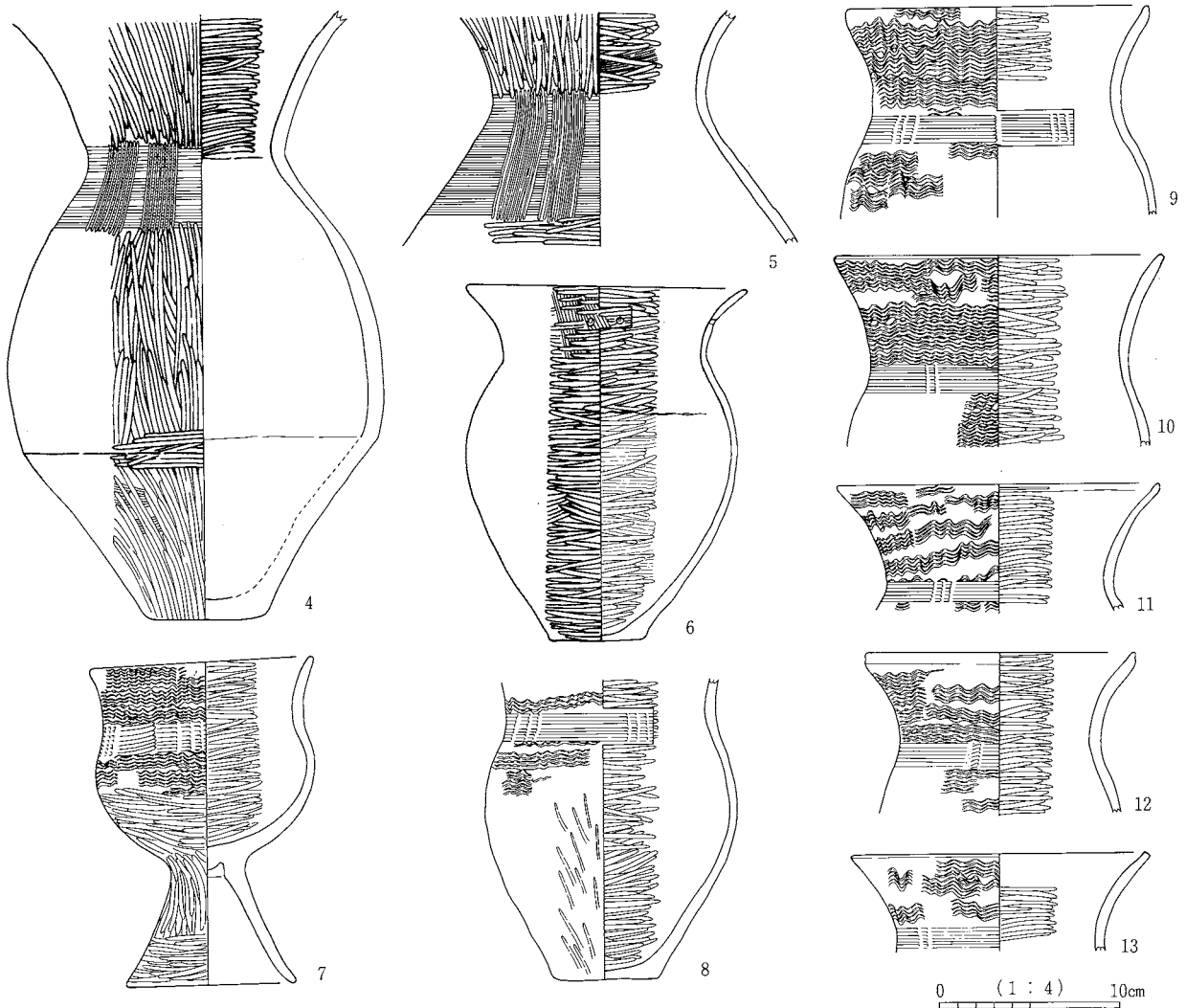
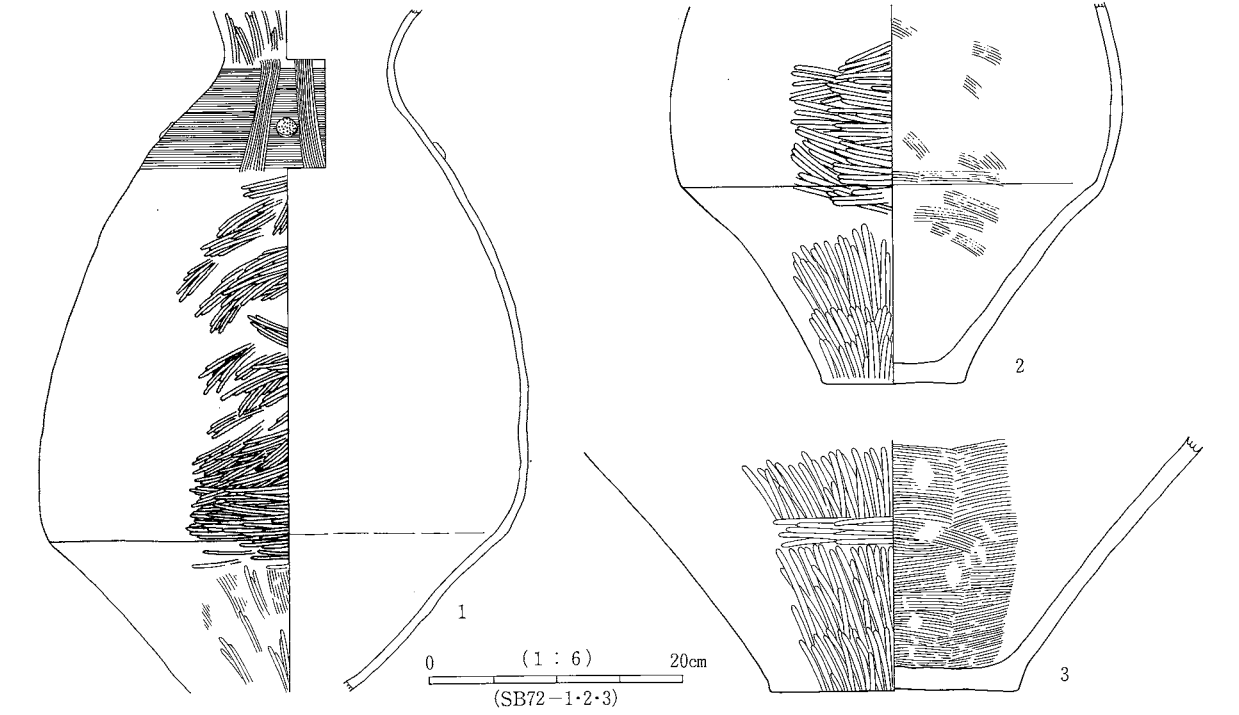

SB72-①

SB72-②

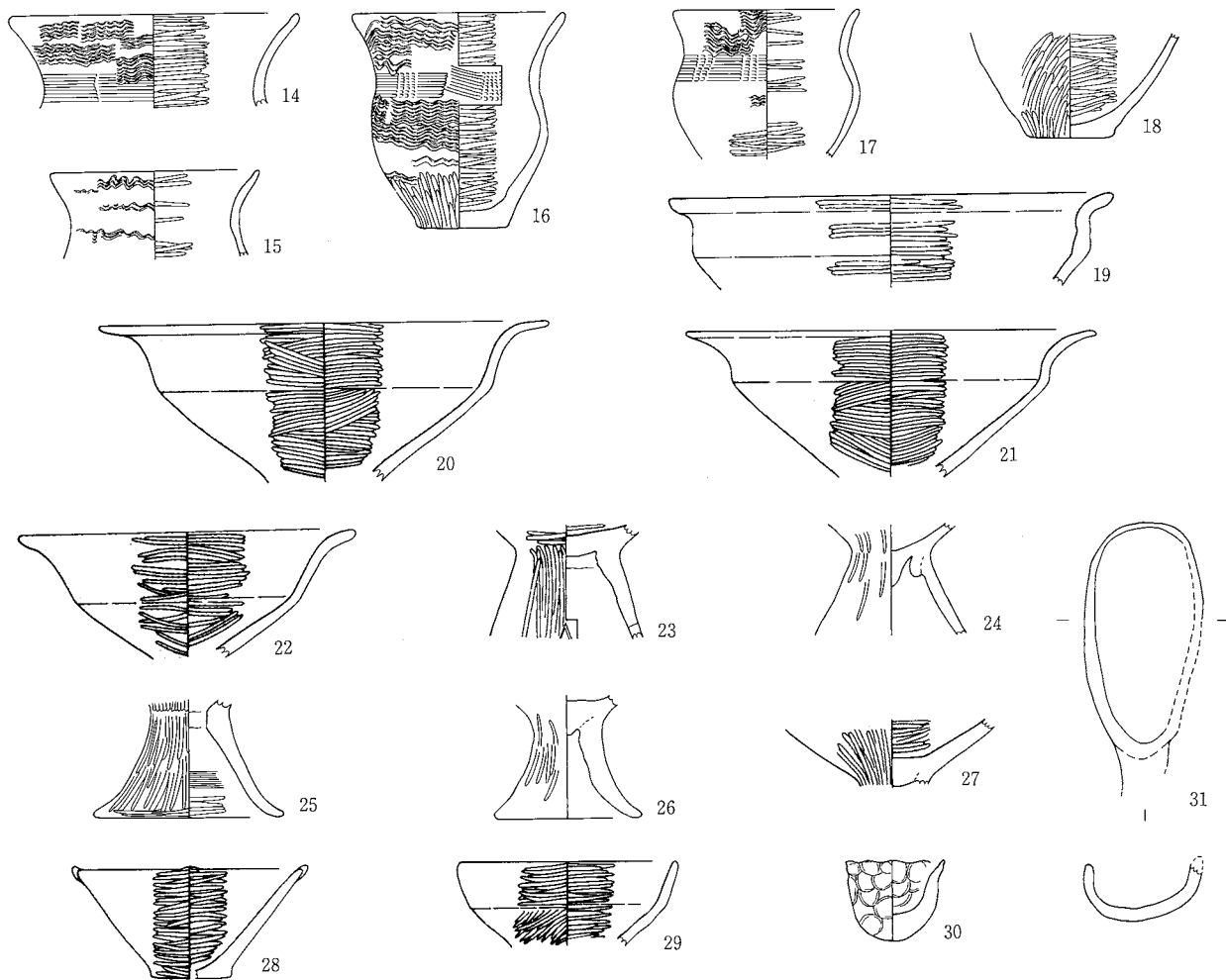

SB82

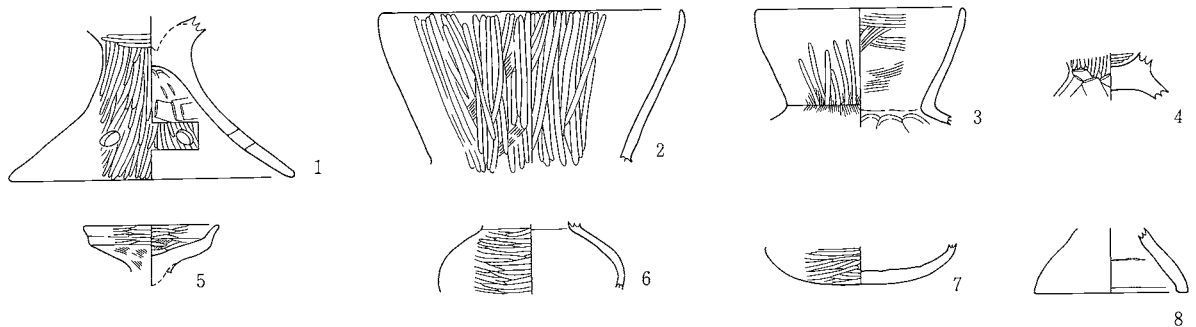

0 (1:4) 10cm

SB81

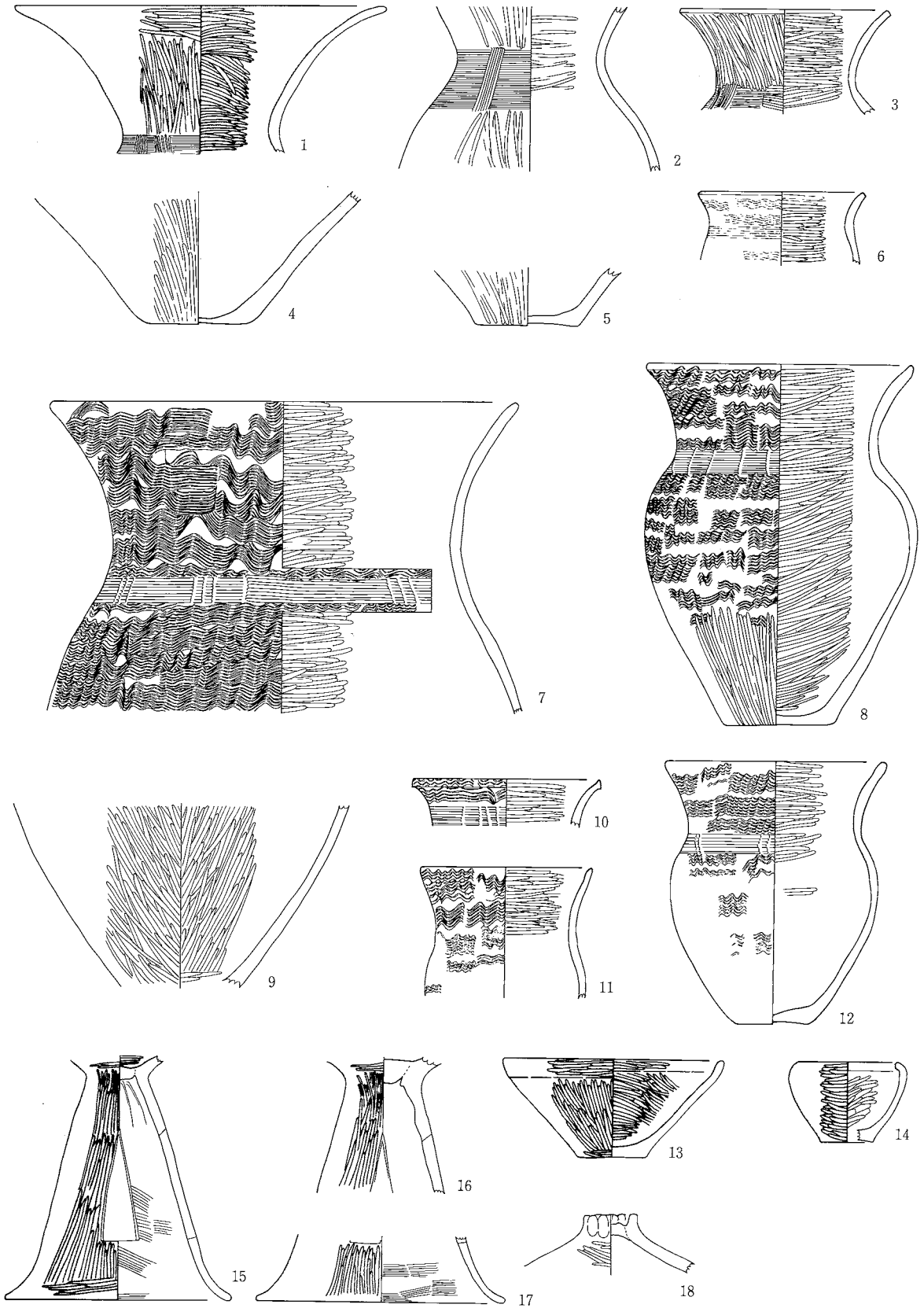

0 (1:4) 10cm

SB81

SB85-①

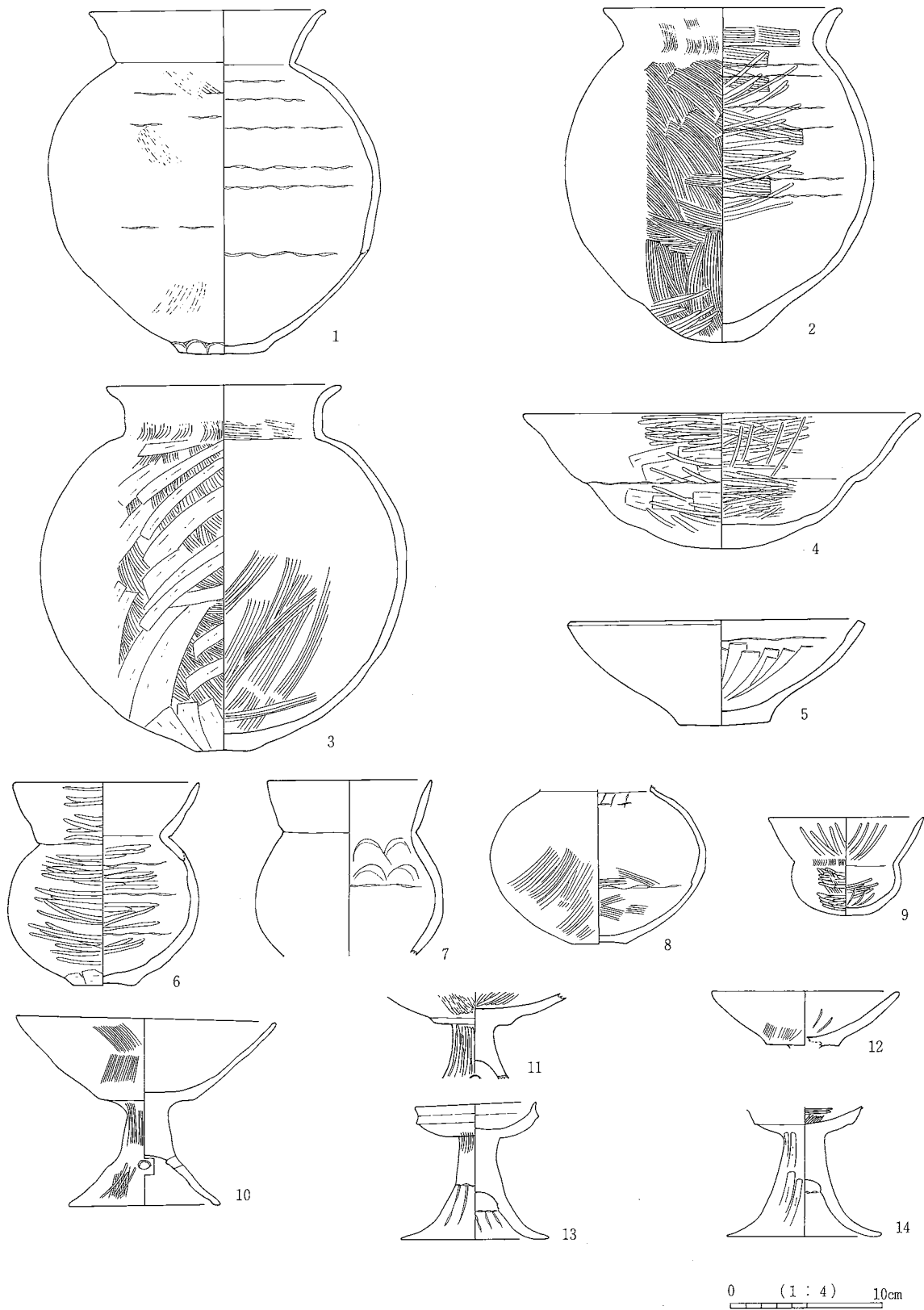

SB85-①

图版30 弥生時代後期～古墳時代前期土器(5)

SB85-②

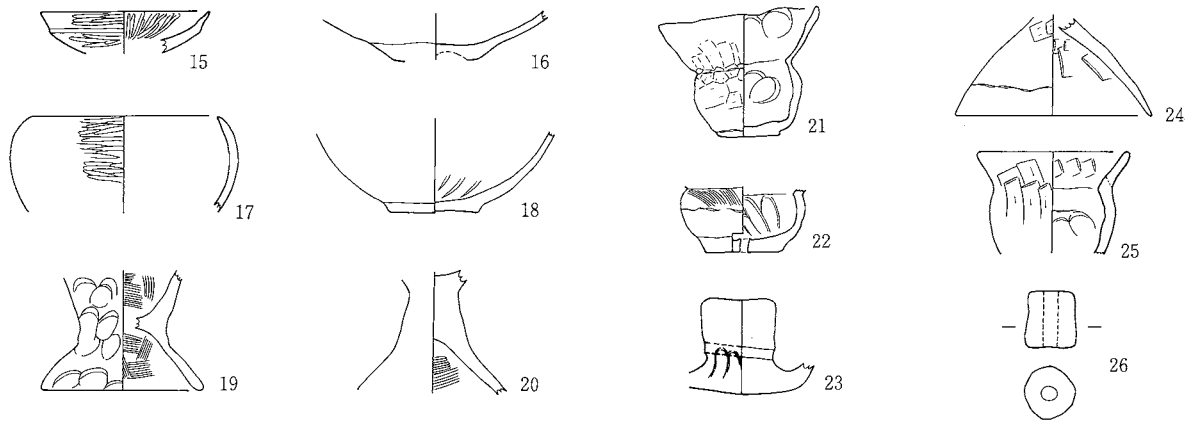

SB86

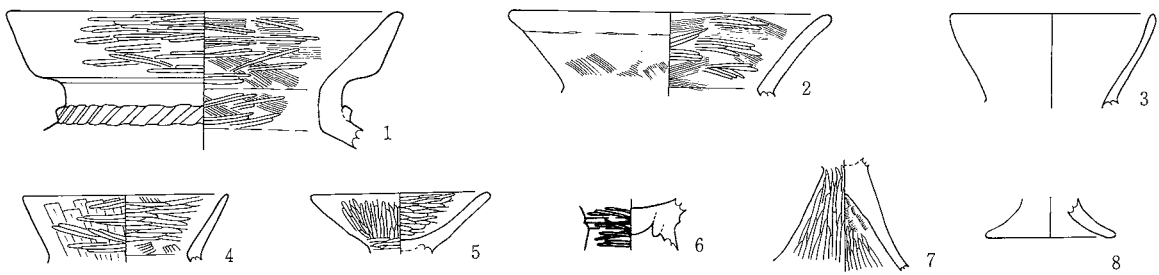

SB101

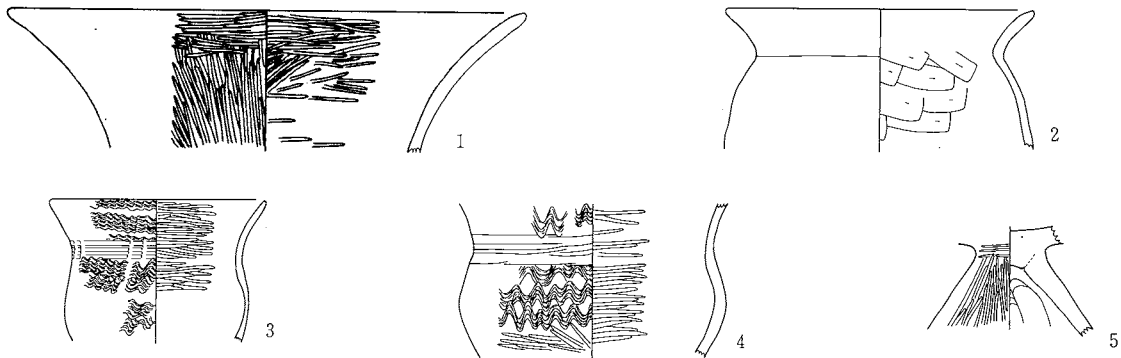

SB102

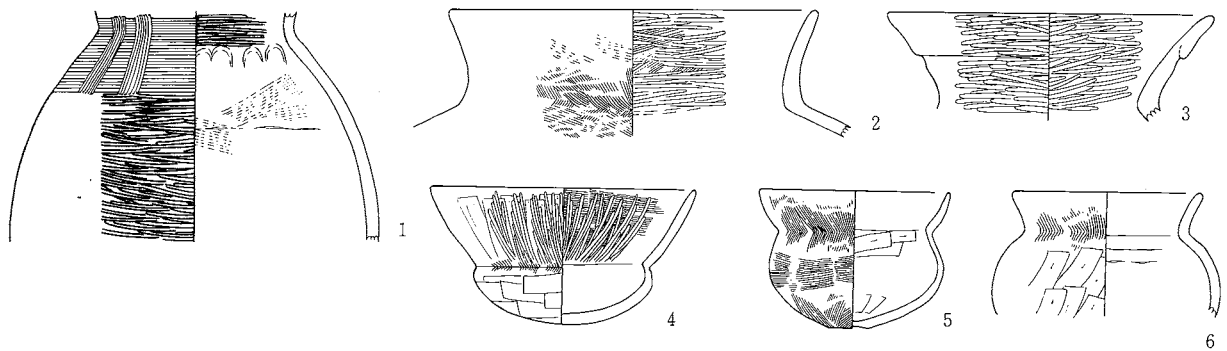

0 (1:4) 10cm

SB107

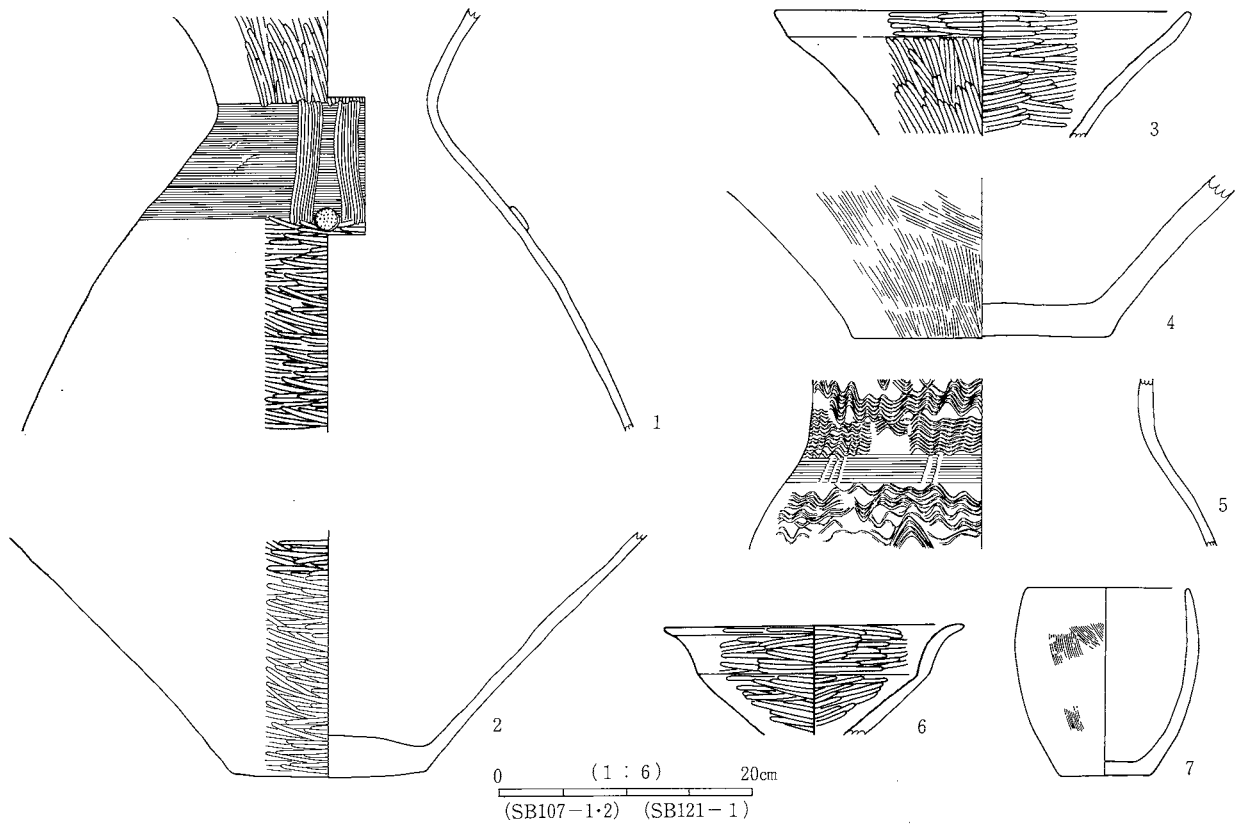

SB108

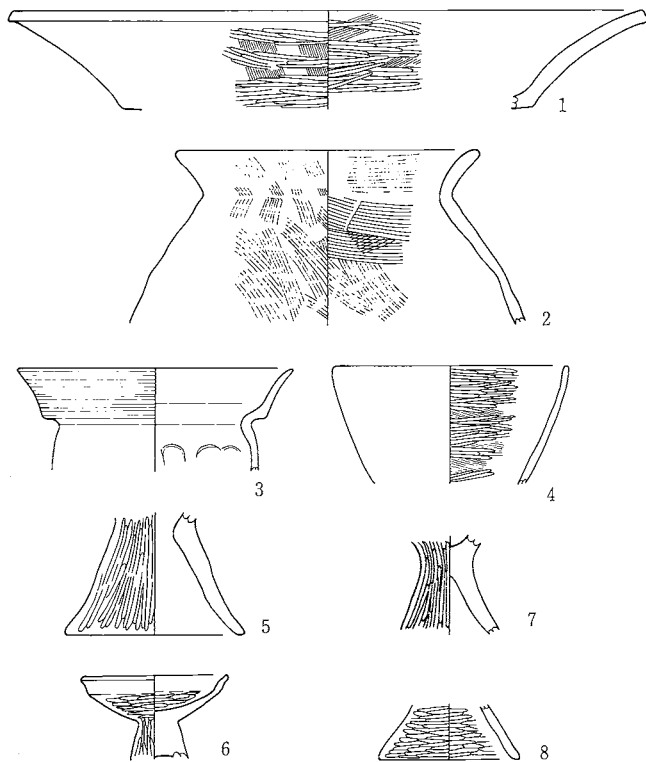

SB121

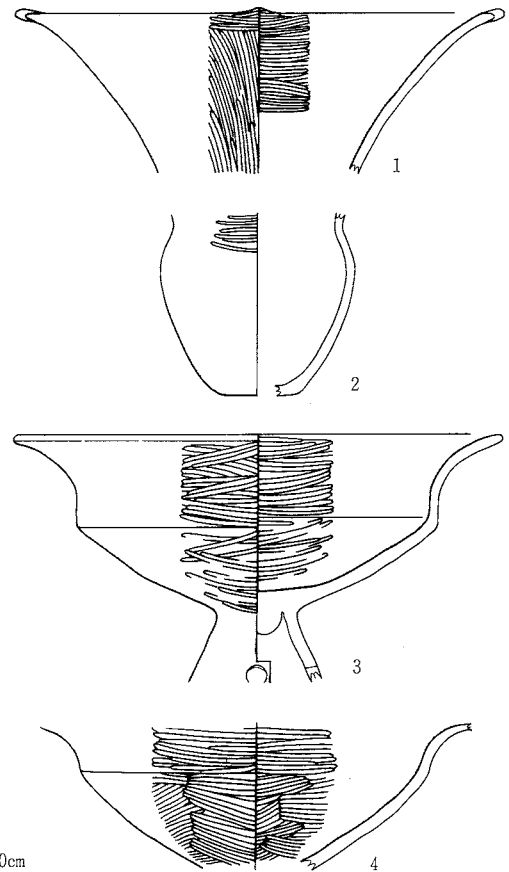

0 (1:4) 10cm

SB107 · 108 · 121

SB122

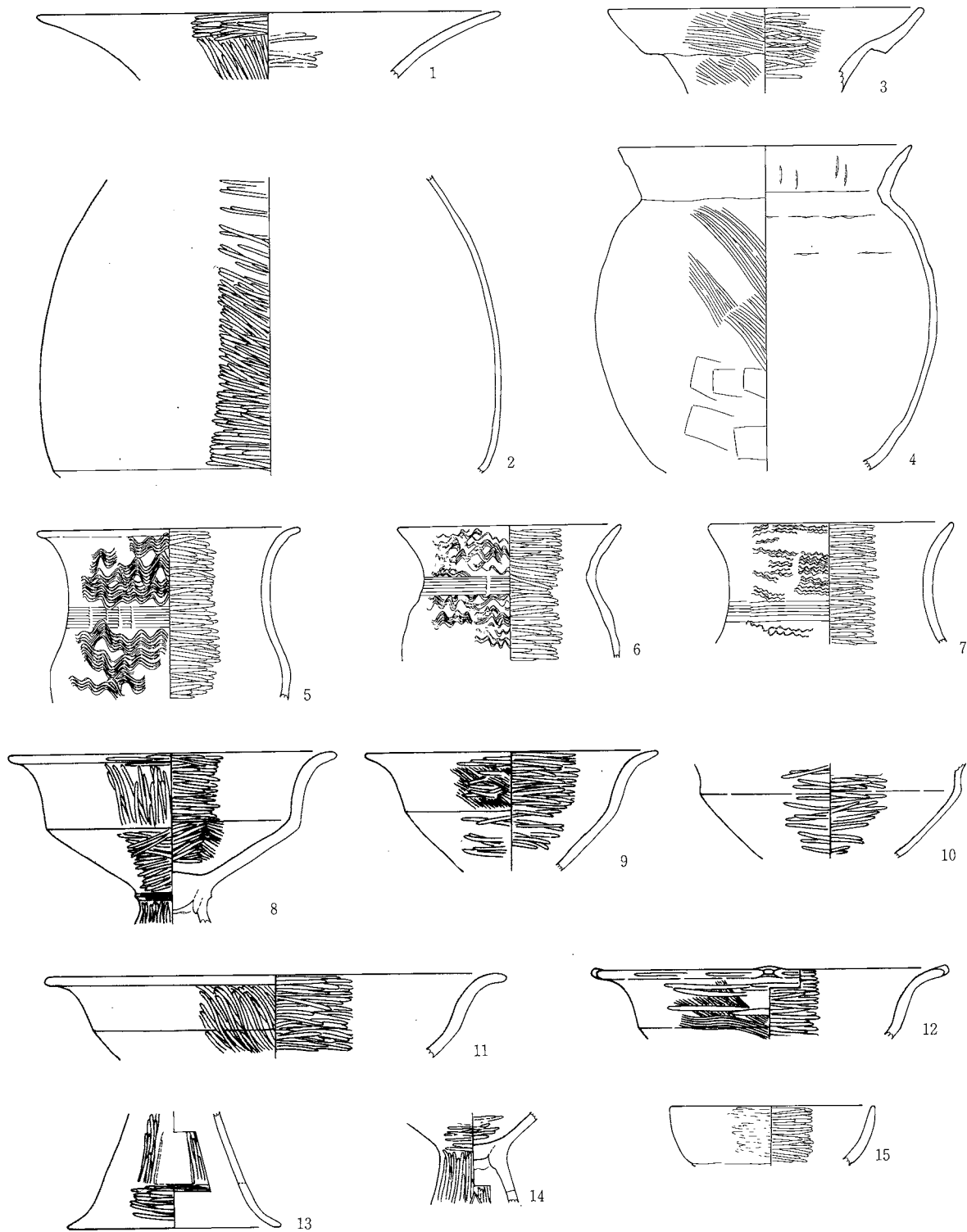

0 (1 : 6) 20cm 0 (1 : 4) 10cm
(SB122-1-2)

SB122

SB123

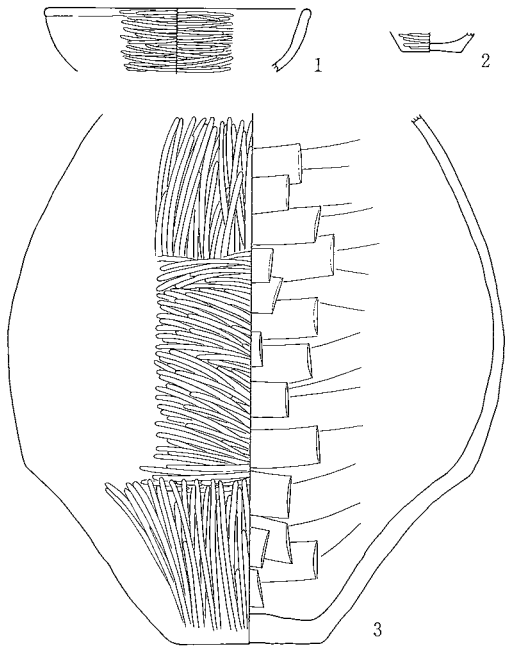

SB124

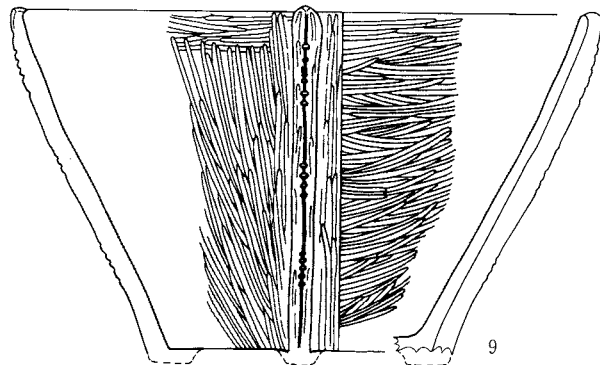
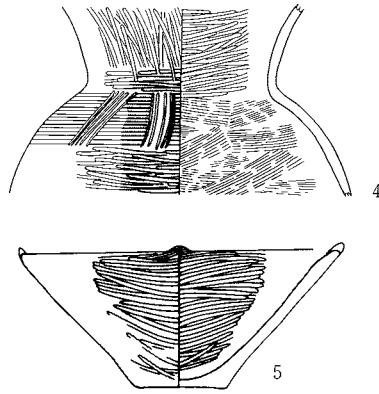
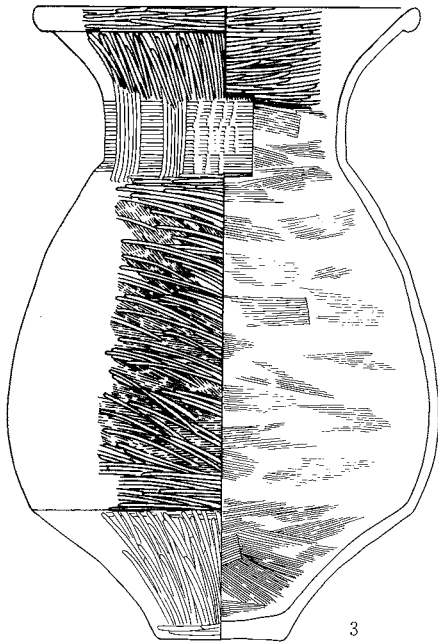
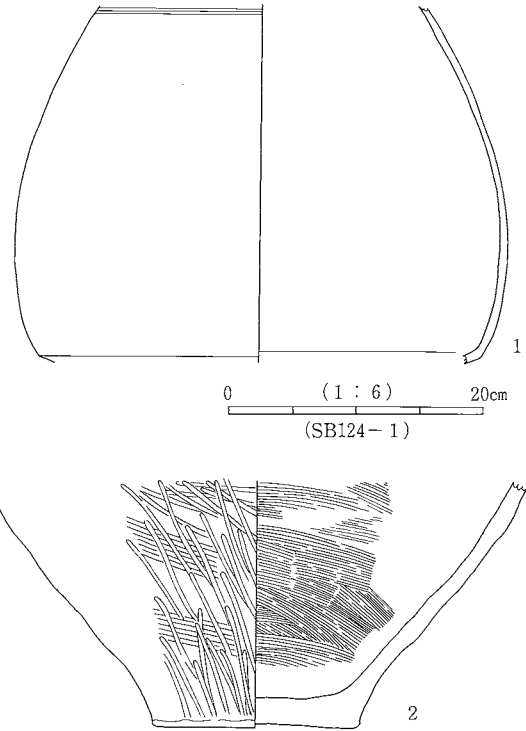

0 (1 : 4) 10cm

図版34 弥生時代後期～古墳時代前期土器(9)

SB125

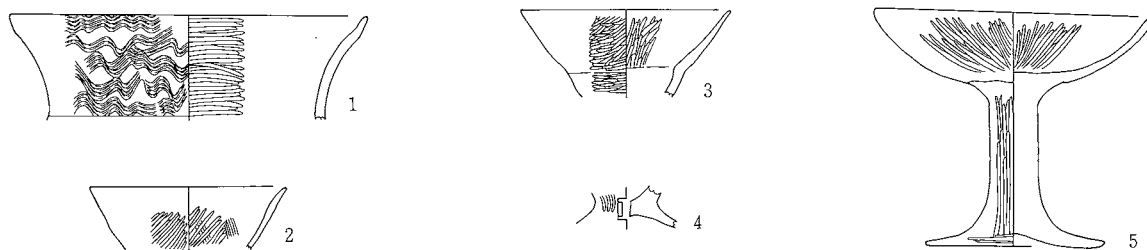

SB191

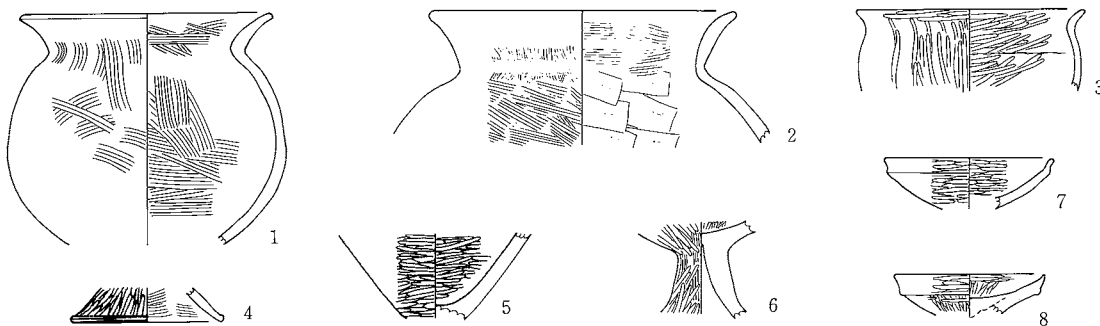

SB195

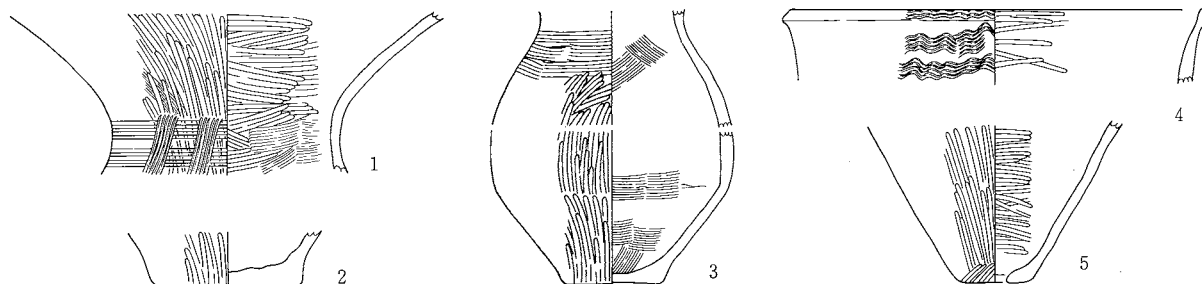

SB217

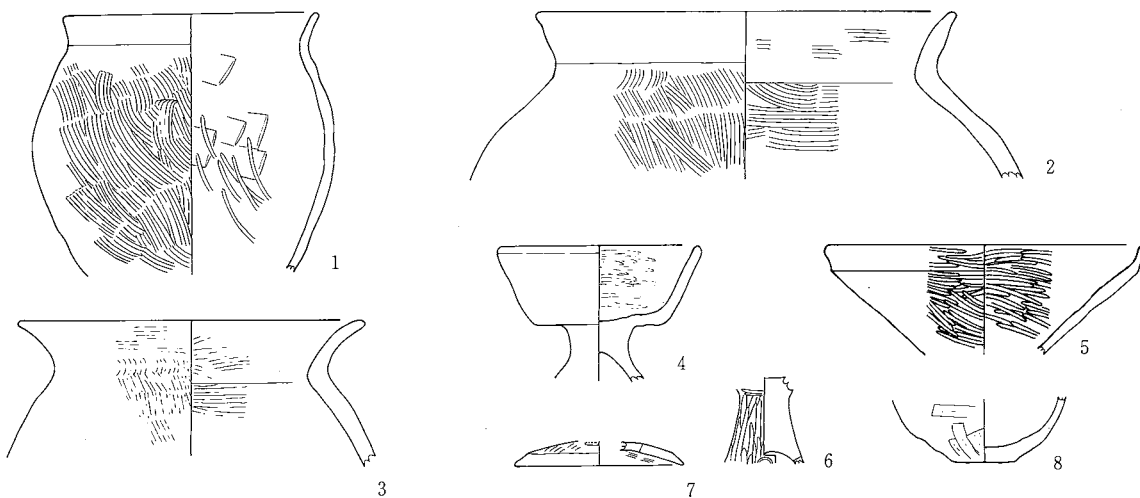

0 (1:4) 10cm

SB222-①

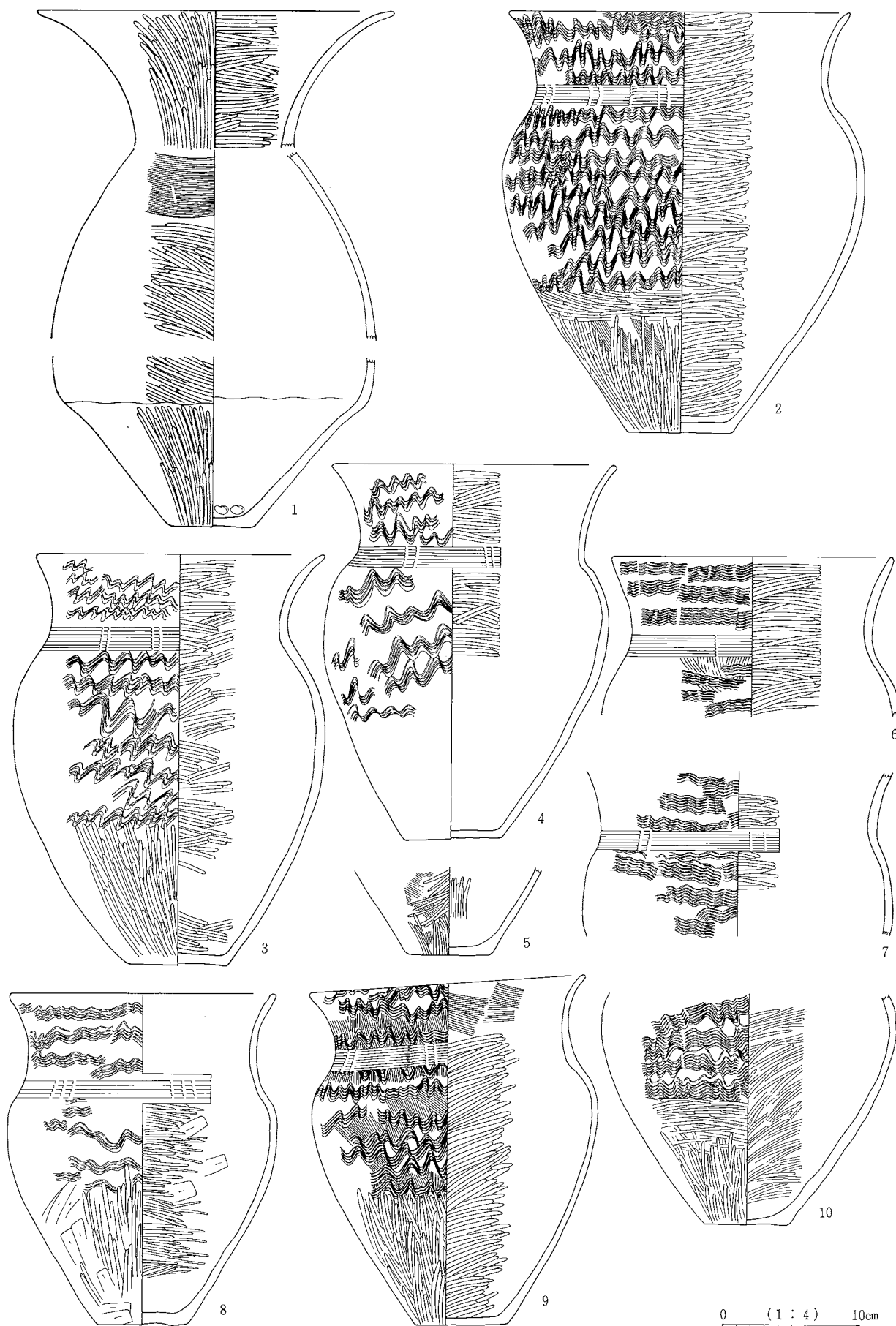

SB222-①

0 (1:4) 10cm

SB222-②

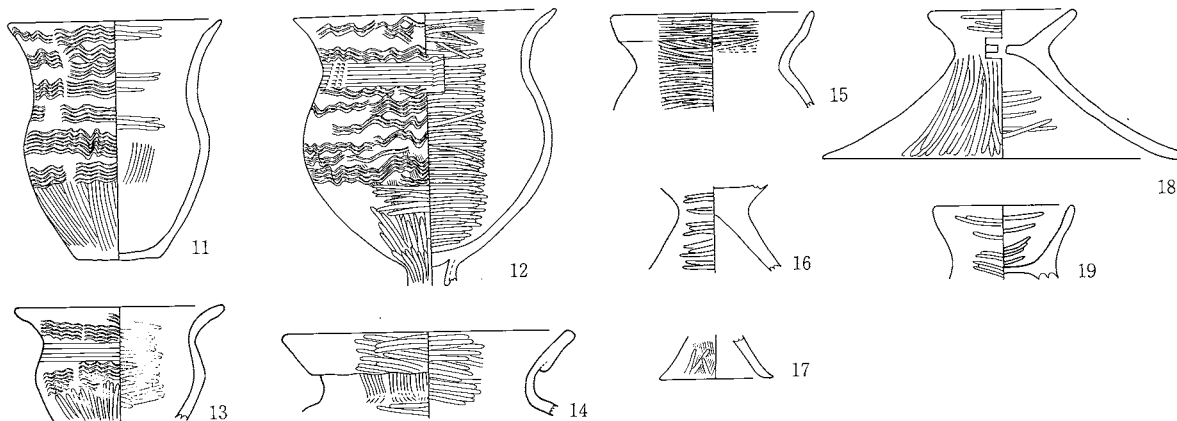

SB252

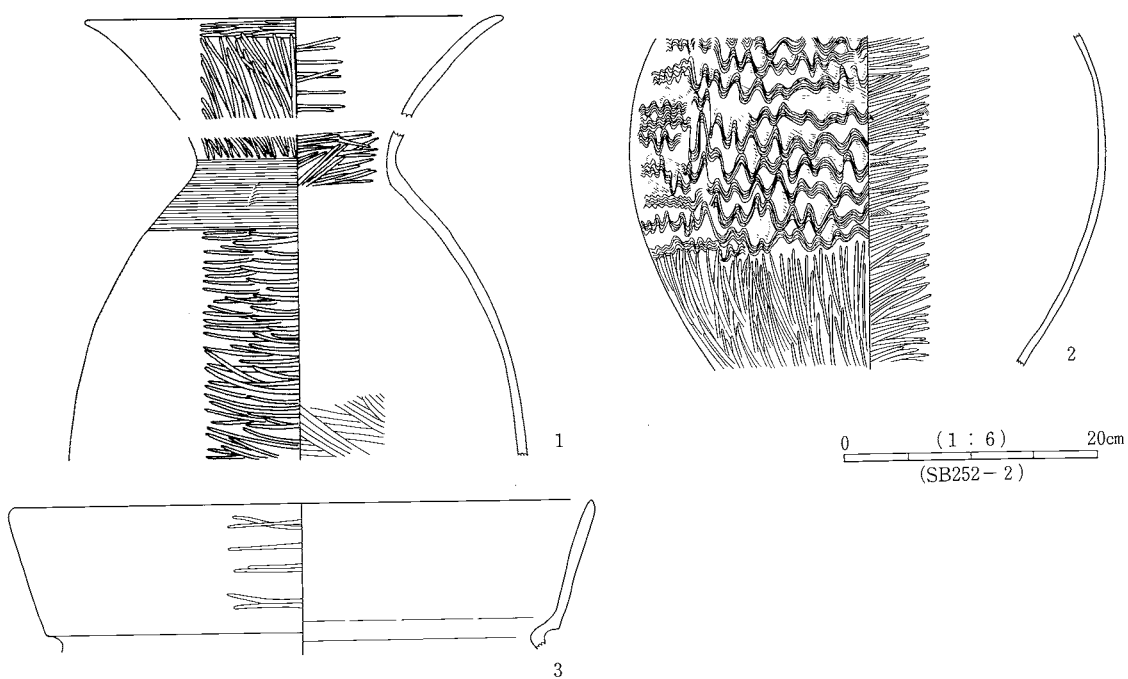

SB253-①

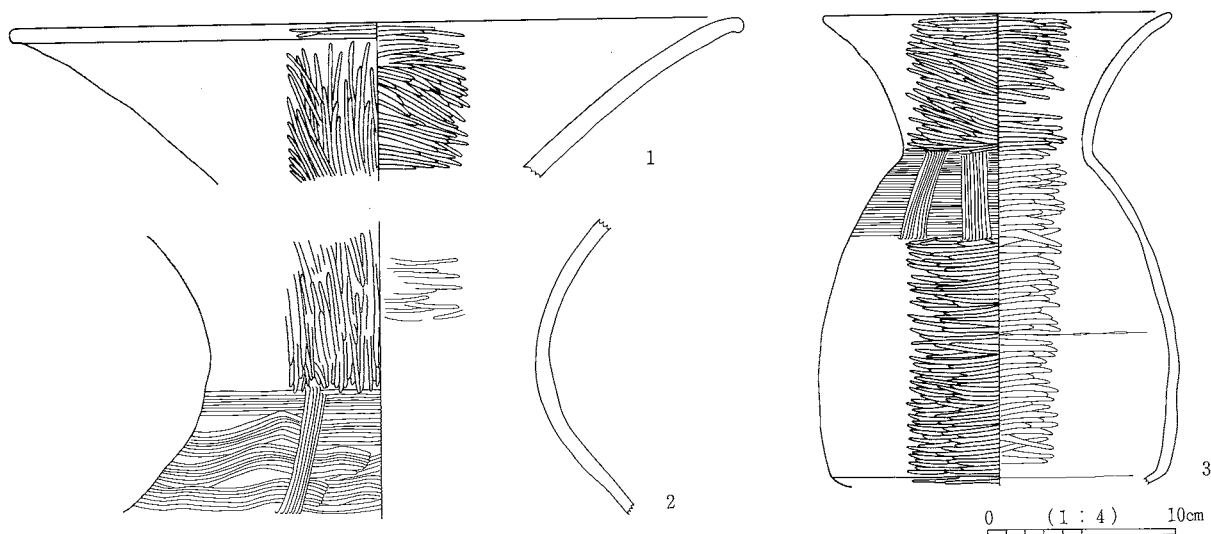

SB253-②

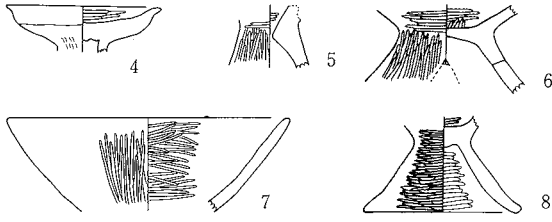

SB293

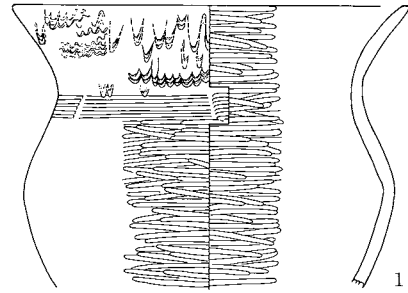

SB294

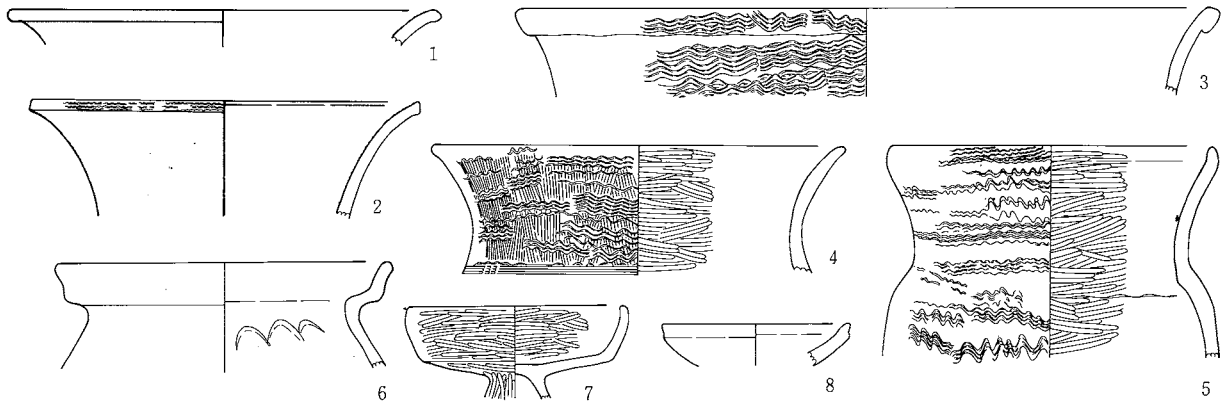

SB297

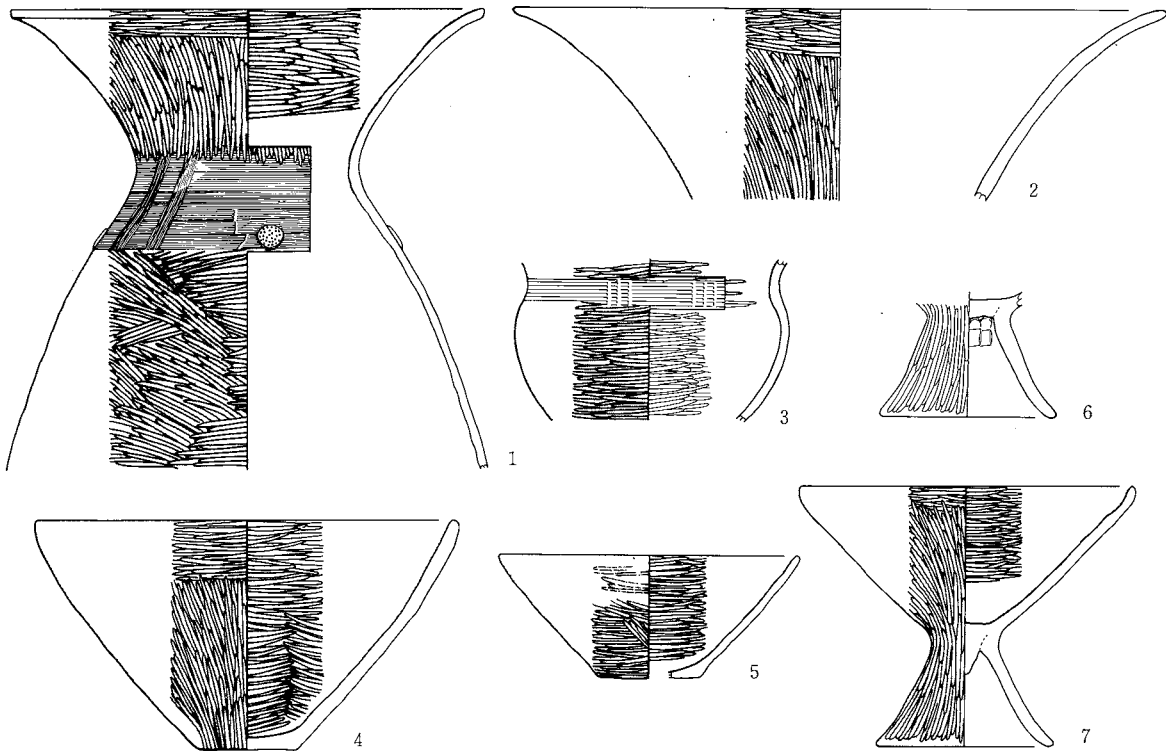

0 (1:6) 20cm

(SB297-1)

0 (1:4) 10cm

SB295

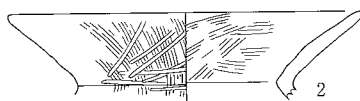
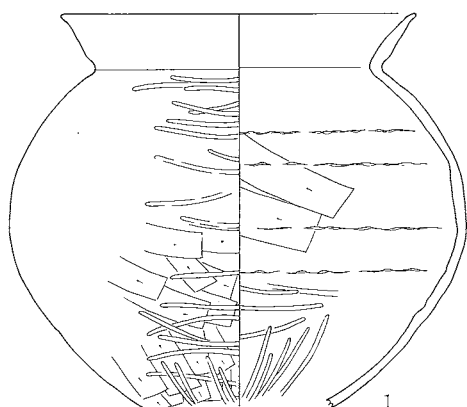

SB300

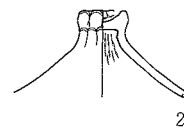

0 (1:4) 10cm

SB302

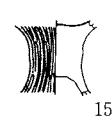
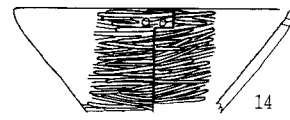
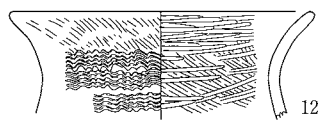
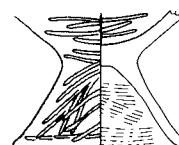
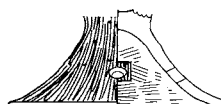
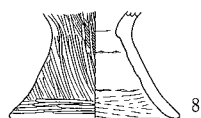
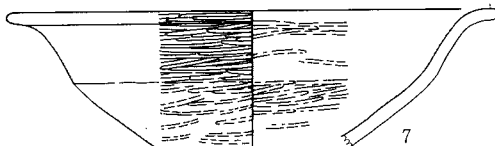
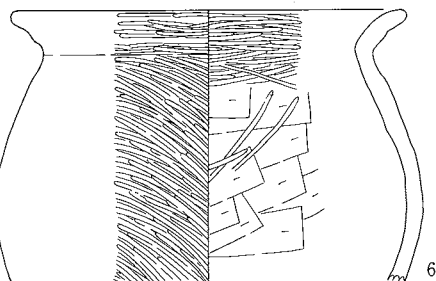
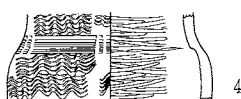
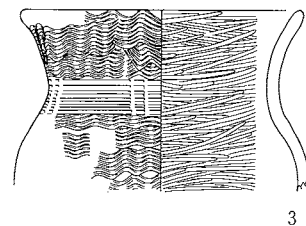
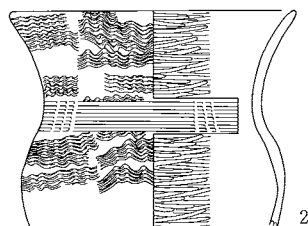
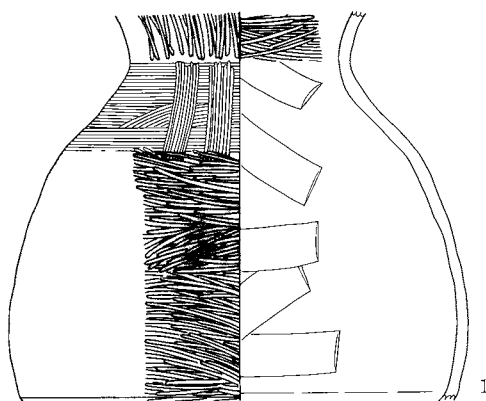

SB307

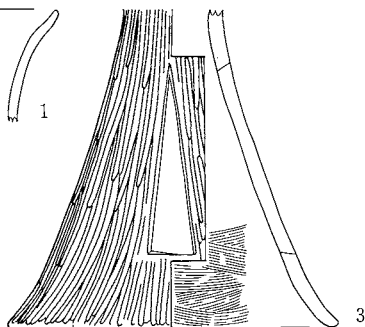
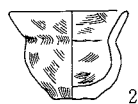
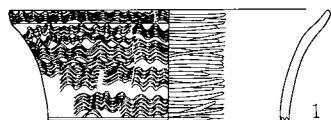

SB312

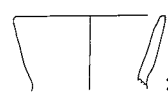
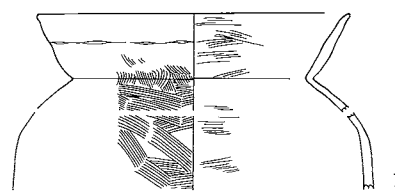

SB295 · 300 · 302 · 307 · 312

SB309

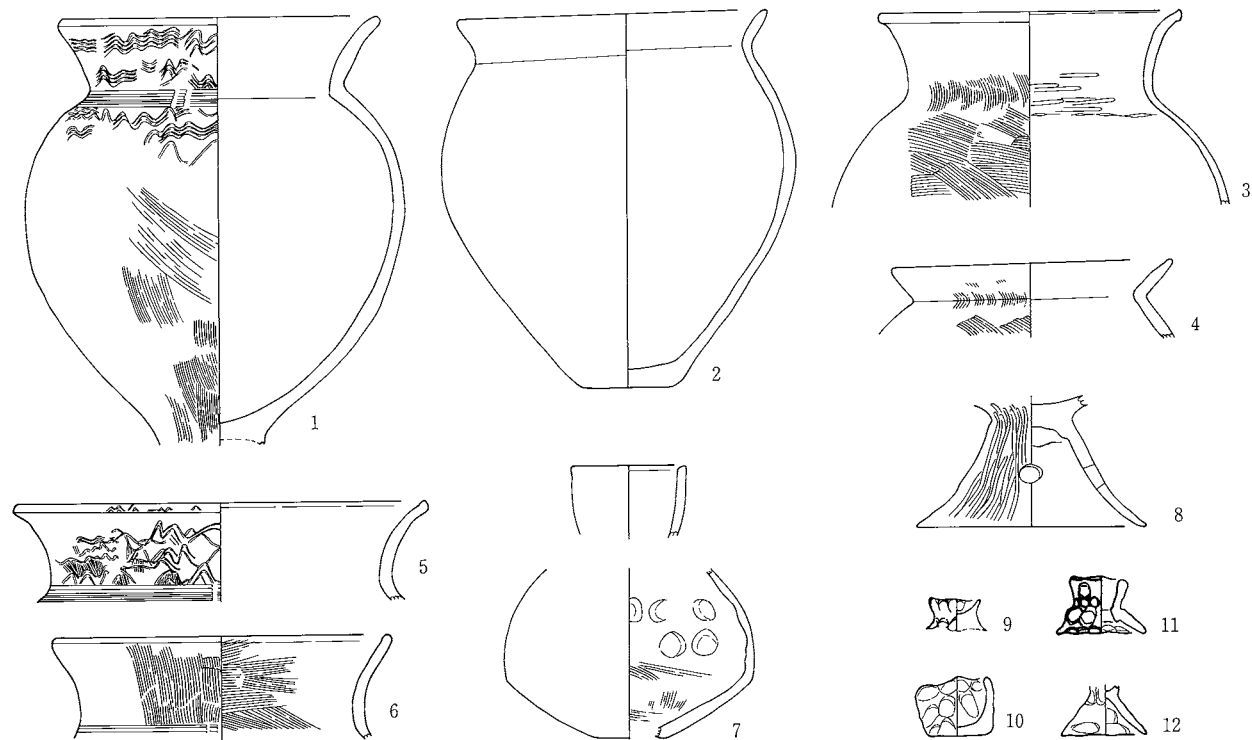

SB318

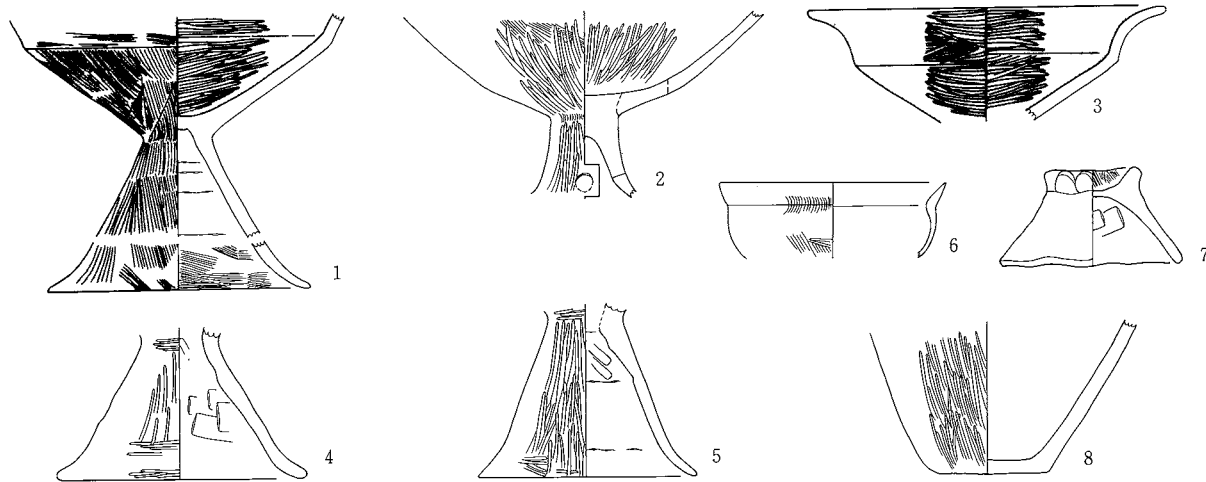

SB319

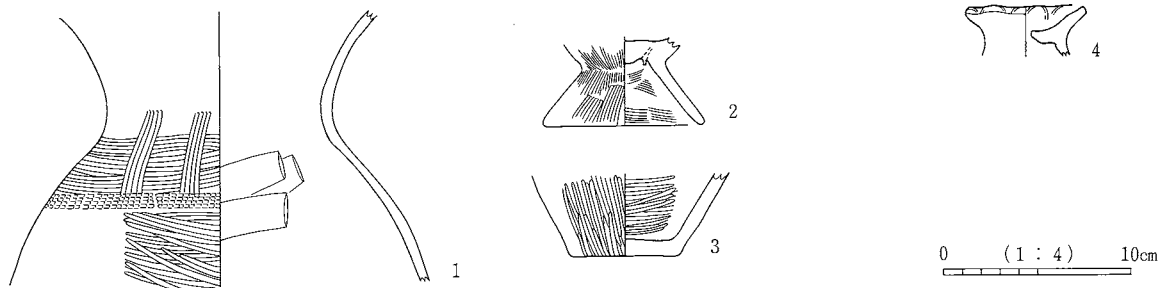

0 (1:4) 10cm

SB309 · 318 · 319

SB382

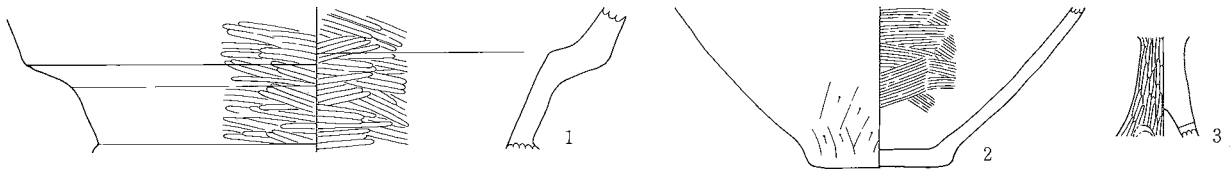

SB384

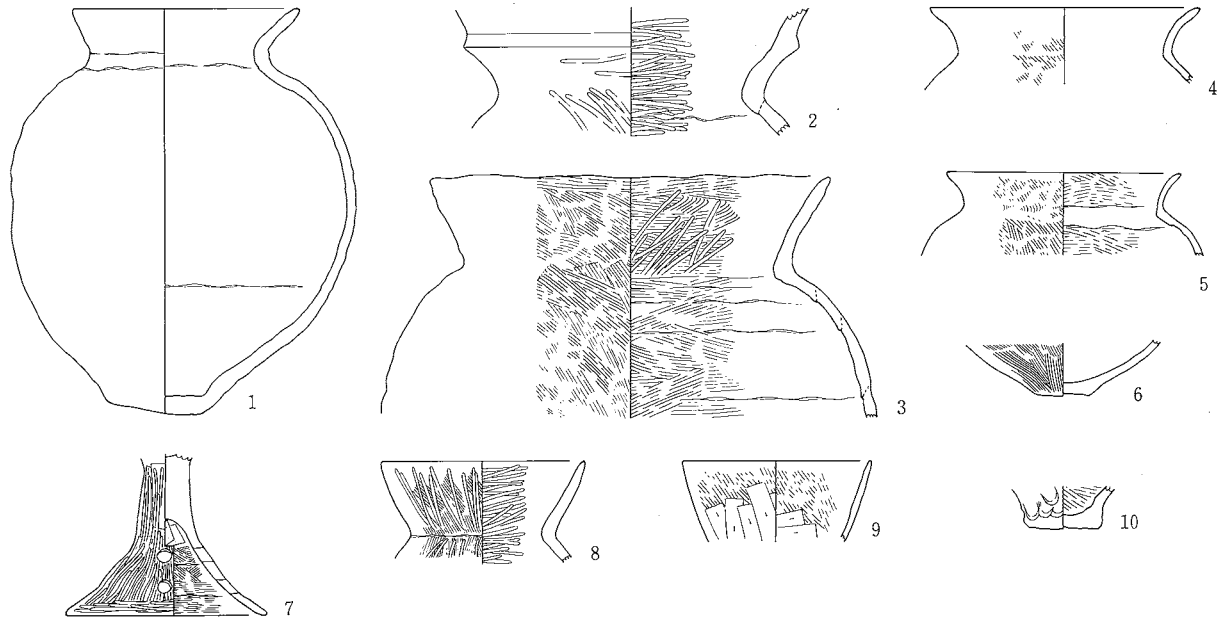

SB591

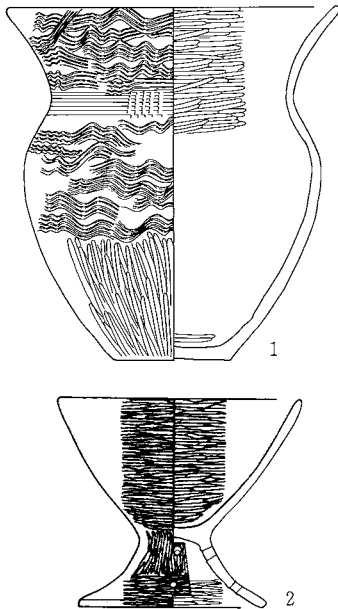

SB1090

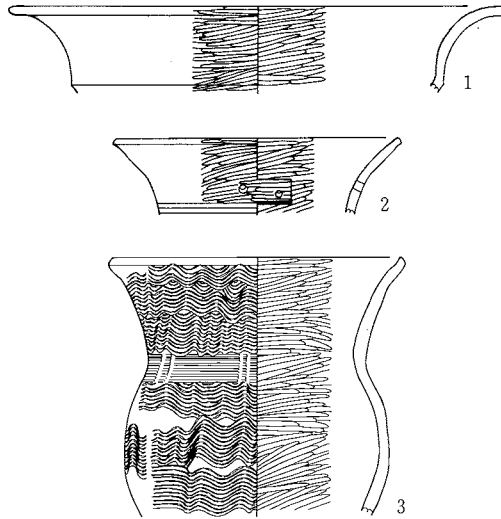

SB829

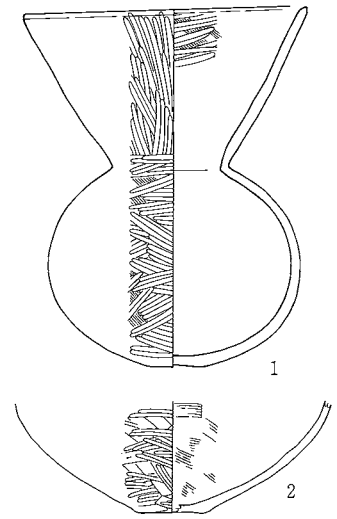

0 (1:8) 20cm
(SB829-2)

0 (1:4) 10cm

SB478

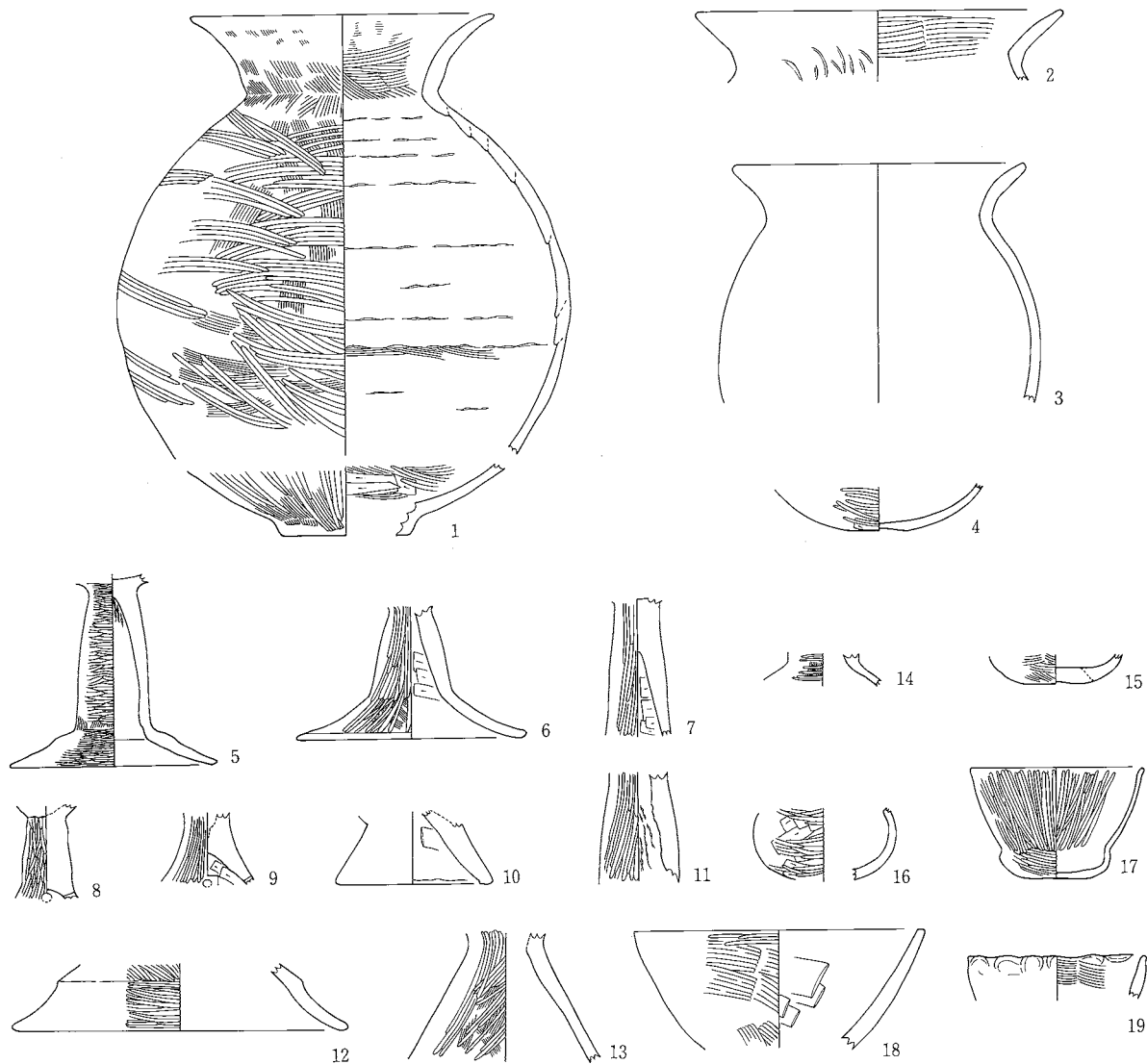

SB830

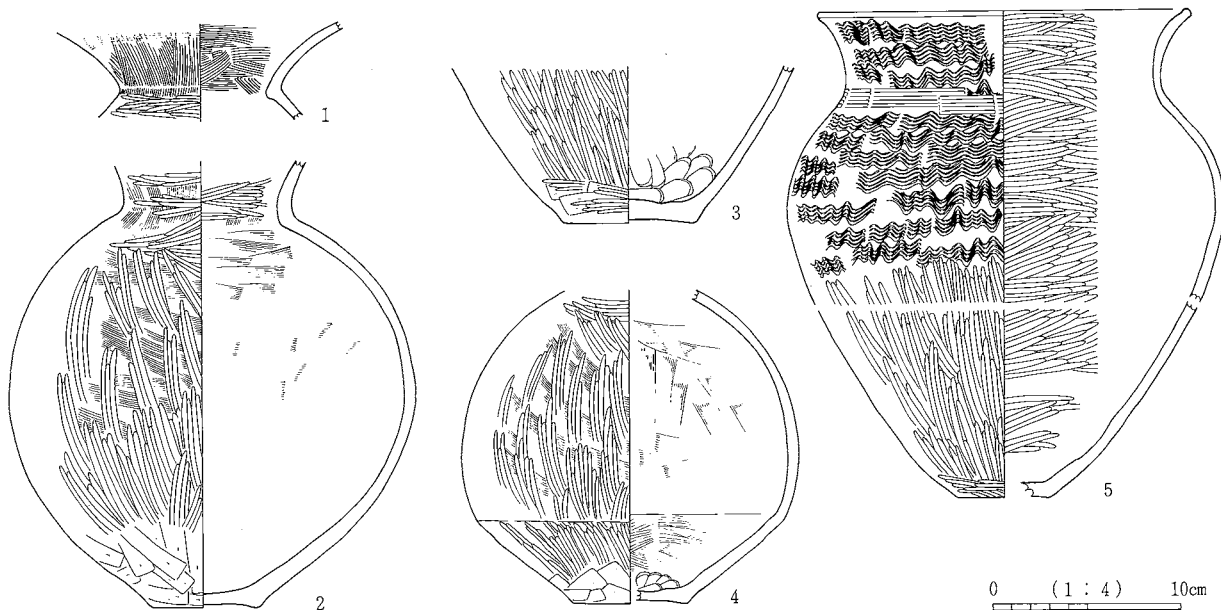

SB478・830

0 (1:4) 10cm

SB1091

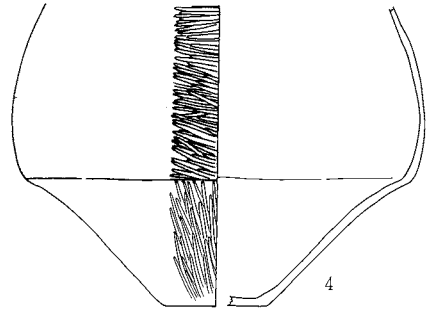
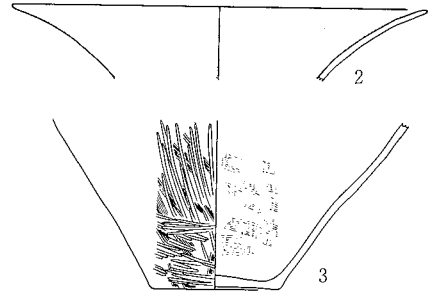
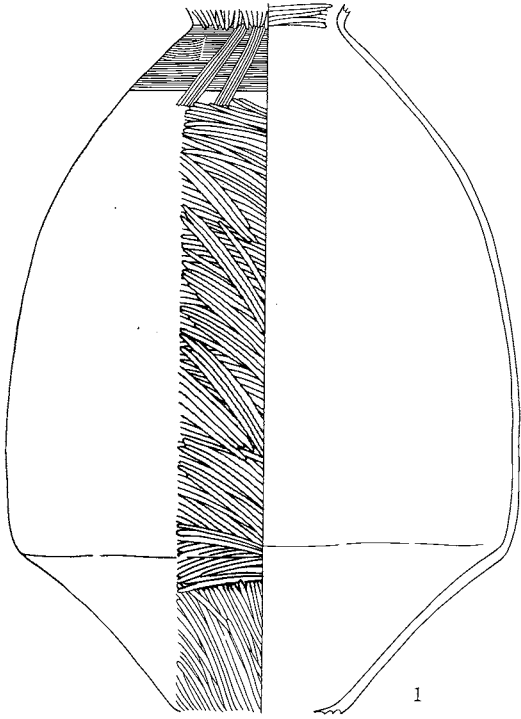

0 (1:8) 20cm
(SB1091-1-2-3-4)

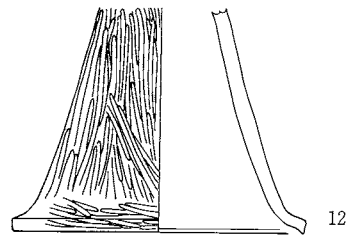
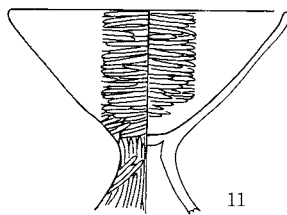
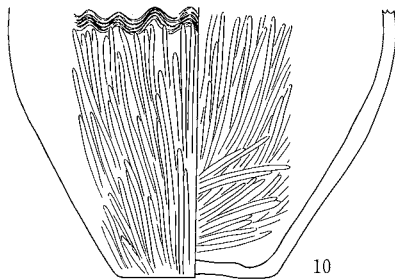
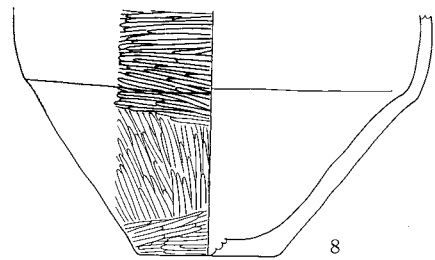
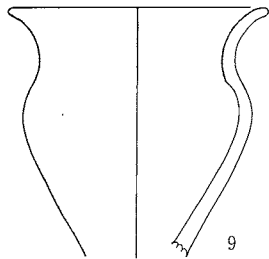
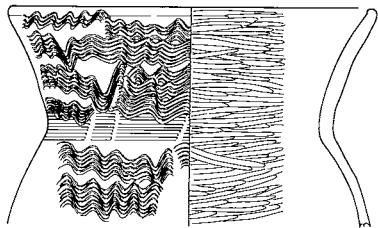
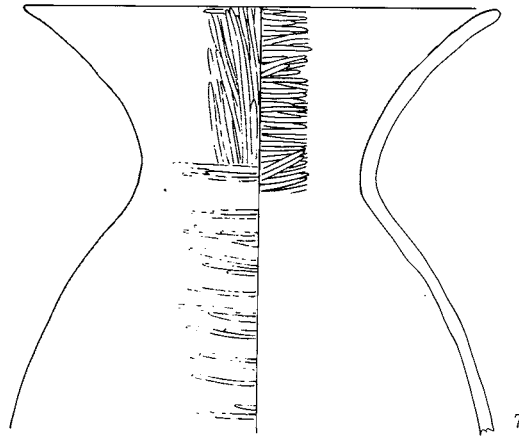
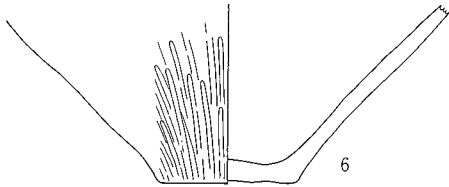
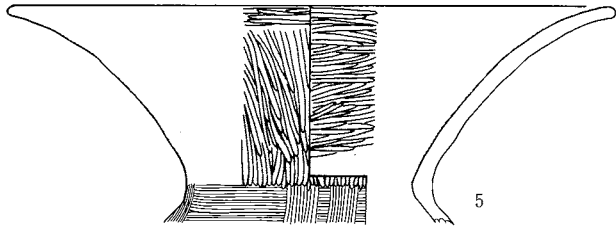

0 (1:4) 10cm

SB1091

SB1101

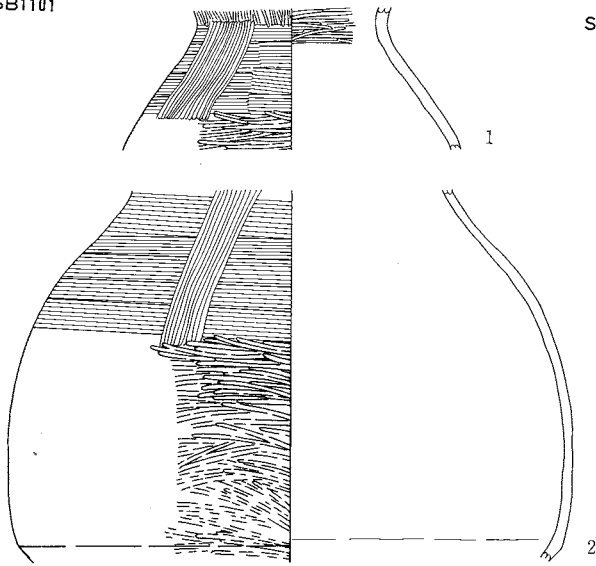

SB1145

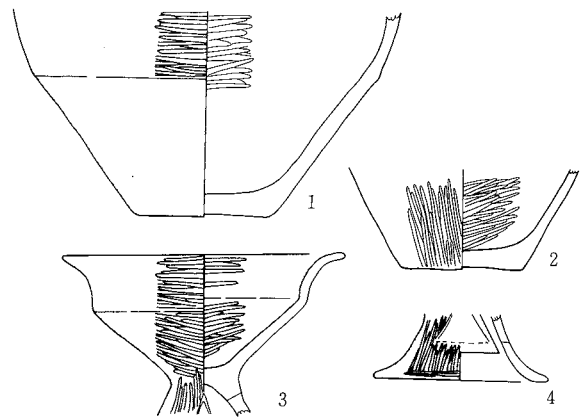

SB1102

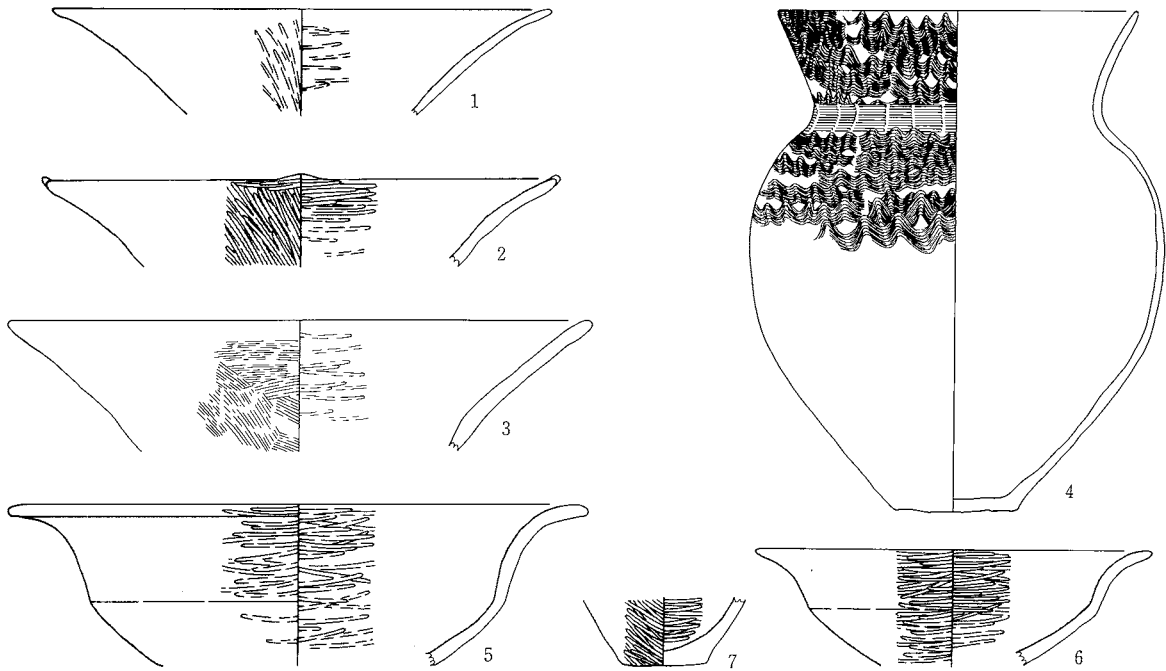

SB1149

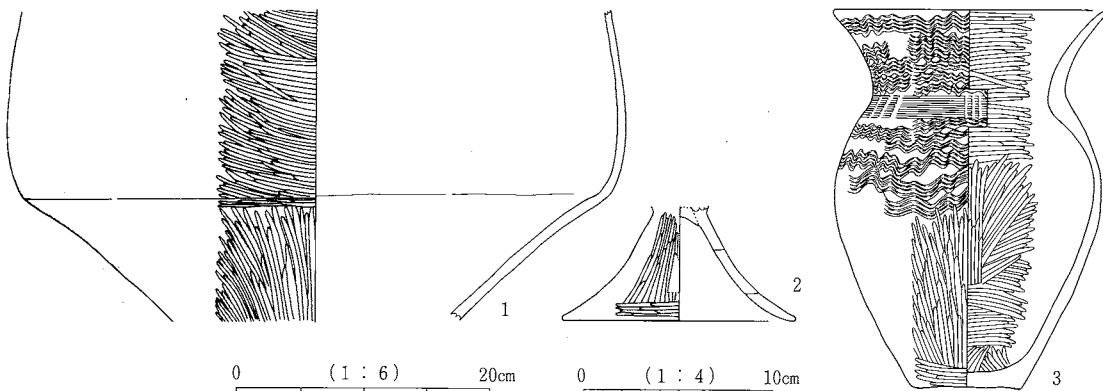

0 (1:6) 20cm
(SB1102-1·4) (SB1149-1)

0 (1:4) 10cm

SB1101 · 1102 · 1145 · 1149

SB1137

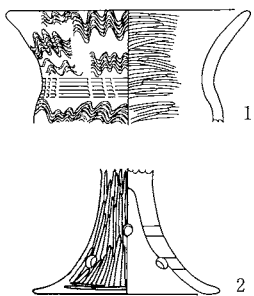

SB1185

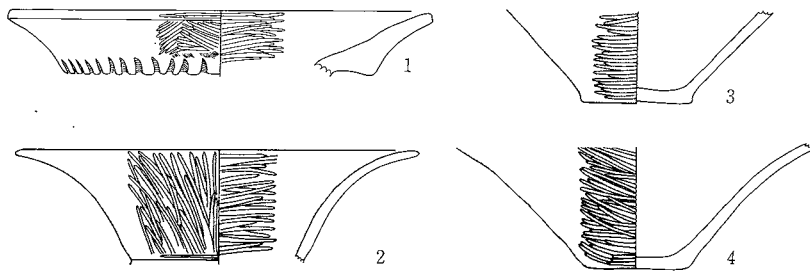

SB1183

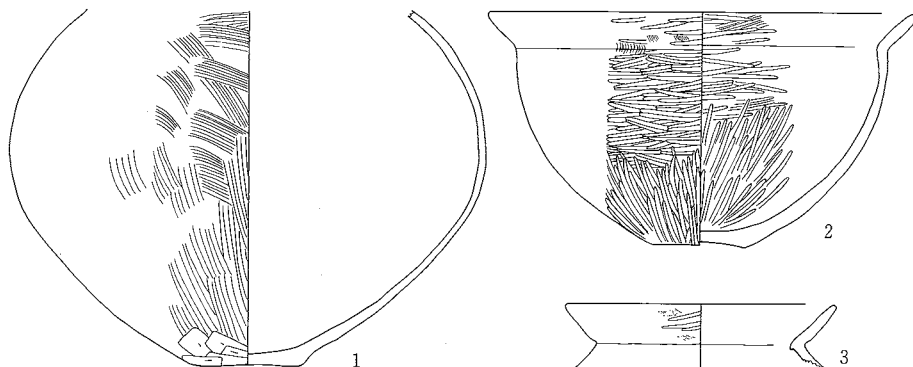

SB1187

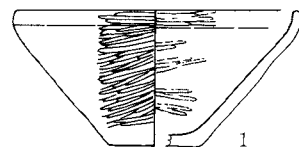

SB1186

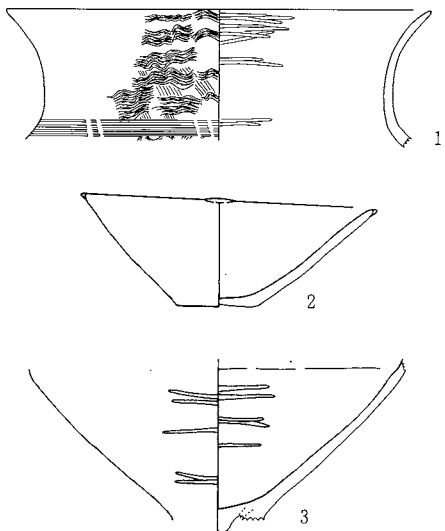

SB1188

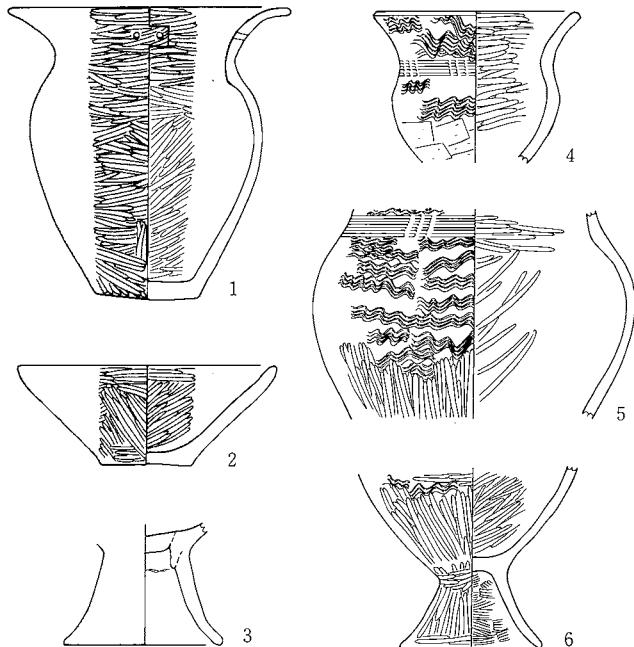

0 (1:6) 20cm
(SB1186-1)

0 (1:4) 10cm

SB1248

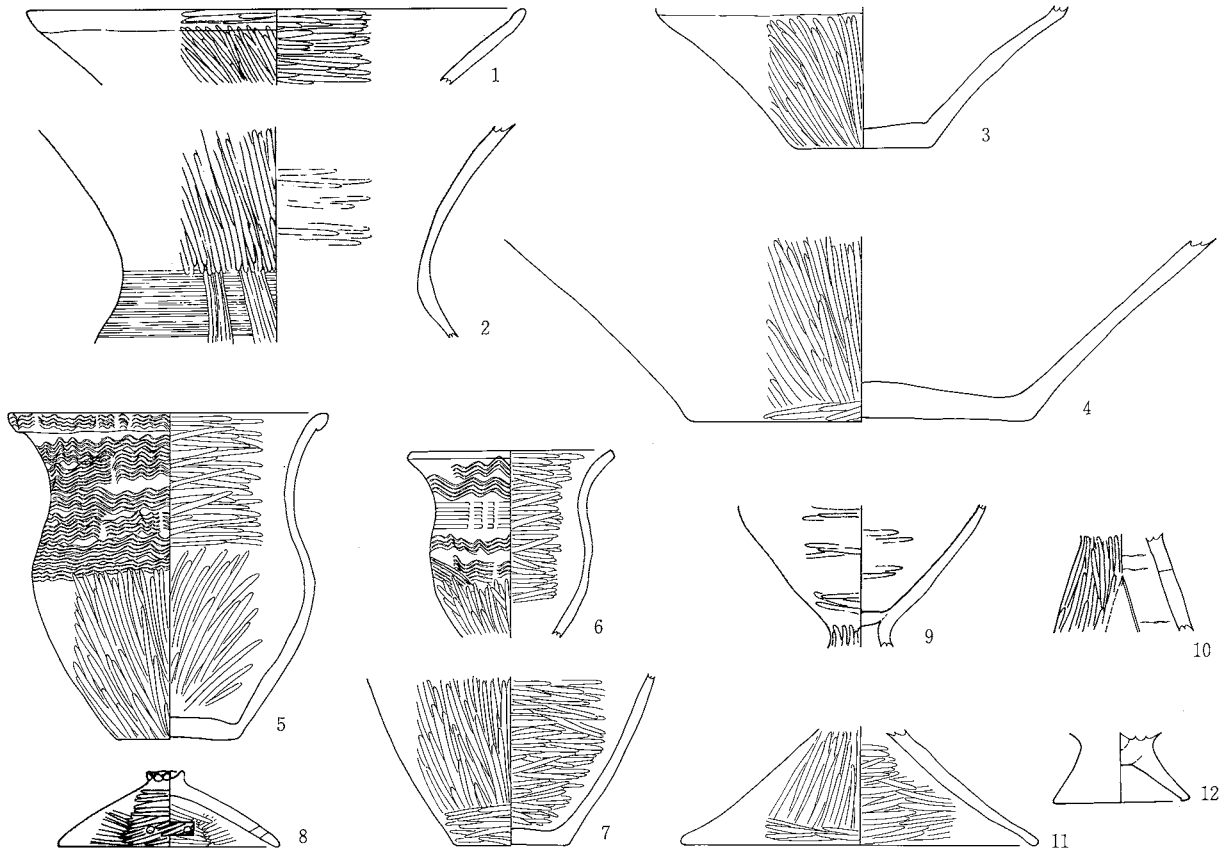

SB1266

0 (1:6) 20cm
(SB1266-1)

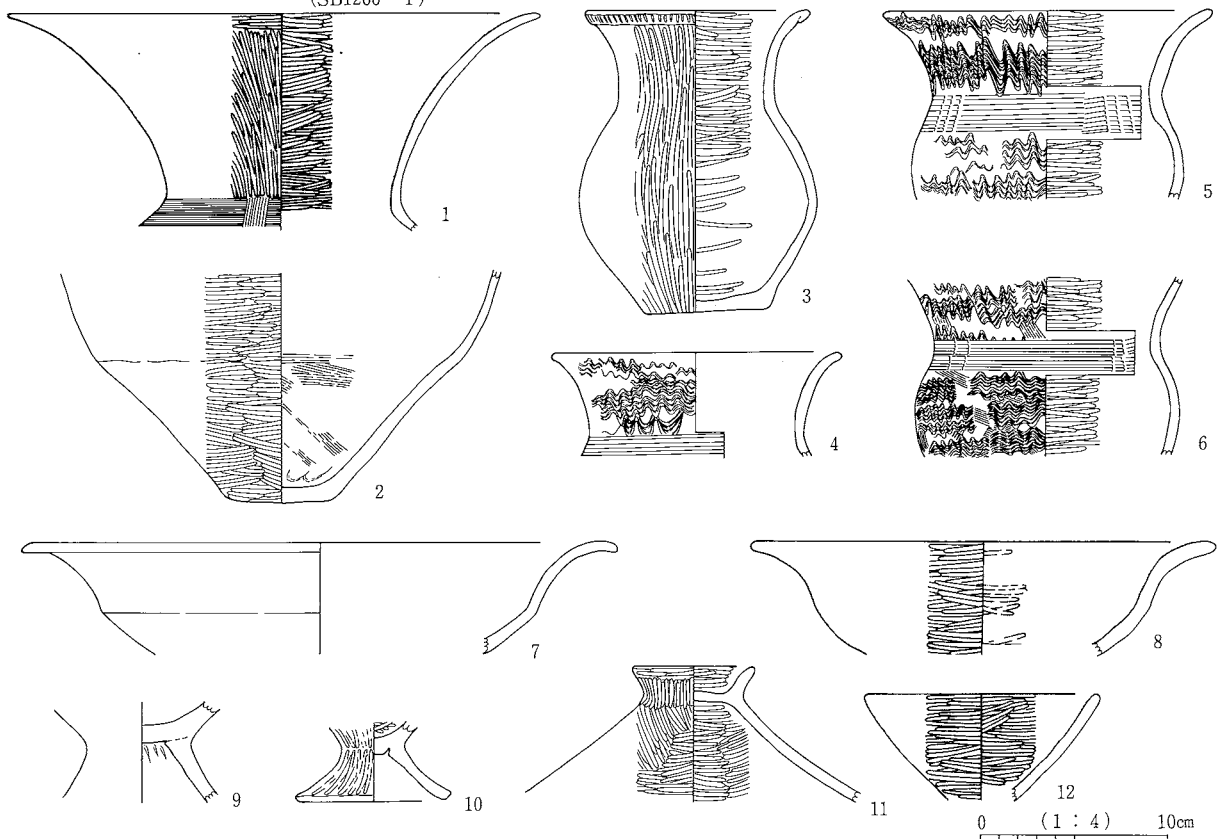

SB1248・1266

SB1268

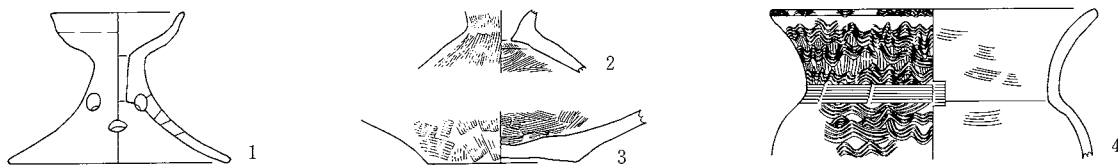

SB1272

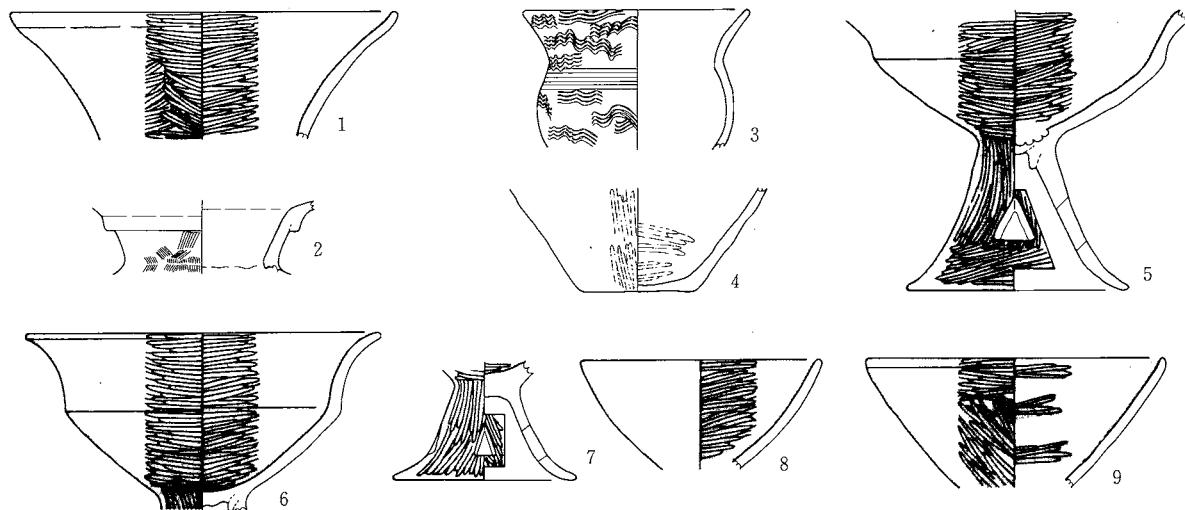

SB1275

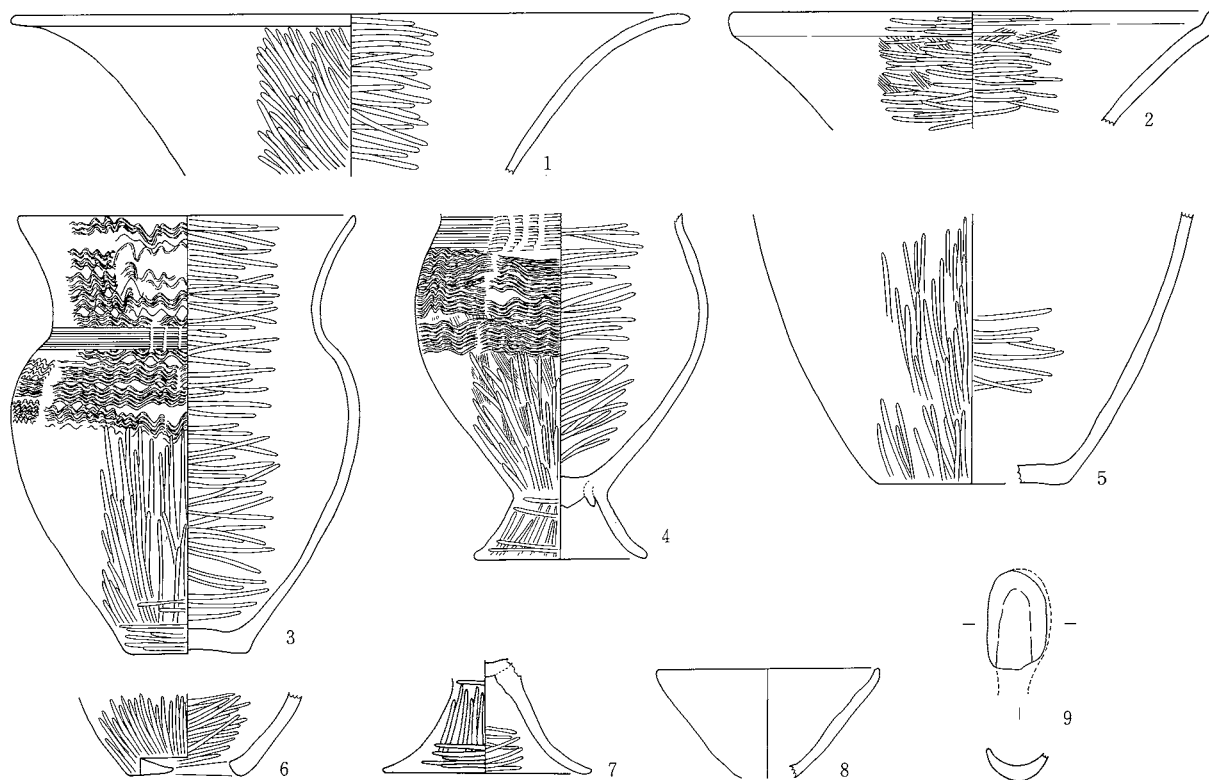

0 (1:4) 10cm

SB1431

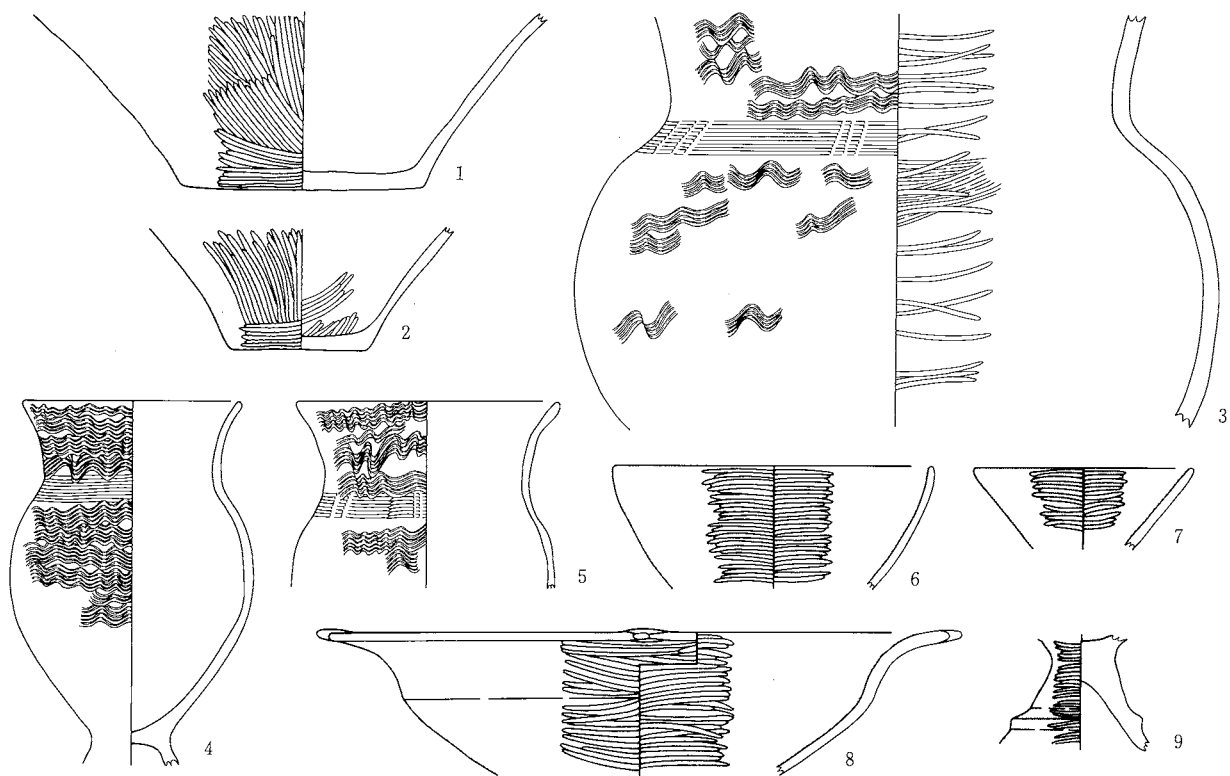

SB1441

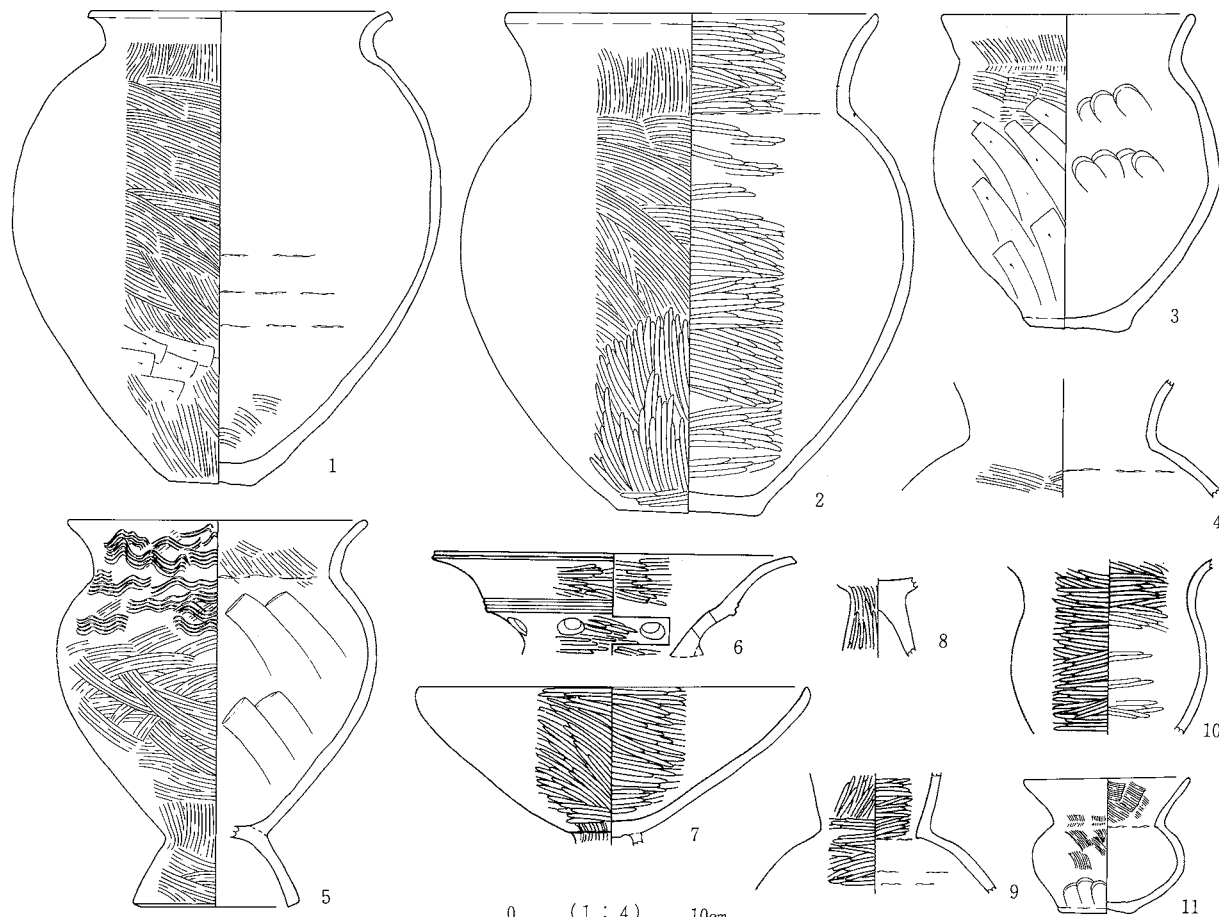

0 (1 : 4) 10cm

SB1431 · 1441

SB1442

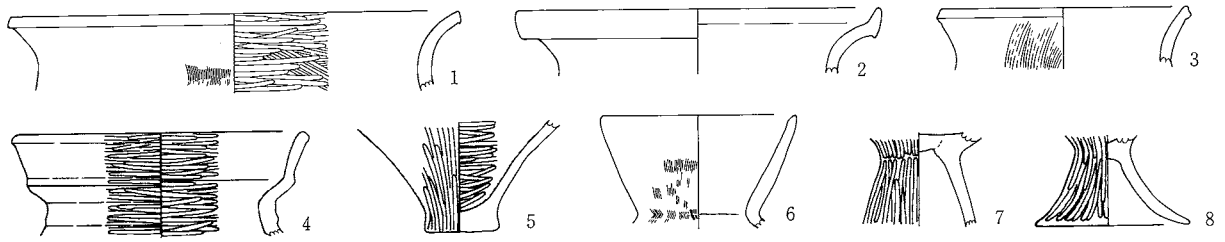

SB1444

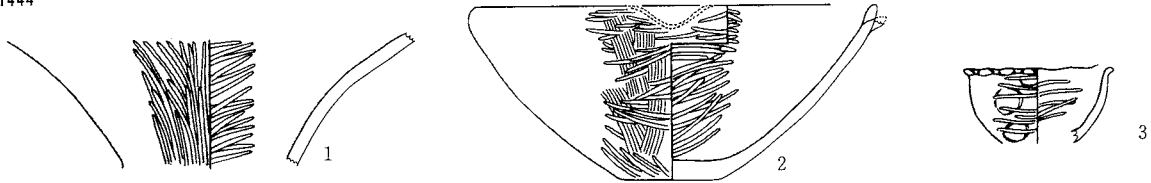

SB1445

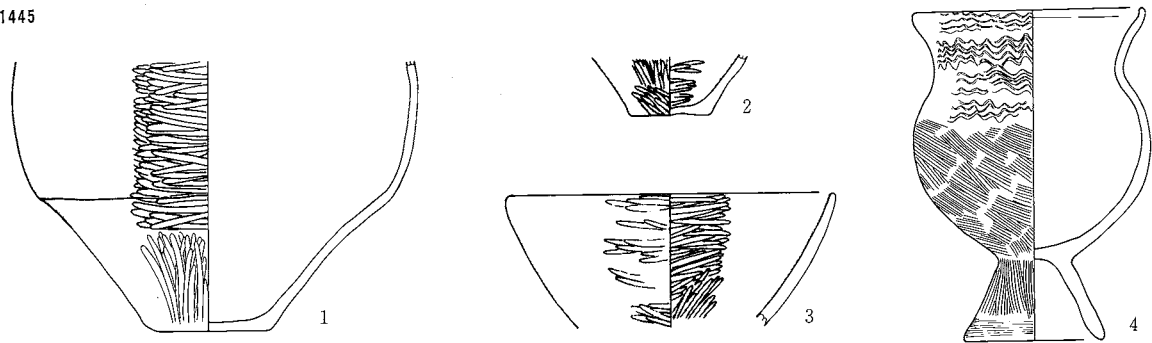

SB1447

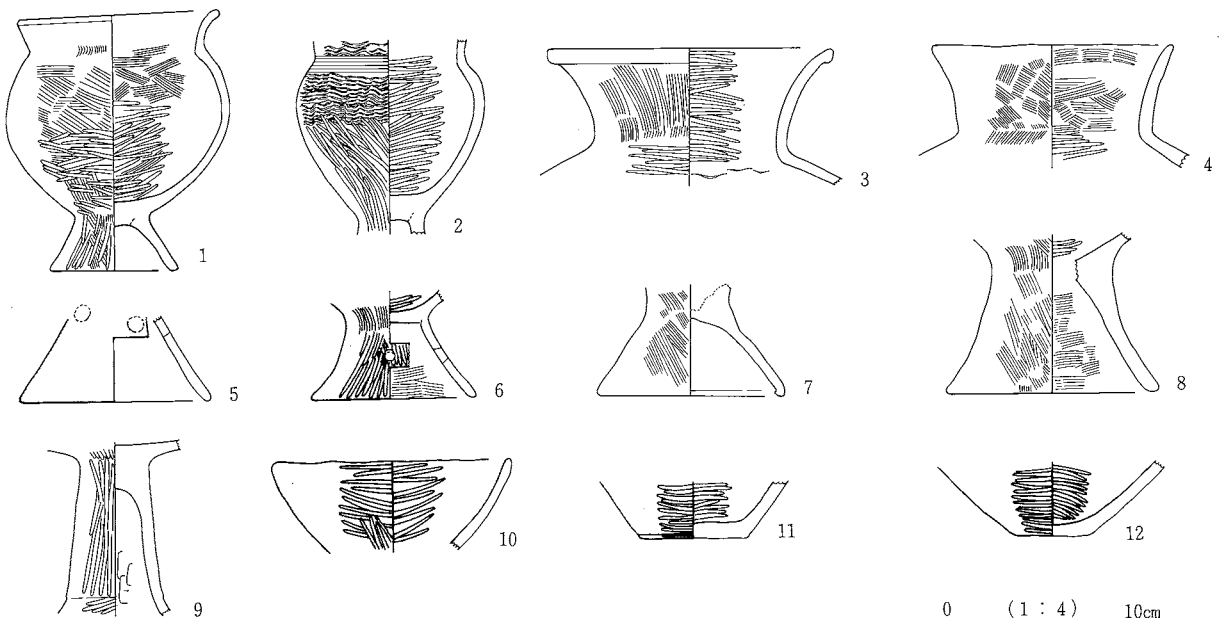

0 (1 : 4) 10cm

SB1448

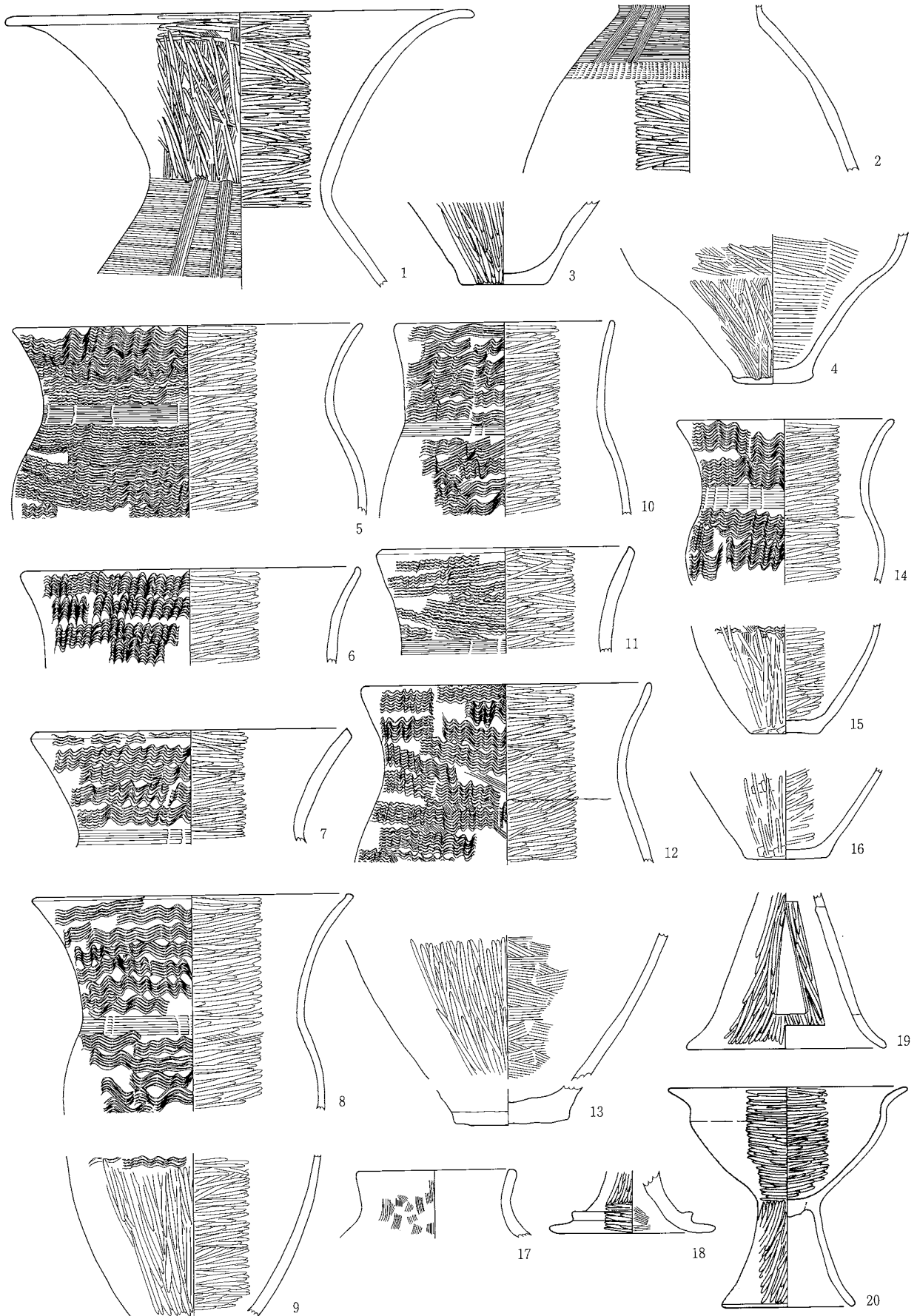

0 (1 : 4) 10cm

SB1448

SB1449

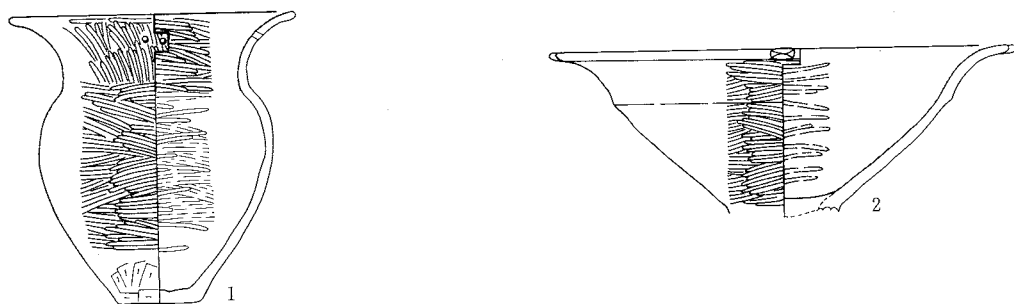

SB1450

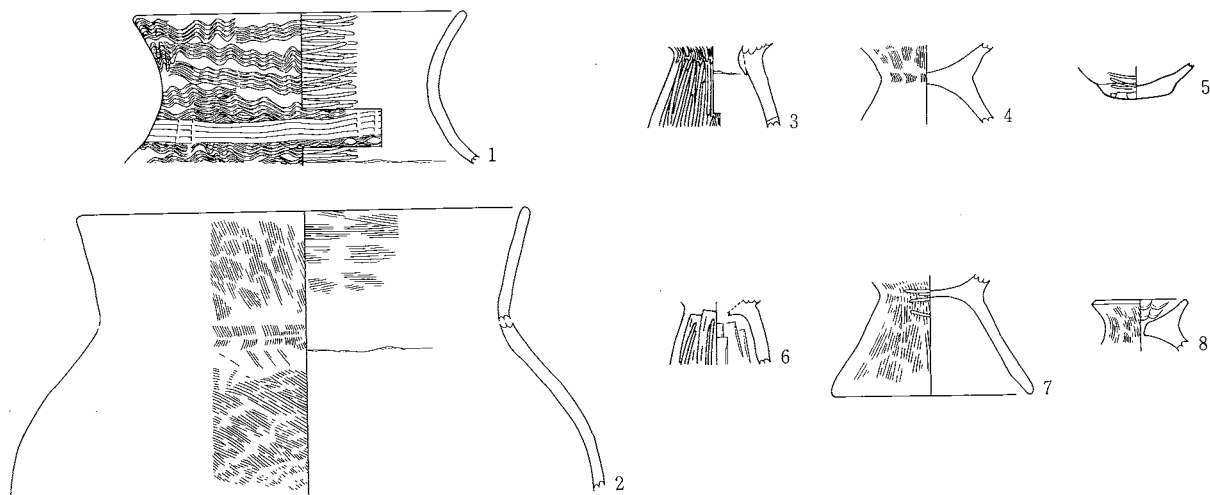

SB1453

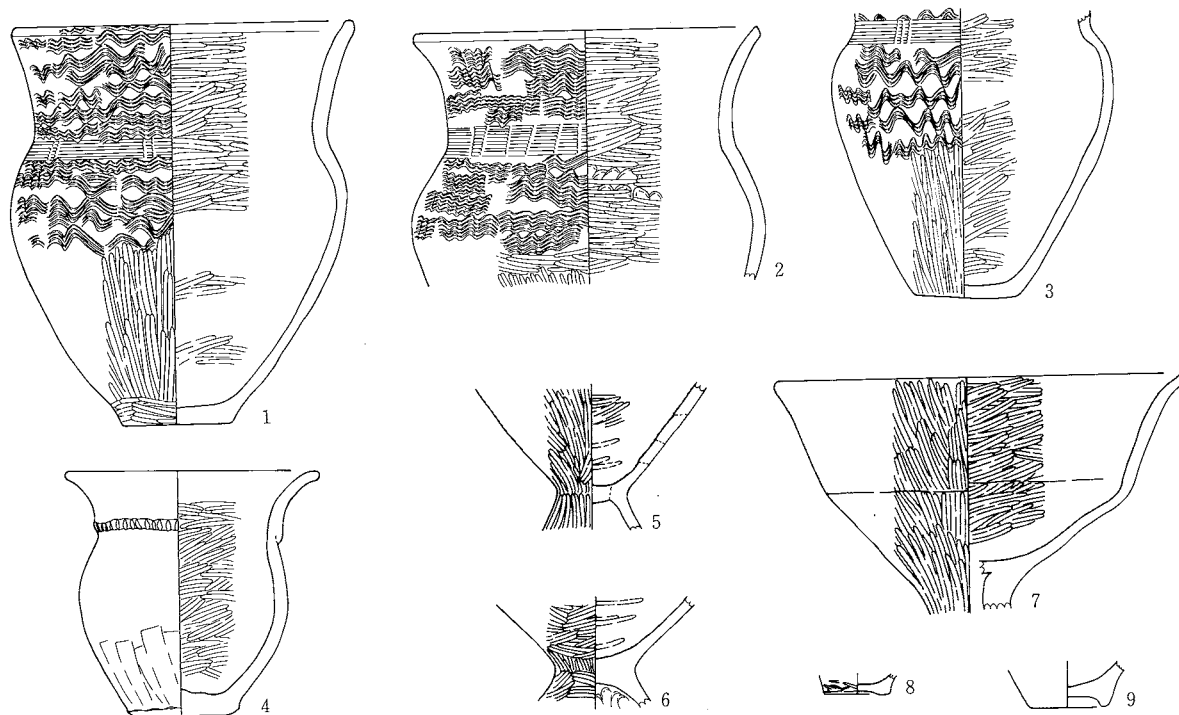

0 (1 : 4) 10cm

SB1454

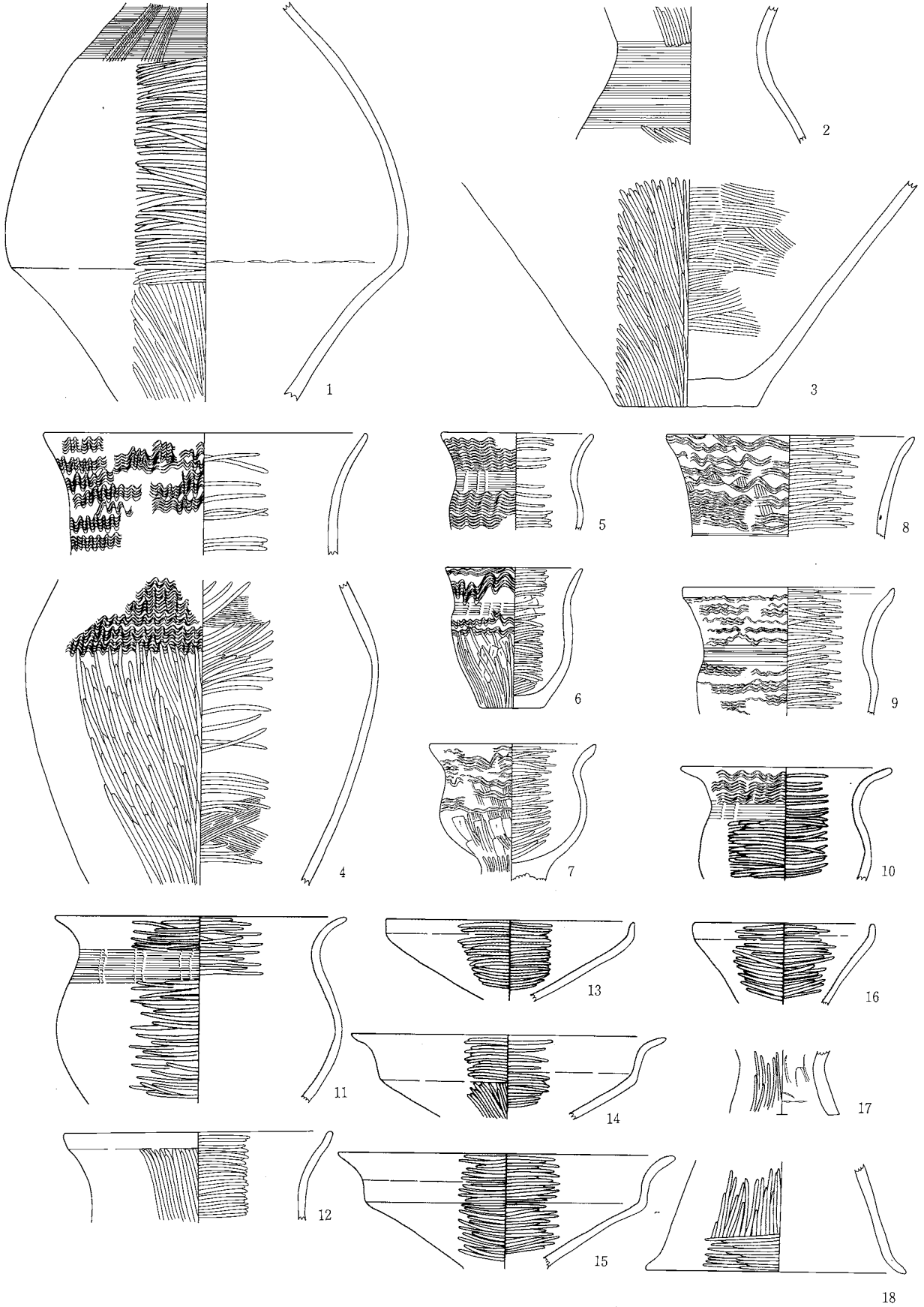

0 (1:4) 10cm

SB1454

SB1458

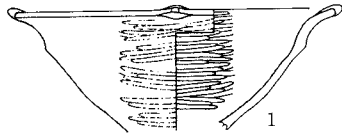

SB1459

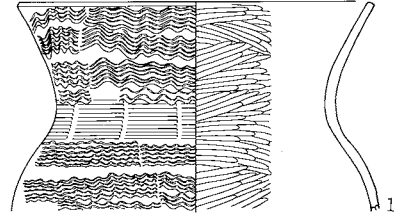

SB1463

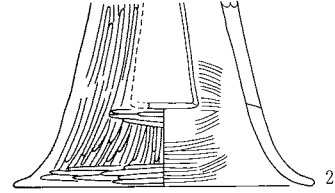
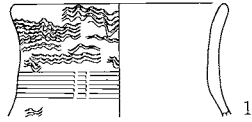

SB1466

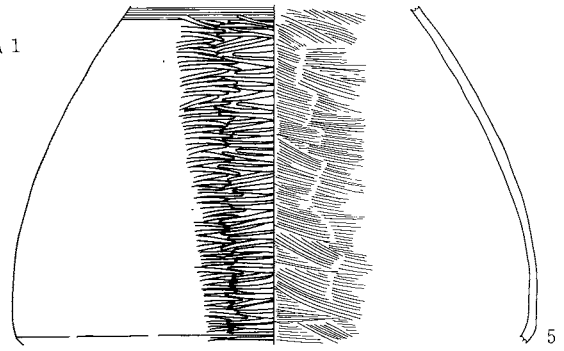
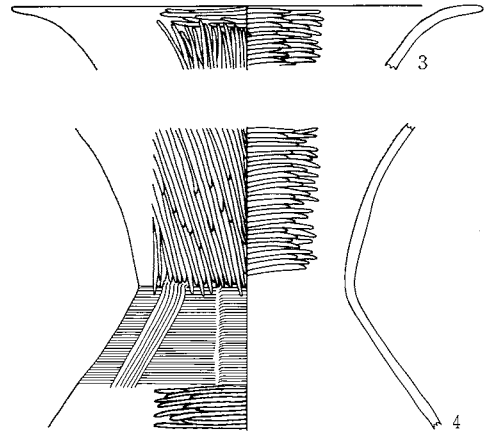
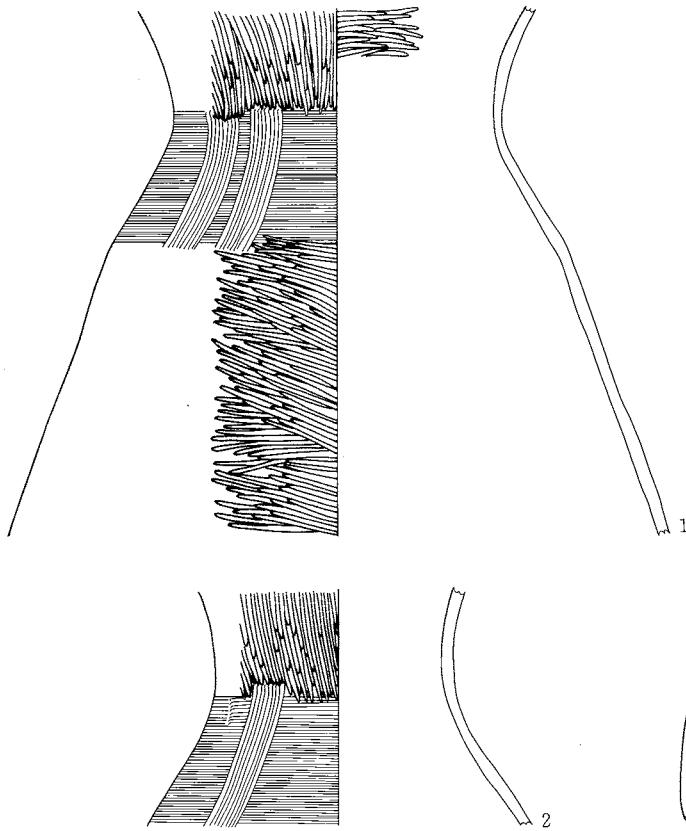

SB1609

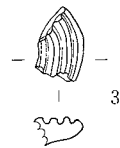
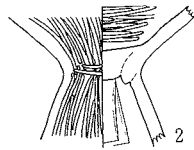
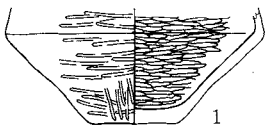

SB1603

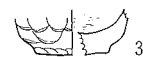
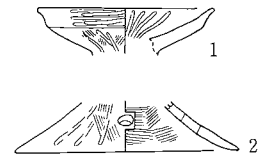

0 (1 : 4) 10cm

SB1458 · 1459 · 1463 · 1466 · 1603 · 1609

SB1464

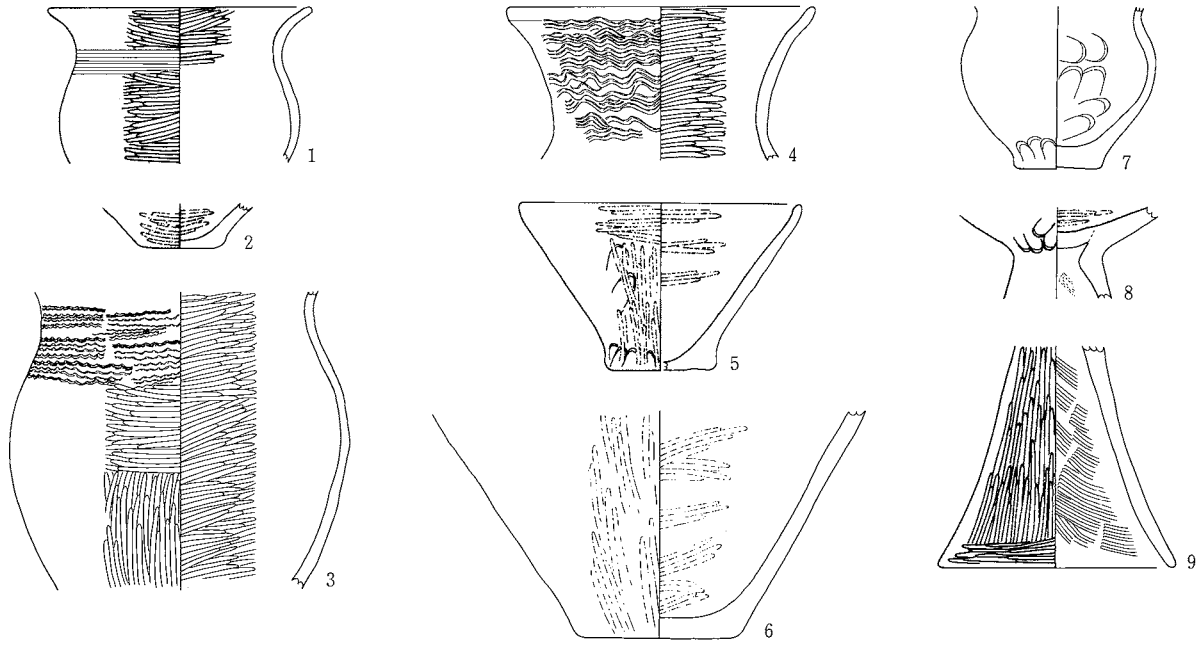

SB1613

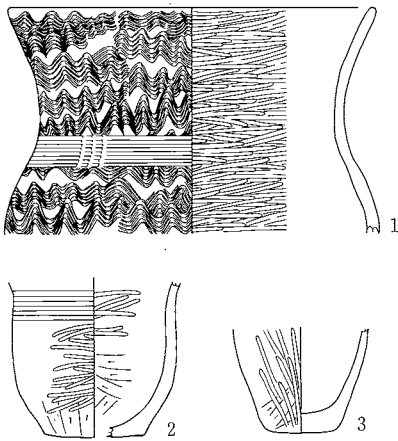

SB1621

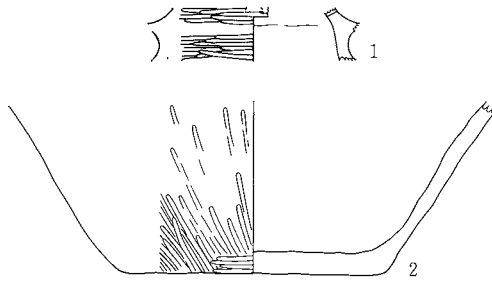

SB1622

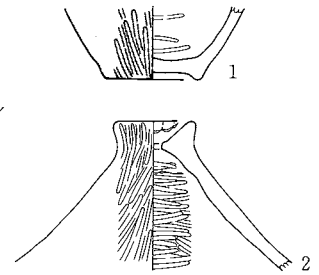

SB1615

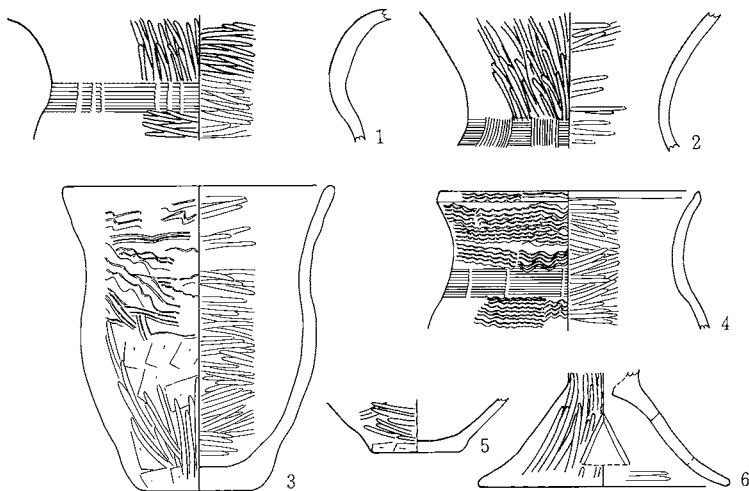

SB1626

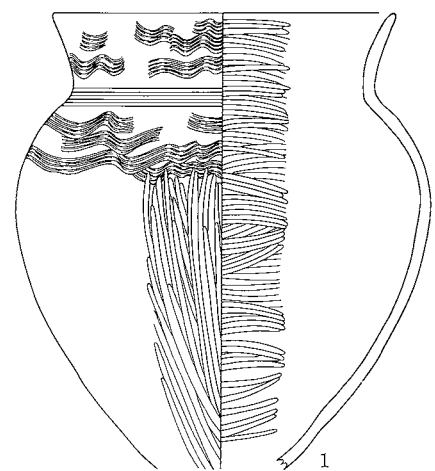

0 (1 : 4) 10cm

SB1624

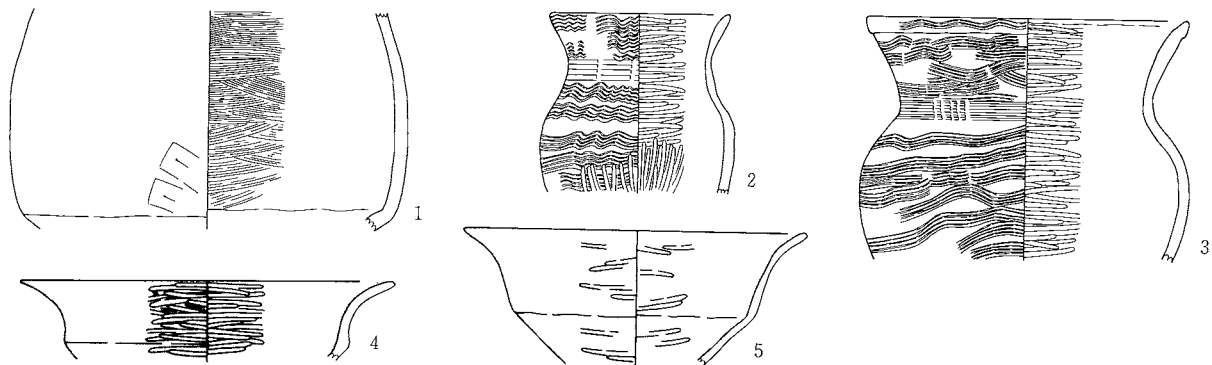

SB1625

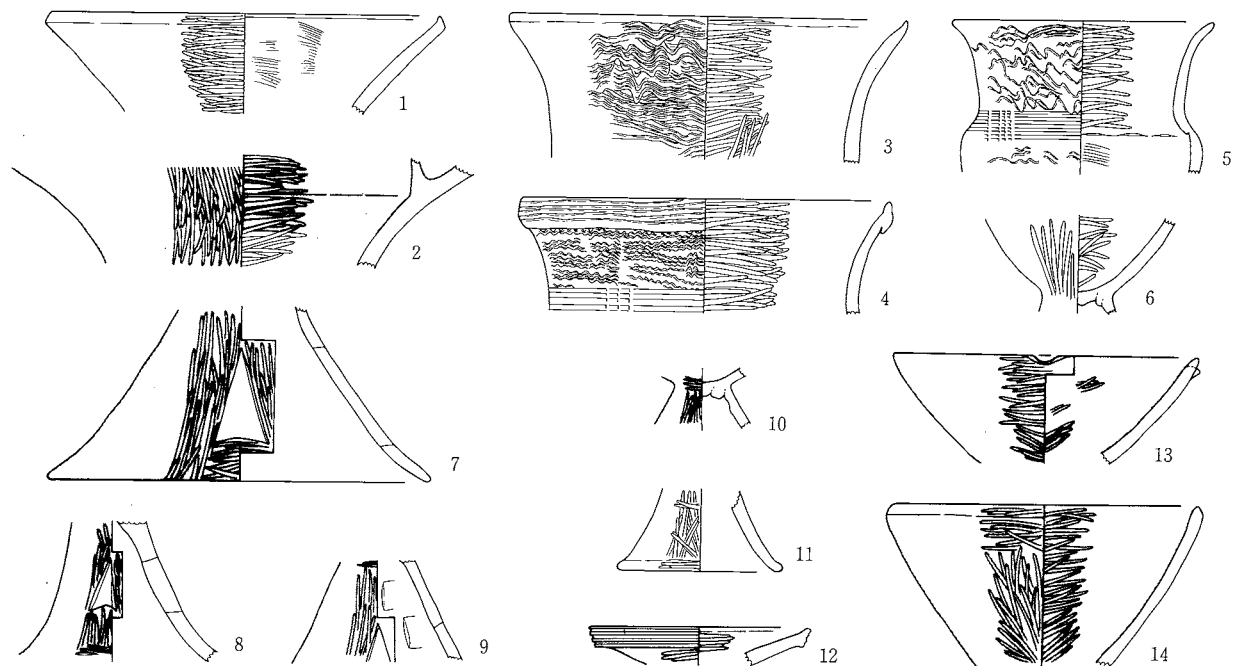

SB1628

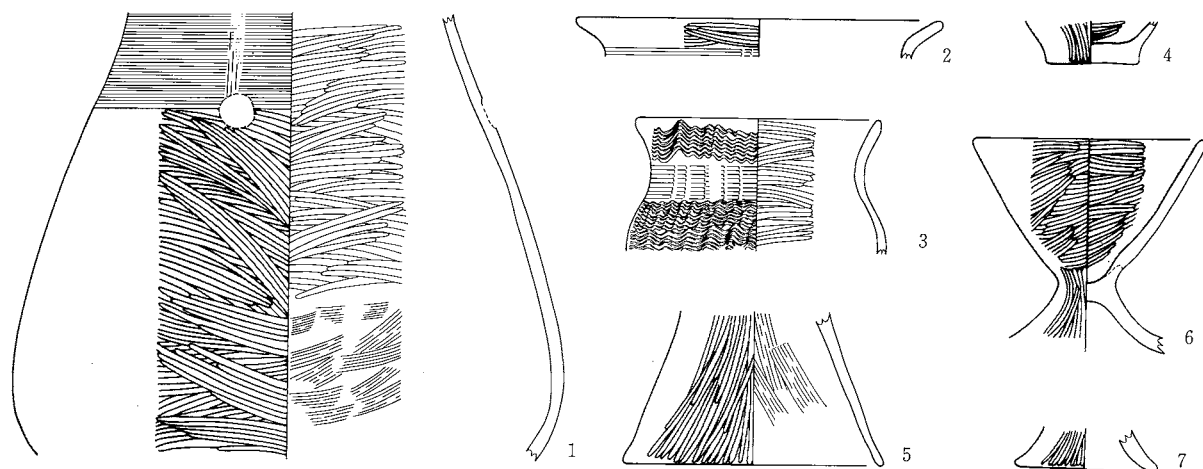

0 (1:4) 10cm

SB1630

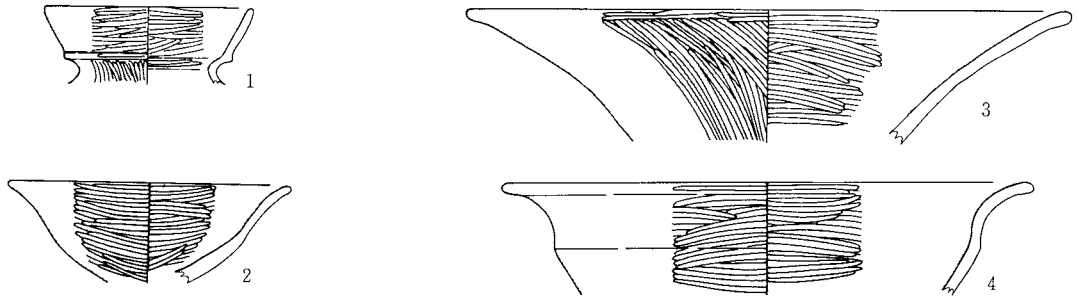

SB1631

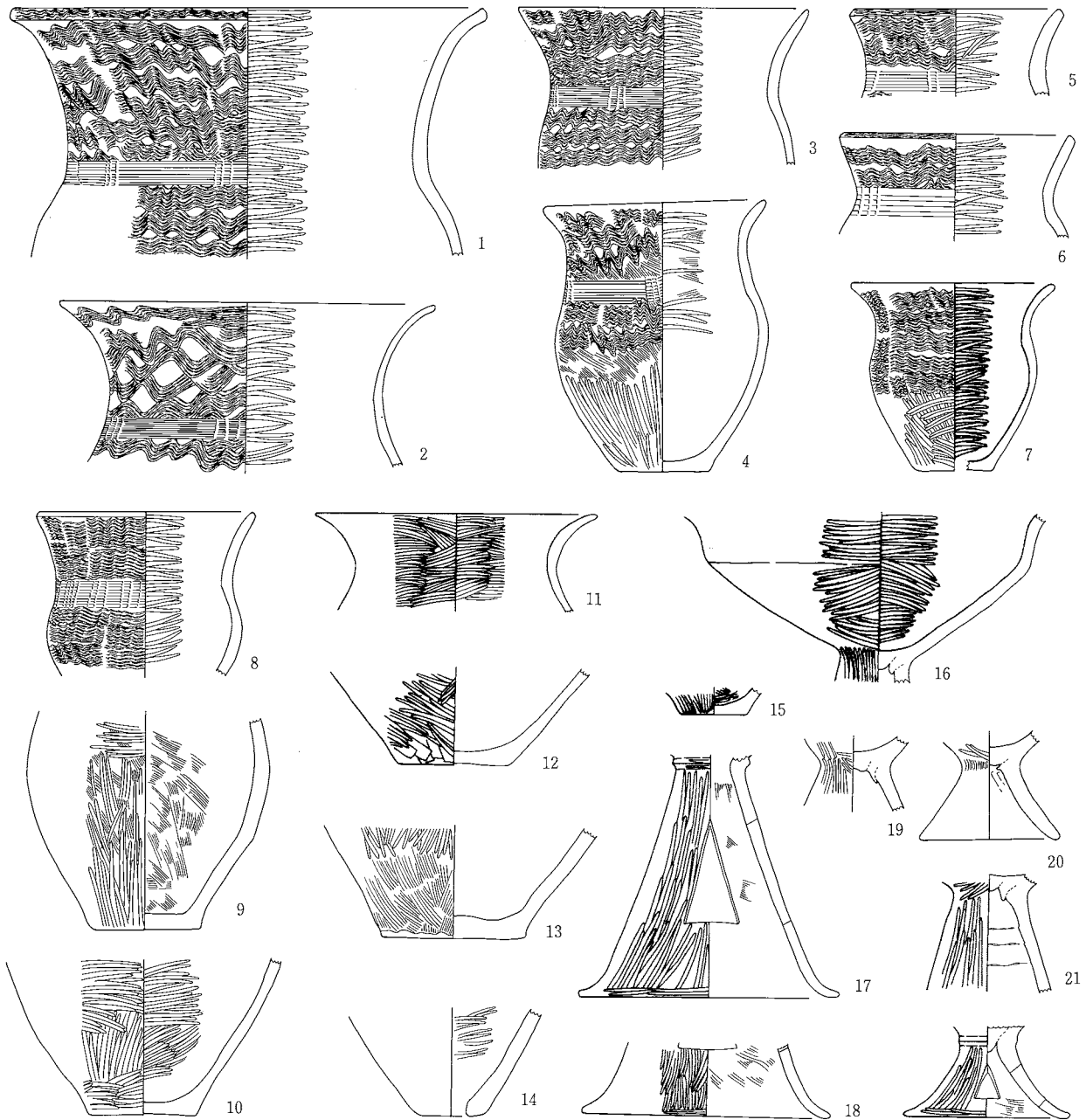

0 (1:4) 10cm

SB1630・1631

SB1632

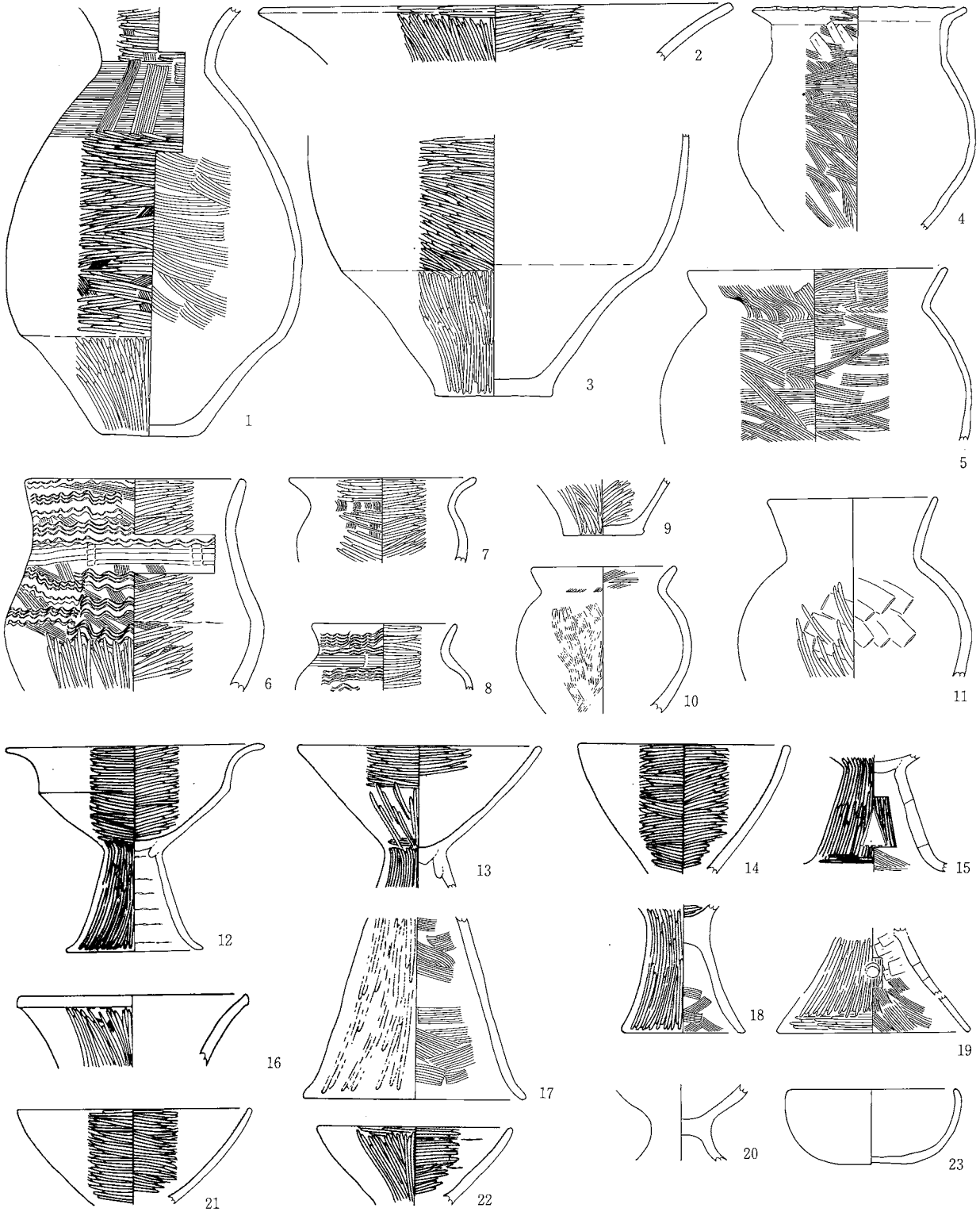

SB1632

SB1634

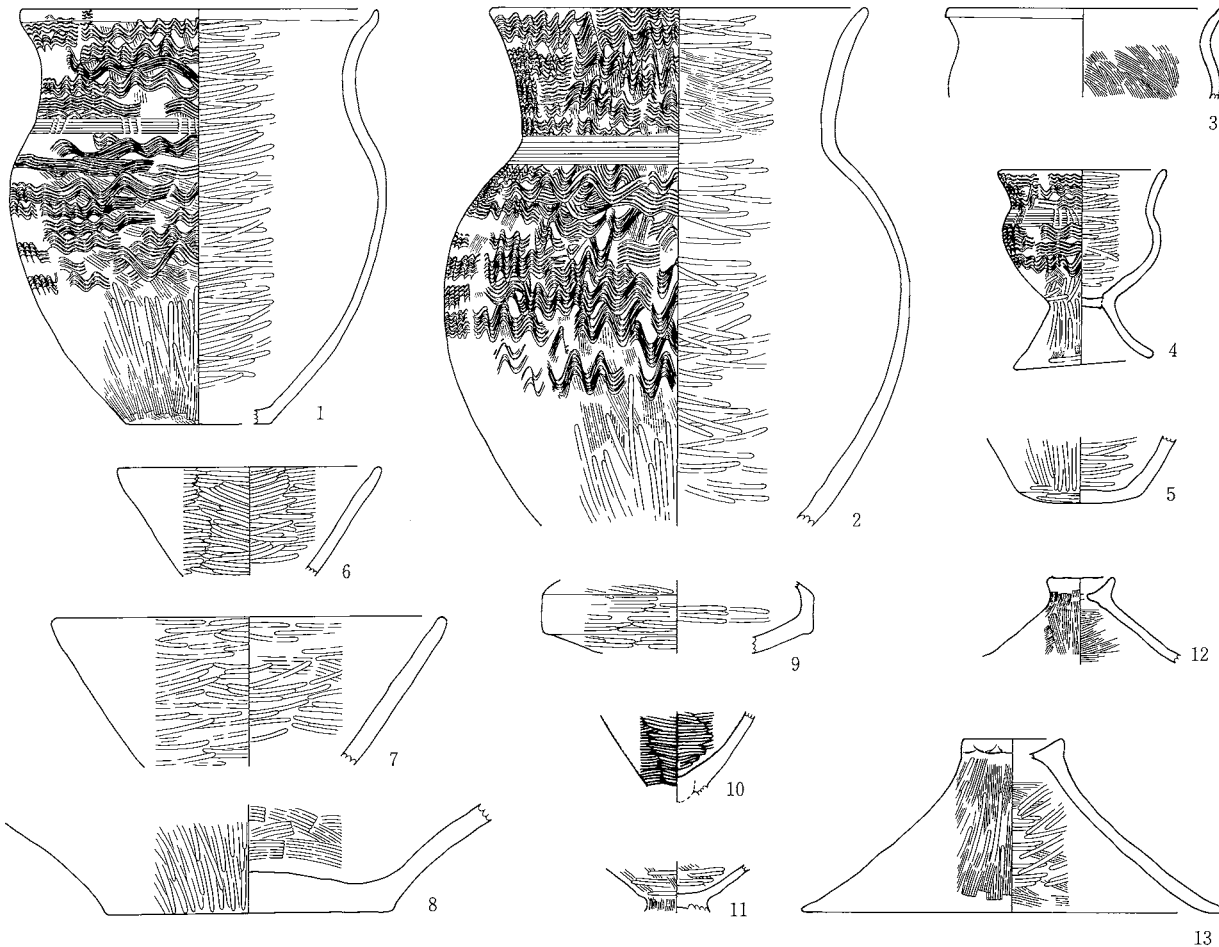

SB1648

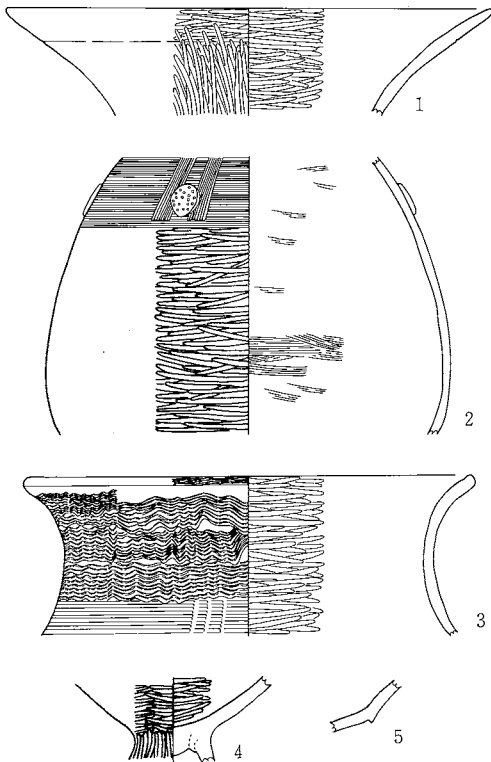

SB1635

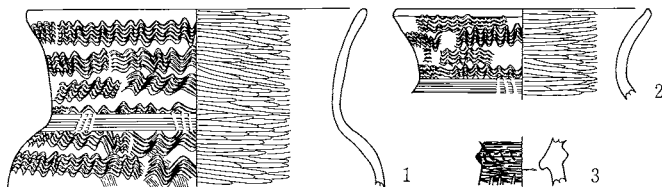

SB1646

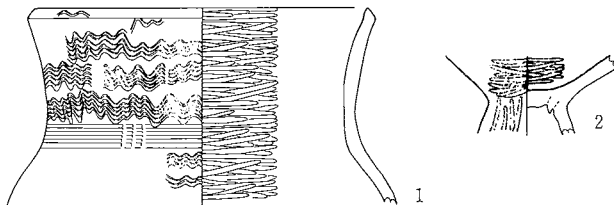

SB1641

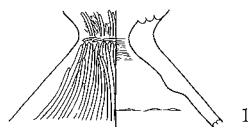

0 (1:4) 10cm

SB1650

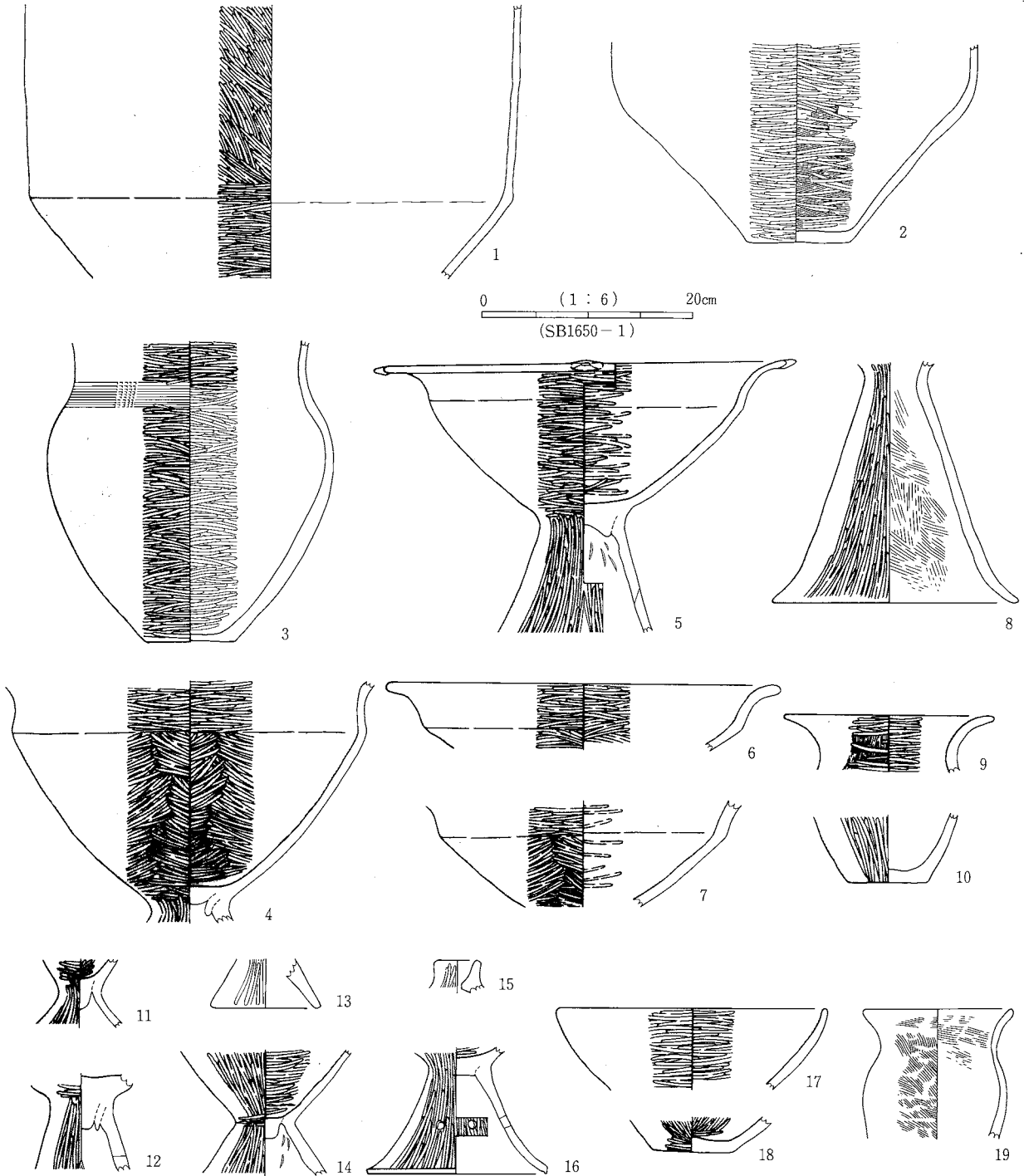

SB1651

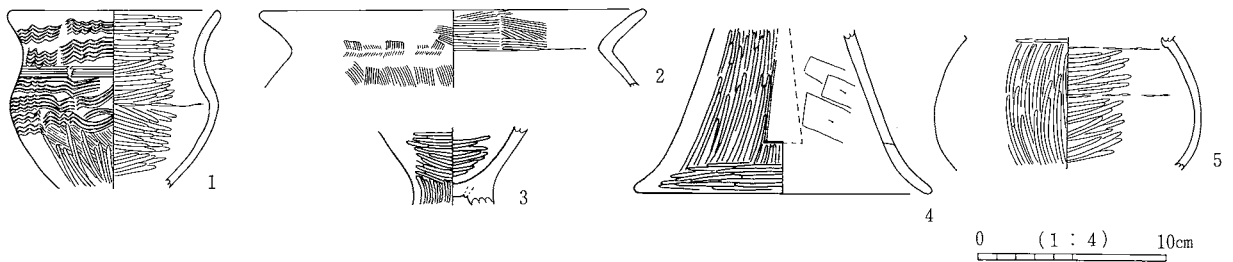

SB1653

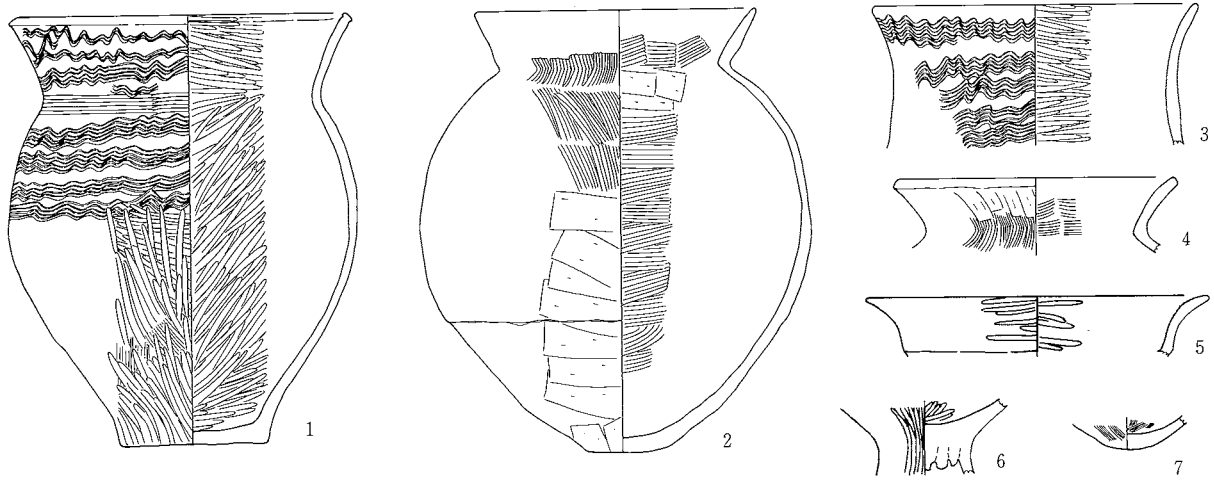

SB1657

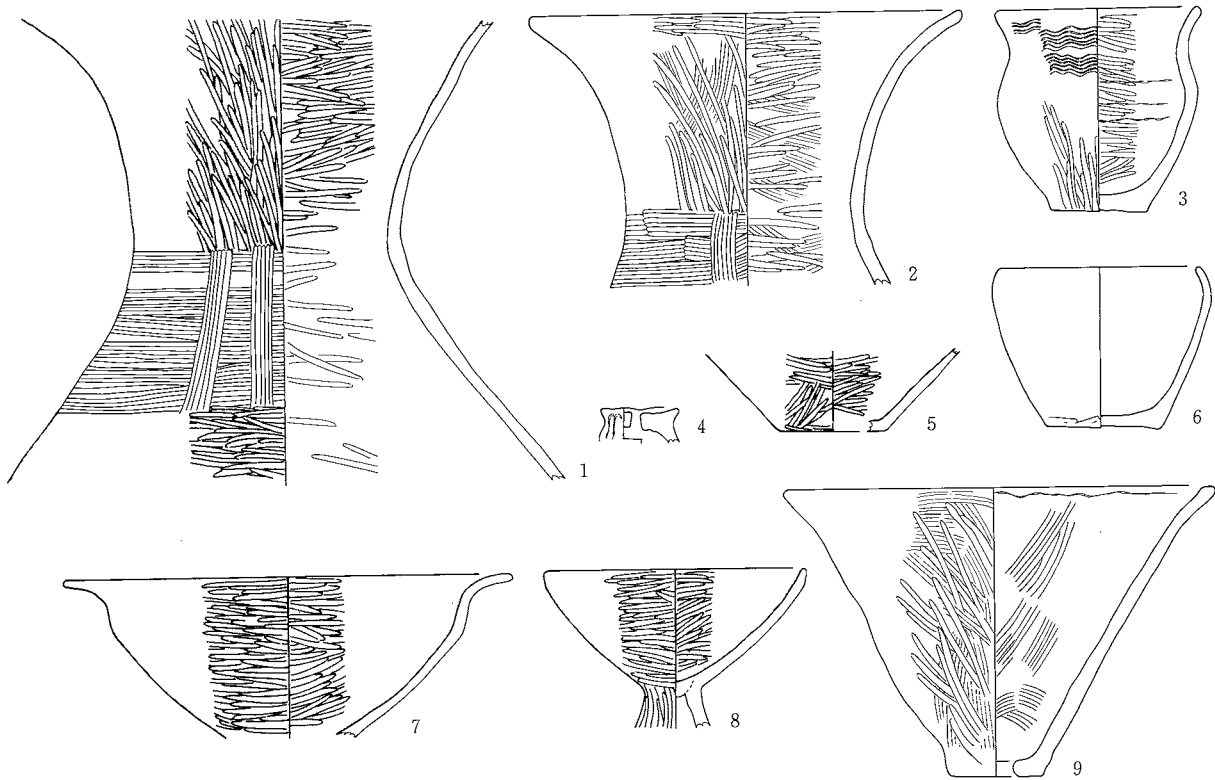

SB1658

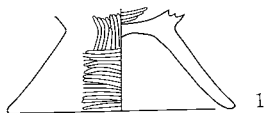

SB1662

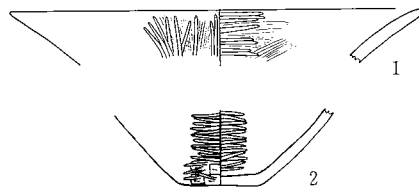

0 (1:4) 10cm

SB1661

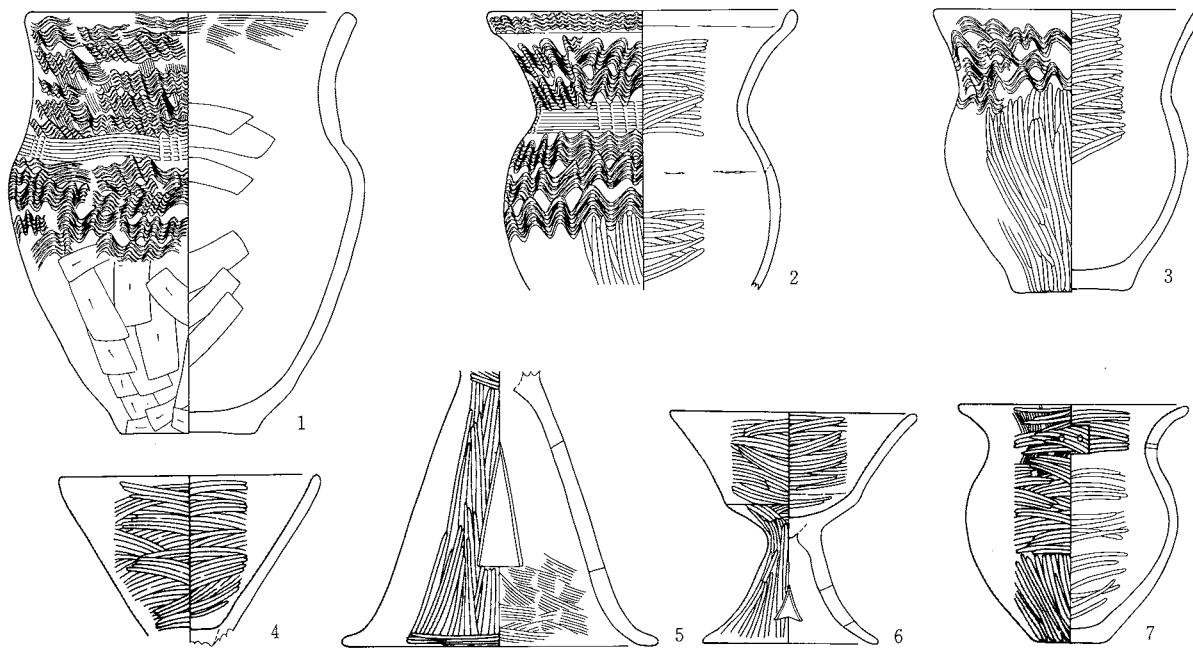

SB1673

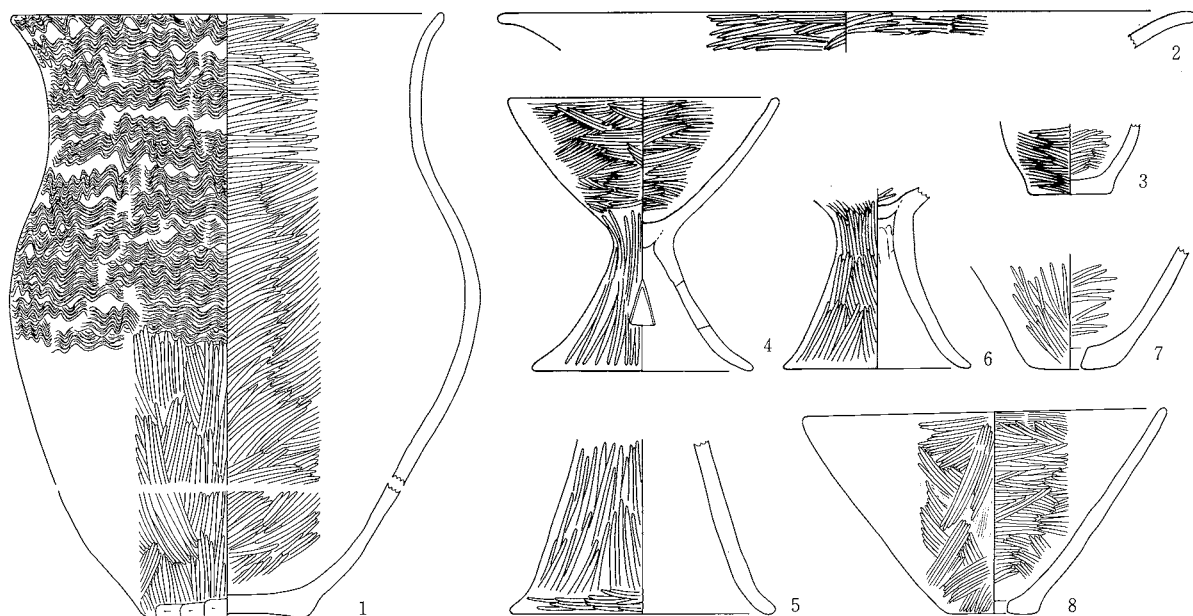

0 (1:4) 10cm

SB1672-①

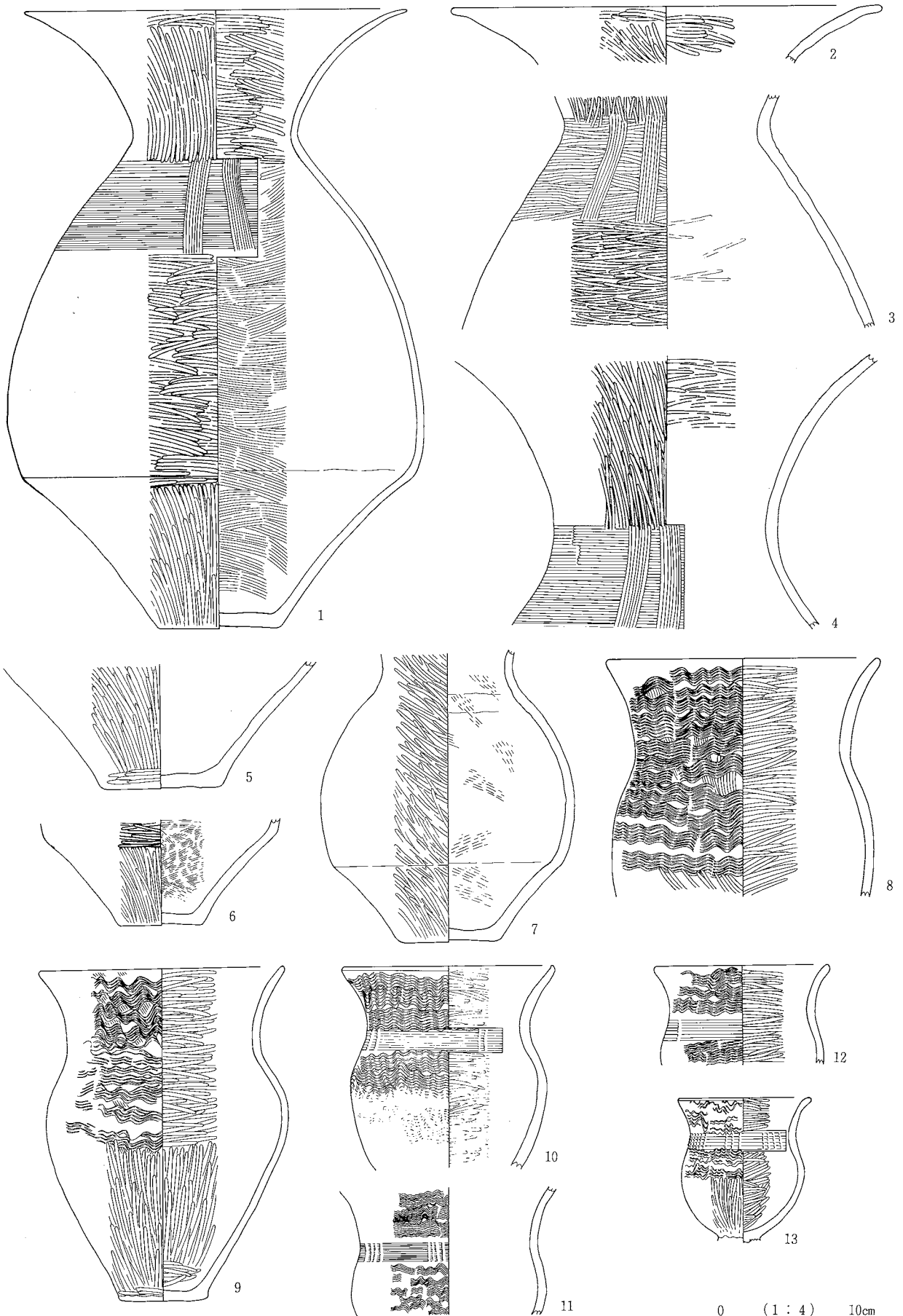

SB1672-①

0 (1:4) 10cm

SB1672-②

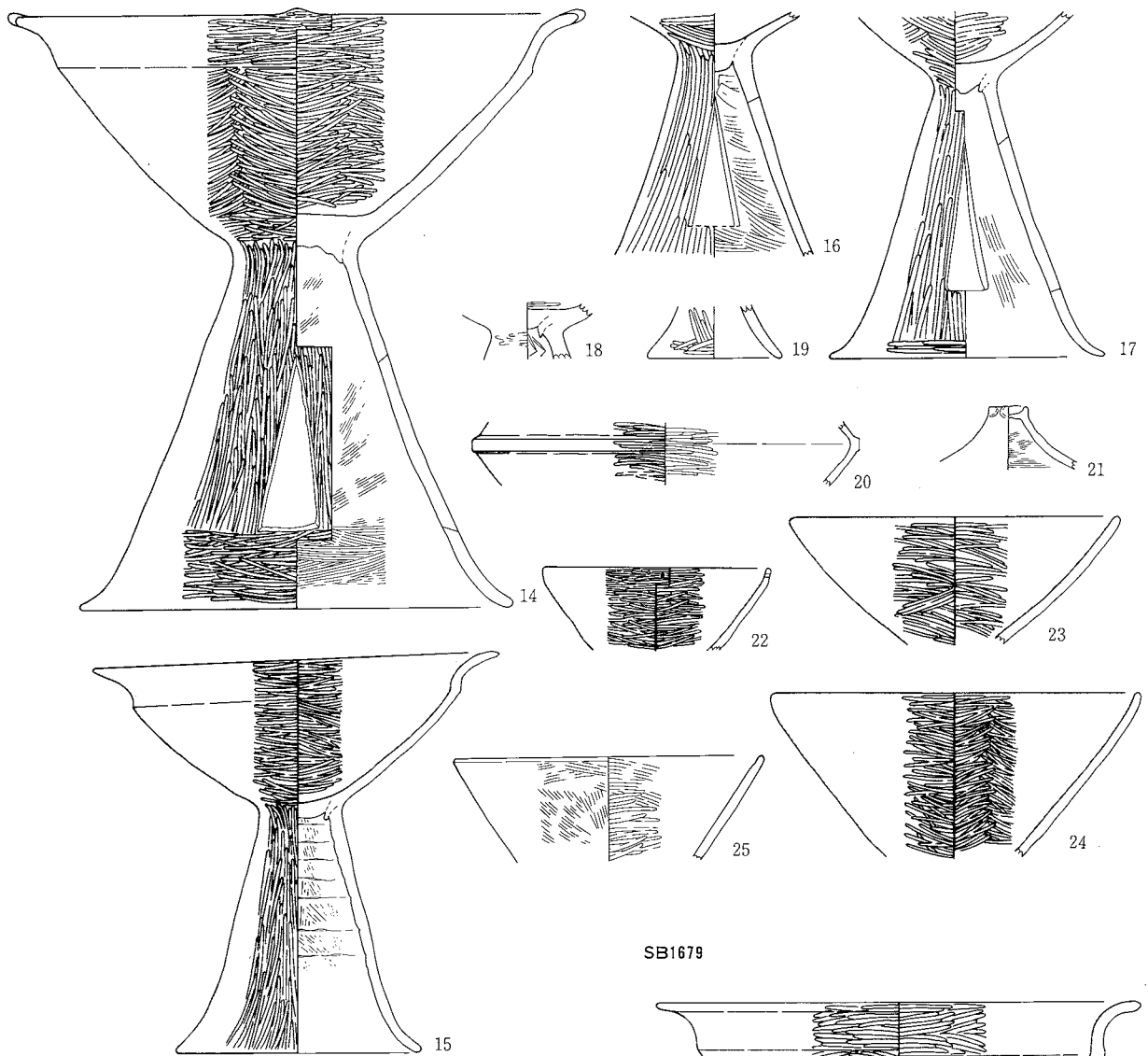

SB1679

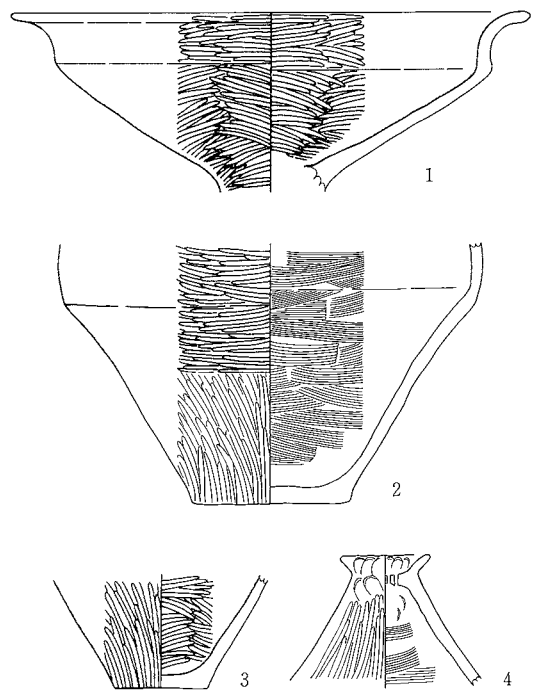

SB1675

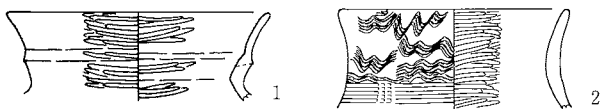

SB1678

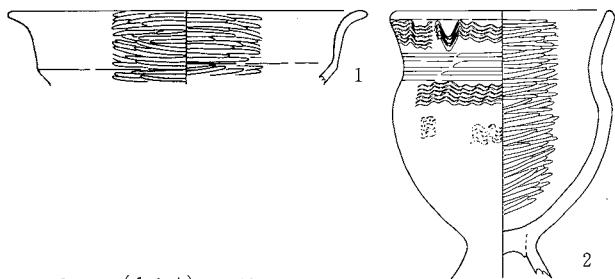

0 (1:4) 10cm

SB1692

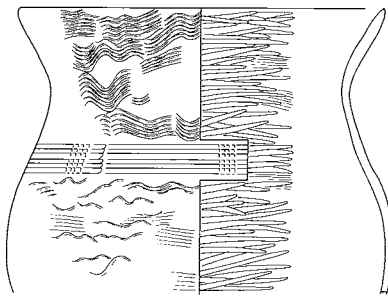

SB1806

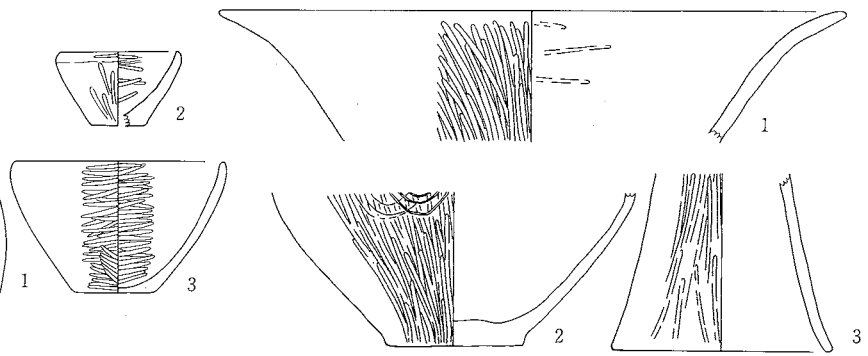

SB1801

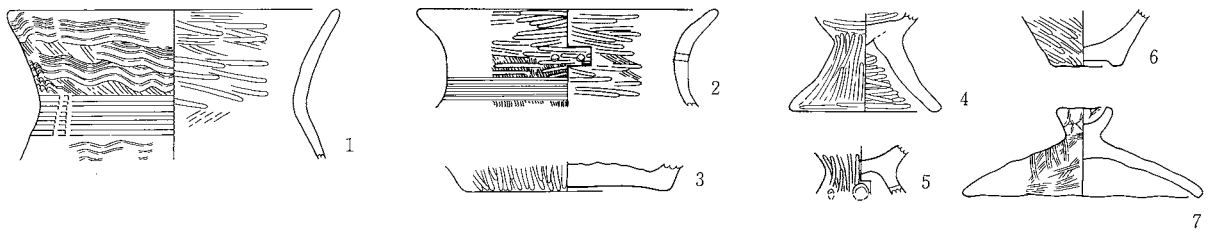

SB1802

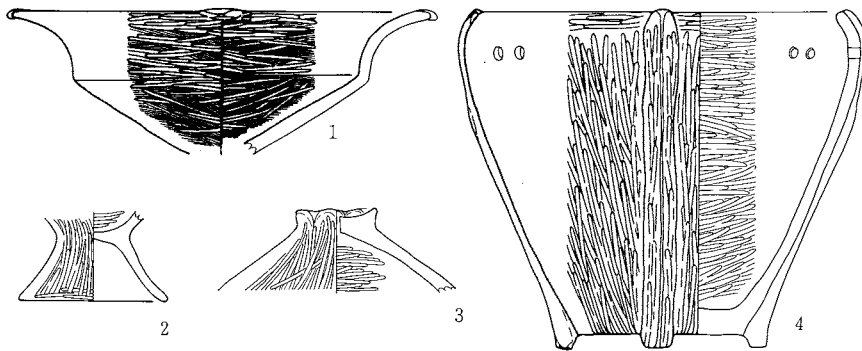

SB1803

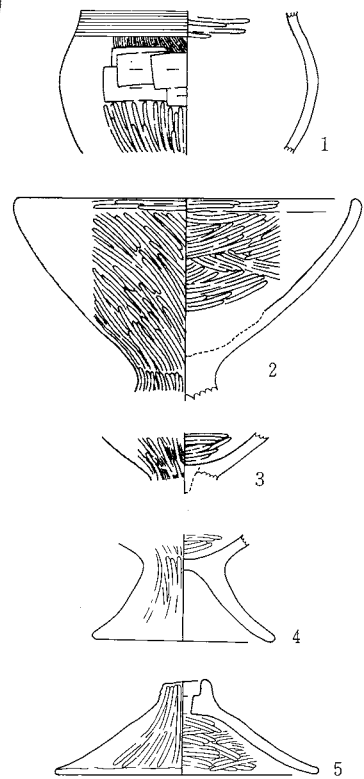

SB1804

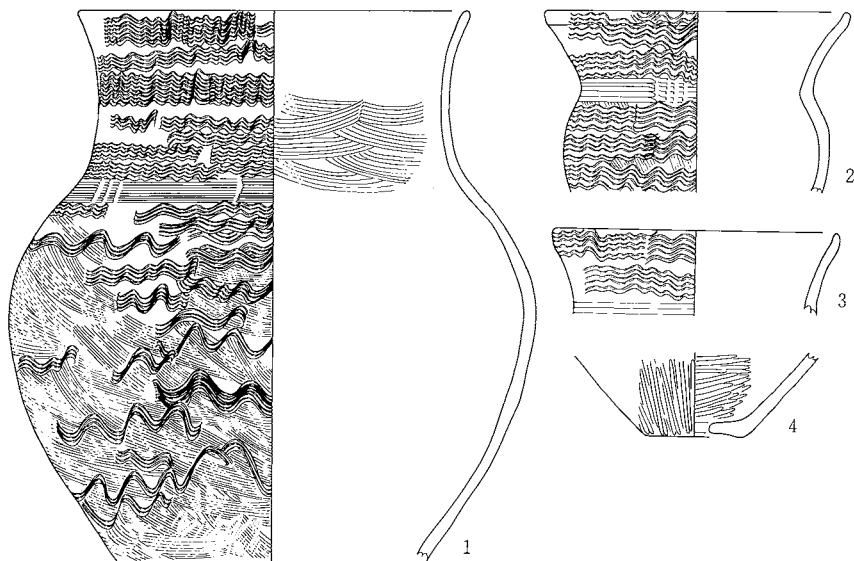

0 (1:4) 10cm

SD62

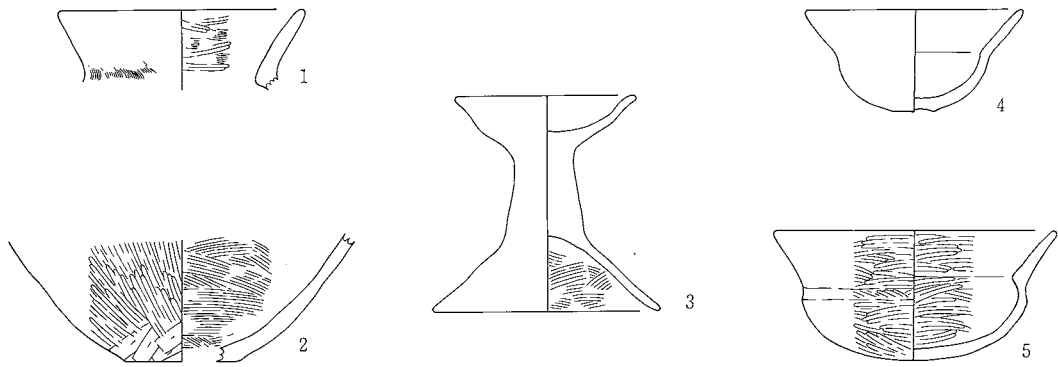

SD63-①

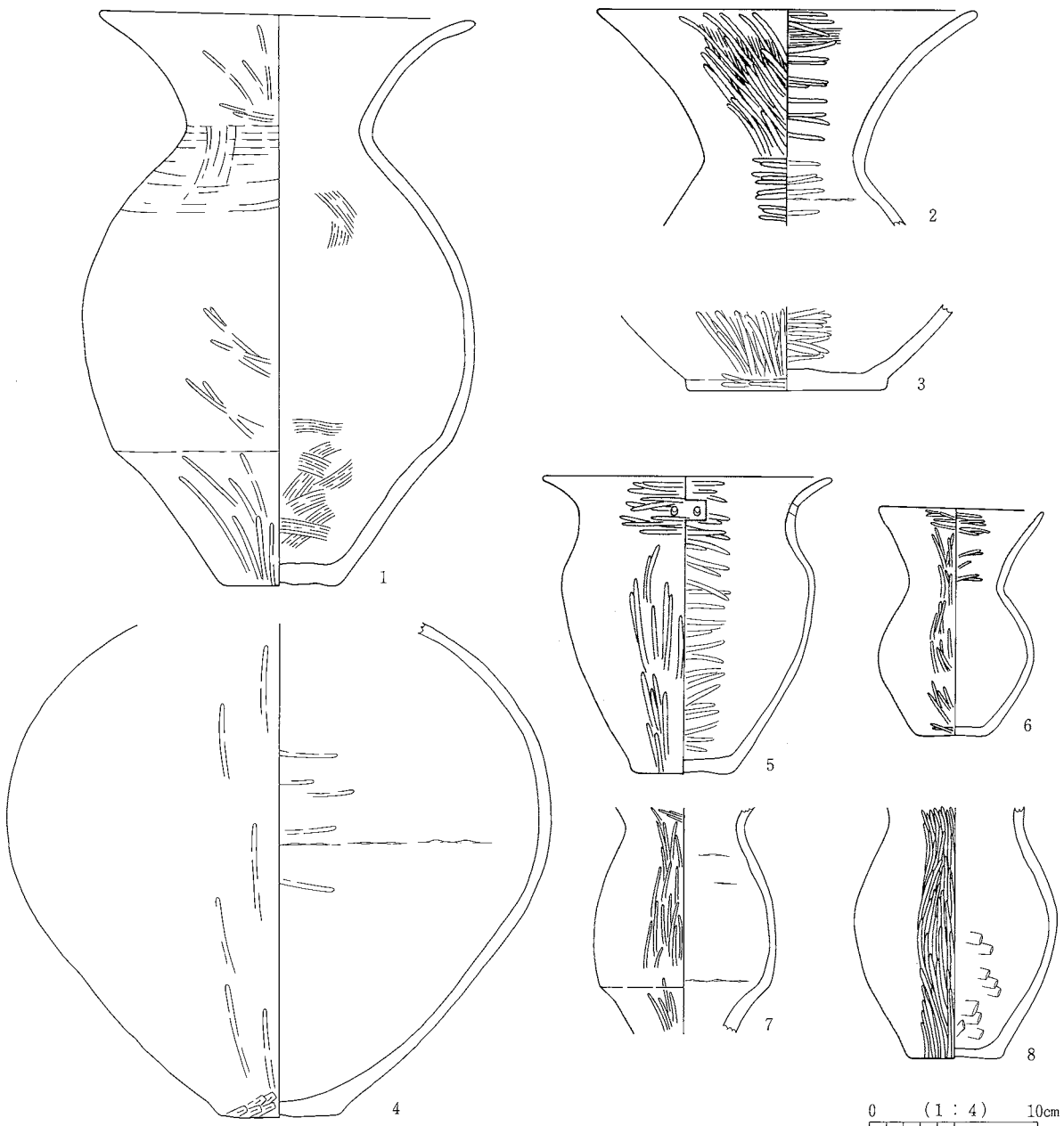

SD62・63-①

SD63-②

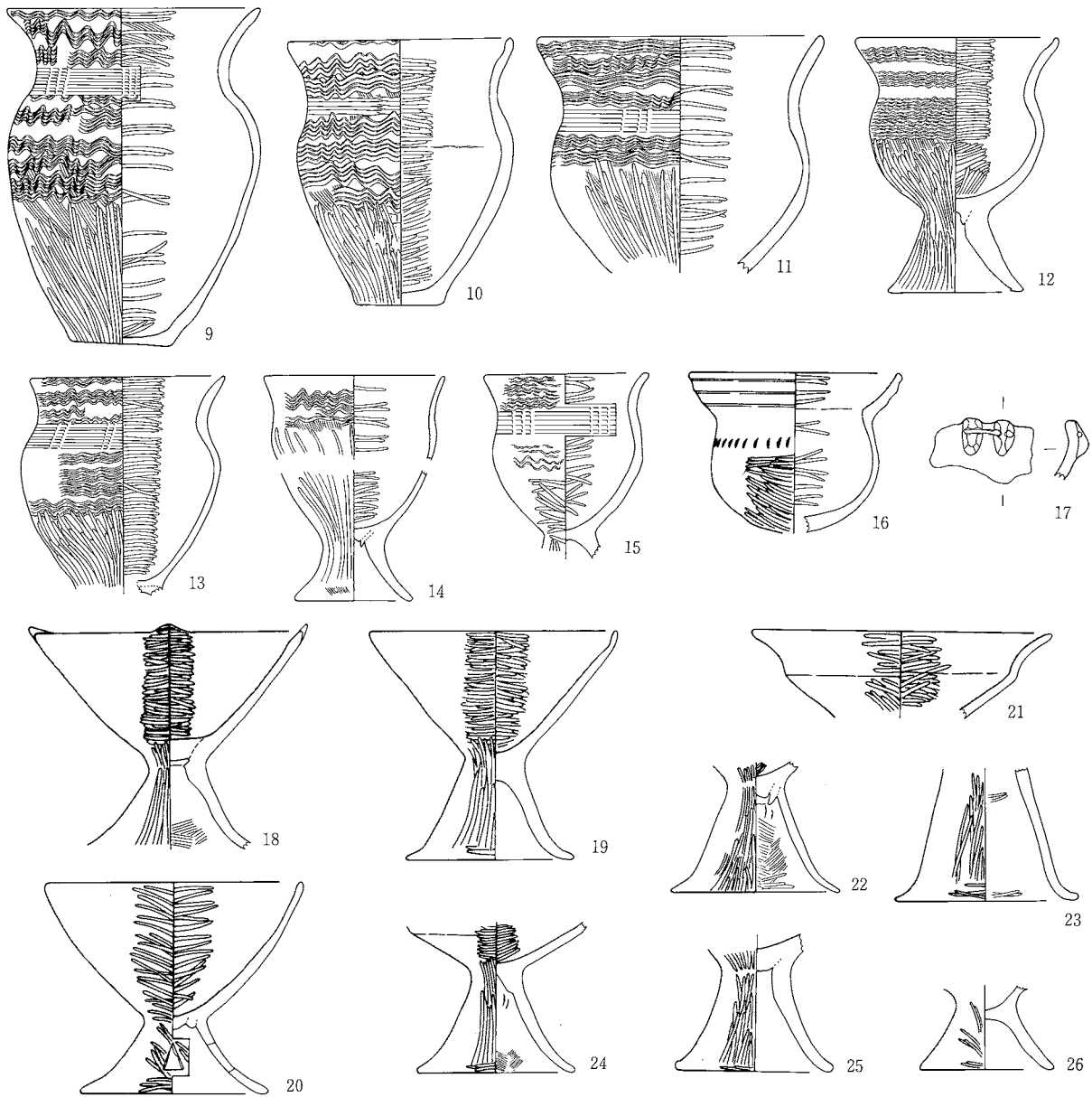

SD72

SD136

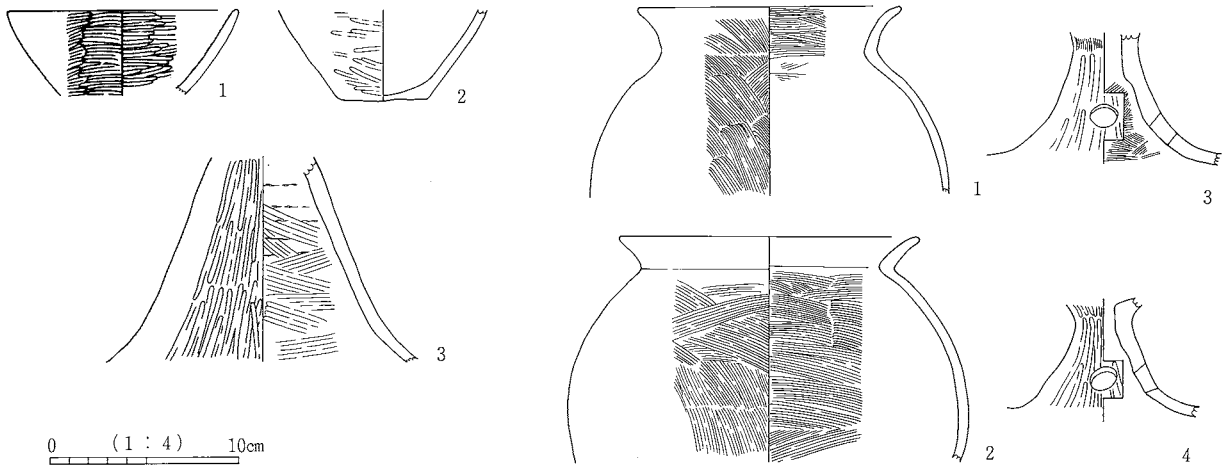

SD77

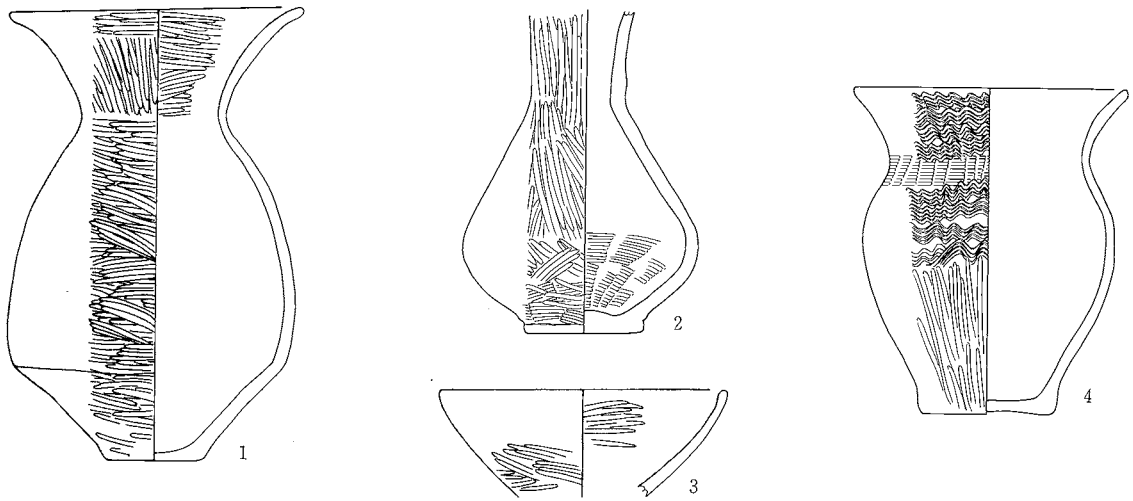

SD91

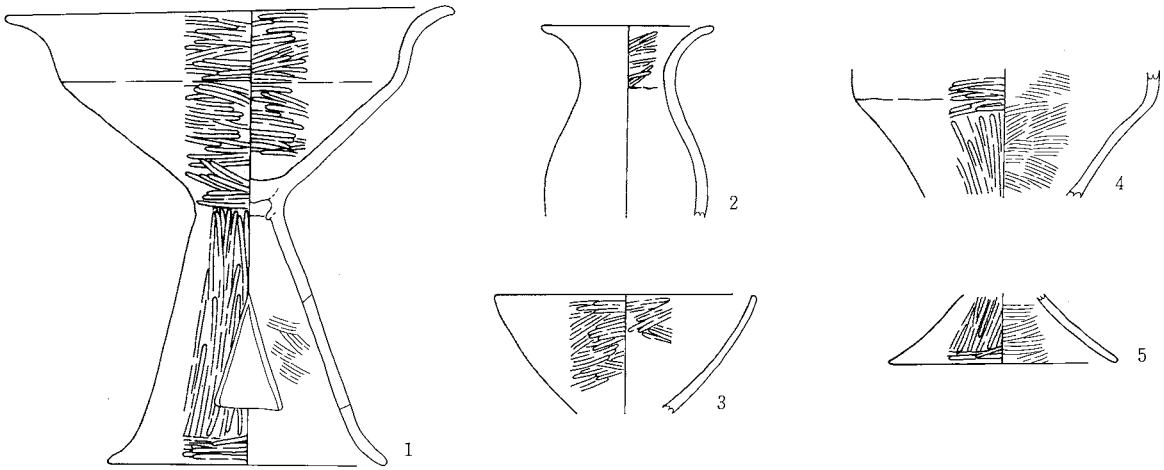

SD165

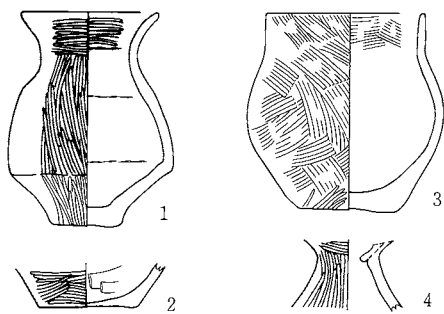

SD173

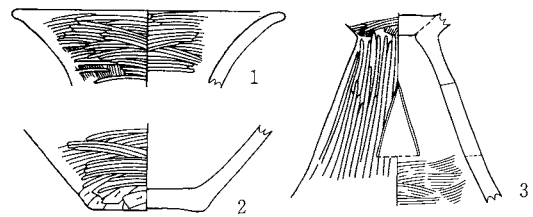

SD169

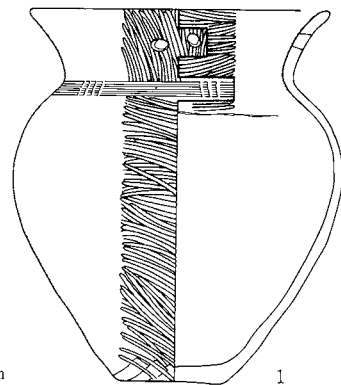

SD161

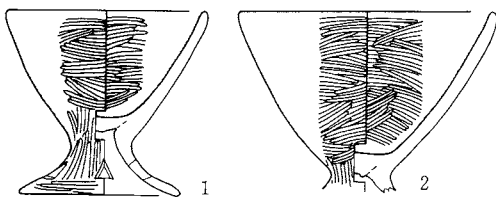

0 (1:4) 10cm

SD183

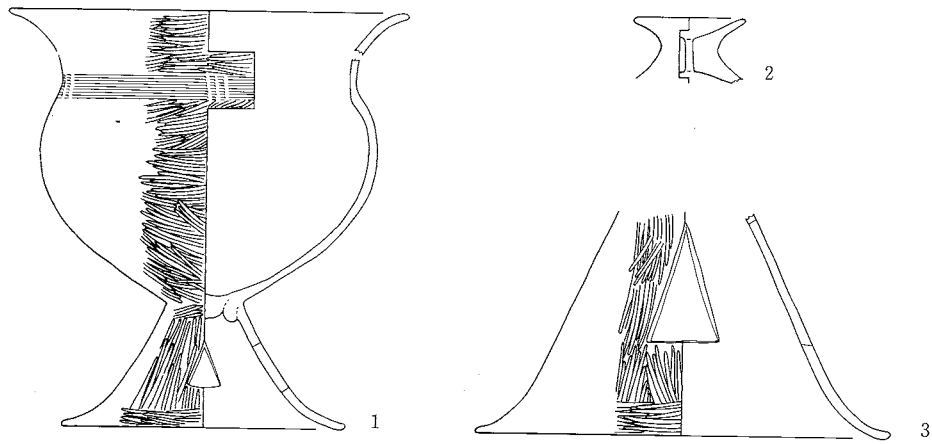

SD185

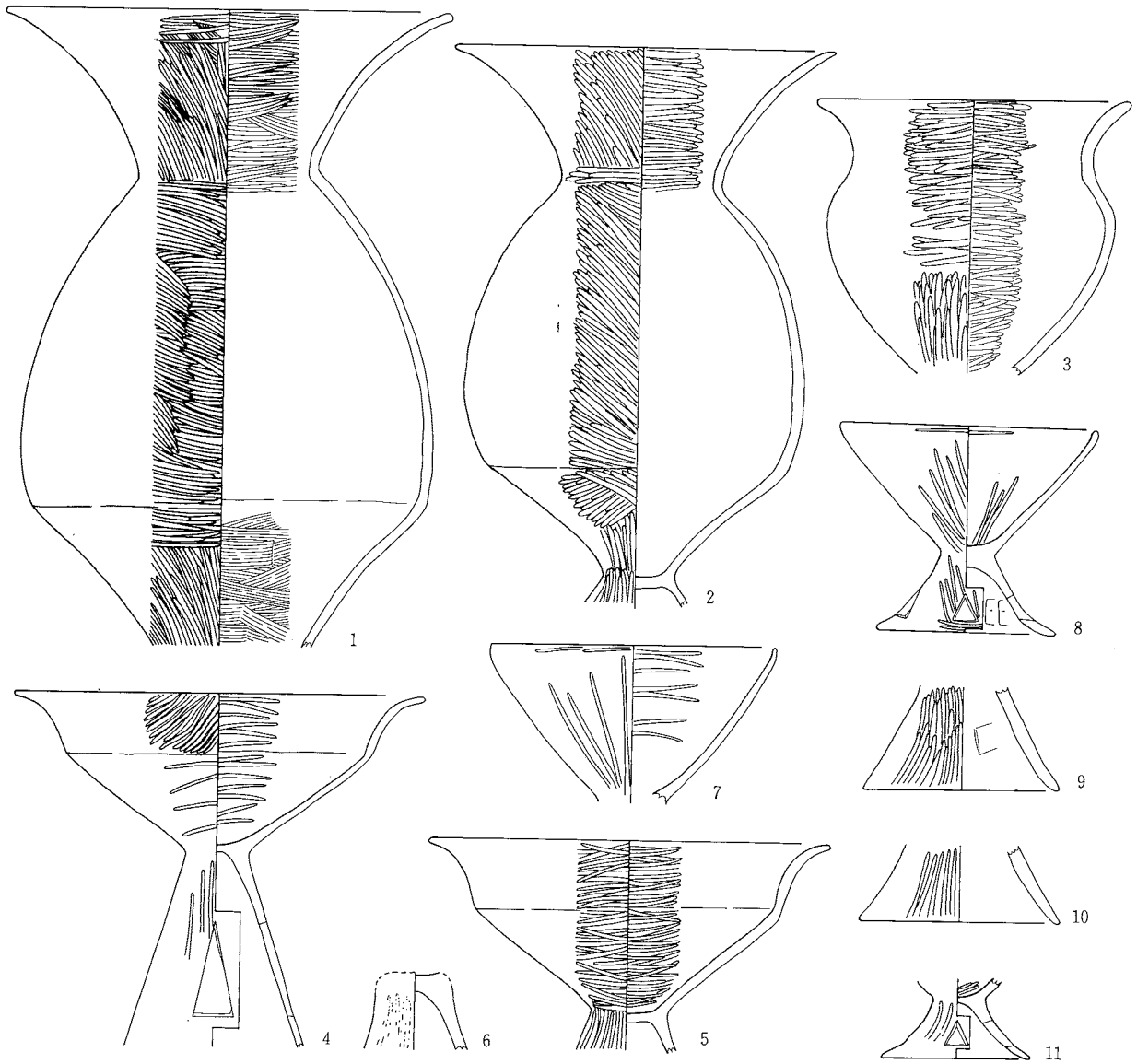

0 (1 : 4) 10cm

SD190

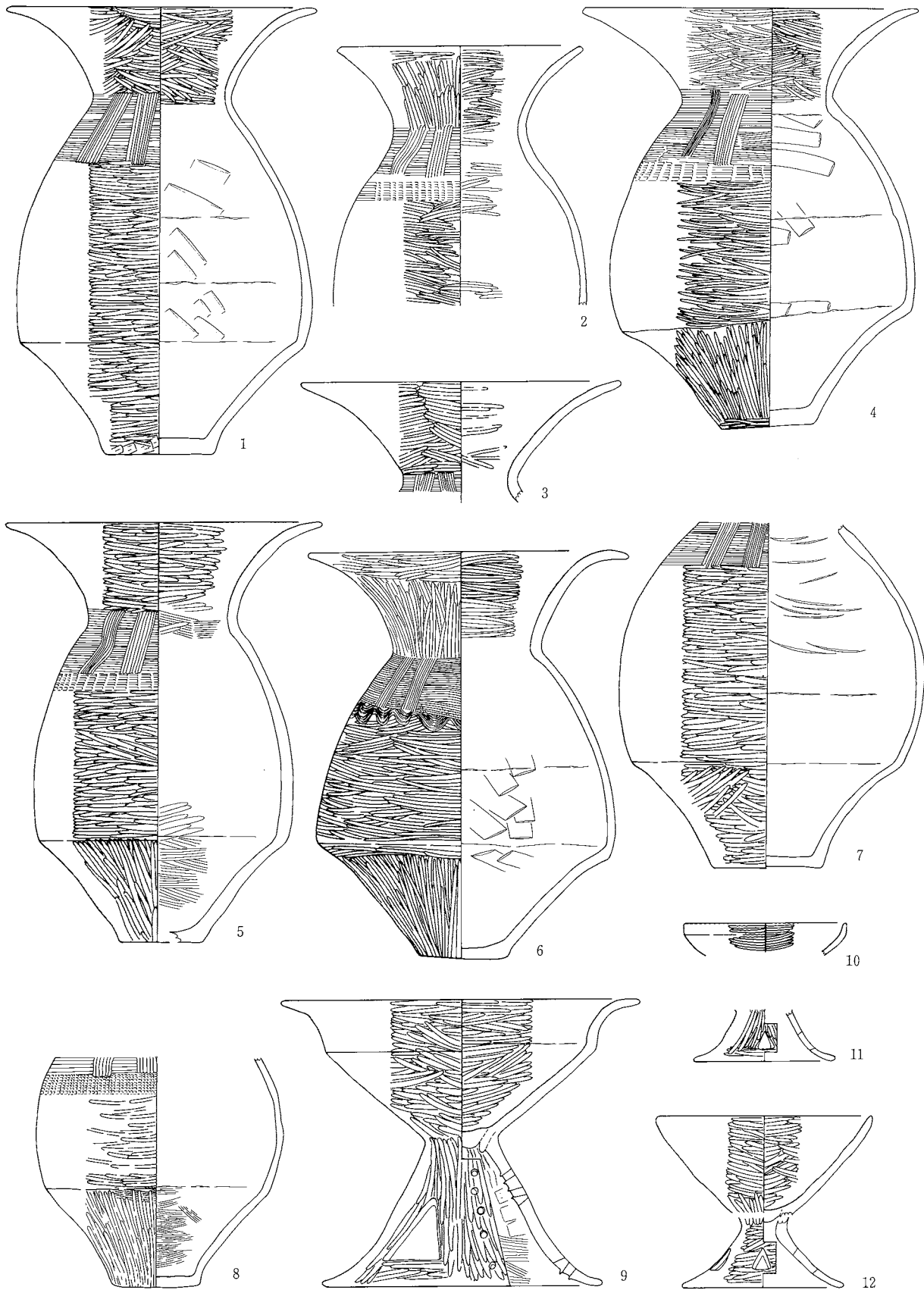

0 (1 : 4) 10cm

SD190

SD311

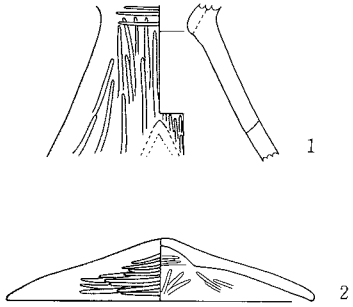

SD314

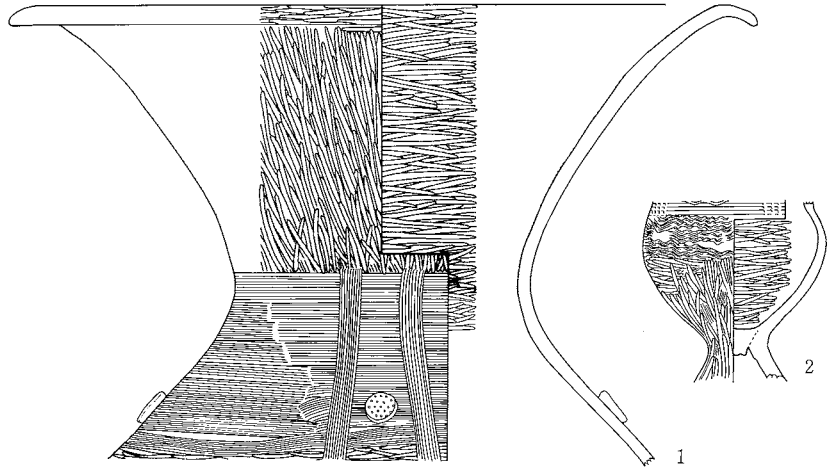

SD418

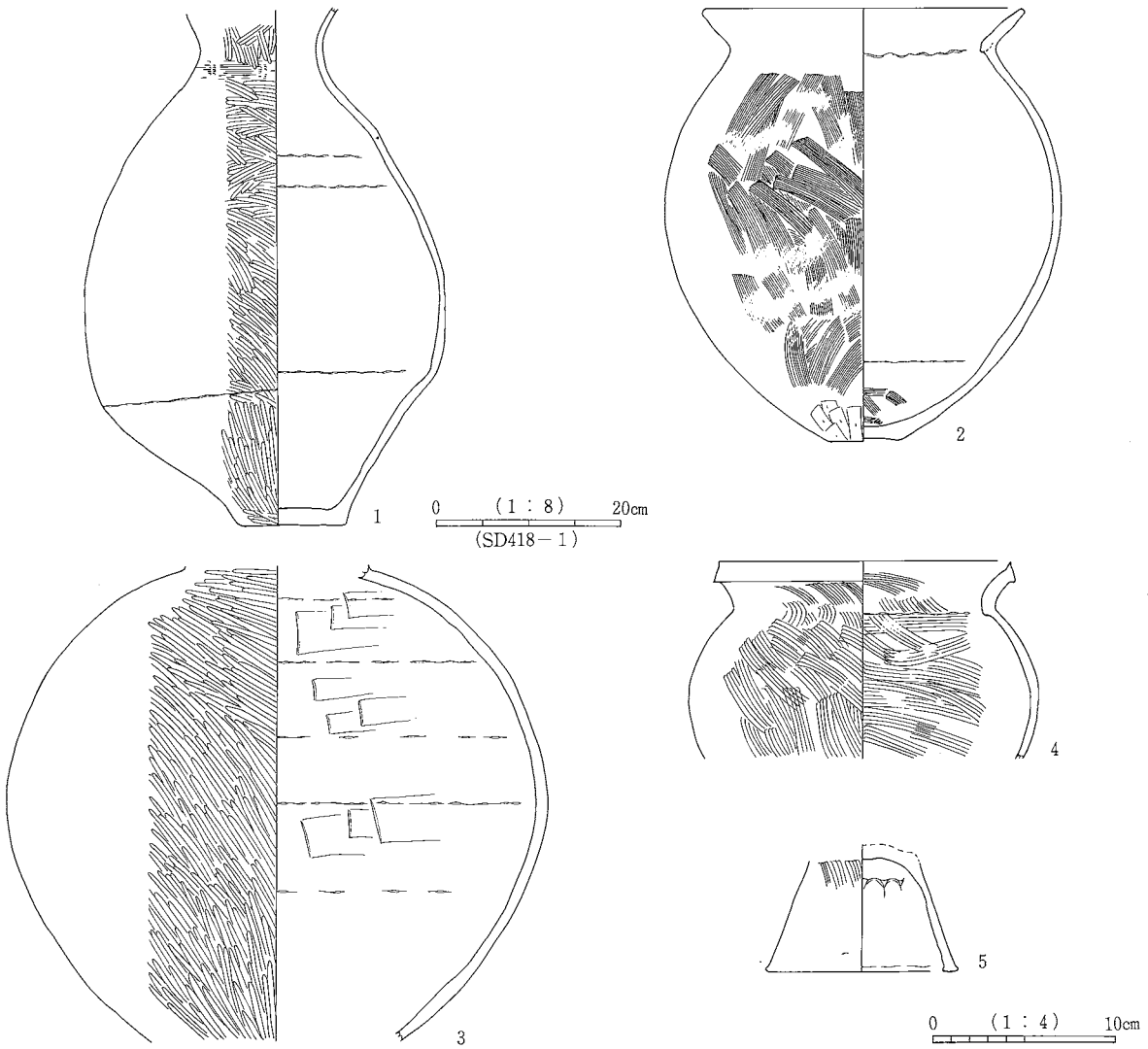

SD311 · 314 · 418

SD323

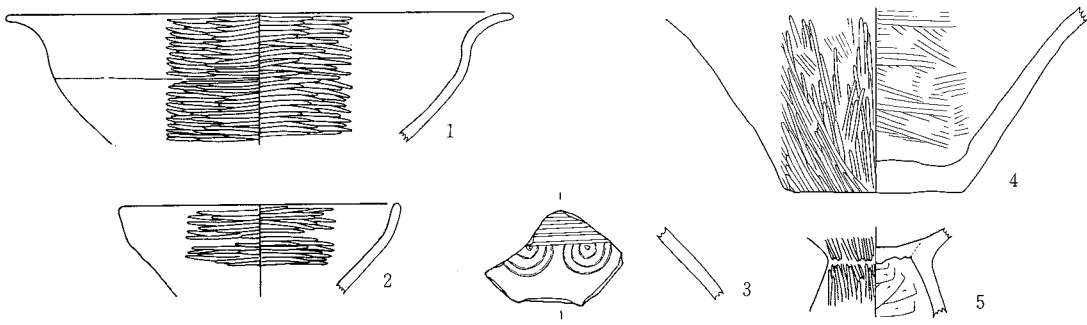

SD326

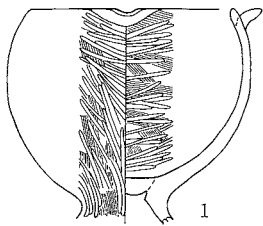

SD330

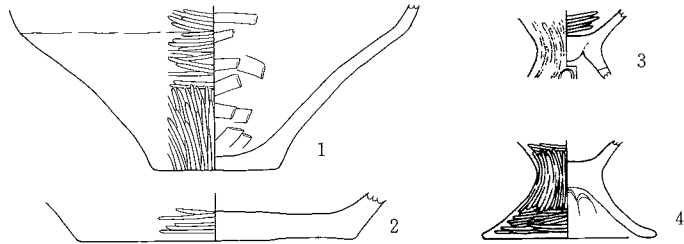

SD509

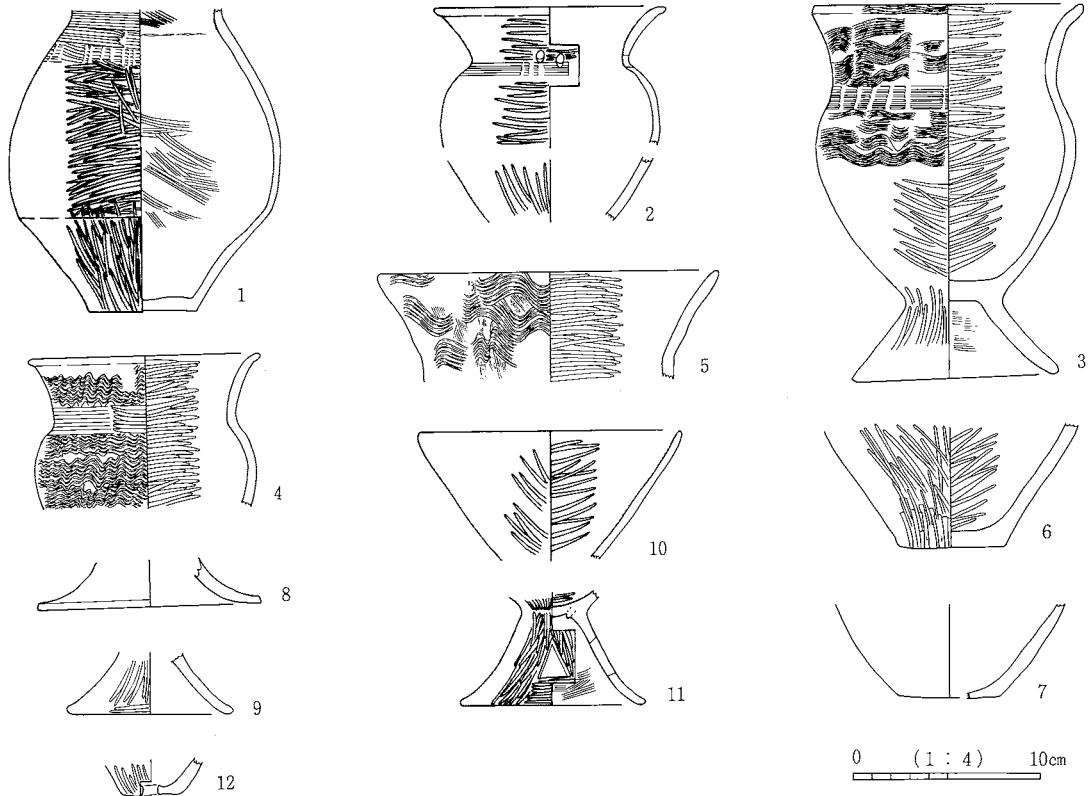

0 (1:4) 10cm

SD323 · 326 · 330 · 509

SD551-①

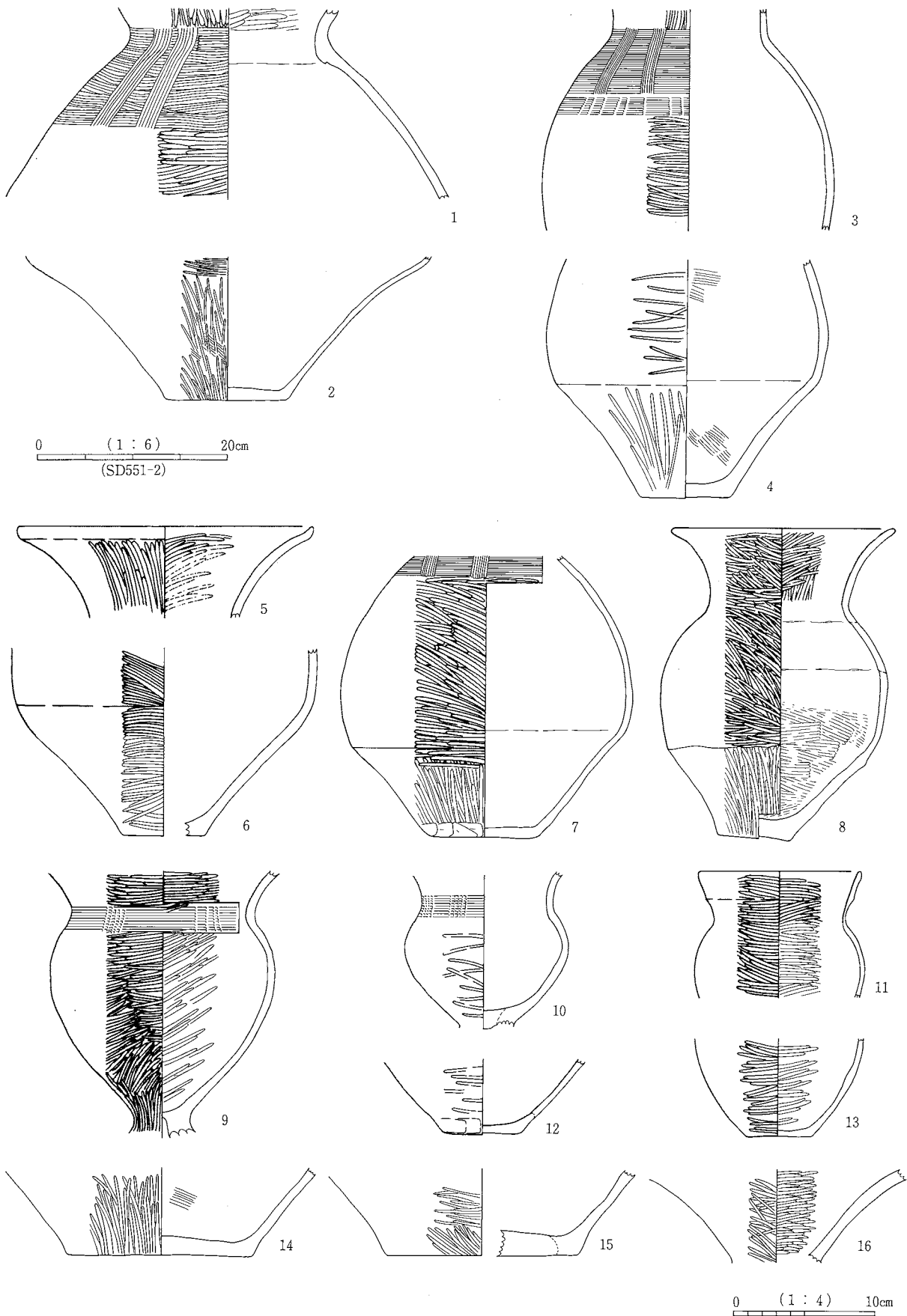

SD551-①

SD551-②

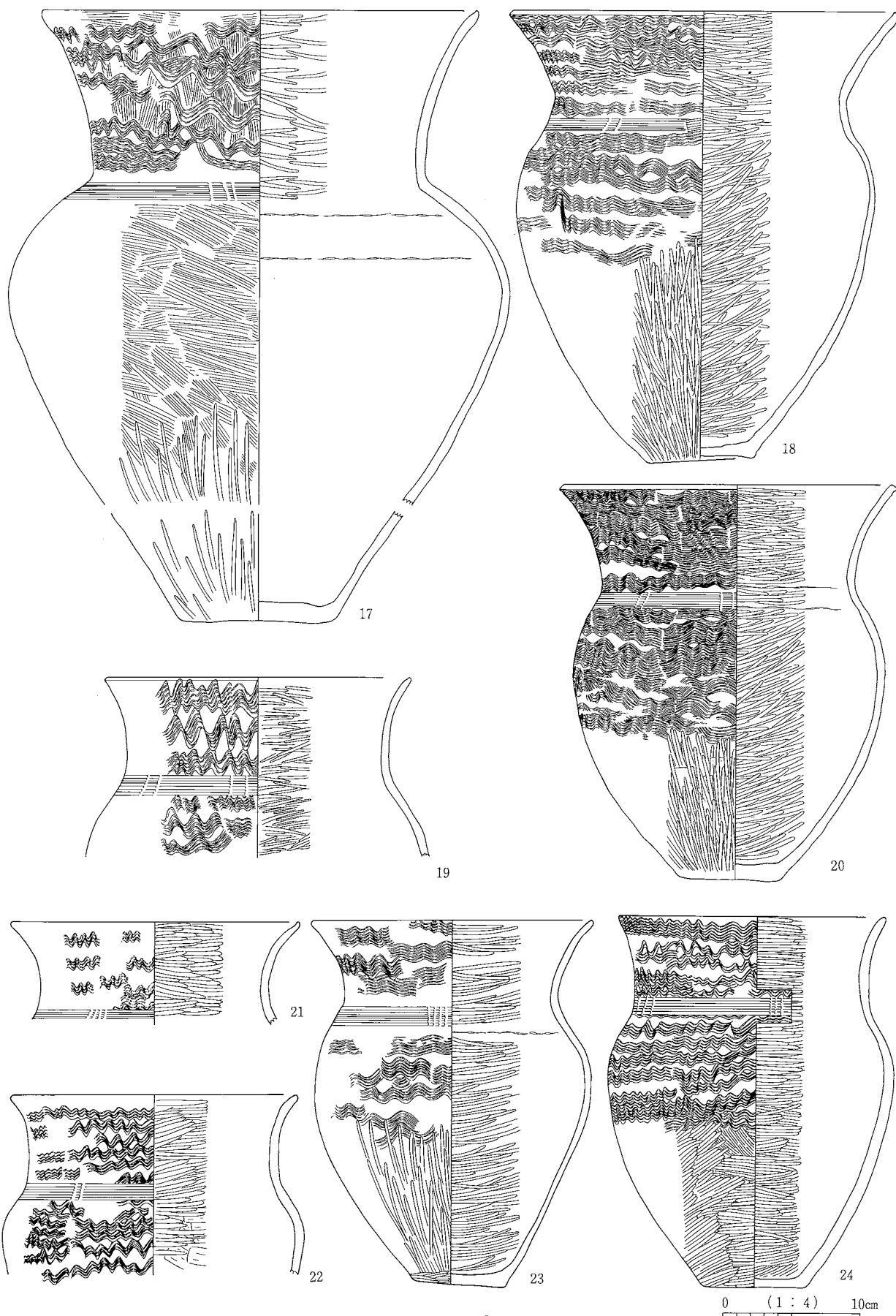

SD551-②

0 (1:4) 10cm

SD551-③

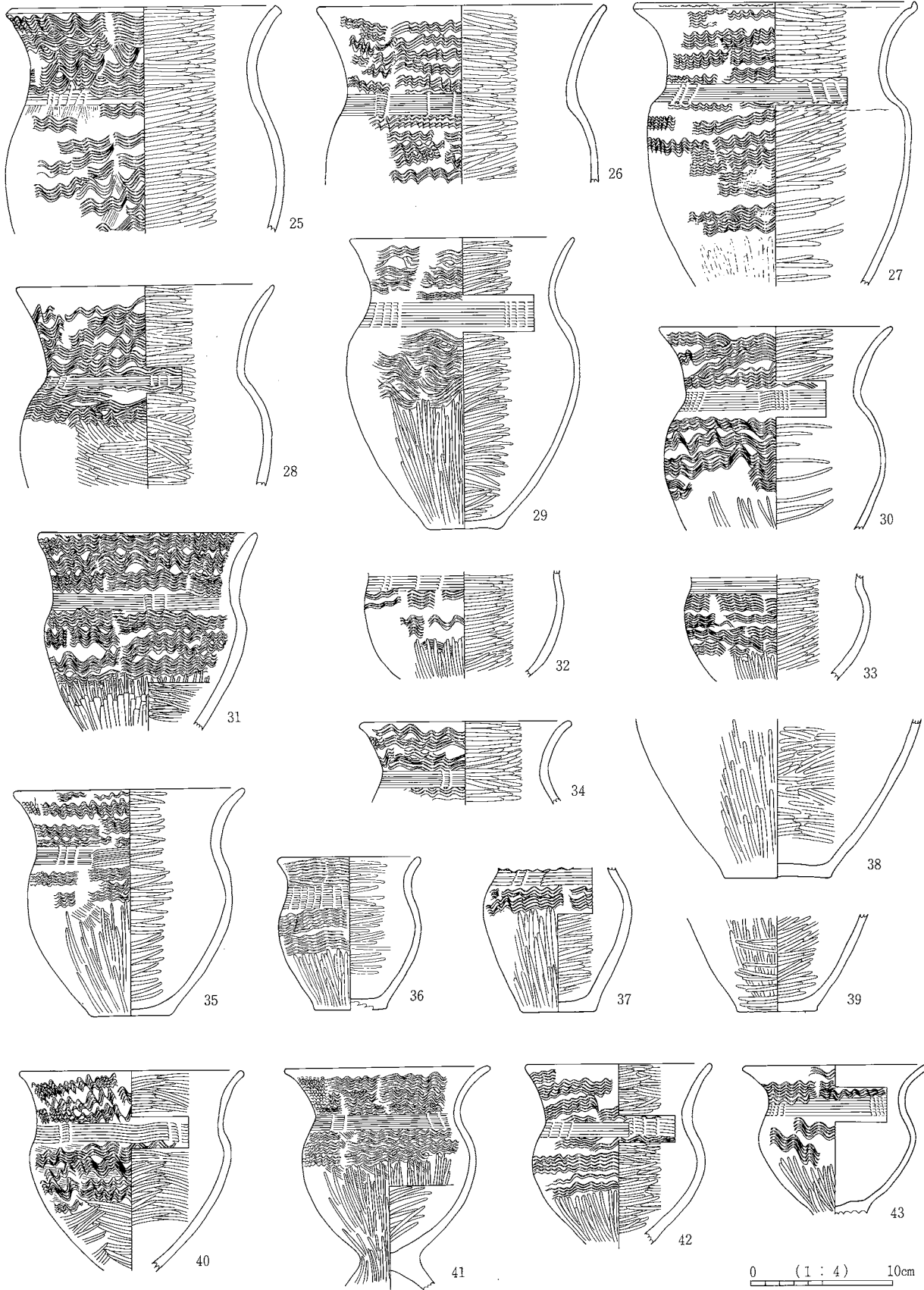

SD551-③

SD551-④

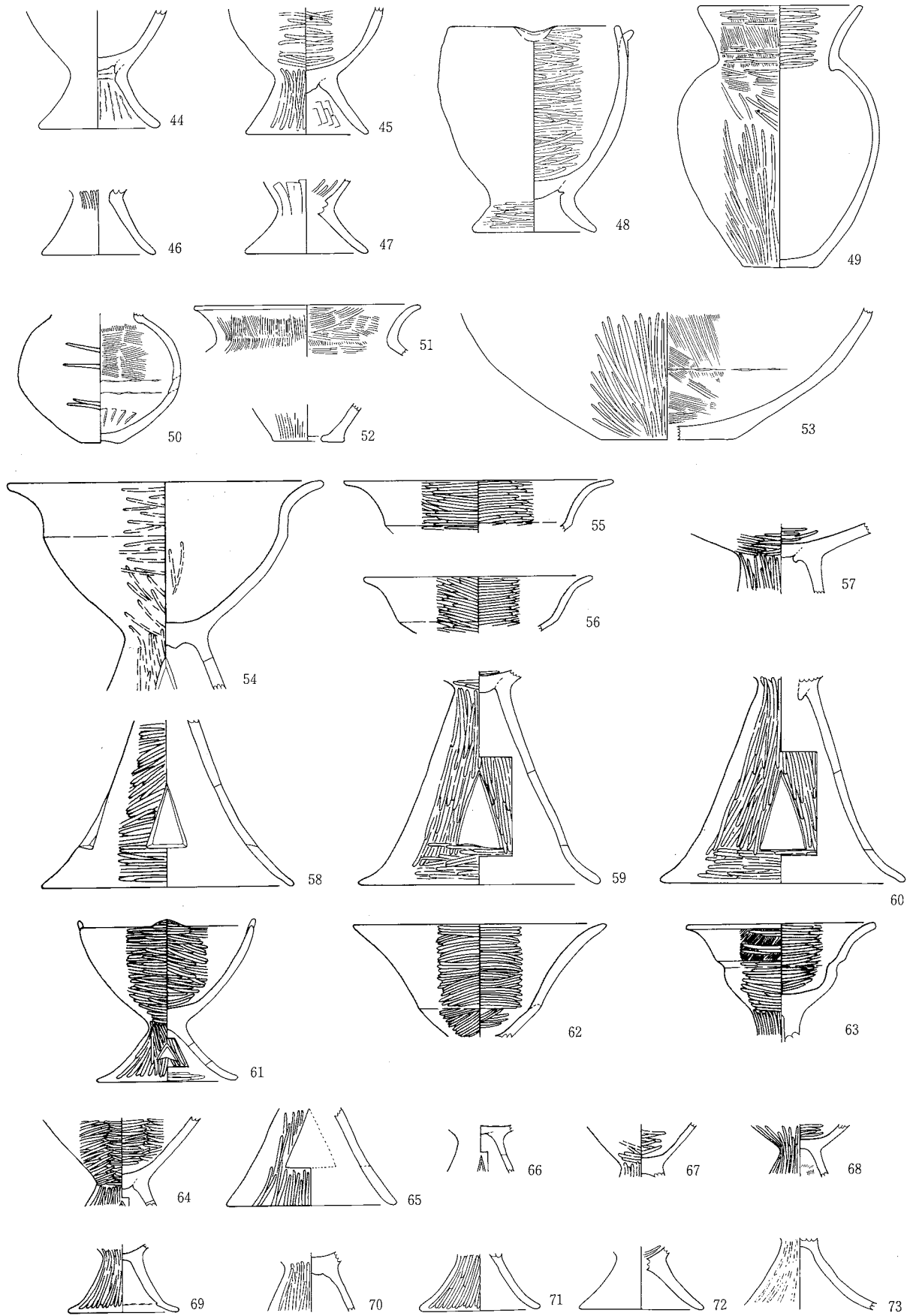

0 (1:4) 10cm

SD551-④

SD551-⑤

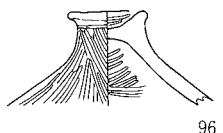
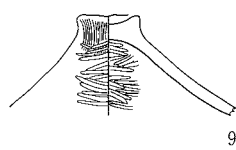
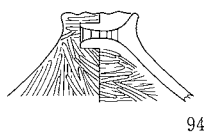
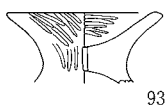
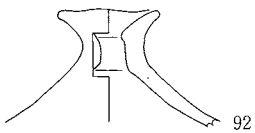
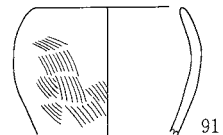
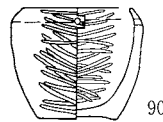
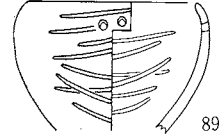
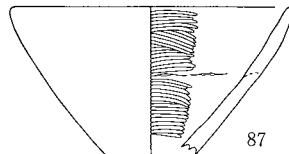
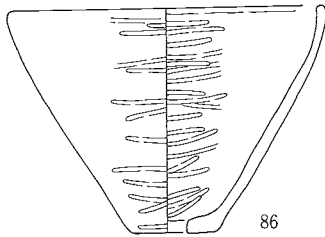
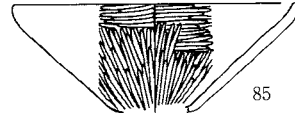
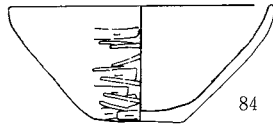
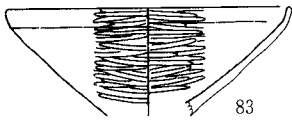
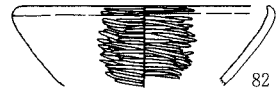
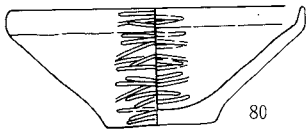
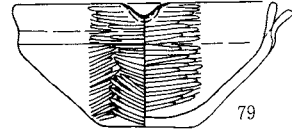
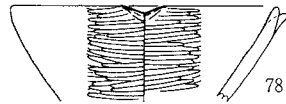
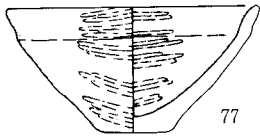
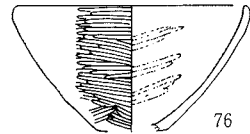
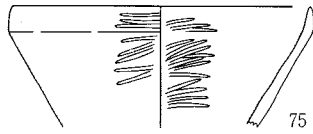
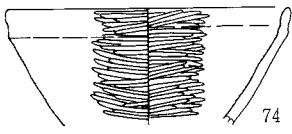

SD556

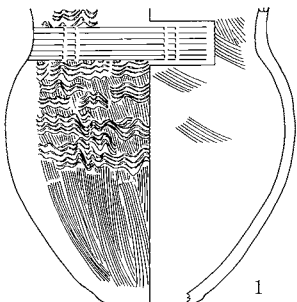

0 (1:4) 10cm

SK703

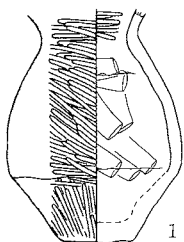

SK1321

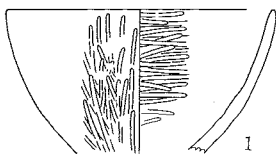

SK1897

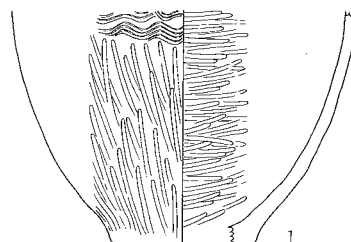

SK1442



SK1635

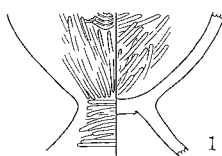

SK2157

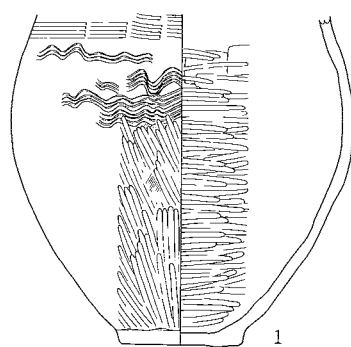

SK1524

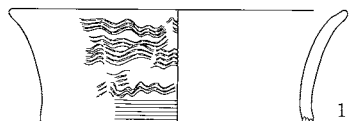

SK1712

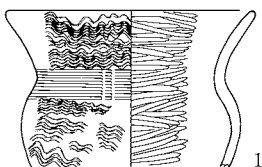

SK2107

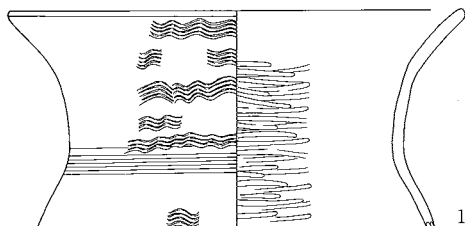

SK2207

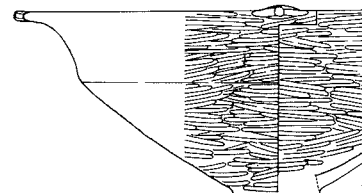

SK2272

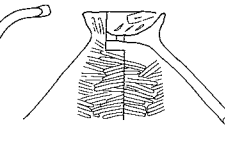

SK3062

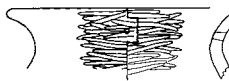

SK2561

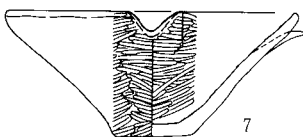
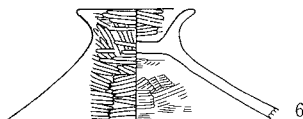
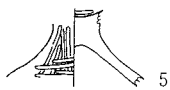
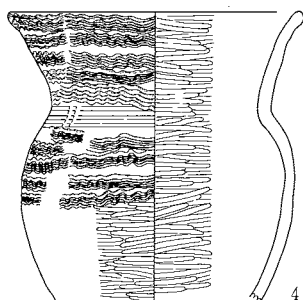
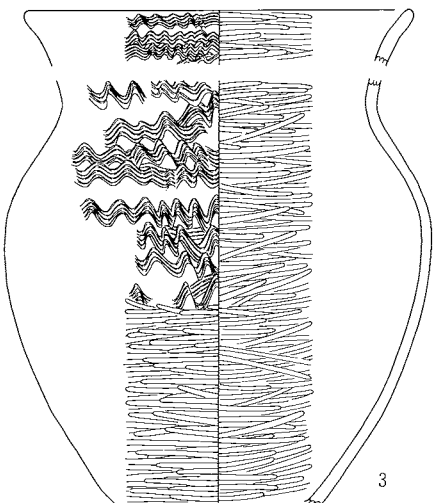
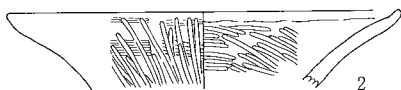

SK3875

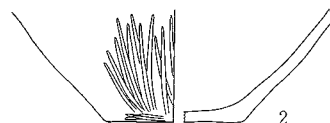
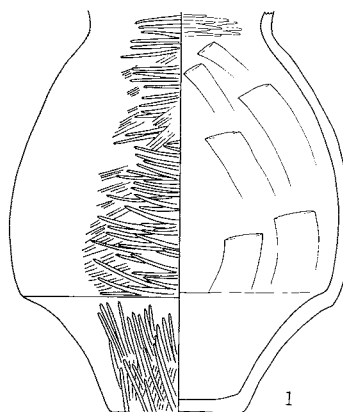

0 (1:4) 10cm

SK4421

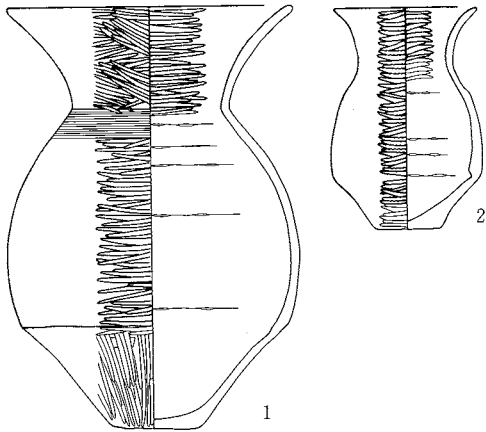

SK5345

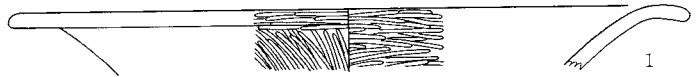

SK5182

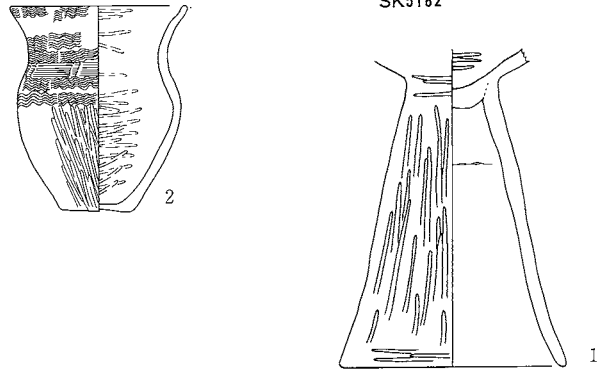

SK5331

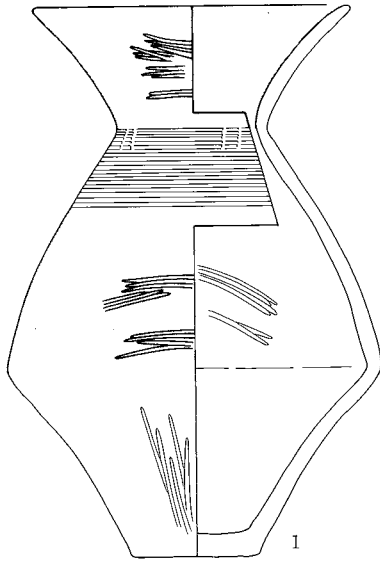

SK5340

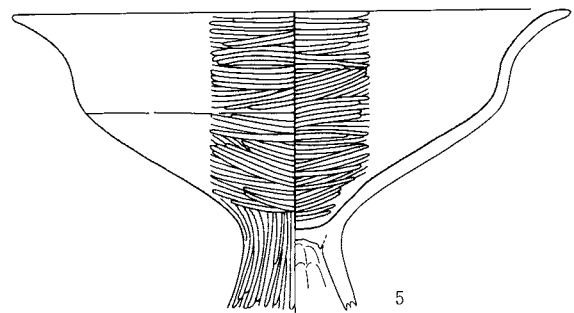
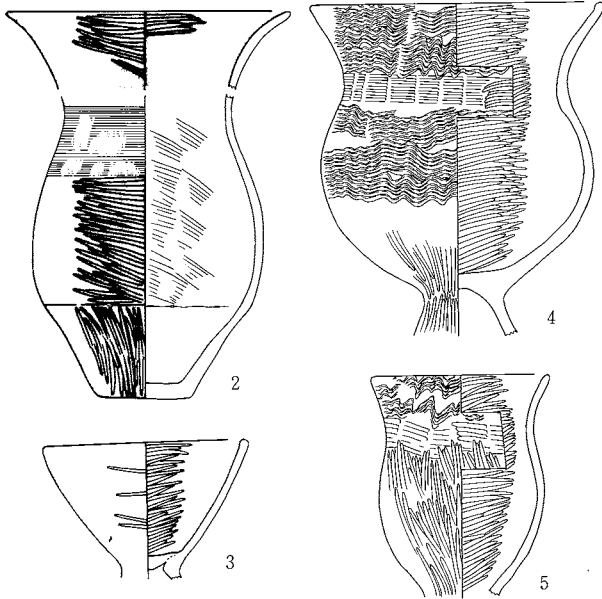
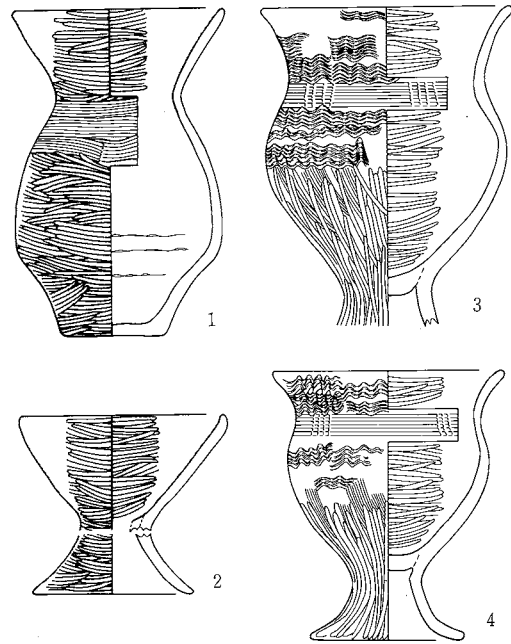

0 (1:4) 10cm

SK5341

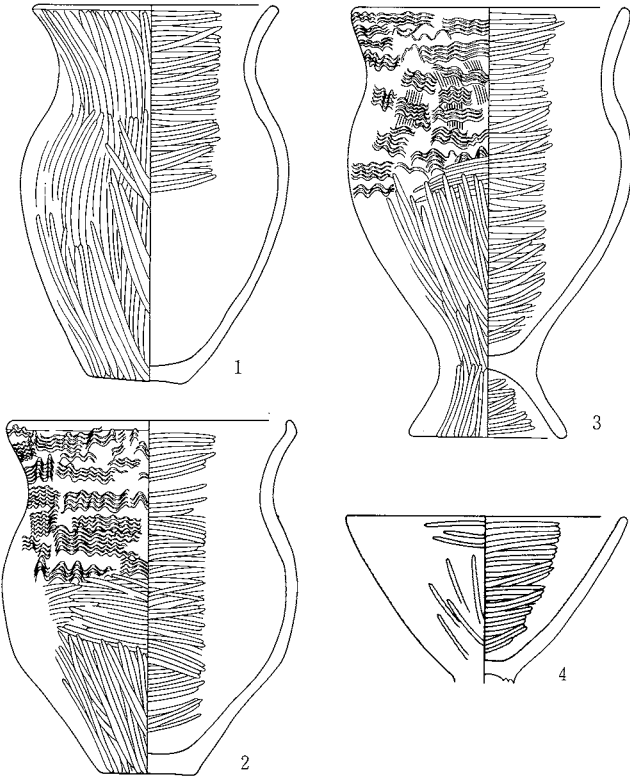

SK5343

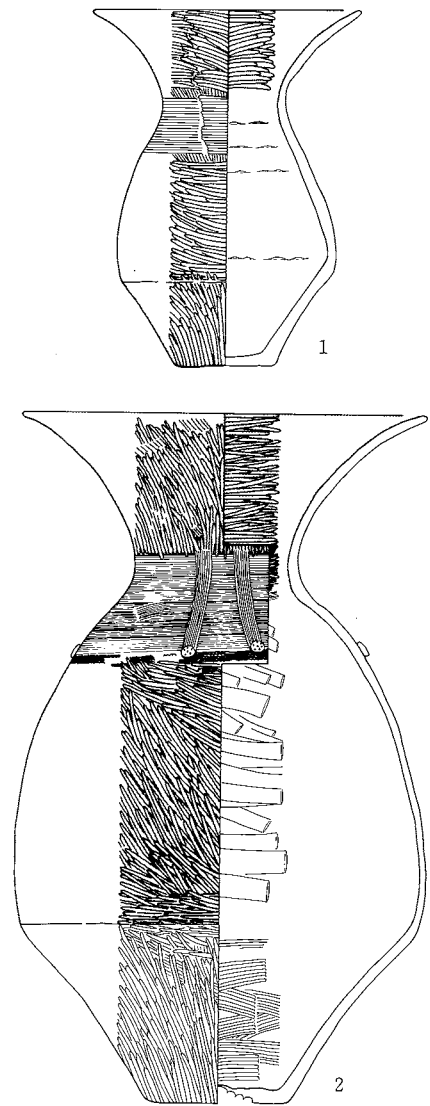

0 (1:6) 20cm
(SK5343-2)

SK5461

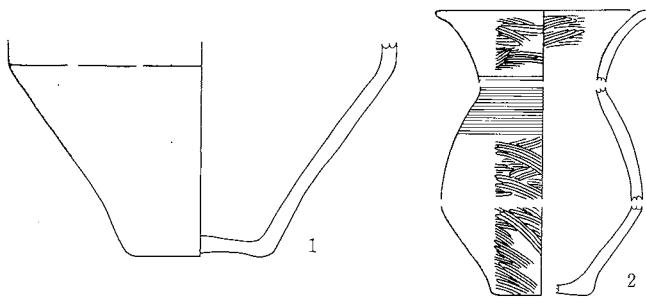

SK6269

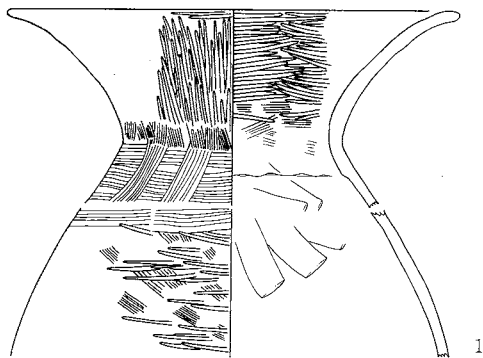

SK7078

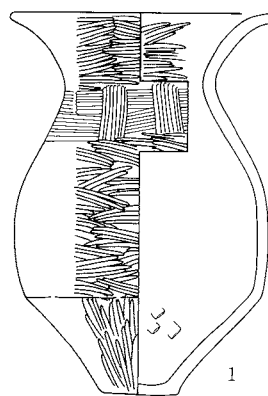

SK7147

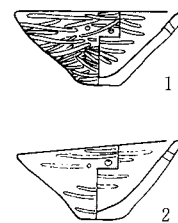

0 (1:4) 10cm

SK5367

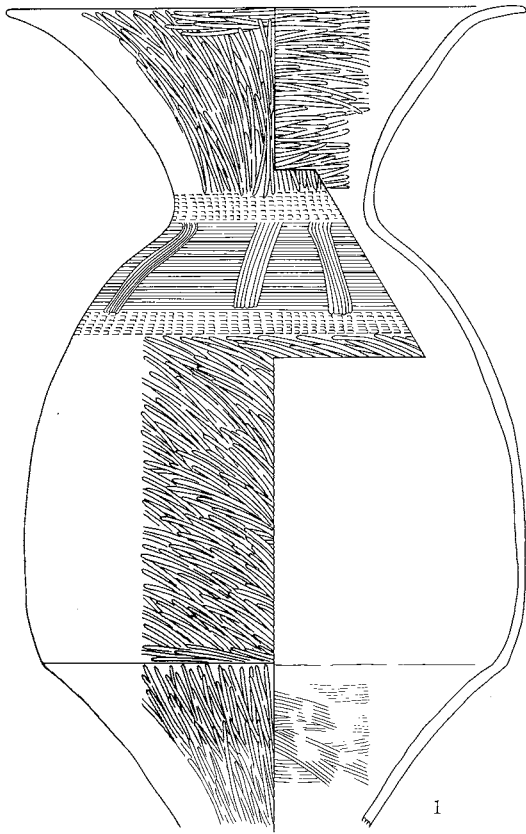

SK7148

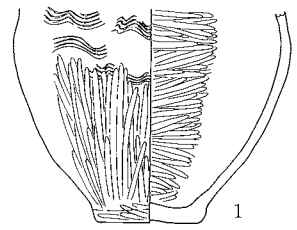

SK7152

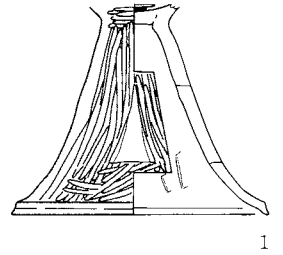

SK9244

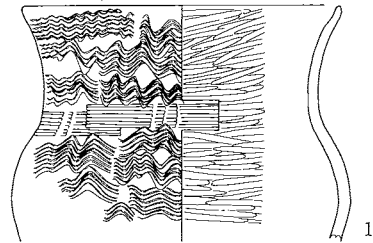

SK5490

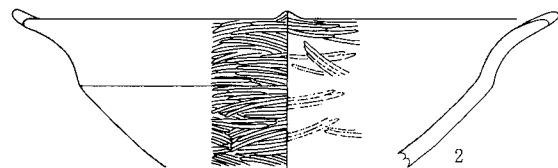
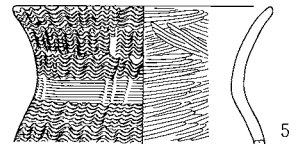
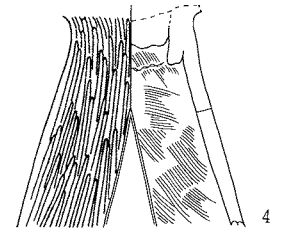
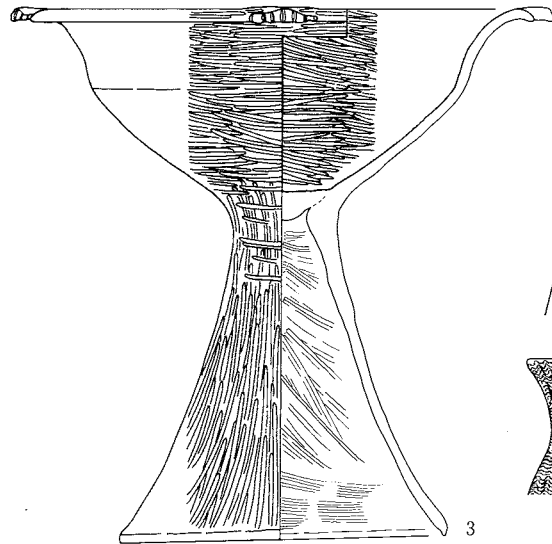
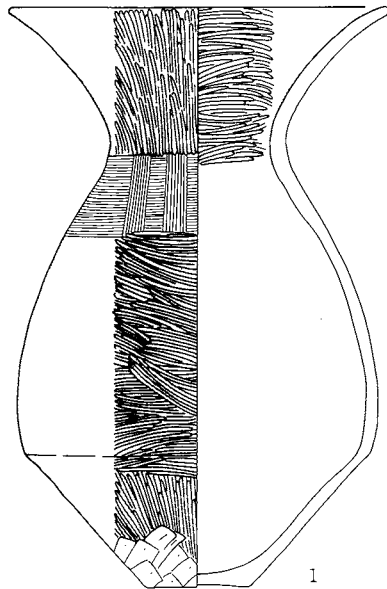

SK14045

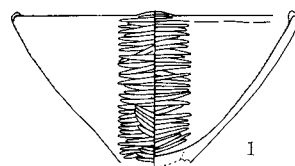

0 (1:4) 10cm

SK5367 · 5490 · 7148 · 7152 · 9244 · 14045

SK7236

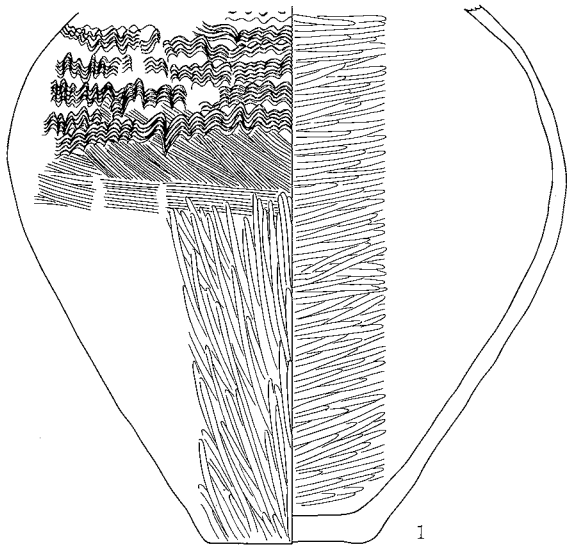

SK14209

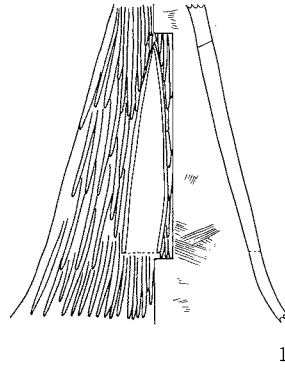

SK16255

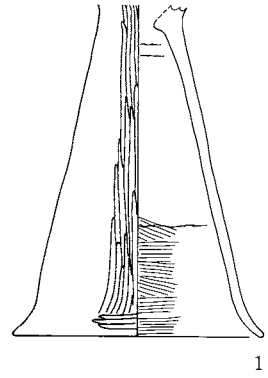

SK14557

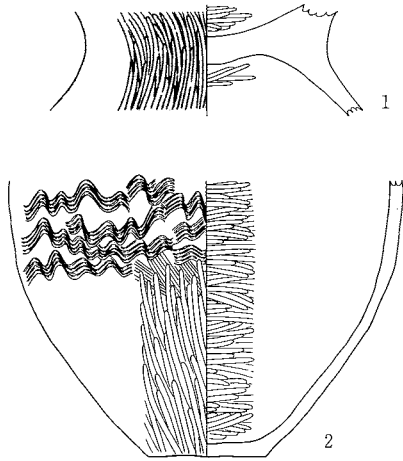

SK16266

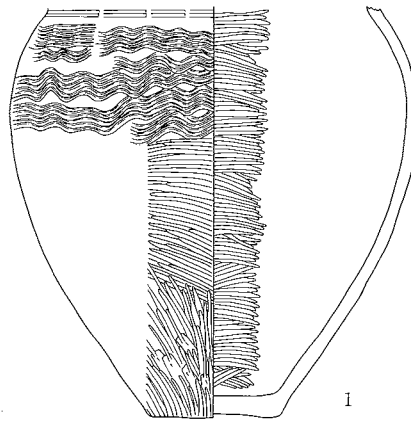

SK16253

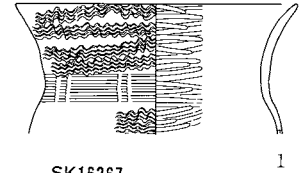

SK16267

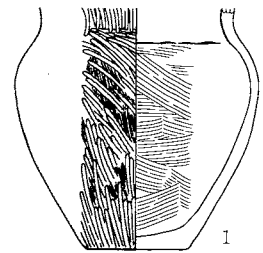

SK16700

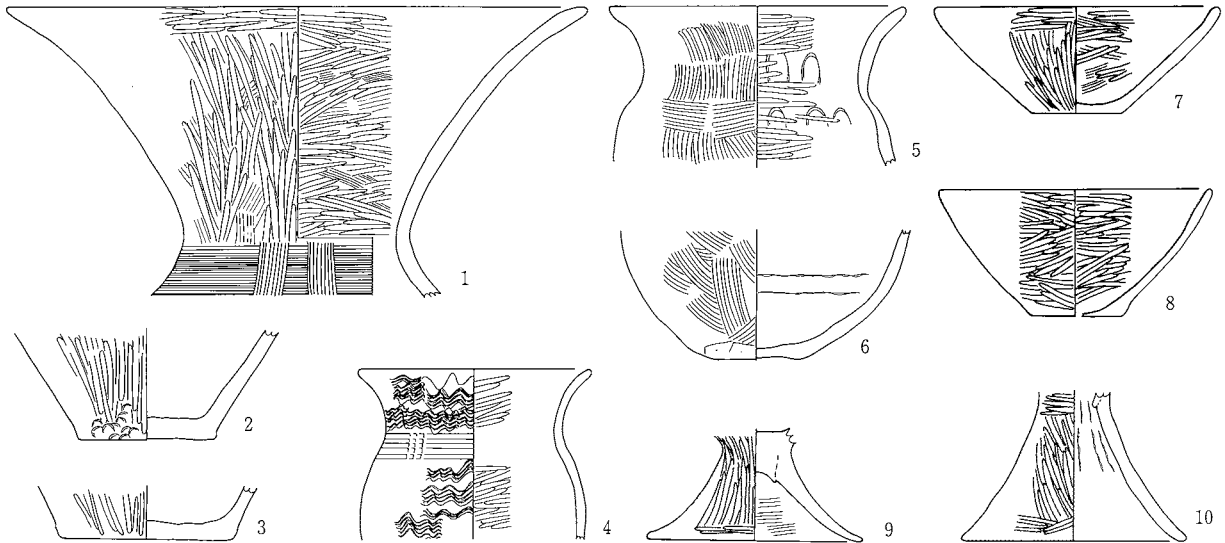

0 (1:4) 10cm

SK7236 · 14209 · 14557 · 16253 · 16255 · 16266 · 16267 · 16700

SK16712

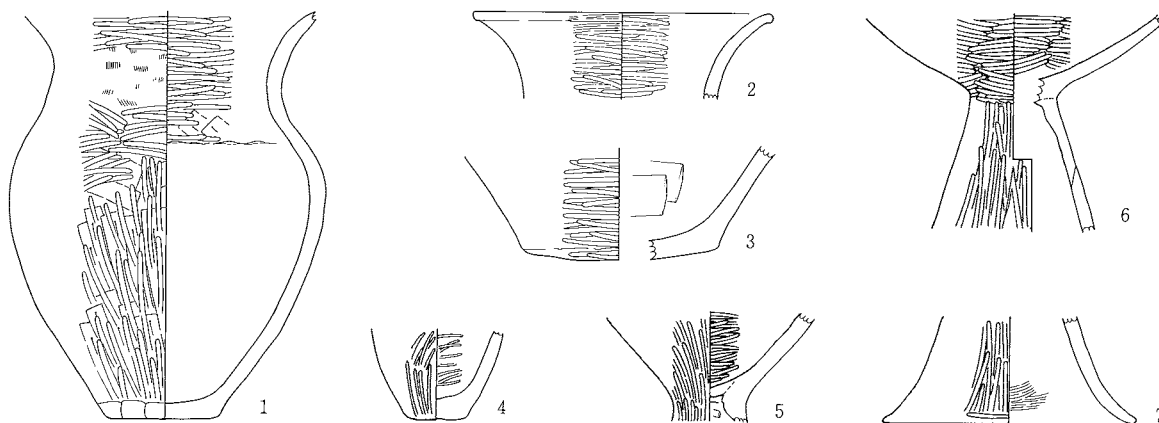

SF7

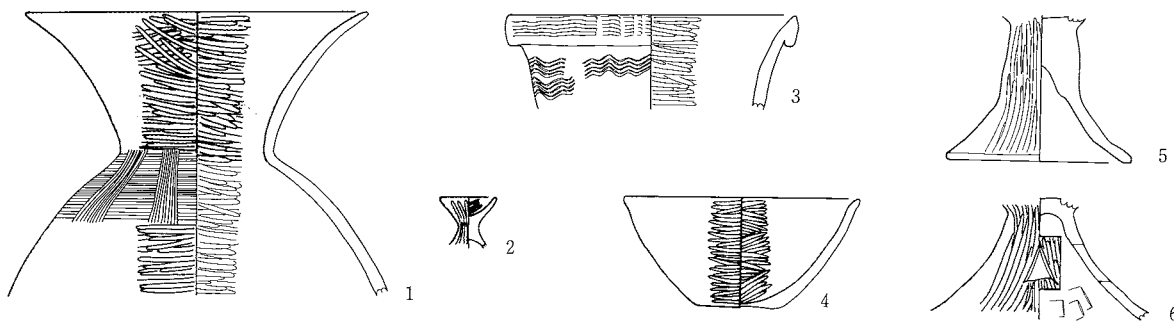

SF303

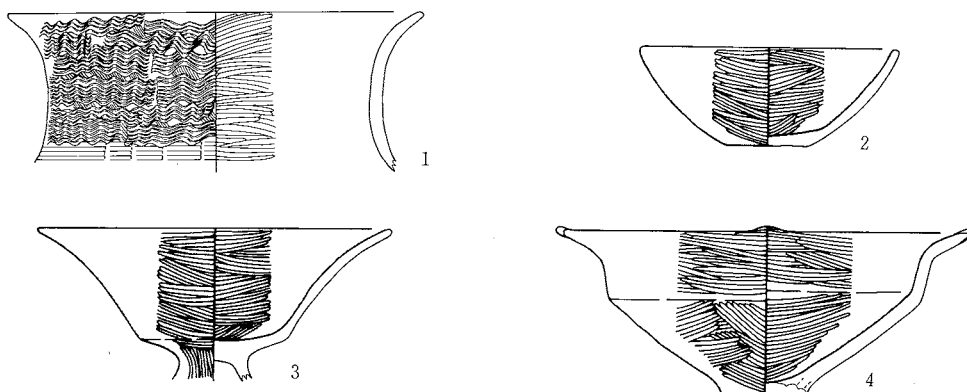

SX509

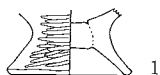

SX511

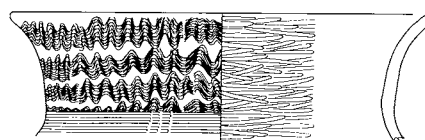

0 (1:4) 10cm

SK16712 SF7・303 SX509・511

SX507

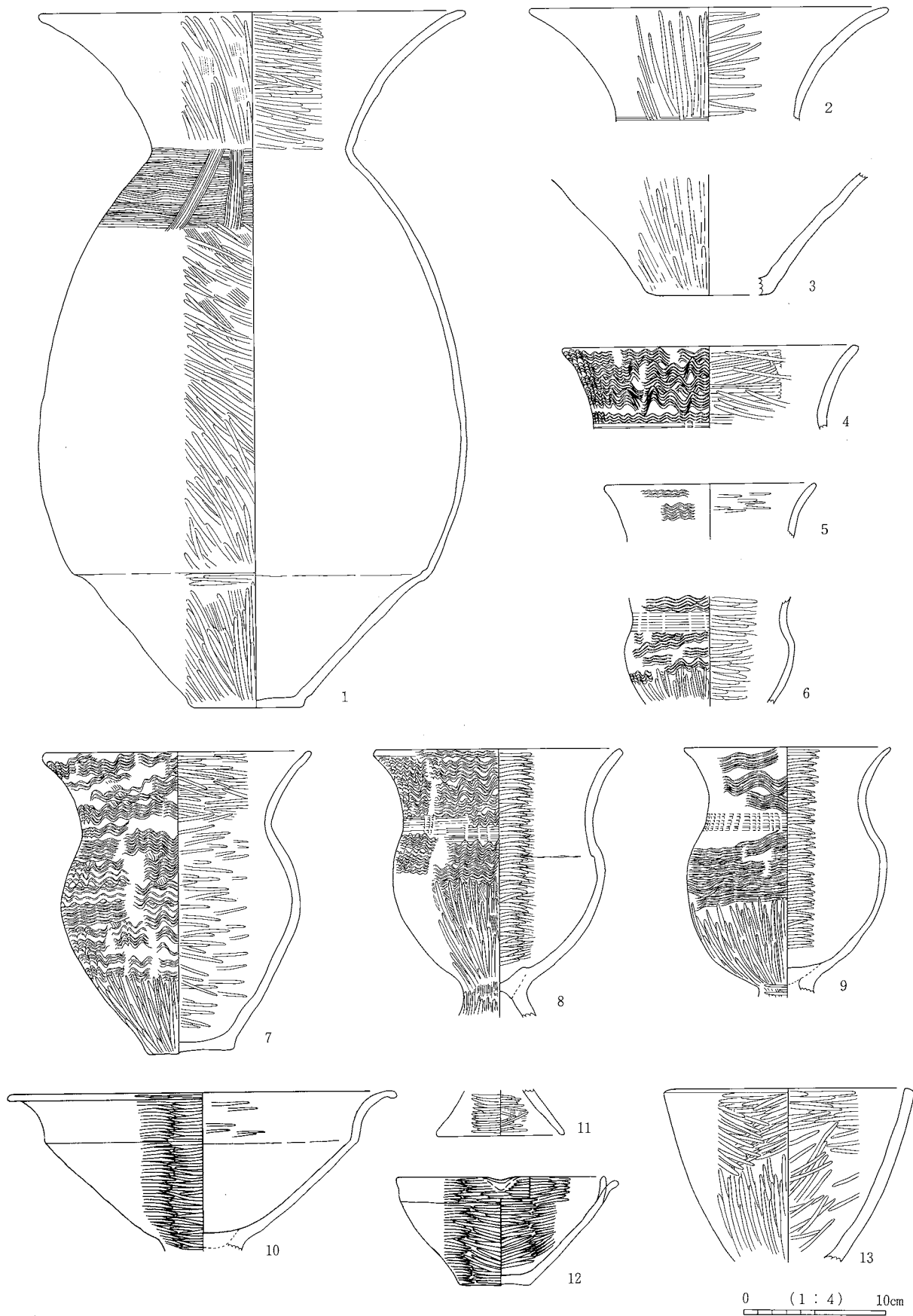

SX507

SX513

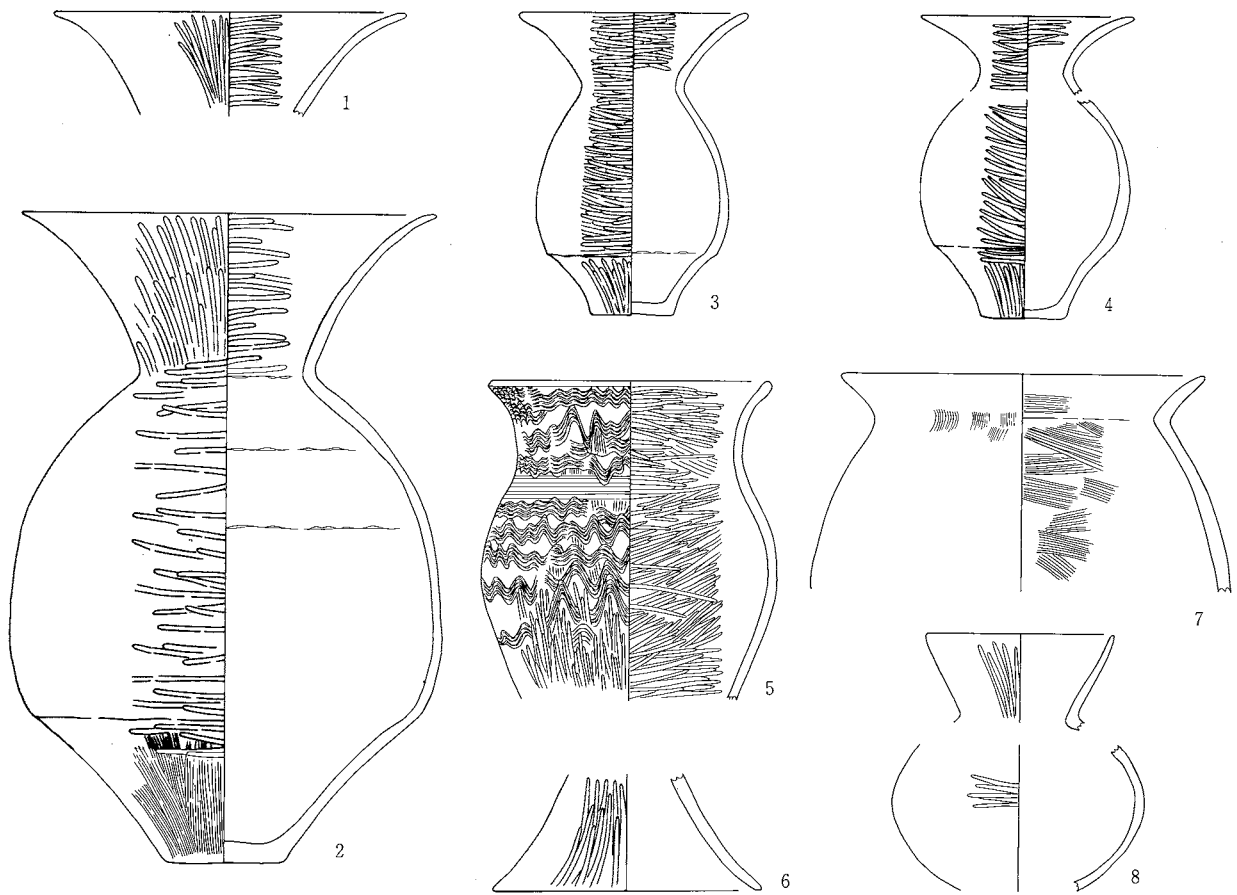

SX516

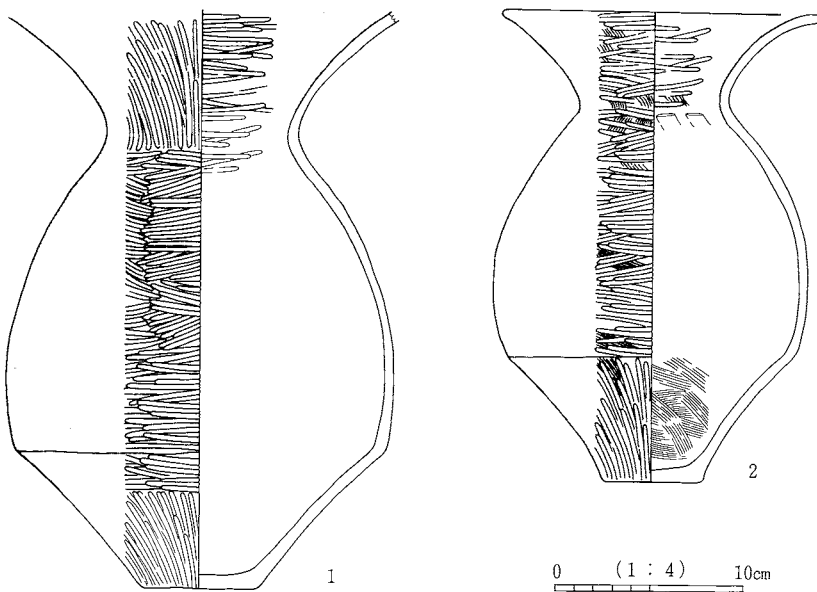

0 (1:4) 10cm

SX513・516

SX514

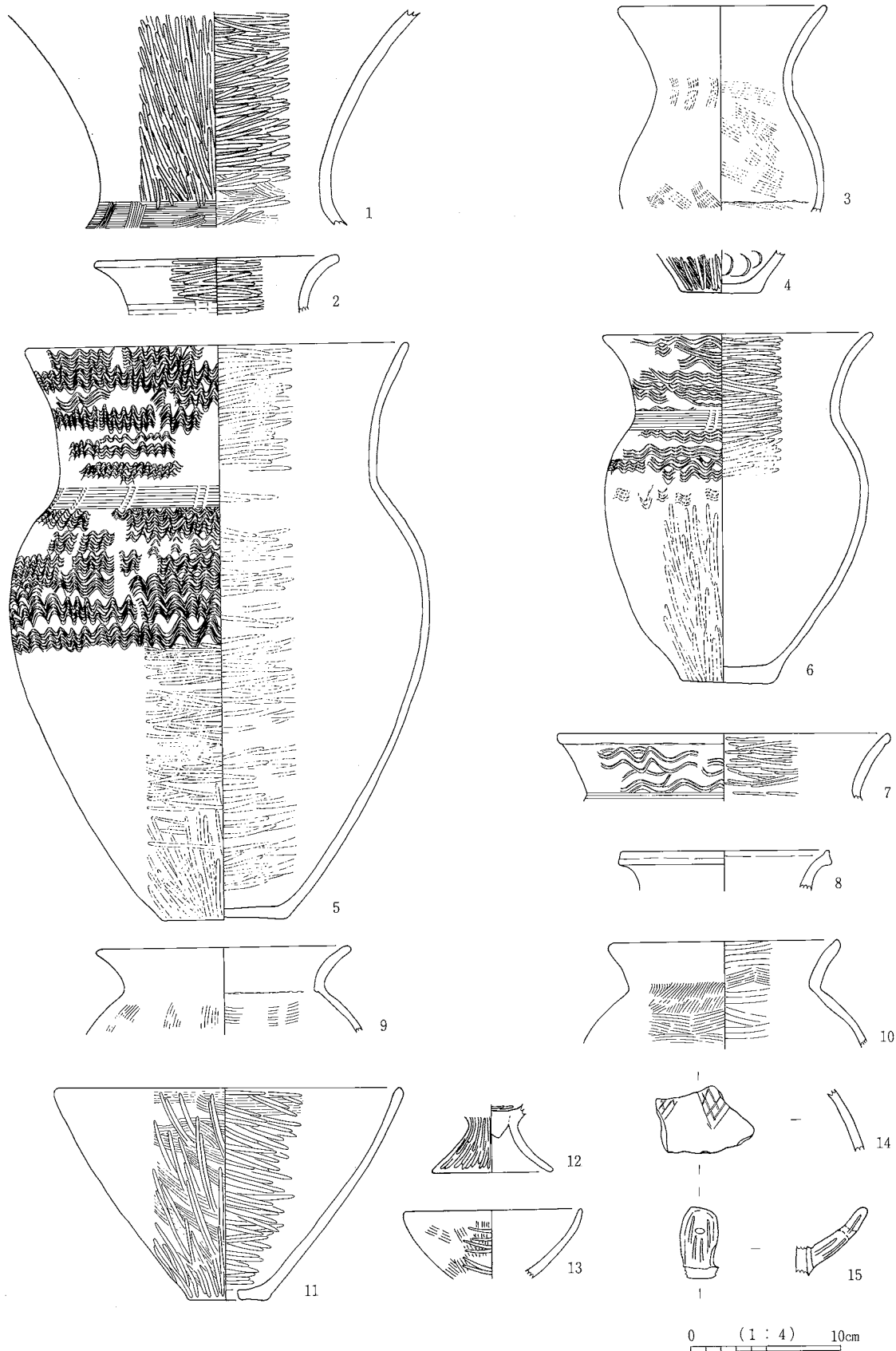

SX514

遺構外-①

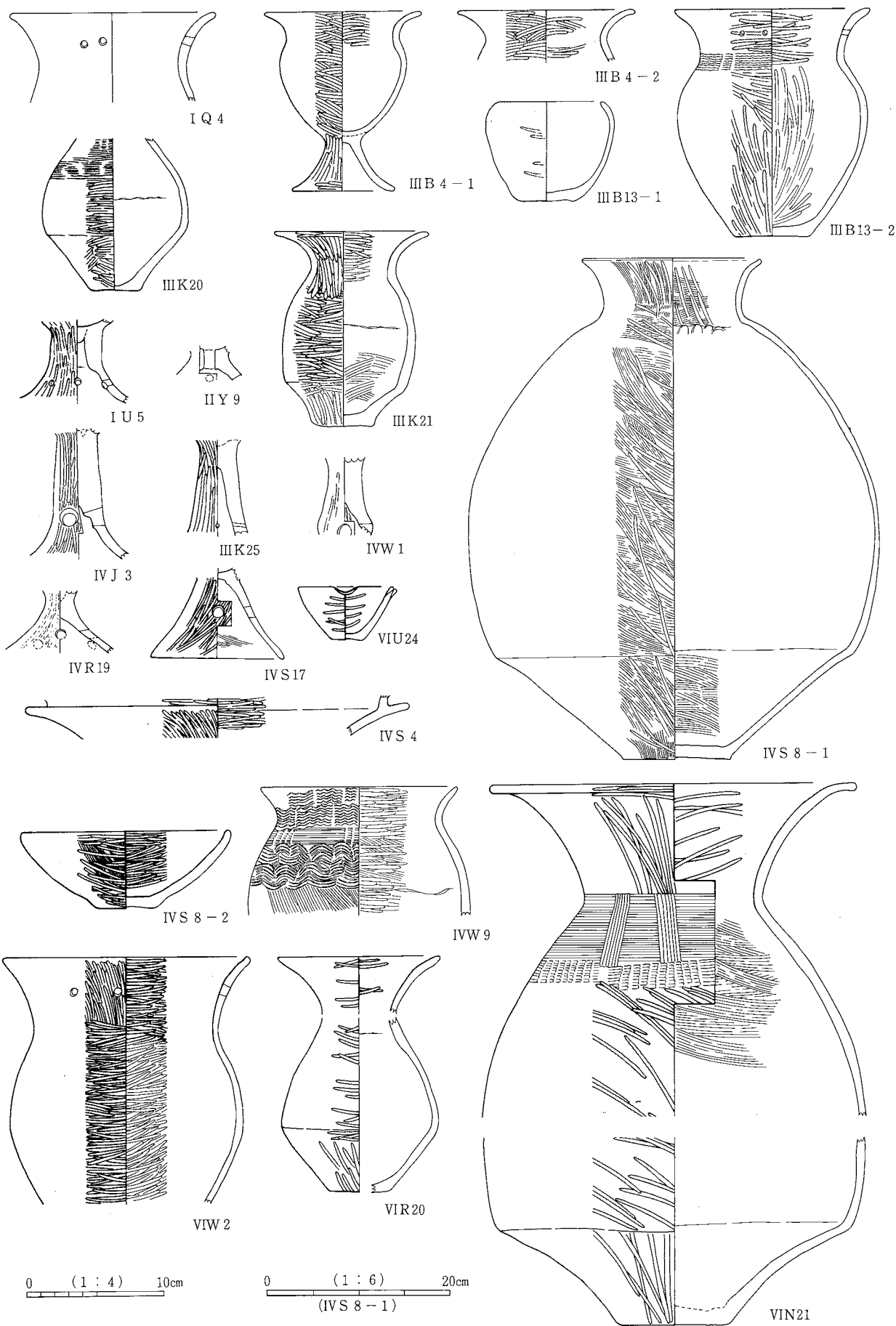

遺構外-①

遺構外-②

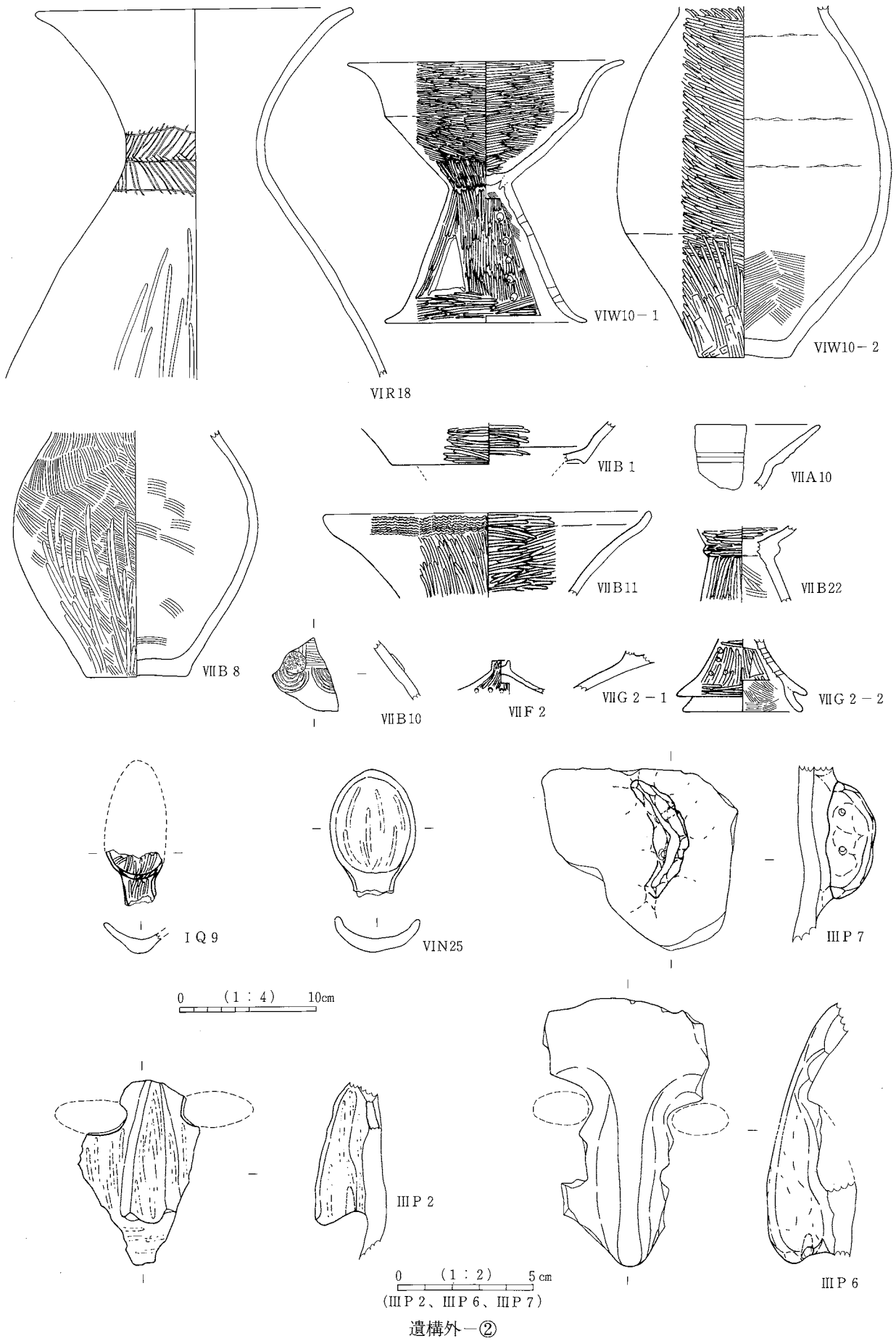

遺構外-②

SB29

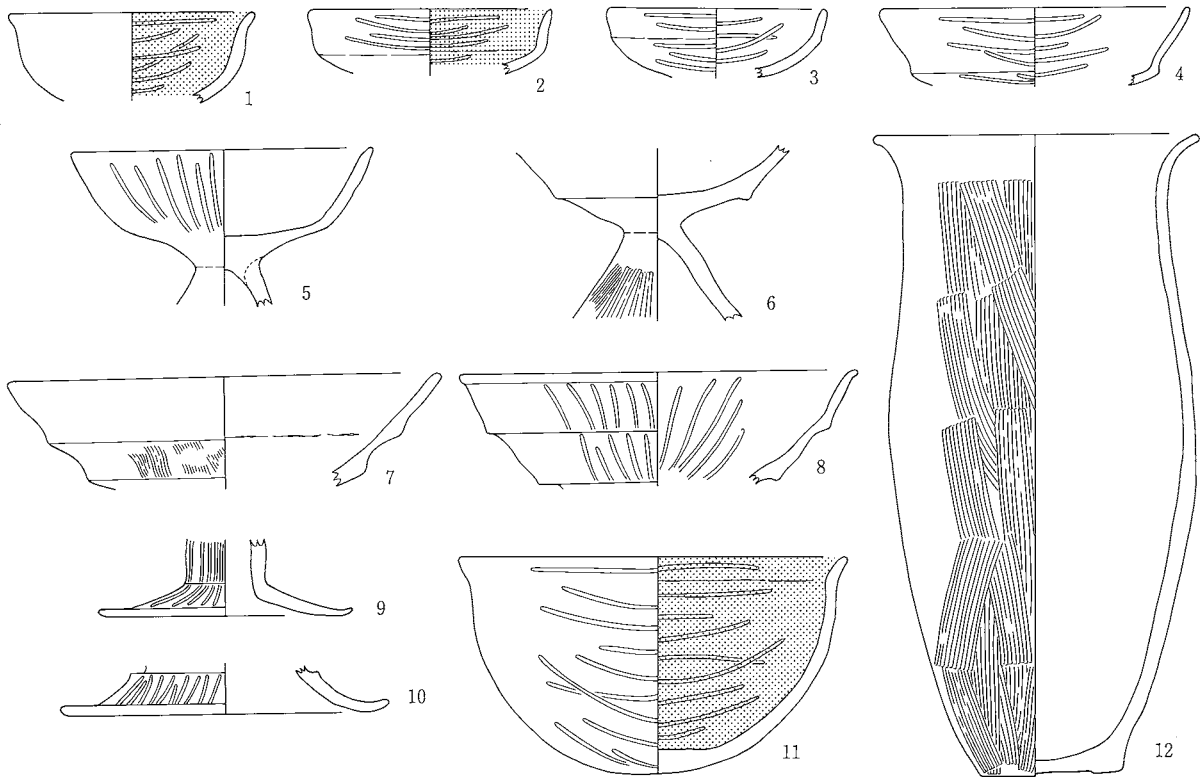

SB42

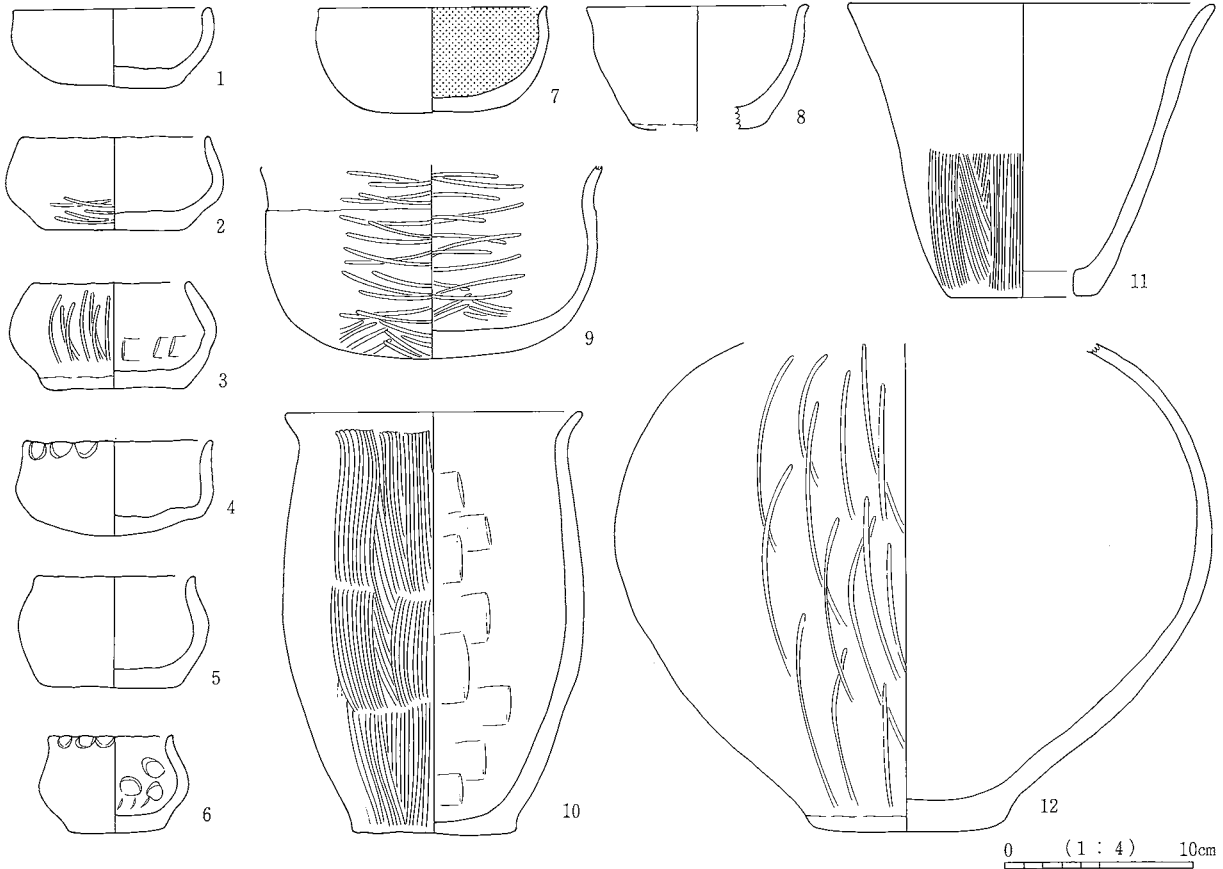

SB50

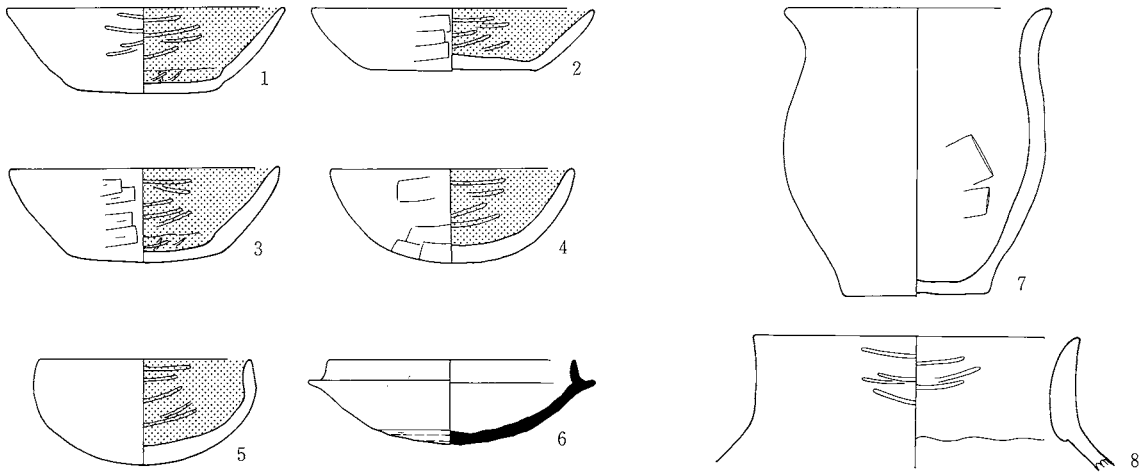

SB56-①

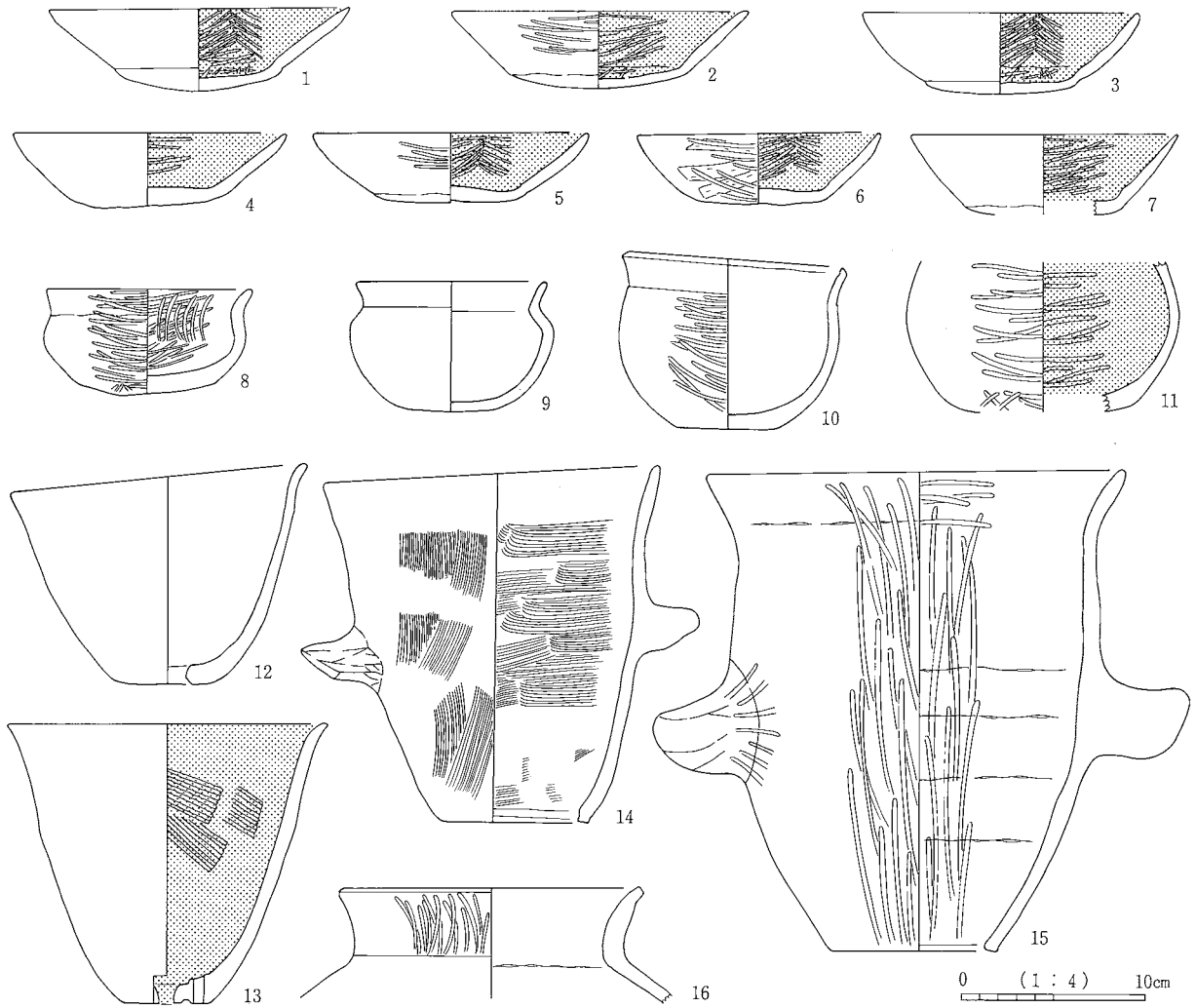

SB56-②

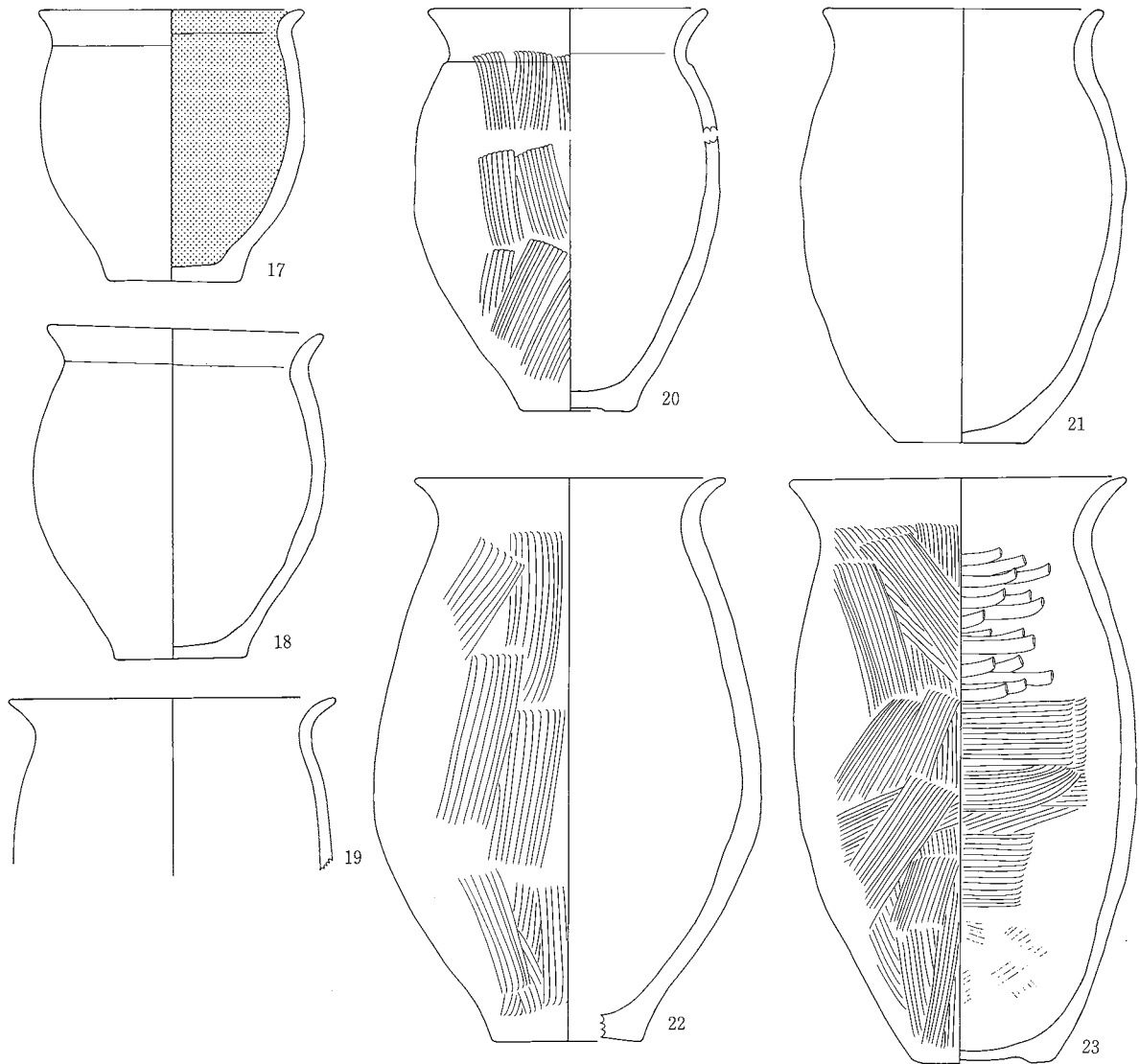

SB64-①

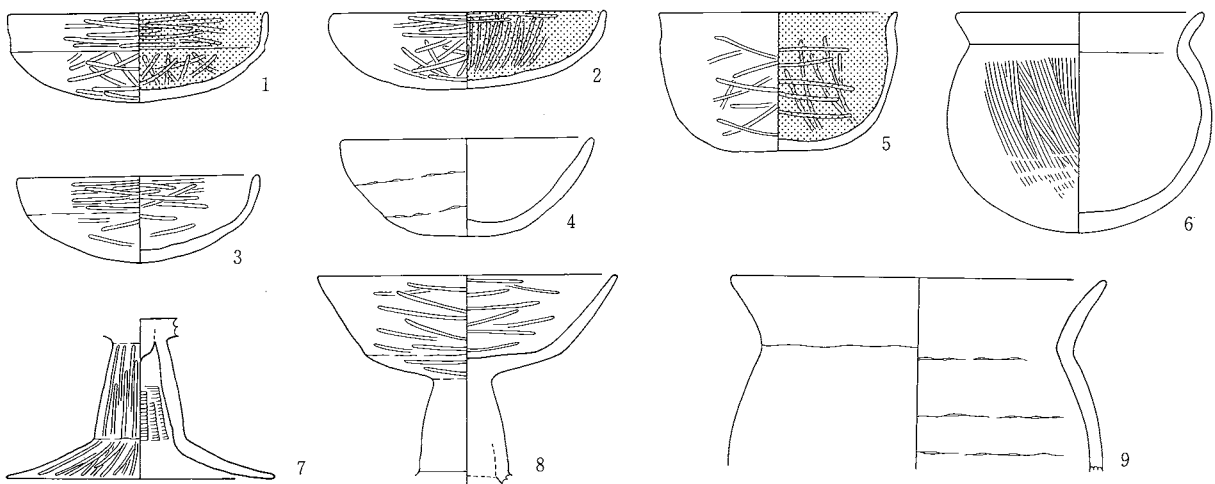

0 (1:4) 10cm

SB64-②

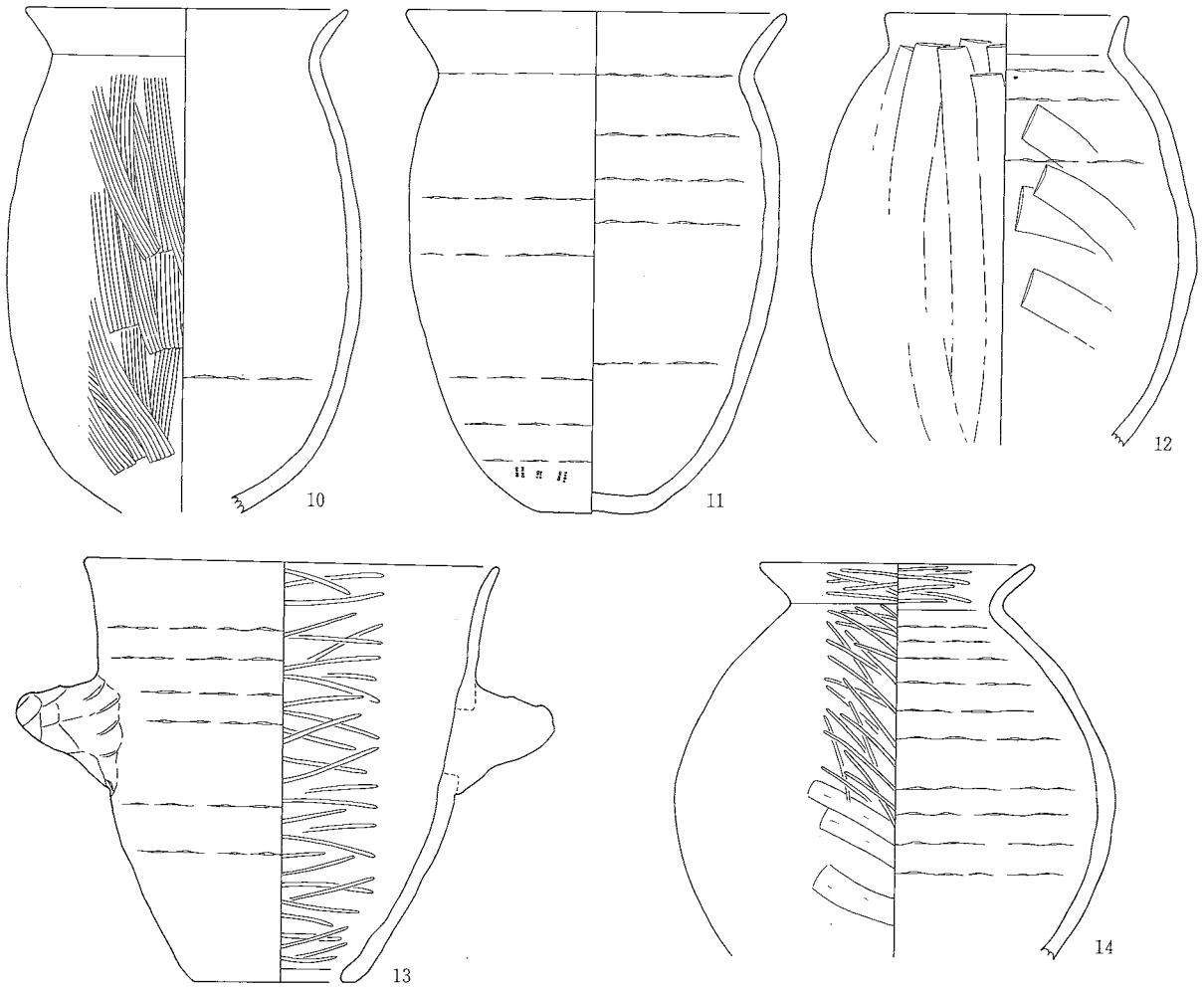

SB69-①

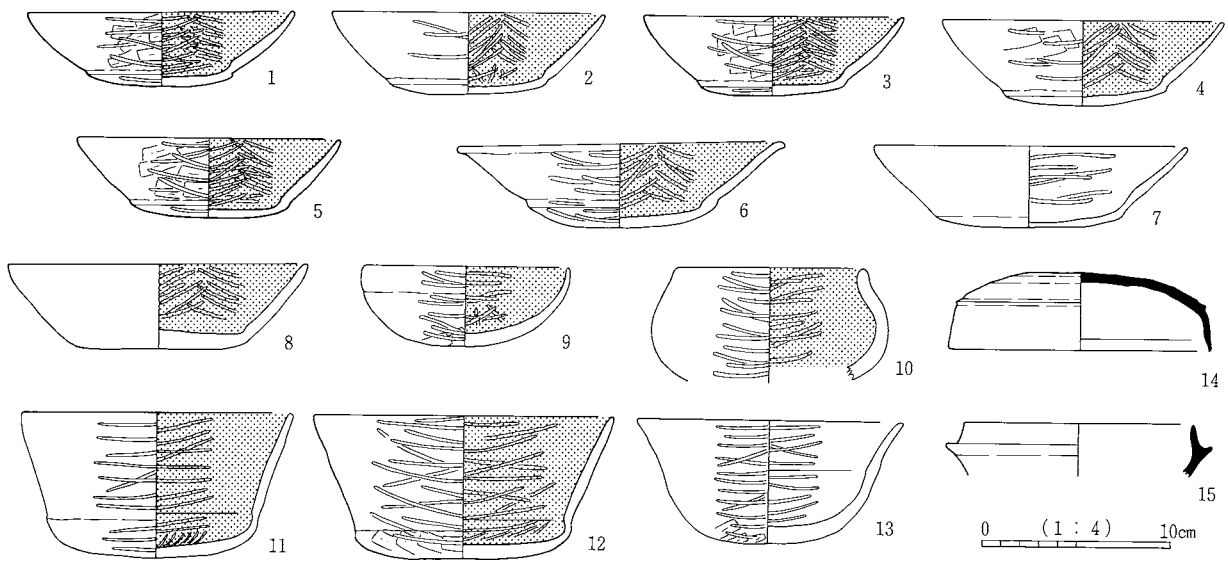

SB69-②

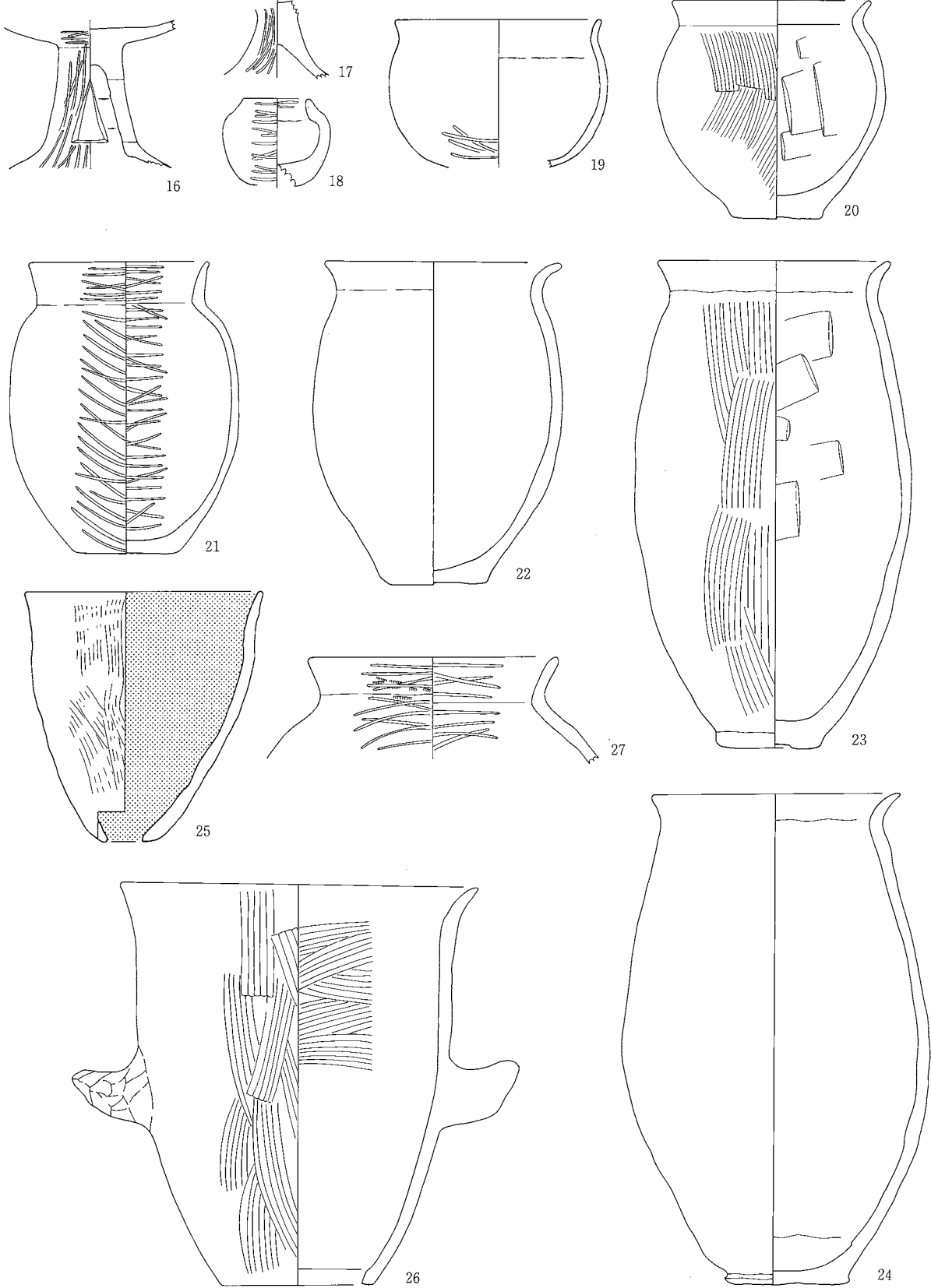

0 (1:4) 10cm

SB69-②

SB70

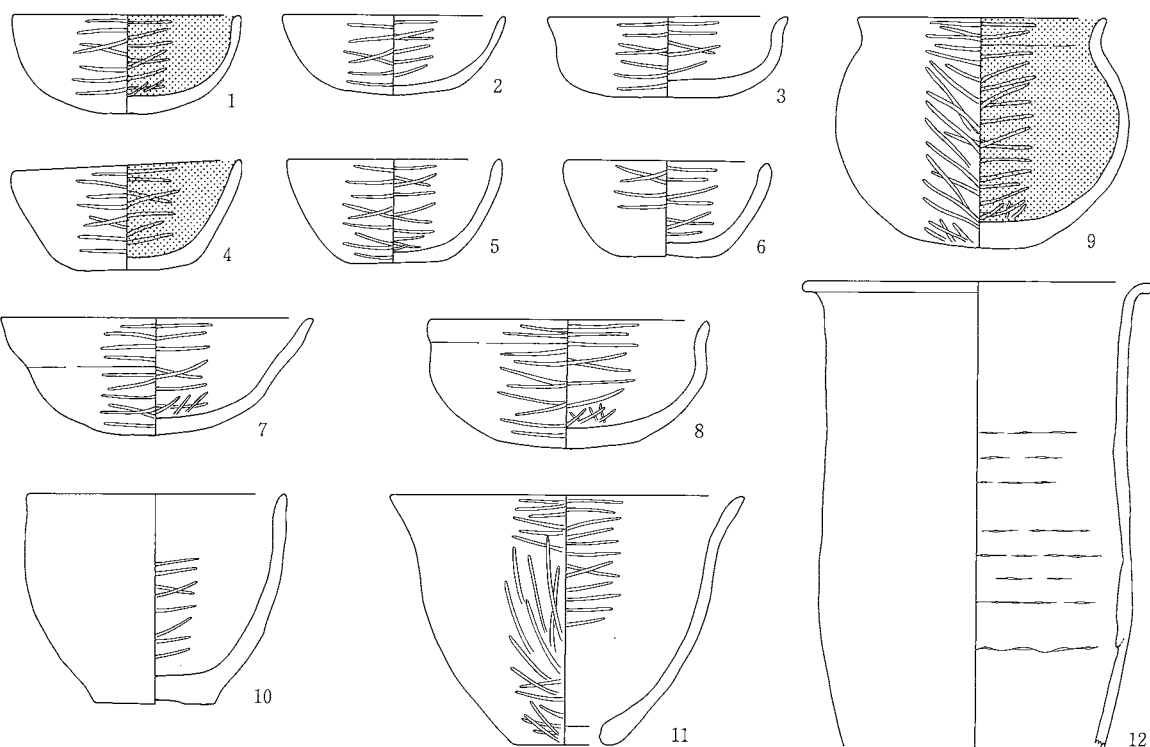

SB73-①

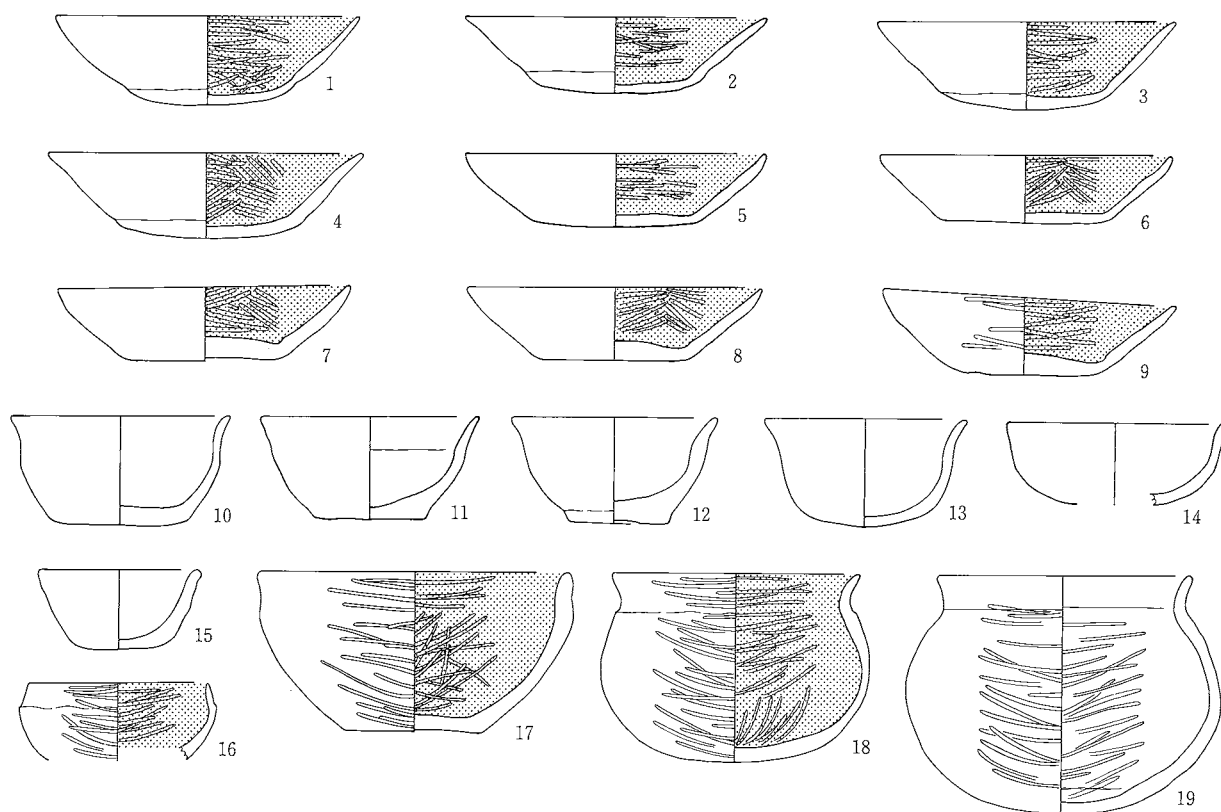

0 (1:4) 10cm

SB73-②

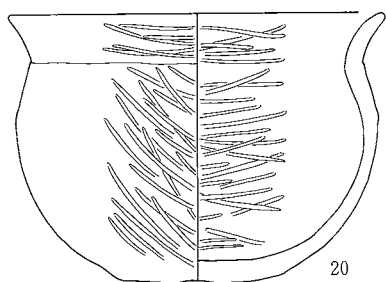

20

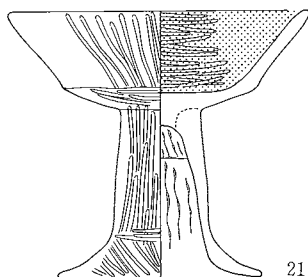

21

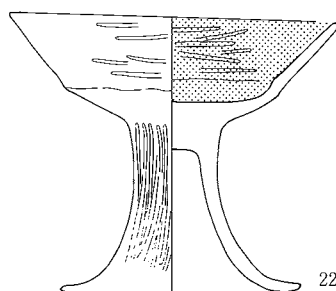

22

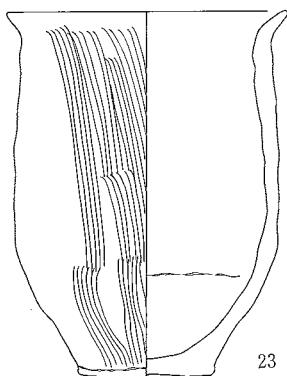

23

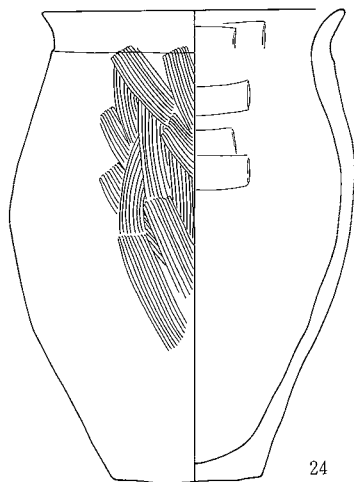

24

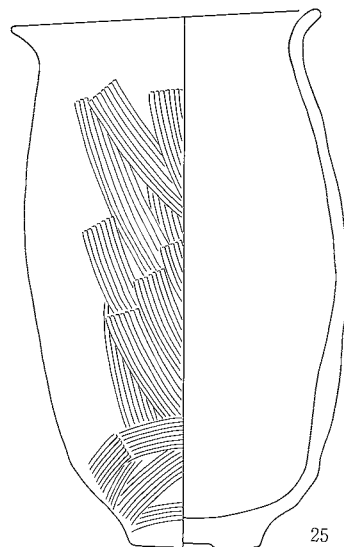

25

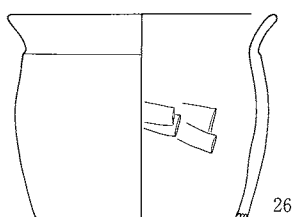

26

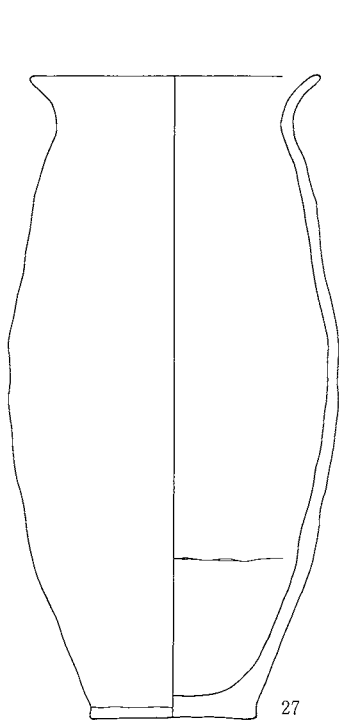

27

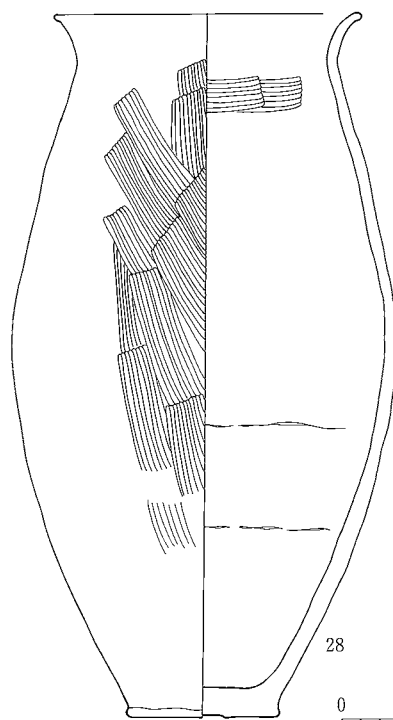

28

0 (1:4) 10cm

SB73-②

SB73-③

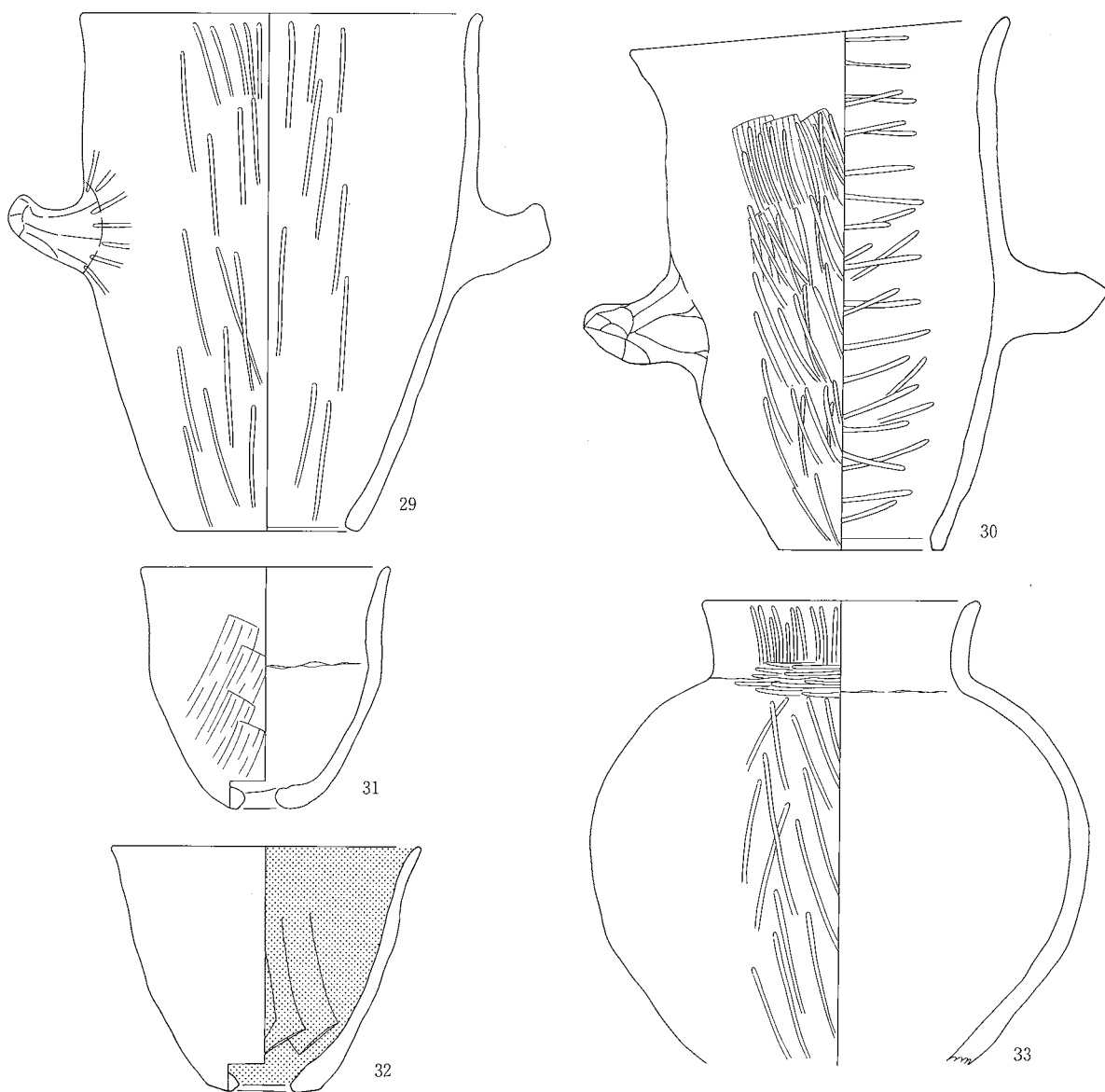

SB75

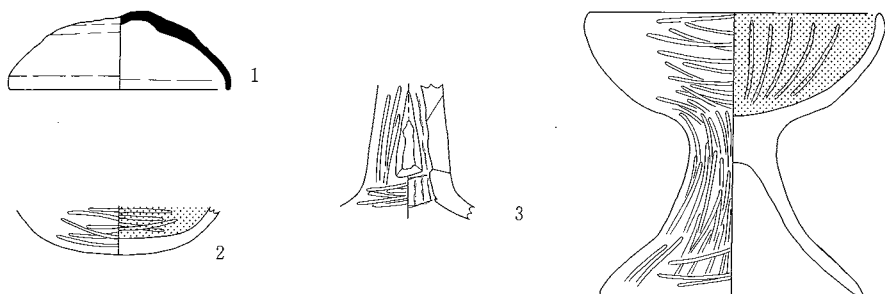

0 (1:4) 10cm

SB83

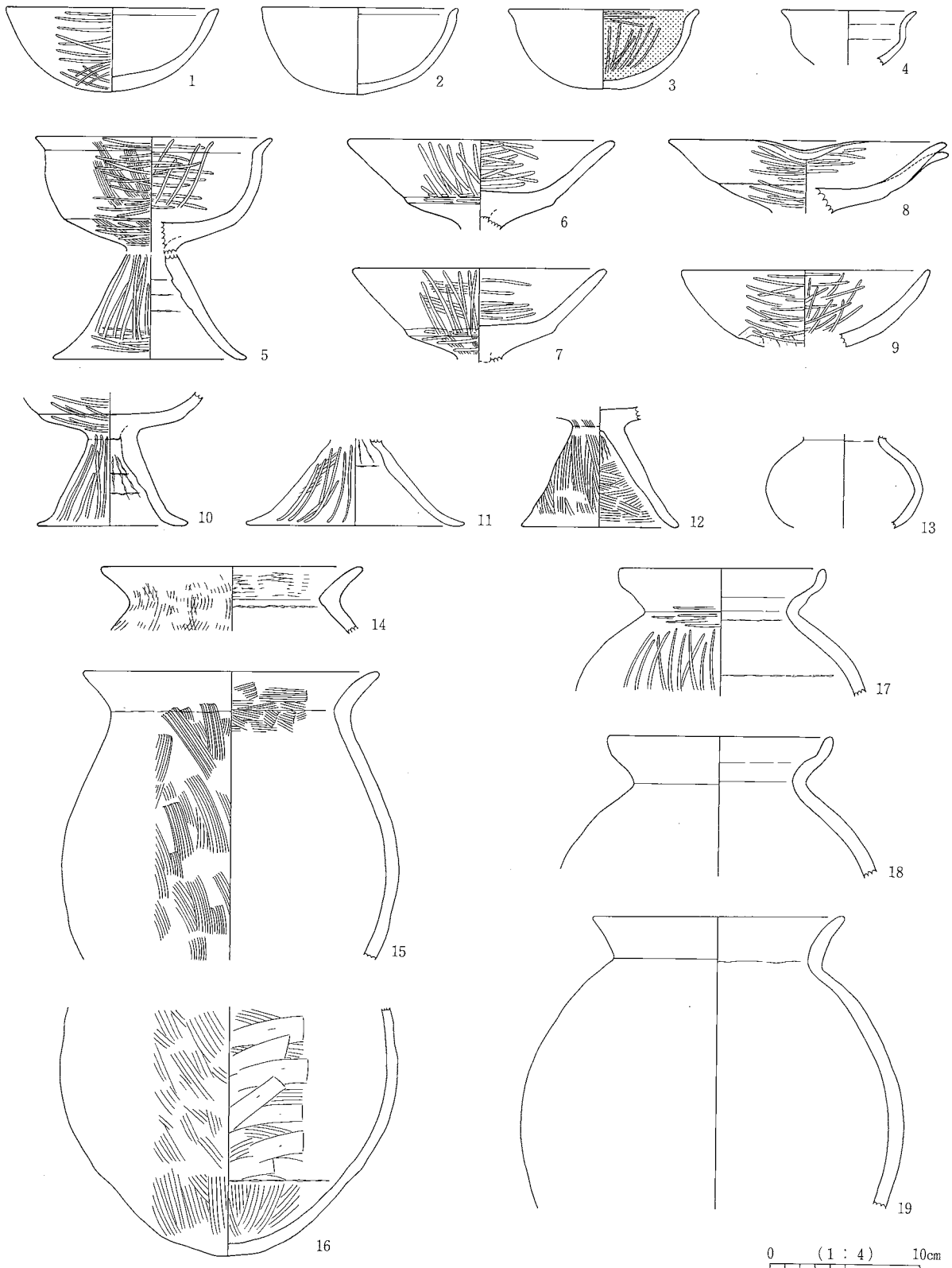

SB83

SB91

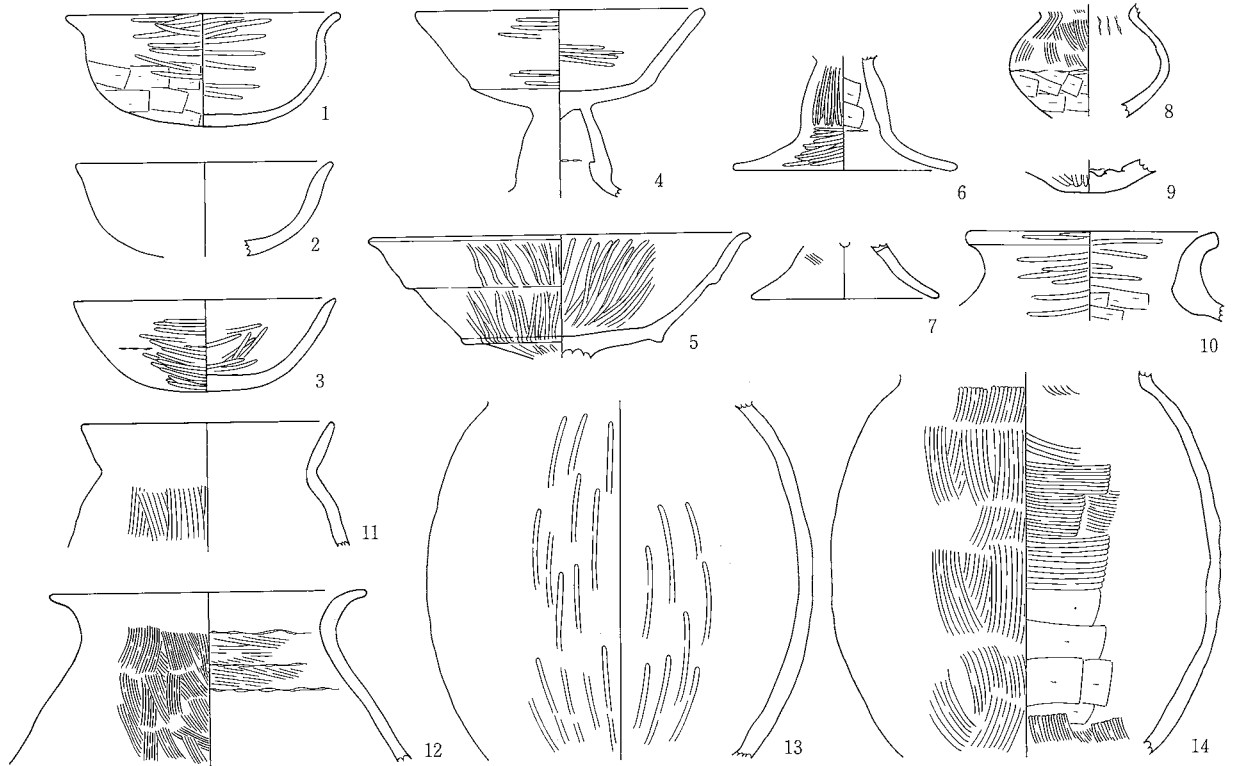

SB98

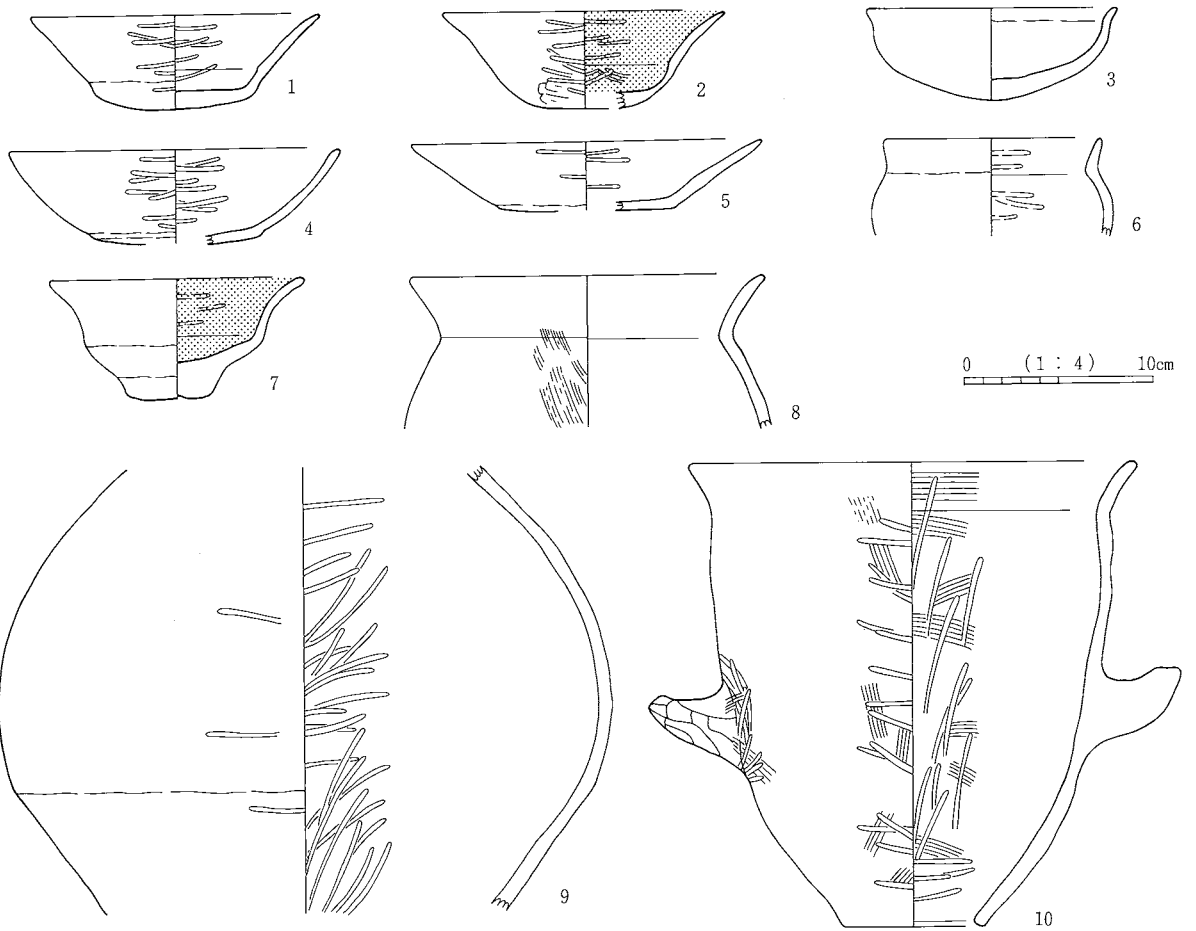

SB115

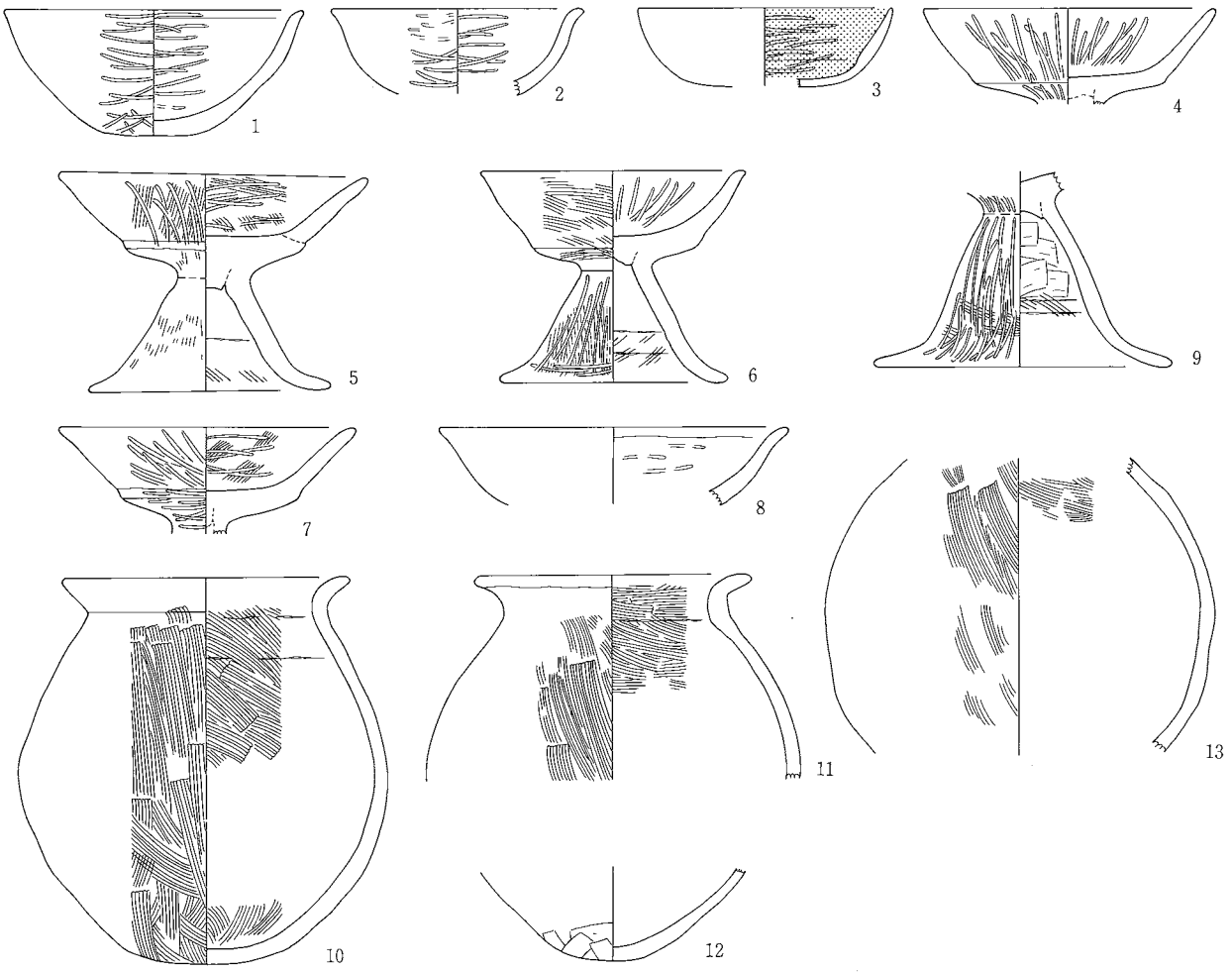

SB118

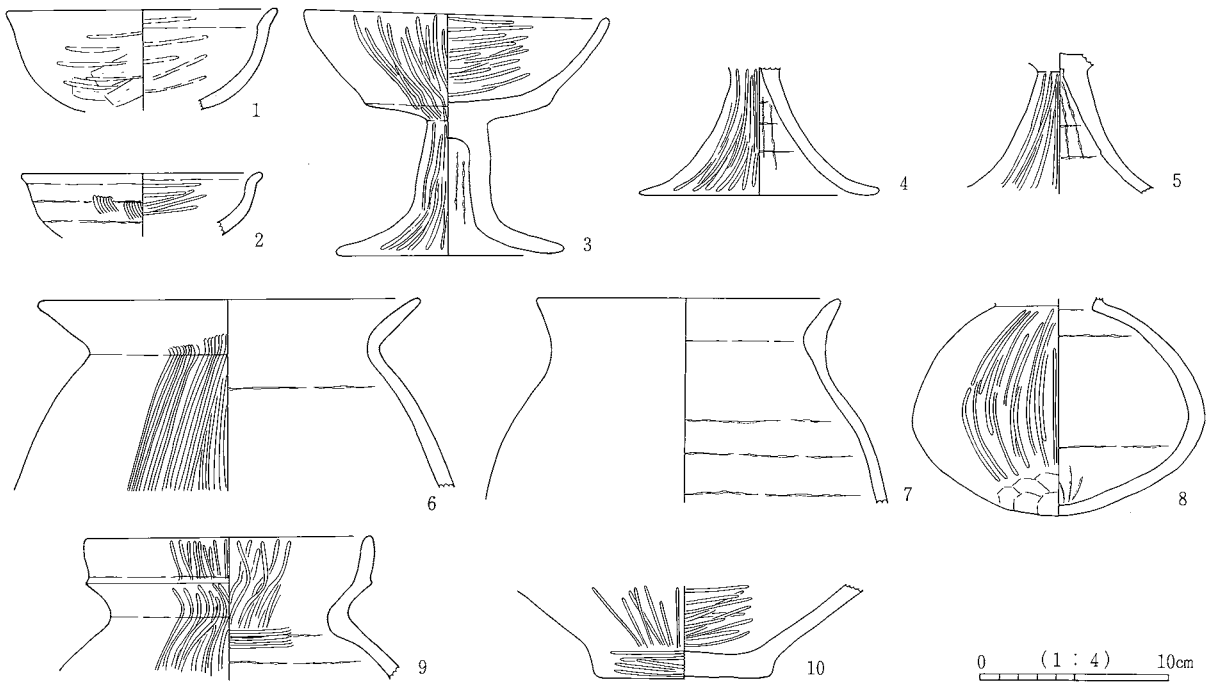

SB126

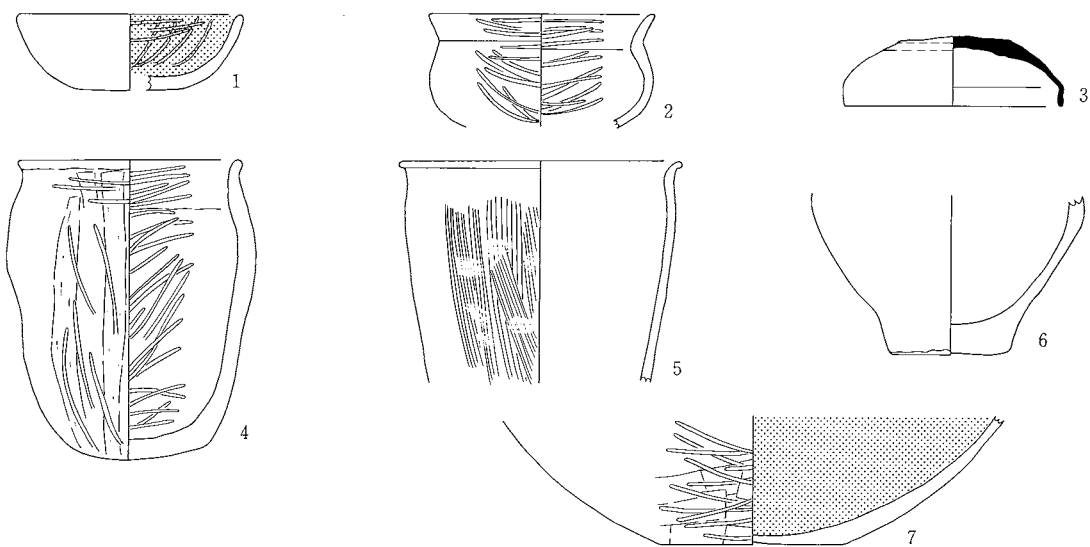

SB148

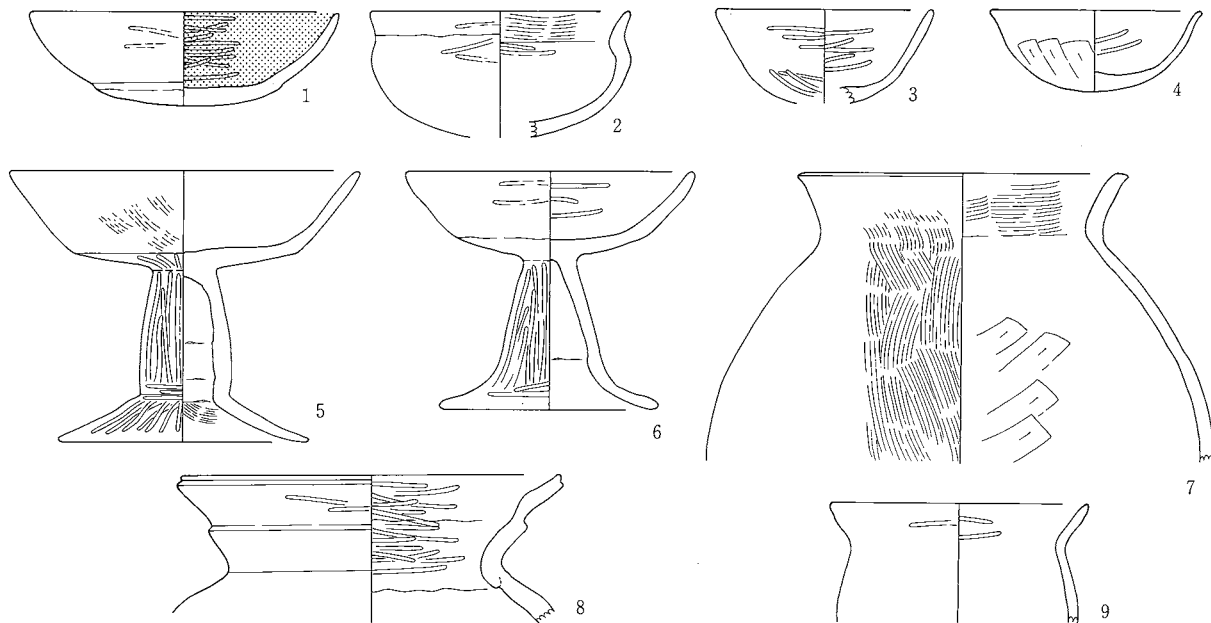

SB164

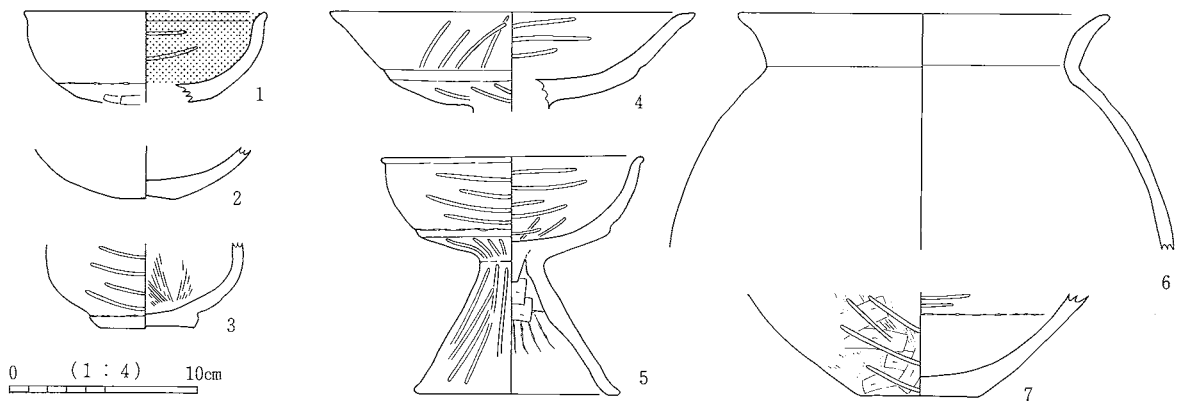

0 (1:4) 10cm

SB163

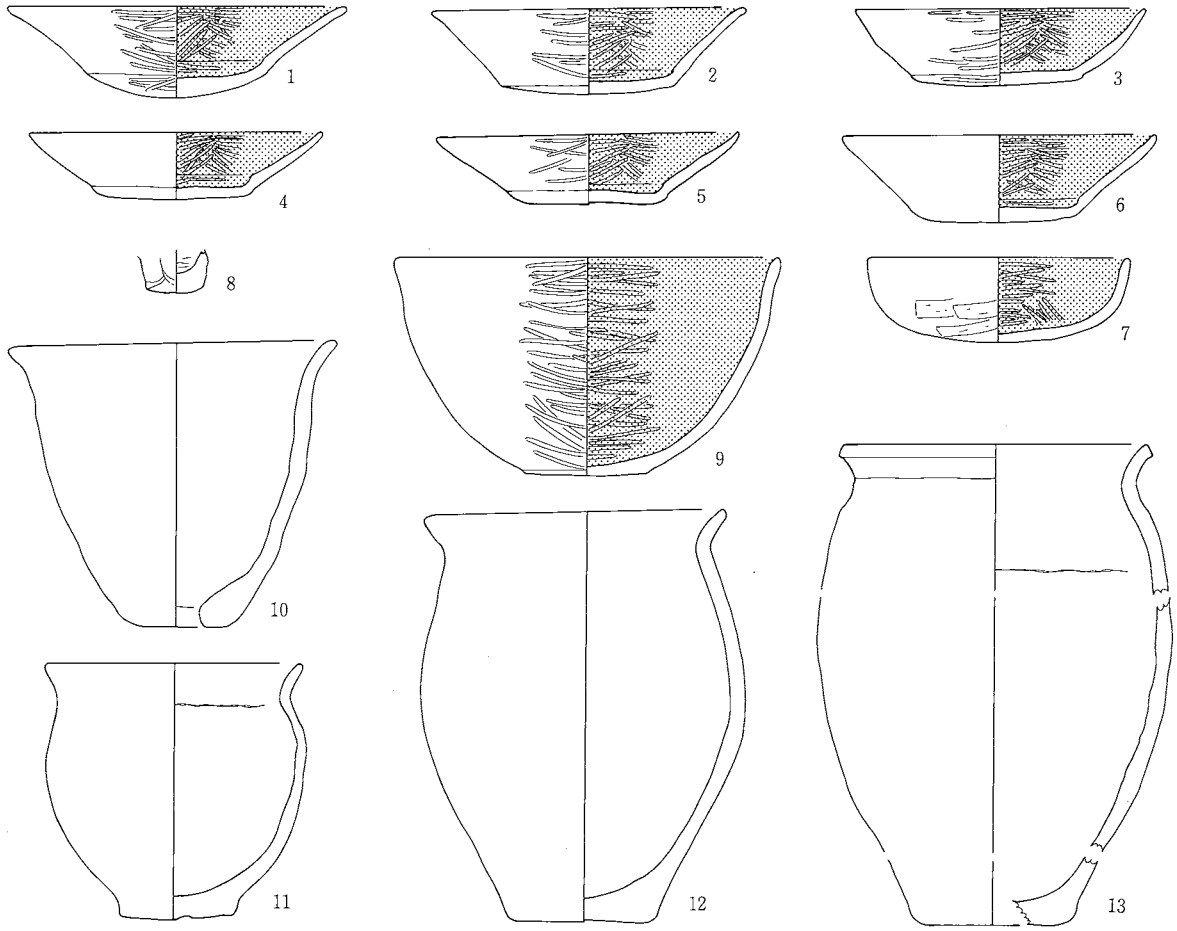

SB167

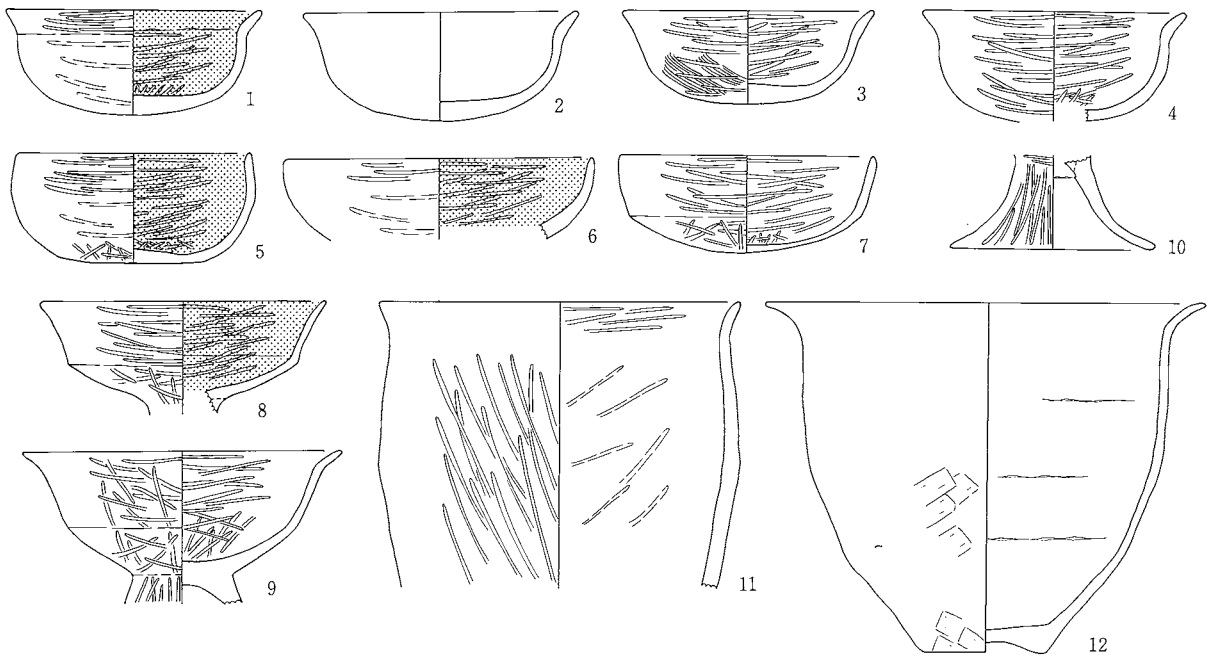

0 (1 : 4) 10cm

SB166

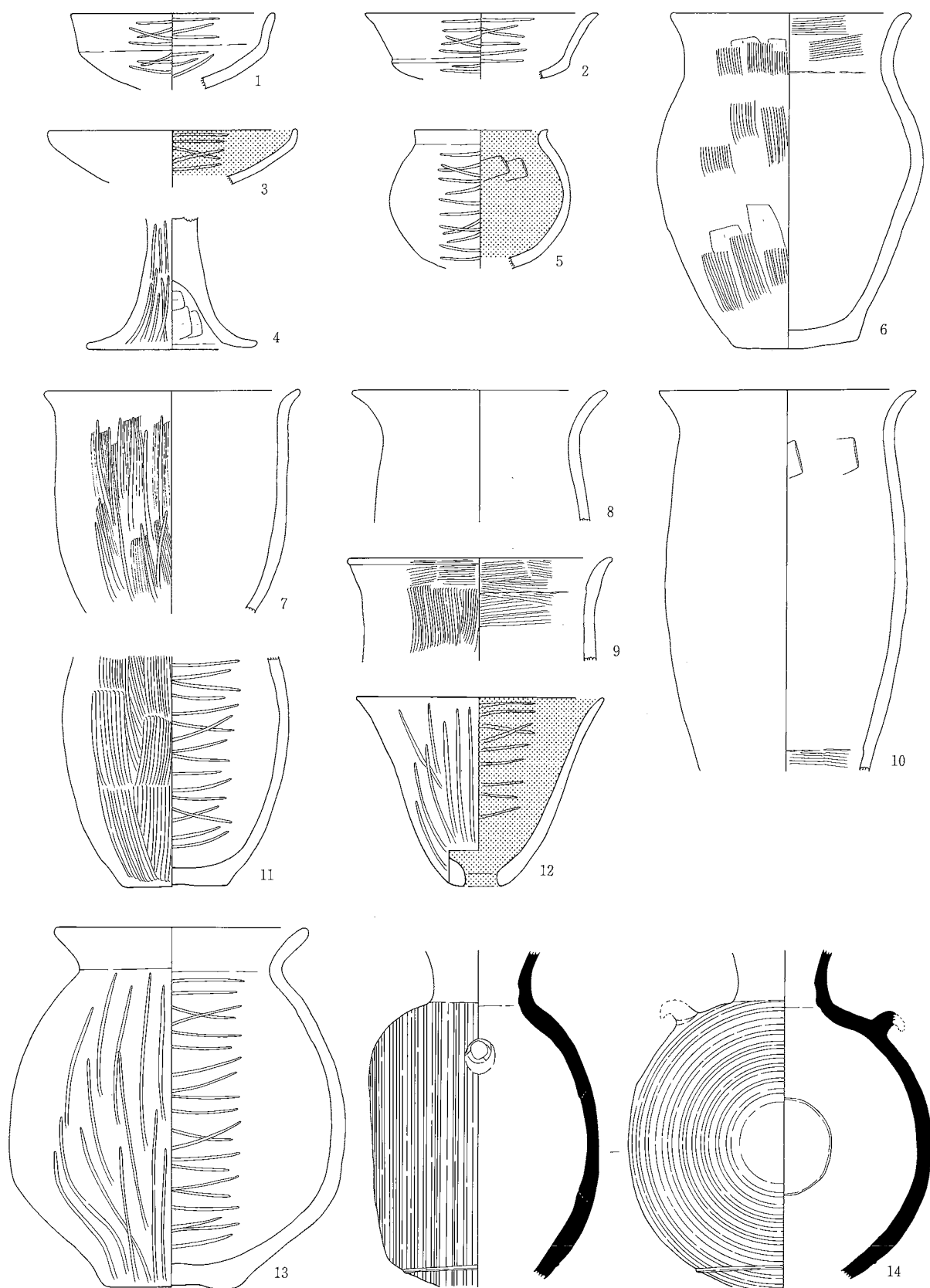

0 (1 : 4) 10cm

SB166

SB172-①

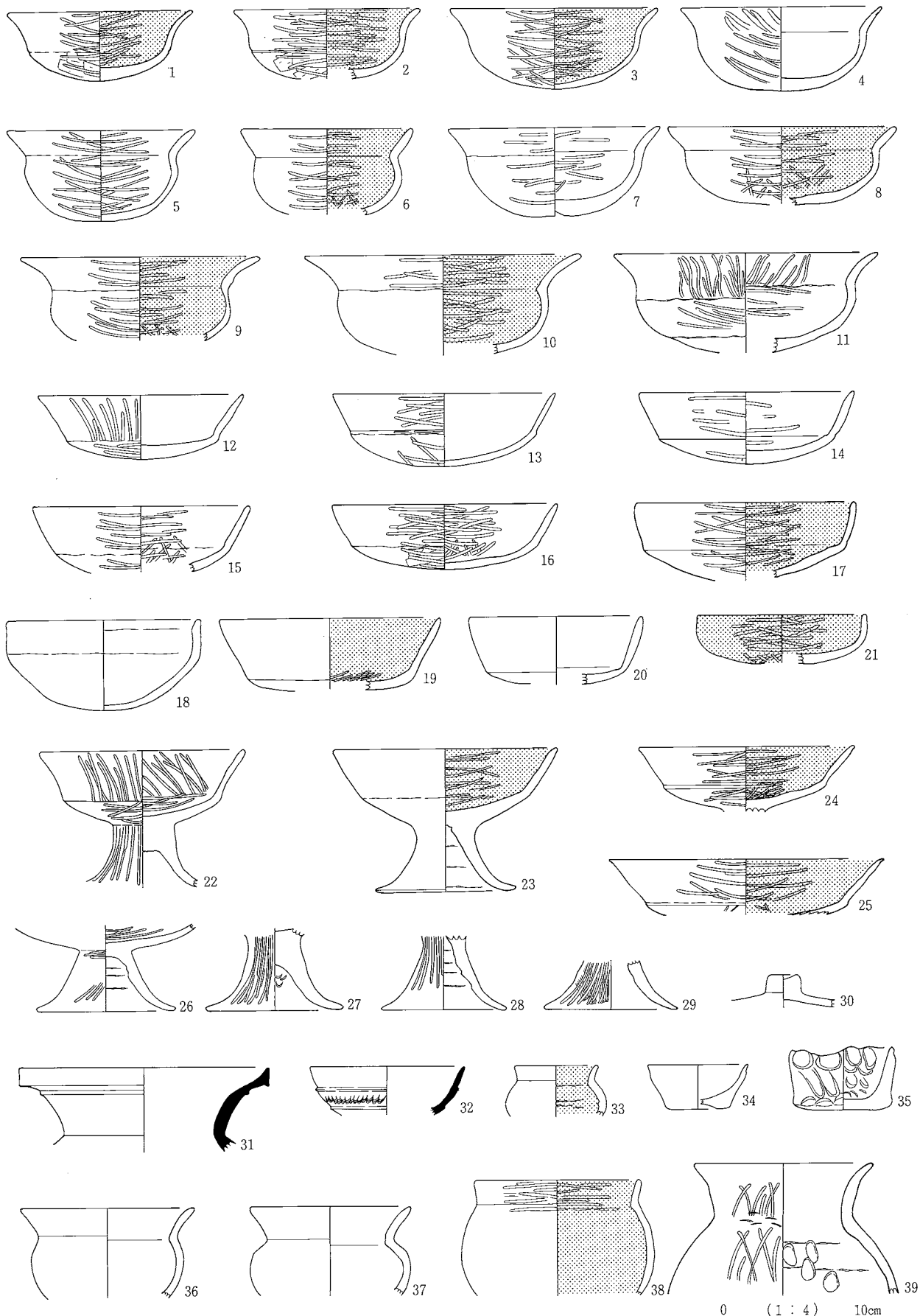

SB172-①

SB172-②

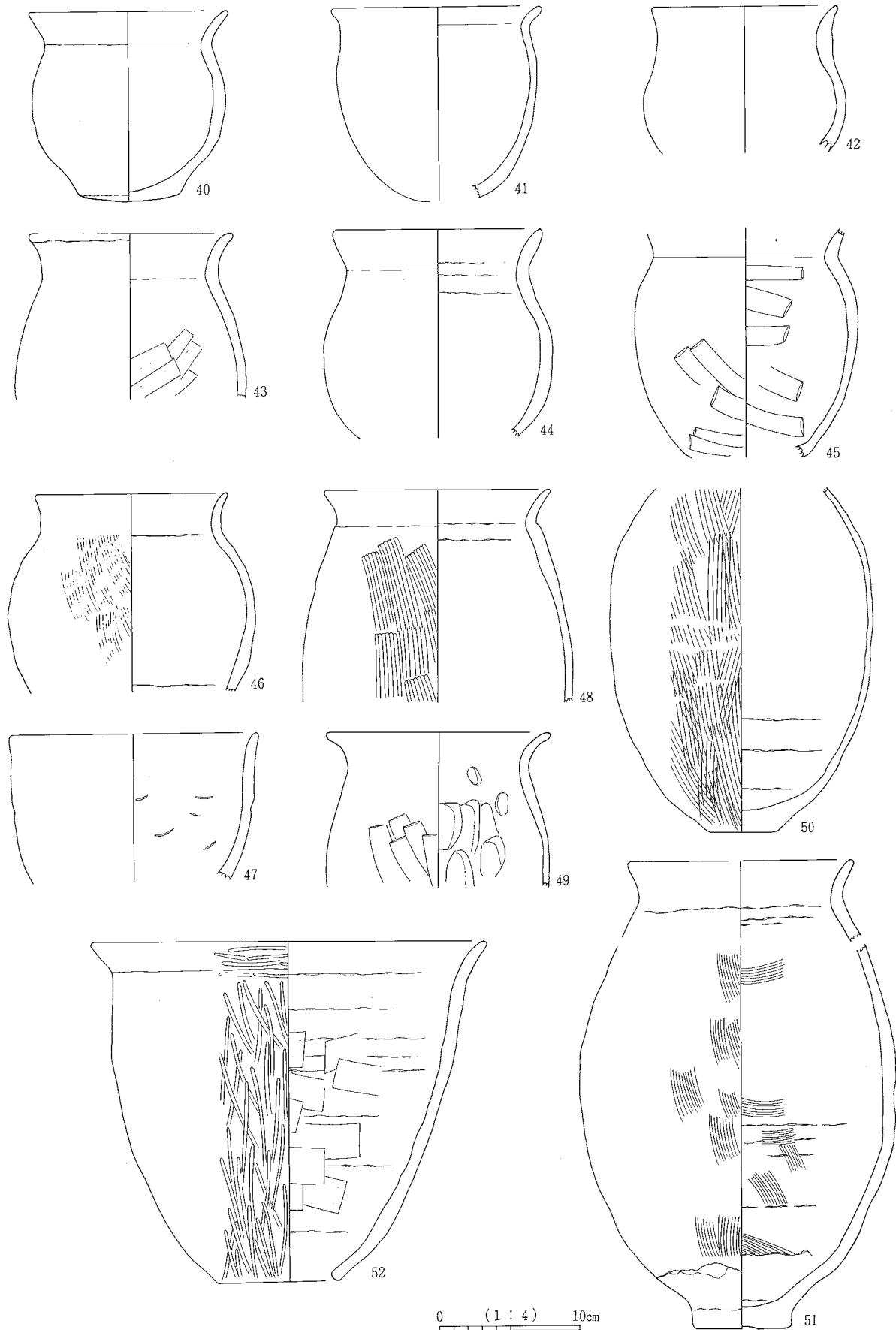

SB172-②

SB180



SB183

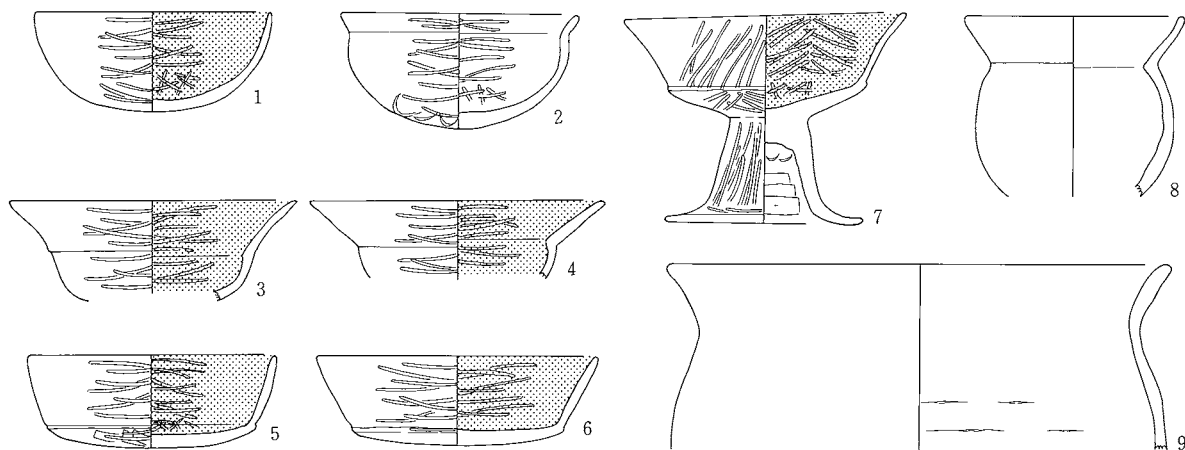

SB186-①

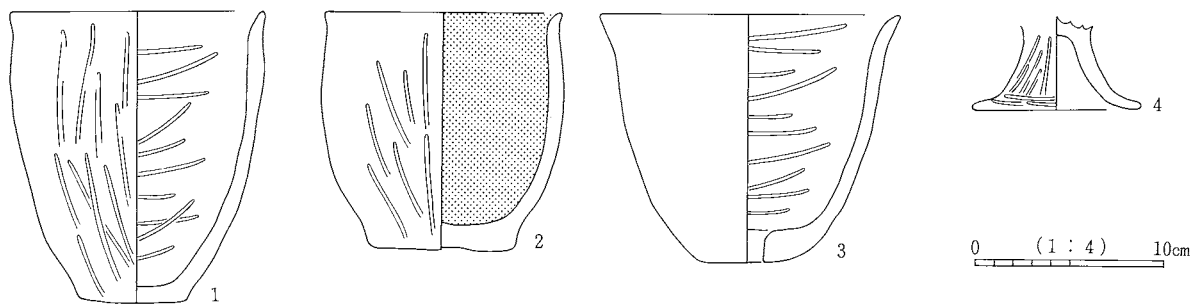

SB186-②

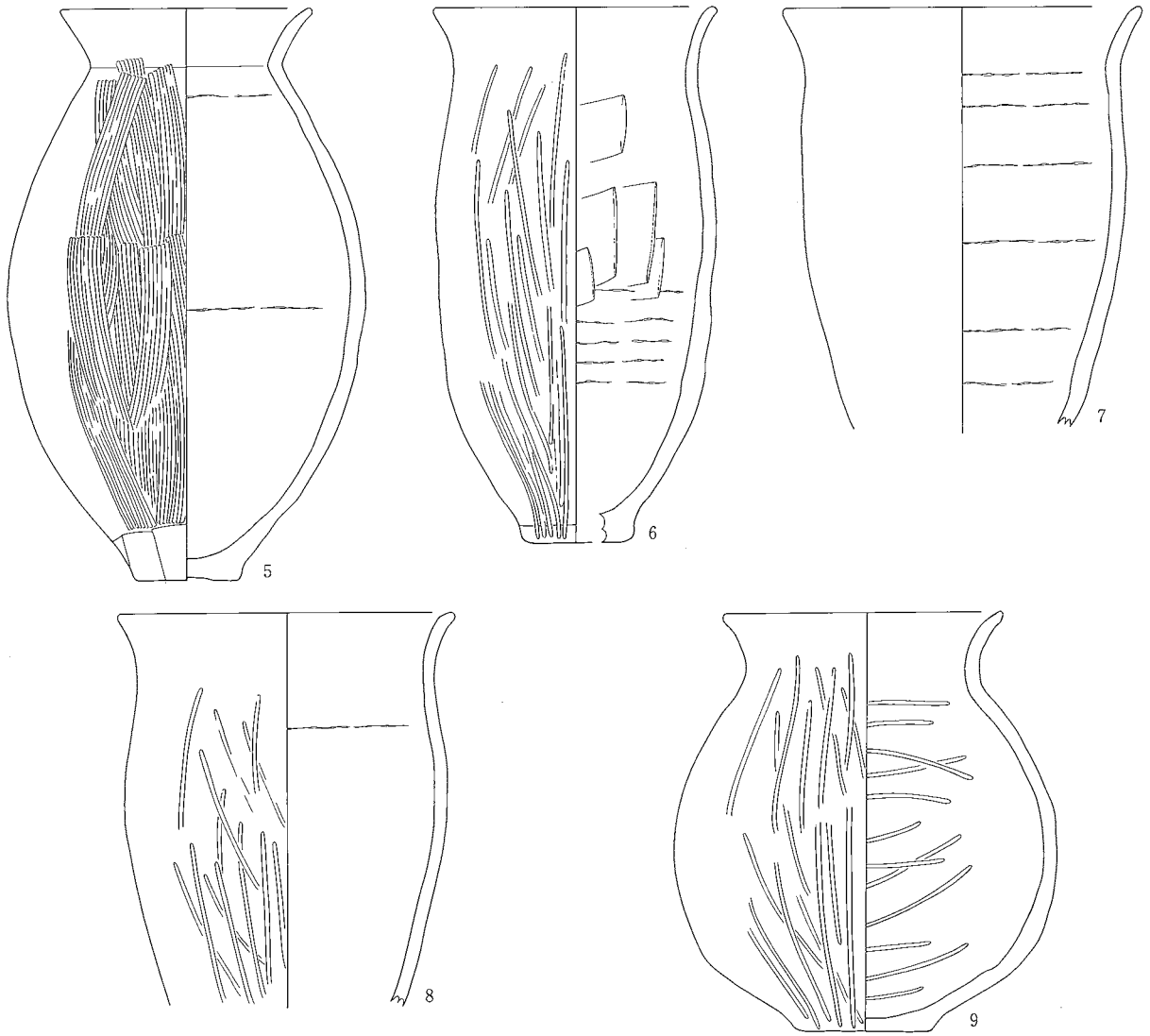

SB196

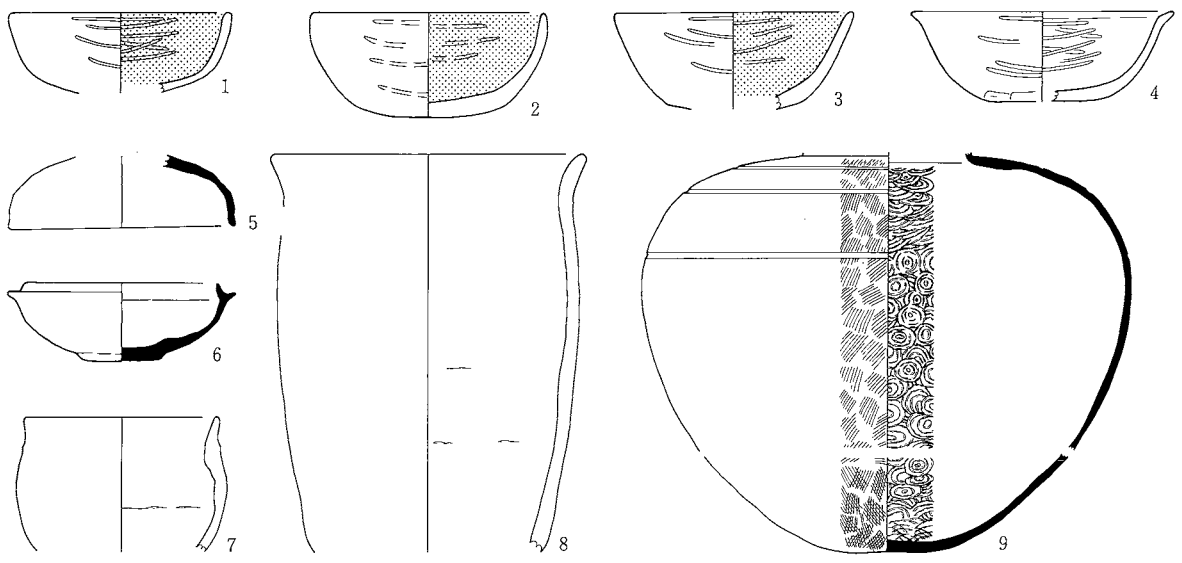

0 (1 : 4) 10cm

0 (1 : 8) 20cm

(SB196-9)

SB181

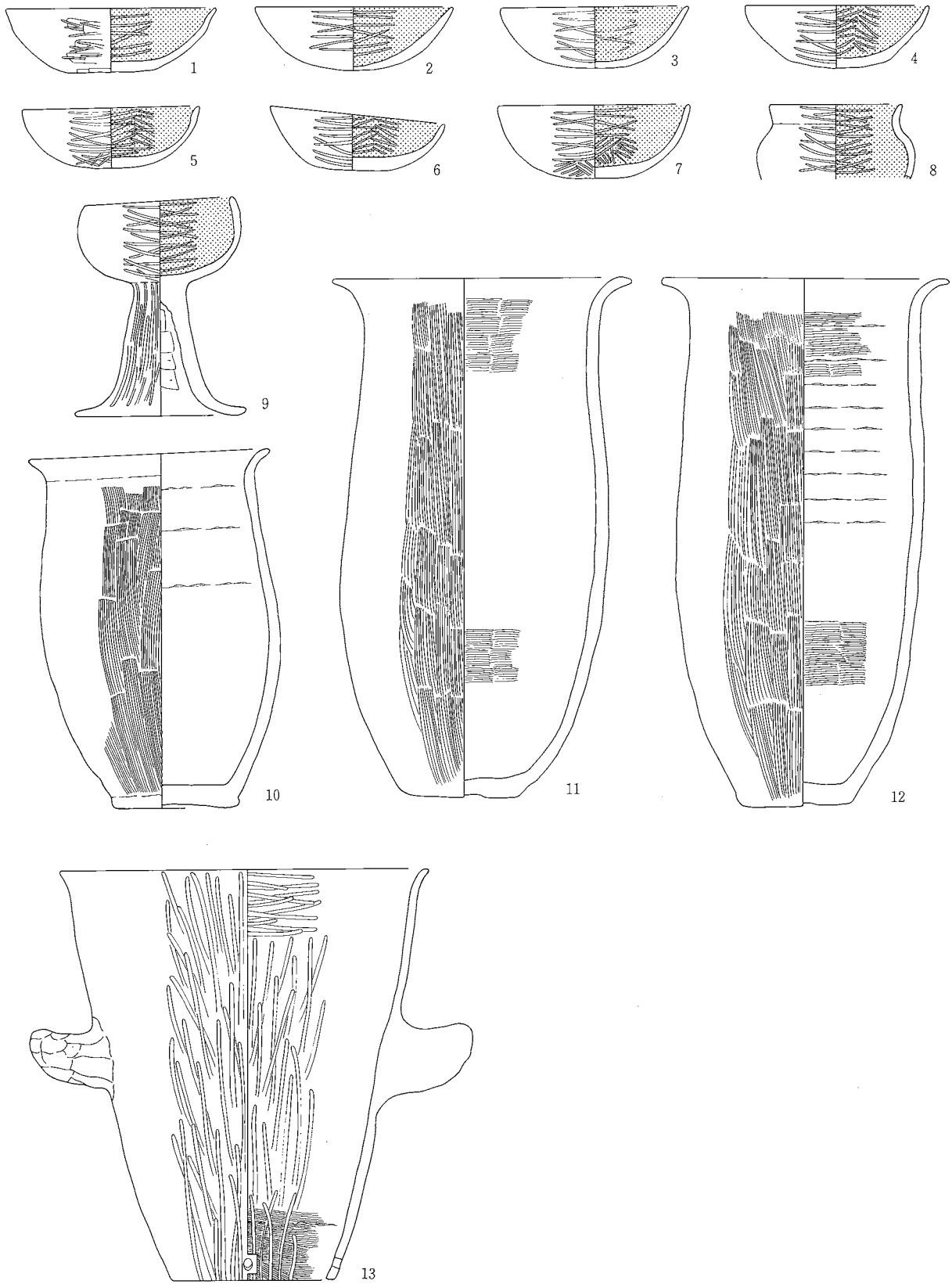

0 (1:4) 10cm

SB181

SB182

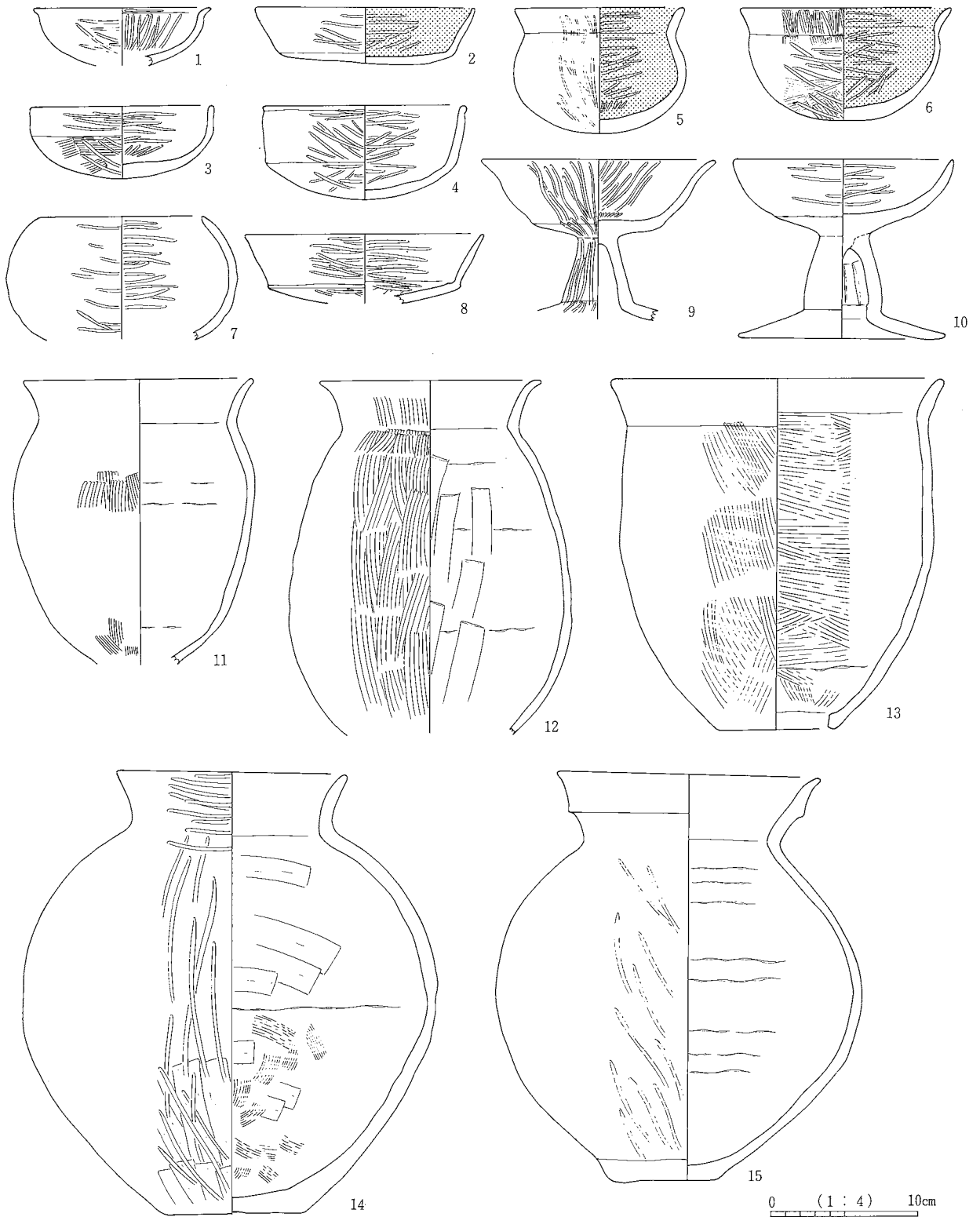

SB182

SB201

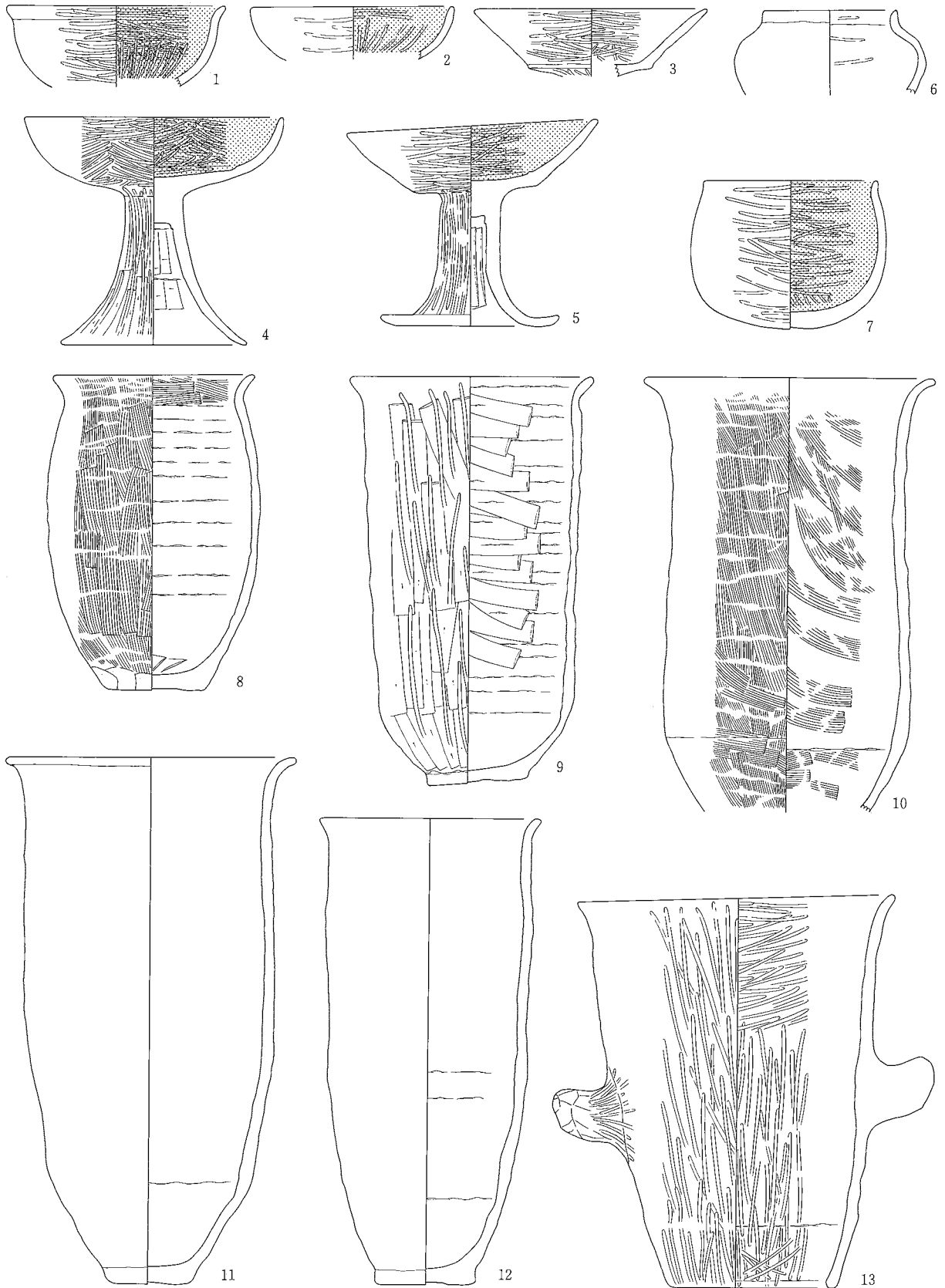

0 (1:4) 10cm

SB201

SB202

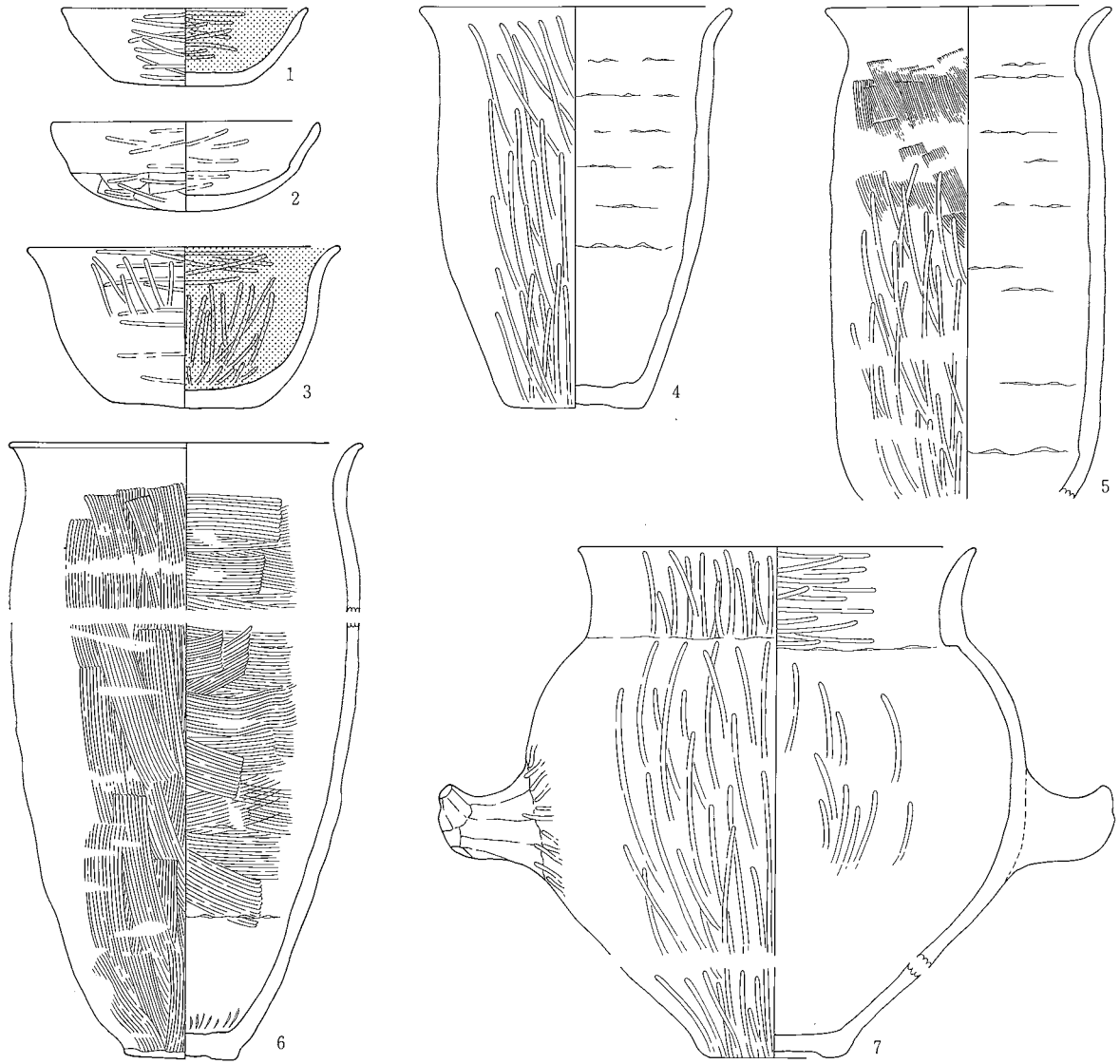

SB214-①

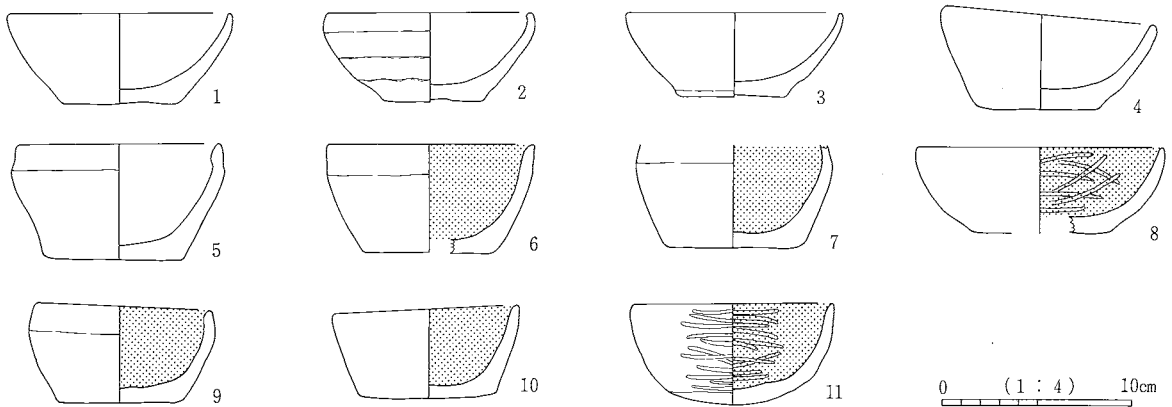

SB202・214-①

SB214-②

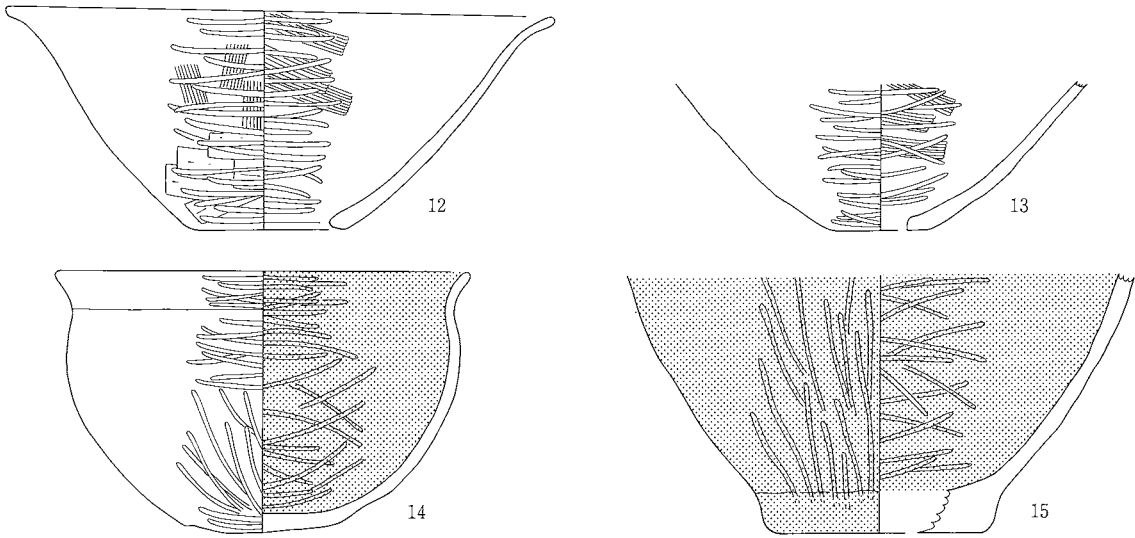

SB218

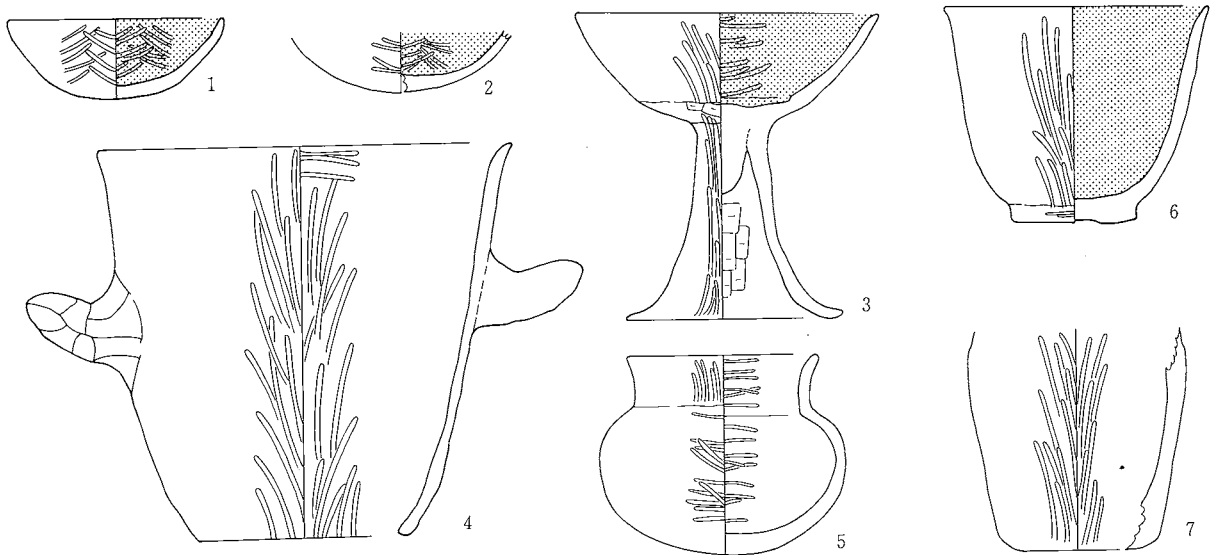

SB232-①

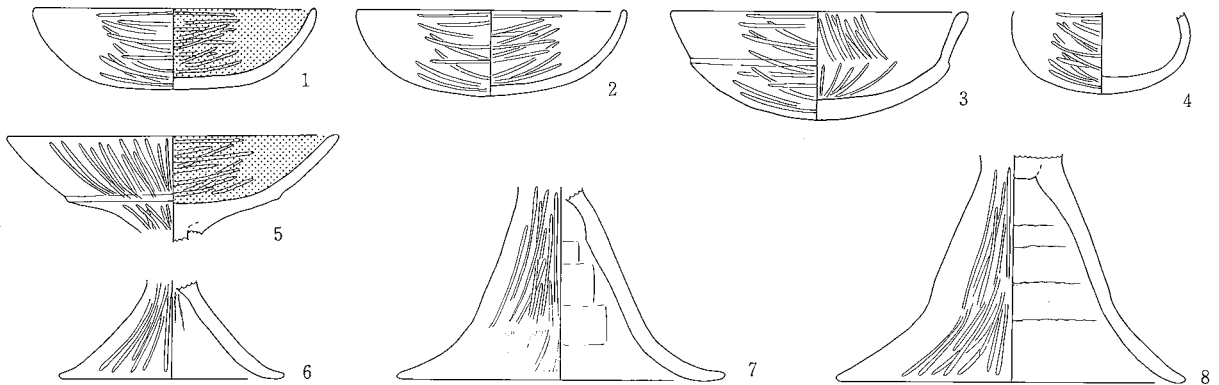

0 (1:4) 10cm

SB232-②

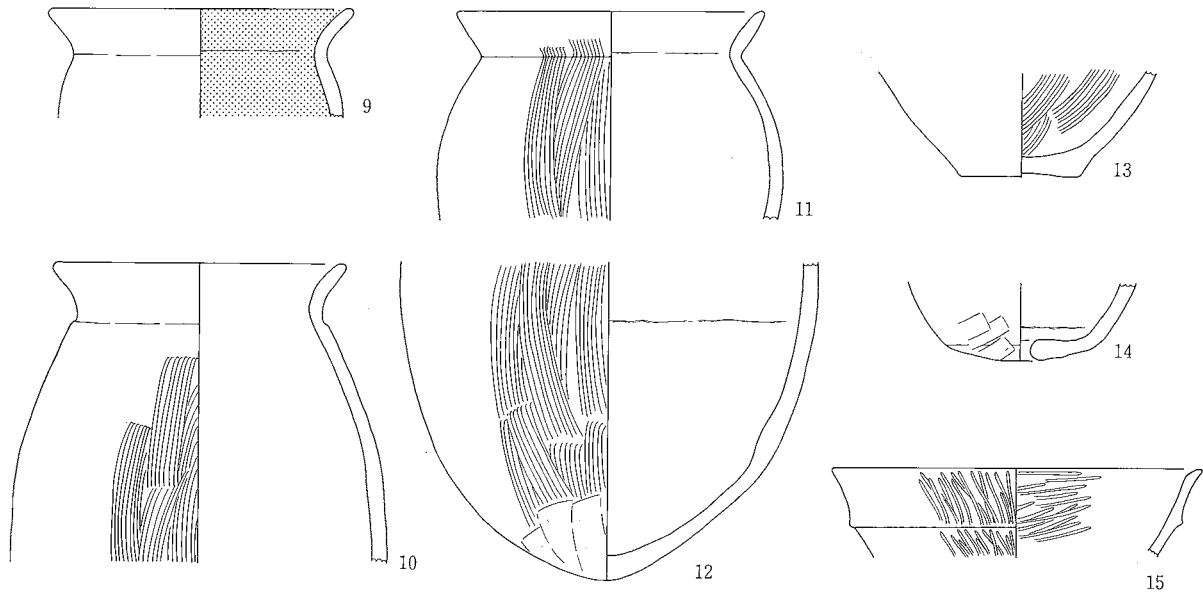

SB240

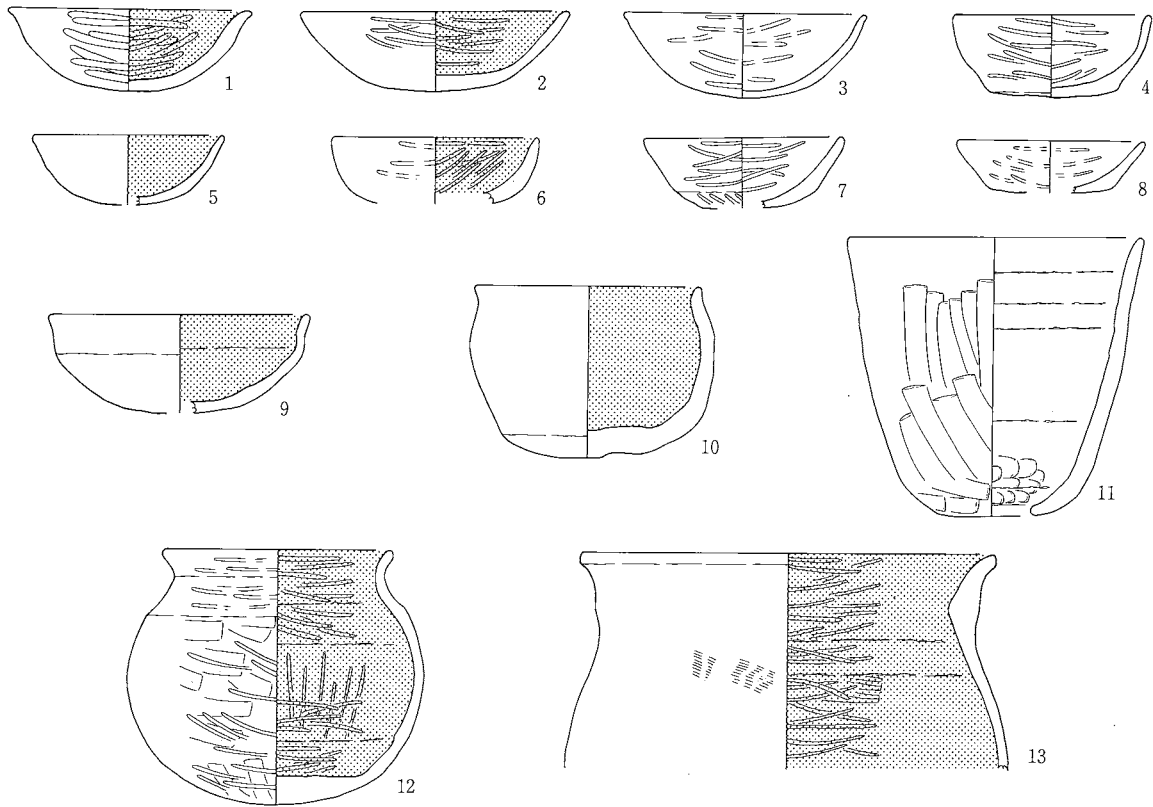

0 (1:4) 10cm

SB235

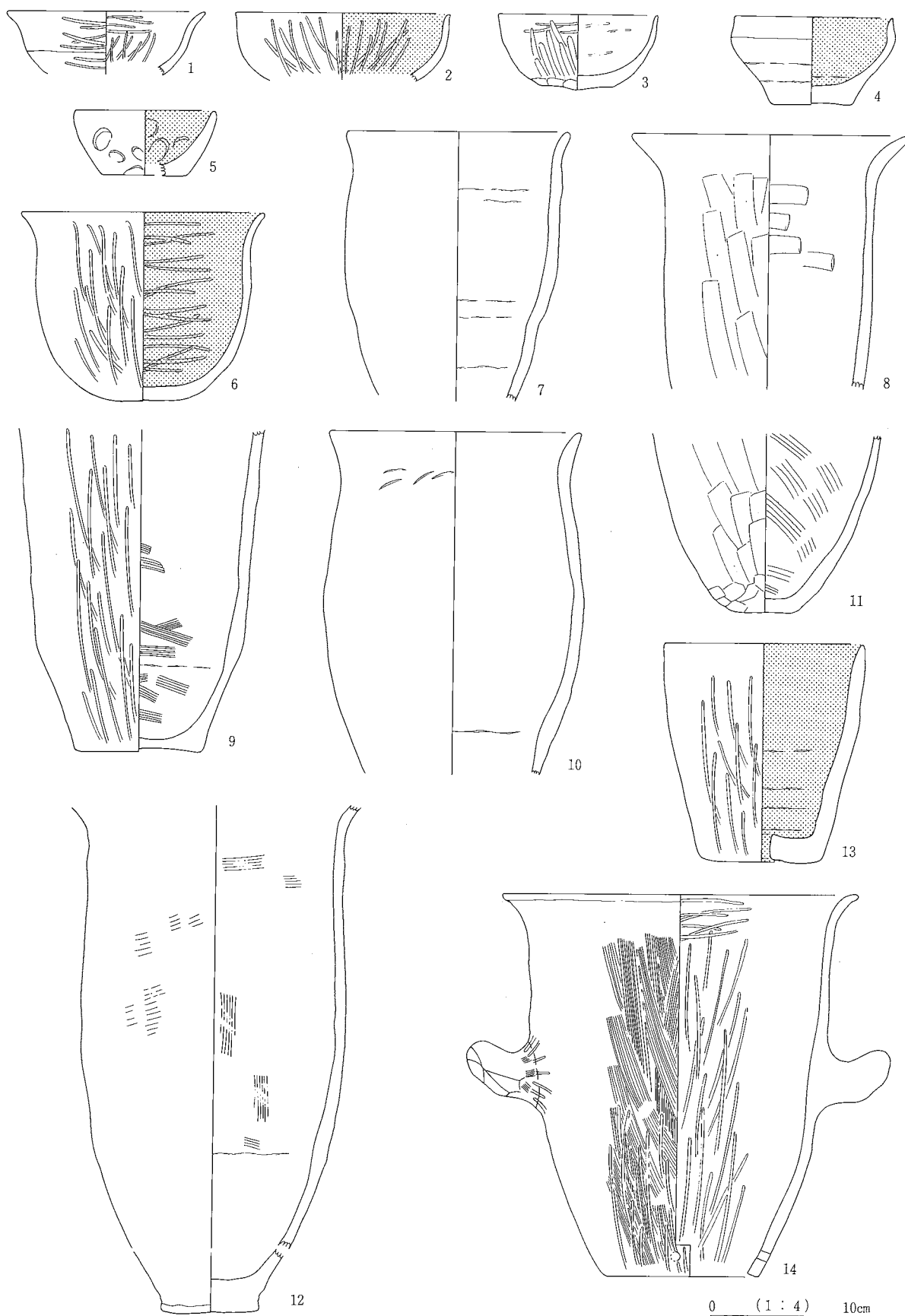

SB235

SB275

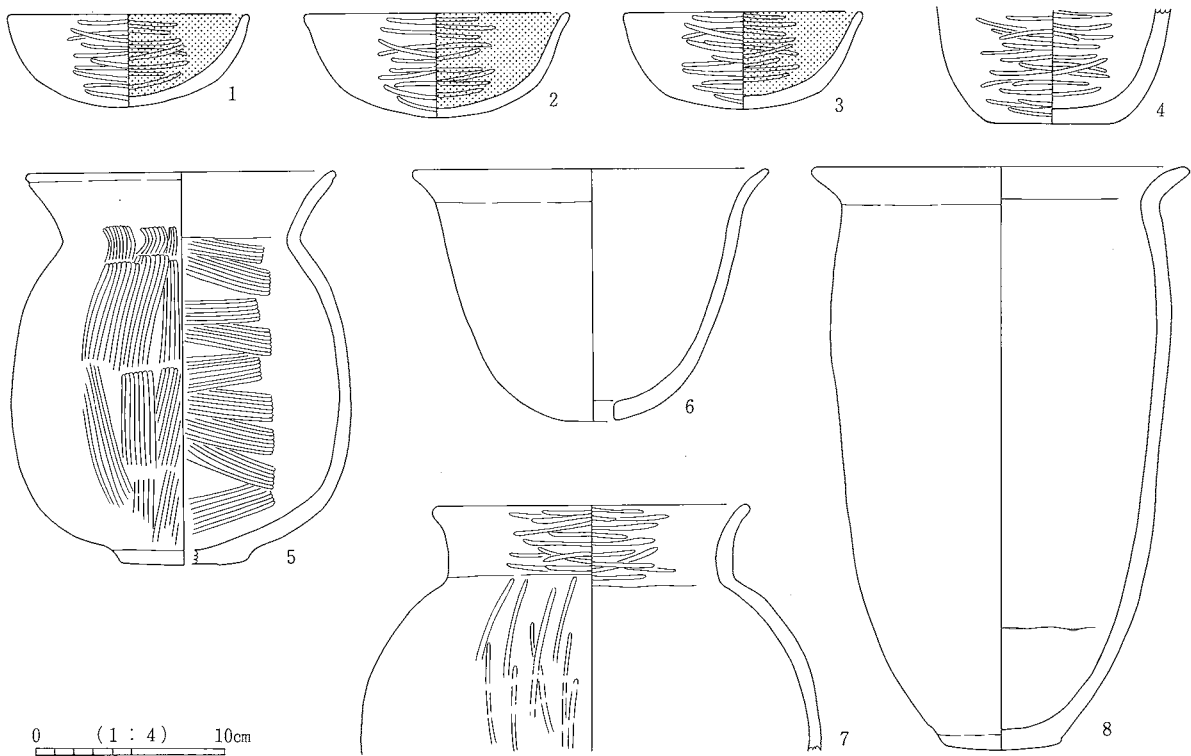

SB316

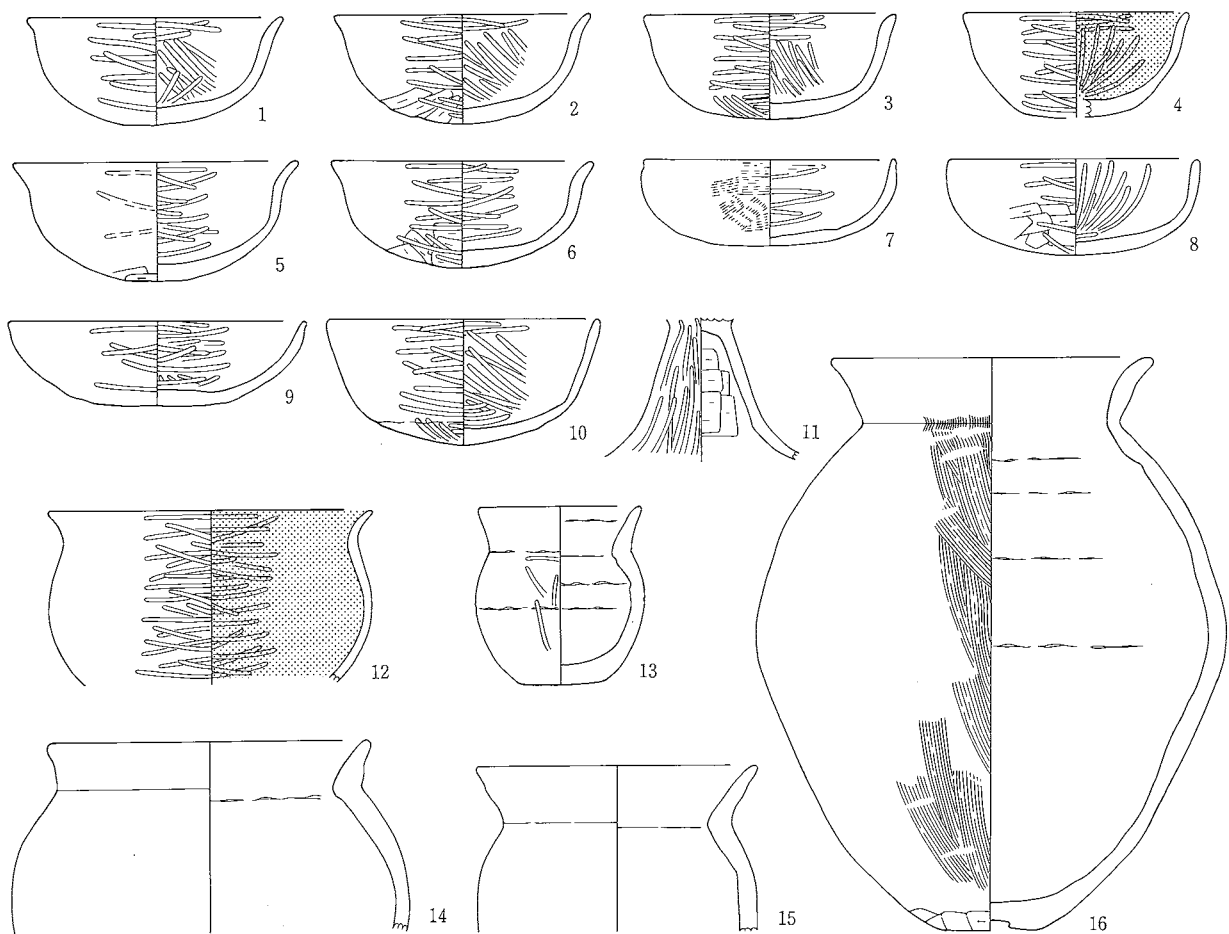

SB282

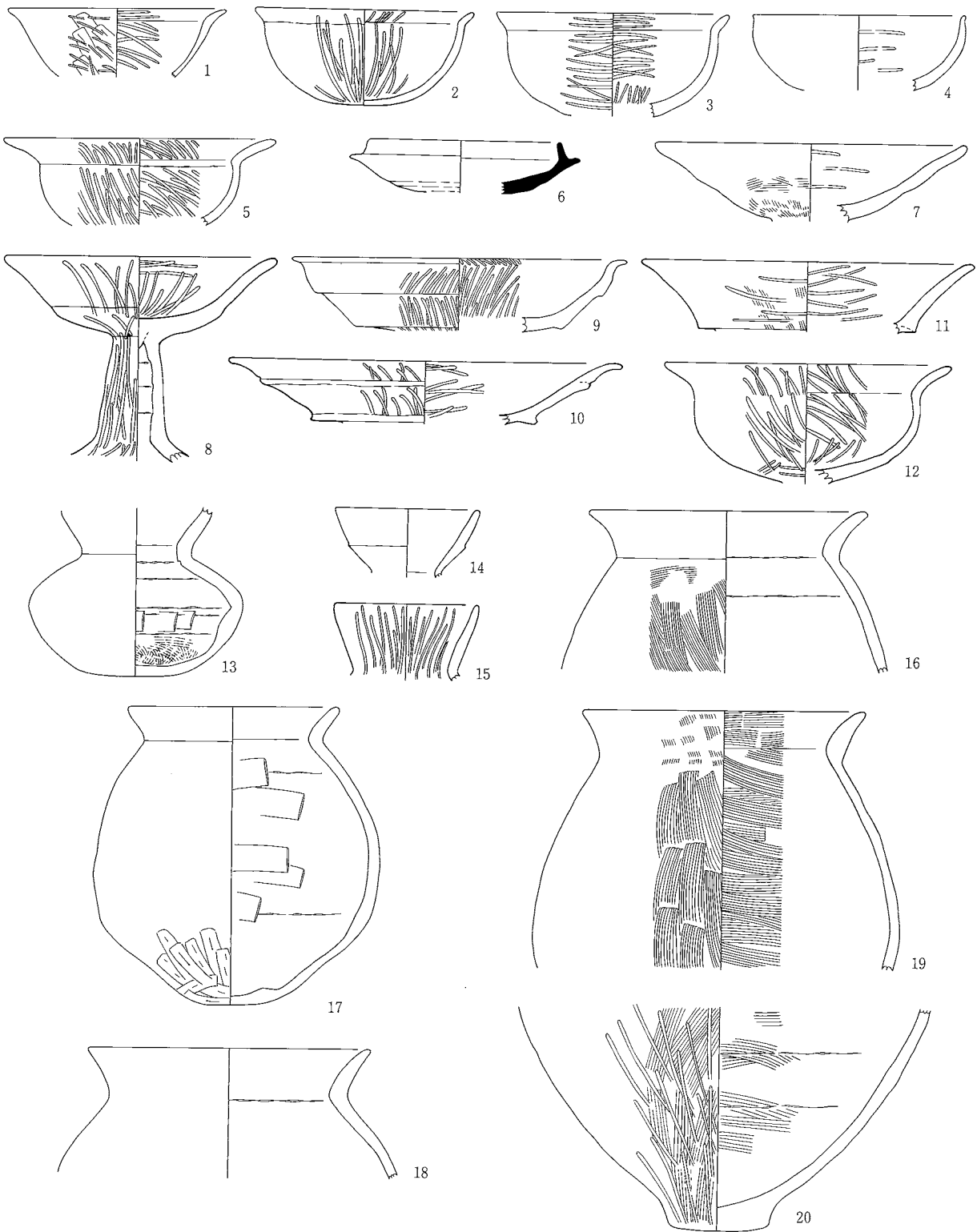

0 (1:4) 10cm

SB282

SB284

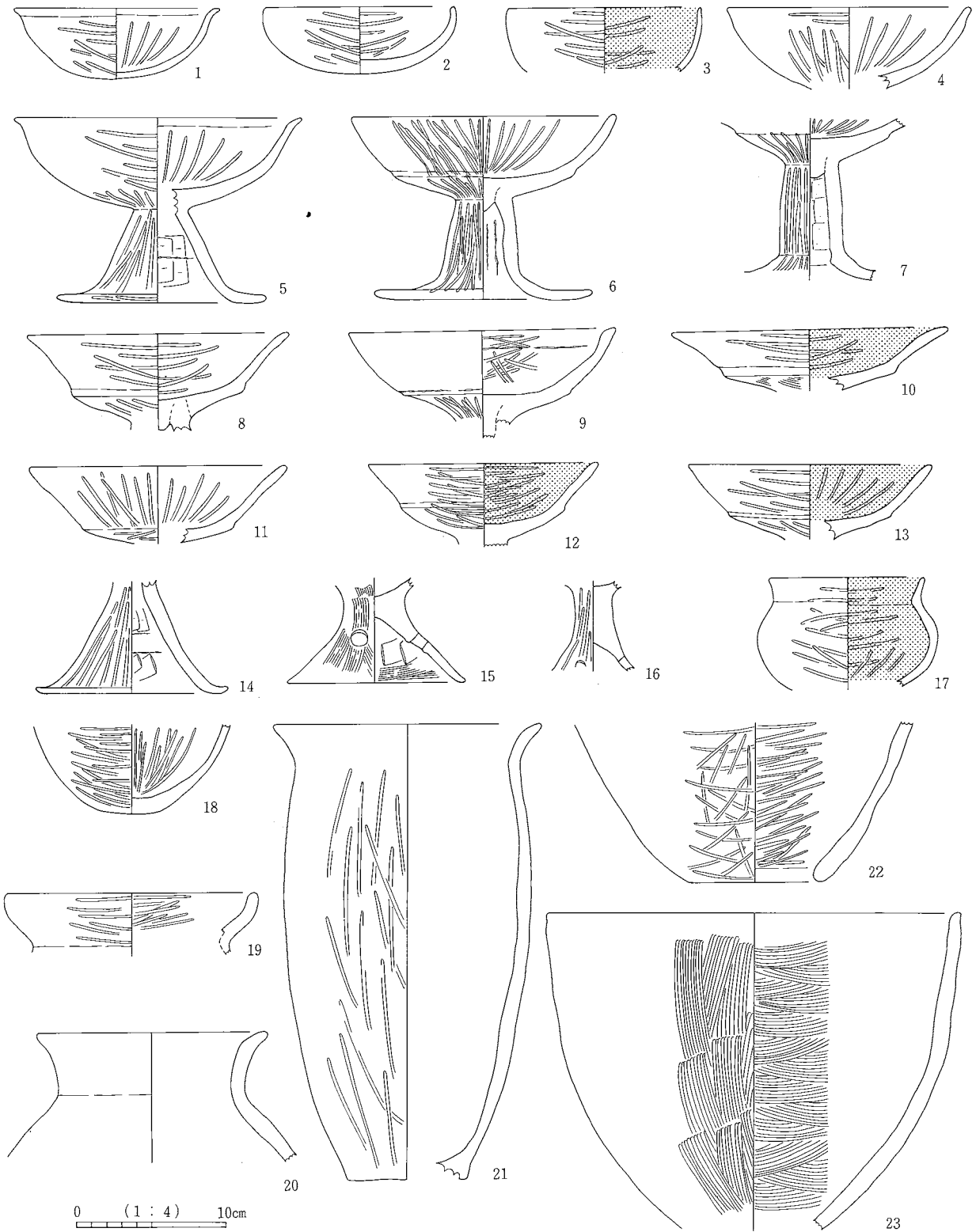

SB284

SB321

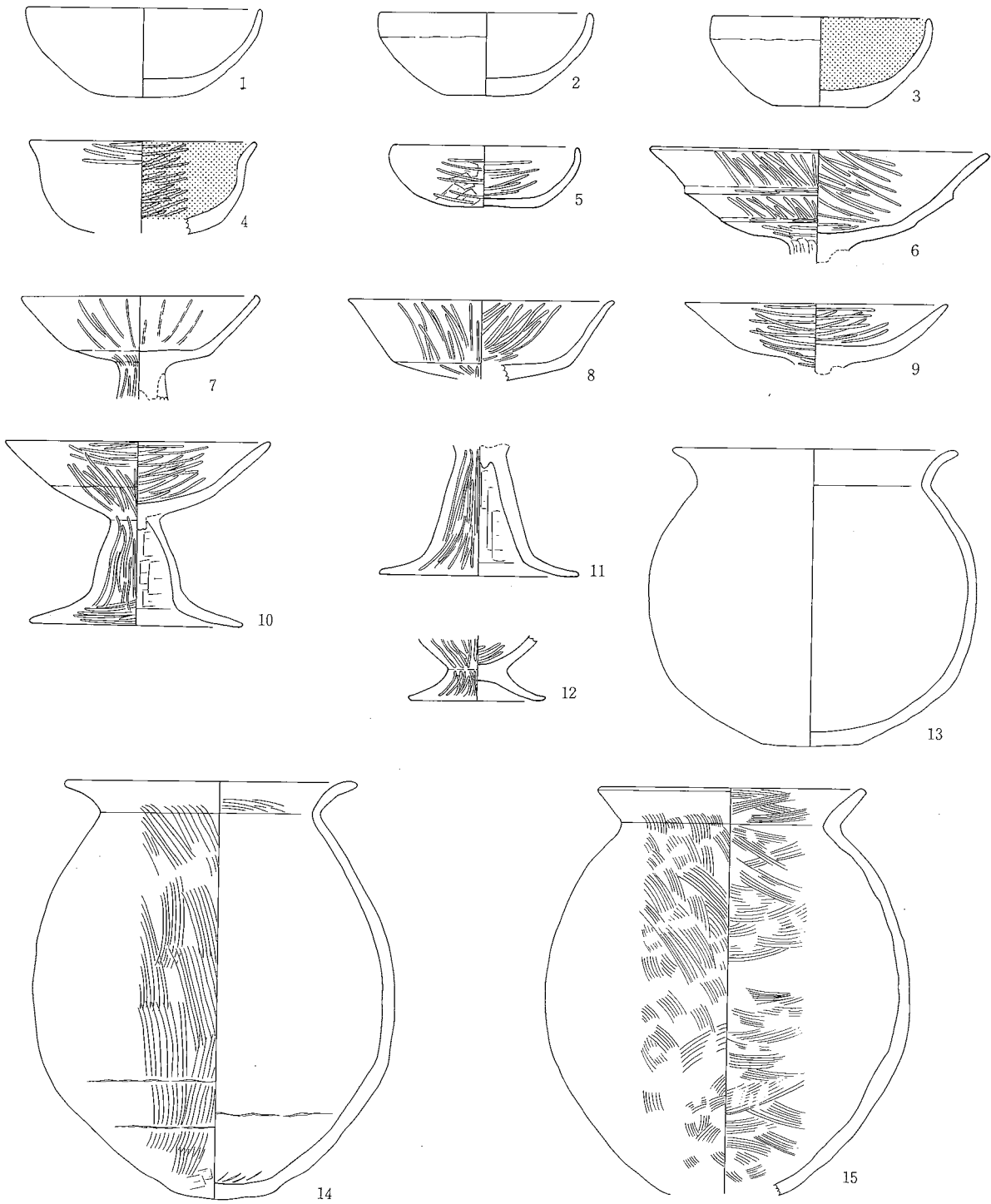

0 (1:4) 10cm

SB321

SB322-①

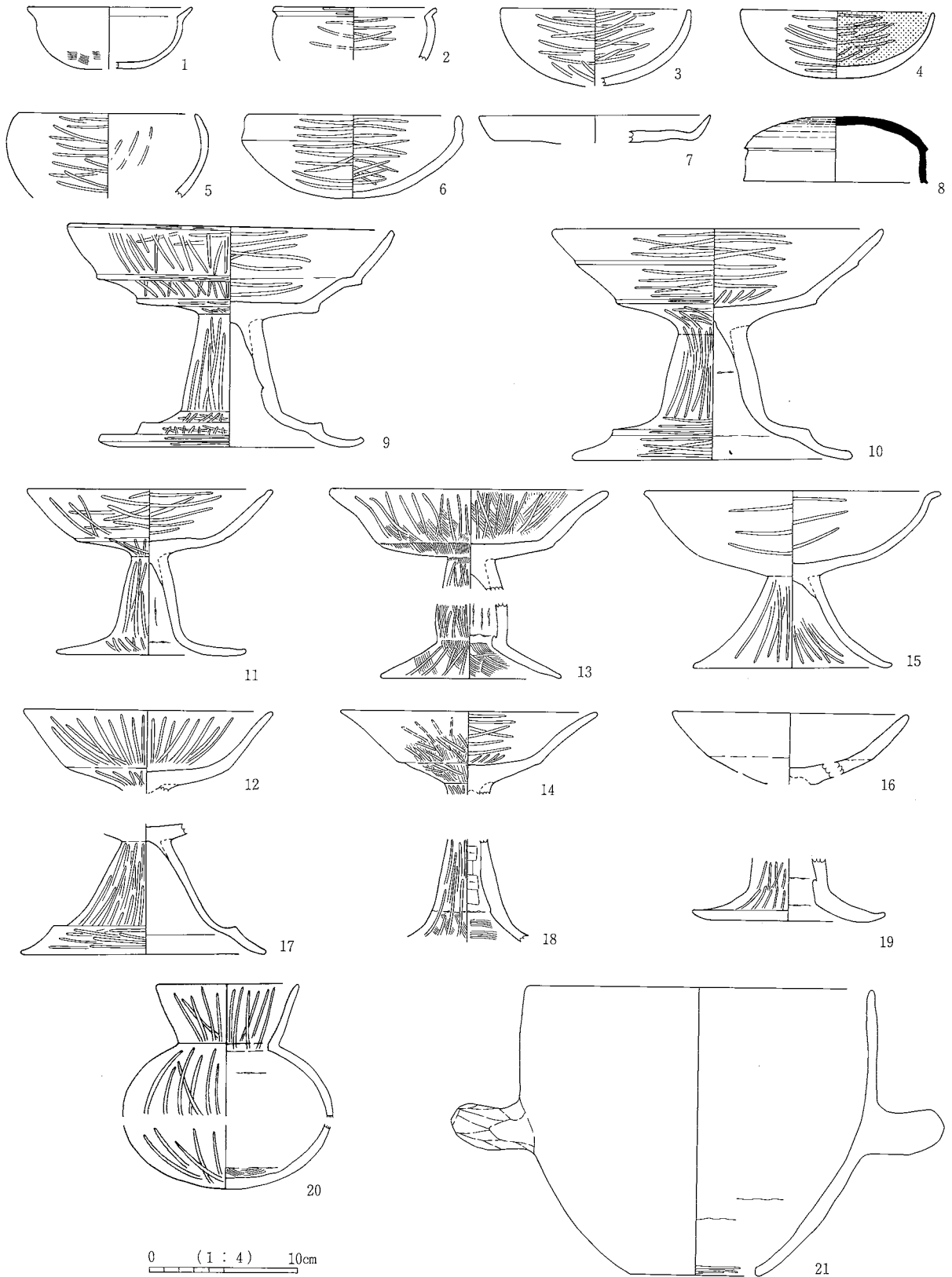

SB322-①

SB322-②

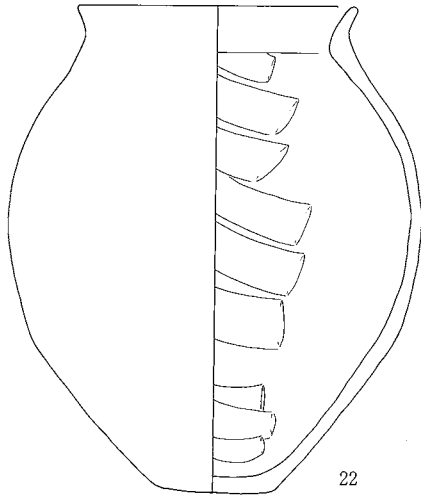

22

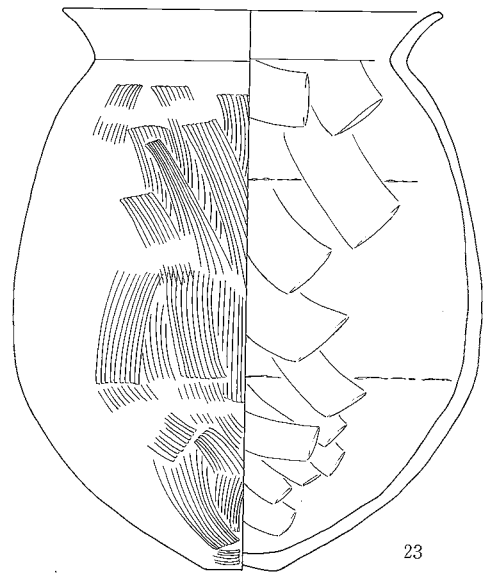

23

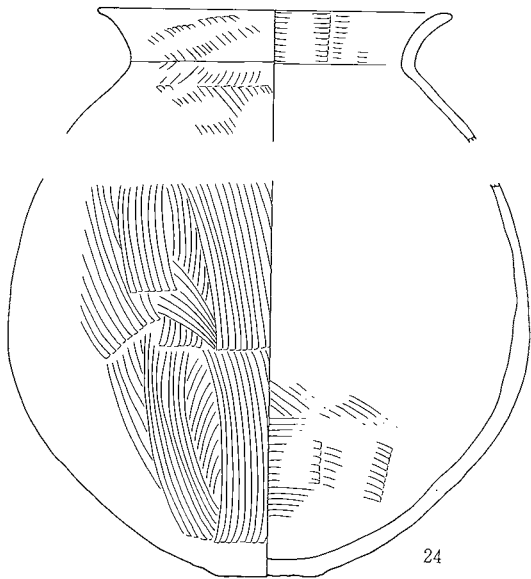

24

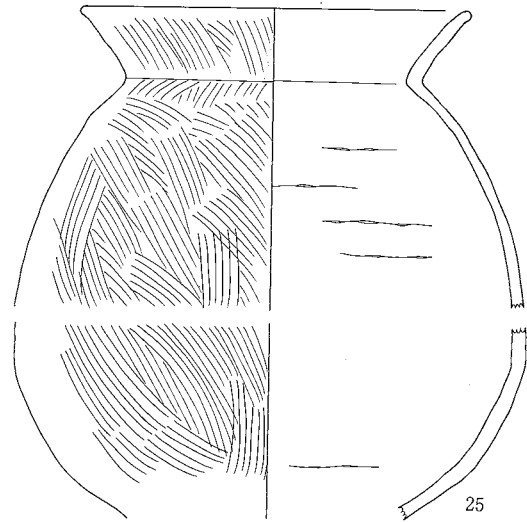

25

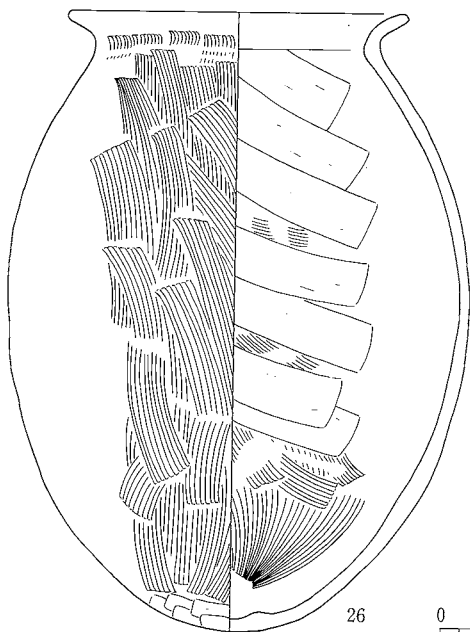

26

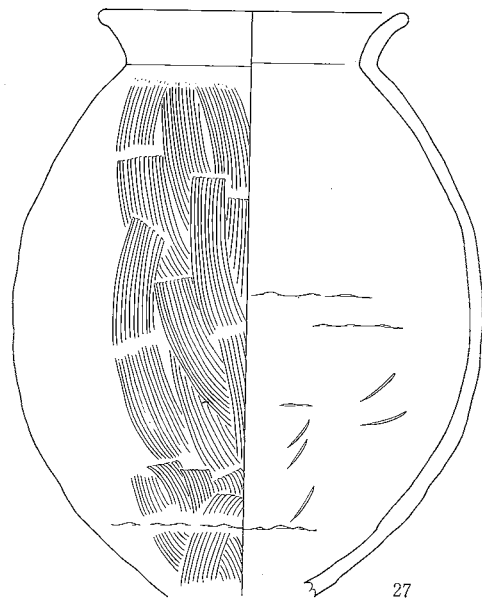

27

0 (1 : 4) 10cm

SB322-②

SB322-③

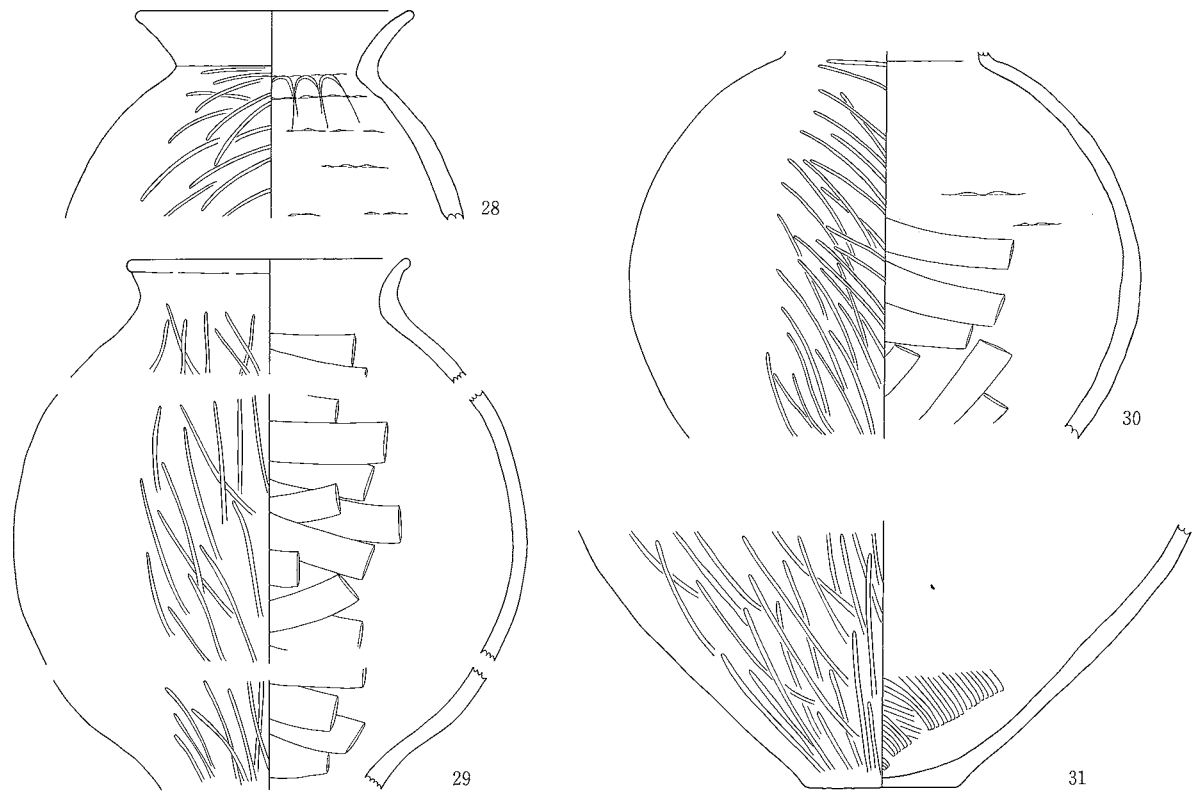

SB327-①

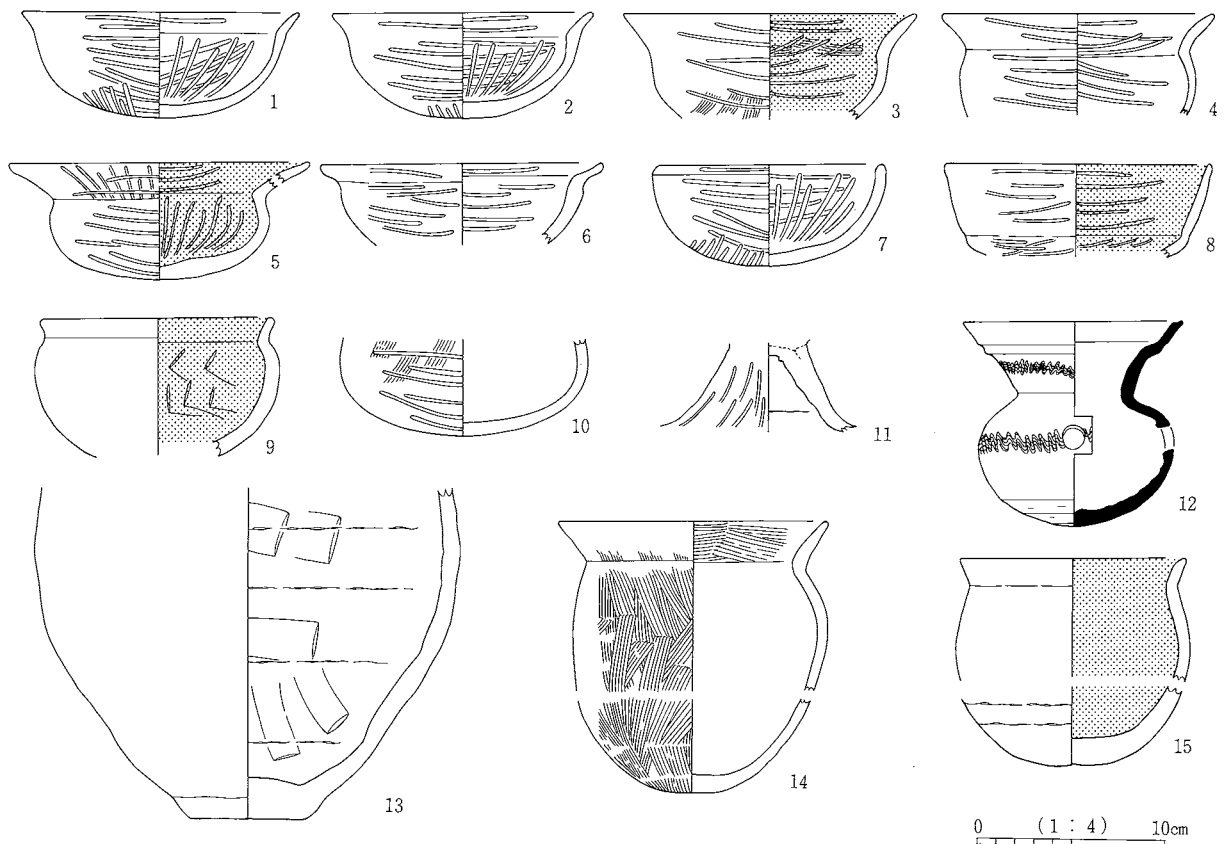

SB327-②

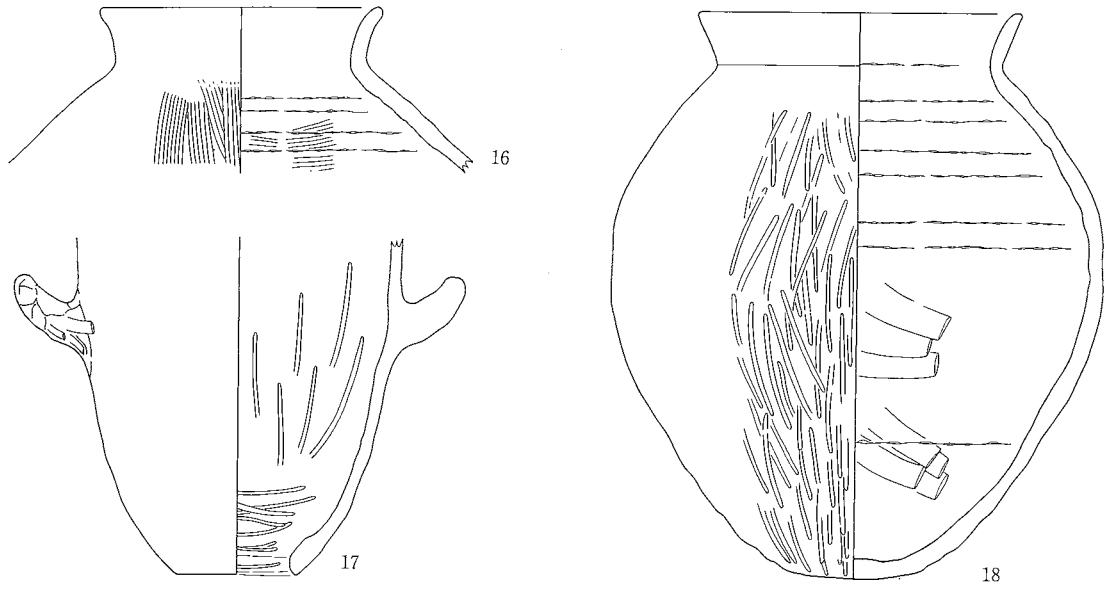

SB333

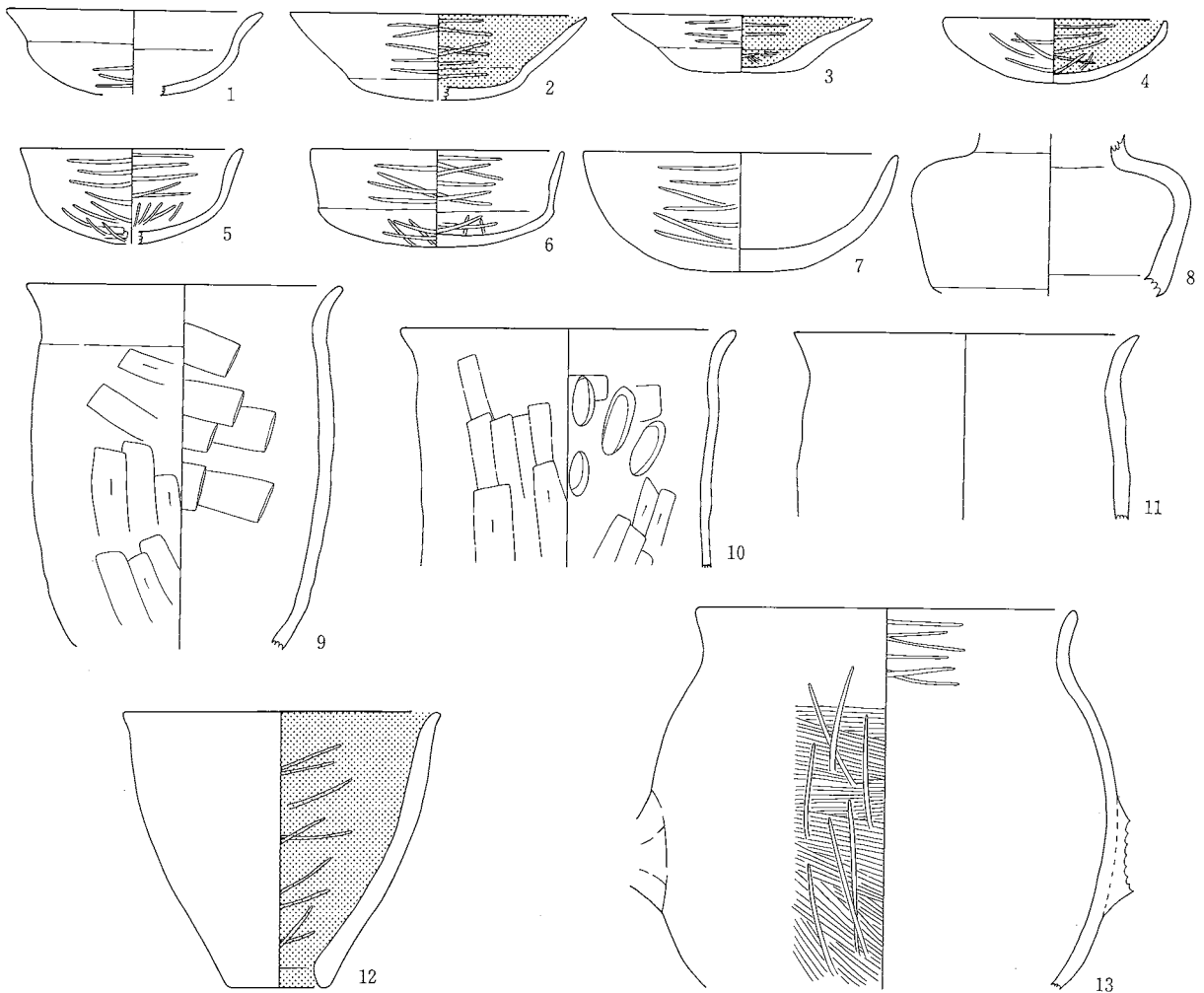

0 (1 : 4) 10cm

SB341

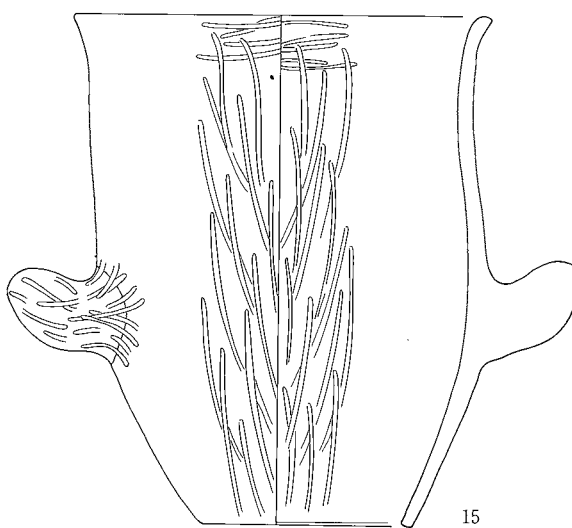
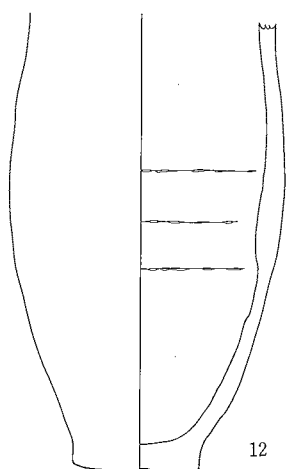
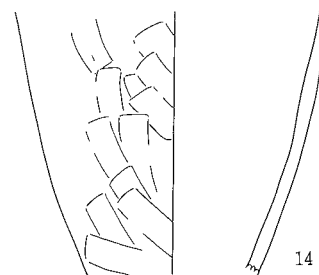
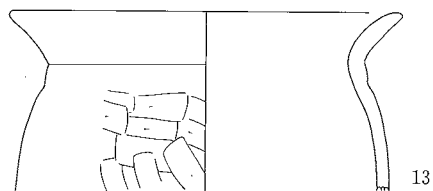
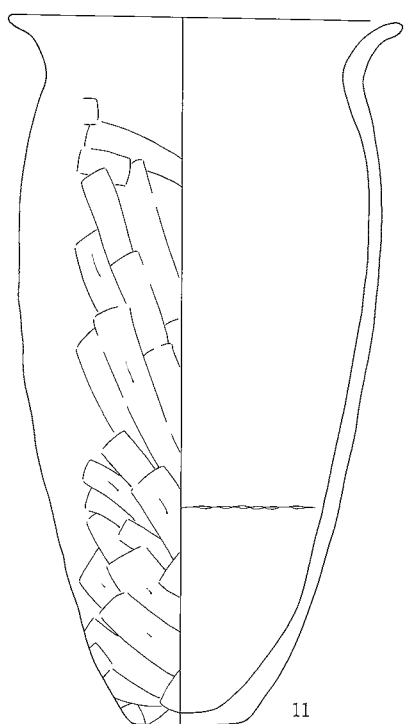
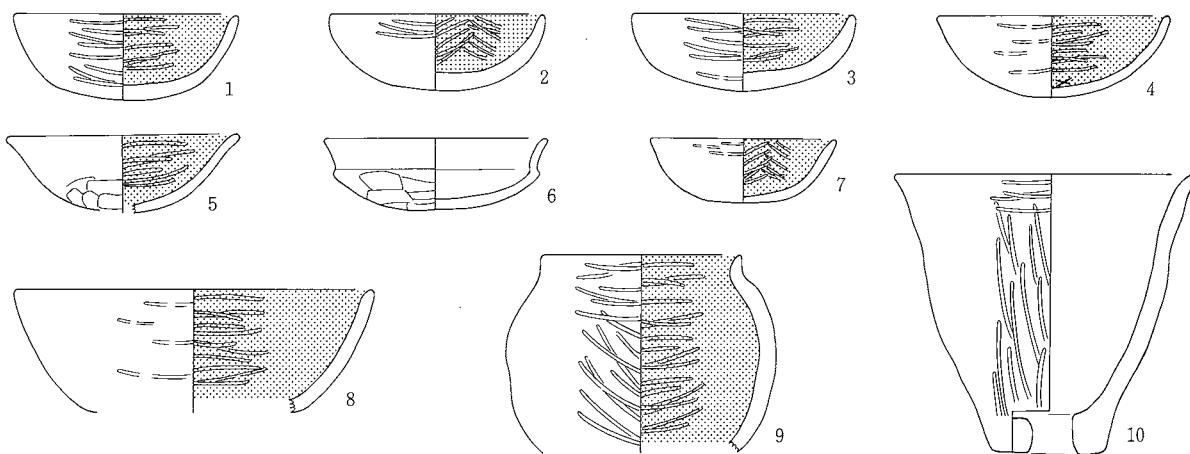

0 (1:4) 10cm

SB341

SB354-①

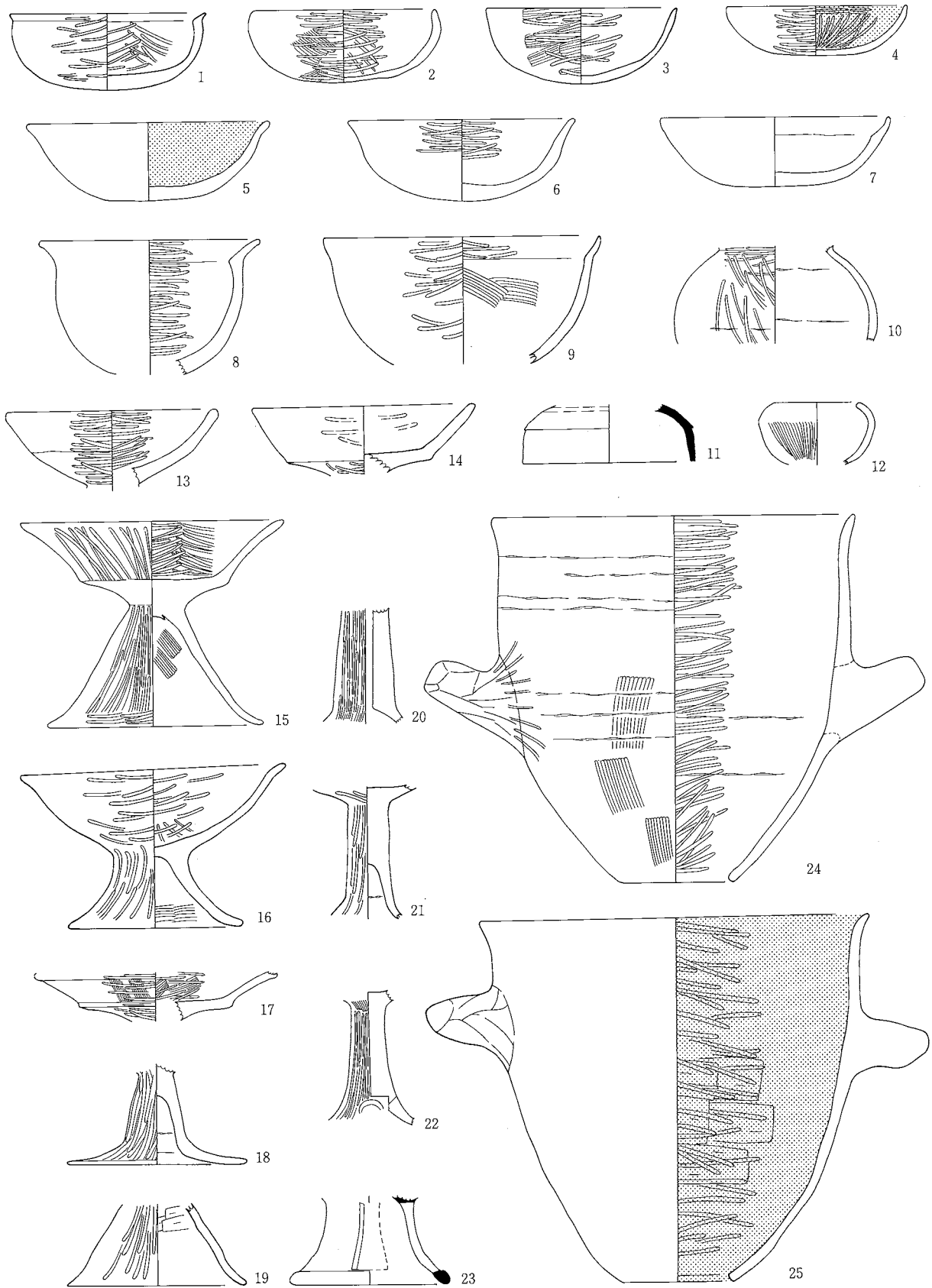

0 (1:4) 10cm

SB354-①

SB354-②

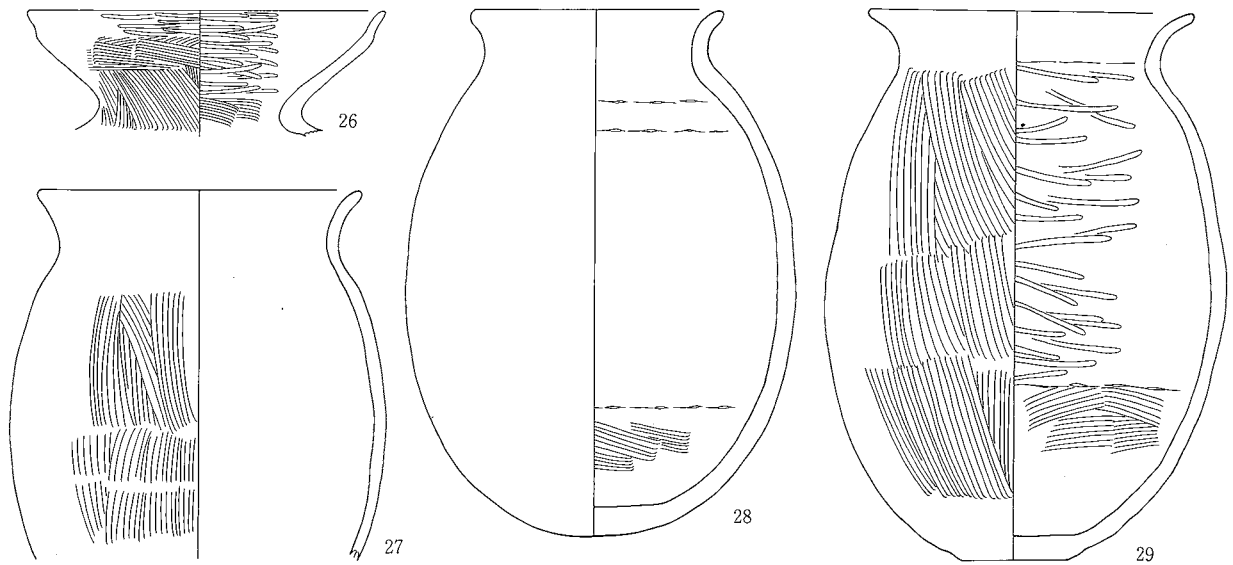

SB355

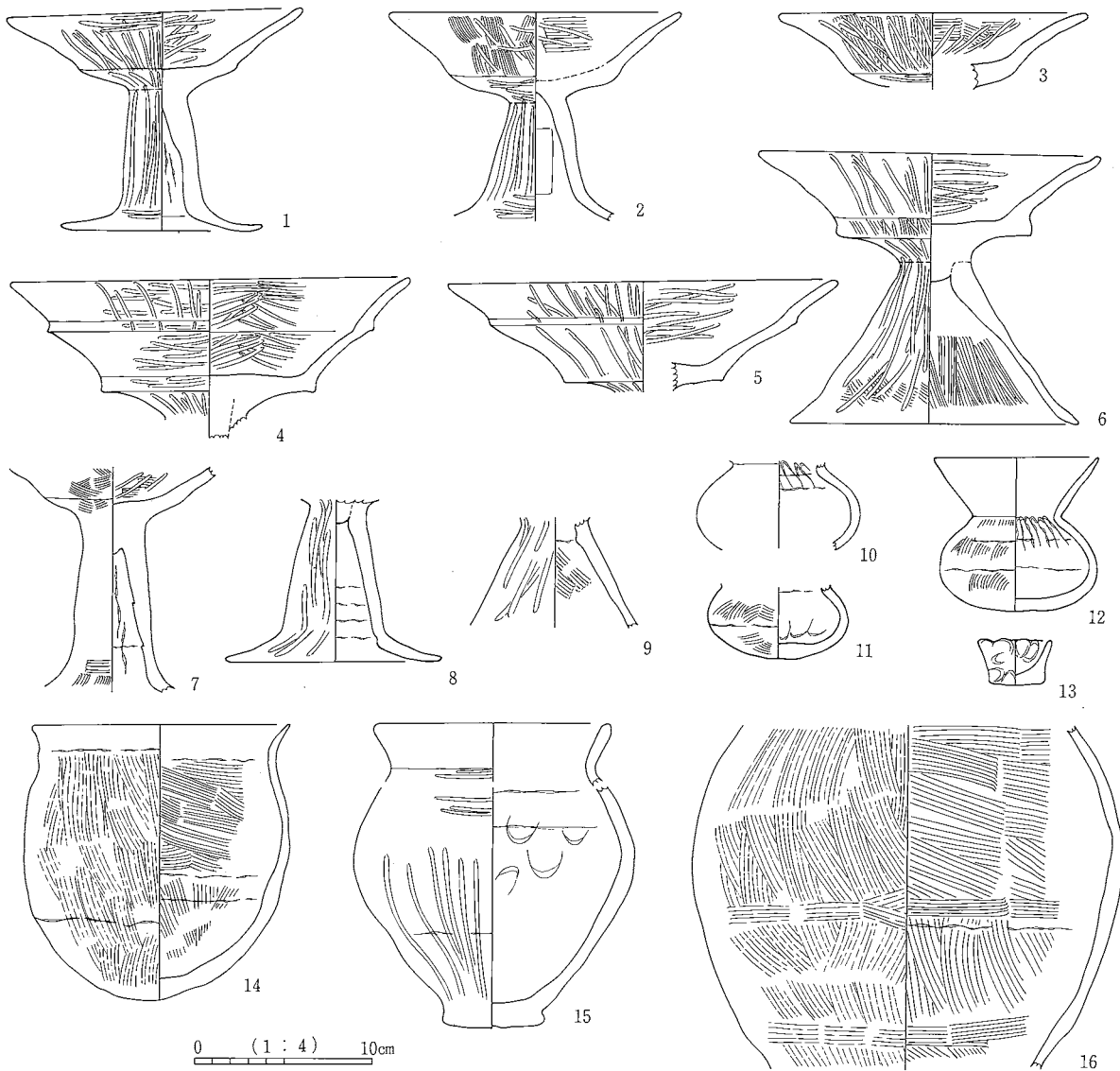

SB361

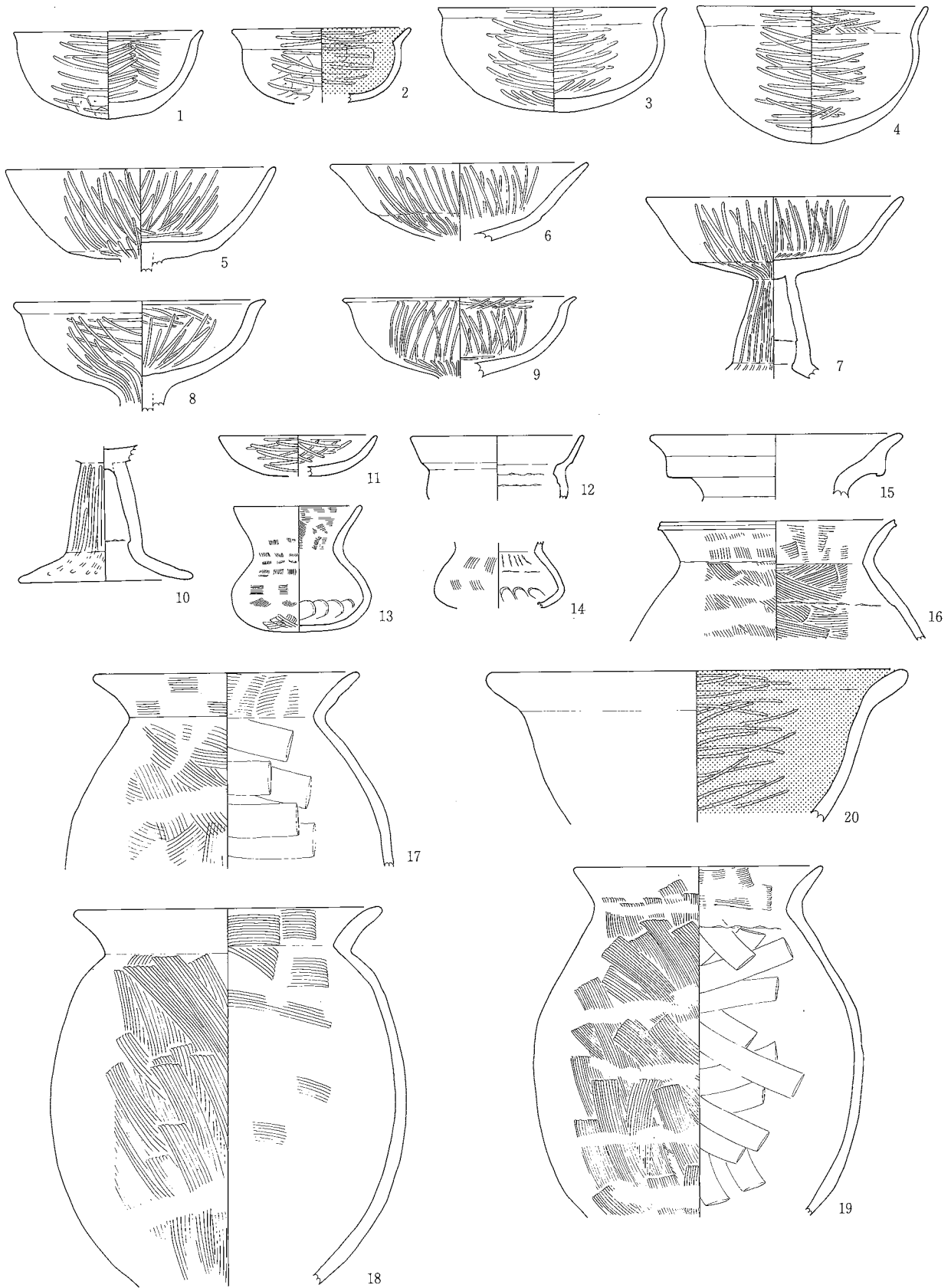

0 (1 : 4) 10cm

SB361

SB377

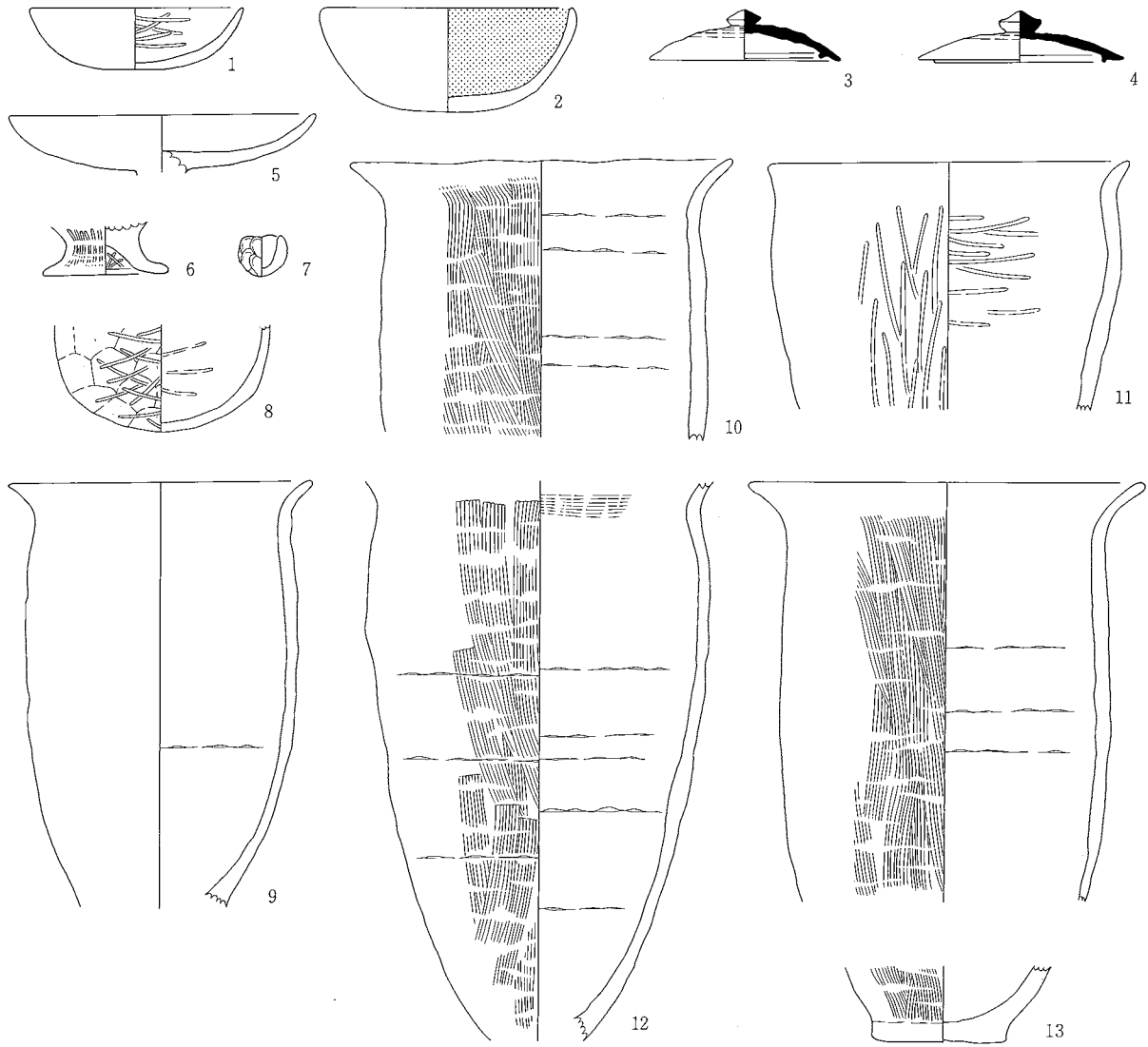

SB380-①

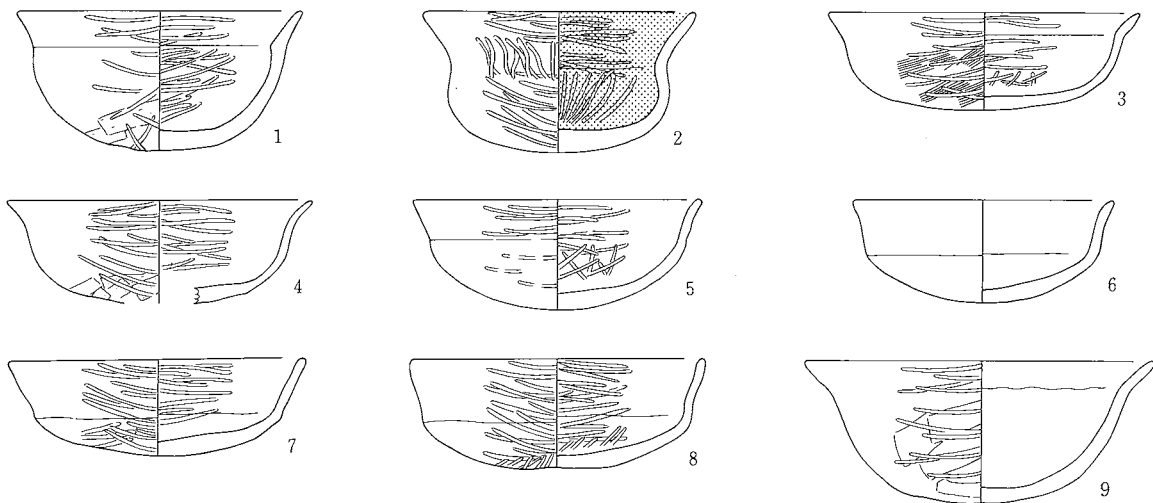

0 (1:4) 10cm

SB377・380-①

SB380-②

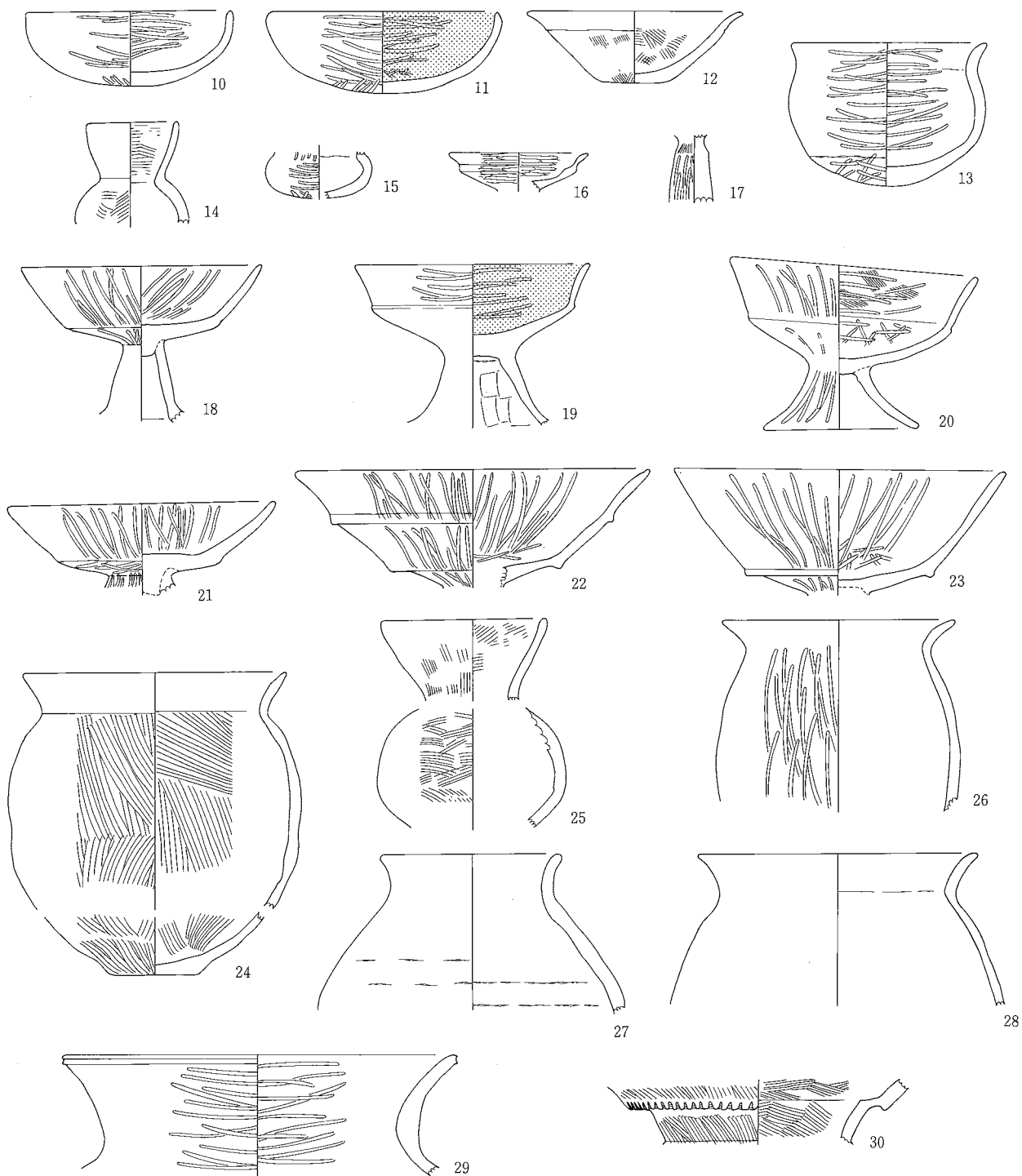

0 (1 : 4) 10cm

SB380-②

SB380-③

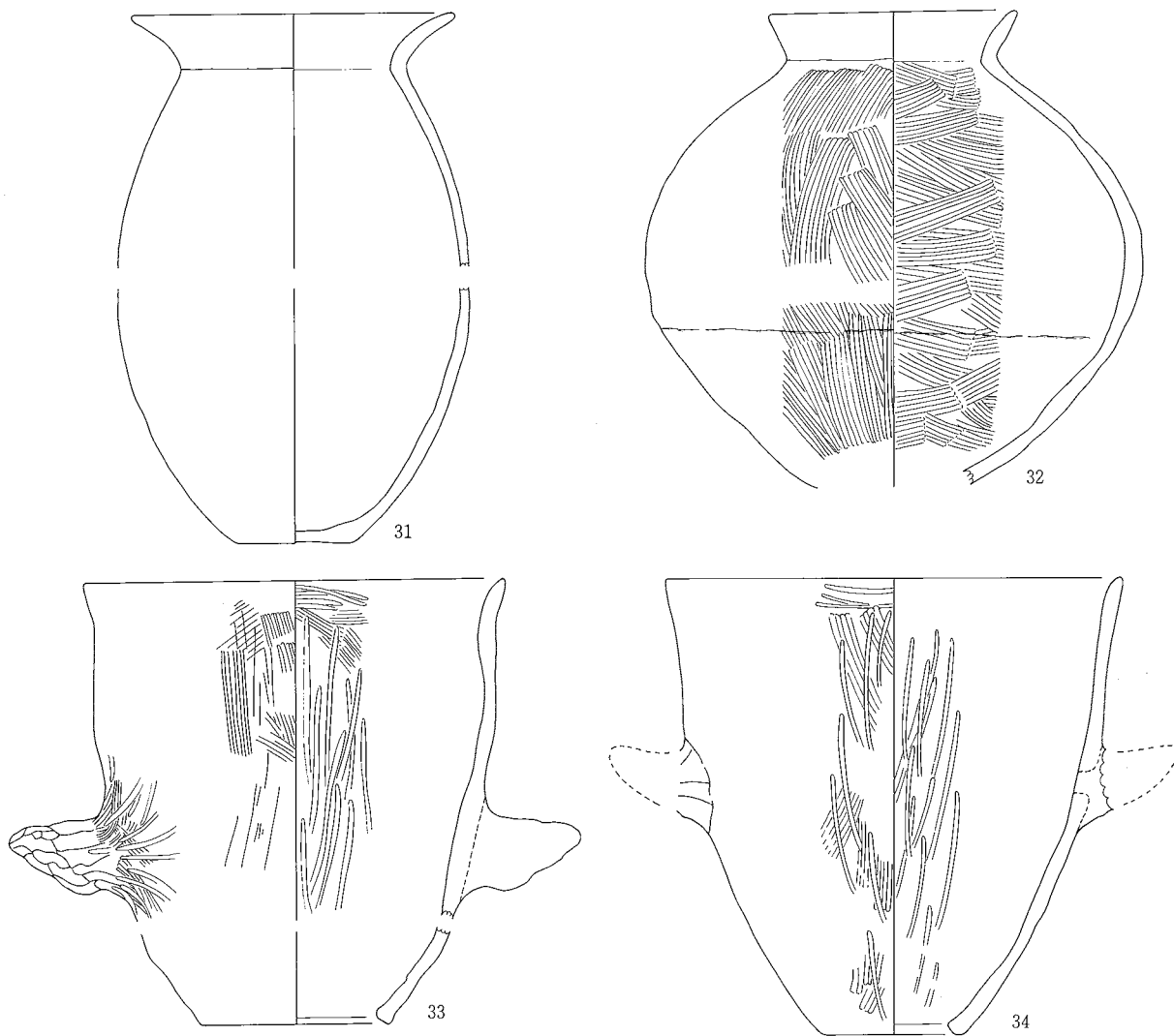

SB383-①

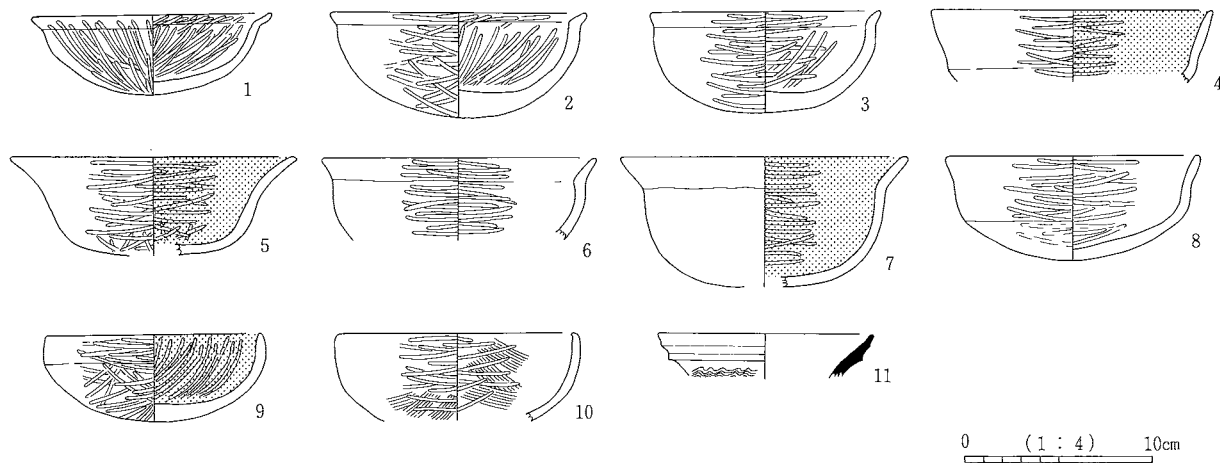

SB383-②

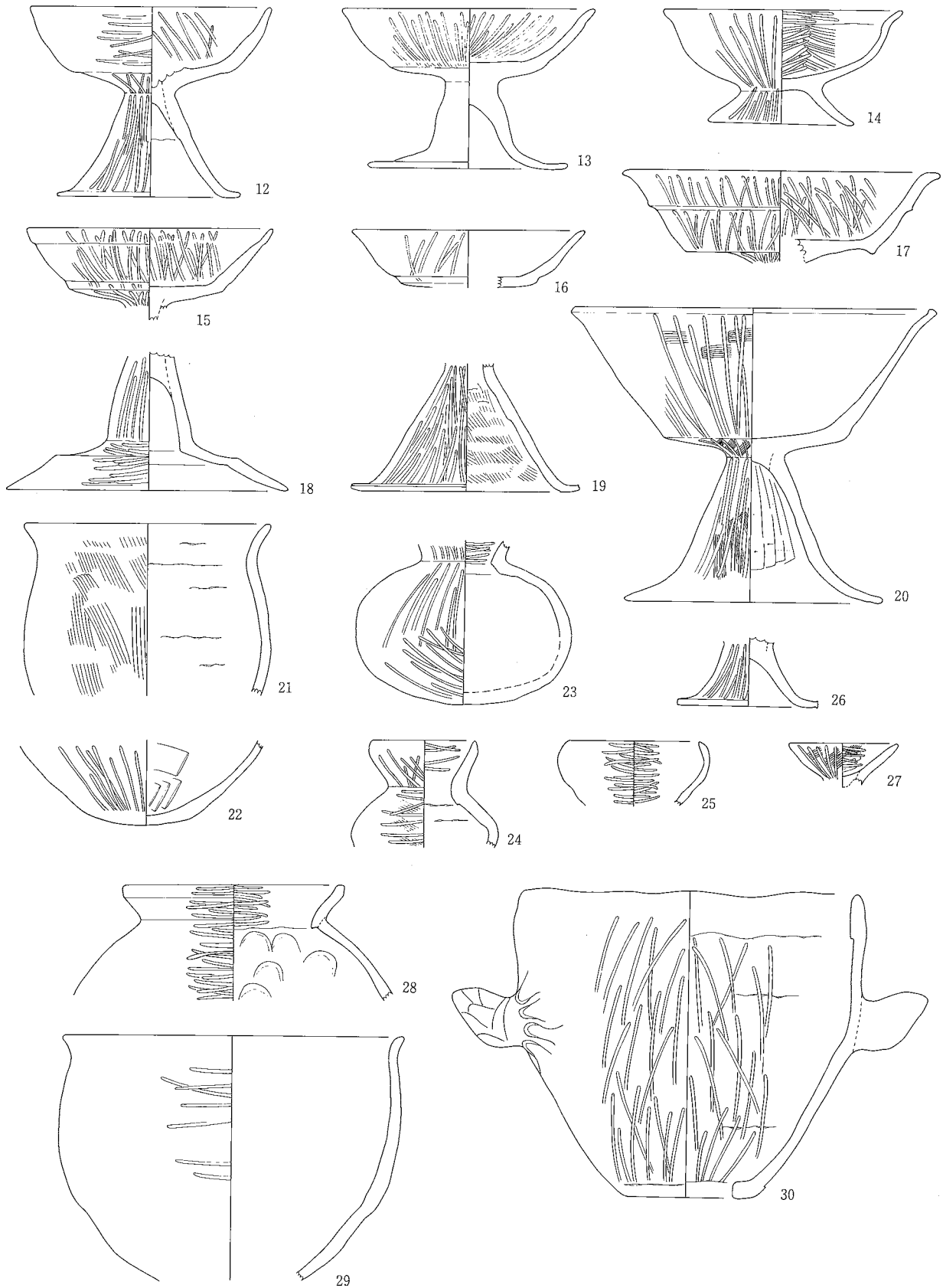

0 (1:4) 10cm

SB383-②

SB383-③

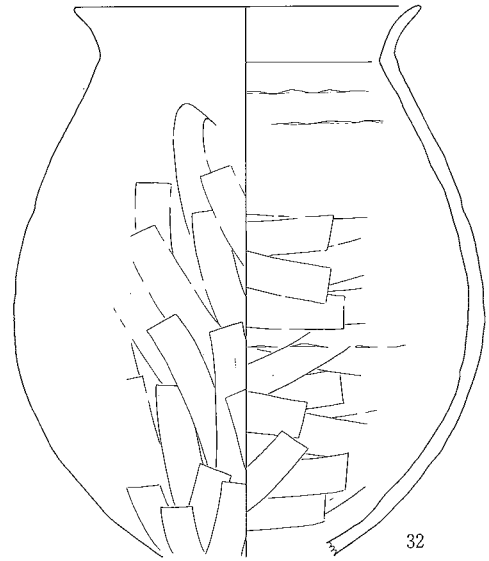
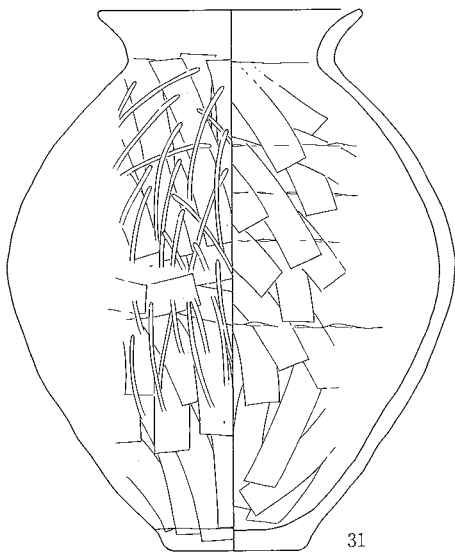

SB390

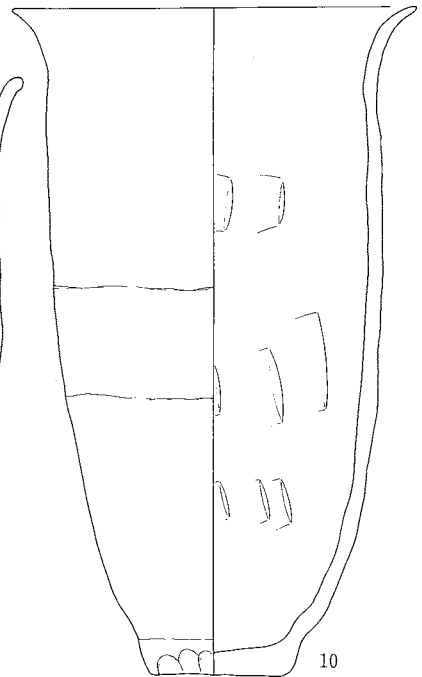
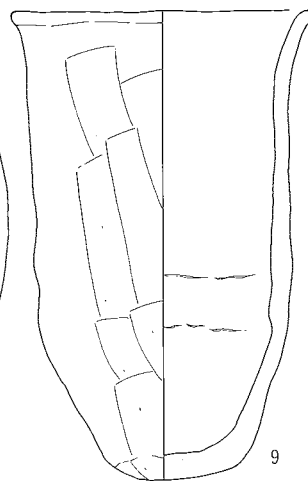
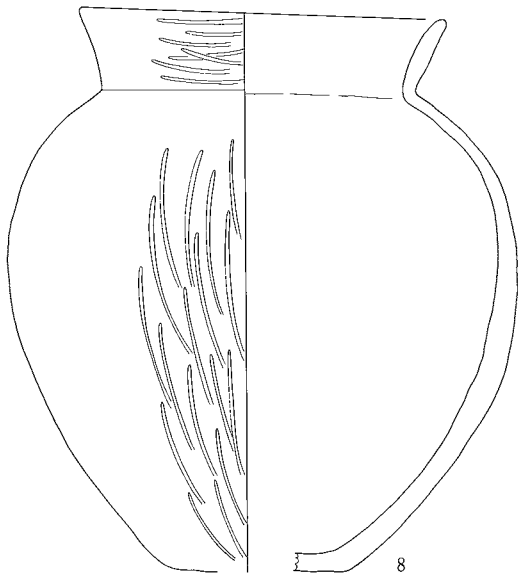
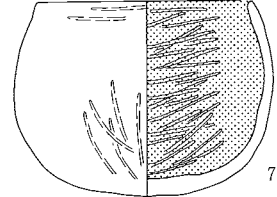
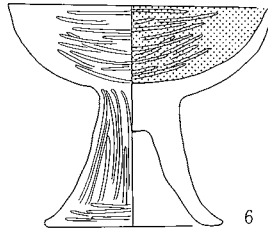
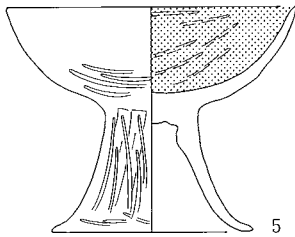
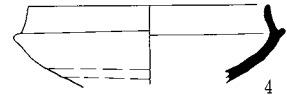
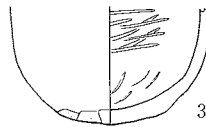
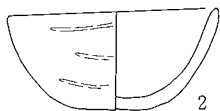
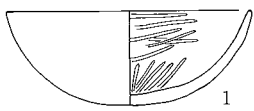

0 (1:4) 10cm

SB391

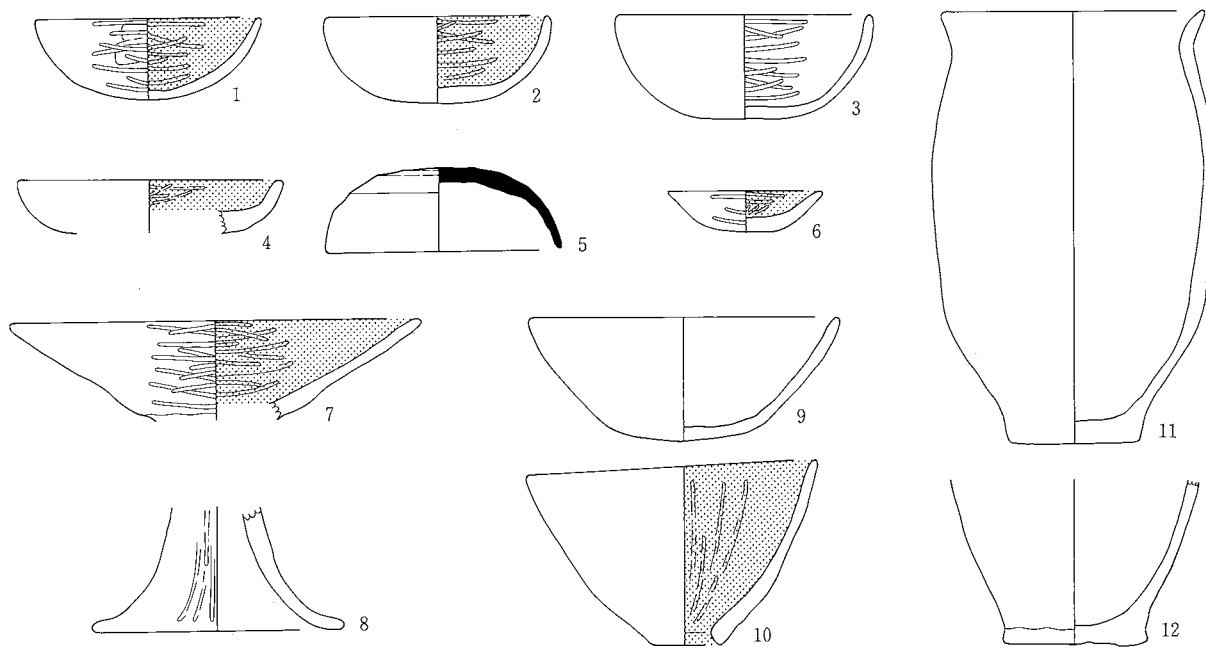

SB392

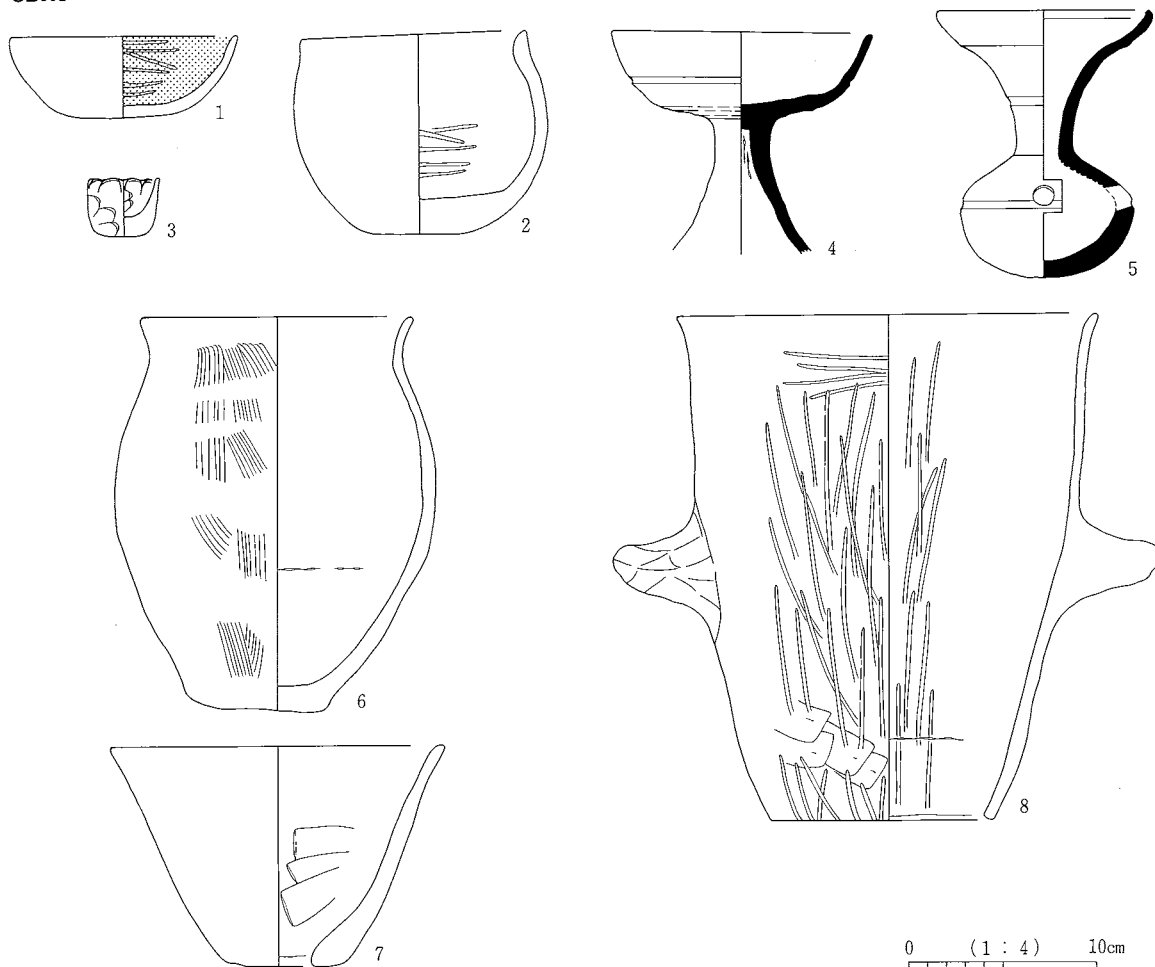

SB395

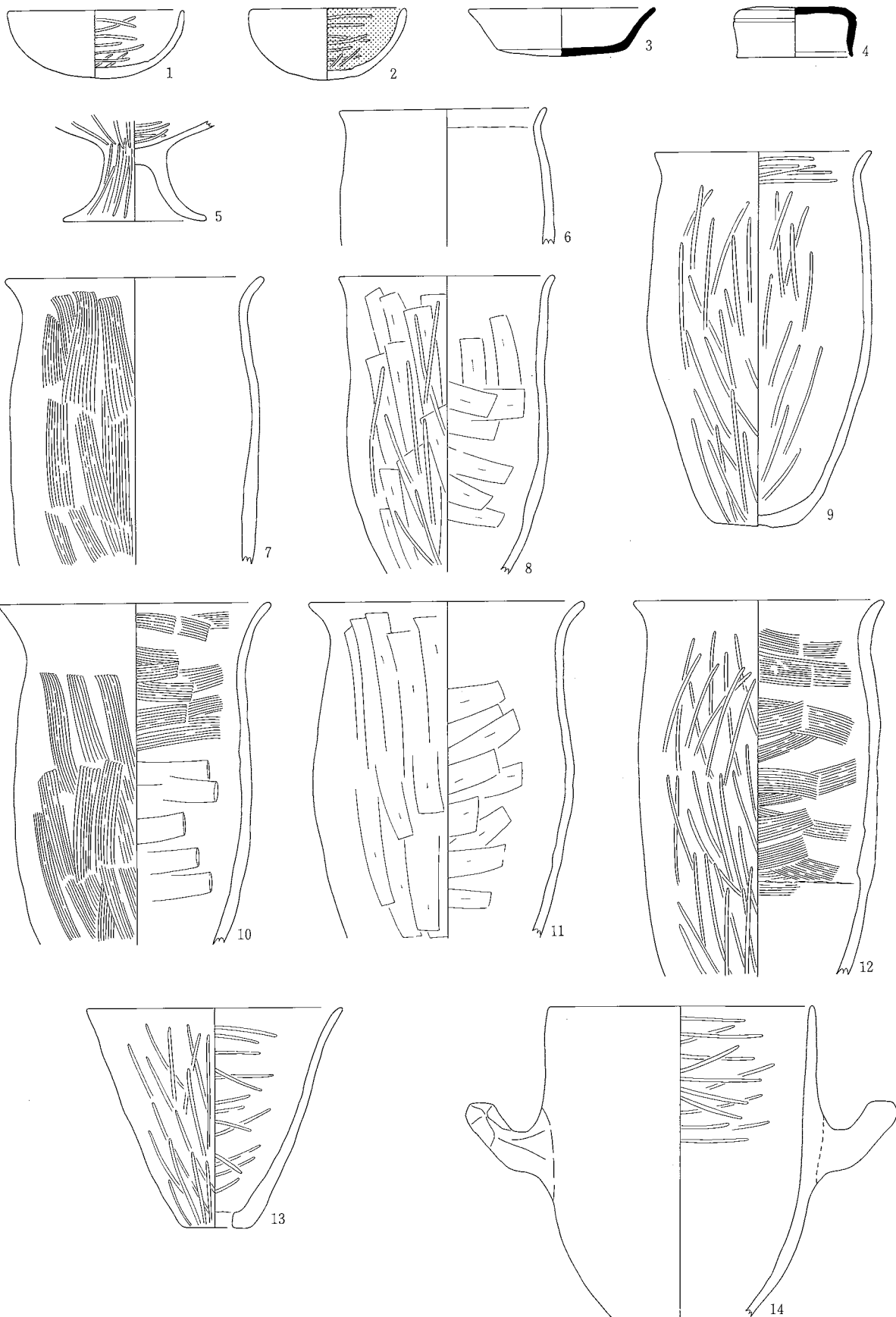

0 (1:4) 10cm

SB395

SB396

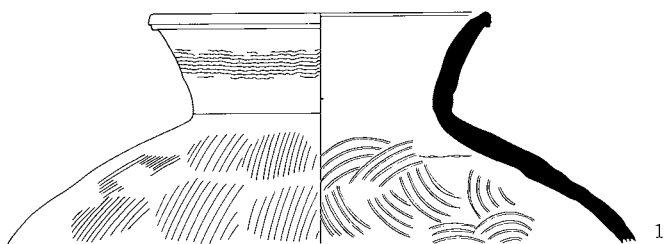

SB450

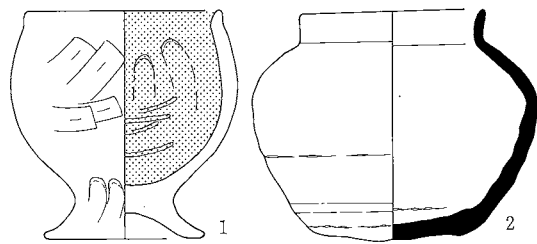

SB477

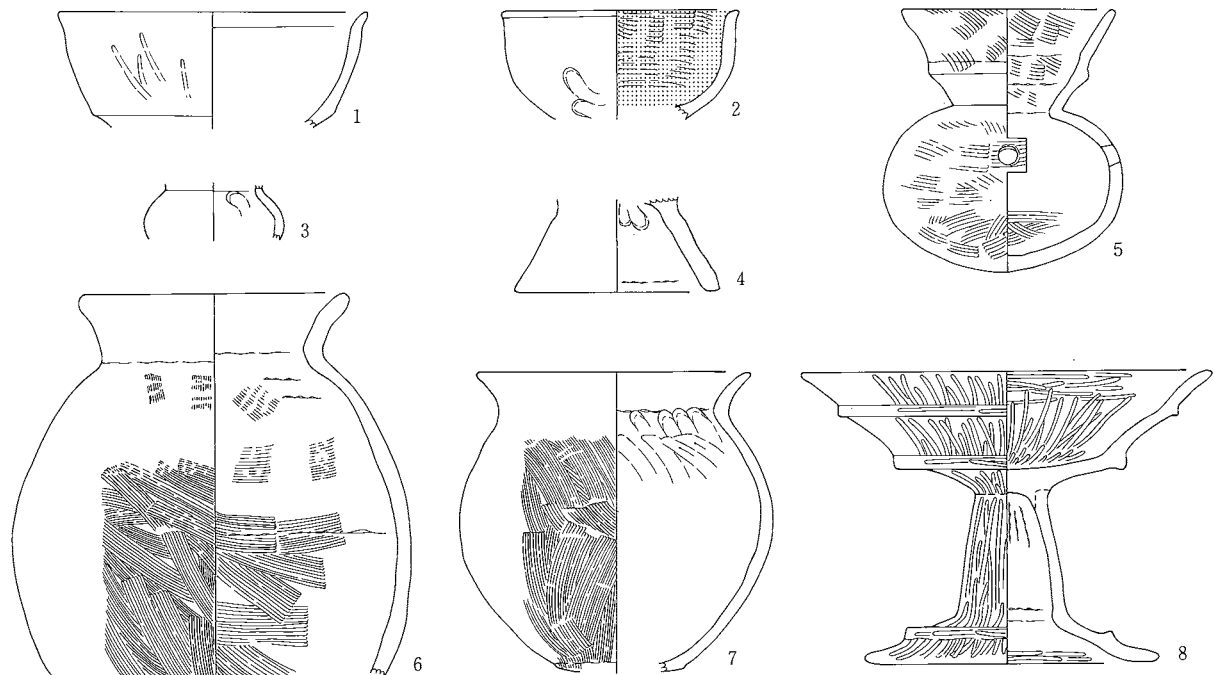

SB486

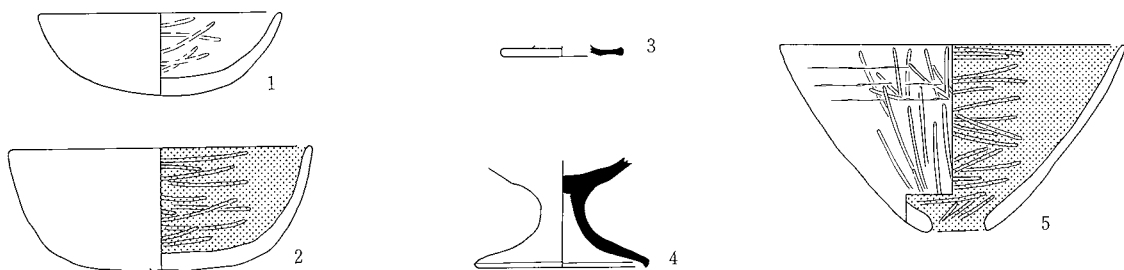

0 (1:4) 10cm

SB526

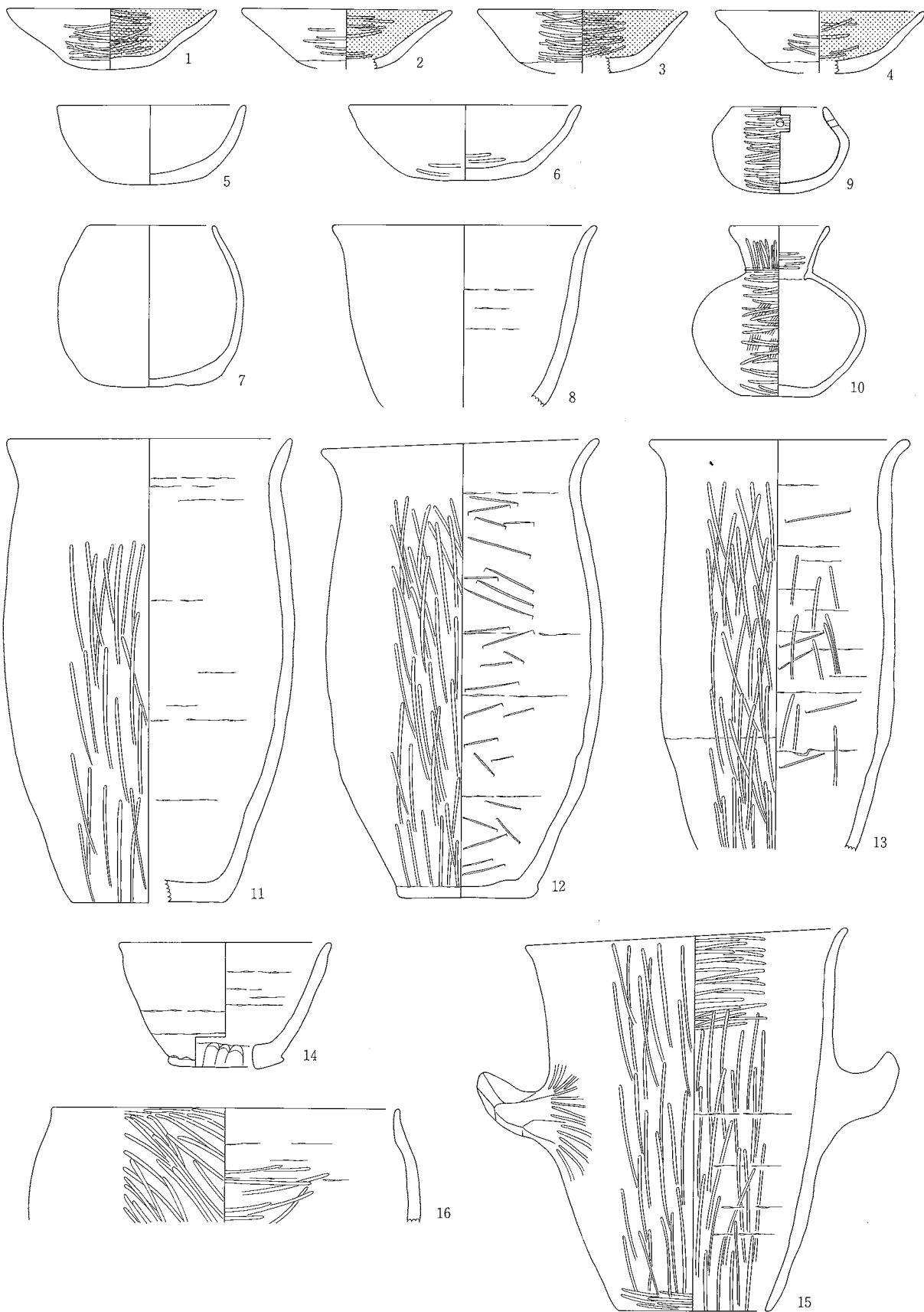

0 (1 : 4) 10cm

SB526

SB531

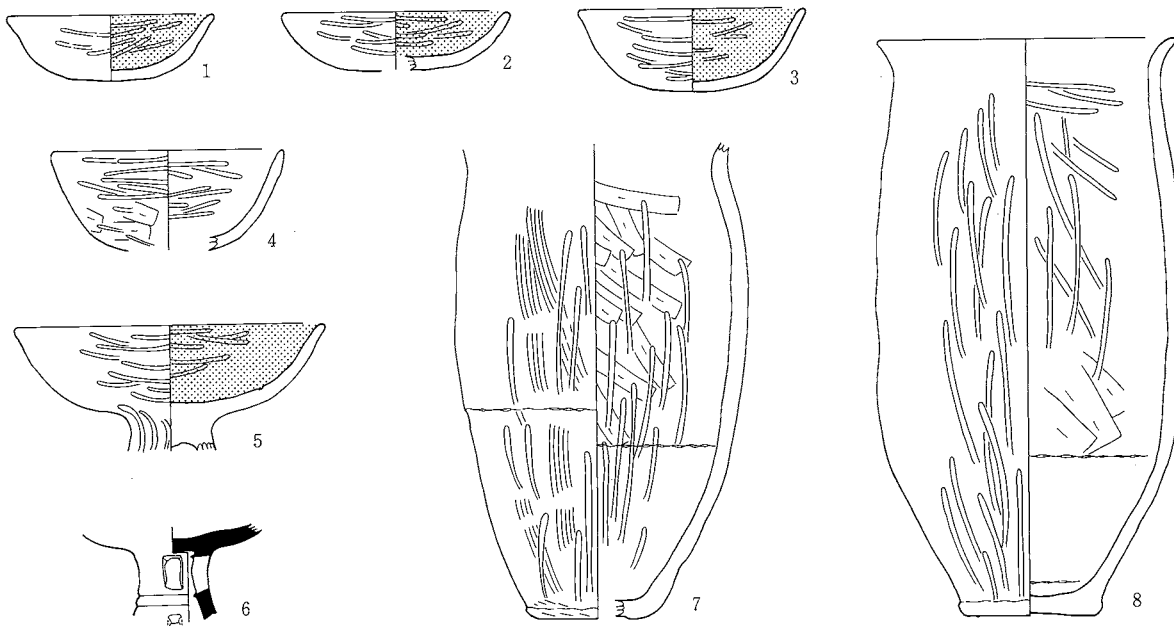

SB558

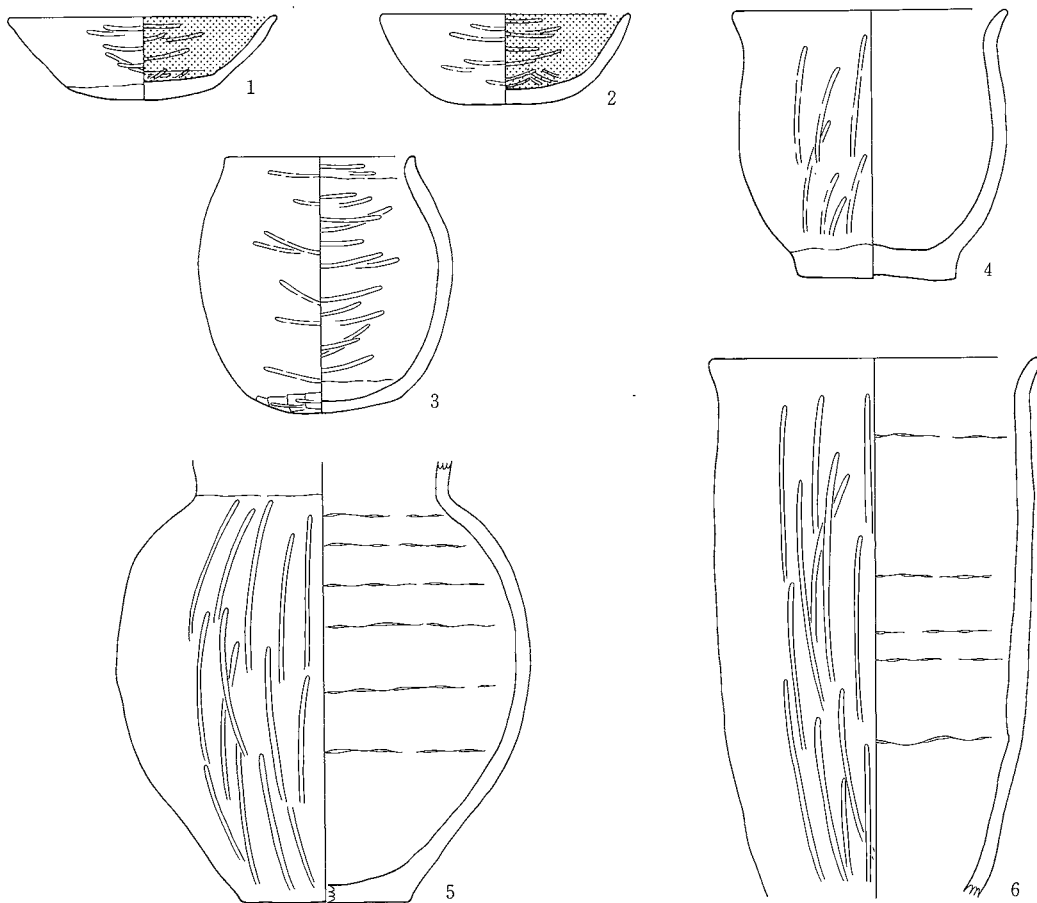

0 (1:4) 10cm

SB542

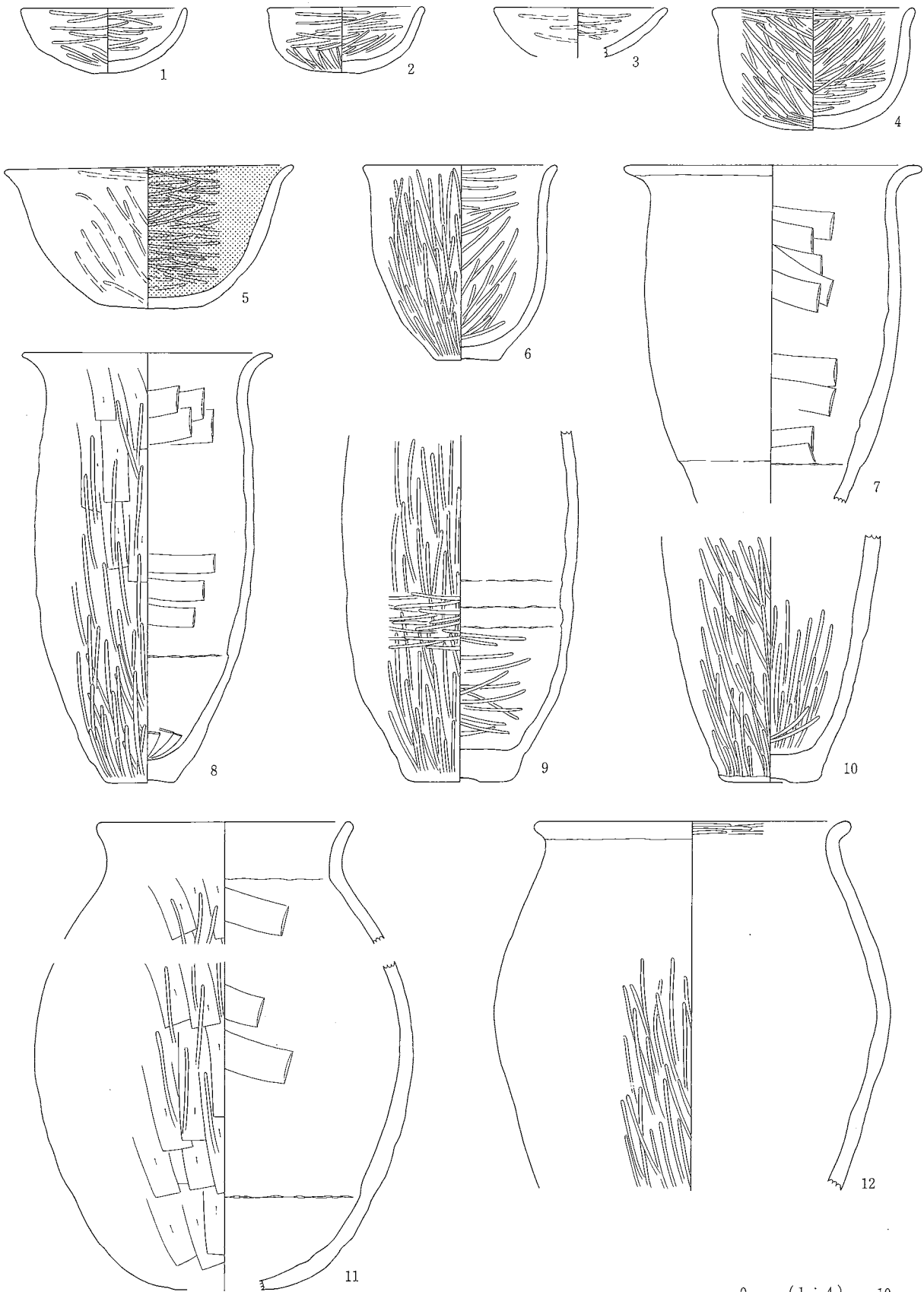

SB542

SB578-①

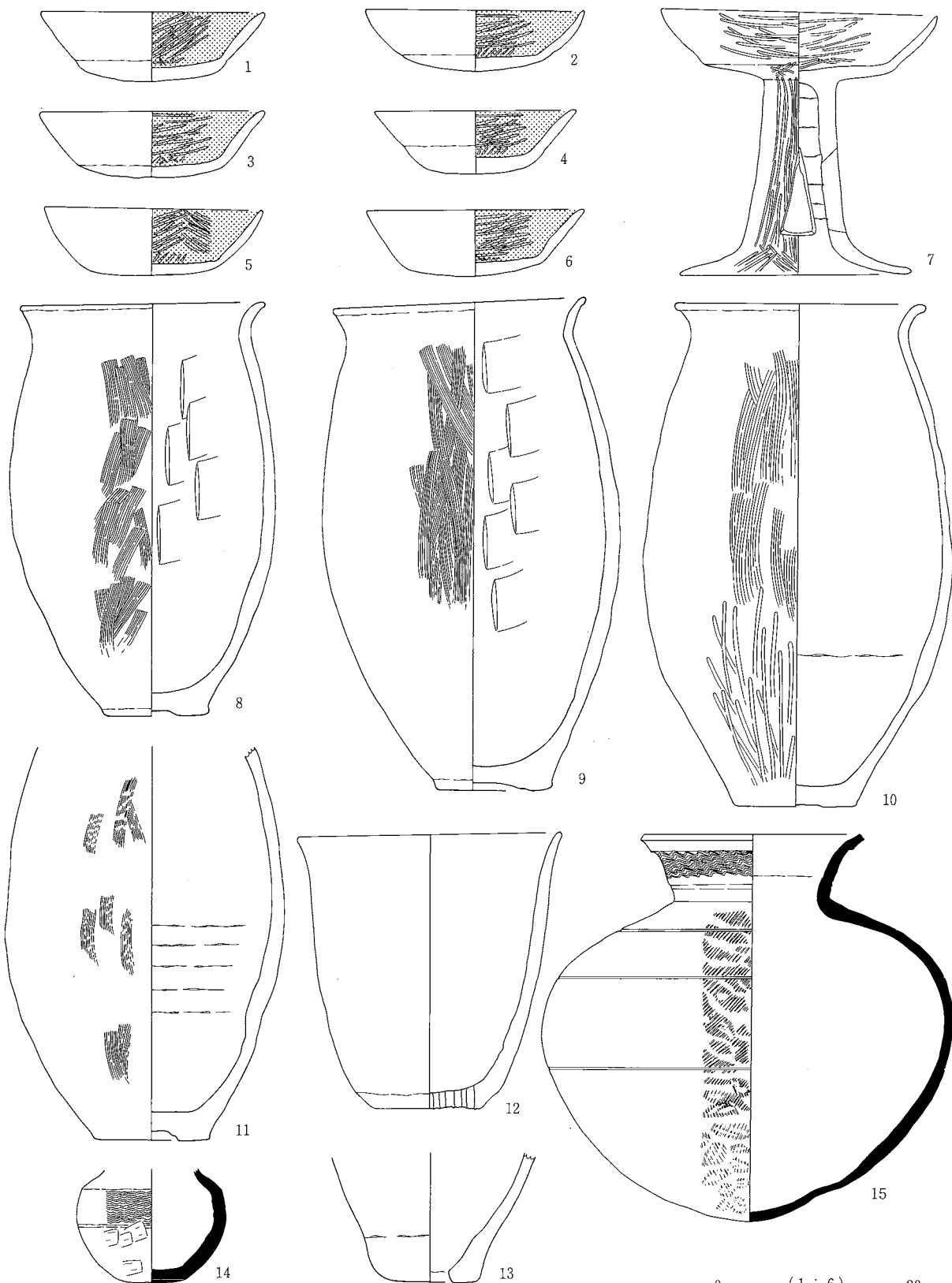

0 (1 : 6) 20cm
 (SB578-15)

0 (1 : 4) 10cm

SB578-①

SB578-②

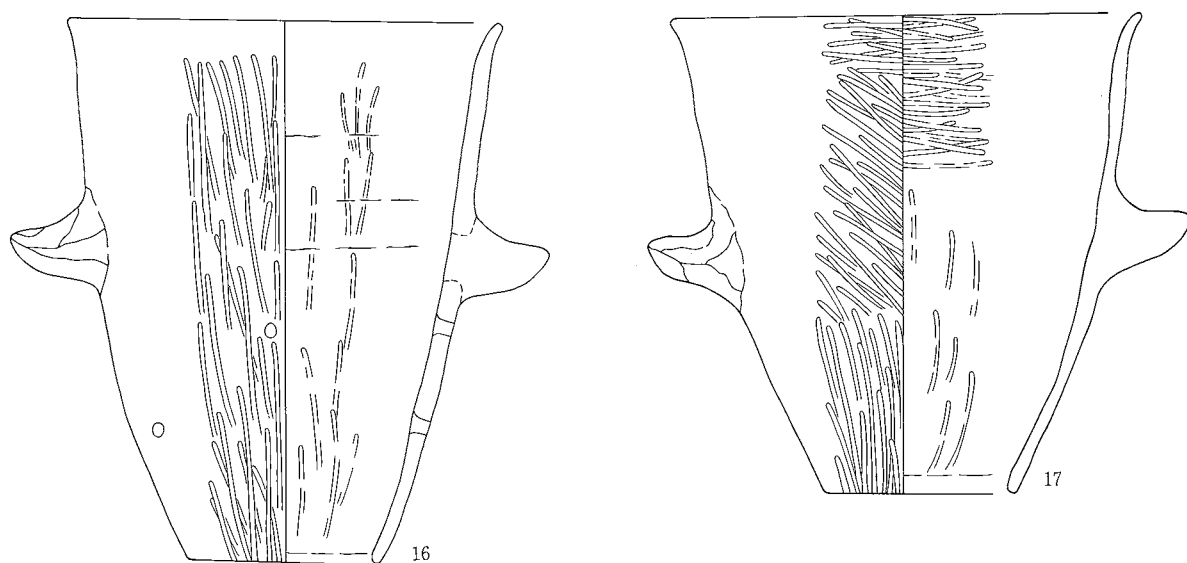

SB590

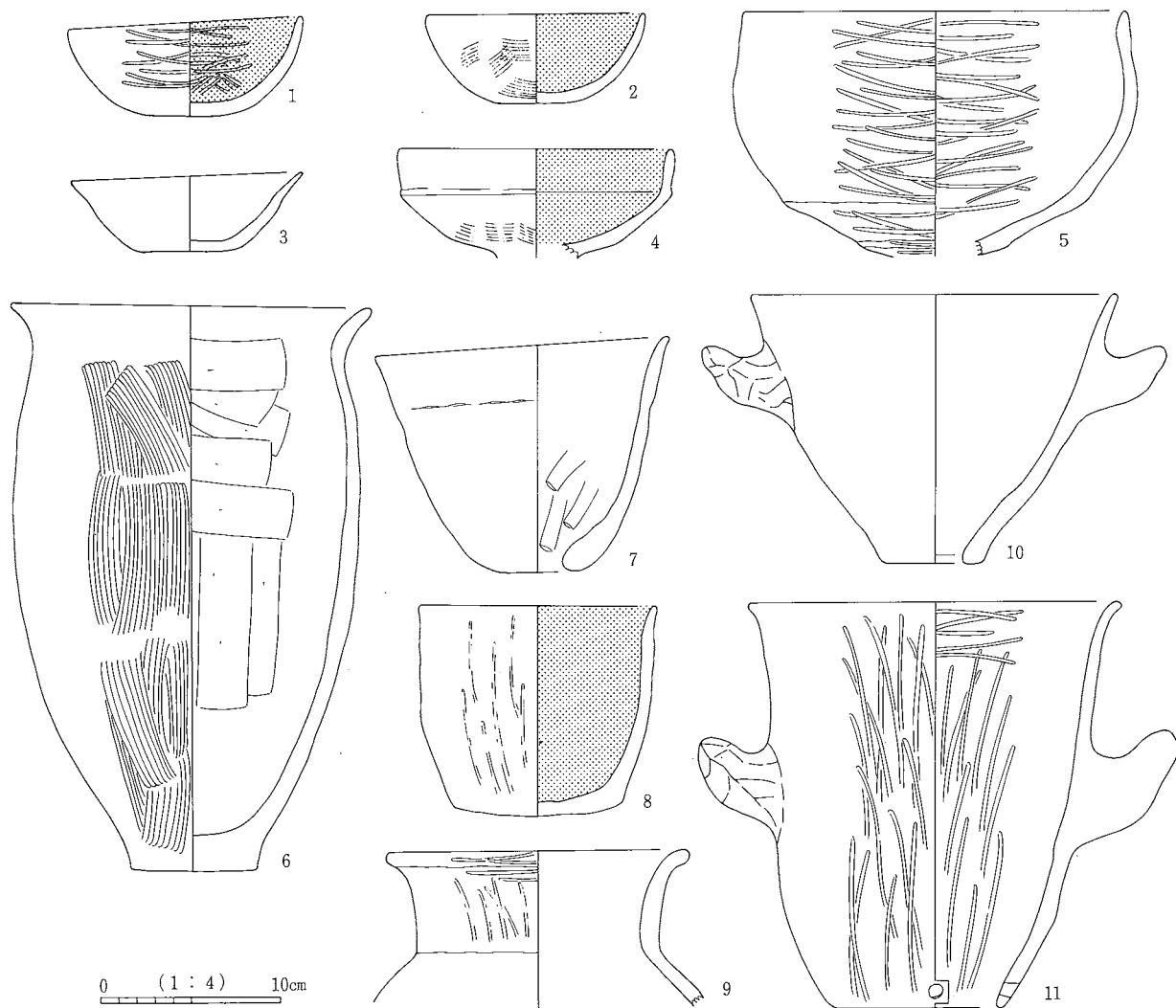

SB595

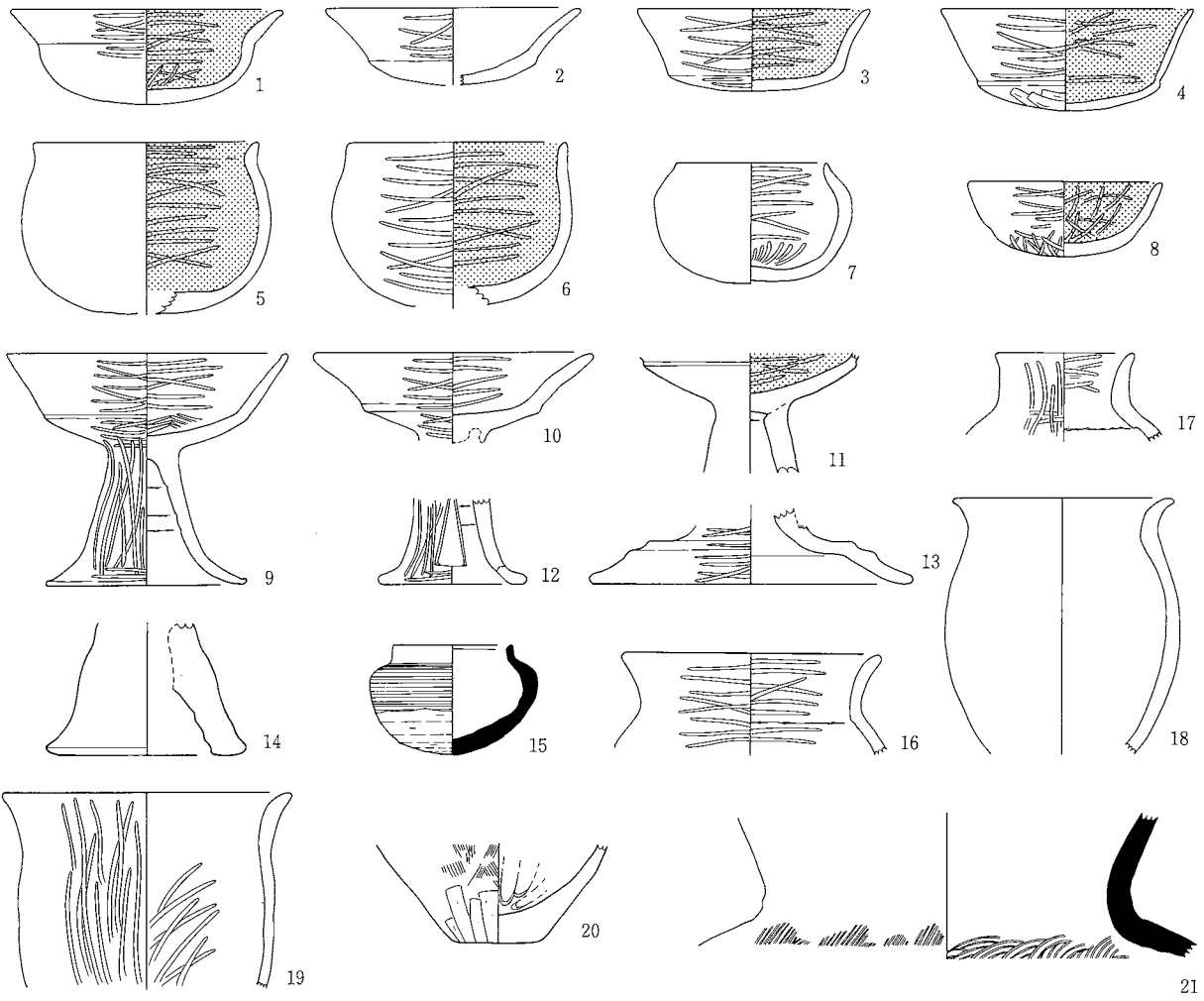

SB623-①

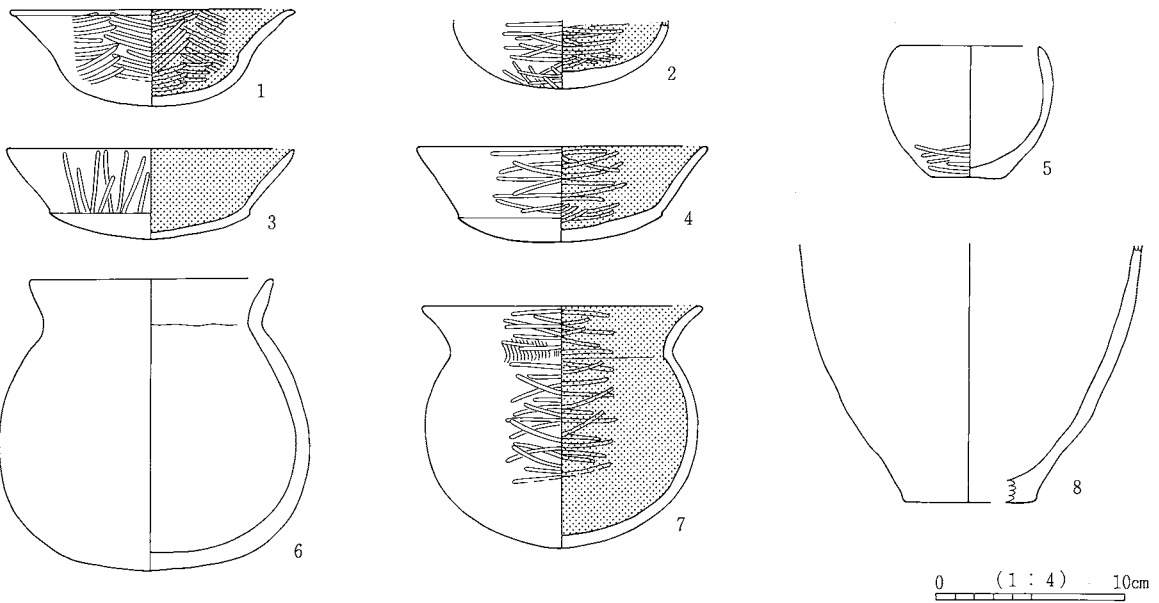

SB623-②

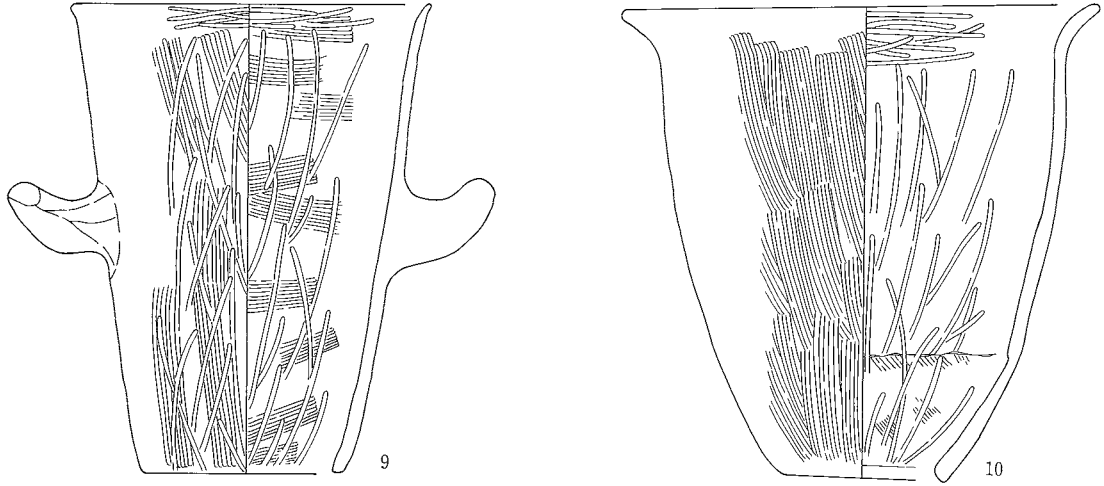

SB625-①

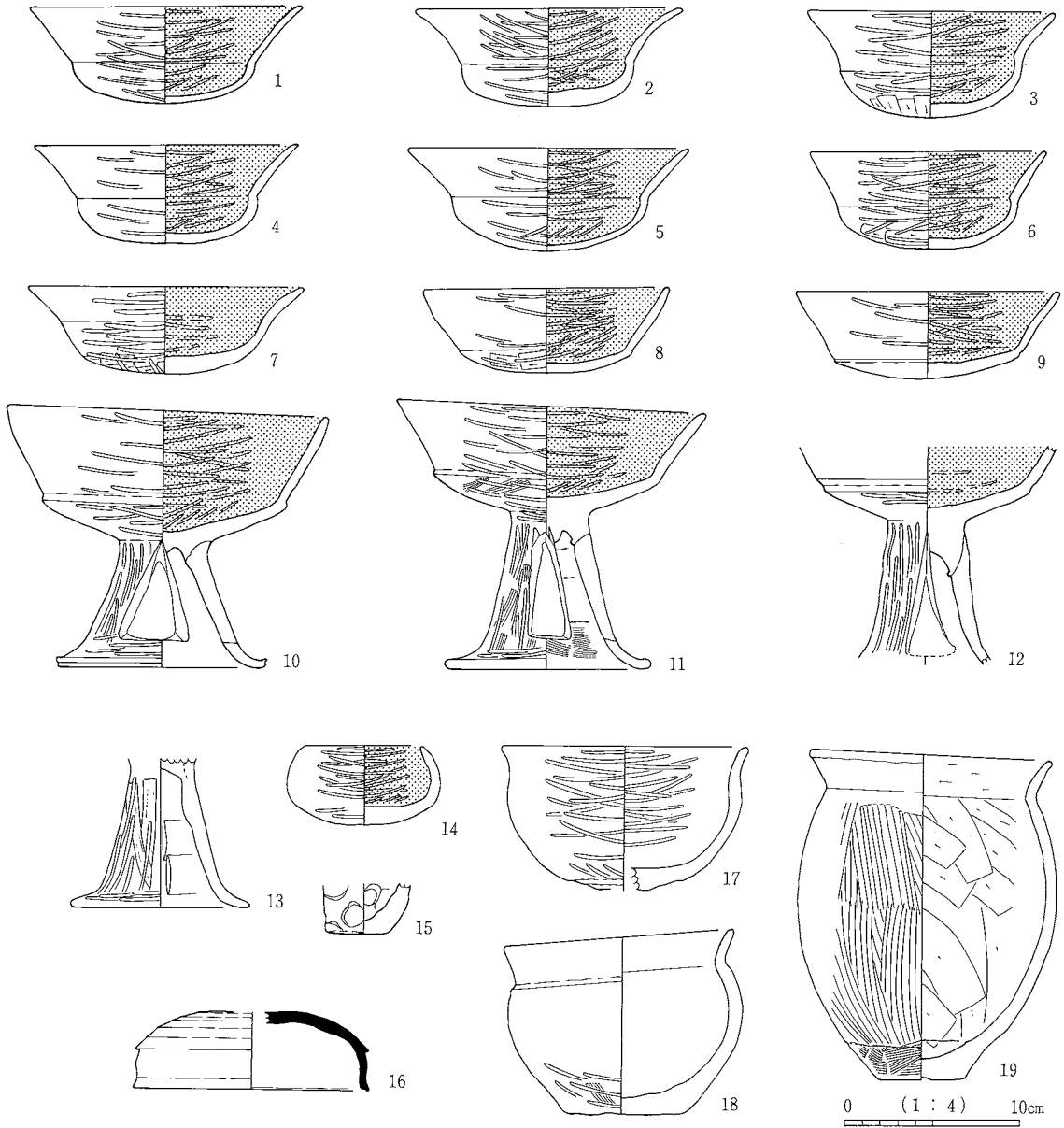

SB625-②

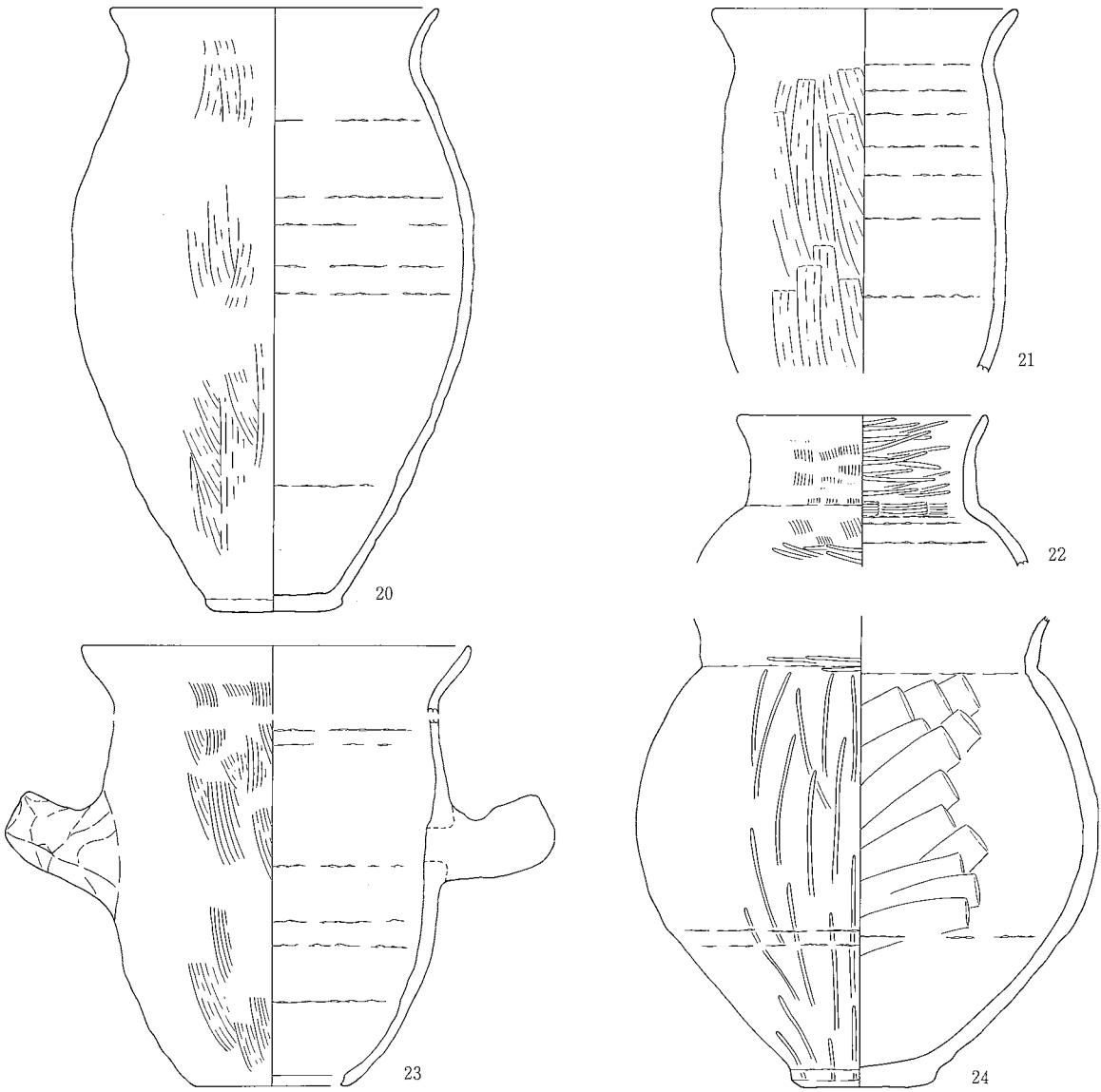

SB627-①

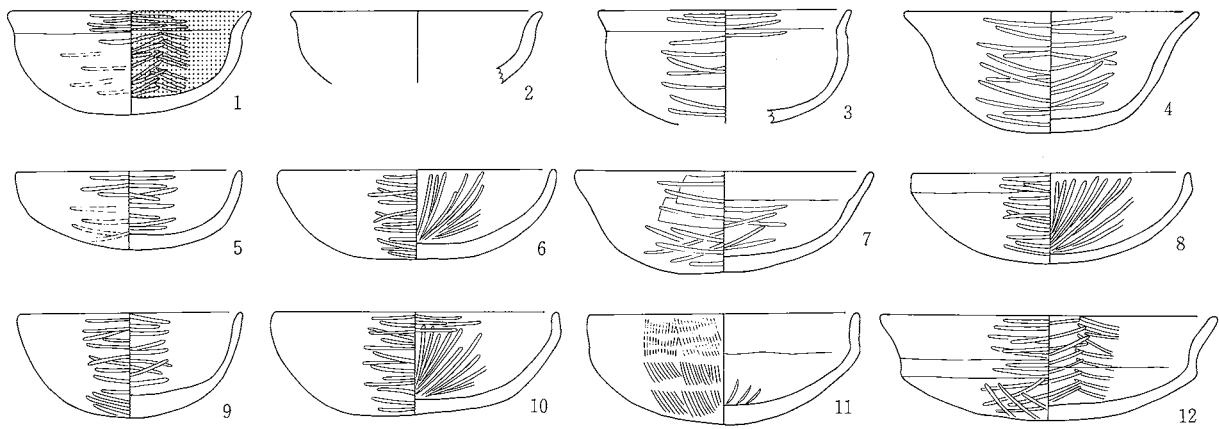

0 (1:4) 10cm

SB627-②

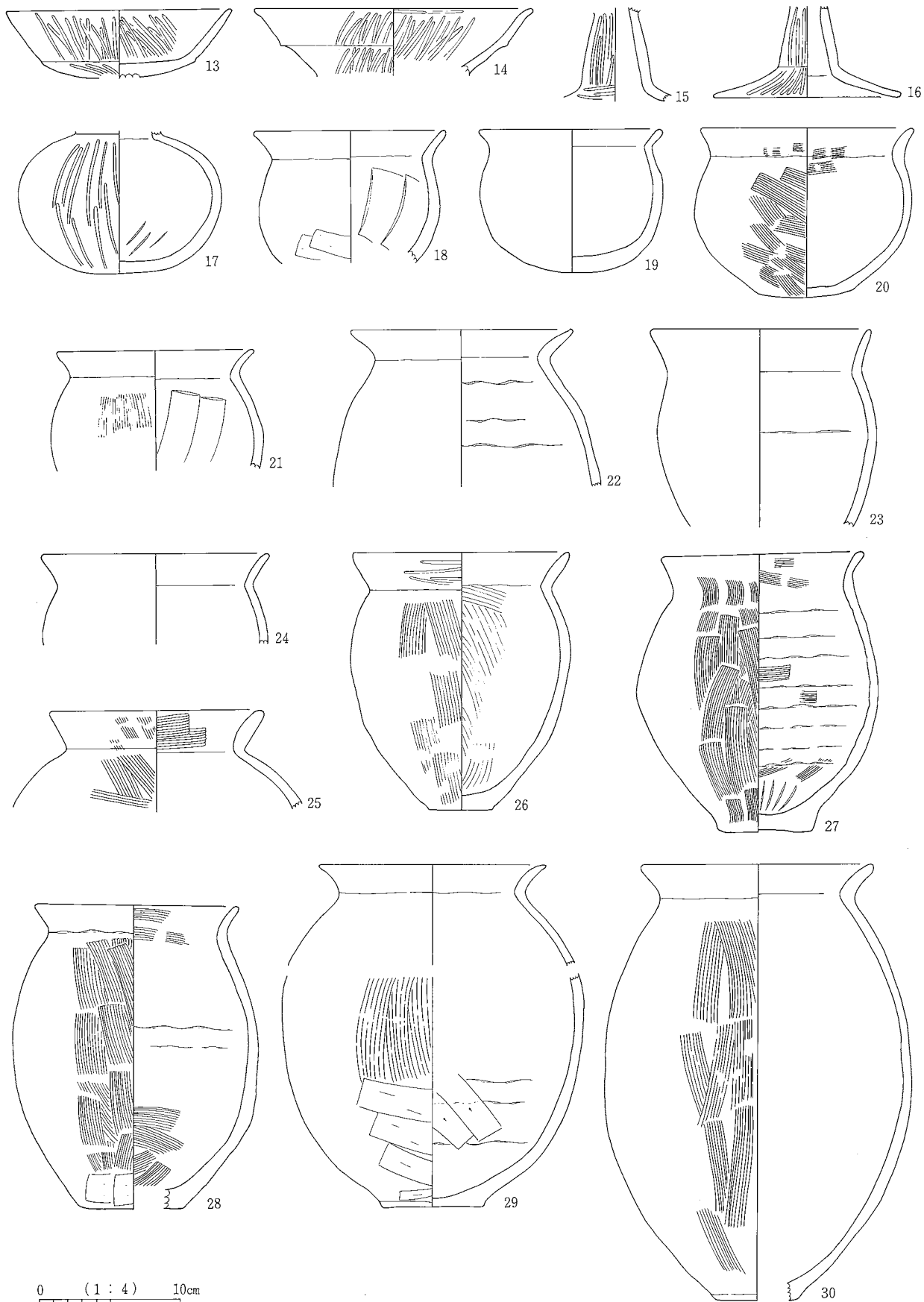

SB627-②

SB635

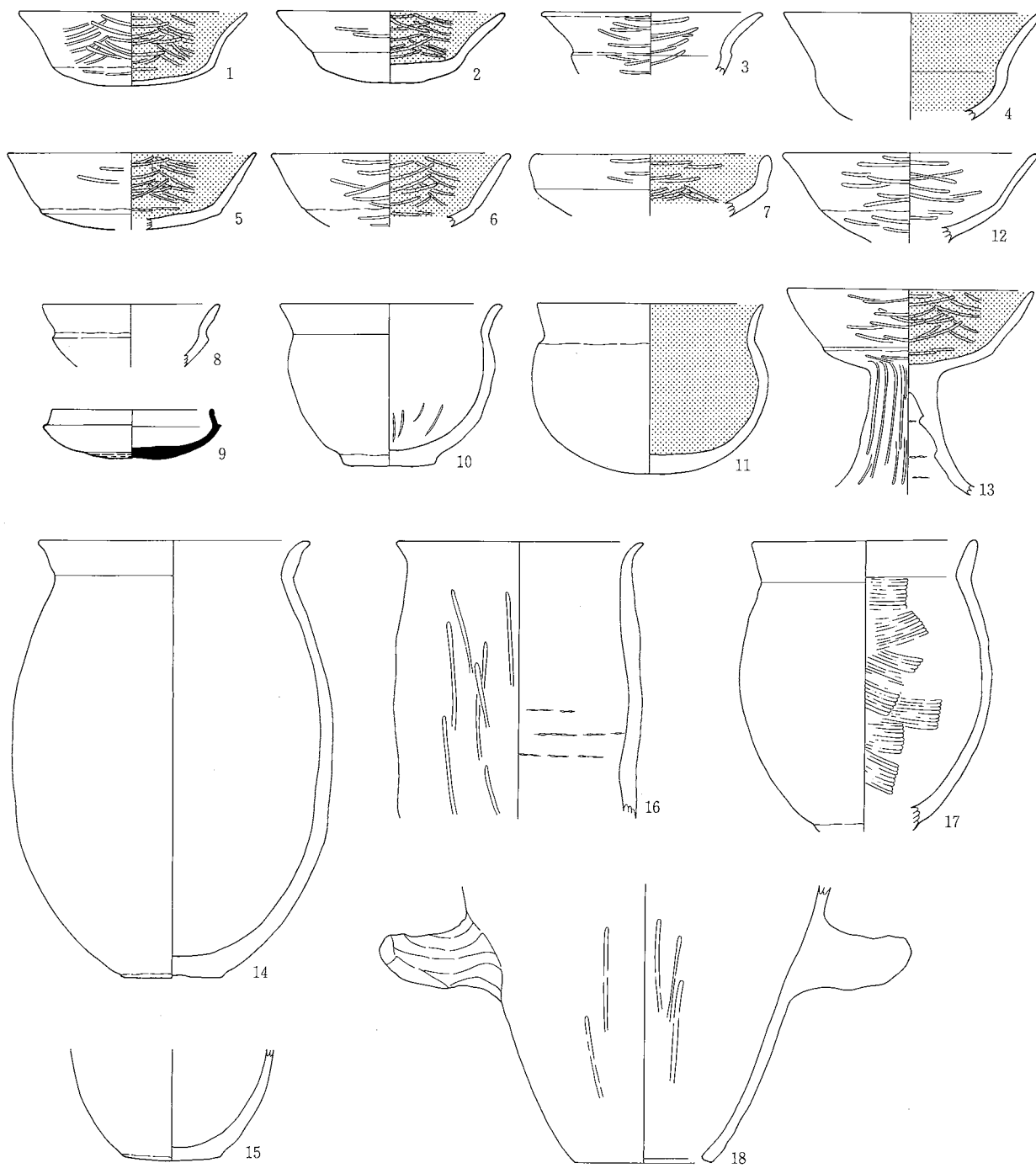

0 (1:4) 10cm

SB635

SB641

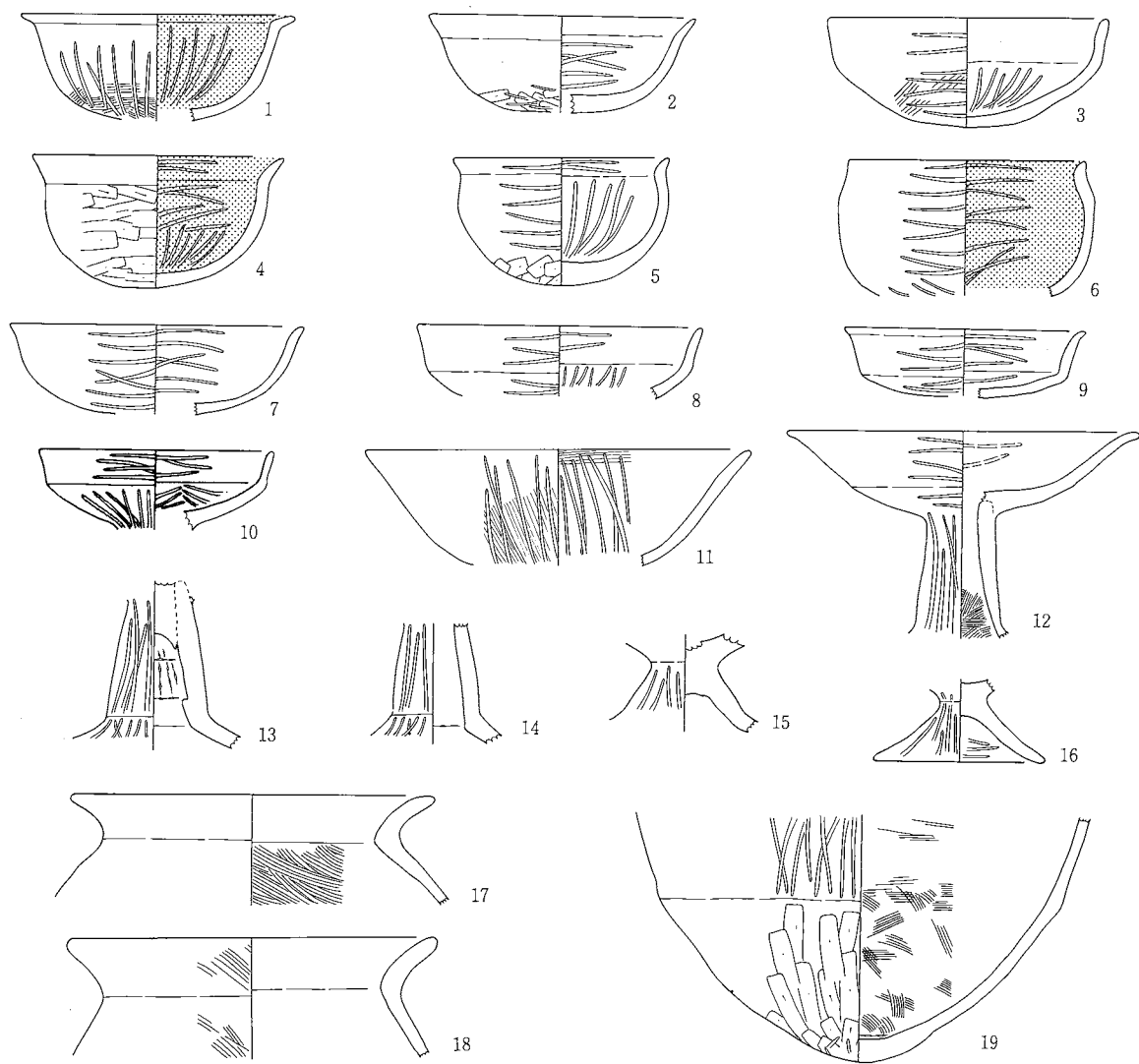

SB644-①

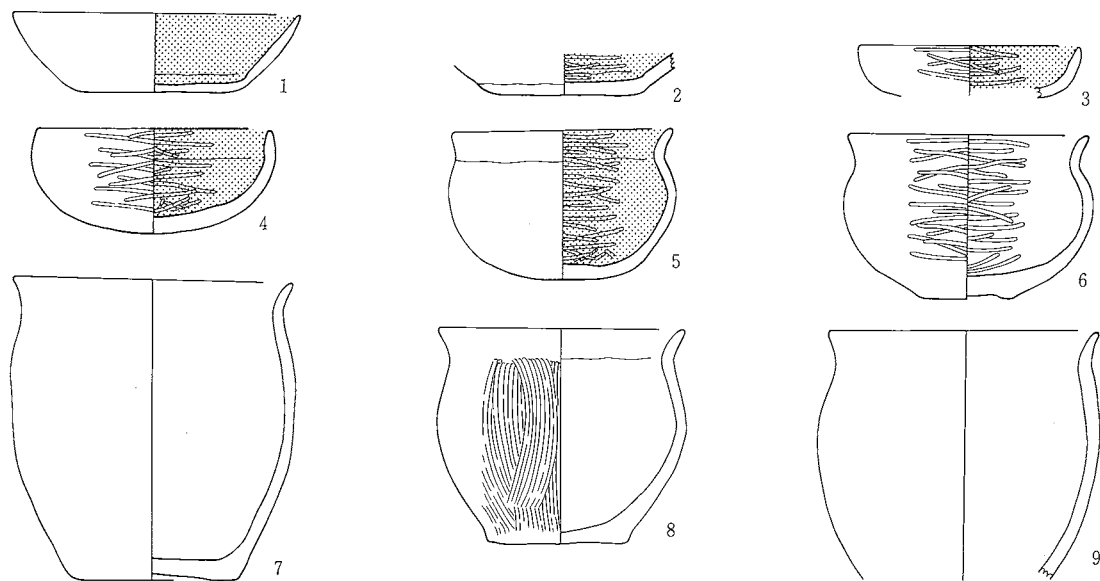

0 (1:4) 10cm

SB641・644-①

SB644-②

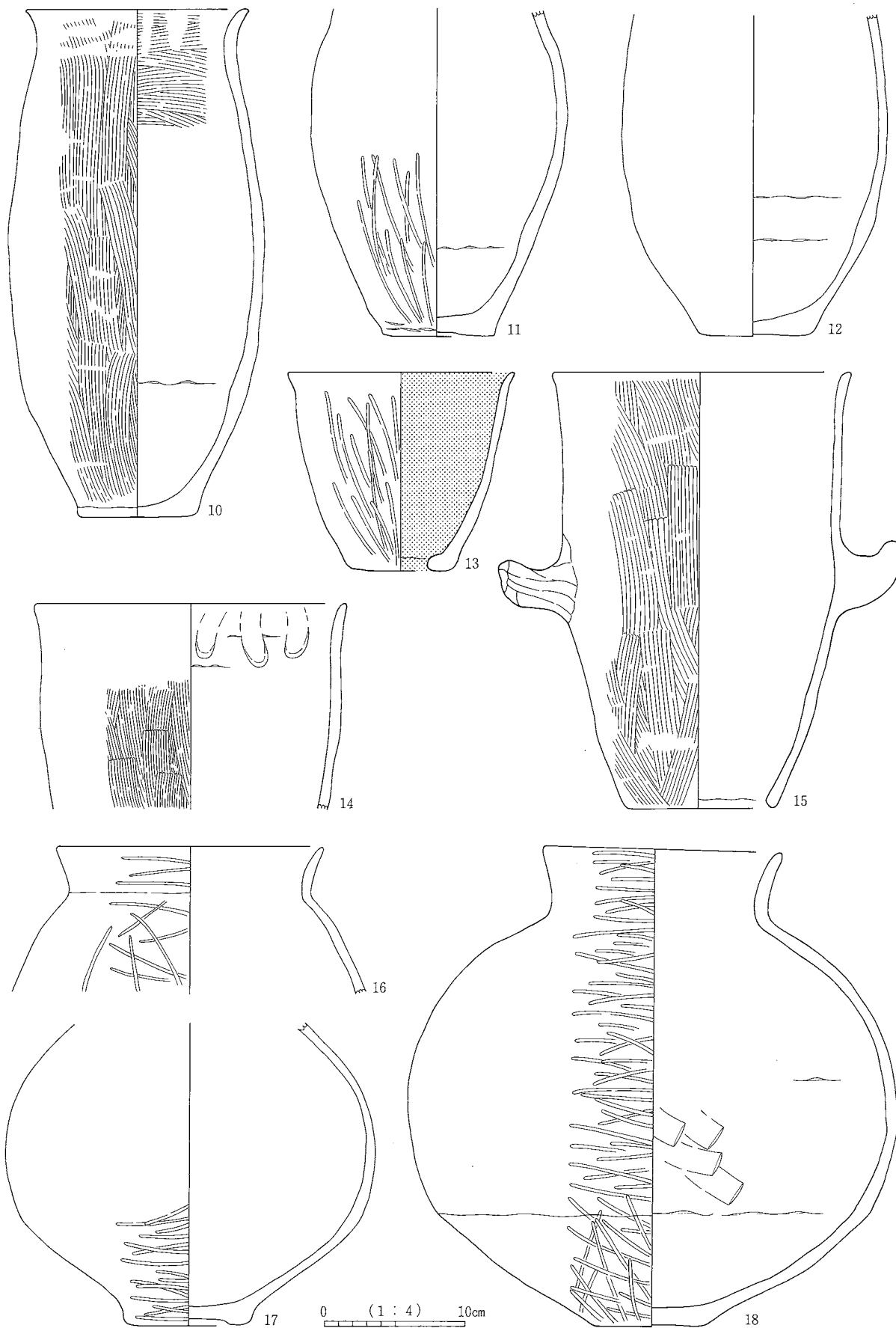

SB644-②

SB643

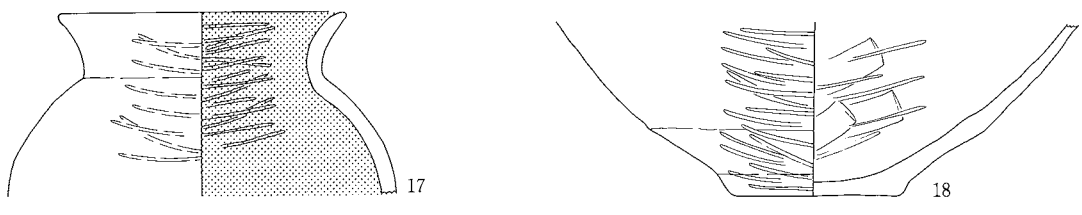
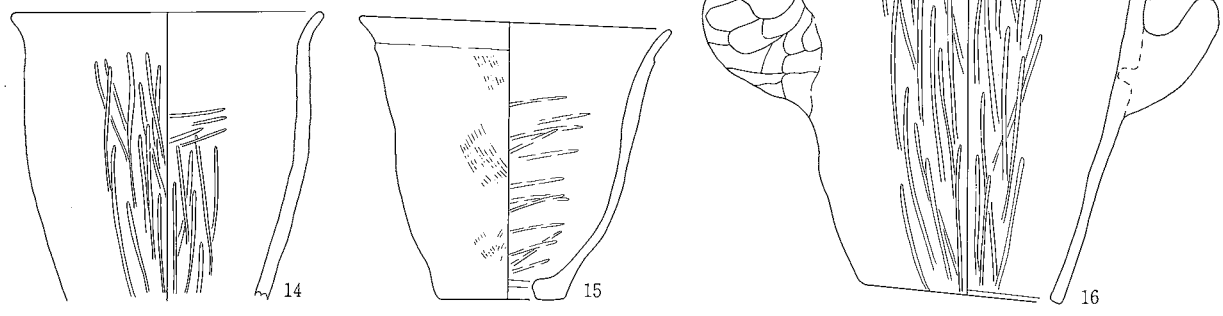
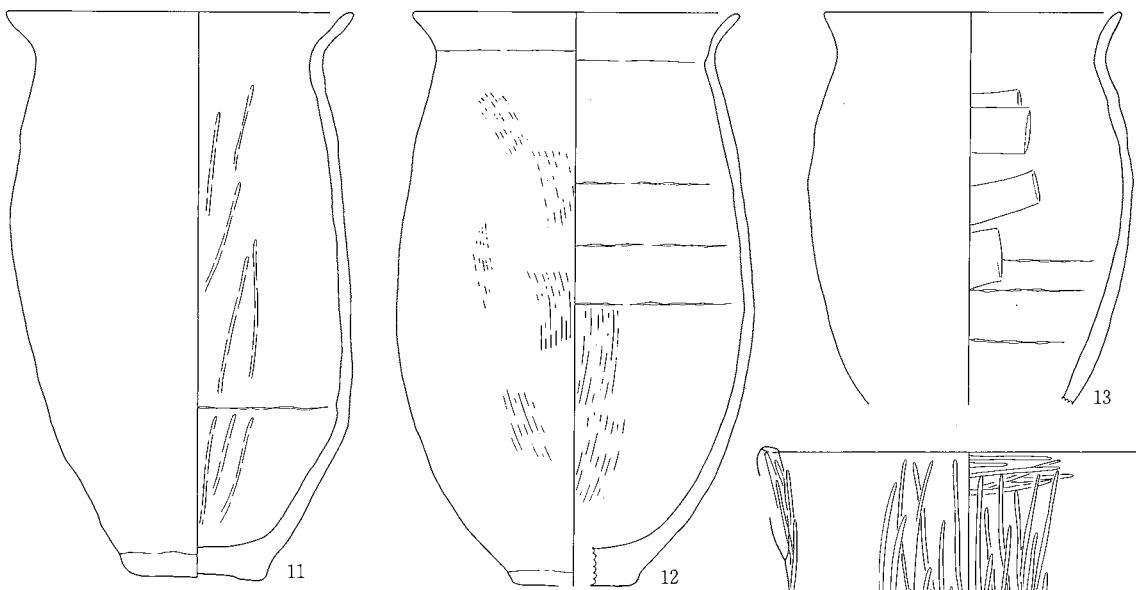
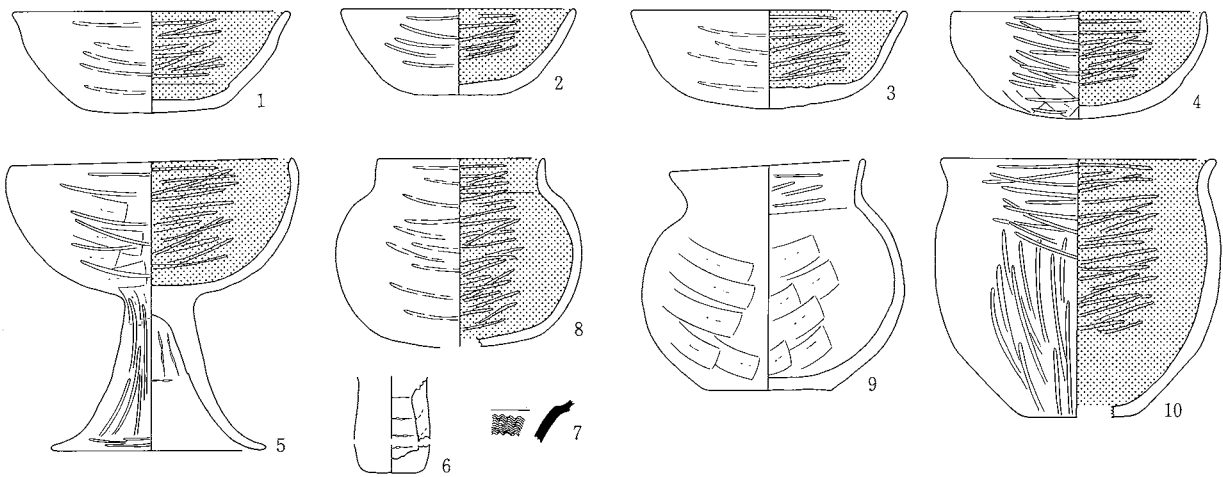

0 (1:4) 10cm

SB643

SB645

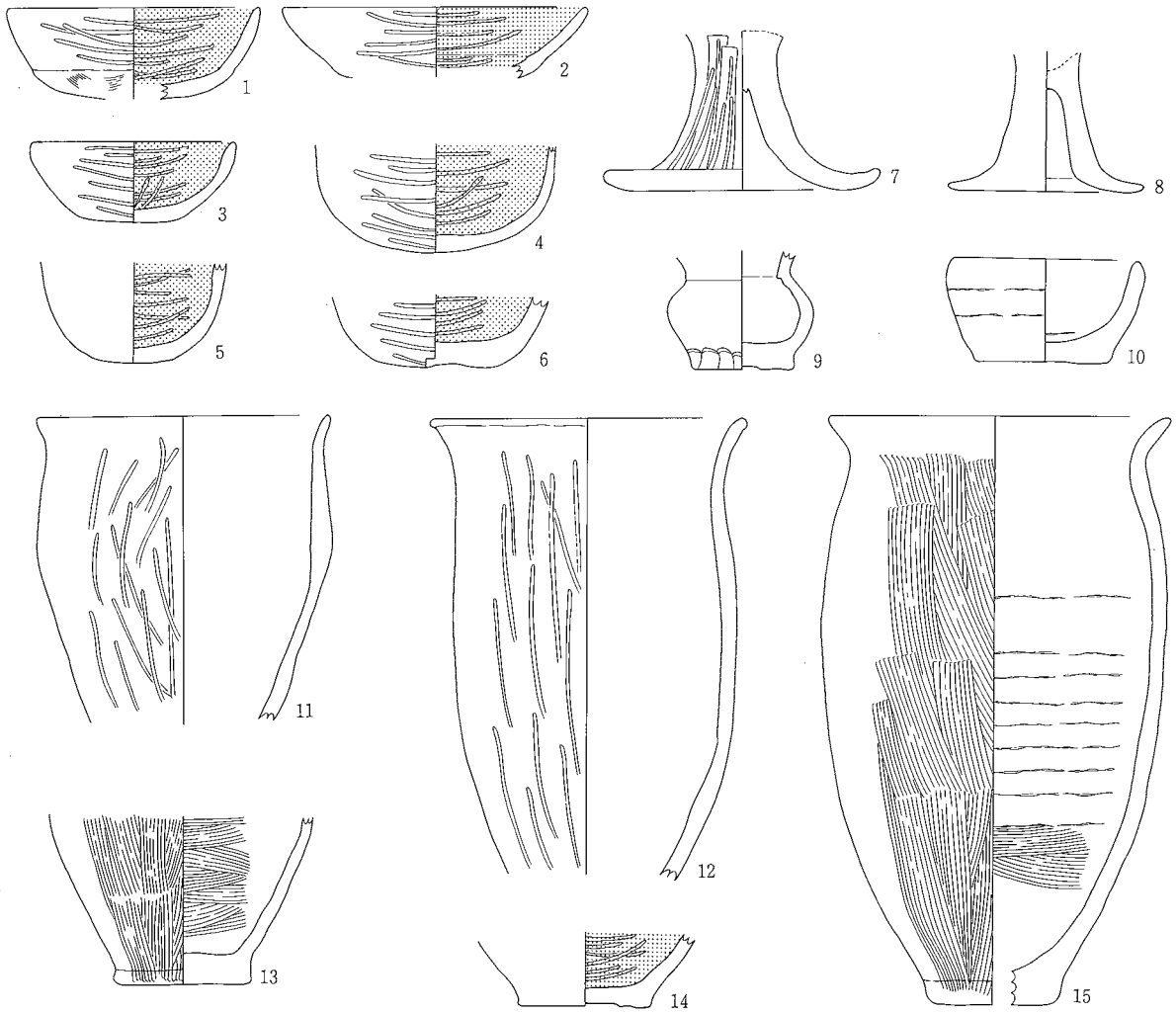

SB663-①

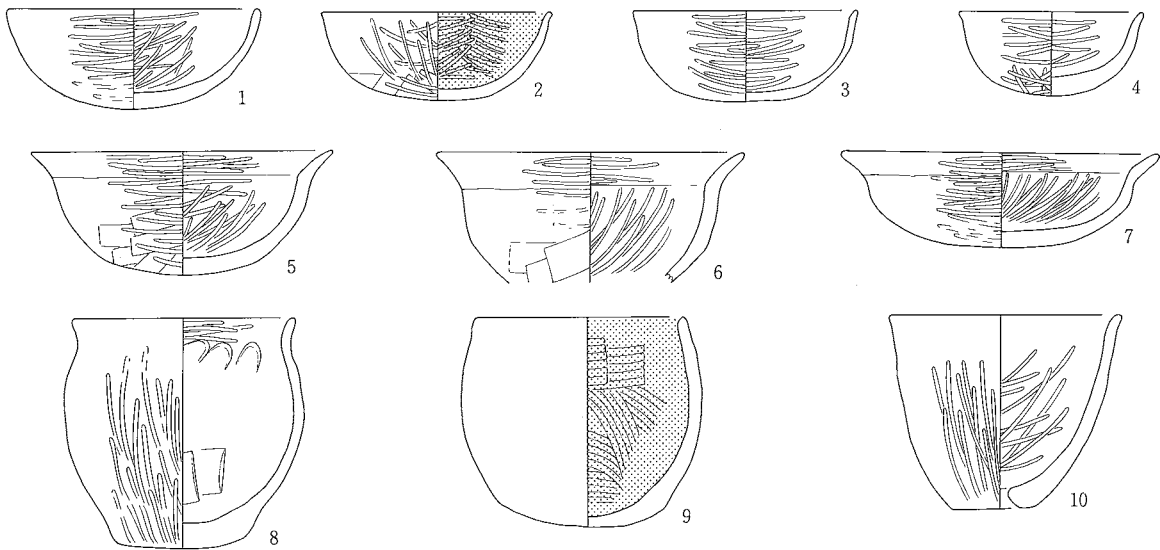

0 (1 : 4) 10cm

SB645・663-①

SB663-②

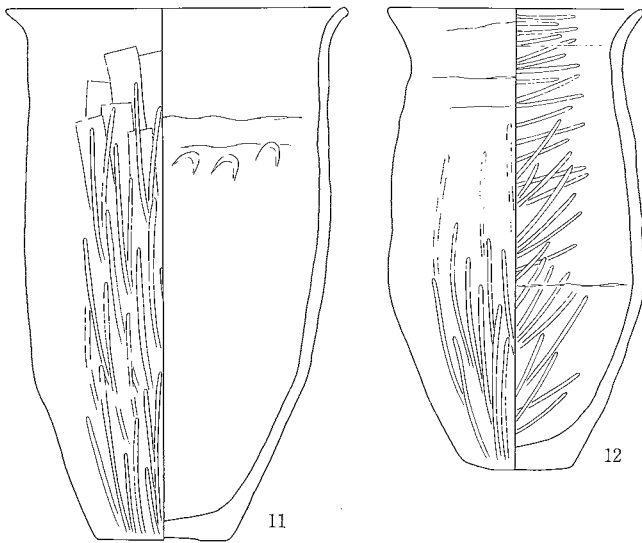

SB677

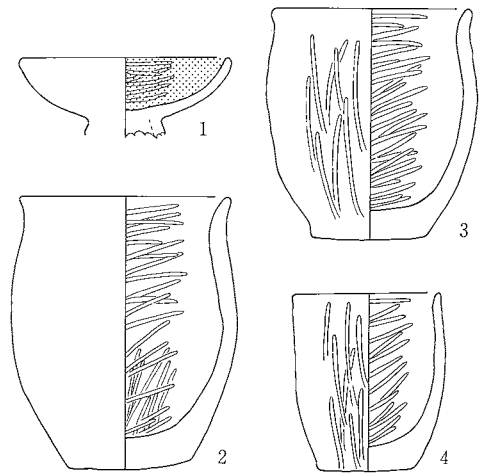

SB685

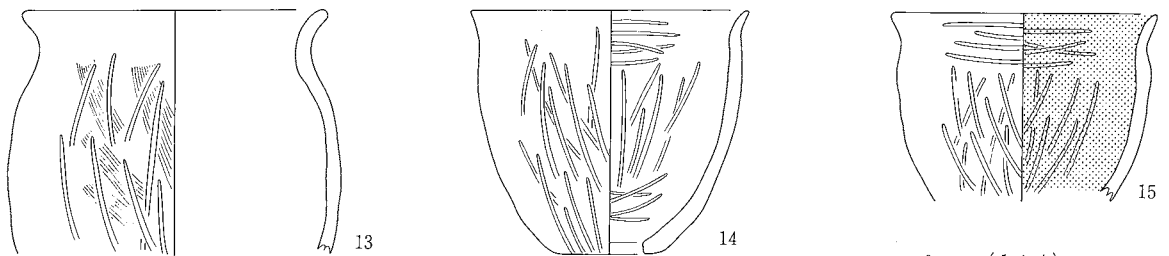
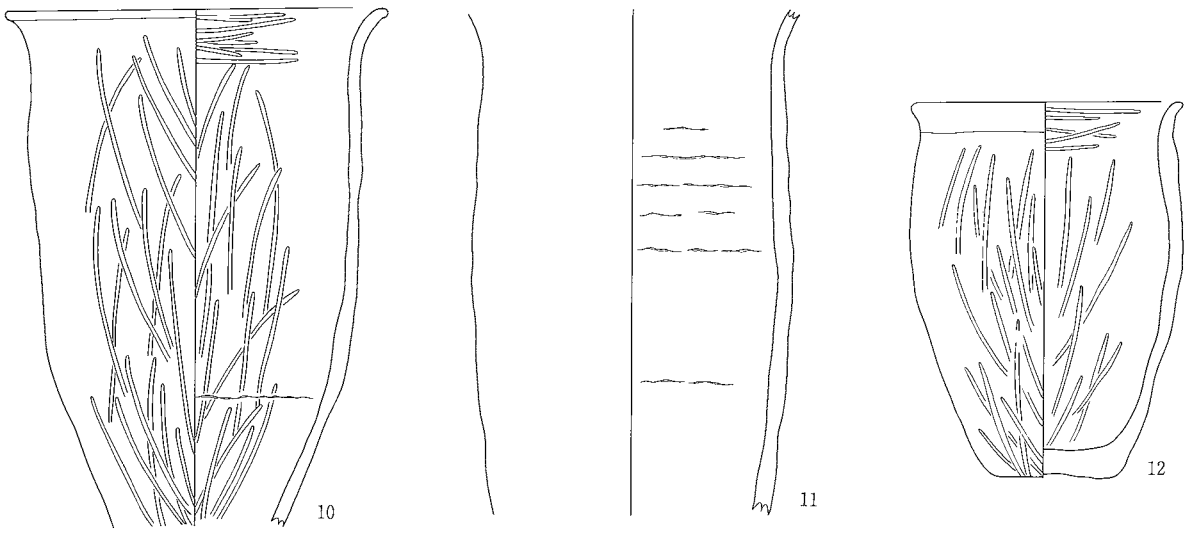
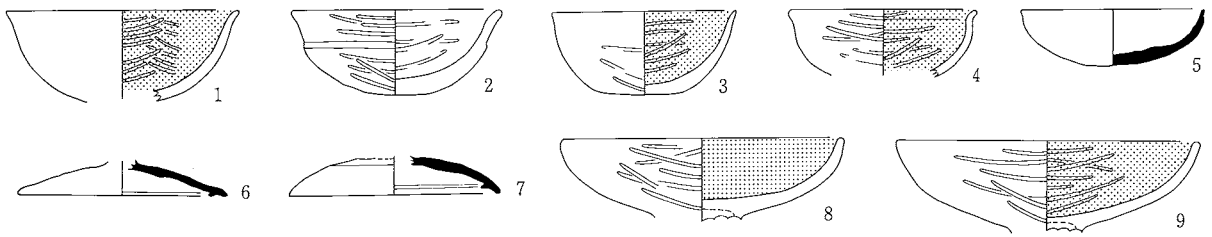

0 (1 : 4) 10cm

SB702

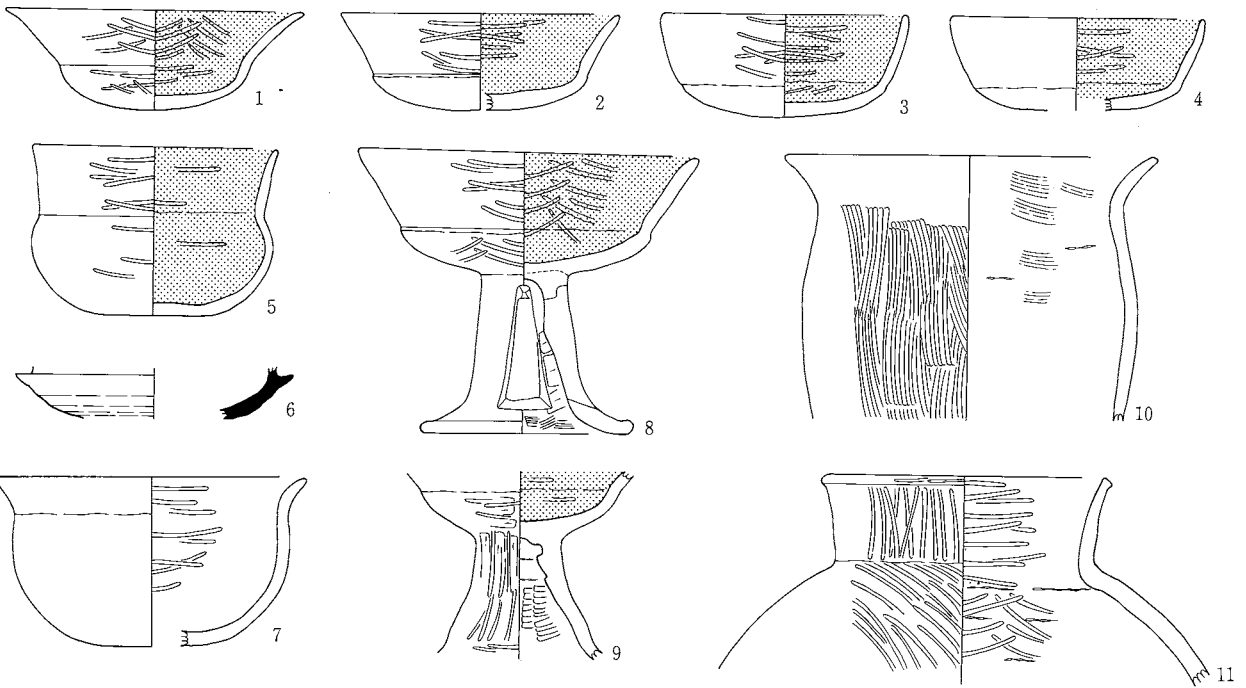

SB736

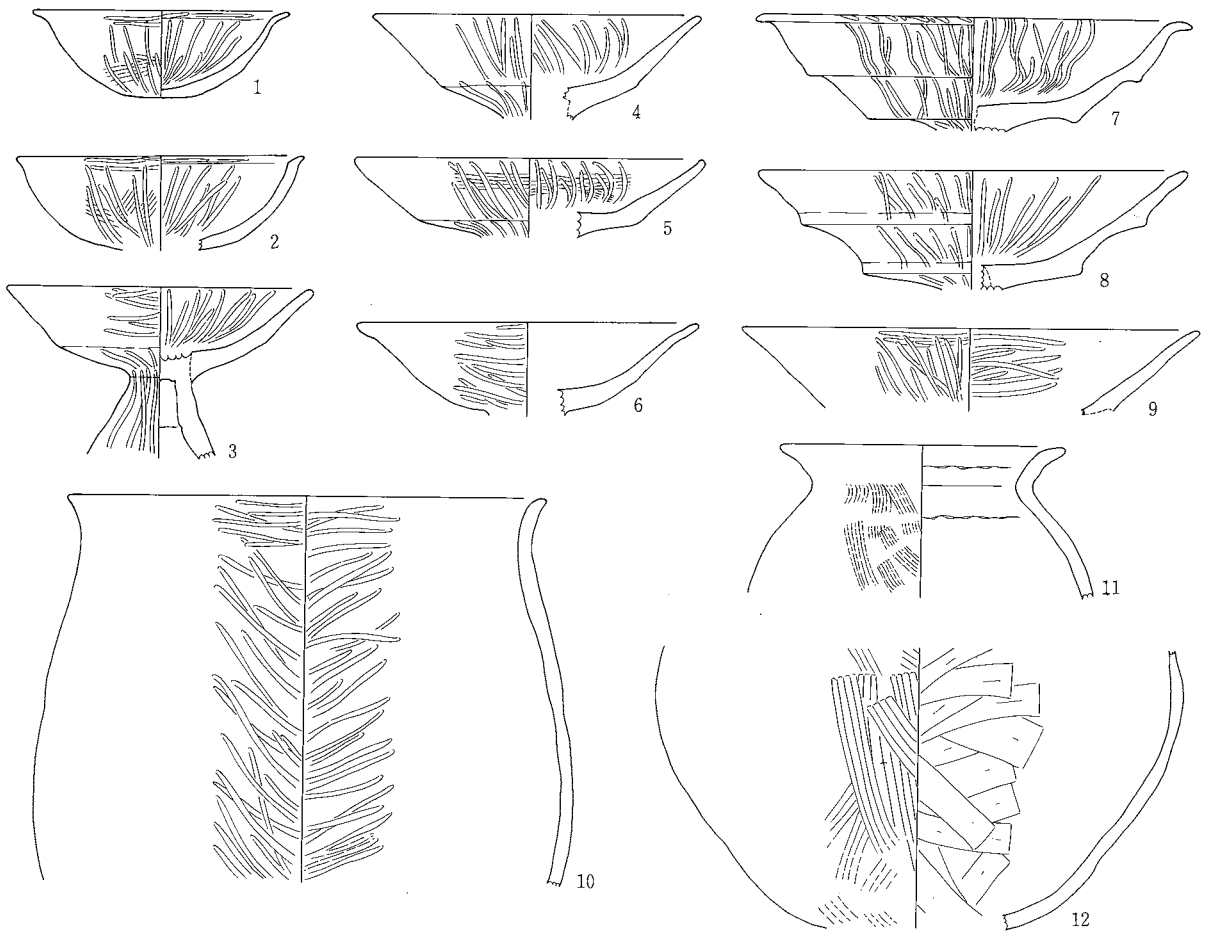

0 (1:4) 10cm

SB702・736

SB742-①

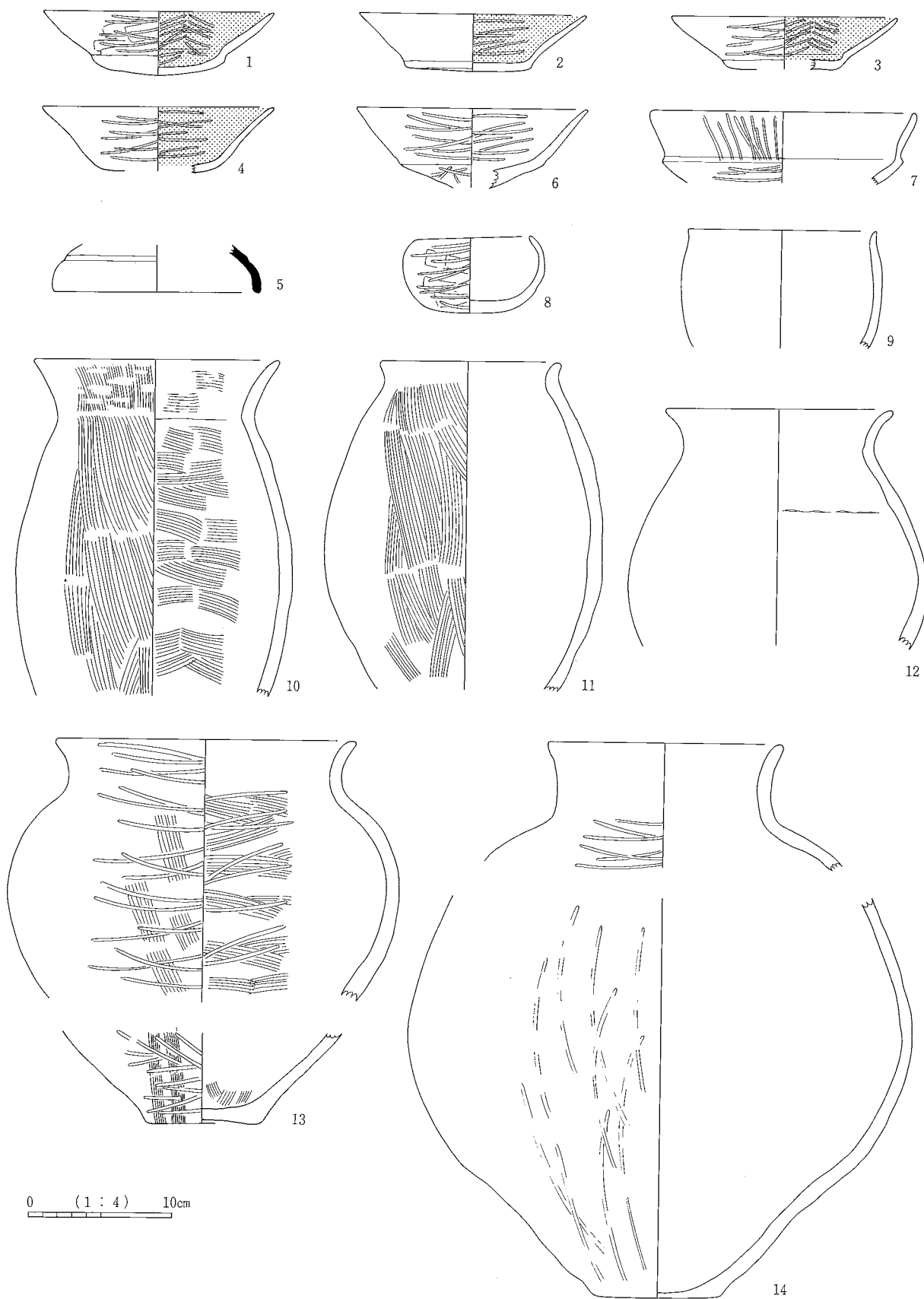

SB742-①

SB742-②

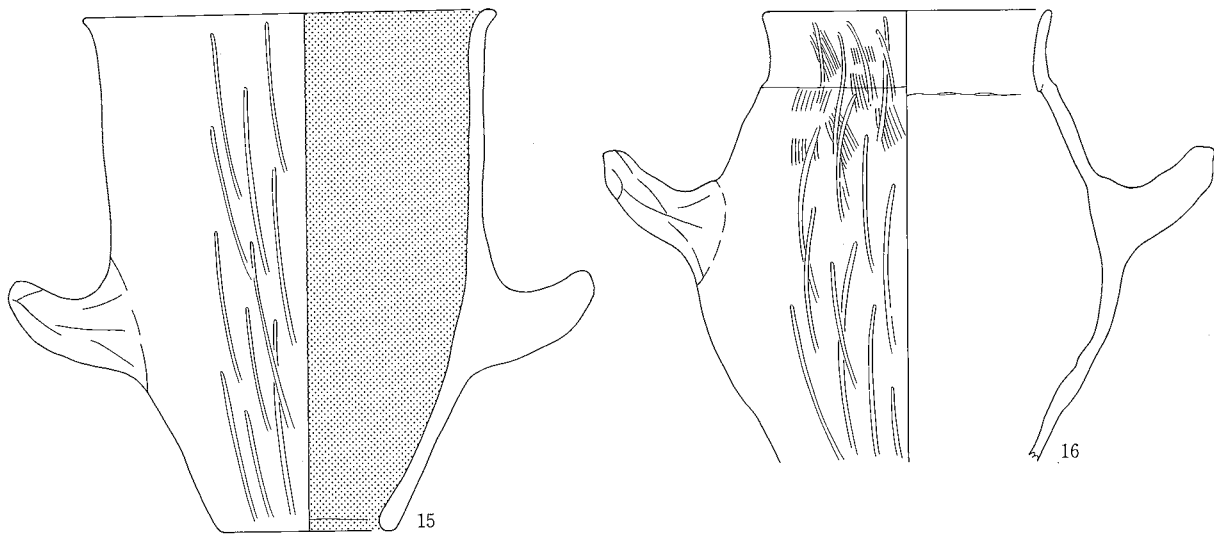

SB746



0 (1:4) 10cm

SB742-②・746

SB752

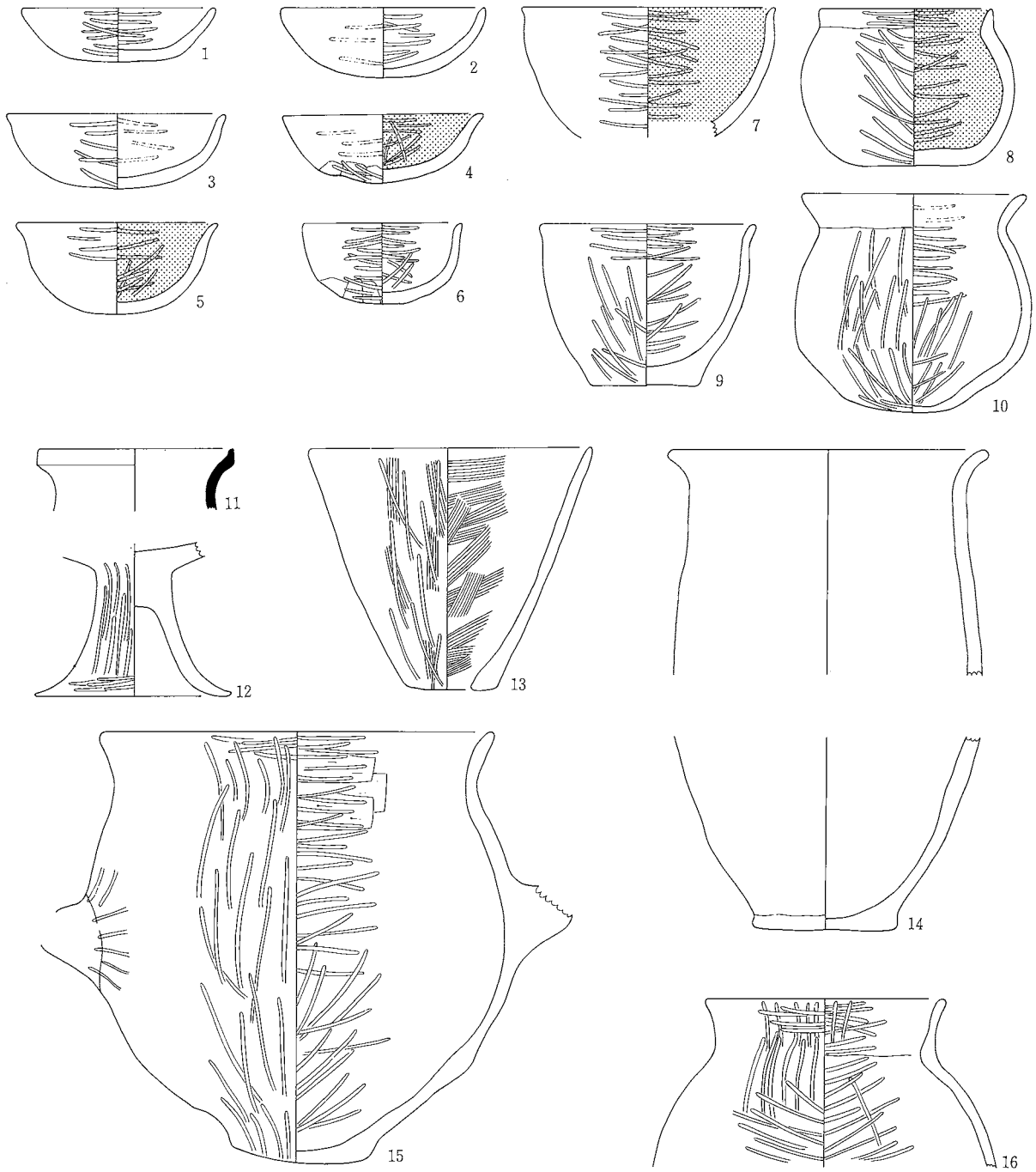

SB756

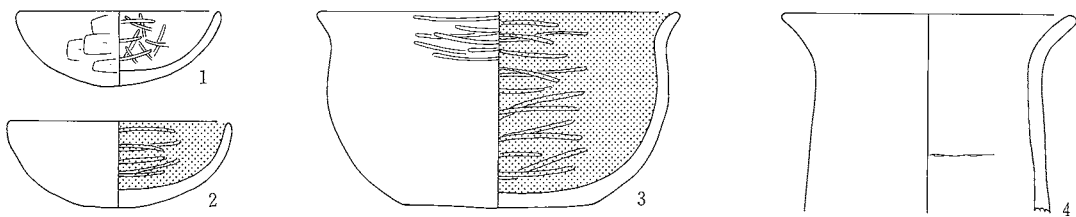

0 (1:4) 10cm

SB803

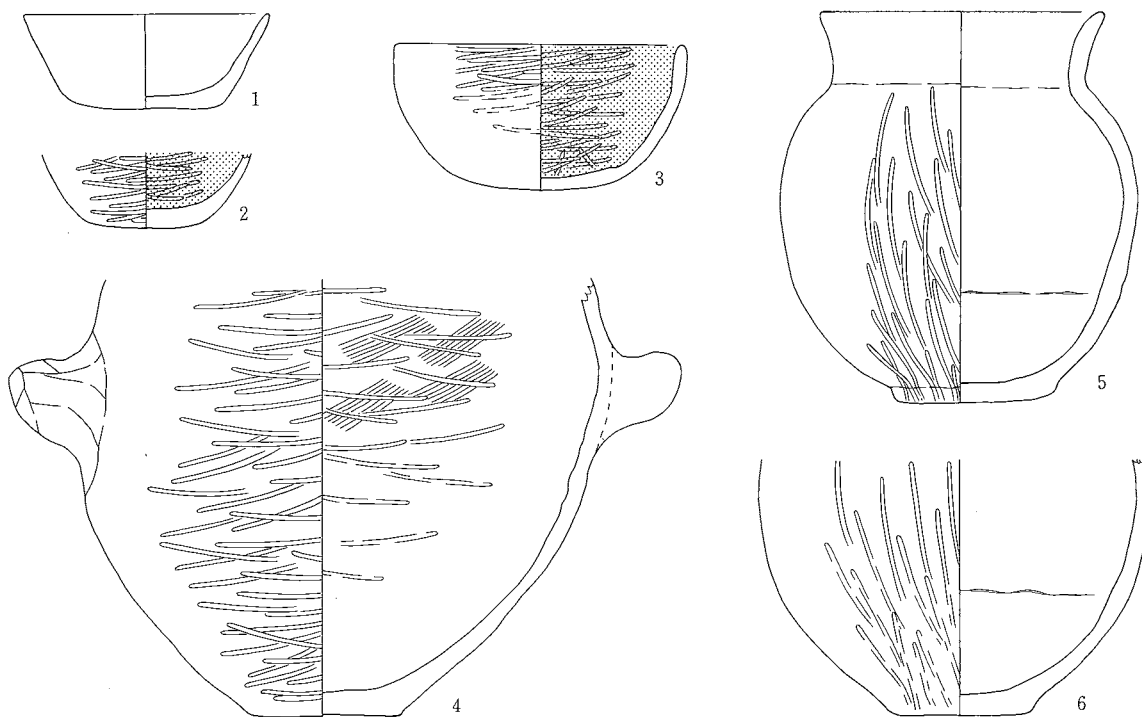

SB806

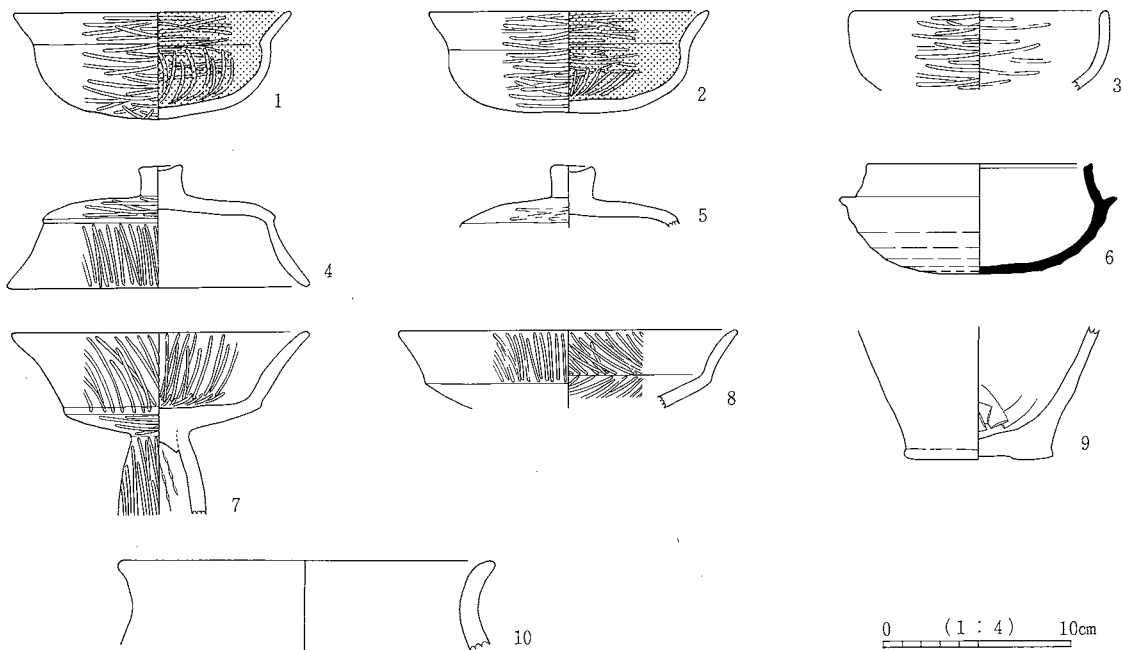

SB803・806

SB808

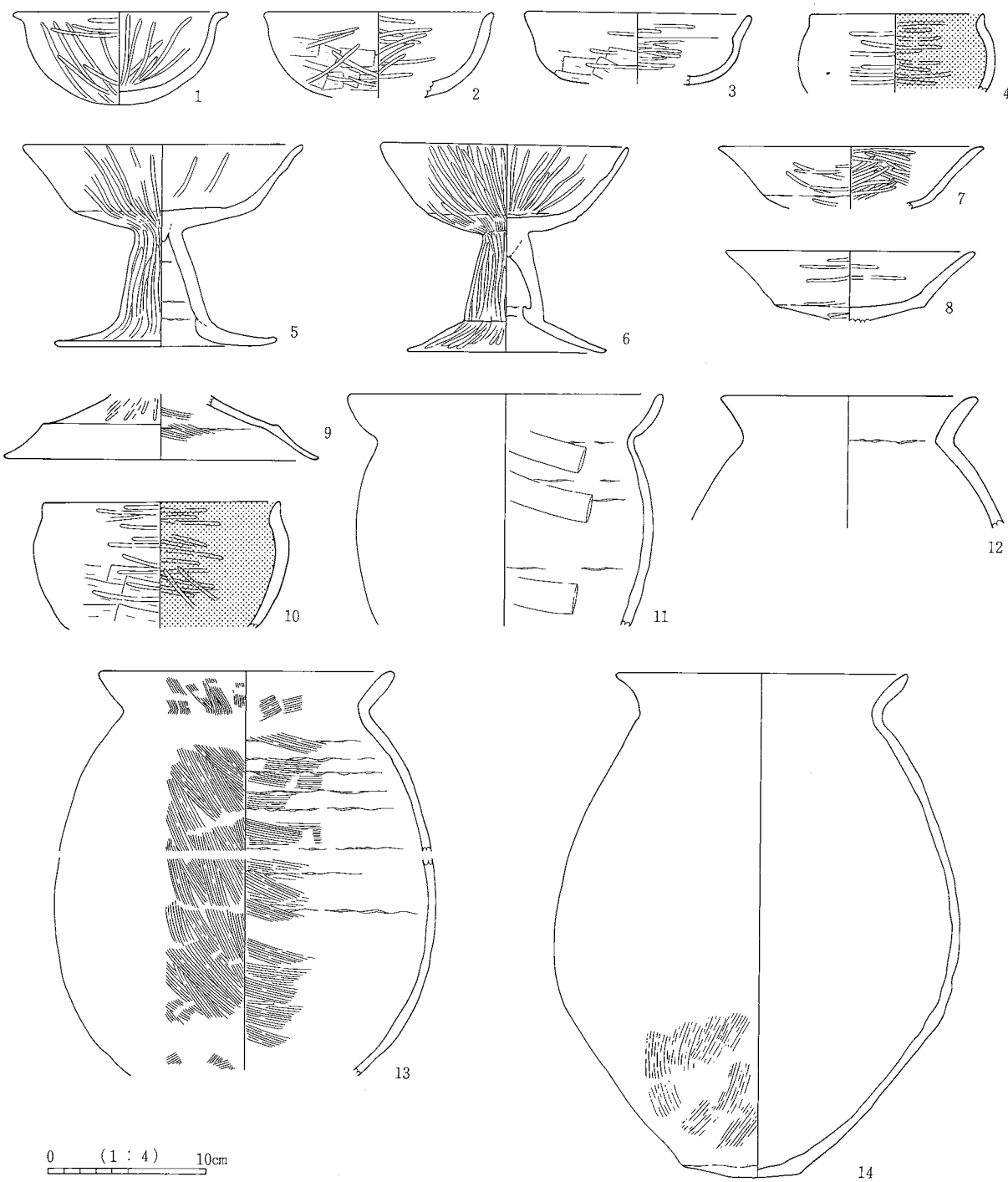

0 (1 : 4) 10cm

SB808

SB811

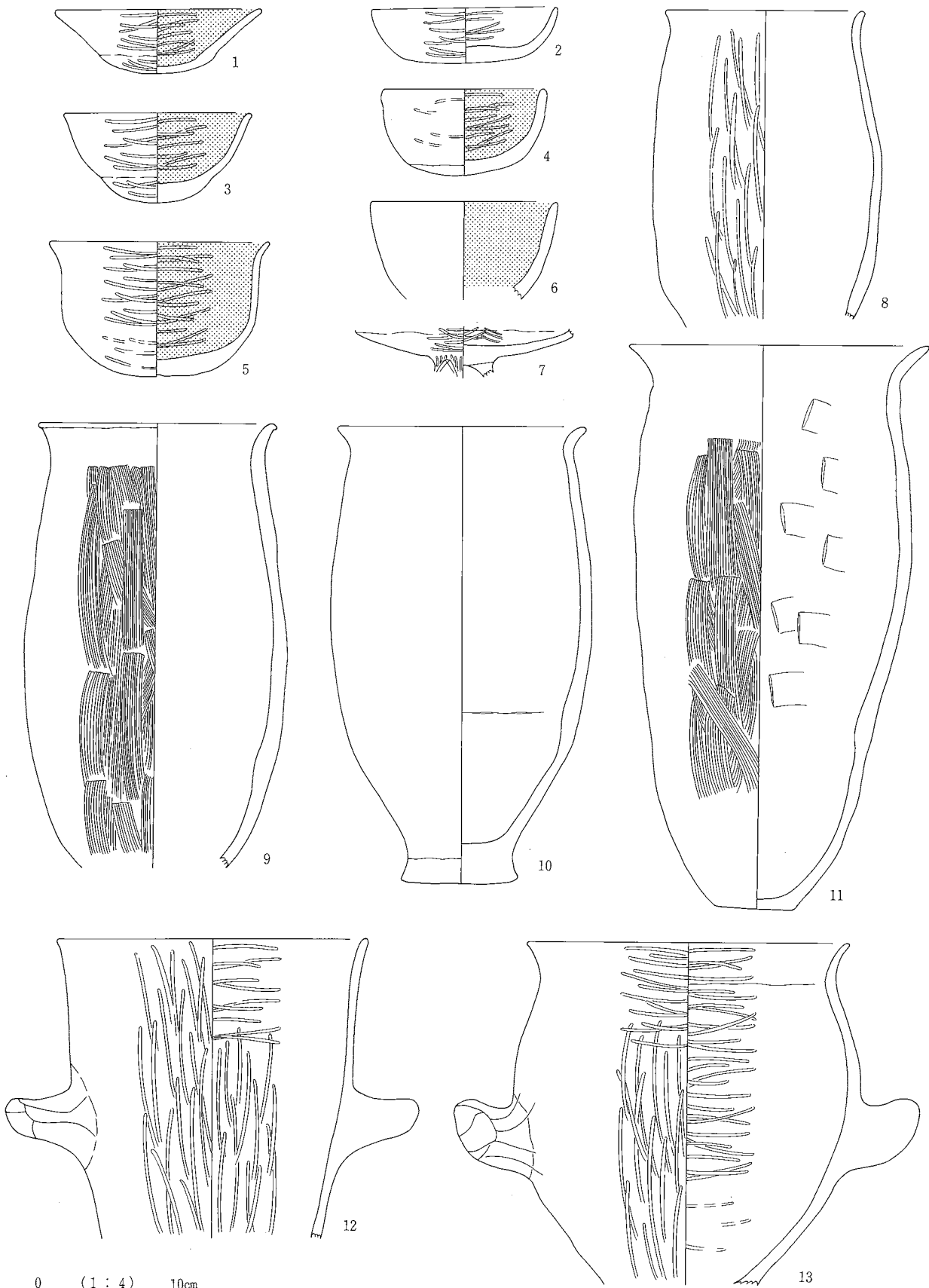

0 (1 : 4) 10cm

SB811

SB813



SB818

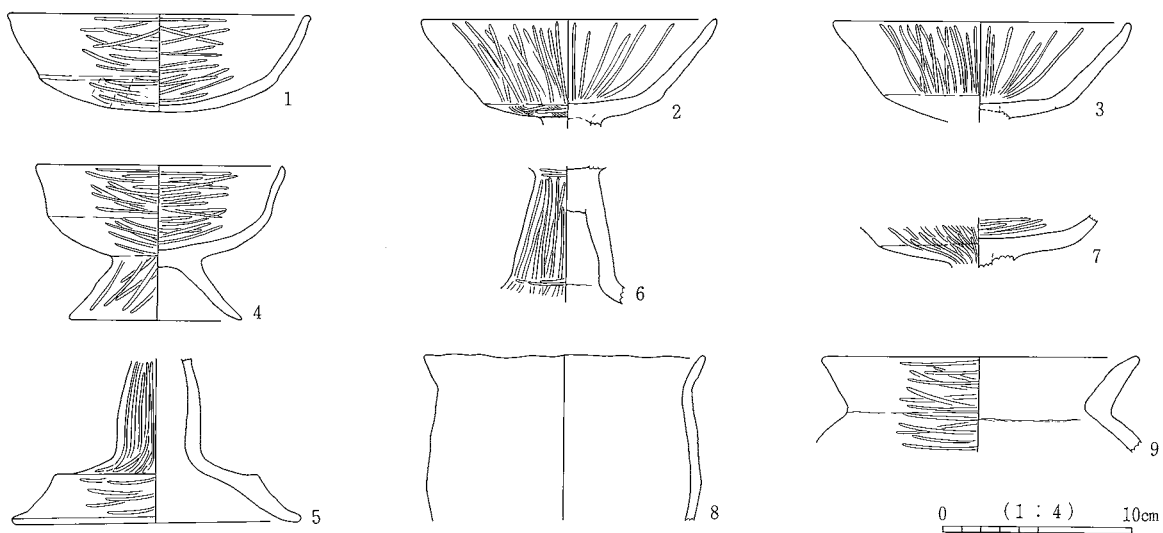

SB825

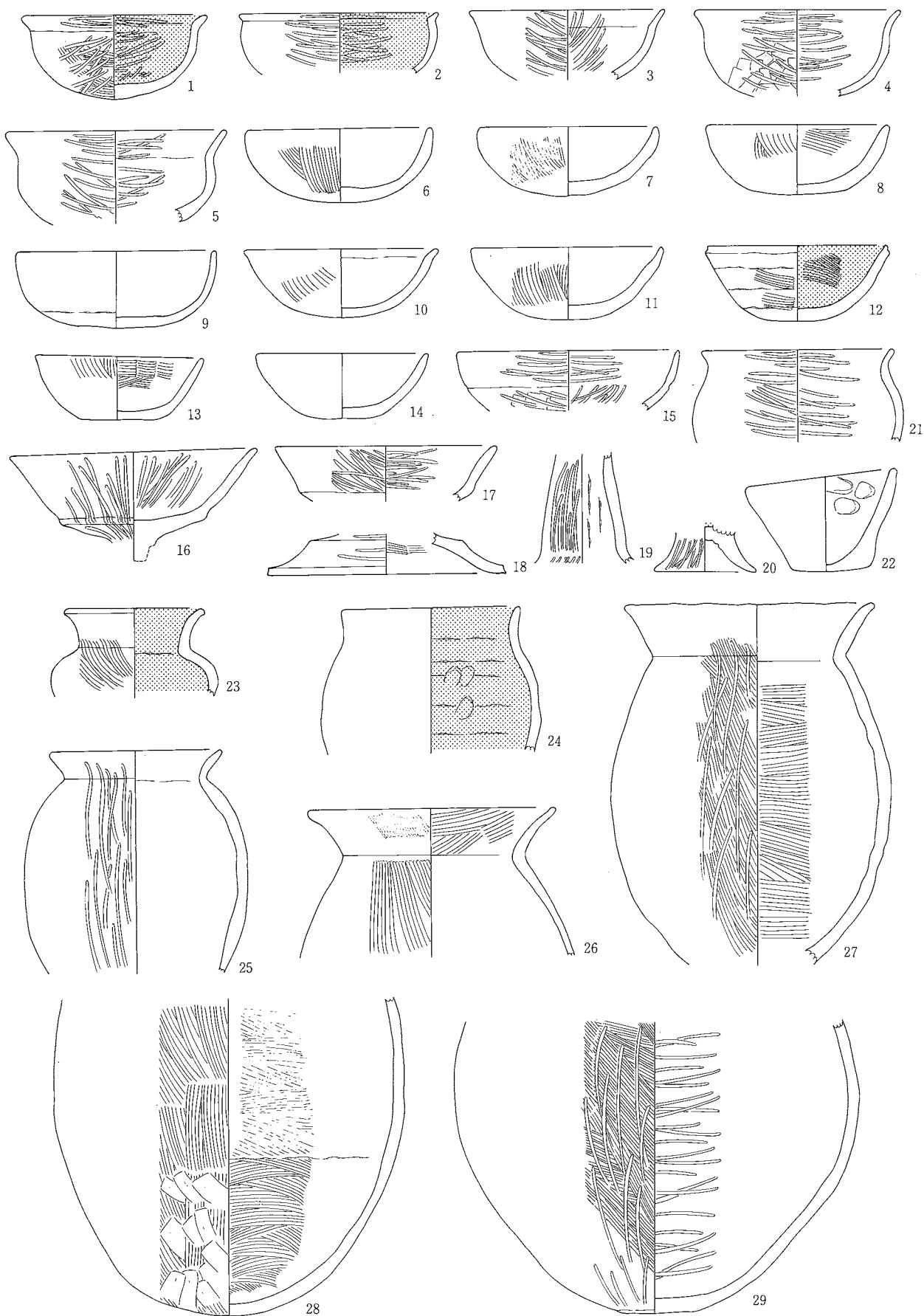

SB825

0 (1 : 4) 10cm

SB828

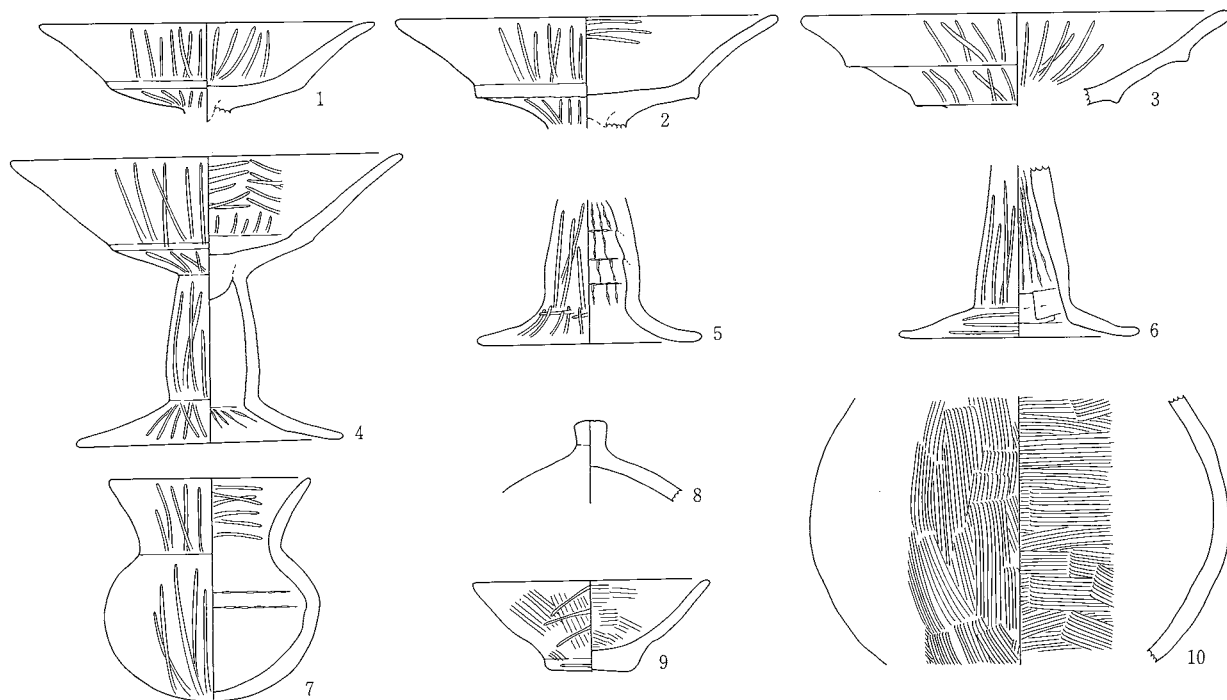

SB1006

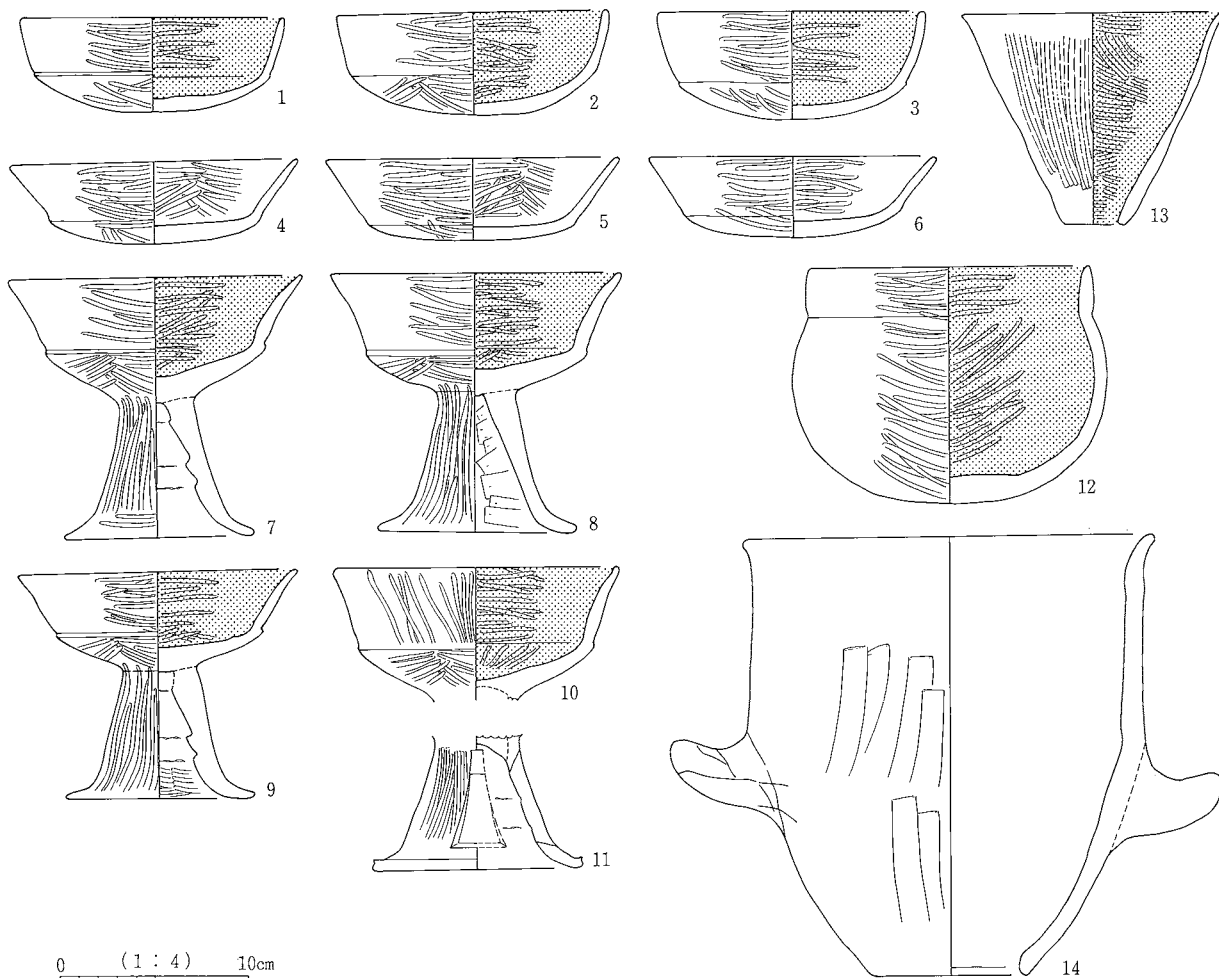

0 (1:4) 10cm

SB1015

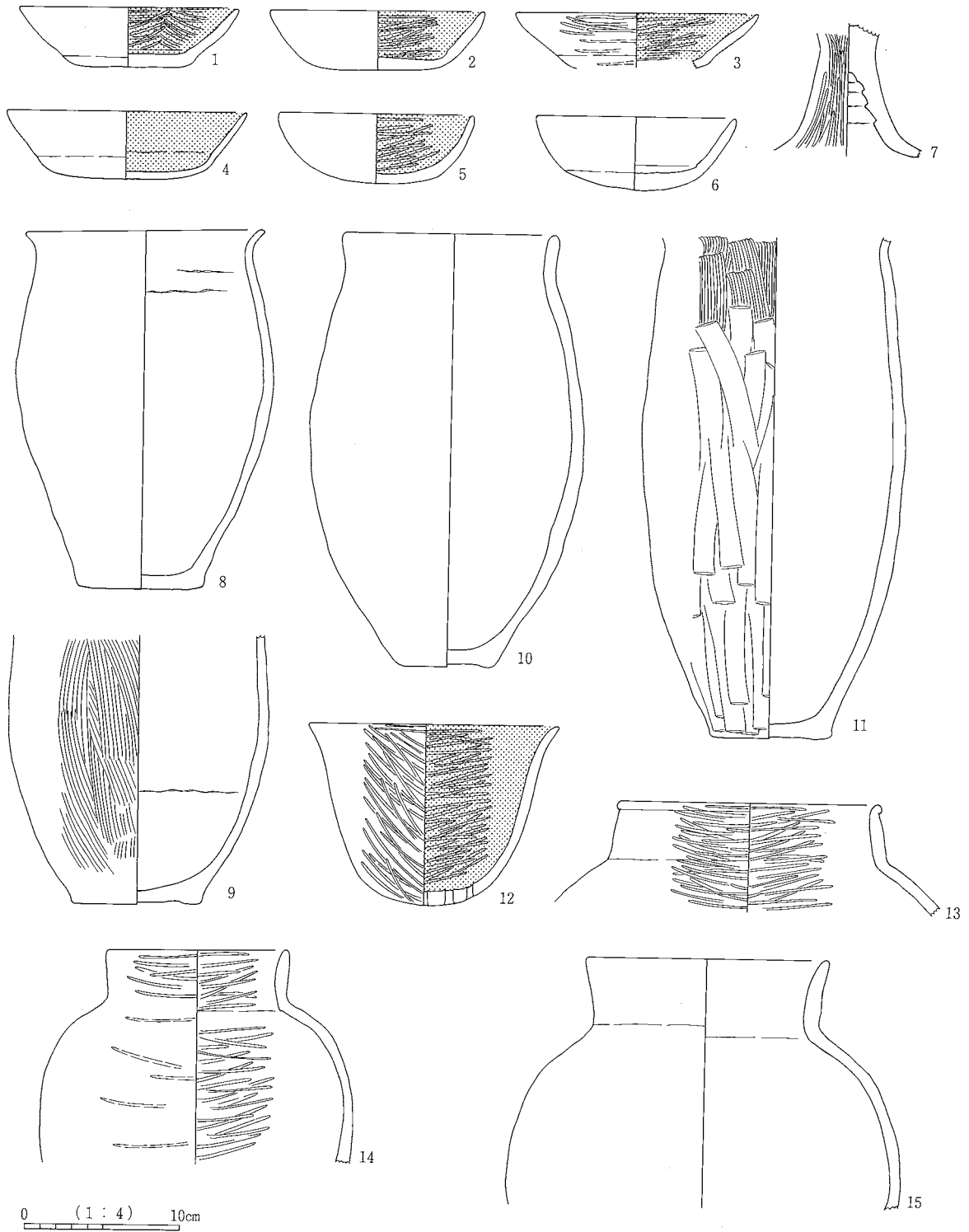

SB1015

SB1023

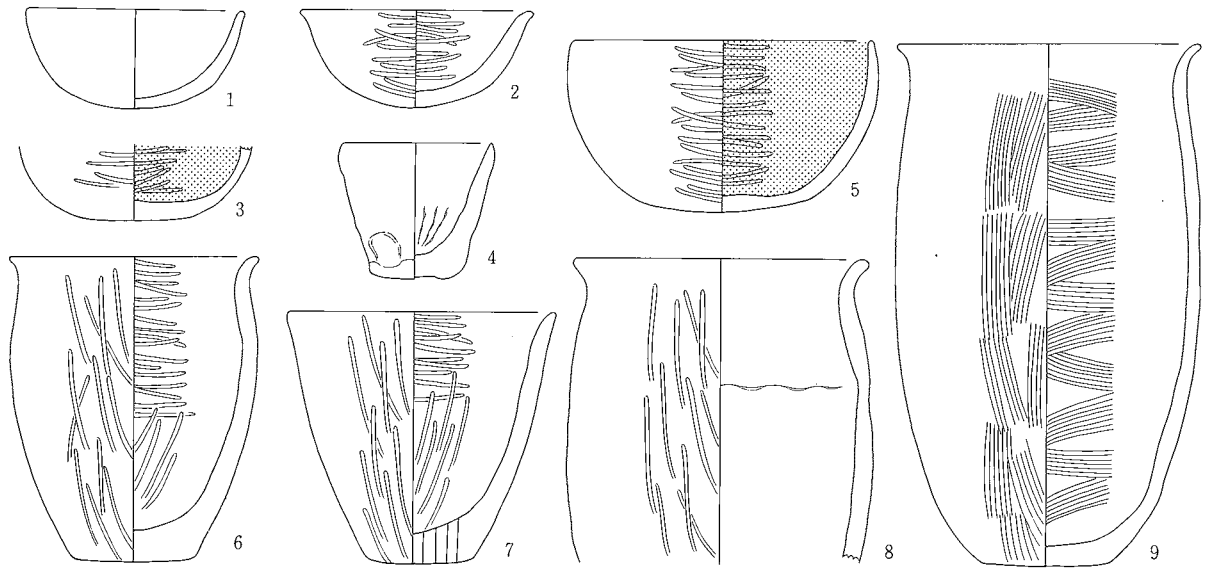

SB1032

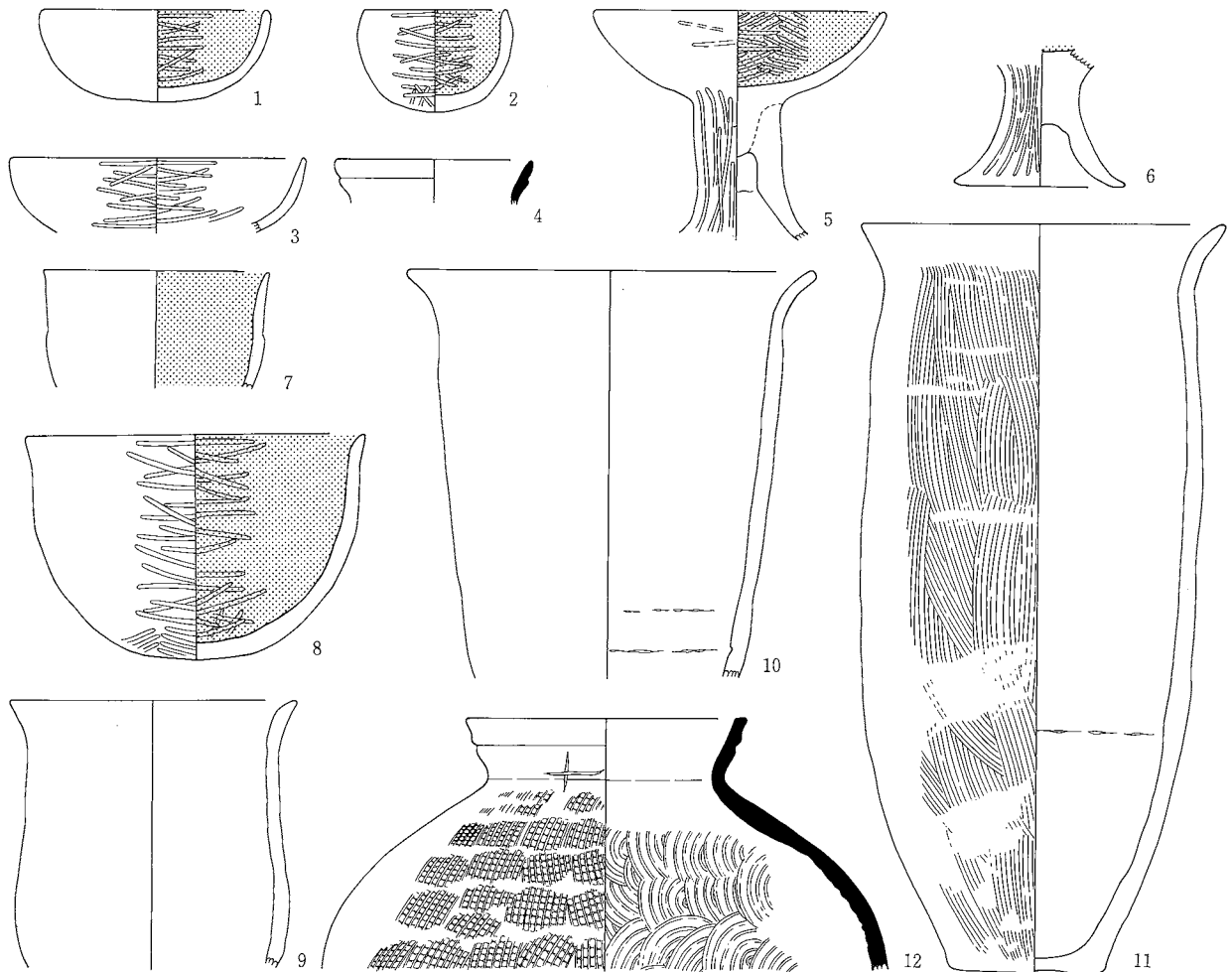

0 (1:4) 10cm

SB1027

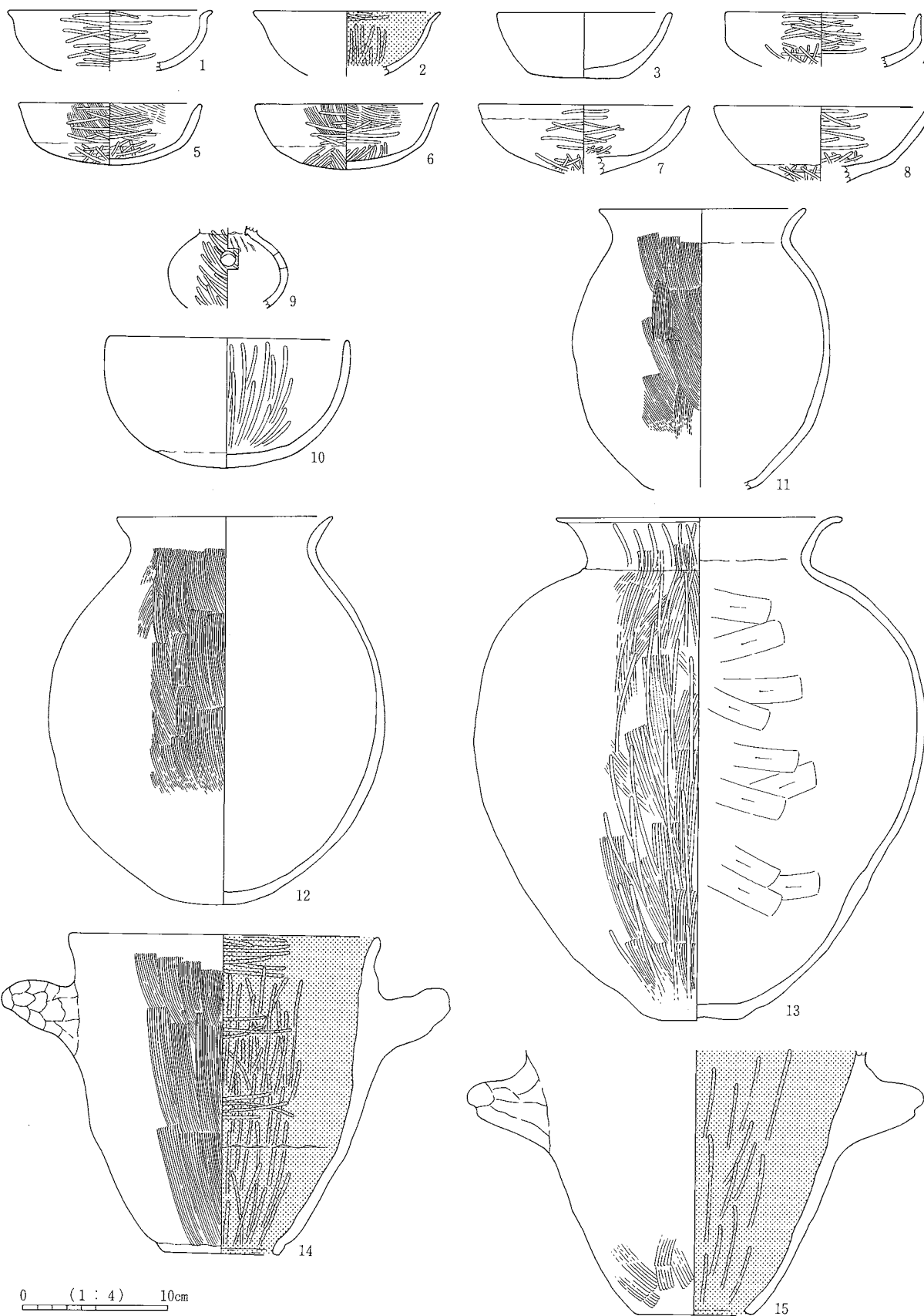

SB1027

SB1034-①

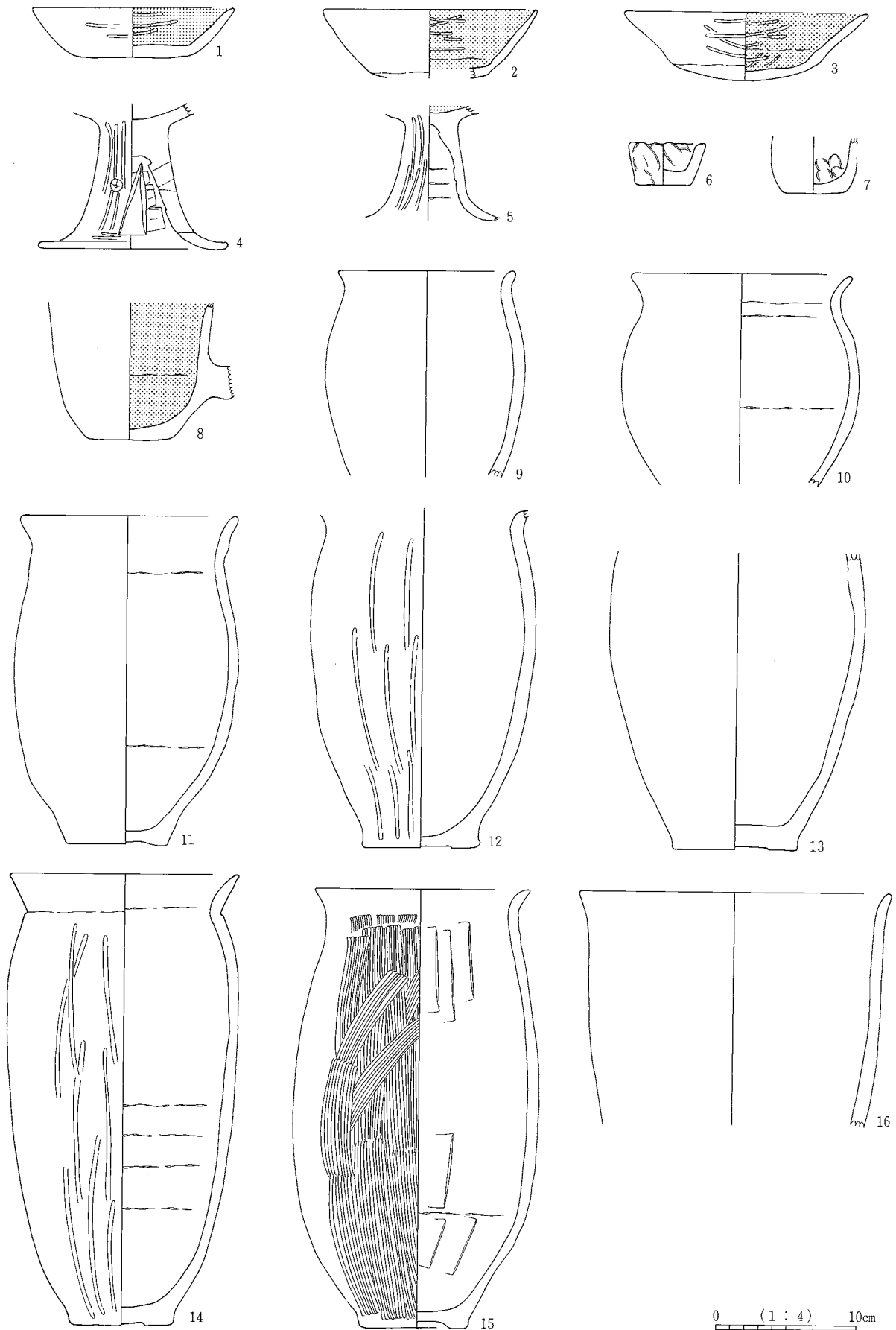

SB1034-①

SB1034-②

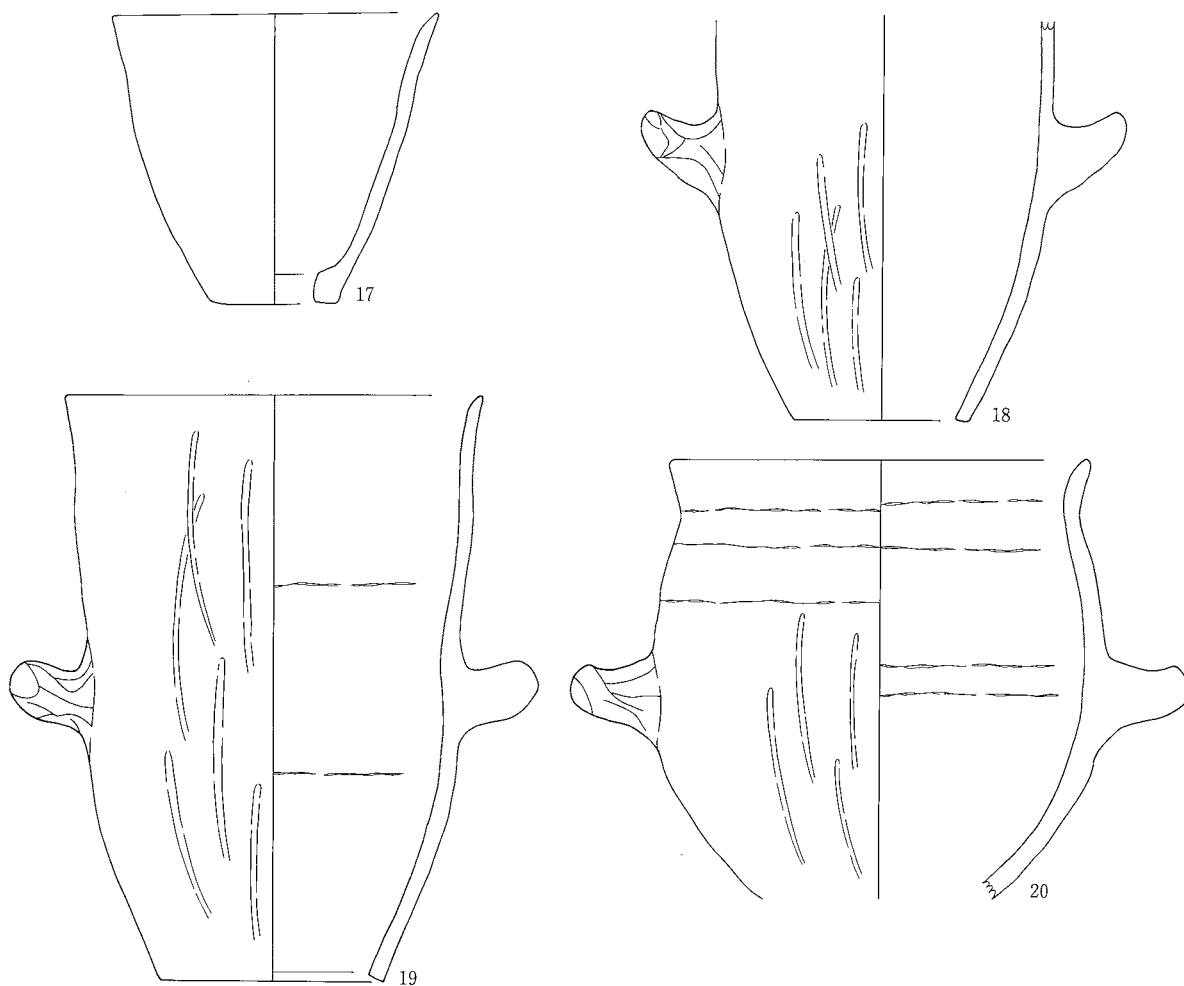

SB1044

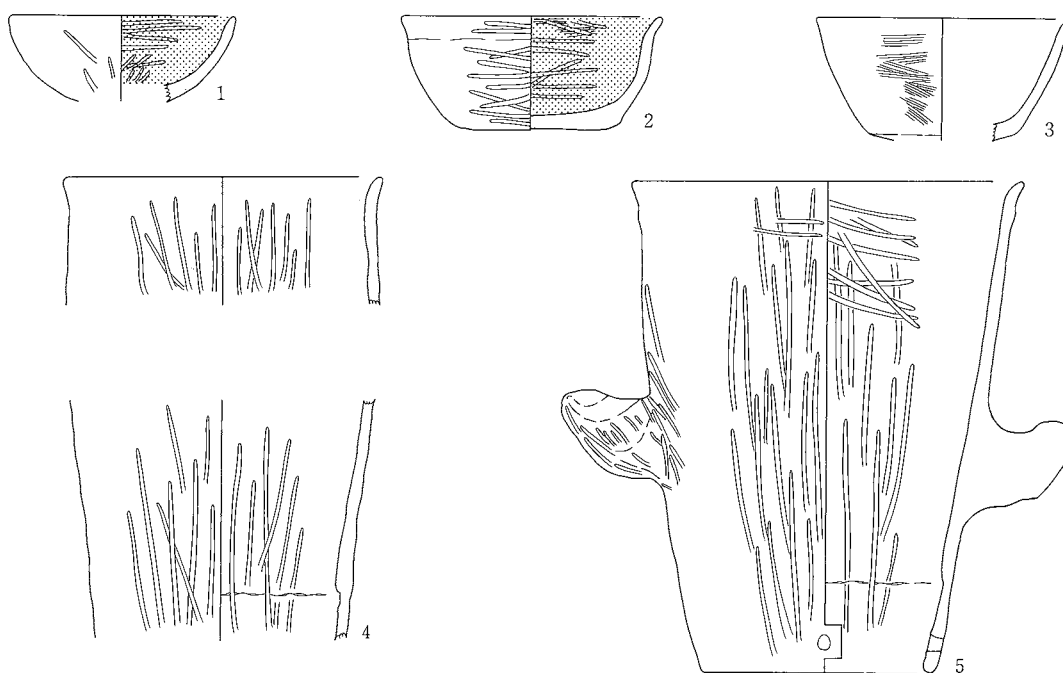

0 (1 : 4) 10cm

SB1034-② · 1044

SB1065

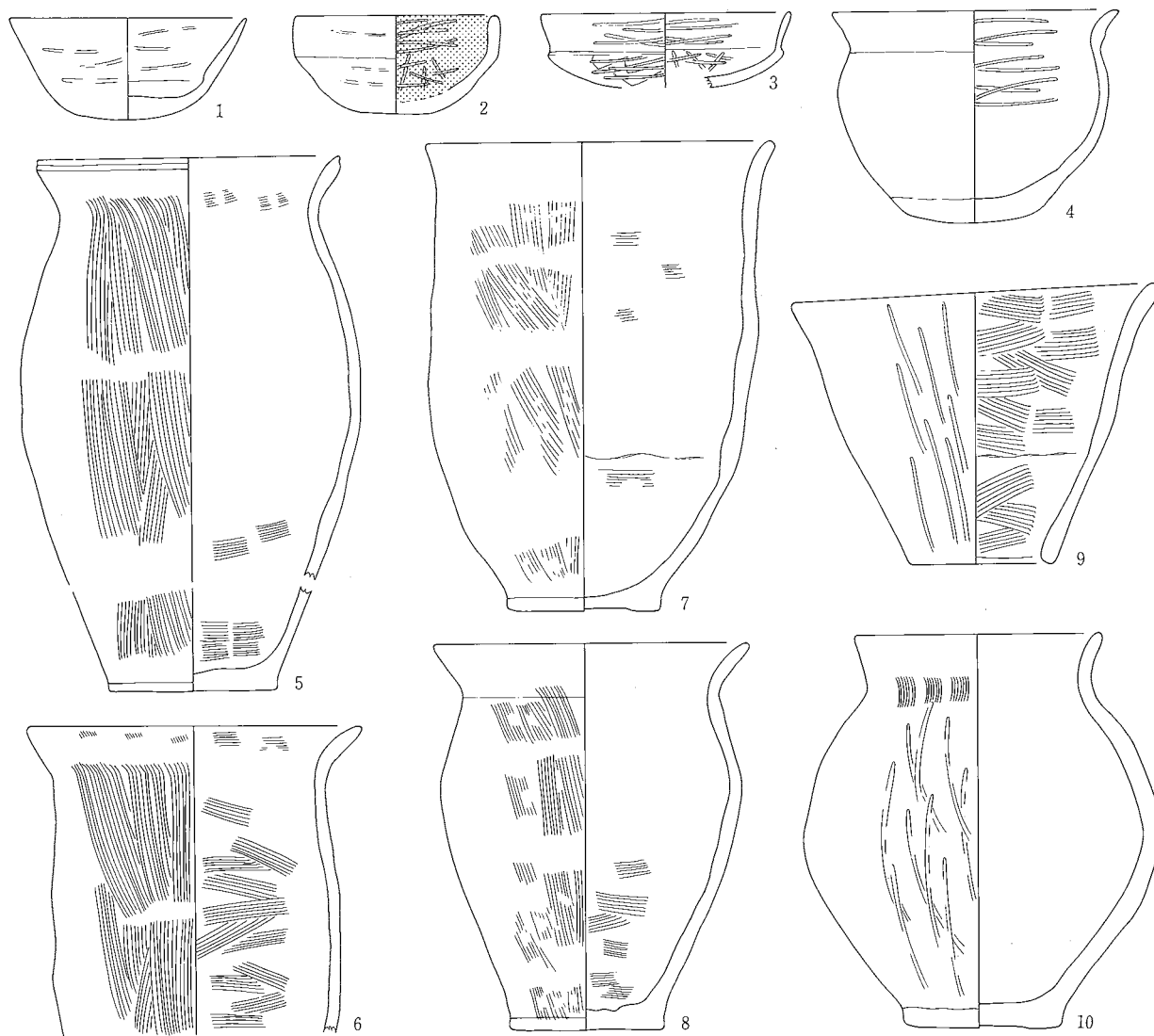

SB1086-①

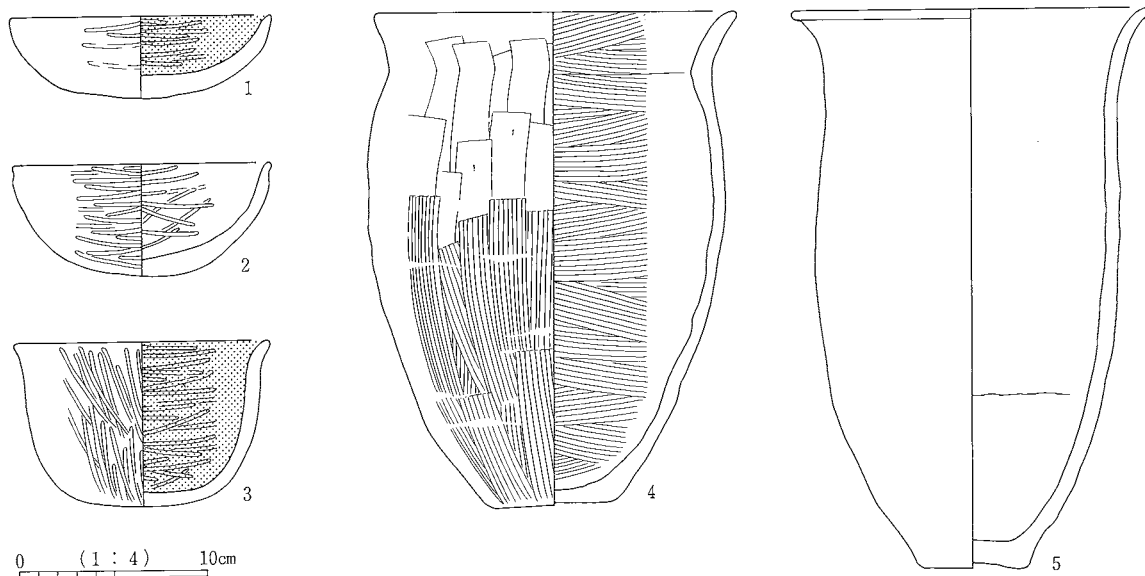

SB1065・1086-①

SB1086-②

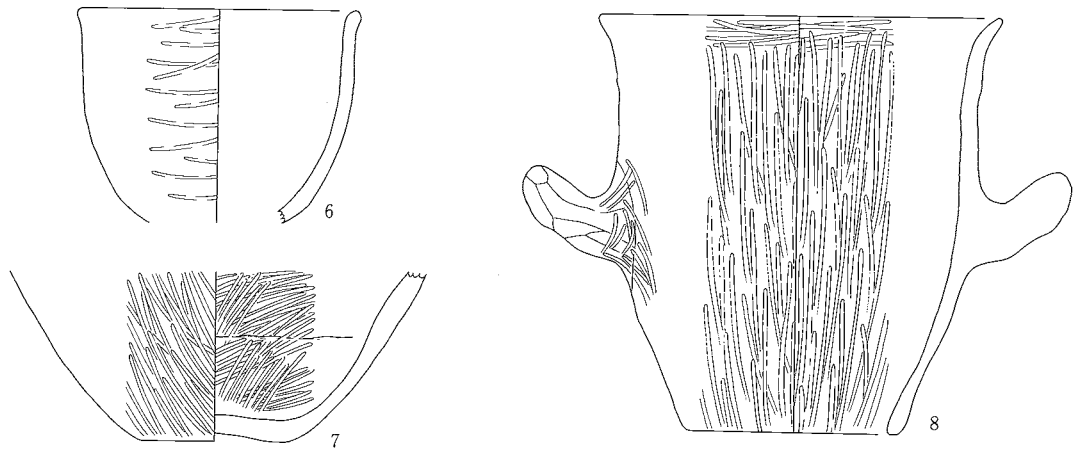

SB1093-①

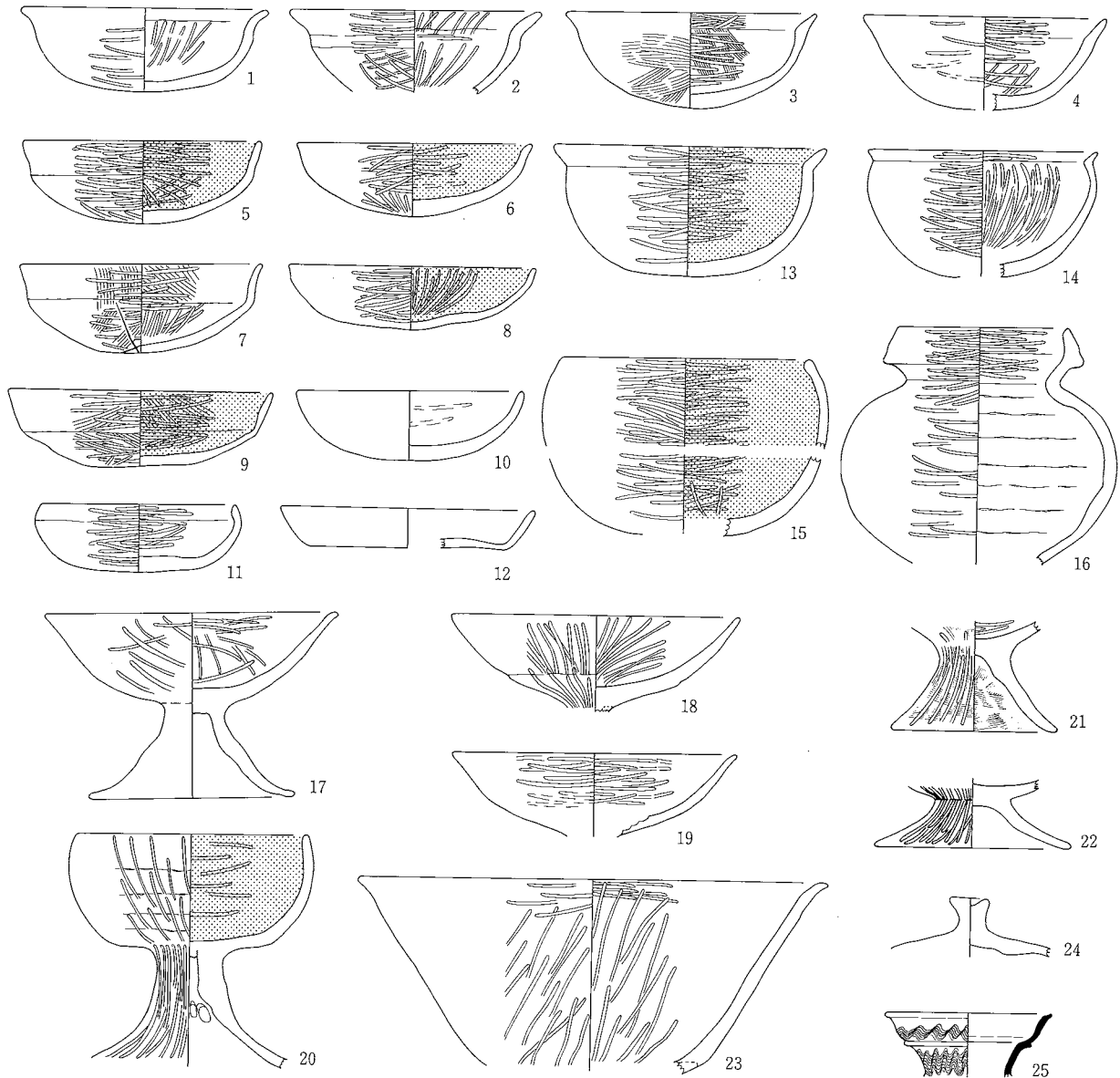

0 (1:4) 10cm

SB1086-②・1093-①

SB1093-②

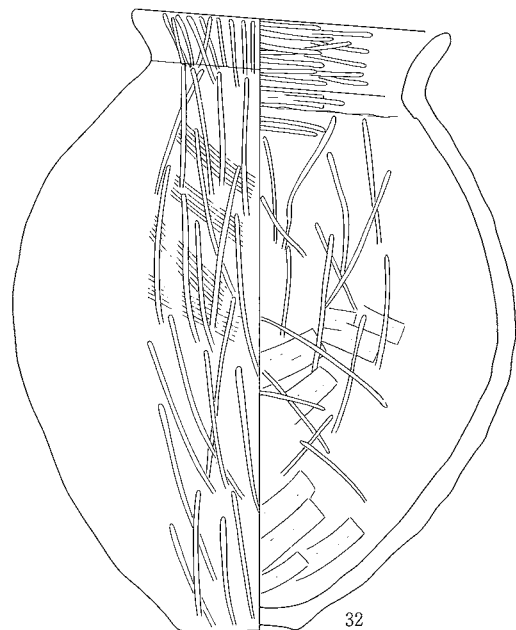
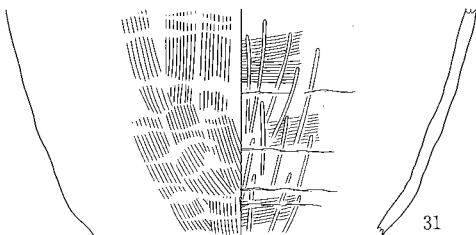
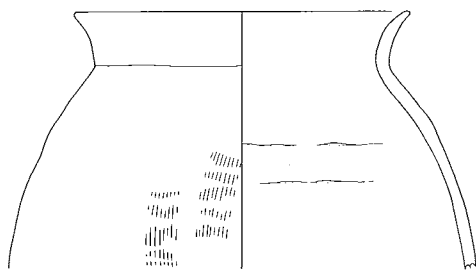
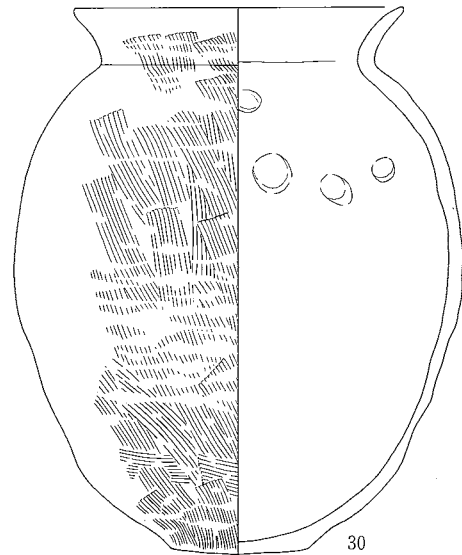
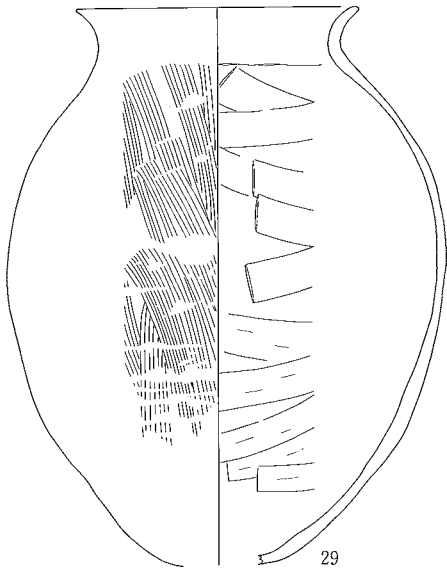
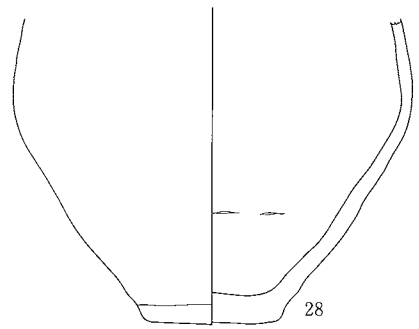
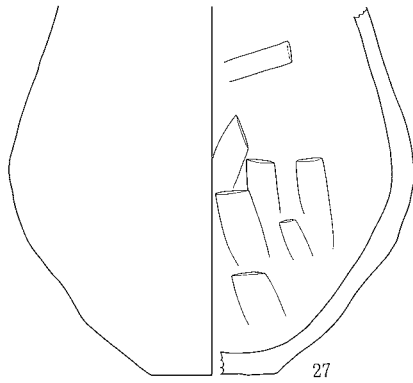
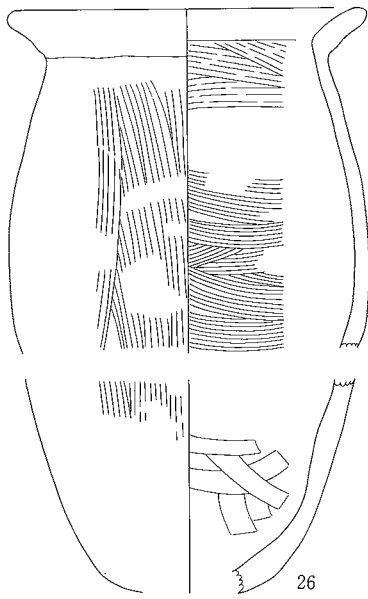

SB1093-②

0 (1 : 4) 10cm

SB1087

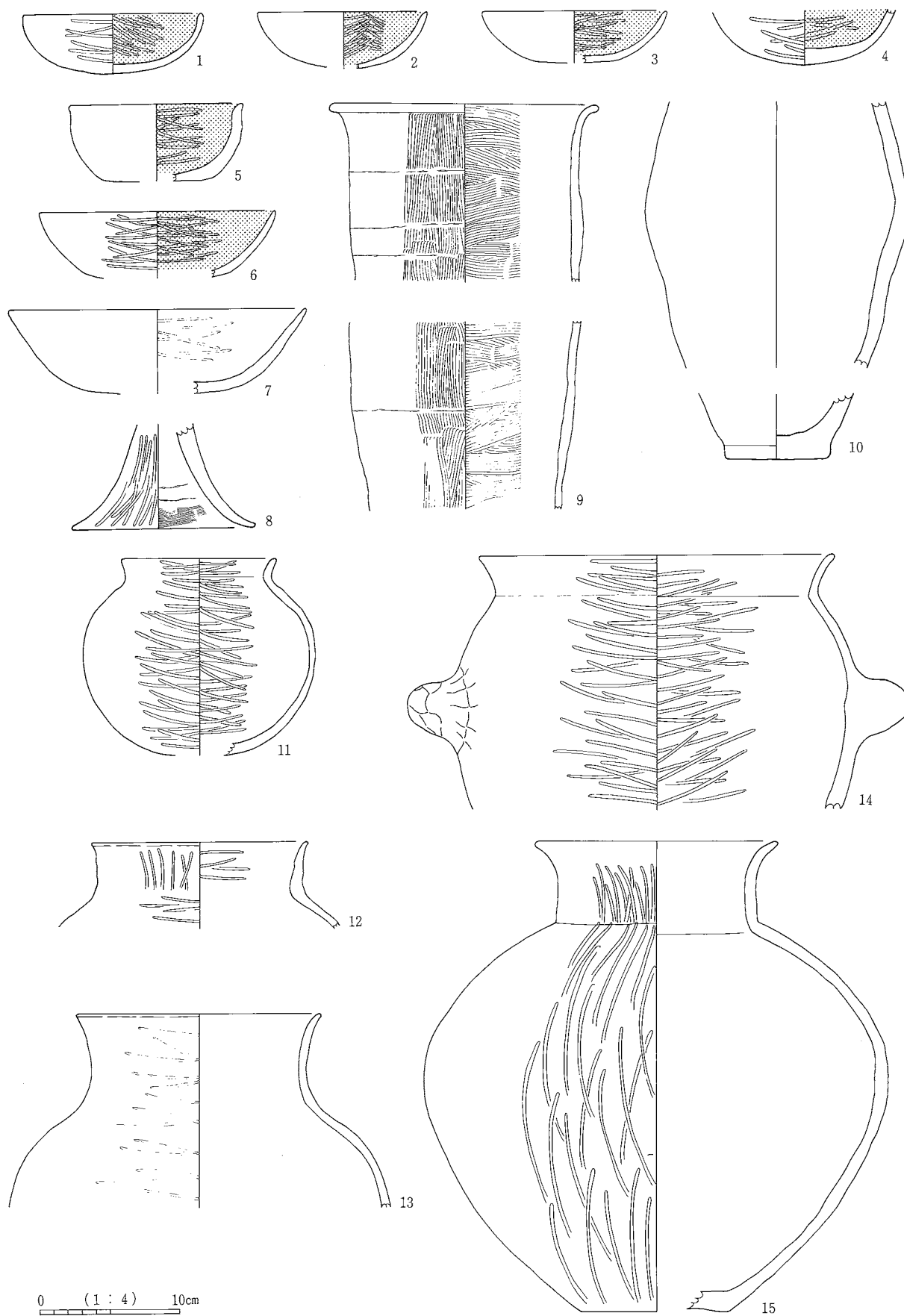

SB1087

SB1105

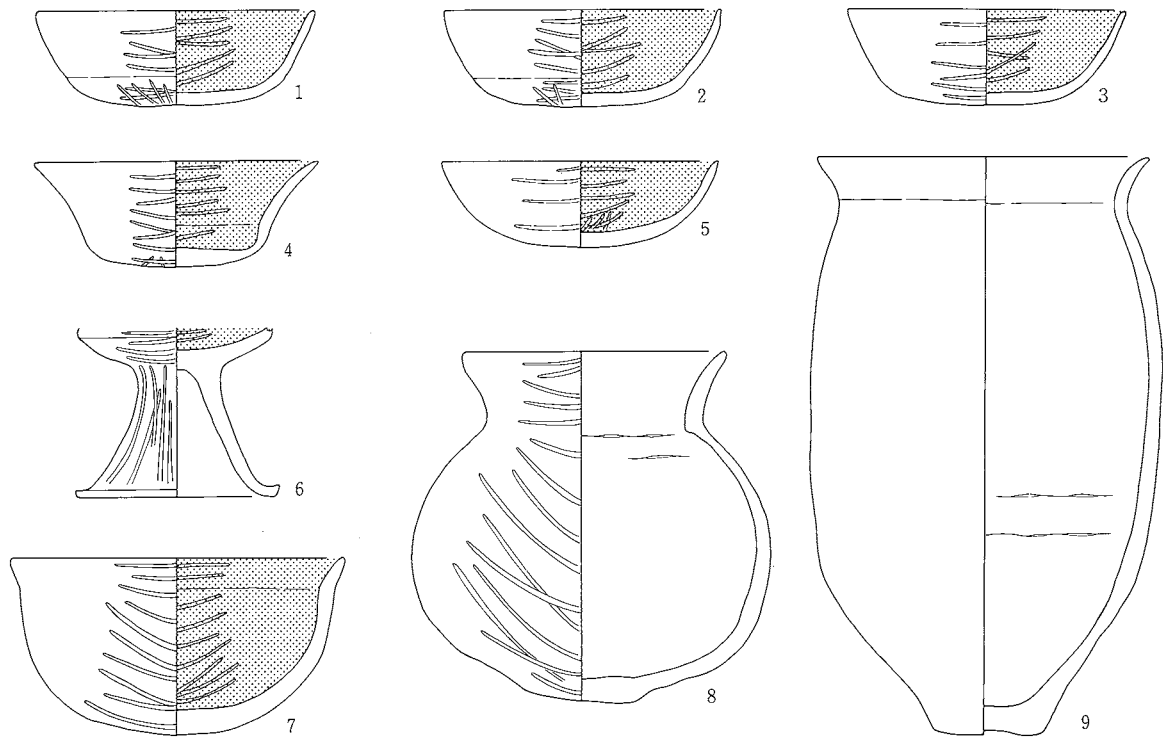

SB1131

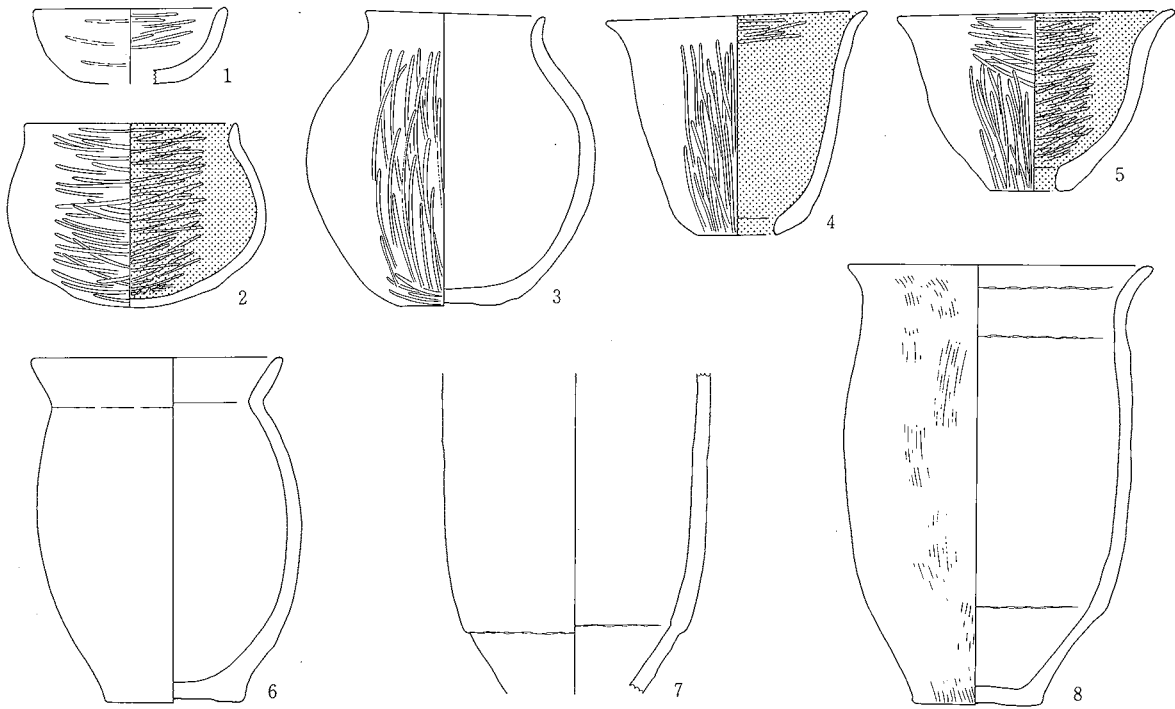

0 (1:4) 10cm

SB1144

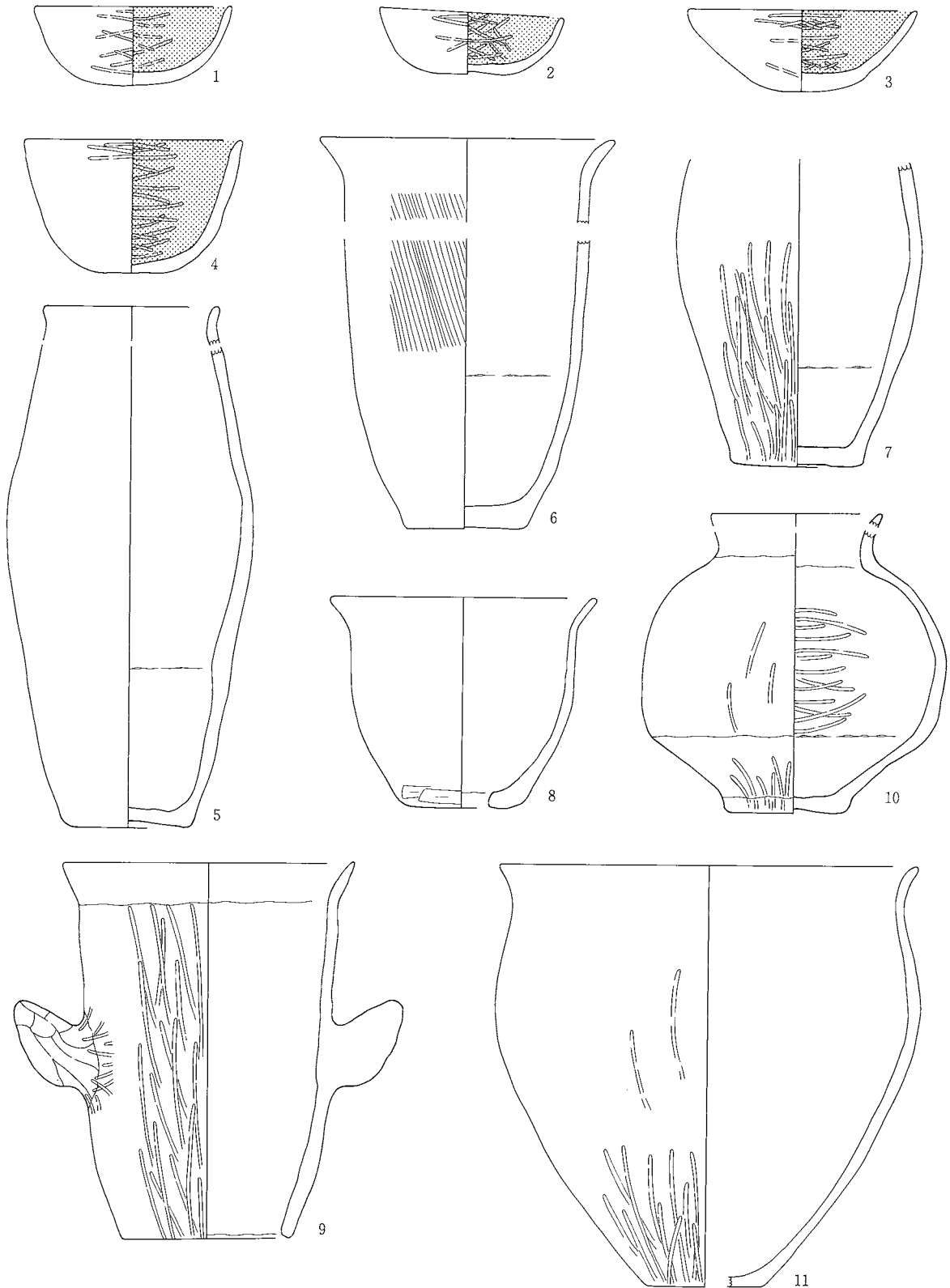

0 (1:4) 10cm

SB1144

SB1151

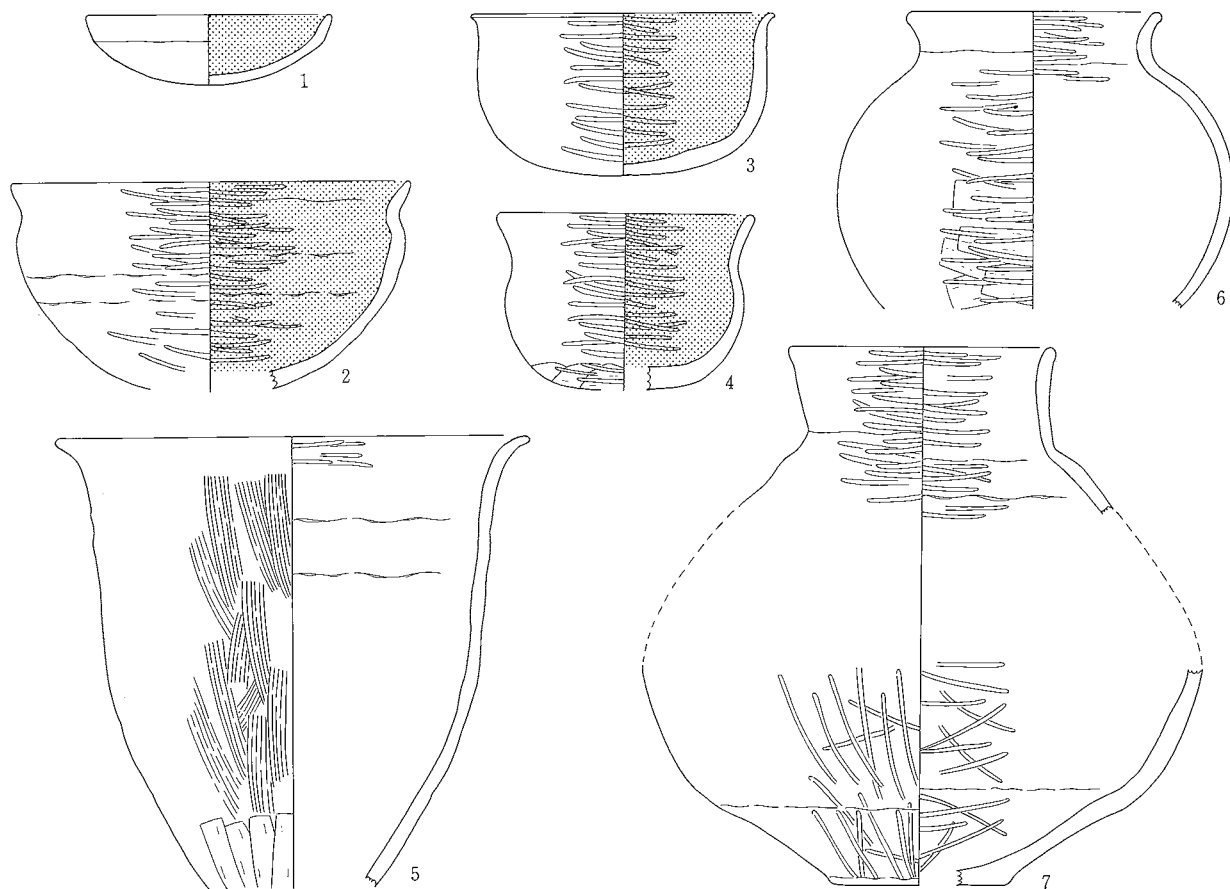

SB1159-①

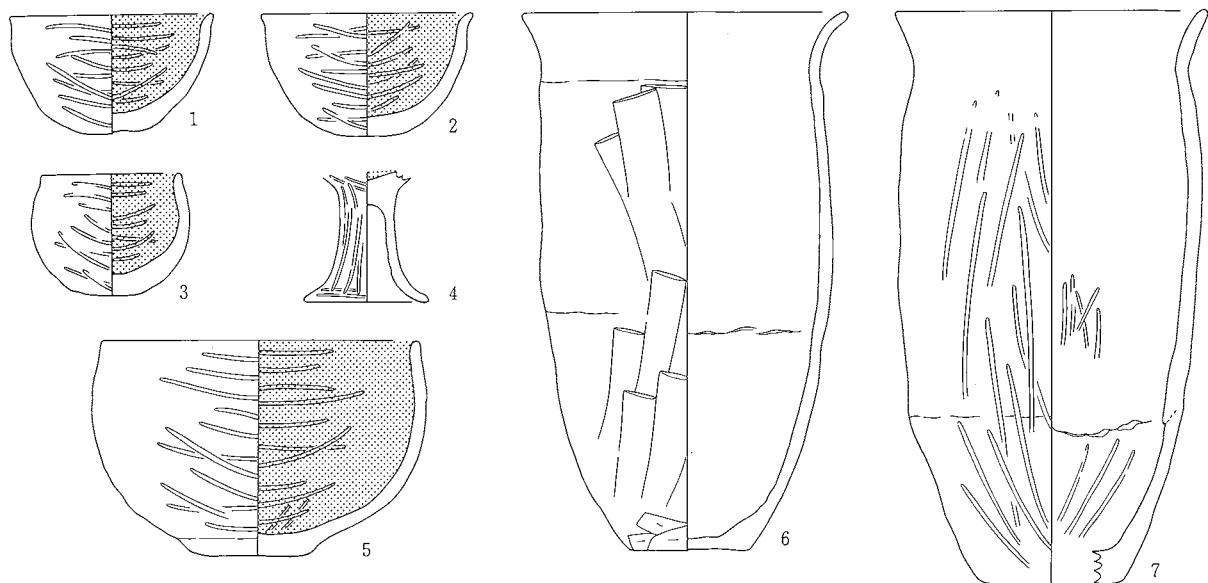

0 (1:4) 10cm

SB1151・1159-①

SB1159-②

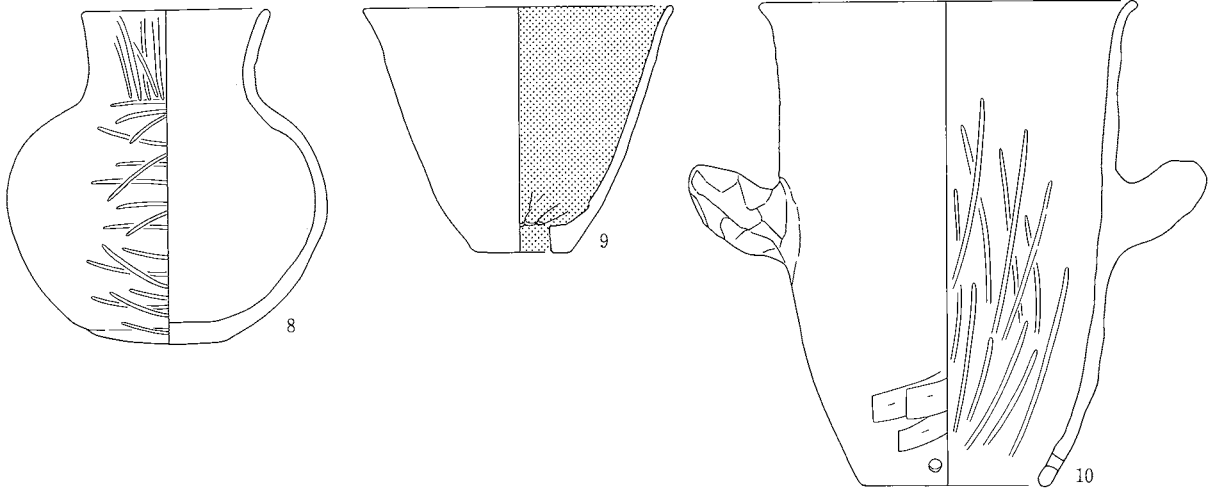

SB1165

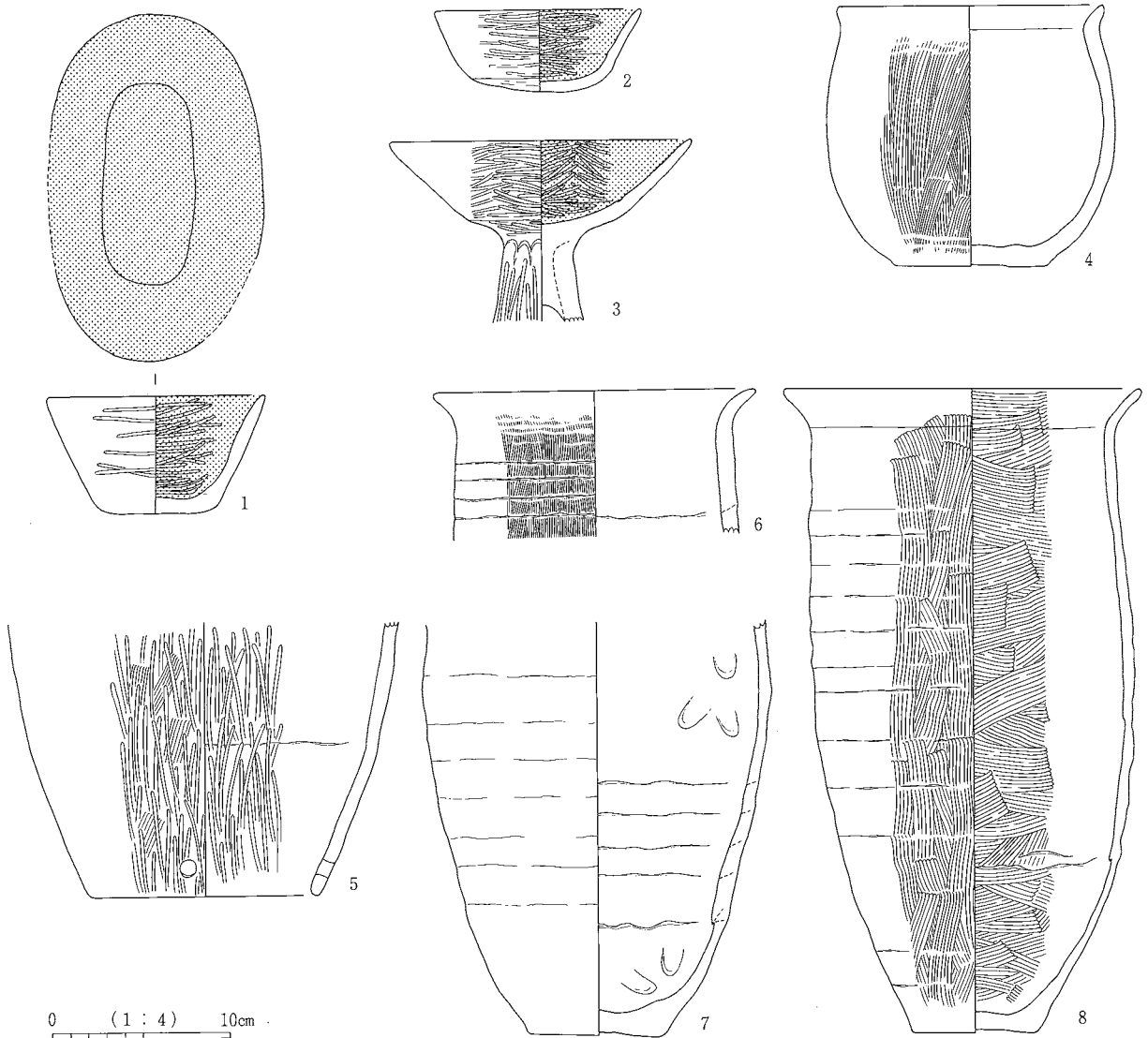

SB1212-①

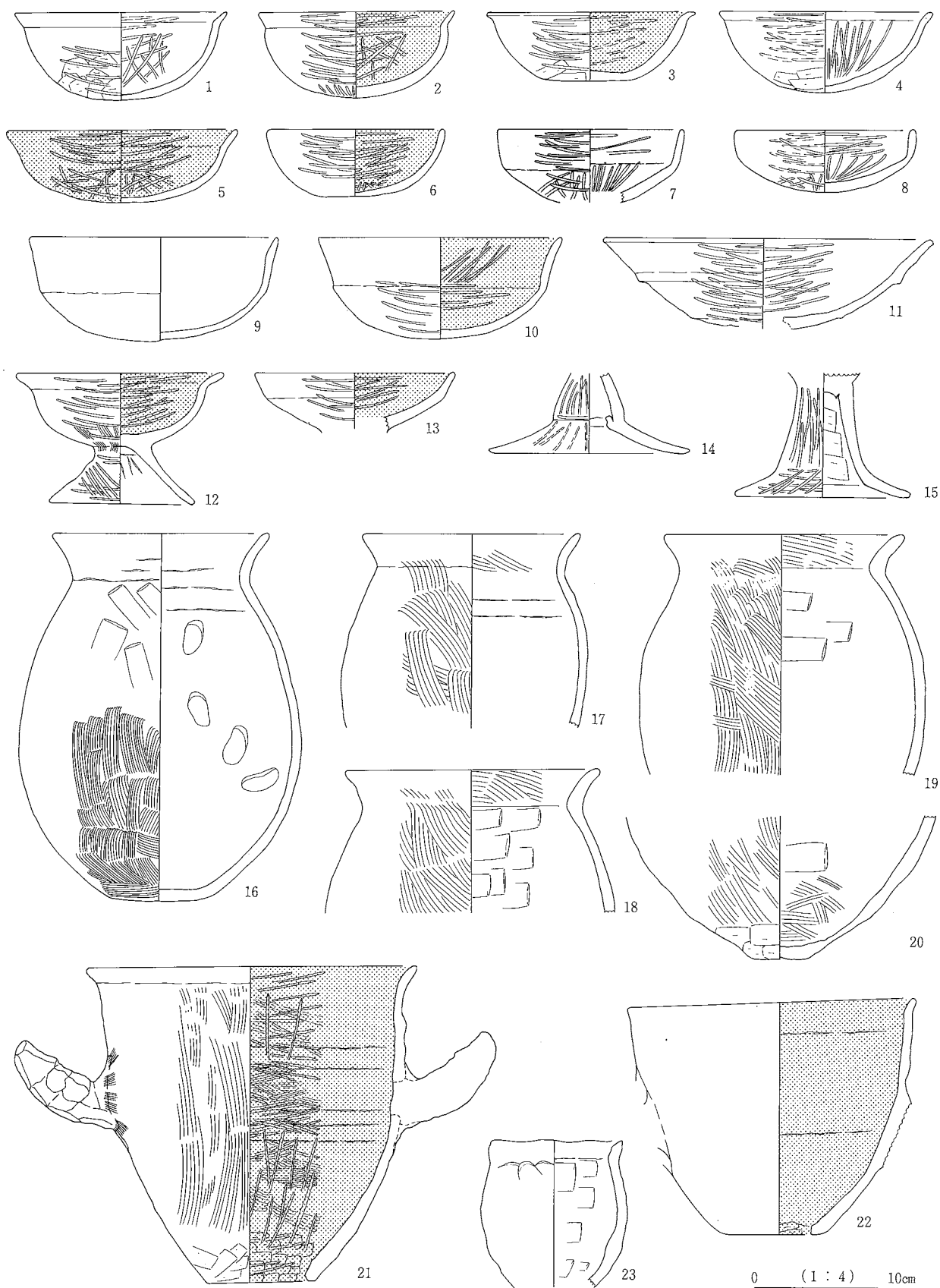

SB1212-①

SB1212-②

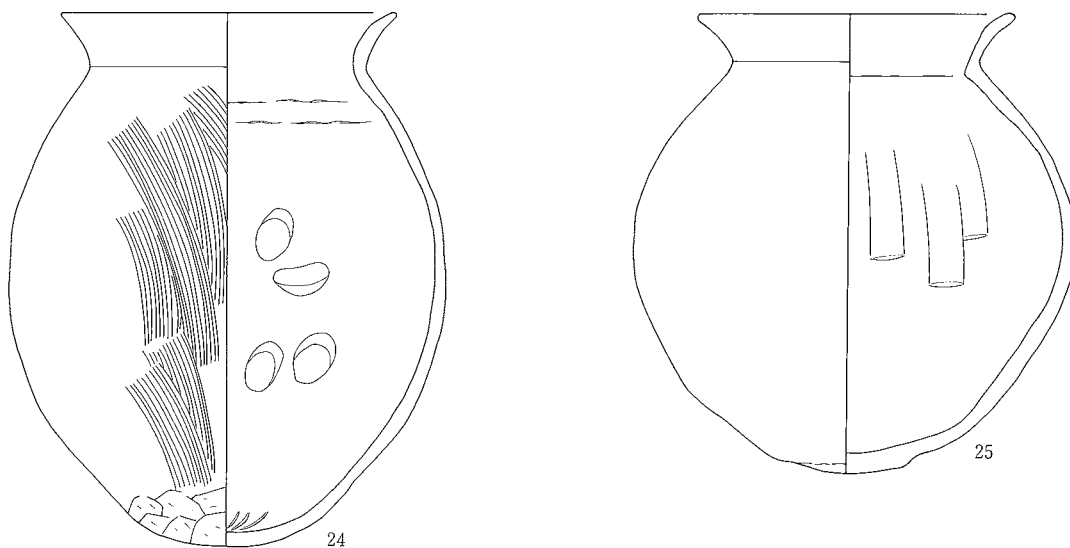

SB1219-①

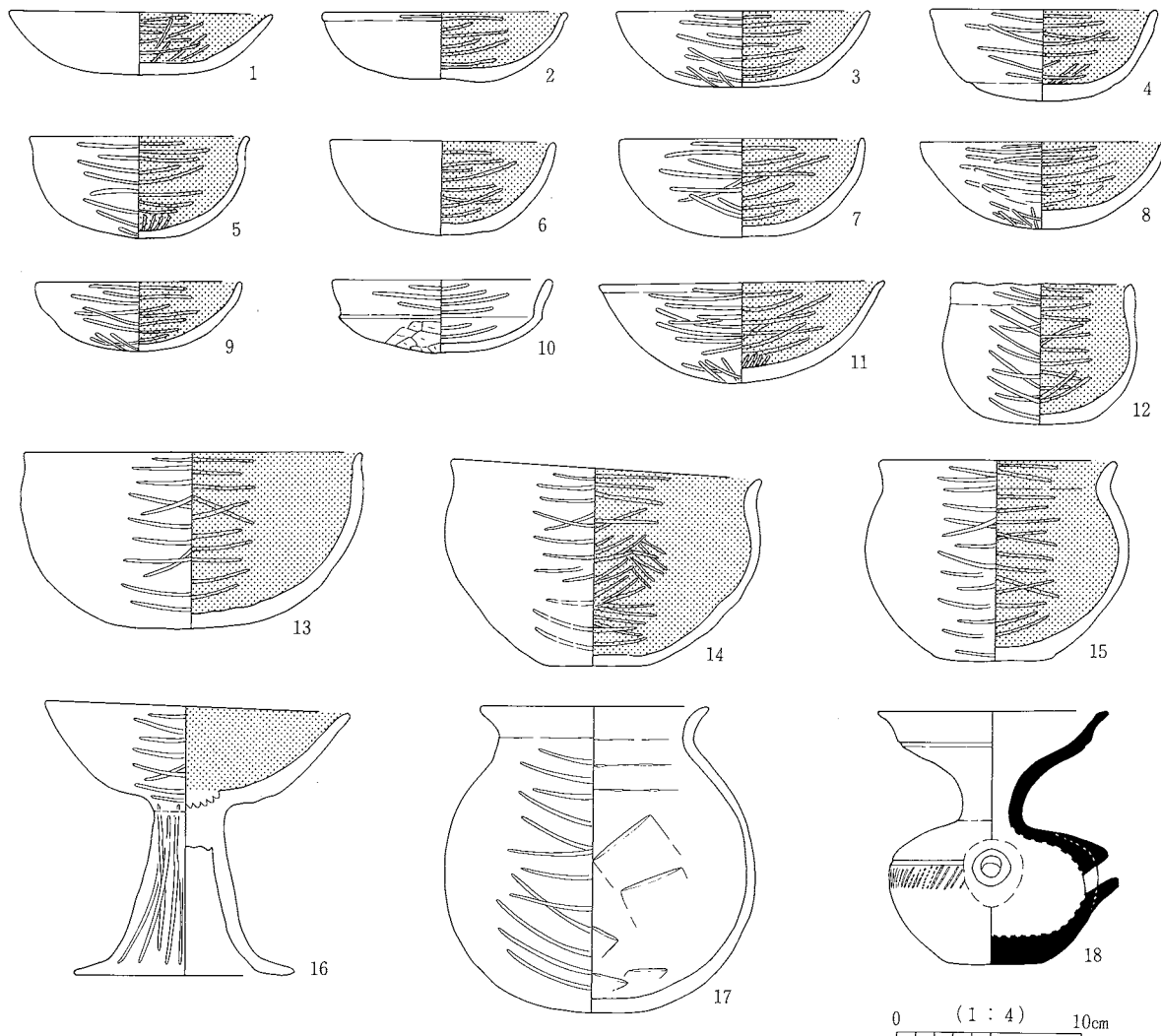

SB1219-②

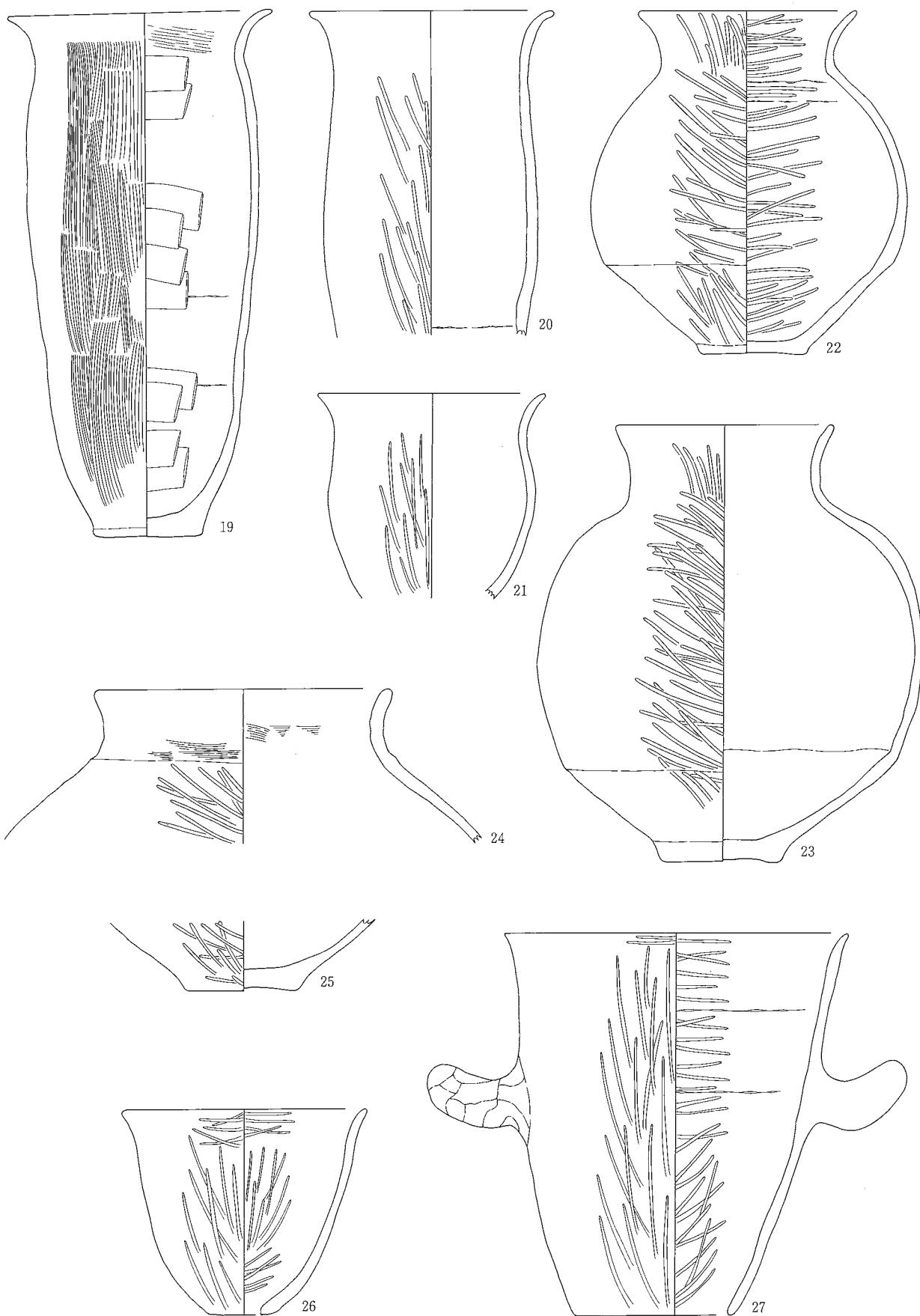

SB1219-②

0 (1 : 4) 10cm

SB1246

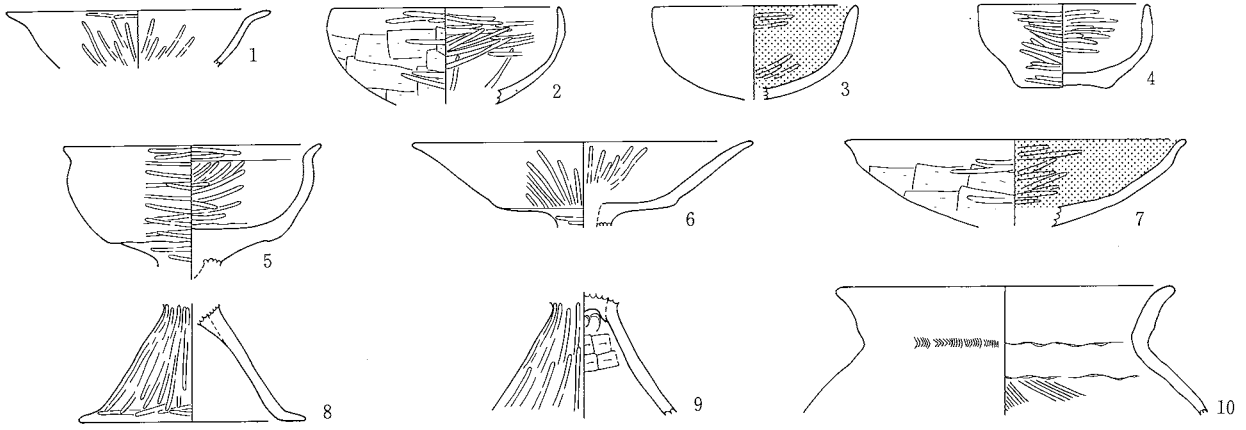

SB1262

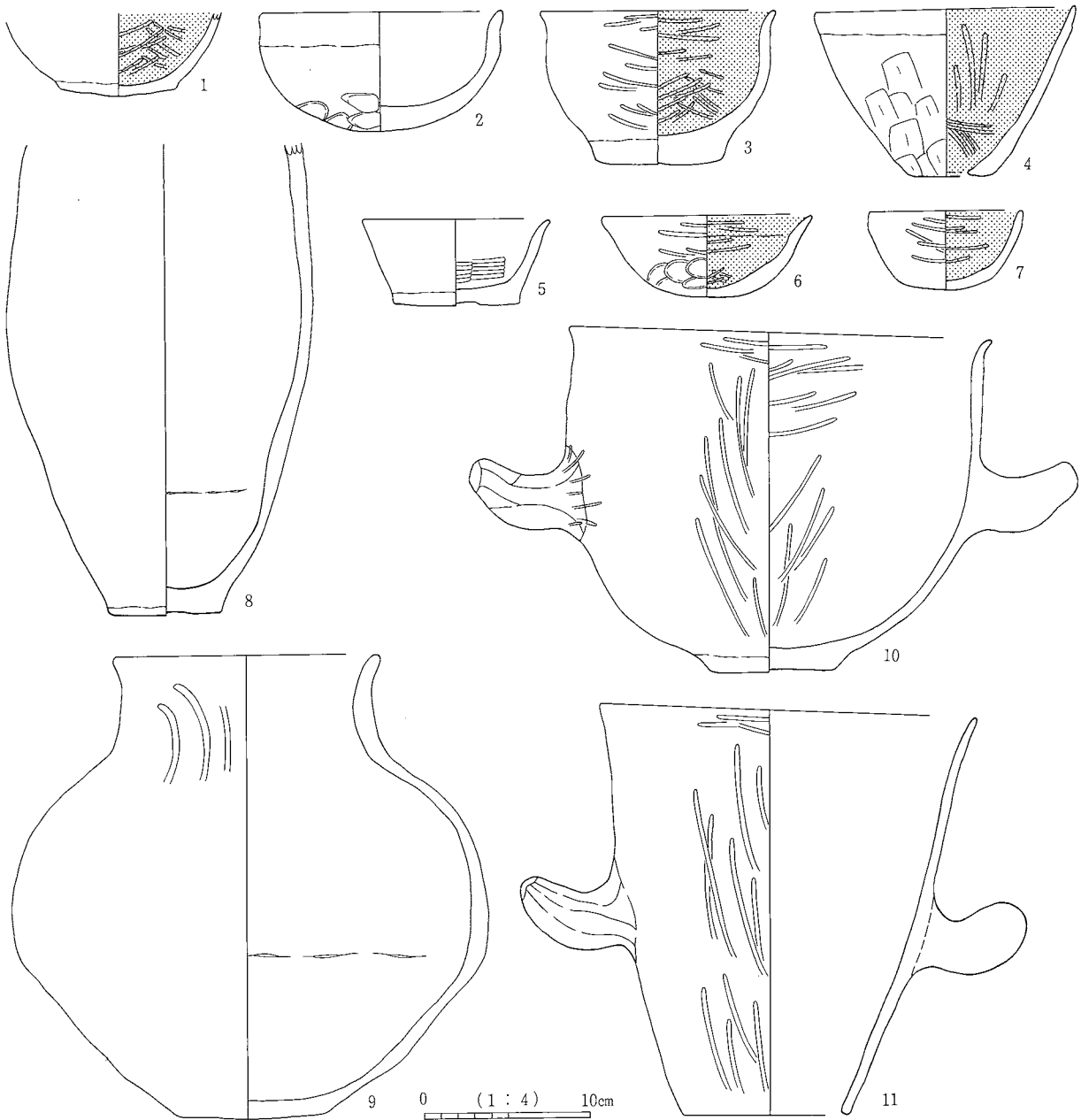

SB1246・1262

SB1263

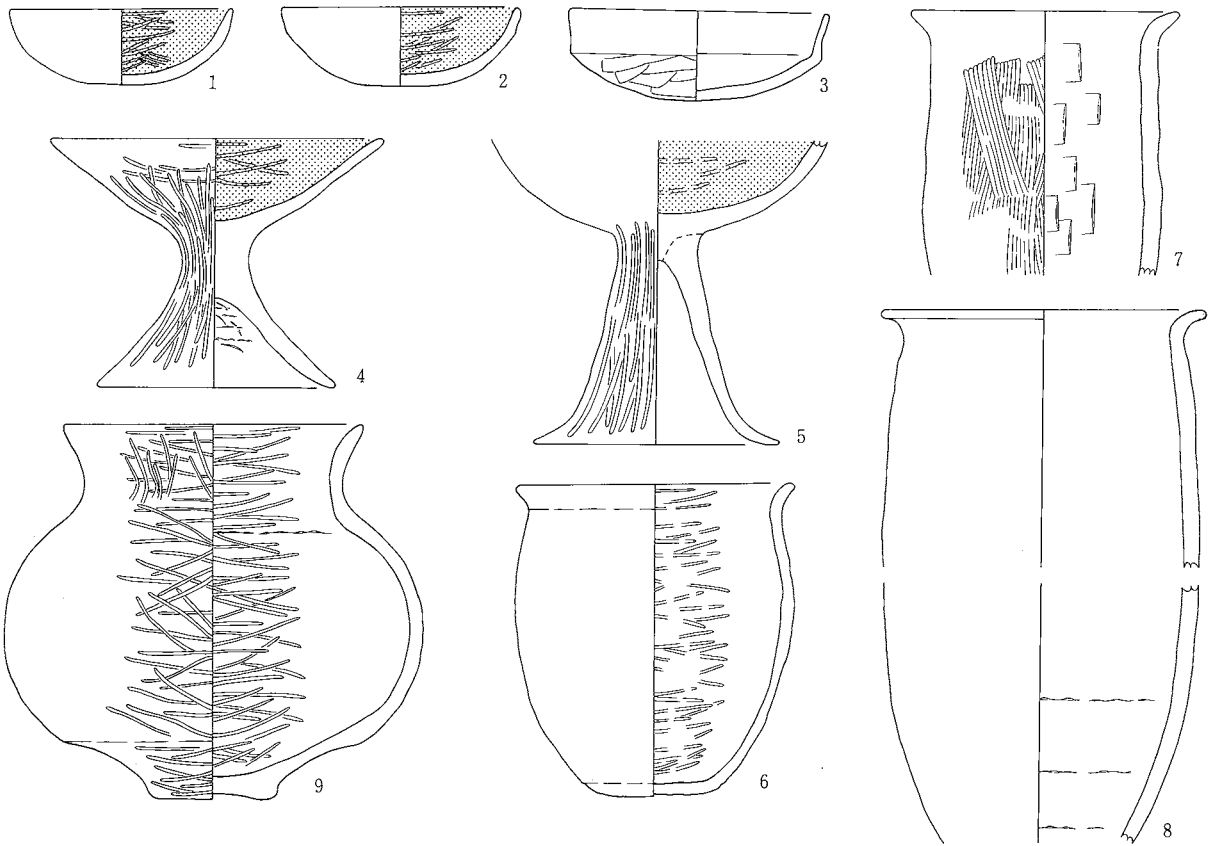

SB1264-①

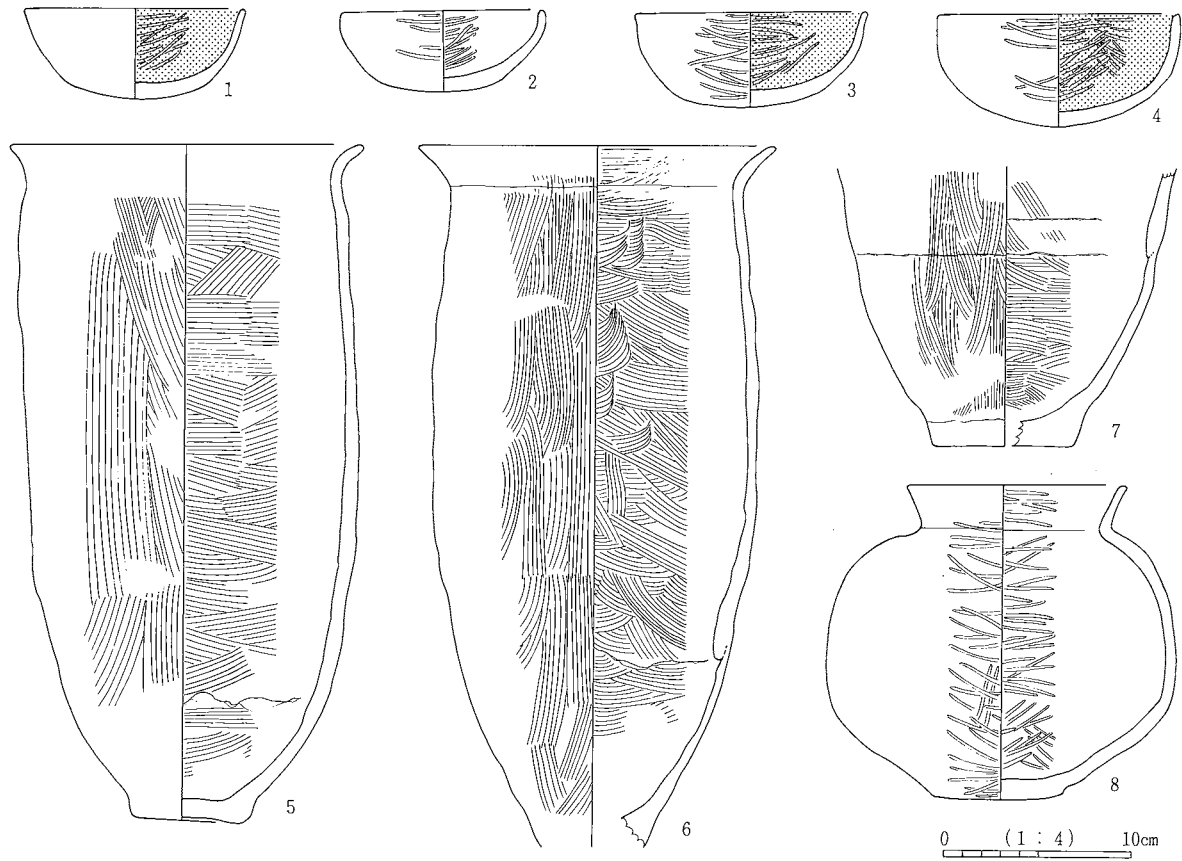

0 (1:4) 10cm

SB1263・1264-①

SB1264-②

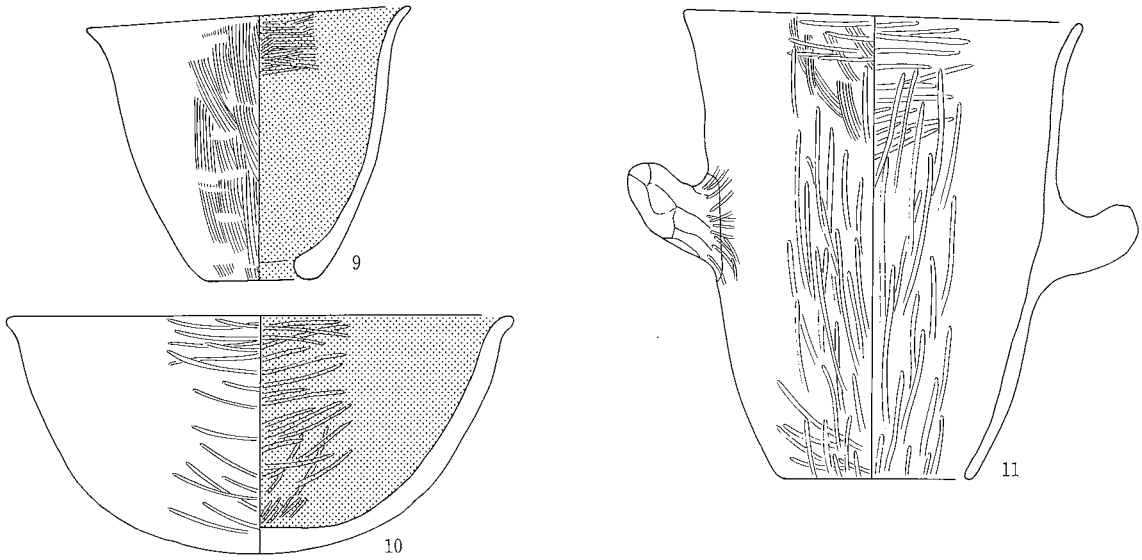

SB1401-①

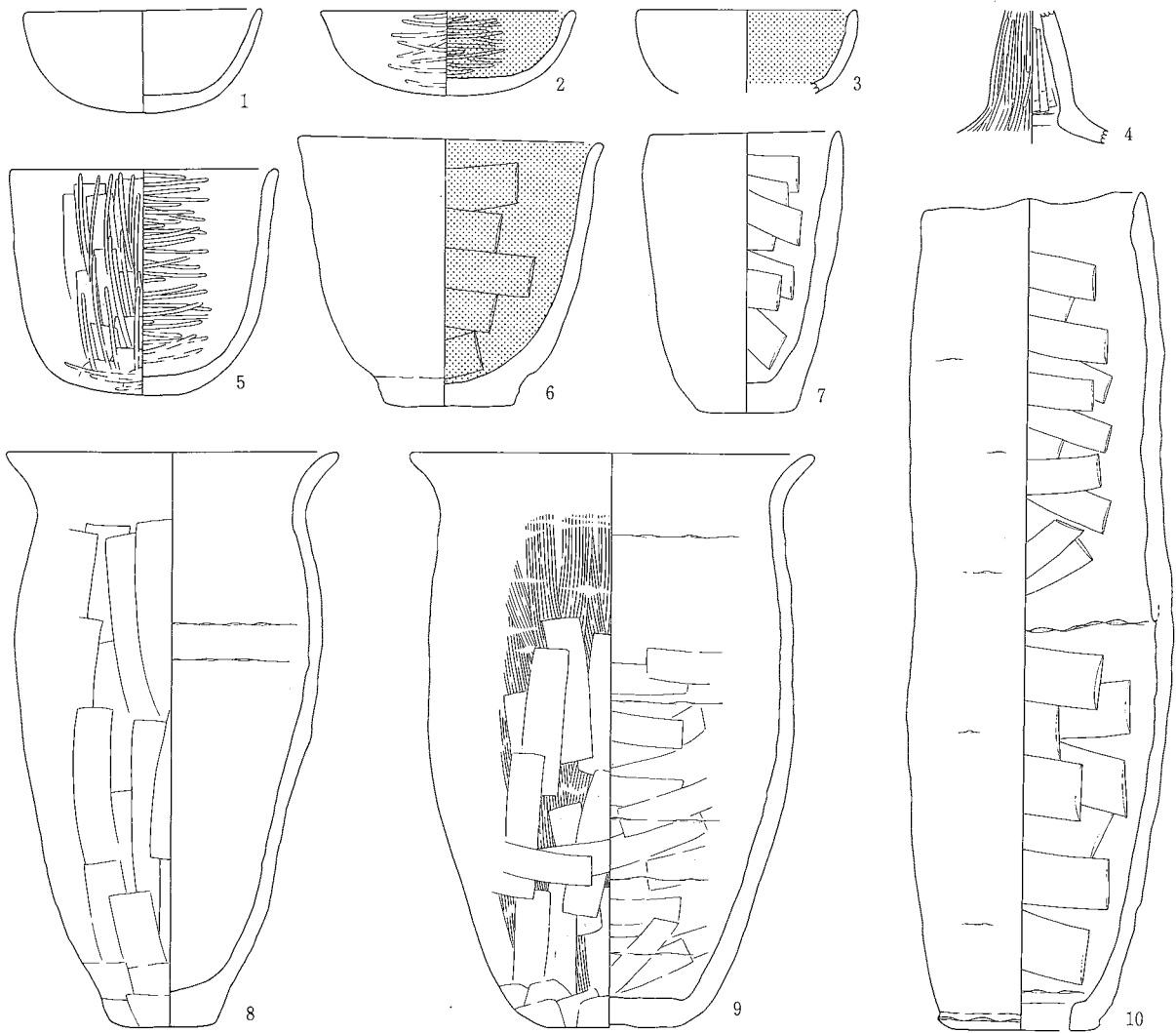

0 (1:4) 10cm

SB1264-②・1401-①

SB1401-②

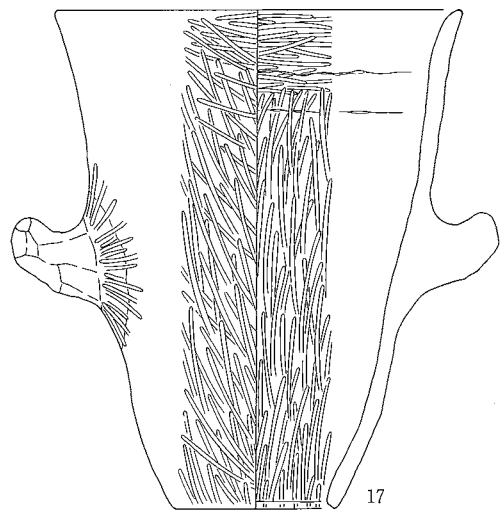
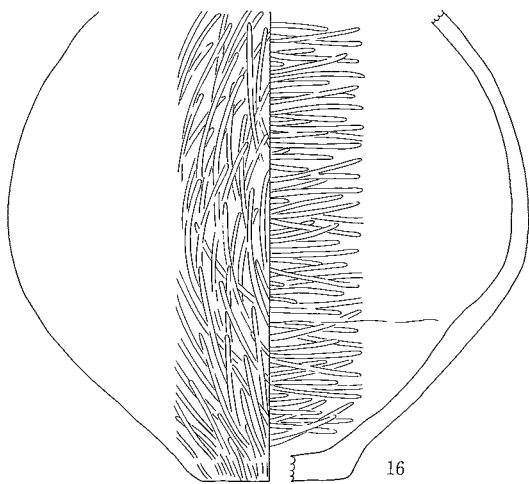
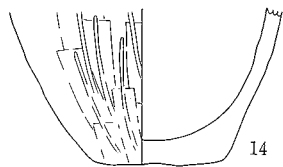
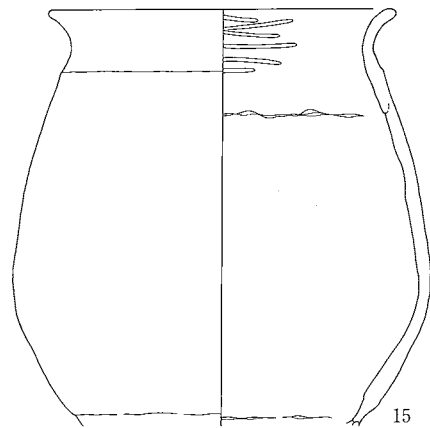
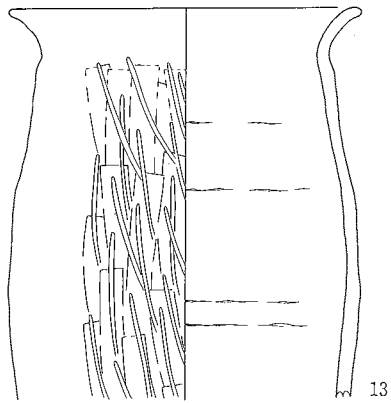
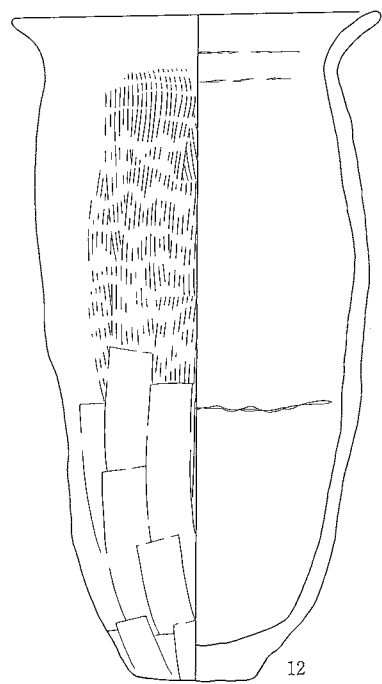
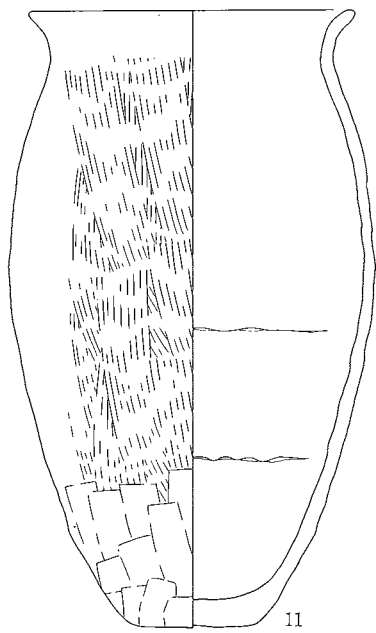

0 (1 : 4) 10cm

SB1401-②

SB1404

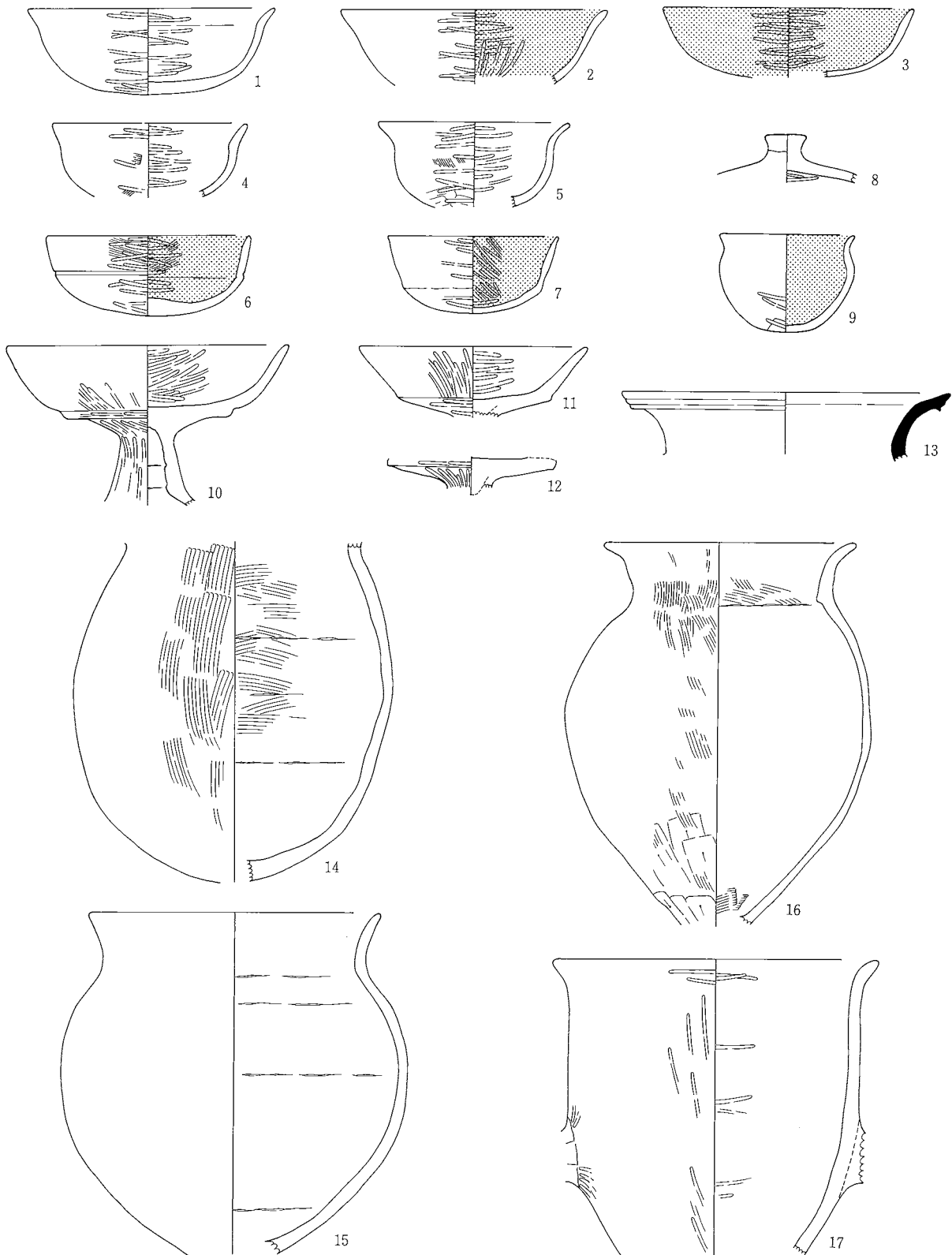

0 (1 : 4) 10cm

SB1404

SB1427-①

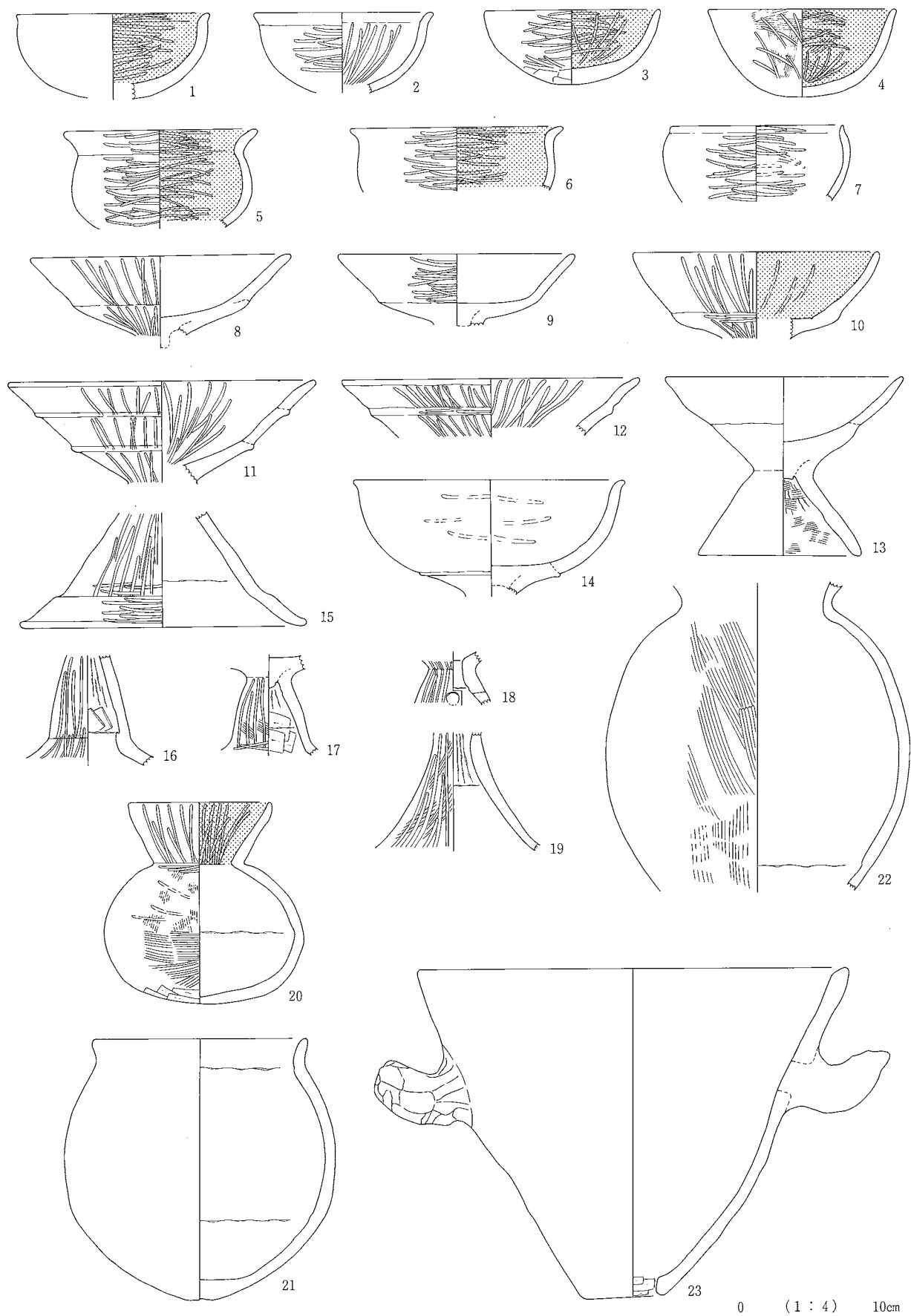

SB1427-①

0 (1:4) 10cm

SB1427-②

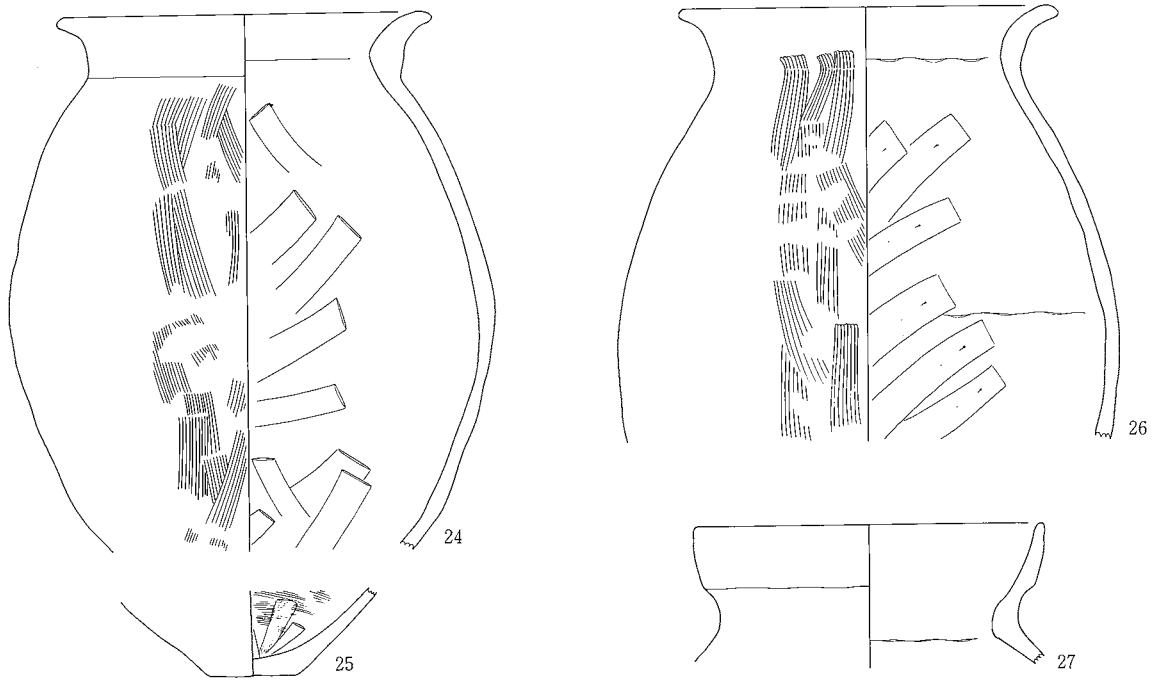

SB1608

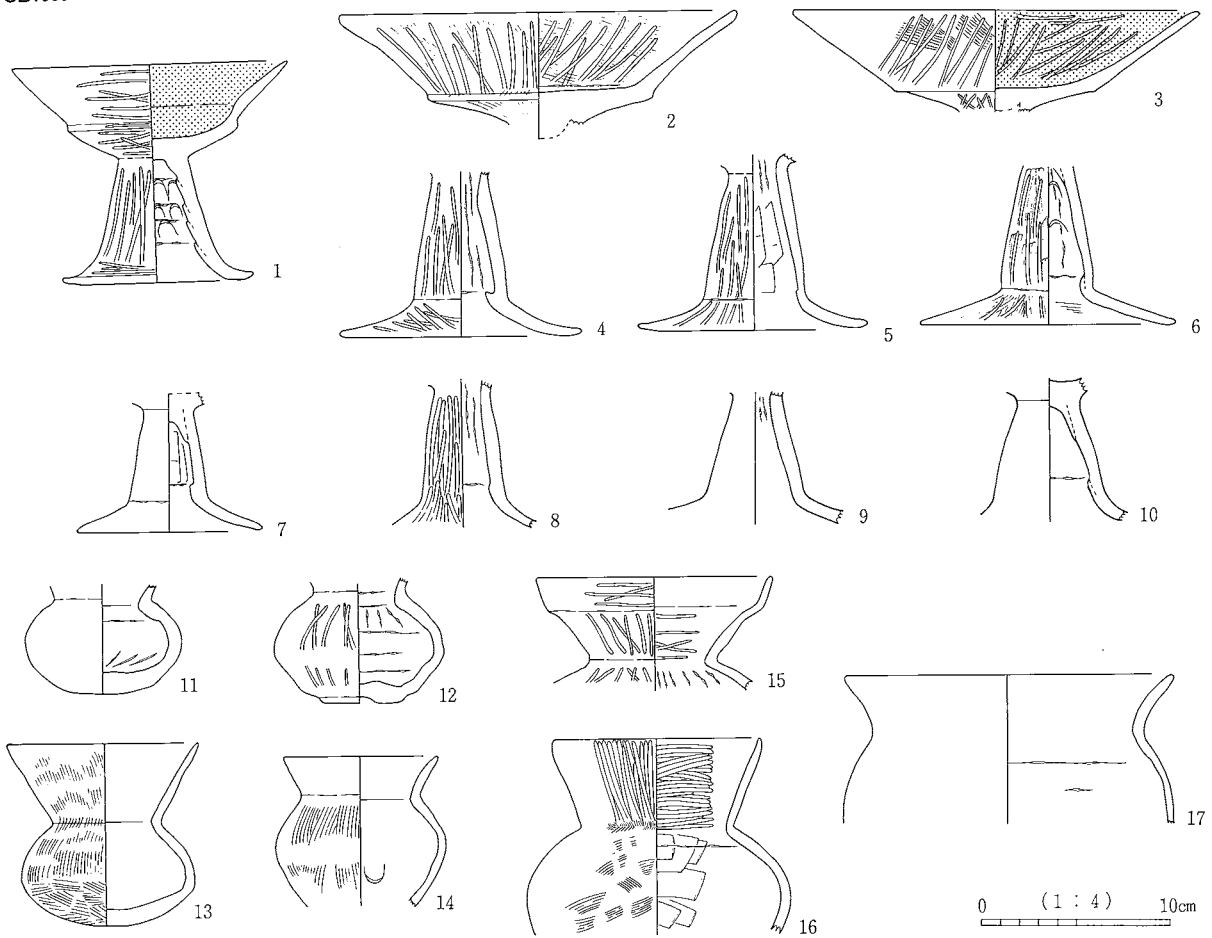

SB1440

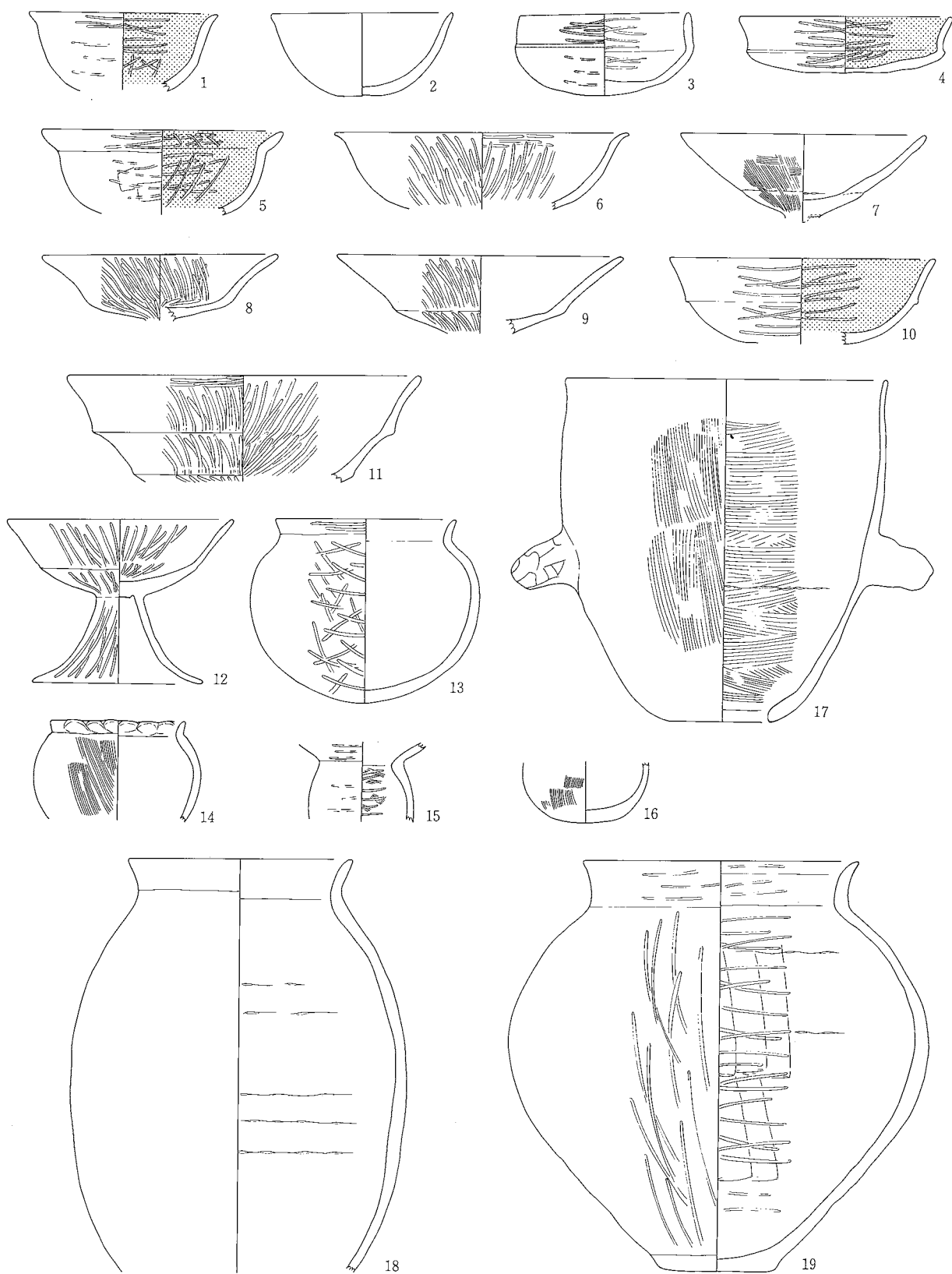

0 (1:4) 10cm

SB1440

SB1611

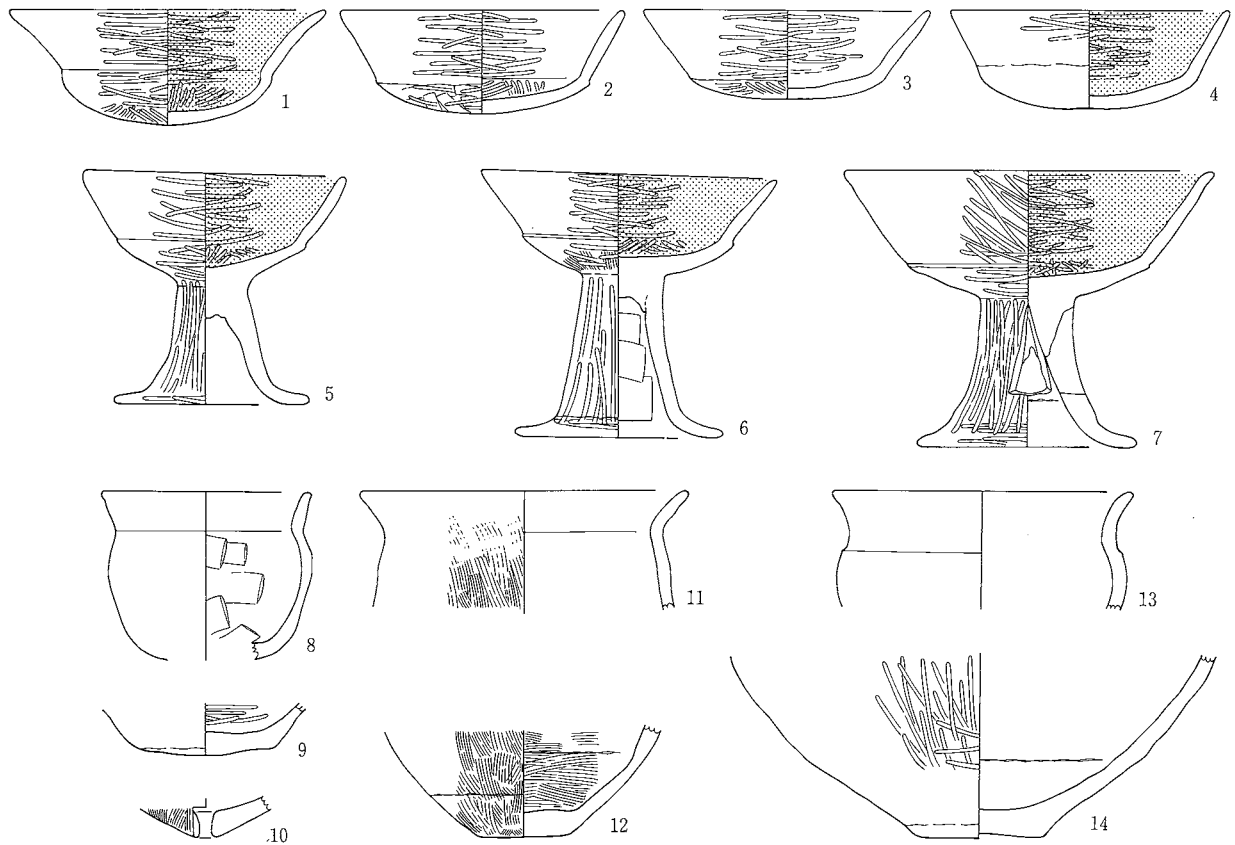

SB1627-①

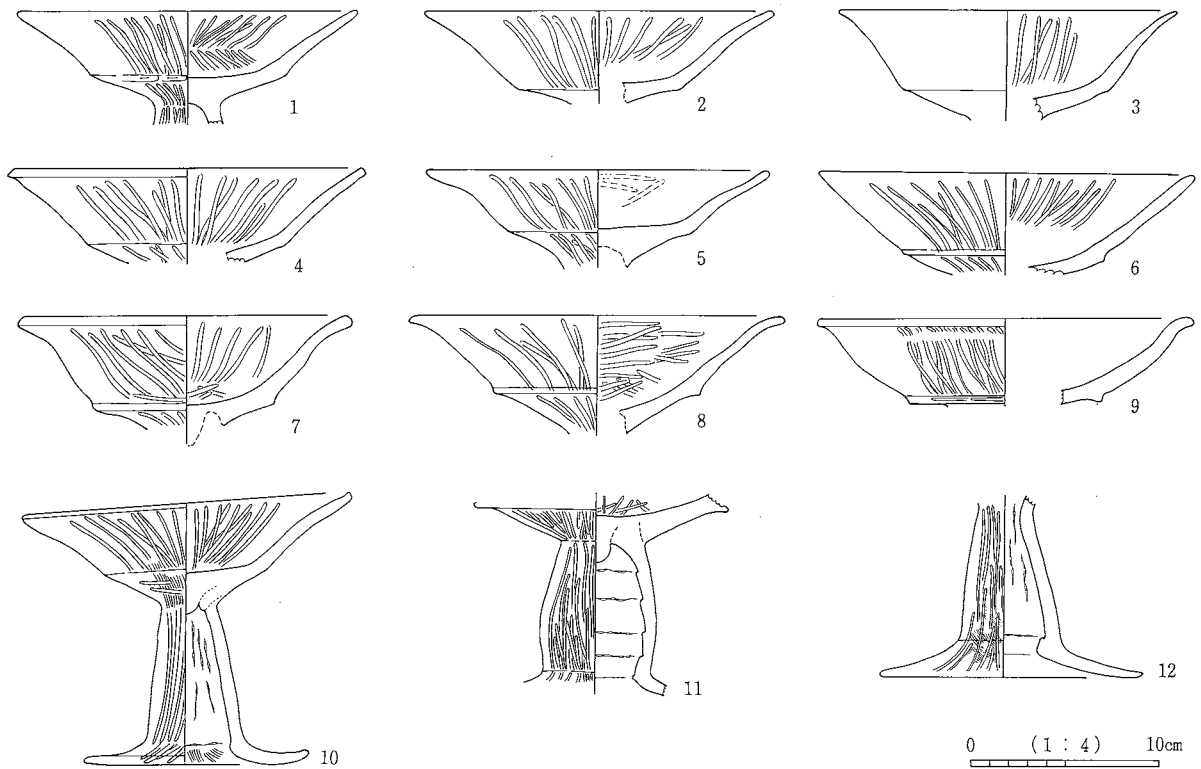

SB1611・1627-①

SB1627-②

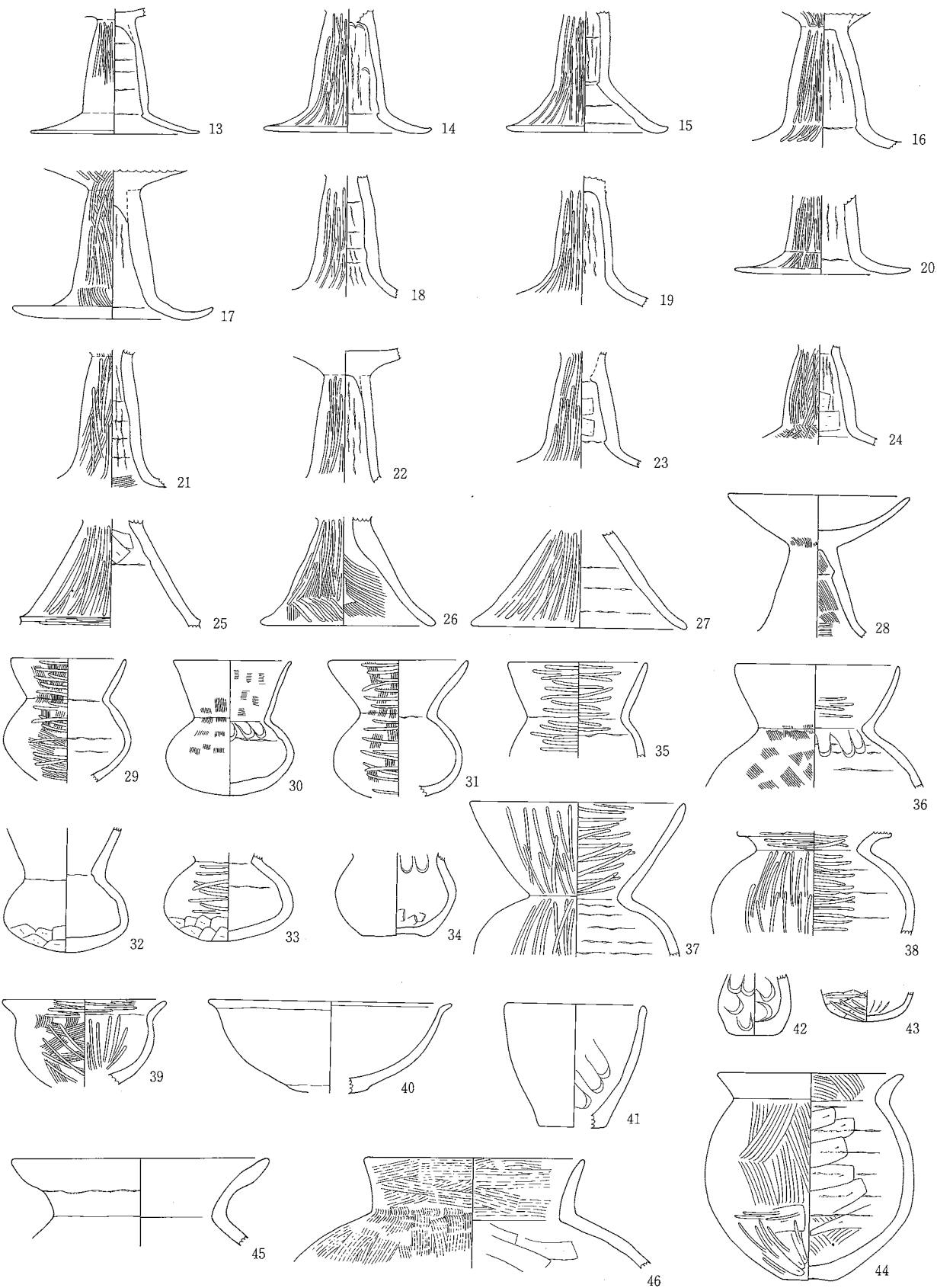

0 (1:4) 10cm

SB1627-②

SB1644

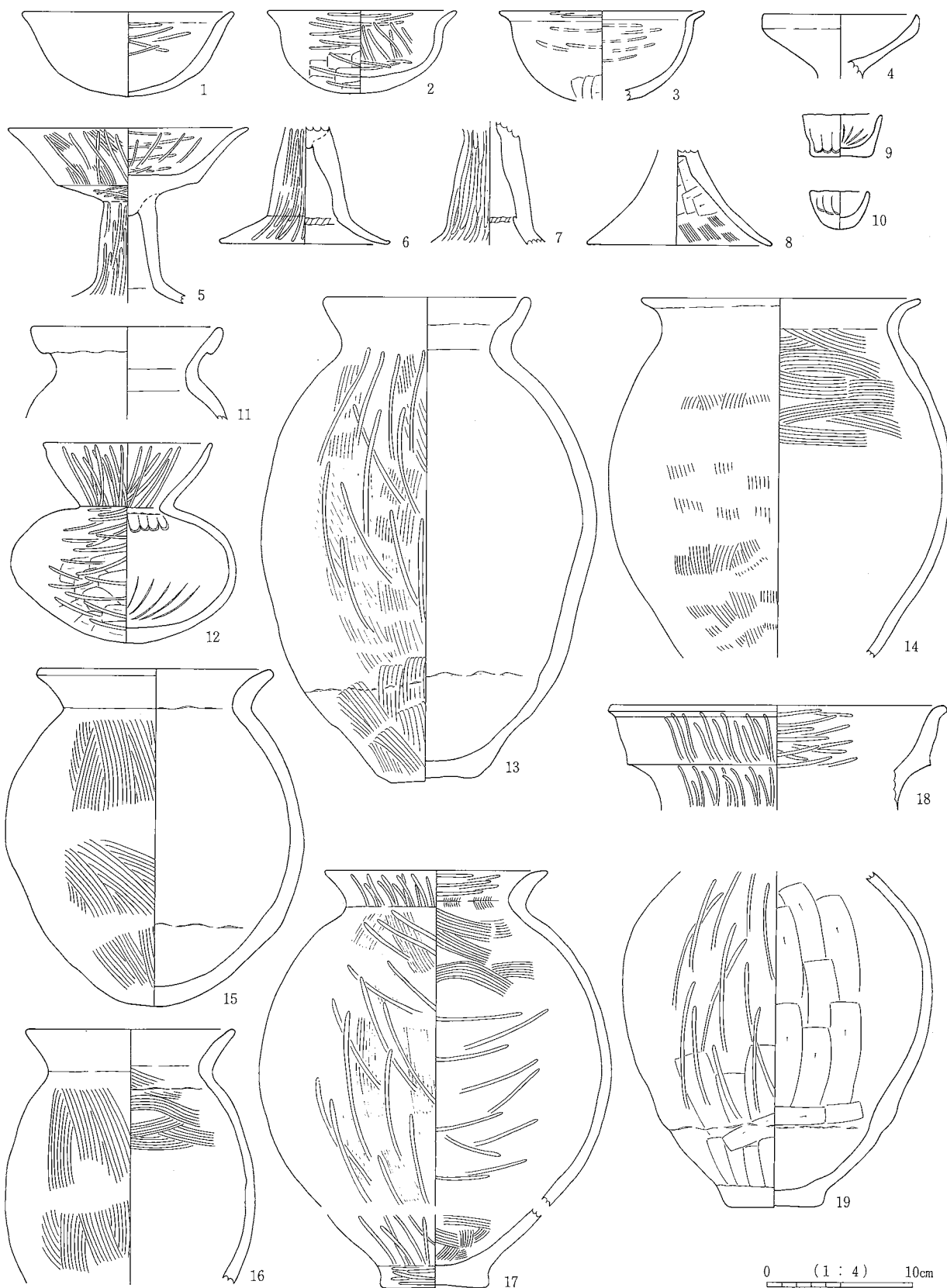

SB1644

SD30

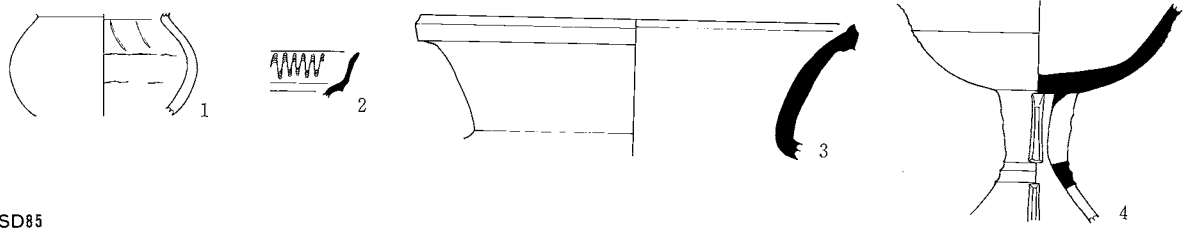

SD85

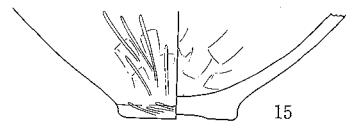
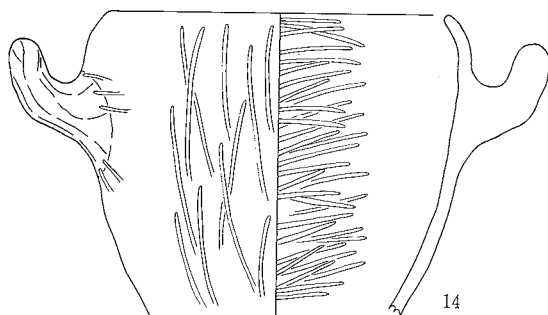
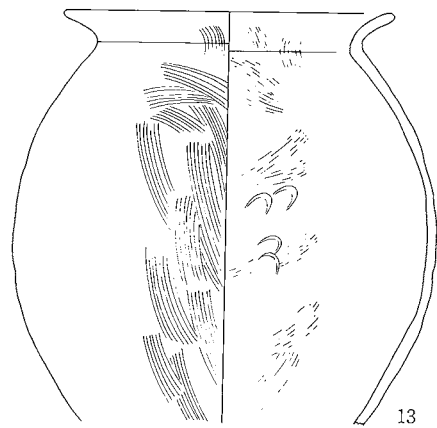
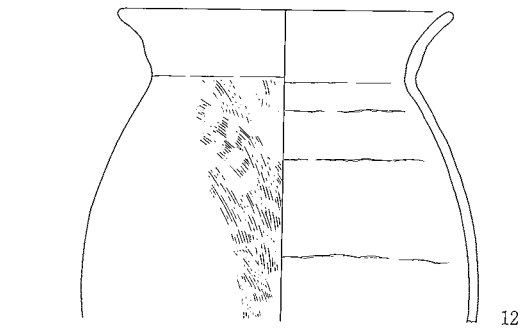
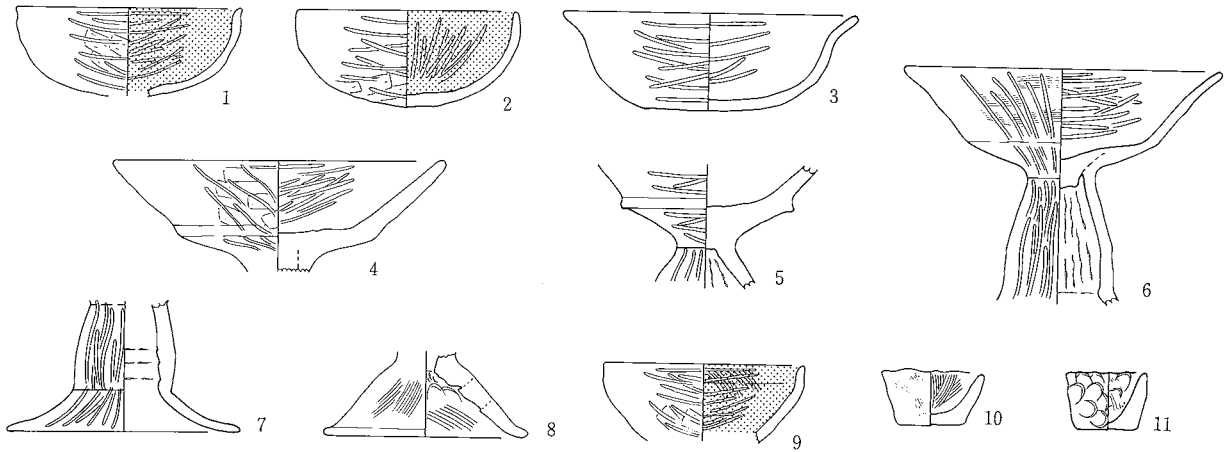

0 (1:4) 10cm

SD122

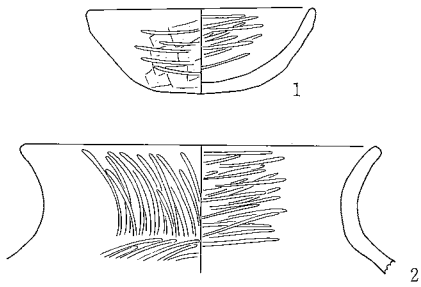

SD125

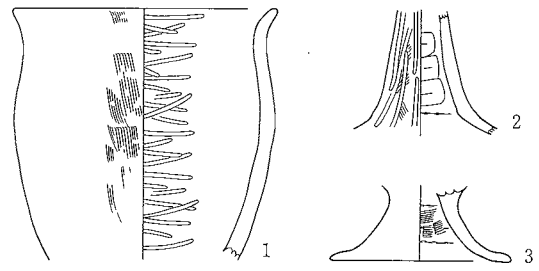

SD123

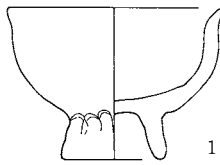

SD511

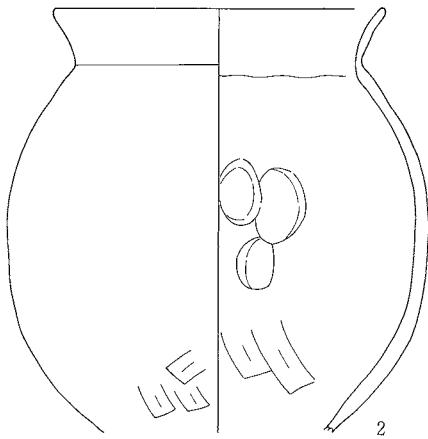

SD413

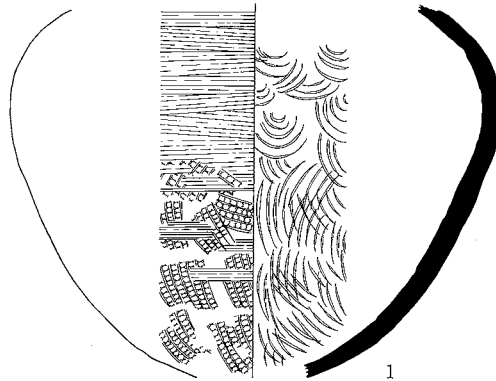

SK2936

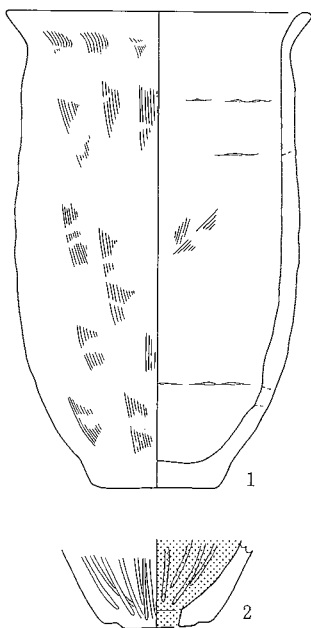

SK9048

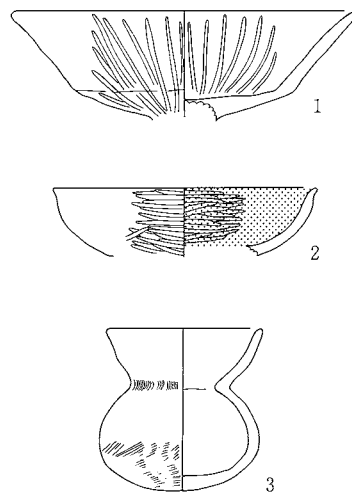

0 (1 : 4) 10cm

SG1

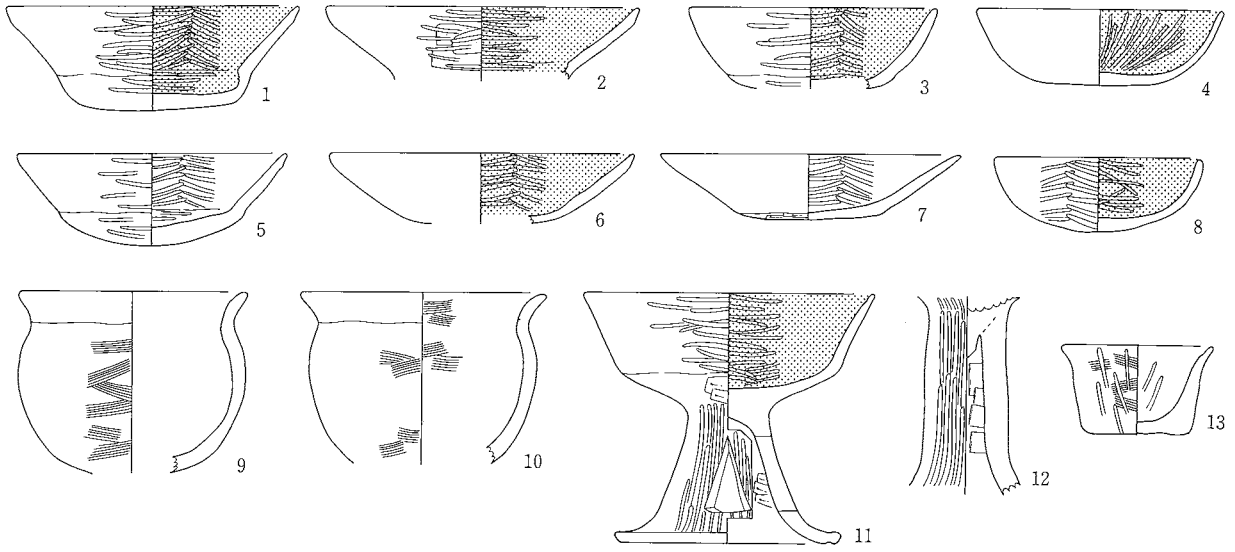

SG2

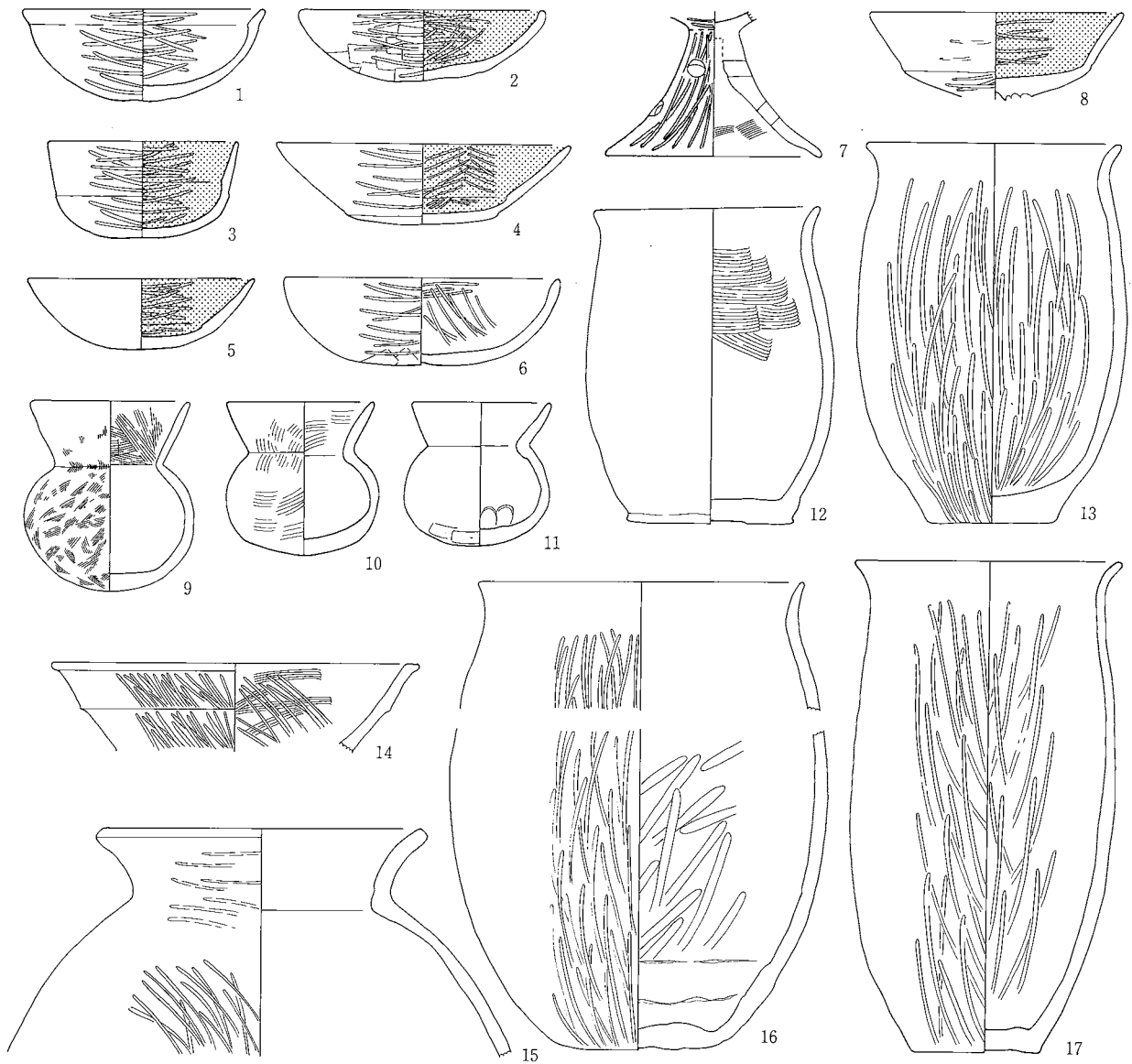

SG1・2

SG3 IV層-①

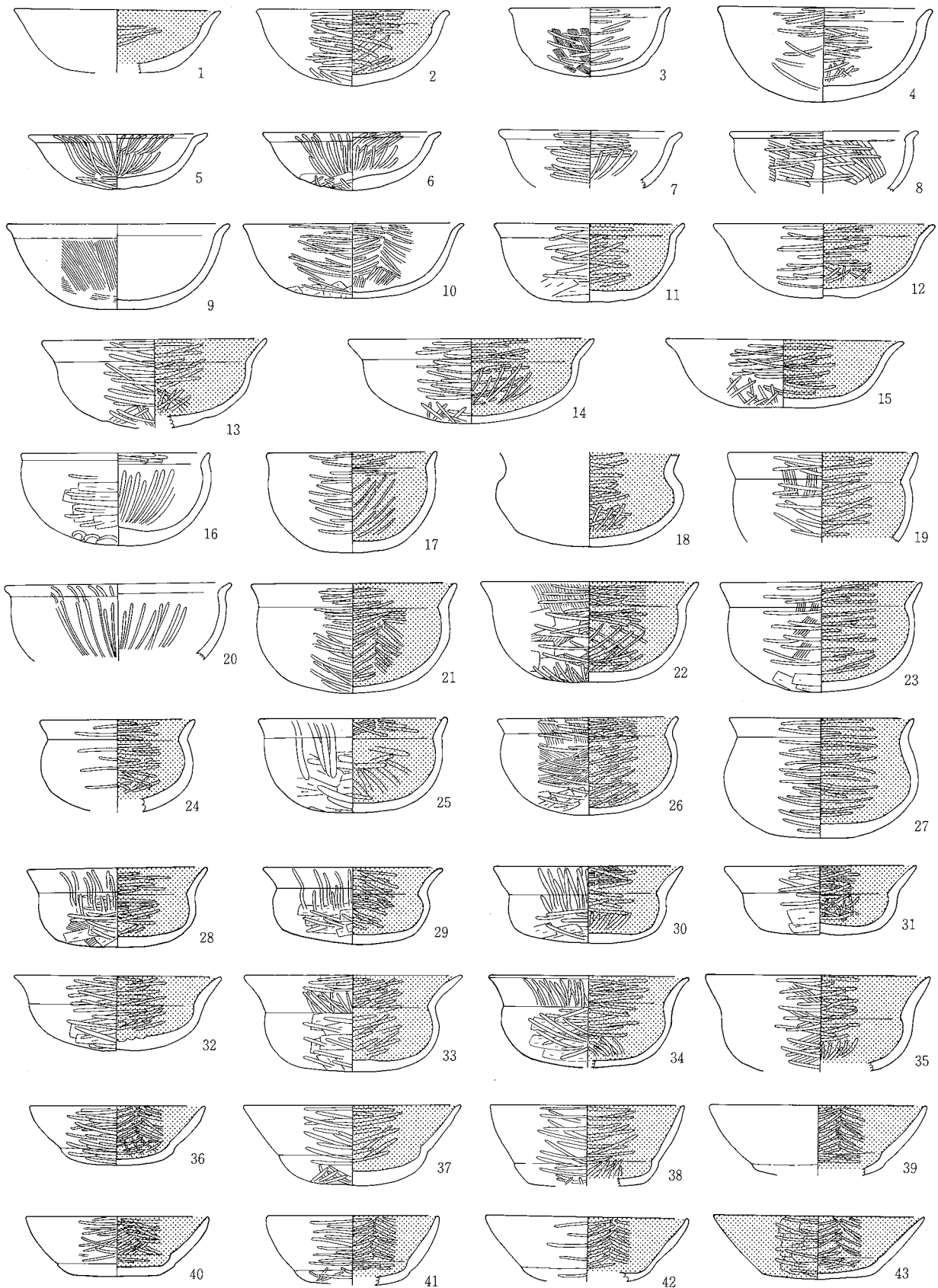

0 (1:4) 10cm

SG3 IV層-②

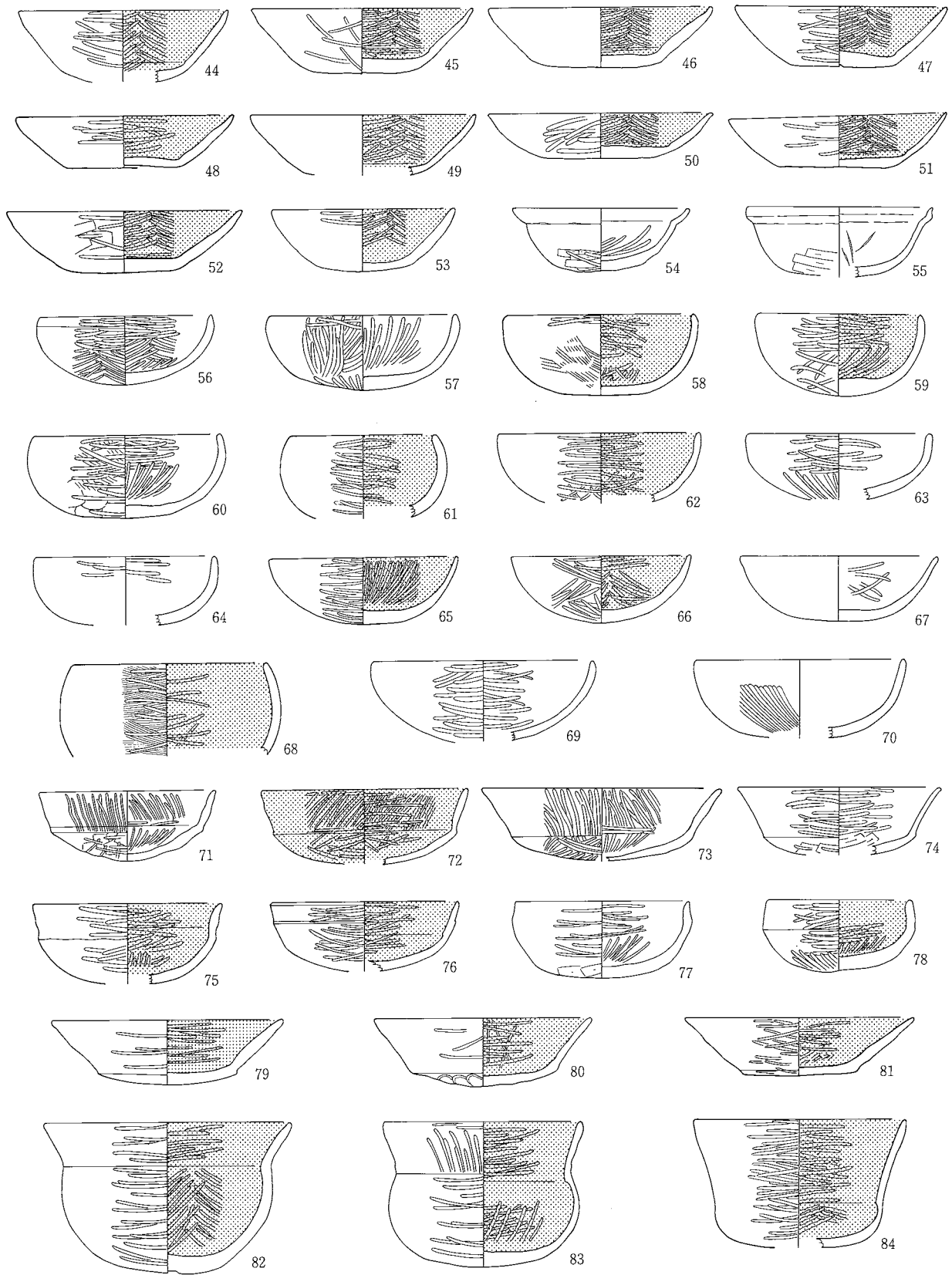

0 (1:4) 10cm

SG3 IV層-③

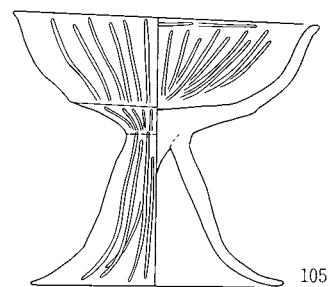
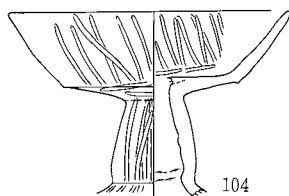
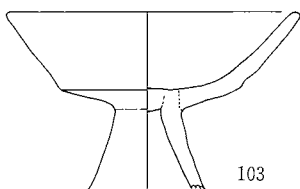
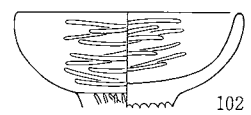
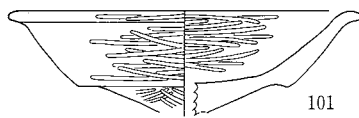
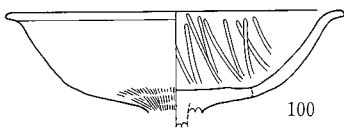
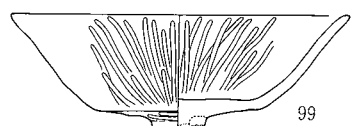
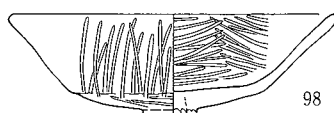
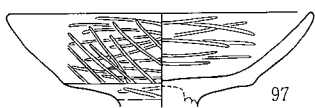
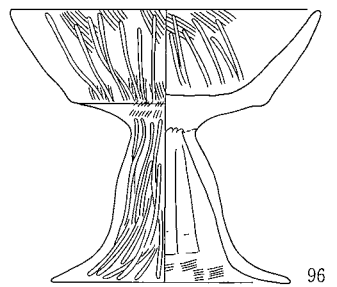
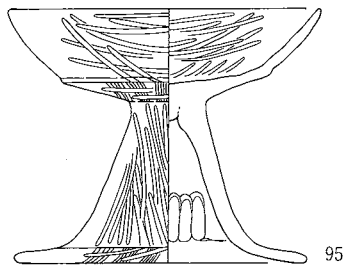
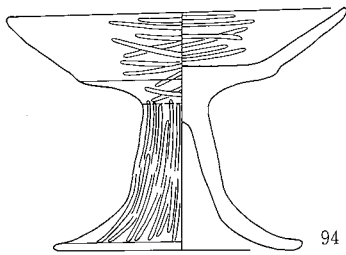
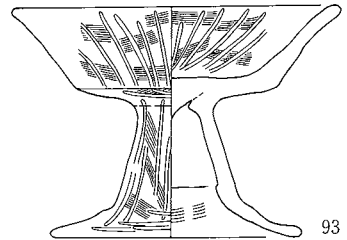
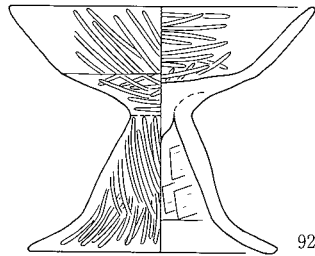
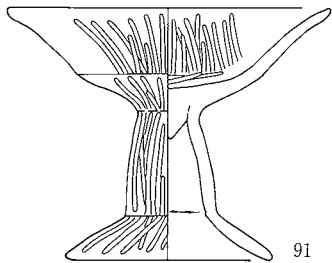
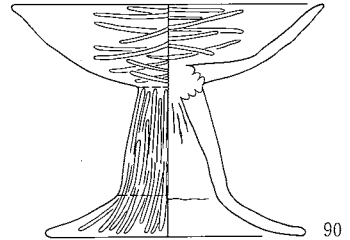
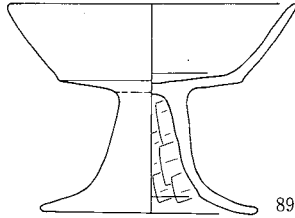
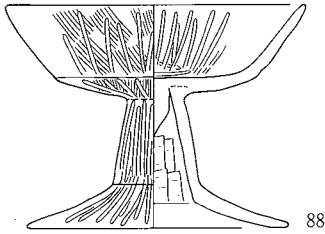
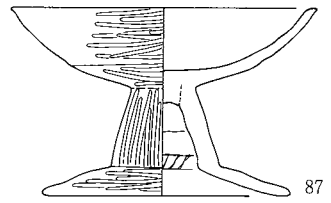
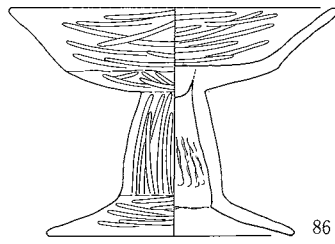
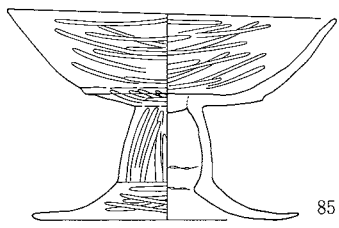

0 (1:4) 10cm

SG3 IV層-③

SG3 IV層-④

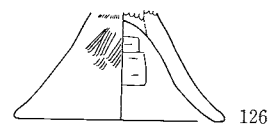
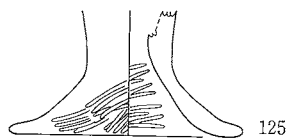
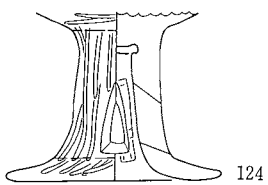
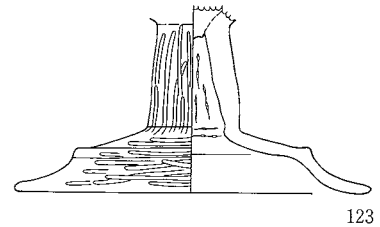
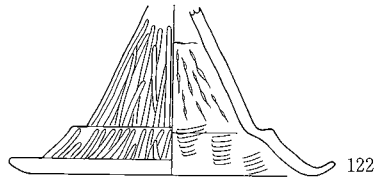
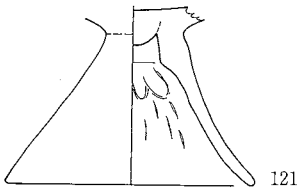
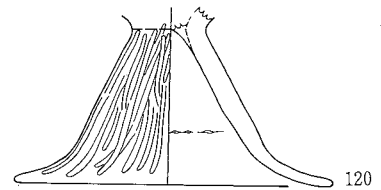
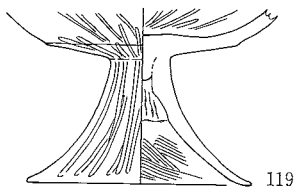
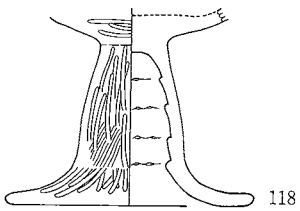
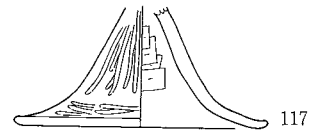
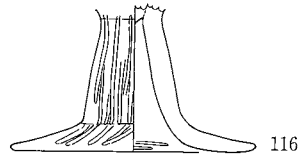
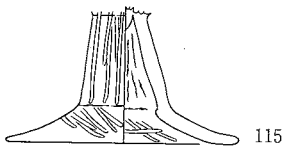
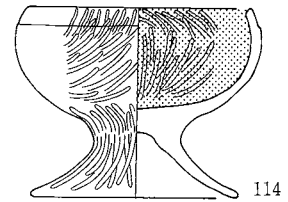
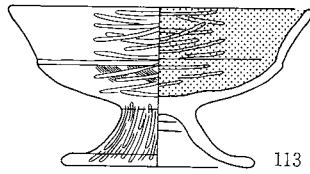
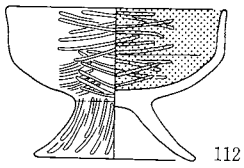
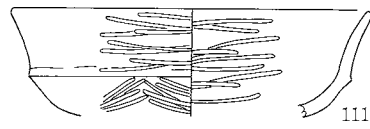
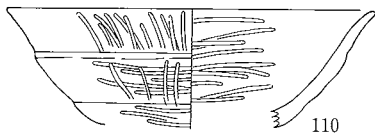
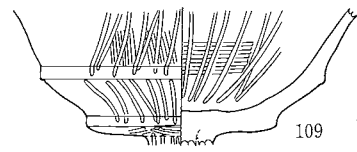
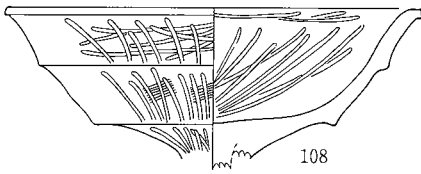
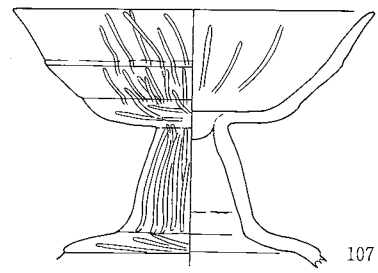
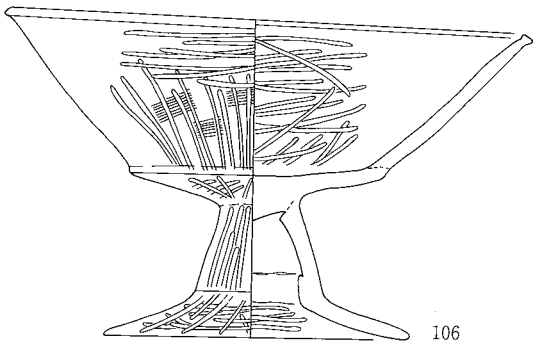

0 (1:4) 10cm

SG3 IV層-④

SG3 IV層-⑤

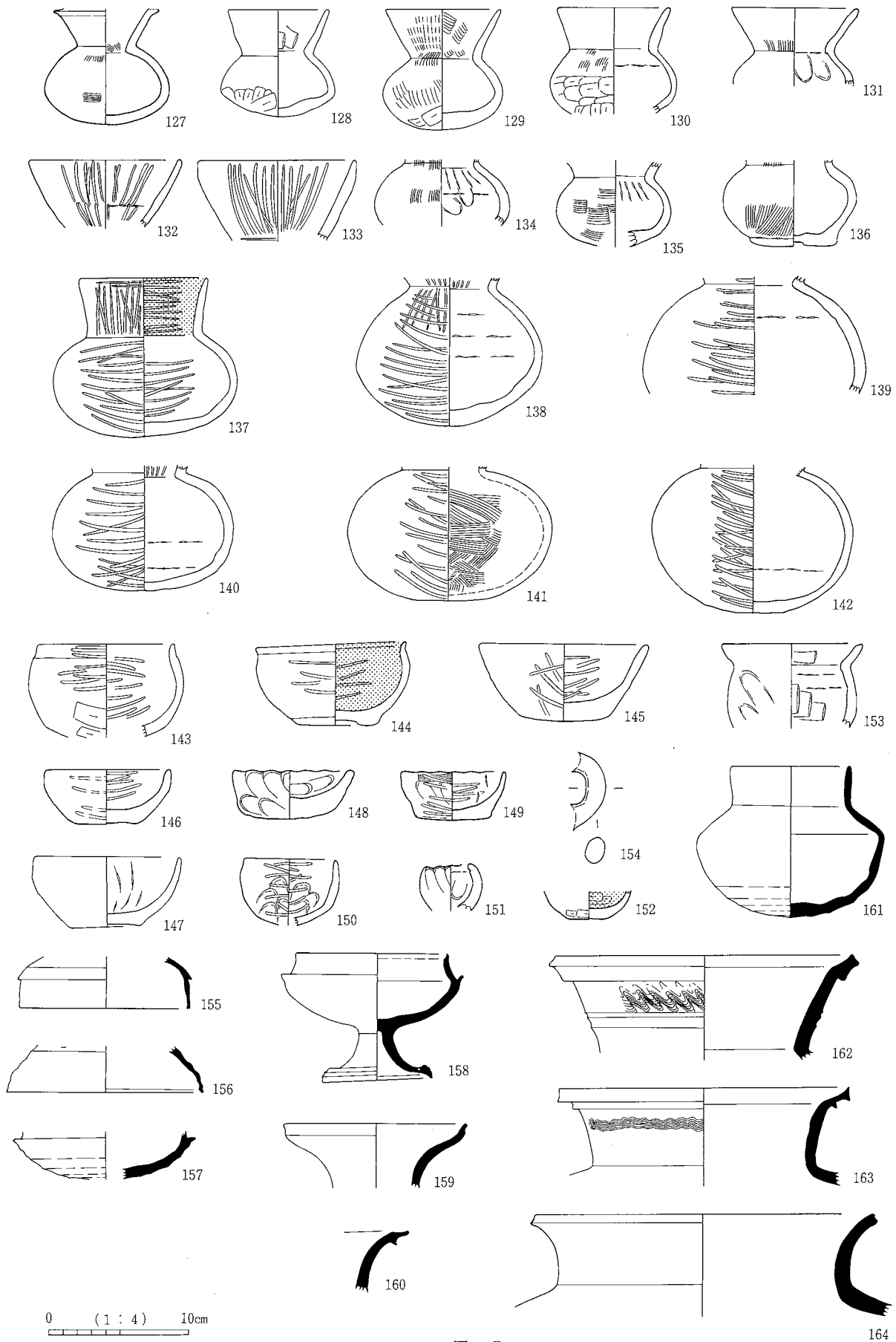

SG3 IV層-⑤

SG3 IV層一⑥

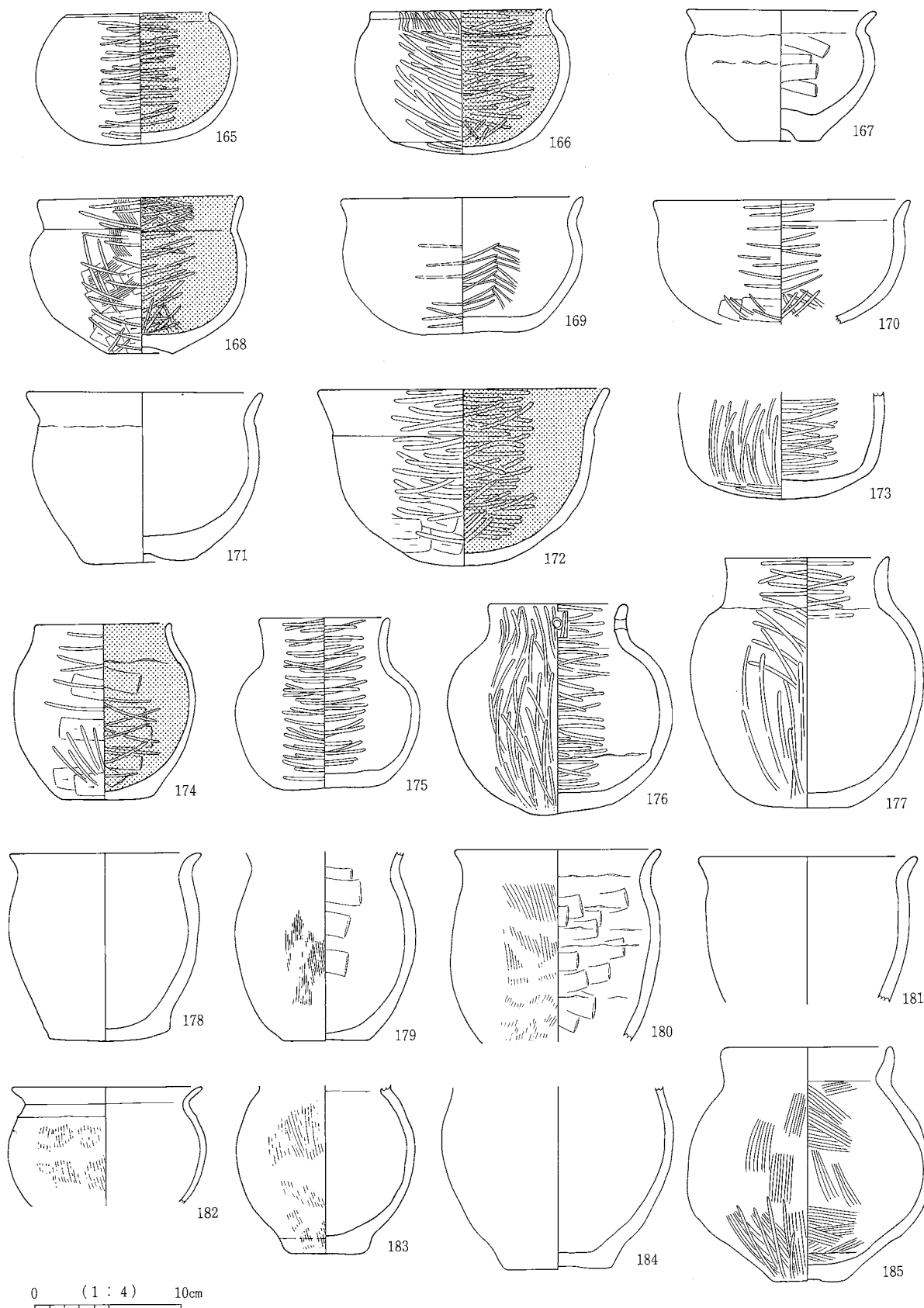

SG3 IV層一⑥

SG3 IV層-⑦

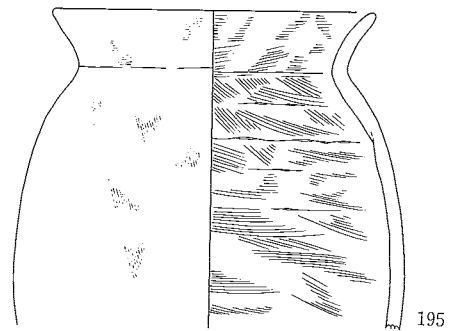
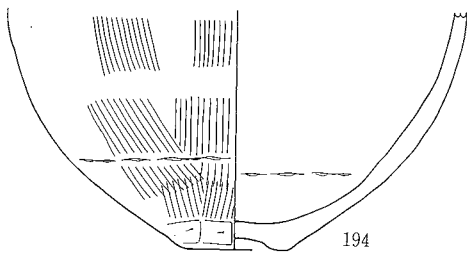
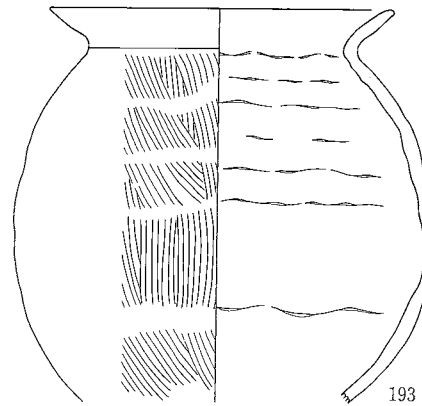
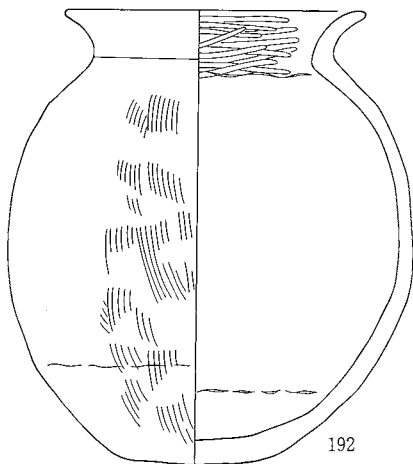
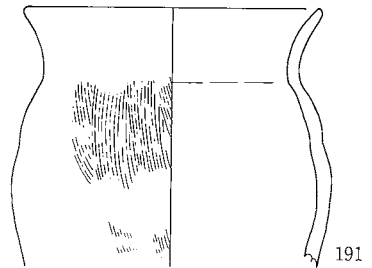
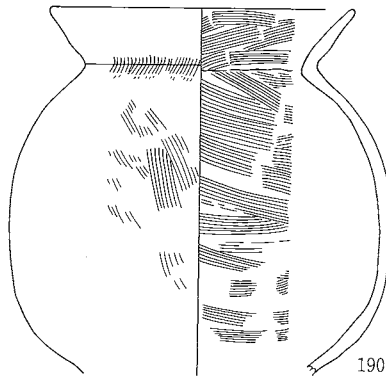
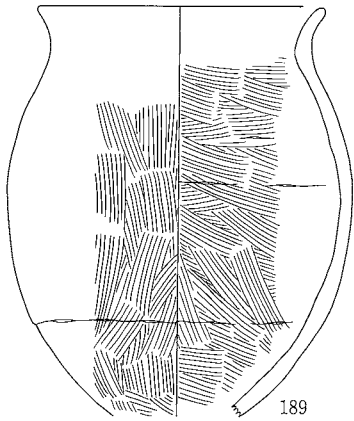
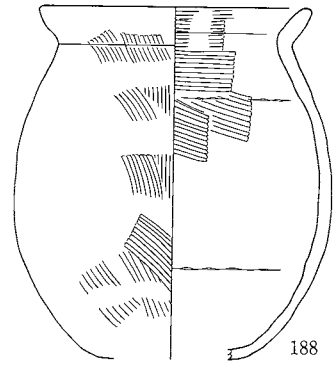
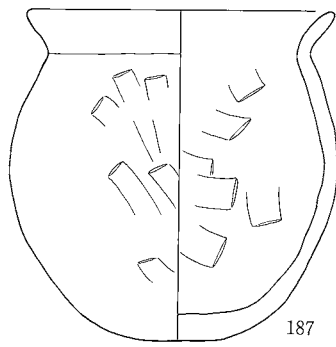
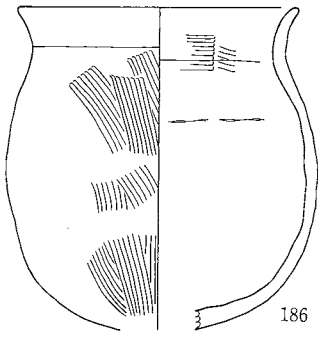

0 (1:4) 10cm

SG3 IV層-④

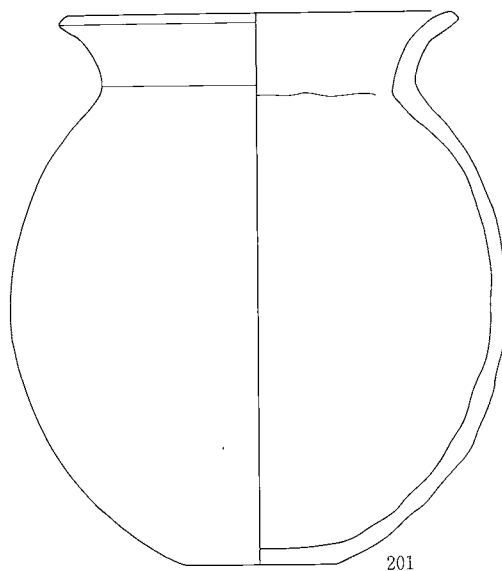
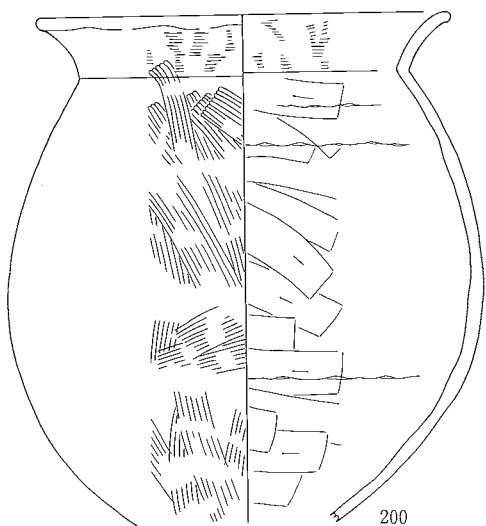
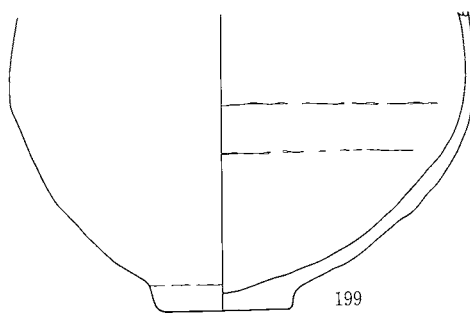
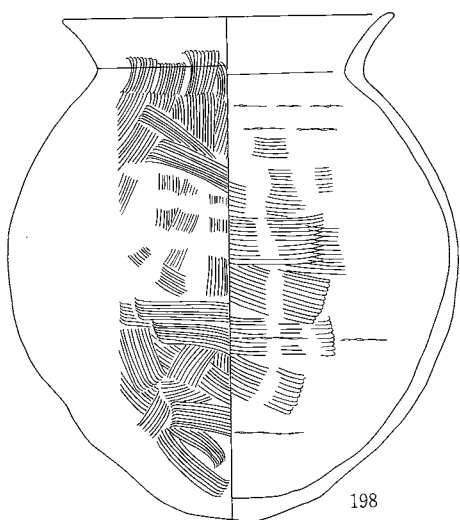
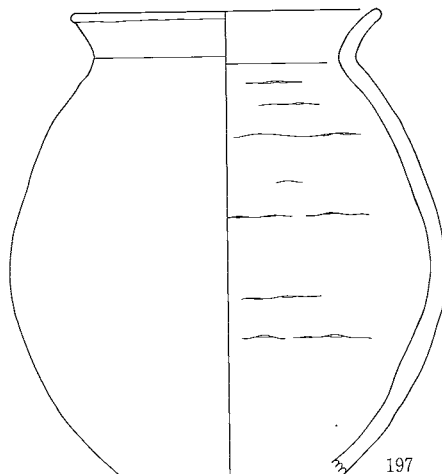
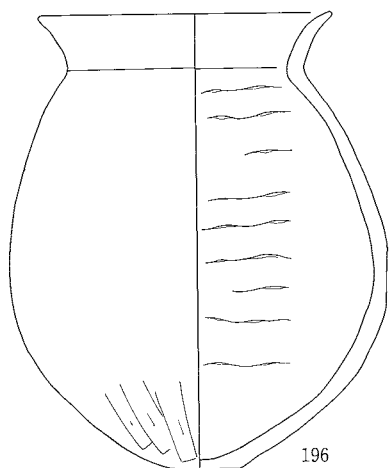

0 (1:4) 10cm

SG3 IV層-⑧

SG3 IV層-④

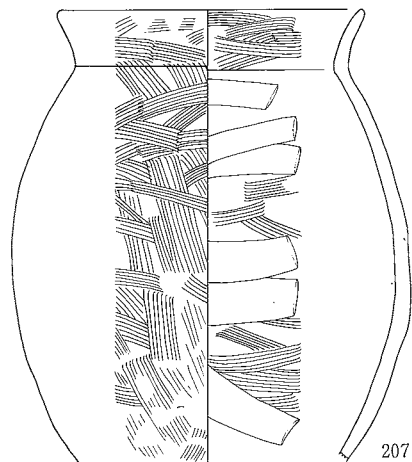
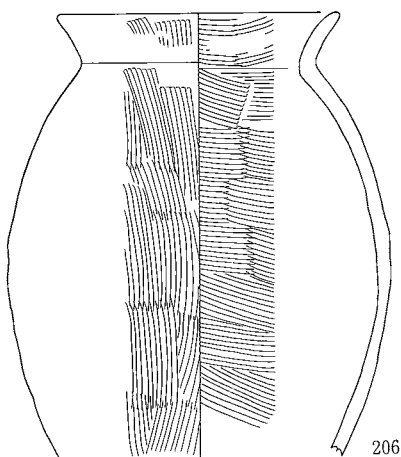
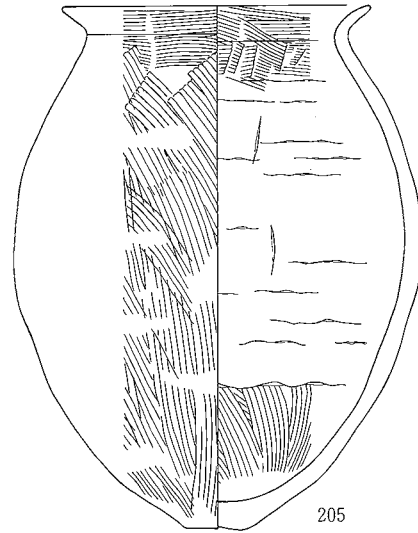
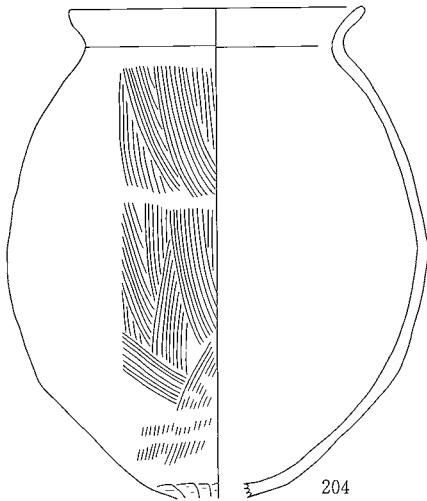
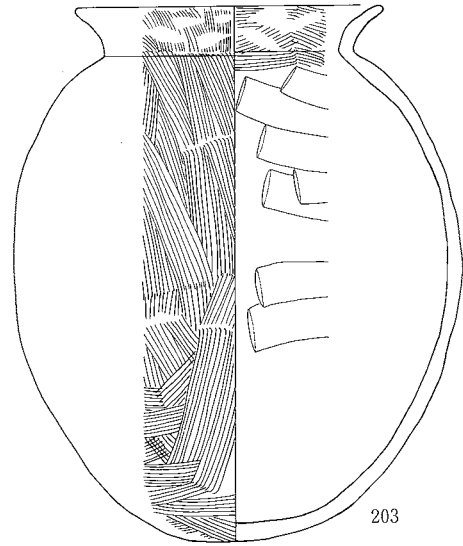
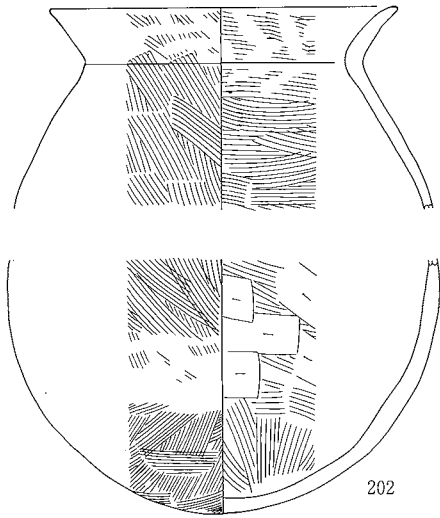

0 (1:4) 10cm

SG3 IV層-④

SG3 IV層一⑩

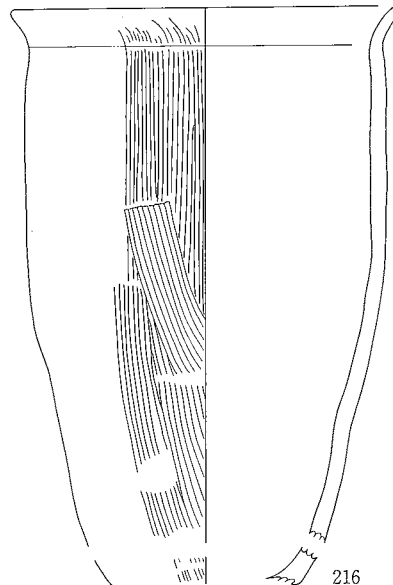
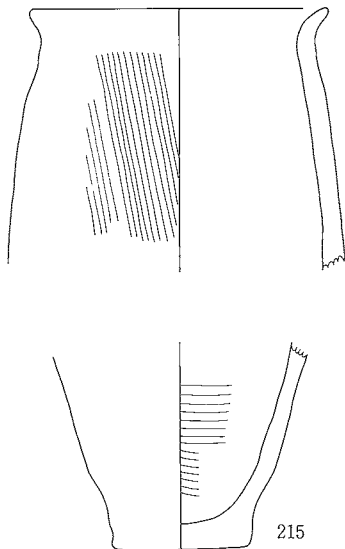
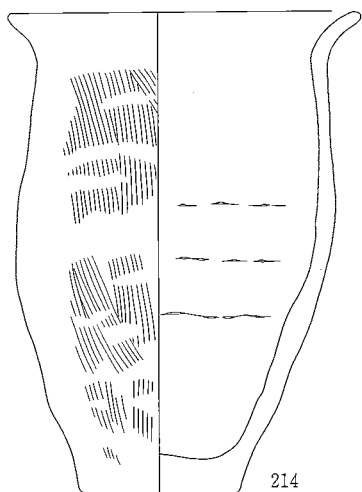
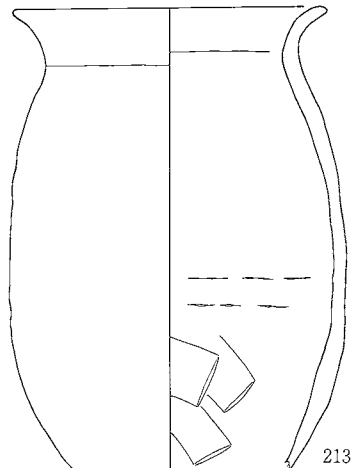
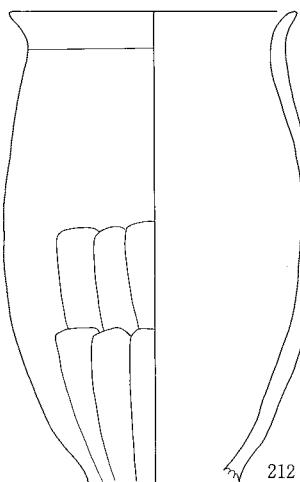
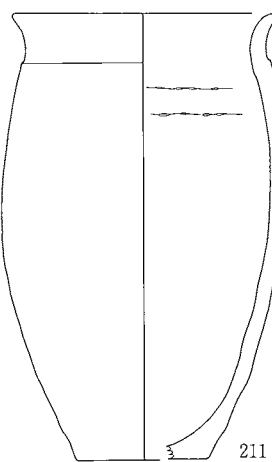
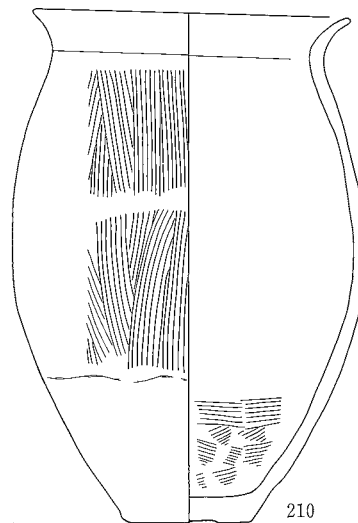
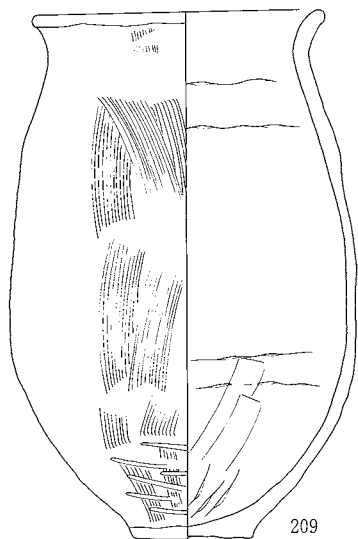
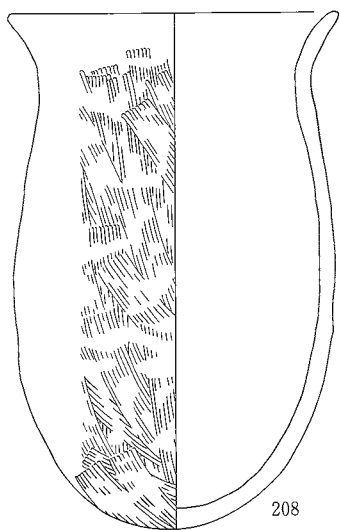

0 (1 : 4) 10cm

SG3 IV層一⑩

SG3 IV層-①

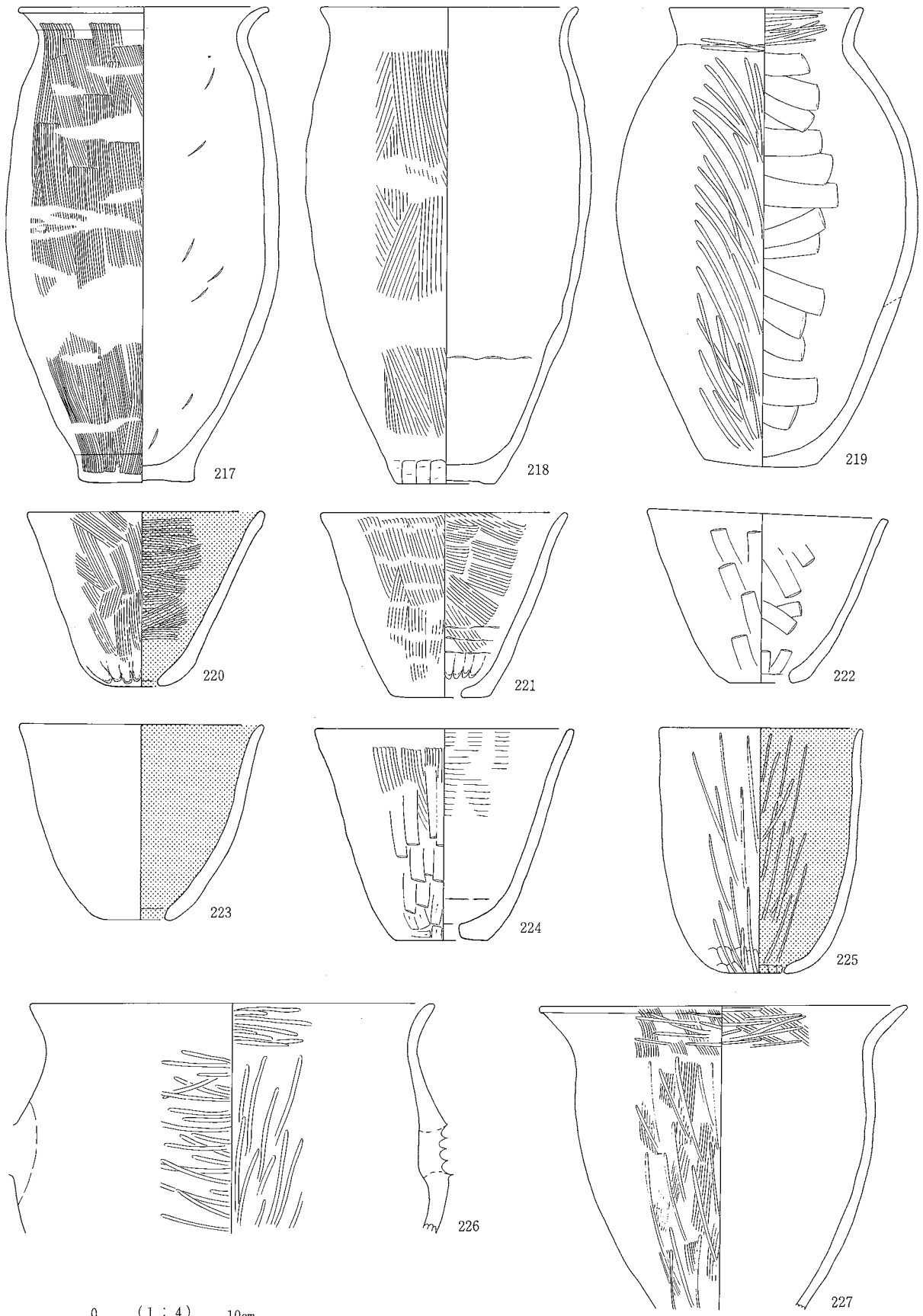

SG3 IV層-①

SG3 IV層-⑫

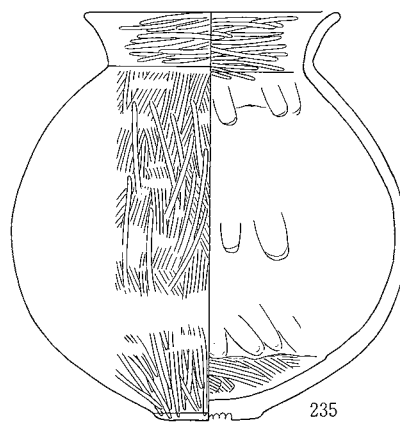
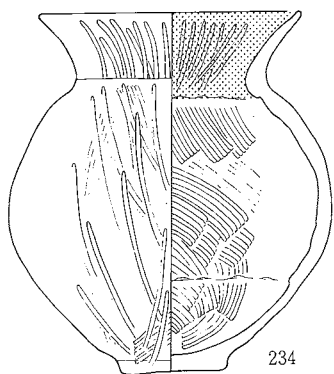
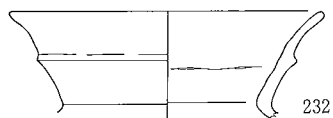
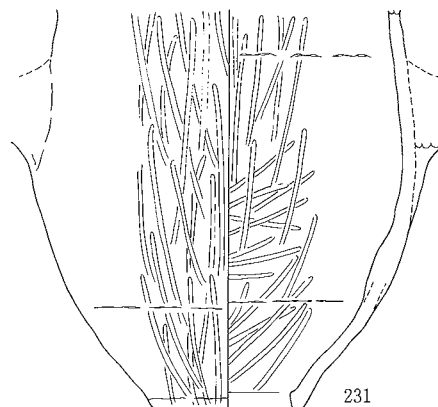
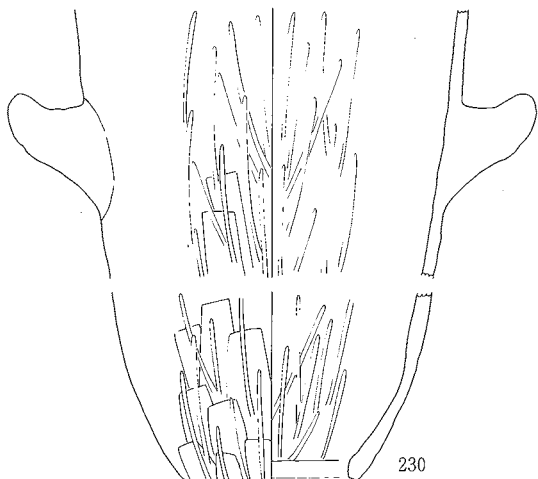
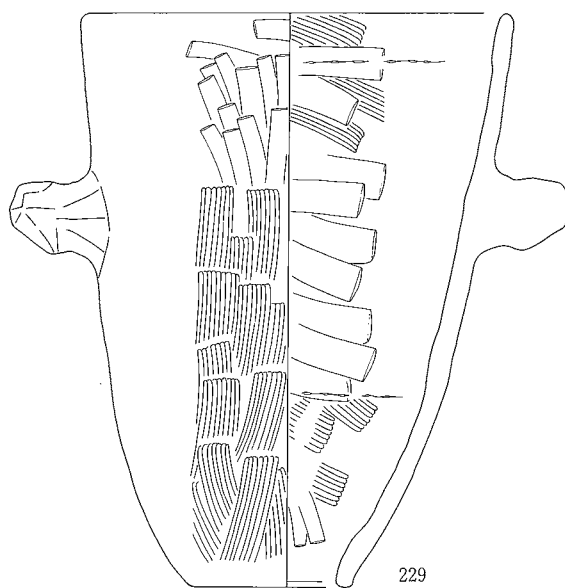
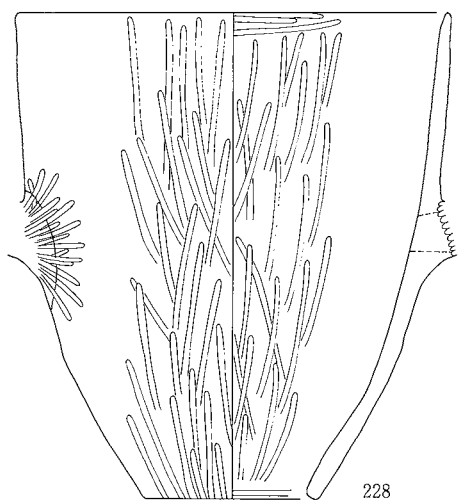

0 (1 : 4) 10cm

SG3 IV層-⑫

SG3 IV層-⑬

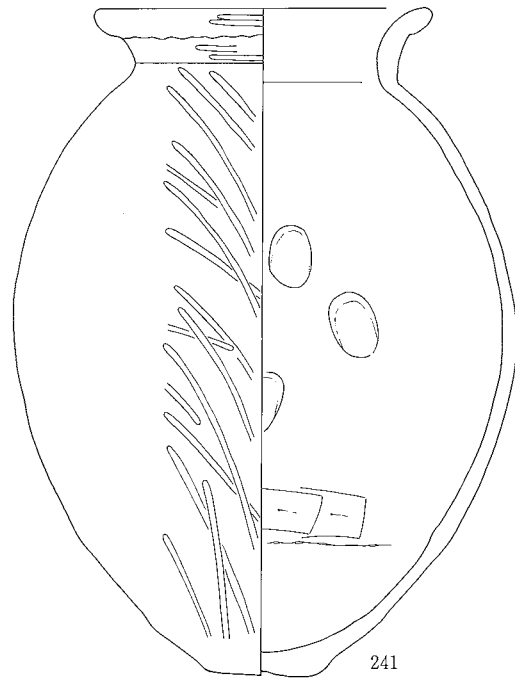
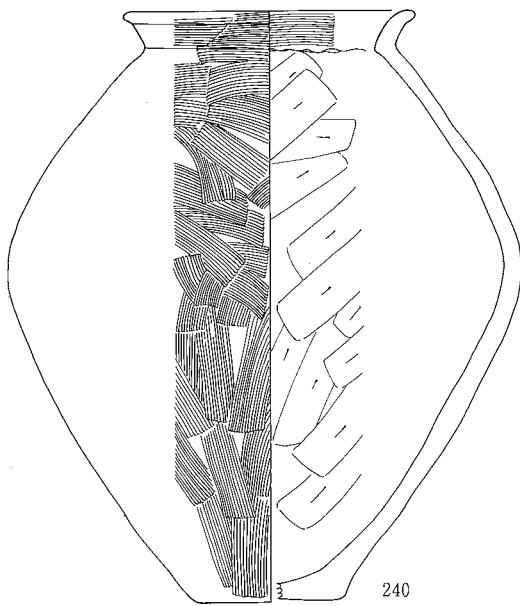
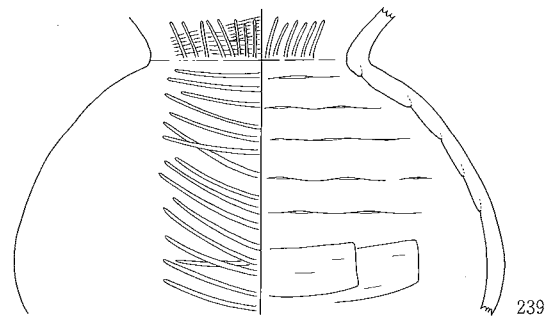
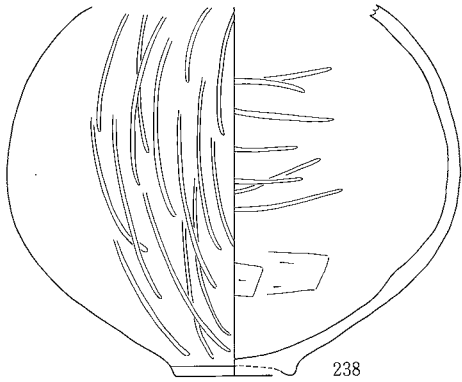
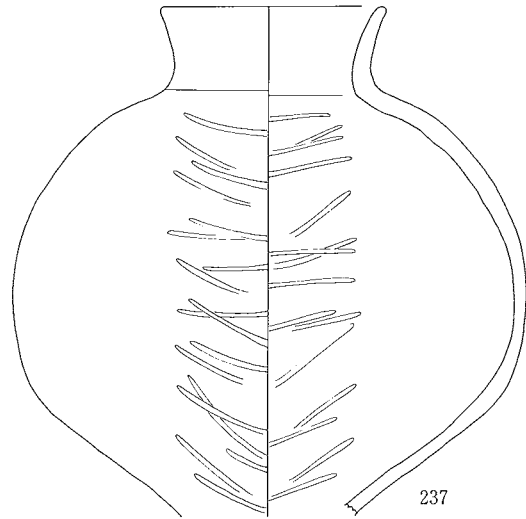
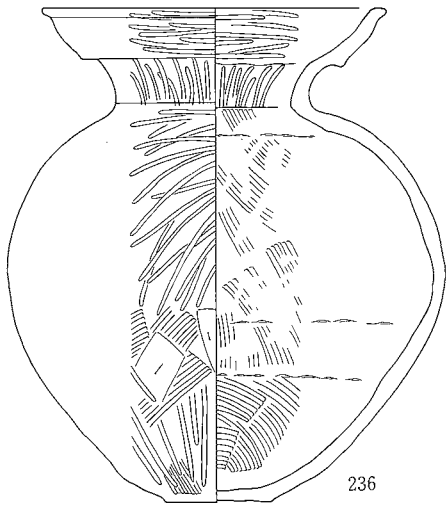

0 (1 : 4) 10cm

SG3 IV層-⑬

SG3 IV層-⑭

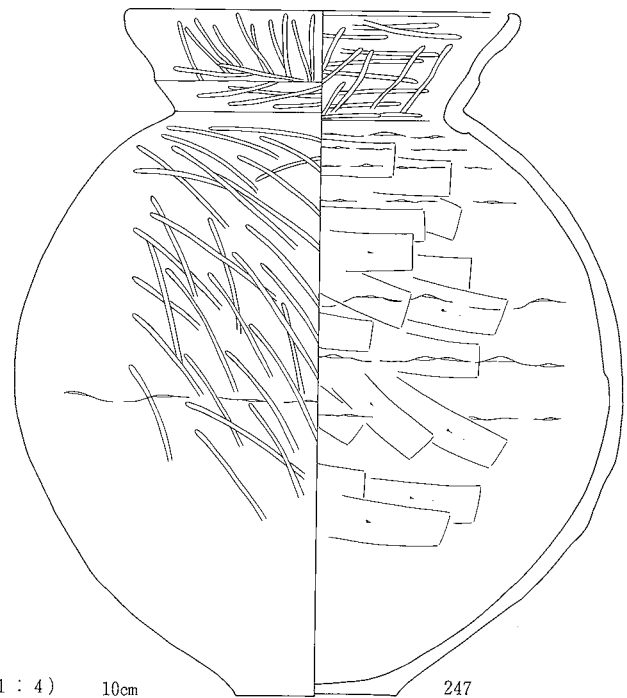
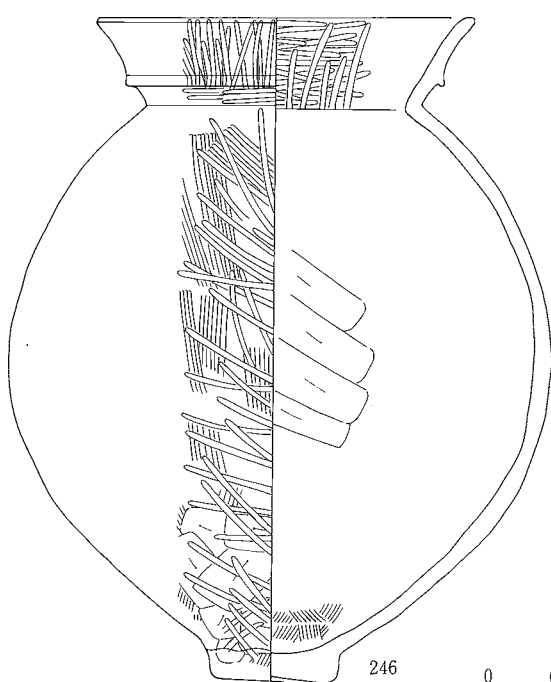
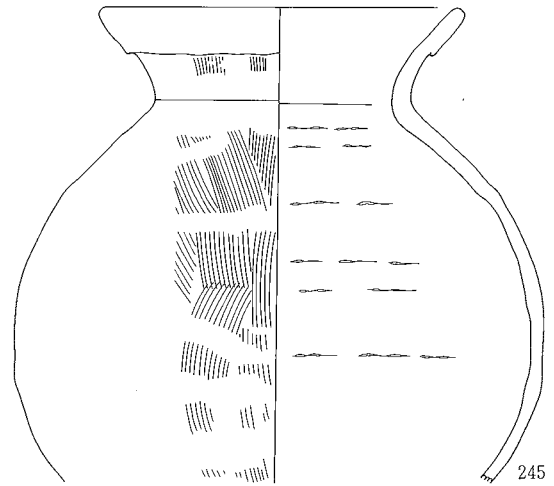
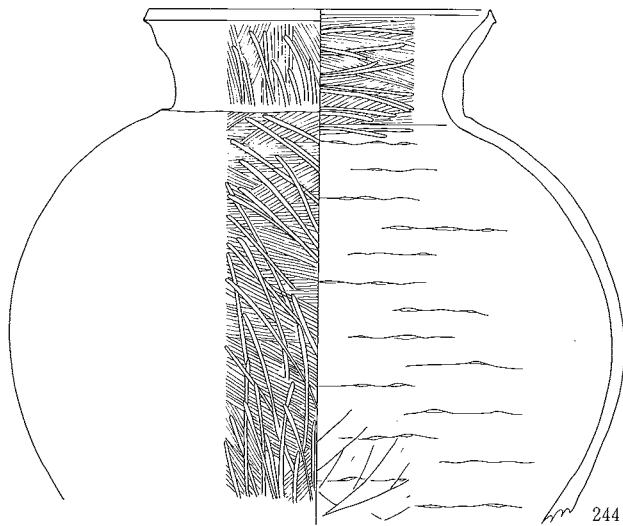
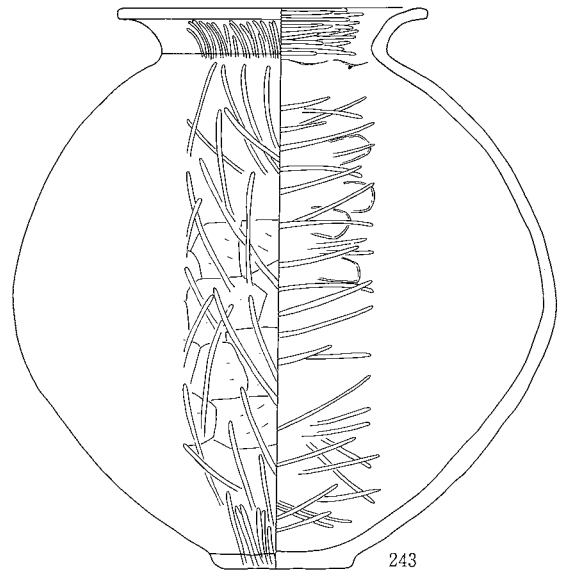
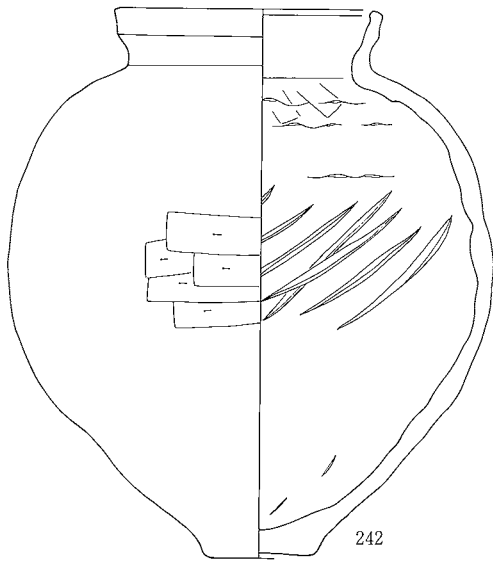

0 (1:4) 10cm

SG3 IV層-⑭

SG3 IV層-⑬

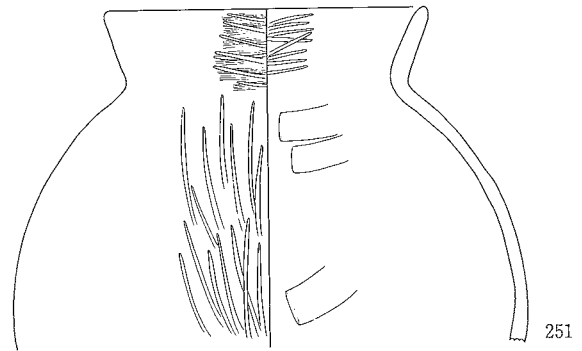
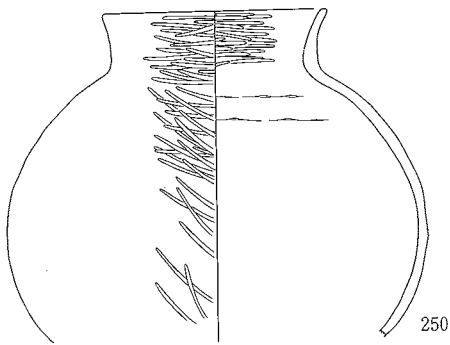
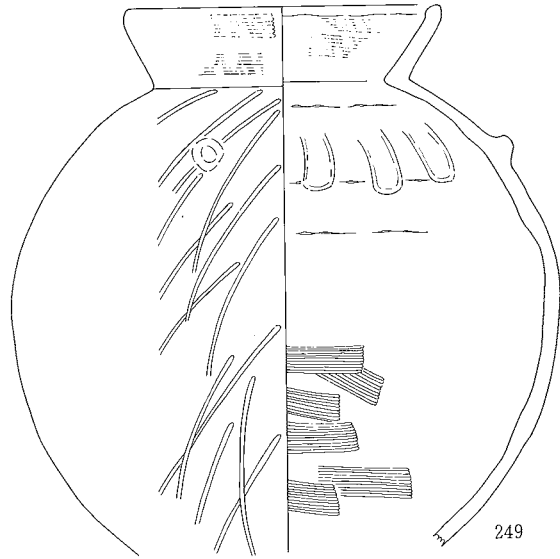
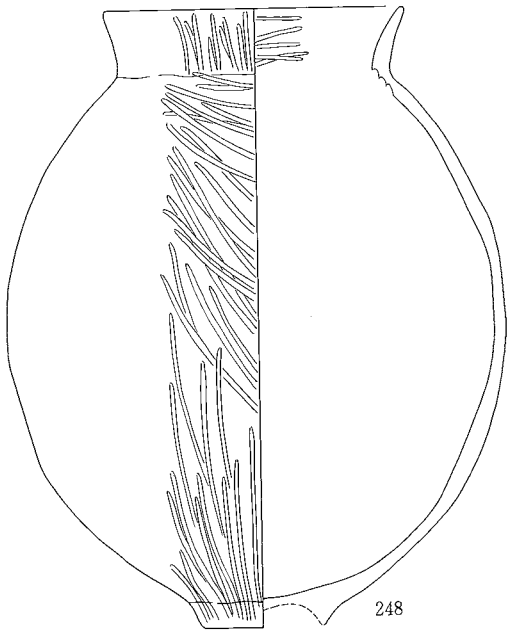

0 (1 : 6) 20cm
(250, 251)

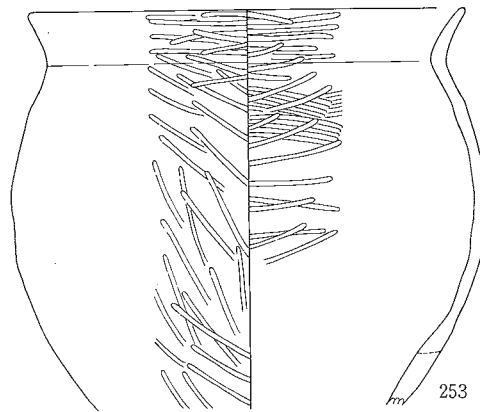
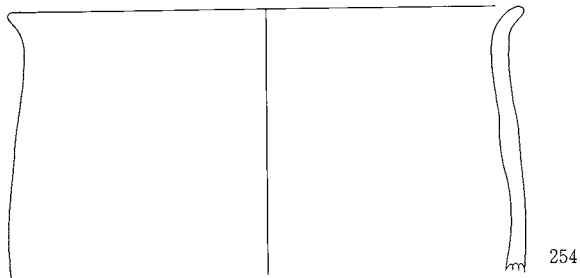
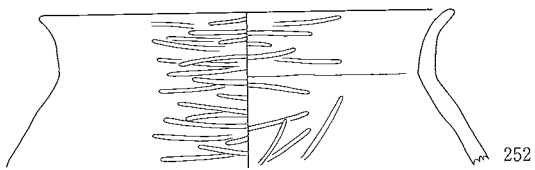

0 (1 : 4) 10cm

SG3 IV層-⑬

SG3 IV層-⑩

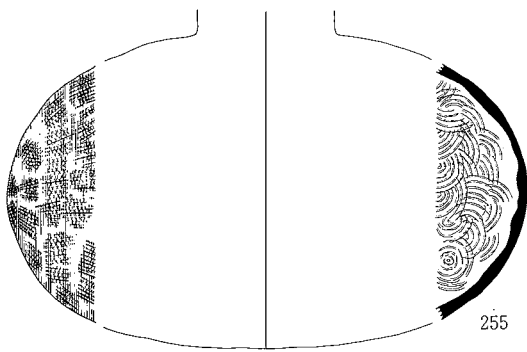

255

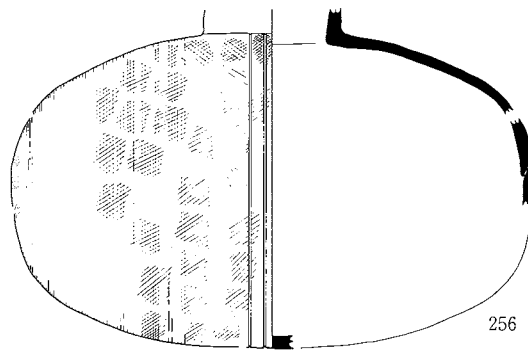

256

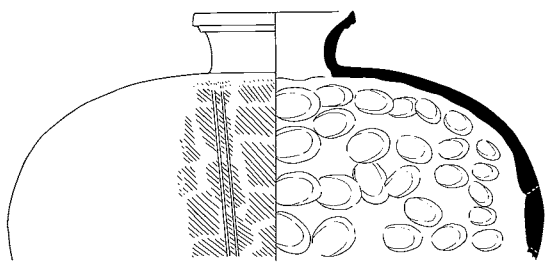

257

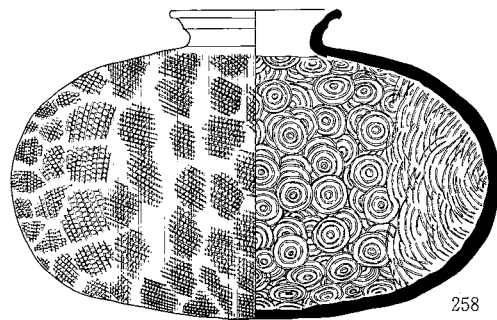

258

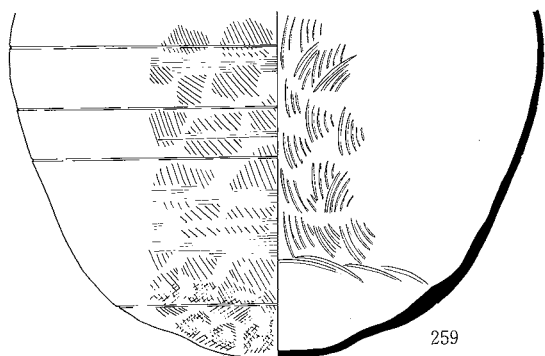

259

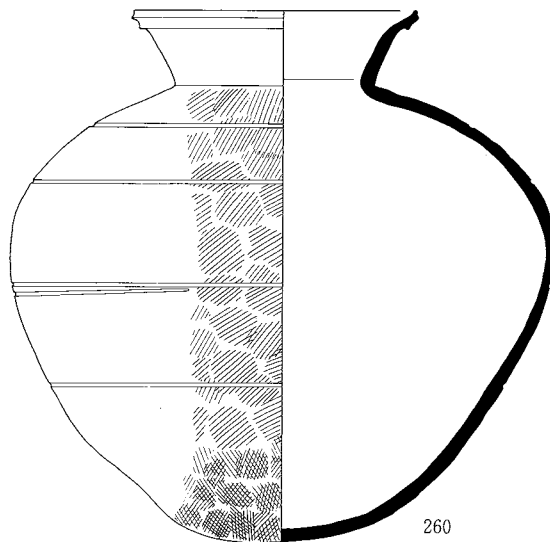

260

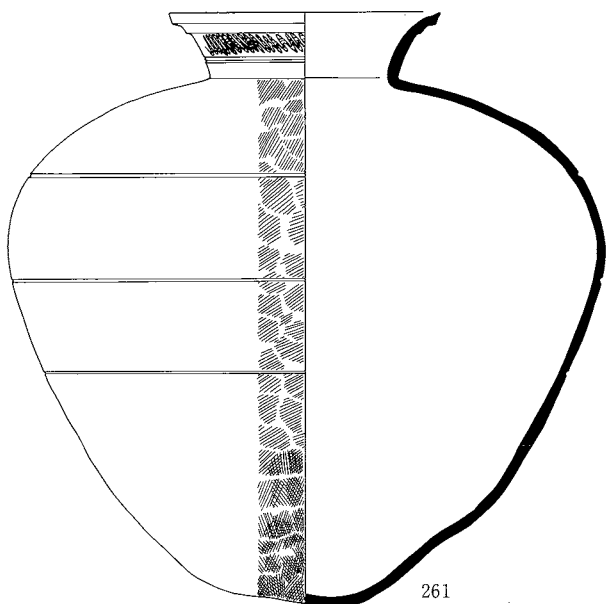

261

0 (1 : 6) 20cm
(255~260)

0 (1 : 8) 20cm
(261)

SG3 IV層-⑩

SG3 V層

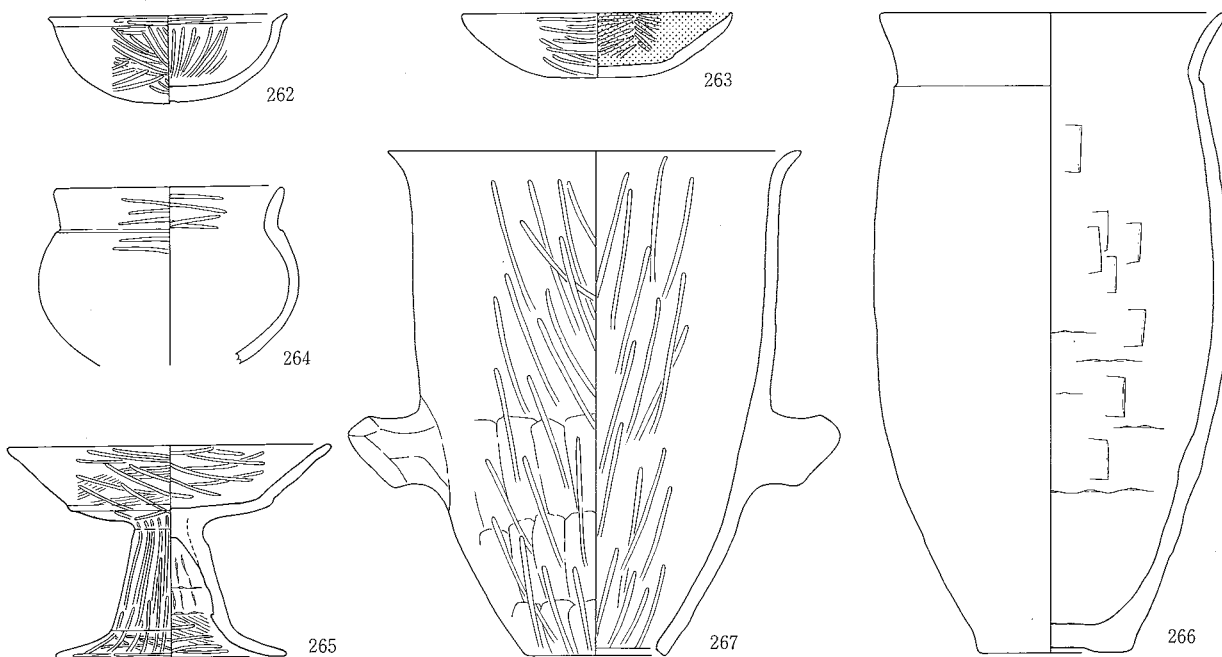

SG3 VI層-①

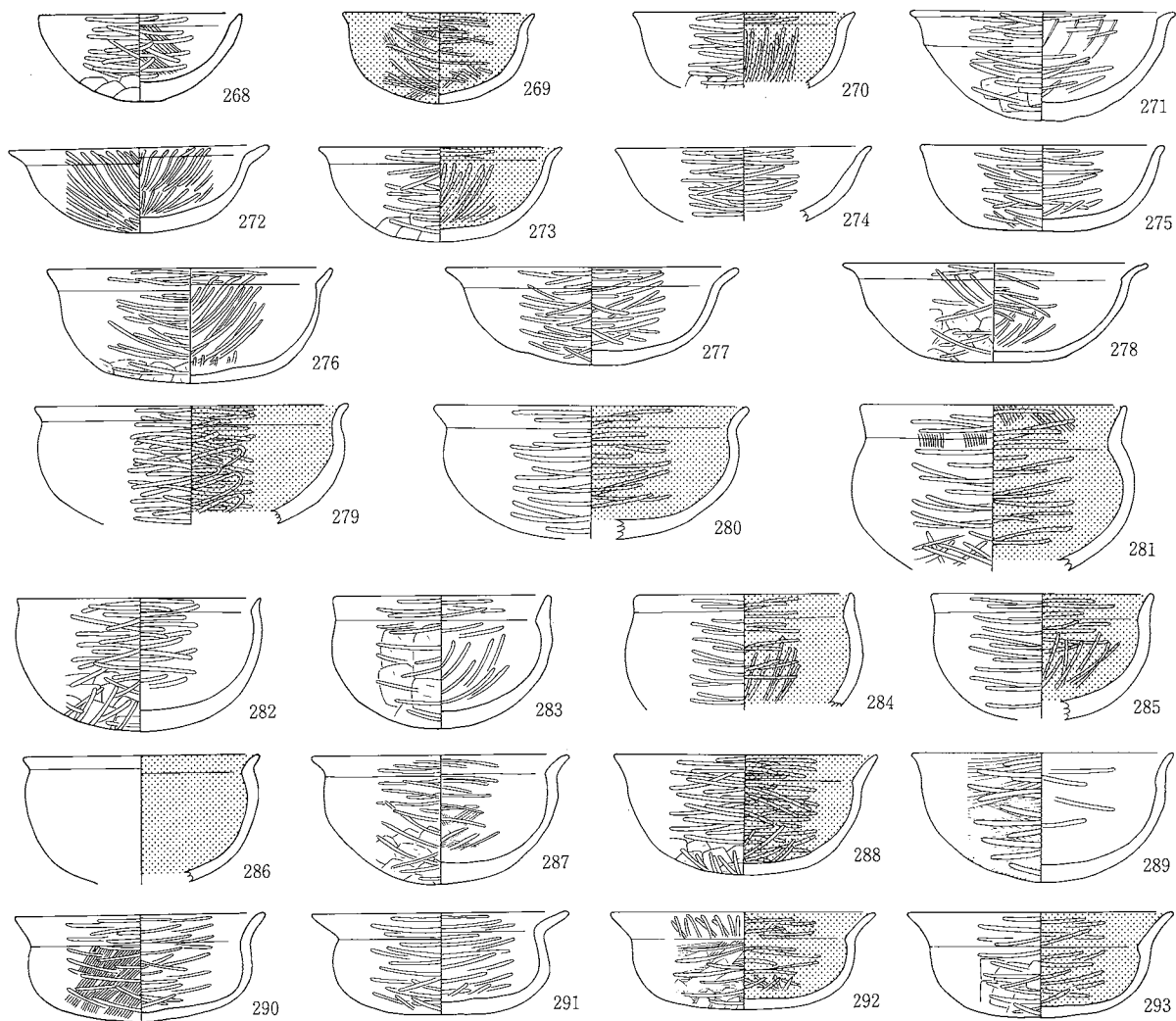

SG3 V層・VI層-①

SG3 VI層-②

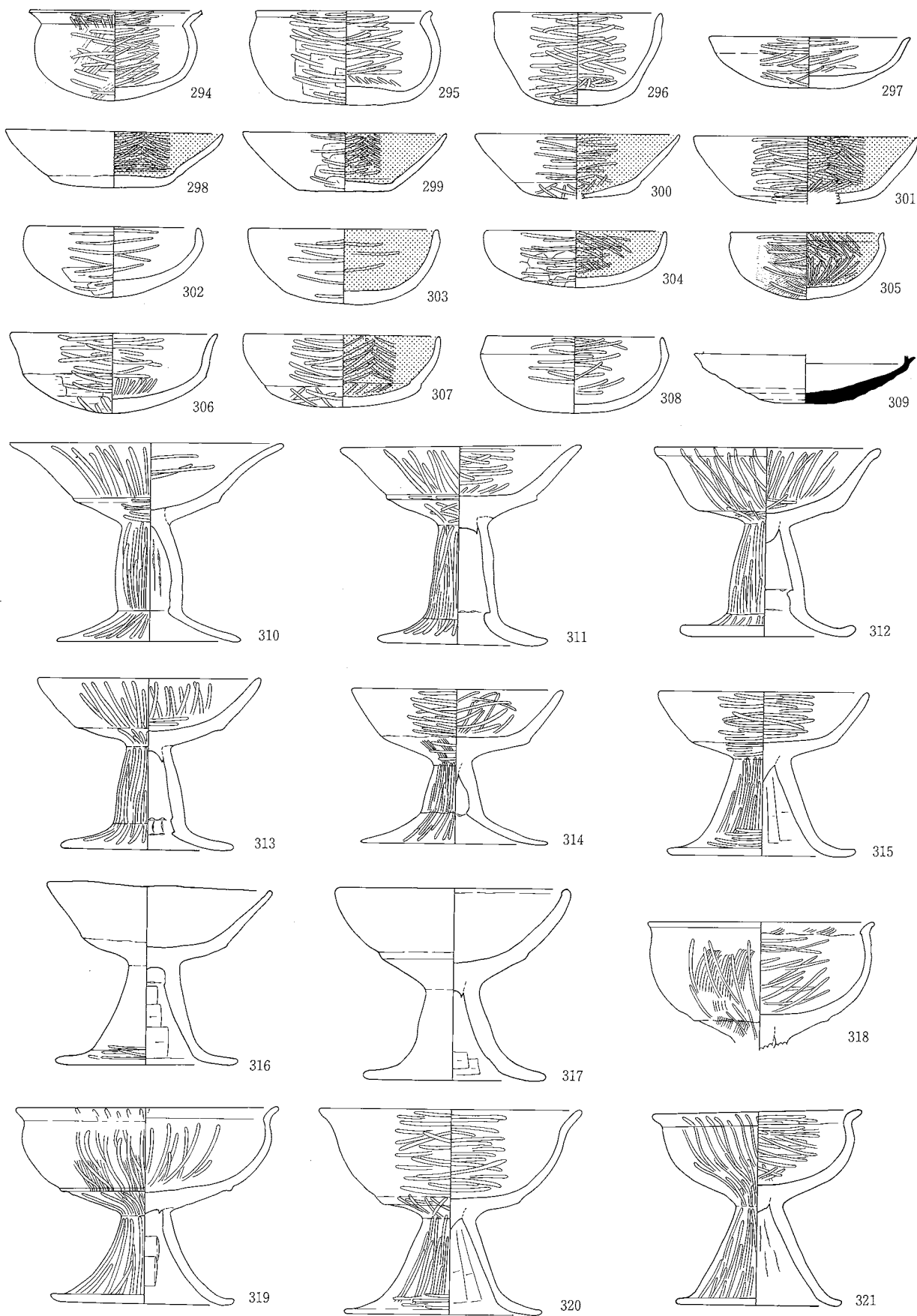

0 (1:4) 10cm

SG3 VI層-③

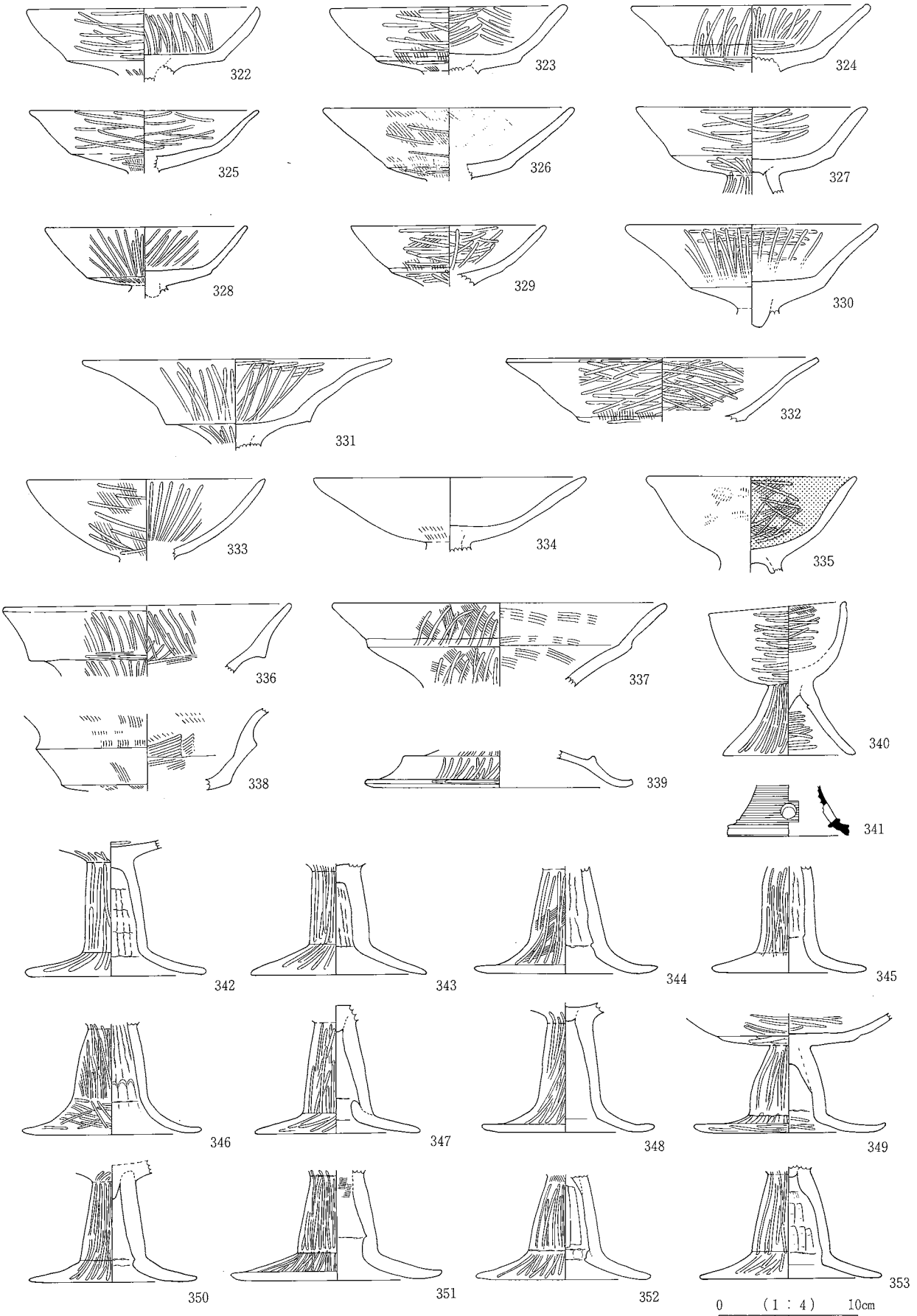

SG3 VI層-③

SG3 VI層-④

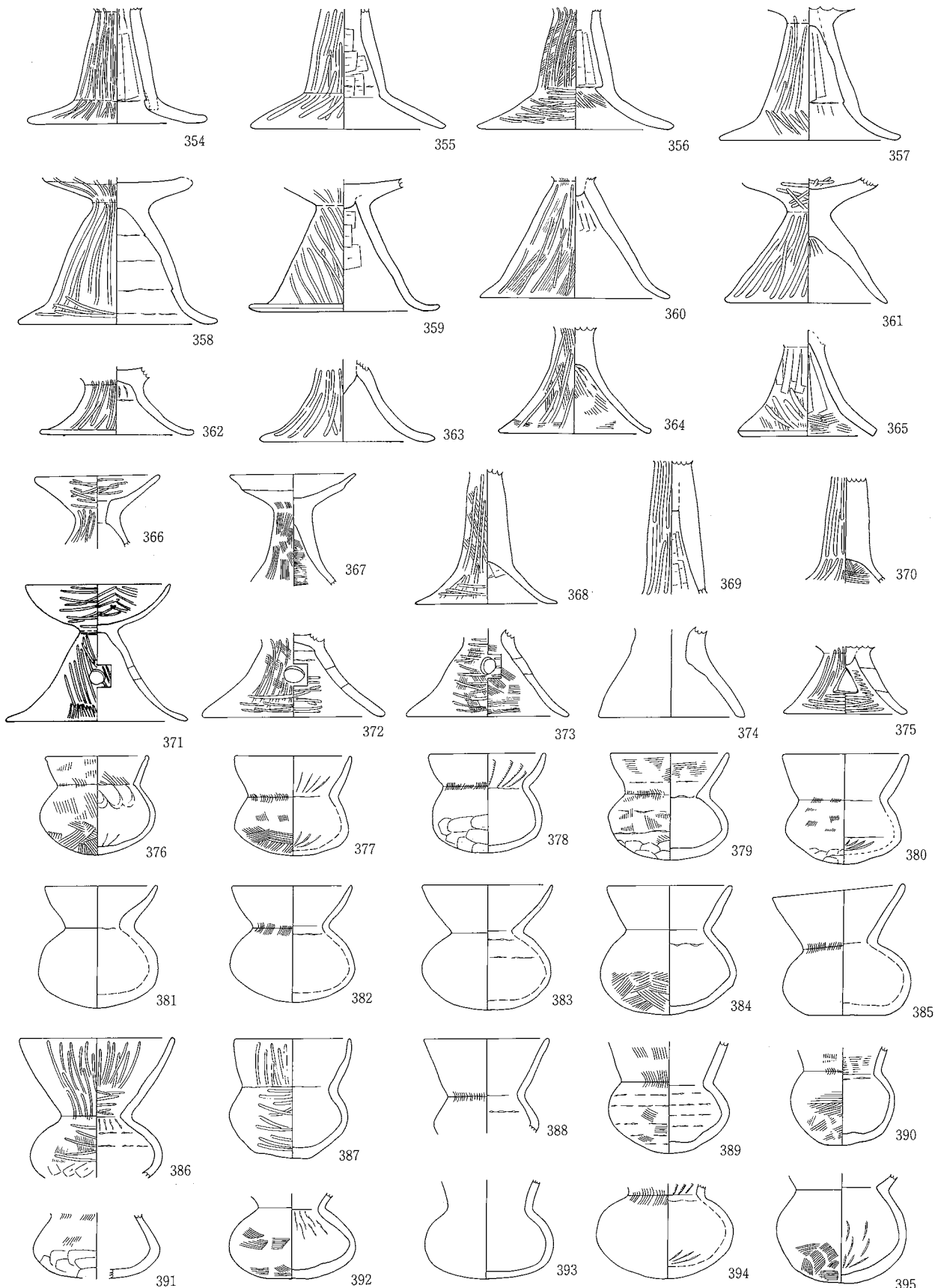

0 (1:4) 10cm

SG3 VI層-④

SG3 VI層-⑤

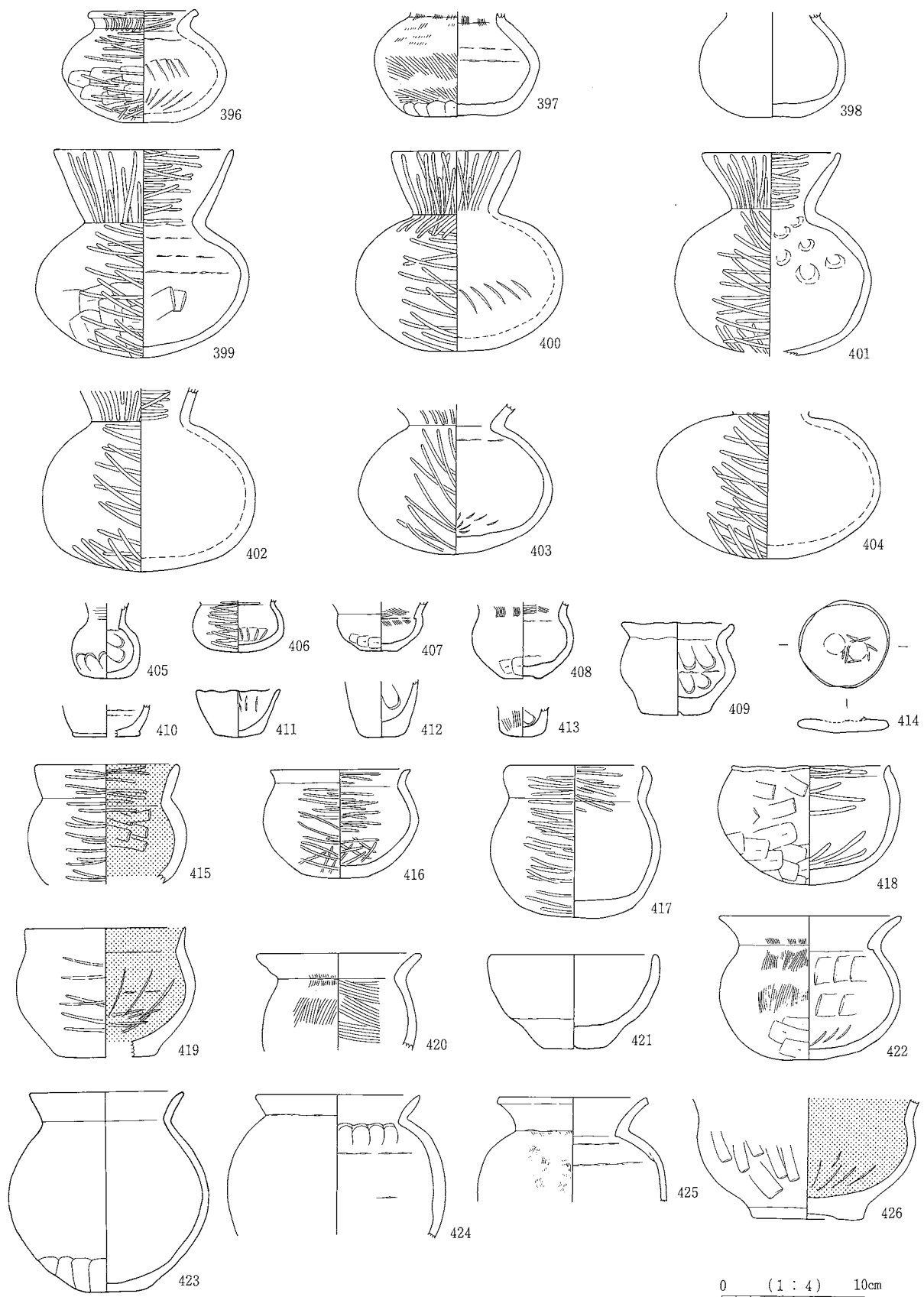

SG3 VI層一⑥

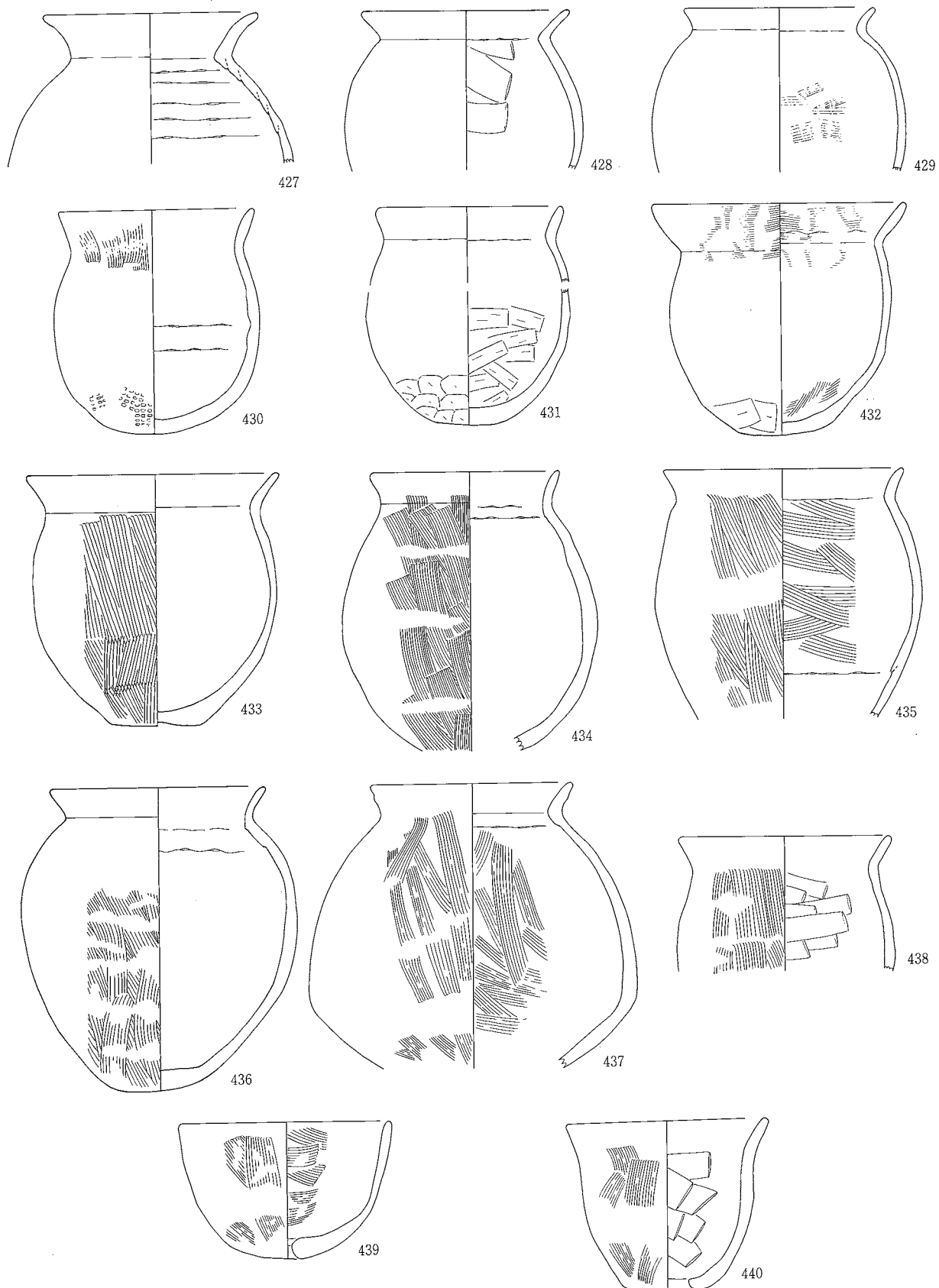

0 (1 : 4) 10cm

SG3 VI層一⑥

SG3 VI層-①

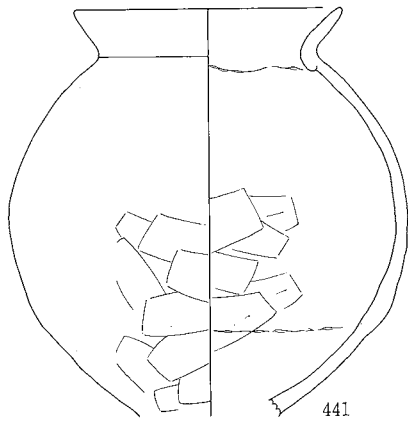

441

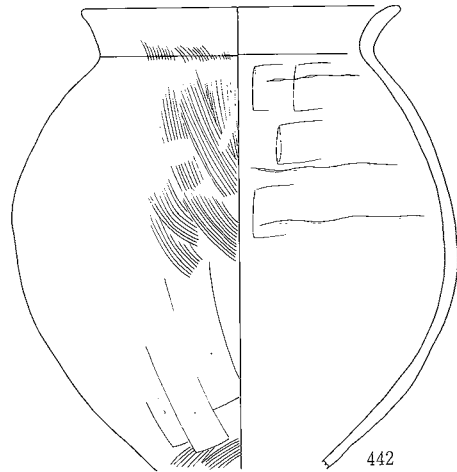

442

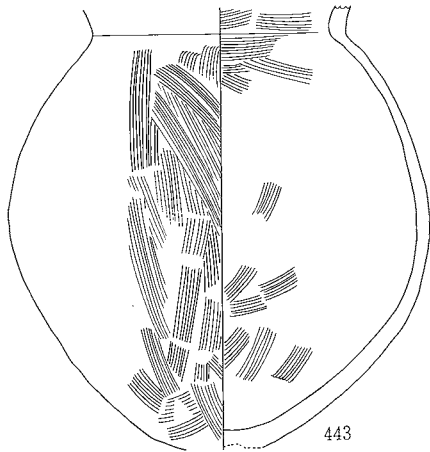

443

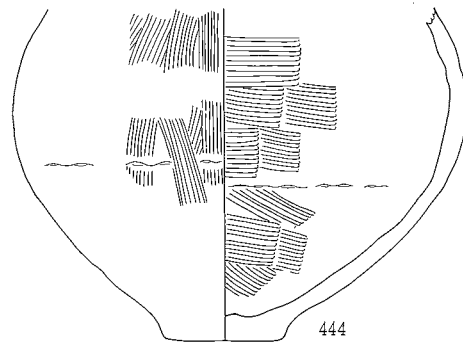

444

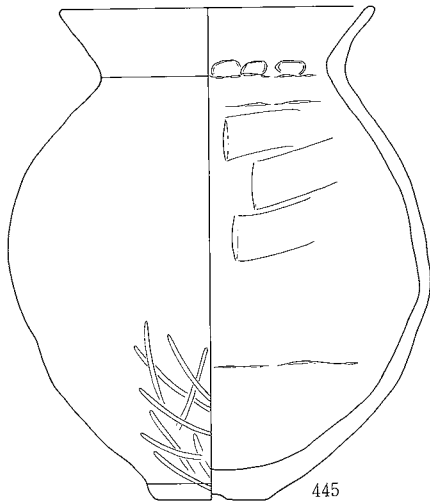

445

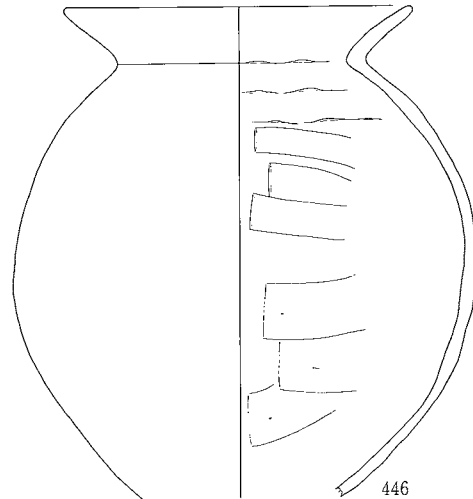

446

0 (1:4) 10cm

SG3 VI層-⑦

SG3 VI層-⑧

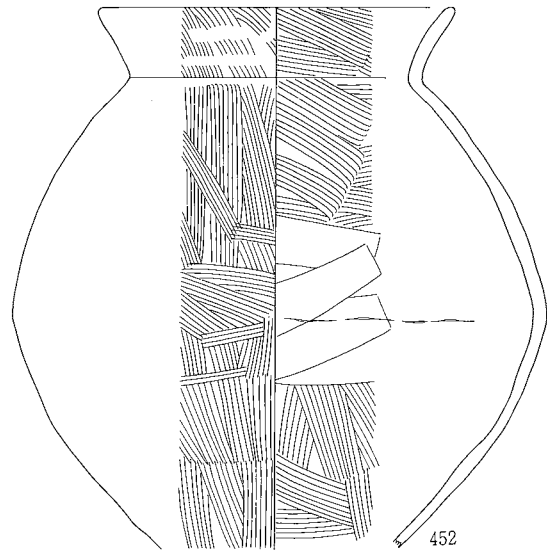
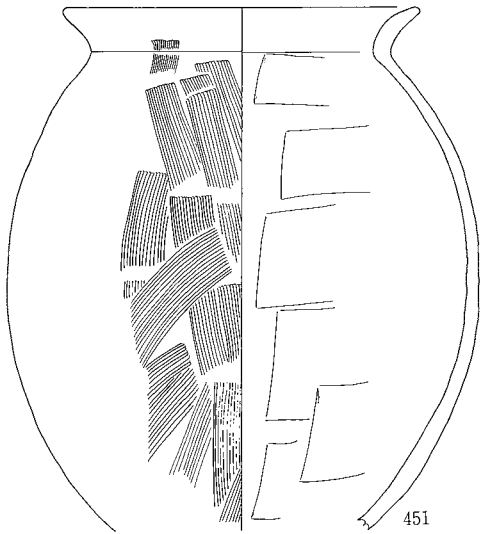
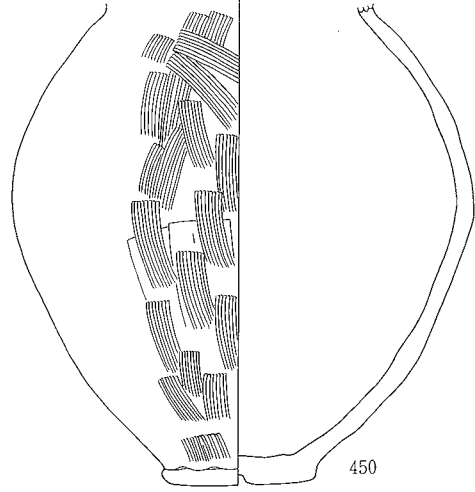
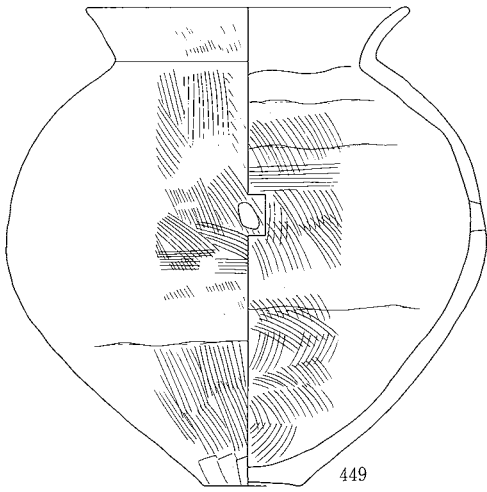
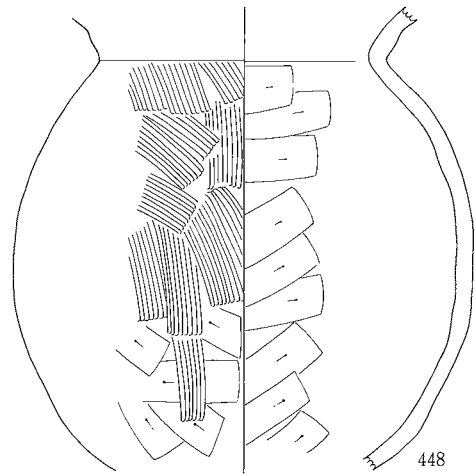
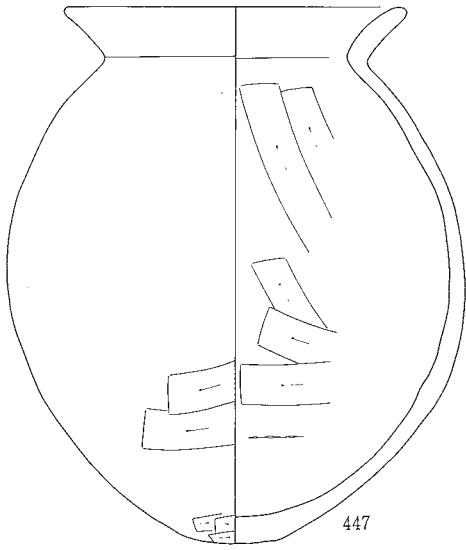

0 (1:4) 10cm

SG3 VI層-⑧

SG3 VI層-⑨

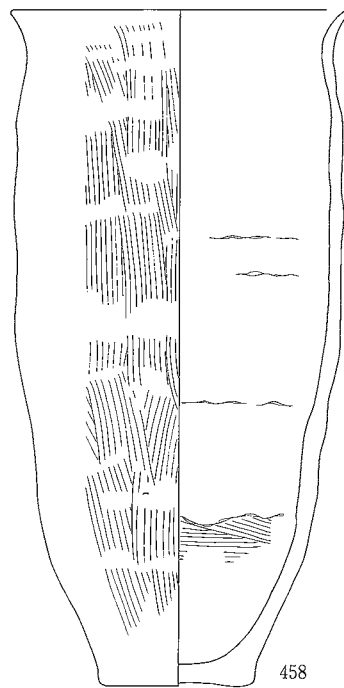
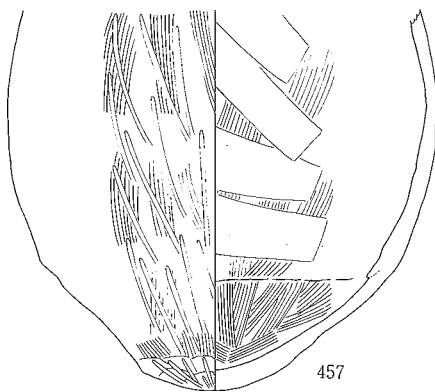
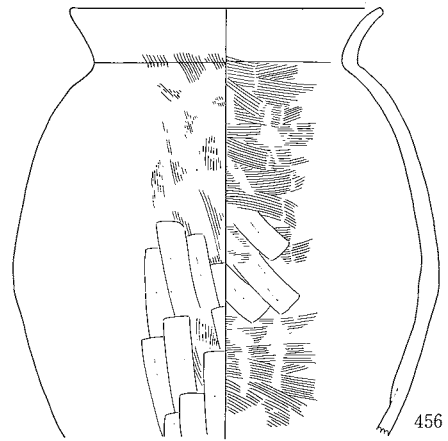
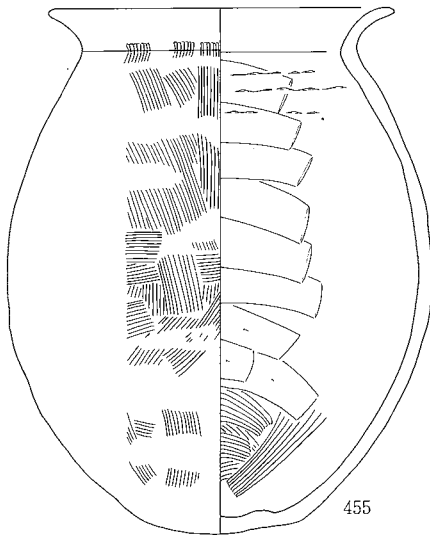
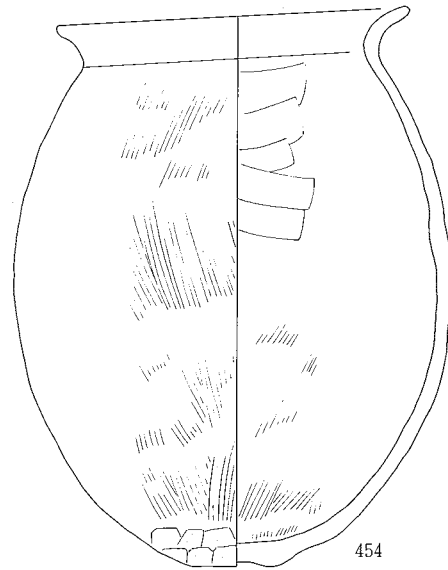
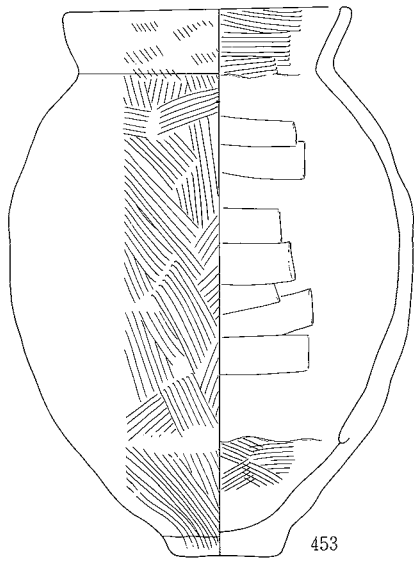

0 (1 : 4) 10cm

SG3 VI層-⑨

SG3 VI層-⑩

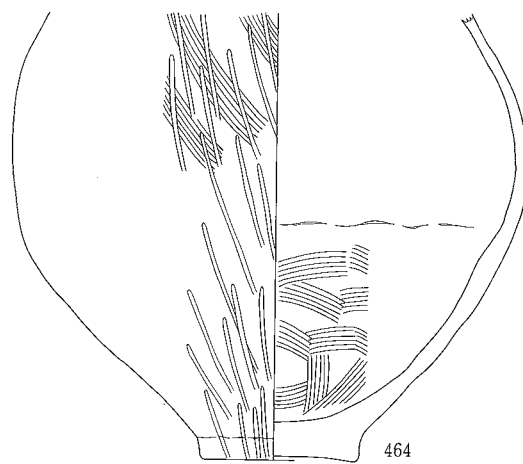
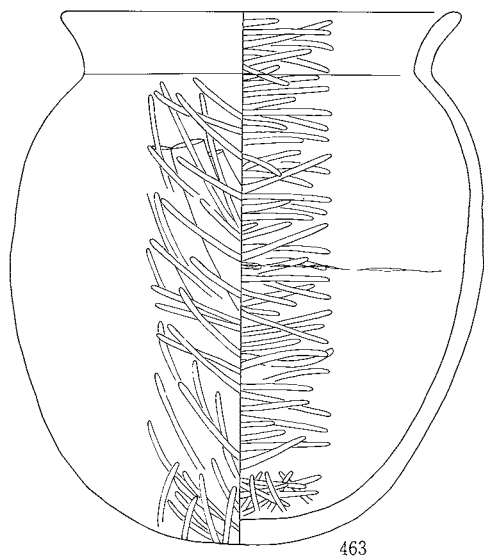
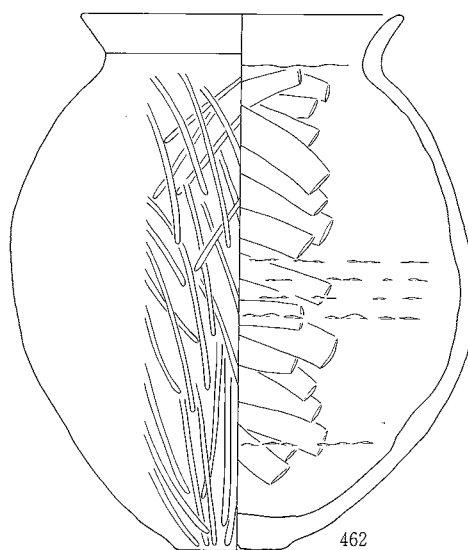
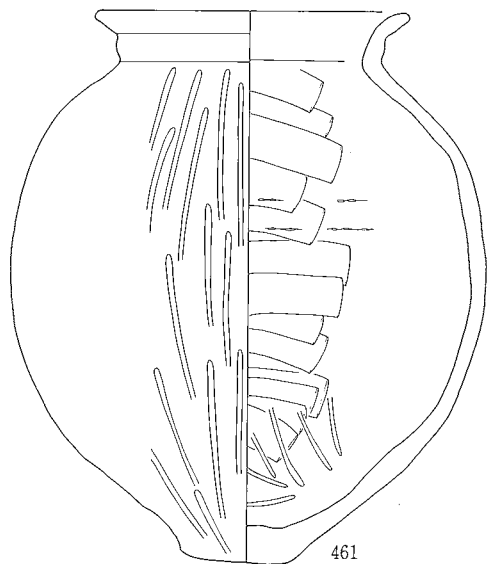
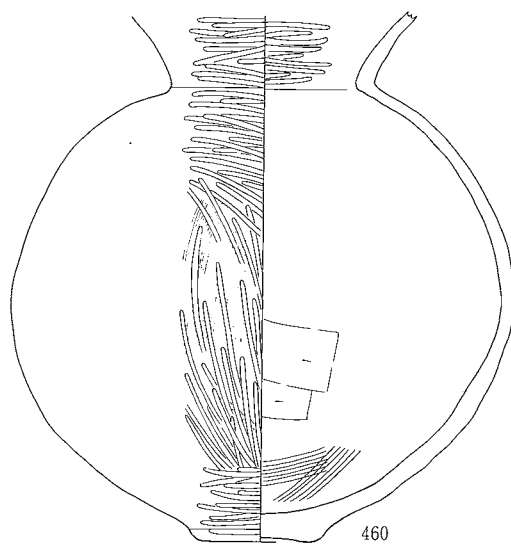
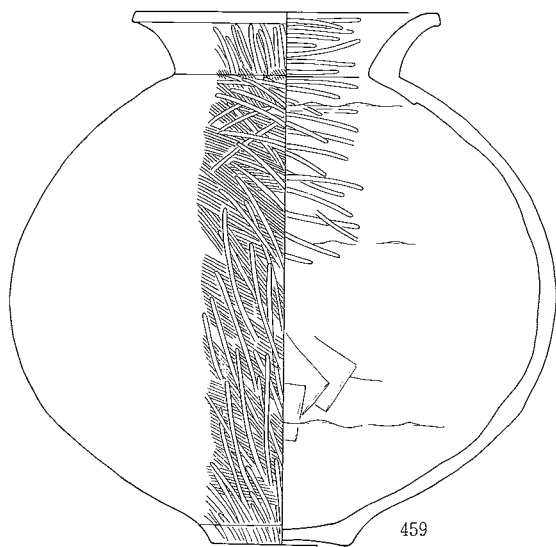

0 (1 : 4) 10cm

SG3 VI層-⑩

SG3 VI層-①

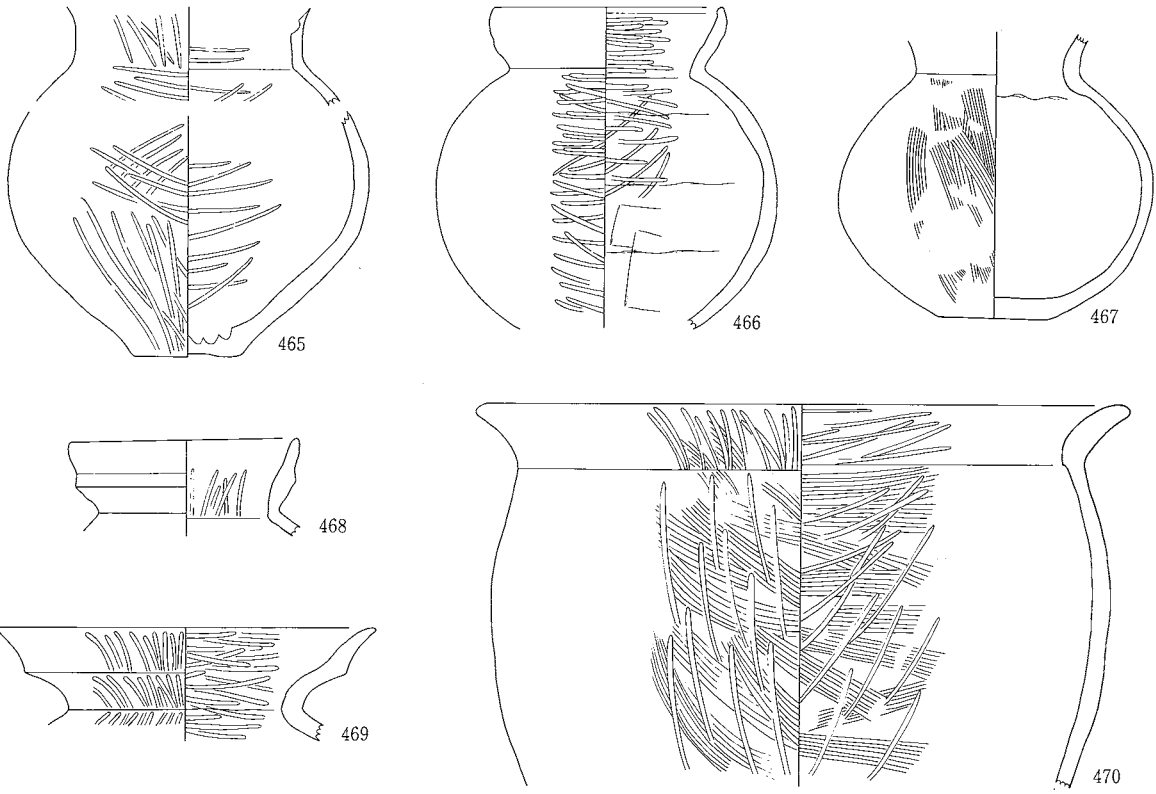

SG3 VII層

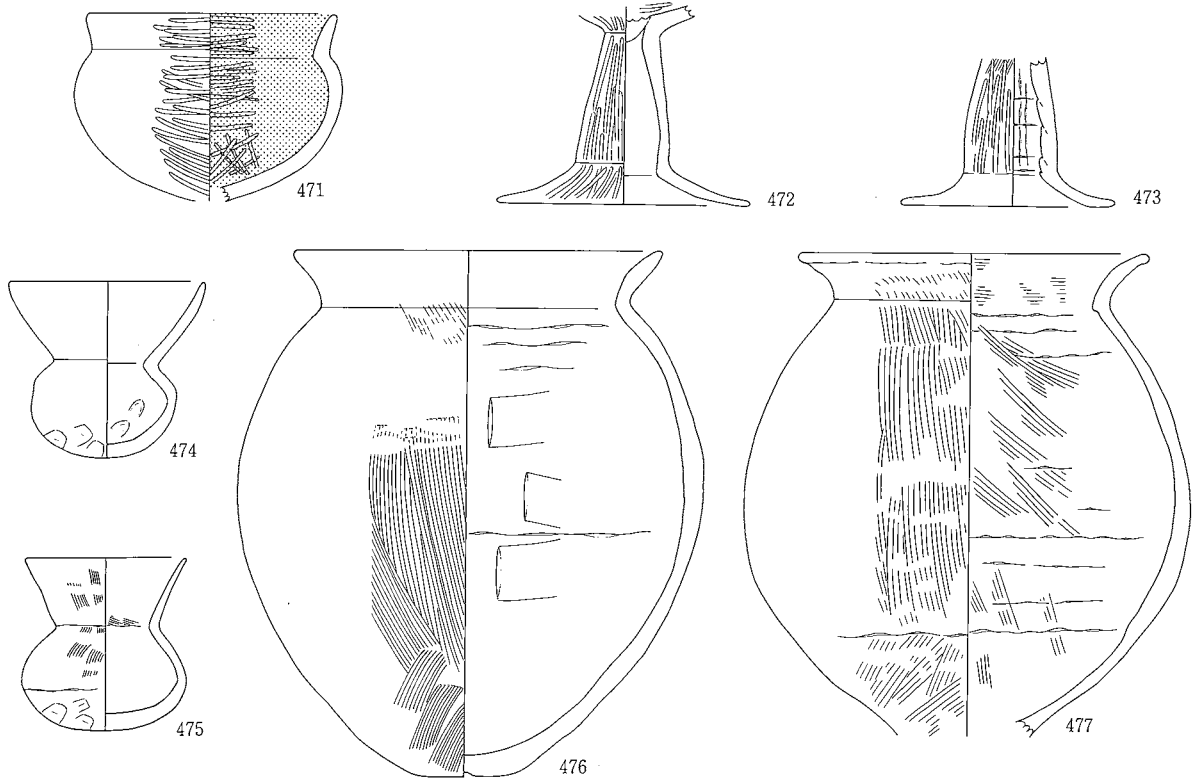

0 (1:4) 10cm

SG3 VIII層-①

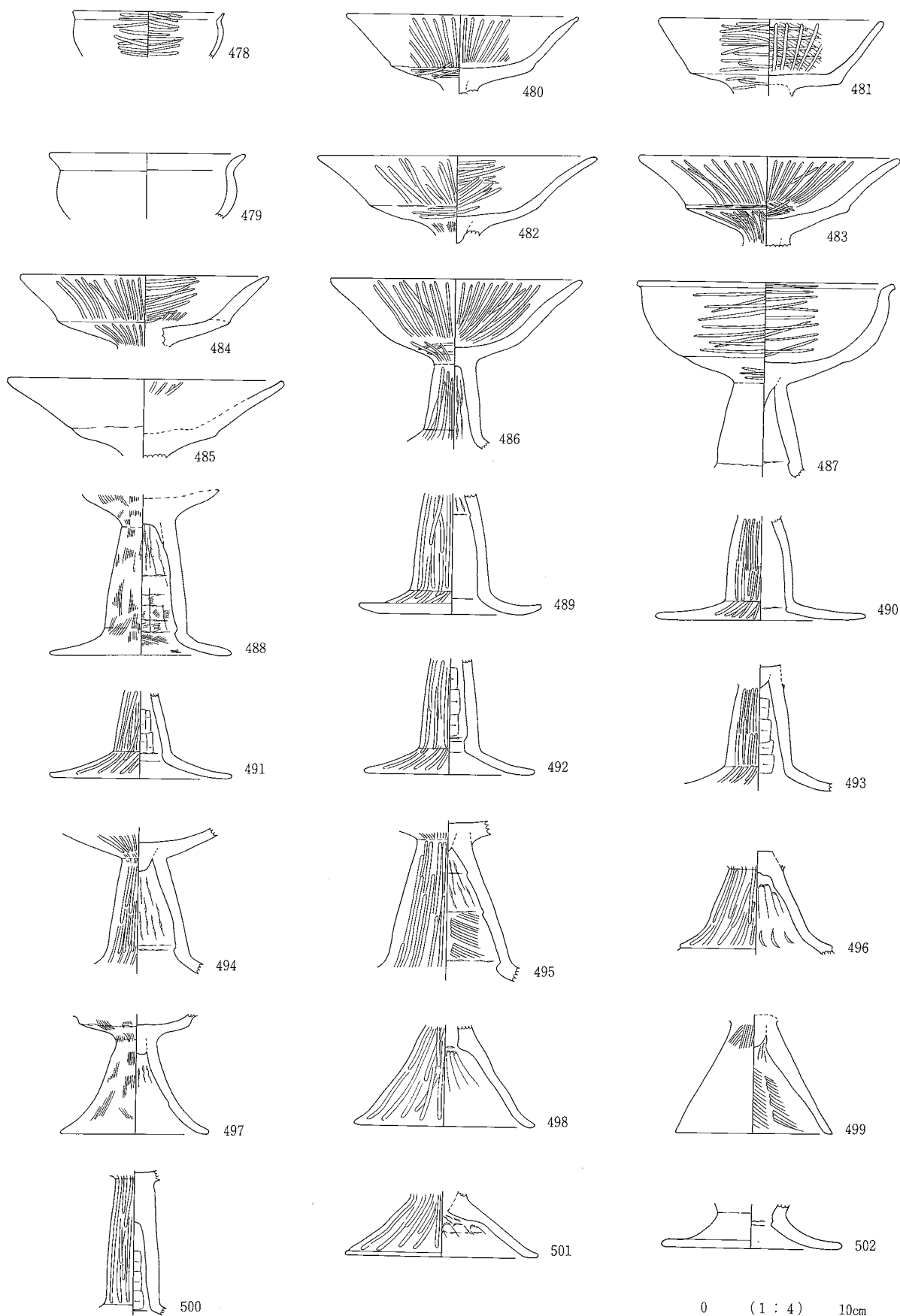

SG3 VIII層-①

SG3 VIII層-②

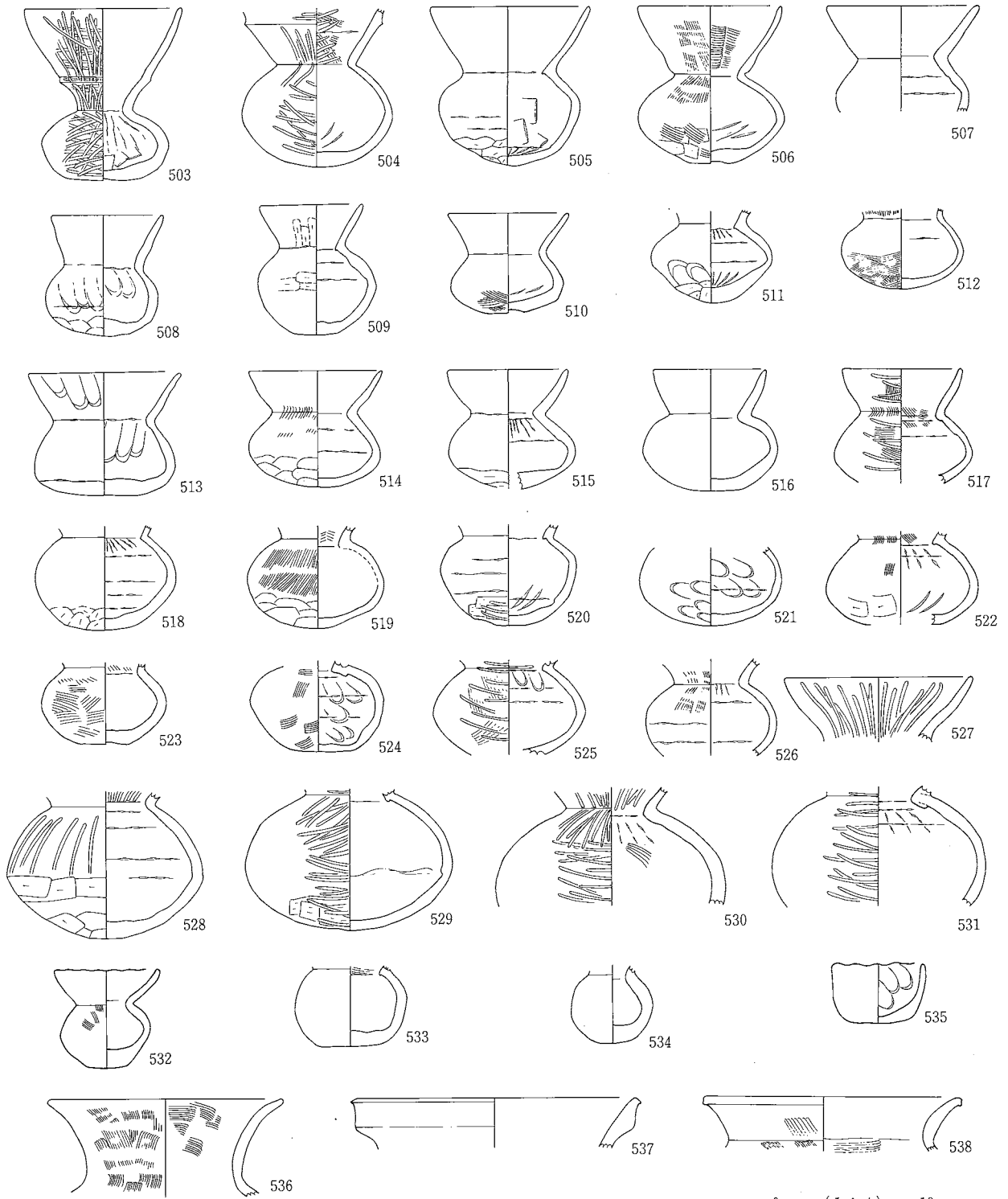

SG3 VIII層-②

SG3 Ⅷ層-③

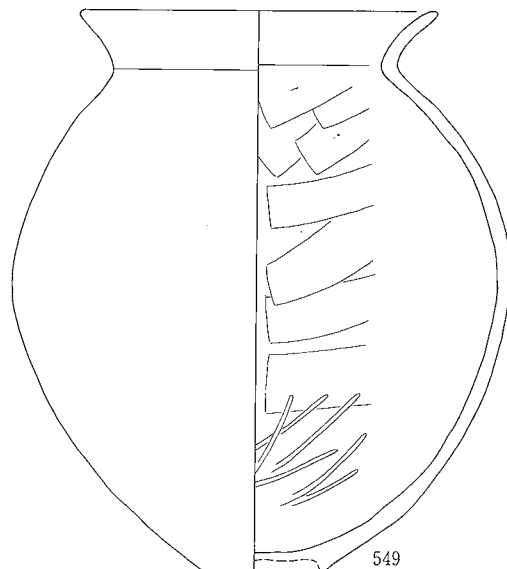
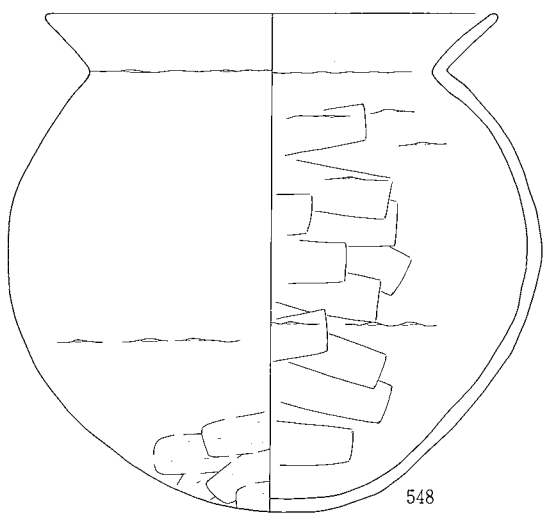
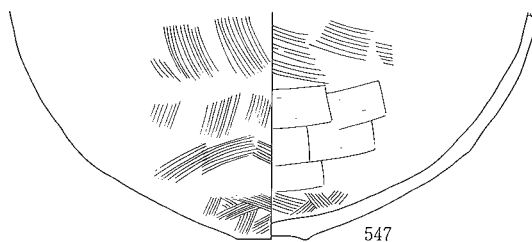
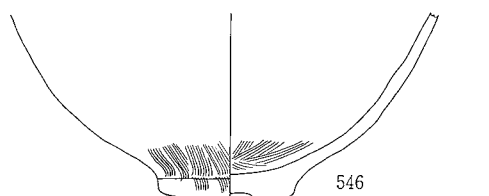
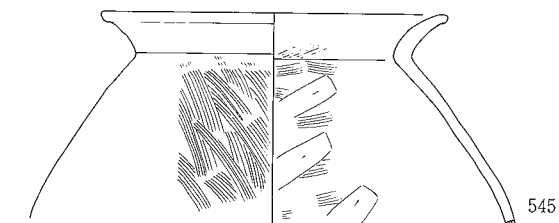
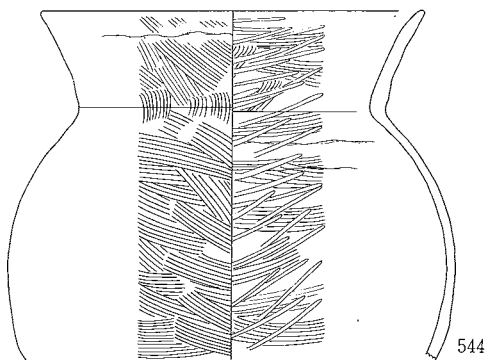
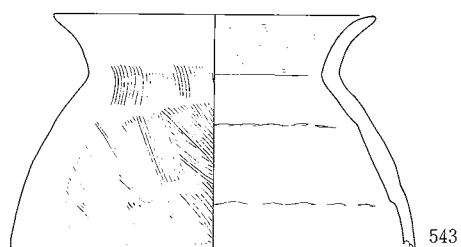
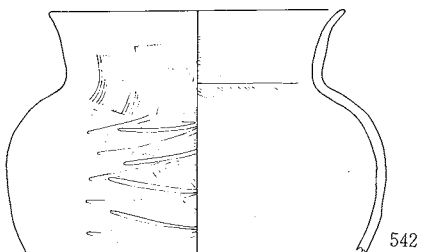
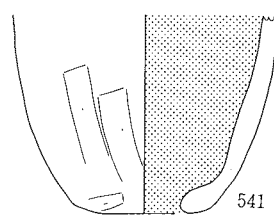
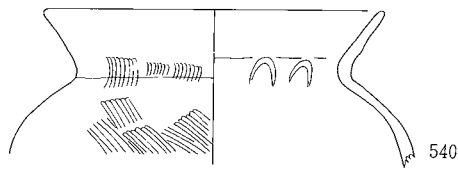
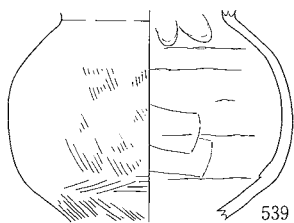

0 (1:4) 10cm

SG3 Ⅷ層-③

SG3 X層

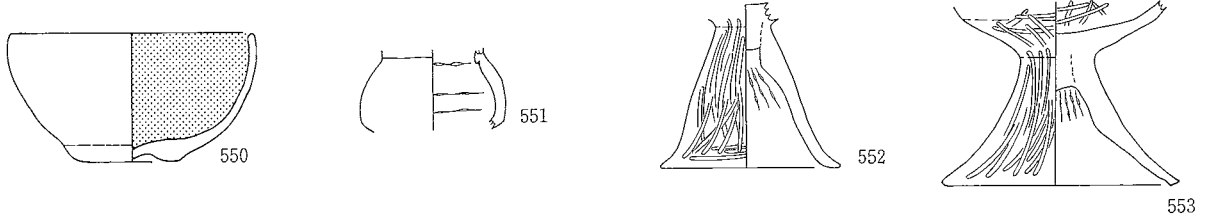

SG3 XII層

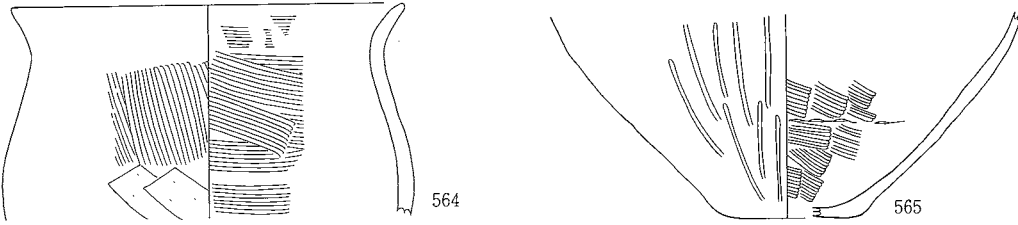
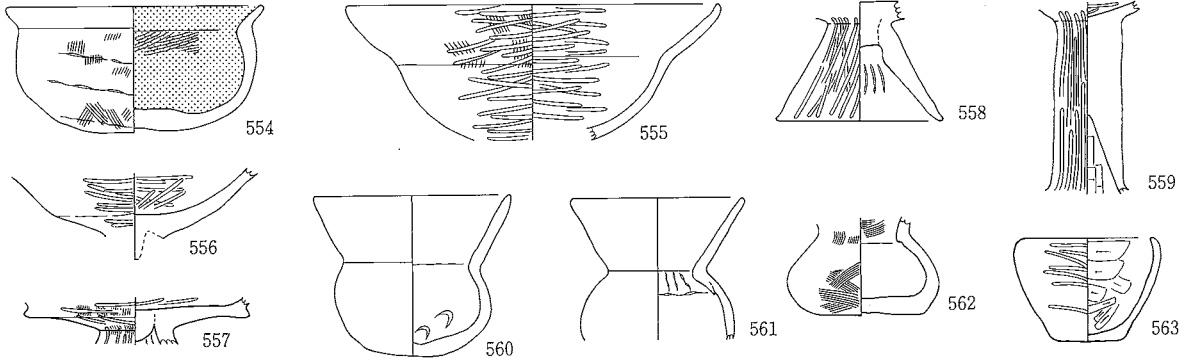

SG3 XV層

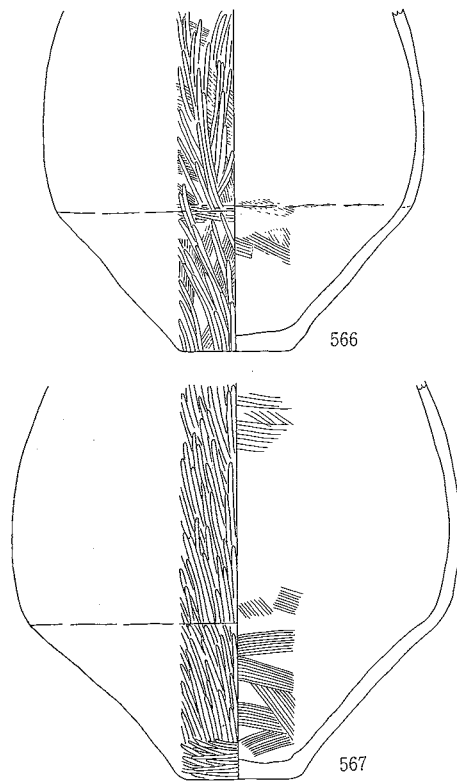

SG3 XVI層

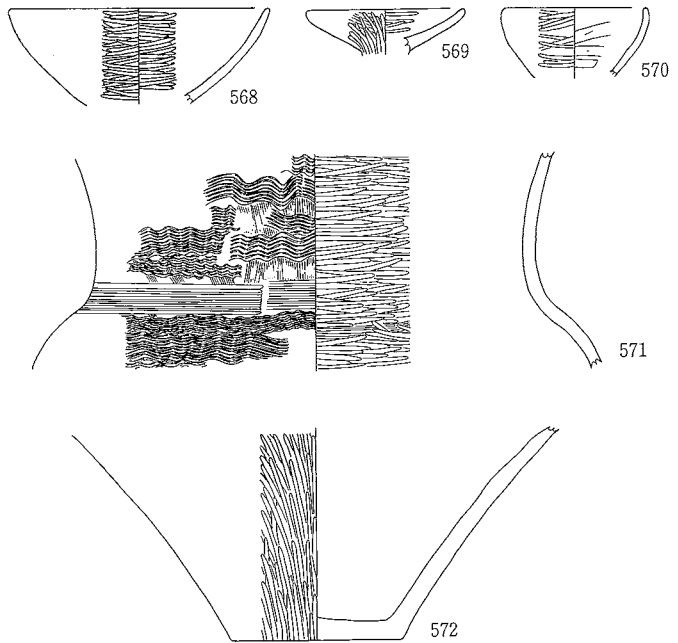

0 (1:4) 10cm

SG3 層位不明

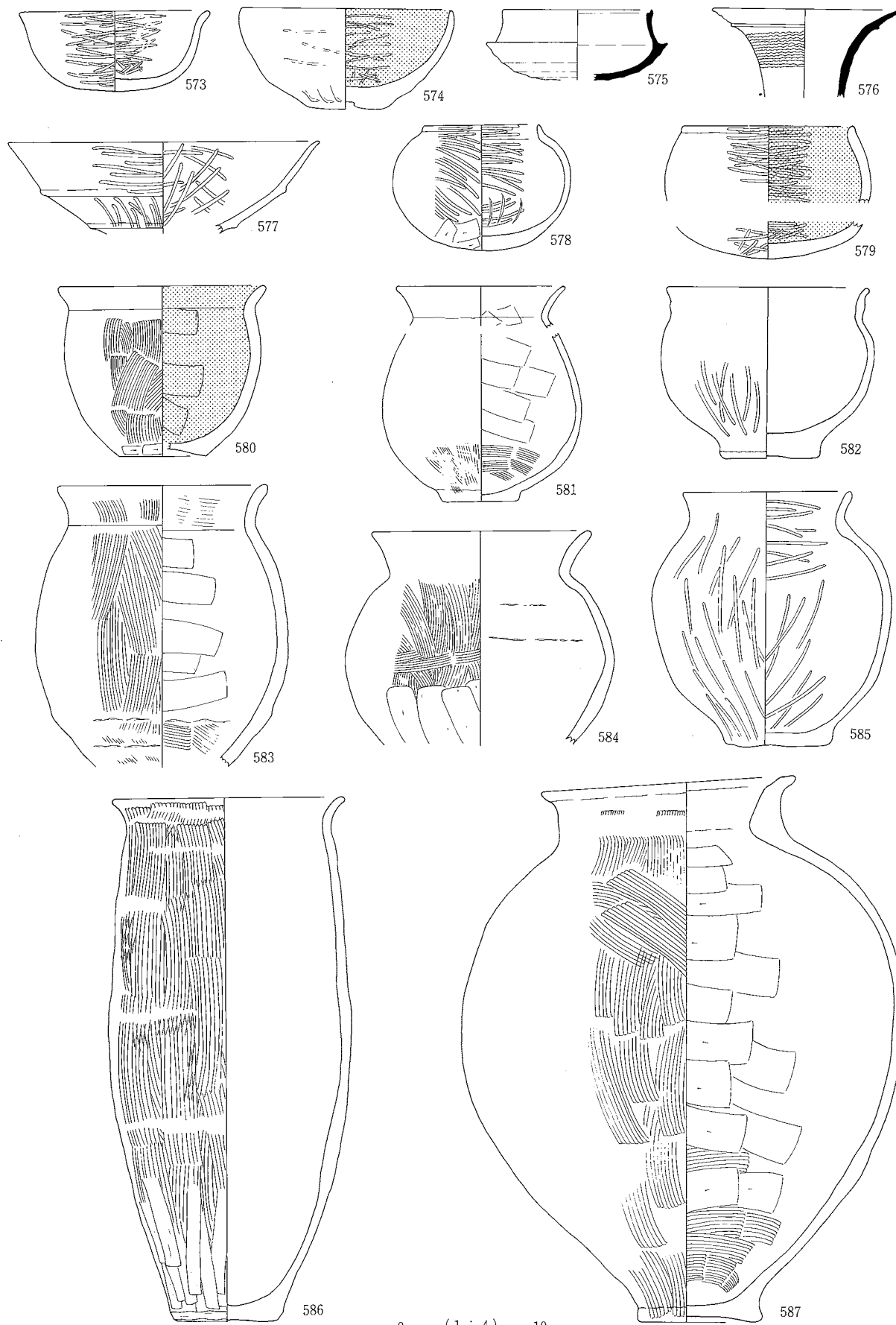

SG3 層位不明

SG3 ②-3A地区-①

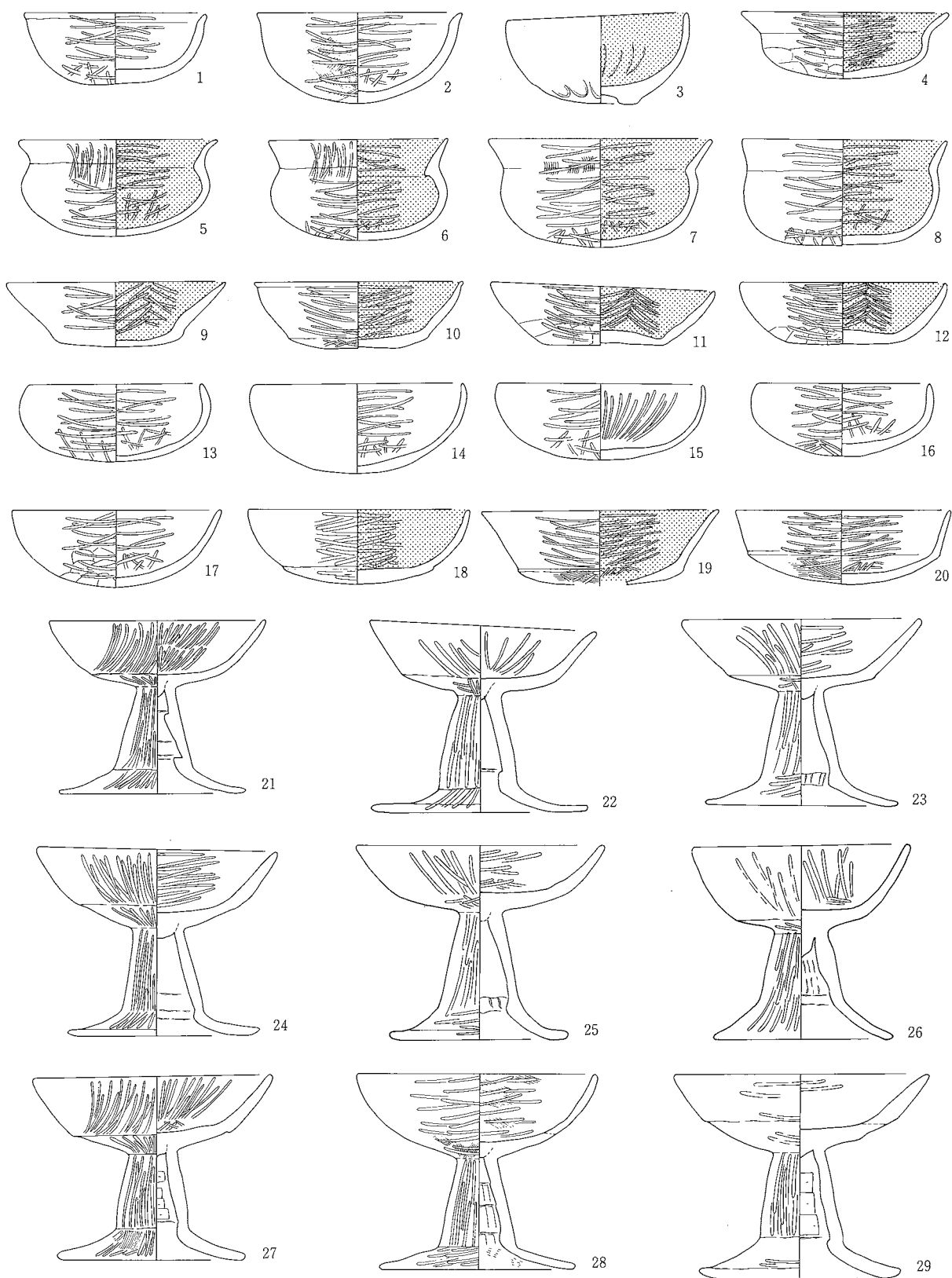

0 (1 : 4) 10cm

SG3 ②-3A地区-①

SG3 ②-3A地区-②

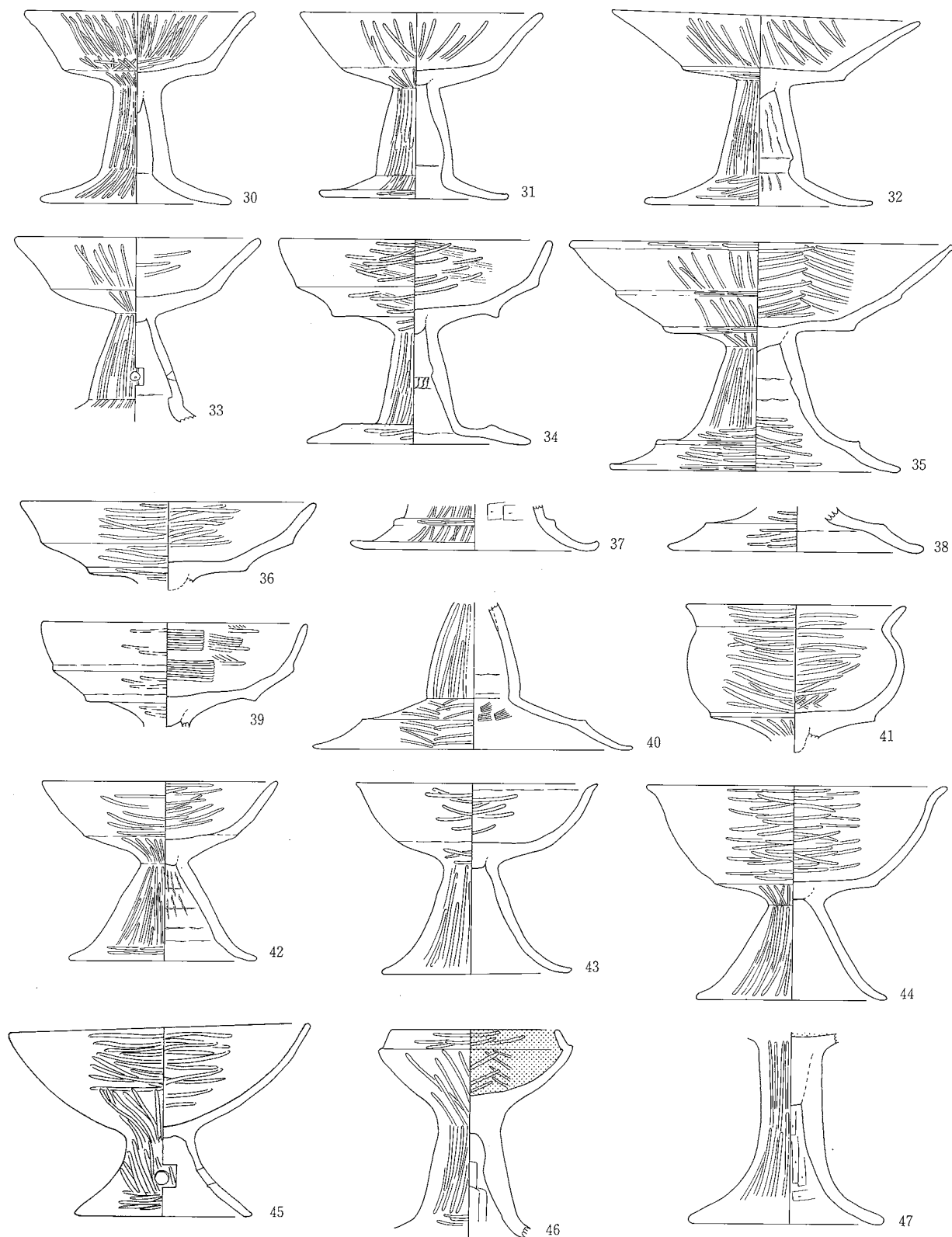

0 (1:4) 10cm

SG3 ②-3A地区-②

SG3 ②-3A地区-③

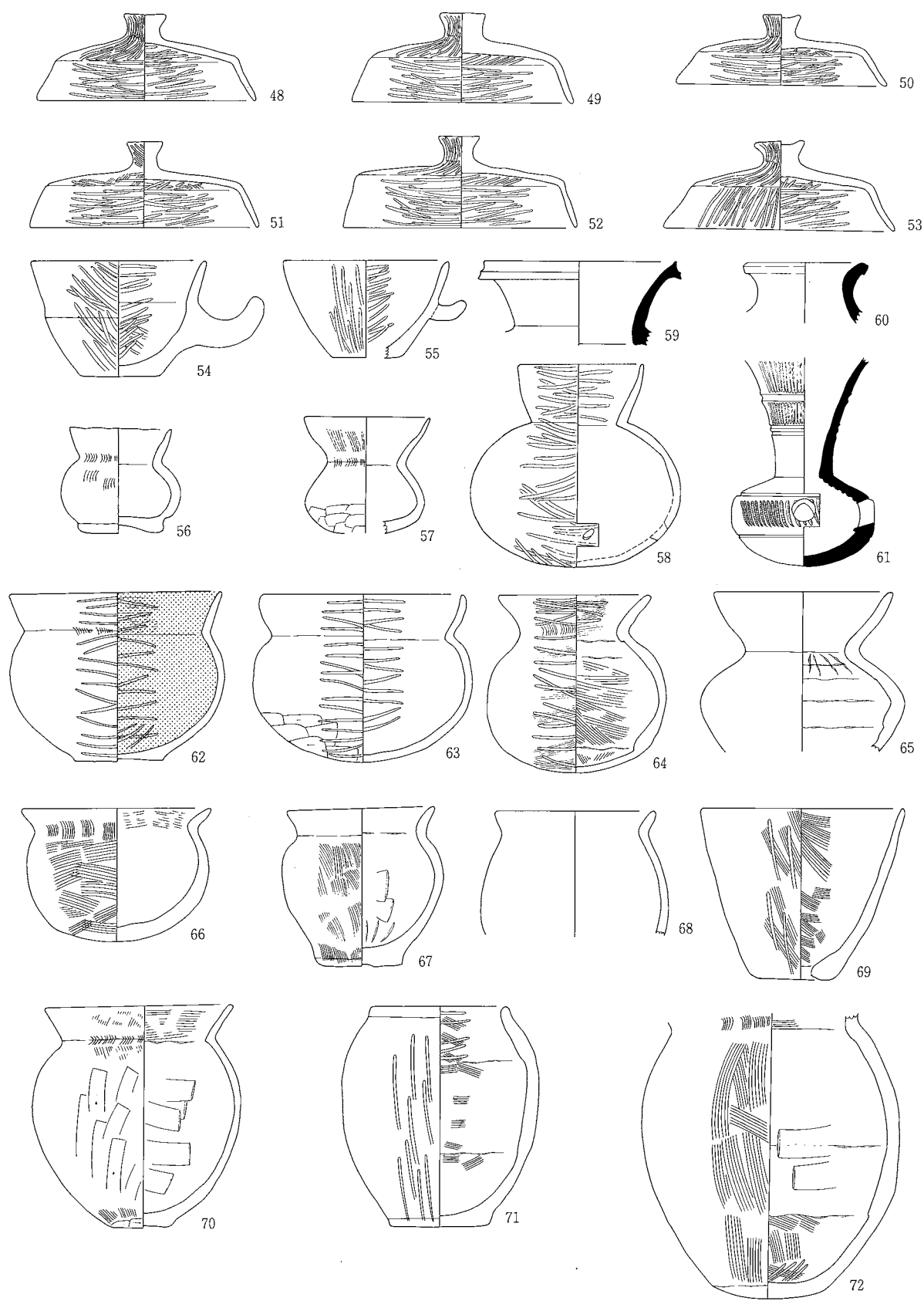

0 (1:4) 10cm

SG3 ②-3A地区-④

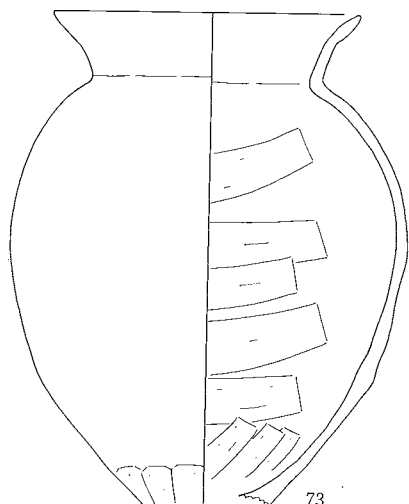

73

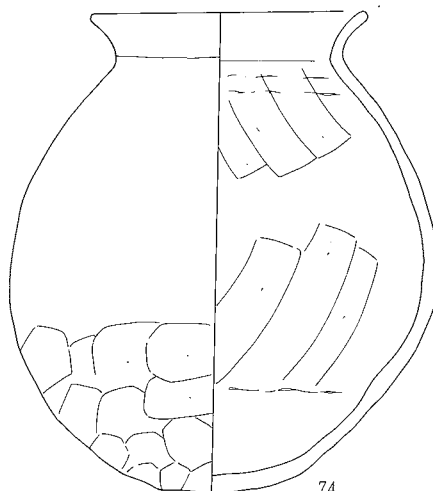

74

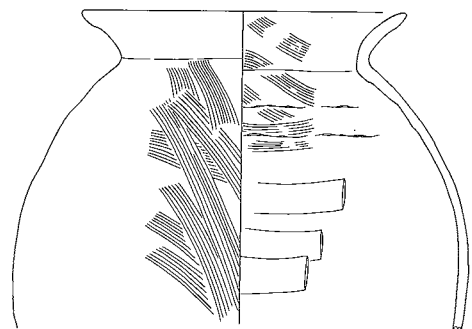

75

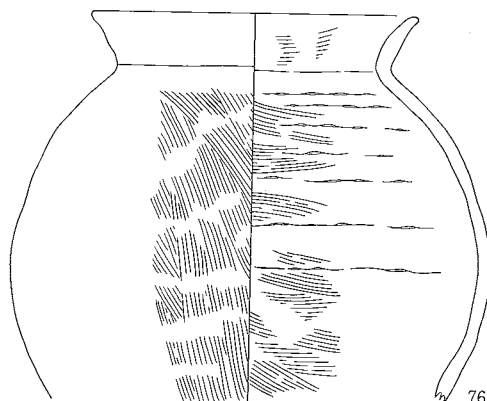

76

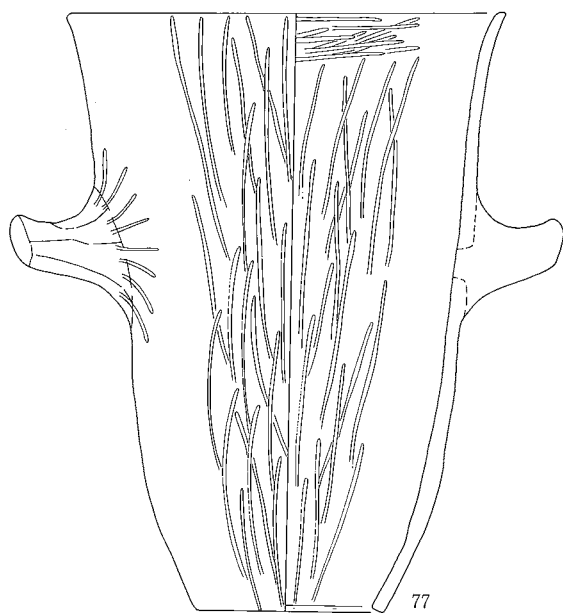

77

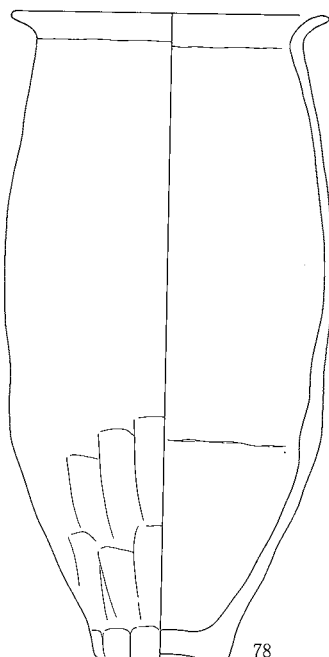

78

0 (1:4) 10cm

SG3 ②-3A地区-④

SG3 ②-3A地区-⑤

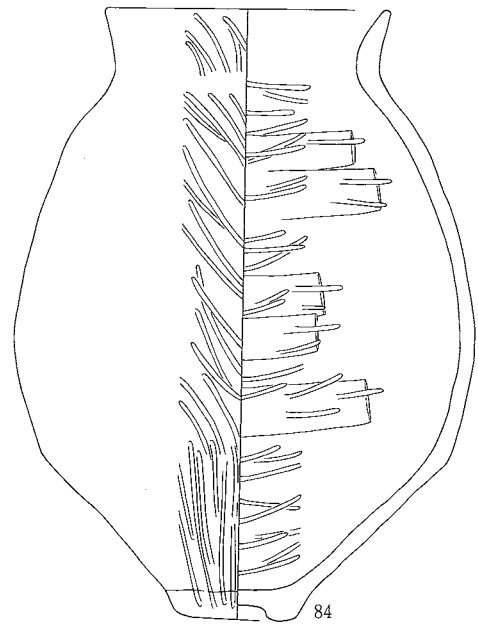
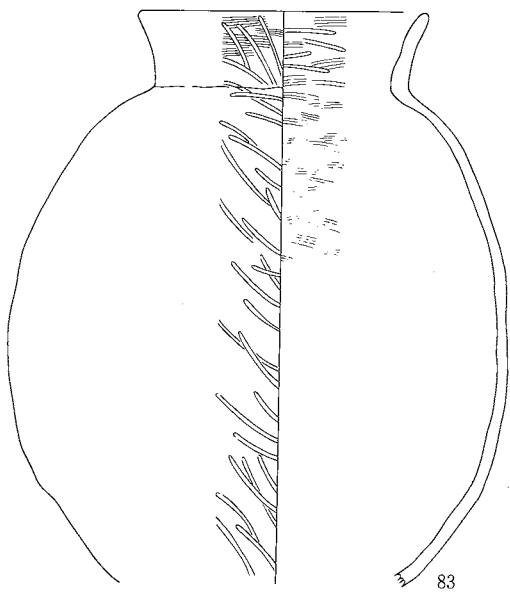
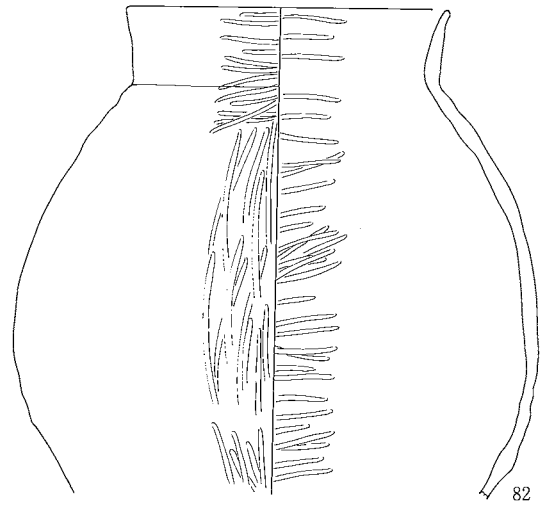
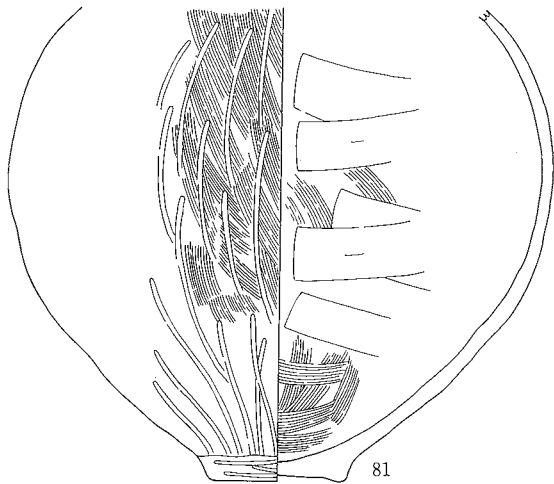
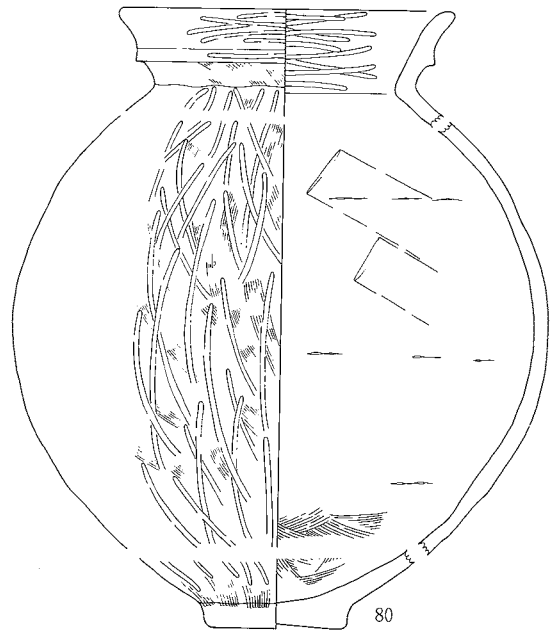
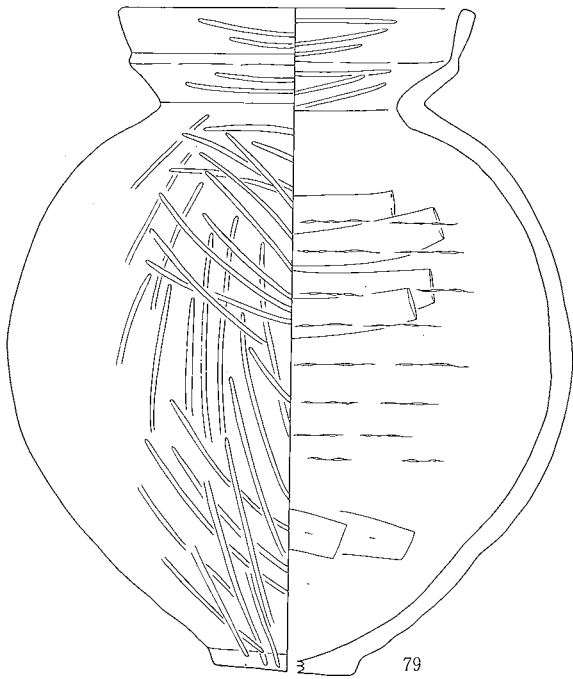

0 (1:6) 20cm

0 (1:4) 10cm

(82·83·84)

SG3 ②-3A地区-⑤

SG4-①

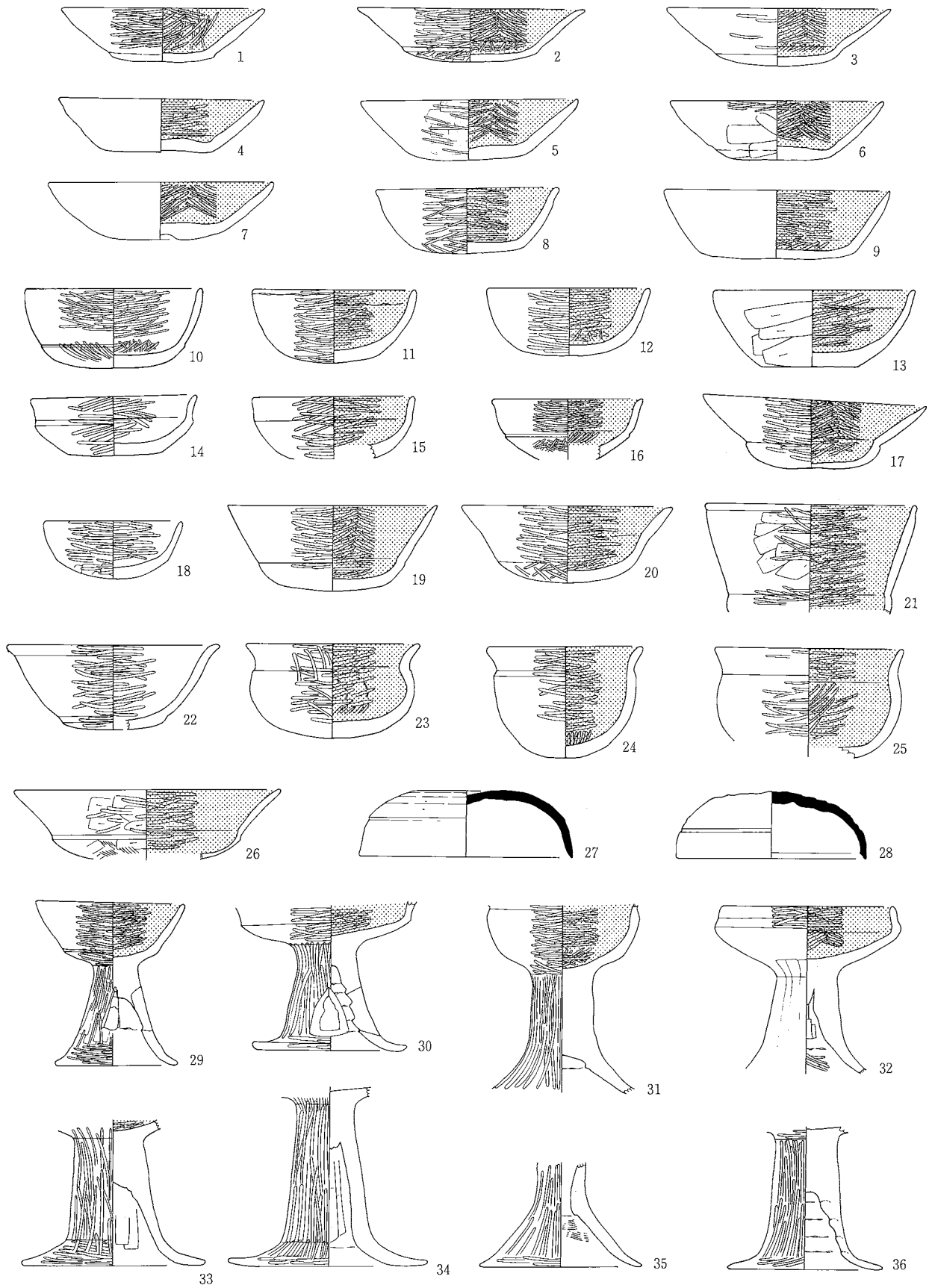

0 (1:4) 10cm

SG4-①

SG4-②

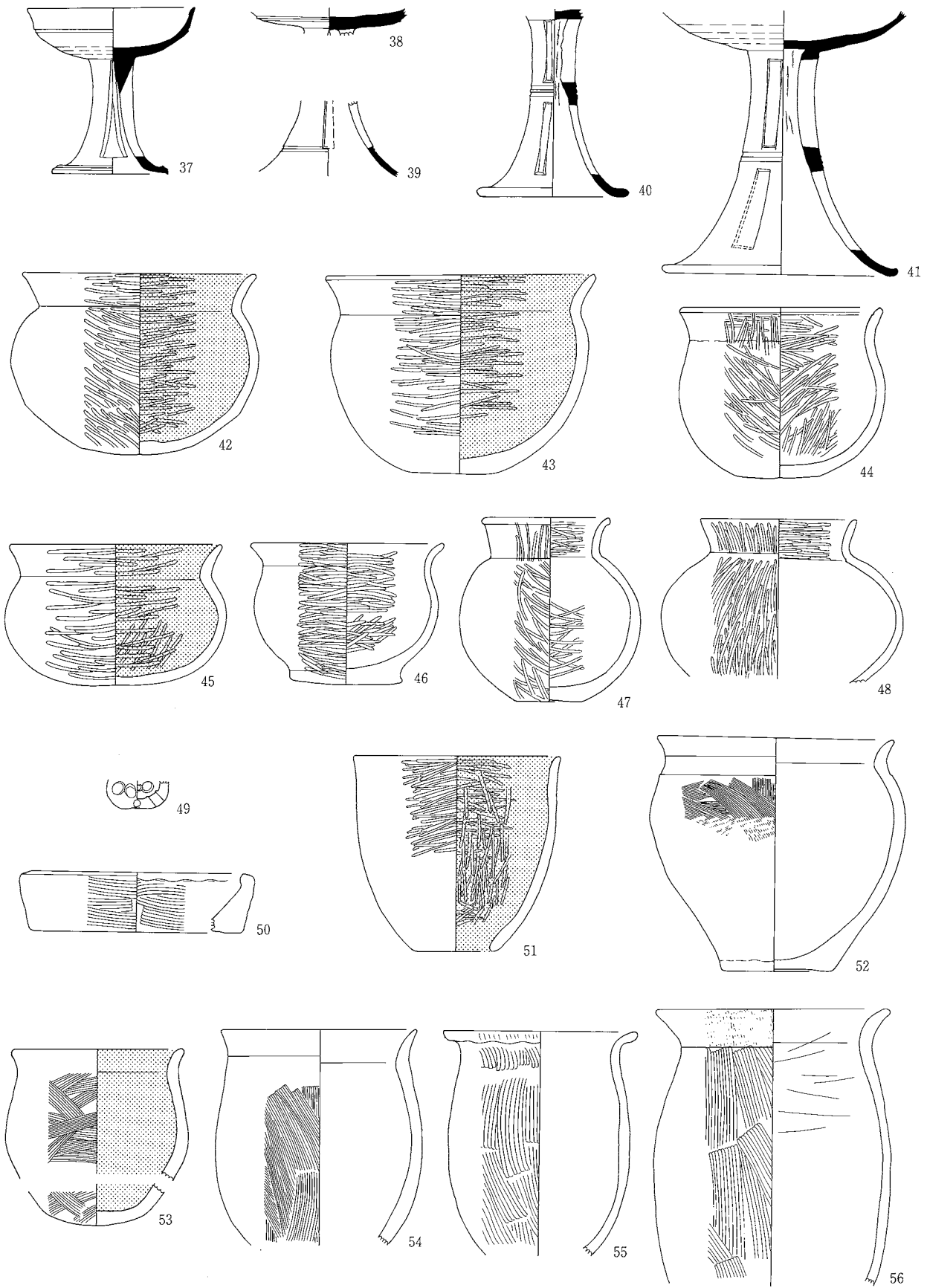

0 (1 : 4) 10cm

SG4-②

SG4-③

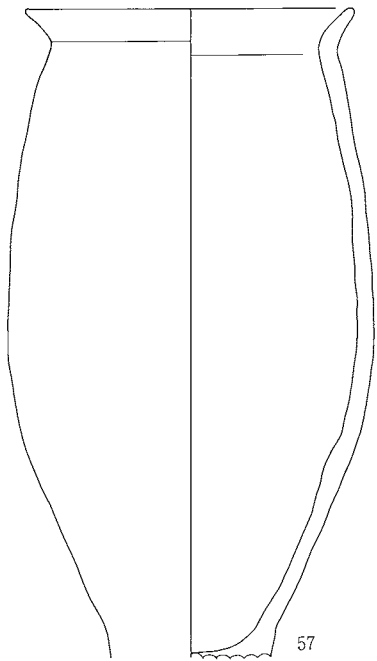

57

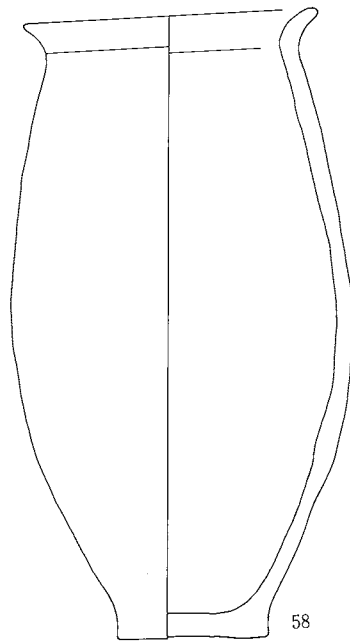

58

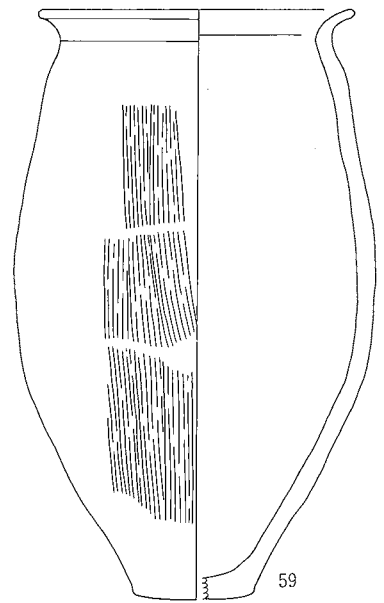

59

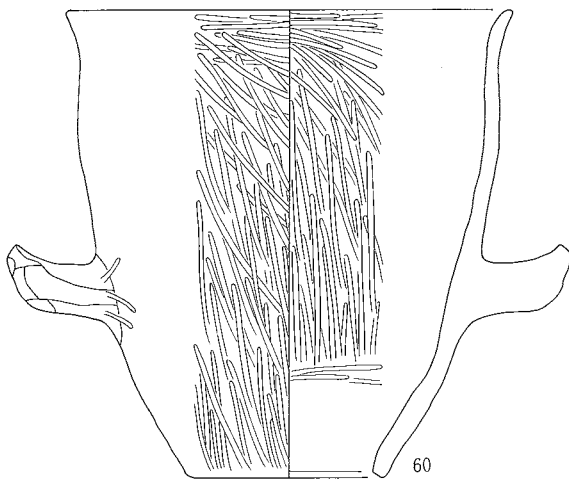

60

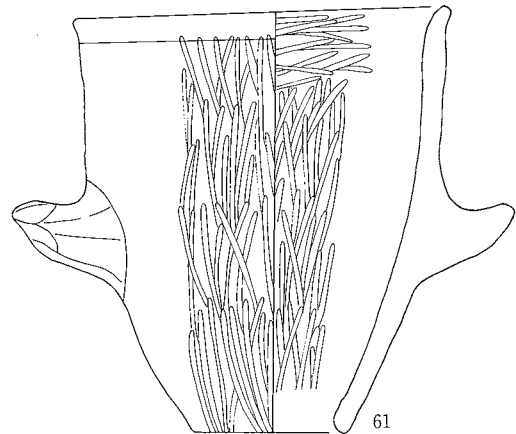

61

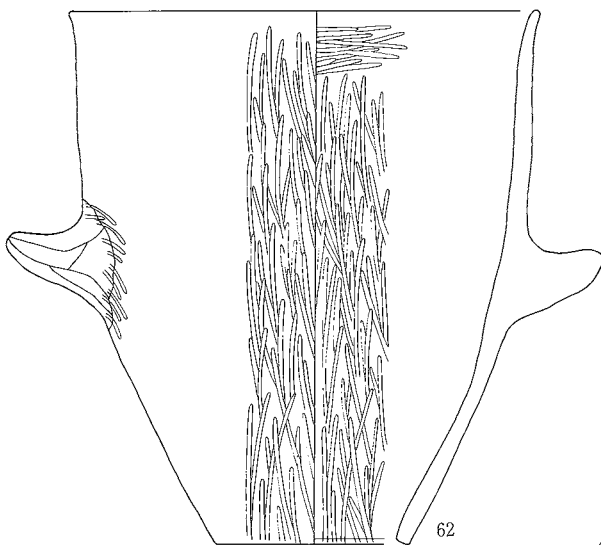

62

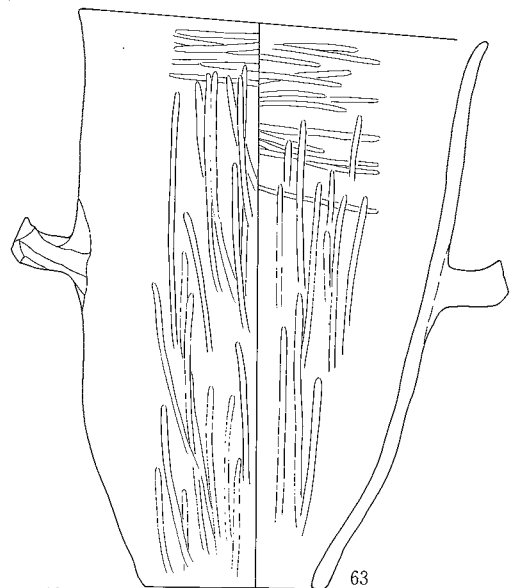

63

0 (1 : 4) 10cm

SG4-③

SG4-④

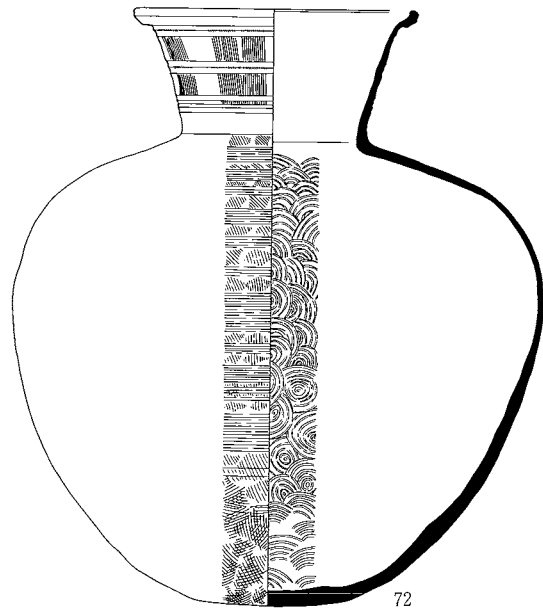
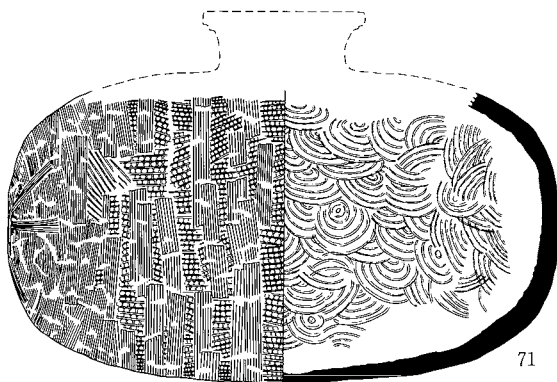
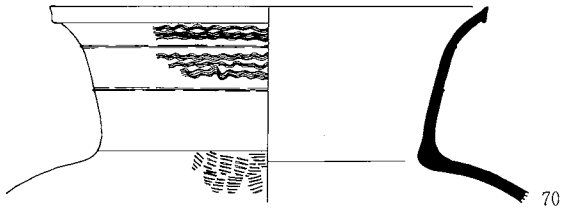
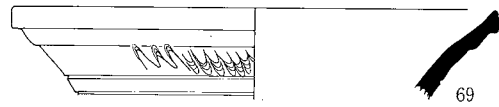
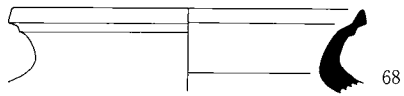
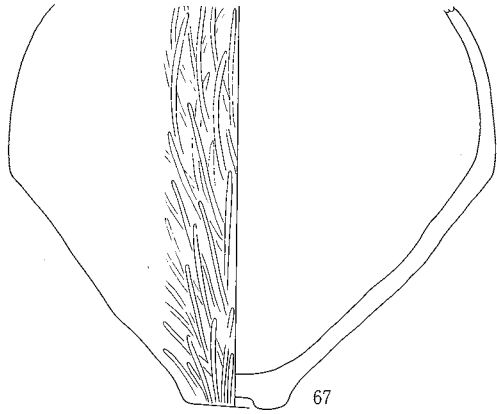
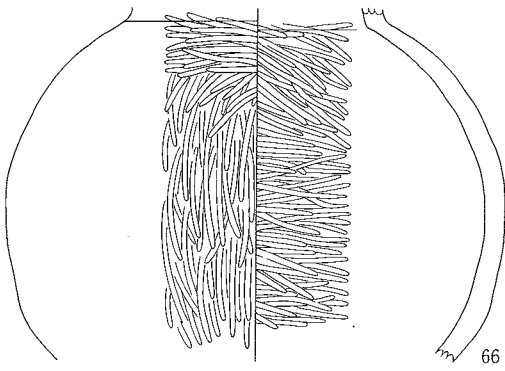
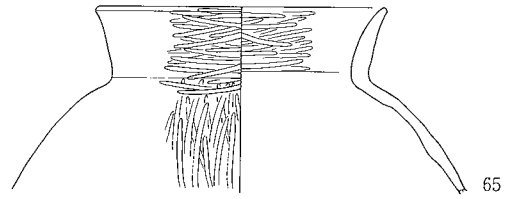
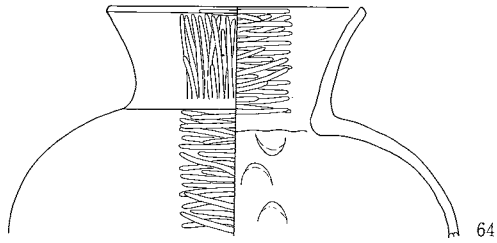

0 (1 : 4) 10cm

0 (1 : 6) 20cm
(65·67·71)

0 (1 : 8) 20cm
(70·72)

SG4-④

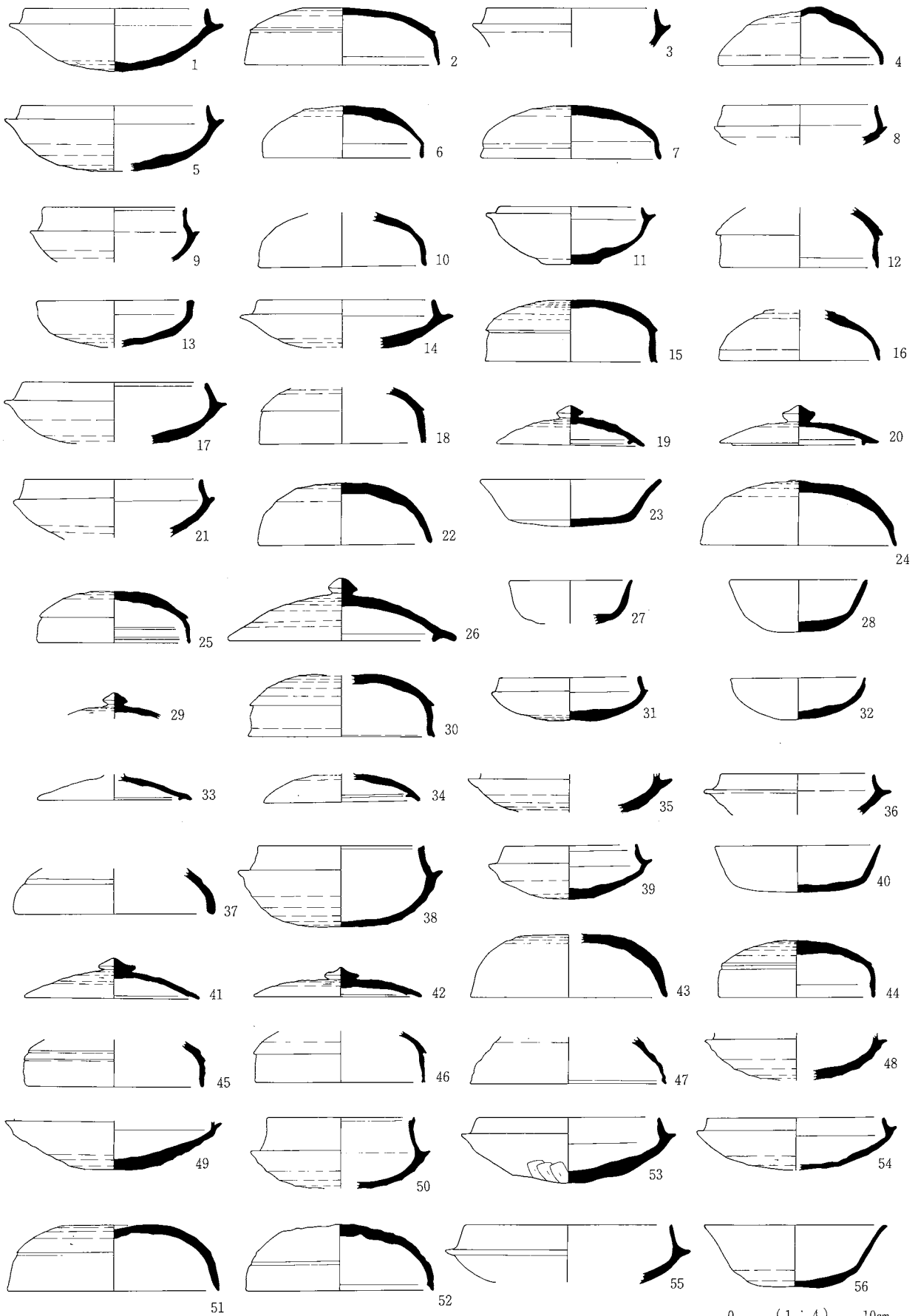

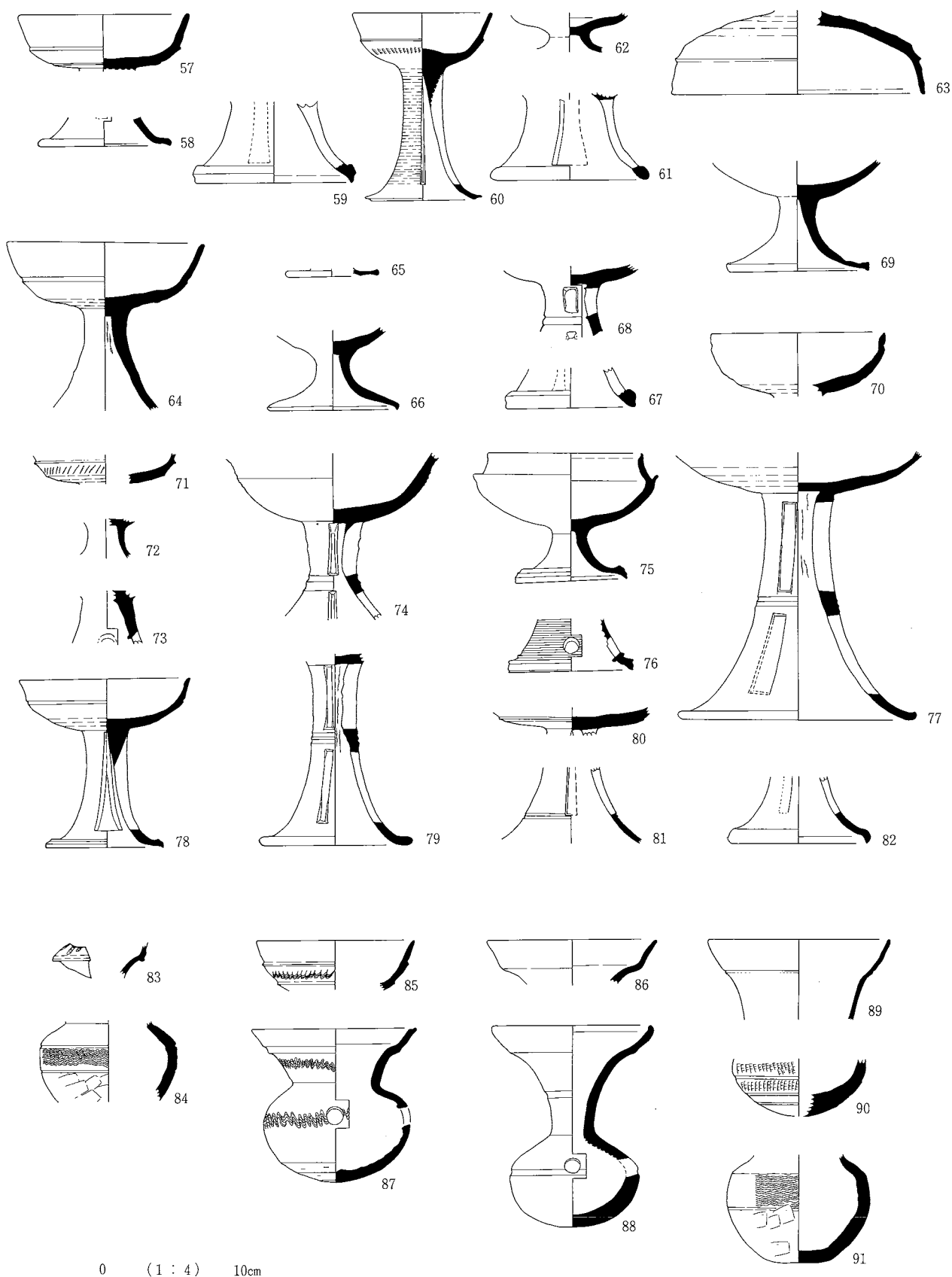

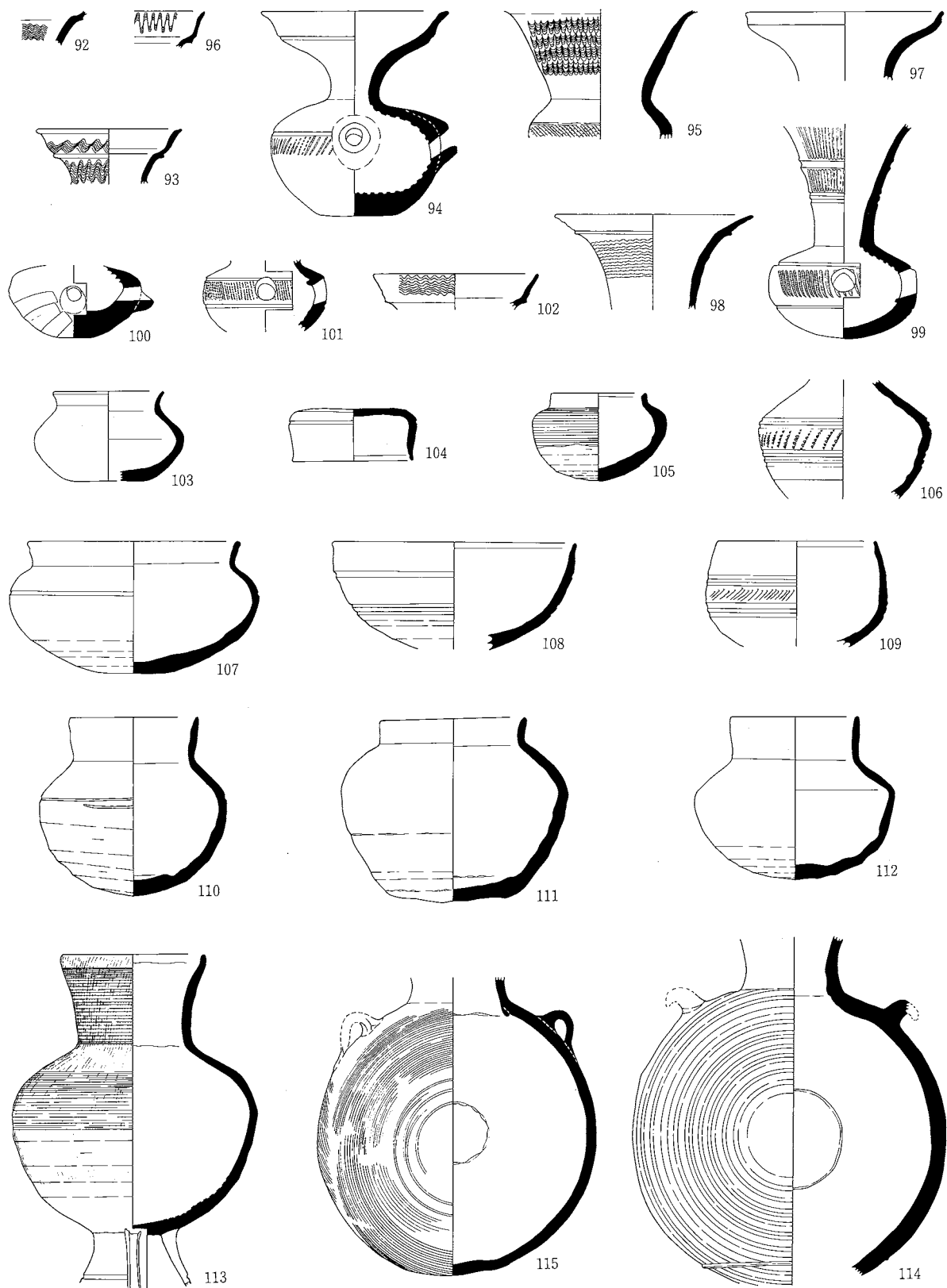

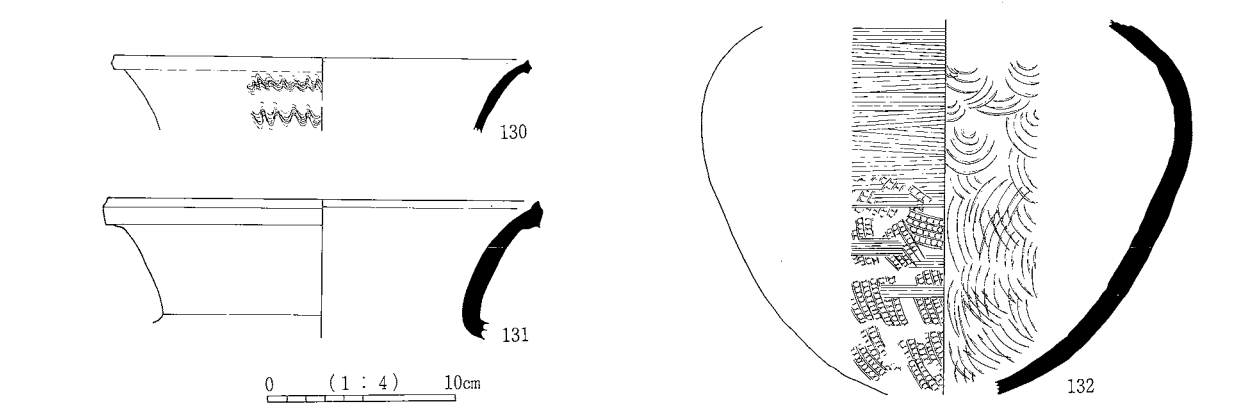
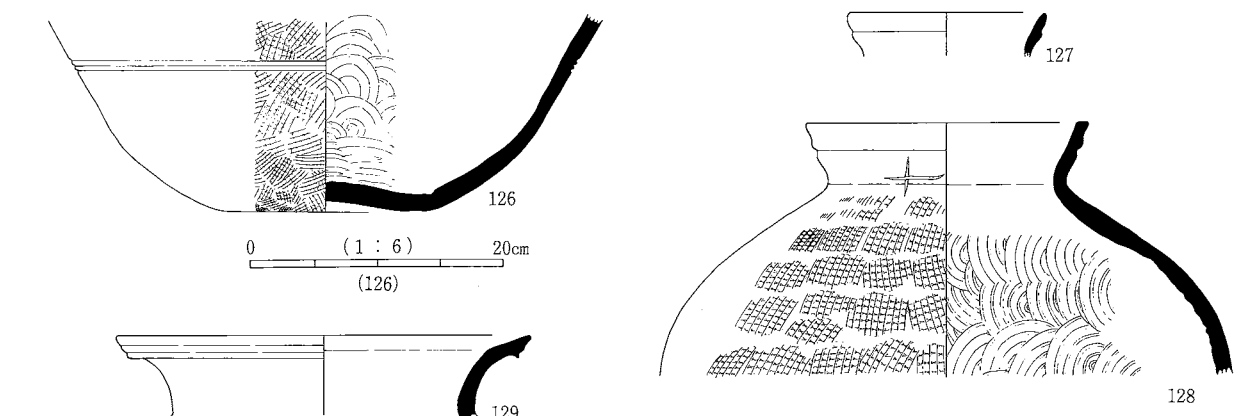
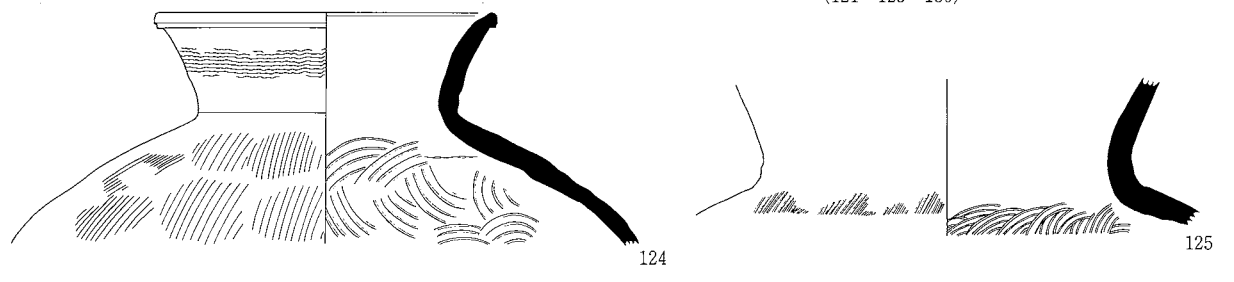
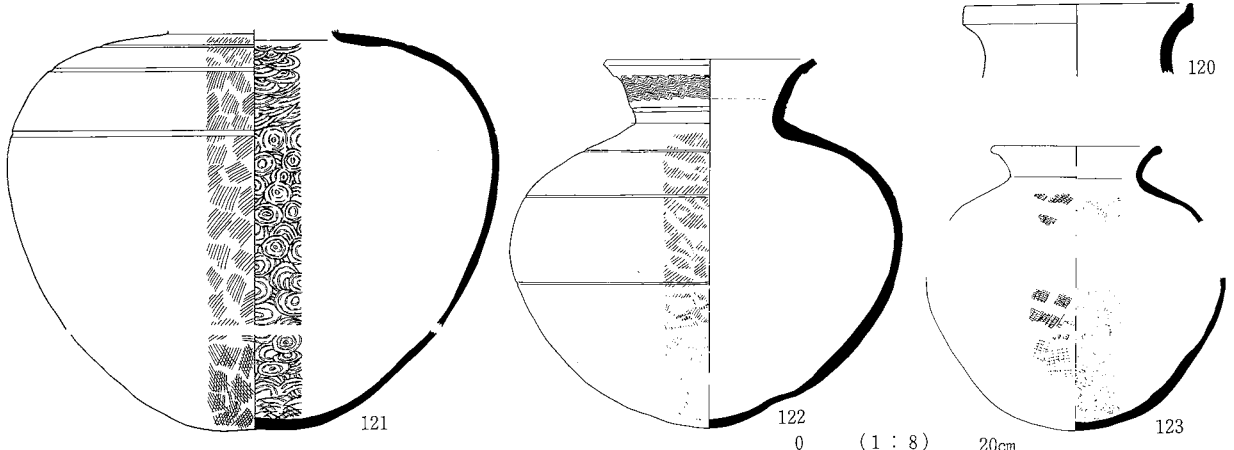
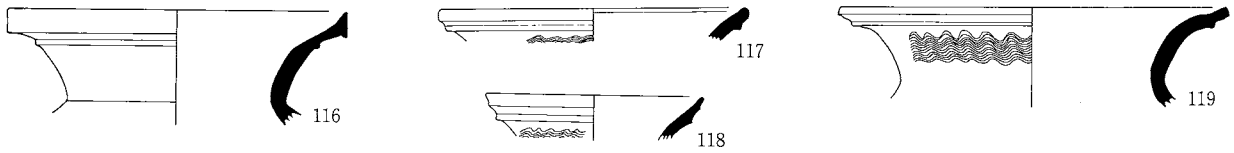

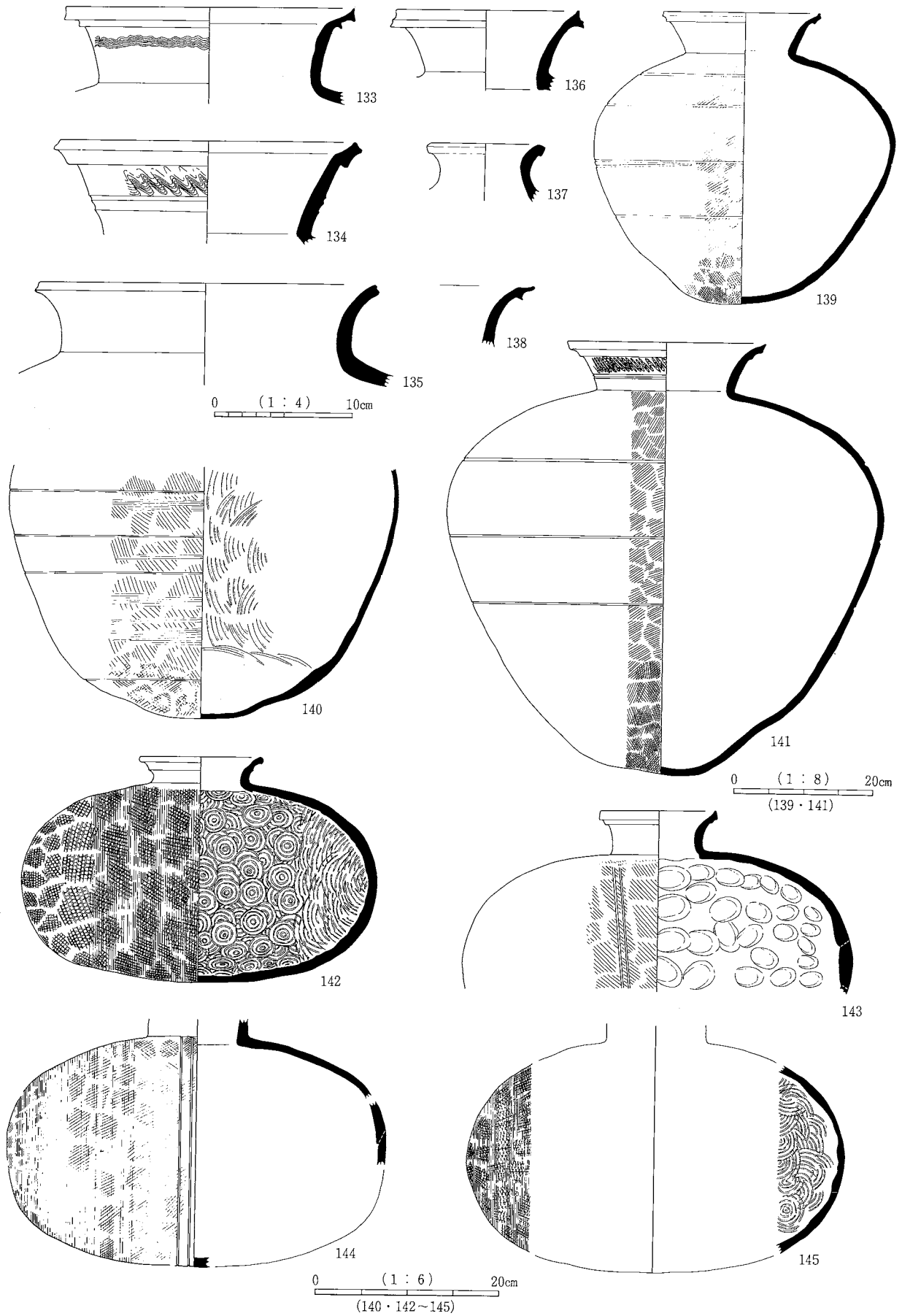

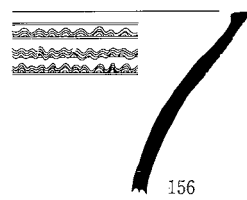
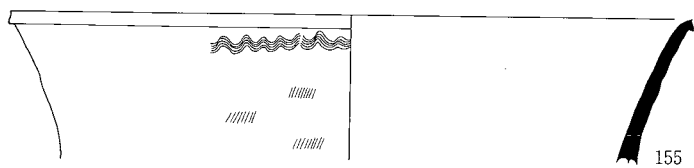
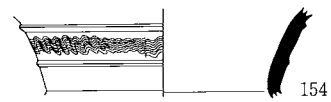
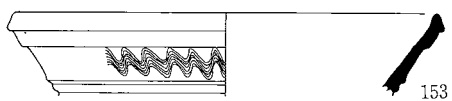
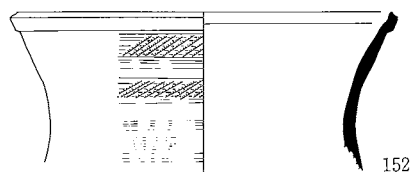
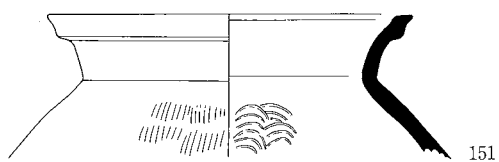
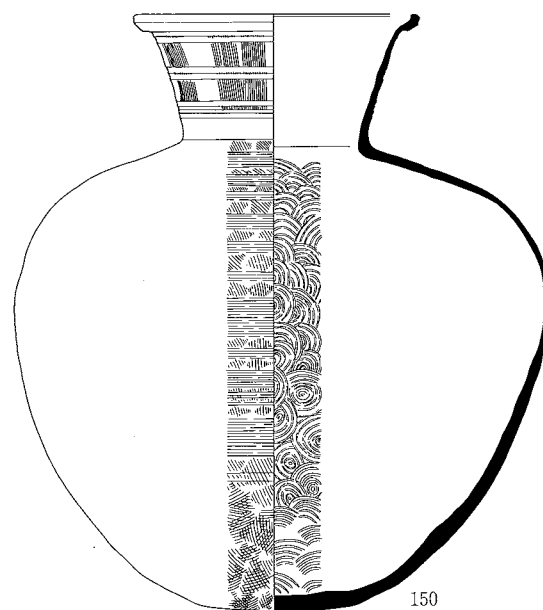
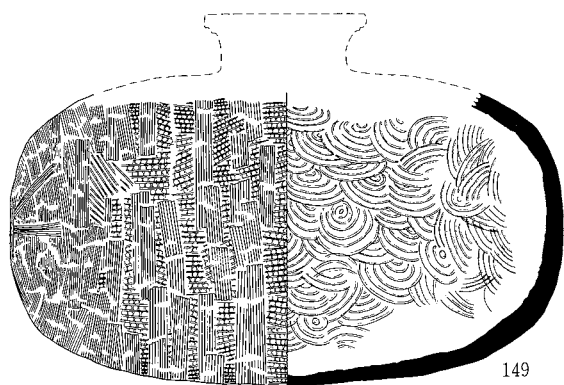
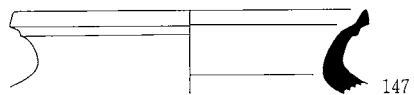
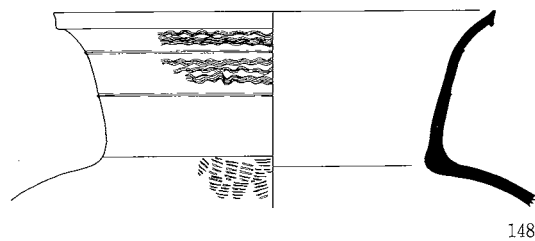
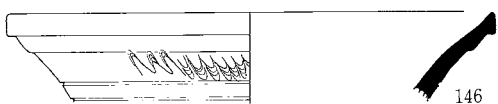

0 (1 : 8) 20cm
(148 · 150 · 152)

0 (1 : 6) 20cm
(149 · 155 · 156)

0 (1 : 4) 10cm

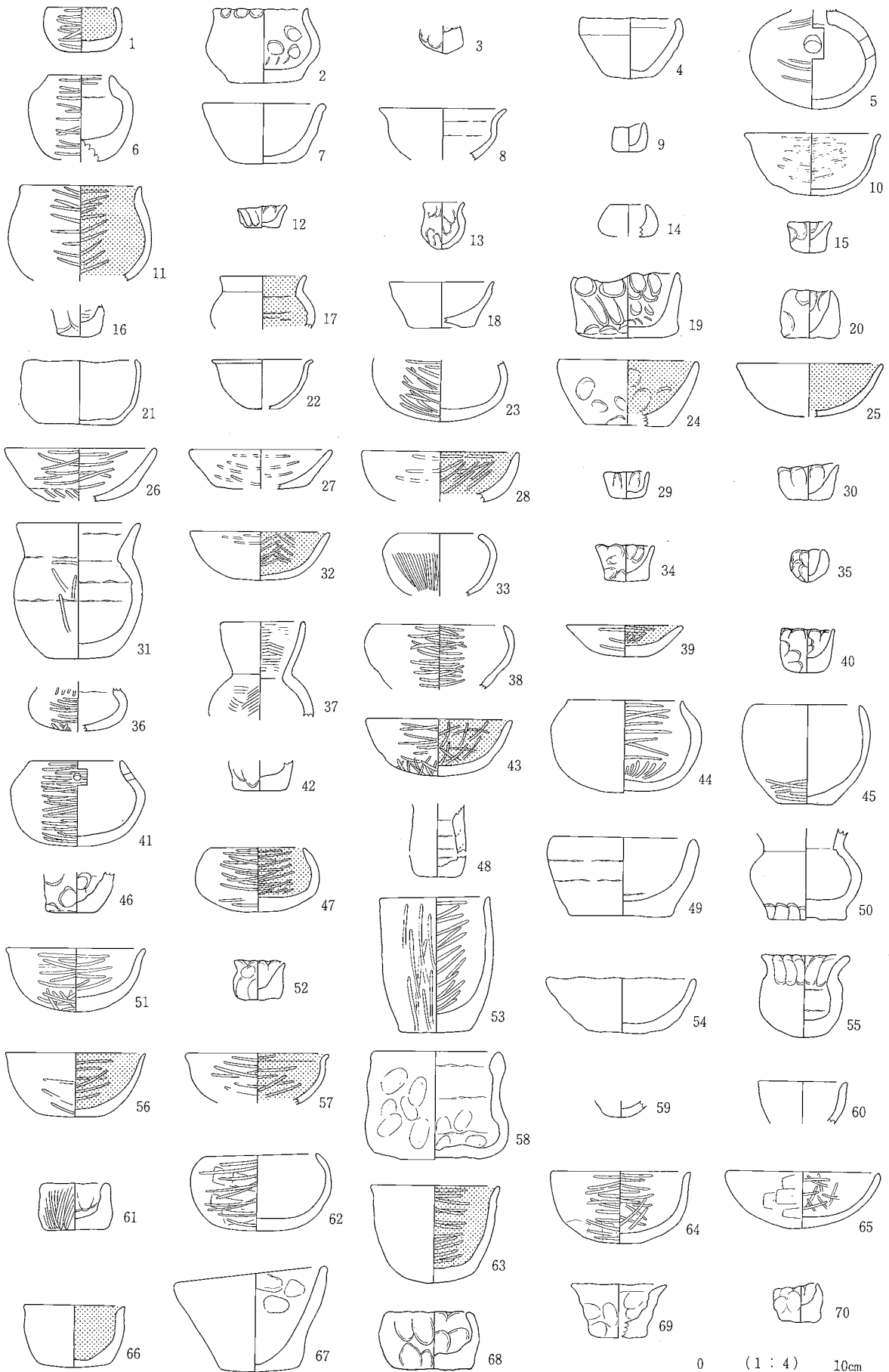

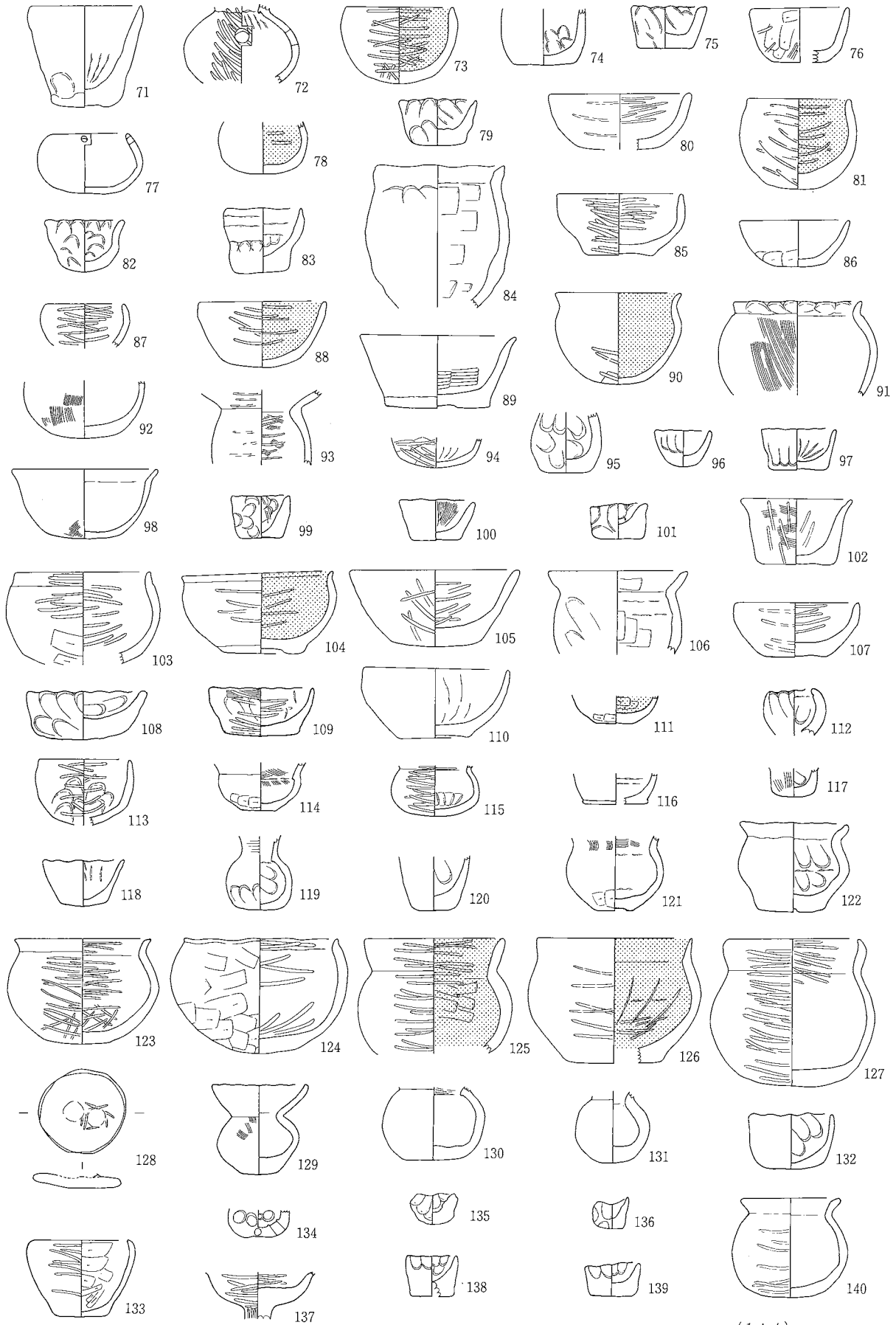

0 (1:4) 10cm

SB1

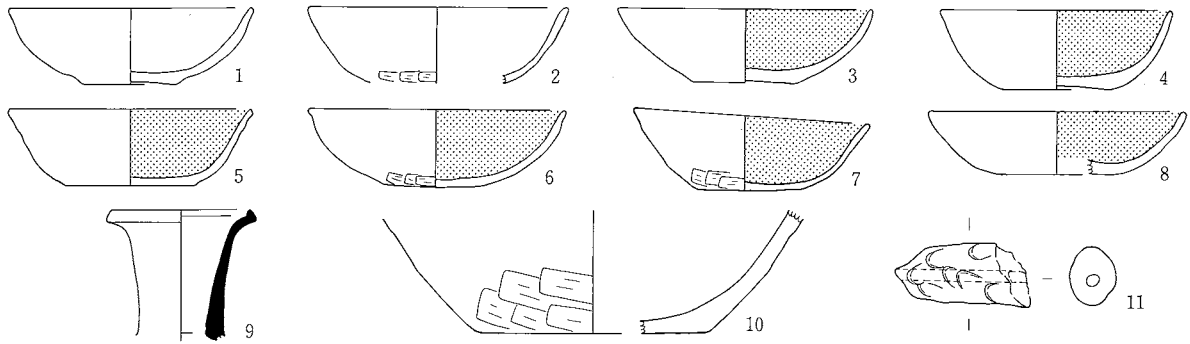

SB2

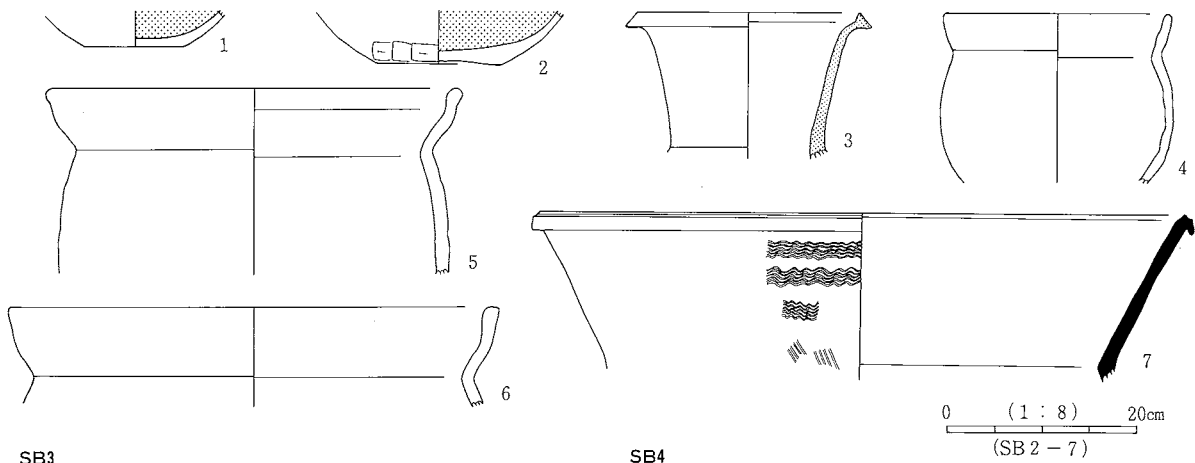

SB3

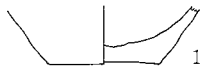

SB4



SB5

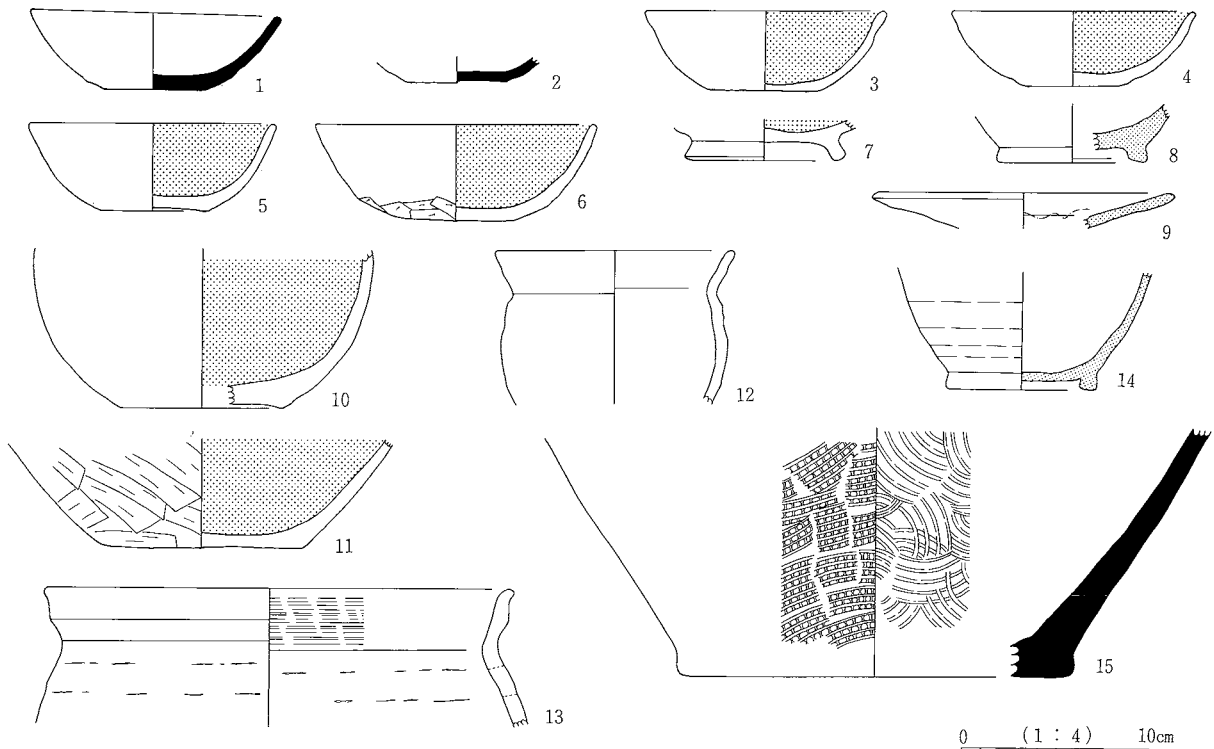

SB6

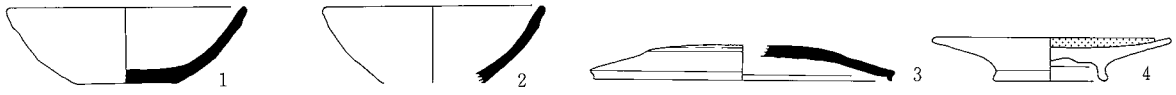

SB8

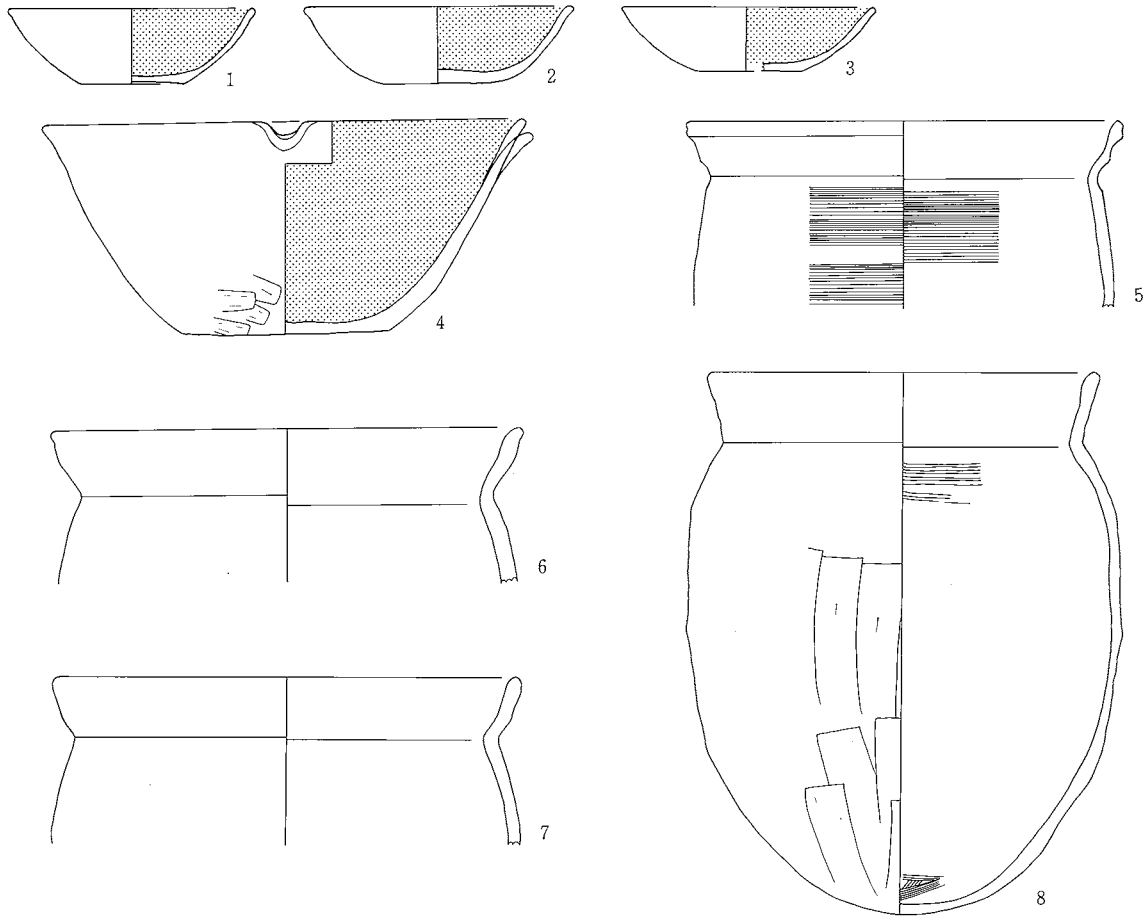

SB9-①

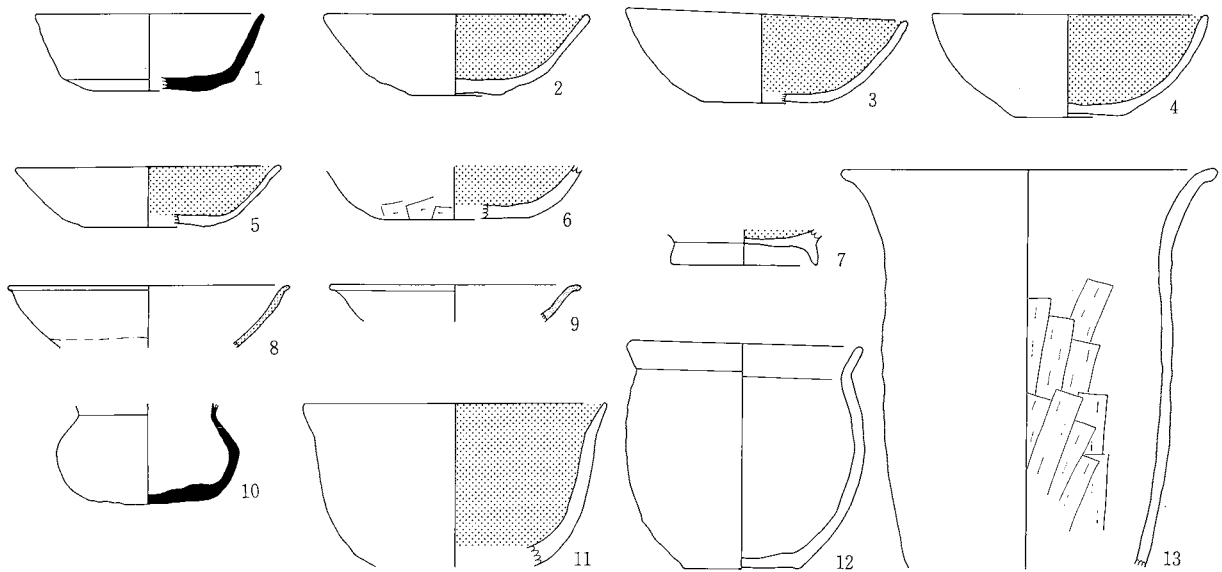

0 (1:4) 10cm

SB6・8・9-①

SB9-②

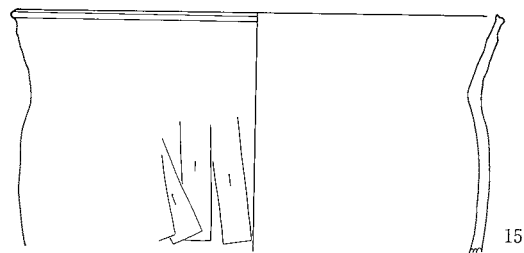
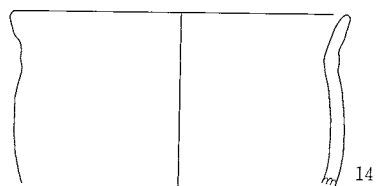

SB11

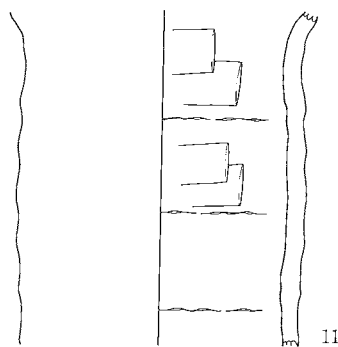
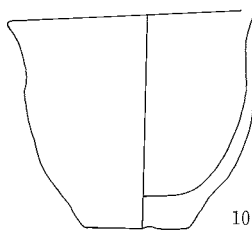
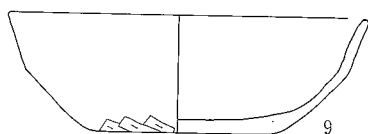
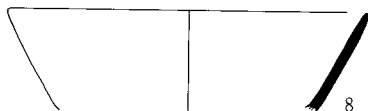
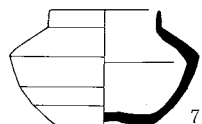
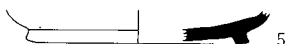

SB25

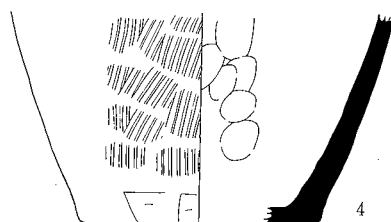
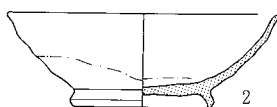

SB26

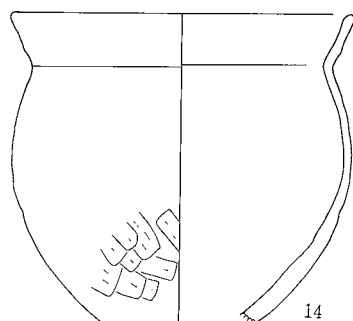
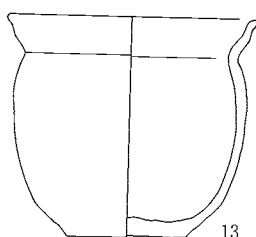
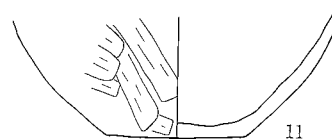
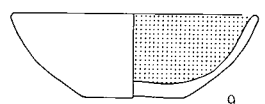
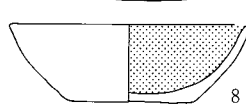
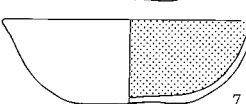
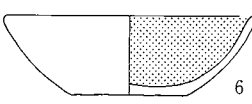
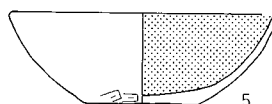
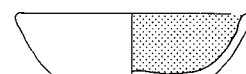
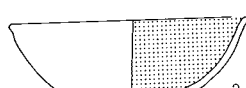
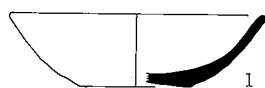

0 (1:4) 10cm

SB28

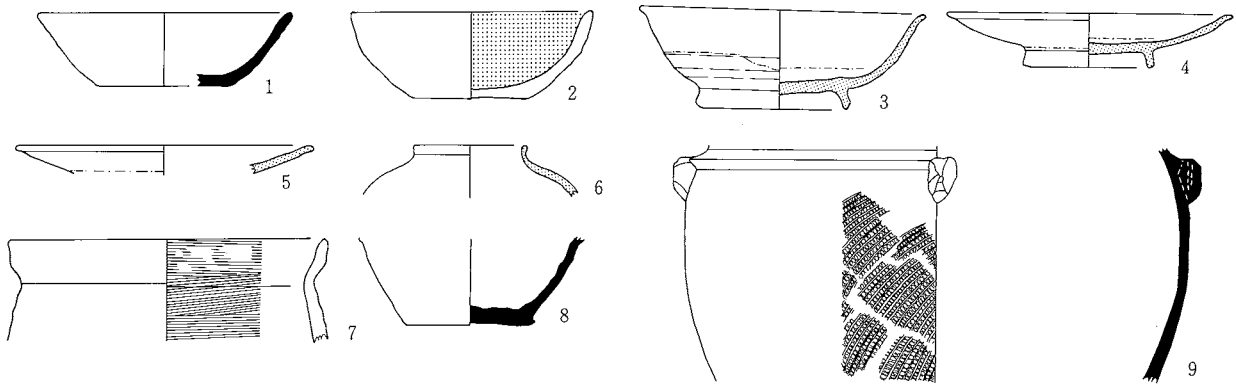

SB30

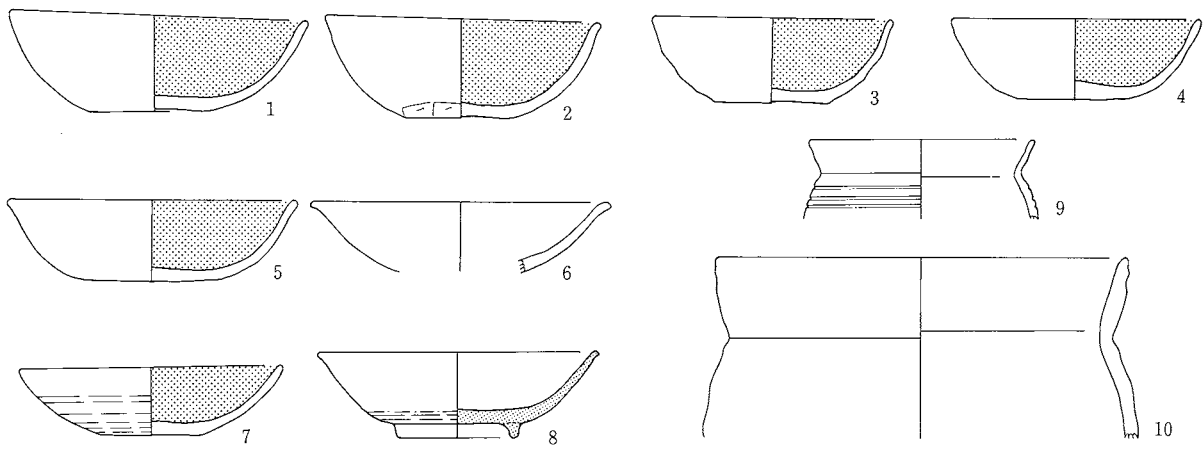

SB32

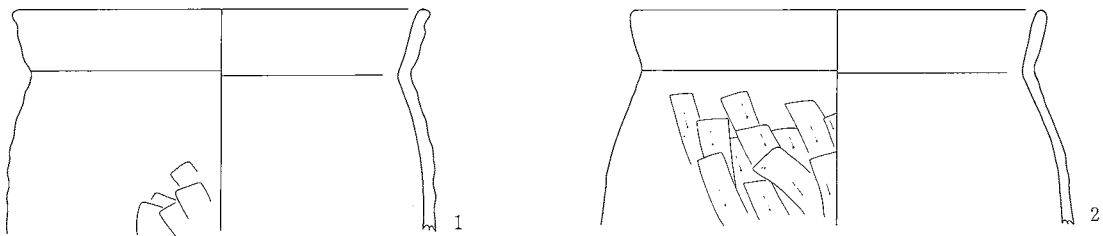

SB49

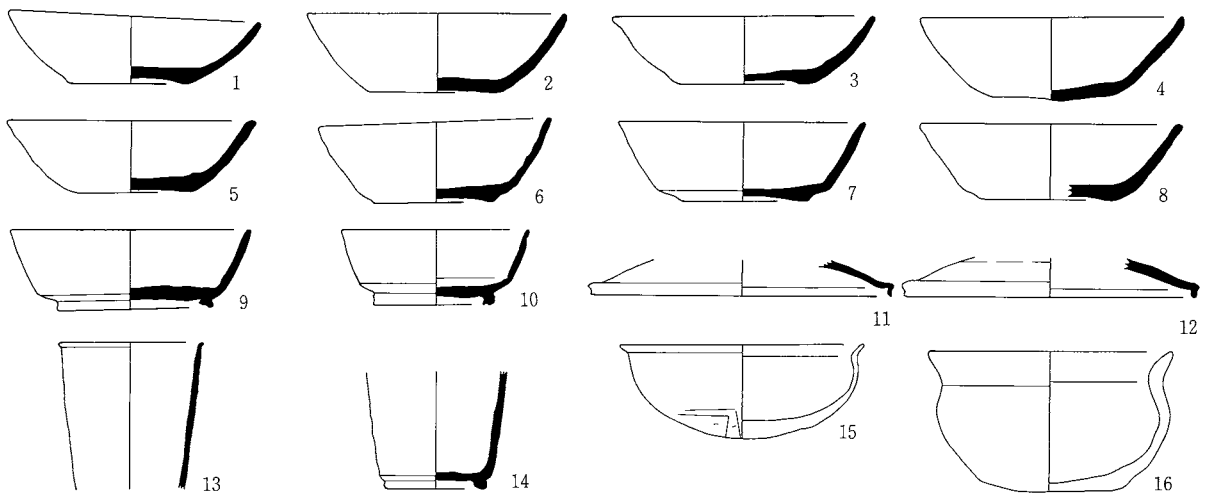

0 (1:4) 10cm

SB33

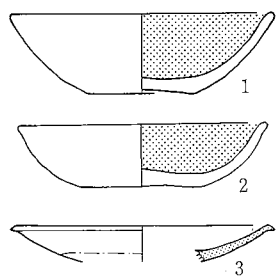

SB76

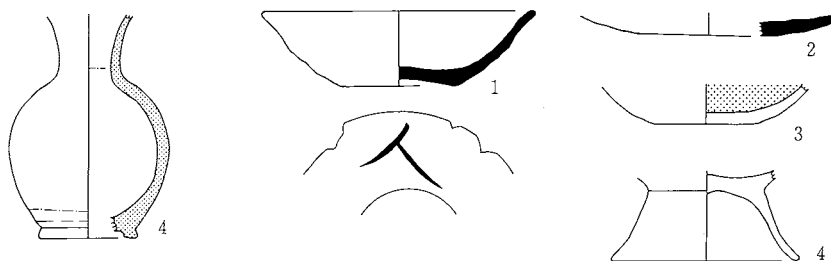

SB104

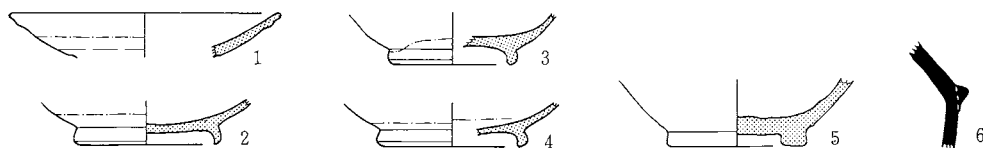

SB480

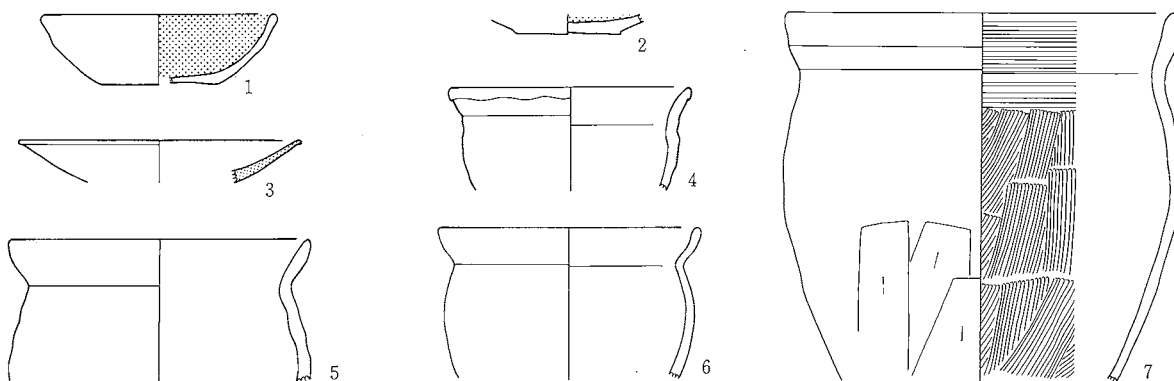

SB503-①

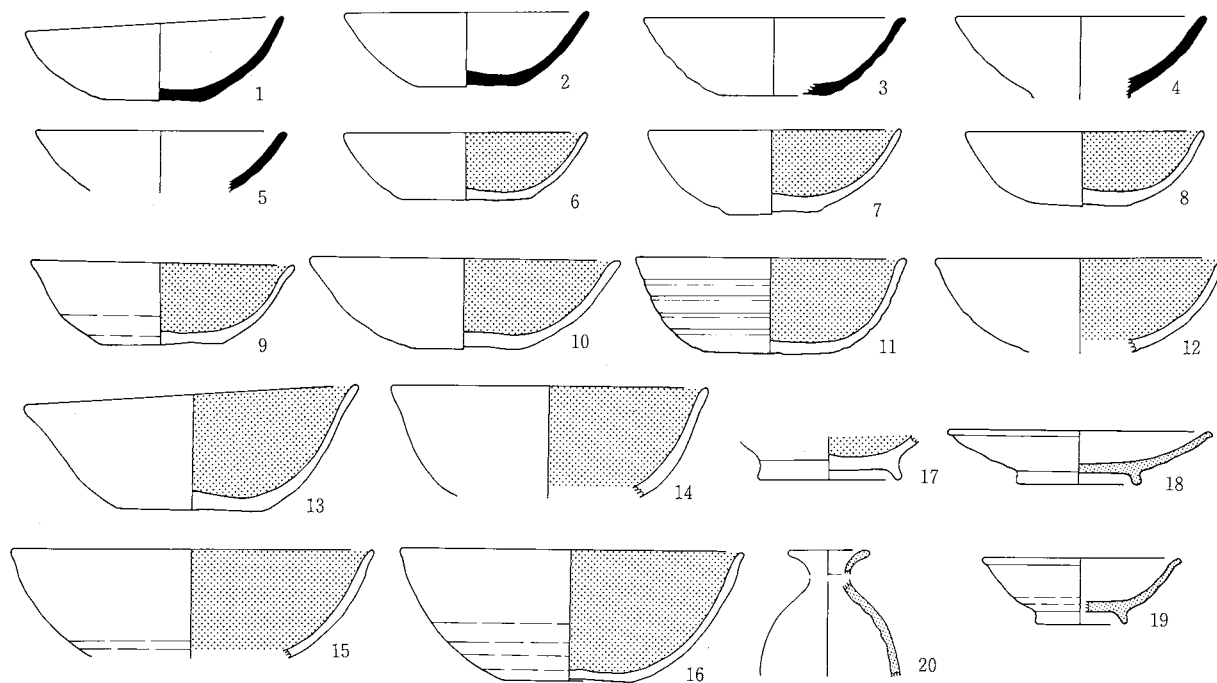

0 (1:4) 10cm

SB503-②

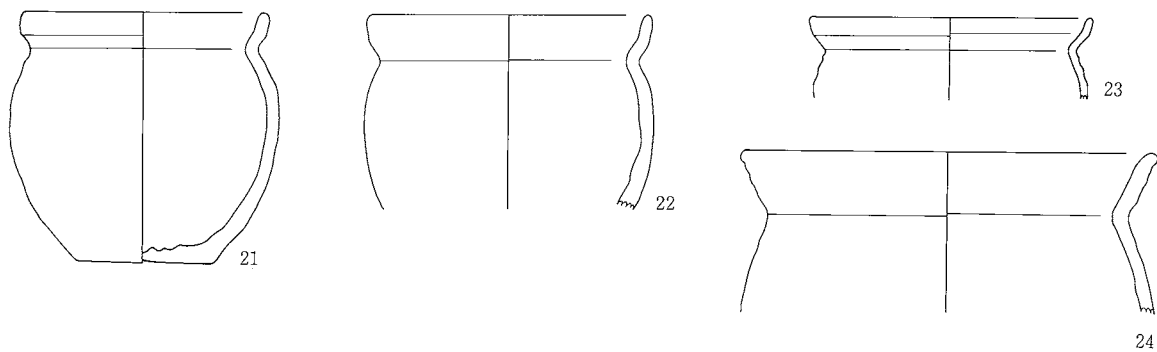

SB504

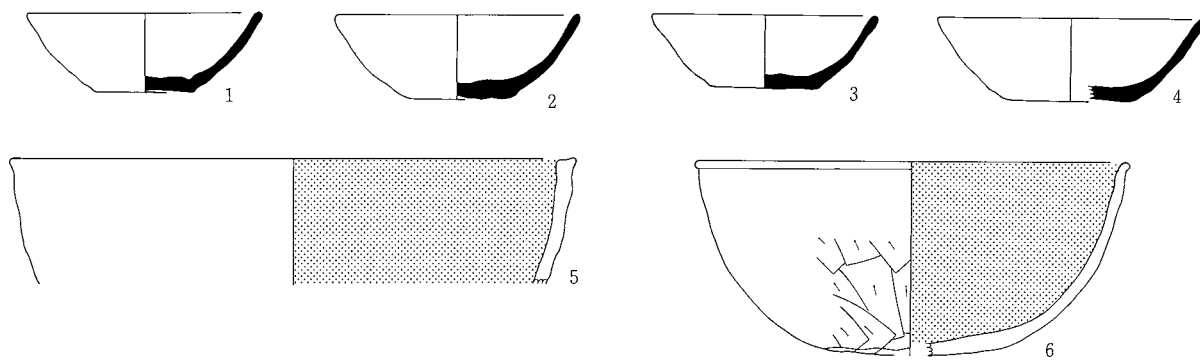

SB511

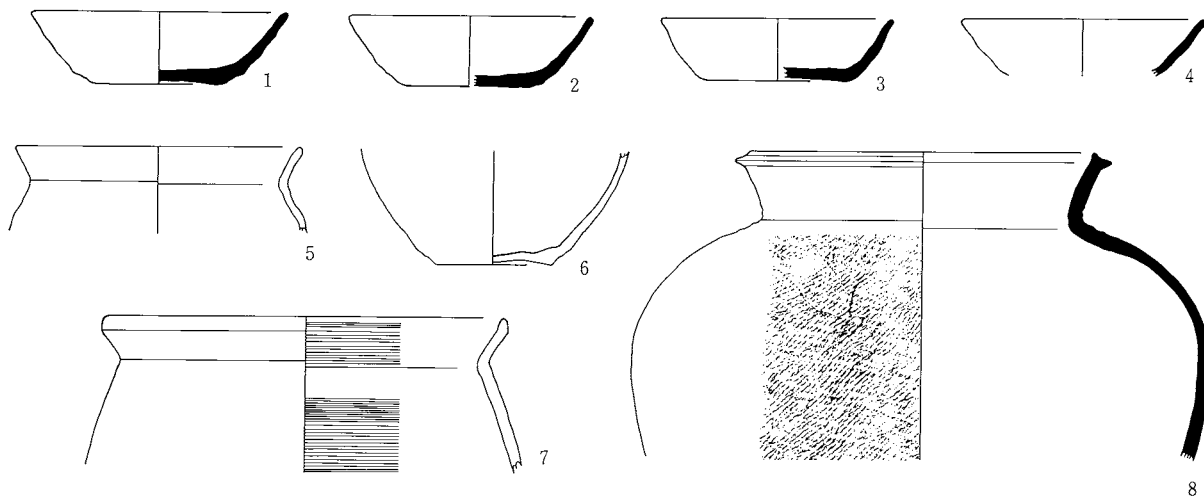

SB512

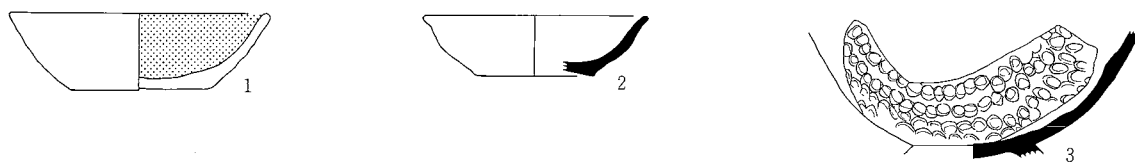

0 (1:4) 10cm

SB513

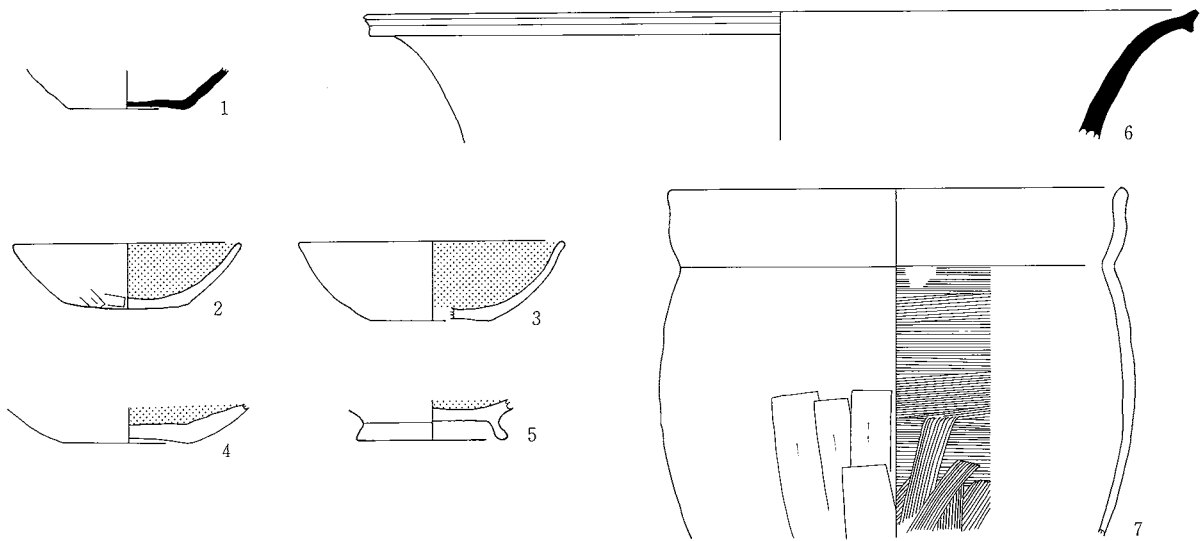

SB514

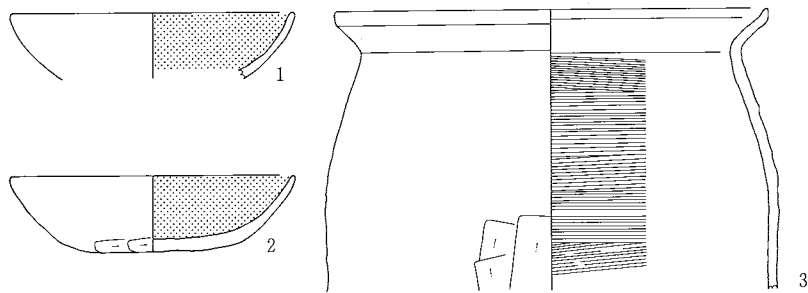

SB517

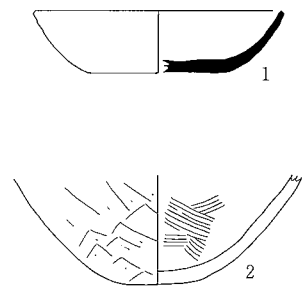

SB515

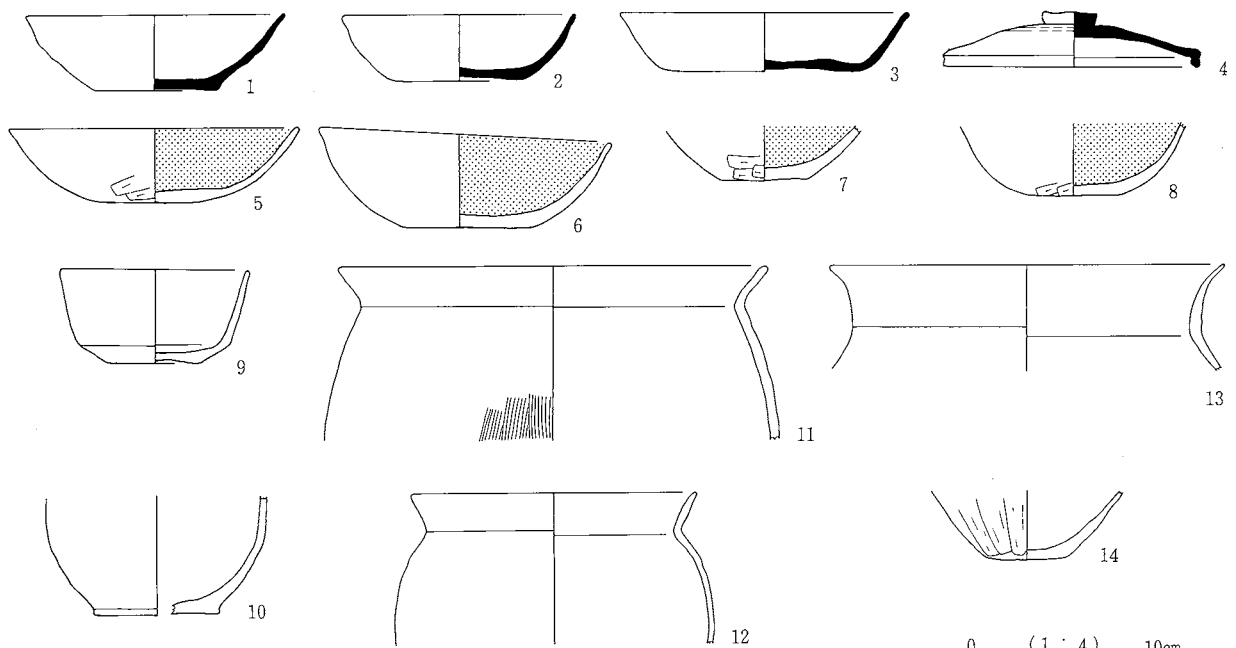

SB513・514・515・517

SB521

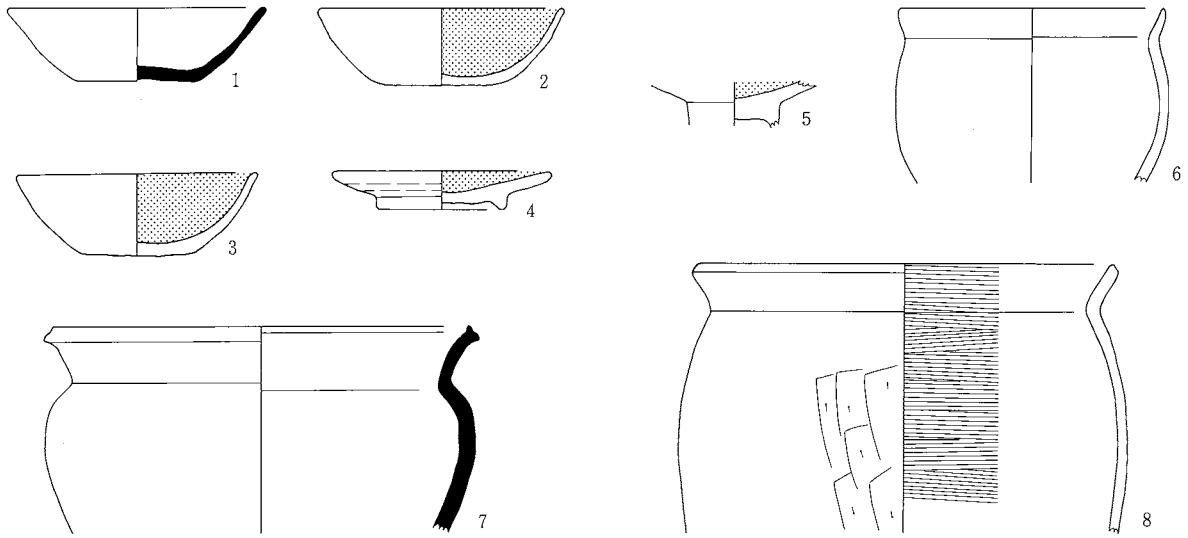

SB577

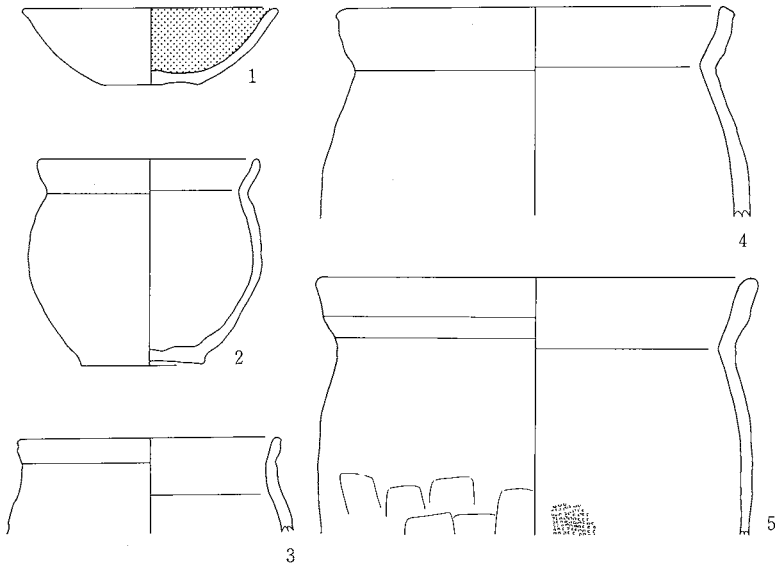

SB528

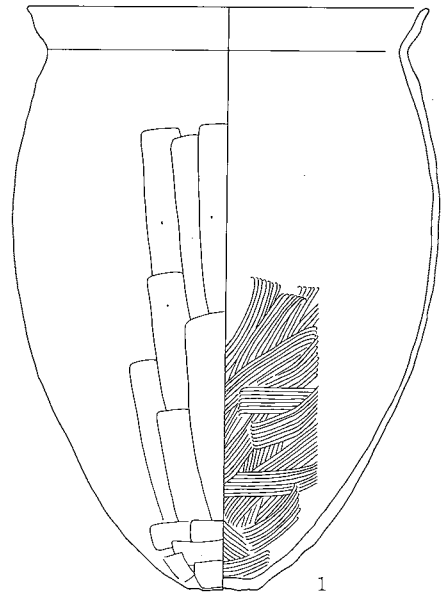

SB1018

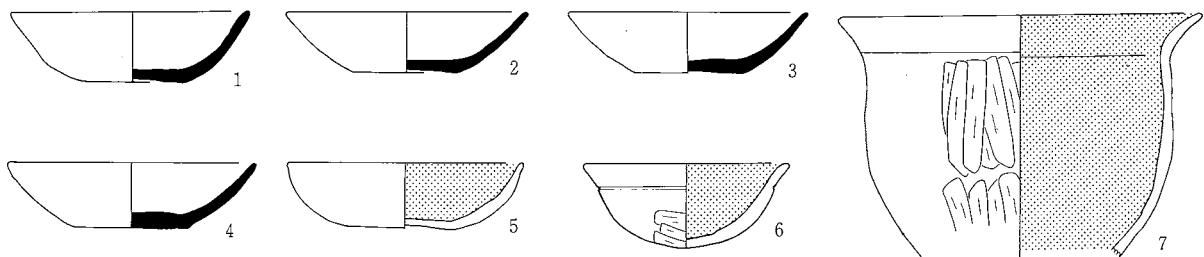

0 (1:4) 10cm

SB521・528・577・1018

図版244 奈良時代～平安時代土器(9)

SB687

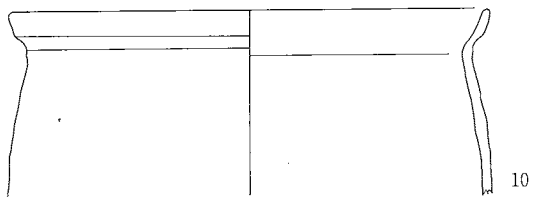
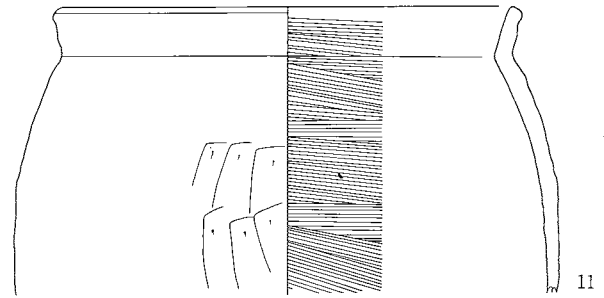
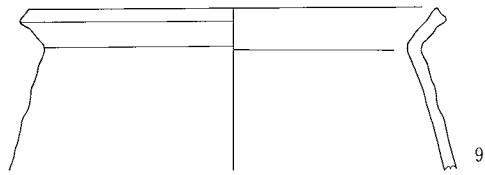
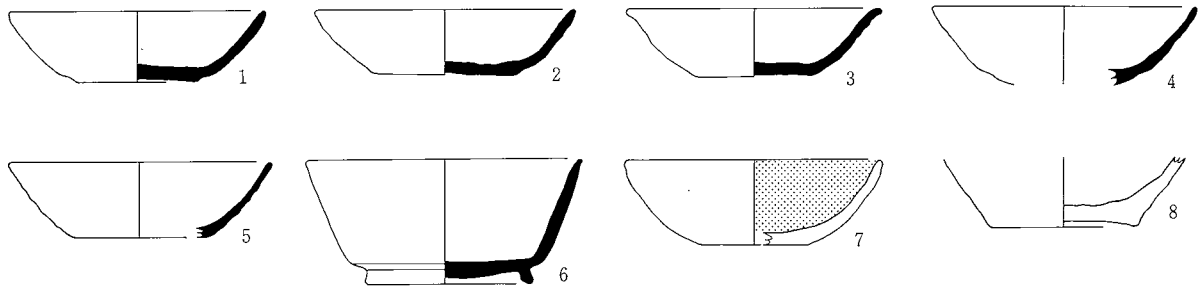

SB1007

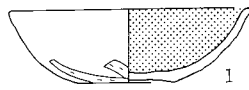

SB1230

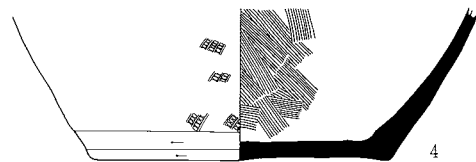
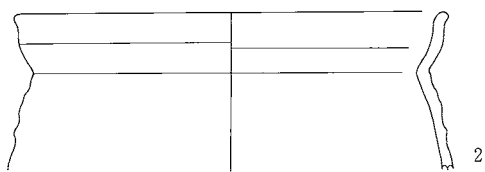
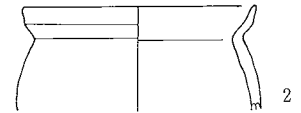
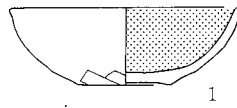

0 (1:4) 10cm

SB687・1007・1230

SD31

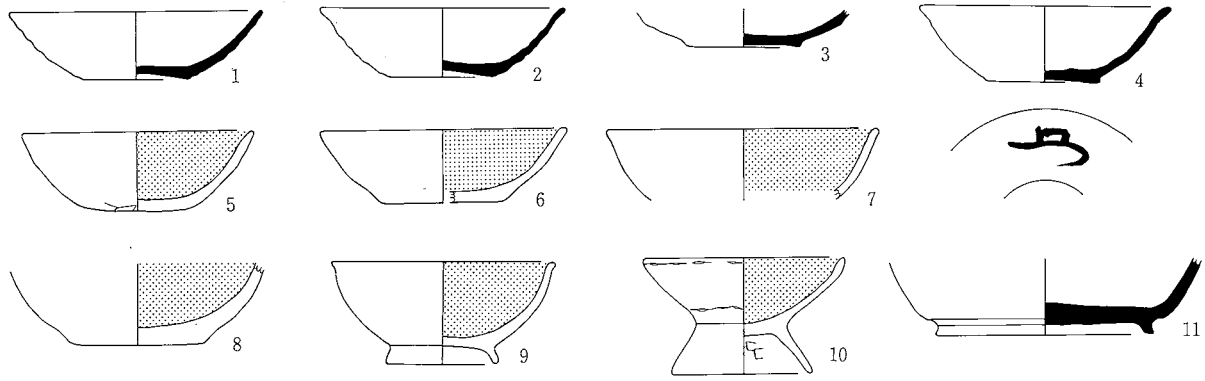

SD33

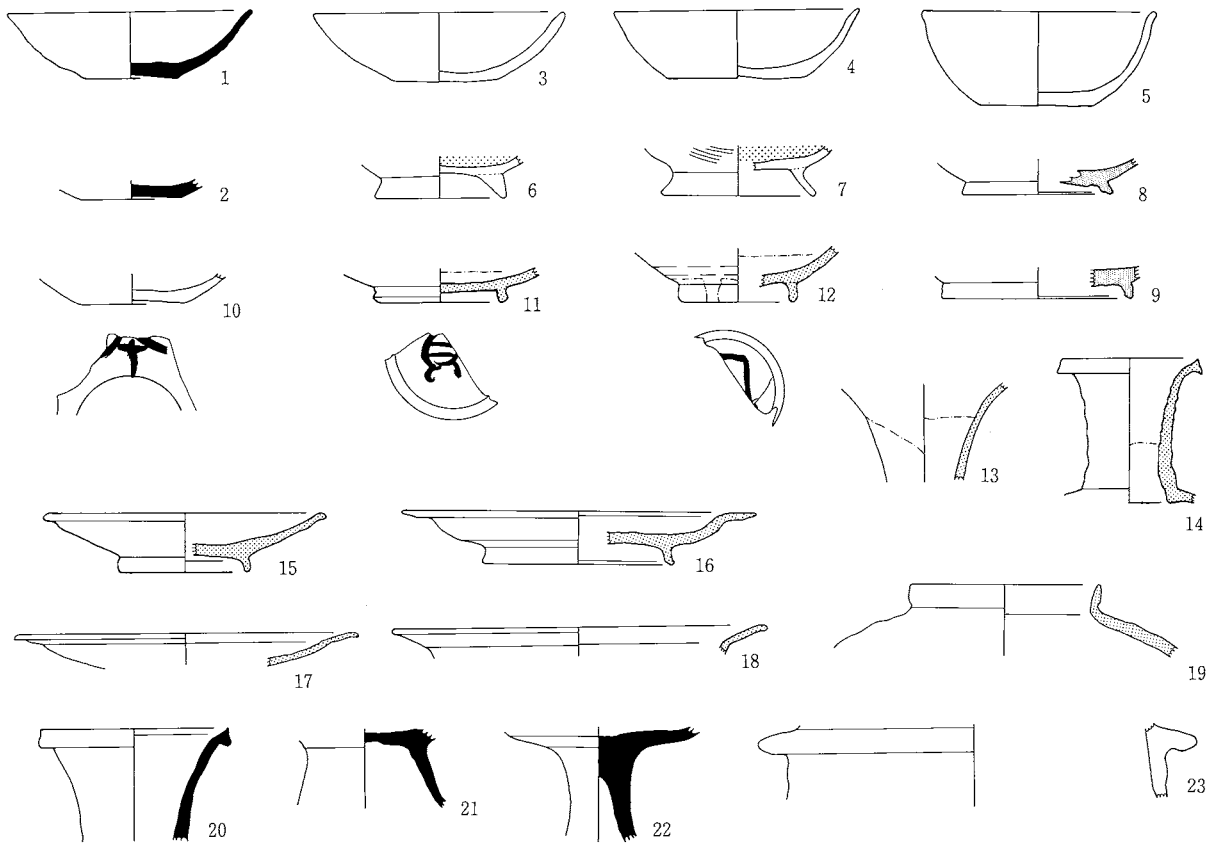

SD37

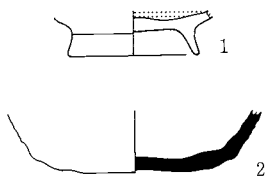

SD39

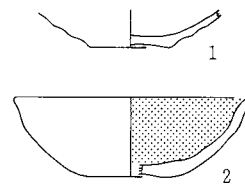

0 (1:4) 10cm

SD47-①

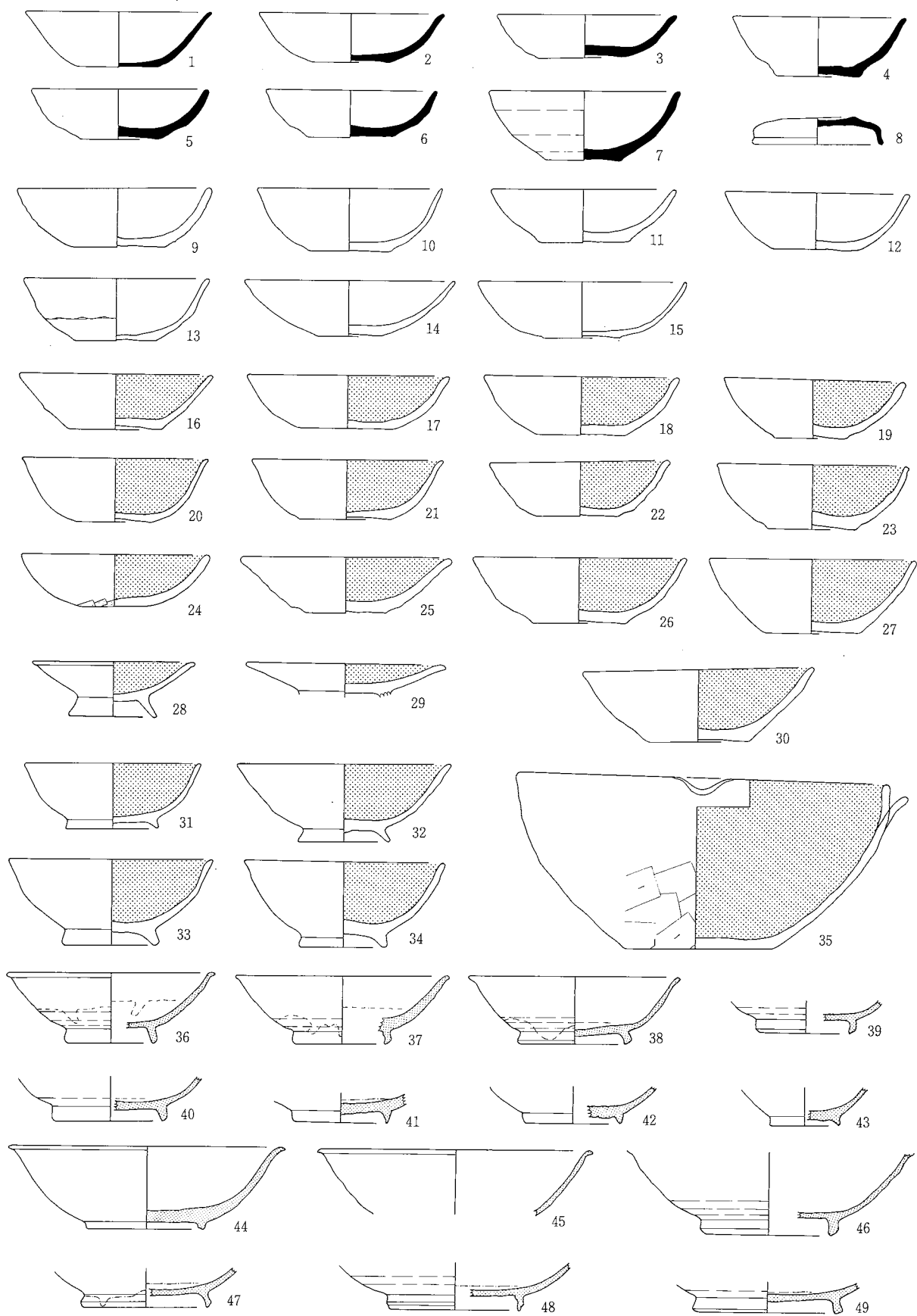

SD47-①

0 (1 : 4) 10cm

SD47-②

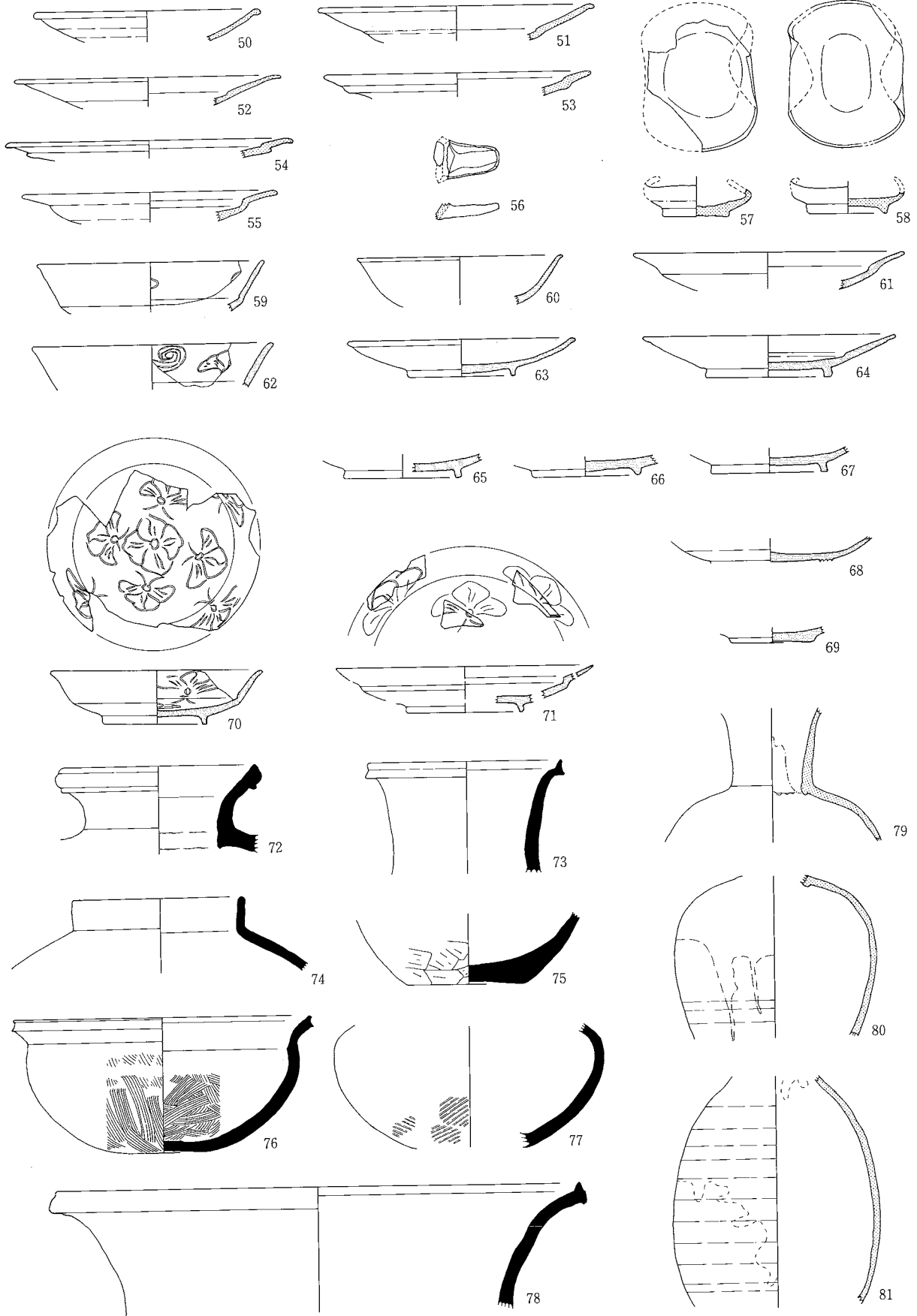

0 (1:4) 10cm

SD47-②

SD47-③

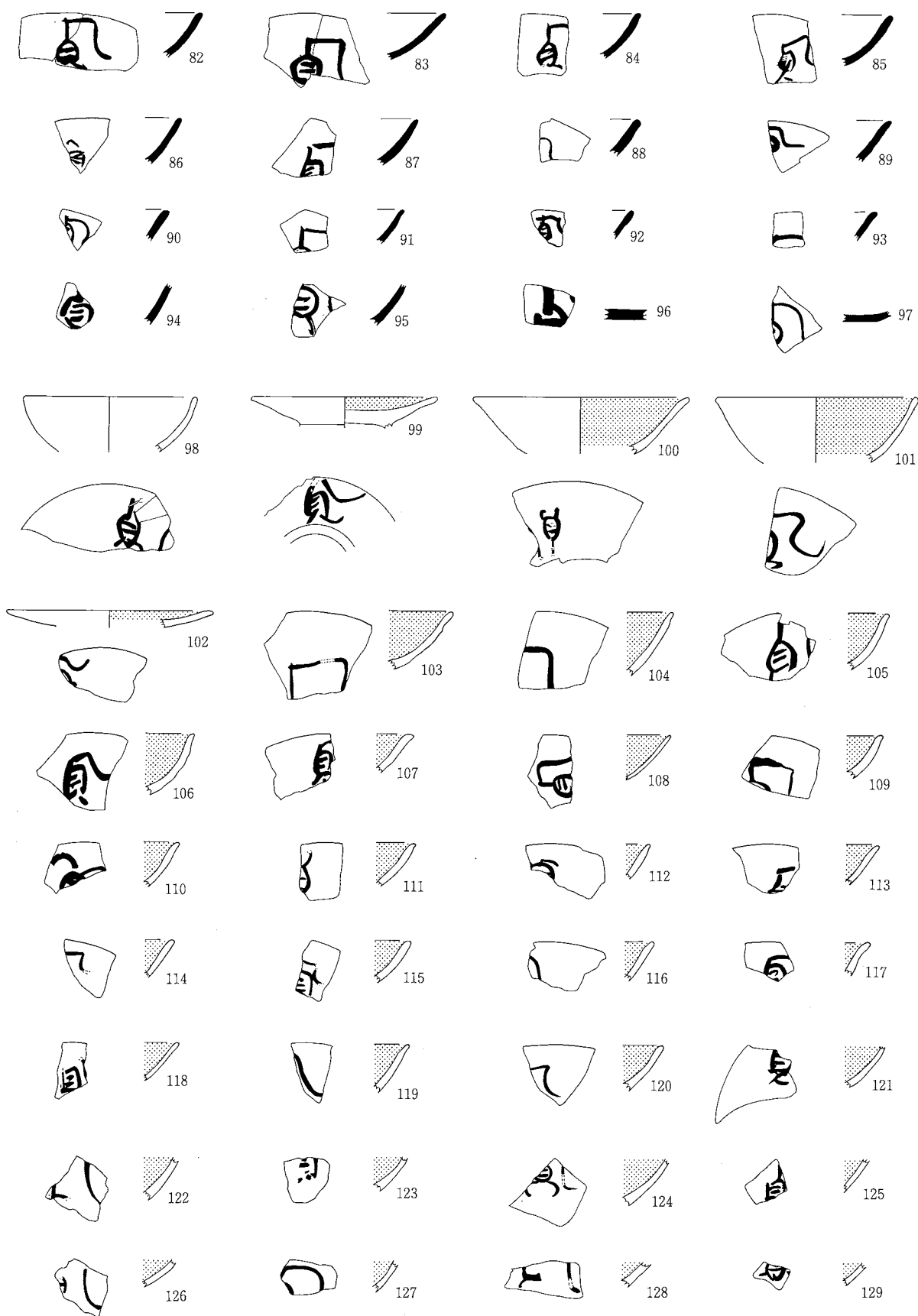

0 (1:4) 10cm

SD47-③

SD47-④

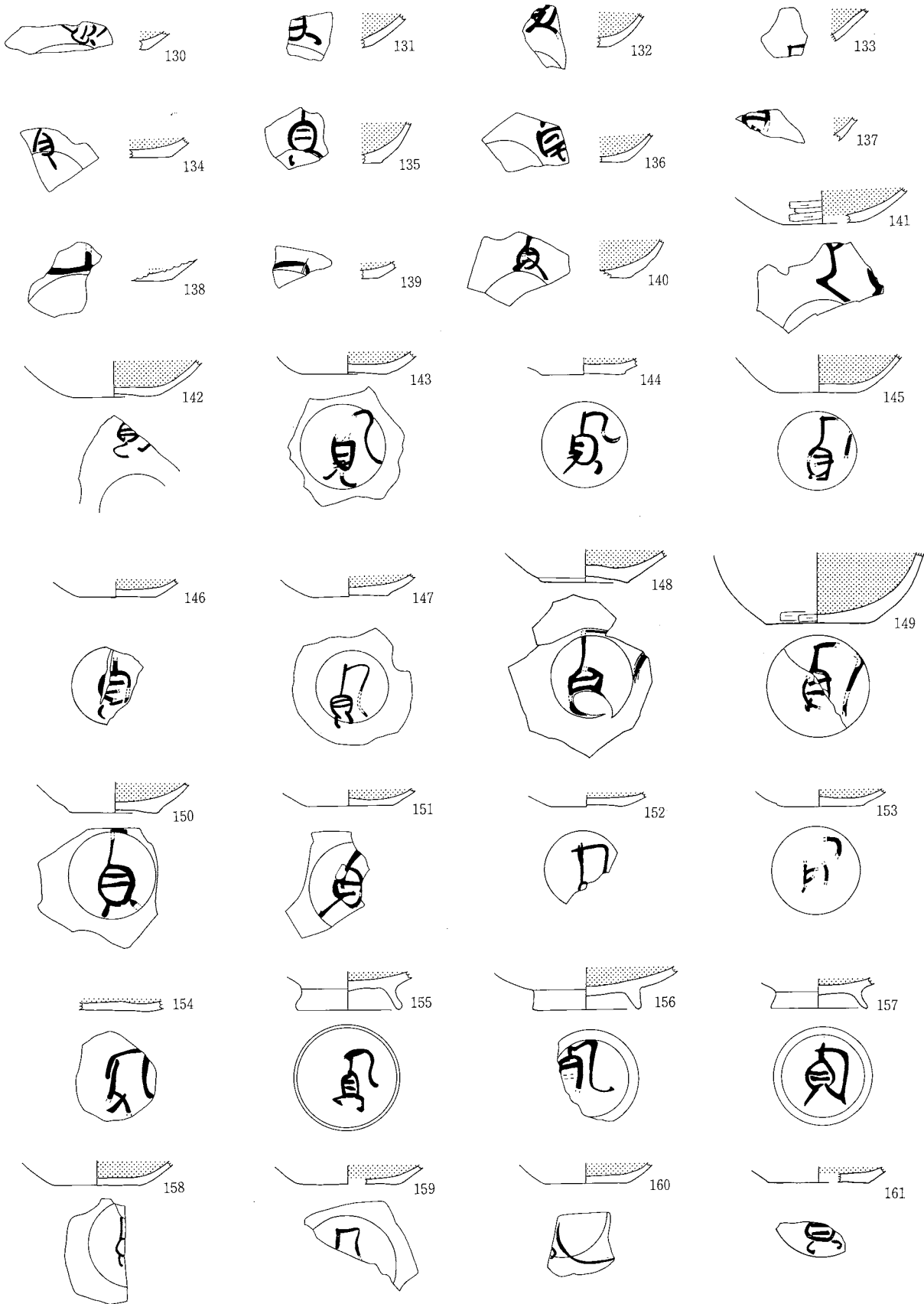

0 (1:4) 10cm

SD47-④

SD47-⑤

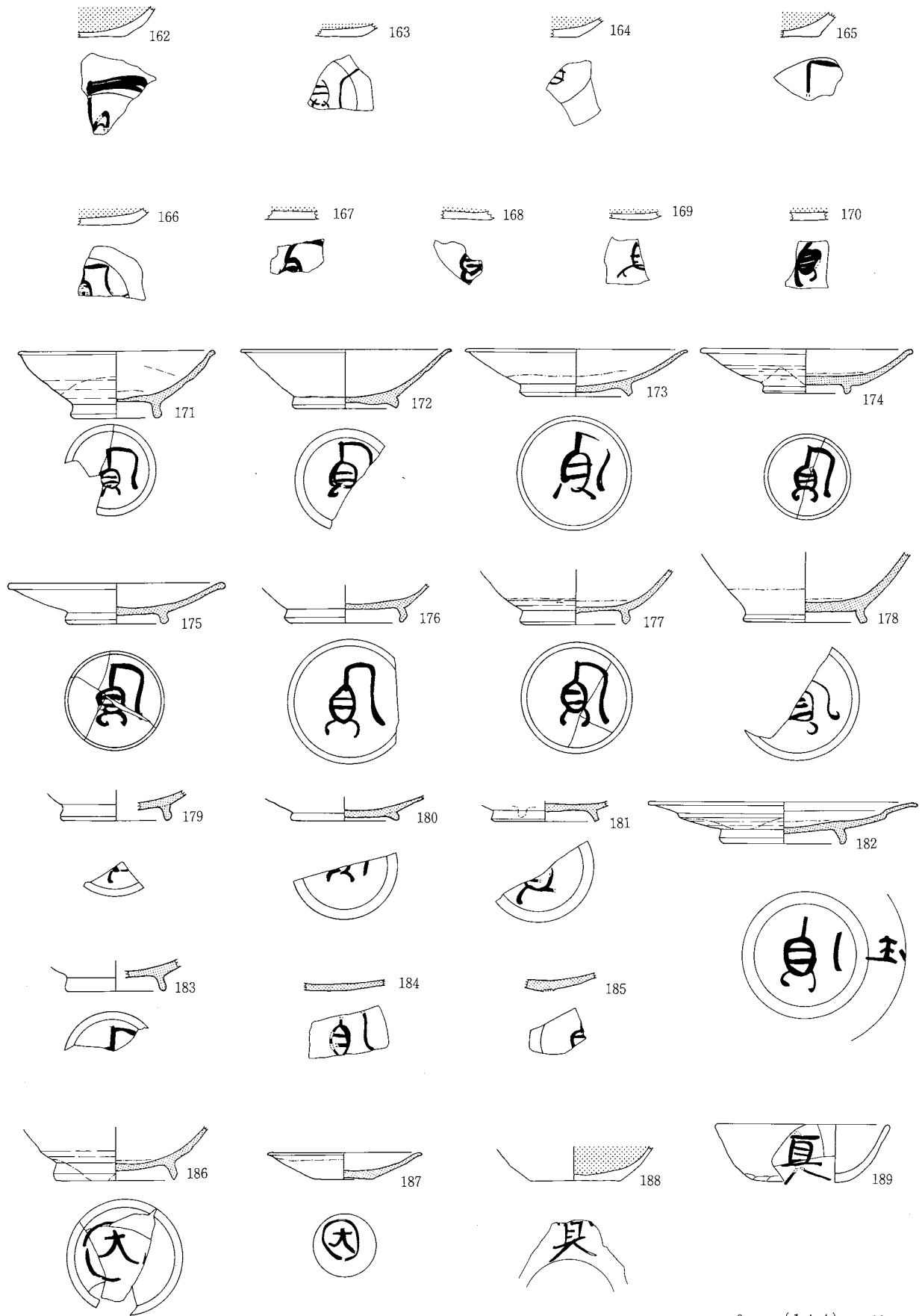

0 (1:4) 10cm

SD47-⑤

SD47-⑥

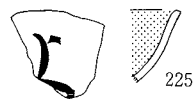
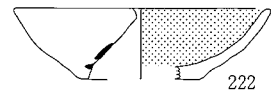
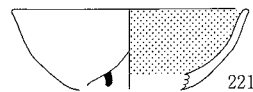
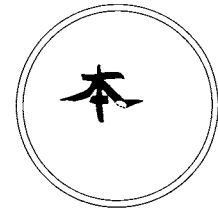
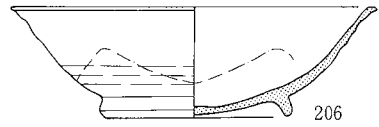
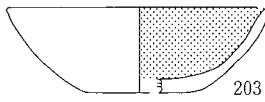
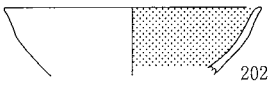
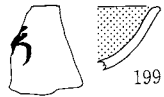
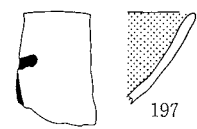
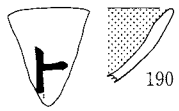

0 (1 : 4) 10cm

SD47-⑥

SD47-⑦

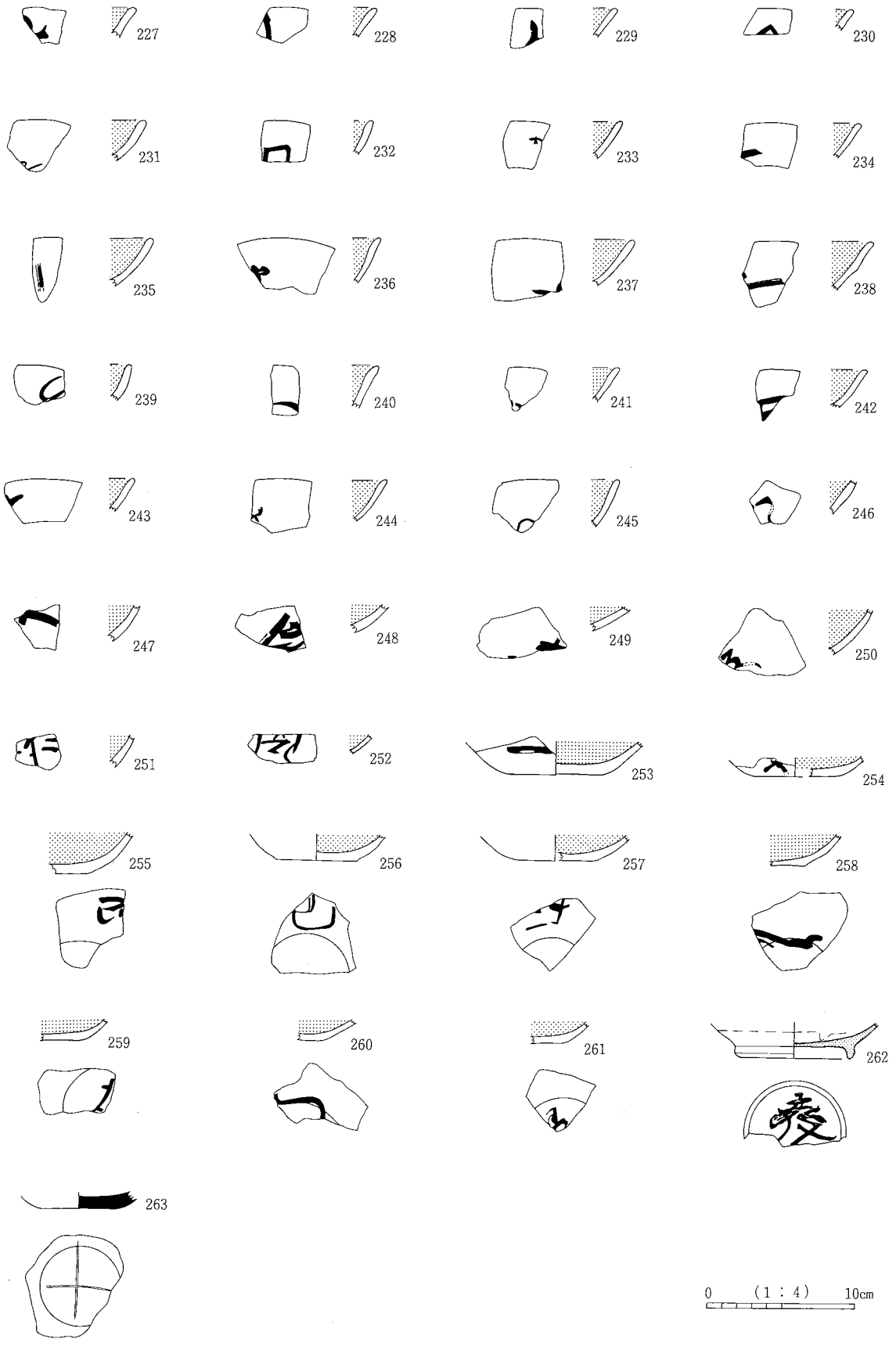

SD47-⑦

SD79

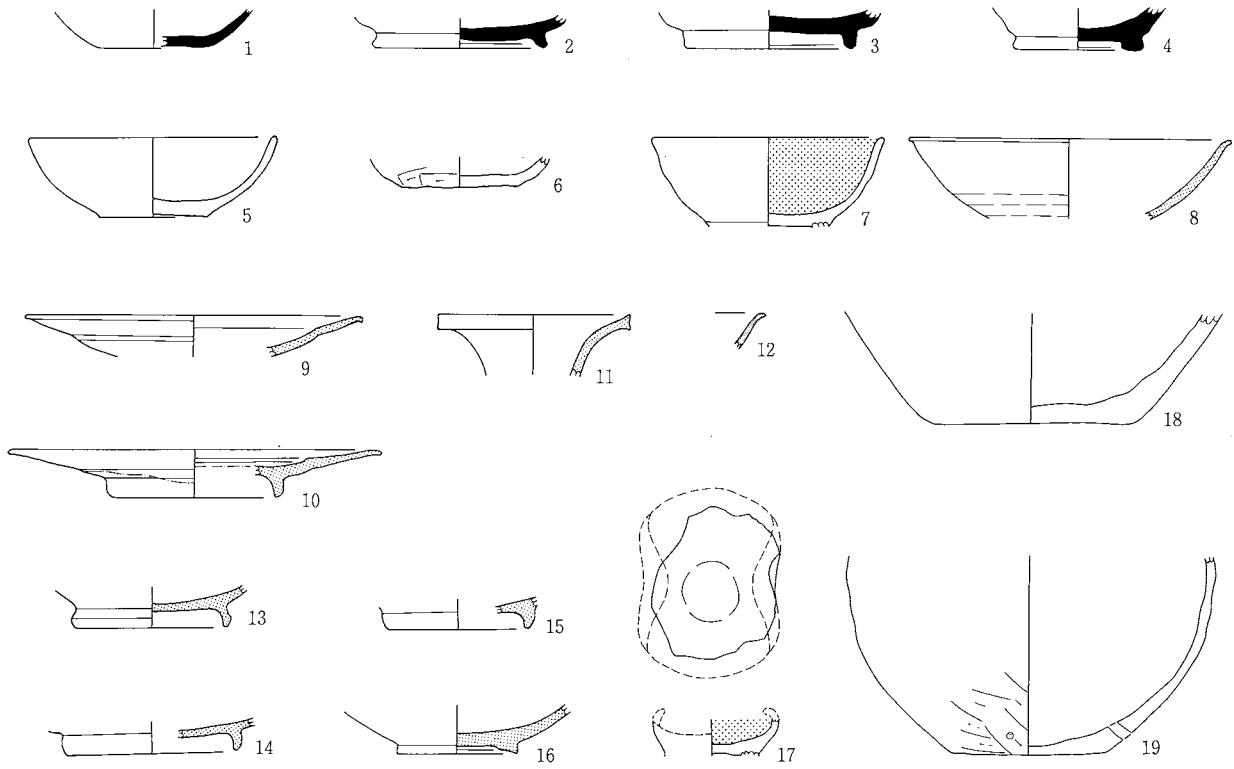

SD189

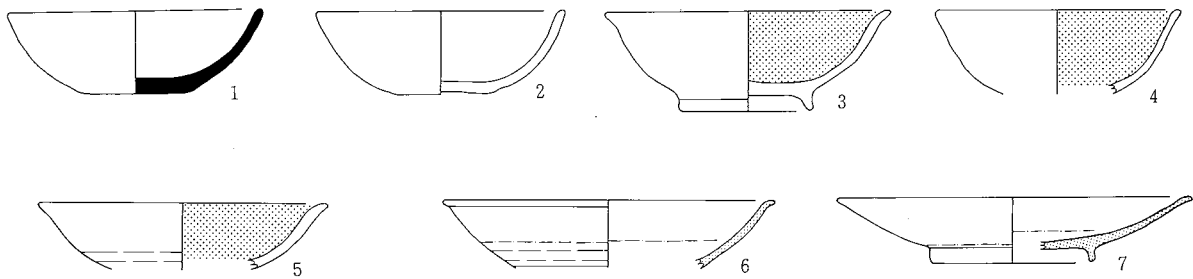

SK4100

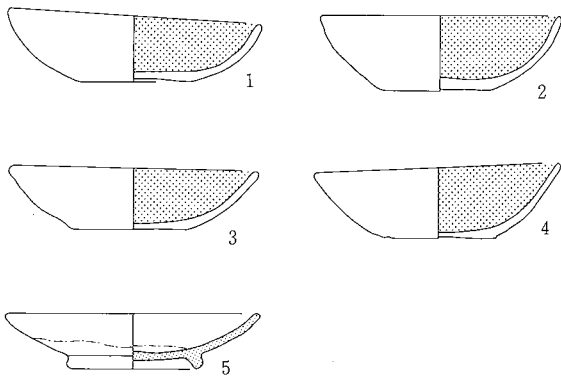

SF1

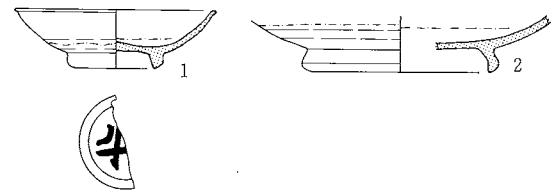

0 (1:4) 10cm

SF2

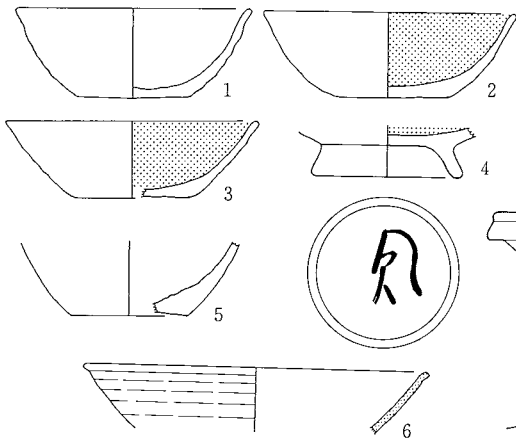

SF12

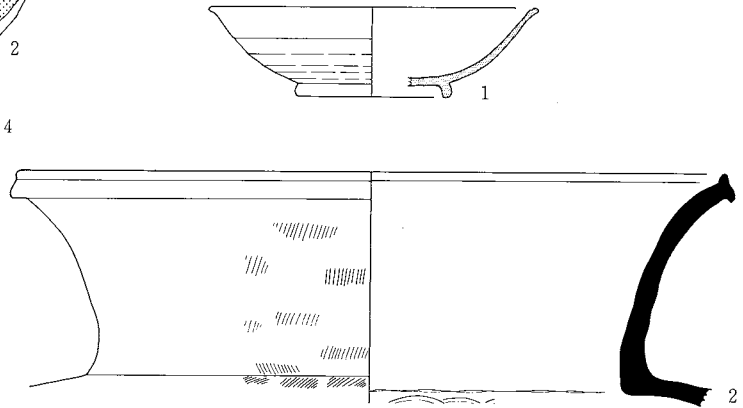

SF401

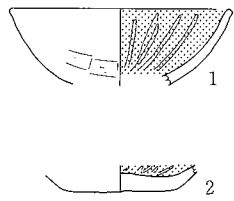

SG4

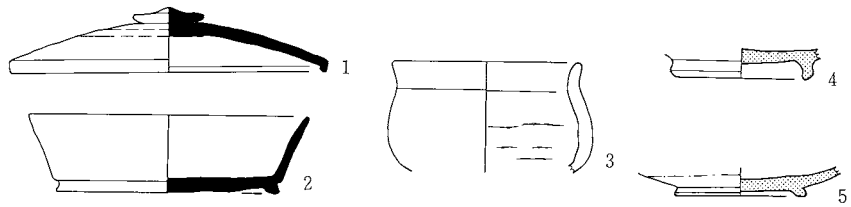

SQ1

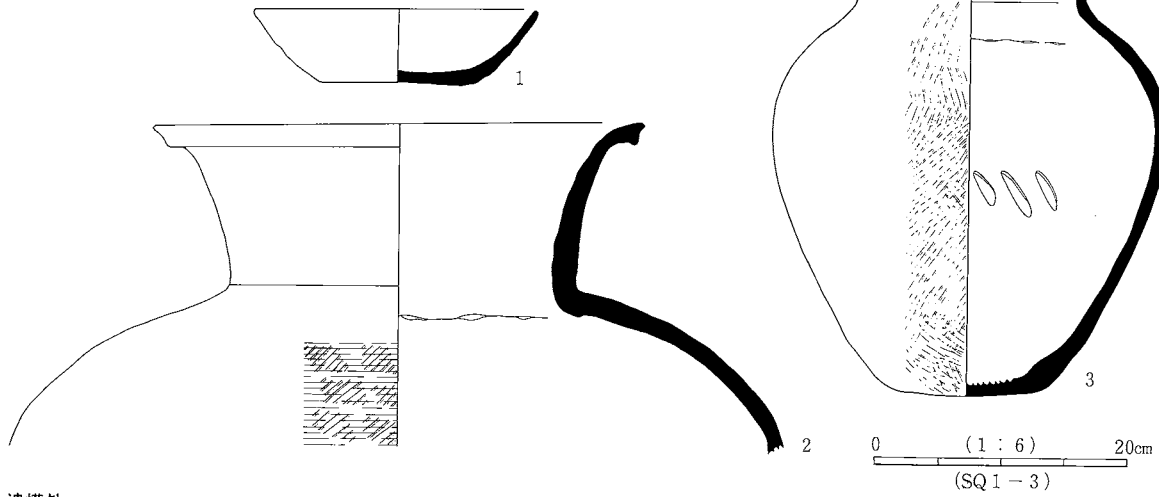

遺構外

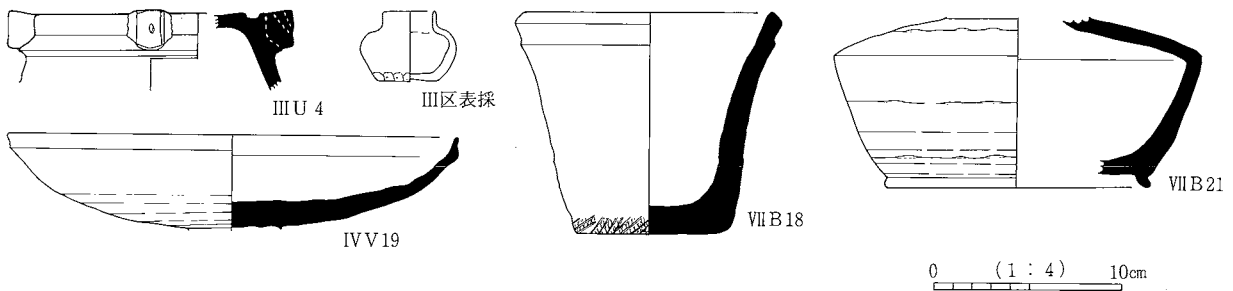

遺構外出土墨書土器・刻書土器

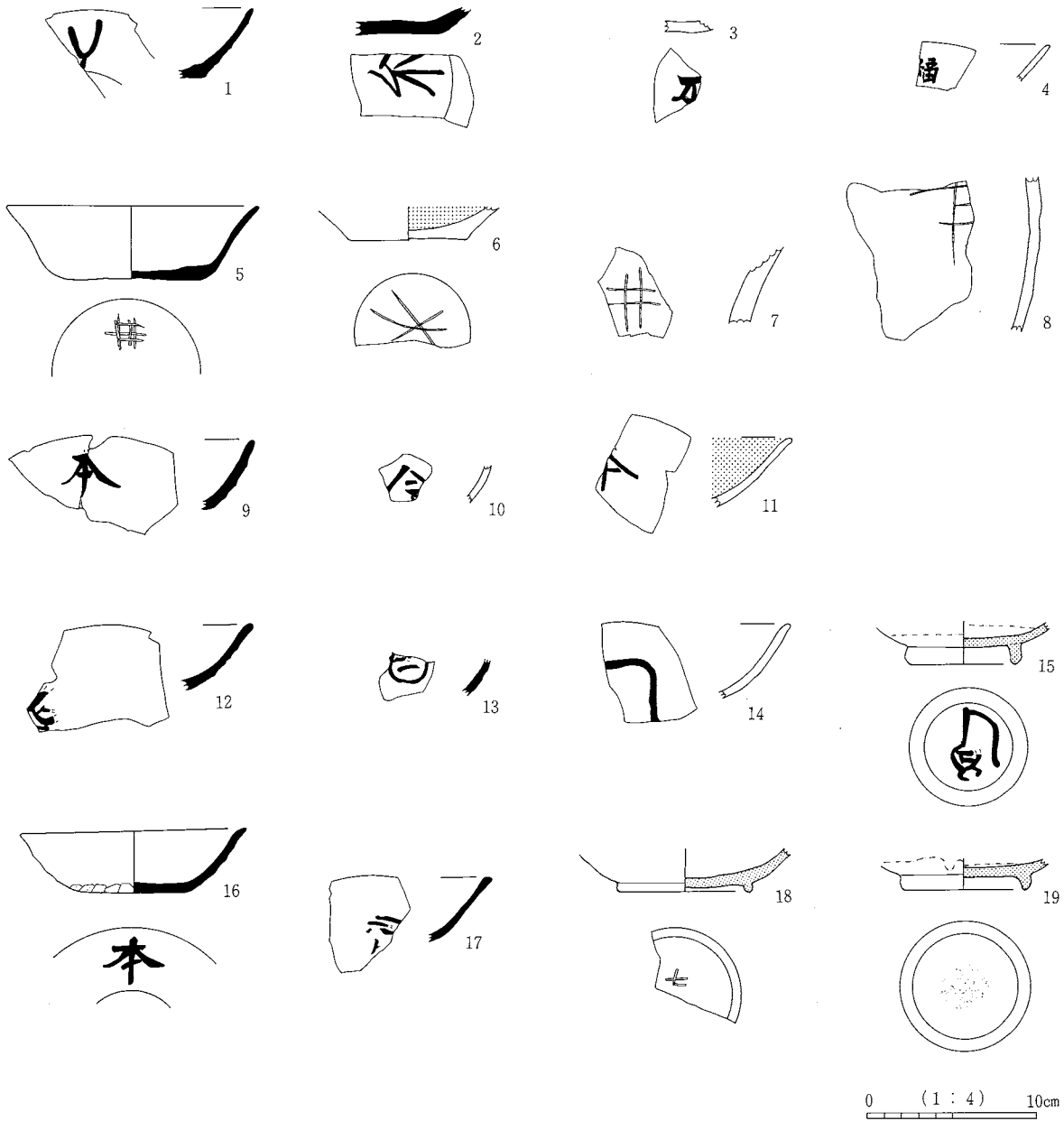

遺構外出土墨書土器・刻書土器

SD1

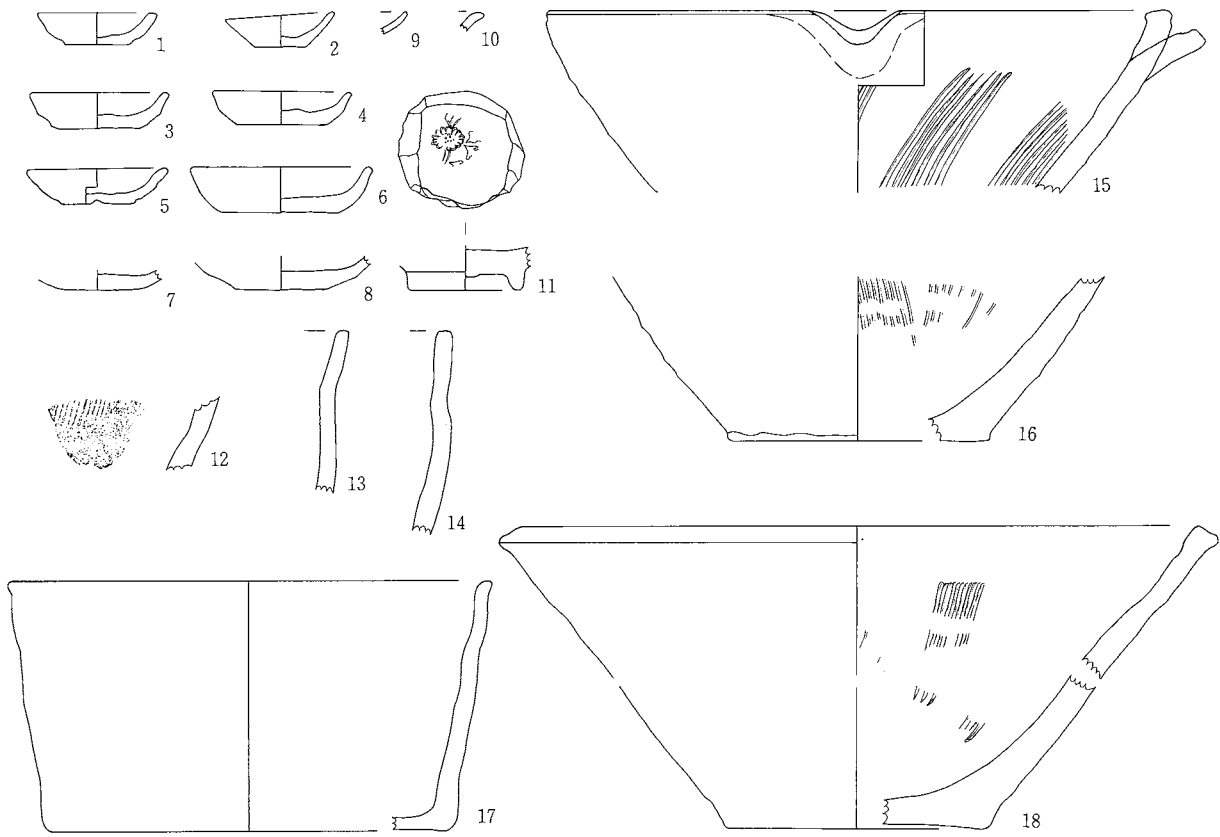

SD13



SD15

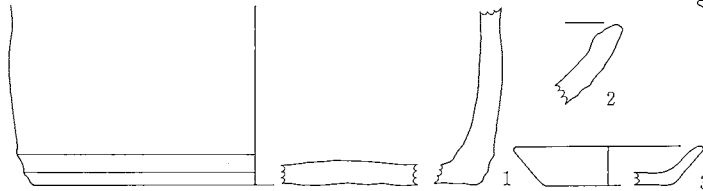

SK778

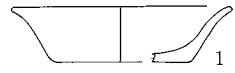

SK316



SK3557

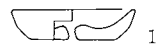

遺構外

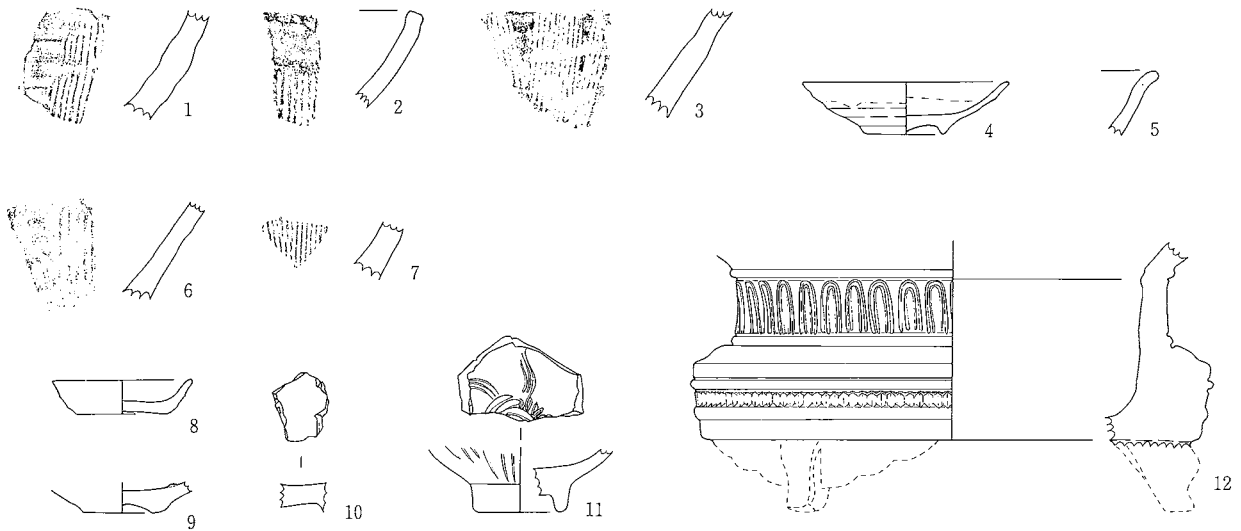

0 (1:4) 10cm

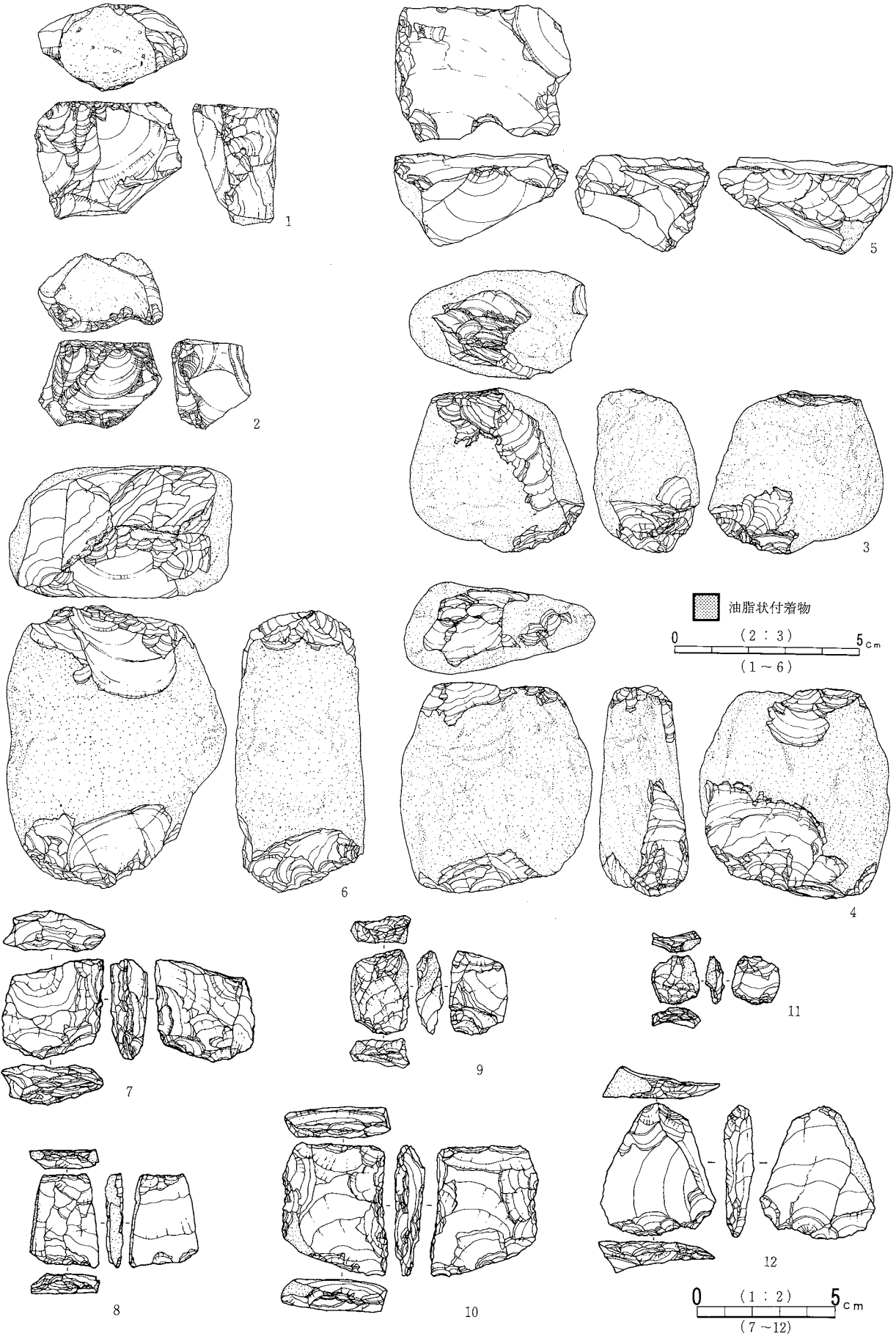

石核・剥片A類

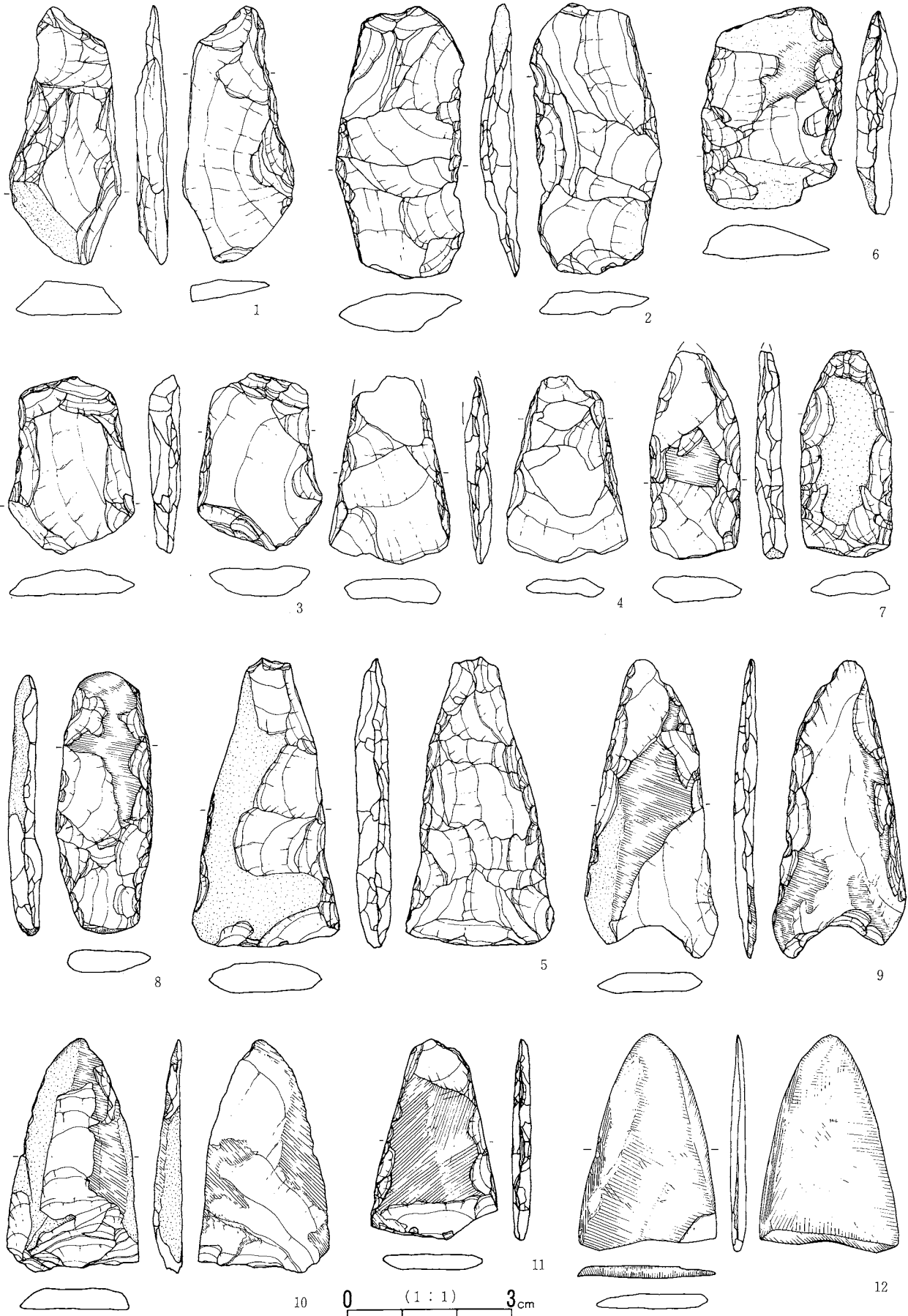

磨製石鏃(1)

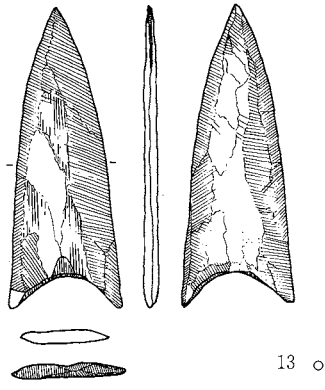

13 ○

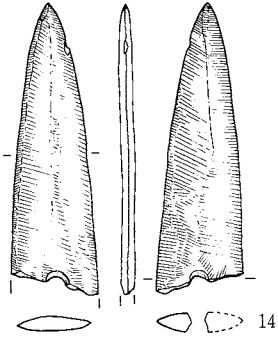

14 ○

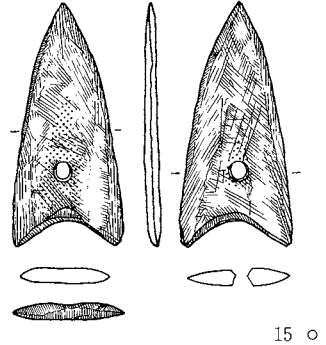

15 ○

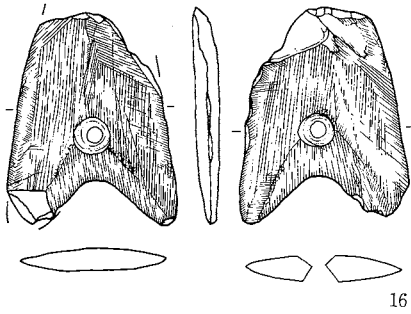

16 ○

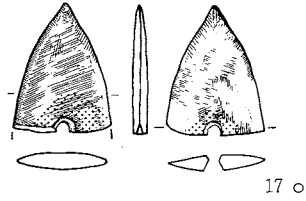

17 ○

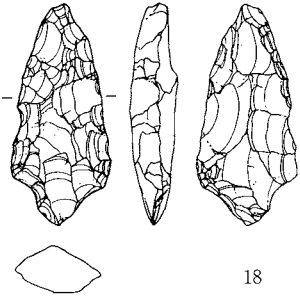

18

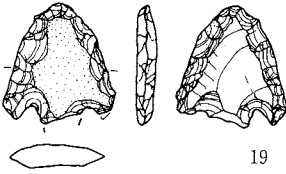

19

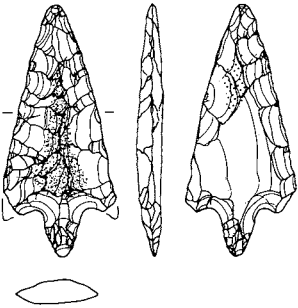

20 ○

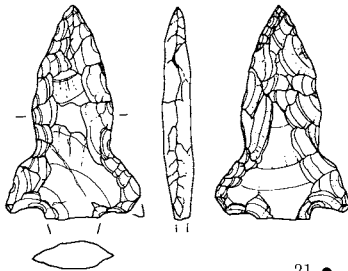

21 ●

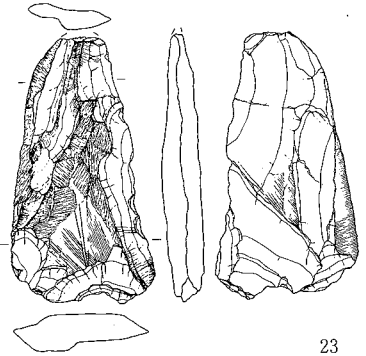

23



22

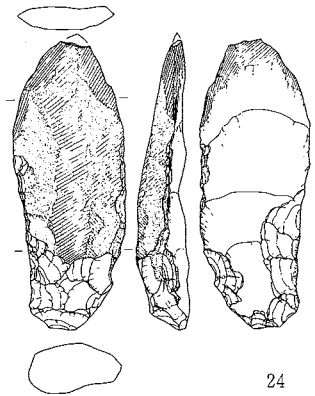

24

● 使用痕
 ■ 装着痕
 ○ 油脂状附着物

0 (1:1) 2 cm
 (13~22)

0 (1:2) 5 cm
 (23~24)

磨製石鏃(2)・打製石鏃・磨製石劍

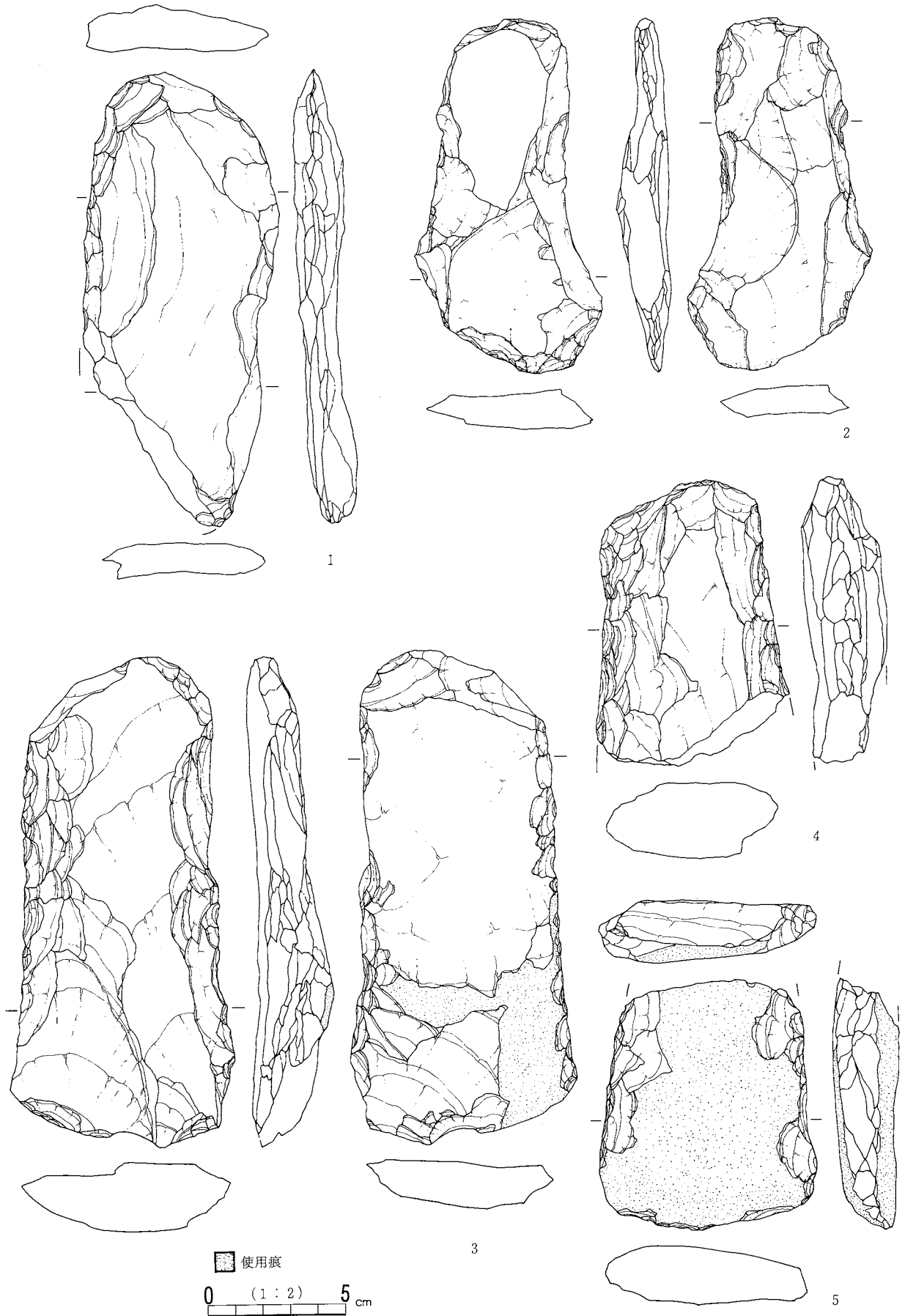

打製石斧(1)

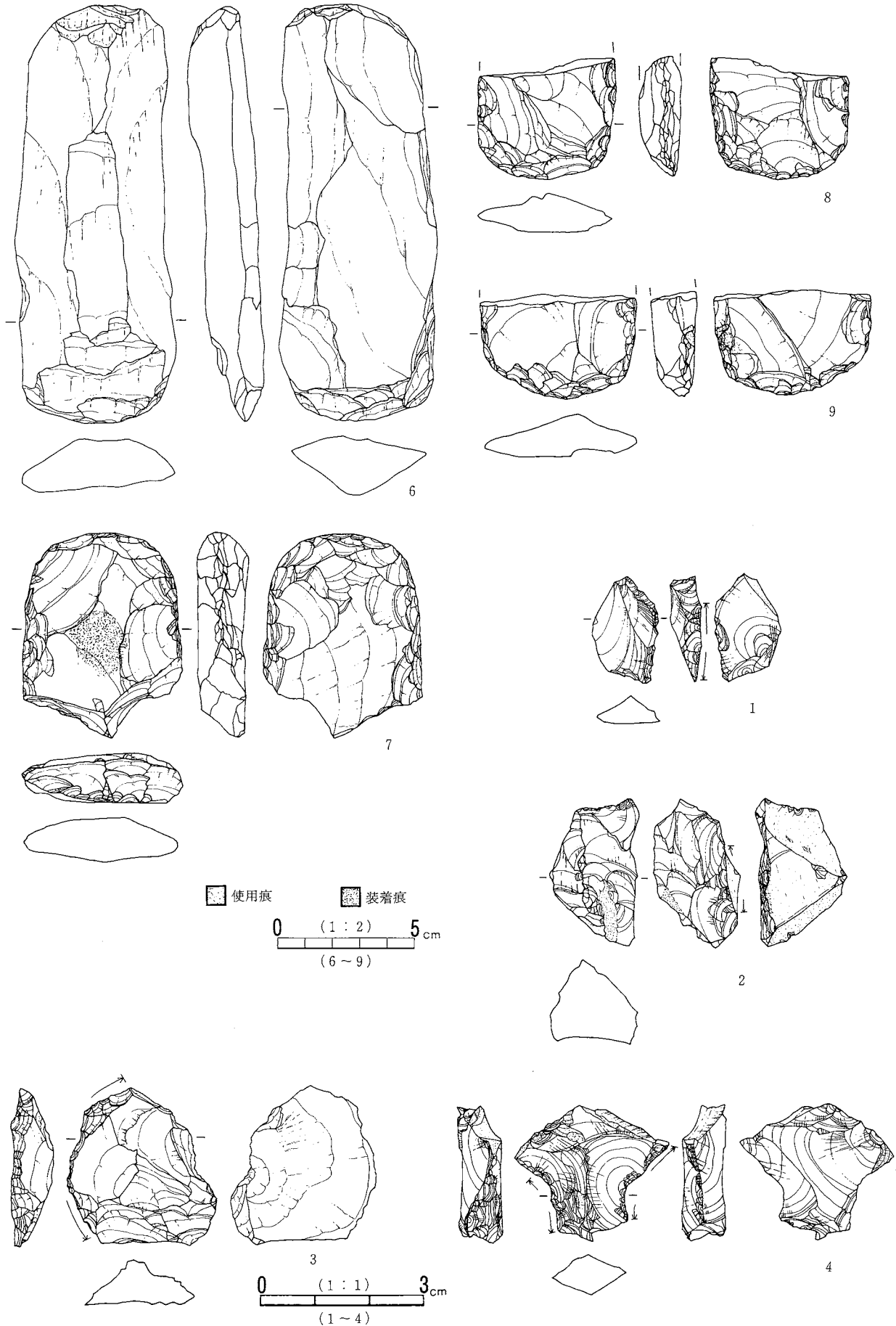

打製石斧(2)・小形刃器

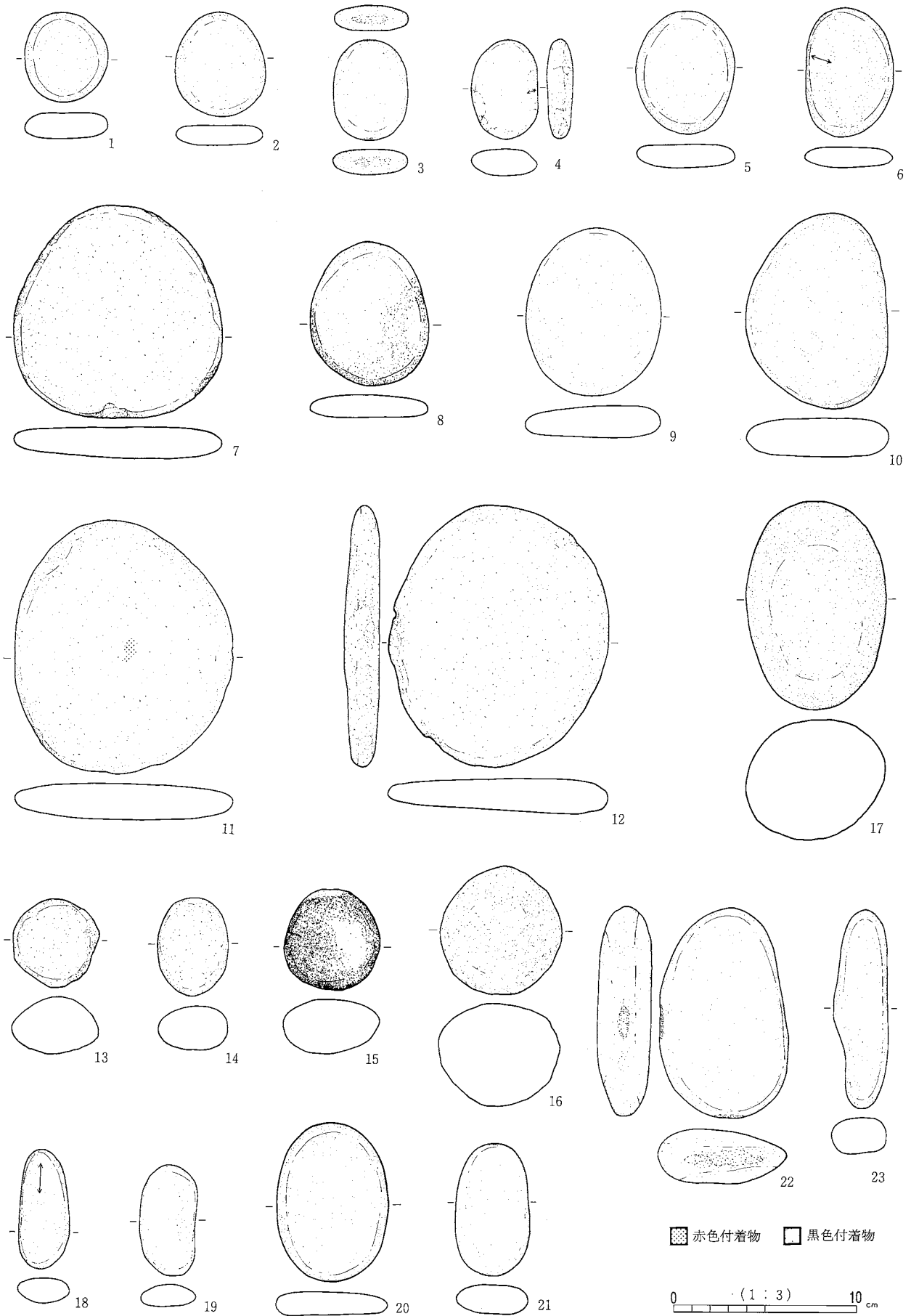

磨石

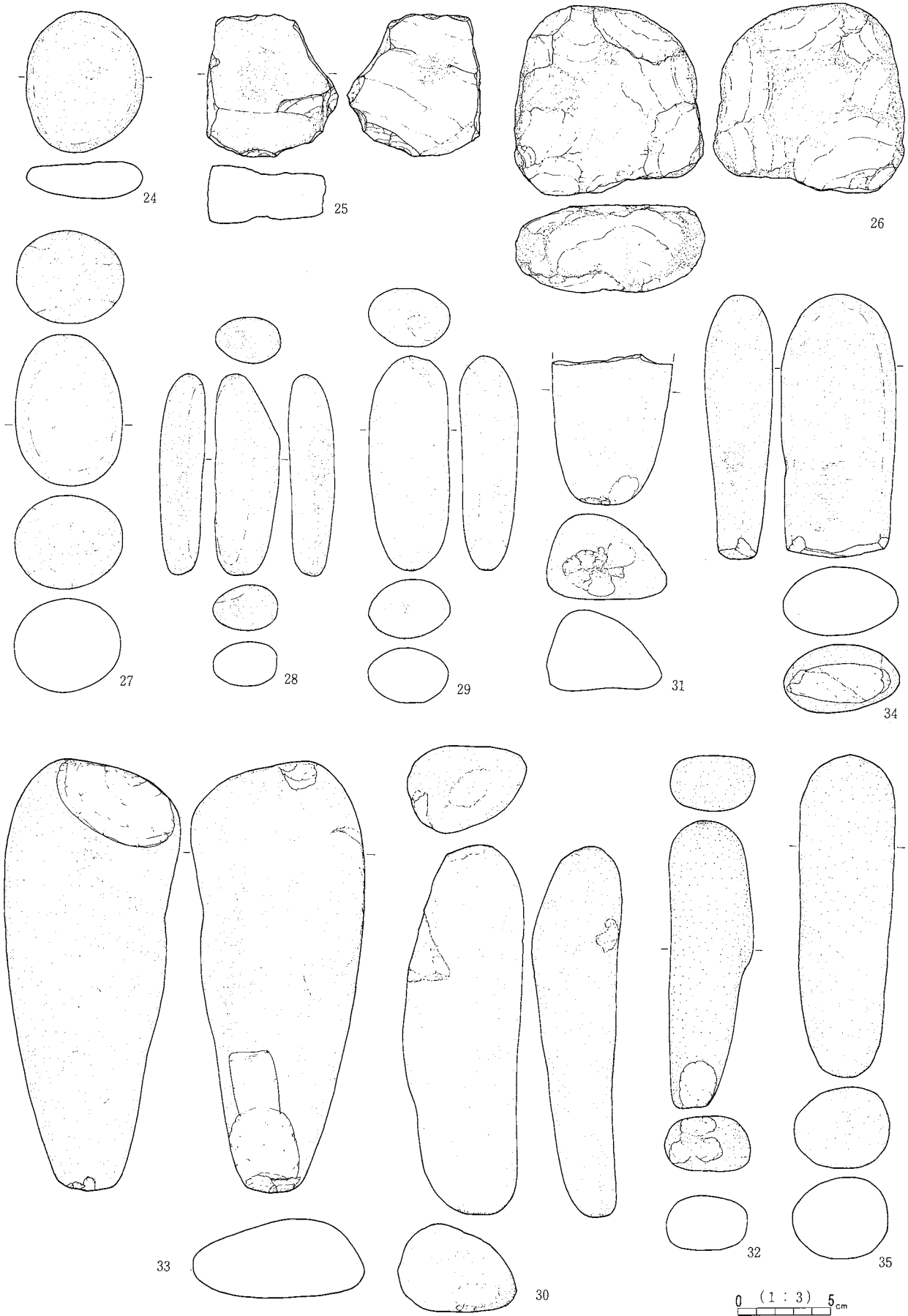

凹石・敲石(1)

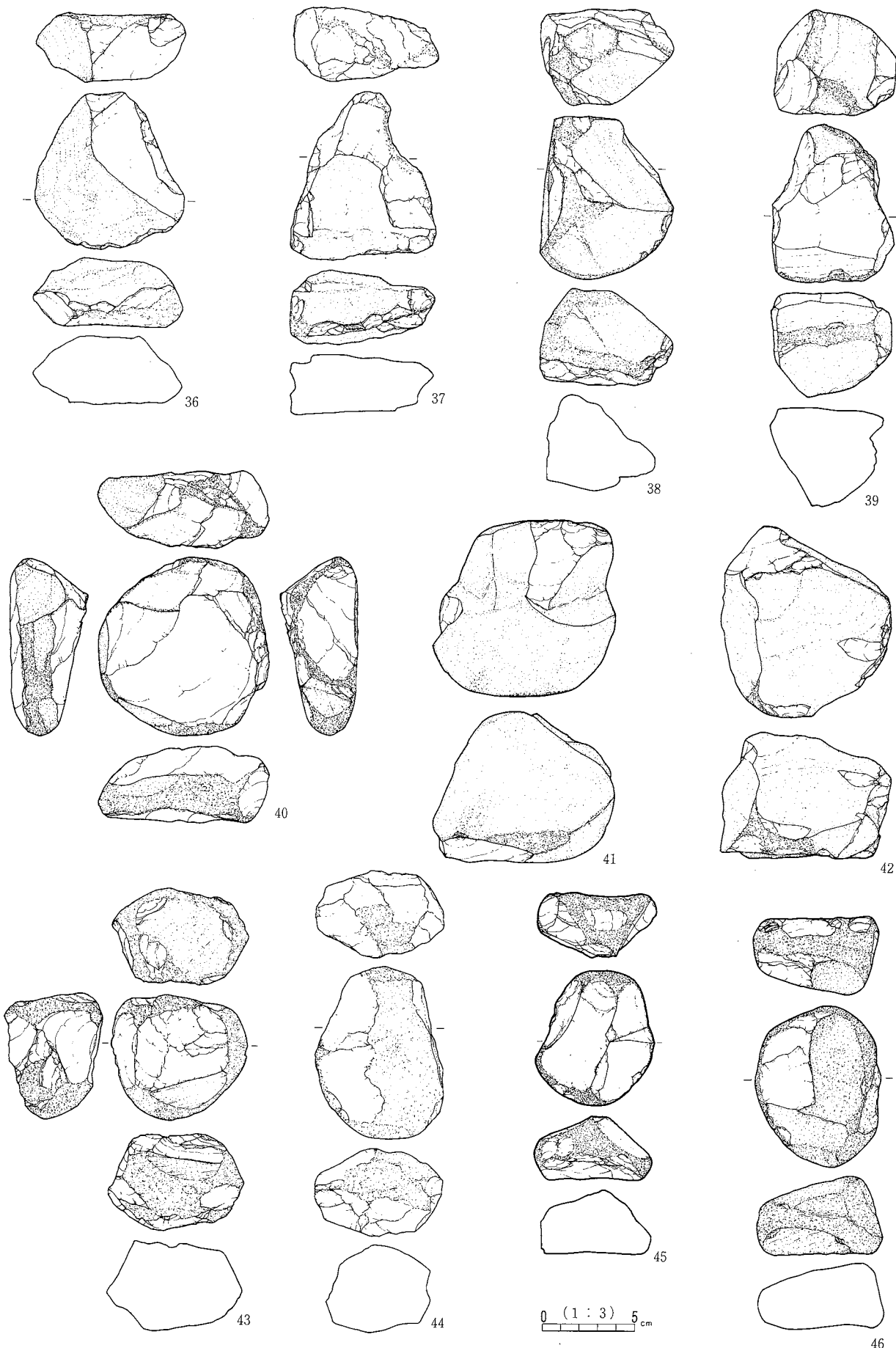

敲石(2)

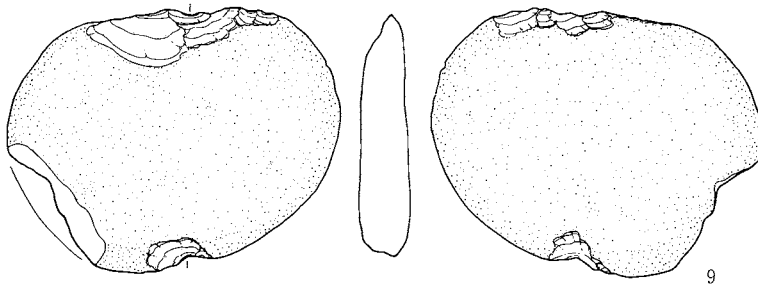
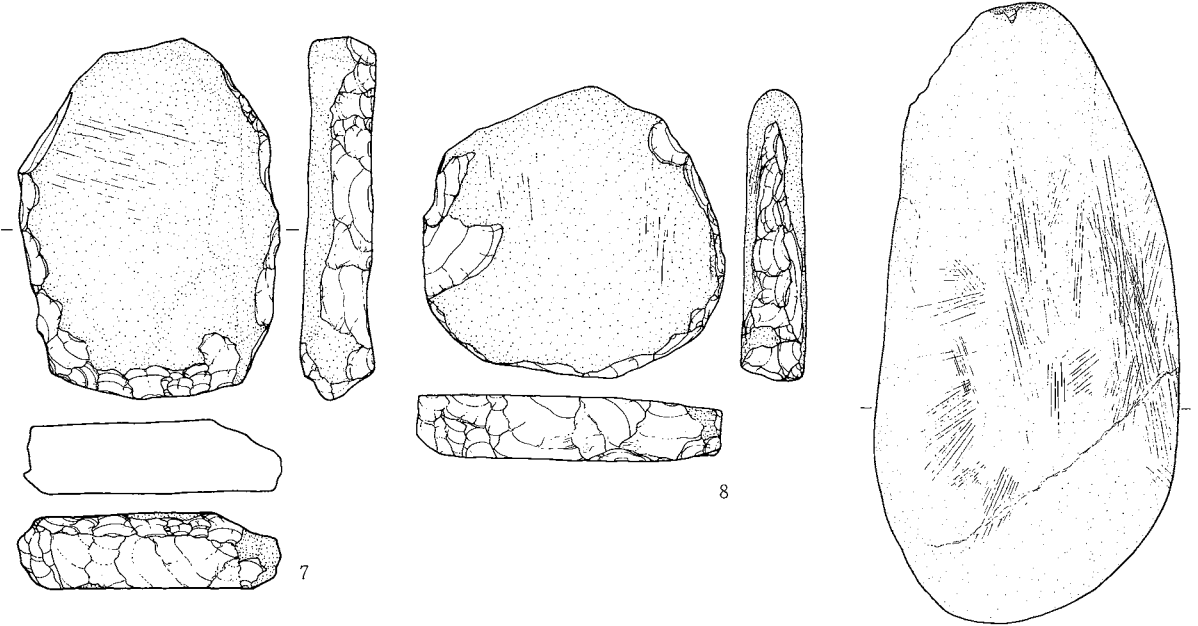
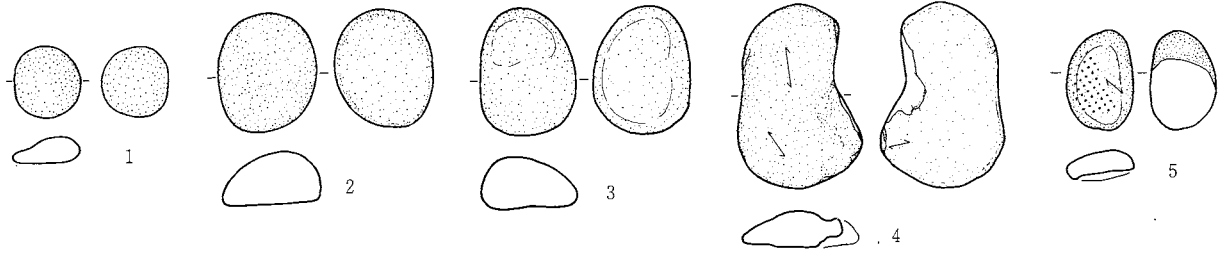

0 (1:3) 5 cm
(6)

0 (1:2) 5 cm

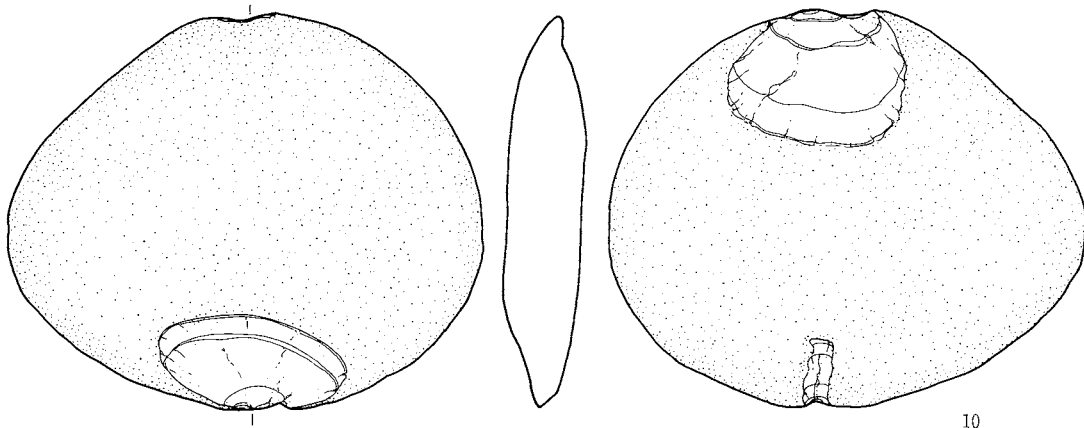

10

みがき石・円盤状石製品・石錘

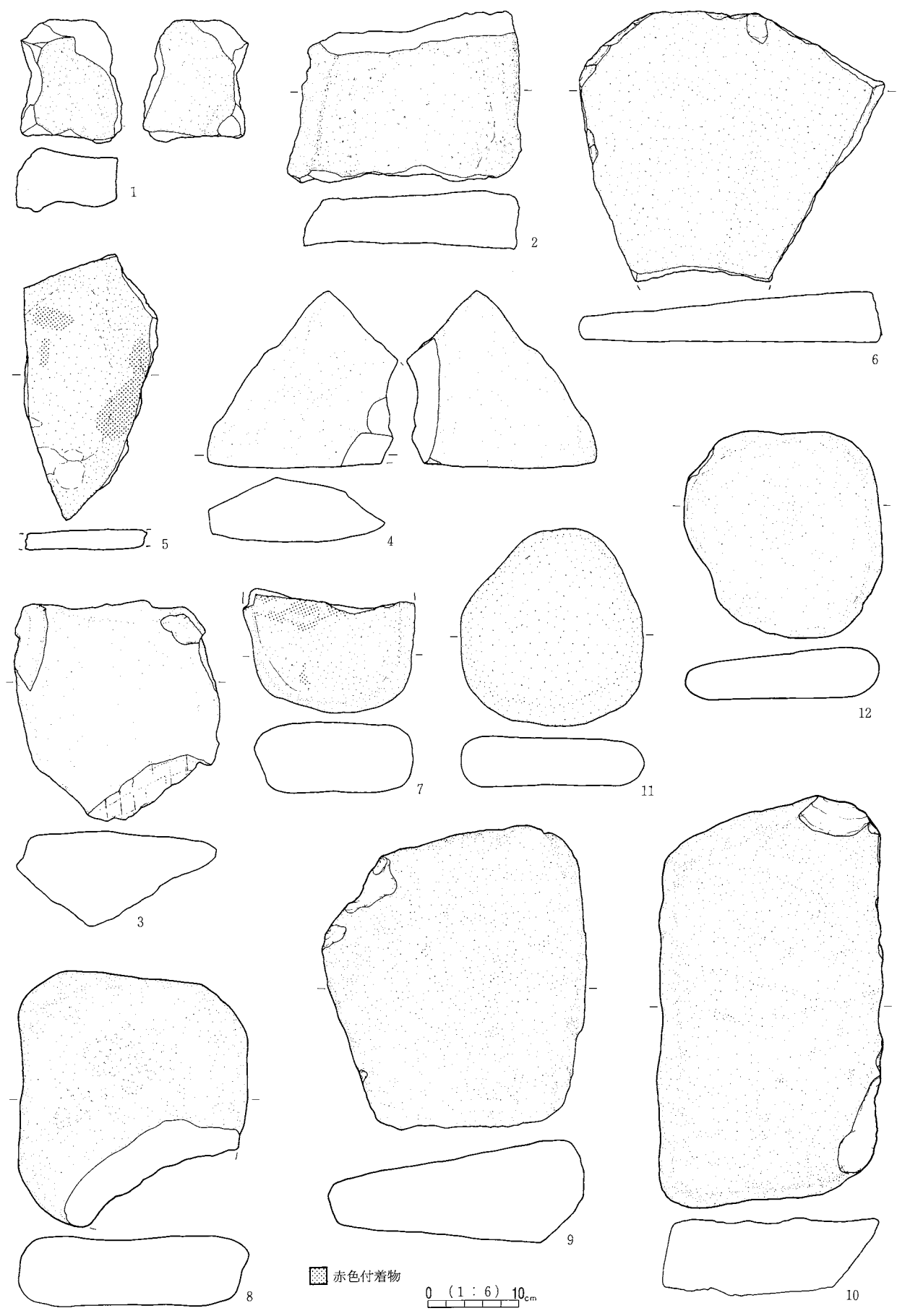

台石・石皿

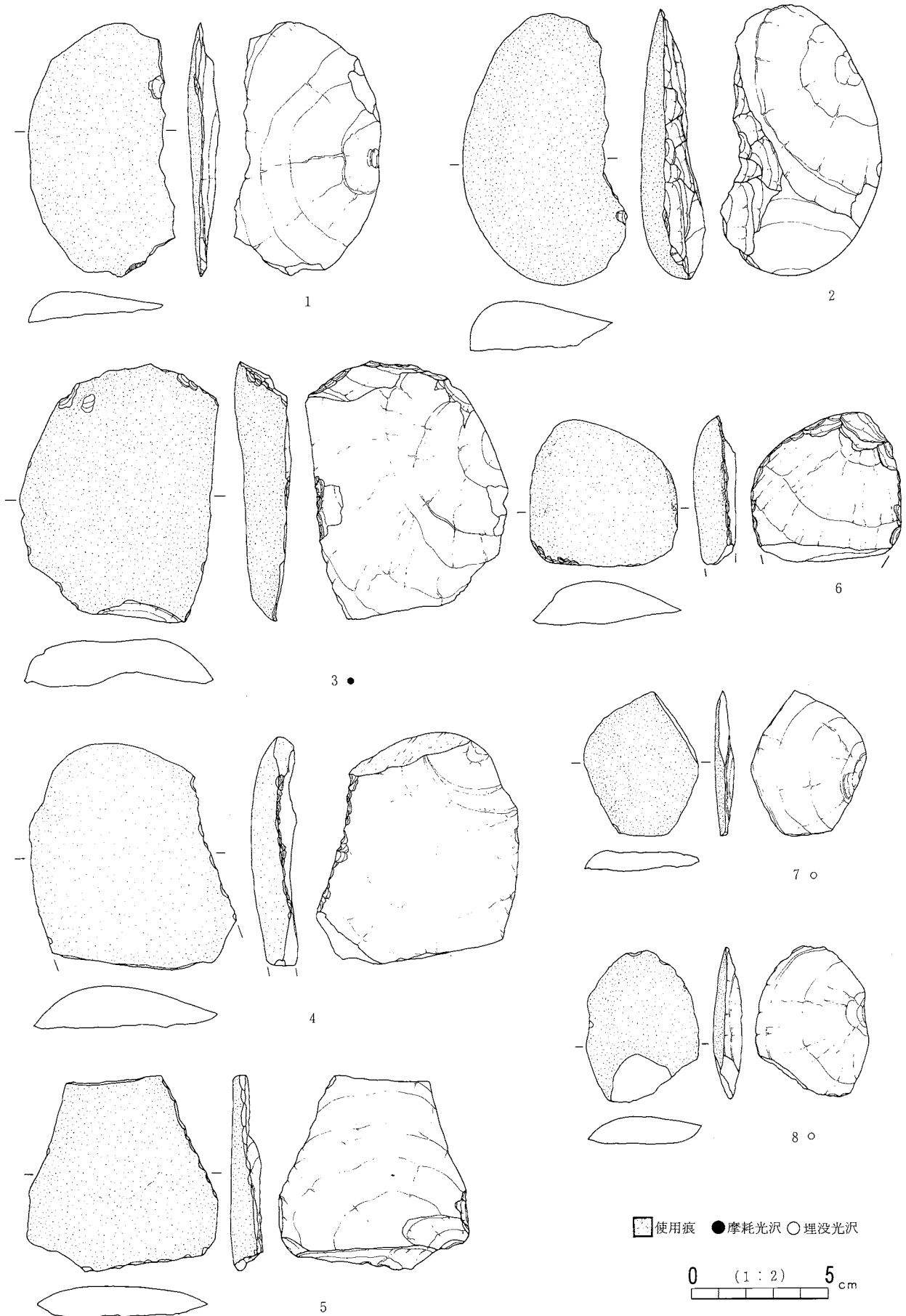

大形刃器(1)

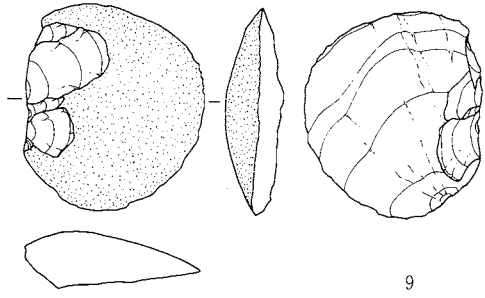

9

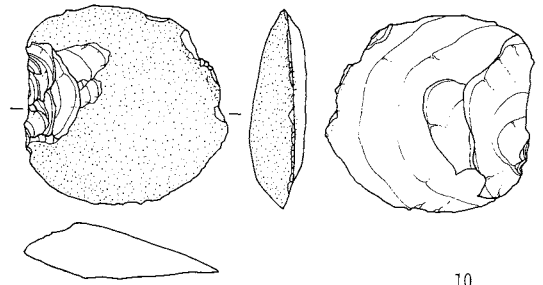

10

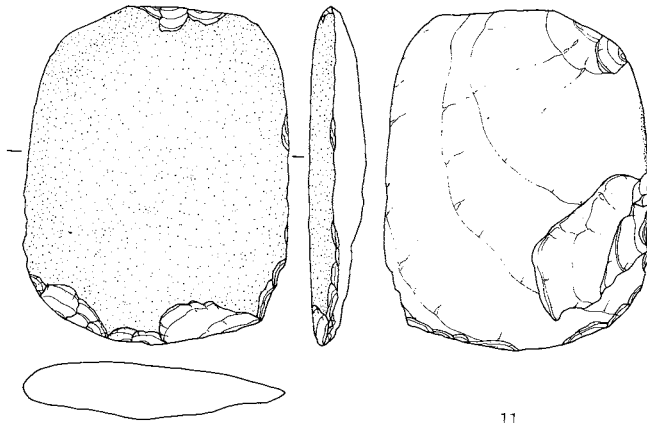

11

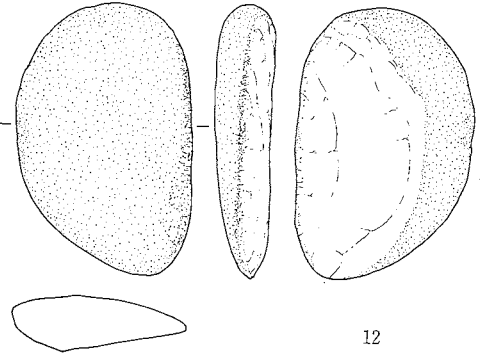

12

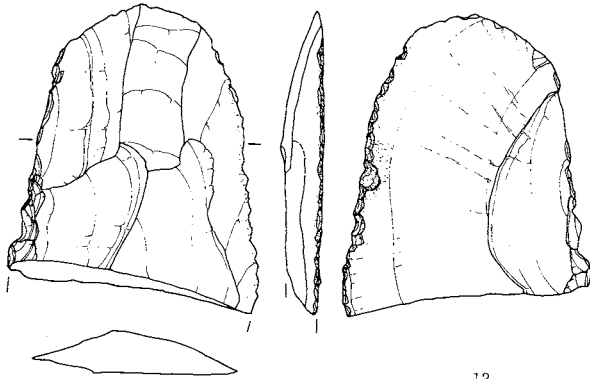

13

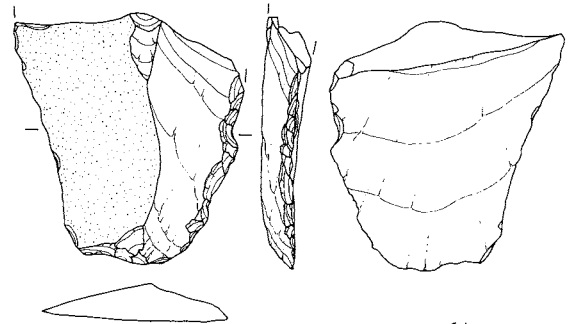

14

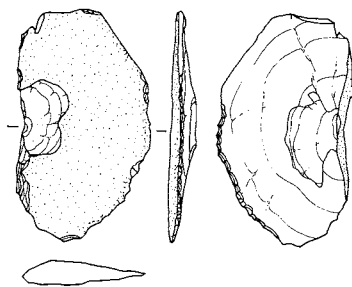

16

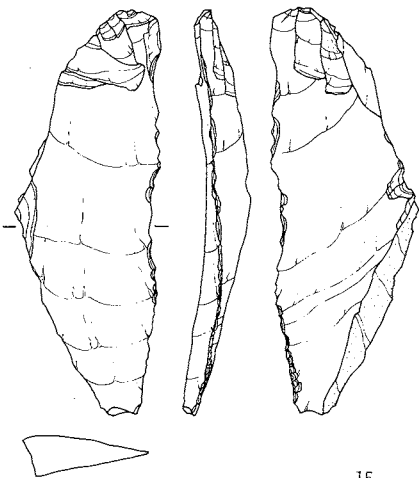

15

0 (1:2) 5cm

大形刃器(2)

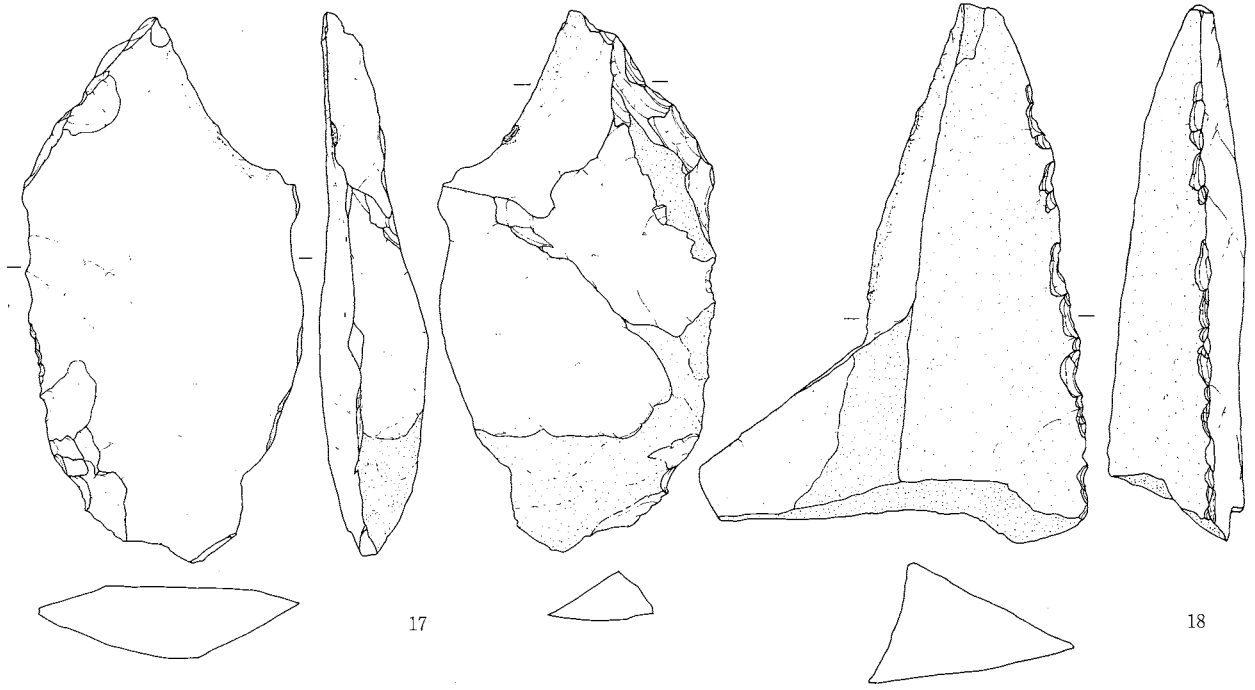

17

18

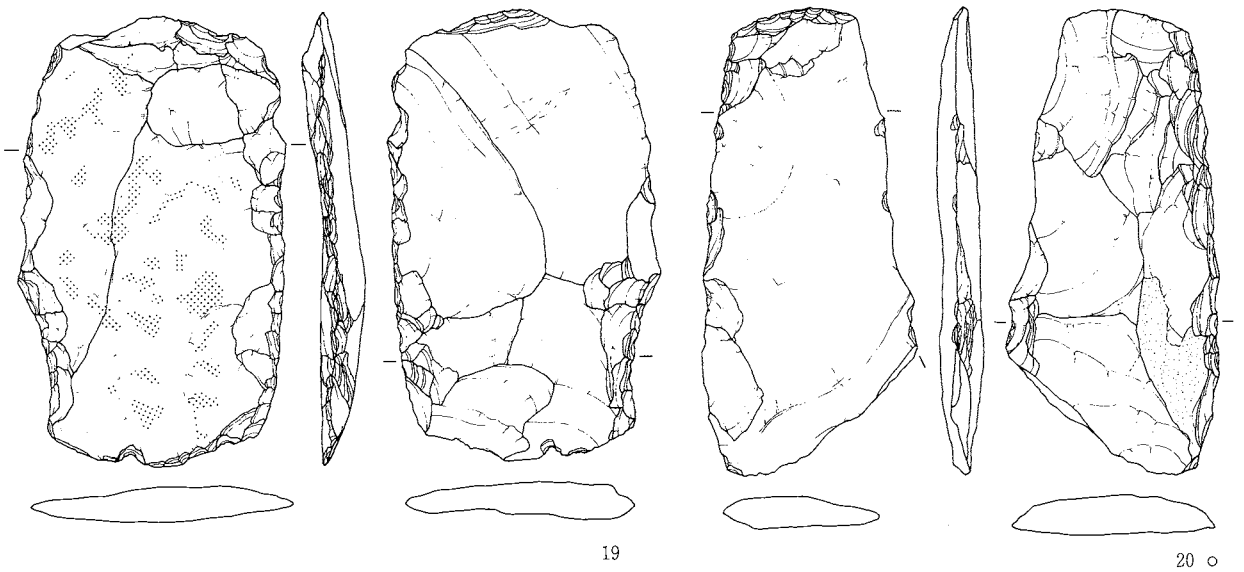

19

20

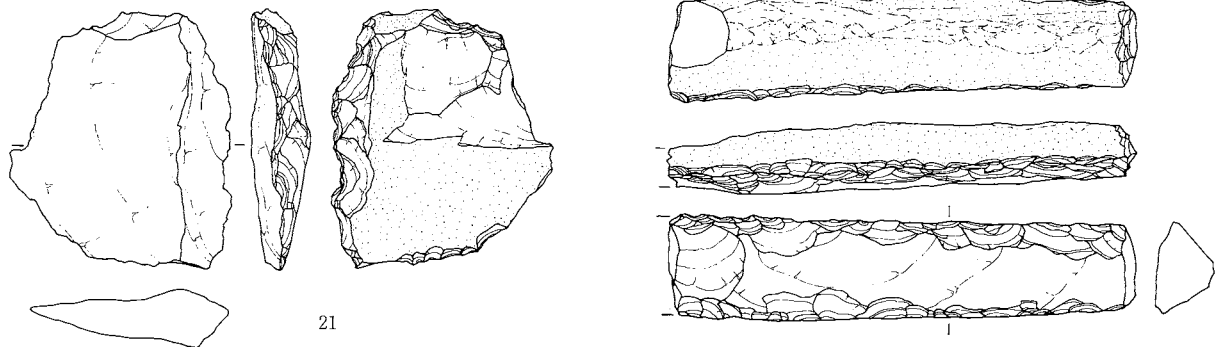

21

22

0 (1:2) 5 cm

白色付着物

大形刃器(3)

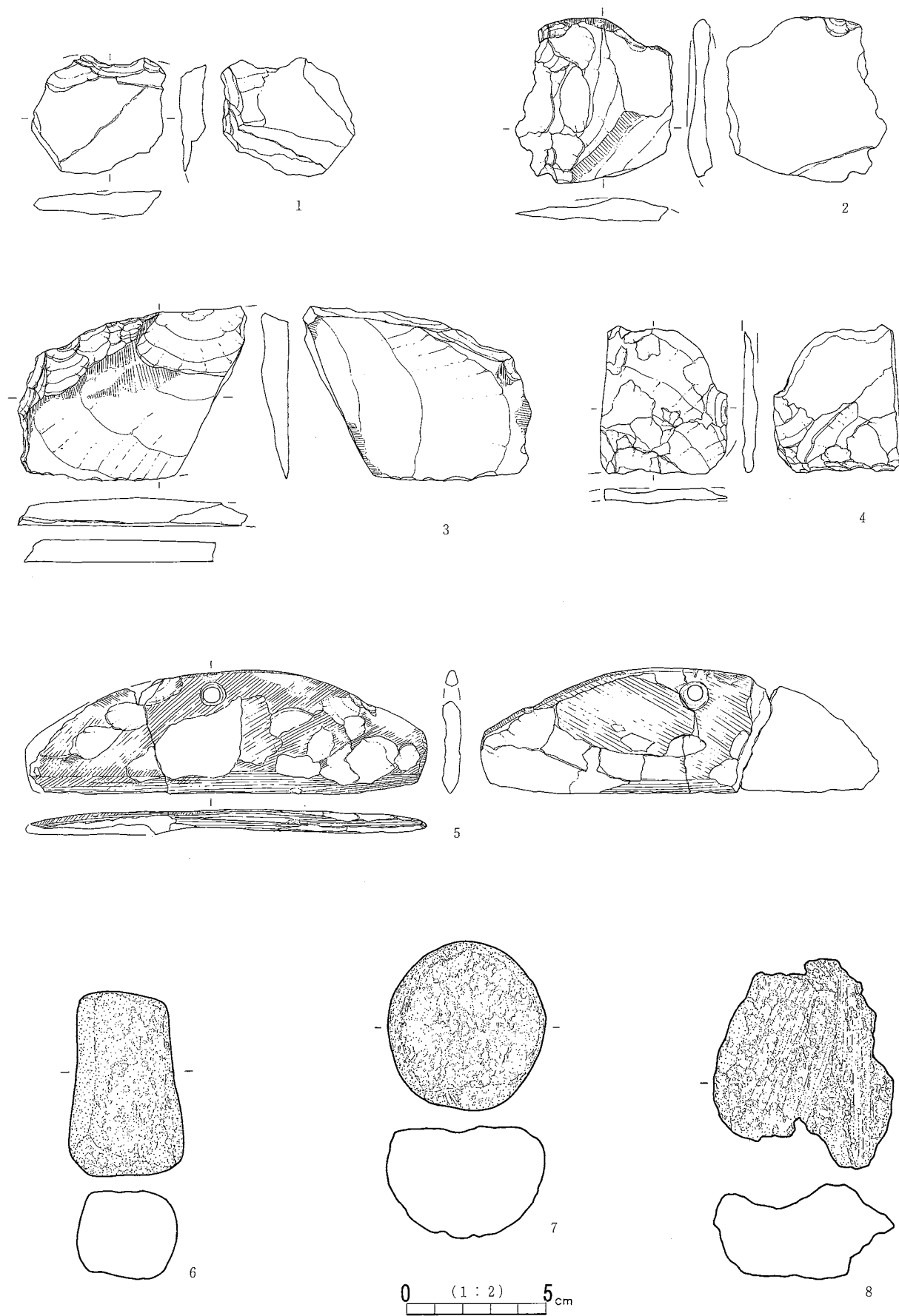

大形刃器(4)・磨製石包丁・軽石製品



砥石(1)

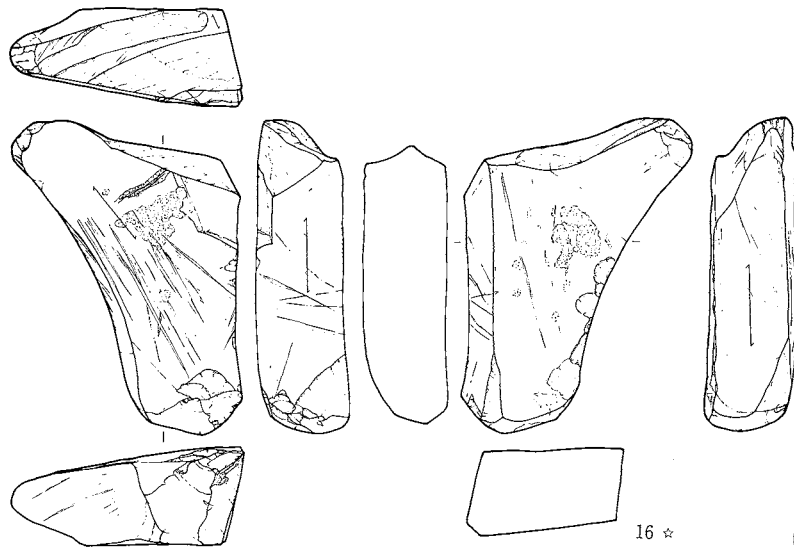
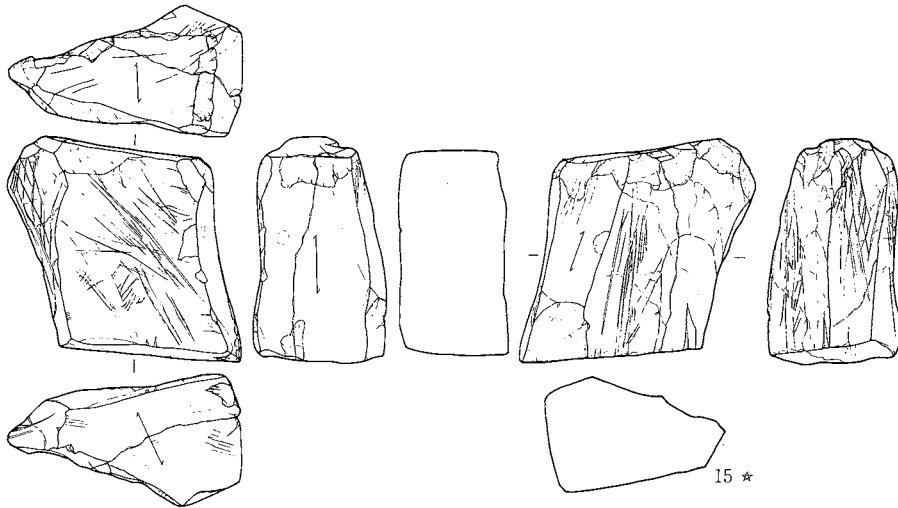
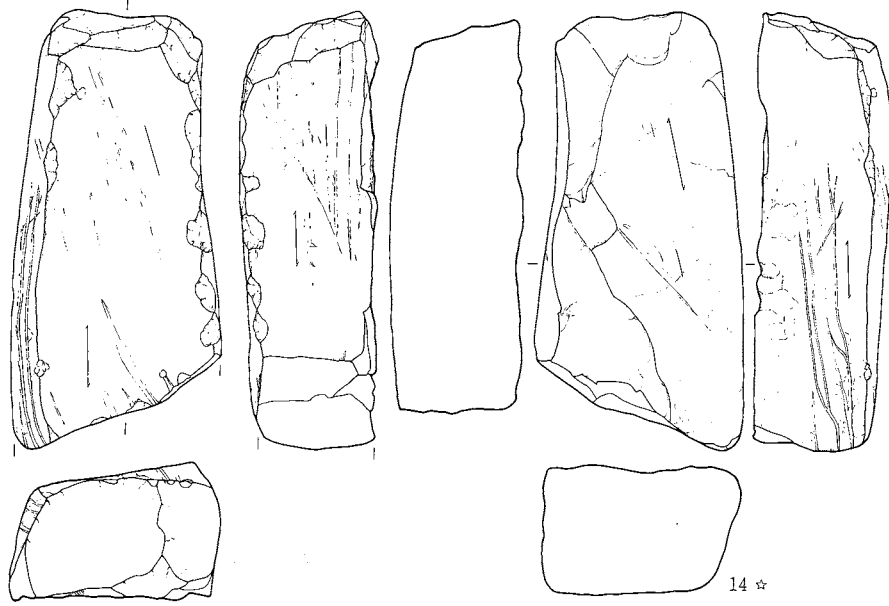

★ 砂岩系
 ☆ 頁岩系
 ☆ 泥岩系

0 (1:3) 5cm

砥石(2)

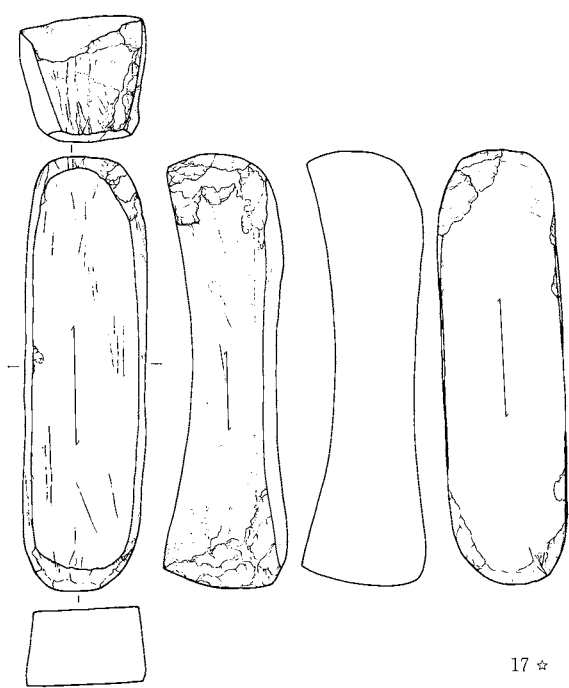

17 ☆

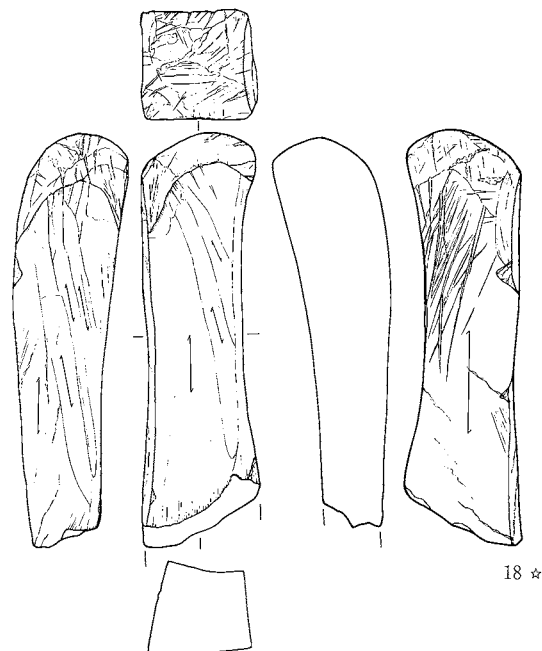

18 ☆

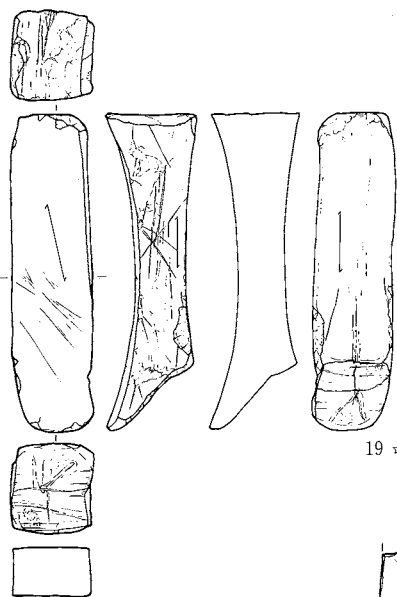

19 ☆

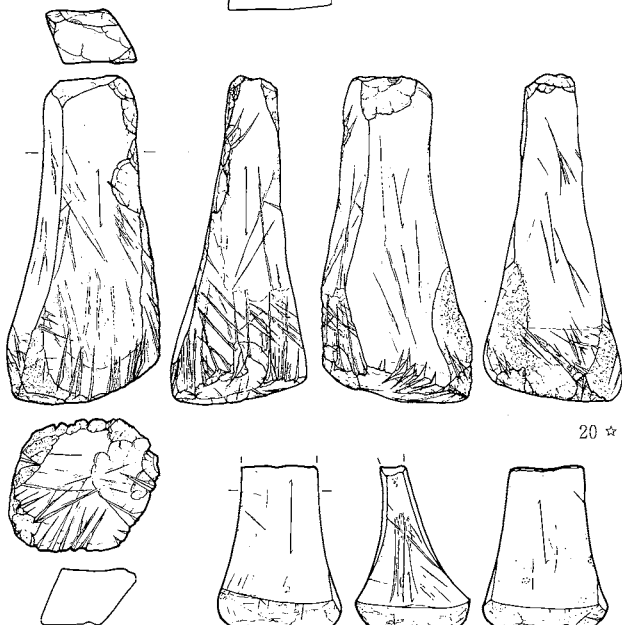

20 ☆

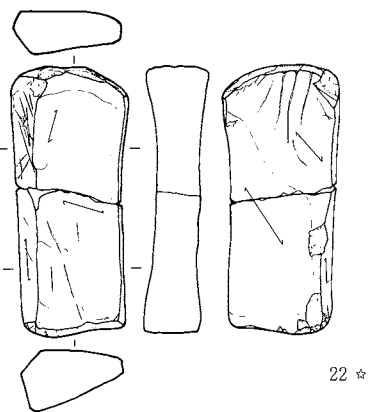

22 ☆

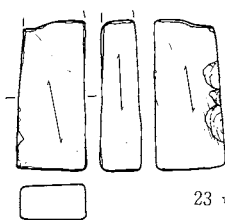

23 ☆

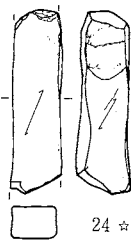

24 ☆



25 ☆

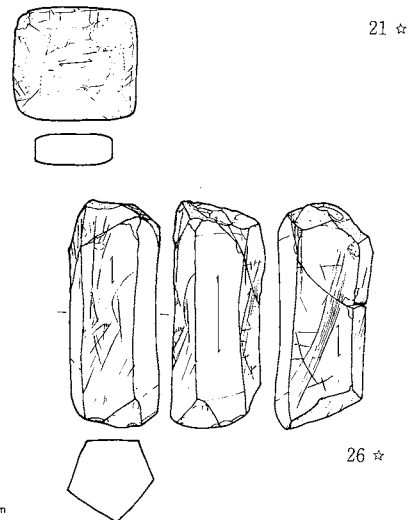

26 ☆

0 (1:3) 5 cm



砥石(4)

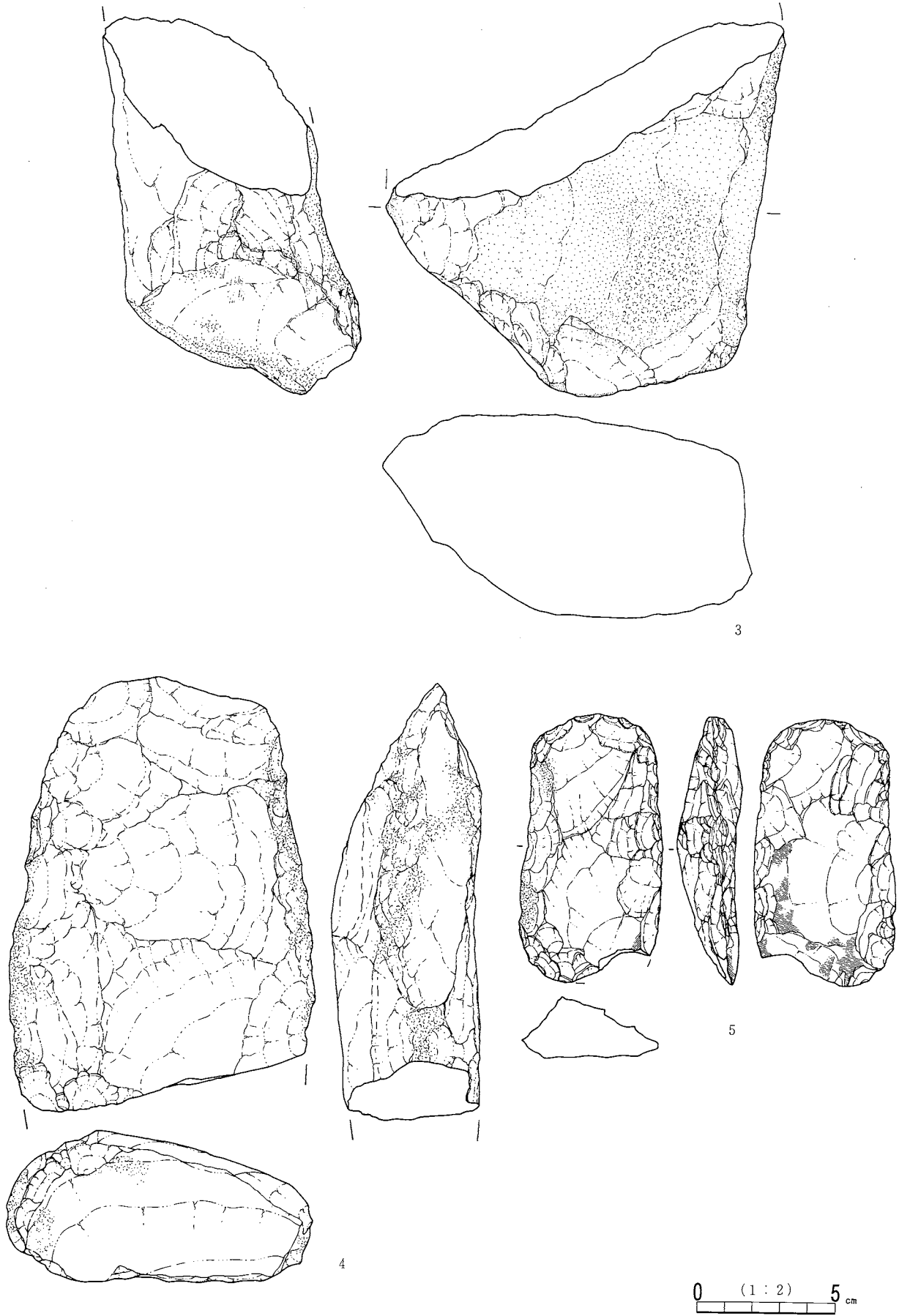

磨製石斧関連 1 (SB457)

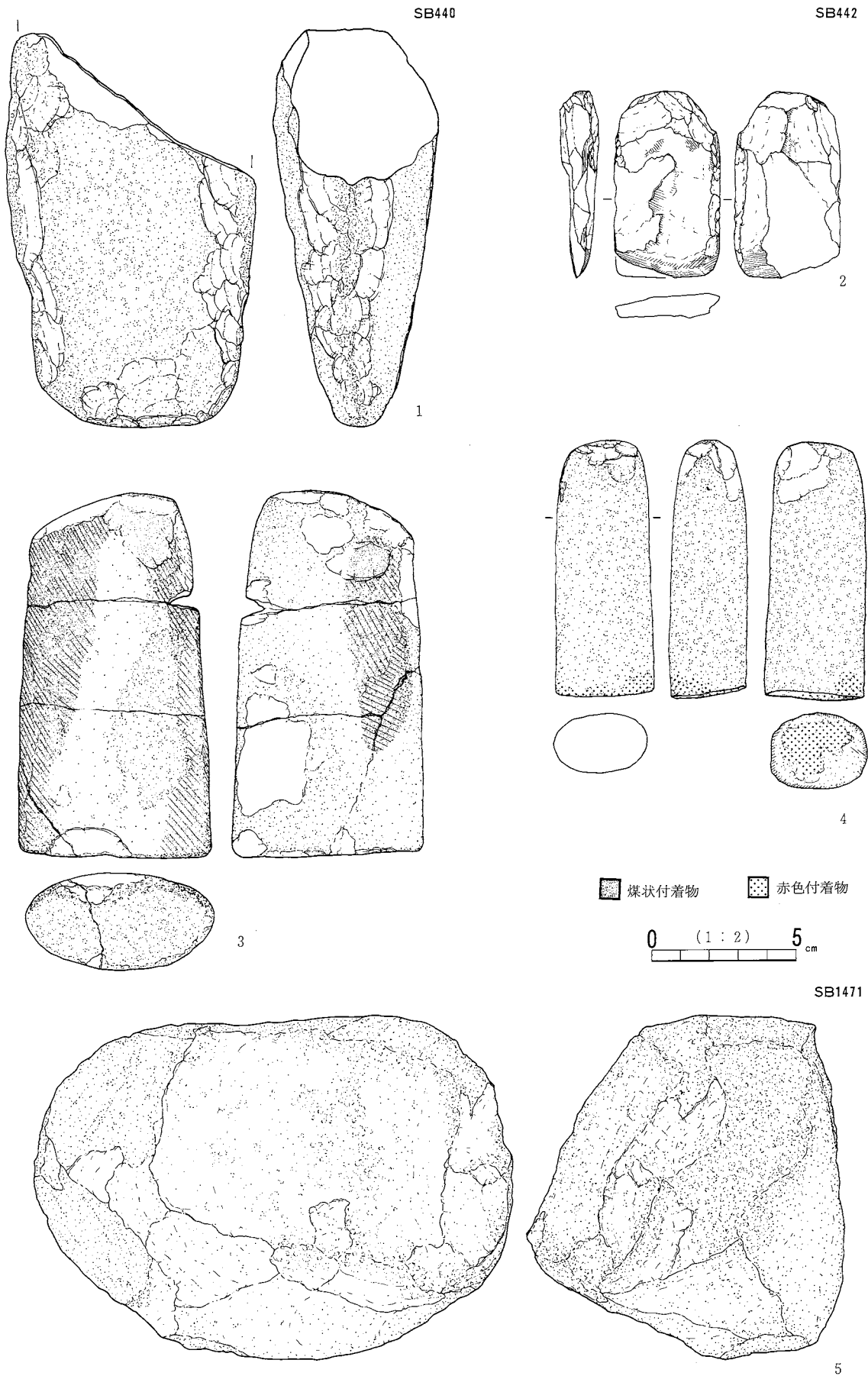

磨製石斧関連 2 (SB440・442・1471)

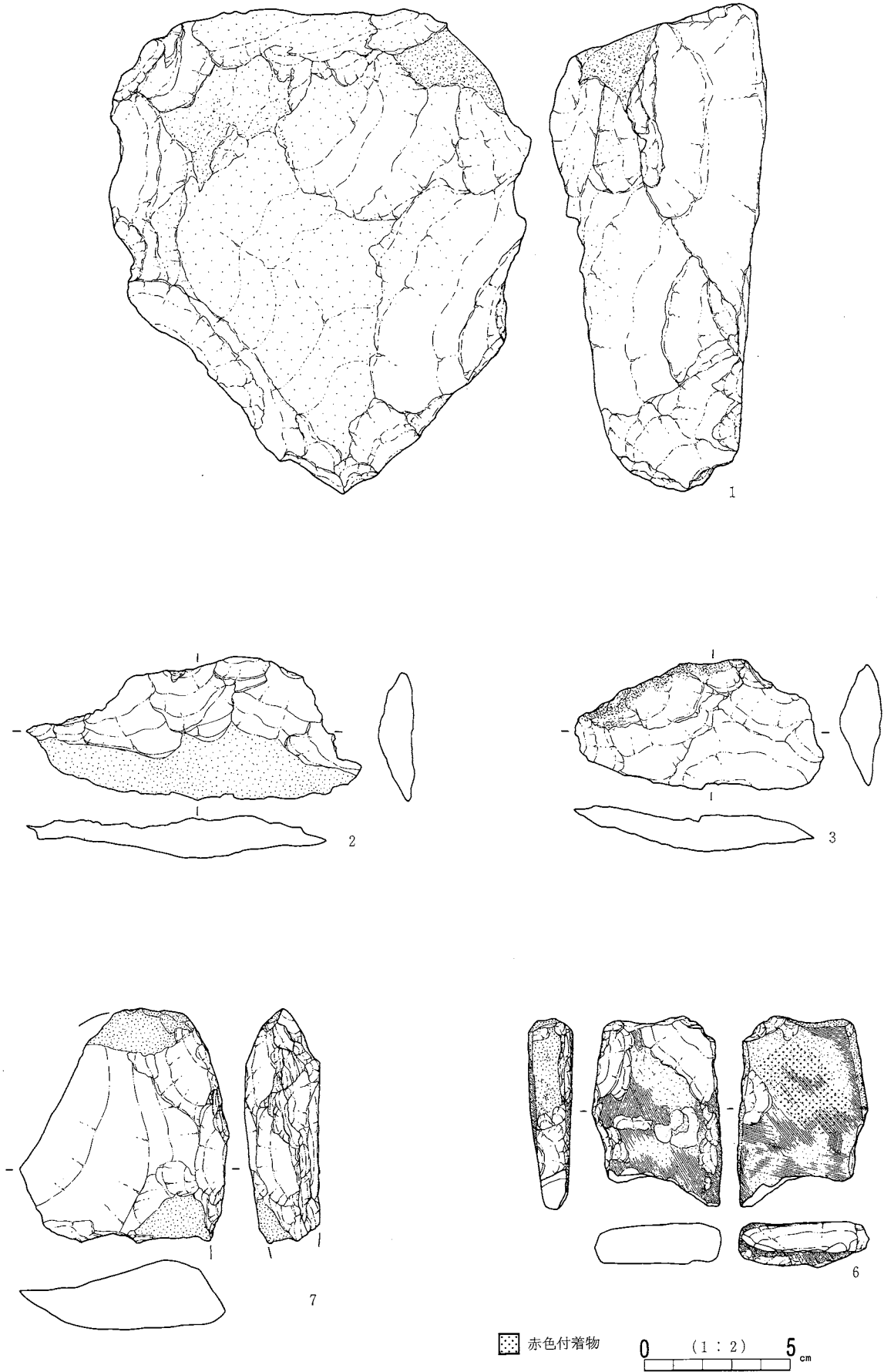

磨製石斧関連3 (SB837その1)

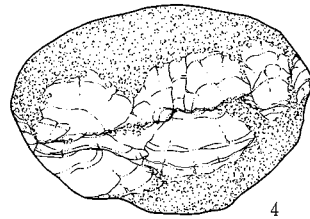
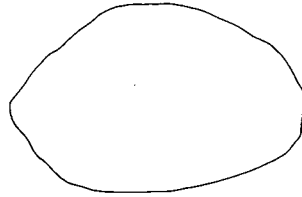
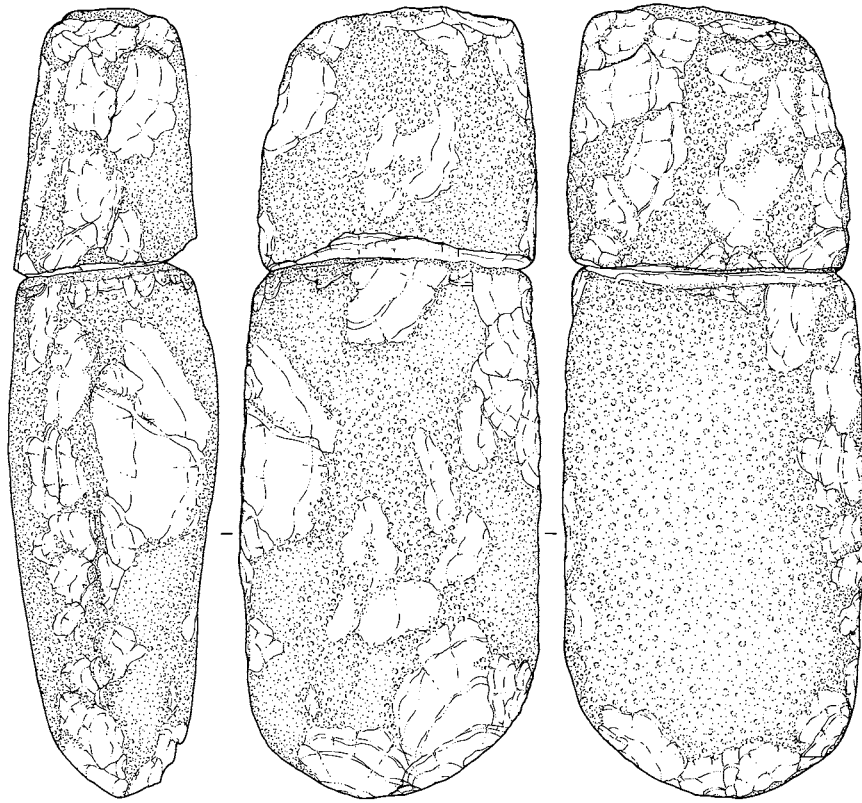

4

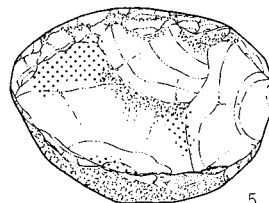
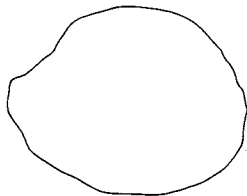
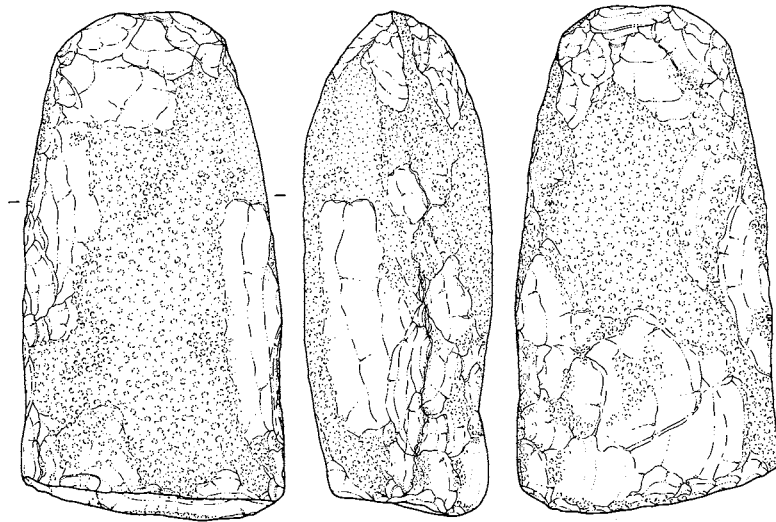

5

赤色付着物

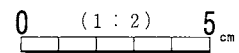

磨製石斧関連4 (SB837その2)

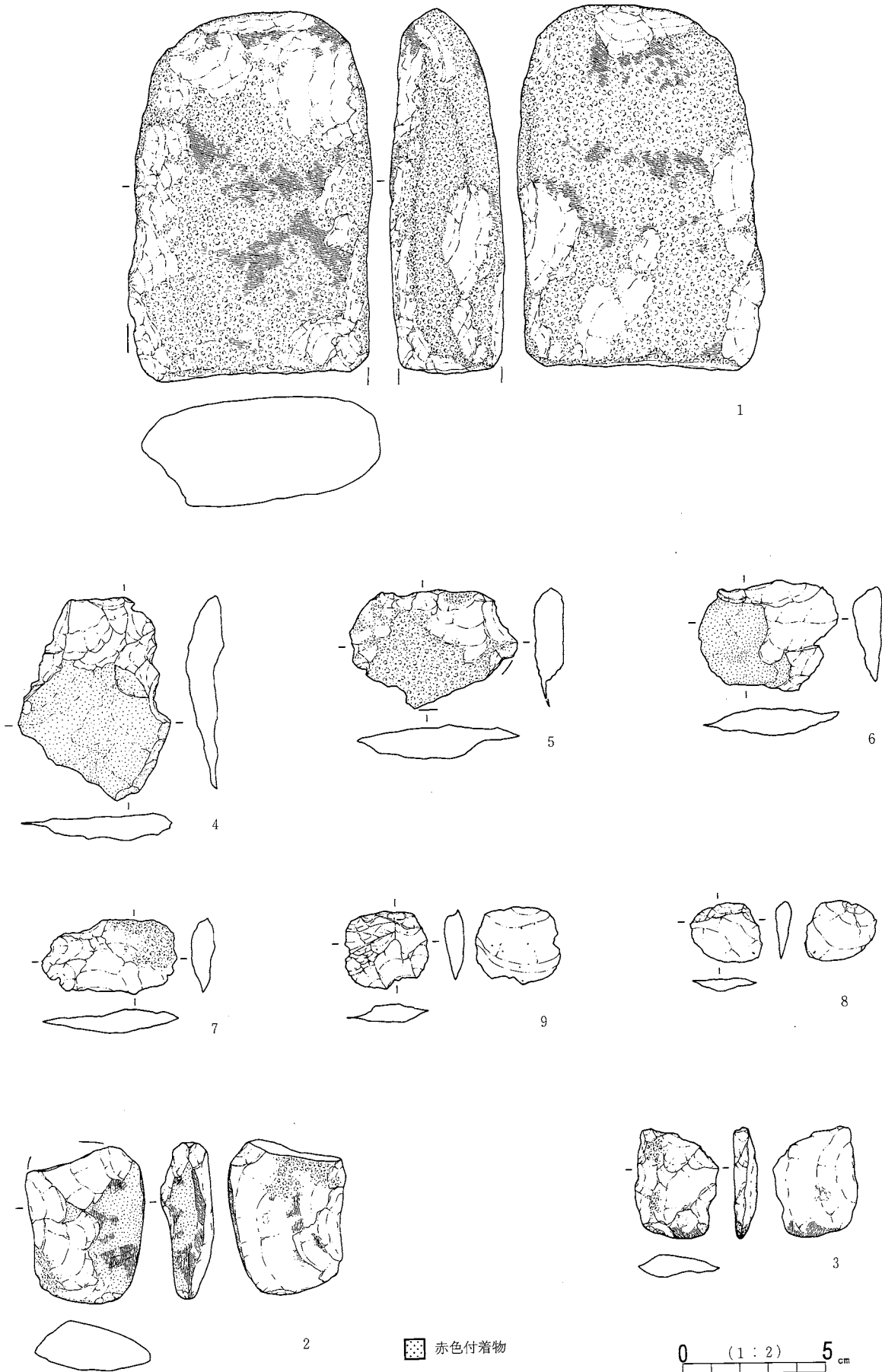

磨製石斧関連5 (SB1468)



1

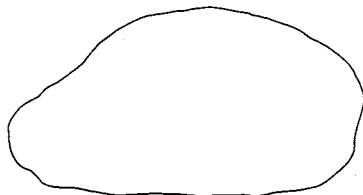
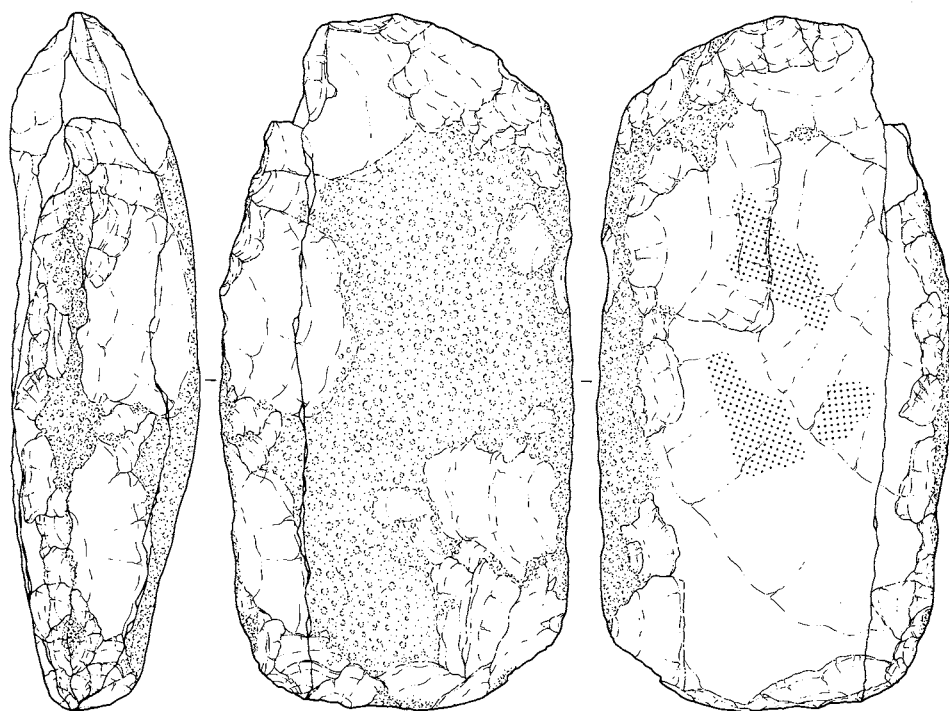

2

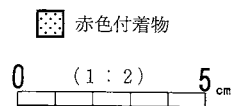

磨製石斧関連6 (SB1469その1)

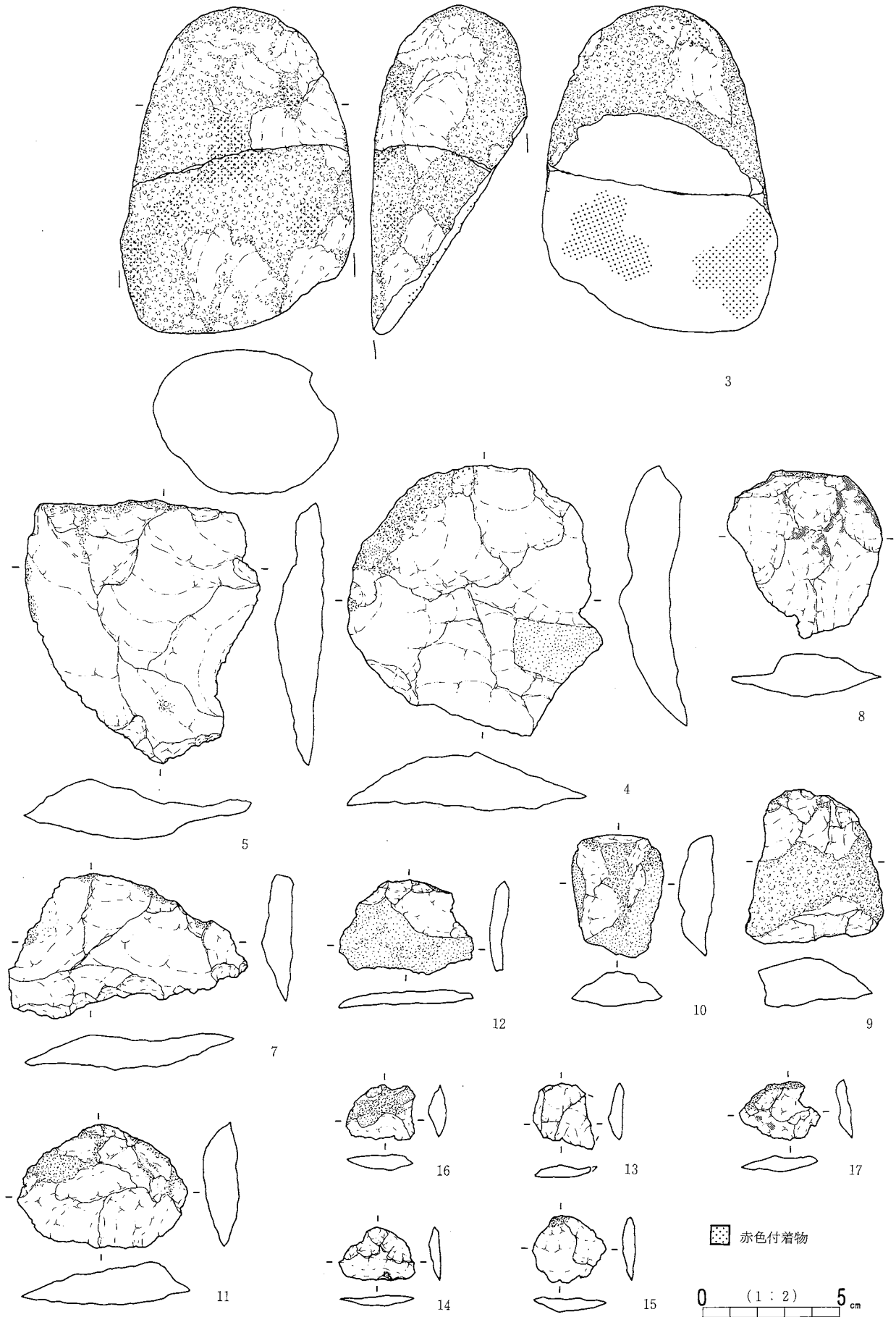

磨製石斧関連7 (SB1469その2)

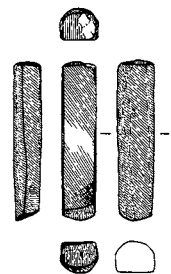
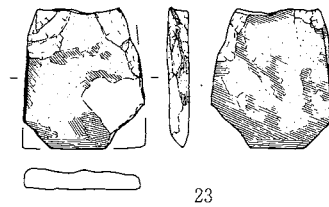
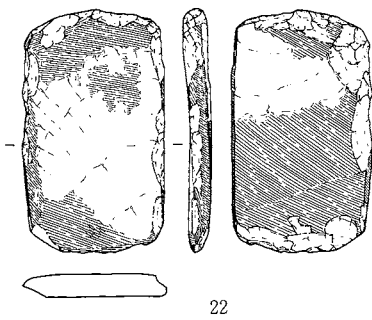
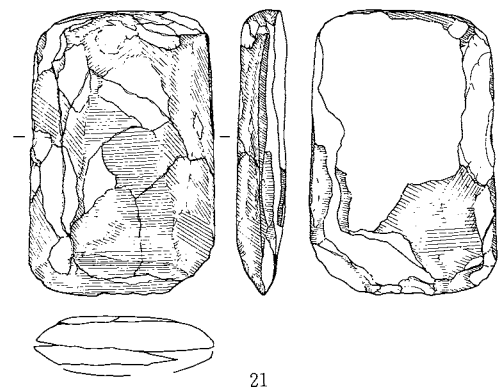
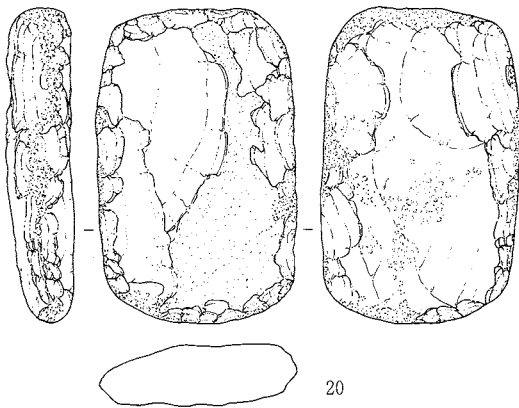
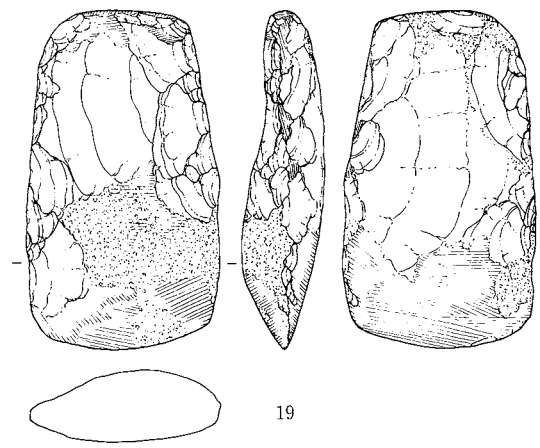
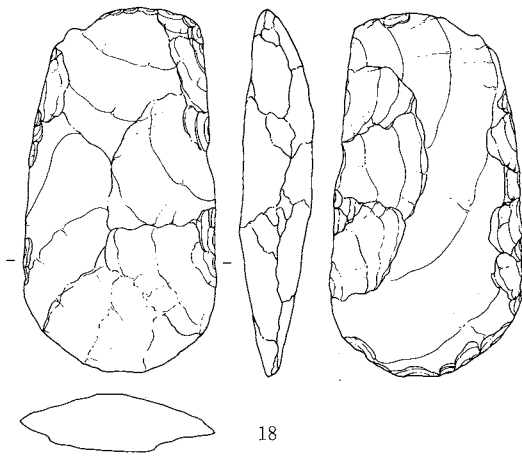

0 (1:2) 5 cm

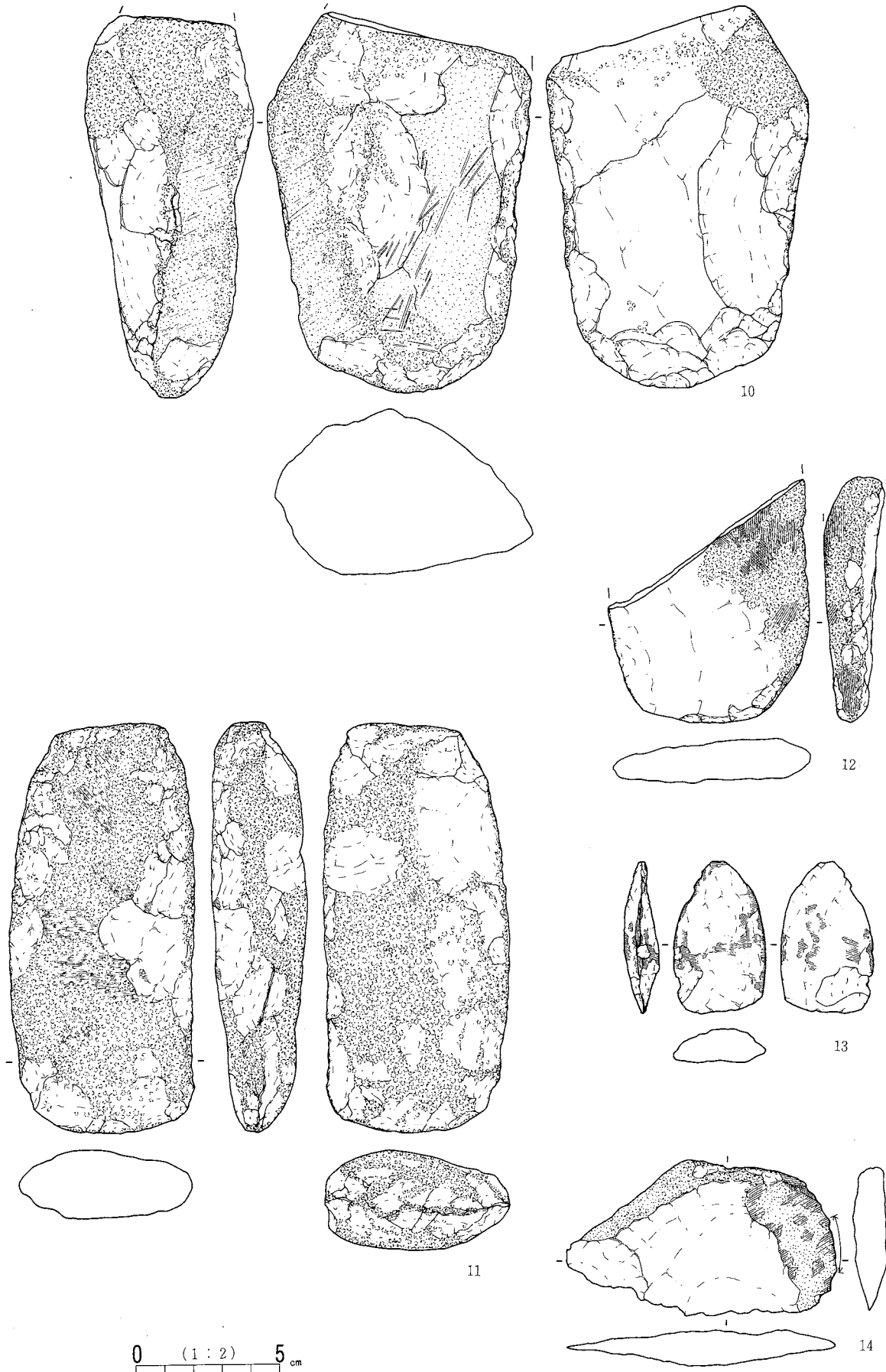

磨製石斧関連9 (SB1470)

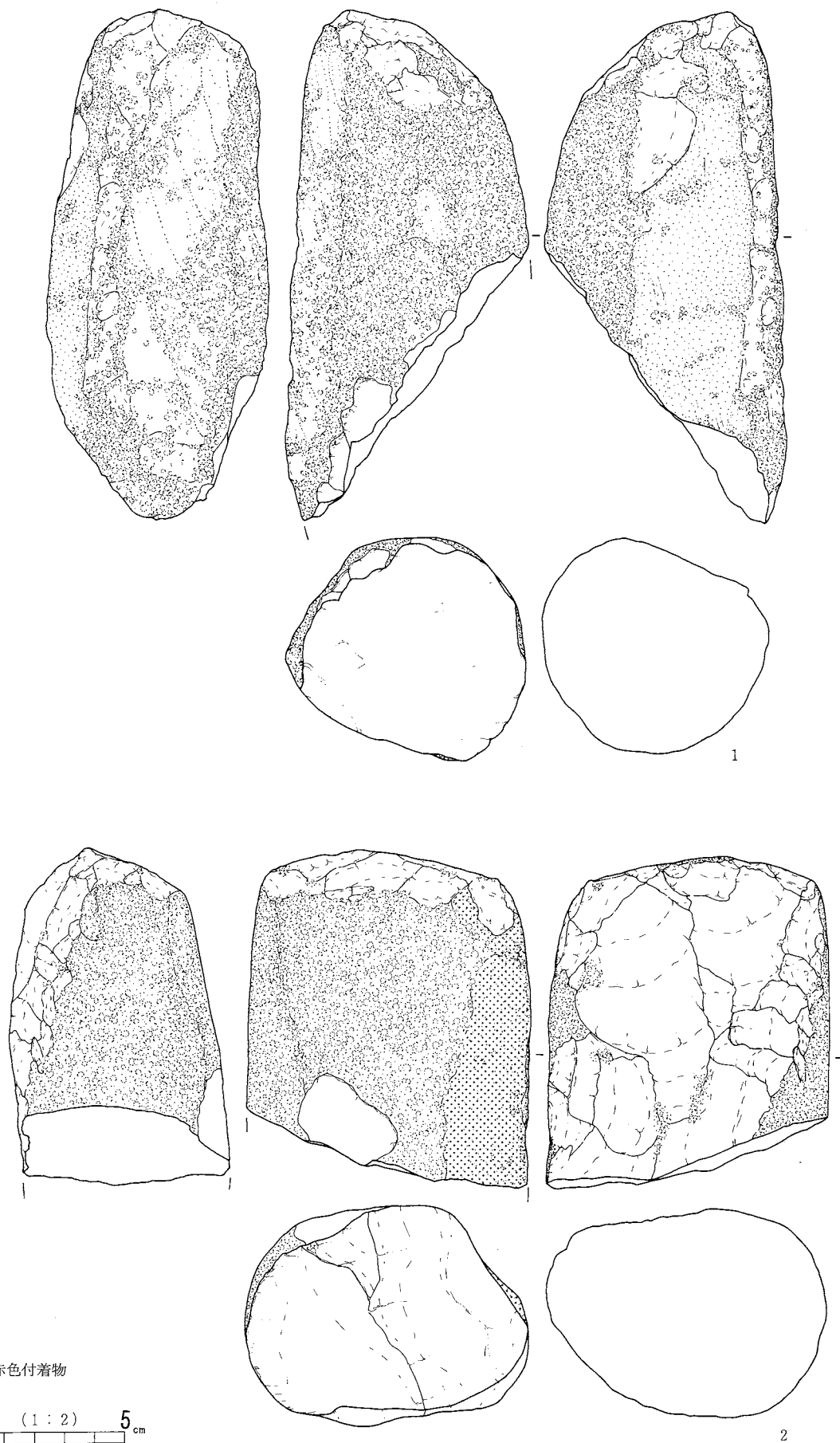

磨製石斧関連10 (SB1473その1)

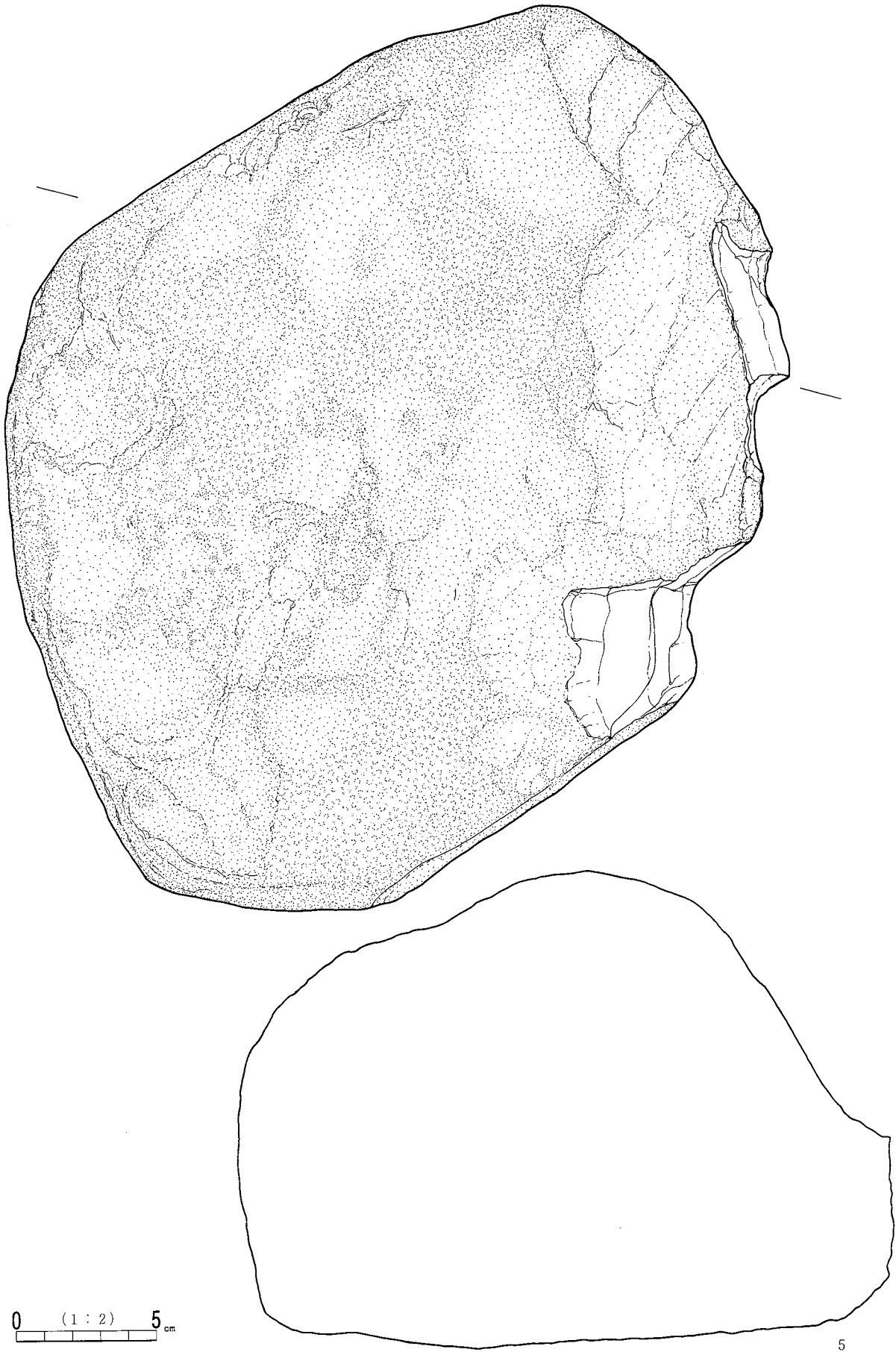

磨製石斧関連11 (SB1473その2)

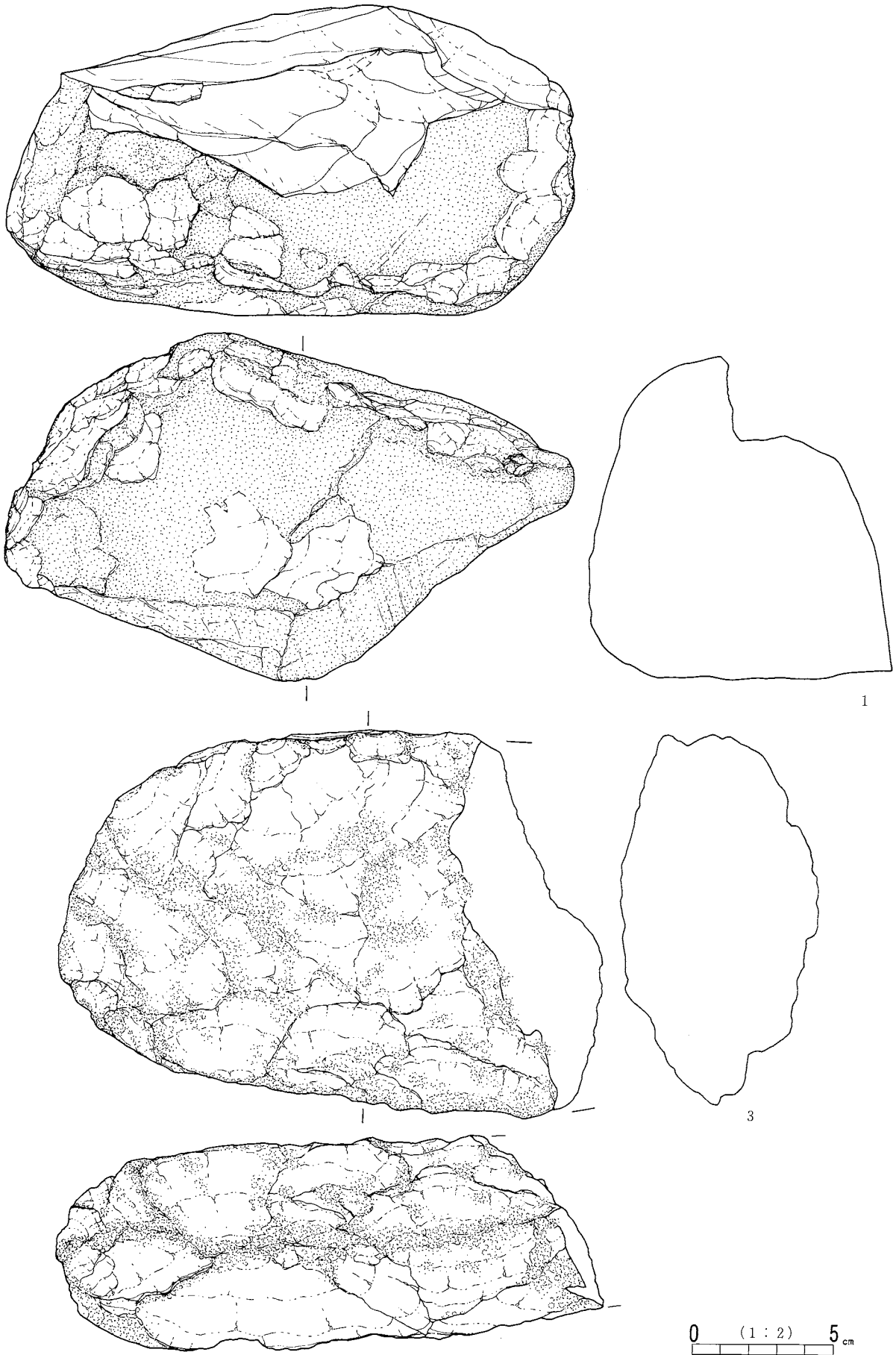

磨製石斧関連12 (SB1474その1)

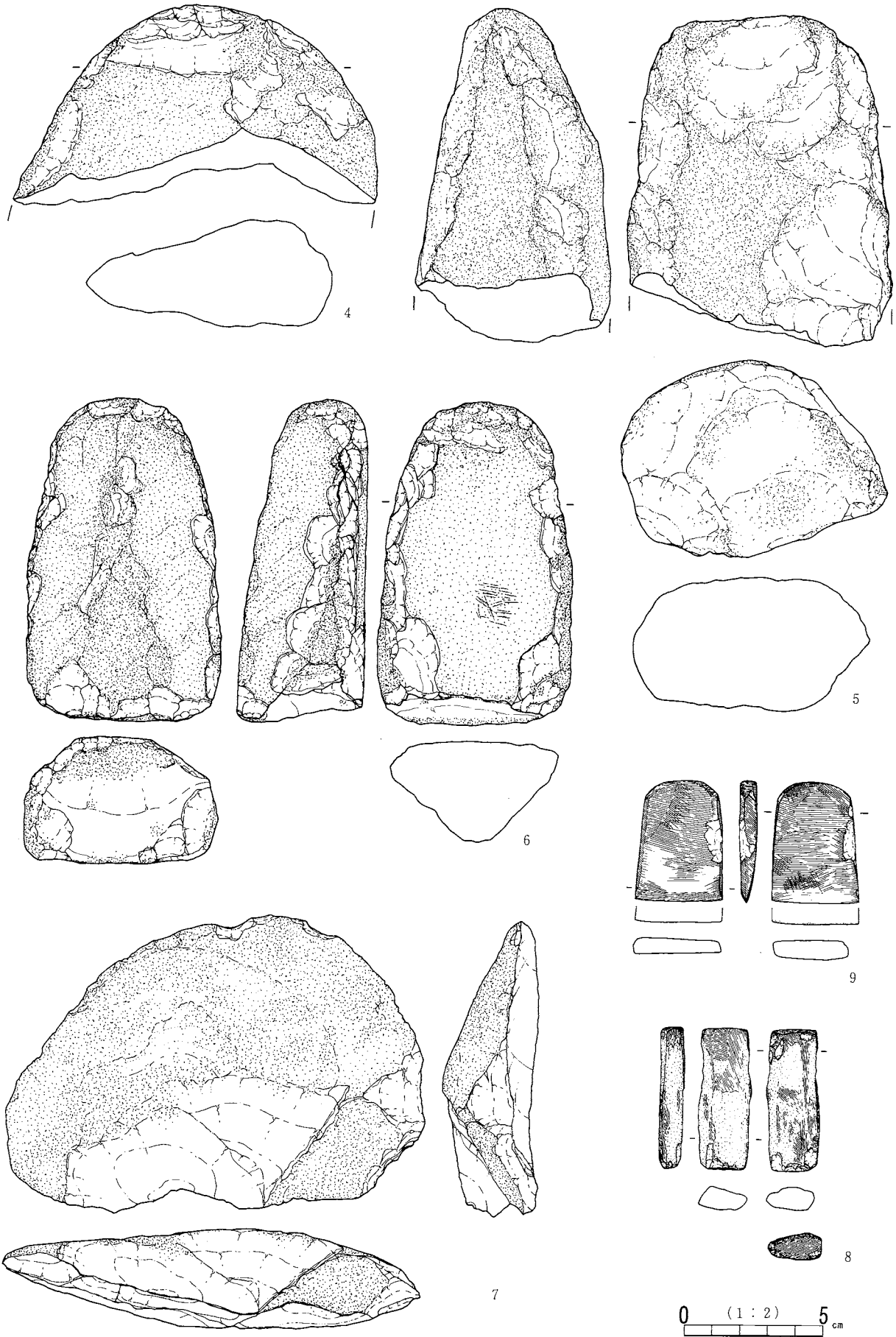

磨製石斧関連13 (SB1474その2)

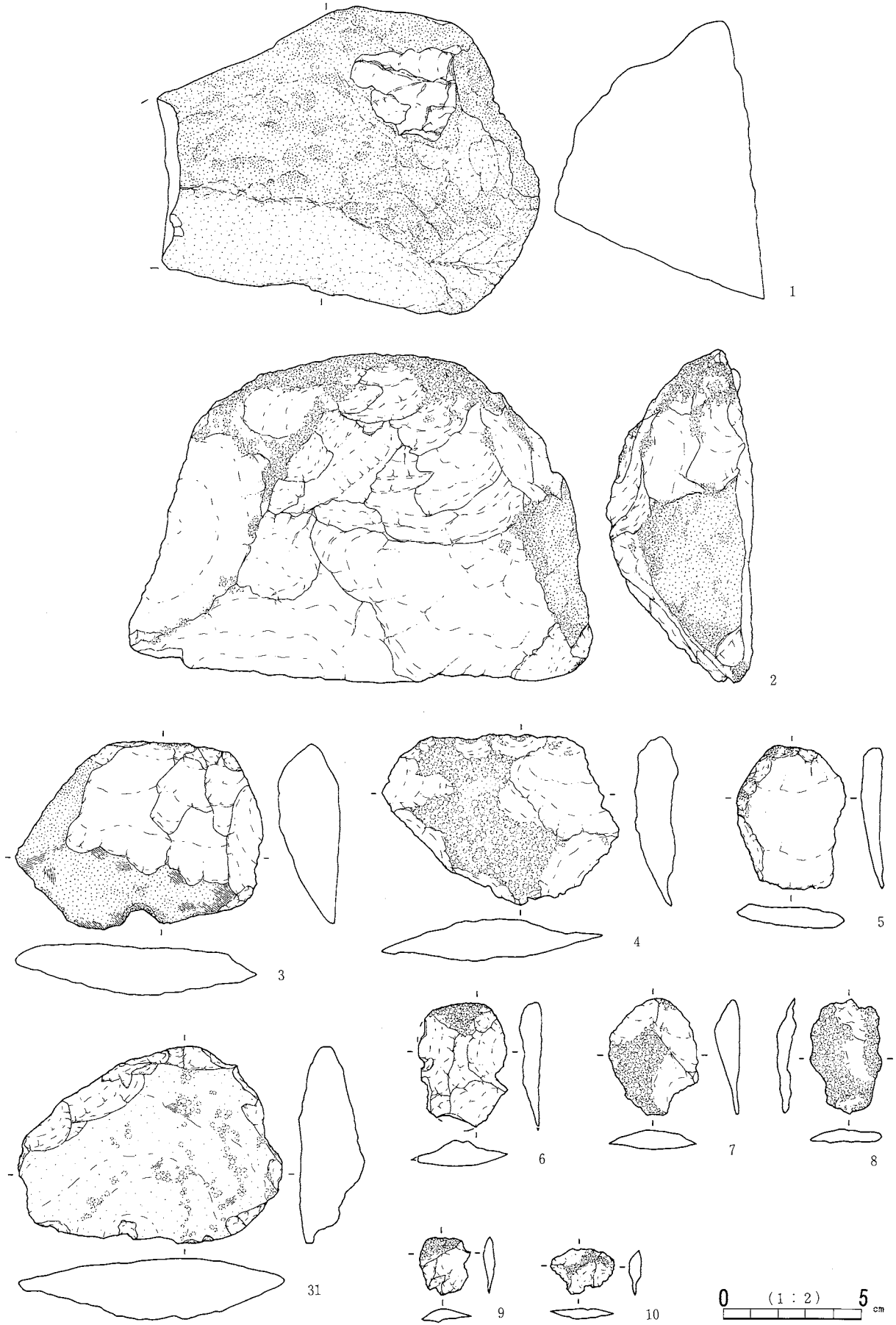

磨製石斧関連14 (SB1482その1)

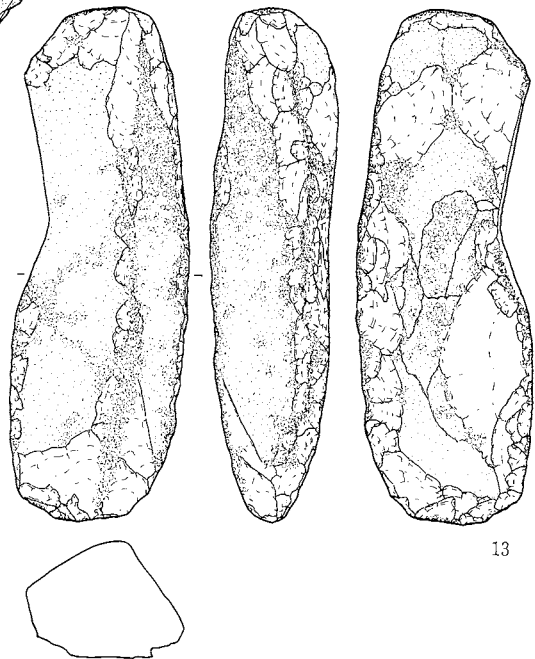
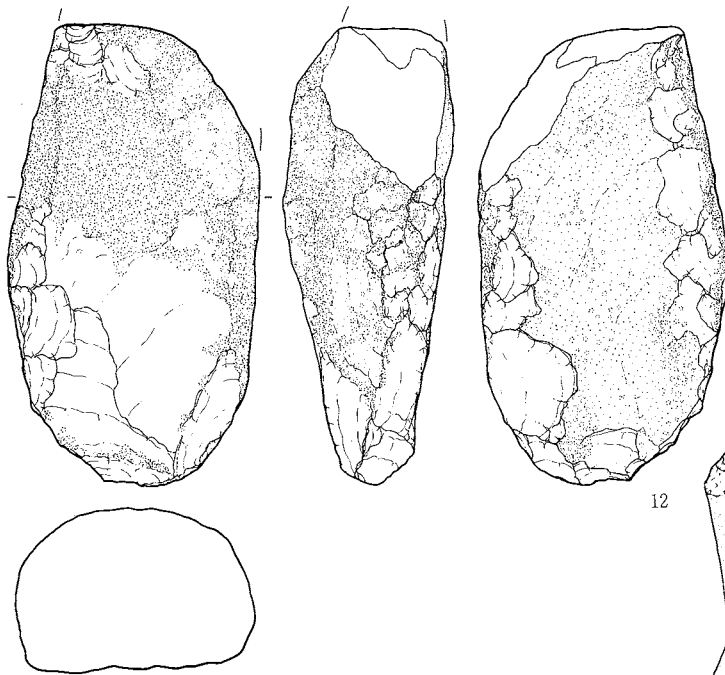
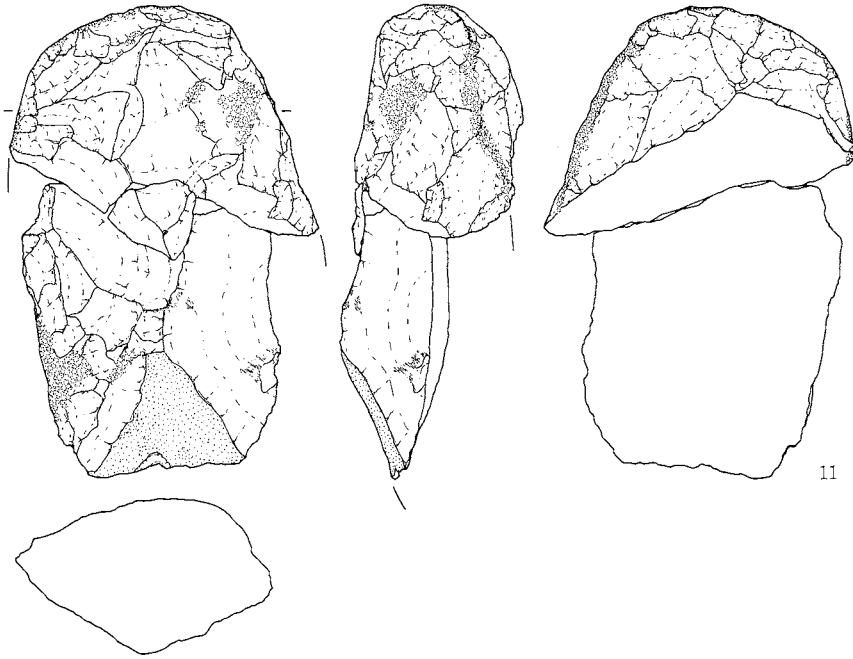

0 (1 : 3) 10cm

磨製石斧関連15 (SB1482その2)

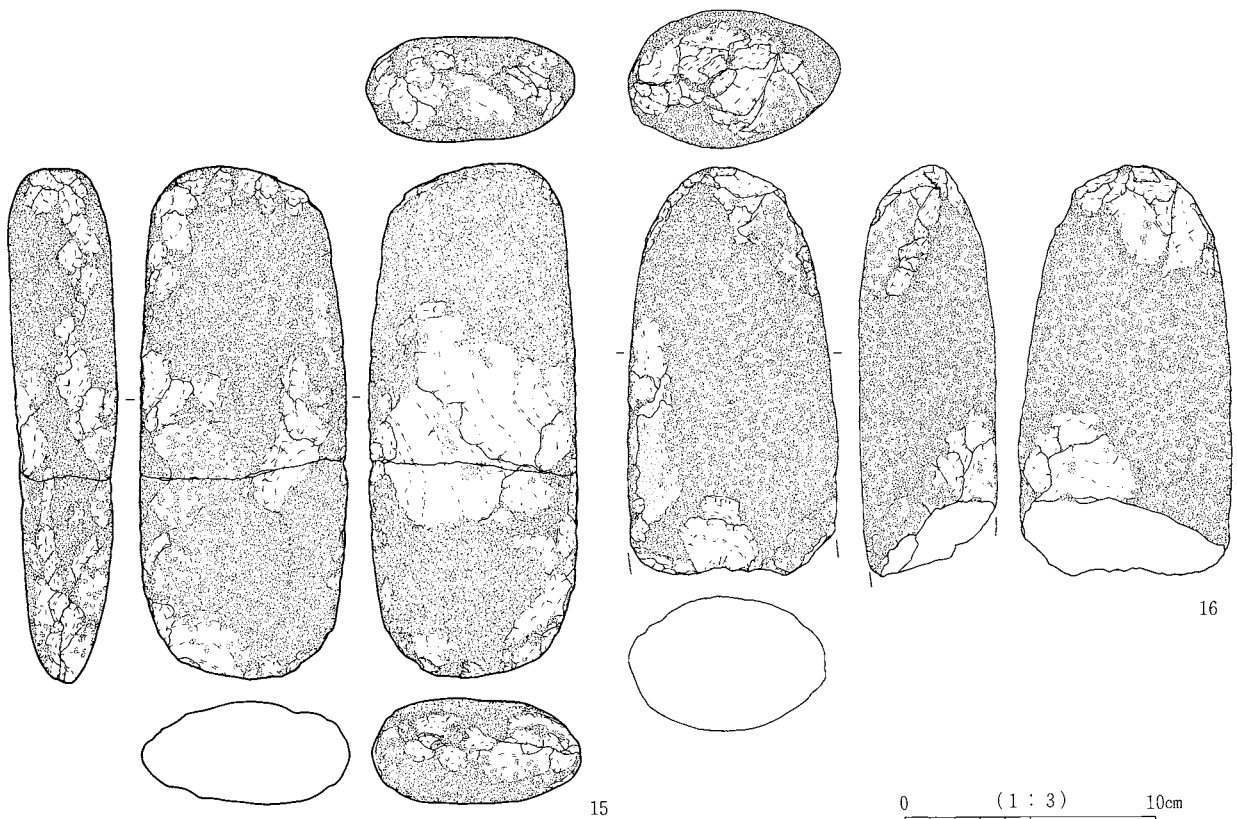
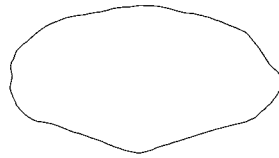

磨製石斧関連16 (SB1482その3)

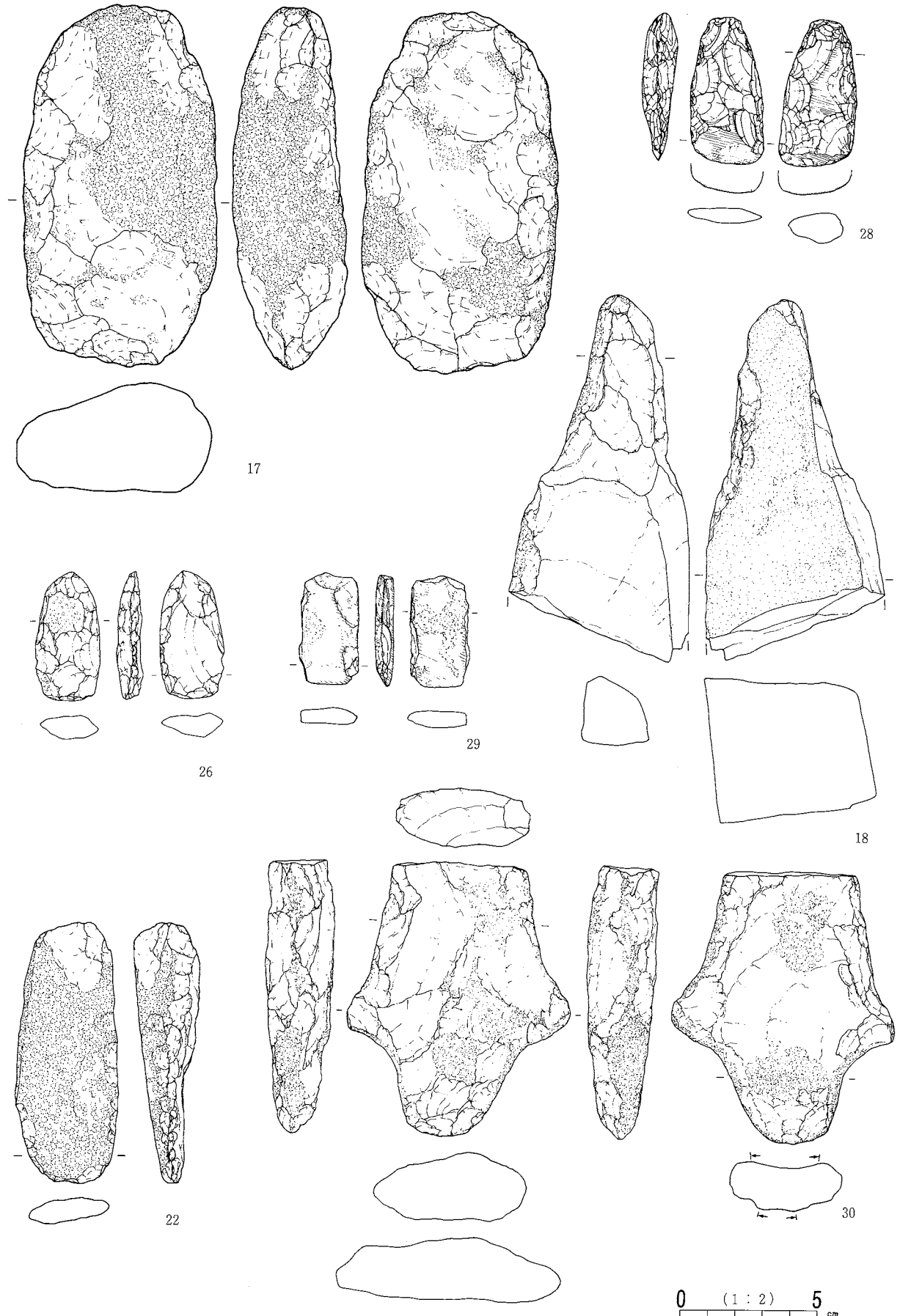

磨製石斧関連17 (SB1482その4)

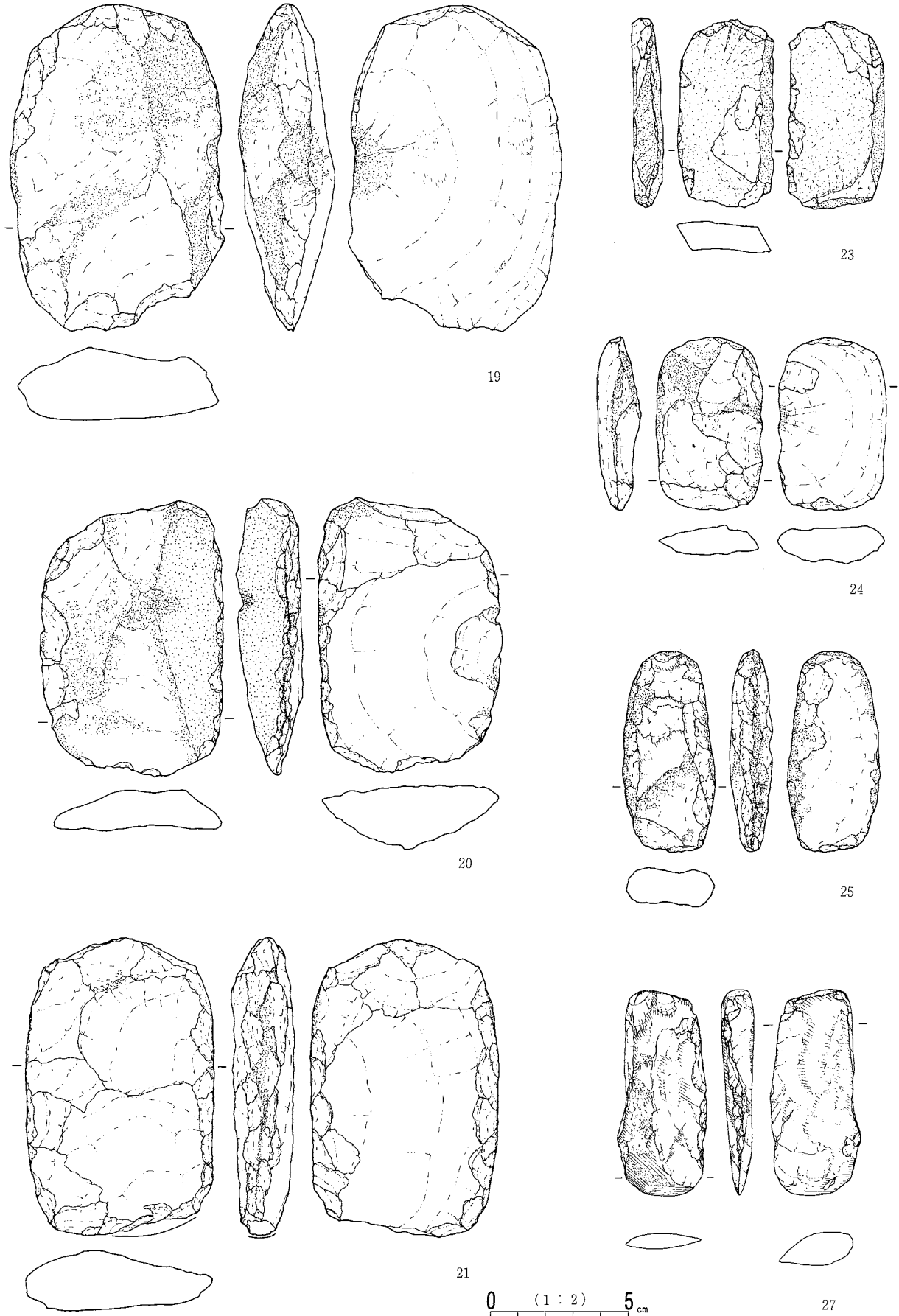

磨製石斧関連18 (SB1482その5)

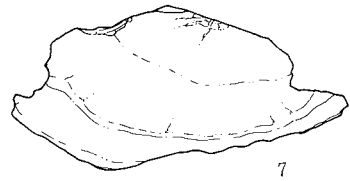
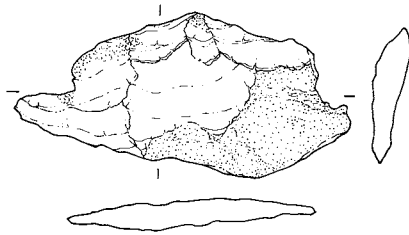
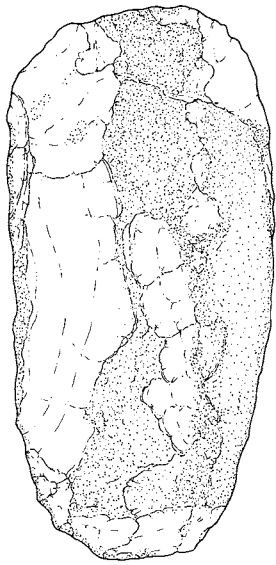

7

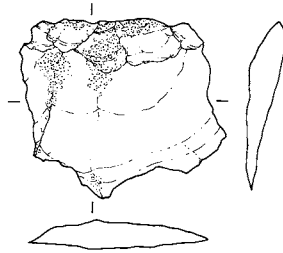

8

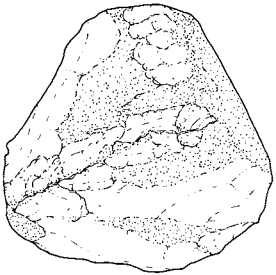

4

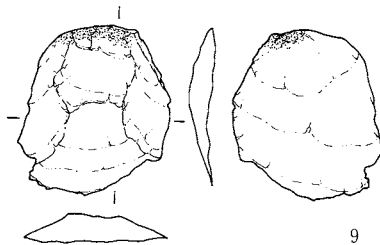

9

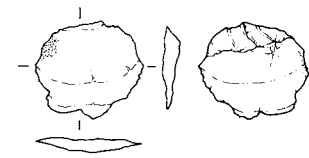

10

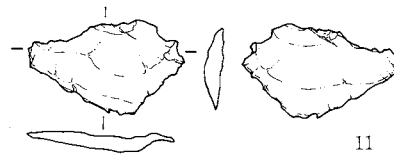

11

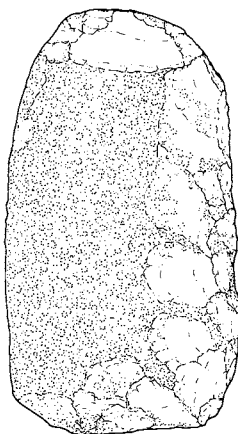

5

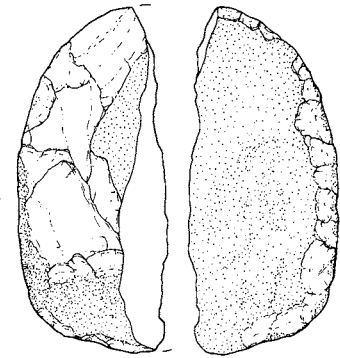

6

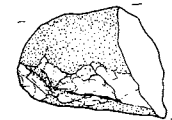

0 (1:2) 5 cm

磨製石斧関連19 (SB1483)



磨製石斧関連20 (SB1484その1)

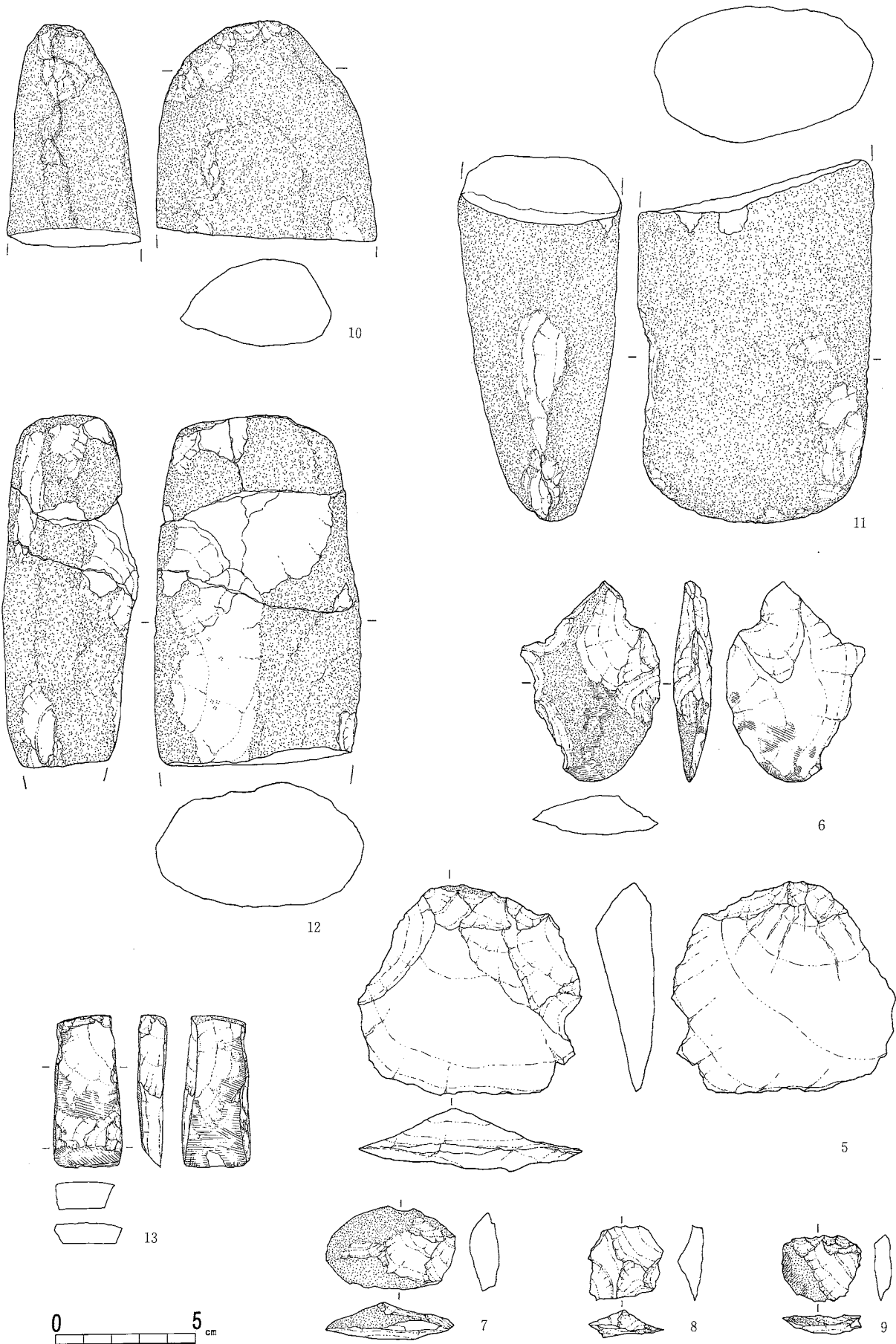

磨製石斧関連21 (SB1484その2)

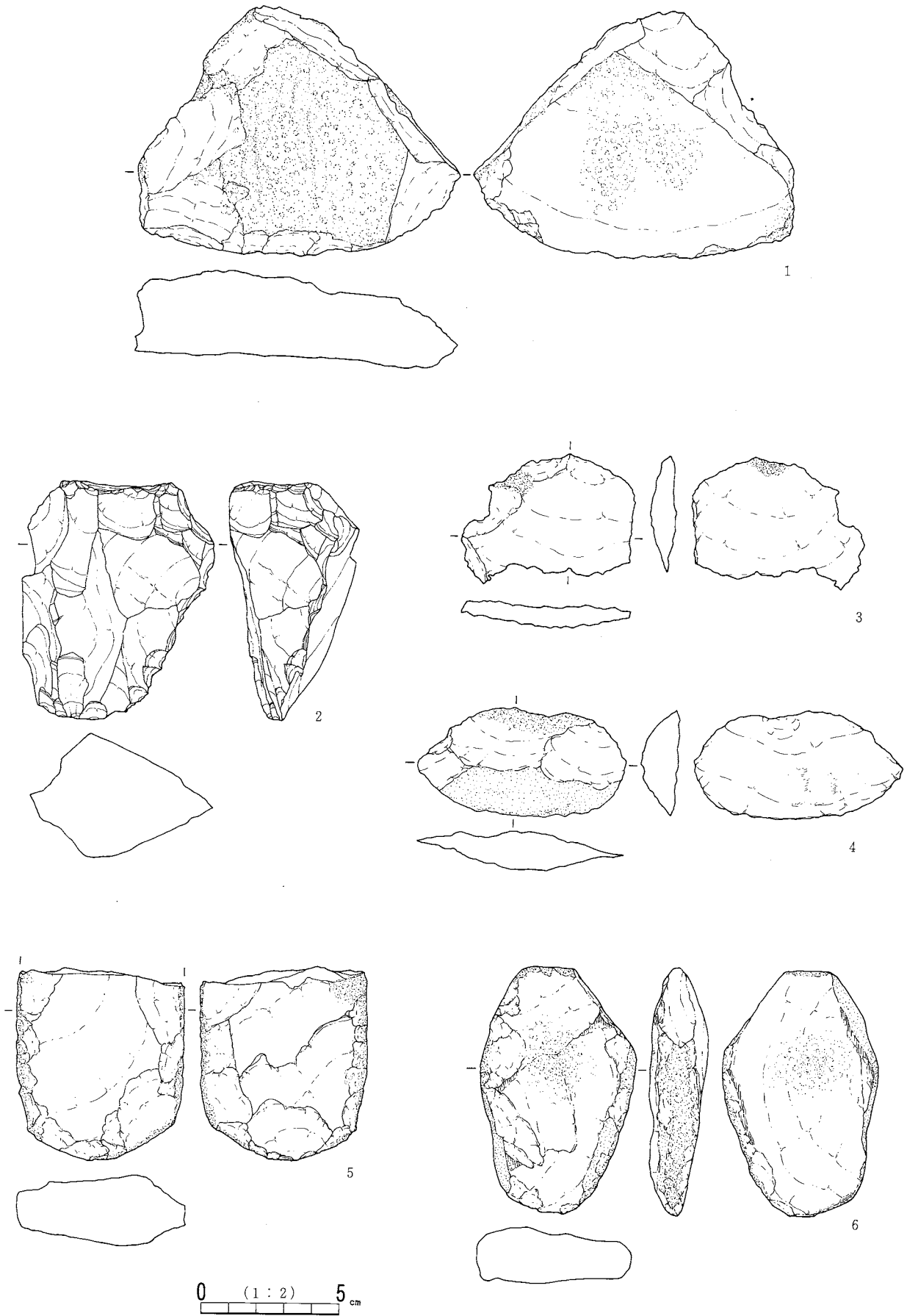

磨製石斧関連22 (SD318)

SK3277

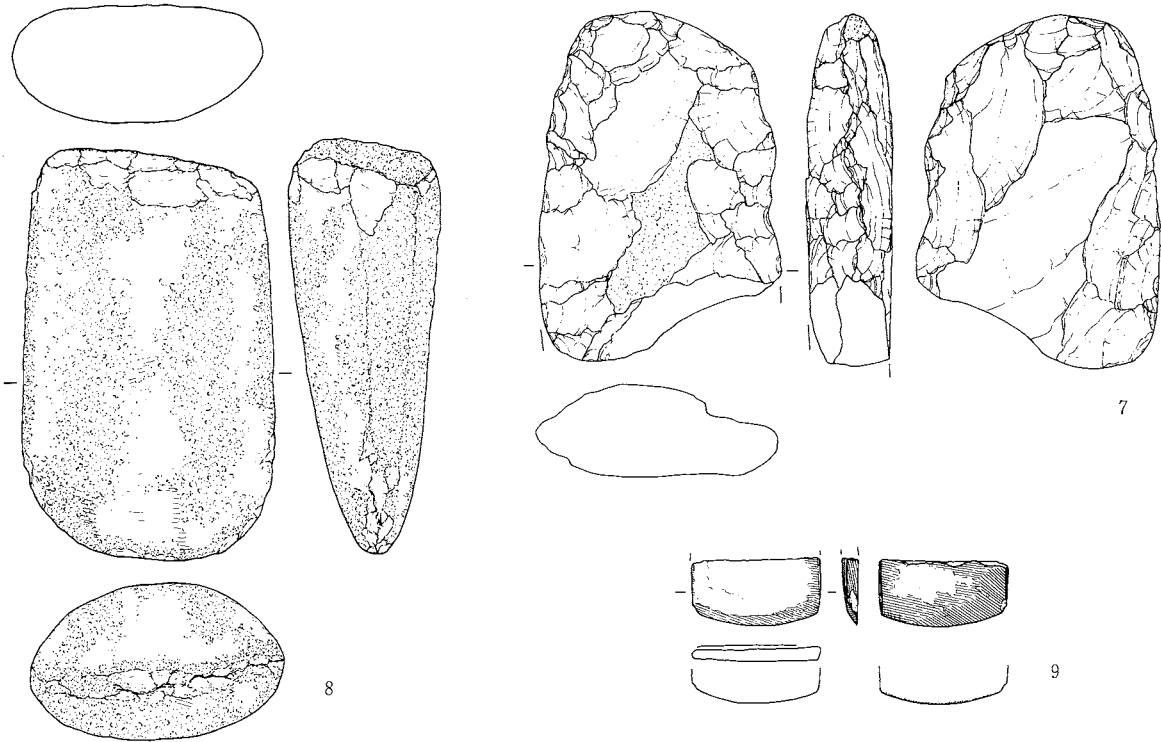

SK14726

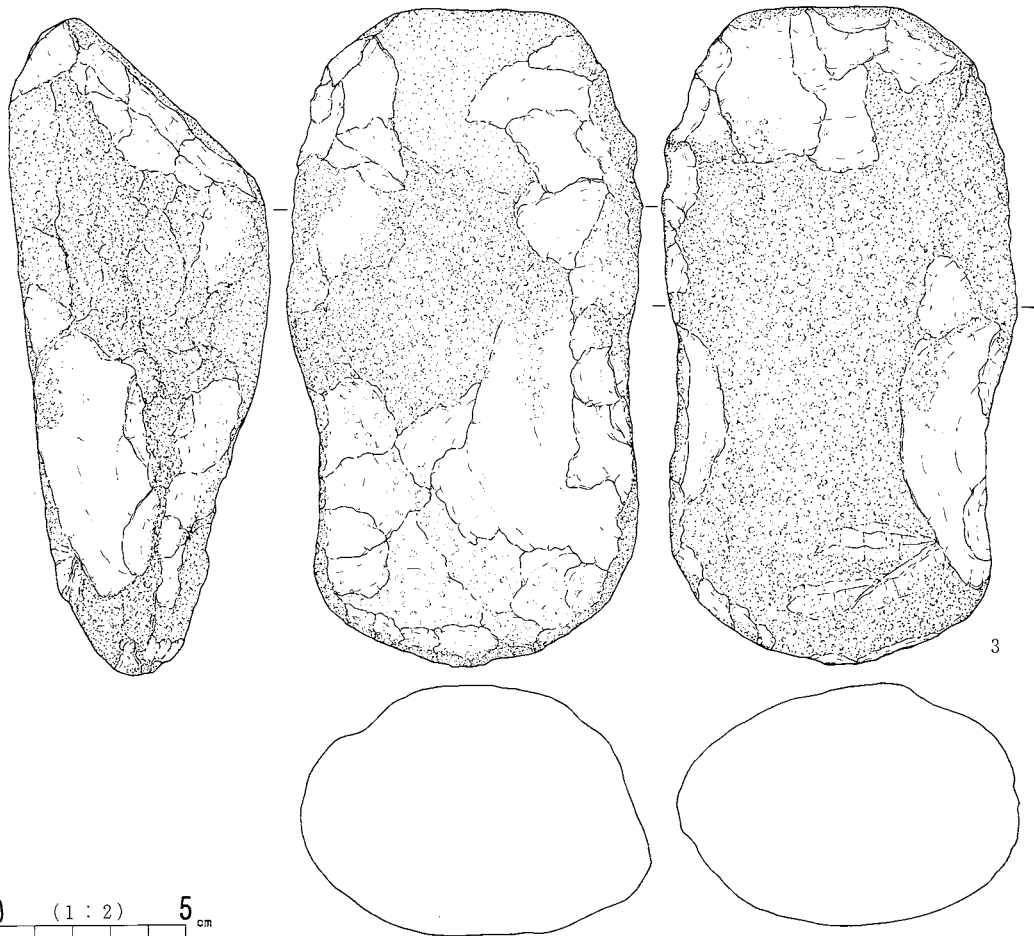

0 (1:2) 5 cm

磨製石斧関連23 (SK3277・14726)

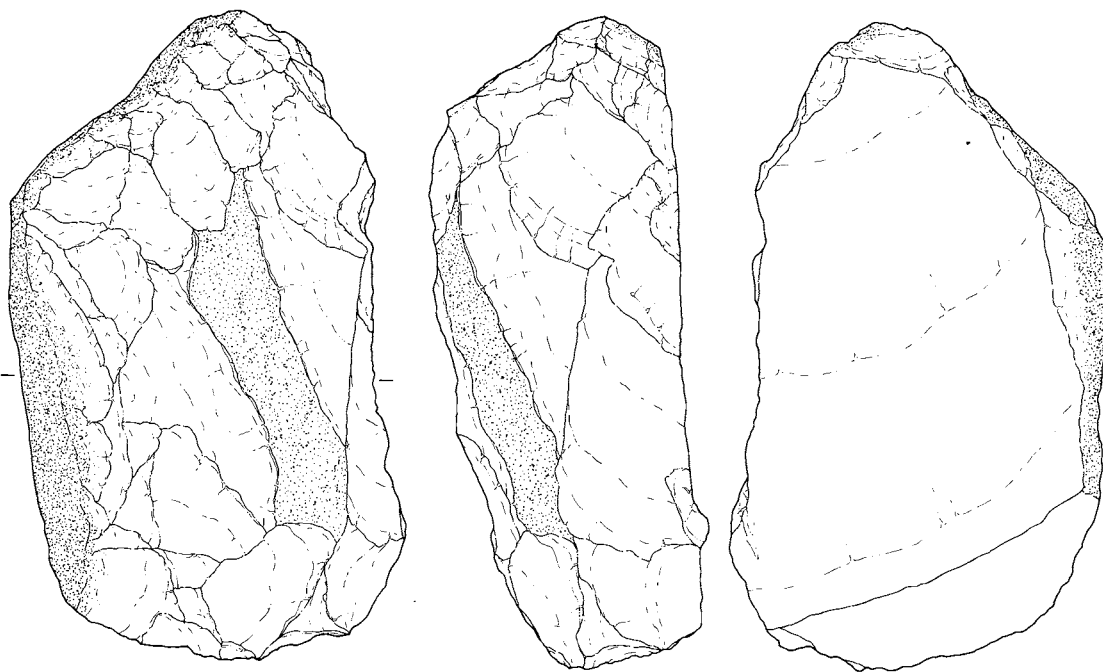

1

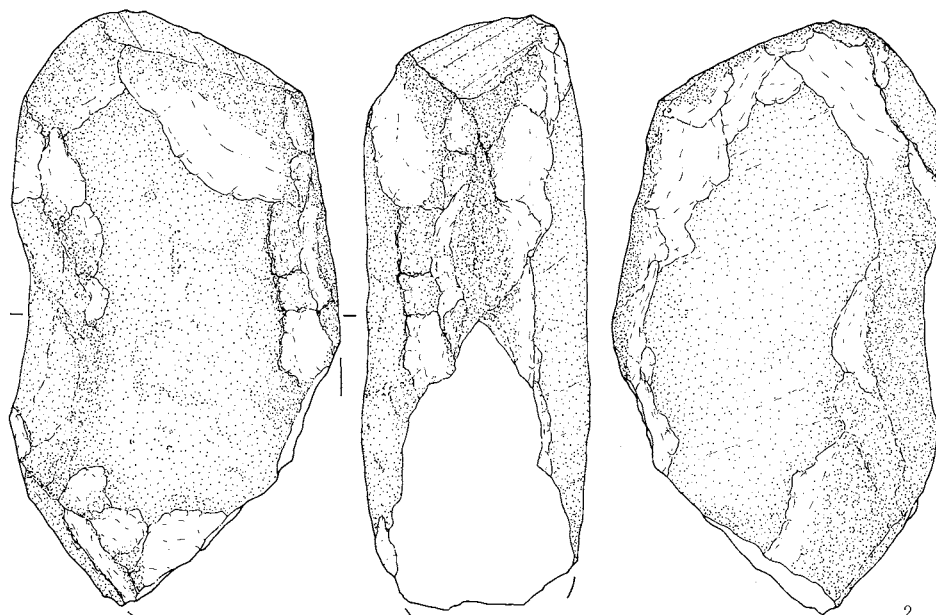
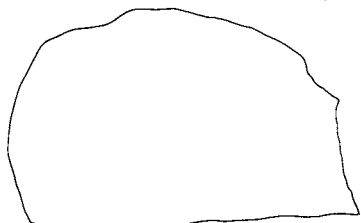

2

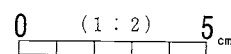
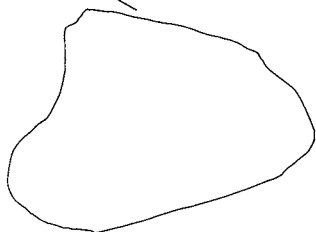

磨製石斧関連24 (SK14770)

SG3

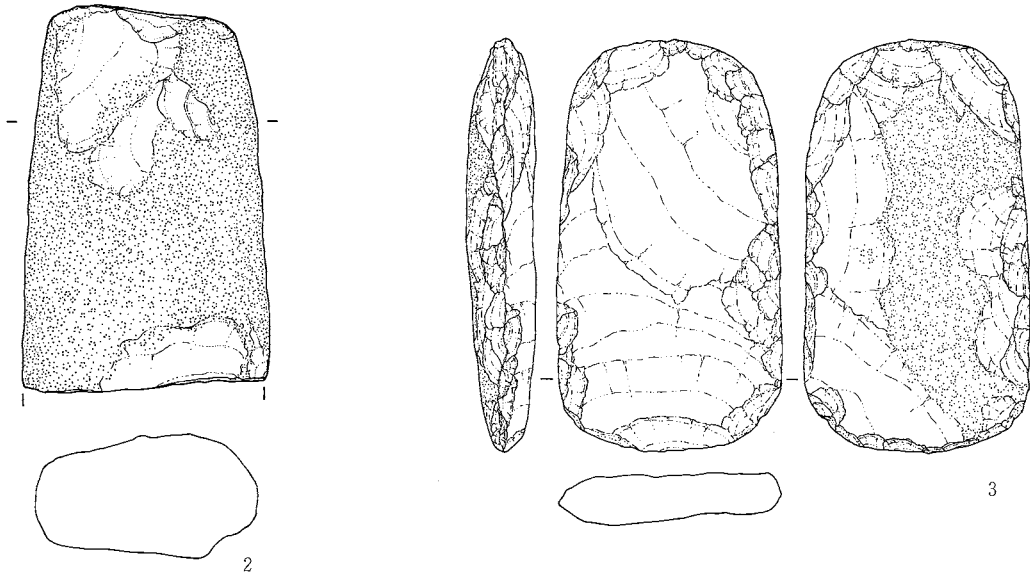

SG4

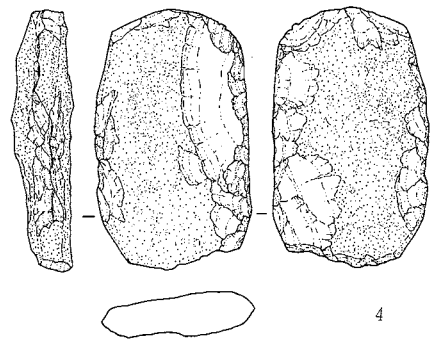
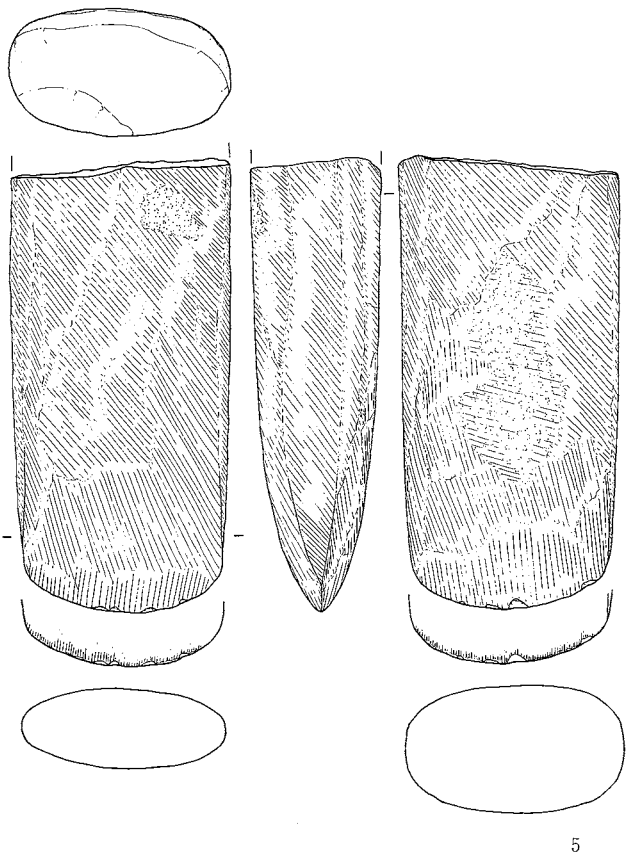

SG1

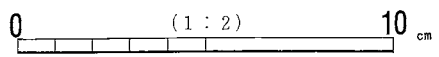
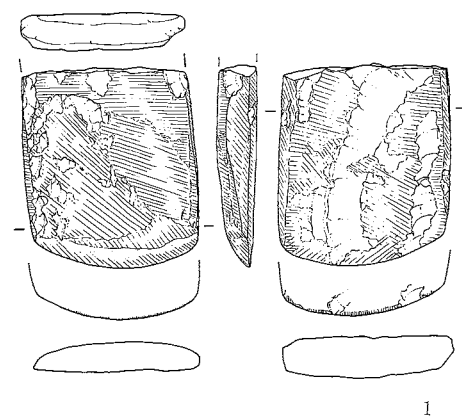

磨製石斧関連25 (SG1・3・4)

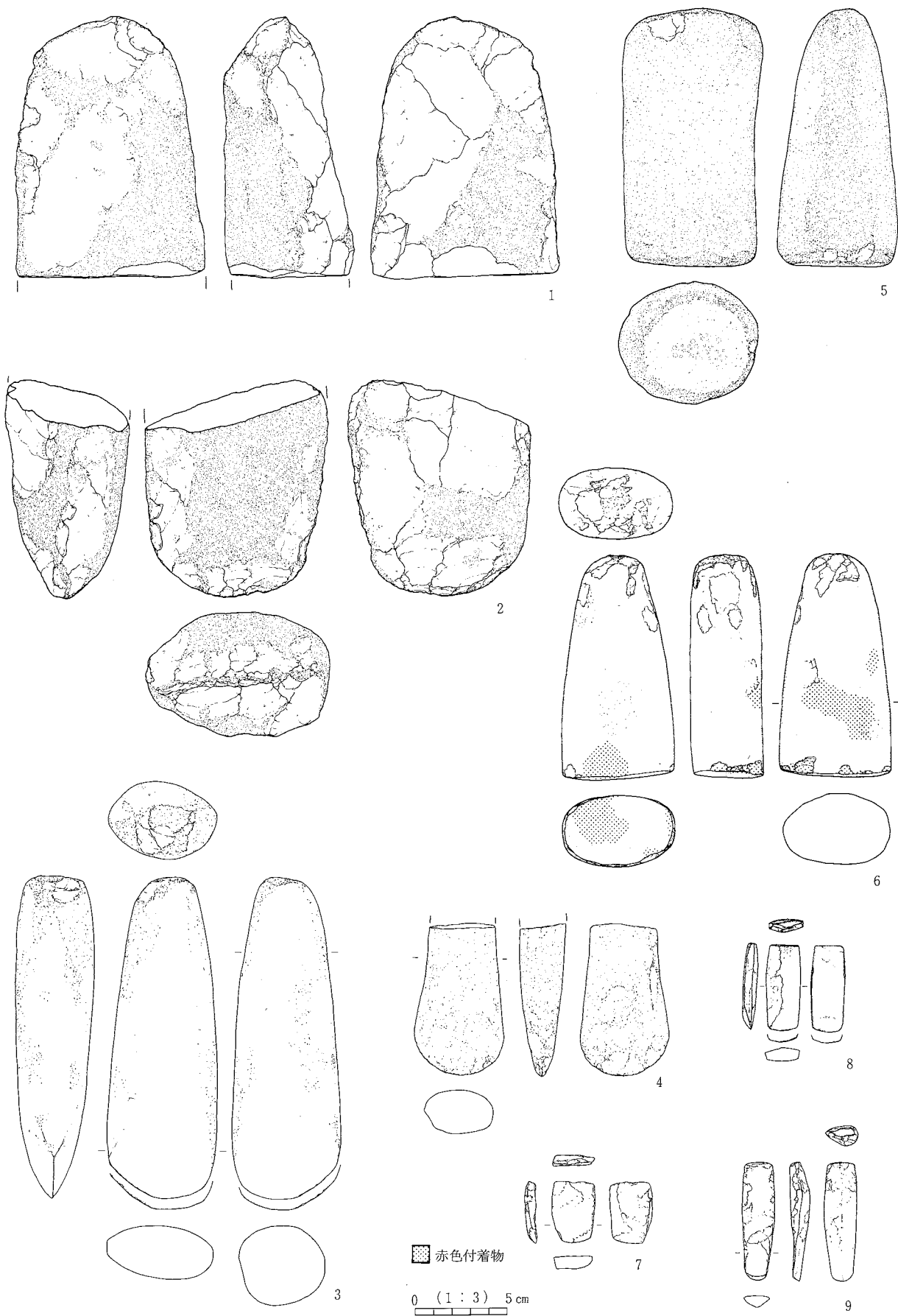

磨製石斧関連26 (IVS・IVR・IVN・VIIB・Z表採)

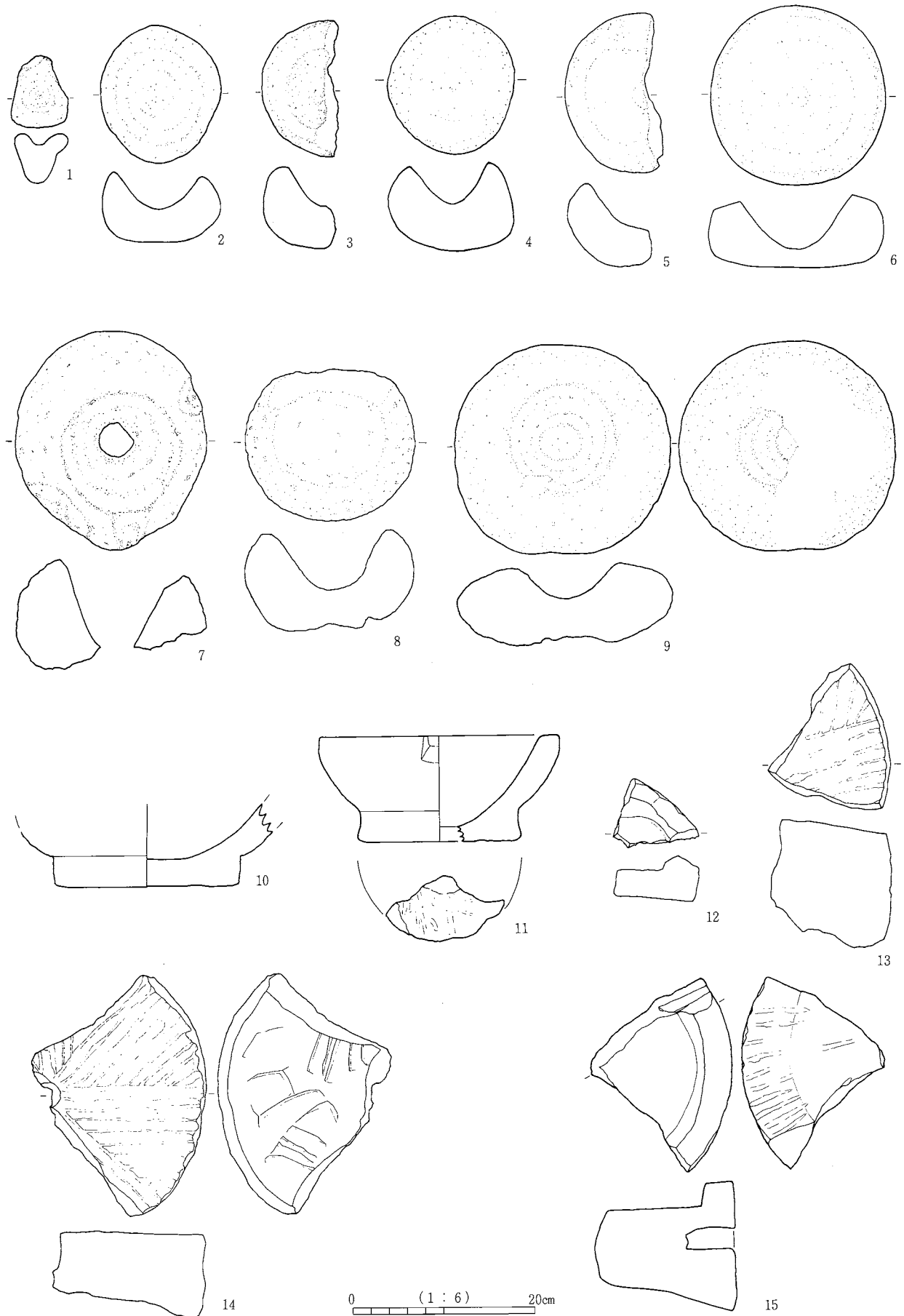

くぼみ石・石鉢・石臼

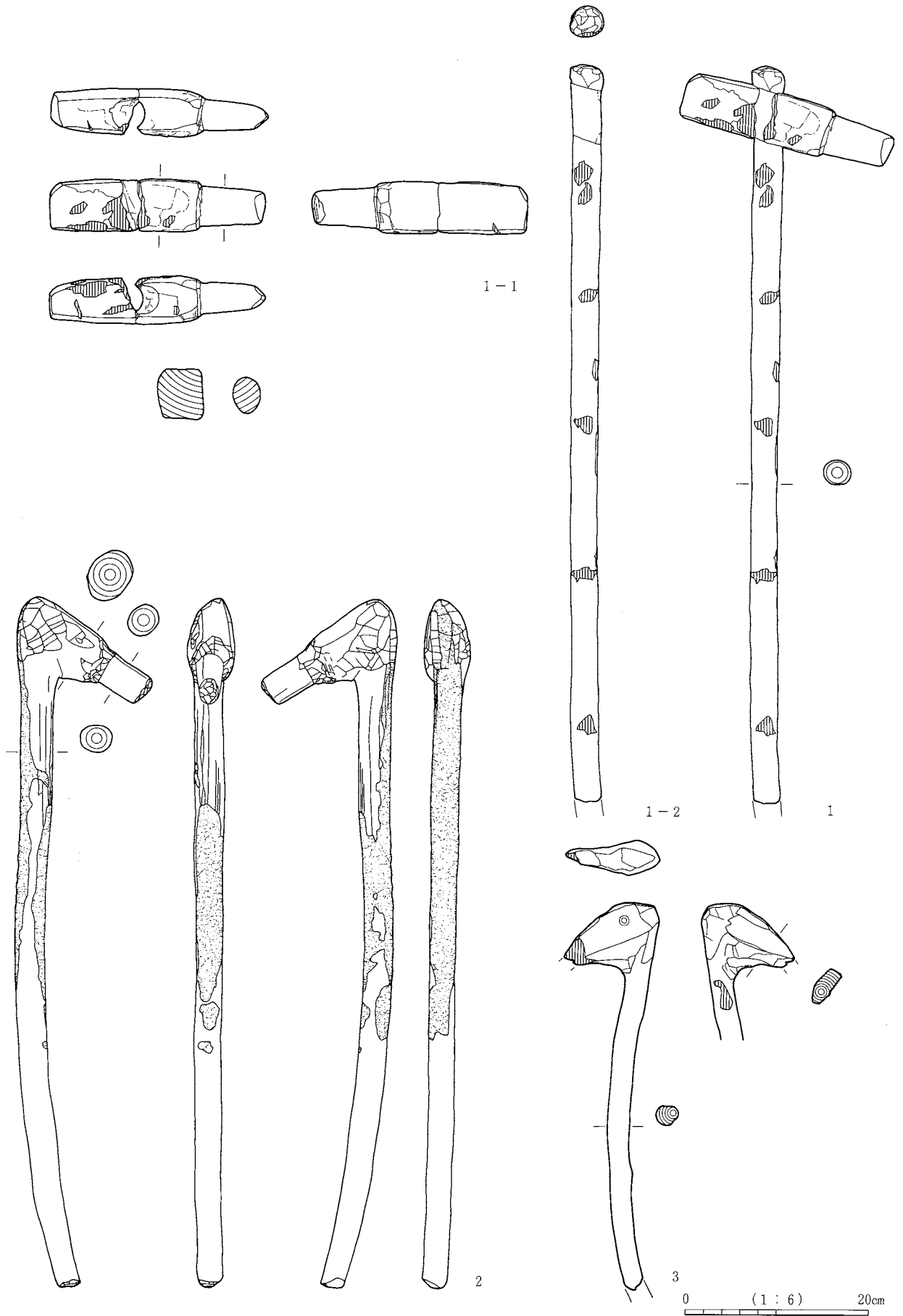

工具1 斧柄(1)

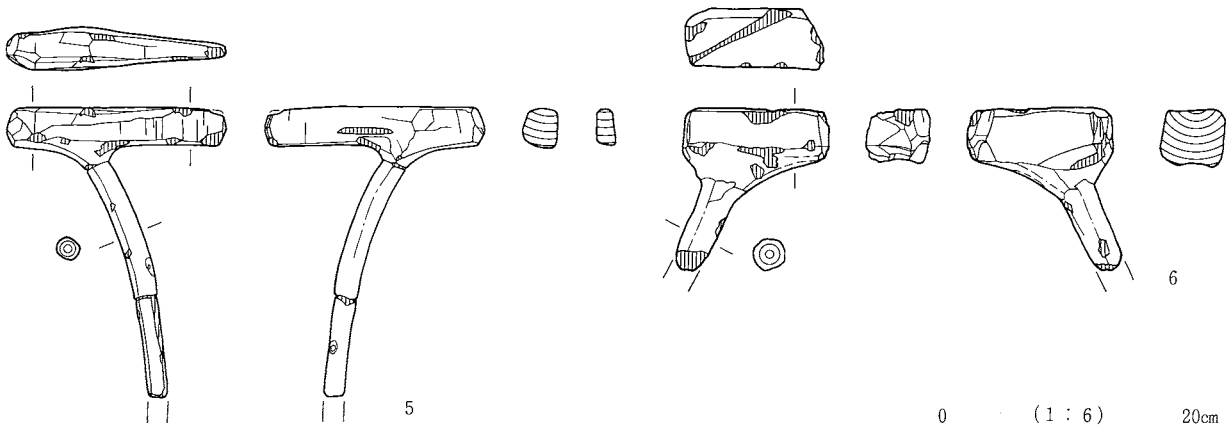
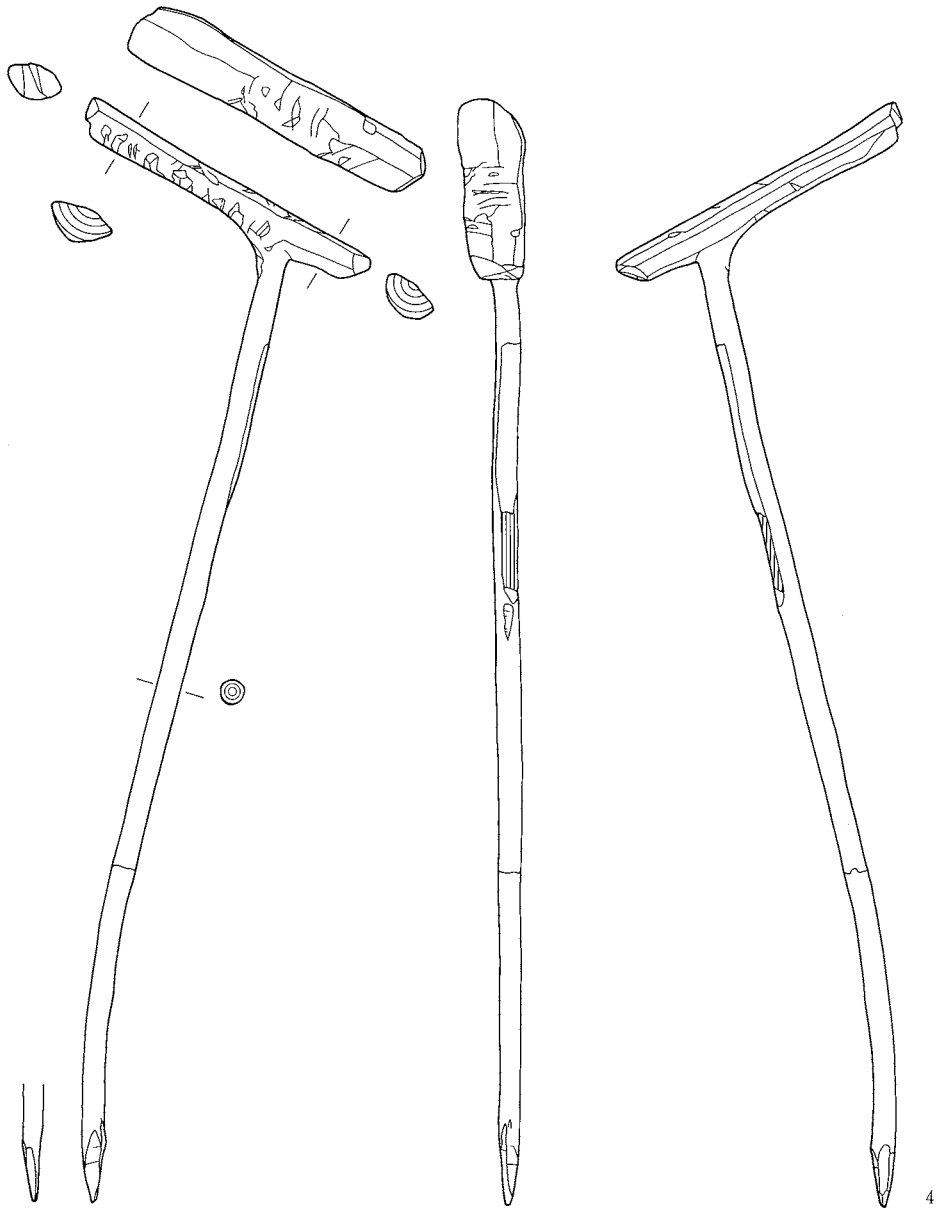

0 (1:6) 20cm

工具2 斧柄(2)

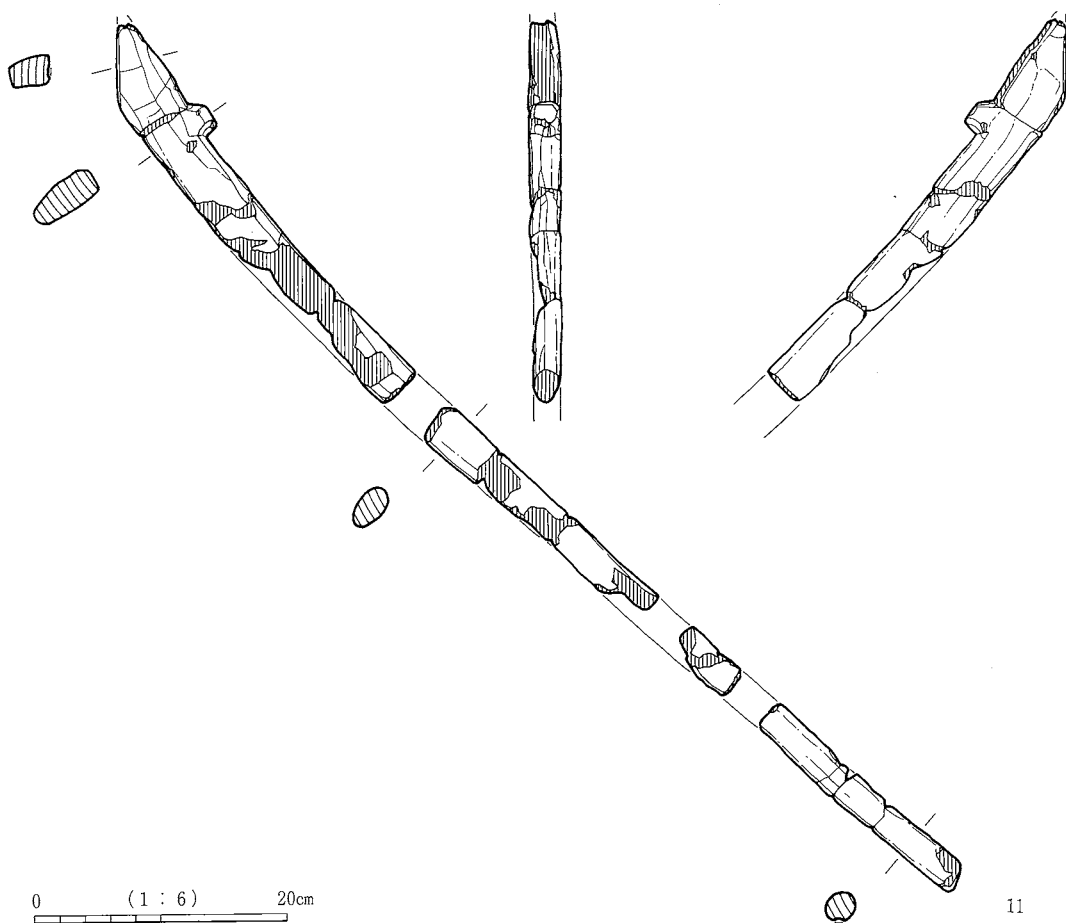
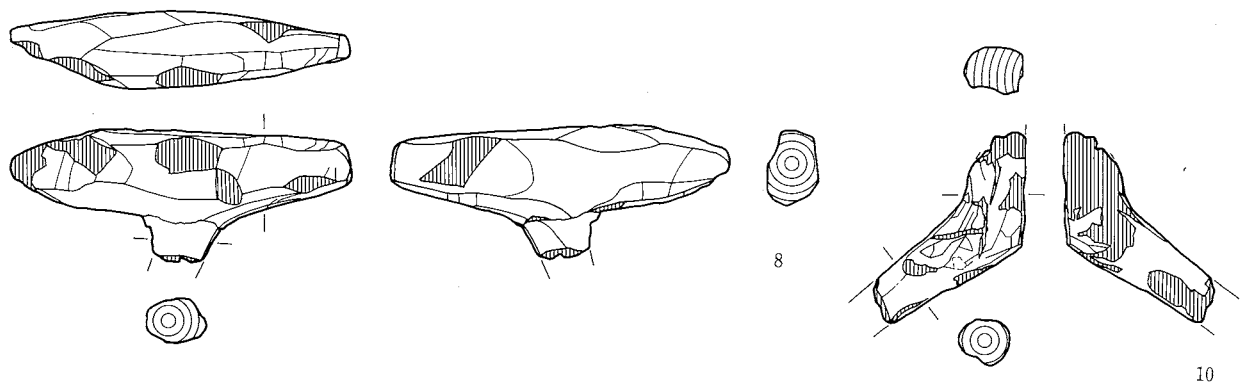
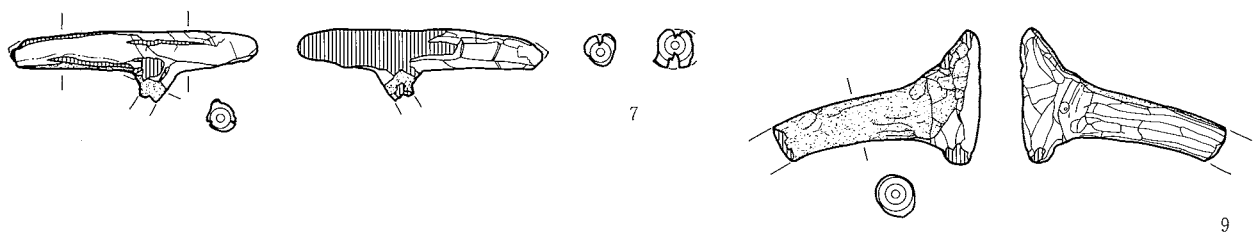

工具3 斧柄(3) 農具1 鍬曲柄

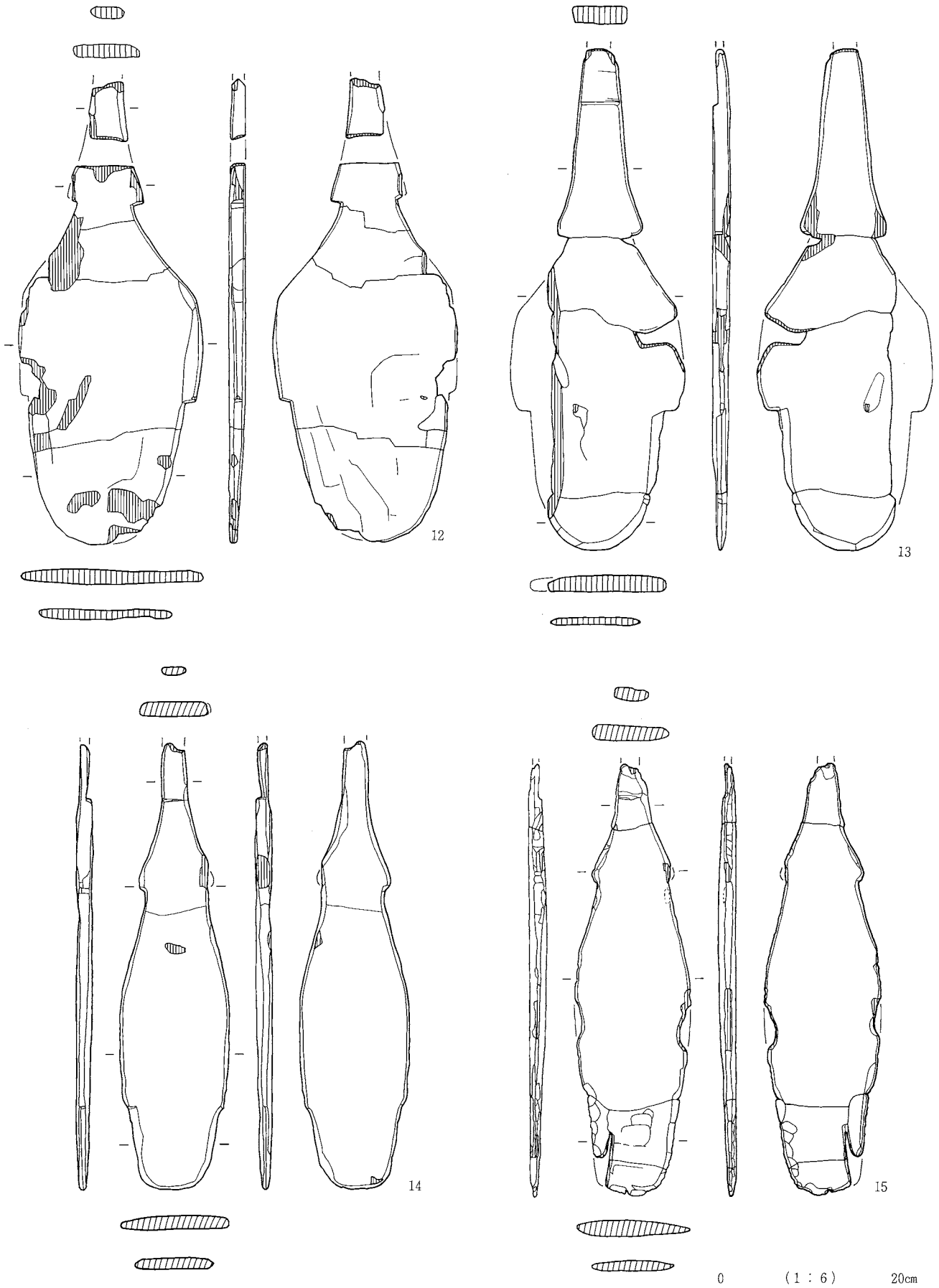

農具2 曲柄平鍬(1)

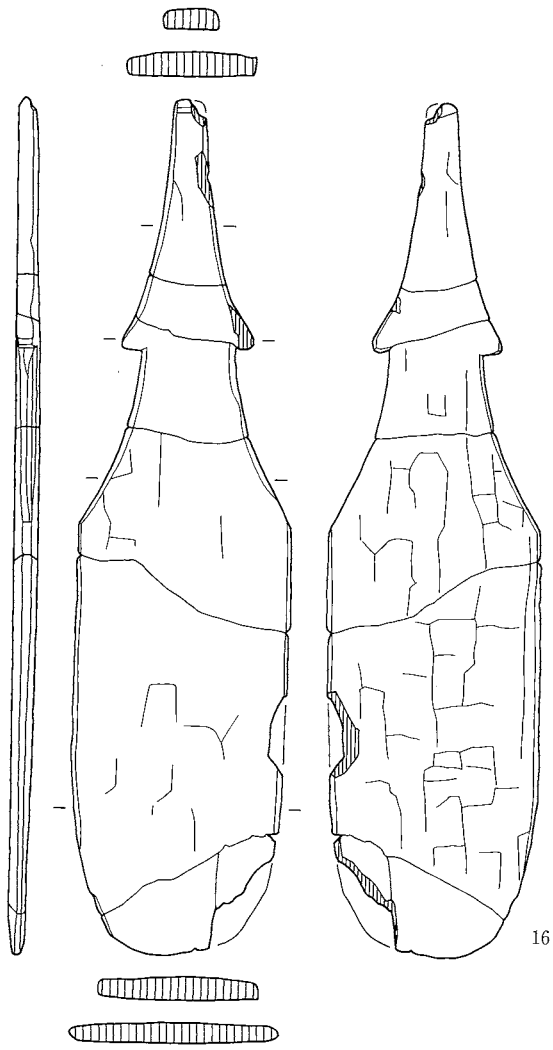

16

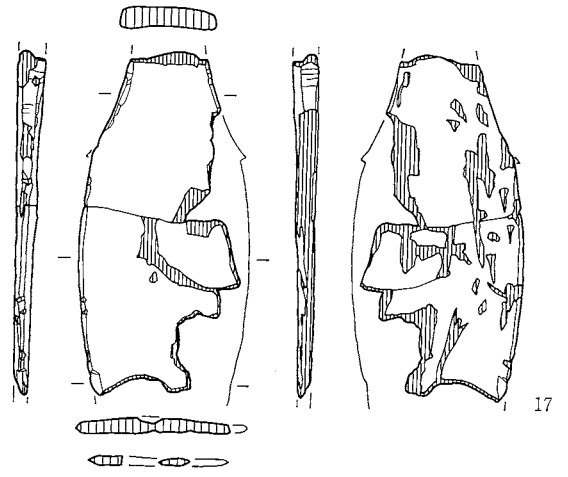

17

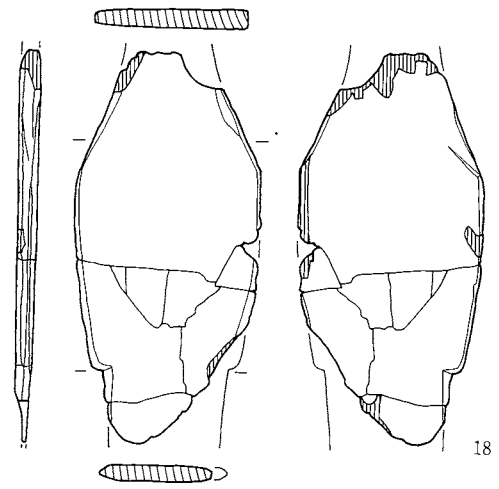

18

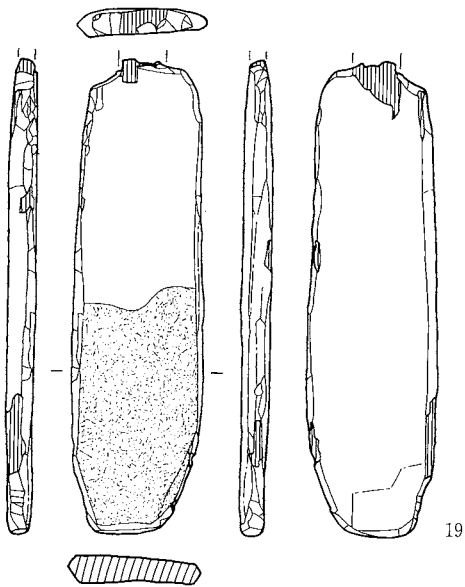

19

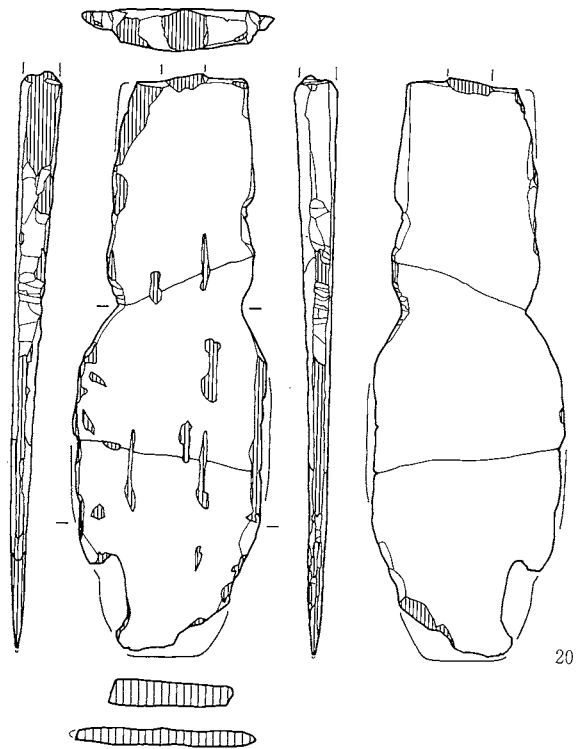

20

0 (1:6) 20cm

農具3 曲柄平鍬(2)

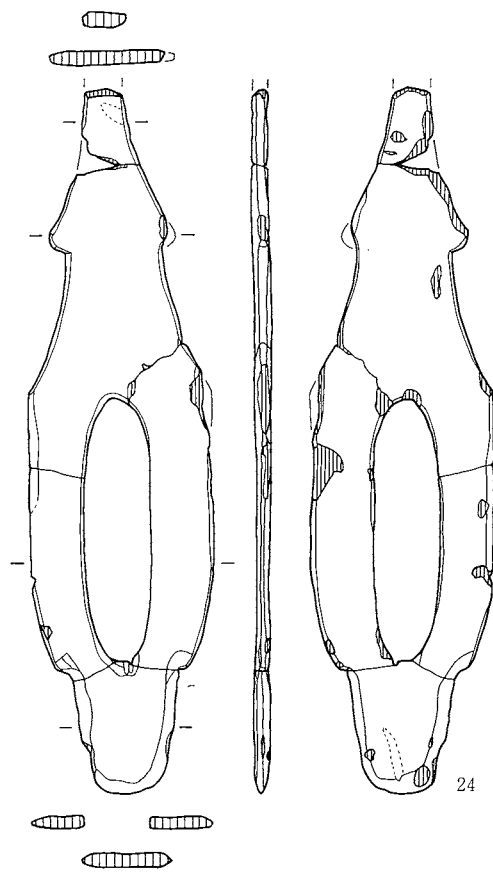
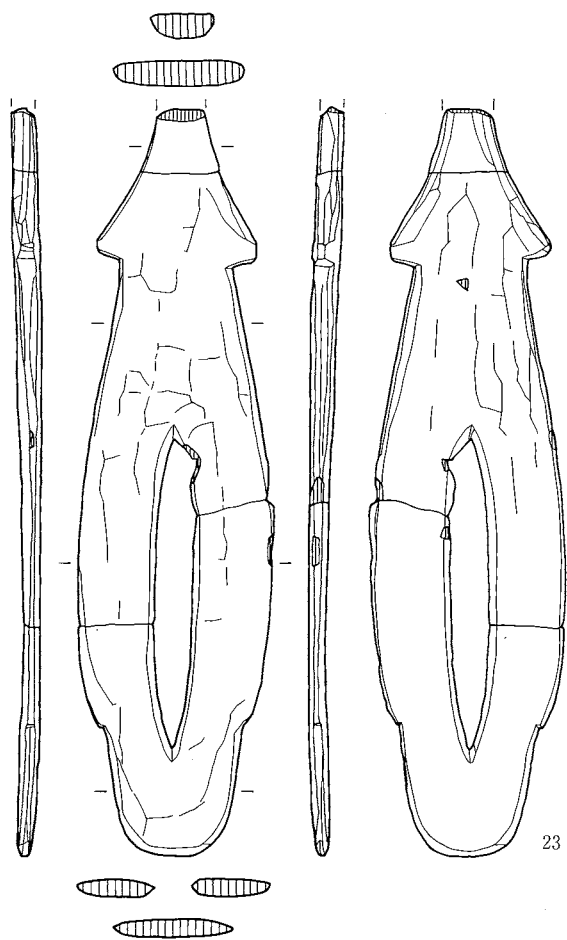
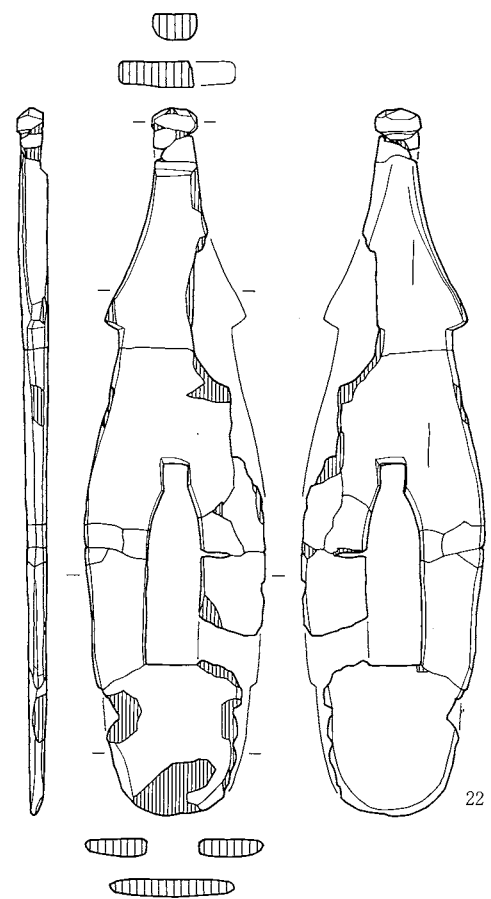
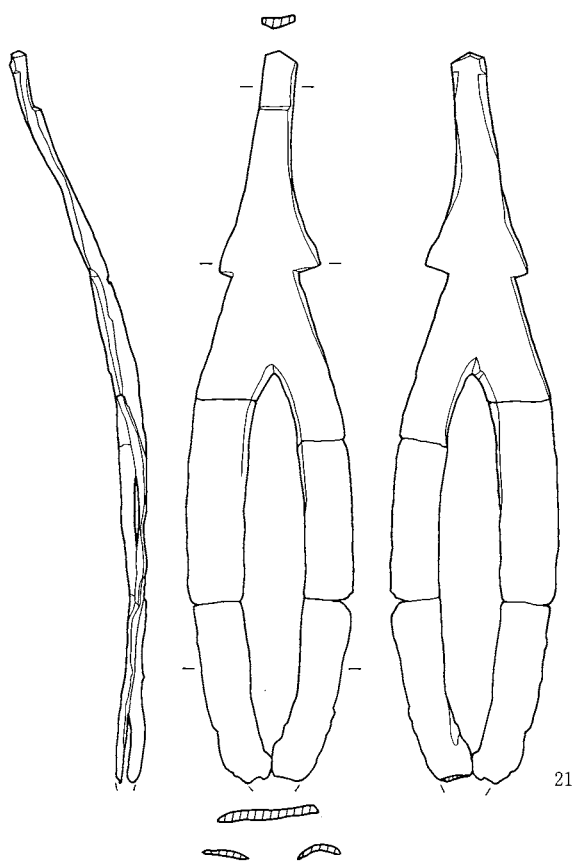

0 (1:6) 20cm

農具4 曲柄平鋏(3)

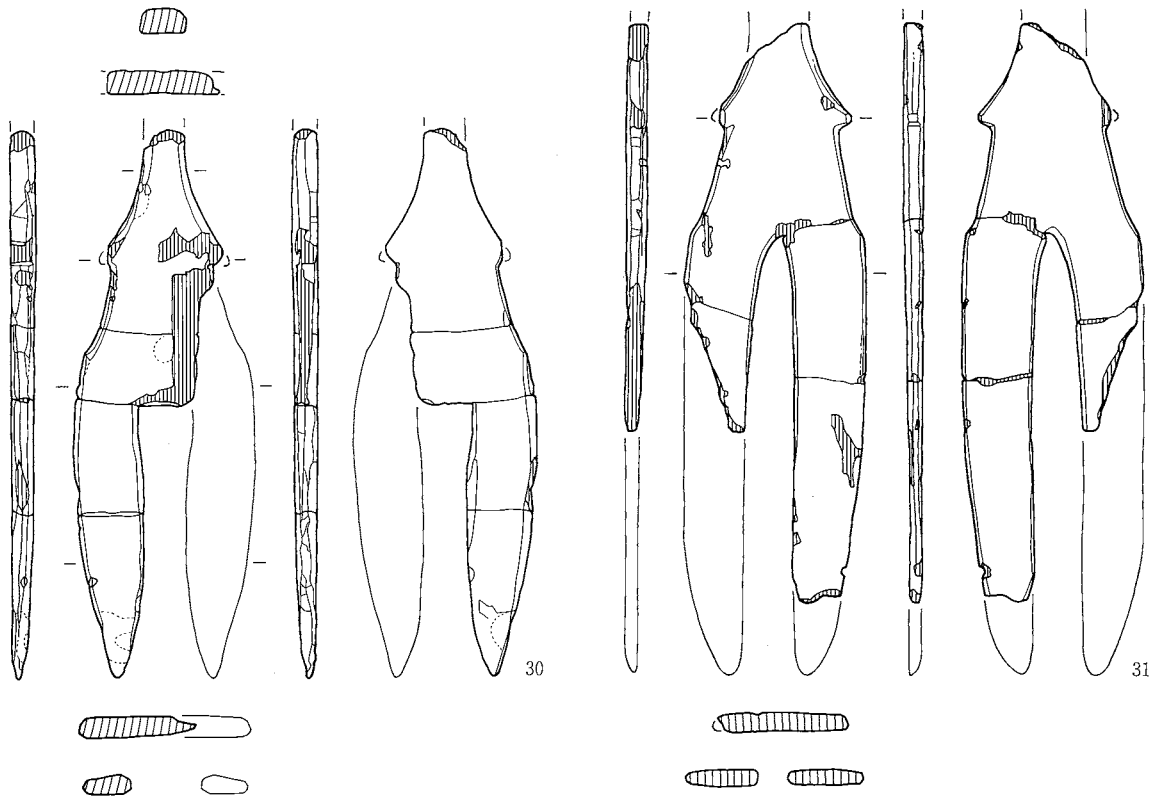
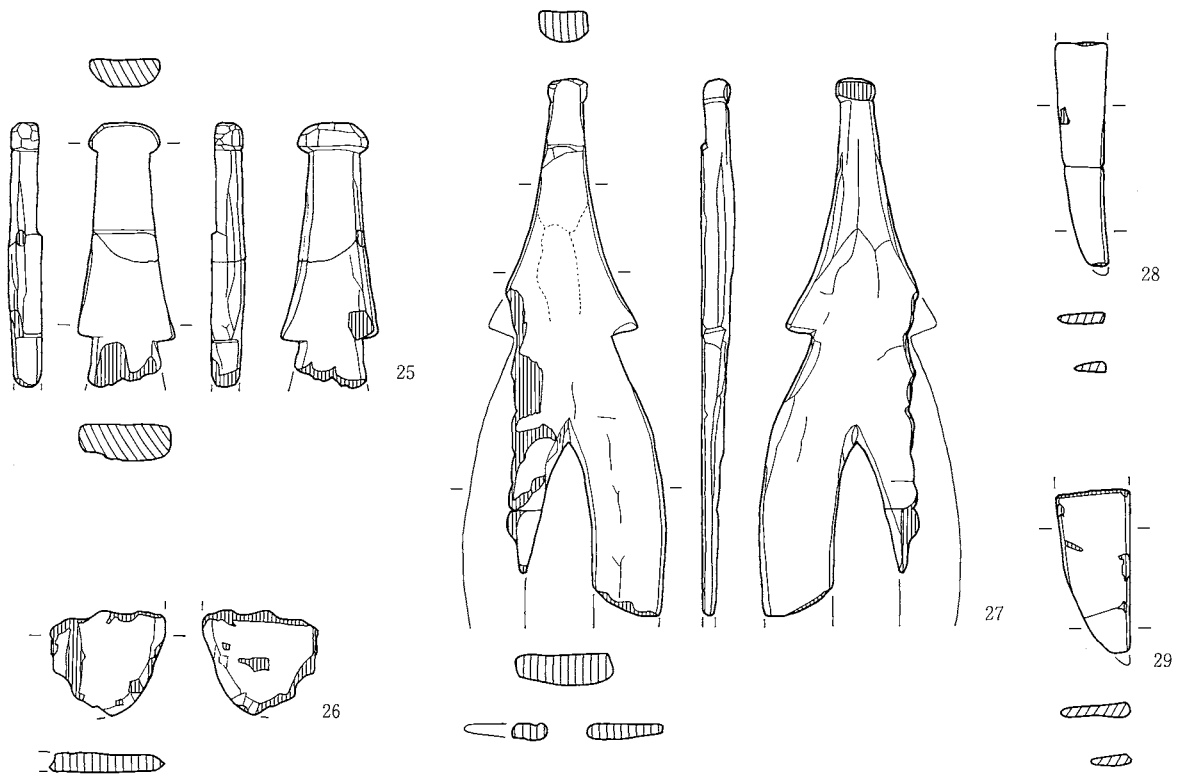

農具5 曲柄平鍬(4)・曲柄又鍬

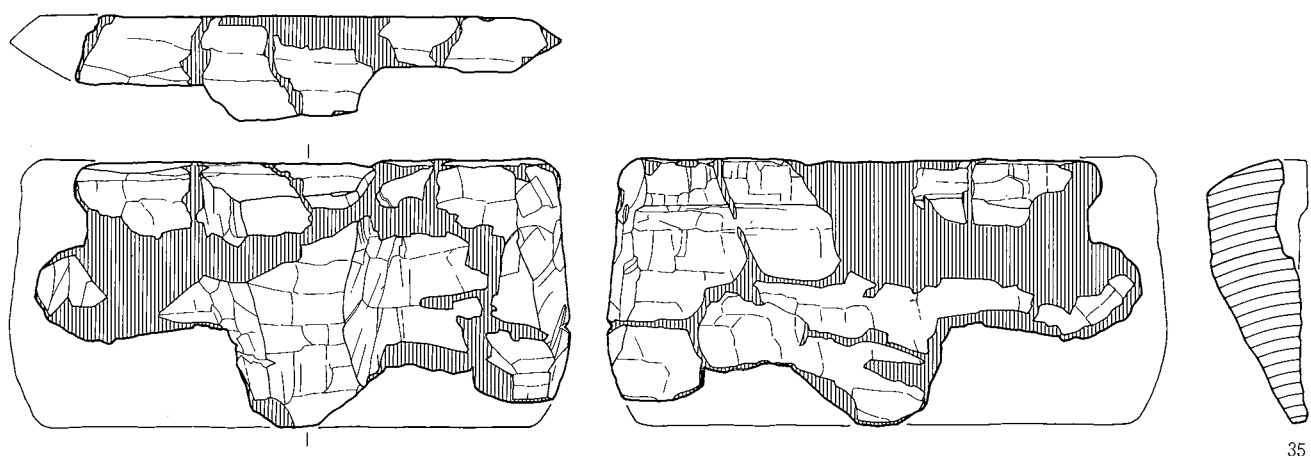
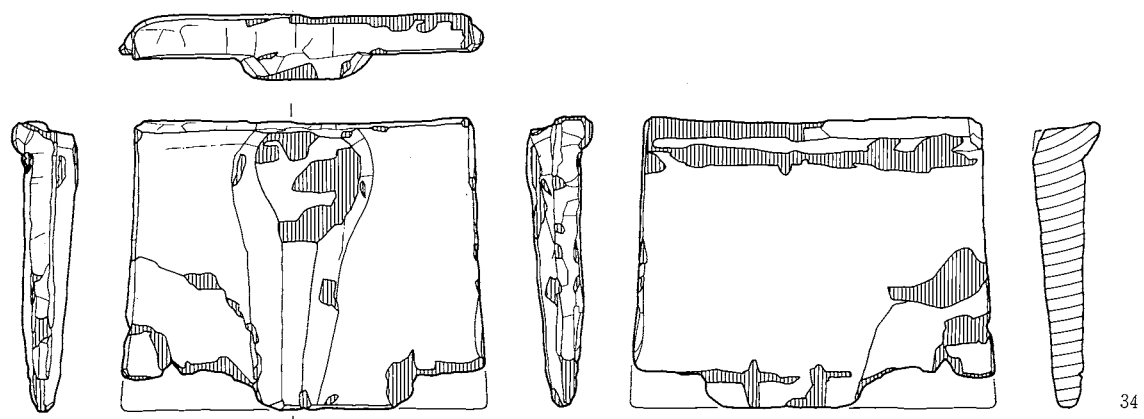
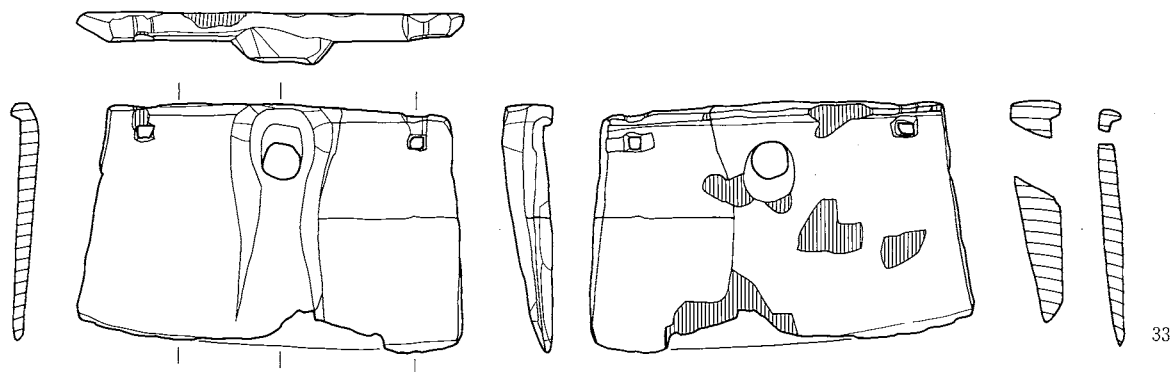
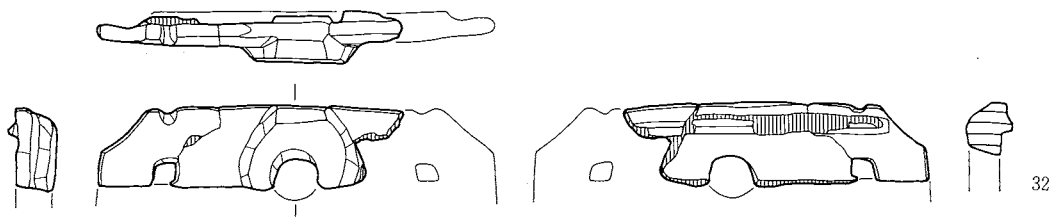

0 (1:6) 20cm

農具6 直柄横鋏(1)

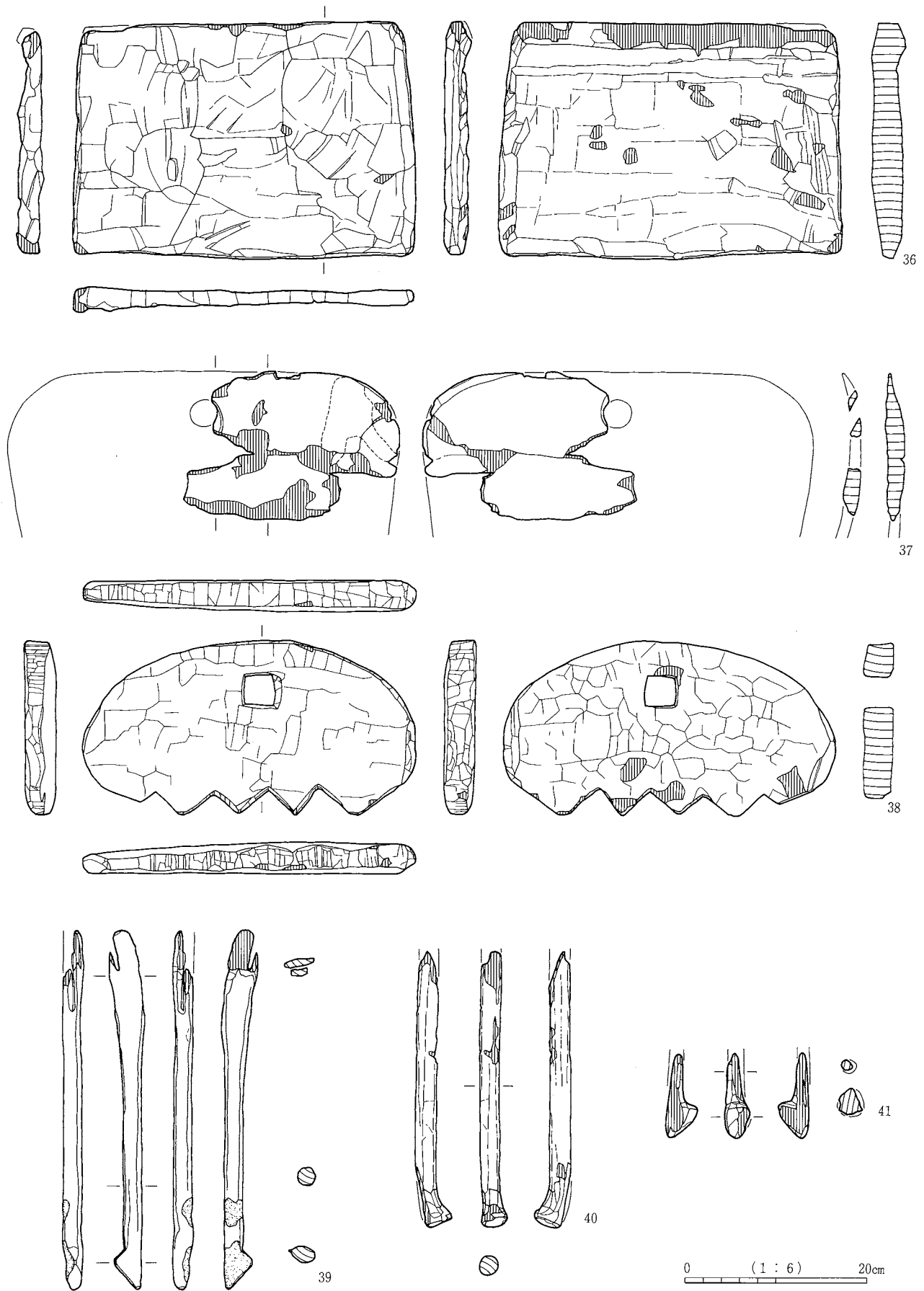

農具7 直柄横鋏(2)・泥除け・えぶり・鎌柄

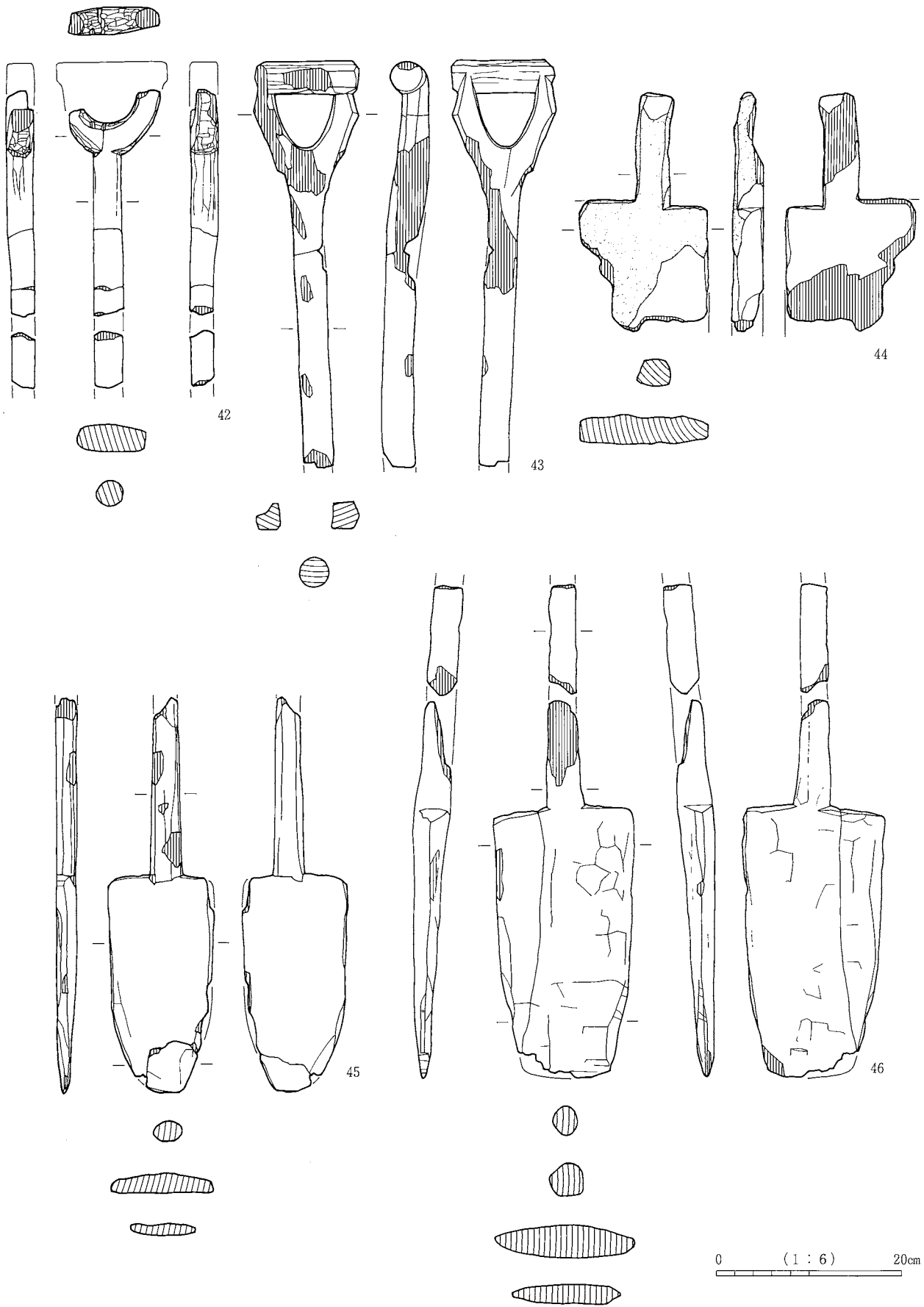

農具8 一木鋤

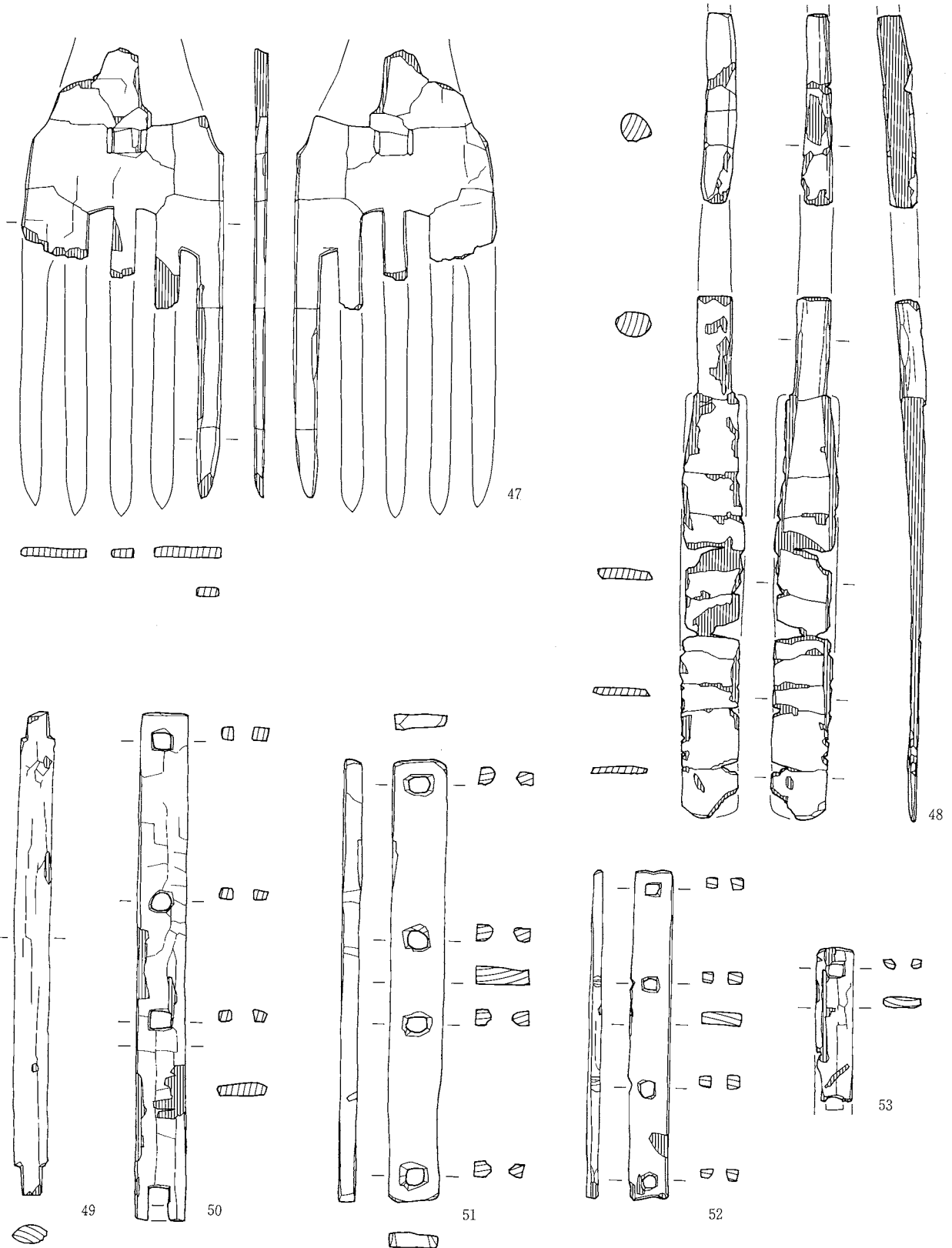

農具9 組み合わせ多又鋤・糶打ち棒・大足

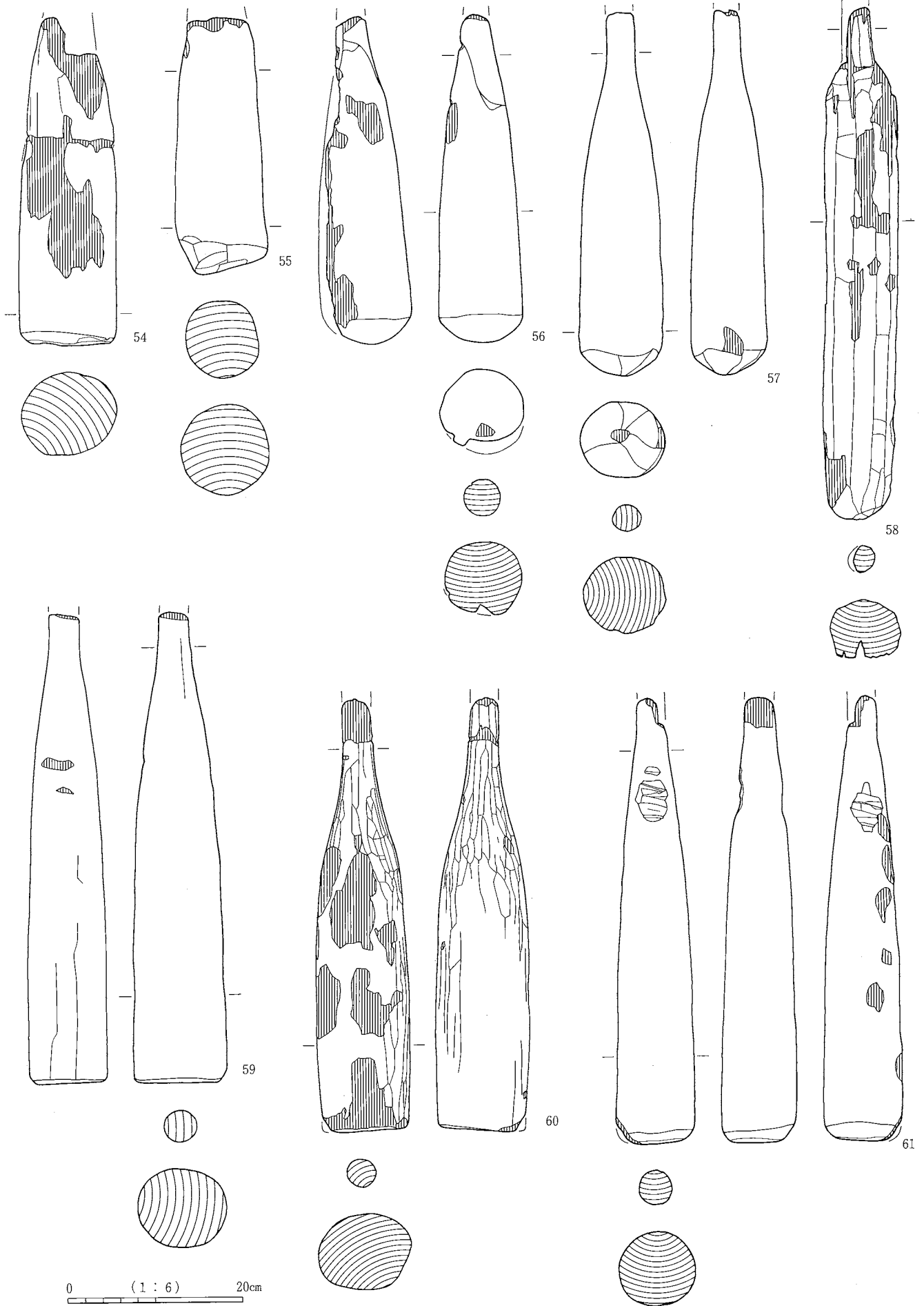

農具10 竖杵(1)

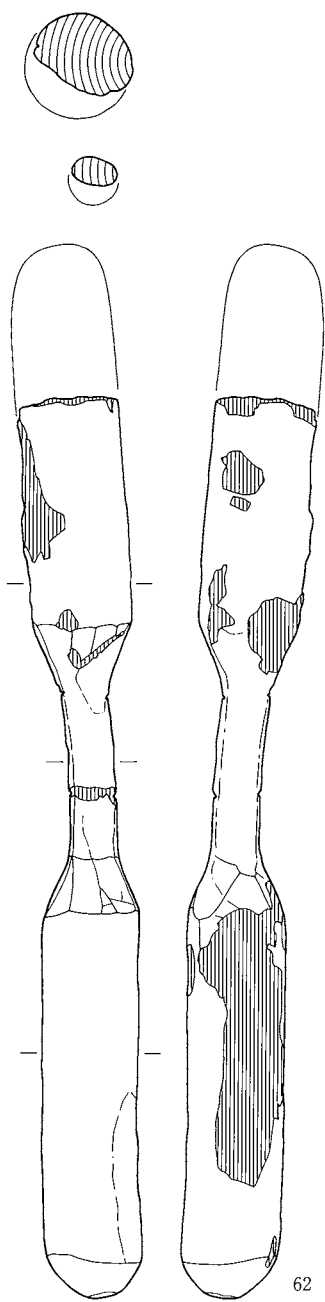

62

0 (1 : 6) 20cm



63

0 (1 : 8) 20cm

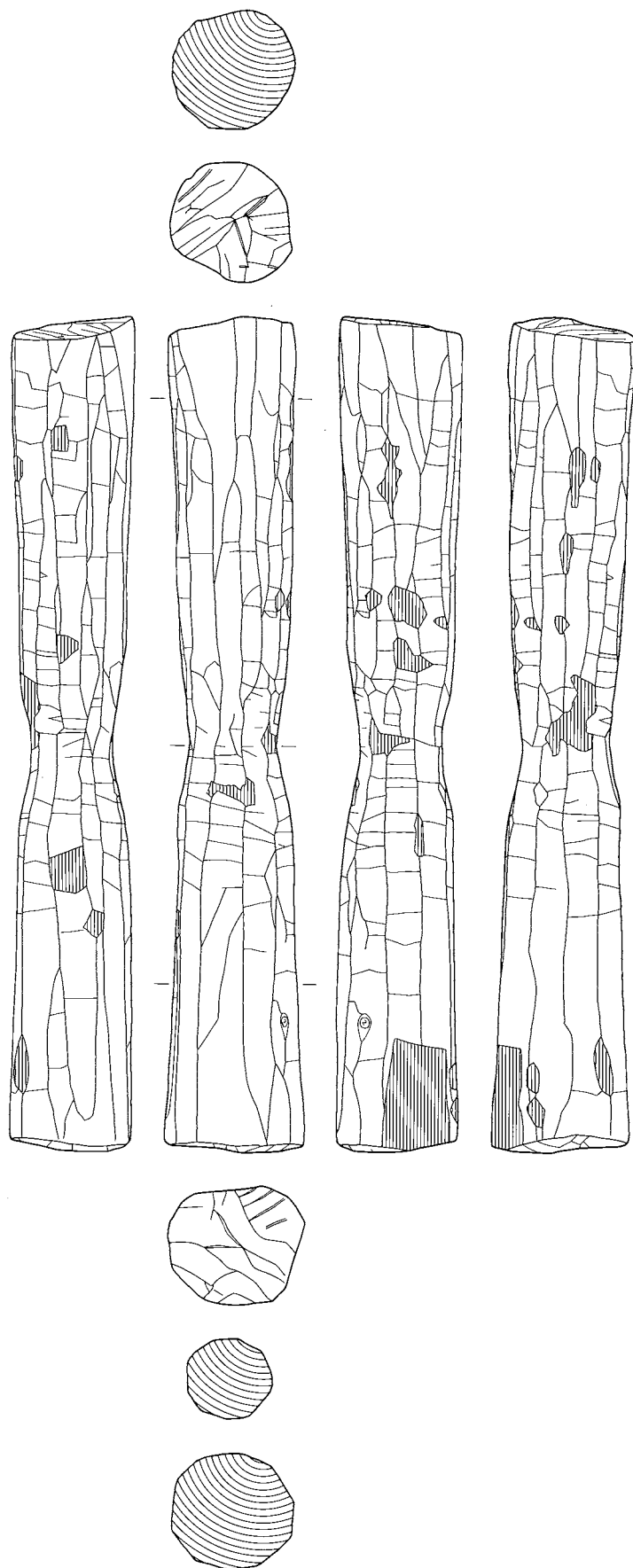

農具12 豎杵(3)

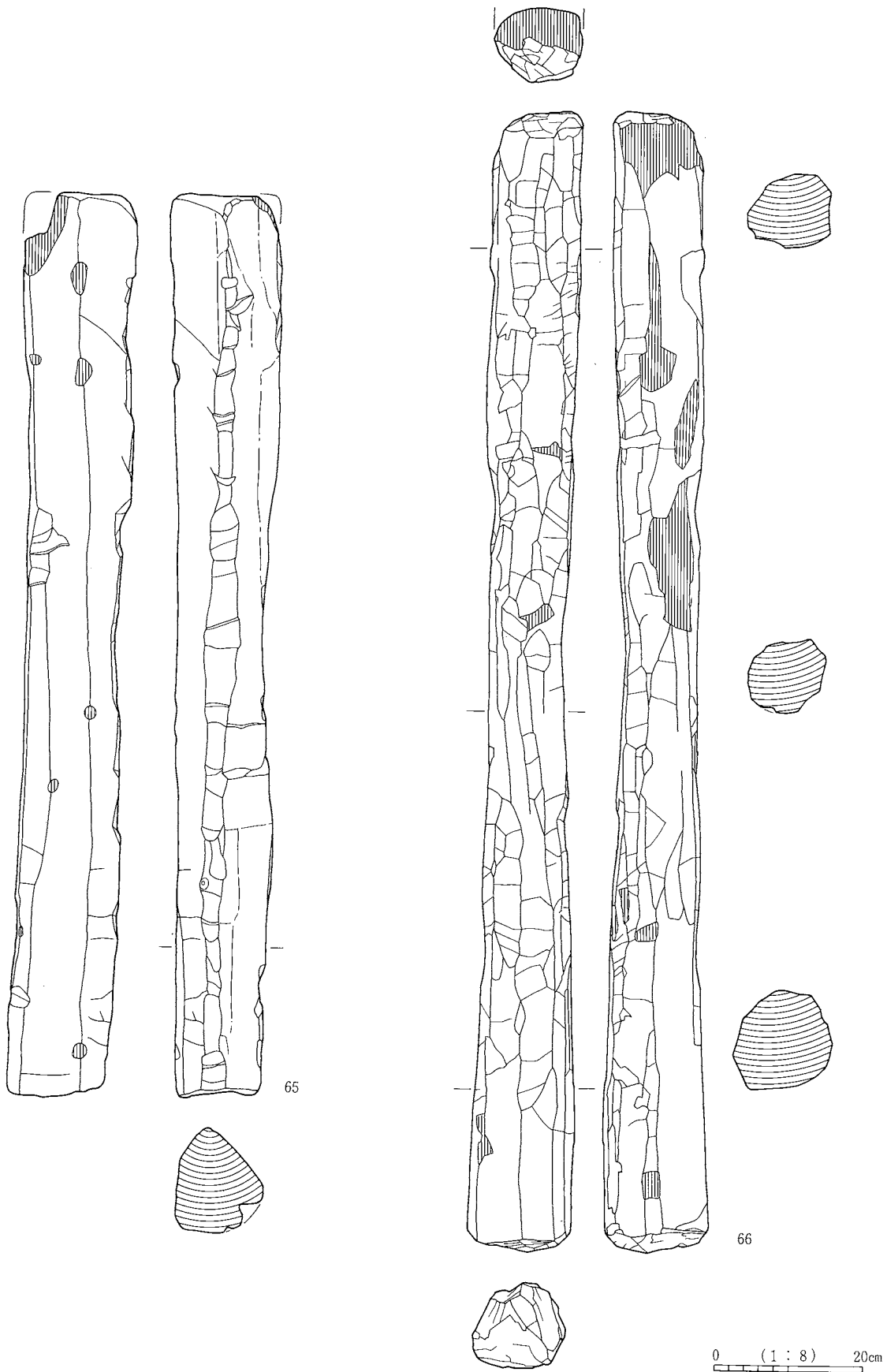

農具13 豎杵(4)

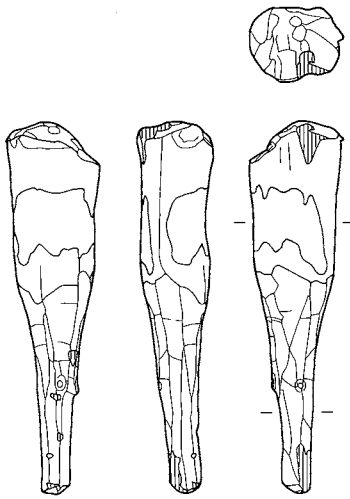

67

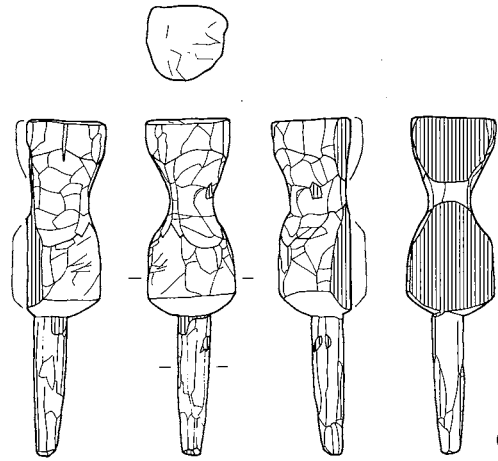

68

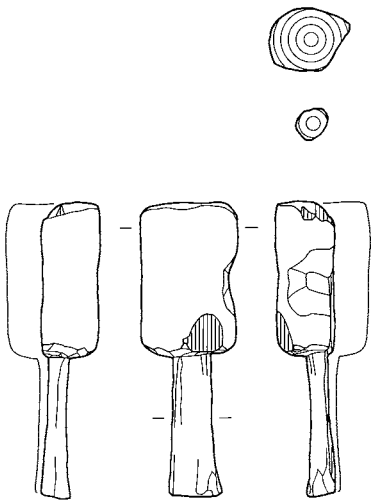

69

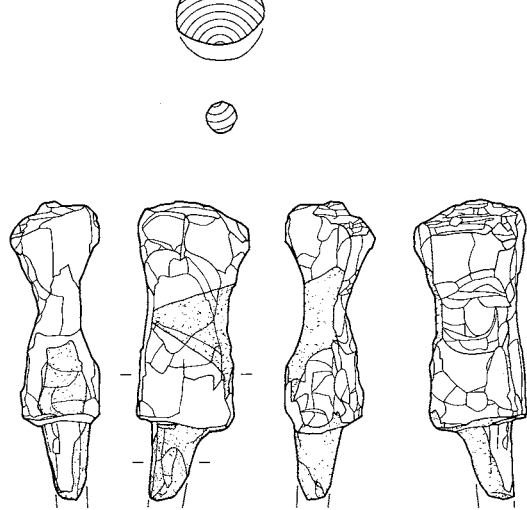

70

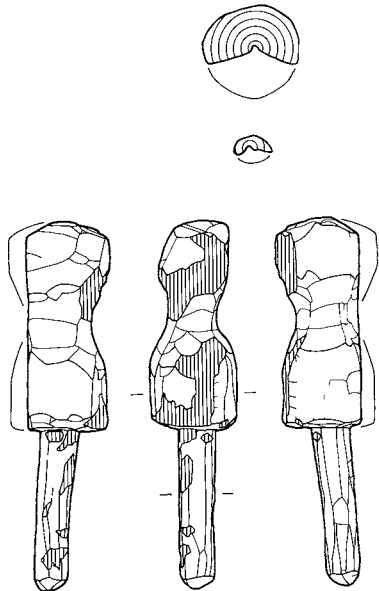

71

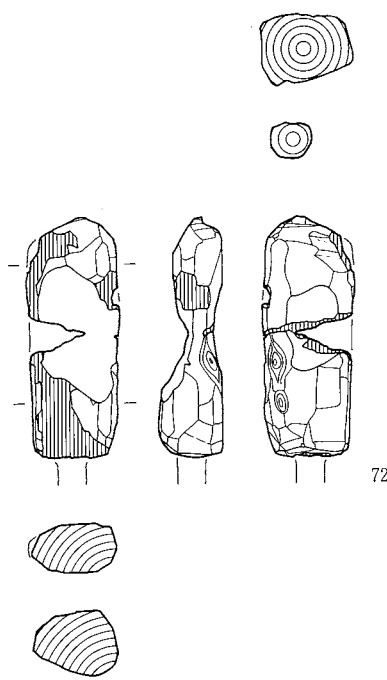

72

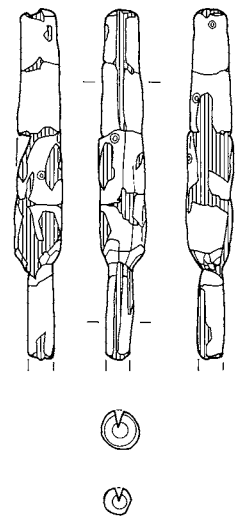

73

0 (1:6) 20cm

農具14 横槌(1)

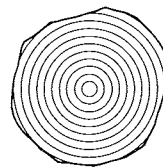
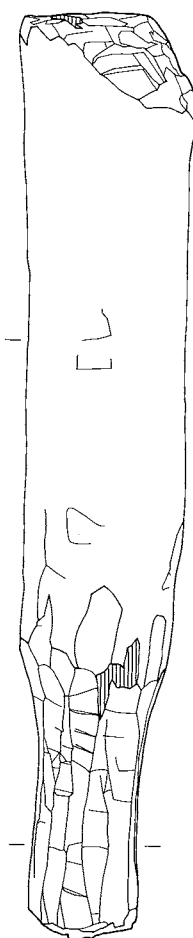
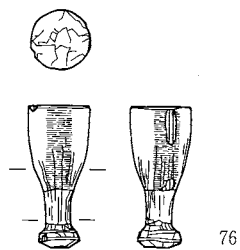
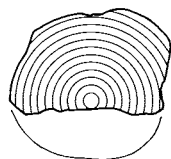
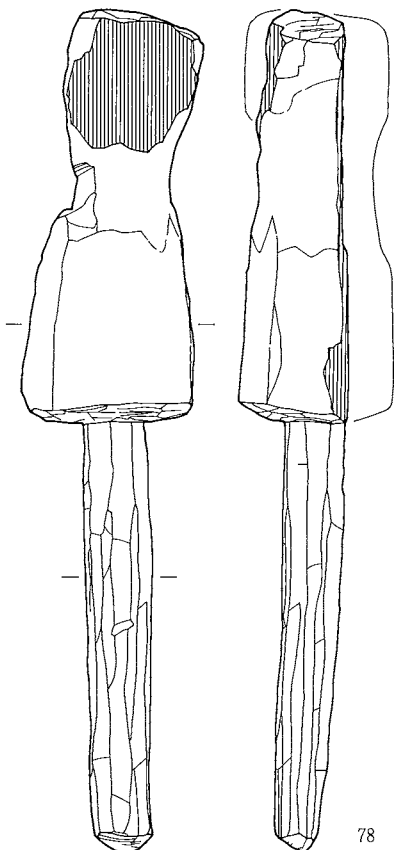
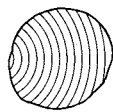
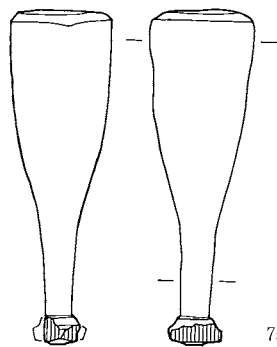
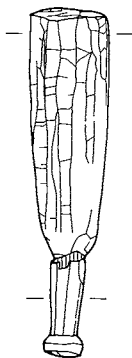
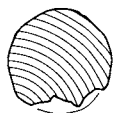
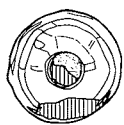
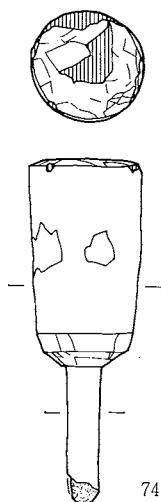

0 (1 : 6) 20cm

農具15 横槌(2)

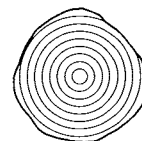
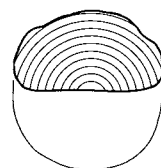
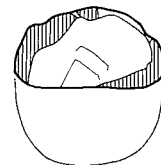
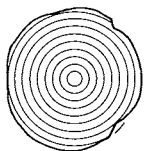
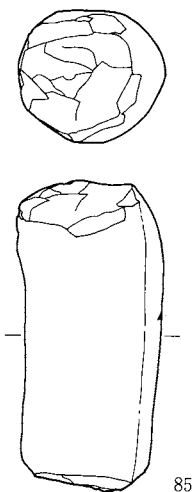
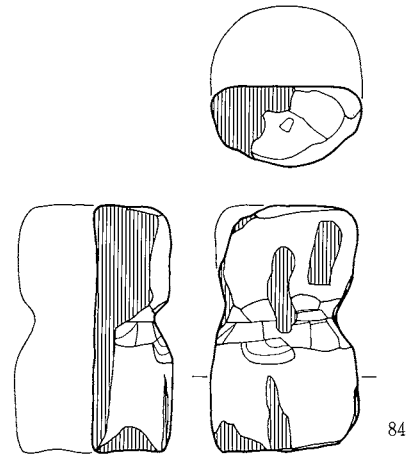
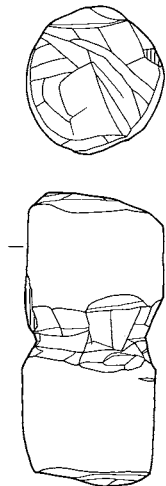
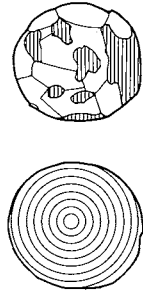
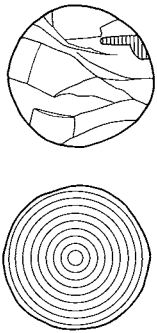
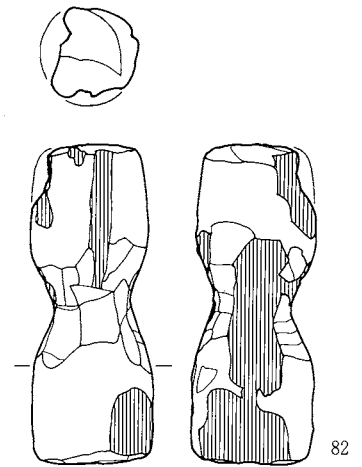
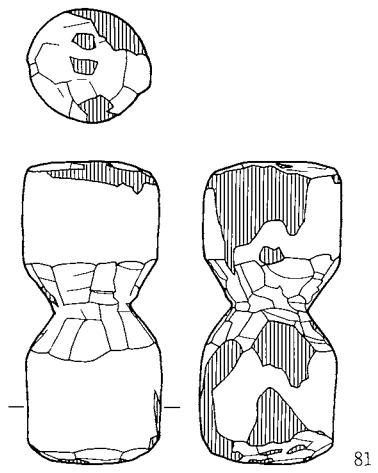
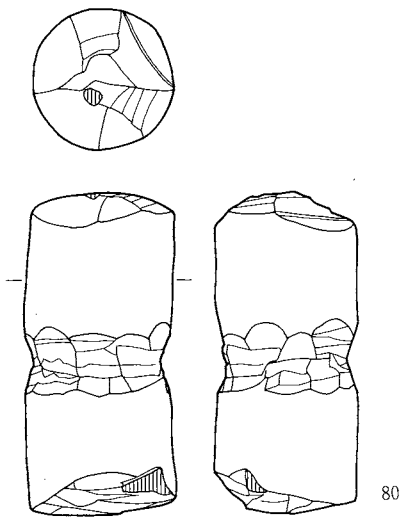

0 (1:4) 10cm

農具16 木錘

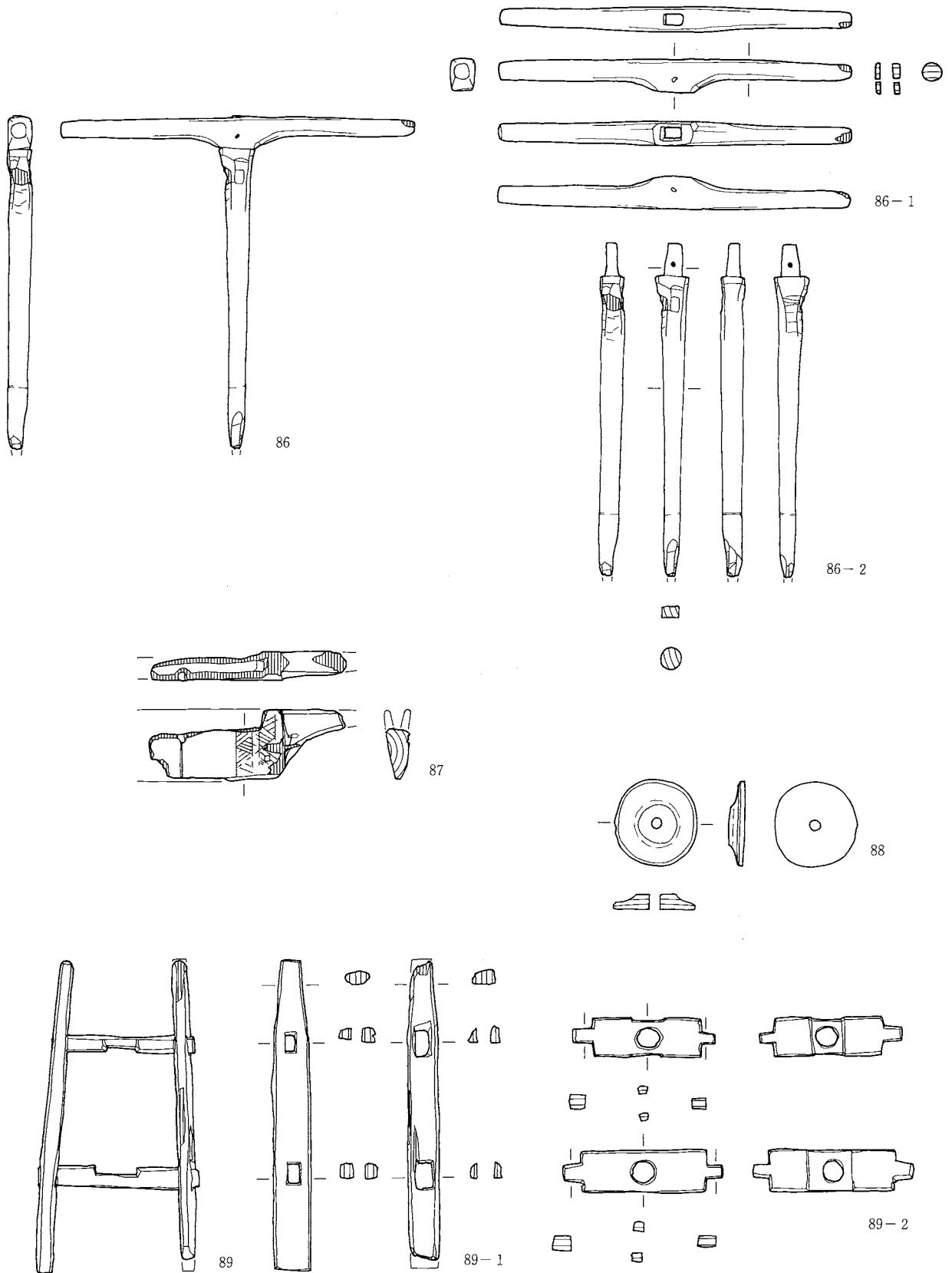

0 (1:4) 10cm
(87・88)

0 (1:6) 20cm
(86・89)

紡織具1 杵・杼・紡錘車・糸巻

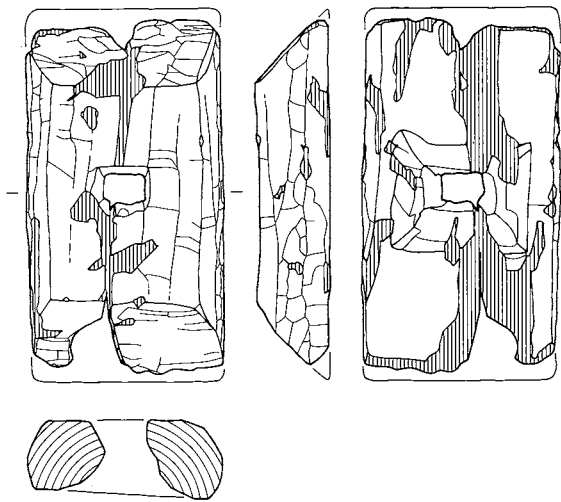

90

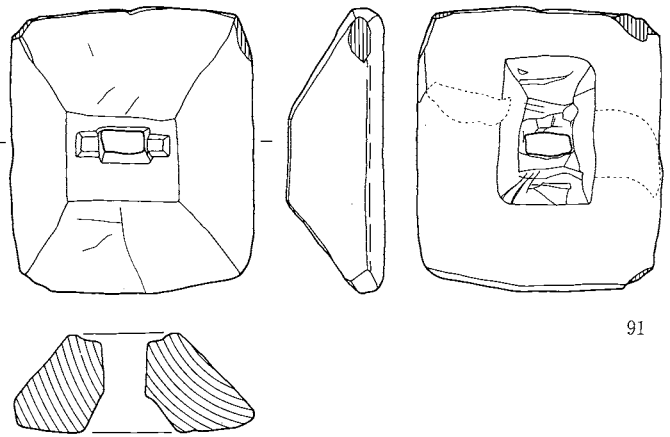

91

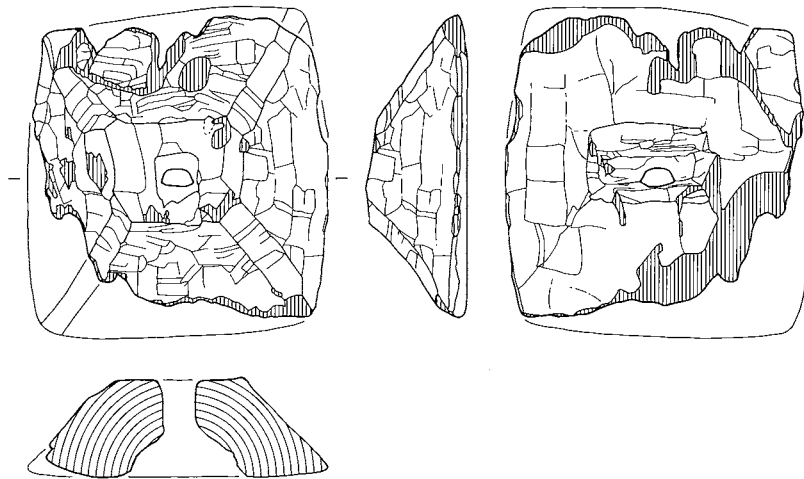

92

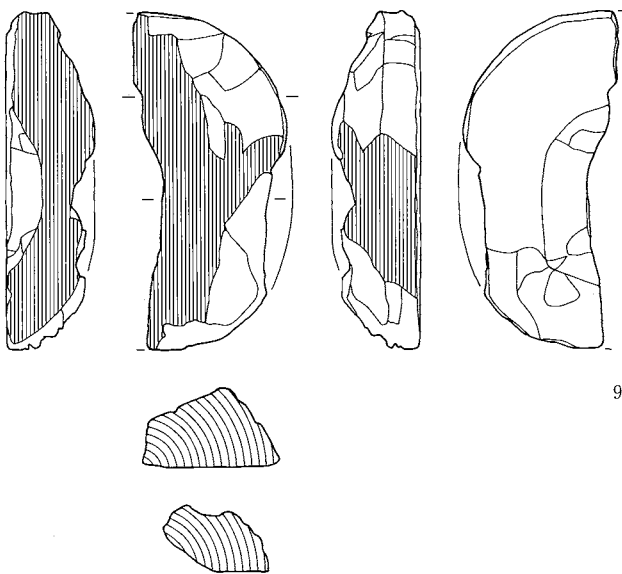

93

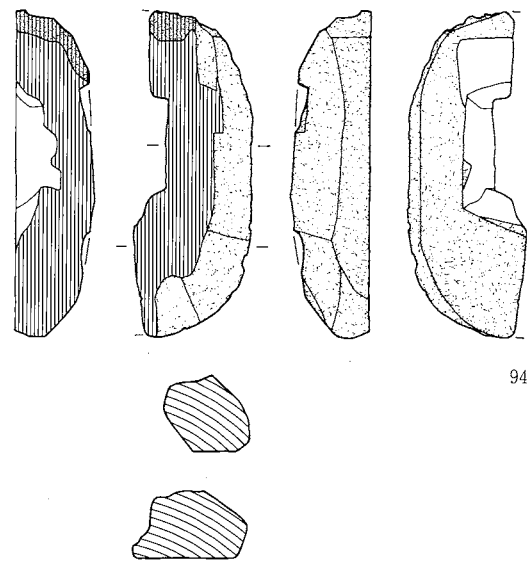

94

0 (1:6) 20cm

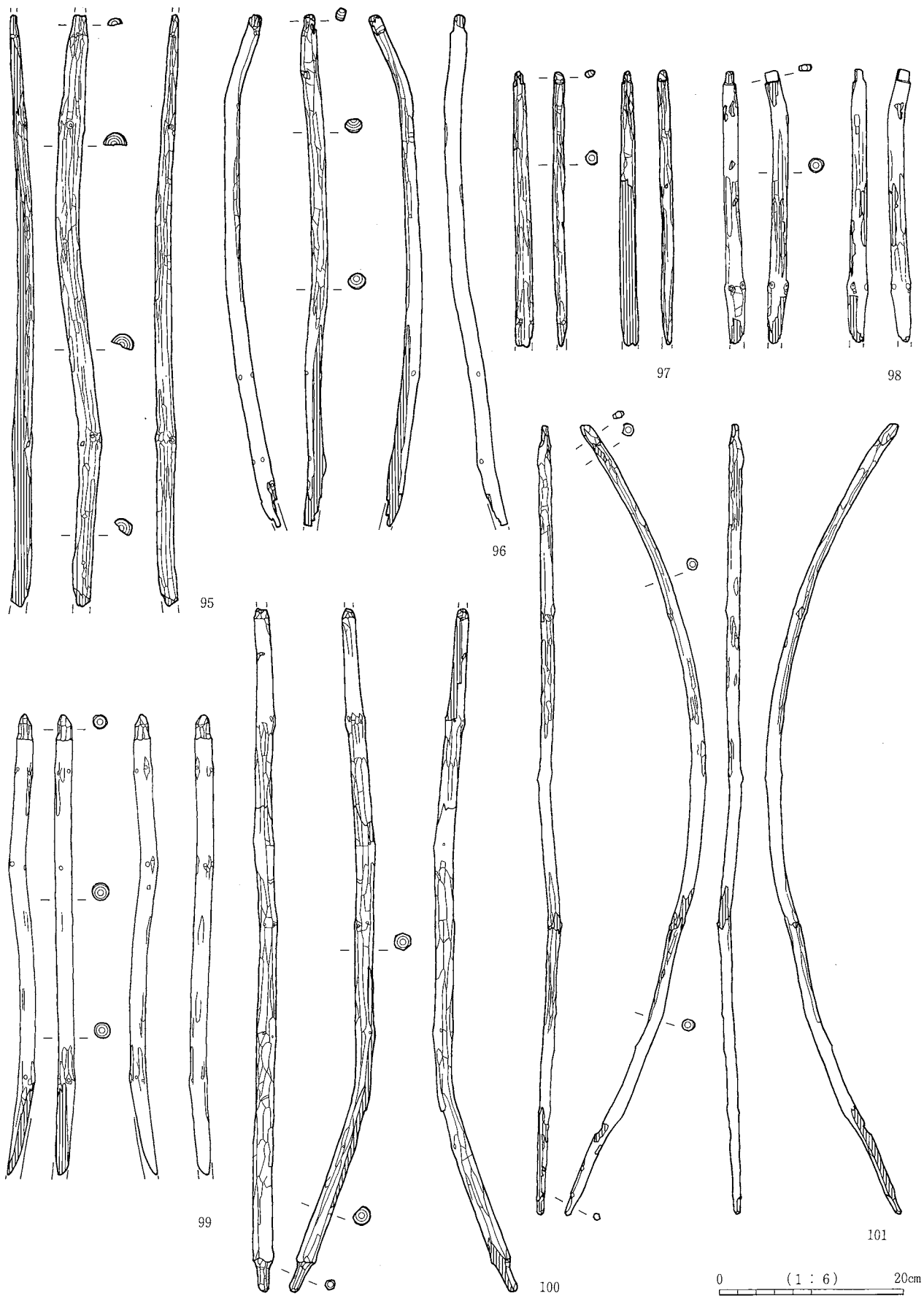

武器・馬具1 弓(1)

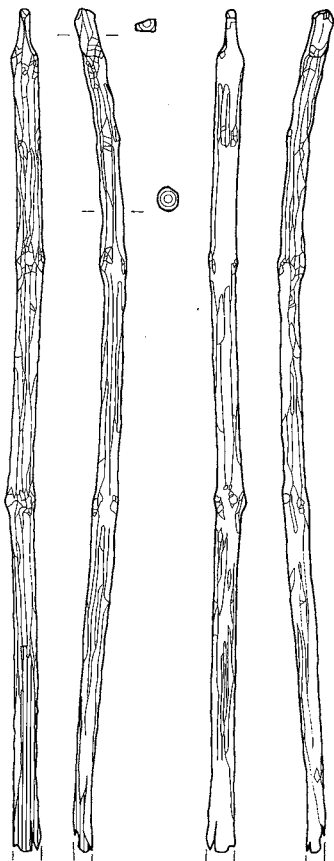

102

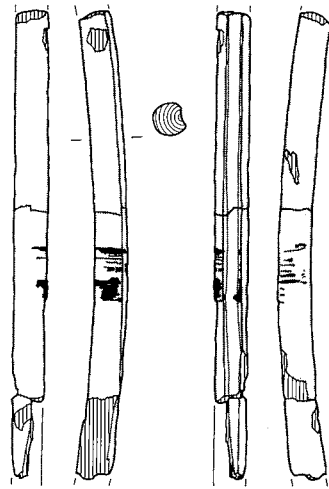

103

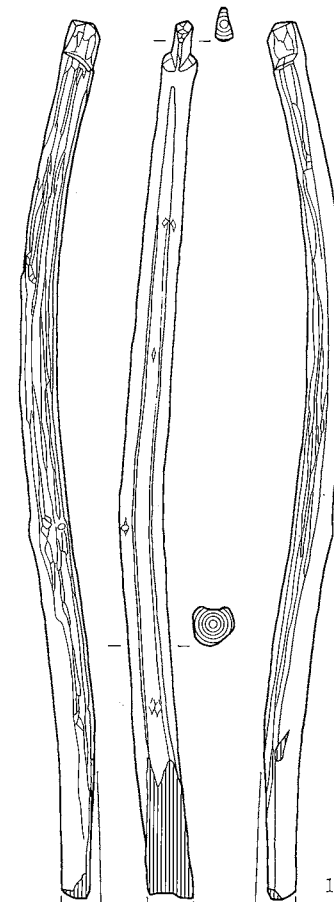

104

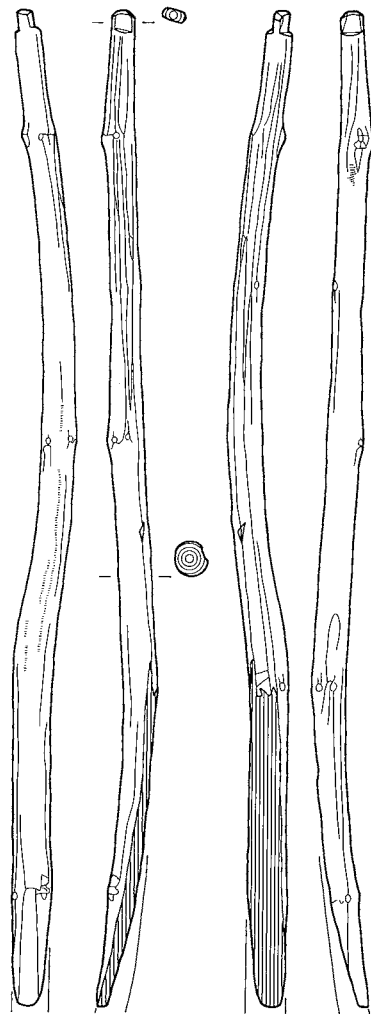

105

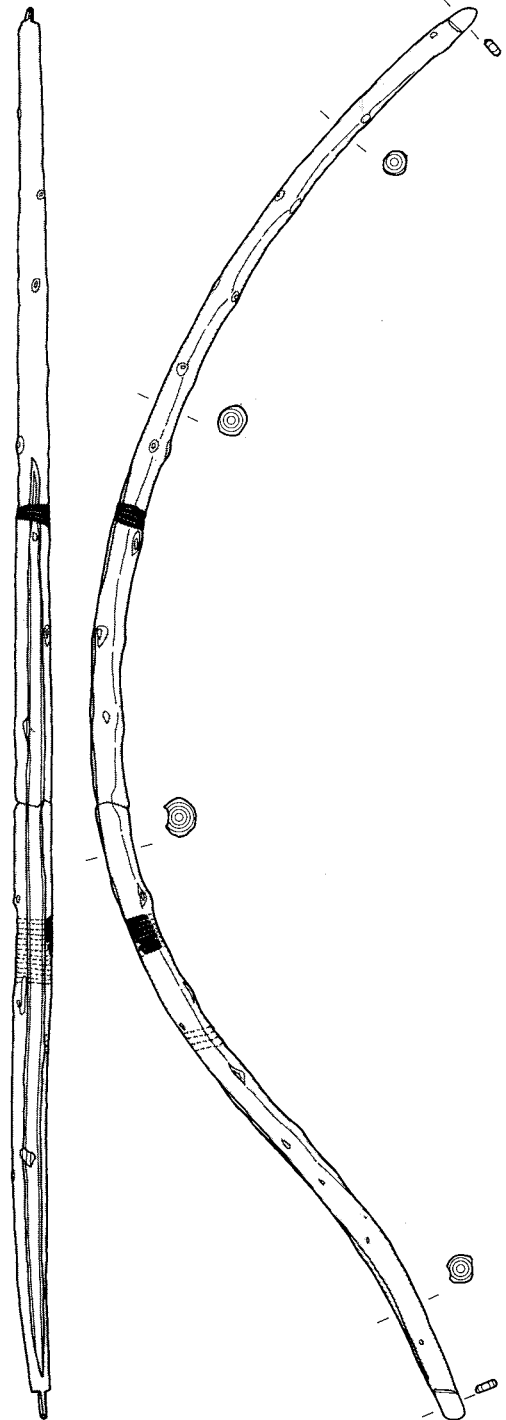

106

0 (1:6) 20cm

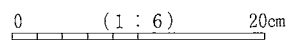
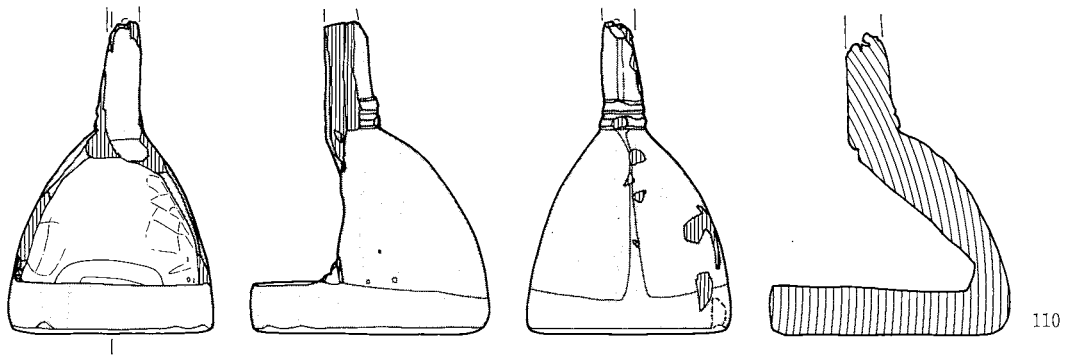
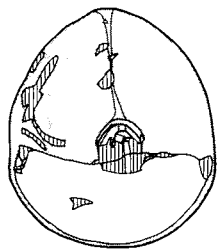
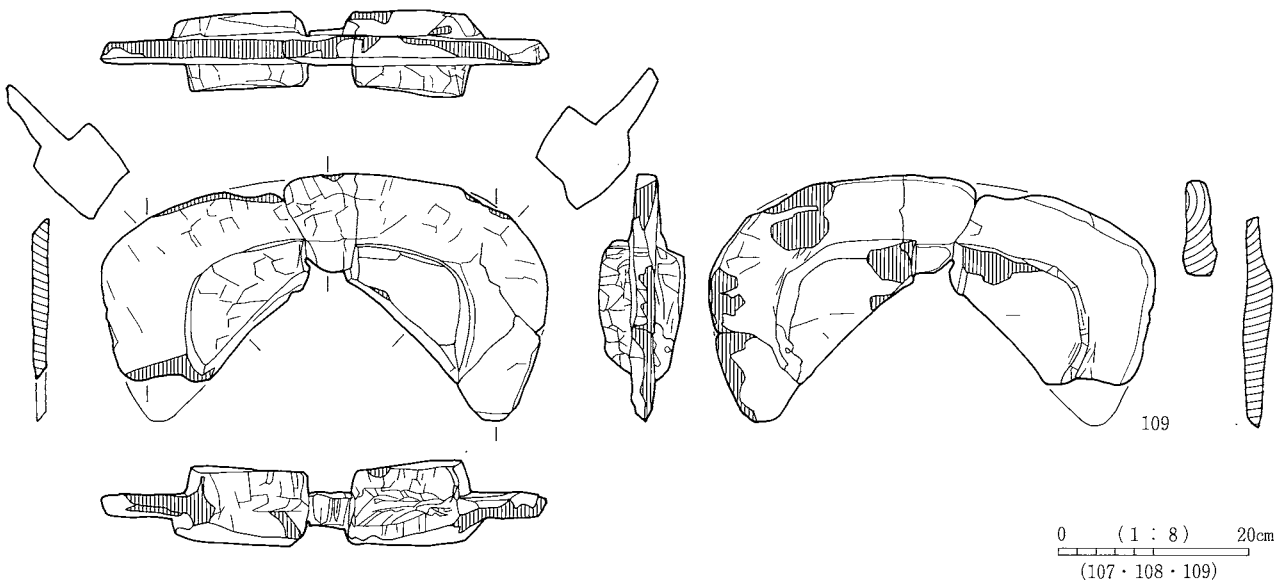
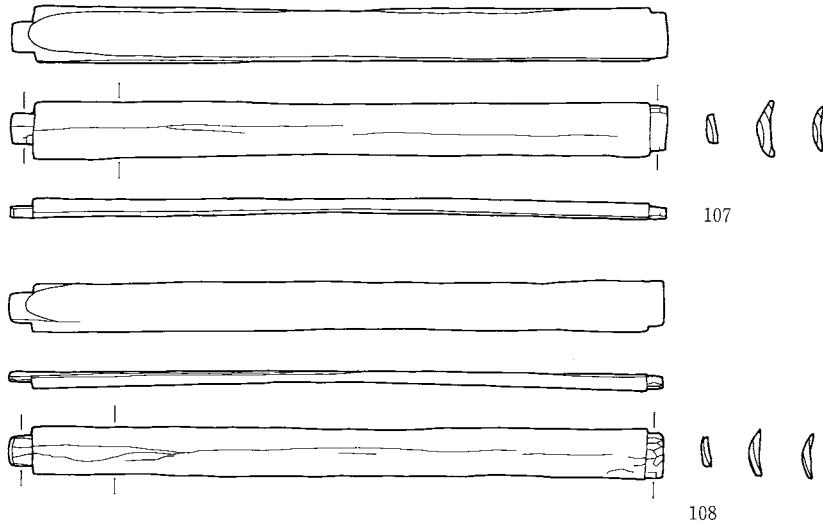

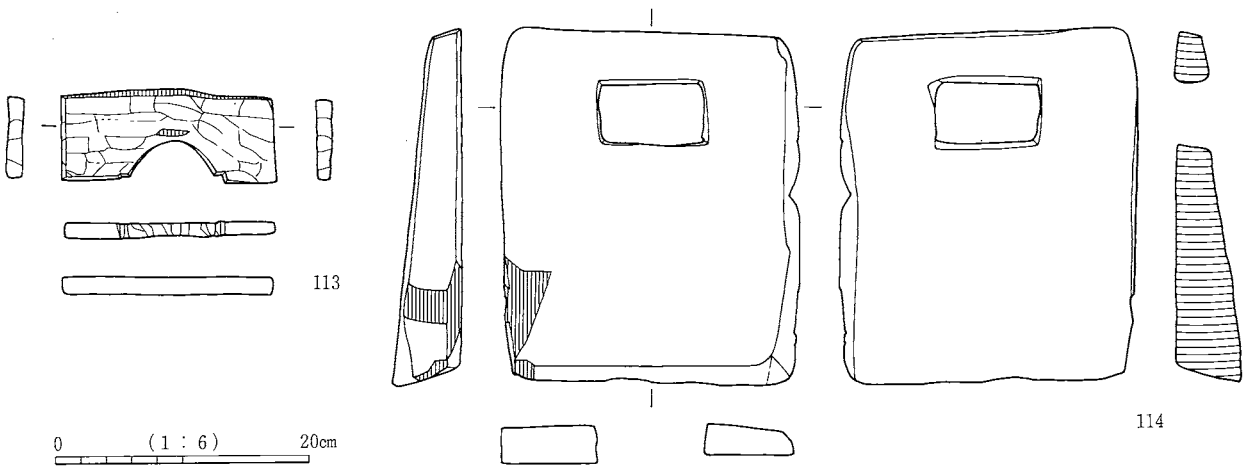
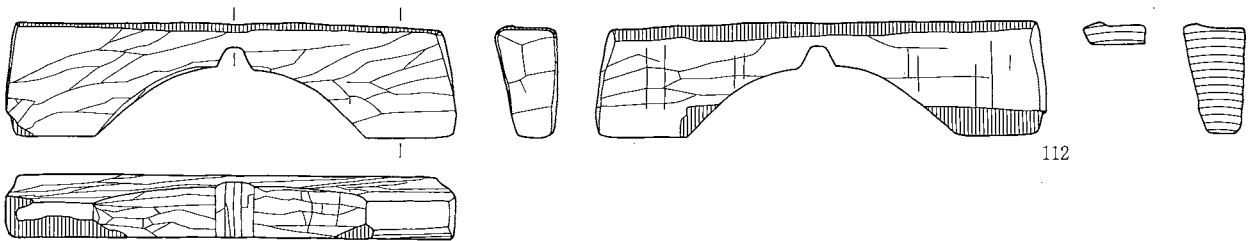
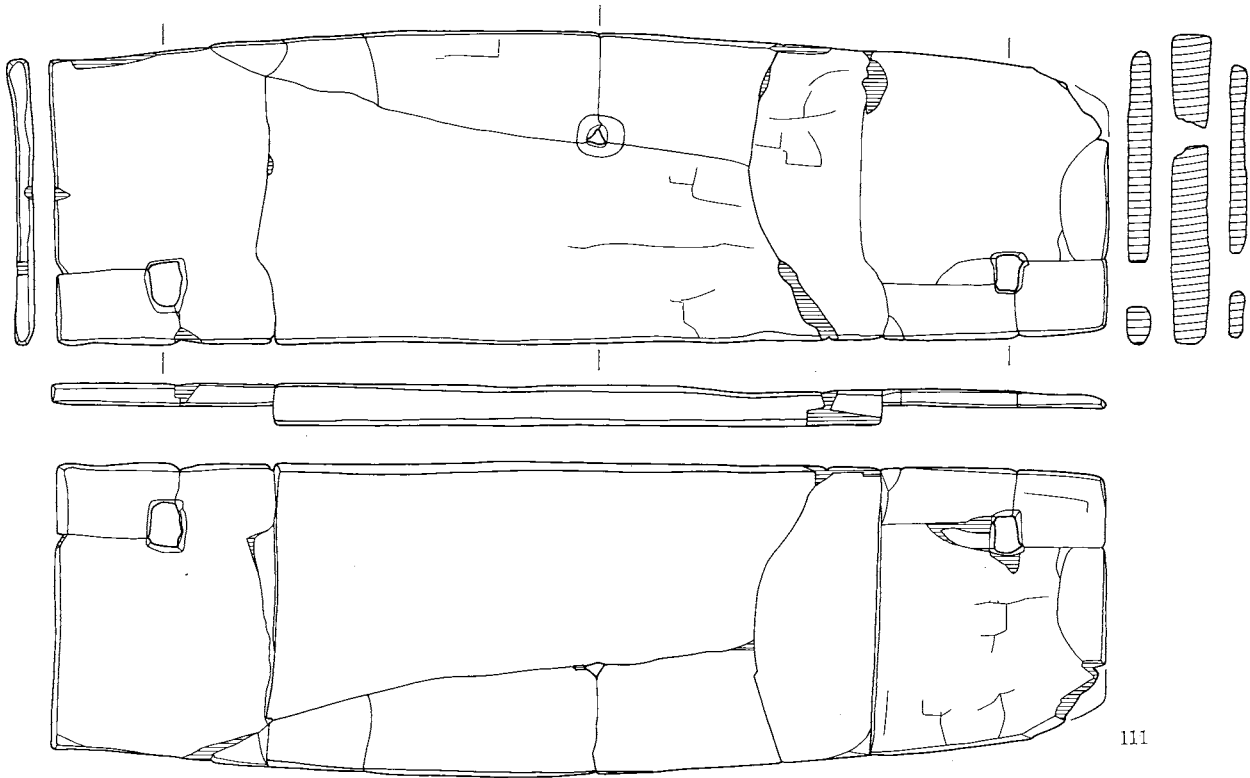

0 (1:6) 20cm

雑具1 案もしくは机状木製品・腰掛け(1)

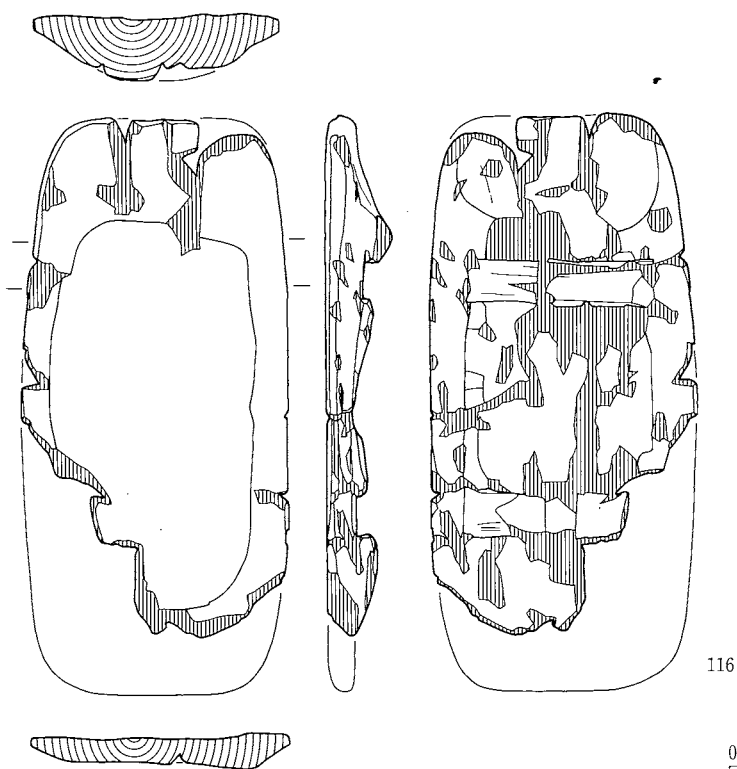
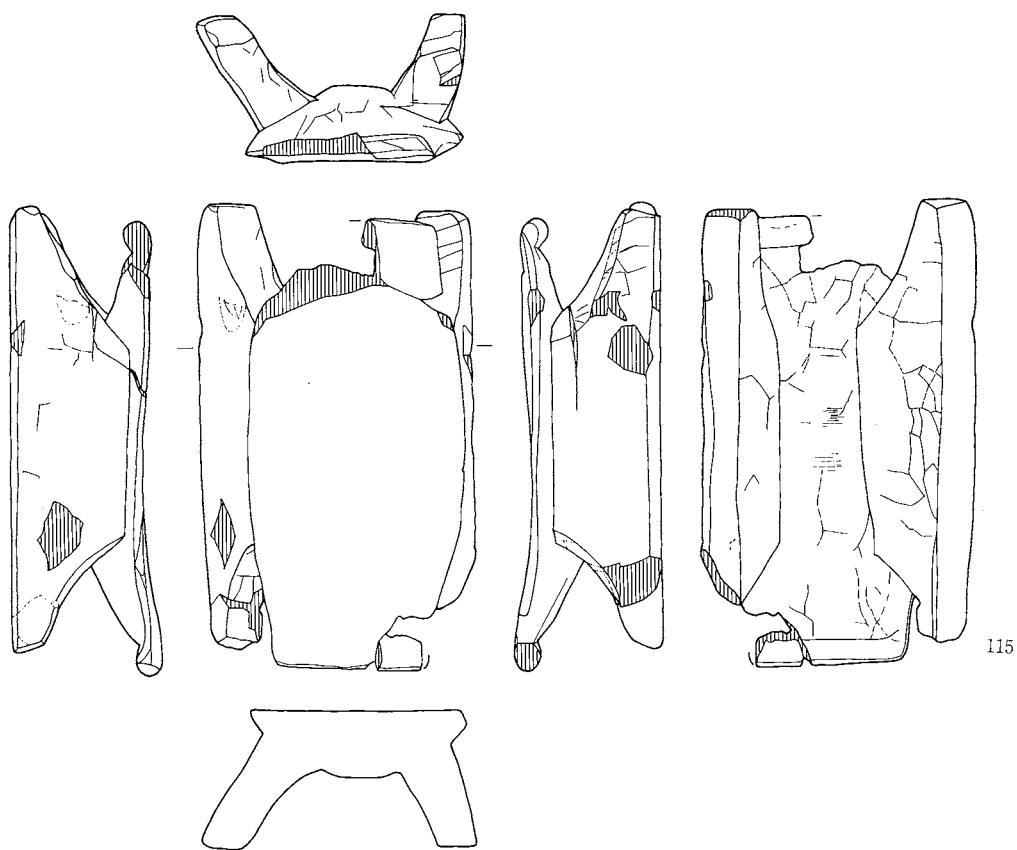

雑具 2 腰掛け(2)

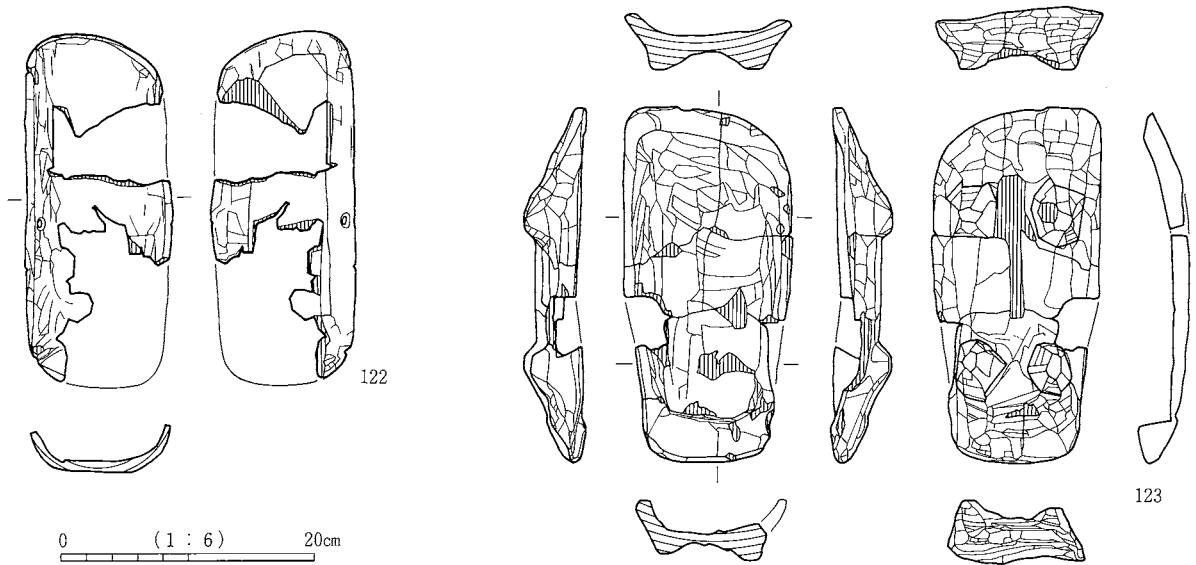
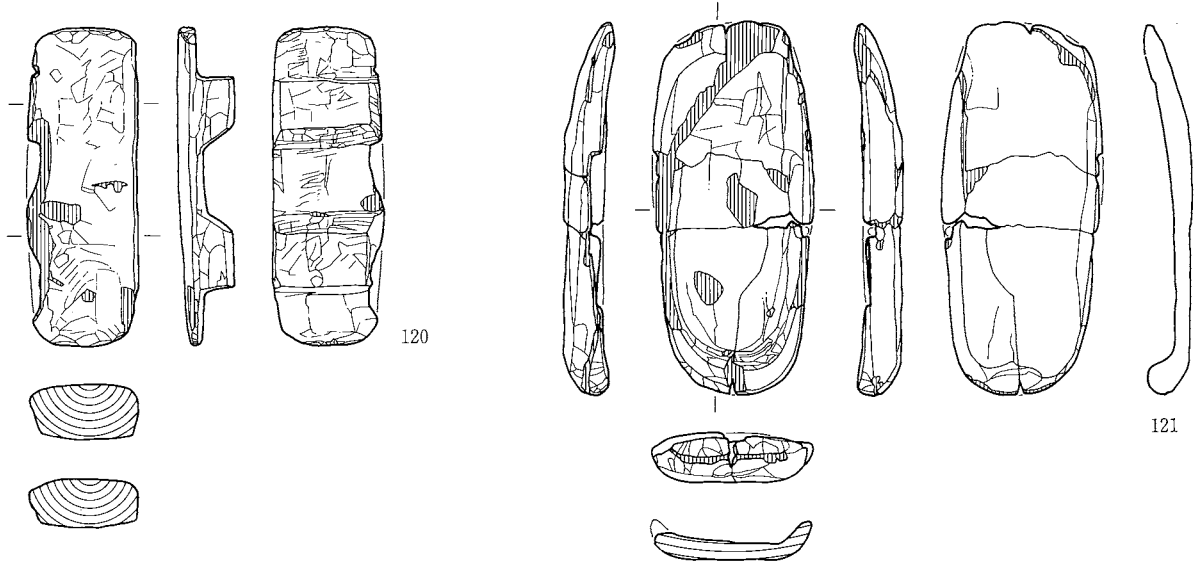
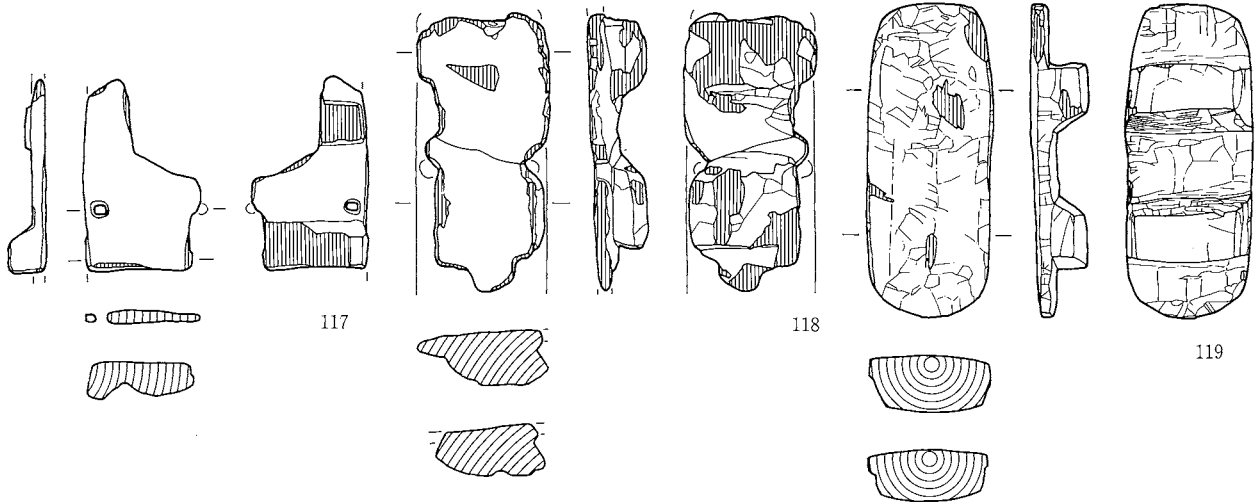

0 (1:6) 20cm

服飾具1 下駄・木履

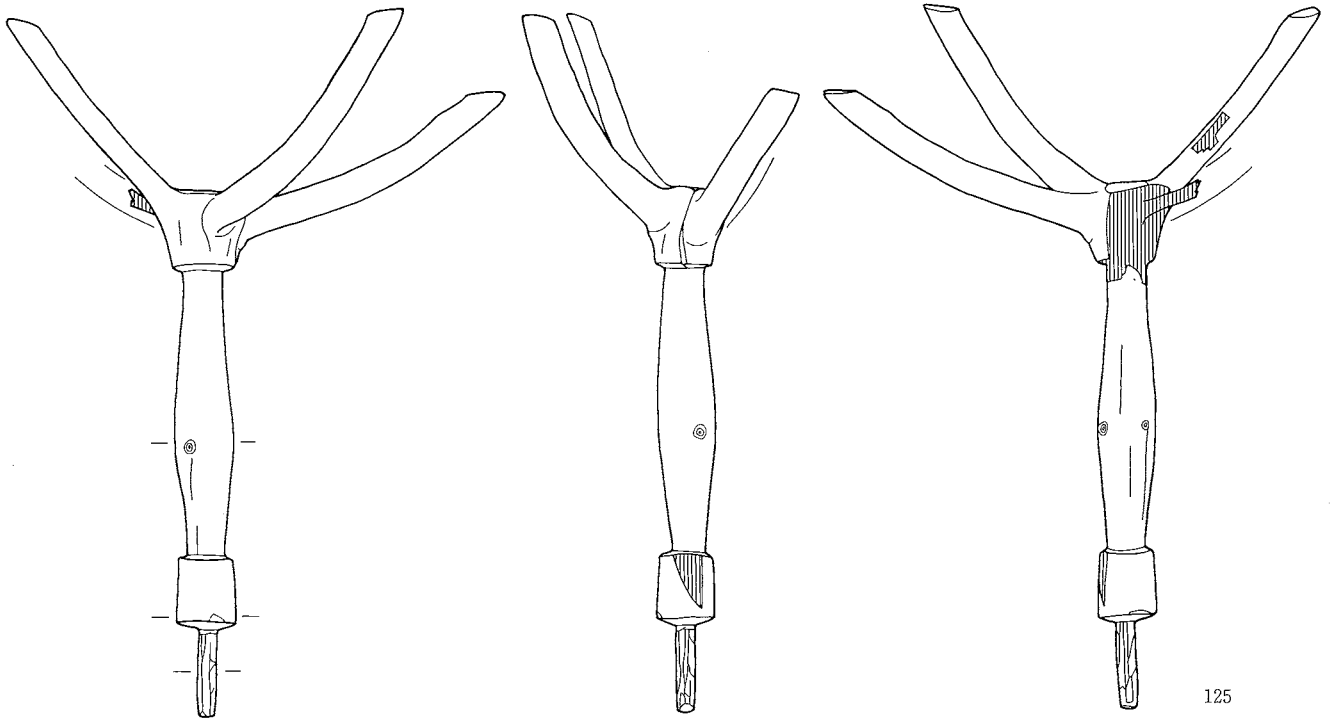
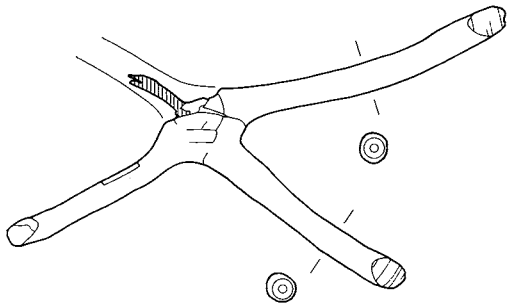
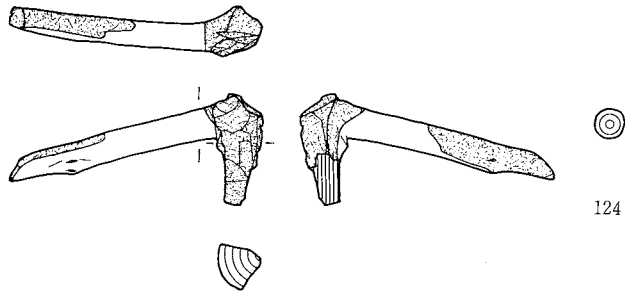

①

0 (1:6) 20cm

服飾具2 きぬがき状木製品(1)

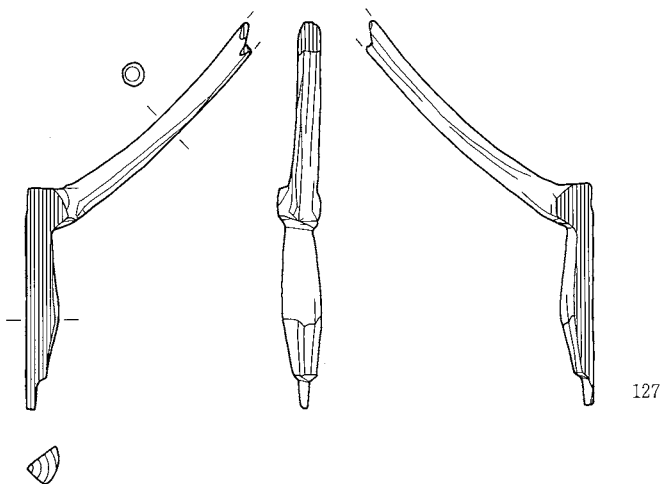
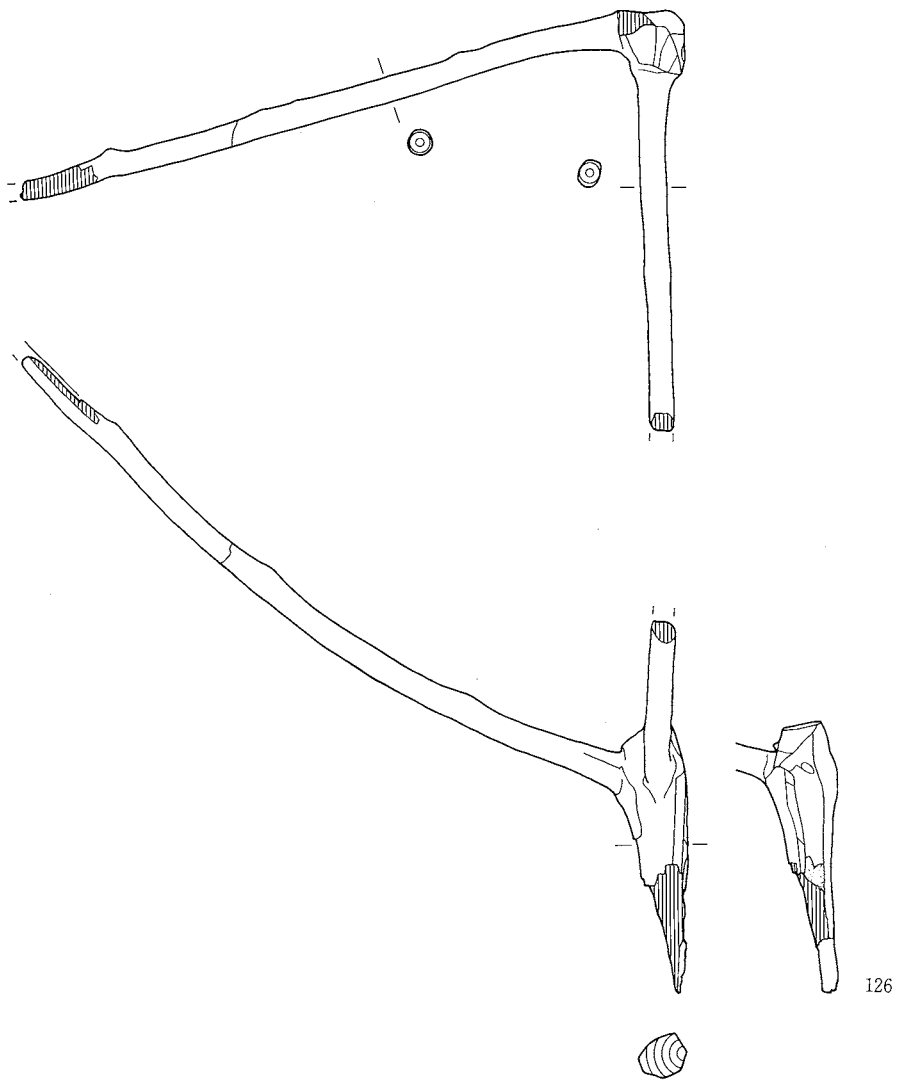

0 (1 : 6) 20cm
(126 · 127)

0 (1 : 1) 2.5cm
(128)

服飾具3 きぬがさ状木製品(2)・櫛

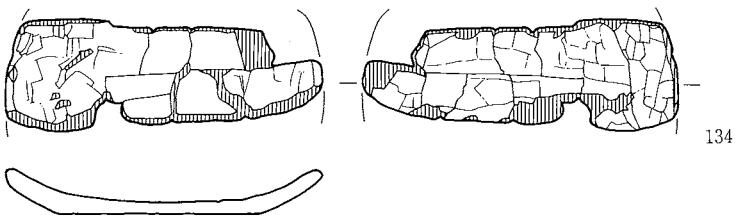
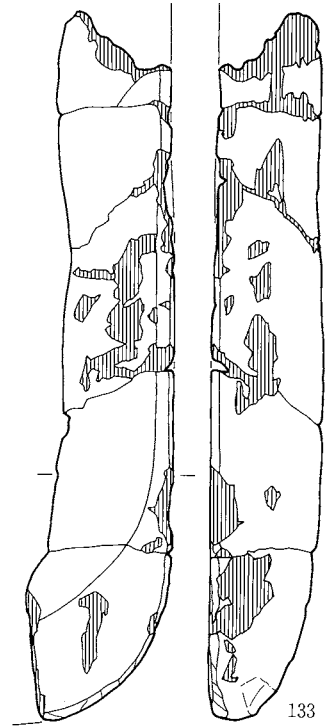
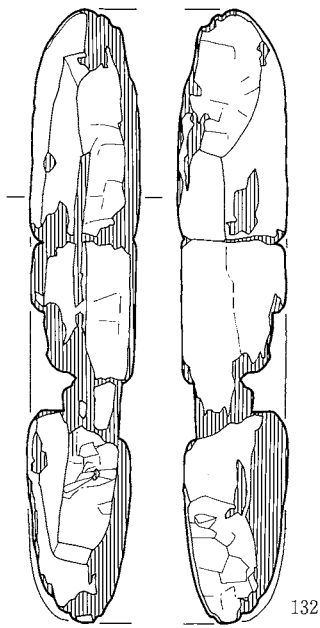
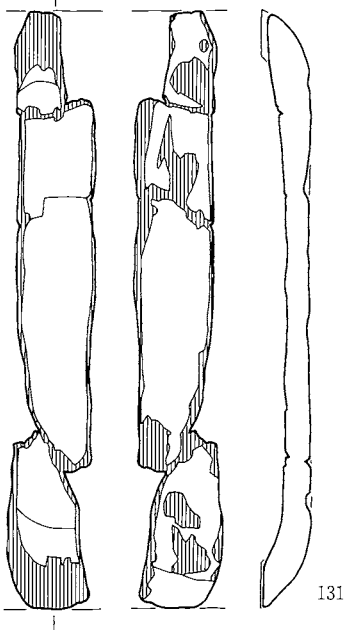
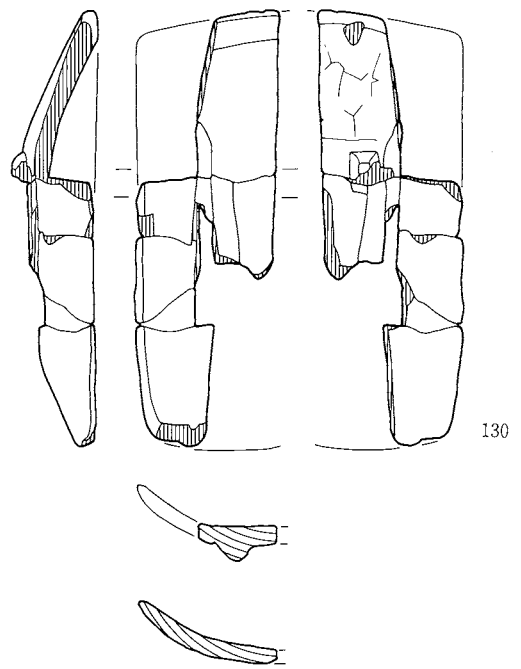

0 (1:8) 20cm

容器1 剝物(1)

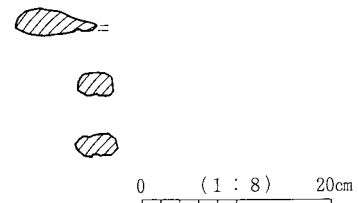
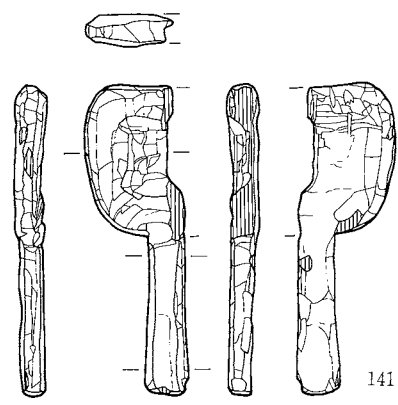
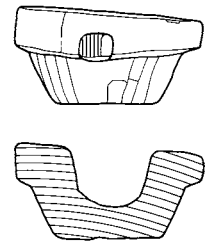
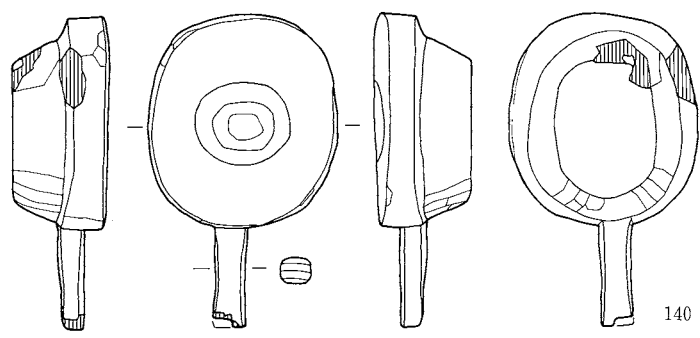
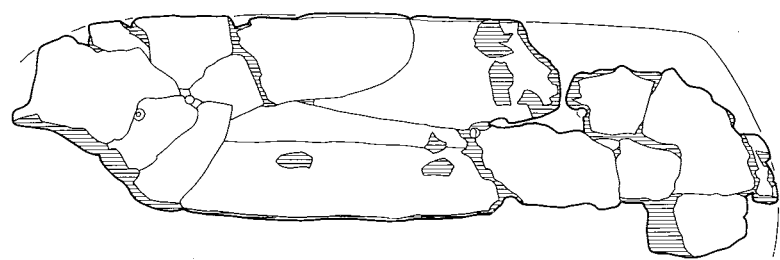
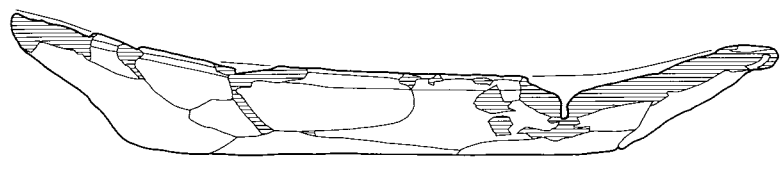
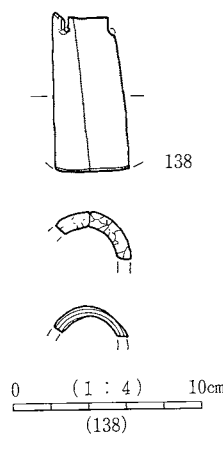
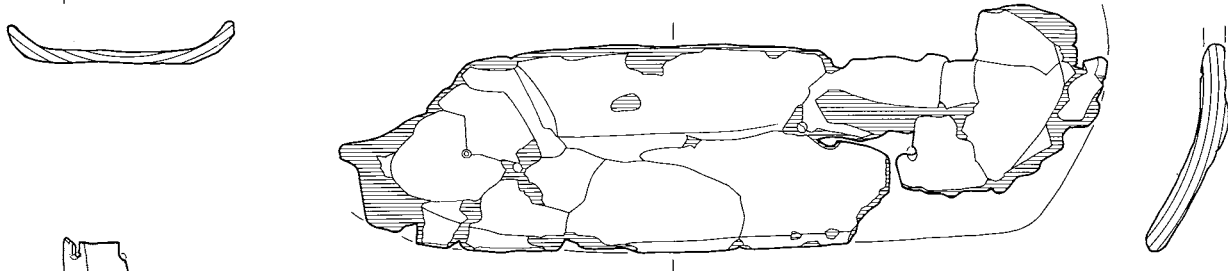
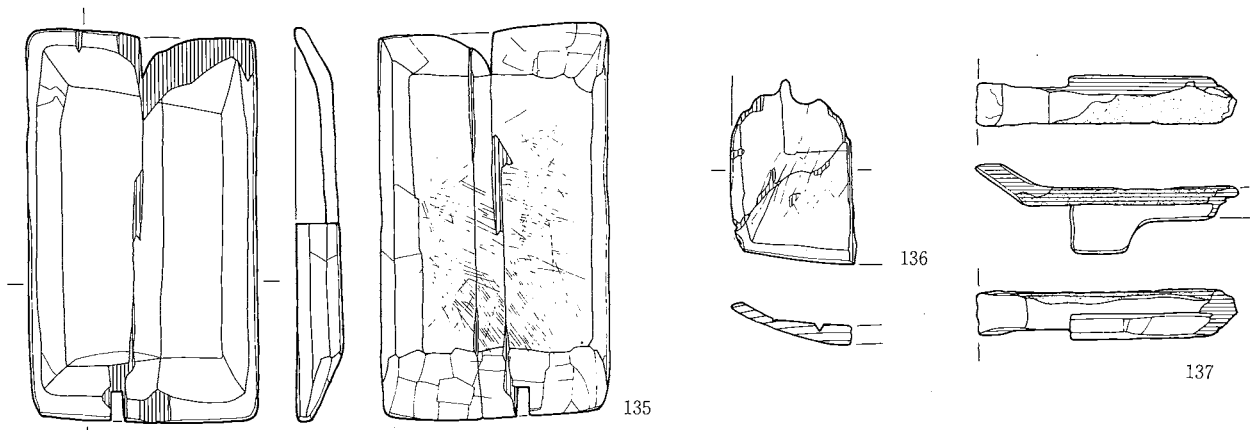

容器2 剝物(2)・円筒状容器・杓子形

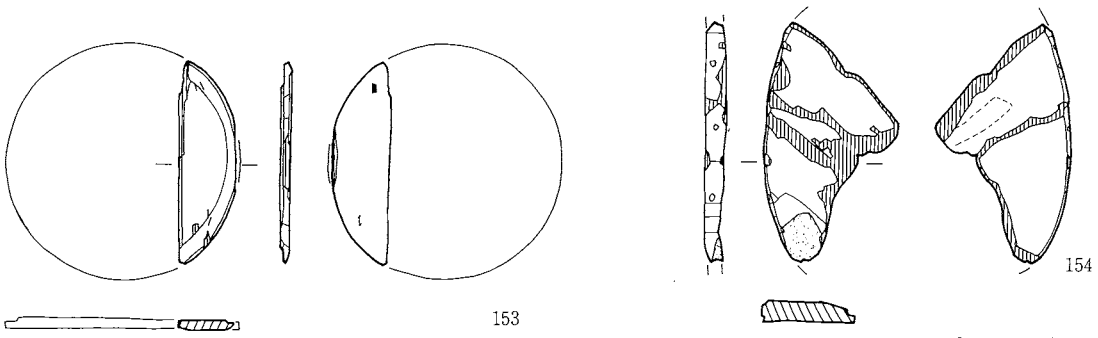
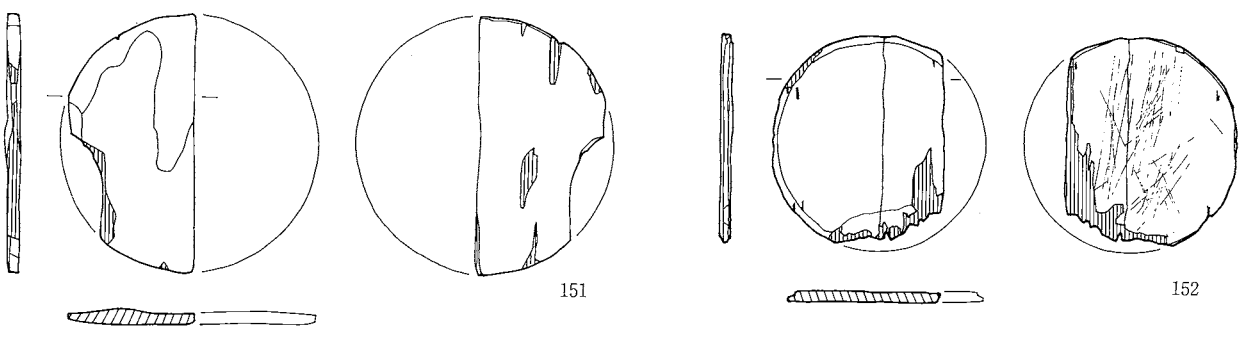
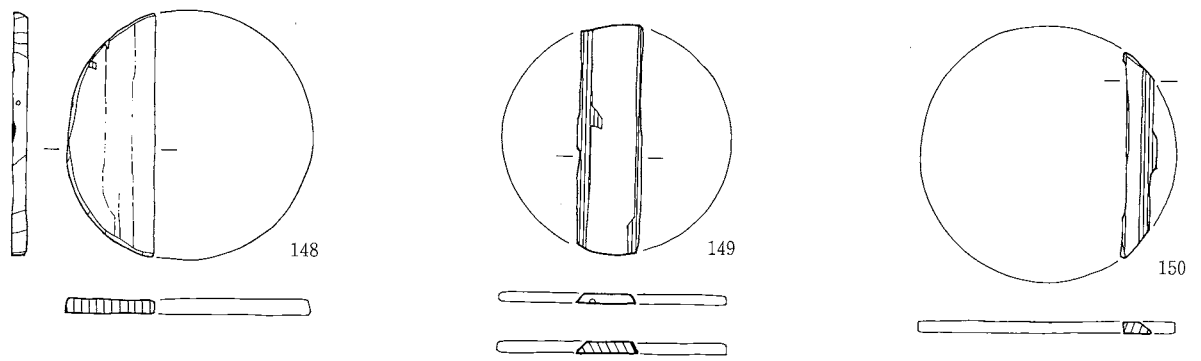
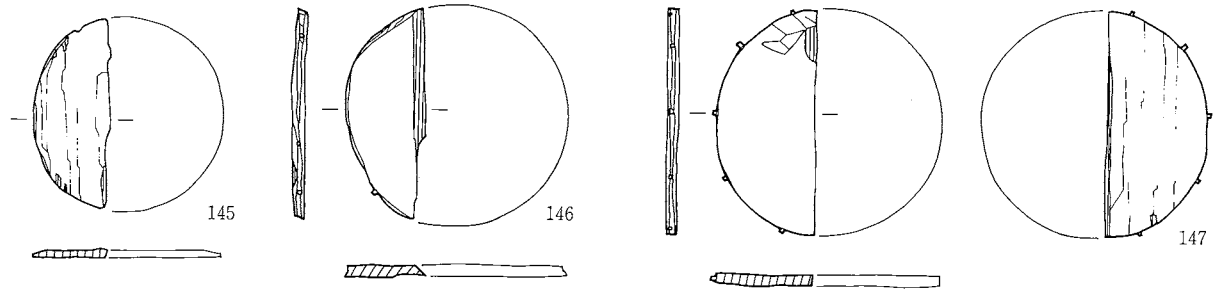
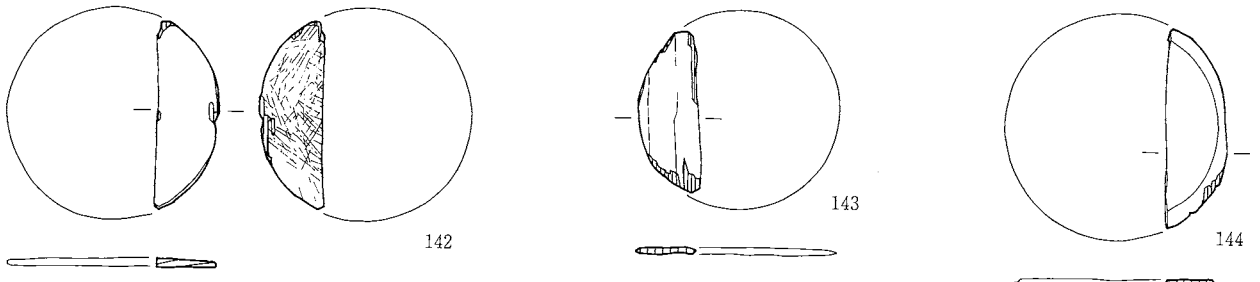

0 (1:6) 20cm

容器3 曲物(1)

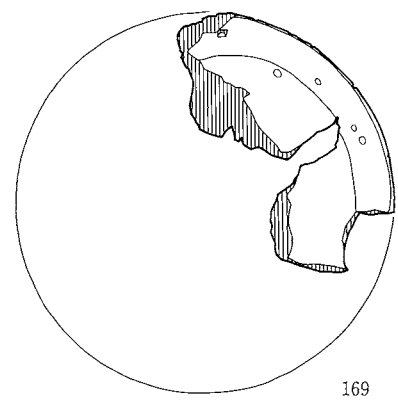
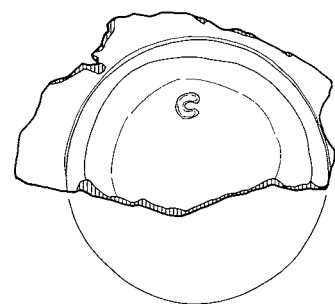
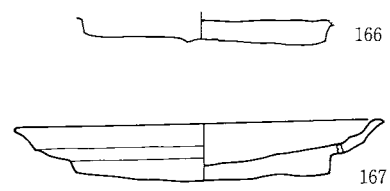
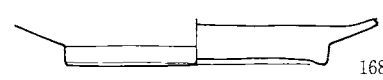
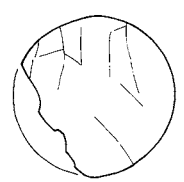
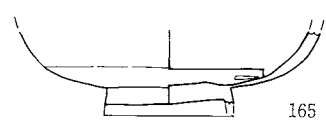
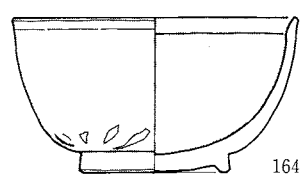
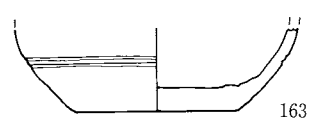
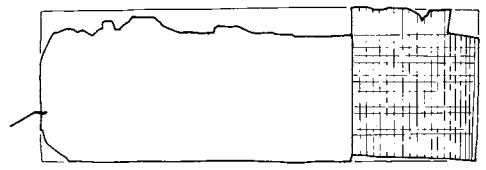
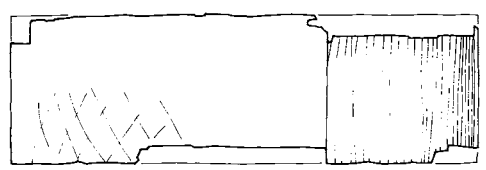
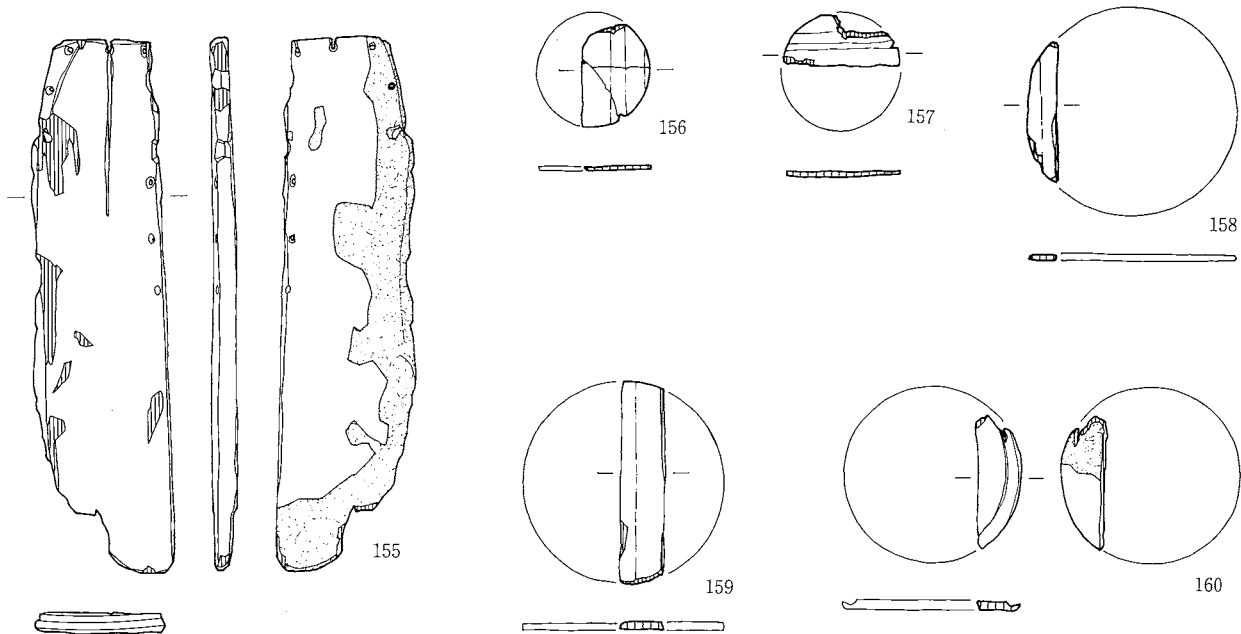

0 (1 : 4) 10cm
 (163~169)

0 (1 : 6) 20cm
 (155~162)

容器4 曲物(2)・挽物

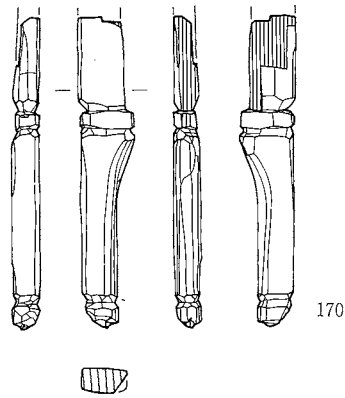

170

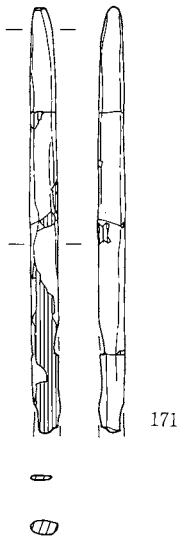
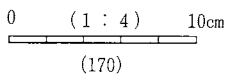

171

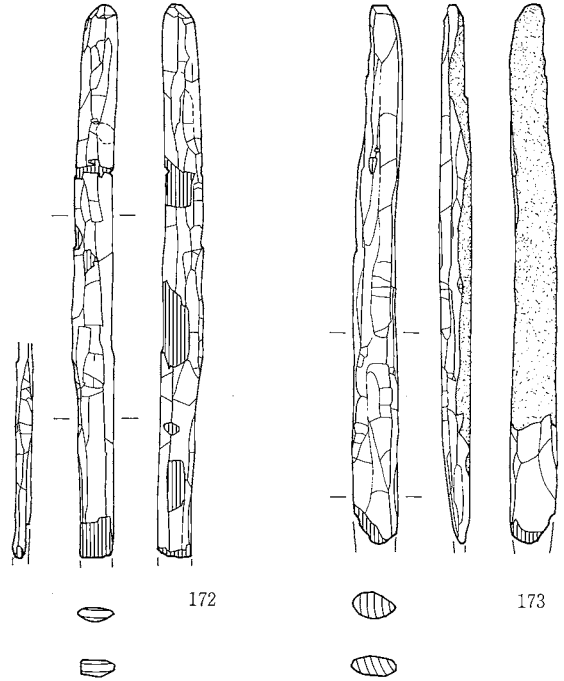

172

173

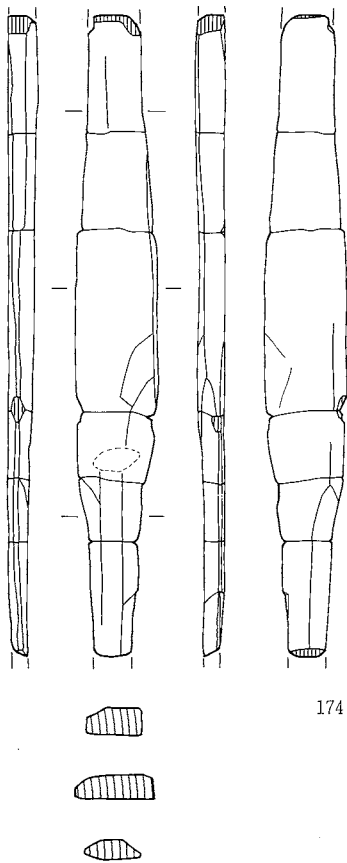

174

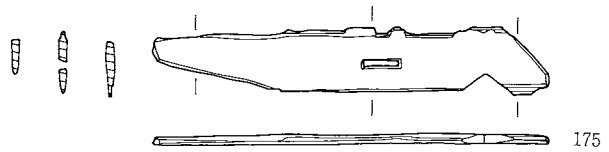
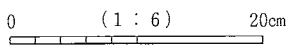

175

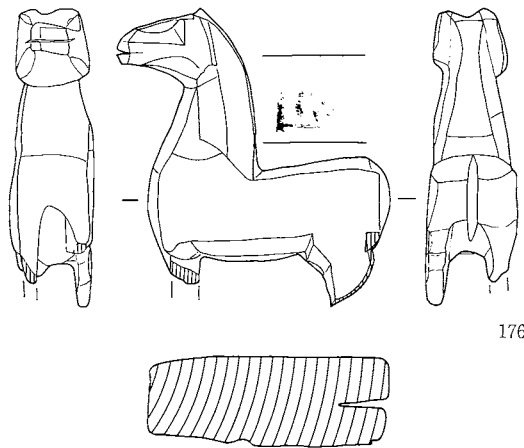

176

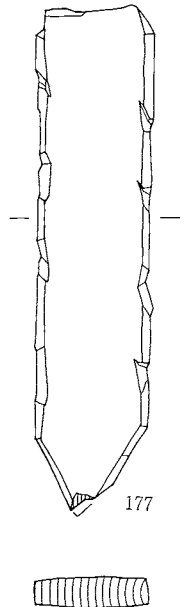
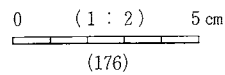

177

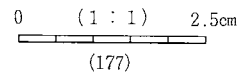

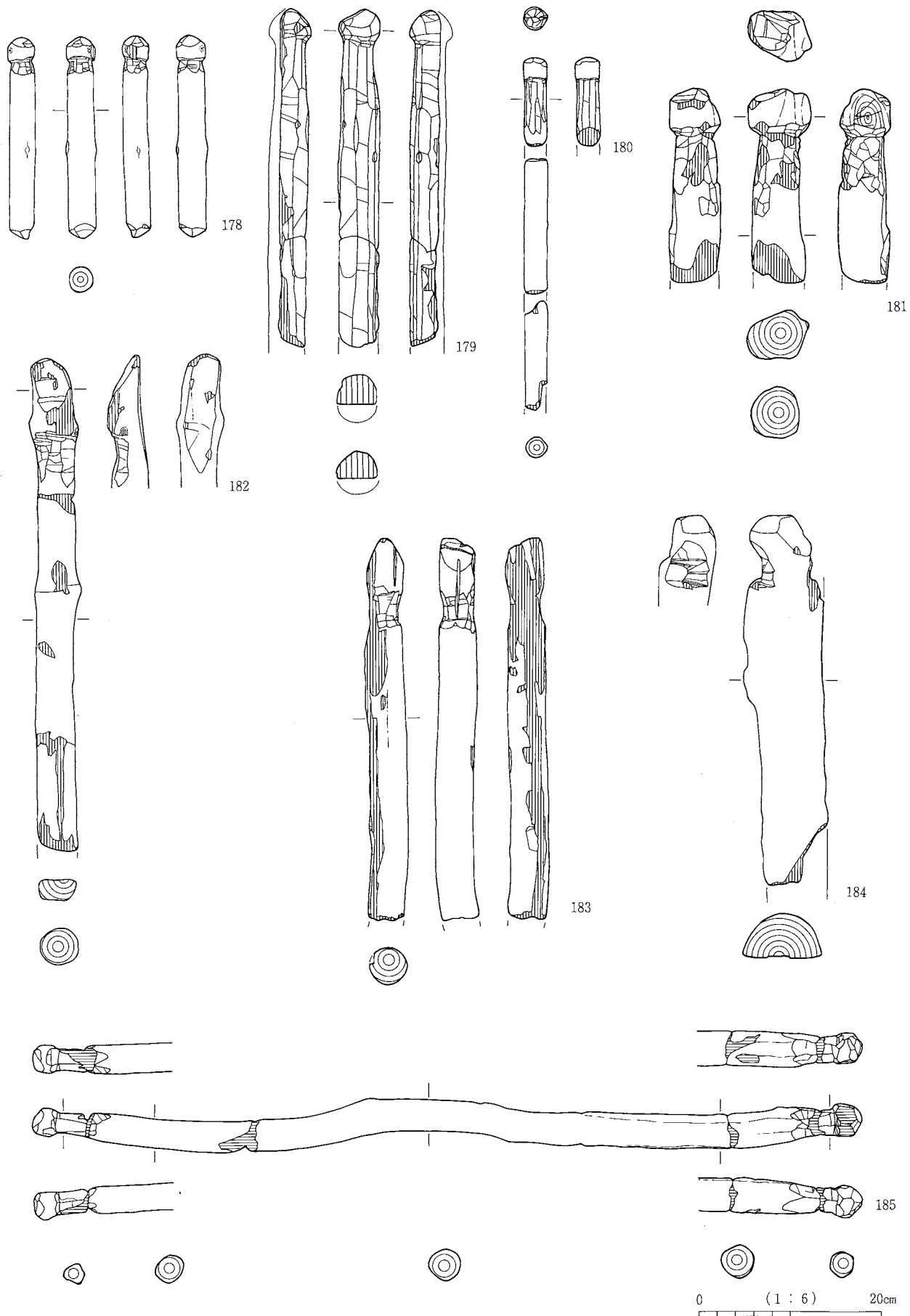

用途不明品 1 有頭棒状木製品

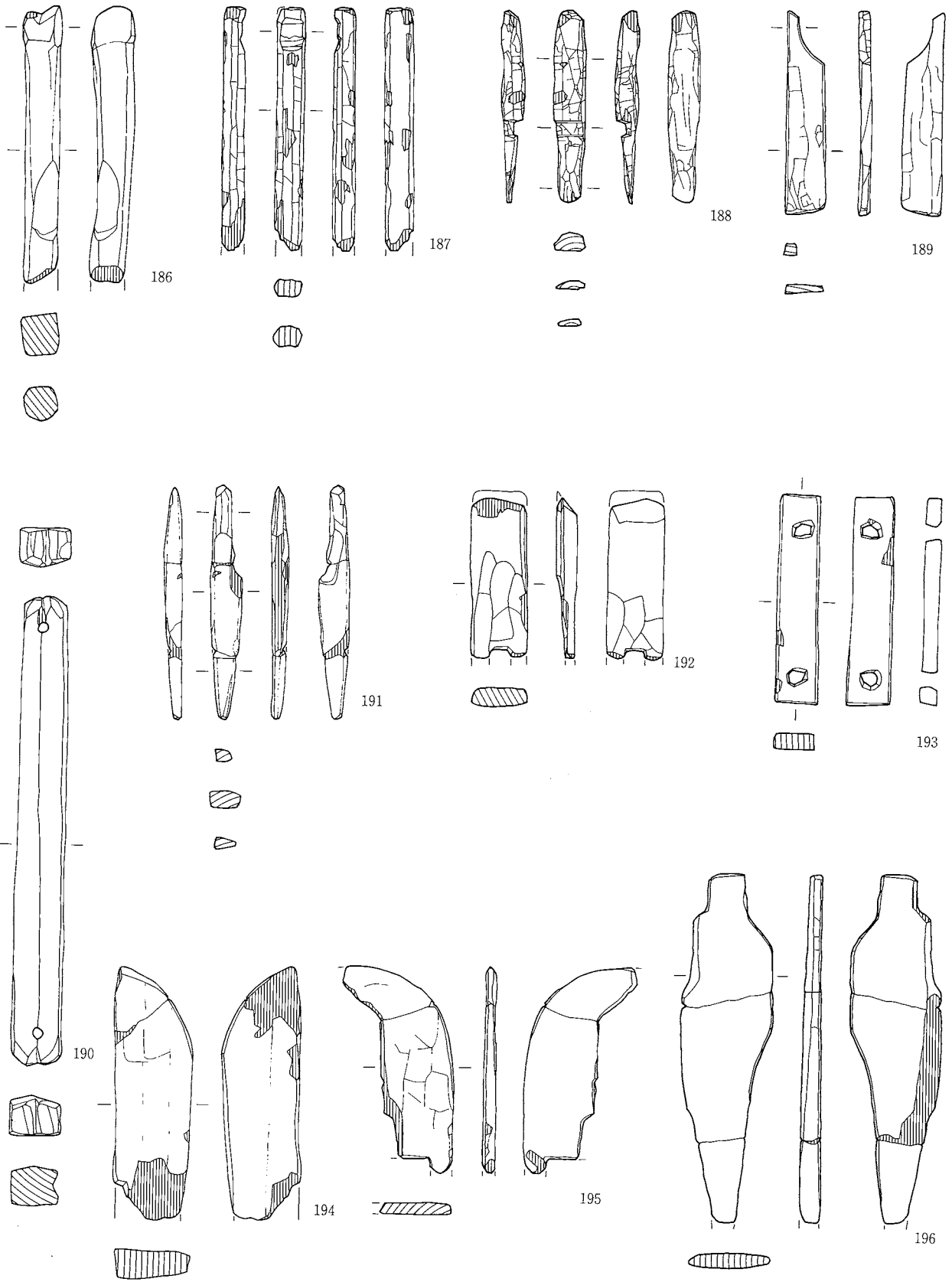

0 (1:4) 10cm

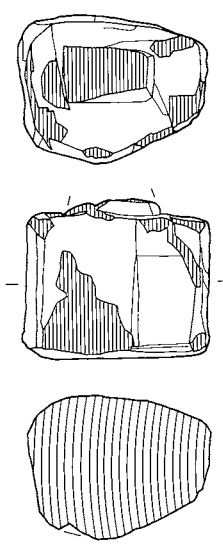

197

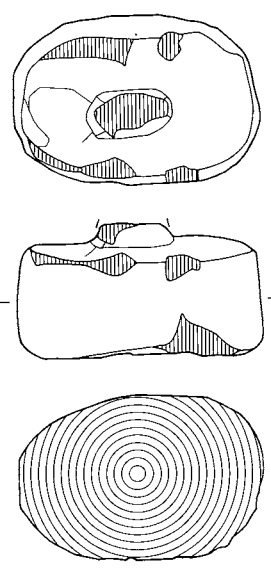

198

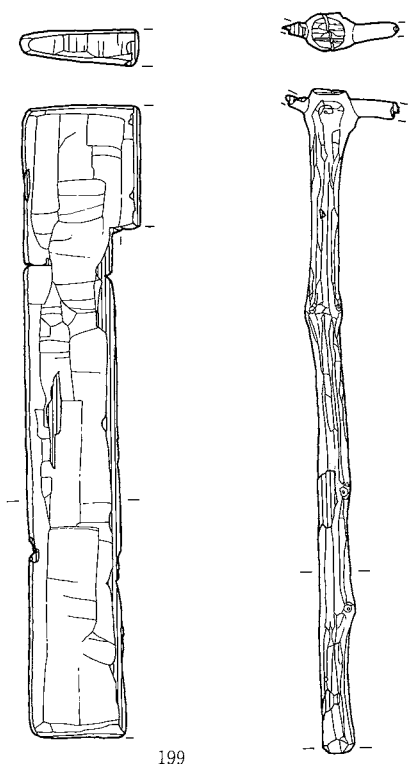

199

200

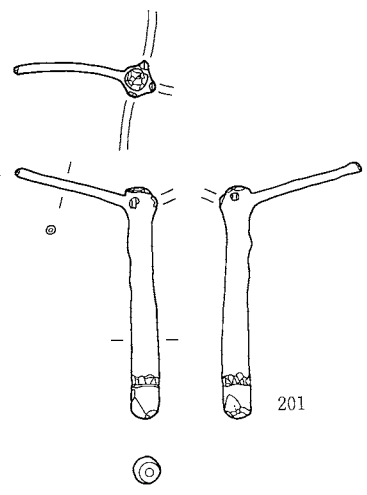

201

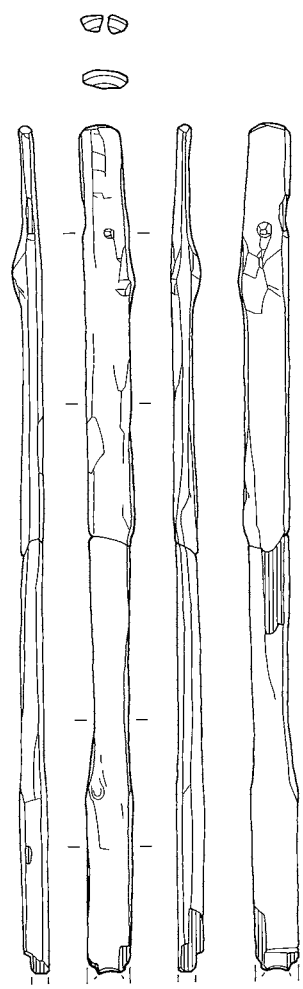

203

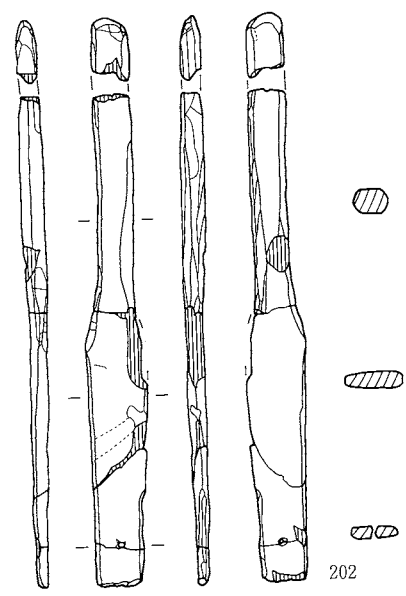

202

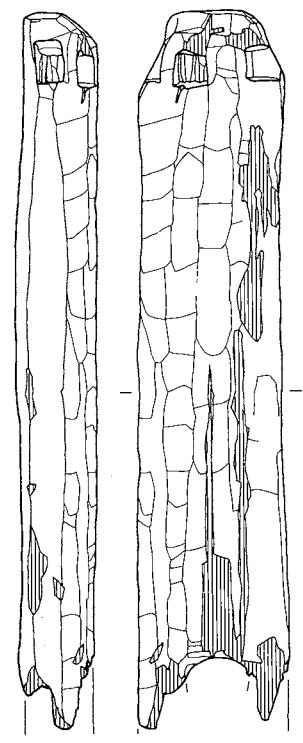

204

0 (1:4) 10cm (197-198)

0 (1:6) 20cm

用途不明品 3

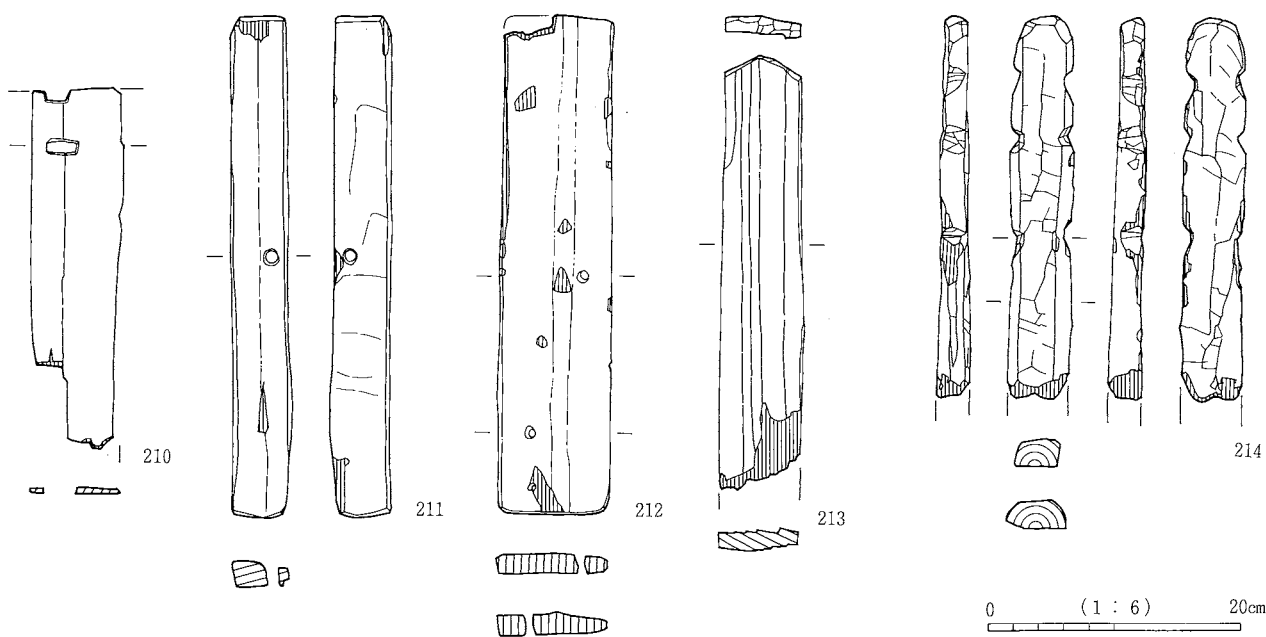
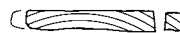
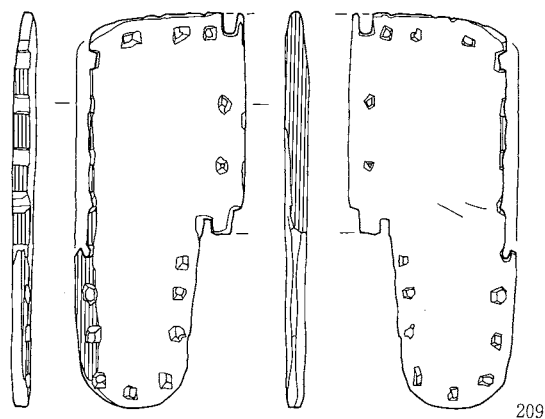
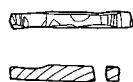
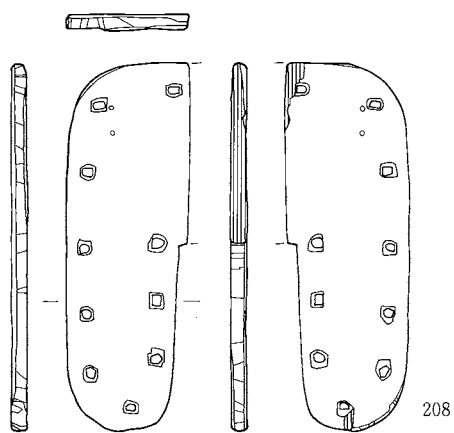
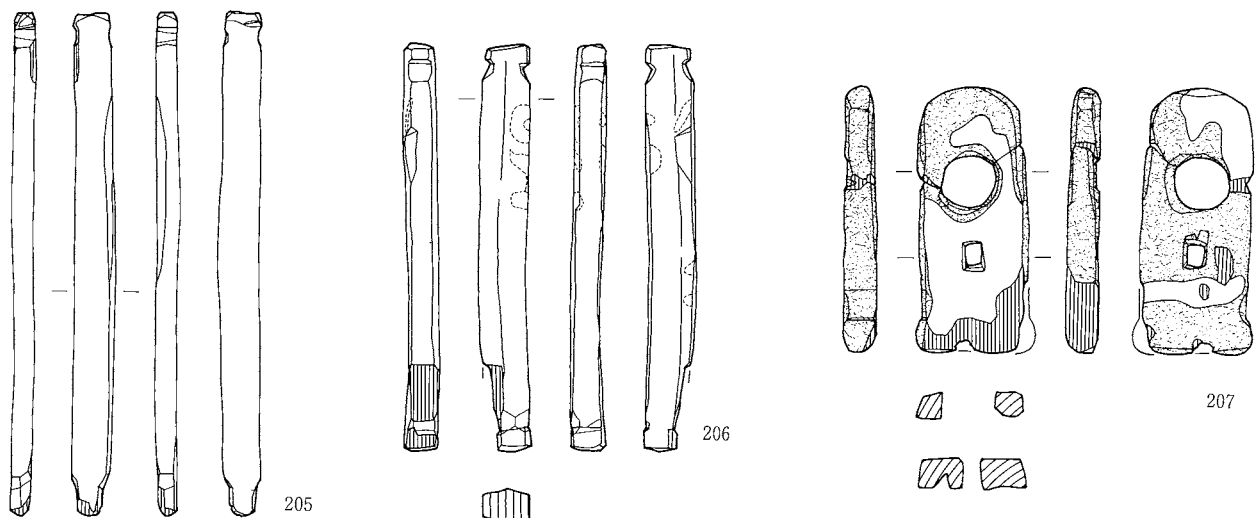

0 (1:6) 20cm

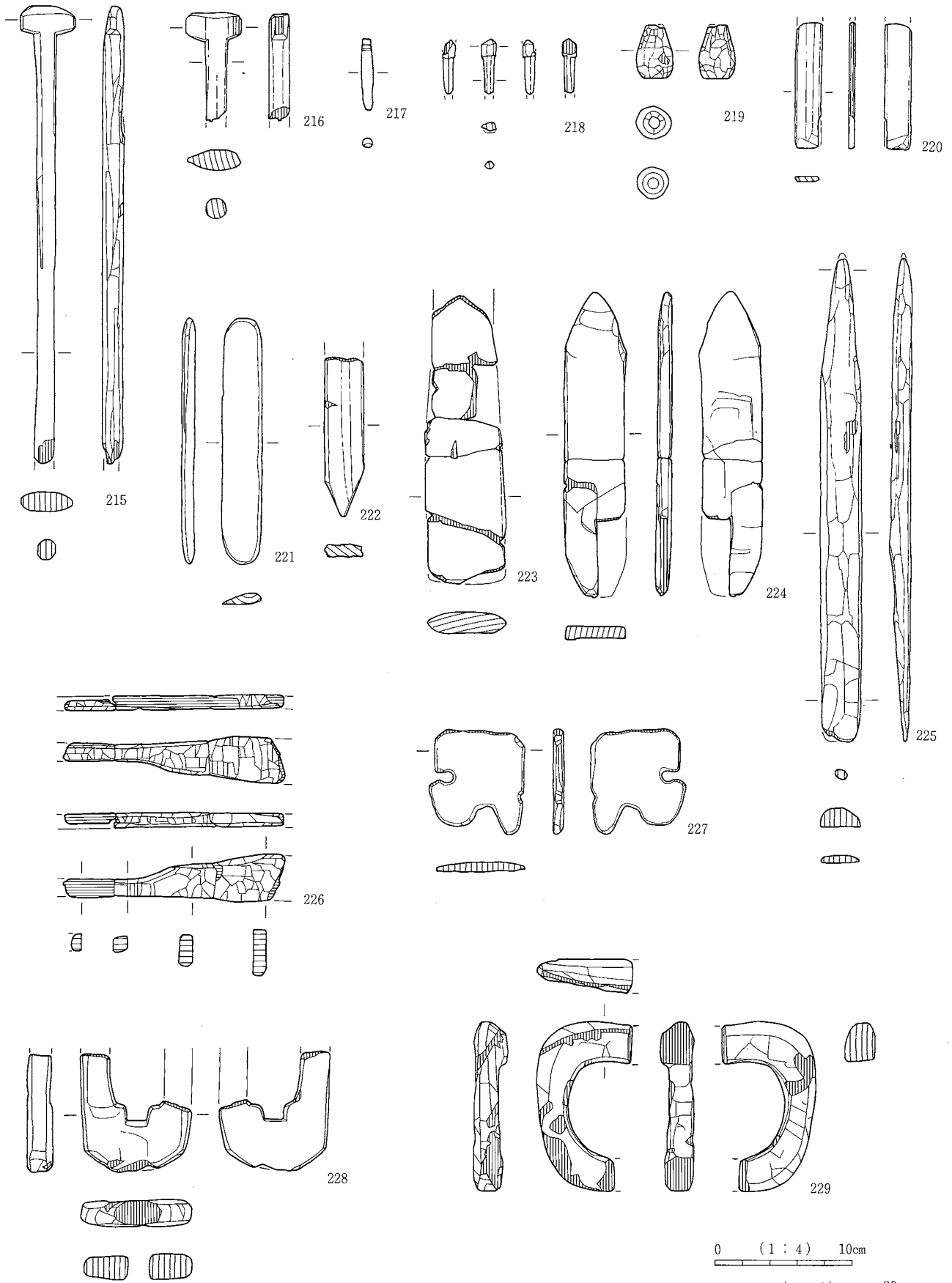

0 (1:4) 10cm
 0 (1:6) 20cm
 (226)

用途不明品 5

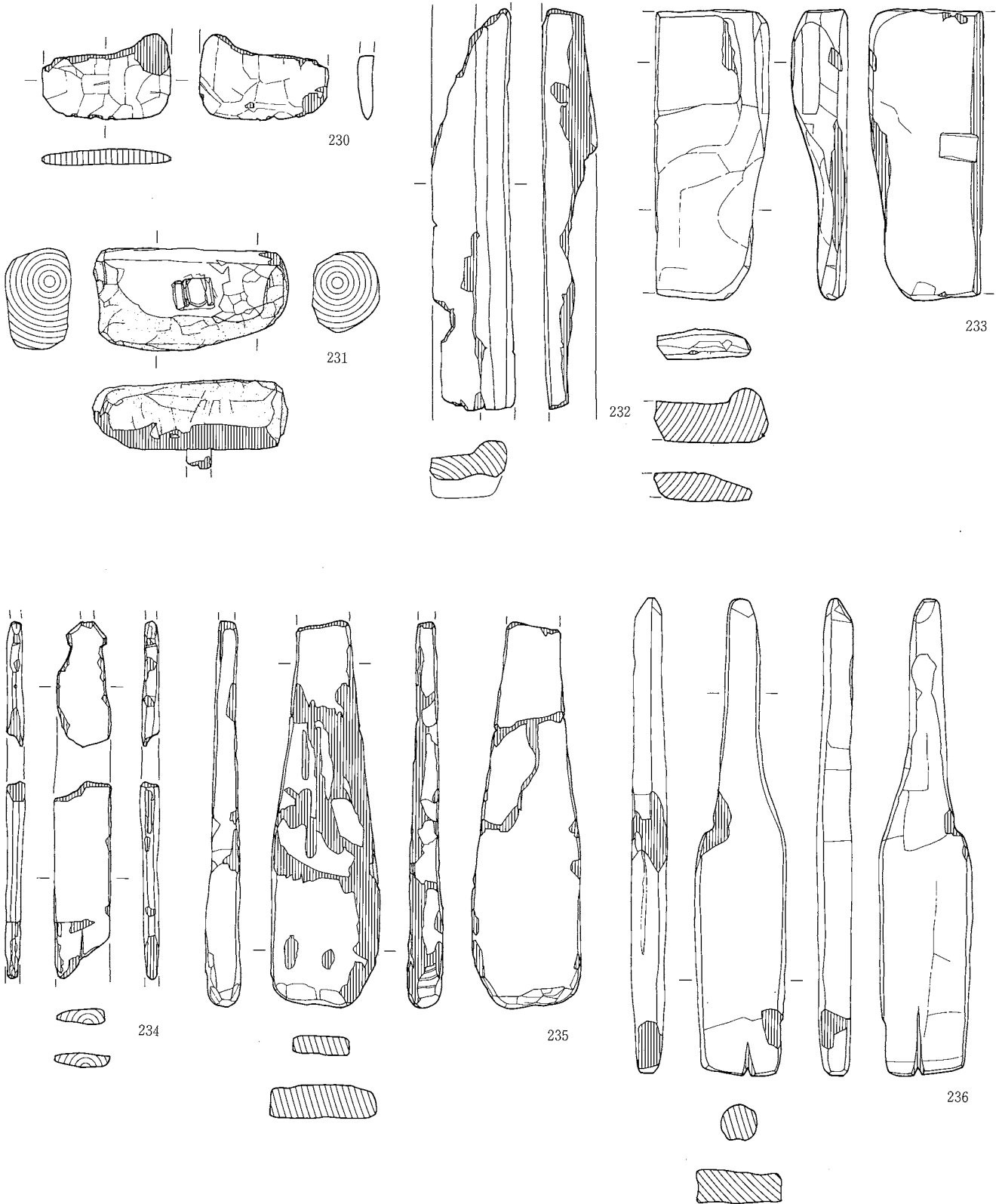

0 (1:6) 20cm

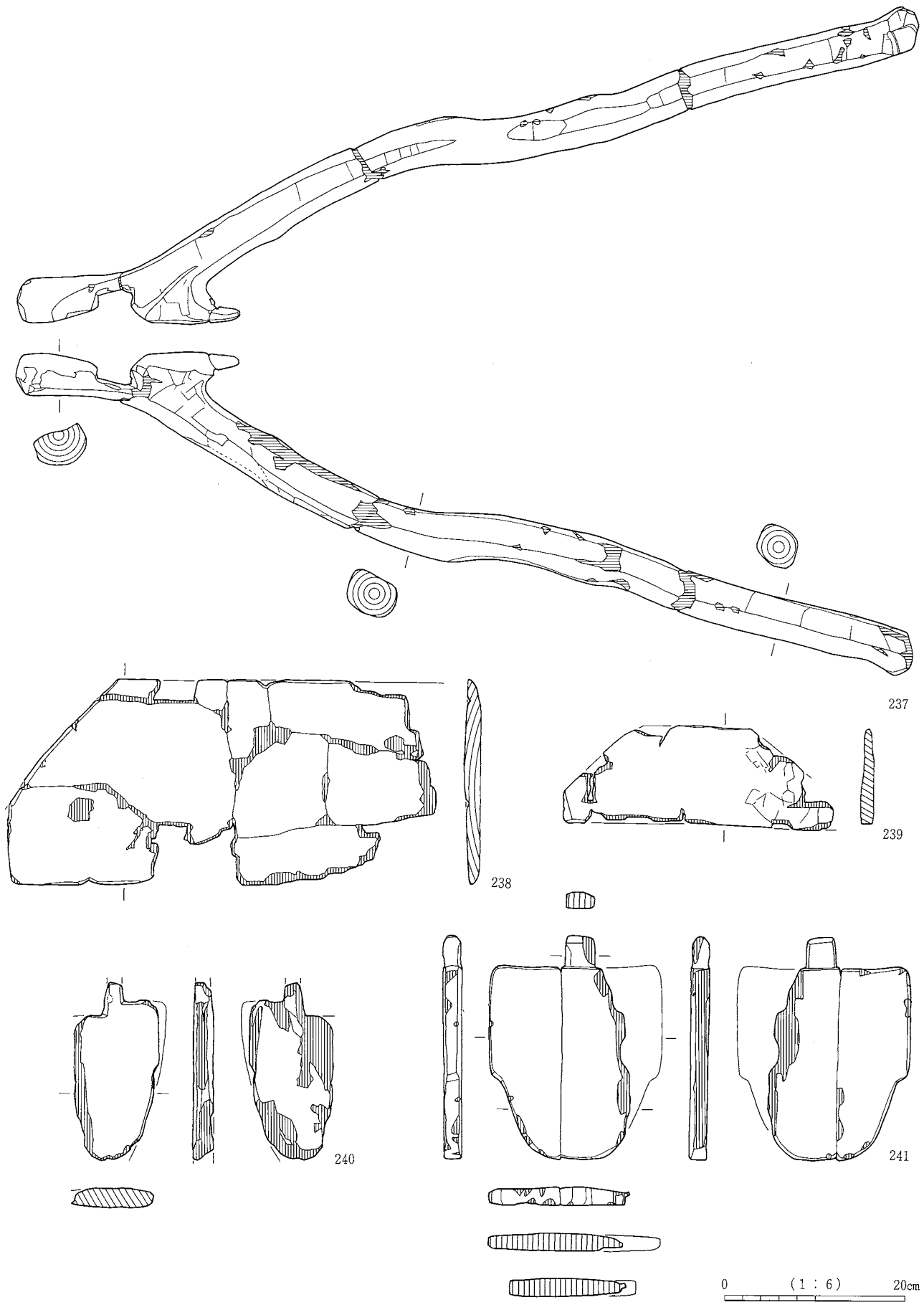

用途不明品 7

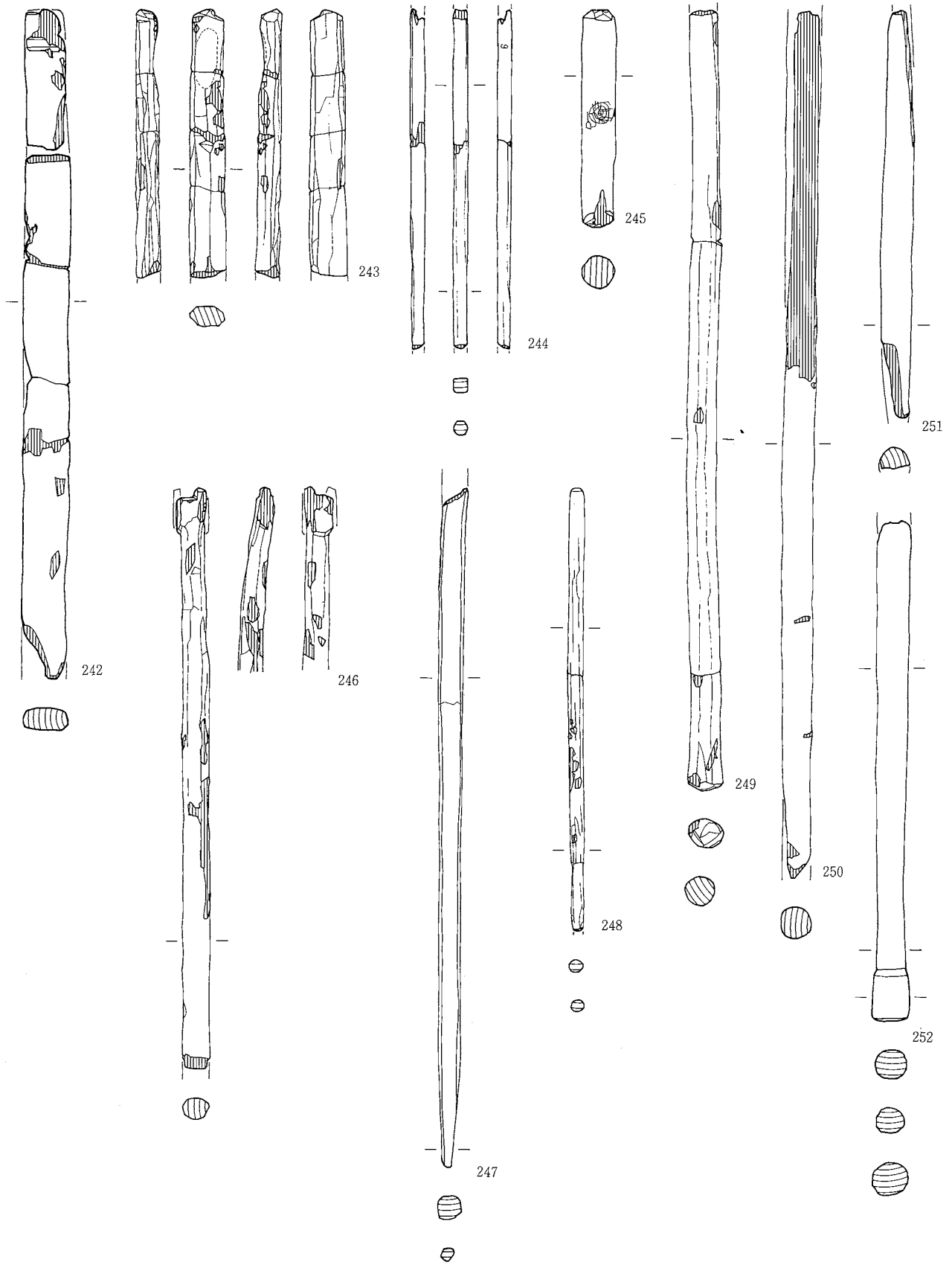

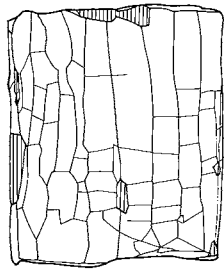
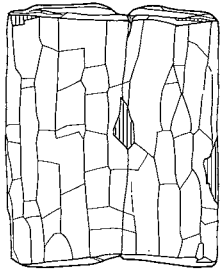
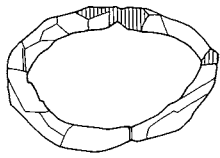

253

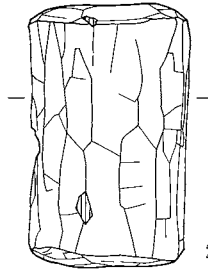
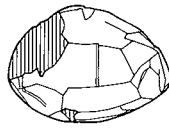
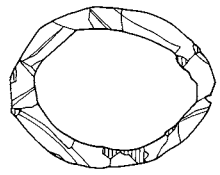

254

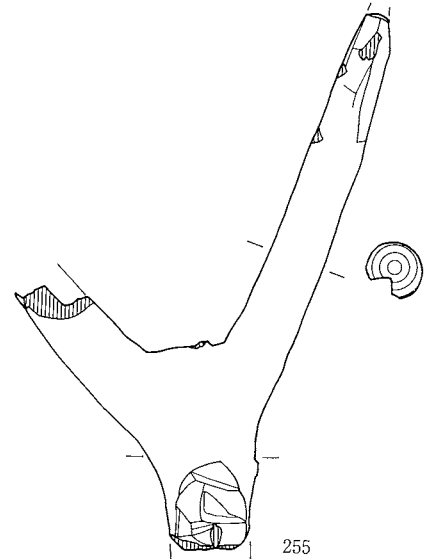
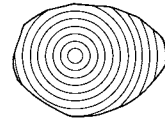
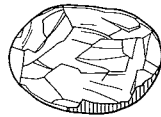

255

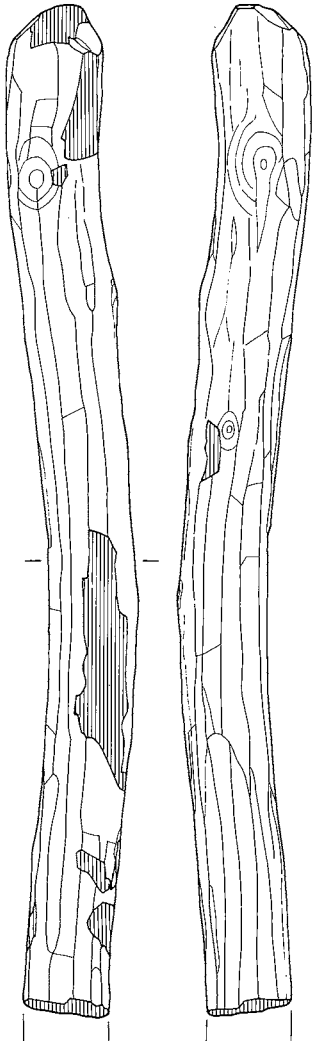

256

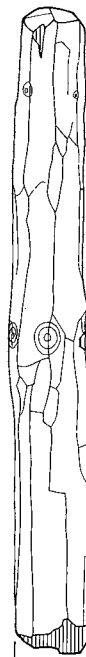
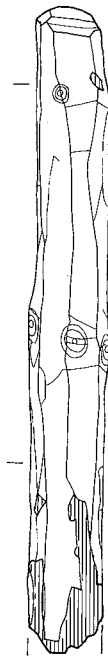

257

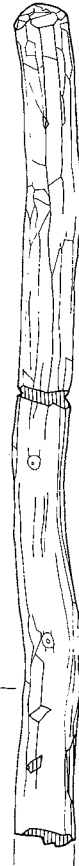

258

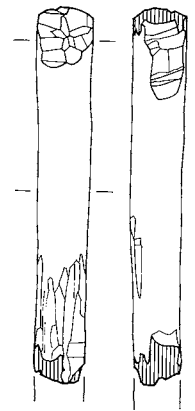

259



0 (1:4) 10cm

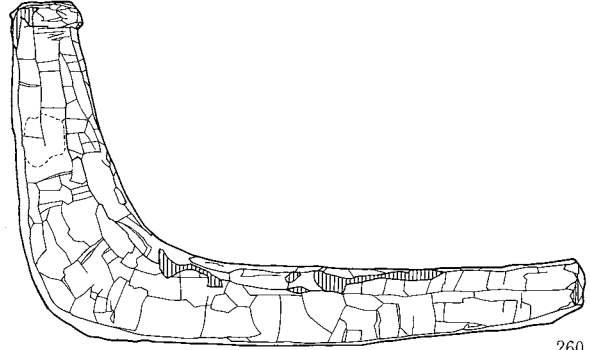
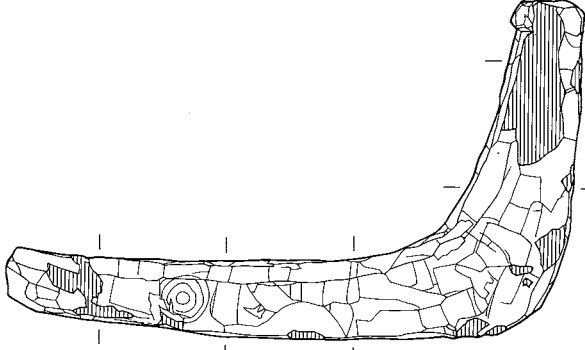
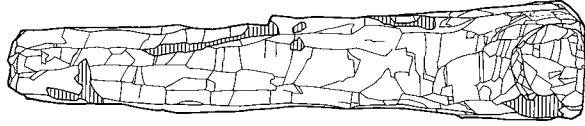

260

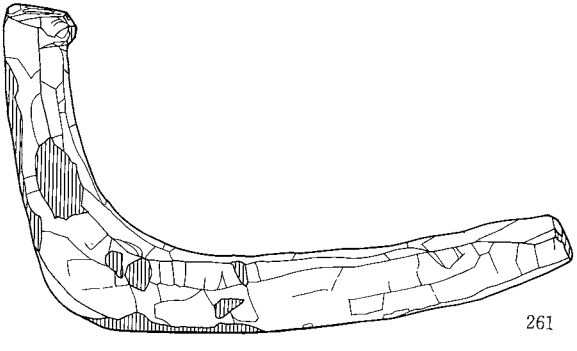
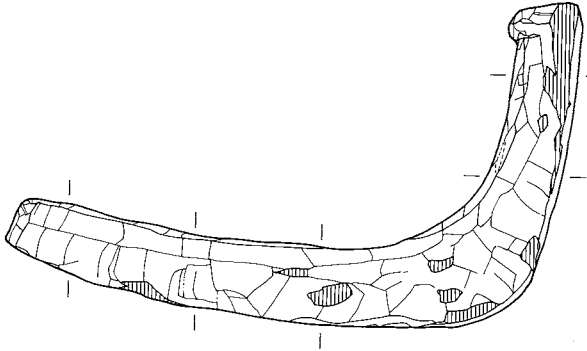
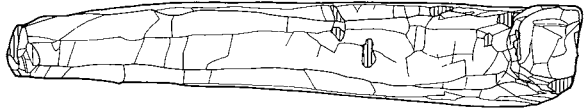
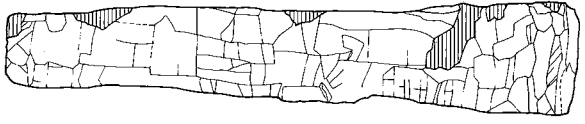

261

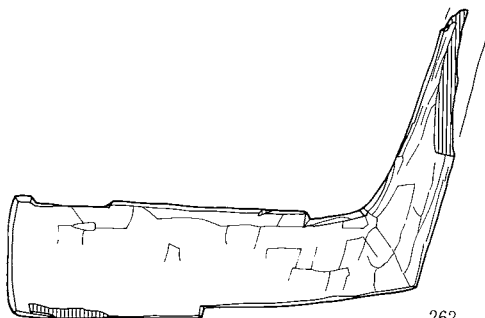
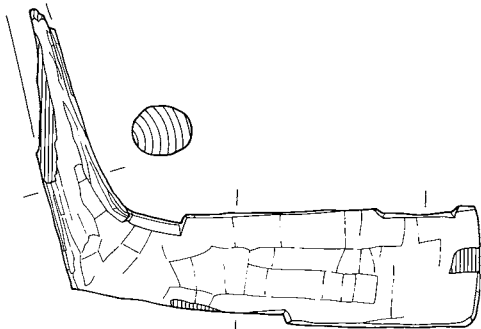
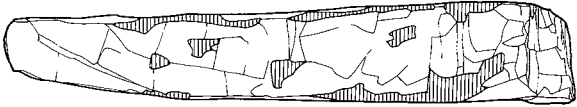

262

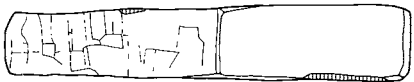
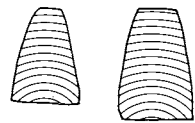

0 (1 : 6) 20cm

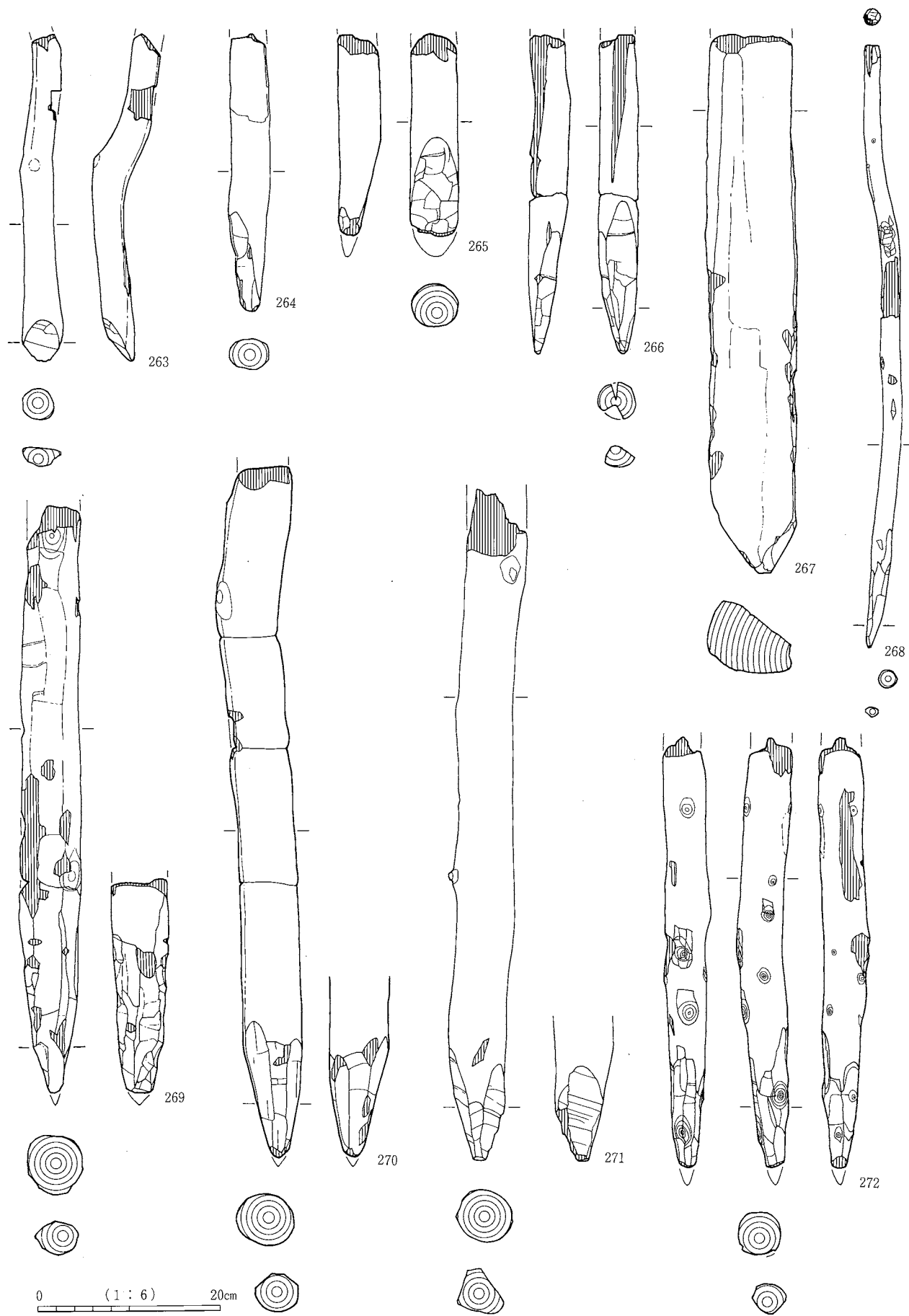

土木1 杭(1)

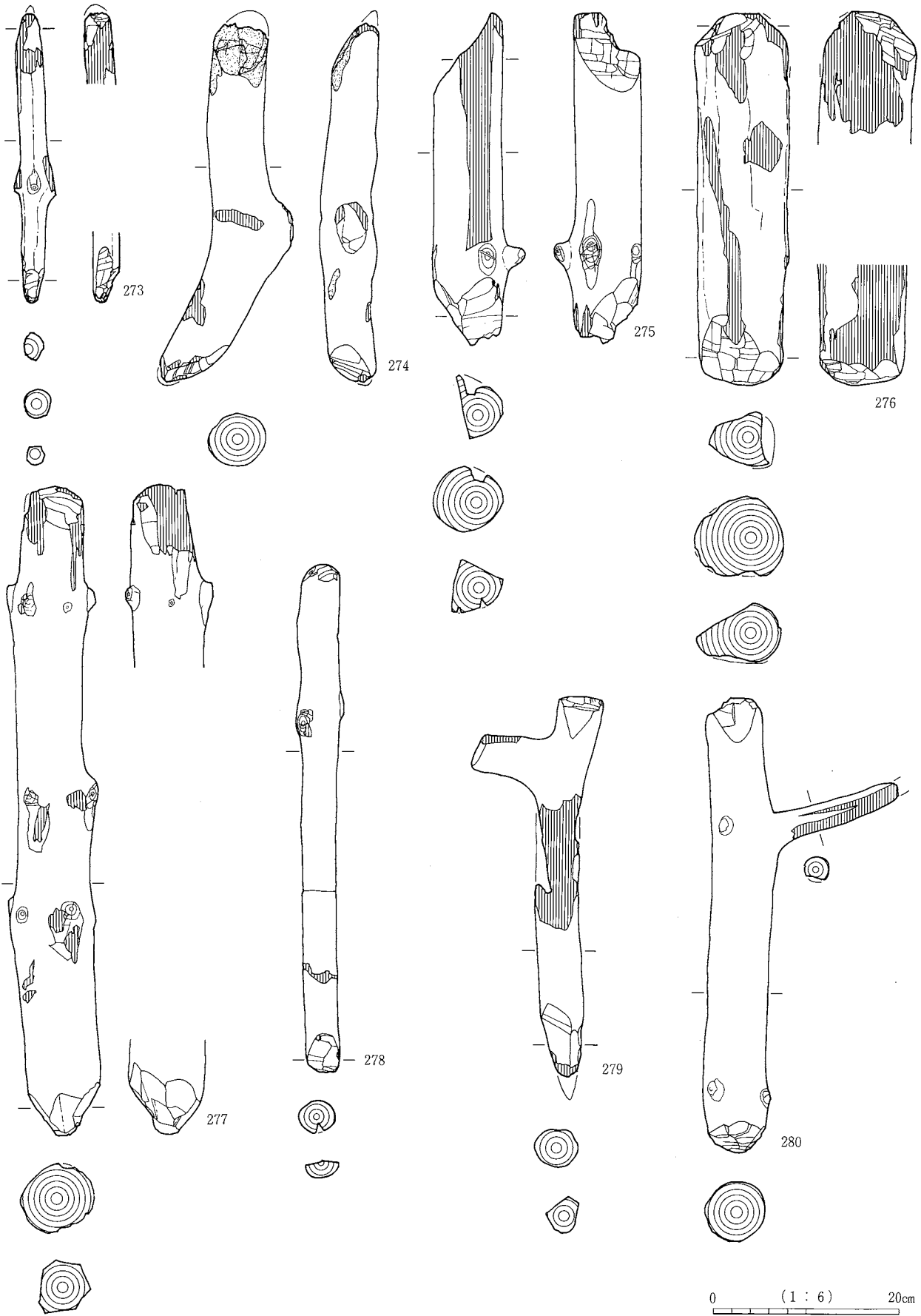

土木2 杭(2)



木屑他(1)

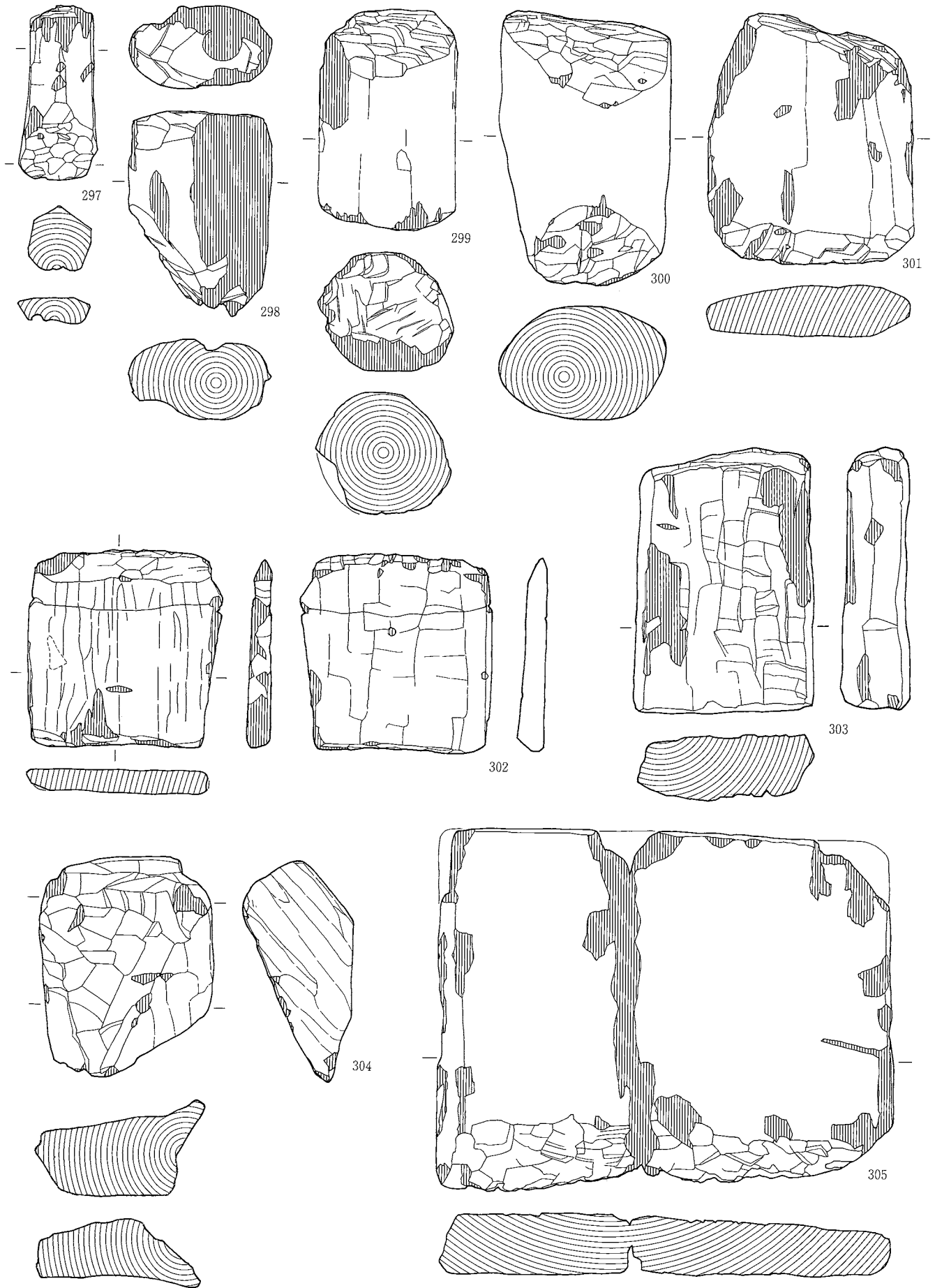

0 (1 : 6) 20cm

木屑他(2)

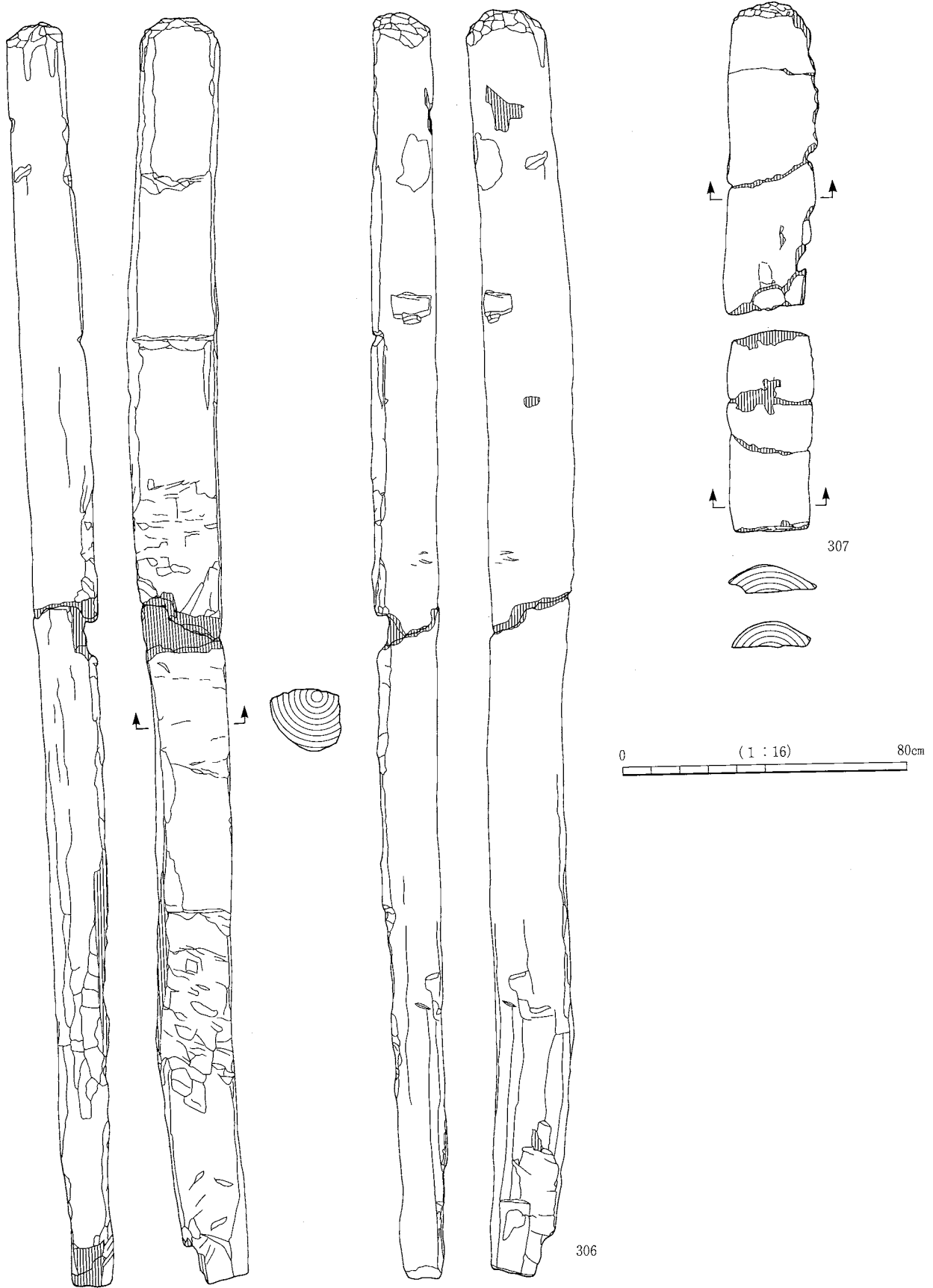

整材1

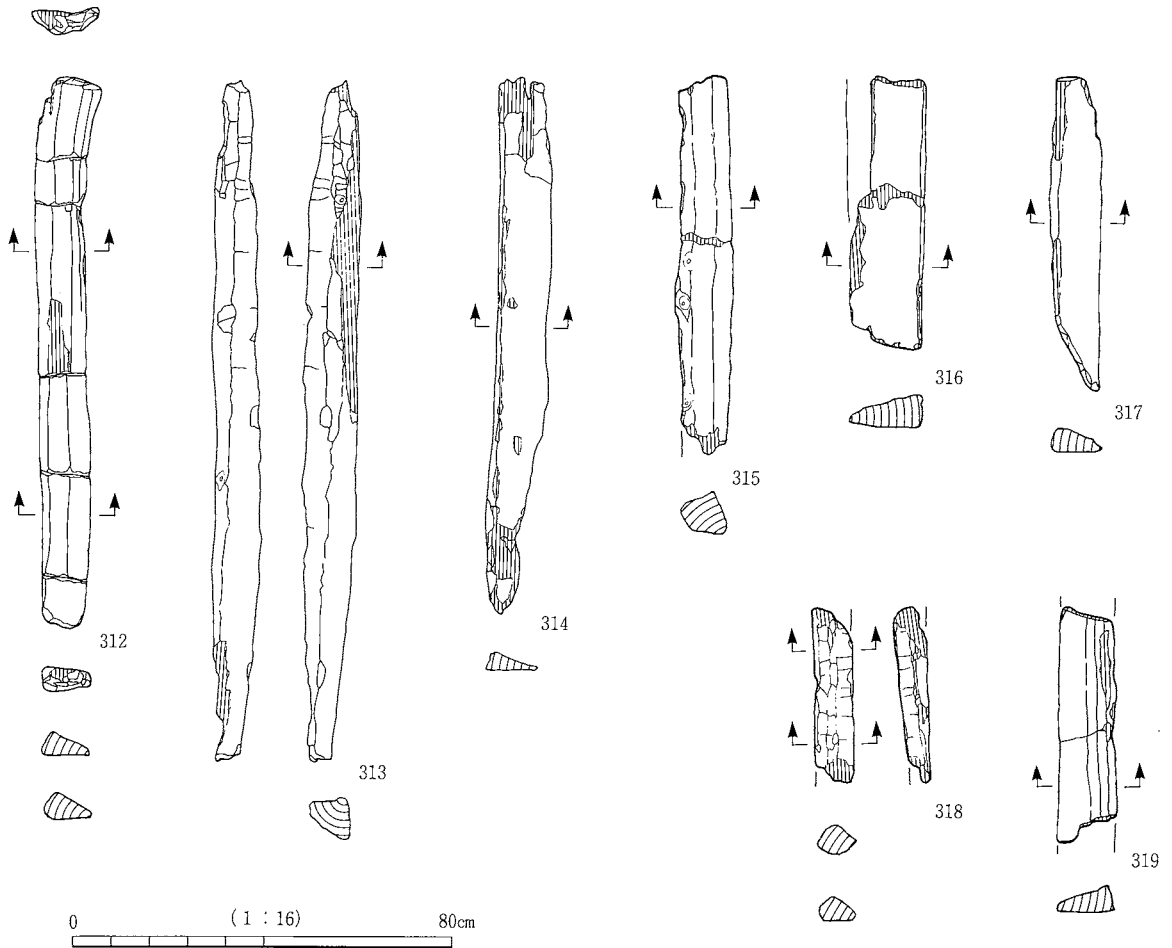
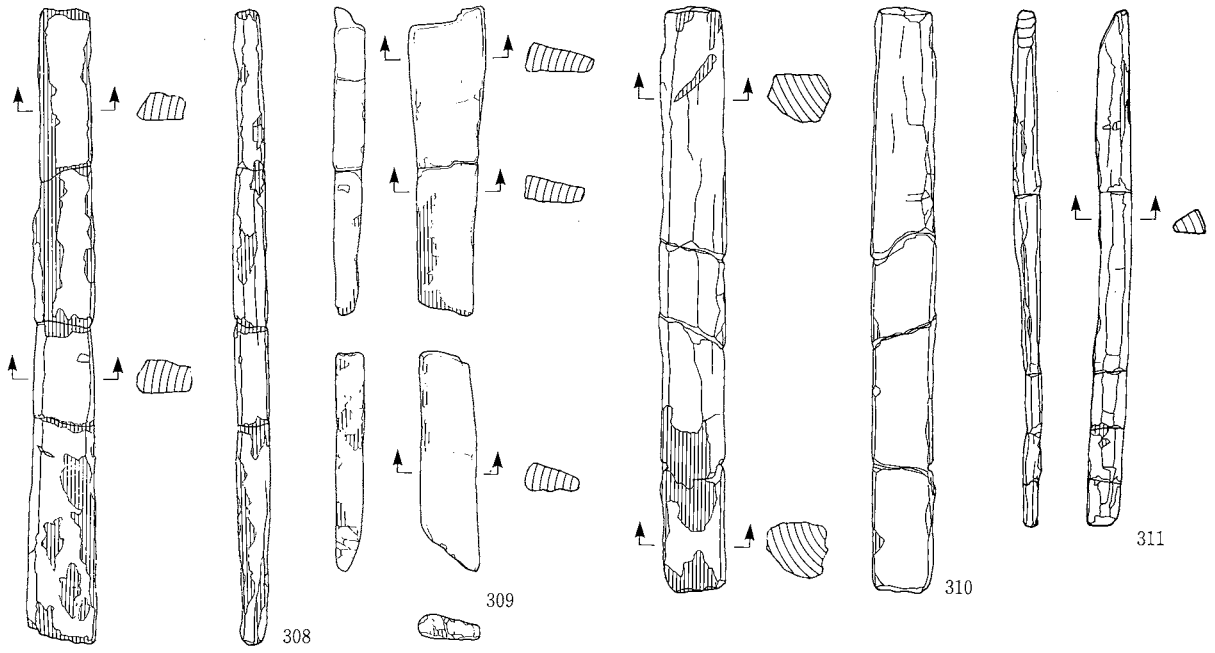

0 (1 : 16) 80cm

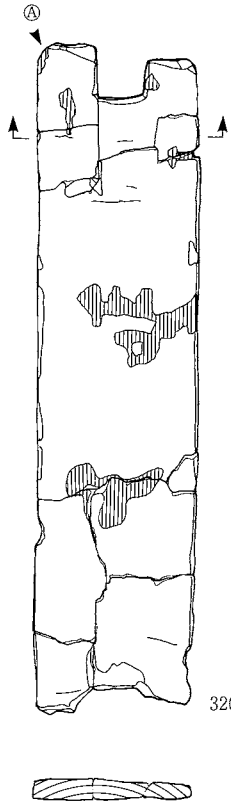

320

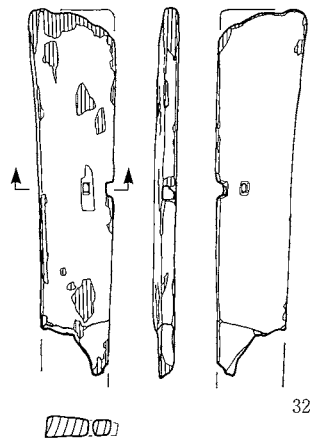

321

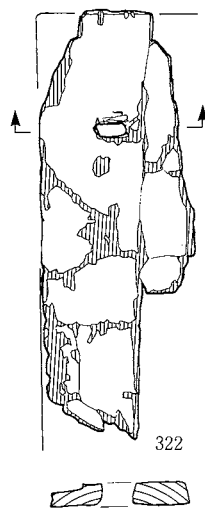

322

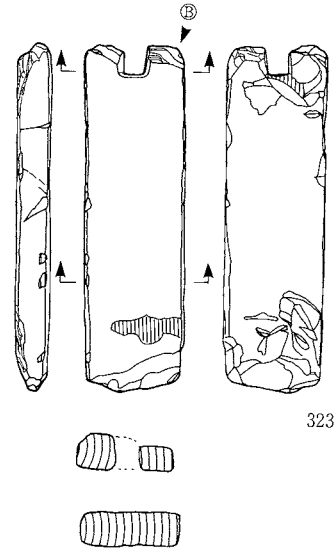

323

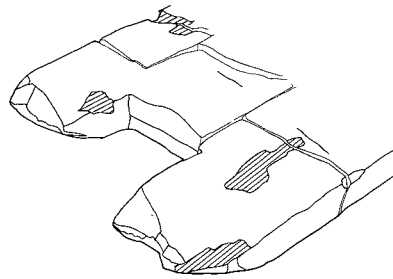

320 ④透視図

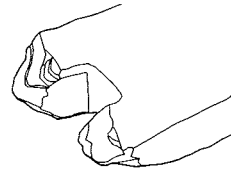

323 ③透視図

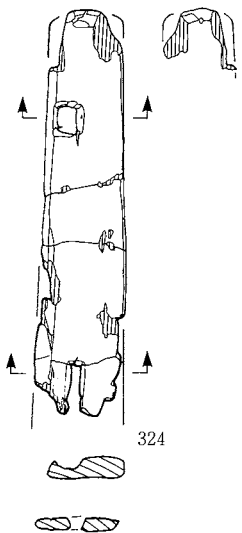

324

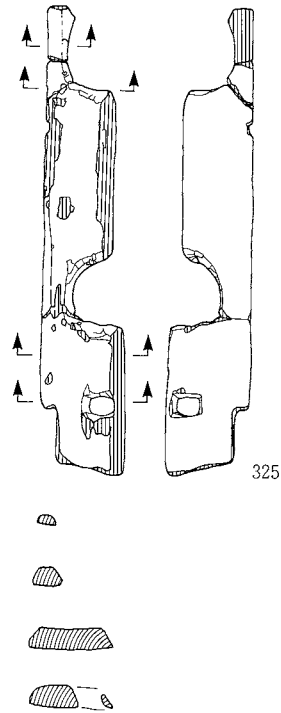

325

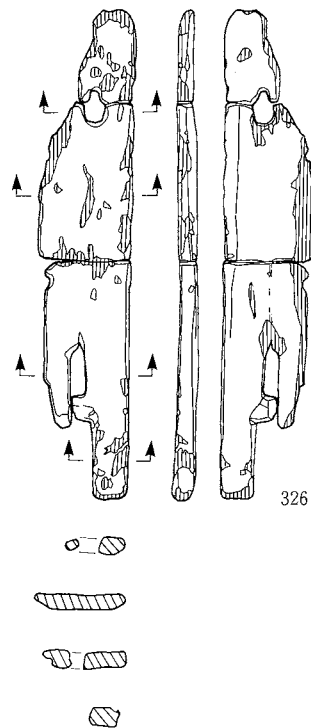

326

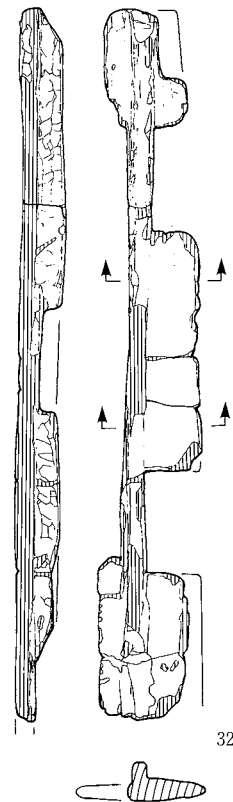

327

0 (1:16) 80cm

台輪 櫂・蹴放

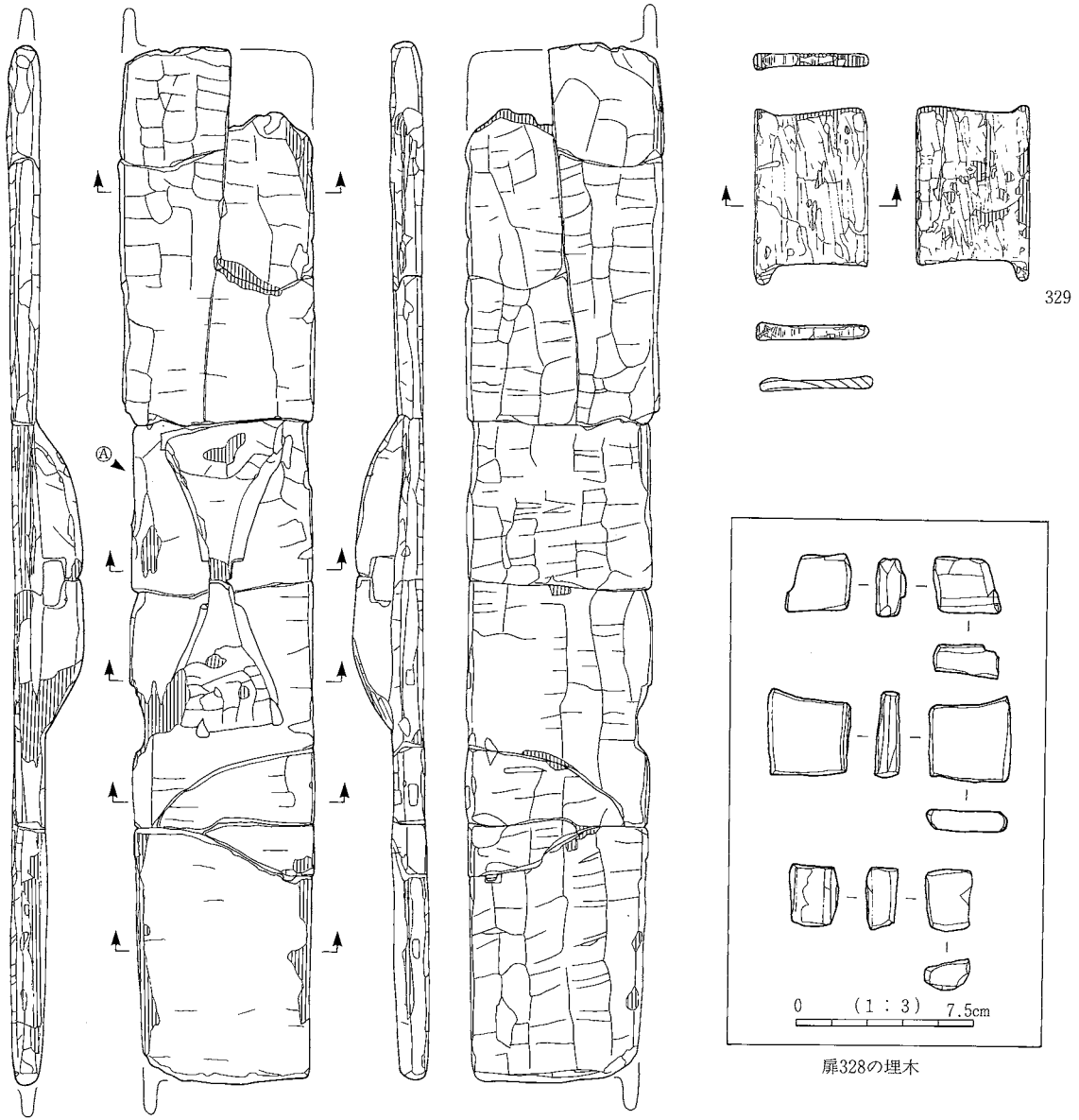

328

329

扉328の埋木

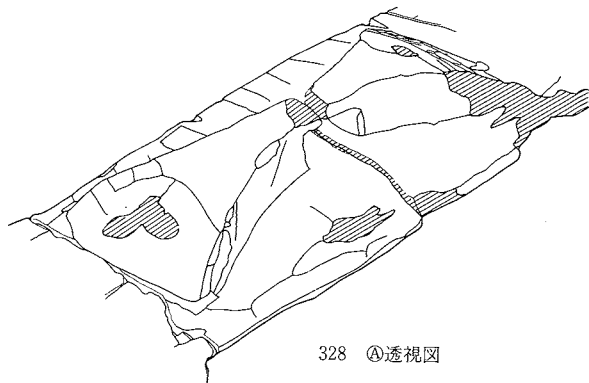
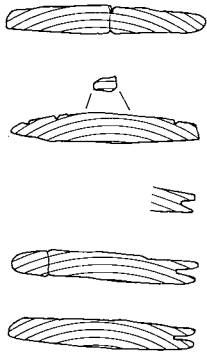

328 A透視図

0 (1:12) 60cm

0 (1:3) 7.5cm

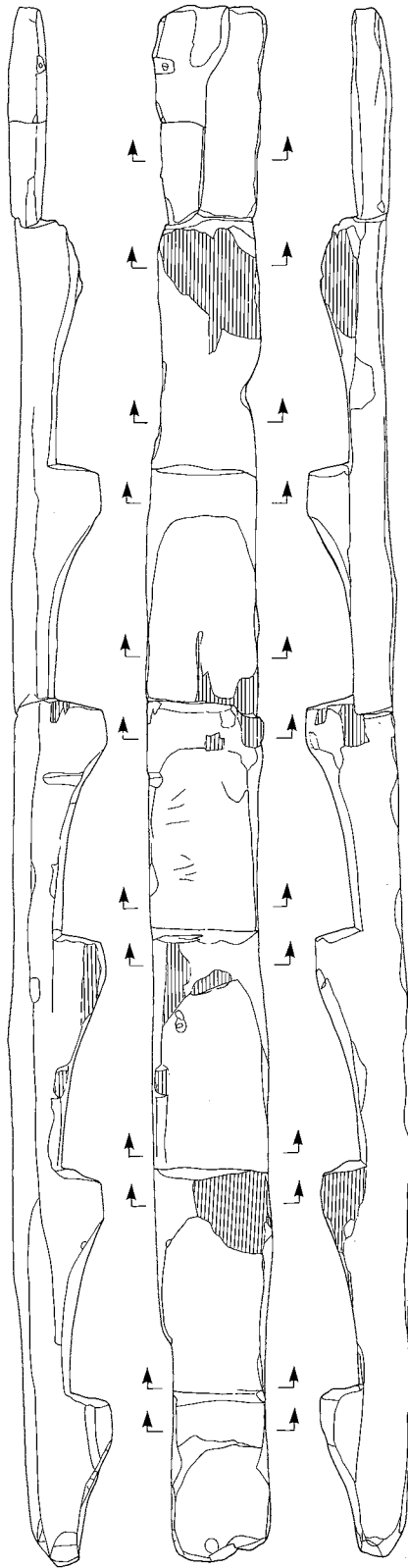

330

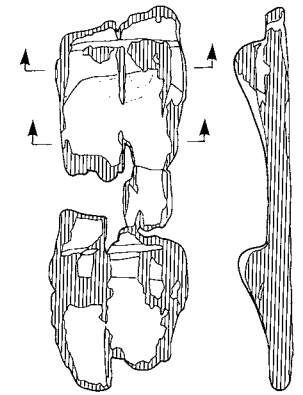
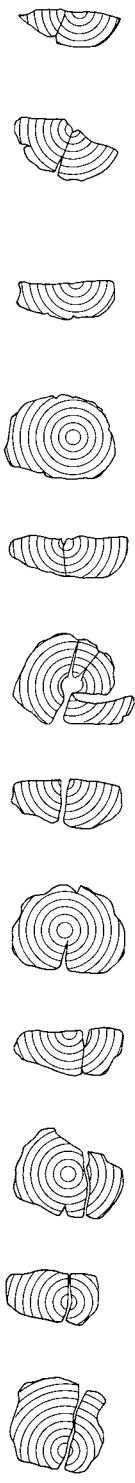

331

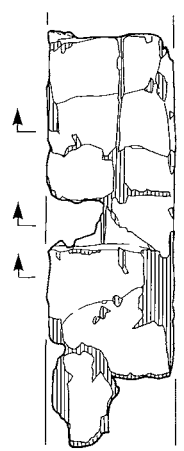
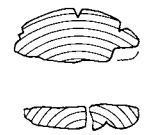

332

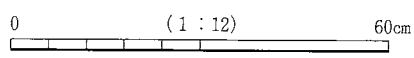
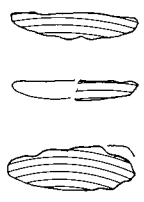

梯子

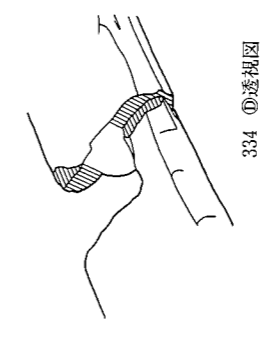
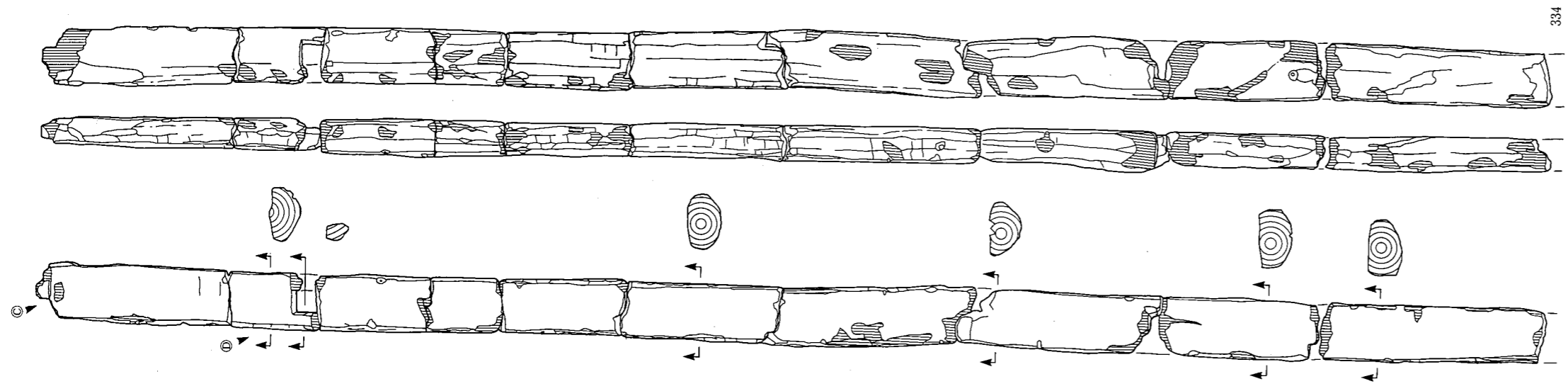

334 透视图

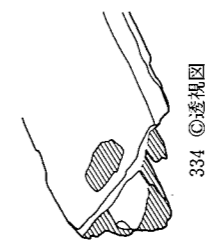

334 透视图

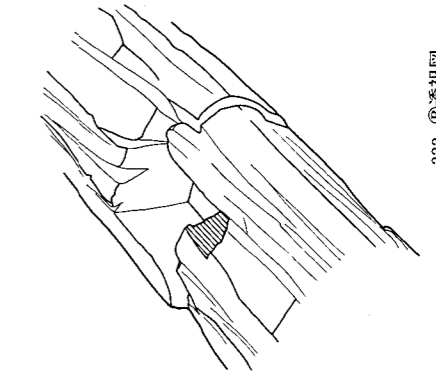
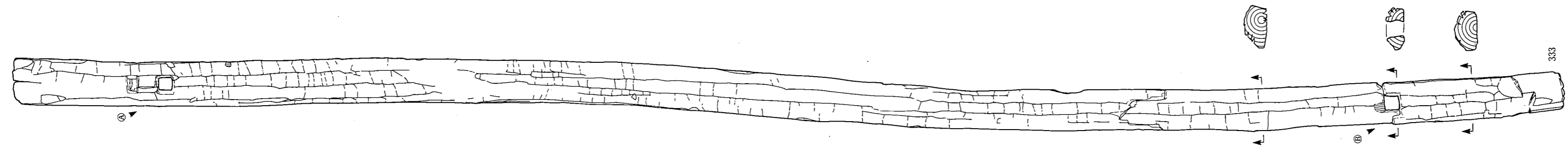

333 透视图

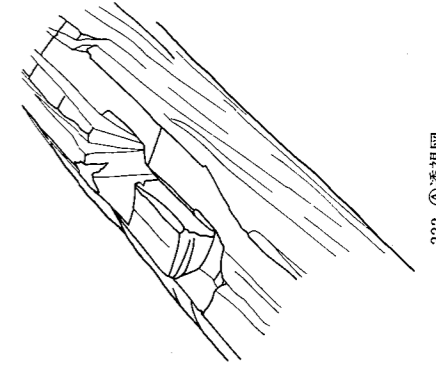

333 透视图

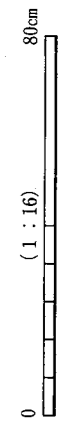

桁 棟木

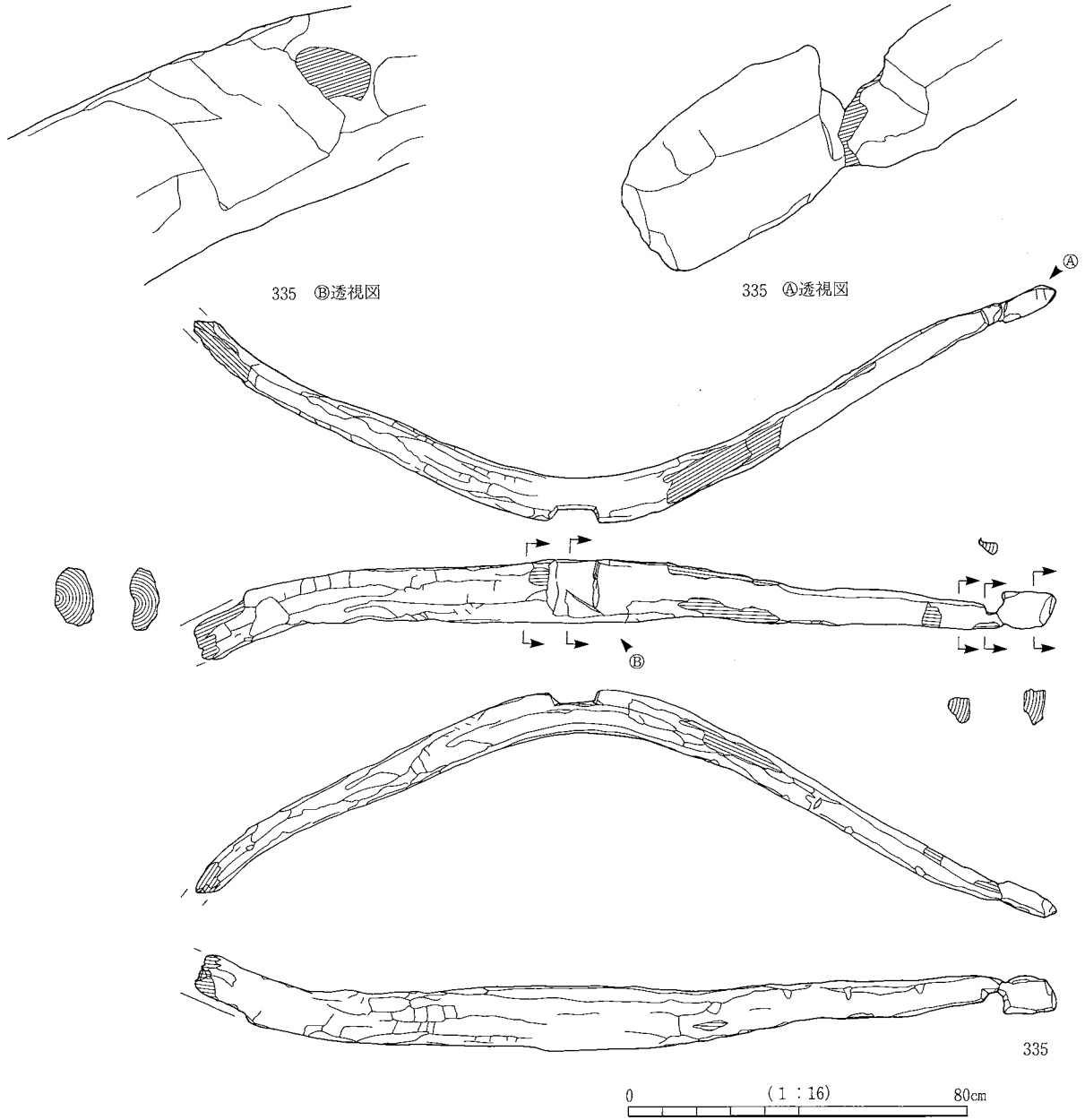

梁

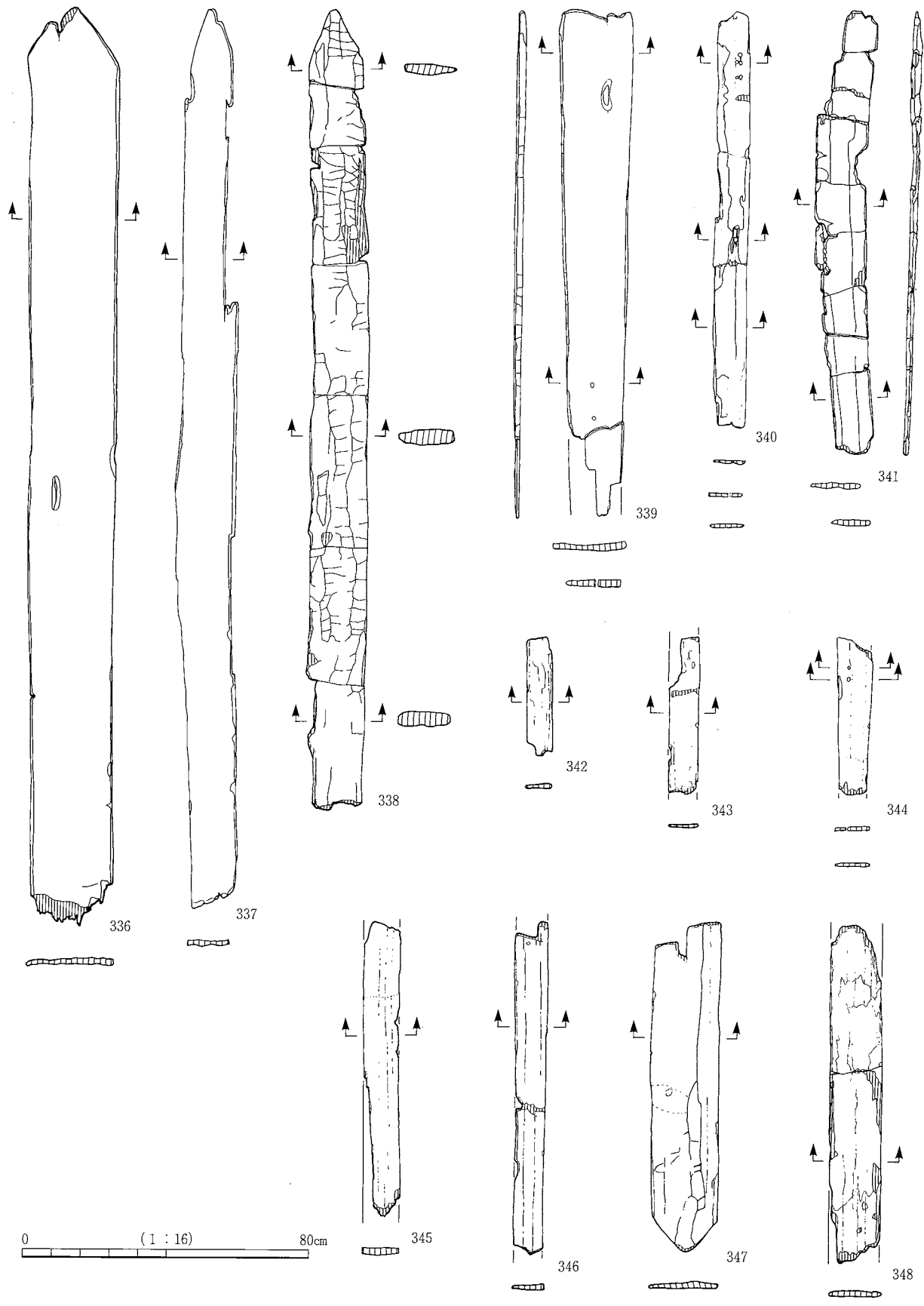

壁板

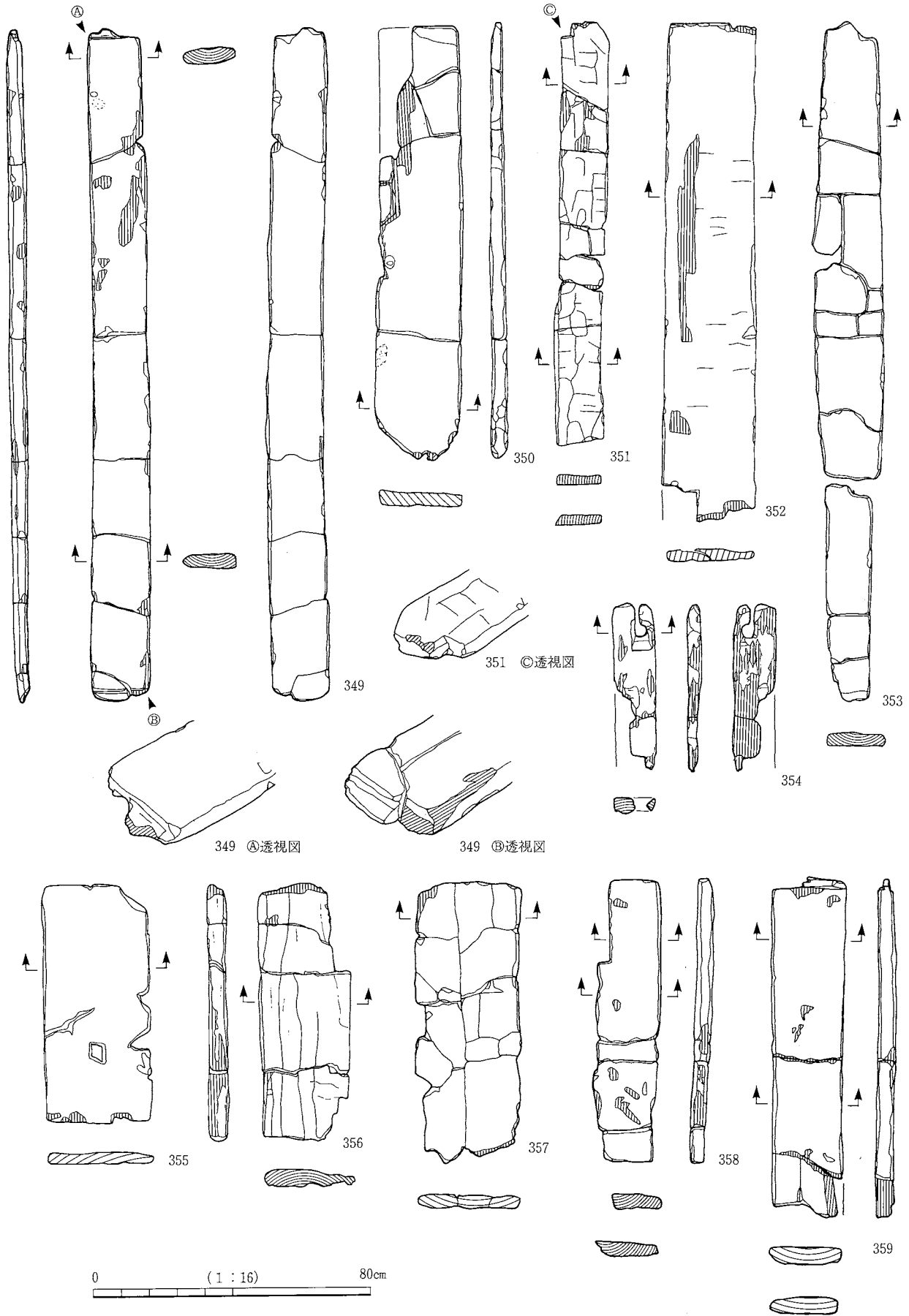

床板 1 その他

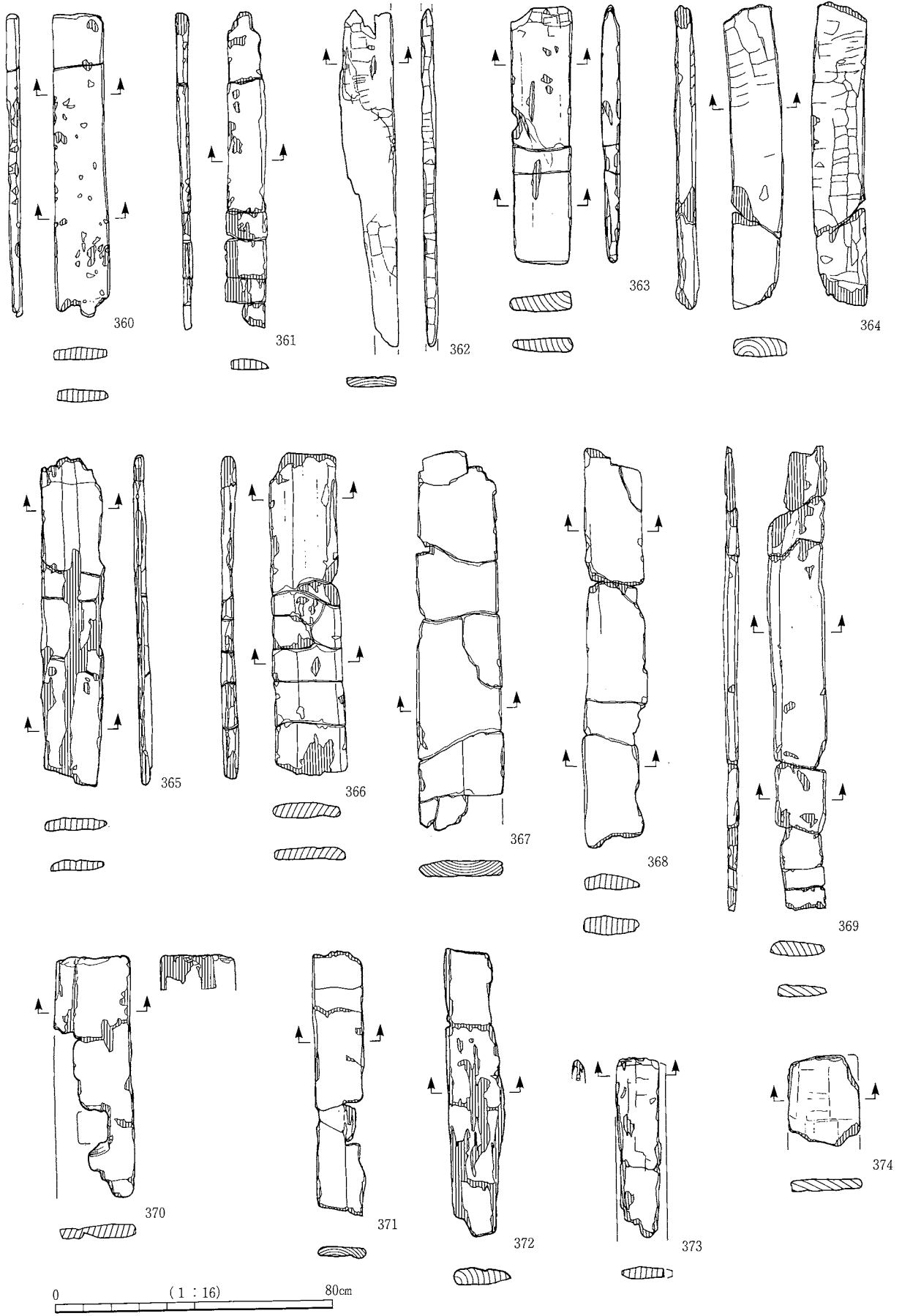

床板 2 その他

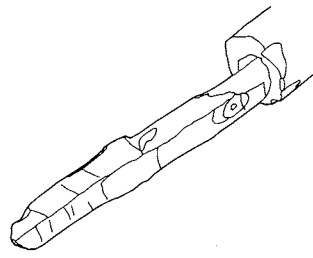
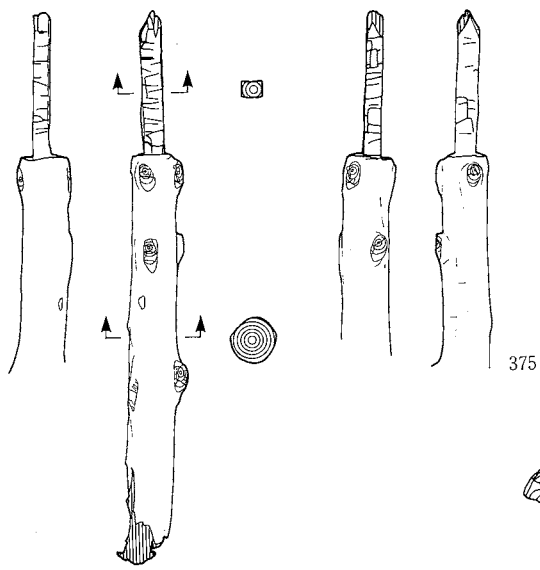

377 ③透視図

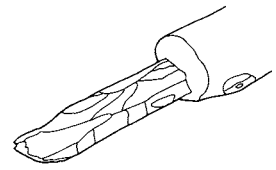

378 ③透視図

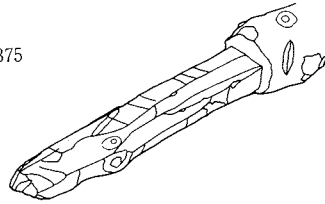

379 ④透視図

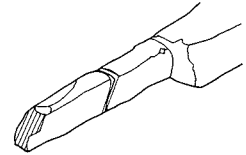

376 ④透視図

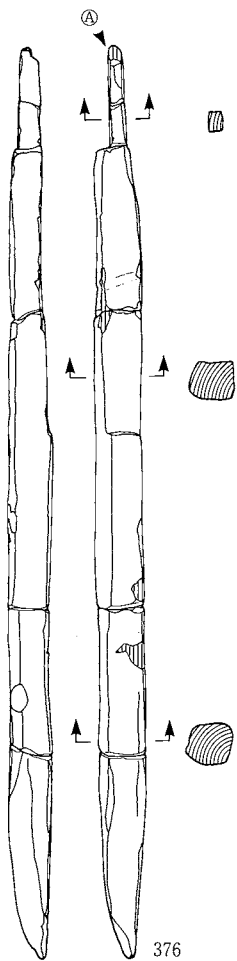

376

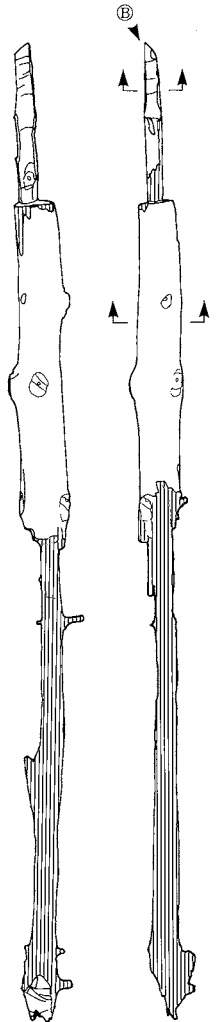

377

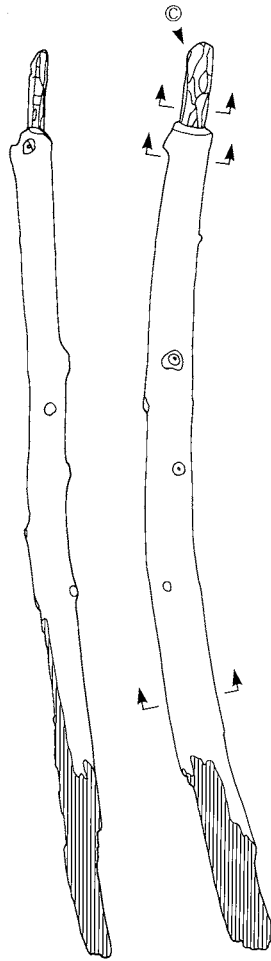

378

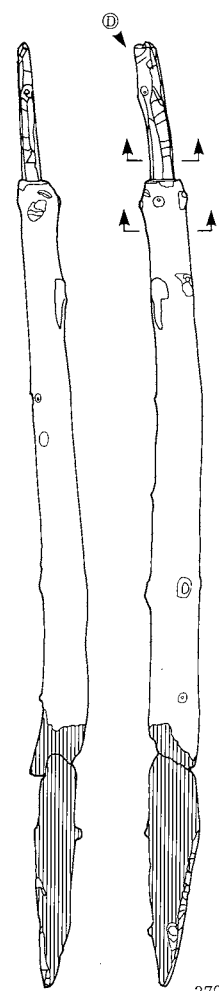

379

0 (1:16) 80cm

柱1 柄付(1)

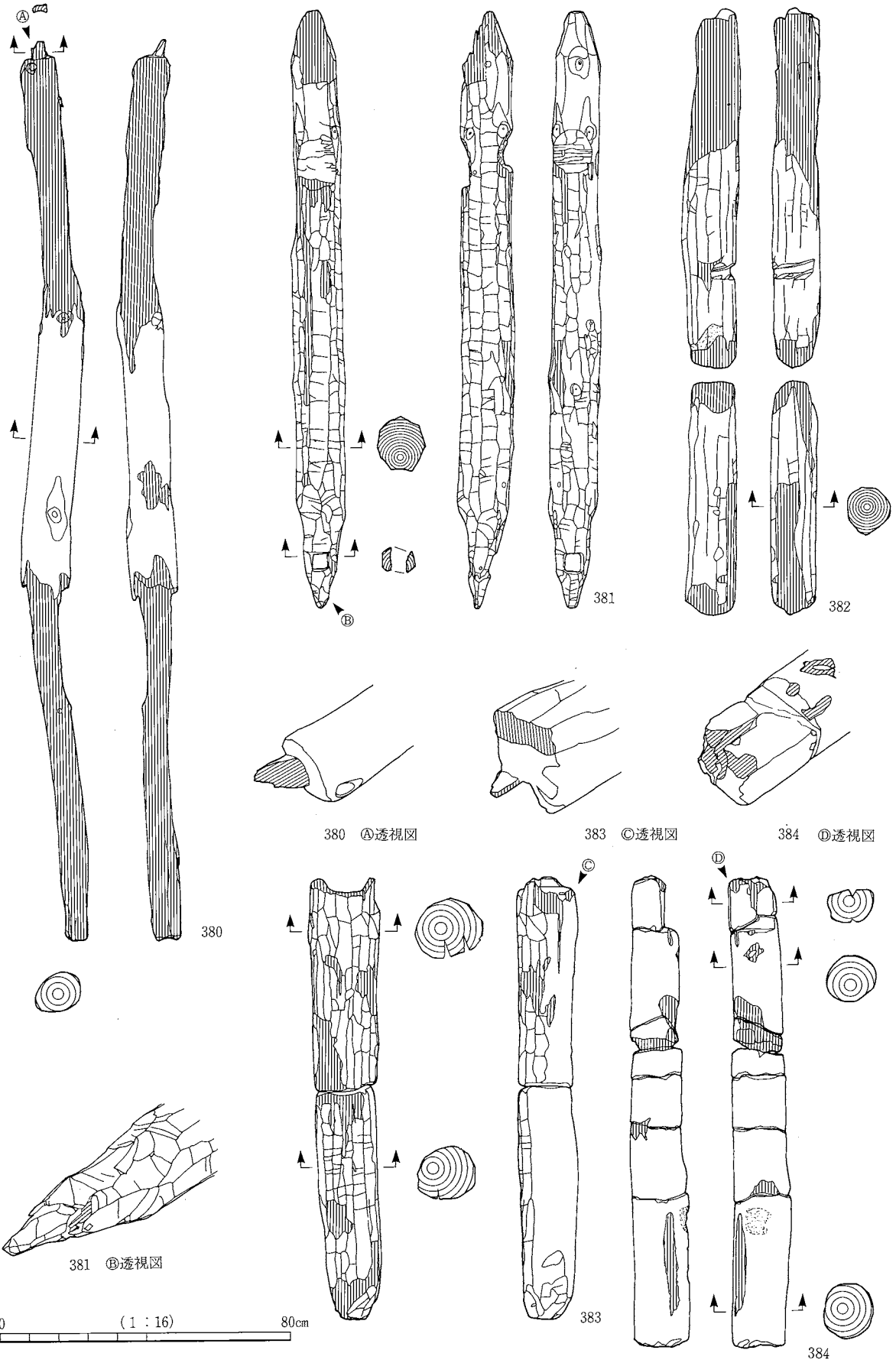

柱2 柄付(2)

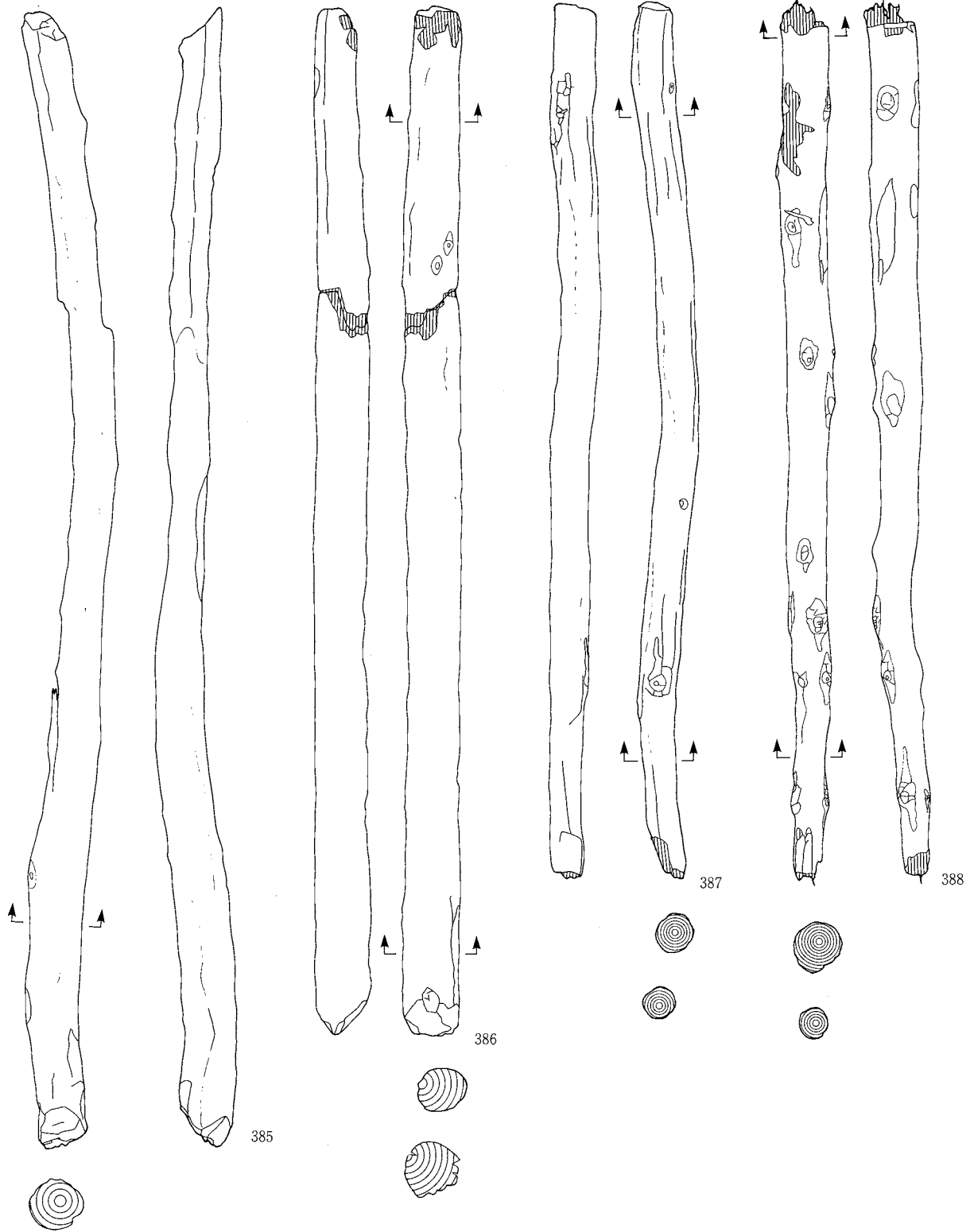

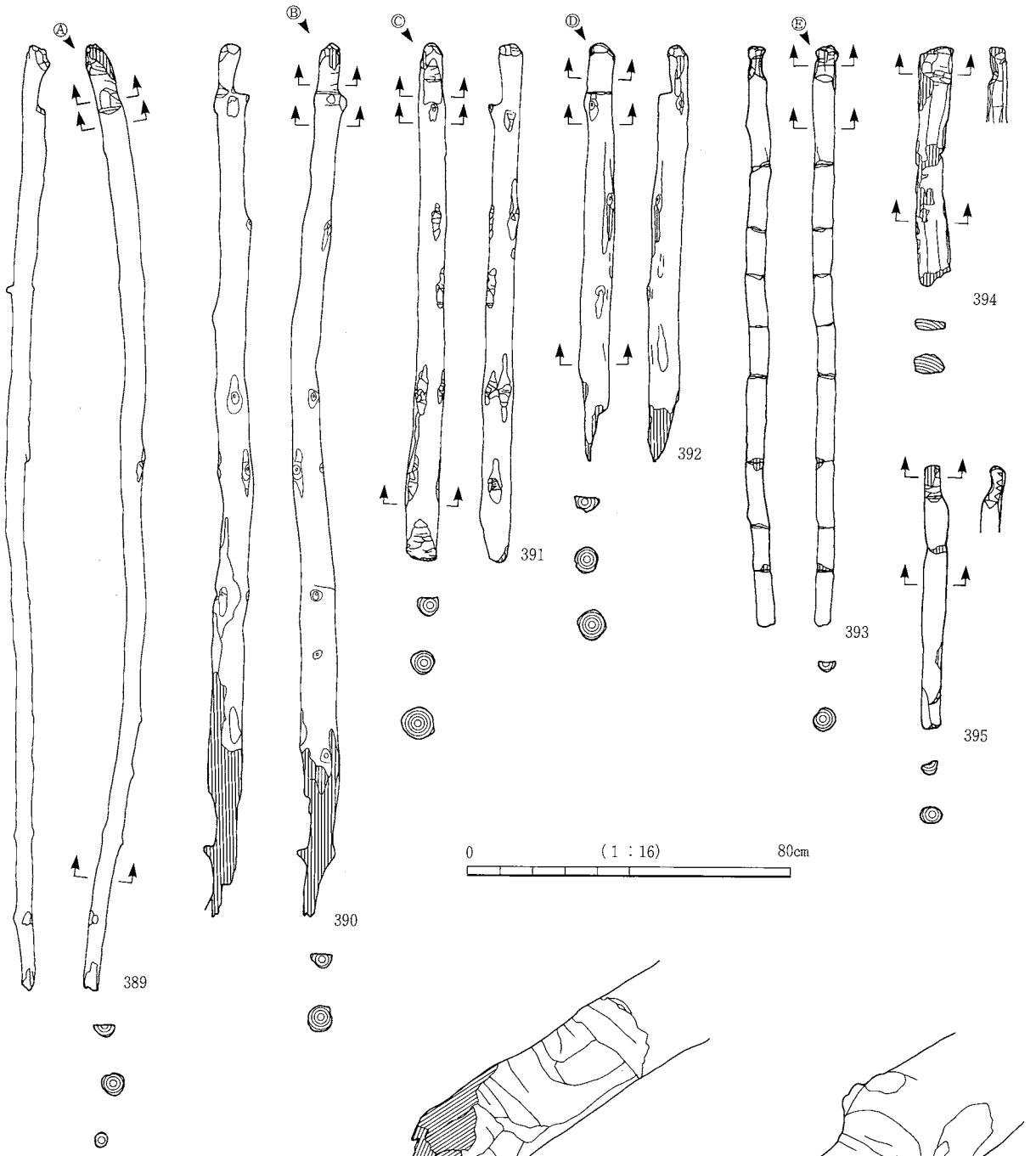

0 (1 : 16) 80cm

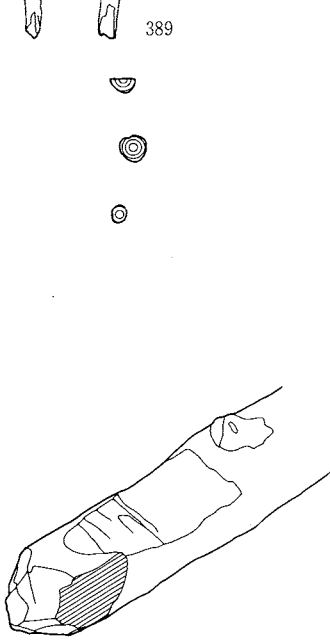

391 ㉟透视图

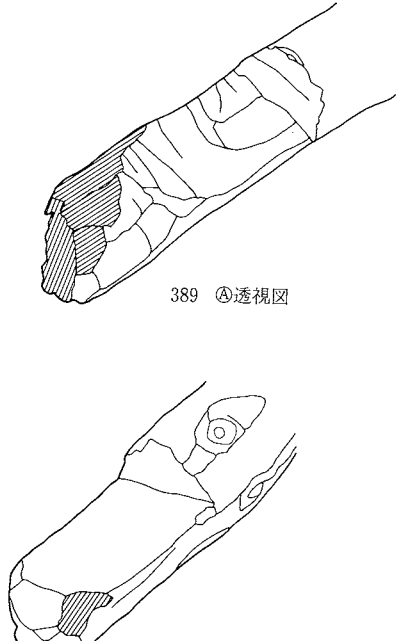

389 ㉠透视图

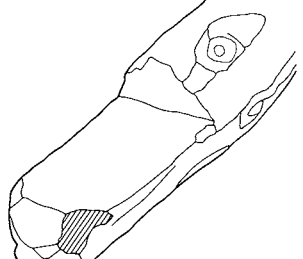

392 ㉡透视图

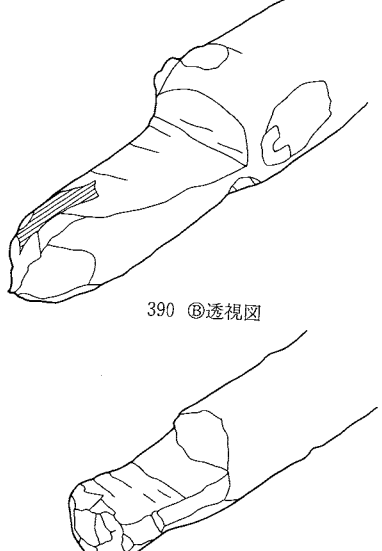

390 ㉢透视图

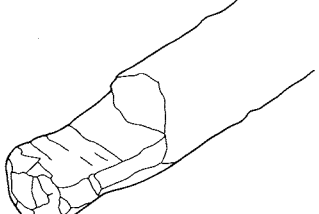

393 ㉣透视图

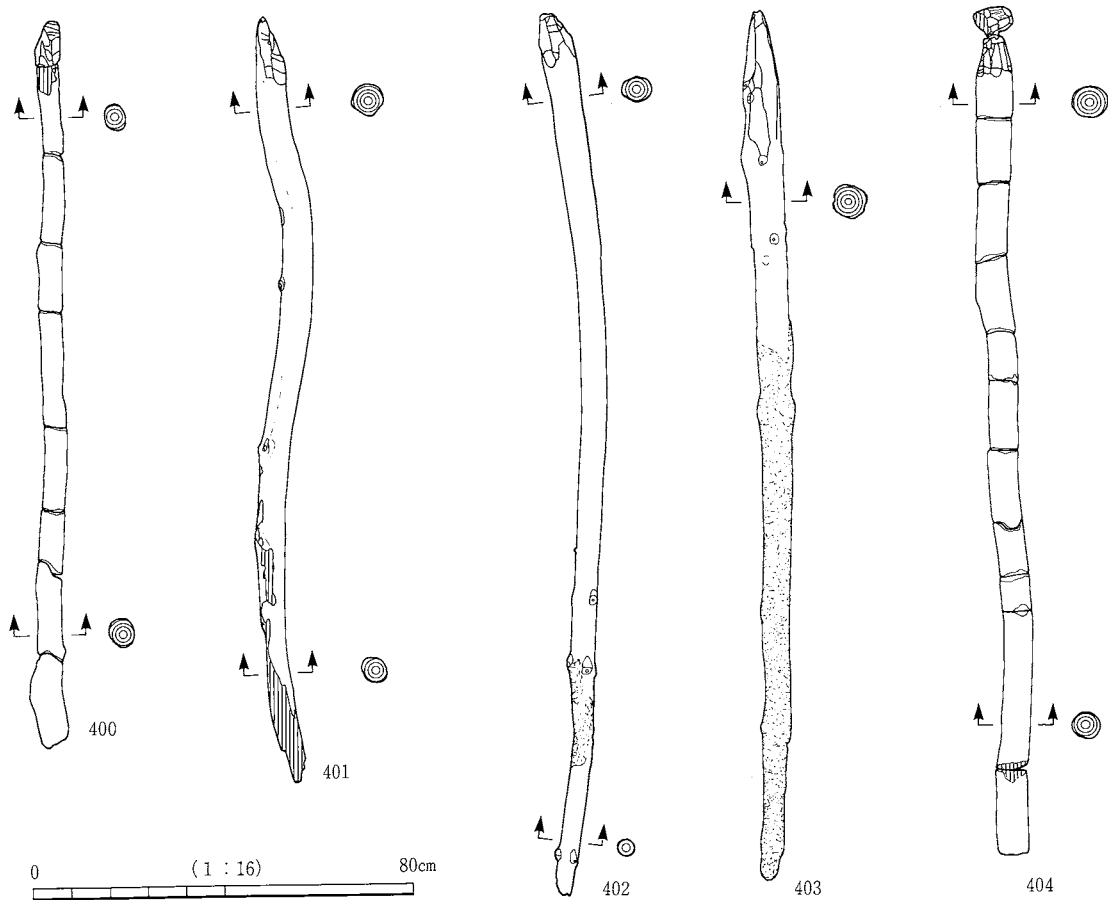
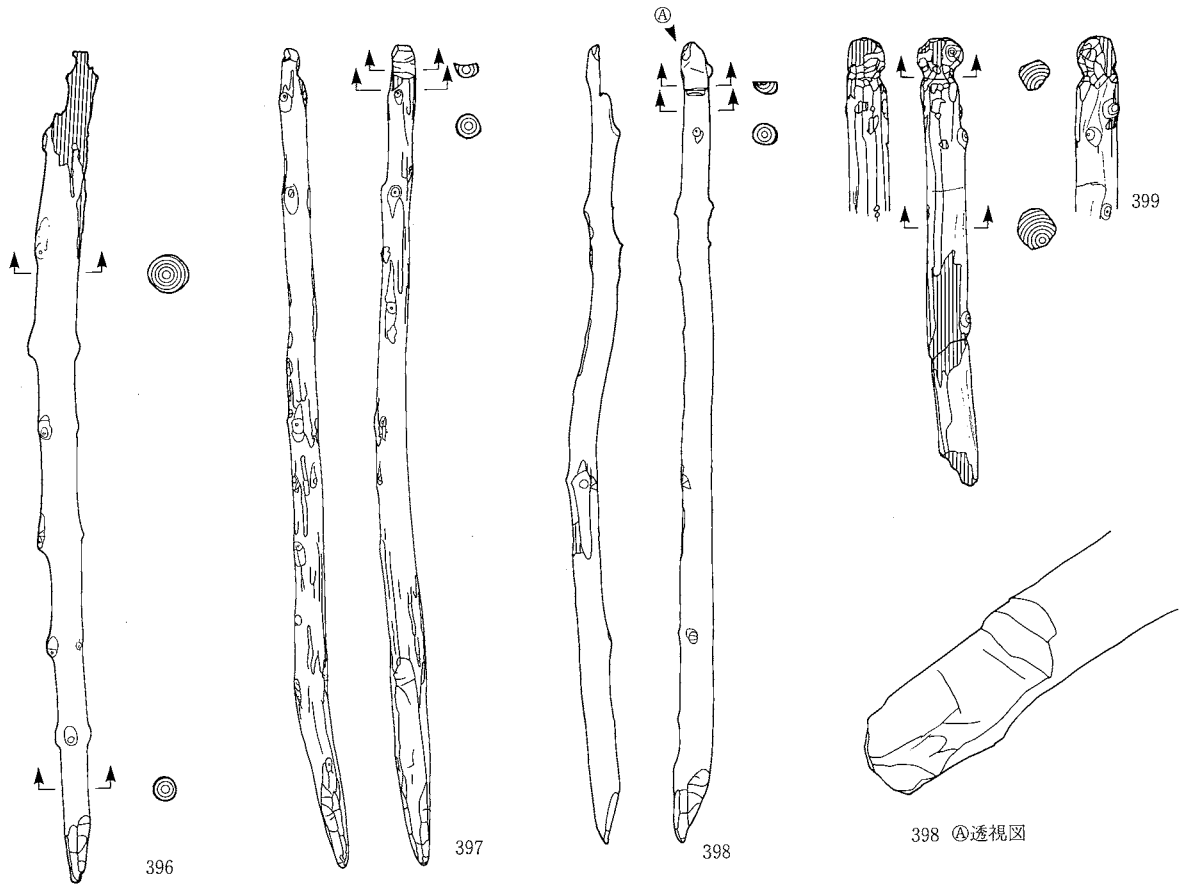

垂木 2 (含・有頭棒状材)

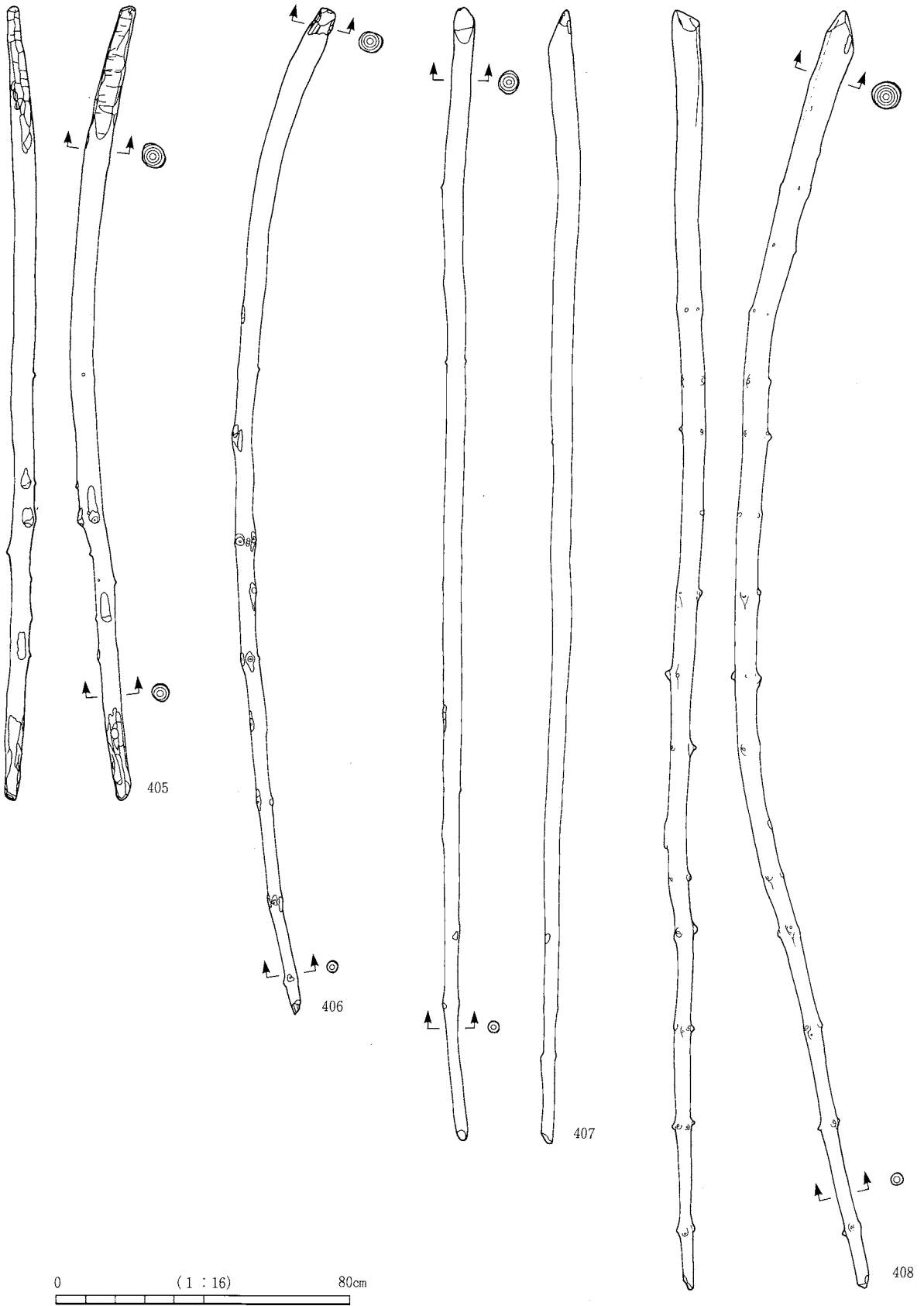

垂木 3

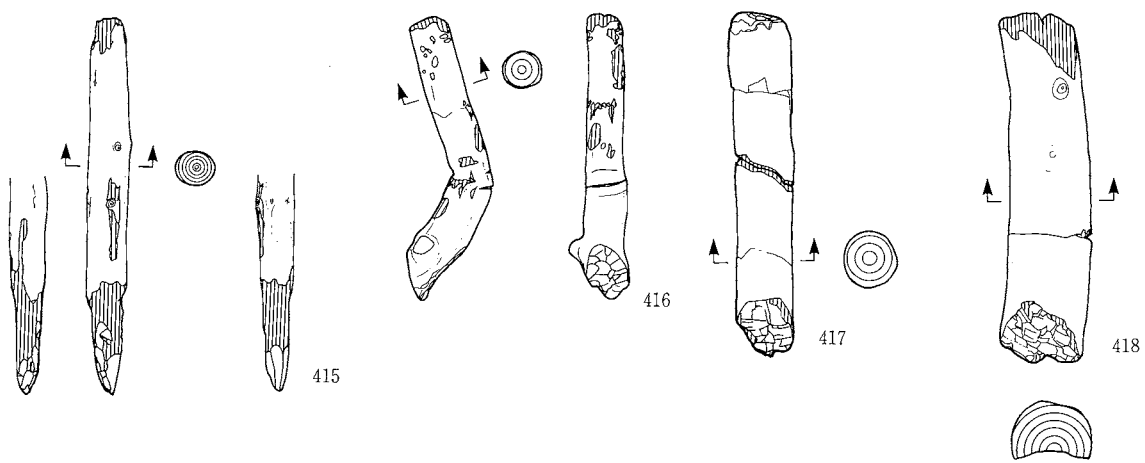
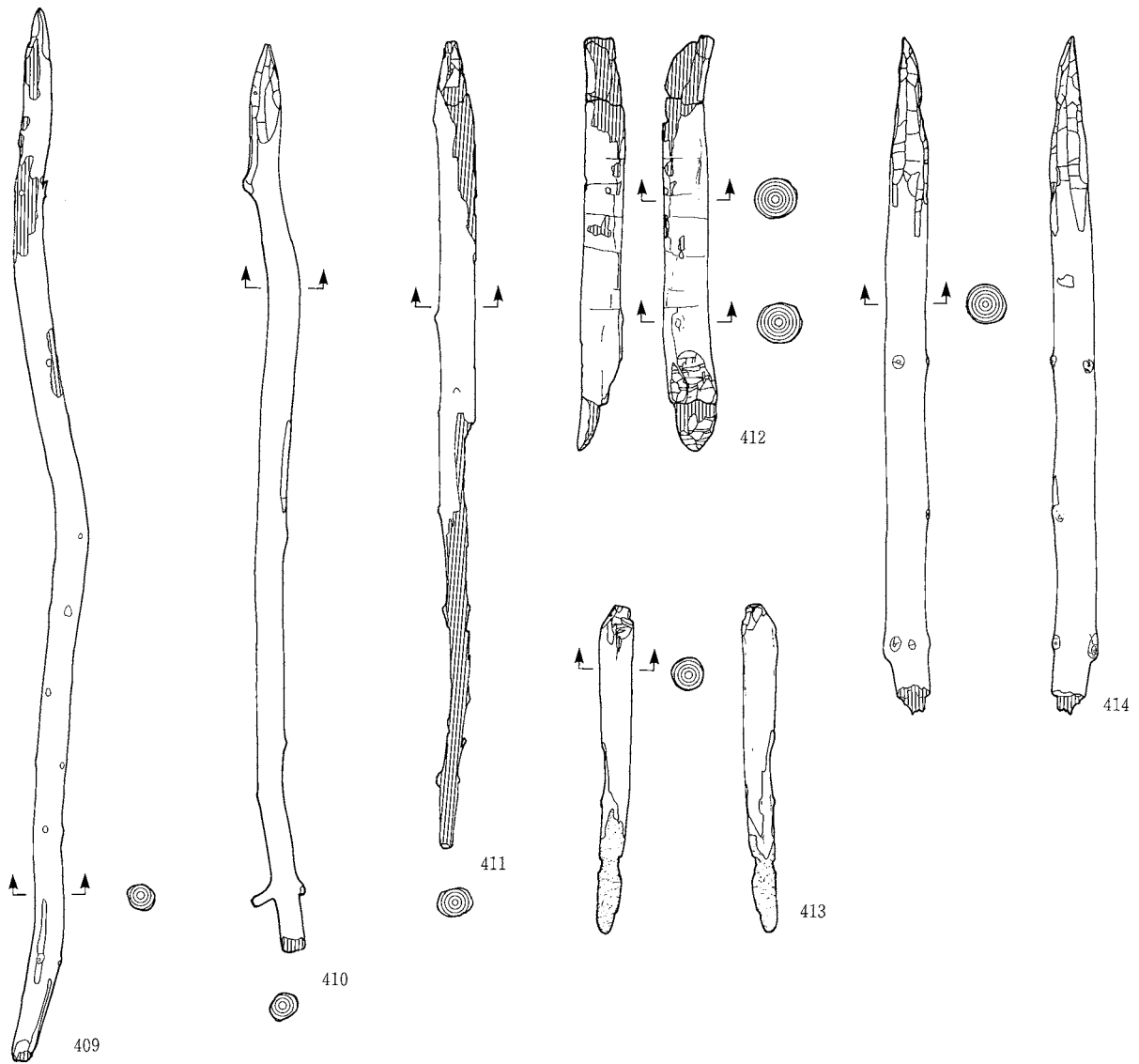

0 (1:16) 80cm

垂木材の転用品(推定) 1 その他

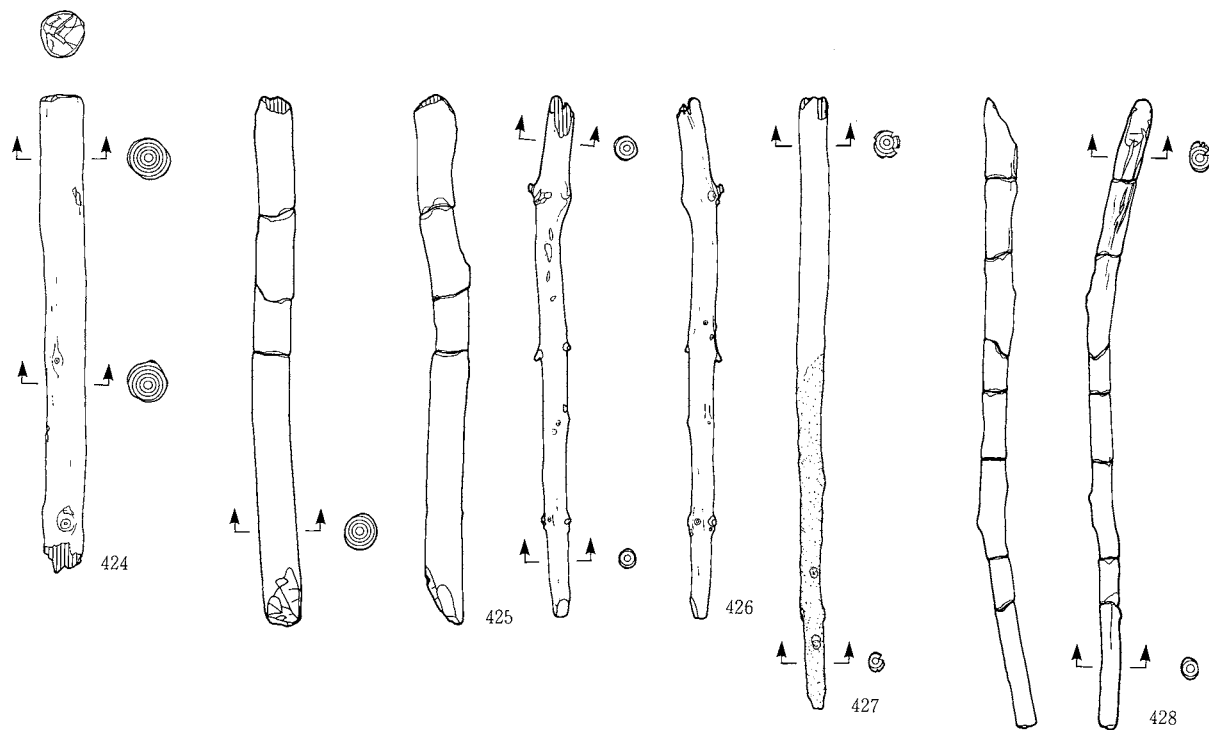
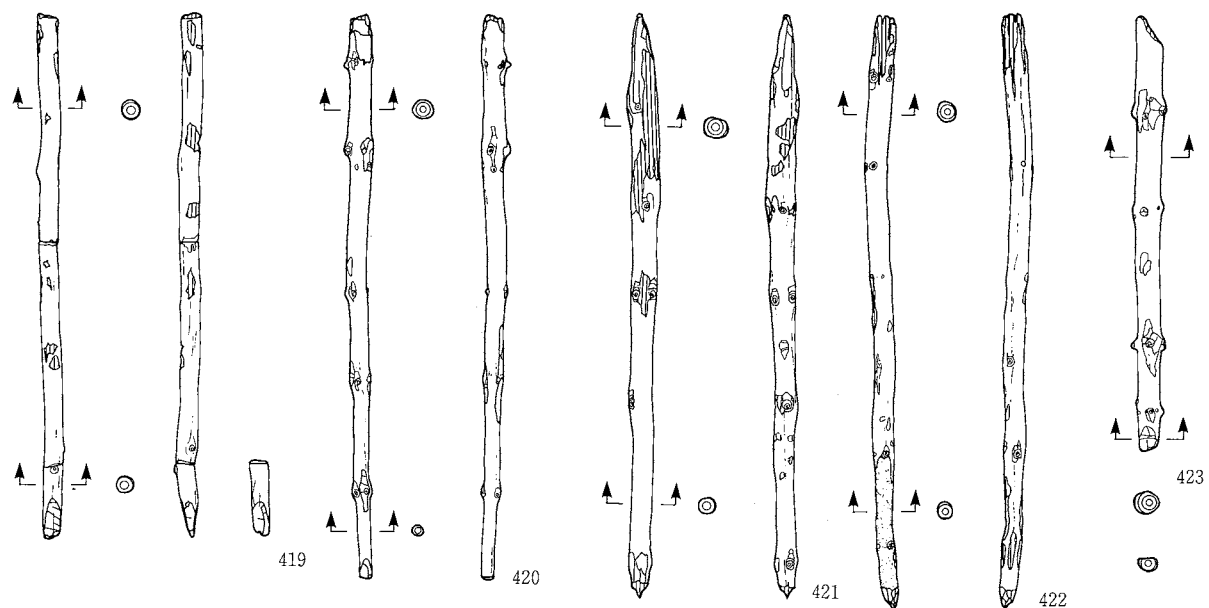

0 (1 : 16) 80cm

垂木材の転用品 (推定) 2

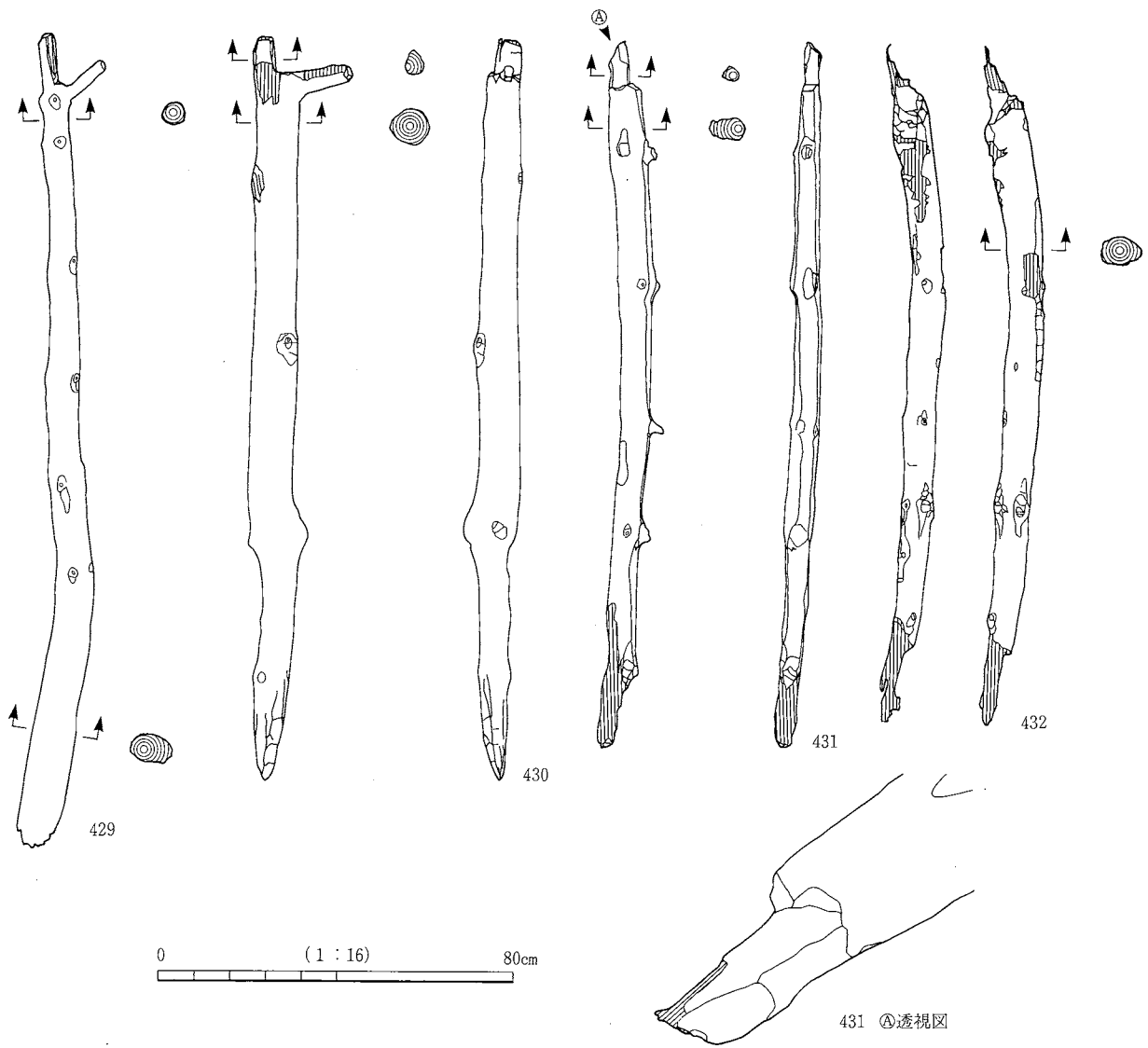

小屋組の形成材 (推定)

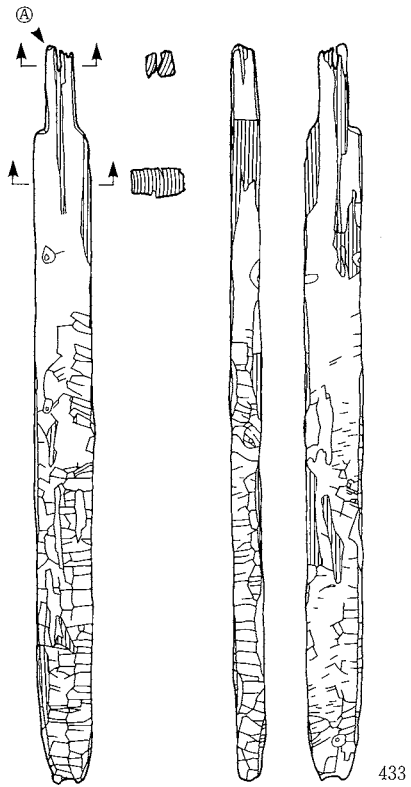

433

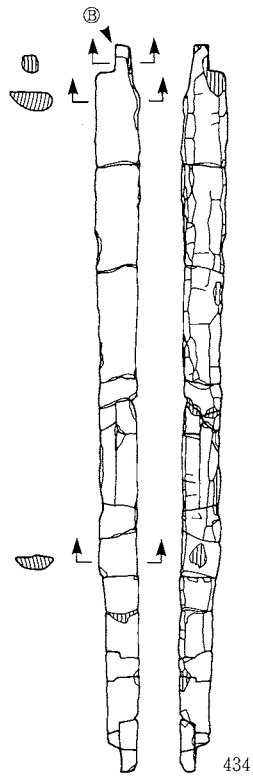

434



435

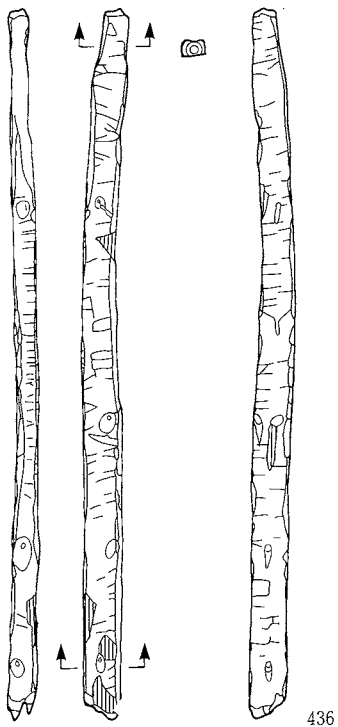

436

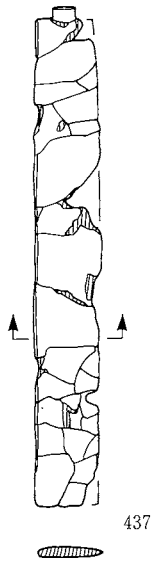

437

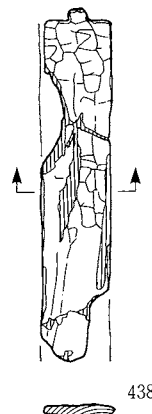

438

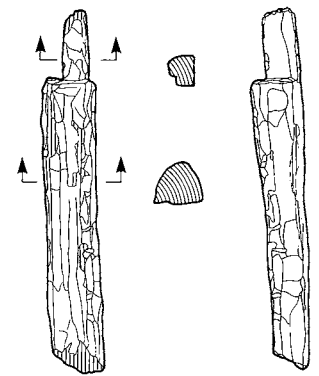

439

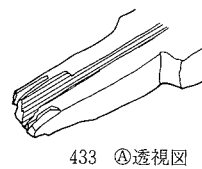

433 透视图

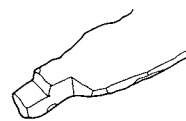

434 透视图

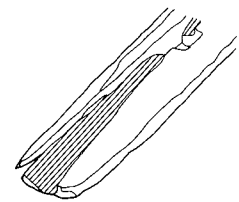

435 透视图

0 (1:16) 80cm

仕口用加工を施す縦材と横架材

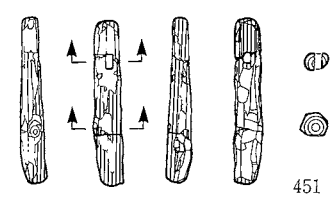
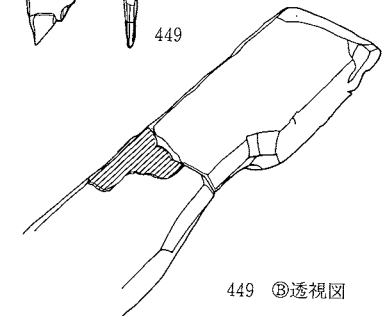
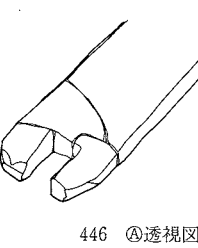
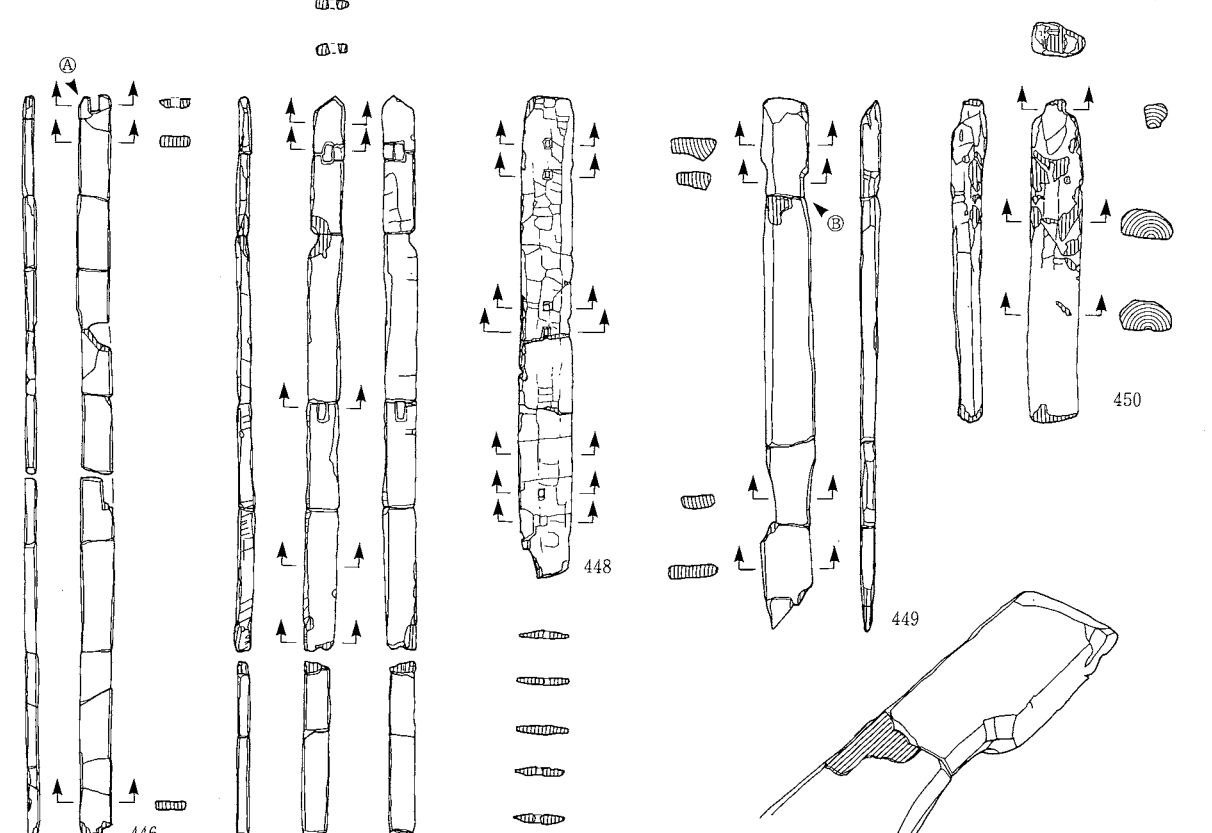
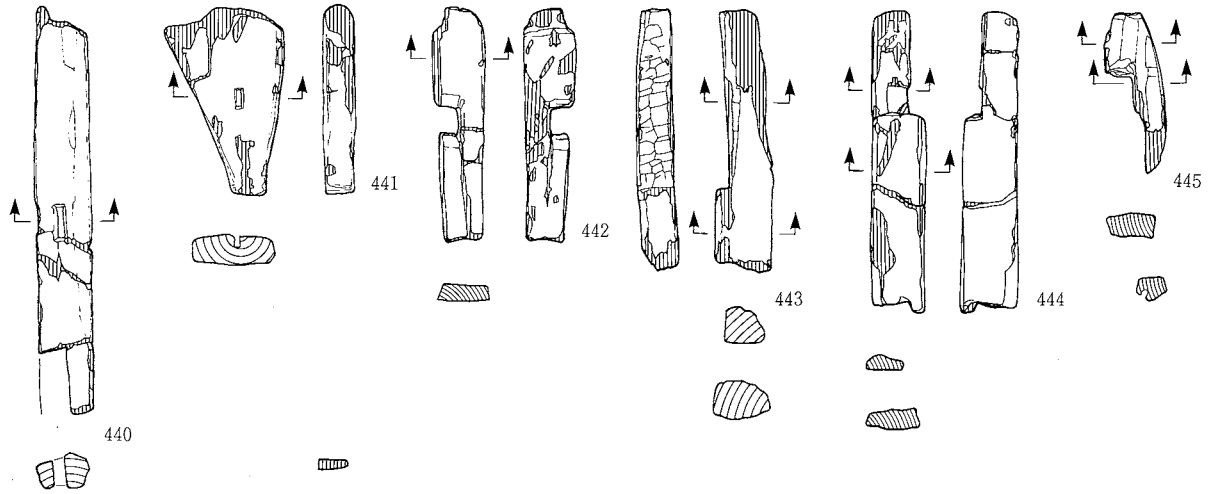

0 (1:16) 80cm

用途不明材 1

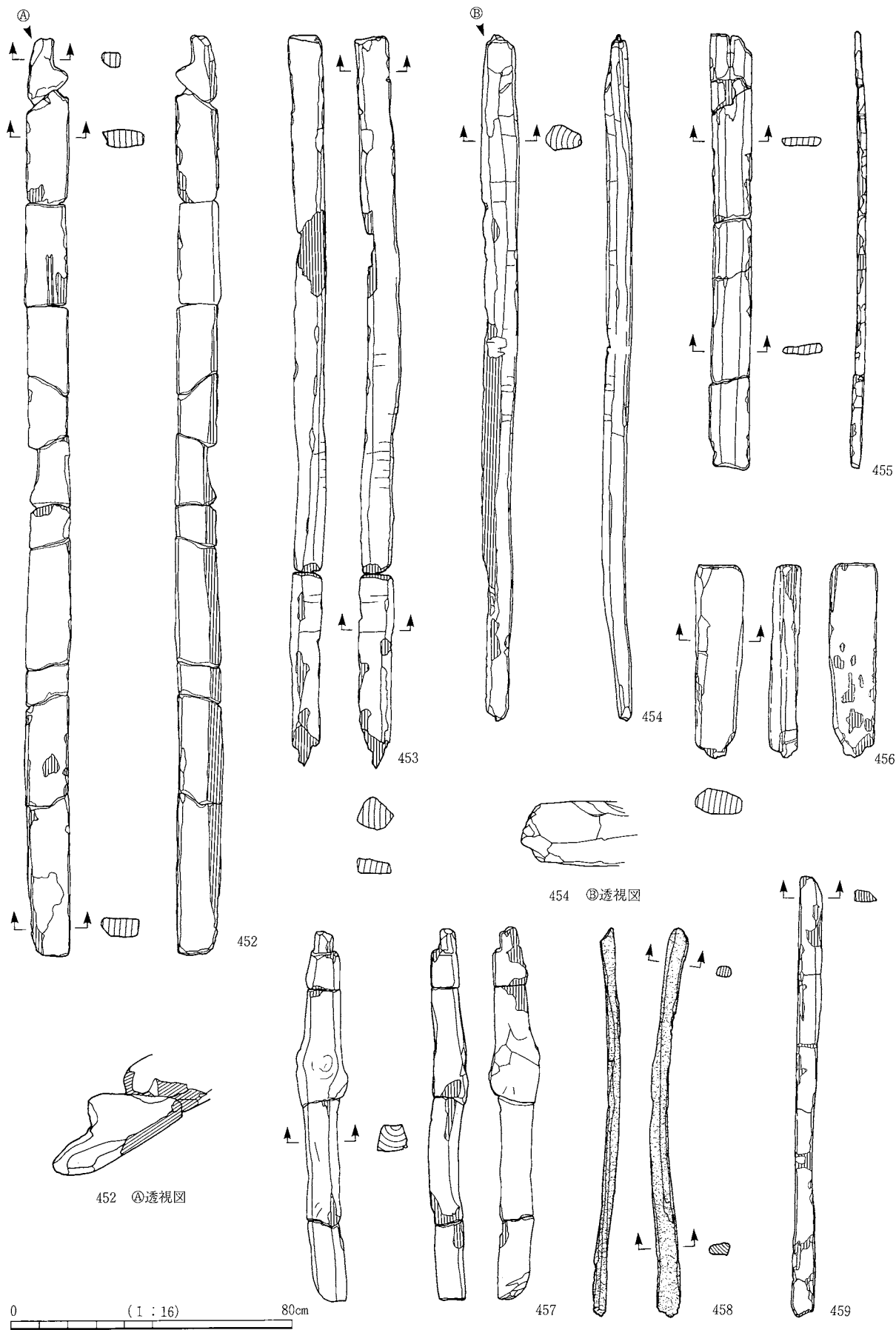

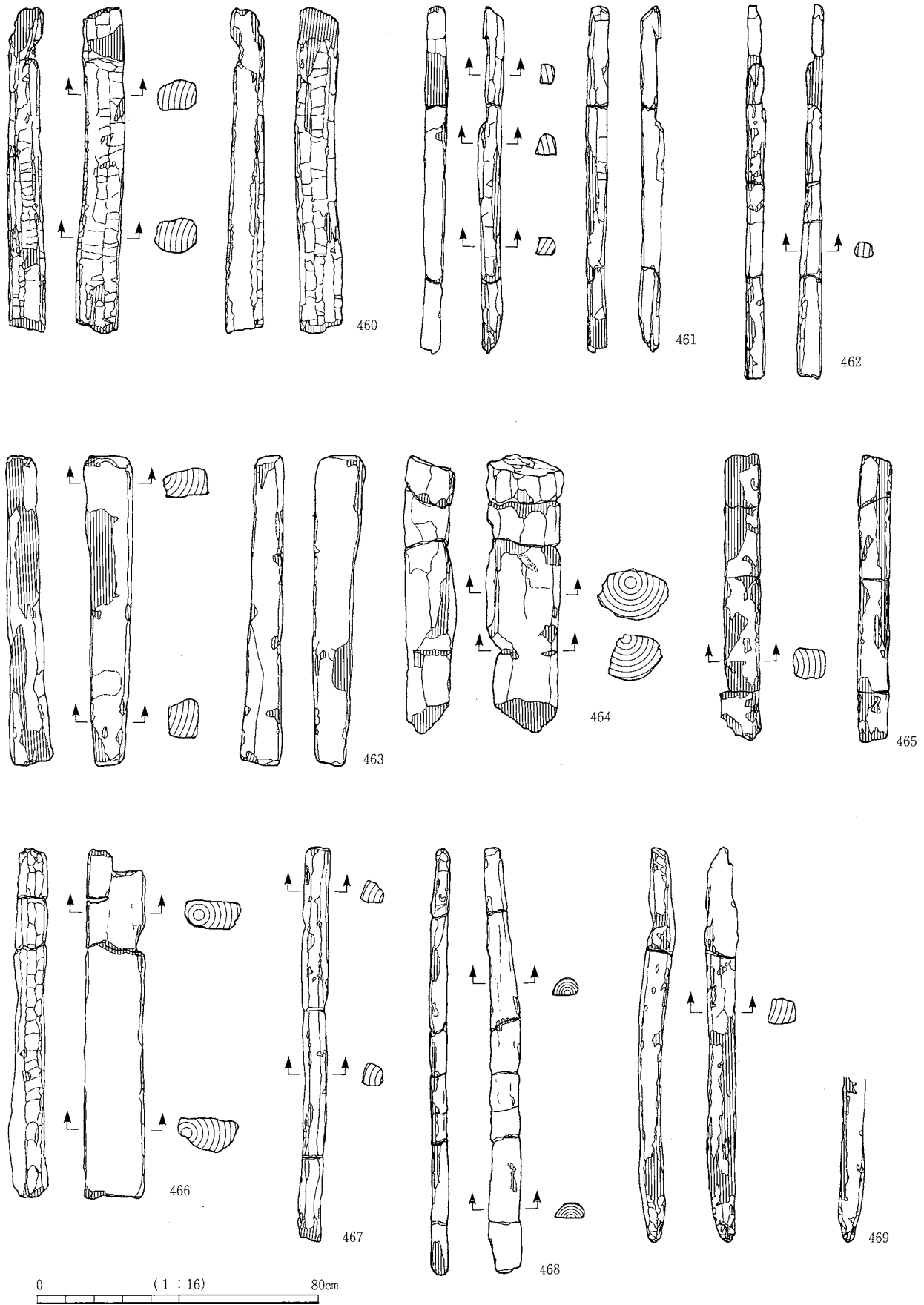

用途不明材 3

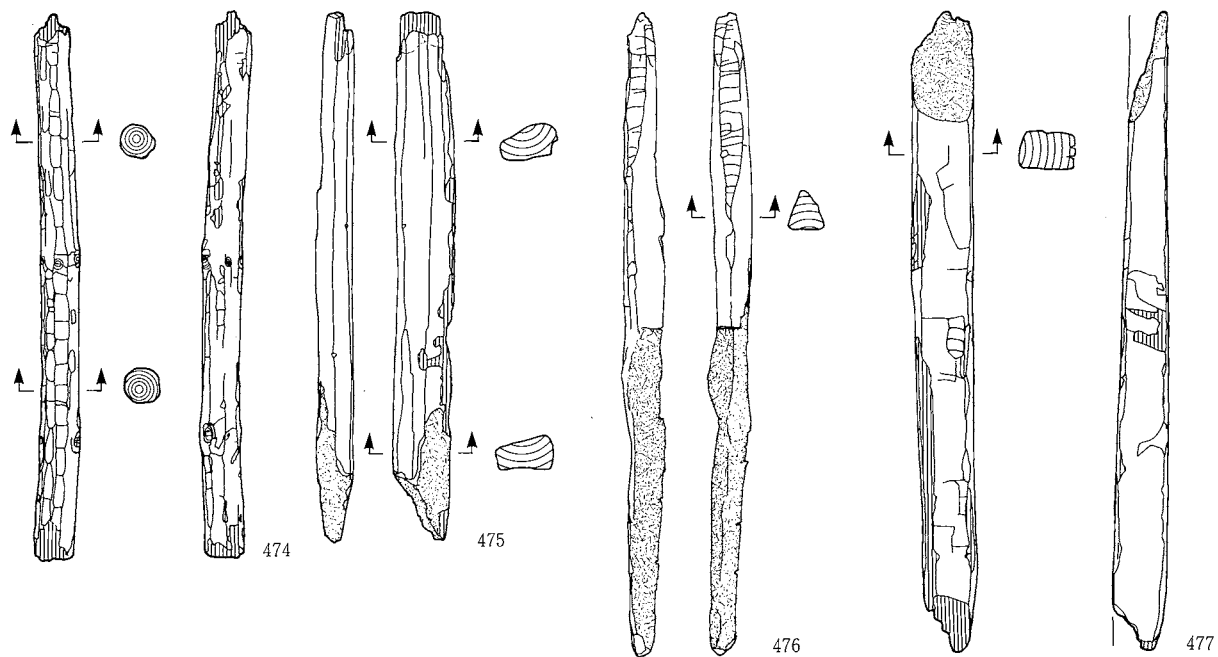
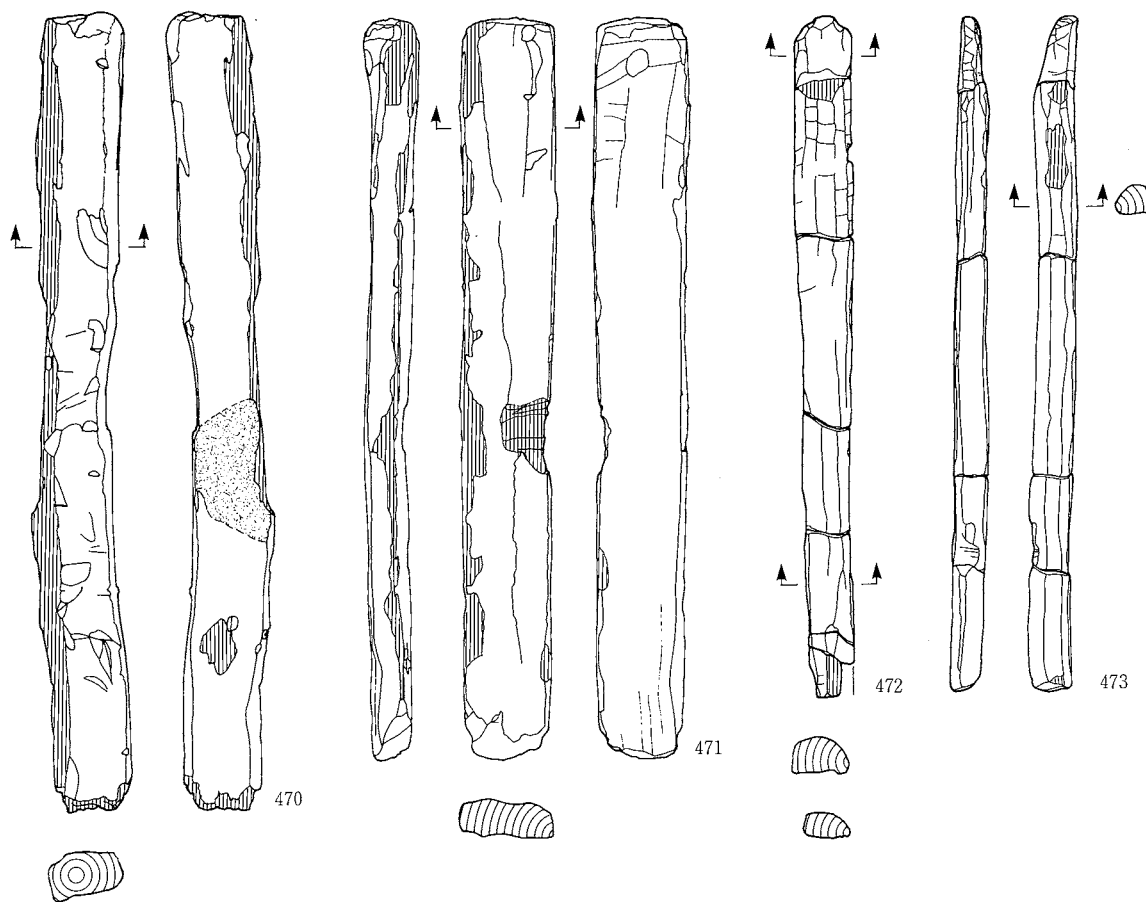

0 (1 : 16) 80cm

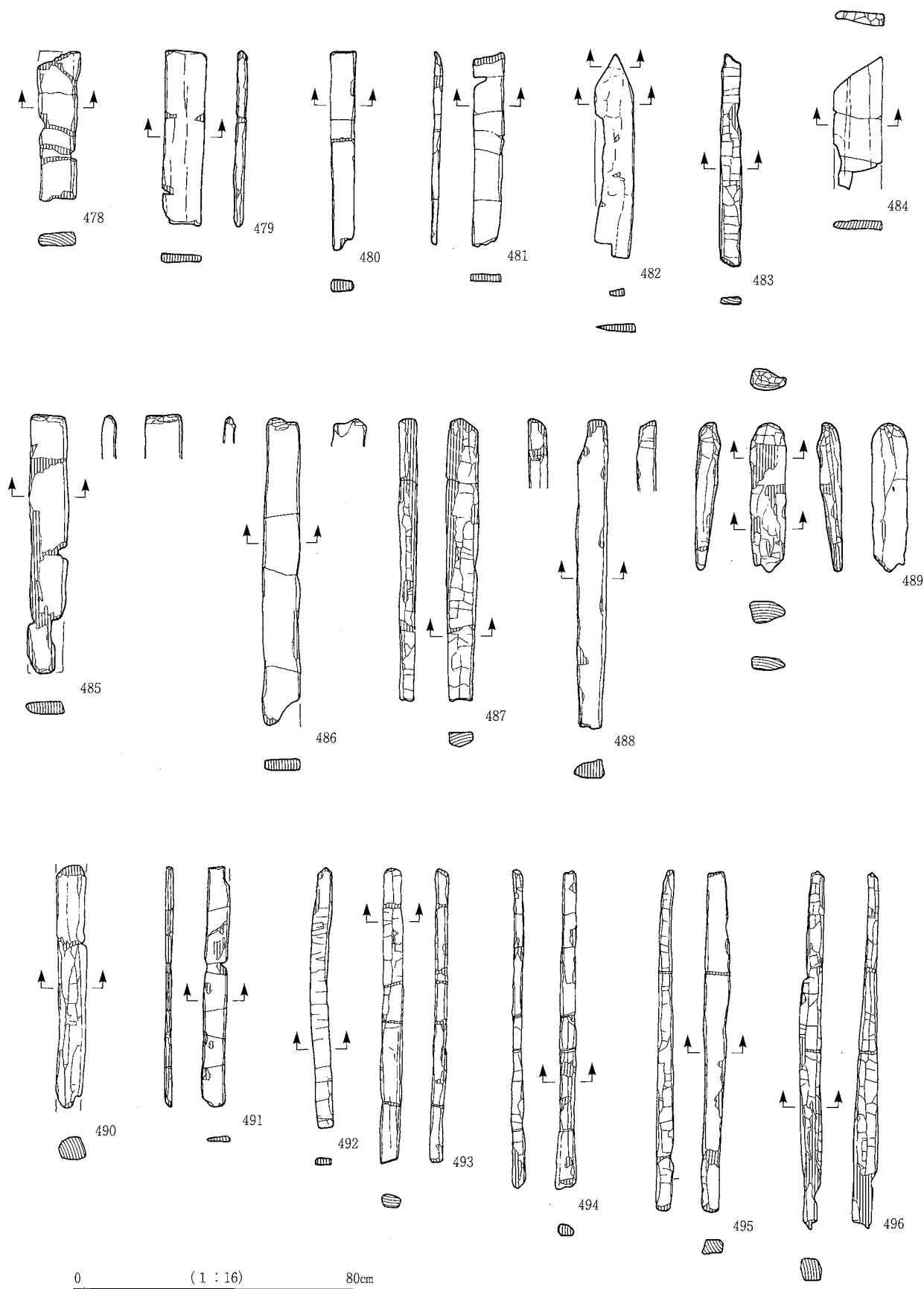

用途不明材 5

弥生時代中期

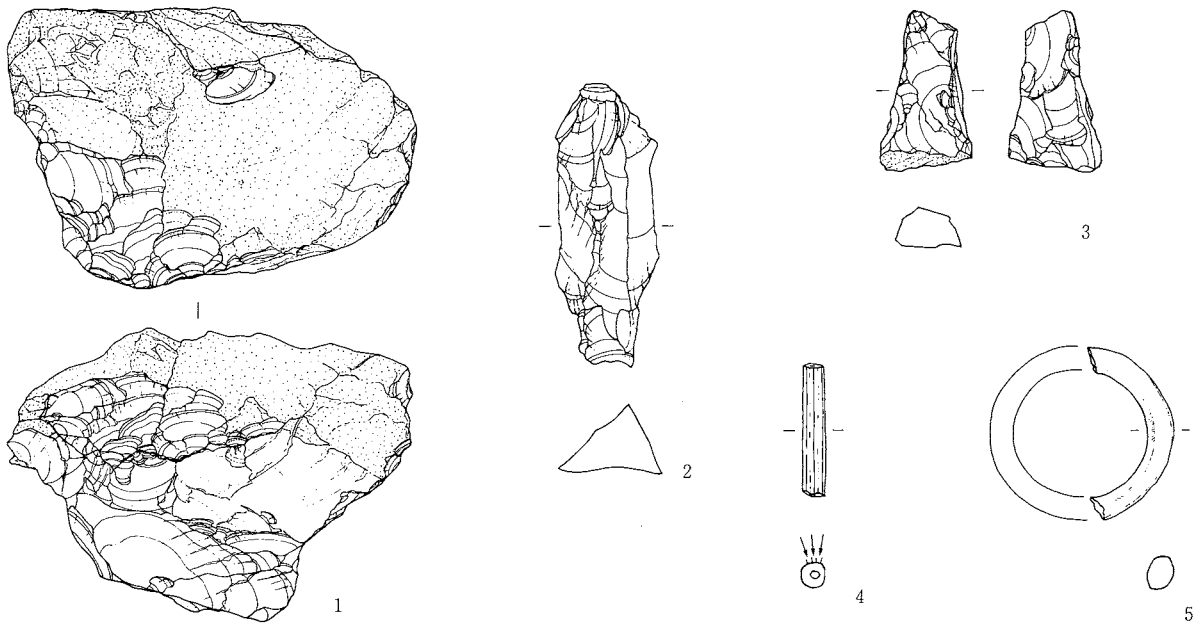

弥生時代後期～古墳時代前期

SB1447出土玉類

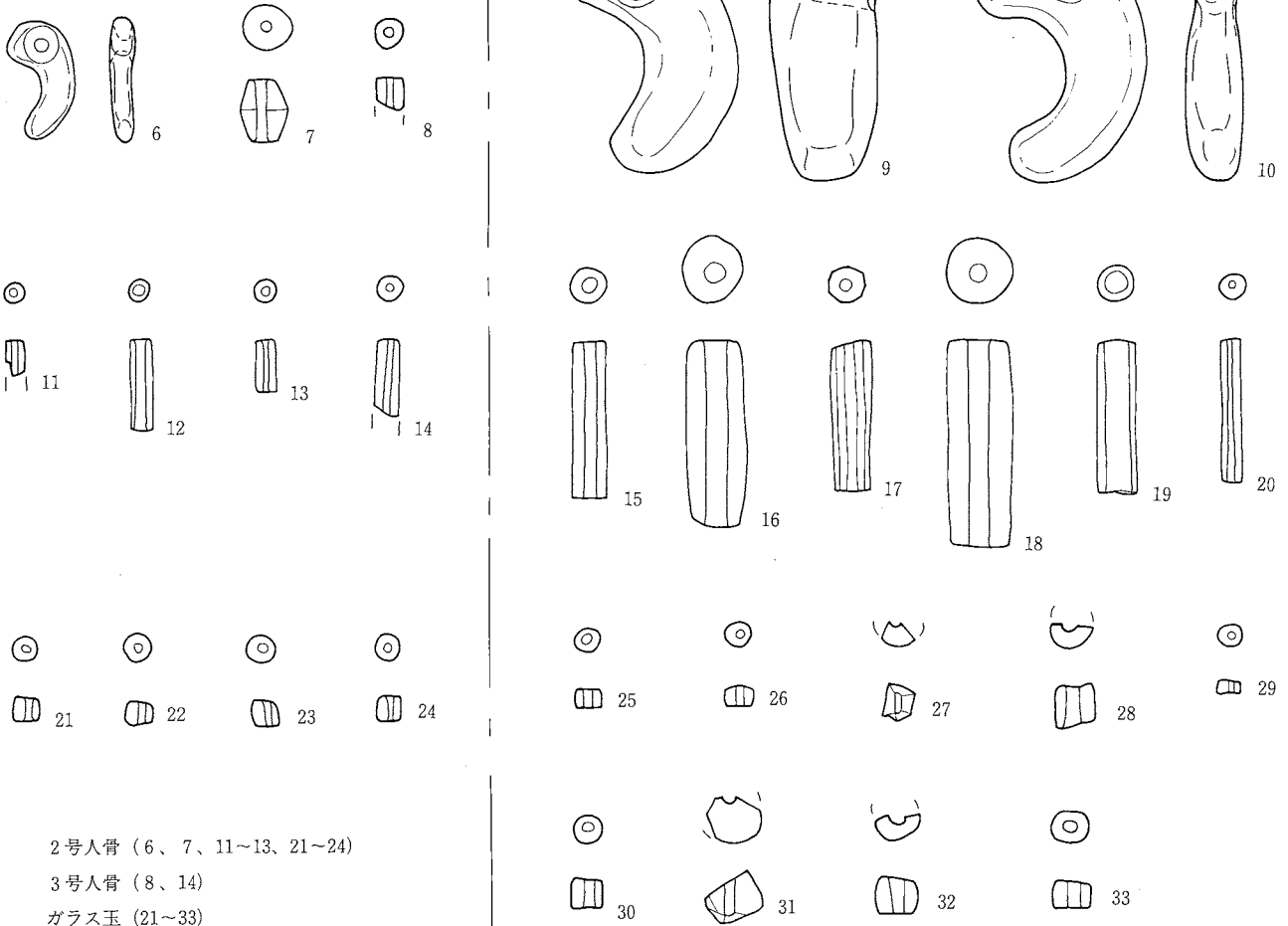

2号人骨 (6、7、11～13、21～24)

3号人骨 (8、14)

ガラス玉 (21～33)

0 (1:1) 5 cm

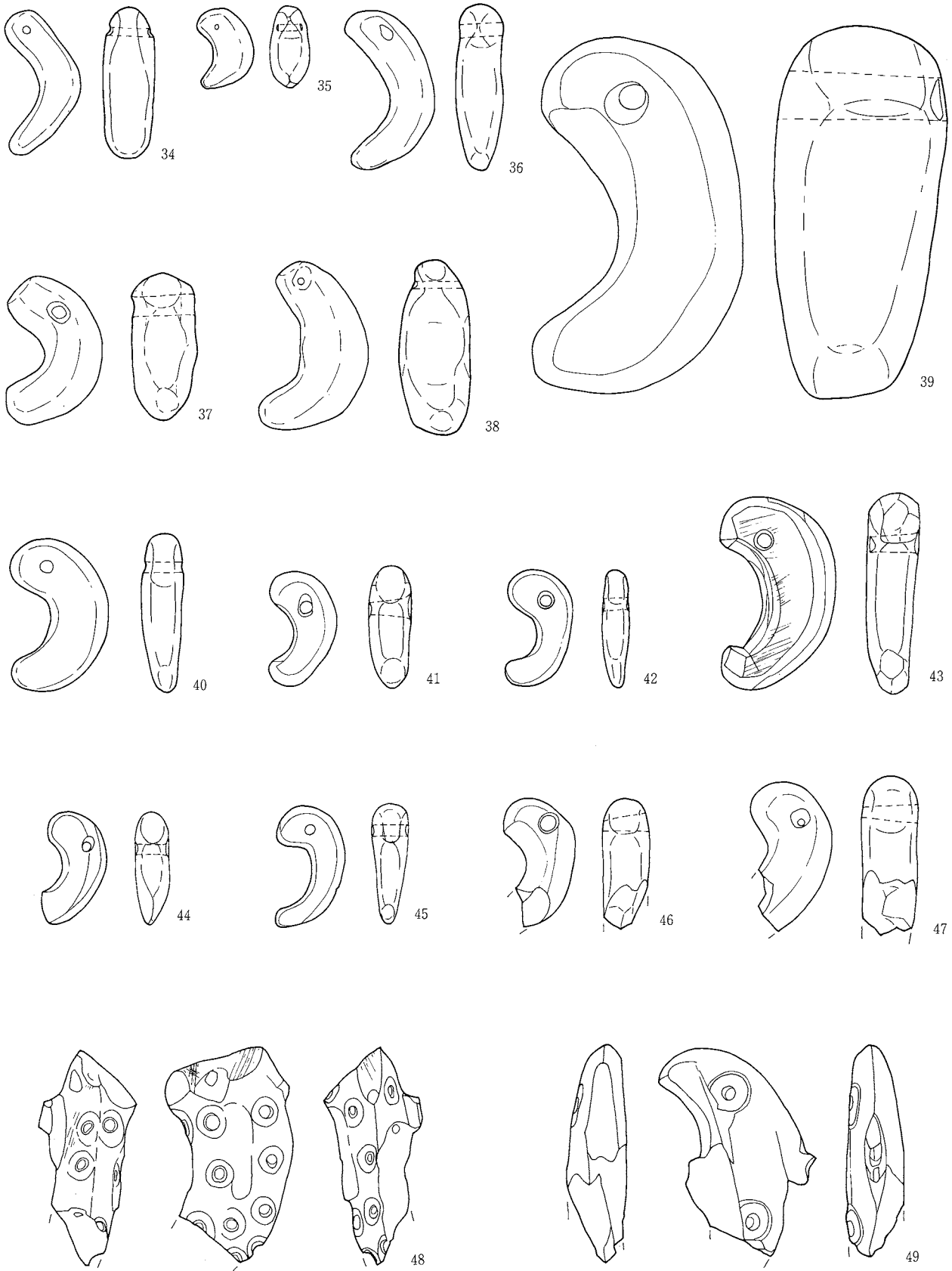

0 (1:1) 5 cm

勾玉

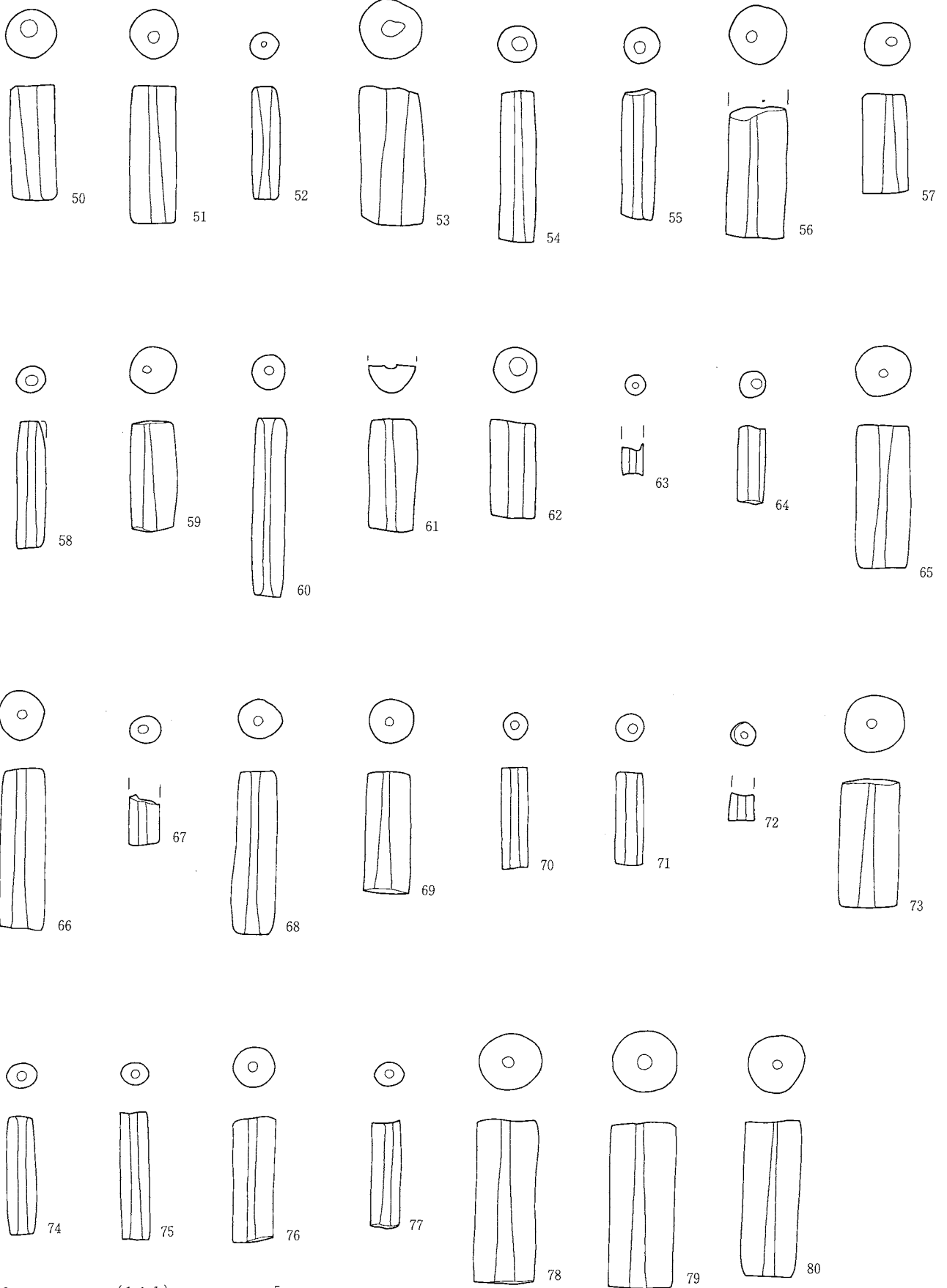

管玉

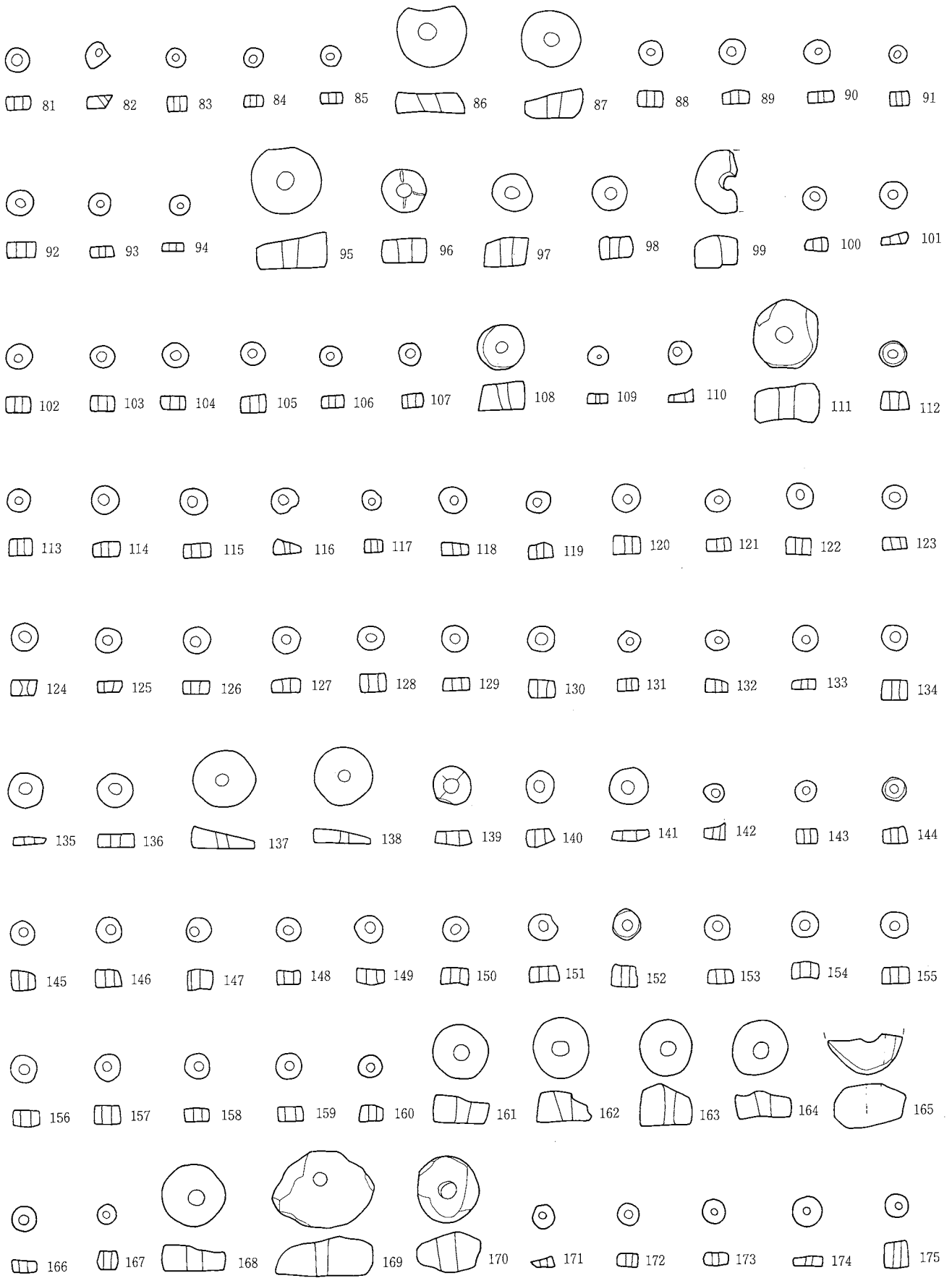

0 (1:1) 5 cm

白玉

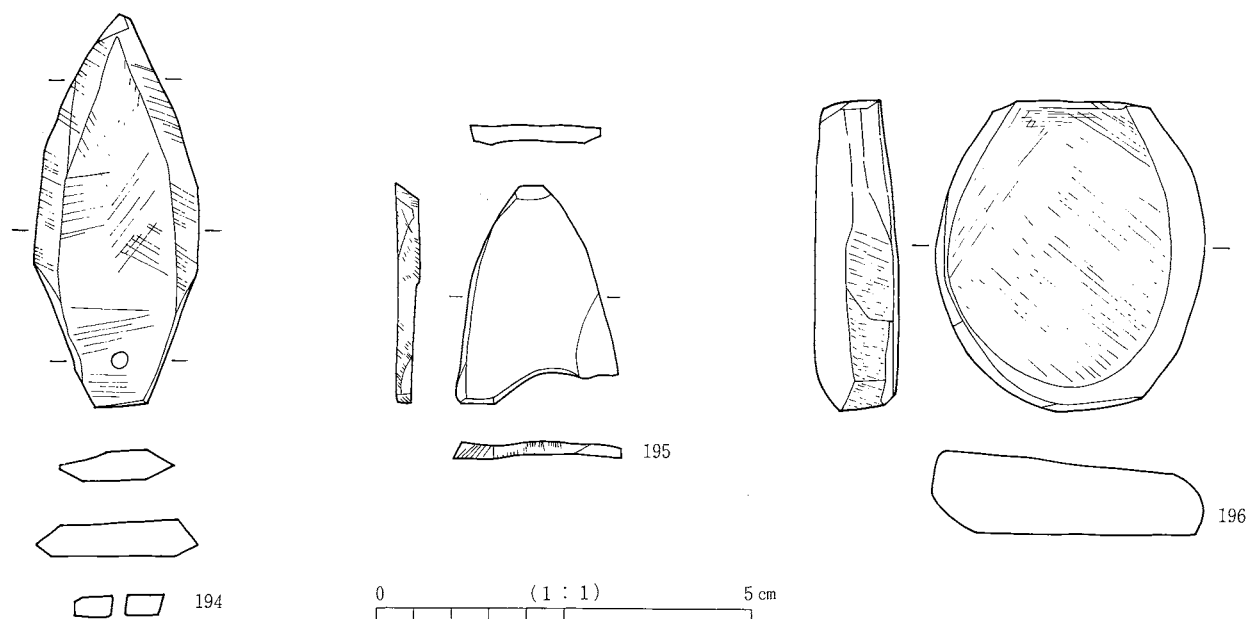
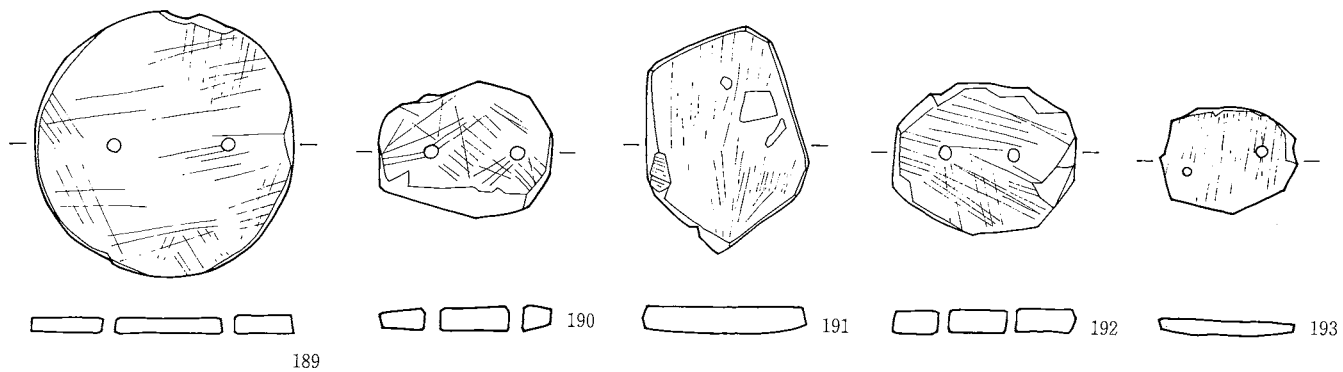
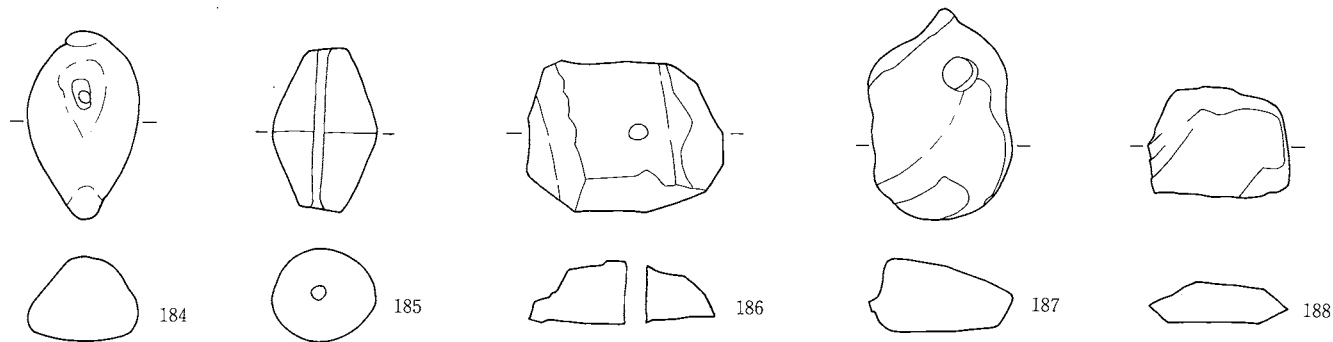
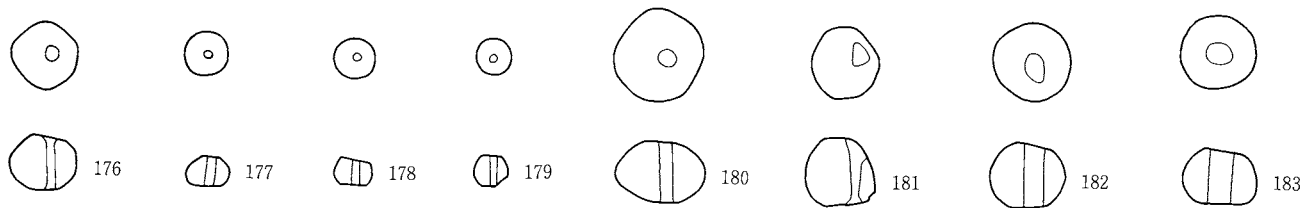

0 (1:1) 5 cm

石製模造品他

弥生時代中期

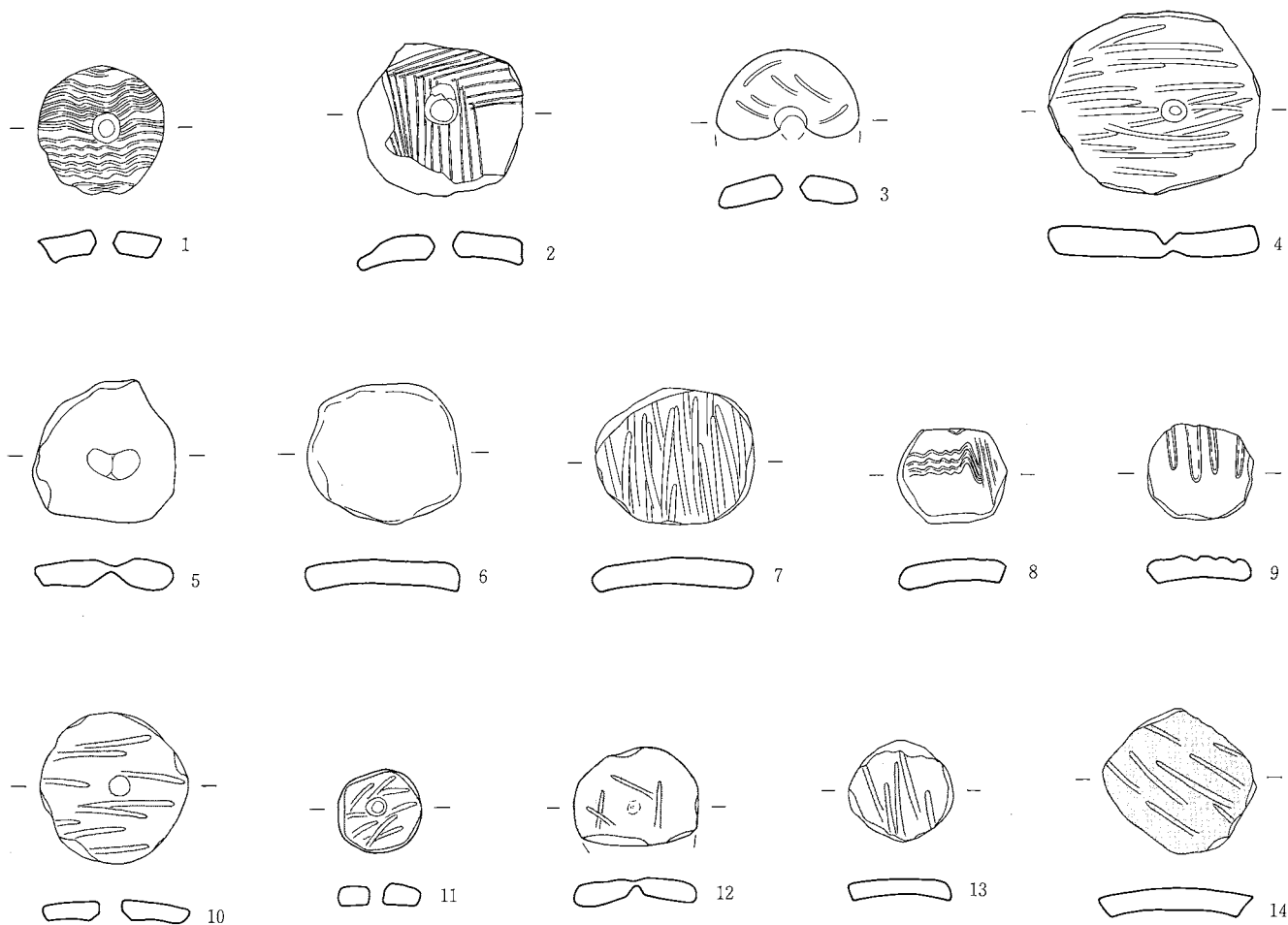

弥生時代後期～古墳時代前期

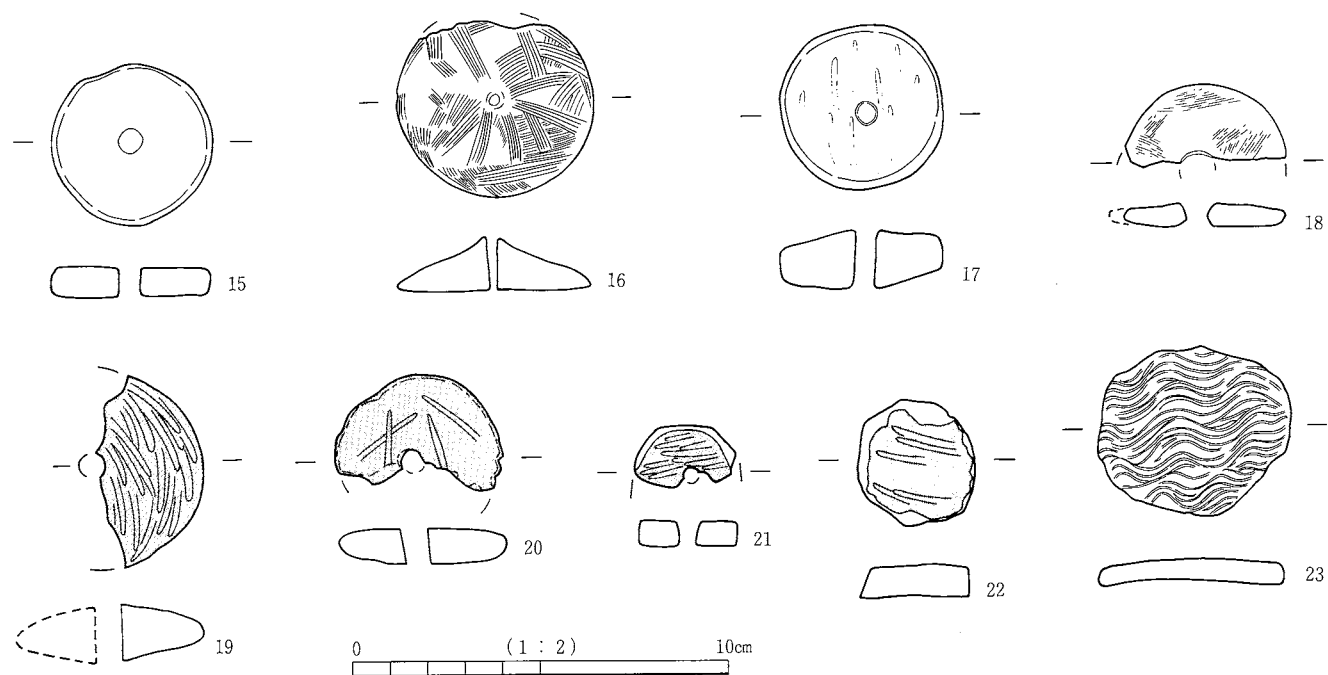

紡錘車

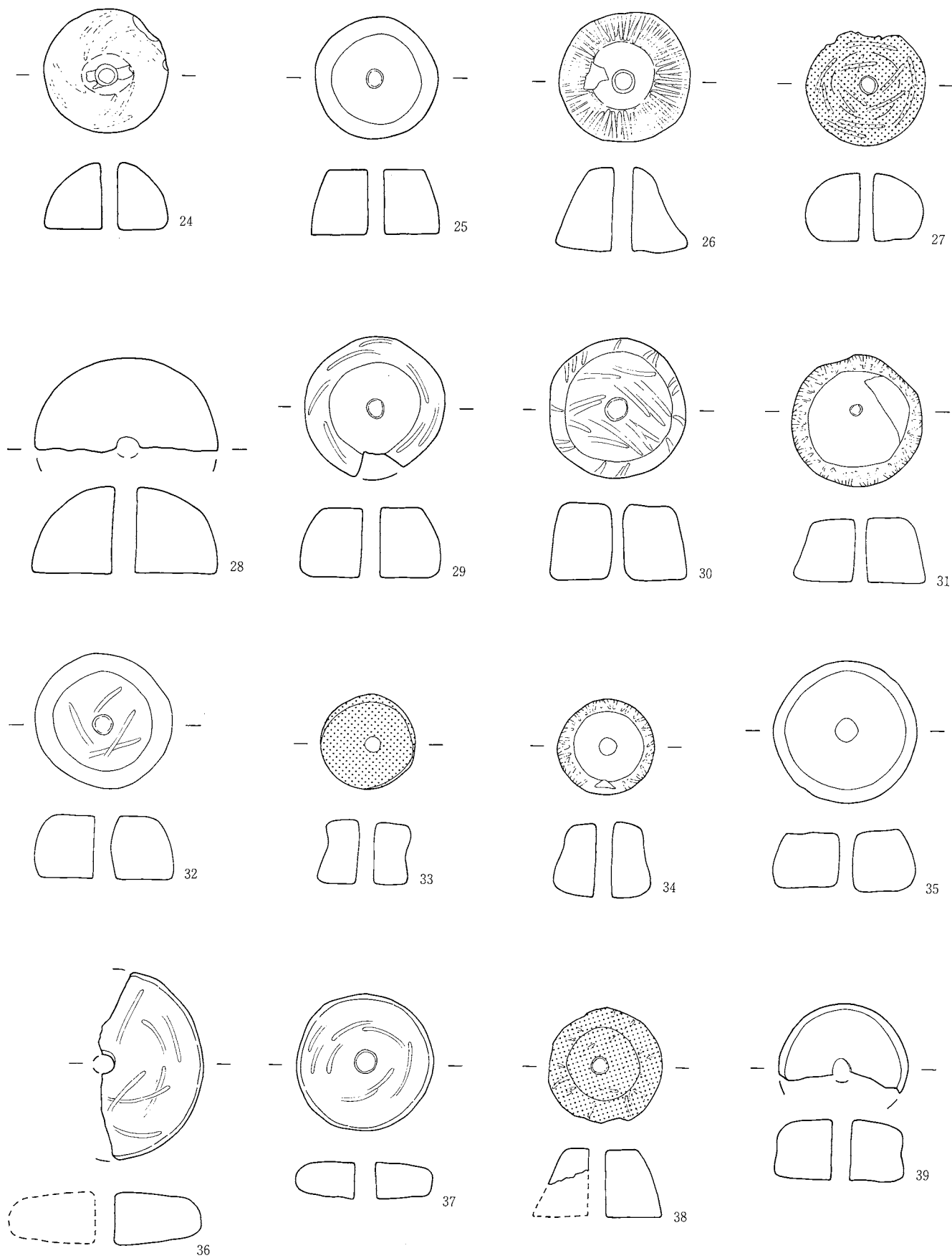

0 (1 : 2) 10cm

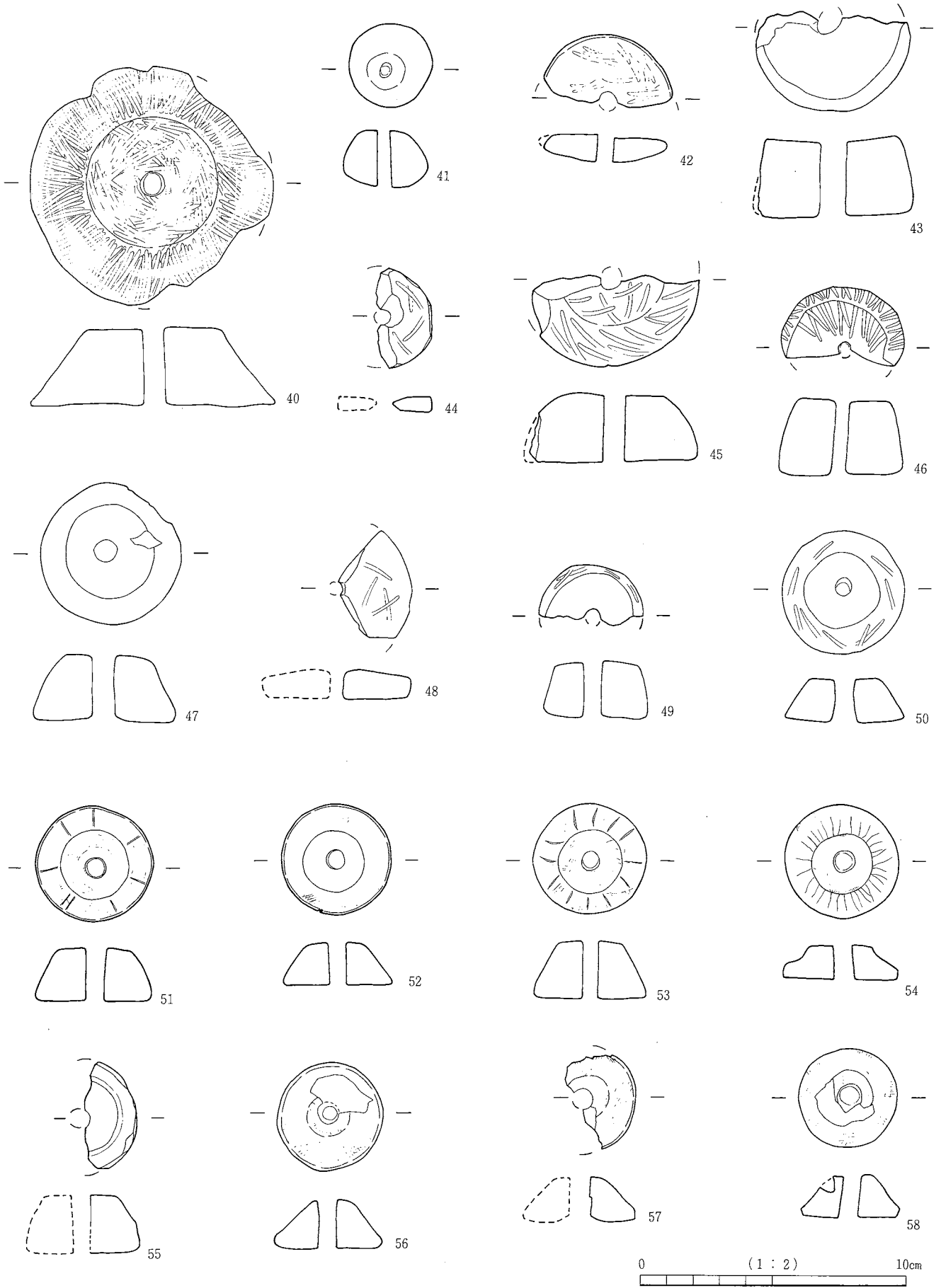

土製紡錘車 (40~50)

石製紡錘車 (51~58)

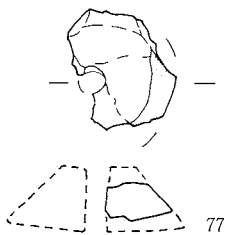
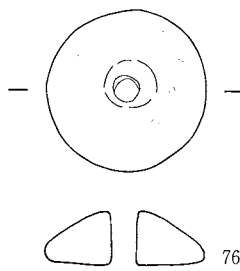
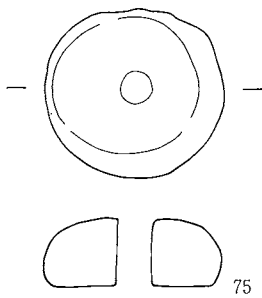
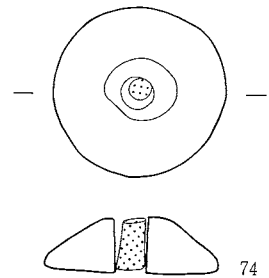
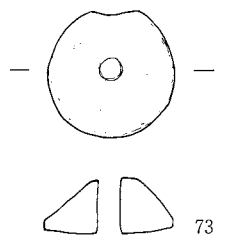
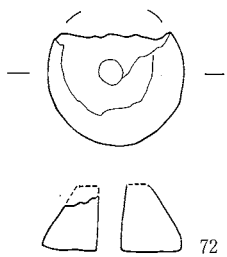
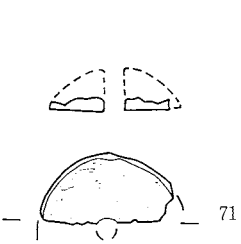
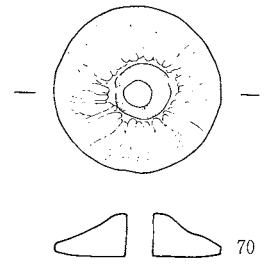
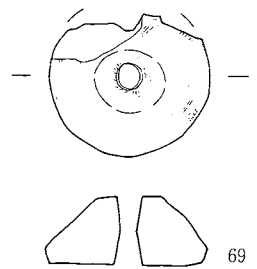
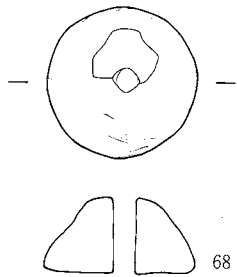
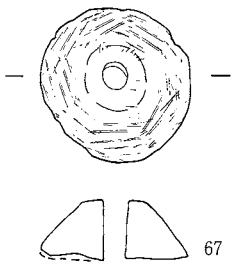
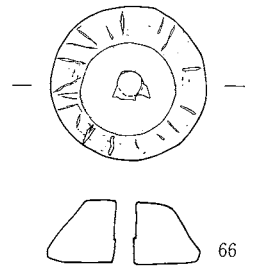
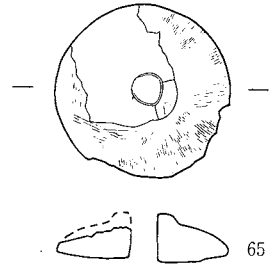
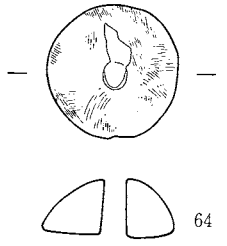
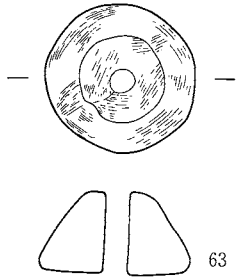
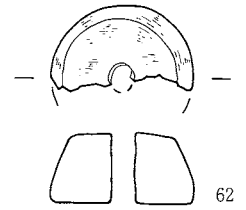
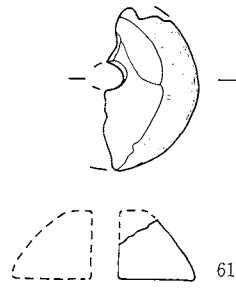
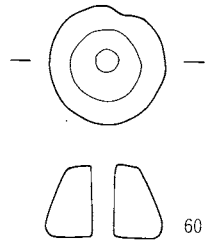
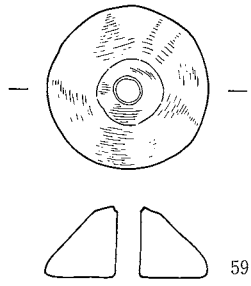

0 (1 : 2) 10cm

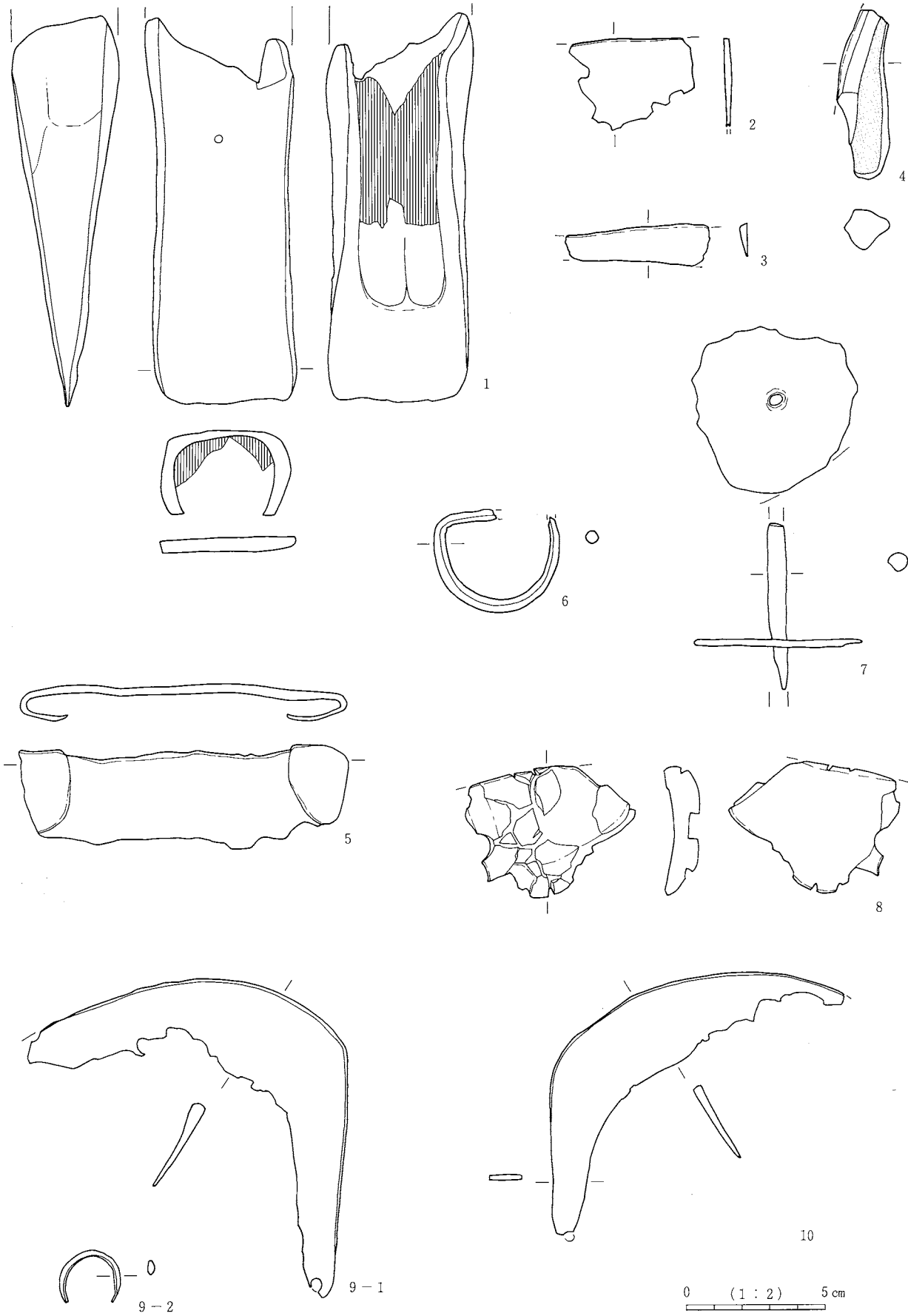

鉄製品

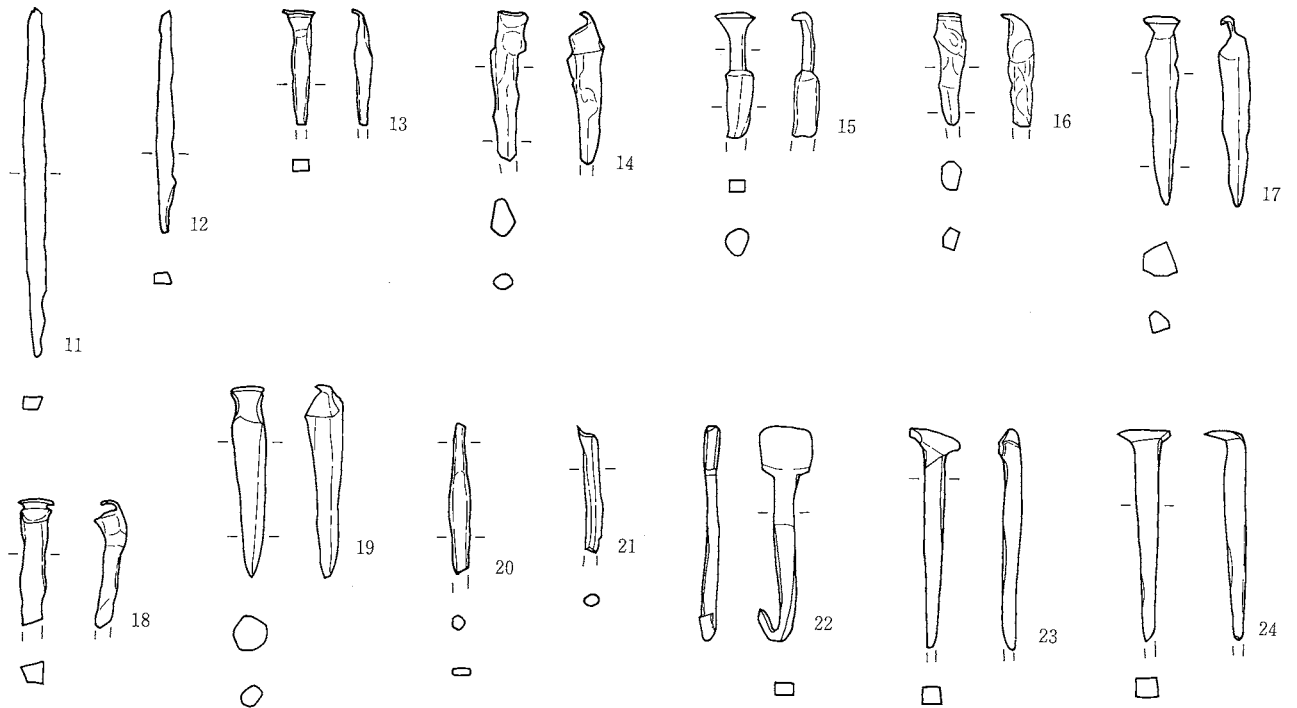

0 (1 : 2) 5 cm

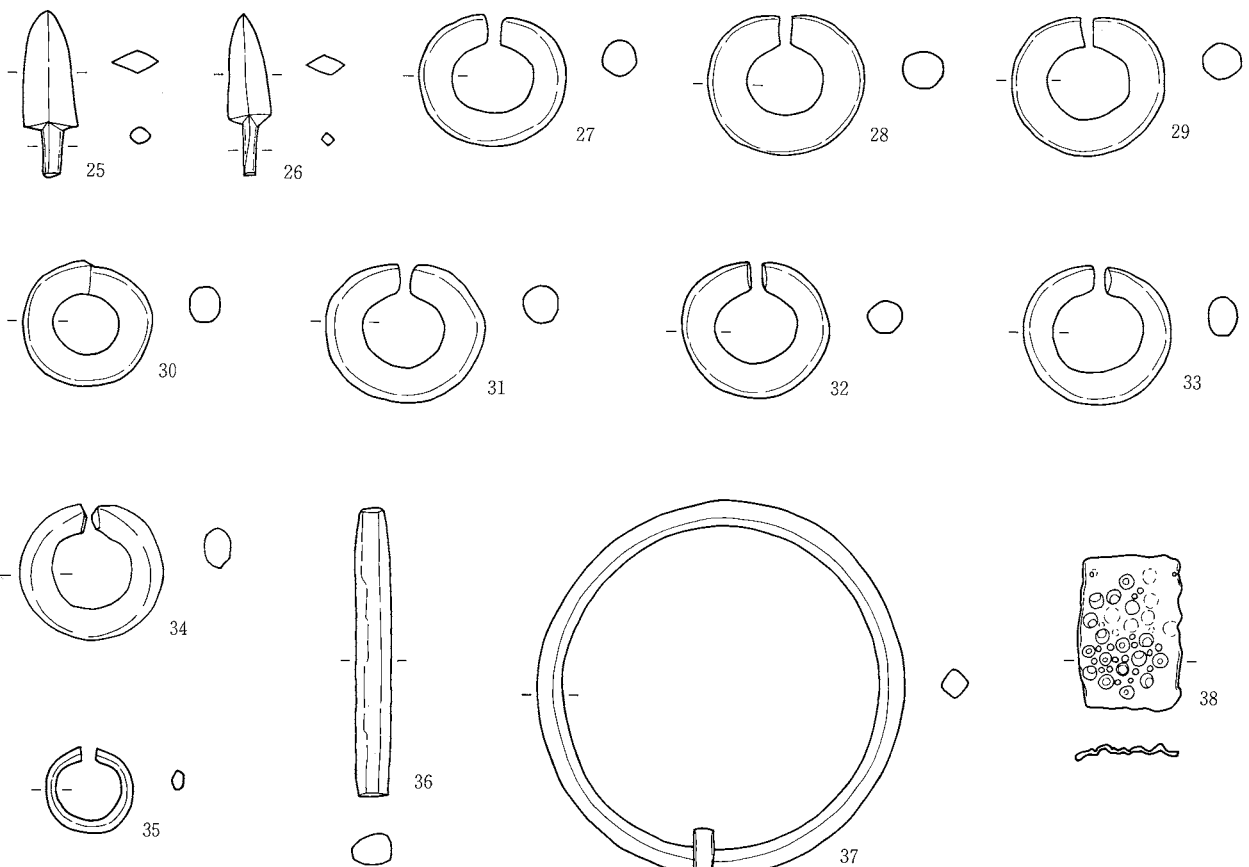

0 (2 : 3) 5 cm

鉄製品 (11~24) 銅製品 (25~38)

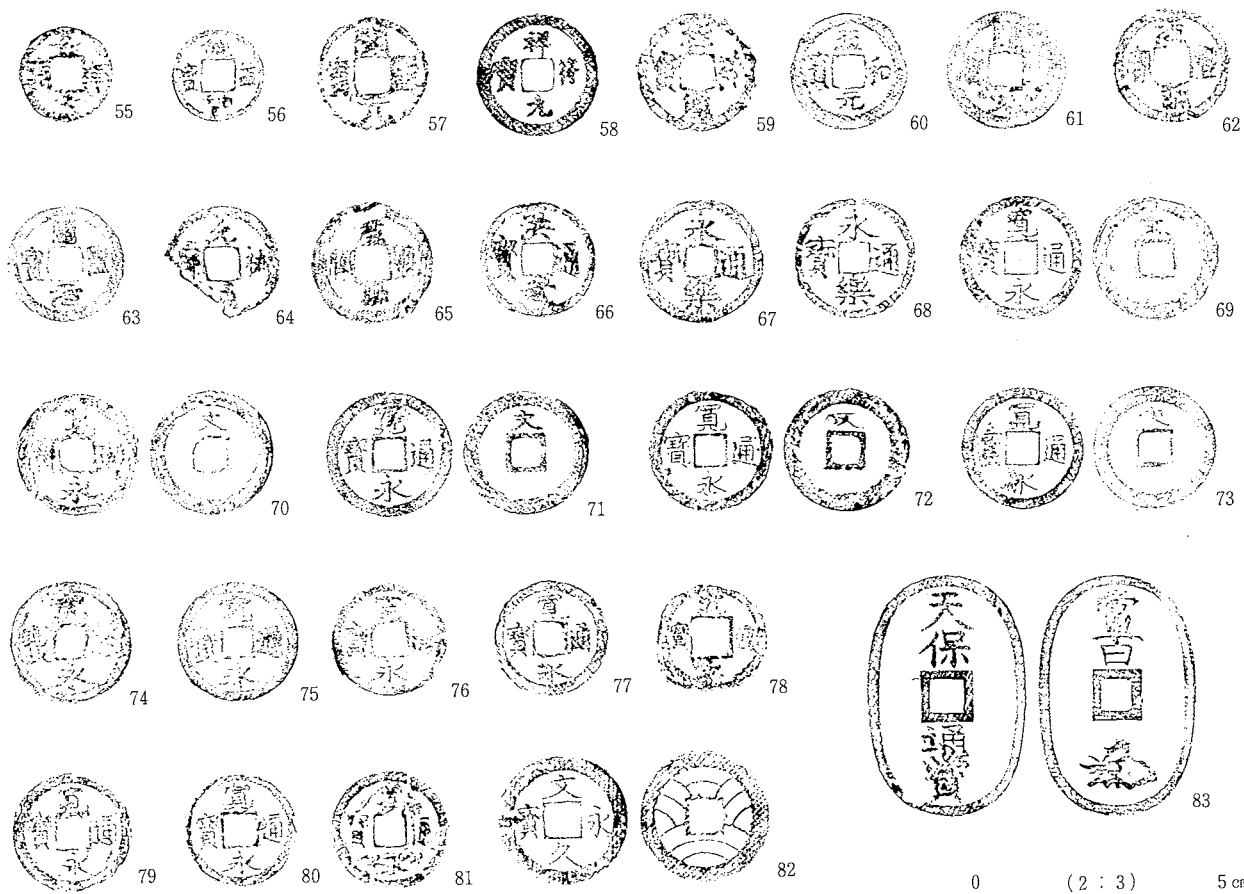
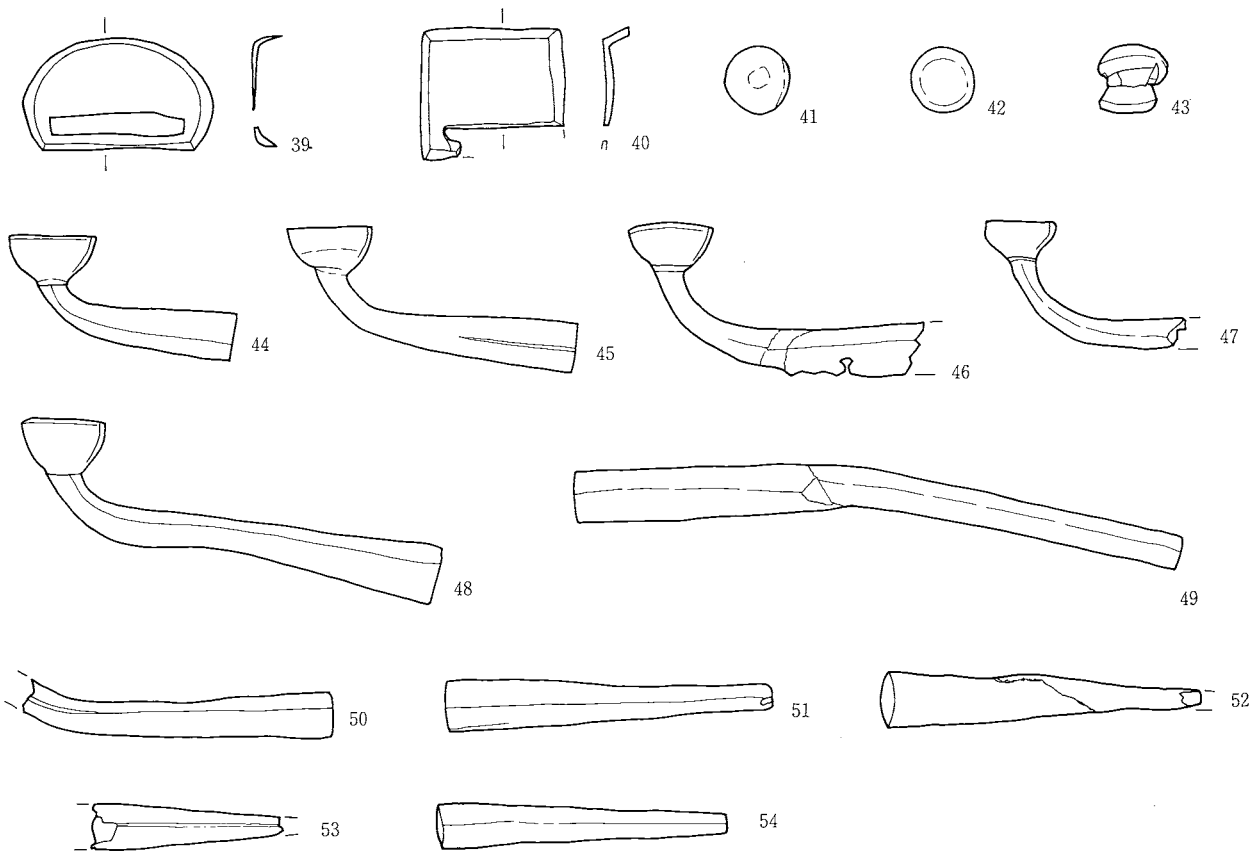

銅製品 (39~54) 古銭 (55~83)

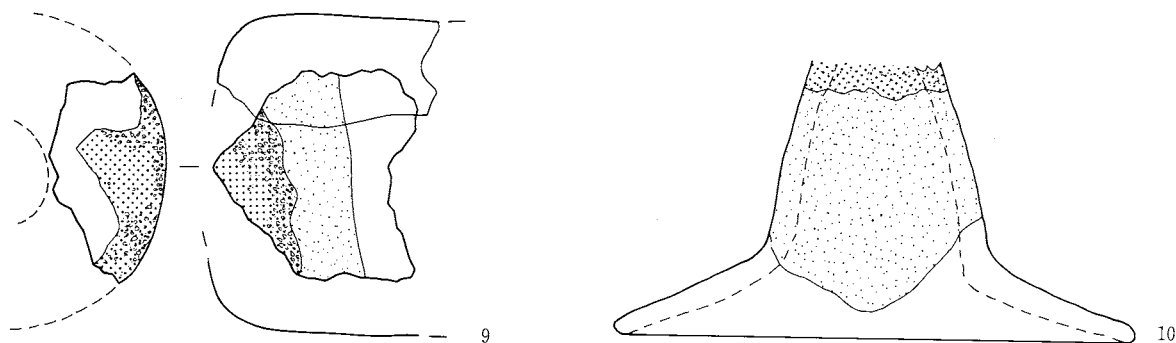
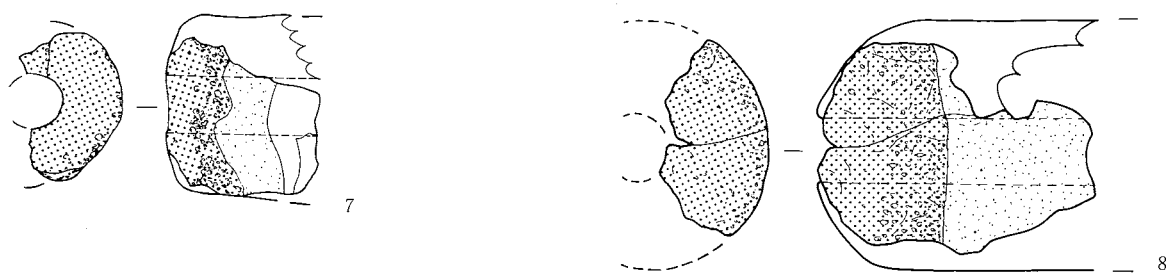
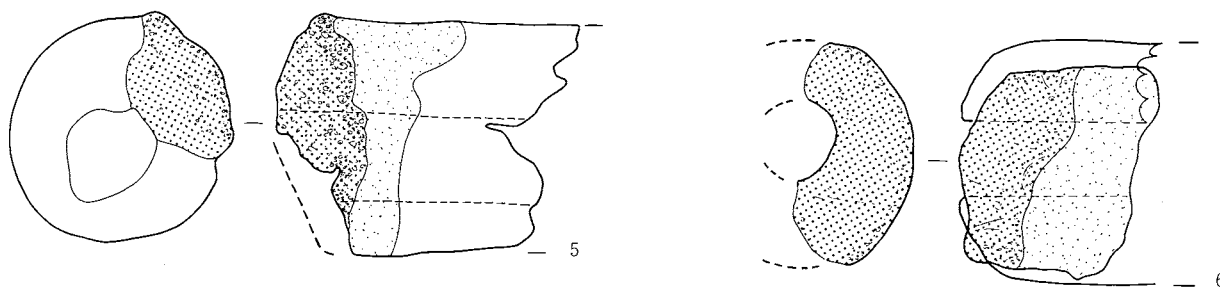
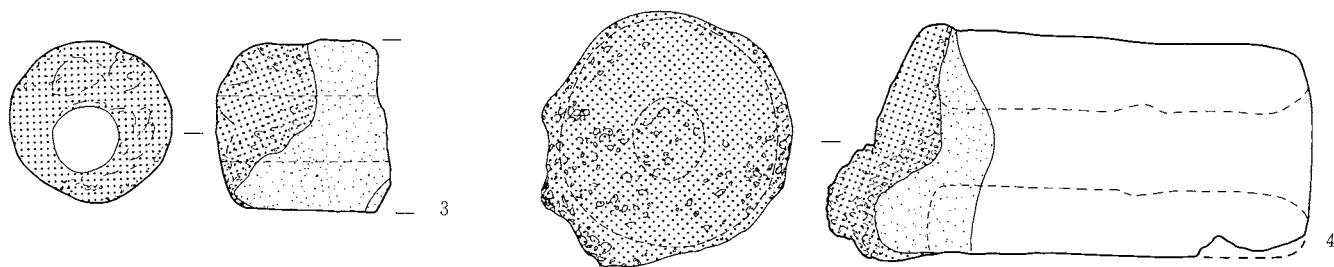
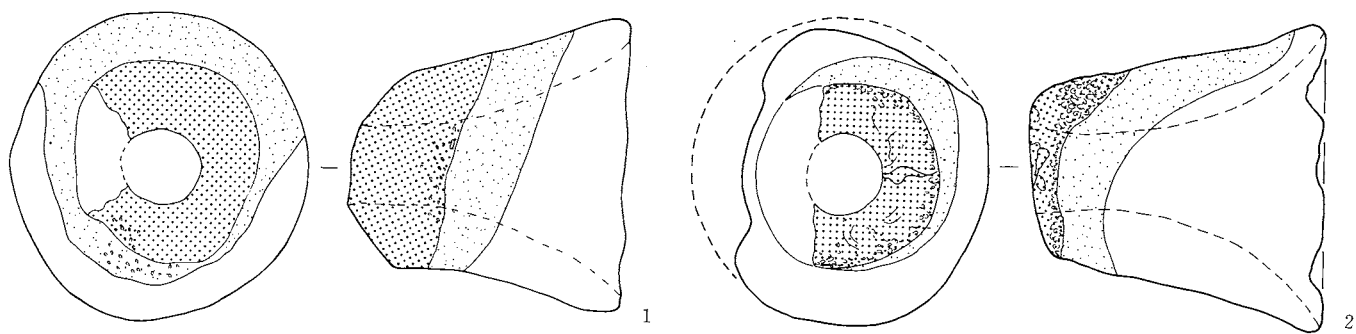

0 (1:2) 10cm

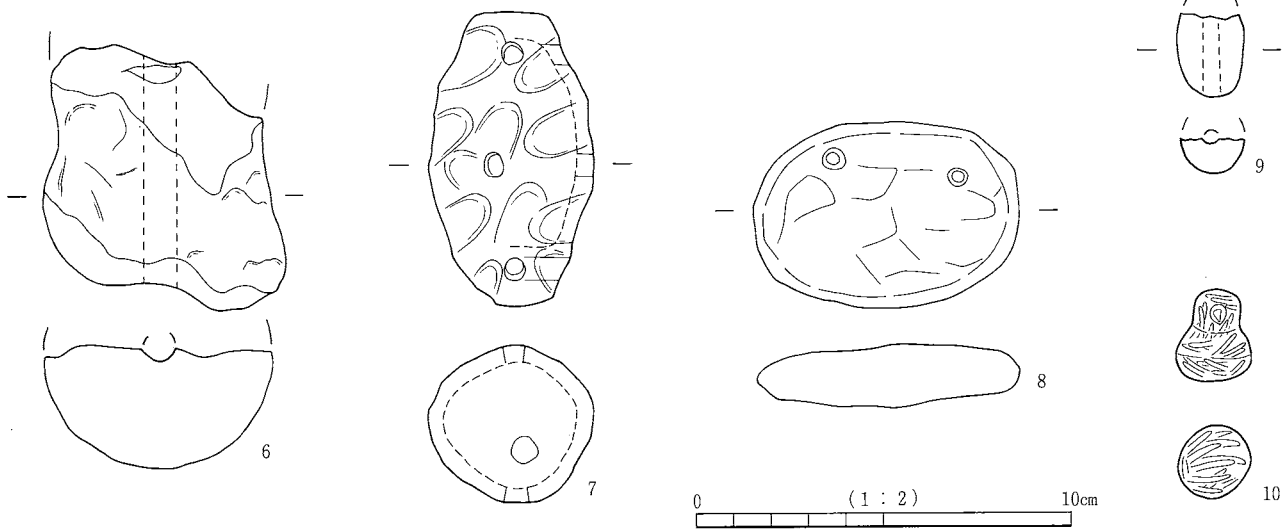
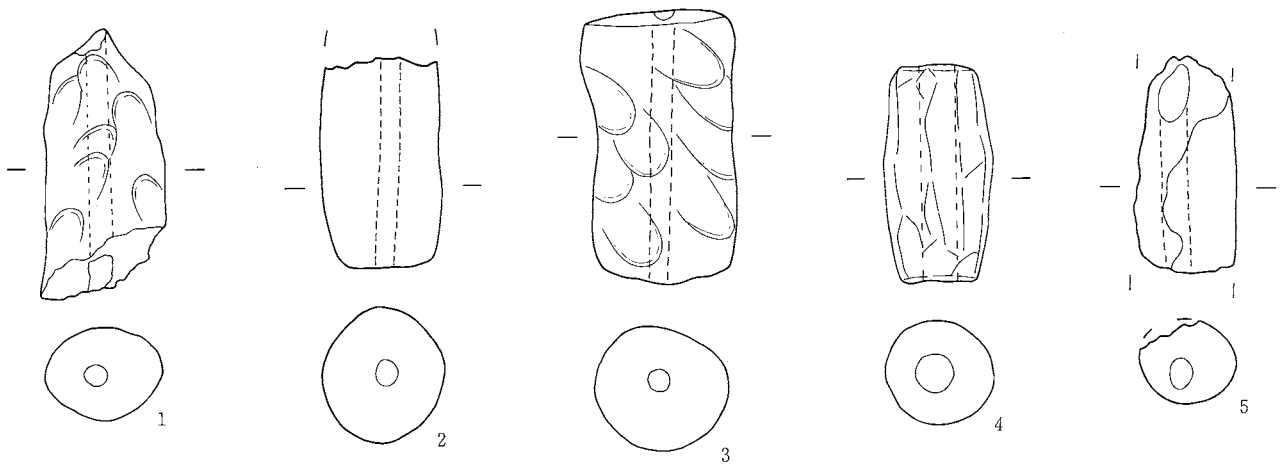
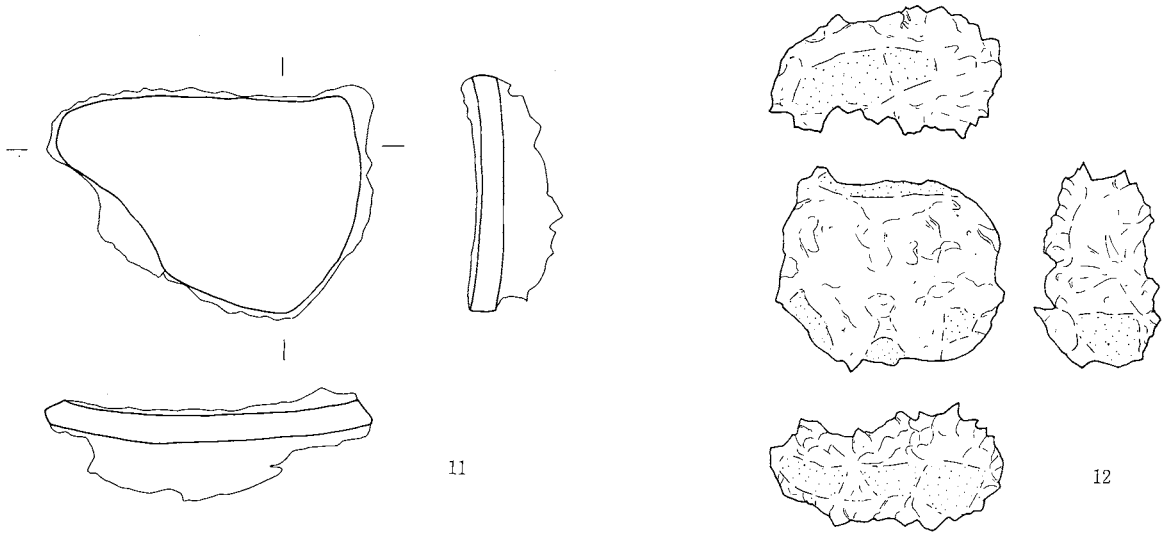

板状鉄滓(11) 碗形滓(12) 土錘(1~6,9) 土製品(7,8,10)

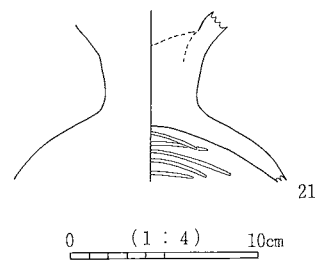
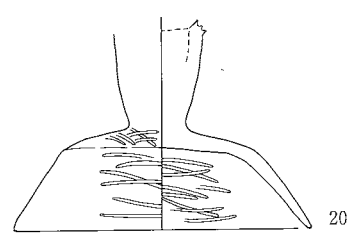
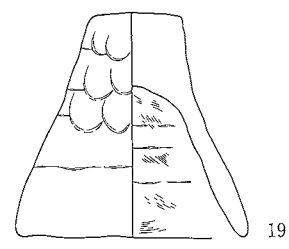
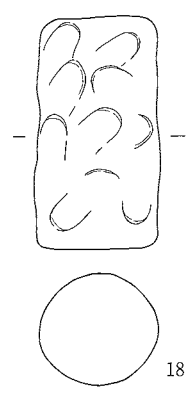
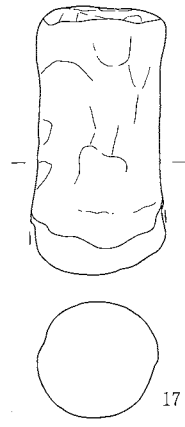
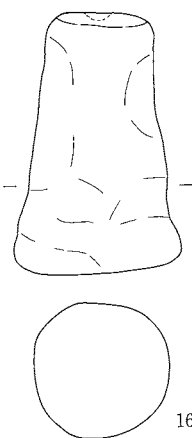
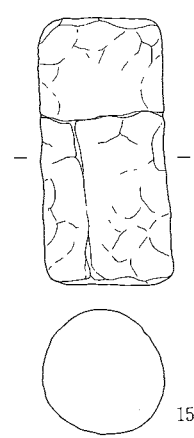
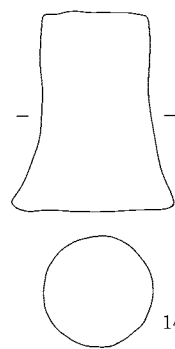
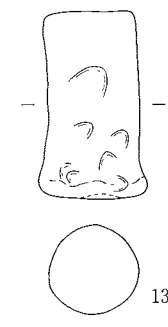
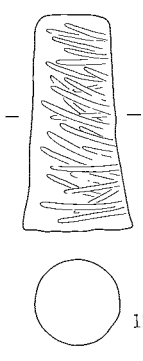
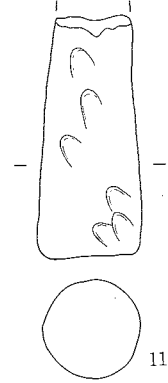
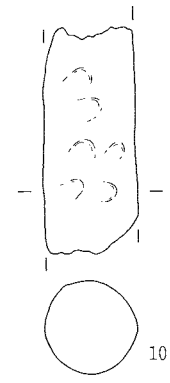
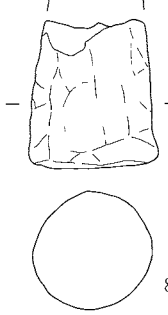
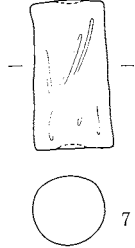
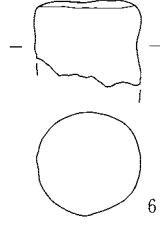
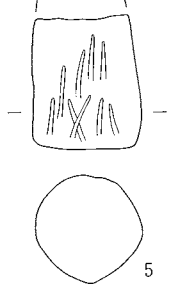
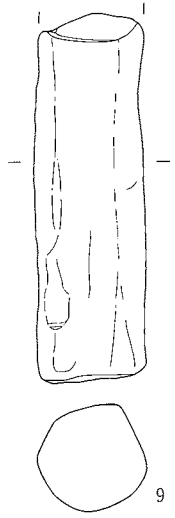
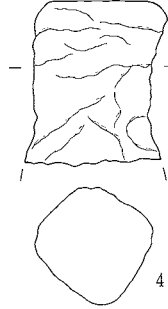
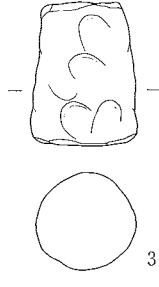
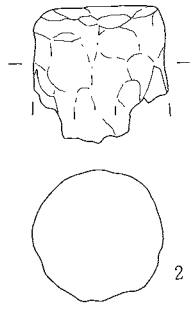
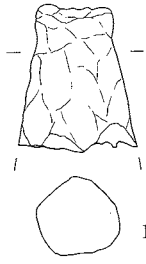

0 (1 : 4) 10cm

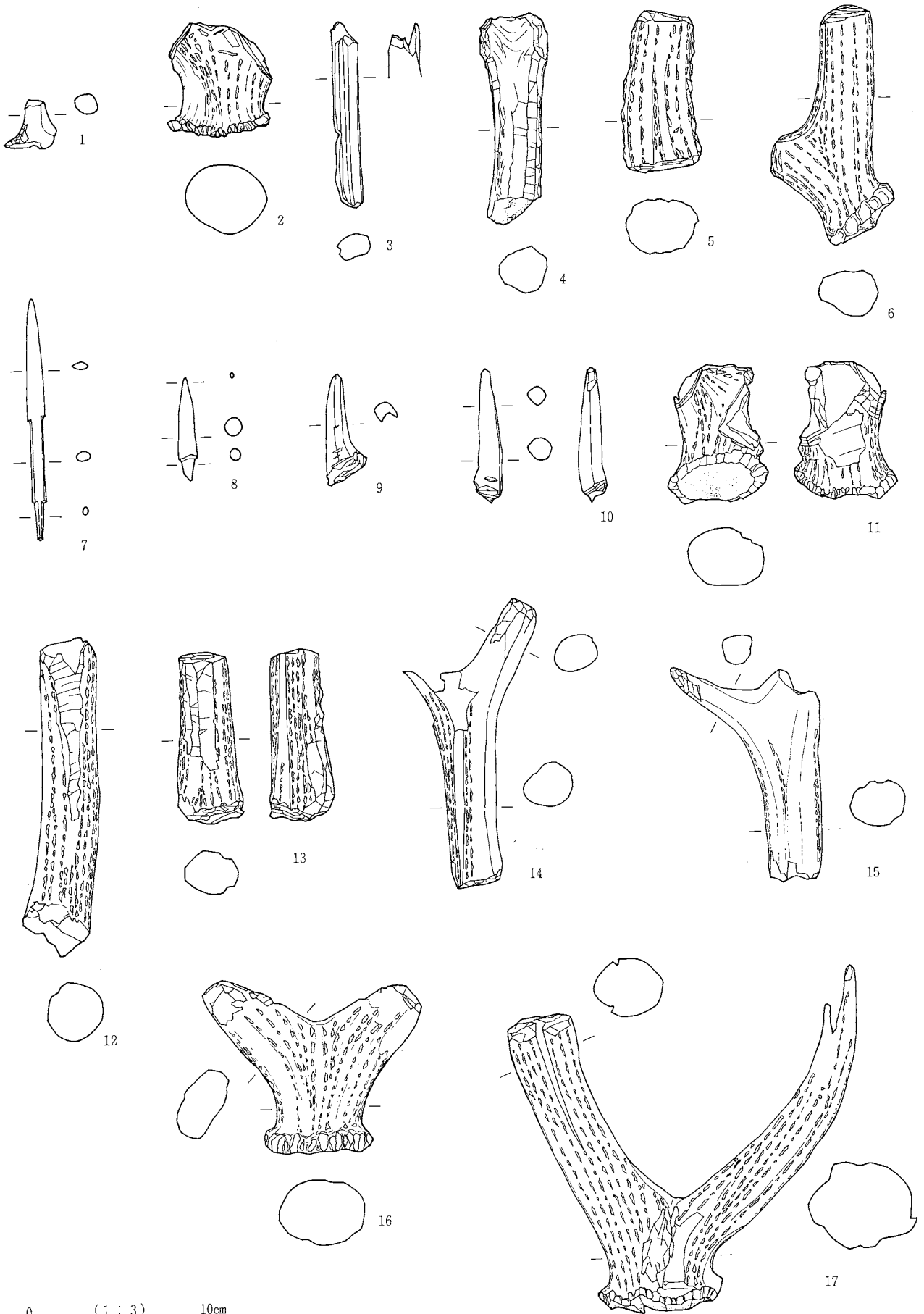

0 (1 : 3) 10cm

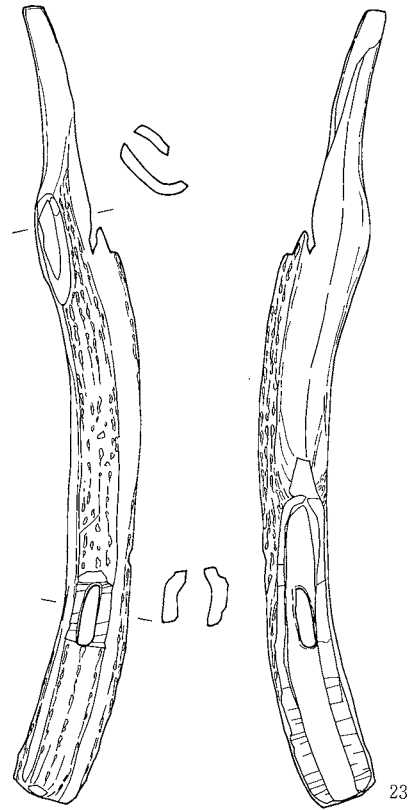
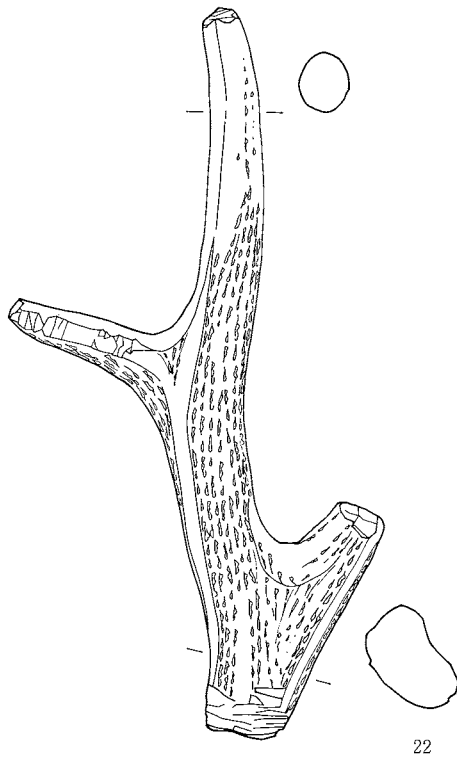
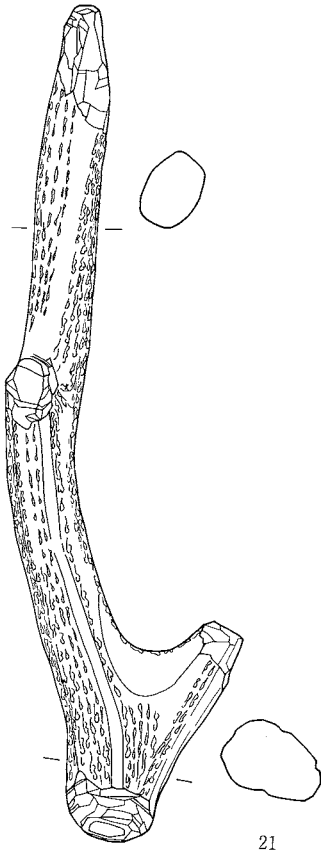
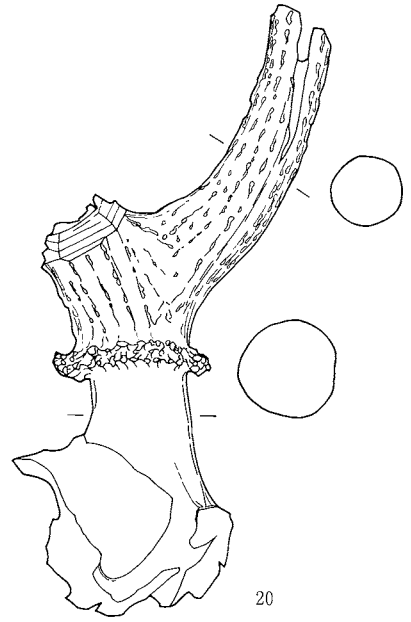
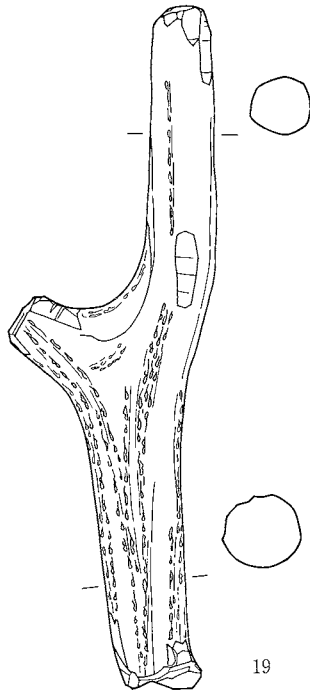
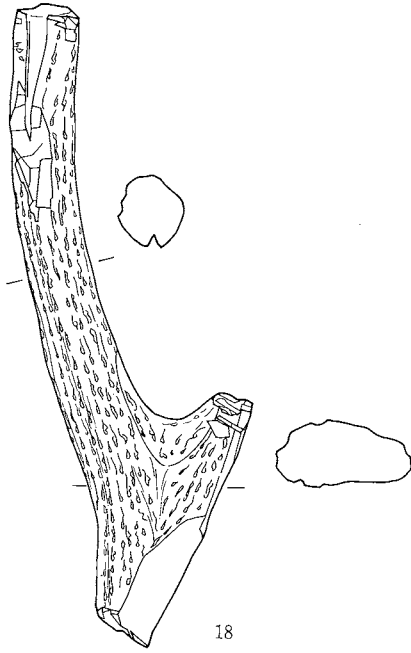



〔窳〕
 窳
 窳
 窳

243 × 20 × 4 051 (2005) 柱目
 S G 3 田層

裏 調整痕跡 表

0 (1:1) 5 cm

長野県埋蔵文化財センター発掘調査報告書 37

上信越自動車道埋蔵文化財発掘調査報告書12

—長野市内その10—

榎田遺跡

第3分冊（遺物図版）

発行	平成 11 (1999) 年 3 月 31 日
発行者	日 本 道 路 公 団 長 野 県 教 育 委 員 会 長 野 県 埋 蔵 文 化 財 セ ン タ ー TEL 026-274-3891 FAX 274-3892
印刷	信 毎 書 籍 印 刷 株 式 会 社 TEL 026-243-2105 FAX 243-3494

