

上信越自動車道  
埋蔵文化財発掘調査報告書 5

—— 長野市内 その3 ——

**松 原 遺 跡**

**弥生・総論 4**

**弥生中期・土器図版**

1998

日 本 道 路 公 団  
長 野 県 教 育 委 員 会  
長 野 県 埋 蔵 文 化 財 セ ン タ ー

上信越自動車道  
埋蔵文化財発掘調査報告書 5

— 長野市内 その3 —

**松 原 遺 跡**

**弥生・総論 4**

**弥生中期・土器図版**

1998

日 本 道 路 公 団  
長 野 県 教 育 委 員 会  
長 野 県 埋 蔵 文 化 財 セ ン タ ー

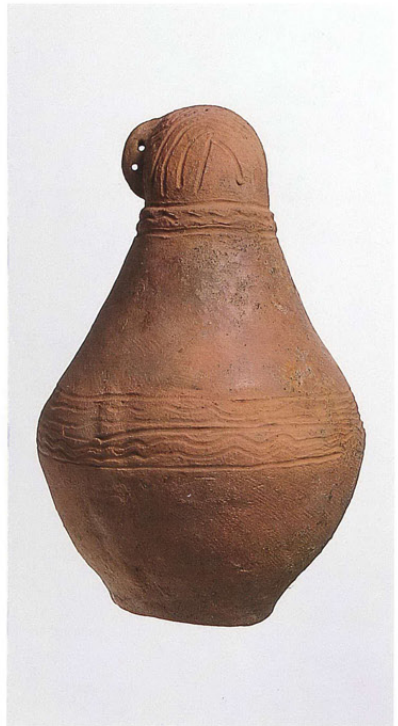
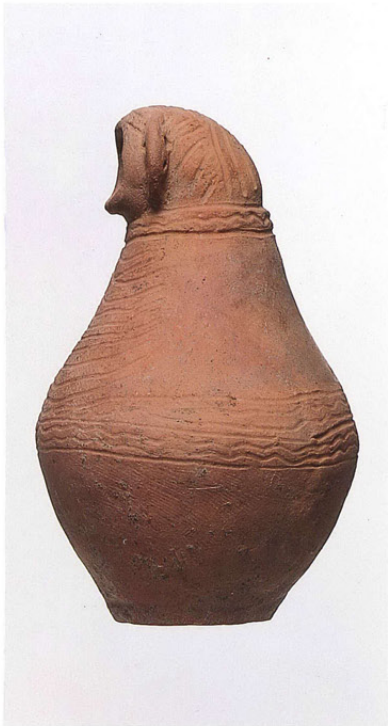

人面付土器



ゆがみ土器

# 第 IV 部

## 弥生時代中期・土器図版

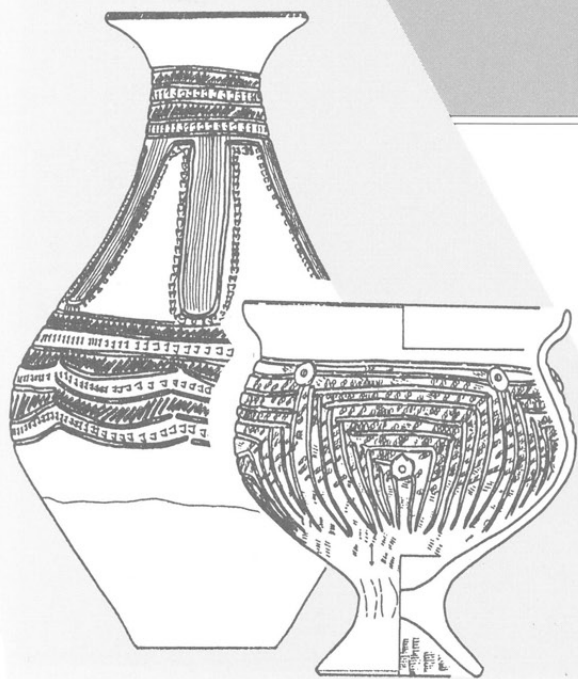

第1分冊	第I部	調査の概要
	第II部	弥生時代中期・遺構 (本文)
第2分冊	第II部	弥生時代中期・遺構 (図版)
第3分冊	第III部	弥生時代中期・土器 (本文)
第4分冊	第IV部	弥生時代中期・土器 (図版)
第5分冊	第V部	弥生時代中期・石器, その他
第6分冊	第VI部	弥生時代後期・古墳時代前期
第7分冊	第VII部	弥生時代・ 考察, 検索
第8分冊	第VIII部	松原遺跡・ 総論, 化学分析

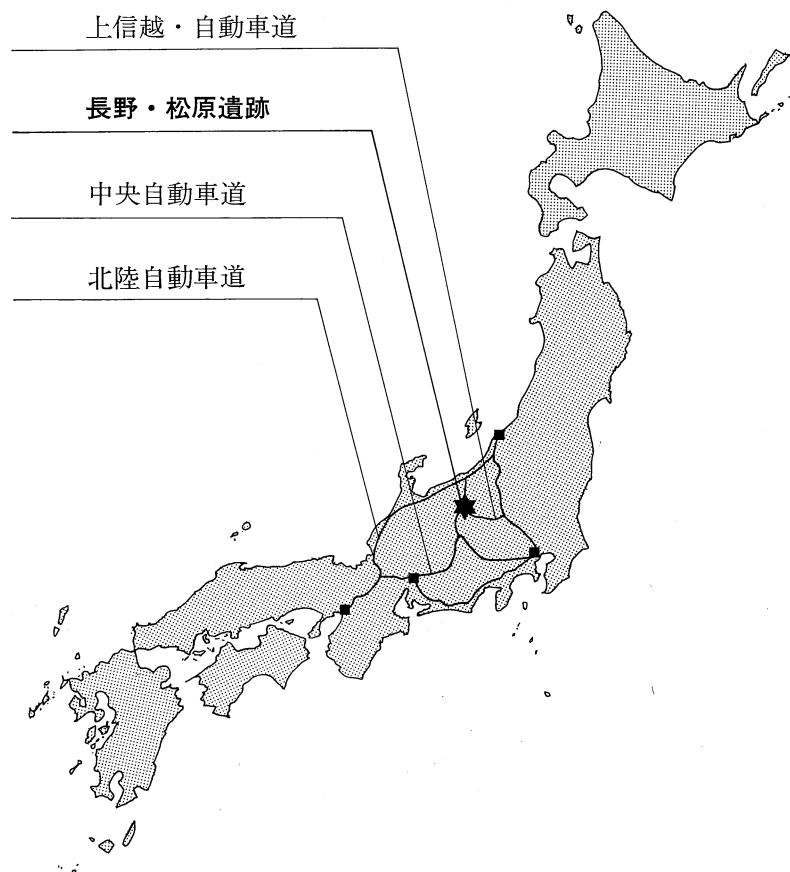

## 例 言

1. 本書は長野県長野市松代町に所在する松原遺跡の報告書である。
2. 本書は『上信越自動車道埋蔵文化財発掘調査報告書5 長野市内 その3 松原 一弥生・総論』全8分冊のうち、第4分冊 弥生時代中期・土器図版編である。
3. 調査は上信越自動車道建設に伴う事前調査として実施し、日本道路公団より長野県教育委員会を通じた委託事業として、財団法人長野県埋蔵文化財センターおよび財団法人文化振興事業団 長野県埋蔵文化財センターが実施した。
4. 調査にあたっては以下の関係機関のご協力を得た。  
長野県教育委員会文化財保護課、日本道路公団名古屋建設局、日本道路公団東京第二建設局、長野市教育委員会、JAグリーン長野農協
5. 発掘調査から本書の刊行に至るまで多くの方々のご指導を賜わり、ご協力を得た。第1分冊「第I部 調査の概要」にお名前を掲げさせていただくが、厚く感謝申し上げたい。
6. 編集作業分担および土器整理作業分担は下記の通りである。  
土器図版編集 青木一男  
写真図版編集 贄田 明  
土器復元 徳永哲秀  
写真撮影 西嶋 力
7. 実測図の作成、トレースは整理補助員があたった。  
浅井とし子 石田多美子 今井せつ子 岡田 暁子 笠井すみ子 加藤 周子 小林奈美江  
滝沢久子 鳥羽徳子 細田あき子 堀本香代子 三上義子 柳沢るり子 涌井恭江  
(敬称略)
8. 土器の管理、台帳類の作成は整理補助員があたった。  
丑山和江 風間春芳 近藤久子 武田多加子 竹鼻多佳子 中村るり子 堀内雅子  
(敬称略)
9. 実測図の一部については、(株)写真測図研究所 (株)シン技術コンサルに写真实測を委託した。
10. 整理補助員の土器実測作業の習得については千野浩・寺島孝典の協力があった。
11. 調査記録、出土遺物は報告書刊行後長野県立歴史館に移管し保管する。
12. 編集は青木一男が行い、百瀬長秀が全体を校閲した。

## 凡 例

1. 本書に掲載した実測図の縮尺は、すべて1：4である。
2. 本書に掲載した遺物写真の縮尺は、任意の大きさである。
3. 土器図版ナンバーは写真図版ナンバーと一致し、遺構出土地点の遺物ナンバー（第2分冊）とも一致する。
4. 実測図のスクリーン等には下記のように用いた。



赤彩



淡い赤彩

◀ 削痕による調整

○ 隆 帯

◁ 焼成後穿孔

長野市埋文センター調査の松原遺跡栗林式土器

SA125

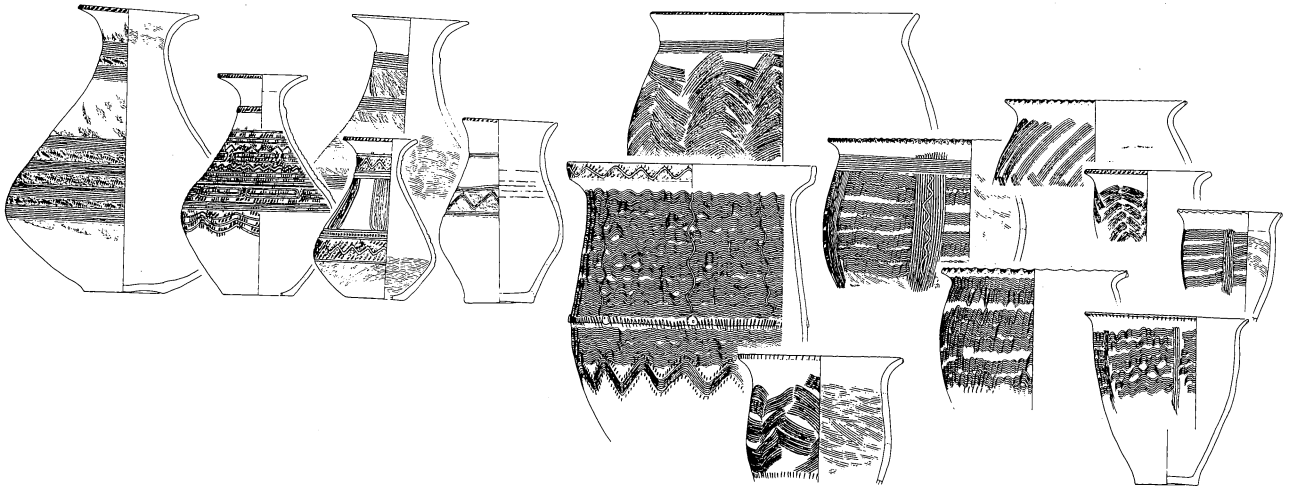

SA146

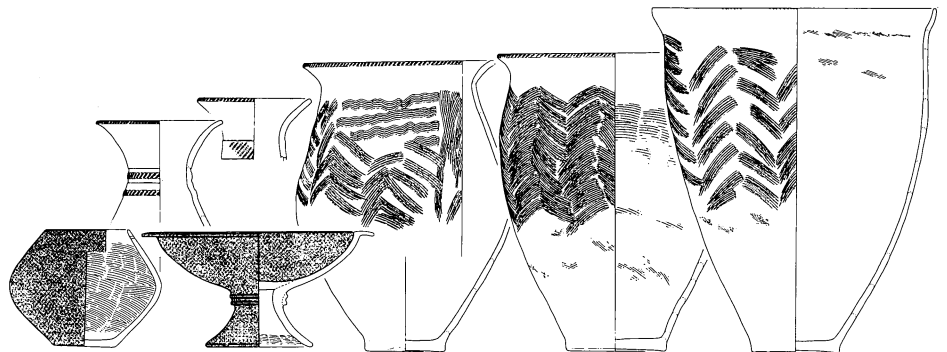

SA120



出典 飯島哲也・寺島孝典ほか 1993年『松原遺跡III』長野市教育委員会

## 插图目次

图版 1	S B 214 · 221	图版38	S B 360 · 362
图版 2	S B 221 · 231	图版39	S B 361 · 362
图版 3	S B 228 · 245 · 246	图版40	S B 361 · 363
图版 4	S B 246	图版41	S B 364
图版 5	S B 246	图版42	S B 369 · 384
图版 6	S B 246	图版43	S B 373
图版 7	S B 246	图版44	S B 362 · 373 · 403
图版 8	S B 246 · 260	图版45	S B 401 · 402
图版 9	S B 260 · 1184	图版46	S B 402 · 404
图版10	S B 260	图版47	S B 404 · 405 · 406 · 407
图版11	S B 260 · 261	图版48	S B 409
图版12	S B 261 · 264	图版49	S B 409
图版13	S B 265	图版50	S B 409
图版14	S B 265 · 266	图版51	S B 409
图版15	S B 267	图版52	S B 409 · 410 · 411 · 414 · 422
图版16	S B 267 · 268	图版53	S B 412 · 425
图版17	S B 271 · 272 · 273	图版54	S B 425
图版18	S B 274 · 275 · 277	图版55	S B 425 · 450
图版19	S B 281 · 282 · 284 · 286	图版56	S B 246 · 360 · 409 · 450
图版20	S B 286 · 287	图版57	S B 267 · 1102
图版21	S B 290 · 302 · 306	图版58	S B 1102
图版22	S B 303	图版59	S B 1102
图版23	S B 307 · 309 · 310	图版60	S B 1102
图版24	S B 312 · 313 · 314 · 316	图版61	S B 1102 · 1103
图版25	S B 317 · 318	图版62	S B 1103
图版26	S B 319	图版63	S B 1103
图版27	S B 319 · 320 · 323 · 324	图版64	S B 1103 · 1104 · 1109
图版28	S B 325 · 326	图版65	S B 1106 · 1108
图版29	S B 328	图版66	S B 1108 · 1110
图版30	S B 328 · 329	图版67	S B 1112 · 1113
图版31	S B 331 · 332 · 351	图版68	S B 1113 · 1114 · 1115 · 1118
图版32	S B 352 · 353 · 354	图版69	S B 1118
图版33	S B 354	图版70	S B 1119
图版34	S B 354 · 355 · 359 · 360	图版71	S B 1119
图版35	S B 360	图版72	S B 1119 · 1120
图版36	S B 360	图版73	S B 1121
图版37	S B 360	图版74	S B 1121 · 1122 · 1127 · 1129 · 1130



函版75	S B1123	函版115	S B1162 · 1168
函版76	S B1123	函版116	S B1163 · 1174
函版77	S B1123 · 1124	函版117	S B1174
函版78	S B1124 · 1125	函版118	S B1172 · 1174
函版79	S B1125 · 1126	函版119	S B1175
函版80	S B1126	函版120	S B1176 · 1177
函版81	S B1126	函版121	S B1178
函版82	S B1126 · 1131 · 1132 · 1134	函版122	S B1178
函版83	S B1134	函版123	S B1181 · 1183 · 1184
函版84	S B1134 · 1135	函版124	S B1184 · 1186
函版85	S B1135	函版125	S B1186 · 1189
函版86	S B1135	函版126	S B1189
函版87	S B1135	函版127	S B1189
函版88	S B1135	函版128	S B1189 · 1190
函版89	S B1135 · 1136	函版129	S B1192 · 1211 · 1256 · 1257
函版90	S B1136	函版130	S B1248
函版91	S B1136	函版131	S B1258 · 1259
函版92	S B1137	函版132	S B1260 · 1261
函版93	S B1142	函版133	S B1261 · 1262
函版94	S B1142	函版134	S B1262
函版95	S B1142 · 1150 · 1151	函版135	S B1263
函版96	S B1143	函版136	S B1263 · 1264 · 1279
函版97	S B1143 · 1145	函版137	S B1276 · 1277
函版98	S B1144 · 1145	函版138	S B1278 · 1280 · 1281
函版99	S B1144	函版139	S B1282
函版100	S B1144 · 1146	函版140	S B1282
函版101	S B1146	函版141	S B1282
函版102	S B1146 · 1154 · 1155	函版142	S B1282 · 1283 · 1288
函版103	S B1155	函版143	S B1284 · 1287 · 1289
函版104	S B1155	函版144	S B1289 · 1291
函版105	S B1155	函版145	S B1290
函版106	S B1155	函版146	S B1292
函版107	S B1155 · 1156	函版147	S B1293
函版108	S B1156	函版148	S B1293
函版109	S B1156	函版149	S B1293 · 1295 · 1296 · 1297 · 1298
函版110	S B1156 · 1157	函版150	S B1294
函版111	S B1157	函版151	S B1294
函版112	S B1160	函版152	S B1296 · 1303
函版113	S B1160	函版153	S B1302
函版114	S B1160 · 1162	函版154	S B1302 · 1304

函版155	S B1304	1953
函版156	S B1304 · 1305	函版193 S K1952 · 1957 · 1961
函版157	S B1305 · 1306	函版194 S K1961 · 1963 · 1972 · 1973 · 1975 ·
函版158	S B1306	1979
函版159	S B1306	函版195 S K1994 · 1995
函版160	S B1306	函版196 S K1996 · 1999 · 2001
函版161	S B1307 · 1308 · 1311 · 1178 · 1185 1258 · S D12	函版197 S D100
函版162	S K127 · 131	函版198 S D100
函版163	S K133 · 141 · 143 · 149 · 150	函版199 S D100
函版164	S K151	函版200 S D101
函版165	S K151	函版201 S D101
函版166	S K153 · 154 · 155	函版202 S D101
函版167	S K156	函版203 S D101
函版168	S K156	函版204 S D102 · 1027
函版169	S K158	函版205 S D1083
函版170	S K158 · 159 · 163	函版206 S D1083 · 1215 · 1305
函版171	S K163	函版207 S D1305 · 18
函版172	S K164	函版208 S D18
函版173	S K164	函版209 S D18
函版174	S K169 · 170 · 171 · 190	函版210 S D18 · S D12 I A10
函版175	S K191	函版211 S D12 I A15
函版176	S K191	函版212 S D12 I A15
函版177	S K192 · 195 · 200	函版213 S D12 I A15, I B16
函版178	S K200 · 237 · 355 · 359	函版214 S D12 I B16, I B21, I G1
函版179	S K345	函版215 S D12 I G1
函版180	S K313 · 354 · 356 · 551 · 1318 · 1319 · 1326 · 1333	函版216 S D12 I G6
函版181	S K1333	函版217 S D12 I G6
函版182	S K1333	函版218 S D12 I G11
函版183	S K1335 · 1349 · 1353 · 1371 · 1373	函版219 S D12 I G11
函版184	S K1377 · 1382	函版220 S D12 I G11
函版185	S K1393 · 1396	函版221 S D12 I G11, I G16
函版186	S K1396 · 1400	函版222 S D12 I G16
函版187	S K1400 · 1695 · 1699 · 1714	函版223 S D12 I G16
函版188	S K1714	函版224 S D12 I G16, I G21
函版189	S K1714	函版225 S D12 I G21
函版190	S K1714 · 1717 · 1718 · 1735	函版226 S D12 I G21
函版191	S K1750 · 1787 · 1861 · 1895	函版227 S D12 I G21
函版192	S K1865 · 1914 · 1945 · 1947 · 1948 ·	函版228 S D12 I G21
		函版229 S D12 I G21, I L1
		函版230 S D12 I L1

図版231 S D12 I L 1, I L 6  
 図版232 S D12 I L 6  
 図版233 S D12 I L 6  
 図版234 S D12 I L 6, I L11  
 図版235 S D12 I L16, I L21  
 図版236 S D12 I L21, I P20  
 図版237 S D12 I P20  
 図版238 S D12 I P20, I Q 1  
 図版239 S D12 I Q 1

図版240 S D12 I Q 1, I Q 6  
 図版241 S D12 I Q 6, I Q11  
 図版242 S D12 I Q11  
 図版243 S D12 I Q16  
 図版244 S D12 I Q16・グリット不明  
 図版245 S B H208・231・243・257・343・361  
 362・371  
 図版246 S T2177・遺構外

### 写真図版目次

P L 1 S B214・228・245  
 P L 2 S B246  
 P L 3 S B246  
 P L 4 S B246・260  
 P L 5 S B260  
 P L 6 S B260・267  
 P L 7 S B267・303  
 P L 8 S B309・319・328  
 P L 9 S B328・354  
 P L10 S B354・360  
 P L11 S B360  
 P L12 S B360  
 P L13 S B360・362・364  
 P L14 S B364・369  
 P L15 S B401・409  
 P L16 S B409  
 P L17 S B409  
 P L18 S B425・450・1102  
 P L19 S B1102  
 P L20 S B1102・1103  
 P L21 S B1103・1118・1119  
 P L22 S B1119  
 P L23 S B1123  
 P L24 S B1124・1126  
 P L25 S B1126  
 P L26 S B1126・1134  
 P L27 S B1134・1135  
 P L28 S B1135

P L29 S B1135  
 P L30 S B1135  
 P L31 S B1135・1136  
 P L32 S B1136・1142  
 P L33 S B1142  
 P L34 S B1142・1143  
 P L35 S B1143・1144・1146  
 P L36 S B1146  
 P L37 S B1146・1155  
 P L38 S B1155  
 P L39 S B1155  
 P L40 S B1156  
 P L41 S B1160・1174  
 P L42 S B1172・1174  
 P L43 S B1172・1178  
 P L44 S B1178・1189  
 P L45 S B1189  
 P L46 S B1189・1258  
 P L47 S B1263  
 P L48 S B1276・1282  
 P L49 S B1282  
 P L50 S B1282・1294・1302  
 P L51 S B1302・1304  
 P L52 S B1304・1306  
 P L53 S B1306  
 P L54 S B1306・S K127・131  
 P L55 S K133・151  
 P L56 S K151・153

PL57	SK153 · 155 · 156	PL75	SD12
PL58	SK156	PL76	SD12
PL59	SK156 · 158	PL77	SD12
PL60	SK158 · 163	PL78	SD12
PL61	SK163 · 164	PL79	SD12
PL62	SK164	PL80	SD12
PL63	SK191	PL81	SD12
PL64	SK191 · 1319 · 1333	PL82	SD12
PL65	SK1333	PL83	SD12
PL66	SK1377 · 1714	PL84	SD12
PL67	SK1714	PL85	SD12
PL68	SK1714 · ST2177	PL86	SD12
PL69	SD100	PL87	SD12
PL70	SD100	PL88	SD12
PL71	SD100 · 101	PL89	SD12
PL72	SD101	PL90	SD12
PL73	SD101 · 102 · 1083 · 18	PL91	SD12
PL74	SD18 · 12	PL92	SD12

# 土器図版

## 凡例

### 1. 遺構番号

SB : 竪穴住居址

SBH : 平地式建物址

ST : 掘立柱建物址

SK : 土壇

SD : 溝

SD100, SD101, SD102,  
は旧河道

### 2. 縮尺

遺物実測図 1 : 4

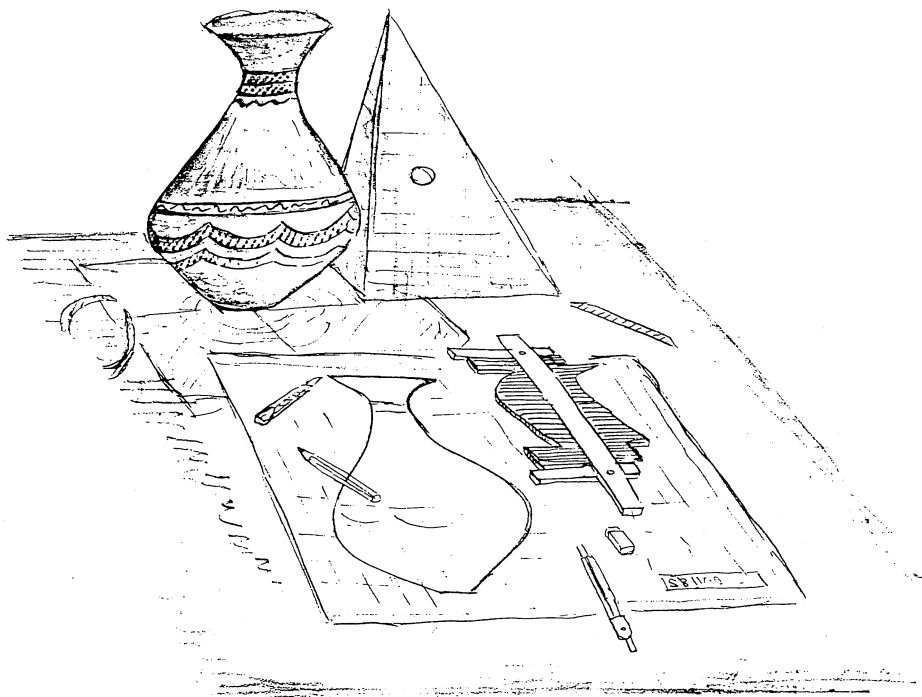

S B214

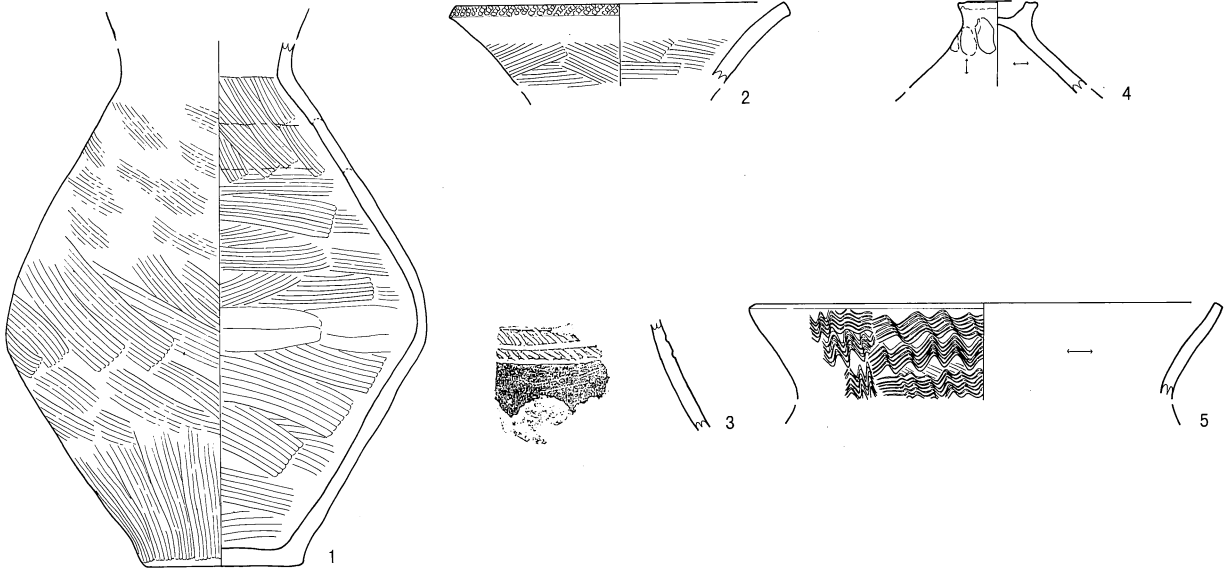

S B221

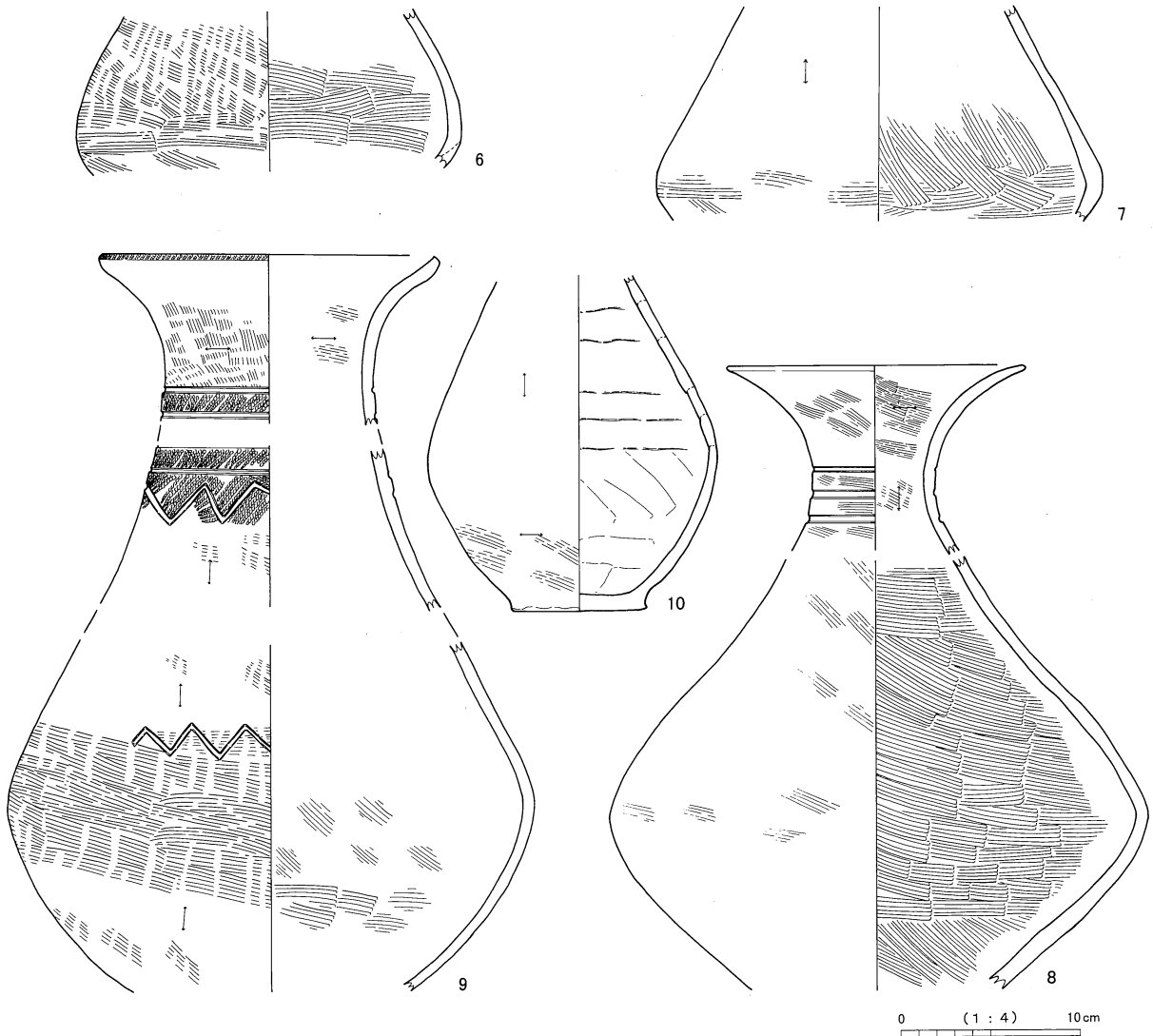

S B214, 1 ~ 5    S B221, 6 ~ 10

S B 221

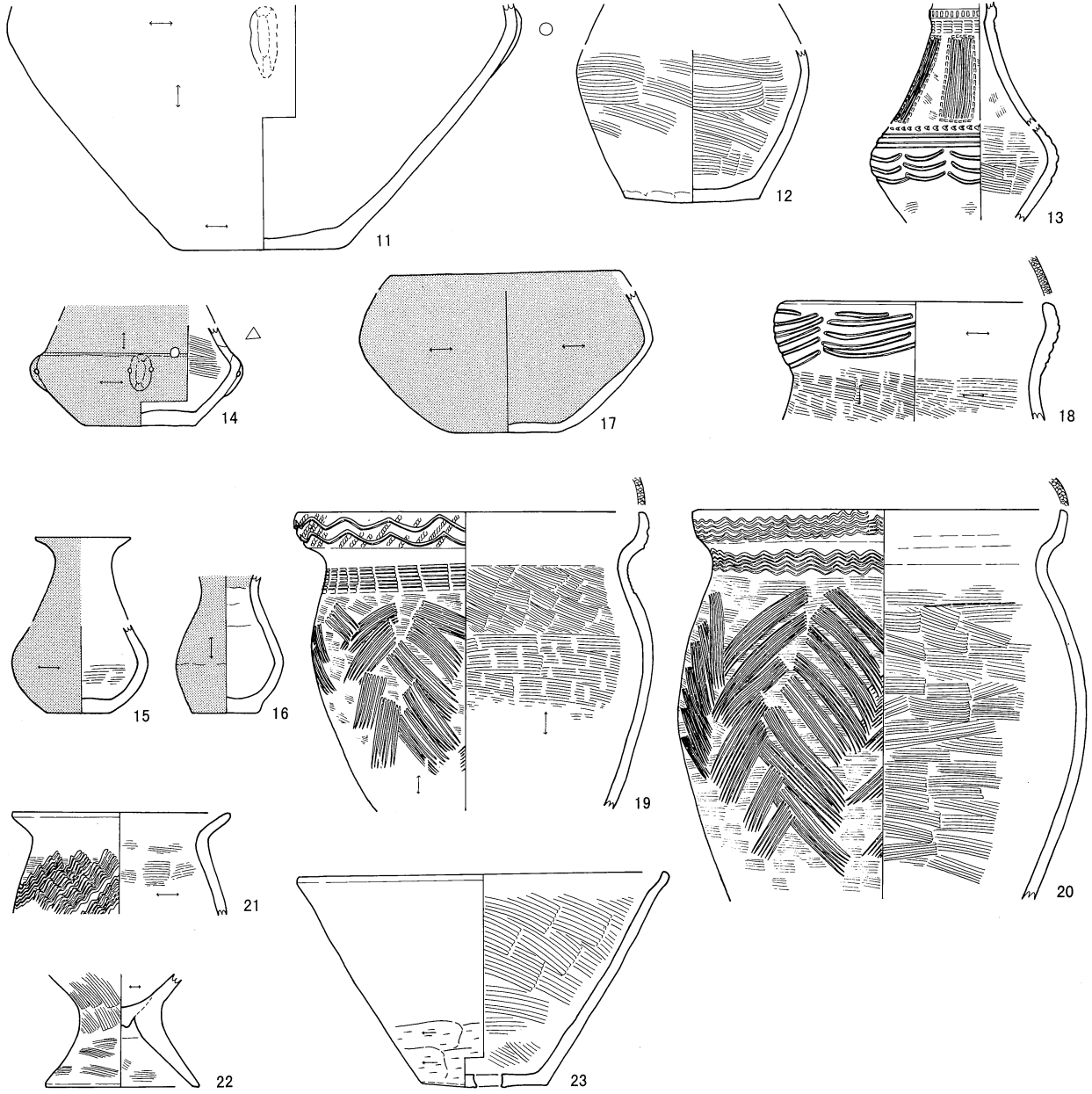

S B 231

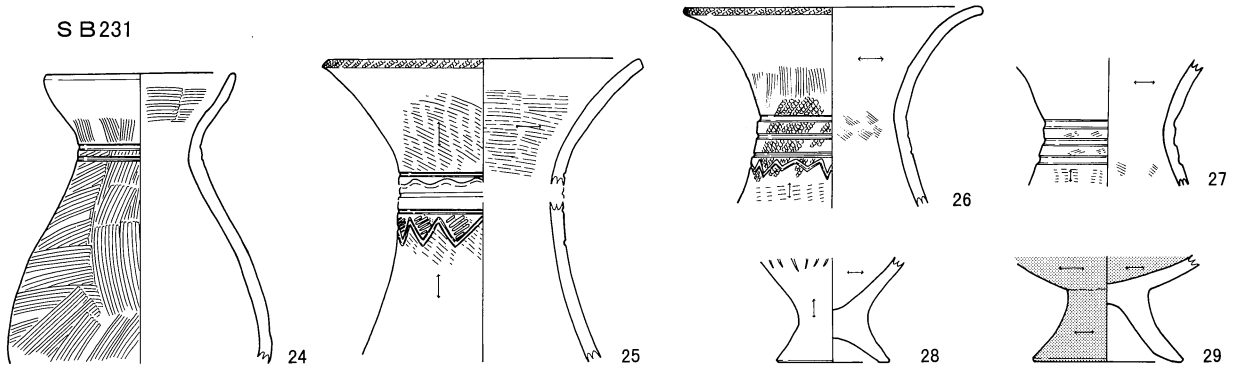

0 (1 : 4) 10cm

S B 221, 11~23 S B 231, 24~29

S B 228

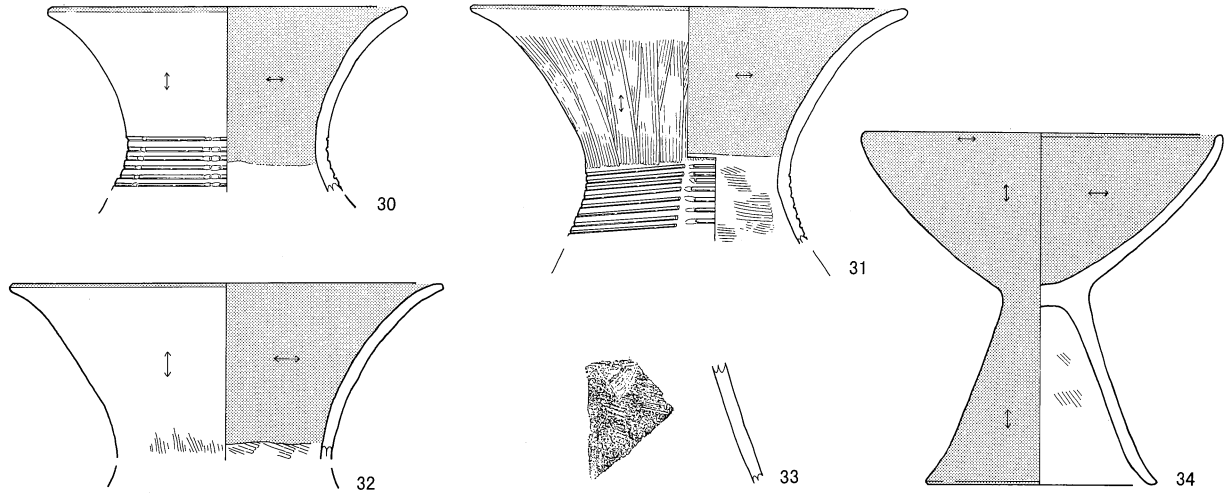

S B 245

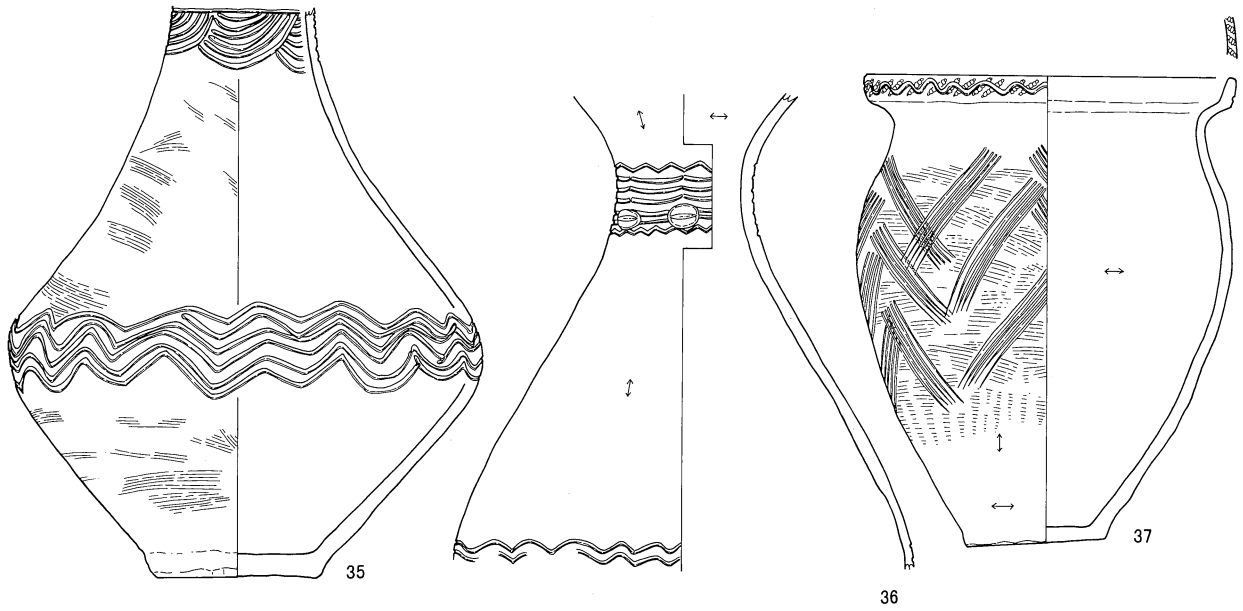

S B 246

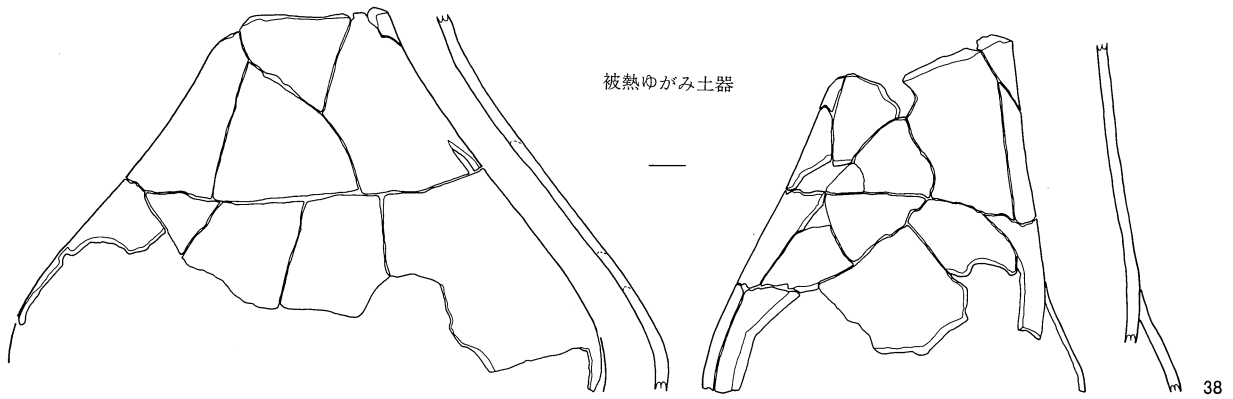

S B 228, 30~34

S B 245, 35~37

S B 246, 38

0 (1:4) 10 cm



S B 246

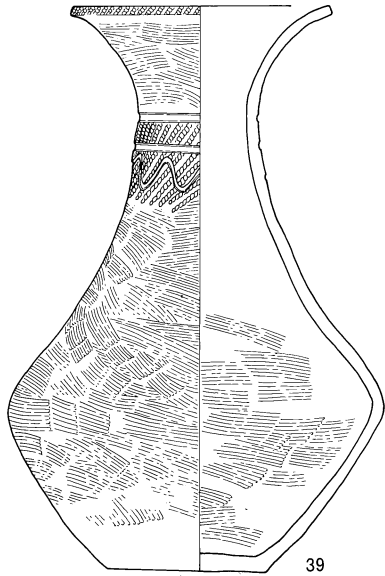

39

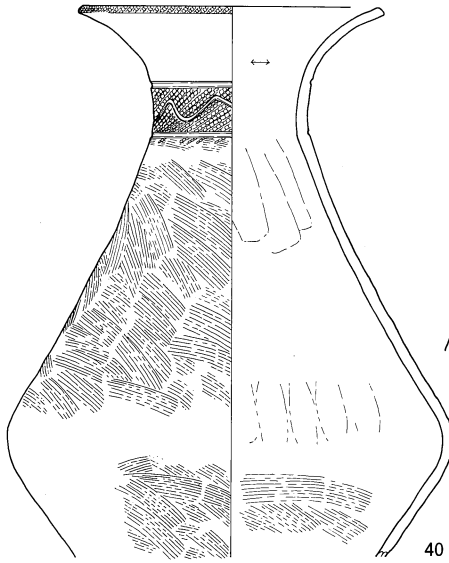

40

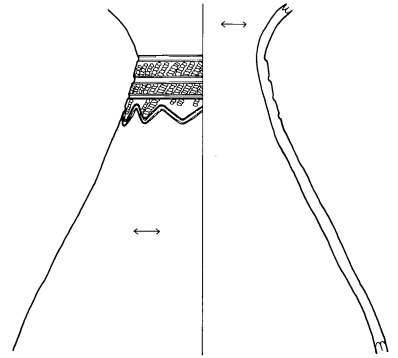

41

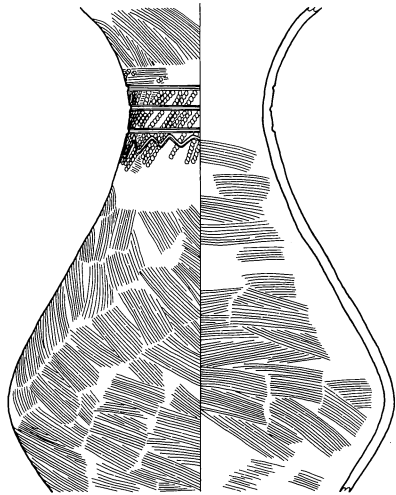

42

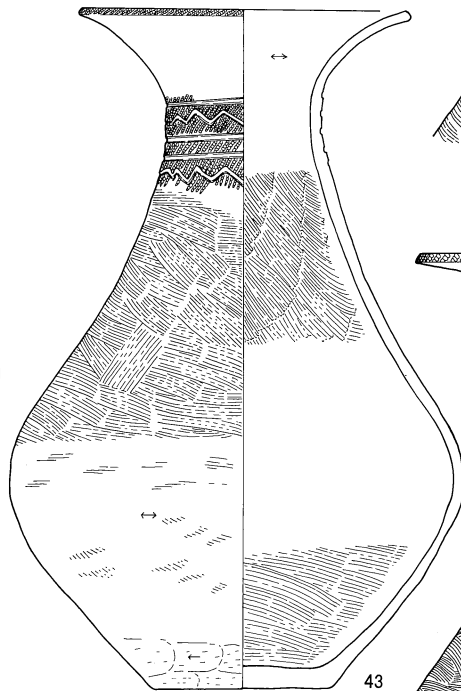

43

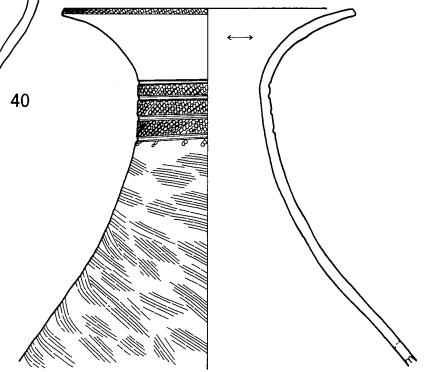

44

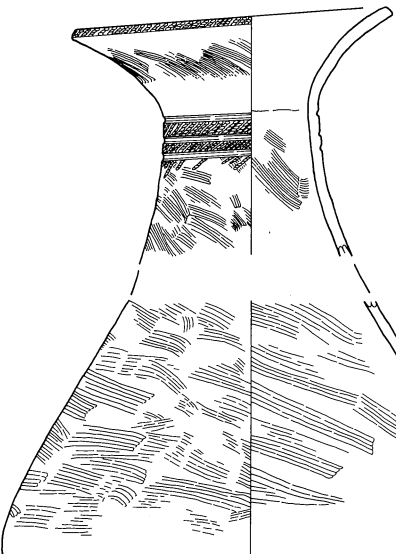

45

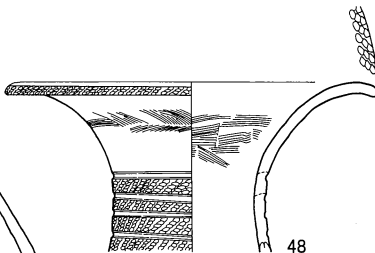

48

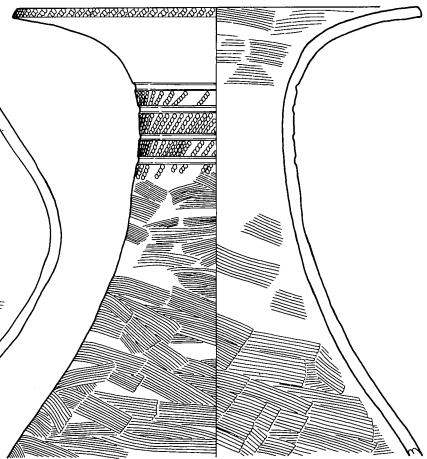

47

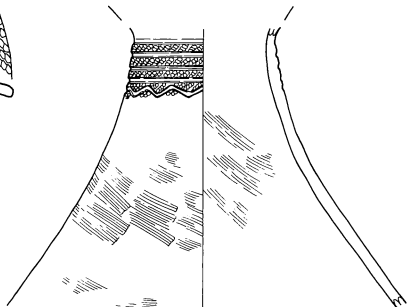

46

0 (1 : 4) 10cm

S B 246

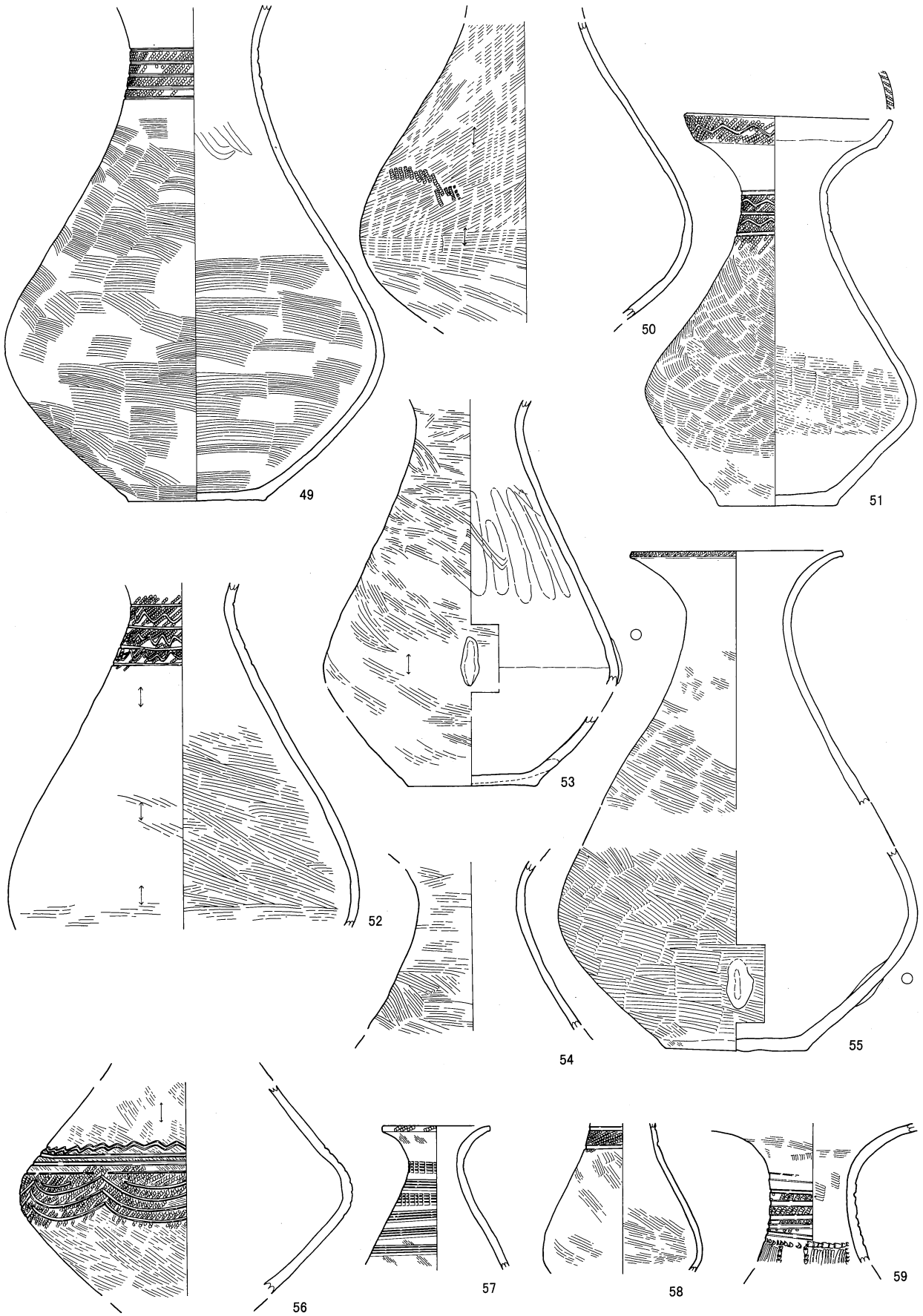

0 (1 : 4) 10 cm

S B 246, 49~59

S B 246

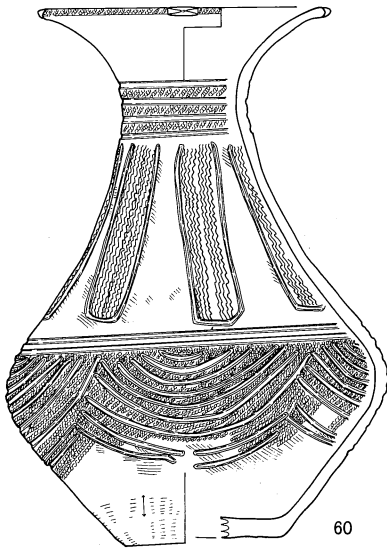

60

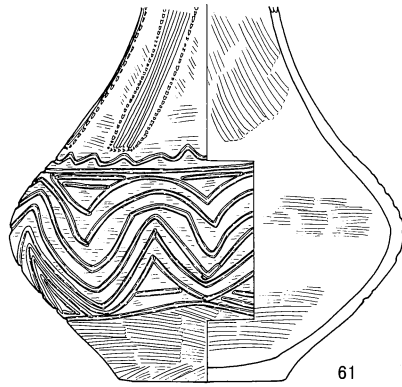

61

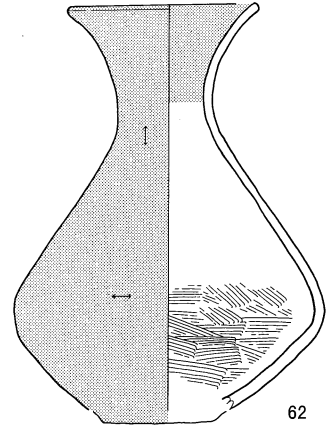

62

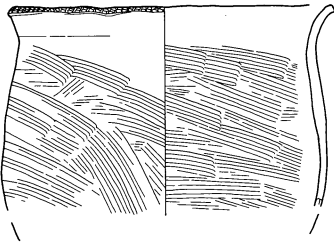

65

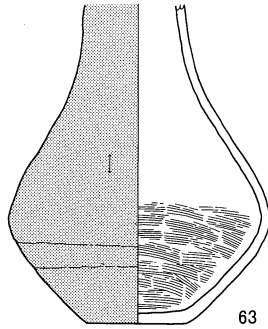

63

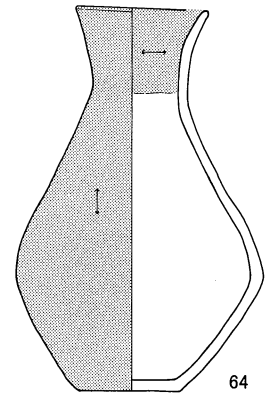

64

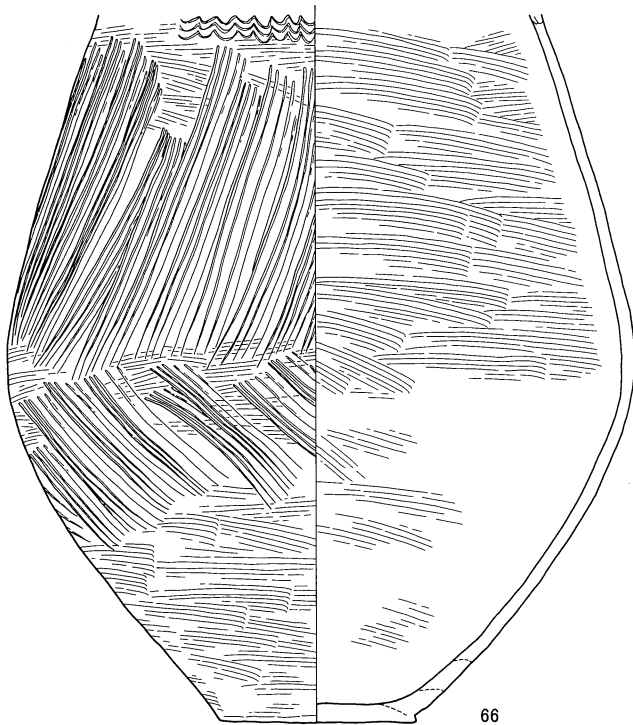

66

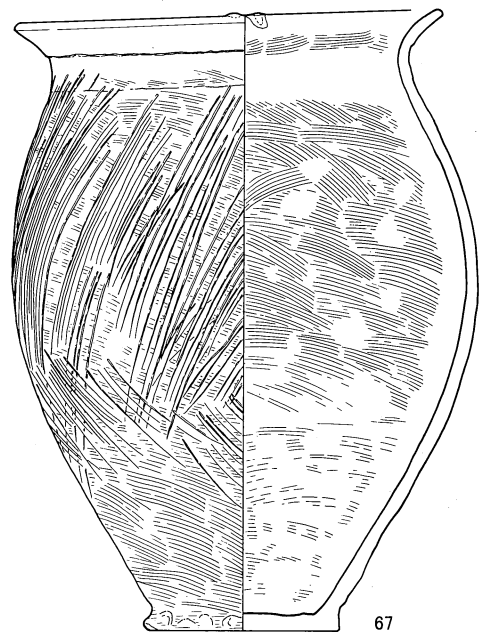

67

0 (1 : 4) 10 cm

S B246

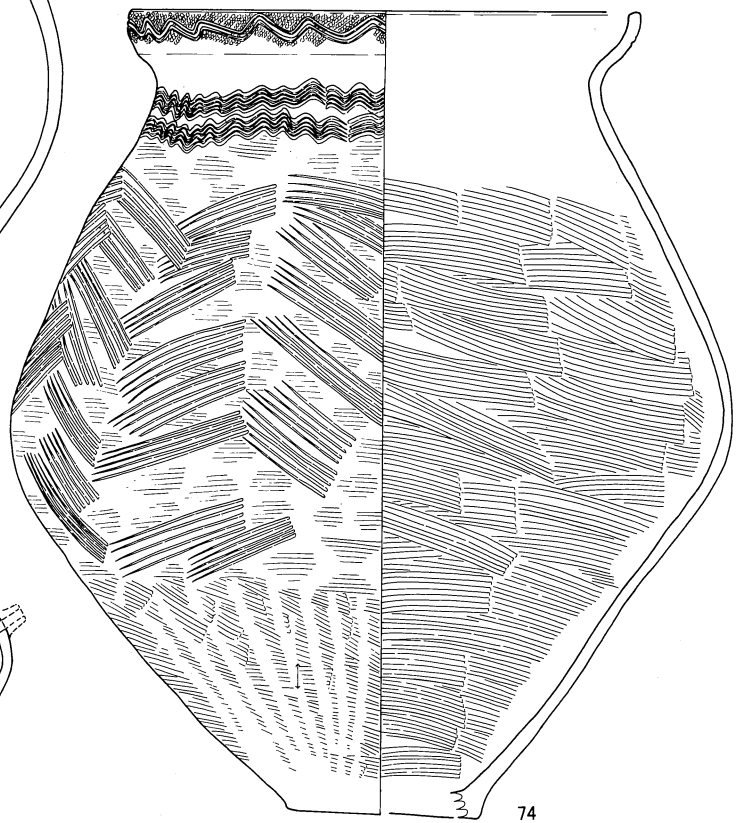
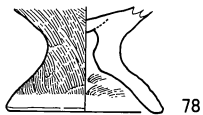
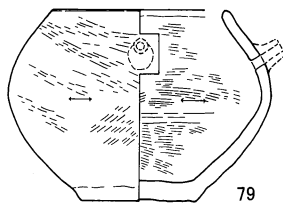
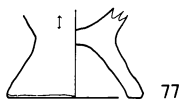
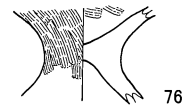
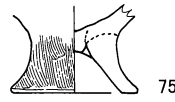
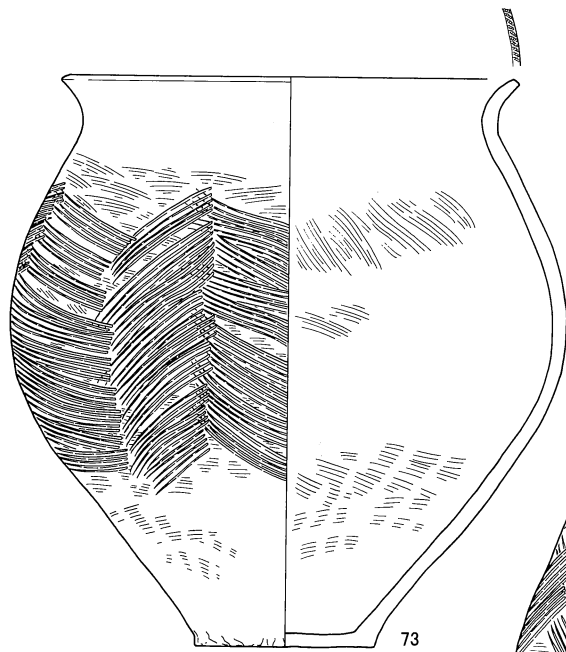
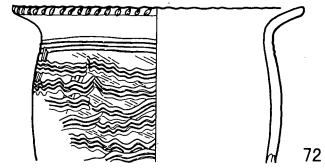
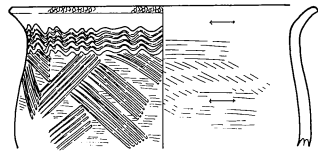
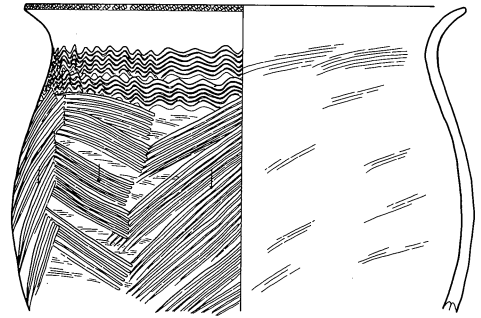
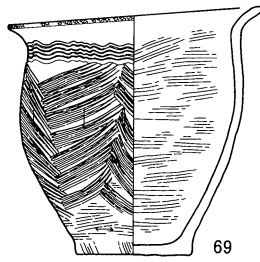
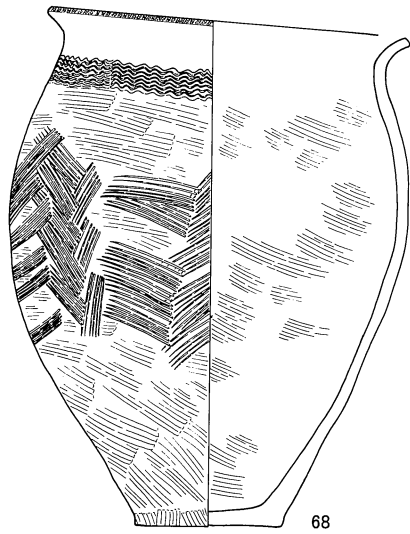

0 (1 : 4) 10cm

S B 246

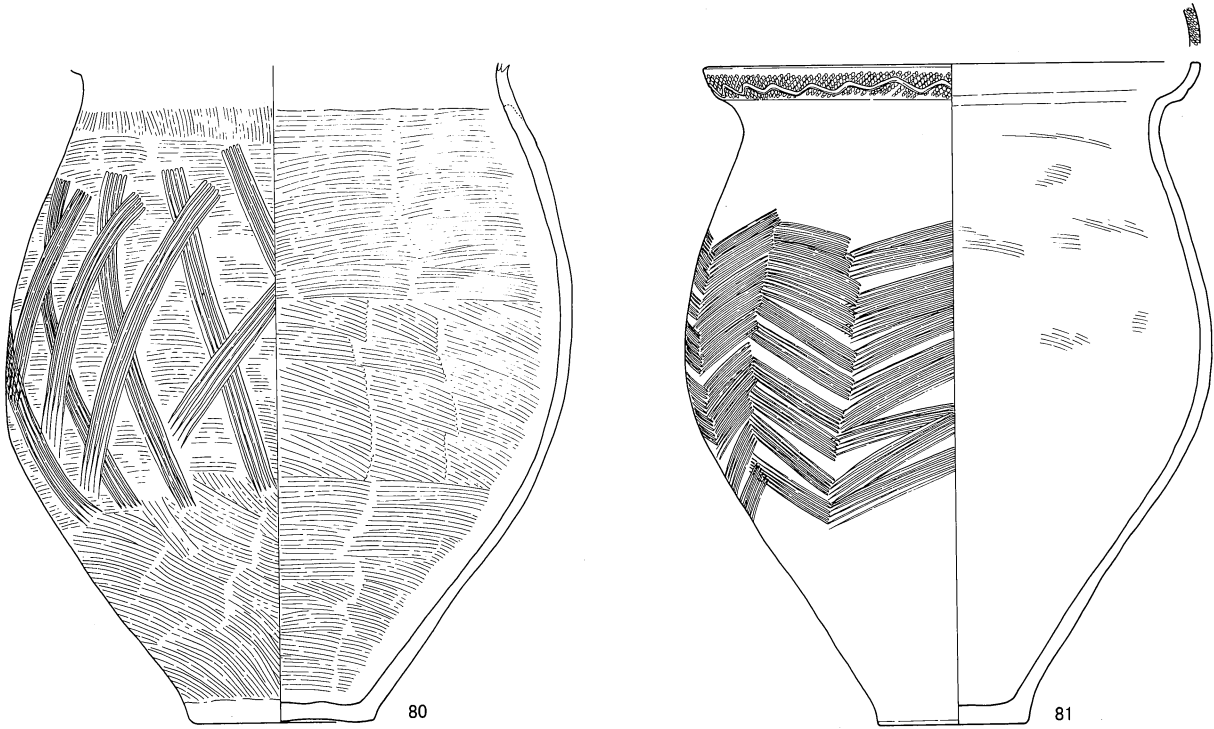

S B 260

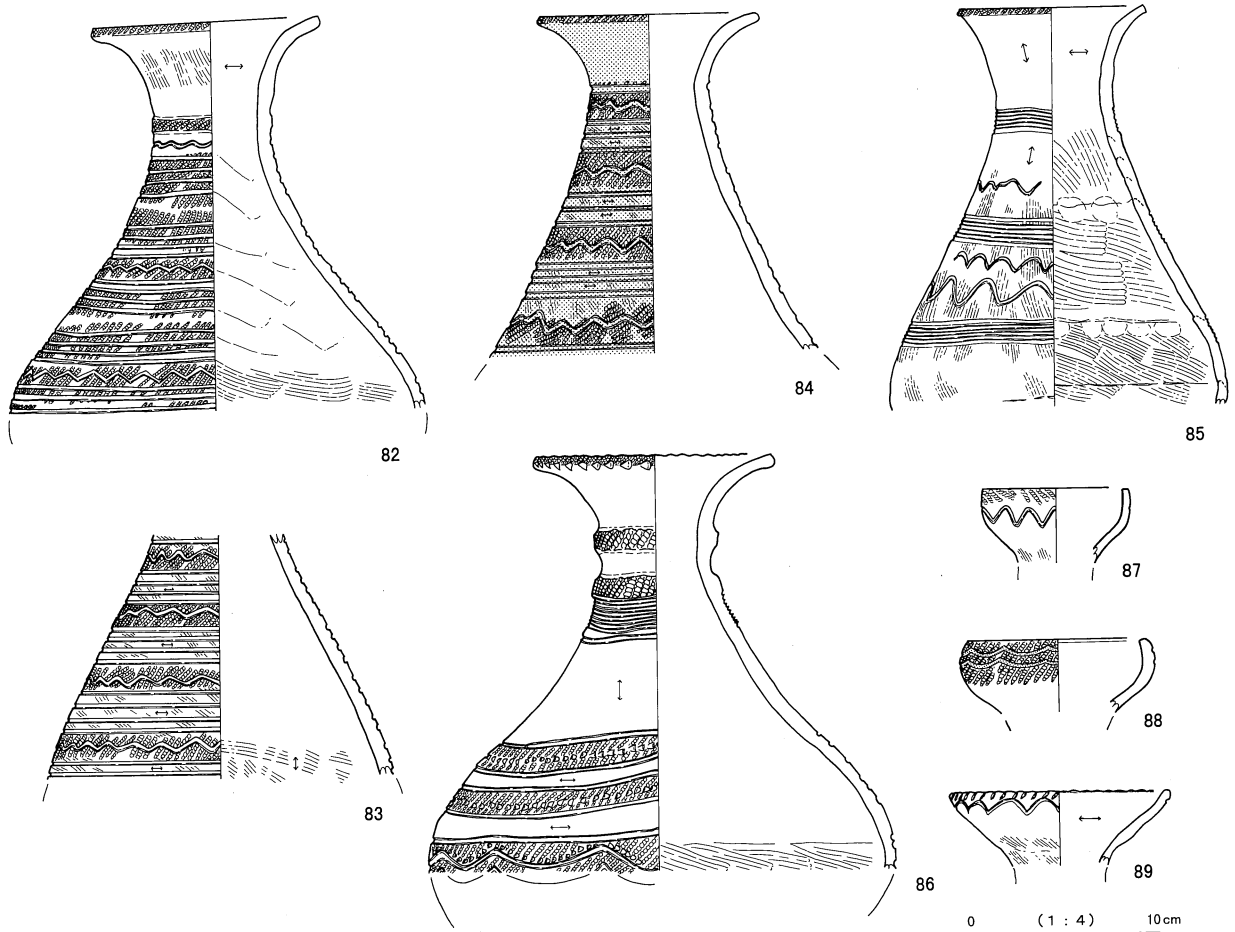

S B 246, 80~81    S B 260, 82~89

S B 260

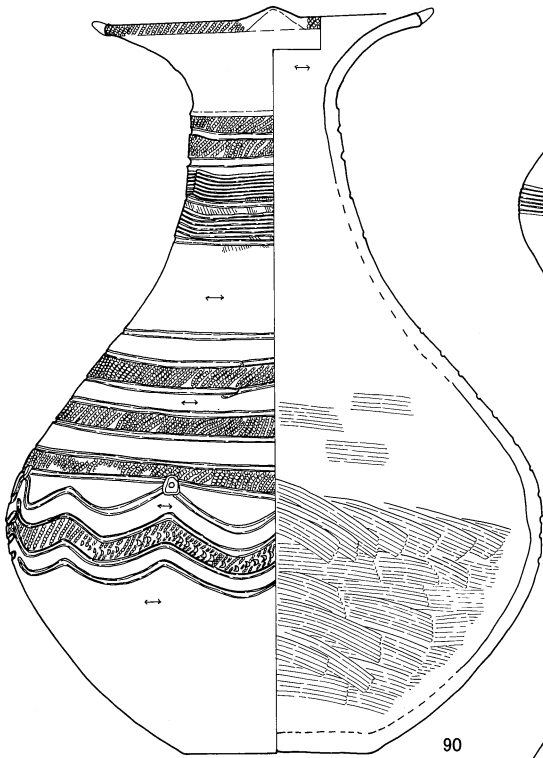

90

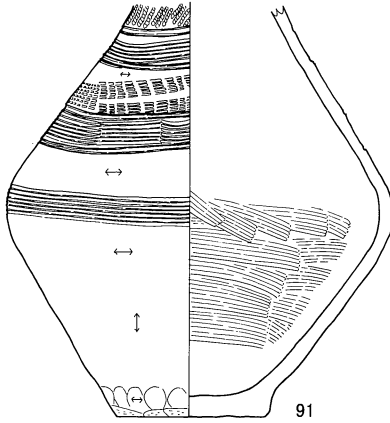

91

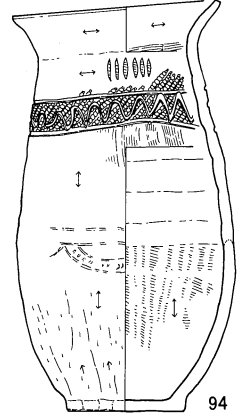

94

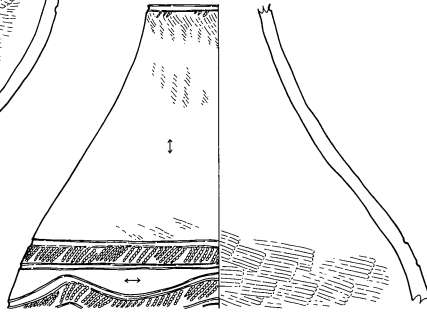

92

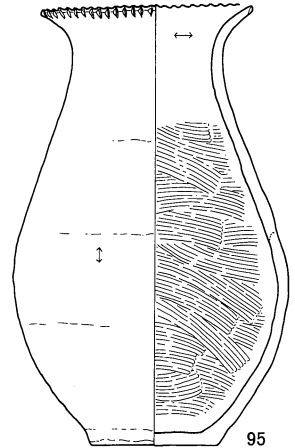

95

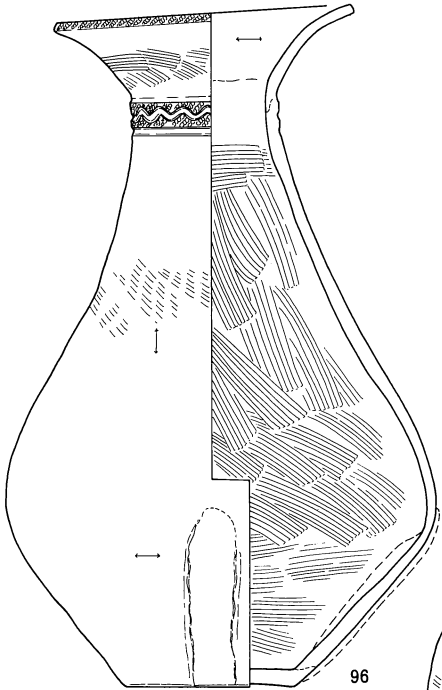

96

※96のみ S B 1184

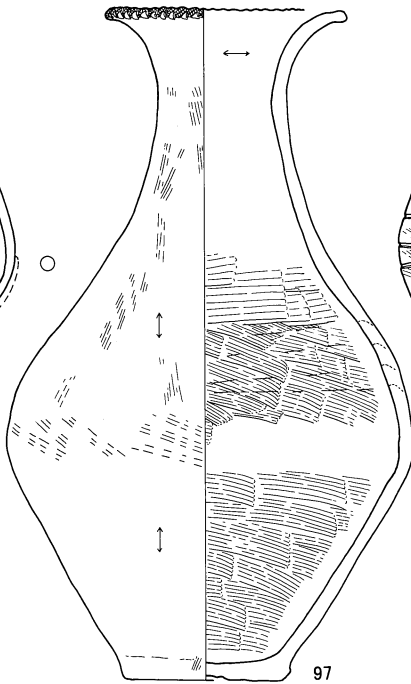

97

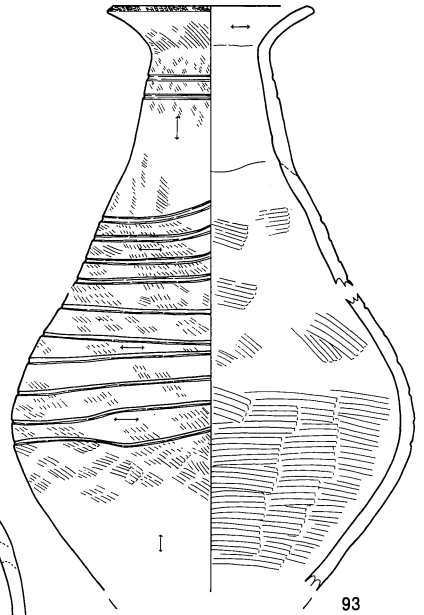

93

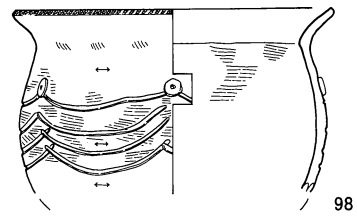

98

0 (1 : 4) 10cm

S B 260

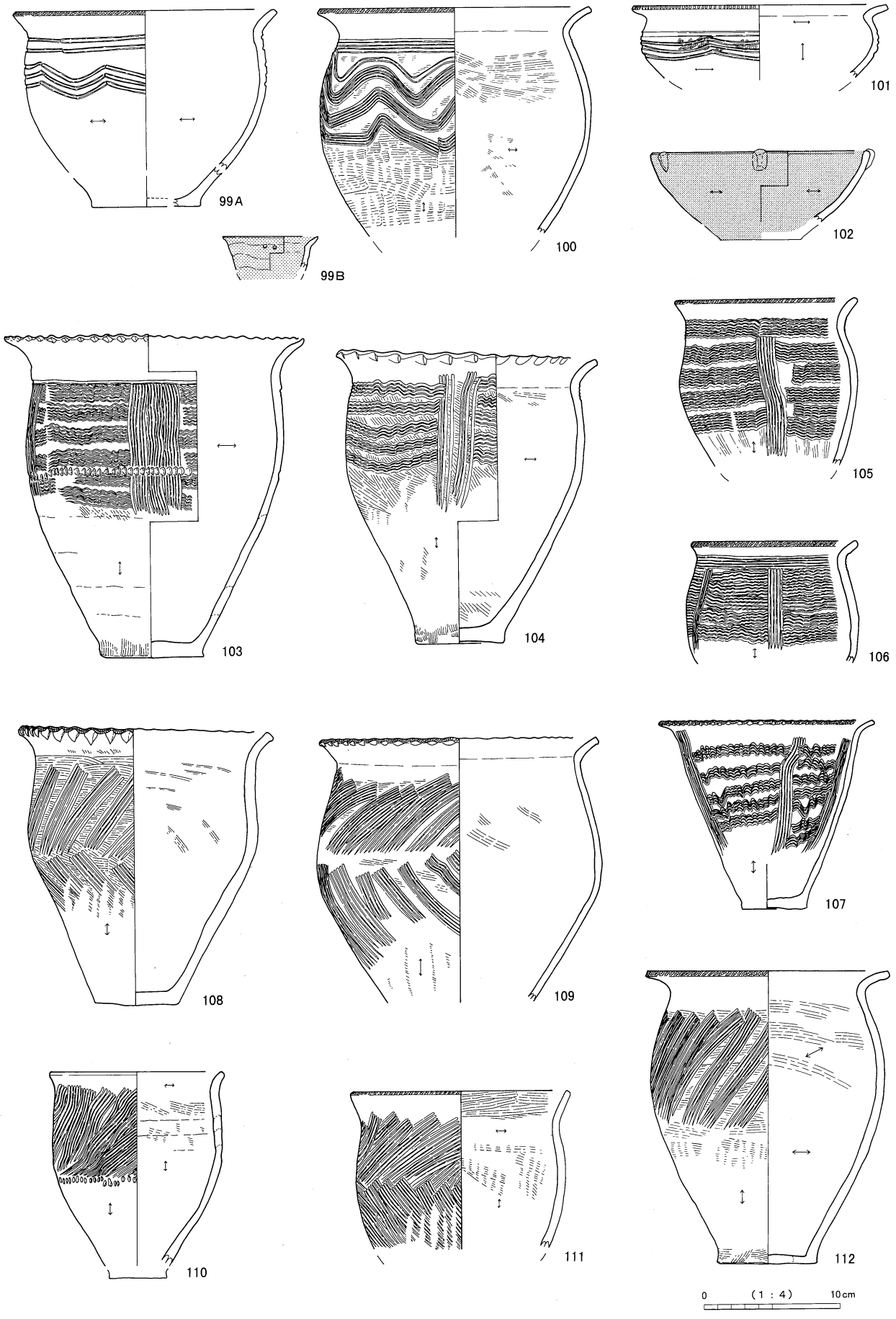

S B 260, 99A ~ 112

S B 260

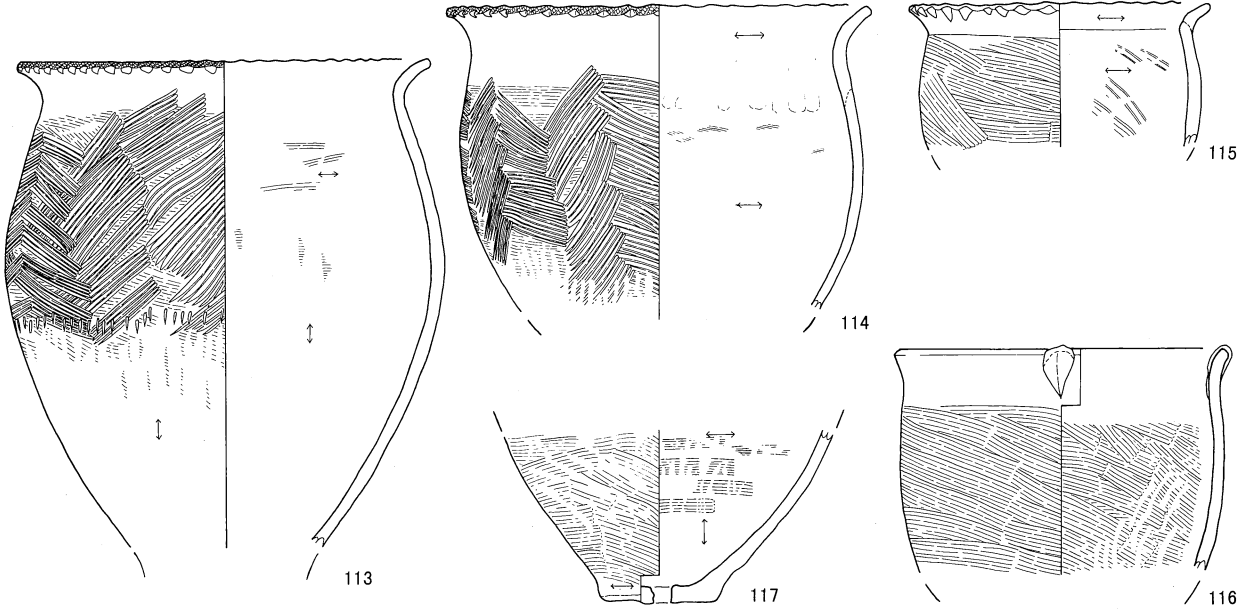

S B 261

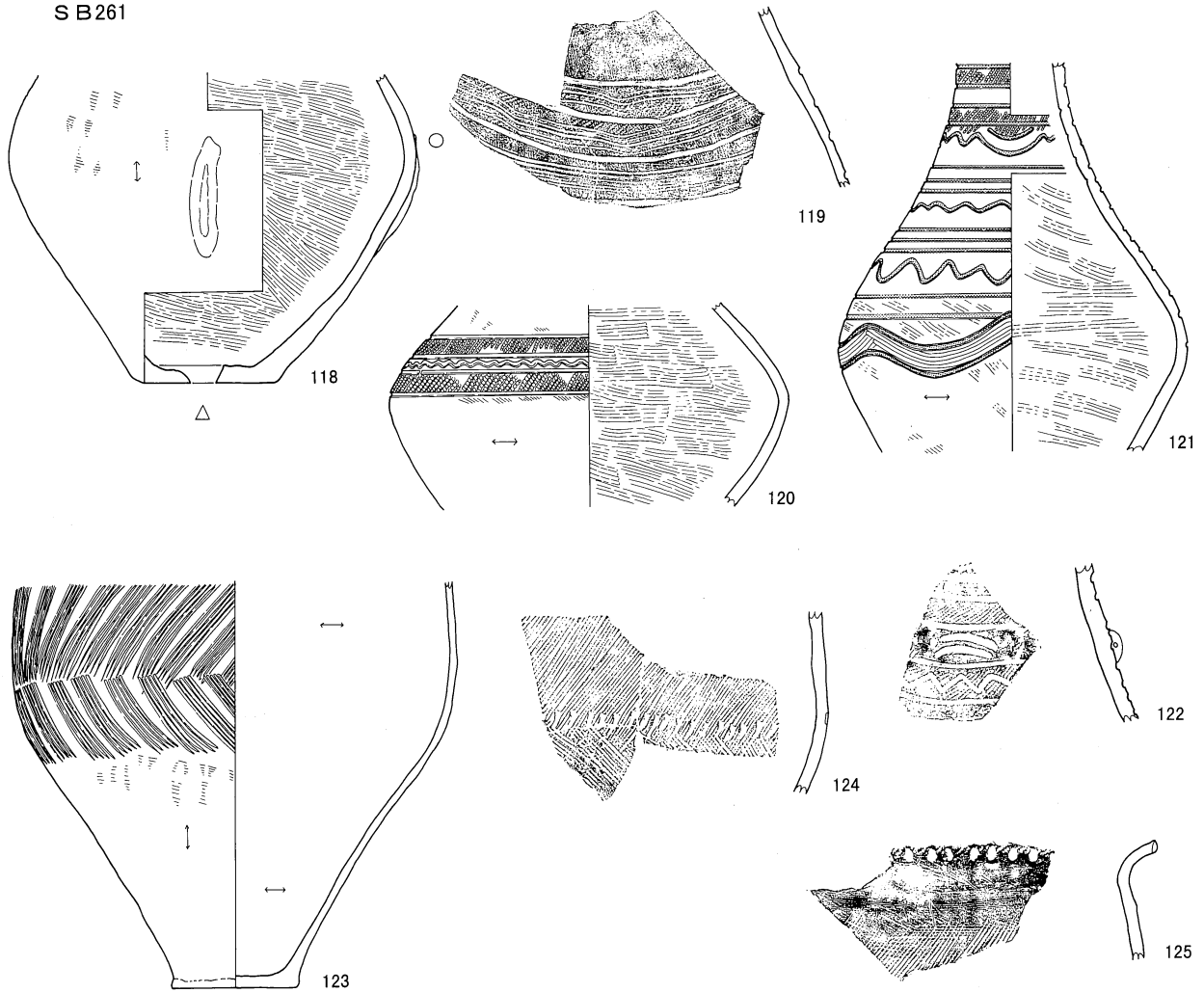

0 (1 : 4) 10cm

S B 260, 113~117 S B 261, 118~125



S B 261

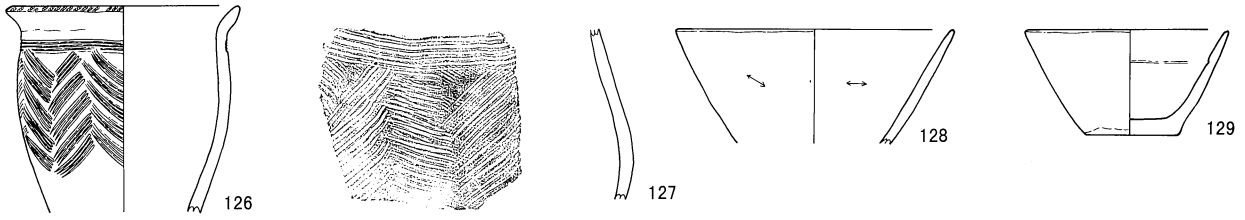

S B 264

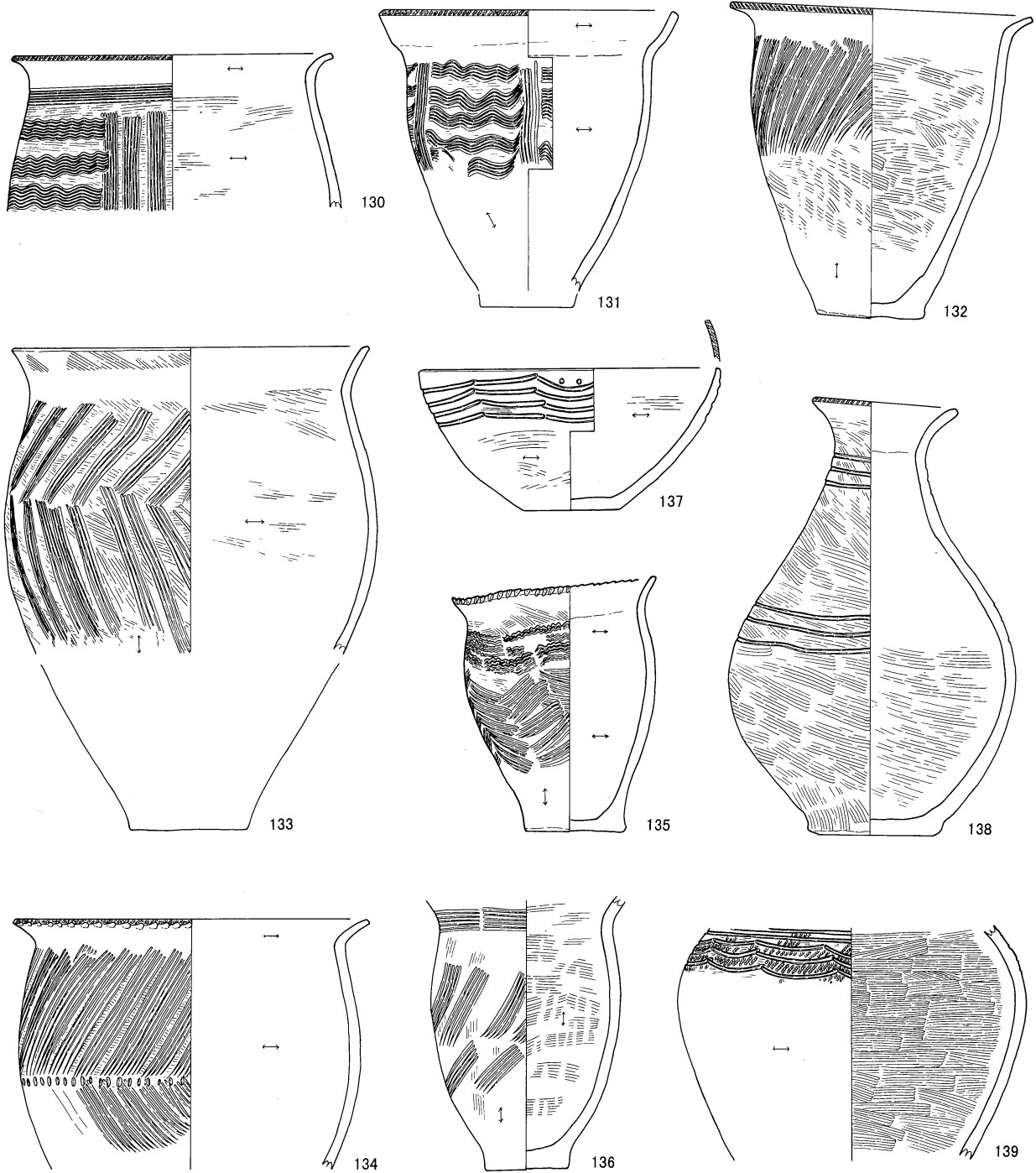

0 (1 : 4) 10 cm

S B 261, 126~129 S B 264, 130~139

S B 265

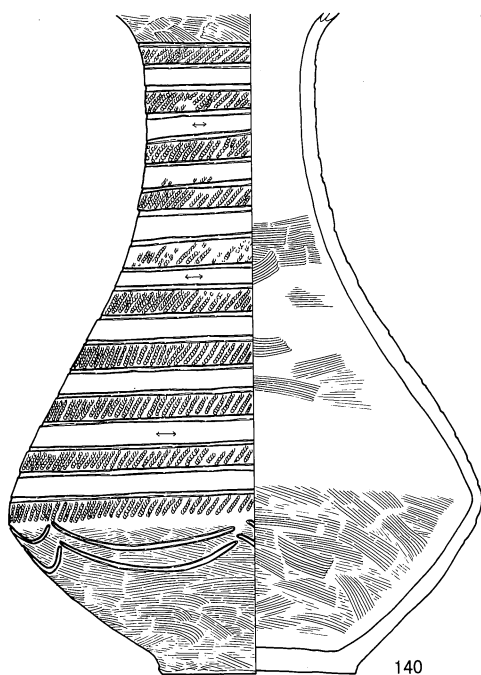

140

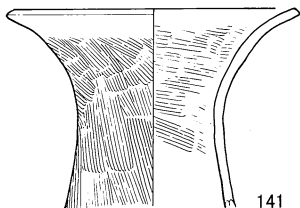

141

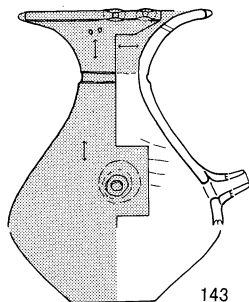

143

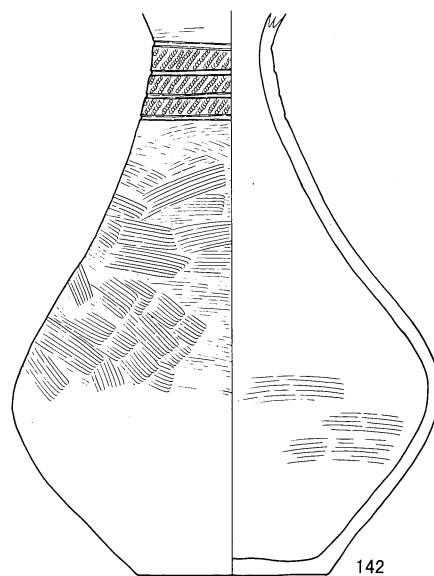

142

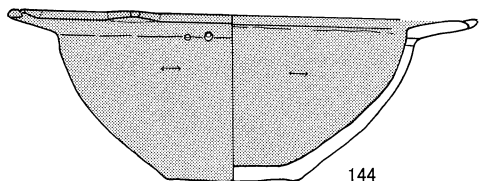

144

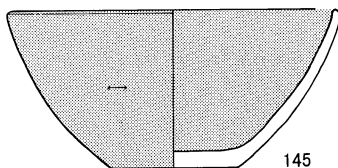

145

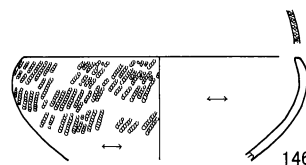

146

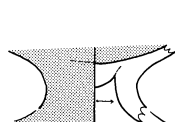

147

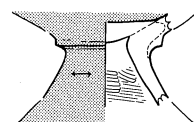

148

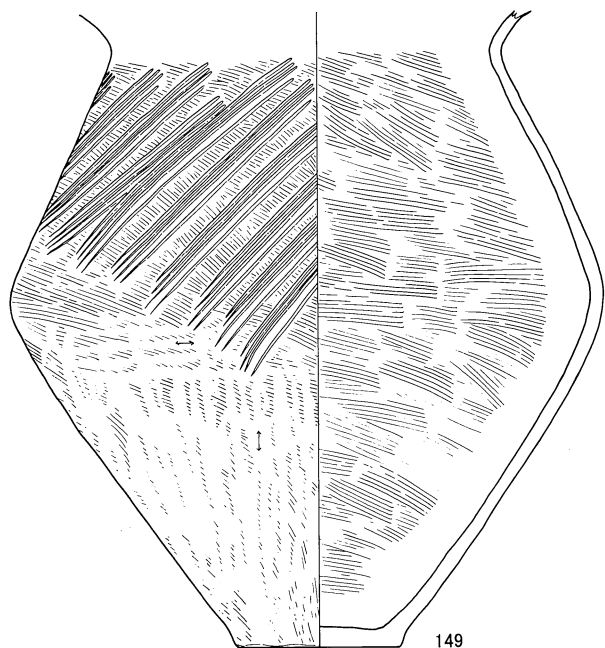

149

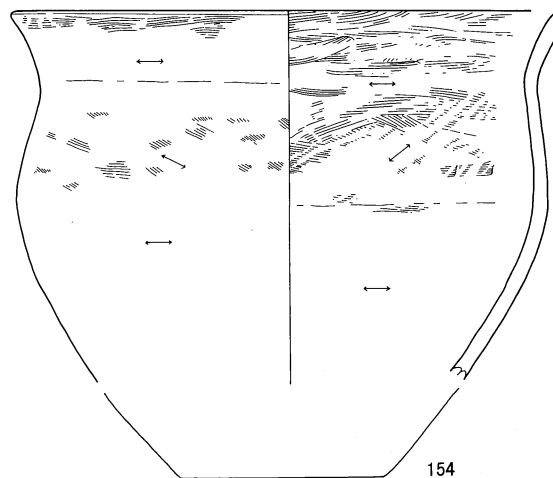

154

0 (1 : 4) 10cm

S B 265

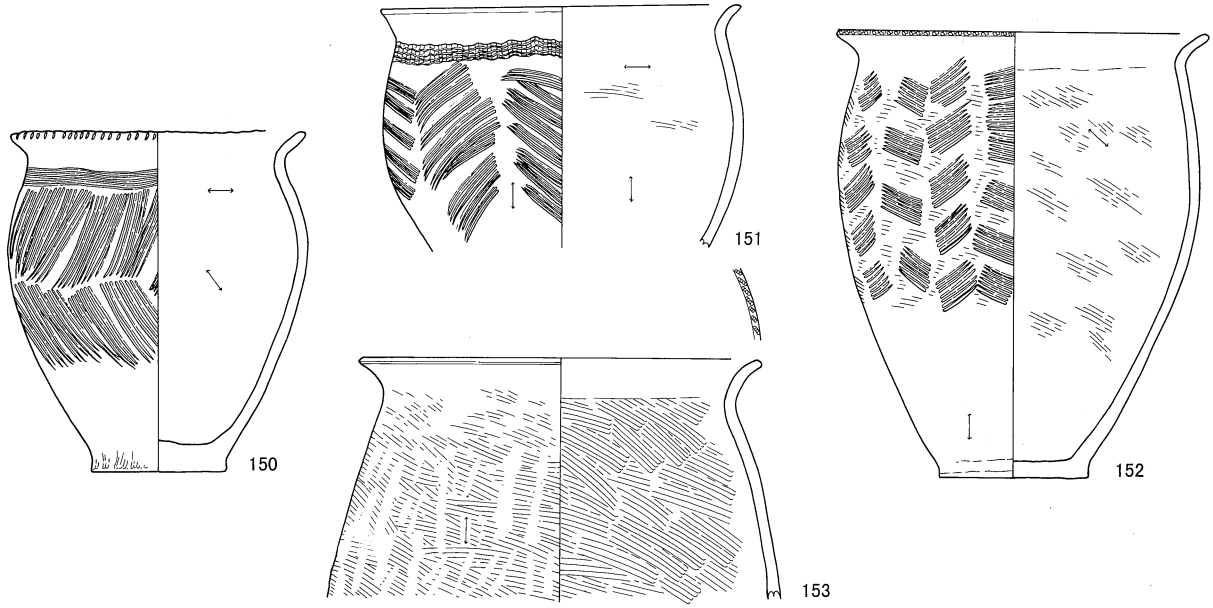

S B 266

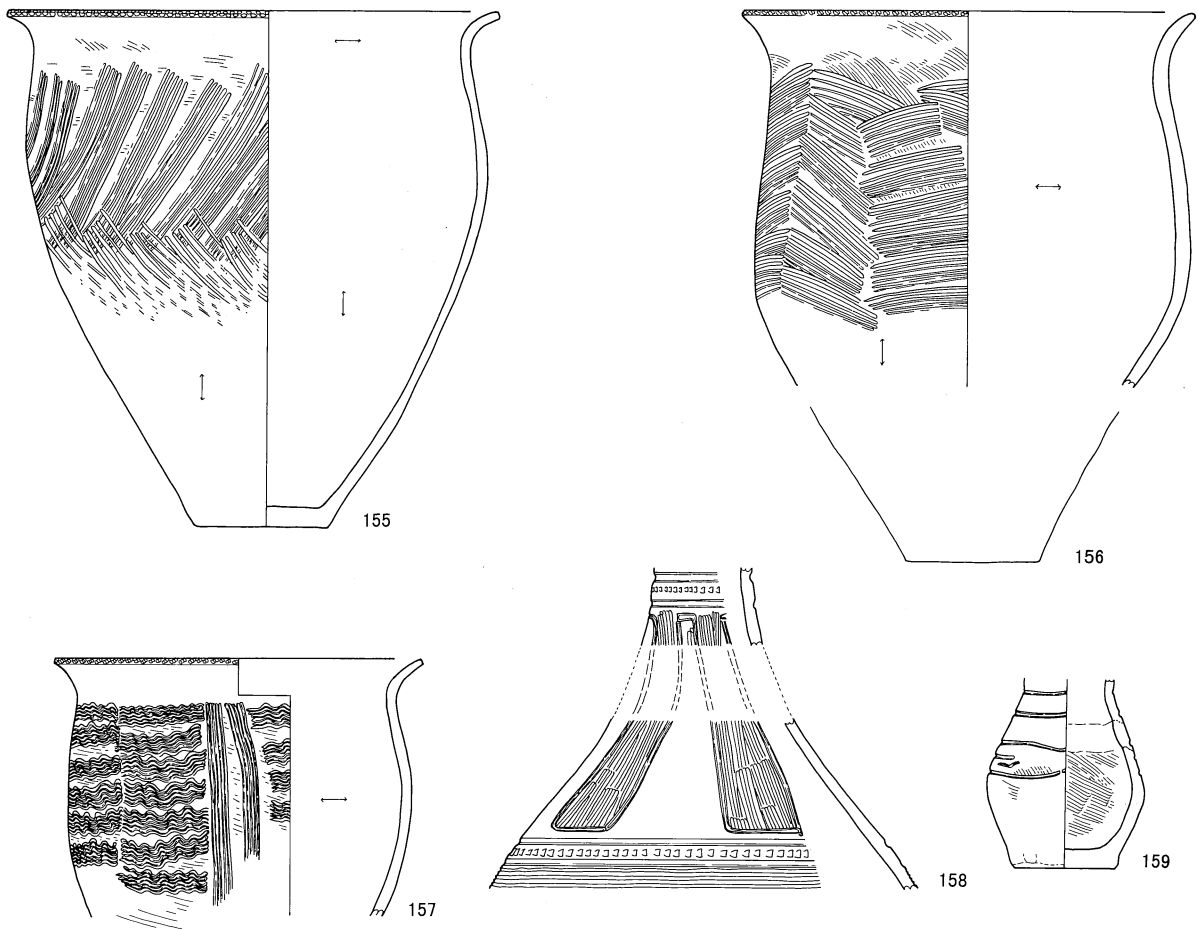

0 (1 : 4) 10cm

S B 265, 150~153 S B 266, 155~159

S B267

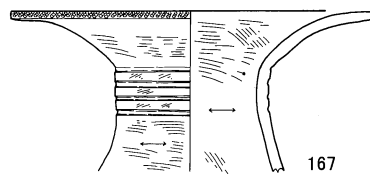
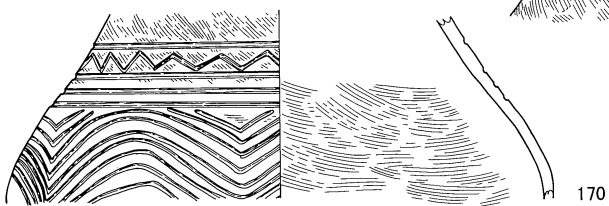
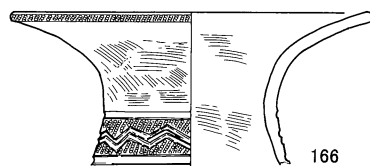
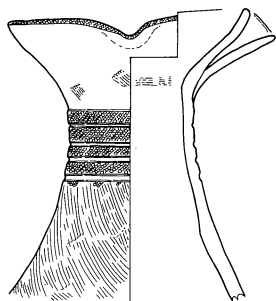
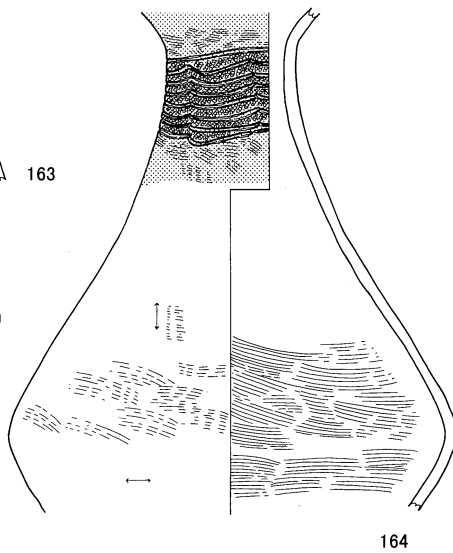
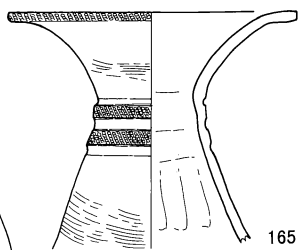
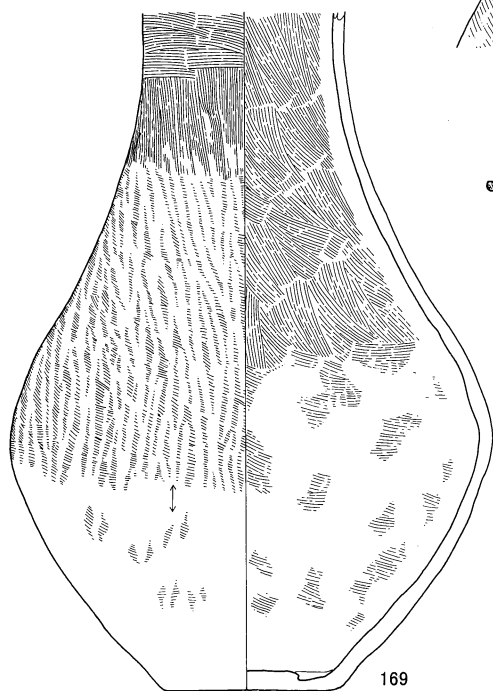
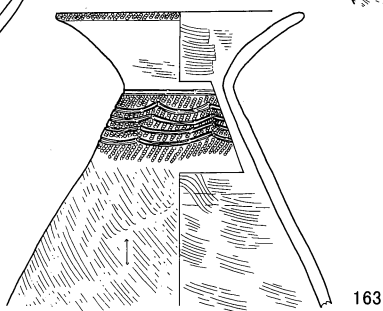
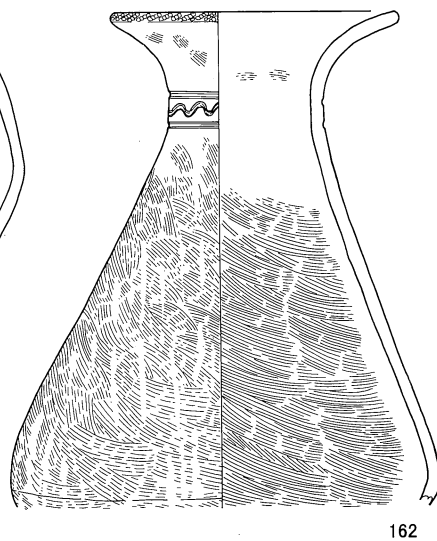
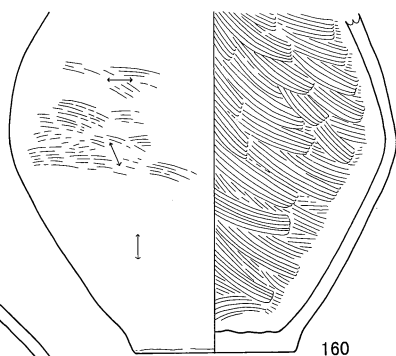
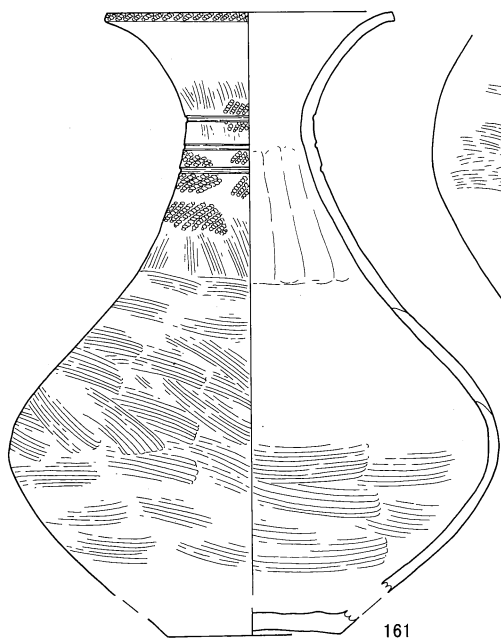

0 (1 : 4) 10 cm

S B267, 160~170

S B 267

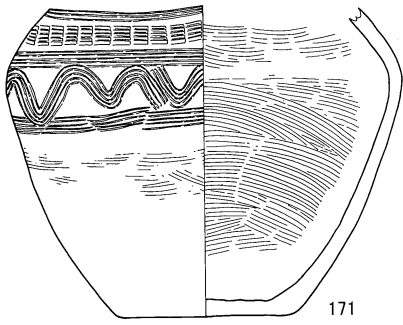

171

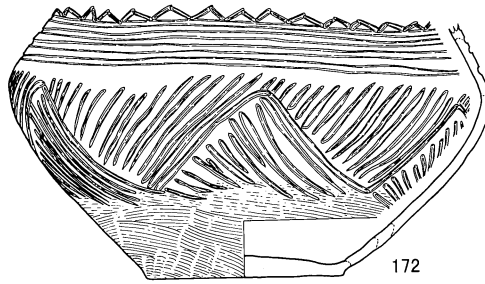

172

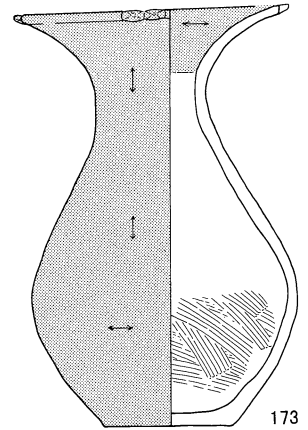

173

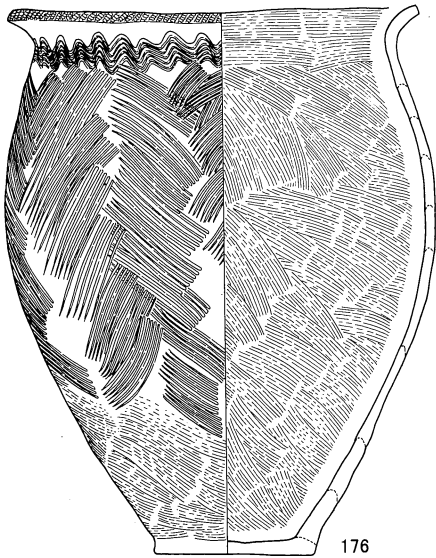

176

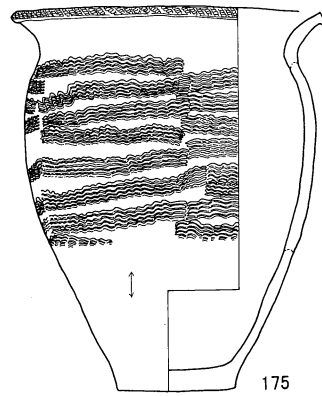

175

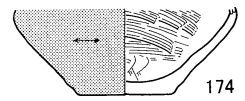

174

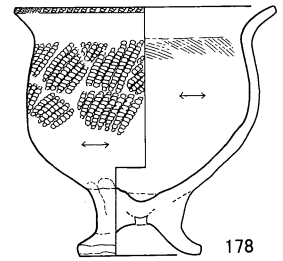

178

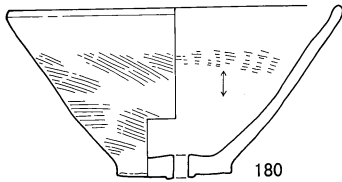

180

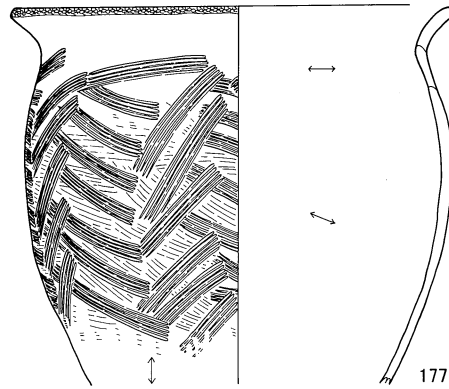

177

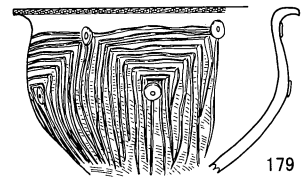

179

S B 268

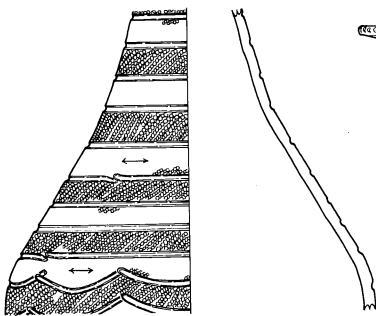

181

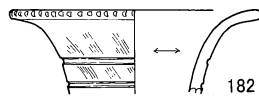

182



183

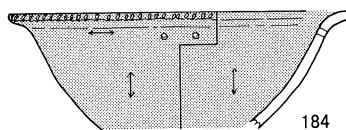

184

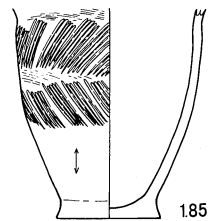

185

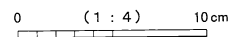

S B 271

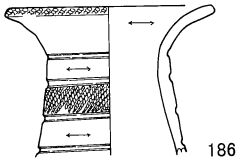

186

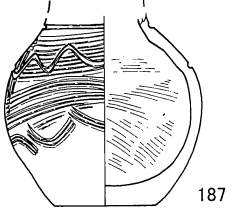

187

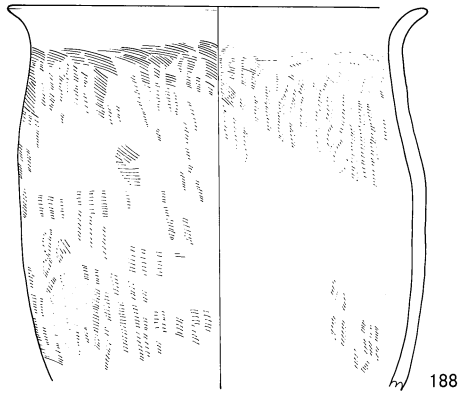

188

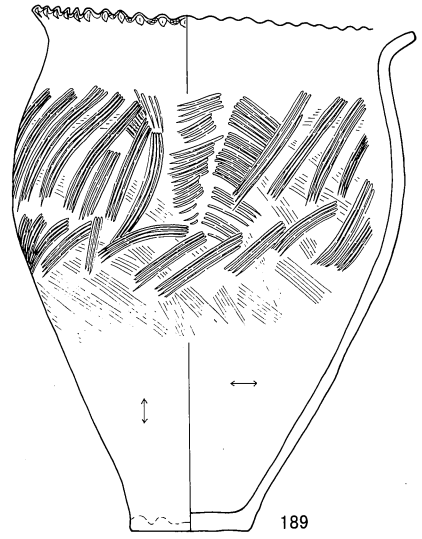

189

S B 272

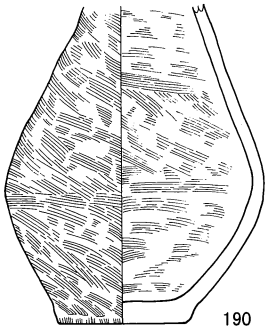

190

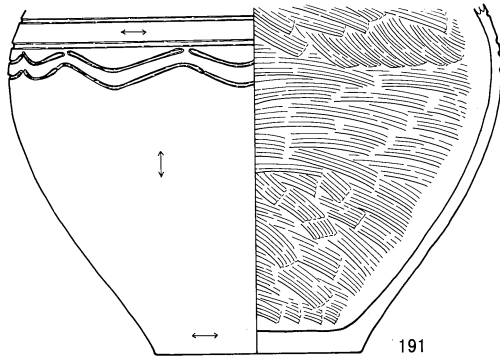

191

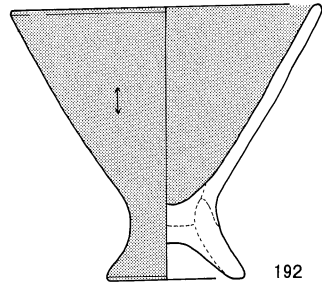

192

S B 273

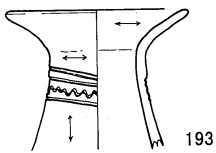

193

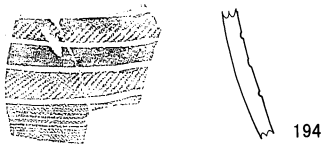

194

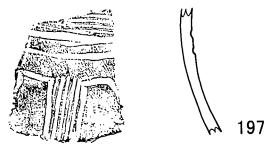

197



198



195



196

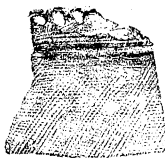

199

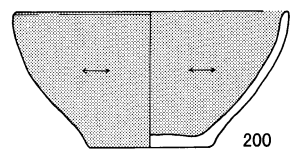

200

0 (1 : 4) 10 cm

S B 271, 186~189

S B 272, 190~192

S B 273, 193~200

S B 274

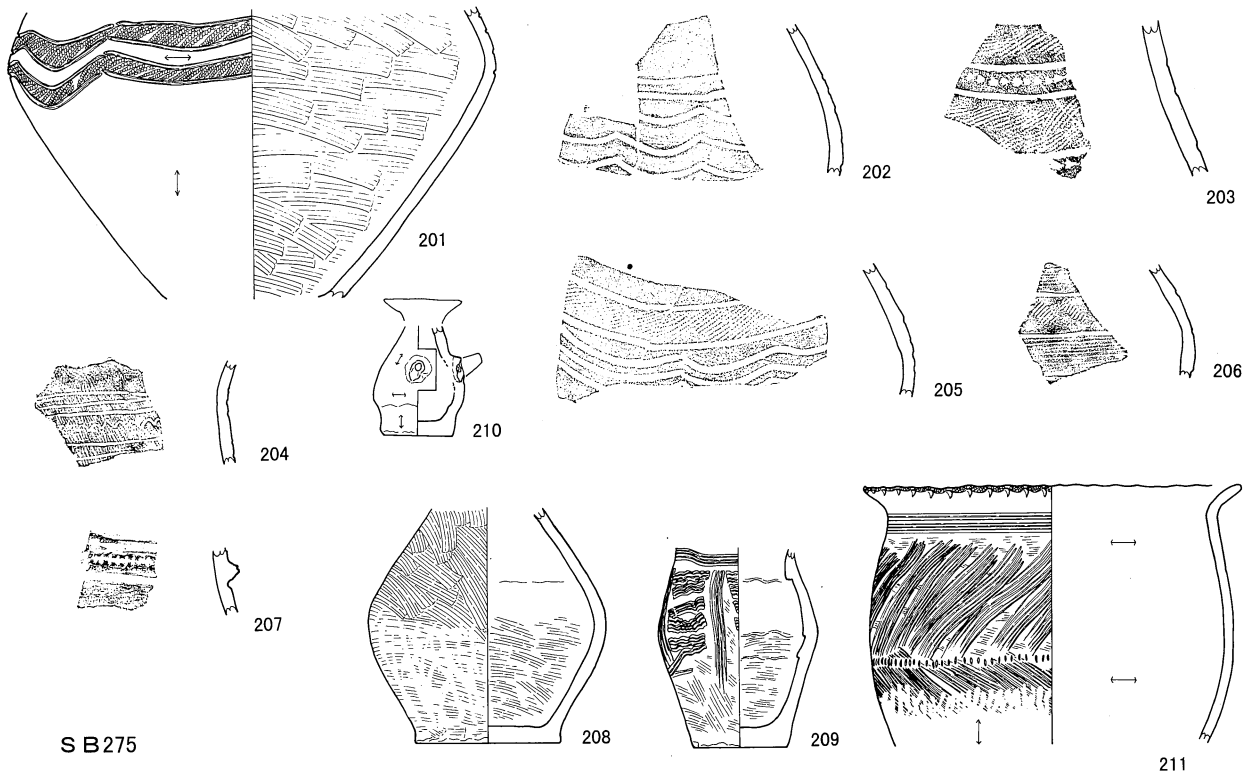

S B 275

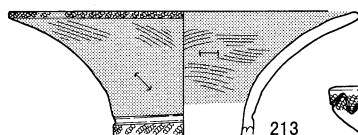
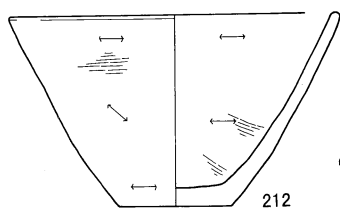

S B 277

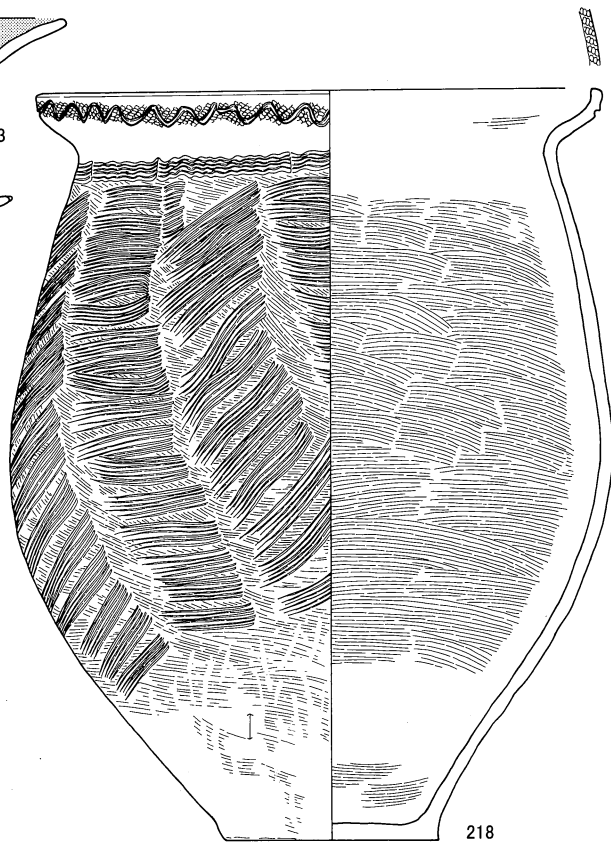
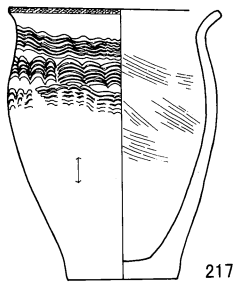
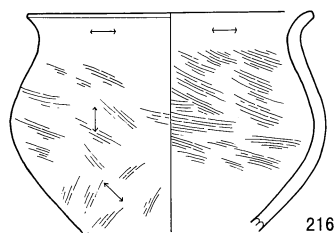
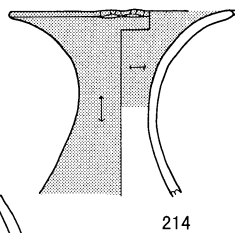
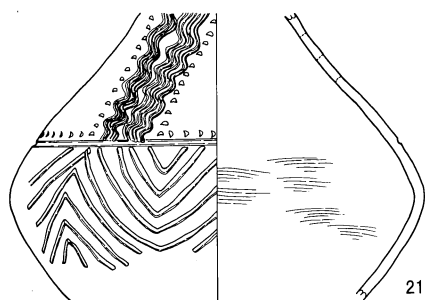

0 (1 : 4) 10 cm

S B 281

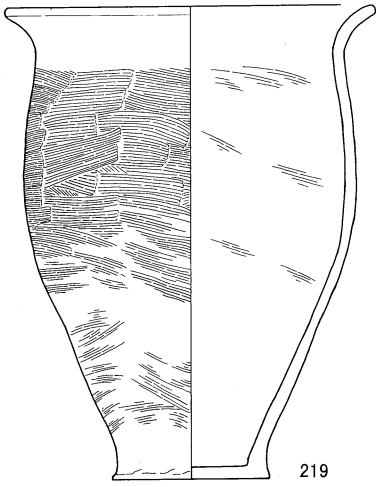

219

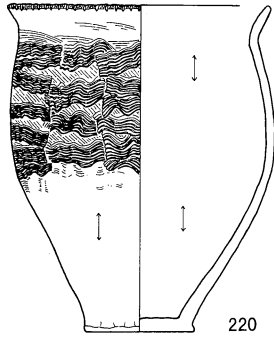

220

S B 282

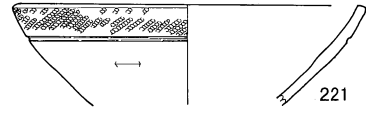

221

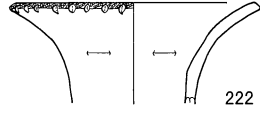

222

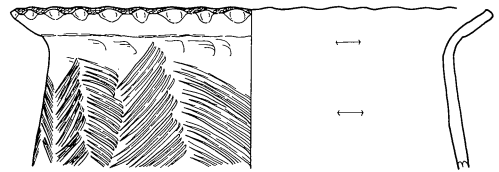

223

S B 284

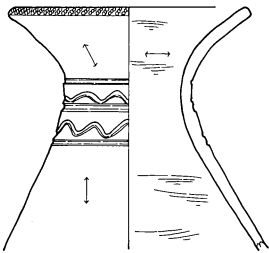

224

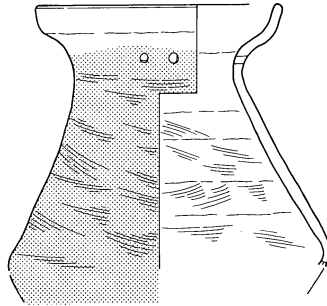

227

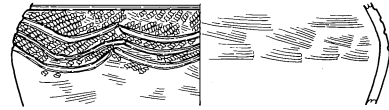

231

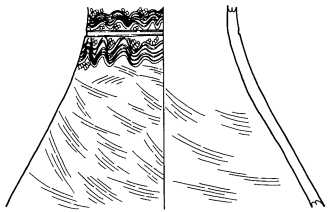

225

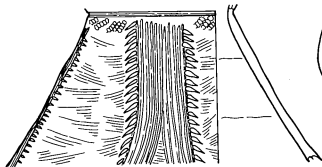

226

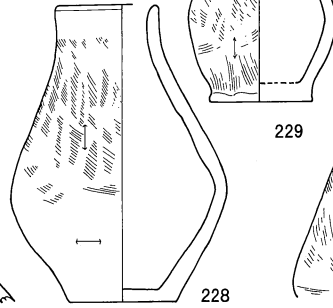

228

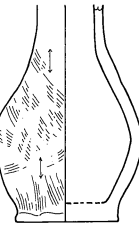

229

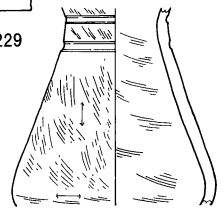

230

S B 286

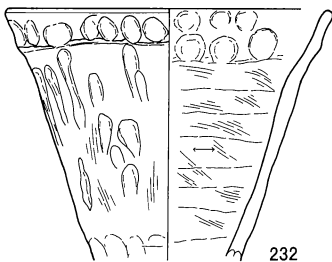

232

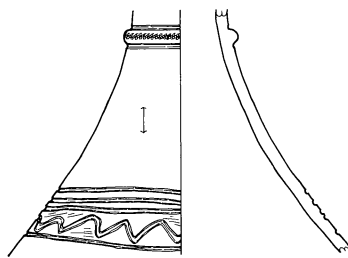

233

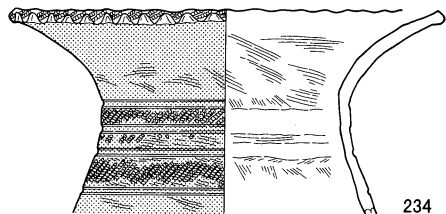

234

0 (1 : 4) 10cm

S B 281, 219~220

S B 282, 221~223

S B 284, 224~231

S B 286, 232~234



S B 286

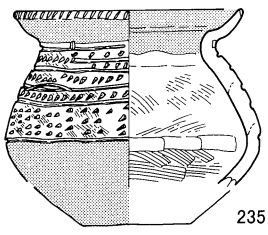

235

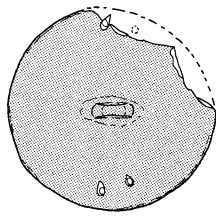
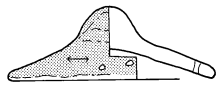

236

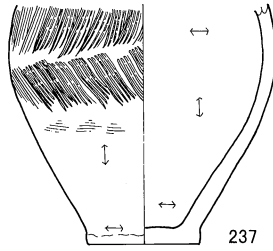

237

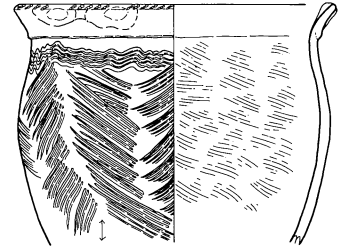

238

S B 287

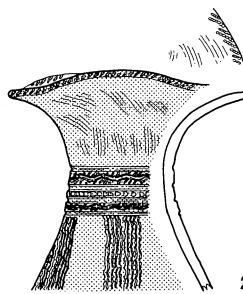
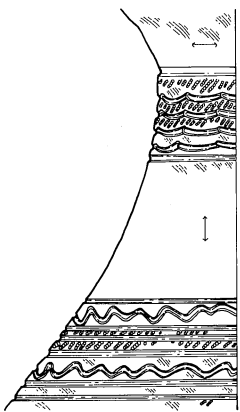

240

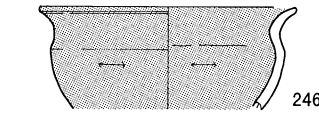

246



243

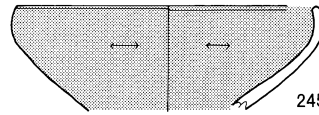

245

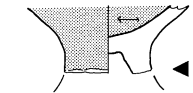

244

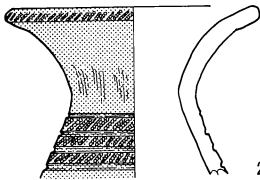

241

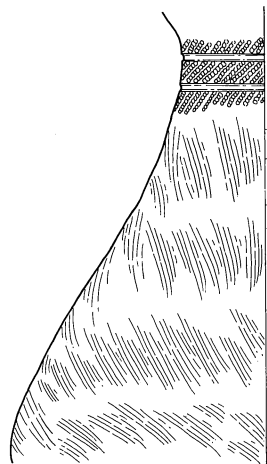

242

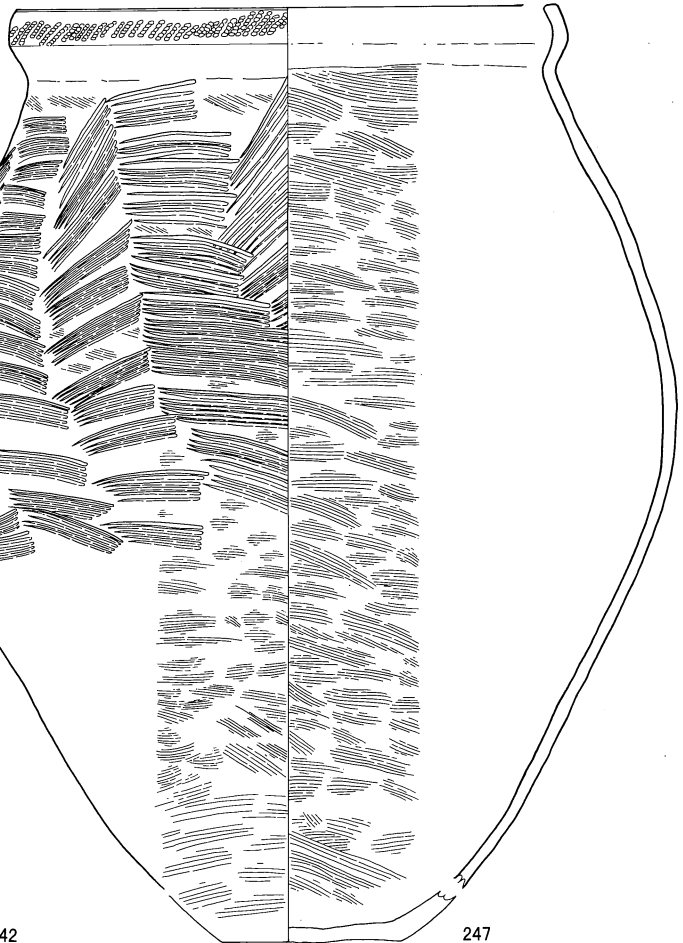

247

0 (1 : 4) 10 cm

S B 290

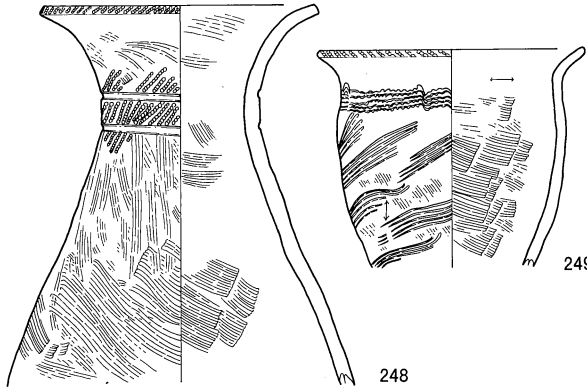

S B 302

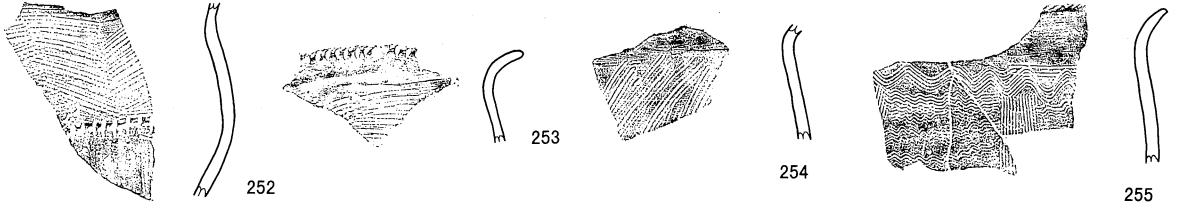
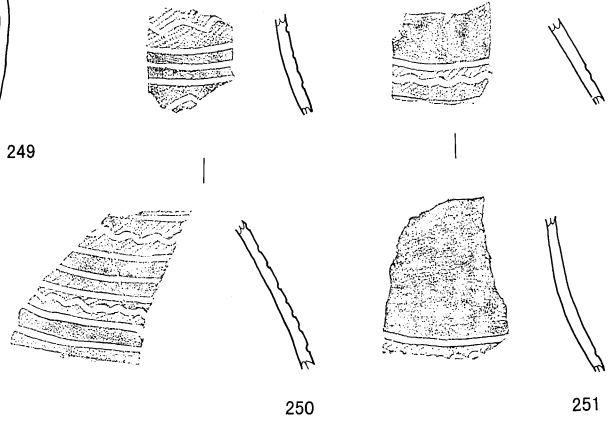

S B 306

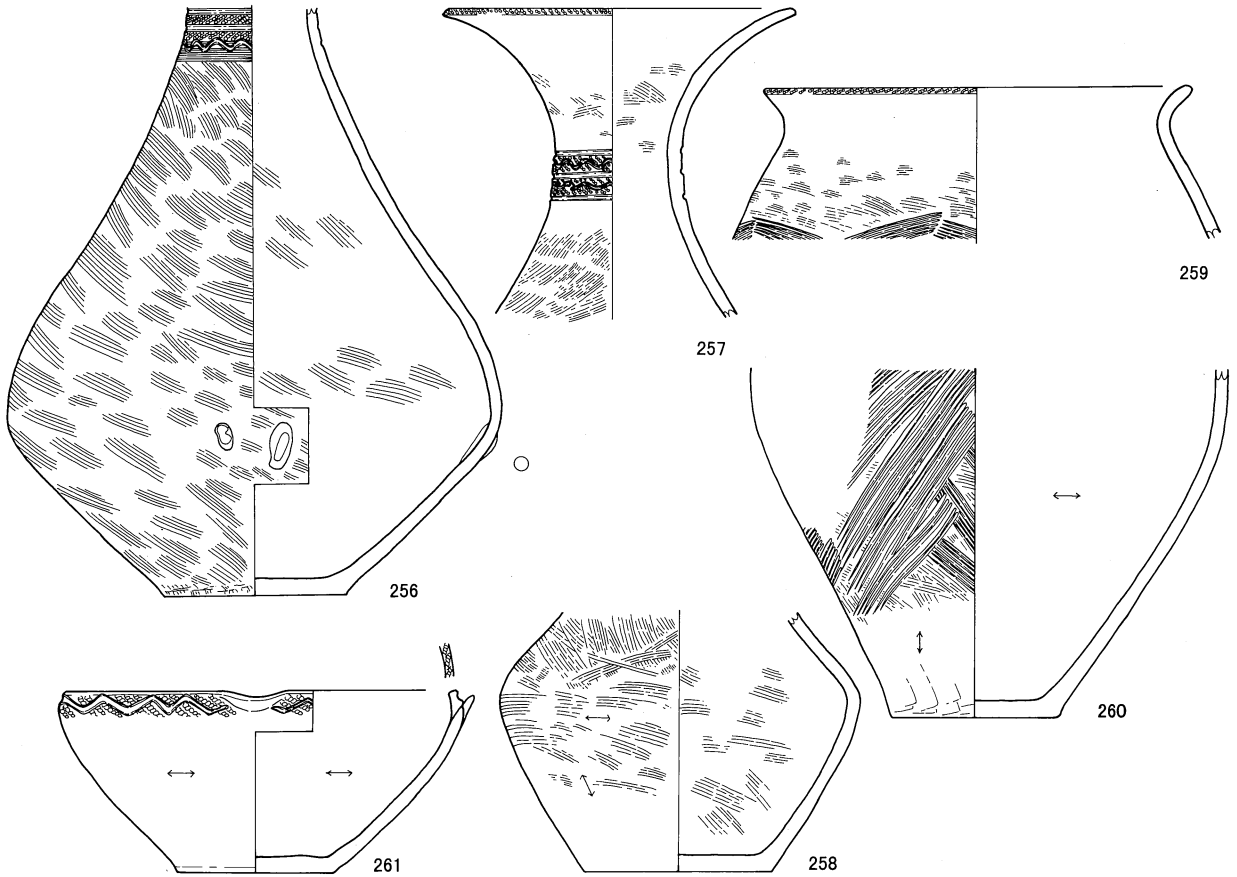

0 (1 : 4) 10 cm

S B 290, 248~249 S B 302, 250~255 S B 306, 256~261

S B 303

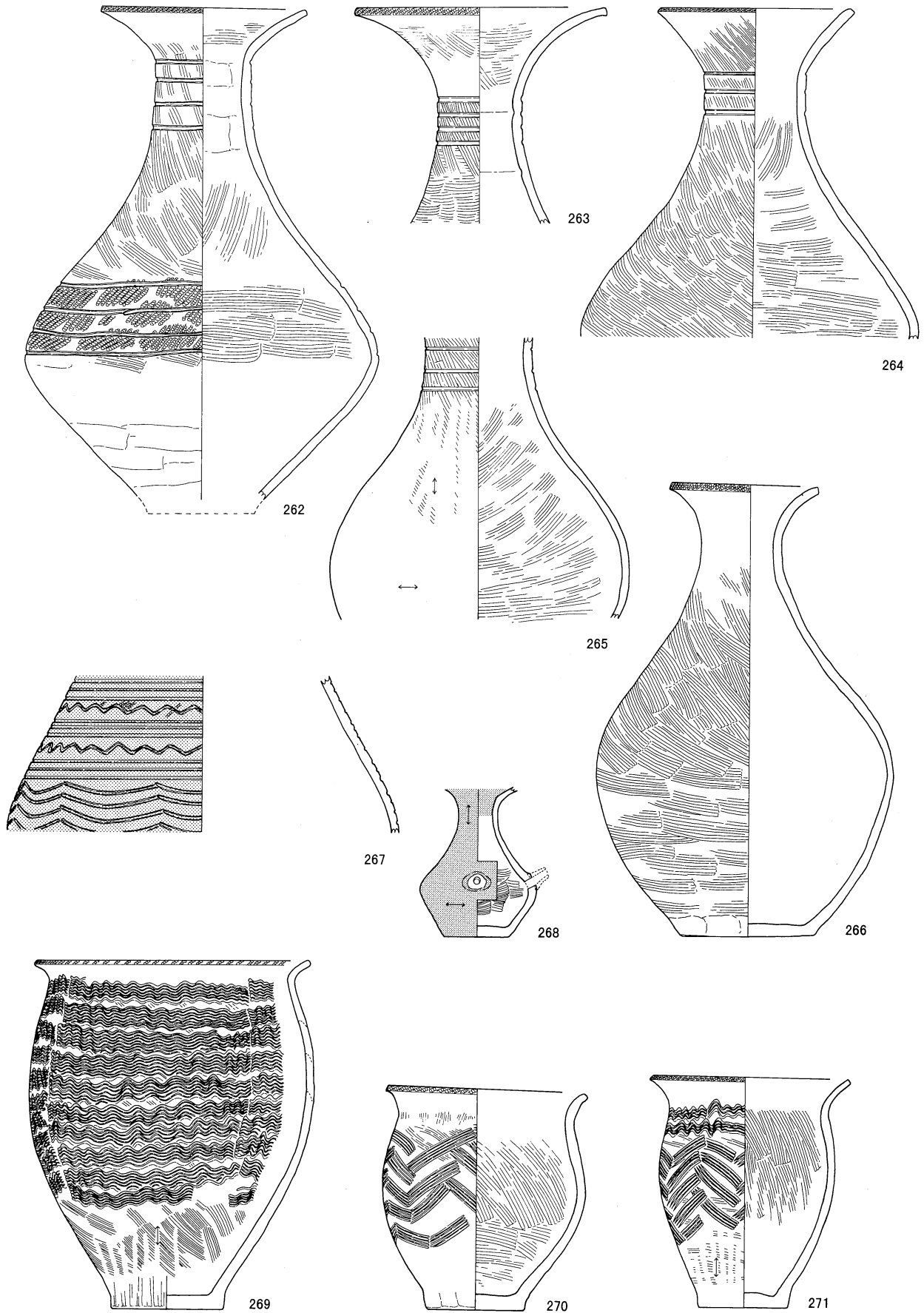

0 (1 : 4) 10 cm

S B 303, 262~271

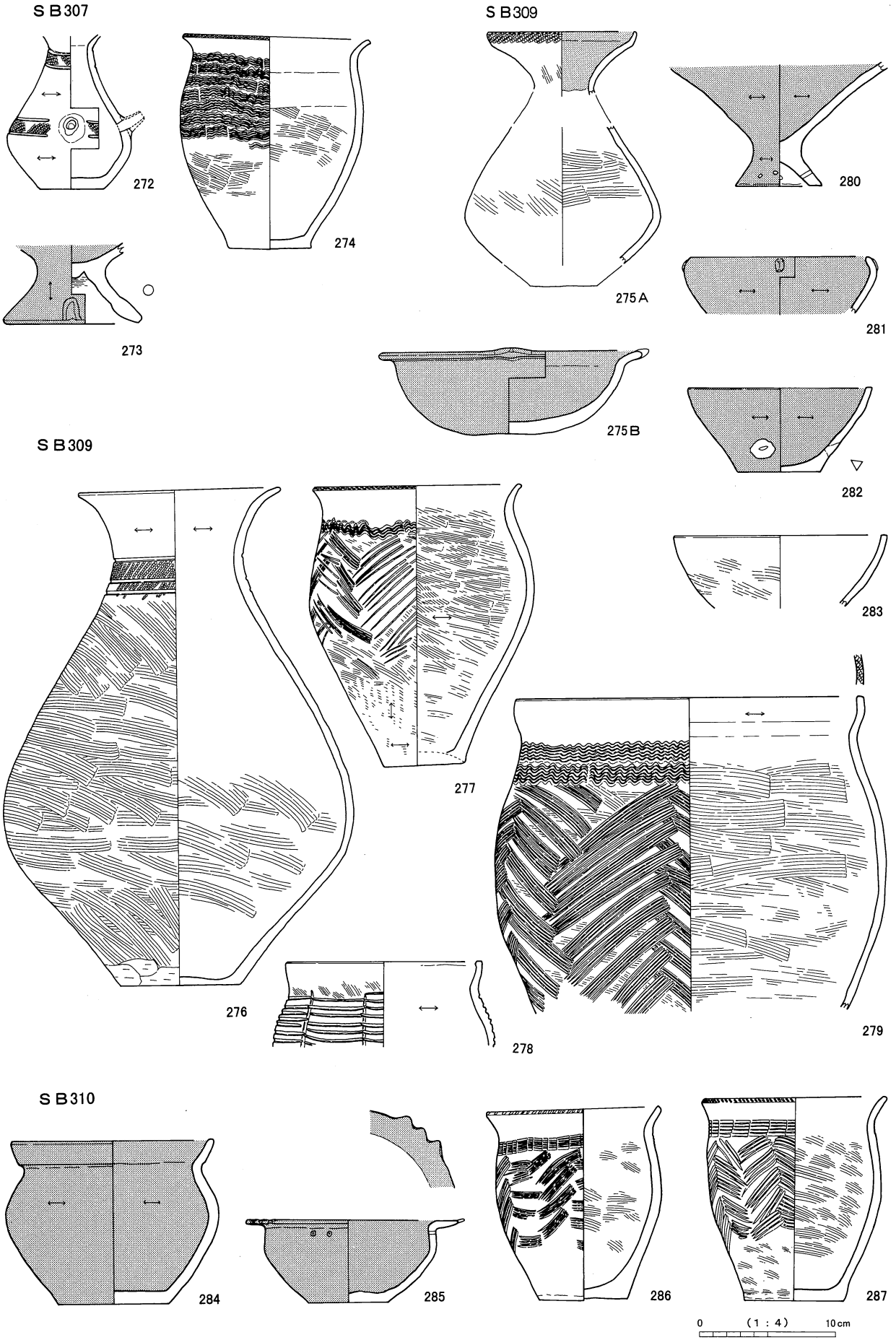

S B 307, 272~274 · 275 B

S B 309, 275 A · 276~283

S B 310, 284~287

S B312

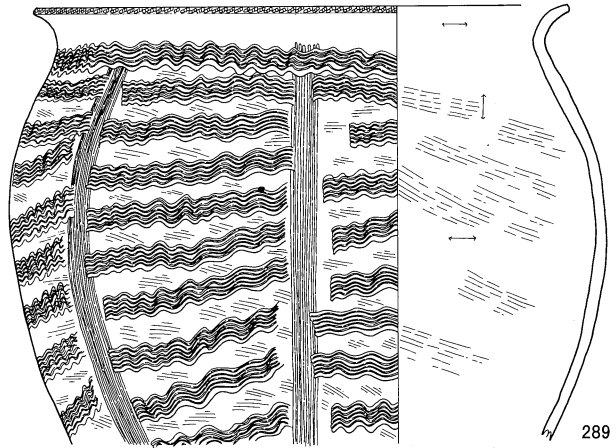
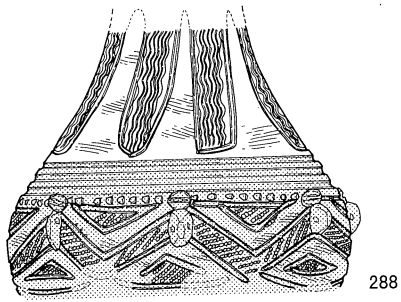

S B313

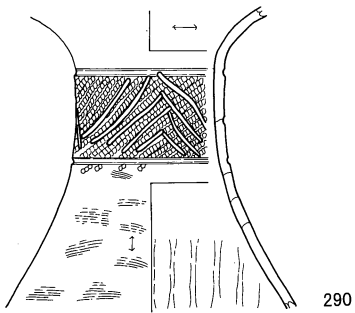

S B314

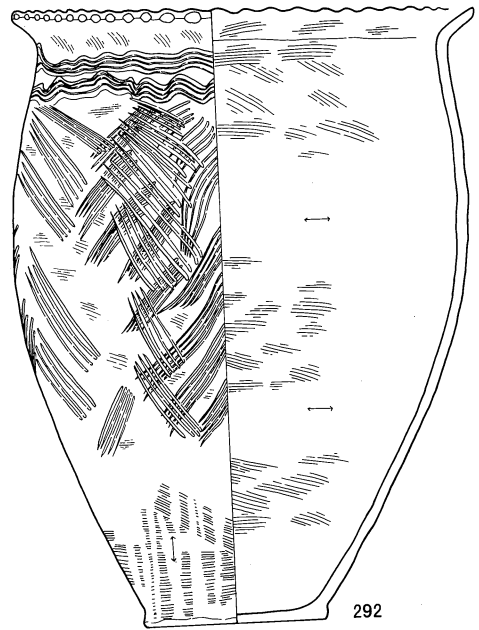
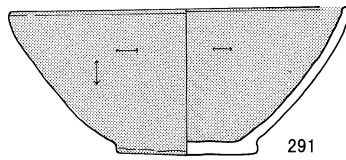

S B316

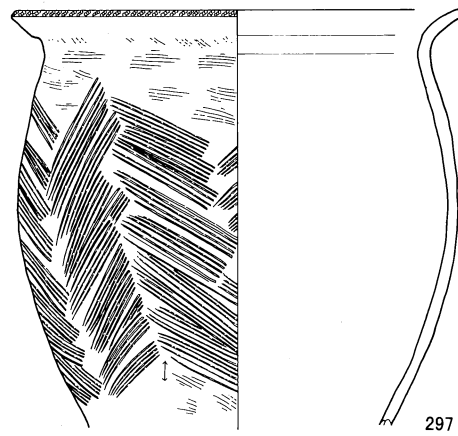
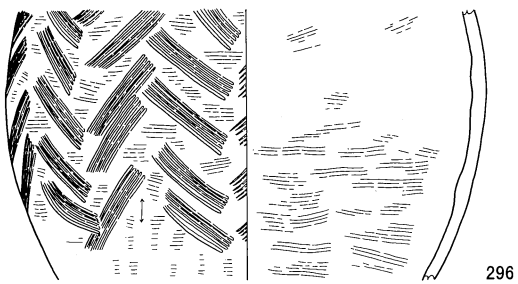
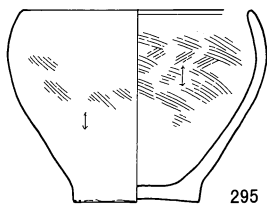
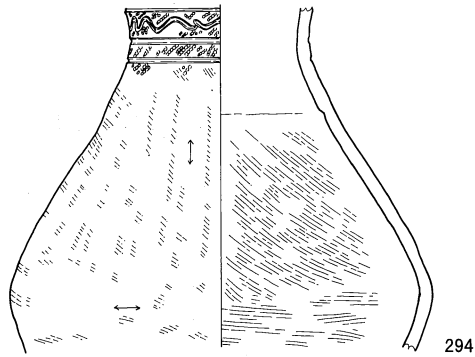
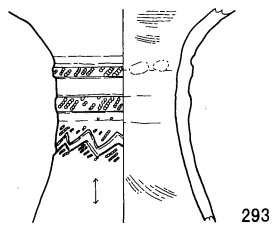

0 (1 : 4) 10 cm

S B312, 288~289

S B313, 290

S B314, 291~292

S B316, 293~297

S B 317

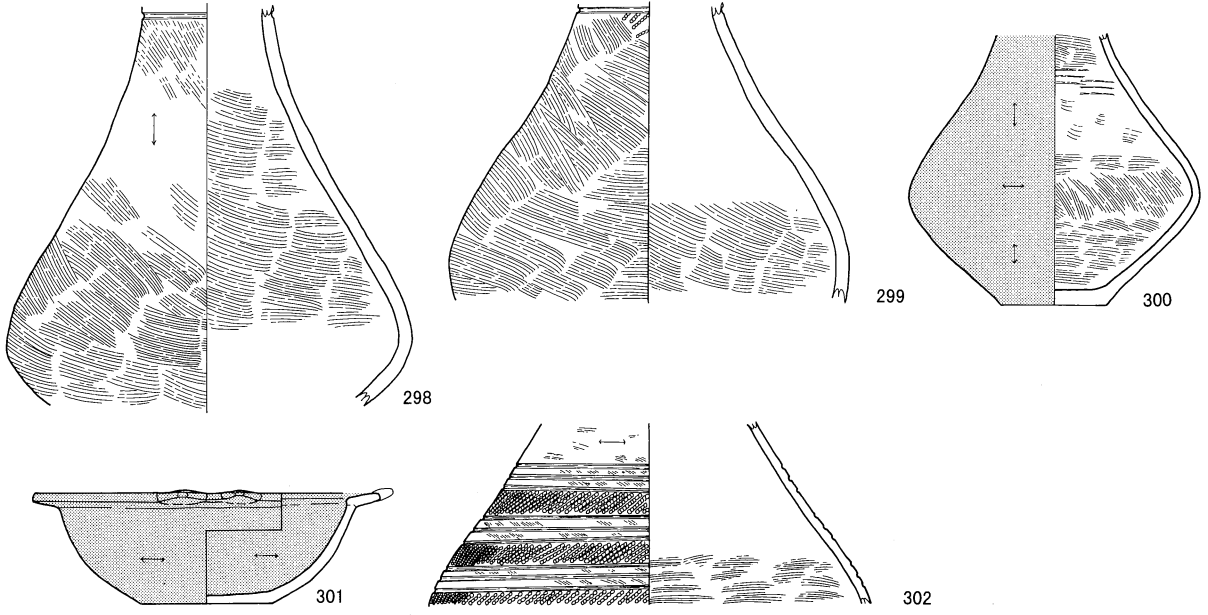

S B 318

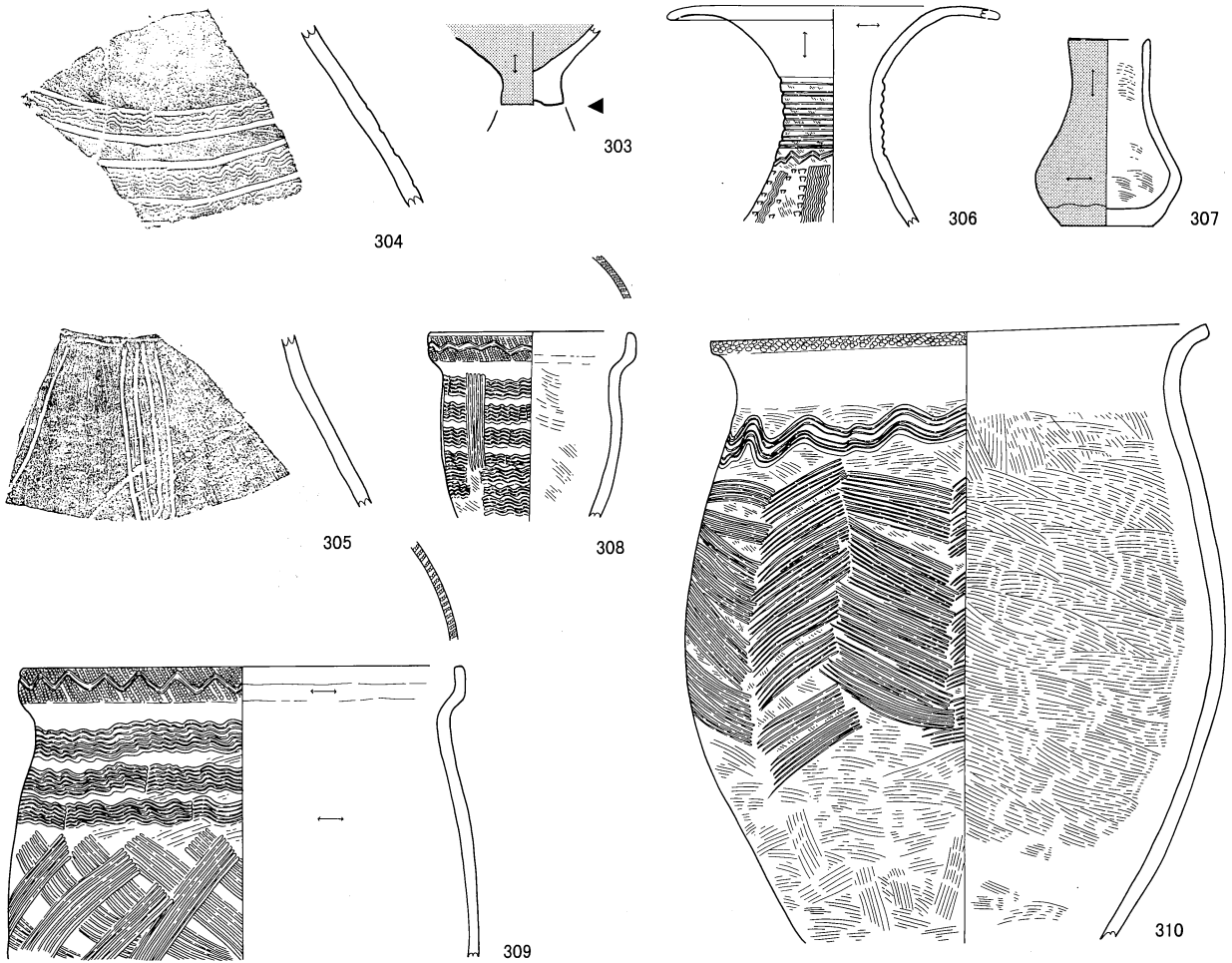

0 (1 : 4) 10cm

S B 317, 298~302 S B 318, 303~310

S B319

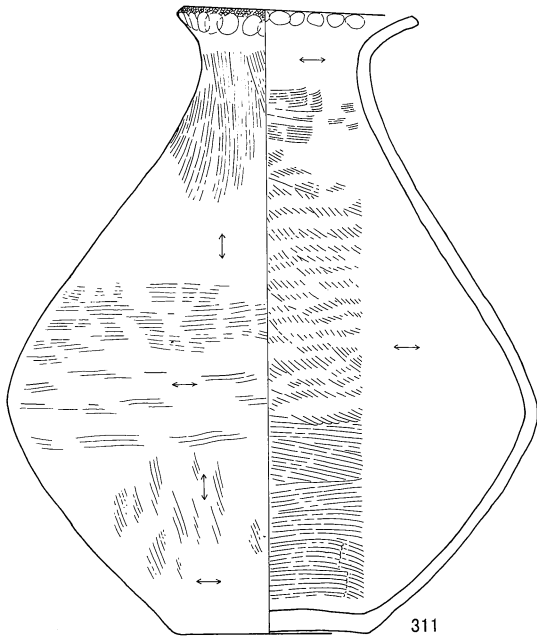

311

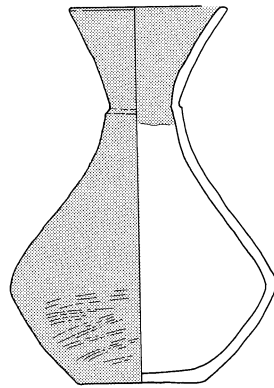

321

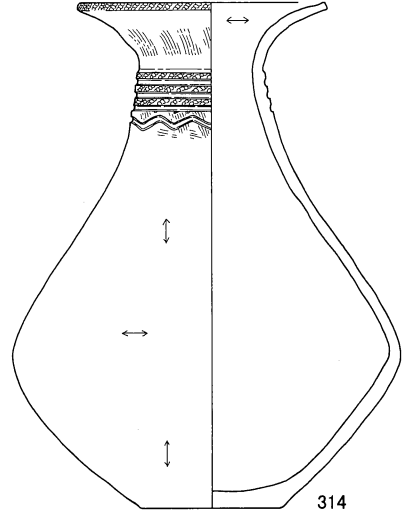

314

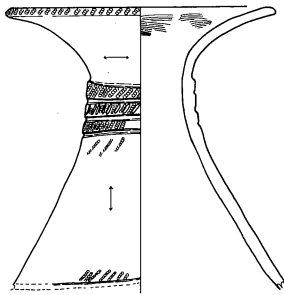

315

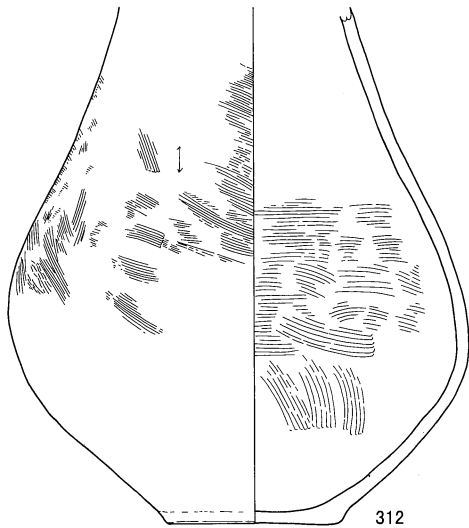

312



317

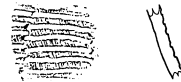

318

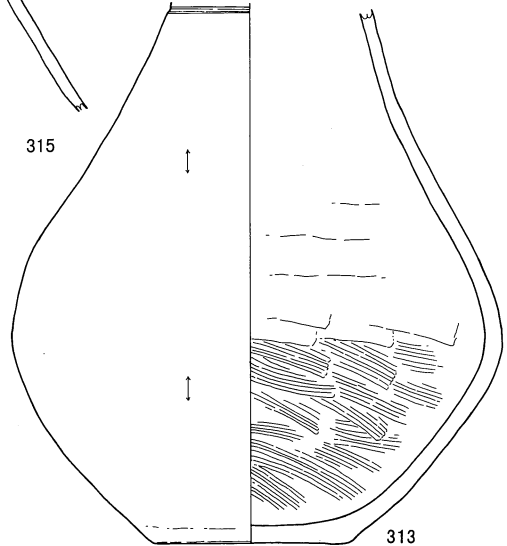

313



319

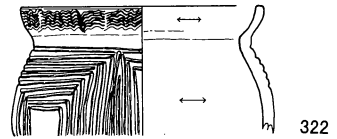

322

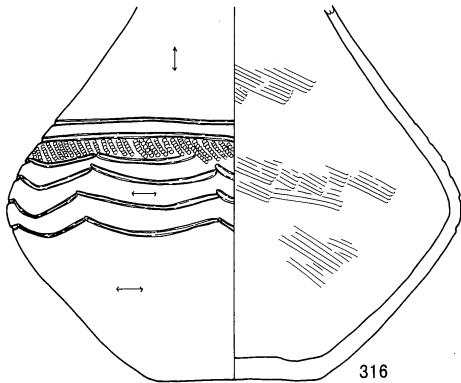

316



320

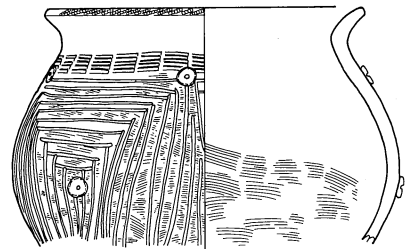

323

0 (1 : 4) 10cm

S B 319

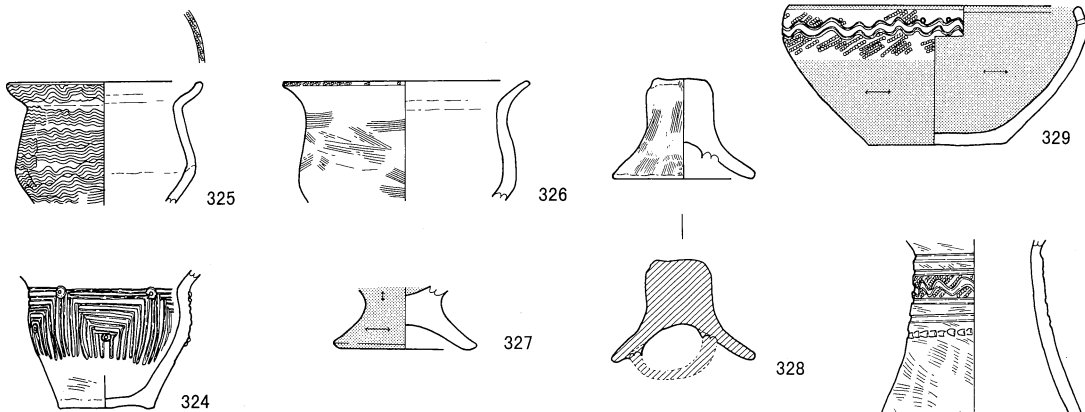

S B 320

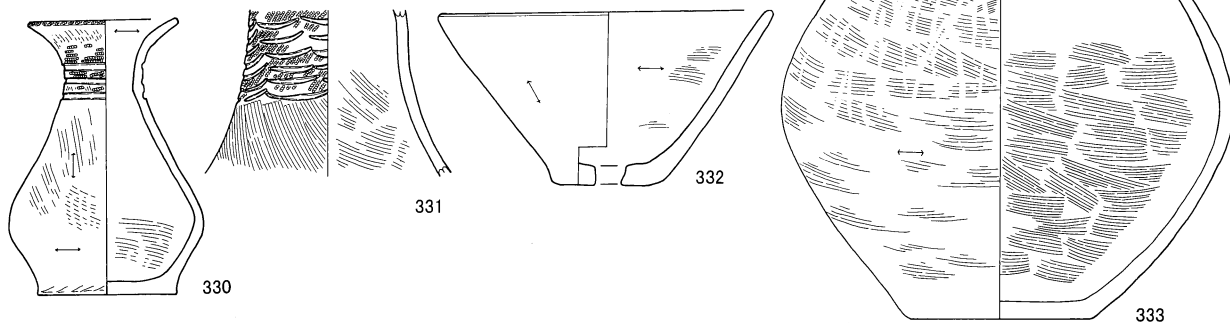

S B 324

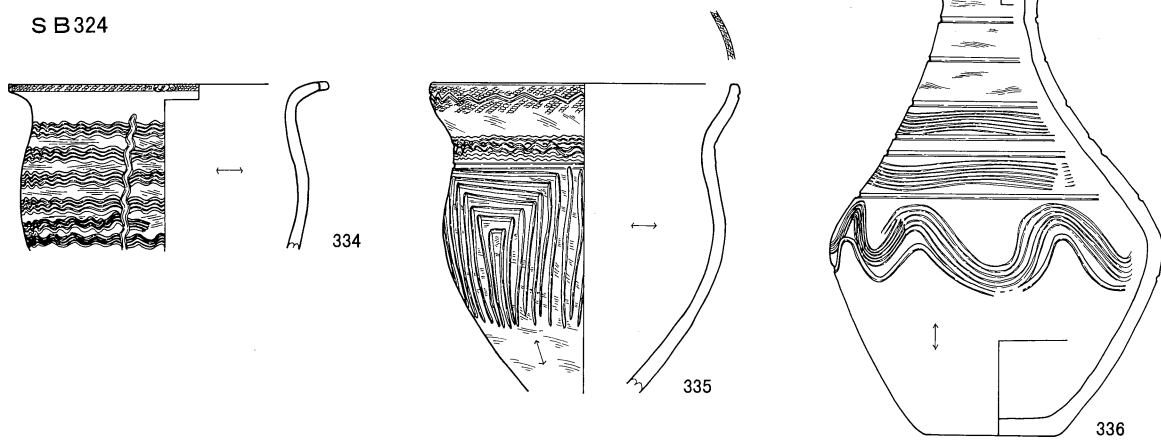

S B 323

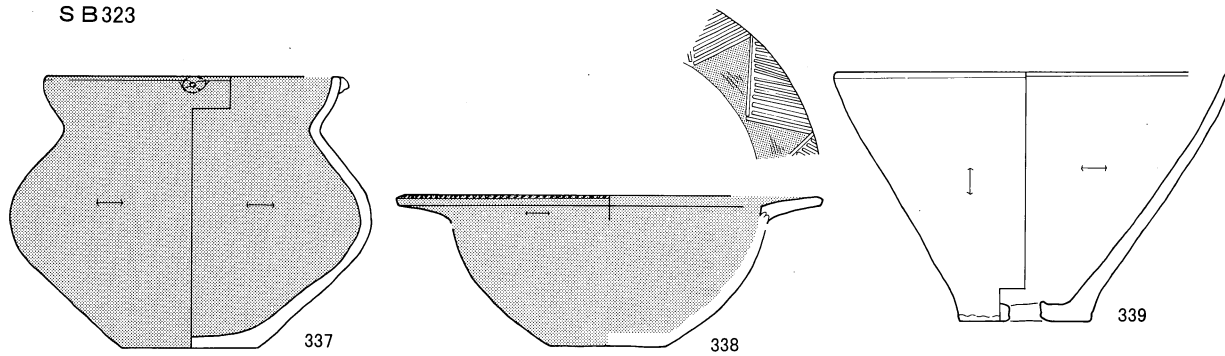

0 (1 : 4) 10cm

S B 319, 324~329

S B 320, 330~333

S B 324, 334~336

S B 323, 337~339



S B 325

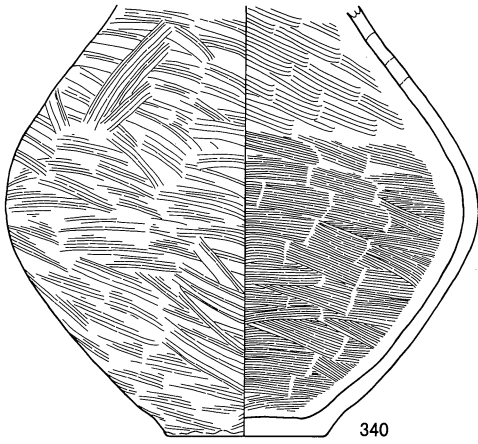

340

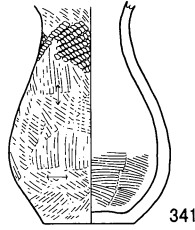

341

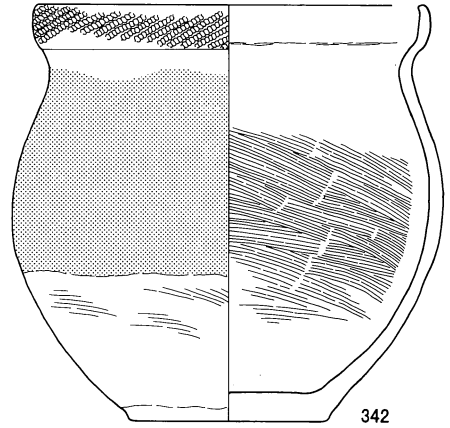

342

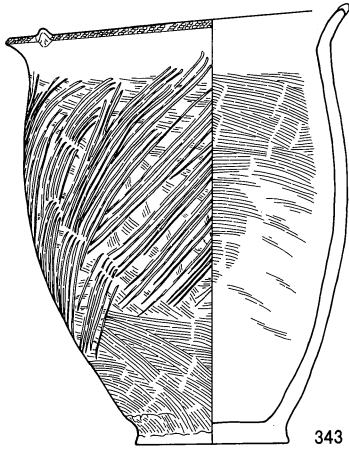

343

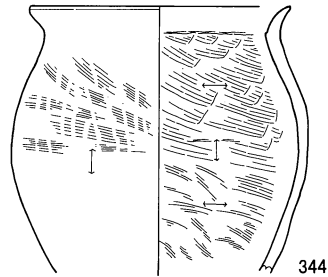

344

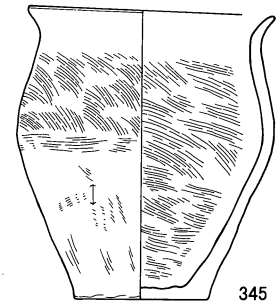

345

S B 326

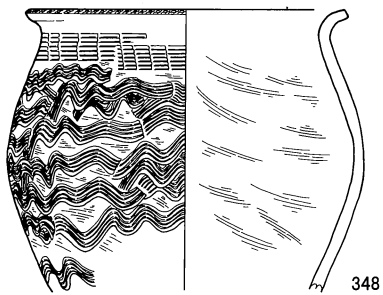

348

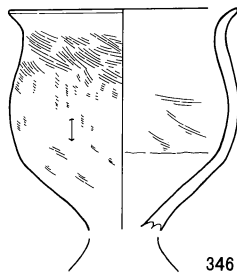

346

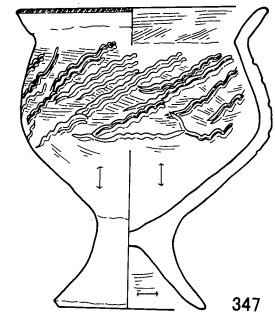

347

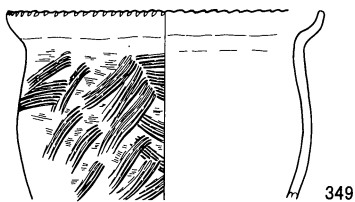

349

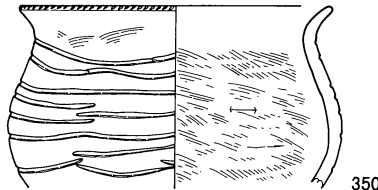

350

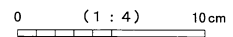

S B 328

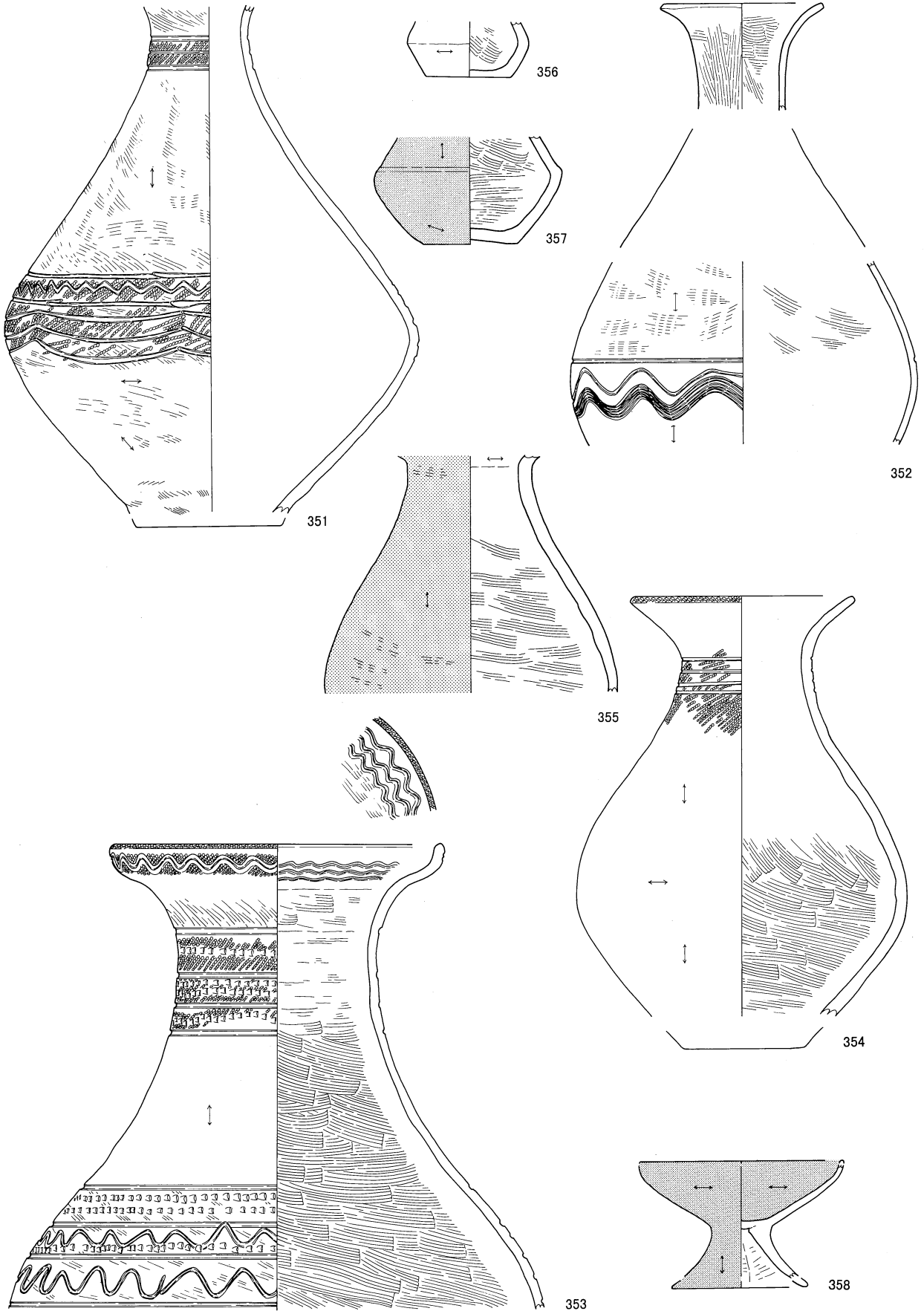

0 (1 : 4) 10cm

S B 328, 351~358

S B 328

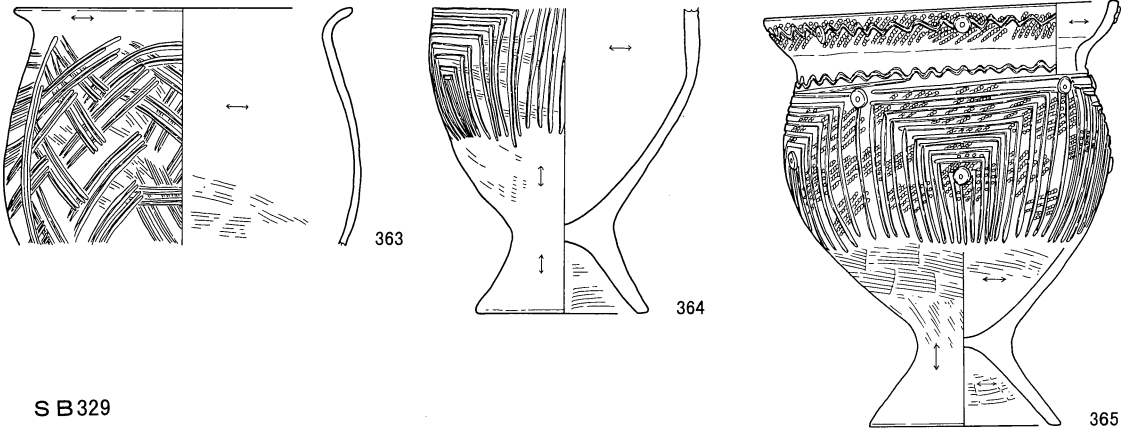
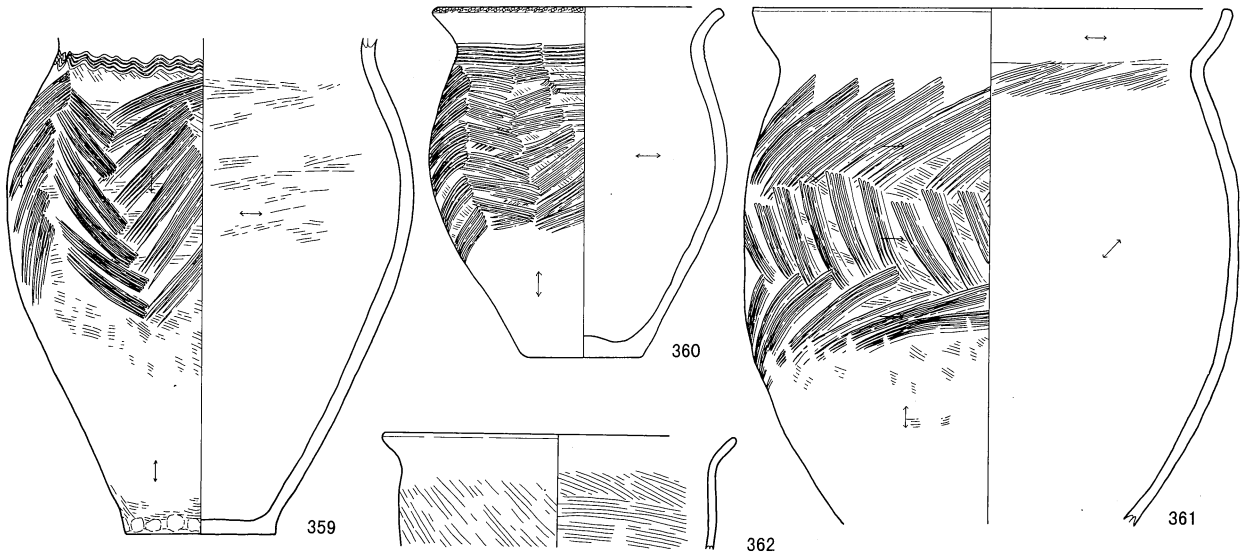

S B 329

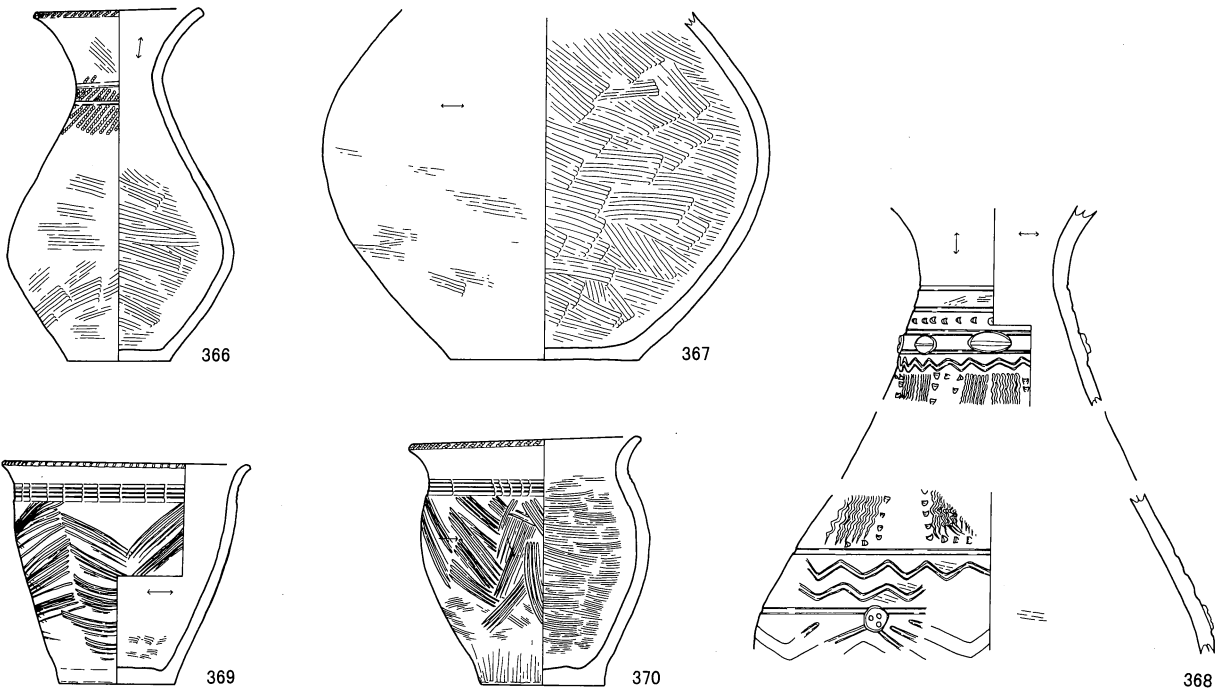

0 (1 : 4) 10 cm

S B 328, 359~365 S B 329, 366~370

S B 331

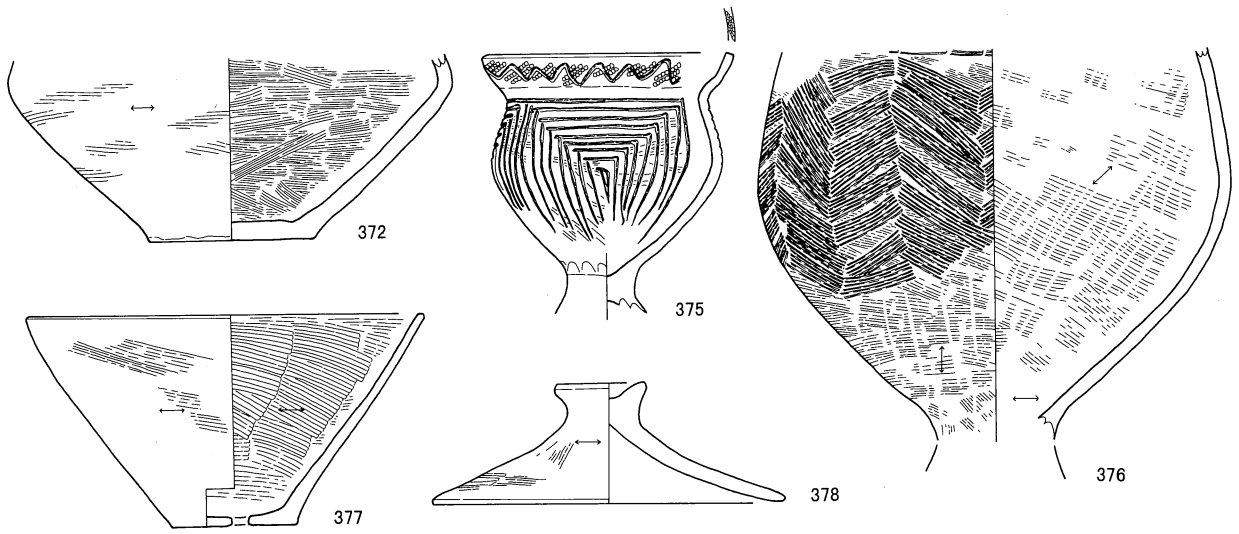
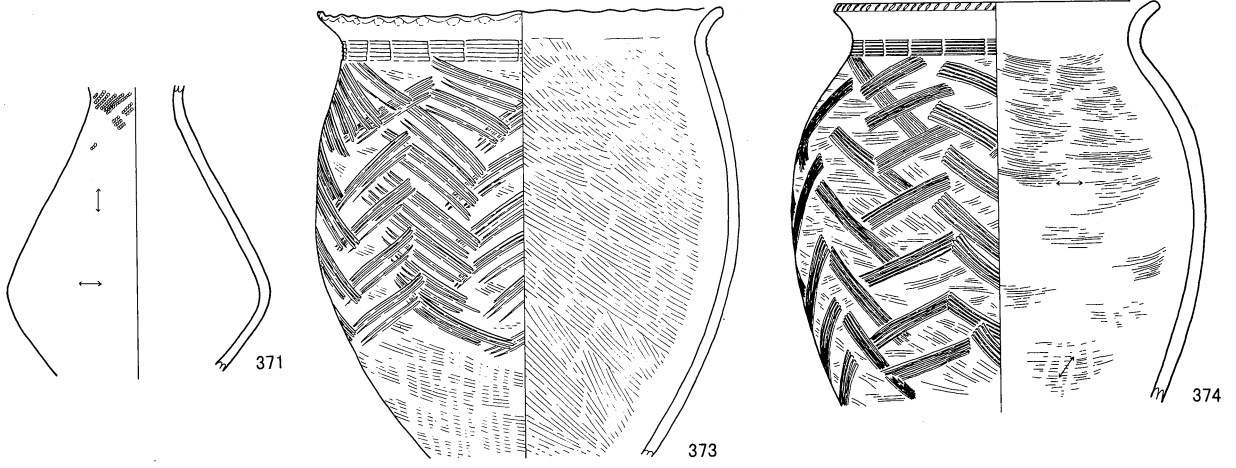

S B 332

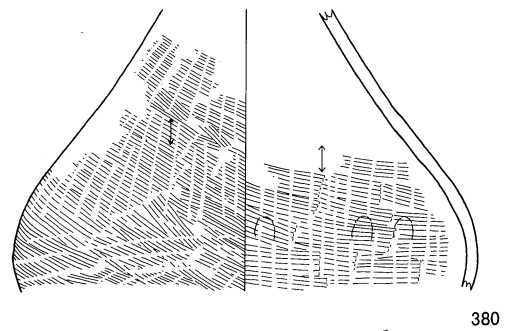
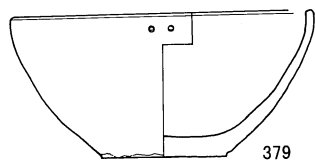

S B 351

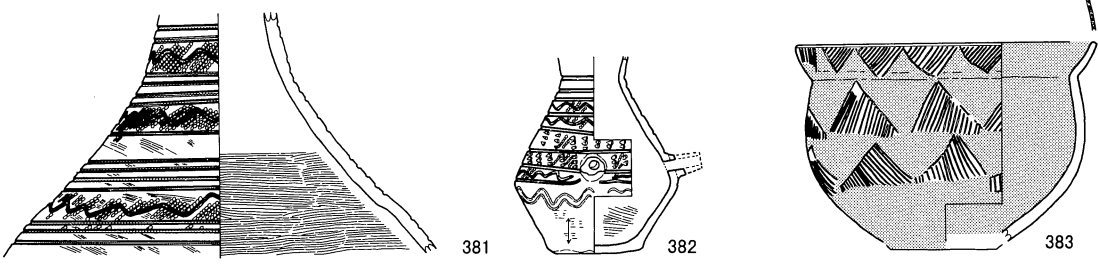

0 (1 : 4) 10cm

S B 331, 371~378 S B 332, 379 S B 351, 380~383

S B 352

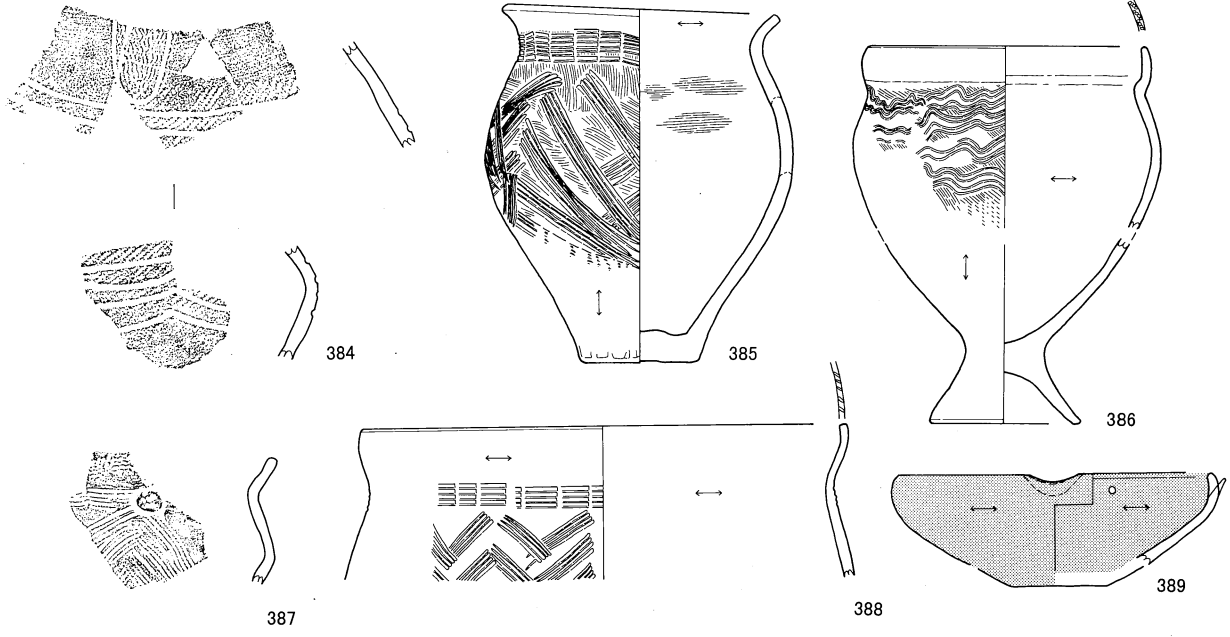

S B 353

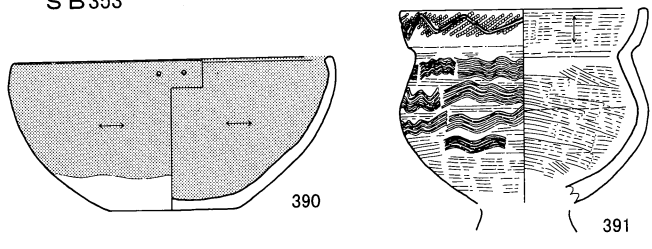

S B 354

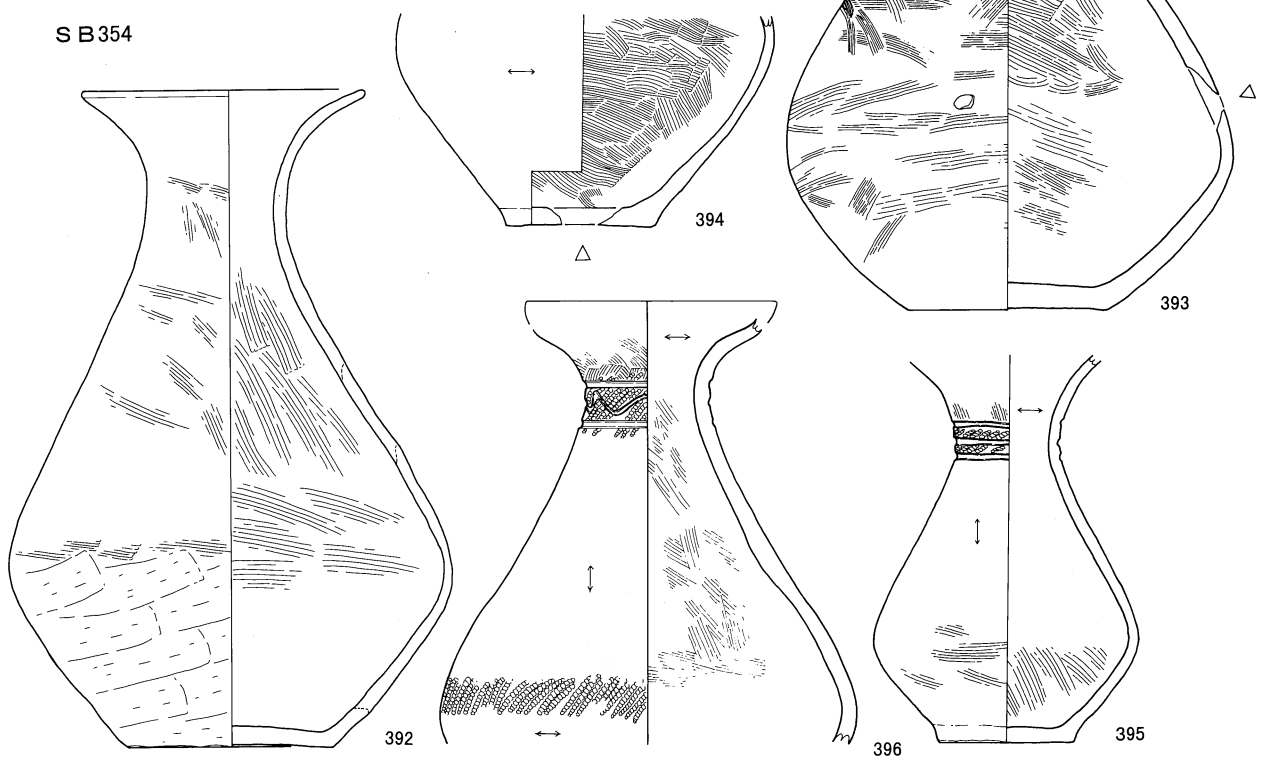

0 (1 : 4) 10cm

S B 352, 384~389 S B 353, 390~391 S B 354, 392~396

S B 354

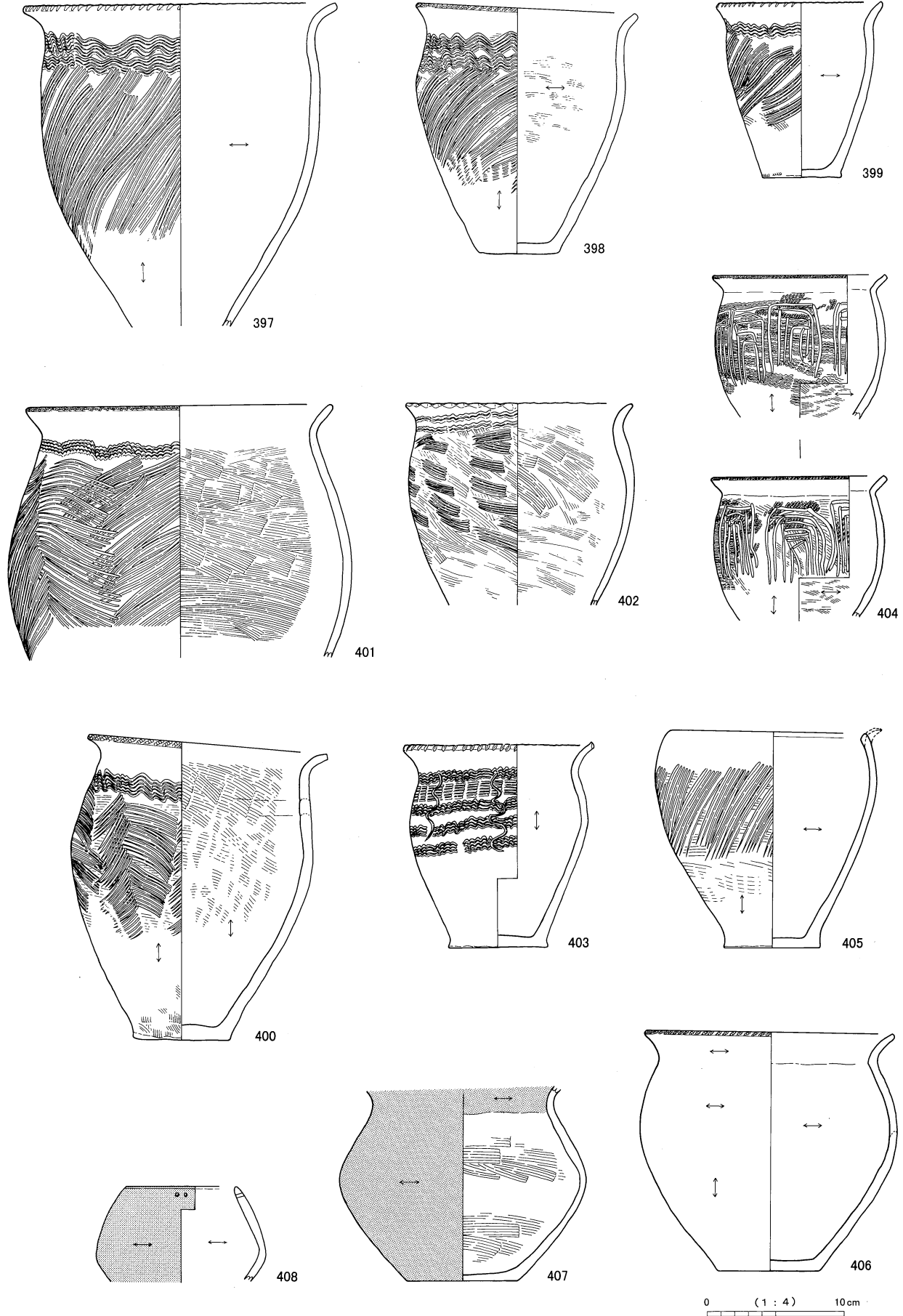

S B 354, 397~408

S B 354

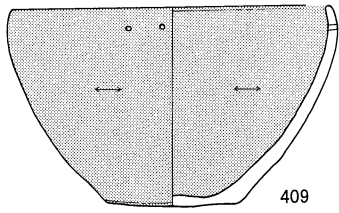

409

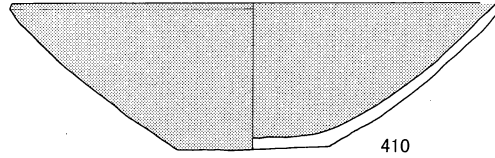

410

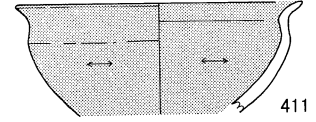

411

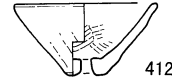

412

S B 355

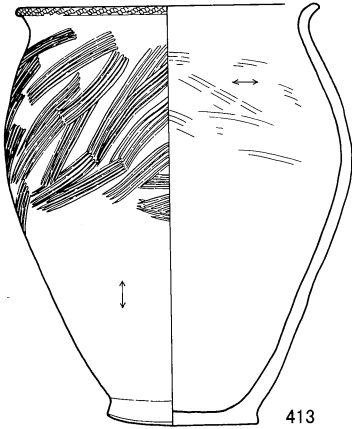

413

S B 359

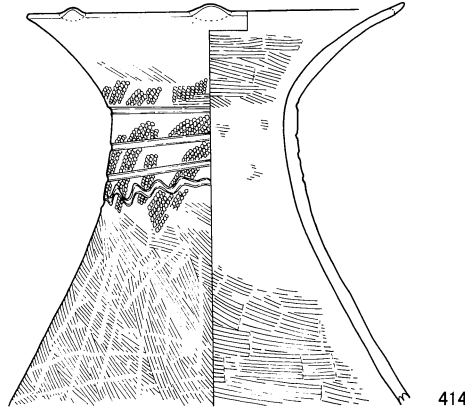

414

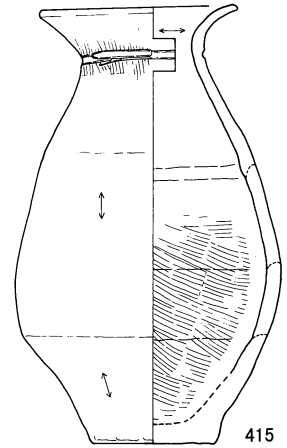

415

S B 359

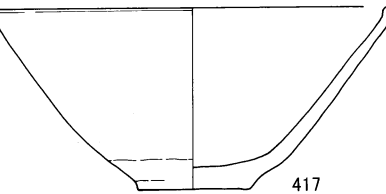
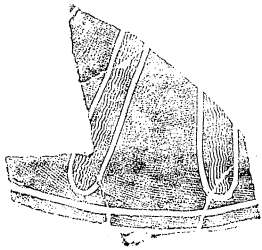

417

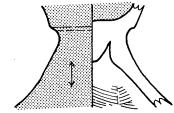

418

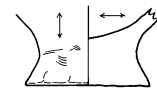

419

S B 360

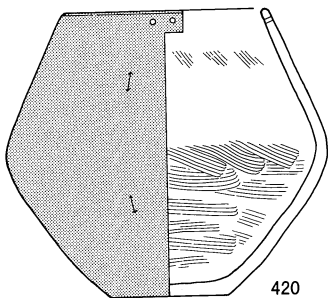

420

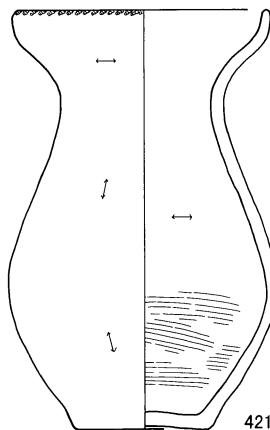

421

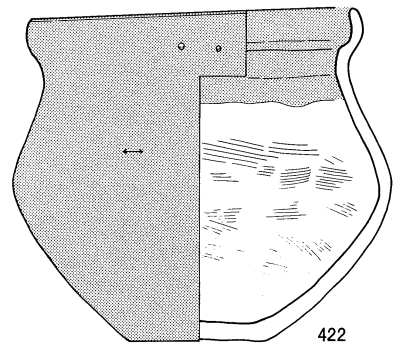

422

0 (1 : 4) 10cm

S B 354, 409~412

S B 355, 413

S B 359, 414~419

S B 360, 420~422

S B 360

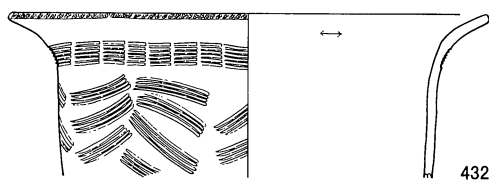
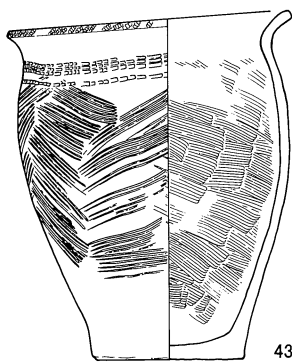
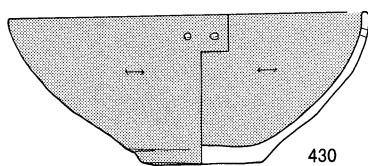
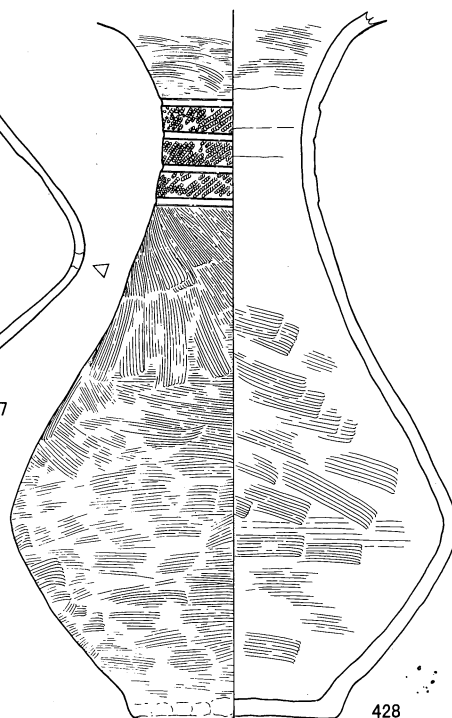
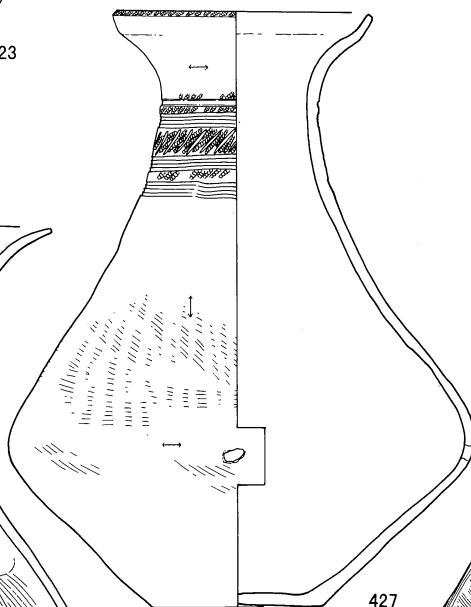
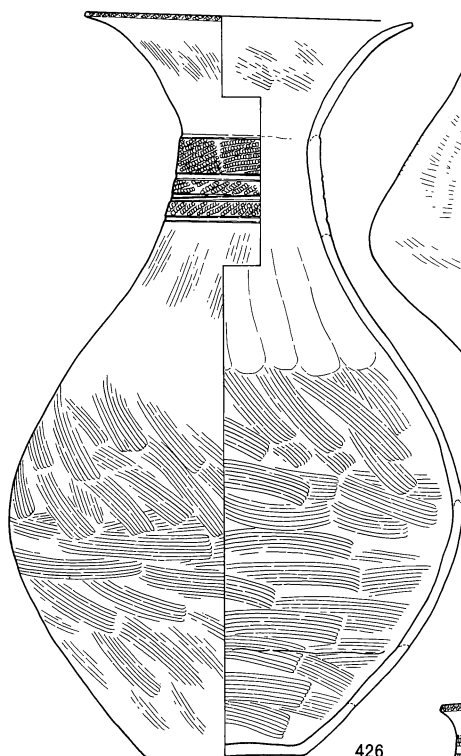
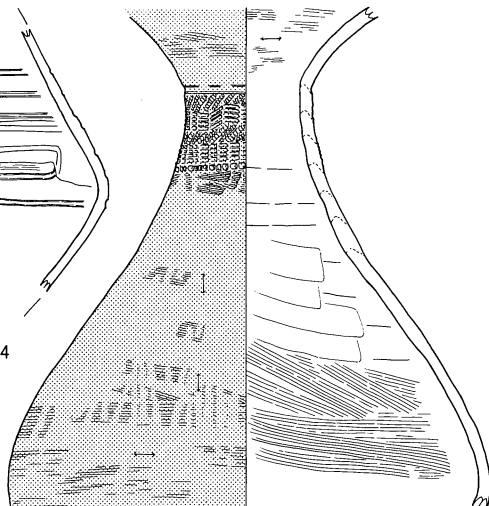
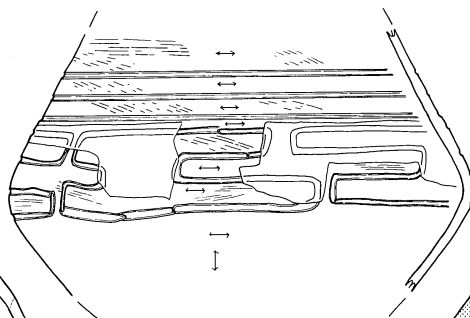
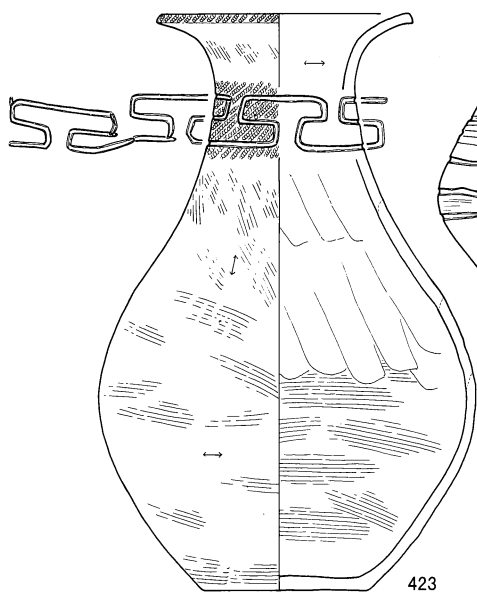

0 (1 : 4) 10 cm

S B 360, 423~428. 430~432



S B360

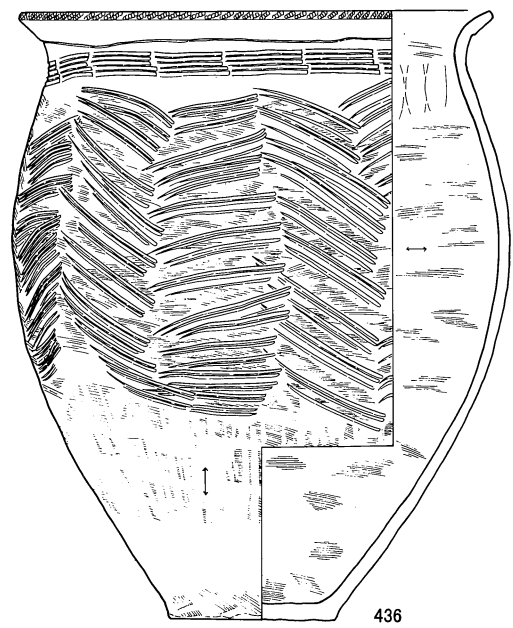
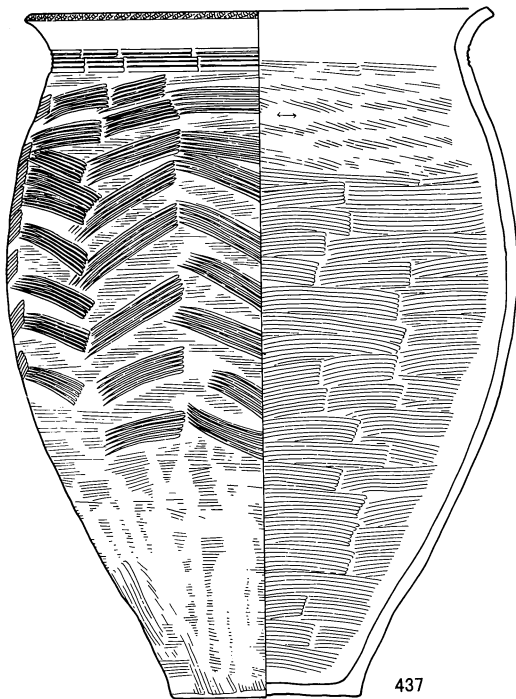
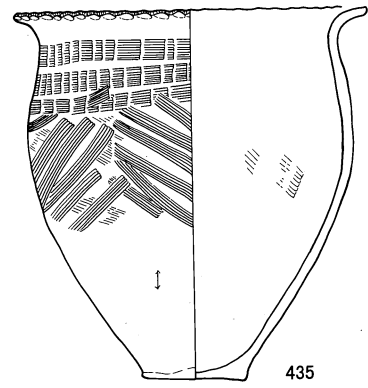
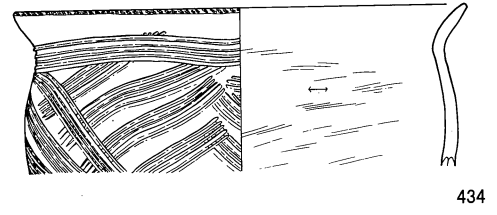
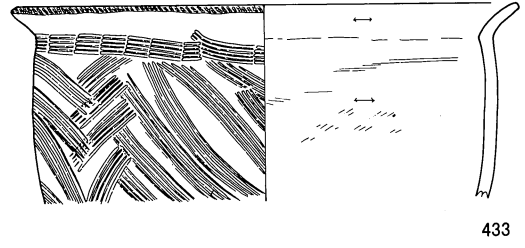
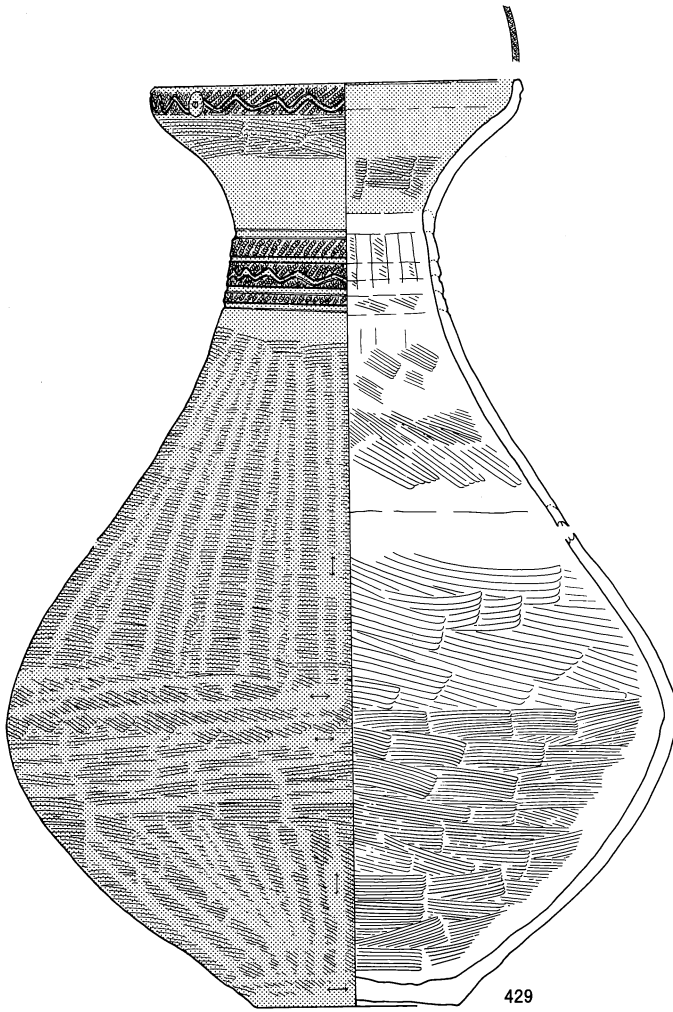

0 (1 : 4) 10cm

S B 360

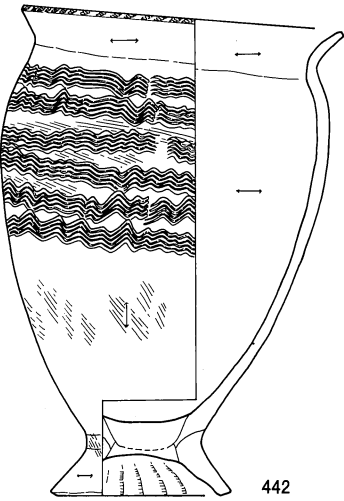
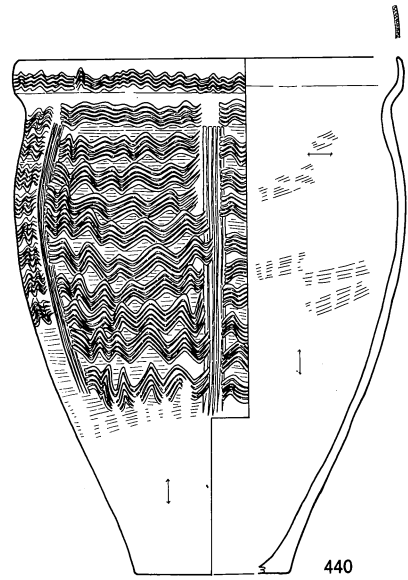
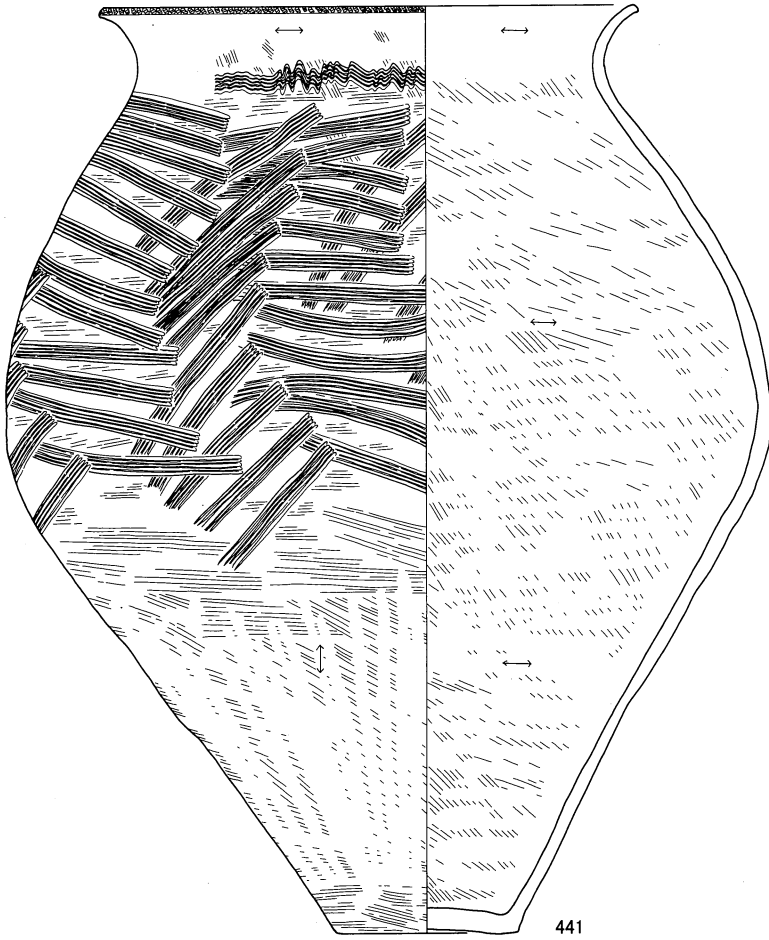
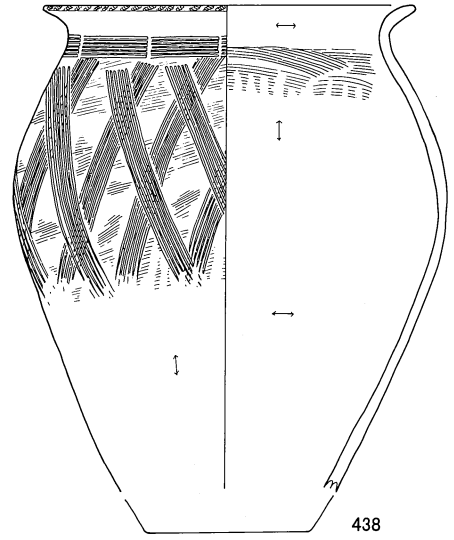
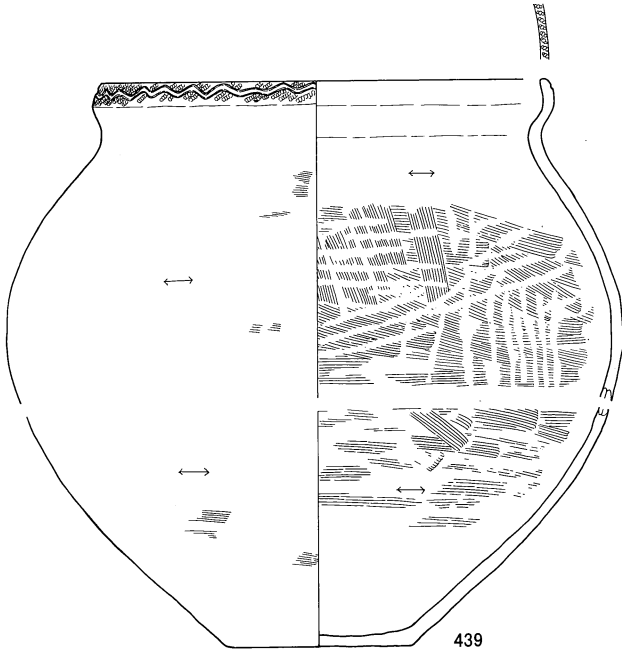

0 (1 : 4) 10 cm

S B 360

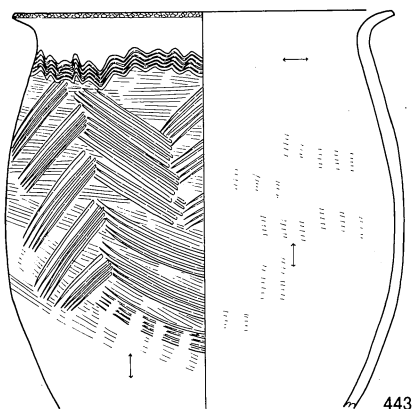

443

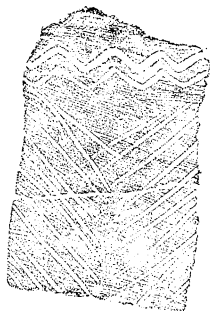

444

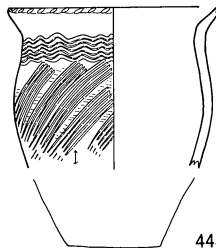

445

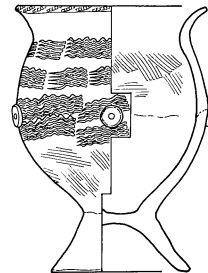

446

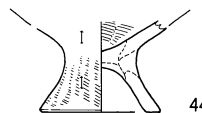

447

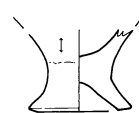

448

S B 362

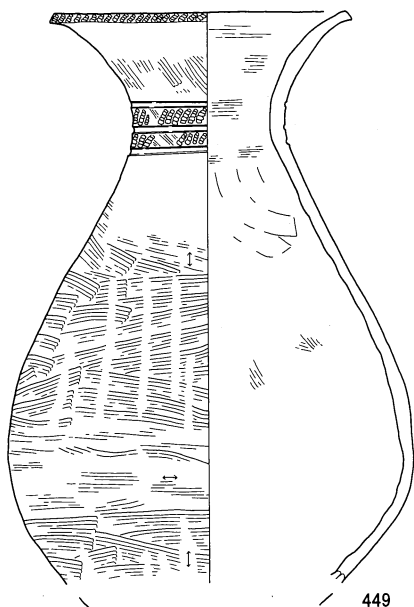

449

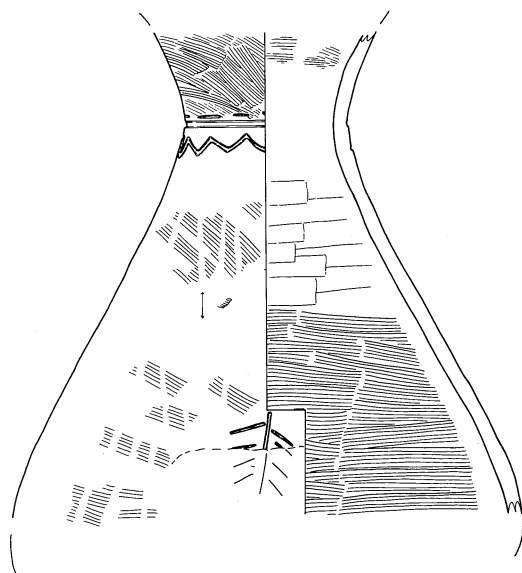

450

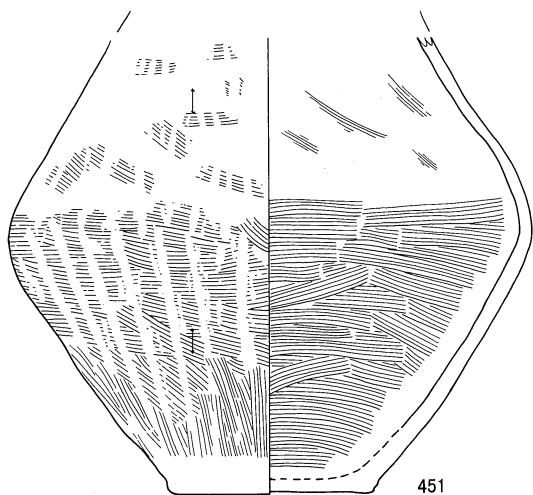

451

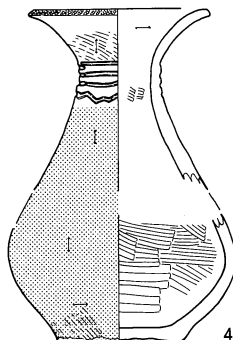

452

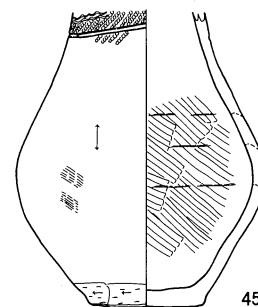

453

0 (1 : 4) 10 cm

S B 362

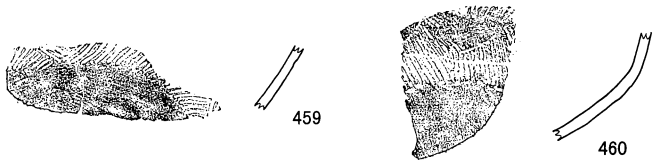
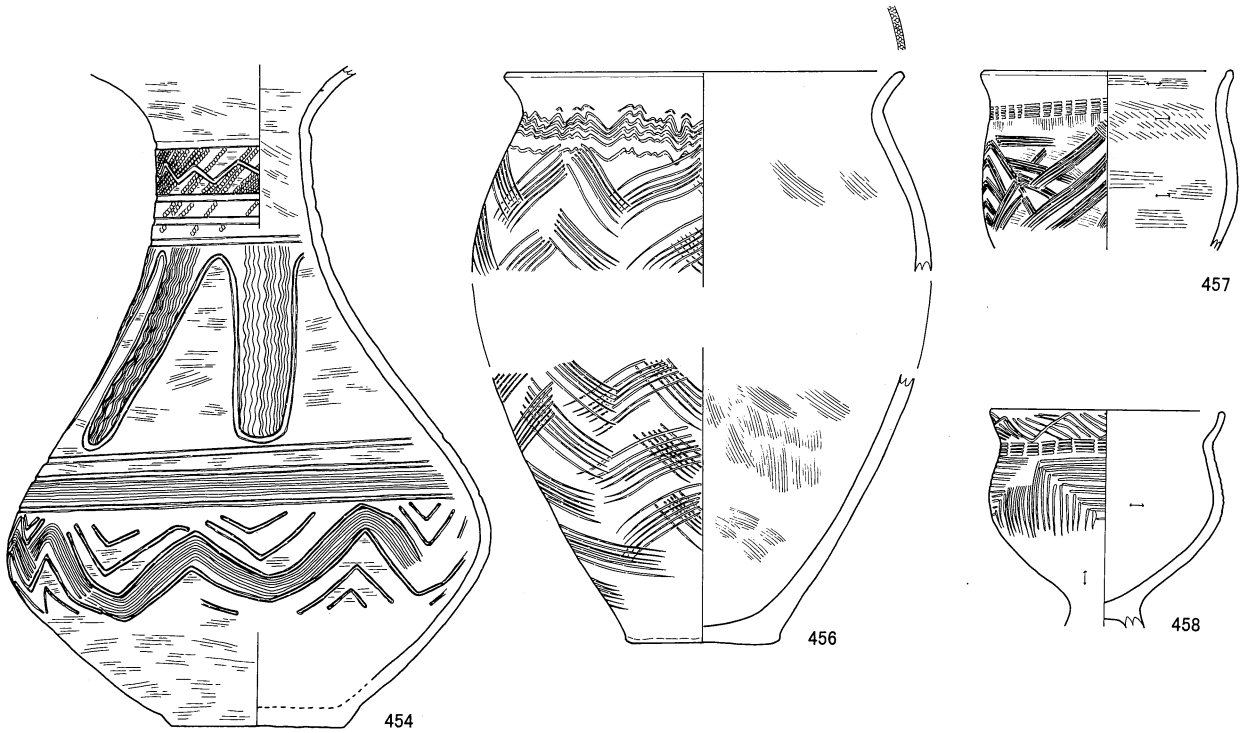

S B 361

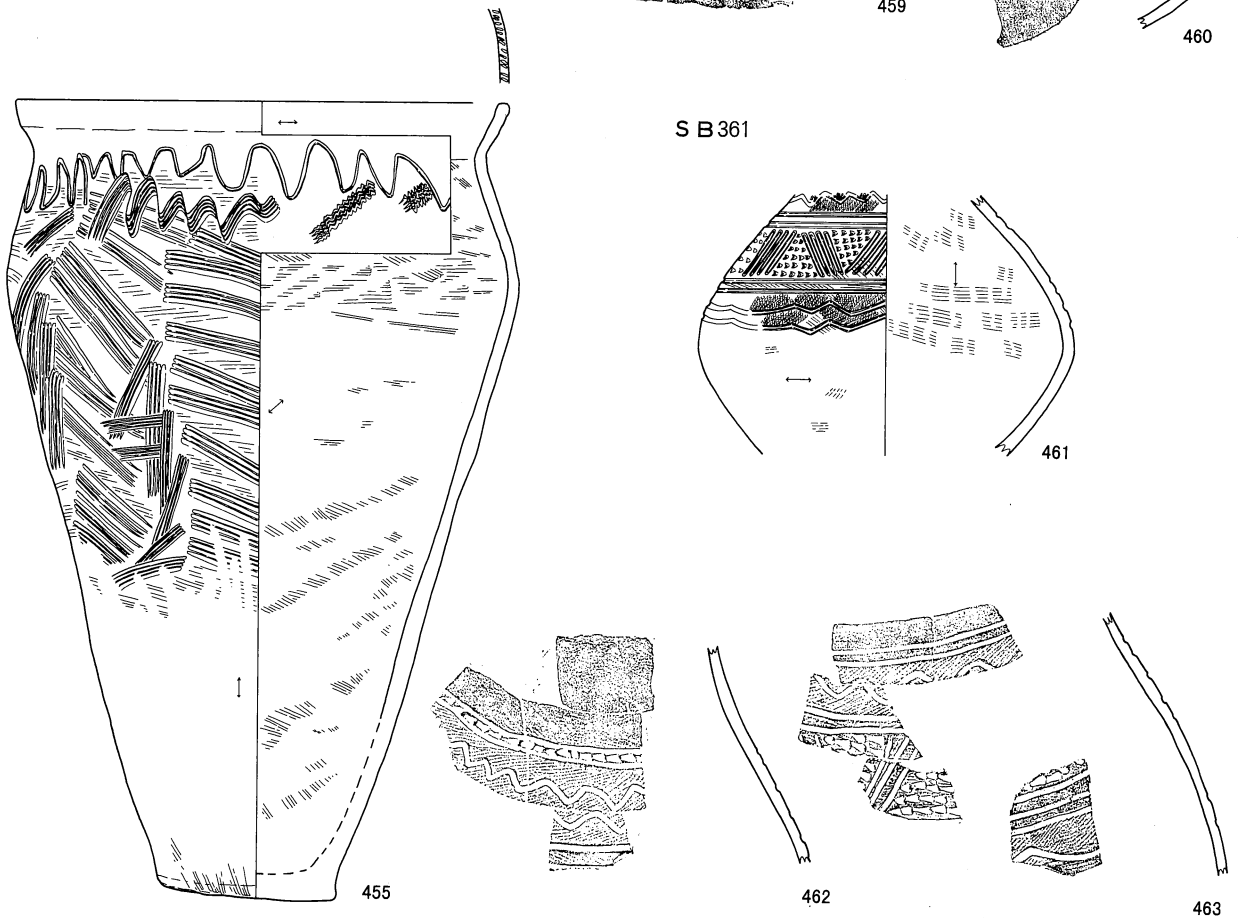

0 (1 : 4) 10 cm

S B 362, 454~460 S B 361, 461~463

S B 361



S B 363

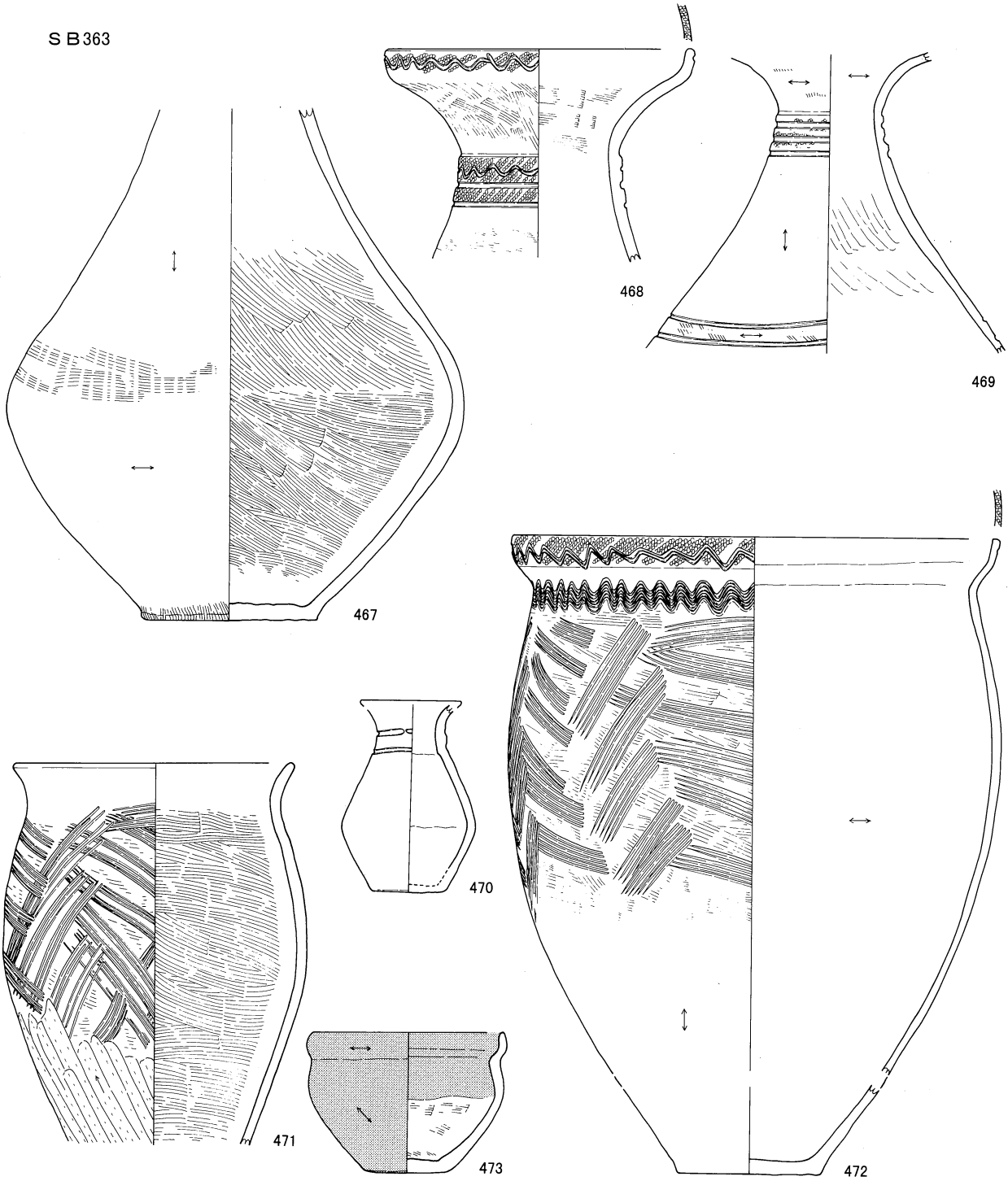

0 (1 : 4) 10 cm

S B364

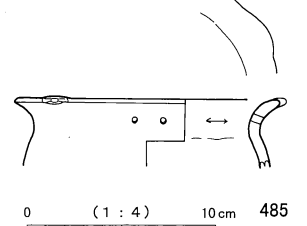
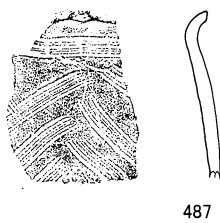
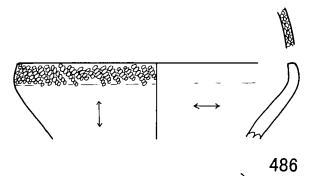
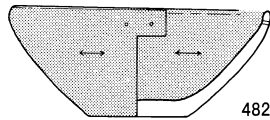
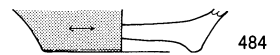
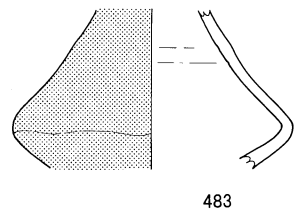
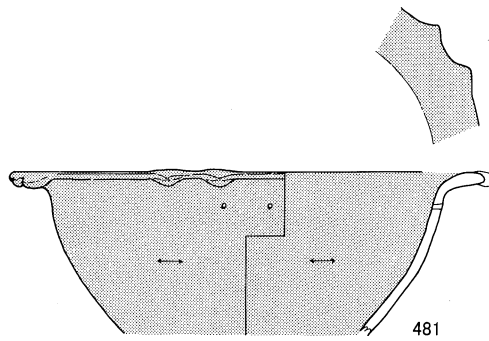
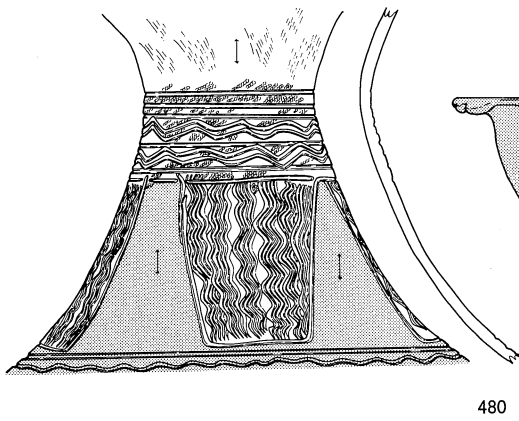
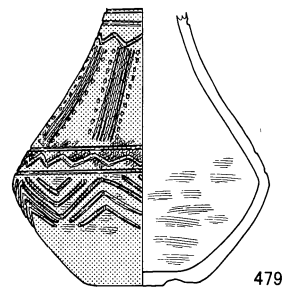
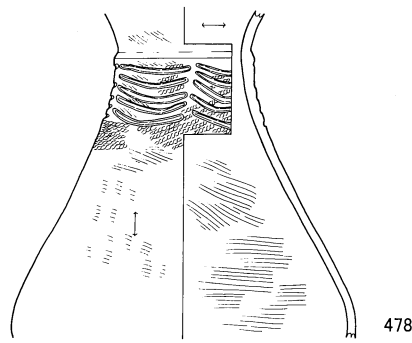
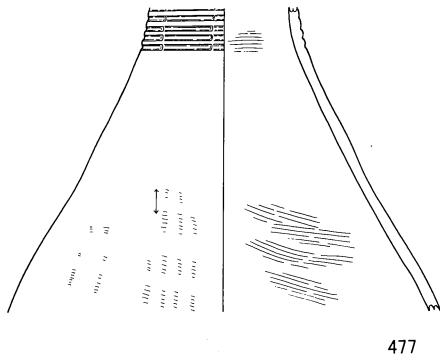
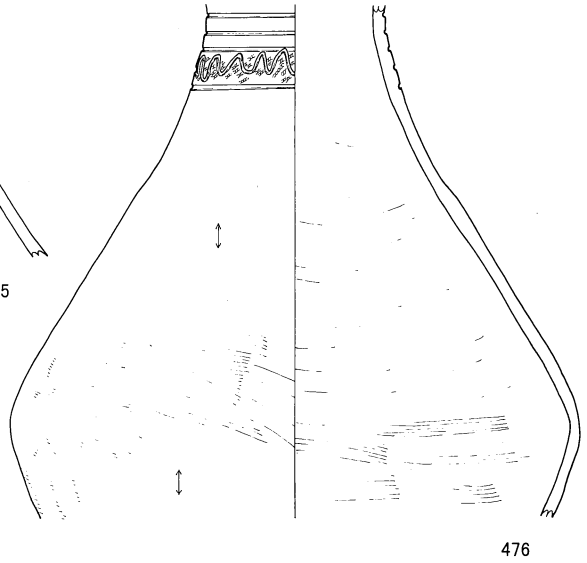
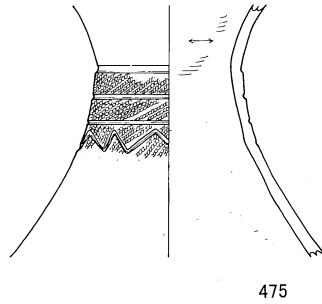
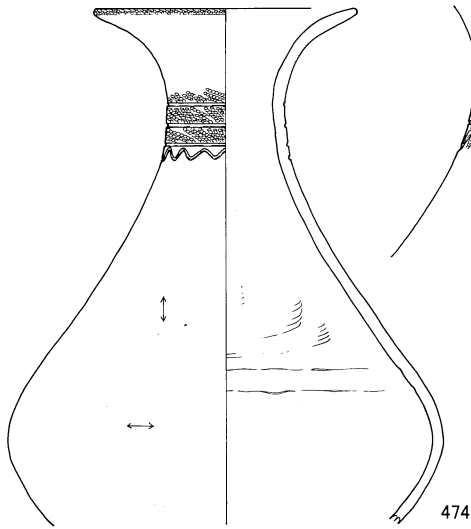

0 (1 : 4) 10 cm

S B364, 474~489

S B 369

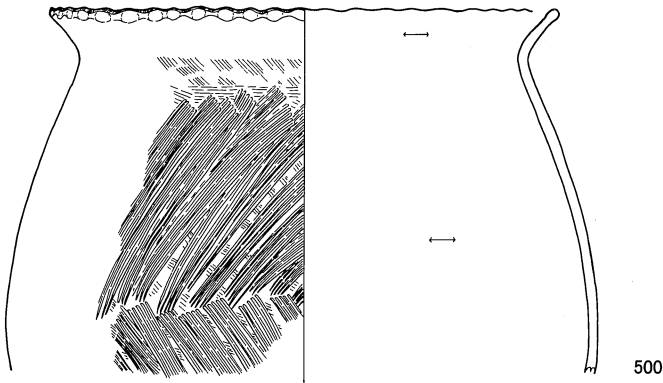
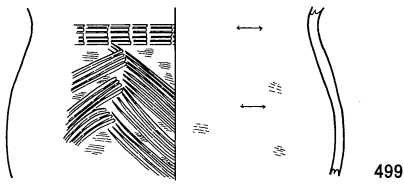
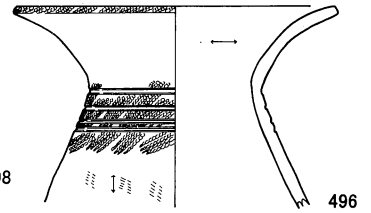
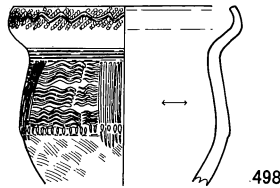
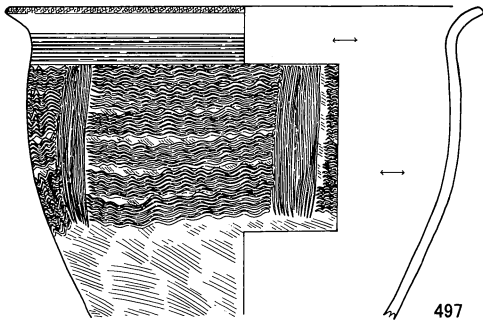
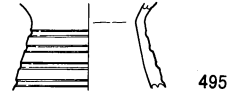
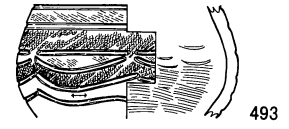
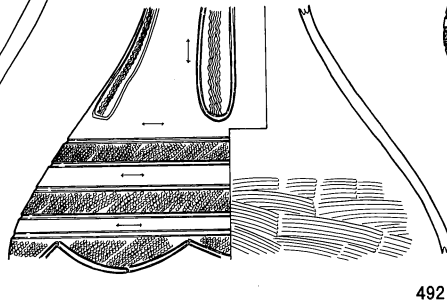
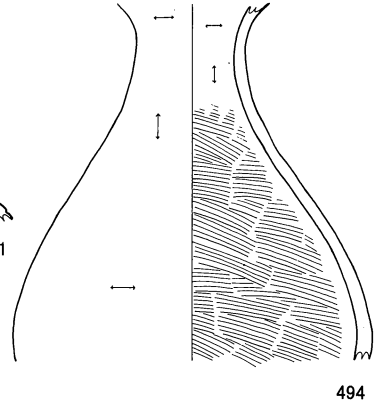
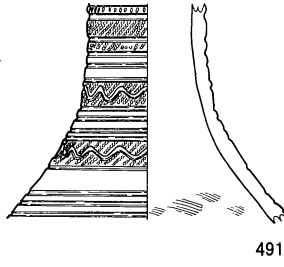

S B 384

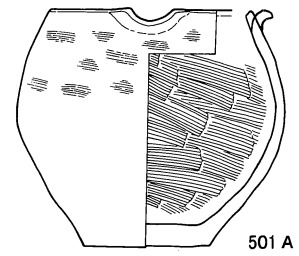

0 (1 : 4) 10 cm

S B 373

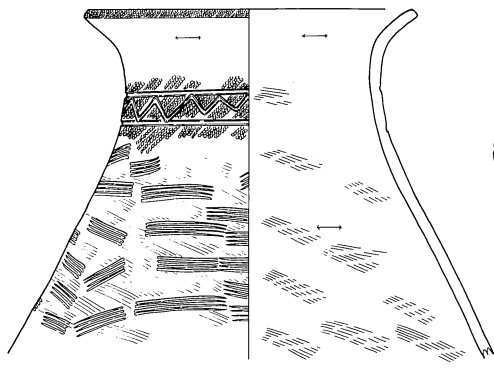

501 B

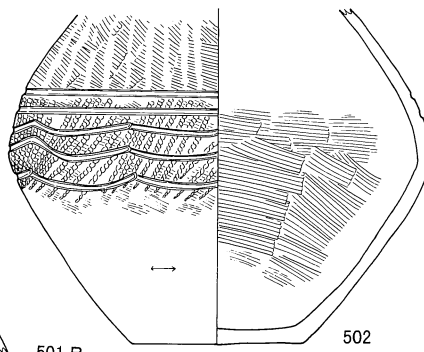

502

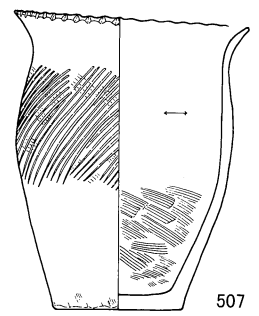

507

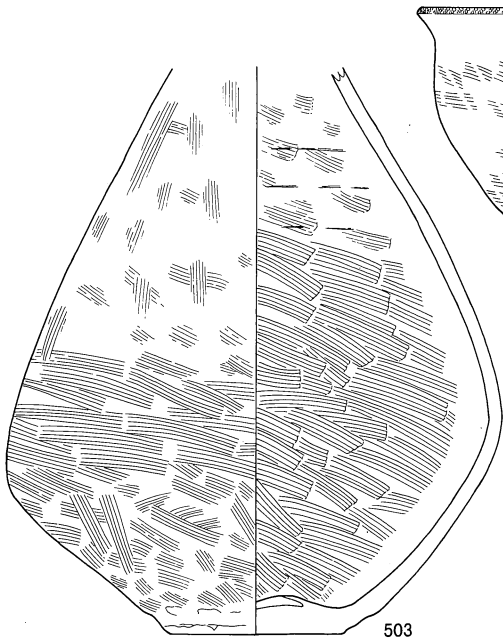

503

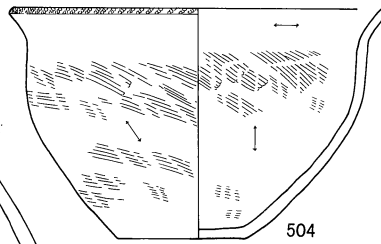

504

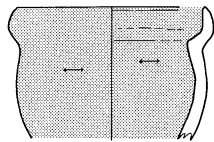

505

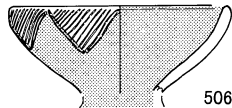

506

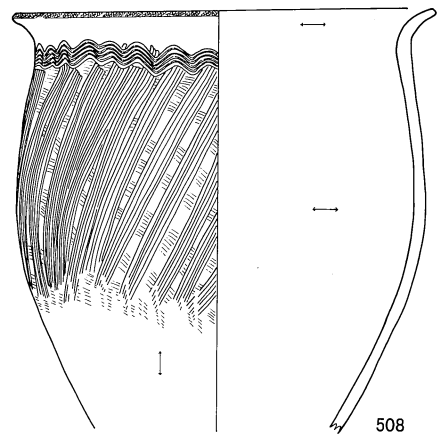

508

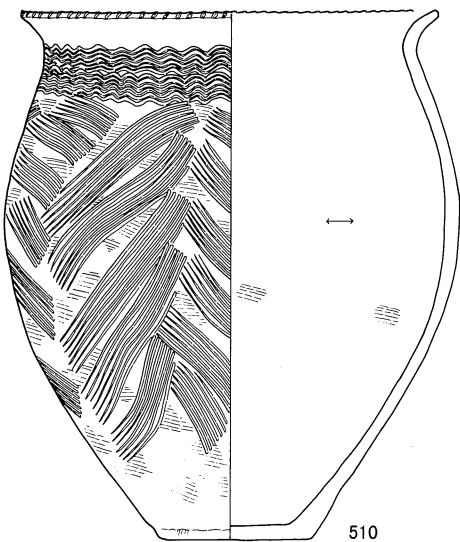

510

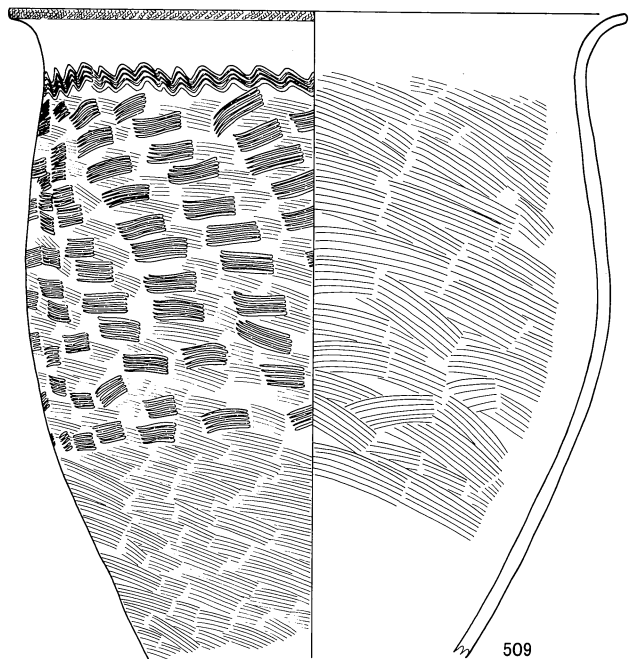

509

0 (1 : 4) 10 cm

S B 373, 501B ~ 510



S B 373

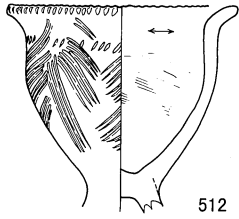
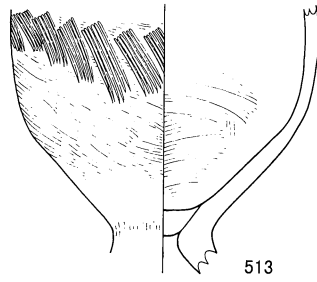
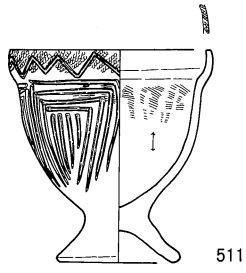

S B 362

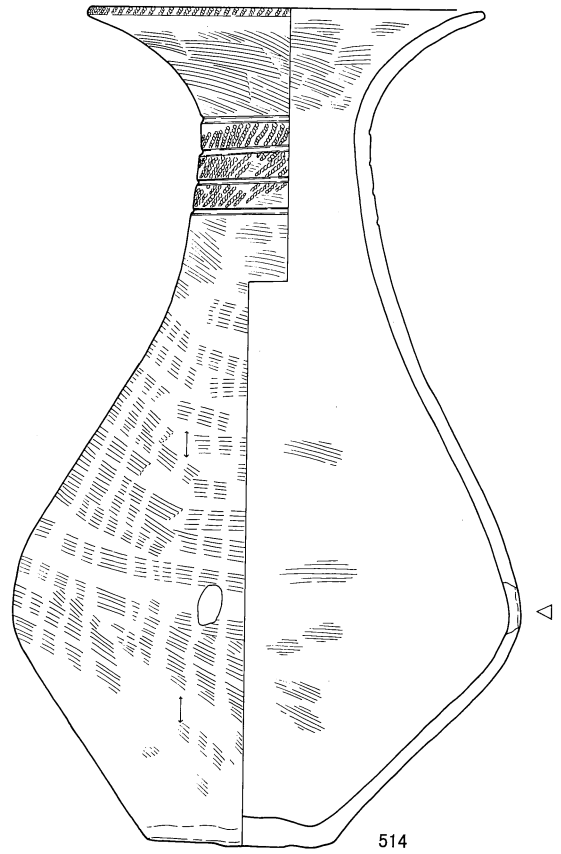

S B 403

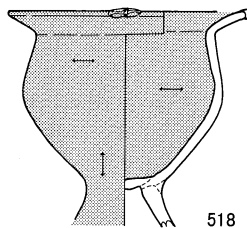
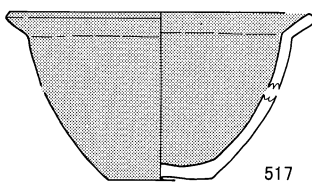
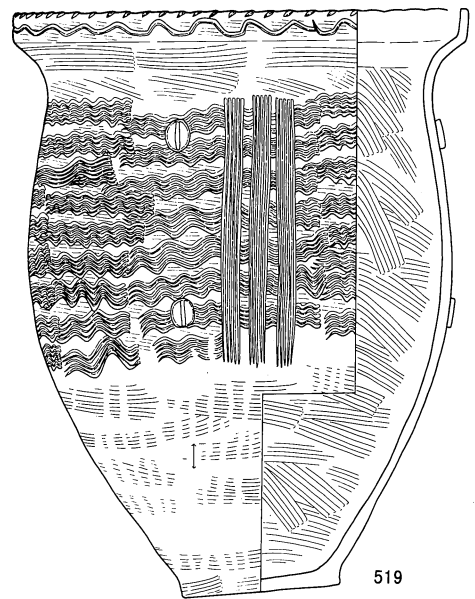
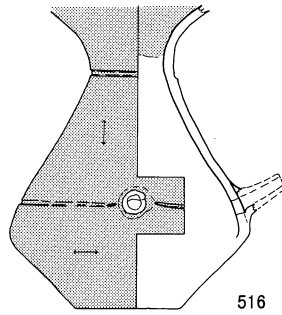
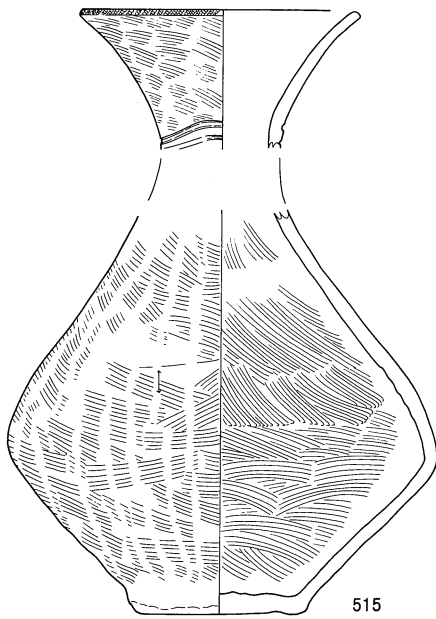

0 (1 : 4) 10 cm

S B 401

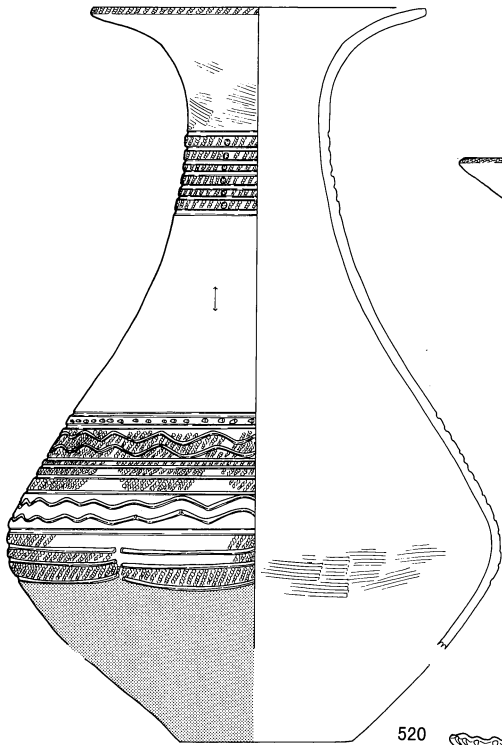

520

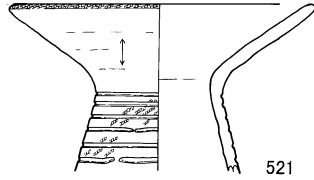

521

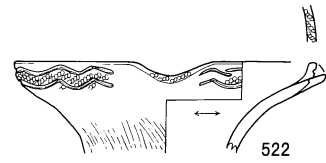

522

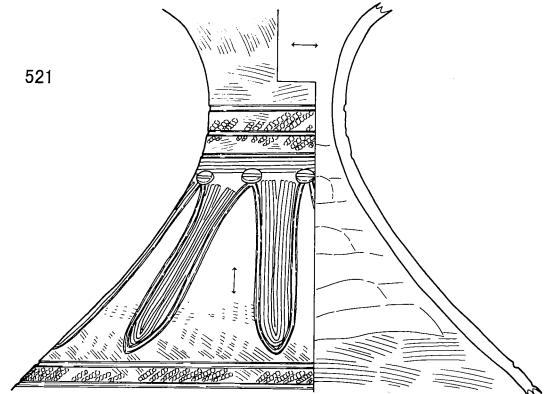

523

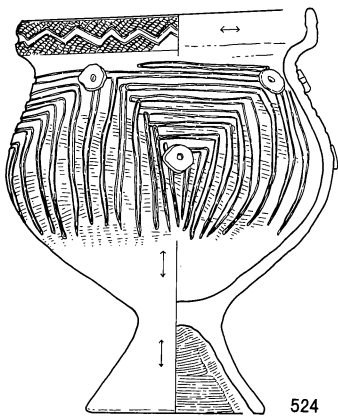

524

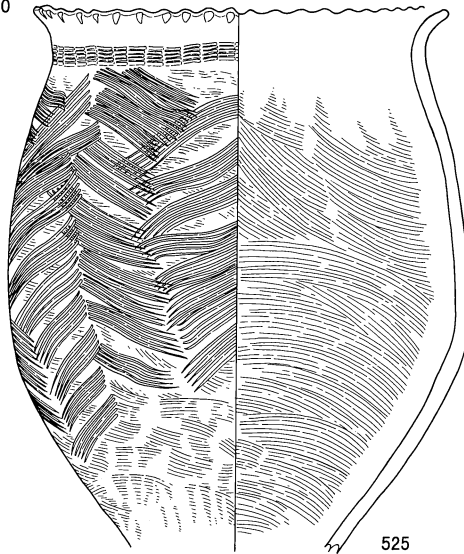

525

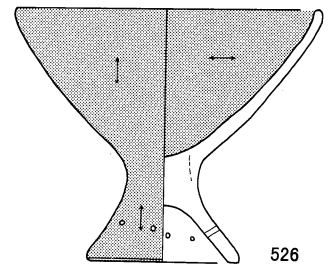

526

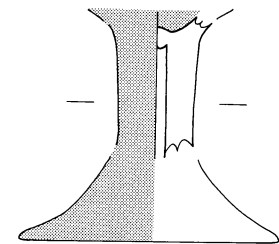

527

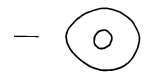

S B 402

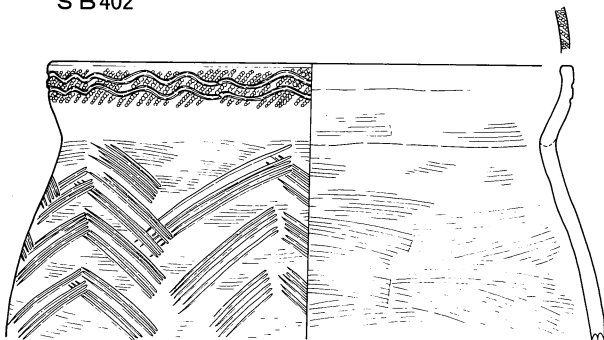

528

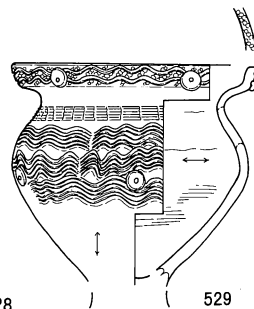

529

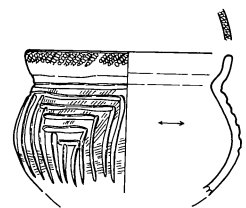

530

0 (1 : 4) 10 cm

S B 401, 520~527

S B 402, 528~530

S B 402

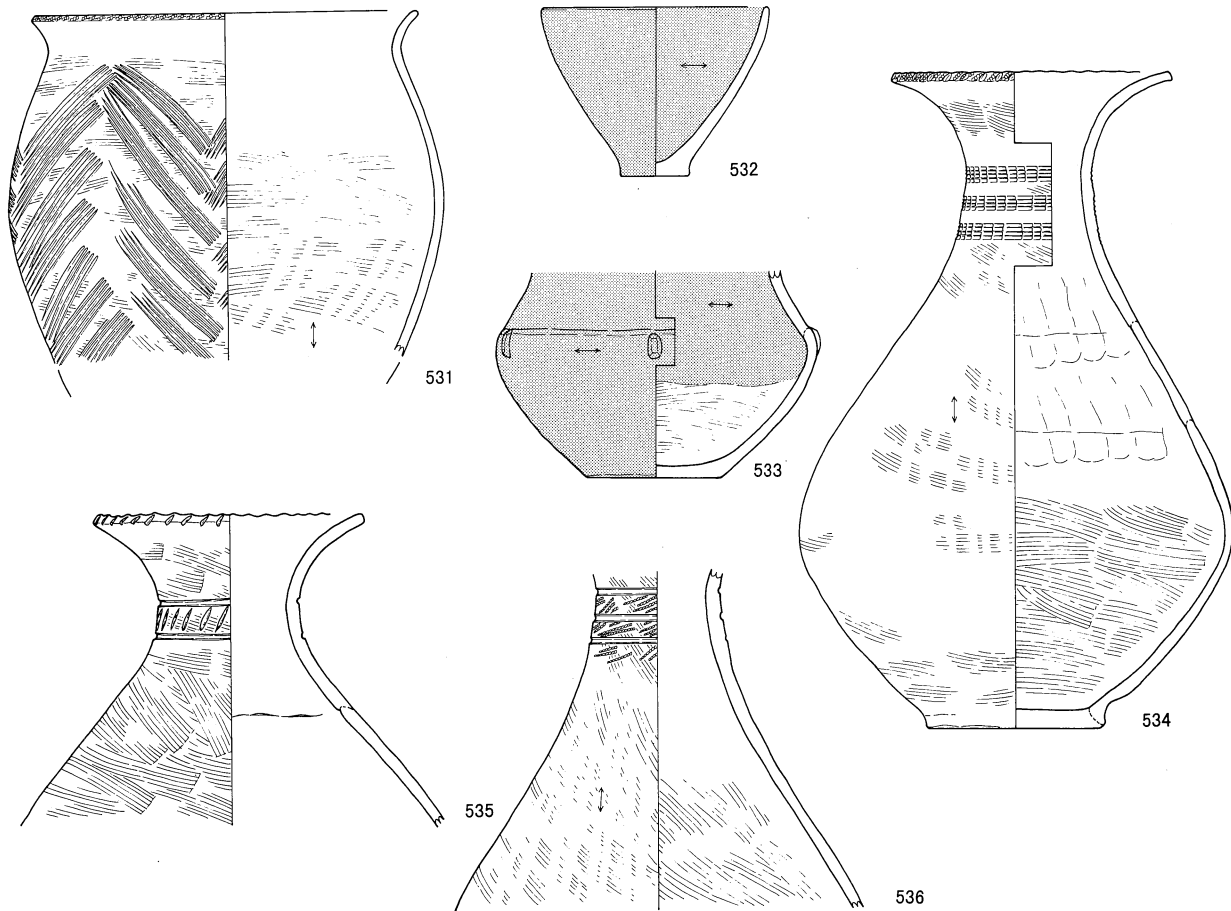

S B 404

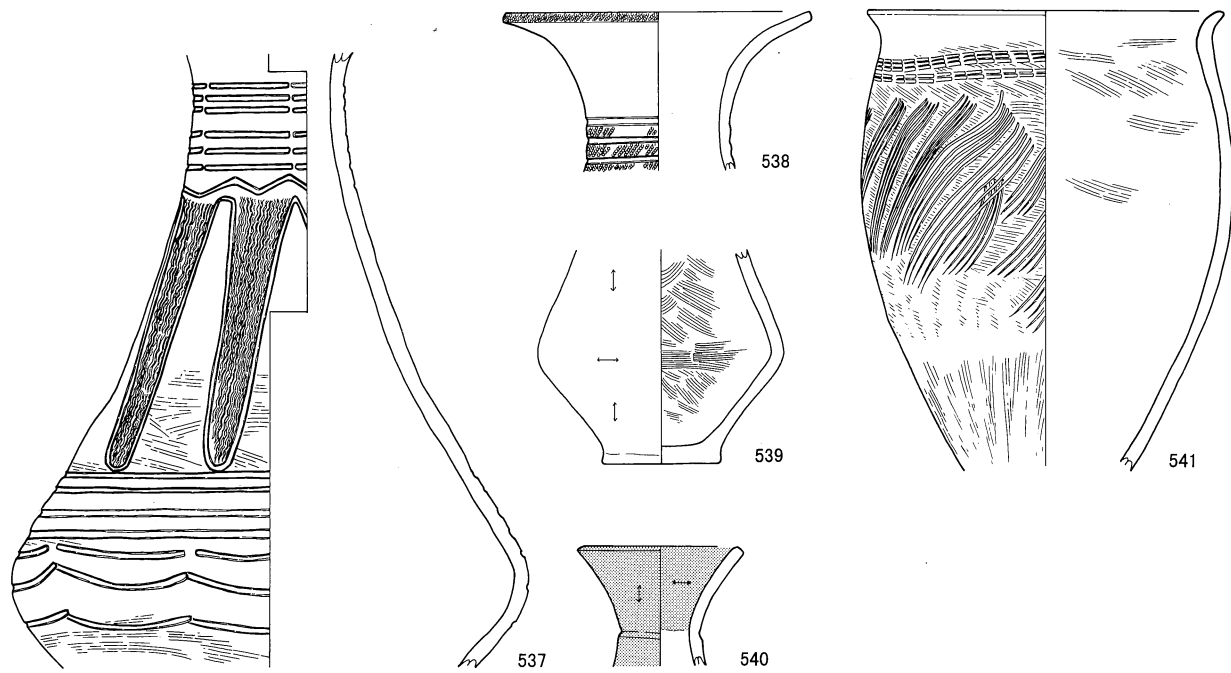

0 (1 : 4) 10cm

S B 402, 531~536 S B 404, 537~541

S B 404

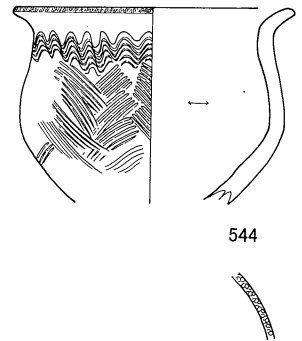
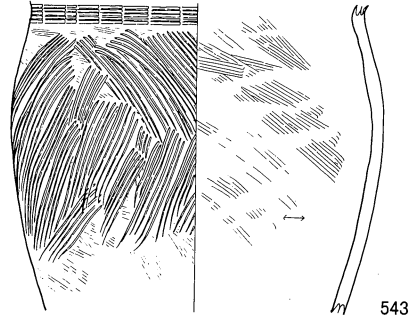
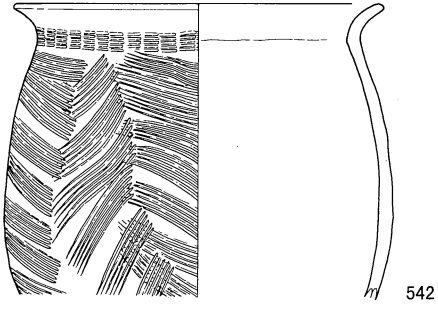

S B 405

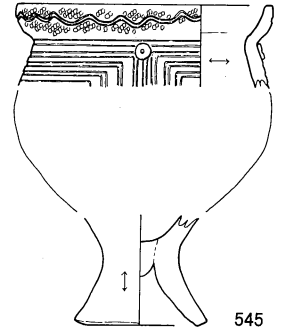
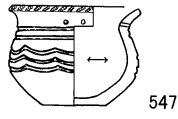
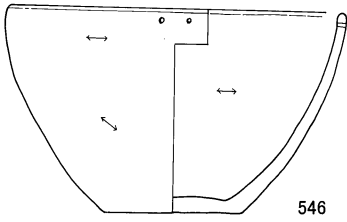

S B 406

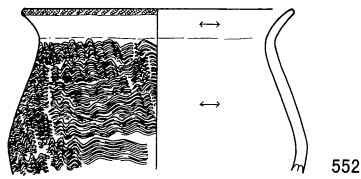
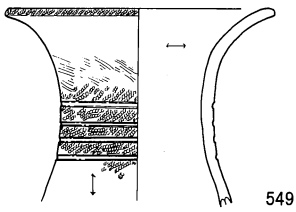
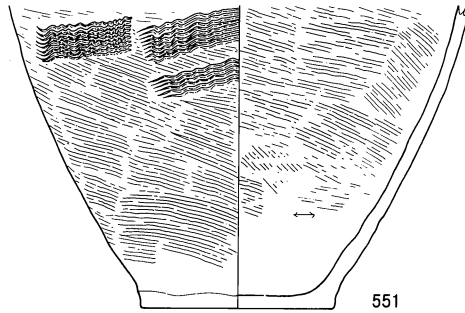
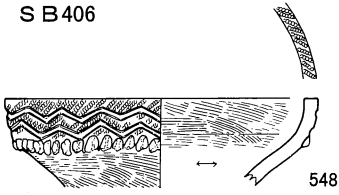

S B 407

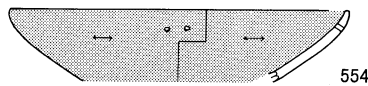
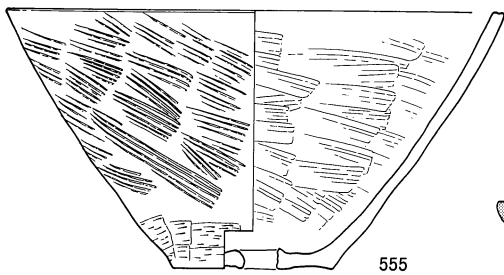
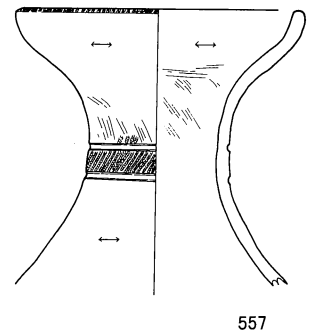
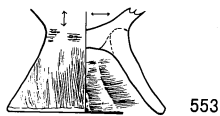
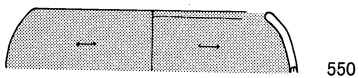
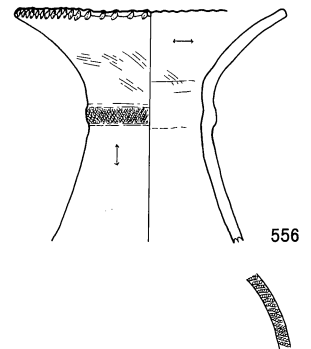

0 (1 : 4) 10 cm

S B 404, 542~545

S B 405, 546~547

S B 406, 548~555

S B 407, 556~557

S B 409

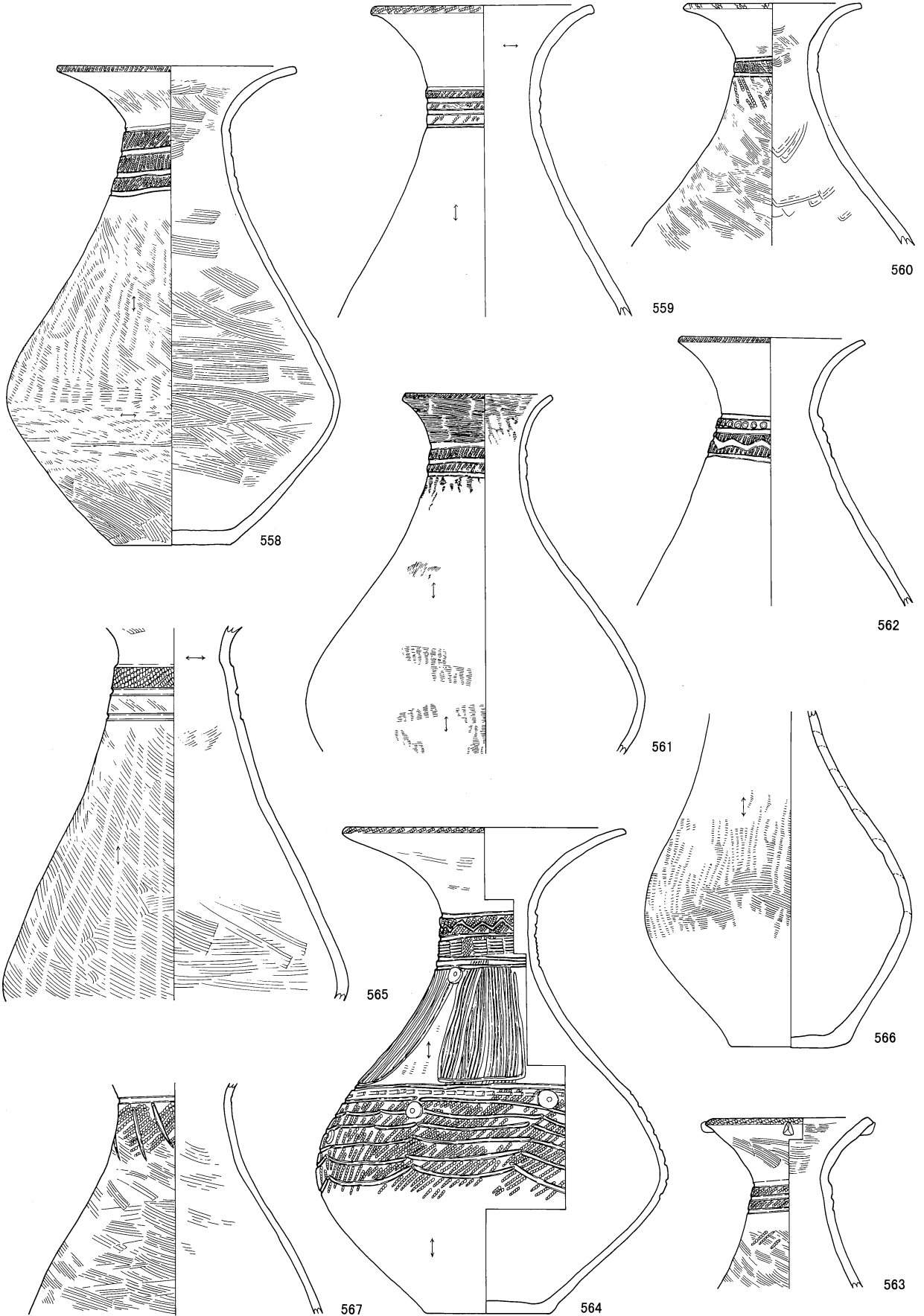

0 (1 : 4) 10cm

S B 409, 558~567

S B 409

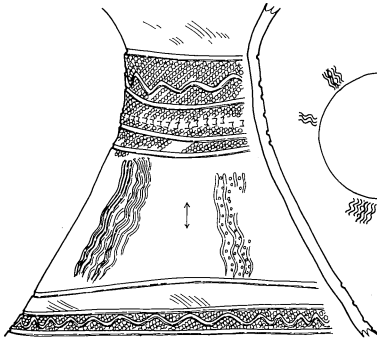

568

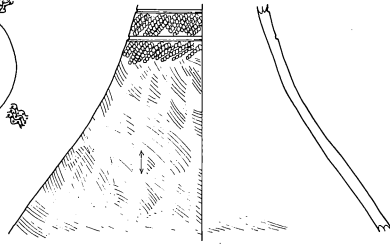

569

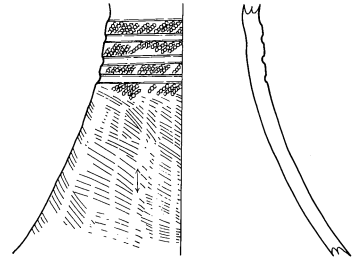

570

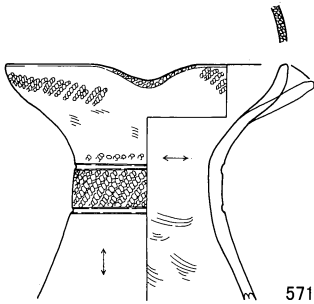

571

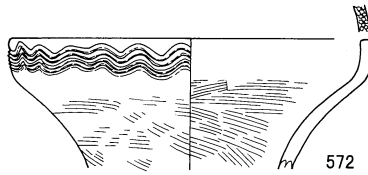

572

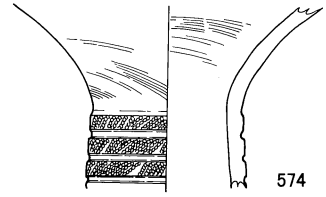

574

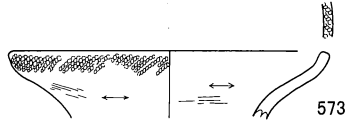

573

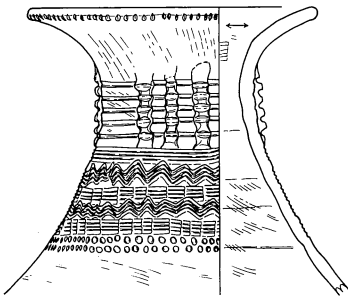

577

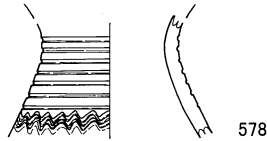

578

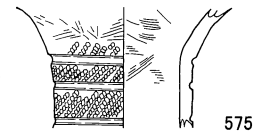

575

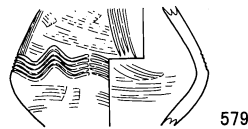

579

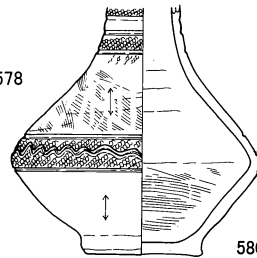

580

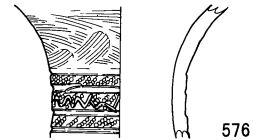

576

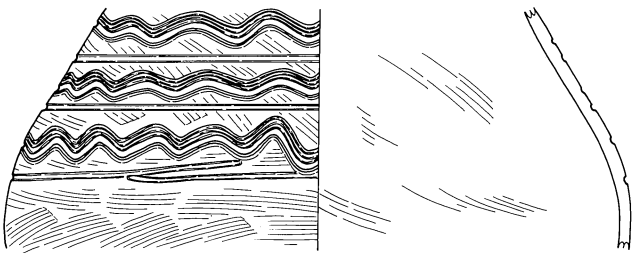

581

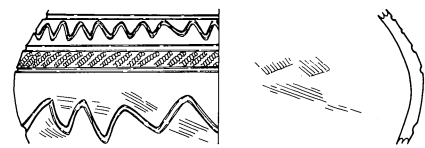

582

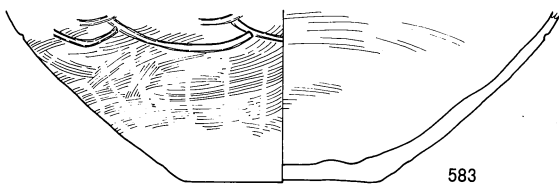

583

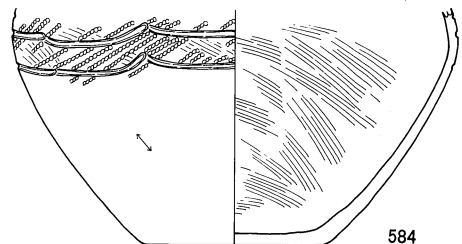

584

0 (1 : 4) 10 cm

S B 409, 568~584

S B 409

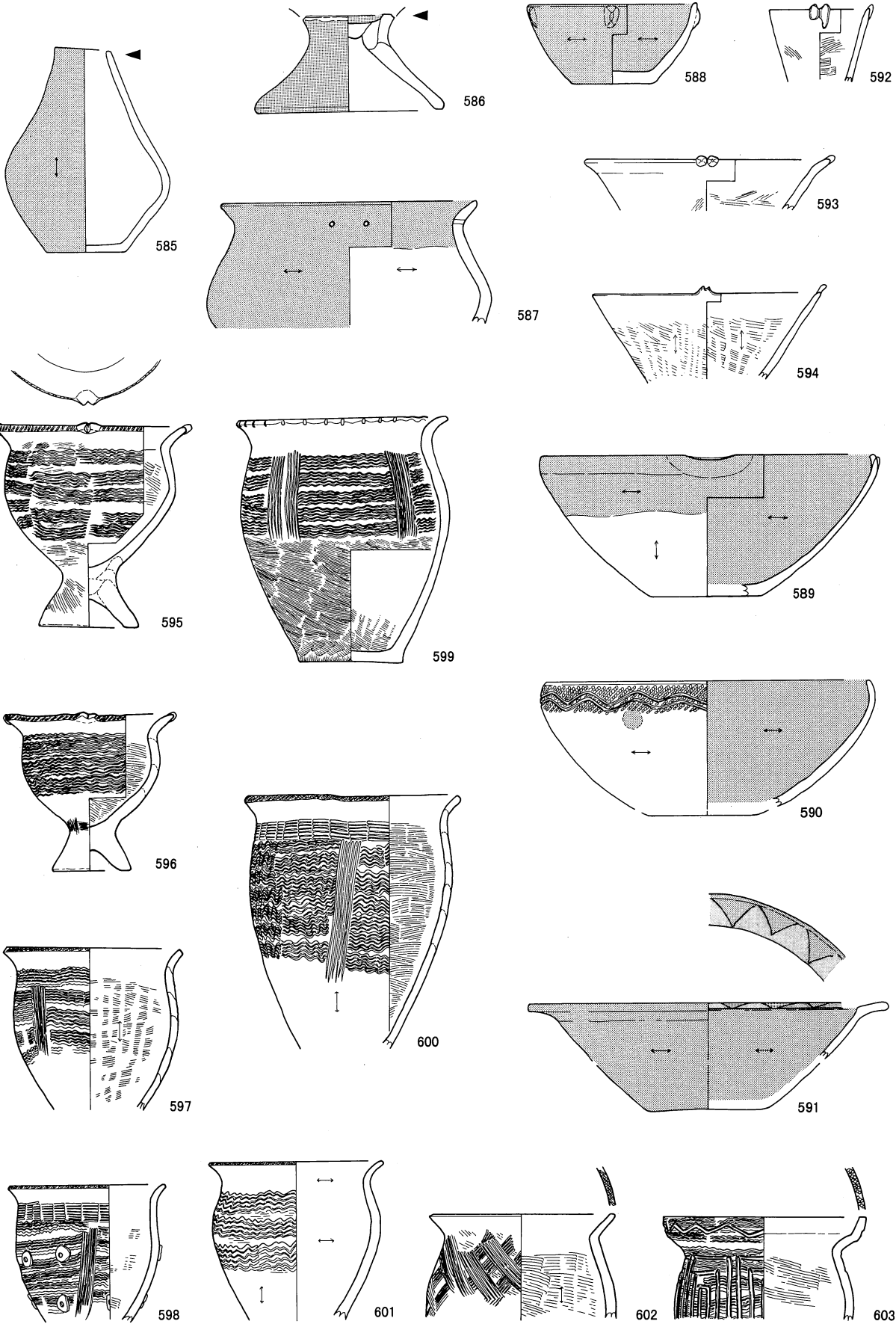

0 (1 : 4) 10cm

S B 409, 585~603

S B 409

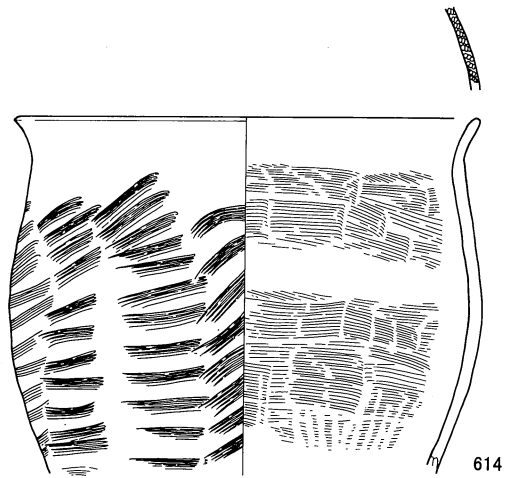
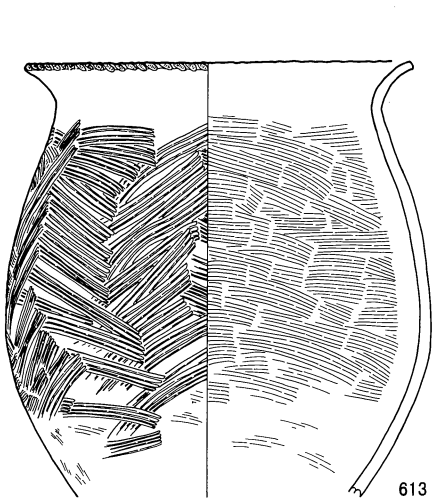
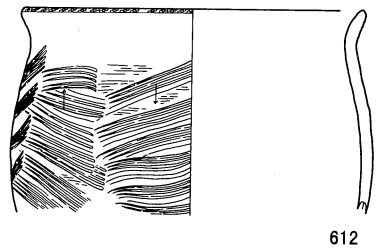
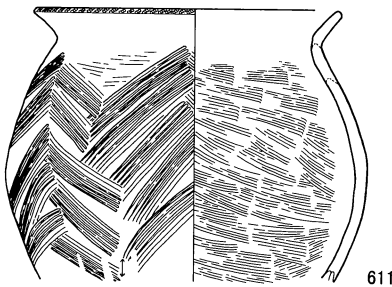
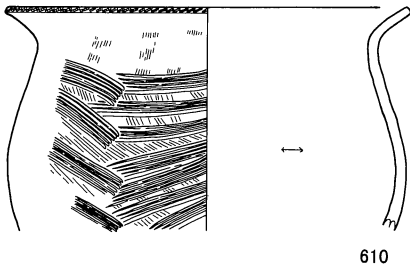
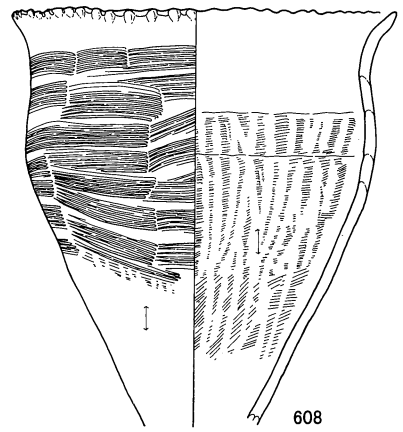
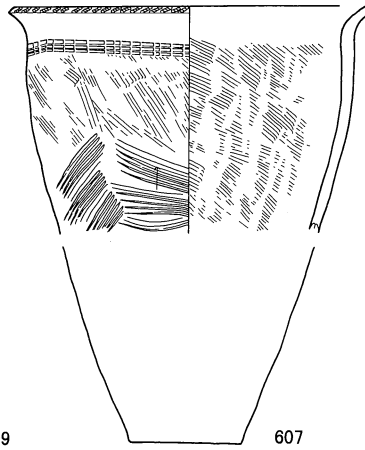
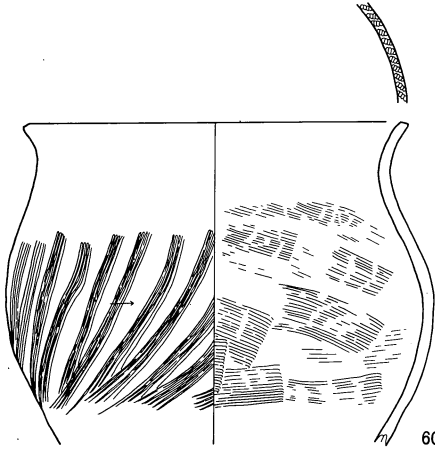
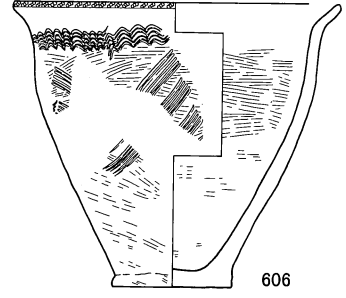
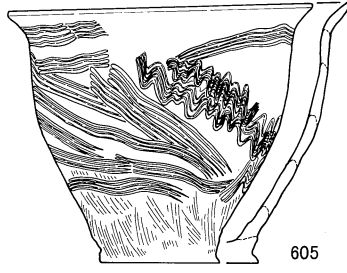
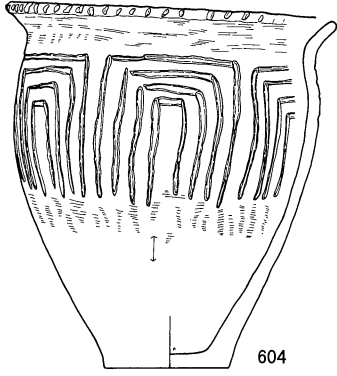

0 (1 : 4) 10cm

S B 409, 604~614



S B 409

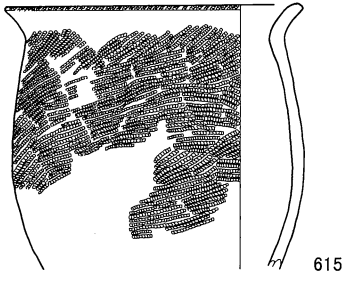

615

S B 410

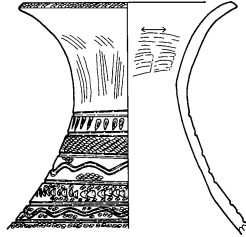

617

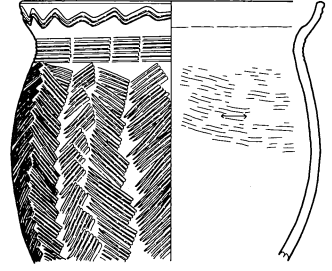

618

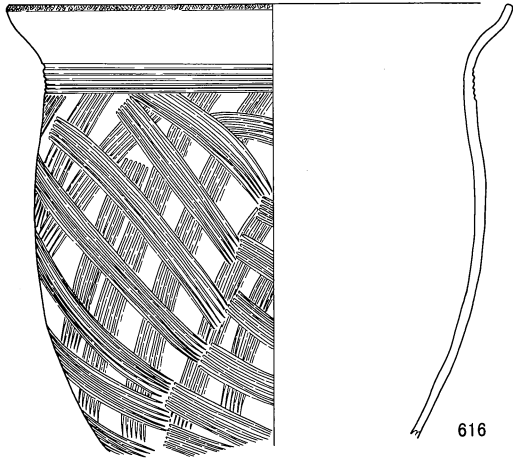

616

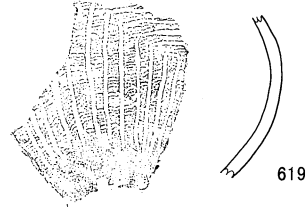

619

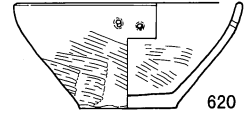

620

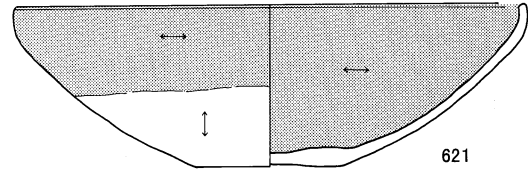

621

S B 411

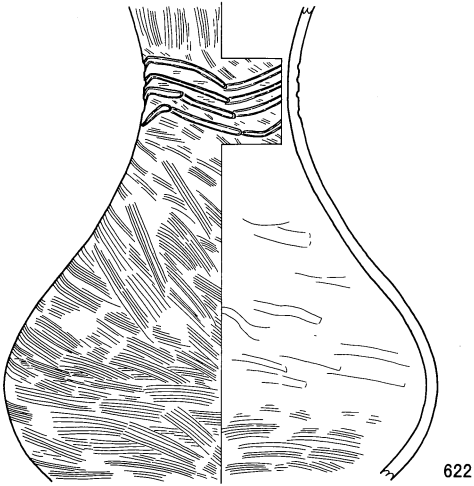

622

S B 422

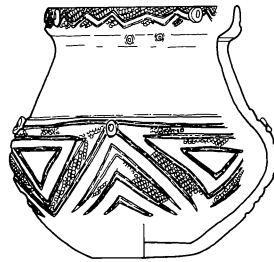

625

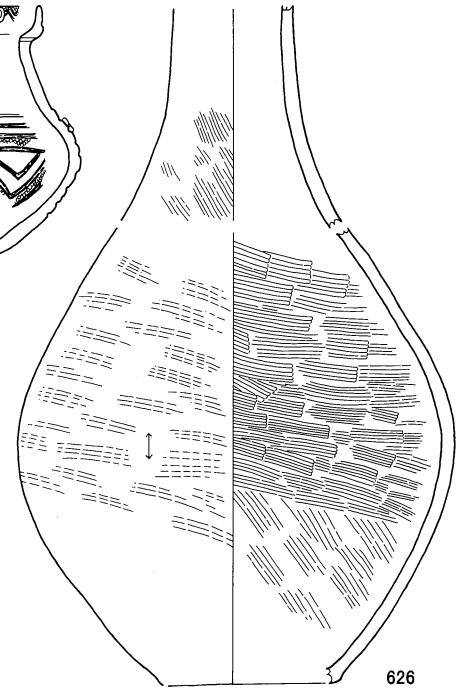

626

S B 414

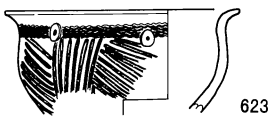

623



624

0 (1 : 4) 10cm

S B 409, 615~616

S B 410, 617~621

S B 411, 622

S B 414, 623~624

S B 422, 625~626

S B412

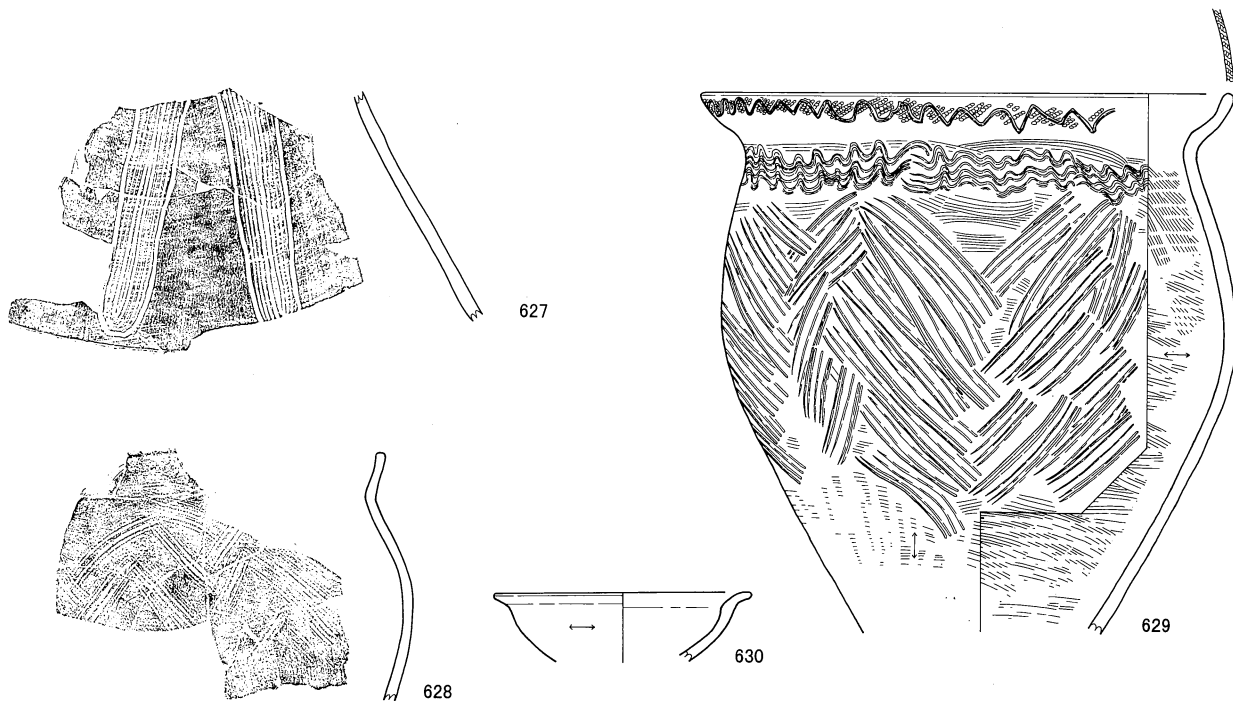

S B425

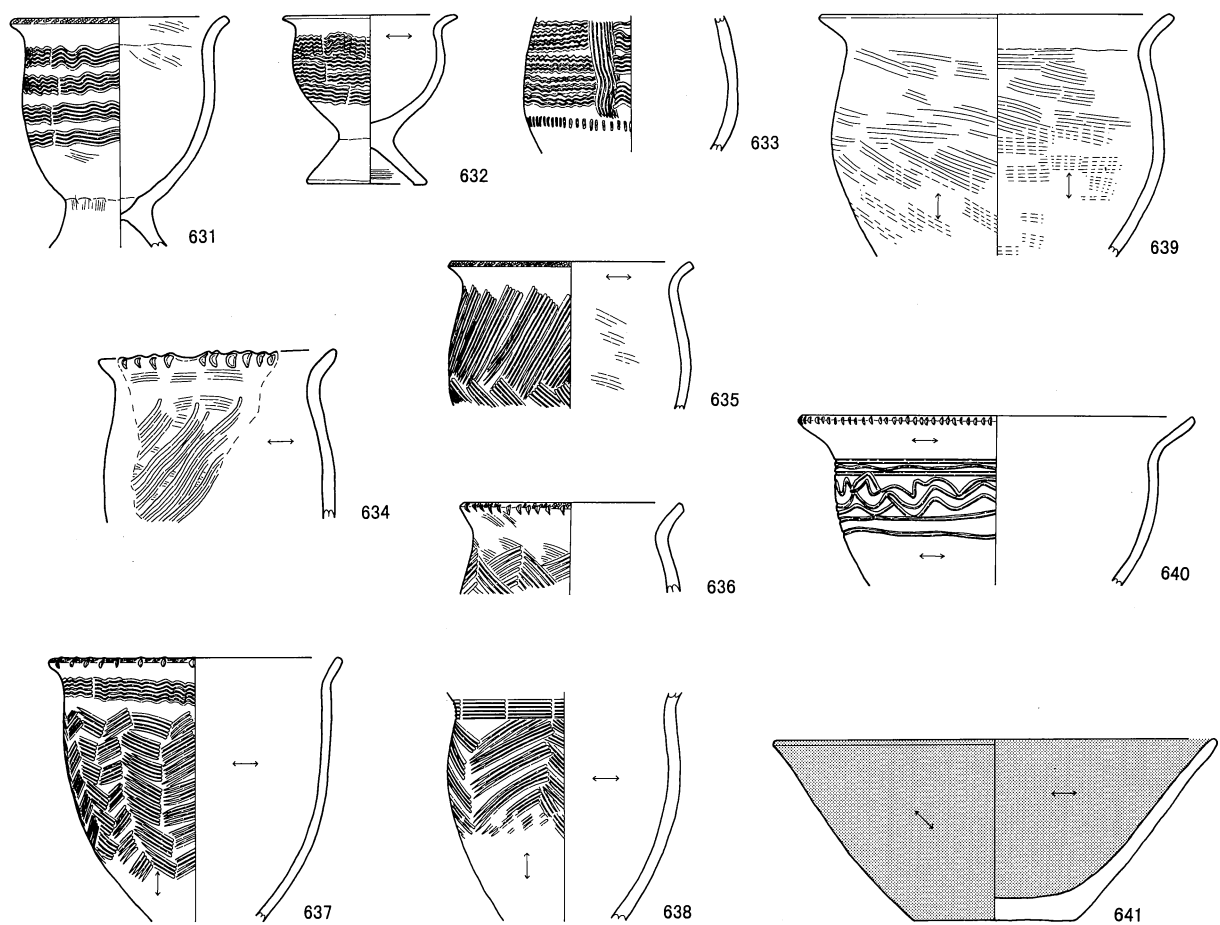

0 (1 : 4) 10cm

S B412, 627~630 S B425, 631~641

S B 425

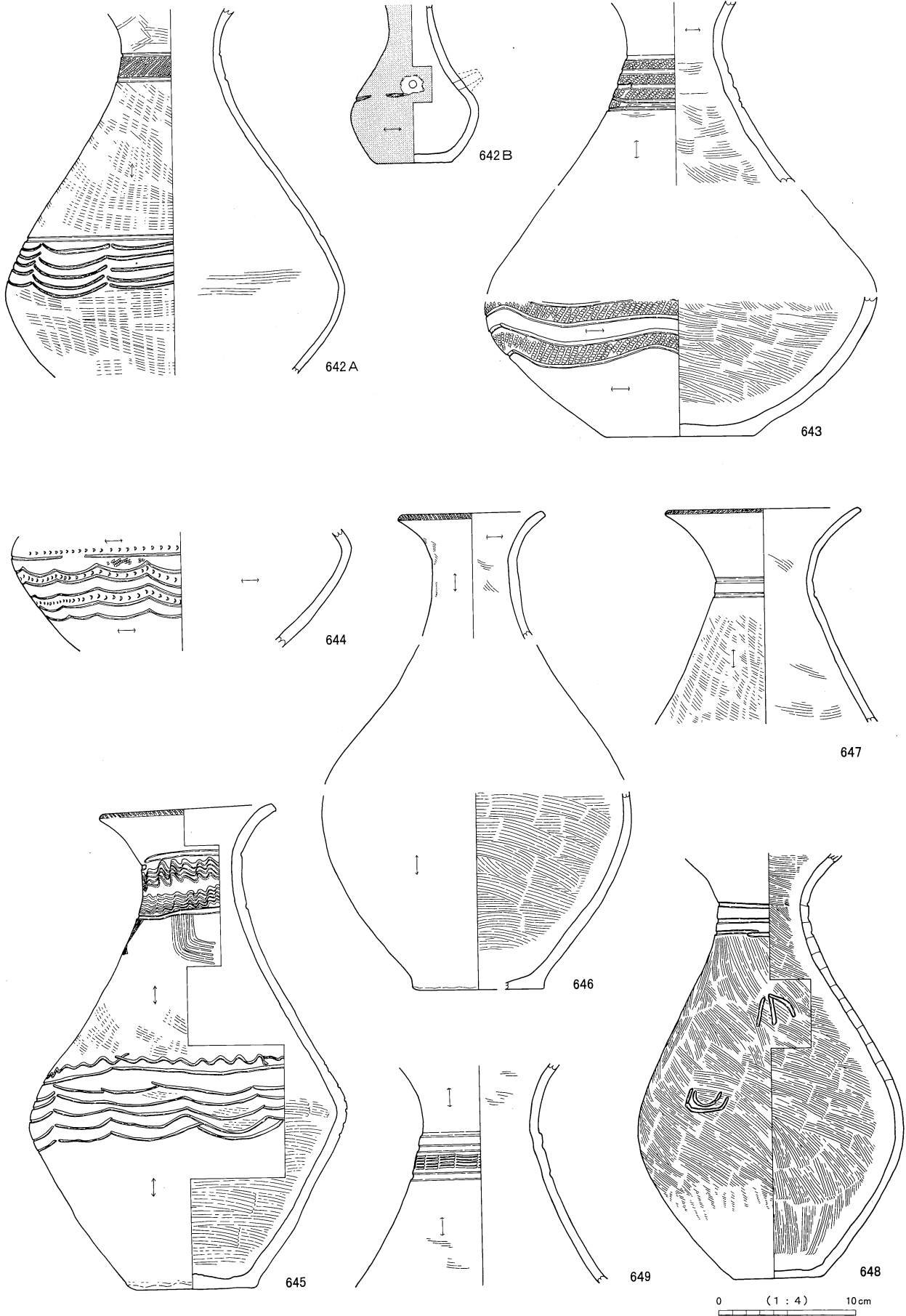

S B 425, 642A ~ 649

S B 425

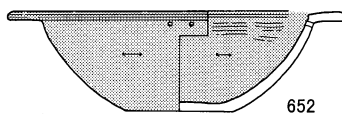
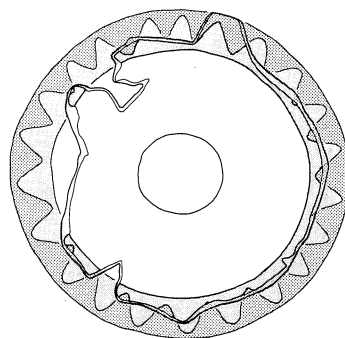
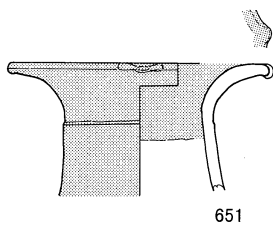
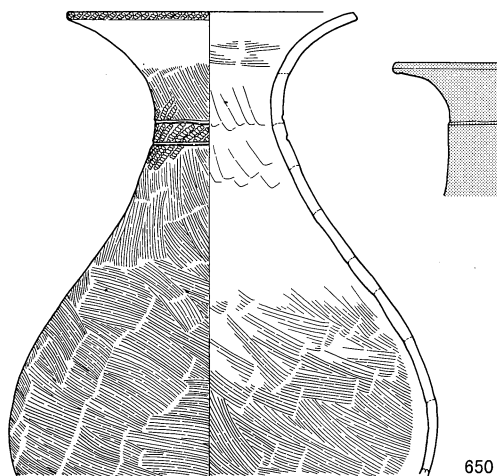

S B 450

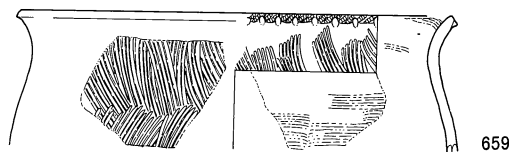
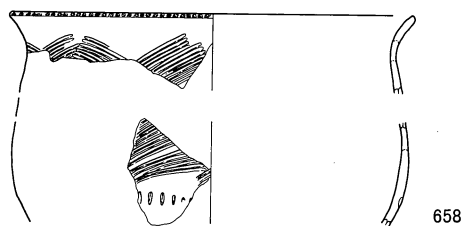
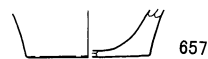
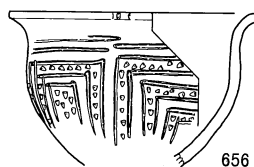
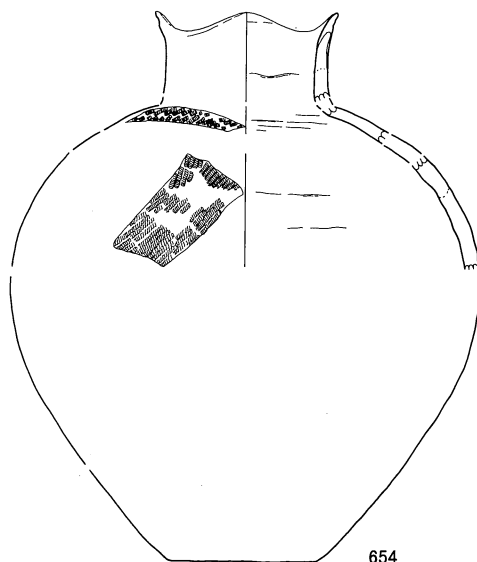
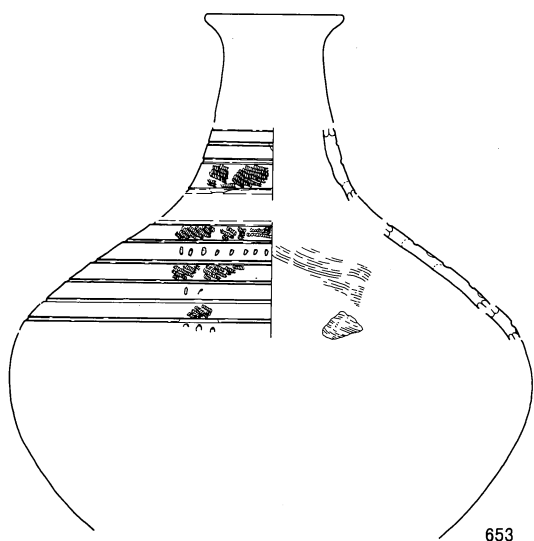

0 (1 : 4) 10 cm

S B 425, 650~652

S B 450, 653~659

S B 450

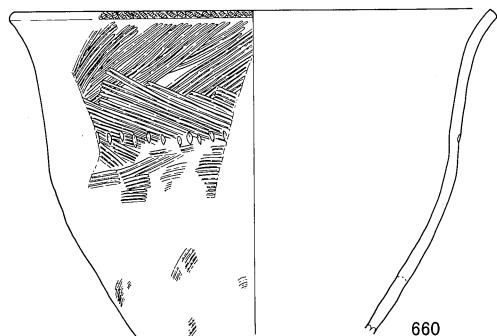

660

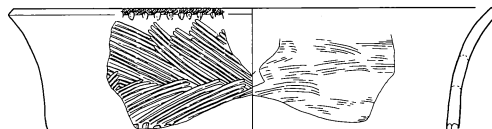

661



662

S B 246 S B 360 S B 409

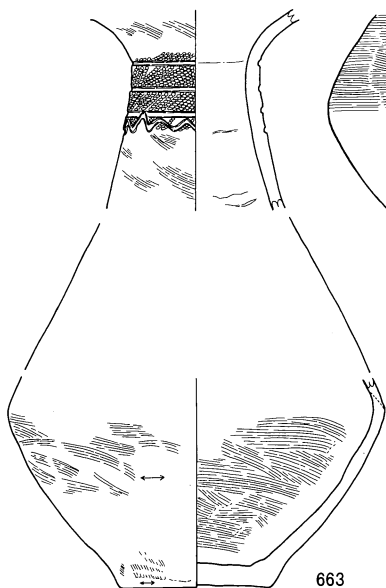

663

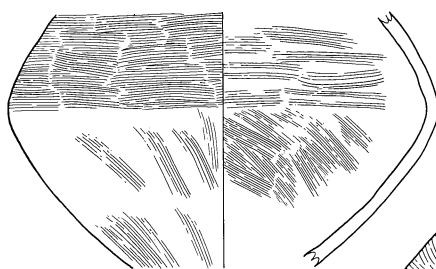

664

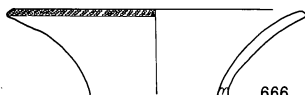

666

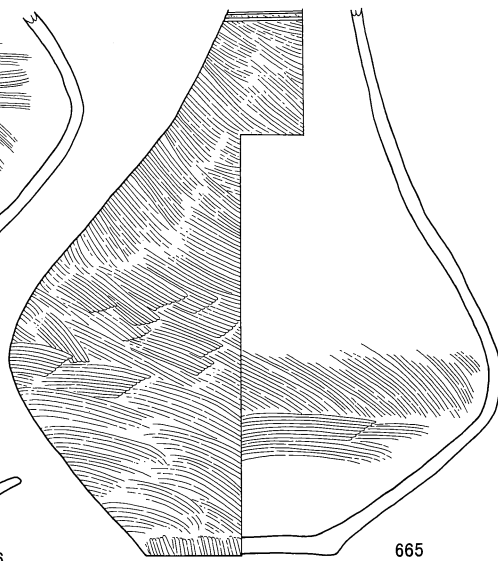

665

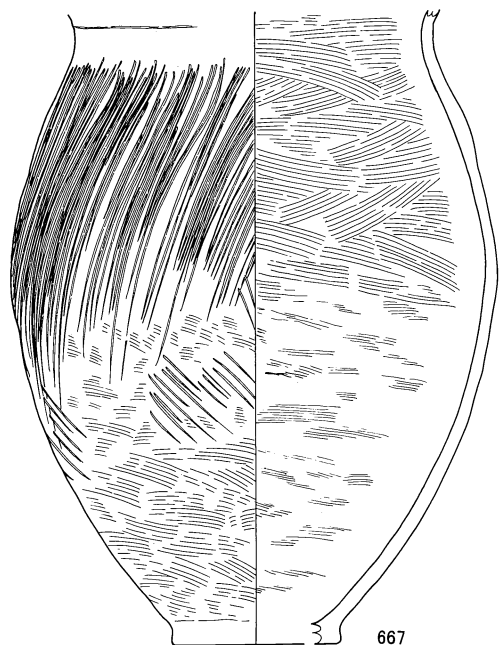

667

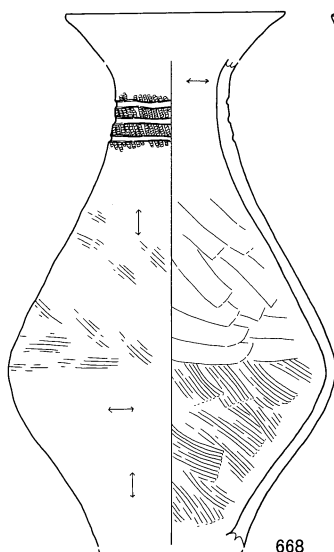

668

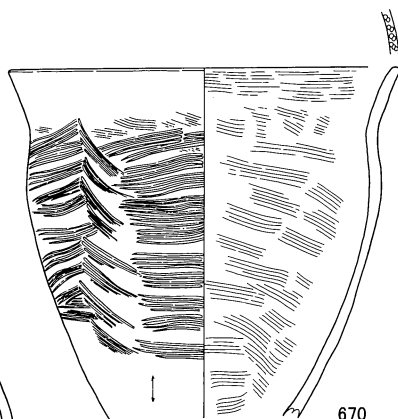

670

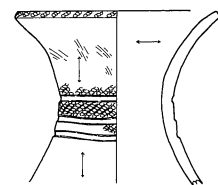

669

0 (1 : 4) 10cm

S B 450, 660~662

S B 246, 663~667

S B 360, 668~669

S B 409, 670

S B 267

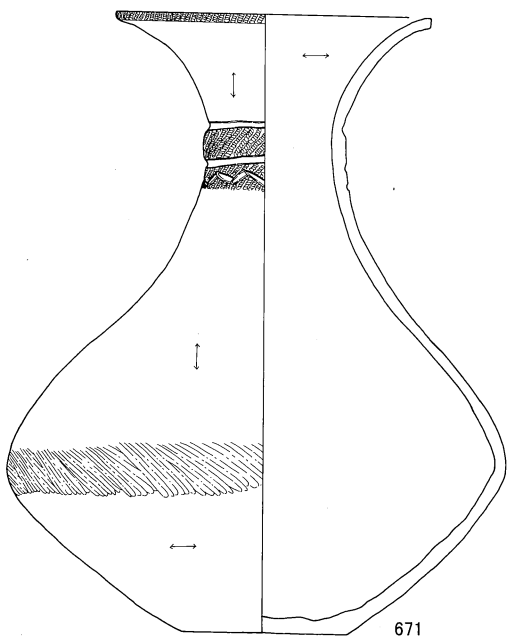

671

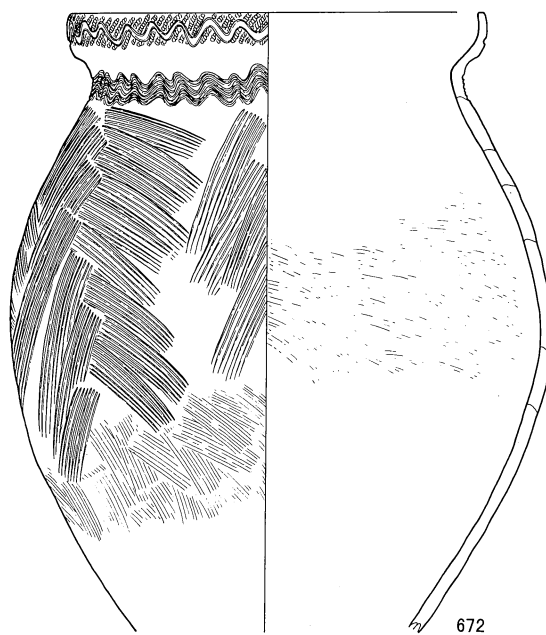

672

S B 1102

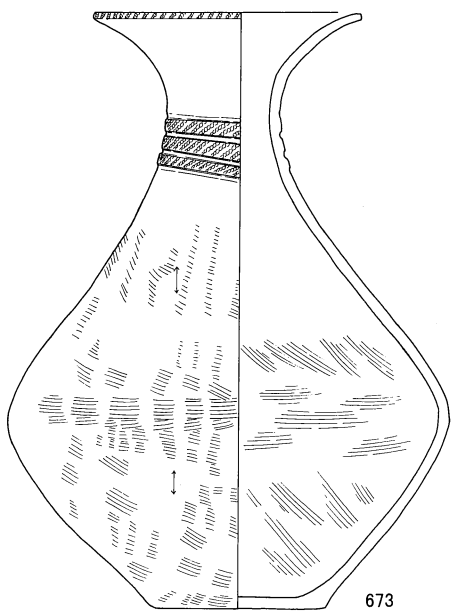

673

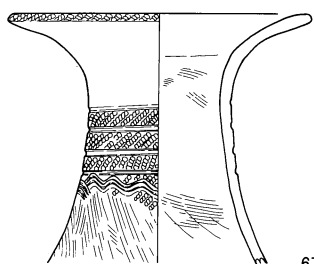

676

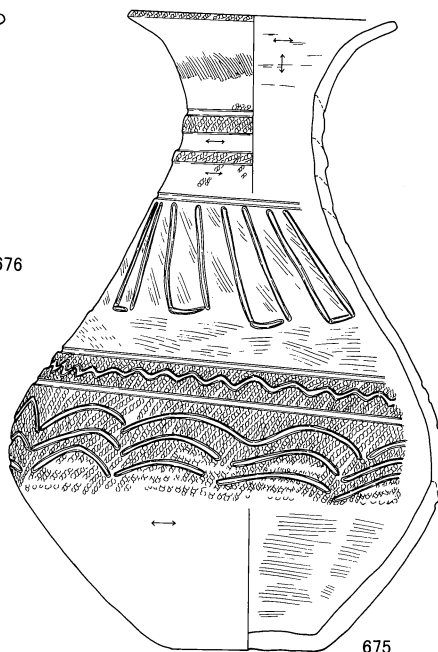

675

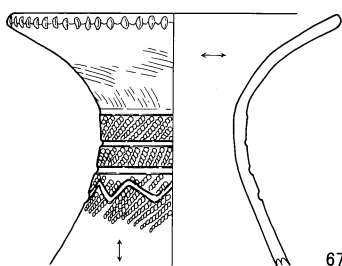

677

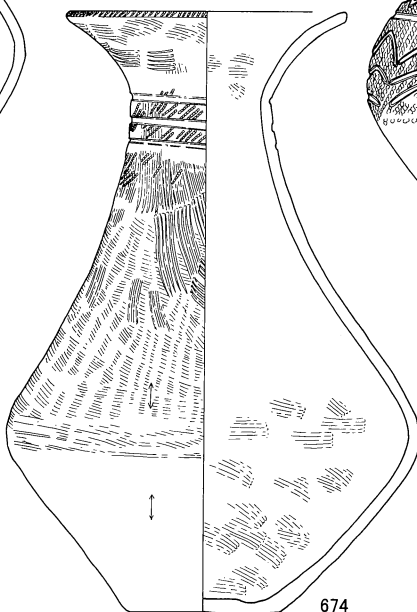

674

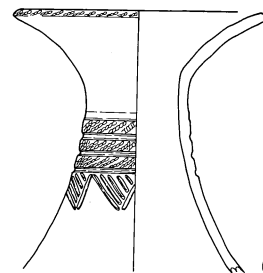

678

0 (1 : 4) 10 cm

S B 267, 671~672 S B 1102, 673~678

S B 1102

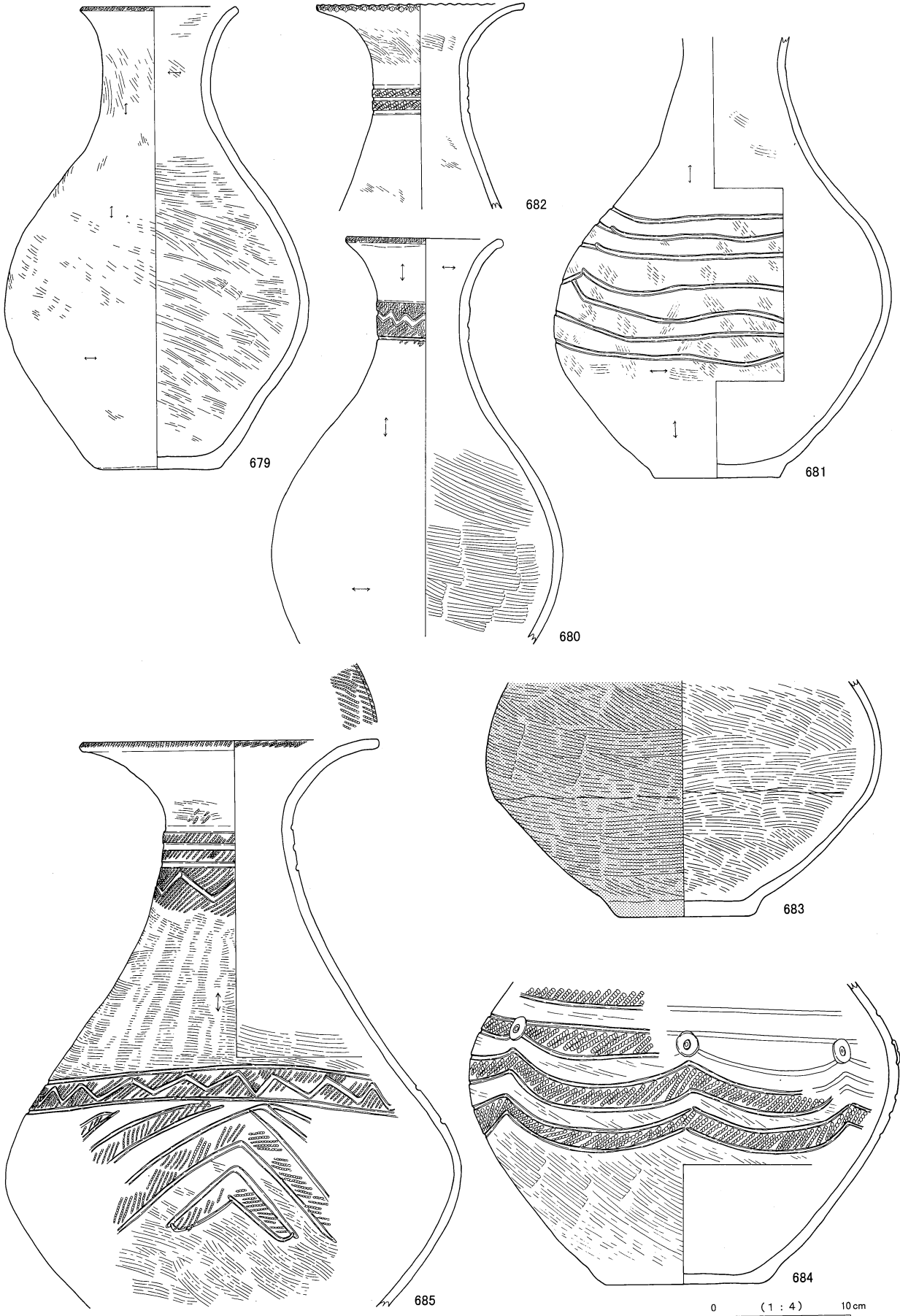

S B 1102, 679~685

S B1102

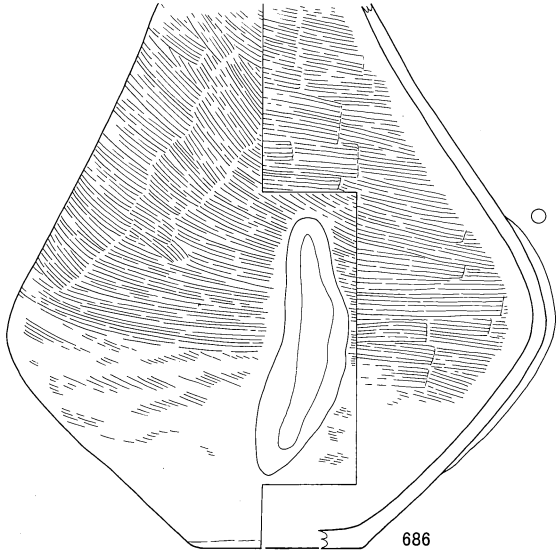

686

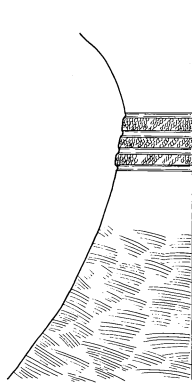

687

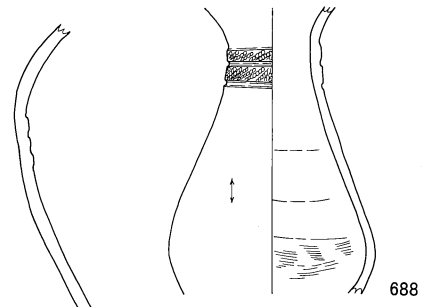

688

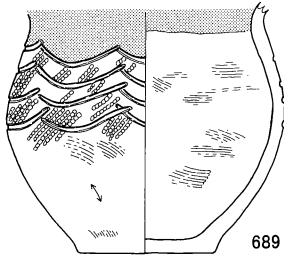

689

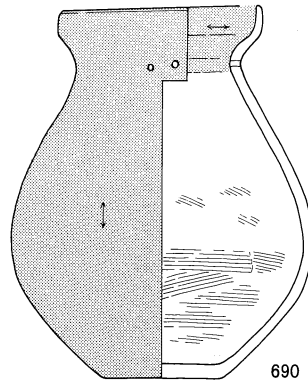

690

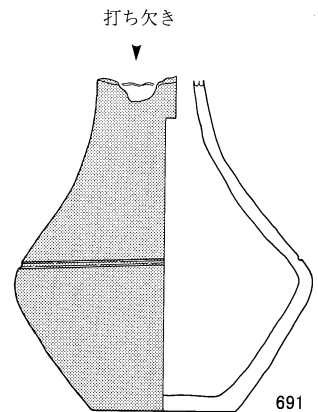

691

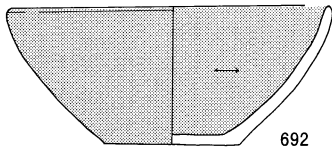

692

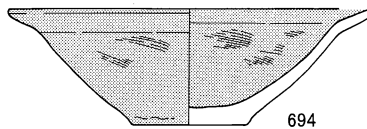

694

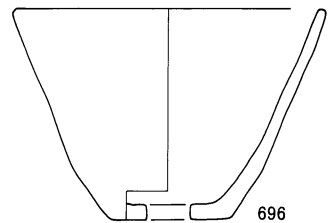

696

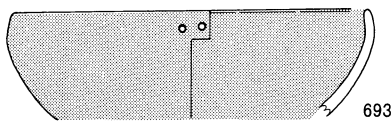

693

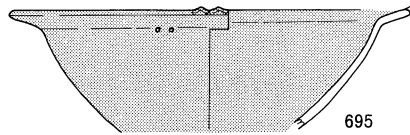

695

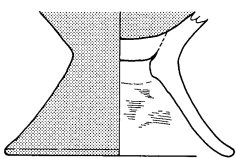

697

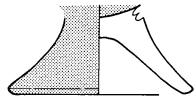

698

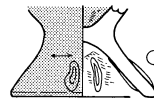

699

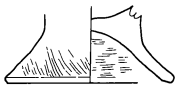

700

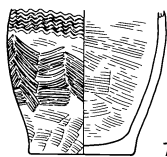

701

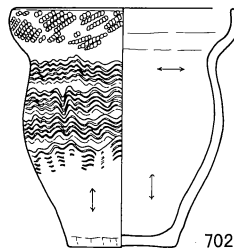

702

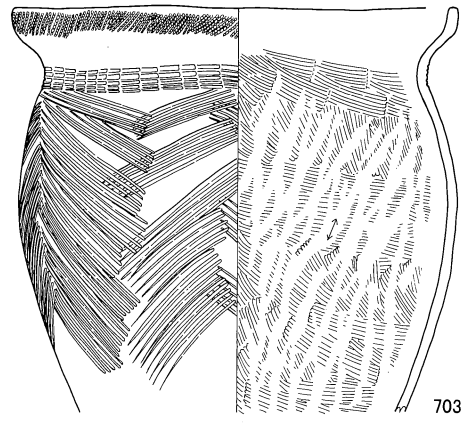

703

0 (1:4) 10cm



S B 1102

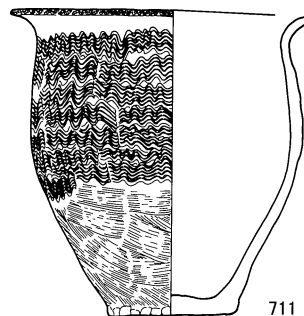
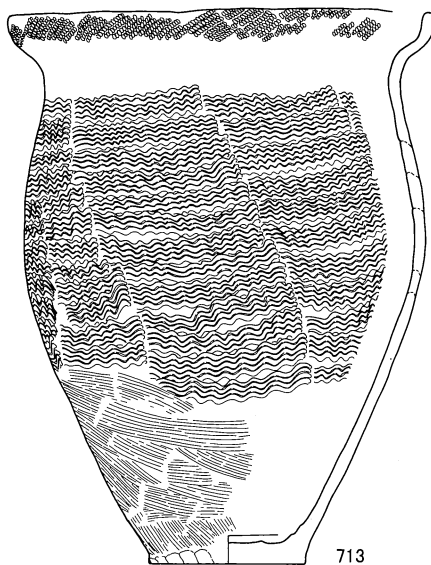
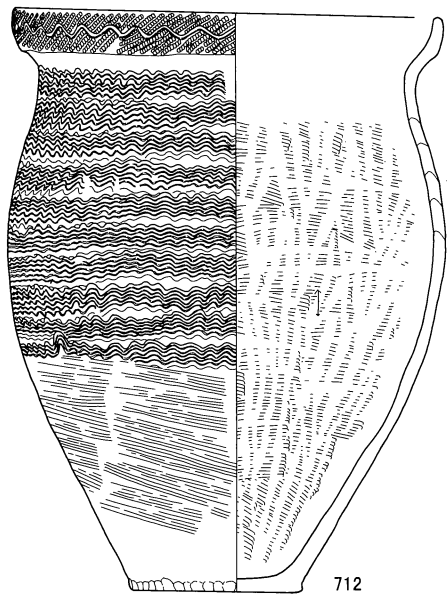
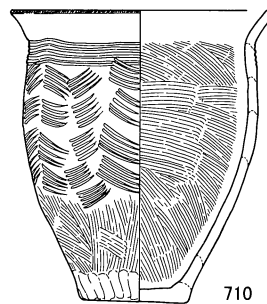
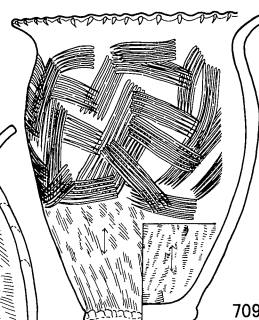
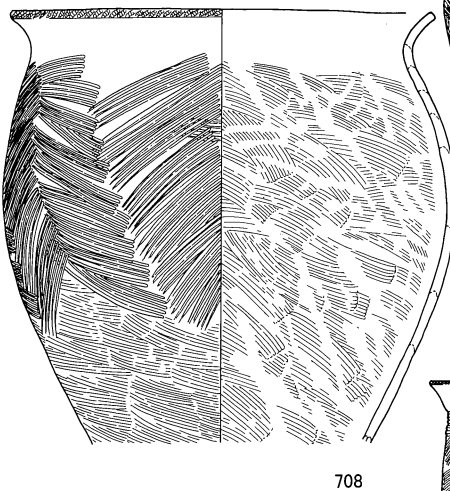
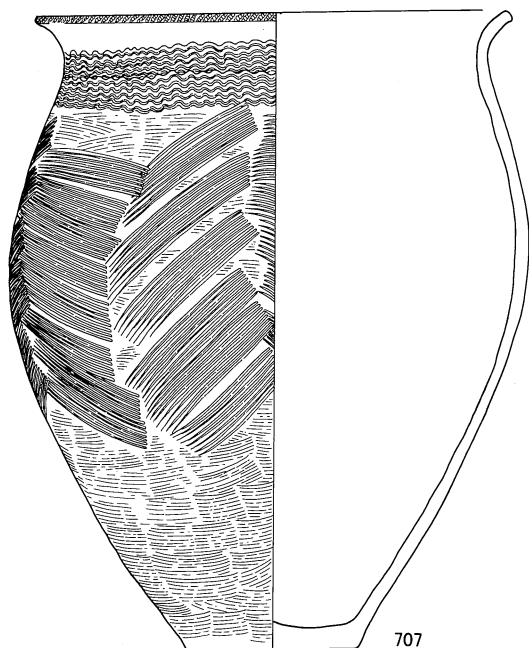
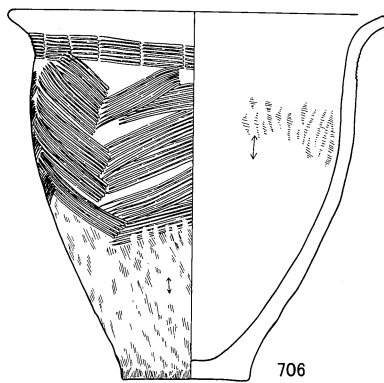
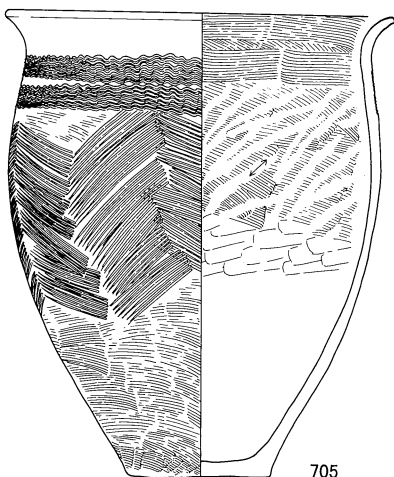
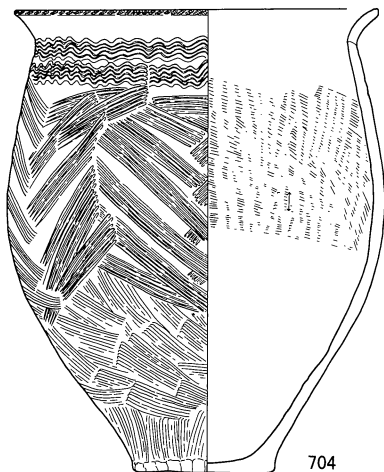

0 (1 : 4) 10 cm

S B 1102, 704~713

SB1102

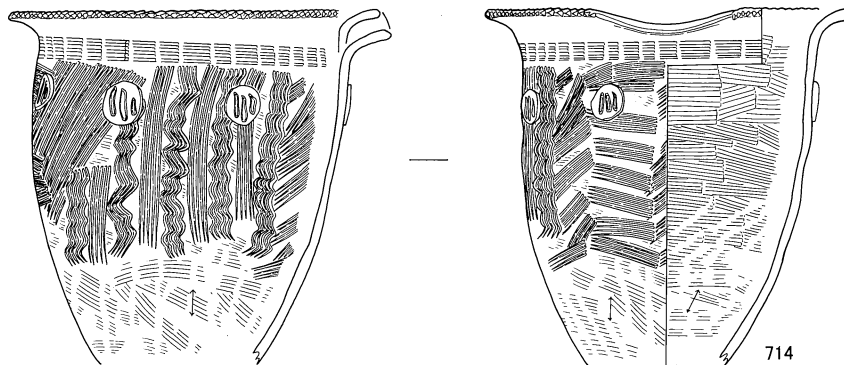

SB1103

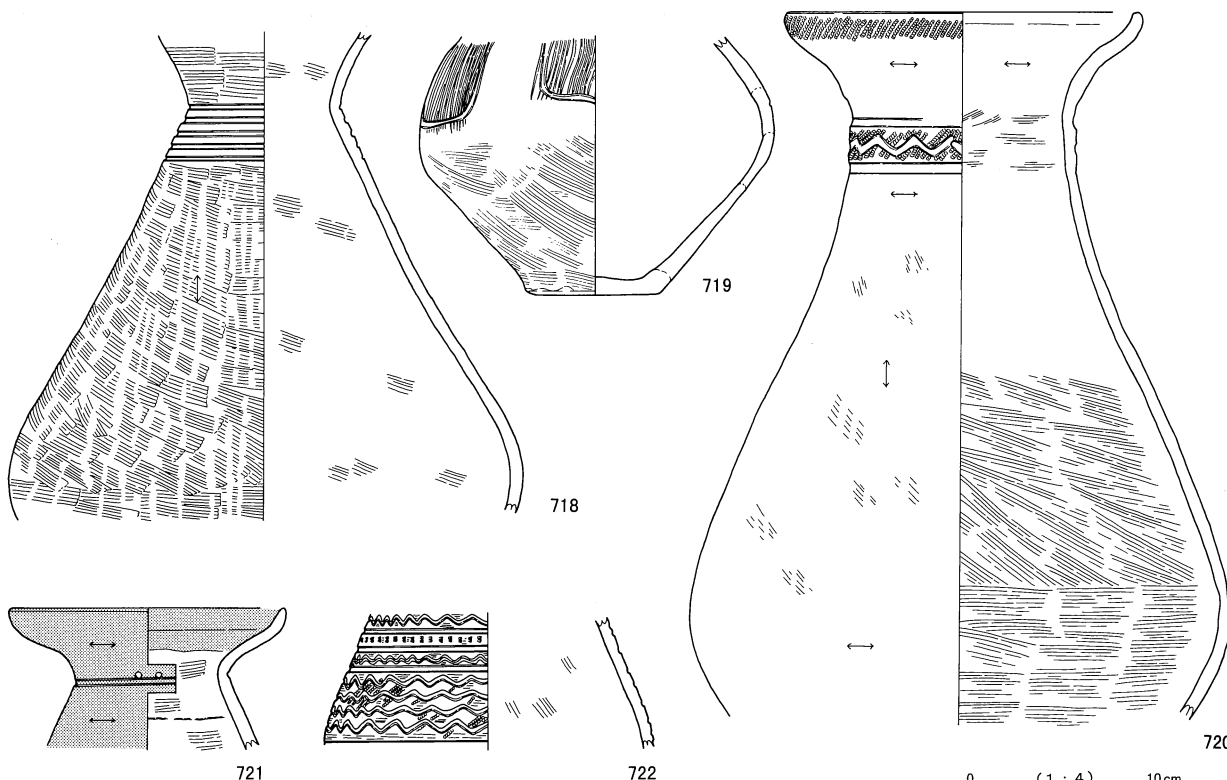
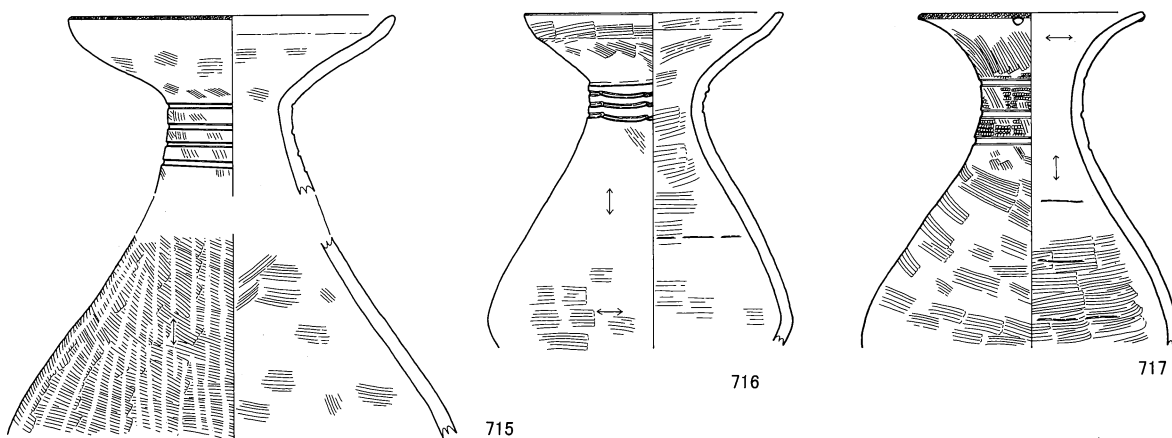

0 (1 : 4) 10cm

S B1102, 714 S B1103, 715~722

S B 1103

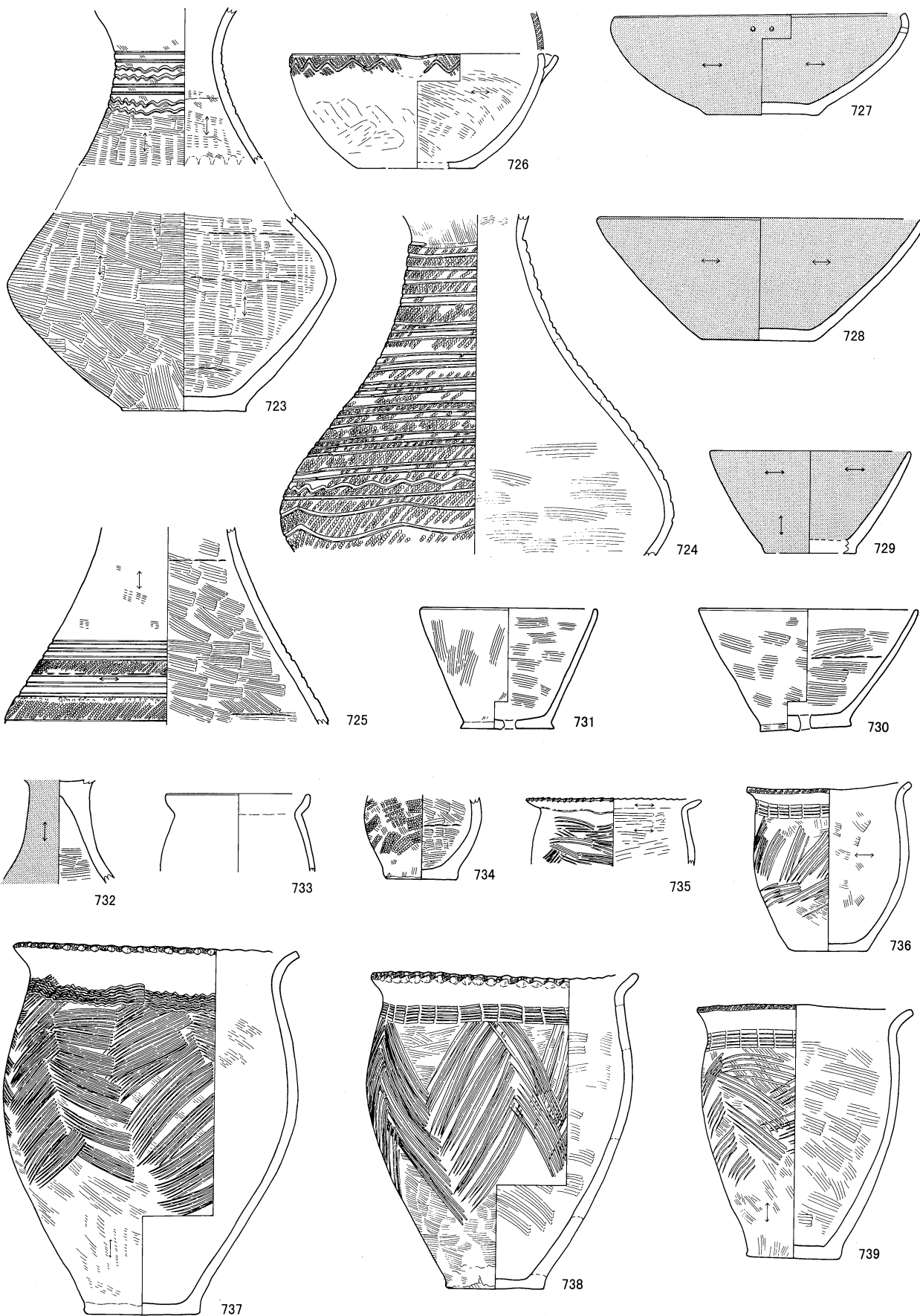

S B 1103, 723~739

S B1103

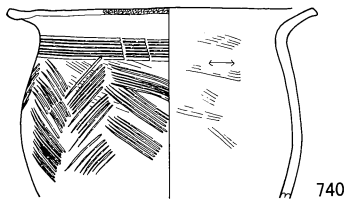

740

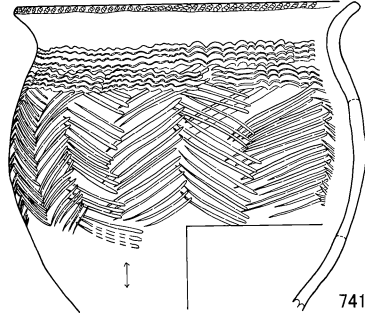

741

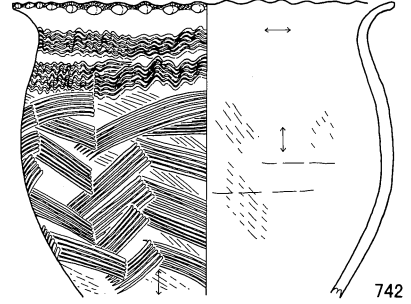

742

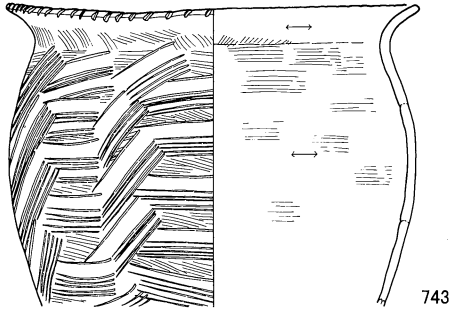

743

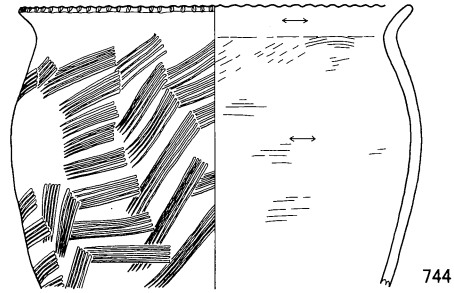

744

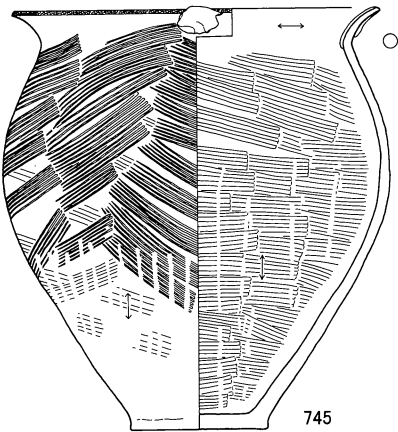

745

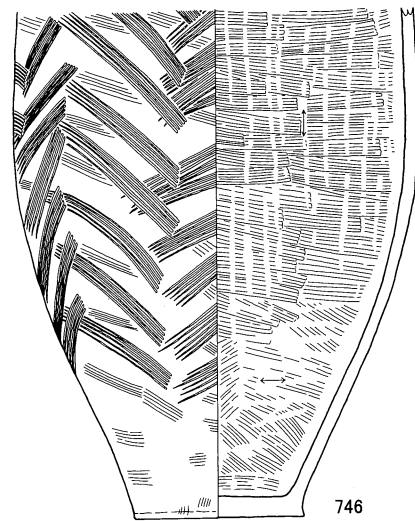

746

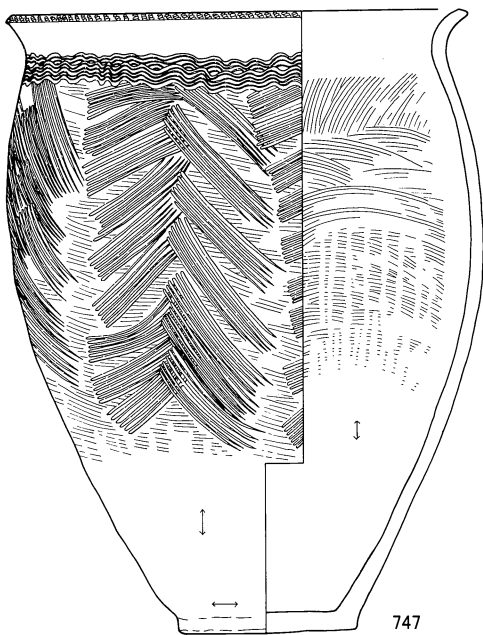

747

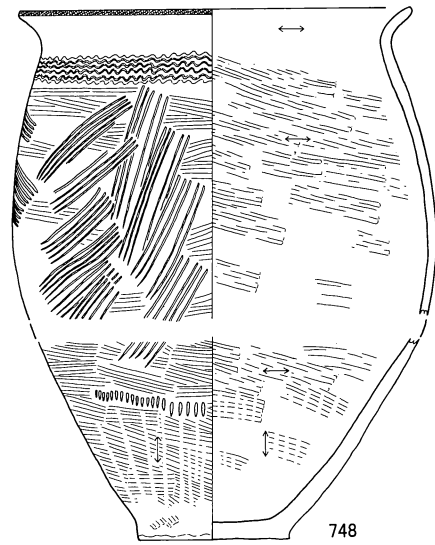

748

0 (1 : 4) 10cm

S B 1103

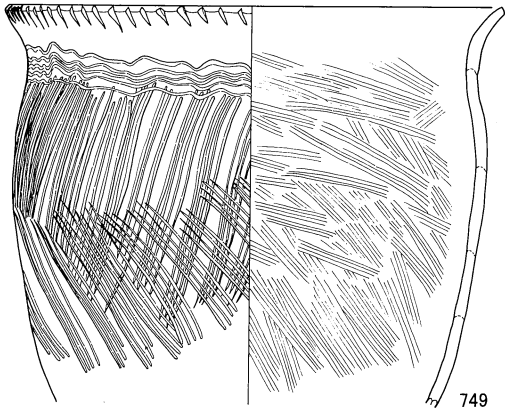

749

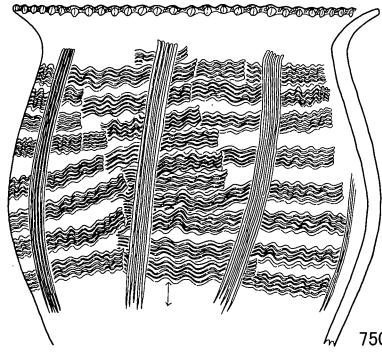

750

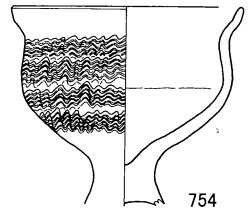

754

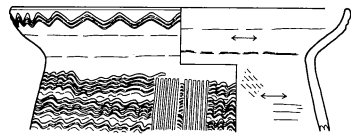

752

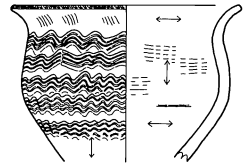

755

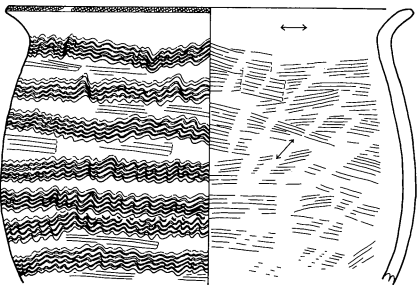

751

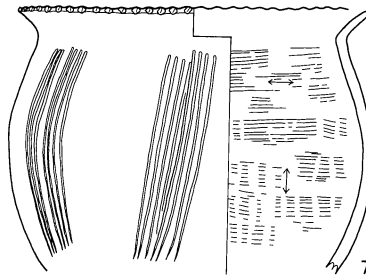

753

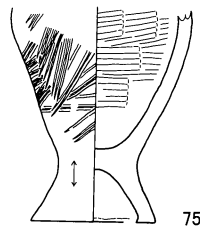

756

S B 1104

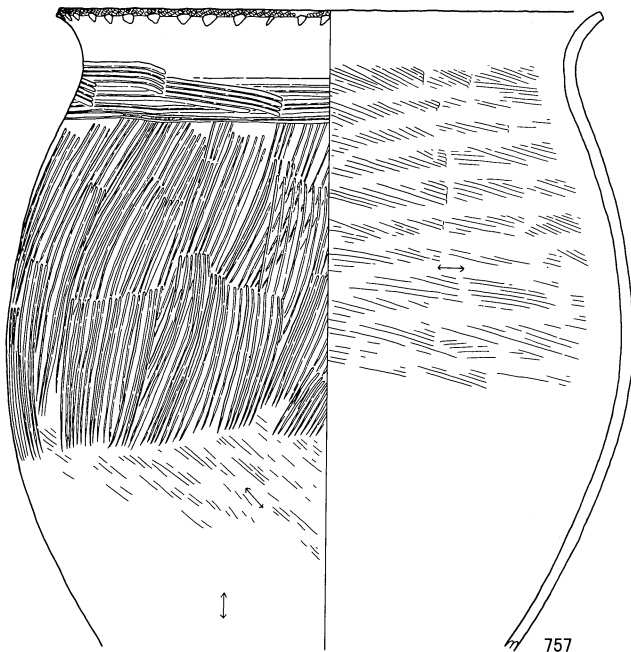

757

S B 1109

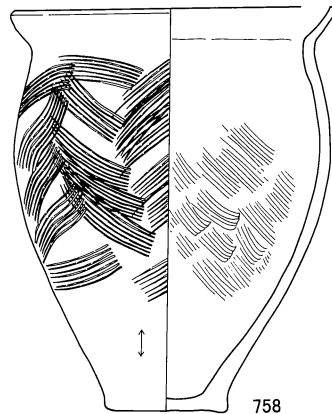

758

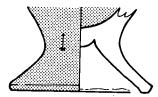

760



761



762

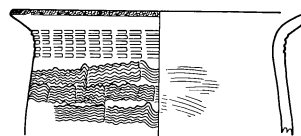

759

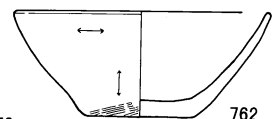

0 (1 : 4) 10cm

S B 1103, 749~756

S B 1104, 757

S B 1109, 758~762

S B1106

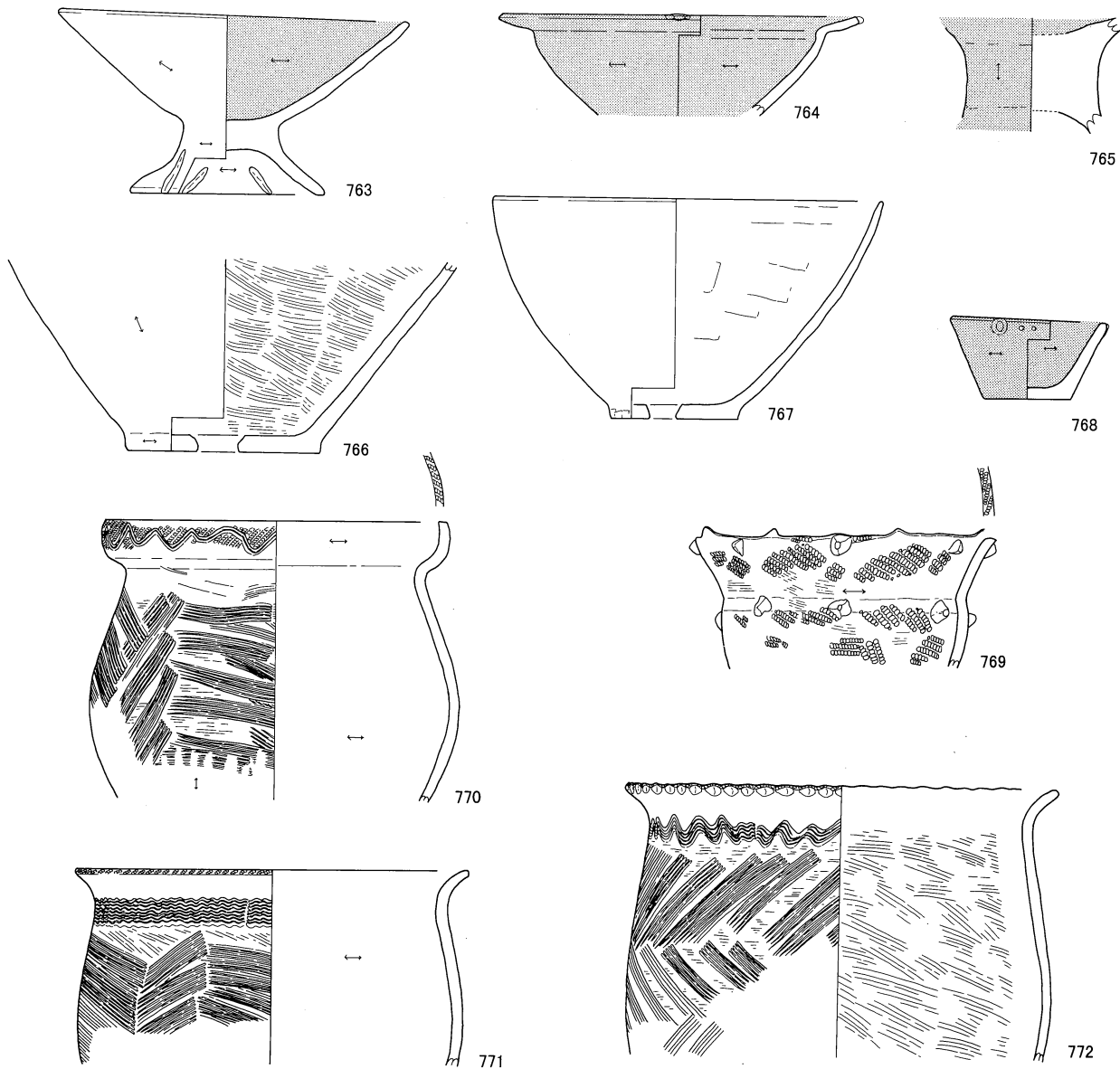

S B1108

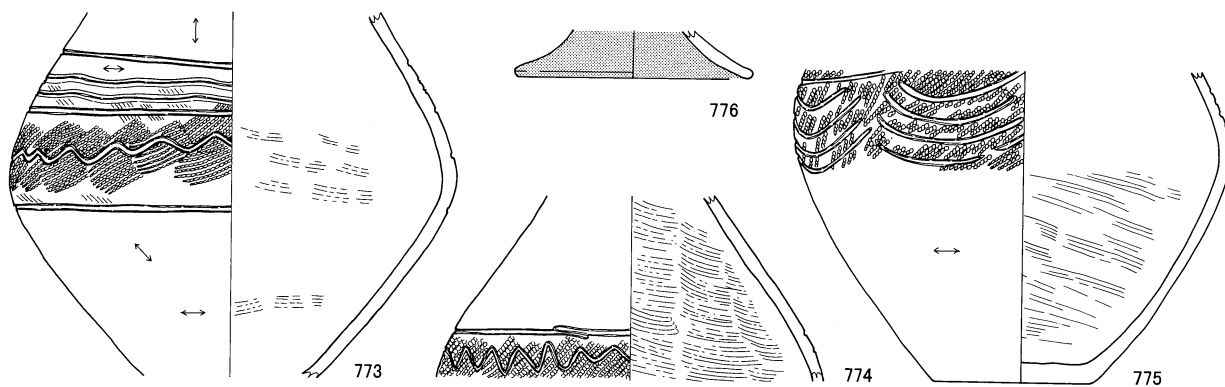

0 (1 : 4) 10cm

S B1106, 763~772 S B1108, 773~776

S B1108

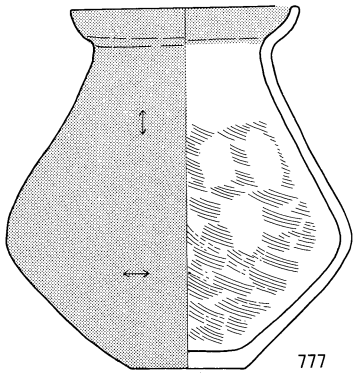

777

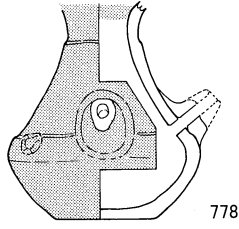

778

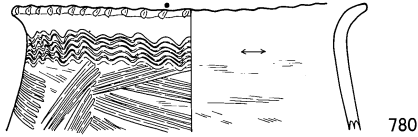

780

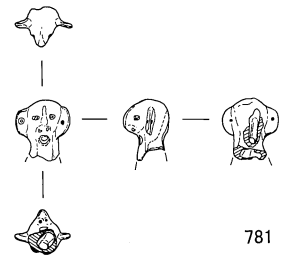

781

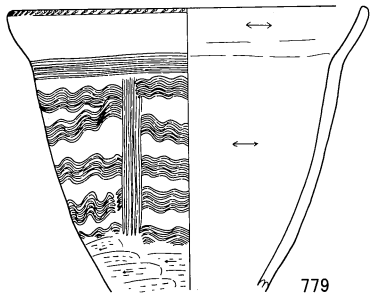

779

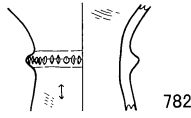

782

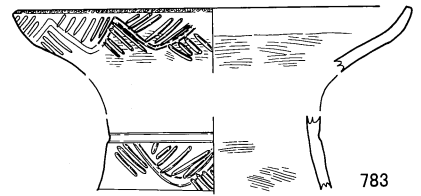

783

S B1110

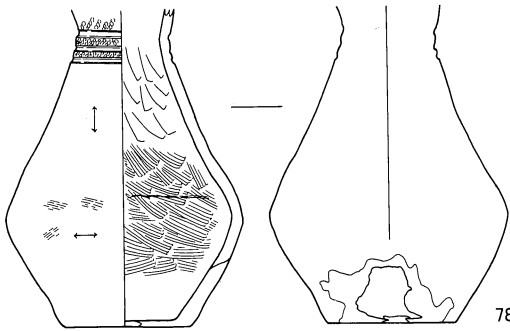

787

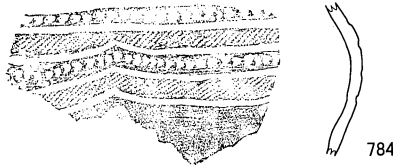

784

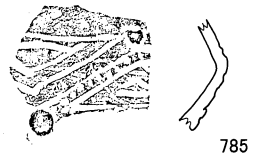

785

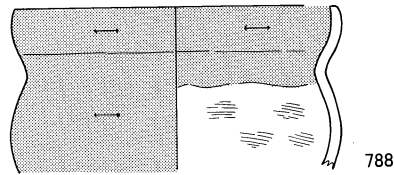

788

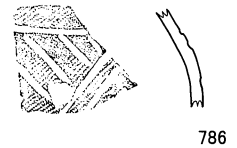

786

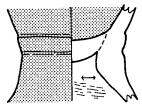

789

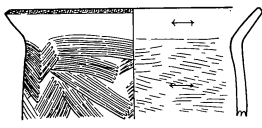

790

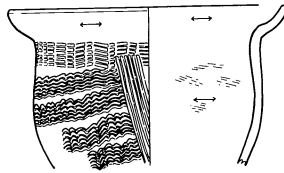

791

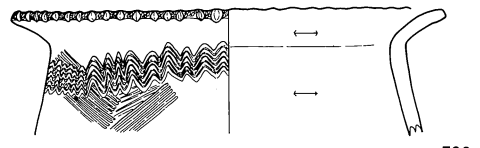

792

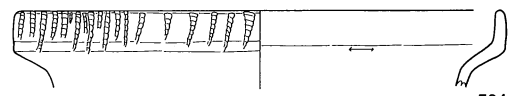

794

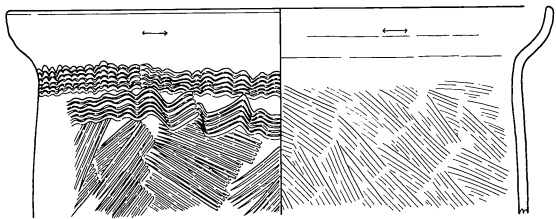

793

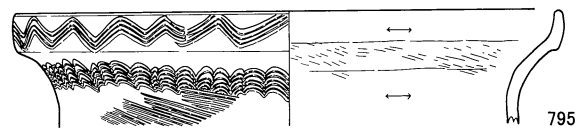

795

0 (1:4) 10cm

SB1112

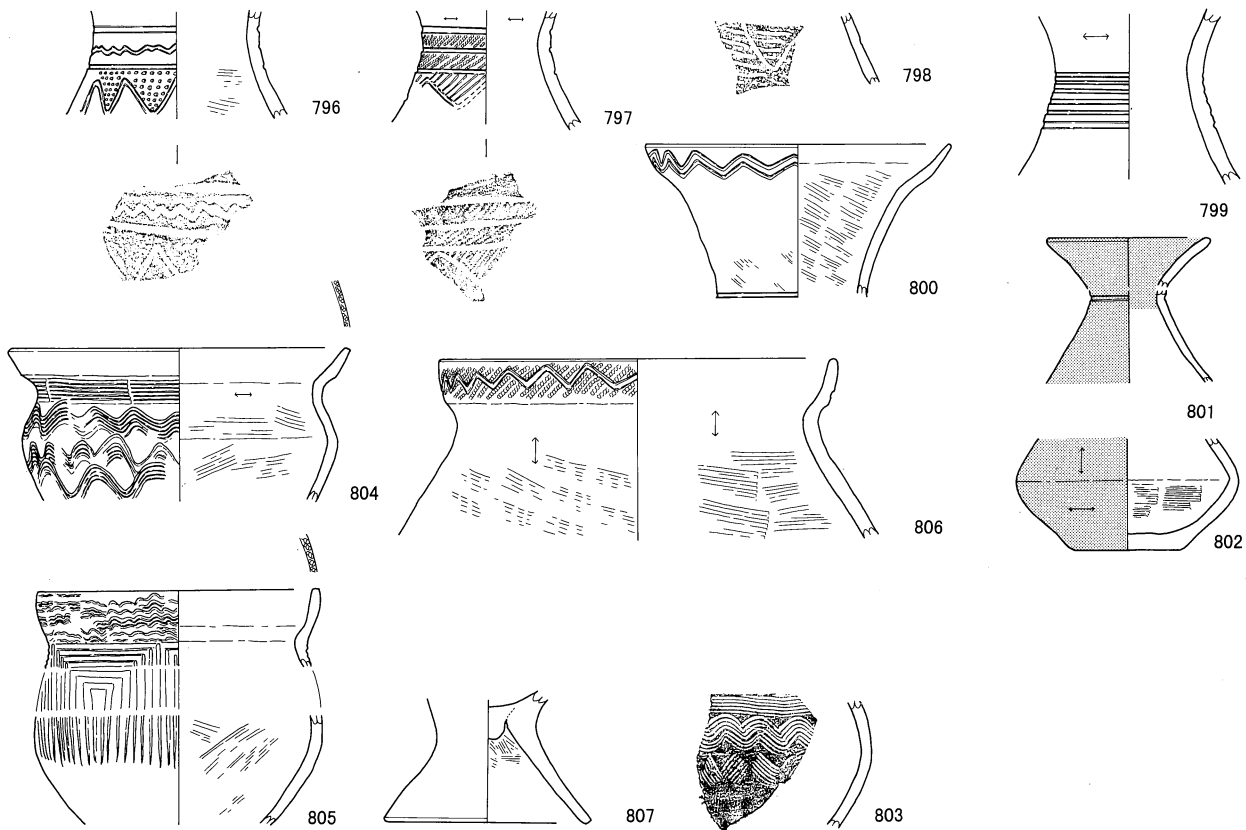

SB1113

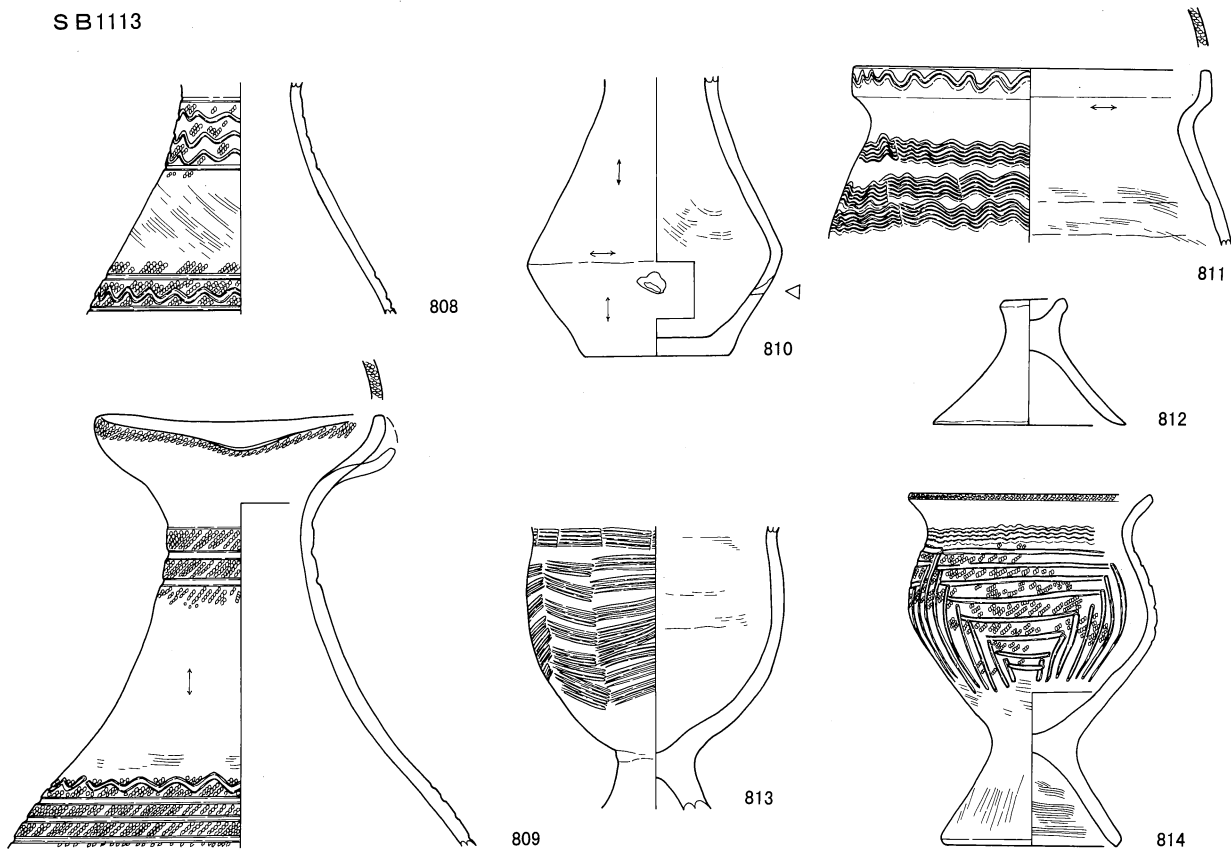

0 (1:4) 10 cm

SB1112, 796~807 SB1113, 808~814



SB1113

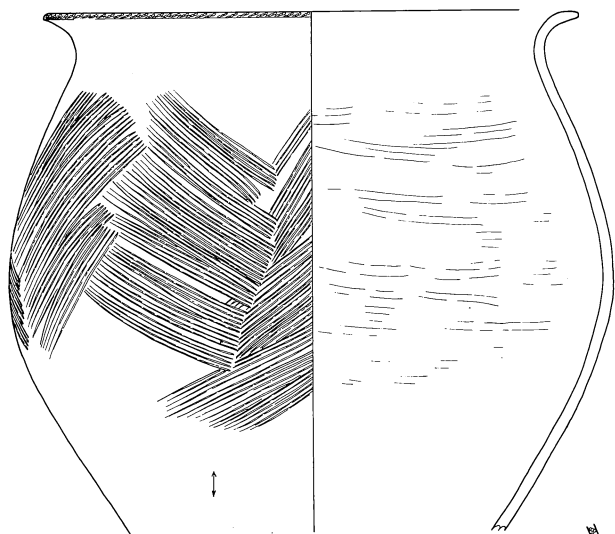

815

SB1114

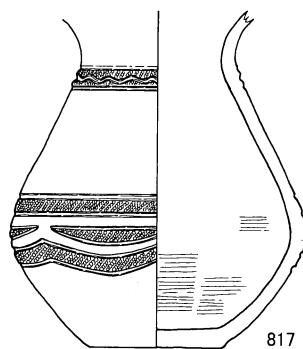

817

SB1115

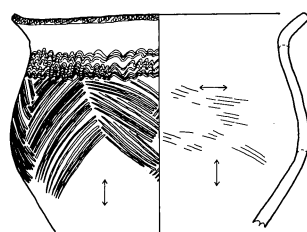

818

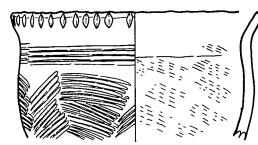

819

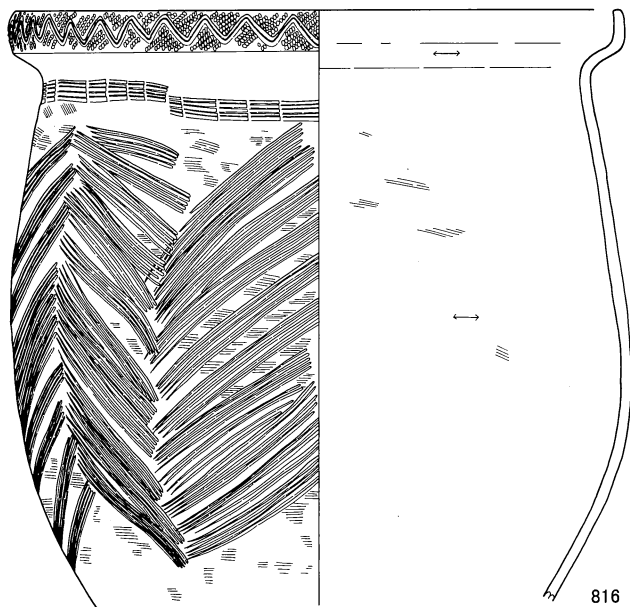

816

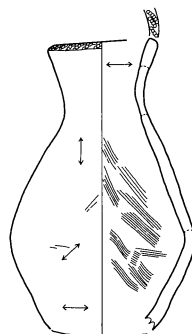

820

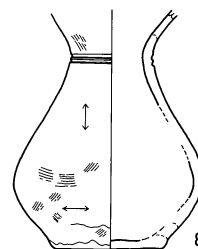

821

SB1118

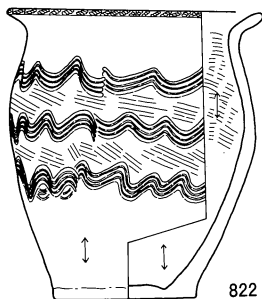

822

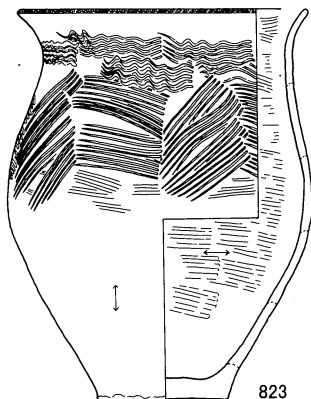

823

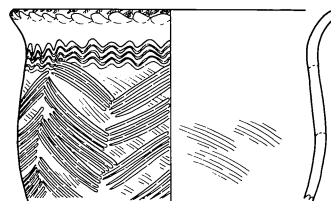

824

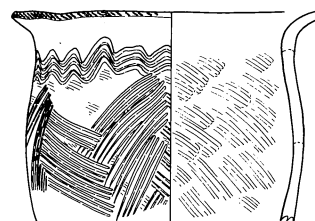

825

0 (1 : 4) 10 cm

S B1113, 815~816

S B1114, 817

S B1115, 818~821

S B1118, 822~825

SB1118

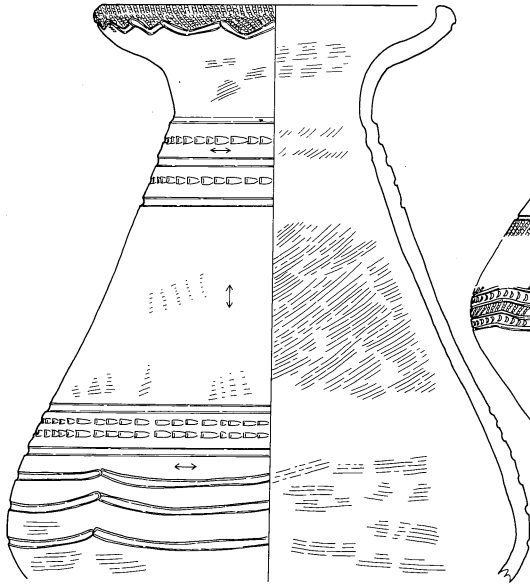

826

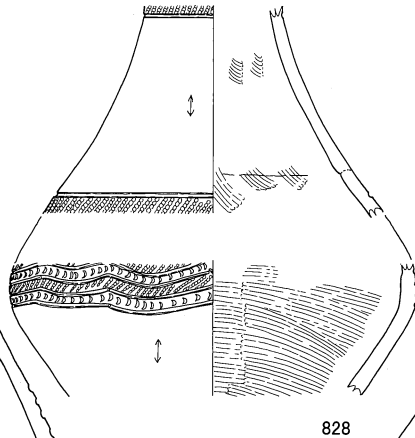

828

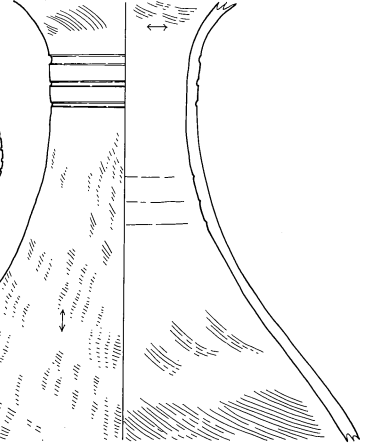

829

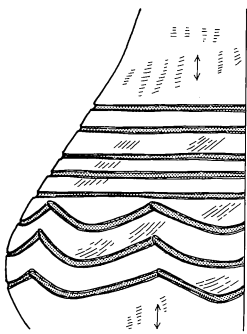

827

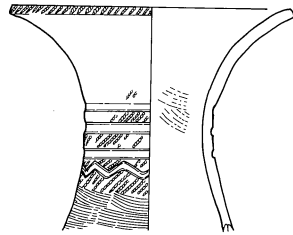
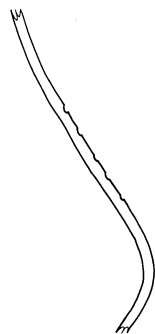

830

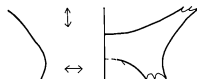

831

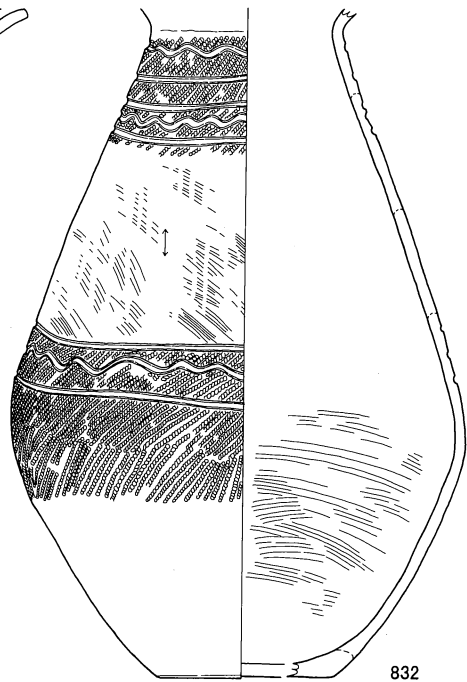

832

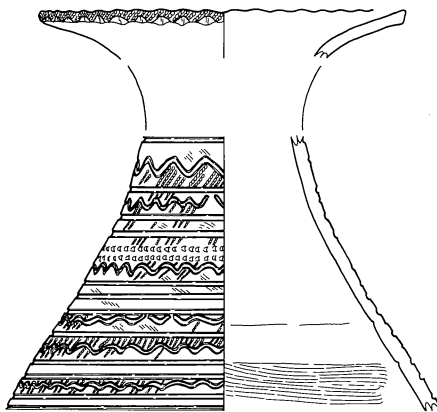

833

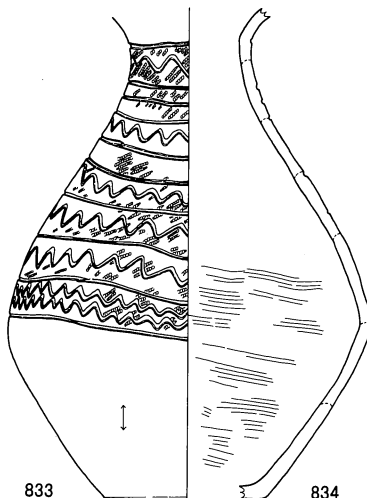

834

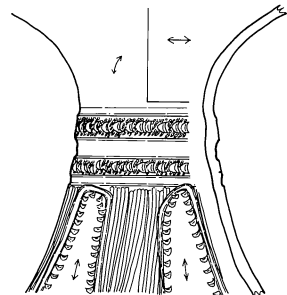

835

0 (1 : 4) 10 cm

SB1118, 826~835

SB1119

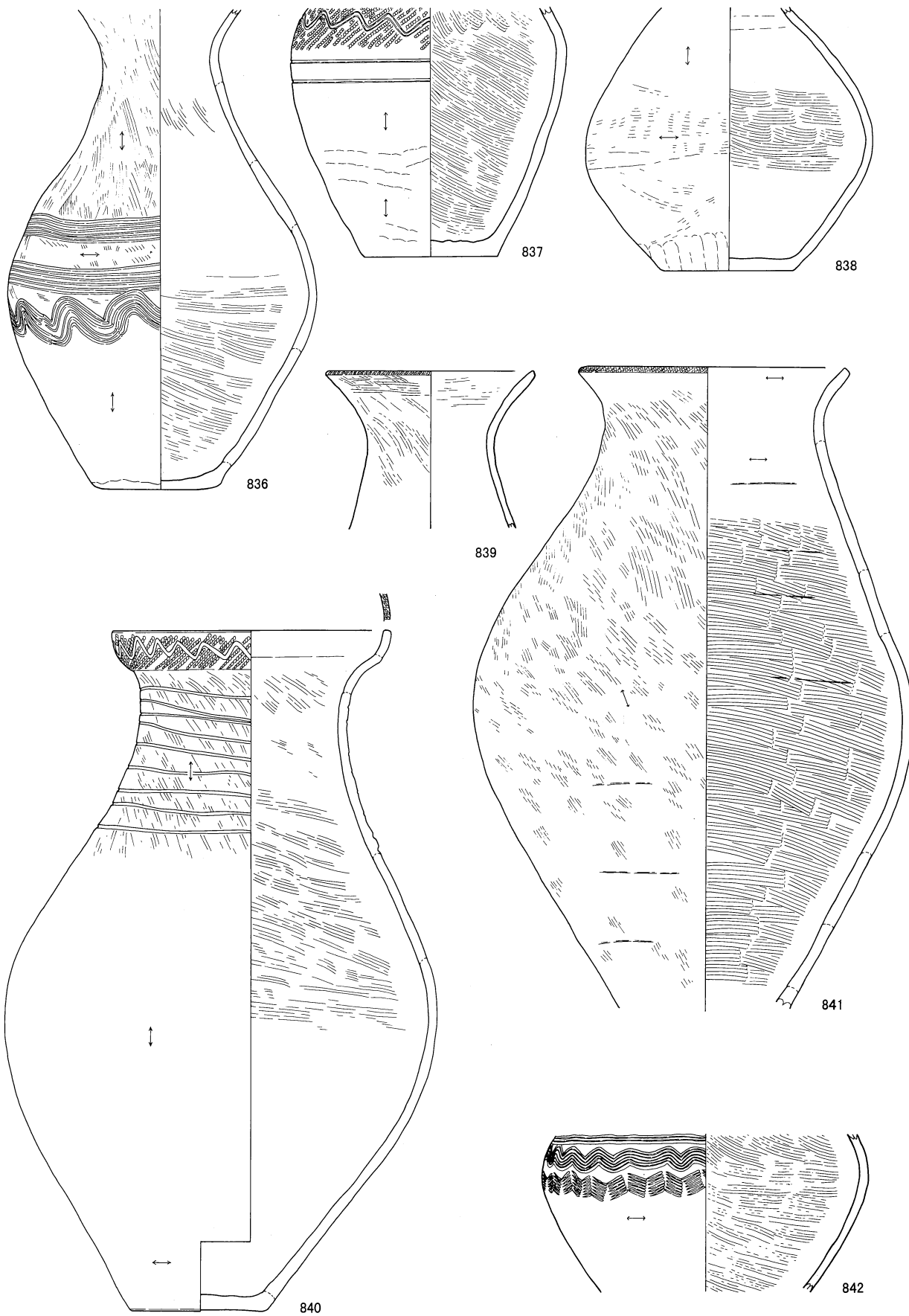

S B1119, 836~842

S B1119

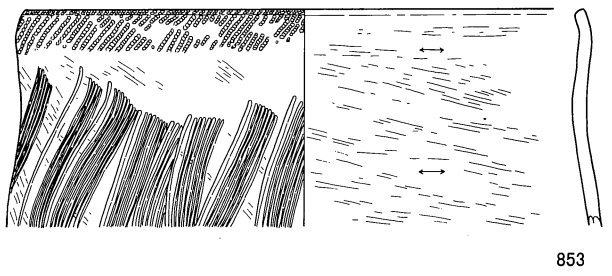
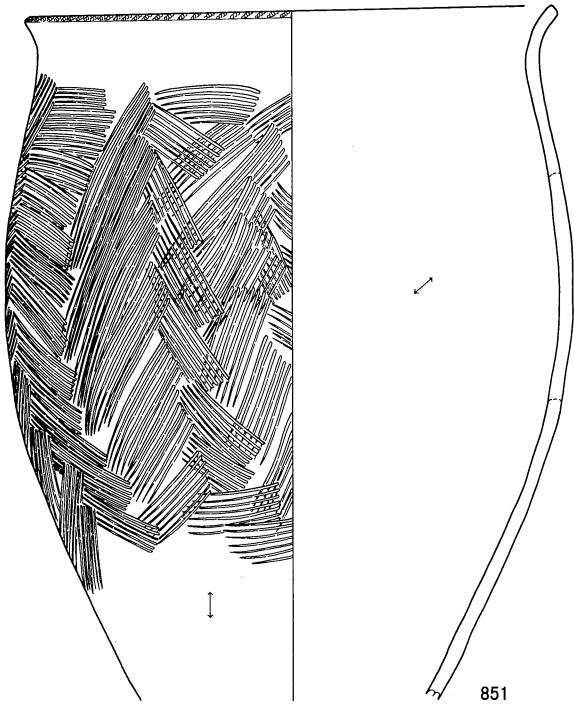
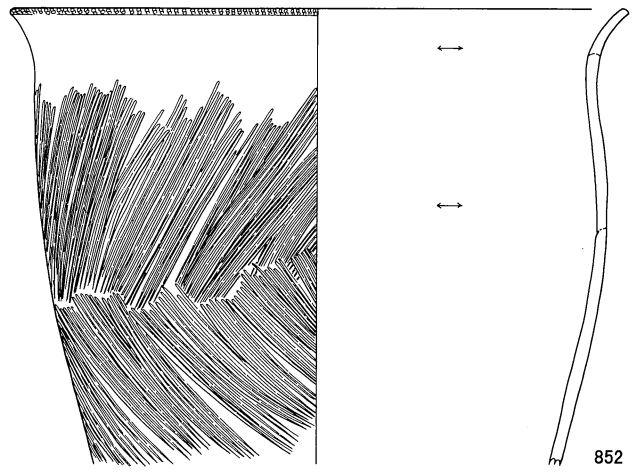
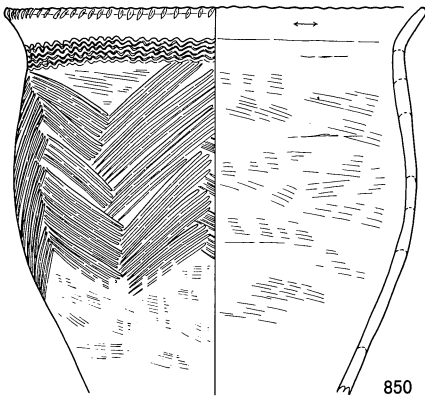
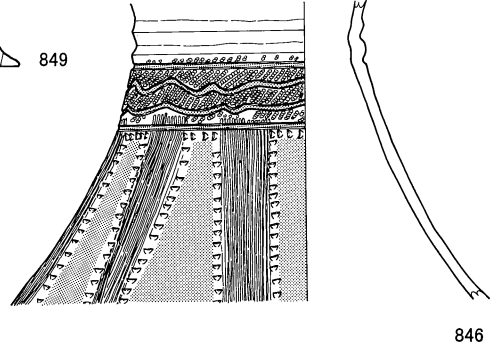
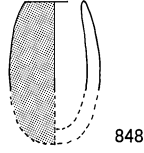
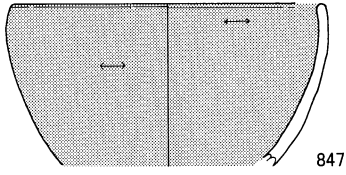
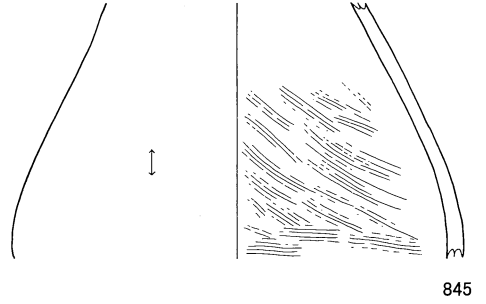
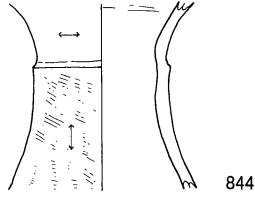
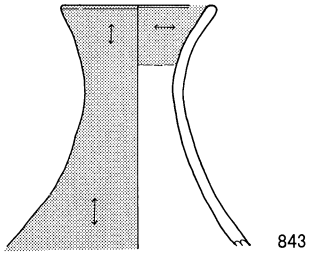

0 (1 : 4) 10 cm

SB1119

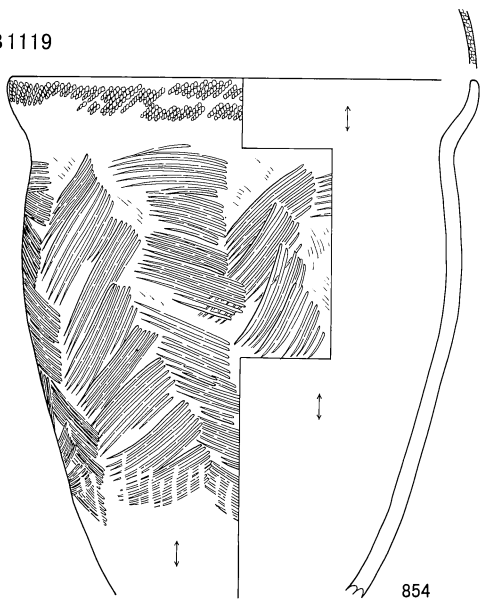

854

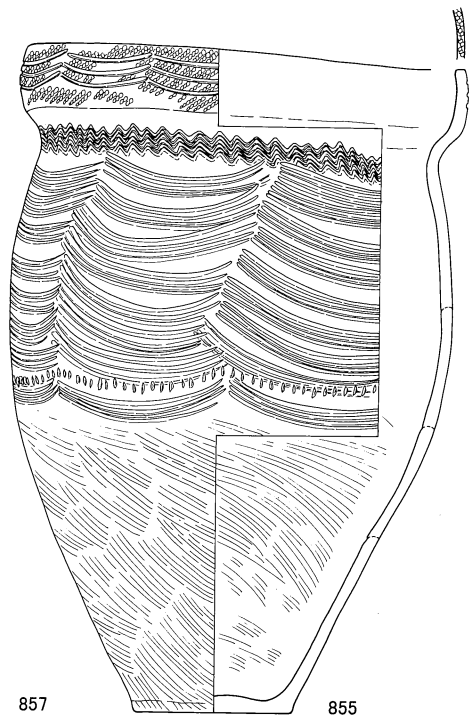

855

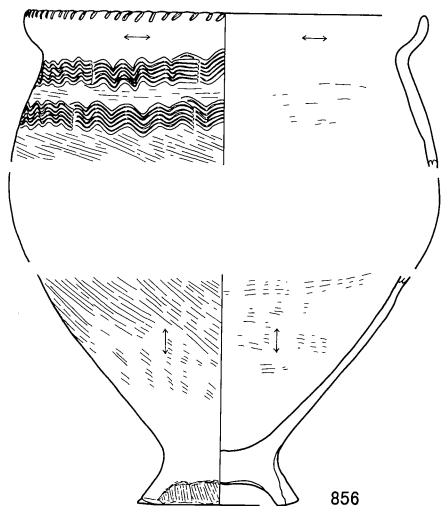

856



857

SB1120

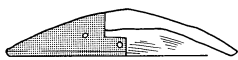

858

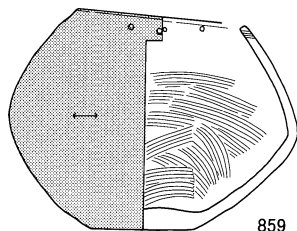

859

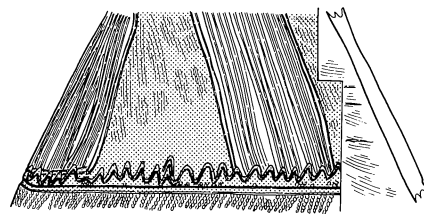

860

SB1120

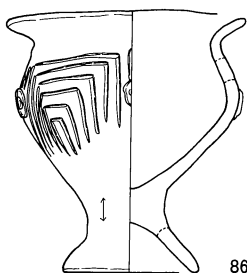

863



861



862

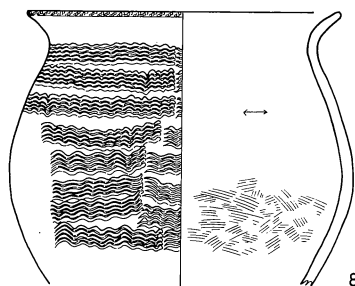

864

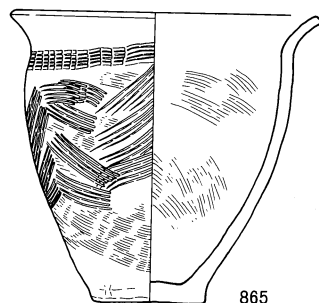

865

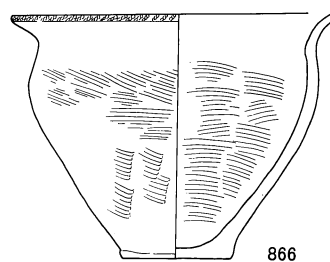

866

0 (1:4) 10cm

SB1121

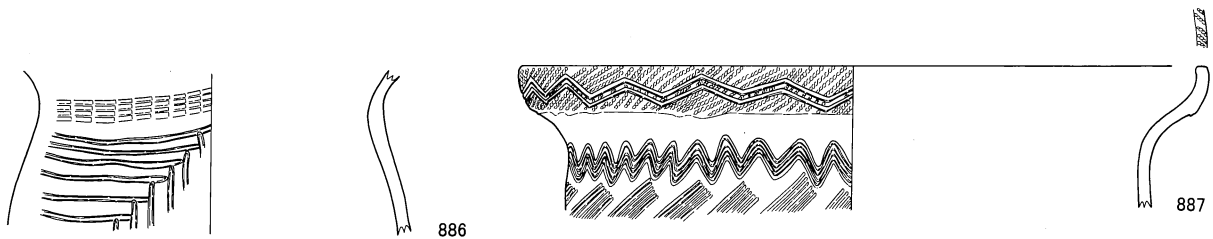
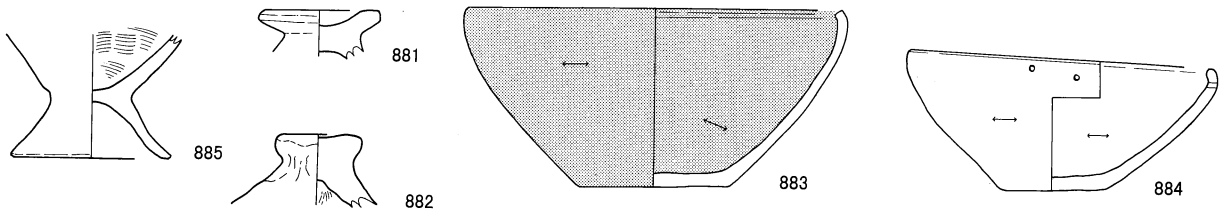
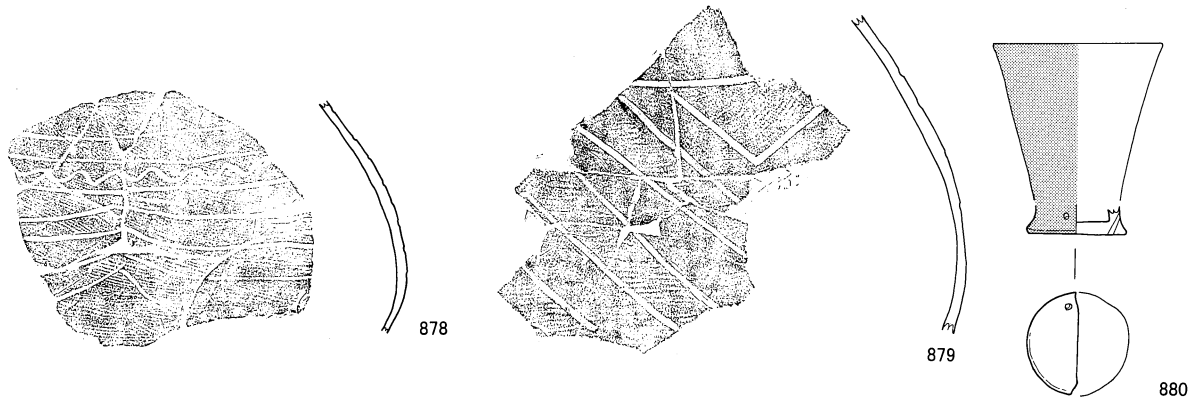
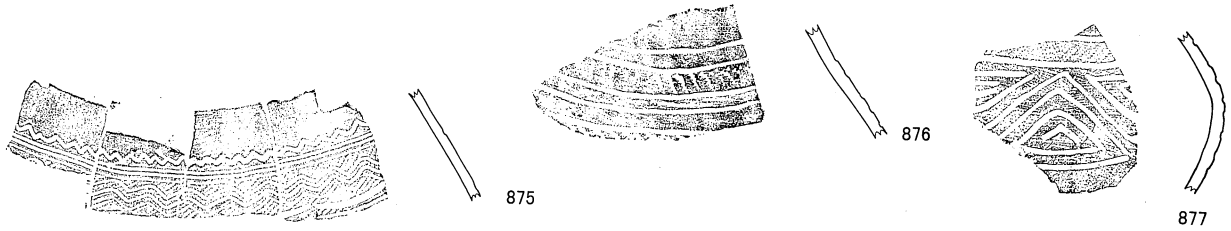
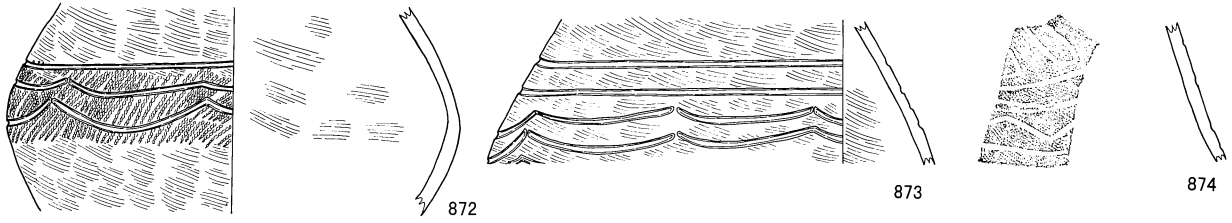
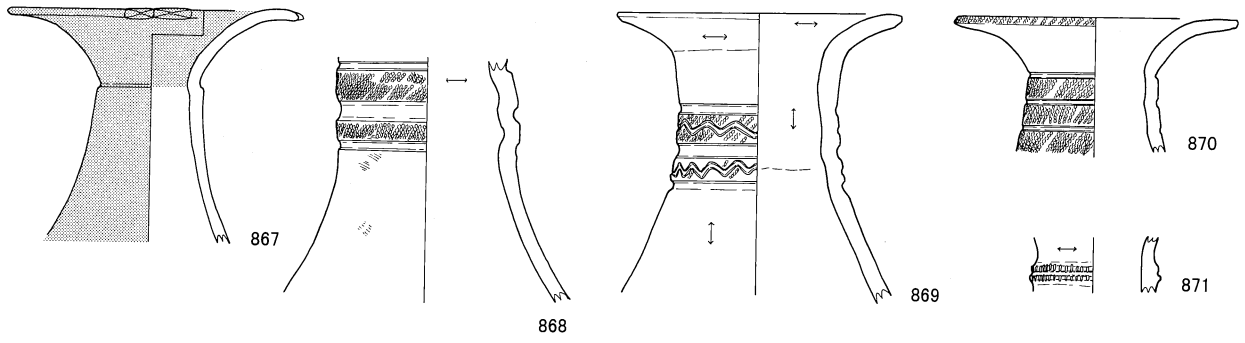

0 (1 : 4) 10cm

SB1121, 867~887

S B 1121

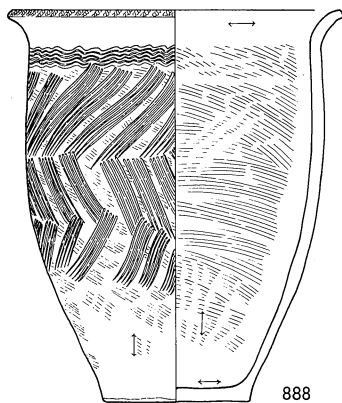

888

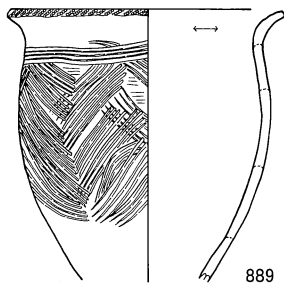

889

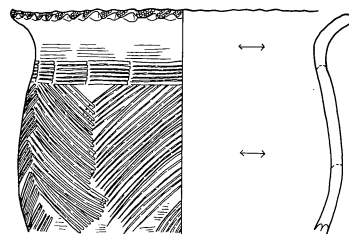

890

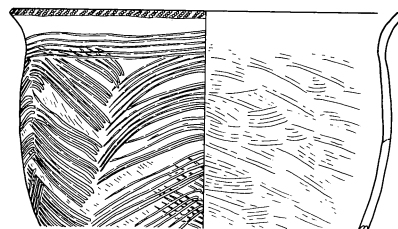

891

S B 1122

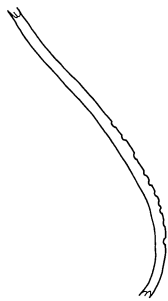
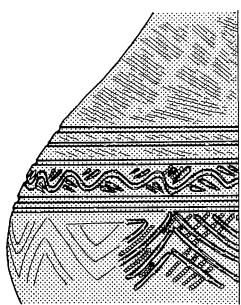

892

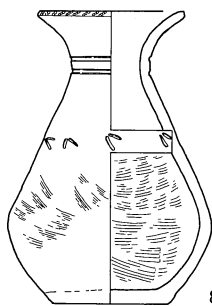

893

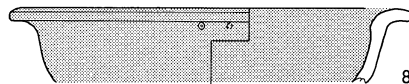

894



895

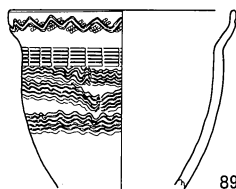

896

S B 1129

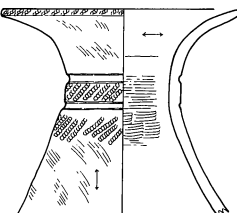
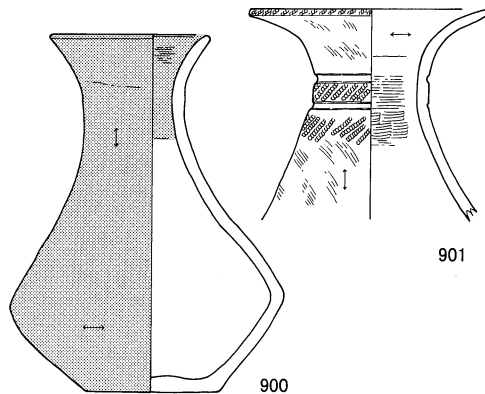

901

900

S B 1127

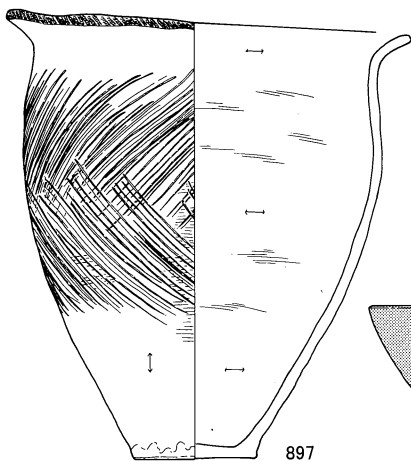

897

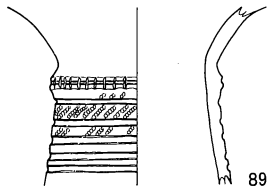

898

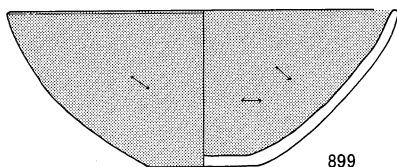

899

S B 1130

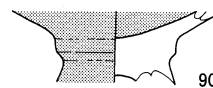

902

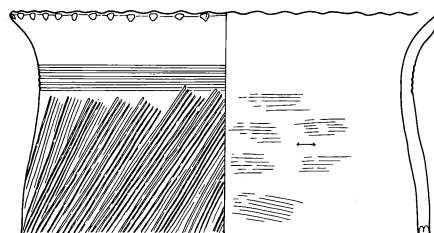

903

0 (1:4) 10cm

S B 1121, 888~891

S B 1122, 892~896

S B 1127, 897~899

S B 1129, 900~901

S B 1130, 902~903

S B1123

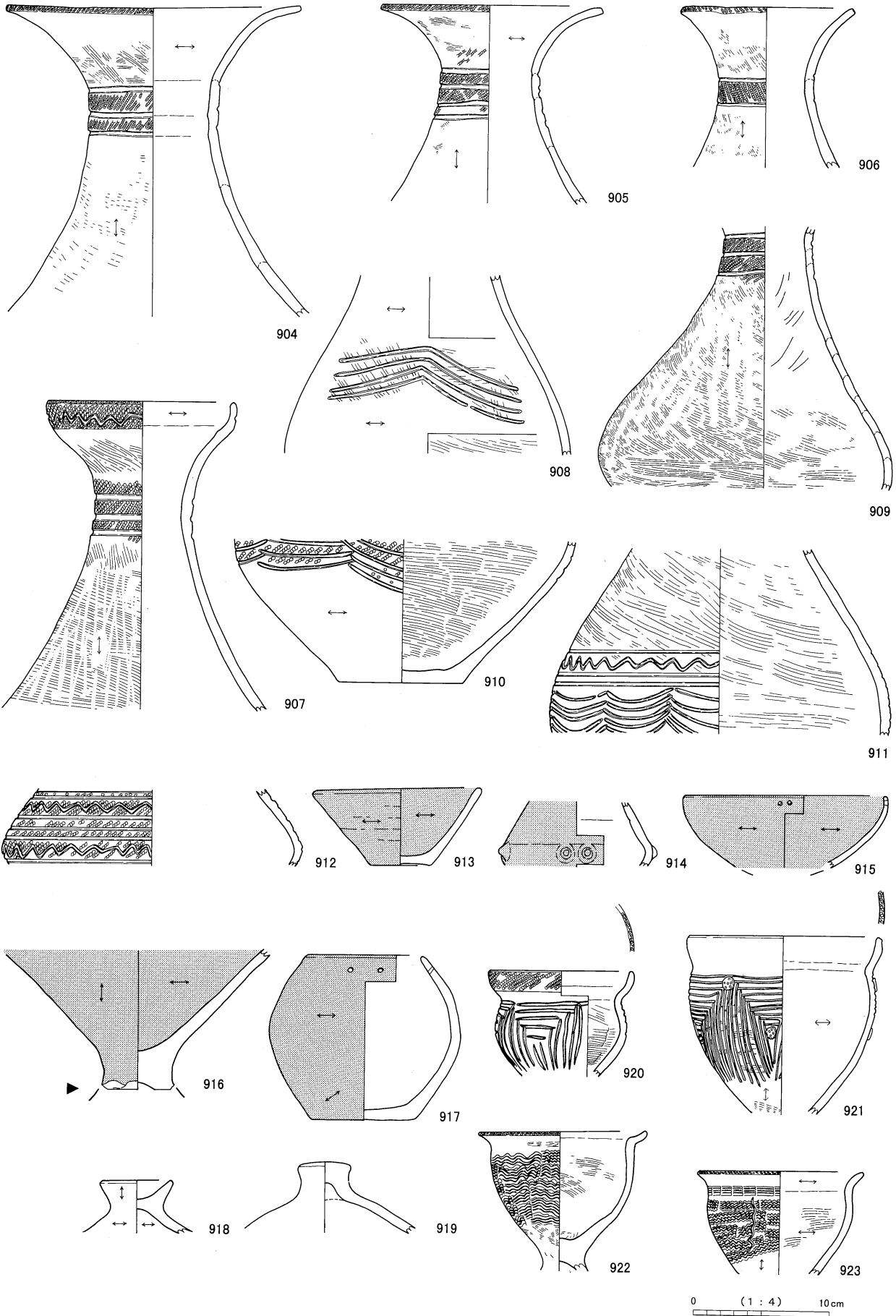

S B1123, 904~923



S B 1123

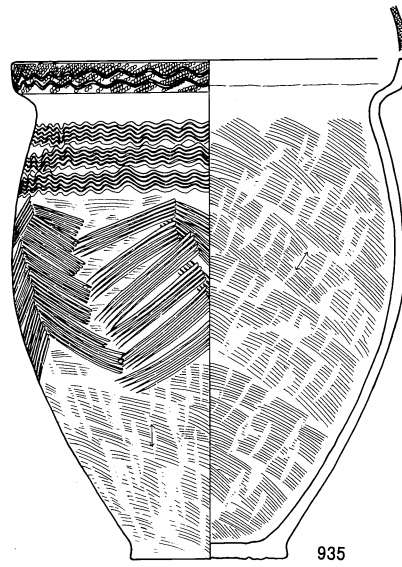
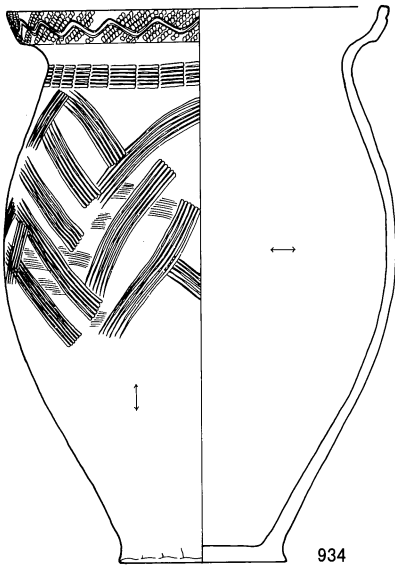
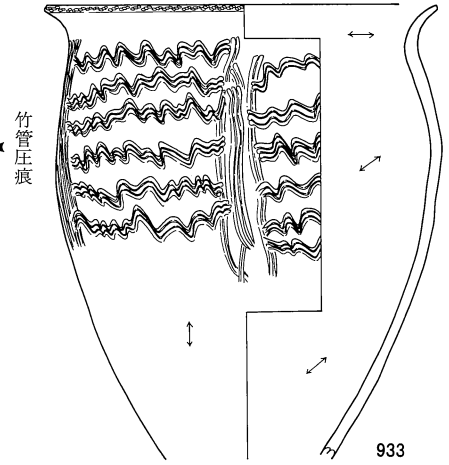
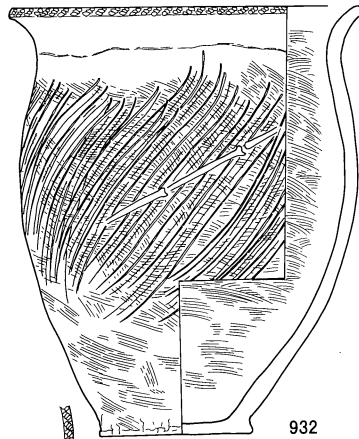
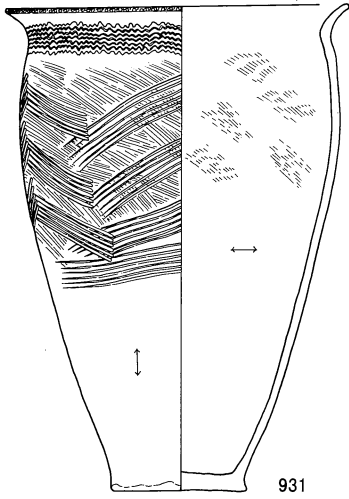
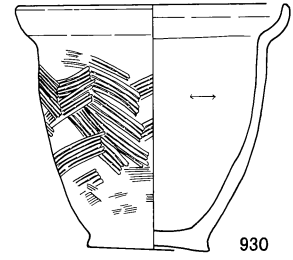
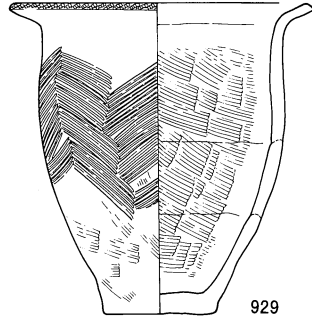
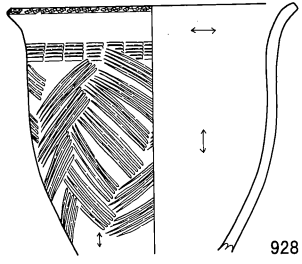
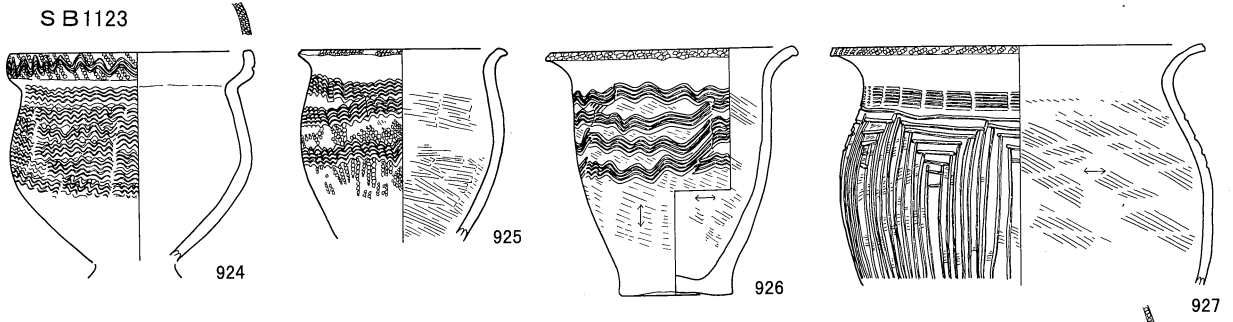

0 (1 : 4) 10 cm

S B 1123, 924~935

S B 1123

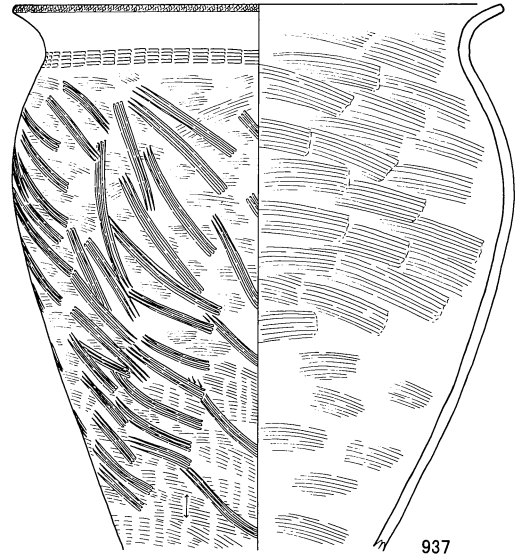
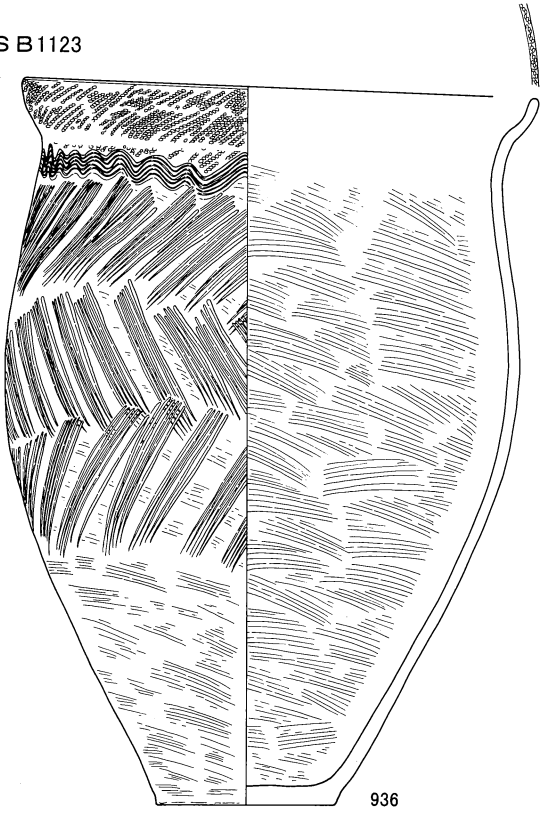

S B 1124

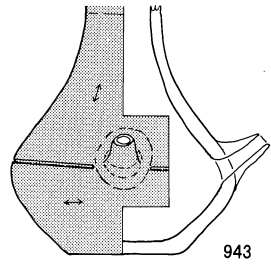
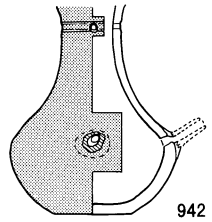
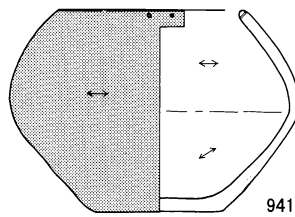
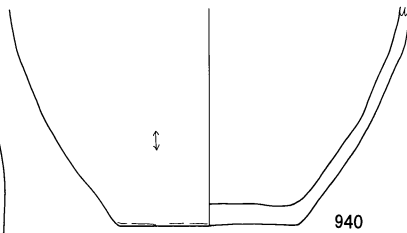
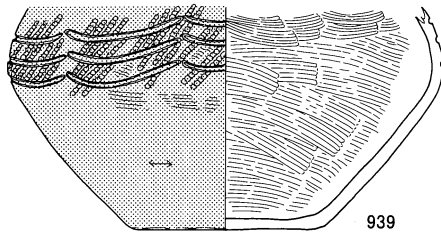
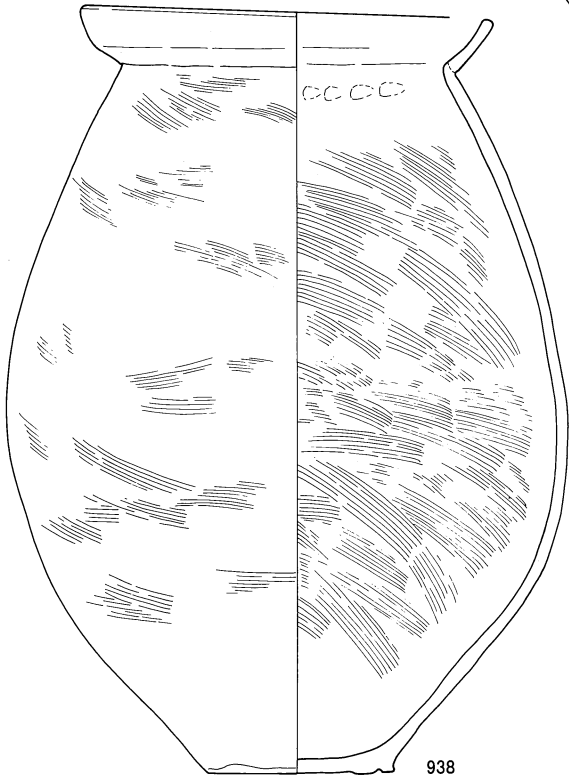

0 (1 : 4) 10 cm

S B 1123, 936~937

S B 1124, 938~943

S B1124

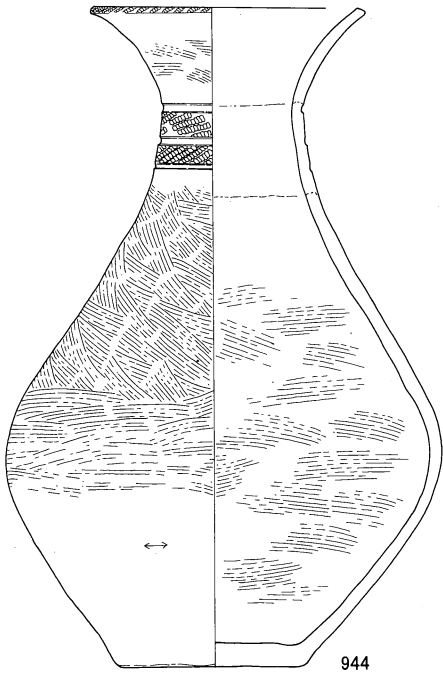

944

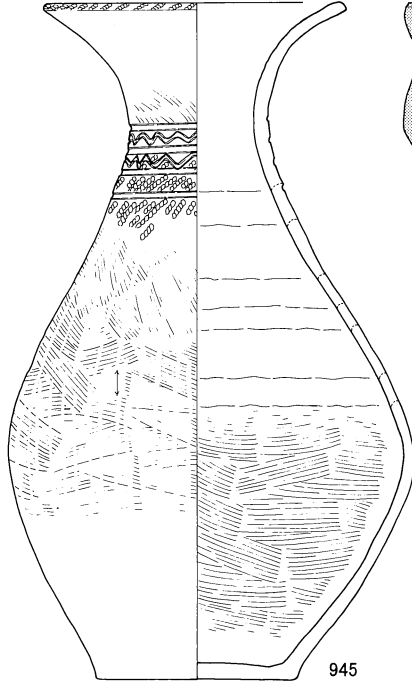

945

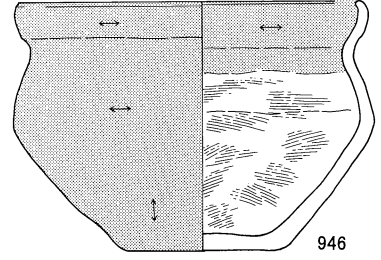

946

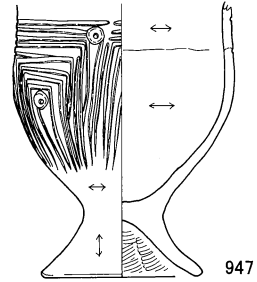

947

S B1125

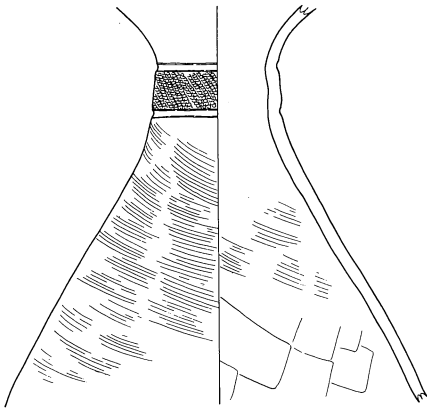

948

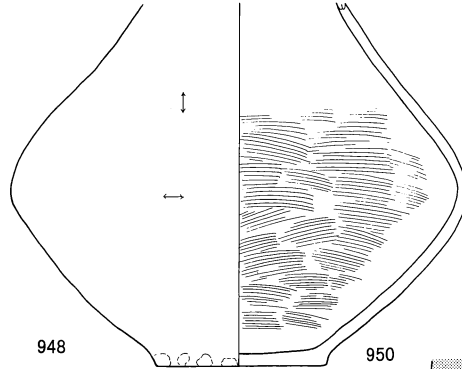

950

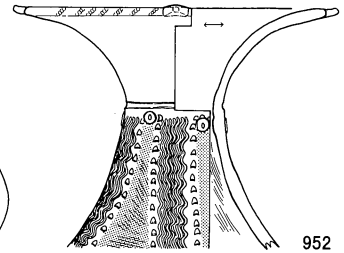

952

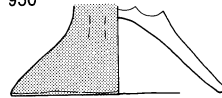

953

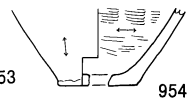

954

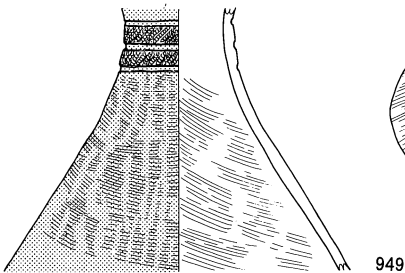

949

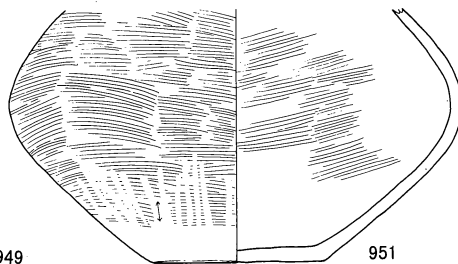

951

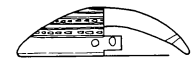

955

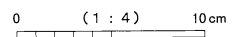

S B1124, 944~947 S B1125, 948~955

S B1125

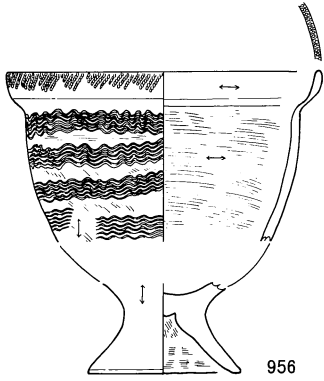

956

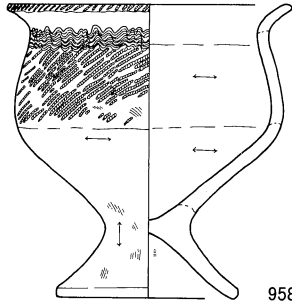

958

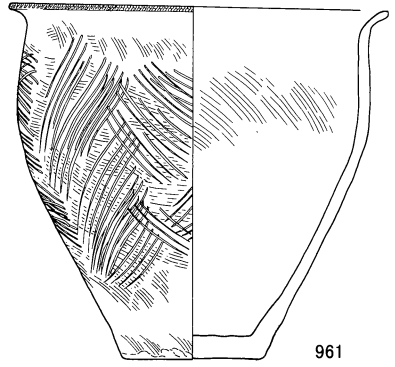

961

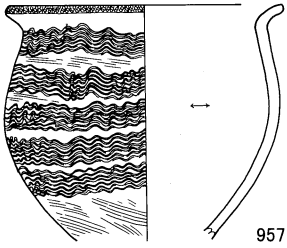

957

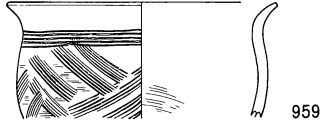

959

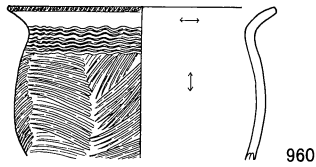

960

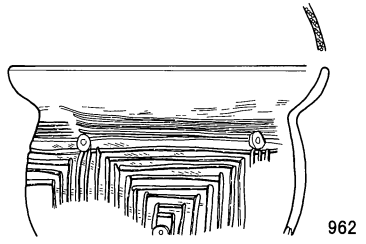

962

S B1126

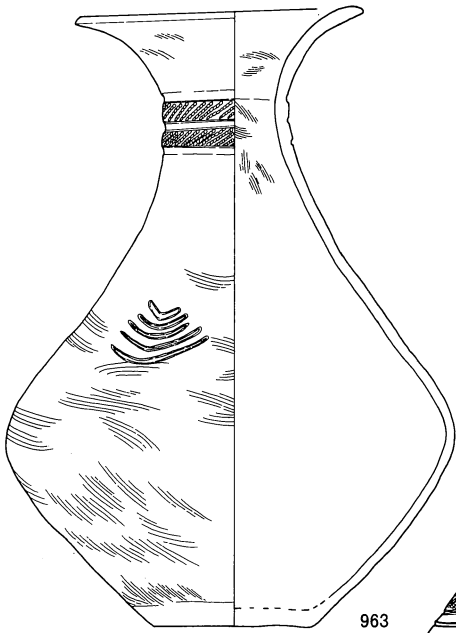

963

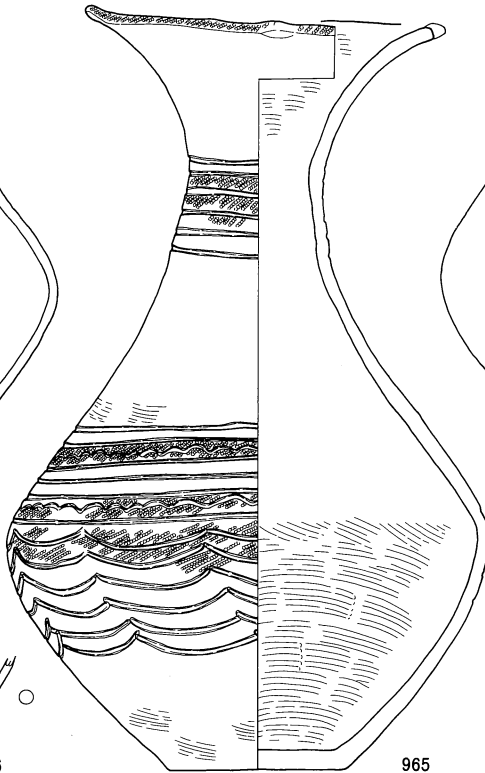

965

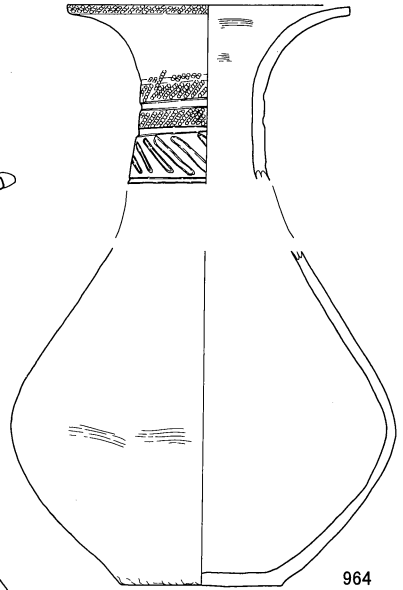

964

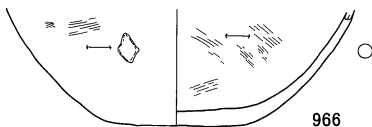

966

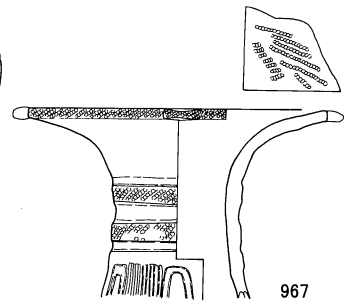

967

0 (1:4) 10cm

S B1125, 956~962, S B1126, 963~967

S B1126

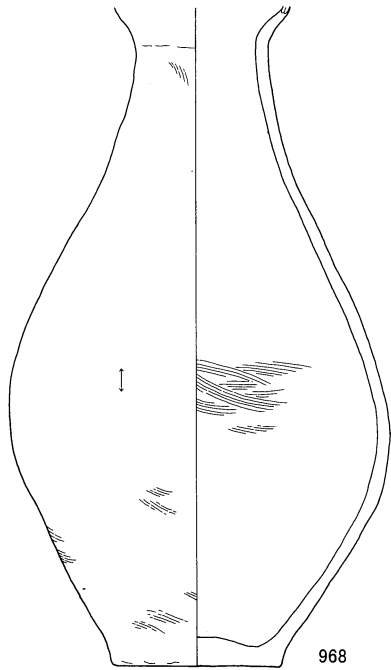

968

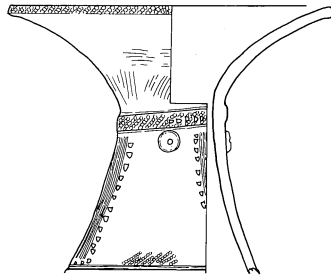

970

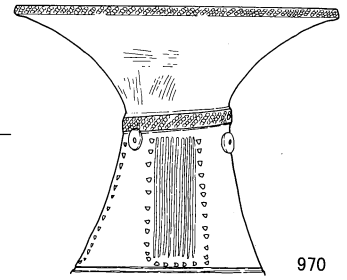

被熱ゆがみ土器

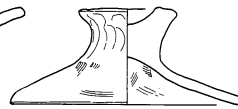
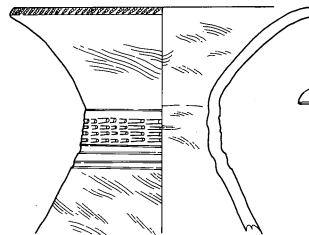

972

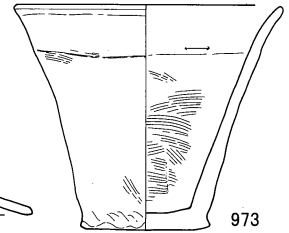

973

被熱ゆがみ土器

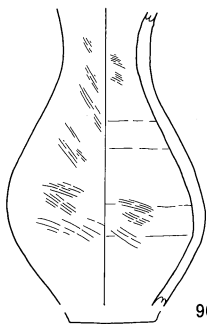

969

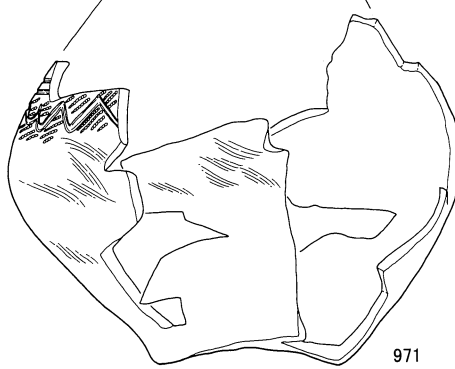

971

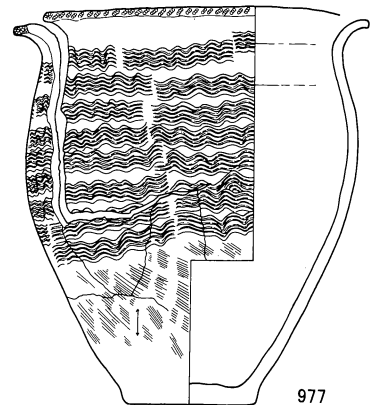

977

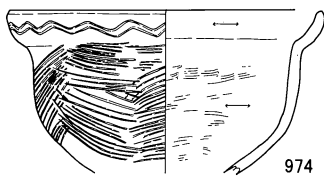

974

被熱ゆがみ土器

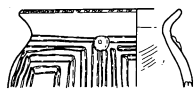

975

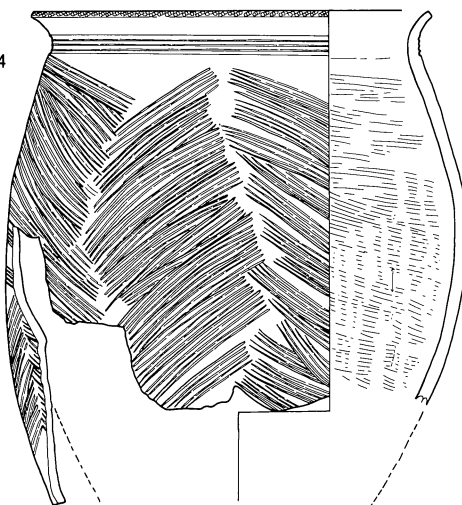

978

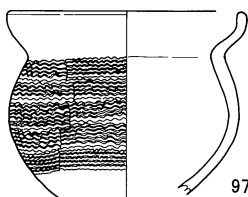

976

0 (1 : 4) 10 cm

S B1126, 968~978

S B1126

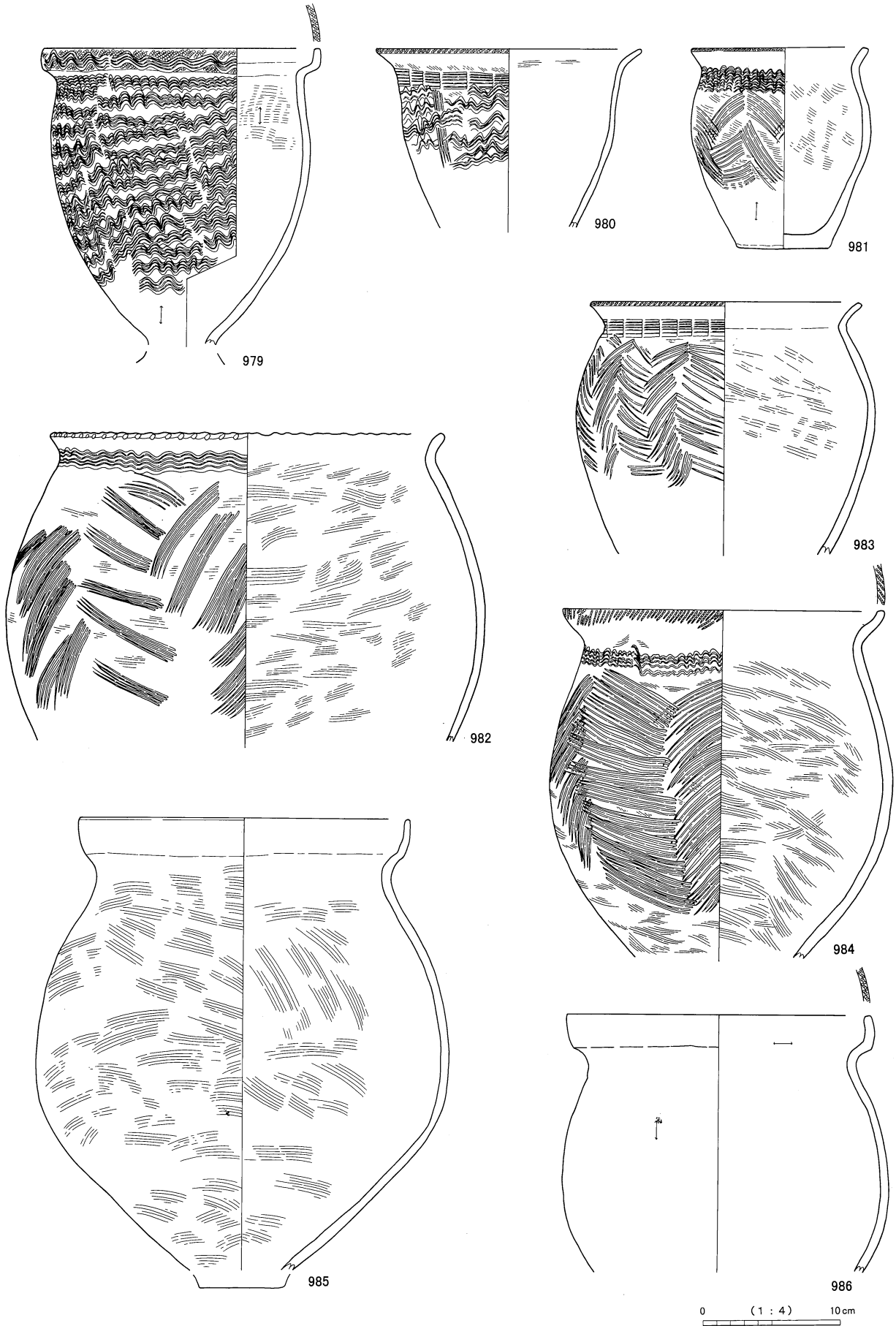

S B1126, 979~986

S B1126

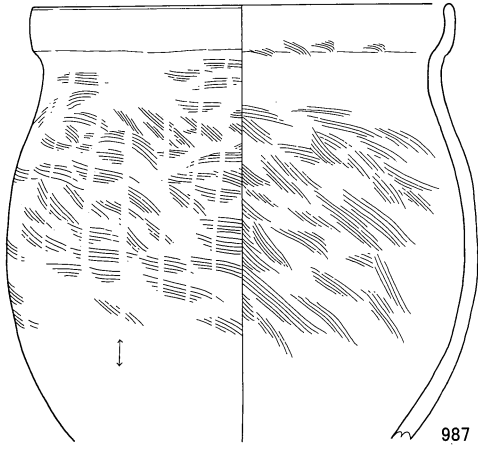

987

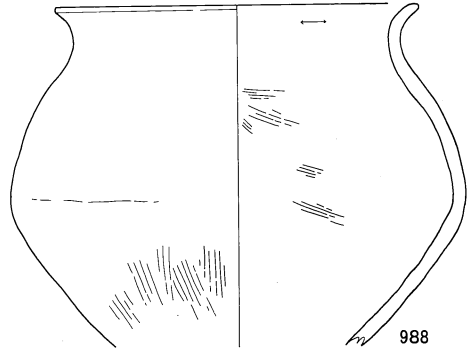

988

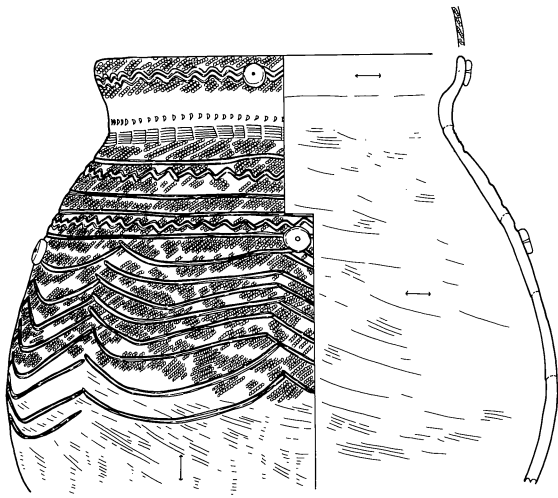

989

S B1132

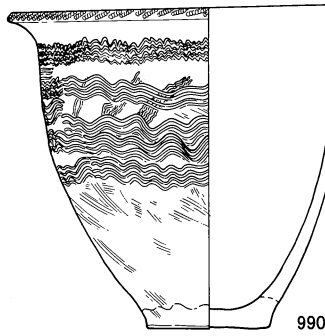

990

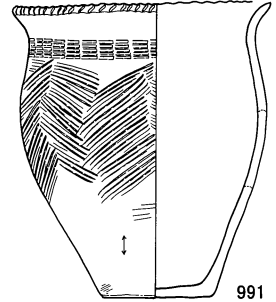

991

S B1131

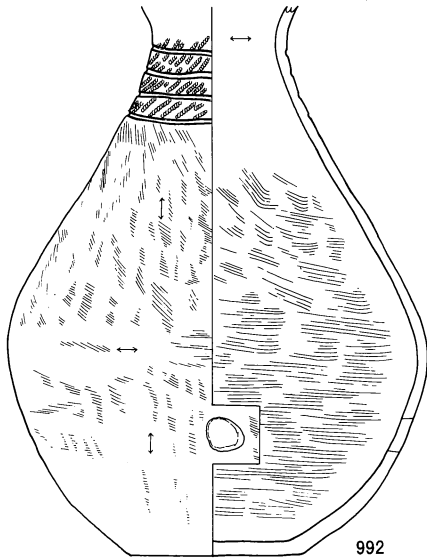

992

S B1134

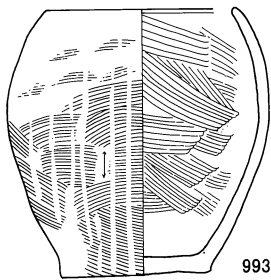

993

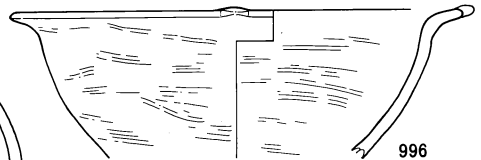

996

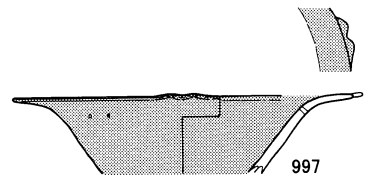

997

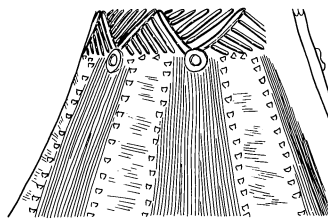

994

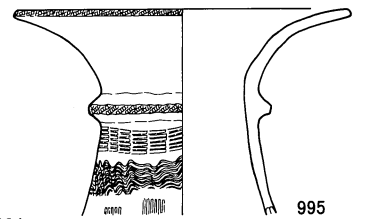

995

0 (1 : 4) 10 cm

S B1126, 987~989

S B1132, 990~991

S B1131, 992

S B1134, 993~997

S B1134

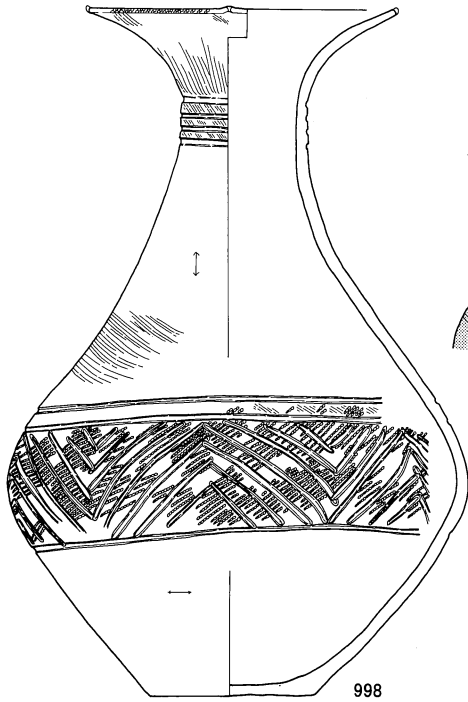

998

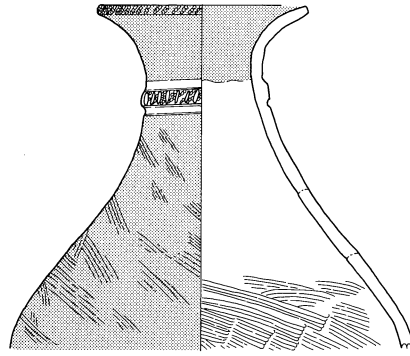

1001

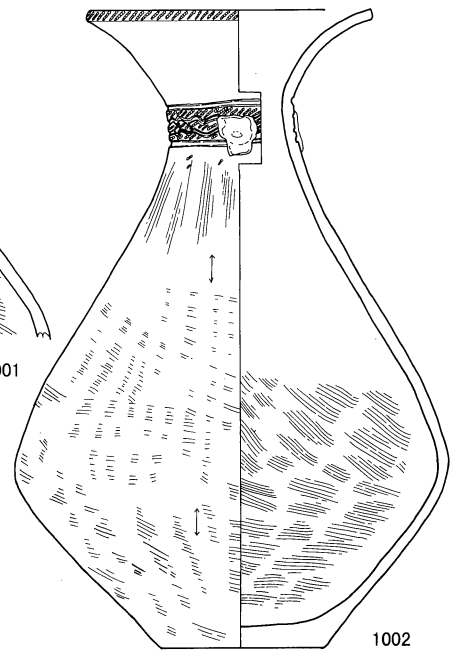

1002

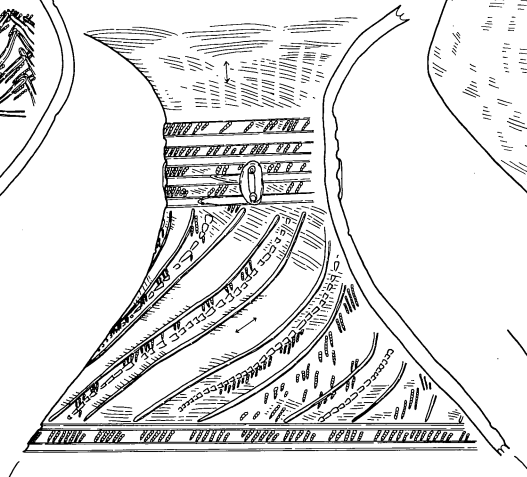

1000

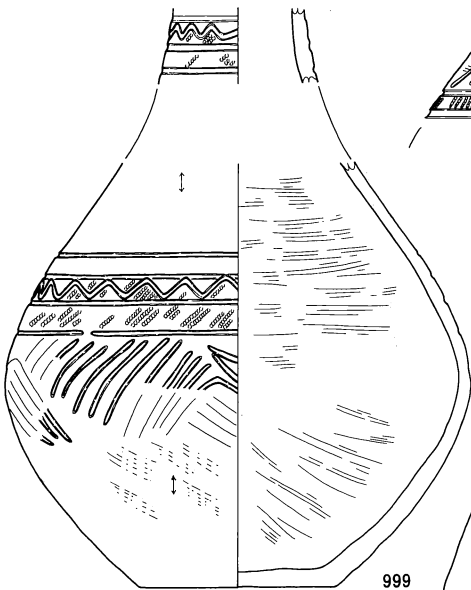

999

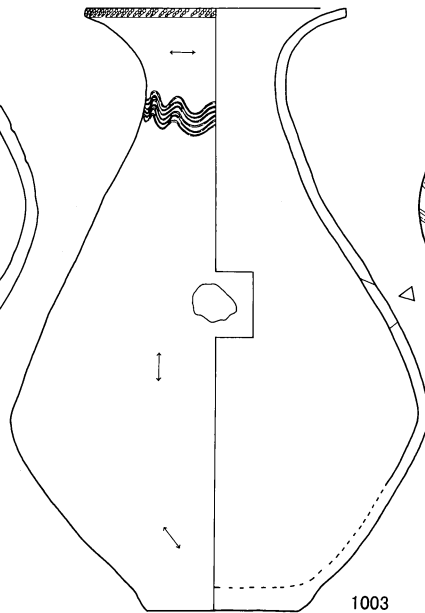

1003

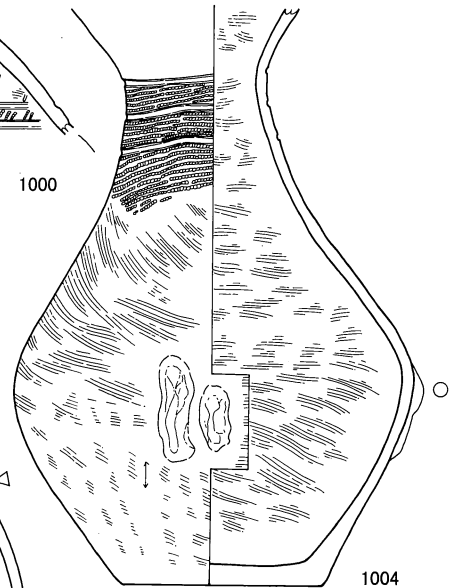

1004



1005

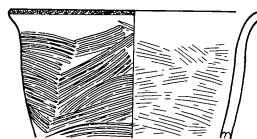

1006

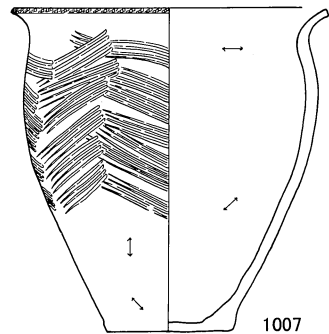

1007

0 (1 : 4) 10 cm

S B1134, 998~1007



SB1134

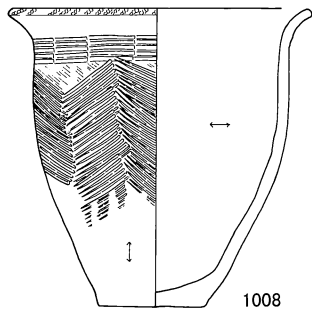

1008

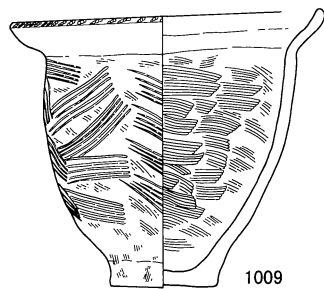

1009

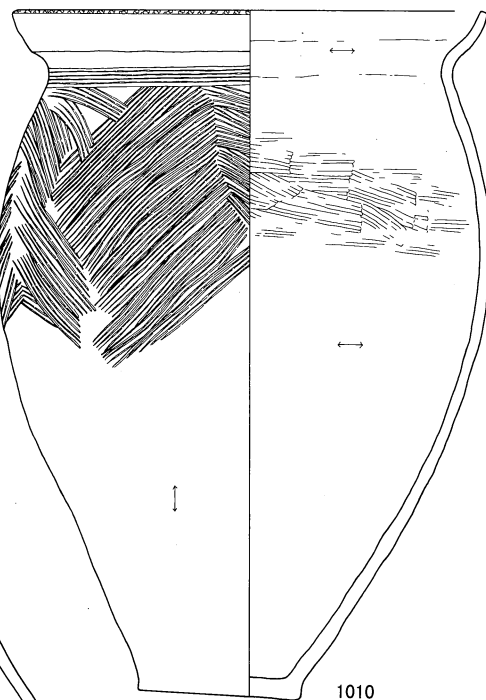

1010

SB1135

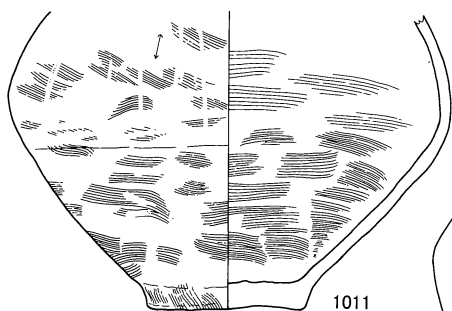

1011

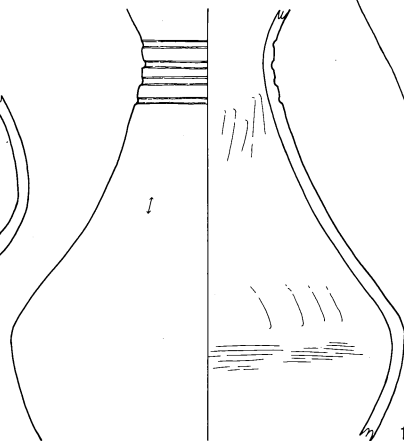

1014

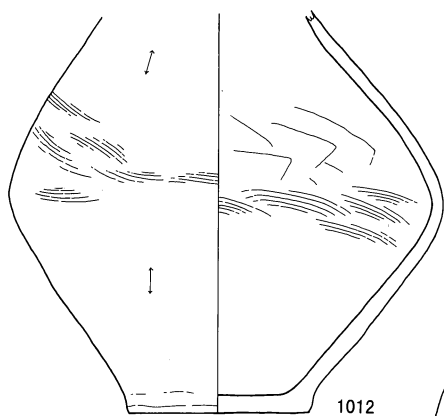

1012

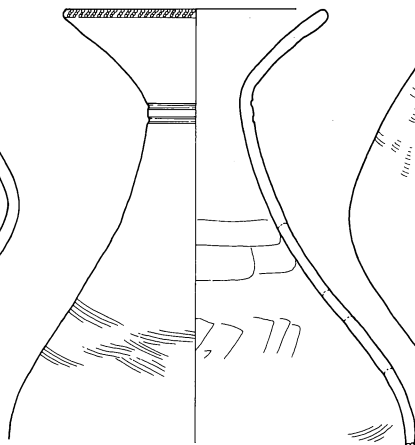

1015

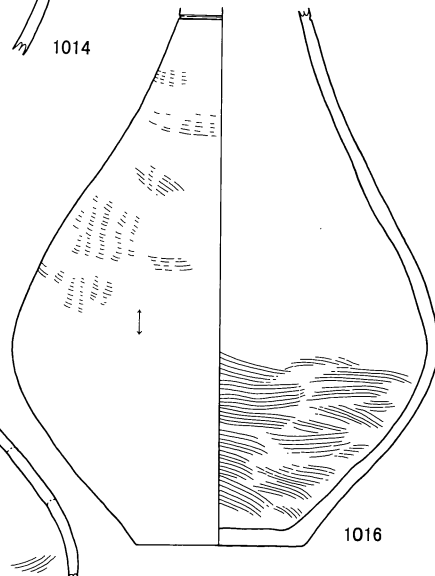

1016

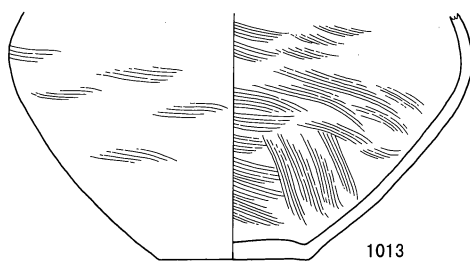

1013

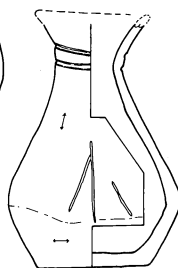

1017

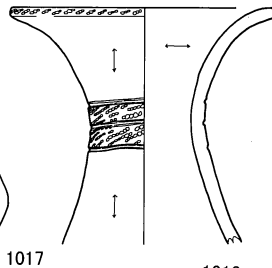

1018

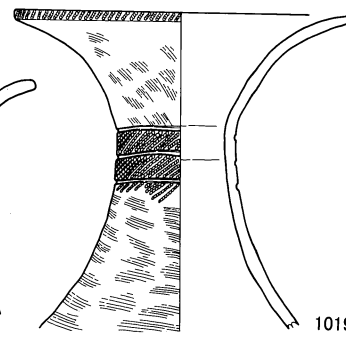

1019

0 (1 : 4) 10cm

S B1134, 1008~1010

S B1135, 1011~1019

S B 1135

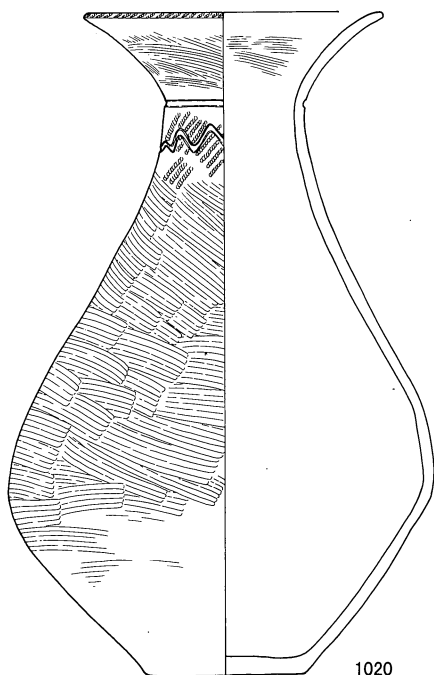

1020

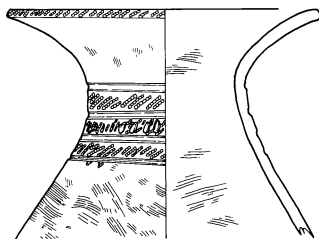

1021

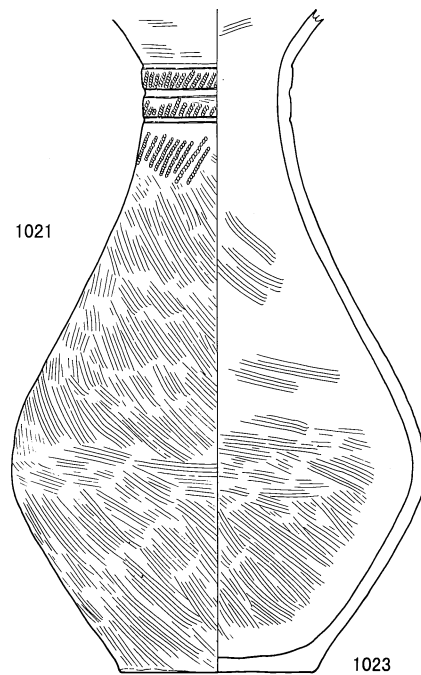

1023

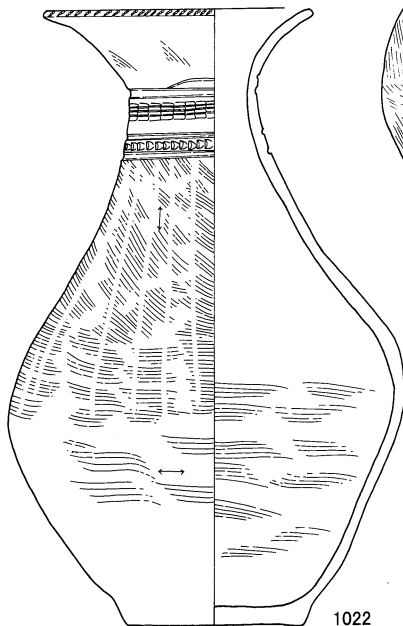

1022

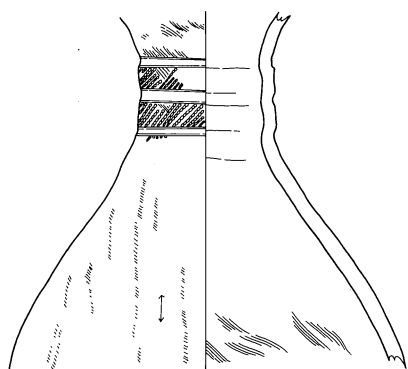

1024

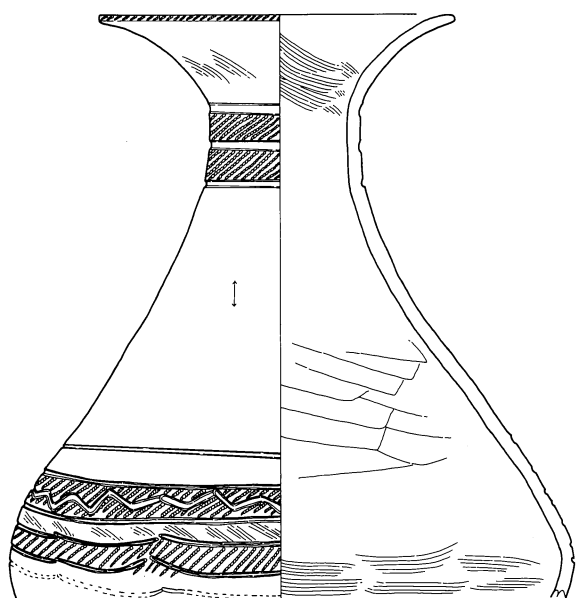

1025

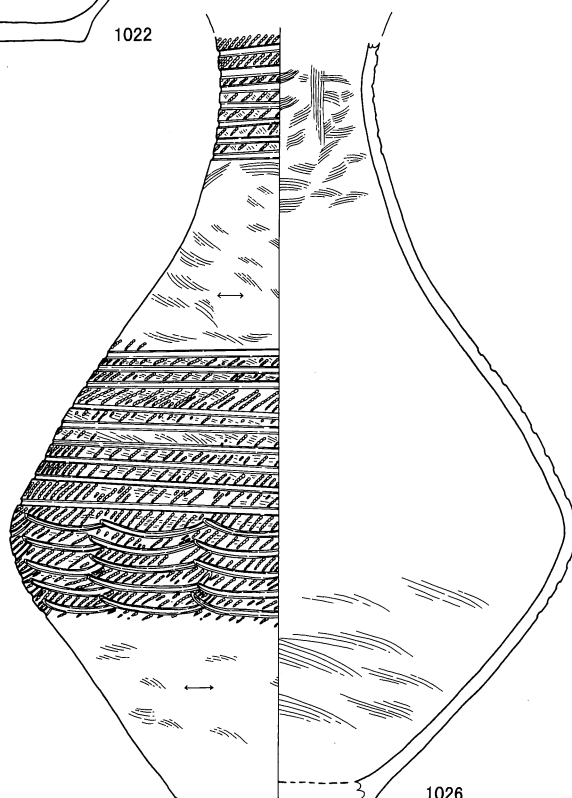

1026

0 (1:4) 10 cm

S B 1135

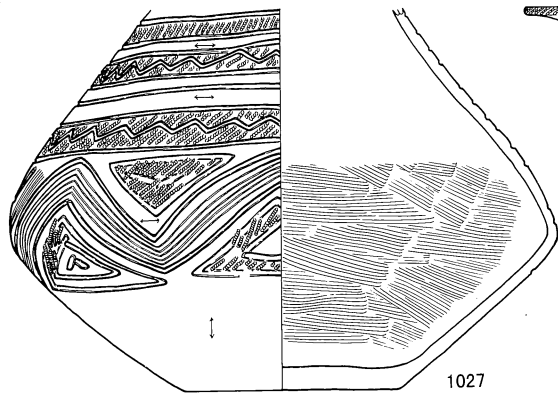

1027

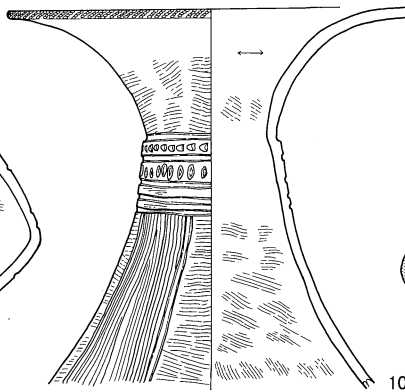

1028

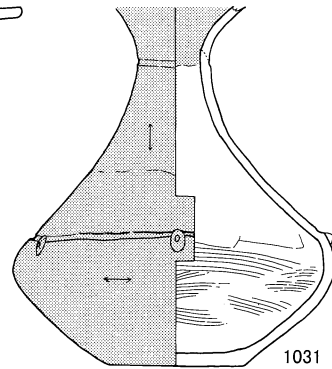

1031

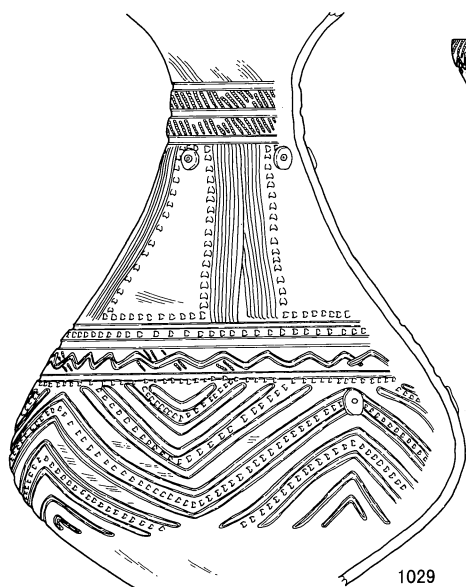

1029

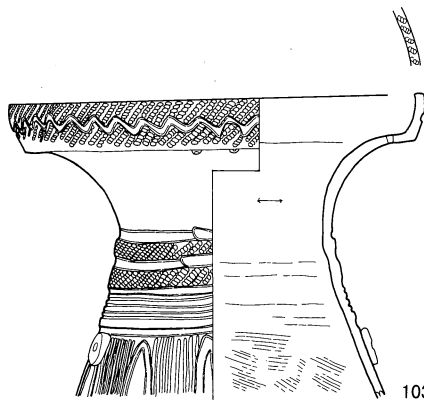

1030

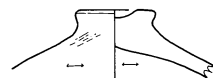

1032

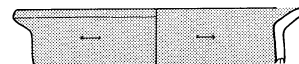

1033

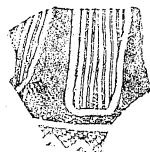

1034

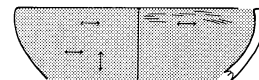

打ち欠き

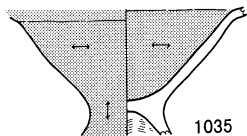

1035

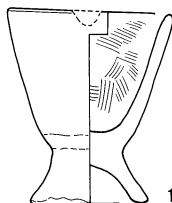

1036

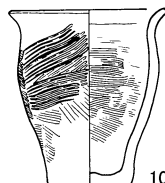

1037

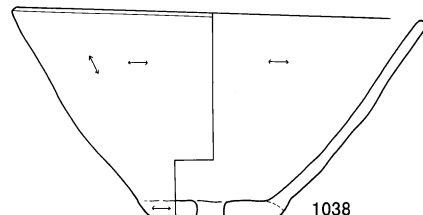

1038

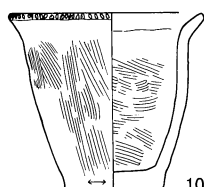

1039

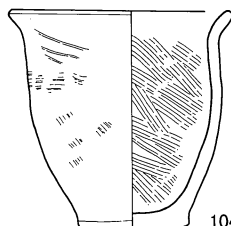

1040

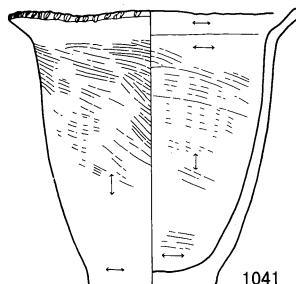

1041

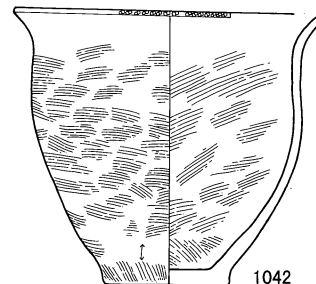

1042

0 (1 : 4) 10 cm

S B 1135

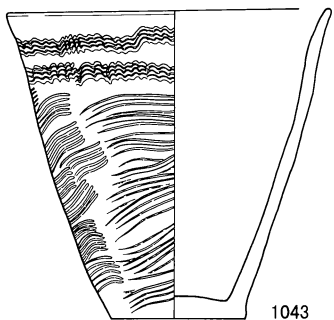

1043

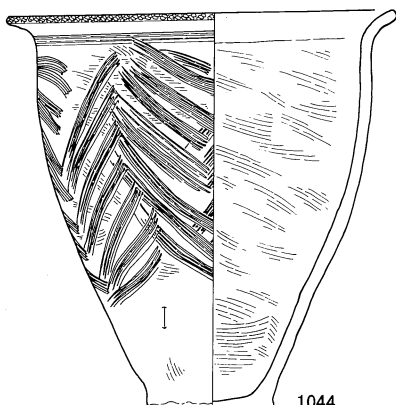

1044

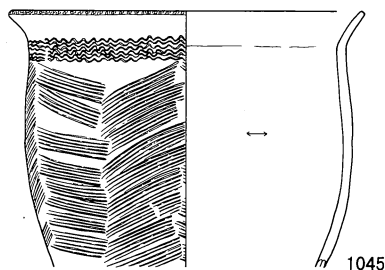

1045

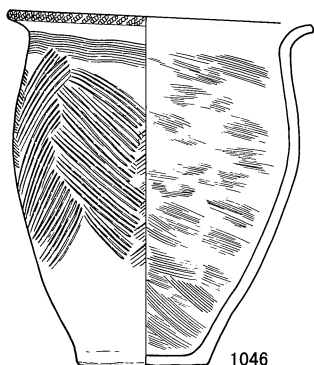

1046

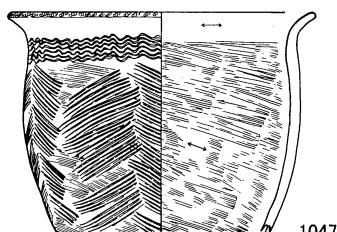

1047

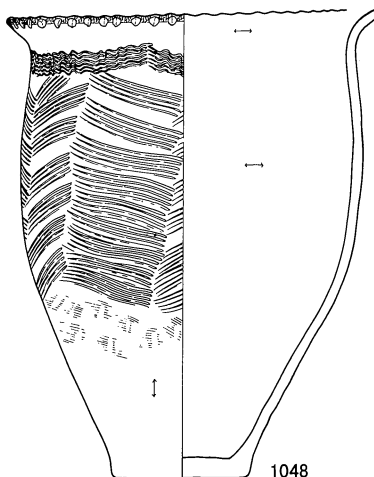

1048

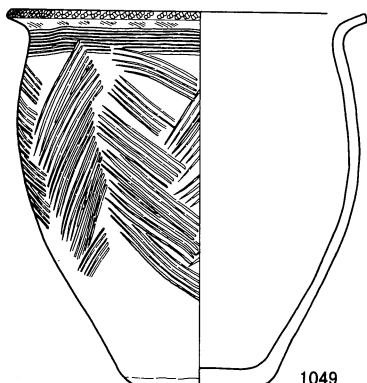

1049

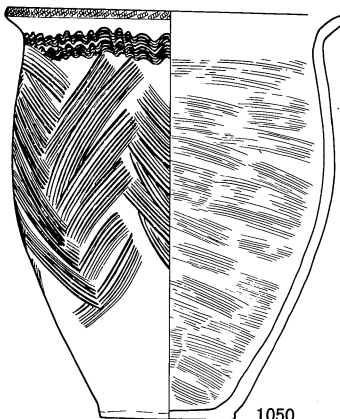

1050

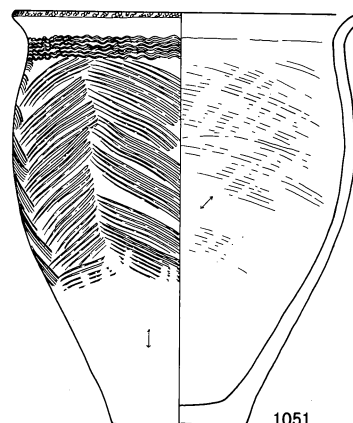

1051

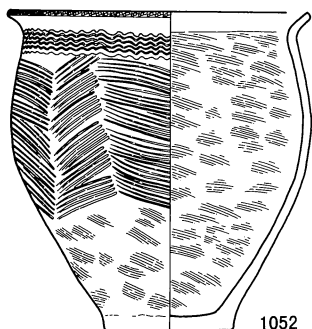

1052

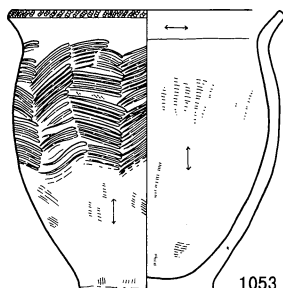

1053

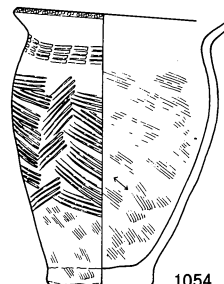

1054

0 (1 : 4) 10 cm

S B 1135, 1043~1054

S B 1135

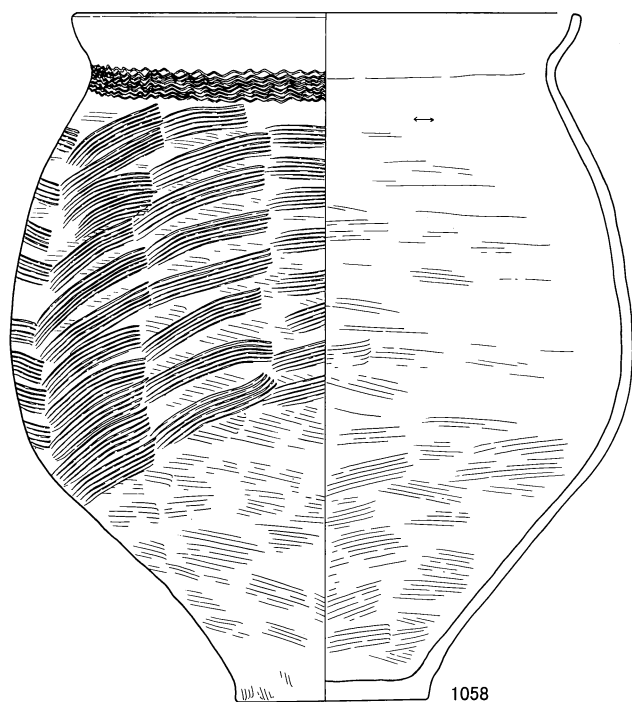
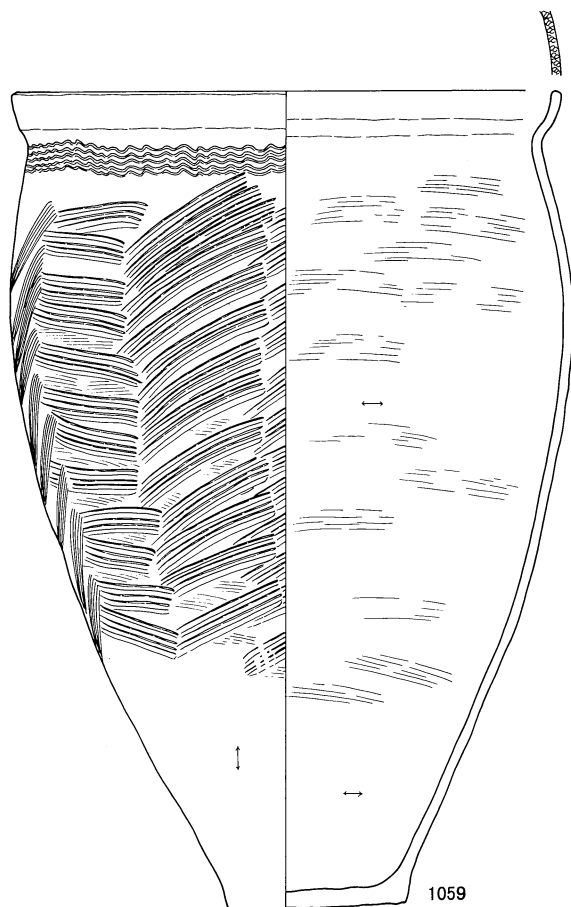
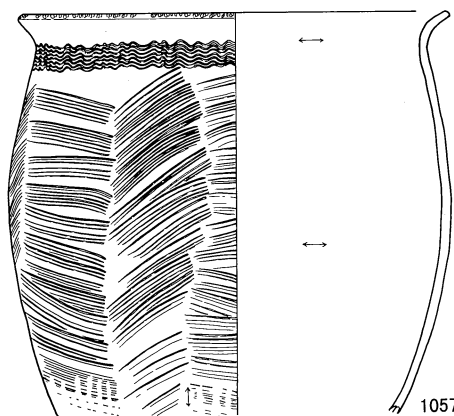
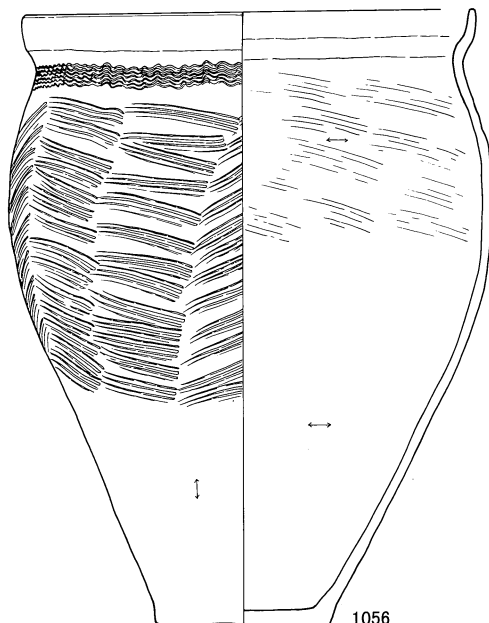
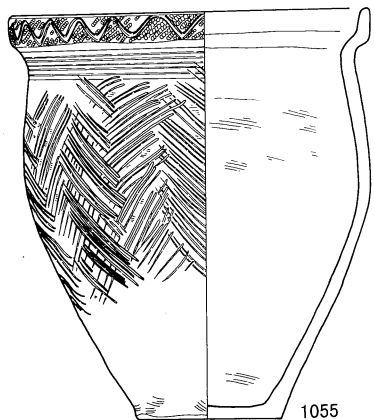

0 (1 : 4) 10 cm

S B 1135, 1055~1059

S B1135

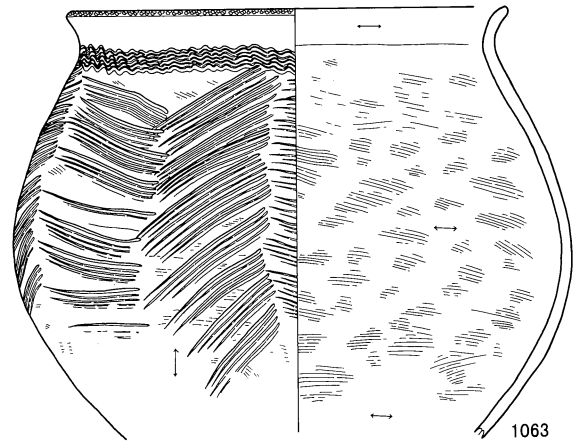
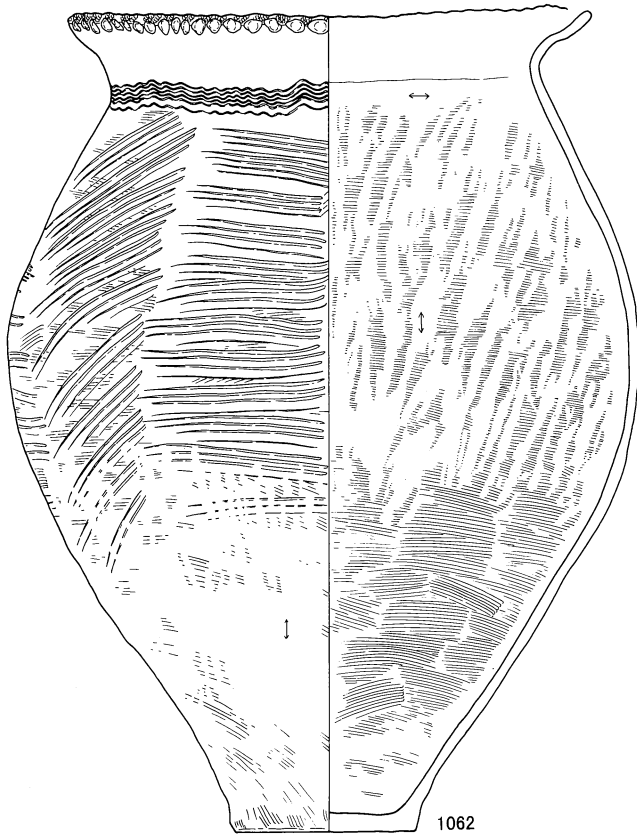
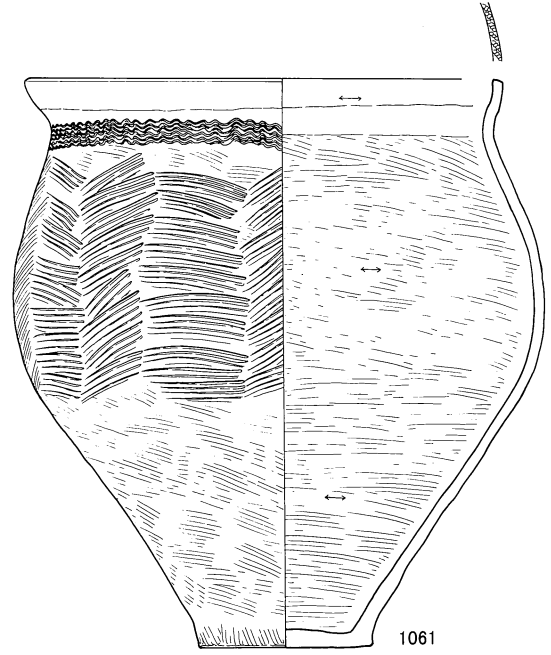
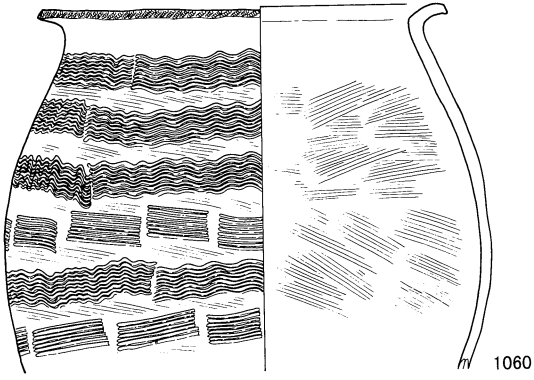

S B1136

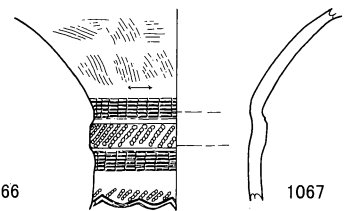
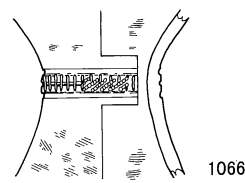
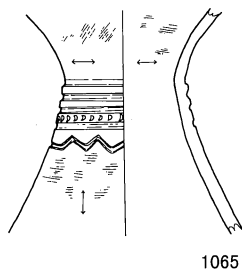
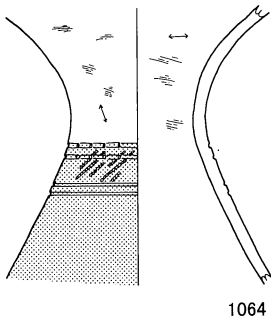

0 (1:4) 10 cm

S B1135, 1060~1063

S B1136, 1064~1067

S B 1136

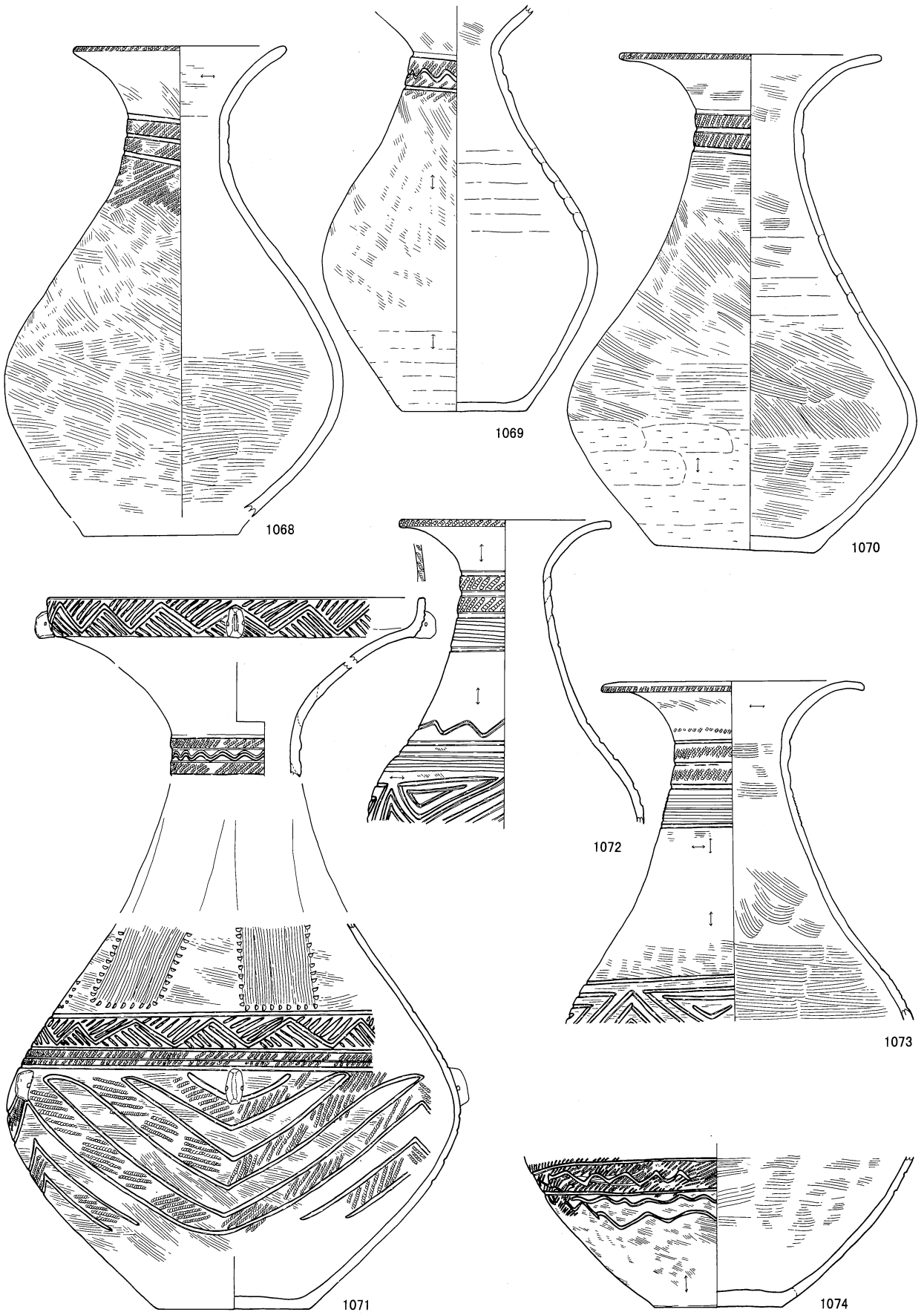

0 (1 : 4) 10 cm

S B 1136

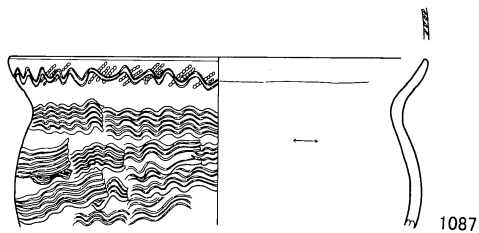
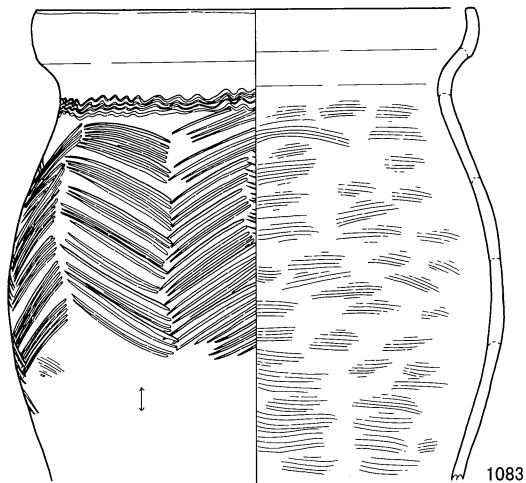
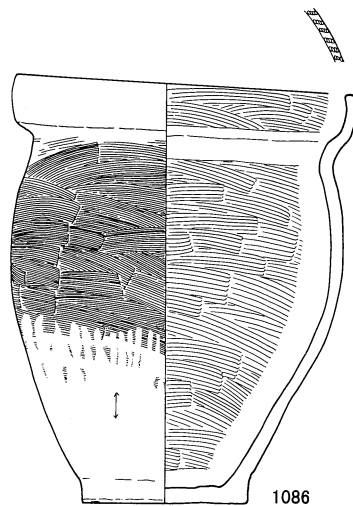
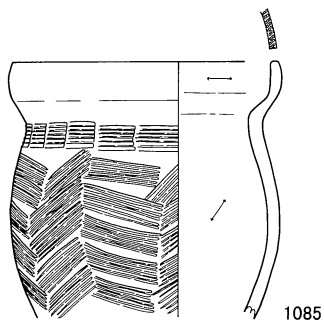
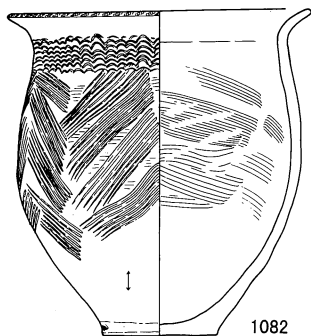
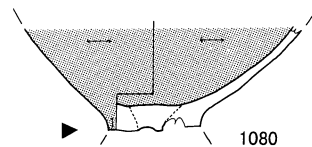
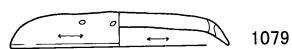
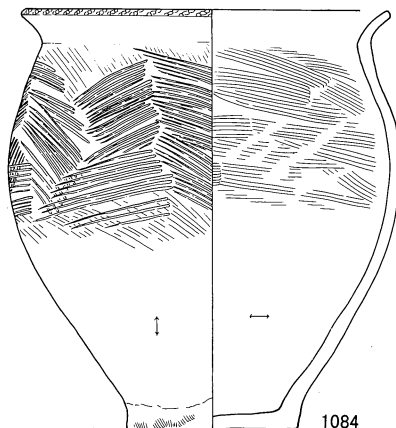
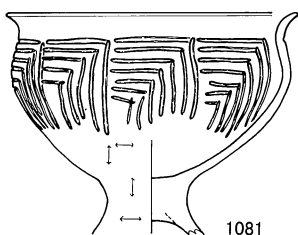
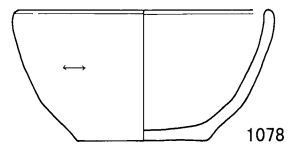
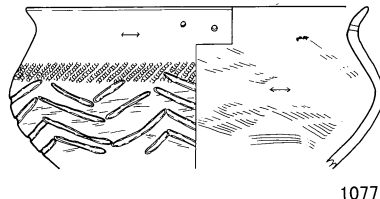
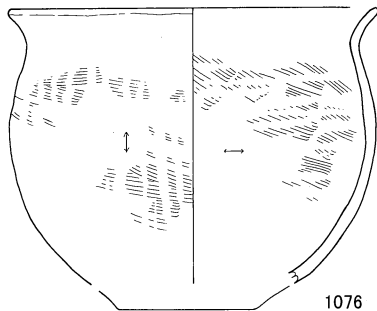
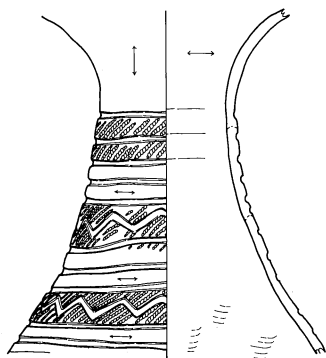

0 (1 : 4) 10cm

S B 1136, 1075~1087



S B1137

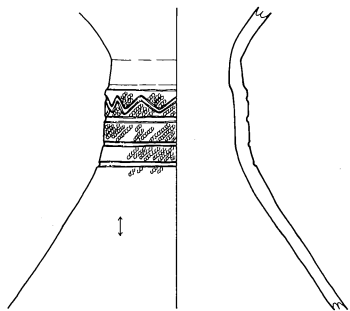

1088

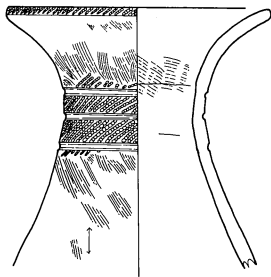

1089

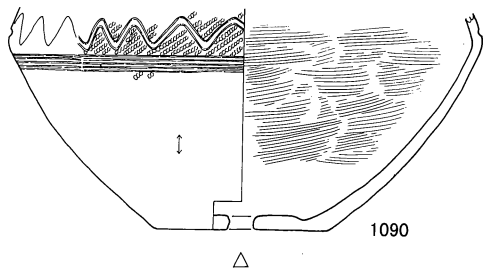

1090

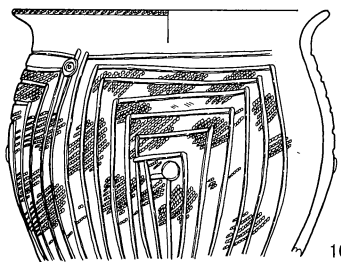

1091

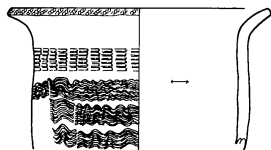

1092

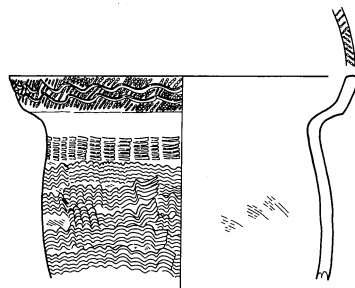

1093

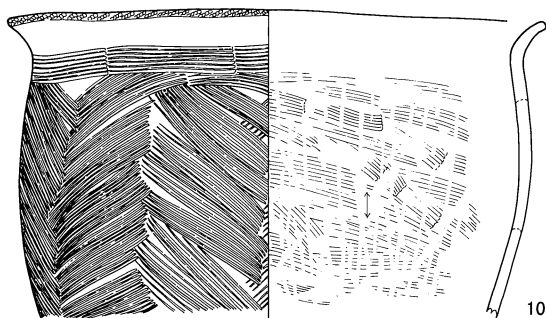

1094

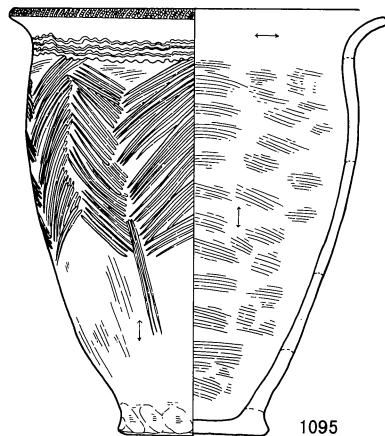

1095

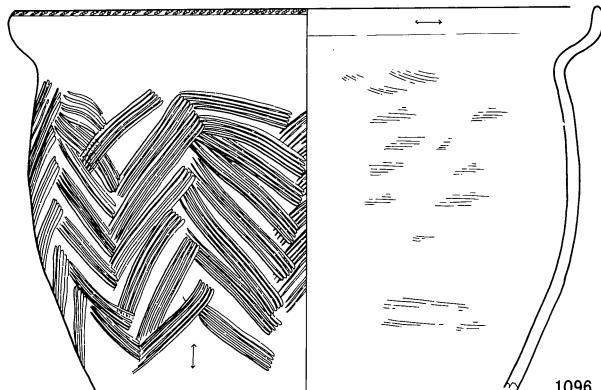

1096

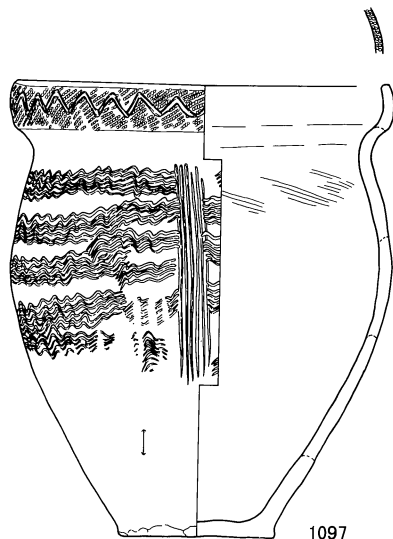

1097

0 (1 : 4) 10 cm

S B1142

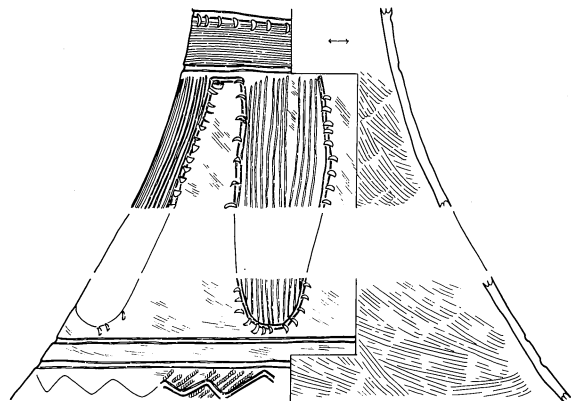
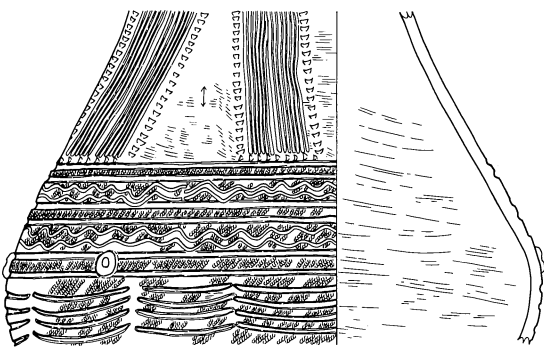
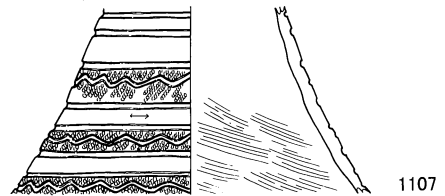
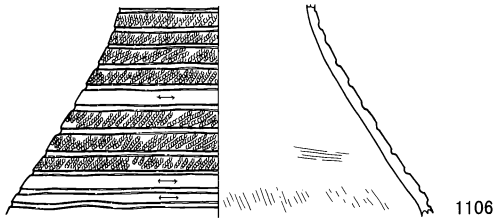
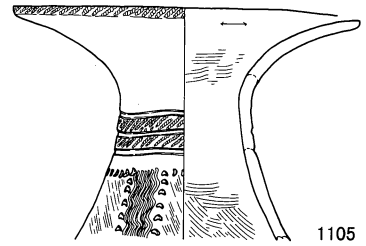
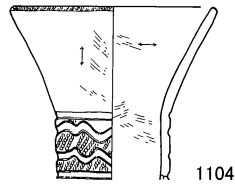
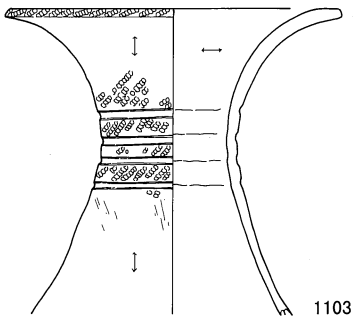
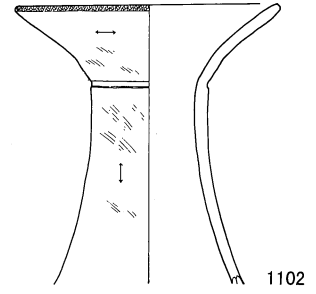
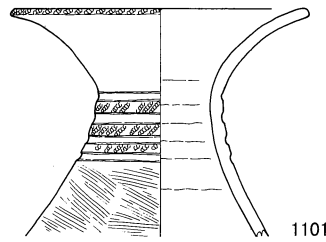
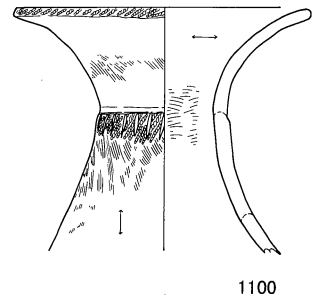
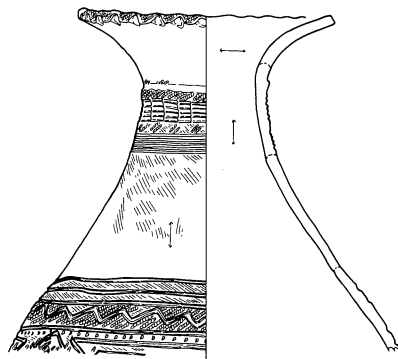
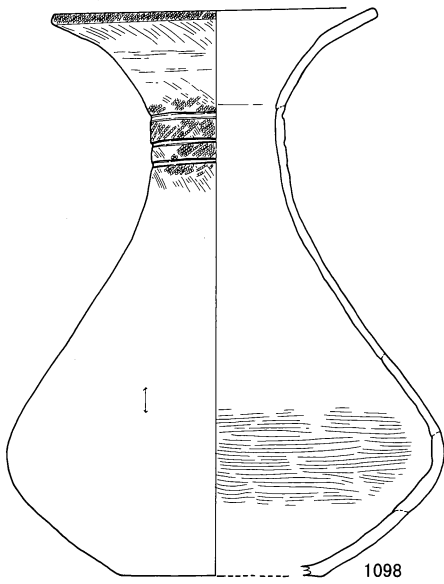

0 (1 : 4) 10 cm

S B1142, 1098~1109

SB1142

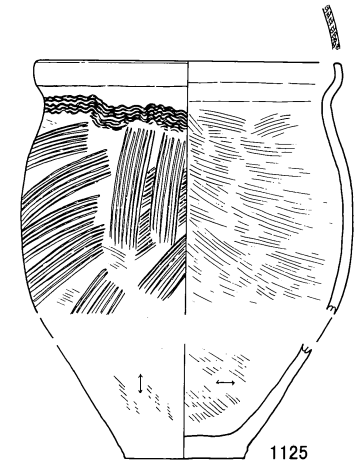
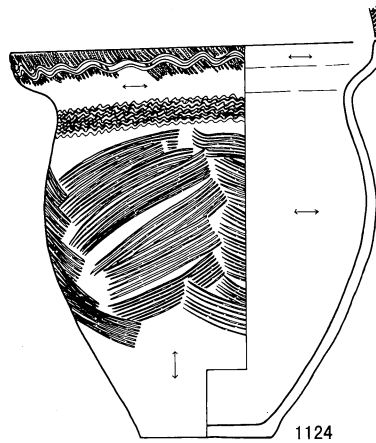
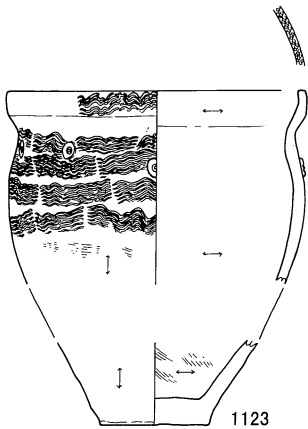
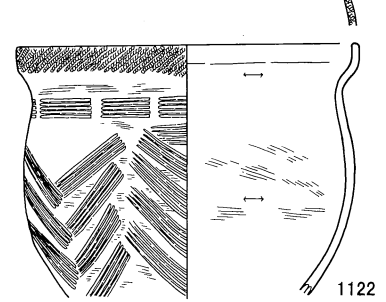
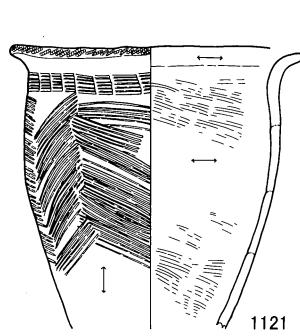
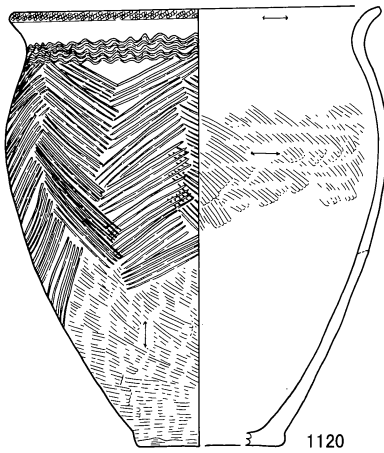
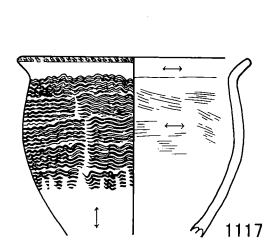
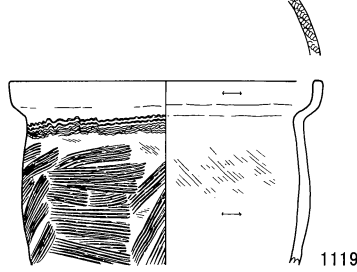
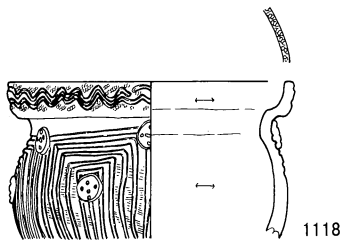
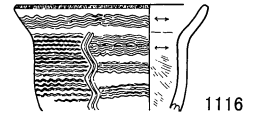
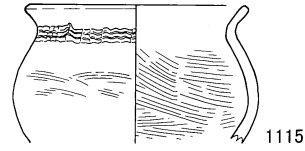
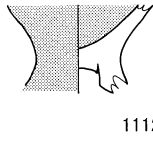
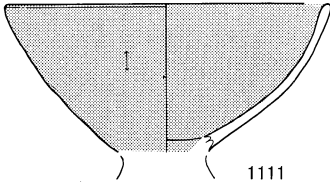
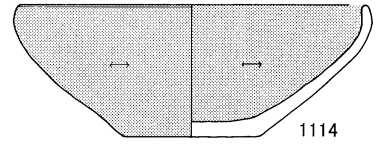
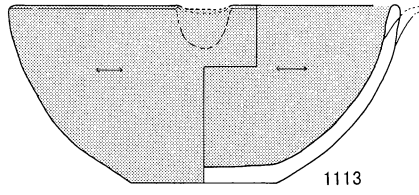
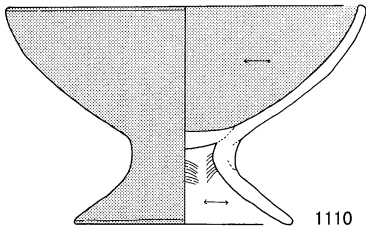

0 (1 : 4) 10cm

S B1142, 1110~1125

SB1142

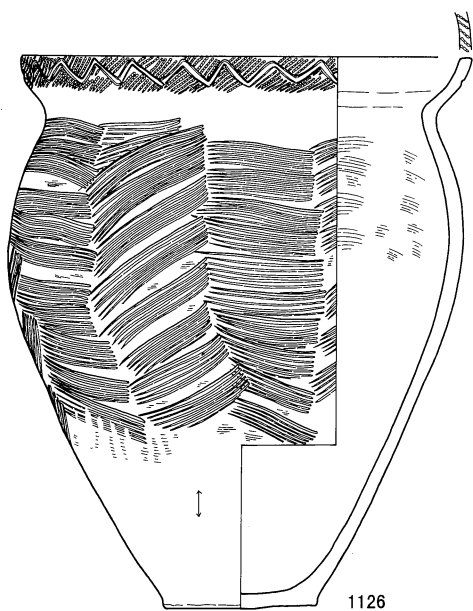

1126

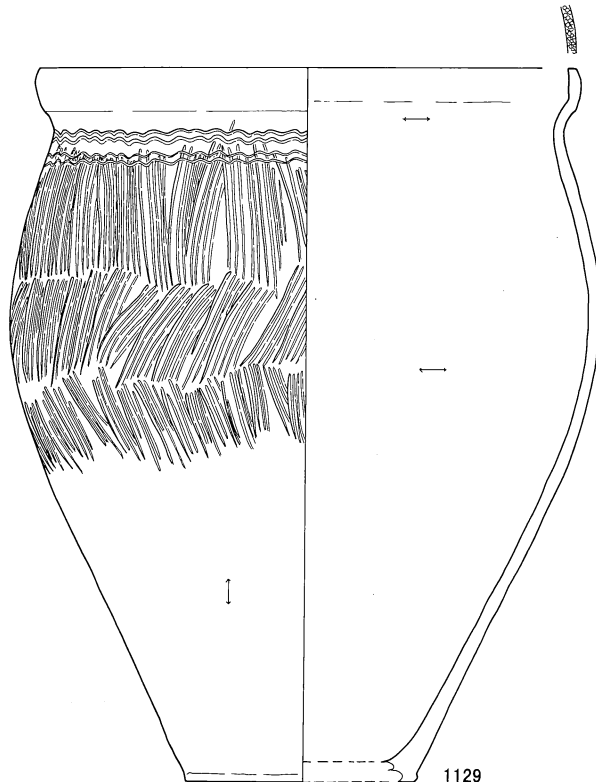

1129

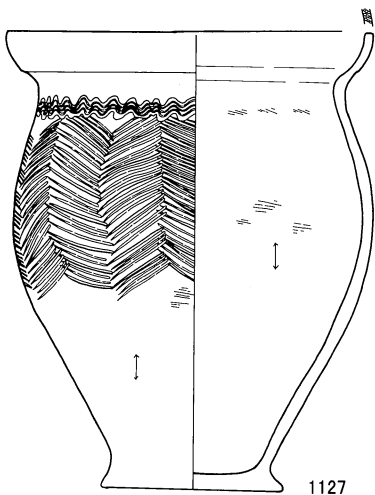

1127

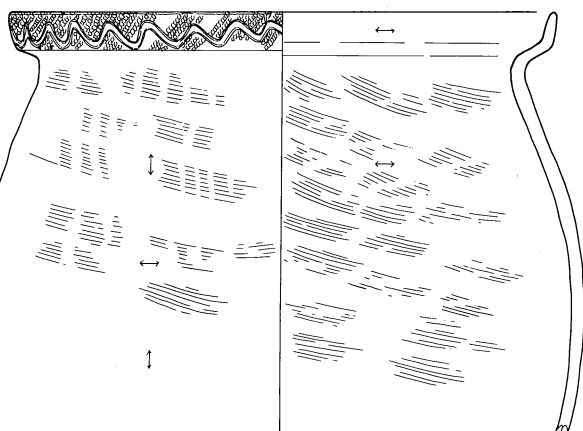

1130

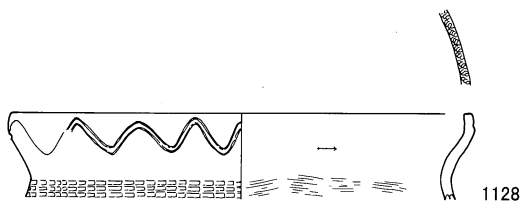

1128

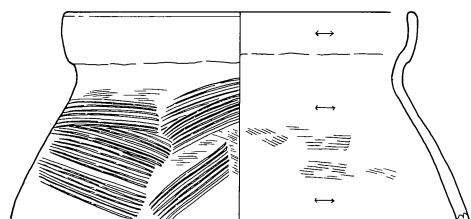

1131

SB1150

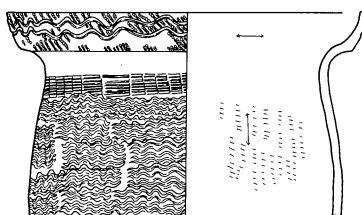

1132

SB1151

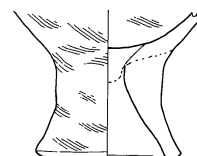

1133

0 (1 : 4) 10cm

S B1142, 1126~1131

S B1150, 1132

S B1151, 1133

SB1143

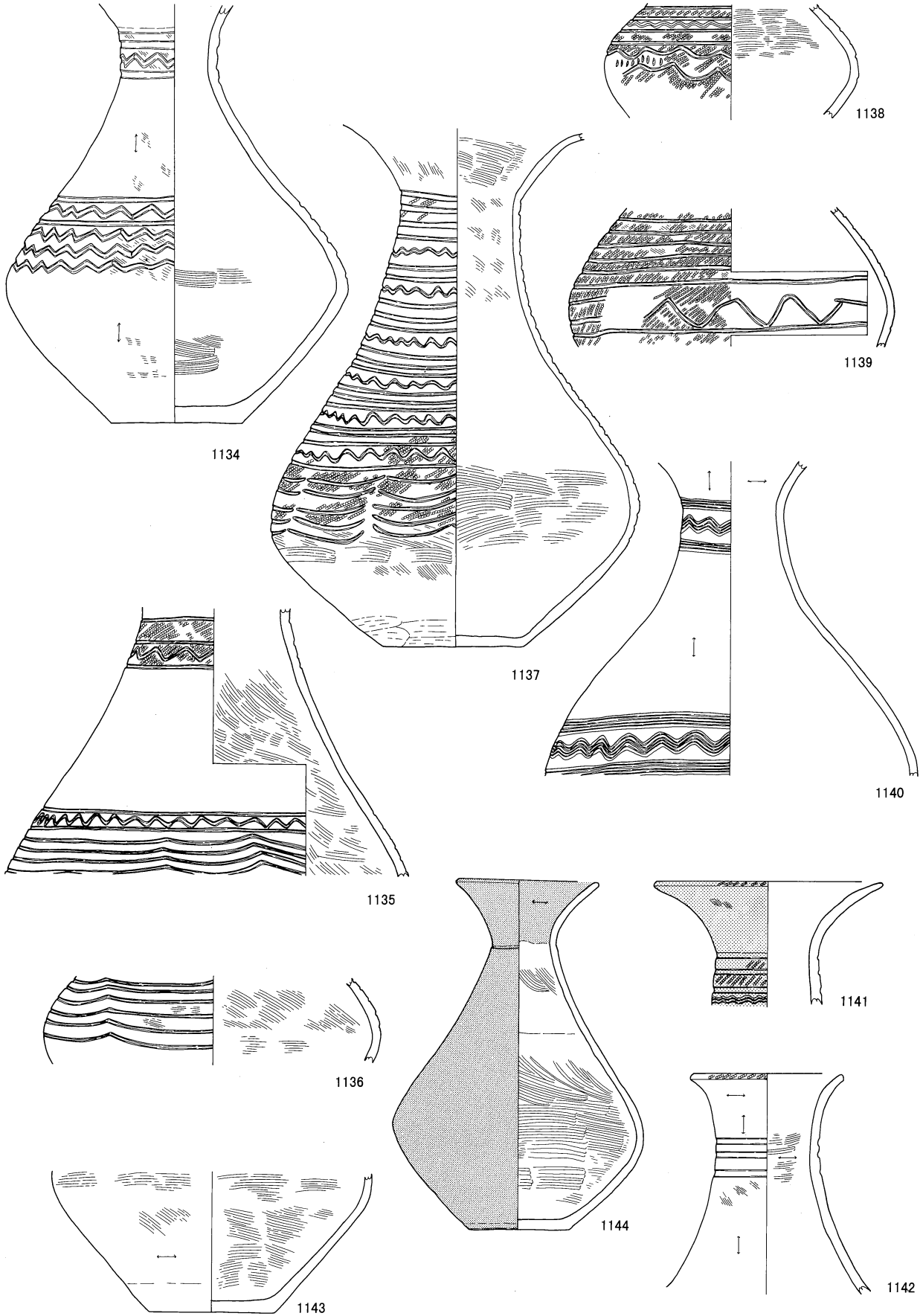

0 (1 : 4) 10cm

S B1143, 1134~1144

SB1143

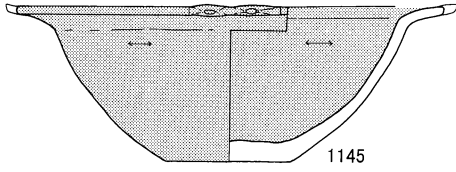

1145

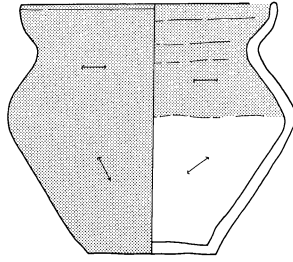

1146

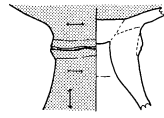

1147

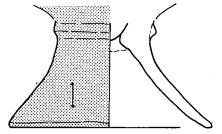

1148

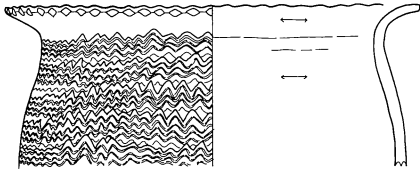

1153

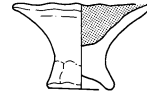

1149



1150

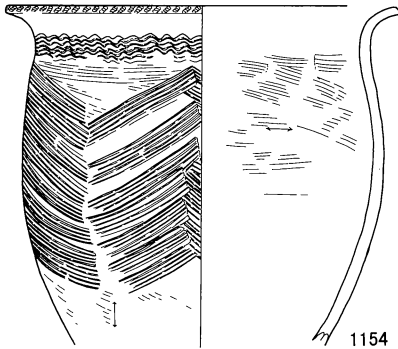

1154

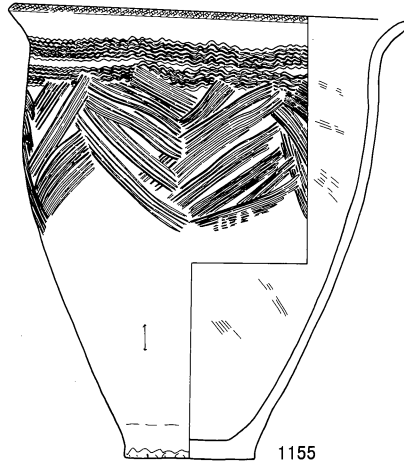

1155

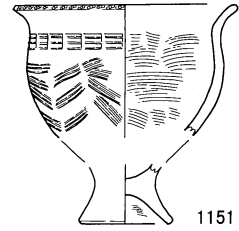

1151

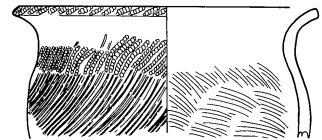

1152

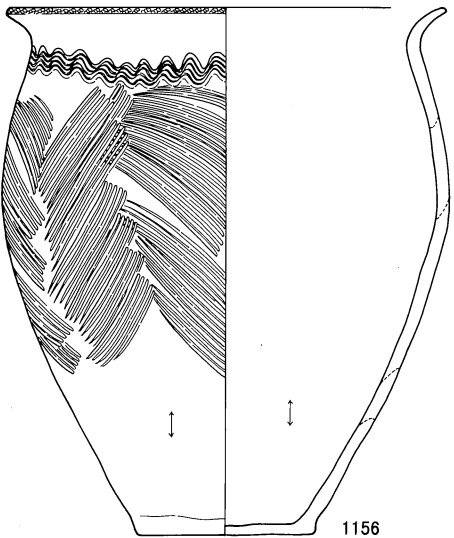

1156

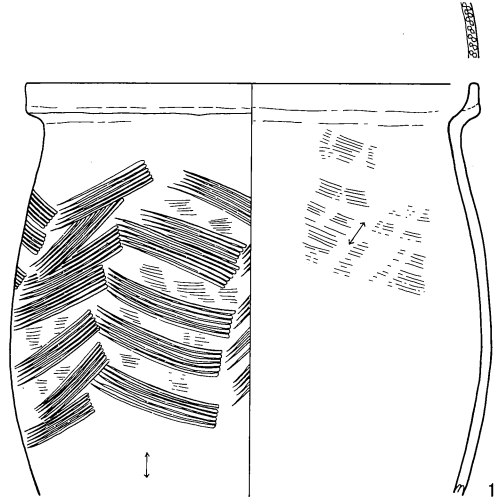

1157

SB1145

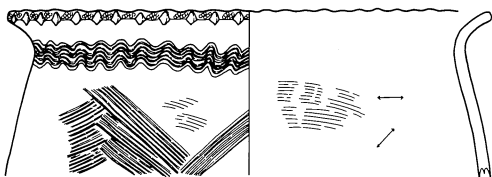

1158

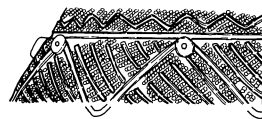

1159

0 (1 : 4) 10cm

SB1143, 1145~1157

SB1145, 1158~1159

S B1145

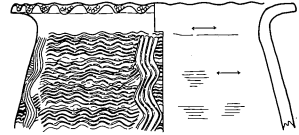
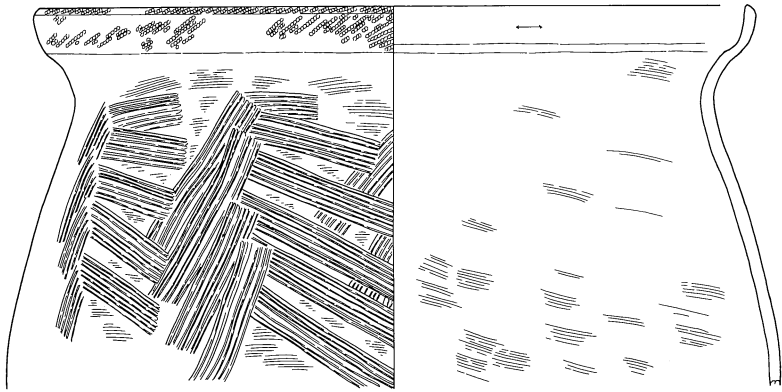

1161

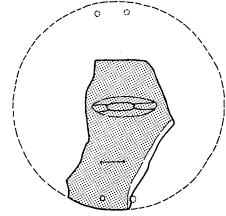

1160

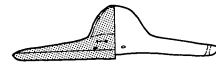

1162

S B1144

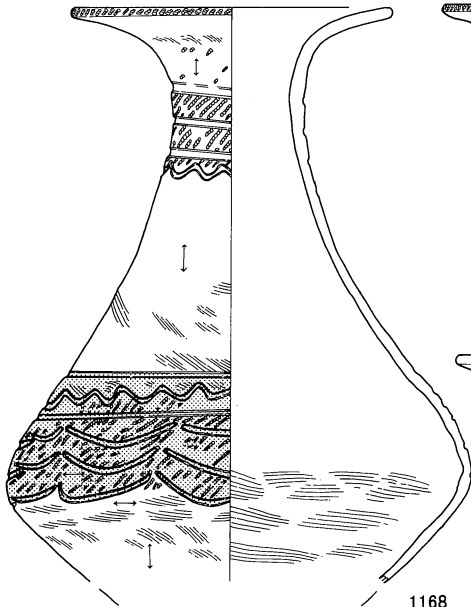

1168

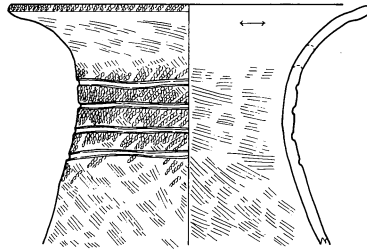

1164

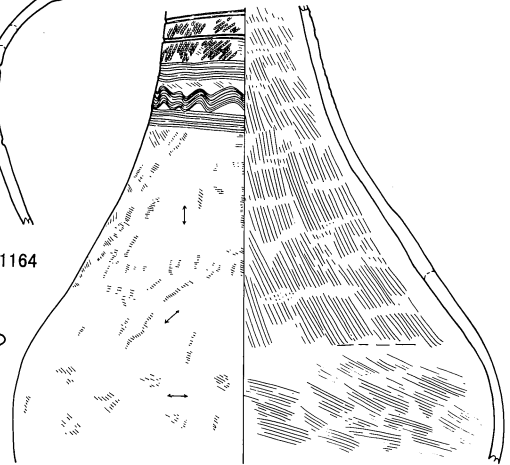

1165

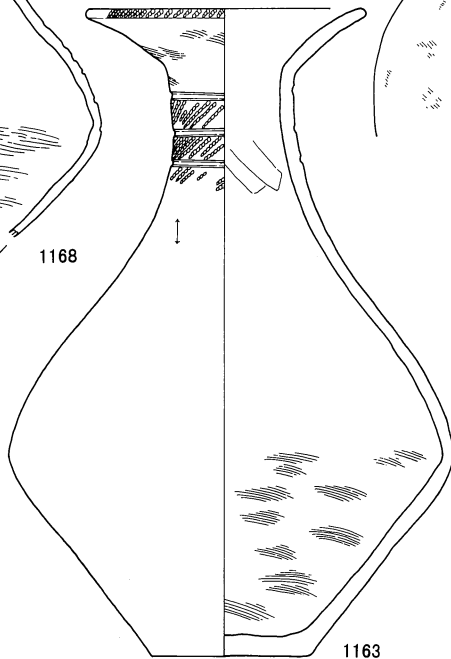

1163

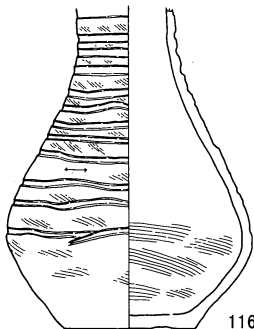

1167

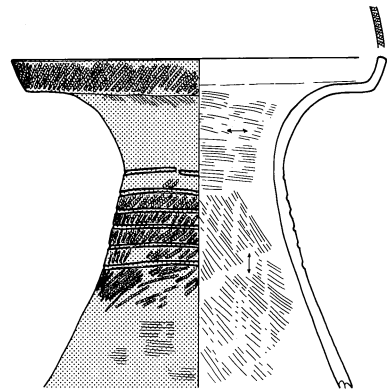

1166

0 (1 : 4) 10 cm

S B1145, 1160~1162 S B1144, 1163~1168

SB1144

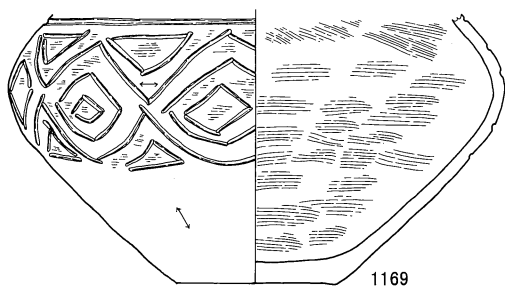

1169

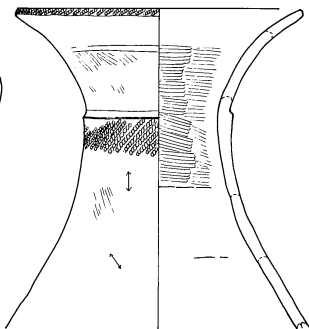

1170

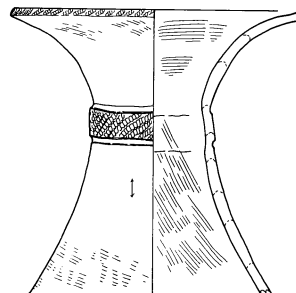

1171

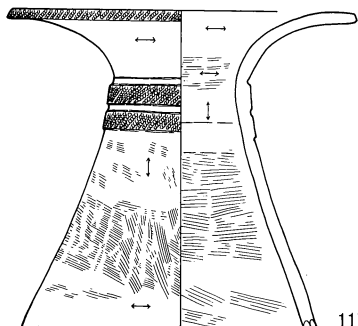

1172

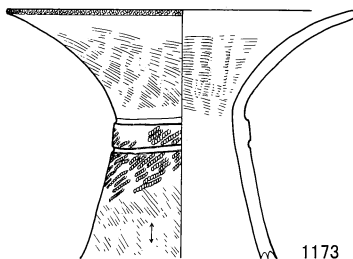

1173

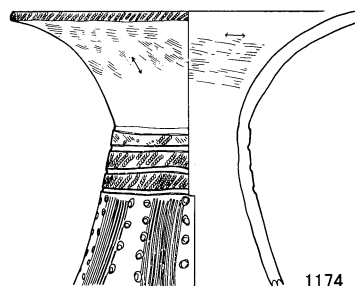

1174

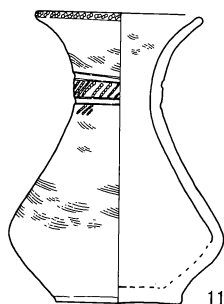

1175



1178

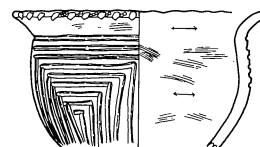

1179

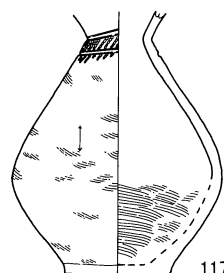

1176

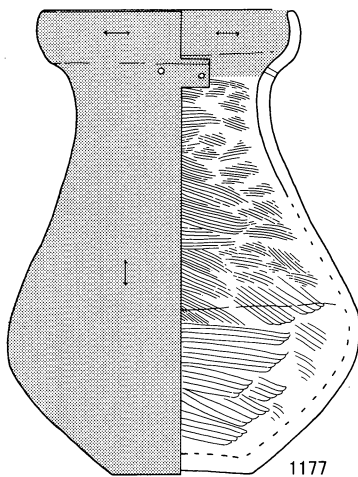

1177

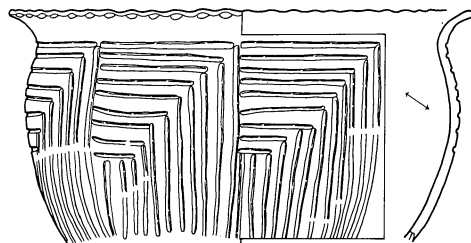

1180

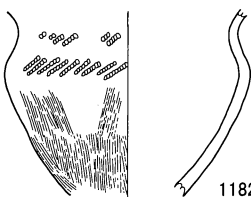

1182

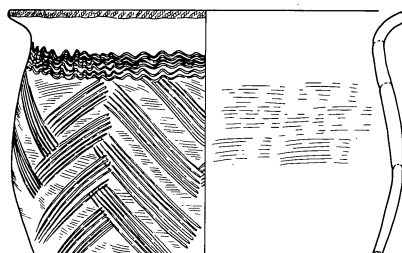

1183

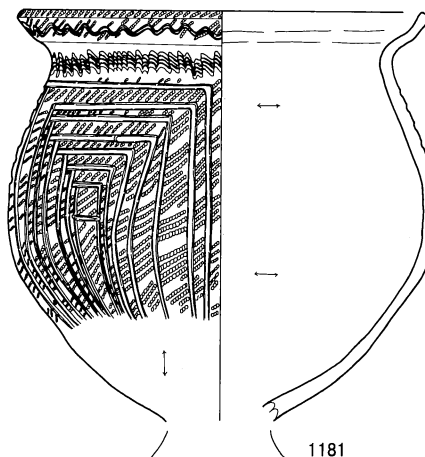

1181

0 (1 : 4) 10 cm

S B1144, 1169~1183



SB1144

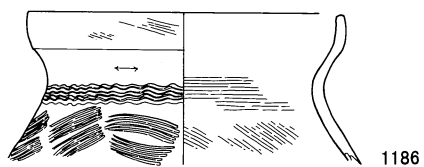
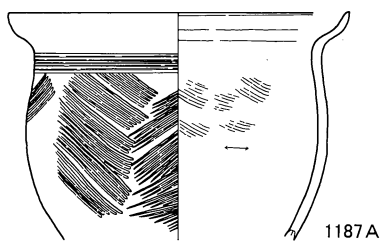
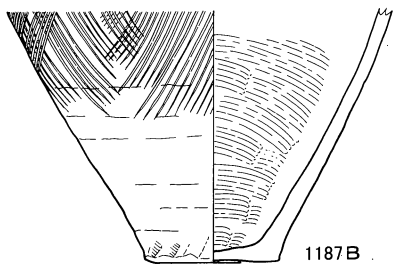
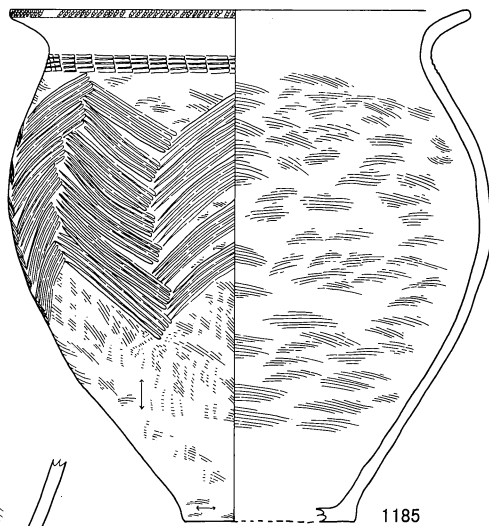
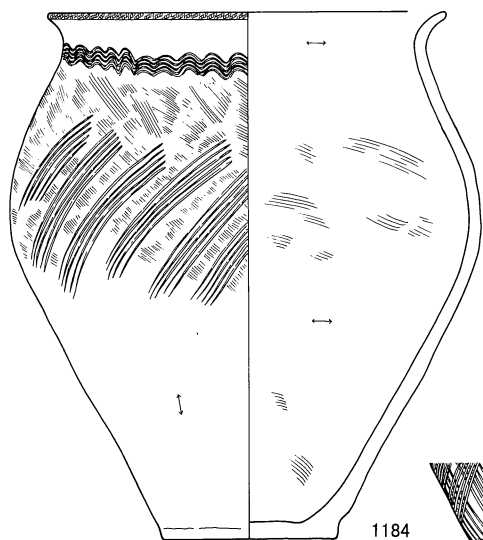

SB1146

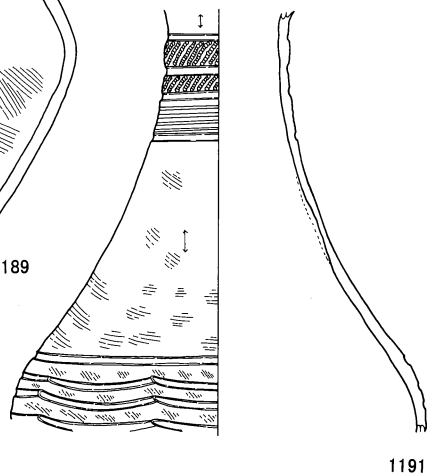
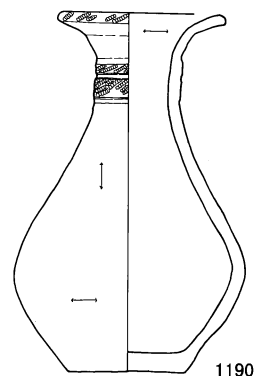
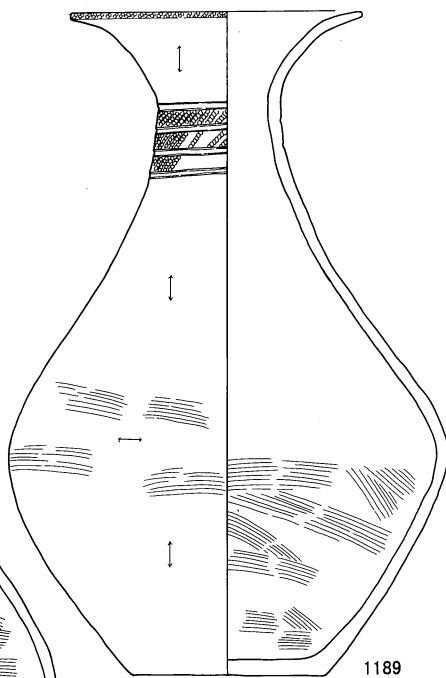
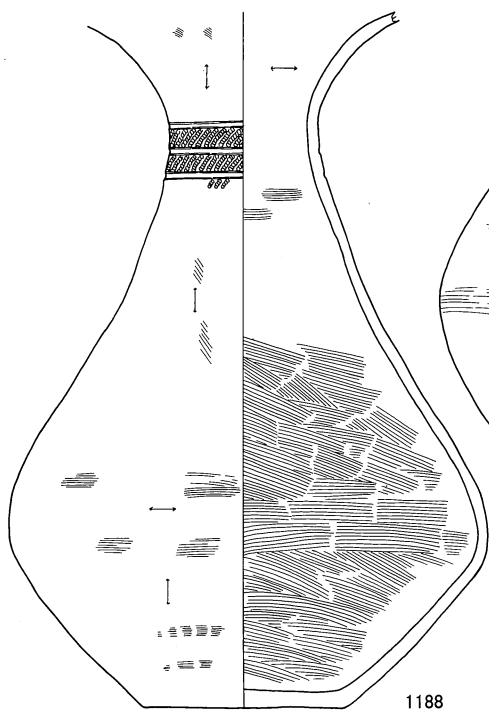

0 (1 : 4) 10 cm

S B1144, 1184~1187B S B1146, 1188~1191

S B1146

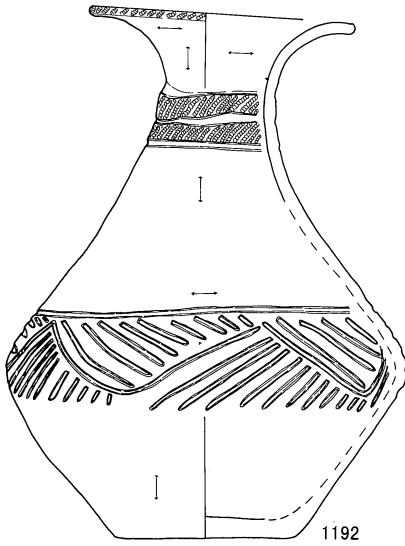

1192

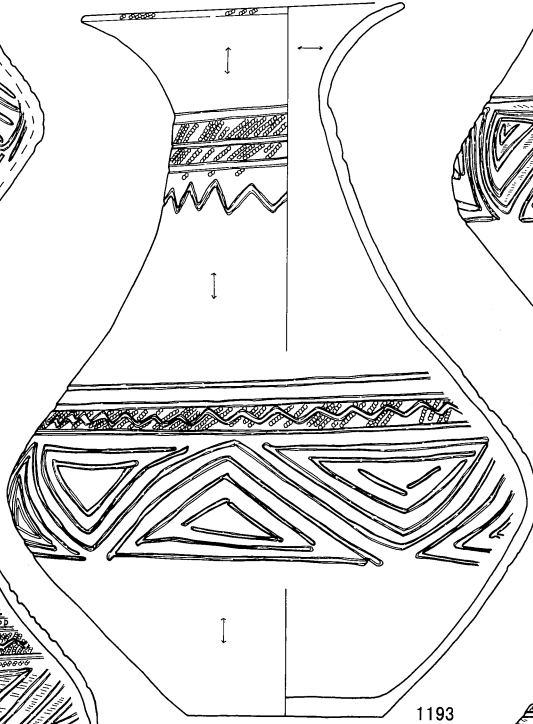
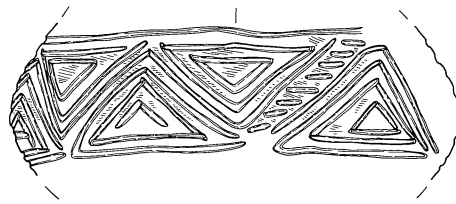

1193

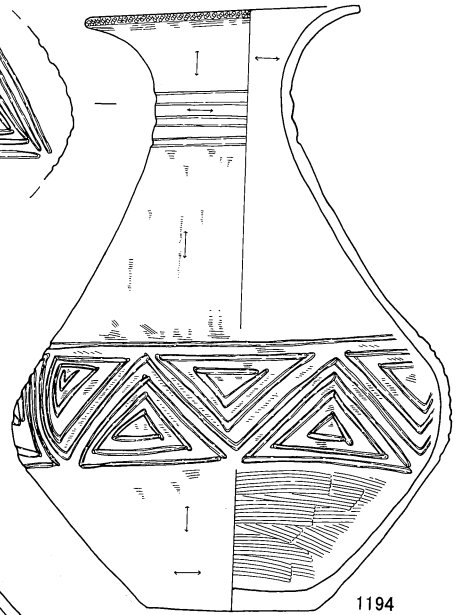

1194

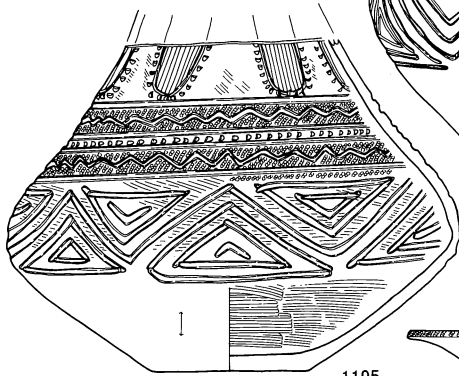

1195

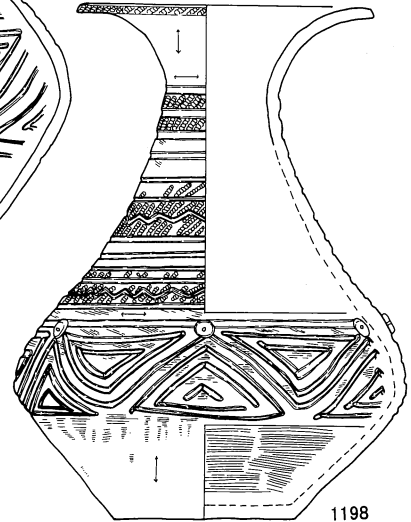

1198

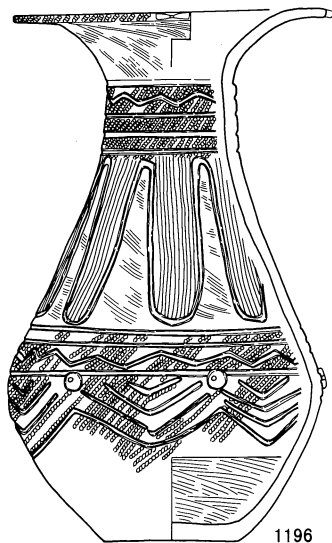

1196

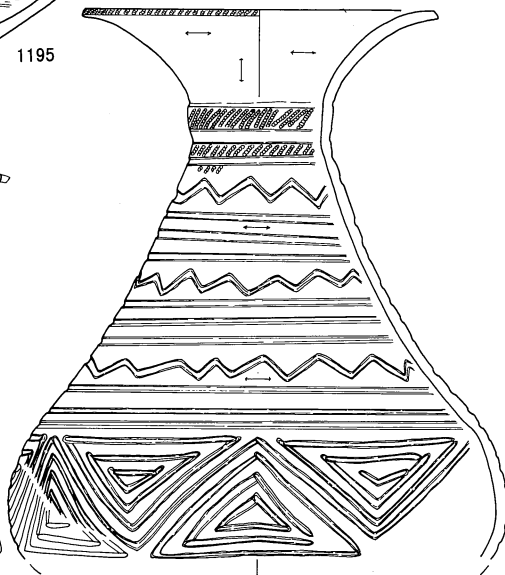

1197

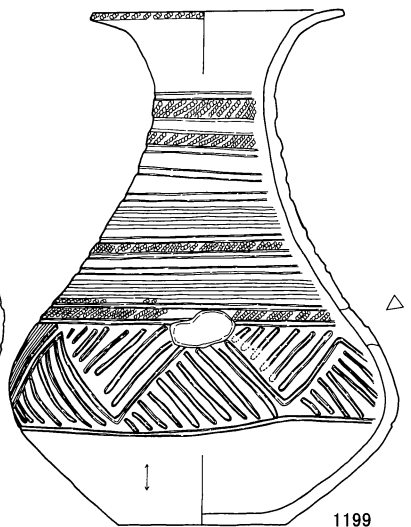

1199

0 (1 : 4) 10cm

S B 1146

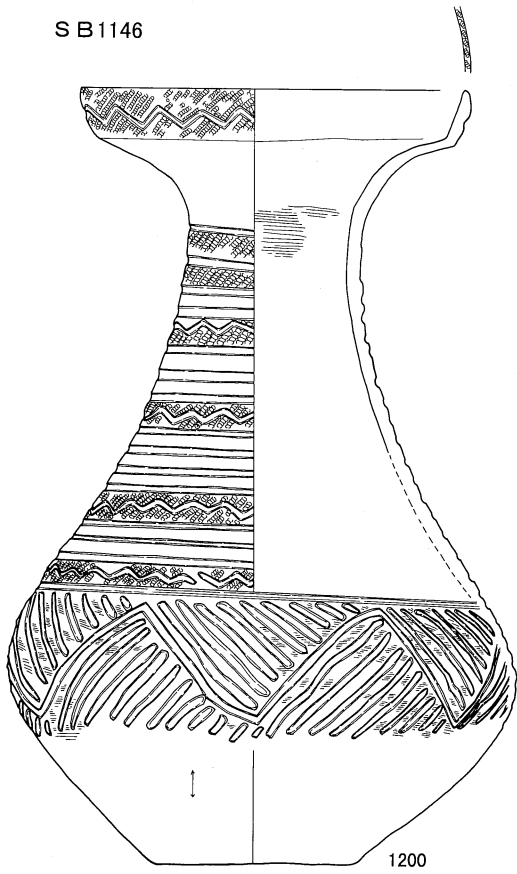

1200

S B 1154

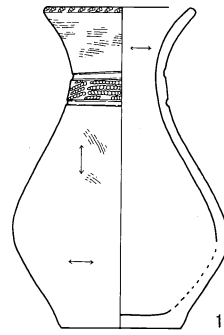

1201

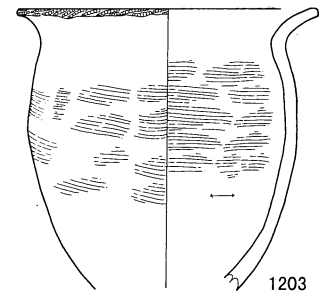

1203

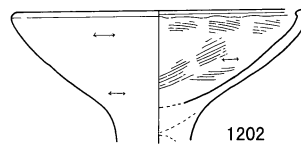

1202

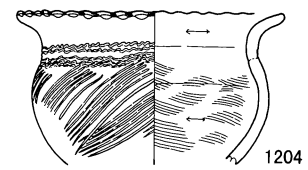

1204

S B 1155

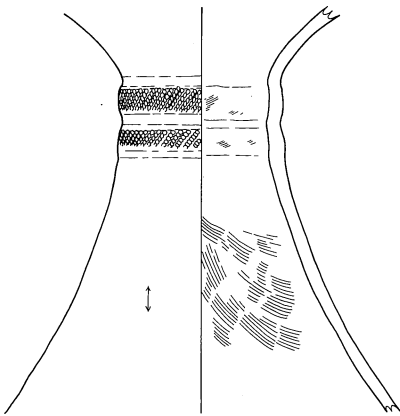

1205

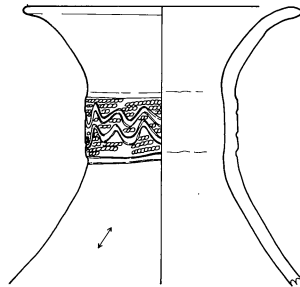

1206

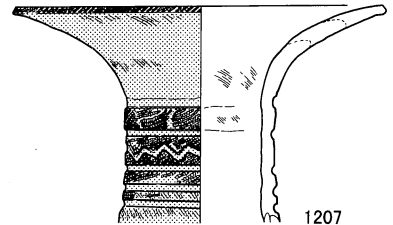

1207

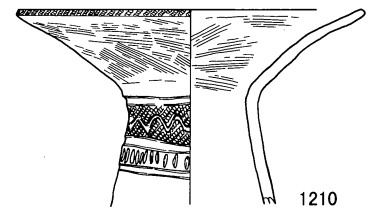

1210

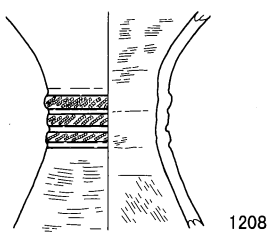

1208

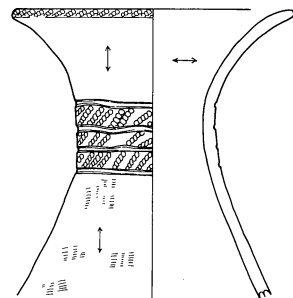

1209

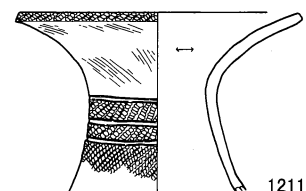

1211

0 (1 : 4) 10cm

S B 1146, 1200

S B 1154, 1201~1204

S B 1155, 1205~1211

SB 1155

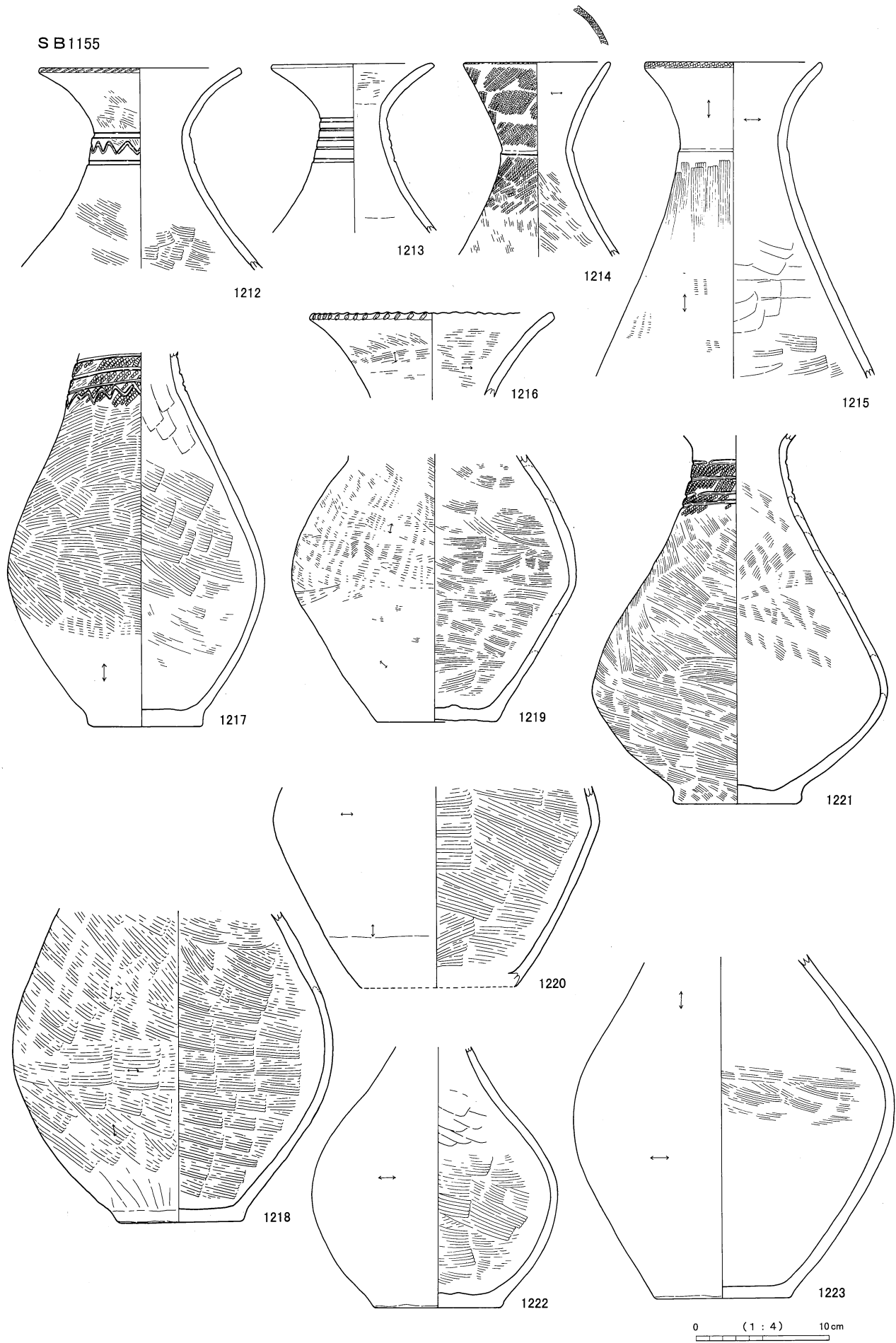

S B 1155, 1212~1223

S B1155

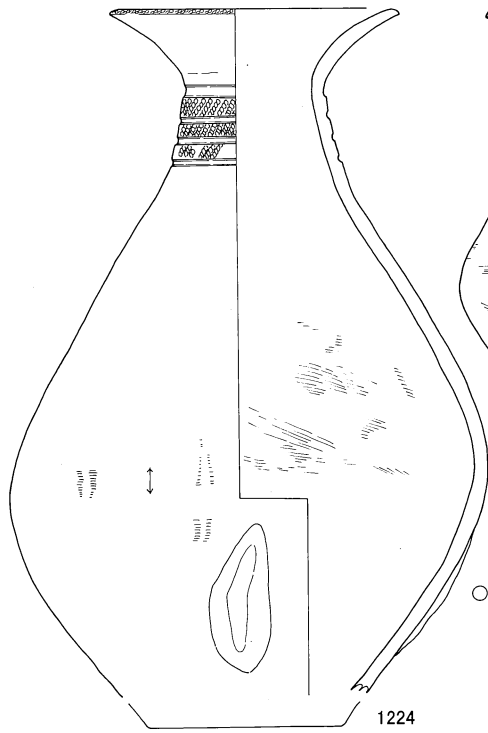

1224

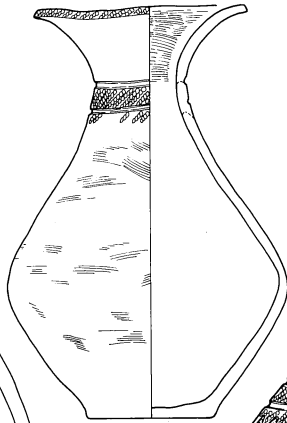

1225

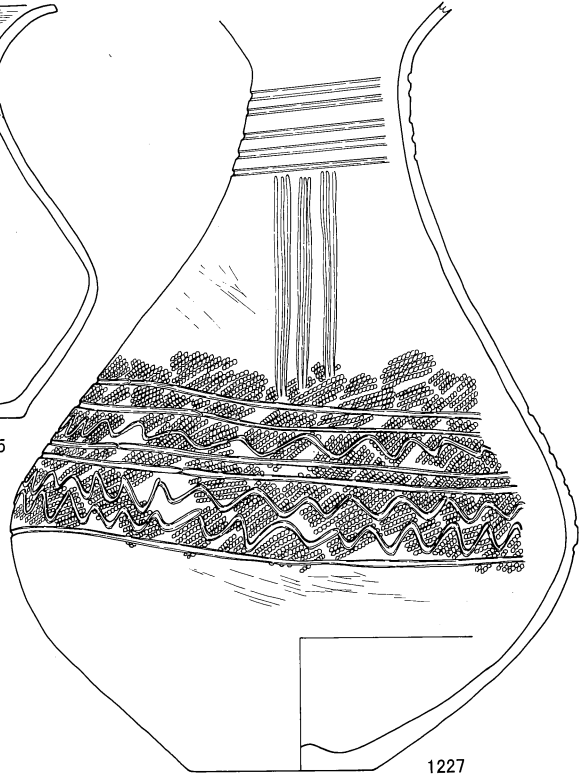

1227

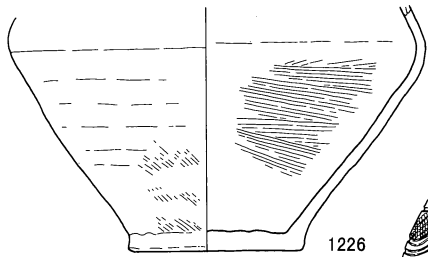

1226

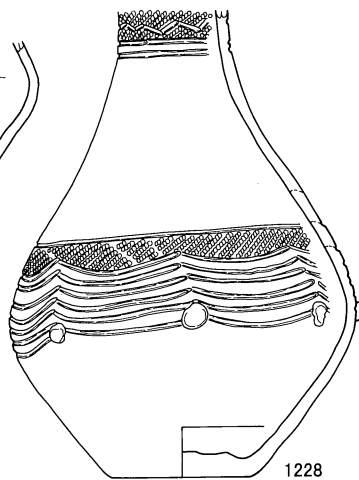

1228

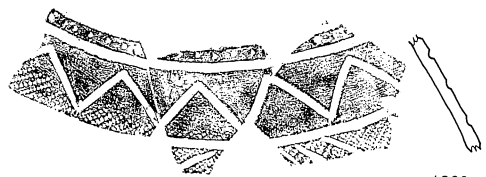

1229

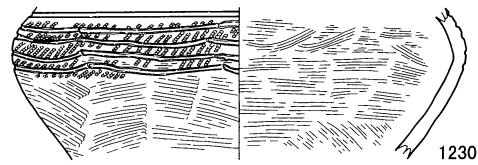

1230

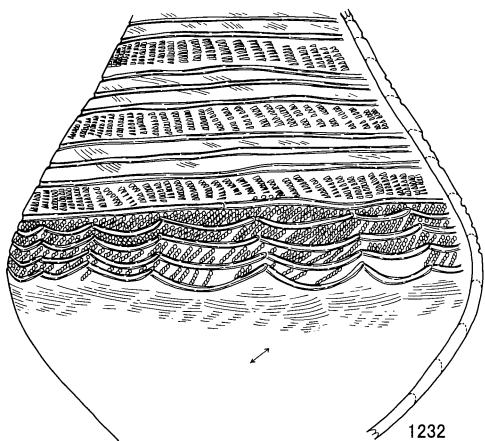

1232

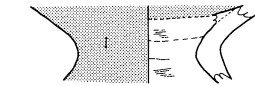

1233

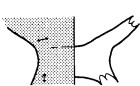

1234

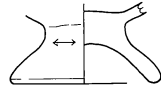

1235

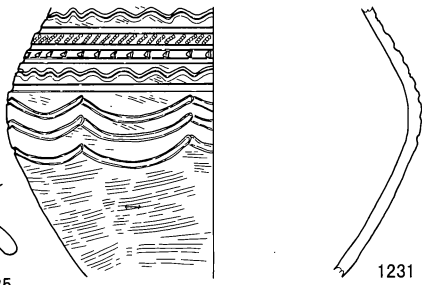

1231

0 (1 : 4) 10cm

S B 1155

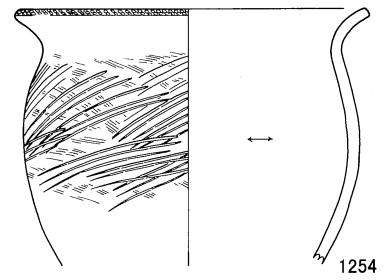
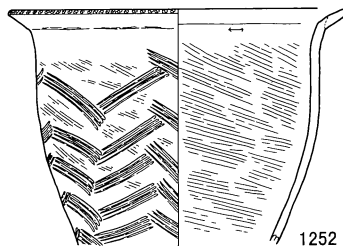
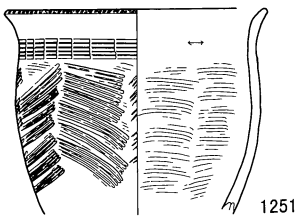
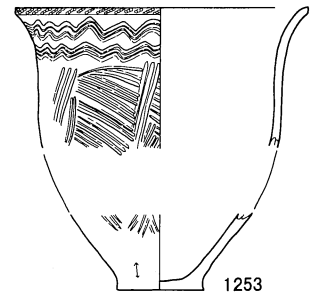
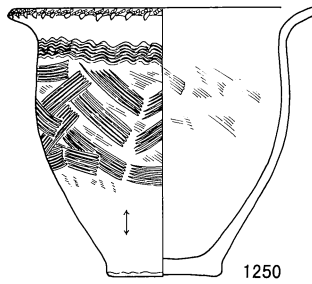
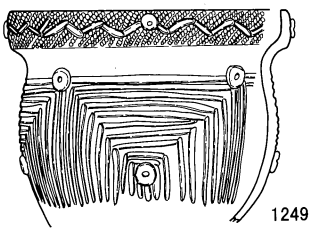
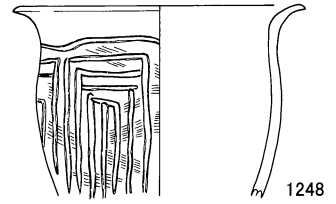
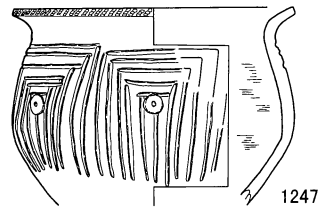
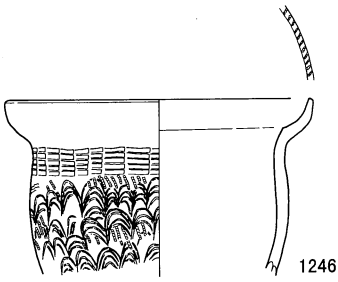
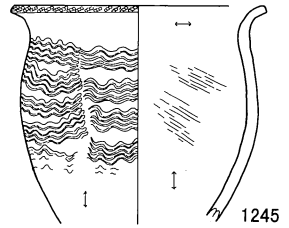
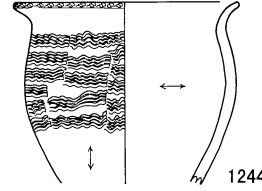
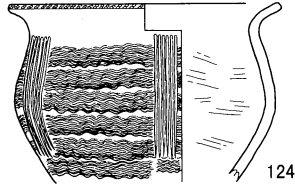
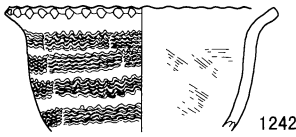
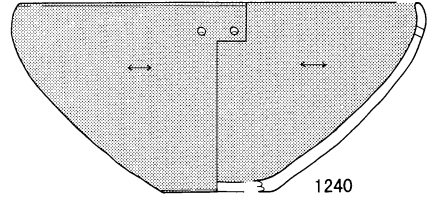
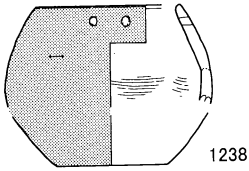
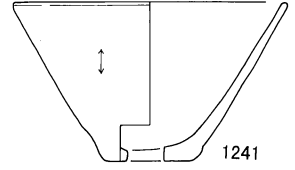
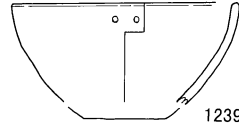
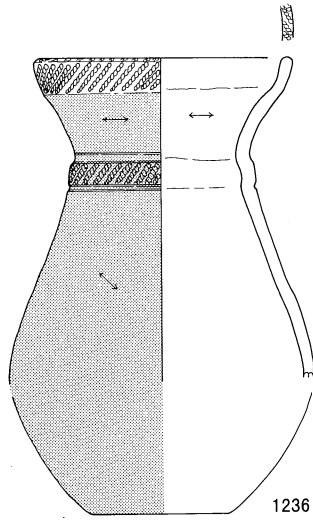
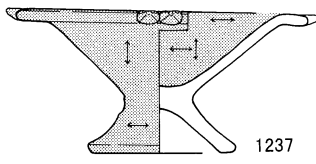

0 (1 : 4) 10 cm

S B 1155, 1236~1254

S B 1155

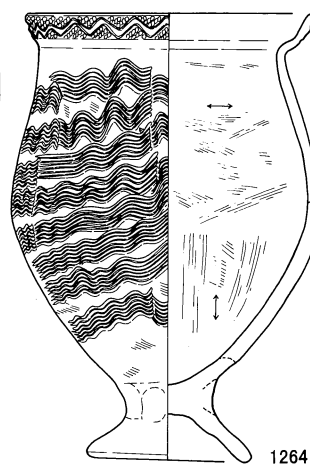
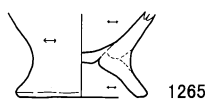
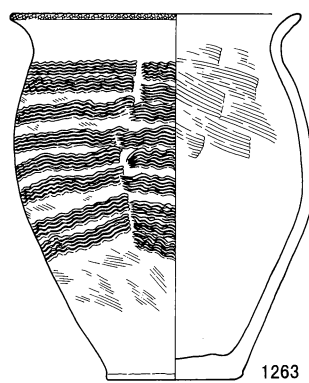
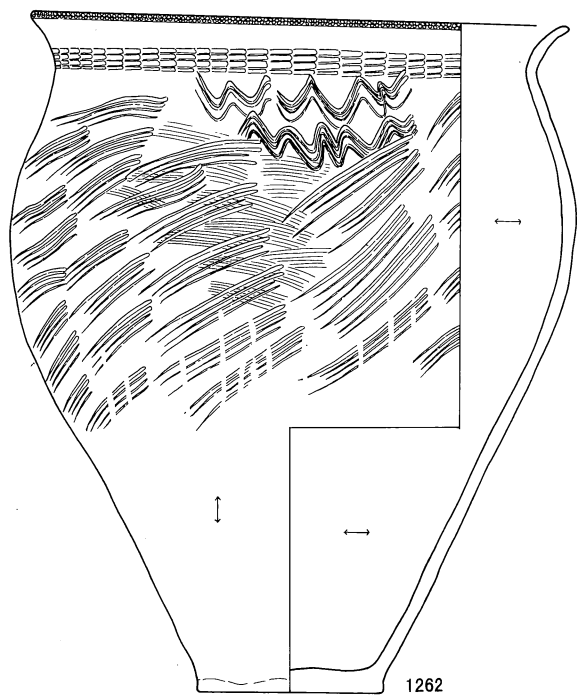
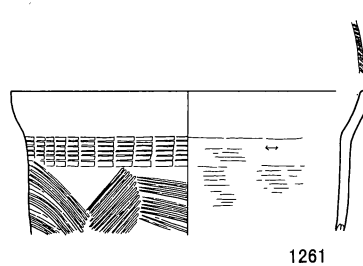
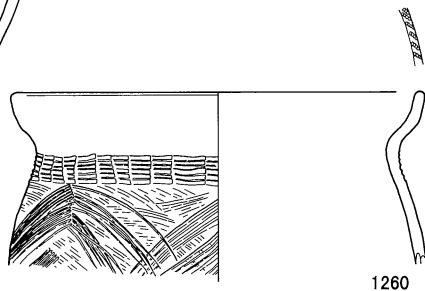
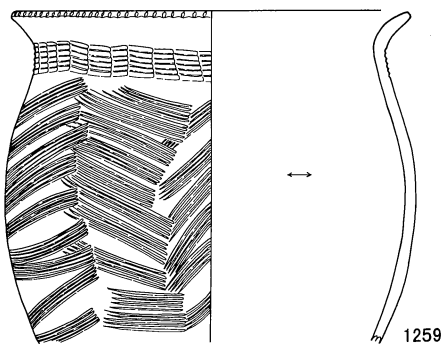
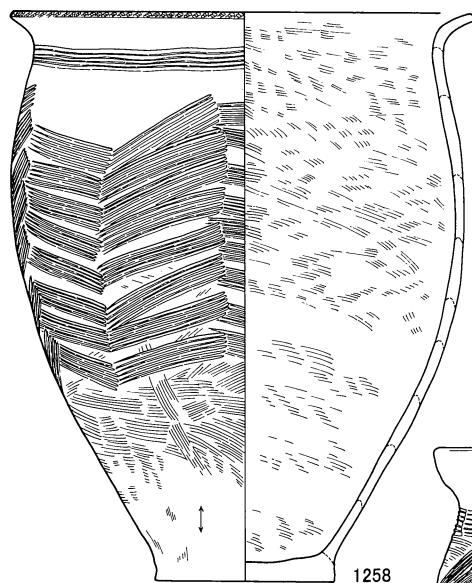
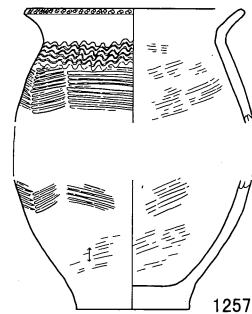
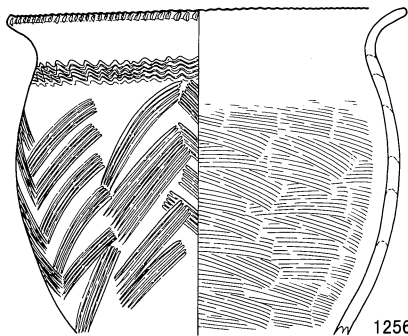
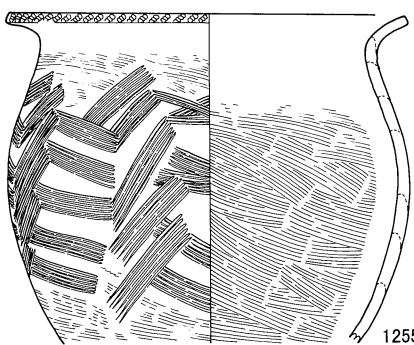

0 (1 : 4) 10cm

S B 1155

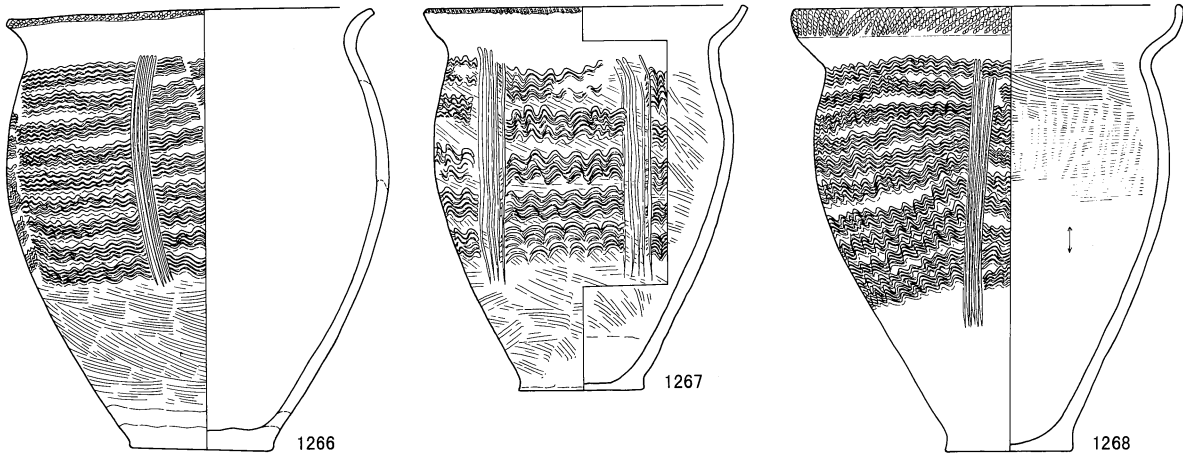

S B 1156

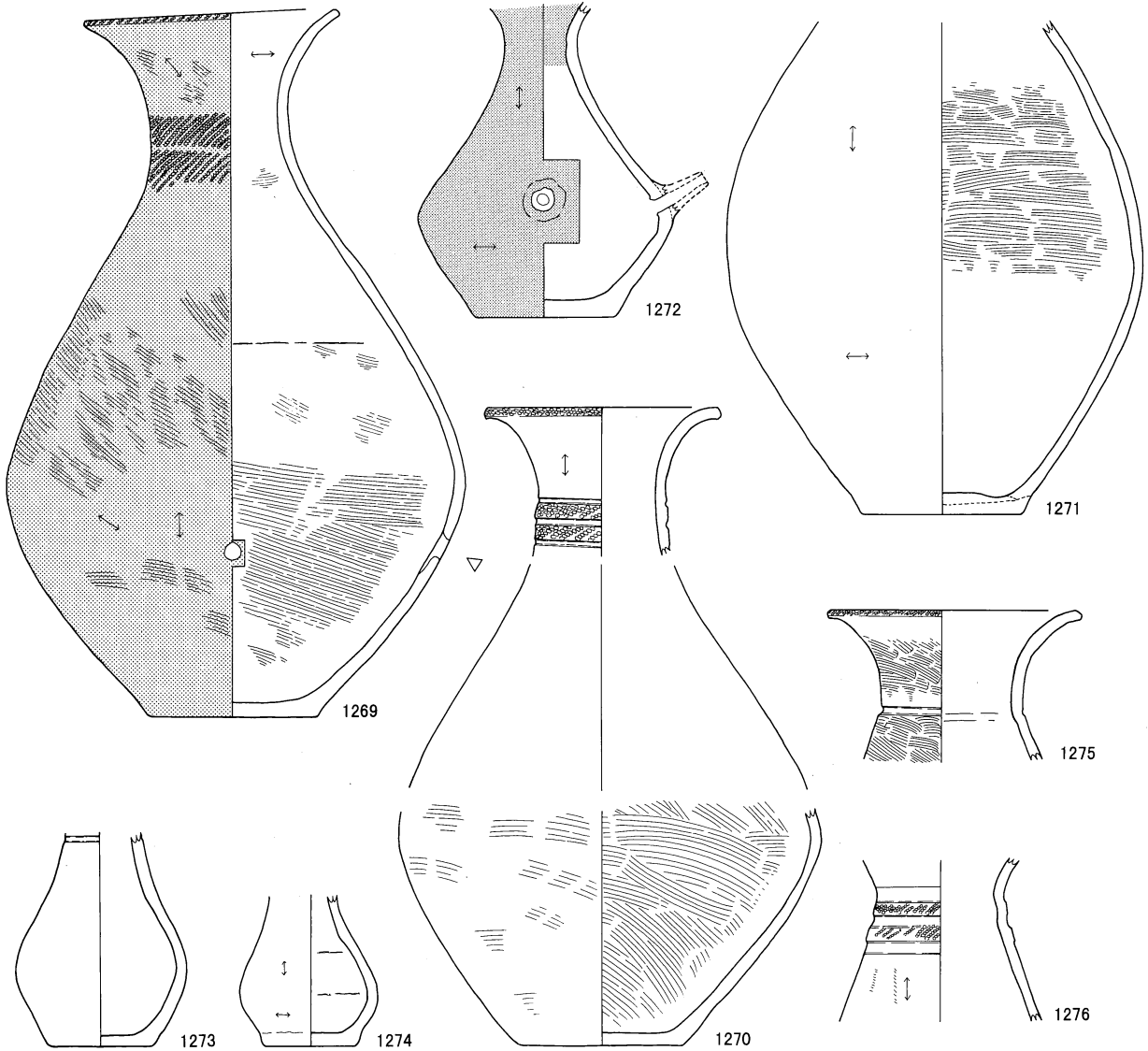

0 (1 : 4) 10 cm

S B 1155, 1266~1268 S B 1156, 1269~1276



S B 1156

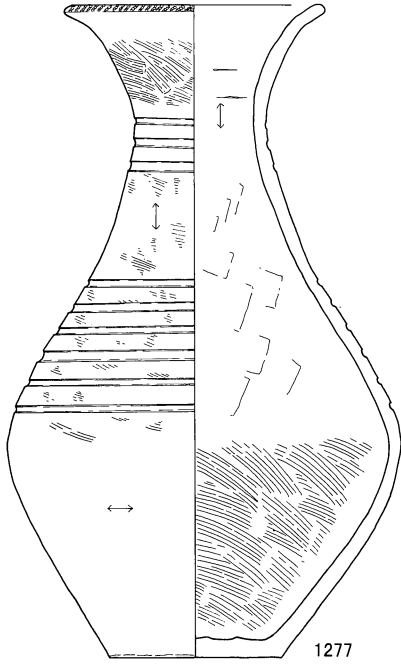

1277

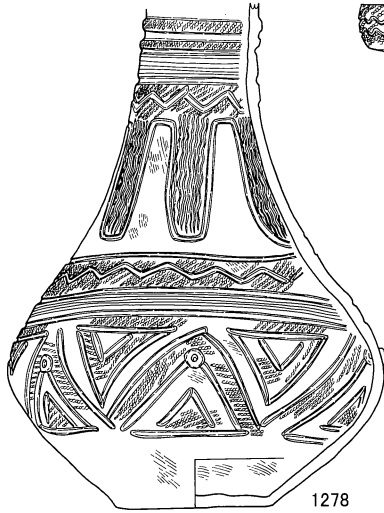

1278

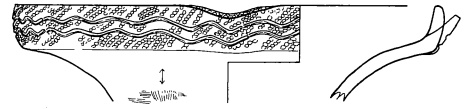

1279



1280

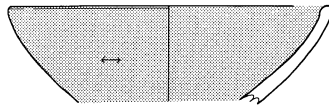

1283

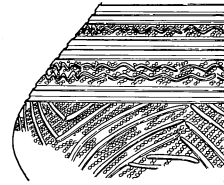

1281

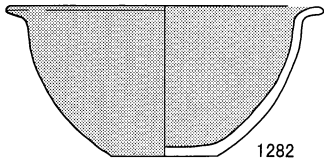

1282

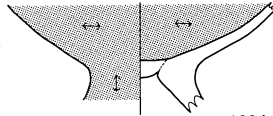

1284

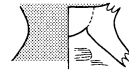

1285

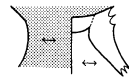

1286

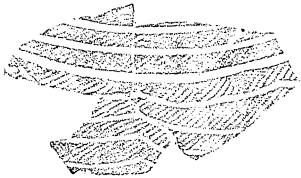

1287

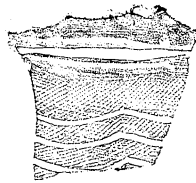

1288



1289

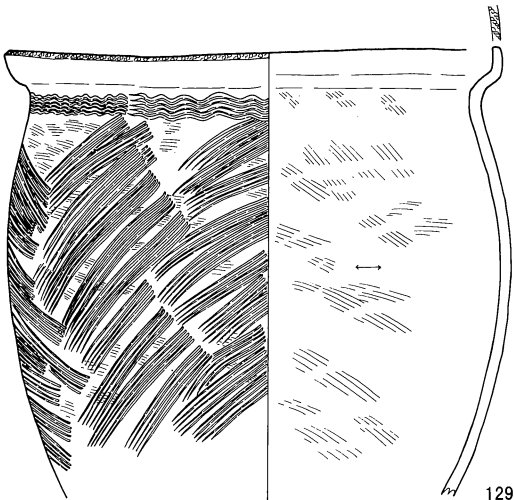

1290

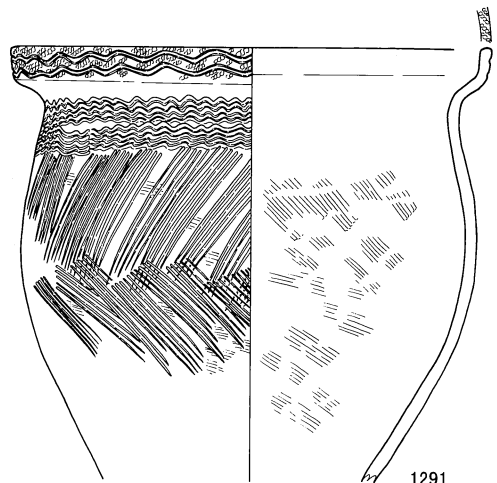

1291

0 (1 : 4) 10 cm

 A horizontal scale bar with markings at 0, 1, 2, 3, 4, 5, 6, 7, 8, 9, and 10 cm.

S B1156

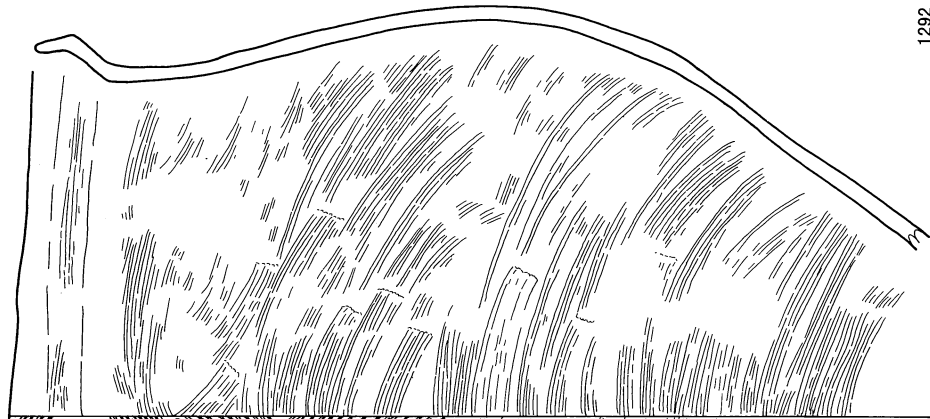
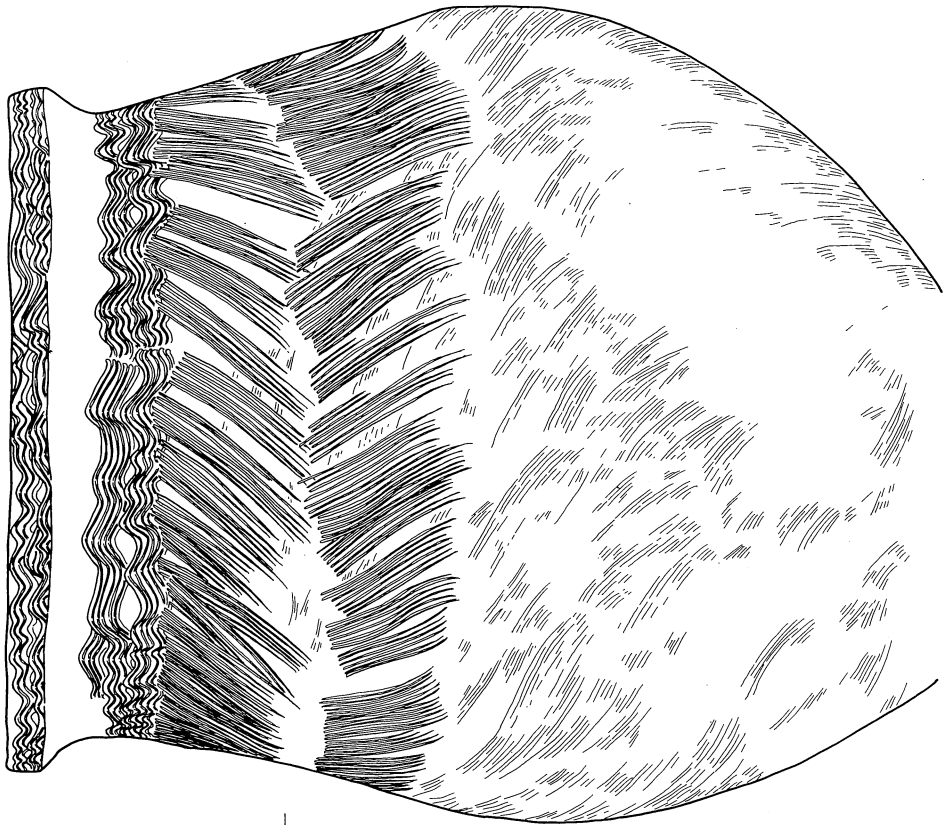

1292

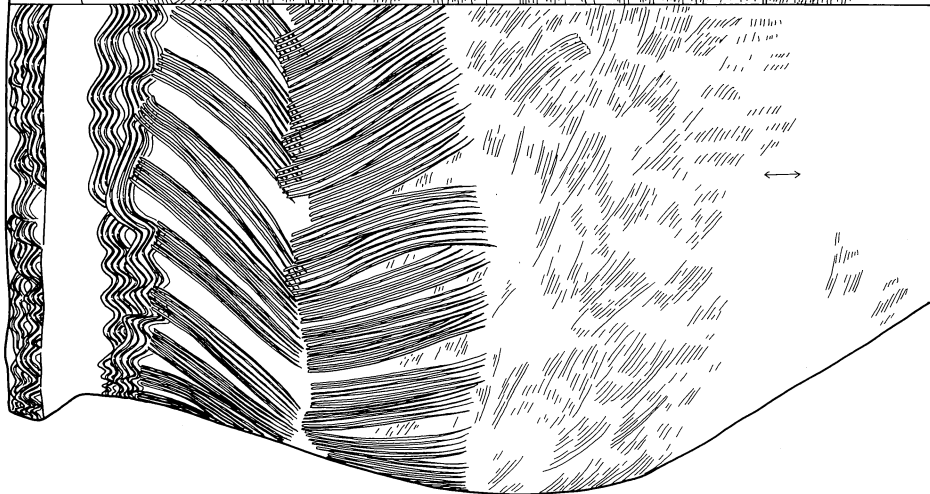

0 (1 : 4) 10cm

S B1156, 1292

S B1156

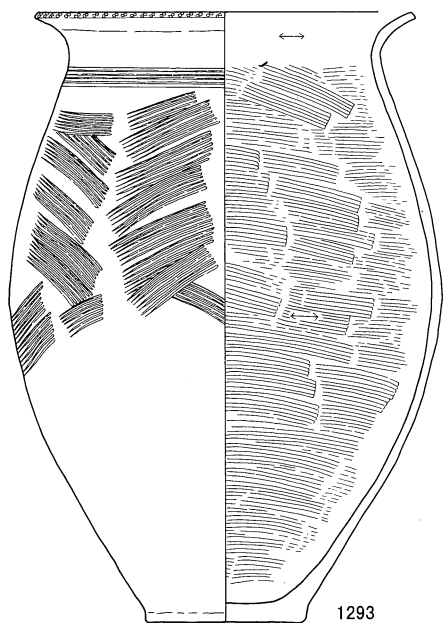

1293

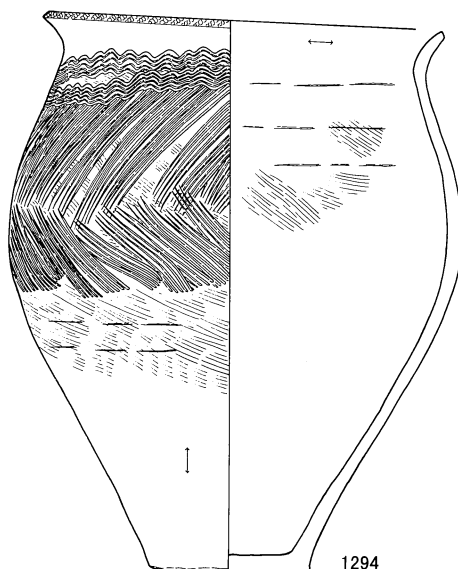

1294

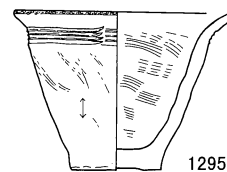

1295

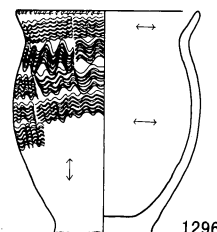

1296

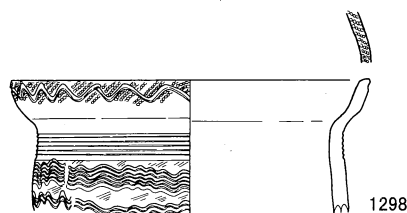

1298

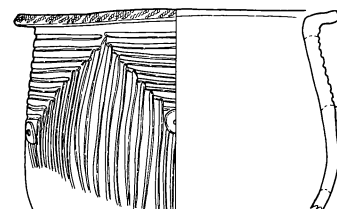

1300

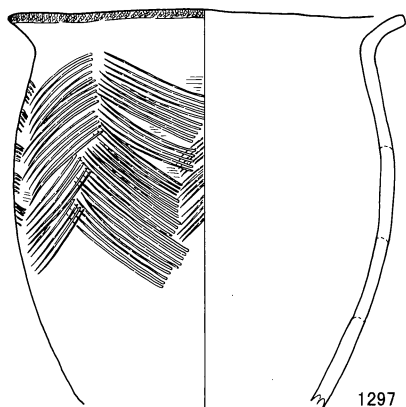

1297

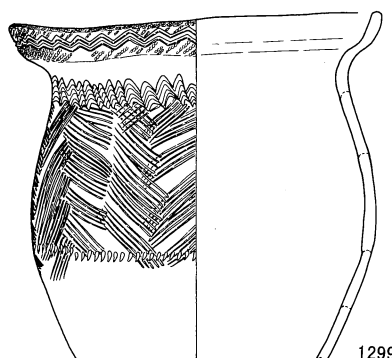

1299

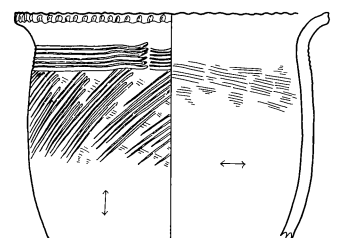

1301

S B1157

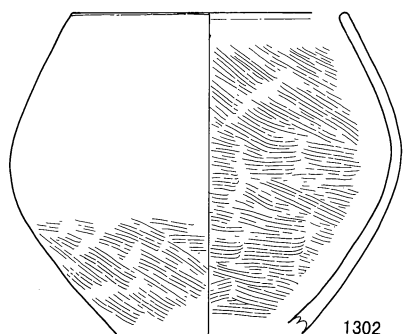

1302

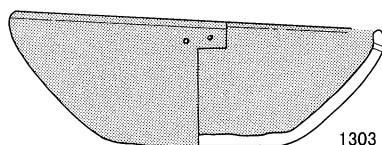

1303

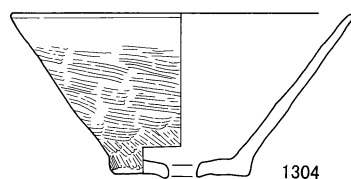

1304

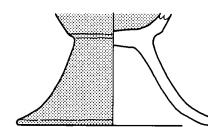

1305

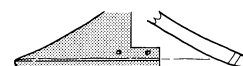

1306

0 (1 : 4) 10 cm

SB1157

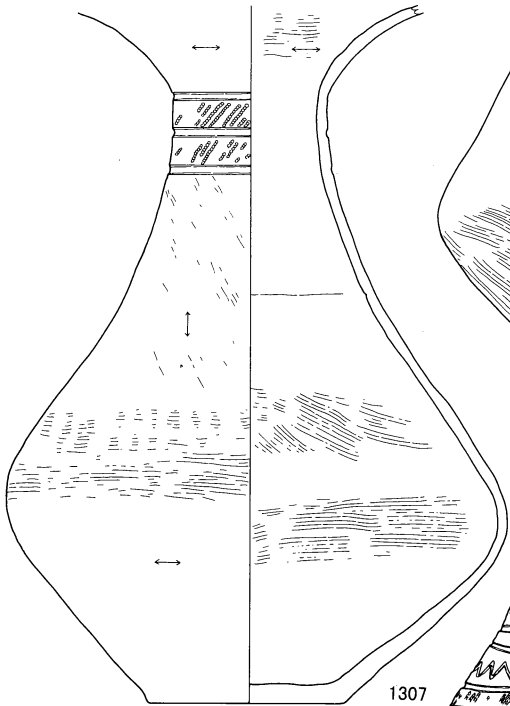

1307

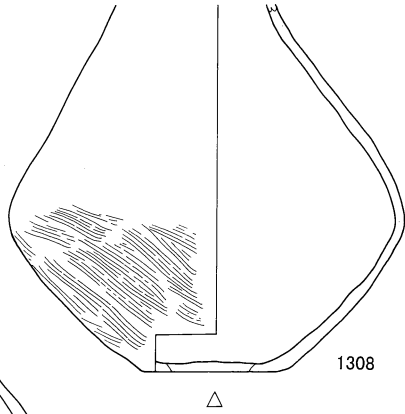

1308

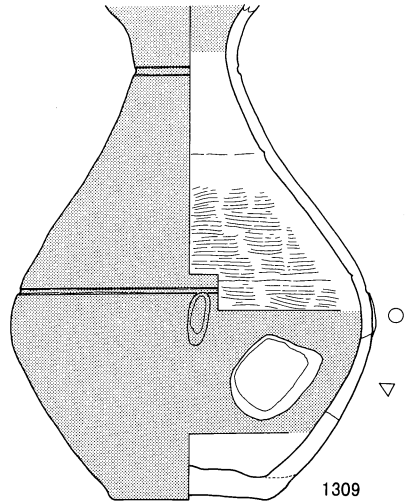

1309

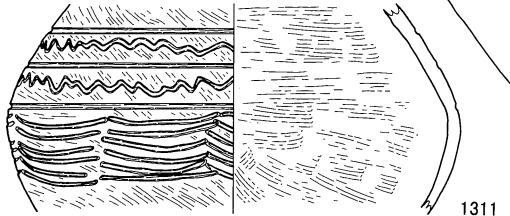

1311



1312

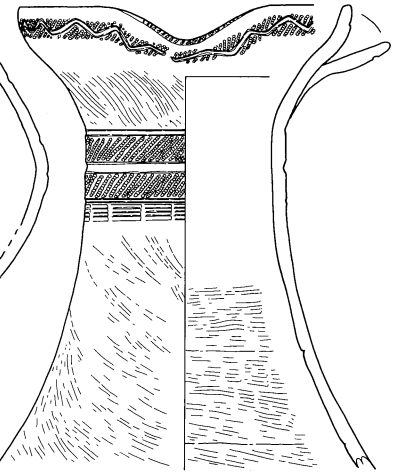

1310

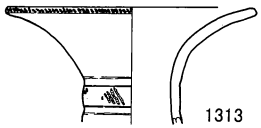

1313

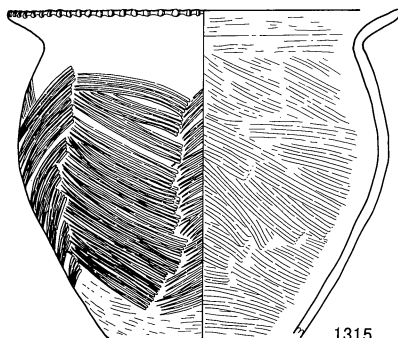

1315

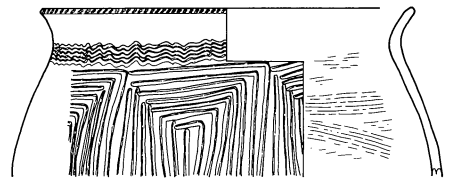

1316

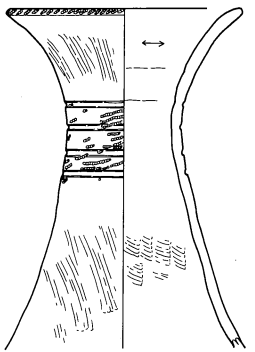

1314

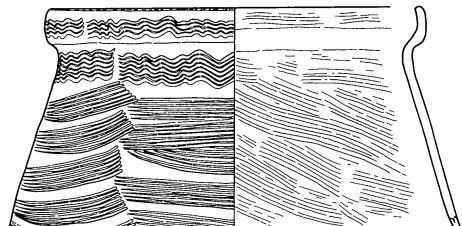

1317

0 (1 : 4) 10cm

S B1160

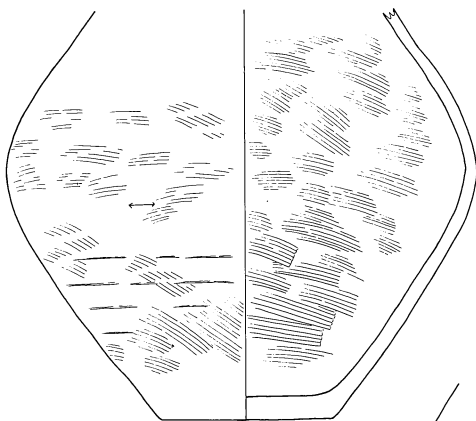

1318

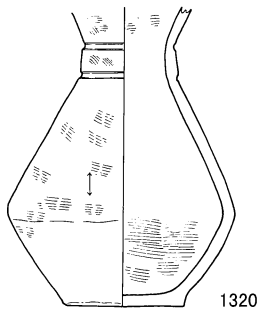

1320

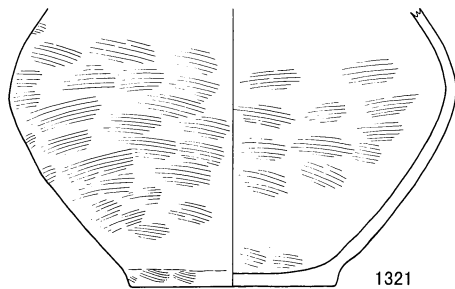

1321

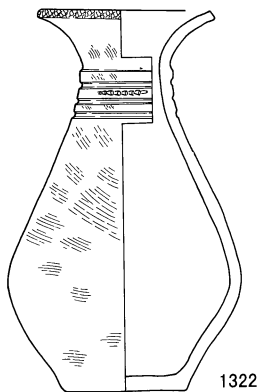

1322

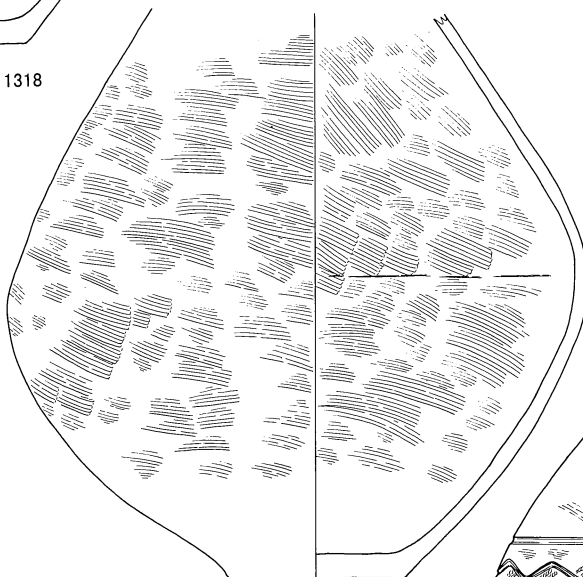

1319

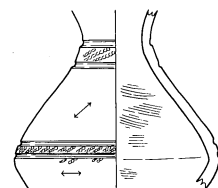

1323

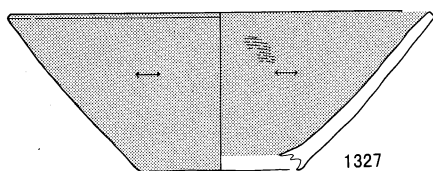

1327

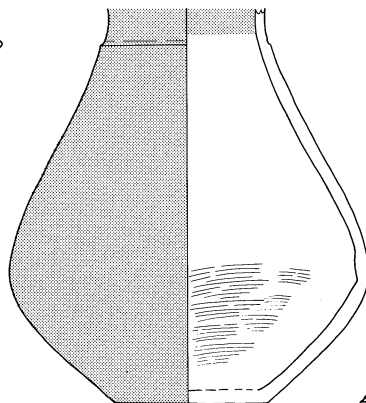

1326

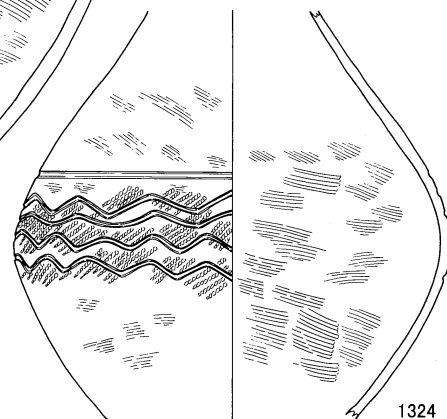

1324

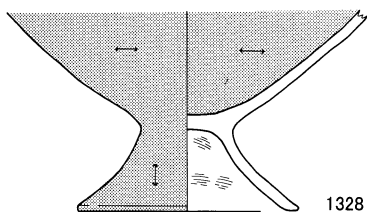

1328

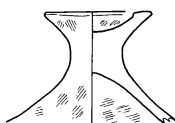

1329

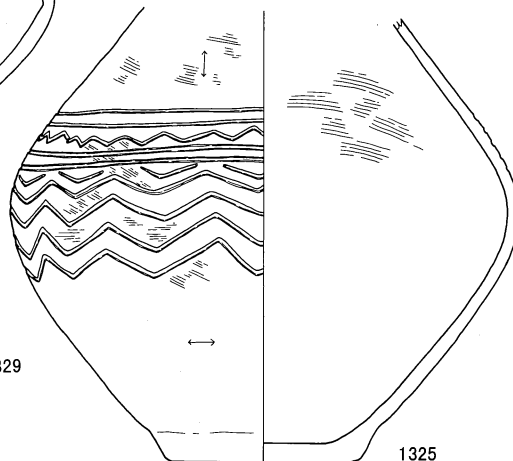

1325

0 (1 : 4) 10cm

S B 1160

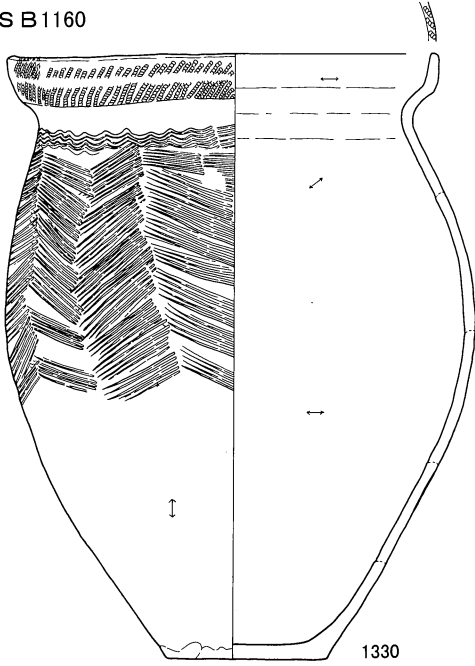

1330

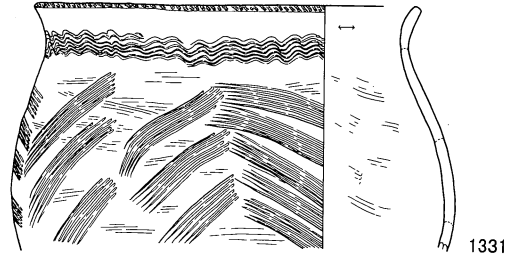

1331

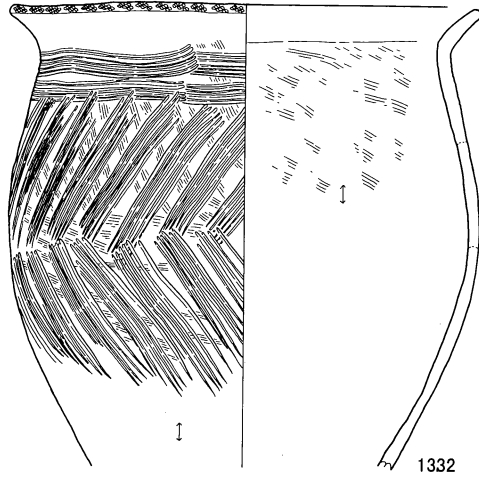

1332

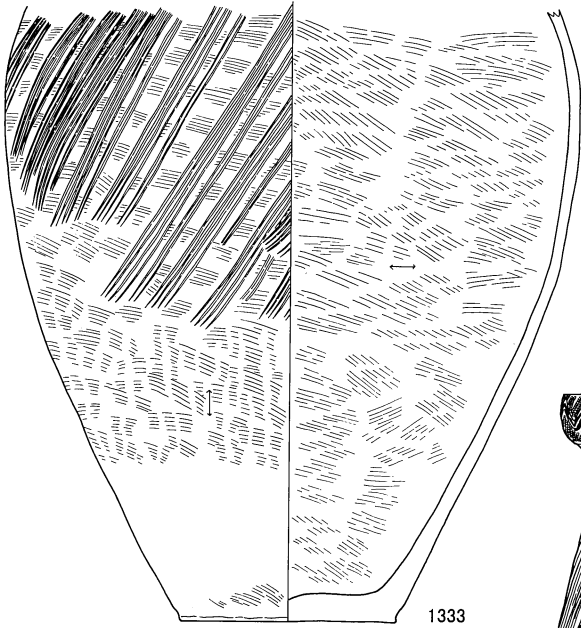

1333

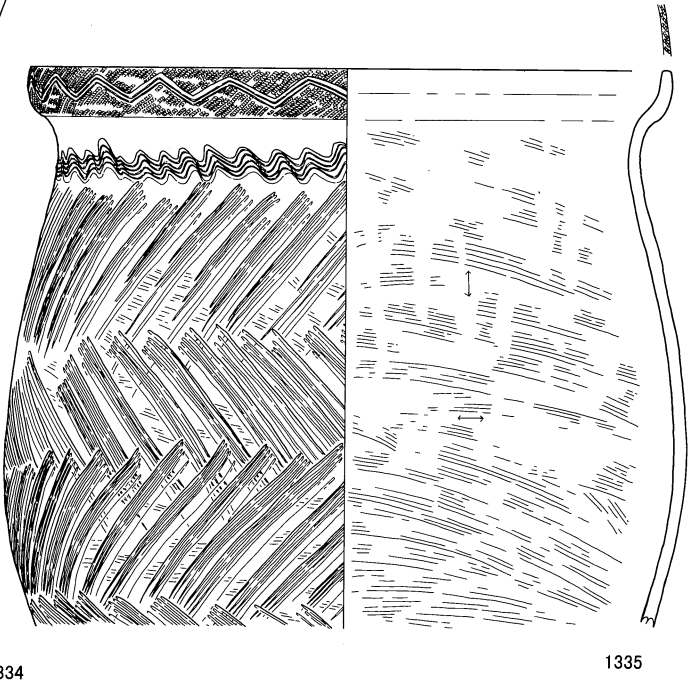

1335

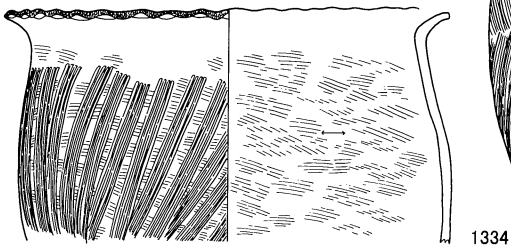

1334

0 (1 : 4) 10 cm

S B 1160, 1330~1335

S B 1160

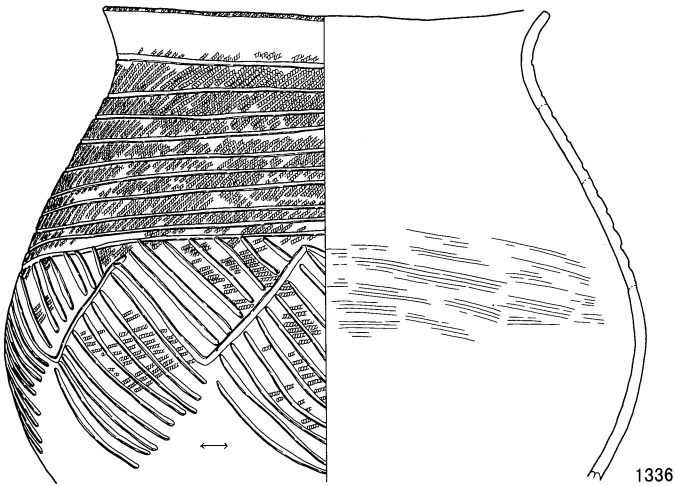

S B 1162

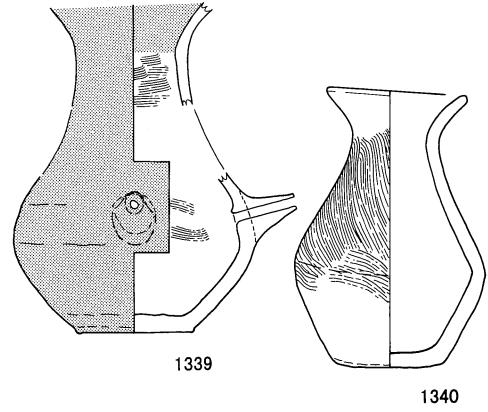
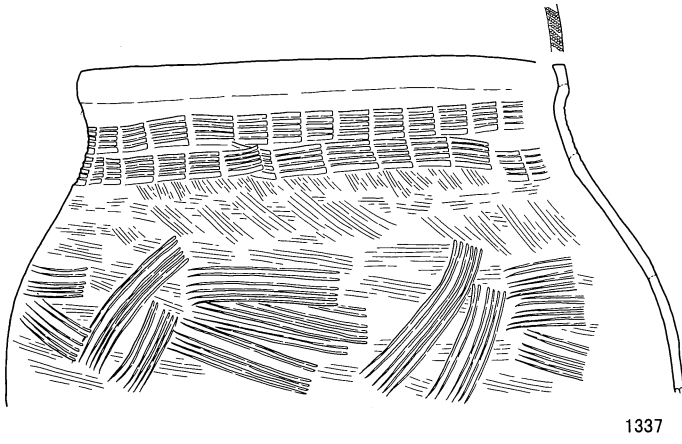
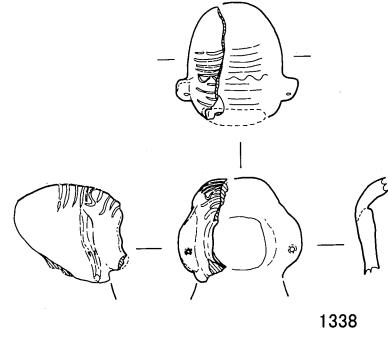

S B 1162

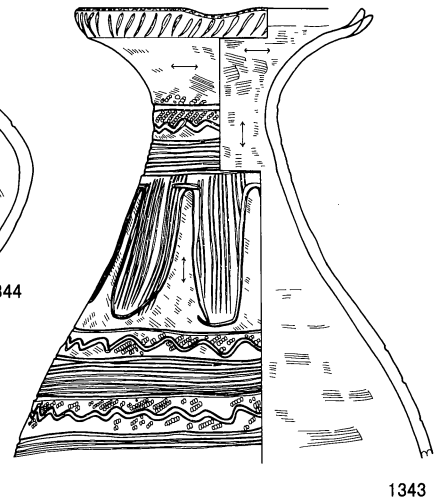
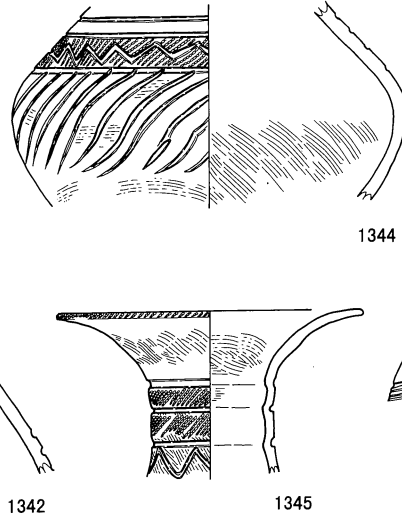
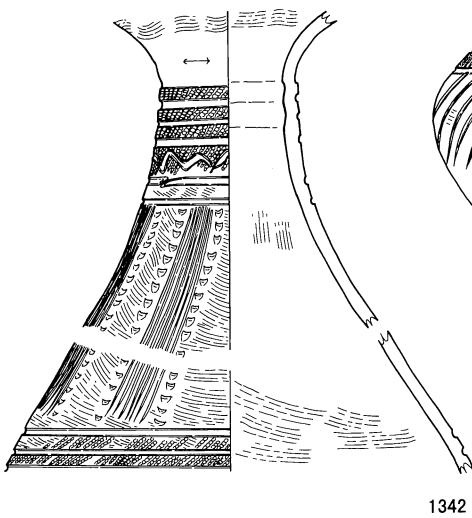

0 (1 : 4) 10cm

S B 1162

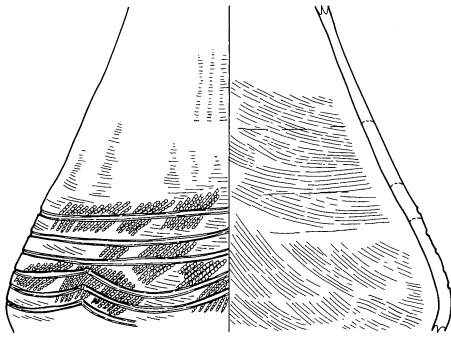

1346

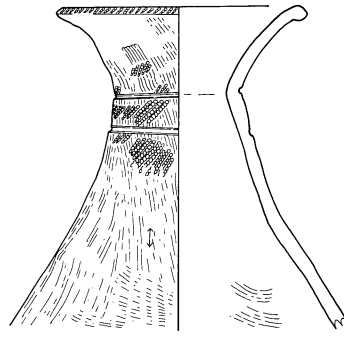

1347

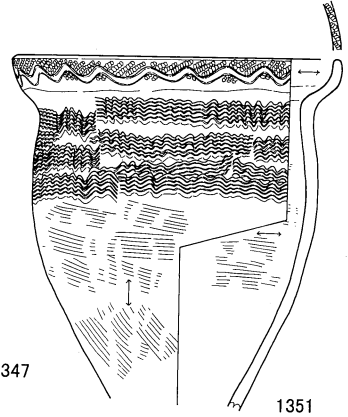

1351

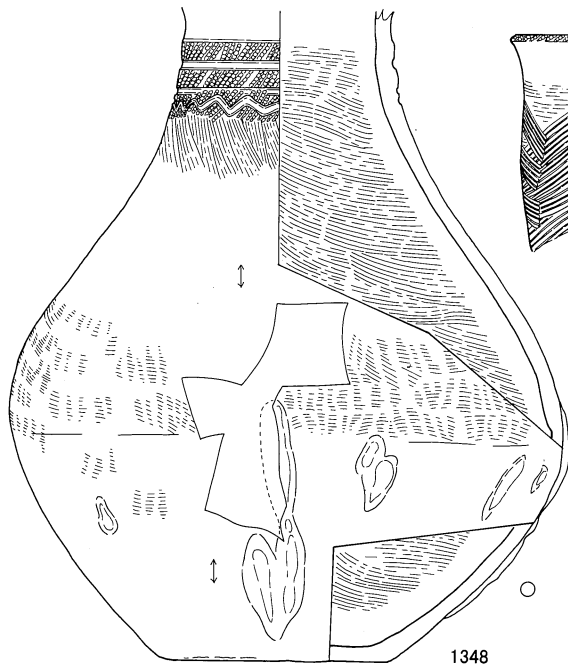

1348

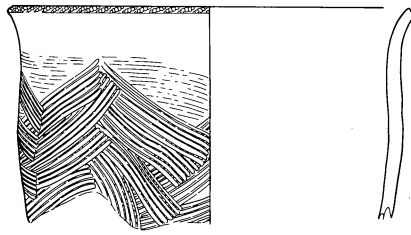

1349

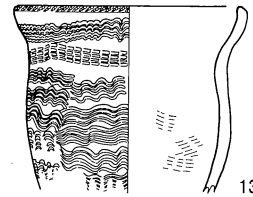

1352

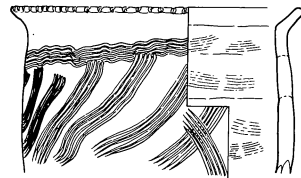

1350

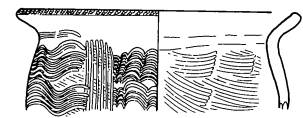

1353

S B 1168

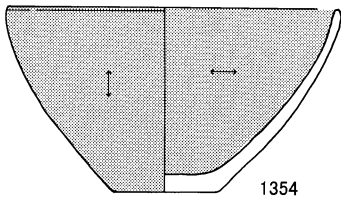

1354

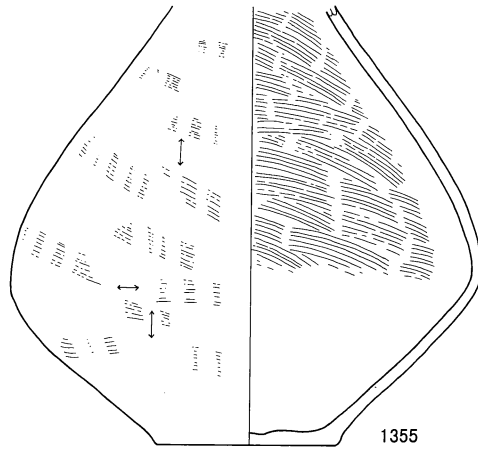

1355

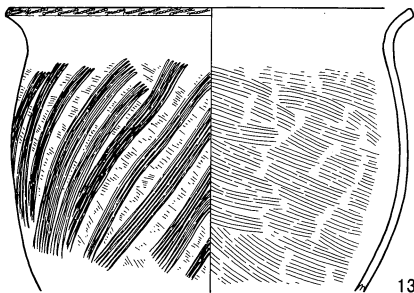

1356

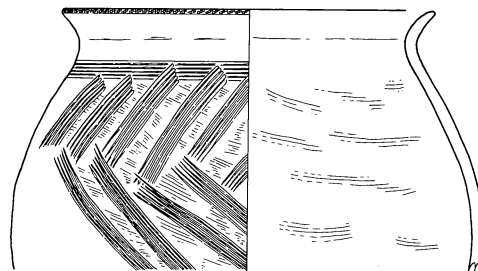

1357

0 (1 : 4) 10cm

S B 1162, 1346~1353

S B 1168, 1354~1357



S B1163

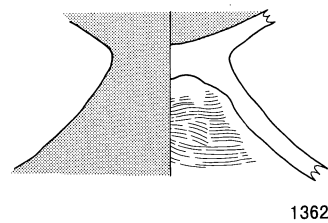
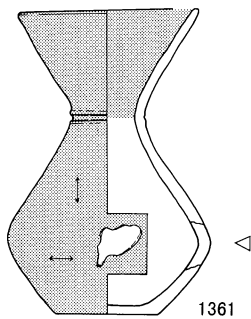
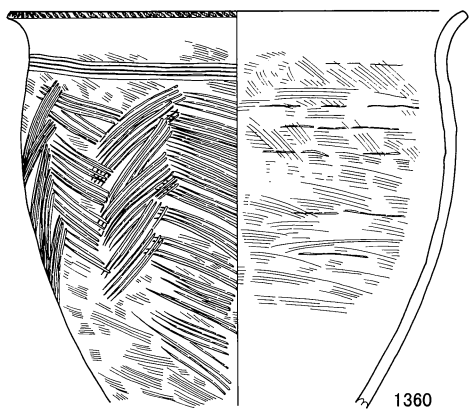
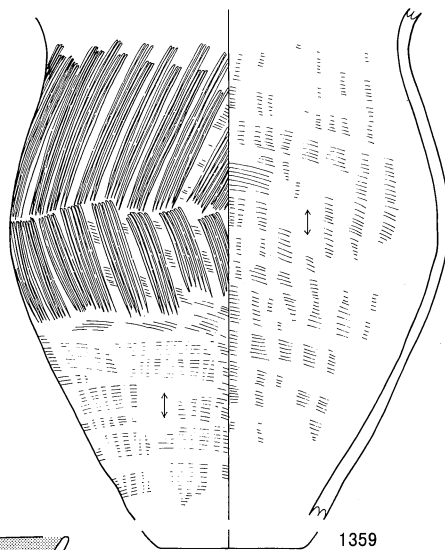
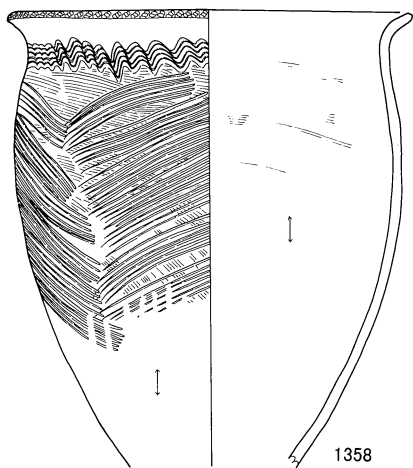

S B1174

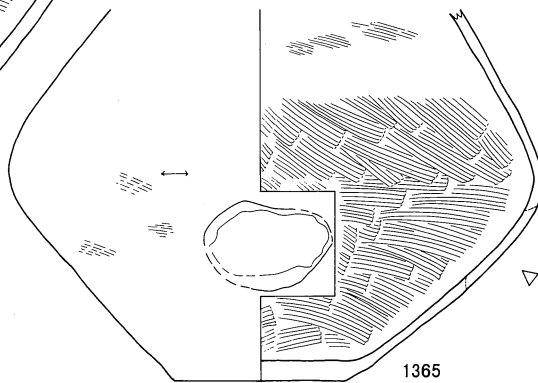
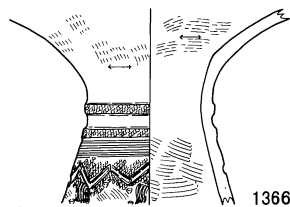
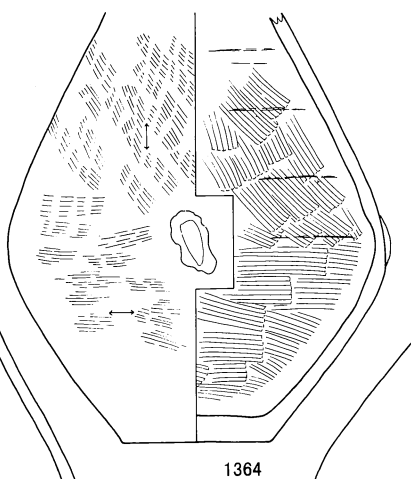
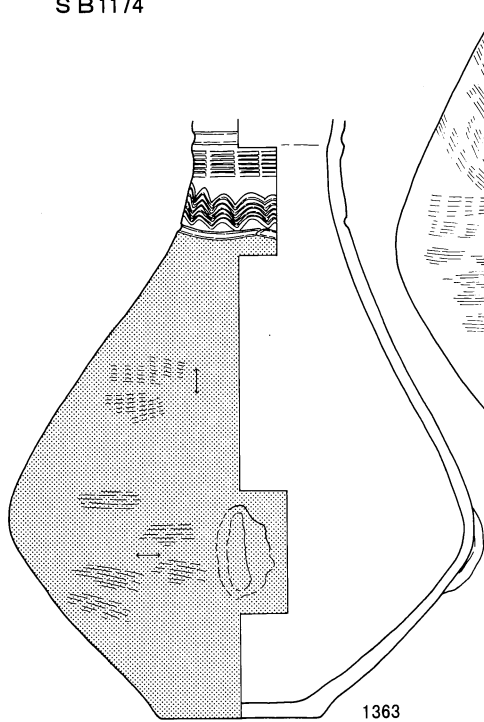

0 (1 : 4) 10 cm

S B1174

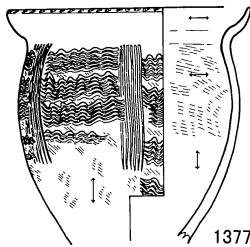
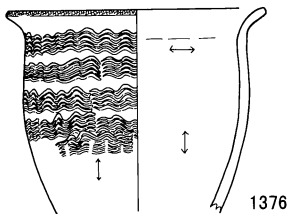
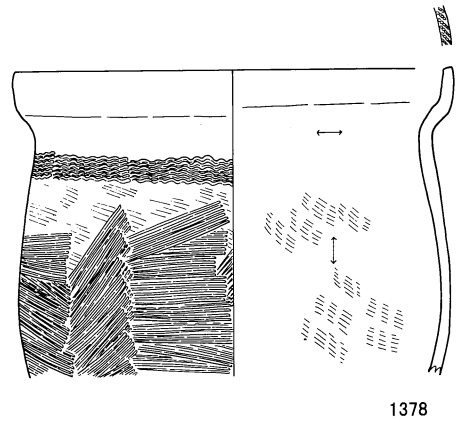
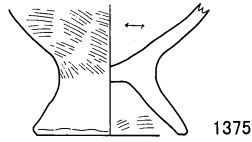
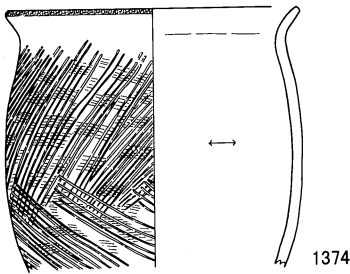
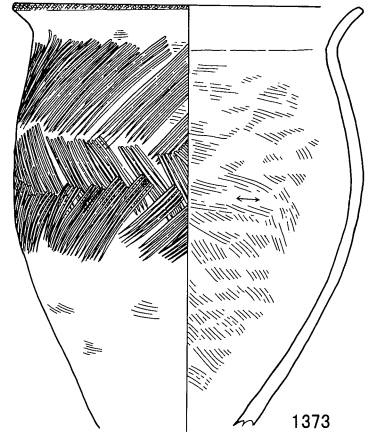
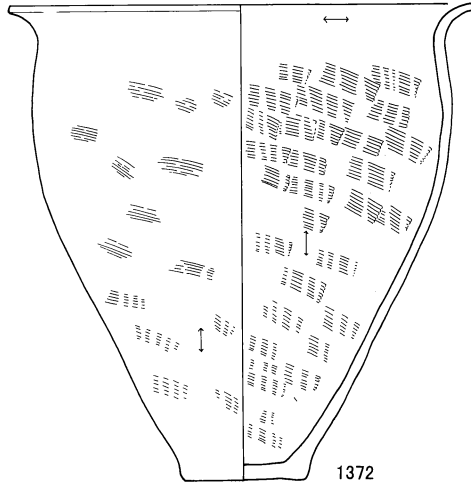
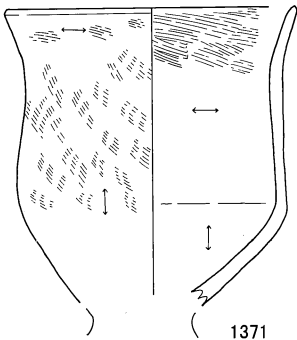
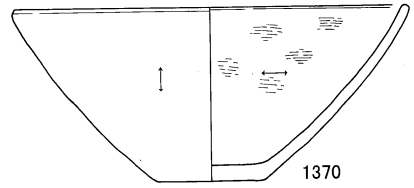
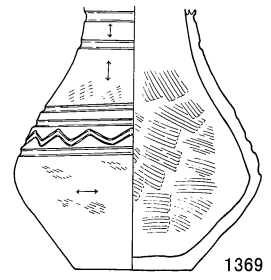
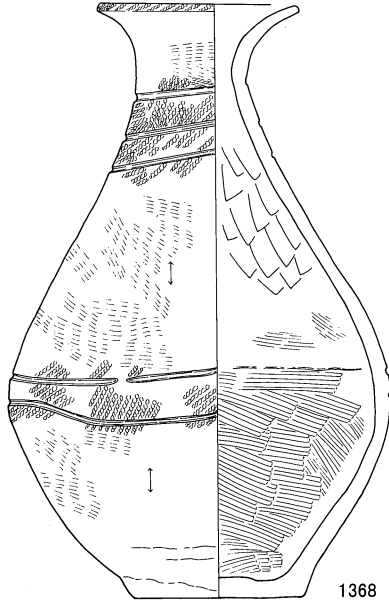
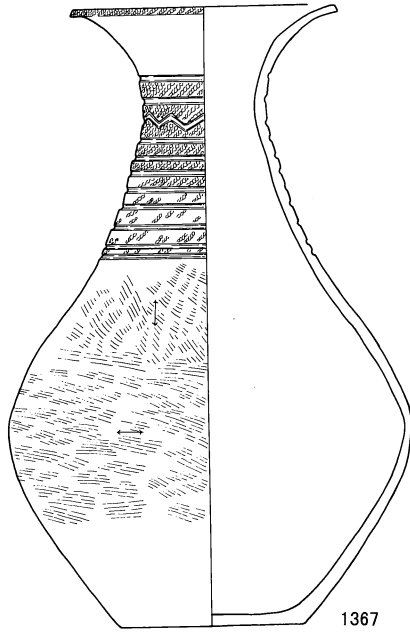

0 (1 : 4) 10 cm

S B1174, 1367~1378

S B 1174

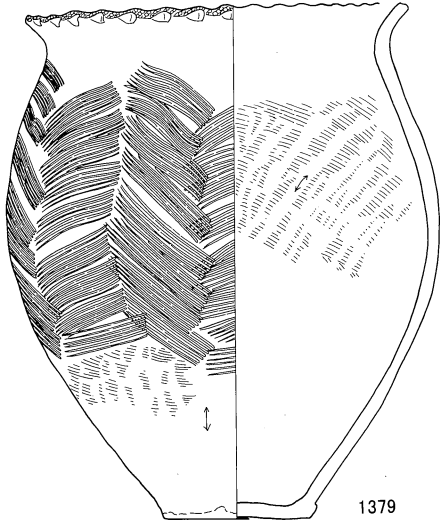

S B 1172

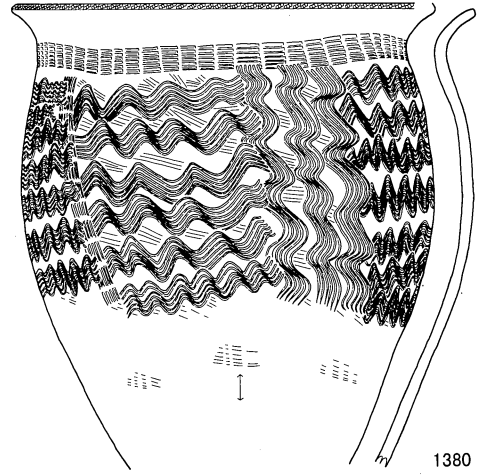

S B 1172

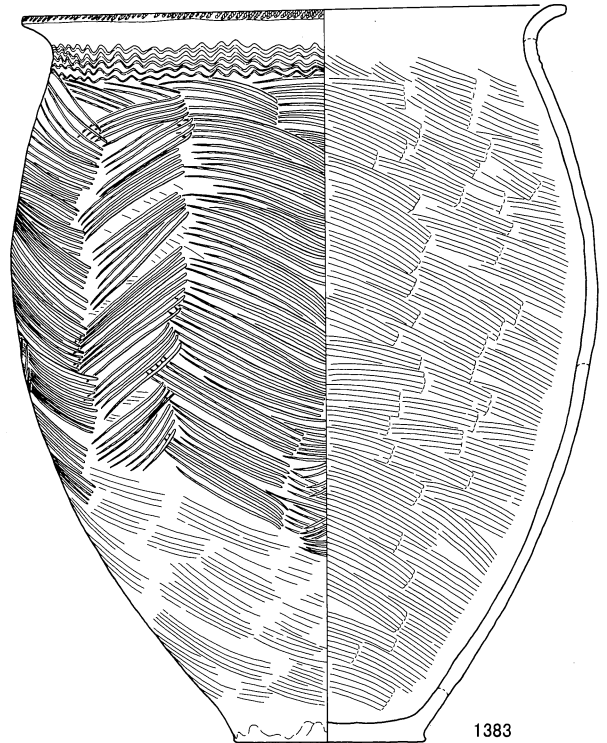
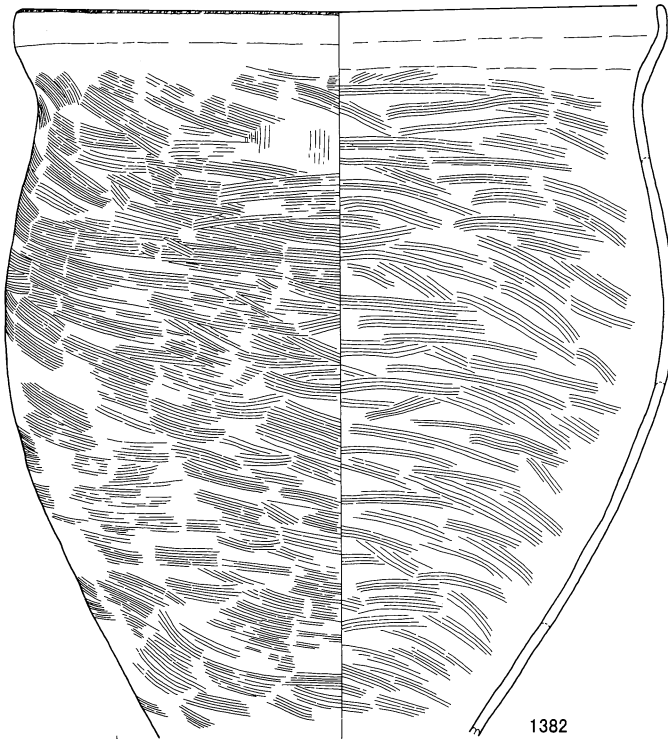
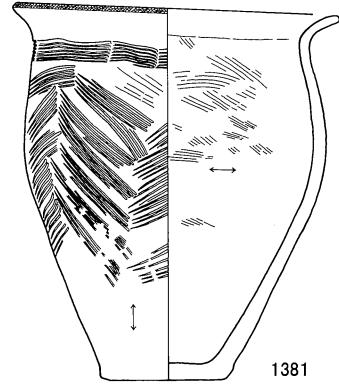

0 (1 : 4) 10 cm

S B1175

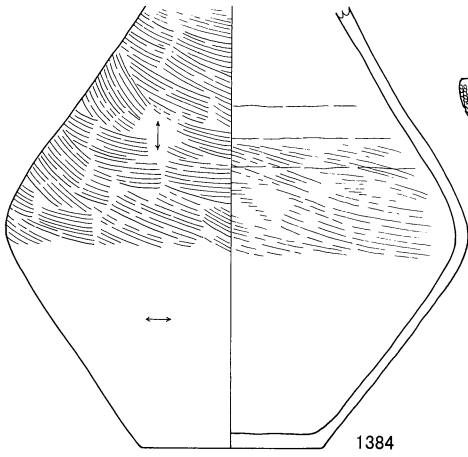

1384

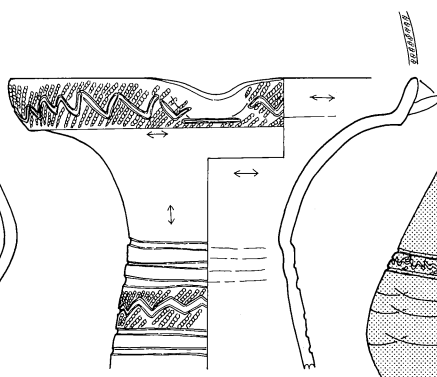

1385

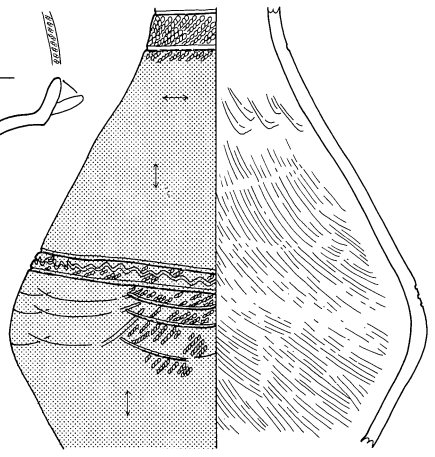

1386

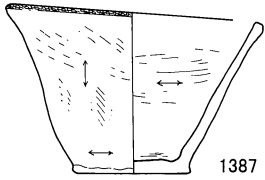

1387

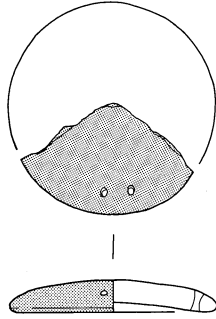

1388

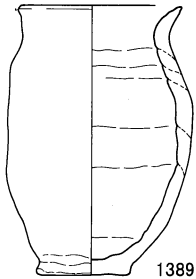

1389

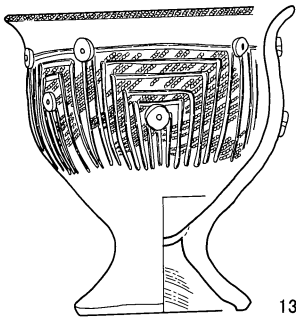

1390

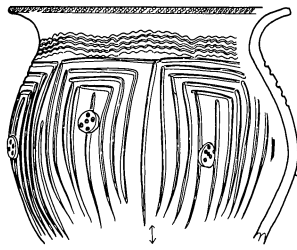

1391

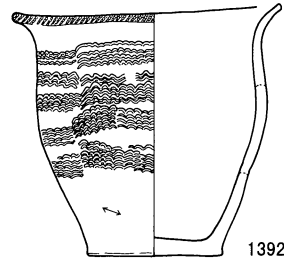

1392

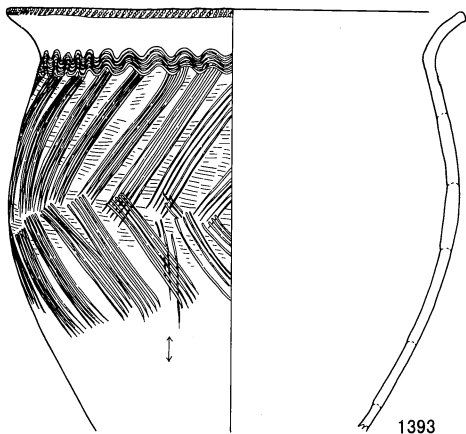

1393

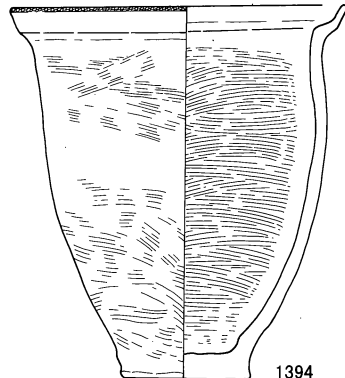

1394

0 (1 : 4) 10 cm

SB1176

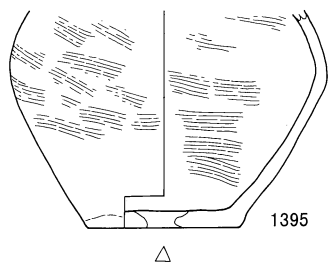

1395

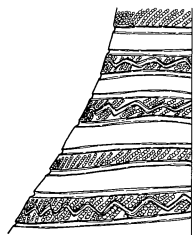

1396

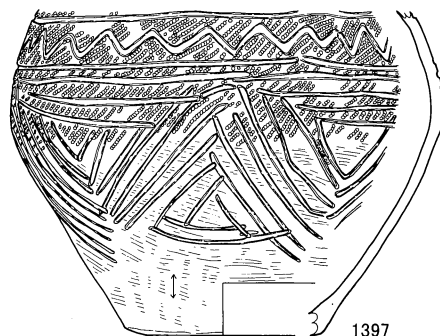

1397



1398



1399



1400

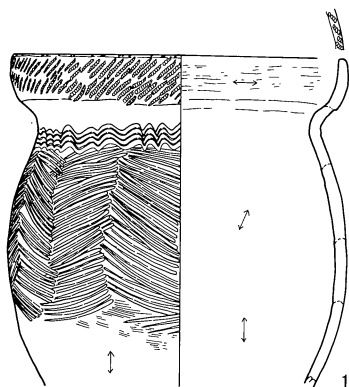

1401

SB1177

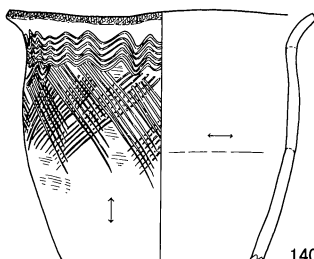

1406

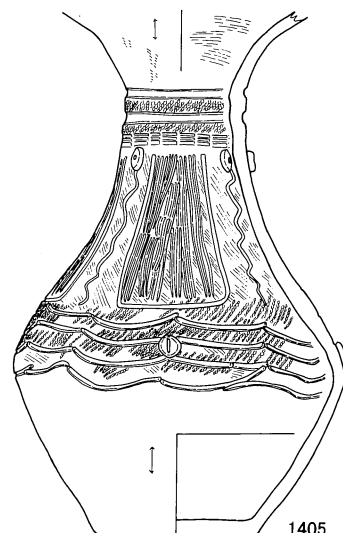

1405

SB1177

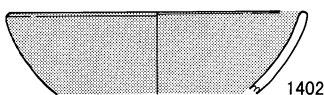

1402

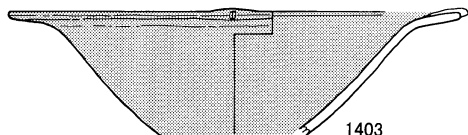

1403

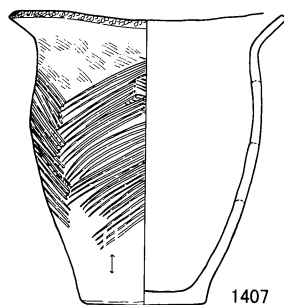

1407

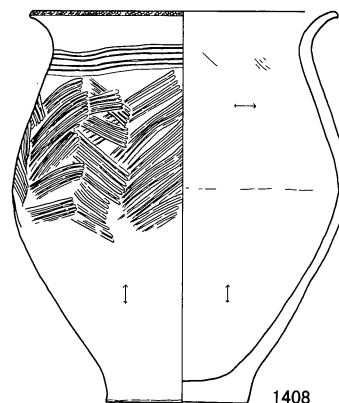

1408

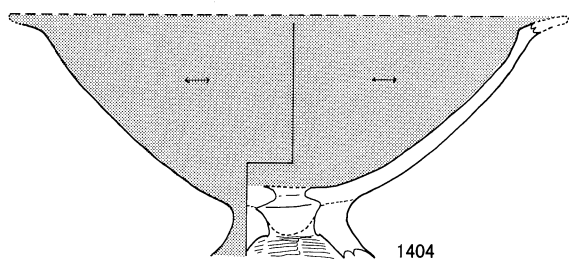

1404

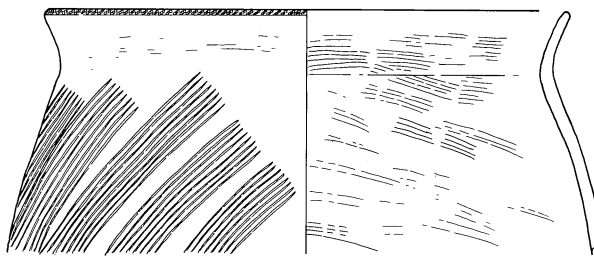

1409

0 (1 : 4) 10 cm

SB1178

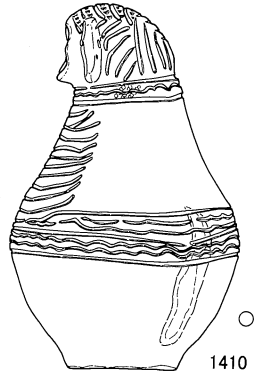
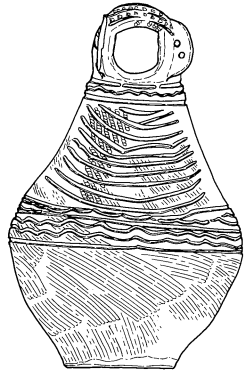
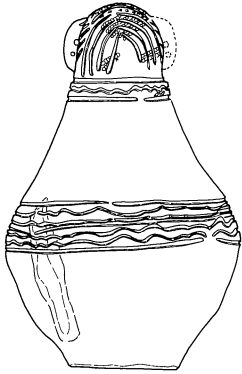

1410

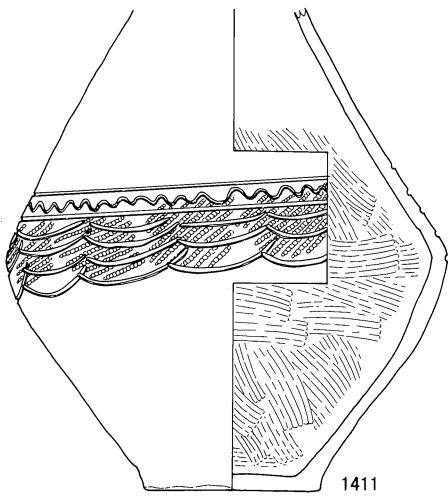

1411

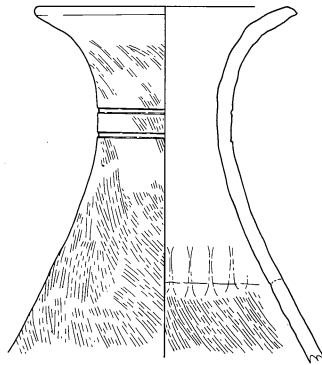

1414

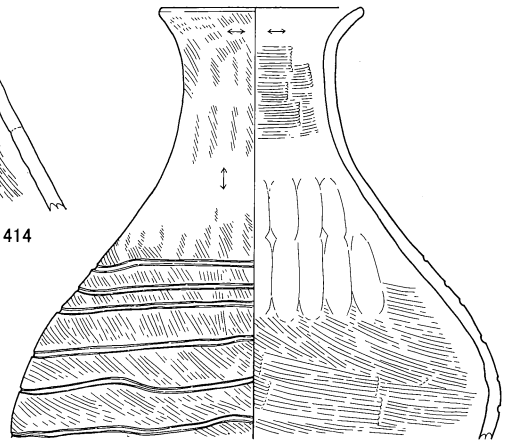

1412

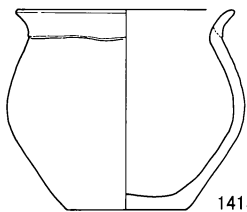

1415

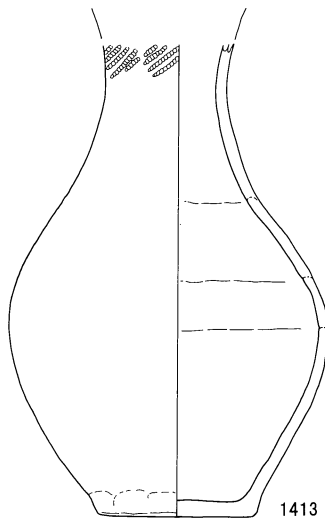

1413

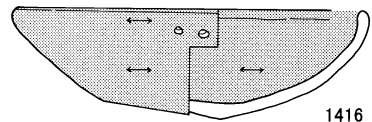

1416

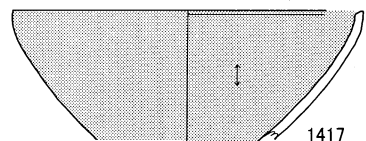

1417

0 (1 : 4) 10 cm

S B1178, 1410~1417

SB1178

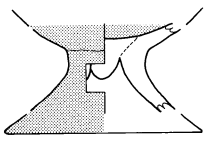

1418

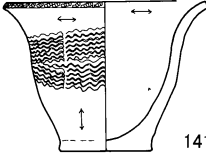

1419

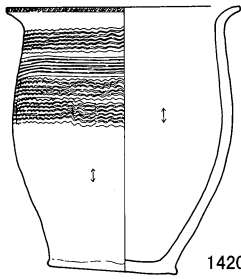

1420

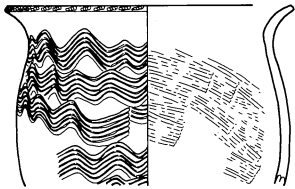

1421

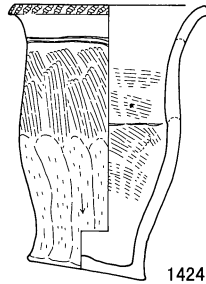

1424

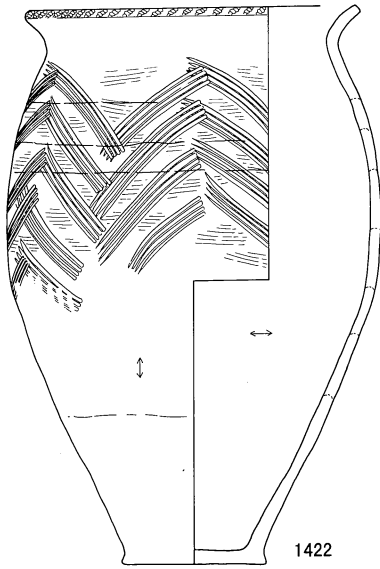

1422

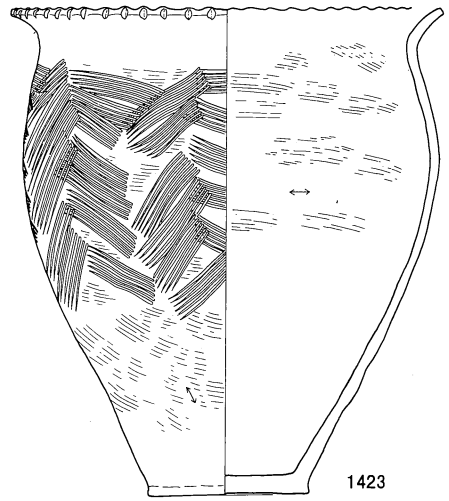

1423

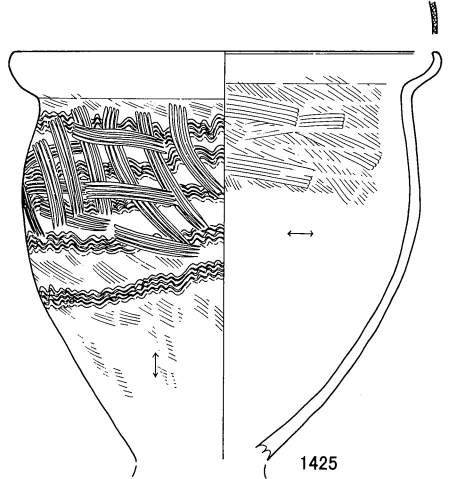

1425

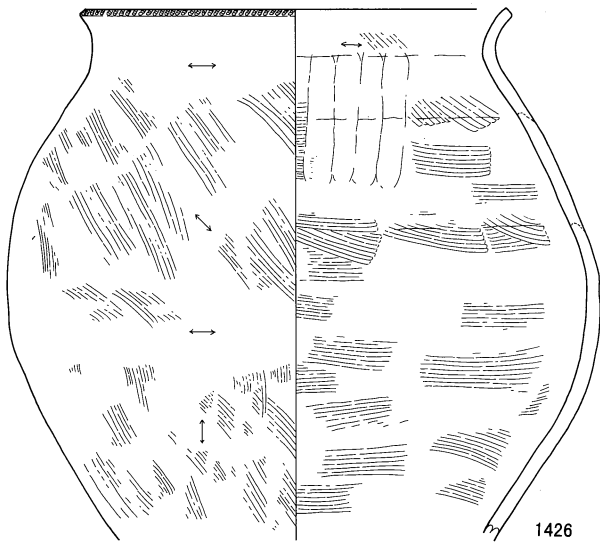

1426

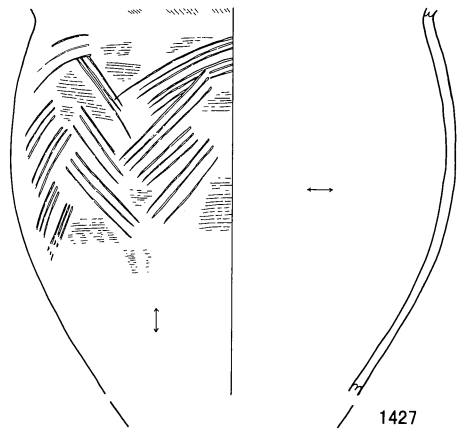

1427

0 (1 : 4) 10 cm

SB1178, 1418~1427

S B 1181

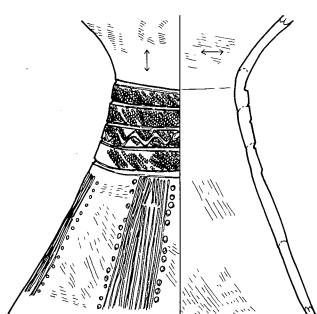

1428

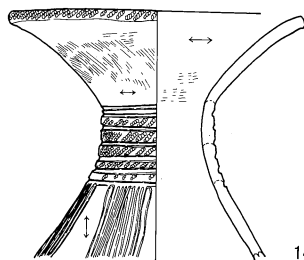

1429

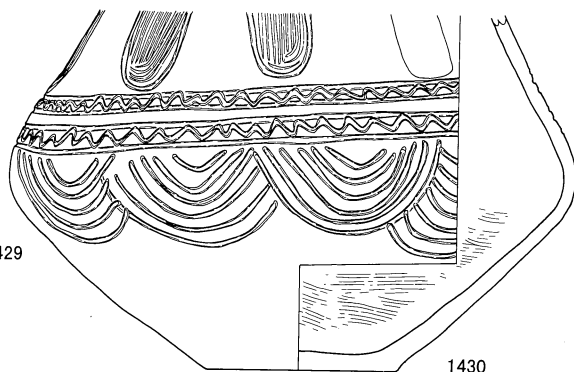

1430

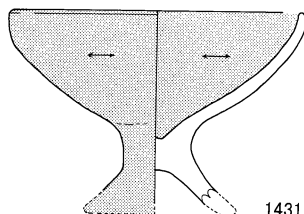

1431

S B 1184

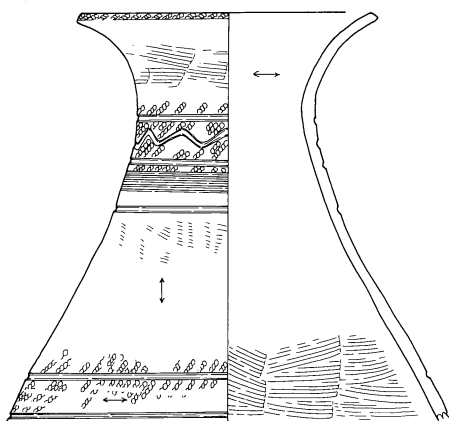

1433

S B 1183

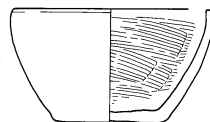

1432

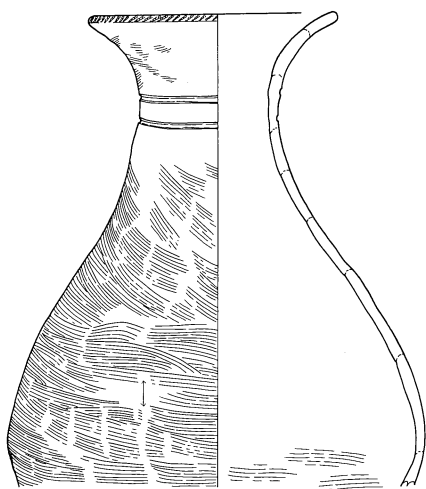

1434

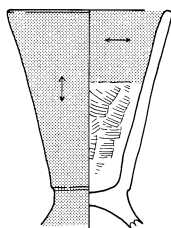

1436

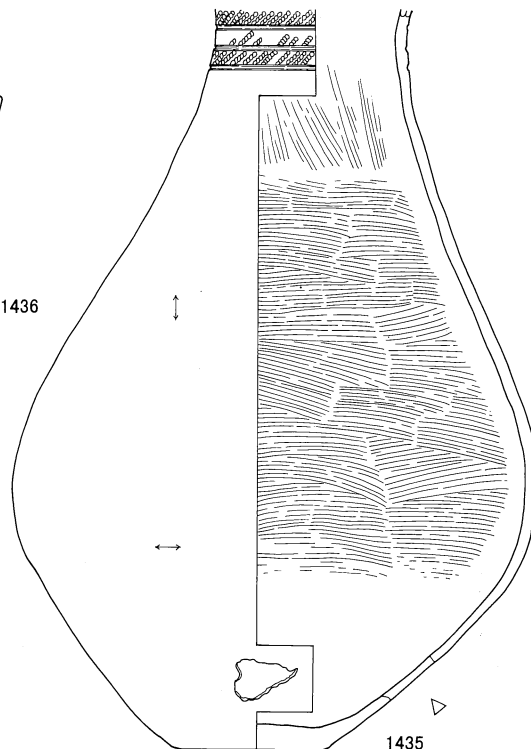

1435

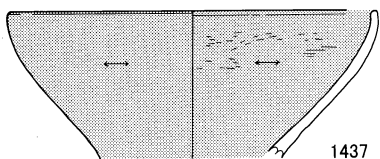

1437

0 (1 : 4) 10cm

S B 1181, 1428~1431

S B 1183, 1432

S B 1184, 1433~1437



S B1184

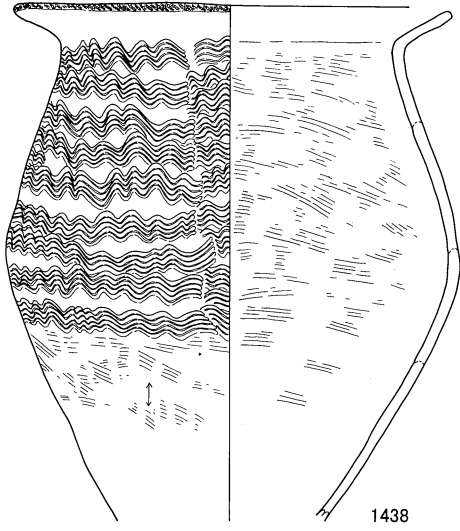

1438

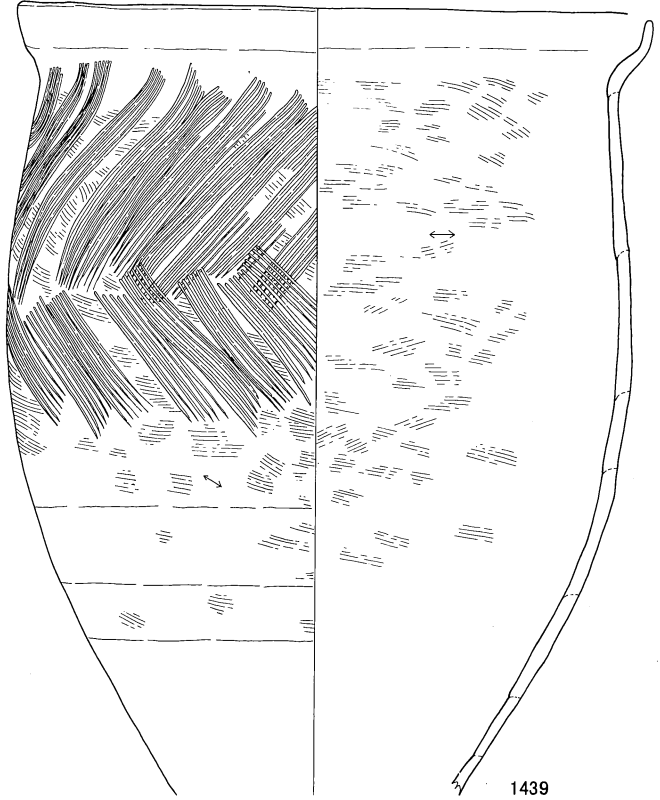

1439

S B1186

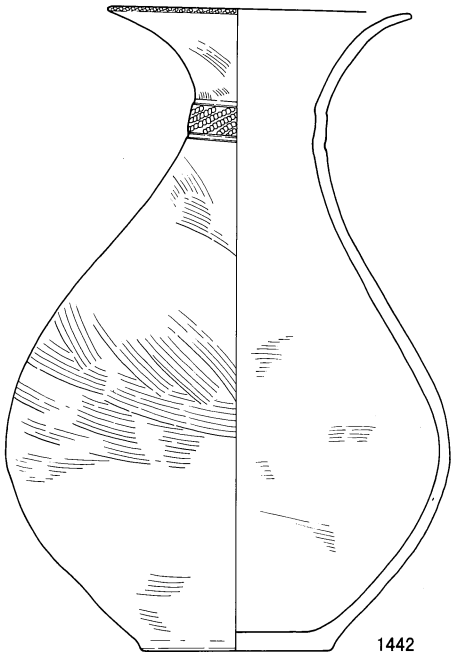

1442

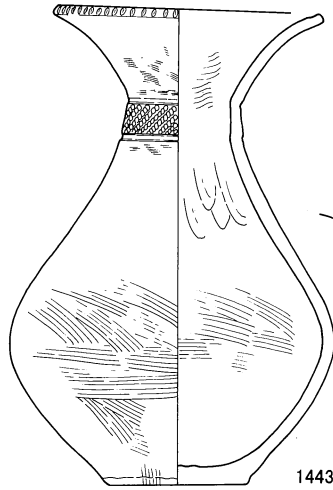

1443

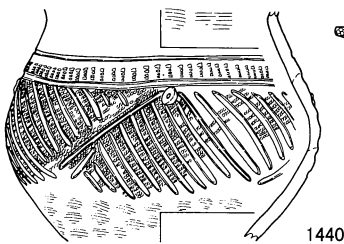

1440

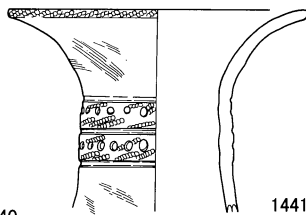

1441

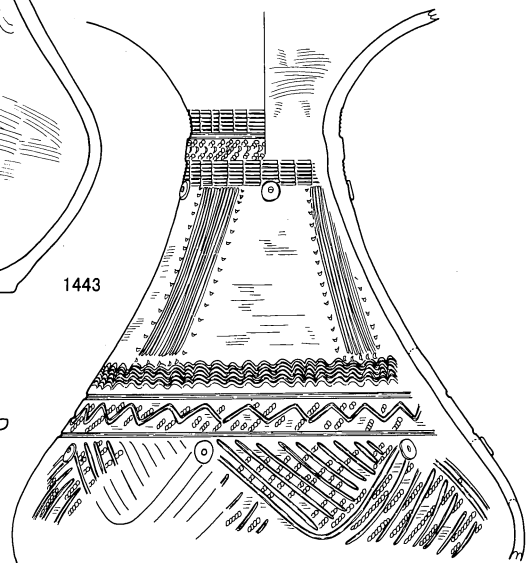

1444

0 (1 : 4) 10 cm

S B1184, 1438~1439

S B1186, 1440~1444

S B1186

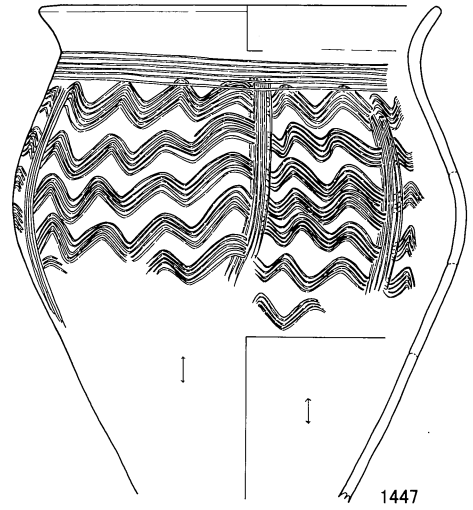
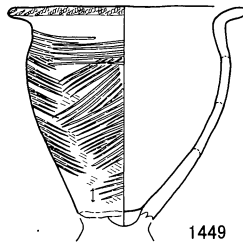
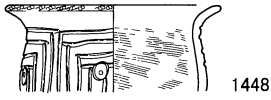
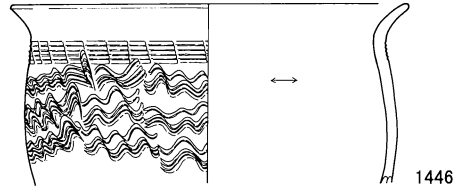
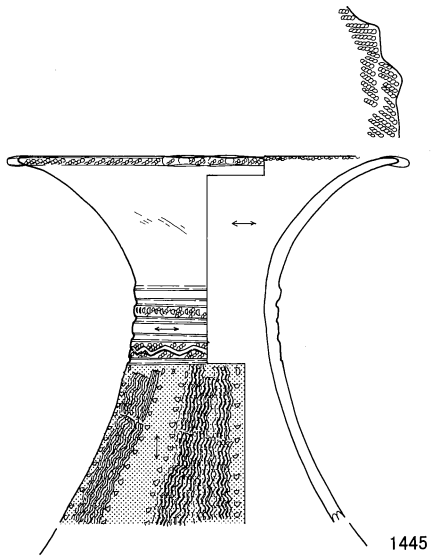

S B1189

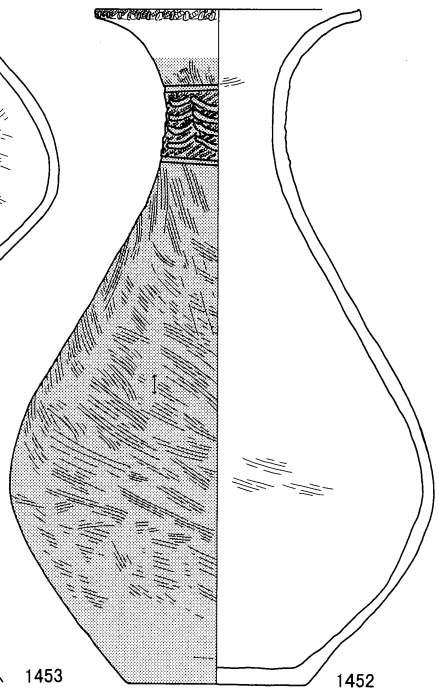
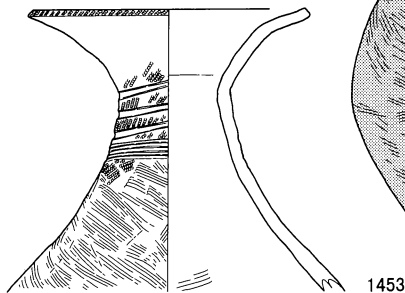
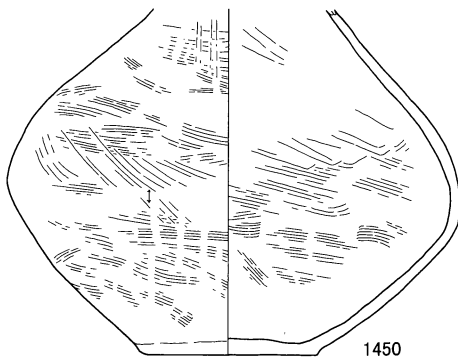
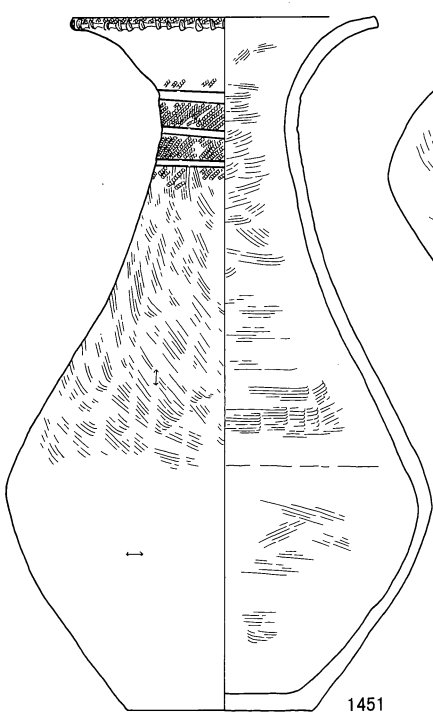

0 (1 : 4) 10 cm

SB1189

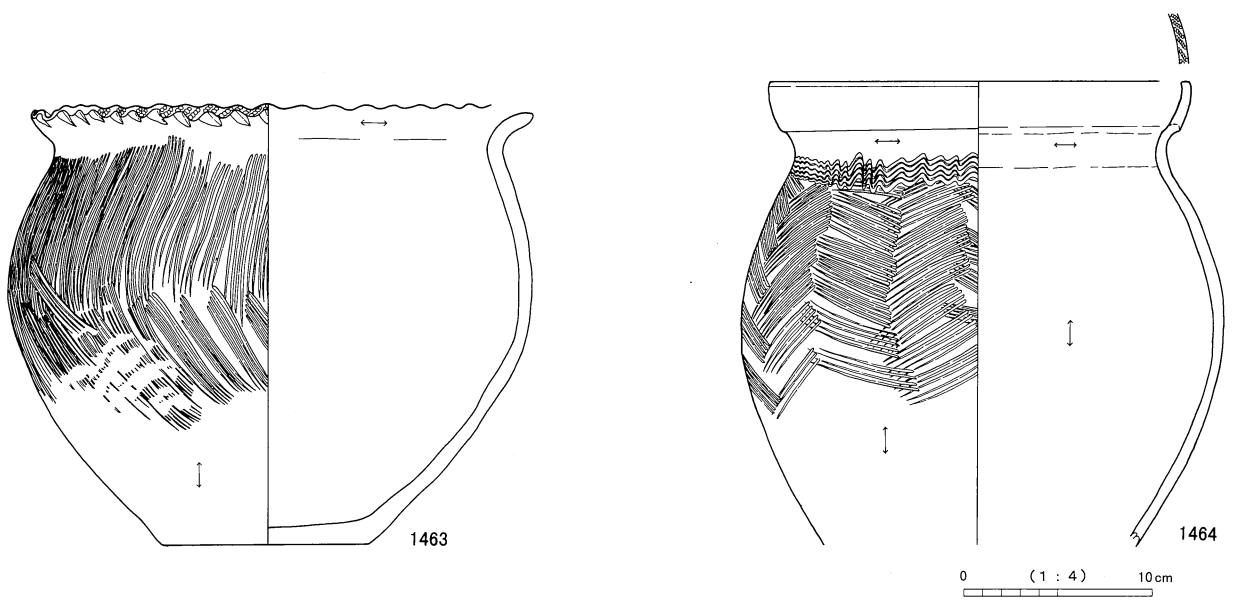
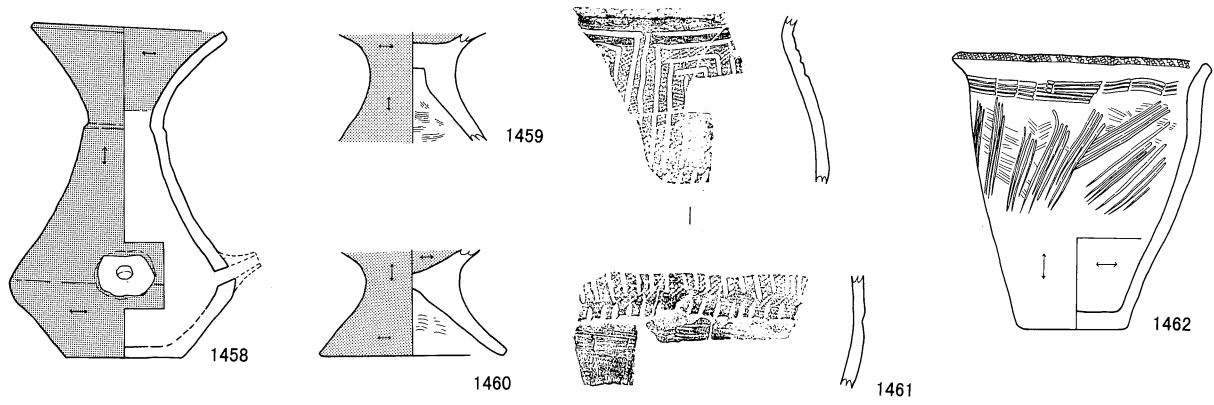
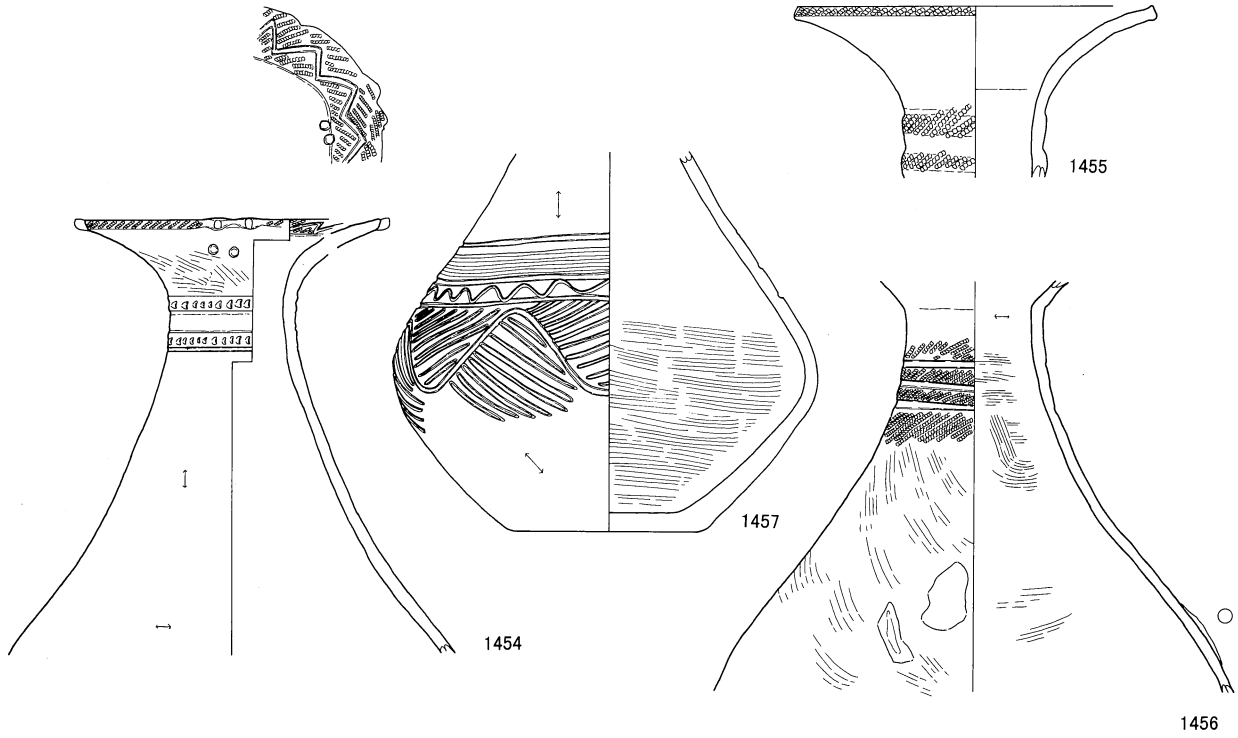

0 (1 : 4) 10cm

S B1189

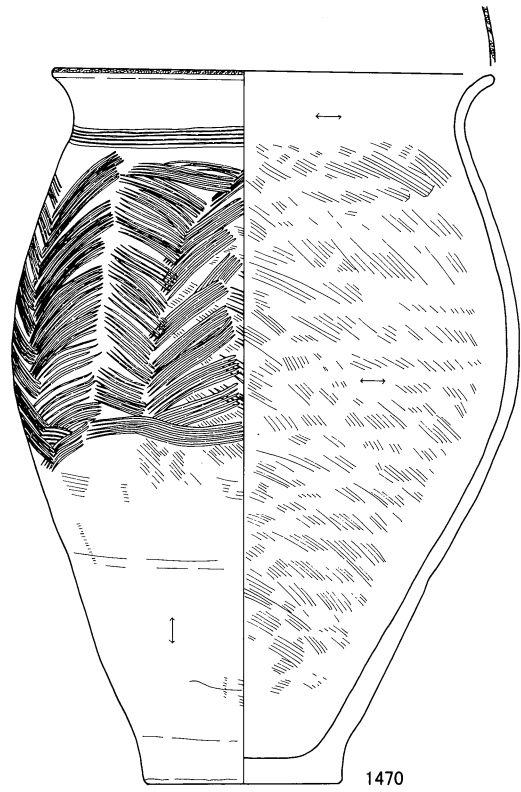
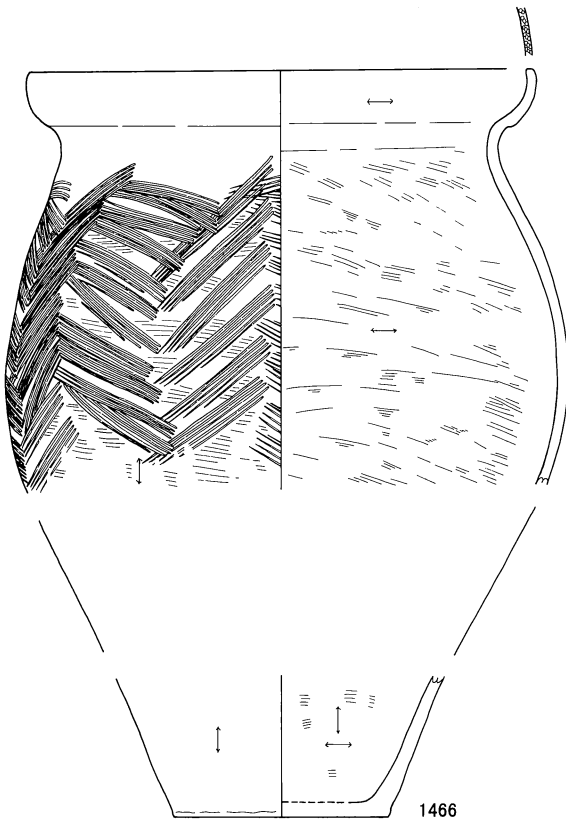
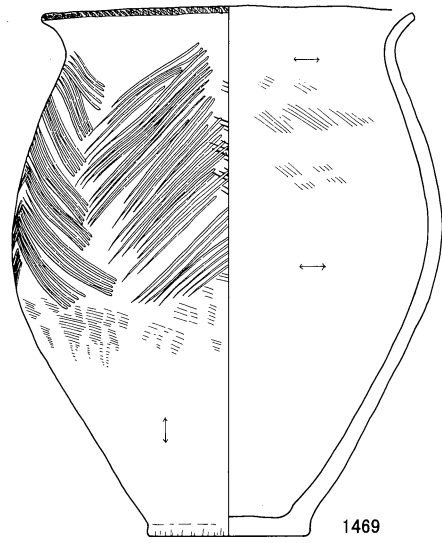
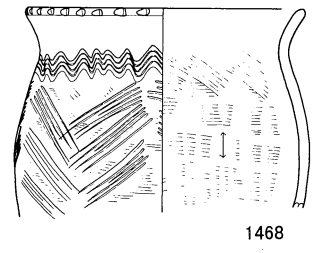
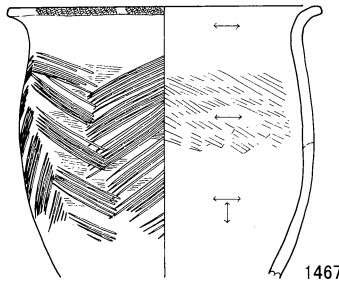
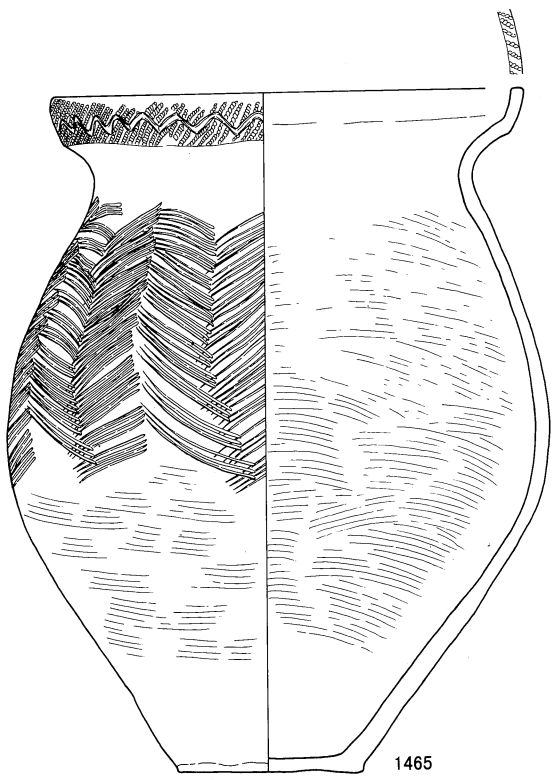

0 (1 : 4) 10 cm

S B 1189

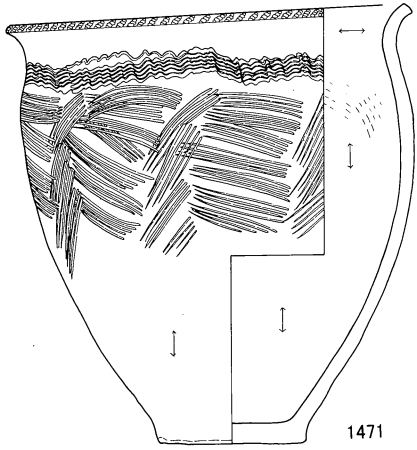

1471

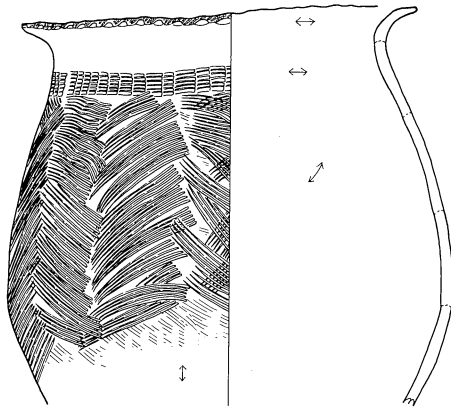

1472

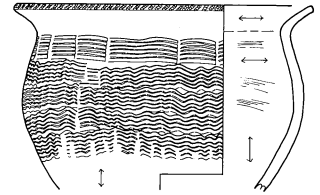

1473

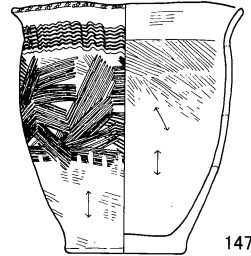

1474

S B 1189·1190

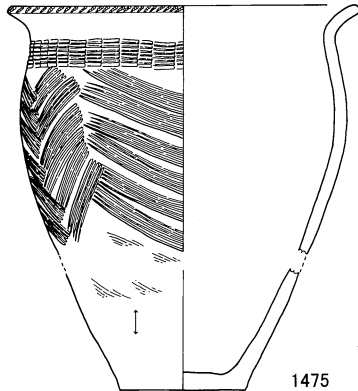

1475

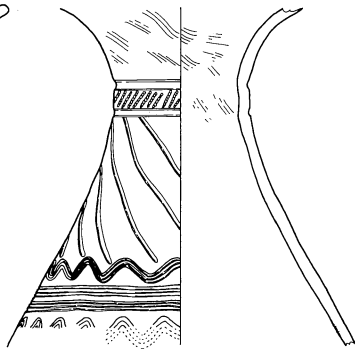

1476

S B 1190

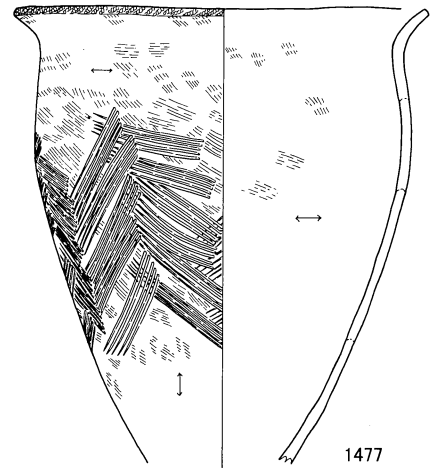

1477

S B 1190



1479

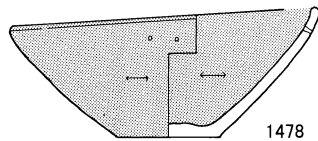

1478

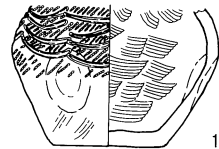

1482

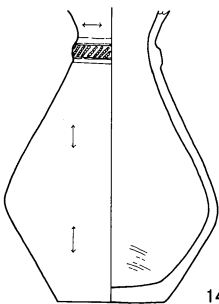

1480

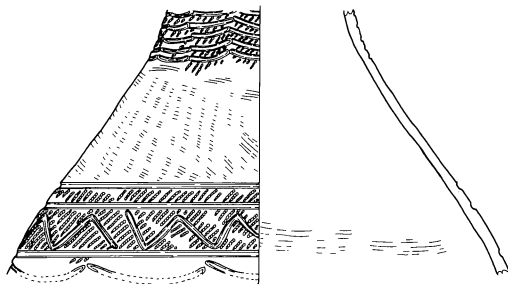

1481

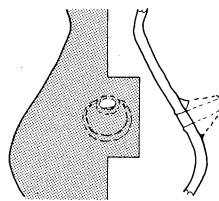

1483

0 (1 : 4) 10 cm

S B 1189, 1471~1474

S B 1189·1190, 1475~1476

S B 1190, 1477~1483

S B 1192

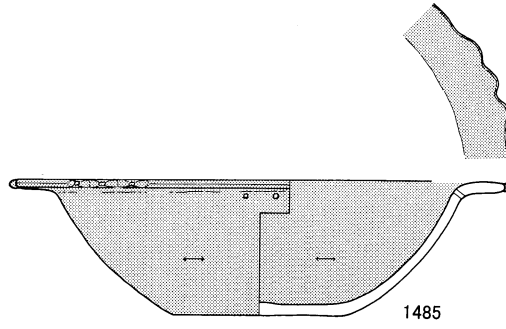
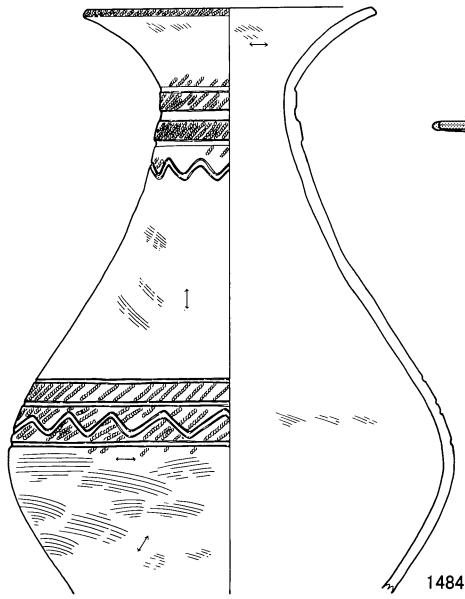

S B 1211

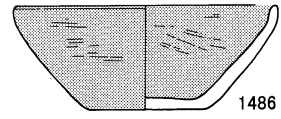

S B 1256

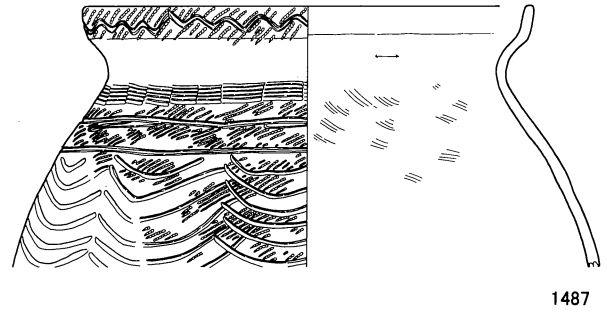
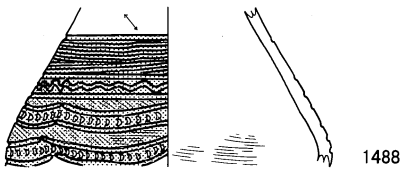

S B 1257

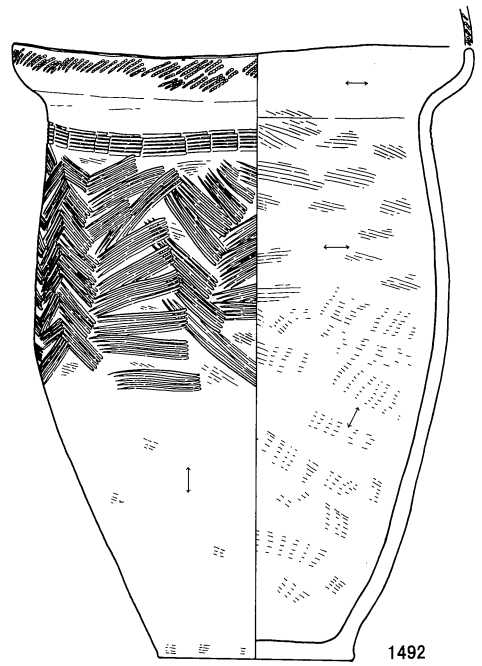
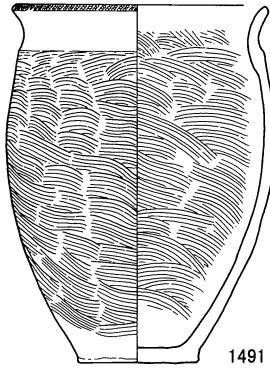
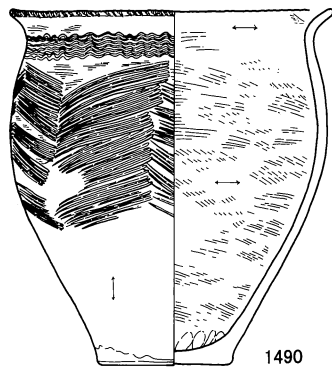
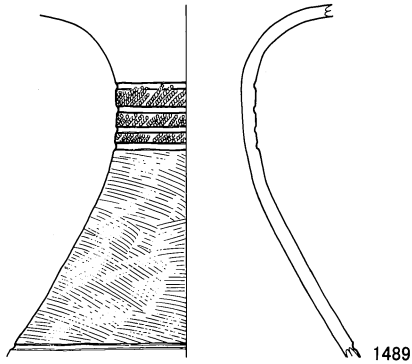

0 (1 : 4) 10 cm

S B 1192, 1484~1485

S B 1211, 1486~1487

S B 1256, 1488

S B 1257, 1489~1492

S B1248

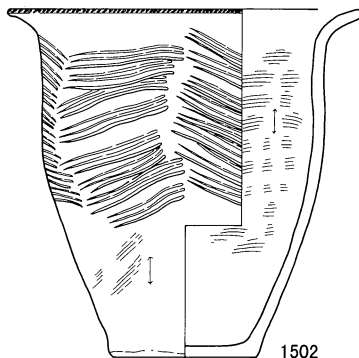
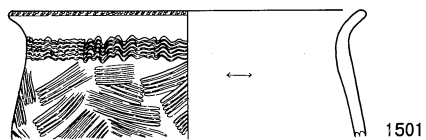
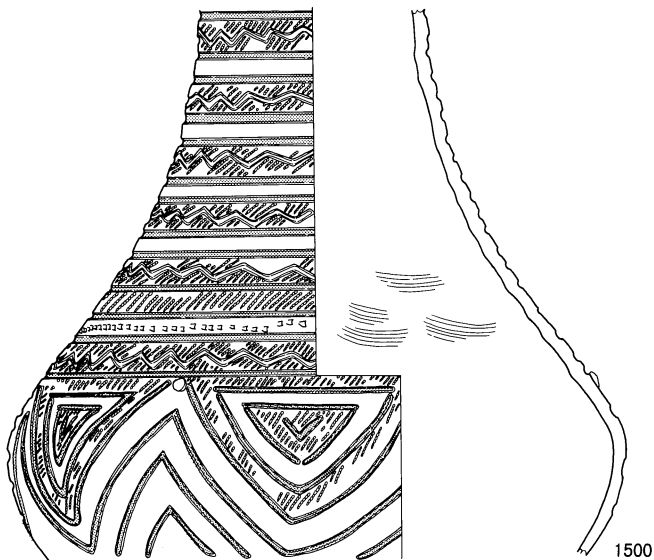
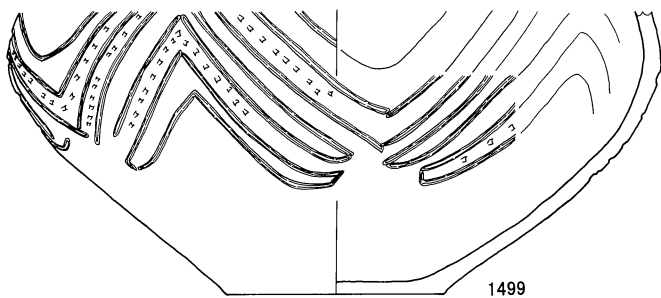
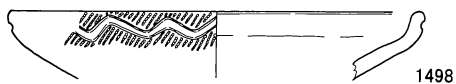
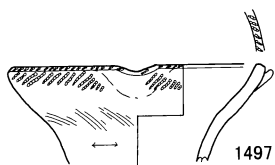
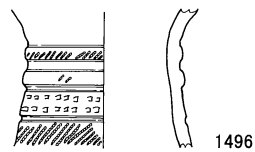
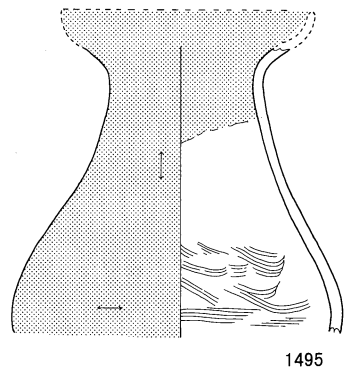
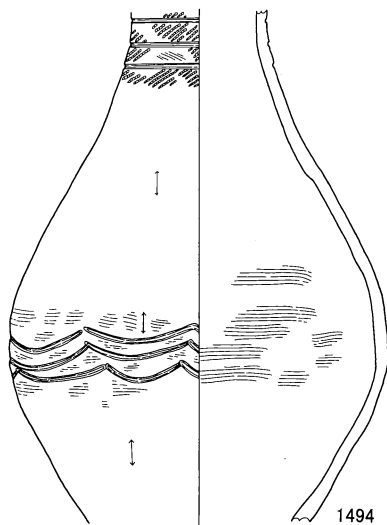
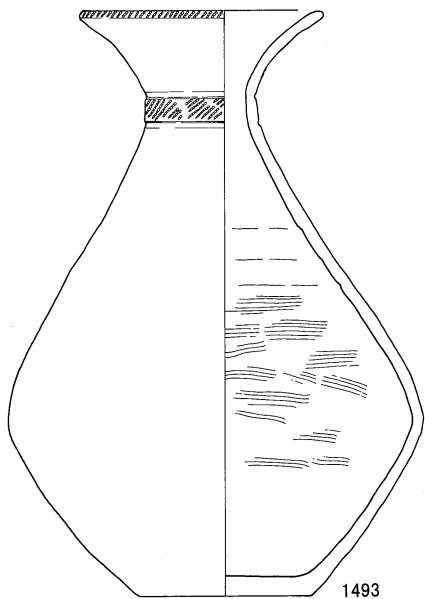

0 (1 : 4) 10cm

S B 1258

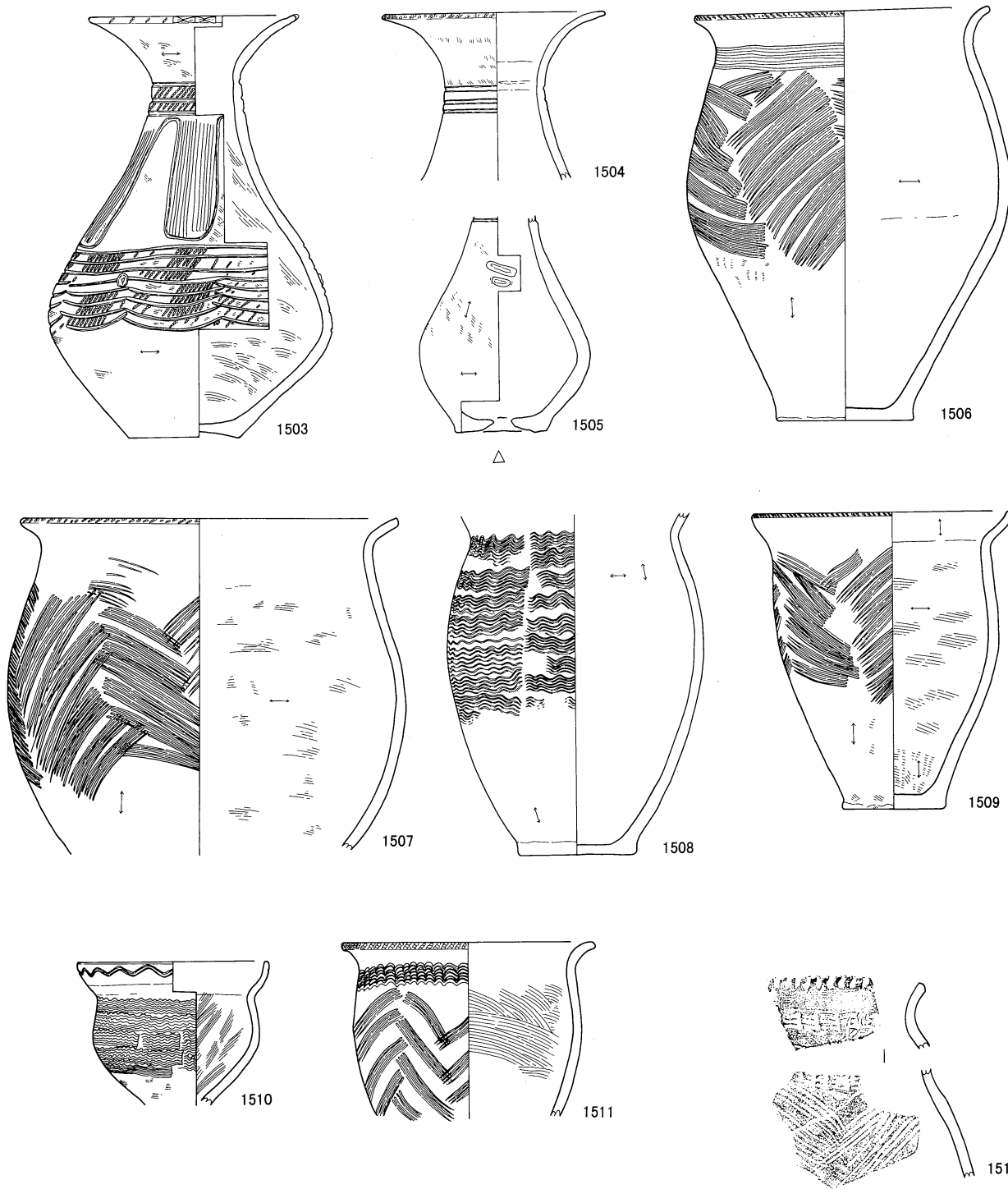

S B 1259

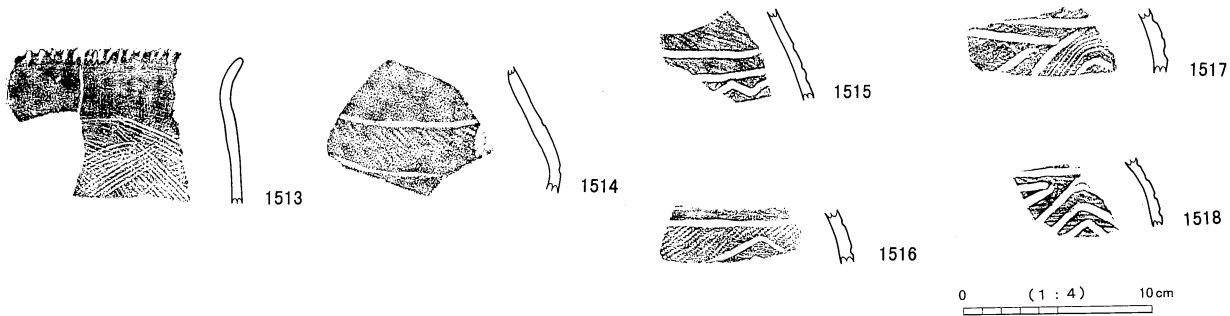

S B 1258, 1503~1511 S B 1259, 1512~1518